

# CAB<sup>®</sup>

## HOOKS, HANGERS & MINE SAFETY PRODUCTS

Made by Cambria County Association  
for the Blind and Handicapped



Proudly Serving the Mining Industry for over 40 Years





# CAB® Cable Clips

*In Round and Flat Wire Designs  
Partially or Totally Coated*



**Round Wire  
CAB 314  
CAB 315**

## CAB® Round Wire Cable Clips

Strong, versatile hangers for supporting pipe or cables from messenger wire, plates, wire mesh or other structure. Made from .156" (4mm) high tensile spring steel wire with 5/8" (16mm) diameter top loops. CAB 961 is an extra long style for running multiple cables.

**CAB 314** 3-5/8" (92mm) dia., 6-1/2" (165mm) long, 100/box, 13 lbs. (5.9kg)

**CAB 315** 4-1/2" (114mm) dia., 7-3/8" (187mm) long, 50/box, 11 lbs. (5kg)

**CAB 961** 6" (152mm) dia., 11" (279mm) long, 50/box, 13 lbs. (5.9kg)



**Round Wire  
CAB 961**

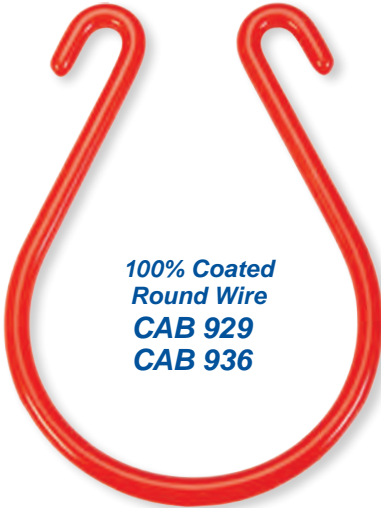

**100% Coated  
Round Wire  
CAB 929  
CAB 936**

## CAB® 100% Plastisol Coated Round Wire Cable Clips

Manufactured as other round wire cable clips but coated over the entire surface with CAB plastisol for total insulation and corrosion resistance. 7/16" (11mm) diameter top loops.

**CAB 929** 3-5/8" (92mm) dia., 6-5/8" (168mm) long, 100/box, 16 lbs. (7.3kg)

**CAB 936** 4-1/2" (114mm) dia., 7-1/2" (191mm) long, 50/box, 12 lbs. (5.5kg)

## CAB® Flat Wire Cable Clips

Provides a safe, insulated 1/2" (13mm) wide surface carrying area for all types of cables. Easy to squeeze and latch for quick installation. Top loops receive special machine forming for additional weight carrying capacity. Corners are rounded for added safety. Made from 1/16" x 3/8" (2mm x 10mm) flat spring steel. 7/16" (11mm) diameter top loops.

**CAB 300** 2" (51mm) dia., 3-7/8" (98mm) long, 100/box, 13 lbs. (5.9kg)

**CAB 299** 2-5/8" (67mm) dia., 4-5/8" (117mm) long, 100/box, 15 lbs. (6.8kg)

**CAB 298** 3-7/8" (98mm) dia., 6-3/4" (171mm) long, 50/box, 9 lbs. (4.1kg)

**CAB 940** 4" (102mm) dia., 10" (254mm) long, 50/box, 15 lbs. (6.8kg)

**CAB 301** 4" (102mm) dia., 18" (457mm) long, 50/box, 18 lbs. (8.2kg)

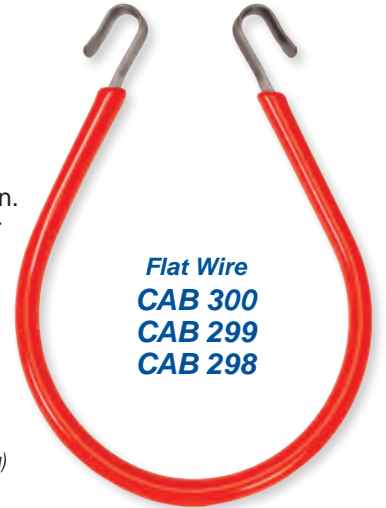

**Flat Wire  
CAB 300  
CAB 299  
CAB 298**



**Flat Wire  
CAB 940  
CAB 301**

## CAB® 100% Plastisol Coated Flat Wire Cable Clips

Manufactured as other flat wire cable clips but coated over the entire surface with abrasion resistant, high dielectric grade plastisol for total insulation and corrosion resistance. .591" (15mm) diameter loops.

**CAB 934** 2" (51mm) dia., 4" (102mm) long, 100/box, 12 lbs. (5.5kg)

**CAB 932** 2-5/8" (67mm) dia., 4-3/4" (121mm) long, 100/box, 15 lbs. (6.8kg)

**CAB 931** 3-7/8" (98mm) dia., 6-3/4" (171mm) long, 50/box, 10 lbs. (4.5kg)

**CAB 933** 6" (152mm) dia., 9-3/4" (248mm) long, 25/box, 9 lbs. (4.1kg)

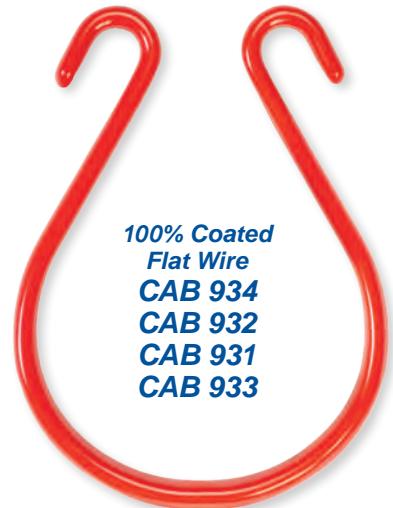

**100% Coated  
Flat Wire  
CAB 934  
CAB 932  
CAB 931  
CAB 933**

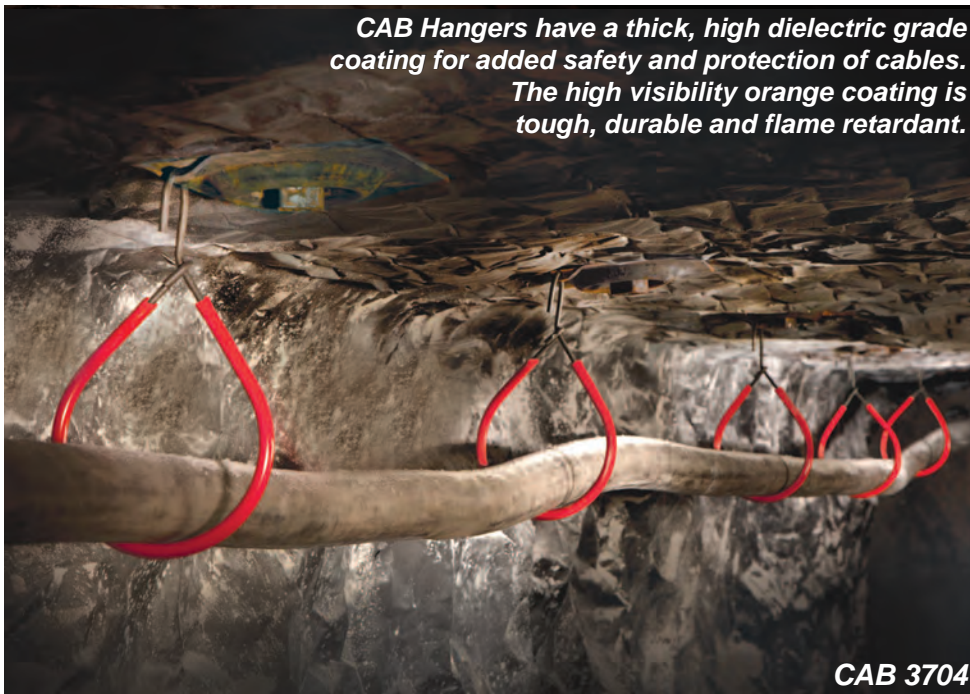

**CAB 3704**



**CAB 308**

**Strong, Durable CAB® Hangers Provide Added Safety and Protection in Mines**

**CAB® Latchbacks** are high quality hangers designed for supporting hose, pipe and cable from roof bolt plates, spads, wire mesh or structure. Manufactured from high tensile spring steel for maximum strength with a 5/8" (16mm) diameter top installation loop. CAB 321 same as 320, but top loop is offset 90° to carrier section.

- CAB 320** 3-5/8" (92mm) dia., .156" (4mm) wire, 7" (178mm) long, 100/box, 15 lbs (6.8kg)
- CAB 321** 3-5/8" (92mm) dia., .156" (4mm) wire, 7" (178mm) long, 90° offset loop, 50/box, 9 lbs (4.1kg)
- CAB 308** 4-1/2" (114mm) dia., .156" (4mm) wire, 8" (203mm) long, 50/box, 9 lbs (4.1kg)
- CAB 306** 4-1/2" (114mm) dia., .187" (4.7mm) wire, 8" (203mm) long, 50/box, 12 lbs (5.5kg)

**CAB® Super Latchbacks** are made from .187" (4.7mm) high tensile spring steel and feature a large capacity 4-1/2" (114mm) diameter carrier. For easier installation, hanger has extra large 1-3/8" (35mm) diameter 90° offset top installation loop.

- CAB 3704** 4-1/2" (114mm) dia., .187" (4.7mm) wire, 9-1/2" (241mm) long, 50/box, 13 lbs (5.9kg)



**Super Latchback CAB 3704**

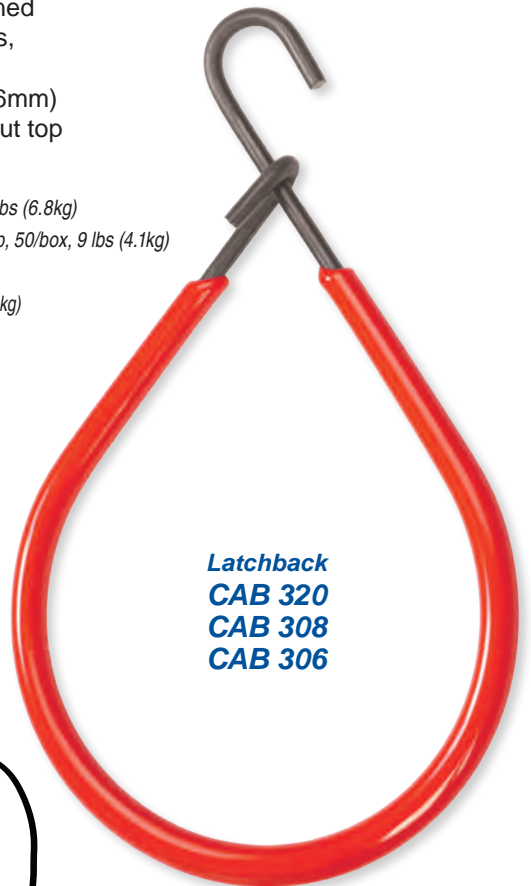

**Latchback CAB 320 CAB 308 CAB 306**

*CAB is the leading supplier of cable hangers for all types of mines and tunnels around the world. CAB's innovative designs and great service have made them an industry favorite for over 40 years!*



For total corrosion resistance in underground applications, use CAB's 100% PVC Coated Cable Clips shown on page 2 or CAB Bosserman Clips shown on page 5.



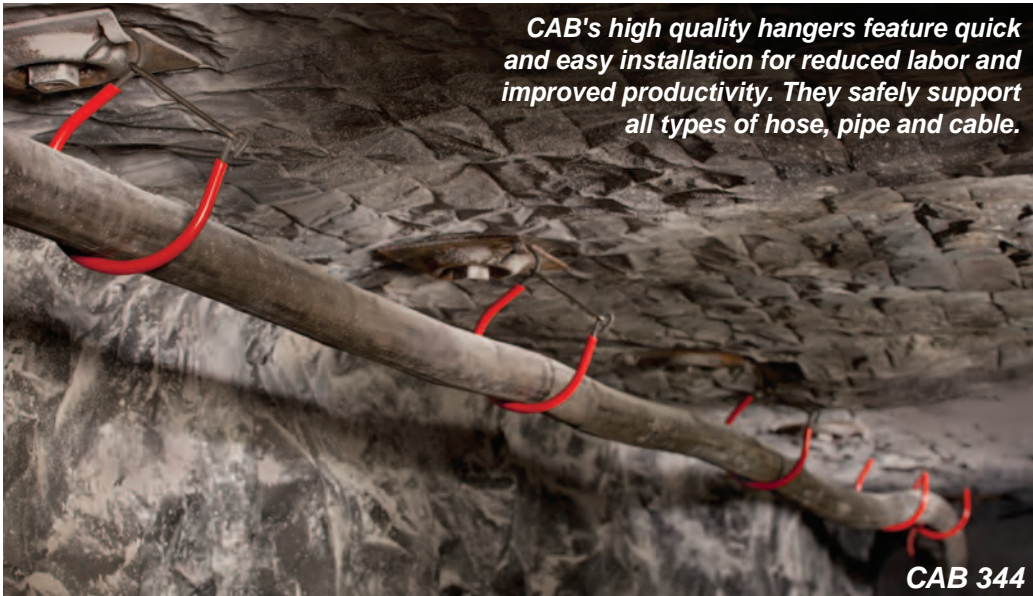

*CAB's high quality hangers feature quick and easy installation for reduced labor and improved productivity. They safely support all types of hose, pipe and cable.*

**CAB 344**



**CAB 344**

## CAB® U-Hangers with Crossbars

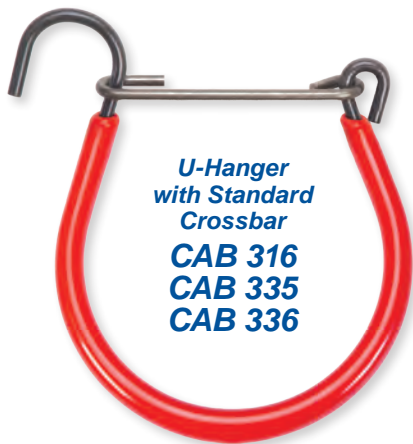

**U-Hanger with Standard Crossbar**  
**CAB 316**  
**CAB 335**  
**CAB 336**

**CAB® U-Hangers** are one of our most popular and versatile hangers for underground cable support. They feature a locking crossbar to retain cables in the hanger and a large 7/8" (22mm) diameter top loop for easy installation. Safety Tip Crossbar models prevent snagging during installation and when crossbars are left unlatched. Made from .187" (4.7mm) high carbon spring steel wire.

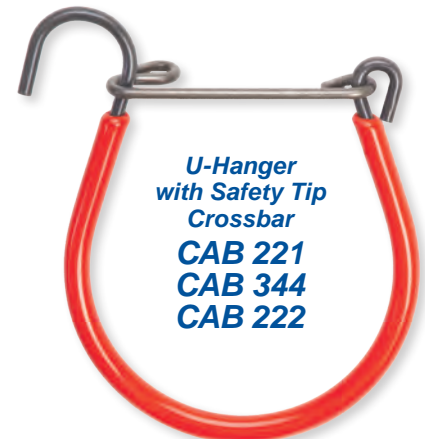

**U-Hanger with Safety Tip Crossbar**  
**CAB 221**  
**CAB 344**  
**CAB 222**

### Standard Crossbar U-Hangers

- CAB 316** 3" (76mm) dia., 4-1/2" (114mm) long, 100/box, 17 lbs. (7.7kg)
- CAB 335** 4" (102mm) dia., 6" (152mm) long, 50/box, 11 lbs. (5.0kg)
- CAB 336** 5" (127mm) dia., 7" (178mm) long, 50/box, 13 lbs. (5.9kg)

### Safety-Tip Crossbar U-Hangers

- CAB 221** 3" (76mm) dia., 4-1/2" (114mm) long, 100/box, 17 lbs. (7.7kg)
- CAB 344** 4" (102mm) dia., 5-7/8" (149mm) long, 50/box, 12 lbs. (5.5kg)
- CAB 222** 5" (127mm) dia., 7-1/8" (181mm) long, 50/box, 14 lbs. (6.4kg)

## CAB® Brattice Hangers

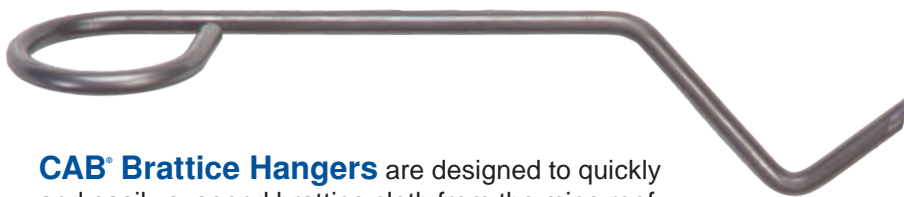

**CAB® Brattice Hangers** are designed to quickly and easily suspend brattice cloth from the mine roof. Sharp offset tip keeps brattice tight to the roof. Made from .187" (4.7mm) wire, 7" (178mm) long with 1-1/8" (29mm) or 1-1/2" (38mm) diameter hole. For proper installation, hanger must be placed on end of roof bolt between plate and roof of the mine.

- CAB 3703** 1-1/8" (29mm) dia. hole, 200/box, 17 lbs. (7.7kg)
- CAB 7647** 1-1/2" (38mm) dia. hole, 200/box, 19 lbs. (8.6kg)

*CAB Brattice Hangers make a tough job easier, and cut down on accidents!*



**CAB 3703**

**CAB Brattice Hangers make installation of brattice cloth quick and easy. No hammers or nails needed. Saves on tire repairs and injuries.**

# CAB® Bosserman Clips

**CAB® Bosserman Clips** are widely respected for their superior ability to safely suspend electrical cables and wiring in a variety of underground applications. CAB Bosserman Clips feature a 100% plastisol coated high tensile spring steel body and locking arm to prevent pull out and slippage. This improved hanger combines all the advantages of steel and plastic for the highest level of performance and safety underground.

## Advantages of Bosserman Clips:

- ✓ **Highly Corrosion Resistant.** Outlasts other cable support methods for cost savings and improved safety. Specified for demanding underground conditions.
- ✓ **Slip Resistant.** Plastisol coated locking arm securely grips messenger wire. Assures uniform spacing, even in steep slopes. Keeps cables safely up and out of the way of moving equipment and machinery.
- ✓ **Totally insulated and spark resistant.** High dielectric grade, flame retardant plastisol is applied on 100% of hanger surface for maximum safety and protection.

*CAB Bosserman Clips are an industry favorite for strong, durable cable support in highly corrosive environments.*

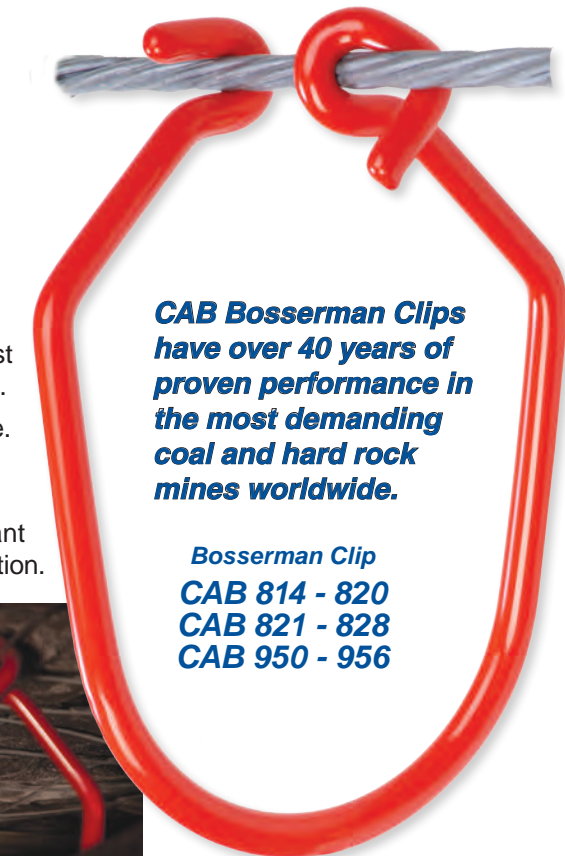

**CAB Bosserman Clips have over 40 years of proven performance in the most demanding coal and hard rock mines worldwide.**

*Bosserman Clip*  
**CAB 814 - 820**  
**CAB 821 - 828**  
**CAB 950 - 956**

**CAB 824**

*CAB's innovative design allows Bosserman Clips to install with a simple twisting motion and securely lock in place. No tools required, and hangers safely hold over 150lb (68kg). Pictured above is CAB Bosserman Clip 824.*

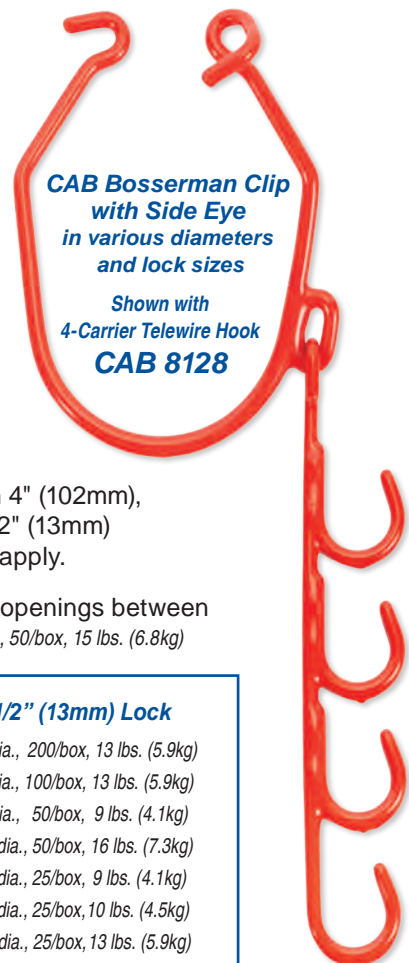

**CAB Bosserman Clip with Side Eye in various diameters and lock sizes**

*Shown with 4-Carrier Telewire Hook*  
**CAB 8128**

## CAB® Bosserman Clips with Side Eye

Welded side eye useful for hanging CAB single or multiple carrier telewire hooks. Available in 4" (102mm), 5" (127 mm), 6" (152mm) and 8" (203mm) diameter sizes. Fits 1/4" (6mm), 3/8" (10mm), and 1/2" (13mm) messenger wire. Contact CAB for part numbers and additional information. Some minimums apply.

**CAB® 4-Carrier Telewire Hook** features four 1-1/4" (32mm) carriers with 5/8" (16mm) openings between carriers and 1/2" (13mm) top loop. Totally coated for added durability. **CAB 8128** 14" (356mm) long, 50/box, 15 lbs. (6.8kg)

### **Bosserman Clip 1/4" (6mm) Lock**

- CAB 814** 1" (25mm) dia., 200/box, 13 lbs. (5.9kg)
- CAB 815** 2" (51mm) dia., 100/box, 13 lbs. (5.9kg)
- CAB 816** 3" (76mm) dia., 50/box, 9 lbs. (4.1kg)
- CAB 817** 4" (102mm) dia., 50/box, 16 lbs. (7.3kg)
- CAB 818** 5" (127mm) dia., 25/box, 9 lbs. (4.1kg)
- CAB 819** 6" (152mm) dia., 25/box, 10 lbs. (4.5kg)
- CAB 820** 8" (203mm) dia., 25/box, 13 lbs. (5.9kg)

### **Bosserman Clip 3/8" (10mm) Lock**

- CAB 821** 1" (25mm) dia., 200/box, 13 lbs. (5.9kg)
- CAB 822** 2" (51mm) dia., 100/box, 13 lbs. (5.9kg)
- CAB 823** 3" (76mm) dia., 50/box, 9 lbs. (4.1kg)
- CAB 824** 4" (102mm) dia., 50/box, 16 lbs. (7.3kg)
- CAB 825** 5" (127mm) dia., 25/box, 9 lbs. (4.1kg)
- CAB 826** 6" (152mm) dia., 25/box, 10 lbs. (4.5kg)
- CAB 828** 8" (203mm) dia., 25/box, 13 lbs. (5.9kg)

### **Bosserman Clip 1/2" (13mm) Lock**

- CAB 950** 1" (25mm) dia., 200/box, 13 lbs. (5.9kg)
- CAB 951** 2" (51mm) dia., 100/box, 13 lbs. (5.9kg)
- CAB 952** 3" (76mm) dia., 50/box, 9 lbs. (4.1kg)
- CAB 953** 4" (102mm) dia., 50/box, 16 lbs. (7.3kg)
- CAB 954** 5" (127mm) dia., 25/box, 9 lbs. (4.1kg)
- CAB 955** 6" (152mm) dia., 25/box, 10 lbs. (4.5kg)
- CAB 956** 8" (203mm) dia., 25/box, 13 lbs. (5.9kg)

Extra Long Styles available for running 2 cables separately from 1 messenger wire or large bundles of cables. For total corrosion resistance and insulation in above ground applications, use CAB Rings which are outlined on page 14.



# CAB® Telewire Hooks



**CAB Telewire Hooks are quick and easy to install. They safely support communication, control, sensor, and electrical cables. CAB specializes in custom sizes and configurations.**

**CAB 219**

## CAB® 302, 311 Telewire Hooks

These J-Hooks are useful for a wide variety of hanging jobs. Can be installed from chain, roof bolt plates, spads, etc. 3/8" (10mm) diameter top loop offset 90° to 1-1/4" (32mm) carrier section. Offered in 2 wire gauges. Packaged 200/box.

**CAB 302** 1-1/4" (32mm) dia., .187" (4.7mm) wire, 16 lbs. (7.3kg)

**CAB 311** 1-1/4" (32mm) dia., .156" (4mm) wire, 11 lbs. (5kg)



## CAB® Drive-In Telewire Hooks

Designed to be installed without a nail. Hooks have a sharp point for driving and an offset opening to prevent wires from accidentally coming out of the hook. Packaged 200/box.

**CAB 342** 3/4" (19mm) dia., .156" (4mm) wire, 10 lbs. (4.5kg)

**CAB 296** 1-1/4" (32mm) dia., .187" (4.7mm) wire, 15 lbs. (6.8kg)

**CAB 334** 1-1/4" (32mm) dia., .156" (4mm) wire, 12 lbs. (5.5kg)



## CAB® Drive-In Closed Loop Hooks

Feature a 540° insulated spiral loop which virtually guarantees that wiring will be safely retained and not accidentally vibrate or jump out of the hook. Easily installed with sharp tip drive-in point. Made from .156" (4mm) wire.

**CAB 911** 1-1/4" (32mm) dia., 100/box, 11 lbs. (5kg)

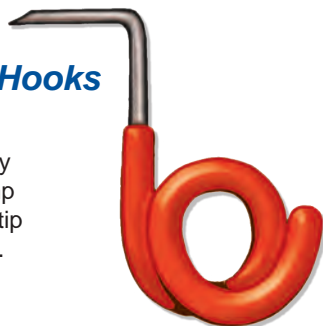

## CAB® Jumbo Telewire Hooks

Extra capacity hooks made for those large jobs. Features same design as the popular 297 and 311 but have larger overall dimensions. Made from sturdy .187" (4.7mm) wire with a 5/8" (16mm) diameter top loop set at 90° to bottom carrier. Packaged 200/box. Available in 2 sizes.

**CAB 223** 1-5/8" (41mm) dia., 17 lbs. (7.7kg)

**CAB 219** 2" (51mm) dia., 19 lbs. (8.6kg)



## CAB® 297 Telewire Hooks

Designed for installation from spad, roof bolt plate or chain. Offset opening helps retain wire in hook. Made from .187" (4.7mm) wire with 3/8" (10mm) diameter top loop offset 90° to 1-1/4" (32mm) bottom carrier.

**CAB 297** 1-1/4" (32mm) dia., 200/box, 15 lbs. (6.8kg)



## CAB® 333, 339 Telewire Hooks

Feature a large 5/8" (16mm) diameter top attachment loop for easier installation. Offset opening retains wiring in support area. Available in 2 wire gauges. Packaged 200/box.

**CAB 333** 1-1/4" (32mm) dia., .156" (4mm) wire, 12 lbs. (5.5kg)

**CAB 339** 1-1/4" (32mm) dia., .187" (4.7mm) wire, 16 lbs. (7.3kg)



## CAB® 340, 341 Telewire Hooks

S-Style hook features 5/8" (16mm) diameter top loop and 1-1/4" (32mm) diameter carrier loop. CAB 340 same as 341 except attachment loop set 90° to carrying area. Made from .156" (4mm) wire.

**CAB 340** 1-1/4" (32mm) dia., 200/box, 11 lbs. (5kg)

**CAB 341** 1-1/4" (32mm) dia., 200/box, 11 lbs. (5kg)



## CAB® Closed Loop Telewire Hooks

Closed loop design prevents wires from vibrating or jumping out of the carrier section of the hook. Made from .156" (4mm) wire with 1/2" (13mm) diameter top loop offset 90° to carrier section.

**CAB 908** 1" (25mm) dia., 200/box, 15 lbs. (6.8kg)

**CAB 912** 1-1/4" (32mm) dia., 100/box, 10 lbs. (4.5kg)

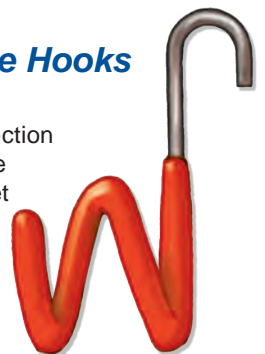

# CAB® Multi-Carrier Telewire Hooks

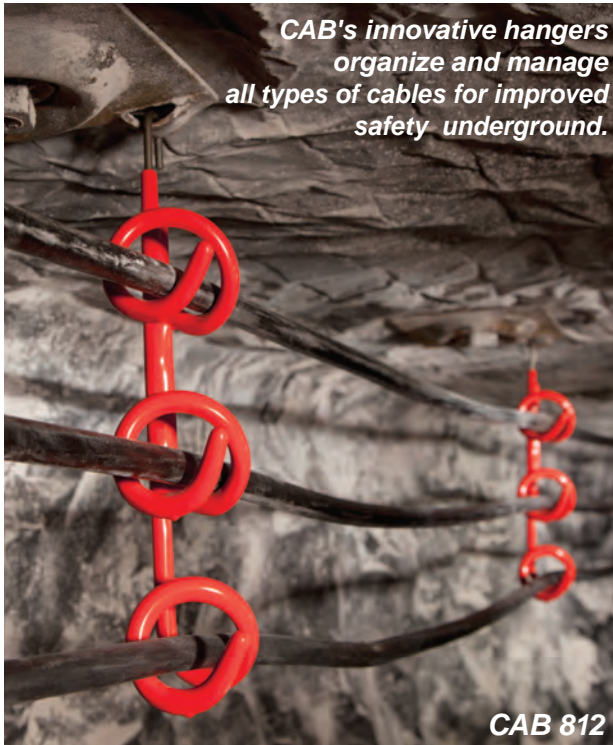

CAB 812

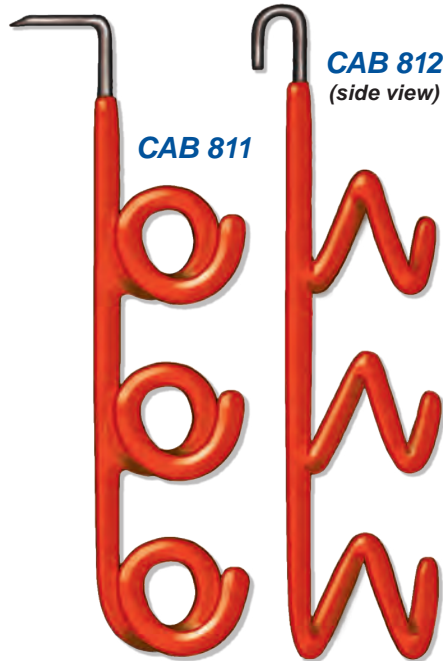

CAB 811

CAB 812  
(side view)

**CAB® 811 and 812** feature three 1-1/4" (32mm) diameter closed loop carriers. CAB 812 has 1/2" (13mm) diameter top loop for installation from plates, spuds or chain. The 811 has sharp tip drive-in point for easy nailing into wood structure. Made from .156" (4mm) wire, 10-5/8" (270mm) long. Packaged 25/box.

**CAB 811** 10 lbs. (4.5kg)

**CAB 812** 10 lbs. (4.5kg.)

**Blasting Wire Hooks**  
**CAB 6130**  
**CAB 4801**  
**CAB 205**  
**CAB 199**

**CAB® Blasting Wire Hooks** are designed to safely isolate blasting or other wiring from the roof, electrical cables or structure. A 1" (25mm) diameter 540° bottom loop securely retains wires in carrier. The 1/2" (13mm) top spiral loop design prevents dislodging of hanger after installation.

**CAB 6130** 4" (102mm) long, 100/box, 9 lbs. (4.1kg)

**CAB 4801** 6" (152mm) long, 100/box, 11 lbs. (5.0kg)

**CAB 205** 12" (305mm) long, 100/box, 15 lbs. (6.8kg)

**CAB 199** 18" (457mm) long, 100/box, 18 lbs. (8.2kg)

CAB 305



CAB 4701



CAB 910



**CAB® 910** features two 1" (25mm) diameter closed loop carriers. Ideal for above beltlines because of short 5-1/4" (133mm) length. .156" (4mm) wire with 1/2" (13mm) diameter top loop.

**CAB 910** 50/box, 9 lbs. (4.1kg)

**CAB® 813** Same design as 910 but features four 1-1/4" (32mm) diameter closed loop spirals which securely retain cables in hanger. Overall length 11" (279mm).

**CAB 813** 40/box, 19 lbs. (8.6kg)

**CAB® 305** has four 1" (25mm) diameter closed spiral loops. 1/2" (13mm) diameter top loop has closed spiral design which prevents dislodging of hanger from beltline chain or other support after installation. Made from .156" wire (4mm), 11-3/4" (298mm) long.

**CAB 305** 25/box, 11 lbs. (5.0kg)

**CAB 231\*** 25/box, 11 lbs. (5.0kg)

\*Same as CAB 305 except with drive-in point for nail-in application.

**CAB® 4701** has three 3/4" (19mm) diameter carriers and 1/2" (13mm) diameter open top loop. CAB 809 is the same except has a drive-in point. 8" (203mm) long. Made from .156" (4mm) wire.

**CAB 4701** 50/box, 10 lbs. (4.5kg)

**CAB 809** 100/box, 15 lbs. (6.8kg)

## CAB® Telewire Bars



**CAB® Telewire Bars** are heavy-duty multi-carrier hangers for roof installations. Top section made from .180" x 1" (4.6 x 25.4mm) safety edge steel and 5/16" (7.9mm) round stock. Bottom carriers made any diameter in closed loop (pictured) or open loop designs. Can be made with 1 to 10 carriers, custom to your specifications.



# Leaky Feeder Hux Hangers

Designed to safely and securely hang leaky feeder cable from roof of mine. Can help to reduce interference and improve signal strength by adding spacing between steel mesh or roof structure and cable. Durable 1-1/2" (38mm) wide polypropylene webbing with heavy-duty top hook. Quick and easy to use. Simply wrap webbing around cable, then insert top hook through bottom loop and pull snug. Provides safe 1-1/2" (38mm) wide surface area to hold cable firmly in position.

**CAB 7719** 10" (254mm) long, 100/box, 9 lbs. (4.1kg)

**CAB 7720** 15" (381mm) long, 100/box, 10 lbs. (4.5kg)

**CAB 7721** 20" (508mm) long, 100/box, 11lbs. (5kg)



**CAB 7719**



**CAB Hux Hangers are an industry favorite for suspending leaky feeder cable. Helps to reduce interference and improve signal strength.**

**CAB 7720**



**CAB 8933** (Patented.)

## CAB® Double Safety Hook Rope Hangers

In response to requests from the mining industry, CAB has developed a unique Double Safety Hook Rope Hanger. This new design speeds installation time and improves safety by keeping all hardware tight to the roof of the mine. Made from 1/4" (6.4mm) flame retardant, hollow braid polypropylene rope with strong .208" (5.3mm) diameter galvanized wire hook. (Patented.)

**CAB 8933** 18" (457mm) long, .208" (5.3mm) hook, 200/box, 24 lbs. (10.9kg)

## CAB® Rope Hangers

Versatile hangers designed to support hose, pipe and cables in many applications. Made from 1/4" (6.4mm) flame retardant, hollow braid polypropylene rope with strong .208" (5.3mm) dia. galvanized wire hooks.

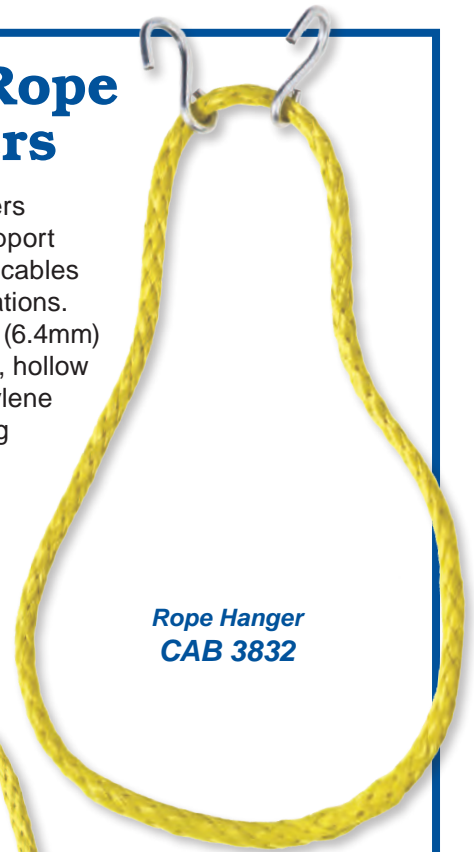

**Rope Hanger CAB 3832**

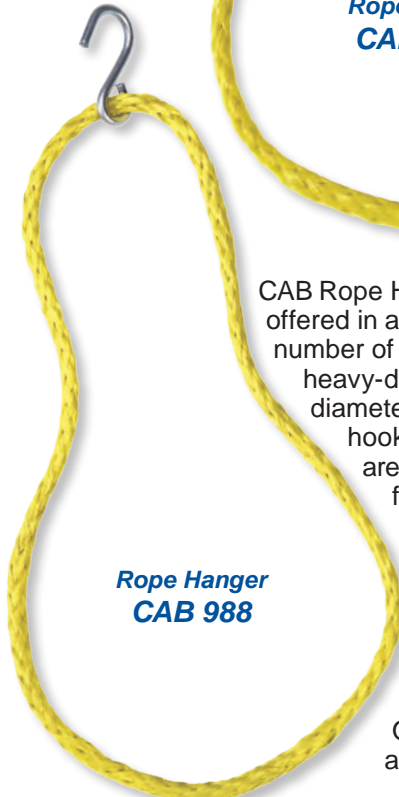

**Rope Hanger CAB 988**

CAB Rope Hangers are offered in any length, with any number of hooks, including heavy-duty .250" (6.4mm) diameter galvanized wire hooks. Rope Hangers are primarily intended for temporary use. For permanent cable support, insulated steel hangers are recommended. Standard sizes listed below. Other sizes available.

**CAB 3708** 12" (305mm) long, .208" (5.3mm) hook, 200/box, 13 lbs. (5.9kg)

**CAB 3709** 15" (381mm) long, .208" (5.3mm) hook, 200/box, 14 lbs. (6.4kg)

**CAB 6012** 15" (381mm) long, .208" (5.3mm) hook/2 ea., 200/box, 24 lbs. (10.9kg)

**CAB 6018** 15" (381mm) long, .250" (6.4mm) hook, 200/box, 19 lbs. (8.6 kg)

**CAB 988** 18" (457mm) long, .208" (5.3mm) hook, 200/box, 15 lbs. (6.8kg)

**CAB 3832** 18" (457mm) long, .208" (5.3mm) hook/2 ea., 200/box, 24 lbs. (10.9kg)

**CAB 4972** 18" (457mm) long, .250" (6.4mm) hook, 200/box, 20 lbs. (9.1kg)

**CAB 6673** 18" (457mm) long, .250" (6.4mm) hook/2 ea., 100/box, 32 lbs. (14.5kg)

**CAB 5965** 20" (508mm) long, 1 strand .208" (5.3mm) hook/2 ea., 100/box, 22 lbs. (10kg)

**CAB 990** 21" (533mm) long, .208" (5.3mm) hook, 100/box, 9 lbs. (4.1kg)

**CAB 989** 24" (610mm) long, .208" (5.3mm) hook, 100/box, 9 lbs. (4.1kg)

**CAB 991** 36" (914mm) long, .208" (5.3mm) hook, 100/box, 11 lbs. (5kg)

**CAB 5042** 48" (1.2m) long, .208" (5.3mm) hook, 100/box, 7 lbs. (3.2kg)

**CAB 5041** 60" (1.5m) long, .208" (5.3mm) hook, 100/box, 7 lbs. (3.2kg)

**CAB 7313** 72" (1.8m) long, .208" (5.3mm) hook, 100/box, 8 lbs. (3.6kg)

**CAB 7070** 96" (2.4 m) long, .208" (5.3mm) hook, 100/box, 11 lbs. (5kg)



# CAB® J-Hooks

CAB J-Hooks provide safe, strong support for all types of hose, pipe and cable. Made from .180" x 1" (4.6 x 25.4 mm) safety edge steel, with a heavy coat of high dielectric grade, flame retardant plastisol for added safety and protection. Keyhole feature useful for hanger adjustment or removal. Can be custom made to any size or configuration.



**Standard J-Hook**  
**CAB 343**  
**CAB 347**  
**CAB 349**  
**CAB 350**

## CAB® Standard J-Hooks

Safe, strong supports for sidewall applications. Keyhole has 1/2" (13mm) opening and 5/16" (8mm) slot. Made from safety edge steel. CAB's 3" (76mm) and 4" (102mm) sizes available in hot dipped galvanized steel.

- CAB 343** 1-1/2" (38mm) dia., 5-1/2" (140mm) long, 50/box, 24 lbs. (11kg)
- CAB 347** 3" (76mm) dia., 5-1/2" (140mm) long, 50/box, 29 lbs. (13.2kg)
- CAB 348** Galvanized 3" (76mm) dia., 5-1/2" (140mm) long, 50/box, 30 lbs. (14kg)
- CAB 349** 4" (102mm) dia., 6-3/4" (171mm) long, 25/box, 18 lbs. (8.2kg)
- CAB 8037** Galvanized 4" (102mm) dia., 6-3/4" (171mm) long, 25/box, 19 lbs. (9kg)
- CAB 350** 5" (127mm) dia., 8" (203mm) long, 25/box, 23 lbs. (10.5kg)



**CAB J-Hooks organize cables and improve safety in mines and tunnels.**

**CAB 5133**

## CAB® Stacked J-Hooks

Heavy-duty 2-carrier hangers for supporting pipe and cables from roof, side or structure. Made from .180" x 1" (4.6 x 25.4mm) safety edge steel and .187" (4.7mm) high strength wire. 1-3/8" (35mm) diameter top loop.

- CAB 965** 1-1/2" (38mm) dia., 9-1/2" (241mm) long, 25/box, 29 lbs. (12.3kg)
- CAB 966** 3" (76mm) dia., 13" (330mm) long, 10/box, 16 lbs. (7.3kg)
- CAB 6188** 3" (76mm) dia., 30" (762mm) long, 25/box, 44 lbs. (20.0kg)



**Stacked J-Hook**  
**CAB 965**  
**CAB 966**  
**CAB 6188**



**Multi-Carrier Hangers safely separate and support heavy cables. Custom sizes available.**

**Side Mount Hanger CAB 5133**

## Double J-Hook

**CAB 213**  
**CAB 155**  
**CAB 156**  
**CAB 4691**

## CAB® Double J-Hooks

For hanging multiple cables from roof. 3" (76mm) diameter hooks with 5/8" (16mm) diameter top loop. CAB 213 and 155 top loop made from .187" (4.7mm) diameter wire; CAB 156 and CAB 4691 from .250" (6.4mm) wire.



- CAB 213** 6" (152mm) long, 25/box, 31 lbs. (14.1kg)
- CAB 155** 12" (305mm) long, 25/box, 35 lbs. (15.9kg)
- CAB 156** 30" (762mm) long, 25/box, 41 lbs. (18.6kg)
- CAB 4691** 36" (914mm) long, 10/box, 40 lbs. (18.2kg)



**Drive-In J-Hook**  
**CAB 353**  
**CAB 462**  
**CAB 479**



**Loop Top J-Hook**  
**CAB 928**  
**CAB 4501**

## CAB® Drive-in and Loop Top J-Hooks

Drive-In J-Hook features sharp tip, installation hole and a special detent to resist pullout. Loop Top J-Hook is made with 1-3/8" (35mm) diameter top loop for versatility in hanging from roof or sidewall in mine or tunnel.

- CAB 353** 3" (76mm) dia., 5" (127mm) long, 25/box, 17 lbs. (7.7kg)
- CAB 462** 4" (102mm) dia., 7" (178mm) long, 25/box, 21 lbs. (9.5kg)
- CAB 479** 5" (127mm) dia., 8" (203mm) long, 25/box, 30 lbs. (13.6 kg)

- CAB 928** 3" (76mm) dia., 6-1/2" (165mm) long, 50/box, 32 lbs. (14.5kg)
- CAB 4501** 4" (102mm) dia., 8" (203mm) long, 25/box, 20 lbs. (9.1kg)

## CAB® Side Mount Hangers

Heavy-duty supports designed to carry multiple cables in highly corrosive environments. Carriers are 3" (76mm) diameter. Can be custom made with any number or size carriers required.

- CAB 6958** 1 carrier, 8" (203mm) long, 25/box, 28 lb. (12.7kg)
- CAB 6959** 2 carrier, 14-1/2" (368mm) long, 10/box, 24 lb. (10.9 kg)
- CAB 5133** 3 carrier, 20" (508mm) long, 10/box, 32 lb. (14.5kg)
- CAB 6681** 4 carrier, 26" (660mm) long, 5/box, 22 lb. (10kg)
- CAB 6704** 4 carrier, 26" (660mm) long, custom heavy-duty style



# CAB® Workhorse Hangers



*CAB Workhorse Hangers are easy to install and load. They organize large bundles of hose, pipe and cable for faster troubleshooting and improved safety underground.*

**CAB 154**

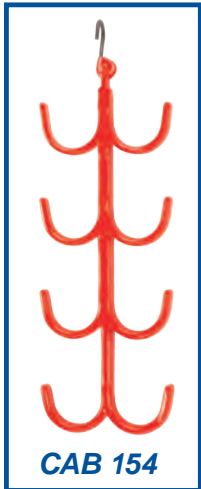

**CAB 154**

**CAB® Workhorse Hangers** are designed to improve safety by organizing all types of hoses and cables used in underground operations. CAB's heavy plastisol coating makes this hanger much safer to use than bare metal hangers with unprotected sharp edges which are often made in fab shops.

Available in two, four, six, eight and ten carrier versions with a strong 1/4" (6.4mm) diameter hook at the top. Also available with 12" (305mm) long extension hook for reduced lifting in higher roof areas.

Made from sturdy .180" x 1" (4.6 x 25.4mm) safety edge steel. All carriers are 3" (76mm) diameter and totally coated with 90 mils (2.3mm) of high dielectric grade plastisol that has a 400-volt per mil (.03mm) dielectric breakdown strength. Coating is very tough, durable, and flame retardant.

**CAB 8026 4-Carrier** 13" (331mm) long, 10/box, 30 lbs. (13.7kg)

**CAB 6322 6-Carrier** 19" (483mm) long, 10/box, 53 lbs. (24kg)

**CAB 154 8-Carrier** 24" (610mm) long, 10/box, 60 lbs. (27.3kg)

**CAB 7406 8-Carrier with extension** 34" (864mm) long, 10/box, 64 lbs. (29.1kg)

## CAB® U-Bolts

Made in a wide variety of sizes and styles with heavy plastisol coating to safely retain cables and hoses. Contact CAB for more information.

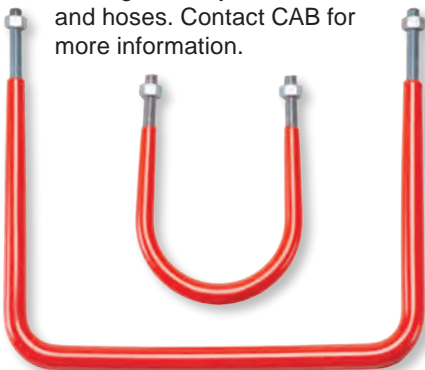

## CAB® MRS Collapsible Hangers

**CAB 6698**



CAB's innovative MRS hangers allow miners to remove cables without entering unsupported roof areas. Bottom two carriers collapse, allowing cables to drop to floor of mine when tension is applied. Each carrier has a safe working load of 22 pounds (10.0kg). Will drop at 70-90 lb. (31.8-40.9kg) load. 5/8" (16mm) diameter top loop, 3" (76mm) diameter bottom carriers.

**CAB 6698** 7-1/2" (191mm) long, 50/box, 11 lbs. (5kg)

## CAB® J-Hooks with Extensions

Made from .180"x1" (4.6 x 25.4mm) wide safety edge steel with 1/4" (6.4mm) diameter round wire extension for easy installation. All carriers are 3" (76mm) diameter with heavy plastisol coating for protection of cables. Top loop is 1-1/2" (38mm) diameter. Single, double, triple and other configurations available.

### Triple J-Hook with Extension

**CAB 244**  
**CAB 243**  
**CAB 245**  
**CAB 250**  
**CAB 189**



#### 1-Carrier, 25/box:

**CAB 7379** 18" (457mm) long, 22 lbs. (10kg)

**CAB 183** 36" (914mm) long, 28 lbs. (12.7kg)

#### 2-Carrier, 25/box:

**CAB 7558** 30" (762mm) long, 45 lbs. (20.5kg)

#### 3-Carrier, 10/box:

**CAB 244** 14" (356mm) long, 22 lbs. (10kg)

**CAB 243** 24" (610mm) long, 25 lbs. (11.4kg)

**CAB 245** 36" (914mm) long, 27 lbs. (12.3kg)

**CAB 250** 48" (1.2m) long, 30 lbs. (13.6kg)

**CAB 189** 72" (1.8m) long, 31 lbs. (14.1kg)



# CAB® Heavy-Duty Hangers

**Tough and Durable for Larger Loads**

Custom sizes and designs are a specialty at CAB. Call for details!



## CAB® Bullhorn Hangers

Heavy-duty hangers made from strong 3/8" (10mm) diameter round stock with a 1/2" (13mm) diameter top loop. Bottom carriers are 5" (127mm) diameter, heavily coated with high dielectric grade plastisol for added safety and protection. Custom sizes available for high roof areas.

## CAB® 3-Carrier Heavy-Duty Hangers

These versatile 3-carrier hangers are made with strong high tensile 1/4" (6.4mm) diameter round wire. Carriers are 3" (76mm) diameter. Spiral top loop provides secure attachment to plates, mesh or structure. Top loop pictured below. Packaged 50/box.

**CAB 228** 1/2" (13mm) dia. top loop, 18" (457mm) long, 47 lbs. (21.4kg)

**CAB 188** 1-1/2" (38mm) dia. top loop, 18" (457mm) long, 47 lbs. (21.4kg)

## CAB® Super Duty Hangers

Made from strong 1/2" (13mm) diameter round stock to carry heavier loads. CAB 5653 is a 5-carrier hanger designed to handle heavy pipes, hoses and cables. Features three 3" (76mm) diameter and two 4" (102mm) diameter carriers with 2" (51mm) diameter top loop. Custom styles available.

**CAB 5653** 57" (1.4m) long

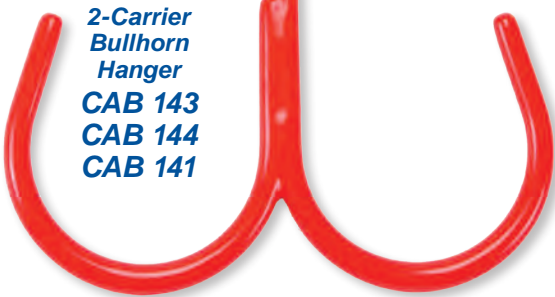

**2-Carrier Bullhorn Hanger**  
**CAB 143**  
**CAB 144**  
**CAB 141**

### CAB® Bullhorn Hangers:

#### 2-Carrier, top loop offset 90° to carrier:

**CAB 143** 18" (457mm) long, 10/box, 20 lbs. (9.1kg)

**CAB 144** 24" (610mm) long, 10/box, 21 lbs. (9.5kg)

**CAB 141** 30" (762mm) long, 10/box, 23 lbs. (10.5kg)

#### 3-Carrier:

**CAB 7628** 19" (483mm) long, 15/box, 34lbs. (15.5kg)

#### 4-Carrier:

**CAB 7683** 19" (483mm) long, 15/box, 41lbs. (18.6kg)

Also available with swivel top hook for faster installation.

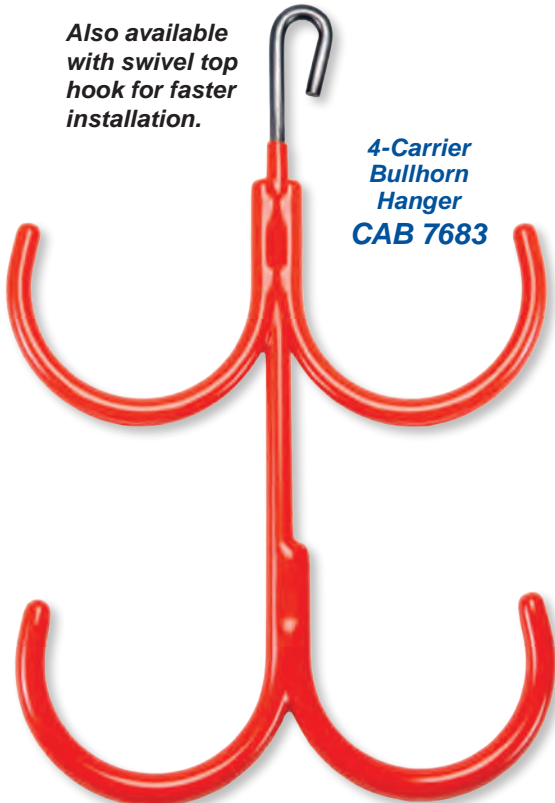

**4-Carrier Bullhorn Hanger**  
**CAB 7683**



**CAB 228**

**Super Duty Hanger**  
**CAB 5653**





# CAB® Webbing Belts, Straps and Hangers



**CAB 897**

## CAB® Webbing Hangers

Strong and versatile for the heavy-duty support of pipe and cable in underground mines and tunnels. Custom offset hooks are securely sewn into the ends of strong 1-1/2" (38mm) wide polypropylene webbing. Hooks are made from 3/16" (5mm) diameter high strength steel in standard non-welded or heavy-duty welded styles. Sizes are measured from end of hooks with webbing fully extended. Custom sizes available.

### Standard Hooks:

- CAB 897** 15" (381mm) long, 100/box, 15 lbs. (6.8kg)
- CAB 898** 23" (584mm) long, 100/box, 16 lbs. (7.3kg)
- CAB 900** 30" (762mm) long, 50/box, 9 lbs. (4.1kg)
- CAB 902** 36" (914mm) long, 50/box, 10 lbs. (4.5kg)
- CAB 6820** 48" (1.2m) long, 50/box, 12 lbs. (5.5kg)

### Heavy-Duty Welded Hooks:

- CAB 893** 15" (381mm) long, 100/box, 15 lbs. (6.8kg)
- CAB 894** 23" (584mm) long, 100/box, 17 lbs. (7.7kg)
- CAB 895** 30" (762mm) long, 50/box, 9 lbs. (4.1kg)
- CAB 896** 36" (914mm) long, 50/box, 10 lbs. (4.5kg)
- CAB 6819** 48" (1.2m) long, 50/box, 13 lbs. (5.9kg)



**CAB 898**

## CAB® Double D-Ring Webbing Hangers

Strong, versatile hangers designed for supporting hose, pipe and cable in a variety of underground applications. Double D-rings allow for quick and easy adjustment of hanger length to keep lines at the desired height. Hanger made from 1-1/2" (38mm) wide orange polypropylene webbing. Top hook and D-rings welded and hot-dipped galvanized for extra strength and durability. Available in lengths of 2' to 20' (610mm to 6.1m) in 1' (305mm) increments. Common sizes listed below. For heavier loads use 1/4" (6.4mm) top hook. Also available with extra heavy-duty 3/8" (10mm) top hook. Size measured by overall length of webbing and hook before assembly.

### Standard 3/16" (5mm) Diameter Top Hook:

- CAB 834** 2 ft. (610mm) long, 50/box, 10 lbs. (4.5kg)
- CAB 835** 3 ft. (914mm) long, 50/box, 11 lbs. (5kg)
- CAB 836** 4 ft. (1.2m) long, 50/box, 12 lbs. (5.5kg)
- CAB 837** 5 ft. (1.5m) long, 50/box, 13 lbs. (5.9kg)
- CAB 838** 6 ft. (1.8m) long, 50/box, 14 lbs. (6.3kg)

### Heavy-Duty 1/4" (6.4mm) Diameter Top Hook:

- CAB 844** 2 ft. (610mm) long, 50/box, 13 lbs. (5.9kg)
- CAB 845** 3 ft. (914mm) long, 50/box, 14 lbs. (6.4kg)
- CAB 846** 4 ft. (1.2m) long, 50/box, 16 lbs. (7.3kg)
- CAB 847** 5 ft. (1.5m) long, 50/box, 18 lbs. (8.2kg)
- CAB 848** 6 ft. (1.8m) long, 50/box, 20 lbs. (9.1kg)



**CAB 845**



## CAB® Webbing Belts and Straps Heavy-Duty Styles for Bundling Hoses and Cables

Belts made from black or orange polypropylene webbing in three widths: 1", 1-1/2" or 2" (25mm, 38mm or 51mm). Choice of high quality corrosion resistant buckles in Double-D, Standard, Cam and Ratchet styles. Especially useful in longwall applications. Custom sizes available.

### Cam Buckle:

- CAB 6127** 1" x 2 ft. (25mm x 610mm) long, 50/box, 6 lbs. (2.7kg)
- CAB 6995** 1" x 3 ft. (25mm x 914mm) long, 50/box, 8 lbs. (3.6kg)
- CAB 7299** 1" x 4 ft. (25mm x 1.2m) long, 50/box, 9 lbs. (4.1kg)
- CAB 3707** 2" x 4 ft. (51mm x 1.2m) long, 25/box, 18 lbs. (8.2kg)

### Standard Buckle:

- CAB 3715** 1-1/2" x 4 ft. (38mm x 1.2m) long, 50/box, 9 lbs. (4.1kg)

### Double-D Ring Buckle:

- CAB 852** 1-1/2" x 2 ft. (38mm x 610mm) long, 50/box, 8 lbs. (3.6kg)
- CAB 853** 1-1/2" x 3 ft. (38mm x 914mm) long, 50/box, 9 lbs. (4.1kg)
- CAB 854** 1-1/2" x 4 ft. (38mm x 1.2m) long, 50/box, 10 lbs. (4.5kg)
- CAB 855** 1-1/2" x 5 ft. (38mm x 1.5m) long, 50/box, 11 lbs. (5kg)

### Ratchet Style:

- CAB 3827** 1" x 12 ft. (25mm x 3.7m) long, 25/box, 25 lbs. (11.4kg)
- CAB 6960** 2" x 6 ft. (51mm x 1.8m) long, 10/box, 25 lbs. (11.4kg)
- CAB 6472** 2" x 12 ft. (51mm x 3.7m) long, 10/box, 28 lbs. (12.7kg)



## CAB® Vent Tube Hangers

Safer, Easier to Install and More Cost Effective than Chain or Tie Wire



Rope Vent Tube Hanger  
CAB 6686

Webbing Vent Tube Hanger  
CAB 7890

Wire Reinforced Webbing Vent Tube Hanger  
CAB 7286  
CAB 6570

Webbing Vent Tube Hanger without Wire Insert  
CAB 7866

CAB offers three styles of high quality hangers to safely suspend vent tubing. All are easier to use, more cost effective and safer than chain or tie wire.

Webbing styles are made from 1-1/2" (38mm) wide polypropylene webbing with two heavy-duty 1/4" (6.4mm) S-hooks and quick release buckle for easy adjustment. Longer styles available with wire inserts sewn in the webbing for easy hook up in high roof areas.

Rope styles have spliced S-hook on one end and floating hook with line tightener on other end. After installation of hooks, tightener is easily adjusted on rope for proper positioning of vent tubing. Rope is sturdy 5/16" (8mm) diameter polypropylene. Size measured by overall length fully extended. Custom sizes available.

### Webbing Style Hangers:

- CAB 7890** 6 ft. (1.8m) long, 50/box, 16 lbs. (7.3kg)
- CAB 7286** 8 ft. (2.4m) long, 15" (381mm) wire insert, 25/box, 19 lbs. (8.6kg)
- CAB 6570** 8 ft. (2.4m) long, 21" (533mm) wire insert, 25/box, 19 lbs. (8.6kg)
- CAB 7866** 6 ft. (1.8m) long, no wire insert, 25/box, 15 lbs. (6.8kg)

### Rope Style Hangers:

- CAB 6686** 5/16" (8mm) rope, 10 ft. (3m) long, 25/box, 12 lbs. (5.5kg)

## CAB® Lifeline Hangers

Designed to Securely Hang Rope or Aircraft Cable Lifeline at Desired Height in Any Mine



Elastic Hanger  
(Stretches five times its original length.)

Aircraft Cable Hanger

Rope Hanger

Quick Release Rope Hanger

Quick Release Galvanized Steel Hanger

(In emergency, if Lifeline is needed closer to mine floor, five to ten pounds of pressure will release Lifeline from Steel Hanger. Installs from roof bolt plates or from top hole.)

**Rope and Aircraft Cable Hangers** quickly attach to lifeline and have a strong hook for attachment to plates, mesh or roof structure. Elastic hangers are especially useful in crosscuts; they stretch five times their original length to lower lifeline during use and return it to original height after use. Quick Release Hangers have a release pin that attaches to hanger hole or edge of the plate. They can be quickly pulled off plates to drop lifeline for emergency escape. Standard sizes listed below. Custom and longer sizes available. Additional rope hangers on page 8.



CAB Aircraft Cable Hanger with CAB Lifeline Marker



CAB Rope Hanger with CAB Lifeline Marker

### Elastic Lifeline Hangers:

- CAB 7335** 1 ft. (305mm) long, 25/box, 4 lbs. (1.8kg)
- CAB 7332** 2 ft. (610mm) long, 25/box, 5 lbs. (2.3kg)
- CAB 7336** 3 ft. (914mm) long, 25/box, 6 lbs. (2.7kg)
- CAB 7337** 4 ft. (1.2m) long, 25/box, 6 lbs. (2.7kg)

### Aircraft Cable Lifeline Hangers:

- CAB 7165** 1 ft. (305mm) long, 25/box, 5 lbs. (2.3kg)
- CAB 7166** 2 ft. (610mm) long, 25/box, 6 lbs. (2.7kg)
- CAB 7167** 3 ft. (914mm) long, 25/box, 7 lbs. (3.2kg)
- CAB 7168** 4 ft. (1.2m) long, 25/box, 8 lbs. (3.6kg)
- CAB 7169** 5 ft. (1.5m) long, 25/box, 9 lbs. (4.1kg)
- CAB 7170** 6 ft. (1.8m) long, 25/box, 10 lbs. (4.5kg)

### Rope Loop Lifeline Hangers:

- CAB 3708** 1 ft. (305mm) long, 200/box, 14 lbs. (6.4kg)
- CAB 989** 2 ft. (610mm) long, 100/box, 9 lbs. (4.1kg)
- CAB 991** 3 ft. (914mm) long, 100/box, 12 lbs. (5.5kg)
- CAB 5042** 4 ft. (1.2m) long, 50/box, 7 lbs. (3.2kg)
- CAB 5041** 5 ft. (1.5m) long, 50/box, 8 lbs. (3.2kg)
- CAB 7313** 6 ft. (1.8m) long, 50/box, 8 lbs. (3.6kg)

### Quick Release Rope Lifeline Hangers:

- CAB 7684** 1 ft. (305mm) long, 100/box, 2 lbs. (0.9kg)
- CAB 7685** 2 ft. (610mm) long, 100/box, 3 lbs. (1.4kg)
- CAB 7686** 3 ft. (914mm) long, 100/box, 3 lbs. (1.4kg)
- CAB 7687** 4 ft. (1.2m) long, 100/box, 4 lbs. (1.8kg)
- CAB 7688** 5 ft. (1.5m) long, 100/box, 5 lbs. (2.3kg)
- CAB 7689** 6 ft. (1.8m) long, 100/box, 5 lbs. (2.3kg)

### Quick Release Galvanized Steel Lifeline Hangers:

- CAB 8697** 3 in. (76mm) long, 50/box, 5 lbs. (2.3kg)



# CAB® Cable Rings & Saddles

## Industry Favorite for Safe, Strong Support of Aerial Cables

CAB Cable Rings provide maximum strength and safety for the support of all types of aerial cables. Rings are manufactured from galvanized steel, copper clad steel or type 316 stainless steel to withstand the most corrosive environments. For added safety and protection, any style cable ring can be totally insulated with CAB's tough 80 mil (2mm) thick coating of high dielectric grade, PVC plastisol. Coating is also flame retardant and UV stabilized for long service life.



**CAB's award winning PVC coated Rings and Saddles are extremely resistant to corrosion and act as a mini-cable tray system for cables.**

For maximum strength, CAB Cable Rings are manufactured from high tensile spring steel in rolled flat wire form. This high quality material provides a smooth, flat surface for the support of cables and rounded edges for the protection of cable jackets. This advanced roll-form design, combined with the strong spring temper of the wire, provides a tight, secure attachment of the cable ring to the messenger wire.



**CAB Cable Ring Saddles provide a 1" wide load-bearing area for extra support and protection of cables.**

CAB Cable Rings are manufactured in standard, medium and long styles. Designed to tightly fit on an exact messenger wire size to prevent slippage. Medium and long style rings have extra length for bundles of cables or for running several cables independently from the same messenger wire. Recommended spacing for ring sizes 1-1/2" through 2-1/2" (38mm through 64mm) is 15" to 20" (381mm to 508mm). Recommended spacing for ring sizes 3" through 6" (76mm through 152mm) is 12" to 15" (305mm to 381mm). Exact spacing varies depending on type of cable, nature of installation and loading requirements. When ordering cable rings, specify size, material, style and size of messenger strand.

### CAB Sizing Guide

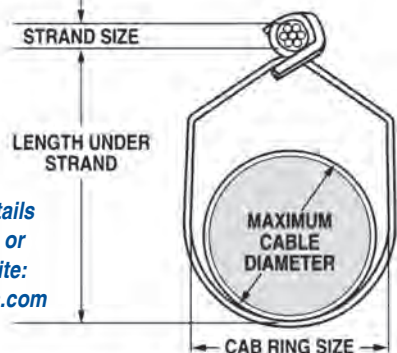

For more details contact CAB or check web site: [cabproducts.com](http://cabproducts.com)

### Standard Style CAB Rings

Medium and long styles also available.

Ring Diameter	Maximum Cable Diameter	Length Under Strand	Standard Rings Packaging	Standard Rings Weight/Box	PVC Coated Rings Packaging	PVC Coated Rings Weight/Box
1-1/2" (38mm)	1-1/8" (29mm)	2-1/2" (64mm)	500/box	25 lb. (11.4kg)	250/box	18 lb. (8.2kg)
2" (51mm)	1-1/2" (38mm)	2-7/8" (73mm)	250/box	19 lb. (8.6kg)	100/box	10 lb. (4.5kg)
2-1/2" (64mm)	2" (51mm)	3-1/2" (89mm)	250/box	26 lb. (11.8kg)	100/box	12 lb. (5.5kg)
3" (76mm)	2-1/4" (57mm)	4-1/8" (105mm)	100/box	12 lb. (5.5kg)	100/box	18 lb. (8.2kg)
3-1/2" (89mm)	2-5/8" (67mm)	4-1/2" (114mm)	100/box	13 lb. (5.9kg)	100/box	21 lb. (9.5kg)
4" (102mm)	3" (76mm)	5" (127mm)	100/box	19 lb. (8.6kg)	50/box	14 lb. (6.4kg)
4-1/2" (114mm)	3-1/2" (89mm)	5-1/2" (140mm)	100/box	19 lb. (8.6kg)	50/box	15 lb. (6.8kg)
5" (127mm)	4" (102mm)	6-1/4" (159mm)	50/box	11 lb. (5.0kg)	50/box	16 lb. (7.3kg)
6" (152mm)	5" (127mm)	7-1/4" (184mm)	50/box	12 lb. (5.5kg)	50/box	18 lb. (8.2kg)



**CAB Cable Rings are recommended for plants, mills, tunnels, mines, pipelines and other highly corrosive environments.**



**Cables can be run separately by using CAB's standard and long style rings.**



**CAB offers a variety of hanger options that safely separate bundles of cables. Available totally coated with durable, high dielectric grade PVC plastisol.**



# CAB® Cable Pullers

**Made for the Tough Job of Pulling Trailing Cables  
in Underground and Open Pit Mines**

CAB Cable Pullers, offered in three styles, are far safer than alternatives such as chain and hemp rope. They are very effective in safety programs designed to reduce mine accidents and back injuries.

Note: Cable Pullers are not designed for lifting.

**CAB Insulated  
Steel Cable Puller  
CAB 878  
CAB 879**



## CAB® Insulated Steel Cable Pullers

Fully insulated steel pull hooks for manually moving trailing cables. Especially useful in safety programs designed to reduce back injuries. Manufactured from 3/8" (10mm) diameter cold rolled steel. Heavy plastisol coating is tough, durable, and high dielectric grade for added safety and protection.

**CAB 878** 24" (610mm) pull hook, 6/box, 12 lbs. (5.5kg)

**CAB 879** 33" (838mm) pull hook, 6/box, 14 lbs. (6.4kg)

**More effective  
at gripping cables...  
than slings...  
lower cost, too!**



## CAB® Webbing Cable Pullers

Made from heavy-duty polypropylene webbing that provides a wide support area for pulling cables. More cost effective than slings and the webbing is not as stiff, so they provide more effective gripping and holding of cables without slippage. For added versatility, one end loop is 11" (279mm) long; the other is 14" (356mm) long. Bright yellow color provides added visibility for improved safety.

### 2" (51mm) Wide Webbing:

**CAB 6371** 5 ft. (1.5m) long, 10/box, 6 lbs. (2.7kg)

**CAB 6372** 6 ft. (1.8m) long, 10/box, 7 lbs. (3.2kg)

**CAB 6370** 8 ft. (2.4m) long, 10/box, 9 lbs. (4.1kg)

**CAB 6373** 10 ft. (3.0m) long, 10/box, 12 lbs. (5.5kg)

### 3" (76mm) Wide Webbing:

**CAB 6323** 5 ft. (1.5m) long, 10/box, 10 lbs. (4.5kg)

**CAB 6324** 6 ft. (1.8m) long, 10/box, 10 lbs. (4.5kg)

**CAB 6314** 8 ft. (2.4m) long, 10/box, 13 lbs. (5.9kg)

**CAB 6325** 10 ft. (3.0m) long, 10/box, 17 lbs. (7.7kg)

**Webbing Cable Puller**

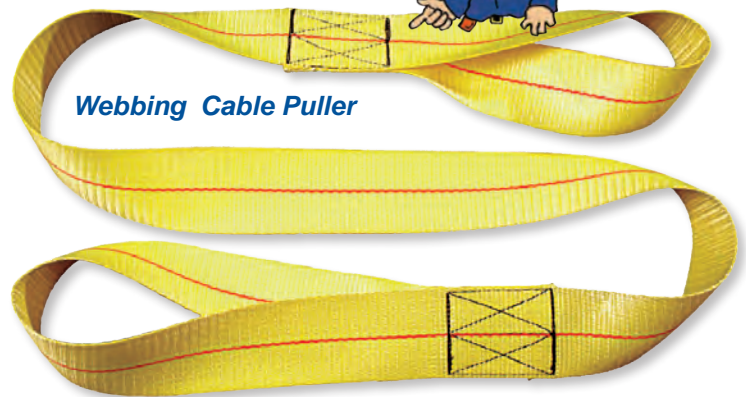

## CAB® Rope Cable Pullers

Made from strong 7/8" (22mm) diameter hollow braid polypropylene rope. Heavy-duty spliced knot on both ends prevents pull-out and provides secure 4" (102mm) end loops.

**CAB 5142** 7/8" (22mm) rope, 5 ft. (1.5m) long, 10/box, 10 lbs. (4.5kg)

**CAB 6009** 7/8" (22mm) rope, 8 ft. (2.4m) long, 10/box, 12 lbs. (5.5kg)

**CAB 7258** 7/8" (22mm) rope, 10 ft. (3m) long, 10/box, 14 lbs. (6.4kg)

**Rope Cable Puller**

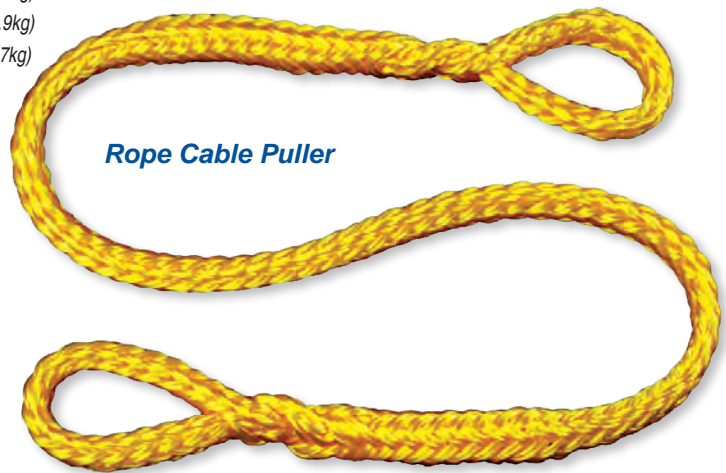

**Heavy-Duty  
Webbing  
Hanger  
CAB 7630**



Available with  
heavy-duty  
hooks.

## CAB® Heavy-Duty Webbing Hangers

Made for hanging PVC pipe in underground applications. 4" (102mm) wide black polypropylene webbing with 3" (76mm) loops on each end. Hanger pictured has folded loops for double thickness when hanging with chain. Also available with 1/4" (6.4mm) or 3/8" (10mm) diameter wire hooks on each end for hanging from plates or structure.

**CAB 7630** 30" (762mm) long, no hooks, 50/box, 11 lbs. (5kg)

**CAB 830** 41" (1m) long, 1/4" (6.4mm) dia. wire hooks, 1/2" (13mm) top loop, 25/box, 15 lbs. (6.8kg)

**CAB 831** 35" (889mm) long, 3/8" (10mm) dia. wire hooks, 3/4" (19mm) top loop, 25/box, 37 lbs. (16.8kg)

**CAB 832** 41" (1m) long, 3/8" (10mm) dia. wire hooks, 3/4" (19mm) top loop, 25/box, 39 lbs. (17.7kg)

# CAB® LIFELINE

*Leading the Way to Safety Since 1985*

*First in Durability, Visibility, and Safety Features*



*CAB Lifeline features large, heavy-duty solid cones for maximum strength, safety and durability. Pictured here with aircraft cable Lifeline.*

**CAB Lifeline** is an emergency escape line designed to help evacuate an underground mine in the event of fire or explosion. Since 1985, the CAB Lifeline has been hand crafted to rigid standards of quality and performance. It is available in rope and heavy-duty aircraft cable styles to meet the wide variety of requirements found in the underground mining industry.

CAB Lifeline meets all state and federal regulations and is accepted by MSHA under Part 18, Title 30 Code of Federal Regulations. Research by NIOSH and the U.S. Bureau of Mines confirms that use of Lifeline can significantly improve chances for successful escape when fire breaks out in an underground mine.

## **CAB® Lifeline is Number One in the Industry** **MSHA Accepted in Aircraft Cable and Rope Styles**

**CAB® Directional Indicators** are molded in large, heavy-duty solid cones. The cone size and shape is specifically designed to quickly identify proper direction of travel and to prevent a handgrip from being broken when in actual use.

CAB Lifeline is hand constructed under rigid quality control by feeding Lifeline through the center of all cones. Cones are then firmly attached to the Lifeline with aircraft cable hardware.

This construction prevents directional cones from being dislodged, tampered with or removed from the Lifeline. Other lifelines on the market use small cones that make it hard to tell proper direction of travel or cones that easily unsnap and fall off, even in normal use.



### **CAB® Color Coded Directional Indicator Cones**

CAB directional cones have 6 reflective bands for high visibility. All cones are securely fastened to Lifeline with aircraft cable hardware. Cannot be accidentally dislodged or removed. Reflective bands available on entire surface or tapered surface only.



*CAB Extra High Visibility Lifeline is easily seen from any direction in escapeways. Lifeline markers hang vertically so they can be seen for long distances up and down escapeways. Markers are flexible so miners' hands can slide easily over them.*

### **CAB® Lifeline Offered in Standard and Extra-High Visibility Styles**

CAB Standard Lifeline has 2" (51mm) wide reflective tape bands wrapped around the Lifeline at 25 foot (7.6m) intervals between cones.

CAB Extra High Visibility Lifeline meets heightened safety standards with reflective markers suspended vertically at 25 foot (7.6m) intervals between cones, as pictured left.

CAB's brilliant extra high visibility markers can be easily seen from any direction in the escapeway. Because of their firm attachment to the Lifeline with aluminum stop sleeves, these reflectors stay oriented to show proper direction of escape at all times.

CAB's flexible retroreflective vinyl markers are the most brilliant on the market. They are sturdy and won't crack, shatter or fall off the Lifeline as hard plastic reflectors do.

Available in 2" x 4" (51mm x 102mm) size as pictured above or in double length 2" x 8" (51mm x 203mm) size as pictured left. Can be reflective on one or both sides in the same or different colors.

### **Now for longwall operations ... Interchangeable Velcro Markers**

CAB Lifeline with Velcro Markers is designed for mines that change color of Lifeline after longwall operations.

Made from strong polypropylene webbing with velcro on one side. High visibility 2" x 6" (51mm x 152mm) reflective markers with velcro backer (sold separately) are quick and easy to attach and change later to another color as mining progresses and escape routes change.



*Double length reflective marker*



# Highest Quality Construction and Advanced Safety Features

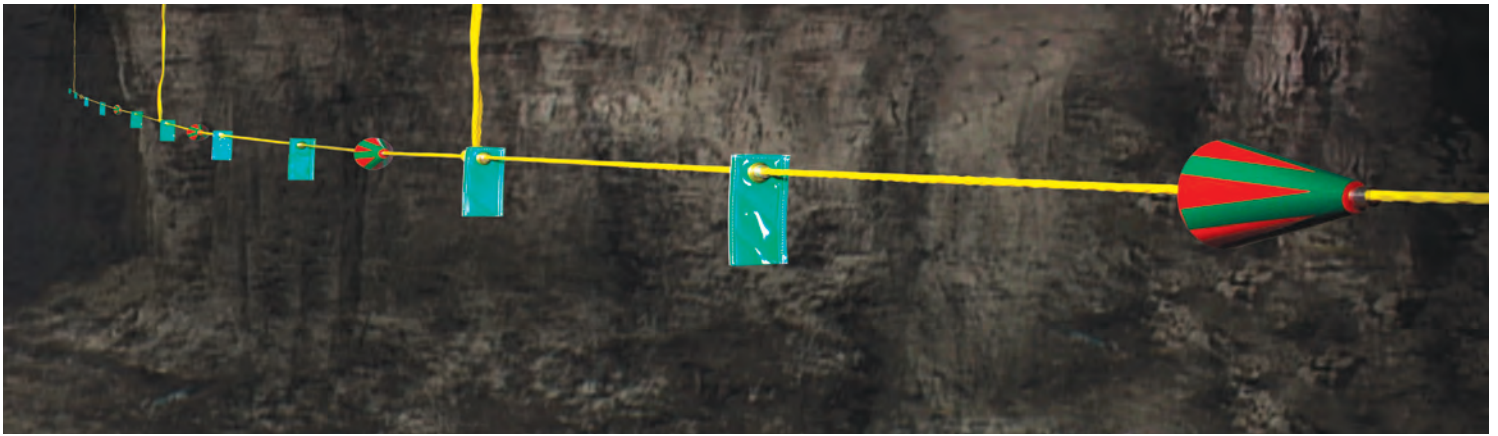

**CAB Extra High Visibility Lifeline features the most brilliant reflective markers in the industry. Markers are firmly attached to Lifeline and can't break or fall off like other reflectors. Available in rope and heavy-duty aircraft cable styles. Lifeline Hangers are shown on page 13.**

## Hand Crafted to Rigid Quality Standards

CAB Lifeline is available in rope and heavy-duty aircraft cable styles. Lifeline sections quickly and securely lock together with heavy-duty aircraft cable oval sleeves, thimbles and quick links. CAB Rope Lifeline is manufactured from 1/4" (6.4mm) diameter, yellow, flame retardant polypropylene rope. Available in 300' (91.4m) and 1,000' (304.8m) spools.

## CAB® Tie-On Markers

CAB Tie-On Markers can be easily added to existing Lifeline. Made from 2" x 4" (51mm x 102mm) brilliant retroreflective vinyl. Stitched on all sides. Strong nylon cord is sewn into top hem for securely tying markers to Lifeline.

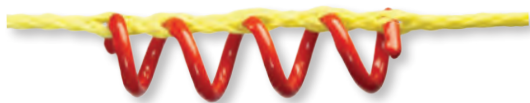

## CAB® Spiral Coil Rumble Strips

Used on branch lines that lead to refuge alternative. Strips measure 2" x 8" (51mm x 203mm) and are easily threaded into strands of existing Rope Lifeline or can be attached with cable ties to Aircraft Cable or Rope Lifeline.

## High Quality Construction and Spooling for Quick and Easy Installation

CAB Lifeline requires no assembly and is ready to install. All parts are integral and securely attached with aircraft cable hardware. Lower in overall cost compared to other brands that require stocking of parts and extra labor for assembly.

**See page 13 for Lifeline Hangers.**

CAB Heavy-Duty Aircraft Cable Lifeline (patent pending) is much more durable, especially in case of mine fires, explosions or rock falls. Made from strong 3/16" (5mm) diameter plastic coated, galvanized aircraft cable for maximum durability and safety. Sold in 300' (91.4m) spools.

## CAB® Split Cones

Identical to standard cones except featuring a pre-engineered hole and slit on one side for easy and secure attachment to previously installed Lifeline. Use two cones on main Lifeline to mark all branch lines. Use four cones, forming two diamond shapes on branch lines, to indicate SCSR storage caches. Sold in kits of 10 cones and 20 stop sleeves.



## CAB® Lifeline Balls

CAB Balls are used for marking location of mine personnel doors. Solid and durable, yet lightweight. Firm, secure attachment features a pre-engineered hole and slit on one side for quick, easy installation. Sold in kits of 10 balls and 20 stop sleeves.



**CAB Cones and Balls are solid, tough and durable. They stay securely attached to Lifeline.**



**No Assembly Required!**

# CAB® High Visibility Reflective Tubes

360° Visibility in 11 Brilliant Reflective Colors

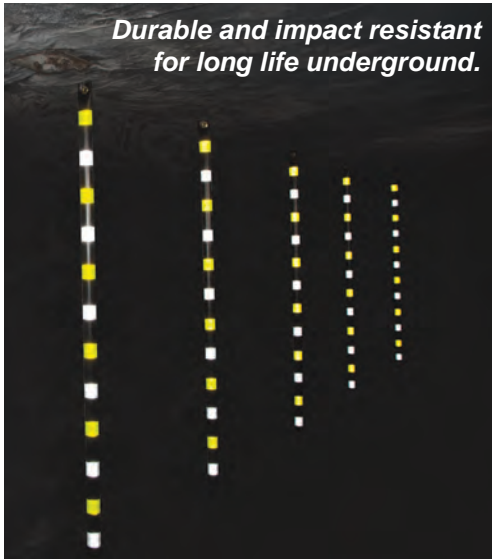

Durable and impact resistant for long life underground.



Reflects true colors for more accurate identification.

Lengths 6 Inches to 8 Feet  
(152mm to 2.4m)



CAB Striped Reflective Tube



CAB Solid Reflective Tube



CAB Tubes and Streamers provide a complete mine color code identification system.

CAB Tubes greatly improve visibility and safety when marking low roof, hazard areas, unsupported roof, etc. Tubes can also be slid over rods for marking haulage roads and unload areas. Eleven different colors may be used alone or in combinations on individual tubes.

Smooth reflective surface won't impregnate with dust and dirt like other reflective materials. Can be wiped clean to restore brilliance. Tubes may be hung vertically with 1 grommet or horizontally with no grommets or 2 grommets. Optional S-hooks available for faster installation. Packaged 50/box.

Striped tubes have reflective bands alternating with sections of black non-reflective tubing. Solid tubes have reflective bands adjoining each other for a solid reflective surface. Made from lightweight, durable 1-1/4" (32mm) diameter thin wall black tubing covered with microprism retroreflective vinyl.

### Tube and Streamer Standard Lengths:

6" (152mm)	24" (610mm)	48" (1.2m)
12" (305mm)	30" (762mm)	60" (1.5m)
18" (457mm)	36" (914mm)	72" (1.8m)
Custom sizes available.		84" (2.4m)

## CAB® High Visibility Reflective Streamers



Heavy weight, double-sided reflectors useful in wide variety of underground applications. Manufactured from microprism retroreflective vinyl with brass grommet. Extremely brilliant with true color reflection. Available in 11 colors for a complete mine color code identification system. Both sides can have same color or 2 different colors. One side may also be non-reflective. Flexible and impact resistant with a smooth surface that can be wiped clean. Available with S-hook or special roof plate clip for quick installation, as shown on opposite page. Streamers are 1-3/8" (35mm) wide in standard lengths listed above. Custom wording available such as "MANDOOR", "CAUTION", "SHUT-OFF VALVE". Packaged 50/box. Some minimums apply on custom orders.

CAB Streamers are tough and durable. They won't bend like metal or shatter like rigid plastic reflectors.

Use CAB Test Streamers with Grip Clips to quickly identify roof test holes.





# CAB® High Visibility Clip-On Markers

Installs Quickly and Easily on Plates or Sidewall



**CAB Clip-On Markers are an industry favorite for identification of primary and secondary escapeways.**



## CAB® Clip-On Markers

Exceptionally brilliant reflectors that quickly and easily attach to roof bolt plates with CAB's exclusive "tight grip" clip-on system. CAB's installation clips are made from heavy-duty galvanized spring steel that firmly grips plate to securely hold reflector in proper position at all times. Quick and easy clip-on system saves time compared to installing reflectors with tie wire or cable ties.

Markers are made from high visibility retroreflective vinyl, exceptionally brilliant and impact resistant. Ideal marker for identification of primary and secondary escapeways. Custom wording available: "DOOR", "PUMP", etc. Markers 2" x 7" or 2" x 9" (51mm x 178mm or 51mm x 229mm). Available in 11 colors. Same or different colors on each side. Minimums may apply on custom orders.

### CAB Clip-On Marker Standard Colors:

- CAB 468** red/green, 2" x 7" (51mm x 178mm), 50/box, 31 lb. (1.4kg)
  - CAB 7201** red/green, 2" x 9" (51mm x 229mm), 50/box, 31 lb. (1.4kg)
  - CAB 469** red/yellow, 2" x 7" (51mm x 178mm), 50/box, 31 lb. (1.4kg)
  - CAB 7202** red/yellow, 2" x 9" (51mm x 229mm), 50/box, 31 lb. (1.4kg)
  - CAB 470** red/red, 2" x 7" (51mm x 178mm), 50/box, 31 lb. (1.4kg)
  - CAB 7209** red/red, 2" x 9" (51mm x 229mm), 50/box, 31 lb. (1.4kg)
  - CAB 474** white/white, 2" x 7" (51mm x 178mm), 50/box, 31lb. (1.4kg)
- (Many other colors available.)

**CAB Clips can also be used on CAB Tubes and Streamers.**



## CAB® Sidewall Markers

Manufactured from brilliant reflexite material for extra visibility. Full size galvanized metal bracket insert with 90° bend and hole for side wall mounting. Markers are 2" x 7" (51mm x 178mm) and reflective on one or both sides. Heavy black webbing on all non-reflective sides. Available with custom wording.



All CAB reflectors have heat-sealed sections to prevent spread of moisture and loss of reflectivity!



## CAB® Color Chart for Tubes, Streamers and Markers

- ✓ Provides complete mine color code identification system.
- ✓ Improves safety by identifying hazards, escapeways, doors, etc.
- ✓ Tubes, streamers, markers made in single or multiple colors.
- ✓ True colors are reflected for improved identification and safety.
- ✓ Microprism retroreflective vinyl is durable and impact resistant.
- ✓ Won't impregnate with dust and dirt like other reflective material.
- ✓ Exceptionally brilliant for improved safety.
- ✓ Reflects at wider angles and greater distances for better visibility.



White



Fluorescent Pink



Fluorescent Orange



Orange



Fluorescent Green



Fluorescent Red Orange



Fluorescent Lime Yellow



Red



Green



Blue



Yellow



## CAB® High Visibility Rock Dust Bags

Provides strong, dry, high visibility storage for rock dust used for fire protection in mines. Made from nylon reinforced vinyl, which is tear resistant, durable and waterproof. Bright red-orange material resists mold, mildew, rotting and most chemicals. High visibility red-orange reflective bands for added safety. High quality features include folded and sewn seams to resist moisture and velcro tabs on front flap for fast access to rock dust. Large capacity bags have 2 heavy-duty webbing handles for 1 or 2 man carry of rock dust.

**CAB 794** 17" x 23" (432mm x 584mm) bag, non-reflective, 25/box, 16 lb. (7.3kg)

**CAB 795** 17" x 23" (432mm x 584mm) bag w/ 1 reflective band, 25/box, 17 lb. (7.7kg)

**CAB 796** 17" x 23" (432mm x 584mm) bag w/ 2 reflective bands, 25/box, 17 lb. (7.7kg)

**CAB 797** 21" x 26" (533mm x 660mm) large bag w/ 1 reflective band, 2 handles, 25/box, 26 lb. (11.8kg)



## CAB® High Visibility Fire Extinguisher Bags

Clean, dry, high visibility storage for fire extinguishers used in mines. Bags help ensure extinguishers will be ready to operate in emergencies. Also helps keep inspection tags from being vandalized, lost or damaged. Made from strong laminated nylon with clear top dome for checking gauges and tags. High visibility reflective band around entire bag provides faster identification of extinguisher.

Bag can be hung anywhere with heavy duty webbing top loop. For added strength, webbing encircles entire bag. Sturdy webbing side handles make fire extinguisher easier to carry. Quick access is provided when handles are pulled apart to open velcro seal which runs along the entire right side of bag. High quality construction and materials. Slip-over and custom bags available for extinguishers up to 150 pounds (68.2kg).

**CAB 805** 10 lb. (4.5kg) extinguisher, 8" (203mm) dia., 21-1/2" (546mm) height, 18" (457mm) opening, 25/box, 17 lb. (7.7kg)

**CAB 806** 10 lb. (4.5kg) long extinguisher, 8" (203mm) dia., 25" (635mm) height, 23" (584mm) opening, 25/box, 18 lb. (8.2kg)

**CAB 807** 20 lb. (9.1kg) extinguisher, 9" (229mm) dia., 25" (635mm) height, 22-1/2" (572mm) opening, 25/box, 21 lb. (9.5kg)

**CAB 808** 20 lb. (9.1kg) long extinguisher, 9" (229mm) dia., 32" (813mm) height, 29" (737mm) opening, 25/box, 23 lb. (10.5kg)



## CAB® High Visibility Custom Bags, Pouches and Holders

CAB offers a wide variety of durable, custom-made bags, pouches and holders in any size for many applications. High visibility features make them ideal for safe, secure storage of batteries, detectors, meters, gauges, tools, communication devices and other equipment.

Made from a variety of heavy-duty materials such as 1000 denier cordura nylon, brattice cloth and nylon reinforced vinyl. Colors may include high visibility orange, black, gray and lime yellow. For added safety and protection, high visibility retroreflective vinyl can be sewn on any bag. See page 19 for the eleven brilliant colors available.



For added utility, CAB offers many custom features. These may include webbing for handles, shoulder straps, belt loops, back straps, and bag reinforcement.

Other features are clear windows for reading gauges, foam padding for protecting contents, snaps for quick attachment, buckles for adjustment and custom lettering for fast and clear identification.

Variety of closures are available including velcro, side-release buckles, zippers and snaps.

Call for more info.





# CAB® Rescue Tag Line

**Helps a Mine Crew Stay Together and Evacuate Safely During an Emergency Escape**



CAB Rescue Tag Lines are carefully coiled on a sturdy plastic carrier with handle to deploy quickly without tangling. Bags are clearly marked with high visibility reflective bands and crew size of unit.

**CAB Rescue Tag Lines** are manufactured from heavy-duty 7/16" (11mm) diameter, bright yellow, hollow-braid polypropylene rope. Each miner is attached to the end of a 3' (914mm) tether that is securely spliced to the main line at 5' (1.5m) intervals. Large capacity, corrosion resistant #2 bronze swivel snaps are used to hook each miner to tether. Swivel snaps are spliced to end of tethers and both ends of main line. Manufactured with extra heavy-duty splices and no hardware other than swivel snaps to reduce possibility of tangling in an emergency.

Can be used individually to evacuate a single crew or linked together to evacuate multiple crews. Tag Lines available in custom styles and small sizes for storage boxes on personnel carriers.

- CAB 7404** 1-2 man Tag Line, 1 main line, 1/bag
- CAB 7405** 1-2 man Tag Line, 1 main line, 2/bag
- CAB 7348** 2-4 man Tag Line, 2 tethers, 1/bag
- CAB 7349** 2-4 man Tag Line, 2 tethers, 2/bag
- CAB 7351** 4-6 man Tag Line, 4 tethers, 1/bag
- CAB 7352** 4-6 man Tag Line, 4 tethers, 2/bag
- CAB 7105** 6-8 man Tag Line, 6 tethers, 1/bag
- CAB 7353** 6-8 man Tag Line, 6 tethers, 2/bag
- CAB 7191** 8-10 man Tag Line, 8 tethers, 1/bag
- CAB 7192** 8-10 man Tag Line, 8 tethers, 2/bag
- CAB 7430** 10-12 man Tag Line, 10 tethers, 1/bag
- CAB 7431** 10-12 man Tag Line, 10 tethers, 2/bag
- CAB 7104** 13-15 man Tag Line, 13 tethers, 1/bag



**CAB Double Bag Rescue Tag Lines** can be used individually or linked together for multiple crews.



**CAB® Belt Pouch Rescue Tag Line** connects one miner to another for emergency escape. Pouch is worn on belt. Tether is 1" (25mm) wide by 5' (1.5m) long, sewn securely to inside of pouch with bronze swivel snap on other end.

- CAB 7542** 1-2 man CAB Belt Pouch Tag Line, 10/box
- CAB 7543** 1-2 man CAB Belt Pouch Tag Line, tether removable with 2 snaps, 10/box



## CAB® Self Rescuer Belt Holders

Designed to firmly and safely hold self rescuers on a miner's belt. Made from heavy-duty polypropylene webbing and brilliant reflexite material for improved visibility and safety. Can be custom made to fit any size self rescuer.



## CAB® Self Rescuer Bags

Extra protection for self rescuers during transport and storage. Constructed with 2 layers of heavy-duty 1000 denier cordura nylon and 1/2" (13mm) thick foam core for extra padding and protection. The brilliant reflexite tape and fluorescent orange cordura greatly improves visibility. Windows allow for reading of gauges. Entire lid sealed with velcro. Sturdy 1-1/2" (38mm) wide webbing straps with buckles for adjustment in both shoulder strap and back pack models. Variety of styles available. Can be custom made for any size rescuer.

## CAB® Heavy-Duty Safety Belt Harness



Greatly improves visibility of miners, contractors or visitors. Made from sturdy webbing with 1-3/8" (35mm) wide brilliant reflective bands over the entire surface. Available in 11 different colors. Velcro closures on shoulders, chest and waist make belts fully adjustable for added safety. Also available with velcro at top of shoulders for a 6 point release. Lightweight, comfortable and easy to work in. Standard color fluorescent green. Minimums apply for other colors.

- CAB 1591** medium, fl. green, 38"- 44" (965mm x 1.1m) circumference
- CAB 1598** large, fl. green, 42"- 48" (1.1m x 1.2m) circumference
- CAB 1606** x-large, fl. green, 48"- 54" (1.2m x 1.4m) circumference
- CAB 1613** 2x-large, fl. green, 54"- 60" (1.4m x 1.5m) circumference

## CAB® High Contrast Safety Belt Harness



Provides excellent 360° visibility for above or below ground. Lightweight, comfortable and easy to work in. Made from 2-1/2" (64mm) wide heavy-duty fluorescent orange laminated nylon. Brilliant fluorescent lime-yellow reflective bands are 1-3/8" (35mm) wide on shoulders and 2" (51mm) wide around waist. Velcro closures on shoulders, chest and waist for easy fit.

- CAB 6994** regular
- CAB 6989** large/x-large
- CAB 6990** 2x-large/3x-large
- CAB 6991** 4x-large

## CAB® High Visibility Suspenders



Manufactured from 2" (51mm) wide fluorescent lime yellow elastic with four sturdy buckles. A 3/4" (19mm) wide silver glass bead reflective strip runs entire length of the suspenders. Two durable slide buckles allow for easy adjustment to any size.

**CAB 2986** 25/box, 10 lbs. (4.5kg)

*CAB's high quality harnesses and suspenders greatly improve visibility to keep you safer! And they're lightweight!*



## CAB® Longwall Gaitors

High quality covers designed to protect longwall cylinders from constant exposure to dust, dirt and water.

Made from heavy-duty material with a strong velcro, zipper or snap closure along one side. CAB Gaitors are more cost effective than factory gaitors and are custom made in a wide variety of styles. Also available with reflective bands for improved safety.

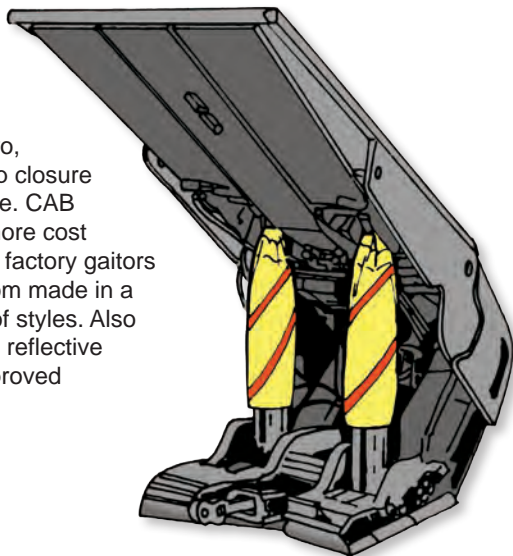

## CAB® Reflective Pipe and Cable Covers



Provides brilliant reflective surface for identification and marking of pipe and cable. Covers are flexible, impact resistant and have a strong velcro closure for quick and easy installation. The 25' (7.6m) covers can be installed on cable reels to alert machine operators that end of cable has been reached in shuttle cars, miners and roof bolters. All covers ordered by circumference of pipe or cable. Available in a variety of sizes up to 25' (7.6m) long. Some minimums apply.

- CAB 515** Fits cable 3-3/4" to 4-1/2" (95-114mm) circumference, lime yellow, 25' (7.6m) long.
- CAB 513** Fits cable 5-1/8" to 6" (130-152mm) circumference, lime yellow, 25' (7.6m) long.
- CAB 516** Fits cable 3-3/4" to 4-1/2" (95-114mm) circumference, red orange, 25' (7.6m) long.
- CAB 514** Fits cable 5-1/8" to 6" (130-152mm) circumference, red orange, 25' (7.6m) long.



# CAB® High Visibility Safety Apparel

CAB safety vests are tops in visibility and durability! Ask about custom logos and wording.



**CAB® Mechanic's Utility Vest with 10-Pockets** *Back of vest with optional pouch.*

Heavy-duty multi-purpose vest made from 1000 denier orange or black cordura nylon with liner. Front velcro closure for easy fit. Ten convenient pockets - two are large and spacious with heavy-duty brass zippers; two are expandable with strong velcro closures; two top pockets are open for fast retrieval of small items. The two inside pockets are oversized for maps and paperwork. Vest is fully reflectorized front and back for high visibility. Option available for large capacity, expandable pouch on back for hauling larger items, as pictured above. This vest is great for organizing and carrying gear to get the job done.

- |                      |                     |
|----------------------|---------------------|
| <b>Orange Style:</b> | <b>Black Style:</b> |
| CAB 8716 large       | CAB 8717 large      |
| CAB 8714 x-large     | CAB 8655 x-large    |
| CAB 8715 2x-large    | CAB 8659 2x-large   |



## CAB® Reflective Stickers

Designed to provide extra visibility to hard hats. Adhesive stickers made from brilliant reflexite material. 1" x 4" (25mm x 102mm) in fluorescent lime yellow and fluorescent orange. 16 peel-off stickers per sheet.

- CAB 6350 fl. lime-yellow, 25 sheets/box, 4 lb. (1.8kg)  
 CAB 6976 fl. orange, 25 sheets/box, 4 lb. (1.8kg)



## CAB® Orange Mesh Safety Vests

High quality, heavy-duty vests greatly improve employee visibility and safety. Made from blaze orange, soft polyester mesh for good flexibility and ventilation. Front and back have three bands of fluorescent lime-yellow retroreflective tape. Open front velcro closure and velcro side adjustments. Extra Reflective Vest has 3" (76mm) wide reflective bands and side closures. Pockets and custom wording available.

- |                        |                                |                   |
|------------------------|--------------------------------|-------------------|
| <b>Standard Style:</b> | <b>Extra Reflective Style:</b> |                   |
| CAB 1544 regular       | CAB 1553 regular               | CAB 1782 x-large  |
| CAB 1557 large         | CAB 1566 large                 | CAB 5812 2x-large |
| CAB 1779 x-large       |                                |                   |
| CAB 1538 2x-large      |                                |                   |



## CAB® Yellow Green Mesh Safety Vests

High quality vests that meet and exceed ANSI/ISEA specifications for Class II high visibility safety apparel. Made from 3.4 oz. soft fluorescent polyester mesh for excellent flexibility and ventilation. Vest has 2" (51mm) wide silver reflective tape with 1/2" (13mm) wide red/orange edging. Open front velcro closure and reflective velcro side closure for adjustment and 360° visibility. Available with 2 full panel width pockets 7" (178mm) deep with velcro closures.

- |                         |                      |
|-------------------------|----------------------|
| <b>Without Pockets:</b> | <b>With Pockets:</b> |
| CAB 7395 regular        | CAB 7399 regular     |
| CAB 7396 large          | CAB 7400 large       |
| CAB 7397 x-large        | CAB 7401 x-large     |
| CAB 7398 2x-large       | CAB 7402 2x-large    |



## CAB® Reflective Arm and Leg Bands

Manufactured from 2" (51mm) wide fluorescent lime-yellow elastic with velcro on each end for attachment. A 3/4" (19mm) wide silver glass bead reflective strip runs entire length of band. Available in two lengths.

- CAB 4012 12" (305mm) long, 50/box  
 CAB 4013 15" (381mm) long, 50/box

# CAB<sup>®</sup> PRODUCTS

**Highest Quality to Improve  
Mine Safety and Productivity**

Throughout the mining industry, CAB Products are widely recognized for their high quality and excellent design. CAB Hangers greatly improve safety and help cut operating costs by supporting and organizing pipe, tubing and all types of cables.

For added safety and protection, the carrier section of every hanger is insulated with a heavy coating of high dielectric grade, UV stabilized, flame retardant plastisol. The bright orange color provides an extra measure of safety and has been a trademark of CAB quality over the years.

CAB also manufactures a wide range of high visibility reflective products that greatly improve safety in mines and tunnels. CAB offers a line of high visibility reflective tubes, streamers and markers in eleven brilliant retroreflective colors to provide a complete mine color code identification system.

Other innovative products include CAB Lifeline, rescue tag lines, self-rescuer bags, rock dust bags, cable covers, and cable pullers. In addition, CAB manufactures a line of high visibility reflective safety vests, safety belt harnesses, suspenders, and other reflective safety gear.



*CAB has two modern facilities  
in Johnstown and Ebensburg, PA.*

## **Cambria County Association for the Blind and Handicapped**

175 Industrial Park Road, Ebensburg, PA 15931-4109 USA

Phone: (814) 472-5077

Fax: (814) 472-7179

E-mail: [cab@cabproducts.com](mailto:cab@cabproducts.com)

Web: [www.cabproducts.com](http://www.cabproducts.com)

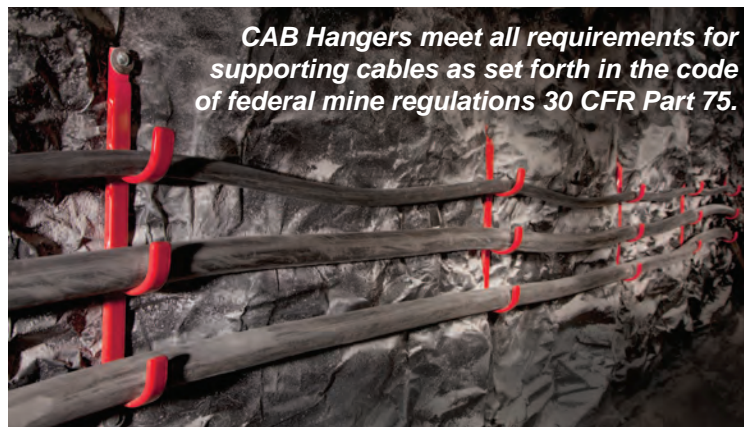

*CAB Hangers meet all requirements for  
supporting cables as set forth in the code  
of federal mine regulations 30 CFR Part 75.*



*CAB has a long tradition of working with the  
mining industry to improve safety underground.*

Partnering with a mine in 1985, CAB was the first company to produce a Lifeline for emergency escape from underground mines. CAB has steadily improved the safety features on the Lifeline, and today the CAB Lifeline is the industry favorite in coal and hard rock mines around the world.



**Made in the USA**

*The Cambria County Association for the Blind and Handicapped is dedicated to providing job opportunities and services to persons with disabilities. All CAB Products are manufactured by CAB employees with great pride and integrity.*

*CAB deeply appreciates the help and support of our customers. Through your orders, many disabled persons have been given the opportunity to be productive and independent. Thank you very much for using CAB Products!*

*CAB Products distributed by:*

***Please contact CAB for product samples.***