

Copyright 2005 jaguar@blackonyx.net

*All things shown or advice given on this internet site is to give you ideas of what can be done. They may not be suited to your vehicle, or your level of skill or even legal in your State or country. I do not endorse any modification/repair shown on this site. You assume all responsibility for any modifications/repairs that you make to your vehicle, and must understand the consequences of each modification/repair you make. I cannot be held responsible for your interpretation of these articles, or your implementation of these modifications/repairs. Anyone who does not have the proper training or background in automotive work should not undertake any mechanical project without proper supervision and instruction. I accept no responsibility or liability for incorrect part numbers, torque values, or any other information. It is advised that any information presented should be verified with official or expert sources. It is up to you to make sure anything shown needs engineering approval or advice before using it. You are responsible for your own actions. *

Around 120,000 miles on the odometer the timing chain tensioners broke on out 1998 XJ8. Usually a ticking sound is preceded by this condition, but we heard none. As they break further a very lumpy idle and lumpy acceleration with a horrible rattle from the front of the engine happen. At this point, if it is possible, you should stop driving any further and have the vehicle towed to your garage or your mechanics. Further driving could cause the chain to skip. If the timing chains skip enough the pistons will come in contact with the valves and bend the valves. Even though the XJ8 was driven 80 miles after the tensioner broke it had no valve damage. It was just luck that the chain didn't skip enough to cause valve damage. This procedure isn't for the weak of stomach and is a pretty involved process. If you don't think you can tackle it, don't. If the chain is not set up properly it can cause further damage to the engine. While every part was not faulty at the time it is best to replace it in case it is so you don't have to go back in when and if it fails. Also, some parts which I have found faulty may not be in your case.

Parts:

- Both primary timing chains
- Both secondary timing chains
- Both primary timing chain outer guides
- Both primary timing chain inner guides
- Both primary timing chain tensioners
- Both secondary timing chain tensioners
- O-rings for the variable valve timing bush carrier (2 each side)
- O-rings for the variable valve timing solenoids (2)
- Two gaskets for the timing chain cover
- Two gaskets for the valve covers
- Four spark hole through valve cover gaskets
- Gaskets for the camshaft cover bolts (about 24)
- Crankshaft pulley o-ring
- Crankshaft pulley bolt (i have heard that they have been known to break upon installation)

Optional but highly recommended:

- Spark plugs (now would be a good time to do those too)
- Thermostat
- Thermostat housing o-ring
- Coolant outlet pipe o-rings
- Coolant bypass hose (behind outlet pipe)
- Upper and lower radiator hoses

-Accessory drive belt pulley

-Accessory drive belt tensioner pulley

Tools required:

-Camshaft setting tool E36401 (303-530) (you could get away with one like I did, but two makes it much easier) (Jaguar specific)

-Timing chain tensioning tool E36402 (303-532) Only one needed (Jaguar specific)

-Wedges, primary chain E36407 (303-533) (Jaguar specific)

-Crankshaft setting plug E36408 (303-531) (Jaguar specific)

-Three foot pry bar

-The longest breaker bar you can find, usually 3' (for the crank shaft pulley bolt)

-10mm hexagonal bit (allen) (timing chain sprockets)

-24mm 6 point socket (15/16" will also work)

-Universal harmonic balance remover (available from sears) (need two 8mm bolts with ~60mm shaft length and hardened washers)

-Torque wrenches (3/8" and 1/2")

-Medium strength lock tight

-Black RTV silicone

-Various metric sockets

For ease of reading I have broken this down into sections

A. Raise the front of the car:

1) Block both rear wheels and set the parking brake

2) Jack each end up either by the lower spring bucket or the jacking points under the front doors

3) Once at a suitable height to gain access to the rear of the engine place jack stands under the lower spring buckets or the jacking points under the front doors (where ever the jack isn't).

B. Drain the coolant:

1) Drain the coolant by either opening the radiator drain plug or removing the lower radiator hose

2) Use a drain tray to catch the coolant and dispose of properly.

C. Hood:

1) With the hood open remove the two lower most bolts on each hinge

2) Disconnect the upper end of each gas strut from the hood

3) Lower the hood, but don't completely close it

4) Pry out the grille inserts (vertical bars) from the top

5) Remove the 4 torx bolts securing the grille bezel. Note that the top bolts have several washers. Note their position and be careful not to lose them.



6) With the grille completely removed you will now see a hole under each hinge that gives you access to the remaining bolts on the hinges. Remove the two bolts.



7) Remove the hood. Having some one help you remove it would be the best idea and it isn't that heavy, but bulky.



D. Air box and intake tube:

- 1) Release the 5 clips that secure the air cleaner cover.
- 2) Release the breather hose from the valve cover by applying pressure to the two spots with lines
- 3) Disconnect the electrical connector from the airflow meter

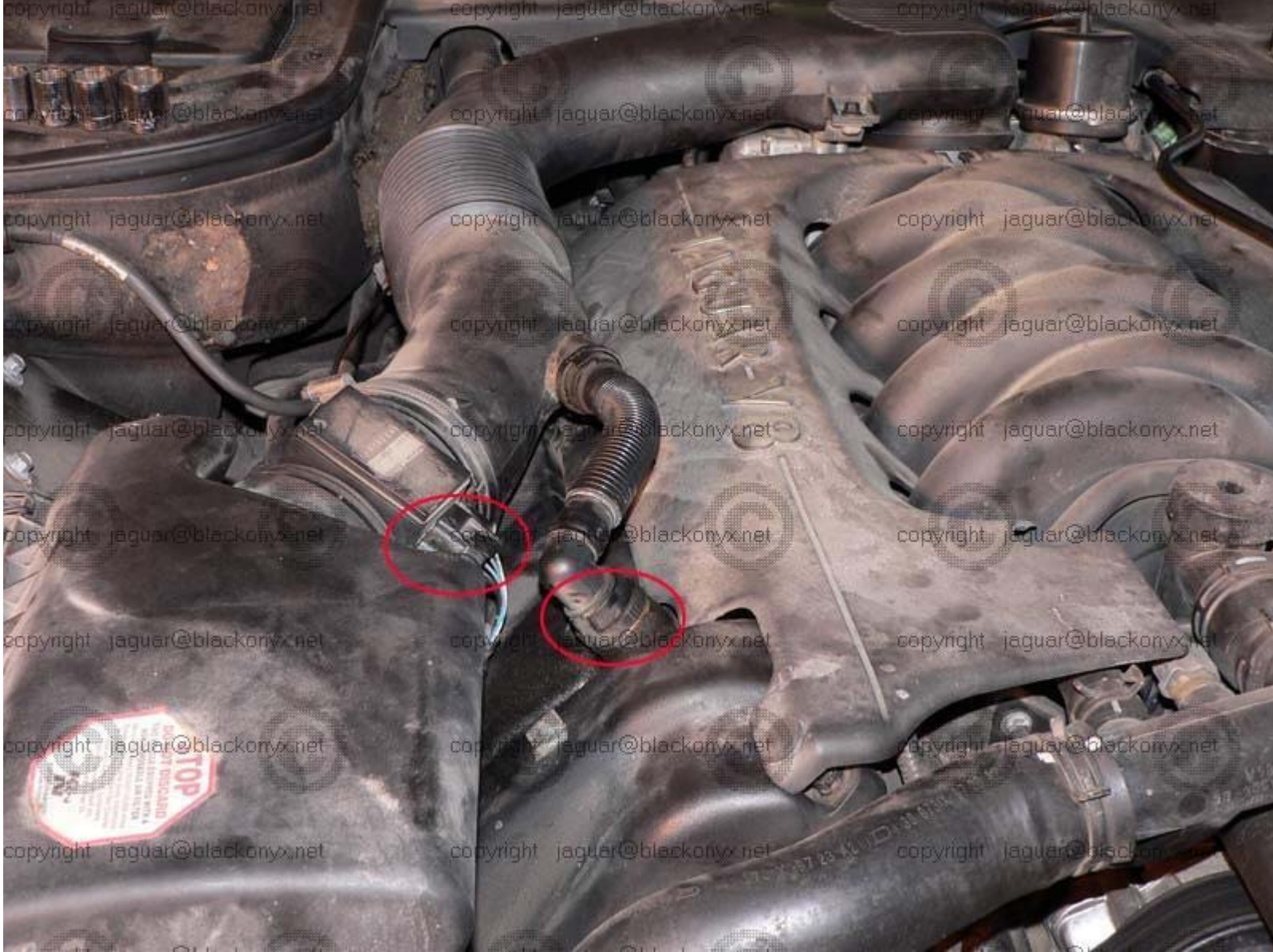

4) Remove the two bolts (10mm; in red) securing the elbow to the throttle body; one towards the front, one towards the rear.





5) Remove the intake tubing from the car

6) Remove the nut (in red) that secures the base of the air box to the rubber mounting (a socket on the nut and a wrench on the top of the rubber mounting)



E. Radiator top mounting panel:

1) Remove the 10 torx head bolts (in red) that secure the radiator top mounting panel.



2) Remove the panel from the vehicle, disconnecting the hood switch if present.

F. Engine covers:

1) Remove the right side engine cover simply by pulling upward

2) Remove the coolant lines from the left side engine cover.



3) Remove the left side engine cover by pulling upward, minding the coolant lines.

G. Coolant lines:

The tool used for the quick disconnects on coolant lines is actually located on one of the connectors. Locate the tool.

1) Use the tool to remove the two quick disconnects from the coolant reservoir near the fire wall by inserting the tool in to the quick disconnect and squeezing.

2) Use the tool to release the single hose on the left side of the radiator.

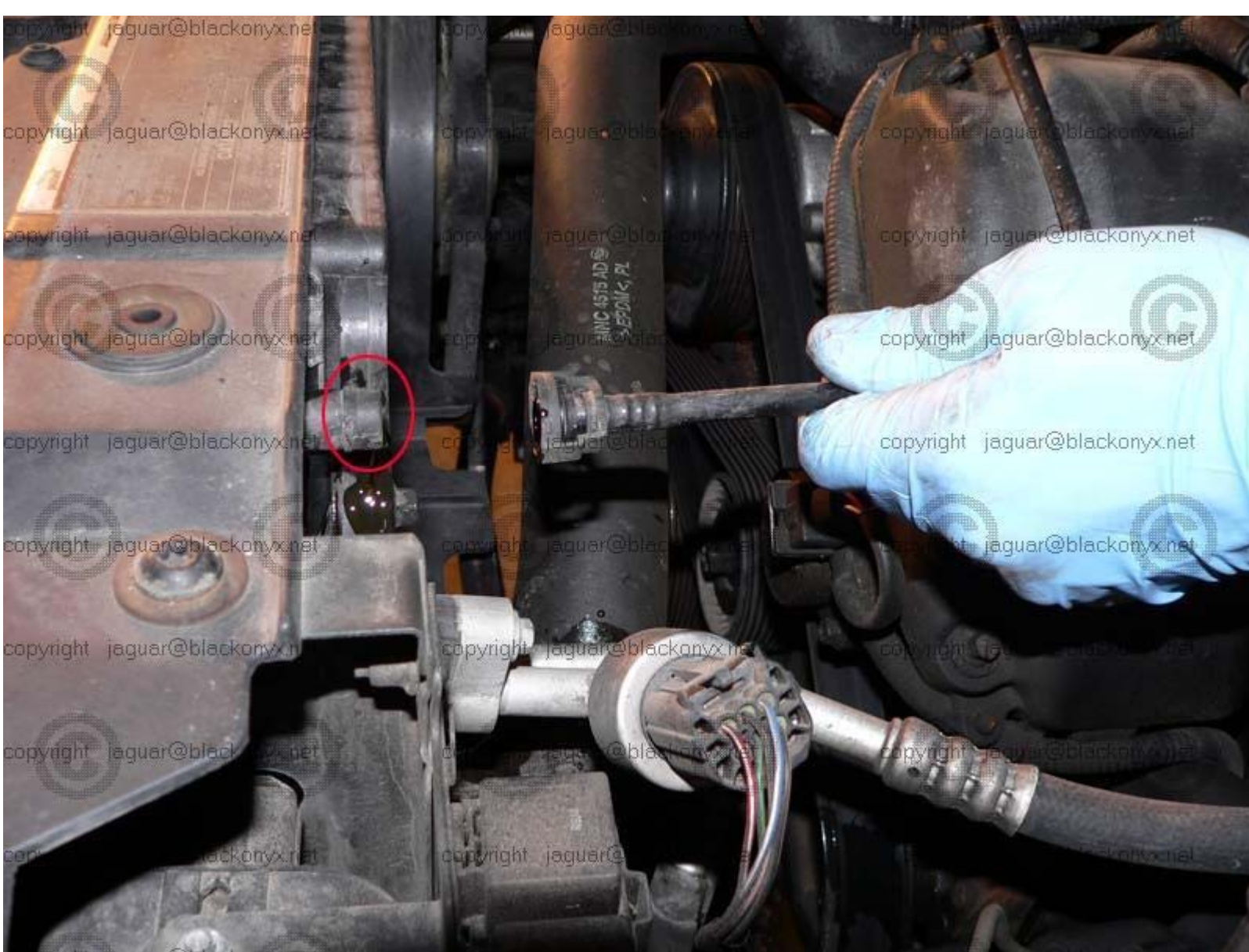

3) Remove the one hose from the engine bay.

So far the engine bay should look like this:



H. Upper radiator hose:

- 1) Release the hose clamp from the coolant out pipe on the engine, positioning the clamp further up the hose. If you don't have the correct tool for those types of clamps (I still don't) a pair of pliers will work.
- 2) Do the same for the radiator side of the hose.
- 3) Remove the hose.

I. Cooling fans and shroud:

- 1) Follow the wires coming off the cooling fan shroud to find the multiplug to disconnect it from the main harness. IIRC it is on the lower left front of the engine bay. You will need to get under the car to unplug it from the main harness.
- 2) Remove the two bolts on either side of the fan shroud.



- 3) Remove the fans and fan shroud as a unit. There may be some resistance from the lower mounting points as you pull the shroud out of the car.



J. Coolant outlet pipe:

- 1) Disconnect the two hoses (circled in green) and multiplug from the coolant outlet pipe (Circled in blue).

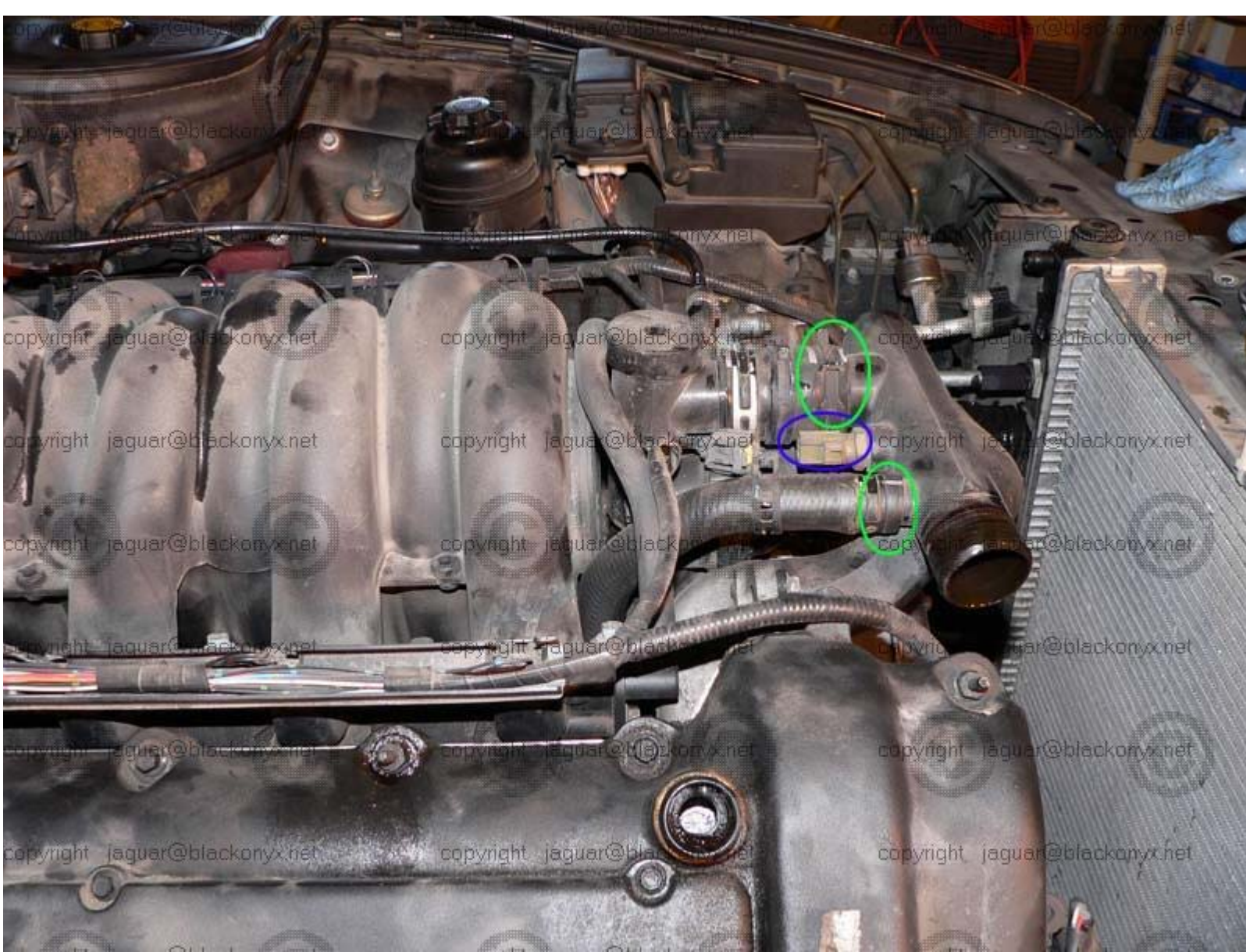

2) Remove the 4 10mm bolts securing the coolant outlet pipe to the engine. Shown below with pipe already removed.



3) Remove the pipe from the engine



K. Lower radiator hose:

- 1) Release the hose clamp from the thermostat cover, positioning the clamp further up the hose.
- 2) Release the hose clamp from the lower radiator.
- 3) Remove the hose.

L. Thermostat and housing:

- 1) Remove the three bolts (10mm) securing the housing to the engine.



2) Remove the thermostat housing and thermostat.

M. Coil covers and coils:

1) Remove the 6 bolts (8mm) per side

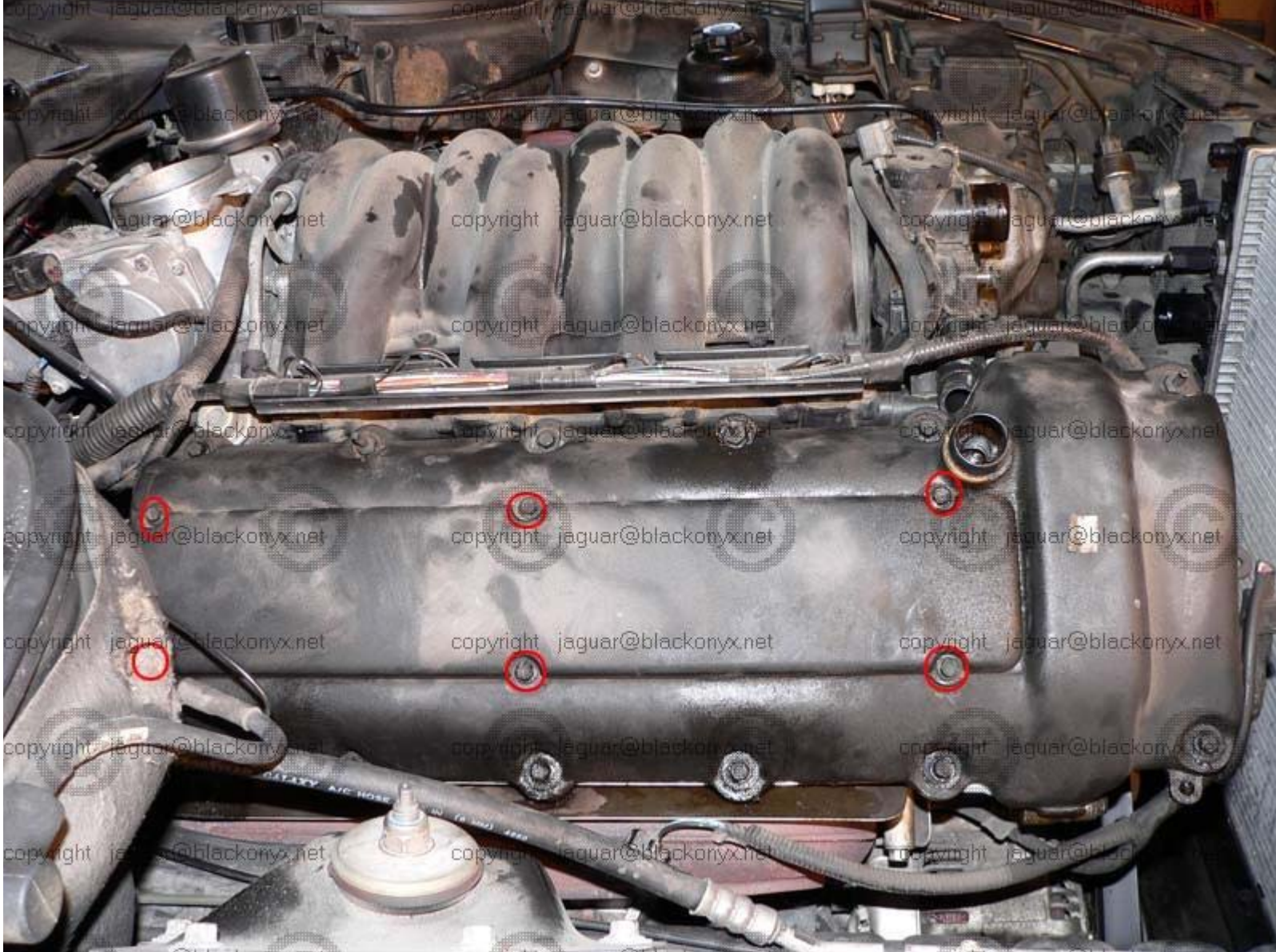

2) Remove cover

3) Detach the harness and mounting clips



4) Position the harness out of the way

5) Remove the two bolts (8mm) securing the coils to the valve cover

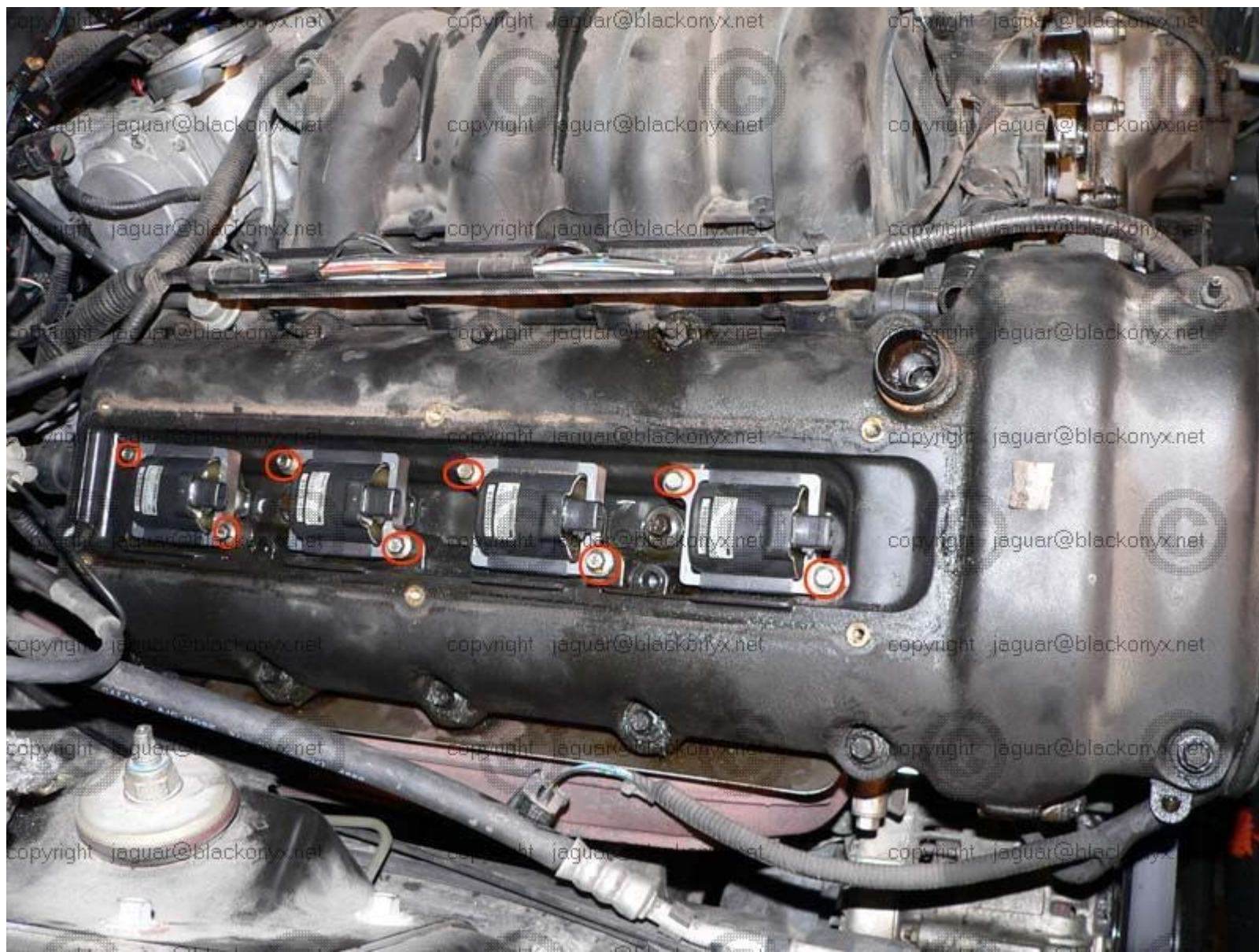

6) Remove the coils by pulling up.

7) Repeat on other head.

N. Valve covers:

1) Release the clips at the front of the cover which secure the engine harness to the cover

2) Remove the 14 bolts (8mm) which secure the cam cover. Note the position of the two inner bolts with the studs. The bolts will be held in place by the seals. You can now remove the seals and bolts together which I recommend for cleaning or if you are replacing the seals.



3) Remove the valve cover. I covered the camshafts in rags to prevent dirt from landing on them.





4) Repeat on other side.



Now we can see one of the failed secondary tensioners (yellow) along with the flat surfaces (blue) on the cam shaft for the cam locking tool:

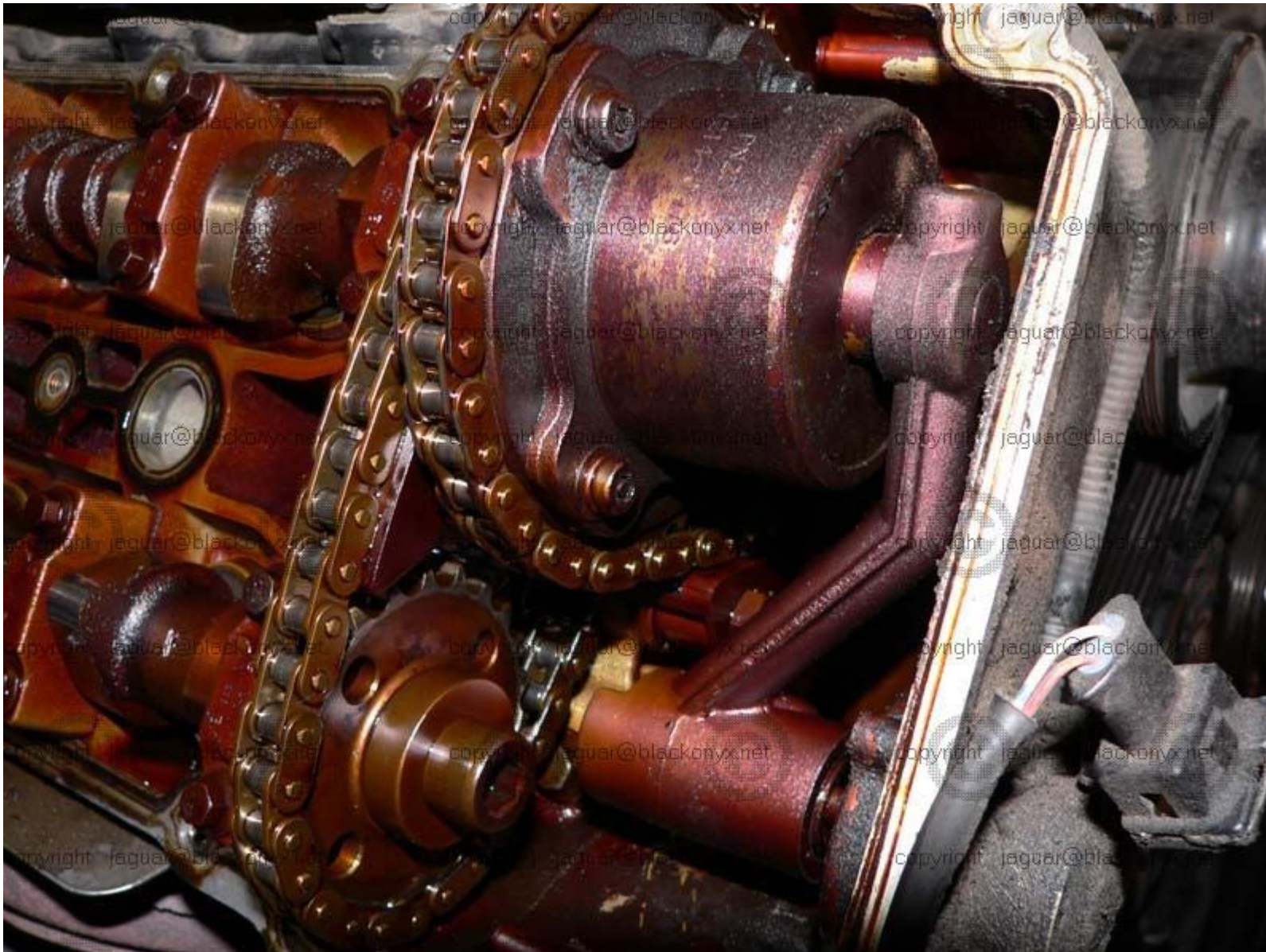
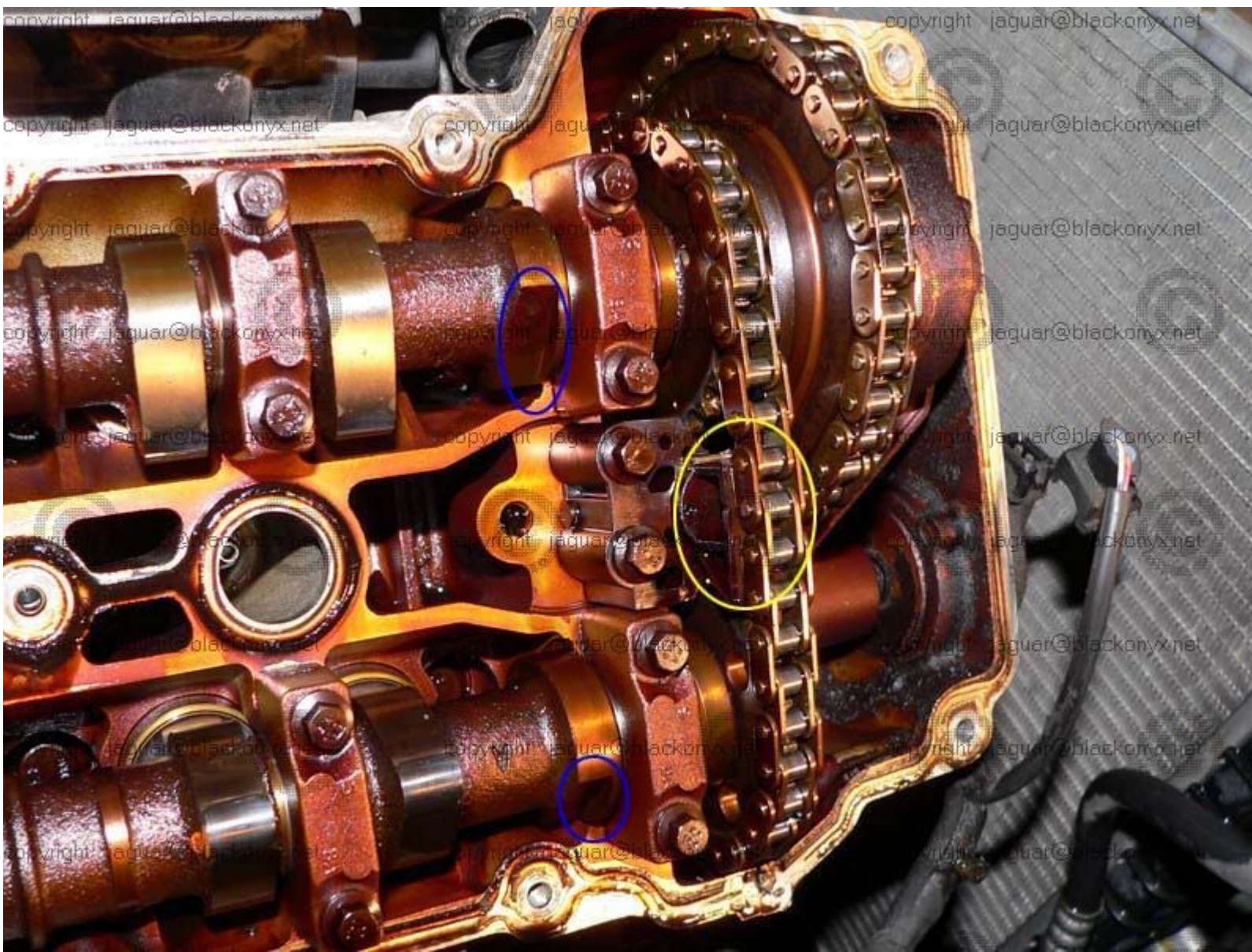

The engine bay this far:



O. Accessory drive belt:

- 1) Position a short breaker bar on the bolt (15mm?) that secures the tensioner pulley



- 2) Apply a counter-clockwise force to the bar until the belt comes loose.
- 3) While still applying pressure to the bar remove the belt from one of the pulleys
- 4) Relax pressure on the bar and remove the belt

P. Accessory drive belt tensioner pulley:

- 1) With the belt off remove the bolt (13mm) that secures the tensioner pulley assembly to the engine. A short breaker bar may be needed.
- 2) Remove the tensioner pulley assembly
- 3) Check for play or roughness in the pulley, if present replace the assembly.

Q. Accessory drive belt idler pulley:

- 1) With the belt off remove the both (15mm) that secures the idler pulley to the engine. A short breaker bar may be needed.
- 2) Remove the pulley.
- 3) As with the tensioner pulley check for play and roughness and replace if necessary. On our XJ8 both of the pulleys were worn and needed replacing.

R. Water pump pulley:

This may be easier to do with the accessory drive belt still in place

- 1) Loosen the three bolts (8mm?) that hold the pulley to the water pump. One trick to do this is to place a wrench on one bolt, rest it against the second bolt at a level to prevent the pulley from spinning and remove the third bolt. Repeat for all the bolts.

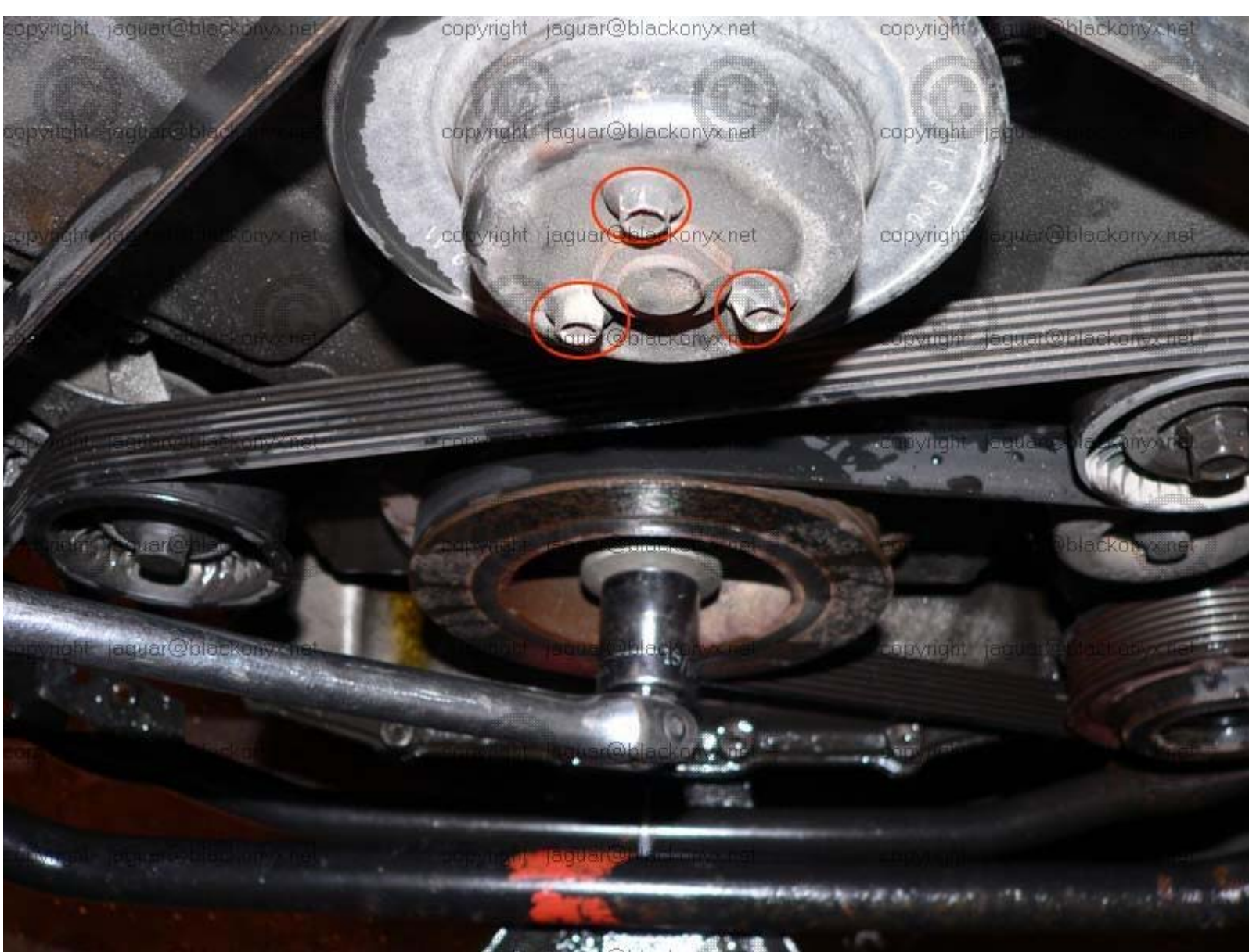

2) Once all the bolts are loose remove the bolts

3) Remove the pulley

S. Crankshaft Pulley:

I found that removing the crankshaft pulley was the most difficult procedure in this whole operation. There is a correct tool to keep the crankshaft from rotating while the bolt is removed, but I didn't feel like buying this tool. Instead I wedged a pry bar between the drive plate on the engine and the torque converter via the transmission access hole. The handle of the pry bar was then placed on a jack to keep it from moving. The crankshaft setting tool nor the camshaft setting tools should be used to hold the crank in place for the pulley removal, nor should they be installed at this time.

1) Place some form of shield behind the radiator to protect it. I used two pieces of cardboard.

2) Apply your crankshaft locking method.

3) Position a 24mm 6 point socket (15/16" will also work) on the pulley bolt.

4) Attach the largest breaker bar you have to the socket (1/2" 3' breaker bar is what I used)

5) Apply an anticlockwise force to the breaker bar. It will take a lot of force to remove this bolt. You may want to brace your self against something.

6) Once the bolt is loose give it a few more turns with the breaker bar.

7) Remove the bolt (I wouldn't reuse this bolt)

8) Mount the universal harmonic balance remover (available from sears) to the pulley using two 8mm bolts with ~60mm shaft length and hardened washers. I initially tried to use the bolts that came with the remover but they bent in the process.



- 9) Apply clockwise force to the large remove bolt. This requires quite a bit of force as well. While doing this watch bolts to make sure they aren't bending.
- 10) Once it becomes easier to turn the remover shaft the pulley should come off.



11) Release what ever method you used to hold the crankshaft.

T. Front engine cover:

- 1) Disconnect the harness from the valve timing solenoids
- 2) Remove the 24 bolts (8mm) that secure the cover to the engine
- 3) Once all 24 bolts are removed the cover can be removed from the engine



4) Remove the gasket from the engine face and discard.

Now we finally have access to the timing chain:

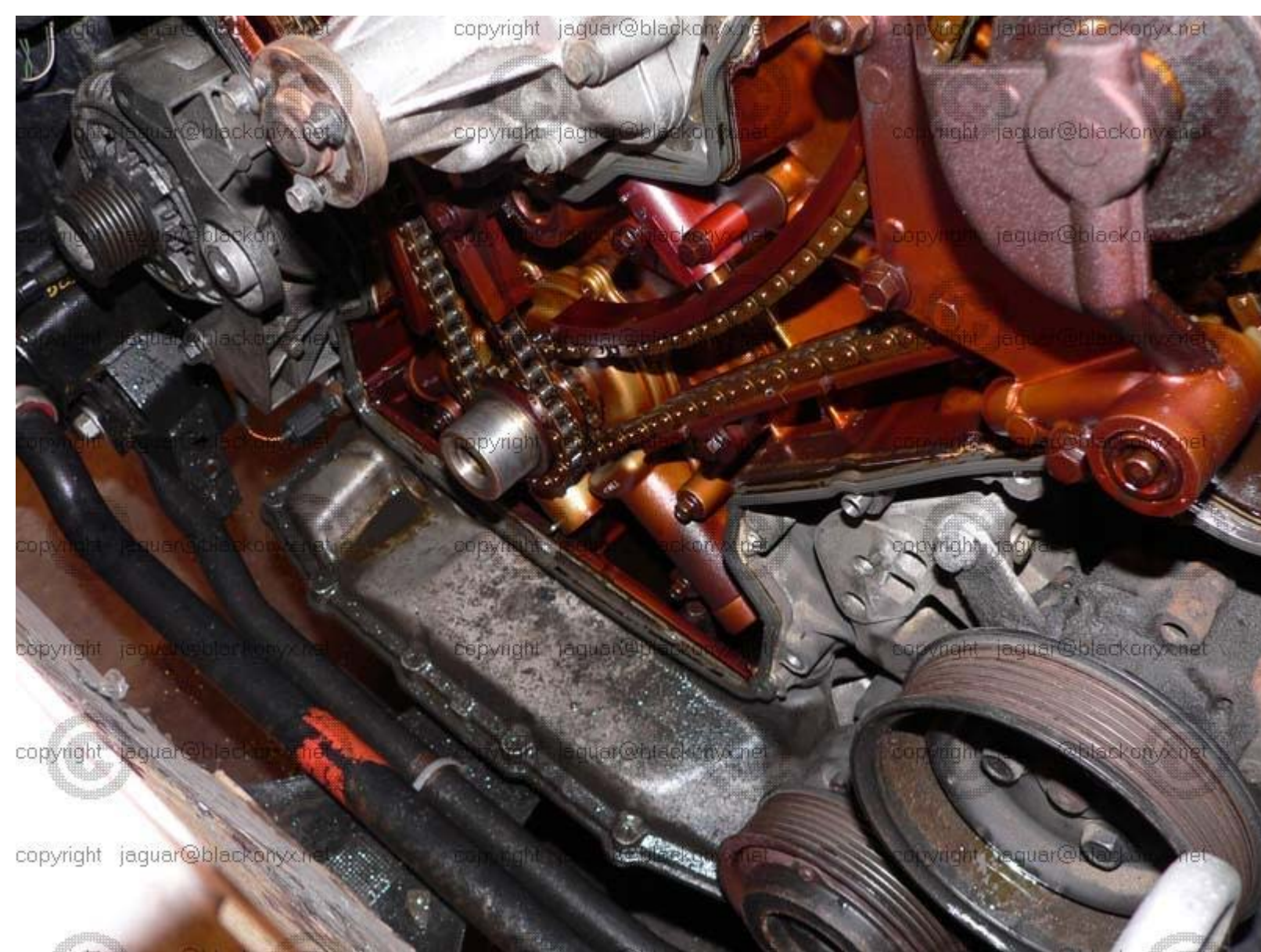

At this point it would be a good idea to clean off the gasket matting surfaces on the engine so any dirt doesn't get on the new timing chain components. Clean off the valve cover surfaces and the timing cover surfaces. You can clean the valve covers and the timing cover off later.

U. Variable valve timing bush carrier:

There are the two brackets the reside in front of the secondary timing chains.

- 1) Remove 2 bolts and 1 nut securing the bush carrier to the engine



2) Remove the bush carrier. You will now see the o-rings on the bush that should be replaced as by now they are hard and brittle.

3) Repeat on the other side.

V. Crankshaft setting plug E36408:

This plug replaces the crankshaft position sensor on the front of the flywheel housing. It keeps the crankshaft from rotation.

1) Remove the access cover for torque converter bolts from the housing.

2) Remove the crankshaft position sensor bolt (10mm)

3) Remove the crankshaft position sensor

4) Rotate the crankshaft (with the pulley securing bolt) until a triangular arrow on the driver plate is seen through the access hole. You will also notice that the flat surface on the camshafts is now at (or near) the top of the engine.

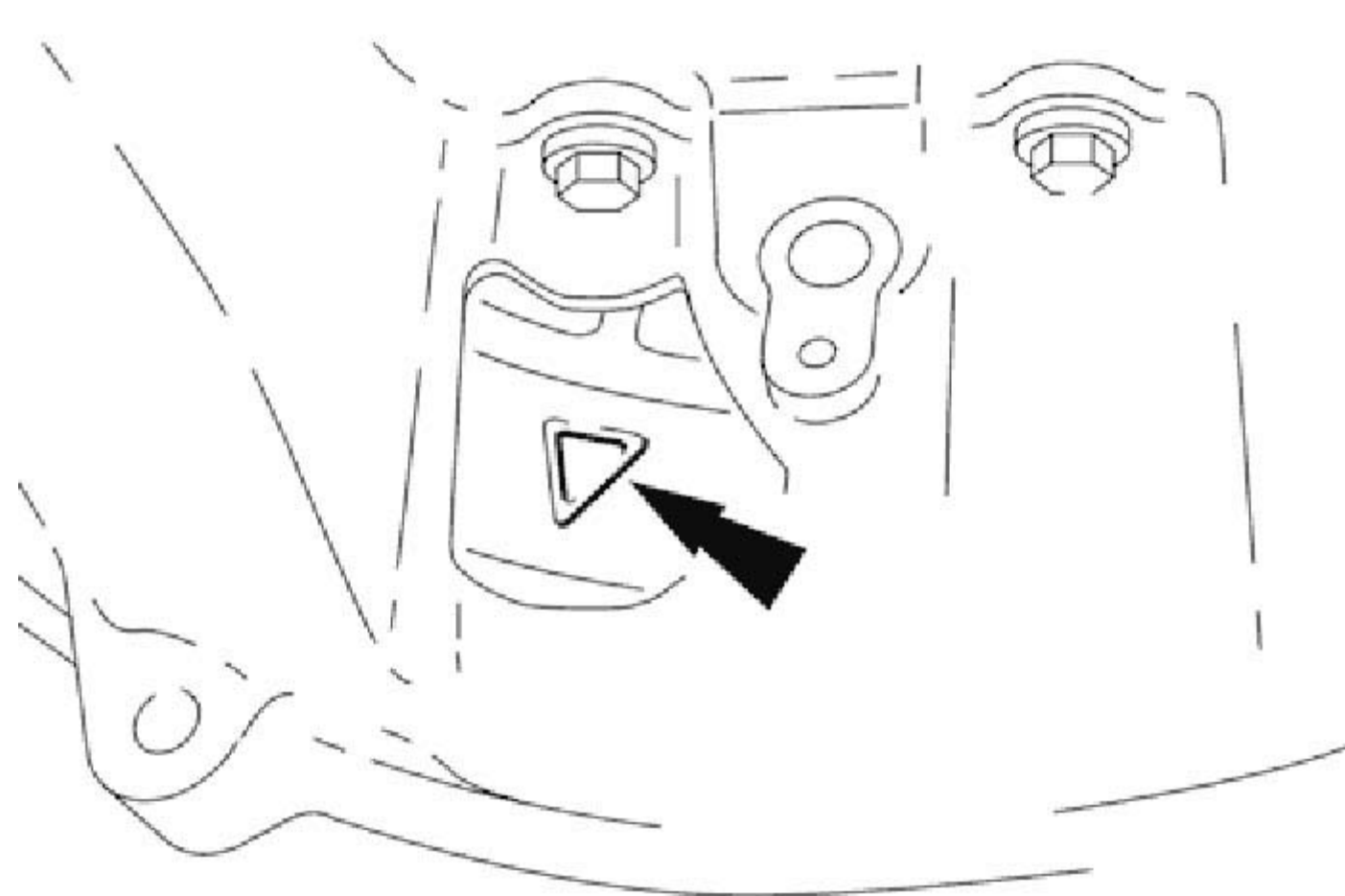

- 5) If you look through the access hole at an angle towards the crankshaft position sensor hole you will now see the timing slot on the drive plate.
- 6) Insert the crankshaft setting plug into the CPS hole making sure that it is fully seated in the slot.
- 7) Replace the CPS securing bolt to hold the plug in.

W. Camshaft locking tool:

I started on the left hand bank because that is the bank with the rear most primary timing chain. I thought it would be easiest that way. If you have two of these (which I suggest) install on both banks.

- 1) You may have to align the cams to get the tool on. The two flat spots behind the from bearing cap on the cam should be mostly parallel to the surface of the head. Also one may be more so out of alignment than the other. Circled in red.

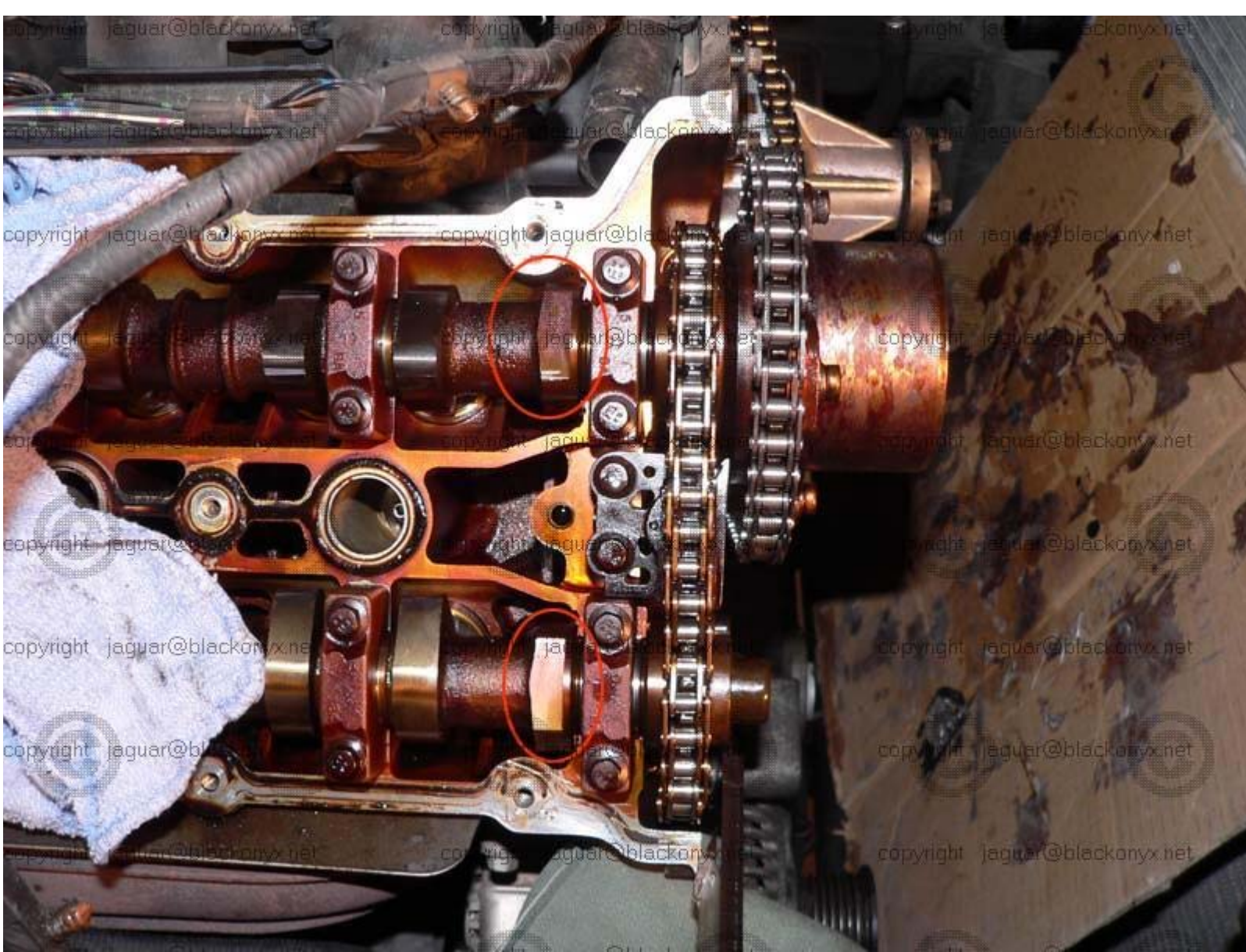

2) Install tool with raised section pointing out. If one of the shafts is really out of alignment you may have to loosen the sprocket bolts prior to tightening the bolts all the way down so the cam is free to rotate. There is also a spot some place near the middle of the cam where a wrench can be fitted to rotate the cam by hand.

3) Secure all 3 bolts. Don't over tighten as the heads are aluminum.

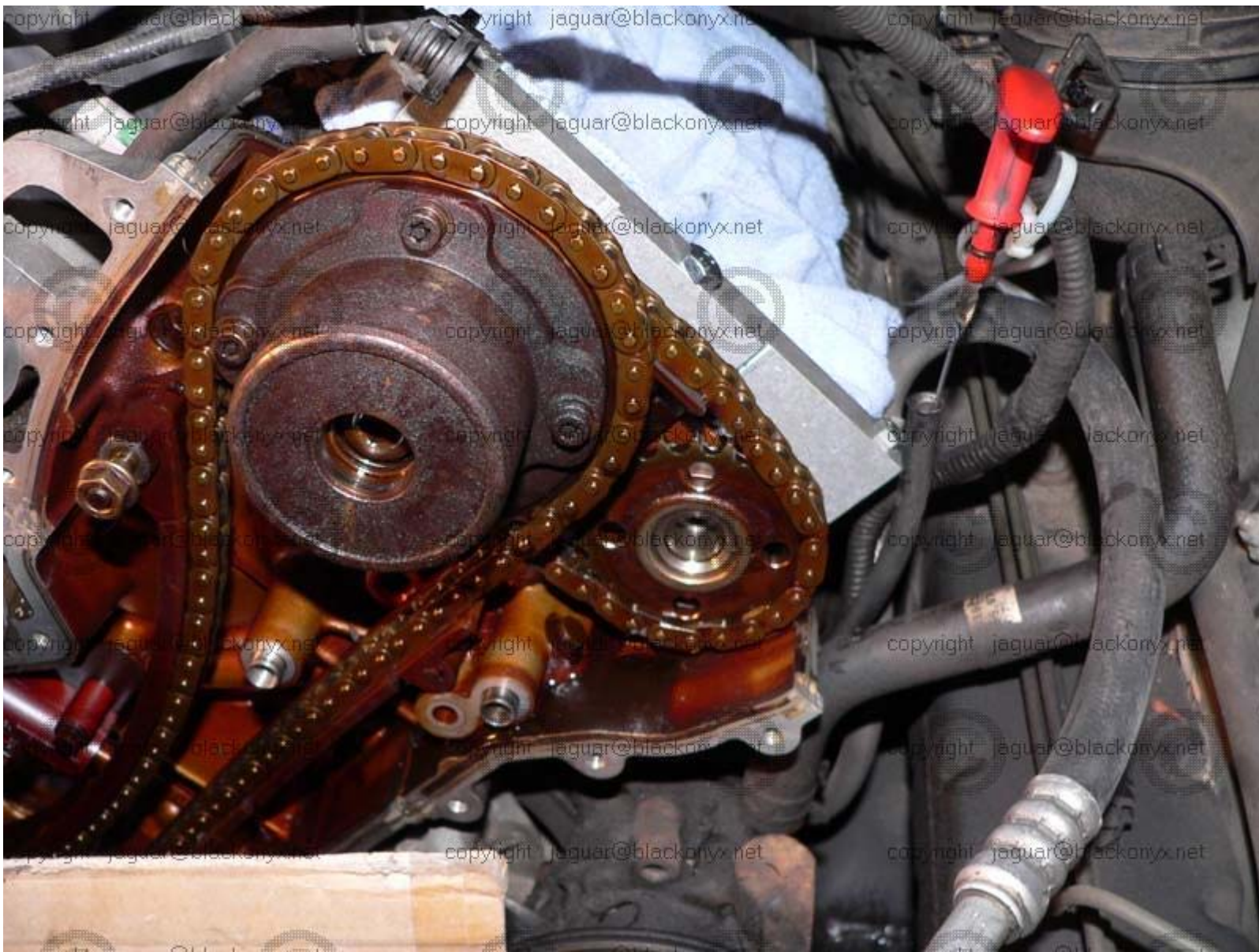

X. Loosen cam sprocket bolts :

- 1) Using a 10mm hexagonal bit and a breaker bar break free the large allen head bolts on the left side only at this time (if you have two camshaft alignment tools do both sides)
- 2) rotate bolt in counter clock wise direction
- 3) Repeat for the VVT sprocket
- 4) Check cam alignment and secure the cam alignment tool fully if not already done.

In the below image I used the tensioning tool, which isn't necessary.

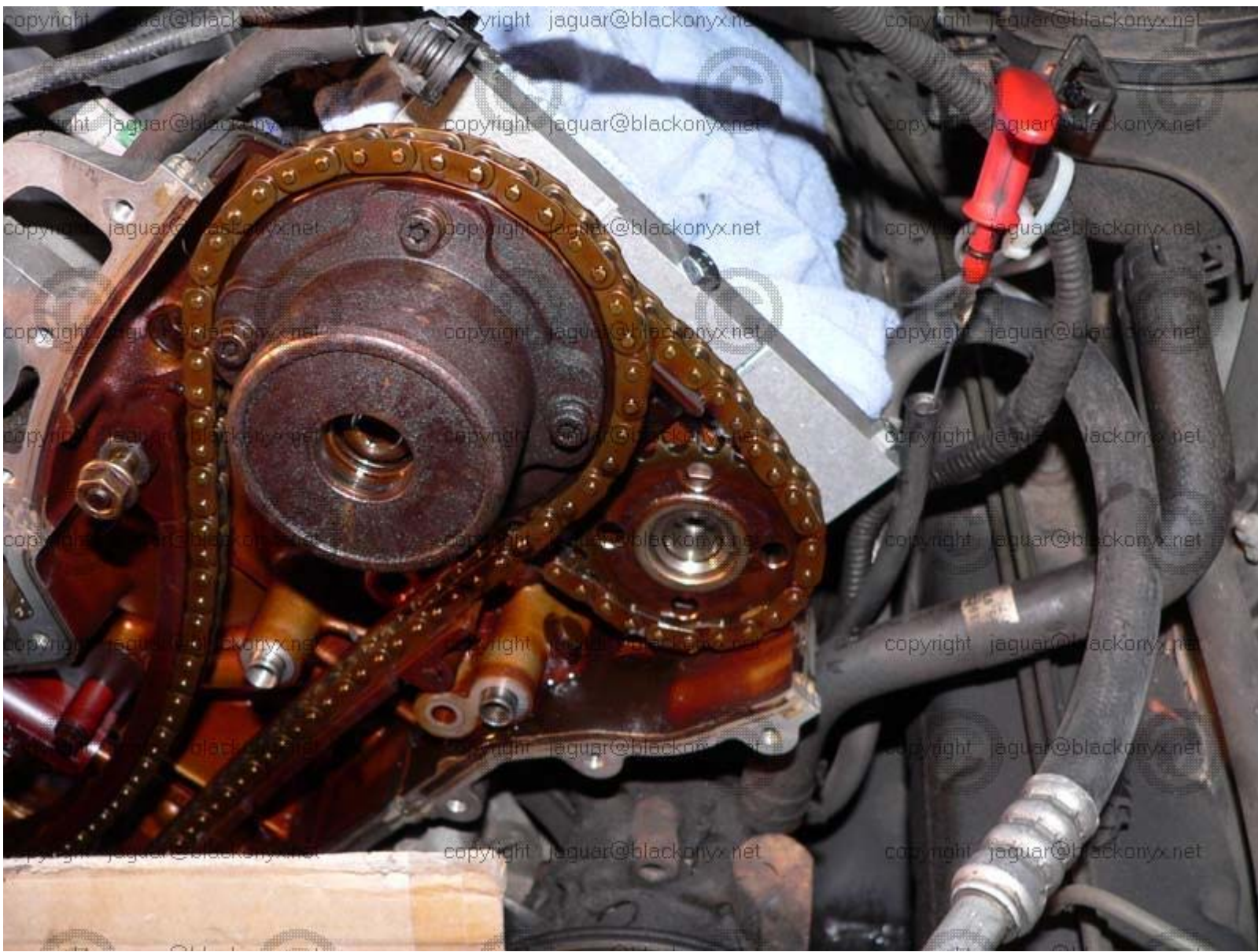

Y. Remove primary timing chain tensioners and guides and primary chain:

Each primary timing chain has 4 pieces: Primary timing chain outer guide, inner guide, hydraulic tensioner, and backing plate for tensioner.

1) Remove the two bolts that hold each primary tensioner. Take note on the orientation of the backing plate.

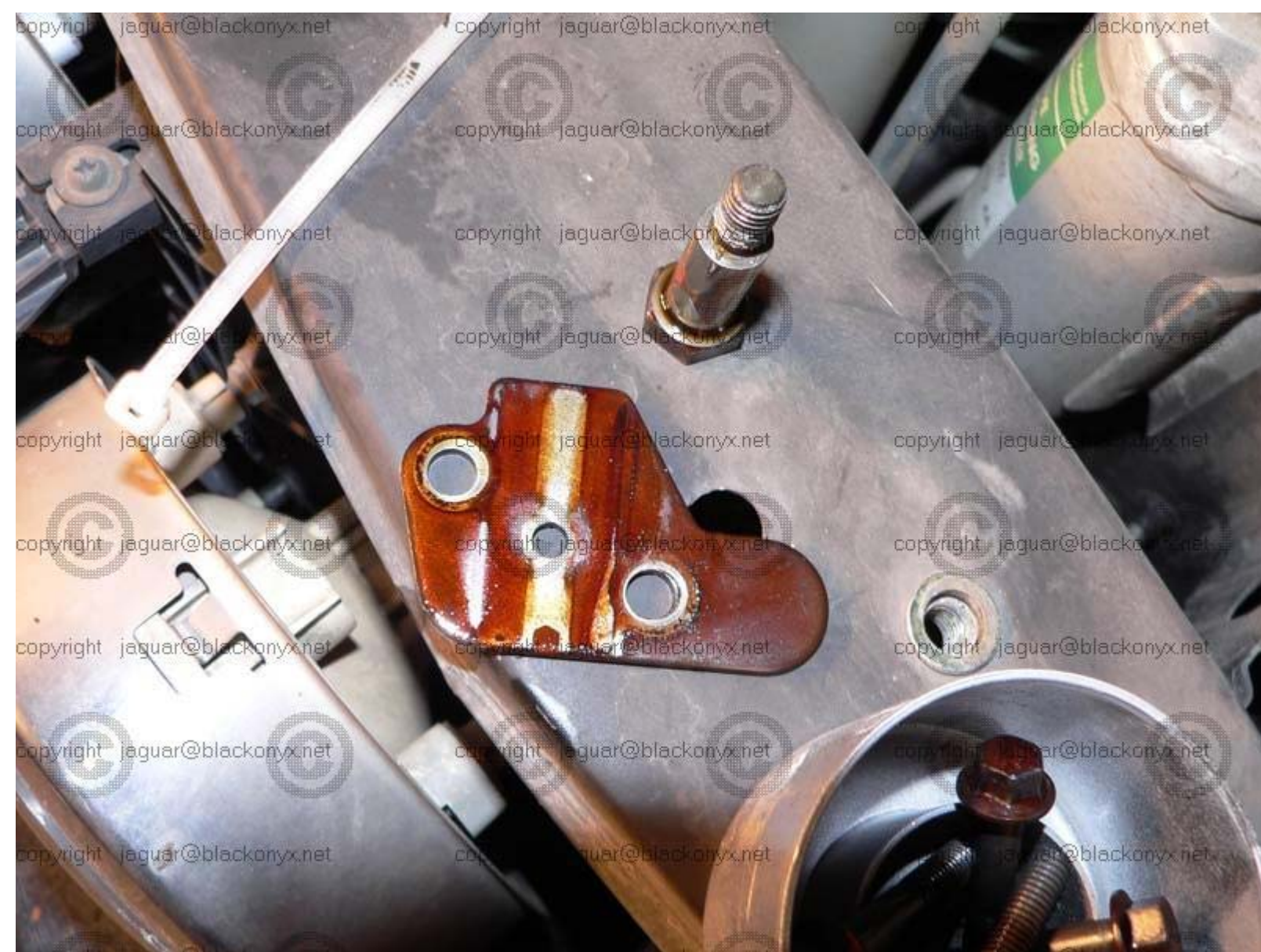



2) Remove the single pivot bolt that holds each inner(curved) guide

3) Remove inner guide

4) Remove the single bolt that holds each outer guide (flat).

5) Remove outer guide.

6) Remove left side chain at this time only (if you have two cam alignment tools installed you can remove both)

Note: All 4 of my guides had cracks in them and needed to be replaced:

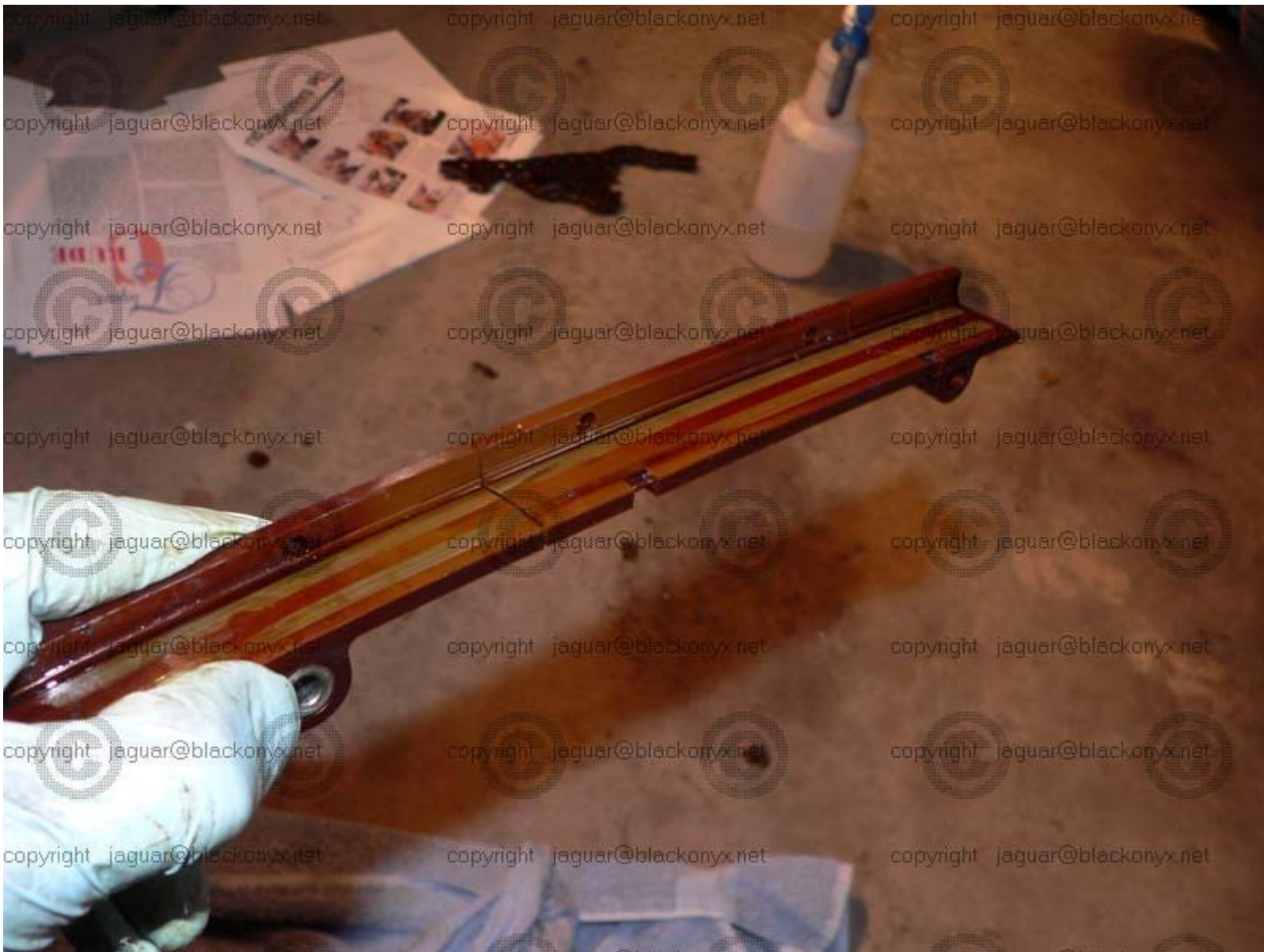

Note: Also notice that the guide bolt had locktite on it:



7) Remove primary chains. If you only have one camshaft locking tool this may be tricky. I was told that the cams on the bank that wasn't secured (right side) with a tool wouldn't move.... They started to move when I was removing the primary chains. What I had to do was remove the chain on the left side with the camshaft locking tool there, then remove and replace the right side's primary chain while holding the cam sprockets with the cam tensioning tool to prevent the cams from turning too much. Then I could place the left's side primary chain on the crank sprocket and let it lay there. Also, if you notice I had to re do that because I put the left chain around the water pump.



Z. Remove VVT sprocket and exhaust sprocket:

The sprockets must be kept in the same orientation, or upon installation make sure that the sprockets are 1/2 of a tooth out of phase.

- 1) Remove both as a unit, keeping them in the same orientation
- 2) Still in same orientation place on new chain and set aside.



AA. Replace secondary timing chain tensioner:

Note: On the left side the spring will be toward the top; on the right side the spring will be toward the bottom.

- 1) Remove two bolts that secure tensioner to head
- 2) Remove tensioner
- 3) Discard old tensioner



4) Fit new tensioner



- 5) Fit both bolts; torque to 10-14 Nm
- 6) Don't remove the tensioner retainer yet (copper colored pull pin)

BB. Fit new primary timing chain guides:

- 1) Position guides on to cylinder block. On outer guide slotted hole goes toward the top
- 2) Tighten inner guide (curved) bolt to 12-16 Nm (don't forget to clean bolt off and renew locktite)
- 3) Tighten outer guide (straight) bolt to 10-14 Nm

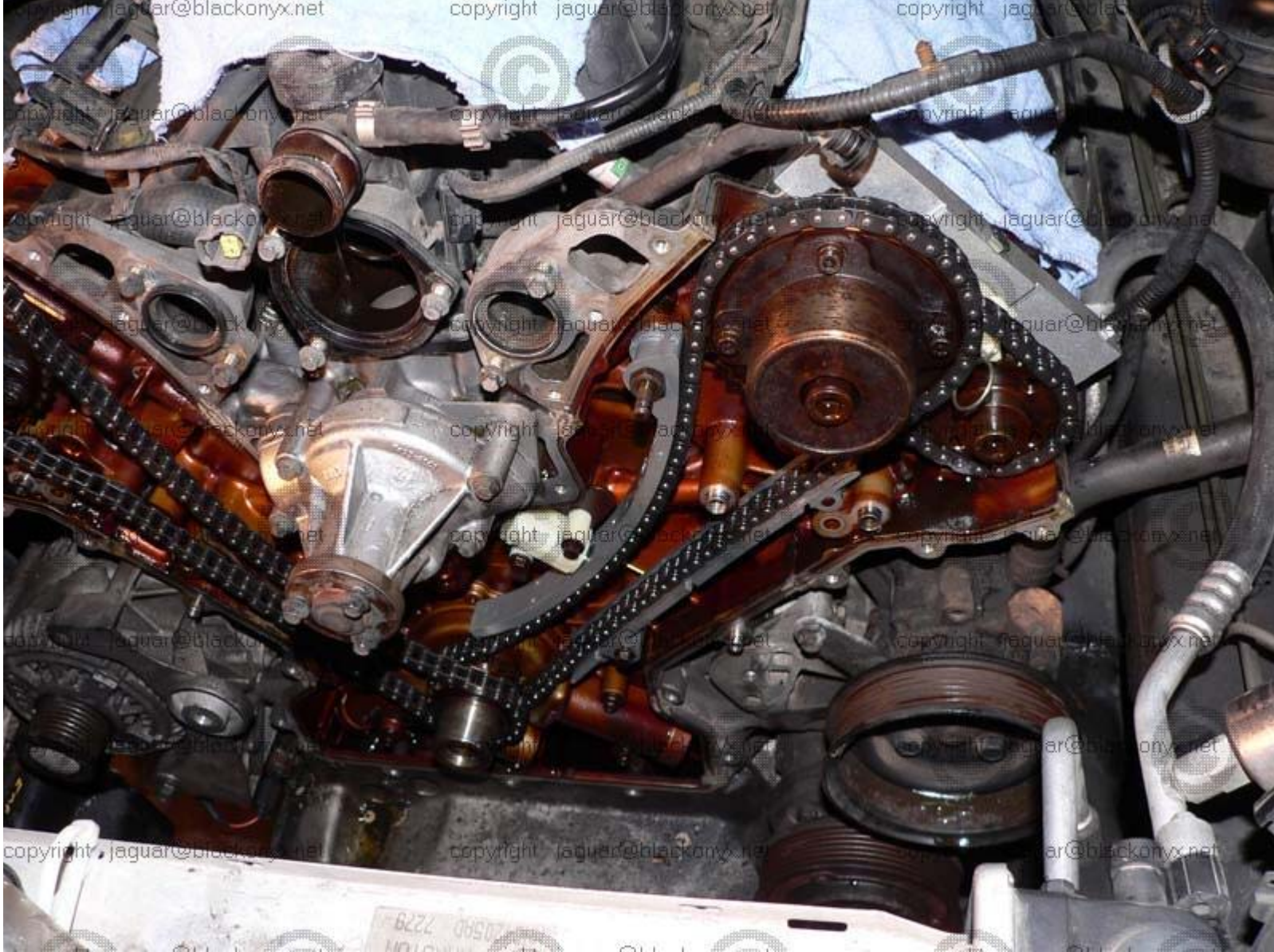

CC. Fit the exhaust and VVT sprocket to the cams:

- 1) Fit the VVT sprocket, exhaust sprocket and new secondary timing chain on to the cams
- 2) Loosely install securing bolts, allowing enough space on the VVT to refit the primary chain.
- 3) Fit the secondary chain tensioning tool to the exhaust sprocket, rotate sprocket if necessary for best position of the tool.



4) Once best position is found the tool can be removed for now.

DD. Fit new left primary chain and tensioner:

- 1) Position the chain over the VVT sprocket
- 2) Position chain between primary chain guides
- 3) Remove slack from drive side of chain (outer most side of chain)
- 4) Fit new primary timing chain tensioner (both sides use same tensioner, so there is no left and right specific tensioner) with backing plate in correct orientation; metal button goes toward timing chain guide
- 5) Fit bolts and torque to 10-14 Nm

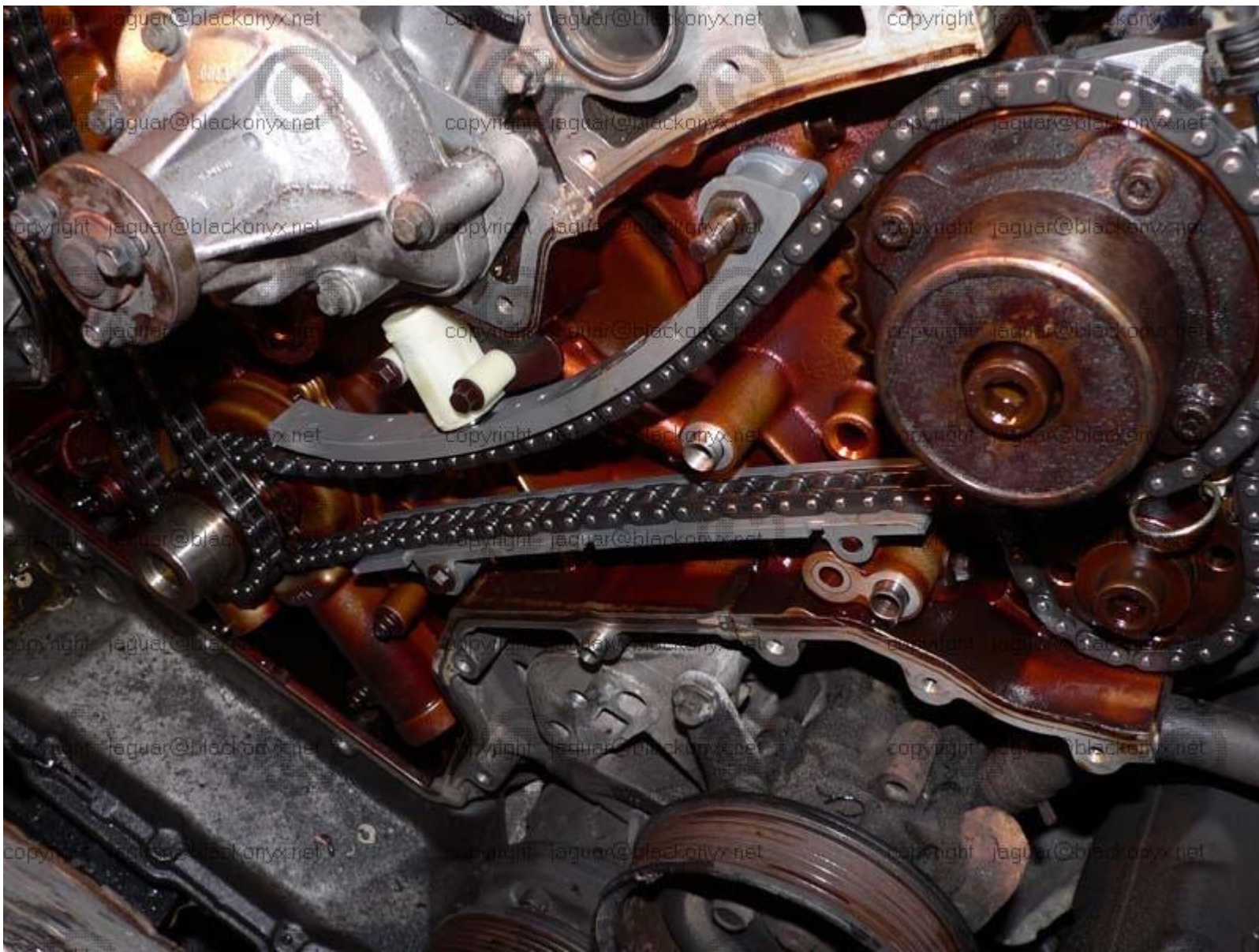

EE. Tighten chains and set timing:

1) Fit wedge tool (or screw driver) between primary timing inner guide (curved) and tensioner. Primary timing chain should be tight.

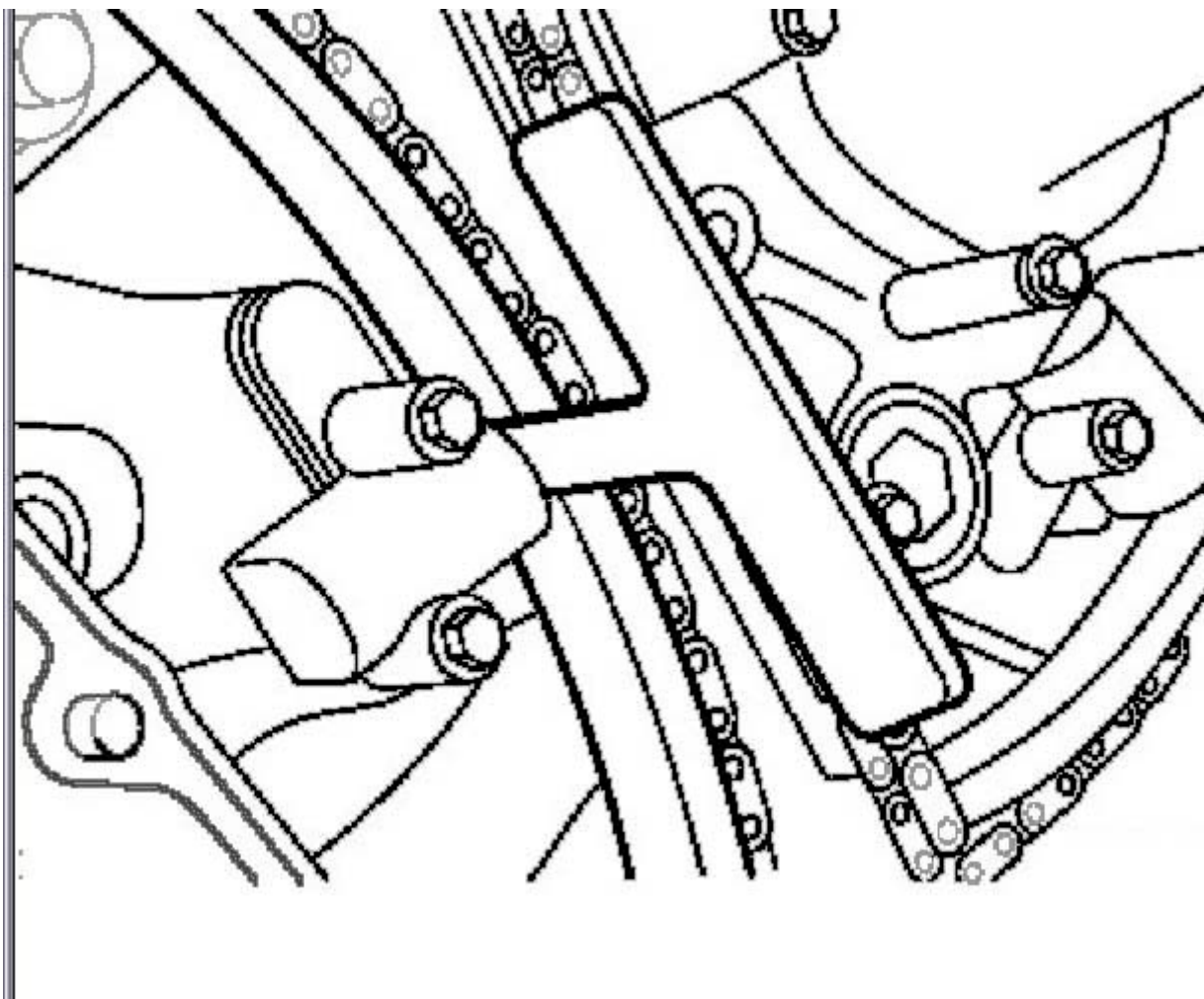

2) Position chain tensioning tool 303-532 to the exhaust camshaft

3) Tighten the exhaust camshaft sprocket securing bolt to 115-125 Nm while applying opposite force in an counter clock wise direction using the chain tensioning tool to tension the drive side of the chains. Continue to apply tension until bolt is fully torqued

4) Tighten the VVT sprocket securing bolt to 115- 125 Nm while still applying opposite force on the chain tensioning tool. Continue to apply force until bolt is fully torqued.

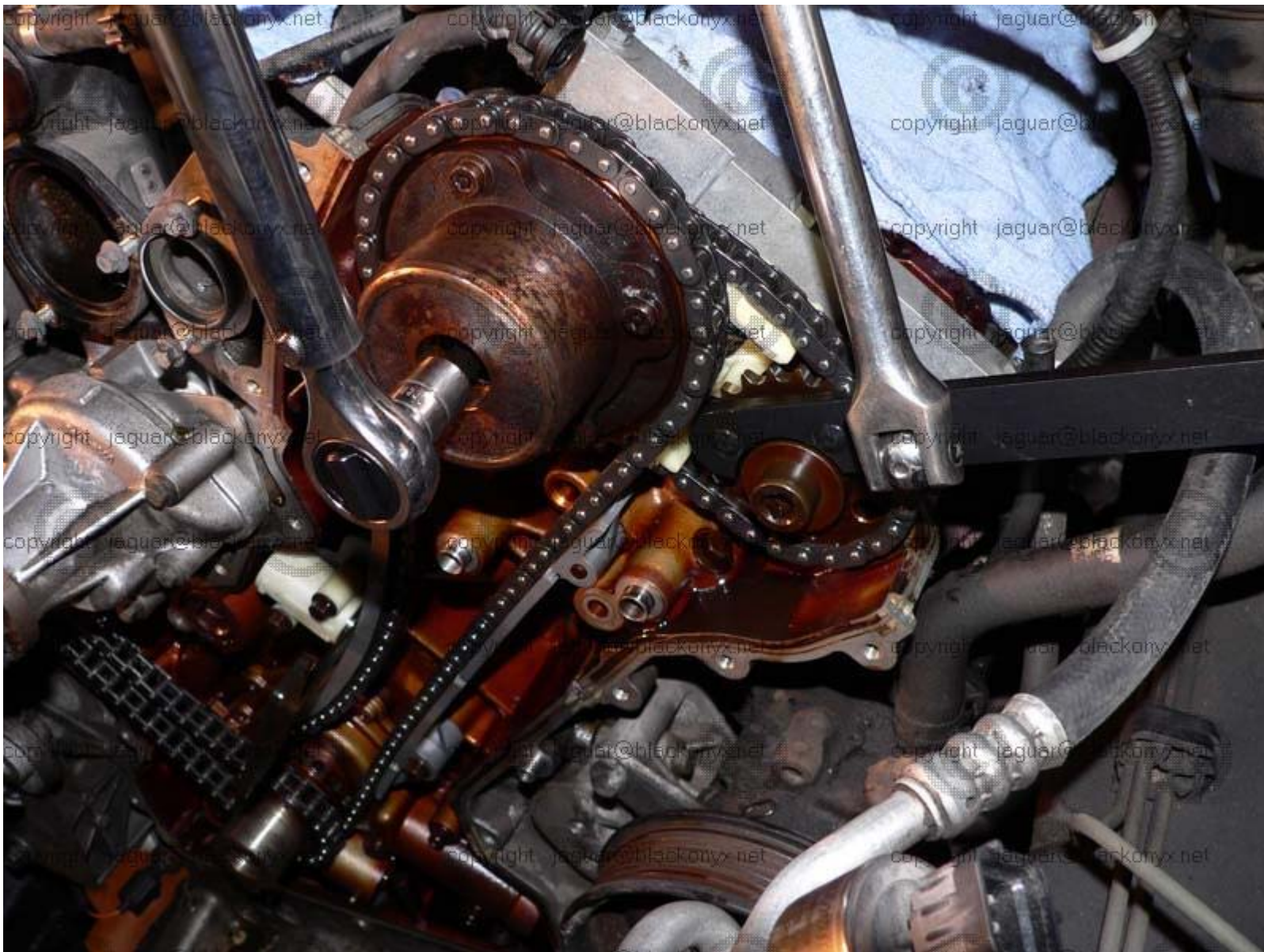
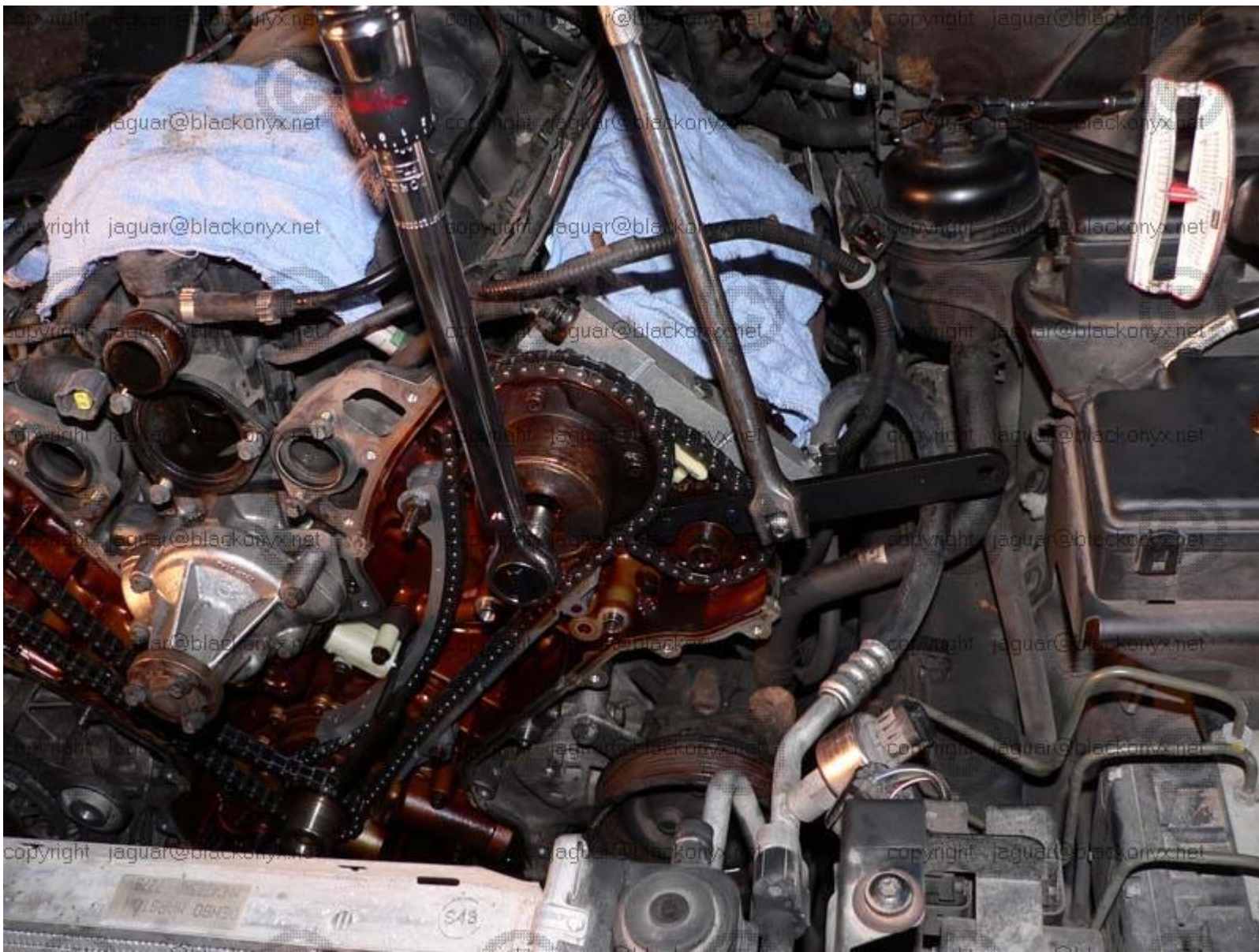

5) Remove the tools from the sprockets and the wedge from the primary chain tensioner.

6) Remove pin from secondary timing chain tensioner. Tensioner will expand.

7) Remove camshaft locking tool from left side. On the left bank the drive side of the chain (flat side) will stay tight, however on the right bank it may go slightly slack due to the cams walking when

5) You have just set the timing and are finished with the left side!

Repeat steps Z to EE on right bank

FF. Remove the crankshaft setting plug:

- 1) Remove the crankshaft position sensor bolt (10mm)
- 2) Remove the setting plug
- 3) Install the crankshaft position sensor
- 4) Install bolt and torque to 8-12 Nm

GG. Refit VVT Bush carrier:

- 1) Install new o-rings on the bush carrier, lubricating the ones that go into the VVT sprocket
- 2) Install 3 bolts(right bank)/ 2 bolts 1 nut (left bank) and torque to 19-23 Nm

HH. Replace the front crankshaft seal:

- 1) Support the timing cover with blocks of wood or other items so it doesn't crack
- 2) Drive the old seal out from the back of the cover
- 3) Install the new seal from the front, keeping the red protective ring in place. Work the seal in evenly so that it sits squarely

II. Replace the O-rings for the variable valve timing solenoids (2):

These solenoids are located on the upper part of the timing cover.



- 1) Remove the two screws that secure the solenoids
- 2) remove old o-rings
- 3) Install new o-rings and lube them
- 4) Refit the solenoids
- 5) Refit the bolts

JJ. Install the timing chain cover:

- 1) Clean all the mating surfaces of the timing chain cover and on the block. Brake parts cleaner works best for this as it leaves no residue.
- 2) Install the gaskets on the timing chain cover
- 3) Apply sealant to the eight joints on the engine face (shown below on the timing chain cover). The sealant bead should be about 12mm long.

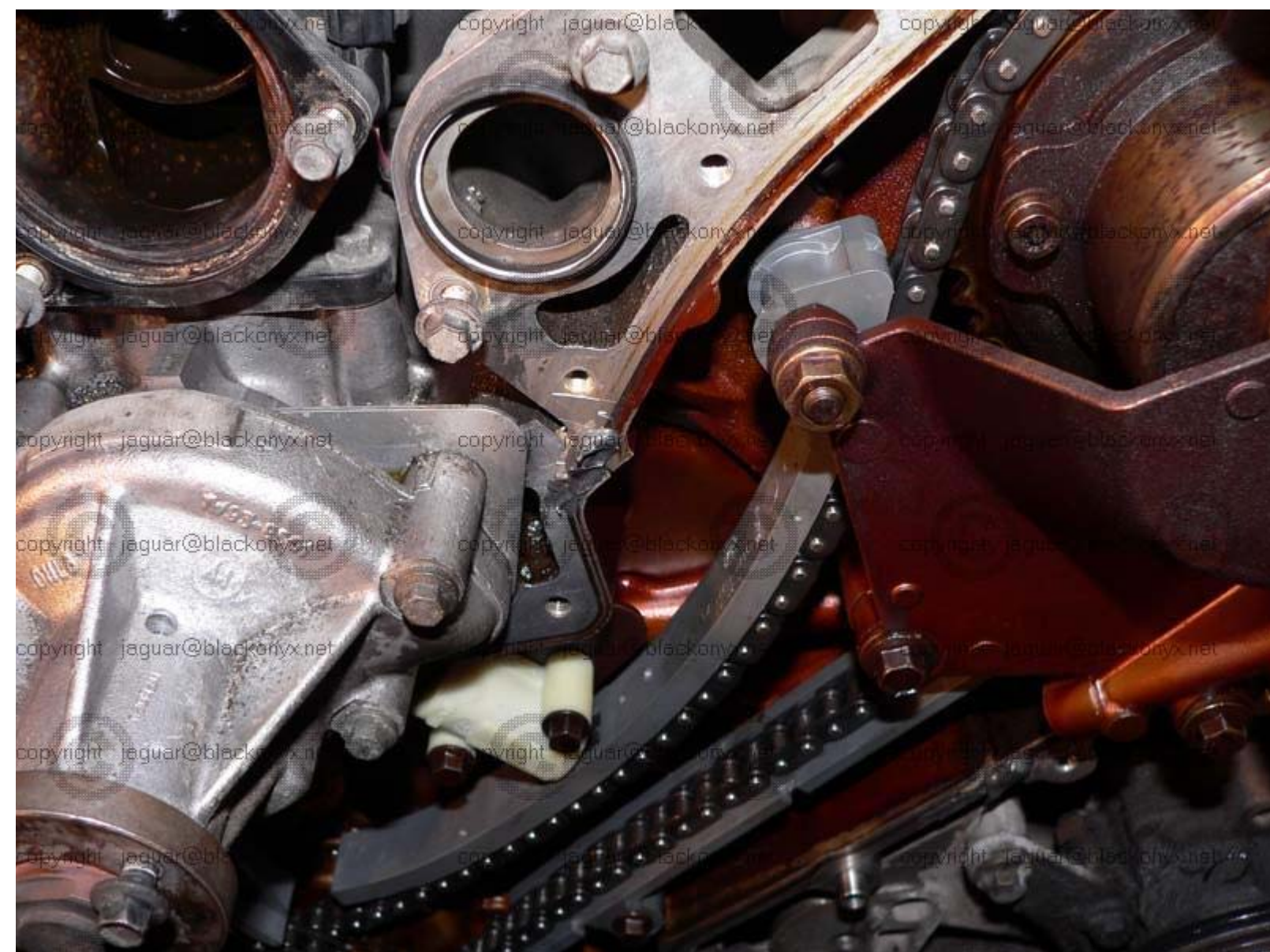

- 4) Refit the timing chain cover to the engine, locating it directly on the dowels so that the sealant isn't smeared
- 5) Refit the 24 bolts (8mm) and torque to 11-13 Nm in the order in the image below:

11 - 13 Nm

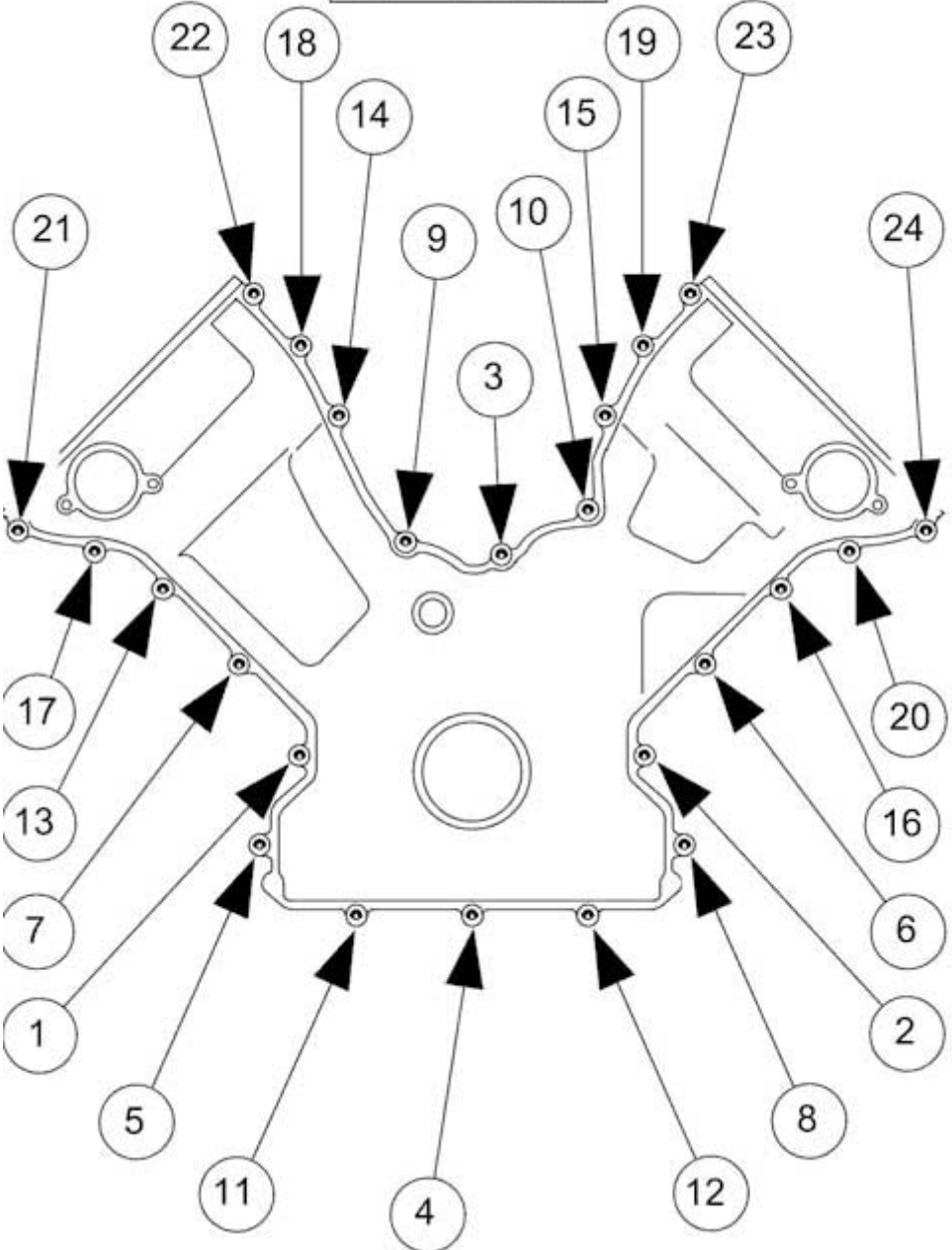

KK. Install the valve covers:

- 1) Clean the valve covers and the mating surfaces on both the covers and the head. Again brake cleaner works well here.
- 2) Install the new gaskets for the cam shaft covers. The red gasket goes on the left cover and the gray on the right cover.





- 3) Install the new gaskets for the spark plug holes.
- 4) Install new gaskets for the valve cover bolts and press into the valve cover gaskets. They should stay where they are. Make sure you put the bolts with studs in the correct location along the upper edge of the valve cover.
- 5) Apply sealant to the two points on each side where the timing chain cover meets the head. Circled in blue.
- 6) Position the cam cover on the head with out smearing the sealant(one side at a time)
- 7) Torque the bolts (8mm) to 9-11 Nm in the order in the image below

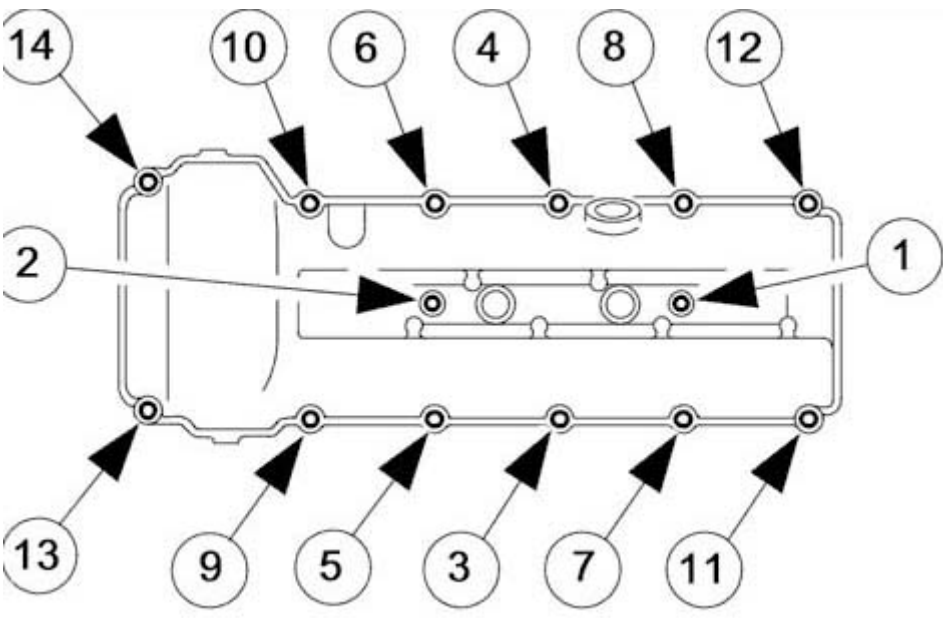

- 8) Refit the clips that secure the engine harness to the valve covers
- 9) Refit sockets on the VVT solenoids

LL. Refit the ignition coils:

- 1) Install the ignition coils on the head

2) Refit bolts (8mm) and torque to 4-6 Nm

3) Refit harness and the sockets on the coils

4) Refit coil on-plug cover

5) Refit coil on-plug bolts (8mm)

MM. Refit crankshaft pulley:

1) As when removing the pulley you need to keep the crankshaft from rotating. I used pry bar between the drive plate and torque converter with the handles supported with a jack to keep it from moving.

2) Place some form of shield behind the radiator to protect it

5) Remove front crankshaft seal protector

6) Put a good amount of grease on crankshaft seal

7) Install a new o-ring on the pulley. Apply some grease to the o-ring.

8) Install the crankshaft pulley

9) Install the split lock ring on to the crankshaft

10) Install the new crankshaft pulley bolt

11) Make sure that the crankshaft setting tool is removed from the torque converter.

12) Tighten the crankshaft pulley bolt (24mm 6 point socket (15/16" will also work)) to 364-386 Nm

13) Remove your method of securing crank.

14) Reinstall the two covers on the torque converter housing.

NN. Refit water pump pulley:

1) Place pulley on water pump flange

2) Thread the three bolts (8mm?) in to the flange

3) Use a similar method as what you used to loosen the bolts to tighten the bolts to 10-14 Nm. One trick to do this is to place a wrench on one bolt, rest it against the second bolt a a level to prevent the pulley from spinning and tighten the third bolt. Repeat for all the bolts.



OO. Accessory drive belt tensioner pulley :

- 1) Check for play or roughness in pulley. If pulley found bad replace pulley. The tensioner and pulley is sold as an assembly.
- 2) position idler pulley to engine
- 3) Tighten bolt (13mm) to 38-48 Nm

PP. Accessory drive belt idler pulley:

- 1) As with the tensioner pulley check for play or roughness and replace if necessary
- 2) Position pulley on engine block
- 3) Refit bolt (15mm) and torque to 53-69 Nm

QQ. Accessory drive belt:

- 1) Check drive belt and replace if necessary
- 2) Position the belt on all pulleys but the tensioner pulley
- 2) Use a short breaker bar with a 15mm? socket on the pulley bolt on the belt tensioner



3) Apply a counter-clockwise force to the bar until the belt slides over the pulley.

4) Relax pressure and remove tools

RR. Thermostat housing:

1) Install new thermostat; make sure that the vent is toward the top of the housing

2) Fit a new o-ring to thermostat housing

3) Position housing on engine

4) Refit 3 bolts (10mm) and torque to 8-10 Nm

5) Refit lower radiator hose, replacing if necessary

SS. Coolant outlet pipe:

1) Fit new o-rings to the outlet pipe

2) Position outlet pipe and bypass hose (small section of hose)

3) Refit 4 bolts (10mm) and torque to 10-14 Nm



4) Reconnect heater hose

5) Reposition hose clamps over hoses (circled in green)

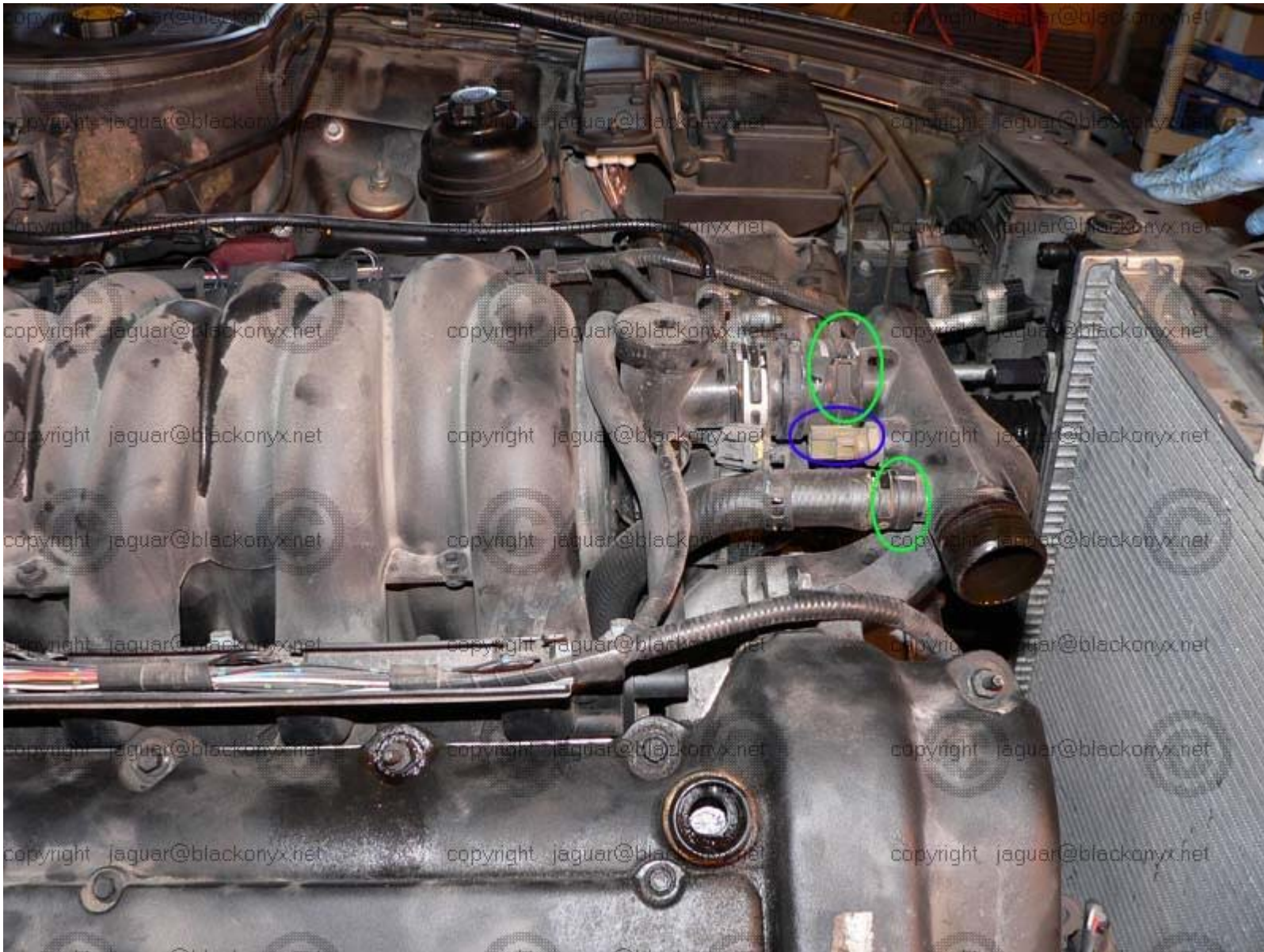

6) Reconnect plug to temperature sensor (circled in blue)

TT. Cooling fans and shroud:

1) Fit the cooling fans and shroud behind radiator. IIRC there should be some tabs at the bottom to slide into mounting slots at the lower edge of the radiator.

2) Refit the two bolts on either side of the shroud



3) Connect the plug at the lower left of the engine bay

4) Reinstall upper radiator hose; replace if necessary.

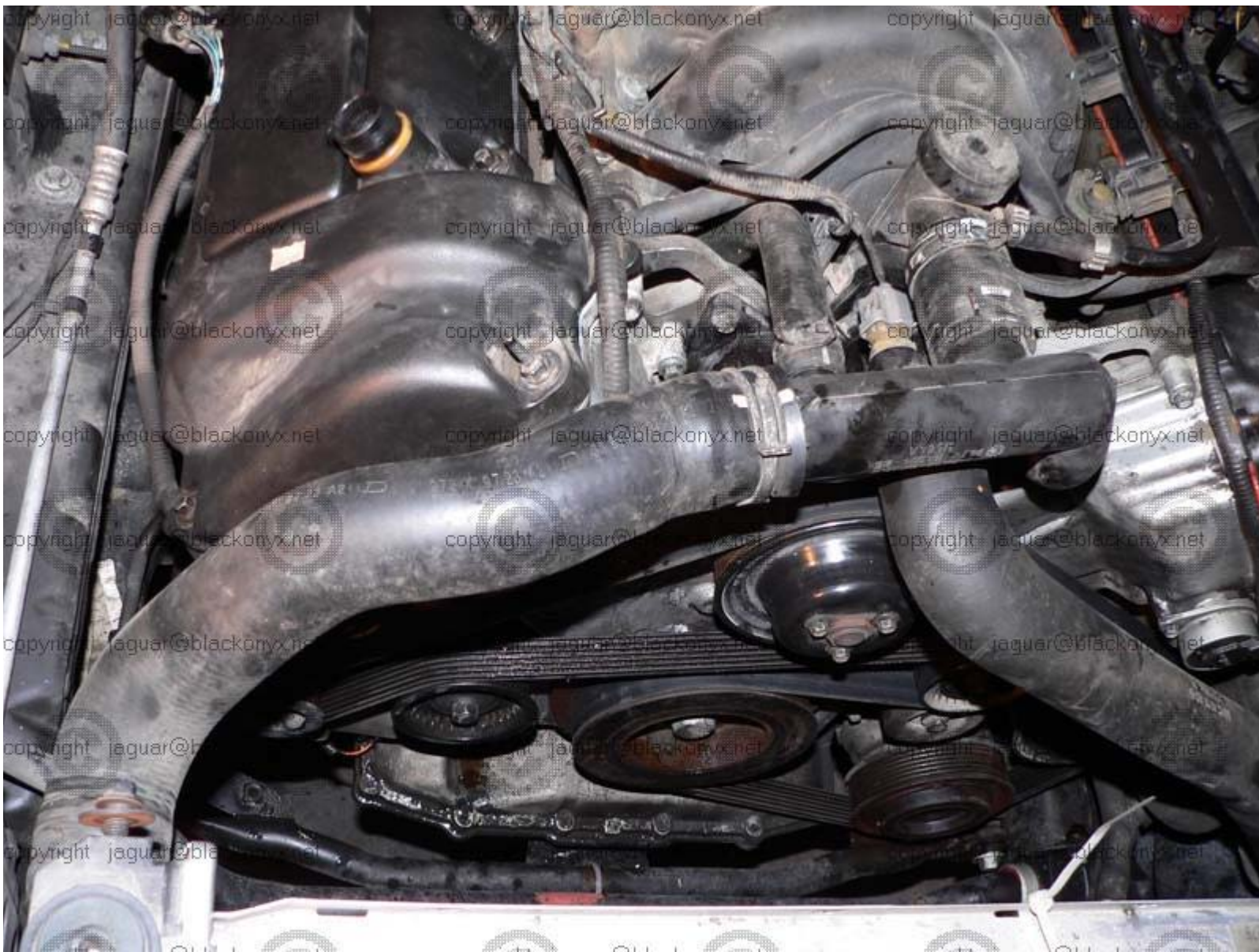

UU. Coolant lines:

- 1) Refit the coolant lines to and from the coolant reservoir simply by pushing them on

VV. Engine covers:

- Refit the two engine covers, making sure to locate them on the studs on the valve cover bolts. The left side must be slid under the coolant lines
- Locate pins in holes on intake manifold.
- Clip the coolant lines on to engine cover

WW. Radiator top mounting panel:

- 1) Fit panel to radiator
- 2) Refit 10 Torx head bolts (in red)

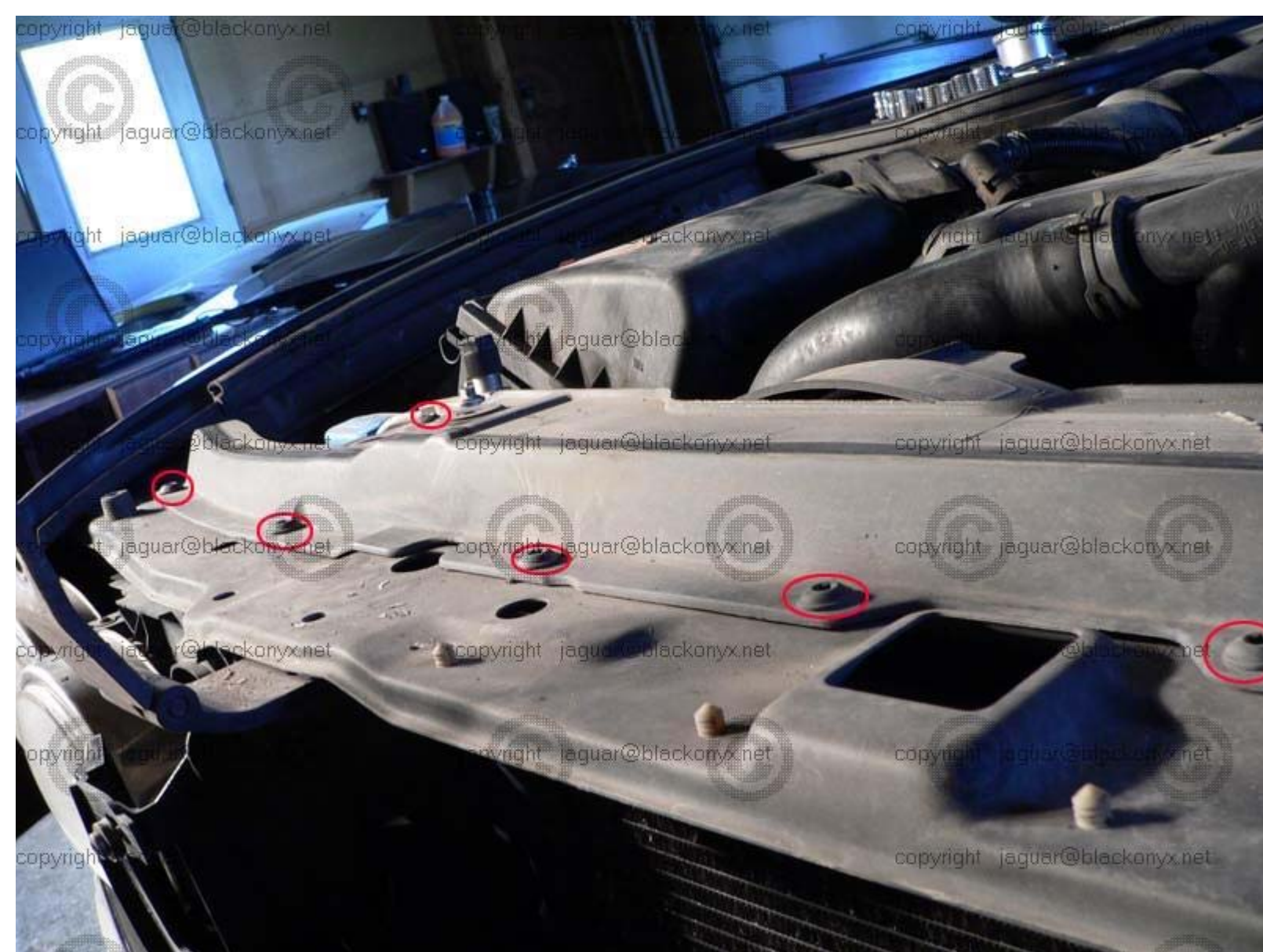

XX. Air box and intake tube:

- 1) Replace the bottom of the air box
- 2) Refit two bolts that secure lower air box



- 3) Reposition air box and intake tube; replace air filter if necessary
- 4) Place tube on throttle body
- 5) Refit two bolts (10mm) that secure tube to throttle body.



6) Reconnect to airflow sensor

7) Reconnect breather hose to valve cover

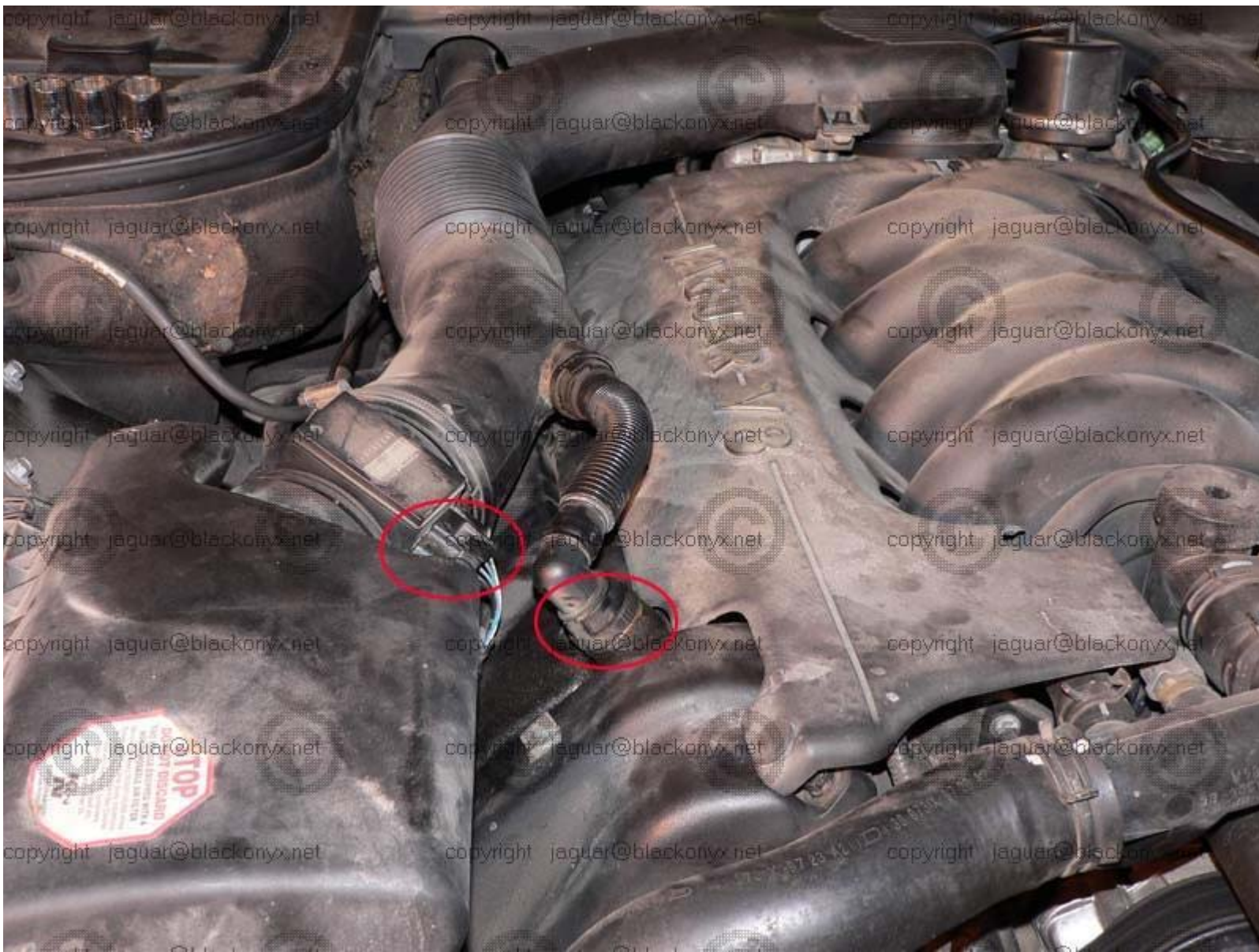

8) Secure 5 clips that hold the air box together

YY. Prior to fitting hood:

- 1) Fill coolant system with fluid via reservoir. 50/50 mix of distilled water and coolant
- 2) Check oil level
- 3) Remove fuel pump relay (in trunk relay box)
- 4) Run the starter for 1 minute to build up oil pressure and to prime the hydraulic chain tensioners
- 5) Reconnect fuel pump relay and start car
- 6) Idle car for about 10 minutes
- 7) Check for leaks
- 8) Check coolant level.
- 9) Fit hood and grill the reverse of removal
- 10) remove vehicle from jackstand and take for a test drive
- 11) Check fluid levels and chekc for leaks again.

A big thank you goes out to the people of Jag-Lovers X300 forum that helped and to Larry (also of the X300 forum) for letting me borrow the tools

Jag poop :

