

# Affordable Overkill.®

Our LaRue trademarked 1-3-5™ Pricing:  
1 at \$80 ea, 3 at \$75 each, and 5 (or more) at \$70 each.

Now available in a Straight Bow version, also machined from solid S7 Tool steel. You won't find a better AR trigger on the market, at any price.



MBT-2S

MBT-2S-SB

Each MBT Trigger comes with a heavier spare spring that adds a pound for those that need it.

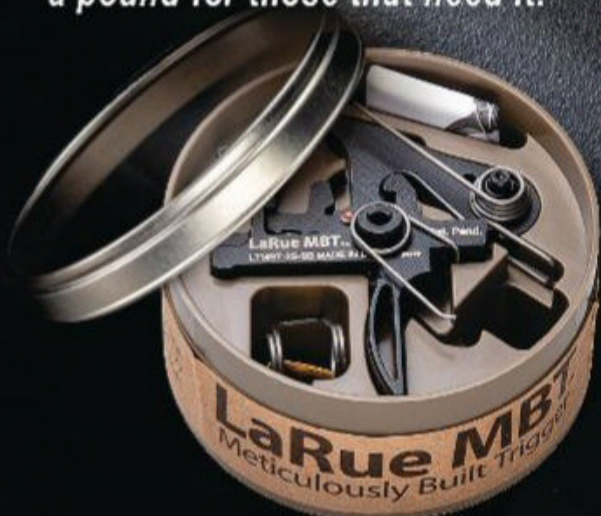

LaRue  
Tactical  
Made Dead-Center  
of Texas, USA

[www.LaRue.com](http://www.LaRue.com)

[www.facebook.com/LaRueAccuracy](https://www.facebook.com/LaRueAccuracy)  
© 2019 APPI, all rights reserved

Visit [www.MBTtrigger.com](http://www.MBTtrigger.com) to get this special deal and read the MBT reviews explaining why we've made and sold over 100,000 LaRue MBT Triggers.



**EVERYDAY CARRY SPECIAL ISSUE!**

# FIREARMS NEWS<sup>®</sup>

GUN SALES, REVIEWS, & INFORMATION

AUGUST 2020 | ISSUE 15

## THE HK VP9SK-B

GIVING THE AMERICAN  
MARKET WHAT IT WANTS  
AND NEEDS

## SIG SAUER'S P365

RETHINKING YOUR  
CARRY GUN? THIS  
IS ONE TO CONSIDER!

## THE 9MM SCCY CPX

RELIABLE AND  
REASONABLY-PRICED  
PERSONAL PROTECTION

PATRICK SWEENEY REVIEWS THE

# WALTHER CCP M2 .380

21<sup>ST</sup> CENTURY POCKET PISTOL

## SPRINGFIELD ARMORY HELLCAT OSP

HELLCAT?  
HELLUVA DEAL!







AMERICAN TACTICAL

Made from light weight high grade 7075 aluminum, the Cavalry series of shotguns weigh in at just over 6 lbs and feature an intricate laser engraved design.

Triggers are single selective, chambered for up to 3" Magnum and come with 5 interchangeable chokes.

## SPECS

- Turkish Walnut Wood Stock
- 12/20/410 Gauge / 3" Chamber
- Brass Front Bead Sight
- 4140 Chrome Moly Steel Barrel
- Auto Ejectors
- Single Selective Trigger

**Please Note** - All Cavalry Shotguns are hand fit at the factory and may vary slightly from the following measurements:

- Length of Pull - 14.23"
- Drop at Comb - 1.45"
- Drop at Heel - 2.2"

### Choke Tube Information:

12GA Cavalry Over/Under Shotguns come with 5 Choke Tubes threaded with Beretta Benelli Mobil Choke System Style threads.



AmericanTactical.us  
1-800-290-0065

Quantities limited. Not responsible for printing errors. Sale subject to stock on hand. Prices subject to change without notice. ATI will ONLY transfer ownership of a firearm to individuals or agencies in possession of a valid Federal Firearms License (FFL). This means we cannot ship directly to you unless you are an FFL holder.

AVAILABLE NOW

# CAVALRY

## OVER/UNDER SHOTGUN



**20% OFF** MSRP

Use **CAV20SUMMEREND** at checkout.  
Only at AmericanTactical.us

Expires 10.11.2020

12 GAUGE# ATIGKOF12SVE  
20 GAUGE# ATIGKOF20SVE  
410 GAUGE# ATIGKOF410SVE

**\$479<sup>96</sup>**  
SPECIAL  
PRICE

MSRP: \$599.95



# RUKKX GEAR™



Special Price is  
**20% OFF** MSRP

Use **ENDOSUMMER20** at checkout.  
Only at AmericanTactical.us  
Expires 10.11.2020



## NEW! DISCRETE AR PISTOL BACKPACK

- Made of 600D Nylon
- Detachable/Adjustable Straps
- Elastic Keepers on Strap Ends
- Barrel Extension Pocket
- Flexible and Detachable Main Storage
- Hidden Ambidextrous Handgun Pocket
- Heavy Duty Detachable Buckles
- Heavy Duty Lockable Zippers
- Dimensions 13.7" x 4.7" x 25.5"

SPECIAL PRICE  
**\$47<sup>96</sup>**  
MSRP \$59<sup>95</sup>



<b>BLACK</b> ITEM:ATICTARPB	<b>BLACK/GRAY</b> ITEM:ATICTARPBG
<b>TAN</b> ITEM:ATICTARPT	<b>GREEN/TAN</b> ITEM:ATICTARPGT



## DOUBLE GUN CASE

AVAILABLE IN 36" OR 42"

- Protects Two Rifles Simultaneously
- Heavy Duty Lockable Zippers
- Made of 600D Polyester
- Water Resistant

<b>36" BLACK</b> ITEM:ATICT3&DGB	<b>42" BLACK</b> ITEM:ATICT42DGB
<b>36" TAN</b> ITEM:ATICT3&DGT	<b>42" TAN</b> ITEM:ATICT42DBT
<b>36" GREEN</b> ITEM:ATICT3&DGG	<b>42" GREEN</b> ITEM:ATICT42DGG

36" SPECIAL PRICE  
**\$63<sup>96</sup>**  
MSRP \$79<sup>95</sup>

42" SPECIAL PRICE  
**\$71<sup>96</sup>**  
MSRP \$89<sup>95</sup>



**NOW AVAILABLE  
IN 42"**

## NEW! RANGE BAG

- Made of 600D Polyester
- Water Resistant
- Hidden Handgun Pocket
- Storage for Mags/Ammo
- Dimensions 16" x 7.5" x 10"

**BLACK**  
ITEM:ATICTRBB  
**TAN**  
ITEM:ATICTRBT  
**GREEN**  
ITEM:ATICTRBG



SPECIAL PRICE  
**\$27<sup>96</sup>**  
MSRP \$34<sup>95</sup>

## SURVIVOR BAG

FOR HUNTING/CAMPING/BACKPACKING/BOATING

FIVE COLORS TO CHOOSE FROM!

- Discreetly Stores a Nomad Shotgun
- Floats with Shotgun and Handgun Inside
- Removable Waist/Shoulder Straps
- Made of 600D Polyester
- Reinforced Webbing
- Heavy Duty Non-Rust Zippers
- Dimensions 20" x 11" x 10"
- Hidden Handgun Pocket
- Water Resistant

SPECIAL PRICE  
**\$63<sup>96</sup>**  
MSRP \$79<sup>95</sup>

<b>BLACK</b> ITEM:ATICTSURB	<b>TAN</b> ITEM:ATICTSURT	<b>BLUE</b> ITEM:ATICTSURBL	<b>ORANGE</b> ITEM:ATICTSURO	<b>YELLOW</b> ITEM:ATICTSURY
--------------------------------	------------------------------	--------------------------------	---------------------------------	---------------------------------



NOMAD SHOTGUN  
AND BAG COMBO  
AVAILABLE SEPARATELY.  
CALL FOR DETAILS





# All inquiries for Advertising, Editorial: 1-800-521-2885, ext. 5064 2 News Plaza, 3<sup>rd</sup> Floor Peoria, IL 61614

## PLACING AN AD

Advertisers will furnish **FIREARMS NEWS** with copy legibly printed or typewritten on one side of the paper only. Please leave a margin of at least 1" on all sides. Classified ad copy can be submitted on disk, e-mailed to [firearmsnews@outdoorsg.com](mailto:firearmsnews@outdoorsg.com), through [www.firearmsnews.com](http://www.firearmsnews.com), or picked up from your web site.

Contact the Art Director before submitting electronic display advertising.

Due care and diligence is used in checking advertising copy for accuracy, but the Publisher makes no warranty, express or implied. Advertisers and **FIREARMS NEWS** are not responsible for typographical errors, mistakes or misprints.

All ads received too late for the current issue will be inserted in the following issue, unless you qualify the submission of the ad. Existing ad copy may be substituted if new copy fails to arrive by the specified date.

Advertising is credit card, check or money order in advance. If uncertain as to the cost of your ad, submit it and we will advise the amount to be remitted, and we will refund any overage.

Artwork is kept in our files for 13 months and then destroyed. Reproduction quality is not guaranteed.

**FIREARMS NEWS** reserves the right to omit any ads that in its opinion are objectionable.

In addition, **FIREARMS NEWS** will no longer accept ads offering the following items for sale: Plans, videos or books for converting semi-automatic firearms into full-automatic firearms.

Sound suppressor plans, and videos. Plans or formulas for making explosives, booby traps, etc.

Lock picks, Slim-Jims, etc. and lock picking instructions.

Also, items related to the above.

**If in doubt about your ad, call us.**

## AD DEADLINE DATES

ISSUE	DEADLINE	ISSUE	DEADLINE
Vol. 74 - Issue 19	Aug. 24	Vol. 74 - Issue 22	Oct. 12
Vol. 74 - Issue 20	Sept. 4	Vol. 74 - Issue 23	Oct. 26
Vol. 74 - Issue 21	Sept. 28	Vol. 74 - Issue 24	Nov. 9

**NOTE: ALL ad space MUST be reserved and art materials MUST be received BEFORE the above DEADLINE DATES!**

## COMPLAINTS AGAINST ADVERTISERS

We want **FIREARMS NEWS** readers to receive prompt, friendly service from our advertisers. If you have experienced bad service from a **FIREARMS NEWS** advertiser, you may submit a complaint in writing to **FIREARMS NEWS**, Dept. CL, 2 News Plaza, 3rd Floor, Peoria, IL 61614. You can e-mail to [firearmsnews@outdoorsg.com](mailto:firearmsnews@outdoorsg.com) or fax to (309) 679-5476. We do not accept complaints by telephone. Note that **FIREARMS NEWS** is not a law enforcement agency and cannot investigate complaints. We will contact the advertiser on your behalf, and a continuing pattern of complaints can cost an advertiser its advertising privileges.

## SUBSCRIPTION INQUIRIES

**BE AWARE THAT FIREARMS NEWS ONLY ACCEPTS SUBSCRIPTION REQUESTS FROM AUTHORIZED AGENTS! WE MAY NOT HONOR REQUESTS FROM UNAUTHORIZED AGENTS, AND YOU THEREFORE MAY LOSE YOUR MONEY IF YOU BUY FROM AN UNAUTHORIZED AGENT.** If you are offered a subscription to **FIREARMS NEWS**, please call 1-800-345-6923 to determine if the agent is authorized. For more information on subscription scams, please visit [www.ftc.gov](http://www.ftc.gov).

**To change your address:** Call our toll-free customer service number or E-mail us with your new address **6 to 8 weeks before** your move. **If you receive a bill after you've paid:** Our letters probably crossed in the mail. Please disregard any bill or renewal notice you receive soon after mailing your payment or order. (If you continue to receive notices, please let us know.)

**If your issue is damaged or missing:** Call our toll-free number or E-mail us. We'll replace the issue or extend your subscription, whichever you prefer. Remember, **FIREARMS NEWS** is published 24 times a year.

**Toll-Free Subscription Number**  
**1-800-345-6923**  
Outside U.S.; call 386-447-6318  
**E-mail: [sgncustserv@cdsfulfillment.com](mailto:sgncustserv@cdsfulfillment.com)**

# FIREARMS NEWS®

An Outdoor Sportsman Group® Publication

### PUBLISHER

Mike Schoby

### EDITORIAL EDITOR

Vincent L. DeNiro

### FIELD EDITORS:

**Senior Field Editor**

David Fortier

### Gunsmithing

Gus Norcross

### Historic Military Arms

Paul Scarlata

### Hunting

Rikk Rambo

### Machine Guns & Tactics

Leroy Thompson

### Movie Guns

Dr. Will Dabbs

### NFA & Airguns

Patrick Sweeney

### Pistols

James Tarr

### Columnists

Mark Chestnut, David Codrea, Jim Grant,

Jeff Knox, Vin Suprunowicz

### DESIGN

### SENIOR ART DIRECTOR

Bill Smalley

### ASSISTANT ART DIRECTOR

Ashley N. Honea

### ASSISTANT ART DIRECTOR

Mark Kee

### PRODUCTION

### PRODUCTION MANAGER

Terry Boyer

### ADVERTISING

### ADVERTISING DIRECTOR

Pat Bentzel (East Region) (717) 695-8095

[patrick.bentzel@outdoorsg.com](mailto:patrick.bentzel@outdoorsg.com)

### ADVERTISING SALES MANAGER

Mark Thiffault (720) 630-9863

[mark.thiffault@outdoorsg.com](mailto:mark.thiffault@outdoorsg.com)

### ACCOUNT EXECUTIVE, AD SALES

Brendan Vorobiev (734) 800-6666

### CLASSIFIED ADVERTISING REPRESENTATIVE

Sue Fitch (309) 679-5064

### Western Region

Hutch Looney & Associates

email: [hutch@hlooney.com](mailto:hutch@hlooney.com)

### NATIONAL AD SALES

### Account Director – Detroit Office

Kevin Donley (248) 798-4458

### National Account Executive – Chicago Office

Carl Benson (312) 955-0496

### Direct Response Advertising/Non-Endemic

Anthony Smyth (914) 693-8700



### PRESIDENT & CHIEF EXECUTIVE OFFICER

Jim Liberatore

### CHIEF OPERATING OFFICER, PUBLISHING & BRANDED MEDIA

Mike Carney

### EVP, GROUP PUBLISHER & OPERATIONS

Derek Sevcik

### VP, CONSUMER MARKETING

Peter Watt

### VP, MANUFACTURING

Deb Daniels

### SENIOR DIRECTOR, PRODUCTION

Connie Mendoza

### DIRECTOR, PUBLISHING TECHNOLOGY

Kyle Morgan

### SENIOR CREATIVE DIRECTOR

Tim Neher

### DIGITAL

**Editorial Director, Fishing** Jeff Simpson

**Digital Editor, Hunting** Drew Pellman

For questions regarding digital editions, please contact [digitalsupport@outdoorsg.com](mailto:digitalsupport@outdoorsg.com)

### MEDIA

[outdoorsg.com](http://outdoorsg.com)

### TELEVISION

[outdoorchannel.com](http://outdoorchannel.com)

[thesportsmanchannel.com](http://thesportsmanchannel.com)

[worldfishingnetwork.com](http://worldfishingnetwork.com)

### HUNTING

[bowhunter.com](http://bowhunter.com)

[bowhuntingmag.com](http://bowhuntingmag.com)

[gundogmag.com](http://gundogmag.com)

[petersenshunting.com](http://petersenshunting.com)

[northamericanwhitetail.com](http://northamericanwhitetail.com)

[wildfowlmag.com](http://wildfowlmag.com)

### FISHING

[bassfan.com](http://bassfan.com)

[floridasportsman.com](http://floridasportsman.com)

[flyfisherman.com](http://flyfisherman.com)

[gameandfishmag.com](http://gameandfishmag.com)

[in-fisherman.com](http://in-fisherman.com)

### SHOOTING

[gunsandammo.com](http://gunsandammo.com)

[handguns.com](http://handguns.com)

[rifleshooter.com](http://rifleshooter.com)

[shootingtimes.com](http://shootingtimes.com)

[firearmsnews.com](http://firearmsnews.com)

*Firearms News* (USPS Periodicals Permit 23130) is published 24 times a year. Semimonthly January through December by OUTDOOR SPORTSMAN GROUP, 1040 6<sup>th</sup> Ave., 12<sup>th</sup> Floor, New York, NY 10018-4618. Periodical postage paid at New York, NY and at additional mailing offices. **POSTMASTER:** Send address change (Form 3579) to *Firearms News*, P.O. Box 37539, Boone, IA 50037-0539. Return undeliverable Canadian addresses to: 500 Rt. 46 East Clifton, NJ 07011. Canada Post Publications Mail-Agreement No. 41405030.

**To know when your subscription expires:** Check the printed address label on the magazine cover. The date your subscription expires appears to the right of your name and address. Allow 6-8 weeks after renewing for the label to reflect your new expiration date.

**Occasionally, our subscriber list is made available to reputable firms offering goods and services that we believe would be of interest to our readers. If you prefer to be excluded, please send your current address label and a note requesting to be excluded from these promotions to: Outdoor Sportsman Group – 1040 6th Ave, 12th Floor, New York, NY 10018-3703 Attn: Privacy Coordinator, or email your label information and note to [privacycoordinator@outdoorsg.com](mailto:privacycoordinator@outdoorsg.com)**

Copyright 2020 by Outdoor Sportsman Group®  
All Rights Reserved. No part of this book may be reproduced without written permission.

**FIREARMS NEWS®** is a registered trademark of Outdoor Sportsman Group® in the United States.

The Publisher and authors make no representations or warranties regarding the accuracy, completeness or timeliness of the information

contained in this publication. Any reliance or use of the information is solely at your own risk, and the authors and Publisher disclaim any and all liability relating thereto. Any prices given in this issue were suggested prices at the press time and are subject to change. Some advertisements in this magazine may concern products that are not legally for sale to California residents or residents in other jurisdictions.

PRINTED IN THE U.S.A.





**Howa**<sup>TM</sup>  
Precision Rifles & Barreled Actions

THE LONG AWAITED HOWA

**.22 LR**

**.22 WMR**

**17 HMR**

# M1100 RIMFIRE

JAPANESE CRAFTSMANSHIP AND PRECISION

**MSRP STARTING AT \$478 RIFLE ONLY**



 Nikko Stirling.  
SCOPE OPTION AVAILABLE

**BLACK**  
**HRF22LRBGP**



 Nikko Stirling.  
SCOPE OPTION AVAILABLE

**OD GREEN**  
**HRF22LRGPP**

## FEATURES

3 Calibers - 22 LR / 22 WMR / 17 HMR	Beavertail Forend	
Two - 10 rd Detachable Mags	OAL - 37"	
18" Thread Capped Barrel	6.3 LBS	
Tactical/Varmint Style Synthetic Stock	Nikko Stirling GamePro Scoped Options Available 3.5-10x44	
Oversize Tactical Bolt Handle	Lifetime Warranty on Rifle and Scope	



FOR MORE INFORMATION VISIT: [LEGACYSPO RTS.COM](http://LEGACYSPO RTS.COM)  
FOR A FREE CATALOG CALL : 1.800.553.4229

**LEGACY**  
SPORTS  
INTERNATIONAL



LegacySportsIntl



LegacySportsInternational



LegacySportsInt



# CONTENTS

## 8 PRODUCT SHOWCASE

Staff



## 12 WALTHER CCP M2 .380

21st Century  
Pocket Pistol  
*Patrick Sweeney*

## 28 SPRINGFIELD ARMORY HELLCAT OSP

Hellcat? Helluva Deal!  
*Patrick Sweeney*

## 40 THE HK VP9SK-B

Giving the American Market What  
it Both Wants and Needs  
*James Tarr*

## 52 SIG SAUER'S P365

If You are Rethinking Your Carry  
Gun, This is One to Consider!  
*David M. Fortier*

## 64 THE 9MM SGCY CPX

Reliable Reasonably-Priced  
Personal Protection  
*Will Dabbs, MD*

## 84 CONGRESSMEN QUESTION ATF BRACE RESTRICTION PLANS

*David Codrea*

# DISPLAY ADS

<b>A</b>	<b>J</b>
Air-Ordnance, LLC..... 45	J&G Sales LTD .....80-82
American Gun Craft ..... 109	<b>L</b>
American Tactical, Inc. .... 2, 3	L&S Supply ..... 102
AMG International Armory	LaRue Tactical ..... 7, 112
..... 107	Legacy Sports Intl LSI ..... 5
AR15MOLD.COM ..... 104, 108	<b>M</b>
<b>B</b>	M&A Parts ..... 67
Black Hills Ammunition, Inc..... 45	MKS Supply, Inc..... 27
Bob Hayley ..... 102	<b>N</b>
Bob's Gun Shop ..... 104	Nextten Stauer, LLC ..... 35
BRAVO Company USA	<b>O</b>
..... 10, 11, 14, 15, 45	Outdoor Sportsman Group ..47, 55, 57
Buffalo Arms Company ..... 105	<b>R</b>
<b>C</b>	Rapidfire Triggers, Inc.
CBRPS, LLC ..... 102	..... 102, 103, 104, 106, 108
Centerfire Systems, Inc..... 107	Robert G. Segel..... 106
Crosscut Saw Co..... 103	Ruben Mendiola, Jr. .... 103, 109
<b>D</b>	<b>S</b>
D.B. Stewart Enterprises, LLC .... 102	S&K Scope Mounts ..... 107
Davidson's..... 111	Sabot Designs, LLC..... 105
De Santis Holster Leather Good..... 23	Sarco, Inc. .... 71, 87-101
<b>E</b>	Sarge's Military Surplus ..... 85
Electric Metering Corporation..... 49	Smith Wesson, Inc..... 17
Evenheat Kiln Co..... 104	Stocky's LLC ..... 49
<b>F</b>	Sturm, Ruger & Co., Inc..... 25
Fobus International ..... 37	<b>T</b>
<b>G</b>	TRUGLO, Inc..... 19
GovMint..... 39	<b>U</b>
<b>H</b>	Uintah Precision..... 37
Handi Racker ..... 104	UltiMAK ..... 49
Harbor Freight Tools..... 63	<b>W</b>
Hornady Mfg Co. Natl..... 105	Walther Arms, Inc..... 31
	Wiley & Sons, Inc..... 106

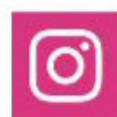



# Affordable Overkill.®

Our LaRue trademarked 1-3-5™ Pricing:  
1 at \$80 ea, 3 at \$75 each, and 5 (or more) at \$70 each.

Now available in a Straight Bow version, also machined from solid S7 Tool steel. You won't find a better AR trigger on the market, at any price.



MBT-2S

MBT-2S-SB

Each MBT Trigger comes with a heavier spare spring that adds a pound for those that need it.

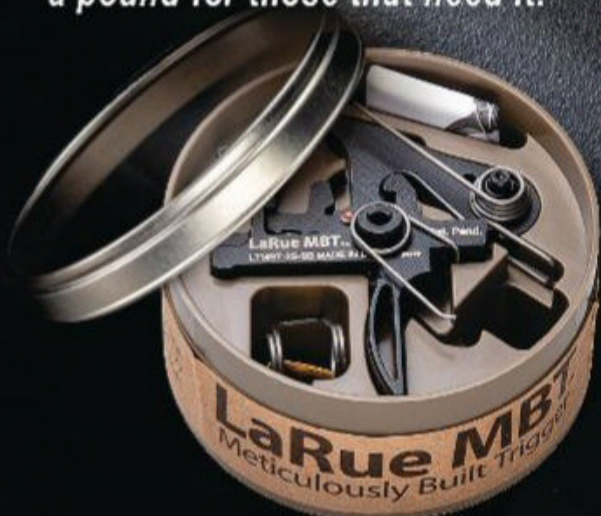

LaRue  
Tactical  
Made Dead-Center  
of Texas, USA

[www.LaRue.com](http://www.LaRue.com)

[www.facebook.com/LaRueAccuracy](https://www.facebook.com/LaRueAccuracy)  
© 2019 APPI, all rights reserved

Visit [www.MBTtrigger.com](http://www.MBTtrigger.com) to get this special deal and read the MBT reviews explaining why we've made and sold over 100,000 LaRue MBT Triggers.



## NEW FIREARMS GUIDE 11TH EDITION COMES WITH 15,198 PRINTABLE GUN SCHEMATICS & ANTIQUE AND MODERN GUN MANUALS!

*Firearms Guide*, the largest gun guide, gun values guide, and gun schematics library just published its 11th Edition that offers complete original antique and modern printable gun manuals.

*"The New Firearms Guide 11th Edition provides over 15,000 printable antique and modern gun manuals, schematics and blueprints. It is the place to go if you are a gunsmith."* says Chris Mijic, publisher of *Firearms Guide*. *"If you need original Russian Tula Arms blueprints for complete AK-47, blueprints for 1911 or AR-15, or you need armorer's manuals for your SIG, Glock, S&W, or just antique manuals for your antique guns then FirearmsGuide.com is your best source. Checking values of modern and antique guns with Firearms Guide is a plus too if you're selling or buying any guns."*

The new 11th Edition of FirearmsGuide.com enables deep, complex searches of antique and modern guns (from black powder muskets to 2020 guns) and side by side comparisons of search results. Guns are cross-referenced with the ammunition database. Guns and ammo are presented with prices, tech-specifications, features, ballistics and up to 12 high-resolution zoom able color pictures (up to 4,000 x 1,240). Now with over 15,198 printable gun schematics, blueprints and original gun manuals for antique and modern guns *Firearms Guide 11th Edition* is a great 27/4 tool for any professional gunsmith or gun enthusiast who wants to repair any gun or air gun. With just a click or two you can find, zoom in on your screen and then print out manuals, schematics, blueprints or parts lists for 15,198 antique and modern guns, both civilian and military guns.

*Firearms Guide 11th Edition is available with updates at [www.FirearmsGuide.com](http://www.FirearmsGuide.com)*

The screenshot shows the Firearms Guide website interface. At the top, there's a navigation menu with 'FG' and various categories like Home, Firearms, Manufacturers, Ammo, Schematics, Targets, News, Blog, and Contact. Below the navigation is a large image of a Colt handgun with the text 'FIREARMS GUIDE' overlaid. Underneath the image, it says 'Find values of antique and modern guns |' and a 'Start Exploring' button. Below this, there are four statistics: 76,000 guns and ammo, 1,300 manufacturers, 55 countries, and 15,198 schematics & manuals. At the bottom, it says 'NEW 11th EDITION PUBLISHED TODAY!' and 'NOW WITH 15,198 GUN SCHEMATICS, BLUEPRINTS AND MANUALS!'. A final line of text reads: 'We believe that you should have all the gun info and knowledge available to you in any situation and at any time. That's why we created Firearms Guide.'

## NEW HOWA MINI ACTION EXCL LITE SERIES – NOW SHIPPING

Legacy Sports Int'l is excited to announce that their NEW HOWA EXCL LITE Mini Action rifle series is now shipping. The HOWA EXCL LITE series is in a HOWA Mini Action and is available in four great calibers — .223, 6.5 Grendel, 7.62x39 — all in 20-inch threaded barrels. A 350 Legend offering is available in a threaded 16.25-inch barrel. All are housed into a tough synthetic free-floating stock with a folding MIL SPEC adaptor which allows the stock to fold for compact storage and handling or it can be locked into full length positions as well. The butt stock is a LUTH Adjustable model allowing LOP from 12 – 15 inches.

The HOWA EXCL LITES are available in three synthetic stock options — American Flag, KRATOS camo, and black, they all come with two-stage match triggers, three-position safety, detachable mags and are also available with the very popular Nikko Stirling GamePro series in 3.5-10 x 44.

MSRP's Start at \$699 to \$999 depending on rifle only and scoped models along with the various color options. Lifetime warranty on rifles and scopes!

*For more information about the HOWA EXCL LITE lineup and the rest of the LSI product line or to request a FREE 2020 catalog please call (775) 828-0555 or visit: [LegacySports.com](http://LegacySports.com)*





# SHOWCASE

## DURABLE TRANSLUCENT MAGAZINES FOR S&W M&P BY ETS

ETS 9mm magazines for the S&W® M&P® are available in 17, 21, and 30 round models. Magazines won't crack or break when dropped, won't become brittle over time, and the feed lips and body won't spread when being stored fully loaded. LIFETIME WARRANTY. MSRP \$21.99

For more information visit: [ETSGroup.us](http://ETSGroup.us)



## VERY DURABLE AND HIGH-PERFORMANCE AK MAGAZINE FROM SARCO!

Sarco has just received what may be the best, most durable, and high-performance AK magazine on the market. Critically tested for reliable feed, locking, and ease of use, this magazine is synthetic and has survived the grueling "Serb" method of mag testing. 7.62x39 with 30-round capacity. New.

Sarco Inc., 50 Hilton St., Easton, PA 18042,  
[E-SarcoInc.com](http://E-SarcoInc.com), (610) 250-3960



## ROYAL MALAYSIAN POLICE MULTI TOOL

Sarco has a limited shipment of U.S. manufactured multi tools made for the *Royal Malaysian Police Force*. Never before offered outside of the contract, this Utica Cutlery manufactured tool sports pliers, files devices including a Tanto knife blade and gutting/belt cutting hook, and six socket drives including a glass breaker. These are new, unused, serialized, and complete with Royal Malaysian Police embossed crest. \$65.



Sarco Inc., 50 Hilton St., Easton, PA 18042, [E-SarcoInc.com](http://E-SarcoInc.com), (610) 250-3960

## HOWA M1100 RIMFIRE SERIES NOW SHIPPING!

Legacy Sports Int'l is excited to announce that their NEW HOWA M1100 rimfire series is now shipping. Complete with the same Japanese precision and craftsmanship that all HOWA owners have come to know and love. The long-awaited arrival of the HOWA rimfire series will be a hit with all rimfire enthusiasts. The HOWA rimfire bolt action comes with an oversized tactical bolt handle, an 18" thread capped barrel, two 10-round detachable mags and is available in three calibers — .22 LR & .22 WMR and 17 HMR. All are housed into a tough synthetic Tactical / Varmint style stock with a beavertail forend with options of OD or Black finish. Overall Length 37". A Nikko Stirling 3.5-10x44 Gamepro Scoped package option is available and a Lifetime Warranty is provided on all Howa and Nikko Stirling optics — a win win all around.

MSRP's start at \$478 to \$589 depending on rifle only and scoped models along with the various color options.

For more information about the HOWA M1100 Rimfire Series lineup and the rest of the LSI product line or to request a FREE 2020 catalog please call (775) 828-0555 or visit: [LegacySports.com](http://LegacySports.com)



MSRP  
**\$395.00**  
"R" Models

**3 RING SILENCER CORPORATION**

**Great Silencer, Great Price**

[www.3RingSilencer.com](http://www.3RingSilencer.com)

Call Us: (215) 949-8378





- Trijicon AccuPoint TR24G 1-4x24 Riflescope \$1,099.00
- BCM® Diamondhead Folding Rear Sight \$119.00
- BCM® KMR-A15 KeyMod Rail Handguard 15 Inch \$199.95
- BCMGUNFIGHTER™ QD End Plate \$16.95
- BCMGUNFIGHTER™ Stock \$55.95
- GEARWARD Ranger Band 20-Pak \$10.00
- BCMGUNFIGHTER™ Grip Mod 0 \$25.95
- American Defense RECON X Scope Mount \$189.95
- BCM® Diamondhead Folding Front Sight \$99.00
- BCMGUNFIGHTER™ KMSM KeyMod QD Sling Mount \$17.95
- BCMGUNFIGHTER™ Vertical Grip Mod 3 \$18.95
- BCMGUNFIGHTER™ Compensator Mod 0 \$89.95
- BCM® Low Profile Gas Block \$44.95
- BCM® A2X Flash Suppressor \$34.95

**B5 Systems SOPMOD Bravo Stock \$58.00**

**Blue Force Gear VCAS Sling \$59.95**

**BCM® PNT™ Trigger Assembly**  
Polished - Nickel - Teflon  
**\$65.95**

**Wilson Combat Tactical Trigger \$269.95**

**Inforce WML-HSP \$129.00**

**Trijicon TA31RCO-M4 ACOG 4x32 \$1,422.05**

**Aimpoint PRO Patrol Rifle Optic \$441.00**

**BCM® KMR-A KeyMod Free Float Rail Handguards**

Same as the fantastic original KMR Handguards but machined from aircraft aluminum!

BCM 9 Inch KMR-A9	.....	<b>\$176.95</b>
BCM 10 Inch KMR-A10	.....	<b>\$179.95</b>
BCM 13 Inch KMR-A13	.....	<b>\$189.95</b>
BCM 15 Inch KMR-A15	.....	<b>\$199.95</b>

**PWS DI KeyMod Rail Handguard**

Free float KeyMod rail for AR15/M4 pattern rifles.

PWS DI 12 Inch Rail	.....	<b>\$249.95</b>
PWS DI 15 Inch Rail	.....	<b>\$249.95</b>

**PWS KeyMod Polymer Bipod Adapter \$23.95**

**Daniel Defense SLiM Rail Handguard**

Slim, Light, Modular KeyMod free float handguard.

DD SLiM Rail 12.0	.....	<b>\$265.00</b>
DD SLiM Rail 15.0	.....	<b>\$265.00</b>

**Daniel Defense KeyMod Bipod Adapter \$48.00**

**Daniel Defense KeyMod 1 O'Clock Offset Rail Assembly \$40.00**

**BCM GUNFIGHTER™ KeyMod 1-Inch Ring Light Mount**

For 1" diameter lights **\$39.95**

**BCM GUNFIGHTER™ KeyMod Modular Scout Light Mount**

For SureFire Scout Light **\$39.95**

**BCM GUNFIGHTER™ KeyMod Modular Light Mount**

For 1913 mounted lights **\$39.95**

**Arisaka Inline KeyMod Scout Mount \$37.00**

**Arisaka Ring KeyMod 1" Light Mount \$45.00**

**Thorntail KeyMod Offset Adaptive Light Mounts**

Thorntail 1.030 Mount **\$70.00**

Thorntail M3M6 1913 Mount **\$50.00**

**Arson Machine Company KeyMod Light Mounts**

Scout M600 Mount **\$48.00**

1" Ring Mount **\$44.00**







- Midwest Industries Folding Front Sight \$79.95
- Midwest Industries ERS BUIS \$93.95
- GEARWARD Ranger Band 20-Pak \$10.00
- BattleComp 1.5 \$155.00
- BCMGUNFIGHTER™ 1913 Modular Light Mount, KeyMod \$39.95
- BCMGUNFIGHTER™ KAG Kinesthetic Angled Grip, KeyMod \$18.95
- BCMGUNFIGHTER™ KMSM KeyMod QD Sling Mount \$17.95
- BCM® KMR-A13 KeyMod Rail Handguard 13 Inch \$189.95
- TangoDown ARC MK2 30 Round Mag \$19.48
- BCM® PNT™ Trigger \$65.95
- BCMGUNFIGHTER™ QD End Plate \$16.95
- BCMGUNFIGHTER™ Stock \$55.95
- BCMGUNFIGHTER™ Grip Mod 3 \$17.95
- BCM® Polymer Trigger Guard \$6.95
- PWS FSC556 Tactical Compensator \$94.95

**BCMGUNFIGHTER™**  
**Comp Mod 0 - 556**  
Threaded 1/2x28 for 5.56 AR15 platform  
**\$89.95**

**Comp Mod 1 - 556**  
Threaded 1/2x28 for 5.56 AR15 platform  
**\$94.95**

**IWC KeyMod QD RL Sling Mount**  
Accepts heavy duty or standard QD swivels  
**\$17.00**

**IWC KeyMod Hand Stop**  
Mount-N-Slot design . . . . . **\$34.95**

**BCM® KeyMod Picatinny Rail Sections**  
Mil-Std 1913 rails, Nylon Rails available in Black, Flat Dark Earth and Foliage Green.

- Nylon Rail, 3 Inch . . . . . **\$8.95**
- Nylon Rail, 4 Inch . . . . . **\$11.95**
- Nylon Rail, 5.5 Inch . . . . . **\$14.95**
- Aluminum Rail, 3 Inch, Black . . . . . **\$19.95**
- Aluminum Rail, 4 Inch, Black . . . . . **\$24.95**
- Aluminum Rail, 5.5 Inch, Black . . . . . **\$29.95**

**PWS KeyMod Picatinny Rail**

- Polymer Rail, 5 Slot . . . . . **\$11.95**
- Aluminum Rail, 5 Slot . . . . . **\$28.95**

**BCMGUNFIGHTER™ Enhanced Lower Parts Kit**  
BCM® PNT™ Trigger Assembly, BCM® Mod 3 Grip, BCM® Trigger Guard, and Mil-Spec hardware kit.  
BCMGUNFIGHTER™ ELPK, semi-auto. . . . **\$119.95**

**BCMGUNFIGHTER™ KAG Kinesthetic Angled Grip**  
Uses a biomechanically efficient forward rake, small profile, textured front and back for positive engagement. Impact resistant polymers, available in Black, Flat Dark Earth, Foliage Green and Wolf Gray.

- KAG-KM, KeyMod Version . . . . . **\$18.95**
- KAG-1913, Picatinny Rail Version . . . . . **\$19.95**

**BCM® KeyMod Rail Panel Kits**  
In Black, Flat Dark Earth, Foliage Green and Wolf Gray.  
5.5 Inch Rail Panels, 5-Pack . . . . . **\$9.95**

**Vltor Carbine EMOD Stock** **\$119.65**

**VTAC MK2 Wide Sling** **\$44.95**

**BCMGUNFIGHTER™ VG MOD 3**  
Low-profile length for increased mobility and decreased "snag". Made in the U.S.A. from impact resistant polymers, available in Black, Flat Dark Earth, Foliage Green and Wolf Gray.

- VG-KM-MOD-3, KeyMod Version. . . . . **\$18.95**
- VG-1913-MOD-3, Picatinny Version . . . . . **\$19.95**

**Aimpoint Comp M4S**  
Red dot sight, fully NVD compatible, with QRP2 Picatinny Rail Mount  
**\$889.00**

**EOTech HOLOgraphic Weapon Sights**

- Model 512 **\$429.00**
- Model 552 **\$529.00**





# WALTHER GOP

## M2 .380

### 21ST CENTURY POCKET PISTOL

By Patrick Sweeney Cover and lead photo by Mike Anschuetz

**T**here are times and places when you just don't need a big gun. Well, when you need a gun, you always need a big gun, but sometimes the price of daily packing it is just too much. Here in Michigan, the summers always include several stretches, sometimes a few weeks each, of "90-90" weather. That is, daily max temps over 90 degrees, and always over 90% humidity. (Ok, I know, in Florida that is "A spring day" but those people are crazy.)

When even the lightest of lightweight Hawaiian shirts is all you can stand wearing, the smaller the gun, the better able you are to keep it hidden.

Then there are people who don't have the hand strength to handle a big gun, or to work the slide. The first person who quotes "The 13th Warrior" will likely

get kicked in the shorts by the nearest grandmother. Not everyone has the option of working out and getting stronger, nor be able to handle a hi-cap or a pistol chambered in .40 or .45. Which is why the .380 has been with us, going strong, ever since John Moses Browning invented it in the first decade of the 20th century. That's right, the .380 dates from before the first moving assembly line that Henry Ford installed. The .380 was a John Browning invention from 1908, and the Highland Park assembly plant, on Woodward Avenue in Highland Park, didn't get up and running until 1913.

In the last decade, we've lived through, the ammunition companies have worked hard to bring the bullet design improvements they've lavished on the 9mm, 40

[Cont. to page 16]







CARL WALTHER ULMIDO.  
MADE IN GERMANY

US IMPORTER  
WALTHER ARMS  
FORT SMITH, AR

CP  
N

WM000952

WM000952

MELT  
SURVIVAL SYSTEMS





# RESOLUTE

PROFESSIONAL GRADE WEAPONRY®

[BRAVOCOMPANYMFG.COM](http://BRAVOCOMPANYMFG.COM)



# BCM GUNFIGHTER™

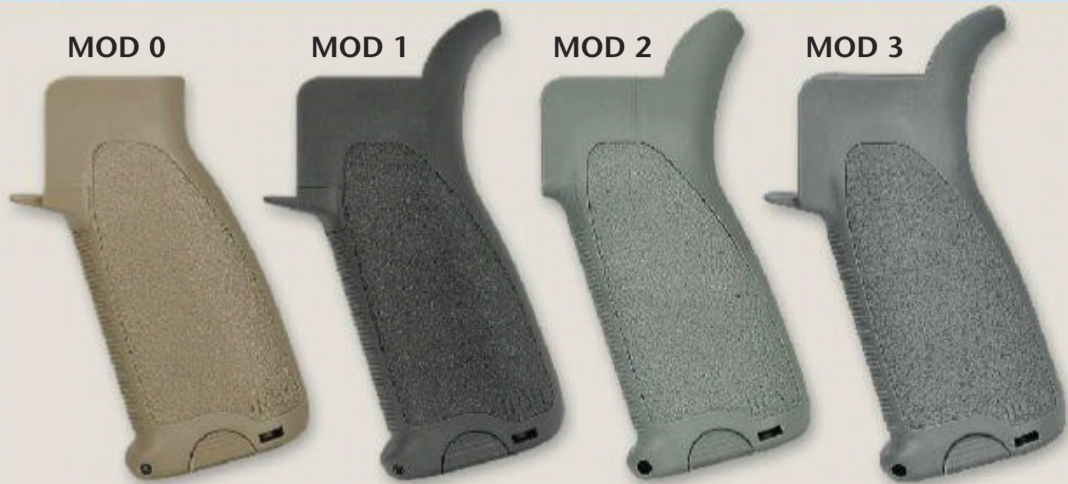

## BCMGUNFIGHTER™ Pistol Grip

- Reduced grip angle keeps wrist in line for improved trigger control
- Hinged Trap Door interior storage with water resistant rubber gasket
- Mod 0 similar to A1/A2 backstrap, Mod 1 with high rise backstrap
- Mod 2 up to 1/4 inch wider with interchangeable backstraps/inserts
- Mod 3 up to 1/4 inch wider with high rise backstrap/extended insert
- All Mods available in Black, Flat Dark Earth, Foliage Green, Wolf Gray

**BCMGUNFIGHTER Pistol Grips . . . . . Prices start at \$17.95**



## BCMGUNFIGHTER™ Stock

- Over a year in design, specifically engineered geometry, with no weak links. New patent pending latch reinvents the interface with the receiver extension, providing superior strength.
- Simple modular, snag free design utilizes only 5 parts and 1 screw
- 2 ambidextrous sling mounting options including QD swivel socket
- Color matched rubber buttpad for secure shoulder placement
- Available in Black, Flat Dark Earth, Foliage Green and Wolf Gray

**BCMGUNFIGHTER Stock . . . . . \$55.95**



## BCMGUNFIGHTER™ Vertical Grip

- Forward angle increases rigidity of the forearm, provides more natural wrist angle
- Featuring an aggressive texture, and generous storage volume
- Cross bolt designed to work with improvised tools
- Reversible clamp for fastener setup on either side
- Made in the U.S.A. from high quality, impact resistant polymers
- Available in Black, Flat Dark Earth, Foliage Green and Wolf Gray

**BCMGUNFIGHTER VG - Screw Mount . . . \$20.00**



## BCMGUNFIGHTER™ Vertical Grip - Short

- Low-profile length for increased mobility and decreased "snag" factor
- Forward angle increases rigidity of the forearm, provides more natural wrist angle
- Aggressive texture, generous storage volume
- Made in the U.S.A. from high quality, impact resistant polymers
- Available in Black, Flat Dark Earth, Foliage Green and Wolf Gray

**BCMGUNFIGHTER VG-S - Short, Screw Mount Version . . . \$35.95**  
**BCMGUNFIGHTER VG-S-KM - Short, KeyMod Version . . . \$39.95**



## BCMGUNFIGHTER™ VG

- Low-profile length for increased mobility and decreased "snag" factor
- The forward angle increases the rigidity of the forearm, while providing a more natural wrist angle
- Can be mounted in reverse angle to increase control when grabbing handguard and grip
- Flat sides with aggressive texture give better control to the shooter
- Anchor and bolt system offers a simple and robust design, while maintaining a light-weight 1.9 ounces
- Made in the U.S.A. from high quality, impact resistant polymers
- Available in Black, Flat Dark Earth, Foliage Green and Wolf Gray

**BCMGUNFIGHTER VG-KM-MOD-3 - KeyMod Version . . . . . \$18.95**  
**BCMGUNFIGHTER VG-1913-MOD-3 - Picatinny Rail Version . . \$19.95**



## BCMGUNFIGHTER™ KAG Kinesthetic Angled Grip

- Forward rake gives positive retention when using "C-clamp" method of handguard support, works as a rest for supported firing positions
- Slight angle without bulk adds just the right amount of strain relief to the wrist without substantially increasing the girth of the handguard
- Small profile, textured front and back for positive engagement
- Innovative patent pending attachment method allows for robust clamping and alignment with minimal hardware and accessory size
- Made in the U.S.A. from high quality, impact resistant polymers
- Available in Black, Flat Dark Earth, Foliage Green and Wolf Gray

**BCMGUNFIGHTER KAG-KM - KeyMod Version . . . . . \$18.95**  
**BCMGUNFIGHTER KAG-1913 - Picatinny Rail Version . . . . . \$19.95**



All pricing is subject to change without notice. Please see our website for current pricing.

Hartland, WI U.S.A. / Toll Free: 1-877-BRAVO CO (1-877-272-8626) / Fax: 262-367-0989 / [BravoCompanyMFG.com](http://BravoCompanyMFG.com)



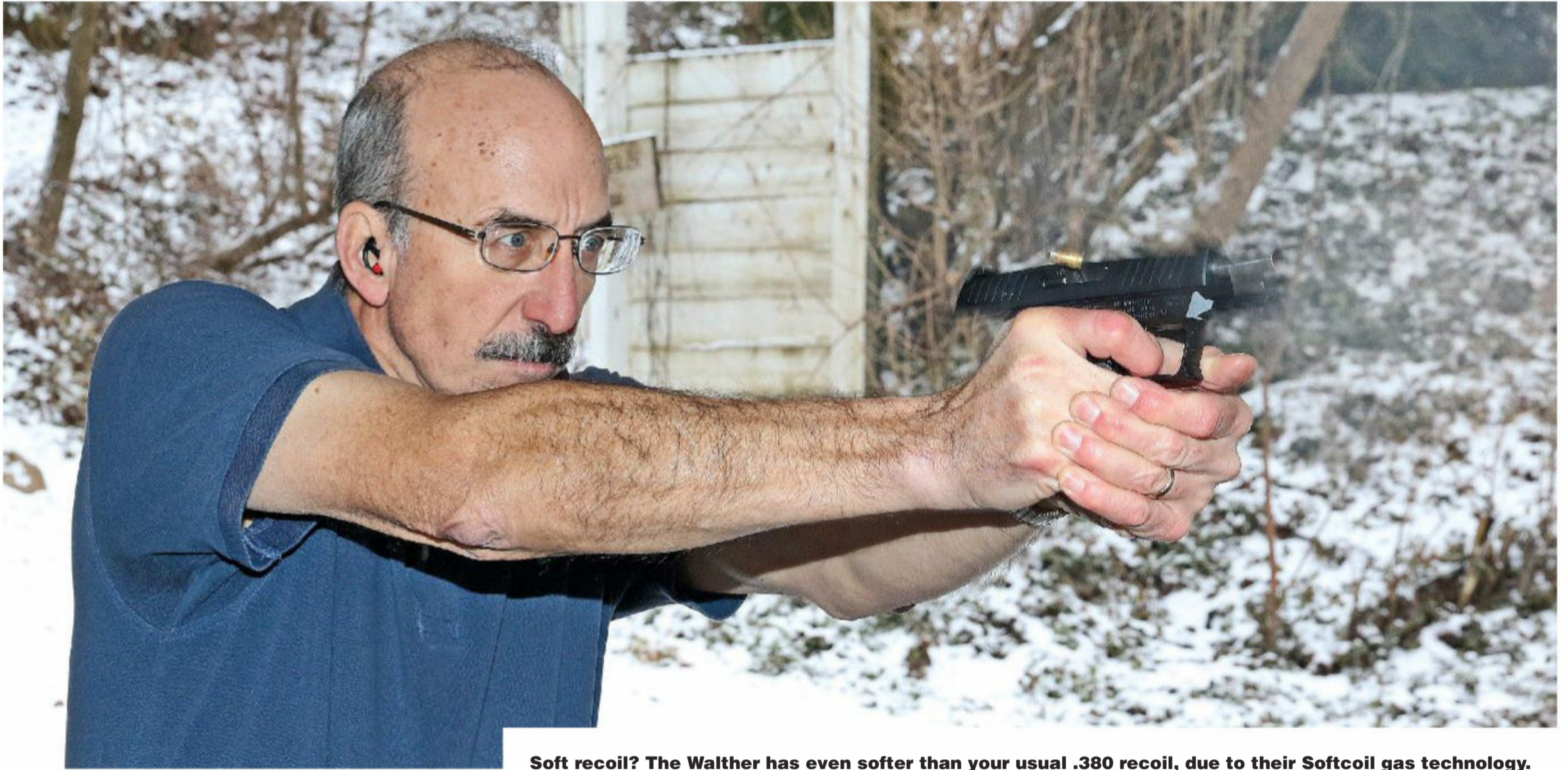

**Soft recoil? The Walther has even softer than your usual .380 recoil, due to their Softcoil gas technology.**

[Cont. from page 12]

and 45, finally to the .380, and now we have a pistol we can put them in and expect good things. The Walther CCP M2 .380.

The new Walther is named the same as its big brother, for the very good reason that they look alike. On top is a somewhat pyramidal in cross section slide, with cocking serrations front and back. The Walther logo interrupts the front left-die serrations, while the other three panels (one front and two in the rear) are left plain.

The Walther ejects to the left, as the vast majority of self-loading pistols do. There's a plenty big enough ejection port, and the spring-loaded extractor rides at the bottom line of the ejection port. The ejection port is also where all the required markings are applied. There are the required proof marks on slide and barrel, and serial number on the barrel and frame below the ejection port. One detail I find very interesting is that the frame serial number is applied directly into the polymer of the frame.

You might be wondering how Walther got away with marking the serial number in the polymer. Federal regulations are quite clear; the serial number must be stamped, etched, laser-marked or otherwise permanently marked, into metal, to a certain prescribed depth. Markings on plastic just won't do. The secret, if secret it be, is simple: what looks like the barrel, isn't. What it is is the frame portion that the fixed barrel is pressed into, and what you see as "barrel" is actually part of the frame. So, there's a serial number on the frame in two places, the barrel hoop and the polymer parts-holder.

The sights are adjustable but low-profile, so you needn't worry about the sights snagging on that rayon floral-printed horror you elected to leave the house wearing. (Yes, I'm looking at you, Jim Tarr. At least

it wasn't made in China.) Walther ships the CCP M2 .380 with extra front sights, and the tools you'll need to remove and replace, should you wish or need to alter the point of impact. On the back of the slide we

have the expected arrangement of panels that hold in the firing components of the slide, and a red-colored cocking indicator. If you see red, the mechanism is cocked. If you don't, it isn't. More on that later.

[Cont. to page 18]



**The Walther CCP M2 .380 is as ergonomic as they come, and all the details of fit and function have been properly attended to.**

**The left side of the CCP M2 .380 has the Walther logo, inset in the forward cocking serrations.**



# PERFORMANCE WHEN IT MATTERS MOST



Performance  
Center®  
by Smith & Wesson®

▶▶▶ VISIT YOUR LOCAL DEALER TO SEE THE COMPLETE  
**PERFORMANCE CENTER® M&P M2.0™ PISTOL LINE-UP**

PRO SERIES® IS USED UNDER LICENSE.



M&P®45 SHIELD™  
NIGHT SIGHTS  
3.3" BARREL

M&P®9 SHIELD™  
OPTICS READY  
PORTED BARREL & SLIDE  
4.0" BARREL

M&P®9 PRO SERIES®  
5.0" BARREL

M&P®9  
PORTED BARREL & SLIDE  
5.0" BARREL

M&P®40 PRO SERIES®  
OPTICS READY  
4.25" BARREL

M&P®9  
OPTICS READY and PORTED BARREL & SLIDE  
5.0" BARREL

Follow Us!



## M2.0®







**The serial number is on the polymer frame, as well as on the "barrel." Actually, that isn't the barrel you see there, it is the frame, and the barrel is press-fit into the frame in that area. So, the serial number is actually on the frame and the polymer shell.**

**The front sight can be changed, using the supplied tools, to alter point of impact.**



[Cont. from page 16]

On the frame, things get interesting. First of all, you will notice the swoopy lines of the frame and grip. Walther has continued to refine the lines, the feel, of their pistols, to make them as ergonomic as possible. Looking at the lines of the grip area, you'd almost swear the Walther grew it, not made it. The frontstrap is undercut, for a higher grip. The frontstrap has one bulge in it, below the trigger guard, and this is to give your second finger more locking when the trigger finger is doing its work. Not a series of finger grooves, just the one bulge to help. The curve of the backstrap fills your hand. The problem with pistols that have finger grooves, as in more than one bulge/lump/hook, is that they are never spaced at the distances of your fingers. Well, my fingers, anyway. That makes them anywhere from useless to uncomfortable. Not so on the Walther CCP .380. The grooves and swells of the sides of the grip give your fingers plenty of leverage for a non-slip grip. And all that is before Walther has even applied the stippling pattern.

Actually, it isn't stippling. It is a raised pattern of tiny arcs of material, organized so any section of it has arcs in multiple directions, so your hand will always find a frictional fit. The non-random random pattern ensures that there is always something (usually a lot of something's) resisting recoil forces, regardless of where your fingers fall on the frame and frontstrap.

The bottom of the backstrap extends slightly past the magazine opening, and this gives you an index point on reloads. The bottom of the backstrap extends until it is flush with the baseplate of the magazine. So, on reloads, you can index the magazine against the bottom edge of the backstrap, to make sure you are getting the magazine in the right place, but once it is locked home it's flush, and doesn't protrude any more than the frame does. This means fast reloads without excess material to snag on clothing or catch and print while carrying.

Oh, and those reloads? The magazine release is a button behind the trigger guard, in the expected American place, and that's why this is the Walther CCP M2 .380. M2 is their designation for the American-location release, instead of the dual-paddle European release.

Magazines have baseplates with a front lip on them, one that continues the curve of the frontstrap. So, if you have large hands, the magazine baseplate acts to



**The rear of the slide has the expected parts-containment plates, but there is also a cocking indicator, the red button in the middle of the striker guide.**

lock the frame not your grip. If your hand isn't large enough to ride on that baseplate lip, no problem, it isn't in the way. And should you need to rip the magazine out on a reload, the front lip gives you plenty of purchase for that.

The magazines are also interesting. The CCP M2 .380 uses a single-stack magazine, because, well, it is meant to be as concealable a pistol as possible, and a slim grip helps there. Each magazine holds eight rounds, and the magazine does not fight you to load it. The Walther method of making a solid tube for a magazine never ceases to amaze me. They take a sheet metal stamping, and then fold it into a tube, but here's the best part: the edges of the main part of the tube are stamped with small rectangular recesses in them. Then, when Walther presses the main part into shape and fits the tabs of a spine of steel into the rectangular recesses, they interlock and provide a rigid fit.

The whole assembly is then permanently attached together, and thus the rear section of the tube is an interlocking, self-reinforcing length of two strips of steel. Oh, and then, for extra longevity and corrosion resistance, it is nickel-plated. I stand accused (and rightly so) of being snarky about German engineering in the past. (Actually, over-engineering, but let's not be too picky, shall we?) But I have to tell you, if I could get all my magazines made this robustly, I would. In-



**The Walther non-slip grip pattern has small arcs or crescents of material, arranged so any small section of it has arcs in different directions, there's always something keeping your hand from slipping.**

between the grip and the slide, we have a collection of good parts, details and points of interest.

If you look closely, you'll see three holes in the polymer shell, each with a roll pin in them. These are the pins that attached the actual firearm, the serial-numbered part, to the polymer. The polymer shell is not the firearm, but the chassis inside is not meant to be user-serviceable. You do not take the chassis out to clean the pistol. It is not meant to be modular, and there are no other sized shells to swap the chassis into, should you even wrestle it out. Nor will there be. It was meant to be what it is, and the chassis and pinned polymer shell is just the best-engineered way to accomplish that.

On the front of the shell, there is an accessory rail, where you can park the expected light, laser, whatever. The front accessory rail is now such a customary thing that I suppose in a short while we gun writers will simply assume it to exist. And we will not mention anything about rails, until we review a pistol that

[Cont. to page 20]



# CUSTOMIZE **BUILD** SHOOT



**RIVAL ARMS™**

Premium parts for those who demand more than the status quo.



PROUDLY MADE  
IN THE U.S.A.





**The Walther CCP M2 .380 is a single-stack .380 that has an eight-round capacity. Very sleek.**

[Cont. from page 18]

lacks one. The use of a light or laser on an every-day carry pistol has become such an expected thing that the makers of lights and lasers make them compact enough to fit onto a pistol such as the Walther CCP .380. Picking one is simply a matter of selecting from an embarrassment of riches.

The trigger guard is right out of the 1980s, with a curved and grooved front face, and a small hook at the bottom. The trigger guard then goes straight back until it has to curve up to meet the frontstrap, at the lifted part of the joint between trigger guard and frontstrap.

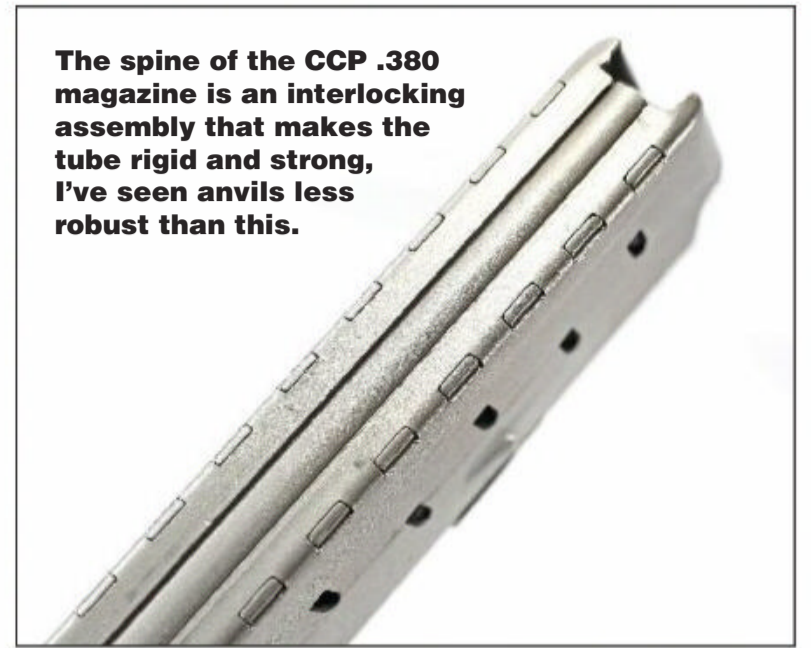

**The spine of the CCP .380 magazine is an interlocking assembly that makes the tube rigid and strong, I've seen anvils less robust than this.**



**The magazine baseplate follows the contours of the frame. The backstrap of the frame protrudes below the mag well opening, and provides an indexing location for reloads.**

## .380 AUTO

**T**he .380 Auto is a mild-pressure pistol cartridge that doesn't really require a locked breech to be handled by a pistol. The original Browning models all used straight blowback designs, and they worked just fine. But, they were all-steel (that was the only way you made pistol back then) and daily carry wasn't as common as it is today.

America was just transitioning to the automobile when the .380 was new in 1908. You could buy a .380 for maybe \$12, and an automobile for \$800. The price of the pistols edged up over time, but the price of automobiles actually came down, once Henry Ford had pioneered assembly-line production. Auto and truck chassis would be transported down a powered track, and assemblers would bolt on the parts they were assigned to install. Pistols, not so much. By 1923, the Model T base price was \$298.

Once autos became pretty much bullet-resistant, the .380 began a gradual decline. Replaced in police service by the .38 Special before WWII, and then the .357 Magnum, the .380 was relegated more and more to back-up gun status, or a ladies' gun.

But the 21st century resurgence of daily carry has changed that. A lot of people now carry, some with

**The original assembly line building is now a shell. The neighborhood is relatively safe, by local standards, but the surrounding Detroit neighborhoods are essentially free-fire zones.**



a .380 as a prime, others with a .380 as a back-up. And they want modern ammo. Federal has just announced their Hydra-Shok Deep .380 load, which penetrates to and past the 12" minimum the FBI test calls for. It does this both in bare gel and heavy clothing tests. As soon as it is available, we'll be testing it. I had thought that the .380 Auto and the .38 spe-

cial were two popular defensive cartridges that could never be made to cross the FBI 12" threshold. So, I'm looking forward to that test.

The fate of the assembly line was not as kind. The original, Highland Park, is now a shuttered shell. One of the biggest ones in Detroit, the Packard plant only five miles away, has been closed for more than half





**On the side of the polymer shell, you can see the three pins that hold the chassis inside the shell. They are not to be removed. The magazine button, behind the trigger guard, is the American location, and thus this is the M2 pistol. Above and behind those are the slide stop and safety.**

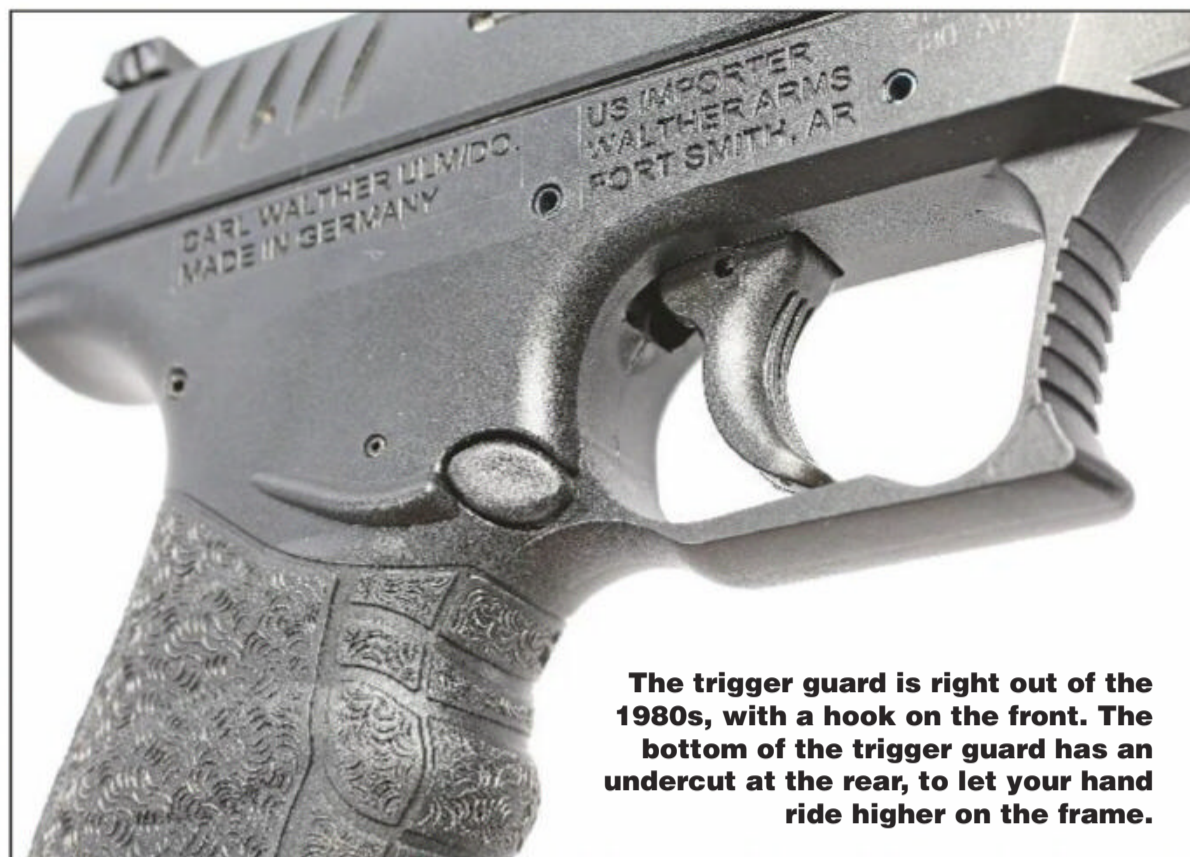

**The trigger guard is right out of the 1980s, with a hook on the front. The bottom of the trigger guard has an undercut at the rear, to let your hand ride higher on the frame.**

The trigger is curved, and lacks an internal, or central, safety blade. Behind it is the slide hold-open lever, or button. You can use this to lock the slide open, or if it is open, press down to release the slide. And behind it, is wonder of wonders, a thumb safety. A right-handed-user-only thumb safety, but a thumb safety. When I first pulled the Walther CCP .380 out of the box, I looked at the safety location and angle and thought "This is going to be a problem." Once I've logged a firearm into the bound book, I will wipe it off and then leave it on the desk while I do my research, email the makers and designers, and plan my range trips. I'll periodically pick it up and handle it,

pushing the safety (if there is one) on and off, pop the magazine out and re-insert it, you know, get the feel of it.

Not once in my handling did I fail to properly push the safety lever off or back on. Hmm, maybe the Walther designers do know a thing or two about pistols, you think?

The next wondrous detail that I noticed came when I test-fired it. I customarily do my chrono work first. This lets me know what velocities any firearm generates, but also does several other things as well. First, I see if it is going to work reliably. Second, I can check to see if it hits to the sights. And third, I get a feel for

the recoil. On the first shot with the CCP M2 .380, I stopped. I pulled out the magazine and gingerly pulled the slide back, fully expecting to have an empty case fall onto the bench. Nope, a loaded round came out.

Well, interesting. I load it back up and shoot some more. As I'm working along, I think "This is the softest-shooting .380 I've ever handled," and now that I'm paying attention, the slide is really easy to retract, as well. And that is due to the gas system. Walther calls it their Softcoil gas technology.

The CCP uses a piston that is pinned to the slide, but the pinned interface has some play to it, it is hinged, essentially. The piston slides into a tunnel in

a century, and is now a subject of photographers "ruin porn" images. Imagine, if you will, of three-and-a-half million square feet of building that stretches for nine city blocks, that would be a perfect setting for a post-apocalypse movie set, if it were not a post-apocalypse site itself. Too hazardous to actually enter, and too dangerous to get to, it is like Chernobyl with gunshots as a soundtrack. Sometimes it is just too depressing to contemplate.

Existing assembly lines now are more often found in countries where the prevailing wage is doggone it,

pretty much like the pay of the original Highland Park assembly line in 1913: five dollars a day. **FN**



**Federal has just announced the new Hydra Shok Deep .380, which promises to exceed the FBI threshold of twelve inches, and also expand.**



**This is what 3.5 million square feet of urban ruin looks like. This used to be an auto plant that employed tens of thousands, and produced products for America and the world. You go in here, you'd better have more than just a .380 on you.**





The front of the frame has an accessory rail, a place to mount a light or laser.



When the safety is up, the safety is on, and the CCP M2 .380 won't fire.



The thumb safety (not common on a .380) looks oddly placed, but falls properly under your hand for use.



The ejection port is plenty big for the .380, and the extractor is robust for the work asked of it.

the frame (below the barrel) and there is a gas port in the barrel, ahead of the chamber. When you fire the CCP .380, the gas, venting through the port, pushes on the piston. The case thrust of the cartridge wants to hurl the slide to the rear. The gas pressure in the piston resists this pressure, keeping the slide closed until the gas bleeds out when the bullet exits the muzzle.

Once pressure drops, the inertia of the case-thrust drives the slide back, but so much has been soaked up by the pressure on the piston, the resulting recoil is very soft. And the recoil spring only has to handle the residual inertia, not all of it, and only needs enough inertia on return to strip off a cartridge and close up for firing. So, recoil is greatly diminished, and the force needed to retract the slide is also greatly diminished.

Those of you who own one, or remember it, will be going "Of course, just like the HK P7." Yes, but without the obnoxiously high slide velocity, and snappy felt recoil the HK had. Also, without the heavy weight of the all-steel P7. Part of the snappiness had to be the HK handling 9mm Parabellum, instead of .380 Auto, but there was also the difference in bore height. I pulled out my HK P7 and compared. Yep, the CCP M2 .380 has the bore closer to the hand. Not much, but add that to the soft-recoiling .380, and the difference is marked, especially given the disparity on weight. The P7 is all steel, and you'd expect it to be softer in recoil. You'd be disappointed.

The ejection of empties from the CCP is to the right, but with a definite upwards component. On my gun clubs covered range, the empties rattled

around in the rafters of the roof before falling to the concrete floor.

The gas-delayed blowback system does have one drawback, or a potential drawback: lead bullets pose a potential cleaning problem. The base of a bullet is exposed to the full heat and pressure of the burning powder. Lead bullets can leave lead behind. This may or may not clog up the gas piston and tunnel in the CCP .380. However, I see this as more of a potential than actual problem. The vast majority of .380 shooters are going to be using factory ammo, and no-one that I know of makes an all-lead-bullet .380 load. Reloaders might, but the cost savings would be minimal. I did a short perusal of component prices, and the reloading difference between loading .380 with lead round-nose, versus plated round nose, came to \$18 per thousand rounds more expensive for plated. Really? For \$18 per thousand rounds, you're going to experiment with cleaning the lead out of the CCP .380 gas system?

The decreased slide spring force makes the Walther CCP .380 attractive to those with diminished hand strength. Not everyone keeps in shape with fingertip pushups, and the force needed to retract the slide on a big-bore pistol, or a regular-sprung .380, can be too much. So, for them, the Walther CCP .380 is a boon.

Another boon is the tool-less takedown. OK, I have a confession to make here. I usually don't bother with the owner's manuals of any of the firearms that pass through here. I've been taking firearms apart for more than half a century, and for more than two decades of that I worked as a gunsmith. Taking firearms apart is a puzzle long-solved. Well, the CCP .380 ended that

## .380 AUTO PERFORMANCE

Despite being depended on for generations now, the .380 Auto has never gotten much love. The basic ballistics of it, a 95- to 100-grain-FMJ-bullet, at something approaching 900 fps at most, don't exactly instill confidence.

The popularity of the round has for a long time been due more to the pistols it could be had in, than the horsepower it generated. The traditional FMJ round nose held on because it was what was used when the round was invented. When we went to JHPs, the first ones didn't expand, so no change, really.

When bullet designs began to actually expand, a problem arose: the work to expand the bullet had to come from somewhere. The end result was decreased penetration. As a result, some law enforcement agencies that allow .380s as back up or off-duty options, mandate FMJ ammunition. They'd rather have the assurance of penetration to and past the FBI 12-inch minimum, than expansion and shallow penetration.

An additional choice I'd suggest is to find the load that your pistol shoots most accurately. With the .380 (with any handgun cartridge, really) you need good, centered, hits, and the more accuracy you have from the start, the better. **FN**

string. I looked at it, I pushed and pulled, I checked all the various parts that seemed like they would do the job, and nothing. Nada. Zippo.

So, with a sigh and expecting points deductions from my man-card, I opened the owner's manual and read the process.

First, make sure it is unloaded. Then dry-fire it. Remove the magazine. Now, with one hand press in the end cap that surrounds the cocking indicator, the gizmo I call the striker guide. See the serrated panel below that? Press that to the right side, and once it clears the engagement it has with the striker guide the guide is pushed out of the slide, and the whole slide is now free to be lifted up and removed from the frame.

Once you know, it is simply a matter of coordinating some fingertip pressures. Until then, it is a complete mystery.

Getting it back together is a bit more work. The difficult part here is getting the piston to slide back into the gas tunnel in the chassis, while at the same time fitting the slide over the barrel, and down onto the frame. I found that the easiest way was to point the muzzle up, and then let the piston hang down freely from its connection on the slide, so I could tip the slide and frame around until the piston lined up with the tunnel as I slid things together. As with all such things, the first few times were a bit of work, but once I learned the touch, it became pretty easy.

Test-firing, as explained, was a pretty enjoyable experience. Along with the soft recoil, the CCP .380 delivered excellent accuracy. That's something that all

[Cont. to page 24]



NO MATTER WHAT YOU CARRY,  
**DeSANTIS HAS  
YOU COVERED**



**PEGASUS**  
by DeSantis

**SLIM-TUK®**

Reliable holsters for the  
largest variety of makes,  
models, and conditions,  
all made in the U.S.A.

WE DIDN'T INVENT CONCEALMENT,  
WE JUST PERFECTED IT!®

**De  
Santis**  
GUNHIDE



**PEGASUS**  
by DeSantis

**DESANTISHOLSTER.COM**



MADE IN THE U.S.A





**1** The start of disassembly. Unload and dry fire. Remove the magazine.



**2** Press the striker guide in...



**3** Then slide the retaining plate to the right....



**4** And once it moves to the right the striker guide is free to push out of the slide.



**5** Once the guide is free....



**6** The slide can be lifted up off of the frame.



**7** The striker guide, at full retraction after the slide assembly has been lifted off.



The piston to keep the action closed is attached to the slide, and can readily be wiped clean when you need to.

[Cont. from page 22]

fixed-barrel pistols seem to bring to the table. Even the least-expensive pistols in .380 and .32 that I've shot, you know, the ones that retailed for not much over \$100 on the high end, delivered accuracy. Those

guns had a track record of breaking with only a bit of shooting. Walther does not make stuff that breaks, so no worries there. In fact, I suspect that if something did break, someone in Ulm, Germany

[Cont. to page 26]



Once disassembled, the CCP .380 only has a few parts to keep track of, and they are all easily cleaned.



# THE RUGER-57™

## FUN TO SHOOT. COOL TO OWN.



The all new Ruger-57™ is just plain cool. Brought to you by the company that revolutionized the innovation of rugged, reliable firearms that the average American can afford, the Ruger-57™ is our most cutting-edge platform yet. Chambered in the high performance and low-recoiling 5.7x28mm caliber, this ergonomic, smooth shooting and accurate pistol is as full-featured as they come.



[RUGER.COM/RUGER57](https://www.ruger.com/ruger57)







**The accuracy of the Walther CCP M2 .380 does not disappoint. For a “pocket” pistol it is the equal of a lot of full-sized pistols.**

[Cont. from page 24]

would be forced into retirement, after a long period of soul-searching and apologizing. Walther products do not break.

The accuracy of the CCP M2 .380 was on-par with that of full-sized pistols with monger sight radiuses,

### CHRONOGRAPH AND ACCURACY DATA

Ammunition	Bullet weight (gr.)	Velocity	Es	sD	Accuracy, Ave & best
Hornady Critical Defense	90	900	46	17.6	2.4" / 2"
Winchester SXT	95	778	70	32.5	2.6" / 2.25"
Browning X-Point	95	810	113	44.2	2.5" / 2.1"
Black Hills FMJ	100	794	58	23.7	2.5" / 2.2"

Accuracy results are averages of 3, 5-shot groups at 25 yards off a Champion shooting rest. Velocities are averages of 10 shots measured on a Labradar chronograph set to read 15 feet from the muzzle.

and bigger frames to hold on to. I attribute this in part to the inherent accuracy of a fixed-barrel pistol, but also to the nice trigger and soft recoil. Don't let anyone kid you: recoil is a hindrance to good groups. A softer-shooting pistol, all other things being equal, is going to be easier to shoot accurately. The trigger, an ounce over five and a half pounds, is clean, and the trigger travel is just over a quarter-inch. If the trigger pull of the Walther CCP .380 is hindering your shooting, you are doing it wrong.

As far as holsters go, a quick check produced an overwhelming array of choices.

So, we have a light, compact, ergonomic .380 pistol, that is accurate, easy to shoot, doesn't bust the bank, and is easy to work due to the light recoil spring tension. And now, not just in black. You can have the CCP M2 .380 with polymer shells in colors such as

Angle Blue, Titanium and Tungsten, and slides either black, or bare stainless steel.

The Walther CCP M2 .380 does not disappoint. **FN**

### SPECIFICATIONS WALTHER CCP M2 .380

<b>Type:</b>	Gas-delayed-blowback pistol
<b>Caliber:</b>	.380
<b>Capacity:</b>	8+1 round
<b>Barrel:</b>	3.5"
<b>Length:</b>	6.4"
<b>Height:</b>	5.1"
<b>Weight:</b>	20 oz
<b>Trigger:</b>	5 lbs., 9 oz.
<b>Finish:</b>	Polymer, black oxide
<b>MSRP:</b>	\$469
<b>Maker:</b>	Walther USA
<b>Contact:</b>	WaltherArms.com, (479) 242-8500

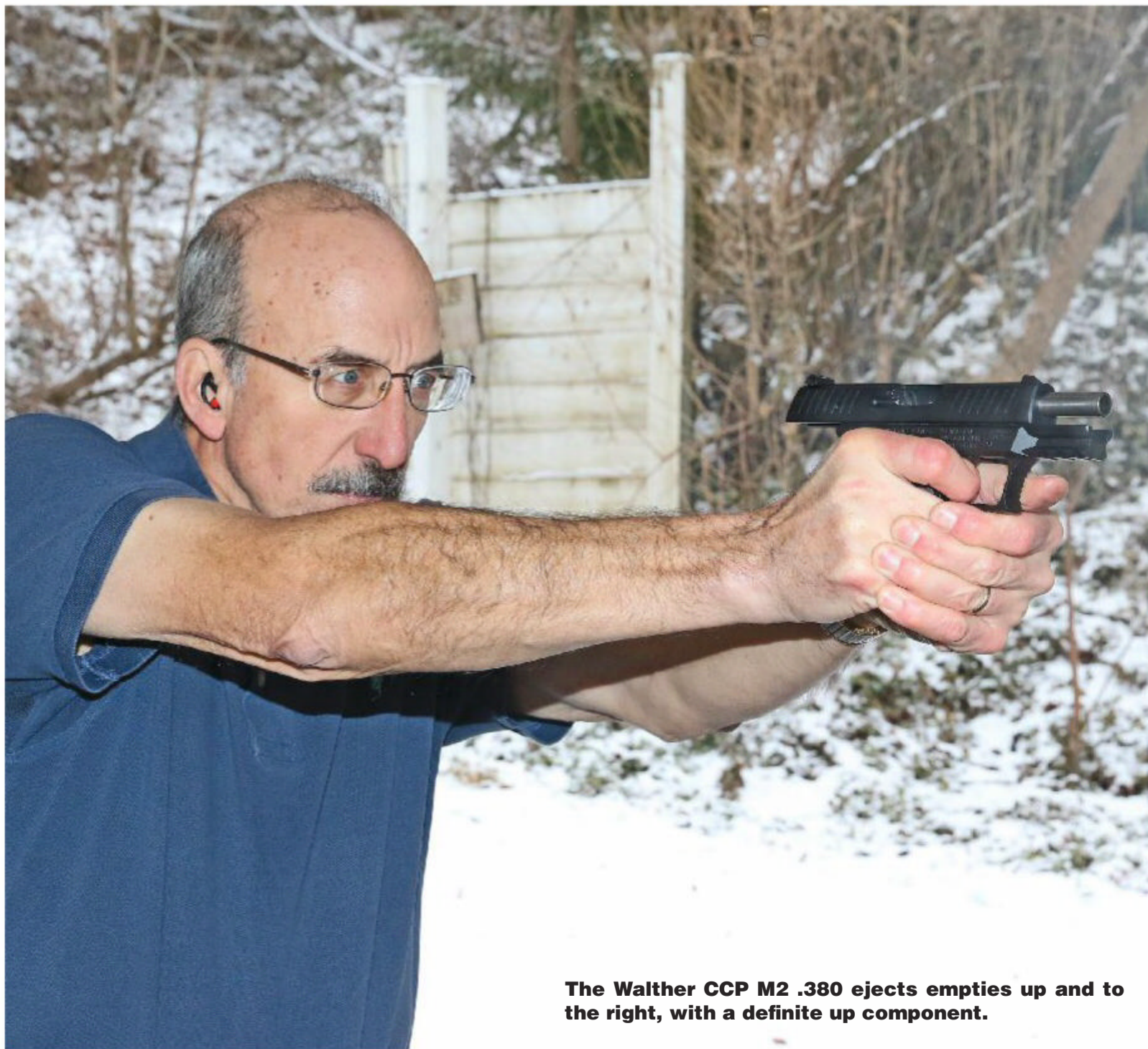

**The Walther CCP M2 .380 ejects empties up and to the right, with a definite up component.**

## GALLERY OF GUNS<sup>®</sup>.com

### WANT A WALTHER CCP M2 .380?

Check out Davidson's Gallery of Guns at [GalleryOfGuns.com](http://GalleryOfGuns.com)!

Davidson's offers the GuaranteeD<sup>®</sup> Lifetime Replacement Warranty which backs all the firearms you buy through GalleryofGuns.com. It works like this: if anything ever goes wrong with any gun you buy with the Davidson's GuaranteeD<sup>®</sup> Lifetime Replacement Warranty, it will be replaced. If no replacement is available, it will be repaired at no charge to you. Simply return it to the retailer where you purchased it, pay for the return shipping and upon receipt Davidson's will ship the returning retailer a brand-new gun for you provided one is available. If a replacement is not available your firearm will be repaired for free. For complete warranty information please refer to the Guaranteed Warranty link found at the home page of GalleryofGuns.com **FN**



PREMIUM RUSSIAN AMMUNITION

**THAT DELIVERS**

INTRODUCING OUR FIRST COMMERCIALY AVAILABLE  
**300 AAC BLACKOUT** STEEL CASE AMMUNITION

- 145GR
- FMJ
- NON-CORROSIVE
- POLYMER COATED STEEL CASE
- SUPERSONIC

**300 BLACKOUT** JUST GOT AFFORDABLE!

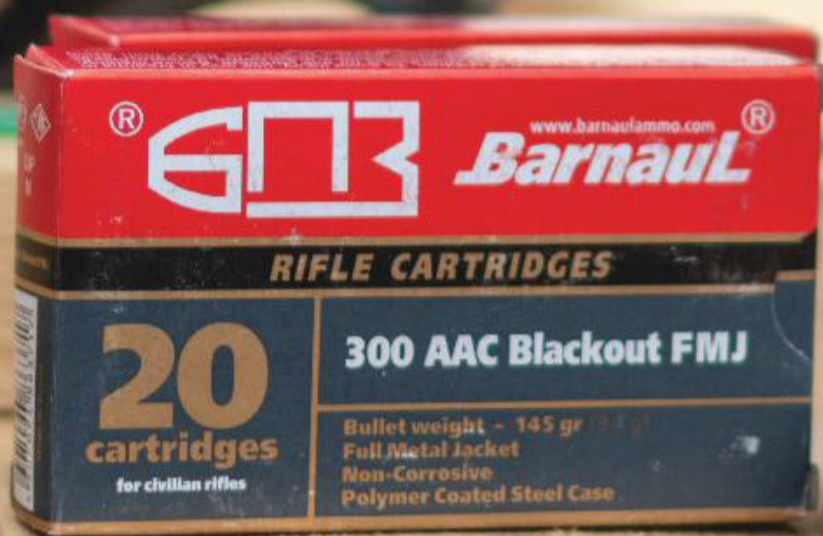

**HI-POINT**  
FIREARMS

Hi-Point Firearms are striker-fired, blow-back action firearms that are suited for every budget. With extreme reliability and accuracy they are ready for anyone looking for a first time firearm purchase or for self-defense.

Hi-Point handguns are available in four popular calibers:

- 380Auto - Model CF380
- 9mm - Model C9
- 40S&W - Model JCP40
- 45Auto - Model JHP45

AMERICAN MADE  
AMERICAN PROMISE



**C9 - 9mm**  
Our flagship 9mm handgun  
3.5" barrel with 8 round magazine  
MSRP \$ 189.00

HI-POINTFIREARMS.COM

TM



# SPRINGFIELD ARMORY HELLCAT OSP

*HELLCAT? HELLUVA DEAL!*

By Patrick Sweeney

**W**e live in a golden age of daily carry options. Back in the prehistoric era of EDC (aka: Before anyone outside of Arkansas knew the name Clinton) daily carry was only for a few, and they had few options. There was the ever-popular 1911, in the full-sized and anvil-weight Government Model (I carried one until I could find something better, despite the backaches it produced) and only ever seen in .45 ACP.

Those with contacts, or lucky enough to score one could opt for a Lightweight Commander, also in .45 ACP. Those two pistols, in .38 Super were also somewhat popular down near the southern border, but the lightweight option was rarely found, indeed scarce, in .38 Super.

Then there were revolvers. You could choose a snubbin' in .38 Special, five or six shots. You even had airweight options there. Those airweight options went away if you wanted more than a .38 Special. Go up to a .357 Magnum, and everything was steel. And if you wanted a bore bigger than .357, you had to get an even bigger revolver.

The apex was the .44 Magnum or .45 Colt. In Detroit, mere .32s were sneered at on both sides of the LE divide. .38s were little guns, Magnums were what a man would carry, and if you could, you carried more. The exemplar here is a Detroit officer who was my customer and the first gunshot save by a Second Chance vest, Ron Jagielski, who carried on and off duty back when I knew him, a six-inch nicked S&W

25-5 in .45 Colt. When he had need of a handgun, he wanted the others involved to know that he was using a big one, a not uncommon attitude at that time, and in that place.

Oh, there were numerous instances of people carrying war-surplus or imported .32s, .380s and other pocket pistols. But they were carried mostly because of extremely hot weather. Or carried in non-permissive environments. Most of those had magazine capacities that topped out at six or seven rounds. And we did not speak among ourselves of such things, as the thought of carrying a .32 was just not talked about in polite company.



The Hellcat came with a test-fire target.





**With a pistol this small, you'd expect an earth-shattering roar. But for being a Hellcat, the Springfield pistol is quite civilized.**





**The Hellcat comes fully equipped. Two magazines, lock, manual, a durable cloth transport/storage case, among other things.**

You'll notice the lack of 9mm options in the sparse offerings.

That's because the offerings were even more limited. Your choices were a Browning Hi Power, or an S&W M-39. The P35 was as big as a 1911, and while it held more ammo, the ammunition choices back then were even more limited than the sidearms. You carried round-nosed FMJ if you packed a pistol, and lead something-or-other if you used a revolver.

The M-39 was even more of a box of hammers. Not only was it as large as a 1911, it only held the same number of rounds, they were 9mm FMJs, and you had the double action trigger to deal with as well.

Oh, there was the S&W M-59, with its 14-round magazine, but it had a grip that was more like a 2x4 in its ergonomics than a pistol. No-one loved that one.

Today?

You can hardly look in the display case of your local gun shop and find choices so sparse as what we had back then. Assuming, of course, that your shop is open, and there is inventory left. But that's a pandemic thing, not a potential firearms choice thing.

And chief among the modern choices is the Springfield Armory Hellcat.

Springfield made their name as the company that made 1911s that worked and cost less than a Colt, and the M1A, a semi-auto-only clone of the M14. They still make both, offering a dizzying array of 1911s, and the finest and most useful variants of the M1A/M14. But they have expanded since then. They entered the hi-cap market with their XD (of which I have a super-custom one I'll be writing up for *Firearms News* readers in the future) and the refined

version of it, the XDm. For 1911 fans who wanted a more-compact version, they shrank the 1911 as much as they could, and then they developed the EMP, a true 9mm-scaled 1911.

But the world has more than just 1911 fans as handgun buyers, and so Springfield had their mad scientists locked in the secret lab in the bunkers in the hinterlands, where they worked up a new pistol.

And thus, we have the Hellcat.

The most succinct description I can give of the Hellcat is that it is a double stack, striker-fired micro compact 9mm pistol. Which is about like saying Marilyn Monroe was a woman with a nice figure.

And the Hellcat OSP is even better.

OK, from the top:

The slide is alloy steel, machined, deburred, inspected, tested, and given a Melonite treatment, which makes it harder than an auditor's heart and more resistant to staining than a Carthusian monk. The slide has cocking serrations fore and aft, and they are an interesting design. The slots are wide, flat-bottomed grooves, and the raised ribs in-between have a small gutter machined down them. So, you have both large and small spaces for your fingers to press into, and gain traction.

On top, the slide is flat, with rounded edges to the sides, and there is an iron sight set there to catch your eye. The front is a big glowing ball of tritium, with a white circle around it. The rear is a half-moon notch with a white half-circle that matches the notch. If this is a set not big enough for you, then we might have to consider getting you a new set of eyes. Springfield calls this their U-Dot system.

The rear of the barrel has a beveled hole in it, as a loaded chamber indicator. You need to see if you have

[Cont. to page 32]



**For fast sight acquisition, it is hard to beat a red-dot sight.**





THE PERFORMANCE LEADER.



**NEW**  
**Q4 STEEL FRAME**

Walther continues their tradition of superiority with a handgun designed specifically for those who only buy the best and nothing less. This is the ultimate representation of high-class performance in a concealed carry package that just can't be found anywhere else.

[WaltherArms.com](http://WaltherArms.com)

© 2020 Walther Arms, Inc. | All Rights Reserved.





The cocking serrations are grooves in the slide, with the tops of the grasping ridges themselves grooved.



The front sight on the OSP is a tritium-inserted blade, with the insert ringed by a yellow outline.



The rear blade has a U-shaped notch, to match the large, round, white-outlined front sight Tritium insert.

[Cont. from page 30]

a loaded pistol? (Really, they are all loaded, aren't they? Isn't that Rule # 1?) Just look through the indicator hole. Forward of the chamber Springfield has roll-marked their logo into the flat top of the slide.

The barrel, while short (that's part of the micro-compact description) at three inches, has an integral feed ramp, so the path from magazine to chamber

is smooth and assured. The barrel is cold hammer-forged, with Enfield-type rifling, so it has no problems with lead bullets, unlike some other striker-fired polymer pistols. The barrel is also given a Melonite treatment, so it is good and hard, and good and smooth.

The back of the slide is flush, there's a plate that contains the striker assembly and its associated parts, such as the striker safety.

You'll notice on the OSP that there are a pair of hefty bolts on the top of the slide. Those hold on the filler plate, which fills the gap for an optic sight. Yes, you can unbolt the plate and remove it, and then install a red-dot optical sight. The Hellcat came with an RMSc on board, and this is a good choice.

The Hellcat sent here is the original, all-black version. New is a Hellcat with a Desert FDE color in the polymer frame, and the slide is given a matching coating over the Melonite slide. The barrel, sights, and controls are left black.

Inside the slide, the Hellcat has a dual-spring recoil system, and a spring guide rod that is the full length of the system. The front end nestles into a recess machined into the rear of the slide nose spring retainer, and the rear slips into a notch machined into the lower lug of the barrel.

On the frame, the designers at Springfield went with a non-slip pattern they call Adaptive Grip Texture. A fine-grained pebbly-looking surface, the tighter you grip, the harder the texture resists movement. The

AGT is also applied to the frame below the slide, but forward of the trigger guard, as an indexing place for your trigger finger. A lot of people park their finger right there. Me, I practically wrap mine up over the top of the slide, but then I've been known to do some things to excess. The AGT wraps around the frame below the magazine release, 360 degrees with no break. Then there are two panels, one on each side, above the magazine release, as extra gripping real estate for your thumb or trigger finger knuckle joint.



You need to know what the name of your pistol is? Springfield has it right there.



The non-slip texture wraps around the grip, and Springfield has even put it on the magazine base plate.



The serial number is stamped into a metal plate, inset in the accessory rail.

## MAGAZINE GIRTH

The very early 1990s were an interesting time. The .45 still held sway in many quarters, and if you were going to offer a hi-cap pistol, it had darned well be offered in .45 ACP. The late 1980s had seen the Para Ordnance arrive. In 1990, the .40 was invented, and suddenly 9mm pistols were not hot properties. The STI frame came along in 1993, and it used .45-sized magazines.

So, we had fat .45 magazines, and scaled-up 9mm magazines for the .40 pistols.

Then there was a seismic shift in USPSA/IPC, and Open guns went full .38 Super. To make the existing pistols work, designers crimped grooves into the tubes, along the sizes, to make the internals work properly with .38 Super, not .45 cartridges.

One manufacturer tried to do it right, Caspian. They made a hi-cap frame that used magazine tubes the right size for .38 Super, and those would not hold .45 ACP. Alas, the Assault Weapons Ban came along just in time to turn the cartons of magazine Caspian had into one-time products.

And so, it went for a couple of decades, until the .40 started slipping in popularity. If you are going to make a micro-compact pistol, chambering it in .40 won't make you any friends. The loss of capacity, and the ferocious recoil made them slow sellers.

Which is now why we have 9mm-only hi-cap magazine tubes, again.

They are a must-have for capacity in really, really compact EDC pistols.

"Everything old is new again" is more than a song in "All That Jazz." It describes some aspects of the firearms industry. **FN**



Down on the bottom of the frame, on the left side, there is a small inset panel that has "Geneseo, IL." cut into the mold. That's the only break in the AGT wrap-around panel.

The front of the frame has a small accessory rail, but that rail is big enough to mount one of the ultra-compact lights or lasers that are now common. The frame is also marked there, denoting it was made in Croatia. The serial number is in a metal panel on the underside of the dust cover, inside the accessory rail.

The frame controls are all on the left side of the frame. In the rear is the slide stop, or hold-open, depending on where you are in the shooting cycle. It is protected by a small fence that borders it on three sides. You will find it highly unlikely that your hand can bump the stop up and lock the slide back before you have run out of ammo.

Up in front of that is the takedown lever. We'll go over that when we discuss disassembly.

Below that, and behind the trigger is the magazine release. It is shielded by a raised portion of the frame, that meets the button from behind and also keeps your hand from inadvertently dropping the magazine.

The trigger has a trigger safety in the center of the straight trigger. OK, straight except for a small curve forward at the very bottom of the trigger. The safety prevents the trigger from moving fully to the rear unless your finger has pressed the safety blade and cammed it out of engagement with the frame.

Then there is the subject of magazines. OK, for many years until recently, 9mm pistols have been designed and shipped with magazines that were initially intended to hold .40 cartridges. To make them work with 9mm ammunition, not only did the feed



Springfield added an indexing location of the non-slip texture, for your trigger finger to rest on.



There's a trigger-mounted safety, so you can carry the Hellcat with the firing system locked out.



The loaded chamber indicator is simplicity itself: a viewing port on the rear of the barrel hood. Note the Springfield logo ahead of the chamber.

lips have to be re-configured, but the tubes internal volume had to be changed. The easiest way to do this, and still have frame commonality between 9mm and 40 pistols, was to crimp grooves into the sides of the



The two magazines, and the third base pad that comes with the Hellcat.



Two magazines come with the Hellcat, an 11 round and a 13 round. That gives you as much as 25 rounds on your person before you invest in extra magazines.



The magazines have witness marks, and those are numbered, so you can keep track.



magazine tube, in essence making the interior smaller (to properly stack the 9mm rounds) but keep the tube externally the same size.

This was the common approach once everyone switched to the .40 back in the very early 1990s. What makers had found back then was, by using 9mm-pro-

portioned magazine tubes in the new cartridge created 40 pistols that held 10-11-12 rounds *in a full-sized pistol*. No one wanted that. So, the engineers re-designed magazines to hold enough .40 rounds to make customers happy, and then compromised to make them hold 9mm for the 9mm versions of the same pistols.

Well, no one wants a .40 anymore.

So, Springfield made the magazines the right size to hold 9mms. There is never going to be a 40 Hellcat, so there is no point in using a compromise 40 magazine. That's what makes the Hellcat both so compact, and still holding so much ammo.

The magazines have witness holes on the back as well as having the holes marked for capacity. The tube also has dual magazine catch slots. On the front, they are stamped "9mm" but that strikes me as overkill. One, try at stuffing a .40 in there, and you'll realize that these are 9mm-only magazines. But, here's always someone who didn't get the memo, hence the marking.

The standard flush-fit magazine holds eleven rounds of 9mm, with one in the chamber. You can get a standard-length magazine with a small finger lip on it, also holding eleven rounds. Or you can jump up to the extended magazine (not extended by much) and that not only has a finger-swell baseplate, but it holds thirteen

[Cont. to page 36]

## ENDURANCE TESTING

**S**ounds like fun, right? Get a pistol, rifle or shotgun, and run as much ammo through it as you and your friends can? Guess again. I've done a bunch of these, and while I can get my test-crew volunteers to show up, getting a full day's work out of them can get problematic.

One of these, I managed to score enough magazines so each of the crew got a magazine, and could fill it and shoot. Line up, load, shoot, get in line again.

It gets old, fast.

We managed to put 6,800 rounds through that gun (not a Hellcat) in one afternoon. And then I was on my own. That one, I managed 15,000 rounds, with one malfunction. The extra shooting took me months after that afternoon.



**When it comes time to do an endurance test, having friends is a big bonus. Of course, friends expect free ammo. Oh, and those with a sharp eye will notice the assistant, lower right. Yes, for good or bad, I got Jim Tarr into gun writing.**

Another, I put 23,000 rounds through a pistol, for two malfunctions. That one was all me, and it took a year. (And that was in addition to all the shooting I was doing with other firearms. This job can get to be a chore at times. No, don't weep for me, that's not necessary.)

I'm in the middle of yet another one, and each time I wrap one up I think to myself "Not doing that again!" until the next one comes along.

The only time my test crew bailed on me was when I had to test an airweight .44 Magnum. Five rounds in, one of them put it down and said, "I'm not shooting that thing again."

Even those who claim to be recoil-insensitive find they have limits. **FN**



**The red dot optics, on the OSP Hellcat, in this case the RMSc, add a dimension to our everyday carry options.**



**The OSP has a plate on the slide that you remove in order to install your red dot optic.**

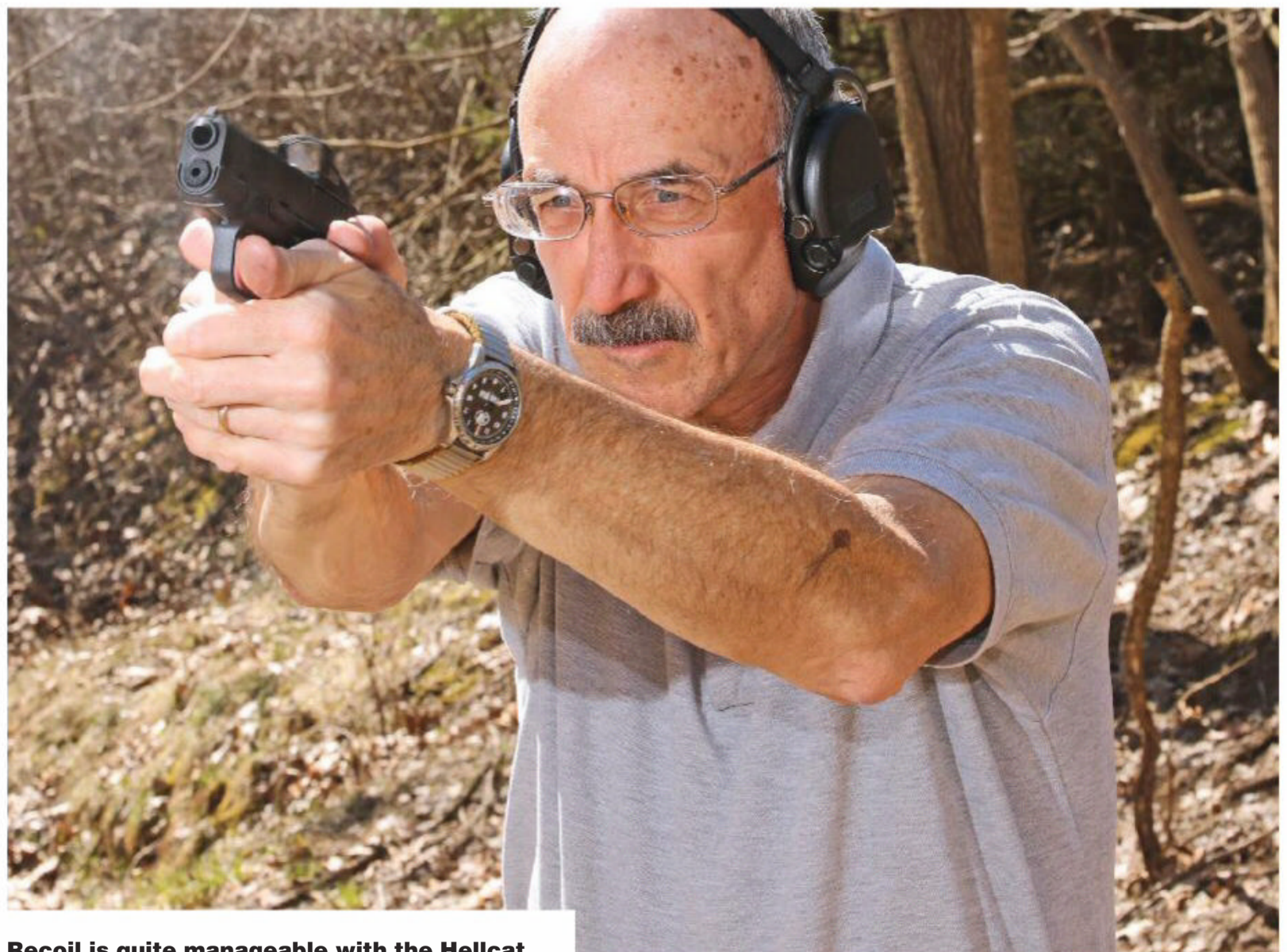

**Recoil is quite manageable with the Hellcat.**



# SECRETS OF A BILLIONAIRE REVEALED

*"Price is what you pay; value is what you get.  
Whether we're talking about socks or stocks, I like  
buying quality merchandise when it is marked down."*  
— wisdom from the most successful investor of all time

We're going to let you in on a secret. Billionaires have billions because they know value is not increased by an inflated price. They avoid big name markups, and aren't swayed by flashy advertising. When you look on their wrist you'll find a classic timepiece, not a cry for attention— because they know true value comes from keeping more money in their pocket.

We agree with this thinking wholeheartedly. And, so do our two-and-a-half million clients. It's time you got in on the secret too. The *Jet-Setter Chronograph* can go up against the best chronographs in the market, deliver more accuracy and style than the "luxury" brands, and all for far, far less. \$1,150 is what the *Jet-Setter Chronograph* would cost you with nothing more than a different name on the face.

With over two million timepieces sold (and counting), we know a thing or two about creating watches people love. The *Jet-Setter Chronograph* gives you what you need to master time and keeps the superfluous stuff out of the equation. A classic in the looks department and a stainless steel power tool of construction, this is all the watch you need. And, then some.

**Your satisfaction is 100% guaranteed.** Experience the *Jet-Setter Chronograph* for 30 days. If you're not convinced you got excellence for less, send it back for a refund of the item price.

**Time is running out.** Now that the secret's out, we can't guarantee this \$39 chronograph will stick around long. Don't overpay to be underwhelmed. Put a precision chronograph on your wrist for just \$39 and laugh all the way to the bank. Call today!

**CLIENTS LOVE  
STAUER WATCHES...  
★★★★★**  
*"The quality of their  
watches is equal to many  
that can go for ten times  
the price or more."*  
— Jeff from McKinney, TX

**TAKE 87% OFF INSTANTLY!**  
When you use your **OFFER CODE**

**Jet-Setter Chronograph \$299†**  
**Offer Code Price \$39 + S&P Save \$260**

You must use the offer code to get our special price.

**1-800-333-2045**

**Your Offer Code: JCW305-02**

Please use this code when you order to receive your discount.

*Stauer...Afford the Extraordinary.®*



Absolute best price  
for a fully-loaded  
chronograph  
with precision  
accuracy...

**ONLY  
\$39!**

Limited to  
the first 1900  
responders to  
this ad only.

*"See a man with a functional chronograph  
watch on his wrist, and it communicates a  
spirit of precision." — AskMen.com®*

- Precision crystal movement • Stainless steel case back & bracelet with deployment buckle • 24 hour military time
- Chronograph minute & small second subdials; seconds hand • Water resistant to 3 ATM • Fits wrists 7" to 9"

**Stauer®** 14101 Southcross Drive W., Ste 155. Dept. JCW305-02, Burnsville, Minnesota 55337 [www.stauer.com](http://www.stauer.com)  
† Special price only for customers using the offer code versus the price on [Stauer.com](http://Stauer.com) without your offer code.





To disassemble, unload and lock the slide to the rear.



Pivot the disassembly lever up, and ease the slide forward.



Once you get the slide flush to the frame, dry fire, and you can then remove the slide forward off of the frame.



The Hellcat, disassembled. The chassis does not come out of the polymer shell.

[Cont. from page 34]

rounds. The extended magazine also has the AGT panels on the sides of the baseplate, which is itself sized to continue the exterior shape of the frame. It is like having a full-sized (or at least, compact instead of micro-compact) frame and a short barrel and slide.

If finger-swell basepads aren't your thing, Springfield includes a flat, flush basepad in the box with the Hellcat.

Now, the OSP. The standard Hellcat models are built with regular sight systems. They also have the rear slide serrations machined to run up and over the top of the slide. You can score a Hellcat with a fiber optic front blade, if that's what you want. On the OSP, the rear serrations are subdued where they run over the optics plate. There are two torx-head screws that hold the plate in place. Remove those and you can then install a red-dot optic.

Underneath the plate you'll find locating studs, to take the jolt of recoil, and bolt-down holes that have been threaded for your red-dot. Now, the instructions for installing a red-dot are quite clear. First, you have to be using a metric-thread screw, specifically M4-0.7. That's the easy part, because your red-dot will in all likelihood come with these.

But, the slide only has so much room, or steel. The holes can only be so deep. So, you must measure the protrusion of the screws out of the bottom of your red-dot and ensure that they are no longer than 0.095" long. This should not be a problem, as everyone involved knows what the deal is, as far as getting red-dots bolted to pistols is concerned.

One detail that I like is that the optics plate does not include the rear sight, that stays on the slide. So, swapping the plate for an optic doesn't change the rear sight, and the optics bed is machined low enough that you can still see the iron sights through the optics window.

The end result is an every-day carry pistol in 9mm that holds twelve or fourteen rounds, with a red dot. A pistol so compact you can easily carry it in comfort.

Now, the designers and shooters at Springfield were quite happy with the Hellcat (Mental video of assembled Springfield staff, holding up pre-production Hellcats, to the sound of trumpets announcing progress), but pre-production isn't real-world. So, one of the first production guns was hauled off to a nearby range over a weekend, and four of the staff (with some extra volunteers) spent their time running 10,000 rounds of American Eagle 115-grain FMJ ammo through it. (The poor thing.)

They had four rounds fail to go off the first time the striker whacks into them, but they all went off the second time around. Four in ten-thousand? Works for me.

The grip circumference of the Hellcat is small, and I find it reminiscent of a 1911 with trim grips. The Hellcat is a little more square-ish, but not a problem. And not noticeable after a bit of shooting.

The trigger is interesting in feel. There's a bit of light take-up, and then the trigger pull gets heavier. Then it rolls, as if it were a very short double-action trigger, with an unpredictable let-off. The reset is short and brisk. In all, a very nice, and useable, trigger for a pistol that has a striker to ignite the primer.

Takedown is easy. Unload the pistol. Remove the magazine. Lock the slide to the rear. Rotate the front end of the takedown lever (that's the one forward of the trigger, on the left side) one-quarter turn up. Grab the slide, and release the slide lock, while easing the

[Cont. to page 38]

### CHRONOGRAPH AND ACCURACY DATA

Ammunition	Bullet weight (gr.)	Velocity	Es	sD	Accuracy (in.)
Norma	108	1,149	52	18.7	2.6
Archon	124	1,002	31	12.1	2.7
Hornady XTP	147	944	34	14.6	2.3
Federal HST Micro	150	881	16	7.0	2.5

Accuracy results were to be averages of 3, 5-shot groups at 25 yards off a Champion shooting rest. Velocities are averages of 10 shots measured on a Labrador chronograph set to read 15 feet from the muzzle.



# CONCEALED CONFIDENCE™

FOBUSHOLSTER.COM

- Rapid Draw
- Innovative Active & Passive Retention
- Maximum Comfort & Concealability
- Durable Injection Molded Polymer
- Hundreds of Holsters and Mag Pouches



ISRAEL'S LEADING HOLSTER MANUFACTURER SINCE 1978



UINTAHPRECISION.COM



TRUE BOLT ACTION  
AR10 / AR15  
RIFLES & UPPERS



[Cont. from page 36]

slide to its forward position. Once there, dry-fire it, and the slide assembly will now come forward off of the frame.

From here the process is the usual, pry the recoil spring assembly out of its seat in the barrel, then tip

## HISTORY OF RED-DOTS

The first red-dot sighting that moved the needle came at the 1990 USPSA Nationals. There, Jerry Barnhart used a red-dot optic (by today's standard, huge, with a narrow view and dim image) to thoroughly kick our butts. It made such an impression that within a few months, Doug Koenig had installed a red-dot on his pistol and used it to win the IPSC World Shoot. By the next season, if you didn't have a red-dot on your pistol, you were not going to win anything. The early years were... interesting. We basically had to fabricate mounts ourselves. Doug even went so far as to weld his together, to make it fit his pistol.



**This is the pistol Doug Koenig used to win the 1990 IPSC World Shoot. Yes, the rings are welded to the base. Hey, it was 1990, remember? Who had pistol scope mounts then?**

1991 was my last year with an iron-sighted pistol, and while I actually managed to place in the top ten in at least one stage at the Nationals that year, I was also building a pistol with a red-dot optic. By then we competitors had gone through two or three generations of optics, and had heinously modified them along the way. By the 1999 IPSC World Shoot, I was using a Modified Division gun that had the red-dot fitted into the slide, not on an external mount. I wrote soon after that that a red-dot optic would in the future be a daily carry, or duty, option on a pistol, just as it was becoming for rifles.

If only my ability to pick lotto numbers matched my ability to predict firearms trends. **FN**

the barrel and pull it down and backwards out of the slide.

The frame has the fire control parts assembled into a chassis that is pinned into the polymer shell. The chassis is not meant to be removed from the shell. This is not a modular design, so don't; go whacking on the pins with a punch and hammer, they aren't meant to come out. The various parts for the Hellcat can be cleaned by the usual methods, with the exception of the red-dot optic. If you have an OSP, and a red-dot on it, you won't be able to run the slide through your ultrasonic cleaner. That's

a small price to pay, to have the speed and accuracy of the RDS.

Reassembly is easy. Put the slide, barrel and recoil spring back together. Make sure the takedown lever is still up. Line the slide up on the frame and run it back to full recoil position. Lock the slide back and lever the takedown lever back to horizontal. That's it.

The trigger of the Hellcat was a great aid in accuracy testing, along with the RSMc red-dot sight. Usually, with a pistol this small and light, accuracy testing is an ordeal, and tests the shooter as much as the pistol. The Hellcat gave excellent results. **FN**



**This is a typical group from the Hellcat, and the credit should go to the really nice trigger, and the red-dot optics.**

### SPECIFICATIONS

#### SPRINGFIELD ARMORY HELLCAT PISTOL

<b>Type:</b>	Hammer-fired semi-automatic
<b>Caliber:</b>	9mm Parabellum
<b>Capacity:</b>	11+1 rounds and 13+1
<b>Barrel:</b>	3"
<b>Overall length:</b>	6"
<b>Weight:</b>	18 oz
<b>Finish:</b>	Melonite, polymer
<b>Grips:</b>	N/A
<b>Sights:</b>	Tritium U-Dot or RDS
<b>Trigger Pull:</b>	5 lbs., 9 oz.
<b>Manufacturer:</b>	Springfield Armory, 800-680-6866, SpringfieldArmory.com
<b>MSRP:</b>	\$599 (RDS extra)

## GALLERY OF GUNS<sup>®</sup>.com

### WANT A SPRINGFIELD ARMORY HELLCAT PISTOL?

Check out Davidson's Gallery of Guns at [GalleryOfGuns.com](http://GalleryOfGuns.com)!

Davidson's offers the GuaranteeD<sup>®</sup> Lifetime Replacement Warranty which backs all the firearms you buy through GalleryofGuns.com. It works like this: if anything ever goes wrong with any gun you buy with the Davidson's GuaranteeD<sup>®</sup> Lifetime Replacement Warranty, it will be replaced. If no replacement is available, it will be repaired at no charge to you. Simply return it to the retailer where you purchased it, pay for the return shipping and upon receipt Davidson's will ship the returning retailer a brand-new gun for you provided one is available. If a replacement is not available your firearm will be repaired for free. For complete warranty information please refer to the Guaranteed Warranty link found at the home page of GalleryofGuns.com **FN**



# UNTAMED ADVENTURE

**BACKCOUNTRY HUNTER** 2019

**DIY! 10 HUNTS TO DO NOW**

INSIDER INFO: BEST UNITS FOR BIG GAME

BOWHUNTING BULLS: TROPHY ELK IN THE COLORADO WILDERNESS

MASTER CLASS: THE SKILLS TO SURVIVE

GEAR GUIDE: MOUNTAIN BIFLE, BACKCOUNTRY PACKS, RIDGED BOOTS, SATELLITE COMMUNICATION

**COMING TO A NEWSSTAND NEAR YOU!**

**LOG ON TO** [osgnewsstand.com](http://osgnewsstand.com)

Also available for iPad, Android Tablets, Kindle & Nook

# Like, comment and share all the latest news!

[www.facebook.com/FirearmsNewsMag](http://www.facebook.com/FirearmsNewsMag)

Find us on

## OWN THE MOST IMPORTANT COIN OF CHRISTIAN HISTORY

### 1,600-YEAR-OLD COIN FROM THE FIRST CHRISTIAN EMPEROR

Constantine the Great was the world's first Christian Emperor. But he didn't start out that way...

Ruling from A.D. 307 to 337, Constantine began as many of his reign as a worshiper of Sol Invictus, "The Unconquerable Sun." But after a vision of the Cross led to his victory at the legendary Battle of the Milvian Bridge, and later to him being crowned sole Emperor of the Roman Empire, Constantine shifted his beliefs.

Believing that Sol Invictus and Christ were one and the same, Constantine legalized Christianity, allowing it to flourish. He merged the worship of Sol Invictus and Christ, creating religious practices still observed by modern-day Christians. And he authorized the striking of this Nummus coin—the first true coin of a Christian Empire, and thus the most important coin of Christian history.

Constantine used the image of Sol Invictus to spread the Christian gospel, this is truly the first coin of Jesus Christ!

**A LEGEND MORE THAN 1,680 YEARS IN THE MAKING**

For nearly seventeen centuries, these stunning coins have survived earthquakes, floods, and the rise and fall of empires. Most coins that survive that long appear flat and worn out—but not these coins!

Each piece has been individually authenticated and certified by Numismatic Guaranty Corporation (NGC) as incredible Extremely Fine (XF) condition—meaning they actually changed hands in commerce!

**Deluxe Coin Holder**

**RESERVE YOUR COIN TODAY!**

Order now and you can claim the first coin of Christianity—struck under the rule of the world's first Christian Emperor—for less than \$100!

But you'll have to move quickly—only 65 of these 1,600-year-old coins of Constantine the Great are available certified in XF condition.

Hold 1,600-year-old Christian history in your hands. Call now!

**Coin of Constantine, the First Christian Emperor \$99.95 + s/h**

**FREE SHIPPING on 2 or More!**

Limited time only. Product total over \$149 before taxes (if any). Standard domestic shipping only. Not valid on previous purchases.

**Call today toll-free for fastest service**  
**1-888-517-8599**  
**Offer Code BCC235-02**  
 Please mention this code when you call.

**GovMint.com®**

**GovMint.com** • 14101 Southcross Dr. W., Suite 175, Dept. BCC235-02 • Burnsville, MN 55337

GovMint.com® is a retail distributor of coin and currency issues and is not affiliated with the U.S. government. The collectible coin market is unregulated, highly speculative and involves risk. GovMint.com reserves the right to decline to consummate any sale, within its discretion, including due to pricing errors. Prices, facts, figures and populations deemed accurate as of the date of publication but may change significantly over time. All purchases are expressly conditioned upon your acceptance of GovMint.com's Terms and Conditions ([www.govmint.com/terms-conditions](http://www.govmint.com/terms-conditions) or call 1-800-721-0320); to decline, return your purchase pursuant to GovMint.com's Return Policy. © 2020 GovMint.com. All rights reserved.



# THE HK





# VP9SK-B

Giving the American Market What It Wants and Needs

By James Tarr



While not the subcompact that its name would imply, the HK VP9SK-B is a very viable CCW pistol that comes with three magazines and night sights. The 'B' version sports an American-style magazine release.





Between the American-style magazine release on the VP9SK-B, its three magazine baseplate options, and the fact that HK is now finally selling a true (semi-auto) version of the MP5 commercially, HK now seems to be selling the firearms American consumers actually want.

**H**eckler and Koch (properly pronounced ‘Coke’) introduced the VP9 in 2014. It was not their first striker-fired pistol, and far from their first polymer framed gun — for example, the HK VP70 machine pistol was produced in the 1970s and is a polymer-framed striker-fired gun.

HK has seen so much success with the VP9 that they are now offering a number of different versions, including one in .40 S&W (the VP40), an “optics ready” model, and a compact version, the VP9SK. They’re also updating the design, for example upgrading the magazines for the full size model from 15 rounds to 17.

For this special CCW issue, I secured a sample of the new VP9SK-B, which is perhaps the version of this design most suited to concealed carry. Not only is it compact, but it comes with three different magazines and night sights, and an American-style pushbutton magazine release (which is the ‘B’ model).

The full-size VP9 has a 4.09-inch barrel and flush magazines hold fifteen (soon to be 17) rounds of 9mm. It is roughly the size of a Glock 17, which means it is a bigger pistol than what most people are willing to carry. The VP9SK model, on the other hand, has been reduced in size for carry. The barrel has been shortened to 3.39-inches, and the grip shortened by nearly three-quarters of an inch so flush magazine capacity is ten rounds.

Now for your brief German lesson. The VP stands for *Volkspistole*, literally ‘people’s pistol’. Which is ironic, considering the restrictive process in which

German citizens must go through in order to own handguns. (In Germany, this pistol is officially the SFP9.) The SK stands for “subkompakt” which I think even Antifa members wouldn’t need me to translate into English, but I’ll do it anyway — SK means “sorta compact.” Because, apparently, Germany has

a different idea about what constitutes a subcompact pistol than most Americans. The ‘B’ in the title means it has an American-style pushbutton magazine release instead of the VP9’s original paddle magazine release. Knowing HK, I’m sure the ‘B’ stands for “bad Americans,” but again I digress.



With the flush magazine inserted the SK-B is a somewhat small gun, however Tarr doesn’t think it actually qualifies as a “subcompact,” as such guns should fit into pockets and this is a holster gun. But it is a great choice for CCW.



Overall, the SK-B is 6.61 inches long, 4.57 inches high, and 1.31 inches thick, weighing 23.07 ounces with an empty magazine in place. It's not the length and height which I think push this pistol out of the subcompact category (it is the same height as a S&W Shield and only half an inch longer) it is the thickness of the gun. For its size it is a very thick gun, which might make it harder to conceal than you might expect from a "subcompact."

Please, don't for a minute think this is a criticism. Small guns are easy to carry and hard to shoot, which is why I've always been a fan of carrying a big gun and

dressing around it. Depending on which magazine you've got in this pistol (more on that in a second) the VP9SK-B is eminently concealable with the right holster/belt/covering garment combo, while shooting as well as many full-sized pistols.

The VP9SK-B is a limited production run of the VP9SK. All the B models fall into the "limited production" category, although HK is selling more of them in the US than the standard VP9 with its bilateral paddle magazine release. The polymer push-button magazine release of the B model is reversible. HK has a brief video on the product page for this

pistol showing how to reverse the magazine release, and it is simple — all you'll need is a flat-head screwdriver and a few seconds.

To HK's credit, they came out with a completely new gun when they designed the VP9. Yes, it does look a lot like their P30, but how many people even know what an HK P30 looks like? HK historically has done a mediocre job of selling themselves to the U.S. consumer market, but that seems to be changing with HK USA.

First to clarify — the VP9 is not a (hammer-fired) P30 that has been retrofitted into a striker-fired gun (cough\*SIG P250=P320\*cough). While it shares a lot of the design points, and the P30 magazine, the VP9 is an all new design, one that takes full advantage of the striker-fired trigger system which allows for a much lower bore than you'll find on any other HK pistol.

The 3.39-inch hammer forged barrel and the slide sport HK's corrosion-resistant "hostile environment finish." As this pistol is made in Germany, you'll see the serial number on the frame, the slide, and the barrel, along with the proof house markings.

There are nicely aggressive flat-bottomed serrations front and back on the slide. They cover a lot of real estate, but the engineers at HK weren't that easily satisfied, they also equipped the pistol with "charging supports." These are polymer ridges that stick out from the very rear of the slide under the rear sight, behind the rear slide serrations, and provide for the ultimate in traction for people wearing gloves or with reduced hand strength. From behind they make the slide look rather fat, but from the side you might not even notice them.

When cocked the rear of the striker is visible through a hole in the back of the slide, and there is a small red dot on it. It does not protrude from the slide at any time. The barrel has polygonal rifling which should be very familiar to anyone who has ever looked down a Glock barrel.

Unique to this pistol variant are the TruDot night sights, made by Meprolight. These are steel sights, and the tritium inserts have white outlines.

**The HK VP9SK-B on the left compared to a full-size VP9 (with original lever magazine release) on the right. The compact pistol retains all the features of the larger one.**



**With the pistol you get three different magazines, three sizes of backstraps, three grip inserts for each side, a magazine loader, and a lockable case.**



## SEISMIC “HIGH MASS” 9mm AMMUNITION



Seismic Ammunition is a new brand with an extremely heavy-for-caliber 185-grain 9mm round. They are promoting it as high-mass ammunition.

I'd been hearing of Seismic "High Mass" Ammunition (SeismicAmmo.com) for quite some time, and after being subjected to a lengthy video featuring a well-known bearded tactical trainer espousing the merits of their 9mm load without providing any factual data (cough\*undeclared paid endorsement?\*cough) I purchased some to test it.

Seismic's heavy 9mm load features a 185-grain bullet loaded as fast as possible to keep it still subsonic, an advertised 900–1050 feet per second depending on whether you're shooting it out of a pistol or PCC. It is loaded to 9mm NATO pressures, which equate to a light +P load. Such a heavy bullet in the 9mm cartridge isn't unheard of, I've read about Navy SEALs in the 1980s experimenting with 170-grain bullets in 9mm to maximize the performance while still keeping them subsonic for their suppressors. This ammo is designed to work best in larger (4-inch+ barreled) handguns.

The bullets are hollowpoints and have a black nitride coating. They are loaded into Shellshock NAS3 hybrid two-piece cases, which have a steel base and an aluminum body. These cases are lighter than traditional brass cases while advertised as being able to handle higher pressures.

Seismic's slogan is "Heavier hits harder." In fact, rifles hit harder than pistols, and it's not because their bullets are heavier, it's because they're travelling significantly faster. However, you simply can't get that kind of velocity out of pistols, which is why Seismic's advertising for this round is all about the mass.

[Cont. to page 46]



The VP9SK-B with a flush 10-round magazine inserted. Next to that is a 10-round magazine with extended finger hook, 13-round magazine with grip extension, and full-size 17-round VP9 magazine for size comparison.



The rear night sight is steel, tritium inserts with white outline rings. When the striker is cocked (as seen here) a red dot is visible at the rear of the slide. The polymer "wings" at the rear of the slide for improved grip are visible.



From the rear the polymer "charging supports" make the slide look fat.

More interesting than the sights, however, is the modularity of the grip. Like the P30, the HK VP9 offers both interchangeable backstraps and side panel grip inserts. Medium-size panels and backstrap were installed on my pistol from the factory, but the small and large ones were in the case in their own foam cut-outs. All the backstraps and grip panels are marked S, M or L, and the grip panels are also helpfully marked Left or Right.

The HK VP9's grip panels slide out to the rear after you've removed the backstrap. To get the backstrap off, all you have to do is push out what most of us would call a roll pin, but HK's engineers term a "clamping sleeve."

I was curious if mixing and matching the different sizes would result in sharp edges or steps between panels and backstraps of differing sizes, but that's not the case. So, if you want a large right grip panel,

small backstrap, and medium left grip panel, go for it.

More important to your performance than the sights or the grip, however (at least in my opinion), are the magazines provided with the pistol. HK provides three — a flush-fitting ten-round magazine, a ten-round magazine with an extended fingerhook basepad, and an extended 13-round magazine with a grip extension.

The front of the frame has two finger grooves, and most people will find two fingers are all they can get on the frame. Their pinkie will most likely be hooked around the baseplate of the magazine. This doesn't provide you with as much control as you might like, but of course carried this way the pistol is more concealable.

With the 10-round magazine with extended fingerhook you can get your entire hand on the pistol,

[Cont. to page 46]



# BCMGUNFIGHTER™



Carbine Length

Mid-Length

## BCMGUNFIGHTER™ PKMR Polymer KeyMod Rail Handguards

- Direct "drop-in" design replacement handguard for AR15's with mil-spec front sight base
- Natural ergonomics, slim, comfortable and lightweight, with an aggressively textured area for enhanced traction
- Featuring a reinforced KeyMod interface for durable accessory support with three, six-hole KeyMod mounting surfaces
- Aluminum heat shield reduces heat transfer to the handguard and shooters' hand
- Patent Pending design, made in the U.S.A.
- Will only fit round carbine-type handguard retaining cap
- Available in Black and Flat Dark Earth

## BCMGUNFIGHTER™ PKMR

Carbine Length .....\$24.95

Mid-Length .....\$26.95

★ **BravoCompanyUSA.com** ★

BravoCompanyMFG.com • Hartland, Wisconsin U.S.A.  
Toll Free: 1-877-BRAVO CO (1-877-272-8626) • Fax: 262-367-0989  
Pricing subject to change without notice. Please see website for current pricing.

# AIR ORDNANCE

made in U.S.A.

**BELT FED**



**100 ROUND DRUM**



**CUSTOMIZABLE**



**FULLY AUTOMATIC .22**

WITH 100 ROUNDS, IT SURE IS TOUGH TO MISS. THIS BELT FED, FULLY AUTOMATIC .22 PELLET GUN COMES IN A VARIETY OF DIFFERENT PACKAGES FROM BASIC GUN TO THE TACTICAL "ELITE" PACKAGE. FUN AT THE RANGE AND IN THE FIELD.

**AIR ORDNANCE**  
800-671-1498  
3518 ADAM CENTER ROAD  
FORT WAYNE IN, 46806

**NOW AVAILABLE**

# 5.56MM 77 Gr. MK 262 MOD 1-C

Group averages of 2" or less at 300 yards

64 MOA maximum/10 shot groups

Each can ships with lot accuracy documentation



Velocity 2750 FPS  
Energy 1293 FT. LBS.

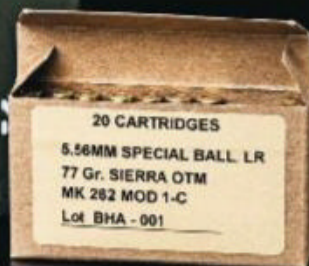

*Ammunition*

TO LOCATE A DEALER  
NEAR YOU, CALL 800.568.6625  
WWW.BLACK-HILLS.COM







The front sight is steel. There is a tritium insert with a white outline. The forward cocking serrations are nicely aggressive.



The compact VP9SK pistols accept the original 15 or the new 17-round magazines meant for the full-size VP9 pistols, as seen here.



With the VP9SK-B you get all sorts of slide serrations front and back, as well as a three-slot tactical rail for mounting a light.

[Cont. from page 44]

but I don't see very many people using this magazine. Why? Because it is the same length as the extended 13-round magazine, and why go with 10 when you can have 13?

This pistol will of course accept the magazines meant for the full-size VP9. The original full-length magazines hold fifteen rounds, and new for 2020 are 17-round magazines. Personally, the 13-round magazine with grip extension makes this feel like a completely different gun, and even though it isn't as concealable that is the magazine I'd have in this pistol if I was carrying it. It vastly improves handling and controllability while shooting.

In the "just because you say something a lot doesn't make it true" category of firearms hyperbole, HK continues to tout that the VP9 has a trigger pull that is "best in class." Now, admittedly, "best" is a subjective term, which makes it nearly disprovable by lawyers. The trigger pull on the VP9 series of pistols is very acceptable — just about as crisp as a striker-fired trigger pull gets, while not being too heavy.

I had to dig through the German HK website to find the official trigger pull specs for the VP9. The standard TR trigger pull is 30–35 Newtons, and their SF (Special Forces) trigger pull is 20–25 Newtons. For those of you still rejecting the Metric system, in addition to whatever the heck measuring system uses Newtons (Martian?), let me translate that into English for you: the standard trigger pull is 6.7–7.8 pounds, and the SF trigger is 4.5–5.6 pounds. Considering every VP9 or VP40 trigger pull I've tested has been under 5.6 pounds, it appears that HK has equipped the pistols heading to the US consumer market with their lighter SF trigger, which both surprises and pleases me. That makes them not quite as good as the Walther PPQ, but better than every Glock except, maybe, the Gen 5s. Trigger pull on my sample SK-B was 5.25 pounds.

The trigger itself is polymer and curved, with a safety lever in the center. The trigger face has some tiny ridges to either side of the safety lever, which itself has a groove in it, so the trigger feels serrated

[Cont. to page 48]



Tarr fired the Seismic 9mm ammo through a pistol (Beretta 92) and a Ruger PCC (from left to right) into both bare gel, and gel covered with heavy clothing. The bullets expanded in bare gel (much more so when fired out of the PCC), but did not expand when fired through gel blocks covered in clothing, although they did penetrate deeply.

[Cont. from page 44]

This 185-grainer is called their Quakemaker +M (mass) bullet. I understand the love of heavy bullets. Heavy bullets usually mean deeper penetration, and you can't convince the bad guy to stop what he's doing if the bullets you're firing at him aren't reaching any of his vital organs. That is why a number of serious gun toters that I know choose 9mm defensive loads with heavy-for-caliber 147-grain bullets.

My experience has shown me, however, that by choosing 147-grain bullets you're almost guaranteeing your bullets won't expand, because of a lack of velocity. Even the best and most modern 9mm bullets in this weight only expand some of the time.

For this evaluation I chronographed and did ballistic gel-block testing with both a pistol and a PCC — in this case a Beretta 92 Elite LTT with a 4.7-inch barrel (which is a duty-sized handgun), and a Ruger PC Carbine with a 16.12" barrel.

Using an Oehler Model 35P chrono, out of the Beretta's 4.7-inch barrel the 185-grain bullet posted 894 fps. Out of the longer barrel of the Ruger PCC it did 992 fps. It remained subsonic even out of the longer barrel, and felt recoil was on par with most 9mm rounds. Velocities were very consistent between rounds, with standard deviations in the teens, showing good QC.

For gel block testing I used blocks from Clear Ballistics. Unlike true FBI-spec 10% ballistic gelatin these blocks are polymer, but provide similar results. Extensive testing by me in concert with the Black Hills Ammunition's ballistics lab, echoed by information I've received from Federal Ammunition, are that bullets expand the same in these Clear Ballistics blocks as FBI-spec gel blocks, however they will penetrate roughly 10% deeper than when fired into actual gel blocks, so keep that in mind.

I fired bullets from both the handgun and carbine into both bare blocks and blocks covered

[Cont. to page 48]



## HOLLYWOOD MAGIC PUT TO THE TEST

Can you really do that? The most memorable action scenes from movies and TV meet real-world science in an all-new season of Hollywood Weapons. Hosts Terry Schappert and Larry Zanoff will break down scenes from *Indiana Jones and the Last Crusade*, *The Godfather: Part III*, *The Three Musketeers*, *MacGyver* and more.

## HOLLYWOOD WEAPONS

**ALL NEW**  
WEDNESDAYS 7P ET

Outdoor







The 'B' in the VP9SK-B means it has an American-style push-button magazine release. It is easily reversible, and low profile to prevent accidental activation.



The only difference between the SK and the SK-B is the magazine release, so all slides are marked SK. Both the takedown lever and slide release are low profile.

[Cont. from page 46]

with the FBI's "heavy clothing" barrier, which consists of two layers of cotton shirt material under a layer of cotton-poly sweatshirt under a layer of denim.

In bare gel the bullet fired from the Beretta penetrated 13.25-inches and expanded to .60", with 100% weight retention. Only the very front of the hollow point expanded. When fired through the carbine the bullet penetrated an even 16-inches while expanding to .70", with again 100% weight retention. This is very good performance and honestly better than what I was expecting.

The FBI heavy clothing test is good because not only do bad guys usually wear clothes, but layers of fabric tend to slow down or prevent the expansion of hollowpoints, and that's what I found with this ammo. When fired out of the Beretta through the heavy clothing barrier, the bullet penetrated 21.25-inches and did not expand at all. When fired from the Ruger PCC through heavy clothing, the bullet penetrated the block 23.25-inches and again did not expand.

Once you do the conversion from polymer to gel blocks even with the impressively heavy bullets these 9mms just barely exceeded the FBI's recommendation of 18 inches of penetration.

However, ... through the FBI's "heavy clothing" barrier the Seismic bullets didn't expand at all. I am unsurprised, this is very common with bullets that are "heavy for caliber." They're just not moving fast enough for their weight to diameter ratio.

If you have studied ballistic testing at all you know a standard 9mm NATO 124-grain FMJ round will penetrate ballistic gel 20- to 25-inches, so if you're only concerned with penetration, buy some FMJ ammo. It's a heck of a lot cheaper than hollowpoints that probably won't expand. **FN**



With the VP9, not only are the backstraps interchangeable, but so are the grip inserts on the sides. Three sizes of each are provided with the pistol.

[Cont. from page 46]

under your finger, although the face of it is relatively flat, which is a good thing.

When I hit the range my goal unique to this pistol was to determine how much the different magazines (and their available gripping surfaces) affected shootability. I timed myself running a plate rack as well as timed strings of fire on an IDPA target, all at realistic defensive distances (7-10 yards).

What I discovered was that I could shoot as accurately with the flush ten-round magazine in place as I could with the larger magazines, just not as fast. If I shot as fast with the flush magazine in place when compared to the mags with the extended basepads, my accuracy suffered.

However, the difference was not as great as I expected, no more than a ten percent spread, and usually less. The difference was in how much control I felt I had over the gun — the extended mags made my hands happier, but didn't produce as much difference downrange as I expected. I think this is due in large part to how controllable this pistol is. Because it is not, in fact, a subcompact, and that matters when shooting. Even with a flush magazine in place recoil is not abusive, the sights are prominent and set a decent distance apart, the dual recoil springs to absorb recoil, the wider gun which spreads recoil over a larger backstrap area — all of these things contributed.

[Cont. to page 50]



### You Will Be Amazed At The Accuracy Inherent In Our Accublock® Stocks!



True Drop-in Models To Fit Most 700's

Long Range Composite Accublock® Stocks

Your Choice **\$219**

Compare at \$329  
★★★★★  
Customer FIVE STAR Rated

### Accublock® Aluminum Bedding System



Instant Precision

Do It Yourself  
Installs In 10 Minutes  
Screws Included

**Stocky's**  
ph (561) 584-8500  
America's Gunstock Specialists!

INSTANT SHIPPING

[www.NewRifleStocks.com](http://www.NewRifleStocks.com)

EXPERT SUPPORT

F R E E D O M

MSRP \$395.00  
"R" Models

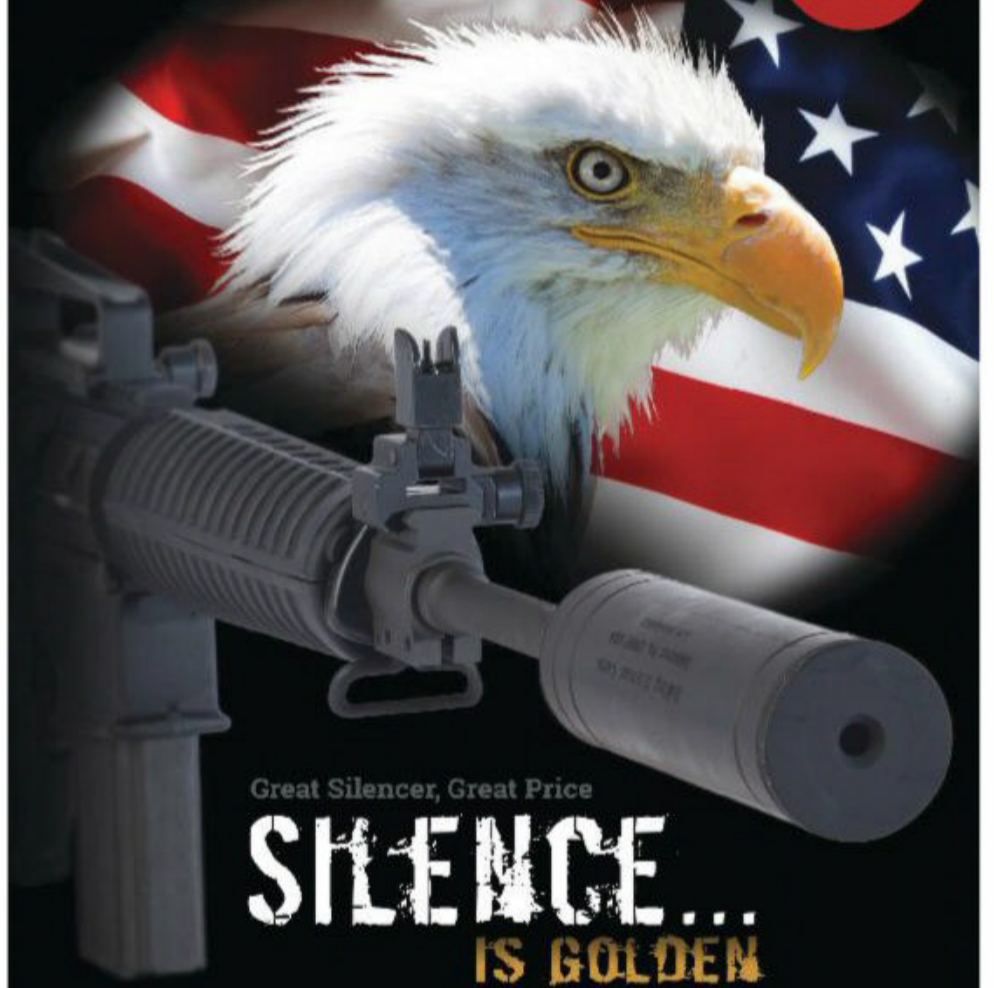

Great Silencer, Great Price

# SILENCE... IS GOLDEN

3 RING SILENCER CORPORATION

[www.3RingSilencer.com](http://www.3RingSilencer.com) • (215) 949-8378

# ON THE GO? GET YOUR DIGITAL EDITION!

(Digital access now included with your paid Subscription!)



## SUBSCRIBE NOW! [WWW.FIREARMSNEWS.COM](http://WWW.FIREARMSNEWS.COM)

CURRENT SUBSCRIBERS GO TO MYMAGNOW.COM AND SELECT "CREATE DIGITAL ACCOUNT"

Digital edition is available on updated iPad/iPhone, most Android devices, and the Microsoft Store for Windows

## Advanced Mounting Solutions

Ultra-low, Forward Optic Mounts for M-14, M1A, Mini-14, M1 Carbine, AK, and M1 Garand

Patented, combat proven rail systems, optics, stock kits & grips.

*"Because Good People Need Better Weapons"*



**UltiMAK™**

Enhanced Performance

2216 S. Main, Suite B2  
Moscow, ID 83843  
208-883-4734

[www.ultimak.com](http://www.ultimak.com)



**With the 13-round magazine in place the pistol isn't as concealable, but Tarr likes the improved handling it provided, as well as the increased capacity.**



[Cont. from page 48]

I loaded up each of the three magazines with ten rounds apiece (in this case with Winchester's USA Ready 115-grain FMJ FP load) and at ten yards shot them at the center zone of an IDPA target, going as fast as I could while still keeping the hits inside the zone. It was not tough. In the accompanying photo you'll see the vertical stringing expected when you're pushing unfamiliar equipment hard and not quite timing your muzzle bounce right. However, the short flush magazine didn't produce the high and low rounds, my accuracy with it in place was just as good, I just had to shoot a tiny bit slower.

Personally, I like the way the 13-round magazine feels in my hand the best, and even though I barely perform any better with it, sometimes confidence is what you

need. Also, those three extra rounds. Sometimes three extra rounds are what you need ... and a reload on your off-side, using a full-length 17-round magazine, just in case you find yourself in the middle of a police-free "peaceful protest" that goes off the rails ...

The VP9SK-B is a newer pistol, and not that common. It will, however, fit into any holster designed for the standard SK, and there are a number of those out there. Actually, it will fit into any holster designed for the full-size VP9 as well, although it will be a little short. DeSantis Gunhide (DesantisHolster.com) is just one of many quality holstermakers which offers IWB and OWB holsters for this pistol, in both leather and polymer. They sent me one of their Mini Scabbards for the SK-B, which is a minimalist leather belt



**The Ultra Custom holster from 1791 Gunleather is leather over a layer of thermoplastic polymer, which can be molded to your specific firearm after heating. These tools help form channels for your front sight when molding the holster to your gun.**

holster that tucks the butt of the pistol in tight to the body, and allows it to just disappear under a loose shirt. This is not a pocket pistol, so you will need both a quality holster and a belt to hang it on.

Another intriguing option is the Ultra Custom IWB holster from 1791 Gunleather (1791gunleather.com). Offered in several different sizes, depending on the general size of your pistol, this is a "user customizable" holster with an exterior leather layer over a thermoplastic sheet inside. What does "thermoplastic" mean? It means you can heat up this holster and then form-fit it to your specific pistol, and when it cools it stays that shape. It provides you a hybrid holster that looks leather but performs (nearly) like a polymer/Kydex holster.

To close out this article, here's another brief German lesson, this one about history — traditionally, HK has just not offered true semi-auto versions of many of



**The Ultra Custom holster from 1791 Gunleather, molded around the HK VP9SK-B. There are several different sizes of holsters to fit various firearms.**



**The Mini Scabbard from DeSantis Gunhide is a minimalist leather belt holster, one of many designs they make for the VP9SK. There is nothing like a leather holster.**





Tarr experimented using the three different magazines, and while he wasn't able to shoot the pistol quite as fast with the flush magazine in place as the extended magazines, the pistol was eminently shootable with all three.

Ten rounds from each of the three different magazines, fired at 10 yards, as fast as Tarr could hit the center zone of the target. The short flush 10-round magazine slowed him down very slightly when compared to the extended fingerhook 10-round mag, and the extended 13-round magazine, but the pistol shot well with all three and was very controllable.

### HECKLER AND KOCH VP9SK-B

Type:	Striker fired
Caliber:	9mm
Capacity:	10+1 (13 round magazine provided)
Barrel Length:	3.39 in.
Overall Length:	6.61 in.
Height:	4.57 in.
Width:	1.32 in.
Weight:	23.07 oz (with empty magazine)
Construction:	Polymer frame, steel slide
Sights:	3-dot Meprolight night sights
Trigger:	5.25-lbs (as tested)
Safeties:	Firing pin, mechanical (trigger lever)
Accessories:	2 10-round magazines, 1 13-round magazine and 3 backstraps/grip panel sets
MSRP:	\$849.00
Manufacturer:	Heckler and Koch (706) 568-1906 HK-USA.com

their storied military long guns, such as the UMP and G36 (don't you dare tell me the USC and SL8 count). This isn't because the German HK brass doesn't understand and doesn't like the US commercial market. Well, it's not just because of that, it is mainly because the German government restricts the commercial availability of firearms designed originally for their military.

When I first reviewed the VP9, I wrote how HK needed to offer a model with an American-style push-button magazine release, not because such a magazine release is superior, but because that's what American consumers want. However, the unofficial official HK customer service motto is, "You suck, and we hate you," so I sincerely doubted that would ever happen. I am happy to have been proven wrong.

I was told by an American employee on the US side of HK that things were changing and that they were making inroads against the stiff German leadership in regard to products for America, which is the single largest firearms market in the world. I am pleased to see this is more than just hyperbole. Between the American-style mag release buttons on the VP9 and the introduction of the SP5, so that we finally have semi-auto MP5 option made by HK, at a competitive

price no less, they now seem to be producing the firearms American consumers want as opposed to the firearms they think the consumers should want. With HK now having production facilities in the US whose products will not be strangled by German law I am eagerly anticipating what comes next.

There are several versions of the VP9SK-B. The base model comes with one 10- and one 13-round magazine, and retails for \$740. This deluxe model with three magazines and night sights has an MSRP of \$849. **FN**

## WANT A H&K VP9SK?

Check out Davidson's Gallery of Guns at [GalleryOfGuns.com](http://GalleryOfGuns.com)!

Davidson's offers the GuaranteeD® Lifetime Replacement Warranty which backs all the firearms you buy through [GalleryofGuns.com](http://GalleryofGuns.com). It works like this: if anything ever goes wrong with any gun you buy with the Davidson's GuaranteeD® Lifetime Replacement Warranty, it will be replaced. If no replacement is available, it will be repaired at no charge to you. Simply return it to the retailer where you purchased it, pay for the return shipping and upon receipt Davidson's will ship the returning retailer a brand-new gun for you provided one is available. If a replacement is not available your firearm will be repaired for free. For complete warranty information please refer to the Guaranteed Warranty link found at the home page of [GalleryofGuns.com](http://GalleryofGuns.com). **FN**

### HECKLER AND KOCH VP9SK-B

Load	Bullet Weight (gr.)	Velocity (fps)	SD	Avg Group (in)
Winchester USA Ready FMJ FP	115	1,121	22	2.9
Black Hills TAC-XP+P	115	1,109	14	2.7
Hornady Am. Gunner	124	1,085	7	3.7
Federal HST	124	1,103	12	3.2

Accuracy results are the averages of four five-shot groups at 25 yards from a sandbag rest. Velocities are averages of ten shots measured with an Oehler Model 35P 12 feet from the muzzle.





Rethinking your carry gun?  
Looking for something  
small and easy to conceal  
but easier to shoot and  
greater capacity? Consider  
SIG Sauer's P365.



# SIG SAUER'S P365

If you are rethinking your carry gun, this is one to consider!

By David M. Fortier







**W**ithout a doubt, more people than ever are thinking about self-protection, and looking to obtain both a pistol and a permit to carry. The question I've heard from many, especially those entirely new to firearms is: which pistol is best? Unfortunately, there is no blanket answer to this question. There is only which pistol best meets your particular needs and requirements, which are likely very different than mine. Now, that said one contender worth serious consideration is the SIG Sauer P365.

Why SIG Sauer's P365? Simply due to the fact that it meets so many requirements for concealed carry. It is small and fairly narrow making it very easy to conceal. Plus, it is light so you can carry it all day without noticing it. Better still, it is chambered for the 9mm cartridge, so it has the performance of a service pistol, but in a smaller package. For peace of mind, it has a capacity of 10+1, 12+1 or 15+1 depending upon which size magazine you select. What I like best though, is it puts all of these features into a pistol which is very easy to shoot well.

Before I delve further into the SIG Sauer P365 though, let's consider what you should look for in a pistol intended for concealed carry. There are some basic, but vitally important points you must take into consideration:

1. It must be 100% reliable.
2. It must be small and light enough so you will have it when you need it.
3. It must be accurate and ergonomic enough for you to be able to make rapid multiple hits at realistic distances with it.
4. It must be of heavy enough caliber to be effective in a life and death struggle.



**SIG Sauer's P365 9mm Micro-Compact pistol offers everything you need for concealed carry.**

[Cont. to page 56]



# THE BEST GUN ENTHUSIAST SHOWS EVER MADE. ONLY ON MY**OUTDOOR**TV.



## 10,000+ Exclusive Shows. Best-In-Class Content.

Watch the best hunting, fishing and shooting shows ever made. Exclusive, premium content added weekly. **MyOutdoorTV** is available on all your favorite devices — stream or download to watch anytime, anywhere.

**MYOUTDOORTV.  
NOW EVERYWHERE.**

Apple TV App Store

XBOX Google Play

amazon fireTV ROKU

**MOTV**  
MYOUTDOORTV®  
MYOUTDOORTV.COM

**START YOUR  
FREE TRIAL**





**A common mistake when choosing a handgun for concealed carry is either going too small or choosing a model with limited capacity.**



**Caliber selection is important when choosing a pistol for personal protection, the 9mm (2nd from left) offers good terminal performance, high magazine capacity and controllable recoil.**



**The J-frame .38 Special and Glock 43 9mm are good carry guns, but with the threat of angry, violent mobs they may not be the wisest choice.**

[Cont. from page 54]

This all sounds relatively straightforward. To a novice though, especially standing in front of a crowded display case at a gun store, it can be a bit overwhelming. There are just so many different makes, models, calibers and options. Trying to figure out which one is “best” can seem like a daunting task when all you have to go on is a bit of online research and what the guy at the gun store recommends.

Two common mistakes when selecting a carry pistol are going either too big/heavy or too small. Of the two, I think going too big/heavy is by far the worst choice. If you choose a pistol which turns out to be too large, bulky or heavy for your particular needs, you will probably not carry it day in and day out. Remember rule number one of a gunfight, have a gun. All too often though, someone selects a carry piece which is physically too large and heavy for them to realistically carry on a daily basis, like they should. Once their short love affair is over, it ends up living in their safe, or on their nightstand. Key point to remember, you don’t know the day or hour of an attack, so you must always be ready. A carry pistol isn’t a fashion statement; it’s a way of life.

The flip side of this is choosing something tiny and “cute” in a poor performing caliber such as .22 LR, .22 Magnum, .25 ACP (6.35mm Browning) or .32 ACP (7.65mm Browning). Ultra-compact pocket pistols have long been popular, despite their under-powered nature. Due to their small size they are easily carried, so you are more likely to actually have it when you need it. Being easily concealed, even in summer attire, is their great virtue. This is what makes them great back-up guns. Due to their tiny nature they can be difficult to shoot well, often have hard to see sights,

and unfortunately poor terminal performance. While quite “lethal”, these small calibers may not have the immediate desired effect on your attacker.

Then there is what many consider to be the “ideal” class of pistols for concealed carry. These are compact single-stack 9mm autos such as the Glock 43,

compact .380 ACPs, and J-frame, and similar size, .38 Special snub nose revolvers. This group is small, light, and easy to conceal while having acceptable terminal performance. Their downside is they can be hard to shoot well and the limited amount of ammunition they carry.

[Cont. to page 58]



**One big selling point of the P365 is it combines small-size with high capacity. 10-, 12- and 15-round magazines are all available from SIG Sauer.**



GUNS & AMMO

# FREEDOM IN ACTION

*Wednesday Night At The Range* is a loud and proud celebration of our freedoms. In one explosive night, we bring you the latest firearms and gear, competitive shooting action, personal defense strategies, historic weaponry and much more.

WEDNESDAY NIGHT  
AT THE RANGE

USA  
Midway

7P ET Outdoor



SHOOTING GALLERY

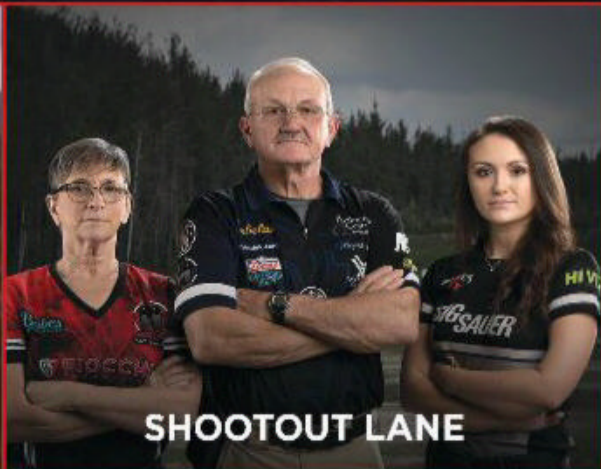

SHOOTOUT LANE



AMERICAN RIFLEMAN



SHOOTING USA

SCHEDULE SUBJECT TO CHANGE





**SIG Sauer describes their P365 as a Micro-Compact pistol sized for everyday carry. It is a polymer frame striker-fired design with a stainless steel slide assembly.**

**It's important to find a pistol which fits you well, and the P365 just seems to fit a lot of people. This is a real plus.**



[Cont. from page 56]

This last point, their limited ammunition capacity, has recently led many to re-evaluate their suitability for concealed carry in light of current events seen on social media and the news. Five to seven rounds seems plenty for a typical self-defense situation involving one or two assailants. But, what if, rather than one or two, you are faced with an angry violent mob? A mass of violent people which makes you fear for your life, and the lives of your loved ones.

The news is filled with outbreaks of civil unrest showing how quickly certain areas can descend into utter chaos. In such situations large groups typically roam in packs. They often block roadways attacking any who happen to drive by. In such situations you are likely to face a large number of armed and unarmed attackers, who will move quickly to surround and overwhelm you. It's not the ones in front of you that are the greatest threat, but the ones circling behind you, watching, waiting for their chance to blind-side you. Once you are off your feet and the mob descends on, well, you know what happens next. In such a situation a 5-shot snub nose revolver or .380 Auto isn't a real confidence builder.

While it's true there are certain situations where you simply can't win, I suggest carrying a handgun which will let you solve any problem that can be solved with a pistol. For daily concealed carry one such option is SIG Sauer's P365 9mm pistol. So, let's take a closer look at this interesting and popular design.

SIG Sauer describes their P365 as a Micro-Compact pistol sized for everyday carry. That pretty well sums it up. It is a polymer frame striker-fired design with a stainless steel slide assembly. The polymer frame reduces weight, and it flexes a bit when the pistol is

fired, and so dampens a bit of the felt recoil. Size-wise it is slightly shorter in the slide and the butt than a Glock 43 single-stack pistol. The first thing I thought when I took it from its box was, wow this is small.

The next thing that came to mind was how good it felt in my hand. While this is very subjective, the curve of the backstrap, texturing, undercut trigger guard and general contour of the frame fit my hand very well. It's important to find a pistol which fits you well, and the P365 just seems to fit a lot of people. This is a real plus.

Next, I noted the X-RAY3 day/night sights on top of the slide. These are bold, easy to see yet contoured to not snag during your draw. The front sight features a green donut with a Tritium insert for lowlight use. The robust rear sight features two Tritium inserts. The sights are dove-tailed into the slide, and are a real aid

to getting the most out of the P365 on the range. Controls consist of a push-button magazine release, slide release and take-down lever. The magazine is triangular in shape and well placed. The slide release is fairly small and unobtrusive.

Then there is the trigger. I have spent decades carrying a Glock, and have gotten used to a generic, nothing-to-write-home-about, but serviceable trigger. The P365 though is different. It is blessed with a very good out-of-the-box trigger, which is definitely an aid to making accurate and quick hits on target. The trigger pull is very smooth, and breaks cleanly. While not



**The snag-free X-RAY3 day/night sights are bold and easy to see. The front sight features a green donut with a Tritium insert for lowlight use.**



**The robust rear sight features two Tritium inserts. The sights are dove-tailed into the slide and are a real aid to getting the most out of the P365 on the range.**



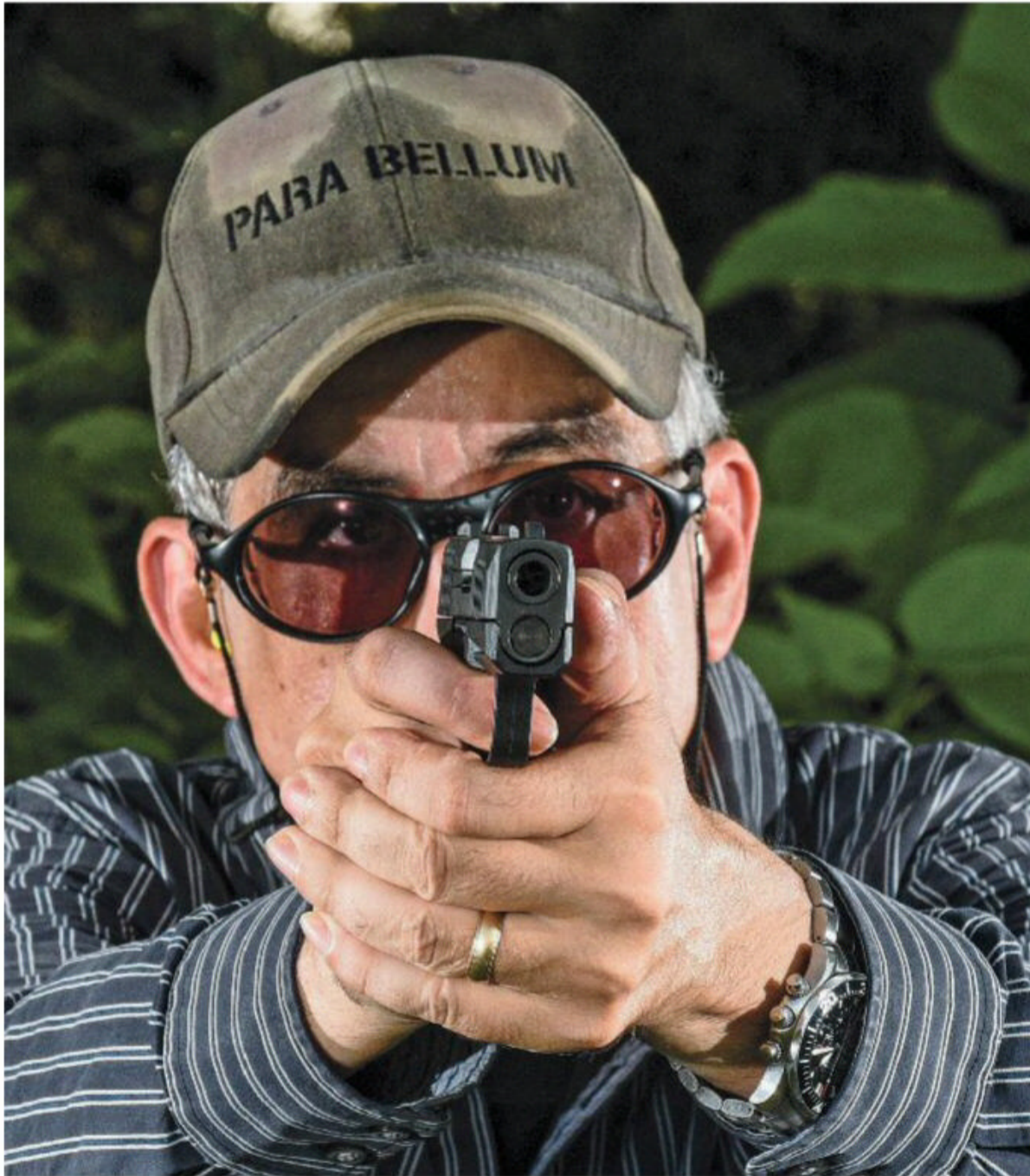

The SIG P365's trigger is very good for its intended usage, being smooth with a clean break.



A look at the P365 stripped down, which is easily accomplished. Note the short 3.1-inch barrel and metal guide-rod assembly with captured dual springs.



You can carry the short 10-round, or slightly longer 12-round magazine in the gun and keep a 15 rounder as a spare.

a match trigger regarding pull weight, it is quite good for its intended purpose. The trigger blade is a curved design, which may not be as attractive as the current in-vogue straight blade to some, but it is quite comfortable. I like the factory trigger a lot.

Barrel length is a short 3.1 inches. Operation is via short-recoil with a tilting barrel. Beneath the barrel is a metal guide-rod assembly with captured dual springs. Overall length is 5.8 inches with a height of 4.3 inches and width of just 1.06 inches. Size-wise the P365 dropped right into my Glock 43 DeSantis polymer holster. The SIG Sauer P365 carries very well, and I do not even notice it is there. This is partly due to its light weight, which is only 17.8 ounces unloaded. Adding a loaded magazine will add a bit of weight, and this is an important topic I will cover next.

The one thing many do like about the various single-stack compact 9mm pistols on the market is their limited magazine capacity. SIG Sauer addressed this with their P365. You can choose a flush fit 10-round magazine, a slightly extended 12-round magazine or a noticeably extended 15 rounder. So, capacity is not an issue with the P365. This provides a bit of peace of mind. Some will opt to carry with the flush fit 10-round magazine and carry a 12-round magazine as a spare. I carry with the 12-round magazine locked in place giving me 13 rounds on tap, and carry a spare 15-round magazine. That is 28 rounds total, in a very small package. This is a huge selling point to many

people, and a feature that really attracted me to the design.

While SIG Sauer's P365 has a real advantage over, say Glock's popular 43, on paper, what about on the range? Does the P365 offer a real advantage over the Glock 43? This was easy enough for me to find out. I have been carrying a Glock 43 for a couple years, and know what it is capable of. So, I began with some informal range testing as soon as the P365 arrived. Frankly, I was excited to get it out onto the range and to put some rounds through it.

Starting at 15 yards I fired a few rounds slow-fire to get a feel for the P365 after firing my Glock 43. Then I began shooting steel silhouettes and plates. My initial impressions were entirely positive. For me, I found the P365 easier to shoot than my Glock 43. I have to work much harder with the Glock 43, just due to the dynamics of the design. The P365 just seemed much easier to hit with. So, I did a basic "Walk Back" drill starting at 15 yards. My target was a steel silhouette.

Rules were simple, fire one shot, and if it was a hit walk back away from the target to a different yard line and fire another shot offhand. The goal was to work my way back until I missed. Keep in mind, this is advertised as a Micro-Compact pistol. I went from 15 yards and slowly made my way back to 50 yards, then 75 yards, and found myself on the 100 yard line. Carefully pressing the trigger I was rewarded with a hit, and continued back. I was surprised to find myself on





**The P365 proved both very fun and accurate on the range where it easily put the knuckles to the author's Glock 43.**

the 135 yard line when I finally missed. I came away extremely impressed by how well this little 9mm pistol performed. It is simply easy to shoot well.

Next, I moved to the bench to do the boring part of testing. Here I fired four five-shot groups with four different loads at 25 yards. Velocity was measured at the muzzle with a LabRadar Doppler Chronograph. Groups were fired off a sandbag, nothing fancy. Keeping in mind just how small the P365 is, it did very well off the bench. The trigger is good for a concealed carry pistol, the sights are bold and easy to see and the recoil is quite controllable.

I can remember testing a Kel-Tec PF-9 and found the recoil to be very snappy, and it was not a particularly pleasant pistol to shoot. The P365 has none of the PF-9's bite, and I enjoyed my time on the range with it. Best accuracy was obtained using Black Hills 124-grain +P JHP load which averaged 2.5 inches at 25 yards. Average velocity of this load was 1,114 fps.

Moving from the bench I ran the P365 through a variety of drills from two to 15 yards. Here I found it to be quick into action. Practical accuracy is very good and it's an easy pistol to run. Due to its small size and relatively light weight you can expect more muzzle jump than a larger and heavy 9mm. This does slow down follow-up shots a tad. But, in my opinion it performs very well for its size, and I greatly preferred it over my Glock 43.

During drills I noticed that due to the shortness of the grip, my hand could prevent the magazine from falling free. I have medium-size hands and my pinky comes to the bottom of the extension on the 12-round magazine. If I move the pistol slightly in my hand to release pressure on the magazine base-plate, then it ejects cleanly. The recoil springs are on the heavy side and retracting the slide is slightly harder than on my Glock 43. With the short 10-round magazine in place the grip is rather short making the SIG easier to conceal but slightly harder to shoot well. There is simply less to hang onto. The 12-round magazine adds a bit of length to the butt; however, it gives you just enough more to hang onto to make it well worth it. Plus, you get another two rounds.

I suppose the real test is how well the SIG Sauer P365 actually carries. So, I carried it for six months before writing this review. The answer to this is simple, it carries very well. Its small size allows it to be tucked easily away. I found it comfortable for AIWB (Appendix Inside the Waist Band), even when seated in a vehicle. Its light weight lets you not even notice it's there as you go about your day.

OK, the SIG Sauer P365 has a lot going for it, but what about its cons? What don't I like about it? Well, let's be blunt, the design has had some reliability issues, especially when first released. Some customers reported problems with the slide not returning to battery. All of these gave me pause about considering the P365 as a carry pistol. This P365 has been out a while now, it is not breaking news, but I waited

[Cont. to page 62]

#### SIG SAUER P365 — 25-YARD ACCURACY AND VELOCITY CHART

Load	Bullet Weight (gr.)	Velocity (fps)	25 yards (in.)
Black Hills +P JHP	124	1,114	2.5
SIG Sauer Elite 365 FMJ	115	1,040	2.9
SIG Sauer Elite V-Crown JHP	124	1,095	2.7
Barnaul FMJ	115	1,128	3

Groups are an average of four 5-shot groups fired from a rest at 25 yards. Velocity readings recorded using an Oehler 35P chronograph at an ambient temperature of 75 degrees F at 1,030 feet above Sea Level.



**GUNS&AMMO**

# AR-15

**Don't miss an issue of the most popular AR-only publication available!**

You'll find detailed photography, the most in-depth reporting and exclusive field tests of what's trending. Every issue includes the greatest ensemble of contributors with proven experience using these rifles while serving in the military, in law enforcement or on the competitive playing field.



On newsstands  
**NOW.**

Available online at [osgnewsstand.com](http://osgnewsstand.com)





**Make no mistake, it's a small pistol and during drills I noticed that due to the shortness of the grip, my hand could prevent the magazine from falling free.**



**Here is a quick five rounds fired using economical Barnaul steel case 115-grain FMJ at 12 yards.**



**Practical accuracy of the SIG Sauer P365 is quite good and it's an easy pistol to shoot well.**

[Cont. from page 60]

intentionally. I finally requested a review pistol in August of 2019 and guess what; it couldn't make it through a magazine. It frequently failed to return to battery with any 9mm load I tried, including SIG Sauer's own ammunition. So, I sent it in for repair. It was turned around very quickly, arrived back and has functioned perfectly ever since. But, it did have problems out of the box.

I tried two more P365s. One obtained directly from SIG Sauer, and another a friend purchased locally. Both of them ran flawlessly with zero issues. Keep in mind I received my first pistol in August of 2019. Once it came back it has run flawlessly ever since, for almost a year now. But, I waited and continued putting rounds on this gun waiting to see if any problems would crop up. They haven't, it runs fine, but this is what I experienced. My only other negative comment concerns the price of spare magazines. They are not

inexpensive. I like to have a fair supply of magazines for any pistol I own, so this just adds to the cost of ownership.

My final thoughts? I never liked my Glock 43 the way I like my old Glock 23 or 19. It carried well, went bang when it was supposed to and that was it. I didn't particularly like shooting it. It was nothing more than a tool to me. The SIG Sauer P365 is different. I really enjoy shooting it; it's a fun gun on the range. I like its features and especially its trigger. For me, it is an ideal carry gun. A 12-round magazine in the gun and a spare 15-round mag and I'm good. I see no need to go back to a five-shot J-frame, or single-stack 9mm ever again. If you have been troubled by current events, and thinking about replacing your current carry gun with something offering increased capacity but without the size and weight, I'd suggest considering a SIG Sauer P365. **FN**

**GALLERY OF GUNS**<sup>®</sup>  
GALLERY OF GUNS

## WANT A SIG SAUER P365?

Check out Davidson's Gallery of Guns at [GalleryOfGuns.com!](http://GalleryOfGuns.com)

**D**avidson's offers the GuaranteeD® Lifetime Replacement Warranty which backs all the firearms you buy through GalleryofGuns.com. It works like this: if anything ever goes wrong with any gun you buy with the Davidson's GuaranteeD® Lifetime Replacement Warranty, it will be replaced. If no replacement is available, it will be repaired at no charge to you. Simply return it to the retailer where you purchased it, pay for the return shipping and upon receipt Davidson's will ship the returning retailer a brand-new gun for you provided one is available. If a replacement is not available your firearm will be repaired for free. For complete warranty information please refer to the Guaranteed Warranty link found at the home page of [GalleryofGuns.com](http://GalleryofGuns.com). **FN**

### SIG SAUER P365

**Caliber:** 9x19mm

**Operation:** Self-loading with tilting barrel

**Barrel length:** 3.1 in.

**Rifling:** 6 groove, 1-10 inch twist

**Trigger:** Striker, 6-pounds

**Capacity:** 10+1, 12+1 or 15+1

**Weight:** 17.8 oz.

**Height:** 4.3 in.

**Length:** 5.8 in.

**Width:** 1.06 in.

**Sights:** X-RAY3 Day/Night sights

**Finish:** Nitron-finished stainless steel

**MSRP:** \$577.99

**Manufacturer:** SIG Sauer  
(603) 610-3000  
[SigSauer.com](http://SigSauer.com)

### AMMO SOURCES

[SigSauer.com](http://SigSauer.com)

[BlackHills.com](http://BlackHills.com)



# HARBOR FREIGHT

QUALITY TOOLS AT RIDICULOUSLY LOW PRICES

Shop When You Need To Online & In-Store

**NO COUPON REQUIRED**

**3-Ply Disposable Face Masks**  
10 Masks per Pack

**\$4.99**

**NEW**

Less Than 50¢ Per Mask



Breathable, Comfortable, Lightweight, Single Use, Non-Medical

ITEM 57593

**In-Store Only**

While Supplies Last

**UNION SAFE COMPANY** (186)

**10 Gun Electronic Security Safe**

**\$279.99**

~~\$339.99~~

Save \$284

Compare to Stack-On SS-16-MB-E \$564.57  
ITEM 64008/64011 shown

MEETS CALIFORNIA DEPARTMENT OF JUSTICE REQUIREMENTS

Contents not included.

Use Online & In-Store

50690807

LIMIT 1 - Exp. 9/25/20

**WOW! SUPER COUPON**

**SAVE 94%**

★★★★★ (4214)

**Swivel Lens Headlamp**



**WOW! 89¢**

~~\$2.89~~

Compare to Energizer HDB32EH \$15.98  
ITEM 63598 61319/64073 64145/45807 shown

Use Online & In-Store

50690809

Exp. 9/25/20

**SCISSOR SUPER COUPON**

**20% OFF**

ANY SINGLE ITEM\*

Use Online & In-Store

50688840

Limit 1 coupon per customer per day. Save 20% on any 1 item purchased. \*Cannot be used with other discount, coupon or any of the following items or brands: Inside Track Club membership, Extended Service Plan, gift card, open box item, 3 day Parking Lot Sale item, compressors, floor jacks, power stations, safes, storage cabinets, chests or carts, trailers, welders, Admiral, Ames, Atlas, Bauer, Central Machinery, Cobra, CoverPro, Daytona, Diamondback, Earthquake, Fischer, Hercules, Icon, Jupiter, Lynxx, Poulan, Predator, Tailgator, Viking, Vulcan, Zurich. Not valid on prior purchases. Non-transferable. Original coupon must be presented. Valid through 9/25/20.

**SCISSOR SUPER COUPON**

**0.30 cal Ammo Box** (7197)

**\$3.49**

~~\$5.99~~

Save 65%

Compare to RangeMaxx 1312-92 \$9.99  
ITEM 63135/61451 shown

**Bunker Hill**

Use Online & In-Store

50694672

LIMIT 4 - Exp. 9/25/20

**PREDATOR** (410)

**9000w Max. Starting Extra Long Life Gas Powered Generator**

**\$599.99**

~~\$649.99~~

Save \$2,189

Compare to Honda EM6500SXK2AT \$2,789  
ITEM 63971/63970 shown  
ITEM 63968/63969, CALIFORNIA ONLY

Wheel kit and battery sold separately.

Use Online & In-Store

50698641

LIMIT 1 - Exp. 9/25/20

OSHA APPROVED GFCI PROTECTION

**SCISSOR SUPER COUPON**

**7 ft. 4" x 9 ft. 6" Camouflage Weather Resistant Tarp** (431)

**\$4.49**

~~\$6.29~~

Save 50%

Compare to Weathermaster 300083999 \$8.99  
ITEM 61765/46411 shown

Use Online & In-Store

50698724

LIMIT 4 - Exp. 9/25/20

**SCISSOR SUPER COUPON**

**Apache Model 9800 Waterproof Protective Rifle Cases** (637)

**\$114.99**

YOUR CHOICE OF COLOR

NEW AVAILABLE IN TAN

2" Heavy duty ball bearing wheels

Save \$155

Compare to Pelican Double Rifle \$269.99  
ITEM 64520

Black ITEM 64520  
Tan ITEM 56862

Case contents not included.

Use Online & In-Store

50699235

LIMIT 1 - Exp. 9/25/20

**SCISSOR SUPER COUPON**

**PITTSBURGH #1 SELLING JACKS IN AMERICA** (1521)

**Rapid Pump® 1.5 Ton Lightweight Aluminum Floor Jack**

**\$59.99**

~~\$79.99~~

Save \$91

Compare to K Tool KT163094 \$151.42  
ITEM 64552 64832/64980 64545 shown

AMERICAN SOCIETY OF MECHANICAL ENGINEERS ASME PASSE COMPLIANT

Use Online & In-Store

50704024

LIMIT 2 - Exp. 9/25/20

**VIKING** (1845)

**4 AMP High Frequency Battery Charger/Maintainer**

**\$27.99**

~~\$37.99~~

Save \$77

Compare to Snap-on EBM500A \$105  
ITEM 63350

Use Online & In-Store

50705024

LIMIT 3 - Exp. 9/25/20

**SCISSOR SUPER COUPON**

**Heavy Duty Foldable Aluminum Sports Chairs** (4731)

**\$19.99**

YOUR CHOICE OF COLOR

~~\$29.99~~

Save 50%

Compare to Coleman 635394 \$39.99

Green ITEM 63066/62314 shown  
Blue ITEM 56719

Use Online & In-Store

50706886

LIMIT 3 - Exp. 9/25/20

**SCISSOR SUPER COUPON**

**LuminaR OUTDOOR** (3321)

**250 Lumen Pop-Up Lantern**

**\$4.99**

~~\$6.99~~

Save 66%

Compare to Go Green Power \$14.99  
ITEM 64110

Use Online & In-Store

50724170

LIMIT 4 - Exp. 9/25/20

**SCISSOR SUPER COUPON**

**8" Hunting Knife with Survival Kit** (94)

**\$6.99**

~~\$9.99~~

Save 53%

Compare to Whetstone 25-87612 \$14.92  
ITEM 61733/61501/90714 shown

Sheath included.

Use Online & In-Store

50712711

LIMIT 4 - Exp. 9/25/20

**COVERPRO** (538)

**10 ft. x 10 ft. Portable Shed**

**\$129.99**

~~\$159.99~~

Save \$170

Compare to Shelter Logic 70833 \$299.99  
ITEM 56184/63297 shown

Use Online & In-Store

50716085

LIMIT 1 - Exp. 9/25/20

**SCISSOR SUPER COUPON**

**PITTSBURGH** (3696)

**130 Piece Tool Kit with Case**

**\$29.99**

~~\$39.99~~

Save 54%

Compare to Anvil A137HOS \$66.39  
ITEM 68998 64263/63248 64080 63091 shown

Use Online & In-Store

50716832

LIMIT 2 - Exp. 9/25/20

**SCISSOR SUPER COUPON**

**CENTRAL PNEUMATIC** (3930)

**3 Gallon, 100 PSI Oil-Free Air Compressors**

**\$39.99**

YOUR CHOICE

~~\$54.99~~

Save 59%

Compare to Porter-Cable PCFPD2003 \$98.62

Hot Dog ITEM 69269 97080 shown  
Pancake ITEM 60637 61615 shown

Use Online & In-Store

50720118

LIMIT 2 - Exp. 9/25/20

**SCISSOR SUPER COUPON**

**U.S. GENERAL** (1574)

**30", 5 Drawer Mechanic's Cart**

**\$199.99**

~~\$239.99~~

Save \$630

Compare to Snap-on Blue-Point KRBC10TBPS \$830  
ITEM 64061, 64722, 64030, 64721, 64031, 64720, 56429

Side tray sold separately.

Use Online & In-Store

50721410

LIMIT 1 - Exp. 9/25/20

**SCISSOR SUPER COUPON**

**WARRIOR** (4901)

**29 Piece Titanium Drill Bit Set**

**\$10.99**

~~\$18.99~~

Save 83%

Compare to Dewalt DW1369 \$68.14  
ITEM 5889/62281/61637 shown

Use Online & In-Store

50721810

LIMIT 4 - Exp. 9/25/20

**SCISSOR SUPER COUPON**

**HARDY** (315)

**Mechanics Gloves**

**\$4.99**

~~\$5.49~~

Save 66%

Compare to Valco 25521 \$14.99  
ITEM 62434, 62426, 62433, 62432, 62429, 64179, 62428, 64178 shown

Use Online & In-Store

50722018

LIMIT 4 - Exp. 9/25/20

**SCISSOR SUPER COUPON**

**drillmaster** (6170)

**4-1/2" Angle Grinder**

**\$9.99**

~~\$14.99~~

Save 50%

Compare to Ironport 61451 \$19.99  
ITEM 69645/60625 shown

Use Online & In-Store

50723452

LIMIT 4 - Exp. 9/25/20

1,000+ Stores Nationwide • HarborFreight.com

\*Original coupon only. No use on prior purchases after 30 days from original purchase or without original receipt. Valid through 9/25/20.

Pricing, promotions, and availability may vary by location and at www.harborfreight.com and are subject to change without notice. We reserve the right to limit quantities. "Compare to" advertised price means that the specified comparison, which is an item with the same or similar function, was advertised for sale at or above the "Compare to" price by another national retailer in the U.S. within the past 90 days. Prices advertised by others may vary by location. No other meaning of "Compare to" should be implied. Although we make every effort to assure that our prices and products are advertised as accurately as possible, we are only human and in the event an error is made, we reserve the right to correct it.







# THE 9mm

By Will Dabbs, MD

# SCCY CPX

Reliable  
Reasonably-Priced  
Personal Protection

The SCCY CPX is an economical concealed carry pistol that was well ahead of its time.



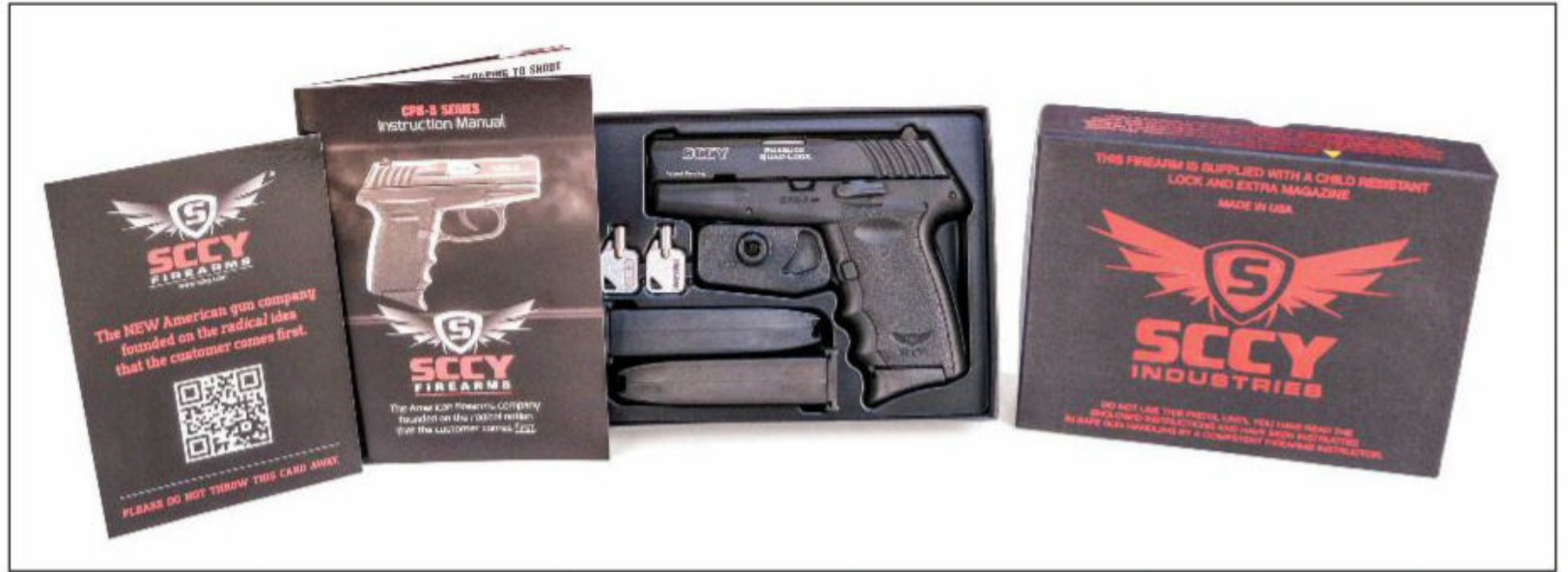

**The SCCY CPX is the concealed carry pistol for the common man. A quality inexpensive defensive arm, the CPX comes in a plain cardboard box with everything you need for basic personal defense and safe storage, and that includes three magazines!**

The Springfield Armory Hellcat and SIG SAUER P365 have shaken the concealed carry world to its core with their compact geometry and impressive double stack magazine capacity. These two guns, rarefied though they undoubtedly are, remain quite expensive. However, it seems a gun company based out of Daytona Beach, Florida, introduced its own compact double stack 9mm concealed carry pistol years ago. The SCCY CPX is a time-tested, reasonably-priced deep cover defensive handgun that is good enough to save your life.

**War Story**

The young man worked in a local minimart and had never before squeezed a trigger. He watched the news

as do we all and felt burdened to protect himself in the face of life's many-splendored chaos. On his 21st birthday, his dad gave him an inexpensive SCCY CPX 9mm pistol.

The man applied for a concealed carry permit and was awaiting its approval. He then planned to get some firearms training and pack the little gun for real. On the day, he picked the pistol up at the gun shop he bought a box of 9mm ammunition and stored the lot in his book bag before reporting to work at the Quik-Stop. Unwilling to carry the gun without training and the permit, he stashed his bag in the break room at the store and got to work behind the cash register.

The bad guy was, as is so typically the case, a short-sighted opportunist. He barged into the minimart

brandishing a weapon and relocated the young man and his coworker to the break room before securing them in place with duct tape. He then explained in unambiguous terms his intent to empty the cash register and then come back to kill them both. When the villain left the room to pilfer the till the young man knew he had minutes at best.

He wrenched himself free from his bonds and got to his book bag. Retrieving his new unfired SCCY handgun he quickly thumbed a few rounds into the magazine. Thusly equipped, he left the break room and confronted the aspiring murderer.

In the ensuing frenetic gunfight this young man fired four rounds, the first four of his life. Two of them connected. When the cops arrived shortly thereafter

[Cont. to page 68]



**From left to right are the SIG P365XL, the SCCY CPX-2, and the Springfield Armory Hellcat. All three guns are reliable concealed carry tools packing at least ten rounds of 9mm Parabellum in the magazine.**

**THE 9mm SCCY CPX**





# M&A PARTS INC. / WWW.MAPARTSINC.COM



964 Donata Ct. / Lake Zurich, IL 60047 / Tel: 847-550-8246 / Fax: 847-550-0654



Hours: 9:00 AM to 5:00 PM CST. Most orders shipped within 24 hours. Send certified check or money order, add approximate shipping. All federal, state and local laws must be adhered to. Illinois residents add 7.75% sales tax. All prices and specifications are subject to change without notice.



**CHECK OUR WEBSITE FOR WEEKLY SALES AND NEW PRODUCTS !!!**

## COMPLETE KITS

Add our Kit to your stripped lower receiver to complete your rifle.

All kits are assembled, head-spaced & test fired.

### CAR Kits



**Mil-Spec Forged Flattop T-Marked Upper**  
Barrel with M4 Feed Ramps / A2 Flash Hider  
Mil-Spec Forged F-Marked FSB / A2 Sight Post  
CAR Handguards w/Heatshield / Collapsible CAR Stock

5.56mm / 16 Inch Chrome-Moly 1:9 .....	<b>\$475.00</b>
5.56mm / 16 Inch Chrome Lined 1:9 or S.S. 1:8 .....	<b>\$520.00</b>
300BLK 16 Inch Chrome-Moly 1:8 .....	<b>\$475.00</b>
7.62x39mm / 16 Inch Chrome-Moly 1:10 .....	<b>\$525.00</b>
9mm / 16 Inch Chrome-Moly 1:10 w/ Colt Mag Block .....	<b>\$695.00</b>
9mm / 16 Inch Chrome-Moly 1:10 for Glock Style Mags .....	<b>\$525.00</b>
458 SOCOM / 16 Inch Chrome-Moly 1:14 .....	<b>\$845.00</b>

### Mid-Length Kits



**Mil-Spec Forged Flattop T-Marked Upper**  
Barrel with M4 Feed Ramps / A2 Flash Hider  
Mil-Spec Forged F-Marked Front Sight Base / A2 Sight Post  
Mid-Length Handguards w/Heatshield / Collapsible CAR Stock

5.56mm / 16 Inch Chrome-Moly 1:9 .....	<b>\$475.00</b>
5.56mm / 16 Inch Chrome Lined 1:9 or S.S. 1:8 .....	<b>\$520.00</b>
5.56mm / 16 Inch Chrome-Moly LtWt 1:9 or 1:7 .....	<b>\$475.00</b>
5.56mm / 16 Inch Chrome Lined LtWt 1:9 or 1:7 .....	<b>\$520.00</b>

### M4 Style Kits



**Mil-Spec Forged Flattop T-Marked Upper**  
Barrel with M4 Feed Ramps / A2 Flash Hider  
Mil-Spec Forged F-Marked Front Sight Base / A2 Sight Post  
M4 Handguards w/Heatshield / Collapsible CAR Stock

5.56mm / 14.5 or 16 Inch Chrome-Moly 1:9 .....	<b>\$495.00</b>
5.56mm / 14.5 or 16 Inch Chrome Lined 1:9 or S.S. 1:8 .....	<b>\$540.00</b>
5.56mm / 14.5 or 16 Inch Chrome-Moly 1:7 .....	<b>\$495.00</b>
5.56 / 14.5 or 16 Inch Chrome Lined 1:7 .....	<b>\$540.00</b>
6.8 SPC II 16 Inch Chrome-Moly 1:10 .....	<b>\$525.00</b>

### CAR Lightweight Kits



**Mil-Spec Forged Flattop T-Marked Upper**  
Ltwt Bbl w/M4 Feed Ramps / A2 Flash Hider  
Mil-Spec Forged F-Marked FSB / A2 Sight Post  
CAR Handguards w/Heatshield / Collapsible CAR Stock

5.56mm / 16 Inch Chrome-Moly 1:9 .....	<b>\$475.00</b>
5.56mm / 16 Inch Chrome-Moly 1:9 .....	<b>\$475.00</b>
5.56mm / 16 Inch Chrome Lined 1:9 .....	<b>\$520.00</b>
5.56mm / 16 Inch Chrome Lined 1:7 .....	<b>\$520.00</b>

### Commando Kits



*Shown with optional RRA Entry Stock*  
**Mil-Spec Forged Flattop T-Marked Upper**  
Barrel with M4 Feed Ramps / A2 Flash Hider  
Mil-Spec Forged F-Marked FSB / A2 Sight Post  
CAR Handguards w/Heatshield / Collapsible CAR Stock

5.56mm / 11.5 Inch Chrome-Moly 1:9 .....	<b>\$475.00</b>
5.56mm / 11.5 Inch Chrome Lined 1:9 or 1:7 .....	<b>\$520.00</b>
300B0 / 10.5 Inch Chrome-Moly 1:8 .....	<b>\$475.00</b>
7.62x39 / 11.5 Inch Chrome Lined 1:10 .....	<b>\$565.00</b>

### Pistol Kits



**Mil-Spec Forged Flattop T-Marked Upper**  
Barrel with M4 Feed Ramps / A2 Flash Hider  
Picatinny Rail Gas Block Front Sight  
Base Aluminum Free Float Tube / Pistol Recoil Buffer

5.56mm / 7 or 11.5 Inch Chrome-Moly 1:9 .....	<b>\$495.00</b>
5.56mm / 11.5 Inch Chrome Lined 1:9 .....	<b>\$540.00</b>
300B0/ 8 or 10.5 inch Chrome-Moly 1:8 .....	<b>\$495.00</b>
9mm / 4 or 10.5 Inch Chrome-Moly 1:10 w/ Colt Mag Block .....	<b>\$695.00</b>
9mm / 4 or 10.5 Inch Chrome-Moly 1:10 for Glock Style Mags .....	<b>\$525.00</b>

### 20 Inch Rifle Kit



**Mil-Spec Forged Flattop T-Marked Upper**  
Barrel with M4 Feed Ramps / A2 Flash Hider  
Mil-Spec Forged F-Marked FSB / A2 Sight Post  
Rifle Handguards w/Heatshield / A2 Trapdoor Stock

5.56mm / 20 Inch Chrome-Moly 1:9 .....	<b>\$495.00</b>
5.56mm / 20 Inch Chrome-Moly 1:9 LtWt .....	<b>\$515.00</b>
5.56mm / 20 Inch Chrome Lined 1:9 or 1:7 .....	<b>\$540.00</b>
5.56mm / 20 Inch Stainless Steel 1:8 .....	<b>\$540.00</b>
5.56mm / 20 Inch DCM Stainless Steel 1:8 .....	<b>\$975.00</b>

### 16 Inch Varmint Kit



**Mil-Spec Forged Flattop T-Marked Upper**  
Varmint Barrel with M4 Feed Ramps  
Picatinny Rail Gas Block Front Sight Base  
Aluminum Free Float Tube / A2 Trapdoor Stock

5.56mm / 16 Inch Stainless Steel 1:8 .....	<b>\$515.00</b>
<i>With optional Fluted Barrel</i> .....	<b>\$575.00</b>
<i>With optional Versa-Pod Bipod</i> .....	<b>add \$85.00</b>

### 20 or 24 Inch Varmint Kit



**Mil-Spec Forged Flattop T-Marked Upper**  
Varmint Barrel with M4 Feed Ramps  
Picatinny Gas Block Front Sight Base  
Aluminum Free Float Tube

5.56mm / 20 Inch Stainless Steel 1:8 .....	<b>\$540.00</b>
<i>With optional Fluted Barrel</i> .....	<b>\$590.00</b>
<i>Shown with optional Versa-Pod Bipod</i> .....	<b>add \$85.00</b>

## KITS OPTIONS & UPGRADES

#### BUTTSTOCKS

A2 Trapdoor or Car Stock .....	No Charge w/o kit <b>\$85.00</b>
M4 Stock (Standard with M4 Kit) .....	add <b>\$25.00</b> w/o kit <b>\$60.00</b>
Magpul MOE Rifle Stock .....	add <b>\$55.00</b> w/o kit <b>\$65.00</b>
Magpul PRS Stock .....	add <b>\$210.00</b> w/o kit <b>\$245.00</b>
Magpul UBR Stock .....	add <b>\$160.00</b> w/o kit <b>\$180.00</b>
Magpul ACS Stock .....	add <b>\$60.00</b> w/o kit <b>\$75.00</b>
Magpul CTR Stock .....	add <b>\$45.00</b> w/o kit <b>\$55.00</b>
Magpul MOE Stock .....	add <b>\$30.00</b> w/o kit <b>\$35.00</b>
ACE Skeleton Stock .....	add <b>\$60.00</b> w/o kit <b>\$75.00</b>
ACE M4 SOCOM Stock .....	add <b>\$135.00</b> w/o kit <b>\$155.00</b>
Luth-AR .....	MBA-1 <b>\$135.00</b> MBA-3 <b>\$150.00</b>
Rock River Arms Operator Stock .....	add <b>\$95.00</b> w/o kit <b>\$110.00</b>
Troy Battle Ax CQB Stock .....	add <b>\$135.00</b> w/o kit <b>\$155.00</b>
Troy SOCC Airborne Stock .....	add <b>\$170.00</b> w/out kit <b>\$195.00</b>

#### LOWER PARTS / GRIPS

Rock River Arms NM Two Stage Trigger .....	add <b>\$80.00</b> w/o kit <b>\$110.00</b>
Geissele SSA Trigger .....	add <b>\$245.00</b> w/o kit <b>\$275.00</b>
KE Arms Drop In Trigger .....	add <b>\$135.00</b> w/o kit <b>\$165.00</b>
Hogue Pistol Grip .....	add <b>\$15.00</b> w/o kit <b>\$20.00</b>
ERGO SureGrip .....	add <b>\$20.00</b> w/o kit <b>\$25.00</b>
ERGO Deluxe Tactical Grip .....	add <b>\$50.00</b> w/o kit <b>\$60.00</b>
Magpul MOE Grip .....	add <b>\$15.00</b> w/o kit <b>\$20.00</b>
Magpul MOE+ or MOE K+ Grip .....	add <b>\$20.00</b> w/o kit <b>\$24.00</b>
Rock River Arms Winter Trigger Guard .....	add <b>\$10.00</b> w/o kit <b>\$15.00</b>
Magpul Enhanced Trigger Guard .....	add <b>\$15.00</b> w/o kit <b>\$20.00</b>
Magpul Enhanced Mag Release .....	<b>\$18.00</b>
Magpul BAD Lever .....	<b>\$27.00</b>
KE Arms Ambi Selector .....	add <b>\$30.00</b> w/o kit <b>\$35.00</b>
Mil-Spec AR15 Ambi Selector .....	add <b>\$20.00</b> w/o kit <b>\$25.00</b>
Mil-Spec M16 Ambi Selector .....	<b>\$35.00</b>

#### CHARGING HANDLES / CARRIERS / HANDGUARDS

Tactical Charging Handle Latch .....	add <b>\$10.00</b> w/o kit <b>\$15.00</b>
PR Big Latch .....	add <b>\$15.00</b> w/o kit <b>\$20.00</b>
Ambi Charging Handle .....	add <b>\$50.00</b> w/o kit <b>\$65.00</b>
BCM Ambi Charging Handle .....	add <b>\$65.00</b> w/o kit <b>\$75.00</b>
Chrome Carrier Group Assembly .....	add <b>\$30.00</b> w/o kit <b>\$130.00</b>
Nickel Boron Carrier Group Assy .....	add <b>\$55.00</b> w/o kit <b>\$155.00</b>
Diamondhead VRS T or X .....	10" <b>\$160.00</b> 13.5" <b>\$185.00</b> 15" <b>\$195.00</b>
2 Piece Car Quad Rail (Imported) .....	add <b>\$25.00</b> w/o kit <b>\$35.00</b>
Carbine 7" Free Float Quad Rail .....	add <b>\$35.00</b> w/out kit <b>\$45.00</b>
M&A Keymod or M-Lok 7" .....	<b>\$60.00</b> 9" <b>\$75.00</b> 12" <b>\$95.00</b> 15" <b>\$110.00</b>
Magpul MOE CAR/Mid .....	add <b>\$25.00</b> w/o kit <b>\$35.00</b>
Troy Alpha or M-Lok 7" .....	<b>\$150.00</b> 9 or 11" <b>\$175.00</b> 15" <b>\$190.00</b>
Troy Alpha w/ Integrated Flip Up Front Sight 11 or 13" .....	<b>\$235.00</b>
YHM Diamond Quad 7" Car .....	<b>\$130.00</b> 9" Mid <b>\$155.00</b> 15" <b>\$170.00</b>

#### GAS BLOCKS / FRONT & REAR SIGHTS

Low Profile GB .750 Alum .....	add <b>\$0.00/ Steel add \$25.00</b>
Single Rail GB .750 Alum .....	add <b>\$0.00/ Steel add \$35.00</b>
Quad Rail Block .750 or .936 Steel .....	add <b>\$65.00</b> w/o kit <b>\$80.00</b>
Rock River Gas Block Flip-Up Front Sight .....	<b>\$85.00</b>
Magpul Polymer Front Sight .....	add <b>\$45.00</b> PRO <b>\$75.00</b>
YHM Flip-Up Rear Sight .....	9680 <b>\$95.00</b> 5010 <b>\$110.00</b>
YHM Flip-Up Front Sight. Gas or Rail Height .....	<b>\$75.00</b>
Troy Flip-Up Front Sight. Rail Height .....	<b>\$90.00</b>
Magpul Polymer Flip-Up Rear Sight .....	<b>\$55.00</b> PRO <b>\$95.00</b>
Mil-Spec Detachable Carry Handle .....	<b>\$85.00</b>
Diamondhead Poly Rear Sight .....	<b>\$60.00/ Steel \$115.00</b>
UTG or Amsport Imported Flip Rear Sight .....	<b>\$30.00</b>
A.R.M.S. #40 Flip-Up Rear Sight .....	<b>\$110.00</b>
Troy Flip-Up Rear Sight .....	<b>\$110.00</b>

### Slings & Adaptors

	<b>Ambi Lock Plate Loop</b> <b>\$10.00</b>
Condor Bungee 1pt .....	<b>\$40.00</b>
Condor Bungee 2pt .....	<b>\$40.00</b>
Magpul .MS3 Sling .....	<b>\$46.00</b>
Magpul MS4 Sling .....	<b>\$55.00</b>
Magpul ASAP Plate .....	<b>\$27.00</b>
Magpul RSA Adapter .....	<b>\$27.00</b>
G.I. Standard Sling .....	<b>\$10.00</b>
QD Lock Plate .....	<b>\$20.00</b>
Ambi Lock Plate, Loop Slip Over Tube Style .....	<b>\$25.00</b>
QD Sling Swivel, Heavy Duty .....	<b>\$12.00</b>
Ambi Lock Plate, For QD Swivel Slip Over Tube Style .....	<b>\$20.00</b>

### Magazines

Brass Catcher .....	<b>\$15.00</b>
CMMG 22LR Conversion w/ Mag .....	<b>\$185.00</b>
CMMG 22LR 26rd Mag .....	<b>\$25.00</b>
CMMG SS Anti Tilt Follower or Braided Spring .....	<b>\$4.00</b>
G.I. Aluminum 30rd .....	<b>\$16.00</b>
FAL 20rd Metric .....	<b>\$25.00</b>
GI Green No Tilt Follower .....	<b>\$1.25</b>
Troy 30rd .....	<b>\$13.00</b>
HK91/G3 Alum .....	<b>\$7.00</b>
10 for .....	<b>\$50.00</b>
Magpul .308 .....	20rd <b>\$20.00</b> , 25rd <b>\$23.00</b>
Magpul 7.62x39 30rd .....	<b>\$14.00</b>
Magpul 5.56 40rd .....	<b>\$20.00</b>
Magpul 5.56 30rd .....	No Window <b>\$14.00</b> , w/ Window <b>\$17.00</b>
Magpul 5.56 10 or 20rd .....	<b>\$14.00</b>

### Flash Hider / Misc.

G.I. A1 or A2 Flash Hider .....	<b>\$8.00</b>
Noveske PIG KX5 .....	<b>\$185.00</b>
Smith Ent. Vortex .....	<b>\$65.00</b>
Troy Midevil Flash Hider .....	<b>\$45.00</b>
YHM 28A .....	<b>\$35.00</b>
Crush Washer .....	<b>\$2.00</b>
Field Repair Kit .....	<b>\$35.00</b>
Brass Catcher .....	<b>\$15.00</b>
Gas Ring (set of 3) .....	<b>\$2.00</b>
Lower Spring Kit .....	<b>\$9.00</b>
Lower Pin & Detent Kit .....	<b>\$15.00</b>
M&A T-shirt (Skull w/ Logo \$ Smoking M4) .....	<b>\$12.00</b>
Misc Parts Kits Fal STG, Romanian AK, Sten III .....	<b>See Website</b>
Misc Parts for the 1911, M1 Carbine, Garand and M1A .....	<b>See Website</b>
Rifle Cases, Mag Pouches, Flashlights & Mounts .....	<b>See Website</b>

### Maintenance/Tools

A1 or A2 Sight Tool .....	<b>\$7.00</b>
AR15/M16 Tech Manual .....	<b>\$5.00</b>
Armor Wrench .....	<b>\$20.00</b>
Box of 1000 Patches .223 .....	<b>\$7.00</b>
Bore Guide .....	<b>\$25.00</b>
Broken Shell Extractor .....	<b>\$10.00</b>
Buttstock Cleaning Kit .....	<b>\$15.00</b>
CAR Spanner Wrench 3pt .....	<b>\$10.00</b>
Chamber Blocking Device .....	<b>\$3.00</b>
Chamber Cleaning Stars .....	<b>\$10.00</b>
Gas Tube Cleaner 50pk .....	<b>\$9.00</b>
Handguard Removal Tool .....	<b>\$12.00</b>
Military Sniper Manual .....	<b>\$5.00</b>
Lower Receiver Vice Block .....	<b>\$20.00</b>
Upper Receiver Vice Clamp .....	<b>\$25.00</b>



[Cont. from page 66]

they found the terrified clerk performing CPR on the man who had just recently planned to kill him.

The police seized the young man's weapon as evidence. His father contacted the company to thank them for producing the tool that had undeniably saved his son's life. SCCY in return flew the young man and his dad to Daytona Beach to tour the factory, meet the employees who made the gun, and accept a replacement weapon free of charge. That was an incontrovertibly dark and horrible experience for the poor kid in that minimart. However, that, my friends, is what it's all about. A responsible citizen forced to face the darkness has the tools to transform himself from prey to predator. The good guy lives on as a productive citizen. The bad guy, not so much.

**The Gun**

SCCY is a reliably different sort of company. Where most gun manufacturers offer a cluttered catalog of sundry sizes, barrel lengths, and disparate designs, SCCY builds a single gun very, very well. That one gun is now available in either 9mm or .380ACP and features either a double action only or striker fired trigger, but the designs of both pistols are similar. This allows the good folks at SCCY to perfect their product.

The gun we reviewed for this project is the traditional CPX-2 DAO variant. The 9mm CPX-1 has the thumb safety. The 9mm CPX-2 does not. The CPX-3 is the .380ACP version without an external safety. The CPX-4 is the same .380ACP gun with the external



The 9mm CPX-2 is shown here flanked by a brace of CPX-3 .380ACP pistols. The basic chassis remains essentially the same throughout the line.



**The SCCY CPX-2 is rugged as a tire tool. Sporting a simple action, superlative workmanship, exceptional design, and modest cost, the CPX is a utilitarian workhorse.**



manual safety. The DVG-1 is the 9mm version with a striker-fired trigger.

I am diagnosably paranoid about handgun safety, but I am comfortable carrying the CPX without the manual safety. The long heavy DAO trigger is smooth and consistent from start to finish and mimics that of

a nice double action revolver. Firing the gun requires no extraneous thought, but it does necessitate some intentionality.

The indestructible polymer frame resists wear and abuse and features pleasant pebbling in the spaces that interface with flesh along with some smooth generic

finger grooves. The trigger guard is undercut to drop the bore axis as low as possible. The magazine release is a modest left-sided button in the expected spot.

Every SCCY CPX comes with two stubby ten-round box magazines along with both flat and finger rest floorplates. These mags look like miniaturized versions of the sorts that feed your full-sized combat pistols. The flat floorplates minimize the gun's footprint, while the finger rest sort offer a spot to park your fifth finger and subsequently enhance control.

The tapered steel slide is built like a main battle tank with deep and aggressive charging grooves. All the edges are nicely beveled for a smooth easy draw.



**The CPX-1 (right) has a manual thumb safety. The CPX-2 does not.**



**The polymer frame is stubby enough to hide while filling the hand adequately to dissipate recoil.**



**The CPX's compact double stack magazine carries ten rounds of 9mm Parabellum.**





The CPX magazine is conceptually similar to those of larger service pistols like this SIG M17.



Interchangeable floorplates allow for maximum concealability or optimal control.

The extractor is wildly overbuilt, and the top of the slide is laser grooved to reduce glare. The sights include three prominent white dots, and the rear sight is drift adjustable for windage. There is a left-sided slide release that is just the right size for easy access without snagging.

The safety is a pivoting thumb lever that features a modest protective ridge at the bottom to minimize the risk of inadvertent deactivation. The lever is oriented in reverse of that of the 1911. The pivot is at the front, and the lever bit points back at the shooter. Deactivation is intuitive and instantaneous. However, I find the protective ridge to be a bit uncomfortable for my tastes. I preferred the version not thusly adorned.

The SCCY CPX is as simple an autoloading handgun as mankind might contrive. The gun has all the

[Cont. to page 72]



Laser engraved grooves help mitigate glare.



The left-sided controls are the perfect size and location.

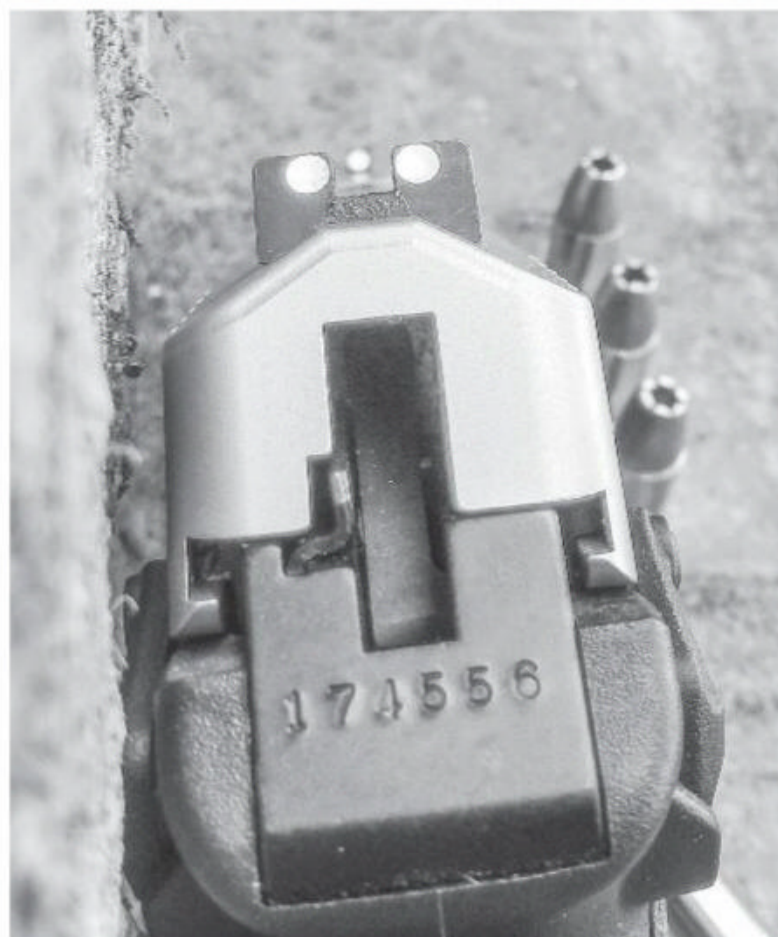

Simple three-dot sights get the job done without extraneous fluff.

## BEWARE THE FEARSOME BLACK HILLS HONEYBADGER

**B**lack Hills Ammunition supplies ammo to some of the most esteemed military and Law Enforcement shooters on the planet. These guys clearly know how to make a superb product. Their line of HoneyBadger solid copper defensive ammo is radically different.

Black Hills offers their HoneyBadger line in nine different calibers. Each turned copper bullet is specifically optimized for the caliber and velocity. These unusual bullets are turned from solid copper and are not designed to expand at all. Think of them more like tiny little screaming airborne power tools purpose designed to foment mischief within the entrails of evil-doers.

The 9mm variants come in 100gr +P fast versions as well as 125gr subsonic loads. Even out of short-barreled concealed carry guns the 100gr rounds are blistering fast. Recoil is ameliorated over heavier loads, and downrange effects are fairly barrier blind and reliably catastrophic. Every round is loaded to Black Hills' exacting standards, and the fluted bullet design looks just scary as heck.

[Black-hills.com](http://Black-hills.com) 



The Black Hills Ammunition HoneyBadger round fires a solid copper defensive bullet designed to be effective via fluid dynamics rather than traditional malleable expansion.



# SARCO, INC.

CALL  
Us!

**LET'S MAKE A DEAL**

CALL  
Us!

**610.250.3960**

AND ASK FOR CHOLLY, DAVE OR MARK

**DAVE MICHELS**

*mgdave@sarcoinc.com*

*ext. 223*

**CHOLLY STEEN**

PRESIDENT & CEO

*csteen@sarcoinc.com*

**MARK DOTTEN**

*mdotten@sarcoinc.com*

*ext.224*

**www.SARCOINC.com**

**50 Hilton Street, Easton, PA 18042**



**EXTRA SURPLUS TO SELL??**

**MATERIAL SITTING AROUND ACCUMULATING ANOTHER YEAR OF DUST??**

SARCO, one of the top 2 gun parts and general surplus dealers & importers in the U.S., is interested in your surplus material! Our primary interest is in gun parts, ammunition, ammo components, guns, cannon, aircraft, military vehicles, uniforms, field gear, etc. We are also interested in commercial firearms or parts, and surplus commercial inventory.

**NO DEAL IS TOO BIG OR TOO SMALL !!**

We will consider all offers and we assure you of our prompt and discreet attention to your offering. Mutually beneficial business is just a call away!

**WE CAN SELL YOU SURPLUS AS WELL ! INQUIRE !!**



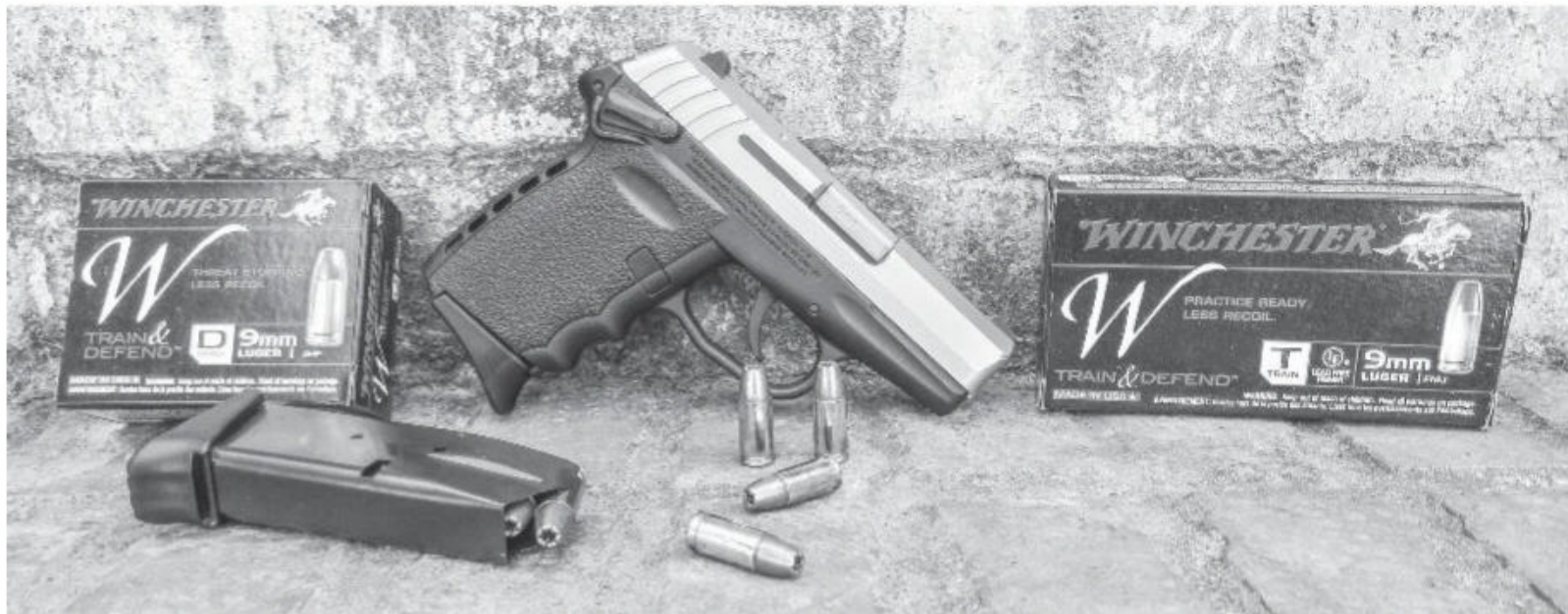

The manual safety is ideologically similar to that of a 1911 but oriented in reverse. The CPX-1 includes a prominent ridge underneath the safety lever.



**Disassembly is painless. The takedown pin can be removed with the rim of a cartridge or a proper human fingernail.**

[Cont. from page 70]

stuff you need without the fluff you don't, and the mechanical interfaces are perfect. Simple in the world of combat pistols equals uncompromising reliability. The unique recoil-driven action is described as the Roebuck Quad-Lock. This feature is named after the CEO of SCCY and designer of the CPX, Joe Roebuck. Joe is one undeniably fascinating guy.

### The Proud Father of the SCCY CPX

I had the privilege of spending some time with Joe Roebuck in his Florida factory a few years ago. Joe is one of those unusual gentlemen who just doesn't seem to operate on the same plane as the rest of us. Like Thomas Edison, Elon Musk, and John Moses Browning, Joe Roebuck simply has a gift. A self-taught engineer, Joe started out working for Schrade Cutlery before becoming their head die maker. He then began designing his own products and building companies to market them. The impact he has had on the world is indeed prodigious.

If you've ever had eyeglass lenses ground while you wait Joe's machine did that. He also built a device that replaces heart stents during coronary angioplasties. With several companies birthed, built, and spun off under his belt, Joe Roebuck focused his not inconsiderable mechanical and managerial talents on building the world's simplest, most reliable handguns.

Joe told me that a passion for quality starts at the top, and SCCY is a reflection top to bottom of Joe's drive and gifts. Unlike literally every other gun company on the planet, SCCY builds every piece of their gun in-house. From the molded polymer frame to the machined steel slide to the magazines and individual small components, SCCY does it all underneath one really big roof. Joe told me that this was the only way he felt that he could control every piece of a machine upon which people's lives might ride. I guarantee you that young man in the minimart is a most fervent fan.

The earliest SCCY pistols many years ago developed a reputation for problems. Joe had never built a



Joe Roebuck is the driving force behind the SCCY CPX.



Joe Roebuck is the singular personality behind SCCY firearms.

[Cont. to page 74]



# It's time to **BE READY!**



All you have to do is read the headlines to know why people all over the country are thinking more about preparedness. Whether it's catastrophic weather, utility breakdowns, terrorist attack or the collapse of civil order, millions of Americans aren't willing just to hope for the best. They are taking more active measures to get ready for the times when stopping at the grocery store or the ATM won't be options. **BE READY!** addresses the skills and supplies they will need to survive.

**ON NEWSSTANDS  
NOW!**

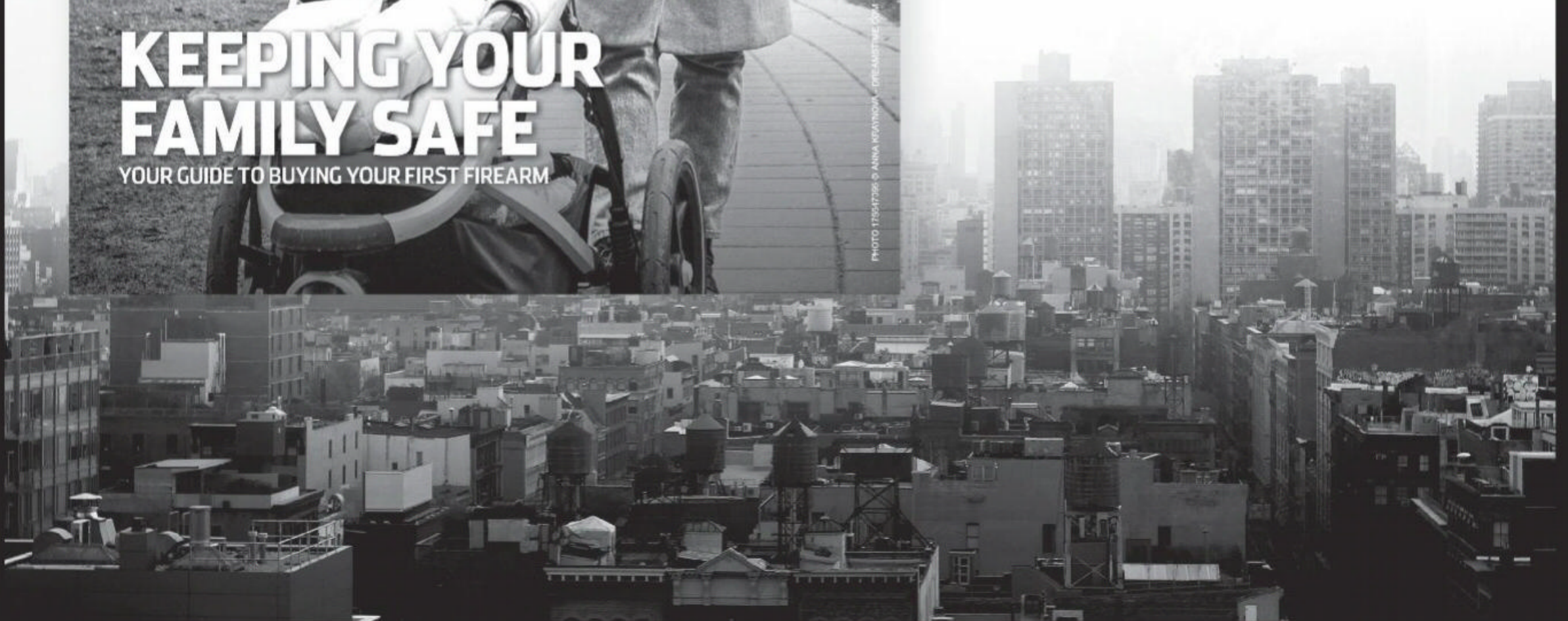



**Joe Roebuck set out to produce a top-tier defensive pistol priced for normal folk who need a “tool” to go with their other daily “tools” as shown in this pocket dump.**



*[Cont. from page 72]*

gun before, and there is an inevitable learning curve. Over time he got the details worked out and the design polished.

How refined is the CPX nowadays, might you wonder? In 2016 SCCY sold 160,000 copies. In 2017, the first year of the Trump administration when the gun market was in a slump that number fell to 150,278.

Today, SCCY has the best warranty in the gun business. If your SCCY firearm fails, breaks, malfunctions, or hiccups for any reason SCCY will repair or replace it for free. That in and of itself is not terribly remarkable. However, if your gun is stolen send them a copy of the police report and SCCY will send you a new pistol. With all those hundreds of thousands of weapons in circulation the SCCY return department is one guy. I met him back when I toured the plant. He told me he was bored a lot.

**How Does She Run?**

The SCCY CPX is like the Russian T34 tank. It is designed for a single mission. The CPX is intended to be easy to carry, easy to shoot, tactically accurate, and unflinchingly reliable. The CPX delivers on all points.

This gun falls comfortably in the palm of your hand. There is enough breadth to accommodate a standard set of human fingers without any extraneous ditzels or protrusions. The slide on my copy locks back reliably on the last round fired, and the empty magazines jump out of the butt like Leftist politicians fleeing responsibility. The overall chassis is compact enough for pocket carry if you are partial to baggy cargo pants.

*[Cont. to page 76]*

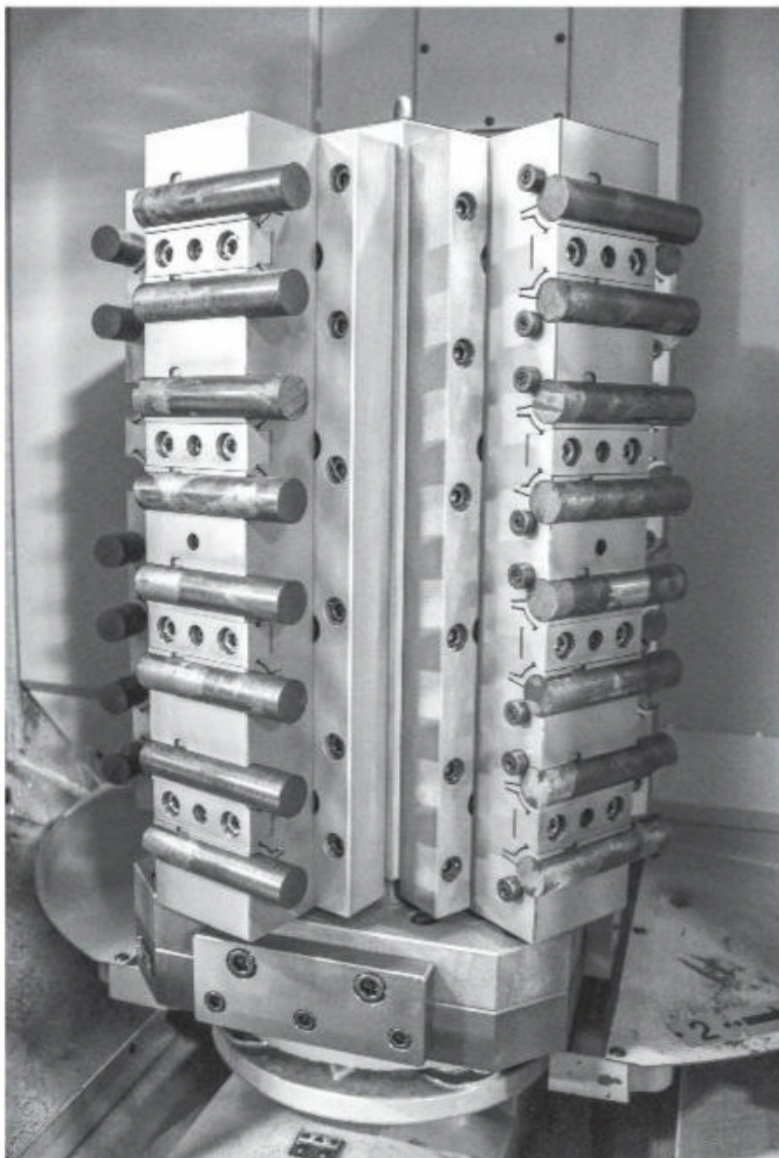

**These steel bars are about to be cut into slides in the SCCY factory.**



**SCCY makes everything, even the magazines and tiny bits, in a single Florida production facility.**



**SCCY makes all of their production fixtures in-house.**



**When I toured the plant SCCY was the fifth largest handgun manufacturer in the country. They make a lot of pistols.**



# THE 2020 *FIREARMS NEWS* **TREASURY** IS BACK.

**ON NEWSSTANDS  
NOW!**

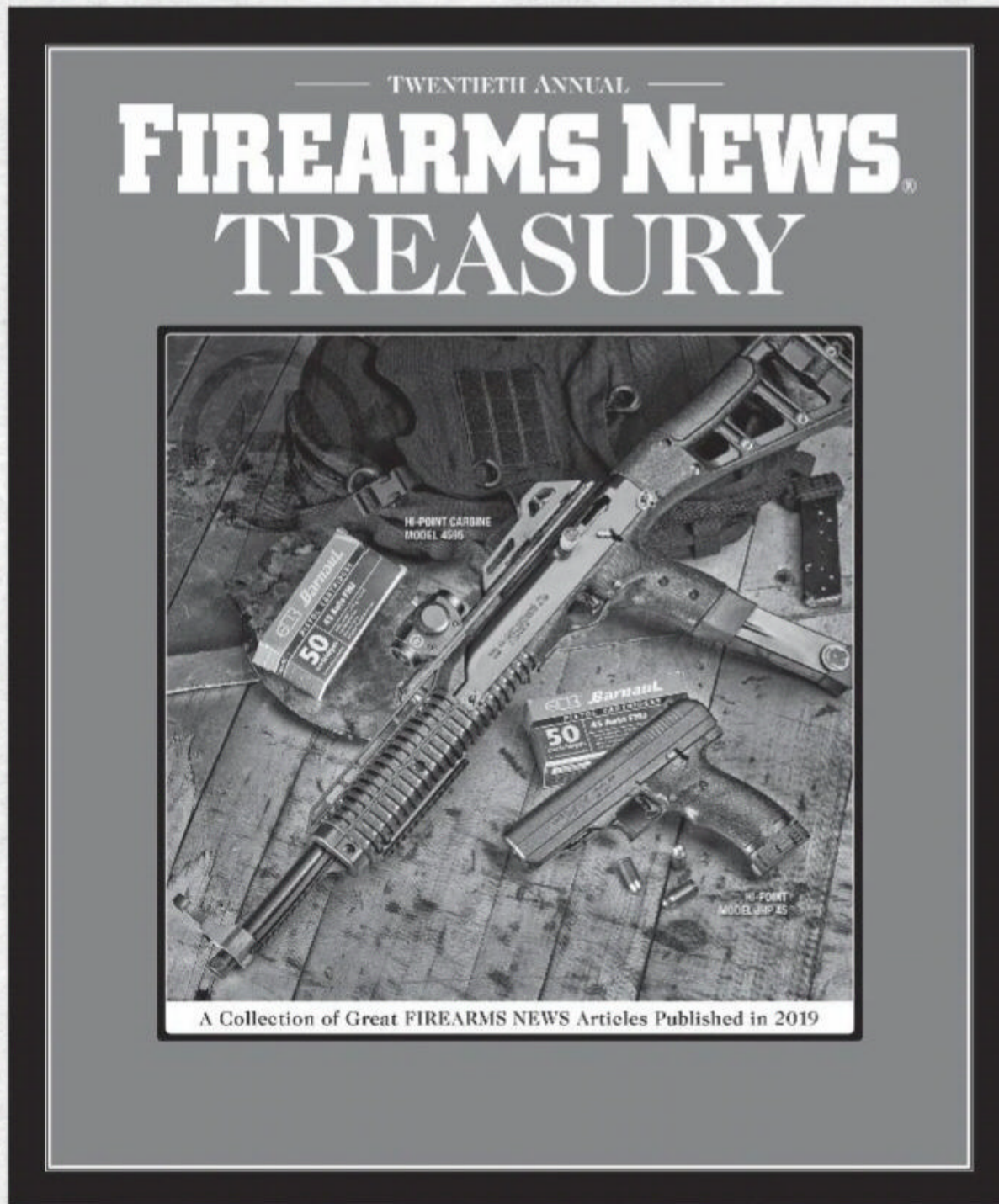

PACKED with some of the most popular stories of the year!

---

*Don't wait — they'll go fast!*

---

On sale at fine retailers like Barnes & Noble and Wal-Mart.





The long, heavy double action trigger takes a magazine or two to master, but the CPX is safe, hard-hitting, concealable, and reliable.



The SCCY CPX shoots plenty straight. These groups were printed at a typical seven-meter defensive engagement range.

[Cont. from page 74]

The gun fits the hand well and points naturally. The trigger pull is a smooth and predictable nine pounds, while the payload is 10+1 of 9mm Parabellum. The SCCY CPX is not a range toy. Given the gun's modest dimensions it jumps around a bit. The experience isn't painful or particularly unpleasant, but it isn't recreational.

If you want a pistol to use for plinking or keeping the burgeoning discarded beverage can population under control, then pick up a Ruger MK IV or a Walther P22. If you want a packable, powerful defensive tool that shoots straight, is easily concealed, and remains just dead nuts reliable then the CPX is your iron.

### Denouement

When Joe set out to design the CPX he made an assessment of the gun market. The country was awash in expensive high-end plastic guns that cost half a grand or more. These combat handguns were undeniably effective but remained out of financial reach of the typical working stiff paying for a mortgage and diapers. At the other end of the spectrum were the cheap pot-metal gangster guns that didn't cost anything but were not packable and could fail in the crunch. Joe's gun was going to bring better quality than the Big Guys at a price within reach of the Common Man.

Every single piece of Joe's CPX is built in one Florida facility by folks who know how to build guns. Joe backs up his baby with the best warranty in the industry. The SCCY CPX is easy to carry and conceal via a variety of platforms. At reasonable defensive ranges the CPX will drop its rounds right where you want them. All this and the MSRP for the CPX is about \$270. The street price is typically lower.

Though the CPX comes in a single chassis, it can still be ridiculously customized. Slides come in either black or natural stainless, while the polymer frames can be had in hues ranging from pedestrian

[Cont. to page 78]

## FEDERAL'S ONE-STOP SHOOTING SOLUTION

While our buddy in the minimart saved his life and that of others with the first four rounds he ever fired, most of us thankfully follow a different path. The capacity to carry and wield a defensive firearm safely requires sober decision-making and ample training. Federal Ammunition now produces a single product specifically designed to meet both training and operational needs. The Practice and Defend 100-Round Combo Pack covers all the bases.

Fifty rounds of Syntech Training Match ammo allow you to exercise your defensive pistol while minimizing metal fouling, barrel heat and friction, and splash-back from shooting hard targets. This dedicated training ammo is clean-shooting, reliable, and accurate. 147-grain bullets perfectly mimic the

behavior, performance, and comportment of the corresponding defensive loads.

This same box also includes fifty rounds of high-performance HST Jacketed Hollowpoint defensive ammo. HST bullets expand reliably despite common barrier materials and consistently penetrate deep enough to get the job done. Developed as the result of generations of real-world law enforcement and defensive experience, Federal's HST rounds reflect the current state of the art. Both loads produce identical velocities, trajectories, and points of impact. Federal Ammunition's Premium Practice and Defend 100-Round Combo Pack is all you need to feed your primary defensive heater in one convenient box.

**FederalPremium.com** 



Federal Practice and Defend ammunition includes two different loads with identical ballistics all in a single convenient box.



# ANYTIME, ANYWHERE

DIGITAL ACCESS NOW INCLUDED WITH YOUR PAID SUBSCRIPTION!

ENJOY DIGITAL ACCESS ON YOUR PHONE, TABLET & MORE\*



# SUBSCRIBE TODAY AT

[WWW.FIREARMSNEWS.COM](http://WWW.FIREARMSNEWS.COM)

CURRENT SUBSCRIBERS GO TO [MYMAGNOW.COM](http://MYMAGNOW.COM)  
AND SELECT "CREATE DIGITAL ACCOUNT"

\*Digital Edition is available on updated iPad/iPhone, most Android devices, and the Microsoft Store for Windows



PERFORMANCE — **SCCY CPX-2 9mm**

Load	Group Size (in.)	Velocity (fps)
Winchester Defend 147 gr. JHP	1.3	927
Black Hills 100 gr. HoneyBadger	0.8	1,129
Federal Syntech 147 gr. FMJ	1.1	899
Federal HST 147 gr. JHP	0.9	877

Group Size is best four of five rounds measured center to center and fired from a simple rest at seven meters. Velocity is the average of three shots fired across a Caldwell Ballistic Chronograph oriented three feet from the muzzle.

[Cont. from page 76]

to otherworldly garish with everything in between. No kidding, they come in eighteen different colors. If you're the sort who wants to blend into the crowd or color coordinate your defensive iron with your underpants, SCCY has the gun for you.

You can certainly spend more on a top-quality defensive handgun. Of course, you could also put your cash in a tidy pile and set fire to it as well. The SCCY CPX offers twenty-one rounds on tap should you care to pack the spare mag and runs as fast as your personal ability might dictate. The CPX is the Volkswagen of defensive handguns. Compact, utilitarian, and undeniably cool in an odd industrial sort of way, the SCCY CPX is a whole lot of peace of mind for not a lot of money. **FN**

**SCCY CPX-2**

<b>Caliber:</b>	9mm Parabellum
<b>Barrel Length:</b>	3.1 in.
<b>Width:</b>	1.26 in.
<b>Length:</b>	6.01 in.
<b>Weight (Empty):</b>	15 ounces
<b>Magazine Capacity:</b>	10+1
<b>Magazines:</b>	2
<b>Sights:</b>	Steel Three-Dot Rear Adjustable for Windage
<b>MSRP:</b>	\$269.99
<b>Contact:</b>	SCCY Firearms (866) 729-7599 SCCY.com



®  
GALLERY OF GUNS

**WANT A SCCY CPX?**

Check out Davidson's Gallery of Guns at [GalleryOfGuns.com!](http://GalleryOfGuns.com)

**D**avidson's offers the GuaranteeD® Lifetime Replacement Warranty which backs all the firearms you buy through GalleryofGuns.com. It works like this: if anything ever goes wrong with any gun you buy with the Davidson's GuaranteeD® Lifetime Replacement Warranty, it will be replaced. If no replacement is available, it will be repaired at no charge to you. Simply return it to the retailer where you purchased it, pay for the return shipping and upon receipt Davidson's will ship the returning retailer a brand-new gun for you provided one is available. If a replacement is not available your firearm will be repaired for free. For complete warranty information please refer to the Guaranteed Warranty link found at the home page of [GalleryofGuns.com](http://GalleryofGuns.com). **FN**

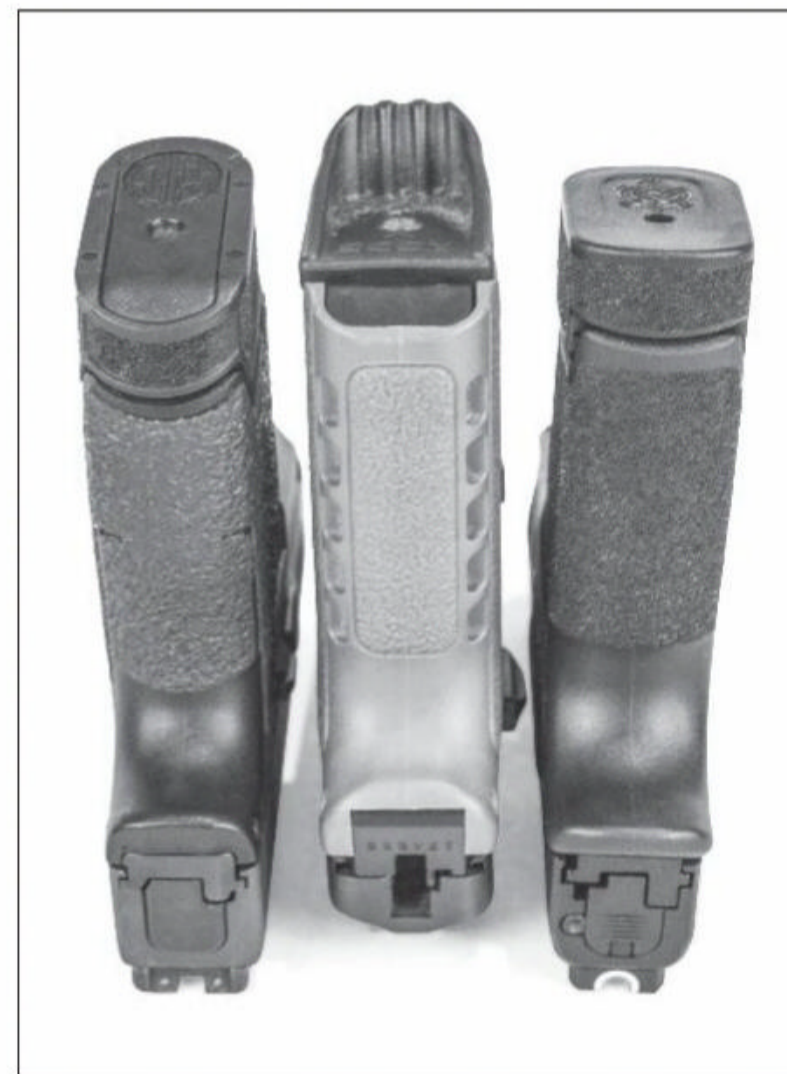

Compared to the SIG P365 (left) and the Springfield Armory Hellcat (right), the SCCY CPX is not too much bigger.



# THE WEST IS CALLING

CREATED SPECIFICALLY TO capture the imagination of the aspirational elk hunter, this magazine is THE SOURCE for those chasing dreams of hunting North America's ultimate big-game animal. Trusted resources like Will Primos, Fred Eichler and Craig Boddington deliver the blueprints as you begin your elk hunting journey.

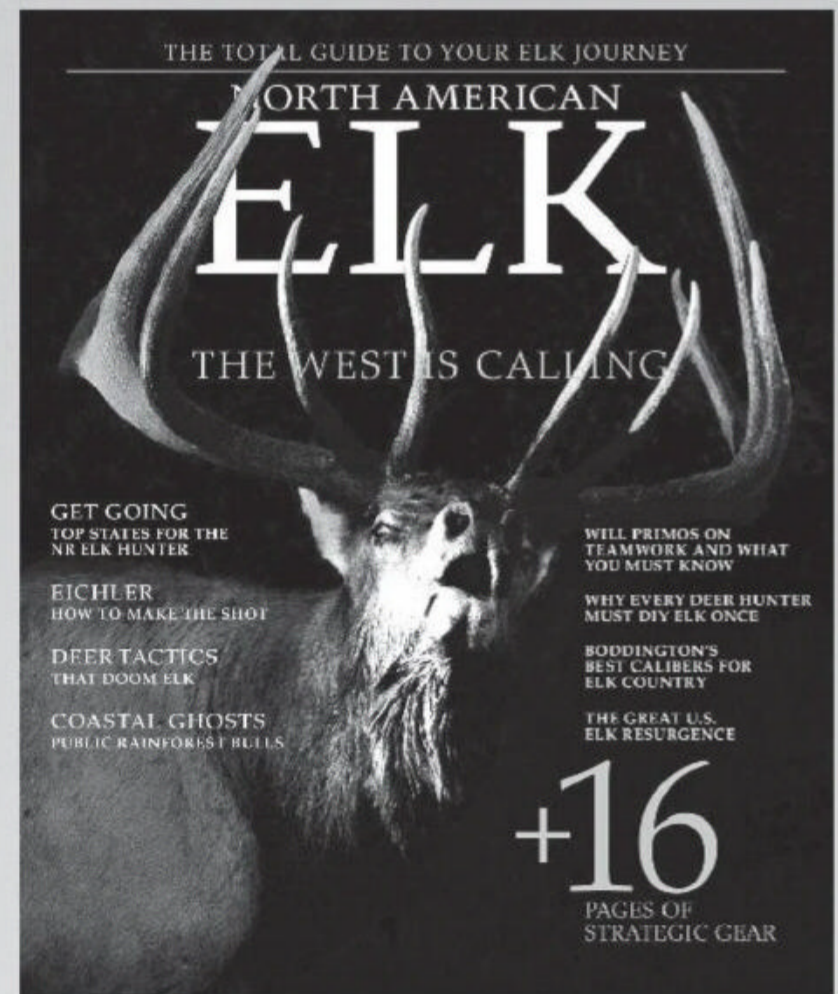

ON NEWSSTANDS NOW!

ALSO AVAILIABLE AT [OSGNEWSSTAND.COM](http://OSGNEWSSTAND.COM)

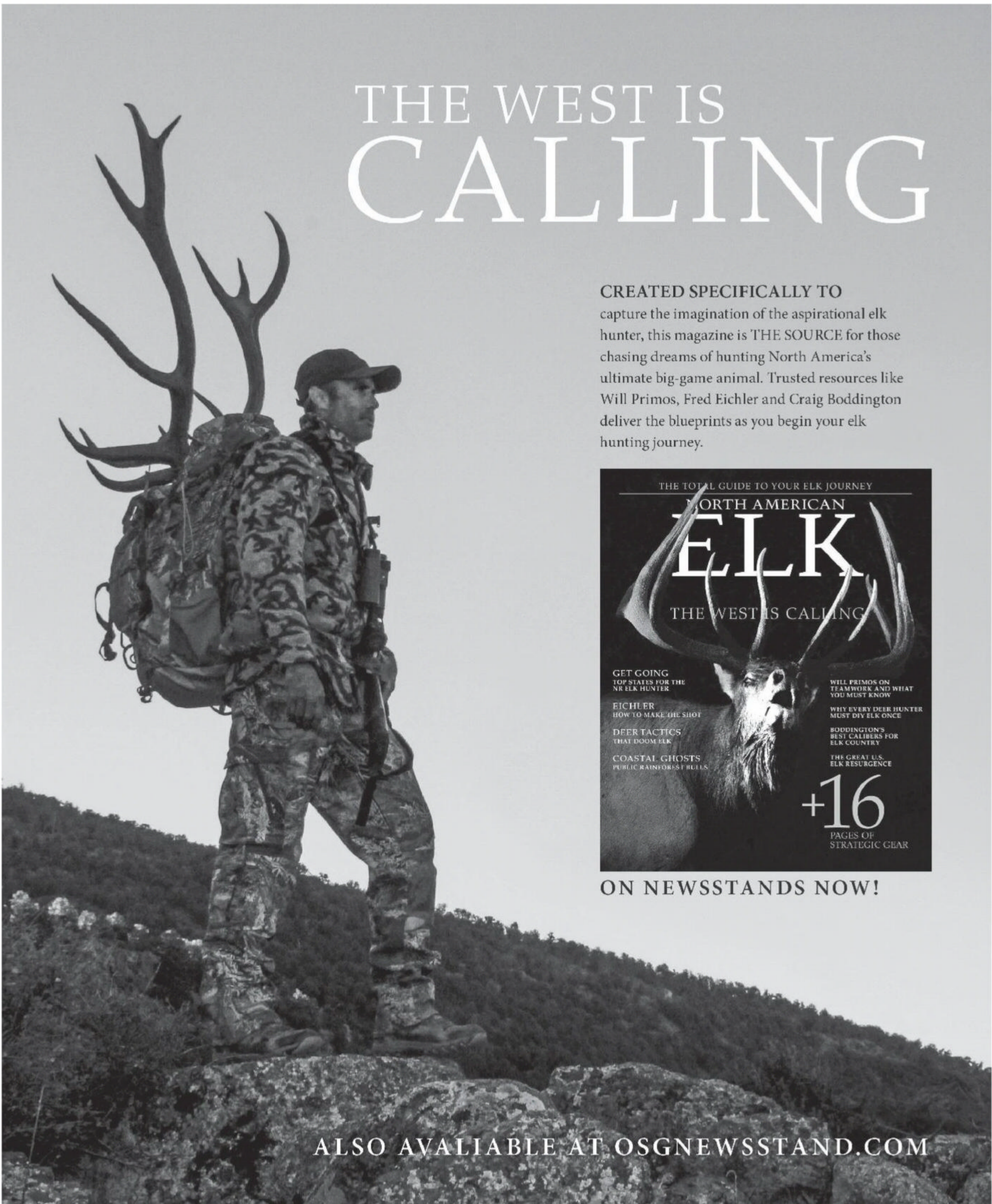



# J & G SALES

Dept. FN / 440 Miller Valley Road / Prescott, AZ 86301

All prices and specifications subject to change without notice

Hours: Mon - Fri: 8 am to 5:30 pm / Sat: 9 am to 3 pm MST • Fax: 928-445-9658

Order Online at:  
**www.jgsales.com**

Order by Phone:  
**928-445-9650**

**Great Deals on Firearms, Ammo & Accessories at J&G Sales!**  
Call or visit [www.jgsales.com](http://www.jgsales.com) for the latest pricing and availability on hard to find firearms, imported or domestic ammo and accessories.



**CURIO & RELIC ELIGIBLE**

## 9x18 Makarov Czech CZ-82

Czech CZ-82 9x18 Makarov semi-auto, surplus sidearm featuring 3.9 inch barrel, black polycoat finish with plastic grips, and ambi safety. A very heavy duty and accurate pistol. Has polygonal rifling for long barrel life (rifling not visible, appears as smoothbore). The CZ-82 replaced the older CZ-52 and served the Czech military in the 1980's and 90's. It comes with one 12 round magazine and leather duty holster. In good condition with coated finish flaking off (sometimes significantly) and scratches on the grips. Holster condition or completeness varies. **C&R eligible. Add \$20.00 for Hand Select.**

**Czech CZ-82** ..... 25-1886 **\$249.95**

**Czech CZ-82 9x18 Makarov**  
Good condition but with chipped grips..... 25-1886 **\$199.95**

**Czech CZ-82 9x18 12 Round Magazine**  
Military CZ magazines for the CZ-82 and CZ-83, work for both 9x18 and .380 ACP calibers. Blued steel double stack mags that hold twelve 9x18 rounds or thirteen .380 rounds. In good condition..... 4-565 **\$49.95**  
**With purchase of CZ-82 Pistol**..... 4-565 **\$29.95**

## 9x18 Sellier & Bellot

95 Grain FMJ • Brass Case • Non-Corrosive • Boxer Primed  
Box of 50 rounds ..... 5-513 **\$15.95**  
500 rounds ..... **\$149.95**  
1,000 rounds..... **\$279.90**



## 9x18 Makarov Brown Bear 94 Grain FMJ

Lacquered Steel Case

Berdan Primed, Non-Corrosive

**Box of 50 Rounds** ..... 5-1088 **\$10.95**  
**500 Rounds** ..... **\$104.95**  
**500 Rounds** ..... **\$199.90**



## .308 Caliber Malaysian Surplus 146 Grain FMJ

Brass Case Berdan Primed Non-Corrosive

**Box of 40 Rounds** ..... 5-820 **\$16.90**  
**300 Rounds in Steel .30 Cal Ammo Can** ..... **\$124.95**

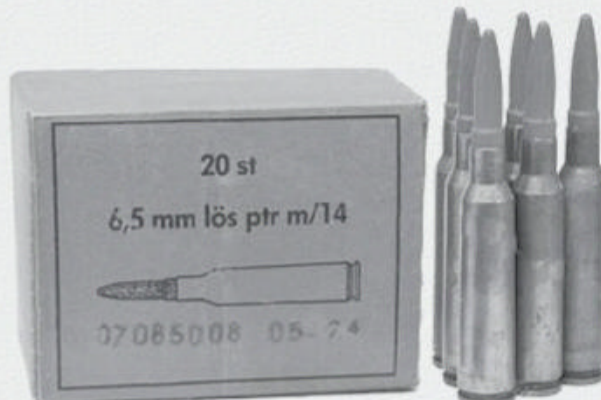

## 6.5x55mm Swedish M14 Blank

Wooden Projectile Tarnished Brass Case Berdan Primed

**Box of 20 Rounds** ..... 5-2159 **\$2.50**  
**200 Rounds** ..... **\$19.98**  
**800 Rounds** ..... **\$59.60**  
**SALE! 4,800 Rounds** ..... **\$96.00**

**Visit [www.jgsales.com](http://www.jgsales.com) and sign up to receive our E-Mail Special Offers!**



**J & G SALES** ORDER ONLINE AT [WWW.JGSALES.COM](http://WWW.JGSALES.COM)  
**928.445.9650**  
 FIREARMS / AMMUNITION / ACCESSORIES 440 Miller Valley Road, Prescott, Arizona 86301

# STAR BM 9mm PISTOL



**see the various grades at [jgsales.com](http://jgsales.com)**

**hand select and extra mag available**

**from \$149.95**

[WWW.JGSALES.COM](http://WWW.JGSALES.COM)



**J & G SALES**  
 FIREARMS / AMMUNITION / ACCESSORIES

ORDER ONLINE AT [WWW.JGSALES.COM](http://WWW.JGSALES.COM)

928.445.9650

440 Miller Valley Road, Prescott, Arizona 86301

**You CAN reload easily**  
**Order all your equipment online**



**Presses and  
 equipment,  
 plus bullets  
 and brass!**

**RCBS  
 Lyman  
 Hornady**

**Lee  
 Sierra  
 Nosler**

[WWW.JGSALES.COM](http://WWW.JGSALES.COM)



The Wingshooting  
**LEGEND**



**WILDFOWL<sup>®</sup>**

Learn more and subscribe today at  
[wildfowlmag.com](http://wildfowlmag.com)



# CONGRESSMEN QUESTION ATF BRACE RESTRICTION PLANS

By David Codrea



“**C**ongressman Matt Gaetz announced... the ATF is crafting secret rules restricting the possession of certain pistol braces by American citizens, and that he has sent them a letter demanding they stop,” a June 16 Hot Take Press Room release reported. The letter, addressed to Attorney General William Barr and ATF Acting Director Regina Lombardo, was co-signed by Republican Reps. Neal P. Dunn, Bill Posey, W. Gregory Steube, John Rutherford, Ted S. Yoho, and Daniel Webster.

“We understand that ATF is currently considering restricting one arm brace model owned by over 700,000 Americans [and] strongly urge ATF to cease taking any actions and reconsider or rescind any secret determinations which call into question the legality of firearms owned by millions of law-abiding Americans.”

ATF making and then changing its mind on rules that result in further infringements, not to mention economic losses for manufacturers and product owners — or loss of freedom for noncompliance — has turned out to be another way to enact bans that bypasses the representatives of the people. It does things by diktat that keep changing with the political winds.

Cases in point on braces:

The Gaetz letter noted, “ATF initially welcomed the advent of pistol arm braces. In 2012, ATF correctly determined that the attachment of arm braces to large pistol platforms does not constitute the manufacture of a short-barreled rifle...subject to registration requirements under the National Firearms Act...”

In 2014, as Guns and Ammo reported, ATF advised a Colorado Police Department that had asked if “firing an AR-15 type pistol from the shoulder, specifically, if doing so would cause the pistol to be reclassified as a Short Barreled Rifle (SBR).”

“[W]e have determined that firing a pistol from the shoulder would **not** cause the pistol to be reclassified

as an SBR,” ATF’s Firearms Technology Branch Chief replied. “Generally speaking, we **do not** classify weapons based on how an individual uses a weapon. FTB has previously determined that the firing of a weapon from a particular position, such as placing the receiver extension of an AR-15 type pistol on the user’s shoulder, does not change the classification of a weapon. Further, certain firearm accessories such as the SIG Stability Brace have not been classified by FTB as shoulder stocks and, therefore, using the brace improperly does not constitute a design change.” [Emphasis in original.]

So, no problem, right? Come and get ‘em!

Then in 2015, NRA-ILA reported on ATF’s “Open Letter on the Redesign of ‘Stabilizing Braces’.”

“Any person who intends to use a handgun stabilizing brace as a shoulder stock on a pistol (having a rifled barrel under 16 inches in length or a smooth bore firearm with a barrel under 18 inches in length) must first file an ATF Form 1 and pay the applicable tax because the resulting firearm will be subject to all provisions of the NFA,” the reversed position stated.

Suddenly we had a problem. A huge problem, with life-destroying felony implications for anyone innocently caught up in a ridiculous bureaucratic net cast by people who either can’t make up their minds or have their minds made up for them by hidden, politically-motivated string pullers.

Fast forward to 2017 and it appeared everyone was happy again. Per a press release from SB Tactical™:

“An NFA firearm has not necessarily been made when the device is not reconfigured for use as a shoulder stock — even if the attached firearm happens to be fired from the shoulder,” the reversed (yet again rule) assured everyone. “To the extent that the January 2015 Open Letter implied or has been construed to hold that incidental, sporadic, or situational ‘use’ of an arm-brace (in its original approved configuration)

equipped firearm from a firing position at or near the shoulder was sufficient to constitute ‘redesign,’ such interpretations are incorrect and not consistent with ATF’s interpretation of the statute or the manner in which it has historically been enforced.”

Then in 2019, rumors were flying that ATF was once more on a reversal tear. This latest development seems to confirm the concerns were well-founded.

So, what’s the issue this time around?

“Unbeknownst to the general public, ATF has ordained in private determination letters that it considers ‘any firearm with a length of pull over 13-1/2 inches to be designed to be fired from the shoulder,’ thereby making it a short-barreled rifle,” the Gaetz letter observes. “However, ATF has also privately proclaimed that even firearms under this length of pull can be classified as a short-barreled rifle, if ATF identifies other (and often unspecified) applicable ‘indicators.’”

And the upshot of that?

“Even more troubling are reports that these non-public standards are being used to criminally prosecute unsuspecting gun owners. Given ATF’s refusal to explain these standards, it is impossible for the public to comply with ATF’s ever-changing body of secret law,” Gaetz and company note. “To criminally charge an individual or threaten a company based on one ATF employee’s opinion of whether an arm brace shares enough unpublished ‘design features’ with a shoulder stock is an appalling abuse of power and shows a blatant disregard for due process.”

Yeah, it’s what they do. This business of conflicting rules is no surprise to those of us who have been watching such things over the years.



In 2005, the Congressional Research Service published a memorandum regarding ATF firearms testing procedures. Among other things, it revealed that the ATF has “over 300 cubic feet of classification letters stored in file cabinets.” The Bureau hasn’t scanned any of these documents into a searchable database to assure consistency of interpretation, to identify and resolve regulatory conflicts. The extent to which this inconsistency has grown and compounded in intervening years is unknown and unknowable without a major organization and review effort.

The damn thing probably looks like the warehouse in *Indiana Jones* by now.

And it’s not just the rules that are a crap shoot, so is the punishment for running afoul of them. We’ve seen Adverse Actions in the past where ATF was violating dealer license revocation rules in defiance of policy and law. That the situation was ultimately “happily” resolved had less to do with fixing internal problems than they picked a target (Brinks) with the resources, will and legal savvy to defend itself. Good luck to the little guy.

“[E]ven during very conservative administrations, like President Trump’s, some do ‘try to make it more

difficult to acquire things that shooters need and gun owners need, for safety and for the unique circumstances that an individual may have,” Gaetz continues. He’s being unduly generous.

The president is who gave the green light to the “bump stock” ban (talk about legal, then illegal, then legal and now illegal again!), which has since been used to produce a court finding equating semiautos with machineguns. His “take the guns first, due process later” kneejerk raised red flags none of us who voted for him had counted on. He appointed gun ban-supporting William Barr as attorney general. He nominated former National Fraternal Order of Police President Kenneth Canterbury, a supporter of Eric Holder and Sonia Sotomayor, to be director of ATF. It’s increasingly hard to champion a man who at times seems set on blowing it “bigly” and the only thing keeping some of us going is the prospect of Joe Biden and all that implies.

What would be very helpful to have at this point would be copies of the private letters Gaetz mentions, and to that end, *Firearms News* has contacted his office via email because those answering the phone are caught up in the COVID-19 shutdown.

“What I am looking for are the ‘private letters’ listing ‘objective design features,’” I wrote to the congressman’s aide. “Realizing that recipients may not want their names made public, I’m wondering if you could provide copies with names and other identifiers redacted so that the firearms community could be informed of the specifics, and of who they came from. I would also be very interested in any for-the-record quote from the congressman in addition to what was stated in the letter and release.”

That was a few days ago, and no response has been received at this writing.

**About David Codrea:**



David Codrea is the winner of multiple journalist awards for investigating / defending the RKBA and a long-time gun owner rights advocate who defiantly challenges the folly of citizen disarmament. In addition to being a regular featured contributor for *Firearms News* and *AmmoLand Shooting Sports News*, he blogs at “The War on Guns: Notes from the Resistance,” and posts on Twitter: @dcodrea and Facebook. **FN**

**CONGRESSMEN QUESTION ATF**



**JOIN US**  
new product updates & specials

 **SARGE'S NEWSLETTER**

<p><b>\$595 / RPD</b> 100 round belt included (shipped where legal)</p> 	<p><b>\$360 / 8mm Mauser Ammo</b> Boxed, 720 rounds per case</p> 	<p><b>\$700 / L1A1 Aussie FAL</b> Includes original 20 round mag (shipped where legal)</p> 
---	---	--

**sargesmilitaryvault.com**  
Check the website for complete product details.

<p><b>\$675</b> AMD 65 AK</p> <p><b>\$1,995</b> Browning 1919 A4 (Excellent Quality)</p> <p><b>\$1,795</b> Browning 1919 A4 (Good Quality)</p> <p><b>\$500</b> IMBEL FN FAL (Unmatched Part Numbers)</p> <p><b>\$575</b> IMBEL FN FAL (Matching Part Numbers)</p>	<p><b>\$750</b> YUGO M53 (SARAC)</p> <p><b>\$375</b> Skorpion VZ-61 with Barrel</p> <p><b>\$395</b> Sterling British L2A3</p> <p><b>\$390</b> 8mm Mauser Ammo, Belted</p> <p><b>\$350</b> 7.62x51 Israeli Match Ammo</p>
---	--



Save money with the #1 source of firearms!

# FIREARMS NEWS

## Firearms & Accessories SUPERSTORE!

FIREARMS NEWS is loaded with exciting bargains on rifles, shotguns, revolvers, and pistols. Save on all kinds, makes, models, manufacturers, and vintages. Plus discover your best buys on ammo, optics, gun parts, and many more accessories, supplies, & services.

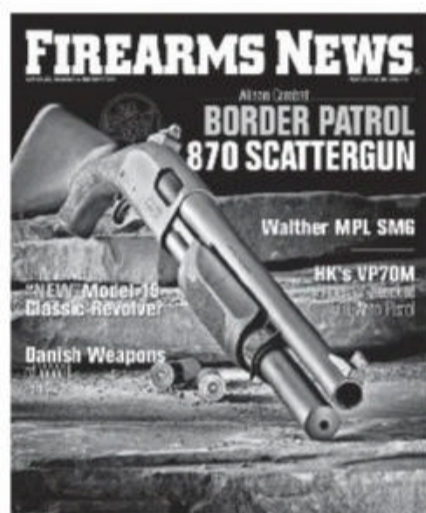

**FIREARMS NEWS**  
GUN SALES, REVIEWS, & INFORMATION  
APRIL 2019 | ISSUE 8

# GSG-16

**ATI**  
Will Not Let Your Dream of Owning an **MP5** Die!

**THE FRENCH MAC 50 PISTOL**

**PISTOLS and LONG GUNS of the 2019 SHOT SHOW**

**NOVA LIBERTY PRE-CHARGED PNEUMATIC AIR RIFLE**

**BULGARIAN SMALL ARMS of WORLD WAR II**  
Part 1

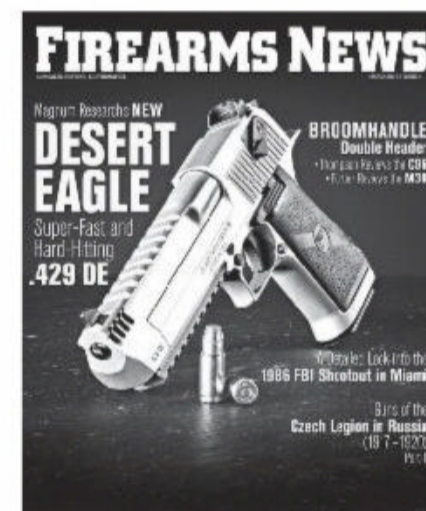

## SUBSCRIBE TODAY

[www.mymagnow.com/p](http://www.mymagnow.com/p) or call 1-800-345-6923



VISA/MASTERCARD/AMEX/DISCOVER



**NOW'S THE TIME!! BE THE FIRST TO KNOW ABOUT OUR DEALS !!!**

Join Our EMAIL BLAST List Today By Texting SARCO to 22828 And Receive A SPECIAL DISCOUNT ! By doing so, you'll get our latest email blast offers, sale items and notifications of new goodies coming in! AND... after you sign up, receive a FREE deck of authentic Cold War, Unissued & Illustrated AIRCRAFT CARDS! Just add them to your cart using part number MISC168 and enter source code EMAILBLAST at check out to receive them for FREE. What are you waiting for?? Get On The List!!

Use your Smart Phone to Scan the QR Code and go straight to our website!



**SARCO**

50 Hilton Street, Easton PA 18042  
610.250.3960  
Fax: 610.438.2548



www.sarcoinc.com

Phones Open:  
Mon - Fri, 8:30am - 5:00pm  
Showroom Open:

Monday - Saturday, 10:00am - 5:00pm,  
Friday til 8:00pm

1



America's 'finest' answer the call to defend those in need and what better motif to personify this, than the American Shield with Star and Chinese Nationalist Sun. A time when the odds were stacked against the free Chinese by the Japanese juggernaut, and Americans came forward to fight for the 'underdog' and win! Replicated emblem from an original with a slightly faded 'off' White, Royal blue, and Maroon leather compilation of sewn pieces like the original. Perfect for decoration or applying to leather flight jackets. 8" high by 7" across like the original



**\$19.95 MISC908**

**Tent Liner for U.S. Military 10 Man Arctic Tent**

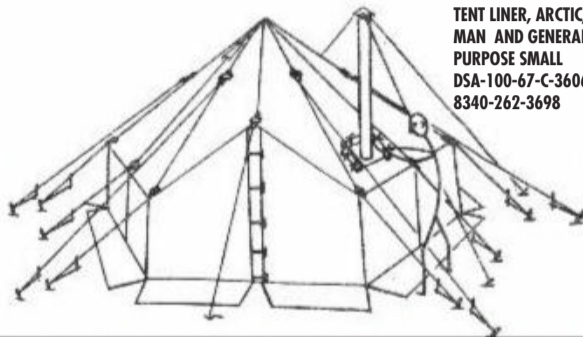

TENT LINER, ARCTIC, 10 MAN AND GENERAL PURPOSE SMALL  
DSA-100-67-C-3606  
8340-262-3698



Interior Tent Liner (canvas), for installation in the U.S. Military Arctic 10 Man Tent as shown above. Used in very good to excellent condition. Hard to find item since most of the tents released from Govt. Service were released without the liners and they are scarce on the market. We have a half dozen and they are bound to go quickly

**\$295.00 MISC920**

**USGI RAMER SKI BINDING SET**

**UNISSUED**

**For Down Hill & Cross Country Skiing**

Produced in the 1990s, these unissued sets of ski bindings are a cost effective way to build those custom or back up pair of cross country skis with 'first rate' hardware. Comes with instructions for mounting the hardware. Very limited



**\$34.95 MISC916**

**USGI BUG NET**



CAN BE USED OVER COTS OR AS A GROUND TENT



USGI surplus unissued 'Bug Nets', Mosquito Nets, Insect Bar, or whatever you want to call it, will help you sleep through the night without being bitten by flying insects. Can be used over a Cot, or as a tent which is roughly 13' long end to end and 7' wide (ground imprint). This net has tie off fabric straps and two areas with reinforcement holes to accept poles if used. Color Olive Drab / Net only

**\$14.95 MISC918**

**AR15 FLAT TOP UPPER COMPLETE PARTS SETS**

Double time it and get these before they're gone.... Everything present in this Kit to make an AR15 type rifle except for the Lower Receiver. All parts included are new mfg parts. Sling and magazine are not included. Buttstock supplied is the telescoping 6 position M4 stock with correct buffer and spring and the 16" barrel is brand new and has the front sight assy. installed. We use the industry standard hammer/trigger pin with a diameter of .154". Most Lower receivers use this size pin although there are some Colt mfg. lower receivers that use .170" pins which are not compatible with standard parts. The Upper Receiver is a flattop model and we offer it with and without the carry handle/rear sight configuration.

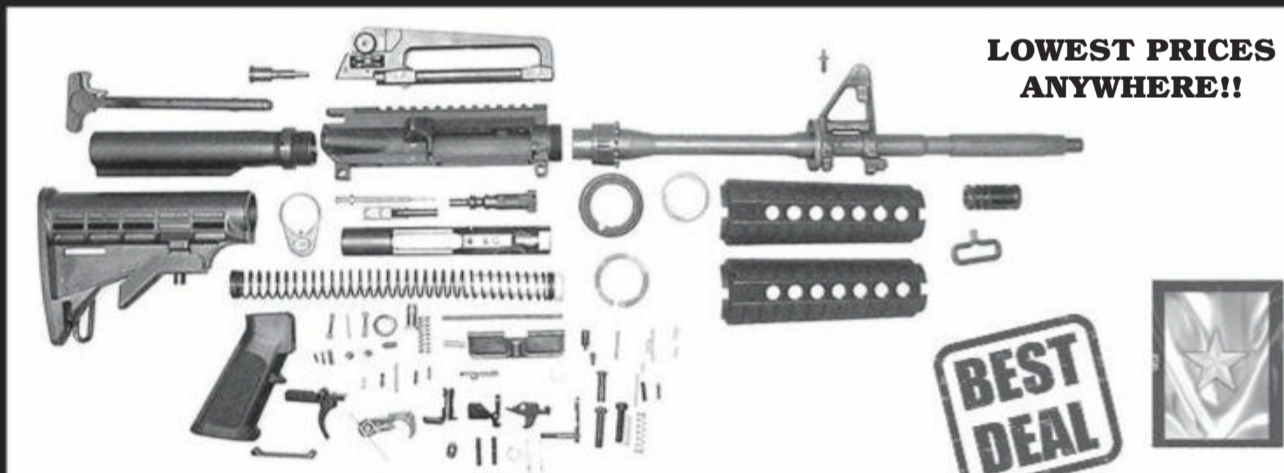

**LOWEST PRICES ANYWHERE!!**



- A. KIT w/ Flat top upper rec. w/ carry handle and rear sight **SALE!!** ..... **\$375.00 \$399.95** AR150 (shown in picture)
- B. KIT w/ Flat top upper rec. without carry handle & rear sight **SALE!!** ..... **\$349.00 \$379.95** AR224

**M4 16" COMPLETE BARRELED FLAT TOP UPPER ASSEMBLIES**

*Comes w/ bolt & carrier assembly*

We have done the hard work for you. These are fully assembled upper halves complete and ready to drop on to your complete lower. All parts made in the U.S.A.! Includes Flat Top Upper, barrel assembly, complete bolt and carrier assembly, charging handle assembly, forward assist and ejection port cover assembly

..... **\$270.00 \$295.00** AR013

Add ons: Kit with carry handle, rear sight assembly ..... **\$290.00 \$324.00** AR014

Add ons: Lower parts kit and collapsible stock and carry handle ..... **\$404.00 \$379.00** AR117



**USGI ARMY ACU CAMO MOLLE ENTRENCHING TOOL COVER**

Released from the military, these covers are in excellent condition and fit the standard fold up Entrenching tool perfectly. Also makes a great utility pouch for Beer, Ammo, etc.... and with MOLLE straps on the back, you can attach it to backpacks and belts **\$9.95 MISC914**



**USGI ENTRENCHING TOOL W/ 2 USGI COVERS !!!**

Original U.S. Military E-Tool in excellent condition comes with 2 original military carriers. One carrier in ACU camouflagage with MOLLE attachment and the other, rubberized case with alligator clips. The ACU pouch on its own is a great utility pouch that can be used to carry beer, ammo, and oh yes... spare toilet paper for the next pandemic. Very small quantity, but loaded with value!!! ..... **\$35.00 MISC913**



**USGI ENTRENCHING TOOL COVER**

Military Entrenching Tool. Cover only **\$7.95 MISC915**



**WINCHESTER 70 RIGHT HAND SHORT ACTION STOCK/SYNTHETIC**

New condition black synthetic stock with butt pad and swivel posts installed. Overall length 29-3/4 inches. For Post 1964 models. Great Price!



**JUST IN !!**

**\$49.95 STK427**

**AR/M16 ARMORER'S KIT**

Be ready when the time comes! Quality tool set for removal & installation of parts. Easily worth the cost just for the quality vise block set! INCLUDES - VISE BLOCK, DELTA WRENCH, TOOL BRUSH, BROKEN SHELL EXTRACTOR, BORE & CHAMBER BRUSHES, 1 SIGHT TOOL, CLEANING ROD SET \$91.50 value for just **\$49.95 \$59.95** AR373



**JUST IN !! USMC HERRINGBONE KOREAN WAR ERA SHORT SLEEVE UTILITY SHIRT**

Rugged Olive Drab short sleeve shirt for combat duty with breast pocket and two large Map pockets inset under the chest. Officers and NCOs loved these shirts and they fade wonderfully and take abuse of the rugged outdoors. Newly manufactured and made with USMC embossed buttons like the original shirts. Sizes available; Medium, Large, XL, 2XL, 3XL. Rare as 'hens teeth' these days, this might be your one chance to obtain one. Very limited

**\$49.00 MISC868**





### M16 ACCESSORY KIT - HEAVY DUTY

Cleaning toothbrush (GI) Silent sling, Front sight tool, Muzzle cover, Magazine dust covers (6), Plastic mag carriers (4) (Israeli G.I.), Broken shell extractor, Cleaning rod, Stripper guide, 2 Grenade launcher tension band (rare). Value \$83.50 **Sarco Special Price** ..... **\$19.95 AR238**

## SALE !! TAKE 20% OFF LISTED PRICE ON ALL TOOLS & FURNITURE IN THIS BOX SALE !!

### AFFORDABLE 'AR' TOOLS & FURNITURE FOR EVERY WALLET!

- A.** Picatinny Sling Swivel Mount for adjustable placement of the sling, complete with rubberized swivel. Fits on picatinny rails ..... **\$7.95 AR462**
- B.** Rail Mounted Front Sight steel sight, flip up style ..... **\$13.95 AR131**
- C.** Rail Mounted Rear Sight Steel with adjustable windage and elevation in the A2 sight style. Clamps to rail mount ..... **\$ 14.95 AR274**
- D.** Vertical Grip, Full Size 4 3/4" long clamps to picatinny rails. 3 colors : Tan, Black, Green.

- Tan..... **\$9.00 AR464T**
- Black..... **\$9.00 AR464B**
- Green..... **\$9.00 AR464G**
- E.** Compact Vertical Foregrip 3 1/8" long in 3 colors:
- Tan..... **\$8.50 AR463T**
- Green..... **\$8.50 AR463G**
- Black..... **\$8.50 AR463B**

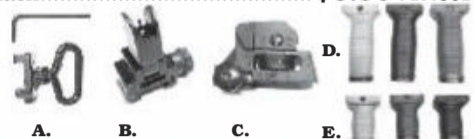

## AR15 AND M16

**SARCO**  
www.sarcoinc.com

### AR15 LOWER RECEIVER PARTS SET

Super price! Includes all parts shown except for the receiver. Comes with late model pistol grip and our hammer & trigger pin diameter is the industry standard at .154. Some Colt made guns use a .170 diameter which is not compatible with our parts ..... **\$36.50 ea.**  
3 for ..... **\$99.00 AR001**



### SARCO'S M16 MULTIPLE MAGAZINE CARRIER

Secure metal clip holds two magazines for quick change firing and tactical applications. We've made thousands for the U.S. Govt.! See our web site for details **\$14.95**, or 4 for ..... **\$45.80 AR203** (metal clip holder only)



### COMPLETE BOLT CARRIER ASSEMBLED

**FULL-AUTO** (works well with semi-auto AR15) **\$99.95 AR263**  
U.S. MADE!



### SIGHT ADJUSTING TOOL BACK IN STOCK!!

AR15/M16A2 SIGHT ADJUSTING TOOL 4 PRONG ..... **\$4.90 AR158**

### M16/AR15 COMBINATION TOOL

Save time with this wrench assy. that will speed up your maintenance of the M16 / AR15 and CAR15 platforms. Built with 4140 powder coated steel, this will outlast your Rifle! ..... **\$17.95 AR440**  
**ON SALE!**



### M16A2 STOCK SET W/ HANDGUARDS, PISTOL GRIP AND BUFFER & SPRING

**\$49.95 AR315**



### COMPLETE M4/AR15 16" BARREL

Complete 16 inch 5.56 NATO barrel with 1 in 9 twist. Ready for installation. Complete with barrel nut, slip ring, waffle spring, handguard retainer, front sight assy, flash hider & front swivel ..... **\$134.00 AR426**



Just Bought 10,000 **M16 GI MUZZLE COVERS!** Buy 100 for **\$24.95 AR192**



### AR15 COMPLETE BOLT ASSEMBLY - SUPER SALE!!

Best deal around! Bolt with all associated parts. Reg. \$75.00 **\$34.95 \$49.95 AR062**



### COLLAPSIBLE AR-15 CARBINE STOCK

• Six Positions • Precision machined Parts for Maximum Strength • Super Quality Aluminum Buffer • Includes complete stock assembly w/ buffer & recoil spring. • Reinforced grids Black



**\$34.95**, 3 for **\$94.50 AR145**  
**SALE! \$28.95**, 3 for **\$85.95**

### AR15/M16 SPRING KIT

A set of all of the coil & torsion springs in the AR15 or M16. Ideal item for your spare parts box. Price if bought separately \$18.30 Kit Price only. Includes recoil springs for Shortie M4 Kit..... **\$12.95 AR134**  
3 for ..... **\$32.95**  
Standard Stock Kit ..... **\$12.95 AR397**  
3 for ..... **\$32.95**

### See our website for M16 RETRO VIETNAM ERA TYPE PARTS

#### Super Sale on AR15

#### Rail Covers

**4 pcs of rubberized 6-7/8" rail covers in Black for the best price of \$4.80 a set!**



**(What a deal! Previous price was \$3.95 each!) 4 Black Rail Covers \$4.80 LA017**

#### AR15 ACCESSORIES

- Cleaning rod 4 pc. CLN030 ..... **\$6.95**
- Muzzle Cap (plastic) AR192 ..... **\$1.50**
- 3 for ..... **\$2.95**
- Stripper clip guide STC005..... **\$1.50**
- Magazine dust covers AR199..... 3 for **\$2.00**
- M16 G.I. cleaning "toothbrush" orig. G.I. issue. AR188 ..... **\$2.00**
- 3 for ..... **\$3.75**
- SPECIAL** one each of all 5 items above. AR321 ..... **\$8.95**
- M16A2 PEEL OFF FLASH HIDER WASHERS AR358 ..... **\$7.95**
- 3 for ..... **\$18.95**
- AR DELTA RING REMOVAL TOOL Makes hand guard removal simple AR326..... **\$8.95**

### M4 AR15/M16 RECEIVER CARRYING HANDLE AND REAR SIGHT ASSEMBLY

Fits Flat Top Upper receiver with Picatinny Rail. Complete with M16A2 rear sight assembly. AR180 **SPECIAL SALE!** ..... **\$29.95**, 3 for **\$84.95**



### SPECIAL SALE ON UPPERS! BEST PRICE EVER! WE GOT A GOOD BUY!! AR FLAT TOP M4 UPPERS



Many choices to suit your needs.  
A: Stripped flat top upper **\$39.95 AR196**  
B: Stripped Flat Top Upper with our complete A-4 carrying handle assy. (includes complete A2 rear sight assy) ..... **\$60.00 AR202**  
C: Stripped flat top upper with M4 carry handle assy and also ejection port cover assy and forward assist assy ..... **\$85.00 AR204**

### AR15/M16 CLEANING KIT & ACCESSORY KIT

- Bore brush
- Cleaning rod
- Tooth brush
- Oiler
- Muzzle cap
- Dual front sight tool
- Chamber brush
- Broken shell extractor
- Stripper clip guide
- Grenade launcher Tension band

**\$17.50**, 3 for **\$49.95 AR240**

### M16 4 PIECE CLEANING ROD

29 1/2" long. Threaded ..... **\$6.95 CLN030**

### M16A2 HANDGUARD SET COMPLETE WITH METAL LINER

CURRENT PRODUCTION **\$16.10 AR184**



### NEW M16A2 ROUND HANDGUARD SETS MILITARY PRODUCTION

Shortie length w/ liner **\$14.95 AR185**



### AR SHORTY BUTTSTOCK INSTALLATION WRENCH

Free Bonus - other end of wrench fits the 1911 barrel bushing ..... **\$2.95 TOOL031**



### M203 RUBBERIZED TUBE GRIP W/O CLIPS

**\$30.00 GRP139**



### AR15/M16 UPPER RECEIVER VICE BLOCKS

To securely hold your upper firmly without damage to the upper or the barrel on barrel installation. Will work on any AR upper (receiver not included)..... **\$29.95 AR467**

### AR15 LONG VENTILLATED FLASH SUPPRESSOR

Steel flash suppressor with standard threading for Govt./Commercial 5.56/.223 barrels. 5.5 inches long ..... **\$19.95 AR212**



### AR15 LONG SLOTTED FLASH HIDER

Steel flash hider similar to the Vietnam CAR-15 with standard threading for Govt./Commercial 5.56/.223 barrels 5.5 inches long ..... **\$19.95 AR213**



M4 stock set with handguards & pistol grip ..... **\$50.00 AR316**  
New M16A2 or M4 pistol grip ..... **\$8.95 AR074**

### AR15/M16 BIPOD, NEW ORIGINAL U.S.

**G.I. METAL \$24.95 AR139**  
Above Bipod with Pouch **\$29.95 AR297**  
Pouch only **\$5.95 AR324**



### 5.56MM/.223 BROKEN SHELL EXTRACTOR

Brand new tool; made for removing stuck headless cases from the chamber of any .223/5.56mm rifle. We've never seen these offered before now ..... **\$5.95 ea. BSE001**  
Our new BSE's work - others on the market don't fit. We learned the hard way!

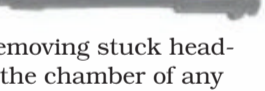

### M16 AUTO SEAR

Few only ..... **\$19.95 AR095**  
Buy a replacement(s) for your legal M16. All NFA rules apply. **Note:** These go out of time with use.

### AR15/M16 CHAMBER BRUSH

Original style ..... **\$3.95 AR205**

### AR 16" BARREL GAS TUBES

Just got a shipment in. these have been tight ..... **\$11.95 AR029**



### M16/AR15 EARLY 'DUCKBILL' FLASH HIDER

Early U.S. Advisors & Air Force 'Model 01' flash hidiers originally issued with the guns starting in 1963. These were succeeded by the standard GI 'prong' flash hider & later in 1969 by the 'birdcage' model. New mfg..... **\$9.95 AR423**



### FLASH HIDERS

M16A2..... **\$8.95 AR007**

### G.I. M16 RIFLE SLINGS

Late production ..... **\$5.95 SLNG001**



### AR15/M16 RIFLE PARTS

- AM136 223 (5.56) Dummy Rounds from Lake City - Original G.I. green tip..... **\$8.95**
- AR098 AR Safety ..... **\$10.95**
- AR100 AR15 Disconnecter..... **\$9.95**
- AR092 AR15 Hammer (Semi auto) ..... **\$15.00**
- AR001 AR15 Lower Receiver Parts Kit (Semi-Auto) ..... **\$36.50 ea.**, 3 for **\$99.00**
- AR102 AR15 Trigger (Semi-Auto) ..... **\$17.95**
- AR082 AR15/M16 Action Spring ..... **\$4.00**
- AR120 AR15/M16 Ejection Spring (shorty style)..... **\$4.00**
- AR032 AR15/M16 Barrel nut ..... **\$7.50**
- AR060 AR15/M16 Bolt Carrier Key ..... **\$6.00**
- AR071 AR15/M16 Bolt Carrier Key ..... **\$13.50**
- AR070 AR15/M16 Bolt Carrier Key Screw ..... **\$1.00**
- AR106 AR15/M16 Bolt Catch ..... **\$7.50**
- AR105 AR15/M16 Bolt Catch Pin ..... **\$1.00**
- AR107 AR15/M16 Bolt Catch Plunger ..... **\$7.50**
- AR108 AR15/M16 Bolt Catch Spring ..... **\$1.00**
- AR057 AR15/M16 Bolt Gas rings, set of 3 ..... **\$3.00**
- AR149 223 cal bore brushes, bronze 10 for..... **\$8.95**
- AR080 AR15/M16 Buffer ..... **\$12.95**
- AR081 AR15/M16 Buffer Short ..... **\$12.95**
- AR087 AR15/M16 Buffer Retainer ..... **\$2.00**
- AR088 AR15/M16 Buffer Retainer Spring..... **\$1.00**
- AR306 AR15/M16 Buttstock hinged trapdoor assy ..... **\$9.95**

- AR307 AR15/M16 Buttstock trapdoor hinge..... **\$4.00**
- AR119 AR15/M16 Butt Swivel A1/A2..... **\$4.00**
- AR056 AR15/M16 Butt Swivel Pin..... **\$1.00**
- AR118 AR15/M16 Butt Swivel Screw M16A2..... **\$2.85**
- AR002 AR15/M16 Charging Handle assy ..... **\$16.95**
- AR188 AR15/M16 Cleaning Toothbrush, G.I. .... **\$2.00**, 3 for ..... **\$3.75**
- AR104 AR15/M16 Disconnecter Spring..... **\$1.00**
- AR178 AR15/M16 Early prong flash hider..... **\$12.50**
- AR036 AR15/M16 Ejection Port Cover ..... **\$7.95**
- AR034 AR15/M16 Ejection Port Cover Snap ring ..... **\$1.00**
- AR035 AR15/M16 Ejection Port Cover Spring..... **\$1.50**
- AR172 AR15/M16 Ejection port cover pin..... **\$2.75**
- AR067 AR15/M16 Ejector ..... **\$3.00**
- AR066 AR15/M16 Ejector Pin..... **\$1.00**
- AR068 AR15/M16 Ejector Spring ..... **\$1.00**
- AR064 AR15/M16 Extractor ..... **\$10.95**
- AR063 AR15/M16 Extractor Pin..... **\$2.00**
- AR065 AR15/M16 Extractor Spring..... **\$1.00**
- AR059 AR15/M16 Firing Pin ..... **\$7.95**
- AR058 AR15/M16 Firing Pin Retaining..... **\$2.00**
- AR011 AR15/M16 Flash Hider Washer ..... **\$1.00**
- AR047 AR15/M16 Forward Assist Pin ..... **\$1.00**
- AR048 AR15/M16 Forward Assist Spring ..... **\$1.00**
- AR077 AR15/M16 Front and Rear Takedown Detent Spring..... **\$1.00**
- AR078 AR15/M16 Front and Rear Takedown Detent

- AR079 AR15/M16 Front Pivot Pin ..... **\$1.00**
- AR020 AR15/M16 Front Sight Detent..... **\$4.95**
- AR021 AR15/M16 Front Sight Detent Spring ..... **\$2.00**
- AR024 AR15/M16 Front Swivel Pin ..... **\$1.00**
- AR023 AR15/M16 Front Swivel Rivet..... **\$1.00**
- AR029 AR15/M16 Gas Tube 16" (Shorty)..... **\$11.95**
- AR028 AR15/M16 Gas Tube 20" (Standard) ..... **\$13.50**
- AR027 AR15/M16 Gas Tube Pin..... **\$1.00**
- AR072 AR15/M16 Grip Screw & Washer..... **\$1.00**
- AR089 AR15/M16 Hammer Pin ..... **\$1.50**
- AR093 AR15/M16 Hammer Spring..... **\$2.00**
- AR275 M16/M16A1 Handguard, new Colt (Right) ..... **\$14.95**
- AR025 AR15/M16 Handguard Cap (Triangular) ..... **\$6.95**
- AR033 AR15/M16 Handguard Slip Ring (G.I.) ..... **\$7.50**
- AR030 AR15/M16 Handguard Snap Ring..... **\$2.50**
- AR031 AR15/M16 Handguard Spring..... **\$6.00**
- AR083 AR15/M16 Lower Receiver Extension ..... **\$20.00**
- AR165 AR15/M16 Mag Carrier ..... **\$7.50**
- AR109 AR15/M16 Magazine Catch..... **\$1.50**
- AR177 AR15/M16 Magazine Catch Button, metal ..... **\$2.50**

- AR111 AR15/M16 Magazine Catch Spring..... **\$1.00**
- AR133 AR15/M16 Pin Kit..... **\$14.95**, 3/ ..... **\$39.95**
- AR043 AR15/M16 Rear Sight Aperture, Standard ..... **\$5.00**
- AR040 AR15/M16 Rear Sight Detent Spring..... **\$1.00**
- AR038 AR15/M16 Rear Sight Drum ..... **\$6.50**
- AR037 AR15/M16 Rear Sight Drum Pin ..... **\$1.00**
- AR046 AR15/M16 Rear Sight Spring ..... **\$1.00**
- AR041 AR15/M16 Rear Sight Windage Screw ..... **\$7.50**
- AR115 AR15/M16 Rear Takedown Pin..... **\$5.75**
- AR050 AR15/M16 Round Forward Assist..... **\$14.75**
- AR130 AR15/M16 Rubberized Swivel front new ..... **\$5.00**
- AR076 AR15/M16 Safety Detent..... **\$2.00**
- AR075 AR15/M16 Safety Detent Spring..... **\$1.00**
- AR095 AR15/M16 Sear Assembly..... **\$19.95**
- AR116 AR15/M16 Sear Spring..... **\$3.00**
- AR145 AR15/M16 Shorty Buttstock Assembly, high strength fiberglass w/steel locking ring ..... **\$39.95**, 3 for **\$85.95**
- AR430 AR15/M16 Slip Ring A1 (early)..... **\$20.00**
- AR134 AR15/M16 Spring Kit..... **\$12.95**
- AR302 AR15/M16 Top sling adapter..... **\$1.95**
- AR103 AR15/M16 Trigger Spring ..... **\$2.00**
- AR176 AR15/M16 Triggerguard, aluminum..... **\$6.75**

- AR112 AR15/M16 Triggerguard Pin..... **\$1.00**
- AR006 AR15/M16A1 Birdcage Flash hider ..... **\$6.95**
- AR085 AR15/M16A1 Buttcap Screw (Short) ..... **\$2.25**
- AR220 M16A1 Butt Swivel Screw..... **\$3.00**
- AR073 AR15/M16A1 Pistol Grip (Used)..... **\$9.95**
- AR214 AR15/M16A2 Burst Trigger..... **\$15.00**
- AR143 AR15/M16A2 Buttstock Crnt Prod. Comes with buffer, spring & all hrwd milspec ..... **\$54.95**
- AR007 AR15/M16A2 Flash hider..... **\$8.95**
- AR144 AR15/M16A2 New Buttstock (Current production) stripped..... **\$34.95**
- AR074 AR15/M16A2 Pistol Grip new..... **\$8.95**
- AR158 AR15/M16A2 Sight Tool (4 Prong) ..... **\$4.90**
- AR229 M16 Bolt Carrier ..... **\$99.95**
- AR127 M16 Magazine 6 Oriltes w/ Carriers ..... **\$59.95**
- SLNG099 M16 Single Point Sling, BLACK..... **\$17.95**
- SLNG100 M16 Single Point Sling, GREEN ..... **\$17.95**
- SLNG101 M16 Single Point Sling, SCORCHED DARK EARTH ..... **\$17.95**
- AR358 M16A2 .... Peel off flash hider washers. Used take off. Work fine..... **\$7.95**
- AR205 AR15/M16 chamber brush ..... **\$3.95**
- AR141 M16 Original G.I. Buttstock, plus lower receiver extension, buffer and spring ..... **\$59.95**





www.sarcoinc.com

50 Hilton Street, Easton PA 18042  
610.250.3960  
Fax: 610.438.2548

**M14 PARTS & ACCESSORIES**

**M14 7.62 NATO CHAMBER BRUSHES**

G.I. ratchet chamber brush originally made for use with the M14 rifle, but will work just as well in most 7.62mm NATO rifles, new ..... **\$2.95** or 3 for ..... **\$6.95 M14016**

**M14 FLASH HIDER PLIERS**

Available once again. New condition. A necessity for your M14 ensemble ..... **\$16.50 ea. TOOL039**

See our website for ITALIAN GARAND BARRELS

**NEW!!! M14 BARRELS IN STOCK**

Brand new .308 cal M14 Barrels made by one of the best U.S. barrel manufacturers ..... **\$175.00 ea. M14124**

**AVAILABLE AGAIN M14 FULL AUTO PARTS KITS**

M14 Selector, Pin & Spring  
M14 Selector Shaft  
M14 Sear Release  
M14 Connector Rod Full Auto  
M14 Selector Lock ..... **\$75.00 M14014**

**M14 WALNUT STOCK**

Nice Military rework... **\$45.00 M14363**

**M14/M1A SIGHT PROTECTORS**

Military style plastic snap-on covers to protect the front and rear sights and the flash hider muzzle of the M14/M1A rifle.  
New ..... **\$6.50**  
3 for ..... **\$17.95 M14022**

**M14 RIFLE CLEANING KIT**

Kit consists of following items:  
G.I. sectional cleaning rod, Rod handle/combination tool, Ratchet chamber brush, .30 cal. bore brush  
G.I. carrying pouch..... **\$12.50 CLN070**

**M14 STRIPPER CLIPS**

12 original clips for **\$9.95 STC016**

**M14 SPECIAL ITEMS**

- M14 Bolt stop G.I. .... **\$22.95 M14091**
- M14 Buttplate assy hinged, G.I. .... **\$29.95 M14047**
- M14 Connector rod G.I. .... **\$19.95**  
3/ ..... **\$49.95 M14049**
- M14 Firing Pin, original G.I. .... **\$21.00 M14058**
- M14 Front stock swivel set, new G.I. .... **\$8.95 M14117**
- M14 Handguard w/retaining clip, Fiberglass G.I. .... **\$12.50 M14005**
- M14 Handguard w/o retaining clip, Fiberglass ..... **\$9.95 HNGD13**
- M14 Handguard, Walnut ..... **\$24.95 M14120**
- M14 Op rod spring guide ..... **\$19.95 M14051**
- M14 Recoil Spring, TRW Orig GI ..... **\$7.45**  
5/ ..... **\$29.95**  
10/ ..... **\$49.95 M14052**
- M14 Rear Sight Aperture, .052 NM ..... **\$41.50 M14127**
- M14 Rear Sight Aperture, .059 NM ..... **\$41.50 M14364**

CHECK OUR WEBSITE FOR A FULL LISTING OF M14 & M1 GARAND PARTS & ACCESSORIES!

**USGI COMBAT BELT FOR INDIVIDUAL EQUIPMENT**

Recently released from U.S. Govt. service, these military combat belts are built to last under extreme conditions. 2-1/4" wide, this belt is size 'Large' for waists over 30 inches. Grommets allow for attachment of load bearing equipment/suspenders. Excellent condition **\$12.95 MISC917**

**M1 GARAND PART SETS**

We can piece together a few M1 Garand parts sets - All but the receiver - The stock and handguard set will be our new stock set GRD278. Condition of all parts is from good to new. Most are G.I. Sorry, but these have to be \$730 as some Garand parts are getting tough to acquire and cost is high. .30-06 ..... **\$730.00 GRD380**

**Just In !! NEW VARIATION OF THE .308 M1 GARAND KIT**

Again, all parts but the receiver with an original Italian .308 barrel. This unit is 1/2 inch shorter than a standard Garand ..... **\$495.00 GRD387**

**FINALLY BACK IN STOCK!!**

**WWII PATTERN WEB GARAND SLING**  
Just reproduced for U.S. complete with markings. OD with all proper metal fittings Beautiful. Proper for Springfield and Garand ..... **\$9.95 SLNG057**

**FOUND A FEW MORE M1C SNIPER RIFLE GRIFFIN & HOWE PATTERN MOUNT BASES**

Parkerized - Complete with the 3 screws & 2 pins ..... **\$24.95 GRD285**  
We also have the pin & screw set for ..... **\$12.95 GRD327**

**M1 GARAND RIFLE 'LINED' JEEP SCABBARD**

Marked improvement over the WW2 issue scabbard! Has the same outward appearance with brass guard for the charging handle and rich brown color with two leather straps and has been improved with a soft lining on the inside to protect your valuable investment from scratches and undue wear. Great for all sorts of similar sized rifles and works beautifully on horseback too!  
**SALE! ..... \$49.95 \$59.95 GRD382**



**LATE T-37 M1 GARAND SNIPER FLASH HIDER**

**\$34.50 GRD111**

**M1 GARAND OP ROD**

.308 length - 1/2 inch shorter than standard. **\$125.00 GRD175**  
**Finally Back In Stock!** We dug out a pile of Garand standard GI Op Rods..... **\$175.00 GRD052**

**M1 GARAND ACCESSORY PACK**

Terrific set of accessories for the Shooter or Reenactor! Made up of both original and reproduction items, the Pack includes the following items:

- GARAND GUN CASE, GARAND CARTRIDGE BELT, MILITARY MANUAL, M10 CLEANING SET w/brush, CHAMBER BRUSH, GI BORE CLEANER, CLEANING ROD STOP, 3 EN-BLOC STRIPPER CLIPS, M15 G.L. SGT.CASE, PULL THRU ROD & CORD

ALSO: Your choice of 1907 Leather Sling or Canvas WW2 style sling. Specify when ordering. A Retail Value of over \$145.00 For Just. **SALE! ..... \$59.95 \$79.95 GRD329**  
\*\*\*A great gift for a Garand owner!\*\*\*

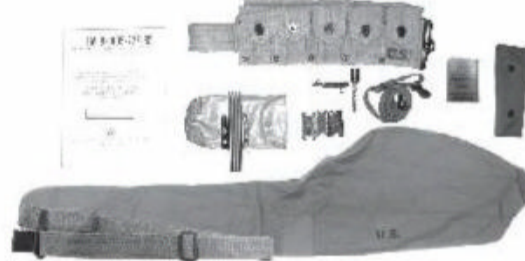

**OUR LATEST FABULOUS BUY ON BARREL BLANKS!**

All previous buys have been a sellout - most of these have been profiled so they are ready for your project.

**NOTE:** These are all first class production. LIMITED SUPPLY  
**NOTE:** We even have .20cal blanks  
**NOTE:** We are told that these blanks sell for up to \$200. These are ALL 1st class blanks. NO rejects, blems or GD2.

Part #	Caliber	Length	Diameter	Profile	Twist	Material	Description	Price
BB056	375 Cal	26 inches	N/A	#3	1 12.	4140	Unfinished Profile Blank	<b>\$59.95</b>
BB058	35 Cal	26 inches	N/A	#3	1 14.	4140	Unfinished Profile Blank	<b>\$59.95</b>
BB059	7MM	24 inches	N/A	#1	1 9.5	4140	Unfinished Profile Blank	<b>\$59.95</b>
BB060	270 Cal	24 inches	N/A	#1 1/2	1 10.	4140	Unfinished Profile Blank	<b>\$59.95</b>
BB062	243 Cal	24 inches	N/A	#1 1/2	1 10.	4140	Unfinished Profile Blank	<b>\$59.95</b>
BB063	22Cal	24 inches	N/A	#1 1/2	1 14.	4140	Unfinished Profile Blank	<b>\$59.95</b>
BB064	8MM	24 inches	1.250 Dia		1 9.5	Stainless	Unfinished Blank	<b>\$34.95</b>
BB065	30 Cal	22 1/2 inch	1.175 Dia		1 10.	Stainless	Unfinished Blank	<b>\$34.95</b>
BB066	20 Cal	24 inches	1.250 Dia		1 12.	Stainless	Unfinished Blank	<b>\$44.95</b>
BB070	5.56 Cal	16 inches	1 Dia		1 10.	Stainless	Threaded & Chambered AR15	<b>\$39.95</b>
BB073	270 Cal	26 inches	N/A	#3	N/A	4140	Unfinished Profile Blank	<b>\$59.95</b>
BB074	22 Cal	26 inches	N/A	#2 1/2	1 14.	4140	Unfinished Profile Blank	<b>\$59.95</b>
BB075	243 Cal	26 inches	N/A	#2 1/2	1 10.	4140	Unfinished Profile Blank	<b>\$59.95</b>
BB079	5.56Cal	16.5 inches	.980 Turned		1 7.	4140	Hub Threaded & Chambered AR15	<b>\$35.95</b>
BB080	9mmCal	16.5 inches	.980 Turned		1 10.	Stainless	Hub Threaded & Chambered AR15	<b>\$39.95</b>
BB081	5.56Cal	20.5 inches	.812 Turned		1 8.	4140	Chamber Only Turned Blank	<b>\$29.95</b>
BB082	300 Blackout	16.5 inches			1 8.	Stainless	Chamber & threaded	<b>\$49.95</b>
BB083	458 Socom	18 inches	1.032 Dia		1 14.	stainless	Milled Finish Barrel Blank	<b>\$59.95</b>
BB084	10/22 Ruger	18.5 inches	.920 Turned			4140	Uncrowned	<b>\$45.00</b>
BB085	Mauser 25-06	26 inches		#3		4140		<b>\$79.95</b>
BB086	260 Rem AR15	22 inches				stainless	Extension, pins & gas holes	<b>\$125.00</b>
BB087	22RF	17 inches	.750 Dia		1 16.	4140	Turned Blank	<b>\$49.95</b>
BB089	308Cal	24 inches				stainless	Hub Threaded & Chambered AR10	<b>\$49.95</b>
BB090	308Cal	20 inches				stainless	Hub Threaded & Chambered AR10	<b>\$49.95</b>
BB091	9mm AR15	17 inches				4140	chambered with machine ext.	<b>\$59.95</b>
BB122	Barrel Blank 16.625"	22LR, 4140, 1 16, 1 dia						<b>\$49.95</b>
BB123	Barrel Blank 19"	45 70, 1 22 SS 1.312 dia						<b>\$49.95</b>
BB124	Barrel Blank 20.5"	5.56, 4140, 1 7, .815 dia						<b>\$49.95</b>
BB125	Barrel Blank 13"	5.56, 4140, 1 7, .98 dia						<b>\$49.95</b>
BB126	AR10 Barrel 18"	6.5 Creedmoor 1 8 SS, 1.190 dia hub, thread, chamber						<b>\$49.95</b>
BB127	77/22 Barrel 24"	22 RF 1 16 Bentz chamber, SS .920 dia.						<b>\$49.95</b>
BB128	77/22 Barrel 24"	22 RF 1 16 Match chamber, SS .920 dia.						<b>\$49.95</b>
BB129	Barrel Blank 17"	9mm 1 10 SS 1.032 dia						<b>\$49.95</b>
BB130	Barrel Blank 11"	9mm 1-10 SS 1.312 dia						<b>\$49.95</b>
BB131	Barrel Blank 12"	9mm, 4140, 1-10 - 1.20 dia						<b>\$49.95</b>
BB132	AR10 Barrel Blank 20.5"	.243, 1-10 SS, 1.190 dia hub, thread, chamber						<b>\$49.95</b>
BB133	AR10 Barrel Blank 13.5"	308, SS 1-10 1.190 dia hub, thread, chamber						<b>\$49.95</b>
BB134	AR10 Barrel Blank 24"	6.5 Creedmoor 1-8 SS, 1.190 dia hub, thread, chamber						<b>\$49.95</b>
BB135	AR10 Barrel Blank 22"	6.5 Creedmoor 1-8, contoured, TM, SS, Hub, thread, chamber						<b>\$49.95</b>
BB136	AR15 Barrel Blank 22"	.224 Valkyrie 1-7 4140 TM, Contoured hub, thread, chamber						<b>\$49.95</b>
BB137	AR15 Barrel Blank 20"	450 Bushmaster 1-24, 4140 hub, thread, chamber						<b>\$49.95</b>
BB138	AR15 Barrel Blank 24"	5.56 1-7 SS, Bull, hub, thread, chamber, crowned						<b>\$49.95</b>
BB139	AR15 Barrel Blank 8.5"	5.7x28 1-7 SS						<b>\$49.95</b>
BB140	AR15 Barrel Blank 12"	OTD, SS, Legend 1-12						<b>\$49.95</b>

**NEW ADDITIONS!!!**

BB095	Barrel Blank 24.5"	.17 Cal 1-9, 4140 1.032 dia						<b>\$49.95</b>
BB096	Barrel Blank 26.75"	.17 cal, 1-9, 4140 1.250 dia						<b>\$49.95</b>
BB097	Barrel Blank 26.75"	.17 cal, 1-9, SS 1.250 dia						<b>\$49.95</b>
BB098	10/22 Barrel Blank 18"	17 1-9 SS .920 dia needs finishing						<b>\$49.95</b>
BB099	Barrel Blank 25.5"	.22 RF 1-16 4140, 1 dia						<b>\$49.95</b>
BB100	Barrel Blank 24.5"	.243, 1-10, 4140, 1.20 dia						<b>\$49.95</b>
BB101	Barrel Blank 24.5"	.25 cal 1-10 4140, 1.20 dia						<b>\$49.95</b>
BB102	Barrel Blank 21.5"	.25 Cal 1-10, SS 1.312 dia						<b>\$49.95</b>
BB103	Barrel Blank 16.5"	.264 cal 1-8 4140, 1.032 dia						<b>\$49.95</b>
BB104	Barrel Blank 18.5"	.264, 1-8 SS 1.032 dia						<b>\$49.95</b>
BB105	Barrel Blank 26.75"	.264, 1-8, 4140, 1.250 dia						<b>\$49.95</b>
BB106	Barrel Blank 26.5"	.264, 4140, 1-8, 1 dia						<b>\$49.95</b>
BB107	Barrel Blank 21.75"	.270, 1-10, 4140 1.2 dia						<b>\$49.95</b>
BB108	Barrel Blank 26.75"	.270, 1-10, 4140, 1.312 dia						<b>\$49.95</b>
BB109	Barrel Blank 11"	.30 cal 1-7 SS 1.032						<b>\$49.95</b>
BB110	Barrel Blank 9.5"	.30 Cal 1-7, 4140 1.2 dia						<b>\$49.95</b>
BB111	Barrel Blank 11"	.30 cal 1-8 SS 1.032						<b>\$49.95</b>
BB112	Barrel Blank 26.5"	.30 Cal 4140 1-10 1.250 dia						<b>\$49.95</b>
BB113	Barrel Blank 22.5"	.303 SS 1-10 1.312 dia						<b>\$49.95</b>
BB114	10/22 Barrel 18"	22Mag 1-16, SS .920 dia						<b>\$49.95</b>
BB115	10/22 Barrel 16.5"	22RF 1-16 Threaded Muzzle 1/2-28, SS .920 dia						<b>\$49.95</b>
BB116	10/22 Barrel 22RF	1-16 18" 4140 .920 dia						<b>\$49.95</b>
BB118	Barrel Blank 9"	12 GA, Smooth bore, SS, 1.312 dia						<b>\$49.95</b>
BB120	Barrel Blank 26.5"	22 Cal 1-14, 4140 #3 contoured blank						<b>\$49.95</b>
BB121	Barrel Blank 24.5"	22 RF 1-16 4140, 1 dia						<b>\$49.95</b>

**New 'Barrel Blanks'**

3 new 'barrel blanks' ready for your next project. Steel barrels, unfinished, with an O.D. of 1 inch, in the white and in 3 different calibers:  
Barrel Blank, 17 Cal., 23" long..... **\$39.95 BB076**  
Barrel Blank, 30 Cal., 18" long..... **\$35.95 BB078**

**.30 CAL BARREL BLANKS**

Cutoff front ends with @9"+/- 1". Bore is rifled. Nice lands and grooves. Perfect for firearm projects ..... **\$9.95**  
3 for..... **\$23.95 CRB204**

**M1 GARAND RIFLE (More on page 4!) 3**

**M1 GARAND CLEANING KIT SALE!!**

Kit contains M10 cleaning rod, bore brush and a G.I. carrying pouch. CLN064 ..... **\$14.95 \$17.49**  
3 for .. **\$39.95 \$49.50**  
Handle for M10 cleaning Rod for Garand Rifle - hard to find ..... **\$4.95 \$7.95**,  
3 for ..... **\$14.00 \$22.50 CLN047**  
Orig G.I. M10 handles ..... **\$6.95 \$9.95 GRD281**

**NEW GI GARAND BUTTPLATES**

We bought 'em 30-40 years ago. Found another small batch in the warehouse sort. Believe this is the end. .... **\$40.00 \$44.95 GRD326**  
Conetta Mfr. While they last!

**BRAND NEW M1 GARAND BARRELS**

Currently produced in USA by a 30 Year Top Line Barrel MFG  
**.30-06 barrels in stock!**

Newly manufactured barrels ready to install on your M1 Garand Receiver. Made by one of the premier barrel manufacturers in the USA, these .30-06 caliber barrels are manufactured from 4140 steel with 4 groove rifling and a 1 in 10 twist. Beautiful high quality parkerized replacement barrels. Because they are made here in the US, they do not have the ungainly import barrel markings. A great chance to get rid of that 'Blue Sky' or other import marked barrel and also restore accuracy! Barrels should always be installed by a qualified gunsmith.

.30 06..... **\$149.95 GRD157**



**M1D SCOPE MOUNT**

Scope mounts for the M1D Garand Sniper rifle. These are for the 7/8" diameter M81 - M82 - M84 Scope. New condition ..... **\$74.00 GRD112**

**We still have a few ORIGINAL WW2 ERA GARAND STOCKS W/ MARKINGS.**

See our website!

**GARAND BROKEN SHELL EXTRACTORS**

.30-06..... **\$7.95 BSE006**



**Just In !! .30 CALIBER BRAND NEW RIFLE BARREL BLANKS**

These are U.S. GI 1903A3 Springfield barrels that have had the front & backend cutoff. Perfect for your special project!

..... **\$19.95**  
3 for ..... **\$49.95 BB141**

**Overall length:** approximately 46.5 cm, **Breech O.D:** 26.4 mm, **Muzzle O.D:** 17 mm





50 Hilton Street, Easton PA 18042  
610.250.3960 Fax: 610.438.2548

www.sarcoinc.com

We have 30 Different  
Variations of Handguards -  
See our website!

### ORIGINAL G.I. M1 GARAND BOLTS

Stripped  
**\$69.95** GRD070  
Complete  
**\$89.95** GRD071

**One Month Only Super Sale!**  
USGI Original Stripped Bolts - VG cond. **\$49.95**  
3 for **\$134.95**

Go to our website for a complete selection of Garand bolts by maker and dash variation. We have sorted out 13 variations we even offer heat treat lots for serious collectors.

### M1 GARAND FRONT & REAR SIGHT COVERS

Perfect for protecting your prized Match Sights installed on the rifle. Plastic covers slip on & off easily. Set of Front & Back covers  
**\$6.00** GRD114

A perfect reproduction of the **GRENAD LAUNCHING RUBBER BOOT** (slip on) for the Springfield and M1 Garand. Absolutely meticulously beautiful!! **\$34.50** MISC088

### M1 STAINLESS STEEL GARAND OP ROD SPRINGS

The Best On The Market!  
Just got a new fresh shipment made from G.I. blueprints. Replace your tired spring or put away a spare now!  
**NEW ITEM!**  
Stainless Steel  
17-7 ..... **\$7.95**  
3 for ..... **\$22.95** GRD171  
Standard op rod Spring ..... **\$5.95**  
3 for ..... **\$13.95** GRD059

### M1 GARAND OPERATING ROD TIPS (pistons)

Brand new, made to Government specs. Replace your worn piston - diameter .5265" (high end + .0005") Made of the proper 174PH steel. **SALE \$7.95**  
**\$9.95**, 3 for **\$21.95** **\$22.95** GRD211

### WW2 ORIGINAL M1 GARAND BARRELS

These are decorator condition w/ poor bores. Few only ..... **\$49.95** GRD330

### SPECIAL M1D SNIPER COMBO SET

T-37 Flash hider, New G.I. Handguard Barrel Block, Scope Mount. Value \$200.00.  
**GRD145 SPECIAL \$149.50**

### BRAND NEW GARAND STOCK & HANDGUARD SETS IN WALNUT

The stocks are new walnut G.I. stocks that were .308 cal & we retrofitted them to .30-06. Fit is perfect for .30-06. There is a tiny hairline from the conversion that is visible. Handguards are new production walnut. Complete stock set (wood only) ..... **\$79.95**  
3 for ..... **\$219.95** GRD278

We can also offer the stock alone which makes a great replacement for your CMP worn out drill rifle or regular Garand stock ..... **\$59.95**  
3 for ..... **\$169.95**  
20 for ..... **\$995.00** GRD279

Quantity purchases, please call Cholly. Will trade on quantities

### GARAND PARTS

GRD330	Barrel G.I. Orig WWII Dated, poor bore & some rust	<b>\$49.95</b>
GRD002	Barrel "Clunker Grade"	<b>\$20.00</b>
GRD071	Bolt (Complete) <b>This Month Only!</b>	<b>\$62.95</b> <del>\$89.95</del>
GRD070	Bolt (Stripped Used) <b>This Month Only!</b>	<b>\$41.95</b> <del>\$59.95</del>
See our website for a complete offering of Collector Garand bolts		
CLN172	Bronze bore brush 30 cal	
10/		<b>\$9.95</b>
100/		<b>\$69.95</b>
GRD198	Bullet Guide, milled, New	<b>\$15.00</b>
GRD065	Bullet Guide, stamped, New	<b>\$12.00</b>
GRD046	Butt Swivel	<b>\$8.00</b>
GRD220	Buttplate Assy, brand new	<b>\$24.95</b>
GRD043	Buttplate Screw Bottom (Long)	<b>\$2.95</b>
GRD044	Buttplate Screw Upper (Small)	<b>\$2.00</b>
GRD115	Carrying Case	<b>\$14.95</b>
GRD021	Clip Ejector	<b>\$4.95</b>
GRD081	Clip Latch	<b>\$24.50</b>
GRD082	Clip Latch Pin	<b>\$3.35</b>
GRD083	Clip Latch Spring	<b>\$1.35</b>
MISC630	Conversion op rod 'tip' (modifies .308 to .30-06)	<b>\$8.25</b>
GRD214	Danish contract Garand oiler	<b>\$3.70</b>
3 for		<b>\$8.95</b>
GRD076	Ejector	<b>\$3.25</b>
GRD077	Ejector Spring	<b>\$1.50</b>
GRD078	Ejector w/ Spring	<b>\$4.95</b>
GRD086	Elevation Pinion (Late Style)	<b>\$29.95</b>
GRD363	Elevating Pinion Assy, Meter graduations	<b>\$29.95</b>
GRD075	Extractor-current production	<b>\$15.95</b>
GRD310	Extractor G.I.	<b>\$24.95</b>
GRD079	Extractor Spring w/ Plunger	<b>\$3.45</b>
GRD074	Firing Pin orig G.I.	<b>\$19.95</b>
GRD186	Flash hider lock bracket G.I. M2	<b>\$25.00</b>
GRD111	Flashider T-37 (Pronged)	<b>\$34.50</b>
GRD062	Follower Arm	<b>\$24.95</b>
GRD064	Follower Arm Pin	<b>\$2.45</b>
GRD068	Follower Assy	<b>\$24.95</b>
GRD061	Follower Rod	<b>\$7.00</b>
GRD066	Follower Slide	<b>\$12.00</b>
GRD109	Front Sight	<b>\$12.00</b>
GRD110	Front Sight Screw	<b>\$1.25</b>
GRD101	Gas Cylinder Lock w/Hump	<b>\$26.00</b>
GRD100	Gas Cylinder Lock (Used)	<b>\$20.00</b>
GRD286	Gage GI barrel diameter-gas cylinder .5991	<b>\$75.00</b>
GRD016	Hammer	<b>\$24.95</b>
GRD015	Hammer Pin	<b>\$2.00</b>
GRD013	Hammer Spring	<b>\$2.00</b>
GRD014	Hammer Spring Plunger	<b>\$4.00</b>
GRD041	Handguard Band Rear	<b>\$5.00</b>
GRD039	Handguard Ferrule Front	<b>\$6.00</b>
GRD032	Handguard, Rear walnut w/o metal, good	<b>\$20.00</b>
GRD033	Handguard, Front walnut w/ metal, good	<b>\$25.00</b>
GRD040	Handguard Spacer Front	<b>\$5.00</b>
GRD089	Hooded Rear Sight Aperture National Match	<b>\$39.95</b>
GRD037	Lower Band	<b>\$15.00</b>
GRD038	Lower Band Pin	<b>\$1.00</b>
OIL002	Lubriplate pot, G.I. 3 for	<b>\$3.95</b>
CLN116	M10 cleaning rod handle	<b>\$7.45</b>
3 for		<b>\$20.00</b>
M84017	M84 Sniper Scope Cover, Orig	<b>\$59.95</b>
OIL035	Oiler, late plastic WWII, new	<b>\$13.95</b>
OIL015	Oiler, brass & throng set, exc	<b>\$35.00</b>
OIL016	Oiler, plastic & throng set, used, exc.	<b>\$8.50</b>
GRD052	Operating rod G.I.	<b>\$175.00</b>
GRD063	Op rod catch Assy	<b>\$30.00</b>
GRD088	Rear Sight Aperture	<b>\$10.00</b>
GRD094	Rear Sight Assembly Late	<b>\$64.95</b>
GRD084	Rear Sight Base	<b>\$25.00</b>
GRD085	Rear Sight Base National Match	<b>\$46.50</b>
GRD093	Rear Sight Cover	<b>\$5.95</b>
GRD017	Safety	<b>\$17.50</b>
GRD112	Scope Mount M1D	<b>\$47.50</b>
GRD011	Sear	<b>\$6.00</b>
GRD114	Front & Rear Sight protective cover with muzzle can	<b>\$6.00</b>
SLNG024	Sling Repro WWI Leather, brass hook	<b>\$16.95</b>
SLNG025	Sling Repro WWII Leather, steel hook	<b>\$16.95</b>
GRD107	Stacking Swivel	<b>\$8.00</b>
GRD108	Stacking Swivel Screw, new	<b>\$2.95</b>
5/		<b>\$11.95</b>
GRD028	Garand stock for .308 NATO cal gun, new	<b>\$49.95</b>
GRD048	Stock Ferrule, new GI In the grease	<b>\$15.00</b>
GRD375	Stock Ferrule Assembly, New	<b>\$20.00</b>
GRD047	Stock Ferrule Stripped	<b>\$10.00</b>
GRD049	Stock Ferrule Swivel	<b>\$6.00</b>
GRD050	Stock Ferrule Swivel Screw	<b>\$2.95</b>
GRD027	Stock U.S. / G.I. Average, Used Condition, No Cracks	<b>\$49.95</b>
GRD024	Stock U.S. / G.I. Select, Used Cond	<b>\$75.00</b>
GRD323	Trigger forging, orig G.I. new	<b>\$99.00</b>
GRD009	Trigger & Sear Assembly	<b>\$4.95</b>
GRD019	Trigger Guard Milled	<b>\$25.00</b>
GRD020	Trigger Guard Stamped	<b>\$16.50</b>
GRD023	Trigger Housing Assembly	<b>\$99.00</b>
GRD022	Trigger Housing Stripped	<b>\$39.95</b>
GRD152	Trigger Housing, Win. Reparked Stripped	<b>\$74.95</b>
GRD008	Trigger Pin	<b>\$2.00</b>
GRD092	Windage Knob early original	<b>\$55.00</b>
GRD090	Windage Knob (Late Style)	<b>\$12.00</b>
GRD212	G.I. winter trigger in orig. pkg	<b>\$19.95</b>

### U.S. WW2 M7 GRENADE LAUNCHER

M7 Grenade Launchers now available! Connects quickly to the M1 Garand Rifle and locks in place with an attached clip. Great compliment to your collection and allows the Rifle Grenades to be mounted. We can offer the launcher on its own, and also with an original inert M11 Rifle Grenade at a savings from buying each item separately. Launcher new mfr.  
M7 Grenade Launcher ..... **\$69.95** RL020  
M7 Grenade Launcher with M11 inert Rifle Grenade ..... **\$99.95** RL021

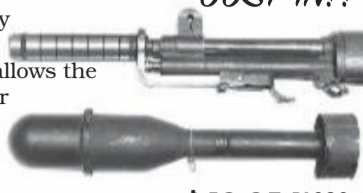

JUST IN!!

### WINCHESTER 97 TRENCH GUN BAYONET LUG & HEAT SHIELD W/ SCREWS

**PLEASE NOTE:** These will only fit original Winchester 97s with the correct grooves cut - If your barrel does not have the grooves cut for the screws, they will have to be machined. These will not fit reproduction Winchester 97s currently on the market. Will ONLY fit P14 & P17 bayonets  
**\$129.00** W97058



### M1 GARAND M82 SNIPER SCOPE

New precision 2.5x scope marked with Govt. part numbers, complete with sun shade and rubber eye cup. Perfect quality scope for making an M1D, M1C or O3A4 sniper rifle. Beautifully constructed and clinically accurate!  
**\$260.00** SCP040



### SPARE PIN & SPRING KIT FOR M1 GARAND

Clip latch spring Hammer pin  
Extractor spring Trigger pin  
& plunger Lower band pin  
Hammer spring Op rod catch pin  
Op rod spring  
Clip latch pin  
Value over \$25 - **\$12.95** GRD219

### GARAND SNIPER LEATHER CHEEKPAD

Special new low price. GRD124  
Exact repro with proper markings **\$18.95** 3 for **\$49.95**



### COMBO. New Style M3A1 TOOLS WITH CHAMBER BRUSH

The Latest and best.  
A. Used G.I. **\$25.00** GRD134  
B. Like new tool w/new brush **\$30.00** GRD138  
C. Absolutely New G.I. WWII original tool in orig G.I. grease & G.I. package (no brush) ..... **\$40.00** GRD165



Available Again - Ratchet chamber brushes for the M1 Garand ..... **\$4.95**, 3 for ..... **\$9.95** TOOL044



Orig. Brass oil & throng set, exc. condition. OIL015 ..... **\$35.00**  
Orig plastic oil & throng set, used exc. condition OIL016 ..... **\$8.50**

### M1C/M1D SNIPER PARTS

1. M1D rear handguard New G.I. original GRD031 ..... **\$25.00**  
2. T37 flash hider GRD111 ..... **\$34.50**  
3. M1D barrel block GRD113 ..... **\$59.95**  
4. M1D scope mount GRD112 ..... **\$47.50**

### M1 GARAND STYLE REAR SIGHT BASE...

**For Your Next Project!**  
Originally designed for the M1 Garand rifle, this great little sight base is perfect for your next project. It allows you to actually add the superb and precise M1 Garand Rear Sight Assy. components onto the weapon of your choice. Imagine having the ability to dial elevation and traverse measurements on a commercial or project rifle the same way you can on the Garand! With the same ease and precision that you don't find on most rifles. The base has a concave bottom with 2 mounting holes. Accepts the superior M1 Garand windage pinion & elevation aperture sold separately. Fits well on the Ruger 10-22 as well, but can be used on almost any project you come up with **\$19.95 ea.**, 3 for **\$17.50 ea.**, 10 for **\$15.00** MISC727



### M1 GARAND LINED GUN COVERS

Olive drab & U.S. marked ... **\$22.95** GRD345



### WW2 M1C GARAND RIFLE FLASH HIDER

M1C Garand Sniper Rifle flash hider as used in WW2, simply and quickly, attaches on the muzzle end & bayonet lug of the rifle. Hard to find item is finally available after more than a decade! Get one before they disappear again! Late mfr. .... **\$125.00** GRD388



**.30 CAL ONE PIECE USGI CLEANING ROD** ..... **\$9.95**, 3 for **\$27.50** CLN113

M84 repro scope buyers from other sources - we have original G.I. unnumbered **M84 SCOPE DATA PLATES** from Libbey Owen Ford (the manufacturer) NOS. You can number your scope to your gun on an original date plate. M84 repro scope buyers from other sources - we have unnumbered M84 scope data plates. You can number your scope to your gun on this data plate ..... **\$29.95** M84014

### ITALIAN WW2 CARCANO RIFLE SLING

**BACK IN STOCK!**  
New made, Italian WW2 brown leather sling is @54.5 inches long and comes complete with Italian Ordnance stamp and date. One end has adjusting buckle and the other end has two holes with stud ..... **\$17.95** SLNG125



### M1 GARAND REAR SIGHT PARTS - STANDARD & MATCH

GRD094 Complete Rear Sight Assy, late model ..... **\$64.95**  
GRD084 Rear Sight Base ..... **\$27.00**  
GRD088 Rear Sight Aperture ..... **\$10.00**  
GRD348 Rear Sight Aperture, Match peep hole .059 ..... **\$13.50**  
GRD093 Rear Sight Aperture Cover ..... **\$5.95**  
GRD090 Windage Knob Assy ..... **\$14.00**  
GRD086 Elevating Pinion Assy, Yard graduations ..... **\$24.95**  
GRD363 Elevating Pinion Assy, Meter graduations ..... **\$29.95**  
**NATIONAL MATCH REAR SIGHT ITEMS**  
GRD095 Complete National Match Rear Sight w/Hooded Cover, (Elevation pinion Assy not included as it is the same as a standard Garand elevation pinion) ..... **\$90.00**

(When ordering, please specify which size aperture hole you would like - two Options shown several items down in this list.)

GRD085 National Match Rear Sight Base ..... **\$46.50**  
GRD091 National Match Windage Knob ..... **\$25.00**  
GRD089 National Match Hooded Aperture (.052 hole) ..... **\$41.50**  
GRD154 National Match Hooded Aperture (.059 hole) ..... **\$41.50**

**Please Note - all sight parts above also work with the M14 too!**  
**Buyers Note - the aperture is made slightly 'oversized' to fit to your Sight Base. The fitting procedure is simple and instructions are included. See our web site for the instructions as an option.**  
**'EARLY' M1 GARAND SIGHT PARTS**  
GRD182 Pinion, early stripped original ..... **\$55.00**  
GRD092 Windage Knob, G.I. original ..... **\$25.00**  
GRD189 Lock Bar, early rear sight ..... **\$35.00**

Once again available!  
**M1 GARAND OPERATING ROD CATCH ASSEMBLIES**  
at a reasonable price!  
**\$30.00** GRD063

### WORLD WAR II PATTERN M1 GARAND CARRYING CASE

WWII military style canvas carrying case for the M1 rifle. These "U.S." marked cases are made of heavy, olive drab canvas and equipped with a zipper, leather tabs and a shoulder carrying strap. GRD115 **\$14.95** ea., 3 for ..... **\$42.95**  
Also available USMC marked case GRD347 ..... **\$14.95**



### FRONT HALF G.I. M1 GARAND RECEIVER

**\$9.95**, 3 for **\$24.95** GRD143  
Neat paper weight!



### M1 GARAND SET OF FRONT/REAR HANDGUARDS W/METAL, BIRCH

Select US GI, Used, Select Condition  
**\$39.95** GRD355



### M1 GARAND CLIPS

**New current production by G.I. contractor GRD275**  
5 for ..... **\$9.95**  
10 for ..... **\$14.95**  
20 for ..... **\$24.95**  
40 for ..... **\$45.00**  
Nice fresh spring tension in your clip  
**SPECIAL GARAND CLIPS**  
1.2 round clip for match shooters **\$8.00** ea.  
5 for ..... **\$24.95** GRD131  
2.5 round hunting clips  
..... **\$8.00** ea. 5 for **\$24.95** GRD130

### M1 GARAND STOCK HARWARE SET

Complete set of M1 Garand Stock Hardware. Either new or excellent parts ..... **\$39.95** GRD136

### FRENCH FOREIGN LEGION BERET OF THE FAMED 2E REP PARATROOPER

Sarco has a very limited 'run' of wool Green Berets with the famed French Foreign Legion 2e REP badge.

A unit famed for fierce fighting, especially in Indochina and Algeria, but also a familiar sight on the frontiers where Mercenaries are operating. Three sizes available. Beret with Badge ..... **\$29.95** HAT10  
( U.S. sizes 7-1/4, 7-1/2, 7-3/4 )



**Victorian handcuffs with key** ..... **\$19.95** MISC719  
**Victorian leg irons with key** ..... **\$24.95** MISC824  
**Set of handcuffs with leg irons** **\$35.00** MISC849  
See Our Website For Pictures & Details!





**STILL LOWER PRICES ON ALL .45 AUTO KITS .45 AUTO**

**"BUILDERS KITS"**

Put together your own .45 "Government" pistol with our Builder Kits. Several different kits available to best fit your needs. Our parts are standard M1911A1/ Pre-'70 Government type. Compare our prices and see how much you will save compared to the competition!

- #1. Builders Kit - All parts in the gun less frame and slide ..... **\$149.95** or 3 for ..... **\$429.95 C45095**
- #2. Builders Kit - All parts in the gun less frame, slide and barrel ..... **\$119.95** or 3 for ..... **\$349.95 C45096**
- #3. Builders Kit - All parts in the gun less frame. Kit includes one of our new current manufacture G.I. type slide (unmarked) ..... **\$239.95 C45097** (Regular value \$300)
- #4. Builders Kit - All parts in the gun less frame. Kit includes one of our new current manufacture commercial slide (unmarked) ..... **\$264.95 C45218**

**Note:** All gun parts may require some fitting and technical knowledge for assembly. If you are not knowledgeable seek professional assistance.

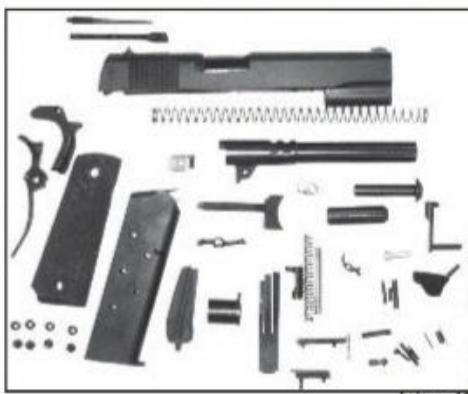

**Military Model 1911 C45097**



**Commercial Model 1911 C45218**

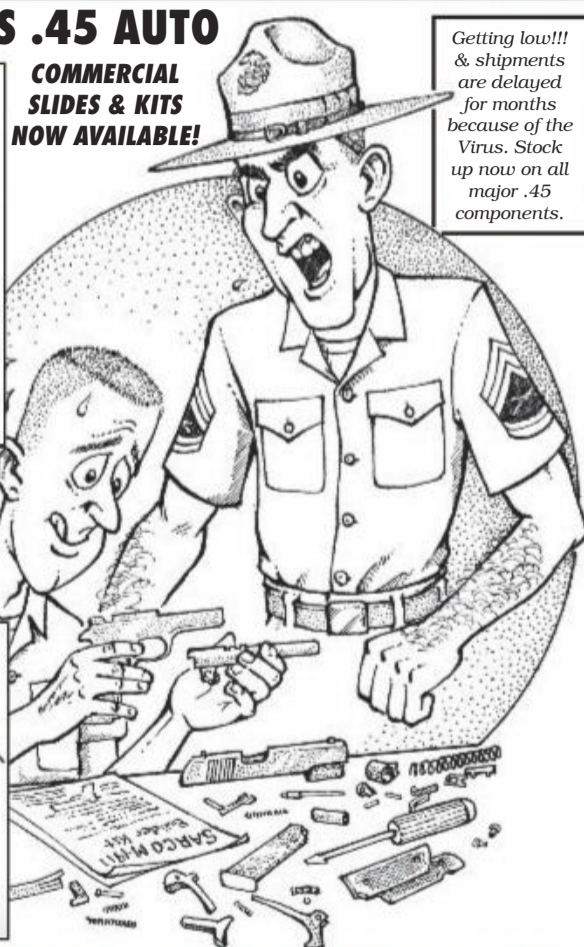

**COMMERCIAL SLIDES & KITS NOW AVAILABLE!**

Getting low!!! & shipments are delayed for months because of the Virus. Stock up now on all major .45 components.

**5 INCH .45 ACP, NO RAMP, STAINLESS STEEL PARA ORDNANCE BARREL \$145.00 PAR1B (F500173) P-14**



**CHECK OUR WEBSITE FOR : PARA LDA Spring Kits #PARA312 PARA Put Away Kits #PARA311**

Have 50 to 100 Special 1911 Slides on our website. Just came in! Have specially marked Para slides and also unmarked special and hard to get standard 1911 slides.

**ROCK ISLAND SLIDE & BARREL SETS**

Rock Island Ultra 1911 Slide & Bull Barrel Combo, 10mm, 4.25" Barrel Type: Black Ramped BULL with link & pin / Front Sight: FIBER OPTIC / Front Sight Cut: DOVETAIL / Rear Sight: SNAG-FREE WEDGE / Rear Sight Cut: LPA / Finish: BLACK / Serration: REAR G.I. / Action Type: SINGLE / Front End: SCALLOPED ..... **\$199.00 \$299.95 AC20**



**SALE !!**

Rock Island 1911 38 Super Slide & Bull Barrel Combo, .38cal, 5" Barrel Type: Ramped BULL with link & pin and Bushing / Front Sight: GI / Front Sight Cut: STAKE / Rear Sight: GI / Rear Sight Cut: DOVETAIL / Finish: BLACK / Serration: GI REAR / Action Type: SINGLE / Front End: SCALLOP CUT FRONT..... **\$199.00 \$304.95 AC23**



**JUST IN!**

**1911 DOUBLE LEATHER MAGAZINE POUCH**  
Slips Onto Your Belt Traditional double leather magazine pouch as issued for WW2 Field Grade Officers not using a standard grommet style pistol belt. Holds 2 single stack standard 1911 magazines. Will last a lifetime! Fits belts up to 2.5 inches wide..... **\$7.50 C45431**



See our website for a big sale on our nice assortment of factory frame castings, others call 80% receivers!

**.45 SLIDE CASTINGS**  
Sizes 3" to 5"  
Colt 1911/1911A1 .45 ACP.  
See Our Website!!

**SERIOUS ABOUT COMBAT SHOOTING? ROTO 4M COMPENSATED BARREL**

DOD contractors have been buying up our Roto 4M barrels because they work! MODEL 1911 COMPENSATED BARRELS in 3 calibers will reduce recoil and speed your target acquisition especially during multiple shots. Takes a minute to install our barrel that comes with Barrel Bushing and permanently attached and ported Compensator. Also there is less weight on the muzzle end than with conventional screw on muzzle compensators. Most people comment on the change of performance, but also that it looks great too! Sold elsewhere for \$175-\$200, Sarcos price is ..... **\$89.95 \$99.95**  
Specify caliber when ordering: New, made in USA. **.38 cal C45024, .45 cal C45015, .400 corbon C45194**



'Cause we're such nice guys, take 35% off the listed price on these 80% frames...

**80% LOWER FRAMES STEEL & ALUMINUM**

1911 Series 80 single stack, single action, full size pistol frames available in either ordnance grade steel or lightweight aluminum! These are finished frames except for several features that are unfinished to comply with BATF directives classifying these as Non-Firearms in their present condition. Slide rails, hammer & sear pin holes, mainspring housing retaining pin, and ejector leg holes remain to be applied. Grip screw holes are drilled and tapped.  
#500649 Extra Small Para Frame for 3" slide. Series 80, aluminum, Double stack, Single action ..... **\$125.00 C45331**  
#500675 Para LDA Officers length grip frame in steel with checkered front grip strap. Accepts 4.25" or smaller slide. Single stack and Double action..... **\$99.95 \$125.00**  
3 for ..... **\$249.95 C45332**  
#500678 "Agent" extra small steel frame with checkered front strap. Single stack, Double action, and fits 3" slide ..... **\$99.95 \$125.00**  
3 for ..... **\$249.95 C45333**  
**NOT FOR SALE IN NJ - See new change in law. Not for sale in PA until further notice.**



**SARCO** www.sarcoinc.com **5**

**G-3 ZF SCOPES & MOUNTS**

Haven't had these in years! Original German military service ZF-1 Sniper Scopes with original claw mounts for the G-3 Rifle. Manufactured by Hensoldt/Wetzlar, these scopes are premium quality and although used, are in excellent condition and come complete with green case, rubber eye pc. protectors, claw mount, filter eyepiece, accessory case **NOTE: We can now offer a SECOND Version of the ZF-1 that has a see-through reticle that can be illuminated.** You can check our website for more info. & pictures.  
**ZF-1 Hensoldt/Wetzlar Sniper Scope package** - Please specify if you prefer version 1 (w/o reticle) or version 2 (w/reticle) when ordering..... **\$495.00**  
..... **\$695.00 SCP058**



Save over \$100\$!

**RAMPED 5" STANDARD BUSHING 1911 9MM BARRELS**

Found a few in the back from our parts paradise! These are the Clark / Para Ord pattern. Each barrel comes with a free link & pin. Sold elsewhere from \$80-\$200, Our Special Price..... **\$69.95**  
3 for ..... **\$199.95 C45429**

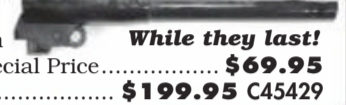

While they last! \$69.95

**NEW G.I. CLONE ROCK ISLAND ARMORY .45 1911 & 1911A1 BARRELS**

The rifling is absolutely beautiful and the bore surface is very smooth. Made from ordnance steel..... **\$49.95**  
3 for ..... **\$143.50 C45202**



BACK IN STOCK!!

**THREADED 1911 BARRELS**

5-1/2 Inch. Brand new black oxide finished barrels in 3 calibers. Thread is standard .578x28 TPI.  
9mm Model 1911 5-1/2" barrel..... **\$60.00 C45360**  
.38 Super Model 1911 5-1/2" barrel ..... **\$60.00 C45361**  
.400 Corbon Model 1911 5-1/2" barrel ..... **\$60.00 C45362**  
.45 ACP model 1911, 5.5" barrel ..... **\$65.00 C45321**



**THREADED PROTECTION CAP FOR THREADED BARRELS**

Barrels with .578x28 threads per inch ..... **\$13.00 C45363**

**OUTSTANDING ASSORTMENT OF QUALITY 1911 BARRELS**

**ROTO 4M HAMMER FORGED .45 ACP, 9MM & .38 SUPER**

Built to precise tolerance by a special hammer forging process, these barrels are the best you can buy! The hammer forging forms the barrel around a precision mandrel and holds the tolerance to .0001". This is much better than the typical broached barrels found elsewhere Note: 5" & 6" .45 barrels are L.H. twist all others are R.H. twisted

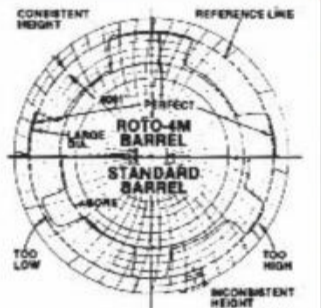

**COMPARE THE ROTO-4M BARREL FOR ROUNDNESS AGAINST A STANDARD BROACHED BARREL FROM A WELL KNOWN MANUFACTURER. ALL ROTO-4M BARRELS ARE MADE IN THE USA.**

Brand new extra length barrels for all Colt/1911/Government Model type automatic pistols. These barrels are made by the Special Roto 4M Hammer forge process which produces the most precise and consistent barrels for the best accuracy. Minor hand fitting may be necessary for some guns.

**Barrels do not include link & pin. Link & pin available w/barrel purchase for additional \$5.00 C45281** Available in:

<b>.400 Corbon Barrels</b>	5" .....	<b>\$54.70 C45017</b>
4 1/4" Commander.....	6" .....	<b>\$61.70 C45009</b>
6" .....	7" .....	<b>\$65.70 C45018</b>
STD 5".....		<b>\$56.70 C45025</b>

<b>.45 ACP</b>	<b>9MM LUGER</b>	
4 1/4" Comm .....	4 1/4" Comm.....	<b>\$56.70 C45163</b>
5" .....	5" .....	<b>\$56.70 C45019</b>
6" .....	6" .....	<b>\$61.70 C45020</b>
7" .....	7" .....	<b>\$65.70 C45021</b>

<b>.40 S&amp;W 1911 5" BARREL</b>	<b>\$56.70 C45277</b>
-----------------------------------	-----------------------

<b>.38 SUPER</b>	<b>\$54.70 C45164</b>
4 1/4" Comm.....	<b>Note: 9mm &amp; .38's will not fit the .45 slide</b>

**NEW MANUFACTURE MODEL 1911 SLIDES AND SLIDE KITS**

Beautiful new slides, precision machined from high quality steel and offered with front & rear sights. The military slide is the perfect 'drop on' replacement slide for your Government Model, manufactured with the improved beveled ejection port! 1911 Military Slide with Sights ..... **\$124.95 C45160**  
**COMPLETE 1911 .45 SLIDE KIT (All Parts For Slide)**  
A complete set of the top half of a .45 Government model. Kit includes one of our new current manufacture slides (unmarked), barrel, firing pin, recoil spring parts, sights, extractor, link & pin, band bushing. Over \$198.00 worth of parts for only ..... **\$174.95 C45092**



ALL SLIDES HERE HAVE SIGHTS

**COMMERCIAL SLIDES ARE BACK IN STOCK!!**

**1911 .45 SERRATED SLIDE** Best Quality Commercial .45 Slides - Special wide angled front and rear cocking serrations for easy grasping. Nice subdued blue finish with sand blasted inner serrations. Lowered beveled ejection port. Unmarked slide. With desirable snag-free rear sight. Also available as Complete Upper Commercial Slide Kit (refer to part # C45200) Note: Due to variations we have seen in frames & parts, slight fitting of ejectors extractors may be necessary ..... **\$139.95 C45172**



**.45 1911 COMPLETE COMMERCIAL SERRATED SLIDE KIT**

A complete set of the top half of a .45 Commercial model. Kit includes one of our commercial .45 slides (part # C45172), barrel, firing pin, recoil spring parts, sights, extractor, link pin, band bushing  
**\$184.95 C45200 PLEASE NOTE: ALL our 1911 parts are for series 70 unless otherwise specified.**







www.sarcoinc.com

**JUST FOUND FROM 45 YEARS AGO!!!** *JUST IN!!*  
**BRAND NEW ORIGINAL COLT 1911 NICKEL PLATED 1911 THUMB SAFETY**  
 A few only!! **\$65.00 each** C45432 We be DIGG'IN!!



**CAMOUFLAGE GREEN BURLAP ROLLS U.S. G.I.**  
 Roll size: 300 feet, 2 inches wide  
 ..... **\$9.95 MISC306**



**BRONZE .45 CAL. CLEANING BRUSHES**  
 5 for **\$4.85 C45098**

**SPECIAL .45 COLT AUTO REPAIR PARTS KIT**

Containing the following parts: 4 grip screws, 2 grip screw escutcheons, 2 mainsprings, plunger tube spring, sear spring, 2 ejector pins, 2 mag. catch springs, 1 firing pin stop, 2 firing pin springs, 4 hammer strut pins, 2 firing pins, 2 mainspring housing pins, 1 recoil spring.  
 Regular \$37.00 **SPECIAL.....\$22.50 C45091**

Sarco has the goods to 'trick out' your 1911 pistol with a wood stock and accessories! Buy a complete set of parts to create a pistol with 16"-.45 barrel, stock, holster and connecting parts or buy individual parts to help you create your own custom stock. We have two full sets to select from ( Pictured items F & G above ), which provide you everything needed for the conversion. Items A thru E can be purchased individually to help you with your own custom project.

- A. Lightweight 1911 Stock ..... **\$49.95 C45402**
- B. Standard 1911 Stock Assy ..... **\$35.00 C45390**
- C. 16 inch .45 ACP Barrel..... **\$82.50 C45016**
- D. Mainspring for Wood Stock Connection ..... **\$18.95 C45391**
- E. 1911 Stock Building Hardware Kit - contains metal parts that will allow you to build your own custom stock and install the pistol to the stock. Contains slotted mainspring housing, 2 brackets with pair of screws and escutcheons, and knurled tightening screw ..... **\$34.95 C45394**
- F. Complete Lightweight 1911 Stock Rig - holster, 16" barrel, slotted mainspring housing, wood stock with metal hardware ..... **\$164.95 C45428**
- G. Complete Standard 1911 Stock Rig - holster, 16" barrel, slotted mainspring housing, wood stock with metal hardware ..... **\$149.95 C45392**
- H. Holster for Stock Rig (Pictured in the sets above) ..... **\$45.00 C45393**



**1911 Stock Rig Conversions**  
 Funnest Way to Extend your 1911 Shooting to the Limit!

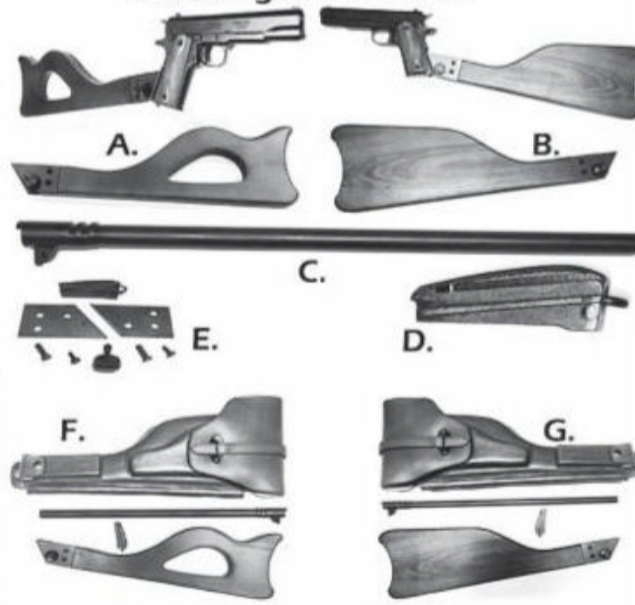

**1911 ORIGINAL SCREW-DRIVER & TAKEDOWN TOOL**

Just In! 1911 new G.I. surplus screwdriver/takedown tool - Limited supply! Wont last long!  
 ..... **\$14.95 C45320**

Grade 1 Ballester Molina Barrel - 95%+ finish ..... **\$59.95 BAL013**  
 See our website for more Ballester Molina barrels and other parts!

**1911 7RD .45 MAGAZINE, US GI ORIGINAL 1911 MAGAZINES**

In very good condition released from the military decades ago. We purchased these long ago and lost track of them. Steel magazines are standard 7 rd, .45 caliber ..... **\$14.95 C45369**

**INCREASE THE MAG CAPACITY ON YOUR REMINGTON 700 BDL TO 6 SHOTS**

For .270 - .30-06 - 7mm mag & .264 no longer made. These have been hidden for years. **\$14.95, 2 for \$24.95 MISC119**  
 The famous coyler clip

**M1911 "DIAMOND" GRIPS**

These brand new walnut grips are made in the original World War I style with the "Diamond" pattern checkering. Give your 45 Auto the classic look and feel of the original Colt 1911 design  
 ..... **\$13.95/pr.**  
 3/ ..... **\$36.50 GRP162**

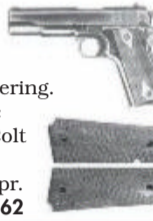

**FULL PIN SET for Colt .45 Auto.**

All seven pins for the M1911. New ..... **\$4.85/ set.**  
 10 sets for .... **\$38.50**  
 100 sets for ..... **\$285.00 C45195**

**WIDE BEAUTIFUL GRIP SAFETY FOR 1911 .45 AUTO**

Stop the pinch in the web of your hand (I used to get bloody) **\$16.50, 3 for \$49.95 C45079** (Note: These are for short rear tang frame. You can fit them to Std. frame)



For Colt mfg revolver barrels, see our website.

**STAINLESS STEEL 1911 PARTS**

- C45150 Reverse recoil spring plug..... **\$6.95**
- C45312 Hammer pin..... **\$2.00**
- C45313 Mag catch lock..... **\$3.00**
- C45314 Mainspring Housing pin..... **\$2.00**

**MODEL 1911, 9MM UPPER PARTS SET!**

Finally In!! A great set of parts to help you complete a 9mm version of the venerable Model 1911 pistol. All parts are quality machined parts including a 10rd. 9mm magazine, both sights, firing pin assy, ramped barrel and extractor. This is for use with single stack, Model 1911 frames. The feed ramp will handle 9mm as well as it does with your .45 ACP ammunition! We include the 9mm/.38 Ejector which replaces your .45 Ejector in the Frame and also included is the correct 9mm mainspring. Awesome pack age deal beats the competition and makes it easier for you to send rounds down range!  
 ..... **\$199.00 C45378**

**JUST IN... FOR YOUR MODEL 1911 PISTOL!**

Model 1911, 8 round .45 ACP stainless steel magazine ..... **\$15.95 RPM306**  
 Model 1911, 15 round .45 ACP stainless steel magazine ..... **\$17.95 RPM307**  
 Model 1911, 15 round .45 ACP standard blued finish magazine **\$17.95 RPM308**



**1911 9MM 10RD MAGAZINE**

For your 1911 chambered in 9mm Luger. Perfect for your 9mm Rock Island 1911 or other 1911 style pistol as replacement or additional magazines!..... **\$24.95 RPM269**



**.45 AUTO FRAME KIT**

All parts to build a 1911A1 frame (except the frame itself). Includes trigger, hammer, grips, sear, mainspring, safety, etc., etc., (no slide stop) **\$89.95 ea. C45099**

**.45 BARREL BUSHING WRENCH**

Free Bonus - Other end is an M16 shorty buttstock installation wrench.. **\$2.95 TOOL031**



**COLT 1911 STEEL MAINSPRING HOUSING**

Housing is grooved for a sure grip 1911A1 style - nicely blued. With Lanyard Loop ..... **\$16.50**  
 3 for ..... **\$47.50 C45081**  
 Without Lanyard Loop ..... **\$16.50**  
 3 for ..... **\$47.50 C45171**



**.45 AUTO SPRING KIT** One each of all 6 springs in a Colt .45. A \$13.25 value for only. Includes sear spring **\$7.75 ea. C45002**. 10 sets for **\$65.00**. 100 sets for **\$450.00**

**NEW, ARMSCOR...45 Recoil Springs** for the 1911 pistol rated at 16lbs ..... **\$4.95 C45326**  
 Mag Catch for wide body 1911 frames. Comes with release and spring..... **\$16.95 C45327**

**SARCO SPECIAL**

Four of our famous 1911 .45 mags with 2 pouches (below) for only **\$20.95, 2/\$39.95 C45310**  
 Two of our famous 1911 .45 mags plus a web mag pouch (below) for only **\$13.95 C45213**

**DOUBLE MAG POUCHES FOR COLT 1911 .45**

Exact repro with WWII markings. We had these 2 years ago but got lost in the warehouse **C45280** ..... **\$4.95**  
 3 for ..... **\$11.95**



**G.I. MARKED 1911 MAGAZINE** marked .45 ACP #1005 00 8694 MFR8R320 ..... **\$10.95, 3 for \$29.95 RPM155**

**WIDE SPUR HAMMER**

Desirable M1911 type checkered wide spur hammers for the Colt .45 auto pistol. These are new, ready to install and upgrade your pistol. Heavily checkered (not grooved) wide spur provides a sure grip when thumb cocking or decocking. **\$12.50 C45054** (Comparable price \$23.00) **Note:** These are due in a month. Send order and get on the list



**MODEL 1911 FIRING PINS FOR SERIES 70 & 80**

Ravenous for firing pins? Sarco's Sale will satiate your appetite....Series 70 and Series 80 firing pins used in 9mm, 38 super,& 40 S&W..... available at a Bulk price...Saving you big \$\$\$\$.  
 Series 70 Firing Pin ..... **\$5.95**  
 3 for ..... **\$14.95 C45268**  
 Series 80 Firing Pin ..... **\$5.95,**  
 3 for ..... **\$14.95 C45301**

**.45 1911 FLAT MAINSPRING HOUSING, NEW**

Brand new, flat (M1911 Style) steel housings, checkered nicely for a sure grip. Matt gray/black finish. These are nice!..... **\$13.50,**  
 3 for ..... **\$37.50 C45082**



**MODEL 1911 9MM BUILDER KIT**

Finally, a Model 1911 Builders Kit to allow you to assemble all parts onto your stripped single stack Model 1911 frame to create a 9mm pistol! Contains all of the internals including slide, ramped barrel, and all parts required for 9mm operation including a 9rd magazine. All parts newly precision made and ready for installation! Includes the traditional diamond cross hatched wood grips too!  
 Very Limited ..... **\$245.00 C45381**



**FOUND IN WAREHOUSE!! ORIGINAL WWII G.I. COLT .45 AUTO COMPOSITION GRIPS**

These were long ago taken off G.I. 1911A1's - when the guns were demilled. V.G. excellent condition ..... **\$24.95 GRP131**  
**Just a solution to your bad/broken CMP grips!**



**1911 SCREW & BUSHING SET**

4 screws & 4 bushings **\$5.95 C45206**

**SUPER SPECIAL**

All 3 kits of springs, pins & screws above for the 1911 Colt. Sale value is \$18.65. Super Sarco Value **\$14.95 for all 3 sets C45259**

**1911 .45 AUTO PISTOL PARTS**

- C45095 Auto Builders Kit (Less Frame & Slide) ..... **\$149.95**
- C45097 Auto Builders Kit (Less Frame) **\$229.95**
- C45096 Auto Builders Kit (Less Frame, Slide & Barrel) ..... **\$119.95**
- C45099 Frame Kit ..... **\$89.95**
- C45091 Auto Repair Parts Kit ..... **\$22.50**
- C45374 Barrel, 5" 1911 Colt, .38 Super, new in the wrap ..... **\$135.00**
- C45010 Barrel, 4 1/4" Commander, Roto, .45 ..... **\$54.70**
- C45017 Barrel, 5" Roto, .38 ..... **\$54.70**
- C45024 Barrel, 5" Roto, .38, w/Compensator ..... **\$101.95**
- C45011 Barrel, 5", Roto, .45 ..... **\$54.70**
- C45015 Barrel, 5" Roto .45 w/Compensator ..... **\$101.95**
- C45025 Barrel, 5" Roto, 400 Cor-Bon ..... **\$56.70**
- C45019 Barrel, 5" Roto, 9mm ..... **\$56.70**
- C45009 Barrel, 6" Roto, .38 ..... **\$61.70**
- C45013 Barrel, 6", Roto, .45 ..... **\$62.70**
- C45020 Barrel, 6" Roto, 9mm ..... **\$61.70**
- C45018 Barrel, 7" Roto, .38 ..... **\$65.70**
- C45014 Barrel, 7" Roto, .45 ..... **\$63.70**
- C45021 Barrel, 7" Roto, 9mm ..... **\$65.70**
- C45016 Barrel, 16" Roto ..... **\$82.50**
- C45040 Barrel Bushing ..... **\$6.50**
- C45087 Barrel Bushing Wear Gauge..... **\$19.95**
- C45085 Barrel Bushing Wrench..... **\$2.95**
- C45026 Barrel Link Pin ..... **\$1.00**
- C45028 Barrel Link, #13, NM ..... **\$8.95**
- C45027 Barrel Link, Std ..... **\$4.95**
- C45098 .45 Cal. Bore Brush ..... **\$1.25**
- C45251 Colt 1911 Cleaning Rod M4 ..... **\$6.95**
- C45045 Disconnecter ..... **\$7.50**
- C45068 Ejector..... **\$4.75**

- C45067 Ejector Pin..... **\$1.00**
- C45030 Extractor ..... **\$12.00**
- C45044 Firing Pin..... **\$4.95**
- C45301 Just in the door! Series 80, 9mm & .38 Super firing pins- Now available for 1911 pistols **\$5.95, 3 for 14.95**  
 Firing Pin Spring..... **\$1.75**  
 Firing Pin Stop..... **\$4.25**  
 Front Sight Al ..... **\$5.00**  
 Grip Safety, Wide Extended Parked (Note: These are for short rear tang frame. You can fit them to Std. frame) ..... **\$16.50**  
 Grip Safety, Long Tang ..... **\$12.00**  
 Grip Screw Bushing..... **\$1.00**  
 GRP131 Grip Set, Plastic, GI, exc ..... **\$24.95**  
 GRP162 Grip Walnut, Diamond Style, new **\$13.95**  
 Hammer Pin ..... **\$1.00**  
 Hammer Strut ..... **\$3.50**  
 Hammer Strut Pin ..... **\$1.00**  
 C45053 Hammer, Regular Spur ..... **\$9.95**  
 C45054 Hammer, Wide Spur..... **\$12.50**  
 RPM155 Magazine, 1911 .45 ACP GI marked #1005-00-8694 MFR8R320 ..... **\$10.95, 3 for \$29.95**  
 RPM319 Magazine, 1911 .45 8rd, Blued ..... **\$16.95**  
 RPM158 Magazine, 1911 .45 Compact ..... **\$24.95**  
 C45060 Mag Catch ..... **\$6.95**  
 C45061 Mag Catch Extended..... **\$9.95**  
 C45327 Mag Catch Wide Body, Armscor ..... **\$16.95**  
 C45062 Mag Catch Lock ..... **\$2.00**  
 C45063 Mag Catch Spring..... **\$1.00**  
 C45094 Magazine Pouch..... **\$7.95**  
 C45047 Main Spring..... **\$2.00**  
 C45084 Main Spring Cap..... **\$1.25**  
 C45083 Main Spring Cap Pin..... **\$1.00**  
 C45059 Main Spring Housing Retainer Pin **\$1.40**

- C45082 Main Spring Housing, Flat (Checked) ..... **\$13.50**
- C45145 Main Spring Housing Flat & Grooved, Composite..... **\$8.75**
- C45081 Main Spring Housing, Steel w/loop ..... **\$16.50**
- C45171 Main Spring Housing, Steel w/o loop ..... **\$16.50**
- C45050 Main Spring Retainer..... **\$1.00**
- C45049 Main Spring, for Alum.Frame..... **\$1.25**
- C45001 Rear Sight..... **\$4.75**
- C45326 Recoil Spring, Armscor ..... **\$4.95**
- C45036 Recoil Spring, Standard ..... **\$2.75**
- C45037 Recoil Spring Guide ..... **\$4.65**
- C45034 Recoil Spring Plug..... **\$4.00**
- C45039 Recoil Spring Plug, Commander length - FRESH OFF THE BOAT! ..... **\$5.00**
- C45232 Recoil Spring Plug G.I. New..... **\$14.95**
- C45126 Recoil Spring, High Speed ..... **\$3.95**
- C45138 Reverse Recoil Spring Plug..... **\$7.50**
- C45074 Safety Plunger ..... **\$1.45**
- C45075 Safety Plunger Spring ..... **\$1.75**
- C45086 Screw Driver & Take Down Tool.. **\$4.95**
- C45058 Sear ..... **\$8.50**
- C45057 Sear Pin..... **\$1.00**
- C45051 Sear Spring..... **\$3.95**
- C45160 Slide, Military ..... **\$124.95**
- C45092 Slide Kit, Military ..... **\$174.95**
- C45076 Slide Stop Plunger ..... **\$1.45**
- C45003 Slide Stop, Standard ..... **\$12.00**
- C45002 Spring Kit ..... **\$7.75**
- C45046 Thumb Safety..... **\$10.00**
- C45365 Trigger Steel, 3 Hole..... **\$12.95,**  
 3 for ..... **\$36.50**
- C45148 Trigger, medium steel non-adjustable ..... **\$11.95**
- C45077 Tube Slide Stop & Safety Plunger ..... **\$4.95**



**SARCO SPECIAL WORLD WAR I PATTERN .45 1911 MAGS WITH LANYARD LOOP**

C45295 - 1911 mag with lanyard loop ..... **\$11.95**  
 Buy 3 mags for **\$34.95** and get a free pistol lanyard for the mags.  
 These are rarely seen now a days. Best way to participate in fast combat shooting where you must drop and load mags quickly. Avoids damage to your dropped magazines. WWI Cavalry and vehicle crews would keep 2 or 3 mags on a lanyard for combat purposes! Original mags came with hemp twine so you could tie them to the lanyards individually. These magazines are made on the same automated machinery as our famous magazines shown above.  
 C45076 Slide Stop Plunger ..... **\$1.45**  
 C45003 Slide Stop, Standard ..... **\$12.00**  
 C45002 Spring Kit ..... **\$7.75**  
 C45046 Thumb Safety..... **\$10.00**  
 C45365 Trigger Steel, 3 Hole..... **\$12.95,**  
 3 for ..... **\$36.50**  
 C45148 Trigger, medium steel non-adjustable ..... **\$11.95**  
 C45077 Tube Slide Stop & Safety Plunger ..... **\$4.95**



**A NEW WORLD OF 1911 .45 AUTO MAGS**

SARCO HAS GONE TO EXTENSIVE LENGTHS TO DEVELOP A SUPERIOR 1911 .45 MAGAZINE. We have sold probably 150,000 of our price busters, but we decided we need a new & better 1911 mag & we are very pleased with our new program. This is the results of over a year of product development.



Plus with all of the above a killer price **\$8.95 ea., 5 for \$39.95 C45298**

This is half the price of most reasonable .45 mags! OEM or Large Quantity Buyers Contact Cholly or Dave at (610) 250-3960 ext. 223. Check our website for additional info & pictures of our fabulous tooling.

**NEW VARIATIONS OF OUR 1911 .45 ACP MAGS - JUST IN THE DOOR**

Stainless steel magazines ..... **\$14.95,**  
 3 for ..... **\$40.00 RPM121**



**1911 .45 ACP 7rd MILITARY MARKED MAGAZINES**

.45 ACP #1005-00-8694 MFR8R320 ..... **\$10.95,**  
 3 for ..... **\$29.95 RPM155**



**8 ROUND .45 MAGAZINE**

New, blued steel magazine for all .45 ACP Government Model/M1911 type pistols. Base plate also acts as finger rest to improve your grip on the gun ..... **\$16.95 ea. RPM319**





### ENFIELD STRIPPER CLIPS

We just bought the last small quantity we know of. They are now dinosaurs. All new original. While they last!



**\$3.00 ea**  
5 for **\$12.95 STC010**  
10 in a pouch for **\$28.95 STC039**

### ENFIELD STRIPPER CLIPS WITH POUCH / 10 PACK

Convenient military pouch with 10- .303 Enfield Stripper Clips, unissued.  
**\$28.95 STC010**

### ENFIELD SMLE MKIII REAR HANDGUARD

New  
**\$34.95 LE3090**

See our website for ORIGINAL ENFIELD #5 JUNGLE CARBINE FOREND & HANDGUARDS !

### #1 MK3 & #4 MK1 ENFIELD SPECIAL ITEMS

- LE3076 #1 MK3 Bolt, .22 LR cal, complete, super rare ..... **\$150.00**
- LE3064 #1 MK3 Bolt, complete..... **\$99.95**
- LE3078 #1 MK3 Buttplate, brass, original ..... **\$20.00**
- LE3074 #1 MK3 Buttstock, original G.I, brand new ..... **\$39.95**
- LE3059 #1 MK3 Extractor spring..... **\$10.00**
- LE3075 #1 MK3 Safety Assy, complete ..... **\$19.95**
- LE3095 #1 MK3 Sliding dust cover, Long Lee and Lee Medford, RARE - few only ..... **\$100.00**
- SING079 #1 MK3 Sling, MLE-SMLE Pattern 14... Reproduction of the "Pattern 14" leather sling used for the SMLE (Short, Magazine Lee Enfield) starting in 1914 ..... **\$9.95**
- LE3049 #1 MK3 Striker (firing pin) new original factory ..... **\$20.00**
- LE4077 #4 MK1 Buttplate, brass, original, VG ..... **\$20.00**
- LE4005 #4 MK1 Bolt head, original standard, brand new ..... **\$26.50**
- LE4117 #4 MK1 Barrel, orig GOOD ..... **\$65.00**
- LE4062 #4 MK1 Cleaning rod pull thru, original, new..... **\$2.95**, 3 for ..... **\$6.95**
- LE4013 #4 MK4 Extractor spring ..... **\$7.85**
- LE4063 #4 MK1 Safety Assy, complete ..... **\$20.00**
- LE4096 #4 MK1 Scope Rings for the brass Israeli #32 scope, for the Israeli #4 Enfield sniper rifle (few only), original ..... **\$59.95/set**
- LE4059 #4 MK1 Stock Set, new (stock & forend & 2 handguards) Original..... **\$149.50**
- LE4079 #4 MK1 Stock & Handguards Set, used ..... **\$134.95**
- LE4111 #4 MK1 Swivel, Early ..... **\$7.00**
- LE5001 #5 MK1 Buttstock Assembly for British Jungle Carbine-late production, includes buttplate assembly..... **\$39.95**

### Now we have delightful #1 MKIII Complete Stock Sets

- Original refurbished buttstock
- Original new rear handguard
- New production forend
- Original front handguard

Bring your Enfield up to the delightful!  
**\$149.95 LE3091**

### JUST IN !!!!! Finally available ENFIELD #1 MK3 FORENDS !

*(May require minor fitting)*  
Finally available.... Brand new stained Beech Forends to replace all of those ugly worn out Forends on the #1 MK3 Enfield Rifles. These forends are properly inlaid on the inside and contoured evenly on the outside to provide your military Enfield #1 Mk3 Rifle the perfect profile & enhancement. Already stained a medium walnut color, they can be further darkened to match your handguards as needed. Best way to improve the silhouette and value of your Enfield ! ..... **\$85.00 LE3110**

SEE OUR WEBSITE... FOR 1000s OF ENFIELD PARTS & ACCESSORIES!!

### ENFIELD RIFLE ID DISC

Engraved brass 1 inch diameter disc w/4 markings (proof marks and/or mfg names, dates, etc) which is fitted into the right side of the Lee Enfield Rifle stock ..... **\$6.95 LE3084**

### LEE ENFIELD RIFLE MAGAZINES

**#1 MK3 Enfield Rifle Magazine**  
.303, 10 rd. capacity  
**\$29.95**  
**\$40.00**  
RMO11

### ENFIELD #4 MAG FOLLOWER AND SPRING!

Put one or more away for the future to protect against mag failures! ..... **\$4.95 ea**, 3 for **\$12.95**  
*Limited Supply* LE4119

Just dug out - A few original British brass oilers for British Enfield Rifles ..... **\$21.75 OIL008**

### BRITISH ENFIELD CANVAS SLING

We are now able to offer you 2 of the Wartime canvas slings used on the Lee Enfield Rifles as well as 1 post war issue sling. These are new made and all feature brass hardware and an accurate cotton weave.



Colors available: KAHKI w/ WWI Brass Stamp SING042  
WWII INK STAMP..... SING044  
BLACK..... SING096  
Your choice... **\$6.95 each**

### LEE ENFIELD #1 MK3 AND #4 MK1 FIRING PIN REMOVAL TOOL

Vital tool necessary to strip a Lee Enfield bolt or replace a firing pin. Fits the .303 MKIII, No. 4 and No. 5 Enfields. Made of 1144 stress proof steel - we couldn't break one ..... **\$8.95 LE3067**

### BRAND NEW !!!! ORIGINAL #1 MK3 ENFIELD BARRELS!

Been sleeping for over 30 years in the warehouse! They have GI blue finish and are original! Like new! While they last..... **\$124.95 each** or 3 for ..... **\$299.95 LE3103**

### COMPLETE SET OF #4 ENFIELD STOCK HARDWARE

Buttplate, bands, swivels, handguard ring, stock bolt and all related screws and washers. 17 parts ..... **\$39.95 LE4103**  
See our website for complete list of parts in kit

### ENFIELD PARTS, PARTS & MORE PARTS!

NOTE: We have most all parts for #1 MKIII, #4 MKI and #5 Enfield- along with many variations & accessories. Check our website.

### BRITISH ENFIELD ACCESSORY KIT

Sling, firing pin tool, oiler, field cleaning rod (pull through), and brush. Value \$22. Special **\$16.95 LE4061**

### PARKER HALE NO. 4 ENFIELD TARGET/MATCH SIGHTS

w/o adjustable aperture **\$49.95 PH007**  
See our website for details

### ENFIELD #1 MK3 CANVAS RIFLE COVER (CASE) W/KHAKI SLING CARRY STRAP, WWII PATTERN

Made from heavy canvas material, this gun case's overall length is 46" and fits the Enfield #1 MKIII, #1 MKIV rifles & many other rifles. Beside the main compartment it has a smaller pouch originally used for a cleaning kit case. Has two sling hoops on the back for attaching a strap so you can carry it over the shoulder. We even include a khaki sling carry strap..... **\$16.95 LE3092**

### BRITISH 9 POCKET CAVALRY BANDOLIER

New made 1903 era British/Australian Cavalry heavy duty leather bandolier held 90 rds. of Enfield ammunition. 40 more rounds of ammunition than the standard infantry bandolier, and frequently was also worn around the neck of the trooper's horse..... **\$45.00 MISC634**

## BAYONETS

See More On The Next Page!

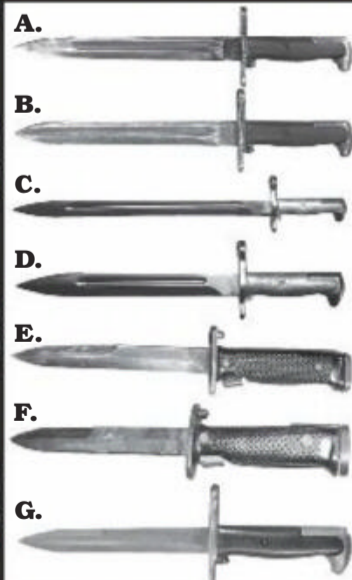

### M1 GARAND BAYONETS

Sarco has a limited quantity of M1 Garand Bayonets in both original, and new/ late production versions with blade lengths from 6.5 to @ 16 inches, sold with, and without scabbards.

A. **Original 10" Model 1943**, Unmodified Bayonet w/ late production US scabbard ..... **\$74.95 BAY193**

B. **Original 10" Model M1905E1**, Modified Spear Point blade w/ late production US scabbard ..... **\$74.95 BAY194**

**DEAL: Buy 1 each of the above 2 bayonets w/scabbards ..... \$140.00 BAY268**

C. **Late production 16" Model 1943 bayonet & scabbard ..... \$39.95 BAY182**

D. **Late production 10" Model 1943 bayonet & scabbard ..... \$32.95 BAY183**

E. **Original M5A1 bayonet w/ M5A1 scabbard ..... \$36.50 BAY189**

F. ALSO... We have **RARE M5A1 Garand bayonets marked KM5A1 ..... \$59.95 BAY020**

G. **Original Korean Army version of the 1943/ 1905 blade** shortened to their requirement of between 6.5-7" length. These were imported from the military by Arlington Ordnance years ago, and we have found a handful remaining in the warehouse. Complete with original Korean short scabbard ..... **\$49.95 BAY240**

H. Also have a few original **Korean scabbards** by themselves  
Used ..... **\$14.95 ea BAY135**,  
Go to our website for a full listing!  
H. **SPECIAL RARE COLLECTOR M1 GARAND BAYONETS. FEW ONLY AVAILABLE. SEE OUR WEBSITE.**

### BAYONET FROGS

- A. SWEDISH MAUSER original, fair condition ..... **\$5.95 MSR258**
- B. JAPANESE ARISAKA late mfg, new, for Type 38 & Type 99 bayonets..... **\$9.95 BAY115**
- C. GERMAN K98 MAUSER late mfg, new, fits WWII K98 bayonets ..... **\$9.95 MSR111**
- D. SWISS BAYONET FROG Swiss military frog as issued for the STGW 57 rifle bayonet. Also works with the K31 bayonets and many other similar style bayonets and scabbards..... **\$8.95 BAY272**

- E. ROMANIAN AK47 BAYONET FROG Original leather military frog in used/very good condition ..... **\$7.95 AK060**
- F. GERMAN 1898/05 WW1 FROG Excellent new made version of the German WW1 frog for bayonets. Perfect for our "Butcher" and "Pioneer" bayonets and with WW1 German markings ..... **\$14.95 BAY290**
- G. WW2 Enfield Canvas Frog For Spike Bayonets, new Mfr ..... **\$7.95 BAY334**

We have 4 leather historical bayonet Frogs for wearing on waist belts.

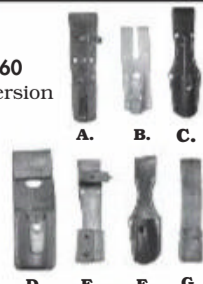

www.sarcoinc.com



### SUPER FIND! ORIGINAL BRITISH ENFIELD BRASS OILERS!

Enfield collectors...we have been so fortunate to find about 100 original Enfield brass oilers in the mountain. Earl has been nice enough to sort out all of these into the original sources. Some we only have one of, while others we have a few. I can't believe he found 22 different variations! Take a look and satisfy your desires while they last - They were covered in 80 years of grease & grunge. He cleaned 'em up so he could read the markings. See our website for the various markings.

Just Found!!



### Project Lovers Special

#### #4 ENFIELD GDII BARRELED RECEIVERS

Lets call 'em "Battlefield Relics" Will have flaws - these are the ones we didn't want to build. As-Is, no returns. 10 for **\$150.00**, 25 for **\$295.00**, 50 for **\$500.00** GUN717 - FFL Required

### HARD TO FIND ORIGINAL BRITISH MILITARY #4 ENFIELD MKII FORENDS

**\$110.00 LE4124**

### ORIGINAL EARLY ENFIELD SLOTTED REAR HANDGUARDS

Excellent - new  
**\$35.00 LE4065**

### BRITISH 1903 ENFIELD AMMUNITION BANDOLIER

Used just prior to WW1 through WW2 and beyond in British Commonwealth forces. Rugged leather combined with brass hardware to provide the soldier and easy method of lugging around ammo. Convenient to take to the range too!



**\$38.00 MISC501**

### #4 MK1 RIFLE MAGAZINE

.303, 10 rd. capacity and broad arrow marked. We've worked on having these made accurately for over 2 years of development & testing. Exactly like the WW2 issue magazine! Extremely difficult to find on the market and we've been very challenged to keep originals in stock. Now all of our hard work to bring these to you can pay off and at an unbeatable price! ..... **\$29.95 each**, 3 for ..... **\$84.95**  
10 for ..... **\$229.95 RM61**



PLEASE NOTE: There are many variations in manufacture of #4 Enfield Rifles - Although we don't get any returns (like zero) we want to make you aware of this and we found at times some minor fitting may be needed.

### ENFIELD #4 MKIT SNIPER RIFLE CHEEK PIECES

Just in the door! Complete with proper brass screws. Use to build your sniper rifle or also to create a high comb buttstock **\$34.95 LE4106**



### NO.4 MK1 WW2 ACTION COVER

Canvas cover as issued during both World Wars. This action cover is newly manufactured in the correct weave, snaps, grommets, and leather tie down. Also comes with period markings. Perfect for completing your Enfield Rifle ensemble..... **\$14.95 LE4115**



### NO.4 ENFIELD SPIKE BAYONET W/ SCABBARD

Excellent condition original WWII, fits all #4 Enfield Rifles. Standard MKII bayonet with MKI scabbard ..... **\$17.95 BAY106**



### ENFIELD #4 RIFLE BUTTSTOCK

Used good condition  
..... **\$35.00 LE4125**



### BRITISH ENFIELD HOOKED QUILLION BAYONET

For the #1 Mk3 Lee Enfield Rifle, this steel bayonet comes with the early style hilt with "Hooked Quillion" which was the original 1907 bayonet issued with the rifle. Blade is 17" long with black finish & wood grips. Late manufacture. Limited ..... **\$38.95 BAY244**



### See our website for CMP GARAND M1 M1943 & M1 10" BLADE BAYONET REPAIR KITS

See our website for BLACK PLASTIC BAYONET GRIPS FOR U.S. 1943 10" & U.S. 1942 16" BAYONETS

### SPRINGFIELD WOOD BAYONET GRIPS

New production, new condition wood grips for the M 1905 pattern bayonet as used on the M1903 Springfield rifle. Fix up or up-grade your old bayonets with these beautiful new grips. Heavily grooved for better holding, just like some originals we found and sent to the wood workers to copy. Nut included. Ready to fit on to your blade ..... **\$9.95 per set** or 3 sets for ..... **\$24.95 GRP143**  
Screw is available if needed. Special price if bought with grips ..... **\$2.00 BAY163**



### BAYONET GRIPS & SCREWS

- BAY164 Original Yugo '98 Mauser bayonet grip sets ..... **\$5.95**, 3 for ..... **\$14.95**
- LE3083 Original grips for Enfield #1MKIII (1907) bayonet ..... **\$9.95**
- BAY163 Original new G.I. grip screws for 1903 Springfield & WWII Garand bayonet ..... **\$3.95 ea.**, 4 for ..... **\$10.00**
- BAY179 Original new grip set for the British #7 bayonet for the #4 Enfield ..... **\$12.95**





www.sarcoinc.com  
BAYONETS CONTINUED FROM PAGE 7

### JOHNSON M1941 BAYONET & SCABBARD

Finally back in stock after a long wait!!! Very rare steel Johnson Rifle bayonet and leather scabbard as issued to the U.S. Marines in WW2. Always been difficult to find, these are newly manufactured and identical to the original with a blade length of about 7.5". Used by select Marine units in WW2 and by 'Mercs' invading Cuba at the Bay of Pigs. Very Limited .....



**\$125.00 BAY024**

#### M1941 Johnson Scabbard

For collectors who have a Johnson bayonet without its scabbard, we have had some extra scabbards made up. New leather scabbard - Johnson M1941 .....

**\$29.95 BAY043**



### ALLIED D-DAY FIGHTING KNIFE

Cruciform 7" blade was a sleek low profile sentry removal tool using the French Cruciform style blade. One of many specialized fighting knives used by allied troops during the D-Day invasion .....



**\$24.95 BAY256**

### M3 FIGHTING KNIFE

M3 Knife w/ leather grip & M6 scabbard w/ WW2 markings. New .....

**\$35.00 BAY331**

M6 leather scabbard (scabbard only)..... **\$14.95 BAY184**



### U.S. 1917 BOLO KNIFE & SCABBARD

Made in substantial numbers during WW1 and in several variations from 1897 to 1917, we can offer this full tang, tempered version of the 1917 model complete with period markings on knife & cloth and leather bound scabbard. This is a real 'Chopper', meant to use both blade and heft to hack things apart from fire wood to the 'Hun' in the Trench. With a little care, it will last a lifetime! .....



**\$99.95 BAY321**

### FINALLY AVAILABLE

1917 Scabbard, U.S.



**\$22.95 BAY278**

### BRITISH SYKES FAIRBAIRN FIGHTING KNIFE W/ SCABBARD

British & Allied soldiers loved this knife which was specifically made for sentry removal and still to this day, serves with the SAS. Steel 7.5" long blade. Sykes Brass Handle Knife w/ Scabbard .....



**\$24.95 BAY274**

Back in stock! Steel handle..... **\$24.95 BAY275**

### BEAUTIFUL LATE PRODUCTION SCABBARDS FOR YOUR CMP AND COLLECTOR BAYONETS

M3 scabbard for 16" M1942 bayonet .....

**\$18.95, 3 for \$45.00 BAY176**

10" Garand scabbard..... **\$12.95, 3 for \$34.95 BAY175**



### INDIA PATTERN SCABBARD #1 MARK 3

**\$19.95 BAY131**



### GERMAN BUTCHER SCABBARD, WWI

Steel replacement scabbard for the First World War German bayonet M1898 /05. This scabbard has been reproduced from an original and fits both the plain and 'sawtooth' variety blades. Scabbard only.....



**\$18.95 BAY273**

### WWI GERMAN 'PIONEER' BAYONET SCABBARD

@23" Long. Scabbard only **\$19.95 BAY276**

### M8A1 BAYONET SCABBARDS

M8A1 Scabbards to fit the following bayonets!

M5 & M5A1 Garand, M3 Trench Knife, M4 for M1 Carbine, M6 for M14 Rifle, M7 for M16



New Military Contract..... **\$19.95 ea BAY083**

Excellent used military contract..... **\$17.95 BAY191**

We have a small quantity of U.S. G.I. M8A1 scabbards.

VG condition..... **\$19.95 BAY040**

(Call Cholly for bulk purchases on M8A1 scabbard BAY083)

Original G.I. new M8A1 scabbard. Just found a few in the warehouse from the old days.

Has original USGI scabbard body..... **\$24.95 BAY041**

### REMINGTON GUN STOCK POMMEL CAPS

Original Remington pommel caps that we purchased from a Remington auction over 20 years ago. Priced right to move. Hard to find, so now's a great time to buy a replacement for that cracked pommel cap!.. **\$10.00 MISC892** *JUST IN !!*



### BLACK GUNSTOCK POMMEL CAPS

Purchased decades ago, these caps are perfect for restoring the cracked caps on old stocks. Smooth black oval shape is roughly 1-7/8"x 1-1/2" and @3/16" deep 3 pcs for .....



**\$8.95 MISC891** *JUST IN !!*

### GERMAN MAXIM 08-15 MACHINE GUN SLING

This canvas & leather sling has been crafted from the original sling as used on the Western Front. A staple of lugging the Maxim 08-15 MG into combat and across 'No Mans Land'



**\$24.00 SLNG127**

### U.S. 1917 PISTOL LANYARD BRAIDED CORD

with brass hardware used mostly with the 1911, but also with Colt & S&W revolvers through WW1 and WW2. New.



**\$19.95 MISC901**

### 1918 U.S. TRENCH KNIFE MODEL

Developed by the American Expeditionary Force, this combat fighting knife was contracted to U.S. and French manufacturers. With over 1.2 million ordered, only about 119,000 were produced before the war ended. Handle of solid brass with a 6.5 inch blade. Our Mark 1 knife is the rarer version and is engraved with the 'Au Lion' cartouche on the ricasso. New .....



**\$39.00 BAY333**  
\*Check your local laws on 'knuckle knives' before ordering. Cannot ship to CA, IL, MI, VT, MO, TX, DE, MA, NY, NJ

### RARE FAL TUBULAR BAYONET

Bayonet w/ scabbard w/o belt connection .....

**\$18.95 BAY171**

Bayonet w/o scabbard .....

**\$9.95 BAY156**



*South African R1 FAL bayonets coming soon - Inquire!*

### A. U.S. 1910 Springfield Leather Bound Scabbard with belt clip



**\$27.95 BAY347**

### B. U.S. Springfield Canvas Bound Scabbard WW1 with belt hooks



**\$29.95 BAY266**

### FRENCH FOREIGN LEGION PARATROOP KNIFE

Version modified from the British Sykes model and carried by Legion Paras through out campaigns in Indochina, Algeria, Kolwezi, etc. Very light and a superior grip to the standard Sykes Fairbairn knife. High Carbon sharpened steel blade is blackened and adorned with low luster French Legion Para emblems. Blade @7" long. Overall length @12". Comes with Sykes style leather scabbard as used by the French.....



**\$59.95 BAY322**

### 1905 BAYONET PROJECT

Set of original and new made parts for assembling a 1905 bayonet. Years ago we had 2,000 blades manufactured and rewelded onto handles with great success, allowing us to sell 1905 bayonets again. Now we have a very limited group of these complete sets of parts remaining. The handles and hilts are from original U.S. bayonets that were demilled by the U.S. govt. Plastic grips and internal handle parts and blade are new mfg. Set of parts: .....

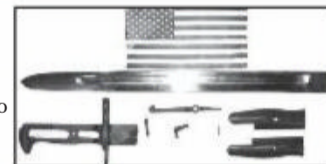

**\$29.95 ea., or 8 for \$199.99 BAY232**

\*Add a scabbard for..... **\$12.95 ea., or 10 for \$99.95 BAY233**

### MOSIN 91/30 BAYONET

Exc condition..... **\$16.95 BAY019**

91/30 bayonet w/ Scabbard..... **\$32.00 BAY084**

MOSIN NAGANT 91/30 BAYO Exc w/New Scabbard, excellent condition .....

**\$32.00 BAY084**

MOSIN NAGANT M91/30 & EARLY CARBINE BAYONET - Mosin short 11.5 inch .....

**\$44.95 BAY261**

MOSIN NAGANT MODEL /44 / CARBINE BAYONET - 2 variations available in limited supplies:

A. Mosin 44 Bayonet w/Single Ear connection. 1945 & earlier .....

**\$44.50 BAY262**

B. Mosin 44 Bayonet w/Double Ear connection .....

**\$44.50 BAY263**

### M16 BAYONETS

Sarco is pleased to offer a selection of original USGI, foreign military contract, and new mfg bayonets.



*(Fits Galil, too)*

A. **U.A.E. (United Arab Emirates) Contract M16 bayonet** with black synthetic scabbard. UAE emblem on handle and also on scabbard. New/unused.....

**\$39.95 BAY237**

B. **Econo M7 bayonet w/ scabbard** - fits and looks like the M7 bayonet and scabbard. New condition.....

**\$19.95 BAY229**

C. **New G.I. M16 bayonet** in original, G.I. packaging. Only A Few Left! .....

**\$39.50 BAY172**

### USGI NYLON CANTEEN COVERS W/ ALLIGATOR CLIPS

Released from Govt. service, these U.S. Military canteen covers are in excellent condition with good snaps and alligator clips. Olive Drab colors may have slight differences as shown in the picture above. Cover only



**\$4.50 each**

### U.S. WW2 CAVALRY CANTEEN COVER W/ HANGER

This cover accepts the standard WW2 U.S. canteen and will connect to a multitude of mounts by way of its large spring loaded clip. Cover only.....



**\$25.00 MISC882**

### METAL BAYONET SCABBARD GRAB BAG

From decades of importing original military bayonets from overseas, we have accrued a 'mound' of metal scabbards which are not perfect, but may help you complete your bayonet collection where scabbards are missing. Some dings, some dents, some rust may appear as well as perhaps missing or damaged throats on some, but on the whole, an interesting group of metal scabbards that range anywhere from 8.5 inches to 19.5 inches long. Set of 10 scabbards, sold as is.....



**\$49.95 BAY355**

*(Picture shown is random set, and there may be variations in sets)*

### BACK IN STOCK!

#### INDIAN FAL BAYONET W/ SAWTEETH

Savage in length and scope, this 10.5 inch blade is longer than other FAL bayonets. Sporting a wood handle and cross serrated saw teeth, it fits the British L1A1 and Indian FAL rifles. Comes with steel scabbard .....

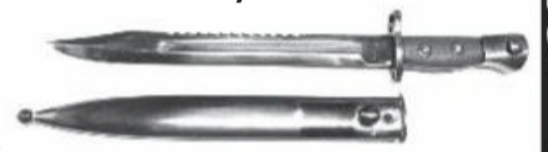

**\$49.95 BAY330**

### BACK IN STOCK!

#### BRITISH ENFIELD # 5 JUNGLE CARBINE BAYONET & SCABBARD

Our new manufacture #5 bayonet is well made and checked for fit on an original military Lug/Flash hider. Fits both the Enfield Jungle Carbine and the Sterling submachine gun .....

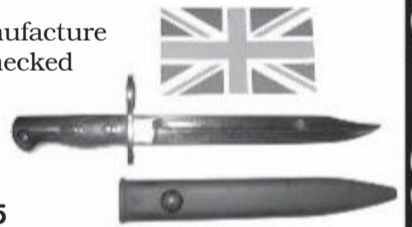

**\$39.90 BAY145**

### GERMAN MODEL 1898 PIONEER SAWBACK BAYONET & SCABBARD

The longest of the WW1 German bayonets primarily associated with the Pioneer troops and NCOs.....



**\$75.00 BAY301**

### GERMAN MODEL 1898 / 05 SAWBACK BAYONET & SCABBARD

Commonly referred to in the family of German Butcher Blades, this was a second variation to the non-sawback butcher blade bayonet that chiefly became the mainstay of WW1 German bayonets. The 'sawback' blade makes it quite intimidating and was far stronger than the 1898 sawback. Our new made bayonet comes with markings on the ricasso and is complete with steel scabbard .....



**\$69.95 BAY302**

### JAPANESE ARISAKA STEEL SCABBARD

See our website for details .....



**\$16.95 BAY303**

### JAPANESE TYPE 38 AND TYPE 99 PROPER HOOK QUILLION BAYONET WITH SCABBARD

..... **\$44.95 BAY178**



### DANISH M8 SCABBARD BODIES

Original Danish military wood Scabbard bodies as used on M8 series scabbards for the M1, M14, Danish G3, & M16 bayonets. Nice wood grain with a hardening coat makes this the perfect replacement scabbard body for upgrading your M8 scabbard from a plastic fiberglass body. Scabbard body is 7 inches long and unissued .....



**\$10.00 Each**

or 3 pcs. for..... **\$24.95 BAY356**

### VARIOUS COLLECTORS BAYONETS & ACCESSORIES

BAY043 Perfect reproduction leather scabbard for 1941 Johnson rifle bayonet. Almost sold out - can't tell from original.....

**\$29.95**

BAY304 1891/M1938 Carcano Cavalry Carbine bayonet, original, steel.....

**\$49.95**

BAY251 1891/M1938 Carcano Cavalry Carbine bayonet, new production .....

**\$30.00**





50 Hilton Street, Easton PA 18042  
610.250.3960 Fax: 610.438.2548

www.sarcoinc.com

**M1 CARBINE PARTS**

CRB090	Banana Clip Pouch.....	\$9.95
CRB023	Barrel Band 1st Model	\$14.95
CRB036	Barrel Band Retaining Spring	\$3.85
CRB025	Barrel Band w/Bayo Lug New, G.I. Parkerized.....	\$19.95
CRB093	Blank Adapter.....	\$9.95
CRB002	Bolt Assembly & Disassembly Tool	\$22.50
CRB096	Brass Deflector.....	\$8.95
CLN172	Bronze bore brush 30 cal	10/ \$9.95
CRB032	Buttplate (Used).....	\$8.00
CRB031	Buttplate Screw.....	\$1.50
CRB094	Carrying Case.....	\$17.50

**U.S. FLAG IN HEAVY DUTY COTTON**  
w/ Embroidered Stars 3x5 foot & will outlast most nylon flags.... **\$34.95 FLAG55**

**BETSY ROSS FLAG** Manufactured with heavy duty cotton layered with 13 embroidered Stars applied in a manner Betsy Ross would be proud of. Perfect for the Fourth of July or flying every day on your flag pole. A beautiful touch of traditional colonial Americana ..... **\$34.95 FLAG56**  
*(High quality, heavy duty cotton.... Not cheap nylon or poly!)*

CRB028	Demilled Front Receiver M1/M2	\$12.50
CRB067	Ejector.....	\$5.00
CRB066	Ejector and Spring.....	\$6.75
CRB068	Ejector Spring.....	\$1.50
CRB063	Extractor.....	\$17.00
CRB065	Extractor Spring	\$1.25
CRB064	Extractor Spring and Plunger.....	\$3.50
CRB069	Firing Pin.....	\$17.50
CRB080	Front sight.....	\$12.50
CRB079	Front Sight Pin.....	\$1.25
CRB175	Front Sight Removal Tool.....	\$29.95
CRB082	Gas Piston.....	\$13.00
CRB083	Gas Piston Nut.....	\$6.00
HNGD06	Handguard, M3 carbine w/hole for M3 sniper scope.....	\$35.00
CRB184	Handguard rivets.....	20 for \$5.00
CRB044	Hammer.....	\$17.00

CRB046	Hammer Pin.....	\$1.50
CRB041	Hammer Spring.....	\$2.50
CRB042	Hammer Spring Plunger	\$5.95
CRB100	M1A1 Pistol Grip Current Production	\$19.95
CRB014	M2 Potbelly stock, used G.I. walnut	\$49.50
CRB113	M3 Sniper Scope Battery Charging Rack. Charges 8-10 batteries. Orig new G.I. in crate can ship UPS (136#)	\$295.00
CRB056	Mag Catch.....	\$13.00
CRB058	Mag Catch Spring and Plunger	\$3.25
CRB057	Mag Catch, late w/mag support	\$13.00
CRB135	Mag Spring Put-Away New G.I. 15 rd	\$2.95

CRB010	Magazine, 15 shot, new	\$5.95
OIL019	Oiler.....	\$4.95
CRB003	Piston Nut Wrench.....	\$12.95
CRB177	Rear Sight Installation Adjustment Tool.....	\$79.95
CRB154	Rear Sight, milled.....	\$29.95
CRB155	Rear Sight, late stamped	\$17.50
CRB001	Recoil Plate.....	\$9.95
CRB030	Recoil Plate Nut	\$2.75
CRB029	Recoil Plate Screw.....	\$2.25
CRB020	Recoil Spring (Hi-Speed)	\$4.50
CRB021	Recoil Spring Guide	\$6.00
CRB022	Recoil Spring Housing (Early)	\$22.50
CRB019	Recoil Spring Std.....	\$3.75
CRB055	Safety (Flip Type).....	\$10.00
CRB059	Safety Spring and Plunger	\$2.95
CRB104	Scope Mount w/Rings	\$24.95

CRB049	Sear.....	\$13.00
CRB050	Sear with hump.....	\$12.00
CRB051	Sear Spring.....	\$1.50
CRB038	Selector Spring.....	\$4.00
CRB015	Slide M1.....	\$75.00
CRB016	Slide, G.I., late M2	\$75.00
CRB017	Slide Stop.....	\$2.95
CRB018	Slide Stop Spring	\$1.50
CRB088	Sling and Oiler Set	\$10.95
SUNG006	Sling Khaki (New Reproduction)	\$9.95
SUNG005	Sling O.D. (New Reproduction)	\$7.95
CRB052	Trigger.....	\$14.95
CRB061	Trigger Housing M1	\$75.00
CRB062	Trigger Housing M2.....	\$85.00
CRB043	Trigger Housing Pin	\$2.00
CRB048	Trigger Pin.....	\$1.25
CRB053	Trigger Spring	\$3.75
CRB004	Trigger Spring Removal Tool	\$3.95

**M1 CARBINE PARTS & ACCESSORIES**

**OUR FAMOUS M1A1**

**PARATROOPER CARBINE STOCKS**

THIS LOT ALMOST SOLD OUT & IT WILL BE MONTHS BEFORE THE NEXT ONE ARRIVES !!

This is a perfect and exact reproduction of the WWII M1A1 Paratrooper Stock. Each stock has a matching handguard, so your treasured carbine will look beautiful.  
*(See website for other M1A1 Stock Parts)*



**\$149.95**  
CRB098

This is absolutely the best quality available

*(Gun Not Included)*

**Other Accessories Available:** Carbine Stock Pouch \$9.45 CRB134  
Sling and Oiler \$10.95 CRB088

Bulk buyers of this great stock, call Dave or Cholly.

Check our website for new **15 & 30 ROUND CARBINE MAGAZINES** - In stock - GI pattern 15rd magazine ..... **\$11.95** CRB010  
30rd magazine ..... **\$14.95** CRB008



Ordering instructions are in the ad or on our website

**M1 CARBINE SLINGS AND OILERS**

SLING AND OILER SET	\$10.95 ea.	
50 sets for.....	\$349.50 (\$7.00/set)	
100 sets for.....	\$599.00 (\$6.00/set)	
CRB088	OILER ONLY.....	\$4.95 ea.
50 for.....	\$149.50	
100 for.....	\$275.00	
OIL019	SLING ONLY.....	\$7.95 ea.
50 for.....	\$300.00	
100 for.....	\$350.00	
SING005	Early WWII pattern Khaki color M1 Carbine sling.....	\$9.95
SING006		

**M1 CARBINE BARRELS**  
New & Made to the G.I. Print !

USA MADE BY OLD SCHOOL BARREL MAKER

Sarco has obtained brand new U.S. made barrels in 4140 steel that are completely machined, bored, properly cut with inlets for the front sight, machined & swedged gas block/piston, breech with proper hood not found on commercial barrels, and bore with a 1 in 20 twist! Barrels are in the 'white', without finish. Finally you can be assured of the perfect replacement barrel for your M1 Carbine.

NOTE: features of this barrel also include: **Short chambered** .015, **Heat treated** 4140 (28-30 RC) **Gas Cylinder/Block** made from 4140 steel, rolled and swedged onto the barrel. These are NOT castings nor are they soldered or welded onto the barrel, but made from forged bar, pressed, swedged, and rolled into place as the original GI barrels were prepared!  
**Sarco's special introductory price: \$149.95** CRB183

**M1 CARBINE MILLED REAR COMBAT SIGHT**  
Back in stock  
**\$29.95**  
CRB154

**M1 CARBINE SLIDE** \$75.00  
CRB015



**M1 TRIGGER HOUSING**

\$75.00 CRB061

**M2 TRIGGER HOUSING, G.I.**  
\$85.00 CRB062



**FN49 PARTS**

Sarco has a full line of FN49 parts in .30-06 & 8x57mm.  
Check our website.

**FN49 RIFLE CLEANING KIT**

Original FN49 Rifle cleaning kits in the aluminum tube. Caps on both ends and brush combo 'pull thru' inserts easily. Difficult accessory to find these days. Can be stored inside the buttstock  
..... **\$12.95** CLN165



**M1 CARBINE MAGAZINE DUST COVER**

Original rubber dust covers back in stock after many years! These are G.I. and in excellent condition. They fit easily over the top feed area of the magazine.  
5 pcs. for..... **\$3.95**,  
10 pcs. for..... **\$5.95**,  
25 pcs. for..... **\$12.50** CRB095

**ORIGINAL BOX OF 100 DUST COVERS**

M1 Carbine fans will love this deal! Original G.I. cardboard box containing 100 pcs. of the rubber carbine dust cover ..... **\$19.95**,  
2 for..... **\$34.95** CRB188

**ROCKOLA T-3 CARBINE RECEIVERS ARE IN STOCK AGAIN!!**

Last ones you'll see!! Check them out on our website or our gun ad in the 2nd issue of the month.

**M1/M2 CARBINE BARREL BAND W/ BAYONET LUG (3RD MODEL)**

GI, Parkerized, Original, G.I.  
**\$24.95 ea.**, 10 for **\$245.00** CRB025



We have a **M1 Carbine straight stocks** and **M2 Carbine potbelly stocks** available...  
Check our website!

**FN49 FLASH HIDERS**

Exact reproduction of the original- Just in the door after waiting 2 years ..... **\$24.95** FN49089



**PISTOL & RIFLE STRIPPER CLIPS**

	EA.	3 for	10 for
STC005	AR15/M16 Guide	\$1.50	\$3.50 \$9.95
STC003	Carcano (may have light pitting)	\$6.95	N/A N/A
STC034	Carcano, brass 6.5mm/7.35, 6rd	\$9.95	N/A N/A
STC009	6.5 Dutch Rifle	\$4.00	\$11.00 \$39.95
STC010	Enfield .303	\$3.00	\$8.25 5/\$12.25
STC039	Pack of 10 Enfield .303 stripper clips w/ pouch	\$28.95	
STC011	Steyr Hahn 9mm Auto for the 1911/1912	\$8.95	\$24.95 N/A
STC014	Mosin Nagant	N/A	\$2.35 \$7.50
STC016	M14	12 for \$9.95	
STC025	1903 Springfield, Brass, Original	\$4.00	\$10.00 \$30.00
STC029	1891 & 1909 Argentine	\$1.50	\$3.25 \$9.00
STC031	Mannlicher 7.65 pistol	\$6.50	\$18.00 \$49.95
STC013	'98 Mauser steel stripper clip	\$2.70	\$7.50 \$22.50
STC018	'93 Mauser brass	\$3.00	\$8.00 \$20.00
STC028	Orig. '98 Mauser brass, never seen before. Few only	\$3.00 ea.	
STC033	Replacement Mauser C-96 Broomhandle 8rd original military	N/A	N/A \$10.00
STC012	C96 Broomhandle, 10rd	\$5.95	N/A N/A
STC006	Rare 1896 Mannlicher	\$24.95	\$59.95
STC020	Swedish Mauser - Back In Stock!	N/A	\$5.00 N/A
STC024	SKS 10rd stripper clips	\$2.00	\$1.50 \$9.95
STC037	Pack of 10 SKS 10rd stripper clips w/ pouch	\$9.95	

Note: all above stripper clips are original except 91/30

**UNIVERSAL 9MM STRIPPER CLIPS**

1/2" wide 3-1/4" long holds 10 rds. Got a pile of 'em so cheap cheap! STC036  
10 for..... **\$9.95**  
50 for..... **\$40.00**  
100 for..... **\$60.00**

**T.V. WATCH'IN PROJECT**

Same 9mm clips as above but some rust - easily cleanable: STC038  
10 for **\$5.95** 500 for **\$125.00**  
50 for **\$19.95** 1000 for **\$195.00**  
100 for **\$29.95**

**STYER HAHN 9MM AUTO STRIPPER CLIPS**  
For the 1911/1912 **\$8.95**, 3 for **\$24.95** STC011

**G-43 RIFLE PARTS**

**G-43 SPRING SET**

We finally completed this project all brand new live springs. Tune up your G-43 or keep a set as a "put away". These kits will run out. Old weak springs not only affect function but also take a toll on the hard parts in your gun. Springs are copied exactly from the originals. This kit is sold elsewhere for \$80.00 and are sold out there! Buy one for your gun & one to put away for when they're gone or go in business at..... **\$14.95/set**,  
2 sets for..... **\$28.95**,  
10 sets for..... **\$140.00** G43067

1 front recoil spring	1 gas piston spring
1 hammer torsion spring	1 safety plunger spring
1 rear recoil spring	1 mag catch Torsion spring
1 trigger torsion spring	

**G-43 Canvas Pouch (repro) w/2 new Mags**  
..... **\$103.95** G43056

**G-43 Canvas Pouch** by itself... **\$12.95** G43002

**G-43 Leather Mag Pouch with 2 new 10rd mags**  
..... **\$103.95** G43061

**G-43 10rd Magazine**, New MFG - Well-made and tested, steel. Meticulously made identical to the original  
..... **\$54.95** G43001



**M1 CARBINE BANDS**

First model barrel band assembly with swivel and screw. Perfect for restoration of an early WWII pattern carbine. New. Just bought a good deal on 1st model M1 Carbine barrel bands and will pass it on to you. Previously \$20-\$25 ea, now!! ..... **\$14.95**, 3 for **\$39.95** CRB023

**M-1 CARBINE POUCHES & MAGAZINE SETS**

Individual pouches for sale as well as combination sets with magazines. Every order with magazines gets a free original USGI rubber dust cover with each mag!

- CARBINE STOCK POUCH holds 2 15 rd. magazines and slides onto the wood stock. New repro. With markings on front & back..... **\$9.45** or 3 for..... **\$24.95** CRB134 (pictured on Left)
- CARBINE BELT POUCH holds 2 15 rd. magazines and slides onto belt. New, GI..... **\$8.00** CRB092
- CARBINE BANANA CLIP POUCH holds 4 30rd. magazines. Slides onto belt..... **\$9.95** or 3 for **\$24.95** CRB090 ( pictured on Right )
- COMBO A: 2 15 rd. Magazines and Stock Pouch w/dust covers ..... **\$29.95** CRB191
- COMBO B: 2 15 rd. Magazines and Belt Pouch w/dust covers .... **\$28.95** CRB192
- COMBO C: 4 30rd. Magazines and Banana Clip Pouch w/dust covers ..... **\$69.50** CRB193

\*Follow State & Local laws when ordering magazines\*

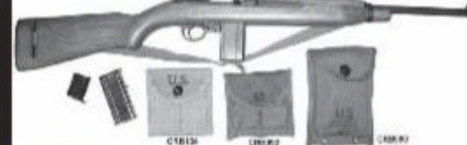

**WWII M1 CARBINE LEATHER SCABBARD**

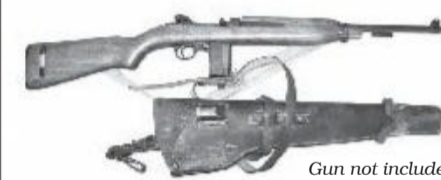

These are truly Scarce as Hens Teeth! For whatever reason there are very few of these remaining on the collectors market so we have thoughtfully had them made from an original utilizing strong leather, brass cover and correct fasteners, and markings. This was used by Cavalry, on motorcycles, jeeps, half-tracks etc. Originally made for the full stock M-1 Carbine, it also fits similar sized firearms like the Ruger® 10/22® with the Sarco stock. Originals can fetch \$400-\$700. Sarco brings this quality leather item to you at the fabulous price of  
..... **\$57.95** CRB189

**M1 CARBINE G.I. COLLECTORS**

Check our website for G.I. M1 sorted collectors parts! We have sorted a lot of G.I. parts - Some are really rare!!

Don't forget to visit  
www.SARCOINC.com for 1000's of Carbine Rifle items!



USGI MOLLE CANTEEN POUCH / UTILITY POUCH
MOLLE GEAR - PERFECT FOR HOLDING AMMO, TOO!!

Recently released from Govt. Service, these woodland camouflage Canteen pouches are in excellent shape with good draw cords, latches, and straps. Two side pouches are intended for water purification tabs and other items, but if a canteen is not used, the main pouch can handle a 'hundred round' belt of 7.62mm or 5.56 ammo perfectly. MOLLE fasteners on back allow it to be mounted on belts, backpacks, etc... Woodland Canteen Pouch only ..... \$9.95 MISC919

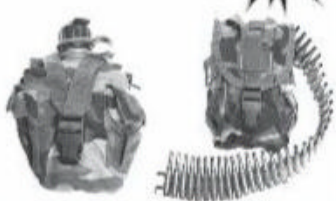

SPRINGFIELD 1903 & 1903A3 'C' STOCKS

BEECH STOCK OPTIONS
Beech C Stock w/ stain ..... \$139.95 SPF2765
Beech C Stock w/o stain(natural)..... \$129.95 SPF276
To either Stock, add a New Handguard for ..... \$23.00
Unstained (so you can stain to match your stock) Beech Handguard SPF377
Stained Beech Handguard SPF377S

Note: many of the currently produced military stocks are made of stained beech & finish up very nicely. The Beech stock that we sell also has a walnut stain and there is an economy in going this route and also in having a beautiful stock! We have sold thousands of Beech Stocks. Your choice. Note: Any stocks ordered with a 1903 handguard will receive a New, GI unstained 1903 handguard.

WALNUT STOCK OPTIONS
Walnut C Stock w/ stain ..... \$159.95 SPF276WS
Walnut C Stock w/o stain (natural)..... \$149.95 SPF276W
To either Stock, add a New Handguard for ..... \$25.00
Unstained (so you can stain to match your stock) Walnut Handguard SPF377W
Stained Walnut Handguard SPF377WS

Beautiful new walnut or hardwood 'C' Stocks in several flavors to enhance your old 1903 Springfield series rifles. All stocks are sanded to USGI specification of 120 Grit for proper G.I. texture.

SARCO www.sarcoinc.com 10

US KRAG & SPRINGFIELD KERR RIFLE SLING

Original complete with the 'NobuckL' sling hardware, cor rect weave, and khaki color. This was also originally used on the 1921 & 1928 Thomp son SMG before they shortened it during the war. Long length of sling is @45", and short length is @14.5". New. .... \$22.00 SLNG104



SPRINGFIELD RIFLE LEATHER KERR SLING

Expensive to make, this leather sling sported the brass Kerr 'NOBUCKL' system for their canvas slings from WW1 thru WW2. Fits loads of rifles and will last a lifetime of use. High quality and a classic! New ..... \$24.00 SLNG115



Note: Almost all of our Springfield parts are original, new G.I. bought 30-40 years ago

FINALLY BACK IN STOCK !!

G3 BARREL
New, U.S. production
\$149.95 G3108

G3 HK91

PISTOL GRIP
Original, O.D./Green plastic
\$65.00 G3100

VIKING & CELT NECK RINGS

Worn around the base of the neck by both men and women Celts and Norsemen, the 'Viking Torque' (or Torc) has been recorded back as far as 1200 BC to 600 AD and is considered imbued with powers of independence for the free born, warrior status, and an earthly connection with deities. We have two of the common types. One of brass and one of Copper antiqued. Your choice..... \$29.95

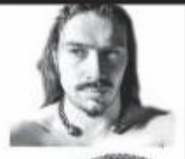

Brass Neck Ring MISC847
Copper Neck Ring MISC846

NEW 1903A3 WALNUT HANDGUARDS

New, unstained..... \$26.50 SPF377W

U.S. M1903 & 03A3 RIFLE PARTS

- SPF001 Band Front Sight 1903 ..... \$13.50
SPF002 Band Front Sight 1903A3 ..... \$12.00
SPF253 Band Lower, new GI blue 1903 ..... \$25.00
SPF011 Band Lower (milled) 1903 ..... \$20.00
SPF012 Band Lower w/Swivel (milled) 1903 ..... \$23.95
SPF014 Band Lower w/Swivel (stamped)1903A3 \$17.50
SPF018 Band Screw Upper Band 1903 ..... \$3.00
SPF019 Band Screw Upper Band 1903A3 ..... \$3.00
SPF263 Band & Hardware Set, milled 1903. \$54.95
SPF265 Band & Hardware Set, 1903A3. \$49.95
SPF003 Base rear sight (not sleeve) ..... \$12.00
SPF306 Bolt, smooth body, bent handle ..... \$125.00
SPF004 Bolt Late (complete) ..... \$42.00
SPF005 Bolt Late (stripped) ..... \$20.00
SPF008 Bolt Sleeve (stripped) ..... \$15.00
SPF009 Bolt Sleeve Lock ..... \$4.75
SPF010 Bolt Sleeve Lock Spring ..... \$1.75
SPF384 Bolt sleeve w/lock & spring ..... \$19.95
SPF308 Bolt smooth body, early straight handle, good cond. .... \$140.00

- SPF352 Bolt stripped & welded in firing pin hole 1903(A3)..... \$3.95, 5 for \$14.95
SPF351 1901 era, Springfield bolt body, smooth, not heat treated..... \$300.00
SPF357 Bolt R marked for early Remington 1941-42, stripped..... \$65.00
SPF358 Bolt BF (Bonnie Forge) Springfield 1941 & 42, stripped, like new ..... \$45.00
CLN172 Bronze bore brush 30 cal..... 10/ \$9.95
SPF091 Butt Swivel (milled) 1903 ..... \$6.50
SPF061 Butt Swivel (stamped) 1903A3 ..... \$5.00
SPF016 Buttplate (milled) 1903(used)..... \$20.00
SPF015 Buttplate (stamped) 1903A3 used ..... \$18.95
SPF121 Buttplate Milled fine checkered..... \$35.00
SPF402 Buttplate milled, heavy (wide) checkering - unchecked trap ..... \$99.95
SPF020 Cutoff..... \$8.50
SPF021 Cutoff Plunger..... \$2.00
SPF023 Cutoff Screw..... \$2.00
SPF024 Cutoff Spindle..... \$3.50
SPF022 Cutoff Spring..... \$1.50

SPRINGFIELD RIFLE CASE, MODEL 1918

WWI canvas case with canvas flap, carry strap, and markings. Not many of these are found today, but this new mfr case is every bit as good. Great for the M1 Garand, too! 47 inches long ..... \$24.00 SPF392



U.S. SPRINGFIELD RIFLE 'PEDERSON' DEVICE MAGAZINE POUCH

\$24.00 SPF395 See our website!

1903 & 1903A3 ORIGINAL G.I. SPRINGFIELD STOCKS

- A. Good, may have arsenal repair, straight stocks ..... \$85.00 SPF118
B. Select, much better than A. Nicer finish. Only very minor or no repairs, straight stocks ..... \$125.00 SPF116S
C. Good cond composite stock and HG..... \$29.95 SPF362
D. Rough composite stock and HG..... \$19.95 SPF363

SPRINGFIELD LATE PRODUCTION STOCKS

- Early Straight Stock, Walnut..... \$149.95 SPF388W
Early Finger Groove Straight Stock, Walnut ..... \$149.95 SPF251W

SPRINGFIELD RIFLE ACCESSORY SET

Canvas roll up pouch with original spare maintenance items to keep your Springfield Rifle running well. See our website for details! .... \$34.95 SPF389

Chrome Springfield Parts - We have 30 different chromed Springfield parts. Very small quantities. Check our website for list. All parts are used off of drill rifle.

1903A3 PIN & SPRING KITS

All the pins & springs in a Springfield rifle - 03 & A3 included ..... \$9.95
3 for ..... \$24.95 SPF341

1903 & A3 SPRINGFIELD BUTTPLATE COLLECTION

See our website!

M1903 TRIGGER GUARDS MILLED (NOT STAMPED 03A3 TYPE)

Absolutely beautiful repro of 1903 Springfield milled trigger guard. Can't really tell from original. Replace the stamped 'A3 guard in your rifle with one of these beauties. Finished in matte black, stripped (no floorplate) \$49.95 ea. SPF117. Complete assy - trigger guard with floorplate & catch assy \$69.50 SPF343

1903A3 TRIGGER GUARD ASSEMBLIES

A brand new complete assembly - trigger guard + follower + spring + 2 screws - \$51 value ..... \$39.50 SPF375
Complete assembly, used surplus - \$51.50 value..... \$39.50 SPF376
Trigger guard only, brand new ..... \$31.50 SPF079

SPRINGFIELD 1907 SLINGS, LEATHER - AS USED IN WWI & WWII

- 1. SLNG024 WWI Model 1907 Sling (w/ brass hardware and WWI date)..... \$16.95 ea.
3 for ..... \$47.95
2. SLNG025 WWII Model 1907 Sling (w/ steel hardware and WWII date)..... \$16.95 ea.
3 for ..... \$47.95

SPRINGFIELD HANDGUARDS

- Original G.I. walnut handguards.
M1903, New, unissued ..... \$14.95 HNGD01
1903A3 used cracked repairable ..... \$59.95 SPF261
10 for..... \$599.95
1903A3 plastic for drill rifle..... \$15.00 SPF043
1903 handguard Type 2 (1910 to 1916) ..... \$150.00
1903 handguard NM..... \$100.00

JUST A FEW - ORIGINAL G.I. SPRINGFIELD STRAIGHT FINGER GROOVED STOCK - good condition, sanded & oiled..... \$175.00 SPF406

BRAND NEW!! SPRINGFIELD 1903A3 BARRELS

High quality 4140, 4-groove barrels with shallow chamber (.044") to accommodate for receiver variations, extractor cut, front sight cut out for base, with a 1 in 10 twist. In the white and unmarked! \$110.00 SPF387 (Very Limited Availability) Can be converted to an '03 barrel by adding an '03 rear sight sleeve!

SPF342 Die cast buttplate assemblies for 1903 Springfield - looks like a milled buttplate (new orig). Super rare! Collector's dream ..... \$39.95

SPF309 Early '03 bolt stop, new orig. G.I. .... \$16.00

- SPF028 Ejector..... \$5.00
SPF029 Ejector Pin..... \$2.00
SPF025 Extractor..... \$14.95
SPF027 Extractor Collar..... \$10.00
SPF026 Extractor w/ Hole..... \$16.50
SPF033 Floorplate (milled) 1903..... \$19.95
SPF034 Floorplate Catch Assembly..... \$8.75
SPF031 Follower (milled) 1903..... \$7.00
SPF030 Follower (stamped) 1903A3..... \$10.00
SPF032 Follower Spring..... \$4.00
SPF036 Front Sight Base Pin..... \$1.50
SPF035 Front Sight Blade 1903..... \$6.00
SPF333 Front sight blade 1903A3..... \$5.00
SPF044 Front Sight Cover ..... \$12.95
SPF093 Front Sight Key 1903A3 ..... \$2.25
SPF037 Front Sight Pin..... \$1.50
SPF039 Front Sight Screw 1903 ..... \$2.75
SPF038 Front Sight w/Stud 1903 ..... \$9.95
HNGD01 Handguard 1903 (new G.I.)..... \$14.95
HNGD37 Handguard 1903 used cracked repairable ..... 10/ \$39.95
HNGD02 Handguard, U.S. 1903A3 (new G.I.) ..... \$65.00
SPF084 Handguard Clips (Two Packs) ..... \$3.85
SPF043 Handguard Plastic (New) 1903A3.. \$15.00
SPF049 Handguard Ring to Receiver 1903A3 ..... \$6.00
SPF347 Lower band assy w/swivel, used orig Remington 1903 ..... \$47.50
SPF349 Lower band screw, new 1903A3..... \$1.95
SPF046 Mainspring..... \$4.00

SPRINGFIELD RIFLE

- OIL035 Oiler, late plastic WWII, new ..... \$13.95
OIL015 Oil and Thong Set (Metal) ..... \$35.00
OIL016 Oil and Thong Set (Plastic) Used ..... \$8.50
SPF371 Rear sight, complete assembly w/base & windage screw (barrel ring not included), 1903..... \$74.95
SPF094 Rear sight, complete without windage screw w/o barrel ring, VG to Exc, 1903 ..... \$69.95
SPF294 Rear sight, G.I. used, 1903A3..... \$40.00
SPF370 Rear sight, perfect repro, 1903A3 ..... \$29.95
SPF273 Rear sight sleeve (around barrel), Orig/Late 1903..... \$60.00
SPF143 Rear sight windage screw, 1903 ..... \$7.50
SPF053 Safety Lock..... \$8.00
SPF054 Safety Low Scope Type..... \$16.50
SPF086 Screw Buttplate Large ..... \$2.95
SPF085 Screw Buttplate Small..... \$2.45
SPF092 Screw Stacking Swivel 1903 ..... \$2.00
SPF056 Screw Trigger Guard Front ..... \$3.00
SPF057 Screw Trigger Guard Rear..... \$3.00
SPF074 Screwdriver Three Blade..... \$9.95
SPF055 Sear ..... \$7.50
SPF087 Sear, Pederson Device..... \$65.00
SPF072 Sear Pin ..... \$2.00
SPF062 Sear Spring ..... \$2.00
SLNG067 Sling keeper, 1/4" for 1907 sling, orig, new GI..... \$5.95 ea.
2 for ..... \$9.95
SPF013 Sling Swivel for Band (milled) 1903 ..... \$7.50

- SPF067 Spring Band Retainer (milled) ..... \$14.50
SPF066 Spring Band Retainer (stamped) ..... \$4.00
SPF058 Stacking Swivel and Band (exact reproduction) 1903A3 ..... \$15.00
SPF068 Stacking Swivel Used G.I. (milled)1903 ..... \$9.50
SPF366 Stacking swivel and band assembly, 1903A3 G.I. used ..... \$18.00
SPF367 Stacking swivel 1903A3 G.I. new ..... \$6.00
SPF335 1903A3 stamped replacement rear sight. Perfect for drill rifles..... \$5.95
3 for ..... \$14.95
SPF113 Stock cross bolt & nut..... \$9.65
SPF090 Striker..... \$7.40
SPF052 Striker Rod..... \$6.00
SPF051 Striker Sleeve ..... \$3.00
SPF076 Trigger Grooved..... \$13.95
SPF077 Trigger Pin..... \$1.50
SPF075 Trigger Plain..... \$9.95
SPF368 Trigger guard, 1903A3 used G.I. .... \$32.00
SPF382 Trigger guard, 1903A3-Reparked ..... \$36.00
SPF117 Trigger Guard 1903 type, Milled ..... \$49.95
SPF078 Trigger Guard 1903, Orig GI..... \$95.00
SPF079 Trigger Guard (stamped) 1903A3 ..... \$31.50
SPF083 Upper Band (stamped) 1903A3 ..... \$16.00
SPF081 Upper Band Used (milled) 1903 ..... \$26.00

COMPLETE HARDWARE SET FOR 1903A3 SPRINGFIELD

Same list as parts to the left only 1903A3 late pattern. Value \$55.00. Special \$49.95 SPF265

1903 SPRINGFIELD LOW SCOPE SAFETY ASSY

\$16.50 SPF054

BORE CLEANING BRUSHES

.30 caliber brass bore brushes, new. \$9.95/10 • \$39.95/50 • \$69.95/100 CLN172

SPRINGFIELD STRIPPER CLIPS

Early brass WWI ..... \$4.00 ea,
5 for ..... \$14.95 STC025

1903 SPRINGFIELD GRENADE LAUNCHING BOOTS

A perfect reproduction of the grenade launching rubber boot (slip on) for the Springfield and M1 Garand. Absolutely meticulously beautiful!! ..... \$34.50 MISC088

See our website for 1903 Springfield Drill Rifle Barrels SPF271

EXTRA LONG REAR GUARD SCREWS FOR 1903A3 RECEIVERS

The standard guard screw only goes up part way in an A3 receiver. This screw fills the hole to make your rifle more attractive. Haven't had these for 20 years. The G.I. screws only engages a few threads. \$3.95 ea, 3 for \$9.95 SPF360

1903 & A3 SPRINGFIELD SPRING KIT

A put-away for the future all springs in the gun - bolt sleeve lock, main, cut-off, sear, floor plate catch, & magazine follow \$15.00 value - Only..... \$4.45.
3 for ..... \$11.45 SPF248

M1903 & 03-A3 "SPRINGFIELD" RIFLE KITS

These kits consist of every part of the "Springfield" rifle except the stock, receiver, and barrel assy. (w/ sight bases). Kits will have bolts, bands, stamped trigger guard, swivels, trigger, etc. Use these kits to build up to a rifle on your receiver or to rebuild an old '03. All parts are in new or like new condition. Note: Rear sight parts may be used G.I.
A. M1903 Parts Kit includes new handguard..... \$159.95 ea. SPF127
B. M1903A3 Parts Kit ..... \$149.95 ea. SPF126
C. For a new G.I. 2 groove 03A3 barrel add ..... \$190.00 SPF080
D. Special on new '03A3 barrels if bought with an '03 or 'A3 kit (can also be converted to an '03 barrel with '03 kit by adding '03 rear sight sleeve) ..... \$100.00 SPF387 (price valid only if purchased with kit)
If you want an unfinished receiver casting in either kit, add \$19.95 SPF405 Not for sale in NJ

SPRINGFIELD 80% RECEIVER CASTINGS

\$39.95 SPF405
Not for sale in NJ

1903 SPRINGFIELD DRILL RIFLE BARRELS

These were removed from drill rifles & have their chambers welded or have a rod in the barrel with a small plug weld to hold it in. Front sight base not included ..... \$12.50 ea.
10 for..... \$99.95.
50 for..... \$400.00 SPF270

BRAND NEW 1903A3 SPRINGFIELD REAR SIGHTS ASSEMBLIES

Forgot we had 'em..... \$29.95.
3 for ..... \$84.95 SPF370
Original G.I. A3 rear sight used VG ..... \$40.00 SPF294
Check our website for A3 Sight Parts Have all parts

NEW GI SPRINGFIELD BARRELS

M1903A3, New, G.I., 2 groove ..... \$189.95 SPF080
M1903A3, New, G.I., 4 groove ..... \$199.95 SPF130

1903 SPRINGFIELD RIFLE 10 RD. MAGAZINE

Steel 10 rd., .30-06 magazine for the 1903 series of Springfield military rifles. Makes a day at the range more fun and looks great on the rifle too! Fits the 1903 trigger guard..... \$69.95 RM84

See our website for all M1 & M2 .22 Springfield parts.

COMPLETE NEW SCREW SET FOR 1903 & 1903A3 SPRINGFIELD

Includes:
Upper band screw ..... Rear guard screw
Front guard screw ..... 3 Small buttplate and swivel screws
Large buttplate screw ..... swivel screws
Stacking swivel screw ..... Cut off screw
Lower band screw
Note: the 1903 kit also includes the front sight screw (value \$23.00) SPF378 - screw set for 1903A3 ..... \$9.95
(value \$26.00) SPF379 - screw set for 1903 ..... \$9.95

See our website for a full listing of our 1903 Springfield Rear Sight Parts

SPRINGFIELD PUT AWAY KIT 1/2 PRICE!

Trigger, 2 sears, 1 milled follower, 2 ejector, 2 strikers, 1 mainspring, 2 trigger pins, 1/2 price special..... \$15.80 SPF095



**ORIGINAL MAUSER '98 AND OTHER MAUSER HANDGUARDS**

MSR216 M98/43 La Corona Handguard **\$35.00**  
 HNGD55 M1912 Chilean Mauser Handguard **\$35.00**  
 HNGD17 M1893 Spanish Mauser Handguard **\$30.00**  
 HNGD34 M1908 Brazilian Mauser Handguard **\$35.00**  
 HNGD36 CZEK VZ24 Mauser Handguard **\$35.00**

**MAUSER "20" ROUND "TRENCH" MAGAZINE** Check your local laws and/ or our website for mag restrictions



**\$49.95 MSR167**

**RARE FIND IN P-17 ENFIELD**  
 Just a handful from sorting P17 Front handguards with Winchester & Remington markings - good to VG cond.  
 Winchester "W" **\$75.00 P17045-W**  
 Remington "R" **\$75.00 P17045-R**

**U.S.M1917 & BRITISH P-14 ENFIELD PARTS**

Almost all parts are new G.I.

P14003 P14 Bolt Stripped **\$32.00**  
 P14002 P14 Bolt, complete **\$99.95**  
 P14004 P14 Extractor, original **\$39.95**  
 P14007 P14, Floorplate **\$9.00**  
 P14009 P14, Follower, Milled **\$8.00**  
 P14008 P14, Magazine Box **\$11.50**  
 P14010 P14, Speed Lock **\$40.00**  
 P14005 P14, Striker (Firing Pin) **\$20.00**  
 P14006 P14, Triggerguard **\$15.00**  
 P17051 P17, Speed Lock **\$39.95**  
 P17016 Bolt Complete **\$75.00**  
 P17017 Bolt, stripped **\$37.50**  
 P17068 Bolt stop Assy, 4 parts w/o ejector **\$15.00**  
 P17041 Buttplate Assembly **\$14.95**  
 P17040 Buttplate Screw Large **\$3.50**  
 P17056 Buttplate Swivel Screw **\$4.00**  
 P17012 Ejector, original **\$17.50**  
 P17043 Extractor **\$24.50**  
 P17034 Front guard screw **\$3.50**  
 P17036 Floorplate **\$10.00**  
 P17038 Follower Spring **\$5.00**  
 P17039 Follower, Milled **\$12.00**  
 P17006 Handguard Ring **\$10.00**  
 P17082 High speed firing pin spring **\$4.95**  
 P17054 Lower Band Assembly **\$10.00**  
 P17037 Magazine Box **\$9.95**  
 P17035 Rear Guard Screw **\$3.50**  
 P17004 Stacking Swivel **\$9.50**  
 P17052 Stacking Swivel Screw **\$4.00**  
 P17059 Stock **\$195.00**  
 P17018 Striker (Firing Pin) **\$18.00**  
 P17031 Triggerguard **\$20.00**  
 P17053 Upper Band **\$9.50**  
 P17046 Rear handguard walnut new G.I. **\$40.00**  
 P17047 Rear handguard walnut used G.I. **\$30.00**  
 P17062 Rear handguard hardwood, new G.I. **\$30.00**  
 P17063 Rear handguard hardwood, used G.I. **\$25.00**  
 P17044 Front handguard walnut new G.I. **\$35.00**  
 P17045 Front handguard walnut used G.I. **\$25.00**  
 P17061 Front handguard hardwood, new G.I. **\$30.00**  
 P17060 Front handguard hardwood used G.I. **\$20.00**

**P14 & P17 Handguards are interchangeable. Order under P17 part #s.** See our website for all other P17 & P14 parts

**BRAND NEW ORIGINAL 98 MAUSER STRAIGHT BODY STRIPPED BOLTS**

Bought from the FN warehouse in Belgium. The original FN production. These came out of the FN Factory in a buy of left over parts in the warehouse. Unnumbered. Never in a gun **\$49.95 MSR517**

Extra Special Our new '98 bolt with new extractor and new firing pin **\$79.95 MSR518**

**MAUSER RIFLE BARRELS VARIOUS MODELS**

1. Kar 88, 8x57, original used, with good bores, 17 1/2" **\$75.00 MSR096** with hand pick bores **\$95.00 MSR097**

2. Rare Argentine M1909 Engineers Carbine barrel - bores vary **\$100.00 MSR512**

3. 1908 Brazilian Barrels:  
 Fair **\$40.00 MSR659**  
 Good **\$60.00 MSR107**

**MISC. 98 MAUSER ITEMS**

1. Original Argentine SOM sniper scope w/base & leather case **\$3495.00**

2. Rare M98/43 La Corona Spanish muzzle cover **\$9.95 MSR217**

3. VZ24 Mauser new original stock disc **\$4.95**  
 3 for **\$12.50 MSR523**

4. Original Israeli K98 grenade launcher, like new **\$49.95 MSR575**

5. Orig Yugoslav, 98 & M48 etc Mauser oller **\$4.95 MSR576**

6. Rare original 1904 Portuguese Verguiero front sight cover, new **\$9.95 MSR591**

**TOKAREV RIFLE & PISTOL PARTS**

**SVT-40 TOKAREV RIFLE SPARES PACK**  
 Sarco has a new spares pack for the venerable SVT-40 Tokarev Rifle. These parts just came in and we can offer you an unbeatable deal on this parts package. Pack consists of Bolt with Extractor, Front End-gas housing & flash hider, Rear Sight-complete, Trigger Housing complete, and Piston Rod. Normally these parts would fetch \$350.00, but Sarco's special price is **\$64.95**, 3 for **\$179.95 TOK089**



**TOKAREV TU-90 GRIPS**  
 Like new **\$14.95**, 3/ **\$29.95 GRP194** See our website for more Tokarev parts!



**TOKAREV BARRELS IN 7.62X25 Original Used.**  
 VG clear rifling **\$64.95 TOKP033**



**K98 MAUSER SPARE PARTS KIT**  
 Been out of these for a while. Now's a great time to pick up a pack of these original parts before they are gone again! Contains: EJECTOR, FOLLOWER, MILLED, TRIGGER SEAR, SAFETY, FOLLOWER SPRING, SEAR SPRING, BOLT SLEEVE, FIRING PIN, FIRING PIN SPRING **\$29.95 MSR370** VALUE \$65.00



**'98 MAUSER SPORTER RIFLE PARTS**  
 Steel hinged trigger guard assembly **\$69.95 MSR326**  
 Single stage trigger (uses original sear) **\$14.95**, 3 for **\$39.95 MSR205**

**Note:** Delightful single stage trigger assembly—this takes the historic 'creep' out of your trigger pull. It is interchangeable with your standard trigger. A must for all shooters looking to improve the performance of their Mauser 98.

**Low scope safety** - for scope mounting on 98 Mauser scoped Sporter. Fits & works on standard military bolt sleeve **\$17.75 MSR162**



**'98K MAUSER ACCESSORY KIT**  
 Cleaning rod. Our famous K98 Repro sling, front sight hood. Value \$55.00  
**Sarco Special** **\$24.95 MSR365**



**K98 RIFLE STOCK DISC**  
 Usually inserted in the right side of Mauser stocks in the 1930s and in Garrison rifles of the Home Guard through the early war years. Would ID mfg., date, serial # **\$4.95 MSR596**

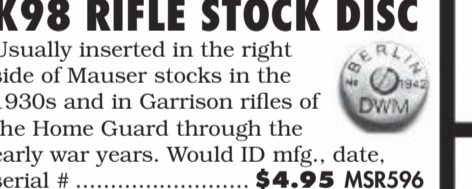

**K98 MAUSER HANDGUARD**  
 Beautiful new hardwood hand-guard ready to replace that old worn out handguard! **\$19.95 HNGD42**



**SEE OUR WEBSITE FOR THE FULL SELECTION OF '98 MAUSER PARTS**

MSR104 Band Retaining Spring, front GEW 98 **\$4.00**  
 MSR105 Band Retaining Spring, rear GEW 98 **\$4.00**  
 MSR106 Band Spring (98K) **\$7.00**  
 MSR107 Barrel, 1908 Brazilian style 7x57mm (30" large ring) **\$60.00**  
 MSR096 Barrel KAR88 Orig Used 8x57 17 1/2" small ring **\$75.00**  
 MSR304 Barrel, Verguiero 8x57mm 23 3/4" Small Ring, New **\$75.00**  
 MSR097 Barrel KAR88 Original (hand picked bores) 8 x 57MM 17 1/2" small ring **\$95.00**  
 MSR114 Bolt (complete) turndown handle **\$84.95**  
 MSR115 Bolt (stripped) turndown handle **\$75.00**  
 MSR117 Bolt Sleeve (new) **\$12.00**  
 MSR118 Bolt Sleeve (used) **\$8.00**  
 MSR120 Bolt Stop (stripped) **\$7.00**  
 MSR121 Bolt Stop Assembly **\$22.50**  
 MSR359 Bolt Stop for 1909 Argentine stripped **\$14.95**

**G-43 SIGHT HOOD**  
**\$14.95 G43040**



**GERMAN MAUSER RIFLE GERMAN MADE H&K DESIGN ADAPTABLE FLASH HIDER**  
 Proven design! 7.62mm (30cal) metric 15 x 1 right hand thread **\$7.95**  
 3 for **\$19.95 MISC795**



**EXTRA LONG LOCKING LUG MAUSER K98 BOLT**  
 To Solve 98 Mauser Headspace Problems - New Mauser '98 bolts FN made from years ago. These are new original bolts with extra length locking lugs to repair excess headspace guns. Been hiding for years. Stripped, brand new original FN. **\$79.95 MSR517L**



**Check our website for a fabulous assortment of '98 Mauser trigger guards over 35 variations - we had a big sort! Have over 30 varieties of Bolts, too!!**



**GERMAN WW2 MAUSER G33 /40 FRONT SIGHT HOOD \$24.95 MSR633**



**'98 MAUSER FRONT SIGHT COVERS Back Again!**  
 New condition **\$6.50**, 3 for **\$17.95 MSR153**



**MAUSER K98 SNIPER RIFLE SPECIAL EXTENDED SAFETY**  
 We have them for the first time! To go with your Mauser sniper rifle project. Others sell for \$69.95 **\$24.95 MSR574**



**MAUSER 98 SPORTER STOCK WITH BUTTPLATE**  
 Our Hardwood Mauser Sporter Stocks are sold out - Now we have walnut sporter stocks with buttplate and nicely checkered pistol grip & forend. Stocks have few minor blemishes that should be easy to fix. Small lot only **\$80.00 MSR662-B**

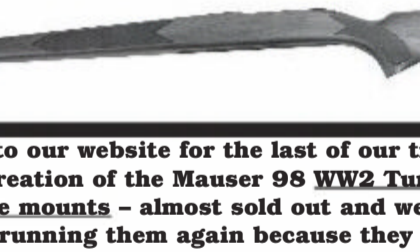

**98 MAUSER GUARD SCREW SET**  
 MSR372 - Military set w/lock screws used **\$9.75**  
 MSR373 - Military guard lock screw set new **\$3.95**

MSR434 Bolt Stop Screw, new **\$2.50**  
 MSR122 Bolt Stop Spring **\$12.00**  
 MSR404 Bolt stripped, straight handle **\$43.50**  
 MSR123 Bolt, complete straight handle **\$98.95**  
 MSR125 Buttplate (cupped) Israeli **\$7.50**  
 MSR126 Buttplate (flat) **\$8.00**  
 MSR127 Buttplate Screw **\$1.25**  
 CLN014 Cleaning Rod 12 1/2" M98/43 **\$12.95**  
 CLN025 Cleaning Rod 15" GEW 98 **\$12.50**  
 CLN018 Cleaning Rod 15" VZ24/G24(T) **\$13.50**  
 CLN013 Cleaning Rod early 10" **\$12.00**  
 CLN049 Cleaning Rod M93 17 1/4" **\$10.00**  
 CLN074 Cleaning Rod Stock Nut **\$5.00**  
 MSR135 Cocking Piece **\$7.00**  
 MSR136 Ejector **\$5.00**  
 MSR138 Extractor **\$19.95**  
 MSR139 Extractor Collar **\$8.00**

**ORIGINAL MILITARY SPEC K98 MAUSER BARRELS - NEW!**  
 Sarco is proud to offer K98 barrels, new in the 'white', in 8mm. These barrels are shallow chambered and four groove. They are from a small overrun production of barrels that were precisely manufactured with military dimensions for German sniper rifles. Great opportunity to obtain a new K98 barrel or rework your old standby rifle or project gun. Very limited. K98 Barrel in 8mm **\$95.00 MSR631**

**MAUSER RIFLE CLEANING RODS**

1. 98K 12.5 inch rod, for most 98K and G 43 rifles **\$12.95 ea. CLN014**  
 2. 98 K 10 inch, for early 98K **\$12.00 CLN013**  
 3. G33/40 Rod, Special length rod used only on the Czech Mountain carbines made by the Germans as the G33/40 **\$14.95 CLN016**  
 4. VZ24 Rod, Correct length and diameter rod for the Czech VZ24 rifles. Also correct for G24 (T) rifle **\$13.50 CLN018**  
 5. Chamber cleaning tool, wood **\$3.95 CLN084**  
 6. 12 1/2" rod for M98/43 Spanish **\$12.50 CLN019**  
 7. Cleaning rod M93 17 1/4" **\$10.00 CLN049**  
 8. Cleaning rod Turkish model 38 Mauser & M98 **\$11.95 CLN127**  
 9. M95 Mauser Chilean rifle **\$13.50 CLN129**  
 10. Argentine M91 & M1909 Mauser **\$10.00 CLN024**  
 11. 1916 Spanish short rifle **\$12.50 CLN136**  
 12. Chilean M1935 short rifle **\$25.00 CLN131**  
 13. Swedish M1938 carbine **\$12.50 CLN021**  
 14. Brazilian M1908 Mauser **\$12.50 CLN026**  
 15. GEW 98 Mauser WWI **\$12.50 CLN025**

**HOODED BOLT SLEEVE ORIGINAL NEW COMMERCIAL FN MADE (FROM THE 60'S)**  
**Note: These are original FN milled from BAR stock - current offerings are castings.**  
 Finally available again, hooded bolt sleeve for use with trigger mounted safety mechanism. These are the type used on all of the high quality Mauser sporters. Our sleeves are original F.N./Belgium manufacture, left over from their production of Mauser Sporters several decades ago. We found a small cache of these desirable hooded bolt sleeves at the FN plant and bought them all. All are beautiful polished steel, new condition **\$49.95 each MSR119**



**MITCHELL ARMS .22 CALIBER PARTS AVAILABLE**  
 Sarco has parts for the following 'Mitchell Arms' .22 cal rifles - Please check our website for details:  
 M16A1/22 AK47/2 GALIL .22



MSR141 Firing Pin Spring **\$3.75**  
 MSR143 Floorplate (used) **\$9.00**  
 MSR142 Floorplate new orig, unnumbered **\$19.95**  
 MSR146 Follower (milled) **\$8.00**  
 MSR147 Follower (stamped, WWII) **\$17.50**  
 MSR148 Follower Spring **\$4.00**  
 MSR151 Front Sight **\$4.00**  
 MSR153 Front Sight Hood, 98K **\$6.50**  
 MSR155 Front Sight Protector VZ24 **\$10.00**  
 MSR157 Guard Screw Bushing **\$2.00**  
 MSR150 Guard Screw, Front (military) **\$4.00**  
 MSR158 Guard Screw Set (commercial) New **\$6.95**  
 MSR158(A) Guard Screw Set (commercial) Used **\$5.00**  
 MSR373 Guard Lock Screw Set, (military) new **\$3.95**  
 MSR372 Guard Screw Set w/Lock Screws (military), Used **\$9.75**  
 MSR159 Handguard, K98 (beechwood, used, orig) Good VG **\$24.95**

**SARCO 11**  
**www.sarcoinc.com**  
**610.250.3960**  
**MAUSER PARTS & ACCESSORIES**  
 See our website for thousands of K98 Parts!

**BACK AGAIN!! NEW PRODUCTION '98 MAUSER FIRING PINS**  
 We just produced these out of the best 4140 steel - The good news is that we redesigned the cocking piece knuckles to fit multiple manufacturing variations of the cocking piece. For years we have suffered pins and cocking pieces that won't fit together and hours and hours of sorting for fit. Problem solved + a new 4140 pin **\$22.50 MSR431**



**MAUSER STOCK MILITARY ISSUE**

1. Israeli K98 handguard only **\$24.95 MSR403**  
 2. 1908 Brazilian Mauser long rifle stock, good cond **\$75.00 MSR366**  
 3. 1908 Brazilian Mauser long rifle stock - Select (very few only) **\$95.00 MSR366A**  
 4. 1908 Brazilian Mauser long rifle stock w/ handguard, good cond **\$85.00 MSR375**  
 5. 1908 Brazilian Mauser long rifle stock w/ handguard - Select (very few only) **\$95.00 MSR375A**  
 6. Steyr M1912 stock w/buttplate & bayo lug **\$79.00 MSR548**  
 7. Steyr 1912 Rifle Stock, good condition **\$89.95 MSR549**  
 8. VZ24 stock, new original **\$95.00 VZ24001**  
 9. VZ24 Stock original, used condition Good **\$85.00 VZ24004**  
 10. VZ24 handguard, used Good - VG **\$38.00 HNGD36**  
 11. VZ24 Stock & handguard set, Good **\$120.00 MSR668**  
 12. Yugoslav M48 Mauser Rifle Stock, good condition **\$95.00 MSR669**

**Use above 1908 Mauser stocks to rework the 1908's with cracked stocks currently on the market.**

**NEW ARRIVALS! RARE '98 CONTRACT MAUSER SLINGS**  
 Brazilian M1908 detachable Sling Swivel, For GEW 98 as well **\$8.50 MSR324**  
 Proper parade sling loop for Brazilian 1908 to go with the butt swivel above **\$4.00 MSR193**  
 Set of above MSR324 & MSR193, only **\$9.95 MSR415**  
 Orig used Spanish Mauser Model 1893 & M1916 rifle sling **\$12.95 SLNG058**

**98 MAUSER 8x57MM STRIPPER CLIPS**  
 Steel 5rd **\$2.70 STC013**  
 Original brass few only **\$3.00 STC028**

**MAUSER 98K WWII STYLE SLING**  
 New MFR **\$14.95**, 3 for **\$39.95**  
 10 for **\$120.00 SLNG011**

**K98 MAUSER RIFLE COMPLETE HINGED TRIGGER GUARD SET (CASTINGS)**  
**We got 'em! \$19.95 MSR626**  
 See our website!

**M98 MAUSER BOLTS**  
 Complete bolt assembly with firing pin, extraction, bolts sleeve, etc. Standard length '98 bolt, fits German 98K, Czech VZ24, Argentine '09, etc. Gew 98 style bolts. Good, original condition **\$98.95 ea. MSR123**



**98 MAUSER COMMERCIAL GUARD SCREW SETS**  
 Commercial set, new **\$6.95 MSR158**

MSR161 Handguard K98 laminated, original. Good-VG **\$34.95**  
 HNGD34 Handguard 1908 Brazilian long rifle **\$35.00**  
 MSR162 Low Scope Safety **\$17.75**  
 MSR129 Lower sling swivel, detachable, 98 WWI GEW **\$8.50**  
 MSR193 Parade sling loop swivel, original 98 WWI GEW **\$4.00**  
 MSR415 Combination of MSR129 & MSR193 **\$9.95**  
 MSR175 Rear sight & handguard screw VZ24 **\$4.00**  
 MSR180 Rear Sight Sleeve **\$15.00**  
 MSR185 Safety **\$4.25**  
 MSR149 Screw, Front (commercial) New **\$3.50**  
 SLNG010 Sling GEW 98 (WWI Style) **\$16.95**  
 STC013 Stripper Clips (8mm, 5 rd) **\$2.70 each**, 3 for **\$7.50**, 10 for **\$22.50**  
 MSR208 Trigger Guard Assy, milled military **\$34.95**  
 MSR206 Trigger Guard stripped **\$23.95**



### RHODESIAN SELOUS SCOUT RIFLE / SHOTGUN CASE

Heavy cotton gun bag very similar to the British rifle bag, but slightly shorter and in a mustard color. About 41" long. Large Rhodesian Selous Scout emblem stenciled on one side. These gun bags will hold some rifles, but were primarily used to hold Greener and Belgian Browning Shotguns in barracks, watchtowers, Eland Armored Cars etc



**\$15.95 MISC394**

### MAUSER SCHNELLEFEUER WOOD STOCK

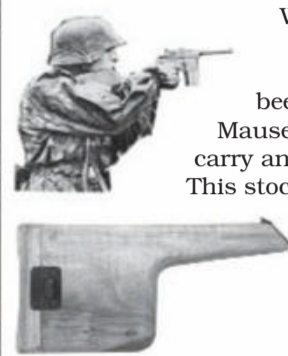

Walnut, late production. Holds pistol with 20rd magazine. A tremendous rarity, we have been able to have the 'wide body' Mauser Schnellfeuer stock made to carry and attach the Automatic pistol. This stock allows you to insert the gun in with the 20 rd. magazine attached which is different from the Mauser 712 standard stock. We have a very limited number in stock so act quickly because we may not be able to offer them again

**\$275.00 MSR667**

### SHOULDER HOLSTER FOR MODEL 712 SCHNELLEFEUER WOOD STOCK

For the rare Mauser C96 pistol 'version' that uses the 20rd. magazine, we have the leather holster for the stock that is designed to hold the entire locked & loaded Pistol with 20rd magazine attached



**\$24.95 HOL193**

### PROPER 8x57mm BORE BRUSHES

Bronze brush - 5 for **\$5.50 CLN124**  
Stainless steel brush for cleaning those tough military bores 5 for **\$8.95 CLN121**

### GERMAN HELMET 1889 PRUSSIAN KURASSIER, PICKELHAUBE

Beautiful Pre-WWI model military helmet made from steel with leather liner, brass scalloped chinstrap, cockades, steel spike and brass emblem. Inscription embossed on brass emblem translates from German as, 'With God for King and Country'. (Mit Gott Fur Koenig und Vaterland)



**\$84.95 HLM012**

### AVAILABLE AGAIN!! SWEDISH MAUSER HIGH FRONT SIGHTS

Specially made tall front sights so you can zero your rifle at 100 yards. Most of these rifles shoot very high at short range as their minimum sight setting is 300 meters. Use of our high sight blade will allow you to get accurate sightings at 100 yards. Made to look like the original sights. These sights install in the existing dovetail. Made in U.S.A., Blued steel, Milspec quality, Swedish M96 and M38 Tall Front Sight. Now back in stock.



**\$13.95 MSR283**

### ABOUT HIGH CAPACITY MAGAZINES:

Although we try to stay abreast of current State gun laws, it is a herculean task with over 20,000 laws on the books. By ordering, you are stating that you are complying with your Local & State laws. Most States allow large capacity magazines. Some do not. If you are unsure on this issue, contact your Local or State law enforcement to confirm what is allowed. This is a partial list of States with some hi-capacity restrictions: NJ, NY, MA, MD, HI, KS, CO, CT, IL and various county laws therein including Chicago, D.C. CA residents - check your laws as they are changing.

### ONLINE ORDERS

Go to [www.sarcoinc.com](http://www.sarcoinc.com)  
Its fast, secure & convenient!

### PHONE ORDERS

Call (610) 250-3960  
Phones opened M-F 8:30am-5pm EST. If possible, please have the part #'s of each item ready for our order takers. If you have any technical questions, they will connect you to the most appropriate department.

### EMAIL ORDERS - [info@sarcoinc.com](mailto:info@sarcoinc.com)

Include your name, full address (indicate if its commercial or residential) and contact info. Include part #'s of items and what ad you saw them in.

### FAX ORDERS

610-438-2548 (order department)  
610-250-3961 (showroom)  
610-250-3962 (gunroom - fax all FFLs here)

### MAIL ORDERS - SARCO, INC.

50 Hilton St, Easton PA 18042  
When writing your check, please include \$9.50 for shipping, (\$12.50 for rifle stocks & barrels). Actual shipping cost is determined by the weight of the package. You will be contacted if amount included is insufficient or a refund is due. There is a \$25.00 fee for all returned checks.

See our page 29 in the 2nd issue of the month for FIREARMS Ordering Info.

### M1895 PRUSSIAN GERMAN FUSILIER REGIMENT HELMETS

Just got another shipment of Picklehaubes - Finely crafted of heavy leather with solid brass trim, cockades, spike assembly and detailed eagle emblem. These are M1895 Prussian German Fusilier Regiment Helmets - Nicely done. All the metal is a beautiful brass. An extremely accurate & detailed recreation and fit for use or display and will be the topic of conversations in your collection or "man cave". German spiked helmet. These helmets were used up to the end of WWI. Beautiful huge brass Prussian spread eagle on the front. Last shipment we sold out for \$99.95. SARCO struck a tremendous deal to bring you this helmet at 1/10th the price of an original.



**\$59.95 HLM015**

### Note About Shipping:

Sarco deals with a lot of material that is very difficult to find and much of the original wartime material undergoes refinishing, manipulation, and repair as needed. With this in mind, we are not Amazon... While our aspiration is to ship your order quickly, some items may take a little more time to prepare so please be patient! Most orders go out quickly.

### SHIPPING

ALL ORDERS WILL BE RECEIVED, PROCESSED AND SHIPPED OUT OF OUR PENNSYLVANIA LOCATION.  
MINIMUM SHIPPING AND HANDLING CHARGES START AT: \$9.50. Rifle Stocks and Barrels...\$12.50  
Call for larger items on prepaid orders  
\* NJ residents please add 6.625% sales tax. Not all items available to NJ residents.  
\* PA residence please add 6% sales tax  
All orders to Alaska and Hawaii shipped via US Mail, unless customer specifically requests Blue or Red Label UPS (not available for online orders). Employees not authorized to modify prices or conditions stated in this advertisement. \*\*Most orders ship within 7-14 days\*\*

### CUSTOMER SERVICE:

[info@sarcoinc.com](mailto:info@sarcoinc.com)

### PARTS QUESTIONS:

[parts@sarcoinc.com](mailto:parts@sarcoinc.com)

### MACHINE GUN QUESTIONS:

[mgdave@sarcoinc.com](mailto:mgdave@sarcoinc.com)

Sarco only sells products to persons 18 years or older

We are forever adding pictures to our website, but we have a lot of stuff and it takes time. If you dont see a picture of something you need, email us. We'll add it to the website and reply back with the link!

### JUST IN! SHOTGUN FRONT BEAD SIGHT AND RAMP

New silver front bead sight with front sight ramp with beveled bottom is great for replacement work on barrels or for creating your custom Shotgun barrel. Set of Bead & Ramp..... **\$12.95 MISC900**



### C-96 BROOMHANDLE STRIPPER CLIPS

Works with both .30 Mauser and 9mm Luger ammunition. The 8 round is an original military stripper clip. 8rd. C96 Clip. 10 for **\$10.00**  
25 for..... **\$20.00**  
50 for..... **\$35.00**  
100 for..... **\$50.00 STC033**



### MAUSER C96 BROOMHANDLE CLEANING ROD

**\$7.95 CLN164**



### C96 MAUSER BROOMHANDLE STOCK & HARNESS

Well-made, beautifully crafted hardwood stock and leather holster. Pistol fitting connects quickly and the pistol can be stored in the wood stock and then inserted in the leather holster. Includes cleaning rod. Made famous during WWI. Stock & harness only. Comes with two 8rd stripper clips for a limited time.



**\$149.95 MSR340**

### MAUSER BROOMHANDLE (C96) PISTOL GRIPS

Available Again! Just got in 600 pair. Custom made WOOD grips to match the originals. Complete with escutcheons & grip screws. Immaculate copies in the many variations.  
GRP125 C96 Mauser standard fine line early grips - 20 lines  
GRP126 C96 Mauser standard fine line early grips with Red 9 - 20 lines  
GRP121 C96 Mauser model 1930 grips - 11 lines  
GRP122 C96 Mauser model 1930 grips with Red 9 - 11 lines  
GRP123 Bolo (small grips) Mauser pistol with standard lines - 20 lines  
GRP124 Bolo (small grips) Mauser pistol with standard lines and Red 9 - 20 lines **\$19.95** a pair, 3 for **\$54.95**

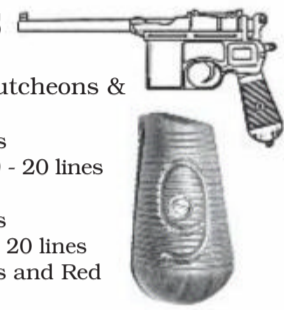

These grips are superb reproductions. Others may sell cheaper but I guess they know what their stuff is worth.

### SWEDISH MAUSER RIFLE PARTS

- MILITARY RIFLE OILER Swedish design double oilers, issued with all variants of Swedish Mauser rifles. **\$1.95 each MSR289**
- CLEANING ROD EXTENSION **\$2.95 ea. MSR269**  
3 for ..... **\$6.95**
- CLEANING ROD GUIDE new original **\$4.95 ea. MSR369**  
3 for ..... **\$11.95**
- M1896 CLEANING ROD..... **\$10.00 CLN020**
- M1938 CLEANING ROD **\$12.50 CLN021**
- M1896 REAR SIGHT ASSY w/sleeve **\$25.00 MSR291**
- SWEDE MODEL CG63 MATCH RIFLE. new original buttplate with crown over "C" crest 5% x 1 3/4" ..... **\$14.95**  
3 for ..... **\$34.95 MSR263**
- Swede Mauser FIRING PIN **\$19.95 MSR494**
- SWEDISH LONG RIFLE MAUSER BOLTS M1896, M38 ..... **\$49.95 MSR260**
- SWEDISH MAUSER ACCESSORY KIT For the Swedish Mauser M1896 and M38 Rifles. Kit includes one each of the following items:

- Cleaning Rod (M96 only)
- Cleaning Brush
- 5 Stripper Clips
- Double Metal Oiler
- Cleaning Rod Guide
- Cleaning Rod Extension

Reg. \$60.00 SARCO PRICE SALE! **\$19.95 MSR253**



### MAUSER 712 (SCHNELLEFEUER) WOOD STOCK

SARCO has a half dozen of the wood stocks specifically designed to hold the selective fire version of the C96 Mauser. Very difficult to find, and this is for the real pistol, not the air soft version. Late production/walnut. Get one while you can. Won't last long! Mauser 712 Wood Stock..... **\$150.00 MSR654**



See our website for Collector Grade M96, CG63 & CG80 Mauser Bolts

See our website for Swedish Mauser Cleaning Rod Extensions #MSR644

**LJUNGMAN AG-42 RIFLE OILER**  
**\$14.95 OIL038**

**SWEDISH LJUNGMAN RIFLE BARREL**  
Original, New  
**\$125.00 AG42010**

~ Swedish Mauser Flash Hiders Are Coming! Inquire ~

### SARCO 12

### SWEDISH MAUSER PARTS

Go to our website for a complete list of Swedish Mauser rifle parts

### C96 MAUSER PISTOL REAR SIGHT ASSEMBLIES

Graduations from 0 to 14. Just found these in the warehouse. Original New in the grease. Not \$125.00! Only **\$75.00!! MSR665**



### BROOMHANDLE C-96 MAUSER PISTOL PARTS & ACCESSORIES

20rd detachable Magazine for Schnellfeuer & Broomhandle detachable magazine handgun **\$65.00 RPM270**  
Bolt stop, new..... **\$30.00 MSR638**  
Extractor, late model current production **\$29.95 MSR329**  
Firing pin & spring ..... **\$35.00 MSR331**  
Firing pin spring..... **\$8.00 MSR332**  
Floorplate ..... **\$60.00 MSR396**  
Trigger spring ..... **\$14.95 MSR343**  
Hammer (Schnellfeuer) 1 only **\$150.00 MSR619**  
Locking block, Original ..... **\$65.00 MSR345**  
Locking block, repro ..... **\$25.00 MSR515**  
Main spring ..... **\$4.50 MSR337**  
Main spring plunger ..... **\$14.00 MSR338**  
Recoil spring..... **\$6.00 MSR341**  
Safety, early model Prewar 1912 (for guns w/22 line grips) ..... **\$35.00 MSR406**  
Safety, Universal 1930 model (for guns w/9 line grips) ..... **\$34.50 MSR407**

### SWEDISH M96 AMMUNITION BANDOLIER

NEW **\$49.95 MSR632**



### NEW SWEDISH MAUSER FIRING PINS

**\$19.95 MSR494**



### COMPLETE SWEDE BOLTS

The stripped bolts & bolt sleeves & extractors & firing pins are new unnumbered. Rest of parts are exc Complete straight bolt **\$129.95**  
**SALE \$49.95**  
**3/\$134.50 MSR493**



### A NOTE ON SARCO GOODS

Many of Sarco's prices are below market price. Some too that this means Sarco sells lower quality... **Not True**. Sarco shops the world and the U.S. for deals and because of our buying power & 55 years of presence in the market, we are able to acquire good deals and pass the savings on to you. For example, we have over 20 vendors we buy AR parts from and are always shopping for the best price and quality.

### FOR PARTS & ACCESSORIES

Visa and MasterCard accepted. Sorry no COD's.

### ORDERING INSTRUCTIONS

Our ads in the Firearms News are catalogue prices and may not reflect any sales or higher pricing found on our website.

Prices are subject to change without notice. We are not responsible for typographical errors or misprints.

Over 95% of our inventory is listed in the Firearms News. We have to move items to our website to make room for new stuff. So if you don't see something, check [www.sarcoinc.com](http://www.sarcoinc.com) or call us.

### DISCLAIMER

Parts sold by Sarco should be installed only by a competent gunsmith. These products are sold as is and without a warranty. No liability is expressed or implied for damage or injury which may result from the improper installation or use of these products.

### OUR GUARANTEE

Our guarantee is simple and easy to understand. If you are not satisfied with any item received from us you have 5 days to return it for a replacement or a refund of the advertised price. All returns must be accompanied by a letter WITH YOUR INVOICE NUMBER and explanation of the problem. Before returning anything, please see our guarantee on our website.

### EASTON SHOWROOM VISIT

Showroom opened Mon-Sat 10am-5pm / Friday Opened til 8pm. For directions to the showroom, see website. In Stock Inventory - If you are planning on visiting the showroom, feel free to call ahead to make sure that we stock the item(s) that you need. Please give us a least a few days' notice before your visit in case we need to retrieve goods in from our other warehouses. Note that the prices in Firearms News are dealer prices and may not be the same prices as in our showroom.

### ORDER PROBLEMS, Damaged or Missing Packages

Call (610) 250-3960 and ask for Liz ext 208 or email [lheisler@sarcoinc.com](mailto:lheisler@sarcoinc.com) **BACKORDERS** Check the status of an existing Backorder. Call (610) 250-3960 or email: [backorder@sarcoinc.com](mailto:backorder@sarcoinc.com) SARCO deals in modern as well as obsolete and hard to find merchandise and offers full & prompt refund on any cancelled backorders prior to ship. **WEBSITE Questions or Issues** Call (610) 250-3960 and ask to be transferred to the e-Commerce Department or email [ecom@sarcoinc.com](mailto:ecom@sarcoinc.com) **INTERNATIONAL** Call (610)250-3960 and ask for Mike ext 210 or email [international@sarcoinc.com](mailto:international@sarcoinc.com)

### REGARDING LOCAL, CITY & STATE REGULATIONS

You warrant by ordering from Sarco Inc., that you are in compliance with the laws of your local, city and State regulations and that you are a legal adult without any legal restrictions in regards to your purchase. With 20,000 plus laws on the books it is difficult for us to know what laws may affect your purchase where you reside. Please check your local and State laws before ordering.

### RETURNS

We offer a 5-day inspection period on all of our merchandise, except for special order items which are not refundable. Items that state they are sold "as-is" are not returnable.  
• **PHONE ORDERS, EMAILED, FAXED OR MAILED-IN ORDERS:** You will need a Return Authorization Number to return something. Please email [returns@sarcoinc.com](mailto:returns@sarcoinc.com) or call (610) 250-3960 for a RT #. Feel free to check on the status of your return, credit or refund.  
• **ONLINE ORDERS:** Please visit our website [www.sarcoinc.com](http://www.sarcoinc.com) and click the Return Policy link. Fill out the printable form and mail it back with your package. Feel free to email our e-Comm department at [ecom@sarcoinc.com](mailto:ecom@sarcoinc.com) to check on the status of your return or call (610) 250-3960 and ask to be transferred to the e-Commerce Department.  
We do not refund any shipping cost unless the error/problem causing the return is our fault. Returns may be subject to a 10% restocking charge.





www.sarcoinc.com  
610-250-3960

## HEAVILY TESTED AK-47 MAGAZINE NEW!

Sarco has just received what may be the best, most durable, and high performance AK magazine on the market. Critically tested for reliable feed, locking, and ease of use, this magazine is synthetic and has survived the grueling 'Serb' method of mag testing. 7.62x39 with 30 rd. capacity. New ..... \$19.95  
3 for ..... \$49.95 RM102



## STEEL TYPE 99 PROTECTIVE SHIELD

As used by Japanese forces during WW2. Complete with handle and monopod. New SALE!..... \$80.00  
\$99.95 MISC443



ALMOST GONE!!

## JAPANESE ARISAKA RIFLE PARTS FOR TYPE 38 & 99 - PLEASE SPECIFY WHEN ORDERING

BAKELITE MUZZLE COVER..... \$11.00 JAP9915  
TYPE 99 DUST COVER..... \$19.95 JAP9903 BACK IN!!  
TYPE 38 DUST COVER Steel .. \$19.95 JAP3811 We've got these too!  
FIRING PIN SPRING..... \$5.00 JAP9905 EXTRACTOR..... \$40.00 JAP3801

### JAPANESE ARISAKA SLINGS

WWII JAPANESE NAVAL SLING FOR ARISAKA & VZ 24 RIFLES \$14.95 SLNG098 BACK IN!!  
TYPE 99 'PACIFIC' RUBBERIZED CANVAS SLING Developed to resist mildew and create a lighter sling. Laminated just like the original w/ brass hardware and markings. Wartime use of 1942-45. Unlike our competitors, we have included the leather sling keeper which the others omit!..... \$19.00 SLNG093  
TYPE 38 Leather Sling brass hardware, brown, 1 1/8" wide..... \$17.50 SLNG027  
TYPE 99 Leather Sling w/steel hardware, brown, 1.5" wide..... \$17.50 SLNG008

### JAPANESE ARISAKA CLEANING RODS

TYPE 99  
LONG ROD @29 3/16"..... \$17.95 CLN044  
SHORT ROD 23 3/4"..... \$14.95 CLN126  
LAST DITCH 'TRANSITIONAL ROD @4 7/8"..... \$12.00 CLN147  
ARISAKA TYPE 1 & 2 PARATROOPER ROD 21 1/2"..... \$17.50 CLN046  
TYPE 38  
LONG ROD @29 1/4"..... \$17.95 JAP3803  
SHORT ROD @23 1/4"..... \$17.50 CLN148  
CARBINE @17"..... \$19.95 CLN008  
TYPE 100 & ARISAKA PARATROOPER BAYONET \$75.00 BAY279  
BAYONET FROG Late mfg., new for Type 99 and Type 38 bayonets. Excellent reproduction..... \$9.95 BAY115

### Japanese Chrysanthemum Metal Hand Stamp

Metal hand stamp with an overall length of @ 3.25 inches and with an imprint diameter of 5/8 of an inch. Slightly concave embossing face. Perfect for marking WW2 military items with the classic emblem of the military Empire of the Sun! Good for leather, wood, copper, brass and other soft metals... \$45.00 STAMP15

Toyada Automatic Loom Works WW2 Arsenal Stamp..... \$45.00 STAMP14

Note: Stamps are NON-Returnable unless damaged or incorrect in which case they will be exchanged for the correct one.

TYPE 99 MONOPOD Nice reproduction of the rifle monopod made in steel just like the original. Great way to complete your rifle since most monopods are missing from guns on the market..... \$29.95 JAP9902

### WW2 ARISAKA RIFLE 'PAPERWEIGHTS'

1 set of Cut Arisaka Receivers..... \$9.95 each.  
or 5 sets for ..... \$38.95 JAP9918

### JAPANESE NATIONAL FLAG

3 x 5 foot cotton flag with cord, with a slight antique faded salmon white back ground similar to aged WW2 Japanese flags ..... \$14.95 FLAG18

### JAPANESE NAMBU TYPE 14 HOLSTER

Clam shell holster as used by Japanese forces in WWII. Very well made hard shell flap and tab with brass hardware .... \$40.00 HOL001

### JAPANESE WW2 PARATROOPER BANDOLIER NEW!

Japanese Khaki bandolier (only) \$27.95 MISC676  
Japanese Khaki bandolier with 17 Brass stripper clips \$39.95 MISC685



## JAPANESE ARISAKA

### JAPANESE RISING SUN FLAG

Cotton 3'x5' flag with loop on top and cord on bottom like the original WW2 flags. Originally adopted by the Army, but later dominated for use by the Japanese Navy..... \$18.00 FLAG12



### JAPANESE TYPE 100 & ARISAKA PARATROOPER BAYONET

BAYONET & SCABBARD for the WW2 Japanese Paratroop rifles, Type 100 SMG, and Type 99/38 rifles \$75.00 BAY279



### JAPANESE WW2 TROPICAL ARMY HAT

Available in 4 sizes:  
7-1/4",  
7-1/2",  
7-5/8",  
7-3/4"  
\$19.95 HAT07 NEW!



### JAPANESE INFANTRYMAN'S OIL BOTTLE

Steel oil bottle with brass top as issued to infantry in order to keep their rifle operational. New ..... \$16.95 JAP9916



### WW2 JAPANESE ARMY HELMET W/ NET

Steel helmet complete with suspension, chin strap, and helmet net as used by Japanese forces during WW2. Excellent quality and perhaps even better than the original. New made..... \$54.95 HLM038



## AK RIFLE PARTS & ACCESSORIES

13

### AK 47 (AMD65 HUNGARIAN HANDGUARD)

Stamped steel handguard in excellent condition actually can work nicely for all sorts of AK and specialty gun projects. Strong and only 4.4 ounces! Original GI..... \$12.50 HNGD54



## JUST FOUND!

### ORIGINAL MILITARY AK FIRE CONTROL PARTS SETS

Consists of hammer, trigger, disconnecter ..... SALE!! \$14.95  
3 for ..... \$39.95 AK067

Also found - Just a few...  
ORIGINAL AK AUTO SEARS ..... \$14.95 AK068

5 & 10rd WASR Magazines in 5.45 x 39 cal.

AVAILABLE NOW! See Our Website!



### More Parts Just in the Door...

AK47 Disconnecter, GI used exc..... \$7.00 AK069

AK47 Hammer, full auto, GI used exc .... \$8.95 AK070

AK47 Muzzle bearing, round, GI used exc ..... \$4.50 AK071

AK47 Rate reducer assy, GI used exc .... \$5.00 AK072

AK47 Sear spring, GI used exc..... \$4.00 AK073

AK47 Trigger single hook, GI used exc \$9.95 AK074

AK47 Trigger double hook, GI used exc ..... \$9.95 AK075

AK47 Trigger Guard Assy. with catch GI used exc. .... \$20.50 AK076

Dust Cover ..... \$10.00 AK042

Extractor gage (orig.)..... \$19.95 AK036  
Blank Adapter ..... \$3.95 AK013

Broken Shell Extractor for 7.62 x 39 Good for SKS & AK \$2.99 ea.  
4 for ... \$10.00 BSE020

AK 3 PRONG FLASH HIDER - M16 pattern. Looks neat on gun ..... \$8.95,  
3 for..... \$25.95 AK033

AK47 MAGAZINE LOADER FOR LOADING & UNLOADING - Double thumb depressing levers. Makes the process easier ..... \$17.99 AK048

JUST IN! AK RIVET SETS Complete set of the PROPER rivets needed to build an AK..... \$9.95 AK051

Back In Stock! AK SEMI PARTS PACK Correct parts for building an AK Semi Auto. Counts as 3 compliant parts under US Sec.922r. Made in the USA by High Standard..... \$25.95 AK052

AK63 / AMD-65 COMPENSATOR Steel flash hider/compensator for AK47 Rifles such as the AK-63, AMD-65, and similar AK47 variants with the same threaded muzzles. 2-7/8" long, 3.95 oz. weight, 14 x 1 left hand thread. Helps make the AK more controllable in automatic or fast semi firing. SALE!..... \$8.95 \$19.95 MISC562

AK47 SLINGS Khaki..... \$6.95 SLNG033-TAN  
Black..... \$6.95 SLNG033-BLK

JAPANESE TYPE 99 PACIFIC RUBBERIZED CANVAS SLING \$19.00 SLNG093

CHINESE GI SKS CHEST BANDOLIER WITH 20 ORIGINAL SKS STRIPPER CLIPS Original military issue SKS Chest Bandolier with 10 ammo pouches. Used in excellent condition. May have some minor lite stains, but washable. Comes with 20 original military SKS Stripper Clips too! ..... \$34.95 SKS103B

STANDARD RPK M72 BIPODS Just in the door, we have excellent condition Yugoslavian M72 series bipods. Perfect replacements and terrific for gun projects where a solid versatile bipod is required. M72 Bipod..... \$27.00 AK078

## SKS RIFLE PARTS & ACCESSORIES

### SKS PHENOLIC STOCK W/ FOREND

China's military machine under Mao, ramped up production of Phenolic or synthetic stocks during the late 60s when it became clear that the tensions along the Sino Soviet border were intensifying toward 'all-out war'. Wood was too precious to strip for the manufacture of millions of Chinese SKS rifles so synthetics were applied to AKs and SKSs alike. Good stocks are getting hard to find. We have a few dozen original SKS stocks w/forend. Some minor color blemishes, but overall very good ..... \$99.95 SKS100

### SKS CHINESE STOCK & HANDGUARD

used with metal and handguard. Good condition \$99.95 SKS090  
Stock is cut for the Chinese spike bayonet.

### SKS STRIPPER CLIPS WITH POUCH

These are ORIGINAL MILITARY ISSUE - Not the reproductions we hear complaints about. 10 SKS Strippers w/ Pouch (ammo not included)..... \$14.95 STC037

### SKS STRIPPER CLIPS (NO POUCH)

Original Chinese from 1980's. NOTE! These are original Chinese military from the 1980's! NOT the current Chinese production that many say don't work. Sarco price for quantity (ammo not included): STC024.  
1 for ..... \$2.00  
10 for..... \$14.95

SKS Chinese bayonet blade stock ..... \$98.00 SKS092

SKS Chinese Stock with handguard - with bayonet slot filled ..... \$99.95 SKS094

SKS043 Accessory kit..... \$9.95  
SKS011 Bolt new..... \$45.00  
SKS093 Buttplate..... \$10.00  
SKS072 Buttplate/rear swivel screw ..... \$2.00  
SKS038 Buttplate trapdoor assembly, new ..... \$5.00  
SKS056 Buttstock anti rattle spring ..... \$3.00  
CLN095 Cleaning jag..... \$2.50  
CLN092 Cleaning rod ..... \$12.00

SKS013 Firing pin, new..... \$15.00  
SKS042 Front sight tool, "T" type ..... \$3.95  
SKS048 Gas port cleaning tool ..... \$2.95  
SKS007 Hold open latch..... \$8.00  
OIL032 Oil bottle..... \$3.00  
SKS002 Piston extension..... \$20.00  
SKS003 Piston return spring, new ..... \$5.00  
SKS035 Rear sight button, new..... \$4.00

SKS036 Rear sight leaf spring, new ..... \$4.00  
SKS055 Rear sight leaf w/slide..... \$25.00  
SKS033 Rear sight leaf, new..... \$15.00  
SKS034 Rear sight slide, new ..... \$6.00  
SKS016 Recoil spring, new..... \$8.00  
SKS071 Rear swivel..... \$8.00  
SKS041 Sight tool, "C" type..... \$9.95  
SLNG041 Sling, exc ..... \$6.95  
STC024 Stripper clips ..... 3/\$4.50

### SKS/AK 'C' TYPE SIGHT TOOL

The original unbreakable carbon steel "C" tool. The "C" tool enables elevation and windage adjustments to the front sights of AKM, SKS, Galil, and similar semi-automatic rifles ..... \$9.95  
3 for ..... \$24.95 SKS041



# SARCO LUGER PARTS

www.sarcoinc.com

See our website for OUR Original Luger Cleaning Kit (#CLN171)

## LUGER SIDE PLATE ASSEMBLY... BACK IN STOCK!

Complete side plate with trigger lever and trigger lever pin installed! Minor fitting required  
..... \$59.95 LGR067

## LUGER PUT AWAY OR SHOP KIT

Extractor, Ejector, Firing pin, Main-spring, Extractor spring, Firing pin spring, Locking bolt spring \$104.50 value - Sarco's Price  
..... \$69.95 LGR161 Stash It Now!

**LUGER SPRING KIT** All the coil springs in a Luger - mainspring, trigger spring, firing pin spring & extractor spring. .... \$9.95, 3 for \$26.75 LGR138

**WE HAVE LUGER 'ARMY' & 'NAVY' WOOD MAGAZINE BOTTOMS - SEE OUR WEBSITE !**

**LUGER DRESS-UP SET**  
Get one of our Luger holsters, a pair of new checkered wood grips, and a new magazine loading tool. All 3 pieces, a \$58.00 value. Only \$49.95/set LGR082

## LUGER ARTILLERY STOCK HOLSTER RIG

Exact reproduction of the Luger Artillery model leather holster rig used by German troops. Our Artillery holster rig includes the holster itself, cleaning rod, carrying strap, leather pieces to connect to a stock board, and 2 pocket magazine pouch which goes on the carry strap. We offer this set with a wood stock and without a wood stock:  
1. Wood Stock with Black leather Artillery Holster Rig ..... \$129.95 LGR175  
2. Black Leather Artillery Holster Rig (without stock) - includes carry strap & magazine pouch..... \$34.95 LGR176

- LGR170 1908 Trigger bar ..... \$45.00
- LGR044 ARMY LUGER WOOD BOTTOM..... \$9.95 ea or 5 for \$45.00
- LGR043 NAVY LUGER WOOD BOTTOM ..... \$9.95 ea or 3 for \$27.95
- LGR153 Breech bolt new, perfect current production..... \$99.50  
May require minor fitting of rails due to variation in receivers
- LGR048 Double mag pouch, Leather..... \$9.95
- LGR087 Double mag pouch w/2 wood base mags (current production)..... \$56.50
- LGR146 Ejector, M1900 beautiful new production..... \$67.50
- LGR016 Ejector, late model, new production..... \$29.95
- LGR145 Extractor, M1900 beautiful new production..... \$67.50
- LGR084 Extractor, new production..... \$26.95
- LGR142 Extractor, new production - a wee bit narrow but works fine. Need cleaning out of the casting - dirt cheap..... \$10.00
- LGR019 Extractor spring..... \$2.00
- LGR160 Extractor & Firing pin combo..... \$44.50

- LGR020 Firing Pin, beautiful & new ..... \$19.95 ea, 3 for \$49.95
- LGR022 Firing pin spring..... \$3.00
- LGR023 Firing Pin Spring Guide..... \$19.95
- LGR159 Full Spring Kit (new) - springs for: hold open latch, extractor, locking bolt recoil, sear bar, trigger mag catch, firing..... \$44.50
- LGR030 Grip screw..... \$5.00
- LGR040 Hold open latch spring, new May require minor fitting due to variations in frame slot length..... \$8.00
- LGR156 Locking bolt spring..... \$12.00
- LGR061 Mag catch spring..... \$8.00
- LGR050 Mainspring (recoil)..... \$4.50
- LGR072 Sear bar (trigger bar) spring, repro..... \$8.00
- LGR149 Side Plate, Original, milled, in the white..... \$49.00  
Check our websites for more Original Luger parts
- LGR066 Side plate, stripped..... \$36.50
- LGR062 Thumb safety, Late Orig..... \$50.00
- LGR074 Trigger lever..... \$19.95
- LGR073 Trigger lever pin repro..... \$7.75

## LUGER ARTILLERY BOARD STOCK WITH METAL (stock may require final fitting) ..... \$74.95 LGR157



**LUGER ATTACHING STOCK IRON**  
Sarco sells the metal part that allows you to attach a stock onto the Navy or Artillery Luger. This is newly machined and has all of the contours of the original military part. We have sold these on our own wooden stocks for years. Great for fixing a bad stock or for making your own custom fit Luger stock. Limited SALE ..... \$44.95 ~~\$49.95~~ LGR148

**LUGER TOOL W/ EARLY MARKING**  
Just in, some Luger tools with the pre WW2 Eagle with drooping wings common on 1930s Lugers  
..... \$8.45 LGR180

**LUGER LOADING & DISASSEMBLY TOOL WITH WW2 MARKINGS**  
\$8.45 LGR068

**NAVY LUGER STOCK**  
We are selling this hardwood Luger Navy Stock originally manufactured in Spain, without the attaching iron for the pistol, but with the metal data disc installed. These are the last of what we brought into Sarco in the late 1980s. Good for making your own custom luger stock with some ingenuity. May be blemishes.... \$39.95 LGR187

**LUGER GRIPS SPECIAL!!**  
Just made a large purchase of beautiful checkered wood grips for the ever-popular Luger pistol. These are the nicest looking reproduction grips we've seen. Sharp checkering, nice color, and properly finished edges make this a sure-fire winner. Due to variations in frames some minor fitting may be necessary. Dress up that old import Luger today GRP118 **Special of the month \$19.95, 3 for \$49.95**

**LUGER ARTILLERY SIGHT**  
Finally back in stock, but only a handful! Graduated leaf assy out to 800 yards. New mnfr.  
..... \$150.00 LGR077

See our website for our LUGER SNAIL DRUM HOLSTER !!

## BROWNING HI-POWER HOLSTER

Well-made copy of the holster as used by German forces after occupation of the Browning factories. Marked with German code and Waffen marks.  
..... \$24.95 HOL021

**1936 BROWNING HI POWER HOLSTER / STOCK RIG**  
Leather combination of 'Sam Brown model belt' and holster to hold the 1935 Hi Power pistol and wood stock. Assembly includes leather belt (adjust between @39-46 inches), a mag pouch (hold 2 mags), cross strap, and leather holster which will hold the 1935 Hi Power pistol and the original style board stock in separate pouches. Wood stock or pistol not included ..... \$115.00 BHP077



**WANTED TO BUY!!! STRIPPERS!**  
Do you have a bunch of old strippers just hanging around? Well if so, sell them to us and we will put them to good use. We will make a cash or trade offer for stripper clips in good used condition. Offers only made on quantities of 100pcs and above. Contact Dave at Ext.130 or email - mgdave@sarcoinc.com



## FRENCH FOREIGN LEGION PARA BADGE

Metal badge, the symbol of the 2eREP French Foreign Legion Foreign Parachute Regiment. Worn by countless soldiers and adventurers in history and a familiar sight throughout Africa where Mercenaries and contract soldiers find post service opportunities. The circled winged armed 'Dextrochere' is a symbol of 'earned' fortitude in the ranks of soldiers worldwide. 1-3/4 inch diameter with retaining pin ..... \$7.95 MISC826

## ORIGINAL WW2 TRAINING AIDS

Weapon Training Aids for 1919A4, BAR, Garand & M1 Carbine. Large Scale for Classroom Use.



Check our website! Contact Dave for details at Ext.223.

## Manufacturers...

Sarco has contracted thousands of reproduction line items in metal, wood, leather & canvas products from different vendors. We would be pleased to hear from new Manufacturing vendors who can offer their services. Contact Mark or Dave. Email at mdotten@sarcoinc.com or mgdave@sarcoinc.com

## GALIL LOVERS

Do you need the attaching pin & spring for the detachable Galil bipods? We had 'em made as we needed them too. They don't exist! Have a few from over production ..... \$14.95/set GAL111

## Just Found from the old Colt Deal - ORIGINAL COLT POLICE POSITIVE FIRING PINS!

\$11.00 CPP11

## MOSIN NAGANT RIFLE

SEE OUR WEBSITE FOR A FULL LIST OF ALL MODELS OF MOSIN PARTS & ACCESSORIES

**ORIGINAL MOSIN M91/30 BAYONET**  
\$16.95 BAY019  
**MOSIN NAGANT 91/30 BAYO** Exc w/ New Scabbard, excellent condition  
\$32.00 BAY084  
**MOSIN NAGANT M91/30 & EARLY CARBINE BAYONET**  
Mosin short 11.5 inch  
\$44.95 BAY261

**MOSIN NAGANT 91 CLEANING KIT, ORIGINAL**  
\$9.95 N91051

1. Takedown tool
2. Cleaning Jag
3. Cleaning Rod Handle Set
4. Muzzle Cleaning Rod Guide
5. Hold All Pouch
6. Oiling Kit, Original

**MOSIN NAGANT SUPER CLEANING KIT**  
Takedown tool, Cleaning Jag, Cleaning Rod Handle Set, Muzzle Cleaning Rod Guide, Hold All Pouch, Oiler, 2 ammo pouches and 10 stripper clips..... \$26.50 N91056

**MOSIN DOG COLLAR 91/30 SLINGS** Original Russian \$19.95 SLNG103



**MOSIN NAGANT LEATHER SLING**  
The leather Mosin Nagant sling was used early on in the issuance of the Model 91/30 rifles \$19.95 SLNG119



**MOSIN DOG COLLAR 91/30 SLINGS**  
We have been out for six months just found a new batch. New mnfr \$12.95 SLNG018



**JUST IN THE DOOR ORIGINAL SLINGS FOR MOSIN MODEL 38 & MODEL 44 CARBINE**  
We've been out for a year \$14.95 ea. 3 for \$34.95 SLNG060



Mosin rifle stripper clips in stock again - 3 for \$2.35, 10 for \$7.50 STC014

## MOSIN-NAGANT RIFLE ACCESSORIES

1. PAIR OF RUSSIAN AMMO POUCHES, original Mosin Nagant.. \$9.95 N91045
2. CLEANING ROD HANDLE Handle for cleaning rod issued on every rifle ..... \$4.95 CLN086
3. FINNISH M28/30 new original handguard..... \$24.95 N91041
4. Original Finnish Mosin oiler (few only) ..... \$6.95 N91069
5. FIRING PIN PROTRUSION GAGE & Screwdriver Tool ..... \$15.00 TOOL050

## MOSIN NAGANT RIFLE PARTS

- N91052 Accessory Kit M91 ..... \$34.95
- N91040 Ammo pouch ..... \$6.50
- N91086 Bolt body, Grade 2 pitted ..... \$29.95
- N91084 Bolt Comp w/Extractor ..... \$59.95
- N91005 Bolt connector & guide bar ..... \$16.50
- N91006 Bolt head ..... \$19.95
- N91087 Bolt Head w/ extractor ..... \$29.95
- N91033 Buttplate ..... \$7.95
- N91043 Cleaning Kit..... \$4.95
- N91051 Cleaning Kit Original M91 ..... \$9.95
- N91030 Cleaning rod, Carbine, 1907 (type 4) ..... \$16.95
- N91029 Cleaning rod (model 91/30) ..... \$15.00
- N91028 Cleaning rod handle..... \$10.00
- N91001 Cocking piece..... \$15.00
- N91011 Ejector..... \$14.00
- N91009 Ejector spring..... \$12.00
- N91007 Extractor, generic..... \$19.95
- N91080 Extractor, reproduction..... \$19.95
- N91003 Firing pin spring..... \$6.00
- N91004 Firing pin..... \$19.95
- N91082 Follower Arm M91..... \$7.50
- N91041 Handguard, Finnish M28/30..... \$14.95
- N91020 Lower band 91/30..... \$8.00
- N91067 Lower mag Follower Spring..... \$5.00
- N91079 M39 Finnish Rear Sight Base Spring..... \$10.00
- N91015 Mag follower assy w/ floorplate M91..... \$18.00
- N91016 Magazine floorplate..... \$12.00
- N91050 Oiler, Original, Brass, Double Spout..... \$3.95
- N91036 Rear sight leaf andslide assembly M1891/30 (type 4) ..... \$15.00
- N91037 Rear sight leaf M1891 (type 2) ..... \$13.00
- N91055 Rings Only for PU Scope Original..... \$95.00
- N91045 Pair of Russian Ammo Pouches..... \$9.95
- N91081 Scabbard, leather w/belt loop and brass ball tip - 91 & 91/30..... \$14.95
- N91078 Sniper Bolt, Comp w/ Extractor..... \$159.95
- STC014 Stripper Clips M91 3 for..... \$2.35 10 for..... \$7.50
- N91025 Stock lug assembly..... \$12.00
- N91056 Super Kit - Cleaning w/2 ammo pouch & 10 stripper clips..... \$26.50
- N91057 Super Kit - Cleaning w/Bolt orig, 2 ammo pouch, 10 stripper clips..... \$51.50
- N91066 Take down tool..... \$3.95
- N91014 Trigger guard stripped..... \$19.95
- N91013 Trigger spring & bolt stop..... \$22.00
- N91012 Trigger..... \$8.00
- N91062 Triggerguard & Magazine Assy Comp. Exc 100% blue..... \$29.95
- N91018 Upper band 91/30..... \$8.00

## ORIGINAL MOSIN RIFLE BOLTS

These bolts fit all Mosins including Dragoon, Cossak M1891 Rifle, M1907 Carbine 91/30 Rifle, M1938 & M44 Carbines, & Finnish models. Also fits Sniper but bolt not bent. Complete bolt w/extractor \$49.95 ~~\$89.95~~ N91084

**ALMOST GONE!** Can you believe we started with 17,000?!



## BROWNING HI POWER

**FINALLY BACK IN STOCK!!!! GET YOURS NOW BEFORE THEY'RE GONE AGAIN!!!**  
**BROWNING HI-POWER WOOD STOCK**  
Brand New! \$145.00  
NFA Rules Apply BHP055

**F.N. HIGH POWER 9MM MAGAZINES**  
Brand new magazines. New commercial quality. 13 rd., blue Ea..... \$17.95, 3 for \$49.50, RPM105 Browning Hi Power Magazine Loader..... \$4.95 BHP072

**BROWNING HI-POWER GRIPS**  
Newly manufactured synthetic grips with the look of black wood grips. Panels are knurled like the original grips ..... \$19.95 GRP179

**BROWNING HI-POWER LANYARD RING & SCREW & STUD ASSEMBLY** New \$19.95 BHP069

**FABULOUS CURRENT PRODUCTION**  
FN pattern wood Hi power Checkered grips. Just like previous FN production. Need minor fitting inside mag well ..... \$17.50 3 for \$44.50 GRP174

## BROWNING HI-POWER PARTS

- We have 30-40 various other Hi Power slides, as well as some barrels - See our website!
- BHP013 Ejector ..... \$22.00
  - BHP014 Extractor (Early) ..... \$49.95
  - BHP015 Extractor (Late) ..... \$22.50
  - BHP087 Extractor Spring ..... \$4.00
  - BHP021 Firing Pin ..... \$10.00
  - BHP012 Firing Pin Spring ..... \$3.00
  - BHP091 Hammer..... \$35.00
  - BHP029 Hammer Spring..... \$6.00
  - BHP026 Hammer Spur..... \$35.00
  - BHP017 Hammer Strut..... \$12.00
  - BHP082 Hammer Strut Nut ..... \$8.00
  - BHP090 Hammer Strut Pin..... \$5.00
  - BHP092 Hammer w/Strut..... \$25.00
  - BHP016 Mag Catch..... \$26.00
  - BHP085 Mag Safety Spring ..... \$4.00
  - BHP083 Magazine Safety..... \$30.00
  - BHP079 Rear Sight Dove Tail..... \$18.00
  - BHP068 Rear Tangent Sight Slide ..... \$45.00
  - BHP032 Recoil Spring..... \$6.00
  - BHP011 Safety Catch..... \$32.00
  - BHP020 Sear..... \$34.00
  - BHP034 Sear Lever..... \$30.00
  - BHP024 Sear Lever Pin..... \$3.00
  - BHP018 Sear Spring..... \$4.00
  - BHP023 Slide Stop..... \$47.50
  - BHP040 Trigger..... \$35.00
  - BHP038 Trigger Lever..... \$35.00
  - BHP036 Trigger Pin..... \$4.00
  - BHP084 Trigger Spring..... \$7.50



**SARCO**

**PISTOL AND RIFLE MAGAZINES**

**WANTED TO BUY**  
up to 5 Grizzly .45 Winchester magazines.  
Call and ask for Cholly, Dave or Mark!

**STOCKS AND FORENDS**

Seriously the best deal we have offered in a long time on wood for firearms under the mfg names such as Mossberg, Marlin, H&R, Savage, Ithaca, S&W, and Winchester. 15 different stock and forends at a fraction of the cost and with no duplicates. Total Value \$587.00, but Sarco's Special Price is 1 LOT (all 15 pieces) for..... **\$150.00** or buy 2 LOTS for..... **\$265.00! STK363**  
This is a great opportunity for Gun Show sale items and if you sell 3 of the 15 items, you're out of it!  
**PLEASE NOTE:** There is a \$20 Handling Fee on this item



**BEST PRICE ANYWHERE !!!**

**GLOCK 17 - 17RD, 9MM MAGAZINE**  
Composite magazine holding 17 rds.  
..... **\$11.99 RPM292**

**MAS 49 & 49/56 MAGAZINE**  
Original 10 rd, 7.5mm French issue magazine. Sold out months ago, but a got a few more back in. Get 'em while you can!  
..... **\$49.95 RM018**

See e-sarcoinc.com for extensive magazine listings

**STAR 9MM SUPER MAGS**  
ORIGINAL MAGS FOR STAR MODELO SUPER 9MM LARGO.  
..... **\$29.95 RPM132**

**LORCIN .380 AUTO**  
Had no stock for years.  
..... **\$22.50 RPM276**

**TOKAREV 7.62x54 RIFLE MAGAZINES**  
New Condition  
..... **\$79.95 MISC053**

**COMPLETE SAVAGE 1905 (Original Body!) .32 AUTO MAG**  
..... **\$35.00 each RPM282**

**RASHEED RIFLE MAG - ORIGINAL!**  
Very Limited  
..... **\$100.00 RM40**

**HUNGARIAN FEG P9R/P9RK PISTOL MAGAZINES**  
Made for the Hungarian High Power clone P9R/P9RK pistol. New 10 rd. original replacement mags. **These magazines DO NOT fit the FEG P9M or FEG P9. These do not fit FN or Canadian Hi Powers. Check your gun—No Returns.** Sold elsewhere for \$25.00! SARCO price. **\$19.95 ea, RPM106**

**G43 RIFLE MAGAZINES**  
BACK IN STOCK!! **\$54.95 G43001**

**HUNGARIAN FEG AP-MBP PISTOL MAGAZINE**  
Original 8 rd. steel magazine in very good condition. 7.65mm. Hard to find so stock up now!  
..... **\$29.95 RPM315**

**MAGAZINES FOR M16/AR15 USGI M261 CONVERSION KIT**  
We've got both the U.S. Army M261 magazine in steel (right), and the rare U.S. Air Force version 'Teflon' magazine (left). Army M261 .22 Magazine ..... **\$24.95 M26120**  
Air Force .22 Magazine ..... **\$75.00 RM44**

**CZ-52 PISTOL MAGAZINE**  
Steel CZ-52, 8rd magazine for 7.62x25mm Ammunition. Original CZ mag body! Get one now before they're gone again!  
..... **\$22.00 CZ5202**

**DESTROYER CARBINE MAGS**  
..... **\$7.95 ea, 10 for \$50.00, 25 for \$79.50 RM004**

**HAKIM RIFLE MAG - ORIGINAL !!**  
VG condition  
..... **\$100.00 HKM060**  
Coming in 4-6 weeks

**RIFLE MAGAZINES**

ITEM NUMBER	DESCRIPTION	PRICE
RM61	#4 MK1 .202 10rd.....	\$29.95
	3/.....	\$84.95
	10/.....	\$229.95
BRN003	BRNO .22 LR bolt action 10 shot mag, Original.....	\$39.95
RM004	Carbine Destroyer.....	\$6.95
RM64	CZ-452 Rifle 10rd Original, steel. Fits CZ-452 rifle and holds 10rds of 22LR. Also good for the Norinco JW-15 rifle. Excellent Condition.....	\$70.00
RM101	Franchi SPAS-15 mag.....	\$135.00
RM39	Joloar, Orig.....	\$60.00
RM43	KKW Mauser & MAS 45 .22 training rifle mag, Original.....	\$24.95
RM011	Lee Enfield MKIII 10 Round, Refurbished.....	\$29.95
RM012	Lee Enfield MKIII 10 Round, Early version w/follower retainer tab.....	\$42.95
RM001	.22 Hornet M4 survival rifle magazine, original.....	\$49.95
RM40	Rasheed, original.....	\$100.00
RM85	Swiss KE 7 Neuhausen LMG.....	\$9.95
RM58	VZ52 Rifle 7.62x45.....	\$64.95
RM72	VZ52 Rifle 7.62x39, 10rd Orig. Exc.....	\$75.00
VZ5801	VZ58 Rifle 7.62x39, 30rd.....	\$17.95, 4/\$70.00
RM002	Winchester M52.....	\$19.95

RPM035	CZ-Model 1936.....	\$26.00
RPM038	Mauser Model 1910.....	\$35.00
RPM037	Mauser WTP, New.....	\$28.00
RPM039	Ortgies.....	\$34.00
RPM040	Raven.....	\$21.95
RPM041	Sterling Model 300.....	\$26.00
RPM042	Unique.....	\$26.00
RPM043	Walther Model # 8.....	\$36.00
RPM044	Walther Model # 9.....	\$42.00
RPM045	Walther Model 2&5.....	\$28.00
RPM046	Webley Model 1906/1909 w/o Ejector.....	\$28.00

**.32 CALIBER**

RPM047	Astra Model 300/3000, Side Magazine Catch.....	\$26.00
RPM048	Bayard Model 1908.....	\$34.00
RPM049	Beretta Model 1919.....	\$34.00
RPM050	Beretta Model 1934.....	\$38.00
RPM051	Beretta Model 70 Puma.....	\$36.00
RPM053	Browning Model 1900.....	\$35.00
RPM054	Browning Model 1910.....	\$35.00
RPM055	Browning Model 1922.....	\$35.00
RPM263	1922 Browning German Marked.....	\$50.00
RPM056	Colt Model 1903.....	\$34.00
RPM057	CZ Model 1927.....	\$43.00
RPM058	Dreyse Model 1907.....	\$34.00
RPM059	Femaru Model 37.....	\$40.00
RPM193	French Mod 1935 A Long, 8rd. Orig.....	\$65.00
RPM170	French Mod 1935 S, 7rd, Orig.....	\$65.00
RPM060	Frommer Stop.....	\$36.00
RPM064	MAB Model D .32 ACP orig.....	\$22.95
RPM065	Mauser 1914, repro.....	\$47.00
RPM066	Mauser Model HSC.....	\$42.00
RPM067	Ortgies.....	\$36.00
RPM070	Sauer Model 38-H.....	\$46.00
RPM072	Steyr.....	\$28.00
RPM073	Walther Model #4.....	\$35.00
RPM075	Walther PP/PPKS, early flat side repro w/ finger rest.....	\$38.00
RPM076	Walther PPK.....	\$34.00
RPM078	Webley.....	\$30.00

**.38 & .357 CALIBER**

RPM079	Colt Model 1900 .38 Auto.....	\$38.00
RPM151	Colt .38 Super.....	\$29.00
RPM080	Llama .38 Super, Narrow Floorplate.....	\$30.00
RPM081	Llama Model 6 .38 Super.....	\$30.00
RPM082	Llama Model 8 .38 Super.....	\$30.00
RPM083	Star Model A .38 Super 9mm.....	\$38.00

**.380 CALIBER**

RPM084	Browning Model 1910.....	\$35.00
RPM085	Browning Model 1922.....	\$35.00
RPM088	Colt Pony (Star-Model D).....	\$38.00
RPM153	Colt Mustang.....	\$28.00
RPM089	CZ DA Model 1938.....	\$36.00
RPM090	CZ Model 1924.....	\$30.00
RPM091	Femaru P-37.....	\$40.00
RPM092	Frommer Stop.....	\$28.00
RPM093	H&K Model # 4.....	\$35.00
RPM094	Mauser HSC Reproduction.....	\$40.00

**PISTOL MAGAZINES**

<b>.22 CALIBER</b>		
RPM001	Astra Constable.....	\$44.00
RPM002	Beretta Minx S.R.....	\$38.00
RPM003	Beretta Model 948 L.R.....	\$43.00
RPM004	Bernardelli Model 60.....	\$34.00
RPM005	Bernardelli V.P. (Vest Pocket).....	\$34.00
RPM006	Browning Challenger/Nomad.....	\$45.00
RPM008	Colt Woodsman Late (Magazine Catch on Side).....	\$38.00
RPM010	Galesi.....	\$30.00
RPM011	Galesi (Vest Pocket).....	\$28.00
RPM012	Hi-Standard Duramatic L.R.....	\$38.00
RPM013	Hi-Standard H.D.....	\$36.00
RPM015	Hi-Standard H.D.M.....	\$43.00
RPM014	Hi-Standard Model B.....	\$45.00
RPM016	Hi-Standard Supermatic.....	\$38.00
RPM274	Jennings .22.....	\$22.95
RPM019	Star Model F.....	\$38.00

**.25 CALIBER**

RPM126	Astra Cub.....	\$34.00
RPM021	Astra Fire Cat, Orig.....	\$28.00
RPM023	Bauer.....	\$35.00
RPM024	Bayard.....	\$30.00
RPM025	Bayard Model 1908.....	\$30.00
RPM028	Beretta Jet Fire.....	\$32.00
RPM026	Beretta Model 1915.....	\$28.00
RPM029	Beretta Model 418.....	\$35.00
RPM030	Beretta Model 950B.....	\$34.00
RPM027	Bernardelli Flat Bottom.....	\$28.00
RPM031	Browning Baby.....	\$32.00
RPM032	Browning Model 1906.....	\$25.00
RPM291	Colt Junior .25 mag, original.....	\$34.95
RPM033	Colt Repro/Hammerless.....	\$32.00
RPM034	CZ-DUO.....	\$32.00

ITEM NUMBER	DESCRIPTION	PRICE
RPM095	Ortgies.....	\$36.00
RPM096	Remington Model 51.....	\$35.00
RPM097	Savage Model 1910/1917.....	\$36.00
RPM098	Walther PPK.....	\$32.00
RPM099	Walther PPK/S.....	\$27.00

**ASTRA 400 MAGS**

9mm Largo - original  
**\$24.95 3 for \$64.95 RPM159**

**MAGAZINES FOR WINCHESTER .22 RIFLES**

(Current production) for model 75, 52, etc.  
**\$19.95 RM002 - found a few more**

**8MM CALIBER**

G43001 German G43 New MFG..... **\$54.95**

**9MM CALIBER**

RPM290	.22 TCM/9mm 17 round.....	\$32.99
RPM159	Astra Model 400.....	\$24.95
RPM101	Astra Model 600.....	\$36.00
RPM316	Beretta 92 FS, 10rd.....	\$19.95
RPM150	Beretta Brigadeer & Helwan.....	\$30.00
RPM105	Browning Hi-Power 13 Round, Blued (9mm Caliber).....	\$17.95
RPM106	Hungarian Hi-Power P9R.....	\$19.95
RPM107	Lahti Original SALE.....	\$7.95 \$20.00
RPM109	Radom.....	\$45.00
RPM110	S&W Model 39.....	\$26.00
RPM111	Star BM, BKM, BKS Starfire, Starlite.....	\$36.00
RPM152	Star Firestar.....	\$30.00
RPM114	Star Model B.....	\$35.00
RPM132	Star Super 9mm Largo (9x23).....	\$29.95
RPM112	Taurus Model 92.....	\$14.95
RPM102	Glisenti repro.....	\$60.00
P38079	Walther P38 1960 'banner marked' Military mag w/Nato stock #.....	\$39.95

**40 S&W**

RPM317 S&W Model 4053, 8rd..... **\$24.95**

**.41 & .45 CALIBER**

C45376	1911 Black Nickel Finish (.45cal).....	\$12.50
RPM307	1911 Stainless Steel 15 rd, (.45 ACP).....	\$17.95
RPM308	1911 Blued Steel 15 rd, (.45 ACP).....	\$17.95
RPM289	1911 Double Stack 13 round (.45 caliber).....	\$24.99
RPM309	1911 Drum (.45 caliber).....	\$64.95
RPM319	1911 .45 Cal 8rd, Blued Magazine.....	\$12.99
RPM158	.45 1911 Compact Magazine.....	\$24.95
RPM269	1911 9mm 10 Round Magazine.....	\$24.95
RPM119	Ballister Molina (.45 Caliber).....	\$5.95
RPM121	Colt Model 1911 Stainless Steel 7 round (.45 Caliber).....	\$14.95
	3/.....	\$40.00
RPM303	Desert Eagle 8rds.....	\$35.00
RPM266	Norwegian Model 1914 Original (.45 caliber) Rare, w/loop.....	\$65.00
RPM118	Star Model S.S. (.45 Caliber).....	\$38.00
RPM117	Star Model PD (.45 Caliber).....	\$42.00

**Super Commercial Stock Deal...all brand new original stocks and forends!**

15  
1908 Brazilian Mauser long rifle stock, good cond..... **\$75.00**  
1908 Brazilian Mauser long rifle stock - Select (very few only)..... **\$95.00**  
1908 Brazilian Mauser long rifle stock with handguard, good cond..... **\$85.00**  
1908 Brazilian Mauser long rifle stock with handguard - Select (very few only)..... **\$100.00**  
BM59 stock & handguard set, new in wrap **SALE!**..... **\$65.00 \$85.00**  
CC053 Carcano 38 stock - new, nice arsenal rework..... **\$99.50**  
FAL305 FAL/FALO stock & forend - RARE..... **\$250.00**  
FN49001 FN 1949 .30-06 cal stock, good condition - will rework well (we did one) - Complete with handguard set..... **\$99.95**  
FN49068 FN49 .30-06 stock..... **\$135.00**  
FN49078 FN49 .30-06 stock & handguards reworked in our shop (this is a reworked #4)..... **\$159.95**  
HKR001 Hakim stock, new original used, very nice..... **\$195.00**  
M36058A MAS 36/51 stock set w/all metal..... **\$125.00**  
STK345 Mossberg144 stock, used exc..... **\$45.00**  
STK385 Mossberg 42B military stock..... **\$36.50**  
STK339 Norinco JW15 .22 bolt action clip fed rifle stock, new original..... **\$34.95**  
P14012 P14 Enfield stock..... **\$200.00**  
P17059 P17 Enfield Stock Set - good cond..... **\$230.00**  
P17044 P17, Front handguard new walnut. Also fits P14..... **\$19.95**  
P17045 P17, Front handguard used walnut. Also fits P14..... **\$18.00**  
P17061 P17, Front handguard new hardwood. Also fits P14..... **\$34.50**  
P17060 P17, Front handguard used hardwood. Also fits P14..... **\$15.00**  
P17046 P17, Rear handguard new walnut. Also fits P14..... **\$32.00**  
P17047 P17, Rear handguard used walnut. Also fits P14..... **\$22.00**  
P17062 P17, Rear handguard new hardwood. Also fits P14..... **\$25.00**  
P17063 P17, Rear handguard used hardwood. Also fits P14..... **\$20.00**  
STK004 Remington 1934 military rifle stock, good..... **\$200.00**  
STK343 Remington 513T target rifle stock, used VG - low comb..... **\$29.95**  
STK341 Stevens 416 .22 TGT stock, VG used, orig..... **\$65.00**  
STK342 Stevens 416 .22 TGT stock w/buttplate, new orig..... **\$100.00**  
STK344 Winchester 75 TGT stock stripped, original, used..... **\$49.95**  
STK401 Winchester 75 TGT stock with all hardware, original - Good/VG condition..... **\$89.95**  
MSR669 Yugoslav M48 Mauser Rifle Stock, good condition..... **\$95.00**

**RARE RIFLE STOCKS**

(Note: For special selection on Winchester 75 stocks, please add \$15)

**Just in! RARE SPAS-15 MAGAZINE**

12 GA, 6 rounds, parkerized steel, new. Best price going  
**\$135.00 RM101**

**AK .22CAL LR (ORIGINAL EAST GERMAN) 15-20 ROUND MAGAZINE** AK .22 cal mag extends from 15 to 20 rounds  
**SALE..... \$9.95 \$15.00 AK006**

**BRAND NEW ORIGINAL TOKAREV MILITARY PISTOL MAGAZINES**  
Just in! **SALE.... \$9.95 \$18.00**, 3 for ..... **\$26.95 \$49.95 RPM160**

**BROWNING HI POWER**  
13 round - Super price.  
..... **\$17.95**, 3 for ... **\$49.50 RPM105**

**AR15/M16 100RD DRUM**

Front of drum is colored while the rear is clear to see remaining rounds. The package comes with a dust cover, a mag loader and a carrying case..... **\$115.00 AR383**  
Specify drum color when ordering:  
Tan, w/black pouch  
Green w/green pouch  
Call for availability on Black drum w/black pouch (\$125.00) See our page 12 or our website for Hi Cap Mag restrictions

See our website for **PARA ORDNANCE MAGS!!**

**TAURUS M92 & M99 9MM MAGAZINE**  
Super price  
..... **\$14.95 ea**, 3 for **\$42.95 RPM112**

**ORIGINAL TOKAREV PISTOL MAGAZINES 7.62x25**

1. Standard mag for Chinese model 213 or Russian TT30 **SALE !!**  
..... **\$9.95 \$18.00 ea**, 3 for .. **\$26.95 \$49.50 TOK052**  
2. Pakistan Frontier Constabulary/ Security Service TT-30/TT-33 Tokarev magazine. 8rd, 7.62x25 Tokarev, New..... **\$18.00 ea**, or 3 for ..... **\$49.95 RPM322**

There are many variations of RUBY - See our website to get the correct magazine

**LAHTI PISTOL MAGAZINES**  
Genuine Swedish surplus magazines for the 9mm Model 1940 Lahti Pistol. Excellent condition **RPM107 SALE!!!**..... **\$7.95 ea**, 3/..... **\$19.95**

**MAGAZINES FOR REMINGTON .22 RIFLES**  
New, blued steel replacement magazine for the 513T series of Rem. .22 rifles and all Rem series 500 rifles 5rd..... **\$19.95 RM058**



**Airguns For Sale S3000**

**AIRGUN REPAIR & SERVICE**  
 Factory authorized Crosman, Benjamin and Sheridan warranty service. We also repair Daisy, Beeman and many other makes of pellet and bb guns. No firearms. Most repairs \$65-\$100. We buy used airguns and parts. In business since 2005.  
**ACCURATE AIRGUNS LLC**  
 Ph: 360-656-5123  
 Email: airguns@comcast.net  
 Website: accurateairguns.com

**Airguns Wanted S3001**

**WANTED:** Air Pistols by Hy-Score. Any model and any cal. Blue or chrome. Tele. Don at 941-755-9308. All payments by Postal Money Order. Also need full bolt with extractor or extractor alone for Spanish Destroyer Carbine 9mm Largo.

**A Miscellaneous For Sale S3100**

**AMF M1 Navy Trophy Rifle.** .308 Caliber. Approximately 5,000 survived.

Looks unfired with box and some documents. \$13,500. Doug Oefinger 863-444-1849. No pictures.

**Colt Named Model For Sale S3280**

**Colt 1918 B.A.R.** serial number 1. Excellent condition. Original wood. No Bipod. Used as a display gun at Colt. \$325,000. Serious inquiries only. Doug Oefinger 863-444-1849. No pictures.

**Heckler & Koch (H&K) S3780 For Sale**

California D.O.J. HK Model 94. Ex

D.O.J. gun, refinished. \$6,500. Doug Oefinger 863-444-1849. No pictures.

**Luger Handguns For Sale S4080**

**LUGERS, P-38'S. Broom Handles, Nambus, Accessories, German, Japanese, War Relics. List \$2. Hoffman, 4105 Stephanie, Branch, MI 49402. 231-462-3594, 863-291-3594.**

**Military Arms For Sale S4200**

1903 A4 Sniper, Overall condition excellent. "W" stamped behind the

trigger, came from the National Guard in the 1960's. \$7,500. Doug Oefinger 863-444-1849. No pictures.

**www.StormWerkz.com Small Arms Upgrades Made in USA**

1903 COLT U.S. property marked 32 and 380 cal. boxes with proper instruction sheet, paper and cleaning rod. \$39.95 plus postage. Ray 847-854-6608.

**GOVERNMENT 1911 A-1 .45 cal.** surplus Kraft boxes: Colt, Remington, ITHACA, US&S with wrapping paper. \$27.75 plus postage. Ray 847-854-6608.

**Military/Automatic Arms S4220 For Sale**

**AKM Underfolder Conversion Gun.** \$25,000. Serious inquiries only. Doug Oefinger 863-444-1849. No pictures.

**MP40** Good numbers matching with matching magazine painted black and appears to have never been blued. \$18,000. Doug Oefinger 863-444-1849. No pictures.

**T161/M60 .308 caliber,** excellent condition, C&R eligible. \$65,000. Doug Oefinger 863-444-1849. No pictures.

**Aircraft Lewis Gun Reg.** Live but welded together, blued, no magazine. \$11,000. Doug Oefinger 863-444-1849. No pictures.

**CLASS II FULL AUTO DRILLING FIXTURES** For MAK-90/AK-47 (w/ pins & bushing)--\$48.50 shipped or AR-15/M-16, M-11/9 & HK--\$33.50 shipped. All NFA Rules Apply. Order online at www.ftfindustries.com or mail to:  
 FTF Industries, Box 68, Hildebran, NC 28637 (cert. funds, M/C or Visa).

**CZ24 REPLACEMENT** Receiver Tube Section w/template. 4130 tubing with correct OD & ID \$45.00 Shipping \$5.50  
 Keller Enterprises, PO Box 563, Safety Harbor, FL 34695. 727-726-2500 www.stenparts.com

**PPSH41 RECEIVER** Section \$50.00, PPS43 Receiver Section \$50.00,

**UNLEASH INCREDIBLE FIREPOWER WITH THE NEW HELL-FIRE GEN2™**

- ◆ Installs quickly and easily
- ◆ Looks built in and part of your rifle
- ◆ Non Bumpfire Technology
- ◆ Can be shot firmly against shoulder
- ◆ Select fire Micro Adjust knob
- ◆ Can be fired with one hand for pistols
- ◆ Adjustable rate of fire-Up to 900 rpm
- ◆ ATF legal certificate
- ◆ Can be retrofit to most anything
- ◆ Made in USA-All Metal-Patent Pending



**\$59.95**  
 (plus S&H)

**ALL NEW SNAP-ON VERSION ONLY \$34.95**

**ROCKINLOCK.COM ♦ FIREQUEST.COM ♦ (770) 249-2991**

**Tremendous Variety Of Custom Classic Cartridge Brass and Specially Cast Bullets**



Whether it's a classic American, British or European metric caliber, we can supply new formed brass, specially cast bullets in almost any caliber. That includes Maynard types, as well as rimfire and pinfire cartridges! Need a 8.15x46R bullet with central driving band? We have them... along with .310 Cadet factory bullets and six-sided Metford bullets. We also offer reloading tools and dies.



This is a partial caliber list:

6mm Lee Navy	.32 Remington	8x60 RS	.401 WSL	.43 Egyptian	.45-120 Sharps
.25 Remington	8mm Kirtz	.33 Win.	.41 Colt	.44 Bull Dog	.50-70 Govt.
6.5x53R Dutch	8.15x46R	.351 WSL	.401 Herters	.44 Russian	.50-95 WCF
7.35 Italian	8mm Lebel	9mm Jap Rev.	.40-60 WCF	.45 Colt blank	.50-110 WCF
32 French Auto	8x50R Siamese	9mm Mannlicher	.40-65 WCF	455 Webley	.50 x 3/4"
.310 Cadet	8x52R Siamese	9.5mm Mannlicher	.40-82 WCF	.45-60 WCF	.56-46
.303 Savage	8x56 Mannlicher	.35 Win.	11mm French Rev.	.45-70 blank	.56-50
7.63 Mannlicher	8x57 R360	.38-56 WCF	.43 Spanish	.45-75 WCF	.56-52
.32 WSL	6x58 Sauer	4-in-1 blank	.43 Mauser	.45-90 WCF	.577 Snider

**Bob Hayley**

211 North River, PO Box 889, Seymour, TX 76380 Phone (940) 888-3352

**Granpa's Gun Parts**  
 US Springfield Parts  
 Krag, 1903, Trapdoors, Muskets & More!  
 www.granpasgunparts.com

**M1 CARBINE PARTS**

Download Our FREE Catalog!!  
 www.bestcarbineparts.com

- Carbine Barrels
- Stock Pouches
- Slings & Early Oilers
- Stocks & Handguards
- Type I Early Flip Sights

- \*Type I, II Dog Leg Hammers
- \*Flat & Round Bolts: \$95.00 & Up
- \*Front Bands Type I, II & III
- \*Front & Rear Sights
- \*Swivels (All Mfgs.): \$18.00 & Up
- \*Mag. Rel. Type I, II & III: \$32.00 & Up
- \*M1A1 Recoil Plate Covers: \$65.00
- \*M1A1 Butt Plate Springs: \$10.00
- \*M1A1 Coil Springs (Pistol Grip): \$10.00
- \*Type I Band Screws: \$7.50

\*\*\* Celebrating 30+ Years\*\*\*

**L&S SUPPLY, INC.**

22211 Lofton Ave. N  
 Scandia, MN 55073  
 E-Mail: lssupply@spacestar.net  
 Or call: (651)773-9972  
 15 DAY 100% Satisfaction Guaranteed

**CBRPS LLC.**

**Bullpup stock kits**

AK  
 SKS  
 Saiga  
 Ruger  
 Remington  
 Mosin Nagant

**www.cbrps.com**



PPS43S Trunnions \$30.00  
Shipping \$11.50  
Keller Enterprises,  
PO Box 563,  
Safety Harbor, FL 34695.  
727-726-2500.  
www.stenparts.com

STEN MkII \$30, STEN MkIII \$35,  
Sterling \$35, Yugo 56 \$45; Receiver  
Tubes w/bonded templates made from  
4130 Tubing. Correct OD/ID  
Shipping extra.  
Keller Enterprises,  
PO Box 563,  
Safety Harbor, FL 34695.  
727-726-2500. www.stenparts.com

STEN MARK II, III,  
& V spring kits \$20,  
\$5 shipping  
KELLER  
ENTERPRISE  
PO BOX 563  
Safety Harbor, FL 34695.  
727-726-2500  
www.stenparts.com

.50 BMG UPPERS,  
.50 BMG RIFLES  
www.SHTF50.com

STEN MARK II & III  
BARRELS,  
New Manufacture,

Original Length \$45.00;  
AMD-65 extended  
muzzlebrakes AK74 style  
\$27.00, Shipping \$5.50  
each.

KELLER  
ENTERPRISES,  
PO Box 563,  
Safety Harbor, FL 34695.  
727-726-2500.  
www.stenparts.com

DEPOT LEVEL Maintenance on  
your U.S. Military Machine Guns.  
Most M16, M60 and .50 cal. parts in  
stock. We can put your M18 or M20  
recoilless rifle back together. Sub-cal  
units available. M60 Mil Spec Channels  
Parked \$150. Gunsmith 203-605-4578.

CROSSCUT SAW COMPANY



THE FINEST IN PEOPLE POWERED GOODS  
P.O. Box 7872, Seneca Falls, N.Y. 13148  
315-568-5755

www.crosscutsaw.com  
Quality Saws, Knives, and  
Hard-to-Find Tools.  
Catalog \$1 U.S. (\$3 Foreign)

Introducing the "ALL NEW"



**HYPERGAT  
TRIGGER SYSTEM**  
Fits most all Rifles and Pistols .22 to .50cal

**NO**  
"Bump-Firing"  
"Slide-Firing"  
No Technique required!  
**BEST of ALL No High Price!!**  
**\$49.95**

"FORCE MULTIPLYER" Complete with the "Hypergat" Trigger System.  
Mounts easily- Does not obstruct trigger-600 to 1000 rpm  
"Fully auto type Fire" - ATF Legal

**THIS IS THE EASIEST BEST RAPID FIRE  
TRIGGER SYSTEM IN THE WORLD! IT IS THE ONLY  
SYSTEM THAT WORKS ON .22'S PERIOD.**

Go to our website or Call 970-417-4860 and get yours today!!  
See our AMAZING videos on our website!  
**WWW.HYPERGAT.NET**

# RUBEN MENDIOLA DEALERNFA, INC.

PO Box 566300, Miami, FL 33256-6300, 305-271-3436  
TOLL FREE: 866-NFA-WANT (866-632-9268), FAX: 866-415-7066,  
CELL: 786-256-6746 for pics or text, EMAIL: Ruben@dealernfa.com  
HOURS: 8am-9pm Eastern, 7 days a week

## !WANTED!

ALL TYPES OF QUALITY LEGAL MACHINE GUNS!



### NO COLLECTION TOO LARGE! GENEROUS FINDER'S FEES GLADLY PAID!

Estate and Machine Gun Appraisals!  
Before Selling Your Guns, Please Call Me To Make Sure You Are Getting The Most For Them!  
CONSISTENTLY PROVIDING EXCELLENT AND DISCREET SERVICE & FAIRLY PRICED HIGH QUALITY MACHINE GUNS SINCE 1985!

Attorney Available for Trust or Estate Matters.

**\*\*WE PAY UP FRONT\*\***

100% of the Agreed Price Before You Ship Your Guns!  
You Will Never Have To Wait Until I Sell Your Guns in Order to Be Paid!  
100% Risk, Worry & Hassle Free Transactions!  
Avoid the Uncertainty of Consignment or Brokering!  
Specializing in Investment Grade Transferable Machineguns  
Specialist in Law Enforcement Purchases and Cashless Trades



**www.dealernfa.com**  
**ALWAYS PAYING TOP DOLLAR!**



**Miniatures, Replicas For Sale S4234**

Range Creedmoors, Mid-Range, Short-Range and Schuetzen Target Models. 509-826-5512, randyman@ncidata.com

**R Miscellaneous For Sale S4560**

**M55 Reising.** Came from H&R in the 1980's. No metal on the wood stock. \$12,000. Doug Oefinger 863-444-1849. No pictures.

"That the people have a right to keep and bear arms;...." Virginia's request for a Bill of Rights, 1788.

**Remington Rifles Wanted S4441**

Buying Remington No. 1 Rolling Blocks & Hepburns in Long

**Accessories For Sale S5200**

AMMO, Antique/Obsolete, in original boxes. Most American sporting calibers including obsolete rimfires. NO lists, reloads, military/foreign. Ray Giles, RTG Sporting Collectibles LLC, 214-361-6577 www.rtgammo.com

**Antiques S5270**

SARCO, INC. -MIG 21 jet fighter cockpit section from the DDR (East

**German) Air Force.** We have only one single-seater. ATF will not allow the import of military aircraft, so this is the end. Ours was saved from the smelter at the last possible minute. The single-seater will be missing the stick and maybe some instruments. The cockpit was cut out of existing planes that were phased out of service. **Single cockpit MIG - \$9000.00 MMP011.** Please call us at (610) 250-3960 to order this item. These are oversized items. Cockpit shipped via truck at our 55% discount. See pictures of the actual unit and read more by visiting our website [www.E-Sarcoinc.com](http://www.E-Sarcoinc.com).

Also, AK floor plates. See us at: [CSSPECS.COM](http://CSSPECS.COM) or Call 386-490-1102

**Gun Parts For Sale S5500**

**B&C Gunsmithing 928-854-8209**  
**Charles Daly** Miroku Shotgun Repairs. Original Parts. Gunsmith with over forty years experience with CDM shotguns. We have 10,000 parts plus 12 other firearms manufacturers. B&C Gunsmithing, Call Monday-Thursday, 12 noon - 4pm, 928-854-8209.

**Barrels For Sale S5280**

**CORSON'S BARRELS** 1000 New, Used, and Obsolete Shotgun Barrels. Buy, Sell, Trade. 928-718-4282 Arizona. [dccorson@citilink.net](mailto:dccorson@citilink.net), [www.corsonsbarrels.com](http://www.corsonsbarrels.com)

**Clips & Magazines For Sale S5380**

VEPR & SAIGA METAL MAGAZINES U.S. Made.

**HEAT TREAT OVENS**

Take control of your heat treating. Evenheat offers a full line of heat treat ovens for private and commercial shops. Prices start at \$730

**evenheat**  
[www.evenheat-kiln.com](http://www.evenheat-kiln.com)

PH: 969-859-2281 FAX: 969-859-4040

**ORIGINAL PRECISION**

MANUFACTURER OF **LOCK DELETE** FOR S&W REVOLVERS **UNIVERSAL MOONCLIP TOOL** MOONS DEMOONS RIM OR NON RIM BRASS MULTI-CAL 32 THRU 460 ALL BRANDS **J.D. @ 480-305-3236 ORIGINALPRECISION.COM**

GUNSMITH'S Assortment: Screws, springs, pins, 100 pieces, \$14.50 plus \$5 shipping: Poppert's, Box 413, Glenside, PA 19038. [www.PoppertsGunParts.com](http://www.PoppertsGunParts.com)

COLT Lightning Springs. One each of the following: Trigger spring, Hand Spring, Strut Spring, Cyl stop spring, Ejector spring, \$24.50 per set plus \$5 shipping. Poppert's, Box 413, Glenside, PA 19038. [www.PoppertsGunParts.com](http://www.PoppertsGunParts.com)

**GUN PARTS:** You name it. Professional service since 1965. General Parts List, \$5. Traders Den, 1655 Olson Dr., Cook, MN 55723. Mail order or by appointment only. 218-666-5083.

**Gunsmith & Dealer Services S5540**

**Gunworks Gunsmithing**, 17 years experience. Kit builds, bolt jewelry,

**TACTICAL GLOCK ACCESSORIES**

Everything you won't find just anywhere

**New Hellfire Legal Auto Fire \$39.95**

**Glock Props \$39.95**

- Stocks \$39.95**
- Arm Braces \$49.95**
- Scopes \$29.95**
- Hand Grips \$19.95**
- Lasers \$24.95**
- Pistol Lights \$14.95**

Call 770-249-2991 or visit [www.rapidfiretriggers.net](http://www.rapidfiretriggers.net)

**ATAC DEFENSE**

[ATACDEFENSE.COM](http://ATACDEFENSE.COM)  
(601) 963-0300

**ADER 5.56 - ATAC DEFENSE ENHANCED RIFLE**

AMBI SAFETY & AMBI MAG RELEASE WITH OVERSIZED MAG BUTTON, LARGE AMBI CHARGING HANDLE AND BOLT RELEASE, MUZZLE BRAKE, NICKEL BORON COATED C158 BOLT CARRIER GROUP, ENGAGE HAND GRIP AND MINIMALIST STOCK

**ADBR - \$1299**

**ADBR 5.56 - ATAC DEFENSE BASIC RIFLE**

**ADBR - \$969**

EACH ADBR IS A SUPERIOR ENTRY LEVEL RIFLE HAND FIT BY MARKSMEN THAT DEMAND ACCURACY AND RELIABILITY

FANATICAL BUILD QUALITY SLICK GERAKOTE FINISH

**WE WELCOME DEALER INQUIRIES**

**MILLIONS OF GUN PARTS!!**

**WE NOW HAVE 300 MODELS ON THE WEB**

VISA-MASTER-DISCOVER Company Check or MO.

**BOB'S GUN SHOP**  
P.O. Box 200  
Royal, AR 71968

**FAX 501-767-2750**  
[www.gun-parts.com](http://www.gun-parts.com)  
[gunparts@hsnp.com](mailto:gunparts@hsnp.com)

**Handi-Racker.com**  
The Safest Way to Rack Your Pistols

Load and unload  
Clear Jams  
Aids in disassembly  
Aids in assembly

patent #9,194,636

Dealer Inquires Welcome

MSRP was \$29.99  
NOW only \$24.99

(515) 480-4905



rebarreling, trigger jobs & more. Call  
Chris 864-608-5095.

**GUN BLUING  
and RESTORATION**  
firearmfinishinginc.com

Firearms Refinishing. No More Rust!  
Parkerizing, Moly, Ceramic. Call 337-  
230-4815, alomar.resources@cox.net

**PMD Gunsmithing**  
Specializing in Firearm  
Restoration  
Rebluing, Stock Refinishing, and  
Repair. Better than New!  
www.pmdgunsmithing.com  
Call 330-240-5960 to receive FREE  
SHIPPING both ways with your  
restoration project.

**RICK'S PLACE**  
Master Gunsmith  
Full Line Gunsmith Shop  
REPAIRS & RESTORATIONS  
Metal & Wood Refinishing  
Custom Barrels-Stocks-Grips-Guns  
Choke Tube Installation/Removal  
Barrels Threaded  
Shotgun Barrel Straightening  
Appraisals - FFL Transfers  
Fire & Flood Insurance Claims  
Bad@\$ Stuck Choke Tube  
Removal Tool & Other  
Custom Gunsmith Tools  
More Services on Website

501-658-7347  
rick@ricksplace.biz  
www.ricksplace.biz

**BARREL RELINING** in .22 RF,  
25-20, 32-20, 38-40, 44-40. Installing  
the finest liners, manufactured by  
Redman's. Professional Craftsmanship  
Guaranteed. Established shop of 41  
Years.

Redman's Rifling & Reboring,  
189 Nichols, Omak, WA 98841.  
509-826-5512.

Prices & info www.redmansrifling.com

**BROOMHANDLE  
BARREL RELINING**  
Broomhandles to 30 Mauser using  
the finest liners. Rust bluing  
available. Guaranteeing the finest job  
around. Established shop of 41 years.

**FLECHETTE  
SHOTGUN AMMO**  
LONG RANGE - BORE SAFE - HIGH PERFORMANCE  
STEEL DARTS  
12 GA PATENTED SABOT HOLDS 19 NEW HEAT  
HEAT TREATED 8 GR FLECHETTES MV 1925 FPS  
2 3/4" SHELL - CALL OR ORDER ONLINE  
12GA 10RDS 12GA 25 RDS 12GA 100RDS  
PRICE INCLUDES GROUND SHIPPING  
**SABOT DESIGNS LLC**  
541-770-6047 10AM-5PM PST  
WWW.SABOTDESIGNS.COM

# GET IN THE RELOADING REDZONE®

## WITH THE LOCK-N-LOAD® AMMO PLANT



Equipped with the most intuitive reloading system, the Hornady® Lock-N-Load® Ammo Plant delivers the speed and performance you need to reload hundreds of your favorite cartridges in record time!

**The Ammo Plant includes:**

- Lock-N-Load® AP™
- Lock-N-Load® Case Feeder
- Lock-N-Load® Pistol Bullet Feeder
- Lock-N-Load® Powder Measure with Case Activated Powder Drop
- Rifle Metering Insert & Rotor
- Powder Cop
- Case Retainer Springs
- Large Primer Pickup Tubes
- Primer Slide Springs
- Die Bushing 10-pack
- Deluxe Die Wrench
- Cartridge Bins
- Decorative Tin Sign



**Hornady®**

800.338.3220  
HORNADY.COM

**We Have a Huge Selection  
of Old and Hard to Find  
Shooting Supplies and  
Accessories!**

Holsters | Gun Cases  
Ammo | Reloading | Sights

**Free Digital Catalog!**



208 263-6953

8am - 4:30pm M - F PST

660 Vermeer Court, Ponderay, ID 83852

**WWW.BUFFALOARMS.COM**





**QUICK DRAW**  
**\$42.95**  
 LOTS OF 24 RIGS  
 VISA, MASTERCARD  
 WILEY'S, 7009 Co. Rd. 2120  
 WILLS POINT, TX 75169  
 1-903-848-7912-FAX-7922  
 www.wileysguns.com

**TOOLED LEATHER - SUEDE  
 LINED - FITS SINGLE ACTION**

ASK FOR CAL. 22-38-357-44-45  
 ASK FOR SIZES: 32-44  
 FEATURES BROWN COLOR  
 LOW DROP ON HIP  
 BBL LENGTHS: 6" OR 7 1/2"

**SELL OUT  
 PRICES**  
 24 RIGS \$42.95 EA.  
 12 RIGS \$44.95 EA.  
 6 RIGS \$46.95 EA.  
 4 RIGS \$48.95 EA.  
 2 RIGS \$52.95 EA.  
 1 RIG \$59.95 EA.  
 Plus Shipping

**Gunsmith & Dealer  
 Services S5540**

Redman's Rifling & Reboring,  
 189 Nichols, Omak, WA 98841.  
 509-826-5512. Prices & Info:  
 www.redmansrifling.com

**REAMERRENTALS.COM  
 ONLINE CATALOG  
 400+ Calibers Available.  
 Call (800) 996-0426.**

**Gunsmith & Dealer  
 Supplies S5560**

**BARREL LINERS:** 17 Mach II,  
 22RF, 25-20, 32-20, 38-40, 44-40.  
 Satisfaction Guaranteed.  
 Prices & info on website at  
 www.redmansrifling.com

**Gun Barrel Reboring Machine**  
 (hydraulically operated), tooling &  
 training. This equipment is for reboring  
 an existing barrel up to a bigger size.  
 Not cheap but a rare opportunity.

509-429-6856.

**Pratt & Whitney Sine Bar Rifling  
 Machine.** Call 509-429-6856.

**SARCO, INC.- COMMERCIAL  
 GUN STOCK LOTS FOR SHOW  
 SALES!** Fabulous opportunity to buy  
 new commercial stocks & forends  
 for brand names like Mossberg,  
 S&W, Ithaca, Marlin, H&R,  
 Winchester, Savage, etc. **One lot of 15  
 Stocks & forends with no duplicates  
 for \$150.+Sh. (STK363).** Sell 3 pcs  
 and your out of it! Rest is profit.  
 Multiple lots get better price! Great for  
 gun show and store sales. Sarco Inc.  
**610.250.3960** or visit  
**www.E-Sarcoinc.com** for a vast  
 wealth of goodies !!

Inspected & Polished.  
 817-834-5716  
 thbrassman@aol.com

**SABOTS!**  
 4,000 FPS out of your .30 caliber rifle?  
 It's possible with our sabots! You can  
 load and shoot .22 caliber bullets in any  
 .30 caliber cartridge. Our six fluted  
 design enables instantaneous separation  
 of sabot from the bullet at the muzzle.  
 Add \$5 for each order. Utah residents  
 add 6.25% sales tax. No COD's or  
 credit cards.  
**J&D Components**  
**75 East 350 North, Orem Utah 84057**  
**www.jdcomponents.com**

INTRODUCING THE ALL NEW...

# HELLFIRE STEALTH

*The name says it all!*

**ONLY  
 \$39.95  
 (plus S&H)**

*You simply just squeeze  
 the trigger.*

*Activate/Deactivate/  
 Adjust with the hidden  
 Micro knob.*

**LEGAL IN ALL 50 STATES!! ATF LEGAL WITH CERTIFICATE.**

This incredible new system installs invisibly within your grip on any AR15 style rifle invisibly. It can be activated or deactivated in seconds. It legally allows you to pull your guns trigger at it's highest rate legally. It installs in minutes and nobody but you will know it's there. It features a micro-adjust for activation and deactivation. It looks absolutely built in. It is revolutionarily the best rapid fire system for these new volatile times. Get them now before new laws outlawing "Fast Shooting" arrive. This may very well be the best system ever devised for AR15 platforms. It is constructed of all Steel for a lifetime of reliability. The shooter always maintains control and single function of the trigger so you can fire single, double, bursts or empty mags and it is the only system that is 100% legal for now in all 50 states!

**ONLY AT ROCKINLOCK.COM AND FIREQUEST.COM**

**New!**

**HANDBOOK of Machine  
 Gun Support Equipment  
 and Accessories 1895-1945**  
 By Robert G. Segel

For more information, reviews and to  
 order your copy, visit:  
**www.EmmaGeeMan.com**

Limited Edition  
 Free Shipping in  
 the U.S.

Foreword by  
 Dolf Goldsmith

**Summer Special!  
 12% Discount  
 Limited Time Only!**

**Over 1,000 color pictures • 415 pages • Covers 77 different classic  
 weapons • Spare parts/tools identified and labeled • Ideal visual  
 reference for collectors, shooters, museums and re-enactors**

**Militaria For Sale S5700**

NAZI, JAPANESE -- ITALIAN  
 Daggers, Swords, Medals, Hats,  
 Documents, Standards, etc.  
 I buy collections, also interested in:  
 Parts, Broken Daggers,  
 Swords & Bayonets.  
 Send \$2 for Large List. Since 1963.  
 Mike Warren, P.O. Box 566,  
 Bethpage, NY 11714.

**SOVIET MILITARIA!**  
 Trade & Buy.  
 Send \$3 for Catalog.  
**RUSSIAN STORE**  
 7657 Winnetka Ave, Suite #203,  
 Winnetka, CA 91306  
 818-999-1257 russianstoreinla@yahoo.  
 com

**Indian Relics - B.C.**  
 \$1.00 for Color Catalog.  
 Indian, P.O. Box 246  
 Independence, KY 41051

**POWDER, BRASS-BULLETS:**  
 Powder: WC844 (223) Virgin  
 surplus 159.00, 4+156.99, WC860-  
 69.00, 4+64.00, SALE WC872-WC867  
 48.00 Surplus, Unfired Primed LC  
 223 from ammo 500-79.99, 1000-  
 149.99; 223 LC military 60m, 45 Auto,  
 Tumbled 1000-89.99, 308 LC Primed  
 Unfired Brass, from ammo, 500-  
 140.00; See web for other Military-  
 Commercial Brass: New and Fired  
**BULLETS:** 308 IMI M-80 147gr.  
 FMJ-500-89.00, Sierra 224-77gr.  
 Special match 500-118.00, WOLF 224  
 55 FMJ 1000-79.99, Hornady 224  
 55gr. PSP-FMJ 94.99m, Federal 223  
 55 FMJ m193 - 94.99m; 223 M855  
 62 FMJ -124.99; 223-M856 tracer,  
 Military Surplus-99.00m; 50 API  
 Silver Unsize 289m, Sized 339m,  
 50 Tracer 279.00, sized 329.00 See  
 web for complete 50 Bullet List, plus  
 WW-Remington-Hornady Commercial  
 Bullets:  
 see web for current Prices:  
 Brian McDonald  
 74880 Johnson Run Rd.  
 Kimbolton, OH 43749  
 9AM-5PM,  
 330-833-4360  
 Fax No. 740-492-0063  
 Web: **PatsReloading.com**

**Militaria Wanted S5701**

**I Want to Buy** Firearm and Militaria  
 Collections. 605-321-4402, Leave  
 Message. ds57110@live.com

**Miscellaneous For Sale S5720**

**Ugly But Cheap!** Prehistoric Authentic  
 Indian Arrow Heads. Complete  
 Undamaged. Found Lake Ozark  
 Missouri. 21 For \$27.50. Makes Nice  
 Display Frame. Indian Head Cent  
 \$3.00; Silver Eagle, \$25.00. Satisfaction  
 Guaranteed. Richard's 126-FN  
 Honeysuckle, Eldon, MO 65026.

**Mercury Metal 99% \$20/lb. \$20  
 Shipping; 5lbs. \$80 \$30 Shipping.  
 Chloroform 99% 8oz./\$15 Shipping  
 \$15. Salow, 270 Bighorn Drive, Estes  
 Park, CO 80517.**

**SARCO, INC. - FLECHETTE  
 DARTS:** 1 inch long military flechettes  
 in stock. Sold in 2 oz. (#MISC288) and  
 1 lb. (#MISC307) packs.  
 Original USGI. Sarco Inc.,  
**610.250.3960.** Visit  
**www.E-Sarcoinc.com** for a vast  
 wealth of goodies !!

**Reloading Components S5801  
 Wanted**

**Reloading Equipment S5820  
 For Sale**

**ONCE FIRED** Remington 3" Mag  
 12 or 20ga \$44.95/1000; Remington  
 12ga High Brass, New Type,  
 Compression Formed, \$39.95/1000;  
 Federal or Remington 3 1/2" 12ga Mag  
 \$79.95/1000. All Prepaid up to zip  
 57300. Others: Add 10.00/1000.  
 Bob Kase, 3475 Palmyra Rd,  
 Marion, NY 14505.

**Reloading Components S5800  
 For Sale**

**BRASS**  
 Once Fired Range Cleaned.  
 9mm. \$35/1000  
 40 S&W \$35/1000  
 223/556 \$80/1000  
 For Other Calibers Call  
 Chuck. 623-341-9122.  
 www.bremersbrass.com

**WANTED**  
 Once Fired 10 Gauge Hulls,  
 3 1/2 & 2 7/8, Priced to Sell.  
**jpgvilla1@att.net**

**Reloading Equipment S5820  
 For Sale**

**Reloading Equipment S5821  
 Wanted**

**RELOADING EQUIPMENT & Gun  
 related stuff WANTED!** Attention  
 Estates, Gun Shops, Collectors! Sell  
 me your no longer used reloading



equipment, casting, gunsmithing equipment & tools. Presses, dies, molds, Stocks, grips and Misc. parts too. I buy the items left over after others buy the guns. Gladly travel for large collections.  
Call Rick (330)806-4169 or email ricketts711@sbcglobal.net

**Scopes, Rings & Bases For Sale S5840**

**RIFLESCOPES**

Browse Online Catalog at **4scopes.com**  
Get Free Shipping!

**Stocks & Grips For Sale S5860**

**Precision Gunstock Duplicating** of any wood. Gunstock repair, custom, restoration, and checking. My pattern and wood or yours. Quality work, fair price, quick turnaround. 570-637-3004, leave message.

**Surplus Gear For Sale S5880**

**SARCO, INC. - FRENCH 73MM BAZOOKA:** LRAC-50 bazooka as used by the post war French in Vietnam & Algeria. Never on the market before. Comes with shield and optics, deactivated to ATF specs. Very limited!

Sarco Inc., 610.250.3960

Visit [www.E-Sarcoinc.com](http://www.E-Sarcoinc.com) for a vast wealth of goodies !!

**SARCO, INC. - RPG-2 ROCKETS (INERT) (#RL005):** Original Vietnam era rockets with the warhead removed and replacement inert head installed.

Great for completing your RPG launchers!

Sarco Inc. 610.250.3960

Visit [www.E-Sarcoinc.com](http://www.E-Sarcoinc.com) for a vast wealth of goodies !!

**SARCO, INC. - WW2 VEHICLE RADIO SETS:** SCR528 (#RAD04), SCR506 (#RAD02), & SCR508 (#RAD03) radio sets with mounting bases. Perfect for completing your military vehicle. Supplies are dwindling. Sarco Inc., Call Dave or Mark: 610.250.3960 or visit [www.E-Sarco.com](http://www.E-Sarco.com) for a vast wealth of goodies !!

**Gun Shows S6150**

**RALEIGH, N.C. Aug. 29-30,** Antique Gun & Military Antiques Show, North Carolina State Fairgrounds, 1025 Blue Ridge Road, Arms & Memorabilia. Civil War, Indian Wars, WWI, WWII, etc. Info: **Carolina Trader Promotions,** 704-282-1339  
[www.TheCarolinaTrader.com](http://www.TheCarolinaTrader.com)

"But it ought always to be held prominently in view that the safety of these States and of everything dear to a free people must depend in an eminent degree on the militia. Invasions may be made too formidable to be resisted by any land and naval force which would comport either with the principles of our Government or the circumstances of the United States to maintain. In such cases recourse must be made to the great body of the people, and in a manner to produce the best effect. It is of the highest importance, therefore, that they be so organized and trained as to be prepared for any emergency." President James Monroe's First Inaugural Address, 1817.

"The right of the people to keep & bear arms has been recognized by the General Government; but the best security of that right after all is, the military spirit, that taste for martial exercises, which has always distinguished the free citizens of these States;.... Such men form the best barrier to the liberties of America." *Gazette of the United States*, October 14, 1789, 211, col. 2.

**AMG INTERNATIONAL ARMORY**

(All Military Gunsmithing)  
Military Gunsmith  
35 yrs. Experience  
Former NATO Defense Contractor  
Kit Building / Rebuild / Repair / Refinish  
• FN-FAL • FN-49 • M-1 • Garand  
• M-1 Carbine • British Enfields • M-1A  
• AR-15 • 98's • O3's  
• All U.S. and Foreign Rifles & Pistols Repaired and much more!  
Full Mil-Spec Finishes Including: Parkerizing, Manganese Phosphate, Polymer, Teflon, Porcelainized Enamel and Bluing.  
**Premium AK Builds and Other Custom Builds Available!**  
**GUY SNELEN** • email: [guyamg@centurytel.net](mailto:guyamg@centurytel.net)  
Phone: 417.754.1097 • M-F 9AM-4PM CST

**RUGER MINI-14 RANCH SCOPE MOUNT**

The absolute best mount for the Ruger Mini-14 Ranch. Machined from solid bar stock & made in the USA.

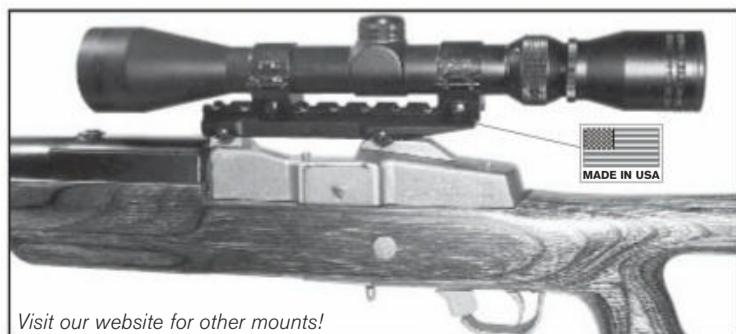

Visit our website for other mounts!

**S&K Scope Mounts**

70 Swede Hollow Rd - Sugar Grove, PA 16350, 800-578-9862  
Email: [comments@scopemounts.com](mailto:comments@scopemounts.com)

[www.scopemounts.com](http://www.scopemounts.com)

STACKIN' EM DEEP AND SELLIN' EM CHEAP

**CENTERFIRE SYSTEMS** since 1992

GIVE US A CALL! IN-HOUSE CUSTOMER SERVICE REPS 6 DAYS A WEEK!



**LOCK ORIGINAL FACTORY PARTS**  
**OEM Factory GLOCK** Very Good Condition, 40S&W Replacement Parts Kit \$339.99 #KIT-G22  
**GUNSMITH'S Garage**  
**1975 Original! Romanian AK 7.62x39mm Rifle Parts Kit** with Wood Furniture \$299.99 #KIT-AK33

**FEAR-HIG SEMI-AUTO AR STYLE 12GA SHOTGUN** Accepts ALL MKA-style Mags & Drums!  
Includes: (2) 5rd mags, (4) chokes + case #SG0116  
**\$399.99** compare to \$529.99

Be the First to get Special Offers & Exclusive Deals sent directly to you when you subscribe @ [centerfiresystems.com/t-subscribe.aspx](http://centerfiresystems.com/t-subscribe.aspx) It's fast, easy, and FREE!

**PPS43-C 7.62x25mm pistol** MADE IN POLAND  
★★★★★  
PPS43-C 7.62x25mm Pistol with (3) FREE! 35rd Mags includes (1) 35rd magazine #PPS43-PI5  
**\$419.99** compare to \$529.99  
PIONEER ARMS CORP. RADON, POLAND

**Bonus! Three for FREE!**

Over 100 aftermarket & factory Mags & Drums for Glock starting at \$9.99  
50rd 9MM Drum for GLOCK Pistols \$69.99 #DRUM0003  
AR-15 223 100rd Drum \$14.99ea  
Original - U.S. PALM AK30 30rd 7.62x39mm AK-47 TangoDown Polymer Magazine Date Stamped May 2015 #MAG0585 \$21.99 compare to \$39.99  
20 or 30 round AK-47 Magazines starting at \$9.99ea  
Over 100 AK-47 HiCap Mags & Drums to choose from  
75rd AK-47 Drum #DRUM0005 \$59.99  
40rd AK-47 Magazines #MAGAKA-KR40 \$14.99ea

**COLT Authentic Parts**  
Vietnam Issue Colt AR .223 M16A1 Parts Kit unmarked #KIT-AR-COLF-D \$249.99

★★★★★  
New Production Complete .45ACP  
**M1911A1 Pistol Parts Kit** \$349.99 #KIT-191101

**GEAR HUNTING TARGETS HOLSTERS FIREARMS MAGAZINES AMMUNITION OPTICS PARTS ACCESSORIES EAR&EYE PRO SURPLUS**  
M-F 9-6 Sat 9-2  
800-950-1231 & [CENTERFIRESYSTEMS.COM](http://CENTERFIRESYSTEMS.COM) and SO. MUCH. MORE...  
↑ 24

PRICES & AVAILABILITY SUBJECT TO CHANGE WITHOUT NOTICE



"An instance within the memory of some of this house will show us how our militia may be destroyed. Forty years ago, when the resolution of enslaving America was formed in Great Britain, the British Parliament was advised by an artful man, who was governor of Pennsylvania, to disarm the people; that it was the best and most effectual way to enslave them; but that they should not do it openly, but weaken them, and let them sink gradually, by totally disusing and neglecting the militia." George Mason at the Virginia Ratification Convention, June 14, 1788.

"A strong body makes the mind strong. As to the species of exercises, I advise the gun. While this gives moderate exercise to the body, it gives boldness, enterprise and independence to the mind. Let your gun, therefore, be the constant companion of your walks." Thomas Jefferson, 1785.

"The supposed quietude of a good man allures the ruffian; while on the other hand, arms like laws discourage and keep the invader and the plunderer in awe, and preserve order in the world as well as property." *1 Writings of Thomas Paine.*

"The supposed quietude of a good man allures the ruffian; while on the other hand, arms like laws discourage and keep the invader and the plunderer in awe, and preserve order in the world as well as property. The same balance would be preserved were all the world destitute of arms for all would be alike; but since some will not, others dare not lay them aside... Horrid mischief would ensue were one half the world deprived of the use of them... (T)he weak will become a prey to the strong." Thomas Paine, at 56 (1894).

# ADVERTISE WITH US

Published for more than 65 years, *Firearms News* (formerly *Shotgun News*) is the world's largest gun sales publication.

## FIREARMS NEWS

### FN 509 Tactical

THE PISTOL THAT MAKES YOU WANT TO OWN A 9mm!

Getting Quiet with SILENT LEGION 9mm Suppressors

CENTURY ARMS' Draco NAK9 AK-type Pistol in 9mm

PAT SWEENEY'S Luger Review & Test of Numrich's 32-Rd. Snail Drum

Swedish WWII Weapons PART 2

MOVIE GUN REVIEW *Escape From New York*

### THE ALL NEW "HELLFIRE RANCH™" RAPID FIRE TRIGGER SYSTEM FOR "NON-ASSAULT RIFLES". (PAT. PEND.)

### INTRODUCING THE "MAGNABRACE™" ADJUSTABLE INSTANT ON/OFF OR PERMANENT PISTOL ARM BRACE. (PAT. PENDING.)



**\$39.95**  
(plus S&H)

Snaps in place easily!

- Perfect for MINI-14, MINI-30, 10/22, and most Ranch Style Rifles with or without pistol grips.
- Goes ON and OFF in seconds.
- All Metal Construction.
- Allows for accurate aimed single shots, bursts, or emptying of magazines.
- Perfect for Varmints, Hog Shooting or Protection from any intrusion.
- Rapid Fire availability when you need it.
- ATF legal



**\$69.95**  
(plus S&H)

- Installs instantly via a super strong directional magnetic system with a 70 lb. pull strength.
- Can be permanently installed with 3m adhesive disc included that is as strong as a metal rivet.
- 3 position snap detent system for quick and positive adjustment.
- Mounts on AK pistols, Dracos, Macs, Uzi and a host of others.
- Adds accuracy and rapid fire controllability.
- Looks fabulous on the guns.
- Tough polymer metal construction with velcro arm strap.
- NFA legality card included.

**CALL (770) 249-2992 or go to ROCKINLOCK.COM or FIREQUEST.COM and watch the videos and get yours today!**

## AAO [www.aaomfg.com](http://www.aaomfg.com)

FOR MORE INFORMATION CALL US AT: (601) 514-0660



AR9 Dedicated Glock Magazine 80% lower with Last Round Bold Hold Open \$109.99



80% AR15 Lower - .223/5.56 - Mil-Spec \$38.50



AR9 Dedicated S&W M&P Magazine 80% lower with Last Round Bold Hold Open \$109.99



Mil-Spec Lower Parts Kits \$42.00

*We are a family owned and operated business that specializes in manufacturing innovative products for the 2A lifestyle.*

For dealers, auctioneers and private sellers, *Firearms News* —both in print and online — provides the best and most active consumers of guns and gun products anywhere.

**CONTACT US TO PLACE YOUR AD TODAY!**  
1.800.521.2885 Ext. 5064



## 12 GAUGE PISTOLS



Your LEGAL-TO-OWN answer for the modern sawed-off double barrel shotgun.



209 Primer IGNITION ML | No license or FFL required, order direct

Check out our entire product line at

**AMERICANGUNCRAFT.COM/products/**

Dealers-Distributors: Inquire about special resale programs

CONVERT YOUR

# GUNS TO CASH

Advertise in *Firearms News* to reach customers anywhere in the country.  
Call today! 1-800-521-2885, ext. 5064

STAY ON

# TARGET



SUBSCRIBE TODAY

FIREARMS NEWS is available on updated iPad/iPhone, most Android devices, and the Microsoft Store for Windows.

For More Information Visit

**FIREARMSNEWS.COM**

# RUBEN MENDIOLA

## DEALERNFA, INC. SINCE 1985

PO Box 566300, Miami, FL 33256-6300, 305-271-3436

**TOLL FREE: 866-NFA-WANT (866-632-9268), FAX: 866-415-7066,**  
**CELL: 786-256-6746 for pics or text, EMAIL: [Ruben@dealernfa.com](mailto:Ruben@dealernfa.com),**

**HOURS: 8am-9pm Eastern, 7 days a week**

## 100s OF MACHINE GUNS ON SALE!!

Colt M16, M16A1, M16A2, 614, AR15 conversions, DIAS, Auto Links, all types and configurations.  
HK MP5, MP5K-PDW, HK33, G3, HK51, HK21, Sear, Double Push Pin & Registered Receiver Guns.  
HK Registered Machine Guns Sear.

Thompsons, Colt 21 & 28, WWII Savage & Bridgeport M1 & M1928 & Commercial Guns, Reisings,  
M2 Carbines, M3 Grease Guns, FNC, Ruger 556, AK47, MP40, MP44, Stens MKII, S&W 76, MK760,  
M10 45ACP & 9mm, M11 9mm & .380.

Maremont and Rock Island M60 & M60E6. Belt Fed 1919A4, 1917A1, Browning M2HB .50 Cal,  
FightLite MCR060 Belt Fed Uppers for AR15 or M16 Platforms.

### Extremely Rare Museum Quality Very Early Presentation Colt 1918 BAR

Pre-May Sales Samples Available only to Dealers.

HK MP5, MP5K, HK33, HK53, Steyr AUGs, FN FAL, BAR, UZI Full Size & Mini, M3 Grease Guns,  
Thompson, Walther MPK & MPL, Beretta 93R LNIB & SC70, Restricted Post Sample: Glock 18

We are Always in the Market to Purchase Quality Machine Guns. We will never sell guns until they have been received and inspected. My staff and I welcome prospective clients to come and inspect the firearms they are interested in purchasing in our state of the art, high security facility. We are dedicated, full time dealers with a full-time staff. Every item we offer for sale is in stock and owned by us. We are not brokers, or a consignment store. We send every HK conversion to Terry Dyer for inspection and upgrade.

*Please visit our website for the full list of inventory specials.*



**WE PROVIDE THE BEST QUALITY GUNS ON THE MARKET.**

*A Dealer You Can Trust!*



**[www.dealernfa.com](http://www.dealernfa.com)**  
**ALWAYS PAYING TOP DOLLAR!**



# INDEX CLASSIFIEDS

## CLASSIFIED CATEGORIES

FIREARMS NEWS offers classified ads in more than 440 categories from airguns to Winchesters. Both for sale and wanted categories are available. You can find the classifications at [www.firearmsnews.com](http://www.firearmsnews.com). Or call (800) 521-2885, ext. 5064.

FIREARMS NEWS is published by Outdoor Sportsman Group®.

Some of the common classifications are:

- Colt M1911 Semiauto Variants For Sale ..... \$3300
- Fabrique Nationale (FN) For Sale ..... \$3620
- Heckler & Koch (H&K) For Sale ..... \$3780
- Military Arms For Sale..... \$4200
- Military Arms Wanted..... \$4201
- Military/Automatic Arms For Sale..... \$4220
- Military/Automatic Arms Wanted..... \$4221
- Remington Rifles For Sale..... \$4440
- SIG Handguns For Sale..... \$4640
- Taurus Handguns For Sale..... \$4840
- Winchester Rifles For Sale..... \$5080

### Accessories, Knives, & Gunsmithing Services

- Accessories For Sale..... \$5200
- Accessories Wanted..... \$5201
- Ammunition For Sale..... \$5220

- Ammunition Wanted..... \$5221
- Appraisal Services..... \$5260
- Archery For Sale..... \$5240
- Archery Wanted..... \$5241
- Aviation For Sale..... \$5250
- Antiques..... \$5270

#### b

- Barrels For Sale..... \$5280
- Barrels Wanted..... \$5281
- Binoculars & Spotting Scopes For Sale..... \$5300
- Binoculars & Spotting Scopes Wanted ..... \$5301
- Books & Magazines For Sale..... \$5320
- Books & Magazines Wanted..... \$5321

#### c

- Cartridge Collections For Sale ..... \$5340
- Cartridge Collections Wanted ..... \$5341
- Clips & Magazines For Sale..... \$5380
- Clips & Magazines Wanted..... \$5381
- Cowboy Action Accessories For Sale..... \$5390
- Cowboy Action Accessories Wanted..... \$5391
- Clubs & Organizations ..... \$5420

#### e

- Education & Home Study..... \$5440
- Engravers..... \$5460

#### g

- Gun Cleaning Supplies..... \$5475
- Lists, Consignments & Collections For Sale ..... \$5480
- Lists, Consignments & Collections Wanted ..... \$5481
- Gun Parts For Sale..... \$5500
- Gun Parts Wanted..... \$5501
- Gun Safes For Sale..... \$5520

- Gun Safes Wanted ..... \$5521
- Gun Shows ..... \$6150
- Gunsmith & Dealer Services ..... \$5540
- Gunsmith & Dealer Supplies ..... \$5560

#### h

- Holsters For Sale ..... \$5580
- Holsters Wanted ..... \$5581
- Hunting Guides ..... \$5600
- Hunting Supplies ..... \$5620

#### k

- Knives & Bayonets For Sale ..... \$5640
- Knives & Bayonets Wanted ..... \$5641

#### l

- Lost & Stolen..... \$5660

#### m

- Metallic Sights For Sale ..... \$5680
- Metallic Sights Wanted ..... \$5681
- Militaria For Sale ..... \$5700
- Militaria Wanted ..... \$5701
- Miscellaneous For Sale..... \$5720
- Miscellaneous Wanted ..... \$5721
- Muzzleloader Accessories For Sale..... \$5730
- Muzzleloader Accessories Wanted..... \$5731

#### p

- POR, Firearms & Miscellaneous..... \$5750
- Print, Stamps & Collectibles For Sale..... \$5760
- Print, Stamps & Collectibles Wanted..... \$5761

#### r

- Real Estate..... \$5770
- Reloading Components For Sale ..... \$5800
- Reloading Components Wanted ..... \$5801

- Reloading Equipment For Sale ..... \$5820
- Reloading Equipment Wanted ..... \$5821

#### s

- Sales & Auctions..... \$6120
- Scopes, Rings & Bases For Sale..... \$5840
- Scopes, Rings & Bases Wanted..... \$5841
- Scopes, Laser Sights For Sale..... \$5850
- Scopes, Laser Sights Wanted ..... \$5851
- Services ..... \$5852
- Shooting Events..... \$6140
- Stocks & Grips For Sale ..... \$5860
- Stocks & Grips Wanted ..... \$5861
- Surplus Gear For Sale..... \$5880
- Surplus Gear Wanted..... \$5881
- Swords For Sale..... \$5920
- Swords Wanted ..... \$5921

#### t

- Taxidermy Services..... \$5940
- Taxidermy Supplies..... \$5960
- Targets For Sale..... \$5980
- Triggers For Sale ..... \$5990
- Triggers Wanted ..... \$5991

#### v

- Videos For Sale..... \$6000
- Videos Wanted..... \$6001

**There are more than 400 other categories: check online or call to get them.**

Category \_\_\_\_\_ PRINT ONE WORD PER SPACE - TWO WORDS FREE

1	2	3	4	5	6
7	8	9	10	11	12
13	14	15	16	17	18
19	20	21	22	23	24
25	26	27	28	FREE	FREE

Please use additional sheet of paper for larger ads.

MAIL completed form to: Firearms News, Dept. CL, 2 News Plaza, 3rd Floor, Peoria, IL 61614  
or EMAIL ad and all information below to: [FirearmsNews@outdoorsg.com](mailto:FirearmsNews@outdoorsg.com)

### PLEASE INCLUDE FULL ADDRESS & PHONE NUMBER FOR OUR RECORDS

NAME \_\_\_\_\_  
 ADDRESS \_\_\_\_\_  
 CITY \_\_\_\_\_ STATE \_\_\_\_\_ ZIP \_\_\_\_\_  
 DAYTIME PHONE \_\_\_\_\_  
 METHOD OF PAYMENT:  Check/Money Order Enclosed  MC  VISA  AMEX  DISCOVER  
 CARD # \_\_\_\_\_ Exp. Date \_\_\_\_\_  
 SIGNATURE \_\_\_\_\_

START DATE: \_\_\_\_\_

_____ X 8pt plain @ 40¢	=	_____
_____ X 8pt bold @ 80¢	=	_____
_____ X 10pt bold @ \$1.00	=	_____
_____ X 10pt bold caps @ \$1.60	=	_____
_____ X 12pt bold @ \$1.80	=	_____
_____ X 12pt bold caps @ \$2.20	=	_____
	X	_____ # of issue(s)
<b>MINIMUM: \$4.00</b>	\$	<b>Total Due</b>

Continue running until notified & charge credit card monthly





# SHOOT THE DISTANCE

## HAWKEYE LONG-RANGE TARGET RIFLE



### Hawkeye Long-Range Target

#47199 6.5 Creedmoor 10+1 26" Barrel

Our latest Exclusive with Ruger is the Hawkeye Long-Range Target rifle chambered in 6.5 Creedmoor!

- Speckled Black on Gray Target stock
- Features a non-rotating, Mauser-type controlled round feed extractor
- 20 MOA picatinny rail secured with four #8-40 screws
- Heavy-contour target barrel with Ruger Precision Rifle Hybrid Muzzle Brake
- Free-floated, cold hammer-forged stainless steel barrel with 5R rifling
- Rugged, one-piece, stainless steel bolt
- Two-tone target stock features a two-way adjustable comb, adjustable length of pull
- QD attachment points and flush-mounted lower M-LOK rail
- Ships with one AI-style magazine

► NO HIDDEN FEES OR TRANSFER FEES!

GET YOURS TODAY AT [GALLERYOFGUNS.COM](http://GALLERYOFGUNS.COM)!

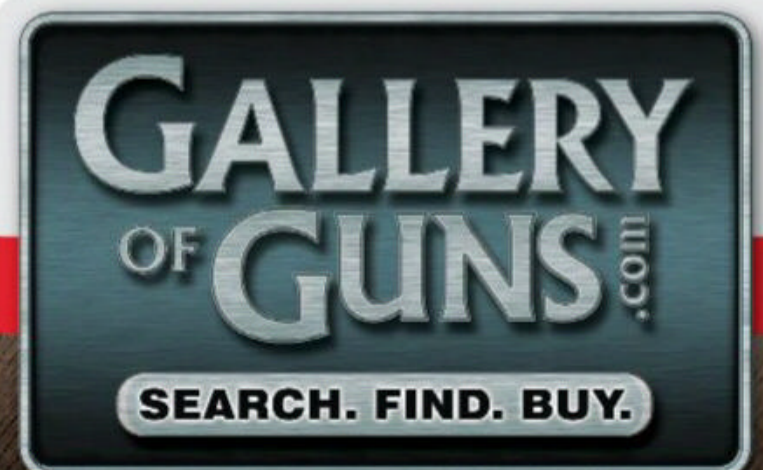

It's simple. If anything ever goes wrong with any new gun you buy with the Davidson's Guaranteed® Lifetime Replacement Program during the time you own the gun, it will be replaced with a brand new gun. Visit [GalleryofGuns.com](http://GalleryofGuns.com) for details.

©2020 Davidson's, Inc. All Rights Reserved.