

WARHAMMER

PERILOUS QUEST



GAMES[®]
WORKSHOP

WARHAMMER

PERILOUS QUEST™

By NIGEL STILLMAN

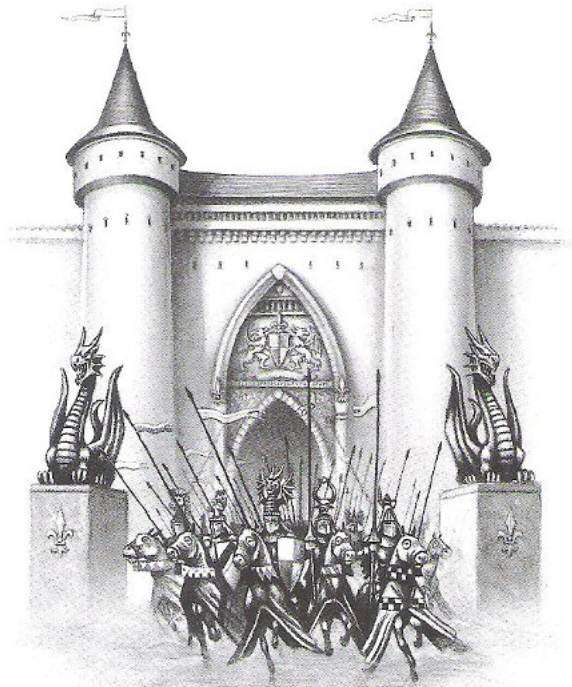

Cover Art by David Gallagher

Art by John Blanche, Wayne England, David Gallagher,
Des Hanley, Toby Hynes, Mark Gibbons, Paul Smith, John Wigley.

PRODUCED BY GAMES WORKSHOP

Games Workshop and the Games Workshop logo, Citadel and the Citadel castle, Slottabase and Warhammer are all registered trademarks of Games Workshop Ltd. Ariel, Bretonnia, Glade Guard, Glade Rider, Grail Knight, Knight Errant, Knights of the Realm, Orion, Questing Knight, the Old World, Wardancer, Waywatcher and White Lion are trademarks of Games Workshop Ltd.

*Scatter dice are UK registered design no. 2017484

All artwork in all Games Workshop products and the images contained therein have been produced either in-house or as work for hire. The exclusive copyright on the artwork and the images it depicts is the property of Games Workshop Ltd.

© Copyright Games Workshop Ltd, 1997. All rights reserved.

GAMES WORKSHOP®

UK
GAMES WORKSHOP LTD.
WILLOW ROAD,
LENTON,
NOTTINGHAM NG7 2WS

US
GAMES WORKSHOP INC.
6721 BAYMEADOW DRIVE,
GLEN BURNIE,
MARYLAND, 21060 - 6401

HONG KONG
GAMES WORKSHOP
2002-2006,
HORIZON PLAZA,
LEE WING STREET,
AP LEI CHAU

AUSTRALIA
GAMES WORKSHOP,
23 LIVERPOOL ST,
INGLEBURN,
NSW 2565

CANADA
GAMES WORKSHOP,
1845 BONHILL RD,
UNITS 9-11, MISSISSAUGA,
TORONTO L5T 1R3

PRODUCT CODE: 60 02 02 99 002

PART NUMBER: 60 31 02 99 003

CONTENTS

WARHAMMER CAMPAIGN 2
BRETONNIANS & WOOD ELVES 2
CHOOSING FORCES 2
ROSTER SHEETS 2
SPECIAL CHARACTERS 2

THE PERILOUS QUEST 3
TROUBADOURS' TALES 3
THE BARON'S SHIELD 4
"BRING ME THE HEAD OF DROGO LE MAL!" 4
THE DEMANDS OF HONOUR 5
CAMPAIGN MAP 6
BEAU QUEST 7



SCENARIO I

THE TOURNEY 8
THE TOURNEY AT QUENELLES 8
ENTER THE WOOD ELVES 8
DEATH BEFORE DISHONOUR 9
FIGHTING THE TOURNEY 9

SCENARIO II

THE BATTLE OF THE TENTS 11
ELF TREACHERY 11
SCENARIO MAP 11
FIGHTING THE BATTLE 12

SCENARIO III

THE PERILOUS PILGRIMAGE 14
THE PRICE OF HONOUR 14
THE LADY OF CHALLOTTE 14
PERILOUS PILGRIMAGE 14
LURKERS IN THE GLADE 15
FIGHTING THE BATTLE 15
SCENARIO MAP 16

SCENARIO IV

BATTLE OF THE TREE OF SHIELDS 17
AGRAVAIN'S QUEST 17
COUNCIL OF WAR 17
AGRAVAIN'S DREAM 18
THE TREE OF SHIELDS 18
FIGHTING THE BATTLE 19
SCENARIO MAP 19

APPENDIX I: THE CHANSON DE CHALLOTTE

TOURNEY AT QUENELLES 21
Brettonnians 22
Wood Elves 22

BATTLE OF THE TENTS 23
Brettonnians 23
Wood Elves 24

THE PERILOUS PILGRIMAGE 24
Brettonnians 25
Wood Elves 26

THE BATTLE OF THE TREE OF SHIELDS 26
Brettonnians 28
Wood Elves 29

BRETONNIAN TOURNEYS

THE FIELDS OF BRETONNIA 30
THE JOUST & THE TABLEAUX DE BATAILLE 30
HERALDS' RULES & TOURNEY ROLLS 31
CREATING A JOUSTING TEAM 31
KNIGHTLY VIRTUES 32
THE LADY'S FAVOUR 33
THE JOUST 33
JOUSTING PLOYS 34
THE TABLEAUX DE BATAILLE 35
THE BLACK KNIGHT 36
CHALLENGING THE BLACK KNIGHT 36
KNIGHTLY VIRTUES 36
TOURNEY PRIZES 36
TOURNEY ROLL 38

CARD BUILDING ASSEMBLY INSTRUCTIONS 40



WARHAMMER CAMPAIGN

Perilous Quest is one of a series of Warhammer Campaign supplements. Each campaign presents a number of encounters between two rival forces, culminating in a decisive battle to determine the winner.

BRETONNIANS AND WOOD ELVES

This supplement describes the adventures of a Questing Knight named Agravain de Beau Quest. He is the hero of a famous Bretonnian troubadour ballad which tells how his quest to rescue La Damoselle de Challotte who appeared to him in a vision, gathered momentum into a small Errantry war against the Wood Elves!

Each Warhammer Campaign supplement is designed around two rival forces, but with the chief emphasis on one army in particular. *Perilous Quest*, as its title suggests, is based around Bretonnians, and will prove a useful supplement for any Bretonnian player. Not only does it include rules for fighting the campaign, but it also includes special rules for Bretonnian jousting tournaments, and a set of card buildings for a Bretonnian encampment and reliquary wagon which will be equally useful in future battles.



Perilous Quest and other supplements in this series are created for players who already have suitable armies. The games are designed so that players who have typical 3,000 point armies should be able to field appropriate troops without purchasing vast numbers of new miniatures. Players who wish to increase their armies by adding a few units or characters especially for the campaign can take the opportunity of so doing.

CHOOSING FORCES

You do not need specific units to fight the campaign. Instead you are allowed to choose forces of an appropriate points value for each battle.

There are some extra restrictions that apply to the choices from your Warhammer Armies list, and in some cases you are allowed more units of a certain type than normally. This is because the Warhammer Armies lists are designed to be generally representative of the armies covered. The campaign armies, on the other hand, are based on specific conflicts.

We have allowed a degree of choice so that players can fight the games with the armies they already have, as well as allowing players to use a bit of cunning to outwit their enemy. The choices permitted though are still consistent with the descriptions of the battles.

To choose your army refer to the relevant Battle Scroll for the battle and your Warhammer Armies book. The Battle Scrolls describe which troops you may choose, whilst the Warhammer Armies books describe their equipment, options and points values. The Battle Scrolls also indicate where magic items are allowed and usually place a separate limit on the maximum points values of permitted magic items.

Note that magic items can only be included as described on the Battle Scroll. This includes magic standards for standard bearers as well as magic items for characters. For players interested in such things we've included a separate list of the forces that fought these battles – these were the forces used by Rick Priestley (Wood Elves) and Nigel Stillman (Bretonnians) when the campaign was fought for the first time.

Each game in the campaign was fought several times and different forces were chosen on each occasion, gradually improving the selection as we got to grips with the objectives of the battle. See Appendix I *The Chanson de Challotte* for our example armies.

ROSTER SHEETS

A pad of roster sheets are included. As you choose your army for each battle, write down the details on the roster sheet so that you can refer to it during the game. You'll find this is more convenient than constantly looking up details in the Armies books.

SPECIAL CHARACTERS

This campaign features a number of special characters for both the Bretonnian and Wood Elf armies. You'll find details and rules for these characters on the Battle Scrolls. They can be represented by any suitable models from the Citadel Miniatures range – whether you wish to purchase and paint new characters for the campaign, or simply use an existing model that fits the description is entirely up to you.



The characters described in *Perilous Quest* are compatible with Bretonnian and Wood Elf armies, and can be used as special characters if you wish. These special characters should only be used with prior agreement by your opponents. Of course any characters prepared for the campaign can be fielded as basic heroes or wizards in your other battles.

THE PERILOUS QUEST

Perilous Quest is based upon the famous Bretonnian troubadour ballad 'La Chanson de Cballotte' adapted by the minstrel Blondel from the earlier Bretonnian chanson 'La Damoselle de Cballotte'.

TROUBADOURS' TALES

Night fell over the Domain de Beaumarchais. A roaring fire lit up the great hall of the castle keep. The travelling troubadour had just finished his song *La Damoselle de Cballotte*, a tale of Bretonnian faith and honour and Wood Elf treachery, and was now tucking into his reward, the best venison and a flagon of good wine.



"I am not afraid of them!" Agravain protested. "If only the King would lift the ban and declare an Errantry war, the forest would make a fine addition to his realm! There are many young Knights looking for land these days. None of them fear anything, and neither do I!"

"What nonsense!" said their mother, the Baroness de Beaumarchais, as she entered the hall. The veils of her tall head-dress wafted elegantly behind her as she sat by the fire to continue her tapestry. "Impetuous youth! I don't want to see you going off on some Errantry war! It's bad enough with your father gone, and he is honour bound to serve the King. Your time will come soon enough, and when it does, for your sake, I hope it is only the Orcs you have to face!"

Agravain, now old enough to bear arms as a Knight Errant, had been left in charge of his father's castle instead of going to war with him as a squire. Sometimes he felt angry at being left behind, but he understood the trust invested in him: to hold and defend his father's domain and protect his sister, mother and all the folk of the village. So he was not at all stung by his mother's rebuke, which in any case was kindly spoken. He knew how she waited anxiously for the Baron's return. As indeed, they all did.

"Are not the King and Queen in the Wood allies of the King of Bretonnia?" asked the Lady Isabelle.

"Yes and no," said her brother Agravain thoughtfully.

"Yes and no, no and yes, yes, no, maybe sometimes, never!" interrupted the jester, brandishing a puppet on a stick in front of Agravain's face.

"Shut up and go away, fool!" snapped the irritated Agravain.

"Do not be nasty to poor Jasper, Agravain! He is the only thing that brings a smile to mother's face now that father is away at war!" said Isabelle. "And you haven't answered my question properly."

Her brother continued, "The fairy folk in the Forest of Loren are loyal to no one but themselves. I have heard of many Knights that have gone on a quest or errand there and never been seen again! Despite this, our King still honours the ancient pledge to respect the fairy realm. As for the fairy folk, the legends say that they helped us of old, but any fool can see that they did it because our enemies were also their enemies!"

"I have another question," said Isabelle. "The Queen in the Wood, is she the Lady of the Lake?"

"Do you not pay attention to anything at the grail chapel?"

"Is she the Fay Enchantress?" asked Isabelle, mischievously baiting her brother.

"Sister, your ignorance amazes me!"

"What is she then, brother, since you know everything!"

"She is called 'La Belle Dame Sans Merci' because she is a fairy who lures valiant Knights to their doom in the forest."

"I take it, brother, that you are afraid of the fairy folk!"

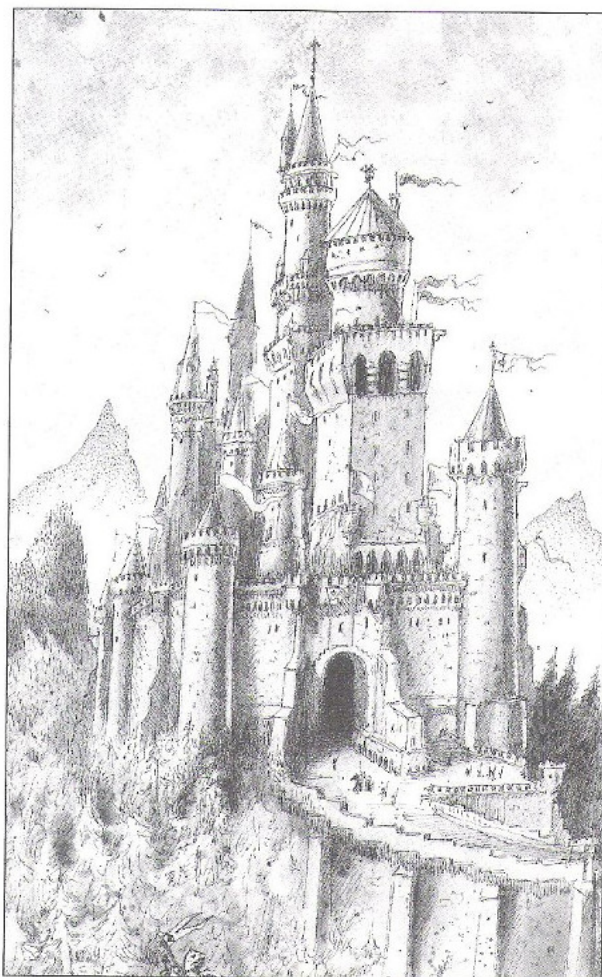

THE BARON'S SHIELD

News travels slowly along the muddy roads of Bretonnia. The Baron had ridden off to war with twenty men in the spring. Now the harvest had been safely brought in. One day, three men rode into the village. They were all that remained of the Baron's retinue of Mounted Squires. The drawbridge was lowered and the Baron's family hurried down into the courtyard to meet them. They were all but dead in the saddle with fatigue and wounds. The Baron was not among them, but one of the Squires was bearing the Baron's battered shield.

"Where is my husband!" cried the Baroness.

The Squires were downcast. "Alas, our Lady, he has fallen in battle!"



The Baroness and her family received the shock of this woeful news with all the dignity that becomes true Bretonnian nobility. The weeping would be reserved for later, not in front of the commoners.

"Why have you returned and not him!" asked the Baroness, accusingly.

"Enough mother!" interrupted Agravaïn. "Do not question the valour of these brave men."

The Squire continued, his voice hoarse with the effort. "We have brought back his shield, my lady. The Baron de Beaumarchais fell with honour, accomplishing a great feat of arms. It was his valour that won us a famous

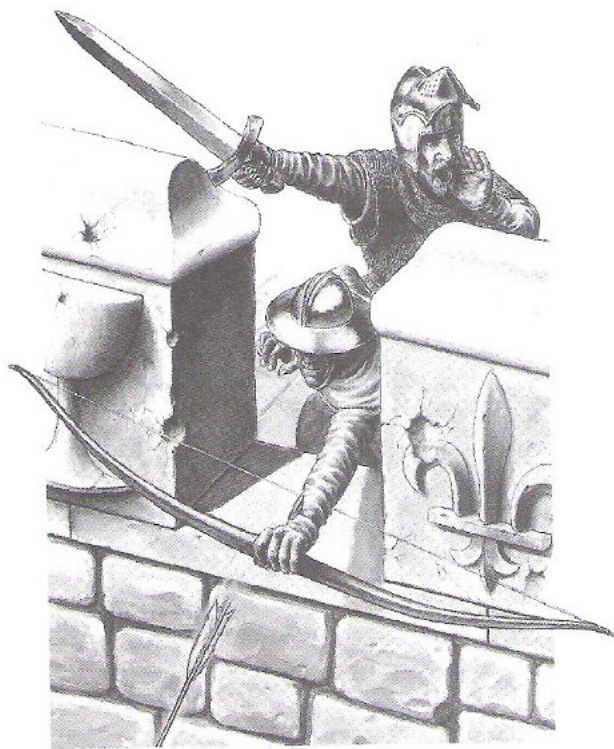

victory as he led the charge into the hordes of Skaven and hurled them back into the sea. But in their spite the enemy struck back with evil spells and dishonourable devices! We were assailed with fire, flame and foul vapours, and of all the retinue we alone survived. We scoured the battlefield madam, but all we could find was his shield."



Then the Baroness spoke. "The shield is a sacred relic from the grail chapel. Alas! I thought it might save my husband from such a cruel fate. Even so, since it is all that is left of him, I shall be buried with it!" Having said this she took the shield and went back into the great keep of the castle. Two days later, the Baroness died. It was said she died of grief and was laid to rest in the grail chapel, beneath her husband's shield.

"BRING ME THE HEAD OF DROGO LE MAL!"

The first frost came. Soon afterwards, Orcs were sighted on the margins of the outlying fields. Agravaïn and Isabelle were warming themselves before the fire in the great hall when old Jules, the Baron's reeve approached.

"There is a matter which I must discuss with you both. It is time to decide the future of the domain and you, my lady, must declare the errand of chivalry and offer the domain to whosoever proves himself worthy of it."

"Whosoever?" repeated Agravaïn, puzzled.

"Yes," said Jules. "There will be another Knight Errant present. Some of the peasants have persuaded Jacques to take up the task. I have arranged for your sister to go before the village and set the task tomorrow afternoon. Orcs have been seen once again so we cannot delay this matter any longer!"

"Why does he dare compete with me, for my own father's lands! Has he no respect?"

"Do not be angry with him, brother," said Isabelle. "He is a good man, I can see why the peasants chose him." Anyway, in the end the Lady of the Lake will decide between you."

Agravaïn was an observant young man. He had seen the way that his sister often smiled at the handsome young shepherd, Jacques, who had already slain several Orcs in defence of his flock. "It was not just the peasants who persuaded Jacques, was it Isabelle?"

Agravaïn's sister blushed. "Much as I desire to see you inherit our father's lands, I do not want to spend my life as a damsel in the grail chapel while the fairest wench in the village sits beside you as Baroness. I want a brave husband! What happens if you do not return from the task, Agravaïn? This way, whoever returns, our father's land shall remain in our blood line, either through you or through me if I marry Jacques. As I said, dear Agravaïn, let the Lady decide!"

The following afternoon two Knights Errant sat mounted upon their warhorses before the castle gatehouse. Agravain was convinced that his mischievous sister would send him on an errand into the Forest of Loren, perhaps never to return again. As they waited for the Lady Isabelle to appear on the ramparts to announce the task, Jacques turned to Agravain. "If only one of us is destined to return, Agravain, then I pray by the Lady that it be you." This brought a great cheer from the peasants and not a few tears from some of the peasant girls.

"Spoken like a true Bretonnian!" replied Agravain, who had enough nobility to know in his heart that Jacques was equally worthy to become lord of his father's domain. "Likewise, Jacques, may I only succeed if you have already fallen!" This raised more cheers and tears from the assembled villagers.

Then a trumpet sounded and the Lady Isabelle appeared, looking radiant, even though she had spent the entire night praying in the grail chapel seeking inspiration for the task she was to set the two fine young men. "I have decided, as is fair and fitting, to set you the same task, so that you will both face equal peril." announced the Lady Isabelle. "Whosoever is first to achieve his errand will become lord of the Domain de Beaumarchais. The task is this..." The assembled crowd hushed, "...bring me the head of Drogo Le Mal!"



The peasant throng erupted into a loud cheer, whilst the womenfolk burst into tears once again, as did the Lady Isabelle as she quickly withdrew into the castle.

It was a very traditional errand of Knighthood. Drogo Le Mal was a persistent scourge on Beaumarchais and the neighbouring domains; a fearsome Dragon who swooped over the fields and plucked ploughmen and milkmaids from their work to feed his ravenous appetite. Knights Errant from neighbouring domains had attempted this task many times before, but the Dragon was still alive and they were not.

Agravain breathed a quiet sigh of relief. Only a Dragon! So he was not destined to vanish forever in the mysterious Forest of Loren like so many before him. At least not yet!

THE DEMANDS OF HONOUR

Later that day the two Knights Errant set out. Soon they reached the fork in the road that led from Beaumarchais to the neighbouring villages. "We must not delay," said Agravain. "Isabelle is all alone, this task must be accomplished urgently!"

"I will not delay!" replied Jacques as he spurred his horse on towards the path that led to Dinan. Agravain took the road towards Payens and Bellay.

As Agravain rode through the villages of Payens and Bellay he questioned the peasants working in their



fields. At Payens he was given hospitality at the castle. At Bellay, he slept in the forest under his shield because the domain was deserted. On the third day, Agravain turned towards Dinan. There, he discovered that the locals had recently been victims of Drogo Le Mal. They pointed to some distant crags, indicating where the Dragon had flown. The crags were within the wild heath that surrounded the mysterious Forest of Loren, beyond the fairy stones which no man may pass. That was why no one had tracked Drogo to his lair before, at least no one who had ever returned!

The peasants said that they had seen another Knight riding in the same direction only a day before, but they had not seen him ride back again. Hearing this, Agravain made haste towards the crags. Soon they were looming before him, rising out of a thick, clammy mist which covered the hillside. Agravain heard a horse neigh somewhere ahead of him. He spurred on his own steed and soon found himself before the gaping mouth of a huge cave. There was a great mass of bones scattered around the mouth of the cave, and the air was heavy with the stench of rotting carcasses. Standing a little way ahead, and waiting in front of the cave was Jacques. "It will be dark soon and Drogo will return. Since you are here Agravain, I give you the honour of the first strike."

"No Jacques, you will have that honour."

"But Agravain, I insist! I give you the first strike, and with it the chance to win your father's lands!"

"No, upon my honour, Jacques, I insist! You were here first, it is your right to strike the first blow!"

"Since we cannot agree, let us both strike when we wish, and whoever strikes the mortal blow shall claim victory in this feat of arms."

"Accepted! Let the Lady decide between us!" agreed Agravain.



AGRAVAIN'S QUEST ON THE BORDERS OF ATHEL LOREN

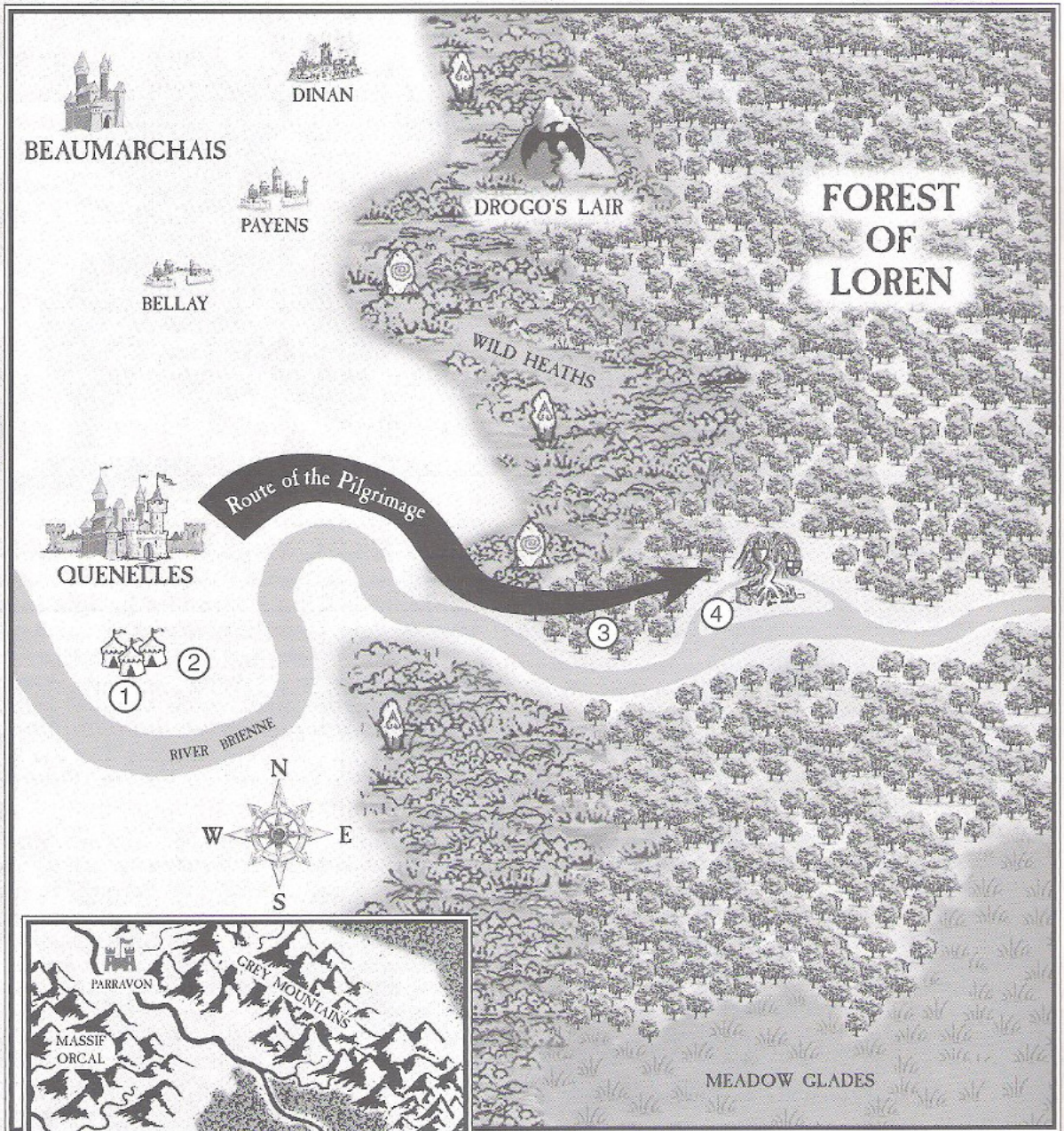

- ① *The Great tourney at Quenelles; first prize being the Chalice of Chanterelle.*
- ② *Battle of the Tents; Athelwyn orders the theft of the tourney prizes.*
- ③ *The Perilous Pilgrimage; Wood Elves ambush pilgrims entering their glades.*
- ④ *Battle of the Tree of Shields; the final clash between Agravain's Knights and the forces of the Wood Elves.*

At that moment there came the deafening roar of the Dragon as it approached. The warhorses began to shy away in fear as Drogo suddenly descended out of the mist and landed directly in front of them. Both Knights levelled their lances, shouted the war cry of Bretonnia and charged.

The Dragon was taken completely by surprise, and just as Drogo opened his great jaws to unleash his fiery breath Agravain thrust his lance deep into its gullet. The lance snapped clean in two as the monster reeled up, mortally wounded. At the same time, Jacques plunged his lance through the beast's heart.

The great carcass tumbled down the craggy hillside. Agravain and Jacques watched as they recovered their breath. Jacques was the one who spoke first.

"Truly Agravain, you struck the mortal blow!"

"No Jacques, it was you who pierced the monster's heart. It is you who inflicted the mortal wound!" Agravain protested.

"I will swear that it was you who struck the mortal blow!" Jacques argued.

"And I will swear that it was you!" replied Agravain.

"If we cannot decide now, we shall have to fight each other in mortal combat when we return to Beaumarchais."

"Indeed we shall!" said Agravain.

BEAU QUEST

The jubilant peasants of Dinan provided a wagon and its driver to carry the head of Drogo Le Mal back to Beaumarchais. Isabelle appeared on the ramparts as soon as they arrived.

"Behold the head of Drogo Le Mal," declared Agravain.

"I give thanks to the Lady of the Lake that you are both alive and well. It is more than I could have hoped for! Now answer me truthfully brother, which of you slew the Dragon?"

"It was Jacques who struck the mortal blow," came Agravain's reply.

"No! I swear it was Agravain who struck the mortal blow!" insisted Jacques.

"Honour demands that we decide this by mortal combat." Agravain called out to the assembling crowd. "Let the Lady of the Lake decide!"

"This lady will decide!" said Isabelle, angrily. "You will not fight each other to the death! It is my right to declare both of you worthy Knights; and this I do!"

"Then who shall be lord of Beaumarchais?" asked Agravain.

"By the Lady of the Lake, that is also my right to decide. I give my hand to Jacques!" Both Agravain and Jacques knew that by accepting the errand they had bound themselves by the strict code of Bretonnian chivalry to accept her decision. There was nothing else to be said and no more to be done than for Agravain to swear fealty to his new brother in law, Jacques, the Baron de Beaumarchais.

He swore to serve him as a Knight Errant until he was granted land of his own, either by the Baron or by the King. The reply of Jacques de Beaumarchais came as a total surprise. "I release you from this obligation, Agravain! You are free to ride to Couronne and serve the King. He is sure to reward such a valiant Knight as you with a worthy domain!"

"No!" replied Agravain. "It is clear what I must do. I hereby declare myself pledged to the grail quest. I swear devotion to the Lady of the Lake. Unto death will I serve her and her alone. Wherever she bids me go, I shall go!"

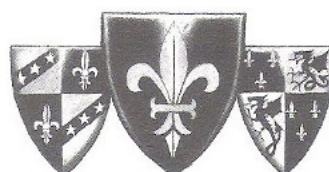

This stunning declaration was met with an enormous cheer from the villagers. Everyone knew that such a vow would bring the good favour of the Lady of the Lake to Beaumarchais. The sun would shine, the crops would grow! Isabelle wept with admiration for her brother and not without a little sorrow for she knew what this vow would mean for him. "Beau Quest!" she declared. "That is the title I shall bestow upon you! Agravain de Beau Quest, you bring honour and blessings upon us all!"

All that remained was for Jacques and Agravain to be properly invested as Knights by Lady Isabelle at the grail chapel. This was followed by the festivities of Isabelle and Jacques' wedding. Agravain spent that night in silent vigil at the grail chapel seeking inspiration for his quest. In his dreams he saw the dim vision of a beautiful lady with a look of sorrowful despair on her lovely face, casting a magnificent golden chalice into a deep river.



THE TOURNEY

Several verses of the Chanson de Chailotte tell of the great tourney of Quenelles in which Agravain and the pride of Bretonnian chivalry jousted with the arrogant Princes of Athel Loren. The prize of the tourney was the Chalice of Chanterelle, the fabled Lady of Chailotte's goblet.

THE TOURNEY AT QUENELLES

Agravain emerged from the grail chapel at Beaumarchais and made ready to leave his ancestral home. He donned the surcoat his sister had sewn for him, bearing the colours of Beaumarchais and the fleur de lys emblem of a Questing Knight. He had forsworn to bear the blazon of a Dragon, which Jacques had chosen for his own coat of arms.

"Where shall you go?" asked Isabelle as she bade farewell to her brother.

"I shall attend the tourney at Quenelles," replied Agravain, revealing nothing of his mysterious vision.

As he left the village, Agravain encountered Blondel the troubadour and Jasper the jester. They begged him to let them accompany him on the quest as his retainers. Agravain finally agreed on the condition that Blondel would compose a chanson to record his feats of arms and that Jasper refrained from cracking jokes and content himself with looking after Agravain's warhorse. Jasper's final joke was to name himself Jasper de Mal Jeste!



Quenelles was only a few days ride to the south east, but Agravain had never been there before. As he rode through the great gate into the bustling streets, he encountered the first great test of his quest: resisting the temptations of Quenelles!



The city was in a state of great festivity as a magnificent tourney was about to begin. Knights had come from the far corners of the dukedom and beyond to attend, among them were Knights Errant who had come to win their spurs on the jousting field, and other Questing Knights like Agravain, perhaps drawn by the mysterious will of the Lady of the Lake.

The prize of the tourney was to be an ancient chalice, unsurpassed in craftsmanship. Local fishermen had taken the relic from the river Brienne almost within the bounds of the Forest of Loren. Some believed that it had been made by the Elves of old, in the days when a splendid Elven city flourished beside the great river, the ruins of which were buried beneath the winding and squalid streets of Quenelles. Some naive and credulous people even believed that it was none other than the fabled healing chalice of Chanterelle, the revered Lady of Chailotte.

Agravain gazed at the chalice which was on display in the prize pavilion. It looked strangely familiar, like something he had seen in a dream. Was it now clear that the Lady of the Lake intended him to win this chalice in order to pursue his quest? Maybe this chalice was the holy grail itself? Other Questing Knights taking part in the tourney doubtless had the same idea.

ENTER THE WOOD ELVES

On the eve of the tourney, there was a great commotion in Quenelles. The cause of this was a retinue of Elven Princes from the realm of Athel Loren who had ridden into the city to enter the tourney. Such a thing was only ever heard of in legends and no one could remember it ever happening in their own lifetime.

Agravain listened with great interest to the rumours and gossip concerning the Wood Elves. It was said that they belonged to the Kindred of the Willows and claimed that the chalice and other prizes rightfully belonged to their kindred since they had been found within the bounds of Athel Loren. Whether or not this was true did not make any difference in Bretonnian eyes. There were many relics scattered throughout Bretonnia. Most were, in all probability, either of Elvish or Dwarfish workmanship and the Bretonnians were used to seeing off dubious Elf and Dwarf adventurers hunting for their ancestral heirlooms. The custom was to settle such disputes by

honourable combat. Such a chalice was thus a worthy prize for the climax of the tourney. Let it be won by whosoever could prove himself worthy of it by valour and feat of arms! If the Elves wanted it so much then it was fitting that they should battle for it according to the rules of chivalry. This, it seemed, was what the Elves intended to do.

DEATH BEFORE DISHONOUR

Next day, before the tourney began, the heralds announced that the Duke of Quenelles had accepted the challenge from the Elven Princes and changed the traditional rules of the tourney accordingly. Instead of the usual jousting contest followed by a tableaux de bataille, where contenders attempt to unhorse the Duke's anonymous champion, the Black Knight, there would be a straight contest between Bretonnian and Wood Elf chivalry. The chalice would be won by the side that had the most riders still upright in the saddle at the end of the tourney. If the Bretonnians won, the chalice would be donated to the grail chapel of Quenelles. If the Elven Princes won, they could take the chalice and all the other prizes back to Athel Loren. Agravain, to his surprise, was nominated by the heralds for the Bretonnian team. Indeed his name headed the list, since word of his valour and nobility had reached the Duke.

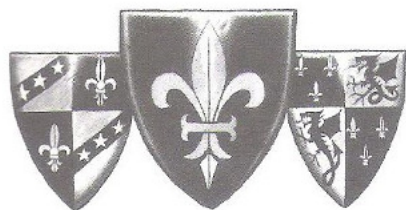

Just before the start of the joust, the herald of the Wood Elf retinue rode onto the tourney field and made a declaration before the assembled dignitaries and peasants who had flocked in from the surrounding countryside. He announced that the Elf Princes were pledged to fight to the death and dared the Bretonnians to do likewise. Of course, the Bretonnian Knights were not going to refuse such a challenge. Honour forbade it! Presiding over the tourney were the Duke and his beautiful daughter La Belle Melisande. Feeling deeply distressed for the young Bretonnian Knights she felt honour bound to offer her favour to each of them in the hope it would bring luck and strengthen their faith.

As each Bretonnian Knight rode past the rostrum he lowered his lance and the fair Melisande attached to it an item of her apparel. Last to ride past was Agravain, by which time the lady had already given up several items of clothing and was starting to blush. To spare the noble lady the ribaldry of the assembled rude and uncouth peasantry, the gallant Agravain declined to beg a favour.

"Upon my honour, you shall have a favour!" said the noble Melisande, drawing her stiletto from her last remaining garter and cutting a tress of her hair for Agravain to tie to his helm. This brought a great cheer from the crowd. Then both teams of contenders took up their positions facing each other across the jousting field as the Lady Melisande drew lots to decide the pairs of opponents in the joust.

FIGHTING THE TOURNEY

The Tourney is a jousting tournament and the first in a series of clashes between the Bretonnians and Wood Elves. The outcome will decide which of the Knights competing will survive to accompany Agravain on his quest, and which of the Elven Princes survive to oppose them.

THE TOURNEY FIELD

The setting for the event is the renowned tourney field of Quenelles, which is located outside the walls of the city beside the river Brienne. The field is represented by the gaming table. Along one side of the field is the great rostrum. Here the Duke of Quenelles, his daughter, the fair Melisande, and all the noble ladies of Quenelles sit to watch the jousting. On either side of the rostrum and on the opposite side of the field are the stalls where the prosperous townsfolk and rude peasantry push and shove each other for a good view of the jousting field.

The middle of the field is divided by a long hoarding. A pair of contesting Knights start at either end of this hoarding, and on opposite sides of it. They then charge, pointing their lances over it to strike each other. The hoarding prevents the horses from colliding with each other as it is considered dishonourable to strike a horse in a joust.

THE JOUSTING TEAMS

The tourney is a contest between an equal number of Bretonnian and Wood Elf Knights. There is no need to work out the points values of the teams, just choose the characters. Each player refers to the Battle Scroll for his side in order to choose his jousting team for the tourney.



SPECIAL JOUSTING RULES

The joust is a special game based on the Warhammer rules. The full rules for Bretonnian tourneys are given on page 30. The game is a knockout contest played as a series of single combats between a Bretonnian Knight and a Wood Elf Prince.

CHOOSING PAIRS OF CONTENDERS

Write the name of each contender on a separate scrap of paper and put all the names for each team in a different cup. At the start of each joust, select which two opponents will fight each other by taking a random pair of names from the cups. At the end of each joust, the names of the unhorsed contenders are discarded. The names of winning contenders are put to one side in order to determine which side wins by having the most characters left.

THE JOUSTING TURN

The joust lasts for as many turns as it takes for one contender to be unhorsed. At the start of each turn, each contender in the pair stands facing each other 12" apart at either end of the tourney field and on opposite sides of the hoarding. Each contender presents his shielded side to his opponent.

CHOOSE JOUSTING PLOY

At the start of each turn, before the contenders charge, each player secretly chooses one jousting ploy. When both players have chosen their ploys they are revealed simultaneously and the contenders charge.

CHARGE

Both contenders charge simultaneously at full gallop. The normal bonuses for charging and using lances are counted for both sides. The choice of jousting ploy determines whether or not a contender strikes first or last unless a magic item or favour allows an automatic first strike. Otherwise, if both opt for the same ploy, highest initiative strikes first. If initiative is equal, roll to see who strikes first. Each contender only strikes once with one attack. A Hero's other attacks are disregarded.

MOUNTS

Mounts do not fight as they are separated by the hoarding, so ignore their attacks. Not only are they prevented from fighting, but the contenders gain no benefit to their save for the mount or its barding, reducing their saving throws by -2. So Bretonnian Heroes have a save of 4+ and Wood Elf Heroes have a save of 5+.

WOUNDS

If a contender suffers a wound, roll a D6 to see if he is unhorsed. On a score of 1, 2 or 3 he is unhorsed and suffers a second wound as he falls from the saddle at full gallop. A contender is automatically unhorsed on sustaining a second wound. An unhorsed contender is assumed to be mortally wounded, and is automatically knocked out of the tourney. Otherwise contenders who win their joust but have only one wound left are assumed to recover and can take part in the final battle.

NEXT TURN

If neither contender was defeated they ride back to their own end of the palisade to charge again next turn. Any Knight whose lance has broken is handed a new one. The jousting continues until one contender is unhorsed. His opponent wins the joust and the unhorsed Knight is knocked out of the contest.

VICTORY OR DEFEAT

The jousting continues until everyone in each team has taken part in a joust. The team with the most remaining in the saddle has won. In the event of a draw fight a further set of jousts until one side wins. Unhorsed Knights cannot take part in the final battle. Agravaïn or Athelwyn however, are fated to survive the tourney even if they are unhorsed. Agravaïn will be healed by the Grail Damsels of Quenelles and Athelwyn will be hastened away to be healed in the glades of his kindred.

JOUSTING PLOYS

The numbers below indicate the order of striking. Lowest number always strikes first.

1. AIM FOR SHIELD

Aim your lance at your opponent's shield to put maximum force behind the strike. You automatically strike before an opponent using any other ploy.

2. AIM FOR HELM

Aim your lance at your opponent's helm. This is hard to hit, but even a glancing blow can wound or unhorse him so you count +1 Strength. You strike after an opponent aiming for Shield, but before one attempting to Dodge, hit your Crest or Swipe.

3. AIM FOR CREST

You can only use this ploy once in the joust and only if your opponent has a crest on his helm! The lance is aimed at your opponent's crest, this is very difficult to hit, and so is unlikely to unhorse him. But it is a great slight upon his honour and counts as two lance breaks! To represent this, you strike after an opponent aiming for Shield or Helm, but before one attempting to Swipe. Count -1 to hit and if you do hit, the crest is knocked off on a further roll of 4,5 or 6.

4. SWIPE

This ploy is acceptable, but not considered to be very honourable! You swipe with the lance across your opponent's front to knock him from his saddle. It is not difficult to hit with this ploy, but is rather slow and not very skillful. To represent this, you strike after an opponent aiming for Shield, Helm or Crest, but you count +1 to hit.

5. DODGE

This is a defensive ploy greatly lacking in honour. You give up your own chance to strike in order to dodge your opponent's lance. This means you do not strike at all, but your opponent suffers -2 to hit (if he is entitled to an automatic hit this is modified to 3+ to hit). If both Knights attempt this then neither one strikes at all.

SCENARIO II

THE BATTLE OF THE TENTS

SCENARIO II

This battle is based on the verse of the Chanson de Chailotte which tells of how the treacherous Wood Elves stole the prizes of the tourney without even waiting to see if their contenders had won it by fair contest! This was to have fateful consequences.

ELF TREACHERY

Realising that a Wood Elf victory in the tourney was by no means assured, and just after seeing yet another Elf Prince tumble from his saddle, Athelwyn gave a discreet signal to one of his hooded retainers who stole away unnoticed. A few moments later, while everyone's attention was focused on the excitement of the jousting, a commotion broke out among the tents and pavilions in the adjoining field. It was here, in the large pavilion, that the tourney prizes were being guarded.

Suddenly a fierce beast, some sort of ferocious wild cat, ran amok among the Bretonnian tents, pursued by a number of Wood Elves. The beast had managed to get loose from the Wood Elf encampment in the woods beside the tourney field and the Wood Elf retainers were

trying to recapture it, or pretending to! The beast caused total confusion as Men-at-arms struggled to catch it, while grooms and servants rushed in all directions to get out of the way.

This was only a diversion. Soon the enclosure was swarming with Wood Elves who quickly overpowered the handful of guards there. The great pavilion was ripped open and the chalice was stolen. Without regard for honour or fair play the Wood Elves had not even waited for the outcome of the tourney. This was despicable behaviour. The Bretonnians were outraged!

The commotion was seen from the Fauberg de Mayonne by the Castellán of Quenelles, overlooking the tourney field. He hastily mustered every available man to try and restore order. It was not until he reached the tents that it was clear the Wood Elves were up to something. Unfortunately all the Knights were attending the joust and were not at hand to stop the wily Elves from looting the prizes. By some secret arrangement Hawk Riders from Loren appeared overhead, ready to take away the stolen items and speed them safely back to the depths of the forest. The Castellán and his men had to act fast!

THE BATTLE OF THE TENTS - SCENARIO II

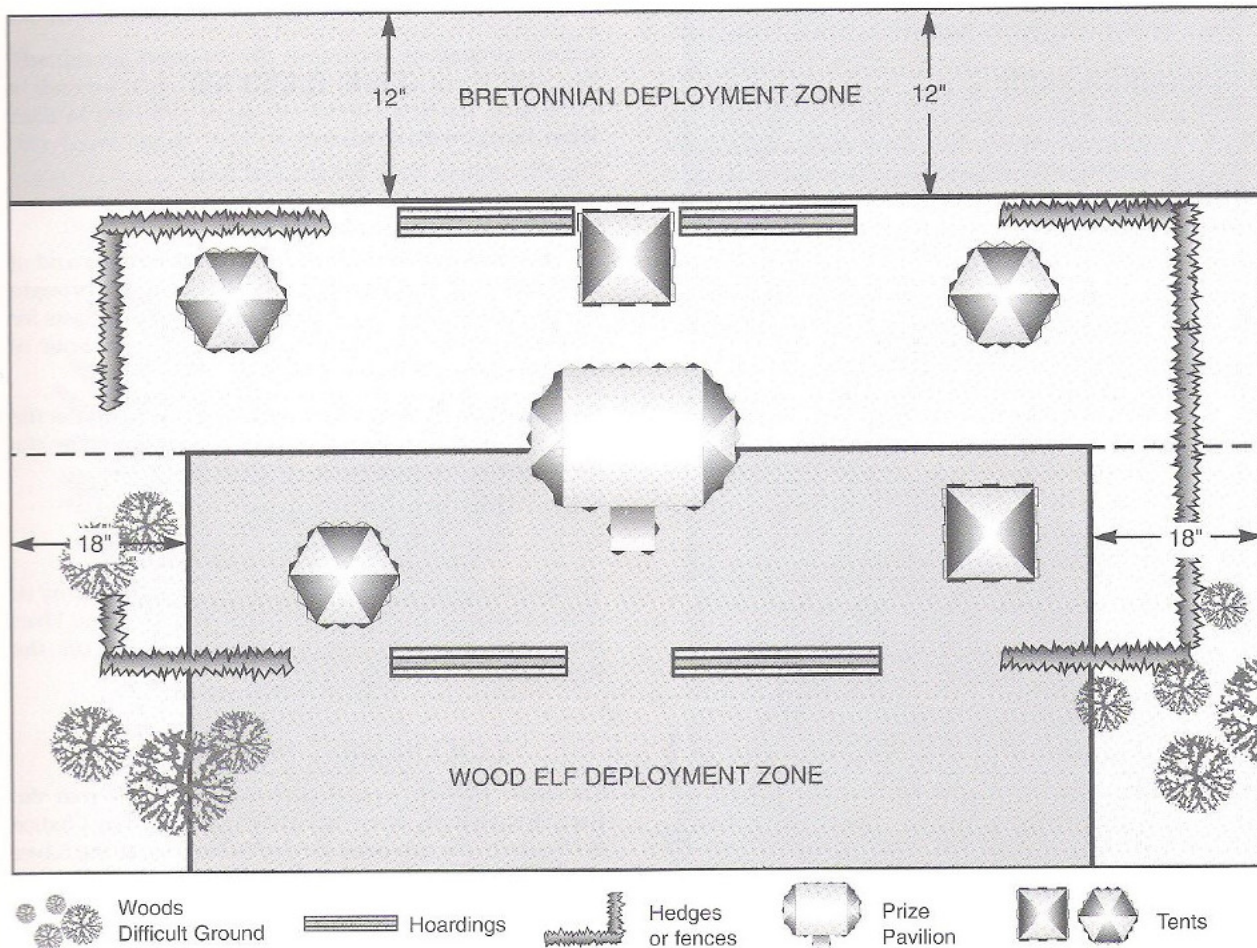

FIGHTING THE BATTLE

The *Battle of the Tents* is the second in a series of encounters between Wood Elf and Bretonnian forces. The outcome of this battle decides how many magic items the Wood Elves steal from the prize pavilion. These can be used by the Wood Elves in the final battle.

THE BATTLEFIELD

The setting for this battle is the tent enclosure next to the tourney field. The tents belong to the various Knightly retinues and are grouped around the prize pavilion. Along one side of the field flows the river Brienne. The tent enclosure is in the middle of the battlefield and is shown on the map as the fenced off area. Use the hoardings provided in the box and other suitable scenery pieces, such as fences or hedges you may have in your scenery collection, to represent the enclosure perimeter. Remember to leave gaps between the hoardings so that both armies are able to get into the enclosure.

Set up the battlefield as shown on the map using the tents and prize pavilion included in this pack. Alternatively, you and your opponent can agree on a variation of the battlefield to suit the scenery which you have available.

The Armies

Each player refers to the Battle Scroll for his army in order to choose forces for the battle. The Battle Scroll also describes any special rules which apply, as well as victory conditions, victory gains and tactical hints.

Deploying for Battle

The Wood Elf army is deployed first. Its units may be deployed up to the middle line of the table but no closer than 18" to the side edges. The Bretonnian army is deployed afterwards. Its units can be deployed within 12" of its table edge.

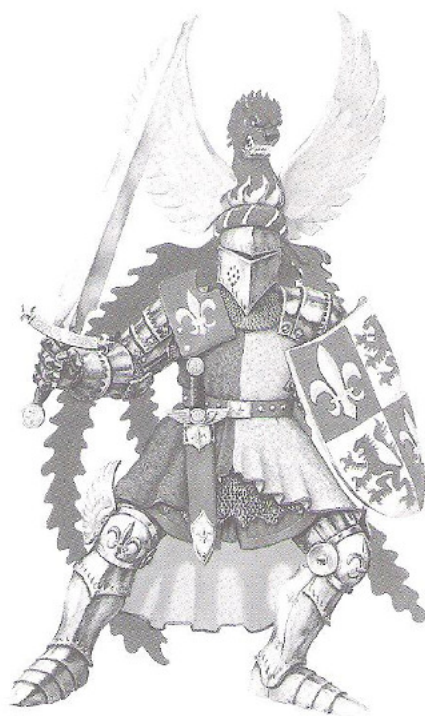

SPECIAL RULES

Waywatcher Traps – Waywatchers that are in the tented enclosure will automatically set traps between the tents, utilising tent ropes, poles, and anything else that comes to hand. Any enemy charging the unit within the enclosure will activate the traps.

THE BATTLE

Who has the first turn?

The Bretonnian army has the first turn.

How long does the battle last?

The *Battle of the Tents* raged from just before the end of the tourney in the late afternoon, until sunset brought an end to hostilities. To represent this the battle lasts for four game turns each representing about one hour of daylight in the original battle.

Each side will therefore complete four turns unless the battle ends earlier in a sudden death victory for the Bretonnians.

VICTORY OR DEFEAT

This battle does not result in a straightforward victory or defeat for one side or the other. Instead, the Wood Elves gain more loot the longer they can hold off the Bretonnians.

LOOTING THE PRIZES

The prize pavilion contains four magic items that the Bretonnians have taken out of Athel Loren. The Chalice is obviously the top prize for the Bretonnians, the Silver Arrow will look nice tacked on a Knight's shield, the Gold Casket is worth a crown or two and the Old Stick is seen as a bit of a booby prize! These are labelled 1st,

2nd, 3rd and 4th prize respectively. At the end of each turn that at least one unit of Wood Elf troops (not characters) remains within 6" of the prize pavilion, they succeed in stealing one of these prizes.

The thieves take the most precious looking objects first, but these are not necessarily the most powerful! The first of these is always the first prize which is the Chalice of Chanterelle. In the Wood Elf player's second turn they steal the 2nd prize, the Silver Arrow. In the third turn they steal the 3rd prize, the Gold Casket and in the fourth turn they steal the 4th prize, the Old Stick. The Wood Elves can use any items that they succeed in stealing in the final battle at no extra points cost!



Quite apart from the combatants on each side, there are a large number of drunken grooms, foppish minstrels, boys with sticks, big ferocious dogs, loose warhorses, dishevelled peasant girls, purveyors of roasted snails and frogs' legs, jonglers, chickens, sellers of small sticky cakes in the shape of a fleur de lys, scandalised Grail Damsels, extremely rotund merchants, blacksmiths trying to remove battered armour from wounded Knights, hurdy-gurdy players and others rushing among the Bretonnian tents in total panic.

The thieves automatically succeed in stealing the chalice at the end of the first turn, but in order to get away with each of the other items the Wood Elf player must roll a dice score higher than the number of Bretonnian units



within the tented enclosure at the end of each of his subsequent turns. A score of 4, 5 or 6 always results in the item being successfully stolen no matter how many Bretonnian units are in the area. For example, if there are only two Bretonnian units in the area, the Wood Elf player needs to roll 3 or more to get away with the item. Otherwise the item is assumed to be dropped or left behind. You only roll once for each item and only in the appropriate turn. So if you drop the Silver Arrow in the second turn, you cannot try for it again in the next turn.

Sudden Death Victory Conditions

If the Bretonnians slay the Wood Elf General then the Wood Elves will beat a hasty retreat and the Bretonnians win a sudden death victory.

PRIZES OF THE GRANDE TOURNEY OF QUENELLES

1st Prize:

The Chalice of Chanterelle

This is the only artefact that really is Bretonnian although the Wood Elves do not know this. It gleams and appears to be very precious and magical, which it is, and so is the first thing the thieves will grab in their haste. It is of no use to them, but has a part to play in the final battle.

2nd Prize:

The Silver Arrow

This is a silver arrow inscribed with Wood Elf spirals and a tiny inscription that reads "I will fell any foe. No armour can protect against me!" If an enemy model is wounded by this arrow he will suffer D6 wounds with no armour save possible. One use only.

3rd Prize:

The Casket of Acorns

This is a golden casket containing a few wizened acorns. A Wood Elf mage will recognise these as magic acorns that will immediately sprout into D6 Dryads if scattered on the ground in the magic phase of any Wood Elf turn. One use only.

4th Prize:

The Old Stick

This is a finely carved wooden staff decorated with a fairy face, intertwined spirals and green gems. Cunningly hidden within the spirals there is an incantation written in runes that only a Wood Elf Mage can understand. When translated it reads, "This is all that remains of Guath the Old, plant me when you are in need of help!"

When the stick is planted into the ground in the magic phase of any Wood Elf turn, it will immediately sprout into a Treeman who will rush to the aid of his fellow woodsmen at no extra points cost. One use only.

THE PERILOUS PILGRIMAGE

The Chanson de Chailotte refers to the perilous pilgrimage to Chailotte, without revealing much about its fate and the mysterious vision which led Agravain to ride to the rescue of the pilgrims. Blondel added verses from the older Bretonnian chanson "Le Damselle de Chailotte" into his own ballad in order to reveal the significance of Agravain's vision and the lost grail chapel that he had to find if he was to fulfil his quest.

THE PRICE OF HONOUR

As soon as the fanfare signalled the end of the tourney, the Wood Elf Princes made a hasty retreat, taking their wounded companions with them. Word was soon brought to the Duke that the Chalice had been stolen. By the time the Duke and the Bretonnian Knights had pushed their way through the throng of peasants, the Wood Elves were already gone, leaving the exasperated Castellan to explain what had happened to his liege.

Although a few Mounted Squires had chased after the fleeing Elf retinue, they soon lost the trail as dusk fell over the countryside and reluctantly rode back to Quenelles. That night the inns and taverns of Quenelles resounded to the sound of drunken peasants discussing the exciting events of the day and impetuous young Knights boasting that they would teach the Elves a lesson for their trickery and dishonour! The Duke threw a huge banquet in the great hall of the castle of Quenelles, which all the best Knights attended. Naturally the dishonourable behaviour of the Wood Elves and what to do about it provoked a heated debate.

A faction of Knights, stirred up by Arnaud de Borron, urged the Duke to lead a foray into the Forest of Loren forthwith, to recover the chalice. However the Duke was not only concerned about the chalice.

"I am deeply outraged by the way the Lorrenards have dishonoured the tourney, and honour demands that they must make amends to us in some way."

This met with unanimous support from the assembled Knights. The Duke called for suggestions of what kind of recompense should be demanded. Various Knights shouted out such things as "One hundred Elven steeds", "One thousand carucates of good farming land" and "The right to hunt deer in the forest".

The Duke paused to ponder these and other suggestions, "These are but trivial recompense. Can no one suggest a worthy forfeit to demand of them?"

Eleanor de Quenelles, Grail Damsel of the renowned grail chapel in Quenelles spoke: "My lord Duke, I beg you consider the holy chapel of Chailotte which lies ruined and forgotten in the Forest of Loren. It is not deep within the fairy realm, yet the fairy folk always scare away any of our pilgrims who are moved by righteous piety to go there! It would be a worthy act of repentance for the folk of Athel Loren to place the chalice in the very chapel where it belongs and grant us a right of pilgrimage to that sacred place."

This raised a great roar of approval from all of the Knights, who began beating the table with their tankards. "And if they dare to refuse us, we'll go there anyway," shouted out one hothead by the name of Aloys de Montjoie. This was followed by yet more cheers and hammering of the benches.

The Duke gave his answer. "The Lady Eleanor has shown us the way to peace with honour! We do not ask them to give back the chalice, merely the right for us to see it! The Lorrenards will grant us this, of that I am sure. My Lady Eleanor, you have my leave to prepare a pilgrimage to the grail chapel of Chailotte forthwith, and you shall have my protection!"

THE LADY OF CHALLOTTE

Agravain was not at the banquet, and his retainers, Blondel and Jasper, were no doubt in some bawdy tavern. Agravain, deeply disturbed that the chalice had been stolen by the Elves, was in the grail chapel of Quenelles which overlooked the river Brienne. Here he had spent the entire night resting his head upon his shield seeking inspiration for his quest. He woke early, disappointed not to have had a dream to guide him and went down to the bank of the river to splash cold water on his face to wake himself up.

Just as Agravain knelt by the river, he saw ripples forming in the water before him. He watched in awe as a small boat slowly drifted past him, emerging from the mist and then vanishing back into it again. A lady of exquisite beauty, with long tresses of coppery red hair and dressed in a fine white robe was sitting in the boat. She turned to Agravain with an expression of anguish on her lovely face. Her eyes seemed to implore his assistance. Her lips parted, but no sound of the words she spoke came forth from them. It seemed to Agravain that her silent lips were saying "Rescue me!"

The vision passed. Agravain called out again and again into the mist and even waded up to his waist in the chill water, but to no avail. The lady was gone, if she had ever been there at all. Agravain was deeply troubled. This was without doubt a sign from the Lady of the Lake, perhaps he had seen the Lady of the Lake herself, but there had been no grail. The meaning of this strange vision puzzled him.

PERILOUS PILGRIMAGE

Agravain knelt for a long time beside the river deep in thought. By the time he made his way back to the grail chapel it was a bustle of activity. Grail Damsels and their servants were making ready a magnificent blue wagon decorated with gold fleur de lys. A throng of pilgrims and pious Knights were gathering ready to set out on the pilgrimage. The Lady Eleanor called out to Agravain, who was now well known in Quenelles due to his exploits on the tourney field, "Will you not join us in our pilgrimage?"

Agravain, of course, had not heard about this perilous and ill-advised pilgrimage and did not want to be distracted from his own personal quest. He tactfully replied that he must first find his two retainers.

Agravain scoured the streets and eventually plucked Blondel out of the gutter and dragged him by the scruff of the neck back to his tent, where Jasper was preparing a midday meal. "Blondel, I want you to sing that chanson which you sang in my father's castle again, I want you to sing *La Damoiselle de Chailotte*."

Blondel began to sing. It was a long ballad. He sang of how, a long time ago, a fair Bretonnian lady had set out on a journey by boat on the river Brienne from the legendary grail chapel of Chailotte to the tourney in Quenelles. He sang of how her retinue was ambushed by cunning foes shooting a hail of arrows from the banks of the river. All the retinue accompanying the lady in her boat were slain, and the boat itself somehow slipped free from the other boat in the retinue. Alas! the boat drifted away with the current and the lady was never seen or heard of again. Only her minstrel reached Quenelles alive and composed the ballad before throwing himself off the top of the tallest tower of Quenelles in sorrow for his beloved lady.

DAMOISELLE DE CHAILLOTTE

As told in the famous Bretonnian troubadour ballad, La Damoiselle de Chailotte.

The grail chapel of Chailotte was located on an island in the river Brienne, surrounded on all sides by the Forest of Loren. The keeper of this blessed sanctuary was the Grail Damsel Chanterelle, a lady of incomparable beauty and kindness who was renowned throughout the realm.

Chanterelle made healing potions in her enchanted chalice. With these she healed many tired and wounded Questing Knights and Knights Errant who had become lost in the Forest of Loren, much to the annoyance of the secretive Wood Elves who dwelt in the wild wood. In gratitude, many of these Knights swore to stay to defend her and the chapel against the many perils and fiendish foes that lurked in the forest. Gallantly the Knights defended their lady, but every day their numbers dwindled as one after the other fell valiantly in mortal combat against all manner of vile foes.

At long last, with her retinue no more than three Squires and a minstrel, Chanterelle decided to attend the tourney in Quenelles to find some more Knights to join her retinue. In fear for the safety of her retinue, she choose to make the perilous journey by way of the river Brienne, in two boats, accompanied by her retinue.

Alas, to no avail, for the boats were ambushed by an unseen foe who shot a hail of arrows from the thickets along the riverbank. All of Chanterelle's escort were struck down around her and her boat somehow came adrift. The broad stream bore her far away, and she was never seen again.

Only her devoted minstrel Rainourt, in the other boat, reached Quenelles alive. After recovering from his many arrow wounds, he composed the famous troubadour chanson *La Damoiselle de Chailotte* for his beloved lady before casting himself in despair from the tallest tower of the city.

Agravain suddenly realised that his own quest was bound up with the pilgrimage to the lost grail chapel of Chailotte. "This morning I saw the Damoiselle de Chailotte in a vision," confessed Agravain. "The Lady of the Lake has called upon me to seek and rescue this fair damsel."

"Are you mad?" cried Blondel. "She vanished hundreds of years ago. It is a foolish task, you must be wrong."

Agravain, however, was now totally in the grip of religious fervour and would not listen to any reasoning or common sense. "The ways of the Lady of the Lake are mysterious to us all, my friend."

As quickly as they could, Agravain's companions packed up the camp and girded their master with his armour. By the time they arrived at the grail chapel in Quenelles, the pilgrimage had already gone on its way!

LURKERS IN THE GLADES

The pilgrims sang with even more fervour as they trudged past the eerie waystones marking the borders of Loren. They crossed the windswept heath without incident, but were not unwatched. Yolath the Elven mage approached the column as soon as it entered the forest. "Why have you come?" he asked in Bretonnian.

"We seek the holy chapel of Chailotte," replied Aloys de Montjoie.

"You are about to enter the glades of my kindred, I urge you to turn back!"

"Your kindred offended us at the tourney of Quenelles, now we demand this small recompense. Let us make this peaceful pilgrimage!" replied Aloys arrogantly.

"I see many armed men among these peaceful pilgrims," said Yolath with Elven sarcasm. "You do not know what you bring upon yourselves. Once again I say, turn back!"

Aloys pushed the mage aside and the pilgrims went on.

It was the beginning of winter in Loren and all the trees were shedding their leaves. The King and Queen in the wood were already within the Oak of Ages awaiting their rejuvenation in the spring. Lacking Ariel's wise counsel the mages of the kindreds raised a hand of restraint to their warriors, but they could not prevent the forest defending itself. The waystones had been passed and the spirits invoked! Shadowy forms began to close in on the doomed pilgrims.

FIGHTING THE BATTLE

Perilous Pilgrimage is the third in a series of encounters between Wood Elf and Bretonnian forces. The Bretonnians have blundered into the glades where the Treeman Gwercus dwells with his retinue of Dryads. These creatures become dormant in winter and react savagely if disturbed. Thus provoked, the Bretonnians are ambushed by Gwercus and the Dryads. They are helped by their Wood Elf friends as it is the sacred duty of every Wood Elf to guard the glades in which the tree spirits live. If the Bretonnians drive off the ambushers, any surviving Treemen and Dryads will abandon the glades and seek a safer refuge to hibernate in. The outcome of this battle therefore decides whether the Wood Elves have Treemen and Dryads in the final battle.

THE BATTLEFIELD

The setting for the *Perilous Pilgrimage* is the dense Forest of Loren. The pilgrim column is struggling along a winding boggy track when it is ambushed by the Treeman and his Dryads who they have accidentally awakened.

The ambush occurs just at the point where the track forks to go around a marsh. Set up the battlefield as shown on the map. Alternatively, you can agree with your opponent on a variation of the map to suit the scenery you have available.

The Armies

Each player refers to the Battle Scroll for his army to choose his forces for the battle. The Battle Scroll also describes any special rules which apply, as well as victory conditions, victory gains and tactical hints.

Deploying for Battle

The Bretonnian army is deployed first because they have blundered into a Wood Elf ambush. The Bretonnians are deployed within a 24" wide strip down the centre of the table which is no closer than 18" to the enemy table edge.

The Wood Elf force is in a position to envelop the pilgrims from three sides. Wood Elf troops may be deployed anywhere on the rest of table but not within 8" of the Bretonnian deployment zone.

THE BATTLE

Who has the first turn?

The Wood Elf army has the first turn.

How long does the battle last?

Perilous Pilgrimage began in the late afternoon when the pilgrim column was beset by the 'wild spirits of the wood' who vanished back into the depths of the forest when the light faded. The battle lasts for four turns, each turn representing an hour of remaining daylight.

VICTORY OR DEFEAT

Sudden Death Victory Conditions

If the Bretonnian reliquary wagon leaves the table via the Wood Elf player's edge the Bretonnians win a sudden death victory at the end of that turn. When the wagon passes through the outer ring of the sacred glade the iron weapons and unquiet bones in the Bretonnian reliquary will break the sanctity of the glade banishing any tree spirits who dwell there. Gwercus and his Dryads will wither into ordinary gnarled trees.

Victory Points

If the battle continues until sunset, decide who has won by counting up victory points as described in the Warhammer rulebook. If victory points indicate a draw, this is counted as a Bretonnian victory instead because the pilgrim has survived the ambush.

THE PERILOUS PILGRIMAGE - SCENARIO III

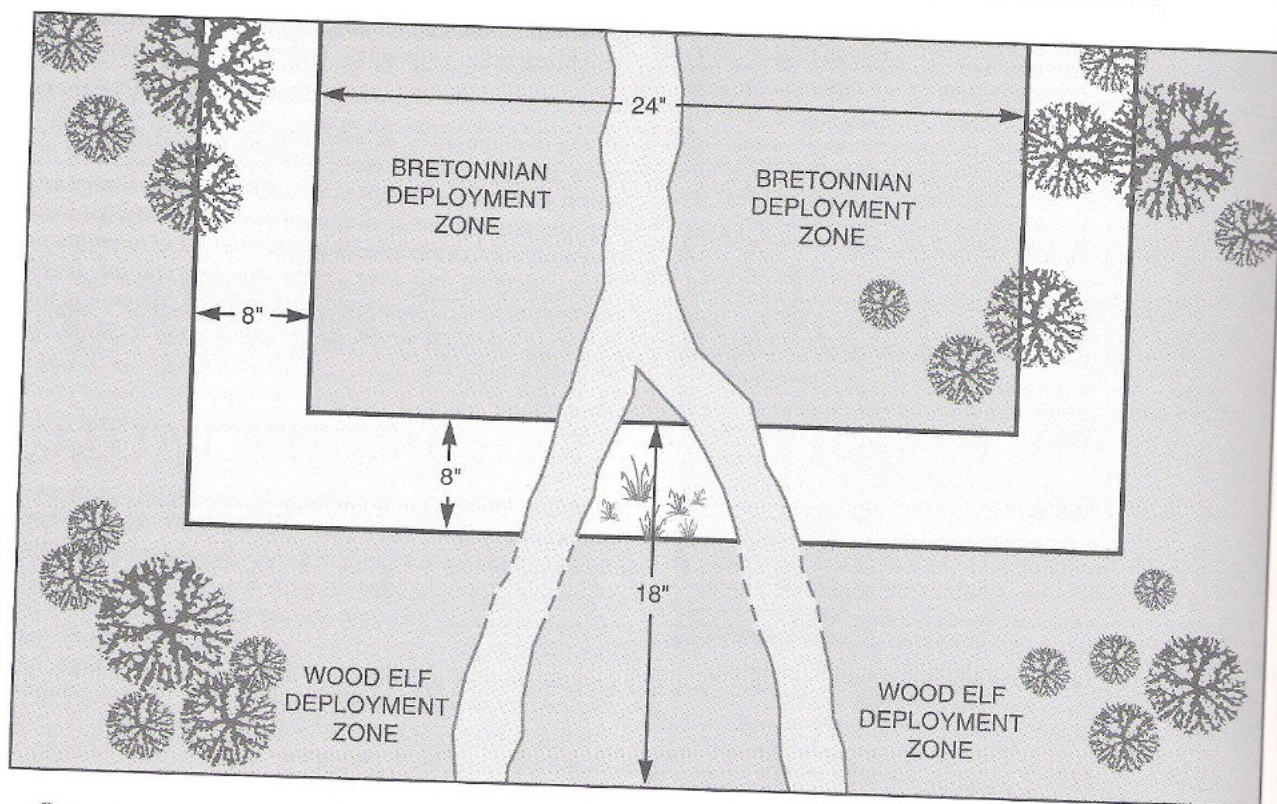

BATTLE OF THE TREE OF SHIELDS

The last part of the Chanson de Challotte tells how, inspired by the vision of the Lady of Challotte, Agravaïn rallies the scattered remnants of the ambushed pilgrimage. With Agravaïn in command, the Bretonnians march on to the holy grail chapel of Challotte in defiance of the Wood Elves who bar their way. The final battle is fought before the mighty Tree of Shields on which are hung the shields of all those Questing Knights who have gone before never to return.

AGRAVAÏN'S QUEST

Agravaïn was not the only Knight who had arrived at the grail chapel of Quenelles too late to join the pilgrim column. Many other Knights had ridden into the city from the surrounding countryside hoping to join in the holy pilgrimage. They intended to ride after the pilgrims the next day. Among them were Questing Knights who believed that the pilgrimage might lead them closer to the grail as well as Knights Errant eager to prove their worth by overcoming the many perils there would be on a pilgrimage of this kind. When Agravaïn announced that he had been inspired by a vision to follow the pilgrimage, the other Knights unanimously proclaimed him as their leader. As the new day dawned, they set off along the muddy, rutted track towards the Forest of Loren.

The Waywatchers saw this new contingent of Knights entering the wood and reported it to the Council of Mages. While the Wood Elves were deciding what to do, Agravaïn and his band of Knights came upon the debris of the pilgrim column, scattered about the glades. The survivors soon gathered around the Knights who were by now deeply enraged that this peaceful pilgrimage had been so treacherously attacked.

Agravaïn and the more experienced Knights organised the remnants of the pilgrimage into a proper column of march, capable of defending itself in enemy territory. The pilgrimage took on an altogether more warlike aspect, with Knights and soldiers now outnumbering the other pilgrims. Nothing was more certain to provoke the Wood Elves into yet further desperate attempts to defend their glades. As for Agravaïn, he was fired not only by a sense of righteous duty to defend the pilgrims like the other Knights, but also by a secret personal desire to fulfil his quest. He was convinced that this could only be done by rescuing the Lady of Challotte, wherever she might be.

COUNCIL OF WAR

As the Bretonnians penetrated deeper into the forest, the Kindred of the Willows gathered for a council of war in the midst of their sacred glade. The debate continued long into the night.

"What have you done Athelwyn?" demanded Yolath the mage pointing his finger at the proud young Elven Prince. "Why have you stirred up the Bretonni against us?"

All the elders of the kindred who were gathered in the council glade looked to Athelwyn to justify his actions.

"I sought only to bring back the heirlooms of our kindred," answered Athelwyn. "They are not meant for their foolish games!"

The mage looked the young Prince in the eye: "You took part in their foolish games and then made the mistake of breaking their rules! That is not the Elven way, Athelwyn!"

At this rebuke Athelwyn became sullen and downcast, but he did not betray the fact that some of the younger mages had been in sympathy with his cunning plan. Nevertheless, his pride was hurt. The other Princes who had gone to Quenelles with him were nobles from the neighbouring kindreds. No doubt they would also meet with the wrath of their Elders. The truth was that these young Princes were rebellious against the authority of the Elders. The age-old rituals were stifling to the younger Elves and the temptations of the outside world gnawed at their keen, enquiring minds.

"I shall give back the chalice."

"It is too late for that, the chalice is not enough. Give it back by all means, try and appease them, but you will see that they are now demanding something more, something that is impossible for us to give!"

"You have spoken to them, what is it they really seek?" asked the mage Idryth who secretly supported Athelwyn's action.

"They seek the destruction of our sacred grove which is on the holy island!" replied Yolath.

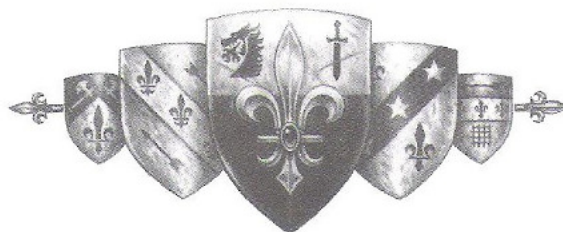

The assembled Elders were aghast. The grove had stood there for many generations. Why would the Bretonni ask such a terrible thing of them? Yolath knew why. He told the council how there had once, long ago, been a Bretonnian shrine on the island. But it had been abandoned and over the years the forest had crept over the deserted ruins to reclaim it back as its own. When the Kindred of the Willows found a grove of mighty willow trees growing on the island, they had settled there. From that time to the present, the kindred had sung to the trees, as all kindreds did and the trees had grown dense and strong.

"Now the Bretonni wish to return," continued Yolath. "And with them will come the plagues and wars and noise and axes and fires and iron and ploughshares and hunting!"

At this the council became very angry. Athelwyn was gripped by deep remorse.

"What can we do, Yolath?" he asked, his voice softened by the weight of remorse.

"There are only two things we can do. The kindred can abandon the sacred island and migrate deeper into the woods, or they stay and defend themselves!"

The matter was debated furiously by all the Elders. No one was for migrating.

Olweth the Old spoke what many were thinking. "Our sacred groves is a unique place, nowhere else do the willows grow so big and so strong as they do here. Therefore I say we should protect the glade!"

Elthryn asked, "Could it be that there is something here which is calling out to the Bretonni? Many of their Knights have come here over the years seeking something, and if they could not be frightened away, we fought them. Now they all come at once in a great army, perhaps we should stay our hand and let them take away whatever it is that they seek."

Then Yolath, deep in wisdom, spoke again: "I fear that whatever calls to them is hidden in the ruins beneath the roots of our sacred tree. The Bretonni would cut it down just to possess whatever is entombed beneath it."

Athelwyn knew that he could not let this happen. "They will not harm a single tree while I still live!"

At this rousing cry all the warriors of the kindred vowed to stand by Athelwyn in defence of their glade. Word was sent to the other kindreds so that their warriors too could come and help.

AGRAVAIN'S DREAM

Meanwhile, the Bretonnians rested for the night not far from the sacred glades. Agravain had posted a cordon of vigilant Squires around the camp and the Knights gathered into small groups around the campfires to sharpen their swords and grease their armour, while their servants grilled frogs' legs and snails with wild garlic from the forest.

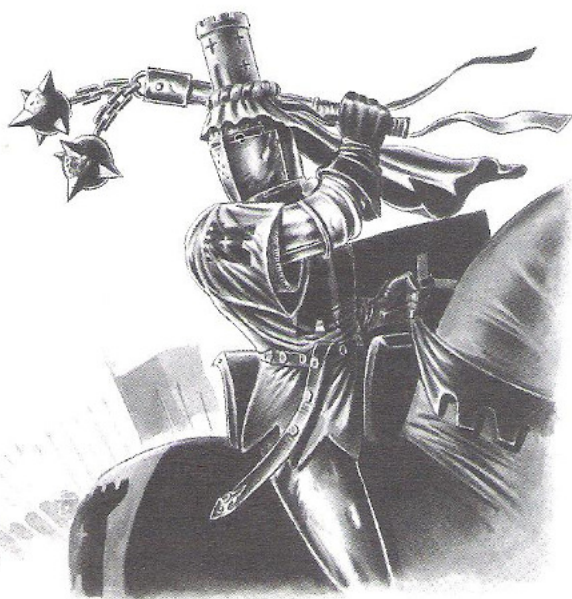

That night Agravain dreamt once more. He saw the same lady drifting alone in a boat on the river. Her expression of despair gave way to one of resignation to her fate. She took a shining chalice out of a casket and dropped it into the water. Then she took off her rings and jewels and likewise cast them into the murky depths. Lastly she took up a phial and put it to her lips and drank the contents. Then she laid down in the boat and closed her eyes. The boat disappeared into the mists.

Then Agravain saw the boat once again, caught in the roots of a willow tree. He saw Wood Elves approaching it stealthily from all sides and watched as they took up the limp body of the lady and wrapped her in a mantle of leaves. Then they brought her up the riverbank, through the trees and overgrown fields and into the crypt of the grail chapel that was on the island. They laid her down upon a bed of fleur de lys and then took staves of willow and wove them into wattles with which they barred the door and every window of the chapel. So skillfully did they weave the willows that soon no vestige of the chapel could be seen at all.

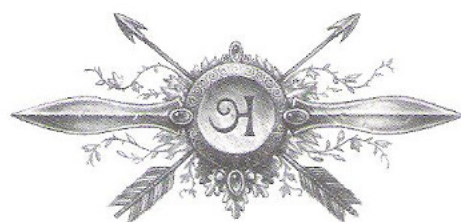

Agravain awoke, greatly perturbed. To him alone had been revealed the fate of the Lady of Chalotte. However there remained one last question. Had the lady taken poison in a last act of defiance against her foes? If so, why had the Wood Elves gone to such great efforts to imprison her forever? Perhaps she was not really dead, only sleeping. Perhaps the potion had been a spell to fool the Wood Elves. Then Agravain thought of all the Questing Knights who had been drawn into the forest over the centuries. Knights who like himself had seen the very same visions, but failed the test and never returned. Many must have been led astray by glimpses of the fairy queen of the Wood Elves, or mischievous Dryads, flitting among the trees. Now their shields hung from the Tree of Shields. Obviously only one Knight was destined to find the Lady of Chalotte and break the spell by waking her from a sleep of a thousand years. The Lady of the Lake had led Agravain this far and honour demanded that he should not fail her now.

THE TREE OF SHIELDS

The Bretonnians entered a broad, open glade of willow trees. The ground all around was marked by the ridges and furrows of the deserted peasant fields of long ago, now covered by long grass and brambles. They stood in the midst of the long-forgotten village of Chalotte. Separated from the glade by a shallow, reed-choked marsh was a small island dominated by enormous willow trees of great antiquity. In the middle of the island was a mound and growing upon it was a gnarled willow tree, its roots embedded in crumbled mortar and masonry. This mound, overgrown with ivy and moss, was all that remained of the venerable and renowned grail chapel of Chalotte.

However, there was something between the Bretonnian host and the objective of their pilgrimage. The warriors of the Kindred of the Willows were drawn up in full battle array on the island. The Bretonnians who were now within sight of the chapel of Chailotte were certainly in no mood to turn back. Agravain and two other Knights rode forward to parley with the foe, as was the Bretonnian custom. "There is no need for bloodshed," declared Agravain. "All we ask is that you allow us to restore this ruined chapel of ours and permit the pilgrims to come here from time to time. We ask this in recompense for the insult to our honour at the tourney of Quenelles. What say you?"

Athelwyn, who knew some Bretonnian words, rode forth to give the answer of his kindred: "The chapel of which you speak no longer exists. The sacred tree of our kindred grows here now! We shall not suffer it to be hewn down by your axes. Take this chalice and be gone from this place. Trouble us no more with your superstitions or we shall hang your shields upon the tree with the others!" With that, Athelwyn hurled the chalice into the no man's land between the battle lines and all watched as it sank slowly into the water amid the reeds and vanished.

Agravain and his companions gazed up into the gnarled branches of the tree. Hung upon them were several battered old shields. They all recognised the questing symbols upon them. Anger stirred in Agravain's heart as he looked upon the proud heraldic blazons, now mere trophies of the fairy folk with which to taunt the honour of Bretonnia! In his fury, he called over the waters to

Athelwyn. "Then the Lady of the Lake shall decide our fate," and galloped back to take his place at the head of the assembled war host.

Steadily the Bretonnian host advanced towards the Wood Elf position, the contingent of Men-at-arms from the Fauberg de Mayonne singing their rousing battle song *the Mayonnaise*, as they approached. On a signal from Agravain, the Knights drew their swords as one. The battle had begun.

FIGHTING THE BATTLE

The *Battle of the Tree of Shields* is the final battle between Bretonnian Knights and Wood Elves described in the famous *Chanson de Chailotte*. The outcome of this battle decides whether the Bretonnians capture their long lost grail chapel and whether or not the Wood Elves are driven out of their sacred glade.

Ultimately it also determines whether Agravain discovers the mysterious meaning of his vision and fulfils his quest. Agravain does not know what to expect if he lives to reach the grail chapel. Could it be possible that the Lady of Chailotte has remained asleep within the ruined chapel, imprisoned by the roots of the tree for centuries, awaiting only a kiss from a valiant Knight to awaken her? Is she the Lady of the Lake and will she reward Agravain with a sip from the holy grail? Is the Lady of Chailotte the spirit of the land itself which is crying out to be restored to Bretonnia? The answer lies beyond the bows of the Wood Elf warriors!

BATTLE OF THE TREE OF SHIELDS – SCENARIO IV

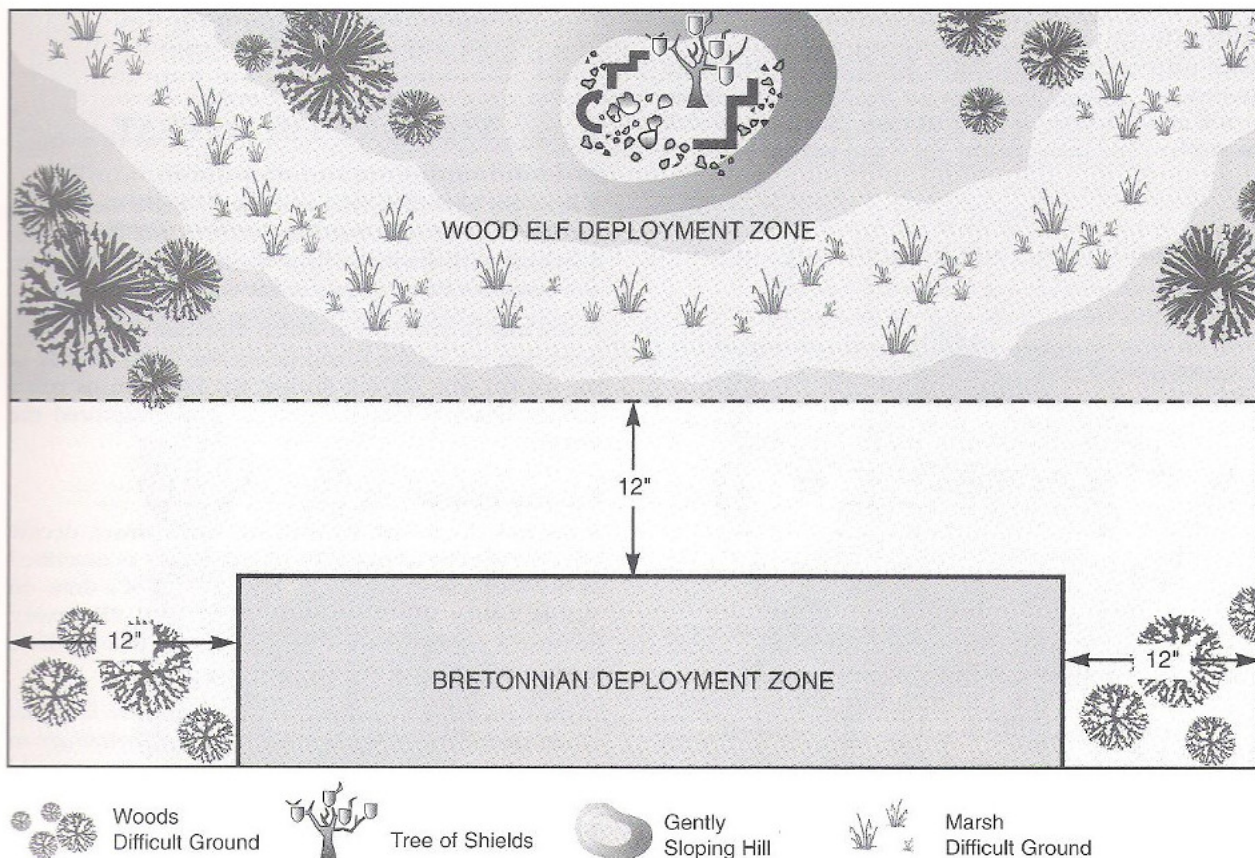

THE BATTLEFIELD

The Battle of the Tree of Shields takes place in a wide glade. Clumps of trees stand on either flank of both armies who face each other across an area of open ground that was once Bretonnian fields. The grail chapel is separated from the rest of the battlefield by the shallow, marshy rivulet into which the chalice was thrown. This is fordable, but counts as difficult ground. It enters and leaves the table via the Wood Elf edge and curves around to enclose most of the Wood Elf half of the table.

Behind the Wood Elf position looms the gigantic wizened willow tree: the Tree of Shields, with its roots embedded in a fairy mound. The ruins of the old grail chapel of Chalotte protrude from between its roots. Deep within is the crypt of the chapel. Arrange the scenery as shown on the map. Alternatively, you might like to agree with your opponent on a variation of the battlefield to suit the scenery which you have available.

SPECIAL RULES

The Mists of Chalotte

Athelwyn made a big mistake when he threw the enchanted Chalice of Chanterelle into the marsh. Almost immediately a strange mist begins to rise from the waters. The old magic of Chanterelle has been invoked and overflows as an enchanted mist which has two important effects on this battle. Firstly the Wood Elves suffer -1 to hit on all their shots when shooting over the marsh. Secondly, any wounded Bretonnian characters who enter the waters will be miraculously healed and regain their original number of wounds. This can only happen once in the game for any character.

The Armies

Each player refers to the Battle Scroll for his own army, in order to choose his forces for the battle. The Battle Scroll also describes any special rules that apply, as well as victory conditions, victory gains and tactical hints.



Deploying for Battle

The Wood Elf army is deployed first. The Wood Elves may be deployed anywhere within their half of the table. Scouts and Waywatchers may use their special deployment rules and can be placed on the table after the Bretonnians have deployed.

The Bretonnian army deploys after the Wood Elf army has deployed. The Bretonnians are deployed no closer than 12" to the centre of the table and no closer than 12" to the side edges.

THE BATTLE

Who has the first turn?

Both players roll a dice and the highest scoring player has the first turn.

How long does the battle last?

The Battle of the Tree of Shields began early in the day so there was plenty of time for repeated Bretonnian attacks upon the Wood Elves. To represent this the game lasts for six turns. The battle ends when the sun sets.



VICTORY OR DEFEAT

Sudden Death Victory Conditions

If Agravaing himself is slain or flees the field, the faith of the Bretonnians will be shaken and they will give up the fight and leave the forest. The Wood Elves will therefore win a sudden death victory at the end of the turn.

At the end of any turn in which there are no Wood Elf defenders left on the island (ie on the Wood Elf side of the marsh) who are not fleeing, the Bretonnians win a sudden death victory, because they have captured the island.

Victory Points

If the two sides continue to battle until sunset, decide who has won by counting up victory points as described in the Warhammer rulebook. In the event of a draw on victory points this is counted as a Wood Elf victory, because it means that the Kindred of the Willows have tenaciously held on to their sacred grove.

In the days that follow more warriors will come from the other kindreds, tipping the balance overwhelmingly in favour of the Wood Elves. They can then expect to hold on to their glade for a long time to come and prevent any further Bretonnian pilgrimages. The quest remains unfulfilled.

APPENDIX I THE CHANSON DE CHALLOTTE

The actual armies that took part in the battles around Quenelles and in the Forest of Loren can be pieced together from the Chanson de Challotte. Naturally the chanson expends many words describing the gallant exploits of Bretonnian chivalry and says rather less about the humble common soldiers or their Wood Elf opponents!

THE TOURNEY

THE TIDE OF BATTLE

The best way to tell the events at the Tourney of Quenelles is to quote the relevant verses of the Chanson de Challothe. After several verses describing the favours of the Lady Melisande, the outcome of the tourney is described with a separate verse for each joust. Please bear in mind that they lose a lot in translation from the Bretonnian version.

FIRST JOUST

Gaufrey de Quercy is unhorsed by Gyforth of the Oaken Glades

*Gaufrey de Quercy, spurred on his charger
no gallant Knight could have struck harder
his adversary's shield, that villain of fairy raids
cunning Gyforth of the Oaken Glades.*

*With guile sly Gyforth swung his lance
to strike gallant Gaufrey perchance!*

*Gaufrey was unhorsed and tumbled down
and so was felled a valiant Knight of such renown
by misdeed of an Elven Prince so high
who caused the noble Melisande to cry.*

SECOND JOUST

Guilbert de Bois d'Auverne is unhorsed by Aelfryc the Tall

*Guilbert de Bois d'Auverne had nothing much to learn
of jousting with the lance when he took his turn.*

*To ride forth against bad Aelfryc the Tall
the sly Elf dodged the lance which saved him from a fall
and so they charged again, the Elf Prince was adept
brave Guilbert was run through and all the ladies wept.*



THIRD JOUST

*Agravain de Beau Quest unhorses Bloedh the Bold
Bretonnian honour rested on brave Agravain de Beau Quest
a Knight of such accomplishment, he clearly was the best
of all the Bretonnian Knights. Against Bloedh the Bold
who had a secret charmed shield or so we are told
but Agravain had the tress of Melisande so fair
of such a thing all scoundrels should beware!
For fairy shields are certainly not proof
against a lady's favour, so Bloedh so arrogant and aloof
quickly found himself upon the ground
and was laughed off the field by rude peasants all around!*



FOURTH JOUST

Jean de Ponthieu is unhorsed by Athelwyn of Athel Loren

*Then out rides gallant Jean de Ponthieu
but Athelwyn the bad was meant for you!*

*A destiny that you did not deserve
robbed the noble lady whom you serve
from your courteous company each day
when Athelwyn the wicked did you slay.*

FIFTH JOUST

Rene de Guyenne unhorses Cuthrun the Wolf

*Rene de Guyenne had seen the fairy trick
of swiping with the lance like a peasant's stick!
And so when he charged forth against his noble foe
Cuthrun the Wolf was sly but also rather slow
not a match for Rene with his lance so fast
and twice wounded fell upon the ground at last.*

SIXTH JOUST

Louen d'Artois unhorses Wykas of the Wychelms

*Louen d'Artois, so modest, brave and bold
of whose gallantry so many tales are told,
was skilled enough to unhorse anyone
and Wykas of the Wychelms was the one!
Both Knights struck each other with the lance
and forsooth it was a very lucky chance
that brave Louen was not knocked upon the ground
for Wykas the wily Elf had drunk a potion
and of this cunning deed we had no notion
but honour always prevails against a spell
he met Louen's lance and on the ground he fell.*

JOUSTING TEAMS

The teams included equal numbers of Knights. As the two armies have different points values to represent the differing skills of their Knights, the points values of the two teams are not equal. Values for the contenders are included because survivors will fight in the final battle.

BRETONNIANS

Agravain de Beau Quest 138 points

Agravain is armed with a sword, lance, heavy armour and shield and rides a barded warhorse. He has the *Questing Virtue* and the *Virtue of Devotion*. Agravain's favour is the *Tress of Melisande*.

Jean de Ponthieu 103 points

Jean is armed with a sword, lance, heavy armour and shield and rides a barded warhorse. He has the *Questing Virtue* and the *Virtue of the Joust*. Jean's favour is the *Garter of Melisande*.

Rene de Guyenne 103 points

Rene is armed with a sword, lance, heavy armour and shield and rides a barded warhorse. He has the *Questing Virtue* and the *Virtue of Purity*. Rene's favour is the *Girdle of Melisande*.

Louen d'Artois 113 points

Louen is armed with a sword, lance, heavy armour and shield and rides a barded warhorse. He has the *Questing Virtue* and the *Virtue of the Impetuous Knight*. Louen's favour is the *Kirtle of Melisande*.

Guilbert de Bois D'Auverne 113 points

Guilbert is armed with a sword, lance, heavy armour and shield and rides a barded warhorse. He has the *Questing Virtue* and the *Virtue of Valour*. Guilbert's favour is the *Wimple of Melisande*.

Gaufrey de Quercy 98 points

Gaufrey is armed with a sword, lance, heavy armour and shield and rides a barded warhorse. He has the *Questing Virtue* and the *Virtue of Discipline*. Gaufrey's favour is the *Veil of Melisande*.

Historian's Comment

On the Bretonnian team, Agravain, Rene and Louen unhorsed their opponents. On the Wood Elf team Athelwyn, Aelfryc and Gyferth succeeded in unhorsing three Bretonnian Knights. The contest was therefore a draw and so a further set of jousts would be in order to decide who should rightfully claim the chalice. However, by this time the Battle of the Tents was raging so Athelwyn and his companions, with scant regard for the rules of honour, took the opportunity to make haste away from the tourney knowing that the prizes were now theirs anyway!

TOURNEYS AT QUENELLES

The old town of Quenelles is renowned for the many splendid tourneys which are held there. At least four times a year a cavalcade of Knights and their retinues throng the rutted tracks and country roads on their way to the tourney at Quenelles. These tourneys are held in mid-winter, spring, mid-summer and harvest time. The festivities are timed to coincide with religious holidays and so there will often be a sacred aspect to the event. Sometimes a holy relic is displayed as the prize. This might be a sword retrieved by a gallant Questing Knight from a ruined grail chapel that had become the lair of a monster, or a chalice of such fine workmanship that it is considered to be like the grail itself, except by credulous and naive peasants who think that it is the real thing!

It is not surprising then, that the tourneys at Quenelles attract more Questing Knights than any other tournament. Knights Errant, often seeking to win their spurs and the hand of a noble lady, tend to gather at Couronne or Parravon which are surrounded by rich feudal domains. There are always some which lack a Knight to defend them. Quenelles, on the other hand, located as it is near to the secret Forest of Loren, has always had a strong association with the perils and mysteries of the grail quest.

WOOD ELVES

Athelwyn of Athel Loren 174 points

Athelwyn is armed with a sword, the *Star Lance*, light armour and shield, and rides a barded Elven Steed.

Aelfryc the Tall 166 points

Aelfryc is armed with the *Heart Seeker Sword*, lance, light armour and shield, and rides a barded Elven Steed.

Cuthrun the Wolf 136 points

Cuthrun is armed with the *Sword of Might*, lance, light armour and shield, and rides a barded Elven Steed.

Gyferth of the Oak Glades 121 points

Gyferth is armed with a sword, lance, light armour and shield, and rides a barded Elven Steed. Gyferth has a *Jade Amulet*.

Wykas of the Wychelms 126 points

Wykas is armed with a sword, lance, light armour and shield, and rides a barded Elven Steed. Wykas has a *Potion of Strength* concealed about his person.

Bloedh the Bold 120 points

Bloedh is armed with sword, lance, light armour, the *Charmed Shield*, and rides a barded Elven Steed.

BATTLE OF THE TENTS

THE TIDE OF BATTLE

Only one verse of the chanson describes the despicable Elf treachery at the Battle of the Tents, but the battle was not much for Bretonnian minstrels to boast about! As soon as he was alerted, the Castellan hastily gathered some men and sallied forth from the gatehouse. By the time he reached the tents, the Chalice of Chanterelle was already concealed beneath a Wood Elf cloak. The Castellan sent his Squires around the enclosure to try and cut off the thieves' retreat while he led two companies of Men-at-arms towards the prize pavilion. A few Squires fell to arrows from Wood Elf Scouts lurking in the trees, but the rest charged headlong into the camp in a vain attempt to ride down the Wardancers emerging from the pavilion.

At the same time, the Castellan led his Men-at-arms in a reckless charge into a dense mass of Glade Guards and Archers standing defiantly between him and the pavilion. The Archers scampered off, with the Castellan and his Spearmen in hot pursuit while the Halberdiers clashed with the Glade Guards.

The Elves though, were rather skilled with their long, stout spears and got the better of the Bretonnians who couldn't use their shields while wielding clumsy halberds. The sight of the fleeing Halberdiers threw the Spearmen into a panic as well, quickly followed in their flight by a handful of Squires beating a rapid retreat from another nasty encounter with the Wardancers.

As for the Bretonnian bowmen standing at a safe distance, they could barely see any Elves to shoot at. The Castellan, always a man to lead by example and now in a real knightly rage, spurred his charger on into the Wood Elf archers rallying in front of him. He shrugged off their arrows, most of which glanced off his armour, and crashed into the enemy, taking on all of them single handed as he flailed at them with his morning star. Although the agile Elves proved difficult to hit, his heroism shamed the Spearmen enough to make them rally to their banner and rejoin the battle.

But it was too late. In the fading light, all the prizes had already been stolen and whisked away by Warhawk Riders suddenly swooping down from the sky.



Historian's Comment

It was a victory of cunning and agility over brute force and righteous indignation! The Castellan felt that his honour was so slighted by the theft of the prizes that he begged the Duke to give him leave to join the perilous pilgrimage to redeem himself! The Duke replied that he could not spare such a good man from his retinue and also that since the Castellan's task was to guard the castle not the tourney field, his reckless single-handed charge had been above and beyond the call of duty and his honour was not in question.

BRETONNIANS

Castellan of Quenelles 107 points

The Castellan is armed with a hand weapon (morning star), heavy armour and shield and rides a barded warhorse. He has the *Knights' Virtue* and the *Virtue of Knightly Temper*.

The Men-at-Arms of the Fauberg de Mayonne

Unit of 20 Men-at-Arms 198 points
Armed with spears, light armour and shields. The unit includes a standard bearer and musician.

The Men-at-Arms of the Donjon de Quenelles

Unit of 20 Men-at-Arms 220 points
Armed with halberds, light armour and shields. The unit includes a standard bearer and musician.

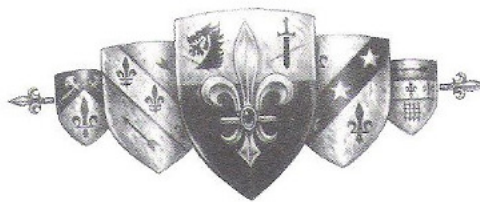

Mounted Squires of Le Duc de Quenelles' household

Unit of 10 Mounted Squires 216 points
Armed with spears, light armour and shields. The unit includes a standard bearer and musician.

Le Chasseurs de Le Duc de Quenelles

Unit of 10 Squires 72 points
The unit is armed with spears and includes a standard bearer and musician.

The Bowmen of the Bastion de Fer

Unit of 15 Bowmen 170 points
The unit is armed with longbows and light armour and includes a standard bearer and musician.

Total Points Value: 983 points

WOOD ELVES

Elthryn 134 points
 Armed with a hand weapon, longbow, *Hail of Doom Arrow* and light armour.

Idryth the Mage 62 points
 Armed with a hand weapon and longbow.

Glade Guards of the Willowglades

Unit of 16 Glade Guards 180 points
 The unit is armed with hand weapons, spears and shields and includes a standard bearer and musician.

The Deerstalkers

Unit of 5 Scouts 80 points
 Armed with hand weapons and longbows.

Watchers of the Willowglades

Unit of 5 Waywatchers 90 points
 Armed with hand weapons and longbows.

Wuthyl's Willowsingers

Unit of 5 Wardancers 100 points
 Armed with two hand weapons.

Greencloaks

Unit of 10 Archers 110 points
 Armed with hand weapons and longbows.

Taroc the Slayer

Champion 70 points
 Armed with a hand weapon, spear and shield and rides a Warhawk. The Champion is accompanying the Warhawk Riders.

Taroc's Falcons

Unit of 5 Warhawk Riders 170 points
 Armed with hand weapons, spears and shields. Accompanied by Taroc making a unit of 5 Warhawk Riders plus champion, totalling 6 models in all.

Total Points Value: 996 points



THE PERILOUS PILGRIMAGE

THE TIDE OF BATTLE

Not much is revealed in the chanson about the fate of the pilgrimage except that it was ambushed in the Forest of Loren and thanks to a miracle of the Lady of the Lake, the pilgrims were spared from certain destruction. Reading between the lines, extolling the virtues of Aloys de Montjoie and Eleanor de Quenelles, we may conjecture the actual sequence of events deep within the forest on that dark winter evening.

As the column of Bretonnian pilgrims followed the long-forgotten path to Chalotte, they encountered a fork where the path went either side of a marsh. They paused to decide which way to go not realising that the Wood Elves had cunningly chosen this spot to ambush them! They were about to enter the glade of Gwercus, the home of a mighty Treeman and his Dryads, who were said to have guarded the approaches to the sacred glade of the Kindred of the Willows.

Led by Gwercus himself, we must imagine the Dryads suddenly emerging from the dense forest on the flanks of the Bretonnian column while more barred the way ahead and arrows rained down from unseen archers concealed in the woods. Aloys de Montjoie sent the wagon on ahead by the most direct route while he formed a rearguard with the Knights and Mounted Squires. Many unarmoured foot Squires running ahead and beside the wagon doubtless fell immediately to the sudden hail of arrows from hidden Wood Elf scouts. This left the reliquary wagon trundling on hauled by the pilgrims, still singing and indifferent to the danger!



The chanson throws most light on the part played by Eleanor de Quenelles in the battle. Apparently Lyr the mage appeared from the trees uttering dire curses which did little to deter the valiant Knights, but unnerved the Men-at-arms behind them. Eleanor of Quenelles spurred on her warhorse, invoking the Lady of the Lake to hearten the Knights and raise any curses that might be upon them. At the sound of her blessed name, the mighty Treeman stopped in his stride and became rooted to the spot as if held fast by unseen hands, while a group of his Dryads spontaneously burst into flame.

The Dryads undoubtedly caught the Knights and Mounted Squires before they were ready to charge. But the brave Knights and Squires stood their ground valiantly, eventually gaining the upper hand. While this was going on the Wardancers, seeing the reliquary wagon proceeding relentlessly towards the sacred glades attacked it only to be hurled back by a magical force beyond their understanding. The sight of Eleanor defying the foe on her own gave renewed heart to the Men-at-arms of the Castellan de Quenelles who rallied to their standard some distance back along the path.

It would certainly take all the faith and power of Eleanor to hold back Gwercus, gnashing and flailing to be free of her spell so that he could wreak vengeance upon the Knights locked in mortal combat with the Dryads. We know that all the gallant Mounted Squires fell loyally, guarding the backs of their beloved lords from these demented creatures. As it says in the chanson, "Never had Knights such honourable and worthy retainers!" A band of cunning Waywatchers concealed on the other side of the track crept out of the woods behind the Bretonnians and shot at Eleanor de Quenelles. She was pierced by two arrows and it was truly a miracle that she was not slain, but instead she defiantly broke off the shafts, determined that nothing should break her hold upon the Treeman. The Men-at-arms rushed forward and made a wall of shields around Eleanor.

As the light faded, things were no doubt looking grim for the tired and bleeding Bretonnians. The pilgrim column was in a total shambles with slain Squires strewn along the forest path, Knights scattered among the trees pursuing elusive Dryads and the reliquary wagon was nowhere to be found. Indeed it was totally separated from its escort and would be easy prey, if any of the foe could get near it.

The enemy were gathering in the trees for another assault. To make matters worse, Eleanor's hold on Gwercus was failing as she began to faint with loss of blood from her arrow wounds, allowing the mighty Treeman to lurch forward at last, uttering a great deep groan of triumph and anger!

Then the true miracle of the pilgrimage occurred. Gwercus suddenly let out a mournful cry of despair. Soon the wailing was taken up by the Wood Elves concealed in the forest on all sides. The Bretonnians, taking this for a war cry, muttered their last prayers in readiness for certain death. However, the keening became more distant and Gwercus himself had vanished, or at least, could no longer be distinguished from the old gnarled trees of the forest. Dazed and surprised, the Bretonnians fell upon their knees to give thanks to the Lady of the Lake for their amazing deliverance!

BRETONNIAN PILGRIMAGES

Bretonnians are deeply religious people. All Bretonnians, no matter what their status may be in the feudal order, revere the Lady of the Lake and put their faith and trust in her. Whereas Knights can always redeem themselves or seek virtue by going on the grail quest, commoners and ladies cannot do this and so they set out on pilgrimages.

The object of the pilgrimage will often be a famous grail chapel of great sanctity, or a lake or spring sacred to the Lady of the Lake. To drink the waters or pray at the chapel ensures good fortune, because the place is blessed with the benign magic of the Lady. The hardships of the journey and its perils are endured with a steadfast fortitude that comes from the pilgrim's unshakable faith.

Historian's Comment

What could have caused the Wood Elves to lose heart at the very moment of victory? It was the wagon bearing the sacred relics of Quenelles!

It had finally passed through the outer ring of the sacred glade. It is a well known fact that no object of iron may be taken into a fairy glade, for this base and profane metal disturbs the magic of the glade and banishes the friendly tree spirits. All Wood Elves obey the ban, and always hang up any iron weapons they may possess well outside the sacred ring of trees. The Bretonnian weapons were of iron and the reliquary of Quenelles contained not only rusting relic swords and armour but also the very bones of warlike Knights! Gwercus and his retinue lost heart in the battle without realising how close they were to destroying the pilgrimage. By holding fast Gwercus, Eleanor probably saved not only the reliquary wagon from destruction, but the entire pilgrimage. Such is the power of Bretonnian faith! Gwercus never moved nor spoke again, much to the sorrow of the Wood Elves. The others who took part in the ambush retreated to the innermost sanctuary where the rest of the kindred were already gathering.

BRETONNIANS

Aloys de Montjoie 117 points

Aloys is armed with a double-handed broadsword, heavy armour and rides a barded warhorse. He has the *Grail Virtue* and the *Virtue of Knightly Temper*.

Eleanor de Quenelles 202 points

Eleanor is armed with a sword and rides a barded warhorse. She has the *Potion Sacre*.

Arnaud de Borron

Battle Standard Bearer 131 points

Arnaud is armed with a sword, heavy armour and shield and rides a barded warhorse. He has the *Knight's Virtue*, *Virtue of Discipline* and carries the pilgrimage banner of the grail chapel of Quenelles which is a *War Banner*.

Questing Knights

Unit of 5 Questing Knights 205 points

The Questing Knights are armed with swords, lances, heavy armour, shields and ride barded warhorses. The unit includes a standard bearer and musician.

The Men-at-Arms of the Fauberg de Mayonne

Unit of 20 Men-at-Arms 198 points
 The Men-at-arms are armed with spears, light armour and shields. The unit includes a standard bearer and muscian.

*Mounted Squires of
 le Duc de Quenelles' household*

Unit of 5 Mounted Squires 90 points
 Armed with spears, light armour and shields.

Le Chasseurs du Duc de Quenelles

Unit of 9 Squires 54 points
 The unit is armed with spears.

Wagon 0 points
 The wagon carries the Reliquary of Quenelles.

Total Points Value: 997 points

WOOD ELVES

Gwercus the Treeman 280 points

Lyr the Elusive, Mage 62 points
 Armed with a hand weapon and longbow.

Dryads of the Willowgroves

Unit of 5 Dryads 175 points

Dryads of the Sacred Glade

Unit of 5 Dryads 175 points

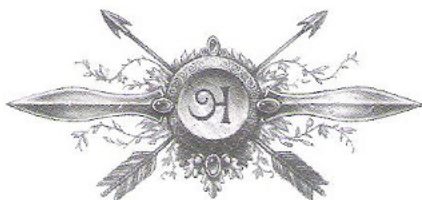

The Deerstalkers

Unit of 8 Scouts 128 points
 Armed with hand weapons and longbows.

The Pathfinders

Unit of 8 Scouts 128 points
 Armed with hand weapons and longbows.

Watchers of the Willowglades

Unit of 5 Waywatchers 90 points
 Armed with hand weapons and longbows.

Wuthyl's Willowsingers

Unit of 10 Wardancers 200 points
 Armed with two hand weapons.

Total Points Value: 1,238 points

**THE BATTLE OF
 THE TREE OF SHIELDS**

THE TIDE OF BATTLE

It is not surprising that the Chanson de Chalotte gives a vivid description of the Battle of the Tree of Shields, albeit from the Bretonnian point of view, since Blondel the author of the ballad fought in the battle himself!

Athelwyn, accompanied by the Elven Princes who had survived the tourney was joined by Glade Riders from the Kindred of Equos who had ridden in to help. These were well placed to make a surprise flanking attack on the advancing Bretonnians.

Agravain guessed that the Elves would try to outflank his army, so he gave the Grail Knights led by Aloys de Montjoie the place of honour on the far right of his line. They formed up in Lance formation with the Knights Errant next to them. Agravain hoped that the impetuosity of the young Knights would lead them forward provoking the Elves to reveal any flank attacks. The Grail Knights would then be well placed to strike the flank of the attackers. On the extreme flank, were the Squires of the Knights who had ridden with Agravain, including Blondel and Jules. Their task was to beat the thickets on the edge of the glade.

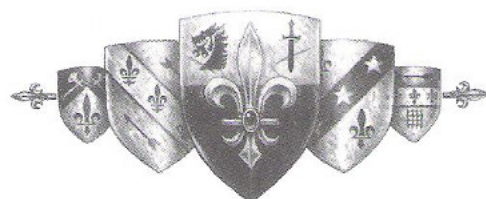

In the centre were Questing Knights and Agravain accompanied by several Knights from the tourney of Quenelles escorting the Lady Eleanor. These gathered pace towards the marsh in order to take the island of Chalotte. On the left were the Men-at-arms of the Fauberg de Mayonne, their numbers now reduced from the previous battle, and the reliquary wagon.

THE LEGEND OF THE TREE OF SHIELDS

Everyone in the dukedom of Quenelles, and many beyond, has heard the legend of the dolorous Tree of Shields. It was rumoured to exist deep in the mysterious Forest of Loren, and features prominently in many chansons, especially the famous Chanson de Chalotte. According to the legend, the tree is hung with the shields of gallant Questing Knights who met a tragic end somewhere in the forest. They were led into the forbidden realm by their visions and dreams, and once they entered they never returned. Then, when their faithful retainers and kinsmen went after them, they too were never seen again. Thus the aged boughs of the tree became weighed down with the shields of the brave, an insult and challenge to all the proud chivalry of Bretonnia!

Arrows began to rain down on the Knights from the woods as they drew closer to the island, mysteriously shrouded in mist. Hidden in the trees was Lyr the Elusive with two of the magic items stolen at the tourney. He scattered the acorns, but due to their great age, only one Dryad sprouted from them. He planted the Old Staff and fell back as it grew into Guath, a Treeman of vast and menacing proportions, who let out a great groan that could be heard across the glade.

The Questing Knights crossed the marsh, with Agravain and his retinue close behind. On the left, the Squires had raised some Wardancers from their hiding place and were milling around in confusion trying to hit them with their boar-spears as they dodged and wove among the horses. Athelwyn leading the Wood Elf riders broke cover and charged, hoping to catch the Bretonnians in the flank as they crossed the marshy rivulet. The Knights Errant immediately wheeled to face them, but were met by the ferocious Guath. Another confused and indecisive melee broke out, with the Knights being unable to harm Guath with their lances while shielding themselves from his flailing blows.

Seeing Athelwyn, arch-enemy and cause of all the trouble, leading the Elven Princes, Aloys de Montjoie could barely contain his anger. He spurred on his warhorse and led the Grail Knights in a thundering charge aimed directly at Athelwyn himself. With two mighty blows from his broadsword, Athelwyn was hewn down. Those Wood Elves that saw their leader fall were shaken and began to retreat back across the marsh. Others reacted with anger and a desire for vengeance. The Grail Knights were suddenly beset on all sides by Elves including Yolath swooping down from the sky. Two of Athelwyn's companions, Aelfryc and Ulthryn, set upon Aloys de Montjoie and were soon joined by the Glade Riders. Surrounded on all sides, Aloys fought them off bravely until he fell, mortally wounded.

The Questing Knights had now charged across the marsh and were fighting in the willow glade against the Glade Guards themselves. Agravain and the Knights accompanying him emerged from the mist onto the island to see the fairy mound of his dreams. Standing before it was a lone Wood Elf hero, Gyferth. Agravain himself fought man to man with the brave and doomed Elf Prince. Gyferth was in every way a worthy and brave adversary, but nonetheless fell to Agravain's lance. The rest of the Wood Elves defending the mound were quickly pursued into the willows and cut down.

The sun was setting over the stricken field. The Kindred of the Willows had been defeated and Agravain and the Questing Knights were in possession of the sacred island. Slain Elves lay like fallen leaves around the mighty Tree of Shields. The cost had been great. All the Grail Knights lay dead around Aloys de Montjoie, mingled with the bodies of many slain Elven Princes. It was then that Agravain tugged out the strange silver arrow entangled in the tress of Melisande which he was wearing around his helm. It had been shot stealthily from Yolath's bow and was fated to slay Agravain had it not been for the lucky favour of the kind and noble lady. The remnants of the Kindred of the Willows took advantage of the gathering dusk to quit the field following Yolath, who saw no need for them to perish utterly in vain combat against insurmountable odds.

Historian's Comment

The Chanson de Challotte goes on to describe the sequel to the battle. The Bretonnians spent the night seeking their wounded and slain comrades, bandaging wounds and resting, exhausted after the terrible fight. Next day with the host assembled on the island of Challotte, Eleanor and the Grail Damsels presided over the blessing of the slain. The Bretonnians were buried around the grail chapel which they had fought and died to recapture. All the survivors were moved by the great sense of faith and honour and knelt in thankful prayer to the Lady of the Lake. Then the dishonoured shields were taken down from the Tree of Shields. A rope was thrown around it and harnessed to a number of mighty warhorses. Slowly the great tree was hauled down, opening up the fairy mound, revealing the carved stonework of the ruined grail chapel.

Agravain and Eleanor de Quenelles accompanied by several other Knights ventured forth into the ruined crypt and immediately fell to their knees in awe at the sight they beheld. Standing before them was the ethereal figure of a lady of incomparable beauty, exactly like the one that Agravain had seen in his dreams and visions. She held out a chalice to Agravain. It was the very image of the one that he had seen at the tourney of Quenelles, yet strangely unreal. It brimmed over with an otherworldly vapour. Agravain sipped from the chalice. The lady slowly melted away before his eyes until there was no trace of her. Indeed the crypt was empty with no trace of anything upon the moss covered mosaic floor that depicted a pattern of fleur de lys. Agravain felt invigorated, indeed blessed. He turned to Eleanor kneeling beside him and she turned to him. Then he saw that Eleanor was the living image of the Lady of Challotte! How had he not noticed this before? Had he not seen her face in his visions? What magic was this?

From that day on, Eleanor de Challotte has been keeper of the restored grail chapel, healing all who make the perilous pilgrimage to the shrine. There in the midst of the forest she is protected by her only retainer, Agravain de Beau Quest, Grail Knight of the chapel of Challotte. Or so it says in the last verse of the Chanson de Challotte, sung throughout the courts of Bretonnia by the minstrel Blondel.

The Chanson de Chalotte

The Chanson de Chalotte was composed by Blondel after the battle of the Tree of Shields, while he was residing at the court of the Duke of Quenelles. By composing the ballad, Blondel fulfilled his feudal oath to his seigneur Agravain. In return Agravain released Blondel from any further obligations so that he could travel throughout the realm singing of the heroic feats of honour, faith and chivalry performed to restore the grail chapel of Chalotte. This Blondel did, immortalising his former liege lord for all posterity. Blondel's Chanson de Chalotte is now regarded as a worthy sequel to Rainourt's *Damoiselle de Chalotte* and the two ballads are usually sung one after the other so that they become one single ballad of enormous length. Of all the Bretonnian chansons these are the ones most favoured by Bretonnian ladies. Should you wish to perform this chanson for yourself, at a banquet perhaps, remember that every alternate verse should be accompanied by spirited playing of the tabor, rebec and musette. As always, a Bretonnian ballad of this length should only be performed if all your friends agree!

BRETONNIANS

Agravain de Beau Quest, General of the Bretonnian Army . . 138 points

Agravain is armed with a sword, lance, heavy armour and shield, and rides a barded warhorse. He has the *Questing Virtue* and the *Virtue of Devotion*.

Rene de Guyenne 103 points

Rene is armed with a sword, lance, heavy armour and shield, and rides a barded warhorse. He has the *Questing Virtue* and the *Virtue of Purity*.

Louen d'Artois 113 points

Louen is armed with a sword, lance, heavy armour and shield, and rides a barded warhorse. He has the *Questing Virtue* and the *Virtue of the Impetuous Knight*.

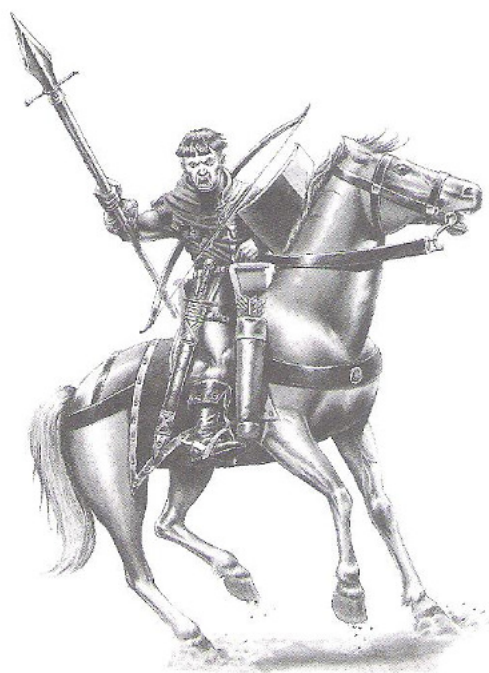

Aloys de Montjoie 117 points

Aloys is armed with a double-handed broadsword, heavy armour and rides a barded warhorse. He has the *Grail Virtue* and the *Virtue of Knightly Temper*.

Eleanor de Quenelles 202 points

Eleanor is armed with a sword and rides a barded warhorse. She also carries the *Potion Sacre*.

Arnaud de Borron, Battle Standard Bearer 131 points

Arnaud is armed with a sword, heavy armour and shield, and rides a barded warhorse. He has the *Knight's Virtue* and the *Virtue of Discipline* and carries the pilgrimage banner of the grail chapel of Quenelles which is a *War Banner*.

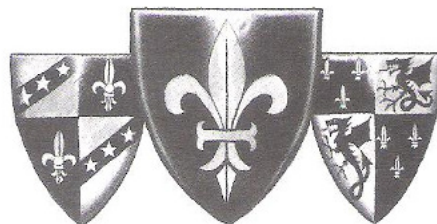

Questing Knights

Unit of 5 Grail Knights 250 points

The unit is armed with swords, lances, heavy armour, shields and rides barded warhorses. The unit includes a musician and a standard bearer who is carrying the *Banner of Courage*.

Questing Knights

Unit of 8 Questing Knights 353 points

The Questing Knights are armed with swords, lances, heavy armour, shields and ride barded warhorses. The unit includes a musician and a standard bearer who is carrying a *War Banner*.

Knights Errant

Unit of 8 Knights Errant 266 points

The unit is armed with swords, lances, heavy armour, shields and are riding barded warhorses. The unit includes a musician and a standard bearer who carries the *Errantry Banner*.

The Men-at-Arms of the Fauberg de Mayonne

Unit of 14 Men-at-Arms 144 points

The unit is armed with spears, light armour and shields. It also includes a standard bearer and musician.

Chasseurs de Quenelles

Unit of 8 Mounted Squires 180 points

The Mounted Squires are armed with spears, light armour and shields. The unit includes a standard bearer (Jasper) and a musician (Blondel).

Wagon 0 points

The wagon carries the Reliquary of Quenelles.

Total Points Value: 1,997 points

WOOD ELVES

Athelwyn of Athel Loren 174 points

Athelwyn is armed with a sword, the *Star Lance*, light armour and shield, and rides a barded Elven steed.

Yolath the Mage 242 points

Yolath is armed with a hand weapon and longbow, and rides a Warhawk. He also has the *Silver Arrow*.

Lyr the Elusive, Mage 62 points

Lyr is armed with a hand weapon and longbow. He also carries the *Casket of Acorns* and the *Old Stick*.

Aelfryc the Tall 166 points

Aelfryc is armed with the *Heart Seeker Sword*, lance, light armour and shield, and rides a barded Elven steed.

Gyferth of the Oak Glades 121 points

Gyferth is armed with a sword, lance, light armour and shield, and rides a barded Elven steed. Gyferth also has a *Jade Amulet*.

BRETONNIAN GRAIL CHAPELS

The original and simplest form of the grail chapel resembles in its plan the sacred symbol of the fleur de lys. Thus the central nave which can be square, rectangular or circular in shape, has three semi-circular apses on three of its sides.

On the fourth side is the entrance porch. The apse at the far end of the nave houses the sacred altar of the grail chapel, on or before which rests the reliquary. Usually the altar takes the form of a basin of sacred water or sometimes a sacred spring or well. The reliquary, usually bound with gold and silver and set with precious stones, contains relics of former Grail Knights or Grail Damsels who served the chapel in the remote past. These may be anything from weapons to talismans or even bones. All around the sacred pool will be chalices of various kinds, presented to the grail chapel by pious Knights. These symbolise the grail because, of course, the true grail is a magical thing which has no physical form and can never be possessed.

The side apses house the tombs of Grail Knights, surmounted by their carved effigies. These depict a Knight resting under his shield. There may be a narrow arched doorway with steps leading down to a subterranean crypt in which rest more Knights and Grail Damsels. The central nave often rises up into a tall tower, resting on strong columns and vaulted arches. The stained glass windows, usually in the form of a fleur de lys, admit glorious multi-coloured light to illuminate the interior and its many hanging tapestries. The floor will usually be decorated with glazed tiles bearing the fleur de lys motif. Next to the chapel will be found the chantry of the Grail Damsels which serves as an infirmary for wounded Knights. All around are grown herbs for potions and, of course, fleur de lys. It is the custom for the Grail Knight to live as a hermit in a secluded chamber near the chapel or even for him to sleep in the porch of the chapel itself, guarding the door.

Uthryn the Mighty, Battle Standard Bearer of the Kindred of the Willows . . . 104 points
Uthryn is armed with a sword, light armour and shield, and rides an Elven steed.

Ceathwyddion, Champion of the Kindred of Equos . . 56 points
Ceathwyddion is armed with a sword, lance, light armour, shield, and rides an Elven steed. He is accompanying the Glade Riders.

Glade Riders of the Kindred of Equos

Unit of 5 Glade Riders 245 points
The unit is armed with swords, lances, light armour, shields, and are riding Elven steeds. The unit includes a standard bearer and musician.

Glade Guards of the Willowglades

Unit of 16 Glade Guards 180 points
The unit is armed with hand weapons, spears and shields. It also includes a standard bearer and musician.

The Deerstalkers

Unit of 6 Scouts 96 points
The unit is armed with hand weapons and longbows.

The Pathfinders

Unit of 6 Scouts 96 points
The unit is armed with hand weapons and longbows.

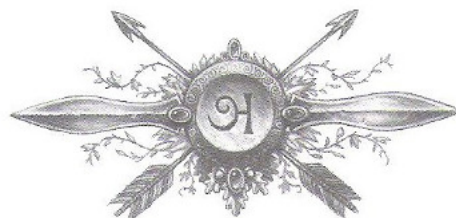

Watchers of the Willowglades

Unit of 5 Waywatchers 90 points
The unit is armed with hand weapons and longbows.

Wuthyl's Willowsingers

Unit of 8 Wardancers 160 points
The unit is armed with two hand weapons each.

Greencloaks

Unit of 8 Archers 99 points
The unit is armed with hand weapons and longbows and includes a standard bearer.

Russetcloaks

Unit of 8 Archers 99 points
The unit is armed with hand weapons and longbows and includes a standard bearer.

Total Points Value: 1,990 points

BRETONNIAN TOURNEYS

When there are no wars to keep the Knights of Bretonnia occupied, they hone their skills by means of colourful contests of martial prowess. These contests are known as jousts, tournaments or, in their grandest and most spectacular form, tourneys! Tournaments are held in each of the great dukedoms of Bretonnia several times a year. These are magnificent events lasting for several days and attended by Knights from all over the realm. Smaller affairs are held at the castles of lesser nobles eager to show off their wealth and influence. On occasions a full tourney is held in order to attract Knights Errant as suitors for the hand of a duke's daughter – a most desirable prize indeed, and what better way for the most worthy Knight to prove himself than by feat of arms in competition with the finest Knights in Bretonnia.

The tourney game is an entertaining variation of Warhammer that can be played in a small area and within a relatively short space of time. The only models needed are a few Bretonnian Knights, so anyone with a copy of Warhammer will be able to take part. The tourney is a contest between rival teams of Bretonnian Knights who joust against each other for a grand prize and, of course, most important of all, the honour of victory! Apart from the hand of an eligible heiress, prizes at tourneys can be many and varied. Sometimes the prize is a magic item, in which case Knights often compete on behalf of their local grail chapel to which they will donate the prize should they win.

THE FIELDS OF BRETONNIA

The greatest tourneys are held each year in the ducal cities of Couronne, Quennes, Parravon, Brionne, Bordeleaux, Gisoreux and L'Anguille, but no longer in Mousillon. Bretonnian tourneys are usually purely Bretonnian affairs attended by Knights from the various dukedoms, but on rare occasions even Elven or Empire Knights have been known to attend. Usually Elven Knights will only take part in a tourney if the prize is a magic item that they believe to be one of their ancient heirlooms and which they desire to win back.

It is, of course, against a Bretonnian Knight's code of honour to use any magic items in the tourney itself. This is a rule which no worthy Bretonnian would even consider breaking, for to do so would besmirch the Knight's honour and bring shame to his family. Elves and such like will of course ignore the rule if they can get away with it. Sometimes even Bretonnians are caught lapsing from the code of honour and have been forced to go on a quest to redeem themselves! It is also against the rules to take part in a tourney riding a monster instead of a warhorse, but such an infringement of the rules is so easily detected that even Elves wouldn't dare attempt it.

Needless to say Bretonnian tourneys are extremely popular, noisy and ribald affairs attended by hordes of commoners from the surrounding countryside as well as all the nobles from miles around. The inns and taverns are filled to bursting point and the feasting, drinking and carousing goes on for many days. Some Knights,

usually Questing Knights or Knights Errant, wander the rutted tracks of Bretonnia entering one tourney after another earning themselves a valiant reputation. Indeed, winning a tourney is sometimes made an errand of Knighthood and a way of acquiring a retinue, since a successful Knight can expect to be followed by a baggage train of prizes, armour and warhorses and a retinue of grooms, Squires and troubadours eager to immortalise his feats in song.

THE JOUST AND THE TABLEAUX de BATAILLE

The tourney in Bretonnia has been refined over the centuries into an art form with many conventions and traditions which can be baffling to foreigners who do not understand the subtle references involved. Tradition dictates that on the first day there is no combat at all. Instead the Knights gather for a parade and to solicit favours from the Bretonnian ladies in preparation for the contests ahead. There are two contests in a proper tourney: firstly there is the joust which takes place over a whole day, and this is followed the next day by the tableaux de bataille. Smaller events often feature only the joust or attempt to cram things together to reduce costs, but a full tourney would not be complete without the pomp of the parade or the final dramatic conflict of the tableaux de bataille.

THE GRANDE TOURNEY

First Day – The Pageant of Honour

The first day of the tourney is devoted to a pageant of honour. The contenders parade around the tourney field and ask for ladies' favours. All contenders are inspected by the heralds for possession of magic items and any misguided individuals found to have such dishonourable items are immediately disqualified in disgrace and struck off the lists. The rest go through to the contests on the second day.

Second Day – The Joust

The second day is the day of the jousting contests. Pairs of Knights joust with each other in a knockout contest. The pairs are determined by lots. The heralds wisely ban personal challenges from friendly tourneys so that Knights cannot use the occasion to pursue personal disputes. Furthermore there is the excitement of not knowing who your opponent is until he stands opposite you on the tourney field! Knights who are unborsed or beaten on lance strikes are knocked out of the tourney altogether. The rest of the Knights in both teams may take part in the contest on the third day.

The Third Day – The Tableaux de Bataille

The third day is the day of the tableaux de bataille. Knights from both teams alternately challenge the Black Knight for the top prize. The order of contenders is determined randomly for each team by lots.



Tourneys are usually fought *a la pleasance* which means fighting with blunted weapons. More rarely they are fought *a l'outrance* which means fighting with sharp weapons. Blunted weapons are used in most tourneys so that the best of Bretonnian chivalry are not slaughtered leaving the realm woefully undefended! Serious wounds are rare and the tourney is an excuse for outrageous fun. However, if sharp weapons are used, contenders may be mortally wounded and such contests are therefore reserved for matters of honour or trials by combat serious enough to warrant fighting to the death. The rules described here are intended for tourneys fought *a la pleasance*, so Knights will rarely die or suffer serious injuries.

HERALDS' RULES AND TOURNEY ROLLS

Tournaments are not open to any old Knight, but only to those considered eligible on grounds of renown, prowess, honour, or in some other fashion. This is a matter for the heralds, who are versed in all matters of chivalry, heraldry and honour. The heralds organise the contending Knights into teams, usually two teams, one consisting of all the Knights from the host's dukedom, and the other comprising Knights from the rest of Bretonnia. The heralds are great sticklers for the rules, and not only do they disregard those who are inexperienced or unknown, but also those who are rather too awesome!

To keep matters in hand the heralds maintain carefully worked out lists of eligible Knights called the tourney rolls. If a Knight is named on the tourney rolls, he may enter the tourney as a contender. The herald selects the teams who will take part from the list of entrants for each tourney. This ensures that the teams are well matched to make for an exciting contest. Bretonnians are not amused by watching one paladin unhorsing a succession of hopeless contenders, a feat that does nothing for honour or entertainment!

CREATING A JOUSTING TEAM

The tourney is fought between two or more teams of Knights and each team is represented by a player. To begin with each player takes an equal number of Bretonnian Knights – the actual number of Knights in a team doesn't matter so long as each team has the same. We suggest you try six Knights as this makes a good sized team for a tourney. As you will see on the accompanying tourney rolls, Tournament Knights employ a slightly different profile because many of the normal characteristics are simply not used in a joust. Knights can be Knights Errant, Knights of the Realm, or Questing Knights – Grail Knights do not normally consider it worthy to partake in such fripperies and the heralds would be unlikely to permit them to do so in any case.

Tournament Knights ride warhorses and carry lances and are perfectly represented by the Bretonnian Knights from the Warhammer box or, indeed, any similarly equipped Bretonnian Knight models. The heralds' rules dictate that Knights may not have magic items or ride monstrous beasts as such things would be an unthinkable affront to the code of chivalry! However, Knights can have Knightly Virtues and may also have Lady's Favours as described later.

To create your team you will need your own tourney roll. This is a blank record sheet with spaces for you to fill in details of each Knight's name, his Knightly Virtues and any Lady's Favour he may have been granted. There is also space to record wounds he might suffer during the tourney. Make a copy of the tourney roll shown on pages 38 or photocopy a batch for future use. Invent a suitable name and shield device for each of your Knights, choose appropriate Knightly Virtues and then roll for a Lady's Favour. You are now ready to begin.

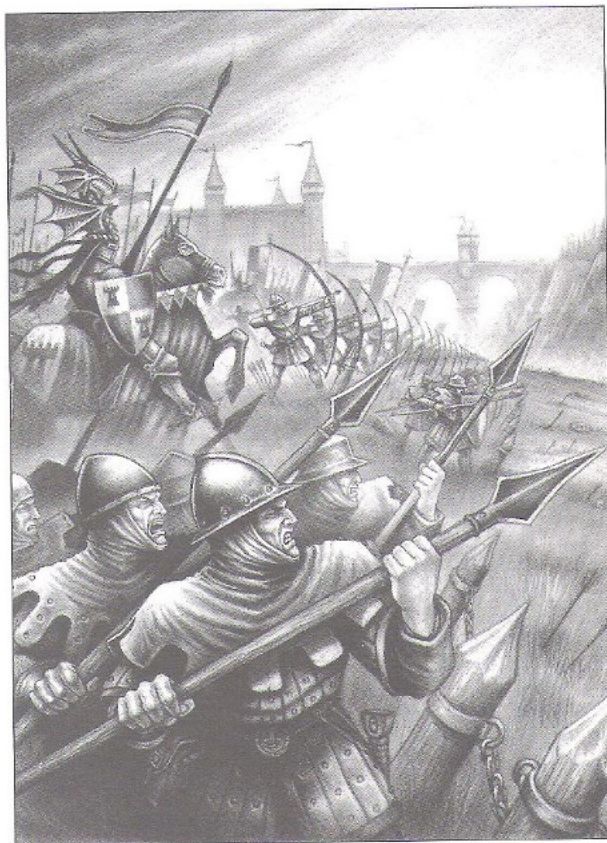

KNIGHTLY VIRTUES

Each Knight is assumed to have the *Knight's Virtue*. In the joust the normal Knightly Virtues of the *Questing Virtue* and the *Grail Virtue* have no effect, so any Knights who would normally have these virtues are assumed to have the *Knight's Virtue* instead. The effect of the *Knight's Virtue* in the game is described below. In

addition each Knight may also have one other virtue chosen from the list below. Knights must have different virtues, the heralds will not allow a team to include more than one Knight with the same Knightly Virtue. Choose which virtues your Knights will have and note these on your tourney roll.

VIRTUE	TOURNEY EFFECT
<i>KNIGHT'S VIRTUE</i>	This is the basic virtue of Knighthood. All Knights in the tournament have this virtue. It has no special effect in the tourney except that any Knights may be nominated as Knights Errant. Knights Errant can have no other virtue, but as handsome and dashing young Knights they are naturally destined to win the heart of a fair damsel. A Knight Errant therefore automatically receives a Lady's Favour! Roll a D6 and treat the score as a double.
<i>DEVOTION</i>	A Knight with this virtue will automatically receive a Lady's Favour entitling him to 3 re-rolls (the Kirtle!).
<i>DISCIPLINE</i>	The Knight practises frequently in the tiltyard and does not have to roll to see if he is unhorsed when he loses a wound.
<i>IMPETUOUS KNIGHT</i>	The Knight spurs on his warhorse and so automatically strikes first. This is regardless of which ploys are used in the joust.
<i>KNIGHTLY ARDOUR</i>	During the first pass of the joust the Knight may add +1 to his Strength to represent the vigour with which he enters into the joust.
<i>KNIGHTLY TEMPER</i>	The Knight gains an extra Attack for each hit scored in the tableaux de bataille. Work out how many hits he scores and then roll that many attacks in addition. This virtue has no effect in the joust.
<i>NOBLE DISDAIN</i>	The Knight completely disregards the first wound he suffers. He bravely shrugs off the wound with a great show of indifference.
<i>PURITY</i>	The Knight may never use a Swipe or Dodge ploy. His extraordinary faith allows him to re-roll failed armour saves! The second result always stands.
<i>VALOUR</i>	The Knight is so gallant and bold that he automatically gains a Lady's Favour. Roll a D6 and treat the score as a double result.
<i>JOUSTING VIRTUE</i>	The Knight automatically hits when using a lance. This is the ultimate ability in a joust, but remember only one Knight in any team may have this ability during a tourney.

THE LADY'S FAVOUR

On the day before the joust, the competitors parade before the assembled crowds where it is custom for the Knights, especially Knights Errant, to ride up to the stands of spectators and ask the ladies for their favours. The favour is regarded as a lucky token and no doubt this belief has come about because some Bretonnian ladies really are secret enchantresses able to bring good fortune to their favoured Knight. Not that these favours are deemed in any way magical or sorcerous, which would be frowned upon of course. They are merely considered to be lucky in a perfectly ordinary and just way.

The Knight chooses the lady whom he regards as the most beautiful to beg a favour from. If she is flattered by the request, or secretly hopes that the Knight will win the contest (perhaps because her hand in marriage is the prize) she will attach an item of her apparel to the Knight's lance. The more intimate the garment the luckier it is believed to be and the higher the Knight can consider himself in her estimation.

Of course this custom always delights the multitudes of uncouth Bretonnian peasants and townfolk whose lewd remarks and whistles often cause the noble ladies to blush. It also requires a lot of bravery on the part of the most beautiful ladies who are invariably asked to give their favour to an embarrassing number of Knights Errant and risk catching a chill by the end of the day. Modest Bretonnian maidens usually attend well prepared in advance with several veils.

ROLL FOR LADY'S FAVOURS

Whether the favours are really lucky no one knows, especially since a favour will boost the courage and confidence of the Knight to the same effect anyway! To represent this, each favour allows the Knight to re-roll one or more dice during the tourney. A re-roll may be used at any time in the tourney, but each one can only be made once and is then used up. So a Knight with several re-rolls will gradually use them up during the tourney until he has none left. The second result always stands and a failed re-roll cannot be re-rolled again.

How many re-rolls the Knight gains depends on the token of the favour. The table below is based on Bretonnian folklore regarding how lucky each garment is believed to be. By tradition, a Knight may only beg a favour from one lady on the first day of the tourney, and if refused, must go without. To represent this roll two dice for each Knight taking part. If he scores a double, he has sufficiently impressed the lady of his choice to be granted a favour. The double score also indicates the nature of the favour he is given.

2D6 score	Token	Re-Rolls
Double 1	Veil	1
Double 2	Wimple	2
Double 3	Kirtle	3
Double 4	Girdle	4
Double 5	Garter	5
Double 6	Tress	6

THE JOUST

The joust is a contest between two Knights who charge at each other three times with lances. The Knight who knocks his opponent from his horse, or breaks more lances by striking his opponent wins the joust.

To prepare for the joust set up the tilt in the centre of your playing area with suitable awnings, tents, and pavilions on either side. Each player lines up his team at one end of the tilt and prepares for the contest.



Write the name of each contender on a separate scrap of paper and put all the names in a different cup for each team. At the start of each joust select which two opponents will fight each other by taking a random pair of names from the cups.

At the end of each joust, the names of the unhorsed contenders are discarded.

The name of each winning Knight is put aside to indicate that he goes through to the next contest: the tableaux de bataille

Scoring in the Joust

The joust consists of three charges or passes. A Knight who knocks his opponent out of the saddle wins outright. Otherwise the winner is the Knight who breaks the most lances upon his opponent!

A lance is deemed to break if you score a successful hit and make a successful roll to wound, even if the wound is saved. In other words the lance is broken on striking his shield, helm or armour and making a successful roll to wound. Striking a crest in the same way counts the same as two broken lances. Keep a tally of the number of lances your Knight breaks. The Knight who breaks more lances than his opponent is the winner.

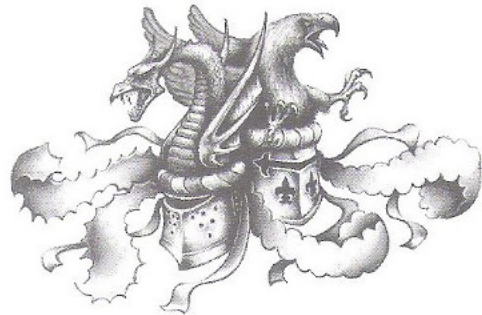

In the event of a draw continue to make more passes until one Knight wins by unhorsing his opponent or by breaking his lance.

The team that wins the most individual jousts wins the day, but all Knights who won their individual jousts go through to the following day's event: the tableaux de bataille.

Get Ready

A joust normally has three passes as described above. At the start of each pass the two Knights stand facing each other approximately 12" apart at either end of the tourney field and on opposite sides of the tilt. Each contender presents his shielded side to his opponent.

Choose Jousting Ploy

At the start of each pass while the contenders stand ready to charge, each player chooses one jousting ploy (see below) and writes this down. When both players have chosen their ploys these are revealed simultaneously and the contenders charge.

Charge!

Both contenders charge simultaneously at full gallop. Since both Knights charge together and both are only using blunted 'courtesy lances' the usual strength bonuses for charging with a lance are disregarded (unless the joust is fought *a l'outrance* of course!). Each contender makes only one strike (that is one attack) with his lance. Further attacks on the Knight's profile are ignored, there is only time for a single attack during each pass.

Who strikes first

The choice of jousting ploy determines whether or not a contender strikes first unless a Knightly Virtue automatically gives the Knight the first strike. The jousting ploys are marked with a number indicating the order of striking, the lower number always strikes before the higher number. If both Knights are entitled to strike at the same time, dice to see who strikes first.

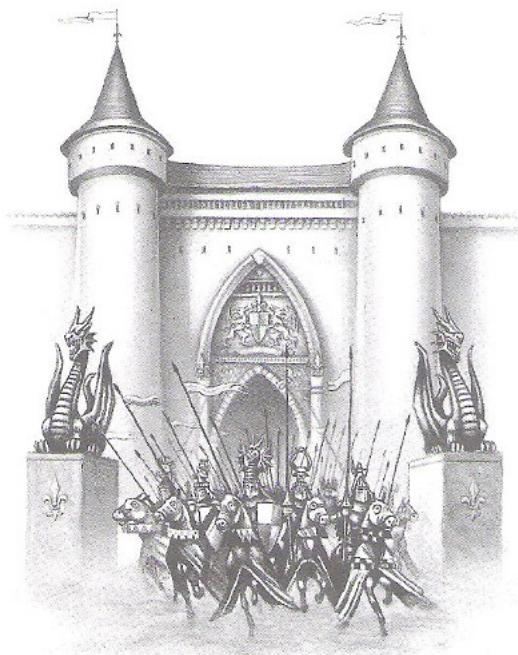

Warhorses

Warhorses do not fight because they are separated by the tilt. Not only are the mounts prevented from biting and kicking at each other, but the contenders gain no benefit to their armour saving throw for their horses' barding. This means that a Knight saves on 4+.

Wounds

If a Knight suffers a wound and the wound is not saved, roll a dice to see if he is unhorsed. On a score of 1, 2 or 3 he is unhorsed and suffers a second wound as he falls from the saddle at full gallop. The Knight will therefore be seriously injured and automatically knocked out of the tourney. Any Knight that suffers a second wound is automatically unhorsed and out of the tournament.

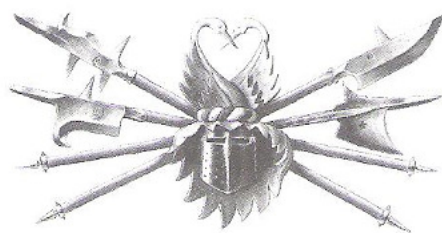

A Knight who suffers a single wound, but who wins his joust, goes through to the next day's event, the *tableaux de bataille*. His wound is recovered automatically in time for the following day's combat.

Next Pass

If both contenders are still in the saddle they ride around the end of the hoarding ready to charge again in the next turn. Any Knight who has broken his lance is automatically handed a new one.

JOUSTING PLOYS

As the two Knights charge at each other, each must use his skill and judgement to strike his opponent. Each Knight can choose to aim at his opponent's shield, helm, helmet crest, to swipe his lance across his opponent's front, or he might decide to dodge his enemy's lance instead. These tactics are called ploys. Each Knight secretly chooses a ploy and once they have done so the ploys are revealed. The effect of each ploy is described on the chart, but the most important thing about them is that they establish which Knight strikes first. Each ploy has a number, and the Knight with the lower number strikes first. If both make the same ploy roll a dice to decide which strikes first.

Of all the ploys the most difficult is to strike the opponent's crest from his helm. This requires great skill and is consequently worth the equivalent of two broken lances! The dodge is the simplest ploy, and not a very honourable one, in which the Knight tries to dodge aside rather than strike with his lance. Although this means he cannot strike himself, he might do this during the final pass of a joust if he is already leading the score in broken lances, thus denying his opponent the chance to catch up.

JOUSTING PLOYS

1. Aim for Shield

You aim your lance at your opponent's shield to put maximum force behind the strike. You automatically strike before an opponent using any other ploy.

2. Aim for Helm

You aim your lance at your opponent's helm. This is hard to hit, but even a glancing blow can wound or unhorse your opponent so you count +1 Strength. To represent the difficulty of hitting, you strike after an opponent aiming for Shield, but before an opponent attempting to Swipe or hit your crest.

3. Aim for Crest

You can only use this ploy once in the joust and then only if your opponent actually has a crest on his helm! The lance is aimed at your opponent's crest. This is difficult to hit, and will never wound or unhorse your opponent. Nevertheless it is a great slight upon his honour and counts as two lance breaks! To represent the difficulty of hitting, you strike after an opponent aiming for Shield or Helm, but before an opponent attempting to Swipe. You count -1 to hit and if you score a hit the crest is knocked off on a further roll of 4, 5 or 6.

4. Swipe

This ploy is acceptable, but not considered to be very honourable! You swipe with the lance across your opponent's front to knock him from his saddle. It is not difficult to hit with this ploy, but is rather slow and not very skilful. To represent this, you strike after an opponent aiming for Shield, Helm or Crest, but you always count +1 to hit.

5. Dodge

This is a defensive ploy greatly lacking in honour. You give up your own chance to strike in order to dodge your opponent's lance. This means that you do not strike at all, but your opponent suffers -2 to hit (if he is entitled to an automatic hit this is modified to 3+ to hit). If both contenders opt for this ploy, then neither will strike at all.

THE TABLEAUX DE BATAILLE

The tableaux de bataille is an imaginative and spectacular contest that is very popular with the Bretonnian ladies. The tableaux usually has an elaborate theatrical setting inspired by one of the many chansons, the troubadours' songs which tell of the legendary feats of arms of various paladins of Bretonnian chivalry. This contest is held on the last day of the tourney. The winners of the previous day's jousting challenge the Black Knight in turn in order to win the top prize. The Black Knight is the best Knight of the dukedom, chosen by the Duke himself, disguised in black armour with no identifying heraldry. He usually unhorses several challengers before someone succeeds in beating him to win the prize!

None Shall Pass!

If the prize of the tourney is the hand of a fair damsel, the heiress to a vacant feudal domain, a mock dungeon tower is set up on the tourney field, surrounded by a moat, over which is a drawbridge. The lady plays the role of a 'damsel in distress' locked up in the tower. She leans out of the window shouting encouragement to the Knights trying to rescue her.

Each challenger tries in turn to cross over the drawbridge and reach the tower to rescue the damsel. Whoever succeeds wins the prize. Unfortunately you can only cross the drawbridge by unhorsing the Black Knight who is the guardian of the tower.

The Ring of Stones

If the prize of the tourney is an enchanted relic, the contenders and spectators make a splendid procession over to a nearby stone circle on the morning before the contest, which is held in the afternoon. This will be the same place where trials by combat are customarily held.

The prize is placed in the middle of the circle on an altar stone. There is only one way into the circle, between two large stones wide enough to admit a rider on horseback. Guarding the circle is the Black Knight who is not permitted to leave the circle. Each challenger enters the circle in turn. The only way to claim the prize is to unhorse the Black Knight.



CHALLENGING THE BLACK KNIGHT

Each contender challenges the Black Knight in turn. The order in which contenders challenge him is determined randomly as for the jousting.

Both the challenger and the Black Knight charge each other with lances, counting only one attack each. The bonus for charging with lance is disregarded as in the joust since the tableaux is also fought *a la plaisance*. Jousting ploys are not used, since both Knights are honour bound to aim for their opponent's shield. Both contenders roll off to see who strikes first in the initial round. If one or other is wounded make a further roll to see whether he is unhorsed and therefore knocked out of the contest. The prowess of the Black Knight is such that he can only be unhorsed on a roll of 1!

Subsequent rounds of the combat are fought with blunted maces or morning stars which make for a noisy, robust and entertaining spectacle in which both Knights end up with their shields well and truly dented! The Knights now make their full number of attacks, and use Initiative to determine who goes first. The contest continues until one or other of the Knights is unhorsed. If a challenger is unhorsed, the next challenger rides out. As in the joust, warhorse attacks and warhorse barding are disregarded.



Wounds taken by the Black Knight are cumulative and when he has suffered his full wounds he is automatically unhorsed which means that his current opponent wins. Your chances of beating the Black Knight are therefore better if your Knights are not among the first to challenge him!

THE BLACK KNIGHT

The Black Knight wears black armour, a black surcoat and carries a black shield bearing no blazon by which he can be recognised. No one knows the true identity of the Knight who plays the role of the Black Knight. All that you can be sure of is that he will be a Knight of great renown and martial prowess! It could be the Duke himself, the best Knight in the Duke's retinue or a hermit Grail Knight from a remote grail chapel somewhere in the dukedom. According to legend sometimes the King of Bretonnia himself has played the role of the Black Knight in the tournament at Couronne!

	M	WS	BS	S	T	W	I	A	Ld
Black Knight	4	6	6	4	4	3	6	3	9
Warhorse	8	3	0	3	3	1	3	1	5

EQUIPMENT: The Black Knight wears heavy armour, carries a shield and rides a barded Bretonnian warhorse. He is armed with a mace or morning star and lance.

SAVE: 4+ (disregarding barded mount).



KNIGHTLY VIRTUES

The Black Knight has the *Knight's Virtue* as do all Knights, although this has no effect in the tournament. He also has the *Virtue of Knightly Temper* and so gains an extra attack for each initial hit scored. Work out how many hits he scores and then roll that many attacks in addition.

TOURNEY PRIZES

It will no doubt occur to many players with Bretonnian armies and a passion for all things Bretonnian to make tournaments part of a campaign set in Bretonnia. As always, it is up to the players involved to agree amongst themselves how to do this and how they might adapt the basic rules to take account of the odd visiting team of Elven or Empire Knights. Indeed the campaign could

The Black Knight in Bretonnian Folklore

The Black Knight is an old and well known figure of Bretonnian folklore and legend. In his aspect as something to be dreaded, he undoubtedly embodies the age old fear of the Chaos Knight, the Dark Elf rider or the Undead horseman who have plagued Bretonnia since time immemorial. Thus he represents the archetypal adversary of a bold Bretonnian Knight. In his less ominous aspect, he represents the anonymous Knight. Such a Knight may wish to disguise his identity under black, shabby robes, lacking any heraldic device by which he may be recognised. Some Questing Knights do indeed adopt such a garb. There is always speculation as to why a Knight should do this, maybe it is because he must redeem his honour, or has he forsaken the true faith like the villain Maldred?

Whatever the reason, is it not the duty of any virtuous Knight to challenge such a character and force him to yield, so that his identity may be made known?

simply take the form of the grand circuit of tourneys in Bretonnia, since each dukedom holds its tourney in a different month to the others, making it possible for Knights to go from one to another amassing renown and prizes as indeed many do! It would of course be great if the tourney prizes were something which you could use in future Warhammer battles, so here are a few suggestions:

Recovery of Characters

Firstly it must be assumed that all Knights eventually recover from wounds received during the tourney unless the tourney was fought *a l'outrance*, using sharp weapons!

For the traditional tourney fought *a la pleasance*, with blunted weapons, roll a dice for each unhorsed character. On a score of 1, his wounds were sufficiently severe for him to miss the next battle or tourney recovering in the delicate care of the local Grail Damsels. All other scores indicate superficial wounds. If the tourney is fought *a l'outrance* simply reduce the chance that the Knight recovers. Any Knight who was lucky enough to have a Lady's favour may re-roll his recovery score if he has any re-rolls left!

Jousting Prizes

Each Knight who successfully gets through the jousting of the second day of the tourney wins great renown and gains experience. To represent this you might consider raising any one of his profile characteristics by +1 as long as no characteristic is ever raised more than once. This is done after all jousting is over, but before the tableaux de bataille on the third day. A character who enhances his profile in this way would be able to use his new profile in subsequent tourneys or in battle. He might also add to his heraldry a special blazon to show that he is a victor in the joust, a striped lance perhaps or a laurel wreath around his helm.



The Prize of the Tableaux de Bataille

This is the ultimate prize of the tourney. If the tableaux de bataille was the tableaux of the dungeon tower then the prize would be the hand of the damsel herself. There is more to this prize than a fair Bretonnian damsel, perhaps a castle and feudal domain complete with a modest retinue of: 1 Mounted Squire, 1 Foot Squire, 1 Man-at-arms and 1 Archer. The Knight would then automatically become a Knight of the Realm if he is not one already. If the Knight is fielded in your army you might perhaps add his retainers to your army at no extra points cost although you would still pay the points for the Knight himself.

If the tableaux de bataille was the tableaux of the stone circle, then the prize would be a magic weapon up to a value of 50 points, which was recently discovered somewhere in the dukedom, or brought back from an errantry war in some far flung place. Such a weapon must be chosen randomly from the Magic Weapon cards by cutting the deck. It can then be used by the character in battle at no extra points cost, but still counts as part of his usual quota of magic items.

Wounded Knights

On the whole, it is rare for contenders to be mortally wounded in a tourney. Knights who are dragged off the field as casualties are usually just stunned, have cuts and bruises or the occasional broken bone. This is mainly because of their effective armour and padded jerkins worn beneath and also because, unlike in battle or trial by combat, a Knight will not deliver the coup de grace to an opponent in a friendly tourney.

Wounded Knights who are not unhorsed have their wounds bandaged up after the day's events and can continue to take part in further tourneys or battles with their full Wounds value.

BRETONNIAN TOURNEY ROLL

KNIGHT

M	WS	BS	S	T	W	I	A	Ld	S _{ave}

KNIGHTLY VIRTUES & FAVOURS

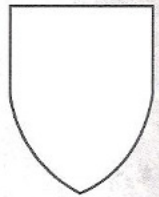

KNIGHT

M	WS	BS	S	T	W	I	A	Ld	S _{ave}

KNIGHTLY VIRTUES & FAVOURS

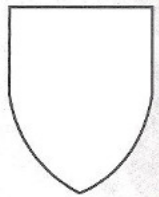

KNIGHT

M	WS	BS	S	T	W	I	A	Ld	S _{ave}

KNIGHTLY VIRTUES & FAVOURS

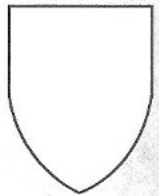

KNIGHT

M	WS	BS	S	T	W	I	A	Ld	S _{ave}

KNIGHTLY VIRTUES & FAVOURS

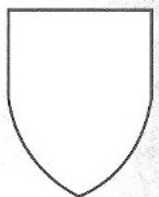

KNIGHT

M	WS	BS	S	T	W	I	A	Ld	S _{ave}

KNIGHTLY VIRTUES & FAVOURS

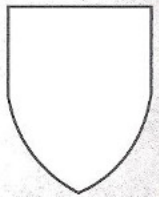

KNIGHT

M	WS	BS	S	T	W	I	A	Ld	S _{ave}

KNIGHTLY VIRTUES & FAVOURS

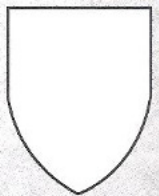

WRITE YOUR KNIGHTS' NAMES IN THE SPACES PROVIDED AND DRAW THEIR HERALDRY ON THE SHIELDS

DESIGNING YOUR KNIGHTS' HERALDRY

Bretonnian Knights declare their achievements and status by decorating their pennants, shields and surcoats with the colours of their realm and bold heraldic devices. This personal heraldry is also incorporated onto their horse's barding.

On this page are templates for you to photocopy and use when you are designing the barding for your Knights' steeds in the first scenario, *The Journey*.

You will also find these templates useful when you are painting your Bretonnian army for other Warhammer battles as well.

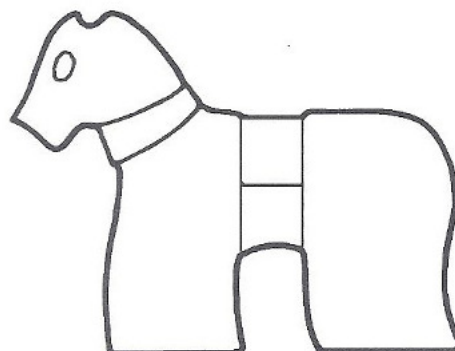
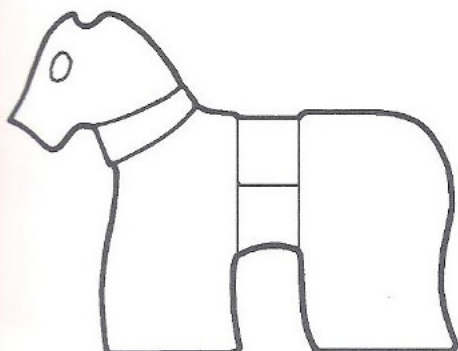
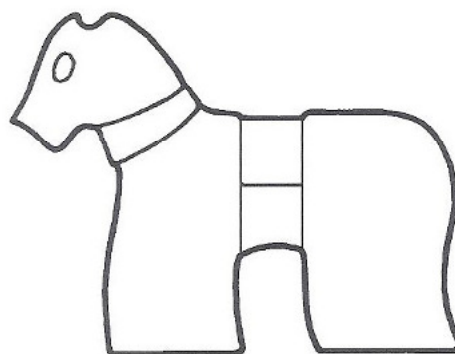
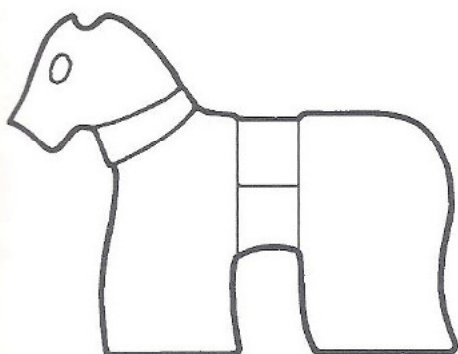
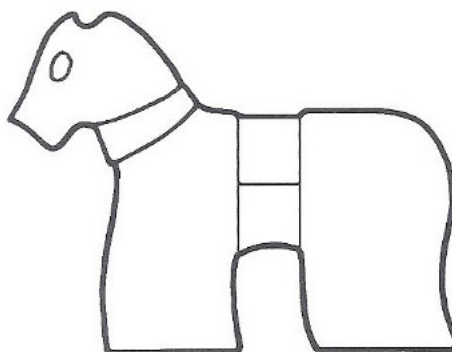
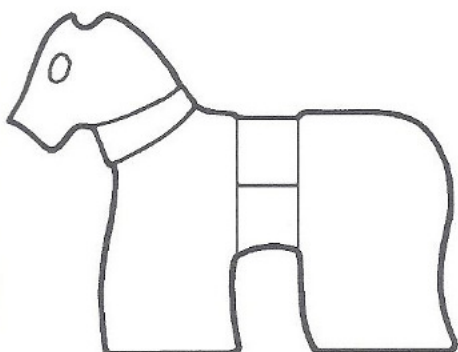

To assemble these structures you will need a sharp modelling knife and a tube of superglue or polystyrene cement. In all cases the toned areas indicate where to apply the glue.

Structure 1 – THE TENTS

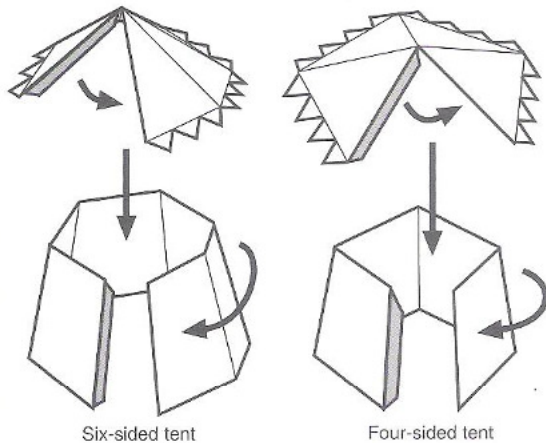

This box contains five small tents – three four-sided tents, and two six-sided ones. The parts of the tents are all labelled so that you can tell which bits go together – roof (1a) goes with walls (1a), roof (1b) goes with walls (1b), and so on.

All of the small tents are assembled in the same way. First, bend the panels of the tent roof so that it forms a cone shape. Next, apply glue to the roof edge which has a tab, and then hold the two roof edges firmly together. Leave the roof to completely dry while you assemble the walls. To assemble tent walls, bend the wall section round, and glue the two edges together where the tab is.

When the walls and the roof are dry, you can make up the tent. Place the roof on top of the walls, and then, holding the two parts together, carefully turn the tent upside down. Glue the roof to the walls on the *inside* of the model, so that any glue spills won't spoil the tent's outer appearance.

Structure 2 – PAVILION

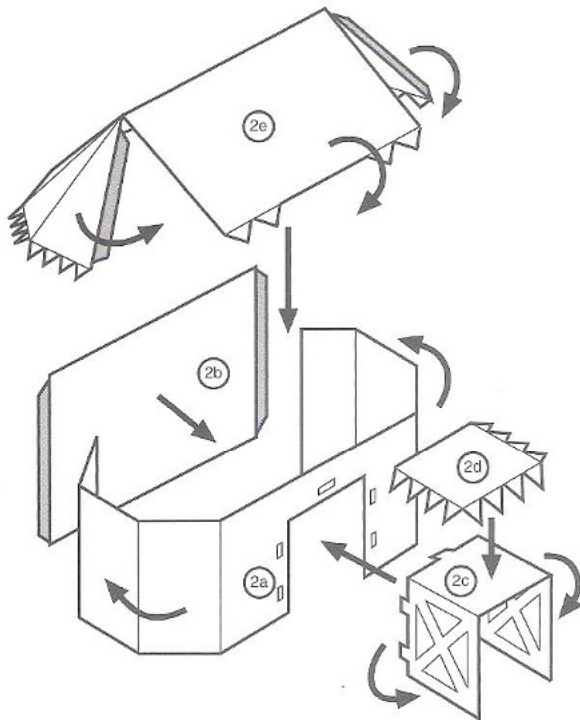

Bend round the two sides of the main wall (2a). Take the back wall (2b) and glue to the two sides of the main wall, ensuring the tabs are on the inside of the tent.

Next, fold down the sides of the porch (2c), and insert into the doorway of the pavilion, using the location tabs. Glue the porch roof (2d) on to the top as shown and fold down the flaps.

Fold one side of the pavilion roof (2e) around, bend the front down to meet it, and then glue the two together using the tabs. Do the same to the other side.

When the roof is dry, position the roof onto the walls of the tent and check that they fit together properly. Carefully turn the structure upside down and glue the walls and roof together from the inside, holding the roof and the walls firmly together for a few minutes until the surfaces have securely bonded.

Once the pavilion is dry, the last stage is to fold down the fringes of the canopy and then your pavilion is complete.

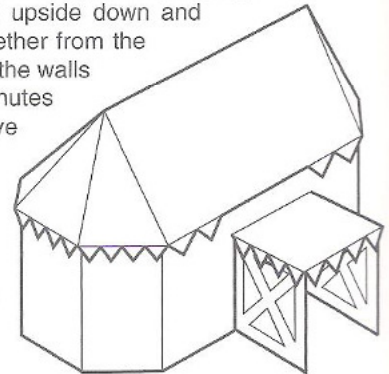

Structure 3 – THE HOARDINGS

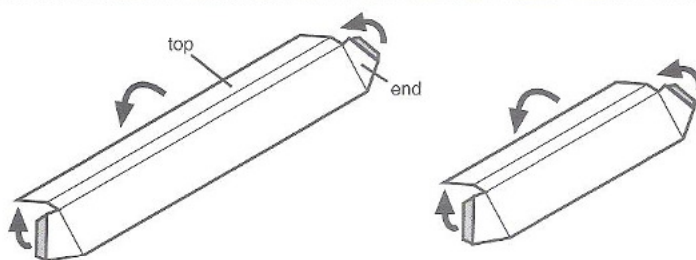

There are five hoardings (also known as *tilts*) in *Perilous Quest*. Although they are different sizes, they are all assembled in the same way. Simply fold over the top of the hoarding, and glue the sides to the two ends, using the tabs provided.

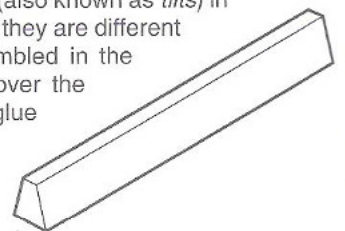

Structure 4 – THE WAGON

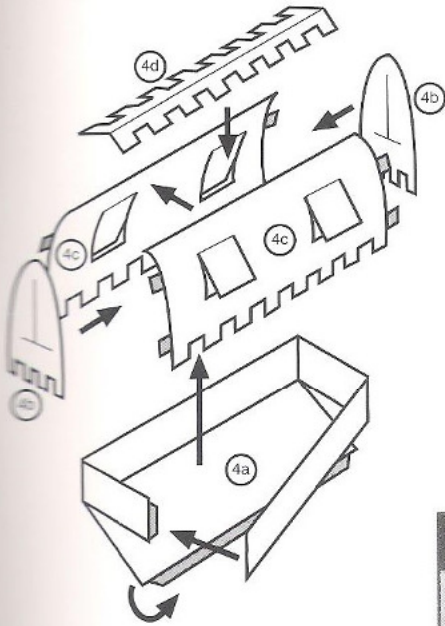

Take the chassis (4a) of the wagon, and fold the side panels around as shown. Glue the base tab to the interior of the side panel and then glue the two together.

Next, take the two wagon walls (4c) and bend them gently inwards, so they match the curve of the wagon ends (4b). Take one of the wagon ends and glue it to one of the wagon walls, using the tabs. Bit by bit, glue along the edges of the two pieces, bending the wall round to fit the curve of the wagon end. When the two pieces are dry and secure, repeat the process with the other side of the wagon wall.

Glue the remaining wall to the structure, one end at a time. To finish the wagon canopy, glue the wagon spine (4d) along the top. Once everything has dried slot the completed wagon canopy onto the chassis.

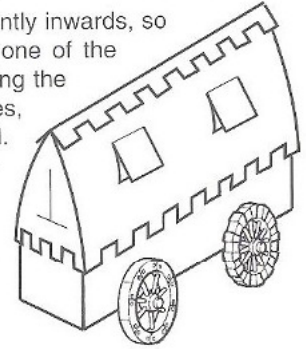

ATTACHING WHEELS TO YOUR WAGON

To attach wheels to your wagon, first remove them from the sprue using clippers or a craft knife. You need to make two axles for the wheels, which can be made from a variety of materials, including matchsticks, cocktail sticks or even offcuts from the plastic sprue the wheels were attached to. Whatever material you choose, cut two strips of equal length, making sure that they are slightly longer than the width of the wagon's base. Glue these axles in place and wait until they've dried. Finally, glue the wheels into position on the ends of each axle.

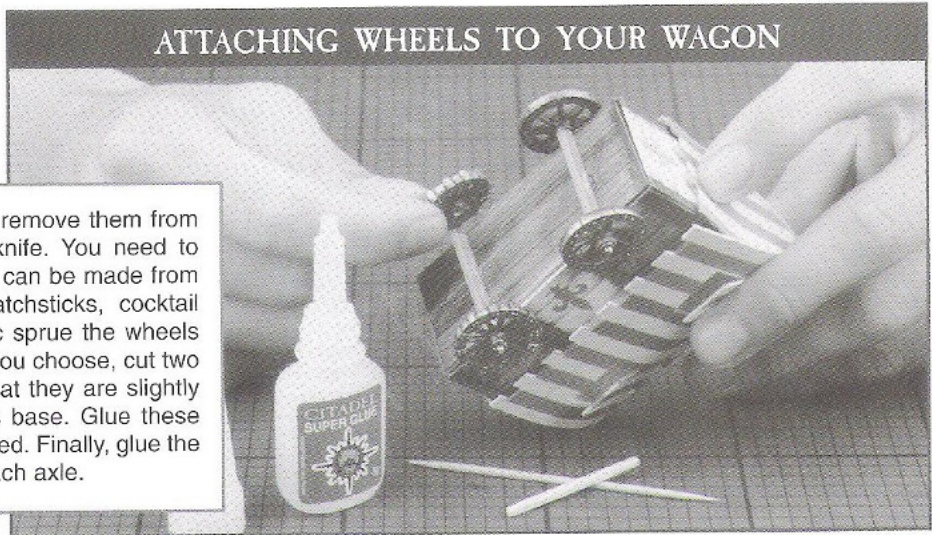

READY FOR BATTLE

Once the structures are complete we recommend that you stick them to card bases as shown below, which makes them stable and more durable. Simply add some Citadel flock and your structures are ready for action.

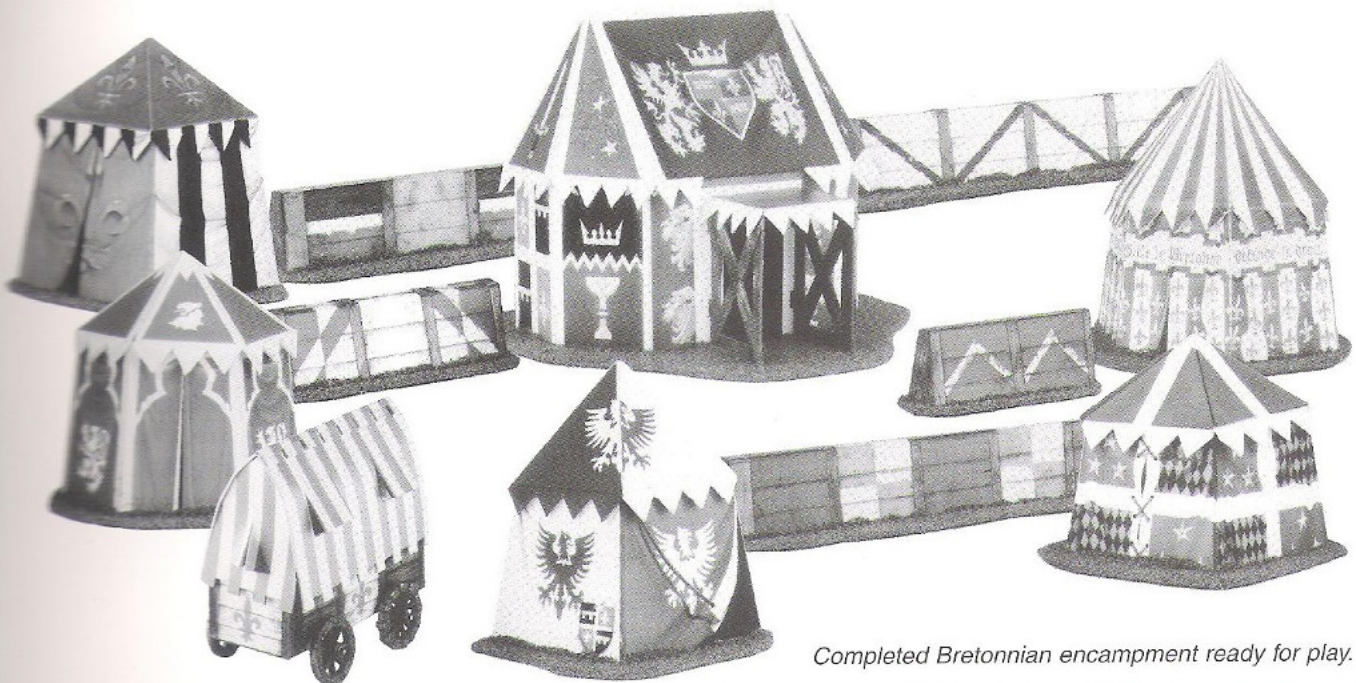

Completed Bretonnian encampment ready for play.

ALOYS DE MONTJOIE

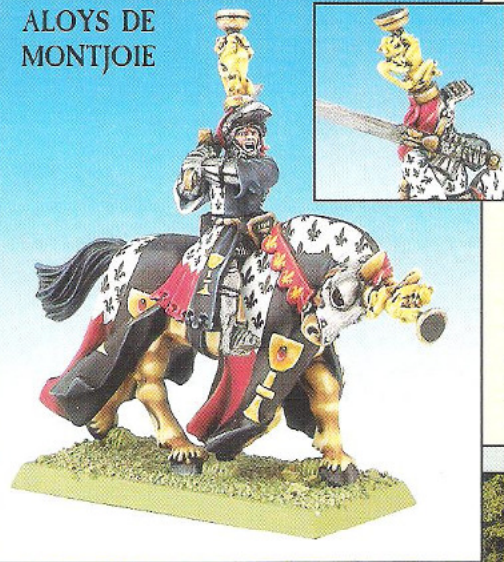

AGRAVAIN DE BEAU QUEST

Agravain de Beaumarchais leaves his ancestral lands on a perilous quest for the Grail, thus earning himself the name Agravain de Beau Quest. Driven by mysterious visions, he is compelled to seek out an abandoned grail chapel on the borders of Athel Loren.

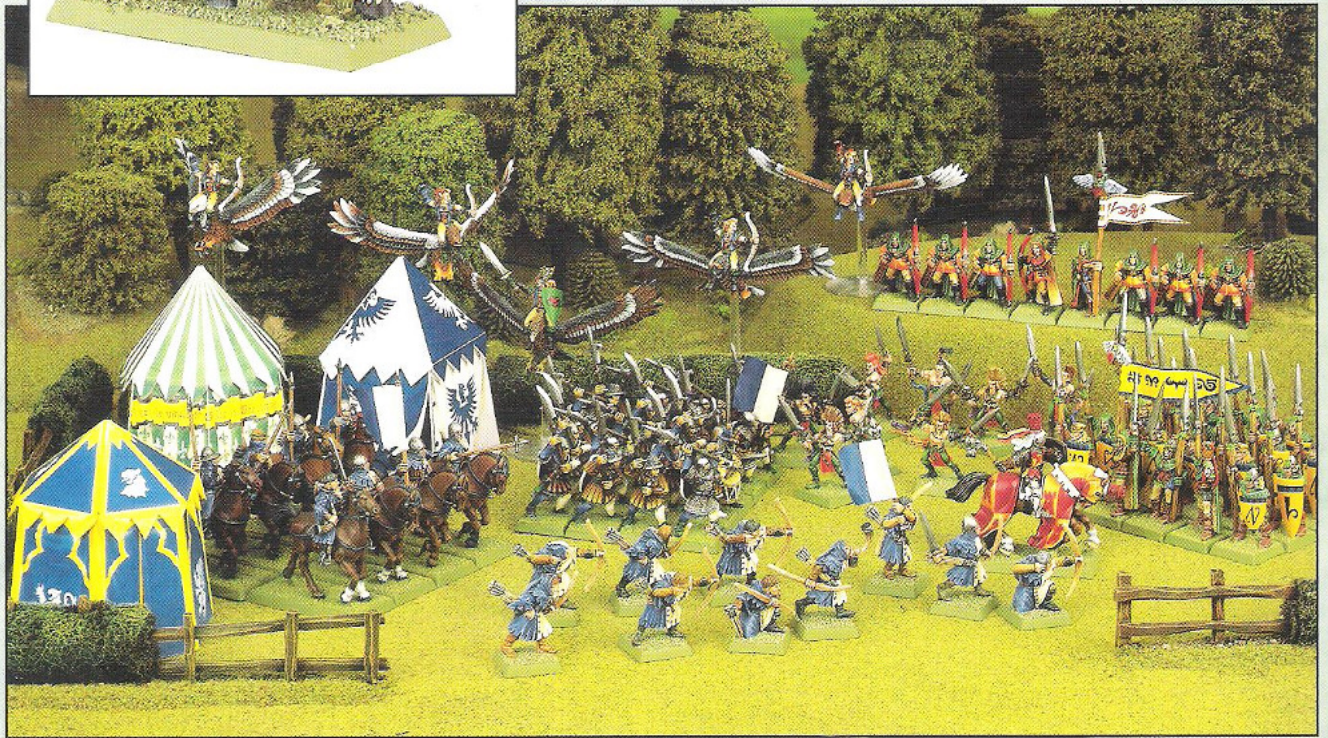
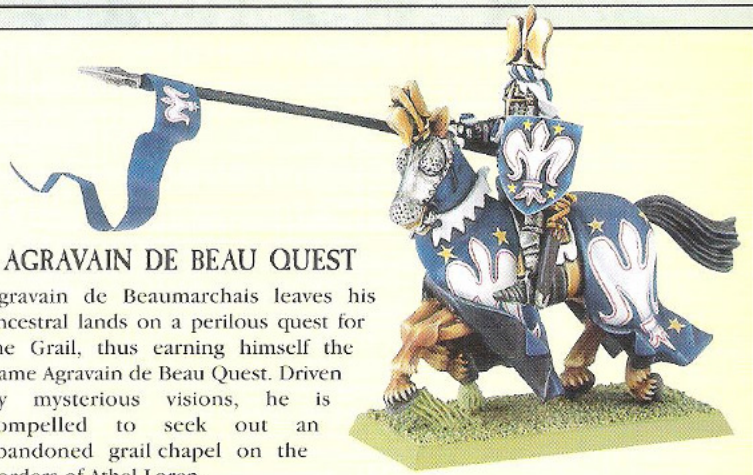

Bretonnian Men-at-arms and Squires follow in the wake of their valiant master, the Castellan de Quenelles, pressing home their attack against the Wood Elf Kindred of the Willow Glades.

Bretonnian Mounted Squires accompany the Knights in times of war as well as when hunting. In battle they form their own regiments, often acting as scouts or skirmishers for their noble masters.

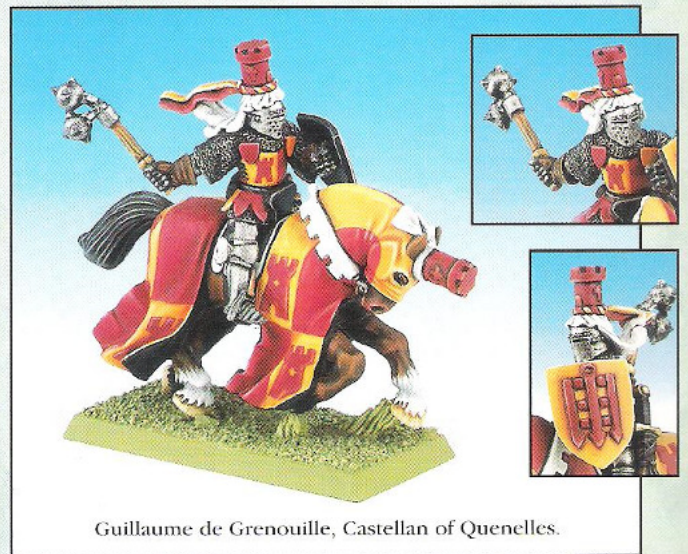

Guillaume de Grenouille, Castellan of Quenelles.

SCENARIO I – THE TOURNEY
Bretonnian Player's Battle Scroll

HERALD'S TOURNEY ROLL

The Bretonnian team consists of Agravain de Beau Quest plus five other Knightly Heroes. Profiles for these are shown here on the tourney roll. In addition choose one virtue from those described below, plus one favour from those listed overleaf. Each Knight must have a different virtue and favour. Choose names for your Knights or you can refer to the *Chanson de Challotte* for suitable Knightly names.

	M	WS	BS	S	T	W	I	A	LD	SAVE
AGRAVAIN	4/8	5	5	4	4	2	5	3	8	4+ (2+ in battle)

Favour: The Tress of Melisande

Virtue: None specific to the joust. See below.

	M	WS	BS	S	T	W	I	A	LD	SAVE
KNIGHTLY HERO	4/8	5	5	4	4	2	5	3	8	4+ (2+ in battle)

Favour:

Virtue:

	M	WS	BS	S	T	W	I	A	LD	SAVE
KNIGHTLY HERO	4/8	5	5	4	4	2	5	3	8	4+ (2+ in battle)

Favour:

Virtue:

	M	WS	BS	S	T	W	I	A	LD	SAVE
KNIGHTLY HERO	4/8	5	5	4	4	2	5	3	8	4+ (2+ in battle)

Favour:

Virtue:

	M	WS	BS	S	T	W	I	A	LD	SAVE
KNIGHTLY HERO	4/8	5	5	4	4	2	5	3	8	4+ (2+ in battle)

Favour:

Virtue:

	M	WS	BS	S	T	W	I	A	LD	SAVE
KNIGHTLY HERO	4/8	5	5	4	4	2	5	3	8	4+ (2+ in battle)

Favour:

Virtue:

KNIGHTLY VIRTUES

Choose one of the Knightly virtues listed below for each Knightly Hero. Each virtue can only be claimed by one Knight. All Knights have the basic Knightly virtue as well, but this has no effect in this joust.

- DISCIPLINE:** The Knight does not have to roll to see if he is unhorsed when he loses a wound.
- IMPETUOUS KNIGHT:** The Knight automatically strikes first regardless of the ploy used in the joust.
- KNIGHTLY ARDOUR:** In the first pass of the joust, the Knight may add +1 to his Strength.
- NOBLE DISDAIN:** The Knight disregards the first wound he suffers.
- PURITY:** The Knight cannot use the Swipe or Dodge ploy, but can re-roll failed armour saves.
- JOUSTING VIRTUE:** The Knight automatically hits during the joust.

Note that the virtues of Devotion, Knightly Temper and Valour have no effect in this tourney.

SPECIAL RULES

FAVOURS OF THE LADY MELISANDE

The Lady Melisande has the following favours to bestow upon the Bretonnian Knights. These are free and cost no extra points. She bestows each Knight with one favour which is unique to them and cannot be given to anyone else. The favours apply only to the tourney, and except for Agravain's favour, will not apply in the final battle.

Choose one of the following favours for each of your Knights. The *Tress of Melisande* is always given to Agravain.

The Veil of Melisande

The Knight may re-roll any dice once in the joust.

The Wimple of Melisande

The Knight's opponent automatically misses with his first strike of the joust.

The Tabard of Melisande

The Knight may re-roll to hit once in the joust.

The Kirtle of Melisande

The Knight automatically hits in the first turn of the joust.

The Girdle of Melisande

The Knight strikes before his opponent, regardless of his opponent's ploy, magic items or Initiative.

The Garter of Melisande

The Knight may re-roll his save once in the joust.

The Tress of Melisande

This favour is given to Agravain and no one else. The first wound inflicted on Agravain is disregarded.

TOURNEY SAVE

In a tourney, Knights are separated from each other by a long hoarding or tilt, making it impossible to strike the Knight's horse. For this reason the horse and its armour save are ignored when working out saves. This means that during the tourney a fully armoured Knight has a save of 4+ rather than 2+ as he would normally have in battle.

VICTORY GAINS

Any Bretonnian Knights who survive the tourney can be chosen for the Bretonnian army in the final battle. Knights who win through to the final battle retain their Knightly virtues at the normal points cost, but use the standard rules for their virtues rather than the tourney version.

These are the only Heroes available to your army for the final battle, and the Bretonnians need every Hero they can get, especially ones with good Knightly Virtues, to lead and bolster their units of Knights.

Agravain de Beau Quest

General of the Knights . . 138 points

Originally known as Agravain de Beaumarchais, son of the Baron de Beaumarchais who fell in the battle of Malmerre, Agravain did not inherit his father's lands, which were won by a rival Knight Errant together with the hand of Isabelle, Agravain's sister. However, Agravain had proved himself a worthy Knight and so chose to take up the Grail Quest. This noble vow of devotion to the Lady of the Lake inspired Isabelle to dub him Agravain de Beau Quest.

Agravain has already been called by visions to find the lost chapel of the Lady of Chalotte. If he succeeds, he may become one of the few Knights who have actually witnessed the grail.

	M	WS	BS	S	T	W	I	A	Ld
Agravain	4	5	5	4	4	2	5	3	8
Bret. Warhorse	8	3	0	3	3	1	3	1	5

EQUIPMENT: Agravain has heavy armour, a lance, sword and shield and rides a barded Bretonnian warhorse.

SAVE: 2+. Note that this save is reduced to a 4+ in the tourney.

KNIGHTLY VIRTUES

Agravain has the *Questing Virtue* and *Virtue of Devotion*. These have no effect in the joust, but will prove useful in the final battle.

SPECIAL RULES

Protected by the Lady of the Lake

Agravain is protected by the Lady of the Lake and cannot be slain until the final battle. If unhorsed in the tourney, he will be taken to the grail chapel at Quenelles where he recovers in time to take part in the final battle.



THE CASTELLAN OF QUENELLES' RETINUE

The Bretonnian force consists of 1,000 points chosen from the army list in the Warhammer Armies Bretonnia book. Choice is limited to the troops listed here. Wherever the scenario calls for an exception to the Warhammer army list, this will be indicated below.

CHARACTERS

Castellan of Quenelles

The Bretonnians are led by the Castellan of Quenelles, who counts as the army's General.

Commoner Champions

You may choose one Commoner Champion for each unit in your army, armed and equipped as the rest of the unit. No Commoner Champions can have magic items.

REGIMENTS

0-1 Unit of Mounted Squires

Your army may include one unit of Mounted Squires.

0-1 Unit of Squires

Your army may include one unit of Squires.

Men-at-arms

Your army may include any number of units of Men-at-arms.

Bowmen

Your army may include any number of units of Bowmen.



VICTORY GAINS

The Bretonnians are unlikely to stop the Wood Elves stealing the Chalice, but they may succeed in preventing them taking the other magic items. If they succeed, they will deny these potent magical items to the Wood Elf player in the final battle.

TACTICAL HINTS

The last two prizes are the most useful to the Wood Elves, though of course neither side knows this yet! Therefore the Bretonnians should try and establish control over the area around the prize pavilion within the first two turns if possible. The best way to do this is to concentrate your attack on the centre of the area. You will of course have to watch out for Wood Elves sneaking around your flanks and guard against this. Do not underestimate the abilities of your Squires in hunting down, beating out and chasing off small units of Wood Elves, after all, the Squires take on more ferocious beasts in the hunt!

The Glade Guards, on the other hand, often prove to be a lot more stubborn than they look. They are a real match for your Men-at-arms and are quite capable of holding off your men from the prize pavilion. This is a good reason for ganging up on them with several of your units. The Castellan has got his work cut out to regain control of the tent enclosure and will be very lucky if he can snatch victory from the Wood Elves. You cannot afford to be put off by the arrows of the enemy!



Castellan of Quenelles

Guillaume de Grenouille 107 points

The Bretonnians are led by the brave and noble Castellan of Quenelles, who counts as the army's General.

Guillaume de Grenouille is a huge man with a large scar across his face and is notorious for his uncontrollable temper. His duty is to guard the castle, the gates and the ramparts of Quenelles for the Duke, which he does very well. He commands a large retinue of Men-at-arms, Archers and Squires all of whom are usually more scared of him than the enemy!

	M	WS	BS	S	T	W	I	A	Ld
Castellan	4	5	5	4	4	2	5	3	8
Bret. Warhorse	8	3	0	3	3	1	3	1	5

EQUIPMENT: The Castellan wears heavy armour, carries a shield and rides a barded Bretonnian warhorse. He is armed with a morning star.

SAVE: 2+

KNIGHTLY VIRTUES

The Castellan has the *Knight's Virtue* and the *Virtue of Knightly Temper*.

SPECIAL RULES

Morning Star

The Castellan is armed with a morning star. This is a weapon that has three heavy, spiked iron balls hanging from short chains attached to its shaft. The Castellan uses this to batter his opponents in hand-to-hand combat. The morning star easily smashes through armour, so opponents suffer an additional -1 modifier to their armour save.



THE PILGRIMS OF QUENELLES

The Bretonnian force consists of 1,000 points chosen from the army list in the *Warhammer Armies Bretonnia* book. Choice is limited to the troops listed here. Wherever the scenario calls for an exception to the *Warhammer* army list, this will be indicated below.

CHARACTERS

Aloys de Montjoie

The Bretonnians are led by Aloys de Montjoie, who counts as the army's General.

Eleanor de Quenelles

You may include Eleanor de Quenelles as a Master Wizard.

Battle Standard Bearer

The army may have a battle standard bearer carrying the *Pilgrimage Banner* of the grail chapel. This may be a magic banner worth up to 50 points.

Questing Heroes

You may choose any number of Bretonnian Knightly Heroes, who are armed as Knights. These are all Questing Knights motivated to join the pilgrimage by dreams, visions and faith and so must have the *Questing Virtue*. They may have one other Knightly Virtue and a magic item worth up to a value of 25 points.

Champions

You may choose a Bretonnian Knightly Champion to accompany each unit of Knights or Mounted Squires in your army. Knightly Champions may have a magic item worth up to 10 points. You may choose one Commoner Champion for each unit of Squires or Men-at-arms armed and equipped as the rest of the unit. None of the Commoner Champions may have magic items!

REGIMENTS

0-1 Unit of Questing Knights

Your army may include one unit of Questing Knights.

0-1 Unit of Mounted Squires

Your army may include one unit of Mounted Squires.

0-1 Unit of Squires

Your army may include one unit of Squires.

0-1 Unit of Bowmen

Your army may include up to one unit of Bowmen.

The Reliquary Wagon

The army includes a Bretonnian wagon carrying the sacred reliquary of Quenelles. This wagon is provided in the pack.

Men-at-Arms

You may include any number of units of Men-at-arms.

The Reliquary Wagon

The reliquary wagon is hauled along by hordes of pilgrims who will defend themselves if attacked. You can attach horses to it if you wish as a conversion. If you do, then the crew are assumed to be riding on the wagon and accompanying it to help push it out of the mud. The horses will make no difference to the profile or movement rate.

The pilgrims accompanying the wagon include grail damsels, townsfolk, peasants, vendors of small lead souvenirs of the grail and others. Definitely not the sort of crowd that Wood Elves like to see beating a pilgrims' way through their sacred glades! The wagon operates as an independent unit and costs no extra points but is worth 1 victory point if destroyed.

	M	WS	BS	S	T	W	I	A	Ld
Wagon/crew	2D6"	3	-	3	7	4	3	D6	7

EQUIPMENT: Crew are armed with hand weapons (pilgrim staves).

SAVE: None

SPECIAL RULES FOR THE WAGON

Religious Fervour

The wagon and its crew of pilgrims are gripped by religious fervour, so they are immune to psychology, will not flee and cannot be broken in hand-to-hand combat. They just die where they stand, making the sign of the grail!

Combat

The D6 attacks represent the defence put up by the pilgrims. When the wagon takes its full quota of wounds, it has been overturned and all its crew become casualties of the battle.

Movement

The Bretonnian wagons move at a random rate of 2D6" due to the boggy, winding forest track. The wagon cannot charge or flee, nor can it pursue.

THE RELIQUARY OF QUENELLES

This is a sacred gold casket containing ancient weapons, armour and fragments of bones of Bretonnian heroes, whose names and deeds have long been lost in the mists of time. It is steeped in Bretonnian honour and enchantment, which creates an aura of sanctuary that can repel the enemies of Bretonnia. Enemy units must pass a Leadership test on 3D6 in order to charge the reliquary wagon or if it moves within 4" of them. If they fail the test, they are immediately moved 4" away from the reliquary wagon.

VICTORY GAINS

If the Bretonnians win, the Wood Elf player may not have Treemen or Dryads in the final battle unless they have the *Casket of Acorns* and the *Old Stick*. It also means that the Bretonnians can use the reliquary wagon in the final battle providing that it was not overturned or smashed up during the battle. If the Bretonnians lose, it is assumed that the Wood Elves burn the wagon and throw the relics into the river Brienne!

TACTICAL HINTS

It will be quite difficult for the Wood Elves to halt the reliquary wagon because of the power of the sacred relics. However, if they do succeed in attacking it, the wagon will be held up even if the pilgrims manage to beat off their attackers. The task of making the way safe for the pilgrimage falls on the gallant Knights and soldiers of Bretonnia. The odds are stacked against them.

Even the most determined Bretonnian Knights will find it difficult to stop the enraged Gwercus and his Dryads. The magic of Eleanor of Quenelles will be vital in tipping the balance in Bretonnia's favour so she should be guarded by a cordon of brave men.

The most important thing is to keep the wagon rolling through the sacred glades. The Knights and soldiers should not allow themselves to be drawn away from the wagon by chasing after elusive enemies. The Knights should be reserved for smashing through the most dangerous groups of enemy barring the way. The Squires can do the work of chasing off bands of Archers and Scouts and the Men-at-arms will have to form up into a shield wall and absorb the shock of whatever comes at them from the woods. If Gwercus and the Dryads can be held up or locked in combat with the Men-at-arms while the wagon rumbles on, all the better. The courage and honour of these humble commoners is going to be tested to the limit and many will perish for their faith.

Aloys de Montjoie

Baron of Quenelles 117 points

The Bretonnians are led by Aloys de Montjoie, who counts as the army's General. He is the most arrogant and impetuous baron in the dukedom of Quenelles. He is also devoutly religious and has an abundance of personal valour to the point of recklessness. Needless to say he is highly respected in Quenelles as a paragon of Bretonnian virtue.



Aloys has been a great benefactor to the grail chapel at Quenelles. Some years ago he relinquished his domain and set out on the Grail Quest. Later he returned having personally recaptured various sacred relics. Now he guards the chapel at Quenelles and it is no surprise that he responded to the pilgrimage and was appointed to lead it.

	M	WS	BS	S	T	W	I	A	Ld
Aloys de Montjoie	4	5	5	4	4	2	5	3	8
Bret. Warhorse	8	3	0	3	3	1	3	1	5

EQUIPMENT: Aloys is armed with a double-handed broadsword, wears heavy armour and rides a barded Bretonnian warhorse.

SAVE: 3+

KNIGHTLY VIRTUES

Aloys de Montjoie has the *Grail Virtue* and the *Virtue of Knightly Temper*.

Eleanor de Quenelles

Master Wizard 202 points

Your army may include Eleanor de Quenelles. As the youngest daughter of the Duke of Quenelles she does not inherit and so will not be called upon to wed the Knight Errant who succeeds to her father's domain. Therefore she has taken holy orders as a Grail Damsel of the grail chapel of Quenelles. Here she is renowned for healing many valiant, mortally wounded Knights, pulling them back from the brink of death. Among Bretonnian women this is considered equivalent to a Knight's feat of arms on the field of battle.

	M	WS	BS	S	T	W	I	A	Ld
Eleanor	4	3	3	4	4	3	5	2	7
Bret. Warhorse	8	3	0	3	3	1	3	1	5

EQUIPMENT: Eleanor is armed with a sword and rides a barded Bretonnian warhorse.

SAVE: 5+



MAGIC ITEMS

Potion Sacre: Like all Grail Damsels, Eleanor is an expert at concocting magic potions. She is therefore equipped with the *Potion Sacre*.

SCENARIO IV – BATTLE OF THE TREE OF SHIELDS

Bretonnian Player's Battle Scroll

AGRAVAIN'S ARMY

The Bretonnian force consists of 2,000 points chosen from the army list in the *Warhammer Armies Bretonnia* book. Choice is limited to the troops listed here. Wherever the scenario calls for an exception to the *Warhammer* army list, this will be indicated below.

CHARACTERS

Agravain de Beau Quest

The army is commanded by Agravain de Beau Quest who counts as the army's General.

Aloys de Montjoie

The army may include Aloys de Montjoie if he survived the third battle.

Eleanor de Quenelles

The army may include Eleanor de Quenelles if she survived the third battle.

Battle Standard Bearer

The army may have a Battle Standard Bearer carrying the banner of the Duke of Quenelles or the *Pilgrimage Banner* of the grail chapel. This may be a magic banner worth up to a value of 50 points.



Jousting Heroes of Quenelles

The army may include any of the Knightly Heroes who survived the tourney at Quenelles. You may equip any of these with a magic weapon worth up to a value of 25 points. These represent various ancestral relics which they may have in their personal baggage, but were not permitted to use during the tourney. The Knightly Heroes must retain the same Knightly Virtues as they had in the first scenario, and except for Agravain's favour the favours of Melisande will no longer apply.

Questing Heroes

The army may include any of the surviving Questing Heroes who took part in the *Perilous Pilgrimage*.

Champions

You may choose a Bretonnian Knightly Champion to accompany each unit of Knights or Mounted Squires in the army. Knightly Champions may have a magic item worth up to a value of 10 points. You may choose one Commoner Champion for each unit of commoners in your army armed and equipped as the rest of the unit. Commoner Champions may not have magic items!

REGIMENTS

0-1 Unit of Grail Knights

Your army may include one unit of Grail Knights. There are only a few Grail Knights in Quenelles and so this unit may not be bigger than 5 models. The unit may have a magic banner worth up to a value of 25 points.

0-1 Unit of Questing Knights

Your army may include one unit of Questing Knights. Almost all the Questing Knights currently in the dukedom of Quenelles have found their way to the pilgrimage. Even so there are not many of them, so the unit may not be bigger than 10 models. The unit may have a magic banner worth up to a value of 25 points.

0-1 Unit of Knights of the Realm

Your army may include one unit of Knights of the Realm.

0-1 Unit of Knights Errant

Your army may include one unit of Knights Errant who may carry the *Errantry Banner*.

0-1 Unit of Mounted Squires

Your army may include one unit of Mounted Squires.

0-1 Unit of Squires

Your army may include one unit of Squires.

0-1 Unit of Bowmen

Your army may include up to one unit of Bowmen.

Men-at-arms

Your army may include any number of units of Men-at-arms.

The Reliquary Wagon

The army may include the wagon carrying the sacred reliquary of Quenelles if the Bretonnians won the third battle and the wagon was not destroyed.

SPECIAL RULES

Righteous Hatred

The sight of the shields of valiant Questing Knights hanging on the tree as trophies is enough to rouse the Bretonnians to *hatred* of their Wood Elf opponents. Roll a D6 for each unit of Knights and each Knightly character at the start of the battle. On a score of 5 or 6 they will become subject to the rules of *hatred* against the Wood Elves in this battle.

VICTORY GAINS

If the Bretonnians win this battle they capture the sacred grail chapel of Challotte. The Kindred of the Willows will abandon their claim to the Isle of Challotte allowing the Bretonnians to establish a permanent pilgrims' way to the restored chapel.

Questing Knights will no longer ride to their doom when they are drawn to the chapel by visions. Agravaïn de Beau Quest himself will reach the grail chapel and be able to fulfil his own personal quest and perhaps even find the Lady of Challotte herself and the holy grail!

TACTICAL HINTS

The main strength of the Bretonnian army is the charge of its Knights. They can be made even more powerful if led by surviving Heroes from the tourney. At least some of them should be given the task of advancing as fast as possible to capture the island, which is the ultimate objective of the campaign. Remember that Bretonnian warhorses enable the Knights to cover ground quickly.

There is a good chance of flanking attacks from very strong forces of Wood Elves. These will try to stop the main force crossing the marsh, so the flanks of your main force must always be guarded.

Once across the marsh, there may be stubborn Glade Guards, Treemen, Dryads or traps to deal with, so attack in strength with several units. It will no doubt be useful to have some Knights attacking in Lance formation to break your stubborn foe.

Do not worry about enemy archery, the mists and your armour will take the edge off this particular threat. There is a great danger from the enemy mages, especially the mage riding the Warhawk. Do not leave Eleanor unguarded as she will be easy prey for her enemies. Her magic is one of the few things that might be effective against the Treemen. Squires and Men-at-arms might be best used as a rearguard for the Knights, preventing them from being attacked from behind.

The Elves may have the *Silver Arrow* which could seal the fate of Agravaïn. However, thanks to the *Tress of Melisande* he disregards the first wound suffered. This means that either her favour will save him or the Wood Elves will have to wait for a better opportunity to shoot at him, which may never come!



SCENARIO I – THE TOURNEY
Wood Elf Player's Battle Scroll

HERALD'S JOUSTING ROSTER

The Wood Elf jousting team consists of Heroes led by Athelwyn. Each Hero should be named as you may want to include surviving Heroes in your army for the final battle. You can either choose names for them or refer to the Chanson de Chailotte for suitable Elven names. Each Hero is armed in the same way as Athelwyn – except that they carry normal lances. Each Hero may also have a magic weapon chosen from the list below. He can use this in the tourney even though it is against the Bretonnian code of honour.

WOOD ELF HERO	M	WS	BS	S	T	W	I	A	LD	SAVE
	5	6	6	4	4	2	8	3	9	5+ (3+ in battle)

ATHELWYN

Magic Weapon: Star Lance.

WOOD ELF HERO	M	WS	BS	S	T	W	I	A	LD	SAVE
	5	6	6	4	4	2	8	3	9	5+ (3+ in battle)

Name:

Magic Weapon:

WOOD ELF HERO	M	WS	BS	S	T	W	I	A	LD	SAVE
	5	6	6	4	4	2	8	3	9	5+ (3+ in battle)

Name:

Magic Weapon:

WOOD ELF HERO	M	WS	BS	S	T	W	I	A	LD	SAVE
	5	6	6	4	4	2	8	3	9	5+ (3+ in battle)

Name:

Magic Weapon:

WOOD ELF HERO	M	WS	BS	S	T	W	I	A	LD	SAVE
	5	6	6	4	4	2	8	3	9	5+ (3+ in battle)

Name:

Magic Weapon:

WOOD ELF HERO	M	WS	BS	S	T	W	I	A	LD	SAVE
	5	6	6	4	4	2	8	3	9	5+ (3+ in battle)

Name:

Magic Weapon:

MAGIC ITEMS FOR WOOD ELF HEROES

Each of the Wood Elf Heroes entering the tourney against the Bretonnian Knights carries one magic weapon chosen from the following list. These weapons are heirlooms of their kindreds and there is only one of each kind so no two characters may have the same weapon.

No points are paid for the magic items in this scenario – but a character who survives to fight in the final battle must carry the same magic item. For this reason the points values are given here.

Blade of Leaping Bronze	50 points
Dragon Blade	50 points
Heart Seeker	50 points
Warrior Bane	35 points
Blade of Sea Gold	30 points
Blade of Leaping Copper	25 points
Dawnstone	25 points
Blade of Ensorcelled Iron	20 points
Parrying Blade	20 points
Sword of Might	20 points
Armour of Fortune	15 points
Relic Sword	15 points
Potion of Strength	10 points
Charmed Shield	5 points
Jade Amulet	5 points

VICTORY GAINS

Any Wood Elf Princes who survive the tourney can be chosen for the Wood Elf army in the final battle. These are the only Heroes available to the Kindred of the Willows for the final battle, and Heroes of proven worth will be badly needed to stand up to the full fury of the Bretonnian Knights.

TACTICAL HINTS

The Wood Elves have a better chance of winning the tourney than you might think, not only because they have magic items, but also on account of their good fighting characteristics.

Your opponents will be much less likely to opt for the trickier ploys than you, because they will be determined to make their brute force count and will want to strike first. There may be more Bretonnians than Wood Elves, but one of your Princes could unhorse more than one Bretonnian opponent before the day is through. Every Bretonnian that can be unhorsed is a severe loss to them because he will not be invading your lands alongside the pilgrimage in the final battle!



TOURNEY SAVE

In a tourney, the Wood Elf Heroes and the Bretonnian Knights are separated from each other by a long hoarding – making it impossible to strike either side's horses. For this reason, the horse and its armour save are ignored when working out saves. This means that during the tourney a Wood Elf Hero has a save of 5+ instead of 3+ as he would normally have in battle.



Athelwyn of Athel Loren

Wood Elf General 174 points

The leader of the Wood Elf Princes is Athelwyn of the Kindred of the Willows. He will stop at nothing to retrieve the magic items taken from Athel Loren by the Bretonnians and already has another cunning plan ready in case the Wood Elves cannot win the prizes by fair contest.

	M	WS	BS	S	T	W	I	A	Ld
Athelwyn	5	6	6	4	4	2	8	3	9
Elven Steed	9	3	0	3	3	1	4	1	5

EQUIPMENT: Athelwyn has a sword, light armour, a shield and the *Star Lance*. He rides a barded Elven Steed.

SAVE: 3+. This is reduced to 5+ in the joust as the steed and its armour do not count.

SPECIAL RULES

Star Lance 60 points

+3S bonus when charging. No armour save allowed.

Fate

Athelwyn is fated to fight at the Tree of Shields. This means that he cannot be slain until the final battle. If Athelwyn is unhorsed during the tourney he will be taken to a hidden glade deep within the Forest of Loren where Wood Elf maidens will treat him with magic potions. Here he will make a miraculous recovery and be able to take part in the final battle.



SCENARIO II – BATTLE OF THE TENTS
Wood Elf Player's Battle Scroll

THIEVES OF LOREN

The Wood Elf force consists of 1,000 points chosen from the army list in the Warhammer Armies Wood Elves book. Choice is limited to the troops listed here. Wherever the scenario calls for an exception to the Warhammer army list, this will be indicated below.

CHARACTERS

Elthryn

The Wood Elves are led by Elthryn, who counts as the army's General.

Champions

You may choose one Champion for each unit in your army, armed and equipped as the rest of the unit. Each Champion may have a magic item worth up to a value of 20 points. One Champion may ride a Warhawk if you choose to include a unit of Warhawk Riders in this battle. One Champion may be a Wardancer Champion if you choose a unit of Wardancers.

0-1 Mage

You may choose one Wood Elf Mage. The Mage is either on foot or mounted on a Warhawk and may have a magic item worth up to 25 points. The Mage may only ride a Warhawk if you choose to include a unit of Warhawk Riders, in which case, the Mage arrives together with the Warhawk Riders after the first turn.

REGIMENTS

0-1 Unit of Wardancers

Your army may include one Wardancer unit. They plan to slip away from the tourney (where they have been entertaining the Bretonnian crowd with some sword dances), to help steal the magic items.

0-1 Unit of Waywatchers

Your army may include one unit of Waywatchers. Usual deployment rules for Waywatchers apply.

0-1 Unit of Scouts

Your army may include one unit of Scouts. Usual deployment rules for Scouts apply.

0-1 Unit of Warhawk Riders

Your army may include one unit of Warhawk Riders.

Archers

Your army may include any number of Archer units. One unit may have a magic standard worth up to a value of 25 points.

Glade Guards

Your army may include any number of Glade Guard units. One unit may have a magic standard worth up to a value of 25 points.

SPECIAL RULES

If you use Hawk Riders, they fly in from the Forest of Loren by prior arrangement and arrive during the battle. They may not enter the table until the start of your second turn. They count as flying high at the start of the turn and may descend to attack in that turn.

VICTORY GAINS

The Wood Elves have a good opportunity to steal the Chalice and may get away with stealing the other magic items as well. Any items captured in this battle can be used by the Wood Elf player in the final battle.

TACTICAL HINTS

The Wood Elves have an excellent chance of making off with most if not all of the prizes, but you can expect very determined opposition from the Bretonnians. Keep enough troops around the prize pavilion to hold them off. These should be good hand-to-hand fighters. Shooting will not be enough to stop the Bretonnians.

Remember that the last prizes are potentially the most useful to you, so you will need to keep control of the tented enclosure to the end of the battle. It will be worth having small fast bands of troops moving about around the tents to try to prevent the Bretonnians concentrating all their forces on the pavilion. The Bretonnian troops opposing you are vulnerable to archers and a few good volleys of arrows may panic them, preventing them from pressing home their attack.



Elthryn

General of the Thieves of Loren. . . 134 points

The Wood Elves are led by Elthryn, who counts as the army's General. Elthryn is a wily individual who often comes to Quenelles to trade. He knows the ways of the Bretonnians and knows how to outwit them by cunning. Naturally, Athelwyn sought him out as an accomplice in his treacherous and dishonourable plan to capture the tourney prizes.

	M	WS	BS	S	T	W	I	A	Ld
Elthryn	5	6	6	4	4	2	8	3	9

EQUIPMENT: Elthryn wears light armour and is armed with a hand weapon and longbow.

SAVE: 4+

MAGIC WEAPONS

Hail of Doom Arrow

Elthryn, having dealt with the Bretonnians before, expected trouble at Quenelles and wisely brought with him one of the rare, precious and deadly *Hail of Doom Arrows* kept in the secret glade of his kindred.

This is the *Hail of Doom Arrow* as described in *Warhammer Magic*.

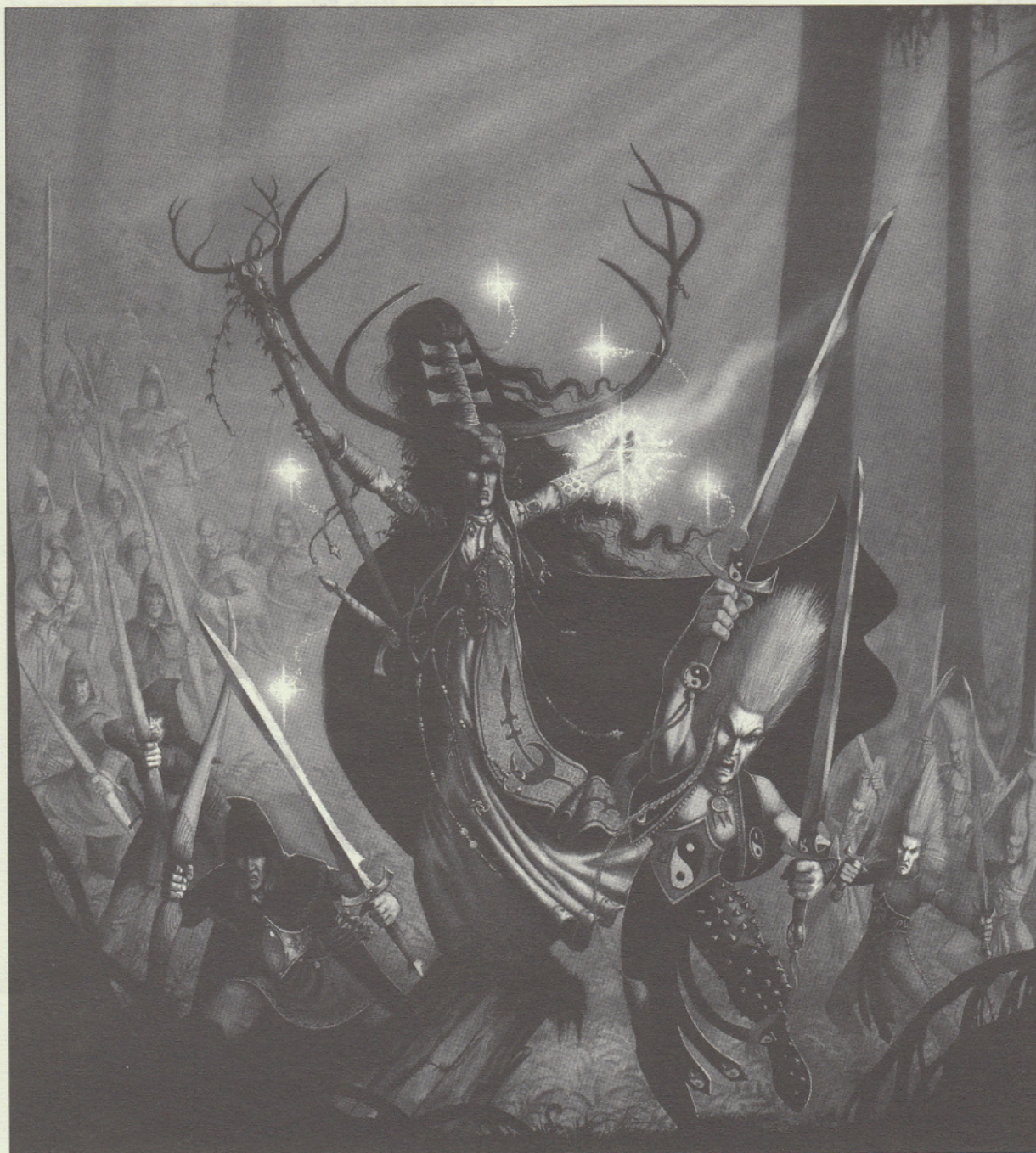

SPIRITS OF THE FOREST

The Wood Elf force consists of 1,250 points chosen from the army list in the Warhammer Armies Wood Elves book. Choice is limited to the troops listed here. Wherever the scenario calls for an exception to the Warhammer army list, this will be indicated below.

CHARACTERS

Gwercus the Treeman

The Wood Elves are led by Gwercus, who counts as the army's General.

Champions

You may choose one Champion for each unit of Wood Elves in your army, armed and equipped as the rest of the unit. Each Champion may have a magic item worth up to a value of 20 points.

0-1 Mage

Your army may include one Wood Elf Mage, who is the tree singer of this glade. He is on foot and may have a magic item worth up to a value of 50 points.

REGIMENTS

0-1 Unit of Waywatchers

Your army may include one unit of Waywatchers.

0-1 Unit of Wardancers

Your army may include one unit of Wardancers.

At least one unit of Dryads

Your army must include at least one unit of Dryads and may include more if you wish.

Scouts

Your army may include any number of Scout units.

SPECIAL DEPLOYMENT RULES

Special deployment rules for Scouts and Waywatchers do not apply in this battle because it is an ambush and so any unit in the Wood Elf army is allowed to deploy as close as 8" to the Bretonnians.

VICTORY GAINS

If the Wood Elves win this battle the Bretonnian pilgrimage will be halted in its tracks. The Bretonnian reliquary wagon will have been prevented from profaning the sacred glade and the Treemen and Dryads who dwell there will not be transformed into trees. The Wood Elf player will therefore be able to use Treemen and Dryads in the final battle.

TACTICAL HINTS

The reliquary wagon is potentially the greatest menace to the Wood Elves. Gwercus should direct his rage against this and smash it to bits. Otherwise, the Treeman and the Dryads should get to grips with the Knights and destroy them. Knights are not very good at defeating Treemen and will find it hard going against the Dryads.

The rest of the Bretonnians are very vulnerable to archery attacks from concealed troops in the woods. You can expect to panic or shoot down many of the Commoners if your archers are well positioned within the trees. In an ambush, it is important to place all the ambushing troops in advantageous positions so that they can strike simultaneously. Usually it's a good idea to block the head and tail of the column at once, gripping it as if in a vice until it is destroyed. The vanguard of the enemy column is quite likely to be strong enough to force its way through, so you should have the strongest part of your force concentrated in that area to bar the way.



Gwercus the Treeman

Treeman 280 points

The Wood Elves are led by Gwercus, who counts as the army's General.

Gwercus is the guardian of the sacred Willow Glades in which the Kindred of the Willows dwell. Most of the time he stands utterly motionless like one of the many ancient, gnarled willow trees in the glades. Indeed it is only possible to tell which one he is when he changes his position to get the best of the sun at different times of the year!

Gwercus is worshipped by the Kindred of the Willows and is attended by numerous Dryads surrounding him among the trees and saplings. Waywatchers also guard him, Mages consult him for oracles and Wardancers perform rituals to awaken or soothe him at the appointed times. Gwercus is very old and so revered that the dwellers of the glade look upon him as a living god, the protective spirit of the glade in which they live. If he becomes angry and roused, they will follow him and attack those who disturb his peace.

There is nothing that irritates Gwercus more than noise, commotion, the bad vibrations from mannish magic and the sound of axes biting the flesh of his tree kindred!

	M	WS	BS	S	T	W	I	A	Ld
Gwercus	6	8	3	6	7	6	2	4	9

SAVE: Unmodified save of 5+

SPECIAL RULES

All the usual special rules that apply to Treemen as described in the Wood Elves book also apply to Gwercus.

Fear: Treemen are huge and frightening creatures that cause *fear* as described in the Warhammer rulebook.

Move: Treemen can move in woods without penalty. Woods do not count as difficult terrain to Treemen.

Woody Skin: Treemen have a thick hide which gives them an unmodified save of 5+.

Fire: Any Treemen hit by a flaming weapon or a magic spell suffers double wounds, so for every wound scored the Treeman takes 2 wounds.

Felled Treeman: When a Treeman is slain, he may topple over onto other models. See the Wood Elves book for more details.

Tree Whack: Treemen are so strong and tough that they can attack buildings and war machines.

Rooted to the Spot: A Treeman does not have to take a Break test if beaten in hand-to-hand combat unless he suffers any wounds. See the Wood Elves book for full rules.



THE KINDRED OF THE WILLOWS

The Wood Elf force consists of 2,000 points chosen from the army list in the *Warhammer Armies Wood Elves* book. Choice is limited to the troops listed here. Wherever the scenario calls for an exception to the *Warhammer* army list, this will be indicated below.

CHARACTERS

Athelwyn

The Wood Elves are led by Athelwyn, who counts as the army's General.

Elven Princes

The Wood Elf army may include any of the Wood Elf Princes who survived the first scenario. These are equipped exactly as they were for the tourney retaining the same magic items which they had in the first scenario.

Elthryn

The army may include Elthryn if he survived the *Battle of the Tents*.

Yolath the Master Mage

Your army may include Yolath the Master Mage. Yolath may be equipped with any of the magic items stolen at the *Battle of the Tents* for no extra points cost.

Gwercus the Treeman

The army may include Gwercus the Treeman if he survived the third battle.

Battle Standard Bearer

The army may have a Battle Standard Bearer carrying the banner of the Kindred of the Willows. This may be a magic banner worth up to a value of 50 points.

Champions

You may choose one Champion for each unit in your army, armed and equipped as the rest of the unit. Each Champion may have a magic item worth up to a value of 10 points.

Up to 2 Mages

Your army may include up to two other mages in addition to or instead of Yolath. Other mages will gather to help defend the sacred glade. These will be first level wizards.

Each mage may be equipped with any of the magic items stolen at the *Battle of the Tents* for no extra points cost. The mages may be on foot or ride Elven Steeds.

0-2 Treemen

Your army may include up to two Treemen in total. You may only include them if the Wood Elves won the third battle. If you choose Gwercus, you may only choose one other Treeman in addition to him.

If the Wood Elves lost the third battle, the *Old Stick* is the only way to use a Treeman in your army.

REGIMENTS

0-1 Unit of Dryads per Treeman

If the Wood Elves won the third battle, you may include one unit of Dryads per Treeman in the army. If they lost, then the *Casket of Acorns* is the only way to include Dryads in the Wood Elf army.

0-1 Unit of Glade Riders

Your army may include one unit of Glade Riders. These are warriors from the Kindred of Equos who have ridden to assist the Kindred of the Willows. The unit may have a magic standard worth up to a value of 50 points.

0-1 Unit of Scouts

Your army may include one unit of Scouts. Special deployment rules for Scouts apply in the battle.

0-1 Unit of Waywatchers

Your army may include one Waywatcher unit. Special deployment rules apply in the battle.

0-1 Unit of Wardancers

Your army may include one Wardancer unit.

0-1 Unit of Warhawk Riders

Your army may include one Warhawk Rider unit.

Glade Guards

Your army may include any number of units of Glade Guards. One unit may have a magic standard worth up to a value of 25 points.

Archers

Your army may include any number of Archer units. One unit may have a magic banner worth up to 25 points.

SPECIAL RULES

Stolen Magic Items

Three of the magic items in the prize pavilion are Wood Elf magic items. The *Chalice of Chanterelle* is a Bretonnian magic item which the Wood Elves cannot use. Any Wood Elf magic items successfully stolen in the *Battle of the Tents* can be given to the mages indicated above for no extra points cost. Only they will know what they are and can do. Note that if the Wood Elves lost the third battle, the only way the Wood Elf army can use Treemen and Dryads will be by means of the *Casket of Acorns* and the *Old Stick*.

The Silver Arrow

This is a silver arrow with an inscription that reads "I will fell any foe. No armour can protect against me!" If an enemy model is wounded by this arrow he will suffer D6 wounds with no armour save possible. One use only.

The Casket of Acorns

This is a golden casket containing a handful of wizened acorns that will immediately sprout into D6 Dryads if scattered on the ground in the magic phase of any Wood Elf turn. One use only.

The Old Stick

This is a finely carved wooden staff decorated with a fairy face and an incantation which says, "This is all that remains of Guath the Old, plant me when you are in need!". Plant the staff in the ground in the magic phase of any Wood Elf turn and it will immediately sprout into a Treeman. One use only.

VICTORY GAINS

If the Kindred of the Willows win this battle they will save their sacred tree from the Bretonnian axes and their sacred groves from becoming a Bretonnian tourist attraction! This area of the forest will remain secure as a home for the kindred. If they lose, they will have to migrate deeper into the wood, surrendering the glades to the Bretonnians. Since these glades have grown over what was once a Bretonnian village, the Bretonnians have a claim to the place and it is doubtful whether the King and Queen in the Wood will risk breaking their ancient pact

with the King of Bretonnia over this when they emerge from the Oak of Ages in the spring. They will counsel the mages of the kindred to lead their folk elsewhere.

TACTICAL HINTS

The Bretonnians will probably attack head on across the marsh with their Knights. They do not have any better options. This attack will be dangerous and difficult to stop.

The counter-tactics call for all the Elf cunning you can summon up. Deploy your forces cleverly and aim to ensnare the Knights so that you can wear them down and surround them. Any of your troops deployed beyond the marsh will be well placed to disrupt the Bretonnian plans and threaten the flanks of the Knights. Your best hope is to make your opponent confused and irresolute. This is a battle in which the Glade Guards can show their worth, perhaps as a last resort for holding the island. A massed unit may be able to hold up the Knights if properly bolstered and supported.

If you have any magic items stolen in the *Battle of the Tents* you will need to choose mages to carry them. With the exception of the chalice which is of no use to the Wood Elves, these items are potentially very powerful and could win you the battle!

The *Silver Arrow* should perhaps be reserved for Agravaing himself, while the *Casket of Acorns* and the *Old Stick* are the only means of summoning a Treeman or Dryads to help you if you lost the third battle. Note that the only Heroes available to your army are those who have survived earlier battles.



Yolath

Master Mage 242 points

Your army may include Yolath, the Master Mage. He is the chief mage of the Kindred of the Willows. His duty is to guard the sacred glades and oversee the rites and ceremonies of the seasons. It was his forebears who led the kindred to this part of the Forest of Loren and he does not wish to be the one to relinquish it to the Bretonnians.

	M	WS	BS	S	T	W	I	A	Ld
Yolath	5	4	4	4	4	3	8	2	8
Warhawk	2	4	-	3	3	1	5	1	7

EQUIPMENT: Yolath is armed with a hand weapon and longbow and rides a Warhawk.

SAVE: 6

MAGIC ITEMS

Yolath may be given any of the magic items stolen during the *Battle of the Tents* for no extra points cost.