

**FREE** RALLY GB PREVIEW  
SUPPLEMENT



# **AUTOSPORT**

# LEWIS BOLTS CLEAR

Hamilton nears fourth world crown  
with record US GP win



**VERSTAPPEN  
DENIED AGAIN**  
WHY RED BULL STAR  
LOST HIS PODIUM





**VISIT US AT THE WALES RALLY GB  
BETWEEN 26TH AND 29TH OCTOBER 2017**



**EXPLORE THE NEW CITROËN C3  
AND WATCH US RACE LIVE**

**FIND US AT OUR FAN ZONE OPPOSITE CITROËN RACING**



# Lots of excitement, then more frustration

## A 'SLOW' CAR GRABBING THE LEAD, A QUICK ONE

starting near the back, and different strategies helped make last weekend's United States Grand Prix one of the best races of the season. And then Formula 1 shot itself in the foot. Again.

Going by the letter of the law, Max Verstappen's last-lap pass of Kimi Raikkonen deserved a penalty. But it was also the most exciting move of an entertaining late-race tussle. For Verstappen to be denied a podium after such a fine drive smacks of missing the point of *racing* and doesn't exactly encourage the sort of attacking driving we all want to see – and which Verstappen is so adept at providing.

Surely there is a better way? Short of putting grass/higher kerbs in certain key places, perhaps some common sense could come into play. After Alex Zanardi's famous Corkscrew move at Laguna Seca in the 1996 CART finale, he was allowed to keep the win but told the move would not be allowed again. Pragmatic and sensible.

Ahead of all the controversy, of course, was Lewis Hamilton, who looked in control despite being beaten off the line. It would take a disaster for him not to be world champion this year, while his Mercedes team has already secured the manufacturers' crown for a fourth straight time. A remarkable and well-deserved feat.

Also set to secure another world title this weekend – this time a fifth – is Sebastien Ogier. We speak to the World Rally Championship star in our Rally GB preview supplement, as well as some of those who are out to beat him. There are also team-by-team and stage guides to help you follow the action, even if you can't make the trip to Wales.



**KEVIN TURNER EDITOR**

kevin.turner@autosport.com

🐦@KRT917



### COVER IMAGES

Hone/LAT;  
Coates/LAT;  
McKlein

### COVER STORY

**16** United States GP report and analysis

### PIT+PADDOCK

- 4** Fifth Column: Nigel Roebuck
- 6** Verstappen and Alonso ink new contracts
- 8** Wickens explains IndyCar switch
- 10** Macau F3 and GT entry lists revealed
- 12** Derek Warwick: a great BRDC president
- 14** In the service park: David Evans
- 15** Feedback: your letters

### AUTOSPORT AWARDS

**35** Your chance to decide the 2017 winners

### RACE CENTRE

**40** MotoGP; ELMS; Australian Supercars; NASCAR Cup

### CLUB AUTOSPORT

- 55** Priaulx Jr steps up to British F4
- 56** Porsche Carrera Cup GB set for Monza
- 58** Race reports: Brands Hatch; Silverstone
- 65** Humble Pye: the voice of club racing
- 66** British GT season review

### FINISHING STRAIGHT

- 70** What's on this week
- 72** From the archive: 1992 Hungarian GP
- 74** Reintroducing: Matthew Wilson

### AUTOSPORT SUBSCRIPTION OFFER

**39** Sign up and get six issues for £6

# FREE INSIDE

## RALLY GB SUPPLEMENT



Cagoule?  
Check.  
Thermos?  
Check.  
Bobble-hat?  
Check.  
And, of course, all you need to follow the action in Wales this week.

# NIGEL ROEBUCK

## The shock of the new

If the spectacle of Lewis Hamilton carving his way to the world title seems familiar, much is changing off-track in the new Liberty era

[@autosport](#)

**THE FAT LADY IS TUNING UP FOR MEXICO CITY**, where this coming weekend Lewis Hamilton needs to finish only fifth to clinch his fourth world championship. Given that since the summer break Hamilton has lost only once – in Malaysia, where he finished second to Max Verstappen – you’d have to rate his chances as somewhat better than average.

After the season he has had, the odds shorten that sooner or later he has to have some sort of mechanical failure, but Mercedes reliability has been remarkable in 2017, and Lewis, freed of the occasional torment that was Nico Rosberg, has driven better than ever before, rather dispelling the age-old theory that drivers give of their best when pressured by their team-mate. Valtteri Bottas has given a good account of himself, once or twice having the better of Hamilton, but Rosberg he ain’t. Only now perhaps are we beginning to appreciate how good Nico was.

For a change, therefore, Lewis’s major opposition has come not from the guy in the other Mercedes, but from Sebastian Vettel and a revitalised Ferrari team. Prior to the summer break the world championship seemed like very much a two-hander between them, but from Spa on Hamilton has been near-faultless, with Ferrari’s simultaneous chapter of

disasters almost impossible to fathom. At least, at the Circuit of the Americas, the cars ran reliably, taking second and third places, but although Vettel made the best of the start, and led Hamilton for five laps, there was an inevitability that Lewis would get by.

This season, the beginning of the Liberty era in Formula 1, I have after each race received from them a list of celebrities who were in attendance, and I confess that on most occasions the vast majority of the names have meant nothing to me. This, I willingly concede, may have

something to do with my vintage – I am bored witless by the whole culture of ‘celebs’, most of whom seem to be folk famous for being famous – but for Austin all the stops had clearly been pulled out, with Bill

Clinton presenting the winner’s trophy to Hamilton, and Usain Bolt – even bigger in the flesh than TV would have you believe – conducting the podium interviews.

Very plainly, we are into a new era, which some will find to their taste, others perhaps not. Approaching the circuit were large roadside hoardings, advertising the event: F1 US GRAND PRIX read the top line, and beneath not LEWIS HAMILTON and SEBASTIAN VETTEL, but JUSTIN TIMBERLAKE and STEVIE WONDER, the stars of the Saturday and Sunday evening concerts at the track.

**“I confess the majority of the celebrity names have meant nothing to me”**



As a racer, IndyCar champ Josef Newgarden was a guest. Roebuck actually recognised



Hamilton's main opposition this year has come from Vettel

There was a time, I said wistfully to a Liberty man, when racing alone was enough to entice the young to buy tickets, and he said yes – but such was no longer the case, and regrettably I know he's right. Thus, the age of the Super Bowl is coming to a grand prix near you.

Undeniably, though, the US Grand Prix, while not on the scale of the Indianapolis or Daytona 500s, did have the feel of a big occasion. COTA may be a modern venue, but the track is undeniably one of Hermann Tilke's best designs, and after five years is starting to get some bottle age.

On Sunday morning the elements, too, played a hand in building the drama. Driving to the circuit felt positively Wagnerian, with rain bouncing off the road in the darkness, thunder crashing right overhead, lightning crackling across the sky. Once in the press room, some of us expressed the hope – in the interests of unpredictability – for a wet race, but by mid-morning the track was drying out, and as the pre-race ceremonies began it was clear and bright.

It was a pleasure to come across such as Mika Hakkinen and Juan Pablo Montoya in the paddock, and I also much enjoyed a chat with Josef Newgarden, who a few weeks ago became IndyCar champion in his first season as a Penske driver. American friends have told me that Newgarden's ambition had always been to get to Formula 1, and he didn't deny it: "There is truth to that, yes, but actually I also wanted to do IndyCar."

Well, back in the day, I said, Mario Andretti used to do both, running all the Indycar races that didn't clash with grands prix. "I know," Josef said, "and I think it's a shame we've gotten away from that. Each discipline in the sport has become incredibly specialised. The way team managers look at it is, 'You're an F1 driver, and that's your full focus' – it's the same with IndyCar and NASCAR. Look at the reaction when Alonso said he was going to run the Indy 500..."

"I actually feel very similar to how Fernando feels – you want to be a *complete* driver, and that's not an abnormal thought: it used to be very common, but for the last 20 years it's almost been pushed on drivers – no, you can't do that. I wish we could reverse that trend, and go back to the way it used to be.

"Will I ever get a shot at Formula 1? I have no idea – maybe, at 26, I'm already too old! I know I have a great career in front of me with Penske, but as a racer, of course I'm always looking at everything else. I saw several grands prix when I was in Europe, doing GP3 back in 2010, and being here this weekend has reignited my love of Formula 1..."

Liberty would kill for an American star, and the personable Newgarden seems a natural fit, but he well knows that in Formula 1 only three teams offer a realistic opportunity of winning, and why would he give up his hallowed Penske drive for anything less? If we never see him in a grand prix car, it would be our loss as well as his. ✨



FORMULA 1

## Verstappen signing puts

THIS CAME AS SOMETHING OF A SURPRISE at last weekend's United States Grand Prix: Red Bull announced that Max Verstappen had signed a fresh contract, which keeps him at the team until the end of the 2020 season.

The reason why it was a surprise is that this has been a season plagued by unreliability for Verstappen. The subsequent frustration had led to speculation that the 20-year-old could escape to join Mercedes or Ferrari in the near future. His existing deal was set to expire at the end of 2019, but is believed to have had clauses that could have allowed him to leave earlier.

But with Sebastian Vettel committing to Ferrari until the end of 2020, and Lewis Hamilton expected to sign a new deal at Mercedes that keeps him there beyond the end of next season, Verstappen has opted to stay at Red Bull and accept what is understood to be a significant salary increase.

"Red Bull has always shown faith and belief in me with actions – inviting me in to the young-driver programme as a 16-year-old, then giving me my start in Formula 1 when I was just 17, and then the opportunity to race with Red Bull, where I had such a dream start," said Verstappen.

"They have always backed me and my ambition and I know we share that ambition. Their support, no matter what plays out on the race track, has always been 100%."

The move raises questions about the future

of his team-mate Daniel Ricciardo, whose current deal expires at the end of next season.

Red Bull team boss Christian Horner said his next priority was to secure a new deal with Ricciardo, but he also said Verstappen "is in the best place to build a team around him to deliver our shared ambition", suggesting he is the one the team is backing long term.

Ricciardo has said he has no worries that Red Bull is starting to become focused on Verstappen. He has added that he is in no rush to nail down his future and, by waiting, he affords himself the luxury of seeing whether Red Bull can deliver a car capable of winning the title next year before committing. The Australian will know he has options elsewhere on the grid in 2019, with Renault having tried to sign him as part of the deal to cancel Toro Rosso's engine contract.

### Alonso sticks with McLaren

McLaren also chose Austin last weekend to make a driver announcement, with confirmation that Fernando Alonso has signed a contract extension that will keep him at the team next year, alongside Stoffel Vandoorne.

The Spaniard has endured a torrid time with the team since returning in 2015, as Honda struggled for performance and reliability. But McLaren has since joined forces with Renault, with Alonso subsequently committing to the team for what he has described as the "long



DAYTONA/LE MANS 24 HOURS

# Is Alonso edging close to Le Mans?

THE IDEA THAT FERNANDO ALONSO MIGHT race in the Indianapolis 500 this year started out as a joke, and it seems that talk of him joining McLaren boss Zak Brown's United Autosports squad for January's Daytona 24 Hours may or may not be bar-room banter for the moment. But it would make sense for the Spaniard to get some endurance-racing experience as he continues his quest to win the unofficial triple crown of motorsport.

How and when Alonso takes on the challenge of the Le Mans 24 Hours, the leg of the triple crown alongside the Indy 500 and the Monaco Grand Prix in which he has yet to compete, remains unclear. But he admits that he could be better prepared than when he pitched up at the Indianapolis Motor Speedway in May.

When Alonso finally gets to Le Mans he won't have problems getting to grips with the machinery, nor the track – the Circuit de la Sarthe is relatively easy to learn. But an outing at Daytona would provide vital experience of multi-class racing.

That will be the biggest culture shock for Alonso whenever he makes his endurance debut. Understanding the nuances of ducking and diving through the traffic can only come with experience.

Brown says there's a seat with Alonso's name on it in one of United's pair of Ligier-Gibson JSP217s at Daytona. That's if there is one available, and they are filling up fast.

Mercedes DTM driver – and Williams Formula 1 contender – Paul di Resta will join the team at Daytona for what will be his endurance-racing debut in the opening round of next year's IMSA SportsCar Championship. McLaren F1 test driver Lando Norris is on the roster too. The talks with Alonso appear to be getting serious, which could make a United superteam in January.

GARY WATKINS

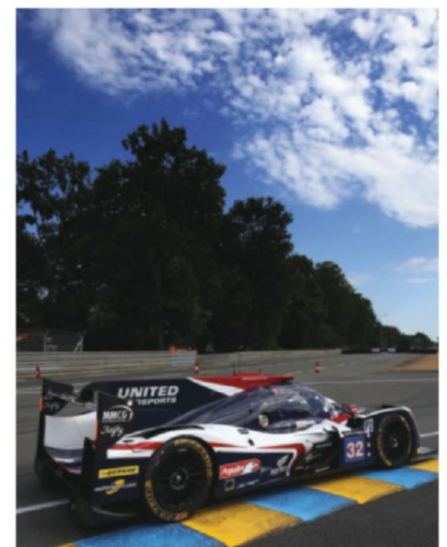

## a cork in driver market

term." He added: "Although the last few years have not been easy, we have never forgotten how to win, and I believe we can achieve that again soon. The last three years have given us the momentum to plan and build for the future, and I'm looking forward to that journey." Alonso said he carefully examined all the options available – which in F1 were very limited – before deciding to stay, in what he described as a "cautious process".

### Di Resta completes Williams test

Alonso could race in next January's Daytona 24 Hours with McLaren executive director Zak Brown's United Autosports team (see story, right), and if he does this he would team up with Paul di Resta.

Scotsman di Resta, who has spent the past four seasons racing in the DTM with Mercedes, remains in contention for a full-time seat at Williams alongside Lance Stroll in 2018 after completing a day of testing at the Hungaroring last week.

Di Resta's mileage, which came in a 2014-spec Williams, came as he pushes for a return following his impressive stand-in performance for the team at this year's Hungarian GP, where

he subbed at the last minute for Felipe Massa. He took over the car in Hungary last week from Robert Kubica, who drove the day before to follow up his test the previous week at Silverstone.

Kubica is viewed as di Resta's main competition for the seat, with Massa and Sauber's Pascal Wehrlein also in the frame. Williams is keen to fully evaluate the Pole's potential of a return to F1, and is currently analysing its findings.

**“We have never forgotten how to win; we can achieve that”**

The squad has been tight-lipped on the details of Kubica's and di Resta's tests in the FW36 machine, describing di Resta's running as "a busy day". Williams added: "These tests are part of the ongoing due-diligence work regarding our 2018 driver line-up, but the team

is in no rush to confirm plans ahead of 2018 while it completes its internal evaluations."

The team's engine supplier Mercedes is pushing for its junior Wehrlein to get the seat as part of the next step of his F1 education. Meanwhile, Massa says he wants to know before his home race, at the start of next month. But Williams is in no rush to make a final decision and has yet to commit to announce its plans before then.

LAWRENCE BARRETT

## Q&A

### CALLUM ILOTT NEW FERRARI PROTEGE



**The Formula 3 star, dropped by the Red Bull junior programme at the end of 2015, has been given a place on the Ferrari Driver Academy. What's next? When did the interest first come from the FDA?**

Massimo Rivola, head of the

Ferrari Driver Academy, has spent a lot of time with Prema [Iloft's F3 team] this year, overseeing the other members [including Guan Yu Zhou, Iloft's 2017 team-mate]. Massimo has a good understanding of me as a person and most importantly can see the potential I have. We got to know each other well and things just evolved.

#### **How exciting is it to be with Ferrari?**

Very. I feel very privileged. I've talked before about the family feeling you get with Italian teams and the support that brings, so I'm glad to be staying Italian. I've always loved Ferrari ever since I was a kid so to become a part of the Ferrari family is very cool.

#### **What benefits will you get from the FDA?**

The biggest benefit will be the chance to learn, develop and have a new structure to my career. I don't come from a motorsport family and since the start we learned the hard way. The FDA was created to develop young drivers, not just on track but off it too. It has a unique and comprehensive programme that isn't just simulator work and human performance. Sometimes being a young driver can be very isolating once you strip away the glamour. The FDA has incorporated a strong fun, family feel into its ethos, so being part of that with shared fun off-track experiences is important.

#### **How are plans for 2018 developing [Iloft is rumoured to be in line for a GP3 switch]?**

I have been approached with some really interesting opportunities for 2018 and not all in GP3 or Formula 2. I'm now working closely with FDA to finalise what next season will look like. I think I'm safe to say I'll be staying in single-seaters!

**MARCUS SIMMONS**

## INDYCAR

# Why Wickens had to quit the DTM

NEW INDYCAR DRIVER ROBERT Wickens says he had to leave Mercedes a year before it quits the DTM at the end of 2018 in order to ensure a switch to the series could happen with Schmidt Peterson Motorsports.

Wickens announced last week that he would leave the DTM for the Honda-powered SPM team – forming an all-Canadian line-up with James Hinchcliffe – and end his association with Mercedes, despite it being keen to help its drivers stay within the marque.

Wickens says he had to move for 2018, despite initially being unsure on a switch to IndyCar. “Mercedes were great,” he said. “They know that they kind of gave all the DTM drivers a pretty unfortunate situation and were very accepting. I feel like I had an opportunity in front of me that was also kind of too good to pass up. It was more or less, I would say, a one-time offer here at IndyCar with SPM.

“That was one of the options [another DTM season]. But then, on the contrary, SPM said that they're not going to leave a seat open for me.”

Wickens also admitted he could have made his SPM and IndyCar debut earlier if he had been able to secure the seat for the final two races of the 2017 season.

He drove with the team in free practice for the Road America round in June (below) when Mikhail Aleshin was late arriving due to visa problems. After the team split with Aleshin, September's Watkins Glen and Sonoma races did not clash with the DTM, but Wickens says his win at the Nurburgring and SPM's

need for drivers with financial backing prevented an early debut.

“I threw it out there saying, ‘Hey guys, I'm available if you want me,’” he said. “But I didn't really pursue it. Before Sonoma, I'd just come from my win at the Nurburgring, and felt like I could actually still challenge for this championship, but I kind of threw [the idea] out there.

“I was feeling a little bit left out because they were more or less only looking to bridge their financial gap that they lost with Aleshin. They told me at a very early stage that they weren't going to use me for the last two races.”

Wickens could find himself part of a three-car line-up at the Indianapolis 500 next year, with team owner Sam Schmidt admitting he has had held discussions with Juan Pablo Montoya.

Montoya is without an Indy 500 ride after Penske scaled back a car due to its new IMSA SportsCar programme with Acura, which Montoya is part of.

Penske is open to Montoya racing at the Indy 500 elsewhere. “Roger deciding to not run Juan at Indy and allowing him to look for alternatives there has opened a door, and so it's something Juan and I have discussed,” Schmidt said.

Kyle Kaiser will also drive at next year's Indy 500 as part of his prize for winning the 2017 Indy Lights title.

Kaiser will race with Juncos Racing – his Lights team – for four IndyCar rounds next season, including the Indianapolis road course, with another two events yet to be decided.

**TOM ERRINGTON**



LAT IMAGES



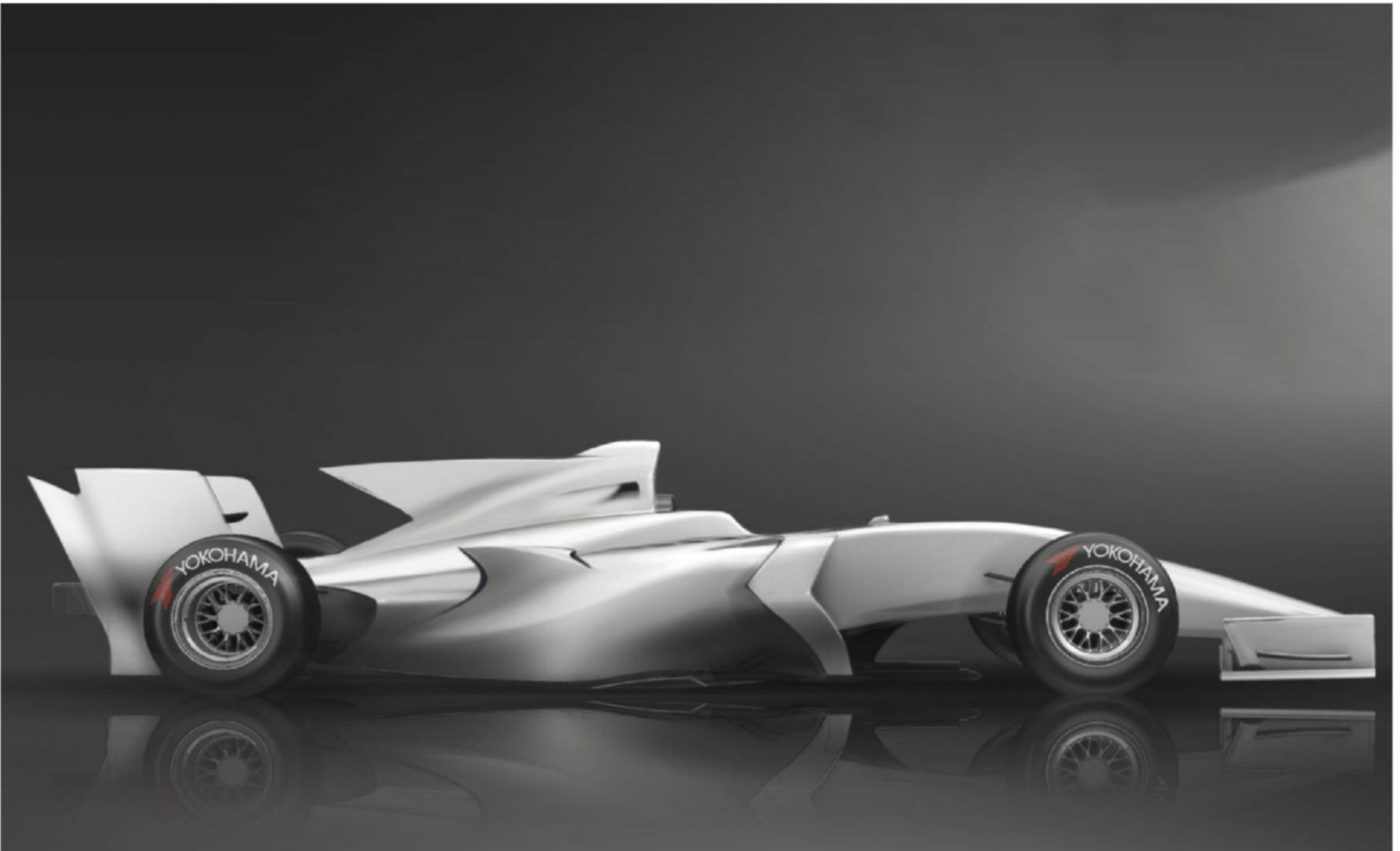

**SUPER FORMULA** Japan's flagship Super Formula single-seater series shows no signs of losing its cachet as one of the most desirable racing cars to drive, if images of the new Dallara SF19, due for introduction in 2019, are anything to go by. The existing SF14 will be phased out after five years of competition at the end of next season, and the new car retains the two-litre turbocharged engine formula as well as the IndyCar-style overtake button. It also features a more robust cockpit design rather than a halo. The series suffers from a lack of overtaking but this is being addressed by relying more on underfloor aerodynamics than wings to generate downforce. Testing begins in July '19.

## SUPER FORMULA

# Gasly title bid thwarted by Japanese typhoon

IF ALANIS MORISSETTE WAS EVER looking for a definition of 'ironic', she could do worse than ask Pierre Gasly.

Gasly had to give up his newly won Formula 1 seat with Toro Rosso for the United States Grand Prix last weekend to Brendon Hartley, because he was committed to trying to win the Super Formula title at the Suzuka finale. Then Typhoon Lan blew over to Japan, and the decision was taken on Saturday to cancel Sunday's two races.

Gasly was just half a point adrift of 2015 champion Hiroaki Ishiura prior to the weekend, with fellow SF rookie Felix Rosenqvist five points in arrears. A soaking wet qualifying session was held on Saturday with a point on offer for each of the two poles, and these were collected by Andre Lotterer and Jann Mardenborough. Rosenqvist crashed at Turn 1 to cause a red flag, while Gasly spun his Honda-powered Dallara due to aquaplaning at the same spot to trigger another session stoppage.

The Frenchman believed he would have topped the times with his previous lap had he not been unwittingly held up by Team Mugen stablemate Naoki Yamamoto, and this theoretically would have given him the title, but he was realistic that without the red flag he caused the times would have tumbled.

"Big congratulations to Ishiura," said Gasly. "It's been a pleasure to race with all the guys in Super Formula. For me it's been a great challenge. Of course I'm disappointed because I wanted to race and wanted to fight, so it's just a bit hard to accept now. But it's been a great year."

The cancellation – which came after consultations with teams – was proved right as 700mm of rain fell in the region on Sunday. Series boss Akira Kurashita explained it was impossible to reschedule the event because of drivers' commitments to other series, including F1, World Endurance, Formula E and Super GT.

**JIRO TAKAHASHI, RACHIT THUKRAL & MARCUS SIMMONS**





## MACAU GRAND PRIX

# MACAU GP FAILS TO HIT FULL GRID...

THE MACAU GRAND Prix, Formula 3's blue-ribbon race, has slumped to a grid of 22 cars for next month's 2017 edition.

The field is the smallest since the race switched from Formula Atlantic to F3 rules in 1983 – that was the previous lowest grid, when 25 cars were hastily assembled by race coordinator Barry Bland. In the 33 years since then, the grid had never fallen below 28.

Bland resigned from his position in the late summer of 2016, by which time most of the legwork had been done in getting the entry together for what was the first Macau run under its new, additional title of FIA F3 World Cup. The 2017 race is the first to be run without any input from Bland, who passed away in July this year.

It's worth pointing out that, by the time the cars emerge from San Francisco Bend on the opening lap, the field can often be depleted below 22 anyway by accidents. And the 2017 running consists of most of the leading lights from the F3 European

Championship. Title winner Lando Norris and runner-up Joel Eriksson lead five-car assaults from Carlin and Motopark respectively, while Maximilian Gunther and Callum Ilott spearhead Prema Powerteam's attack.

Hitech GP is giving the race a miss, forcing Ralf Aron and Tadasuke Makino into berths at Van Amersfoort Racing and Motopark respectively. Motopark also runs Formula 2 race winner Sergio Sette Camara and Formula Renault Eurocup race-winning Red Bull junior Dan Ticktum. Another Renault star is points leader Sacha Fenestraz, with Carlin.

Japanese title winner Mitsunori Takahashi is missing, but the B-Max team he drove for is fielding previous F3 champions Yuhi Sekiguchi (2011) and Kenta Yamashita ('16).

While the small field isn't great for F3, teams in the European series are reporting great interest for 2018, the last season before the category switches to the FIA's new International F3 regulations in '19.

**MARCUS SIMMONS**

## MACAU GRAND PRIX ENTRY

<b>Carlin</b>	Lando Norris, Jehan Daruvala, Ferdinand Habsburg, Sacha Fenestraz, Devlin DeFrancesco
<b>Prema Powerteam</b>	Callum Ilott, Guan Yu Zhou, Maximilian Gunther, Mick Schumacher
<b>TOM'S</b>	Sho Tsuboi, Ritomo Miyata
<b>Motopark</b>	Joel Eriksson, Tadasuke Makino, Marino Sato, Dan Ticktum, Sergio Sette Camara
<b>Drago Corse</b>	Alex Palou
<b>B-Max</b>	Kenta Yamashita, Yuhi Sekiguchi, 'Dragon'
<b>Van Amersfoort Racing</b>	Ralf Aron, Pedro Piquet

## MACAU GT WORLD CUP

# ...but GT field is top-class

The magic of Macau has lured a top field to the FIA GT World Cup this year. Lucas di Grassi explains why

# I

t's a race that every top professional with even a tenuous link to the world of GT racing seems to want to do. Macau's GT Cup, which became the FIA GT World Cup in 2015, offers drivers the chance to maybe rekindle past successes from their days in Formula 3 or maybe just bid for glory in an event of growing stature on one of the most challenging circuits around.

Lucas di Grassi, winner of the F3 GP with Manor back in 2005, is one such driver. The reigning Formula E champion may not be a regular in a GT car of any kind, but getting back to Macau for a first time since he signed a contract with Audi ahead of the 2013 World Endurance

Championship was a target for '17. And his employer has obliged him with a seat in an R8 LMS fielded by the HCB-Rutronik Racing squad.

"I love Macau – it's one of the tracks I love racing on the most," says the Brazilian. "I'd wanted to do it every year since I raced a Ferrari in 2012, but there was always the clash with the Bahrain WEC race. I always said after Audi left the WEC that I didn't want to do another full programme alongside FE, but there are certain big races that I made it clear I wanted to do and Macau is one of them."

Di Grassi hints at a high level of competition for seats at the Belgian WRT squad, last year's winner of the World Cup and again the team that will lead Audi's assault on the race. It has picked DTM driver Nico Muller, who drove a factory Phoenix car last year, and Macau debutant Robin Frijns for the sought-after seats. "Everyone wanted to do Macau and WRT had its own drivers," explains di Grassi. "I'm fortunate Audi have found a team for me."

That love of Macau means that di Grassi (below) is prepared to take a major risk in signing up for the World Cup this year. He'll be up against a line of GT3 experts, both from inside and outside the Audi camp, while he'll be getting his first taste of an R8 LMS in first free practice. It will also be his first time in a GT3 car since his one-off with AF Corse five years ago, and only his second in total. Few remember that he was entered for that year's Nurburgring 24 Hours in a McLaren but never got to drive in the race.

"I'll have the same amount of testing that I do before a FE race," he says, "so I'll just have to figure it out."

**GARY WATKINS**

## MACAU GT ENTRY

<b>Audi</b>	Robin Frijns, Nico Muller, Lucas di Grassi, Markus Pommer, Fabian Plentz
<b>BMW</b>	Augusto Farfus, Tom Blomqvist, Marco Wittmann, Chaz Mostert
<b>Ferrari</b>	Felix Rosenqvist
<b>Honda</b>	Renger van der Zande
<b>Lamborghini</b>	Mirko Bortolotti
<b>Mercedes</b>	Edoardo Mortara, Daniel Juncadella, Raffaele Marciello, Maro Engel
<b>Porsche</b>	Laurens Vanthoor, Darryl O'Young, Romain Dumas, Hiroki Yoshimoto



## BRITISH TOURING CAR CHAMPIONSHIP

# Long-distance Snett for BTCC diamond jubilee

THE BRITISH TOURING CAR Championship will feature an extended 60-mile race in the middle of next year's campaign to highlight the series' diamond-anniversary season.

The third race of the Snetterton round will be run over 20 laps of the track, which takes just under two minutes to lap in the dry. The race will have its own qualifying session on Saturday, and none of the cars will be required to carry their usual levels of success ballast. All competitors will also be fitted with the series' medium Dunlop tyres.

Double champion Gordon Shedden said he welcomed the idea to revamp the format for a

special race, but thinks that the BTCC bosses could have gone further.

The Team Dynamics Honda Civic driver said: "While I like anything that will mix things up a little bit, it would have been great if we could have had something like a pitstop race. In the modern BTCC, all the cars are so close it would have been good to have something that would involve the teams as well. It would be nice for them to have an impact in the race results. Also, how about a two-driver race...?"

Shedden said that the length of the special feature race would also have serious strategy implications. "You are going to have to be really

careful on tyres, particularly on a front-wheel-drive car," said Shedden. "It's really going to be some punishment for them, but at least we won't have the success ballast."

Series director Alan Gow said that the race was part of a raft of events planned for the celebration season. "We believe this race, roughly double the distance of a normal BTCC encounter, will add a further sporting twist to what will be a fantastic and memorable season," he said.

Snetterton has hosted special BTCC races before. It was the venue for the first BTCC night race in July 1999.

MATT JAMES



## FORMULAE

# Mortara joins all-Merc Venturi electric line-up

VENTURI WILL FIELD TWO MERCEDES DTM drivers in the upcoming Formula E season, having chosen Edoardo Mortara to partner Maro Engel for 2017-18.

Mortara drove for the team for the first time in private testing in August and joined Venturi for the official pre-season test at Valencia. He shared the car in Spain with James Rossiter and development driver Michael Benyahia, but gearbox problems blighted all Venturi's running.

Engel continues for a second season in FE after a strong rookie campaign with Venturi that featured a best result of fifth in the team's home race in Monaco.

Mortara joins the city-centre racing series with strong street-circuit pedigree. He claimed back-to-back Macau Grand Prix titles in Formula 3 in 2009 and '10, and won the Macau GT race in 2011-13 driving privateer Audis.

The 30-year-old finished second in the DTM in 2016 driving for Audi, but has had a tricky first season with Mercedes and scored just one podium finish.

Mortara's appearance in testing with Venturi, aligned with Engel's suspected ongoing role with the team, had sparked speculation he was being placed there by Mercedes. The German manufacturer is joining FE in 2019-20 and has been linked to a proxy entry with its favoured race team HWA in 2018-19.

Mortara will race on home soil in Rome (right) on April 12. FE has unveiled the track layout for the Italian capital, where the 21-turn circuit will be the second-longest of the season at 1.77 miles.

It is based in the Esposizione Universale Roma (EUR) district. Now a significant residential and business hub, EUR was chosen by Italian dictator Benito Mussolini to celebrate fascism in the 1940s. Although the idea of the 'world fair' was never realised, it did trigger the design and construction of the Colosseo Quadrato, a building symbolic of fascist architecture, which will be a backdrop to the FE circuit.

SCOTT MITCHELL



WORLD RALLY CHAMPIONSHIP

## TANAK MOVE TO TOYOTA MEANS OGIER STAY CRUCIAL

M-SPORT TEAM PRINCIPAL Malcolm Wilson is stepping up his efforts to retain Sebastien Ogier after losing Ott Tanak to Toyota for next season.

The Estonian's decision to depart M-Sport after a six-year association with the Cumbrian squad was announced last week. The 30-year-old is contractually bound not to comment on his move and Autosport understands he may not test the Yaris WRC until the start of next month.

"Losing Ott is a tough one," said Wilson, "but we saw it coming. Tommi [Makinen, Toyota team principal] was chasing him hard even last year. I can understand Ott's decision: M-Sport's all he's ever known, so I've wished him well and told him he'll be back here in two years anyway!

"There's no further movement with Seb [Ogier] and I don't expect there to be while we're in Wales [for this week's Rally GB]. I'm trying very hard to keep him. I'm not 100 per cent confident, but I'm hoping we will be OK."

At the same time as discussing Tanak's (below) arrival, Makinen confirmed the departure of Juho Hanninen after this week's Rally GB.

Makinen said: "We're delighted to have secured the services of Ott - he represents the perfect blend of youth and experience. I would like to express my thanks and appreciation for everything that Juho has done for us."

Hanninen's co-driver Kaj Lindstrom takes over as the team's sporting director from next month's Rally Australia.

DAVID EVANS



BRDC

## Why Warwick's shoes are so hard to fill for the BRDC

FILLING DEREK WARWICK'S SHOES AS BRITISH Racing Drivers' Club president will be a difficult task.

Warwick, who last week stepped down from the position he held since 2011, is an unsung hero of British motorsport. His four podiums from 146 Formula 1 starts do his driving ability a disservice, but it's the passion, commitment and experience he has brought to support young drivers that is most impressive.

The 63-year old has been key to boosting the McLaren Autosport BRDC Award, plays an active role in the process and still makes himself available to finalists after the tests are over. Current Formula 2 frontrunner Oliver Rowland won the Award in 2011. He hasn't had the smoothest time off-track and Warwick has stepped in to keep things heading in the right direction more than once.

There are other stories of drivers speaking to Warwick about their concerns with teams or difficult situations.

As BRDC president, he put huge amounts of time and energy into British drivers, the British Grand Prix and Silverstone, although he doesn't shout about it. He's been part of a push to find Britain's next F1 star, which helps the British GP, which in turn is a key pillar of the successful motorsport industry in the UK.

The British GP is still under threat. Among the many reasons it should survive is that it would be a fitting reward for Warwick's hard work, as would a home victory for one of the many talented Brits he has helped. That's quite a challenge for Warwick's successors, starting with Paddy Hopkirk, who was appointed shortly afterwards.

KEVIN TURNER



**AUTOSPORT INTERNATIONAL/RALLY GB** The M-Sport factory Ford Fiesta WRCs of Sebastien Ogier and Ott Tanak will carry Autosport International decals during this week's Rally GB. This is the third year in succession Autosport's season-opening show (January 11-14) at the Birmingham NEC has featured as part of M-Sport's livery for its home World Rally Championship round.

## IN THE HEADLINES

### ELECTRIC VW SPORTS-PROTO IN BUILD

Volkswagen is developing an electric sports-prototype for next June's famous Pikes Peak hillclimb in the US. The manufacturer aims to beat the electric record for the 12.4-mile Colorado course, which stands at 8m57.118s, set by Rhys Millen on his way to second overall in 2016 in his Drive eO PP100.

### NASCAR ACES SAMPLE CHARLOTTE ROVAL

NASCAR Cup drivers got the chance to sample the new Charlotte 'roval' in a Goodyear tyre test last week. The layout will be the first road circuit to feature in the Playoffs, and will host a 312-mile race - NASCAR's longest road event. Current points leader Martin Truex Jr said: "It's very narrow, it's very rough, there's a lot of swells and loop-de-loops. There's all kinds of craziness going on."

### AUDI MAN MULLER GETS WEC RUN

Audi DTM defensive maestro Nico Muller is the latest to join G-Drive Racing's revolving cast of World Endurance Championship stand-ins. The Swiss will step into the cockpit of the TDS-run ORECA for the next round at Shanghai alongside Roman Rusinov and Pierre Thiriet.

### MONTEIRO SIDELINED ONCE AGAIN

Honda World Touring Car Championship star Tiago Monteiro will have to sit out this weekend's Motegi round as he is still not yet fully recovered from his high-speed Barcelona testing crash. Monteiro, who sits just half a point off series leader Thed Bjork, was replaced by Gabriele Tarquini last time out at Ningbo, but the Italian veteran has clashing TCR commitments, so Campos Chevy ace Esteban Guerrieri will take his place in Japan.

### PETER LUMSDEN 1929-2017

A noted racer of Lotus and Jaguar cars in endurance events, Peter Lumsden died recently at the age of 88. After domestic success in a Lotus Mk9, Lumsden took class wins in an Elite with Peter Riley in the Le Mans 24 Hours (1959) and Nurburgring 1000Km ('59 and '61). He then moved onto Jaguar E-types, finishing fifth overall at Le Mans in '62 with Peter Sargent. He took another Nurburgring 1000Km class win in '65, this time with Peter Sutcliffe in a Ferrari 250GTO. After his retirement from racing, Lumsden was awarded the CBE for his role as treasurer of the Chest, Heart and Stroke Association.

### DOUBLE R SPREADS TO EUROFORMULA

Formula 3 stalwart Double R Racing is expanding into Euroformula Open next season with a two-car team alongside its BRDC British F3 and British F4 squads. The team also retains its FIA F3 European-spec cars and has not ruled out a return to this series in 2018.

### US F3 CAR LAUNCHED - WITH HALO

The new US F3 Honda-powered Ligier Crawford was launched at last weekend's US GP, and is the first junior single-seater to feature a halo. The F3 Americas Series in which it will race will kick off in April.



## F1 PREVIEW

# Mexican Grand Prix

## October 27-29

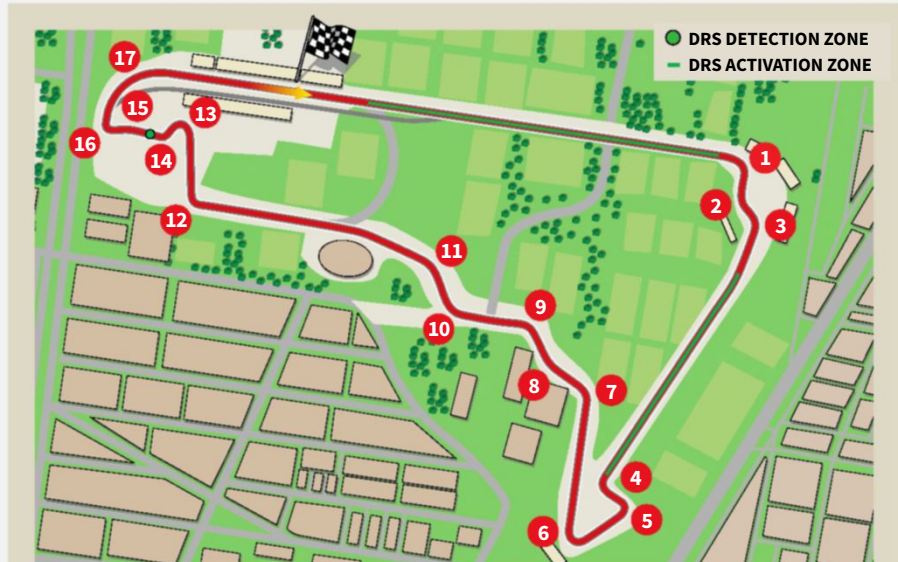

## MEXICO CITY

LENGTH 2.674 miles NUMBER OF LAPS 71

2016 POLE POSITION Lewis Hamilton 1m18.704s

POLE LAP RECORD Lewis Hamilton 1m18.704s (2016)

RACE LAP RECORD Nico Rosberg 1m20.521s (2015)



### TYRE ALLOCATION

HARD	MEDIUM	SOFT	SUPER-SOFT	ULTRA-SOFT	INTERMEDIATE	WET
-	-	AVAILABLE	AVAILABLE	AVAILABLE	AVAILABLE	AVAILABLE

### UK START TIMES

#### LIVE ON SKY SPORTS F1

##### FRIDAY

FP1 1600 FP2 2000

##### SATURDAY

FP3 1600 QUALIFYING 1900

##### SUNDAY

RACE 1900

##### CHANNEL 4 HIGHLIGHTS

RACE 2230

BBC RADIO 5 LIVE 1830

### PREVIOUS WINNERS

2016	Lewis Hamilton	Mercedes
2015	Nico Rosberg	Mercedes
1992	Nigel Mansell	Williams
1991	Riccardo Patrese	Williams
1990	Alain Prost	Ferrari
1989	Ayrton Senna	McLaren
1988	Alain Prost	McLaren
1987	Nigel Mansell	Williams
1986	Gerhard Berger	Benetton
1970	Jacky Ickx	Ferrari

### THEMES TO WATCH

#### HAMILTON CROWNING

The United States Grand Prix winner is on a roll, and only needs to finish fifth in Mexico this weekend to clinch his fourth world championship.

#### TRACK-LIMIT TURMOIL

The FIA copped a lot of flak for penalising Max Verstappen at Austin. Track limits was a big issue in Mexico last year and will be a talking point again.

#### HARTLEY'S SECOND

Porsche WEC racer Brendon Hartley has been handed another chance to impress Toro Rosso in Mexico, after finishing 13th on his F1 debut in the US.



# Some Finn special

Tipped by those in the know as the most gifted Finnish driver yet, Kalle Rovanpera is about to take on Rally GB – aged just 17...

By David Evans, Rallies Editor

[@daviddevansrally](#)

**FORTUNATELY FOR KALLE ROVANPERA, I WAS WITH** him. He'd be OK with me at his side. Not often you hear that, is it: the World Rally Championship's most talked-about young driver needing Autosport to look after him.

He was in a bar. And, at the time of talking, 16. That's why. Fortunately, he was only drinking Red Bull neat.

Using my time as Rovanpera's responsible adult wisely, there was only one thing to talk about. This week; his moment. Twenty-five days ago, Kalle turned 17. Inconveniently, October 1 fell on a Sunday this year and Finnish driving test centres are shut on a Sunday. The day after, Kalle passed his driving test.

And yes, you're absolutely right, the minimum age for driving in Finland is 18. Unless, like Rovanpera, you get a waiver from the government to allow you to get behind the wheel 12 months early. This is not normal. Such agreements are usually reserved for those living in the depths of rural Finland, usually with dependent parents or relatives.

Nascent rally drivers? Not so much. Then again, this son of one-time World Rally winner Harri Rovanpera is definitely not your average 17-year-old.

Does he do 17-year-old things? "Yeah, I do the normal things," he says, slightly defensively. "I go out. I like being outside with friends."

Increasingly, they're less likely to be school friends. For Rovanpera, school's so last year.

"I stopped it now," he says. "Last year I was there for only one month with all of the travelling and testing. There was no point this year. And when you have been to school for nine years in Finland then you can choose."

Kalle's chosen rallying. There is nothing else for him.

"I have no Plan B," he says. "What's the point? If you do something, you do it properly. I don't remember how old I was when I first drove a car, but I was seven or eight when I first drove a rally car. For the first couple of years I was a kid enjoying myself – I'd played *Colin McRae Rally*, like everybody else, but this was the next thing.

"After a couple of years, I knew this was all I wanted to do. And that's never changed. I drive or ride every day."

All of this single-mindedness could sound a wee bit unhealthy in one so young. And I guess interests away from cars may not be a bad thing. But he's simply not interested. He's utterly focused and, already, exceptionally fast.

A very well-placed friend of mine in the sport, who wishes to remain nameless on this occasion, told with utter conviction that Rovanpera will take his first World Rally Championship win at Rally Sweden, 2019. That, just so you know, will be his maiden outing on a WRC winter round. And probably only his second event in a World Rally Car. That's how good he is.

"Trust me," says my friend. "I have seen Kalle drive in the snow and he is the most naturally gifted driver I think Finland has ever had."

Note, not 'one of...' but 'the most'. That's a big call in a country not known for slow rally drivers.

"Snow is my favourite surface," says Rovanpera, who made his name as an eight-year-old YouTube sensation involving a rear-drive Toyota Starlet and a snow-walled stage carved out of a frozen lake. "I prefer the snow to gravel; my style is quite smooth and this is the fastest way on the snow. When you are on the gravel, you have to force the car more."

Not that he minds the gravel. Especially not this week, when he'll be making his World Rally Championship debut on Rally GB.

Rovanpera will drive an M-Sport-run Ford Fiesta R5. Competing in Latvia since the end of 2013, he moved up to an R5 car at the start of last season and took to it immediately.

This year he was allowed to compete on rounds of the Finnish Championship in a Skoda Fabia R5. He won them. So far, it's only Italian asphalt that has foxed him. But he's a fast learner.

It's not quite the deepest of deep ends into which Rovanpera will dive in Wales, but a capacity WRC2 round, running against the likes of Pontus Tidemand and Teemu Suninen, won't be easy. I'm almost relieved to say he's admitting to some nerves ahead of the biggest moment of his career to date.

"It will be a tricky event," he says. "My dad doesn't give me so much advice these days, but he told me this is a tough one with the weather and the changing grip. I'm quite nervous."

But the confidence of his years is never far away. What would be a good result in Wales, Kalle?

"A win," he replies. "This is really the only good result. Second isn't so interesting. But on this rally, for me, a podium or maybe a top-five place would be good for my first event."

We've been waiting for this moment for a while now, him more than anybody. The playing field is level and Kalle's lacing up his boots. Except that analogy doesn't really work.

"I don't do team sports or ball games. Just rallying." ❄️

**"So far, it's only Italian asphalt that's foxed him. But he's a fast learner"**

# FEEDBACK

## When the rules clash with 'the show'

Liberty Media must be spitting feathers at the actions of the stewards in demoting and penalising Max Verstappen after his stunning overtake of Kimi Raikkonen, especially the clumsy manner in which it was done in the full glare of the media.

Many people watching will not have understood the subtlety of Verstappen's rule infringement. Even the purists will see the inconsistency as there were numerous examples of positions gained or retained throughout the race as a result of exceeding track limits where no penalty was applied. The balance between 'the show' and the rules needs to be agreed between the promoters and the rulemakers to avoid a repeat of this type of thing.

In the meantime, congratulations to Lewis Hamilton on yet another victory, to Max for entertaining us and to Carlos Sainz for a superb debut with Renault.

**Steve Tan**  
Runcorn



### Great track = great racing

I have just watched the US Grand Prix and it was great! Action from start to finish with real racing and overtaking, in the dry!

What went wrong? Surely this is against Formula 1 rules these days?

The answer, of course, is that Austin is a great track designed for racing and there are very few of those in modern F1.

FIA please take note. We need more tracks like this, not like Abu Dhabi, the Hungaroring or Singapore!

**John Napper**  
Riode Janeiro, Brazil

### Don't hinder the drivers

If grid penalties are to remain, then those responsible should be penalised. If the driver is responsible he gets the penalty but if, as is the case in most situations, the team is responsible then it loses constructors' points.

Qualifying would become more

Austin put on a great show. More tracks like this on the F1 calendar, please, says reader Napper

meaningful and drivers could race without artificial hindrance. The only downside – we wouldn't get the chance to witness Max Verstappen's wonderful drive through the field to a 'podium' finish.

**Andrew Andersz**  
By email

### Wings cause a flap

I was intrigued to see the Motorsport.tv 3D Porsche F1 car proposal (October 19)... but – spot the deliberate error! As Porsche would only enter F1 after the new regs come in in 2021, surely showing the car with the insane and ludicrous current front wings would indicate a serious failing in framing the new regulations?!

**Guy Dormehl**  
South Africa

### Hill versus Button

Why choose the similarity of book titles to belittle a modern driver's achievements compared to one from the past (Letters, October 19)? Perhaps Mr Andersz should read Nigel Roebuck's 'Equal opportunities' piece in the same issue. I'm old enough to have witnessed both Graham Hill's and Jenson Button's fine careers and achievements. If we could bring them together in a timewarp, I would not bet against Jenson matching Graham.

**John Turner**  
By email

## HAVE YOUR SAY, GET IN TOUCH

**Autosport editorial**  
Autosport Media UK Ltd  
1 Eton Street  
Richmond  
TW9 1AG

@  
**E-mail**  
autosport@  
autosport.com

  
**Twitter**  
twitter.com/  
autosport

  
**Facebook**  
facebook.com/  
autosport

# Lewis inflicts a painful defeat

By Edd Straw [@eddstrawF1](#)









**SEBASTIAN VETTEL MADE A GREAT START TO GET AHEAD OF LEWIS HAMILTON** in the United States Grand Prix but, as he struggled to build a substantial gap, it soon became clear that the Mercedes had a clear performance advantage. Hamilton used this to claim another win, widening his drivers' championship lead and sealing another constructors' crown for Mercedes.

But Vettel's loss at Austin to Hamilton was superficially the mildest of Ferrari's recent disasters. His Ferrari finished second and there was no start catastrophe or mechanical malady to be distraught about, but this will nonetheless have been the hardest of hard knocks.

For this was a long, slow death at the hands of the dominant combined force of Hamilton and Mercedes. Unlike Singapore, Malaysia and Japan, all races Ferrari could argue it might have won, this was defeat – pure, simple and emphatic.

Hamilton underdelivered in qualifying and left a few tenths on the table, thanks to failing to improve with his final Q3 run, but he was still on pole position by 0.239 seconds. After losing track position at the start, he still reclaimed the lead from Vettel with surprising ease. Even when Mercedes left Hamilton vulnerable to a Vettel attack by delaying his pitstop, the tables still did not turn in favour of Ferrari. As Vettel put it, "there was no real secret other than that they were quicker than us".

The only possible case for the defence of Ferrari is Vettel's iffy Friday, which resulted in a precautionary monocoque change triggered by the alleged jelly-like feeling of the front axle. But even Vettel mentioned that only in passing. He knew exactly what this result said about the relative performance of Ferrari

and Mercedes at the Circuit of the Americas.

While his mood after the race was subdued, in the early seconds of the race Vettel must have been delighted. He hooked up the start superbly, quickly pulling alongside Hamilton's Mercedes on the inside line on the run up the hill to the Turn 1 left-hander.

"My start was good," said Hamilton. "The initial phase was the same as his and then the second part of the getaway was just a little bit stronger for him. I had a bit of wheelspin. The last 10 years Ferrari have always been very good at starts and this year they have definitely taken a step."

Hamilton jinked to the left, eager to keep Vettel pinned tightly to the inside and compromise his exit from the first corner, but it was to no avail. Vettel simply made use of the wide expanse of runoff at the exit of Turn 1 to carry in a little extra speed by letting his Ferrari run just beyond the white line demarking the edge of the track and over the kerb. The lead was his.

Vettel completed the first lap 1.3s clear, but it never got better than that. At the end of lap three, he was still 1.3s ahead and just out of DRS range, but on the next two laps Hamilton was on average 0.142s faster to start the decisive sixth lap just 1.045s behind. By the time they were running downhill to Turn 2, that was down to seven tenths and Hamilton saw his chance.



LAT IMAGES

Vettel took lead at Turn 1 ahead of Hamilton (above) and led for five laps



On Vettel's tail through the fast sweeps of the first sector and then out of the Turn 11 hairpin onto the back straight, Hamilton had the advantage of the DRS. When the inevitable attack came, it was relatively straightforward and Hamilton was able to pass up the inside, with Vettel seemingly taken by surprise and reacting too late to make any kind of defensive move.

"I was kind of chilled about it, just knowing in the past that you can overtake here," said Hamilton of the phase when he was behind Vettel. "Having that battle, trying to get close, trying to get in the DRS, it was very reminiscent of 2012 here, seeing Sebastian up ahead and wanting to have a wheel-to-wheel battle. Obviously it came down to the overtake in Turn 12. I was a little bit surprised Sebastian didn't defend more – I would have."

Vettel, too, was surprised – not just by that move but also by

the fact that he couldn't live with Hamilton on race pace. "It started off well with a great start, but then we were just not quick enough," said Vettel. "I felt the car and the tyres suffering quite a lot after three or four laps and Lewis was easily able to stay with us, close the gap and easily get into the DRS, which is not easy after the fast section, so he was just quicker.

"I tried to block, maybe I could have done a bit more, but on the other hand I think he was just so much quicker that it didn't happen."

But while Vettel said Ferrari had to understand exactly where the lack of pace was, and why he was struggling with the tyres, Hamilton claimed to know exactly what was happening. The usual strategy for a driver in second place would be to bide your time, but Hamilton could see something was wrong.

"I noticed I was able to remain relatively close," said Hamilton. >>



Hamilton got back in front on sixth lap

“Initially, I was thinking maybe I would just have to stay close and wait for the pitstops, but then I could see him pushing. I’m thinking, ‘I’m pretty good on my tyres right now, and he’s going too quick through that corner so he’s going to kill his tyres’, and that’s what he did.

“He was driving too quick through some of those corners and the temperatures would have been going up. If he had backed off in those places he would have been able to keep me behind, but he didn’t. He made a few mistakes, he was locking up, and I thought, ‘I’ve got this.’”

And that was that. Or rather, it should have been. It was clear Mercedes was concerned about tyre life, so when Vettel made his first pitstop on lap 16 after suffering front blistering – slotting into a handy gap between the Red Bull of Max Verstappen, who had charged up from 16th on the grid after engine penalties, and Renault newcomer Carlos Sainz Jr – the decision was made not to react immediately. After all, Hamilton said he could comfortably extend the stint and Mercedes wanted to minimise the risk of late-race tyre trouble.

Hamilton stayed out for three more laps, with Vettel bashing in the two fastest laps of the race up to that point. As he emerged from the pitlane, Vettel was right with Hamilton and for a few moments it seemed possible the Ferrari driver might attack. But with that possibility repulsed, Hamilton quickly re-established his margin in what was then the de facto lead as the yet-to-stop Kimi Raikkonen and Verstappen were up ahead.

**“He made a few mistakes, he was locking up, and I thought, ‘I’ve got this’”**

By the end of his out-lap, Hamilton’s lead was up to 1.4s. He could only ask over the radio, “why was he allowed to get so close?”

It’s easy to call this an error by Mercedes, and it was certainly a case of cutting it fine. But the prodigious speed of the third of Vettel’s laps, aided by running beyond track limits at Turn 19 to pick up some extra time, caught the team on the hop. That, combined with the nature of the first corner, exaggerated how close things really were.

With Raikkonen pitting on lap 21, the only stumbling block remaining for Hamilton was the super-soft-shod Verstappen. He cleared that particular obstacle a couple of laps later with a move

that started at Turn 12 but took a couple more corners to complete. By the time Verstappen pitted and Vettel moved back up into second, Hamilton’s advantage was 3.441s.

Fifteen laps later, when Vettel peeled into the pits

to make a second stop triggered by fifth-placed Verstappen being called in a lap earlier, he had lost a further 0.3s per lap to Hamilton. That’s on the same soft-compound Pirellis, on the same track and with only a three-lap tyre-age disadvantage.

While Hamilton continued on his way to a ninth win of the season, things had become a lot more complicated behind him. Vettel’s stop was to react to the Verstappen threat, and he came out of the pits just ahead of the Red Bull. But he still had to catch and pass Raikkonen and Valtteri Bottas.

Bottas had run third early on, repulsing some forceful attacks from Daniel Ricciardo before the Red Bull driver pitted, then retired

Vettel leads  
Verstappen after  
second stop



LAT IMAGES

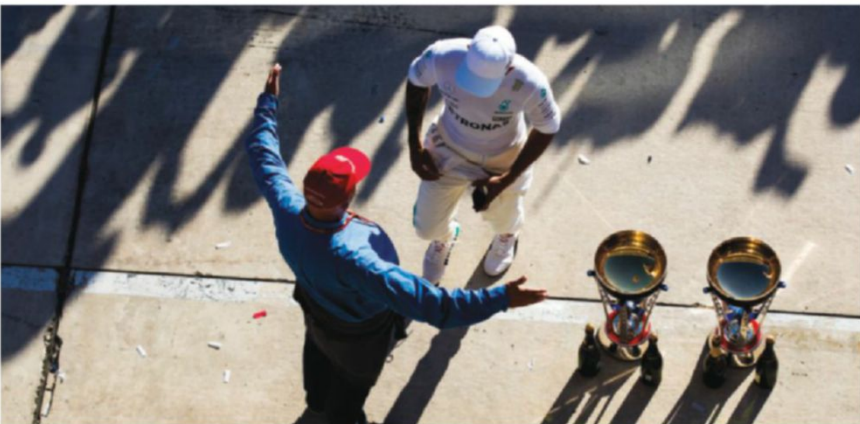

Mercedes' Niki Lauda  
greets Hamilton  
after the race

with an engine problem. Subsequently, he came under pressure from Raikkonen, with the pair locked together in a fight for third. Once Vettel had made his stop and emerged on fresh super-softs, he was 17 seconds behind the battle that was now for second place. It was clear that neither had any intention of stopping again and, while Raikkonen was always going to let his team-mate past, it was going to be no easy task clearing Bottas's Mercedes. The challenge was made more straightforward when Raikkonen passed Bottas with a regulation move up the inside of Turn 12 after assistance from the DRS. As Bottas was on soft Pirellis, with 17 more laps on them than Vettel's fresh super-softs, the gap evaporated over the next 13 laps. With just under five laps remaining, the pair happened upon Stoffel Vandoorne's lapped McLaren, with Bottas diving to the >>

## QUALIFYING



Hamilton dominated  
qualifying again

THERE WAS NEVER ANY DOUBT THAT LEWIS HAMILTON WAS going to take pole position for the United States Grand Prix but, dominant as his performance to take a 72nd F1 pole position was, there was still something left tantalisingly on the table.

Fastest in all three free-practice sessions, and in Q1 and Q2, then on provisional pole after the first runs in the top-10 shootout with a lap of 1m33.108s, it seemed certain that Hamilton would break into the 1m32s on his next run. But despite being a tenth and a half up after the first sector, he ended up posting a 1m33.229s on his second attempt. "I got caught out by a bit of a gust of wind," he said – and he wasn't the only one, as team-mate Valtteri Bottas also failed to improve on the second attempt and was shuffled back to third behind Sebastian Vettel.

It was something of a late show from Vettel, who was playing catch-up after a difficult Friday. FP1 went OK, but in the second session a spin into the gravel at the penultimate corner cost him some track time, before he returned only briefly to post a time and

**“It was quite tricky with the wind, so I struggled”**

Sebastian Vettel

complain that the front axle felt “like jelly”. One overnight chassis change later (Ferrari could not detect any problem, but because chassis changes between Friday and Saturday are not penalised it was a sensible precaution), and Vettel was able to make some progress.

But his first Q3 run wasn't great, leaving him fourth and behind team-mate Kimi Raikkonen, despite benefiting from the upgraded diffuser that the sister Ferrari did not have. It wasn't until the second run that things clicked. "I was lacking a bit the rhythm, especially in the transition of the first to second sector," said Vettel. "It was quite tricky with the wind, so I struggled a bit there. But finally I got it right, in the last run, when it mattered."

Bottas ended up 0.460s slower than Hamilton, admitting to struggling in the final sector (see Trackside, p22). He was fortunate not to slip behind Raikkonen and the Red Bulls, with fourth-placed Daniel Ricciardo less than a hundredth behind.

Raikkonen would have been third had he hooked up his perfect lap, saying that "I just lost some time in some corners where I had some difficulties". As for Verstappen, he described this as one of his poorest qualifying performances of the season.

"It's easy to say now that I should have been up there, but if you make two reasonably big mistakes, it's not what you want," said Verstappen. "I'm not happy with myself and it's one of the worst qualifying of the year for me."

It didn't cost him too much, as a 15-place grid penalty for power-unit element changes resulting from a Renault engine upgrade left him down in 16th.

Force India's Esteban Ocon was best of the rest, ahead of impressive Renault newcomer Carlos Sainz Jr. Team-mate Nico Hulkenberg didn't run in Q2 for strategic reasons given he had a 20-place grid penalty.



“HAMILTON’S TURN-IN TO T15 IS CLEAN AND DECISIVE”

Turns 13-15

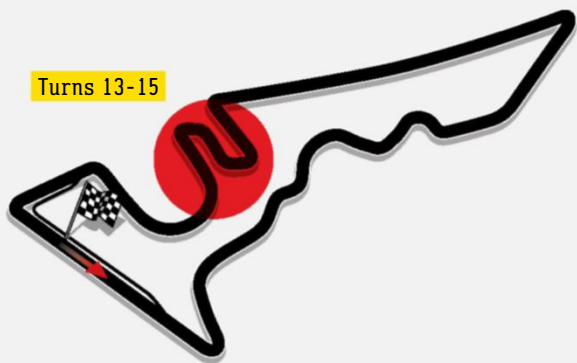

ONE OF THE LESS CELEBRATED PARTS OF AUSTIN’S CIRCUIT of the Americas is Turns 14-15, a low-profile but technically challenging section that, in a few short metres, can tell you a lot about the cars and the drivers – not to mention having a big impact on lap time.

Turn 14 is a medium-speed right-hander, the second part of a two-part corner started by Turn 13. Crucially, it forces drivers to exit on the left of the track, then pull the car over to the right in double-quick time while scrubbing speed off for Turn 15. Maximising the braking is not easy, doubly so given the Pirelli front tyres can bite you when you are simultaneously loading them up longitudinally (by braking) and transversally (by turning).

Watching from the inside of Turn 15, the first thing that’s striking is how all over the place the two Haas drivers are. Romain Grosjean loses the rear out of Turn 14 dramatically, gathering it up – but it’s no surprise to see him spinning into the gravel at Turn 7 on the next lap.

The contrast between team-mates at other teams is unmissable. Lewis Hamilton, in a section almost made for his great feel under braking, excels with no sign of a lock up. Valtteri Bottas, by contrast, isn’t slow as such, but one movement does not flow into another, his turn-in to T15 hesitant and comprising many adjustments, Hamilton’s clean and decisive. The ‘body language’ of Bottas’s car is stuttering and uncomfortable.

“There are things I’ve been struggling with with this car, with the brake modulation and front locking and transferring the weight between the four wheels,” said Bottas. “It’s fine details, but I just struggled to get it together. Many times, 13-15, I lost time.”

Watching Toro Rosso new boy Brendon Hartley is fascinating. At first, he is a little lead-footed on the throttle, leading to several moments of wheelspin as he adapts to conditions. Late on, he is comfortable but doesn’t attack the braking zone as much as others on his qualifying simulation run. As he would point out after qualifying, the peak grip of fresh rubber takes some getting used to.

Hamilton through exit of Turn 14



SUTTON IMAGES

inside at Turn 1. Vettel stayed wide for the entry and, with Bottas leaving far too generous a space, the Ferrari slotted between the Mercedes and the McLaren to secure third, which became second a lap later when Raikkonen let him by.

Hamilton, meanwhile, was cruising up front. Once Vettel was up to second, the lead was just north of 15 seconds. So, even with the tyre advantage, Vettel had only closed up by 11 seconds, eventually crossing the line 10.143s down.

With Verstappen passing Bottas for fourth, shoving him wide in the process and leading the second Mercedes to dive into the pits for a late change of Pirellis, the focus at the end of the race was on the battle for third.

Raikkonen was struggling for fuel and Vettel dropped back a little to give his team-mate a tow and, crucially, to try to give him the use of the DRS on the last lap. The plan failed, though, with Raikkonen shown as 1.040s behind as he passed the DRS detection point before the previous hairpin, and Verstappen comfortably within range of the Finn to close up even further.

Come the quick three-part right-hander of Turns 16-18, Verstappen was right with Raikkonen. He had an overlap by the first apex, but made the move for third by taking to the inside kerb – with all four wheels behind the white line – in the middle of the corner. That gave him a decisive advantage over Raikkonen.

Whatever your position on the consistency or lack thereof of track-limit regulations, Verstappen was unquestionably off the track and taking an advantageous quicker line through the corner. As his front wheels were still behind those of Raikkonen at the point he committed to the piece of bonus track, you cannot argue he didn’t gain an advantage. The fact that the current track-limits regime is clearly broken doesn’t change that.

Hamilton took a comfortable win and sealed a fourth consecutive constructors’ title for Mercedes

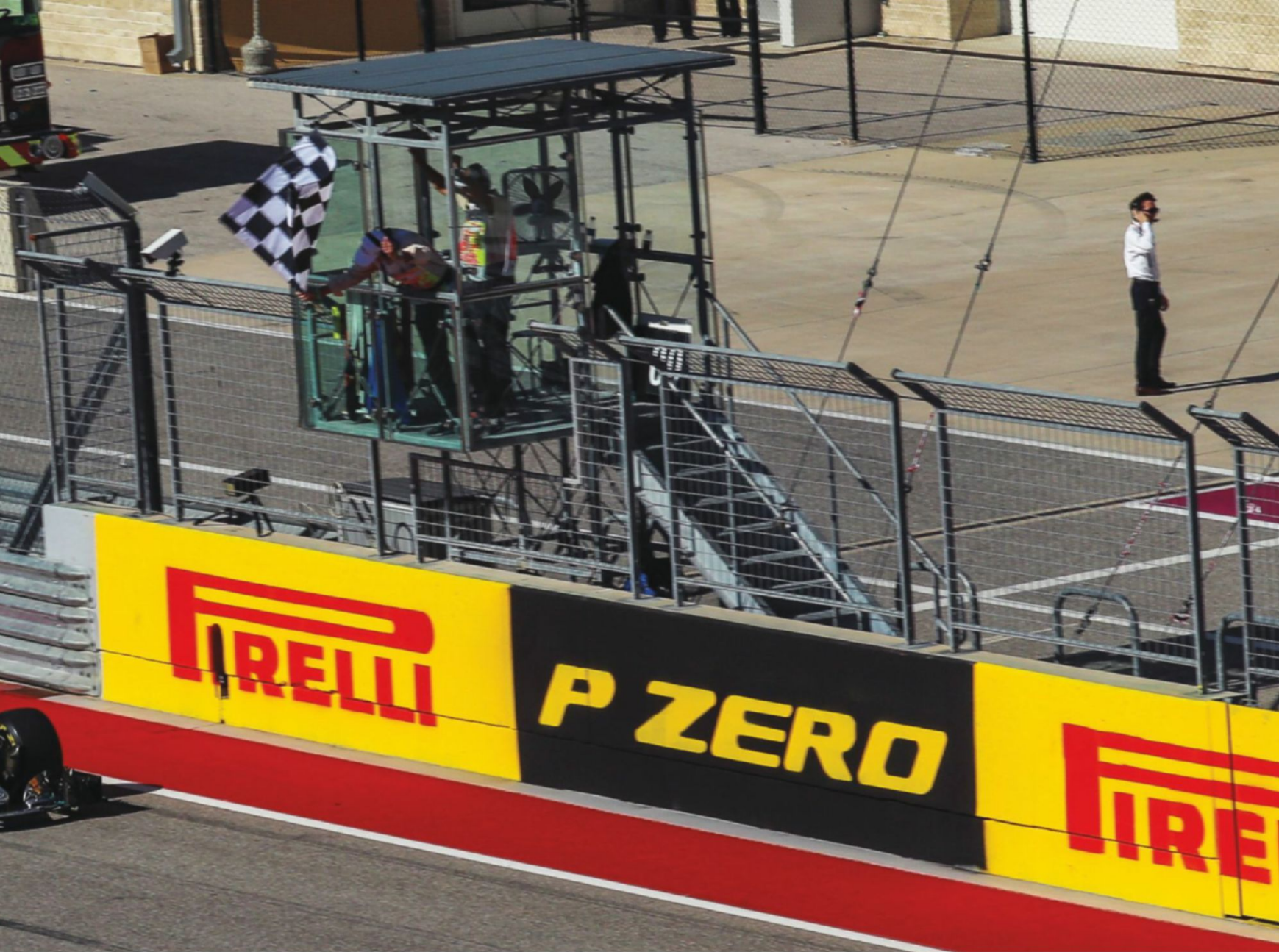

Verstappen's subsequent five-second penalty cost the race a dramatic last-lap pass for a podium position, and you can certainly argue other track-limits violations of a different nature were ignored, but it was a swiftly executed decision that the facts of the specific case proved to be absolutely correct.

The final indignity for Vettel and Ferrari was that Hamilton clearly had a ball winning this race. Just as it was a kick in the teeth for all at Maranello to be so emphatically beaten, so Hamilton revelled in what was only his second proper racing pass of Vettel this season as Mercedes clinched a fourth consecutive constructors' championship.

"Barcelona was an enjoyable one, and Montreal – there have been a couple of really great races where I have enjoyed driving the car to the point like it's almost a roller-coaster ride, where you want to put your hands up," said Hamilton. "That's how the track has felt like with these cars.

"During the race there have been times where it's been like 'Wow, this is just so awesome'. That was probably when I was behind Sebastian, because when I'm in a real fight with Ferrari, that's what I dreamed of doing when I was growing up watching Michael [Schumacher] race. I hope these next couple of races we have more of that."

The only negative for Hamilton was that he didn't clinch his fourth drivers' championship. But that's just a mere formality and only a matter of time. He was more interested in fighting with Vettel, and winning, in the process underlining his supremacy.

"It probably wasn't our race to win," was Vettel's conclusion. Something that he and his Ferrari cohorts certainly couldn't have said after the previous three grands prix. And that is what will hurt more than anything. ❄️



President Clinton gave the first-place trophy



## ERICSSON PUNISHED AFTER MAGNUSSEN ACCIDENT

MARCUS ERICSSON WAS HIT WITH a five-second penalty for causing a collision with Haas's Kevin Magnussen during the closing stages of the race.

The Sauber driver started 13th thanks to a combination of his own strong qualifying performance, relative to the machinery, and the various grid penalties that were issued. He quickly slipped back to 16th in the early stages of the race, and was running 14th behind Magnussen as the pair were lapped by Sebastian Vettel's Ferrari on the back straight.

Ericsson attempted to pass Magnussen on the inside into the Turn 12 left-hander, but the move came too late and his front-right wheel hit the rear-left of Magnussen's car.

Ericsson accused Magnussen of turning in on him over the radio, but the FIA stewards (including former Sauber driver Mika Salo) quickly decided against him. This did not impact on Ericsson's result, as he remained 15th, and he still finished ahead of Magnussen.

Ericsson's Sauber team-mate Pascal Wehrlein retired much earlier after a clash of wheels on the opening lap with Magnussen, during which Wehrlein's car suffered floor damage. Magnussen was forced to make an early pitstop after this contact, but no penalties were given.



# Why Verstappen lost third place to track-limits call

THE STRIPPING OF MAX Verstappen's third place after the chequered flag, but before the podium ceremony, led to widespread criticism of Formula 1's application of track-limits regulations.

Verstappen started 16th after being given a 15-place grid penalty thanks to the introduction of the upgraded Renault engine package to his Red Bull, and he charged to sixth place in the first seven laps. He was the first of the frontrunners to make a second stop, passed Valtteri Bottas to run fourth, and was with Kimi Raikkonen's Ferrari on the final lap.

Verstappen attacked Raikkonen through the Turns 16-18 triple right-hander, cutting to the inside with all four wheels inside the white line delineating the edge of the track as he passed the Finn.

Article 27.3 of the sporting regulations states: "Drivers must make every reasonable effort to use the track at all times and may not deliberately leave the track without a justifiable reason. Drivers will be judged to have left the track if no part

of the car remains in contact with it and, for the avoidance of doubt, any white lines defining the track edges are considered to be part of the track but the kerbs are not.

"Should a car leave the track the driver may rejoin, however, this may only be done when it is safe to do so and without gaining any lasting advantage. At the absolute discretion of the race director a driver may be given the opportunity to give back the whole of any advantage he gained by leaving the track."

For the case in question, it's clear why Verstappen was given the penalty. He did place all four wheels off the track and did gain a lasting advantage. While there is justifiable criticism of the fact that other offences, albeit involving the use of runoff on the exit of corners, were not penalised, taking this incident in isolation, the decision made by the stewards was the correct one.

Verstappen hit out at the call, also hinting that one steward in particular had it in for him.

"We had a really great race, but with those stupid decisions you really kill the sport," said Verstappen. "It's one idiot steward up there which always makes decisions against me. At the end of the day everybody is running wide everywhere, there are no track limits. At Turn 9 you can run wide, at Turn 19 you can go off the track and nobody will say anything."

Mercedes F1 chairman Niki Lauda said the decision was "the worst I've ever seen", and there was widespread condemnation of it by fans on social media. This is indicative of a wider problem with track-limit regulations — had Verstappen not been penalised despite gaining an advantage, there would likely have been similar criticism.

Sebastian Vettel twice exceeded track limits (on lap one at the first corner and at Turn 19 on his first in-lap in the race) during his battle with Lewis Hamilton, and there were multiple other occurrences not penalised as they were not felt to have conferred a lasting advantage.

## Force India fighting fires yet again after team-



Perez felt that he was faster than Ocon





Jubilation over third place was short-lived



## Orders dispute

SERGIO PEREZ COMPLAINED about being held up by Force India team-mate Esteban Ocon shortly before being overtaken by Carlos Sainz Jr during the race at Austin, but the team later justified ordering him to hold station.

Perez finished eighth, two places behind Ocon, having been overtaken by Sainz's Renault on lap 33. This was during a phase of the race where Perez did appear to have more pace, although the team made it clear to him over the radio that the reason for this was that Ocon was managing his tyres.

"Even if we let Checo past, the team wouldn't have scored any more points," said Force India CEO Otmar Szafnauer. "We frankly don't care which one scores the point — we don't want to swap them around.

"There are many reasons why it happened, including if you push the tyres too early then you don't have them to defend. Esteban was managing his tyres better and towards the end could defend against Carlos."



Ricciardo's engine went into a safe mode

## Ricciardo's race ended by oil leak

DANIEL RICCIARDO'S UNITED States Grand Prix came to an end on his 15th lap after he suffered an oil-related engine problem.

The Australian started fourth after qualifying ahead of Ferrari driver Kimi Raikkonen — they set identical lap times, but Ricciardo had completed his lap 18 seconds earlier. He held on to fourth position at the start, but made two bold attempts to better it over the course of some spectacular opening laps, challenging

Mercedes driver Valtteri Bottas.

When that came to nothing Ricciardo opted to make a relatively early stop, at the end of lap 12, to undercut his way past. But he slowed just three laps later when the engine lost power accelerating out of a slow corner.

"Daniel had an engine oil issue," said team principal Christian Horner. "He was losing oil and then it went into a safe mode. So I hope the engine is salvageable. It's a great shame, because he was

hustling Valtteri very hard and looked very competitive at the beginning of the race."

Ricciardo was using the old-specification Renault engine while team-mate Max Verstappen had the upgraded unit. Horner suggested that the difference in performance could not be measured since it is only a small step — although Red Bull uses ExxonMobil fuel and lubricants rather than the upgraded BP spec used by the Renault team.



## DRAWING BOARD

BY GIORGIO PIOLA

### FERRARI UPGRADE PACKAGE

Ferrari arrived at Austin with a batch of modifications, but it wasn't enough to challenge Mercedes.

#### FRONT-WING ENDPLATE

The front-wing-endplate modifications, achieved by opening up the gap at the rear of the white section of the endplate, are to allow more airflow to be turned around the outside of the front tyre. This means the front wing will



work that little bit better, creating more downforce. It will also help increase the intensity of the vortices that are created by the front tyre where it opens up from the contact patch.

If rotating in the correct direction, these vortices go down the side of the floor and help reduce the airflow leakage that would normally reduce the performance of the underfloor. Under the car's flat-floor area, the air pressure is lower than outside

and these developments work like a skirt, helping to seal the airflow that would normally be pulled under the sides of the underfloor.

I'm pretty sure they have done all this to allow them to run a higher rear rideheight or, as it's known, 'more rake' – as Red Bull does very successfully. But as we have seen even with Mercedes' latest upgrades, it can take a race or two to get the best from any developments.

**GARY ANDERSON**



#### FLOOR CHANGES

Ferrari has also changed the slot arrangement in front of the rear tyres, going from five slots to four, which are now nearer the rear tyre.

This detail becomes more important the higher the rear rideheight you're trying to run, as the slots feed into the airflow that's being squeezed around the outside of the rear tyre as the tyre rotates onto the ground. This helps to extract

airflow from the top of the floor that would normally be pulled under the floor.

**GARY ANDERSON**

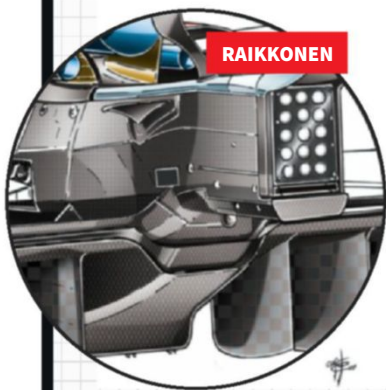

#### NEW DIFFUSER

Sebastian Vettel's car had a new floor, modified in the central section of the diffuser. Whereas the previous

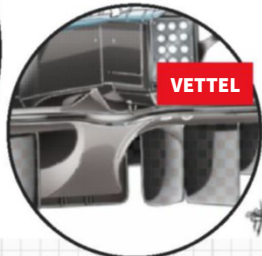

example had two slot gaps (see Raikkonen's floor) near the upper trailing edge, now it has none. This will make the diffuser work harder at higher rear rideheights, but increase the potential for this central section, or the area just beside it where it joins the main diffuser section, to have a higher rear-rideheight aerodynamic-stall problem.

**GARY ANDERSON**

### HAAS BARGEBOARD

Haas introduced what can only be called a 'Venetian-blind' forward-facing addition to its bargeboard arrangement. This component will be working in conjunction with the main bargeboard

arrangement and sidepod outer vertical vane to help scavenge airflow from under the front of the chassis, allowing the underfloor to create more downforce. As can be seen, this area has increased in complexity and

is one of this year's biggest development zones. It contributes to the front-wing and underfloor performance, which is so important to the overall car's aerodynamic performance.

**GARY ANDERSON**

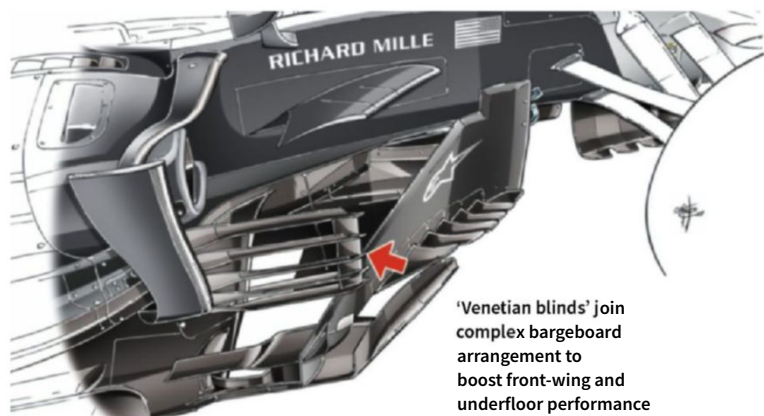

'Venetian blinds' join complex bargeboard arrangement to boost front-wing and underfloor performance

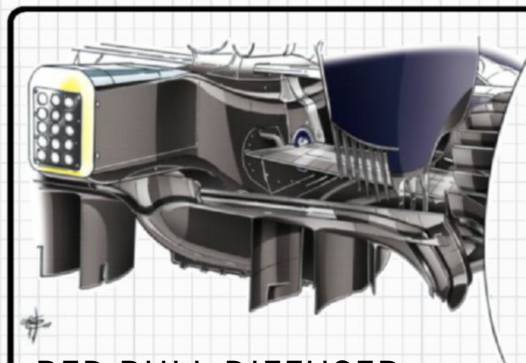

### RED BULL DIFFUSER

Red Bull has altered the central section of its diffuser to be smoother and reduced in volume.

As the outer sections of the diffuser are to the maximum height allowed by the regulations, this central area is the only section where the diffuser can be redesigned to allow it to work harder,

hence creating more downforce.

The very small vertical sections protruding from the trailing edge of the horizontal lower central sections are probably vortex generators to reduce the risk of airflow separation when the car gets lower to the ground.

**GARY ANDERSON**

# MACH 2018 – Be part of it...

Be part of the UK's largest engineering and manufacturing event, with dedicated zones delivering quality sales leads, direct to your stand.



## Key benefits of exhibiting include:

- Access to over 25,000 quality visitors from across UK manufacturing
- Gain valuable face-to-face time with buyers and specifiers with budget authority, looking to invest
- Meet new prospects and strengthen relationships with existing customers
- Showcase your latest products and services for engineering and manufacturing at a professional, business focused event
- Raise your profile, exhibiting alongside some of the largest names in UK manufacturing

To book your space at MACH 2018, please contact the sales team: 0800 470 4690



Organised by the industry,  
for the industry



Join in the conversation  
@MACHexhibition  
#MACH2018

**MACH**  
09-13 April **2018**  
NEC Birmingham UK  
[machexhibition.com](http://machexhibition.com)

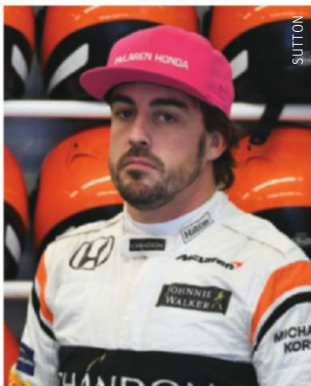

## NO REWARD FOR ALONSO'S 'SUBLIME' PERFORMANCE

FERNANDO ALONSO DESCRIBED his United States Grand Prix weekend performance as "sublime", despite being forced to retire with an MGU-H problem while running eighth.

The Spaniard, whose deal to remain at McLaren next year was confirmed last Thursday, started eighth after setting the ninth fastest time in qualifying, jumping Renault's Carlos Sainz Jr off the line and then holding off his attack through Turn 3.

After he pitted on lap 14, Alonso retained the position once that sequence of stops had shaken out and was between the Force Indias of Esteban Ocon and Sergio Perez when he slowed on lap 24.

He looked likely to finish seventh, since he would have moved ahead of the late-stopping Felipe Massa, but had his sights set on challenging Esteban Ocon for what would have been sixth place.

"The level this weekend was sublime, both in qualifying and in the race," said Alonso. "The championship standings don't reflect that. It doesn't change much for me to be 12th or 17th in the championship [he is 16th], but on merit I think we should be a lot higher up."



# Hartley proves himself on debut

BRENDON HARTLEY FINISHED 13th on his grand prix debut, suggesting he might have had a shot at finishing in the points had he been able to run the weekend again.

The 27-year old, World Endurance champion in 2015, was called up by Toro Rosso in place of Pierre Gasly, who was at Suzuka for the Japanese Super Formula finale. His last F1 test was for Mercedes in September 2012 and he had never driven the Toro Rosso before Friday practice, with only some simulator days as preparation.

Hartley qualified 18th, although he lapped only 0.054s off a Q2 place, but started 19th owing to a grid penalty for multiple power-unit element changes. After a poor start, he ran last before making his first stop on lap eight while ahead of early stopper Kevin Magnussen. He jumped Williams driver Lance Stroll to run 17th, and was aided by the retirements of Pascal Wehrlein and Nico Hulkenberg. Hartley admitted

he was caught out by the power of the DRS and should have used his overtake button to defend.

"I was a bit frustrated Lance got back by me," said Hartley. "He blew behind me in the straight and I was stuck behind him for half the race, which is a bit frustrating because we had good pace in the car. I should have gone to the overtake button with Stroll, which I didn't."

Hartley finished 13th, having passed the ailing Romain Grosjean and Marcus Ericsson after making two stops. He admitted he was too conservative on the tyres.

"There's so much experience I can take forward if I get the opportunity," he said. "If I was to drive the race and qualifying again tomorrow, I would be very tight [for the points] but would have so much more experience to call on."

Hartley will get the chance to apply what he learned, having been confirmed for the Mexican Grand Prix on Monday, alongside Gasly.



Hartley hadn't driven an F1 car since 2012

## Mercedes seals the constructors' title

MERCEDES CLINCHED ITS fourth constructors' championship in a row at Austin, as Lewis Hamilton's victory and Valtteri Bottas's fifth place gave it an unassailable 147-point lead.

This places Mercedes fifth alongside Red Bull in terms of total constructors' crowns won, behind Ferrari (16), Williams (nine), McLaren (eight) and Lotus (seven).

The success comes in a more difficult season than the previous three. Though mostly quick, the Mercedes F1 Wo8 has proved inconsistent and difficult. While Mercedes will not match its win

tallies of 16 (2014 and '15) and 19 ('16) achieved over the previous three seasons, owing to the resurgence of Ferrari and Red Bull, it has clinched the title with three races to spare.

"Achieving it in Austin, three races early, feels really unbelievable," said Mercedes team boss Toto Wolff. "It's just reward for so many hard-working people."

"You always try to identify silver bullets that make the difference, but the fact is that we have really great dynamics in the team and we enjoy doing what we do and putting it all together."

Bottas, involved in a title bid for

the first time, admitted that being part of the success was a boost for him, despite initially feeling let down by his fifth-place finish.

"After the race I was super-disappointed because it could have been a not bad result for us, so I was not happy about finishing fifth," said Bottas. "But now with the team celebrating, it starts to feel real that I've been part of this team getting the constructors' title. So it's a good feeling and special when it's the first one I've been part of."

The success of Mercedes means Ferrari has now gone nine seasons without a constructors' title.



Mercedes took a fourth consecutive constructors' title



LAT IMAGES



Stroll was punished for holding up Grosjean in qualifying

LAT IMAGES

## Magnussen and Stroll punished for impeding

KEVIN MAGNUSSEN AND LANCE Stroll were both hit with three-place grid penalties for impeding rivals during qualifying, putting them in a group of six drivers who were subject to penalties.

Stroll was adjudged to have got in the way of Romain Grosjean at the exit of the penultimate corner, having jinked to the right and off the track to give Daniil Kvyat more room while the Haas driver was already going around the outside.

For his part, Magnussen held up Sergio Perez in Turn 14 after what the team described as a "miscommunication" led to him believing the Force India driver was

only on a warm-up lap.

Stroll was 17th in qualifying after suffering an MGU-K problem that he reckoned cost 0.8 seconds on his final Q1 run, while Magnussen was 20th after picking up floor damage at Turn 4 on his first flying lap that cost him significant grip. But they started 15th and 17th respectively thanks to grid penalties given to Max Verstappen (15 places), Brendon Hartley (25 places), Stoffel Vandoorne (30 places) and Nico Hulkenberg (20 places) for power-unit element changes.

This meant the last three rows of the grid were populated by drivers with grid penalties.

## Sainz seventh on Renault debut

CARLOS SAINZ JR FINISHED SEVENTH ON HIS FIRST outing for Renault, having made an early switch from Toro Rosso. The result allowed Renault to move ahead of Haas in the constructors' championship.

The 23-year old was eighth fastest in qualifying, starting seventh thanks to Max Verstappen's grid penalty. He ran eighth early on after being jumped by Fernando Alonso and was then relegated to ninth by the charging Verstappen.

Sainz picked up a place when Fernando Alonso retired, before passing Sergio Perez in a spectacular battle that started at Turn 12 and only reached a conclusion at the penultimate turn seven corners later.

### Q&A

#### CARLOS SAINZ JR RENAULT DRIVER



##### How was your race?

It was very close to perfect. The first lap I wanted to take it easy to make sure I did the full race distance. From there on, we just picked up pace and started attacking the Force Indias. I passed one of them and then started attacking Esteban [Ocon]. In the end, I had to stop attacking him because I was running out of fuel.

##### Were you disappointed not to get past Esteban?

It was all fair, they just had very high top speeds. I tried to do something in the infield instead of the straights because they have such strong straightline performance. I had my go at it. As soon as I pushed for one lap, the team told me I had to bring it home because we were really tight on the fuel.

##### Was this as good a weekend as you could have hoped for?

I think so, especially because Force India have been particularly strong in the last few races. They have been really far ahead. Suddenly I arrive in my first race and I battle with them. I overtake one of them and nearly the other one. It has been a great achievement. Thanks to the whole team for making me feel so at home right from the beginning.

##### And you did exactly what you were signed to do, help Renault in the championship...

Cyril [Abiteboul, team boss] and everyone were pretty clear they wanted me to take a lot of points from the other teams right from the beginning – what I've been doing the whole year at Toro Rosso, to just keep doing it at Renault. That's been the case this weekend. I'm really, really happy.

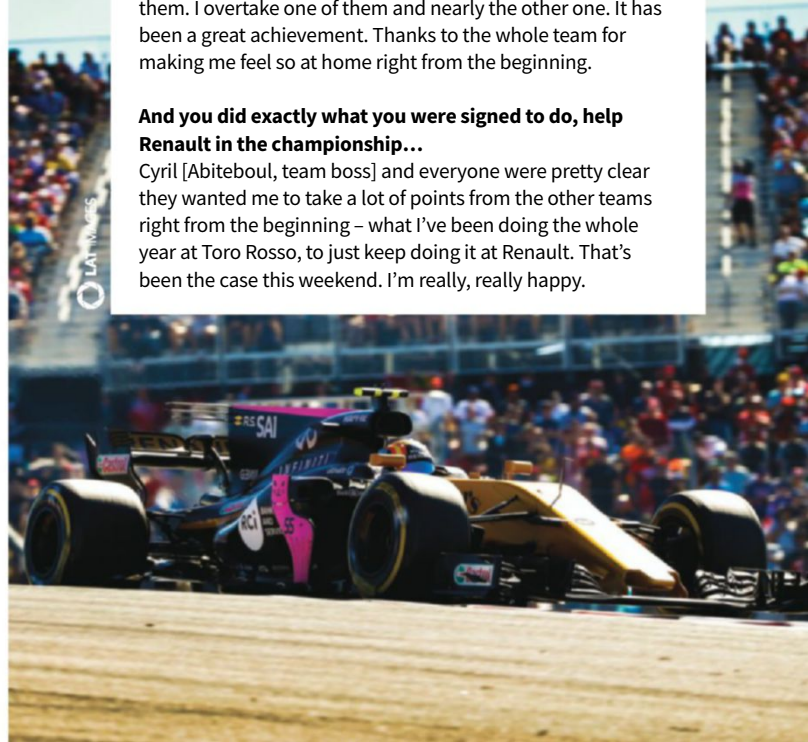

LAT IMAGES

# F1/UNITED STATES GRAND PRIX RESULTS

## STARTING GRID



## Race results / 56 laps - 191.643 miles

## Fastest laps

POS	DRIVER	TEAM	FINISH TIME	LED	TYRES	TIME IN PITS	POS	DRIVER	TIME	GAP	LAP
1	Lewis Hamilton (GB)	Mercedes	1h33m50.991s	48	●●	23.402s	1	Vettel	1m37.766s	-	51
2	Sebastian Vettel (D)	Ferrari	+10.143s	5	●●●	47.920s	2	Bottas	1m37.767s	+0.001s	54
3	Kimi Raikkonen (FIN)	Ferrari	+15.779s	1	●●	23.575s	3	Magnussen	1m37.893s	+0.127s	51
4	Max Verstappen (NL)	Red Bull-Renault	+16.768s	2	●●●	47.748s	4	Verstappen	1m38.060s	+0.294s	39
5	Valtteri Bottas (FIN)	Mercedes	+34.967s		●●●	46.713s	5	Hamilton	1m38.776s	+1.010s	48
6	Esteban Ocon (F)	Force India-Mercedes	+1m30.980s		●●	24.502s	6	Raikkonen	1m38.809s	+1.043s	42
7	Carlos Sainz (E)	Renault	+1m32.944s		●●	24.525s	7	Stroll	1m39.666s	+1.900s	38
8	Sergio Perez (MEX)	Force India-Mercedes	-1 lap		●●	24.326s	8	Hartley	1m39.979s	+2.213s	47
9	Felipe Massa (BR)	Williams-Mercedes	-1 lap		●●	23.772s	9	Ricciardo	1m40.102s	+2.336s	14
10	Daniil Kvyat (RUS)	Toro Rosso-Renault	-1 lap		●●	24.883s	10	Massa	1m40.131s	+2.365s	36
11	Lance Stroll (CDN)	Williams-Mercedes	-1 lap		●●	49.446s	11	Vandoorne	1m40.349s	+2.583s	27
12	Stoffel Vandoorne (B)	McLaren-Honda	-1 lap		●●	23.578s	12	Sainz	1m40.462s	+2.696s	43
13	Brendon Hartley (NZ)	Toro Rosso-Renault	-1 lap		●●	48.629s	13	Ocon	1m40.499s	+2.733s	53
14	Romain Grosjean (F)	Haas-Ferrari	-1 lap		●●	24.897s	14	Perez	1m40.851s	+3.085s	14
15	Marcus Ericsson (S)	Sauber-Ferrari	-1 lap		●●	25.841s	15	Kvyat	1m40.971s	+3.205s	19
16	Kevin Magnussen (DK)	Haas-Ferrari	-1 lap		●●	50.380s	16	Ericsson	1m41.041s	+3.275s	42
R	Fernando Alonso (E)	McLaren-Honda	24 laps-engine		●●	23.796s	17	Grosjean	1m41.259s	+3.493s	36
R	Daniel Ricciardo (AUS)	Red Bull-Renault	14 laps-engine		●●	23.604s	18	Alonso	1m41.537s	+3.771s	21
R	Pascal Wehrlein (D)	Sauber-Ferrari	5 laps-accident		●●	31.334s	19	Hulkenberg	1m44.270s	+6.504s	2
R	Nico Hulkenberg (D)	Renault	3 laps-oil pressure		●	-	20	Wehrlein	1m47.073s	+9.307s	2

WEATHER Sunny, 27C. WINNER'S AVERAGE SPEED 122.515mph. FASTEST LAP AVERAGE SPEED 126.140mph.

● New ● Used ● Ultra-Soft ● Super-Soft ● Soft ● Medium ● Hard ● Wet ● Intermediate

<h3>6</h3> <p>Hamilton's sixth United States GP victory makes him the most successful driver in its history</p>	<h3>9</h3> <p>Hartley is the ninth New Zealander to start a world championship race, the first since 1984</p>	<h3>26</h3> <p>Ocon has finished all 26 of the grands prix he has started, a record run from his debut in 2016</p>	<h3>75</h3> <p>This was the 75th victory for Mercedes in F1, achieved in 165 races</p>	<h3>117</h3> <p>Hamilton set a new record for front-row starts in F1, eclipsing Michael Schumacher's 116 mark</p>	<h3>2004</h3> <p>Hartley's F1 debut came 2004 days after his previous single-seater start, in GP2 in 2012</p>	<h3>14014</h3> <p>Raikkonen broke the 14,000 mark for F1 laps raced, making him sixth in the all-time list</p>
---	---	--	--	---	---	--

## Lap chart / What happened, when

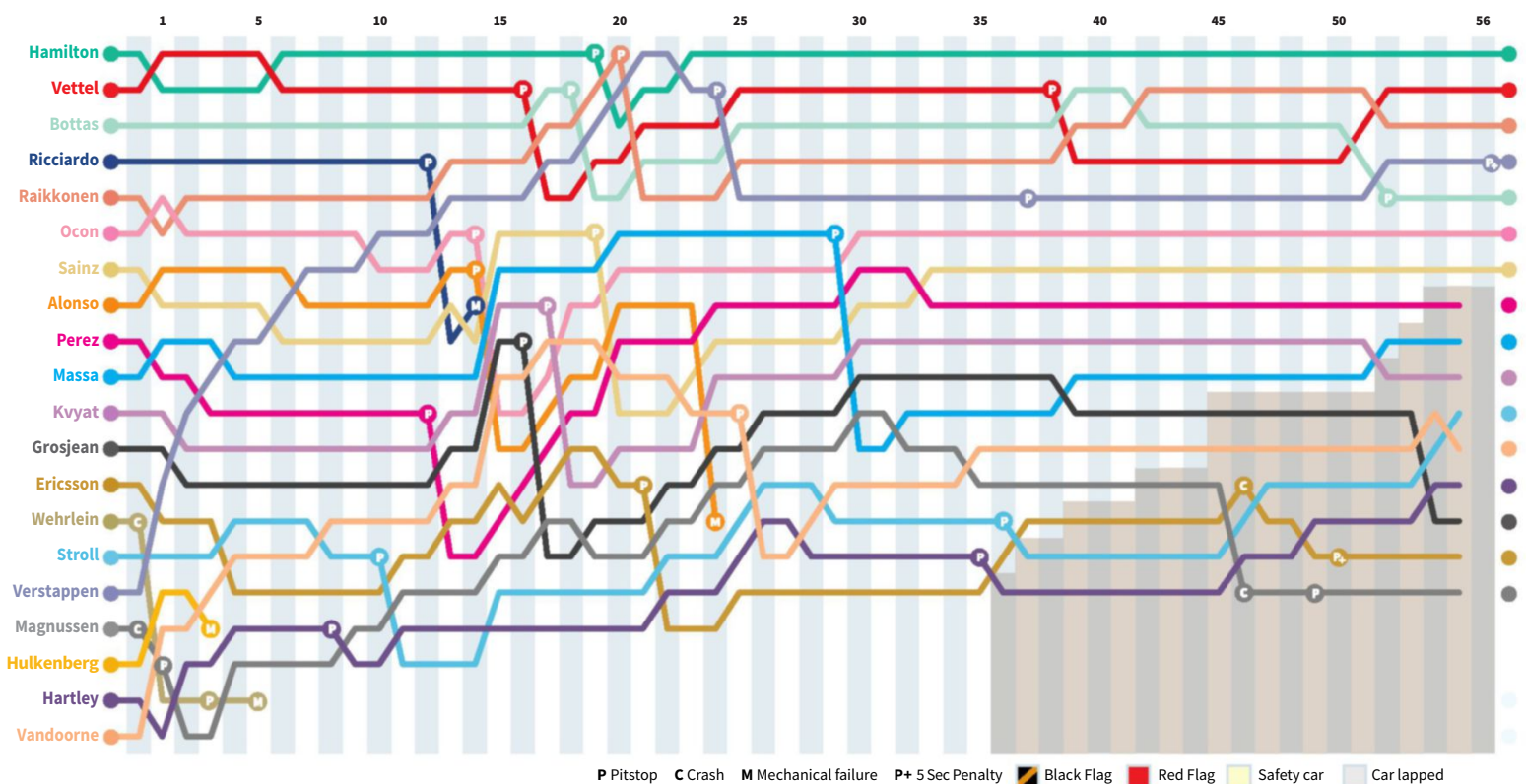

<b>12 Grosjean</b> #8 1m35.870s	<b>14 Wehrlein</b> #94 1m37.179s	<b>16 Verstappen</b> #33 1m33.658s	<b>18 Hulkenberg</b> #27 no time	<b>20 Vandoorne</b> #2 1m35.641s
<b>13 Ericsson</b> #9 1m36.842s	<b>15 Stroll</b> #18 1m36.868s	<b>17 Magnussen</b> #20 1m37.394s	<b>19 Hartley</b> #39 1m36.889s	

### Qualifying 1

POS	DRIVER	TIME
1	Hamilton	1m34.822s
2	Verstappen	1m34.899s
3	Bottas	1m35.309s
4	Vettel	1m35.420s
5	Sainz	1m35.517s
6	Massa	1m35.603s
7	Raikkonen	1m35.649s
8	Alonso	1m35.712s
9	Hulkenberg	1m35.740s
10	Ocon	1m35.849s
11	Ricciardo	1m35.991s
12	Kvyat	1m36.073s
13	Vandoorne	1m36.286s
14	Perez	1m36.358s
15	Grosjean	1m36.835s
16	Ericsson	1m36.842s
17	Stroll	1m36.868s
18	Hartley	1m36.889s
19	Wehrlein	1m37.179s
20	Magnussen	1m37.394s

### Qualifying 2

POS	DRIVER	TIME
1	Hamilton	1m33.437s
2	Bottas	1m33.769s
3	Raikkonen	1m33.840s
4	Vettel	1m34.103s
5	Ricciardo	1m34.495s
6	Verstappen	1m34.716s
7	Perez	1m34.789s
8	Sainz	1m34.899s
9	Alonso	1m35.046s
10	Ocon	1m35.113s
11	Massa	1m35.155s
12	Kvyat	1m35.529s
13	Vandoorne	1m35.641s
14	Grosjean	1m35.870s
15	Hulkenberg	no time

### Qualifying 3

POS	DRIVER	TIME
1	Hamilton	1m33.108s
2	Vettel	1m33.347s
3	Bottas	1m33.568s
4	Ricciardo	1m33.577s
5	Raikkonen	1m33.577s
6	Verstappen	1m33.658s
7	Ocon	1m34.647s
8	Sainz	1m34.852s
9	Alonso	1m35.007s
10	Perez	1m35.148s

WEATHER Sunny, 31C

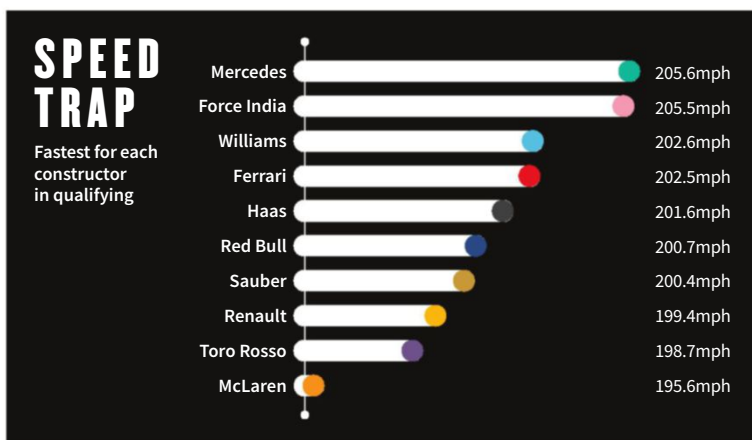

### Race briefing

#### FRIDAY PRACTICE

SEAN GELAEI replaced Kvyat at Toro Rosso

CHARLES LECLERC replaced Wehrlein at Sauber

#### GRID PENALTIES

VANDOORNE 30-place penalty for additional power unit elements used

HARTLEY 25-place penalty for additional power unit elements used

HULKENBERG 20-place penalty for additional power unit elements used

VERSTAPPEN 15-place penalty for additional power unit elements used

MAGNUSSEN Three-place penalty for impeding another driver

STROLL Three-place penalty for impeding another driver

#### RACE PENALTIES

ERICSSON Five-second penalty for causing a collision

VERSTAPPEN Five-second penalty for leaving the track and gaining an advantage

### Free practice 1

POS	DRIVER	TIME
1	Hamilton	1m36.335s
2	Vettel	1m36.928s
3	Bottas	1m36.979s
4	Verstappen	1m37.339s
5	Vandoorne	1m37.352s
6	Massa	1m37.570s
7	Raikkonen	1m37.598s
8	Ocon	1m37.808s
9	Perez	1m37.861s
10	Sainz	1m38.093s
11	Magnussen	1m38.408s
12	Stroll	1m38.534s
13	Hulkenberg	1m38.904s
14	Hartley	1m39.267s
15	Grosjean	1m39.336s
16	Ricciardo	1m39.366s
17	Gelael	1m40.406s
18	Ericsson	1m40.448s
19	Leclerc	1m40.828s
20	Alonso	no time

WEATHER Damp/overcast, 21C

### Free practice 2

POS	DRIVER	TIME
1	Hamilton	1m34.668s
2	Verstappen	1m35.065s
3	Vettel	1m35.192s
4	Bottas	1m35.279s
5	Ricciardo	1m35.463s
6	Raikkonen	1m35.514s
7	Alonso	1m36.304s
8	Massa	1m36.460s
9	Perez	1m36.481s
10	Ocon	1m36.490s
11	Sainz	1m36.529s
12	Hulkenberg	1m36.534s
13	Kvyat	1m36.761s
14	Magnussen	1m37.285s
15	Vandoorne	1m37.463s
16	Stroll	1m37.788s
17	Hartley	1m37.987s
18	Wehrlein	1m38.165s
19	Ericsson	1m38.262s
20	Grosjean	1m38.387s

WEATHER Weather: Dry, cloudy 28C

### Free practice 3

POS	DRIVER	TIME
1	Hamilton	1m34.478s
2	Vettel	1m34.570s
3	Bottas	1m34.692s
4	Raikkonen	1m34.755s
5	Verstappen	1m35.103s
6	Massa	1m35.346s
7	Hulkenberg	1m35.608s
8	Sainz	1m35.650s
9	Ricciardo	1m35.723s
10	Perez	1m35.802s
11	Ocon	1m35.965s
12	Stroll	1m36.118s
13	Alonso	1m36.239s
14	Vandoorne	1m36.599s
15	Hartley	1m36.818s
16	Magnussen	1m37.271s
17	Ericsson	1m37.319s
18	Wehrlein	1m37.807s
19	Grosjean	1m37.891s
20	Kvyat	1m38.500s

WEATHER Weather: Light cloud, 28C

# SEASON STATS

## Drivers' championship

1	Hamilton	331
2	Vettel	265
3	Bottas	244
4	Ricciardo	192
5	Raikkonen	163
6	Verstappen	123
7	Perez	86
8	Ocon	73
9	Sainz	54
10	Massa	36
11	Hulkenberg	34
12	Stroll	32
13	Grosjean	28
14	Magnussen	15
15	Vandoorne	13
16	Alonso	10
17	Palmer	8
18	Wehrlein	5
19	Kvyat	5

## Constructors' championship

1	Mercedes	575
2	Ferrari	428
3	Red Bull	315
4	Force India	159
5	Williams	68
6	Toro Rosso	53
7	Renault	48
8	Haas	43
9	McLaren	23
10	Sauber	5

## Wins

Hamilton	9
Vettel	4
Bottas	2
Ricciardo	1
Verstappen	1

## Fastest laps

Hamilton	7
Vettel	4
Raikkonen	2
Alonso	1
Bottas	1
Perez	1
Ricciardo	1

## Pole positions

Hamilton	11
Vettel	3
Bottas	2
Raikkonen	1

## Qualifying battle

HAM	12	5	BOT
RIC	6	11	VER
VET	12	5	RAI
PER	11	6	OCO
STR	2	14	MAS
STR	1	0	DIR
VAN	3	13	ALO
VAN	0	1	BUT
KVY	1	0	HAR
GAS	0	2	SAI
KVY	6	8	SAI
GRO	11	6	MAG
HUL	0	1	SAI
HUL	16	0	PAL
ERI	6	9	WEH
ERI	2	0	GIO

# No lone stars in Texas

More than one performer came close to perfection last weekend

By Edd Straw, Digital Content Manager

[@eddstrawF1](#)

## MERCEDES



**9 LEWIS HAMILTON**  
Another excellent performance from Hamilton, who was again on a different level to his team-mate. It was just the second time in 2017 he's had to pass Vettel on track to win. His failure to improve on his second Q3 run after being caught out by a gust of wind costs him a perfect score on an otherwise faultless weekend.



**7 VALTTERI BOTTAS**  
It's still not coming easily for Bottas, who struggled in the slower corners and admitted to problems with modulating the brakes. His qualifying performance was so-so but, while his race result was poor after having to abort a one-stopper, his pace in the first sector in particular was good. Better, if not great.

## RED BULL



**8 DANIEL RICCIARDO**  
While Ricciardo wasn't quite as quick as Verstappen overall, with the caveat that he didn't have the upgraded Renault engine (unlike his team-mate), he did nail it when it mattered on his second Q3 run to earn fourth. He was his usual aggressive self early on before an engine-related problem put him out.

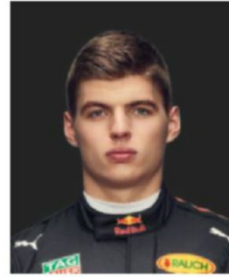

**9 MAX VERSTAPPEN**  
At his flamboyant best, Verstappen surged from a penalised 16th on the grid to get among the frontrunners early on. He was fast and incisive, but confessed to having made "two reasonable mistakes in qualifying". Even a spectacular race can't make up entirely for that, so we'll factor it into our final rating.

## FERRARI



**8 SEBASTIAN VETTEL**  
An off on Friday during a troubled FP2 set him back, but Vettel pulled a good qualifying lap out of the bag at the last attempt. Had a great start and made an opportunistic pass on Bottas, but he did ask too much of the tyres early on, didn't defend well against Hamilton, and had a few scruffy moments.



**7 KIMI RAIKKONEN**  
This was one of Raikkonen's better weekends of the season. Lacked some of Ferrari's upgrade, including the modified diffuser and floor, so was slower than Vettel. Underachieved on his final Q3 run and overdid the fuel use in the race while catching Bottas, but drove a tidy and brisk enough race to a good result.

## FORCE INDIA



**7 SERGIO PEREZ**  
His qualifying was compromised by only having one set of tyres for Q3 while his team-mate had two, and despite a good race his impatience when behind Ocon compromised his race. He was unable to keep Sainz behind, which Ocon did manage to do, but he did at least keep Massa at bay. Good, but a few rough edges.



**9 ESTEBAN OCON**  
Emphatically best of the rest in both qualifying and the race, despite struggling with illness, this was a classy performance from the ever-improving Frenchman. A control-unit scare on the grid didn't put him off his stride and, unlike team-mate Perez, he was formidable in keeping Sainz at bay.

## WILLIAMS



**6 LANCE STROLL**  
Wasn't at Massa's level even though his quali performance looked far worse than it was thanks to an MGU-K problem costing him around 0.8s on the back straight. Not helped by a penalty for impeding, Stroll stuck to his task in the race and was close to the points, which was a decent result on a testing weekend.

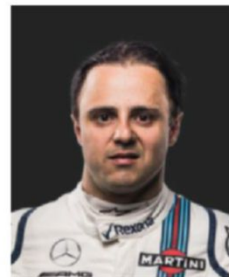

**7 FELIPE MASSA**  
Massa probably should have made Q3 given his theoretical ideal lap would have been top-10. 'Reverse' strategy, starting on the super-softs and finishing on the ultra-softs, made the race hard work for him, and he ran out of time to get past Perez, but that was caused more by circumstances than the driver.

## McLAREN



**7 STOFFEL VANDORNE**  
Vandoorne took a version 6 upgrade before qualifying, although that five-place grid penalty became far worse when an MGU-H problem necessitated more pre-race changes and relegated him to the back. Battled back well and wasn't too far off the points, but never looked quite as comfortable as Alonso was.



**9 FERNANDO ALONSO**  
Alonso was operating at his usual high standard during the weekend, which is more than can be said for the MGU-H, which developed a problem and forced him out of the race when he was on course for a decent points finish. His commitment on track was obvious, and he was set to finish seventh.





Hamilton again trumped his team-mate

SUTTON IMAGES

## TORO ROSSO

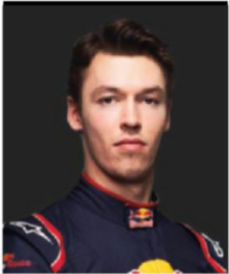

**8 DANIIL KVIAT**  
With his F1 future at stake, Kvyat showed commendable fortitude to deliver what he suggested was his best weekend of the year. With the caveat that Sainz's departure deprived Toro Rosso of a yardstick, Kvyat did everything that could be asked with a decent qualifying lap and then a strong race.



**8 BRENDON HARTLEY**  
Any judgement of Hartley's performance has to be framed in the context that he'd never driven the car before, and last raced a single-seater in 2012. Given that, he performed well. He felt he could have delivered more in qualifying and was conservative on tyres in the race, but deserves more chances.

## HAAS

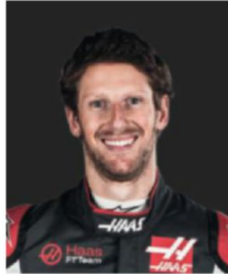

**6 ROMAIN GROSJEAN**  
Unpredictability of the Haas during the weekend makes it difficult to judge either driver, although Grosjean was the only one to be caught out by the struggles to switch the tyres on. Qualified superbly, but had a mundane race in which he struggled for pace, this time complaining of unusual degradation.

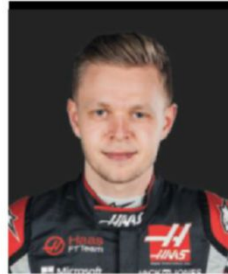

**6 KEVIN MAGNUSSEN**  
Magnussen at least managed to keep the lairy Haas on the track throughout practice, unlike his team-mate. But after a kerb strike led to floor damage at the start of Q1, he was condemned to the back of the grid. He drove well but was perhaps fortunate to get away with the first-lap contact with Wehrlein.

## RENAULT

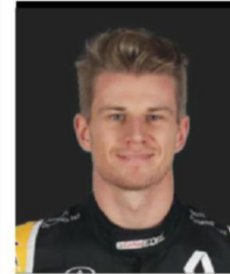

**7 NICO HULKENBERG**  
With a 20-place grid penalty, thanks to taking the latest Renault engine, Hulkenberg was always facing an uphill battle. Given that his race lasted only a few laps, there's very little meaningful data to go on other than to say that he sailed through Q1 with only one run, compared with his team-mate's two.

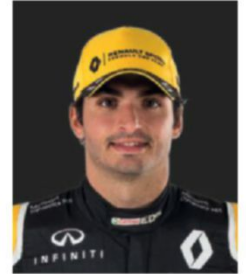

**9 CARLOS SAINZ JR**  
If you are to be hyper-critical, he really should have made it through Q1 with only one run and therefore had two fresh sets of tyres for Q3, and it's possible he could have beaten Ocon. But when you consider this was Sainz's first weekend in an unfamiliar car, you can't hold that against him too much.

## SAUBER



**8 MARCUS ERICSSON**  
Comfortably had the measure of his team-mate during the weekend, outqualifying Wehrlein by just over three tenths. He then delivered a decent race; he quickly fell behind Verstappen, Stroll and Vandoorne, but he was losing out to quicker cars. The clash with Magnussen was needless, though.



**6 PASCAL WEHRLIN**  
This was a trying weekend for Wehrlein, for while he was unfortunate to have his race effectively ended by a clout to the left-rear from Magnussen on the first lap, he seemed to struggle to get the most out of the car. Sitting out the first practice session to let Charles Leclerc have some mileage won't have helped.



Verstappen was gladiatorial in the race

LAT IMAGES

## TOP 10 AVERAGE RATING

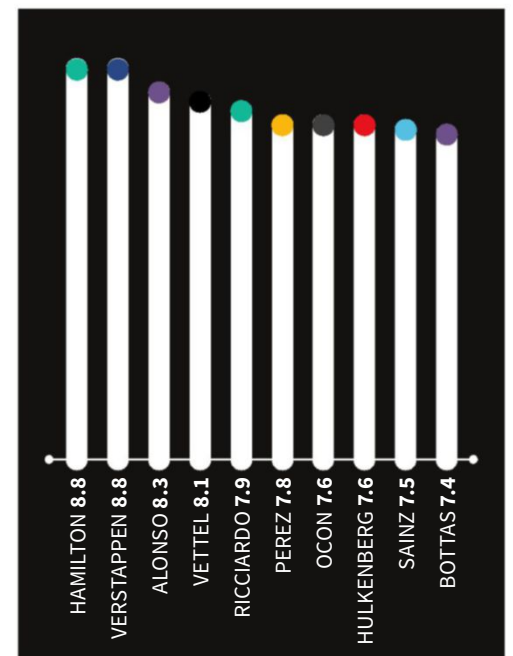

ENTERTAINMENT FOR ALL THE FAMILY!

# TRUCK RACING AND FIREWORKS!

HUGE FIREWORKS DISPLAY



MONSTER TRUCK RIDES



HUGE FUN FAIR



FULL PROGRAMME OF TRUCK AND SUPPORT RACES



SHOW TRUCK DISPLAYS



0843 453 9000 [brandshatch.co.uk](http://brandshatch.co.uk)

Adult Admission (Online)\* - £19 Teens 13-15 (Online)\* - £12  
Children (under 13) - FREE

\*Advance tickets available until midday Wednesday 1 November. Postage fee applies. Calls will cost 7p per minute plus your telephone company's access charge.

**BRANDS HATCH**  
**SUN 5 NOVEMBER**

## Formula Renault NEC, where history is made

The Formula Renault NEC (Northern European Cup) is a recognised, cost-effective step for aspiring Formula 1 and professional racing drivers looking to move into international motorsport. Our calendar takes in world-famous F1 and Formula 3 circuits, including Spa-Francorchamps, Silverstone, Hockenheim and the Nurburgring.

With past successes for the likes of Valtteri Bottas, Daniil Kvyat, Carlos Sainz Jr. and Sebastian Buemi in the category - which features a single make Tatuus chassis with a 2.0 litre Renault engine - The 2018 season will again be the place for aspiring drivers to make their mark. So, what are you waiting for? Head to [necup.com](http://necup.com) and get in contact with one of our experienced, highly-competitive racing teams to discuss how you can join one of the most exciting grids in European single-seater racing next season!



FORMULA  
RENAULT  
NORTHERN EUROPEAN CUP

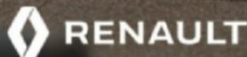



# AUTOSPORT

## AWARDS 2017



## INTERNATIONAL RACING DRIVER OF THE YEAR

Open to professional racing drivers competing at an international level



### 1 FERNANDO ALONSO

He ensured the motorsport world's focus was diverted from the Monaco GP with great Indy 500 run, and always excelled in difficult F1 McLaren-Honda.

### 2 LUCAS DI GRASSI

Stuck it out when all looked lost in the Formula E title fight, made up ground when Buemi was absent, and then snatched the title at the last gasp for Abt Audi.

### 3 LEWIS HAMILTON

Stunning second half of the season with Mercedes has enabled him to overhaul Vettel and waltz to an almost-guaranteed fourth world title.

### 4 JOSEF NEUGARDEN

In his first season at IndyCar's top table with Team Penske, he stole the show from under the noses of the veterans to become a fully deserving champion.

### 5 MAX VERSTAPPEN

Bore the brunt of Red Bull's mechanical ills but was on hand to take a brilliant win in the Malaysian GP. Yet again his talent is lighting up the front of F1.

### 6 SEBASTIAN VETTEL

Ferrari turnaround for 2017 made Vettel look like he was heading for the title, until a litany of woes in the second half of the season derailed his bid.

## RACING CAR OF THE YEAR

Open to cars competing in any class of circuit racing



### 1 FERRARI SF70H

After a pretty poor 2016, Ferrari jumped right back to the top of the tree in F1 with this car to give Mercedes a lot of sweat this year, before late-season dramas.

### 2 MERCEDES F1 W08 HYBRID

Once again the F1 standard has been set in Brackley – albeit not to quite the same crushing extent as in 2014, '15 and '16!

### 3 PORSCHE 919 HYBRID

Barring miracles this machine will claim WEC manufacturer and driver titles for Porsche. It even got to the flag at Le Mans...

### 4 RED BULL-RENAULT RB13

The later-season F1 races have featured a proper revival from Red Bull, with the team in there pitching – and winning.

### 5 RENAULT Z.E.16

Di Grassi won the Formula E title for Audi, but the e.dams-run Renault was the standard-setting car, witness the incredible run of victories from Sebastien Buemi.

### 6 VOLKSWAGEN POLO RX SUPERCAR

The car to beat in rallycross, with Johan Kristoffersson netting the title and team boss/driver Petter Solberg sitting second in points.

## INTERNATIONAL RALLY DRIVER OF THE YEAR

Open to professional or semi-professional rally drivers in international events



### 1 ELFYN EVANS

Totally came of age this year. Second in Finland and Argentina (by 0.7s...) is an indication of just what a step he's taken in terms of pace with the M-Sport team.

### 2 JARI-MATTI LATVALA

A changed man since his departure from VW to Toyota. Loving life outside Ogier's shadow, he's back to his best. Or possibly even better this season.

### 3 KRIS MEEKE

Remains one of the top three fastest in the WRC and his win in Spain demonstrated a much needed, more controlled and relaxed approach with Citroen.

### 4 THIERRY NEUVILLE

Hyundai man had Monte and Sweden in the palm of his hand. Had he won them, he might be champion already. Still been among the season's quickest.

### 5 SEBASTIEN OGIER

Still the master. New car (Ford), same story. Won fewer rallies this year, but showed brilliant consistency as well as speed when it mattered most.

### 6 OTT TANAK

Like team-mate Evans, more mature, faster and more consistent than ever. It's paid dividends, with two victories and six podiums from 11 rallies.

## RALLY CAR OF THE YEAR

Open to cars competing in rallying from international to national level



### 1 FORD FIESTA R5

Remains the R5 weapon of choice for drivers around the world as M-Sport nears its 300th sale. A regular WRC2 winner and took the ERC title to boot.

### 2 FORD FIESTA RS WRC

Comfortably the most neutral of all the 2017 World Rally Cars and, with the most wins, clearly the quickest as well. Incredible work from the Cumbrian garagistas.

### 3 HYUNDAI i20 WRC

The first of the new generation to break cover and set the initial pace. But recurring reliability issues have hit the South Koreans hard this season.

### 4 PEUGEOT 3008 DKR

Once again the dominant force in cross-country and the car to deliver another Peterhansel Dakar win. The only downside was Loeb's mechanical woes.

### 5 SKODA FABIA R5

Factory cars were the class of the WRC2 field through the early part of the season; Pontus Tidemand delivered back-to-back class titles for the Czech firm.

### 6 TOYOTA YARIS WRC

Nobody gave Tommi Makinen's new car a hope at the start of the season. But it was winning by round two, and was the fastest of the fast in Finland too.

## BRITISH COMPETITION DRIVER OF THE YEAR

Open to British drivers competing in categories at international level



### 1 SAM BIRD

Once again he's been a force in two completely different disciplines, scoring race wins in Formula E and class victories with Ferrari in the WEC.

### 2 JAMES CALADO

In the sister Ferrari to Bird's, he currently leads the GT points standings in the WEC after a stellar season. Also claimed pole for Spa 24 Hours GT3 classic.

### 3 LEWIS HAMILTON

When does a three-time world champion get better and better? Answer: when he's Lewis Hamilton and it's 2017. Stunning as ever for much of the season.

### 4 LANDO NORRIS

Still only 17 and on his first season out of the 'baby' categories, Norris beat fierce opposition for a superb European F3 title success.

### 5 OLIVER ROWLAND

'Best of the rest' in F2, but when the champ is Leclerc with Prema then the title is always going to be a tall order. Great season to be runner-up with DAMS.

### 6 GEORGE RUSSELL

Stepped sideways from Euro F3 to GP3 and didn't take long to nail himself to the mantle of top dog in a quality ART line-up, taking title with a round to spare.



**RIDER OF THE YEAR**

Open to riders competing in any of MotoGP's three racing categories

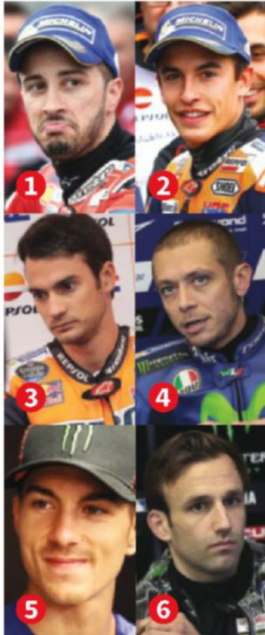

- 1 ANDREA DOVIZIOSO**  
He wasn't expected to be a title threat on the Ducati, but Dovizioso has been Marquez's biggest rival this season.
- 2 MARC MARQUEZ**  
Six wins for the reigning champion have allowed the Honda star to overcome a batch of DNFs and lead the standings with two races to go.
- 3 DANI PEDROSA**  
A win, seven other podiums and strong early title challenge made sure the diminutive Spaniard kept his doubters silent for another year.
- 4 VALENTINO ROSSI**  
A broken leg derailed his 10th title charge, but a determined Motorland Aragon comeback and a Dutch TT win proved the 38-year-old is still hungry.
- 5 MAVERICK VINALES**  
Three wins from the first five races in his first year at Yamaha cemented Vinales as a frontrunner and made him title favourite for a stretch.
- 6 JOHANN ZARCO**  
The double Moto2 champion is 2017's top rookie after scoring a French GP podium as well as two poles on year-old Yamaha machinery.

**ROOKIE OF THE YEAR**

Open to professional racing drivers in their first season in their respective categories



- 1 FERNANDO ALONSO**  
Aged 35, he rocked up for his first crack at the Indy 500 and immediately fought wheel to wheel at the front of the pack.
- 2 PIERRE GASLY**  
Japanese racing is super-tough, and he took a couple of rounds to get to grips with Super Formula, then vaulted straight into title contention.
- 3 CHARLES LECLERC**  
As GP3 champion he was expected to fight at the front from the off in F2. But the way he won the title, and his pole run, set new standards.
- 4 LANDO NORRIS**  
Was always going to be a contender in Euro F3, but performed beyond that during a brilliant campaign with Carlin to clinch the title.
- 5 LANCE STROLL**  
There was a lot of focus on the Canadian, and his early steps were tentative. But to finish third in Baku and qualify on front row at Monza was superb.
- 6 STOFFEL VANDORNE**  
How to destroy a newcomer: put them alongside Alonso. But he knuckled down and showed real promise at McLaren.

**NATIONAL DRIVER OF THE YEAR**

Open to drivers racing in the BTCC, British GT or at FIA F3/GP3 level



- 1 PHIL KEEN**  
One of Britain's best under-the-radar pros, Keen carried the torch for the Barwell Lambo team in British GT, only losing the title at the last gasp.
- 2 SEB MORRIS**  
The switch from single-seaters paid off with a memorable British GT title clinched at the finale with the Team Parker Racing Bentley boys.
- 3 LANDO NORRIS**  
There was a rich vein of Brit talent in Euro F3 – they finished 1-2-3-4 at Zandvoort – but Norris was the most consistently up there in 2017.
- 4 GEORGE RUSSELL**  
It hasn't been an easy battle against fellow Brit and ART team-mate Jack Aitken in GP3, but Russell was able to break free and show his class.
- 5 ASH SUTTON**  
Only his second season in the BTCC, and a new car for him in the form of the Subaru. But a great mid-season run preceded title glory in dramatic finale.
- 6 COLIN TURKINGTON**  
Classy, trusty pro turned in another quality season in the BTCC with BMW, and narrowly missed out on a third title.

**BRITISH CLUB DRIVER OF THE YEAR**

Open to British drivers in any class of TOCA supports or equivalent and below



- 1 ENAAM AHMED**  
Pretty much demolished the field in BRDC British F3 and took 13 wins with Carlin. Top talent ready to step up to the international racing ranks.
- 2 MIKE BUSHELL**  
The Clio Cup had quality in depth this year, but in his second season back from his BTCC foray he set a 21st-century record for title-winning margin.
- 3 JAMIE CAROLINE**  
Unstoppable in the first half of the campaign, he built up a British F4 title-winning margin that proved impregnable for the rookies getting up to speed.
- 4 CHARLIE EASTWOOD**  
The Porsche GB scholar had to sweat for his Carrera Cup title after a gripping fight with Cammish and Zamparelli.
- 5 TOM GAMBLE**  
Ginetta Juniors are always a highlight of BTCC meetings. Gamble shot to prominence by winning a very close title battle – and endured a team switch.
- 6 BEN HINGELEY**  
On his second season out of the club-racing ranks, he looked very good in BRDC British F3 with Fortec to finish third, and top non-Carlin driver.

**To vote by mail**

Fill in the form below and return to us by following the instructions overleaf

My vote for International Racing Driver of the Year is

My vote for Racing Car of the Year is

My vote for International Rally Driver of the Year is

My vote for Rally Car of the Year is

My vote for British Competition Driver of the Year is

My vote for Rider of the Year is

My vote for Rookie of the Year is

My vote for National Driver of the Year is

My vote for British Club Driver of the Year is

**To vote online**

Please visit [autosport.com/awardsvoting](http://autosport.com/awardsvoting)

**AUTOSPORT AWARDS  
AUTOSPORT MEDIA UK LTD  
1 ETON STREET  
RICHMOND  
TW9 1AG**



**YOUR DETAILS** – must be completed and no photocopies will be accepted (BLOCK CAPITALS, PLEASE)

Title: \_\_\_\_\_

Name: \_\_\_\_\_

Surname: \_\_\_\_\_

Address: \_\_\_\_\_

Postcode: \_\_\_\_\_

Telephone: \_\_\_\_\_

Email: \_\_\_\_\_

Your personal information will not be kept or used for marketing purposes once voting for award winners closes. Closing date: November 20, 2017

fold here



Affix stamp





# 6 issues for £6 when you subscribe to



# plus save up to 57% on the cover price



### Unlimited access offer

- ✓ **SPREAD THE COST** – Pay just £6 for the first 6 issues followed by £40.99 every 13 issues by direct debit
- ✓ **FULL ACCESS** to autosport.com
- ✓ **AUTOSPORT IPAD EDITION SUBSCRIPTION**
- ✓ **GREAT SAVINGS OF 57%**

### Magazine only offer

- ✓ **SPREAD THE COST** – Pay just £6 for the first 6 issues followed by £34.99 every 13 issues by direct debit
- ✓ **SAVE 29%** on the cover price
- ✓ **FREE P&P** – Every issue DELIVERED to your door



SUBSCRIBE ONLINE [www.autosportmedia.com/offer/ASPOCT17](http://www.autosportmedia.com/offer/ASPOCT17)

# CALL 0344 848 8817

OVERSEAS +44 (0)1604 251 451

QUOTE THE PROMOTIONAL CODE **ASP1017MB** FOR PRINT AND DIGITAL ACCESS  
**ASP1017MP** FOR PRINT ONLY

**TERMS AND CONDITIONS** This offer is open to UK residents only. Overseas rates are available on +44 (0)1604 251 451. Please allow 35 days for delivery of your first issue. Direct Debit rates are valid for one year after which they are subject to change – should prices change we will inform you in writing. Should you wish to cancel your subscription it will be cancelled on expiry of the current term, which will not be refundable other than in exceptional circumstances. Details of the Direct Debit Guarantee are available on request. If your subscription includes access to autosport.com and the Autosport digital magazine, you can set up your Autosport online account by visiting [www.autosport.com/subs/magazine.html](http://www.autosport.com/subs/magazine.html). You'll need to enter your subscriber number along with your email address to access your content. You will be emailed instructions on how to gain access to your iPad edition within 24 hours of your order being processed. Savings are based on standard UK print cover price of £3.90, digital cover price of £2.99 and autosport.com subscription rate of £5.50 a month. **Offer ends November 2 2017.**

## Marquez makes most of a fantasy Island



Scrap at the front: Marquez leads Rossi, Zarco and Iannone

**MOTOGP**  
**PHILLIP ISLAND (AUS)**  
**OCTOBER 22**  
**ROUND 16/18**

IT WAS A NEAR-PERFECT WEEKEND FOR Marc Marquez in Australia, the Honda rider leaving Phillip Island with not only an impressive, hard-fought race win under his belt, but also one hand on the 2017 MotoGP title.

The reigning champion was billed as the man to beat heading into the weekend, and from the word go he lived up to the hype.

Marquez was quick in the cool, dry conditions on Friday morning, quick in warmer dry running on Friday afternoon, and quick again on a wet track on Saturday morning. He then stormed to pole on a dry track in ominous fashion, reiterating that he was ready to run at the front regardless of the weather.

In the end, though, it wasn't the weather that Marquez had to worry about on race day. Instead the challenge was a breathless, physical battle for the lead, involving as many as eight riders, which was later described as being like a high-speed Moto3 race.

It was actually Jack Miller, a consistent top-five performer from Friday onwards despite coming into the weekend recovering from a broken leg, who led early. The Marc VDS Honda-straddling home hero streaked away at the start, banking some valuable TV time as he headed the field for the opening five laps.

With Miller's charge done for the day, Valentino Rossi took over at the front, leading an eight-bike train that also included Marquez,

Johann Zarco, Maverick Vinales, Miller, Andrea Iannone, Cal Crutchlow and Alex Rins.

It was a bruising battle too, Zarco, Rossi, Marquez and Iannone among those to trade rubber, a lot of which ended up on the riders' leathers. The most popular spot to rub shoulders with tyres was at Honda, with factory Yamaha stars Rossi and Vinales and plucky Tech3 Yamaha privateer Zarco all diving down the inside of the right-hander to take their shot at leading the race.

Having survived a close call with Zarco early in the race, and a hair-raising moment with Rossi on the run to Honda with eight laps to go, Marquez made his move. With four laps to go he charged into the lead, flexing his muscles with a 1m30.05 that helped him break what had become a clear top four with the factory Yamahas and Zarco.

Marquez ended up taking the flag a relatively comfortable 1.7s clear of Rossi, who had to

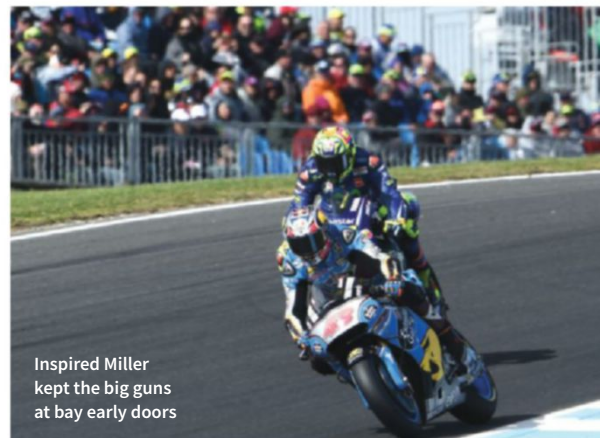

Inspired Miller kept the big guns at bay early doors





LAT IMAGES

slipstream past Zarco. The Frenchman was also beaten to the line by Vinales, less than half a tenth separating all three.

“Honestly it was an amazing race,” said Marquez. “From the beginning I tried to warm the tyres well, tried to be calm. But already on the second or third lap, first contact from Johann I think, I started to realise this will be tough.

“It was a big group like a Moto3 race. I enjoyed it a lot. I started to realise in the middle of the race that I need to attack or they will overtake me everywhere. It was a little bit dangerous sometimes, but in the end I attacked a lot, especially in the middle of the race.”

While the action was going on around him and behind him, the overwhelming sensation for Marquez was curiosity. There was more than one cheeky glance over the shoulder during the race, as the Honda rider did his best to eyeball Andrea



**RESULTS** ROUND 16/18, PHILLIP ISLAND (AUS), OCTOBER 22, 27 LAPS – 74.624 MILES

POS	RIDER	TEAM	TIME
1	Marc Marquez (E)	Honda	40m49.772s
2	Valentino Rossi (I)	Yamaha	+1.799s
3	Maverick Vinales (E)	Yamaha	+1.826s
4	Johann Zarco (F)	Tech3 Yamaha	+1.842s
5	Cal Crutchlow (GB)	LCR Honda	+3.845s
6	Andrea Iannone (I)	Suzuki	+3.871s
7	Jack Miller (AUS)	Marc VDS Honda	+5.619s
8	Alex Rins (E)	Suzuki	+12.208s
9	Pol Espargaro (E)	KTM	+16.251s
10	Bradley Smith (GB)	KTM	+16.262s
11	Scott Redding (GB)	Pramac Ducati	+21.652s
12	Dani Pedrosa (E)	Honda	+21.668s
13	Andrea Dovizioso (I)	Ducati	+21.692s
14	Karel Abraham (CZ)	Aspar Ducati	+26.110s
15	Jorge Lorenzo (E)	Ducati	+26.168s
16	Tito Rabat (E)	Marc VDS Honda	+26.252s
17	Alvaro Bautista (E)	Aspar Ducati	+36.377s
18	Loris Baz (F)	Avintia Ducati	+39.654s
19	Sam Lowes (GB)	Aprilia	+40.400s
20	Hector Barbera (E)	Avintia Ducati	+45.901s
21	Danilo Petrucci (I)	Pramac Ducati	+48.768s
22	Broc Parkes (AUS)	Tech3 Yamaha	+57.711s
R	Aleix Espargaro (E)	Aprilia	7 laps-accident

**Winner's average speed** 109.662mph.  
**Fastest lap** Zarco 1m29.572s, 111.082mph.

**QUALIFYING 2**

**1** Marquez 1m28.386s; **2** Vinales 1m28.719s; **3** Zarco 1m28.744s; **4** Iannone 1m28.937s; **5** Miller 1m28.964s; **6** P Espargaro 1m29.030s; **7** Rossi 1m29.203s; **8** A Espargaro 1m29.271s; **9** Smith 1m29.321s; **10** Crutchlow 1m29.429s; **11** Dovizioso 1m29.496s; **12** Pedrosa 1m29.546s.

**QUALIFYING 1**

**1** Rossi 1m29.346s; **2** Smith 1m29.705s; **3** Rins 1m29.824s; **4** Rabat 1m29.847s; **5** Abraham 1m29.961s; **6** Lorenzo 1m30.085s; **7** Baz 1m30.224s; **8** Petrucci 1m30.471s; **9** Barbera 1m30.543s; **10** Redding 1m30.806s; **11** Parkes 1m30.889s; **12** Bautista 1m30.900s; **13** Lowes 1m31.158s.

**RIDERS' CHAMPIONSHIP**

**1** Marquez 269; **2** Dovizioso 236; **3** Vinales 219; **4** Rossi 188; **5** Pedrosa 174; **6** Zarco 138; **7** Lorenzo 117; **8** Petrucci 111; **9** Crutchlow 103; **10** Jonas Folger 84; **11** Bautista 70; **12** Miller 65; **13** A Espargaro 62; **14** Redding 61; **15** Iannone 60; **16** P Espargaro 49; **17** Rins 46; **18** Baz 45; **19** Abraham 30; **20** Rabat 29; **21** Barbera 25; **22** Smith 20; **23** Michele Pirro 18; **24** Mika Kallio 11; **25** Lowes 5; **26** Katsuyuki Nakasuga 4; **27** Sylvain Guintoli 1.

**MANUFACTURERS' CHAMPIONSHIP**

**1** Honda 319; **2** Yamaha 285; **3** Ducati 278; **4** Suzuki 87; **5** Aprilia 64; **6** KTM 58.

Dovizioso. Marquez was ultimately rueing a decision to tell his Honda crew not to keep him updated on the Ducati ace's progress, which bugged him as the race wore on.

“Before the race we had a meeting – they asked me if I want to know where Dovi was,” Marquez explained. “I said, ‘I don't care’. But then in the middle of the race, I had that question mark – ‘Where is Dovi?’”

He needn't have worried. The reason he couldn't see the Ducati was because it was so far back. Even in the scheme of damage limitation, it was a disaster of a weekend for Dovizioso.

The Italian was never expected to match Marquez at Phillip Island, but banking enough points to keep the title fight interesting seemed well within his reach, particularly based on practice pace on Friday and Saturday morning.

In Free Practice 4, however, things took a turn for the worse. At a critical point of confidence-building before qualifying, Dovizioso went down hard coming over Lukey Heights. It stripped him of all momentum going into qualifying, and directly contributed to a lacklustre performance that yielded just 11th spot on the grid.

Things didn't get any better on race day either. Dovizioso made little progress on lap one, before running wide at the first corner on lap two. He was lucky the high-speed off didn't take him out of the race on the spot, although it did drop him way down to 20th.

After a race-long scrap with Dani Pedrosa, Dovizioso at the very least looked like he was going to come home 11th, only to be drafted by Scott Redding (quite amazingly the best classified Ducati) and Pedrosa on the run to

the flag. He's now 33 points behind Marquez in the standings, with 50 points left on offer across the final two races of the season.

“It's a very bad result for sure,” said the 31-year-old. “For sure my mistake on the second lap created a bad situation. But the reality is not that. The reality is we weren't fast. The characteristic of this track is to have good turning [ability]; we confirmed we still have that limit. We finished the tyres eight laps to the end, but all that is a consequence [of poor turning].”

“We did really good races this year at tracks where we weren't fast in the past, but this track has a particular characteristic and the turning is so important. But anyway, we want to think positive for the remaining two races. We know fighting for the championship will be difficult, but fortunately in this sport it can happen.”

**ANDREW VAN LEEUWEN**



Brit Redding was the best Ducati finisher



Bradley and co gave French team Graff another victory

# Graff plots win; G-Drive takes title

**EUROPEAN LEMANS SERIES**  
**ALGARVE CIRCUIT (P)**  
**OCTOBER 22**  
**ROUND 6/6**

MEMO ROJAS AND LEO ROUSSEL CLAIMED G-Drive Racing's second straight title, despite their ORECA finishing behind the Ligier of their main title rival United Autosports.

Rojas and Roussel, joined in the DragonSpeed-run G-Drive ORECA by Toyota protege Ryo Hirakawa, placed fourth in a race won by the Graff ORECA driven by Richard Bradley, Gustavo Yacaman and James Allen. Graff spent much of the contest battling with United, which needed to win and for G-Drive to finish outside the top five if it was to overcome its 18-point deficit.

The race started brightly for United as Hugo de Sadeleer took the lead from polesitter Fabien Barthez, but the Swiss dropped to second when Yacaman pressured him into a mistake at the end

of the first hour. United's advantage was restored in the pits when de Sadeleer handed to Will Owen after more than two hours behind the wheel, and the Ligier looked set to win, with the ORECA struggling to meet its fuel quota. But a 55s stop-and-hold for speeding in the pits dashed United's hopes with 80 minutes remaining, despite Graff needing to make an extra stop.

Filipe Albuquerque reinstated the Ligier in second with a late overtake on Matevos Isaakyan (SMP Dallara), but that was trivial in the grand scheme as Hirakawa wrapped up G-Drive's title.

United didn't leave the Algarve empty handed, as Sean Rayhall and John Falb confirmed themselves as LMP3 champions by finishing second in class – behind the sister UA Ligier of Wayne Boyd, Christian England and Mark Patterson – after starting from the back.

JMW Motorsport Ferrari pair Jody Fannin and Rob Smith – joined for the race by Will Stevens – clinched the GTE title from the TF Sport Aston

Martin squad, although Porsche junior Matteo Cairoli made a late pass on Fannin for the race win.

**DANIEL LLOYD**

## RESULTS

**1 Gustavo Yacaman/James Allen/Richard Bradley (ORECA 07)** 139 laps in 4h01m17.867s; 2 Filipe Albuquerque/Will Owen/Hugo de Sadeleer (Ligier JSP217) +38.169s; 3 Egor Orudzhev/Matevos Isaakyan (Dallara P217); 4 Memo Rojas/Ryo Hirakawa/Leo Roussel (ORECA); 5 Andrea Belicchi/Roberto Lacorte/Giorgio Sernagiotto (Dallara); 6 Nathanael Berthon/Timothe Buret/Fabien Barthez (Ligier). **LMP3 1 Wayne Boyd/Christian England/Mark Patterson (Ligier JSP3)**; 2 Sean Rayhall/John Falb (Ligier); 3 Alexandre Cougnaud/Antoine Jung/Romano Ricci (Ligier). **GTE 1 Matteo Cairoli/Christian Ried/Joel Camathias (Porsche 911 RSR)**; 2 Will Stevens/Jody Fannin/Rob Smith (Ferrari 488 GTE); 3 Nicki Thiim/Euan Hankey/Salih Yoluc (Aston Martin Vantage V8). **Points 1 Rojas/Roussel 110**; 2 de Sadeleer/Albuquerque/Owen 98; 3 Allen/Bradley 86. **LMP3 1 Falb/Rayhall 103**; 2 Jung/Cougnaud/Ricci 81; 3 England/Patterson/Boyd 63. **GTE 1 Fannin/Smith 104**; 2 Hankey/Thiim/Yoluc 102; 3 Ried/Camathias/Cairoli 80.

# McLaughlin wins thanks to triple Triple 8 undercut

**AUSTRALIAN SUPERCARS**  
**SURFERS PARADISE (AUS)**  
**OCTOBER 21-22**  
**ROUND 12/14**

JAMIE WHINCUP LEAPED INTO THE POINTS lead, even though the Triple Eight Holden ace together with co-driver Paul Dumbrell missed out on victory in Sunday's race to the DJR Penske Ford of Scott McLaughlin and Alexandre Premat.

Whincup and Dumbrell had taken sixth in Saturday's wet encounter, after Dumbrell was penalised 15 seconds for punting the Prodrive Ford of Steve Owen into a spin. Owen recovered and, with Chaz Mostert at the wheel, the car moved into the lead in the final stint when

Mostert passed team-mate Cameron Waters, whose car had been started by Richie Stanaway. The Brad Jones Racing Holden of Tim Slade and Andre Heimgartner led for a long way, but water in the airjack system caused a delayed stop, although Slade was able to fend off Shane van Gisbergen in the closing stages for third.

McLaughlin's victory on Sunday hinged on his being the first of the leading cars to make its final pitstop. Up until that point, it was Whincup in front, ahead of van Gisbergen (sharing with Matt Campbell) and Craig Lowndes (driving with Steven Richards) in a 1-2-3 for the Triple Eight Holdens.

McLaughlin's undercut left him defending his lead from Whincup, who was last of the Triple Eight guys to stop, and he held on by 1.5 seconds.

Pre-weekend points leader Fabian Coulthard, sharing with Tony D'Alberto, was ninth on Sunday and a penalised 19th on Saturday.

## RESULTS

**Race 1 1 Chaz Mostert/Steve Owen (Ford Falcon)** 94 laps in 2h18m28.8455s; 2 Cameron Waters/Richie Stanaway (Ford) +2.4916s; 3 Tim Slade/Andre Heimgartner (Holden Commodore); 4 Shane van Gisbergen/Matt Campbell (Holden); 5 Michael Caruso/Dean Fiore (Nissan Altima); 6 Jamie Whincup/Paul Dumbrell (Holden). **Race 2 1 Scott McLaughlin/Alexandre Premat (Ford)** 102 laps in 2h05m17.3924s; 2 Whincup/Dumbrell +1.4752s; 3 van Gisbergen/Campbell; 4 Craig Lowndes/Steven Richards (Holden); 5 Mark Winterbottom/Dean Canto (Ford); 6 James Courtney/Jack Perkins (Holden). **Points 1 Whincup 2580**; 2 Coulthard 2563; 3 McLaughlin 2553; 4 Mostert 2454; 5 van Gisbergen 2391; 6 Lowndes 1950.



## 'Round of 8' succeeds round of 78

**NASCAR CUP**  
**KANSAS SPEEDWAY (USA)**  
**OCTOBER 22**  
**ROUND 32/36**

MARTIN TRUEX JR HAD ALREADY QUALIFIED for the final eight of the Playoffs anyway, and further cemented his status as a top title contender by scoring his second Kansas Speedway success of the season in his Furniture Row Racing Toyota.

Truex led the race from pole, but was penalised for changing lanes before the restart after the first caution. That dropped him to 31st, but he recovered to eighth by the end of the first stage.

He then worked his way to the front, passing the Joe Gibbs Racing Toyota of Kyle Busch for the lead with 60 laps remaining.

Busch's brother Kurt fought back following an unscheduled early pitstop for right-side tyres after brushing the wall to claim second position in his Stewart-Haas Racing Ford.

Third place was enough to keep Ryan Blaney in the Playoffs. He started 40th and last after his Wood Bros Ford failed post-qualifying scrutineering, but moved into contention during the second caution when he stayed out on track as

most of the others pitted. Blaney headed home fellow Playoff qualifiers Chase Elliott (Hendrick Chevrolet) and second-stage winner Denny Hamlin (Gibbs Toyota).

Kevin Harvick finished both the first two stages in the top three before falling away to eighth, but he made the final-eight cut. So too did Kyle Busch, who won the first stage but pitted three laps before the final caution and had to climb back to 10th after dropping to 22nd. Jimmie Johnson caused two cautions with spins, but he made it into the last eight with 11th, as did 13th-placed Brad Keselowski.

The unluckiest was Kyle Larson, who suffered an engine failure and dropped from third to ninth in points. Matt Kenseth and Jamie McMurray were involved in a shunt and dropped out of the Playoffs, and the other eliminated was Ricky Stenhouse Jr.

### RESULTS

**1 Martin Truex Jr (Toyota Camry)** 267 laps in 3h11m57s; 2 Kurt Busch (Ford Fusion) +2.284s; 3 Ryan Blaney (Ford); 4 Chase Elliott (Chevrolet SS); 5 Denny Hamlin (Toyota); 6 Chris Buescher (Chevy); 7 Dale Earnhardt Jr (Chevy); 8 Kevin Harvick (Ford); 9 Aric Almirola (Ford); 10 Kyle Busch (Toyota). **Points 1 Truex 4069**; 2 Kyle Busch 4042; 3 Brad Keselowski 4026; 4 Harvick 4017; 5 Jimmie Johnson 4017; 6 Hamlin 4014; 7 Blaney 4009; 8 Elliott 4006.

## IN BRIEF

### MOTO2

Miguel Oliveira scored KTM's first Moto2 win at Phillip Island, with Brad Binder completing a one-two for the Austrian make. Takaaki Nakagami had emerged from a frantic scrap for second with Binder and Franco Morbidelli and was catching Oliveira when he fell as rain-warning flags waved. Third position for Morbidelli extended his series lead over 10th-placed Thomas Luthi.

### MOTO3

Joan Mir took his ninth win of the season at Phillip Island and clinched the title in a race cut short by red flags due to a sudden downpour. With main rival Romano Fenati down in sixth, that was enough for Mir, who headed home Livio Loi and Jorge Martin.

### ITALIAN FORMULA 4

Ferrari junior Marcus Armstrong made up for missing out on the German title by claiming the Italian crown in the finale at Monza, although the New Zealander didn't win any of the races. Armstrong's Prema Powerteam car was leading the first, but was jumped by Artem Petrov (DR Formula) on a restart. Armstrong beat main title rival Job van Uitert to second to become champion. Petrov won again in race two from van Uitert, who slipstreamed from a pitlane start to second, and Leonardo Lorandi. Petrov, Armstrong and van Uitert battled for the lead in the finale but multiple contact between them left victory to Lorenzo Colombo (Bhaitech) from Ian Rodriguez and Kush Maini.

### MICHELIN LE MANS CUP

There was heartbreak for Phil Keen and Lee Mowle, who missed out on the GT3 title at the last gasp at the Algarve Circuit. Their Amd-run Mercedes was running second, enough for the title, when the third-placed Lamborghini pitted with problems. That promoted the Ebimotors Lambo of Fabio Babini and Emanuele Busnelli to fourth, the extra points giving them the crown after they'd lost seven minutes early on repairing damage. Class victory went to the Porsche of Ben Barker and Andrew Baker. The DKR Norma of Alex Toril and Jean Glorieux, LMP3 champions already, won on the road overall after Colin Noble was given a track-limits penalty while chasing Glorieux. But the Norma failed its fuel analysis, giving victory to the Motorsport98 Ligier of Andy Meyrick and Eric de Doncker.

### V8 STOCK CARS

Series leader Daniel Serra won the opening race at Taruma from Galid Osman and Max Wilson. Second-race honours went to Ricardo Mauricio from Atila Abreu.

### NASCAR XFINITY SERIES

Truck Series starlet Christopher Bell won an ill-tempered late fight at Kansas Speedway with Gibbs team-mate Erik Jones that left Jones ploughing into Bell's truck. Tyler Reddick was second from Ryan Blaney.



# WEB DIRECTORY

## AWNINGS



**aireshelta**  
No1 for Inflatable Structures.  
With you from the Paddock to the Podium.  
[www.aireshelta.com](http://www.aireshelta.com)

## HELMET GRAPHICS

**Mike Fairholme Designs**  
Sole approved painter of Arai helmets.  
Silver Birches, Corby Birkholme, Nr Grantham, Lincs NG33 4LE.  
Tel: 01476 550630. Fax: 01476 550029.  
email: fairholmedesigns@btconnect.com  
[www.fairholmedesigns.co.uk](http://www.fairholmedesigns.co.uk)

## MOTORSPORT LEGAL ADVICE

MOTORSPORT CONTRACTS AND LEGAL ADVICE  
(NATIONAL AND INTERNATIONAL)

CALL JAMIE CHAMPKIN  
07880 965001

[info@champkin.uk.com](mailto:info@champkin.uk.com) - [www.champkin.uk.com](http://www.champkin.uk.com)

## RACE RADIO

**Pit to Car Autotel**  
Radio solutions **Digital Race Radio**  
0044(0)1508 528837  
[www.raceradio.co.uk](http://www.raceradio.co.uk)

## EXHAUSTS

Inconel & Stainless Steel Specialists  
**SIMPSON**  
Race Exhausts  
Tel: 01753 532222  
[www.simpsonraceexhausts.com](http://www.simpsonraceexhausts.com)

## MEMORABILIA



**FINAL LAP**  
For Everything Formula One  
[www.finallap.net](http://www.finallap.net) **WE BUY AND SELL**  
+44 (0) 1245 287588 / 07771 920345

## GEARBOXES

**Gearboxman.com**  
COMPETITION TRANSMISSION SERVICES  
Gearboxes & Axles for Road, Race, Rally and more  
Telephone: 01582 840008 Fax: 01582 840007

## MOTORSPORT LEGAL ADVICE

Motor Sport Legal Advice  
Tudor Alexander, LL.B Solicitor  
[tudor@fletcherday.co.uk](mailto:tudor@fletcherday.co.uk) 07887 713512  
Fletcher Day 56 Conduit St  
Mayfair London W1S 2YZ

## RACE PARTS

**JJC** race and rally  
PASSIONATE ABOUT MOTORSPORT  
[www.jjcraceandrally.com](http://www.jjcraceandrally.com)

**ARE DRY SUMP SYSTEMS**  
ARMSTRONG RACE ENGINEERING INC.  
[WWW.DRYSUMP.COM](http://WWW.DRYSUMP.COM) (916) 652-5282

## RACING

**MARDI GRAS MOTORSPORT**  
[www.mardigras.co.uk](http://www.mardigras.co.uk)

**CARTEK MOTORSPORT ELECTRONICS**  
Info@cartekmotorsport.com  
023 80 487747  
[www.CARTEKMOTORSPORT.COM](http://www.CARTEKMOTORSPORT.COM)

## RACING

[www.mcrracecars.co.uk](http://www.mcrracecars.co.uk)  
phone: 07771 762145  
MCR's for sale  
arrive & drive packages

**PORSCHE SHOP**  
10% off with website  
voucher code AUTOTEN  
Or Call: 0121 585 6088

**demon tweeks**  
[www.demon-tweeks.co.uk](http://www.demon-tweeks.co.uk)

## RACING

AUTHORISED DISTRIBUTOR  
**OMP YBRACING**  
MOTORSPORT & PERFORMANCE  
[WWW.YBRACING.COM](http://WWW.YBRACING.COM)

## RACEWEAR

**GPR Grand Prix Racewear**  
Silverstone  
The best of racewear & kartwear  
[www.gprdirect.com](http://www.gprdirect.com)

## TRAILERS & TRANSPORTERS

**HUSLIG COLLECTIVE**  
Luxury designs for custom vehicles  
[sales@husligcollective.com](mailto:sales@husligcollective.com)

## TRAILERS & TRANSPORTERS

**Signature RV.co.uk**  
RV SALES AND SERVICE

**BRIAN JAMES TRAILERS**  
» Connected to you  
[www.brianjames.co.uk](http://www.brianjames.co.uk)

[www.EMPIRE RV.co.uk](http://www.EMPIRE RV.co.uk)  
Living the high life  
Tel: +44 (0) 1761 300 489  
[www.EmpireRV.co.uk](http://www.EmpireRV.co.uk) ■ [info@EmpireRV.co.uk](mailto:info@EmpireRV.co.uk)



TO ADVERTISE IN THE WEB DIRECTORY  
PLEASE CALL **0203 405 8109**  
OR EMAIL [ads@autosport.com](mailto:ads@autosport.com)

**BRIAN JAMES TRAILERS**

» Connected to you



[www.brianjames.co.uk](http://www.brianjames.co.uk)

## Speed is of its essence

Built to outperform, the Race Transporter 6 has been designed around your race weekend.

Light-weight materials and clever design provide strength throughout. Combined with a proven wheels under the bed chassis and advanced suspension your journey with a Race Transporter will be competent and comfortable.

In the paddock the Race Transporter 6 includes many specific race weekend orientated features providing a comfortable work environment. Tyre and equipment storage is available in several places, with enhanced options also offered. Interior lighting, remote controlled electric winch and a full set of side doors with hatches all contribute to making loading effortless and speedy.

Race Transporter trailers are available from £ 7,499 + vat

Race Transporters are available ex-stock at many UK dealers. Please visit our website or call us for further details.



**T +44 (0)1327 308 833**

For more information and details on the Brian James Trailers range, please contact our head office

**RACE TRANSPORTER 6**

# QUALITY THAT WE ARE PROUD OF

Woodford GRP covered trailers - Value for money. Superior in design, quality and finish

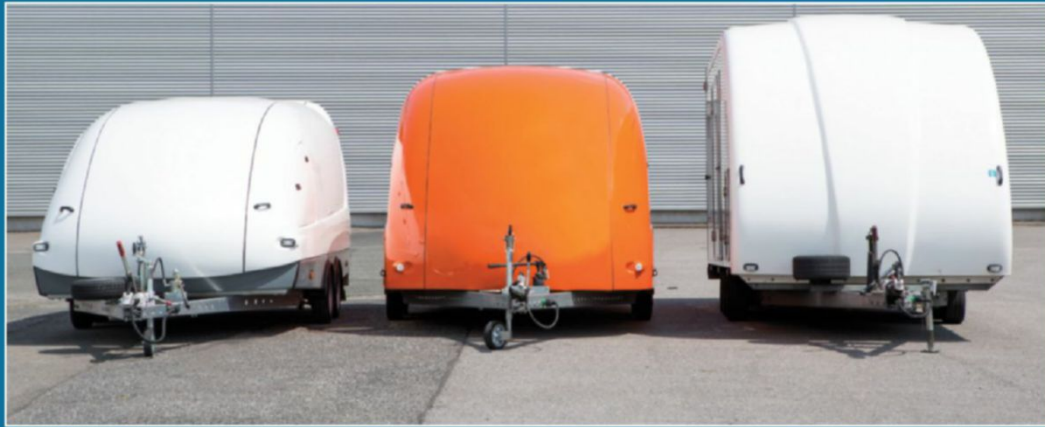

**DEALERS WANTED - All Woodford Trailers have full European Type Approval**



## WOODFORD TRAILERS DEALERS UK

**POTSMOUTH**  
BLENDWORTH TRAILER CENTRE  
Tel: +44(0)2392 412731  
E: sales@blendworthtrailers.co.uk  
W: www.blendworthtrailers.co.uk

**LONDON**  
VINTAGE & PRESTIGE FINE  
MOTORCARS  
Office ++44 (0) 1442 236711  
Mobile ++44 (0) 7967 260673  
E: richard@vandp.net  
W: www.vandp.net

**LONDON-KENT**  
SOUTHEAST TRAILERS  
498 London Road  
Ditton, Kent  
me206bz.  
Tel: 07933842719  
E: ellisviner@btinternet.com  
W: www.southeast-trailers.co.uk

**SOUTH LONDON**  
SOUTH LONDON TRAILER CENTRE  
Hackbridge Station Depot  
London Road  
Wallington, Surrey, SM6 7BJ  
Tel: 0208 647 0110  
Mob: 07836 224250  
E: steve@sltc.co.uk

**WINCHESTER**  
TRAILERTEK LTD  
Warren Farm  
Micheldever Station  
Winchester, Hampshire  
SO21 3AS  
E: info@trailers.co.uk

**SLOUGH**  
BERKSHIRE COUNTY TRAILERS  
Mobile: 07853263484  
Tel: 01628 559782  
E: sales@berkshirecountytrailers.co.uk  
W: www.berkshirecountytrailers.co.uk

**ESSEX**  
1 STOP TRAILERS  
Tel: +44 (0)1787 249737  
Tel: +44 (0)7850 554776  
E: 1stoptrailers@mail.com  
W: www.1stoptrailers.co.uk

**BRIGHTON**  
HALF MOON BAY (LEISURE) LTD  
Smart-Trailers.co.uk  
Monastery Lane  
Storrington, West Sussex  
RH20 4LR  
Tel: 07950 968348  
E: Alan@Smart-Tow.com  
W: www.smart-tow.com

**LEICESTER**  
MARSDEN BARN TRAILERS  
Unit 1  
Marsden Barn  
Huncote Road  
Stoney Stanton  
Leicester  
LE9 4DJ  
Tel: 01455641367  
Mob: 07968888624  
E: marsdenbarntailers@gmail.com

**NOTTINGHAM**  
APPLEYARD TRAILERS  
The Kennels  
Main St  
Strelley  
Nottingham  
NG8 6PD  
Tel: 01159293901  
Mob: 0785075014

**MID WALES**  
HUMPHREYS & FOULKES  
Unit 6  
Lion Works  
Pool Rd,  
Newtown  
Powys  
SY16 3AG  
Tel: 01686 628144

**LEEDS**  
ROTHWELL TRAILERS  
126 Wakefield Road  
Rothwell  
Leeds  
LS26 0SB  
Tel: 01132887179  
E: sales@rothwelltrailers.co.uk  
W: rothwelltrailers.co.uk

**READING**  
LOVELL TRAILERS  
James Farm  
Grazeley Green  
Reading  
RG7 1NB  
Tel: 01183240403  
E: sales@lovelltrailers.co.uk  
W: www.lovelltrailers.co.uk

**NORTHERN IRELAND**  
MONTGOMERY MOTORSPORT  
Tel: 0044(0)2885549851  
W: www.montgomery-motorsport.co.uk

[www.WOODFORDTRAILERS.com](http://www.WOODFORDTRAILERS.com)  
HIGH QUALITY TRAILERS FOR CLUB, PRIVATE AND PRO MOTORSPORTS

Woodford Trailers Limited • 14 Great Central Way • Daventry • Woodford Halse • Northants • NN11 3PZ  
Telephone: 01327 263384

# TRAILERS & TRANSPORTERS



## OFFICE & HOSPITALITY TRAILER **FOR SALE**

Custom Built for Porsche in 2008

In exceptional condition with very low mileage, the trailer consists of: luxury meeting room; salon toilet/shower; bedroom/office/store; kitchenette/staff area; communication/PR office with separate access stairs; onboard 27KVA silent running generator; large storage lockers.

Now looking for a new role in life: £49,000 plus VAT

**CONTACT 07802 402484**



# EMPIRE RV

*Living the high life*

With our **MONSTER** selection, we are Europe's largest supplier of **American RVs!**

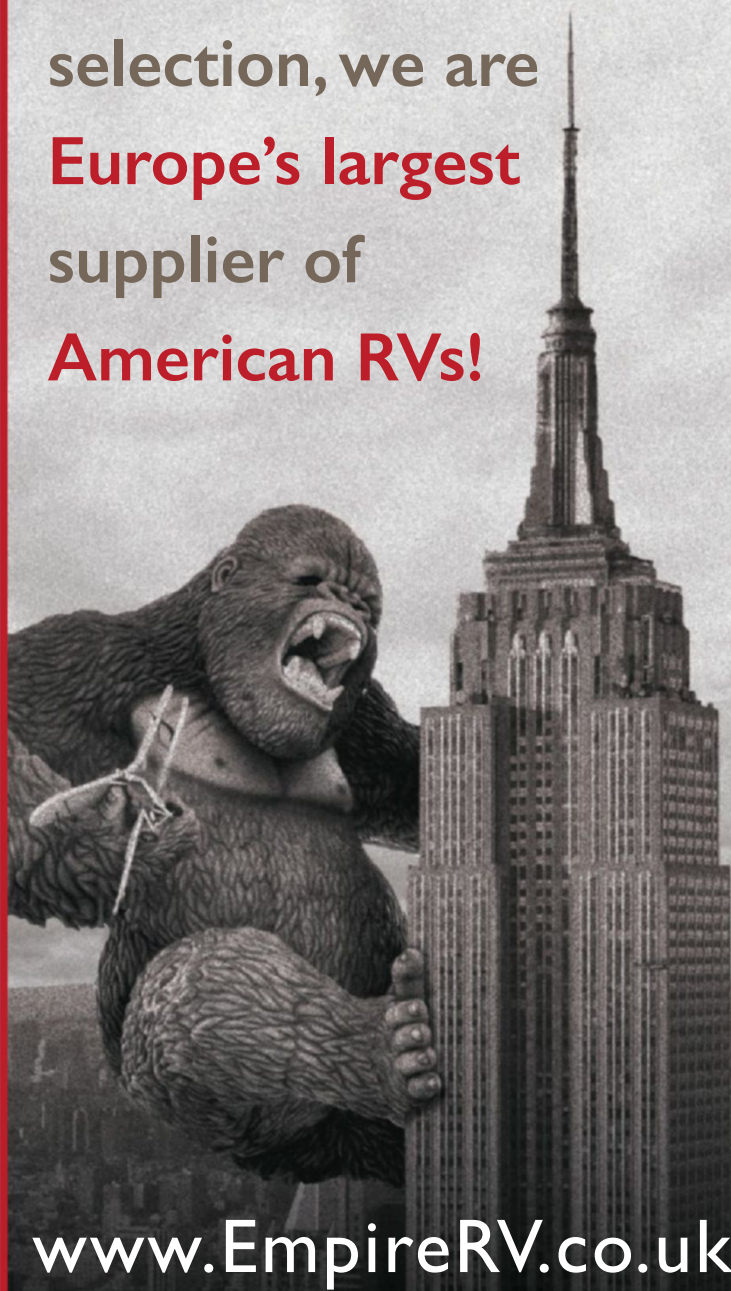

[www.EmpireRV.co.uk](http://www.EmpireRV.co.uk)

Tel: +44 (0) 1761 300 489

SALES ■ CORPORATE RENTALS  
VEHICLE MANAGEMENT ■ SERVICING

## AUTOSPORT

If you wish to advertise your products and services with Autosport in print and online

please contact

[Francesca.hall@](mailto:Francesca.hall@motorsport.com)

[motorsport.com](http://motorsport.com)

or call

0203 405 8108



# WORLD'S FIRST ONLINE Motorsport Engineering Degrees

**FdSc Motorsport Engineering - BSc (Hons) Motorsport Engineering**  
**NEW for January 2018 - MSc Advanced Motorsport Engineering\***

\* MSc subject to validation. All degrees awarded by our academic partner Staffordshire University



NMA Students at Silverstone GP - NMA Mosler MT900 - GT Cup 2017

The only **TRULY FLEXIBLE** route to gaining your **Motorsport Engineering Degree**

- APPLY ONLINE, choose your own start date & study from anywhere in the world
- Earn while you learn, study flexibly around work & family commitments
- 40% lower fees than other universities
- Access to student loans for UK students
- Latest industry standard CAD & Simulation software FREE

**NMA now has students from Formula 1,  
The World Endurance Championship & The World Rally Championship!**

<http://motorsport.nda.ac.uk>



**+44 (0)1159 123456**



# MARKETPLACE

## FLOORING

### Turn your garage into a showroom



Robust interlocking floor tiles  
 No messy adhesives  
 Installation service available  
 Call **01676 523386** for your no obligation quotation



CHOICE OF 11 ATTRACTIVE COLOURS

**DYNOTILE**

Typical 20ft x 17ft garage supplied and installed with skirting for less than £1500.00. Installation service not available in all areas of the UK - contact Dynotile for details.

**WWW.DYNOTILE.CO.UK**

#### MEMORABILIA

**F1 COLLECTORS .COM**

**#1 FOR F1 MEMORABILIA & AUTOGRAPHS**  
 We buy and sell F1 items  
**AYRTON SENNA specialists**  
 Call CHRIS GRINT  
**01763 274448**  
 email:- sales@f1collectors.com

#### AUTOSPORT

If you wish to advertise your products and services with Autosport in print and online please contact **Benjamin.kavanagh@motorsport.com** or call **0203 405 8109**

#### RACE PRODUCTS

**demon tweeks**

**0844 375 2196** **www.demon-tweeks.co.uk**  
LOW CALL RATE CALLS MAY BE RECORDED FOR TRAINING PURPOSES

MEDIA CODE: NZ252A **EXPERT ADVICE • MASSIVE STOCK • RAPID DELIVERY**

#### RACE PRODUCTS

## Elite Carbon Fibre

Carbon fibre race car component manufacturer

EliteCarbonFibre Ltd.  
 Units 20-22 Norwich Road Ind. Est.  
 Watton, Thetford, Norfolk IP25 6DR

Contact - Dave Greenwood 07809390316  
 Email - davecarbonelite@googlemail.com  
 Website - elitecarbonfibre.co.uk

**Carbon Composite Wings, Bodywork & Repairs**

# MARKETPLACE

## RACEWEAR



*Silverstone*

*The best of racewear & kartwear*

*www.gprdirect.com*

## STORAGE



SYSTEM  
STORE  
SOLUTIONS LTD

### SETTING THE STANDARD IN MOTORSPORT WORKSHOP DESIGN & STORAGE

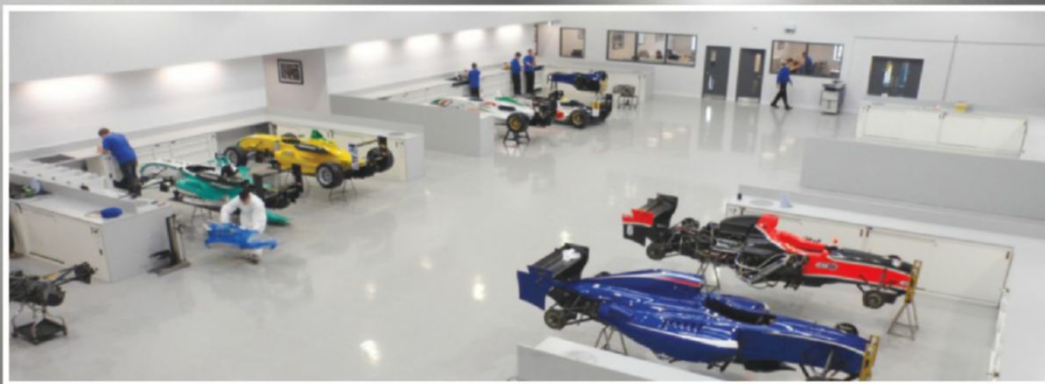

Working with teams and companies in classic/historic racing right through to Formula One.

We provide everything from single cabinets to a total design, layout and installation service, including project management, consultation, technical advice and no obligation site surveys.



- ✓ Race bays
- ✓ Machine shops
- ✓ Stand-alone workstations
- ✓ Transporters
- ✓ Mobile storage units

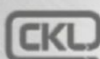

01622 859522 | SALES@SYSTEMSTORESOLUTIONS.COM | SYSTEM-STORE.COM

# MARKETPLACE

RACEWEAR

PREMIUM FORMULA 1 RACE SHOP  
**START THE SEASON RIGHT  
WITH THE BEST GEAR**

SHOP NOW AT [WWW.RACE-GEAR.COM](http://WWW.RACE-GEAR.COM)



## AUTOSPORT

If you wish to advertise your products and services with Autosport in print and online

please contact

[Benjamin.kavanagh@motorsport.com](mailto:Benjamin.kavanagh@motorsport.com)

or call

0203 405 8109

RACE PREPARATION



Historic Engine Specialists

Ford Cosworth BDA/BDG,

Lotus Twin Cam, BMW M10



Craig Beck Racing Ltd

T: 07876 221 932

E: [craig@craigbeckracing.co.uk](mailto:craig@craigbeckracing.co.uk)

[www.craigbeckracing.co.uk](http://www.craigbeckracing.co.uk)







**GTECHNIQ**  
SMART SURFACE SCIENCE

LEADING THE WAY IN  
**AUTOMOTIVE**  
**DETAILING**  
**TECHNOLOGY**

THREE WISHES  
FOR YOUR CAR:

- 1  APPLIED BY A MASTER  
GTECHNIQ  
ACCREDITED  
DETAILER
- 2  THE BEST AVAILABLE  
PRODUCT  
PERFORMANCE  
& FINISH
- 3  **7** YEAR **GUARANTEE**

Crystal Serum is the only ceramic coating that comes with its own **Gtechniq Accredited Detailer**.

The unique service ensures your car is detailed to unrivalled levels of perfection, with a product that offers the ultimate durability, scratch and chemical resistance. Plus, the same slick finish and candy-like gloss you can expect from the world's finest carnauba waxes.



**Meet Adam**  
One of our Gtechniq Accredited Detailers.

**GENIE**  
WITH A BOTTLE

[service.gtechniq.com](http://service.gtechniq.com)



# CARS FOR SALE / MOTORSPORT JOBS



GT Marques



**991 CARRERA CUP CARS STILL IN FACTORY SPEC  
CHOICE OF 2015 AND 2016 AVAILABLE NOW  
£POA**

Please contact Paul for further information  
on 07831 486 876/ 01494 474 or email [paul@gtmarques.com](mailto:paul@gtmarques.com)



AMG  
PETRONAS  
FORMULA ONE TEAM

Mercedes-Benz has been setting the standard in racing for over 100 years, and the Mercedes-AMG Petronas Formula One™ Team continues the proud history of the legendary Silver Arrows. We have some exciting opportunities at our Championship winning team within our Vehicle Dynamics team.

VEHICLE DYNAMICIST

REF: SW1805

We are looking for a Vehicle Dynamicist who will be responsible for the creation and development of modelling and analysis tools, methods and processes to enhance car performance. The ideal candidate will have experience with simulation and vehicle dynamics from a top motorsport organisation or high end engineering company.

We invest in our greatest asset: people. They embody our values: Passion, Respect, Innovation, Determination and Excellence.

We succeed when everyone delivers their tenth of a second. No matter which area of the team you work in, you will determine how we perform on and off the track.

Every person here takes immense pride in playing their part to the highest standards. Each and every day. Working here is fast. It demands technical excellence and teamwork. And it calls for great reserves of motivation and resilience.

Own your tenth of a second. Play your part. Join us.

To find out more, visit:  
<http://careers.mercedesamgf1.com/>

Closing Date: 9 November 2017

# AUTOSPORT

Want to advertise a motorsport job?  
If you are recruiting in motorsport and wish to advertise with  
Autosport in print and online please contact  
[Jonathan.King@motorsport.com](mailto:Jonathan.King@motorsport.com)  
or call 0203 405 8110.

For all current vacancies advertised please visit  
our website [www.autosport.com](http://www.autosport.com)



**CELEBRATING ANOTHER SUCCESSFUL SEASON!**

**1ST BRITISH GT CHAMPIONSHIP GT3 TEAMS'**

**2ND BRITISH GT CHAMPIONSHIP GT3 DRIVERS'**

**2ND BLANCPAIN GT SERIES ENDURANCE CUP PRO/AM TEAMS'**

**2ND BLANCPAIN GT SERIES ENDURANCE CUP PRO/AM DRIVERS'**

**PLUS 9 WINS FROM 17 RACES**

**4X BRITISH GT CHAMPIONSHIP  
3X BLANCPAIN GT SERIES ENDURANCE CUP PRO/AM  
2X BLANCPAIN GT SPORTS CLUB**



# CLUB AUTOSPORT

NATIONAL RACING • HISTORICS • HILLCLIMB • TRACK TESTS • FEATURES



Priaulx set the pace in Arden F4 test

EBREY

BRITISH F4

## Priaulx joins Arden ahead of 2018 British F4 campaign

GINETTA JUNIOR RUNNER-UP SEB PRIAULX will graduate to British Formula 4 next season, driving for the Arden squad.

The 16-year old son of triple World Touring Car champion Andy had already tested an F4 car with JHR Developments last year, and was quickest of a number of drivers that Arden tested earlier this month. He now joins his father – a Ford driver in the World Endurance Championship – in having links with the manufacturer, which supplies its EcoBoost engine to British F4.

Priaulx is already the third driver confirmed at Arden for 2018, and joins Red Bull-backed karting graduates Jack Doohan and Dennis Hauger. “To make the step up to single-seaters and race in British F4 is a real milestone in my career,” said Priaulx. “It’s always been my aim to live the single-seater dream. Winning in British F4 opens

doors and it’s the starting point for Formula 1.

“Arden is a team that can take you from British F4 all the way up to F2. When I visited the workshop I could get up close and personal with their Formula 2 cars. As a young driver it’s really inspiring to be able to see the next steps on the FIA single-seater pyramid right in front of you.”

Priaulx added that he was keen to move on from a chaotic Ginetta Junior season in which he was docked more than 100 points for an alleged engine irregularity. He later got the points reinstated, before having to switch teams to HHC Motorsport when JHR was suspended while Ginetta investigated its conduct.

“This year I showed determination,” he said. “It was difficult, but that’s racing and it’s definitely made me stronger. I’m really looking forward to next year now.”

### IN BRIEF

#### TOM PRYCE MEMORIAL TROPHY

The prestigious Tom Pryce Memorial Trophy has been awarded to the Anglesey Circuit to celebrate its 25th anniversary and its £4 million reconfiguration. The award is presented annually either to an individual or a group in Wales that has made a significant contribution to the country. Pryce, who died in 1977, is the only Welshman to ever win an F1 race.

#### TF SPORT RETAINS AM DRIVERS

TF Sport will return to the British GT Championship next year with both of its Aston Martins after re-signing Derek Johnston and Mark Farmer. Tom Ferrier’s squad won the overall GT3 title in 2016 with Johnston and Jonny Adam sharing a car.

#### TOM DOOLEY 1927-2017

A minute’s silence was held before the start of the Formula Ford Festival final at Brands Hatch to honour the life of BRSCC president Tom Dooley, who died last week. Dooley, who had also been chairman of the BRSCC’s North Western Centre, gave more than 60 years of his life to the club.

#### DAVIDSON STEPS UP A CLASS

Newly crowned Fiesta Junior champion Jack Davidson (below) plans to graduate to the senior championship next year. BRSCC Fiesta Championship regulations allow Davidson to use the Jamsport-prepared car he took to seven wins this year with minimal changes.



READ

Comprehensive motorsport insurance products to keep you on track;

- Accident damage On Track
- Rally damage On Event
- Storage and Transit
- Liability
- Personal Accident
- Track day

Log on to [www.ryanmi.com](http://www.ryanmi.com) to obtain your online quote  
Email – [info@ryanmi.com](mailto:info@ryanmi.com) Tel – +44 (0)1799 524202

Ryan Motorsport Insurance Limited is an appointed representative (557405) of Independent Broking Solutions Limited who are authorised and regulated by the Financial Conduct Authority. Its Financial Services Register number is 312026

**RYAN**  
MOTORSPORT INSURANCE

PORSCHE CARRERA CUP GB

# Carrera Cup GB heads to Monza in 2018



THE PORSCHE CARRERA CUP GB WILL race at Monza next season, supporting the European Le Mans Series.

Autosport reported last month that the British Porsche series was targeting the historic venue, and it has now secured two races during the May 11-13 event.

Porsche GB motorsport manager James MacNaughton said talks had been ongoing since June, and he was delighted to have secured a place. "It's been a long time coming – we started talks when we were at Le Mans, as it's the same group of people who organise ELMS and Le Mans," he said.

"Our options were reducing a little because of the way the World Endurance Championship [which the series has supported at Le Mans and Silverstone in the past two years] is formed now."

The series has held an overseas round in recent seasons, with trips to Le Mans and Spa, but this is the first time it will visit Monza.

"The paddock is very excited about going," said MacNaughton. "For the Am drivers it's a big box for those guys to tick to race at a circuit like Monza. For the Pro drivers, although I'm sure they don't mind as much where they race, it's great to give them the chance to race on those big circuits that they may compete at when they graduate from the Carrera Cup."

The series will also appear at the Donington Park, Oulton Park, Snetterton, Knockhill, Silverstone and both Brands Hatch British Touring Car rounds.

MacNaughton added that a number of orders have already arrived for the new 911 GT3 Cup car that is being introduced next season, with entries for the 2018 season opening this week.

**2018 CALENDAR**

APRIL 6-8  
APRIL 27-29  
MAY 11-13  
JUNE 8-10

**BRANDS HATCH INDY  
DONINGTON PARK  
MONZA  
OULTON PARK**

JULY 27-29  
AUGUST 24-26  
SEPT 14-16  
SEPT 28-30

**SNETTERTON  
KNOCKHILL  
SILVERSTONE  
BRANDS HATCH GP**

**C1 CHALLENGE**

## Rockingham hosts Citroen C1s for circuit's first 24-hour race

ROCKINGHAM WILL HOLD ITS FIRST 24-hour race next year as the C1 Racing Challenge adds a second long-distance event to its calendar.

The C1 Challenge ran a twice-round-the-clock race at Spa last weekend to cap its inaugural year, and is staging the May 11-13 event at Rockingham on the track's 17th birthday.

Meyrick Cox, chairman of the C1

Racing Club, said: "Rockingham has among the best facilities of any circuit in the UK, so we are thrilled that Rockingham and East Northants Council have been so supportive.

"The C1 Racing Challenge is going from strength to strength. Our first season saw grids building from eight cars to over 40 cars at Spa."

Rockingham chief executive

Peter Hardman, who will be taking part in the event as a member of the circuit staff's team, said: "This is the first 24-hour race to be held at Rockingham, so I am delighted the C1 Racing Club has chosen to hold its UK meeting at our circuit next season."

• Richard Dalton's Daltonator team won the 24-hour race at Spa last

weekend. Former 2CV champion Dalton's son Jake shared the car with British GT champion Seb Morris, GT racer James Fletcher and Carrera Cup driver Lewis Plato. British Touring Car racer Josh Cook brought his Fats & Furious team home in second, three laps down, sharing with cousin Ollie, Jon Maybin and Joel Shipton.

**LEADERS IN MOTORSPORT INSURANCE**  
A service driven broker for a fast moving world  
[www.integrogroup.com](http://www.integrogroup.com)

Integro Insurance Brokers Ltd. Authorised and regulated by the Financial Conduct Authority. Registered Office: 100 Leadenhall Street, London EC3A 3BP. Registered Company No. 2957627 England.





Dempsey (leading) wants to race in the US

WALTER HAYES TROPHY

## Dempsey joins Kevin Mills Racing

JORDAN DEMPSEY WILL SWITCH TO a Kevin Mills Racing Spectrum 011C for the end-of-season Walter Hayes Trophy.

The 17-year-old has raced in the Northern Irish and British Racing and Sports Car Club FF1600 National Championship with his family-run squad this year, but wanted to switch to another team ahead of a potential

move to the US. "For me as a driver I want to move on and I want to get over to America in F4 as they are support to the Formula 1 and WEC," he said. "I need to get working with professional teams and Kevin Mills has a good track record at Silverstone."

KMR plans to run at least five cars in the WHT at Silverstone on November 4-5.

WALTER HAYES ALLCOMERS RACE

## Le Mans Prototypes to Walter Hayes

THIS YEAR'S WALTER Hayes Trophy support bill will feature two Le Mans prototypes.

Rollcentre Racing boss Martin Short will run his Judd V10-engined Dallara SP1 in the 20-lap Allcomers race that supports the Formula Ford knockout event. It will be joined by a Creation-AIM

CA07, which, run by Chamberlain-Synergy Motorsport, qualified 10th at Le Mans in 2007 in the hands of Jamie Campbell-Walter. It will be driven by either team owner Bob Berridge or former Peugeot works driver Nicolas Minassian, if he is available that weekend.

"I wanted to support James

[Beckett, WHT organiser] so decided to run the Dallara as a bit of fun," said Short.

"We'll give ourselves a very leisurely pitstop to even the field out and it'll be great fun charging through to catch the MGB that'll likely be leading!"

Berridge added: "This is an opportunity to support a great event like the WHT."



Campbell-Walter drove Creation at Le Mans in 2007

BRITCAR

## M3 ace Shepherd makes GT bow

M3 CUP CHAMPION ADAM SHEPHERD scored a podium on his debut Britcar outing last weekend at Oulton Park.

Shepherd was sharing a Team Hard Ginetta G55 GT4 with regular driver Darron Lewis, ahead of a possible move to the GT4 Supercup next season, and the pair finished sixth in the opener before taking second in a very wet race two.

"This was just such an amazing experience," said Shepherd. "I had 10 laps

in the wet and eight in the dry before qualifying. It was my first time on proper slick and wet racing tyres too.

"The braking is unbelievable and the cornering too. I think I picked it up quite quickly in the end. I had always wanted to drive a car like this.

"I want to go into the Ginetta Supercup next season. As usual it's all down to budget, but with Tony Gilham's help Team Hard has got me this far."

BARC

## Grimes/Mowlem win at Oulton

THE FF CORSE FERRARI 458 CHALLENGE of Bonamy Grimes and Johnny Mowlem was a double winner in the Britcar Endurance races at Oulton Park last weekend.

Poleman Rob Wheldon had built a lead of more than 20 seconds when his Radical RXC GT3 went off at Shell. Jayde Kruger's Ginetta G55 GT4 took the lead, but after Chris Papageorgiou took over, he was caught by Mowlem. Adam Wilcox followed Mowlem through in Michael Igoe's Porsche 911, with Ross Wylie taking third on the last lap in Witt Gamski's Ferrari 458 GTE.

Mowlem and Grimes were never headed in the second race, with Darron Lewis and Adam Shepherd's G55 a lap clear of Papageorgiou/Kruger in third.

Joe Spencer clinched the CNC Heads Sports/Saloon title in his Locosaki after another double class win. Paul Rose's Saker charged to the front on the opening lap of race one, with Steve Harris making it a Saker one-two despite a spin at Lodge. Luke Armiger's Vauxhall Tigra managed to consolidate third over Spencer.

Harris was a comfortable race-two winner, with Rose second after a pitlane start and late alternator problems. Spencer completed the podium from Armiger, Danny Bird (Spire) and David Harvey (Locosaki).

Dan Clark also secured the 2017 MSA British Superkart Championship.

SUNOCO AND WHELEN CHALLENGES

## Parfitt gets GT4 drive at Daytona

BRITISH GT CHAMPION RICK PARFITT JR HAS won a funded drive at Daytona next year after topping the annual Sunoco 240 Challenge contest, which awards points for race wins, pole positions and fastest laps.

Parfitt, who steered a Team Parker Racing Bentley Continental GT3 to the British GT crown this year, will get an outing in an as-yet unspecified GT4 car in the four-hour BMW Endurance Challenge race that supports January's Daytona 24 Hours.

Parfitt narrowly beat Mini Challenge champion Brett Smith in the contest. "I'm over the moon, this is the icing on the cake on what's been an awesome season," said Parfitt. "Needless to say I can't wait to race at the incredible Daytona International Speedway."

British GT4 champion Stuart Middleton leads the sister Whelen Challenge contest, which rewards the winner with a funded seat in a Cadillac Daytona Prototype in the 24 Hours. Only Radical racer Stuart Moseley can beat him if he scores enough points across the European Masters event at Barcelona this weekend.



**BRANDS HATCH**  
**FORMULAFORD FESTIVAL** OCTOBER 21-22

# Fighting Foster takes Festival triple

THOSE IN THE KNOW SAY THAT to win the Formula Ford Festival even once you need a combination of speed, experience, and a little bit of luck.

Joey Foster found he had heaps of all three as he took his third Festival win, 13 years after his last triumph, sealing it with an incredible overtaking move around the outside into Paddock Hill Bend that will live long in the memory.

The 35-year old was the man to beat of the 75 entries at Brands Hatch from the outset. He took pole for heat one and his Ray GRo8 romped to victory on a damp but drying track against a field containing 2017 National Formula Ford champion Luke Williams, and current Scottish Formula Ford king Ross Martin.

Foster didn't have everything his own way in the semi-final, though. For this encounter he started second behind the Van Diemen JL13 of Matt Cowley, on account of his win being the slowest victory of the three heats.

Foster, the 2009 Australian Formula 3 champion and ex-British GT racer, soon found himself locked in a three-car fight with Cowley and Irishman Keith Donegan, dropping to third at the midway point.

But Foster proved he would be the man to beat in the final by completing two near-identical overtakes on Donegan's Van Diemen and then Cowley on the inside of Clearways to claim victory.

It was Cliff Dempsey Racing's Neil MacLennan who would start on pole for the final, though. And he appeared to be the only driver capable of challenging Foster, having charged through to win his semi-final from third.

A strong start from MacLennan in his Ray GRo9 ensured he held fellow front-row starter Foster at bay for the

initial laps, with a gaggle including Chris Middlehurst (Van Diemen), Cowley and Donegan in hot pursuit.

The gap was never large, and when three cars entered the gravel at Paddock Bend on lap three of the 20-lap affair, bringing out the safety car, it closed the field up even further. Despite getting the jump on his rivals at the restart, MacLennan soon had to run defensive lines, and the decisive move came just before half-distance. MacLennan kept to the inside into Paddock as Foster risked it all and swept around the outside, coming within

Foster pulled off an incredible overtake for the lead on the outside into Paddock Bend





Foster (Cornish flag on helmet) had to get past Maclennan (red car) to win

ALL PICS: HAWKINS

millimetres of the gravel in a pass that brought gasps and cheers from the crowd.

“He [Maclennan] was defending so heavily and I got a good slipstream,” explained Foster. “I’d tried it [the pass] in the semi-final and it didn’t work, but when I pulled it off I thought I’m going to remember that for a while. I was either going to make it or end up in the gravel.”

As Foster tried to escape, a frenetic battle erupted behind as Maclennan lost second place to Cowley at Paddock and then third to Donegan seconds later into Druids. The charging Donegan, who’d set up his Van Diemen JL13K to come on strong in the latter stages, had battled his way through from sixth and was proving to be the fastest man on track, setting a 50.579s on lap 12, which would remain unbeaten.

His chase for the victory became easier when, three laps from home, Cowley took an excursion through the Paddock gravel, rejoining down in sixth.

The luck that so many pundits had said was needed to tame the Festival became evident on the final lap, when what would be a popular win for Foster almost disappeared within sight of the flag.

An electrical problem was causing the engine aboard his Ray to occasionally lose full power, enabling Donegan to close in and finish just 0.107s behind at the flag.

“I lost a bit of power and it felt like one more lap and we would lose the lead,” said a relieved Foster.

For 20-year-old Donegan, second place was a fantastic result, having only raced sporadically this year. He now provisionally holds a ticket to the Mazda Road to Indy Shootout, although Mazda has yet to confirm his place.

“I’ve had three seconds this year and each time I’ve thought, ‘I just need one more lap,’” he said. “If I had one more lap maybe I could have made a move.”

A delighted Maclennan took third and was left to admire the pass through which Foster had relieved him of the lead and any realistic chance of victory.

“I take my hat off to Joey, that move he pulled there was pretty unreal,” said Maclennan. “I thought at one point, ‘Nah, you’ve lost it’, and then, when he got it back, when he got it to the bottom, I thought ‘He’s got this’”

Fourth went the way of Josh Smith, >>



Donegan heads Foster and gaggle in semi-final

## How the key players made it to the Festival final

IT WAS A LIGHTS-TO-FLAG VICTORY FOR JOEY Foster in heat one, nursing his Ray GR08, which was using a wet set-up, through drying conditions in the closing stages. Neil Maclennan and Josh Smith comfortably completed the podium once Luke Williams retired five laps from home.

Jamie Thorburn finished a disappointing fourth in heat two, having led before being blocked by backmarkers on two occasions at Clearways. Poleman Chris Middlehurst capitalised to win ahead of Keith Donegan and Darren Burke, while Michael Eastwell dropped from fifth to 13th after being tapped into a spin on the last lap at Clearways.

Heat three polesitter Jake Byrne went off-line and into the barrier at Surtees, gifting victory to Matt Cowley ahead of Matt Round-Garrido and Luke Cooper. Oliver White had charged through from 24th to sixth before being excluded for a yellow-flag infringement. Foster battled hard for victory against Cowley and Donegan in the slower of the two semi-finals, which was interrupted by a safety car.

Jordan Dempsey finished seventh but was excluded after colliding with Thorburn going up to Druids, which forced Thorburn into retirement.

Maclennan surged through from third to win the other semi-final with a late lunge on Middlehurst at Graham Hill Bend. James Roe Jr, Ross Martin and Eastwell completed the top three spots of the last-chance race after all three had excursions during their heats and semi-finals. Thorburn’s charge from the back of the grid ended with a crash coming out of Druids following contact with Jason Down.

STEFAN MACKLEY



Ferguson (7) pipped Martin and Eastwell to last automatic grid slot



who'd been left frustrated in his semi-final after his Van Diemen kept jumping out of gear, forcing him to come through from 10th on the grid in the final.

Former McLaren Autosport BRDC Award finalist Middlehurst was muscled down the field from his starting position of third and finished back in fifth place, just ahead of Cowley, who was left to rue his late off-track excursion.

The trio of Darren Burke, Noel Robinson and Matt Round-Garrido had been locked in a race-long battle and finished together in seventh, eighth and ninth. Former Castle Combe Saloons champion Jason Cooper completed the

**Donegan, Foster and Maclennan celebrate on the final podium**

**Right: Middlehurst leads Round-Garrido and Maclennan in semi**

top 10 in his Swift SC16 with an impressive drive, staying out of trouble and capitalising on others' mistakes.

Younger brother Luke had shown great pace throughout the weekend, but contact with Burke heading up to Druids and then a spin in frustration at his lack of progress in the final dropped him to 14th at the flag after he had run strongly inside the top 10.

But the 2017 Festival belonged to Foster, now with the knowledge that he is the man to beat as the Formula Ford fraternity heads to Silverstone and the Walter Hayes Trophy. That's an event he has won three times already...

**STEFAN MACKLEY**

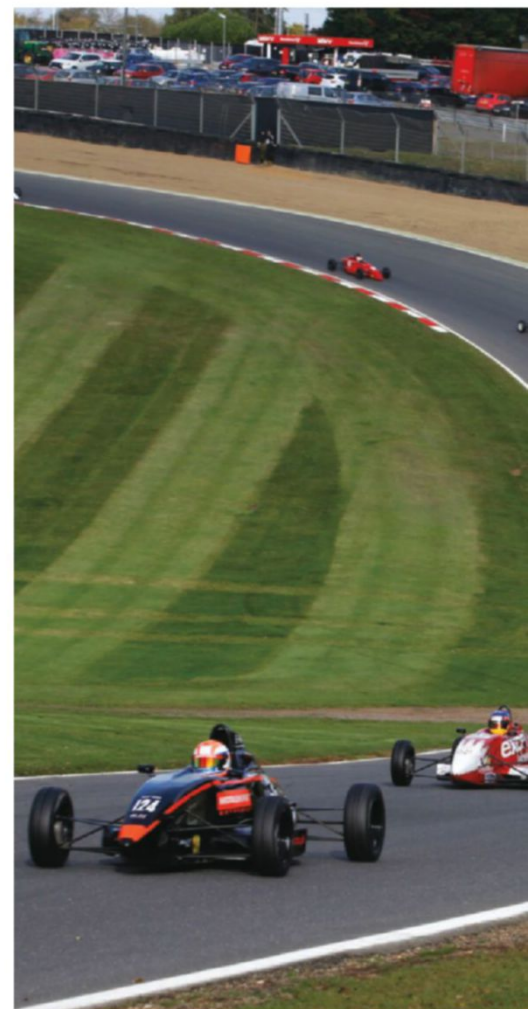

## Festival format punishes event favourites in heats

"I'M GUTTED, IT'S JUST ONE OF those things but I just can't believe we did 400 laps in testing with no problems and then something that costs 20 pence breaks."

That was 2017 National Formula Ford champion Luke Williams's assessment of this year's Festival after he was forced out in heat one when a throttle linkage broke on his Firman RFR16 while sitting in fourth position.

The 25-year old was one of a number of pre-event favourites who found that the nature of

the Festival can be unforgiving. Even the slightest problem or mistake was severely punished. Williams's retirement from the heat meant he was unable to make it through to the semi-final, and he was joined on the sidelines at that early stage by other notable names.

Jake Byrne, poleman for heat three, had been looking quick aboard his Ray GR13 and was leading until he went off-line through Surtees and spun into the barriers. Oliver White, a Mazda Road to Indy Shootout finalist last year, was another to fall by the wayside.

Having been excluded from qualifying for passing while red flags were being shown, White guided his Medina Sport JL17 through from the back of the field to sixth in heat three at the chequered, only to be excluded again for passing under yellows.

**STEFAN MACKLEY**



### RESULTS

**FORMULA FORD FESTIVAL HEAT 1 (15 LAPS) 1 Joey Foster (Ray GR08); 2 Neil Maclennan (Ray GR09) +2.953s; 3 Josh Smith (Van Diemen JL13); 4 Ross Martin (Ray RGS17); 5 Jordan Dempsey (Van Diemen RF00); 6 Ben Hurst (Ray GR12). Class winners Mark Armstrong (Van Diemen RF80); Olaf Schulte (Van Diemen RF87). Fastest lap Foster 56.496s (76.97mph). Pole Foster. Starters 25.**

**HEAT 2 (15 LAPS) 1 Chris Middlehurst (Van Diemen LA10); 2 Keith Donegan (Van Diemen JL13K) +1.958s; 3 Darren Burke (Van Diemen JL014K); 4 Jamie Thorburn (Ray GR15); 5 Noel Robinson (Van Diemen JL012K); 6 James Roe Jr (Van Diemen RF99). CW Oliver Playle (Hawke DL19); Henry Campbell (Reynard FF89); Ian Jeary (Elden Mk8). FL Donegan 52.575s (82.71mph).**

**P Middlehurst. S 24. HEAT 3 (15 LAPS) 1 Matthew Cowley (Van Diemen JL13); 2 Matt Round-Garrido (Medina Sport JL17) +1.185s; 3 Luke Cooper (Swift SC16); 4 Rory Smith (Van Diemen JL15K); 5 Sebastian Melrose (Ray GR14); 6 Michael McPherson (Ray GR14). CW Conor Murphy (Mondiale M89S); Nicholas Gibson (Crosle 40F).**

**FL Jake Byrne (Ray GR13). P Byrne. S 24. SEMI FINAL 1 (15 LAPS) 1 Foster; 2 Cowley +0.241s; 3 Donegan; 4 Cooper; 5 J Smith; 6 Jason Cooper (Swift SC16). CW Klaus-Dieter Hackel (Van Diemen RF88); Gibson. FL L Cooper 50.436s (86.22mph). P Cowley. S 30.**

**SEMI FINAL 2 (15 LAPS) 1 Maclennan; 2 Middlehurst +1.146s; 3 Round-Garrido; 4 Burke; 5 R Smith; 6 Henry Chart (Van Diemen RF022). CW Armstrong; Kevin Bottomley (Reynard 88FF). FL Martin 50.789s (85.62mph). P Middlehurst. S 30. LAST CHANCE RACE (8 LAPS) 1 Roe Jr; 2 Martin +0.091s; 3 Michael Eastwell (Spectrum 011); 4 Dean Venter (Ray GRS07); 5 Hackel; 6 Vincent**

Jay (Ray GR10). CW Hackel; Armstrong. FL Eastwell 49.828s (87.27mph). P Martin. S 23. **FINAL (20 LAPS) 1 Foster; 2 Donegan +0.107s; 3 Maclennan; 4 Smith; 5 Middlehurst; 6 Cowley. FL Donegan 50.579s (85.97mph). P Maclennan. S 30.**

**BRSCC PORSCHE (17 LAPS) 1 Ed Hayes (Boxster); 2 Adam Southgate (Boxster) +5.378s; 3 Richard Avery (Boxster); 4 Alex Stocker (Boxster); 5 Kevin Molyneaux (Boxster); 6 Garry Lawrence (Boxster). CW Pip Hammond (924); Andrew Baker (Boxster). FL Hayes 1m03.122s (68.89mph). P James Coleman (Boxster S). S 27.**

**RACE 2 (22 LAPS) 1 Hayes; 2 Avery +5.719s; 3 Lawrence; 4 Stocker; 5 Nick Hull (Boxster); 6 Molyneaux. CW David Jones (924); Baker. FL Hayes 53.515s (81.25mph). P Hayes. S 27. **RACE 3 (20 LAPS) 1 Hayes; 2 Avery +0.455s; 3 Southgate; 4 Lawrence; 5 Molyneaux; 6 Hull. CW Jones; Baker. FL Hayes 53.529s (81.23mph). P Southgate. S 25.****

**CLASSIC FORMULA FORD (15 LAPS) 1 Scott Mansell (Crosle 35F); 2 Rick Morris (Royale RP26) +0.180s; 3 Adriano Medeiros (Van Diemen RF80); 4 Mark Armstrong (Van Diemen RF80); 5 Stuart Kestenbaum (Crosle 16F); 6 Simon Jackson (Javelin JL5). CW Kestenbaum. FL Mansell 1m02.770s (69.27mph). P Morris. S 20.**

**RACE 2 (15 LAPS) 1 Armstrong; 2 S Mansell +9.107s; 3 Medeiros; 4 Kevin Mansell (Crosle 32F); 5 Jackson; 6 Kestenbaum. CW Kestenbaum. FL Medeiros 51.839s (83.88mph). P S Mansell. S 19.**

**FORMULA FORD FESTIVAL MASTERS (15 LAPS) 1 John Ferguson (Spectrum 012); 2 Jake Byrne (Ray GR13) +0.068s; 3 Miles Johnston (Ray GR16); 4 Keith Wood (Swift SC93); 5 Simon Jackson (Javelin JL5); 6 Peter Daly (Royale RP21). CW Jackson; Stuart Kestenbaum (Crosle 16F); Kevin Bottomley (Reynard SF88). FL Byrne 51.414s (84.58mph). P Ferguson. S 17.**



ALL PICS: HAWKINS

**BRANDS HATCH**  
SUPPORTS OCTOBER 21-22

# Hammond seals 924 title as Hayes takes three wins

ED HAYES CONFIRMED HIS POSITION as this year's star driver in the BRSCC Porsche Championship by securing a hard-fought hat-trick of race victories in the final round of the season.

The newly crowned series champion made a flying start in a sodden race one to leapfrog double Rockingham race winner and pole position holder James Coleman, leading the chasing pack on the opening tour. Behind the top two, Adam Southgate held third ahead of Garry Lawrence, but a wild spin at Graham Hill Bend on lap two dropped Lawrence back several places. Southgate had a similar moment at Surtees shortly after but maintained third, while Hayes and Coleman were able to break clear.

After hounding Hayes for the entire race, Coleman spun and slammed into the tyre wall exiting Druids on the final lap, ending his hopes of snatching the win. Hayes eased to victory thereafter ahead of Southgate and Richard Avery.

Coleman was in the wars again in the second race, hitting the rear of Lawrence's similar Boxster at Graham Hill Bend as the pair battled over third. Lawrence emerged unscathed and held the position to the flag behind Avery and the victorious Hayes. Avery looked set for race three glory after overcoming early pacesetter Southgate, but Hayes produced a demon pass at Paddock Bend on the penultimate lap to end his title season in fitting style. In the 924 class, Pip Hammond erased the memory of a nightmare weekend at Rockingham to secure the title with victory in race one. David Jones recovered from spinning off in the opener to claim the spoils in races two and three.

Adriano Medeiros was another driver to enjoy title success, claiming his second successive Classic Formula Ford 1600 championship despite not topping the podium over the weekend. Scott Mansell



Michael Gibbins took one win aboard his MCR

narrowly beat the Royale RP26 of category legend Rick Morris to claim an emotional success in a wet first encounter in his Crossle 35F. Mark Armstrong won race two in his Van Diemen RF80 after Mansell and Medeiros (RF80) tangled at Druids dicing for the lead on the first lap.

After a crash in his heat denied him an appearance in the Festival showpiece, Jake Byrne hoped victory in the sole Formula Ford Masters event would offer some consolation. He gave his all to overcome a superb defensive drive by Spectrum 012 driver John Ferguson, but missed out by a mere 0.068s. Felix Fisher (Reynard 88FF) tried to do likewise in the Historic Festival for pre-90 cars, but Klaus-Dieter Hackel emerged victorious in his Van Diemen RF88 after other potential race winners Mark Armstrong and Conor Murphy were eliminated in a first-corner shunt.

Steven Dailly kept it clean to beat season-long title rival James Gornall in both BMW Compact Cup encounters, but two runner-up finishes were enough to confirm Gornall's second consecutive championship win. Owen Hunter and Samuel Carrington Yates fought each other hard to claim a third apiece.

Peter Barrable was another champion to be crowned, finishing fourth in the first combined Irish Supercar/Global GT Lights event to wrap up the Supercar title. Graeme Colfer won the opener, while Bob Cameron fended off the GT Lights trio of James Thompson, Conor Farrell and Max Drennan to win race two.

Paul Trayhurn (Gunn) and reigning champion Michael Gibbins (MCR) shared the wins in the two Sports 2000 races.

**MARK LIBBETER**

**HISTORIC FORMULA FORD FESTIVAL (15 LAPS)**

**1 Klaus-Dieter Hackel (Van Diemen RF88);** 2 Felix Fisher (Reynard R88) +2.199s; 3 Peter Daly (Royale RP21); 4 Stuart Kestenbaum (Crossle 16F); 5 Henry Campbell (Reynard FF89); 6 Ian Jeary (Elden Mk8). **CW** Daly; Kestenbaum.

**FL** Fisher 52.069s (83.51mph). **P** Mark Armstrong (Van Diemen RF80). **S** 15. **BMW COMPACT CUP (13 LAPS)**

**1 Steven Dailly;** 2 James Gornall +0.279s; 3 Owen Hunter; 4 Samuel Carrington Yates; 5 Matthew Parkes; 6 Ruairidh Clark. **FL** Gornall 57.691s (75.37mph). **P** Dailly. **S** 31.

**RACE 2 (16 LAPS) 1 Dailly;** 2 Gornall +0.730s; 3 Carrington Yates; 4 Hunter; 5 Parkes; 6 Tom Griffiths. **FL** Dailly 57.793s (75.24mph). **P** Dailly. **S** 31.

**IRISH SUPERCARS/GLOBAL GT LIGHTS (15 LAPS)**

**1 Graeme Colfer (ASK Supercar);** 2 Bob Cameron (Supercar) +0.640s; 3 David Parks (Supercar); 4 Peter Barrable (Supercar); 5 Philip Jones (Supercar); 6 Conor Farrell (GT Light). **CW** Farrell. **FL** Barrable 59.838s (72.67mph). **P** Barrable. **S** 21.

**RACE 2 (17 LAPS) 1 Cameron;** 2 James Thompson (Light) +0.374s; 3 Farrell; 4 Max Drennan (Light); 5 Mark Braden (Light); 6 Jones. **CW** Thompson. **FL** Drennan 51.824s (83.91mph). **P** Cameron. **S** 20.

**SPORTS 2000 DURATEC & PINTO (26 LAPS) 1 Paul**

**Trayhurn (Gunn TS11);** 2 Michael Gibbins (MCR) +5.230s; 3 Tim Tudor (MCR); 4 David Houghton (MCR); 5 Lewis Kent (Ray); 6 Nick Bates (MCR). **CW** Gibbins; Steve Head (Van Diemen RF05); Peter Needham (Tiga SC80); Mike Dodd (Tiga SC79); Mike Fry (Lola T86/90). **FL** Trayhurn 47.551s (91.45mph). **P** Trayhurn. **S** 25. **RACE 2 (37 LAPS)**

**1 Gibbins;** 2 Houghton +7.187s; 3 Tudor; 4 Bates; 5 Giles Billingsley (MCR); 6 Mike Turner (MCR). **CW** Billingsley; Peter Brouwer (T88/90); Needham; Dodd; Damien Griffin (TS98). **FL** Trayhurn 47.696s (91.17mph). **P** Trayhurn. **S** 24.



GT Lights men Drennan and Finlay look for the pot of gold

**SILVERSTONE**  
HSCC OCTOBER 21-22

# King Richard the lionheart triumphs



“I HAD TO WIN THAT RACE; NOTHING else could do,” said a mentally drained Richard Tarling, having snatched the Historic Formula Ford crown in his Jamun from beneath the noses of Merlyn men Michael O’Brien and Callum Grant in a classic Silverstone slipstream finish. It had been an emotional rollercoaster of an HSCC Championship Finals meeting in which the fortunes of all three waxed and waned over the double-header, and two dropped scores became the key arbiters.

The three title aspirants, plus Cameron Jackson (Lola), each led one of the first four laps of Sunday’s frenetic opener, in which they jockeyed for position relentlessly. Tarling, winner of five of the previous six rounds, believed he had engineered another 25-pointer when Jackson, lunging on the outside, tagged him at Brooklands on the last lap. Having been shuffled as low as sixth, poleman O’Brien gratefully shot past to grab his second round victory, although since he had scored in every round it would add but 11 points to his total.

Grant finished second ahead of Ed Thurston and Jackson. Tarling somehow salvaged sixth, which left him 16 points behind O’Brien – 220 to 236, having discarded Croft’s zero – with eight to drop in the decider as opposed to O’Brien’s 14. Grant, also on 220 and carrying forward eight to discount, was still in the hunt too if O’Brien faltered.

With a glorious rainbow over Cope but no rain, Tarling, O’Brien – apparently cruising confidently to the title – and Jackson exchanged the lead as Grant was frustrated by young Thurston’s apparent unwillingness to work together to catch them. There was to be no pot of gold at the end of the arc for O’Brien and Speedsport, however, for agonisingly a left-rear puncture torpedoed him. Once lower than fourth he could add no points and so he pitted disconsolately, leaving Tarling and Jackson to duke it out.

“The tow down the Wellington Straight was always going to be the decider,” said Tarling. “It was quite funny how Cameron wasn’t keen to lead out of Becketts on the final lap – and Callum

was closing.” Tarling threw caution to the wind to outfox Jackson as Brooklands presented his final opportunity, a seventh campaign win tipping the balance in his favour by a point. Second would have left him four shy of O’Brien...

Another finely crafted pair of class wins allowed Singer Chamois stalwart Steve Platts to deservedly snare the coveted Historic Touring Car crown with outgoing double champion Simon Benoy (Imp) as tail-gunner. Peter Hallford won both races and the K1 class title, but the Canadian found Alex Thistlethwayte, whose similar Ford Mustang led out of the blocks each time, no pushover. Rick Belcher (Lotus Cortina) split them briefly on Saturday before American horses told. Belcher finished third again on Sunday,

**Ex-hillclimber  
Goodyear landed  
a first circuit racing  
win in Formula Libre**





Tarling (53) was in the thick of the Historic FF1600 action



Hallford won both Historic Touring Car contests



Puncture forced O'Brien into the pits and out of the HSCC FF1600 title hunt

ahead of Jo Gomm's BMW 1800.

Restarted after Barry Davison's Lotus Elan was hit and erupted into a fireball at Becketts on the first lap, the HRS drama didn't end there. Points leader Peter Shaw was advantaged when fellow Elan pilot John Davison, Barry's son, spun his lead away at Brooklands. "Although I knew Dad was OK, my heart wasn't in it," he said. Shaw grappled with the Morgan Plus 8s of dad and lad Richard and resurgent title challenger Will Plant, who had arrived at Copse 10th from P2.

Davison screamed back into the equation, eventually splitting the Moggies. "I'm sorry that [taking maximum points meant] Peter didn't win the title, but [race winner] Will deserved it," said Davison. "We've run wheel to wheel all season and not touched." Richard Plant, in Kevin Kivlochan's 2015 winner [his old car] was a close third. Shad Eddin recovered from a poor start to win a splendid triple Ginetta G4 scrap, while Shaun Haddrell beat outgoing champ Dick Coffey in Turners.

Mark Woodhouse and Cameron Jackson doubled up in Historic Formula Junior, but both titles went to the wire. Following an extraordinary Elva-BMC 100 1-2-3 on Saturday, in which Justin Fleming (Lola-Ford Mk2) spun at Becketts but salvaged fourth behind Woodhouse, Nick Taylor and 18-year-old Charlie Besley – in father Crispian's

Elva – Taylor or Fleming could still wear the front-engined crown.

Taylor shot into the lead, but Woodhouse forged past into Becketts, only to outbrake himself and emerge fourth. Woodhouse jostled the Speed King car back to the front, leaving the title protagonists to fight it out. "I was conscious of not getting in their way," he said. Taylor ultimately prevailed over Fleming by 1.199s.

With Fleming now out of the UK championship running, Peter de la Roche (BMC Mk2) – beaten to Saturday's drum-braked honours by Michael Hibberd in Nick Grewal's ex-Mark Donohue Elva 300 – started Sunday's finale six points clear of Benn Tilley in Paul Smeeth's Lotus 22. Third on day one, behind the scrapping Cameron Jackson (ex-Jimmy Twisk Brabham BT2) and Andrew Hibberd (22), Tilley couldn't quite match them, then lost third to Silverstone maestro Sam Wilson (ex-Dave Charlton Lotus 20/22), who missed day one with a stomach bug.

De la Roche, chased in class by the evergreen Jim Blockley (Caravelle), thus earned the title after a fine campaign in the pencil-slim California-built chassis, with teenager Tilley runner-up. Crispian Besley (Cooper T56) twice beat Andy Harrison (Envoy) in Class C2.

Putting Zandvoort and Snetterton engine woes behind him, local hero Jon

Milicevic finished 0.074s behind Andrew Hibberd to nail the 1000cc Historic F3 title in Saturday's singleton race. Both were outgunned from the concurrent Historic Formula Libre section by ex-hillclimber Mark Goodyear, elated to land a maiden outright circuit win in the ex-Craig Hill Castrol Lotus 59 twin-cam. Star of the show was Danish karter Mads Gravsén, who qualified Chris Sharples's FFord Palliser second and finished fifth in strong company on his car debut.

Classic F3 champion Gaius Ghinn coolly won both legs of Sunday's finale in his Peter 'Zeus' Sneller-prepared Ralt-VW RT3, staying ahead of Toyota-powered British F3 veterans Richard Trott (Chevron B43) and Ian Flux (in Sean Walker's March 783) and spinner Cameron Jackson (ex-Oscar Larrauri Euroracing-Alfa Romeo 101) in the morning. Jackson harassed Ghinn in race two until his engine detonated, promoting Trott.

Debutant Tom Smith – impressing in Iain Rowley's March 793 – pounced for third when understeer hobbled Flux. The 2015 FF2000 champ was stunned to keep Ian Jacobs (ex-Carlos Abella Ralt RT3) behind after a mighty drive through the field, a front-suspension bolt having sheared on lap one of the opener. Having fought Jackson then before retiring, Pat Gormley's dash to sixth in the Safir RJO3 was another eyecatcher. Adrian Langridge >>>

(Dastle) won the 1600cc F3 title while Jon Finch was invincible in URS FF2000, beating fellow Van Diemen RF82 racer Chris Lord and Andrew Lancaster (Pilbeam MP52) respectively.

The Derek Bell Trophy race was the highlight of a gloomy Saturday, which started wet and in squally winds was revisited by drizzle. Leader Michael Lyons pitted his F5000 Eagle when its gear lever's spherical joint disintegrated, but a clonk with a hammer found a cog and – to marshals' amazement – the FIA Historic F1 champion masterfully unwound a lap's deficit, defying rain to thunder past Jamie Brashaw (F5000 March) within sight of the chequer. Brashaw harassed Lyons until his tyres faded on Sunday, lapping third-placed Neil Glover (F5000 Chevron B37), who started from the back after a hairy spin through Woodcote ended his Saturday run.

Double Historic FF2000 champ Andy Park (Reynard) was back having missed Snetterton, and showed Ian Pearson (Royale) and Benn Simms (Reynard) the way home again. A moment at Becketts trying to round Simms briefly dropped Park to fourth in the curtain closer. "That made it even more fun," he beamed.

Callum Grant put the Delta marque back on the podium with a superb second in race two. Runaway Class B champ Tom White missed qualifying but landed seventh and fifth.

Alan Cook was a new Classic Clubmans winner in his Charlie Mallock-prepared U2, diff failure having denied Mark Charteris a seasonal clean sweep. David Wale and early spinner John Harrison completed the top trio. B-Sport champion Clive Wood trumped predecessor Barry Webb among the FF1600-engined combatants.

The spectacle of the Schryver cousins (Will and James) and Charlie Allison in Chevron-BMWs hounding Simon Hadfield's Elva Mk7S in the early stages of Saturday's Guards Trophy race was tremendous. But it wasn't until Will's father Michael leapt into his ex-Peter Taggart B6 that its advantage grew decisively. A pit-speeding infringement cost James Schryver second, promoting Allison, and Mike Gardiner/Dan Cox (TVR Griffith) to third overall. The title had long fallen to John Davison (Elan 26R), who again dominated his class.

Runaway 70s Road Sports champion Charles Barter romped to victory in his faithful Datsun 240Z, his task eased when son Julian parked his Lotus Europa on lap one with electrical gremlins and Will Leverett's didn't start. Dan Pickett threaded his Morgan +8 to P2, with Richard Attwood breathing down his neck in the PCGB Porsche 928. "I wanted it to pour with rain," said the 1970 Le Mans winner. "I'd have got him then..."

**MARCUS PYE**



Park leads away the Historic FF2000 field en route to a double win



Barter claimed 70s Road Sports glory in his Datsun

**RESULTS**

**HISTORIC FORMULA FORD (BOTH 14 LAPS)**

**1 Michael O'Brien (Merlyn Mk20);** 2 Callum Grant (Merlyn Mk20) +0.842s; 3 Ed Thurston (Elden Mk8); 4 Cameron Jackson (Lola T200); 5 Sam Mitchell (Merlyn Mk20); 6 Richard Tarling (Jamun T2). **Class winner** Neil Shinner (Merlyn Mk20). **Fastest lap** Mitchell 1m03.985s (92.22mph). **Pole** O'Brien. **Starters** 36. **RACE 2 1 Tarling;** 2 Jackson +0.636s; 3 Grant; 4 Thurston; 5 Max Bartell (Merlyn Mk20); 6 Benn Tilley (Merlyn Mk20). **CW** Rob Smith (Merlyn Mk20). **FL** Jackson 1m04.046s (92.13mph). **P** O'Brien. **S** 33.

**HISTORIC TOURING CARS (BOTH 13 LAPS)**

**1 Peter Hallford (Ford Mustang);** 2 Alex Thistlethwayte (Ford Mustang) +4.583s; 3 Richard Belcher (Ford Lotus Cortina); 4 Jonathan Gomm (BMW 1800); 5 Jonathan Lewis (Mini Cooper S); 6 Philip House (Ford Lotus Cortina). **CW** Belcher; Lewis; House; Tom Bell (Mini Cooper S); Bob Bullen (Ford Anglia); David Hall (Ford Lotus Cortina); Steve Platts (Singer Chamois); John Marsden (Mini Cooper S). **FL** Hallford 1m09.409s (85.01mph). **P** Hallford. **S** 27. **RACE 2 1 Hallford;** 2 Thistlethwayte +2.328s; 3 Belcher; 4 Gomm; 5 James Clarke (Ford Lotus Cortina); 6 Lewis. **CW** Belcher; Clarke; Lewis; House; Hall; Dan Lewis (Mini

Cooper S); Platts; Marsden. **FL** Hallford 1m09.923s (84.38mph). **P** Hallford. **S** 26.

**HISTORIC ROAD SPORTS (22 LAPS)**

**1 William Plant (Morgan Plus 8);** 2 John Davison (Lotus Elan) +0.629s; 3 Richard Plant (Morgan Plus 8); 4 Peter Shaw (Lotus Elan); 5 Bruce Stapleton (Morgan Plus 8); 6 Larry Tucker (Ford Mustang). **CW** Davison; Shaun Haddrell (Turner Mk1); Jonathan Rushton (Morgan Plus 4); Nick Smith (MGB); Richard Owen (Triumph TR2); Paul Brown (MGB GT). **FL** W Plant 1m06.772s (88.37mph). **P** Davison. **S** 28.

**FORMULA JUNIOR FRONT-ENGINE (12 LAPS)**

**1 Mark Woodhouse (Elva 100);** 2 Nick Taylor (Elva 100) +4.257s; 3 Charlie Besley (Elva 100); 4 Justin Fleming (Lola Mk2); 5 John Chisholm (Gemini Mk2); 6 Ian Phillips (BMC Mk1). **CW** Graham Barron (Gemini Mk2); Tony Pearson (Bandini); Richard Utley (Caravelle Mk1). **FL** Woodhouse 1m10.237s (84.01mph). **P** Woodhouse. **S** 15. **RACE 2 (13 LAPS) 1 Woodhouse;** 2 Taylor +2.575s; 3 Fleming; 4 Besley; 5 William Grimshaw (Moorland Mk1); 6 Phillips. **CW** Barron; Utley. **FL** Woodhouse 1m10.053s (84.23mph). **P** Woodhouse. **S** 14.

**FORMULA JUNIOR REAR-ENGINE (BOTH 14 LAPS)**

**1 Cameron Jackson (Brabham BT2);** 2 Andrew Hibberd (Lotus 22) +0.238s; 3 Benn Tilley (Lotus 22); 4 Jack Woodhouse (Lotus 20/22);

5 Michael Hibberd (Elva 300); 6 Peter de la Roche (BMC Mk2). **CW** M Hibberd; Crispian Besley (Cooper T56); Clinton McCarthy (Lotus 18); Peter Williams (Brabham BT6). **FL** Jackson 1m04.440s (91.56mph). **P** Jackson. **S** 18.

**RACE 2 1 Jackson;** 2 A Hibberd +4.257s; 3 Sam Wilson (Lotus 20/22); 4 Tilley; 5 de la Roche; 6 Jim Blockley (Caravelle Mk2). **CW** de la Roche; Besley; McCarthy; Rudolf Ernst (PBA Mk2); Williams. **FL** Wilson 1m04.119s (92.02mph). **P** Jackson. **S** 20.

**HISTORIC F3/HISTORIC FORMULA LIBRE (19 LAPS)**

**1 Mark Goodyear (Lotus 59);** 2 Andrew Hibberd (Brabham BT18) +3.603s; 3 Jon Milicevic (Brabham BT21B); 4 Steve Smith (Chevron B15); 5 Mads Graven (Palliser WDF1); 6 Michael Scott (Brabham BT28). **CW** Hibberd. **FL** Goodyear 1m03.969s (92.24mph). **P** Milicevic. **S** 16.

**CLASSIC FORMULA 3/CLASSIC FF2000 (15 LAPS)**

**1 Gaius Ghinn (Ralt RT3);** 2 Richard Trott (Chevron B43) +0.788s; 3 Ian Flux (March 783); 4 Cameron Jackson (Euroracing 101); 5 Paul Smith (Ralt RT1); 6 Tom Smith (March 793). **CW** Jon Finch (Van Diemen RF82); Adrian Langridge (Dastle Mk10); David Mercer (Reynard SF78). **FL** Trott 59.895s (98.51mph). **P** Pat Gormley (Safir RJ03). **S** 27. **RACE 2 (19 LAPS) 1 Ghinn;** 2 Trott +3.740s; 3 T Smith;

4 Ian Jacobs (Ralt RT3); 5 Flux; 6 Gormley. **CW** Finch; Langridge; Mercer. **FL** Jacobs 59.582s (99.03mph). **P** Ghinn. **S** 27.

**DEREK BELL TROPHY (20 LAPS)**

**1 Michael Lyons (Eagle FA74);** 2 Jamie Brashaw (March 73A) +1.782s; 3 Mark Dwyer (March 742); 4 Dan Eagling (Chevron B29); 5 Michael Bletsoe-Brown (Chevron B27); 6 Steve Worrard (Chevron B49). **CW** Dwyer; Eagling; Adam Simmonds (Lola T142). **FL** Lyons 53.593s (110.10mph). **P** Lyons. **S** 12.

**RACE 2 (23 LAPS) 1 Lyons;** 2 Brashaw +5.841s; 3 Neil Glover (Chevron B37); 4 Dwyer; 5 Marc Mercer (March 73B); 6 Eagling. **CW** Dwyer; Mercer; Simmonds. **FL** Lyons 52.221s (112.99mph). **P** Lyons. **S** 13.

**HISTORIC FORMULA FORD 2000 (15 LAPS)**

**1 Andrew Park (Reynard SF81);** 2 Ian Pearson (Royale RP30) +3.769s; 3 Benn Simms (Reynard SF77); 4 Callum Grant (Delta T78); 5 Guy Sheppard (Reynard SF77); 6 David Walton (Royale RP27). **CW** Tom White (Osella FAF); John Stapleton (Tui BH2). **FL** Park 1m01.066s (96.62mph). **P** Park. **S** 29. **RACE 2 (10 LAPS) 1 Park;** 2 Simms +3.555s; 3 Grant; 4 Pearson; 5 White; 6 Matthew Dunne (Royale RP27). **CW** White. **FL** Park 1m01.349s (96.18mph). **P** Park. **S** 26.

**CLASSIC CLUBMANS (20 LAPS) 1 Alan Cook (Mallock Mk20/21B);** 2 David

Wale (Mallock Mk20/21) +1.262s; 3 John Harrison (Mallock Mk21); 4 Mike Lane (Mallock Mk18); 5 Spencer McCarthy (Mallock Mk20B/21); 6 Steve Chaplin (Phantom P79). **CW** Clive Wood (Mallock Mk20B); Roger Waite (Royale S2000M). **FL** Mark Charteris (Mallock Mk20/21) 57.912s (101.89mph). **P** Charteris. **S** 16.

**GUARDS TROPHY (36 LAPS)**

**1 Michael Schryver/Will Schryver (Chevron B6);** 2 Charles Allison (Chevron B8) +12.631s; 3 Mike Gardiner/Dan Cox (TVR Griffith); 4 John Spiers (TVR Griffith); 5 Philip Nelson (Chevron B8); 6 Simon Hadfield/James Hadfield (Elva Mk7S). **CW** Gardiner/Cox; Hadfield/Hadfield; Bob Brooks (Merlyn Mk6); Brian Casey (Lenham P69); John Davison (Lotus Elan); Andrew Hayden (Austin-Healey 3000); Tim Jacobsen (MGB); Peter Illingworth (MGB). **FL** James Schryver (Chevron B8) 1m03.394s (93.07mph). **P** J Schryver. **S** 28.

**70S ROAD SPORTS (22 LAPS)**

**1 Charles Barter (Datsun 240Z);** 2 Daniel Pickett (Morgan Plus 8) +26.110s; 3 Richard Attwood (Porsche 928); 4 David Karaskas (TVR 3000M); 5 Mark Bennett (MGB); 6 David Hall (Vauxhall Firenza). **CW** Pickett; Hall; Steve Skipworth (Lotus Europa); Neil Brown (Lotus Eclat); Chris Fisher (MG Arkley). **FL** Barter 1m09.793s (84.54mph). **P** Barter. **S** 31.





# Club racing at its very best at season's end

By Marcus Pye, the voice of club racing

[@autosport](#)

**I DON'T HAVE TO THINK BACK TOO FAR TO WARMER** days at Silverstone, but would be hard pressed to name a more exciting and action-packed club meeting than last weekend's HSCC Championship Finals.

The short National circuit, with four major corners plus ballsy high-speed Maggotts and Woodcote sweepers, may not top many drivers' list of favourites, yet often provides magnificent sport simply because there are so few variables to sort aces from also-rans. Racecraft, and luck, play their part too in larger fields and, as widely predicted, the Historic Formula Ford races were scintillating, and slipstreaming onlookers were treated to a spectacle.

Despite having won seven races to Michael O'Brien's two and third-placed Callum Grant's three, Richard Tarling only squeaked the Pre-1972 title by a point in the class's sensational 50th anniversary season.

It was worthy of comparison with the hallowed 1000cc F3 screamers at the height of the 1964-70 era. Closely matched machines, quick in a straight line but with limited cornering grip, are great to watch.

The orange army at trackside – the all-important marshals who staunchly man their posts from dawn to the last chequered flag – have long been the best barometers of quality. When the racing is likely to be top-drawer stuff, clean and fast, their turnout is always strongest. The loyal HSCC troupe was still bubbling about Michael Lyons obliterating a lap's deficit – following a pitstop to address gear-linkage issues – in Saturday's soggy Derek Bell Trophy aboard a ferocious Formula 5000 Eagle-Chevrolet FA74.

The Becketts marshals' training was evident when they dealt brilliantly with a major blaze on lap one of the Historic Road Sports race. "I saw somebody spinning in front of me and tightened my line," explained Barry Davison, the tail of whose Lotus Elan was subsequently torn off.

Its foam-filled alloy safety tank ruptured as it was ejected by impact from Andy Shepherd's Lotus 7. Fortunately Davison was out of the intact cockpit very rapidly. "You're dead right I was – I thought my arse was on fire," he said, but his truncated car was worryingly hidden by the flames for a few seconds and the pall of smoke could be seen from Woodcote.

This Saturday, Silverstone's Historic Grand Prix Circuit will again be the scene of the 750 Motor Club's Birkett Six Hour Relay contest, which many competitors rate number one in their calendars. A capacity entry of 70 teams of up to six drivers is subscribed to the annual beano – originated at the Northamptonshire venue in 1950 – and more have regrettably been turned away, according to organiser-in-chief Giles Groombridge. BRDC member Ross Hyett will bring Group C-era Le Mans experience to the fray in a Sports 2000 Tiga.

Among the widest range of machinery for some years are three Radical-equipped teams chasing scratch honours, Sakers, the Hart Attacks Clubmans squad and others spanning the club's portfolio of championships and marques seeking handicap glory. Two 750 Formula equipes are listed, Peter Bove's a contender for name of the year with Five Straights and a Tranny reflecting the layout of their 1108cc Fiat engines.

Knowing that the race guarantees great entertainment, a healthy posse of marshals will be on duty. 🍷



## US WINS FOR THORNTON AND KUBOTA

Lotus racers Greg Thornton (91-5) and Katsu Kubota (78-4) won the Masters USA's Historic F1 US GP support races at Austin's Circuit of the Americas last weekend. Saturday victor Thornton spun in Sunday's wet leg, which the Japanese won. Mike Cantillon (Tyrrell 010) took second twice, closing his deficit to Kubota.



## NOVICE SHINES IN PALLISER WDF1

Danish car debutant Mads Gravsen, 18, nephew of Chris Sharples, stunned HSCC regulars by qualifying Sharples's Formula Ford Palliser WDF1 second in the wet for Saturday's Formula Libre race at Silverstone. When the X30 karter finished fifth, Sharples also stood down from Sunday's HFF final, where Gravsen went from 33rd to 13th.



## KING COBRA DUO DEFENDS FIA TITLE

Keith Ahlers and Billy Bellinger (Cooper-Ford T61M King Cobra) successfully defended their FIA Masters Historic Sportscar Championship title – with an eighth second-class victory – against Andy Wolfe/Graham Wilson (Lola-Chevrolet T70 Spyder) in Sunday's Estoril finale. Wolfe/Wilson finished fourth on the road.



# Bentley breaks status quo

Parfitt and Morris rocked all over the world. Well, the UK anyway

By Rob Ladbrook, Special Contributor

🐦 @LaddersMN

JAKOB EBREY

Considering it's been around since 2013, Bentley's Continental GT3 took a fair chunk of time to finally hit the top on home turf to join a long list of home-grown manufacturers to celebrate a British GT Championship title.

A development year for the M-Sport-developed car in 2013 was troubled; 2014 was just a bit-part campaign, and then the focus shifted to Europe. Bentley was strong everywhere aside from its own back yard, until the trio of Seb Morris, Rick Parfitt Jr and Stuart Parker came along.

They returned the Crewe brand to British GT for 2016 and showed glimpses of Bentley's potential in year one. Parker is more versed in running championship-winning Porsches, while Morris had just joined from GP3, and Parfitt from Ginetta. All three factors needed to learn and gel, and this year they solidified into something special.

"I think the biggest difference this year was just familiarity," says Parker. "The first year we were learning everything: new car, new data, new drivers and engineers. This year it all felt like progression, instead of starting again. We knew base set-ups for the car for each track, and that meant we had a good platform everywhere we went and could improve the areas we needed to."

The Continental still required some work to become a consistent winner, but the biggest improvement came from

its drivers. Morris eliminated the mistakes that afflicted his campaign in 2016 and now looks like a well-rounded GT driver, showing pace, consistency and an enhanced team spirit. He played a key role in bringing on Parfitt's performance, which ultimately proved the differentiator this year.

"I felt like I drove better this year than I ever have, I've had the season of my life," said Parfitt. "Seb worked with me a lot, and I learned a load from him. But this year was still a real battle."

Parfitt's performances were more impressive when you consider the demons he had to beat. The loss of his father – Status Quo legend Rick Parfitt Sr – on Christmas Eve 2016 brought heartbreak, and the stress of his private life caused multiple flare-ups of his debilitating Crohn's disease. Parfitt would often be doubled up in pain before races, but somehow always managed to strap himself in and get the job done.

When asked how he managed it, his usual reply was: "I just had to block it out and get on with it. My engineer even once said to me, 'You drive better when you're feeling shit!' Which I guess is a compliment!"

Team Parker worked hard to improve the Bentley's consistency during races. The car has always suffered from a lack of traction, meaning stop-start circuits such as Snetterton have always been its Achilles' Heel, so the team instead focused on making the car more consistent on longer runs. That made the Bentley a weapon in the endurance rounds that score one-and-a-half-times points. This became the mainstay of Bentley's challenge.



Aston Martin took one-two in final race at Donington



Sprint races were the Huracan's forte

Minshaw's spin early in the Donington finale sealed their fate, and effectively handed Team Parker the title.

Both the second Lamborghini and Bentley dropped out of the title picture relatively early. The Huracan of British Touring Car convert Sam Tordoff and Liam Griffin struggled against the vast experience in the sister car, though Tordoff acquitted himself well in his first year of GT racing and could be a star of the future given more seat time.

The Bentley of Callum MacLeod and Ian Loggie suffered dire luck, with a few punctures and the odd crash in Loggie's hands. But MacLeod was rapid when he did get out and the pair's win at Spa shows their potential for a strong future together.

Having won the previous two drivers' titles, Aston Martin endured a difficult season. The two TF Sport cars suffered differing fortunes, but did finish the year with a flourish.

Reigning champions Jonny Adam and Derek Johnston slumped badly mid-year, which cost them a chance to defend their title. Johnston retired from round two at Rockingham after clouting a kerb too hard, which caused a chassis defect that held the car back for much of the rest of the year. It led to unpredictable handling, switching from oversteer to understeer at will. The team switched chassis for Spa and improved, then Adam/Johnston won the Donington finale in their fully repaired car. Jon Barnes/Mark Farmer lost their way a little with set-up as they diverged from the number one car's settings, but when things were sorted for Donington they came so close to another win as TF's one-two showed what could have been.

The MacMillan AMR team, running the all-Silver pairing of Jack Mitchell and James Littlejohn, was another interesting factor. They often starred in qualifying but couldn't overcome the weight and pitstop penalties to snatch an overall win before funding issues forced the team out before the final round.

Considering the fears over the future of GT3 this time last year, the class endured well, courting entries into the low-teens at most rounds. Teams are already reporting increased interest ahead of next season, which will be crucial in ensuring the category's survival against the rapidly growing GT4 division.



Morris and Parfitt seized the title

## “I felt like I drove better this year than I ever have, I’ve had the season of my life”

Parfitt and Morris won three of the four longer events, which ultimately tipped the fight in their favour. Parfitt's stints were often so good that they almost made Morris's half look comfortable. But while the Bentley's strength lay in the longer races, if the championship had been decided on single-hour rounds alone, then Barwell Motorsport's Phil Keen and Jon Minshaw would have been untouchable.

Keen and Minshaw started the year in stellar form in their Lamborghini Huracan with three wins from the first four rounds and looked the odds-on title favourites. The Huracan's change to a wider front wheel forced Barwell into a heap of extra testing to try to find a comfortable balance with the car, since the additional grip at the front caused oversteer and made it notoriously tricky for amateur drivers.

The change wasn't particularly noticeable in the shorter stints, but Minshaw did struggle on longer runs as the car became more of a handful, often losing too much ground to Parfitt for Keen to recover once he had climbed aboard.

### 2017 BRITISH GT3 POINTS

DRIVERS	CAR	POINTS	WINS
Seb Morris/Rick Parfitt	Bentley Continental	200	3 wins
Phil Keen/Jon Minshaw	Lamborghini Huracan	167	4 wins
Jonny Adam/Derek Johnston	Aston Martin Vantage	150.5	2 wins
Jon Barnes/Mark Farmer	Aston Martin Vantage	135.5	
Sam Tordoff/Liam Griffin	Lamborghini Huracan	134	

\* Callum MacLeod and Ian Loggie (Bentley Continental) also won



## BRITISH GT4

THEY SEEM TO GET YOUNGER EVERY year, don't they? Just when you thought a combined age just shy of 36 was verging on the unbeatable, along come William Tregurtha and Stuart Middleton (whose combined age reached 35 in October) to blow the history books into the weeds.

The pair were arch rivals in the Ginetta Junior Championship last year – Tregurtha took the title while Middleton secured second – but this season opted to combine their talents and team up in British GT4 in the Leeds company's venerable G55 GT4.

Two drivers new to senior GT racing were also run by a team brand new to this area of the sport. Charlie Kemp's HHC Motorsport concern was too busy winning BRDC Formula 4 titles to bother with GT4 in the past. But this year it made a change of direction.

The recipe simply shouldn't have worked. The drivers should have shown far too much youthful exuberance to succeed in their first year of GT racing, and HHC should have fallen down on technical knowledge while learning the car and running against the established

GT4 category attracted a healthy grid once again

GT4 teams. The reality was that none of that happened. Instead the trio dominated almost from start to finish.

Tregurtha and Middleton took to GT4 with extraordinary aplomb, and were often indistinguishable in the car. Their lap times would sit within a tenth of each other, they liked the same feelings from the car, and they were almost the same height and weight. They were essentially the dream GT4 pairing.

"We knew we were on to a winner with the two drivers," says Kemp. "Watching them race against each other in Juniors you could tell they were more mature than most, and ready to make the step. We recruited well engineering-wise so, while this incarnation of HHC was new to British GT, the guys behind it weren't.

"But the surprising thing is we only did three test days all year. Will and Stuart had never been around Silverstone GP, Spa or Donington GP before this year. That made their achievements all the more remarkable."

A podium in the season opener at Oulton Park showed promise, but their first win at Rockingham rammed home their title credentials. The duo took pole in the combined time before scampering off to win by almost 10 seconds. The pair took turns in running the first stint in races, and often stayed out until the end of the window to take advantage of the clear track space.

Another win at Snetterton gave them a boost, but that weekend also nearly spelled disaster as Tregurtha crashed out of the second race. That issue was compounded by a non-finish in the Silverstone 500 after an early driveshaft

## TOP 5 PRO DRIVERS



**1 PHIL KEEN**  
Barwell Motorsport  
Lamborghini  
Huracan GT3

What more does Keen need to do to win this championship? His pace aboard the Huracan was often staggering. Every time he went out, he lit up the timesheets. Barwell needed a superstar driver after losing Alexander Sims for this year, and Keen filled that void.



**2 JOE OSBORNE**  
Tolman Motorsport  
McLaren 570S GT4

Dropping back to GT4 for this year, Osborne got more from a McLaren than anyone. His lap times were exceptional, and team-mate David Pattison has improved massively under his tutelage. With better luck – and more durable tyres – they'd have been in the title hunt.



**3 WILL TREGURTHA/  
STUART MIDDLETON**  
HHC Motorsport  
Ginetta G55 GT4

They're the same in the car, so they're the same here. Both GT4 newcomers were superb all year. They would trade fastest laps and showed amazing consistency. That's two British titles in two years for Tregurtha too, who boasts a strike rate of 30 top-five finishes in 33 races.

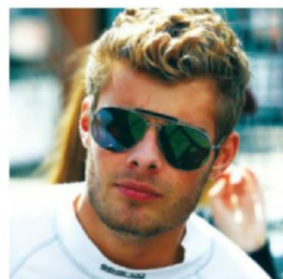

**4 SEB MORRIS**  
Team Parker Racing  
Bentley Continental  
GT3

Fourth may seem harsh, but that's only because of the two stand-out GT4 performers; he's safely second in the GT3 rankings. Super-consistent and removed the mistakes of 2016. Another year like this and expect to see him up there in European GTs.

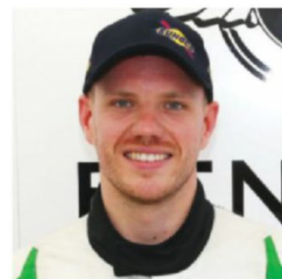

**5 CALLUM MACLEOD**  
Team Parker Racing  
Bentley Continental  
GT3

Flew under the radar a fair bit this year, purely because of bad luck befalling his side of the garage, but check the timesheets and you'll see his pace. Was often the fastest Bentley driver this year, when the car was running and he was able to get in it, that is.

failure. Regardless, the pair kept their heads and finished on the podium in each of the last four races, once on the top step, to secure the title.

In a year when GT4 dramatically changed shape with an influx of new McLaren 570S GT4s, it was a familiar brand that held sway, as Alex Reed and David Pittard proved to be the biggest obstacle to HHC's young steamroller. The pair's Lanan G55 so nearly made it a one-two in the championship for Ginetta, but lost out in a dramatic final round after their luck turned sour mid-year.

Reed was due to share with Joey Foster, until business commitments forced Foster out and Pittard slotted in at late notice. The pair won at Oulton and took top points in race one at Spa, but were nerfed off by an errant guest GT3 entry in race two. Following that they were forced out of Brands Hatch with steering failure and retired from Donington after Reed was caught in a freak accident with the malfunctioning Academy Aston Martin.

Reigning GT4 champions Graham Johnson and Mike Robinson secured runner-up spot. They started the year in a Ginetta with Optimum, but swapped to



New McLarens changed the racing dynamic

a McLaren after three races and grew in pace as they learned the car. Their win in the finale was dominant and shows promise for next season.

The Tolman Motorsport McLaren set the pace for the Woking contingent. Joe Osborne was often exceptional, and David Pattison put in some great performances too. A series of punctures hurt their results, and a braking issue put Osborne off in the finale. Without those problems the car was often the fastest in the field and would have been in the title hunt.

The Garage 59 McLaren of Sandy Mitchell and Ciaran Haggerty had an indifferent year. The pair looked title favourites early on but lost points too often. A retirement from the Oulton opener with a wheel problem hurt, and being stripped of victory in race two for an incorrect pitstop time compounded that. The pair did recover to win at Snetterton, but that's as good as it got. The car was excluded from Spa when Haggerty and Middleton tangled after the chequered flag and a costly crash at Brands Hatch spelled an early end for Haggerty's year.

The Track Club McLaren of Adams Balon and Mackay was rapid, winning twice – including the Silverstone 500 showpiece – but fell down on reliability toward the end of the year. Macmillan's Aston Martin improved over the year with Jan Jonck and Will Phillips at the wheel, and took a fine win at Brands, just before the team was forced out and Phillips jumped ship to an In2 McLaren to try to keep his bid for third in the championship alive. He fell short, and finished his second GT4 season in fifth.

## “We knew we were on to a winner with the two drivers”



### 2017 BRITISH GT4 POINTS

DRIVERS	CAR	POINTS	WINS
Stuart Middleton/ Will Tregurtha	Ginetta G55	185	2 wins
Mike Robinson/ Graham Johnson	Ginetta G55/ McLaren 570S	135	1 win
David Pittard/Alex Reed	Ginetta G55	133	1 win
Adam Mackay/Adam Balon	McLaren 570S	112.5	2 wins
William Phillips	Aston Martin Vantage/ McLaren 570S	101.5	1 win

\* Charlie Fagg/Matthew Graham (Maserati GT MC, two wins) and Ciaran Haggerty/Sandy Mitchell (McLaren 570S) also scored victories

## TOP 5 AM DRIVERS



**1 RICK PARFITT JR**  
Team Parker Racing  
Bentley Continental GT3

This time last year we got a text: “Dude, why didn’t I make the top five?” Quickly followed by: “Sorry, just realised. Made too many mistakes. Ignore me.” There was no ignoring him this year. British GT is won and lost on the Am drivers. And he drove like a Pro. Class act.

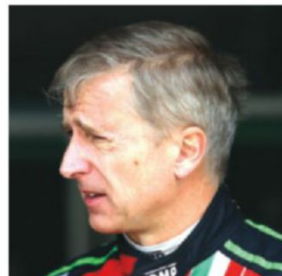

**2 JON MINSHAW**  
Barwell Motorsport  
Lamborghini  
Huracan GT3

Another year, another last-round heartbreak for Minshaw. Forget the spin in the finale – he had to push since it was his only chance of stealing the title. Gave it his all this year and his form at the start was supreme. Let’s hope he has another go next season.



**3 ALEX REED**  
Lanan Racing  
Ginetta G55 GT4

You have to feel sorry for Lanan. If not for a bungling one-off GT3 entry whacking them at Spa, Reed and Pittard may well have been champions. That kick-started a run of bad luck. But Reed always put in solid performances, and had a great bond with Pittard.

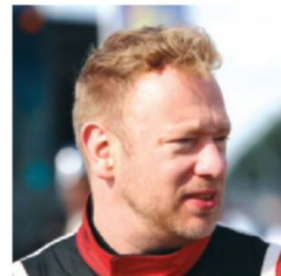

**4 GRAHAM JOHNSON**  
Optimum Motorsport  
McLaren 570S GT4

“See, told you I’d get back to outqualifying the kids before the end of the year,” he beamed at Donington. The move to McLaren essentially sacrificed this year’s championship, but Johnson is a great example of an Am driver working hard to catch, and beat, the Pros.



**5 MARK FARMER**  
TF Sport  
Aston Martin  
Vantage GT3

He’s come a long way in his two years in British GT and probably should have won more races this year. Farmer and Jon Barnes are turning into a fine partnership for TF. Farmer had the slight edge over last year’s champion Derek Johnston for much of the year.

# WHAT'S ON

JACQUES VILLENEUVE'S  
PRIVATE PARADISE

## When driver hobbies go bad

IT MUST BE TERRIBLE TO BE A Formula 1 driver. A weekend-heavy schedule and a winter off-season (arranged around training schedules and media obligations, of course) means that many drivers need other pastimes.

Some stick to the motorsport bubble, setting up karting schools or racing in winter categories, while others eschew the day job and opt to try new things. Famously, renowned mountain-botherer Ukyo Katayama scaled Everest, while Jarno Trulli took to viticulture in his native Abruzzo region of Italy. Lewis Hamilton has enjoyed cursory flirtations with the music business, but he's not the first world champion to do so. Just over 10 years ago, 1997 champion Jacques Villeneuve revealed his own debut album.

In 2007, *Private Paradise* was released to little fanfare; although Villeneuve's outspoken critique of F1 always attracts a lot of attention, his music career failed to gain similar media traction. Was that a consequence of poor promotion, or were reviewers sparing his blushes? Perhaps, then, it's time to revisit his

magnum opus, on which he provides lead vocals and guitar.

Quite fittingly, the opening track is called *Foolin' Around*, and starts with a jangling acoustic guitar which wouldn't be out of place in a university bar. Then Jacques opens his mouth. It becomes apparent very early that he isn't the most technically gifted singer around, uncertainly wrapping his French-Canadian accent around his own lyrics. These days Jacques's forthright public pronouncements are prone to upsetting a just few people, but his singing has

Villeneuve in contemplation during Silverstone F1 testing in 1999

*The Accepterais-tu* single used to promote *Private Paradise* a year before its release



the potential to upset the vast majority.

*You Are* has a little more energy, but it's a bland, mumsy Jamie Cullum-esque composition. Then, again, Jacques opens his mouth, and later bequeaths a misguided attempt at falsetto.

If you get past the opening two tracks then you'll be offered some brief respite, as Jacques's sister Melanie picks up lead-vocal duties on *Father*, a tribute to Gilles. Thankfully, Melanie isn't too bad, and although her diction behind the microphone is a little muddled, her voice has a reasonably soothing quality atop a mournful soundscape — soft guitar and delicately tickled piano. But then, halfway through, Jacques opens his mouth.

The compositions themselves aren't the worst ever conceived, but *Private Paradise* offers little deviation from the acoustic-vocals-chords formula. That's not to say that Jacques isn't afraid to experiment, and *The Ones* and *Vaguement* probably offer the greatest level of intrigue. *The Ones* sounds like an early Snow Patrol demo, pairing wheezy guitar effects with a perky

**READ  
AUTOSPORT  
ON THE  
MOVE**

**DOWNLOAD IT  
NOW FROM**

 autosport.com



## HOT ON THE WEB THIS WEEK

 **YouTube** **CROSSING THE LINE IN TEXAS**

**Search for Verstappen's Last-Lap Pass Of Raikkonen: All The Angles**

A chance to examine the evidence in the wake of the Max Verstappen US GP brouhaha. As always, there's entertainment to be had below the line, including the theory that the penalty was levied to prevent a 'minor' from consuming alcohol...



## INTERNATIONAL MOTORSPORT

### MEXICAN GRAND PRIX FORMULA 1 WORLD CHAMPIONSHIP

**Rd 18/20**  
Mexico City, Mexico  
**October 29**  
**TV Live** Sky Sports F1, Sunday 1830. Radio BBC Radio 5 Live, Sunday 1830. Highlights Channel 4, Sunday 2230

### PORSCHE SUPERCUP

**Rd 8/8**  
Mexico City, Mexico  
**October 28-29**  
**TV Live** Eurosport 2, Saturday 1500. Highlights Eurosport 1, Sunday 1030

### WORLD TOURING CAR CHAMPIONSHIP

**Rd 8/10**  
Motegi, Japan  
**October 29**  
**TV Live** Eurosport 1, Sunday 0445

### FORMULA RENAULT EUROCUP

**Rd 10/10**  
Barcelona, Spain  
**October 28-29**  
**TV Live** BT Sport 3, Saturday 1115. BT Sport 2, Sunday 0915. BT Sport ESPN, Sunday 1430

### EUROFORMULA OPEN

**Rd 8/8**  
Barcelona, Spain  
**October 28-29**  
**TV Live** BT Sport ESPN, Saturday 1345, Sunday 1200

### INTERNATIONAL GT OPEN

**Rd 7/7**  
Barcelona, Spain  
**October 28-29**  
**TV Live** BT Sport ESPN, Saturday 1445, Sunday 1300

### NASCAR CUP

**Rd 33/36**  
Martinsville, Virginia, USA  
**October 29**  
**TV Live** Premier Sports, Sunday 1830

### ASIAN LE MANS SERIES

**Rd 1/4**  
Zhuhai, China  
**October 29**

### MOTOGP

**Rd 17/18**  
Sepang, Malaysia  
**October 29**  
**TV Live** BT Sport 2, Sunday 0645

## UK MOTORSPORT

### WORLD RALLY CHAMPIONSHIP

**Rd 12/13**  
Rally GB  
October 26-29  
**TV Live** BT Sport 2, Saturday 1200. BT Sport 3, Sunday 0900, 1200. Red Bull TV, Saturday 1150.

Highlights Motorsport.tv, Friday, Saturday and Sunday 2235

### OULTON PARK MSVR

**October 28**  
Trackday Championship, Trackday Trophy, F3 Cup, VAG Trophy

### SILVERSTONE 750MC

**October 28**  
Birkett Six-Hour Relay

### MONDELLO PARK MPSC

**October 28**  
Fiesta Endurance Race

### BRANDS HATCH MSVR

**October 28-29**  
FF1600, Allcomers, SsangYongs, Single-Seaters, Formula Vee, Victor Meldrew Trophy

drum pattern. Melanie is back, albeit with a more saccharine quality than before, and the vocal treatments appear to have stripped back the rawness from *Father*. Then Jacques opens his mouth.

*Vaguement* is perhaps Jacques's attempt to channel a range of continental French chanteurs, but without success. If his singing isn't already a frustrating factor in English, he repeats the feat in French.

The cookie-cutter nature of each song, and Villeneuve's less-than-adequate vocals, contribute to a hugely forgettable album, one best reserved for the bargain bin. Low points include *Accepterais-tu*, which Jacques used as teaser material before the album's launch (if this was the song used to pull people in, it's not hard to see why it flopped), while *Lullaby*, in a twist of Alanis Morissette-grade irony, is simply nightmarish.

Perhaps Jacques's stab at creating an album is a metaphor for his own racing career. It all seems to be going OK, and then he opens his mouth.

JAKE BOXALL-LEGGE

## NEXT WEEK

**ON SALE THURSDAY**



**➔ MEXICAN GRAND PRIX**  
All the reaction from F1's visit to the Autodromo Hermanos Rodriguez

CAMP



COURTAULDS

Marlboro  
HONDA

2

Shell





## FROM THE ARCHIVE

An impressively grubby Gerhard Berger (McLaren-Honda MP4/7A) leads Benetton-Ford B192 drivers Martin Brundle and Michael Schumacher in the 1992 Hungarian Grand Prix. Berger finished third; Nigel Mansell (Williams-Renault FW14B) was second, clinching the world championship in the process; and the race was won by Berger's teammate Ayrton Senna.

[www.mcklein.de](http://www.mcklein.de)  
[@mcklein\\_rally](https://twitter.com/mcklein_rally)



# MATTHEW WILSON

## BENTLEY GT3 BOSS HEADS BACK TO HIS RALLYING ROOTS

**M**atthew Wilson fits very well into the young racing driver mould. He's young, good-looking, skinny and quick. His sunnies are usually found buried in an expensive-looking hairdo and he goes places in an Audi RS6. He may not have got muddy much in recent years, but he hasn't forgotten how to rally.

Malcolm Wilson's son started his career on the track, when he took the 2002 T Cars title. A year on and Wilson was outgunned by his Formula Renault team-mate – a certain Lewis Hamilton, so we'll forgive him that. But rallying was where it was at; like father, like son.

Wilson Jr dived into the British Rally Championship in 2005, where he became the youngest event winner when he scored a Trackrod Rally victory aged 18 and eight months. That victory was particularly impressive given that it came just months after he bounced his Ford Focus RS WRC into the trees at Gartheiniog and shattered his left knee.

Unperturbed and with a long-term deal with Stobart, Wilson embarked on six years in the WRC, scoring seventh in the standings for three consecutive seasons between 2009 and '11.

But at the end of 2011 it was time for a new challenge and Wilson became the race team manager for M-Sport's Bentley GT3 campaign. "The Bentley project was perfect," says Wilson, who guided M-Sport to this season's Blancpain Endurance title. "I must admit, at the time I was feeling a bit sorry for myself and if this had been a rally programme I'd have forever been looking at the drivers, thinking, 'I could do that'. Racing was different – another world."

But now he's back in his old world and will contest this week's Wales Rally GB in a Ford Fiesta R5 with Stuart Loudon. "I can't wait," he says with a big grin. "I've done a bit of testing and Stu and I finished second on the Pirelli Rally last year, but I'm really looking forward to this."

Wilson's return to the stages means not talking about them for once – he joined Red Bull TV as co-presenter for its WRC coverage this year. But he won't miss that: "It's one thing talking about it, but quite another to be behind the wheel and between the trees!"

DAVID EVANS

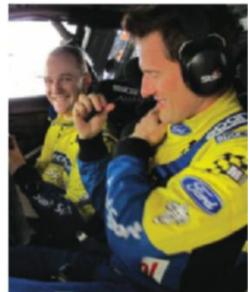

- Age** 30
- 2016** 2nd, Pirelli International
- 2014** Starts running Bentley team
- 2013** Works on Bentley GT development
- 2012-'14** Occasional WRC starts
- 2009-'11** Stobart M-Sport WRT 7th in WRC
- 2008** Stobart M-Sport WRT 10th in WRC
- 2007** Stobart M-Sport WRT 11th in WRC
- 2006** Stobart M-Sport WRT 28th in WRC
- 2004** WRC debut at Rally GB



Autosport Media UK Ltd, 1 Eton Street, Richmond, TW9 1AG  
**Tel** +44 (0) 20 3405 8100 **Email** autosport@autosport.com  
**Individual email** firstname.surname@motorsport.com  
**Website** www.autosport.com **Twitter** @autosport

### Editorial

Editor **Kevin Turner**  
 Deputy Editor **Marcus Simmons**  
 Grand Prix Editor **Ben Anderson**  
 F1 Correspondent **Lawrence Barretto**  
 Assistant Editor **Alex Kalinauckas**  
 Chief Sub-Editor **Peter Hodges**  
 Executive Editor **Stuart Codling**  
 Group National Editor **Jack Benyon**  
 Rallies Editor **David Evans**  
 BTCC Correspondent **Matt James**  
 Art Editor **Lydney Elliott**  
 Senior Designer **Michael Cavalli**  
 Office Manager **Joanne Grove**

### Autosport.com

Editor **Glenn Freeman**  
 Deputy Editor **Matt Beer**  
 Autosport Plus Editor **Scott Mitchell**  
 International Editor **Jack Cozens**  
 Social Media Editor **Fatema Chowdhury**  
 Technical Team Leader **Geoff Creighton**  
 Head of UX and Digital Design **Amar Vijay**



### Photography

Steven Tee  
 Glenn Dunbar  
 Sam Bloxham  
 Zack Mauger

### Special Contributors

Gary Anderson  
 Alan Eldridge  
 Tom Errington  
 Rob Ladbroke  
 Stephen Lickorish  
 Stefan Mackley  
 David Malsher  
 Marcus Pye  
 Dieter Rencken  
 Nigel Roebuck  
 Caroline Stammers  
 Jim Utter  
 Gary Watkins

### Correspondents

**Argentina** Tony Watson **Australia** Phil Branagan **Austria** Gerhard Kuntschik **Belgium** Gordon McKay **Brazil** Lito Cavalcanti **Finland** Esa Illoinen **Germany** Rene de Boer **Greece** Dimitris Papadopoulos **Italy** Roberto Chinchero **Japan** Jiro Takahashi **New Zealand** Bernard Carpinter **Russia** Gregory Golyshev **Spain** Raimon Duran **Sweden** Tege Tornvall **USA** Bruce Martin, Jeremy Shaw **UK & Ireland** Pete Allen, Lee Bonham, Stephen Brunsdon, Jonathan Crawford, Dom D'Angelillo, Kerry Dunlop, Charlie Eustice, Joe Hudson, Jake Jones, Samarth Kanal, Matt Kew, Mark Libbeter, Stefan Mackley, Dan Mason, Damian Meaden, Lucy Morson, Will Moulton, James Newbold, Jason Noble, Mark Paulson, Brian Phillips, Graham Read, Hal Ridge, Peter Scherer, Ian Sowman, Chris Stevens, Oliver Timson, Ian Titchmarsh, Eddie Walder, Rob Watts, Richard Young

### Advertising

**Tel** +44 (0) 20 3405 8106 **Email** autosport.ads@motorsport.com  
 Sales Manager **James Robinson**  
 Display Advertising **Don Rupal, Karen Reilly, Jamie Brooker**  
 Classified Advertising **Fran Hall, Ben Kavanagh**  
 Autosport.com Sales Manager **Fiona Bain**  
 Online Advertising **Chris Hermitage**  
 Sales Director **Matthew Witham**

### Advertising Production

Senior Production Controller **Abbey Gunner**  
**Tel** +44 (0) 20 3405 8131 **Email** abbey.gunner@motorsport.com

### Subscriptions

**UK** +44 (0) 344 848 8817 **Overseas** +44 (0) 1604 251451  
**Email** help@asm.secureorder.co.uk **Back issues** 0344 8488817  
**Laura Paterson** +44 (0) 20 3405 8129

Autosport, ISSN number 0269946X, is published weekly by Autosport Media UK Ltd, 1 Eton Street, Richmond, TW9 1AG, United Kingdom. Airfreight and mailing in the USA by agent named Air Business Ltd, c/o Worldnet Shipping Inc., 156-15, 146th Avenue, 2nd Floor, Jamaica, NY 11434, USA. Periodicals postage paid at Jamaica NY 11431. Subscription records are maintained at Autosport Media UK Ltd, 1 Eton Street, Richmond, TW9 1AG. Air Business Ltd is acting as our mailing agent.



### CIRCULATION TRADE ENQUIRIES

Seymour Distribution Ltd, 2 East Poultry Avenue, London, EC1A 9PT.  
**Tel:** +44 (0) 20 7429 4000.  
 Printed by William Gibbons & Sons Ltd, 28 Planetary Road, Willenhall, Wolverhampton WV13 3XT.  
 ISSN 0269-946X. Autosport is published weekly by Autosport Media UK Ltd, 1 Eton Street, Richmond, TW9 1AG.

### ©2017, AUTOSPORT MEDIA UK LTD

Trading as Autosport Media UK. Publishing, trade and further subscription details on www.autosport.com. While due care is taken to ensure the contents of Autosport are accurate, the publishers and printers cannot accept liability for errors and omissions. Advertisements are accepted for publication in Autosport only upon Autosport Media UK's Standard Terms of Acceptance of Advertising, which are available from the Advertising Department.



## Flexible Travel Options

Travel the World with our Escorted Tours and UK Travel Team



### ALL FORMULA ONE EVENTS

Join me for our F1 Escorted Tours; by Air - Coach options

◇ Winter & In Season Testing ◇ Team Factory Visit

2018 Book Now All Formula One Grand Prix

Extended Holiday options; China, Canada, Singapore, Japan, US Austin, Mexico



### US GP ROAD TRIPS

Vegas, Route 66  
Monument Valley  
Grand Canyon

NASA Space Centre  
New Orleans, Memphis  
Nashville, Indianapolis

### COMBINED TOURS

Monaco Historic with  
Mille Miglia

F1 France + Austria  
F1 Germany + Hungary  
F1 Belgium + Italy  
F1 US Austin + Mexico

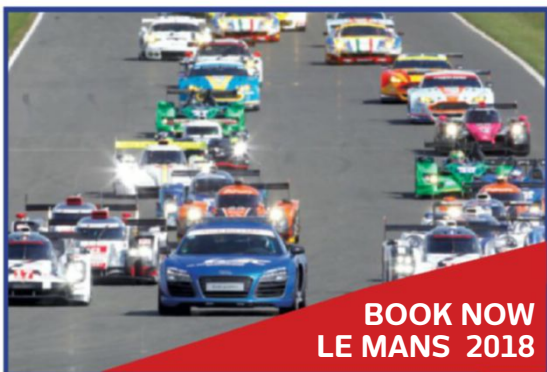

### LE MANS 24HR - WEC - ENDURANCE RACING

LE MANS 24HR  
15 Coach Tour options  
Self Drive | By Air | Train with Camping or Hotel

BLANCPAIN: Monza | Spa 24HR | Barcelona

WEC 6HR SPA | Silverstone

### HISTORIC MOTORSPORT RACING EVENTS

- ◇ MONACO HISTORIQUE
- ◇ MILLE MIGLIA
- ◇ LE MANS CLASSIC
- ◇ GOODWOOD FESTIVAL OF SPEED
- ◇ GOODWOOD REVIVAL



**UK TRAVEL TEAM: +44 (0) 1451 833 721**

**BOOK ONLINE: [enquiry@selectmotorracing.com](mailto:enquiry@selectmotorracing.com)**



We have made some dramatic improvements recently to help you find those **vital seconds or tenths**, or just to really enjoy your race driving, or launching A NEW car. In an incredibly beautiful environment, nature's best, our enthusiasm is contagious! and our service is second to none.



Our new VIP complex is 650M<sup>2</sup> and includes 10 new garages all with air con, heating, wide electric doors, flat floor set up areas, engineers offices, VIP toilet & shower changing area, temporary sleeping rest areas, even a clothes washing machine, fridges for cold drinks, coffee machine, large screen TV etc. All constructed with the finest "up to date" insulating materials, also allowing excellent natural light.

Also a new catering event area to seat up to 100 persons with a superb view of the circuit and pit lane.  
**Now more UK flights to Granada airport now means only 35mins travel time to the circuit.**



For further information contact: Clive Greenhalgh **0034 660329070**

Email: [clive@guadixcircuit.com](mailto:clive@guadixcircuit.com) • [www.guadixcircuit.com](http://www.guadixcircuit.com)

[www.facebook.com/circuitoguadix](http://www.facebook.com/circuitoguadix)

To view 500 photos, including a full set of track photos, in car video link [www.flickr.com/photos/guadixcircuit-direct-photos/](http://www.flickr.com/photos/guadixcircuit-direct-photos/)  
**SITUATED IN SOUTHERN SPAIN NEXT TO GRANADA**

 **AUTOSPORT**

# RALLY GB PREVIEW

## CAN THE BRITS STOP OGIER?



**IS THIS THE  
GREATEST  
WRC SEASON?**

**McRAE'S  
FINAL HOME  
VICTORY**

**ESSENTIAL  
GUIDE TO ALL  
THE STAGES**

## Temporary Car Insurance

- ✓ For Cars and Vans
- ✓ From 1 day to 1 month
- ✓ Aged 19 to 75



### Why would I need it?

- ▶ Test drive a car
- ▶ Borrow a van to move house
- ▶ Drive a friend's car in an emergency

### Where to find us!

- ▶ [dayinsure.com](http://dayinsure.com)
- ▶ @Dayinsure
- ▶



SPONSORS OF THE WALES RALLY GB 2017





Meeke leads strong British and Irish attack

**REALITY DOESN'T OFTEN OVER-DELIVER ON HYPE.**

But it has with this year's World Rally Championship. For much of last season, we talked about the eagerly awaited 2017-specification World Rally Cars and the spectacle they would provide; the past 11 rallies have provided ample proof that this particular pudding hadn't been over-egged.

And now it's the UK's turn. From Casino Square to Scandinavia, through Europe's east and west and America's north and south, via a spot of Mediterranean island hopping, and we're here: Rally GB. And the stage – and stages – is set for a sensational four days of competition.

What's more, for the first time since 2009, our round of the WRC looks well set to decide the direction of one, if not two, of the titles. British firm M-Sport comes home on the cusp of a first manufacturers' crown in 10 years, while its #1 Ford Fiesta WRC driver Sebastien Ogier is looking to clinch a fifth straight season-long success in Llandudno on Sunday afternoon.

Before then, there's close to 200 miles of flat-out driving to do through some of the world's finest forest stages. In the coming pages, we'll guide you through where to go and what to look out for when you get there.

In terms of drivers, the championship fight's a three-way affair, with Ogier 37 points ahead of his team-mate Ott Tanak and Hyundai's Thierry Neuville one point behind the Estonian. Tanak and Neuville need to win if they're to stand any chance of denying the French master.

But if they want to win, they're going to have to get the better of the strongest British and Irish contingent since the Colin McRae and Richard Burns years. Kris Meeke, Elfyn Evans and Craig Breen all arrive on Deeside with cars that have won this year and the desire to deliver in front of what will be considerable home support.

Talking of spectators, the organisers have reported a significant hike in advance ticket sales – little wonder with the fastest rally cars ever on offer – and are recommending fans arrive as early as possible in the car parks.

And when you get stage-side, stay safe, listen to the marshals and make sure you enjoy this new world of ours.



*David Evans*

**DAVID EVANS**  
RALLIES EDITOR

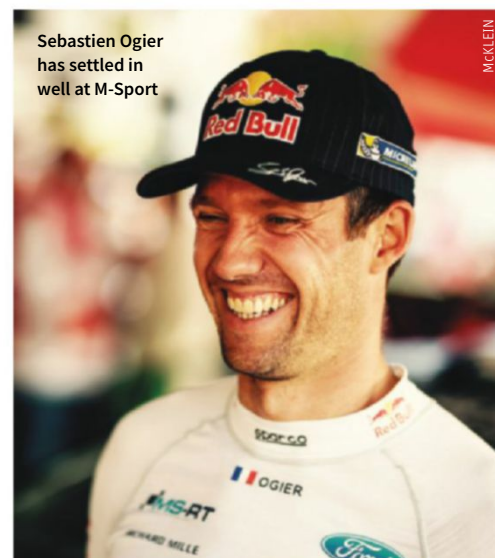

Sebastien Ogier has settled in well at M-Sport

**4 OGIER'S NEW HOME**

Some thought Sebastien Ogier would struggle without Volkswagen, but the champion is happy at M-Sport

**10 MEEKE AND EVANS**

Both Kris Meeke and Elfyn Evans have had tough seasons, but they are aiming for the top at home

**16 DEBATE: IS THIS THE WRC'S BEST SEASON?**

Colin Clark, the voice of the WRC, and our own David Evans disagree on when rallying was at its best

**20 TEAM BY TEAM**

Our runners-and-riders guide on who to look out for on the Welsh stages this week

**24 HOME HERO'S LAST WIN**

We recall Colin McRae's 1997 victory for Subaru against up-and-coming Brit Richard Burns

**28 NATIONAL RALLY**

A bumper National entry has been attracted to Rally GB this year. We look at the changes and likely stars

**30 ARCHIVE**

Rally GB has a rich history, so we've delved into the archive to pick out one of LAT's best shots

**33 ESSENTIAL INFO**

Our guide to this year's stages, timetable information, and where to watch if you can't make it to Wales



Colin McRae's last Rally GB win came in '97

# OGIER'S NEW HOME

FOR THE FIRST TIME SINCE HE STARTED WINNING WORLD CHAMPIONSHIPS, SEBASTIEN OGIER WILL ARRIVE AT RALLY GB WITHOUT HAVING ALREADY SEALED THE TITLE. BUT THE FOUR-TIME WORLD CHAMPION HAS NO REGRETS ABOUT SIGNING FOR M-SPORT AFTER VOLKSWAGEN'S WITHDRAWAL FROM RALLYING

BY **DAVID EVANS** PHOTOGRAPHY **McKLEIN**



A silver Ford Mondeo pulls off the road and looks entirely ill-at-ease in its surroundings. This mud-flecked motorway cruiser doesn't really do a gravel set-up, but it's served its purpose. Sebastien Ogier has learned the road. Julien Ingrassia has made his notes. The pair step out of the car in search of a Ford with an M-Sport badge. One that was made to deal with dirt.

As the championship leader shuts the door on the Mondeo, he shields his eyes. It's sunny and he wasn't expecting that. "It's beautiful," he says. "This place, the weather, it's beautiful."

It's hard to argue. Larches dotted through the woods have started to do the autumn thing and a sea of green is turning multicoloured. Nature's wont is forgotten when the quiet of this absolute middle-of-nowhere is broken by the ever so slightly lazy turnover of something deep inside a trailer. It catches and the noise starts.

Ogier disappears into a big blue command truck – M-Sport's test unit. Darkened windows hide walls lined with laptops logging every millimetre of wheelspin and degree of slip. Ogier's team-mate Ott Tanak was running yesterday and he's keen to familiarise himself with the Estonian's progress before he sets off on road number two.

These are important days for Ogier and for M-Sport. The settings signed off in the next 48 hours could help or hinder the delivery of two world titles. "It would mean so much to

do it here," says Ogier quietly, digging his hands deep into his jacket pockets. The sun might be bright, but it's still low. It's not quite eight in the morning yet.

'It' is the title double: one for Ogier, one for M-Sport. Here, is Wales; Bala, to be precise, in the woods above the lake. This is day two of M-Sport's Rally GB test and day one for Ogier. This is the time to dig deep; this is the time where world championships are made. Ten hours of suspension changes, diff tweaks and roll bar revisions will precede a lengthy debrief and reprep for the next day of running. "This is quite a big test," says Ogier. "We came out of Spain and it's important to get back with the muddy feeling – feeling for the lower grip we have on these roads." Ogier checks himself before he adds: "We all know we have an important target to reach in GB."

For the first time since 2012, Ogier is testing for Britain's round of the world championship without already having the title in his pocket. "In the past," he says, "I liked the fact I arrived more relaxed because the championship was done. This event, it's a difficult one. I took a few years to learn about GB. When I first came, I had some fear with this event. You have to face the hard weather – the fog, the bad visibility, the really heavy rain. Honestly, this one can be very tricky and you have to really make the right set-up, you have to make the car right. But I've learned a little bit over the years and now I'm feeling a bit more comfortable here."

Comfortable? That's one way of describing

the feeling that has delivered four years of domination on the mid- and north-Wales roads. Comfortable is also a fine adjective for Ogier's position at M-Sport. There were those who couldn't see this Anglo-French alliance coming off. But Ogier was never one of them.

Once the shock of Volkswagen's withdrawal announcement had subsided, the four-time world champion was faced with a straight choice between M-Sport's Ford Fiesta WRC or Toyota's Yaris WRC. He tested both, and knew straight away: he was heading north, just not to Finland's far north.

"At the time last year, the main thing was for me to defend my title," he says. "That was all that mattered to me. I tried both cars and I could immediately see the potential with the Fiesta. I thought they would need more time with the Toyota. The long-term budget was there to do things right and they should be able to become a strong team. But short-term, my priority was the title and this season we have proved that we have a real chance to do that. Toyota will not be world champion, that is sure for this season. So, from that side, we made the right decision."

One thing that rankles with any driver who takes titles with just one team is the suggestion that it could be machine rather than man making the difference. This year has offered Ogier the chance to do something his former Citroen team-mate and nine-time world champion Sebastien Loeb never did: silence those suggestions. ▶





Red Bull

Red Bull

Red Bull

**DOMINATION  
IS IN OUR DNA.**



**ARE YOU DRIVER ENOUGH?™**

**THE OFFICIAL TYRE CONQUEROR OF THE DAKAR RALLY**

It doesn't matter when – or where.  
Earn the title 'Driver Enough' when you drive on our tyres.

**#DriverEnough** [BFGoodrich.co.uk](http://BFGoodrich.co.uk)



**“I WAS LOOKING FORWARD  
TO WORKING WITH MALCOLM AND  
I HAVE NOT BEEN DISAPPOINTED.  
HE IS VERY PASSIONATE  
IN HIS WORK”**

Driving for a private team is a refreshing change for Ogier, who appreciates being part of Wilson's M-Sport "family" (below)

Ogier considers that point and adds: "I remember last year when the decision was coming for my future and some of my rivals were saying, 'I hope he goes to M-Sport', because they were pretty sure I would not be able to defend my title in this way. If we do it, this would make me very happy. It would also close the mouth of some people who said we only made it in the easy conditions before."

No matter which way you cut it, VW's millions made life more straightforward. But Ogier brings more perspective. "There are plenty of examples of big companies with big budgets who have not made it in motorsport," he says. "I am proud of what we achieved with Volkswagen. I was involved from the very start, from the very first kilometres with the car, and I helped make it into a winning car."

But it wasn't always champagne and championships. Talk to those at VW about the months leading up to January 2013 and they'll tell you of a frantic time in Hannover. About last-minute engine modifications, suspension developments and transmission tweaks just weeks out from the Monte Carlo opener. Ogier was in the thick of a fight to make a potentially good car great. He played his part, made his luck, and built his winner.

The suggestion that he would be motivated solely by vast resources and the sort of material comforts that were second nature to the world's biggest carmaker is insulting to the integrity and character of the WRC's greatest fighter of his generation. Ogier is the ultimate competitor.

When he saw the same steel in team boss Malcolm Wilson, he knew M-Sport's Dovenby Hall was the place for him.

"I was looking forward to working with Malcolm and I have not been disappointed," says the 33-year-old. "He is a guy who is very passionate in his work and who does everything for the team. Jost [Capito, former VW Motorsport director] was the same, but with Malcolm it's different; it's more of a family in M-Sport. I really like this; I like to work with Malcolm and Elaine [Wilson's wife] – they both made things very easy. Immediately they did everything they could for Julien [Ingrassia, co-driver] and me."

M-Sport's status as a private team is refreshing for Ogier. The reduction in sponsor days and PR commitments couldn't have come at a better time. "That works for me," he says. "I have fewer obligations working here than



I did before. My life has changed; I've been a father for 16 months and I'm very happy to have more free time."

What hasn't changed for Ogier in all his years at the forefront of world rallying is his single-minded determination and refusal to look back. Some may wonder if he regrets his decision not to sign for Toyota after seeing the speed it found from the Yaris once this season was underway. Having tested the car, is there any regret when he sees results like Jari-Matti Latvala's Rally Sweden win or Esapekka Lappi's storming success at home in Finland?

"When I tested, I don't think I drove the car they're using this year," says Ogier. "When you take a decision in life, look forward. It's never good to look behind and say, 'Shit, I should have done this differently'. Take the decision and make the best of it. I think there are times when we would say the [Toyota] is better than we expected, but I made the right choice."

Ogier's M-Sport decision also brought benefit to the sport in the shape of an upturn in Latvala's form and fortune. "Jari really is one of the good guys," says Ogier. "He's one of the drivers when [if] I'm not winning I'm going to say, 'OK, if it's not me then I'm happy it's him winning'. I heard a lot about the time when we were together at Volkswagen and I heard it was a big weight for him to have me there – it was more pressure. Now he's the team leader, maybe this has helped him to go to another level."

When Ogier arrived at M-Sport, it had the opposite effect on incumbent drivers ▶

# Dayinsure: Title Sponsor of the GB Round of the World Rally Championship 2017

dayinsure

**D**ayinsure is one of the UK's leading short-term car insurance firms, who offer immediate cover for a variety of vehicles on a temporary basis.



the 1980s when it was known as the 'RAC Rally', so sometimes I still have to pinch myself when I see it being called the 'Dayinsure Wales Rally GB'. However, on top of my personal history, another reason we're involved is because

Working within this industry also means that the team at Dayinsure take a keen interest in all-things motoring. This interest and expertise however goes beyond their day-to-day work, as they are also the proud title sponsor of the GB round of the World Rally Championship. The firm had previously sponsored the WRC back in 2016 and have continued this partnership into this year's round.

it's also held near our base in Tarporley near Chester. We also know that many of our customers, advocates and go-to people for car advice are also big fans of the event.

Dayinsure Chairman, Dennis Ryan, offered his thoughts on the sponsorship and explained a little more about why Dayinsure chose to get involved in this important date on the British motorsports calendar: 'I'm a motoring man and a true petrol head at heart, so when people ask me why Dayinsure became the title sponsor of the GB round of the World Rally Championship, the answer is simple; it was impossible not to.'

As well as this, I'm proud to say that this sponsorship has brought national and international recognition for the brand. Ultimately, in life I follow the belief that you should always look for 'win-wins', and to me, being able to sponsor an event I love, while at the same time getting the name Dayinsure out there, certainly falls into this category.'

I have a passion for Rally and I've followed this particular event since

The Dayinsure Wales Rally GB, is the 12th and last stage in the European leg of the WRC and this year promises to be the most exciting and thrilling in the event's history. This means that as well as Mr Ryan, everyone from diehard petrol heads, to those getting their first taste of what Rally has to offer are sure to enjoy an experience they won't forget.



Left: Ben Taylor (Managing Director of Dayinsure Wales Rally GB) Middle: Dennis Ryan (Chairman of Dayinsure) Right: Ken Skates (Welsh Government Economy Secretary)

# EVERYONE LOVES THAT FAST CAR SMELL.



**NOW ANYTIME CAN BE GO-TIME.**

K&N® high-flow air filters are designed to increase horsepower with up to 50% more airflow. And with five-minute installation, better performance doesn't get much easier. Order yours online today.

KNFILTERS.COM



SUPERIOR AIRFLOW. SUPERIOR PERFORMANCE.™

Ott Tänak and Elfyn Evans. But the Cockerthorpe team has evolved and the upturn in form of Ogier's junior team-mates is more than coincidental.

Ogier has brought genuinely hard-learned experience – his professional career has been both bitter and sweet. In that order. His departure from Citroen at the end of 2011 was as acrimonious as his rule at VW was harmonious, happy and ultimately devastatingly successful.

"I learned a lot from my time at Citroen," he says. "I have to never forget this [time with Loeb] pulled me in the right direction. But it's no secret that there was a lot of politics and this became too much for me. From this experience, I did all I could do to never see this again. I didn't like to be number two in the team, and I promised myself I will never want to be in this position to be number one – because I never want my team-mate to feel [they're number two]."

"If you want to really enjoy and feel that you are the best inside, you have to know you have done it the right way. It's been really nice for me to discover Ott and Elfyn this year. We have no secrets in the team – everything is shared for the set-up. I like this. When you leave the service park and you are alone in the car, then you are the rival, but at the other times, we work together."

His battle with Loeb and subsequent regulatory scraps with the FIA and some of his colleagues have made Ogier one of the more outspoken drivers in the service park. He sees nothing wrong with having a voice:



"When it's too flat, for sure it's boring. We live in a world where there is a tendency to be more and more flat, but it's important for us to show character, to have an opinion and not [for drivers] just to say what they have been told to say."

Ogier's arrival in Britain without the title already won is testament to the increased competition this season. Suggestions that he's lost some of the motivation or drive he's had in previous years are, to the man himself, laughable.

"The approach is the same," he says. "There has been less domination and there were fewer wins earlier in the year, but in the 11 rallies we have done so far, I think we've been on the podium eight times. OK, sometimes we have not had the pace or the performance we might have wanted, but I have still tried

to be clever and make the points."

Ogier's continued presence in the championship comes courtesy of a change in attitude from the FIA. Forcing the championship leader to run first on the road for the first two days enraged him in recent seasons, but restricting that policy to WRC Fridays is one he's firmly in favour of.

"It was very unfair and it was hard to live with that rule," he says. "Even now, on some rallies, when I come to the recce and I see the conditions, I have to fight very hard mentally not to give up immediately."

He won't be giving up in Wales this week. Certainly not when, in contradiction of the season's other gravel rallies, running at the front will be favourable. One more win in Wales would mean one more title.

But the time for talking is up and the time for testing has returned. The question of 'what next?' remains unanswered, partly by design: Ogier is fed up with talking about the talk. He has offers, and one of those is the option to stay at home with wife Andrea and son Tim. Maybe a fifth title in something other than a Polo would be a good time to depart, at the height of his powers.

Like he says, winning this year would silence the doubters. But the simple acknowledgment of these non-believers could be interpreted by some as insecurity. You could also think of it as further demonstration that Ogier is a thoroughly decent bloke. Competitive, hard, firm, fair, but ultimately fast. Very, very fast. ■

**"WE HAVE NO SECRETS IN THE TEAM. I LIKE THIS. WHEN YOU LEAVE THE SERVICE PARK, THEN YOU ARE THE RIVAL, BUT AT THE OTHER TIMES WE WORK TOGETHER"**



Stint at VW (top) delivered four world championships, but Ogier now wants to silence critics by winning the title in a different car

# CLARK, MCRAE,



# BURNS...



KRIS MEEKE AND ELFYN EVANS WILL  
BE VYING TO BECOME THE FOURTH  
HOME-GROWN WINNER OF BRITAIN'S  
WORLD RALLY CHAMPIONSHIP ROUND.  
BUT CAN THEY PERFORM?

BY DAVID EVANS PHOTOGRAPHY MCKLEIN

**T**his was it. For McRae and Burns, read Meeke and Evans. The start of the year, two Brits in the box seats, and we were back to the good old days of the World Rally Championship. Let the wins roll in.

Wins? There have been two of them, both taken by Meeke, although Evans was within a second of his maiden victory in Argentina.

But there's also been the odd rock and the odd roll from Citroën driver Meeke. Not to mention the occasional hard place for M-Sport's Evans. In short, Brit-watching so far this year has been a roller coaster, from the highest of highs to Meeke being dropped for Poland, from second in Finland to nowhere in Spain for Evans. But for Meeke, Spain brought redemption – and that second win.

And now to Wales. Home for Evans; home-ish for Meeke. And some refuge from what, at times, has been a brutal season.

"Coming to Wales off the back of a win in Spain is great," says Meeke. "It's good for the confidence, for me, for Paul [Nagle, co-driver] and the whole team. There's no denying this has been a hard year and that last result was very welcome. Listen, I've made too many mistakes this year and we've had some issues with the car, but none of those is insurmountable. A lot's been made of this whole technical side of the car, but fundamentally we have a good car that needs some work and refining in a few areas."

For Evans, the reverse is the case. There's no denying the pedigree and pace of M-Sport's Ford Fiesta WRC. It's the car that's won the most rallies this season and it's the car that looks set to land the Cumbrian team its first world title in 10 years in Wales this week.

"There's no doubting the ability of this car," says Evans. "It's fantastic – we've seen that all year."

As has been the case for much of the season, you sense a 'but' coming at the end of most sentences from the outgoing British Rally champion. And that sentence ends with a question-mark centred on the four corners of his Fiesta: the DMACK tyres.

Evans is far too professional to be caught pointing the finger, but you only have to look at the consistency of his inconsistency. That may sound odd, but in specific conditions Evans is miles away, and in another set of conditions he's bang on the pace. Take the season-opener in Monte Carlo as a case in point. Day one brought zero grip on the ice and he struggled to break into the top 10 times. Fast-forward 24 hours to the end of the bone-dry Breziers stage and it was a different story: Evans had just clocked his third scratch of the day's five stages and he was flying. This rally was Evans's year in microcosm.

DMACK decided to bring in a new-compound and construction gravel tyre for the final three rallies of the season. ▶

# STOP STONE CHIPS

WITH XPEL

NEW 10.2 MIL ULTIMATE XT!

INCREASED DURABILITY FOR TOUGHER CLIMATES

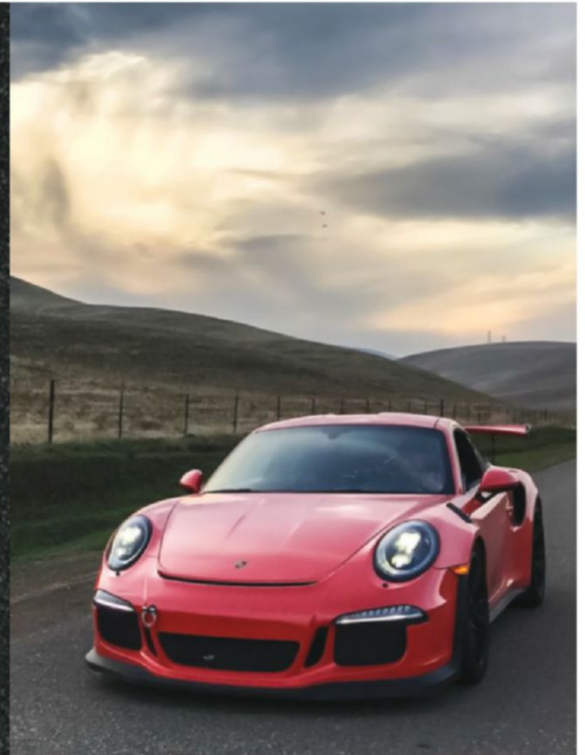

GET PROTECTED AT  
**XPEL.COM**

TO FIND AN INSTALLER NEAR YOU

**XPEL**  
PROTECTIVE FILMS

**stilo**

RACING SERVICE

## WALES RALLY GB

Service Park Support

On location at:

**Deeside Service Park**

Wednesday 25th & Thursday 26th

### Rally supplies on site:

- Stilo Helmets & Electronics
- Racewear
- Rally Essentials



**NG**

nickygrist.com

Free delivery for pre-orders

Contact Us:

INFO@NICKYGRIST.COM

**01981 241040**







**“WHEN YOU SEE THE  
HOME SUPPORT IN WALES,  
IT DEFINITELY GIVES YOU A LIFT.  
THE ATMOSPHERE IS AMAZING.  
YOU FEEL IT”**

Evans flew to  
second place  
in Finland

In reality, the new boots were aimed squarely at Rally GB; the soft is that bit softer than the Michelin, and the pattern that bit more open. If it's wet, wet, wet in Wales, this could make the difference. But if the surface cleans on a dry second run, there's a good chance the blocks will start to move – and a lack of precision on some of these super-quick stages is the last thing a driver wants.

“Let's wait and see what the weather does,” says Evans. “I think it's fair to say our chances are pretty dependant on the weather. But still, it's home and that's a really nice feeling. I've got to be honest, it is pretty surreal at times to be driving the same World Rally Car so close to my house. The week after the event, I'll be coming down the same road to go and buy a loaf of bread or something!”

Twelve months ago, Evans spent his home round of the championship on the sidelines after being dropped from M-Sport's frontline team for 2016.

“The weather played an important role in my decision on last year's Rally GB,” he says, “but that decision was whether or not to go out and spectate! I did go and watch. I actually worked as one of the weather crews, feeding information back to the team about temperatures and road conditions, that kind of thing – but I can honestly say, missing last year's [Rally GB] was one of the hardest parts of my career.”

The Irish Sea may be in the way of Meeke and his home in Northern Ireland, but he'll still feel the warmth of the welcome in Wales this week.

“I've always said the same: coming to Wales does feel like home to me,” he says. “I competed in Wales a lot in my early career; my first event was there and I love the roads, the conditions, the fans and the atmosphere. There's something special there and coming into Wales off the back of the win gives us a lift, that's for sure. But at the same time we have to remember nothing has changed overnight. There's still work to do and, like Elfyn said, we'll be pretty reliant on the weather.”

The nature of the roads on Britain's round of the world championship is such that, if it's a typically damp autumn (the kind already underpinned by a typically damp summer), they will offer the best grip at the front of the field. Twelve-hundred kilos of World Rally Car thundering down the stage tends to stir the surface, soften it and bring the mud to the top. Five or six cars in and the edge has definitely gone. Evans is sixth down the road on day one, Meeke ninth.

“When you come out and see the home support in Wales, it definitely gives you a lift,” says Meeke. “When we come through Irish Corner in Dyfnant it's incredible to see the fireworks – the atmosphere is amazing, really amazing. You feel it. And that can raise your level again. But after that corner, you're away

and into a dark forest again and you have to contain everything. As soon as you start overdriving, you start losing time. You start to slide wide, you push harder, you slide wider. It's a vicious circle.”

Evans agrees and adds: “GB and the RAC before it had this reputation for being the sort of rally where you took it by the scruff of the neck and forced the car down the road and really pushed as hard as it would go. You can't do that. Now it's the same as every rally: you have to be technically perfect in the way you drive.”

That probably doesn't sound very exciting. Don't worry, it will be.

“Oh, it will be,” says Evans. “These new cars are incredible. They're more spectacular, noisier, better to look at and so enjoyable to drive for us. And, from the reception they've had around the world so far this season, they're pretty special to watch out on the stages.”

Neither Meeke nor Evans is interested in dwelling on what might have been this season. Both are in superb form ahead of this week's penultimate round of the season. Meeke brushes aside concerns that his pre-event test took place in France and not Wales, pointing out that there's an area of south-west France that is very similar to the rolling hills of mid-Wales. He's learned that certain things – usually budget-related – aren't going to change and fighting against them ▶

**TAKE YOUR TEAM TO THE TOP!**

# MOTORSPORT MASTER

**DOWNLOAD IT NOW**  
**FREE GAME**



[www.motorsportgaming.com](http://www.motorsportgaming.com)



[www.motorsportnetwork.com](http://www.motorsportnetwork.com)

© 2017 MOTORSPORT NETWORK. All rights reserved.



Above: Meeke crashed out of Argentina – a rally that Evans came so close to winning. Right: Evans came a cropper in Sardinia, and Meeke was forced to miss the next round after he rolled out while leading



is nothing but a waste of energy.

Meeke will push this week, make no mistake about it. He'll leave nothing in the locker, but at the same time he knows where his and the car's limits are, and risking everything for a corner of glory is not what he's about. It's bigger-picture time, and that bigger picture is about further refining the C3 WRC in changeable conditions. In Poland this year – with weather similar to what we can expect in Wales – the Citroen was shocking. There have been improvements since then. But this isn't about eureka moments.

"We know where we are," says Meeke quietly. "We know where we're strong and where we need to work. Just because this is Wales, it doesn't change anything. If everything comes together we've seen the car can be quick – let's just see what we get this week."

So speaks the man who's been through the wringer this season. Meeke remains at the forefront of Citroen's plans next year, and he's well aware that miles and experience on a new car's first outing at an event are just as important as stage wins and outright glory.

For Evans, the position is slightly different. Not for him the pressures of leading a team. Instead, he's got the joker up his sleeve. Statistically, he's got the best car out there under him and, if the stars align, he could have a peach of a tyre as well.

So, forget the trials and tribulations of the season so far. Focus on Wales this week. The Brits are back and they're heading in the right direction. ■

## BREEN'S UNFINISHED BUSINESS

AS THE CROW FLIES THERE'S not really a lot in it, but Rally GB probably edges the Circuit of Ireland in terms of proximity to Craig Breen's home town of Waterford.

The Citroen star has now moved to Italy, but Wales will always have a place in Breen's heart after his Carmarthen co-driver Gareth Roberts died in their Targa Florio crash in 2012.

Roberts is never far from Breen's thoughts, as was evident from his arrival at the end of the first stage of last year's Rally GB. "I drove like an idiot in there," he said after pulling his DS 3 WRC to a halt at the end of Myherin. "Somebody up there was looking after me."

And smiling down on him. Driving like an idiot or not, he was fourth fastest.

Unfortunately, second time through that stage he rolled and retired. This time he wants to finish the job. "That

was so frustrating last year," he says. "It's not ideal going back to Wales having not driven the car competitively since Germany, and not on the gravel since Finland at the end of July, but I'm just so happy to have this chance."

And, let's face it, it's a whole lot more ideal than turning up in that terrible Peugeot 208 T16 he ran in 2015. Or with the radio mic he had in his hand working as a WRC Live reporter the year before. "Yeah," he smiles. "Put it that way and it's not a bad job, is it..."

Third in Finland last year demonstrated Breen's prodigious pace, and this year has shown his ability to play to the strengths of the car beneath him. He may not have won this season, but he remains Citroen's biggest points scorer, even though he's competed on one event fewer than Meeke. Six fifth places this season demonstrate consistency

and patience – even if that patience has worn thin at times.

His quote about being "petrified" of the car in Poland remains at the forefront of many minds. And a repeat of that changeable weather and fluctuating grip levels will test the post-summer development of the C3 WRC.

For Breen, as for his English co-driver Scott Martin, coming to Wales is always a pleasure. "It's funny," he says, "I suppose it is closer from where I grew up to the stages in Wales than it would be to the Circuit – so it's like a home event. Especially with all the support we get from fans travelling over for the event.

"And I won the [WRC] Academy in 2011 and SWRC [Super 2000 World Rally Championship] the following year on this rally. You don't forget those kind of results."

And you certainly don't forget a co-driver like Roberts.

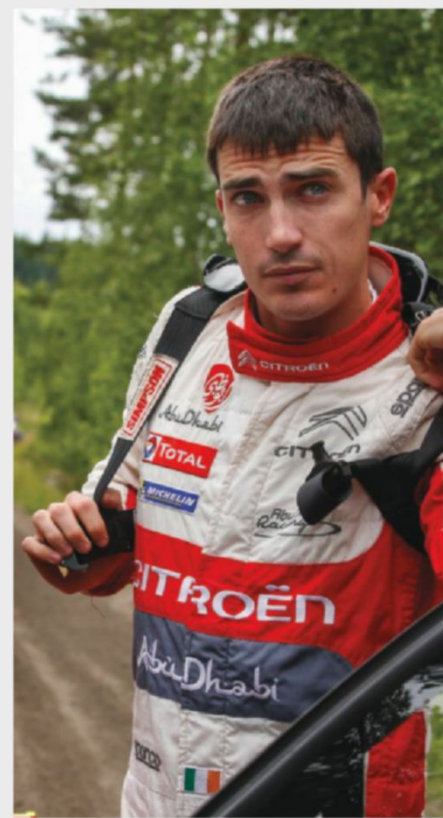

# DEBATE

## IS THIS THE BEST WORLD RALLY CHAMPIONSHIP SEASON EVER?

BY **COLIN CLARK AND DAVID EVANS** PHOTOGRAPHY **MCKLEIN**



**YES**

COLIN CLARK  
VOICE OF THE WRC

I DON'T KNOW WHY WE'RE EVEN HAVING THIS debate. This is, by some margin, the best season in the history of the world championship. Maybe you should just think back to last year – or even the year before – when the rule changes were first talked about and we heard about more power, bigger aerodynamics on lighter cars. Remember that? From that moment the anticipation started to build and it just didn't stop. All the way through those incredible videos of the Polo, that was the first car up and running. Then Citroen's #Test1, M-Sport's mule car and, of course, the Yaris.

Our world came alive last year and has gone from strength to strength this season. The first four rallies brought four different winners in four different cars. Ahead of this week in Wales, we've had six different winners. Doesn't that tell you something about just how competitive this year is?

But it's not just about the competition, it's about the passion and the support that has returned to the championship. I've been in the sport a while now, but talking to the folk who have been in it for a lot longer than me, they've haven't seen fans in the sort of numbers we've seen this year since the mid-1980s and the days of Group B. But the big difference this year is that, thanks to the superb work from the FIA, we've got cars that are spectacular and as safe as we can hope. That safety aspect adds further weight to the fact that this is the best year yet.



**NO**

DAVID EVANS  
RALLIES EDITOR

I CAN'T AND WON'T TRY TO ARGUE ON THE SAFETY point; I agree completely we are night-and-day safer than we were 30 years ago. You'd kind of hope so. But, I'm afraid, on pretty much every other aspect, Colin, you're wrong.

It's easy to get caught up in the emotion of this season. Yes, it's great that we've got these fancy new cars that go faster and make lots of noise, but that doesn't make this the best season in the sport's history. If you want noise, I'd point you in the direction of an on-song Lancia Stratos or ask you to stand behind a Ford Escort BDA being launched off the line. Both make a better noise than today's cars. And that's without even mentioning a Metro 6R4...

And, before you go down the road of arguing about the speed, I agree these are the fastest rally cars in history. Again, speed contributes, but doesn't make a season great.

You've mentioned six winners in a season, and close competition and uncertainty of outcome is a big driver in making sport great. So how about considering some really close seasons? If we're talking numbers, six from 11 rallies this year is good, but the second year of the championship in 1974 is a bit better – try seven different winners in eight rallies. Sandro Munari was the man who took the two wins. And I'm afraid there was more variety in terms of makes as well, with Lancia winning three, Ford two, while Mitsubishi, Fiat and Renault shared a win apiece.

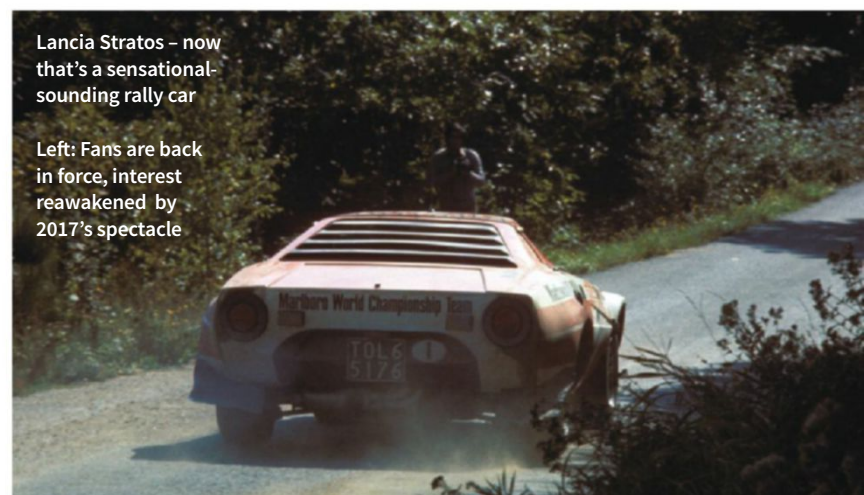

Lancia Stratos – now that's a sensational-sounding rally car

Left: Fans are back in force, interest reawakened by 2017's spectacle



Above: Muscle power: Ford, Toyota, Citroen and Hyundai hang tough



Left: Hyundai part of manufacturers' upturn in interest

**YES** Ah, Mr Evans, it's so easy to look back on the good old days with watery-eyed nostalgia and rose-tinted reminiscence. And you know what, I'm there with you – some of the time. But we're talking about the best-ever season in the history of the WRC here, and to definitively answer this one we have to put into context where we are and where we've come from.

## “THIS YEAR LOOKS LIKE SOMETHING OF A MIRACLE REBIRTH”

The halcyon days you so warmly remember and so brilliantly evoke blossomed during a period of massive investment from motor manufacturers. Monster, win-at-all-costs budgets were thrown into motorsport and into rallying in particular. Success was almost determined not by the swiftness of the motors, but by the witness of the accountant's pen.

Contrast this to where we are now. The WRC was in a dark place, a very dark place not long ago. Manufacturers were leaving in droves and, when Subaru pulled the plug at the end of 2008, we were left with only Ford and Citroen. The global financial crisis had taken hold, car sales began to tumble and motorsport budgets were slashed.

It was a period in which the very future of the championship was in doubt. Throw in having no promoter for the whole of the 2012 season, and you can see why this year looks like something of a miracle rebirth.

Not only are we seeing the most incredible competition on the stages, massively increased TV coverage, fans full of enthusiasm, but – perhaps most importantly for the long-term health of our sport – we are seeing manufacturers once again taking the sport seriously. We've rebuilt our credibility this season. And that, more than anything, is why this is the greatest season ever.

**NO** You're not wrong that we're in a better place than we were a decade ago and that this year has, quite possibly, seen the fastest growth in terms of television viewing figures or some such numbers, but is it the best? I'm afraid not.

You talk about context, but what would be much more helpful here would be some sort of measurables. It's impossible to compare media coverage from the 1970s with today's digital age. And the same goes for the quality: your very own kitchen-table videos are produced to a far higher quality than Dickie Davies could ever have hoped to have achieved with *World of Sport*.

The one reliable measurement we have is manufacturer numbers. More cars means more drivers, more drivers means more competition and more competition inevitably means more winners and a better story. To that end, I'm going for 2001. Fourteen rallies, seven manufacturers, eight different winners in five different cars and four men going for the title on the final round.

Manufacturers are not the answer to everything; they're a major contributor to the cyclical, boom-and-bust nature of motorsport, but in that year, having so much metal around made the championship easier to promote. It's no coincidence that this was the heyday of David Richards's massive investment in areas of timing and tracking technology. In 2001, the sport came out of the dark ages and produced its best season ever. ▶



Evans reckons 2001 was zenith of World Rally Championship

# THE UK'S BIGGEST & BEST CLASSIC MOTOR SHOW

10-12 NOVEMBER 2017

NEC BIRMINGHAM



**TICKETS NOW ON SALE!**  
**BOOK YOURS TODAY - QUOTE CMS17AS**

[NECCCLASSICMOTORSHOW.COM](http://NECCCLASSICMOTORSHOW.COM)

CALL 0871 230 1088\*

Over 2,500 stunning classic cars | 240 car clubs | Celebrity guests | Discovery Live Stage  
The UK's biggest indoor autojumble & trader village | Classic cars for sale  
Meguiar's Club Showcase | Silverstone Auctions | Lancaster Insurance Pride of Ownership  
Restoration Theatre | Dream Rides | Arrive & Drive a classic car experience with HERO  
**Free** entrance to the Classic Motorbike Show

Headline Sponsor



Official Partners



\*To book tickets by phone, please call 0871 230 1088. Calls cost 13ppm plus standard network charges. Ticket prices include a show guide with the value of £7.50. Advance tickets are available until midnight Thursday 9th November 2017. After that date, tickets will only be available at the show. All bookings are subject to a single transaction fee of £1.60. Please be aware the above code does not equate to a discounted rate and is solely for marketing purposes. All information correct at time of publishing. Full T&Cs online: [www.necclassicmotorshow.com/tickets](http://www.necclassicmotorshow.com/tickets)



M-Sport is flying high, looking good for a title-silverware clean-sweep

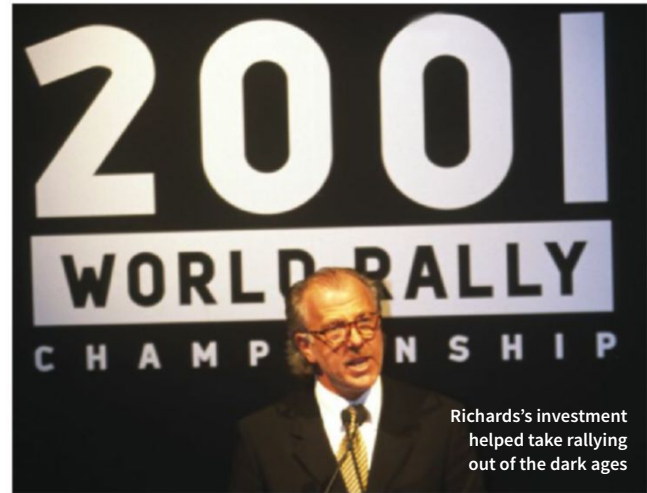

Richards's investment helped take rallying out of the dark ages

**YES** You've very much validated the argument for contextualisation. As with so many things, you are right – it's almost impossible to compare absolute measurables. But by picking the one factor that is directly measurable, you've shot yourself in the foot. Bigger, as I've had to learn over the years, is absolutely not guaranteed to be better.

Let's look at other sports to finally lay this one to rest. I know you are a keen follower of that gentleman's pursuit that involves a bit of wood and a piece of leather. Are you seriously telling me that more is better in cricket? Five days of tedious ball watching while slowly going mad with boredom under the summer sun? Or 20 overs of frenetic, adrenalin-filled slogging and sledging under the evening floodlights? It's a no-brainer. Less is more in cricket.

As I say, you can't claim 2001 was better than '17 just because it was bigger; that doesn't hold water with me.

So, if you won't buy my 'put-it-in-context' argument, here's one you have to admit puts 2017 up there as the greatest season of all time.

Malcolm Wilson. Just saying his name alone wins the argument for me. Up against the full factory might of Citroen, Hyundai and Toyota, this man and his privateer team from Cumbria have slain all before them. With a minuscule budget, a car that came to testing later and did many fewer kilometres than all the others, Mr Wilson was derided by some as the whipping boy of the championship.

But they underestimated his tenacious character, his shrewd business brain, his engineering brilliance and his utter determination. And it looks odds-on now that he will lift both the manufacturers' and the drivers' titles. When was the last time a private team did this in rallying? Or, for that matter, when did it last happen in motorsport? Debate over, arise Sir Malcolm.

**NO** So, we've descended to calling this the best year because it has a worthy cause? Malcolm Wilson and M-Sport's efforts have been – and remain – truly magnificent this season. And that's just one component of what's been a very, very good year. Just not the best one.

How you can't see the simple fact that more manufacturers makes for a more exciting championship is beyond me. It works on every level: developing more heroes, potentially giving other drivers a chance to shine... remember Jesus Puras's win in Corsica? Or Thomas Radstrom's Swedish podium for Mitsubishi? Those were side stories in 2001, but they contributed to making it the best season ever.

I could go on... so I will. Harri Rovanpera, a forerunner to Dani Sordo as the service park's nicest bloke, took his only WRC win in Sweden; Portugal provided startling pictures of rallying's fight against the elements when it was almost washed away; there was a Colin McRae hat-trick; a sensational top-flight-debut second place from a chap named Sebastien Loeb in Sanremo; and, such was the profile of and demand for our sport, fags and booze still flew with Marlboro and Martini.

Clark, you give me Wilson and I'll raise you Colin McRae, Richard Burns, Carlos Sainz and Tommi Makinen. Those were the four men who provided the perfect finale, a scintillating four-way title decider. And who can forget Rally GB, 2001? That McRae crash, that Burns win. Brilliant. And the best World Rally Championship season. Bar none.

Now, what's this Twenty20 nonsense you're talking? ■

**“FOUR MEN PROVIDED A SCINTILLATING TITLE DECIDER”**



Wilson's giant-slaying endeavours define the 2017 season



McRae's 2001 season ended in dramatic Rally GB shunt

# TEAM BY TEAM

PHOTOGRAPHY **MCKLEIN**

## M-SPORT WORLD RALLY TEAM



CAR **FORD FIESTA WRC**  
TEAM PRINCIPAL **MALCOLM WILSON**



### SEBASTIEN OGIER

**Nationality** French  
**Age** 33  
**Co-driver** Julien Ingrassia (F)  
**Rally GB starts** 9  
**Rally GB wins** 4 (2013-16)  
**WRC starts** 121  
**WRC wins** 40  
**WRC titles** 4

There's nothing particularly newsworthy about a Frenchman called Sebastien breaking records in rallying, but this could be a special one for Ogier. Victory in Wales this week would make him the first driver ever to take five straight Rally GB wins. And the past four years would indicate that he's more than up to the task. In many ways, he's better equipped than ever, running in a British team that knows these woods better than anybody.

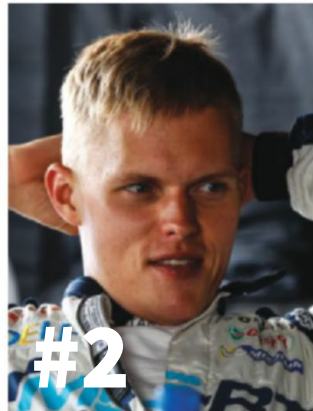

### OTT TANAK

**Nationality** Estonian  
**Age** 30  
**Co-driver** Martin Jarveoja (EST)  
**Rally GB starts** 6  
**Best Rally GB finish** 2nd (2016)  
**WRC starts** 77  
**WRC wins** 2  
**WRC titles** 0

Tanak has come of age this year. He's shown exceptional pace – most often in Poland – in the past few years, but this season he's strung it all together and blended speed and consistency. The new Fiesta suits him perfectly; the comfort in the car is reflected in wins on rallies as diverse as Sardinia and Germany. Tanak's a genuine contender in Wales this week: he loves the roads and is at home on fast gravel, whatever the weather.

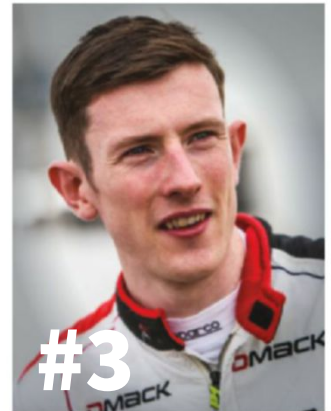

### ELFYN EVANS

**Nationality** British  
**Age** 28  
**Co-driver** Dan Barritt (GB)  
**Rally GB starts** 5  
**Best Rally GB finish** 5th (2014)  
**WRC starts** 61  
**WRC wins** 0  
**WRC titles** 0

The car's beyond question this season. What could make or break the event for Evans is the DMACK tyres beneath him. The Cumbrian firm has cooked up a new cover, including a new tread pattern tailored to the damp demands of Wales in late October, and this week will reveal just how successful it's been. Evans came within 0.7 seconds of winning in Argentina this year; a home victory would certainly make up for that disappointment.



# HYUNDAI MOTORSPORT



CAR **HYUNDAI i20 COUPE WRC**  
TEAM PRINCIPAL **MICHEL NANDAN**



## HAYDEN PADDON

**Nationality** New Zealander

**Age** 30

**Co-driver** Seb Marshall (GB)

**Rally GB starts** 7

**Best Rally GB finish** 4th (2016)

**WRC starts** 71

**WRC wins** 1

**WRC titles** 0

Paddon needs to put a shocking season so far out of his mind and just drive. He's grown up on wet-dry-wet gravel rallies running through the forests, and the fact that they've been on the other side of the world shouldn't make too much difference. On paper, the Kiwi should be right on the money for this one, but strangely he's never managed to get it all hooked up in Wales. How he'd love to this time around.



## THIERRY NEUVILLE

**Nationality** Belgian

**Age** 29

**Co-driver** Nicolas Gilsoul (B)

**Rally GB starts** 5

**Best Rally GB finish** 3rd (2013; '16)

**WRC starts** 82

**WRC wins** 5

**WRC titles** 0

Ogier's biggest threat this season. After a couple of years in the doldrums, he's got his head around life at Hyundai and has certainly found the i20 Coupe WRC's sweet spot. He's shown superb speed – and has consistently set the most fastest times all season – but he's also made mistakes and suffered a real off week in Finland, the last full gravel rally before GB. A contender for the win, but needs to be error-free.

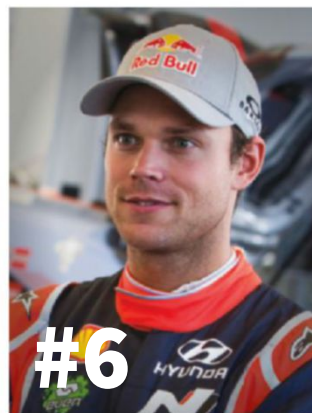

## ANDREAS MIKKELSEN

**Nationality** Norwegian

**Age** 28

**Co-driver** Anders Jaeger (N)

**Rally GB starts** 7

**Best Rally GB finish** 3rd (2015)

**WRC starts** 85

**WRC wins** 3

**WRC titles** 0

Only his second event in the Hyundai since he joined the South Korean squad in September. Mikkelsen's a fast learner, so expect him to be on the pace of his fellow i20 drivers. Like so many, his chances in Wales will depend heavily on the conditions and his place on the road. He does, however, know the area well, having lived in Ruthin from the age of 17 when he started out in the discipline. He's since moved to Monaco.



## DANI SORDO

**Nationality** Spanish

**Age** 34

**Co-driver** Marc Marti (E)

**Rally GB starts** 9

**Best Rally GB finish** 3rd (2008; '09)

**WRC starts** 151

**WRC wins** 1

**WRC titles** 0

It's fair to say that this isn't one of Sordo's favourite events. When he's got good grip and firm faith in the car beneath him, he's a genuine contender for a podium spot on most rallies. In Wales this week the grip will vary on a metre-by-metre basis and he'll struggle to dial the car into the set-up to get the best out of the limited traction available. A top-six would be a sensible target for the likeable Spaniard.

# CITROEN WORLD RALLY TEAM



CAR **CITROEN C3 WRC**  
TEAM PRINCIPAL **YVES MATTON**



#7

## KHALID AL QASSIMI

Nationality Emirati

Age 45

Co-driver Chris Patterson (GB)

Rally GB starts 3

Best Rally GB finish 11th (2010)

WRC starts 68

WRC wins 0

WRC titles 0

Hasn't competed on Rally GB since 2010, but the Sheikh is an adaptable driver who will find his feet and his rhythm quickly. If it's wet and muddy, he will struggle with the worst of the conditions, but the good news for Al Qassimi is who's sitting alongside him: Chris Patterson first started this event in 1993 and twice finished on the podium while co-driving Petter Solberg. He's one of the best in the business.



#8

## CRAIG BREEN

Nationality Irish

Age 27

Co-driver Scott Martin (GB)

Rally GB starts 6

Best Rally GB finish 12th (2010)

WRC starts 46

WRC wins 0

WRC titles 0

Showed brilliant pace early on last year (when he was driving a World Rally Car on his 'home' round of the championship for the first time), and needs to focus on that and pick up where he left off – shortly before he rolled in Myherin second time through. Breen's development over the past two years has been rapid and there's more speed to come from him and the C3 – providing the car does its thing...



#9

## KRIS MEEKE

Nationality British

Age 38

Co-driver Paul Nagle (IRL)

Rally GB starts 9

Best Rally GB finish 2nd (2015)

WRC starts 83

WRC wins 5

WRC titles 0

His victories in Mexico and Spain show that Meeke remains one of the fastest drivers in the world championship. He knows the Welsh woods and these conditions as well as anybody, but the big question for home fans in the forests is: what's the Citroën capable of? In changeable conditions, it's been a bit of a pig from time to time this year (Poland, anybody...?), but when it works, it works well. Fingers crossed. Everything crossed.

# TOYOTA G



CAR **TOYOTA YARIS**  
TEAM PRINCIPAL **TO**



#10

## JARI-MATTI LATVALA

Nationality Finnish

Age 32

Co-driver Miikka Anttila (FIN)

Rally GB starts 15

Rally GB wins 2 (2011-12)

WRC starts 180

WRC wins 17

WRC titles 0

Latvala cut his stage-rallying teeth in Britain as a 17-year-old and treats this event as a second home rally. He knows it well, he's won it twice and he's one of the favourites for more success this season. If his Toyota runs without trouble, Latvala will definitely be in the thick of the fight; the Finn has come alive again this year after four troubled seasons chasing his French team-mate in a German car he clearly couldn't figure out.

# AZOO RACING



WRC  
MMI MAKINEN

# NEW WRC CARS MAKE UK DEBUT

FOR THE PAST 10 MONTHS, THESE pages have been filled with news of how the 2017 World Rally Car is rallying's equivalent to the Second Coming. Well, this week you get to judge for yourself. And we're pretty sure you won't be disappointed.

As a quick reminder, here's what to look out for with the new motors.

More dramatic aerodynamics. This is the first thing you'll notice with the cars; the pictures just don't do them justice. Today's World Rally Cars have real and genuinely intimidating presence. Think hardcore DTM runner between the trees, covered in mud and on gravel tyres. And that aero will really work as well. Once they're north of 60mph, the downforce generated plugs these things into the road like never before. Forget the Group B tea-trays, these are windtunnel-tuned, CAD-fettled devices aimed at making the absolute most out of airflow.

And then there's the power and weight: more of one and less of the other; music to our ears, and yours too. Talking of music, these things sound sensational. Loud and lairy, they're also very, very fast. The best place to pay homage to a turbo restrictor three-mil bigger than last year (36mm rather than 33mm) is in the medium to high-speed corners.

Hairpins are great, but last year's cars were pretty sprightly up and away from the slow stuff.

No, find yourself a big, ballys corner and watch as the best drivers in the world dial these very special cars into these very special roads.

One of the key areas for development that will help in Wales will be the reintroduction of an active centre differential. The return of active transmission means another switch on the steering wheel, but this is the one that allows the drivers to radically alter the handling of their cars when they go from section to section through conditions varying from slow corners and deep mud to motorway-smooth quick bits.

And it's not just factory drivers in factory cars who will be enjoying these new toys. As well as the men and machines listed here, Mads Ostberg and Henning Solberg will each be at the wheel of privately entered Ford Focus WRCs. Ostberg starred the last time the WRC was on gravel – earlier this month on day one of Rally Spain, where he wrestled Andreas Mikkelsen for the lead. Ostberg will be a threat to the established order once again in Wales. As for Solberg, he's always quick and hugely entertaining. A bit like his car.



#11

## JUHO HANNINEN

**Nationality** Finnish

**Age** 36

**Co-driver** Kaj Lindstrom (FIN)

**Rally GB starts** 4

**Best Rally GB finish** 14th (2007)

**WRC starts** 54

**WRC wins** 0

**WRC titles** 0

Toyota's chief tester from last season has failed to make the kind of impact he would have wanted in his first – and more than likely last – full season in a factory World Rally team. Hanninen has the credentials to go well here and there's never been more of an incentive. Third at home in Finland (the last all-gravel round before Wales) was a career-best and an indicator of what he's capable of when everything works.



#12

## ESAPEKKA LAPPI

**Nationality** Finnish

**Age** 26

**Co-driver** Janne Ferm (FIN)

**Rally GB starts** 1

**Best Rally GB finish** 11th (2016)

**WRC starts** 27

**WRC wins** 1

**WRC titles** 0

Lappi hit the headlines with a quite extraordinary victory on this year's Rally Finland – only his fourth-ever start in a World Rally Car – and demonstrated just that kind of aptitude in Wales last year, when he came to these roads for the first time and took a WRC2 win to seal the title for Skoda. Could he win this year? Common sense says no, but with Lappi, clearly, anything is possible!



New aero and more power makes 2017 cars spectacular

JAAANUS REE/RED BULL CONTENT POOL

# McRAE

## HOME HERO'S FINAL WIN

BY DAVID EVANS PHOTOGRAPHY MCKLEIN



**A**t the time it seemed almost inconceivable that this would be Colin McRae's last win on his home round of the World Rally Championship. How could it be? In 1997, McRae was at the height of his power and apparently winning for fun.

But 20 years ago McRae celebrated his final RAC Rally win. He'd done three on the bounce – admittedly interrupted by Armin Schwarz's non-championship victory in 1996 (McRae didn't enter) – and hadn't looked seriously troubled by anybody on his way to that famous

hat-trick. The most serious threat in 1997 came from the Briton who would take on the home-hero mantle and win the next three: Richard Burns.

Two decades ago Burnsie was coming onto McRae's radar as a serious threat, not that he'd have admitted as much. But on the Cheltenham-based event, Burns landed some serious blows and, briefly, had his Subaru-driving rival on the ropes.

Two decades ago the RAC was following its then-traditional format of a Sunday morning start and Tuesday afternoon finish. The day-one spectator stages were dispatched

without drama, but all that changed first thing Monday morning. The run up to mid-Wales was broken up by an early-morning dash through the Radnor test. Just over the border, the 10-miler climbed to around 2000 feet and, running at just after seven on a late November morning, daybreak arrived shrouded in fog.

Fog was McRae's nemesis. His pacenotes were written with sight and speed in mind; compromised conditions hit the Scot harder than most.

McRae's co-driver Nicky Grist remembers that stage well. "If there was a kink in the road and Colin could see straight through it, he

# McRAE'S RAC YEARS

## 1987

**Colin McRae/Derek Ringer**

Vauxhall Nova Sport **crashed**

A 19-year-old McRae made his home WRC debut in a 1300cc Vauxhall Nova, but went off the road before the finish.

## 1988

**Colin McRae/Derek Ringer**

Peugeot 205 GTi **holed radiator**

McRae's first official drive came as one of Peugeot's Young Lions. A holed radiator in Penmachno marked the end of his outing.



## 1989

**Colin McRae/Derek Ringer**

Ford Sierra RS Cosworth **crashed**

A full Group A Sierra was readied for 1989, but McRae went off the road early, returning only to land his Ford on top of team-mate Franco Cunico, who had departed Kielder on the same corner minutes earlier.



## 1990

**Colin McRae/Derek Ringer**

Ford Sierra RS Cosworth 4x4 **6th**

His first RAC finish and the big break. Plagued by problems – and with Ringer's door kept shut by a bolt liberated from a farmer's gate – McRae pressed on and scored his first-ever fastest times at WRC level. The world took notice. McRae had delivered.

## 1991

**Colin McRae/Derek Ringer**

Subaru Legacy RS **crashed**

McRae arrived at the RAC on the back of his first British championship title and led for the first time. Unfortunately, he rolled after failing to make a right-hander over a crest in Grizedale. ▶



McRae dug deep, producing the kind of performance that helped cement his legendary status

wouldn't necessarily put it into the notes," he says. "That was a problem in the fog..."

Conversely, Burns's notes were incredibly detailed, describing the road ahead in detail. McRae was lost, quite literally.

"Colin was getting really frustrated," says Grist. "He just couldn't see and then he started trying to drive with the lights on, then off, then on. In the end I said, 'Leave the lights off and concentrate on getting us to the end of the stage!'"

McRae followed the advice, but was livid at the end of the test. And that was before he found he'd dropped a minute and a half to RB.

Burns had been sublime, catching and passing Didier Auriol's Toyota. At the end of the stage, the Frenchman jumped out of his factory Corolla and opened Burns's door – and congratulated the Mitsubishi star on being the first man ever to catch him when he was running without problems.

A fuming McRae took some calming down as he and Grist journeyed north. The good news for Colin was that the next stage was Hafren, the very same test where he had retaken the lead on his way to an RAC win and the 1995 World Rally Championship.

The mood was still dark at the start of ▶

## 1992

**Colin McRae/Derek Ringer**

Subaru Legacy RS **6th**

Led the event again, but this time hopes were dashed by being forced into a ditch by a spectator driving down the middle of the road on the liaison section, damaging his car's suspension and transmission.

## 1993

**Colin McRae/Derek Ringer**

Subaru Impreza 555 **holed radiator**

Led the event into Kielder, where a branch pierced the front of the Impreza, holed the radiator and cooked the flat-four in Kershope.



## 1994

**Colin McRae/Derek Ringer**

Subaru Impreza 555 **1st**

Finally! The win Britain had been waiting for ended an 18-year hiatus since Roger Clark's second RAC success.

## 1995

**Colin McRae/Derek Ringer**

Subaru Impreza 555 **1st**

McRae overcame a puncture in Pundershaw and broken suspension in Newcastleton with a staggering turn of speed through Wales. Demolished Carlos Sainz on his way to a second home win and first world title.



## 1997

**Colin McRae/Nicky Grist**

Subaru Impreza WRC97 **1st**

Overcame a swearsy run through two fog-bound stages to take a third win on the bounce.

## 1998

**Colin McRae/Nicky Grist**

Subaru Impreza WRC98 **engine**

Ended his time with Subaru watching the Impreza go up in blue smoke in a BUILT WELLS cowshed.

## 1999

**Colin McRae/Nicky Grist**

Ford Focus WRC **crashed**

Struggled to make much of an impact on the rally, then crashed out in the dark on the second run through Myherin.

**“THE TOP TWO BRITS SET  
ABOUT 23 MILES OF RHONDDA  
WITH A MINUTE AND A HALF  
IN HAND OVER THE BEST  
OF THE REST”**

Burns took the fight to McRae, but his challenge was ended by a puncture.

Below: bittersweet moment for McRae and Grist, with the rally won but the battle for the championship lost



the stage. Eighth overall and 1m19s off the lead, McRae reckoned he'd lost interest. What was the point? Nothing less than a win would do for him to take the championship, and what chance that?

Did anybody really believe that? McRae produced a masterpiece of a drive, tearing through the woods to take 28 seconds out of everybody. It would have been more had he not spun halfway through. Pantperthog, Dyfi, Gartheiniog went the same way. A lack of visibility – this time caused by a misted-up windscreen – meant he dropped a second to Burns, whose lead had been slashed by a minute and four seconds in four stages.

By now, even Burns had accepted his fate and expected the Impreza WRC97 to be leading his Carisma GT back to Cheltenham that night. In the end, they went in tied on time, partly thanks to a botched rear-suspension change that cost Burns a 10s penalty.

So, to South Wales for one last blast. St Gwynno opened proceedings, where half-light and full fog returned to haunt McRae.



This time he 'only' dropped 17s to his rival and immediately pulled three of those back on the following Tyle stage.

In that era, the final day of a WRC round still meant something in terms of mileage, and the top two Brits set about 23 miles of Rhondda with a minute and a half in hand over the best of the rest. This one was about home rule.

Halfway through and disaster struck for Burns. He clipped a stone and the front-right Michelin on his Mitsubishi went flat, forcing him and co-driver Robert Reid to stop and change. Gutted didn't come close. Fourth was zero consolation.

Unaware of his rival's problem, McRae pressed on and finished the stage fully 40s quicker than his nearest rival. Two minutes in the lead and with only four meaningful stages remaining, the Subaru star's side of the deal was done. And he would duly head Finland's Juha Kankkunen over the ramp with a lead of close to three minutes.

In doing so, McRae became the first Briton to win the RAC three times and the first driver to

complete a hat-trick on Britain's round of the world championship since Timo Makinen in 1975. But none of that really mattered. In terms of the score across the spread of the season, McRae had come up short by the most painful of margins: a single point. Tommi Makinen had to finish sixth to secure a successful defence of his 1996 title. And he did that. Just.

The Mitsubishi driver had been well and truly floored by the flu, but he managed to do just about enough to stay on the road and in the hunt.

Subaru and McRae had hoped team-mate Kenneth Eriksson might have been able to intervene, possibly even Piero Liatti as well. But when the Swede's engine failed on stage one (something of a running theme through Subaru's 1997 season) and the Italian upended his car in Hafren, McRae was on his own.

But still, we told ourselves, there would be another year. And another. And there was. But there wouldn't be another McRae win on the RAC. Unbeknown to the masses, an era had ended with glorious success and global failure.

## McRAE'S HAT-TRICK

### 2000

**Colin McRae/Nicky Grist**

Ford Focus RS WRC **crashed**

Leading by 45 seconds, the good times were back for McRae and his legion of home fans. Unfortunately, it wasn't to be – he crashed out on the second run through Rheola.

### 2001

**Colin McRae/Nicky Grist**

Ford Focus RS WRC01 **crashed**

Led with a blinding turn of speed through the opening forest stage, but crashed heavily after mishearing a pace note and cutting an uncuttable corner in Rhondda.



### 2002

**Colin McRae/Derek Ringer**

Ford Focus RS WRC02 **5th**

A difficult end to a troubled year – one in which he and Grist split – and his final season in the Focus. An unusually subdued McRae finished fifth without scoring a single fastest time.

### 2003

**Colin McRae/Derek Ringer**

Citroen Xsara WRC **4th**

With an enforced retirement from the sport looming large, Colin's final Rally GB as a full-time driver was a world away from the swashbuckling stories he'd written a decade earlier. The car didn't suit him and the time had come to say goodbye.



### 2005

**Colin McRae/Nicky Grist**

Skoda Fabia WRC **7th**

Two years after his GB finale, super-Mac was back. And back on form. On a rally forever remembered for the loss of Michael 'Beef' Park, McRae guided a Skoda to some impressive times, which kick-started talk of a longer-term return.





# SHORT AND SWEET

## RALLY GB'S NATIONAL RALLY HAS GONE THROUGH A REVAMP FOR 2017, AND IT'S LOOKING LIKELY TO BE A SUCCESS

BY **JACK BENYON** PHOTOGRAPHY **JAKOB EBREY**



Less is more' is a cliché of the blandest order, but that has been the case with the Rally GB National Rally and its format for 2017.

The event became irrelevant in its old three-day format almost overnight when, thanks to an FIA rule change, cars that were not homologated were allowed to enter the full International rally. That meant Dave the Rave from South Wales could enter his Ford Escort Mk2 from 1981 into the full International event using the same stages, doing the same recce as Sebastien Ogier.

That rendered a three-day National rally useless, so it was back to the drawing board. What the organisers have come up with is a 60-mile rally, down from 100, which just takes in Saturday and Sunday. It's a boiled-down version of last year's event, which ran one loop of the roads on all three days.

The change has produced a number of benefits. "We've come across issues with timing, which means we've had to cut the itinerary short for the Nationals in order to preserve the start time for the Internationals," says Rally GB managing director Ben Taylor.

"That's not fair," he accepts. Friday was the problem child in terms of scheduling but, with that struck from the National, the event has more room to breathe. "I think the chance of losing stage miles is slim compared to previous years," adds competitor Brynmor Pierce. "The event seemed to be losing Hafren Sweet Lamb almost every year."

So it's fewer stage miles, with those planned more likely to be completed.

The big gain (or saving in this case) is cost. Although the entry fee is only £250 cheaper

than the 100-plus-mile event last year, the running costs and, more importantly, time away from work for the competitors is significantly reduced.

The one criticism is of the Sunday, when only 15 of the 100-plus total miles are competitive. That's bizarre, but the rally has to take into consideration TV timings for its International event, and there isn't an obvious alternative to this.

Joe Evett, a competitor in the 1400 class, sums up the mood. "The Sunday is only 15 miles or so," he says. "It seems stupid in terms of how many road miles to competition miles there are. But it will be a laugh and good fun either way."

The competitors do their talking best with their feet, via event entries. They're up nine to 88 for 2017 and, despite all the changes, better than ever. Last year's winner Bruce McCombie heads the order, despite not finishing in the top five of a rally he's entered this year – he hadn't last year, and that didn't stop him piloting his Mitsubishi Lancer E9 to victory. Up against him, Roger Duckworth (Subaru Impreza WRC) and Tom Preston (Skoda Fabia R5) should challenge for the win.



McCombie is a favourite after winning in '16





National entries are up this year

## WALES RALLY GB NATIONAL CHANGES

	2016	2017
<b>DAYS</b>	3	2
<b>STAGES</b>	12	8
<b>STAGE MILES</b>	108.03	59.78
<b>ENTRY FEE</b>	£1000	£750
<b>ENTRIES</b>	79	88

Reduced running should mean more of the planned stages are completed with little decline in the spectacle

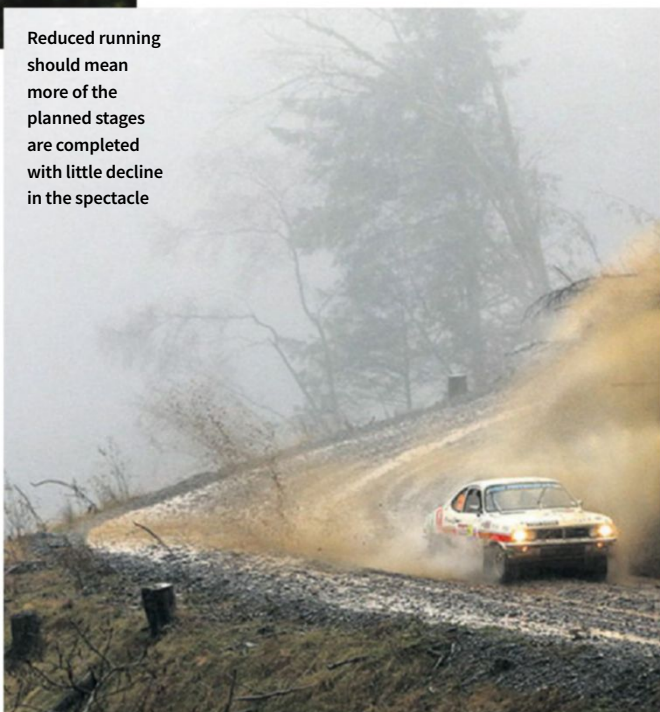

## TOP 10 NATIONAL ENTRIES

#	DRIVER/CO-DRIVER	CAR
200	Bruce McCombie/Michael Coutts	Mitsubishi Lancer E9
201	Roger Duckworth/TBC	Subaru Impreza WRC
202	Thomas Preston/TBC	Skoda Fabia R5
203	Dylan Davies/Llion Williams	Subaru Impreza
204	John Wink/John Forrest	Hyundai i20 R5
205	Andy Davies/Max Freeman	Subaru Impreza
206	Simon Hay/Calum Jaffray	Mitsubishi Lancer E6
207	Barry Jordan/James Gratton-Smith	Citroen DS 3 R5
208	Keith Parry/Eryl Evans	Subaru Impreza
209	Alasdair Graham/Laura Stuart	Mitsubishi Lancer E9

## WRC2 AND WRC3



Cave is aiming for a podium with Ford Fiesta

THE WRC2 TITLE IS ALL WRAPPED up heading into Rally GB, but there's still a host of interesting entries for the event.

Teemu Suninen is one of the fastest of the flying Finns, and finished fourth overall on Rally Finland this year in an M-Sport Ford. Driving a Fiesta R5, he returns to WRC2 for the event in which he won the class in 2015, and as an established future star he'll be tough to beat.

Suninen heads team-mate Eric Camilli by eight points in the fight for second in the championship, but Suninen can still go to the final round in Australia for more points (even if that's unlikely), whereas this event is Camilli's last chance to score under the ruling that restricts each driver to a maximum of seven events.

Skoda's works effort is headlined by Pontus Tidemand, already crowned as the 2017 WRC2 champion. OC Veiby also drives a Fabia and the youngster is improving all the time. He won in Poland back in the summer, and both went well on Rally GB last year, when Tidemand finished second to Esapekka Lappi.

Headlining Hyundai's charge is Jari Huttunen, having just won a prize to drive for the squad in WRC2 full-time in 2018. Huttunen won the class in Finland and could be a strong outside bet.

Switching back from a Hyundai to a Fiesta for this event is Welshman Tom Cave, who is targeting a home victory.

And then there's Kalle Rovanpera. Labelled rallying's Max Verstappen, the 17-year-old makes his WRC debut with M-Sport. Can he upset the applectart?

THE WRC3 CHAMPIONSHIP IS sparse, with two entries. Raphael Astier (Peugeot 208 R2) could take second in that championship, but, with Enrico Brazzoli the only other regular attending, there's little to gain by going all-out. Three class points will give Astier second in the championship behind the absent Nil Solans.

Freshly crowned European Under-27 champion Chris Ingram is Britain's best hope for R2 class glory with his Opel Adam. He's won the division before and heads to the event high off the back of his title success in Europe.



Ingram hopes to add R2 win to his collection





## FROM THE ARCHIVE

The RAC was never a particular favourite of Frenchman Didier Auriol, but the infamously wintry 1993 event stands out as a particular toughie for the man who would be champion a year on from this shot. Auriol flew over the jump at Chatsworth to ultimately finish sixth, 14 minutes adrift of Toyota team-mate and winner Juha Kankkunen.

latimages.com  
@latimages

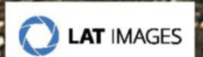



**motorsport**  
**JOBS**

# Find your dream job in motorsport.

Here at Autosport we've been helping people find great jobs in motorsport for over 60 years. Today we're launching a new global motorsport jobs site, where you can:

- Find the latest jobs in motorsport
- Apply for a job with just one click
- Upload your CV and let recruiters find you
- Set up job alerts - don't miss out on your dream move

Register at [motorsportjobs.com](https://motorsportjobs.com) today 🔍

RECRUITMENT DRIVEN BY PASSION

# WHAT YOU NEED TO KNOW



## OUR GUIDE TO THE STAGES THIS WEEKEND

### THURSDAY OCTOBER 26 SS1 TIR PRINCE

New for this year. This one's based around a trotting track and a couple of link roads with a jump. Nobody's going to make a load of time on this stage – it's one to drive as neatly and tidily as possible – but you know what drivers are like when they see a load of spectators: almost impossible not to do some skids. An entertaining start.

### FRIDAY OCTOBER 27 SS2/5 MYHERIN

Unfortunately, some of the best hairpins on the route (the ones known as Pikes Peak near what was the start) are now a car park – good for fans' access, but a shame for the drivers. New for this year is Elfyn's Corner (#ELFYNSCORNER), established by a group of his fans. This corner is right in the middle of one of the fastest and most flowing stretches through the windfarms. Finland without the jumps.

### SS3/6 SWEET LAMB

People call this a spectator stage, but it's not your average spectator stage – it's the best spectator stage in the world! Watching the cars tear down that famous hill into the watersplash (where drivers have to be careful to get the car into the water square on, or it can throw them off) and into the main bowl area, is brilliant fun.

### SS4/7 HAFREN

Kris Meeke's favourite. And it's not hard to see why, especially when it's running at the full length, like this time. You'll get a good view of the cars for a long time from car park D, while E will take you to an uphill hairpin left. There are so many surface and grip changes in this stage, reading the road and interpreting the colour of the mud are vital. This stage isn't as quick as Myherin: there are a few more corners and junctions to slow the pace down a little bit.

### SATURDAY OCTOBER 28 SS8/15 ABERHIRNANT

A very fast start to Saturday morning. One of the fastest sections of the stage is now being used as a car park, but the rest of the road is far from slow. There are a few surface changes in there and, from what we've been told, there's been quite a bit of logging activity in the middle. Wherever there's been a lot of work done in pulling the trees, the road can be quite badly affected. Fully loaded, these logging trucks weigh around 40 tonnes, so it's not hard to see how they stir the mud up and, almost regardless of the weather, can make a bit of a mess. The crews will note these sections on the recce, but if the mud's quite deep they'll have to slow down or there's a real risk of going off and into a pile of logs. This stage is also one of the highest on the route. If the fog comes in, especially for the second run through at night, it'll make the thing really interesting. ▶

### SS18/21 BRENIG

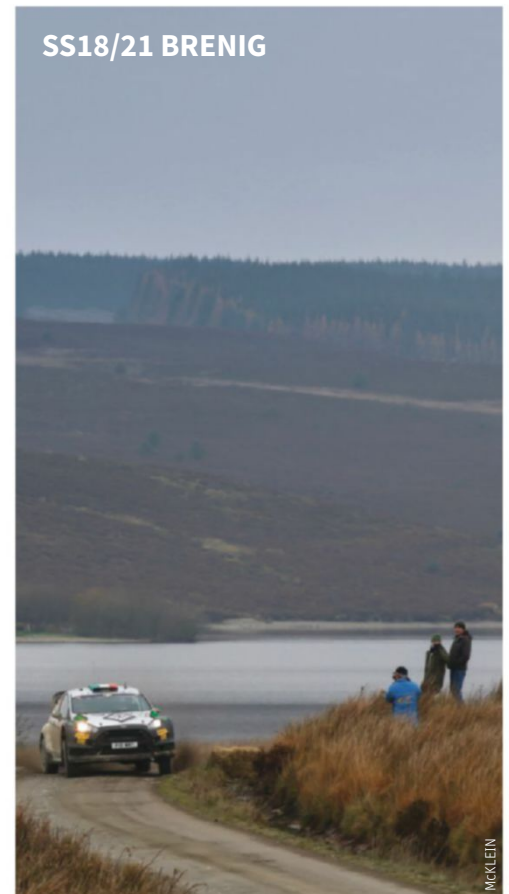

## STAGE GUIDE

### SS9/16 DYFNANT

One of the most famous and visited stages on the route, with the hairpin right in the middle a popular place to watch. If you walk away from that junction in the same direction as the cars – always following the marshals' instructions – you'll come to a fast right-hander known as Irish Corner. Dyfnant flows nicely, but the surface can change quite a lot second time through. This one tends to polish a bit, which makes it a bit more slippery on the rerun.

### SS10/12 GARTHEINIOG

Elfyn Evans's favourite. Even though there are a couple of tight hairpins in the stage, this one flows very nicely. And there's good news for this year – the organisers have extended the stage at the start by about 800 metres, which means the cars will come charging up the road into a tricky right-left sequence, with some great spectating on offer there (from car park H).

### SS11/13 DYFI

If it's been raining, this road will be really slippery – especially near the start, where there's always the risk of a bit of standing water on the inside of some corners. But the worst place for grip is on the bedrock, which comes in the middle of the stage. After that, once it starts to climb, this one just gets better and better, with plenty of medium and high-speed corners.

### SS14 CHOLMONDELEY CASTLE

The only stage on the route that crosses the border into England. It's a great place to bring the family, with loads going on. All cars are required to do a 360-degree spin in the middle of the straight. This RallyFest stage is the only one on the route where there will be an autograph session straight after the leaders have been through – but this time the stage will keep running while the signing takes place.

## SUNDAY OCTOBER 29

### SS17/20 ALWEN

This is the first of the North Wales forests and there are a few junctions. The grip's not always the best, especially when it's been raining. It's a great challenge and nice and quick in places. And, like Brenig, there's plenty of spectating off the B4501.

### SS18/21 BRENIG

This is the powerstage again this year, but it's been shortened and changed around a little bit. The road alongside the lake is really quick and open to the elements – you can watch the cars in this section standing on the dam – but then it goes into trees and the road will get more slippery and a bit narrower. After that, there's a Tarmac section that takes the crews to the finish.

### SS19 GWYDIR

Gwydir stands out from the others a little bit in that you feel you're driving through more of a parkland-type forest rather than some of the denser woods in mid-Wales. The surface changes quite a lot, which means the drivers have to be on guard for varying grip levels. In the right weather, there are some lovely views from up on the top of this stage – then again, the trees have grown a bit since the event was there in 2013. And you wouldn't have seen the view then, because it ran in the dark!

## ITINERARY

### STAGE TIME

#### THURSDAY OCTOBER 26

SS1 Tir Prince (0.93 miles)	1900
-----------------------------	------

#### FRIDAY OCTOBER 27

SS2 Myherin 1 (12.60 miles)	1020
-----------------------------	------

SS3 Sweet Lamb 1 (2.63 miles)	1100
-------------------------------	------

SS4 Hafren 1 (21.84 miles)	1115
----------------------------	------

Tyre zone, Newtown	1253
--------------------	------

SS5 Myherin 2 (12.60 miles)	1431
-----------------------------	------

SS6 Sweet Lamb 2 (2.63 miles)	1511
-------------------------------	------

SS7 Hafren 2 (21.84 miles)	1526
----------------------------	------

Chester control	1901
-----------------	------

Service	2001
---------	------

#### SATURDAY OCTOBER 28

SS8 Aberhircant 1 (8.64 miles)	0755
--------------------------------	------

SS9 Dyfnant 1 (11.13 miles)	0847
-----------------------------	------

SS10 Gartheiniog 1 (7.84 miles)	0959
---------------------------------	------

SS11 Dyfi 1 (16.07 miles)	1028
---------------------------	------

SS12 Gartheiniog 2 (7.84 miles)	1208
---------------------------------	------

SS13 Dyfi 2 (16.07 miles)	1237
---------------------------	------

SS14 Cholmondeley Castle (1.12 miles)	1548
---------------------------------------	------

Service Deeside	1655
-----------------	------

SS15 Aberhircant 2 (8.64 miles)	1855
---------------------------------	------

SS16 Dyfnant 2 (11.13 miles)	1947
------------------------------	------

Service	2226
---------	------

#### SUNDAY OCTOBER 29

SS17 Alwen 1 (6.47 miles)	0834
---------------------------	------

SS18 Brenig 1 (4.00 miles)	0908
----------------------------	------

SS19 Gwydir (4.65 miles)	1006
--------------------------	------

SS20 Alwen 2 (6.47 miles)	1109
---------------------------	------

SS21 Brenig 2 (4.00 miles)	1218
----------------------------	------

Finish Llandudno	1335
------------------	------

## TV

### CHANNEL 5

Saturday October 28 0005

Highlights from Friday

Sunday October 29 0120

Highlights from Saturday

Sunday October 29 1200

Live powerstage/SS21

Tuesday October 31 1900

Regular highlights show

### BT SPORT

#### ESPN/1/2/3

Multiple broadcasts on all channels

Saturday October 28 1200

SS12 live

Sunday October 29 0900

SS18 live

Sunday October 29 1200

SS21 live/powerstage

### RALIO

#### WELSH, BUT ENGLISH SUBTITLES

Thursday October 26 2200

Friday October 27 2025

Saturday October 28 2135

Sunday October 29 2030

Monday October 30 1830



## TOP 10 RUNNING ORDER

#	DRIVER/CO-DRIVER	CAR
1	Sebastien Ogier/Julien Ingrassia	Ford Fiesta WRC
2	Ott Tanak/Martin Jarveoja	Ford Fiesta WRC
5	Thierry Neuville/Nicolas Gilsoul	Hyundai i20 Coupe WRC
10	Jari-Matti Latvala/Miikka Anttila	Toyota Yaris WRC
16	Dani Sordo/Marc Marti	Hyundai i20 Coupe WRC
3	Elfyn Evans/Dan Barritt	Ford Fiesta WRC
11	Juho Hanninen/Kaj Lindstrom	Toyota Yaris WRC
8	Craig Breen/Scott Martin	Citroen C3 WRC
9	Kris Meeke/Paul Nagle	Citroen C3 WRC
4	Hayden Paddon/Seb Marshall	Hyundai i20 Coupe WRC



Destination for all  
**MOTORSPORT**  
merchandise.



**motorstore**



Support your team  
in style with the very best  
of replica and lifestyle  
Motorsport fashion!



[MOTORSTORE.COM](http://MOTORSTORE.COM)

# SCHROTH RACING CHAMPIONS CHOICE

**SCHROTH**<sup>®</sup>  
RACING



**XLT  
CARBON**



**NEW FIA Standard 8853-2016  
available right now**

## Wide Range of HANS Devices, Harness Belts & Racing Nets

Visit [www.schroth.com/racing](http://www.schroth.com/racing) to learn more about our products.



Follow us on Facebook  
[www.facebook.com/schrothracing](http://www.facebook.com/schrothracing)