

Emergency & Rescue Catalogue 2011



When it's critical.

When lives are on the line, there is a company just as dedicated to protecting people and saving lives as you are.

Every day, Ferno Australia's equipment is trusted by medical, rescue, safety professionals and volunteers. Ferno products are used on scene at accidents, emergencies, rescues and workplace incidents, for treating and transporting the wounded or deceased, to providing the optimum rescue and safety performance through pre-and post-incident response. We know that first responders face a broad array of situations daily, from natural disasters to minor medical incidents. This is why Ferno Australia's goal in creating products for the emergency and rescue market is to drive the design of innovative technology that accounts for human limitations when under extreme stress.

Our latest catalogue features ambulance & rescue stretchers, immobilisation and vacuum products, ventilation and defibrillation devices, medical and first aid cases, edge management and rope rescue hardware, response vehicles, extrication tools, communications and personal protective equipment. This broad range of equipment, made by Ferno Australia or sourced from other trusted manufacturers, provides a solid place where professionals who participate in disaster preparedness and emergency response can begin their equipment and inventory planning.

New products featured in this catalogue include:

Ambulance cot and lift-off stretcher	Page 2
Stretcher equipment table	Page 12
Rescue baskets and sleds	Pages 14 - 20
Tri-fold evacuation board	Page 22
Assault ladders and truss bridge	Page 27
Powered tracked stair chair	Page 31
Baby Pod paediatric transport device	Page 44
Oxygen regulator, AS approved	Page 48
CPAP device	Page 51
Trauma and burn kit and contents	Pages 81-83
Emergency, controlled rate, descent device	Page 98 - 99
Open gate, prusik minding pulley	Page 105
Full body rescue harnesses	Page 112 - 114
Heavy duty edge rollers	Page 122
Industrial helmets	Page 143

The quality and dependability of Ferno Australia's brand is well recognised and our products are available through distribution partners across Australia, New Zealand as well as the UK, Europe, North America, Asia Pacific and the Middle East.

From small beginnings as a supplier of ambulance stretchers 36 years ago, Ferno Australia now develops, manufactures and distributes more than 10,000 products, providing essential emergency, rescue and safety equipment for any situation.

Ferno Australia is proud of our market leadership position in the emergency, rescue and safety markets, and we enjoy providing people with well designed, strong products which perform when it's critical. And while no-one can predict when an emergency situation or disaster will occur, Ferno Australia can help you prepare for it.



Care of this equipment

Always inspect your equipment before use for any signs of wear and tear. If in doubt retire the item. Our products are susceptible to abrasion, corrosive chemicals and UV degradation. When stitching becomes frayed or damaged it should be retired or repaired. Wash periodically in luke warm water and mild detergent. Air dry away from direct sunlight. Store your equipment out of direct sunlight and dust. Do not store equipment wet. Do not tumble dry or dry clean. If any of our equipment is subject to a serious fall it should be retired.

Use of this equipment

If you use Ferno equipment, you are responsible for learning and utilising safe techniques. We disclaim all liability for any injury or loss arising from the use of this equipment. It is the user's responsibility for maintaining this equipment in correct working condition. The products in this catalogue are designed for specific purposes and must not be used in any manner other than for which they are designed. Do not use any equipment in this catalogue until you receive proper training in the use of that equipment.

© Ferno Australia Pty Ltd 2010

All rights reserved. No part of this publication may be reproduced or transmitted in any form or by any means without the prior written consent of Ferno Australia. Whilst every care has been taken to prevent printing errors, colours and reproduction is subject to the usual tolerances of the printing process. Specifications may be changed in line with current legislations and standards E&OE.

Contents

Ambulance Stretchers & Accessories (Page 2 to 13)

Ambulance Stretchers
Powered Ambulance Stretchers
Adult Harnesses
Child Harnesses
Baby Capsule Harness
Patient Restraints Systems
Psychiatric Restraint Set
Walk Belt
Mattresses
Floor Locks
V Poles
Torch Holder
CPR Board
Transfer Board
Carry Sheets
Disposable Sheets
Stretcher Cover
Equipment Bracket
Stretcher Tables
Bariatric Stretcher Accessories

Rescue/Industrial Stretchers & Accessories (Page 14 to 30)

Basket Stretchers
Res-Q-Mate Stretcher
Res-Q-Mate Stretcher Handle Kit
Paraguard Stretcher
Sked Rescue Stretcher
Lifesaver Stretcher
Vertical Rescue Stretcher
Med Sled Rescue
Med Sled Evacuation
Folding Emergency Stretchers
Catastrophe Stretcher
Saver Foldable Bed
Aviation Stretchers
Mantis Tri-Fold Evacuation Board
Lifting Bridles
Stretcher Handles & Shoulder Harness
Litter Shield
Floatation Collars
IV Poles
Rescue Blanket/Pillow
Patient/Basket Cover
Tagline Set
Stretcher Carry Cases
Stretcher Carriers
Litter Stands
Assault ladders and truss bridges
Evacuation Litters
Evacuation Litter Accessories
Hypothermia Prevention Blanket

Carry/Stair Chairs (Page 31 to 32)

Powered Stair Chair
Evacuation Chair
EZ Glide Headrest
Compact Carry Chairs

Spinal Care/Immobilisation/Splinting (Page 33 to 43)

Scoop Stretchers
Najo Backboards
Fibreglass Backboard
DragOne SCBA Board
Ferno XT Rapid
Short Wooden Backboard
Extrication Devices
Backraft Air Mattress
Full Body Vacuum Mattress
Vacuum Splint Set
Traction Splints
Ferno Frac Splint
Sam Pelvic Sling
Sam Splint
Cardboard Splints
Finger Splint Kit
Neck Collars
Head Immobilisers

Infant Transport (Page 44)

Baby Pod II
Paediatric Backboards

Resuscitation/Ventilation/Airway (Page 45 to 57)

Oxygen Therapy Kits
Oxygen Resuscitation Kits
CPR Resuscitation Masks
Resuscitators
Oxygen Regulators

Oxygen Demand Valve
CPAP Ventilation Mask
Ventilators
Modul CPAP
Suction Devices
Combat Application Tourniquet
Laryngoscope Systems
Airway Accessories
Oxygen Therapy & Suction Disposables

Defibrillation/Diagnostic (Page 58 to 63)

Defibrillator/Transport Monitor
AEDs
Pulse Oximeter
Field Corpsman Kit
Otoscope
Ophthalmoscope
Stethoscopes
Sphygmomanometers

Emergency & Temperature Controlled Packs (Page 64 to 76)

Temperature Controlled Cases
Emergency Hard Cases
Trauma & ALS Packs
Airway Management/Oxygen Packs
Oxygen Packs
Responder Vests
Radio Harnesses
Belt Holsters
Glove Pouches
Intubation/Airway Packs
IV & Med Packs
Belt First Aid Packs
First Aid Packs

Medical & First Aid Cases (Page 77 to 79)

Medical Boxes
First Aid Boxes
Compact First Aid Boxes
First Aid Cabinets

Burn Care (Page 80 to 82)

Dressings
Hydrogel
Burns Kits
Fire/Trauma Blankets

Trauma Kit Contents (Page 83)

ALS Kit
BLS Kit

Casualty Room Equipment (Page 84 to 86)

Medical/Instrument Trolleys
Pedal Bin
Step-Up Stools
Couches
Privacy Screen
Lamps
Wheelchair

CPR/Training Manikins (Page 87 to 92)

Laerdal CPR Manikins
Ambu CPR Manikin
Simulaids Rescue Manikins
Lifetec Training Manikins

Response Vehicles/Rescue Trailers (Page 93 to 94)

Personnel Carrier
Mini Module Ambulance
Emergency Response and Rescue Trailer
Fire and Emergency Light Tanker

Edge Management/Rescue & Escape Systems (Page 95 to 101)

Tripod
Rescue Winch
Davit System
Arachnipod
Min-Evac Descent Device
Lift-Evac Descent Device
Rescue Pulley Systems
Res-Q-Link Recovery Pole
ResQmax Line Deployment Kit
Escape Systems

Rope Hardware/Connectors (Page 101 to 110)

Descenders
Ascenders
Rescue Belay
Pulleys
Rope Grab
Anchor Plate
Swivel Pulley
Karabiners
Wire Connectors
Maillon Rapide

Full Body/Rescue Harnesses (Page 111 to 114)

Spreader Bar
Patient Lifting Sling
Rescue Strop/Harness
Paediatric Rescue Carrier
Full Body Harnesses
Sit Harnesses
Rappel Belt

Rope/Webbing/Bags/Gloves & Accessories (Page 115 to 123)

Gloves
Rope
Rope Finishing
Rope & Equipment Bags
Haul Bags
Throwline Bag Sets
Slings
Daisy Chain
Rescue Personal Lanyard
Etriers & Aiders
Edge Protectors
Tool Wrist Loops
Rope Protectors
Rope Washer
Rope and Harness Wash
Rope Measurer
Hot Knife

Major Incident Response (Page 124 to 126)

Toilet Kits
Waste Treatment
Tents & Shelters
Triage Tags
Triage Kit
Body Bags

Extrication/Rescue Tools (Page 127 to 136)

Rescue Cutters
Rescue Spreaders
Rescue Combination Tools
Rescue Forcible Entry Tool Kit
Rescue Rams
Ram Extension Kits
Rescue Pumps
Air Hydraulic Pump
Lifting Bags
Tool Mounts
Couplers

Tools/Knives/Lighting (Page 137 to 140)

Flashlights
Headlamps
Safety Lights
Rescue Tools
Seat Belt Cutter
Safety Knives
Scissors

Communication/PPE (Page 141 to 148)

Smoke Filters and Masks
Elbow & Knee Pads
Helmets
Rescue Sunbrero
Whistles
Communication Systems
Confined Space & Rescue Training Manual
Patient Assessment Guide
Cuff First Dispensing System
Nitrile & Latex Gloves
Surface Disinfectant Solution
Cool Vest RPCM Technology



Ferno Mondial™ with RS-2 Lift-Off Stretcher

Code FWE-ST64 (Mondial low leg) FWE-ST70 (Mondial high leg) FWE-RS2 (lift-off stretcher)

The new Mondial has been designed with Ferno Smart-Load, system technology to make your job easier with smooth, simple, ergonomic operation of the transporter when loading and unloading from an ambulance, and when lifting or lowering a patient.

Key features

- Smooth, safe and easy loading and unloading with the exclusive EZ Load, auto-release system
- Ergonomically designed front and rear leg automatic release mechanism
- Easy, intuitive operation with color coded controls
- Positive feedback when the legs are locked or unlocked using the leg lock indicator
- Lift assistance on heavy patient loads with side lift handles
- Head and foot end telescoping handles
- Easy rolling over all types of terrain with large 150 mm wheels
- Tight space maneuverability with swivel wheel lock/release mechanism
- Rear wheel brakes
- Easy patient transfer using multiple height positions
- Shock contour frame and gas assist backrest
- Nighttime visibility with reflective labels
- RS2 Lift-Off Stretcher supplied with four 100 mm wheels
- Head end extension for taller patients or patients with leg splints
- Under backrest storage tray
- Reversible patient loading: head first or feet first
- Conforms to International Standards EN1865, EN1789
- Lock interface available for Ferno LA50-FL floorlock



RS-2 Lift-Off Stretcher



Ferno Mondial™



Swivel wheels



Side lift handle



Extending backrest



Foot-end handle

Product Specifications

Model	Length	Width	Height Max	Loading Height	Weight	Load Limit
Mondial ST64	1970 mm	550 mm	990 mm	640 mm	28 kg	270 kg
Mondial ST70	1970 mm	550 mm	1120 mm	700 mm	28 kg	270 kg
RS-2 Lift-Off Top	1950 mm	550 mm	150 mm	-	22.9 kg	230 kg

Optional Accessories

417 Adult Harness  BRH-417-50	QR PediMate  BRH-678-QR	Baby Capsule Harness  BRH-419 / BRH-420	IV Pole  083-2024	Stretcher Cover  FWESC	Mattress  037-4874	Floor Lock  0573080
--	--	--	--	--	---	--

Ferno 50-E Ambulance Stretcher Code FWE50-E (undercarriage), FWE155E (top), FWE50QFX-155E (lock interface)

Winner of an Australian Design Award. The Ferno 50-E Ambulance Stretcher was developed in Australia in consultation with ambulance services and ergonomists and offers enhanced ergonomics and manoeuvrability. Carefully designed loading features reduce the physical demand on the operator during the load and unload phase. The operator simply pulls one handle to break the front legs while the rear legs stay locked and take the weight of the stretcher and patient. As the stretcher rolls into the ambulance the front load wheels and additional intermediate wheels continue to take the weight of the patient. The rear legs automatically fold once the rear leg touch bar comes in contact with the ambulance. Throughout the loading sequence only a small proportion of the weight is carried by the operator.

Key features

- Front and rear automatic leg release touch bars provide minimum lift loading
- Intermediate load wheels for a smooth friction-free loading
- On-demand 4 wheel swivel option
- High visibility frame with reflective labelling for better on-scene visibility
- There are 5 adjustable height positions for improved patient transfer
- Tracker electronic cycle counter
- 230 kg safe working load
- Gas-assist backrest with infinite positions
- Multiple shock positions
- Extending carrying handles
- Dynamically crash tested and compliant with AS/NZS 4535:1999



Mattress and restraints sold separately



FWE155E Top Only
Mattress and restraints sold separately

The 50-E consists of two main parts. The 50-E undercarriage and the 155-E stretcher top. The 155-E stretcher top can be removed and swapped with other 50-E undercarriages to eliminate the need to transfer or man handle a patient. It is supplied with a gas assist backrest, multiple shock position and extending carrying handles.

Product Specifications

Length	Width	Load Height	Highest Level	Middle Level A	Middle Level B	Lowest Level	Folded	Weight	Load Limit
1980 mm	560 mm	710 mm	855 mm	762 mm	645 mm	427 mm	175 mm	49 kg	230 kg

Optional Accessories

417 Adult Harness	QR PediMate	Baby Capsule Harness	Stretcher Cover	Bolstered Mattress	Floor Lock	IV Pole
BRH-417-50	BRH-678-QR	BRH-419 / BRH-420	FWESC	MCM-50	LA50-FL	LAIV-2030

Ferno 26-E Ambulance Stretcher Code FWE26-ELL (low), FWE26-EHL (high)

The Ferno 26-E Ambulance Stretcher is designed in consultation with various ambulance services personnel and ergonomists across Australia, the 26-E stretcher offers improved manoeuvrability, superior stability and load capacity as well as many enhanced loading and handling features requested by end users.

Key features

- Load limit of 275 kg when supported by all 6 carry handles
- Available in low or high leg versions for ambulance fleets of varying heights
- High visibility frame with reflective labelling for better on-scene visibility
- 4 x 150 mm wheels with increased surface area for easy rolling and longer life
- On-demand 4 wheel swivel option
- Pull-out side handles to assist loading heavy patients and easier manoeuvrability on rough terrain
- Longer wheel base for increased stability
- Independently operated, self loading legs for ease of loading
- Bed level function for improved transfer of patients
- Shortening feature for improved manoeuvrability in confined spaces such as lifts and narrow passageways
- Two-stage shock position
- Gas-assist backrest with infinite positions for patient comfort
- Head end extension for taller patients or patients with leg splints
- Tracker electronic cycle counter
- Dynamically crash tested and compliant with AS/NZS 4535:1999









Mattress and restraints sold separately

Product Specifications

	Length	Length Shortened	Width	Loading Height Range	Height Highest Level	Height Mid Level	Height Low Level	Weight	Load Limit
Low Version	2060 mm	1720 mm	580 mm	580-650 mm	770 mm	440 mm	200 mm	46 kg	275 kg
High Version	2060 mm	1720 mm	580 mm	670-755 mm	860 mm	440 mm	200 mm	46 kg	275 kg

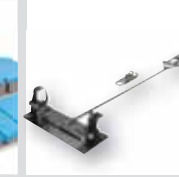
Optional Accessories

417 Adult Harness 	QR PediMate 	Baby Capsule Harness 	Stretcher Cover 	Bolstered Mattress 	Floor Lock 	IV Pole 
BRH-417/26E	BRH-678-QR	BRH-419 / BRH-420	FWESC	MCM-2650	LA26-FL	LAIV-2030



Ferno Powerflexx Powered Ambulance Stretcher *Code FWEPF*

The Powerflexx Powered Ambulance Stretcher has been designed to meet the increased demand for better management of bariatric patients. The battery operated Powerflexx will comfortably lift 318 kg at the touch of a button or carry/transport up to 454 kg in the lowest transport height. The capabilities of the Powerflexx can be further extended by accessories such as the Large Body Surface attachment (LBS Jr), In-vehicle Integrated Charging System (ICS), Push Pull Handle Kit plus many more.

Key features

- 318 kg lifting capacity with no lift assistance
- 454 kg transport capability in lowest position
- Lead-acid battery has no memory and provides power for 20 full squad runs
- Manual release handle to adjust stretcher height without using the power system
- Battery charge indicator placed at operator end for easy reference to battery level
- Improved patient surface area increases surface length by 16 cm
- Wide thumb controls provide effective gripping and control from a variety of positions with or without gloves
- Five stage shortening feature and multi-position foot-end lift bar providing better leverage and movement in confined spaces
- Infinite bed height adjustment from 33 cm to 104 cm
- 150 mm wheels provide better transport over all types of terrain
- Wide wheel base with lower centre of gravity for higher stability
- Reflective labelling for better on-scene visibility



Operator control pad



24 V battery pack



5 Stage Shortening feature



Includes mattress and restraints

Product Specifications

Length	Width	Bed Height Range	Max Load Height	Weight	Lifting Capacity	Load Limit	Load Limit Loading Position	Power
211 cm (max) 155 cm (min)	61 cm	33 cm -104 cm	84 cm	60 kg	318 kg	318 kg	454 kg	24 VDC

Optional Accessories

Ferno 513 IV Pole	417 Adult Harness	Bariatric Harness	Large Body Surface Jr	Integrated Charging System	Bariatric Towing Ring	Bariatric Push-Pull Handles
LAIV-513	BRH-417-50	FWE-PFBH	FWEPF LBS Jr	FWEICS	082-2121	FWEPF-BPH



Ferno 35X PROFlexx X-Frame Stretcher Code FWE35X

The Ferno 35X PROFlexx X-Frame Stretcher has a low centre of gravity and offers greater stability during patient transportation. The 35X features a robust leg design that will transport 318 kg in any of its seven height positions or 500 kg in the lowest position.

Key features

- Lower centre of gravity offers greater stability
- Pull-out side handles that provide additional grip points for assistance with heavy patients
- 4 x 150 mm wheels (2 fixed and 2 swivel with rolling and swivel wheel locks)
- 5 position shortening feature
- 7 height positions
- Wider bed surface with heat-sealed mattress
- Wide head frame for large patients
- Gas assist backrest and shock position for rapid patient positioning
- Safety bar and hook provide safety while unloading from ambulance



Includes mattress and restraints

Product Specifications

Length	Width	Bed Height Range	Max Load Height	Weight	Load Limit Loading Position	Load Limit Lowest Position
1990 mm (max) 1620 mm (min)	610 mm	350-980 mm	790 mm	42 kg	318 kg	500 kg

Ferno 28Z PROFlexx Ambulance Stretcher Code FWE28Z

The new Ferno 28Z PROFlexx Ambulance Stretcher provides maximum versatility for patient transport and is ideal for confined spaces such as tight hallways, narrow staircases, and small elevators, eliminating the need to transfer the patient. The 28Z is lightweight, with superior stability and load capacity. Flexible handling features minimise situations that may cause injury to either the operator or patient.

Key features

- Transition from stretcher to chair provides manoeuvrability in confined spaces
- 120 cm length in chair position
- Lightweight at 31 kg
- Pull-out side handles and optional flip-out foot-end handles
- 4 x 150 mm wheels (2 fixed and 2 swivel with rolling and swivel wheel locks)
- 318 kg load capacity
- Gas-assist backrest with infinite positions
- Wider bed surface with heat sealed mattress
- Reflective labelling for better on-scene visibility



Includes mattress and restraints

Product Specifications

Length	Stretcher Height	Chair	Chair/Stretcher	Load Limit
2030 mm (folded) 1910 mm (raised) 1200 mm (chair position)	230 mm (folded) 840 mm (raised) 660 mm (loading height)	1400 mm (max height) 640 mm (overall width) 1220 mm (overall depth)	31 kg (weight)	318 kg



Ferno Model 30 Stretcher *Code FWE30*

The Ferno Model 30 is a classic lift in style stretcher. The simple X-frame undercarriage provides multiple height adjustment. It is a low cost alternative to other stretchers on offer.

Key Features

- Lightweight 26 kg
- Six levels of height adjustment
- Foot end lead handle
- Swing-down side rails
- Four swivel wheels and telescoping head-end frame reduces overall length for manoeuvring
- Adjustable backrest
- Includes mattress and two patient restraints



Includes mattress and restraints

Product Specifications

Length	Width	Height	Weight	Load Limit
194 cm (max)	58 cm	82 cm (max)	26 kg	181 kg
163 cm (min)		31 cm (min)		

Ferno 26T Stretcher *Code FWE26T*

The Ferno 26T has been the work horse of Australian ambulance services for many years. It is a simple, economical low maintenance stretcher.

Key Features

- Three height positions including load, ground and an intermediate bed or transfer height.
- Adjustable backrest
- Shock position
- Swing down side rails
- Shortening feature
- Foot and head end extending handles
- Compliant with ambulance crash test standards AS/NZS 4535:1999



Mattress and restraints sold separately

Product Specifications

Length	Width	Height	Weight	Load Limit
244 cm (handles extended)	55 cm	81 cm (highest)	27 kg	181 kg
201 cm (handles folded)		48 cm (intermediate height)		
172 cm (shortening feature)		24 cm (folded height)		

Ferno Model 25 Ambulance Stretcher *Code FWE25*

The Ferno Model 25 Ambulance Stretcher is a low cost alternative that is both simple and durable in its design.

Key Features

- Independently operated legs for ease of loading
- There are 2 height levels: fully elevated and ground level
- Adjustable backrest angle from 0° to 75°
- Swing down side arms for convenient patient transfer
- There are 2 stationary and 2 swivel wheels

Product Specifications

Length	Width	Folded Height	Weight	Load Limit
192 cm	55 cm	24 cm	22 kg	181 kg



Mattress and restraints sold separately

Ferno 417 Adult Harness Code BRH-417

Developed in conjunction with various Australian ambulance services, the multi-functional two-piece design allow users to fit or remove the harness to the patient while on the stretcher. The design also allows the harness to be fitted under or over existing linen, allowing for easier, uninterrupted transfer of patients. The Ferno 417 Adult Harness is part of a complete suite of approved and compliant harness systems that provides restraint for newborns to obese adults.

The Ferno 417 Adult Harness has been dynamically crash tested to 20 G forward and 10 G sideward and is compliant with ambulance crash test standards AS/NZS 4535:1999.*



Ferno QR Pedi Mate Code BRH-678-QR

The Ferno QR Pedi Mate is an innovative, fully adjustable, seven point harness and restraint system that provides the ideal solution for the safe control of paediatrics during ambulance transportation. The Ferno QR Pedi Mate can be used with the backrest inclined or supine. An illustrated patient pad and simple quick release buckles allow for efficient fitting and removal from stretcher. The patient restraints and buckles are smaller and low profile and provide a safe, logical and non intrusive fit to paediatrics. The Ferno QR Pedi Mate rolls to a compact size, allowing for ease of storage and quick retrieval and is suitable for paediatrics between 3.2 kg and 18 kg. The Ferno QR Pedi Mate Harness is part of a complete suite of approved and compliant harness systems that provides restraint for newborns to obese adults.

It has been dynamically crash tested with a 9 kg and 18 kg crash dummy to 20 G forward and 10 G sideward as per ambulance crash test standards AS/NZS 4535:1999.*



Ferno Baby Capsule/Convertible Chair Harness

Codes BRH-419 (Baby Capsule Harness), BRH-420 (Convertible Chair Harness)

Ferno Baby Capsule and Convertible Chair Harnesses have been developed as an interface between various Ferno stretchers and Australian style baby capsules and convertible chair/capsules and form part of the complete suite of approved and compliant harness systems that provides restraint for newborns to obese adults. The harnesses have been dynamically crash tested to 20 G forward and 10 G sideward and are compliant with ambulance crash test standards AS/NZS 4535:1999.*



Ferno Patient Restraints

Ferno offers a complete range of restraints with various colour and length options. These include:

- BRR-TRAVREST Two-piece five foot double bar buckle
- BRR-43017 One-piece seven foot metal buckle
- BRR-43017P One-piece seven foot plastic buckle
- BRR-43025 Two-piece five foot metal buckle
- BRR-43025SC Two-piece five foot metal buckle with speed clip connectors
- BRR-43025P Two-piece five foot plastic buckle
- BRR-43025PSC Two-piece five foot plastic buckle with speed clip connectors
- BRR-43027 Two-piece seven foot metal buckle
- BRR-430VSC Velcro one-piece restraint, variable in length, with speed clip connectors

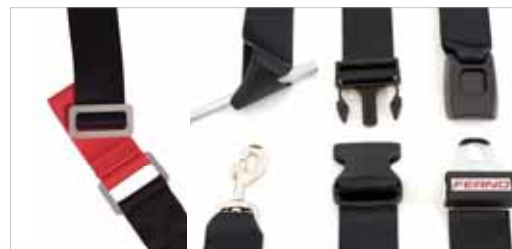

Ferno 414-OL Wrist Restraints *Code BRR-414OL*

The Ferno 414-OL Wrist Restraints are conveniently adjustable and fastened to both sides of the stretcher to secure a patient's wrists in their lap. The security of these restraints is complemented by velcro closures.



Ferno 414-R Sidearm Wrist Restraints *Code BRR-414R*

Ferno's 414-R Sidearm Wrist Restraints securely hold a patient's wrists to the top of the stretcher's side rails. These restraints utilise velcro closures and are available in a set of two.



Ferno 415 Ankle Restraints *Code BRR-415*

Ferno 415 Ankle Restraints hold a patient's ankles securely in place to both sides of the mainframe. These restraints conveniently allow each leg to be individually secured and released.

Universal Psychiatric Restraint Set *Code BRH-MPR*

The Universal Psychiatric Restraint Set is designed for use on a variety of stretchers or beds. It features two single wrist cuffs and a double ankle cuff strapping system. Each cuff features a padded, double overlap, strap system secured with velcro and is adjustable to a variety of limb sizes. An adjustable tie down loop provides some flexibility in attachment points and length of strap and is fitted with a quick connect, double action, industrial rated buckles. Machine washable.



Ferno Faststrap Restraint System *Code BRR-770*

The Ferno Faststrap Restraint System is an 10 point, five strap system that is used to secure patients to backboards, scoop stretchers and other devices. Colour-coded webbing, prominent labelling and stiffening within the main skeleton of the restraint allows for rapid, hassle free application in patient immobilisation.



Ferno Walk Belt *Code FWE-WB-LS*

The Ferno Walk Belt has been purpose designed for paramedics and emergency healthcare professionals to assist patients while walking, particularly where an ambulance stretcher, chair or board can not easily be used or for patients that are able to walk a short distance with some assistance. The Ferno Walk Belt secures around a patients waist and is fitted with eight handles, four horizontal and four vertical handles as well as 2 leg straps that substantially reduces the effort required to assist a patient whilst walking. The Ferno Walk Belt can be machine washed and reused repeatedly.



Ferno Bolstered Mattress *Code MCM-2650 (26 Series mattress) and MCM-50 (50 Series mattress)*

Ferno has designed a bolstered mattress to suit the harsh environment and road conditions experienced in Australia. Our mattress combines four layers of foam with varying densities and shapes to provide the ultimate comfort for patients. Slow recovery foam with bolstered sides creates a centring action that stabilises patients, providing support in transit. Each mattress is covered in soft, flexible, medical grade vinyl on the patient area with durable, hard wearing, medical grade vinyl on the underside to prevent mattress damage. Each mattress is heat sealed to prevent ingress of fluids.



Ferno Floor Locks Code LA26-FL and LA50-FL

Made from die-cast stainless steel the Ferno Floor Lock provides unrivalled strength, yet is simple in design and use. The stretcher floor lock hooks are designed to fully capture the front and rear attachment points of the stretcher with one simple pull of the floor lock lever. When fitted correctly the Ferno Floor Lock combined with an approved Ferno harness restraint will provide the user with a complete AS/NZS 4535:1999 system that safely and securely restrains a patient to the stretcher and the stretcher to the ambulance. Ferno Floor Locks have been dynamically crash tested to 20 G forward and 10 G sideward and are compliant with ambulance crash test standard AS/NZS 4535:1999



LA26 FL is compatible with most 26 and 2650 series stretchers

LA50 FL is compatible with most 50 series stretchers

Ferno 2030 IV Pole Code LAIV-2030

The Ferno 2030 IV Pole is a lightweight permanently attached IV pole that conveniently fits within the side rail of most Ferno stretchers. For after-market installation, each Ferno 2030 IV Pole comes complete with a new side rail for quick and easy fitting. Includes bracket mount for IV accessories and hooks for two IV bags. The IV pole is for mounting on the (patient) left hand side of stretcher only.

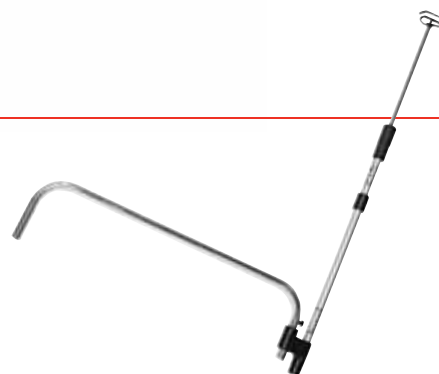

Ferno 513 IV Poles

Code LAIV-513-10 (swing down) and LAIV-513-13 (removable pole)

Permanently mounted base with either a removable or swing down pole. Maximum load 2 kg fully extended and 23 kg at retracted length. Suitable for most Ferno stretchers.

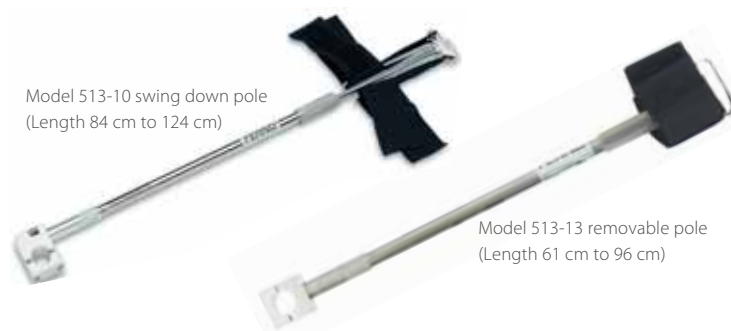

Model 513-10 swing down pole (Length 84 cm to 124 cm)

Model 513-13 removable pole (Length 61 cm to 96 cm)

Ferno Eclipse Torch Holder Code LA-2080

The Ferno Eclipse Torch Holder allows a small torch to be placed virtually anywhere on a stretcher for hands free illumination of the immediate area. By adjusting the integral stretch cord it allows manipulation of the torch so that it can be positioned at various angles allowing for perfect adjustment and illumination.



Ferno CPR Board Code FWECPRB

The Ferno CPR Board is ideal for CPR training and CPR administration by providing a firm surface that helps to properly position a patient to ensure a constant, open airway. The head cup maintains proper alignment of a patient's head, whilst the contoured sides make lifting the patient easier.

Product Specifications

Length	Width	Weight
59 cm	44 cm	2 kg



Ferno Transfer Board Code FWESPS

The Ferno Transfer Board has a smooth top and bottom surface which allows for easy, low friction gliding, facilitating patient transfers. Comfort, convenience and adaptability are built into this transfer board. Manufactured from high impact polyurethane it features six grab slots with rounded, smooth edges for operator ease. The Ferno Transfer Board is latex-free.



Product Specifications

Length	Width	Depth	Weight
125 cm	46 cm	0.5 cm	2.3 kg

Ferno 341 Carry Sheet Code FWE341

The Ferno 341 Carry Sheet is widely accepted as a vital aid in the rapid evacuation of non-ambulance patients from hazardous situations. Suitable for use with medical, surgical, psychiatric and geriatric patients, it is instantly available in emergency situations. Constructed of heavy-duty rip-stop PVC, the Ferno 341 Carry Sheet is easily cleaned and reusable.



Product Specifications

Length	Width	SWL
68 cm	175 cm	159 kg

Ferno Manta Rescue Transfer Sheet Code FWEMRA (orange) FWEMRA-DO (drab olive)

The Manta Rescue Transfer Sheet meets many rescue transfer needs. It can be used to transfer and evacuate patients up to 363 kg and is also ideal for rescues in confined areas. Pockets at both ends will hold a backboard, patient's feet and head and has drain holes for possible water disbursement. Fire retardant. Available in Orange or Drab Olive.



Product Specifications

Length	Width	Weight	Load Limit
222 cm	115 cm	2 kg	363 kg

Ferno Disposable Sheets

The Ferno Disposable Sheets guard against stains, spills and is an aid in infection control. Available as a flat sheet or as a universal fitted sheet for stretcher mattresses.

Code	Description	Carton Qty
DPL-FS50	Stretcher Sheet Fluid Resistant Envelope 180 cm x 75 cm	Pkt 50
DPL-FSXL50	Single Bed Sheet (75 mm) Fluid Resist Envelope 190 cm x 90 cm	Pkt 50
DPL-PTS50	Flat Sheet Fluid Resistant 230 cm x 120 cm	Pkt 50
DPL-TS	Stretcher Sheet with Absorbent Pad, Envelope	Each
DPL-PS50	Pillow Slip Open 75 cm x 50 cm	Pkt 50



Ferno Patient/Stretcher Cover Code FWESC

The Ferno Patient/Stretcher Cover protects bedding, equipment and will keep patients dry in inclement weather. It is made from lightweight, coated nylon and the cover contains a dual zip that opens from both ends to access patient or equipment. The cover can be rolled or folded and stuffed into its self contained storage pouch which can be attached to the stretcher with the integral Velcro attachment straps. The Ferno Patient/Stretcher Cover has a full length, elasticised rim and outer Velcro straps that allows it to be fitted to any cot or basket stretcher or patient. Supplied in safety orange with two reflective silver strips for night time visibility.



Ferno 2020 Equipment Bracket Code FWE2020

The Ferno 2020 Equipment Bracket is compatible with most Ferno stretchers. It allows for convenient storage of gear while the stretcher is not in an ambulance. The bracket is spring loaded which allows it to automatically retract within the stretcher frame when not in use.



Ferno 274 Pac Rac Stretcher Table Code LA50-274/1 and LA26-274

The Ferno 274 Pac Rac Stretcher Table is designed to securely hold essential emergency equipment during patient transport. Quick clip mounting allows the table to be attached directly to the rails of a stretcher. The Ferno 274 is lightweight and folds for portability and storage. There are two versions that allow compatibility with most Ferno stretchers. The LA 50-274/1 is compatible with most 50 series stretchers, whilst the LA26-274 is compatible with most 26 and 2650 series stretchers.

Product Specifications

Length	Width	Height	Weight	Load Limit
54 cm (table surface) 57 cm (overall length)	34 cm	37 cm	3.8 kg	34 kg



Ferno Equipment Table Code FWE-2100

The Ferno Equipment Table is designed to securely hold essential emergency equipment during patient transport. Tube clamps allow the table to be attached directly to the rails of a stretcher and a side opening gate allows patient transfer without the need to remove the table from the cot. Two integral IV poles with securing velcro straps provide safe and secure transport of up to four IV bags. The Ferno Equipment Table has been dynamically tested with 29 kg to 20G in forward and sideward directions making it the choice of equipment tables for both aeromedical and road ambulance use. It is lightweight and folds for portability and storage and suitable for use on the 155 series litter tops.



Product Specifications

	Length	Width	Depth	Weight	SWL
Tray Surface	52.5 cm	36.5 cm	38 cm*		
Folded	60 cm	60 cm	12 cm	5 kg	29 kg**

* 38 cm from stretcher frame ** SWL = 25 kg on tray plus 2 x 1 litre IV bags per extended IV pole.

Ferno Large Body Surface Jr (LBS Jr) *Code FWEPF-LBS Jr*

Convert your Ferno Powerflexx Stretcher with the Ferno Large Body Surface Jr. (LBS Jr) The unique design increases the width of the Powerflexx stretcher to 106 cm to accommodate larger patients. The LBS Jr also features folding wings that provide the option to reduce its profile from 106 cm to 74 cm for better manoeuvrability through doorways or tight walkways. The LBS Jr. attaches by a system of pins and mounting blocks and does not interfere with the function of the stretcher. When not in use the LBS Jr. folds flat, ready for deployment. The Ferno Manta Rescue Aid is also provided with each LBS Jr. to assist in moving the patient.

Key Features

- Increases patient surface to 106 cm width or 74 cm with wings raised
- Supports up to 454 kg when at lowest load position
- Includes restraint extenders, mounting blocks and hardware
- Folds easily and flat for storage
- Includes a Ferno Manta Rescue Aid for patient transfer
- Includes patient pillow wedge



The optional LBS Jr Mattress provides added comfort and folds or rolls up for storage.

Code FWEPF-031-4050 (LBS Jr Mattress)

Ferno Bariatric Push-Pull Handles *Codes FWEPF-BPH*

The Ferno Bariatric Push-Pull Handles have been designed by Ferno Australia in conjunction with various Australian ambulance services.

They provide emergency personnel with ergonomically positioned handle(s) that allow head and foot end operators to safely and carefully guide and propel a bariatric patient up to 454 kg on stretcher when being transported in the stretcher's lowest position. Each handle kit is supplied with mount brackets and when fitted do not interfere with the stretcher's operations.

The handles can be purchased as a full head and foot end kit or individually. The head end handle kit attaches to the Powerflexx stretcher frame while the foot end handle kit attaches to the Ferno LBS Jr.



Ferno 417 Bariatric Harness *Code FWE-PFBH*

Ferno has drawn on its understanding of current ambulance crash standards and knowledge of Australian fall protection standards to produce an extensive bariatric harness that will withstand the excessive G forces should a bariatric patient be involved in an accident during transportation. The harness is constructed with oversize high strength webbing with adjustable buckles and attaches to both the standard stretcher harness mount points as well as six pre-positioned, floor mounted tie down points via 50 kN steel karabiners. The 417 Bariatric Harness is compatible with the Ferno Powerflexx stretcher fitted with the Ferno LBS Jr.



Bariatric Harness shown with optional LBS Jr Mattress

Traverse Gazelle Basket Stretcher Code FWETBG (standard) and FWETBGCS (confined space)

The Traverse Gazelle Basket Stretcher is a light, disaster response stretcher that is ideal for industrial rescue organisations. Its steel frame geometry and construction with durathene netting provides impressive strength along with durability and versatility. The tubular runner rails that extend the full length provide a durable base that minimises stretcher damage. Flat carbon steel patient supports bars extend down the length of the stretcher. The Traverse Gazelle represents a cost effective alternative that will meet the needs of infrequent stretcher users.

Key Features

- Tested to and beyond a 408 kg static threshold
- Supplied with three steel double bar restraints
- Durathene netting allows water and air flow
- Black powder coated all carbon steel frame construction
- Tubular bottom runner rails
- Compatible with any Ferno backboard
- Tapered feature allows easier access in confined areas
- Cost effective

Product Specifications

	Length	Width	Weight	Load Rating
standard	211 cm	62 cm	13 kg	408 kg
confined space	211 cm	46 cm	12 kg	408 kg



Saver Basket Stretcher Code FWE71SAVER FWE71SPSAVER

Ideally suited to moving or rescuing an injured person from a building site, quarry, mine or mountain. The Basket Stretcher can be dragged, carried or hand lifted across rough or muddy terrain without affecting the patient's wellbeing. Providing full body protection, it comes complete with four movable patient straps and a footrest for comfort and stability.

The Saver Basket Stretcher is not suitable for horizontal or vertical lifting with lifting bridles.

Key Features

- Padded inner for patient comfort
- Hand holes for easy transporting
- Location points for patient restraints
- Compatible with Ferno spine and backboards
- Split version folds in two for easier storage

Product Specifications

	Length	Width	Height
One-piece	218 cm	61 cm	19cm
Two-piece	218 cm	61 cm	19cm



Traverse Titan Basket Stretcher (Stainless Steel)

FWETBT (Stainless Steel - one-piece), FWETB-SP (Stainless Steel - split version)

The Titan Series Basket Stretcher is specifically designed to perform in a technical rescue environment. It is made with superior materials that allow it to survive in almost all conditions, while the design itself provides a user-friendly platform from which to work. Constructed with TIG welded stainless steel, it relies on its frame geometry, construction methods and materials for its ultimate strength.

Unique features include the four StratLoad Attachment Points that make it quick, easy and safer to secure the litter bridle and protects the karabiners from wall and rock faces. The 25.4 mm reinforced, double top tube on the head and foot end provide reassuring strength in vertical haul or lowering operations. The Durathene netting allows water and air to easily pass through the patient compartment, yet the small holes keep from snagging debris as easily. Tested to and beyond a 1136 kg (11 kN) static load test threshold, users can be ultimately confident in their use of the Traverse Titan Basket Stretchers.

Traverse Titan Basket Stretcher (Titanium)

Code FWETTI (Titanium - one-piece) and FWETTI-SP (Titanium - split version)

For the ultimate in strength to weight ratio, the Titan Titanium Basket Stretchers sets a new standard for rescue litters. It is made from ASTM Grade 2 titanium tubing making it less than half the weight of the Titan Stainless Steel stretchers. The Titan Titanium one-piece design with a one inch top tube weighs only 6.1 kg and the split version at 7.6 kg, making them ideally suited for applications where weight saving is your ultimate goal.

Common Key Features

- Tested to and beyond a 1136 kg (11 kN) static threshold
- StratLoad Attachment Points for secure bridle connection
- Reinforced 25.4 mm double top tube
- Supplied with 4 steel double bar restraints
- Durathene netting allows water and air flow
- Compatible with any Ferno backboard
- Tapered feature allows easier access in confined areas
- Moulded, high density polyethylene back support

Split Version Key Features

- Interlocked, pinless, bottom hinges
- Integral top rail with threaded collets
- Completely solid connection between the two parts of the stretcher
- Assemble or un-assemble in approximately 15 seconds
- Engineered to nest together for storage when split



FWETBT-SP (Split Version)

FWETBT (One-Piece)



Stratload attachment point



Integral top rail with threaded collets

Product Specifications

	Length	Width	Height	Weight	Load Rating
Stainless Steel One-piece	211 cm	58 cm	18 cm	14 kg	1136 kg (11 kN)
Stainless Steel Split	211 cm	58 cm	18 cm	16.3 kg	1136 kg (11 kN)
Titanium One-piece	211 cm	58 cm	18 cm	6.1 kg	1136 kg (11 kN)
Titanium Split	211 cm	58 cm	18 cm	7.6 kg	1136 kg (11 kN)

Titan 32 Basket Stretcher Code FWETBT-32

The Titan32 Basket Stretcher has all of the main features of the Titan Series Stainless Steel Basket Stretchers but is made specifically to deal with larger patients. Measuring 81 cm wide, it gives extra room for those special cases where the size of the patient dictates a different approach in handling.

As with the other Titans, the Titan 32 is rated to 1136 kg (11 kN) and is made entirely of stainless steel. The back supports span the entire length of the stretcher (between the cross-braces) and are also made of stainless steel in order to give additional support.

Key Features

- 81 cm wide
- Tested to and beyond a 1136 kg (11 kN) static threshold
- StratLoad Connectors for secure bridle connection and karabiner protection
- Stainless steel back support slats
- Reinforced, 25.4 mm double top tube
- Supplied with 4 steel double bar restraints
- Durathene netting allows water and air flow
- Compatible with any Ferno backboard
- Tapered feature allows easier access in confined areas
- Moulded, high density polyethylene back support



Stratload attachment point



Product Specifications

Length	Width	Weight	Load Rating
211 cm	81 cm	19.2 kg	1136 kg (11 kN)

Traverse Advantage Basket Stretcher Code FWETAB

The Advantage Basket Stretcher is a complete redesign from any other plastic style basket stretcher available today. The fully-internal stainless steel frame provides a 1136 kg (11 kN) strength rating while giving a single-plane sliding surface on the bottom. The outer High Density Polyethylene (HDPE) shell is attached to the top tube, allowing the secondary rail to be completely exposed to provide full options for tying in your patient for the most technical rescue.

Generous cut-out sections in the shell provide loads of exposed top rail for handling, and the 22 mm tubing allows for a more comfortable grip. The patient pad is made of closed-cell foam that will not allow fluids to soak into, and is able to withstand even the harshest cleaning agents. It is glued in such a manner that allows it to be removed and replaced if required. Standard on the Advantage Basket Stretcher is the patented StratLoad attachment points.

Key Features

- Plastic outer shell
- Full internal stainless steel frame
- Designed for technical use as well as general use
- Standard StratLoad attachment points
- Foam patient pad
- 1136 kg (11 kN) strength rating
- Supplied with four steel double bar restraints



Stratload attachment point



Product Specifications

Length	Width	Height	Weight	Load Rating
216 cm	60 cm	19 cm	13 kg	1136 kg (11 kN)

Ferno 71 and Ferno 71-S Basket Stretcher Code FWE71 (one-piece) and FWE71S (split version)

The Ferno 71 Basket Stretcher is constructed of a high density polyethylene shell supported by a permanently attached heavy-duty aluminium frame. Moulded-in runners and handholds make it easy to handle. This basket stretcher is chemical, UV, rust and corrosion resistant. An easily replaceable mattress is attached inside the stretcher for patient comfort. Supplied standard with four two-piece quick release patient restraints. The Ferno 71-S two-piece Basket Stretcher has the same features as the one-piece Ferno 71 Basket Stretcher but separates in half for compact storage or backpacking to a rescue site.

Key Features

- Brass grommets strategically located for quick use with the Ferno BRB-TLB-TX11S Adjustable Lifting Bridle
- Moulded runners and handholds

Additional Features of split 71-S

- Separates for compact storage or backpacking to rescue site
- Stretcher halves store nested together
- Stretcher is quickly assembled and secured with pins



	Length	Width	Height	Weight	Load Limit
One-piece	218 cm	61 cm	19cm	10 kg	272 kg
Two-piece	218 cm	61 cm	19cm	10 kg	272 kg

Ferno Res-Q-Mate Rescue Stretcher Code FWE2060

Ferno's Res-Q-Mate Rescue Stretcher is specifically designed for rapid evacuation in building collapses, mine rescue, helicopter and confined space rescue. The rigid frame also provides an ideal platform to evacuate suspected spinal injuries.

Torso and leg flaps comfortably wrap around the patient while a head restraint and four adjustable, colour-coded, chest, thigh and lower leg straps assist in securing the patient. Additional restraint is provided via an exterior v-shaped arm strap and a long foot end strap designed for a figure-of-eight configuration. There are also six built-in carry handles that provide rescuers with various carrying options. Constructed of high grade stainless steel and quality synthetic materials the Res-Q-Mate is impervious to oil, water, grease and other petroleum products making it easy to clean and also resistant to rot and corrosion. When not deployed the unit folds compact and sits neatly inside a heavy-duty reflective backpack.

Each Ferno Res-Q-Mate Rescue Stretcher comes complete with a four-point lifting bridle, 50 m tag line system, adjustable head restraint, head pillow and reflective backpack.



	Length	Width	Depth	Weight with pack & bridle	Load Limit
Folded & Packed	100 cm	28 cm	18 cm	17.5 kg	-
Deployed	185 cm	28 cm	10 cm	17.5 kg	180 kg

Ferno Res-Q-Mate Stretcher Handle Kit

Code FWE2062 (Carry Handles pair with bag)

When the Ferno Res-Q-Mate Stretcher needs to be carried for any lengthy period the Handle Kit offers greater carrying options for the rescuer by providing more comfortable and lift friendly positions. The Handle Kit conveniently locks in position at either end of the stretcher. Ideally the Res-Q-Mate Handle Kit should be used with the Ferno Stretcher Handle Shoulder Harness so that the combined weight of the patient and stretcher can be transferred from the arms and evenly shared through the shoulders, chest and back.



shown with optional stretcher handle shoulder harness



Paraguard Excel Rescue Stretcher *Code FWE1411*

The Paraguard is designed for a variety of rescues and is a compact and versatile rescue stretcher that is entrenched in NATO and various defence forces around the world. This stretcher is approved for use by many authorities including NATO 6530-99-446-9403. For storage and ease of transport the Paraguard folds and nests within a backpack supplied as standard.

Options and Accessories

- 4 point lifting bridle
- Carry handles (pair)
- Shoulder harness system

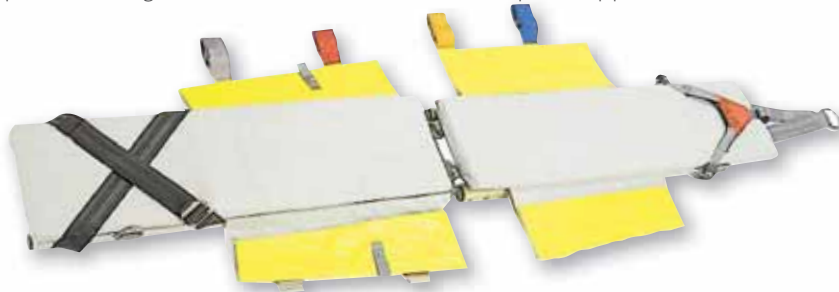

Length	Width	Height	Weight with pack & bridle	Load Limit
182 cm	25 cm	10 cm	14 kg	136 kg

SKED Rescue Stretcher *Code CMC752001*

Compact storage, ease of use and flexibility while transporting has made the SKED Rescue Stretcher popular with rescue squads, military and ski patrols. Made from a heavy sheet of plastic, the stretcher becomes rigid when folded around the patient.

A variety of handles and straps assist with multiple forms of stretcher transportation including vertical and horizontal lifts with rope systems and helicopter transportation. These handles and straps also help with towing the stretcher. Sliding is made possible with the smooth bottom surface of the stretcher.

The full system comes complete with the stretcher, Cordura nylon backpack/towing harness, 2 x straps, horizontal lift slings, vertical lift sling, large steel karabiner and four removable web handles.



Length	Width	Weight
91 cm	23 cm	8.2 kg (full system)

Ferno LifeSaver Rescue Stretcher *Code FWELS*

The Ferno LifeSaver Stretcher is a modern version of the traditional Neil Robertson Stretcher and is designed to be both quick and easy to use in horizontal and vertical lift situations where minimum bulk is a consideration. The LifeSaver Rescue Stretcher comes complete with integral leg and torso flaps that envelope the patient like a traditional corset which is complimented by a simple head restraint, five built-in patient restraints and a long foot strap. It is fitted with various carry handles and stainless steel rings that are used at the foot and head end for guiding and lifting the stretcher in vertical applications. The compact, roll-up design makes storing and transporting the stretcher easy. The LifeSaver Rescue Stretcher is made with full length 5 mm ribs interwoven in tough 1000 denier, high tenacity, nylon fabric to provide full body splinting in a very narrow patient package. Also available in military colours.



Length	Width	Height	Weight	Load Limit
153 cm	104 cm	3 cm	5 kg (full system)	159 kg

Ferno Vertical Rescue Stretcher Code VRES STRETCH

The Ferno Vertical Rescue Stretcher's roll-up, compact and lightweight design makes it ideal for high angle, confined space, horizontal or vertical rescue. When deployed the wrap-around concept becomes rigid and gives the patient a feeling of security as well as protecting limbs and body from further injury during evacuation procedures. The Vertical Rescue Stretcher is fitted with many carry handles as well as six lifting slings that provide a good variety of options for transportation and lifting. Also supplied standard is an integral and comprehensive, colour-coded, full body restraint system that includes a padded head restraint, six over body restraints, shoulder and groin straps along with a generous foot strap to assist with vertical lifts. When not in use the Vertical Rescue Stretcher rolls up and is easily housed within the cordura storage bag which doubles as a backpack. Also available in military colours.

Key Features

- Constructed from internal high density polyethylene with a mixture of tough 1000 and 1680 denier Cordura with a heavy polyurethane coating
- Various carry handles and lift slings provide many options for transport or evacuation lifting
- Integral, colour-coded, head, shoulder, groin and foot restraints
- Six exterior restraint straps assist to wrap and secure stretcher around the patient
- Includes a Cordura storage bag with backpack shoulder straps



Product Specifications

Length	Width	Weight	Load Limit Horizontal	Load Limit Vertical
202 cm	77 cm	8 kg	350 kg	250 kg

Ferno VRS 6 Point Lift Bridle Code BRB-VRS

Code BRB-VRS

The Ferno VRS 6 Point Lift Bridle has been designed specifically to fit the Vertical Rescue Stretcher. Each adjustable sling arm is colour coded and identified to ensure correct placement. Rated to 25 kN



Med Sled Rescue *Code MS-MS36VLR (red) MS-MS36VLR-DO (drab olive) MS-MS36VLR-CB (coyote brown)*

The Med Sled Rescue dramatically reduces the effort required for moving and rescuing the wounded and gives you all the traditional functionality and tactical evacuation methods with a less complicated, more durable and less expensive system.

Key Features

- Dramatically reduces the effort of moving wounded
- Sled design enables a one-on-one rescue or evacuation
- Slides easily for safe and immediate evacuation
- Utilises high density and very durable polyethylene
- 455 kg rated perimeter tether secures the patient and expedites the evacuation process
- Utilises 1818 kg rated cross straps with side release, quick connect buckles
- Decontamination capable
- Vertical and horizontal lifting bridle included
- Lifting bridle rated to 455 kg
- Rapid deployment backpack with four exterior pockets included
- Packaged compact, ready for use, no assembly required.
- Lightweight 2.75 kg
- Available Coyote Brown, Red or Drab Olive



Med Sled Evacuation *Code MS-MS36 (standard) MS-MS48 (bariatric)*

Be disaster prepared. When timing is critical, Med Sled Evacuation enables carers to safely transport a patient and provides the ability to control the descent down a stairwell to exit a multi floor building. No lifting is required when using the roll and drag method.

Each Sled has eight handles for lifting, 3 securing cross straps and a tether and stairwell braking system. The Med Sled Evacuation rolls up and fits into the supplied compact bag with shoulder strap.

(Bariatric Sled also available)

Dimension 91.5 cm x 221 cm



Ferno Emergency Pole Stretcher Code FWE108AF (dual fold) and FWE108A (single fold)

The Ferno Emergency Pole Stretchers 108A and 108AF are lightweight, high-strength emergency stretchers suitable for first aid response, industrial sites and casualty rooms. They are made with PVC coated nylon covers that are heat sealed making them resistant to blood, body fluids and mildew and easy to clean. All Ferno Emergency Pole Stretchers feature lightweight aluminium poles with contoured, flexible hand grips for easy handling. Both stretchers fold however 108AF also hinges at the centre permitting the stretcher to dual fold for compact storage. Available in standard emergency orange with optional wall mounted carry cases. Accessories include carry case for the 108AF model MCC-383B and MCC-384C for the 108A.



Product Specifications

Length	Width	Height	Weight	Load Limit
231 cm	55 cm	14 cm	6 kg	159 kg

Ferno 11 Folding Emergency Stretcher Code FWM11

The Ferno 11 Folding Emergency Stretcher is a simple, fold away, flat stretcher featuring folding head end 10 cm wheels and folding foot end posts. The centre hinges and folding head end wheels and foot end posts enable the stretcher to fold for compact storage. The stretcher comes with a load capacity of 159 kg and can be used with the Model 385-A carry case. Supplied standard with two patient restraints.



Product Specifications

Open Length	Folded Length	Width	Height	Weight	Load Limit
187 cm	94 cm	47 cm	21 cm	7 Kg	159 Kg

Saver Stacking Catastrophe Stretcher Code FWES2032

The Saver Stacking Catastrophe Stretcher is the ideal product for mass casualty and catastrophic situations. The Saver Stacking Catastrophe Stretcher conveniently stacks onto itself for compact storage and quickly deploys to accommodate multiple victim scenarios. It is constructed of durable, lightweight aluminium, and heavy-duty vinyl coated nylon that is fire retardant and stain resistant.

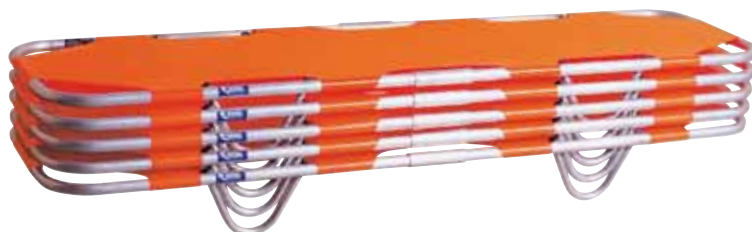

Product Specifications

Length	Width	Height	Unit Weight	Load Rating
187 cm	48 cm	18 cm	3 kg	159 kg

Saver Foldable Bed Code FWES2033

The Saver Foldable Bed has been designed to help you provide a fast, effective, and economical response to mass casualty and hospital surge situations. It supports up to 159 kg and folds for easy storage and transport, and it sets up in seconds. Supplied with two IV pole holders.



Product Specifications

Length	Width	Height	Unit Weight	Load Rating
195 cm	80 cm	45 cm	10 kg	159 kg

Ferno Model 9 Emergency Stretcher with Wheels Code FWE9

The Ferno Model 9 Emergency Stretcher is a simple to use, flat stretcher featuring an adjustable backrest. Load wheels at the head end of the stretcher and a low profile design serves well in vehicles where headroom is limited. The Ferno Model 9 also features a telescoping head end frame for manoeuvring in tight spaces. Centre hinges enable the stretcher to fold for compact storage. Made with lightweight aluminium with a heavy-duty, vinyl-coated nylon cover.

Aviation model is also available. Supplied with FAA approved heavy-duty vinyl coated stretcher cover and two each model PR-STFL FAA approved black patient restraints.

Key Features

- Centre hinges enable the stretcher to fold for compact storage
- Telescoping head end handle shortens for easier manoeuvring
- Includes 2 quick release patient restraints
- Adjustable backrest
- Low profile head end wheels and foot end stationary posts
- Can be used with Model 385-A Storage/Carrying Case



The Ferno 9 Emergency Aviation Stretcher has been successfully installed and certified in many aircraft around the world, however, it is not supplied with a certificate of approval for aircraft application. This is the responsibility of the customer as it needs to be completed in conjunction with an engineer due to issues such as the aircraft structure, fastener or retention system and patient restraint system.

Product Specifications

Open Length	Folded Length	Width	Height	Weight	Load Limit
187 cm	94 cm	47 cm	16 cm	8 kg	159 Kg

Ferno 1400 Series Aviation Stretcher Code FWE1401, FWE1402 and FWE1403

The Ferno 1400 Series Aviation Stretcher is a popular option for many different types of aircraft because of its accommodating option package. Available in a non-folding, bi-folding or tri-folding base, each base offers options and accessories including square or tapered foot and head ends, location or locking pins, rollers, trackball, non-rolling or flat bottom. Standard features include backrest and two lock down studs.



The Ferno 1400 Series Aviation Stretcher has been successfully installed and certified in many aircraft around the world, however, it is not supplied with a certificate of approval for aircraft application. This is the responsibility of the customer as it needs to be completed in conjunction with an engineer due to issues such as the aircraft structure, fastener or retention system and patient restraint system.

Mantis Tri-Fold Evacuation Board FWE-MTF

The Mantis Tri-Fold Evacuation Board represents the ultimate in simplicity and durability. It is ideal for vehicle extraction because of its compact size and rapid employment. It is made of light weight aluminum and has zero risk of the fire hazards, cracking, warping and gouging that's common with plastic and composite boards in tactical and vehicle operations. The Mantis has generous hand holds and accepts all common restraint systems.

Key Features

- Deploys in seconds
- 227 kg load rating
- Optional backpack carrier



Product Specifications

Length (open)	Length (folded)	Width	Weight	Load Limit
183 cm	63.5 cm	41 cm	5.8 kg	227 kg

Ferno Adjustable Lifting Bridle

Code BRB-TLB (24 mm screw gate karabiner) and BRB-TLB-TX11S (65 mm screw gate karabiner) and BRB-TLB-LTA (large triplock karabiner)

The Ferno Adjustable Lifting Bridle is available with a variety of karabiner options. Common features include adjusters on each of the four arms so the stretcher can quickly be set at the best angle for patient comfort or for the individual rescue requirements. The BRB-TLB is supplied with four steel, screw gate karabiners with 24 mm gate opening suitable for use with the Traverse Titan and Gazelle Stretchers. The BRB-TLB-TX11S (steel, screw gate karabiner) and the BRB-TLB-LTA (steel, triplock karabiner) have extra large gate openings making them suitable for use with the Ferno 71 Series stretchers.

Key Features

- Individually adjustable arms
- Drop forged lifting ring, adjusters and sliding bar buckles
- UV resistant webbing rated at 2520 kg (25 kN)
- Additional wear strips where hardware meets webbing
- Big bright orange tabs for easy adjustment
- Choice of karabiners available



Res-Q-Mate Lifting Bridle Code BRB-2063

Designed around the lifting points found on the Res-Q-Mate Stretcher, this bridle is fixed in length for weight distribution and supplied with four lightweight karabiners.



CMC Rescue Vertical-Lift Stretcher Harness Code CMC724133

Confined spaces and narrow openings require the stretcher to be rigged with the patient held vertically in order to fit, and these openings usually end with a 90-degree transition. The Vertical-Lift Harness eases the transition over an edge when a high anchor point is not available, such as a parapet roof, out a window, off a tank top or over a handrail. This reduces the manpower requirements, improves patient care and reduces risk. The unique spreader bar allows the stretcher to pivot between the side straps as the head of the stretcher clears the edge. Constructed of 2720 kg breakforce, 25 mm flat web for high strength and lightweight. Buckles allow easy adjustment.

Weight: 1.3 kg. Delta Quick Link included.



Traverse Stretcher Handle (Pair) Code FWETBLH

Add a handle to the end of your Traverse Gazelle or Titan Stretchers. The stainless steel handles slide onto the end of the stretcher for easier lifting and carrying. Rubber grips provide a secure grip. For longer hauls attach the Ferno Stretcher Handle Shoulder Harness (sold separately) to the eye on each side of the handle to transfer the weight to your shoulders, chest and back.

Weight: 1 kg.



Ferno Stretcher Handle Shoulder Harness Code BRH-2061

Designed to be attached to either the Res-Q-Mate Handle Kit or the Traverse Stretcher Handles. For longer hauls and walk outs the Shoulder Harness combined with a handle kit offers rescuers a more comfortable, balanced lift options and transfers weight solely from the arms and distributes to the shoulders, chest and back.



CMC Rescue Original Litter Shield

Protect your patient from further trauma during stretcher evacuations and carry outs. The shield provides the patient with protection from falling rocks and debris, inclement weather and scrub without compromising access to and visibility of the patient's head. Moulded of thick Lexan, the Litter Shield offers impact resistance with the clarity and weather-ability of glass.

The CMC Original Litter Shield attaches to a mount on the stretcher rail that allows the shield to pivot and nest on top of the stretcher side rails. A quick release pin allows the shield to be completely removed if necessary. Weight: 2.7 kg.

Each shield requires a railing clamp that must be ordered separately.

CMC740000	Litter Shield, Original, CMC Rescue	CMC 740016	Railing Clamp for Traverse Titan Series
CMC 740011	Railing Clamp for Gazelle Stretchers	CMC 740017	Railing Clamp for Advantage Basket
CMC 740012	Railing Clamp for Ferno 71 Series	CMC 740015	Pin, Litter Shield Replacement, CMC



Ferno 471 Floatation Collar *Code FWE471*

An orange 3 m long floatation collar that folds around the outer head end perimeter of basket stretchers to assist rescuers in keeping the patients head above water line. The floatation collar provides over 20 kg of floatation and attaches with 14 side release buckles providing flexibility for a variety of stretcher shapes. Made with polyethylene foam covered with a nylon shell. Can be easily stored inside the basket stretcher and is compatible with the Gazelle, Titan and Ferno Series Basket Stretchers.



SKED Floatation System *Code CMC756001*

The SKED Floatation System maintains the patient in a near-vertical position. It is designed so that a patient in the water can be loaded into a stretcher. Self-correcting, this floatation system will keep the patient's head above water even in rough seas.



Ferno 513-4 Series IV Poles *Code LAIV-513/4*

The Ferno 513-4 Series IV Poles clamp onto any handhold of the model 71 or 71-S Basket Stretcher. The pole is adjustable and holds two IV bags.

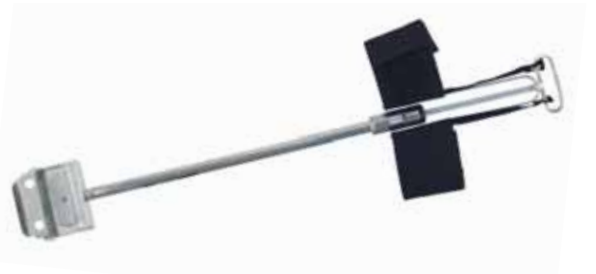

Traverse Stretcher IV Pole

Carrying an IV bag while manoeuvring a stretcher along a trail is difficult at best and runs the risk of injuring your patient. The Traverse Stretcher IV Pole provides a place to suspend the IV bag when you need it, but quickly unclips from the mounting block for storage.

Height: 51 cm Weight: 539 g

Code	Description
FWETBIV	Traverse Stretcher IV Pole
TRAV-15-00120	Mount for Gazelle Baskets
TRAV-15-00118	Mount for Titan Baskets
TRAV-15-00119	Mount for Advantage Baskets



Traverse Rescue Pillow/Blanket Code TRAV-EB700YP

The Traverse Rescue Pillow is made from an easy clean vinyl and conveniently holds a Traverse blanket that can be removed from the case and used to keep the patient warm or the blanket can stay inside the case to be used as a pillow. The pillow has two velcro attachment strips on the back to prevent it from slipping or falling out. The blanket is made of an extremely lightweight fleece and is washable.



Ferno Patient/Stretcher Cover Code FWESC

The Ferno Patient/Stretcher Cover protects bedding, equipment and will keep patients dry in inclement weather. It is made from lightweight, coated nylon the cover contains a dual zip that opens from both ends to access patient or equipment. The cover can be rolled or folded and stuffed into its self contained storage pouch which can be attached to the stretcher with the integral Velcro attachment straps. The Ferno Patient/Stretcher Cover has a full length, elasticised rim and outer Velcro straps that allows it to be fitted to any cot or basket stretcher or patient. Supplied in safety orange with two reflective silver strips for night time visibility.



CMC Rescue Stretcher Pack Code CMC432401

Designed to hold stretcher harnesses, stretcher straps, tie-in straps or web, and anything else you need to go with your stretcher. Convenient velcro straps allow the bag to be connected to the stretcher rail. The stretcher pack features a handle and karabiner loops and is made from tough cordura nylon.

Size: 51 cm x 18 cm



Ferno Tagline Set Code VRES TAGLINE

A tagline controls the movement of the stretcher during a short haul or hoist operation. The Ferno Tagline Set includes 50 m of 3 mm cord, a steel oval maillon rapide (quick link) and a quick release stainless steel snap shackle. It is stored in a bag that is large enough to fit other stretcher accessories if required. Weight 600 g.



Ferno Stretcher Carry Cases

Ferno offers a range of carry cases to suit many of the stretchers shown in this catalogue. Made from heavy-duty, rip-stop, PVC.

- MCC-383B Carry case for 108AF Pole Stretcher
- MCC-385A Carry case for Ferno 11 Stretcher
- MCC-889 Carry case for Najo Backboards and 889P Spineboard
- MCC-385C Carry case for EXL and Saver Scoop Stretchers
- MCC-387A Carry case for one-piece basket stretchers
- MCC-387B Carry case for two-piece basket stretchers
- MCC-2040 Carry case for Ferno 2040 Series Stair Chairs
- 031-4023 Carry case for Ferno 59T and 59 Evacuation Chair



Traverse Mule II Stretcher Wheel

Codes TRAV11-0110 (Mule Stretcher Wheel Only) and TRAV11-0111 (Mule Adjustable Handle - one side only)

The Mule II Stretcher Wheel is designed to fit the Traverse Titan, Gazelle and Ferno 71 series baskets and easily accepts any other type and style of basket stretcher. The all terrain oversized single wheel design allows for ease of movement in the roughest terrain. Ideally suited for narrow trails, it easily tracks over ruts, roots, rocks and snow. The single wheel design also navigates across slopes without tipping, all while providing the patient with the smoothest possible ride.

The Mule II Stretcher Wheel is supplied with two securing straps (2 universal hooks per strap) and uses a strong ratchet locking device. The wheel can be quickly and easily removed for storage and transport. The optional handles for The Mule II Stretcher Wheel offer tremendous flexibility with eight adjustable handle height positions for various terrain, to compensate for different operator heights or at its lowest position to assist with loading the litter and general stability. The wide set handles provide superior leverage compared to the top rail of a stretcher and are coated with a textured urethane coating for maximum gripping power. When not deployed the handles fold on top and under the wheel to dimensions not much bigger than the wheel itself.



Deployed with two handles



Folded with handles



Product Specifications

	Product	Weight
TRAV11-0111	Mule Adjustable Handle - one side only	2.25 kg
TRAV11-0110	Mule II without handles	15.5 kg

Premier Stretcher Carrier (PSC)

Code MIR-PSC-C and MIR-ROLL-EEZ (with Roleez Wheels)

The Premier Stretcher Carrier (PSC) is a revolutionary means of transporting patients over almost any kind of terrain not accessible by vehicles. The frame is made of heavy-duty aluminium and can be adapted to sandy or boggy terrains by fitting the optional Rolleez wheels.

Key Features

- Foot prop folds up and out of the way when transporting
- Wide wheel base keeps patient stable
- Supplied with 4 hand clamps for quick stretcher attachment
- Optional Roleez wheels for sand, mud or rocky terrain
- One PSC frame will accommodate either the narrow conventional wheels or the Roleez wheels with their respective axles



Roleez Wheels



FTS Folding Transport Stretcher

Code FWE-FTS

The Folding Transport Stretcher is a transporter which has been designed for easy storage in compact areas such as aircraft baggage compartments, vehicle boots and carrying cases. In aircraft operations the FTS can be quickly removed from the baggage compartment and rapidly deployed for moving the stretcher from aircraft to the medical facility. The FTS has four 150 mm locking wheels and is lightweight and compact.



shown with optional NATO litter and litter mount kit

Product Specifications

Length (open)	Length (folded)	Width	Weight	Load Limit
137 cm	85 cm	42 cm	13 kg	159 kg

ALLEvac™ 10G Litter Arms & Base Plate

The ALLEvac 10G Litter Arms work in conjunction with the ALLEvac Base Plate and interface. These arms provide a strong, stable and lightweight platform for any NATO style litter in any military vehicle. Complete with one hand quick release and capture capability, the litter arms can be stowed vertical or horizontal when not in use. The AllEvac Litter Arms greatly simplify evacuation of litter casualties and eliminates the challenges of Tactical Vehicle Evacuation. They are extremely lightweight yet are load-tested to hold one critical casualty and exceed the army cross country mobility load requirements. The ALLEvac base plate can be installed to any vertical or horizontal surface, including overhead surfaces. The base plates can also be ordered to custom lengths.



FMS Basic Assault Ladder

Ferno Military Systems Basic Assault Ladder weighs as little as 3.4 kg to 4.3 kg depending on length and width, with a load capacity not to exceed 136 kg. Each ladder can be carried by hand by any war fighter in full combat gear. Made from aircraft grade aluminum, finished with FMS low noise signature paint.

Product Specifications

Code	Length	Rung Width	Weight	Load Capacity
FA574A1400-12	1830 mm	304 mm	3.4 kg	136 kg
FA574A1400-19	1830 mm	482 mm	3.6 kg	136 kg
FA574A100-12	2130 mm	304 mm	3.6 kg	136 kg
FA574A100-19	2130 mm	482 mm	4.3 kg	136 kg



FMS Bridging / Climbing Ladders

Ferno Military Systems Bridging / climbing ladders weigh as little as 7 kg to 9.9 kg depending on length and width with a load capacity of 136 kg. These ladders provide both climbing and bridging capabilities as needed. Each ladder can be carried by hand by any war fighter in full combat gear. Made from aircraft grade aluminum, finished with FMS low noise signature paint. Special Use (SU) ladder is designed for K-9 units.

Product Specifications

Code	Length	Rung Width	Weight	Load Capacity
FA598A200	2440 mm	482 mm	7 kg	136 kg
FA598A100	3050 mm	482 mm	8.8 kg	136 kg
FA598A100-SU (Special Use K-9 bridge has no climbing cutouts in sheet metal)	3050 mm	482 mm	9.9 kg	136 kg

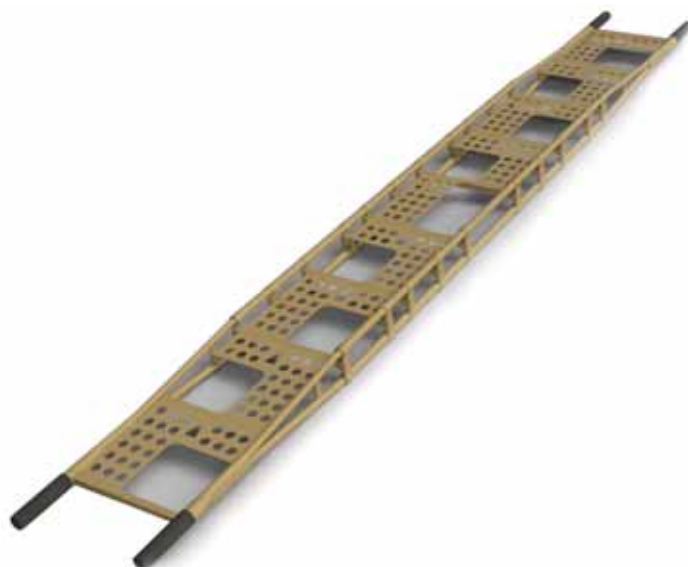

All FMS Assault Ladders are high performance hand-made ladders for professional use only. Every ladder is specifically designed to meet the strict demands of special operator requirements, with the primary focus being featherweight design, low noise signature, strength and durability. Each ladder has a specific weight threshold not to be exceeded and they are not meant for commercial or civilian use of any kind. The sole purpose of all FMS Assault Ladders is to aid the modern war fighter, or law enforcement equivalent, in the acquisition and breaching of targets.

Litter Stands 33" (Pair) Code NARP-60-0014

Lightweight and compact aluminum folding litter stands, designed to ideally lock into place on either side of litter stirrups to restrict the litter from sliding front to back and provide a stable platform for the patient. Once the stand is opened, the cross member easily locks into place. Designed for litters up to 57 cm in width, compatible with Talon, T3 and Ferno 108 series. SWL for pair is 545 kg. Available in OD Green.

Weight: 4.5 kg, Height when open: 84 cm.



Talon II 90C Collapsible Handle Litter Code FWERT90C

The Talon II 90C Collapsible Handle Litter is the most versatile, compact evacuation and treatment litter today. It is purposely designed for special operations and to provide urgent casualty evacuation from the battlefield. The new design allows patient transport in restricted compartments and non-conventional commercial vehicles. By simply extending the ergonomically designed handles it transitions to a standard NATO compatible evacuation platform. The unique, patented dual fold hinge system automatically locks when deployed and retractable handles allow the Talon II 90C Collapsible Litter to be compactly packed.

Key Features

- Compatible with all NATO patient evacuation platforms
- Exceeds US military 3X decontamination requirements
- Ergonomically designed, retractable lifting handles
- Includes 6 IV pole attachment points
- Supplied with two patient restraints
- Ground clearance of less than 4 cm
- Meets all NATO standards (except overall length 229 cm)



Product Specifications

	Extended Length Width Height	Extended Handles Retracted Length Width Height	Folded Length Width Height	Weight	Load Limit
90C	229 cm x 57 cm x 15 cm	198 cm x 57 cm x 15 cm	49.5 cm x 20 cm x 20 cm	6.8 kg	545 kg

T3 Lightweight Assault Litter Code NARP-60-0022

The T3 Lightweight Assault Litter is designed to support special operation forces where every gram matters. State of the art materials and technologies have allowed weight reduction without compromising the overall strength and performance. The overall length of 206 cm enables floor loading interchangeability with most transport platforms while allowing for maximum manoeuvrability during casualty evacuation in urban terrain. Weighing in at less than 5.4 kg, the T3 Assault Litter is the lightest rigid litter in the world.

Key Features

- Weight 5.34 kg
- Load limit 545 kg
- Ergonomically designed handles
- 4 x IV attachment points

Product Specifications

Extended Length Width Height	Folded Length Width Height	Weight	Load Limit
206 cm x 57 cm x 15 cm	52 cm x 18 cm x 15 cm	5.34 kg	545 kg



OSL Oversized Litter Code NARP-60-0023

The OSL Oversized Litter is designed to safely evacuate larger patients with both comfort and ease. The design includes an increased patient surface area, extra padded carrying handles, flame-retardant cover and additional stirrups offering firmer patient support as well as better weight distribution on the floor. Like the Raven 90C, the OSL has a bi-fold configuration. The cover material is a very durable Nomex/Kevlar blend. Also, a supplemental backrest (not shown) to support the patient at both 90° and 45° angles may be purchased separately.

Special Features

- Bi-fold configuration
- Ergonomic, padded carrying handles
- 6 padded, side loop carrying handles
- 6 IV attachment points
- 3 patient securing straps
- Attached storage pouch



Product Specifications

Extended Length Width Height	Folded Length Width Height	Weight	Load Limit (on ground)	Load Limit (hanging)
228 cm x 79 cm x 15 cm	114 cm x 23 cm x 22 cm	11.8 kg	725 kg	545 kg

Raven Bi-Fold Evacuation Stretcher Code FWERAV90C

The Raven Bi-Fold Evacuation Stretcher is identical to Talon II Model 90C, with the exception of bi-fold configuration and retractable handles. Official litter for the US Navy.

Key Features

- US Air Force safe to fly certified
- Meets all NATO requirements
- Exceeds military 3X decontamination requirements
- Meets US civilian and military fire safety codes
- Compatible with the NATO patient evacuation platforms
- Ergonomically designed lifting handles
- Includes 6 IV pole attachment points
- Ground clearance of 4 cm

Product Specifications

Extended Length Width Height	Folded Length Width Height	Weight	Load Limit
229 cm x 57 cm x 15 cm	115 cm x 20 cm x 20 cm	7.5 kg	545 kg



Stingray Poleless Stretcher Code FWESR

Constructed with non-skid, flame-retardant monofilament polypropylene material. Two web straps secure the stretcher around the body, while six heavy-duty handles make it easy to carry. The Stingray is ideal for decontamination roller systems and moving wet patients. The Stingray is tested and approved by US federal and private laboratories using live warfare agents.

Key Features

- Slip resistant surface
- Great for long term storage: resistant to mildew, acids, alkalis and penetration liquids
- Easily washed with soap and water
- Exceeds US military 3X decontamination requirements
- Meets US civilian and military fire safety codes

Product Specifications

Extended Length Width Height	Folded Length Width Height	Weight	Load Limit
198 cm x 61 cm x 5 cm	31 cm x 31 cm x 31 cm	0.7 kg	454 kg



Talon Backrest *Code NARP-60-0027 (standard), Code NARP-60-0024 (OSL Litter)*

The Talon Backrest attaches to the side main frame of the Talon II and Raven litter system allowing placement of the patient at both a 90° and 45° angle. The backrest cover is made of Nomex/Kevlar blend. Optional backrest available for OSL Oversized Litter.



Adjustable IV Pole *Code FWERT90CIV*

Compact IV pole integrated to fit into any pre-moulded hole on the Talon, Raven or T3 Lightweight Litters.

Product Specifications

Clearance	Height	Weight
46 cm	Adjusts to height of 81 cm	455 g



Talon II Litter Carrier *Code NARP-60-0009 (black), NARP-60-0011 (tan)*

Designed to enable the war fighter and/or tactical healthcare professional to carry the Talon II Litters or T3 Lightweight Litter into battle by itself or as part of the load carriage system. Equipment attachment points (MOLLE Style) are sewn on the exterior to maximise the ability to carry additional kit if needed. Weight 455 g.

Product Specifications

Height	Width	Depth
51 cm	23 cm	25 cm

Note: Litter not included



Warrior Aid & Litter Kit (WALK) *Code NARP-60-0015*

Designed using input from the war fighter and tactical healthcare professional. The WALK has a stream-lined pocket system built around the capacity to carry the Talon II Litters or T3 Lightweight Litter. The WALK increases the war fighter's survivability at the point of wounding by providing basic self and buddy aid level medical equipment with space for an evacuation litter.

Product Specifications

Height	Width	Depth
61 cm	38 cm	29 cm



Hypothermia Prevention and Management Kit HPMK *Code NARP-80-0027*

The Hypothermia Prevention and Management Kit™ (HPMK™) is designed to meet the extreme and specific needs of patient warming during casualty evacuation. The HPMK consists of two components, the high performance Heat Reflective Shell (HRS™) and the outer Self Heating Blanket. The HRS allows for 360° access to the casualty and closes to the underside, it is lined with an absorbent pad and has a built-in hood for total protection of the patient during transport. The outer shell consists of a Self Heating Blanket with a four-cell shell wall liner designed to sustain continuous dry heat. The HPMK is vacuum-packaged in a rugged, pliable pouch with quick-rip tabs that allow easy access and rapid deployment. Weight 1.35 kg

Product Specifications

Height	Width	Depth
19 cm	24 cm	7.5 cm





Ferno EZ Glide Power Tracked Stair Chair *Code FWE59-TP*

The EZ Glide Power Stair Chair powers patients up and down stairs with the push of a button. The Ferno EZ Glide Power Stair Chair is designed to climb or descend stair with a push of a button, no lifting or carrying is required. A motorised track system carries the load greatly reducing operator fatigue and the chance of injury. Once on the ground the EZ Glide Power Stair Chair can be wheeled over various surfaces with its 15 cm rear wheels and 10 cm front swivel wheels. A large seating area, back panel, along with a hinged, extending footrest provides exceptional patient comfort.

Key Features

- Belted track system powers patients up and down stairs without carrying or lifting.
- Chair assumes the weight reducing fatigue and the chance for injury.
- Easy push button operation to stop, climb or descend stairs
- Variable speed climb and descent
- 15 cm rear and 10 cm front swivel wheels
- 2.5 cm clearance between ground and track allows greater manoeuvrability
- Manual override allows operator to use in unpowered mode.
- Large patient seating surface with removable ABS plastic seat and back panels
- Folding footrest
- Safe working load 227 kg



Shown with optional rear lift handles



Ferno EZ Glide Evacuation Chair *Code FWE59-T (with track)*

Also available with all the same features and options of the EZ Glide Power Track Stair Chair, without motor and ascending feature



Product Specifications

	Weight	Load Limit	Folded Height	Folded Width	Folded Depth
With motor	26 kg	227 kg	95 cm	52 cm	20 cm
Without motor	15 kg	227 kg	95 cm	52 cm	18 cm

Options and Accessories

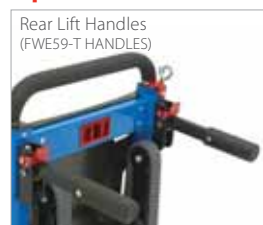

Ferno EZ-Glide Headrest

The EZ-Glide Headrest is designed to support the patients head when transporting or carrying on stairs. The EZ-Glide Headrest secures firmly into place between the rear lift bars of the 59T EZ-Glide Evacuation Chair and can be easily adjusted to suit the patient's height by sliding to the appropriate position. For additional security and patient comfort a simple head restraint strap is also supplied. The EZ-Glide Headrest conveniently folds to a compact size for storage in a handy carry case that can be stored at the back of the 59T EZ-Glide Chair ready for immediate use. Weight 600 g



Ferno Compact Carry Chairs

The Ferno Compact Carry Chairs are simple, effective and lightweight for use in the ambulance and pre-hospital environments. They fold to a compact size for convenient handling and in vehicle storage. A tall back section offers support across the patient's shoulders and a large foot area is also provided for patient comfort. Moulded foot and head-end hand grips enhance comfort and stability for the attendant. Each model is supplied standard with chest and ankle restraints. Available in two widths, the most narrow (38 cm) is suitable for narrow aisle evacuation such as aircraft, bus and trains. An optional storage/carry case is available.



Ferno Carry Chair 2040 *Code FWE2040*

The Ferno Carry Chair 2040 has two large 150 mm rear wheels and is supplied with 1 x 50 mm plastic buckle chest restraint and 1 x 25 mm plastic buckle ankle restraint.

Ferno Carry Chair 2041 *Code FWE2041*

The Ferno Carry Chair 2041 has all the features of the Ferno Carry Chair 2040, however it is 20 mm narrower and has two additional wheels positioned under the footplate at the front of the chair to assist with the manoeuvrability in confined spaces and aisle ways such as those found on buses, trains and aircraft. The Ferno Carry Chair 2041 is supplied with 2 x 100 mm velcro chest and thigh restraint and 1 x 25 mm plastic buckle ankle restraint.

Ferno Carry Chair 2042 *Code FWE2042*

The Ferno Carry Chair 2042 has the same chair structure as the 2041, with small front swivel wheels under the foot plate but has the wider width of the 2040 at 400 mm. The 2042 is supplied with 2 x 50 mm metal buckle restraints.

Product Specifications

	Length	Width	Height	Weight	Load Limit
Model 2040 Open	126 cm	40 cm	91 cm	11 kg	160 kg
Model 2040 Folded	81 cm	40 cm	20 cm	11 kg	-
Model 2041 Open	126 cm	38 cm	91 cm	12 kg	160 kg
Model 2041 Folded	81 cm	38 cm	20 cm	12 kg	-
Model 2042 Open	126 cm	40 cm	91 cm	12 kg	160 kg
Model 2042 Folded	81 cm	40 cm	20 cm	12 kg	-

Ferno EXL Scoop Stretcher

Codes BSSF-EXL (yellow 3 restraints) BSSF-EXLP (yellow with pins - no restraints) BSSF-EXLG (grey 3 restraints)

The Ferno EXL Scoop Stretcher provides superior comfort and safety to patients who need spinal immobilisation. The EXL supports the patients in the position found and eliminates the need for log-rolls, reducing the risk of further injury. The Ferno EXL Scoop Stretcher has many features not found on traditional scoop stretchers.

Key Features

- Made from lightweight, high-impact composite materials
- Thermally-treated polymer construction does not get too hot or cold
- Recessed head section to assist with appropriate cervical alignment
- Easy to clean surface is impervious to fluids
- Narrow foot end for use in confined space immobilisation
- Oval profile and angled handles provide ergonomic ease of use
- Four adjustable length options accommodate patients of different heights
- Twin aluminium safety locks provide smooth, non-binding locking and unlocking
- Folds compact for storage
- X-ray transparent
- Can be used with Model 385-C Storage/Carrying Case



Product Specifications

Length	Width	Height	Weight	Load Limit
118 cm (folded) 165 cm (min) 202 cm (max)	43 cm	7 cm	8 kg	159 kg

Saver Scoop Stretcher Codes BSSS-265 (with three restraints)

The Saver Scoop Stretcher is designed so emergency personnel can uncouple either or both ends of the stretcher and gently scoop up the patient using a scissor-type closing motion. This scoop stretcher is ideal for hip and spinal injuries and supports the patient in the position found, reducing risk of further injury.

Key Features

- Twin aluminium safety locks provide smooth, non-binding locking and unlocking
- Telescoping tubes allow length adjustments for various patient heights
- Narrow foot end frame for handling in confined areas
- Open-centre design permits patient to be X-rayed
- Folds compact for storage
- Can be used with Model 385-C Storage/Carrying Case



Twin safety locks

Product Specifications

Length	Width	Height	Weight	Load Limit
120 cm (folded) 166 cm (open) 201 cm (max)	43 cm	7 cm	9.7 kg	159 kg



Najo Lite *Codes BSBN-L (standard) and BSBN-LP (with pins)*

The Najo Lite is our lightest and most popular Najo backboard at just 6.5 kg. It features a central slot in the lower half of the board to allow immobilisation of each leg separately. The Najo Lite also features two handholds at the tapered end and angled edges for easy log-rolling. Strong, one-piece HDPE construction is impervious to all body fluids. It is easy to decontaminate and provides 100% X-ray translucency. This board is also buoyant and can be used to float a patient during water rescue operations. Available with optional speed clip pins.

Product Specifications

Length	Width	Height	Weight	Load Limit
183 cm	41 cm	4 cm	6.5 kg	204 kg



Najo RediBoard *Codes BSBN-RB (standard) and BSBN-RBP (with pins)*

The Najo RediBoard is a revolutionary backboard that does not have a designated front, back, top or bottom so the patient can be positioned and immobilised faster. The Najo RediBoard is made from strong, lightweight, one-piece HDPE construction and impervious to all body fluids, is easy to decontaminate and provides 100% X-ray translucency. This board is also buoyant and can be used to float a patient during water rescue operations. Guaranteed for life under normal usage. Available with optional speed clip pins.

Product Specifications

Length	Width	Height	Weight	Load Limit
183 cm	41 cm	6 cm	7 kg	272 kg



Najo RediHold *Code BSBN-RH*

The Najo RediHold is our top of the line backboard with two handles at a tapered end for stable transport. The head area is smooth to insure all head immobilisation devices adhere to the board and the edges are angled for log-rolling. Strong, lightweight, one-piece HDPE construction is impervious to all bodily fluids, is easy to decontaminate, and provides 100% X-ray translucency. This board is also buoyant and can be used to float a patient during water rescue operations. Guaranteed for life under normal usage. Available with optional speed clip pins.

Product Specifications

Length	Width	Height	Weight	Load Limit
183 cm	41 cm	4 cm	7 kg	272 kg



Najo RediWide *Codes BSBN-RW (standard) and BSBN-RWP (with pins)*

The NAJO RediWide is an extra 50 mm wider than other Najo Backboards for patients that require more backboard. The RediWide is 4 cm thick with angled edges for smooth log-rolls and painless patient placement. The rectangular shape allows patient placement from either end. Strong, lightweight, one-piece HDPE construction is impervious to all bodily fluids, is easy to decontaminate, and provides 100% x-ray translucency. This board is also buoyant and can be used to float a patient during water rescue operations. Guaranteed for life under normal usage. Available with optional speed clip pins.

Product Specifications

Length	Width	Height	Weight	Load Limit
183 cm	46 cm	4 cm	7 kg	272 kg



Ferno 889P Fibreglass Backboard

Code BSBF-889P (with 3 velcro restraints), BSBF-889P/B (no restraints)

Patient and user comfort is paramount in the Ferno 889P Fibreglass Backboard design.

Key Features

- 10 raised hand grips that allow easy hand access
- Wide and thick handgrip spaces for comfortable lifting
- 10 restraint pins
- Foot and head ends are tapered for manoeuvring in confined spaces
- Concave surface which cradles patient
- X-ray transparent
- Dimensions: L 183 cm x W 41 cm
- Weight 8 kg
- Load Limit 159 kg



DragOne Board

Code RGP-DRAG1-Y

The DragOne Rescue Board is changing the way rescues are done for those safety personnel wearing SCBA units. Roto molded plastic provides a seamless design to prevent fluids from entering and eliminates cross-contamination. The board is resistant to gasoline, diesel, kerosene and bio-hazards.

The design features fins on the bottom to reduce friction when dragging victims. Each end has handles to accommodate a two man carry. Ease of use will get your victim out of a building in a fraction of the time it would normally take in an emergency evacuation.

The DragOne Rescue Board weighs 4.5 kg with a weight capacity of 227 kg. It will withstand heat up to 700 degree Celsius and comes with a life time guarantee.



Ferno XT

Code FWE-XT1/2

The Ferno XT is a revolutionary utility board designed for rapid extrication and spinal immobilisation in confined space areas and critical situations. It can accommodate a wide range of patients and clinical protocols including paediatric, special needs, bariatric, and pregnant women.

Key Features

- Fast extrication: less than 20 seconds with simplified application procedure.
- Easy application with four hi-visibility colour coded restraints and buckles
- Lightweight composite fibre board
- 100% x-ray translucent
- Easy to decontaminate
- Comes with QHI Quick Head Immobiliser with head/chin strap with storage pouch
- Dimensions: L 83 cm x W 30 cm
- Weight 2 kg



Ferno Short Wooden Backboard

Code BSBF-75 (Short Backboard) and BSBF-77 (Short Backboard with restraints, head straps and neck roll)

The 75 and 77 Ferno Short Wooden Backboards are traditional boards designed to extricate patients from vehicles or confined areas. The notched head section enables head straps to be positioned according to patient size and multiple openings on the board allows various strapping methods. The board is constructed of a seven ply 13 mm marine grade plywood and is finished with a clear varnish on both sides. The Ferno 77 Wooden Backboard comes with 3 colour-coded patient restraints, neck roll and 2 head straps.



Product Specifications

Length	Width	Height	Weight	Load Limit
81 cm	32 cm	2 cm	2 kg for 75 3.5 kg for 77	159 kg

Ferno KED (Kendrick Extrication Device) Code FWE125

The Original Ferno KED is a versatile means of immobilising and extricating patients from vehicles or confined spaces. The wrap-around vest design provides horizontal and vertical rigidity and immobilisation of the spine, neck, and head during extrication. X-rays or advanced life support procedures can be performed with the KED in place. The Ferno KED includes wrap-around vest, neck roll, two head straps and a carrying case. Heavy-duty, vinyl-coated nylon is durable and easy to clean and the KED stores rolled up, ready for immediate use.

Product Specifications

Length	Width	Height	Depth	Weight	Load Limit
84 cm	81 cm	4 cm	11 cm	3 kg	227 kg



Ferno KED Pro Extrication Device Code FWE125-2

The Ferno KED Pro has many industry requested improvements to the original Ferno KED. These improvements enhance patient comfort and user functionality, resulting in better patient outcomes.

Key Features

- Colour-coded webbing
- Improved head/chin straps
- Wide padded spine support section
- Additional deceleration strap for holding shoulders back
- Better head stability and security is achieved via a wider head support piece
- Fold back chest flaps allow access for chest examinations and placement of electrodes
- Padded leg straps with quick connect buckles for confined space rescue operations
- Two additional standing take down manoeuvre straps
- Carry bag with pack away backpack straps and room for storage of neck collars
- Rated rear handles can be used for lifting out of confined spaces using dedicated KED Pro lifting bridle code BRB-KED Pro (available as accessory)



Thomas Backraft Codes THOM-BR (mattress) and THOM-BRP (pump)

The Thomas Backraft is a low-cost, resposable air mattress that provides patient comfort and reduces secondary injury, such as pressure sores, commonly associated with prolonged immobilisation on a hard surface such as a flat spineboard.

The Thomas Backraft inflates in seconds and fills the voids between the patient and backboard but allows for full function of the backboard during extrication and transportation. The Thomas Backraft is X-ray transparent and compatible with spineboard and patient restraint system. Pump sold separately.



Hartwell Full Body Vacuum Mattress

Codes SVVM-H (mattress), SVVM-HC (carry case) and SVVS-HVL (pump)

The Hartwell Full Body Vacuum Mattress provides comfortable, effective and fast immobilisation of a patient by moulding to the body and reducing both pressure point tenderness and rehabilitation time. This mattress is X-ray and MRI compatible. Six padded handles assist with lifting. Carry case and pump supplied separately.

Length	Width	Height	Weight	Load Limit
200 cm	75 cm	7 cm	5.5 kg (mattress only) 7.5 kg (mattress, case & pump)	125 kg



Ferno Full Body Vacuum Mattress Codes SVVM-AGB (mattress, pump & case) SVVM-AGB-PUMP (pump only)

Ferno All-In-One Vacuum Mattress offers great patient support for the immobilisation of casualties in cases of suspected vertebra, pelvis or limb trauma. Extracting air from the mattress forces it to become hard and mould around the patient allowing full body immobilisation without inward pressure, reducing the risk of additional trauma.

The underside of the Ferno Vacuum Mattress contains three fire-retardant layers for extra protection against punctures. The mattress will remain air tight for more than 24 hours and has a load capacity of up to 220 kg delivering consistent and rigid support to all patients, including bariatric.

The Ferno Vacuum Mattress has 12 carry handles and is compatible with most stretchers. It is also X-ray translucent and easy to clean. Supplied standard with 4 colour-coded patient restraints, carry bag, repair kit and an upgraded, high quality pump that can quickly extract air to 700 hPA.

Product Specifications

Length	Width	Height	Weight	Load Limit
205 cm	80 cm	7 cm	9 kg (mattress) 1 kg (pump)	220 kg



Ferno Vacuum Splint Set Code SVVS-F

The Ferno Vacuum Splint Set provides maximum support with minimum effort. Each splint is constructed of durable vinyl coated nylon that is supple enough to be moulded around an injured extremity. Air is extracted via the pump supplied forcing the splint to become hard and mould around the patient providing local immobilisation without inward pressure, reducing the risk of additional trauma. The complete set includes three splints (small, medium and large), compact vacuum pump, repair kit and carry case.

Product Specifications

	Length	Width	Depth
Small	51 cm	33 cm	3 cm
Medium	74 cm	61 cm	3 cm
Large	109 cm	61 cm	3 cm



FernoTrac Traction Splint Codes SVTS-FA (adult), SVTS-FC (child)

The FernoTrac Traction Splint has been the standard for ambulance services for treating patients with suspected long bone fractures of the lower extremities. It provides easy to use, dependable traction to relieve pain and reduce the possibility of further vascular and nerve damage. Available in both paediatric and adult versions.



Donway Traction Splint Codes SVTS-DA (adult), SVTS-DC (child)

The Donway Traction Splint fits most patients from eight years to an adult of 208 cm. The child splint fits children between four and eight years. This splint provides quantifiable pneumatic powered traction and no lifting of the limb is required. The Donway Splints are compact with a flat profile for easy storage. Supplied with carry bag.



Kendrick Traction Device (KTD) Code SVTS-KTD

Cost effective, compact and lightweight, the Kendrick Traction Device (KTD) is ideal for remote area operations and outdoor activities. The traction pole length quickly adjusts for adult or paediatric application, eliminating the need for patient roll-over or unnecessary leg raising. There is no ischial bar, which reduces pressure problems. The KTD comes complete within a very compact storage pouch with easy-to-follow instructions.



Product Specifications

	Length	Width	Weight
Size (stored)	24 cm	9 cm	567 g

Ferno Frac Cardboard Splint Code SVCB-FF

The Ferno Frac Cardboard Splint is a low cost, compact and convenient leg splint that can be shaped to fit all leg sizes. The waxed cardboard is water resistant, X-ray transparent and MRI compatible. The Ferno Frac Cardboard Splint folds and locks into position to offer ankle and foot support. Packs flat ready for use. One size can be shaped to suit all.

Product Specifications

Length	Width
99 cm	33 cm



Sager Emergency Traction Splints

Sager splints are anatomically and medically engineered to provide the first responder with a single, fast, easy, fail-safe and compact traction device. Sager provide the world's only emergency traction splints with quantifiable, dynamic traction which ensures the correct amount of safe, secure traction that is able to decrease as the spasm releases. This patented system allows you to accurately document how much traction has been applied. Sager Emergency Traction Splints conveniently stay within the adult body's silhouette making it ideal for emergency transfers and transportation. Sager Splints are indicated for treatment in proximal third and mid-shaft femoral fractures offering a much broader range of application and use than other traction devices.

Sager Bilateral Splint *Code SVTS-S304*

The Sager Bilateral Splint treats either single or bilateral lower limb fractures for both adults and children from 5th to 99th percentile. This splint has an articulating base that hinges to apply counter traction more directly on the ischial tuberosity.



Sager Extreme Splint *Code SVTS-S404*

The Sager Extreme Splint is ideal for extreme environment capabilities. It is compact, robust and lightweight and is easily stored or carried in most backpacks and folds into a 35 cm x 28 cm x 11 cm carry case. The Sager Extreme Splint is radiolucent to all areas of a femoral fracture. It treats single or bilateral lower limb fractures for both adults and children from 5th to 99th percentile. This splint has a multi-patented articulating base and is hinged so that it swings left or right to apply counter traction more directly on the ischial tuberosity in all types of body shapes.



Sager Emergency Fracture Response System (SEFRS) *Code SVTS-S405*

The Sager Emergency Fracture Response System (SEFRS) treats any limb fracture in the human body without traction. Extrication is easy, enabling the splinting of fractures in the position that the patient is found. The SEFRS is compact, durable, robust and lightweight. It is easily stored in most backpacks and treats all body fracture types.

Key Features

- Radiolucent design enables X-rays
- Universal; will treat any fracture
- Enables splinting in position found
- Rapid assembly and application on fracture in less than 2 minutes
- Splints within the body silhouette
- Closed cell foam - does not absorb fluids, easily cleaned and decontaminated
- Wide range of Tensor Cravats - 3 widths, 12 lengths - ensures universal fit
- Secure cravat packaging allows instant size identification and application



Sager Infant Bilateral Splint *Code SVTS-S300*

The Sager Infant Bilateral Splint is the only splint in the world that is designed to treat children from birth up to the age of six. The Sager Infant Splint eliminates the risk of over-traction and its detrimental effects to epiphyseal growth centres, knee edema and excessive distraction of bone ends.



Sam Pelvic Sling Codes SVSP-S (extra small), SVSP-M (standard) and SVSP-L (extra large)

The Sam Sling is built for quick, easy use under less-than-perfect conditions. Used and recommended by leading Australian emergency departments and ambulance services, the SAM Pelvic Sling is the first and only force controlled circumferential pelvic belt designed to provide safe, effective reduction and stabilisation of open-book pelvic fractures. The SAM Sling was developed over three years of rigorous laboratory and clinical studies. Reports from numerous scientific conferences and in peer-reviewed medical journals have documented that it effectively reduces and stabilises unstable pelvic fractures. The features and benefits of the SAM Sling reflect the recommendations of trauma surgeons and emergency healthcare professionals.



Key Features

- Cannot be over tightened as the patented autostop buckle ensures the force applied is safe and correct each and every time
- The standard size sling fits 95% of the population
- Available in military OD green in standard size
- Easily applied by a single emergency responder
- Contoured design allows urinary catheterisation and access to the abdomen and femoral vessels
- Can be used in MRI scanners as long as the Sam Sling is not removed in the MRI room



Extra Small	Standard & Military	Extra Large
71- 114 cm	84-127 cm	91- 150 cm

Sam Splint Soft Codes SVPS-SSS9 (9"), SVPS-SSS12 (12") and SVPS-SSS15 (15")

Exceptionally comfortable and versatile, strong and malleable like the Sam Original Splint, the Soft Shell Splint is designed for quick and easy application when a patient needs to wear a forearm splint for more than a few hours or even several weeks. The soft aluminium core allows it to be moulded to fit the patient's hand, wrist and forearm. With the proper combination of curves, the Sam Splint Soft can be moulded in seconds into any of four basic shapes shown below. The Sam Splint Soft is thicker on one end than on the other, providing two levels of rigidity. Add the comfort of an open-cell foam interior covered in terry cloth and you have the most versatile forearm splint available today. The Sam Splint Soft is available in three sizes.



Product Specifications

	Product	Length	Width
SVPS-SSS9	Sam Splint Soft 9"	22.5 cm	10.5 cm
SVPS-SSS12	Sam Splint Soft 12"	30 cm	10.5 cm
SVPS-SSS15	Sam Splint Soft 15"	38 cm	10.5 cm

Cardboard Splint Codes SVCB-S (small) and SVCB-L (large)

The Cardboard Splint is a low-cost, compact and convenient alternative with the capacity to immobilise a broad range of injuries. Available in two sizes.

Product Specifications

	Length	Width
Large	77 cm	33 cm
Small	41 cm	25 cm



Sam Splint Original

The Sam Splint Original is an extremely pliable multi-purpose splint and is built from a thin core of aluminium alloy, sandwiched between two layers of closed cell foam. Bent into various shapes and curves, it becomes extremely strong and supportive for any fractured or injured limb. The Sam Splint Original is also ideal for splinting IV's. Available in a range of sizes, it is lightweight, radiolucent, reusable and very portable - almost any bone in the body can be splinted.



Product Specifications

	Product	Length	Width
SVPS-S36	Sam Splint 36"	91 cm	10 cm
SVPS-SG36	Sam Splint 36" Grey	91 cm	10 cm
SVPS-S36XL	Sam Splint 36" XL	91 cm	14 cm
SVPS-S18	Sam Splint 18"	46 cm	10 cm
SVPS-S9	Sam Splint 9"	23 cm	10 cm
SVPS-SF	Sam Splint Finger	9.5 cm	4 cm

Ferno Finger Splint Kit *Codes FWE-FSK*

The Ferno Finger Splint Kit contains a variety of the most commonly used splints. The splints are manufactured from soft aluminium which makes them X-ray translucent and ensures ease of application. The Splints are malleable and can easily be formed to fit each patient exactly. Each kit contains 5 different splints in a variety of sizes for a total of 25 splints.



Ferno Wizloc Collar Code CCF-WL (pink) CCF-WLG (green)

The universal design of the Ferno Wizloc Collar provides a collar capable of fitting 90% of patients. With its three-step adjustment, application is simple and fast regardless of patient position. The unique self centring mandible support allows you to custom fit the Ferno Wizloc Collar to the patient. A simple adjustment to the occipital support also accommodates all ends of the sizing spectrum.

Key Features

- Designed for use on a wide range of patients, 2-year-old through to adult
- On-patient sizing for greater accuracy
- Can be decontaminated and reused up to 10 times
- Three position occipital support with keyhole lock pin
- X-ray transparent and MRI compatible



Also available in OD green

Laerdal Stifneck Collar Select Code CCL-SS

The Laerdal Stifneck Collar Select fits all adult patients and delivers the same superior immobilisation you would expect from the individual sized Stifneck Collars.

Key Features

- Uses the same sizing and application method as the original Stifneck Collars
- Easy access for pulse checks through oversized trachea hole
- Room for large fingers to slide through rear panel opening for palpation
- Directions moulded into collar
- Radiolucent, MRI and CT scan compatible



Laerdal Stifneck Collar Pedi Select Code CCL-SSC

The Laerdal Stifneck Collar Pedi Select fits paediatric patients and uses the same easy sizing application method as used on adults.

Key Features

- Improved sizing to fit a wider range of paediatric patients (mini, midi and pedi)
- Oversized tracheal and back panel opening for advanced airway management and ongoing cervical assessment



Laerdal Stifneck Collar

Codes CCL-SCT (Adult Tall), CCL-SCR (Adult Regular), CCL-SCS (Adult Short), CCL-SCN (Adult No Neck), CCL-SCP (Paediatric), CCL-SCB (Baby No Neck)

The Laerdal Stifneck Collar with outstanding motion restriction and optimal sizing. The Stifneck extrication collar remains the standard of care for suspected cervical spine injuries.

Key Features

- Easy access for pulse check, advanced airway procedures and visualisation through oversized trachea hole
- Radiolucent, MRI and CT scan compatible
- Outstanding motion restriction without hyperextension or limiting access to airway
- Provides optimal size selection with simple, accurate finger-sizing method and colour codes
- Fits entire patient population with four adult sizes and two paediatric sizes



Philly Patriot Collar Codes CCPC-PA (Adult) and CCPC-PP (Lil Patriot)

The Philly Patriot Collar is moulded from high density polyethylene with foam padding and a patented chin support. The one-piece design enables efficient storage where space is limited. The multi-height adjustment fits almost all adults (four positions) and paediatrics (three positions). The one-piece design can easily be used. Simply measure patient, adjust and lock selected height and apply. For either a supine or seated position, application is quick and easy.



Philly One-Piece Collar

Codes CCPC-1PI (Infant), CCPC-1PP (Paediatric), CCPC-1PL (Low), CCPC-1PS (Short), CCPC-1PR (Regular) and CCPC-1PT (Tall)

The Philly One-Piece Collar is completely injected moulded from high density polyethylene with foam padding and a patented chin support. The one-piece design is essentially flat; storage is efficiently managed where space is limited. Colour-coded labels and velcro fasteners ensure easy recognition of sizes. Application is quick and easy in either a supine or seated position. X-ray, CT and MRI translucent.

Key Features

- Oversized trachea opening
- Level chin support for patient neutral alignment
- X-ray, CT and MRI translucent



Ferno Universal Head Immobiliser Code CCI-445

The Ferno Universal Head Immobiliser is simple to use, lightweight and easy to clean. Composed of two plastic coated, closed-cell foam head supports, a universal attachment base and two durable head straps. The head supports can be used on standard backboards, or reversed for use on the Ferno EXL or Saver Scoop Stretcher.

Key Features

- Unique head strap is designed to conform to patient's forehead
- Large ear holes for monitoring the patient's ear canal
- Minimal interference with X-ray, MRI or CT scan procedures
- Waterproof plastic coating makes it easy to clean
- Compatible with all flat backboards as well as Ferno Scoop Stretchers



Ferno Head Immobiliser EXL Code EXL CCI-365E

The Ferno Head Immobiliser EXL provides all the great features of the Universal Head Immobiliser with a unique shape specifically designed to fit the Ferno Scoop EXL. Unique head strap is designed to conform to patient's forehead Large ear holes for monitoring the patient's ear canal Minimal interference with X-ray, MRI or CT scan procedures Waterproof plastic coating makes it easy to clean



QHI Quick Head Immobiliser Code CCI-QHI

An uncomplicated head immobiliser designed for universal and rapid deployment. Made with low density, polyurethane coated foam that is easy to clean. The shallow V shaped design allows the patients head to rest on two points providing improved stability. A neoprene head strap with double sided adjustment provides a variety of fixing options. Fully compatible with Ferno Scoop and Ferno Backboards.



Ferno HeadHugger Head Immobiliser Code CCI-455

The Ferno HeadHugger is ideal for situations where retrieving equipment quickly is difficult or for use in mass casualty accidents. The corrugated plastic is durable, water resistant and has a low profile design for storage.

Key Features

- Independent support panels fold around the patient's head and held in place with velcro fasteners
- Radiolucent and does not interfere with CT scanners or MRIs
- Dual head supports can be moulded to fit the contour of each patient
- Single use



Baby Pod II

Baby Pod II provides non electric, paediatric, thermo-stable environment and is designed to safely hand carry or stretcher transport patients up to 9 kg for evacuation, search and rescue, ground ambulance and inter-hospital transport.

Baby Pod II consists of a lightweight carbon fibre outer shell, which is lined with a shock absorbent foam inner layer. The Baby Pod unique metal free construction ensures that it is X-ray translucent and MRI compatible.

The Baby Pod II has a transparent lid for viewing the baby, stretcher fixing straps to secure the device for transport, safety straps to secure the infant inside the device during transport and contains a patient positioning vacuum mattress.

Baby Pod II is designed for paediatrics up to 9 kg and has been crash tested to the CEN 1789 standard (10G in six directions) It also allows for the addition of improved O₂ environment, external ventilation and direct attachment of syringe pumps.

Accessories for the Baby Pod II include a carry bag and the single use TransWarmer Infant Transport Mattress, a non electric patented WarmGel technology which provides even, regulated heating for up to 2 hours while assisting with vibration absorption during transport.



Supply Schedule:

Code	Description
BP-EVO3-STD	Baby Pod II
BPOD2-CBAG	Baby Pod II Carry Bag
BPOD2-006	Baby Pod Set of External Straps
NEON03	Baby Pod TransWarmer Mattress

Product Specifications

Length	Width	Height	Weight	Weight Limit
100cm	43 cm	30 cm	9.5 kg	2-9 kg

Medkids Baby Board Code BRH-676

The Medkids Baby Board helps maintain cervical neutral alignment in infants with the self-contained Pneumatic Positioning Device (PPD). It accommodates the wide range of thoracic elevation requirements without any extra padding. Features a palm style pump with an air release valve for precise inflation and deflation, and offers versatile strap configurations with its adjustable three-point harness system. Made of durable Dupont Cordura and is X-ray translucent.

Key Features

- Compatible with Ferno stretchers and isolettes
- Crescent shaped head blocks secure cervical spines for infants too small for standard size cervical collars
- Accommodates all central lines, umbilical lines, chest tubes, urinary catheters and other invasive and non-invasive equipment
- Designed for preterm neonates and larger infants ranging from 1 kg to 7 kg



Medkids Paediatric Backboard Sleeve Code BRH-677

The Medkids Paediatric Backboard Sleeve fits over standard adult backboards and functions in a similar way to the Medkids Baby Board to help maintain cervical neutral alignment with larger infants from 5 kg to 27 kgs. It accommodates the wide range of thoracic elevation requirements without any extra padding and features a palm style pump with an air release valve for precise inflation and deflation. The sleeve has a versatile patient strap configuration with an adjustable three-point harness system. The backboard sleeve is X-ray translucent and made of durable Cordura.

Key Features

- Adjustable to fit over standard adult backboards
- Rolls into a small, self-contained carrying case for storage
- Crescent-shaped compressible head blocks allow access and visual monitoring of the ears while maintaining immobilisation
- Designed for infants and children ranging from 5 kg to 27 kg



Oxy-Therapy Kit Contents *Code OXK-T*

The Oxy-Therapy Kit Contents are suitable for the delivery of oxygen therapy in the home or workplace. It can also be used in an emergency to resuscitate using the Ferno E-Mask. Kit contents exclude oxygen cylinder and softpack. Kit contents can be purchased individually. The ideal softpack to store the contents is the FAHAD5120 as displayed.

Contents

- Multiflow regulator 0.25 to 25 LPM
- Three adult and child therapy masks
- Pocket mask with O₂ inlet, face strap and case
- Cylinder spanner

Kit contents exclude oxygen cylinder and softpack.



Oxy-Resusc Kit Contents *Code OXK-R*

The Oxy-Resusc Kit Contents were developed as an emergency resuscitation kit and can be utilised by a range of users, from industry through to first response emergency personnel. The kit also provides for the supply of oxygen therapy. Kit contents can be purchased individually. The ideal softpack to store the contents is the FAHAD5120 as displayed.

Contents

- Multiflow regulator 0.25 to 25 LPM
- Three adult and child therapy masks
- Pocket mask with O₂ inlet, face strap and case
- Cylinder spanner
- Adult resuscitator with adult and child mask
- Guedel airways sizes one to five

Kit contents exclude oxygen cylinder and softpack.



Oxy-Demand Kit Contents *Code OXK-D*

The Oxy-Demand Kit Contents are designed for use by those highly trained in oxygen resuscitation. It offers oxygen on-demand, oxygen therapy plus an extra high pressure outlet. This allows for inclusion of an additional high pressure resuscitation line or venturi suction system. Kit contents can be purchased individually. The ideal softpack to store the contents is the FAHAD5100 or the FAHAD2140.

Contents

- Multiflow regulator 0.25 to 25 LPM with two high pressure outlets
- Oxygen demand valve with mask and tubing
- Three adult and child therapy masks
- Airway sizes one to five
- Pocket mask with O₂ inlet, face strap and case
- Cylinder spanner

Kit contents exclude oxygen cylinder and softpack.





Oxy-Medic Kit Contents *Code OXK-M*

The Oxy-Medic Kit Contents have all the same features as the Oxy-Resusc Kit with the added benefit of a venturi suction system. Kit contents exclude oxygen cylinder and softpack. Kit contents can be purchased individually. The ideal softpack to store the contents is the FAHAD 5100 as displayed, or the FAHAD 2140 .

Contents

- Multiflow regulator 0.25 to 25 LPM with two high pressure outlets
- Adult resuscitator with adult and child mask
- Oxygen powered suction unit
- Three adult and child therapy masks
- Guedel airways sizes one to five
- Pocket mask with O₂ inlet, face strap and case
- Cylinder spanner

Kit contents exclude oxygen cylinder and softpack.



Oxy-Rescue Kit Contents *Code OXK-RV*

The Oxy-Rescue Kit Contents are for use by personnel highly trained in the delivery of oxygen resuscitation. It has the same features as the Oxy-Demand Kit but has the added benefit of a venturi suction system. The Oxy-Rescue Kit can also be used with various Ferno softpacks. Kit contents can be purchased individually. The ideal softpack to store the contents is the FAHAD 5100 as displayed, or the FAHAD 2140.

Contents

- Multiflow regulator 0.25 to 25 LPM with two high pressure outlets
- Oxygen demand valve with mask and tubing
- Oxygen powered suction unit
- Three adult and child therapy masks
- Airways sizes one to five
- Pocket mask with O₂ inlet, face strap and case
- Cylinder spanner

Kit contents exclude oxygen cylinder and softpack.



Ferno E-Mask *Codes RMF-EM (mask) and RMF-EMOWV (one-way valve/filter)*

The one-way valve and directional diaphragm on the Ferno E-Mask allows no backflow of air or contaminants (fluids) to pass from the patient to rescuer/rescuer to patient and provides superior protection against viruses and bacteria. The Ferno E-Mask comes with an O₂ port, head-strap and hard shell case. Fittings are a standard 22 mm and can be used with any Ferno resuscitator. The Ferno E-Mask fits both adult and child patients. Once used, the mask can be sterilised and a replacement one-way valve/filter can be fitted.



Keyring Resuscitation Masks *Code RMAG-K*

Keyring Resuscitation Masks are a convenient way of ensuring that you are always prepared whenever an emergency situation arises. Keyring Resuscitation Masks provide rescue breathing protection and come conveniently packed in a durable woven nylon keyring case.



Ferno Disposable Resuscitators Codes RBMF-AD (Adult), RBMF-CD (Child) and RBMF-ID (Infant)

Inexpensive and so effective you won't believe they are disposable, the Ferno Disposable Resuscitators are 100% latex-free. The highly polished PVC bag, valve housing and mask allow the operator to view critical function areas. The soft feel provides good feedback, while the resilient construction allows for quick stroke deliveries. Ferno Disposable Resuscitators are completely disposable, eliminating the need to clean, disinfect or sterilise the device. The patient valve incorporates a vomit deflector/peep valve adaptor. Available in adult, child and infant sizes. A full range of air-cushioned masks are also available.

Contents

- Bag
- Mask
- Patient and intake valves
- Reservoir bag
- 2 m of O₂ drive-line



Ferno Reusable Resuscitators Codes RBMF-AR (Adult), RBMF-CR (Child) and RBMF-IR (Infant)

The fully autoclavable Ferno Reusable Resuscitators offer great value and exceptional quality. They are manufactured to the highest standards using 100% latex-free, transparent silicone. The Resuscitators have exceptional recoil which allows for quick stroke deliveries. The high polished silicone bag, valve housing and mask allow the operator to view critical function areas, while the soft feel provides good feedback. The transparent durable silicone used enables inspection before, during and after use. The Ferno Reusable Resuscitator has total disassembly for cleaning and optional pop-off valves on adult sizes (this is a standard feature on child and infant versions). A full range of mask sizes are also available.

Contents

- Bag
- Mask
- Patient and intake valves
- Reservoir bag
- 2 m of O₂ drive-line



Weinmann Combibag Code WM -11050

The Weinmann Combibag has the unique advantage of allowing resuscitation for adults and children with one bag. Vary the air volume by simply turning the Combibag in your hand and you always have the correct-sized resuscitator ready for use. The safety valve prevents excessive ventilation pressure and protects the patient regardless of whether you ventilate via tube or mask.

Key Features

- The two recessed grips in Combibag make it possible to provide small volumes to children and to ventilate adults
- Safety valve with two pressure levels: 20 and 60 mbar
- PEEP valve, demand valve or oxygen reservoir can be connected for better oxygenation
- Single-layer construction makes disinfection easier

Supply Schedule:

- WM -11050 Combibag with size 5 mask
- WM -11052 Oxygen Reservoir
- WM - 5074 Size 3 mask
- WM - 5086 Size 1 mask



Optional
Oxygen
Reservoir

Spiracle BRAVO₂ Oxygen Regulator *Codes OXR-S831A and OXR-S833A*

The new Australian Standards approved Spiracle BRAVO₂ Oxygen Regulator is supplied with two Australian compatible high pressure outlets. The new design is constructed from a solid piece of brass, creating a uni-body style regulator that provides added strength and safety. The quality crafted internal brass components provide a safe and effective regulator. The proven and durable Spiracle BRAVO₂ Oxygen Regulator comes with or without high pressure outlets. Both versions offer 11 variable flow rates from 0.25 to 25 LPM.

Product details

- OXR-S831A: Brass regulator with 11 variable flow rates from 0.25 to 25 LPM and 2 high pressure outlets
- OXR-S833A: Brass regulator with 11 variable flow rates from 0.25 to 25 LPM



Comweld Series-O Regulators *Code OXR-CC*

The Comweld Series-O Regulator has been the industry leader in Australia for many years. The simple but effective design and ease of use make these single stage regulators a very low maintenance yet high performing product that can be used in a variety of environments.



Flow Meter Ball/Chamber 515800 *Code OXFM-B*

This pressure compensated flow meter delivers an accurate prescribed gas flow to the patient. It is suitable for most types of respiratory therapy.

Key Features

- Flow rate is 0 to 15 LPM
- Accuracy + - 5%
- Medical Oxygen Gas specific inlet
- Large bold print provides clear readability



Flow Meter Gauge Type TM17 *Code OXFM-G*

This gauge flow meter is the ideal substitute when it is not possible to mount a ball/chamber type flow meter vertically. It delivers an accurate prescribed flow to the end user from the gas source and is suitable for most types of oxygen respiratory therapy.

Key Features

- Operates in any positional orientation
- Flow range of 0 -14 LPM
- Reliable, accurate and durable
- Colour-coded inlet fittings, outlet fittings, and control knobs prevent fitting to the wrong gas type



Micro-Manager O₂ Administrator *Code OXR-903*

The Micro Manager delivers a preset constant flow of oxygen to multiple patients. The Micro Manager can be configured for use with either 2, 4, 6, 10 or 15 LPM DISS barbed fittings, or a combination of fittings to meet specific emergency needs. Each Micro Manager can service up to five (5) patients. The unit may also be connected in sequence to additional Micro Managers, increasing the number of treated patients. The Micro Manager is a perfect addition to any ambulance, major incident response kit/trailer or oxygen resuscitation kit where multiple patient oxygen delivery is required. Comes standard with either five 2 Lpm, 4 Lpm, 6 Lpm, 10 Lpm or 15 Lpm screw on outlets.

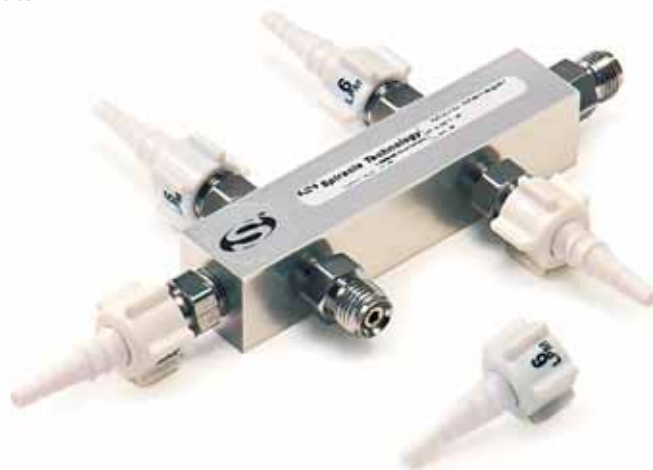

Oxygen Demand Valve *Code OXD*

The Oxygen Demand Valve provides a fast, simple and effective means to ventilate non-breathing patients or provide 100% oxygen on demand to patients suffering from respiratory distress. The Oxygen Demand Valve comes with an audible pressure relief system and manual ventilation button, hose and resuscitation mask.



HFOC High Flow Oxygen Conservor *Code OXD-HFOC*

The HFOC High Flow Oxygen Conservor addresses the need to deliver 100% oxygen during resuscitation and performs the function regardless of resuscitator rate and bag stroke volume. The lightweight, HFOC High Flow Oxygen Conservor operates from any standard 50 psi gaseous oxygen source. The quality designed device has an integral back pressure relief diaphragm which functions to relieve pressure greater than atmospheric. Adapters are available to attach the HFOC to the most popular brands of bag valve resuscitators. Comes with 1 x 180 cm O₂ supply hose.



Weinmann Joyce CPAP Ventilation Mask

The mask is the most critical interface function in therapy. If it doesn't fit properly, the patient won't accept the mask and the success of ventilation is put at risk. The Weinmann Joyce CPAP Ventilation Masks fit perfectly, stand up to high therapy pressures and allow the patient to exhale easily. They are kind to the skin, quiet and simple to use. The modular design of the Joyce Mask allows adjustment to individual patient needs.



Joyce Full Face Gel NV40 hPa

Code	Size
WM-26461	Small
WM-26471	Medium
WM-26481	Large
WM-26491	X Large

Joyce Full Face Gel

Code	Size
WM-26462	Small
WM-26472	Medium
WM-26482	Large

Weinmann Medumat Standard A

The automatic respirator Medumat Standard A offers controlled ventilation as well as an assisted ventilation mode with fixed minute volume (SIMV). Other functions such as oxygen inhalation or secretion suction can be added via the Modul system. Electronic alarms warn of disconnection, stenosis, pressure decrease in oxygen supply, insufficient battery voltage, system failure and missed triggering in assisted ventilation mode. Medumat Standard A offers the greatest safety for users and patients for emergency and transport usage.

Supply Schedule:

- WM-22800 Medumat Standard A complete
- WM-22670 Wall mount bracket (20G force)
- WM-22520 Reusable patient hose system with patient valve
- WM-28110 Disposable patient hose system with patient valve



Width	Height	Depth	Weight
190 mm	110 mm	90 mm	1.1 kg

Weinmann Modul CPAP

A simple oxygen driven CPAP device for the treatment of acute pulmonary oedema in the emergency environment. Utilising a Boussignac valve to create the CPAP pressure the Modul CPAP takes over the supply, management and monitoring of your patient. A robust device for the emergency environment the Weinmann Modul CPAP provides the following benefits.

Key Features

- Setting and monitoring of CPAP therapy in a single device
- Simple and fast setup – device is immediately ready for use
- CPAP pressure can be adjusted exactly to the needs of the patient
- Infinitely adjustable from 0 to 15 mbar

Supply Schedule:

- WM-29125 Weinmann Modul CPAP complete with airway
- WM-29119 Complete Boussignac Valve



Weinmann Life-Base Light

The Weinmann Life-Base Light provides a clever transport solution for various Weinmann portable systems for emergency medical services and hospitals. It allows the use of Medumat ventilators and Modules without an integrated oxygen source. The ready to use system, which works with an external O₂ source, offers the proven modularity that Life-Base is known for with its space saving dimensions, varied fastening options and a clever bag system. The protective and accessories bags easily accommodate parts needed for operation and keeps the device safe and secure.



Weinmann Medumat Easy

Ideal for remote nursing, mines, oil rigs or the trained but infrequent user. The Medumat Easy provides simple and sure guidance through volume ventilation thanks to its single-button operation and easy to understand voice prompts, the user can concentrate completely on the patient. The ventilation is started in standard mode for use with a mask. With the press of a button the user can switch to invasive ventilation.

Key Features

- Visual and acoustic alarms
- Voice prompts help to identify and solve problems
- Illuminated ventilation pressure display
- Small and light, fits in any emergency backpack or case
- W 100 mm, H 145 mm, D 90 mm, Weight: 600 g

Supply Schedule:

WM-28000	Medumat Easy Ventilator complete
WM-22520	Reusable patient hose system with patient valve
WM-28110	Disposable patient hose system with patient valve



Weinmann Medumat Easy CPR

A voice guided ventilator optimised for cardiopulmonary resuscitation. The Weinmann Medumat Easy CPR is extremely safe and easy to use. Ideal for remote areas such as mines, oil rigs and remote area medical centres. The Medumat Easy CPR can be used as ventilator or used in resuscitation situations where the device guides the user through the CPR process giving key voice commands and correct timing for chest compressions. The ventilator lets you manually generate a ventilated breath using the Medutrigger on the mask.

Key Features

- Voice prompts and metronome function for support of CPR
- Spoken instructions help with detection and resolution of problems
- Simple and safe selection of settings for controlled ventilation
- Rotary dial for setting of tidal volume and respiratory frequency
- Switching for setting of ventilation pressure limits 20 mbar/45 mbar
- Visual and acoustic alarms
- Illuminated pressure display ideal for dark situations
- Small and light ideal for emergency response situations
- W 100 mm, H 145 mm, D 90 mm, Weight: 600 g

Supply Schedule:

WM-28140	Medumat Easy CPR Ventilator complete
WM-22520	Reusable patient hose system with patient valve
WM-28110	Disposable patient hose system with patient valve



Medutrigger on the mask





Weinmann MEDUMAT Transport

Code WM-28400 (with CO2 measurement), WM-28300 (without CO2 measurement)

The Medumat Transport offers primary and secondary ventilation and permits usages previously unheard of from emergency medical services, trauma rooms and intra-hospital transfers.

The Medumat Transport is used in primary and secondary care of emergency and intensive-care transport patients and offers you great flexibility, thanks to the different types of ventilation. Five pressure controlled and three volume controlled modes with switch over from non-invasive ventilation to any of the other modes. It supports you with ventilation monitoring, a component that we believe has to be part of the ventilator.

The Medumat Transport provides simple operation with clarity and intuitive user guidance. The Medumat Transport can be supplied with or without CO₂ measurement (capnography).



Features

- Immediate overview of the most important ventilation parameters in a large colour display and parallel presentation of up to three monitoring curves
- Differentiated ventilation makes possible high-quality ventilation
- Intuitive user guidance
- Emergency mode supports fast and sure reaction in stressful situations
- Disposable and reusable patient hose systems. The user can switch from one system to the other
- Uninterrupted ventilation even during oxygen supply switch-over
- Economical oxygen measurement by means of a non-consumable oxygen sensor

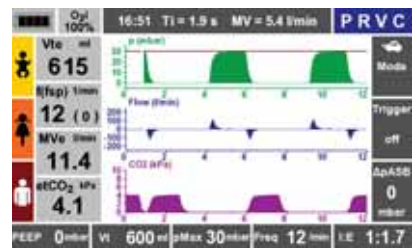

Displays up to three curves simultaneously

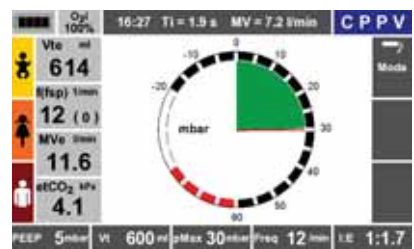

An innovative emergency mode

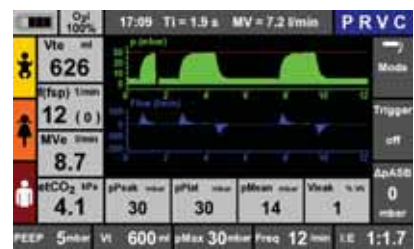

Night colours can be activated



Simple functional check



Intuitively understood start up for immediate use



Simple and quick battery replacement



Ventilation hose system: no risk of confusion



All connections accessible on front of device



Large visible alarm lights

Weinmann Accuvac Rescue

The Accuvac Rescue can be used anywhere because it adapts immediately to any suction need. Electronic controls allow finite adjustment for each situation and the Accuvac Rescue is highly portable and tough enough to deal with extreme weather conditions. As a 12 volt unit the Accuvac Rescue is independent from a stationary power supply so that it can work at the scene of an emergency or in a rescue vehicle. In addition to its use as suction pump for airway suction, it can also be used to deflate vacuum splints and mattresses. Available with reusable or disposable collection canister. Optional wall mounting bracket available.



Supply Schedule:

- WM-10609 Accuvac Rescue with 12 volt power connection/charger & disposable canister, accessory bag and wall bracket
- WM-10620 Accuvac Rescue with 12 volt power connection/charger & reusable canister, accessory bag and wall bracket
- WM-15208 Wall bracket
- WM-10655 Accessory bag for Accuvac units
- WM-15268 Disposable canister set
- WM-2610 Power pack and battery charger for 240 volt AC



Reusable Canister



Wall bracket (240v compatible)

Width	Height	Depth	Weight	Operating Temperature	Suction Capacity
370 mm	280 mm	140 mm	5.1 kg	-18 to +40 °C	20 L/min

Weinmann Accuvac Basic

Accuvac Basic fulfills the requirements for quick, safe and effective aspiration of patients. All the functions have been ergonomically designed. The device permits adaptation to every suction situation thanks to its infinitely variable negative pressure regulation. The Accuvac Basic is highly portable and tough enough to deal with extreme weather conditions. Equally important is independence from a stationary power supply so that it can work at the scene of an emergency or in a rescue vehicle. In addition to its use as a suction pump for airway suction, it can also be used to deflate vacuum splints and mattresses. Available with reusable or disposable collection canister. Optional wall mounting bracket with charger available.



Supply Schedule:

- WM-10700 Accuvac Basic with 240 volt charger & disposable canister
- WM-10709 Accuvac Basic with 240 volt charger & reusable canister
- WM-15208 Wall bracket
- WM-10655 Accessory bag for Accuvac units
- WM-10630 Reusable canister complete with hose
- WM-15238 Disposable canister complete with hose



Disposable Canister



Wall bracket (240v compatible)

Width	Height	Depth	Weight	Operating Temperature	Suction Capacity
385 mm	280 mm	140 mm	5.4 kg	-18 to +40 °C	20 L/min

Weinmann Manuvac Code WM-10800

The reliable helper in any emergency the Manuvac can be operated by hand, foot or knee. The design is compact, rugged and maintenance-free. A reliable suction device for any case.

Width	Height	Depth	Weight	Suction Capacity
205 mm	175 mm	105 mm	1.4 kg	160 L/stroke



Ferno Manual Vacuum Pump Code OXSM-F

The Ferno Manual Vacuum Pump (MVP) is a robust, light, portable high vacuum with a manual vacuum pump used for the clearing of airway obstructions. This is the only unit available that has the added benefit of being able to disengage and rotate the handle 360° relative to the patient's position, providing accessibility in tight situations.

Key Features

- 300 ml disposable collection jar
- 6 mm and 13 mm disposable suction catheters
- Overflow protection mechanism



Oxygen Powered Suction Unit Code OXSU-OP

The Oxygen Powered Suction Unit is capable of fast effective suctioning of excess quantities of fluid and particles from a patient's airway. The unique on/off button allows for fast, effective suction in emergency situations. Each suction unit comes complete with a catheter ready for immediate use.



Combat Application Tourniquet (C-A-T) NARP-30-0001

The C-A-T® is a true one-handed tourniquet proven to be 100% effective by the U.S. Army's Institute of Surgical Research. Tests proved that the C-A-T® completely occluded blood flow of an extremity in the event of a traumatic wound with significant hemorrhage. The C-A-T® utilises a durable windlass system with a free-moving internal band providing true circumferential pressure to the extremity. Once adequately tightened, bleeding will cease and the windlass is locked into place. A Hook and Loop strap is then applied, securing the windlass to maintain pressure during casualty evacuation. The C-A-T®'s unique dual securing system avoids the use of screws and clips which can become difficult to operate under survival stress or where fine motor skills are compromised.

Key Features

- Awarded as one of the "Top 10 Greatest Inventions" by the U.S. Army
- Official Tourniquet of the U.S. Army
- True, one-handed application tourniquet
- Small and cost-effective



6515-01-521-7976 (black)

Special Operations Laryngoscope Set Code NARP-10-0001

A lightweight, compact, and highly innovative Special Operations Laryngoscope Set that is designed to operate effectively under the most extreme environmental conditions. The laryngoscopes are packaged with spare bulbs and batteries, the fibre optic handle is water, sand and dust-proof and features a textured gripping surface. The set includes single-use fibre optic blades made from an enhanced polymer for exceptional strength and rigidity. For added convenience, the handle's removable light source is designed to work with any standard (green-spec) fibre optic blade. The complete set is lightweight at 285 g and rolls up for easy storage and transport.

Contents

- ENT Pocket Light with two AAA Batteries
- Laryngoscope Handle
- Miller #3 Laryngoscope Blade
- Mac #3 Laryngoscope Blade
- Laryngoscope Pouch
- Spare exam light bulb
- Two spare AAA batteries



Laryngoscope Systems

Ferno offers a full range of laryngoscope blades and handles in various sizes including fibre optic blades and matching handles, halogen blades and handles as well as a full range of single use blades.



Product Specifications

Disposable

	Type	Size	Blade
AWLH-FO	Fibreoptic Handle	-	-
AWLB-0MILD	Disposable Fibre optic	0	Miller
AWLB-1MILD	Disposable Fibre optic	1	Miller
AWLB-2MILD	Disposable Fibre optic	2	Miller
AWLB-2MCD	Disposable Fibre optic	2	Macintosh
AWLB-3MCD	Disposable Fibre optic	3	Macintosh
AWLB-4MCD	Disposable Fibre optic	4	Macintosh

Halogen

	Type	Size	Blade
AWLH	Halogen Handle	-	-
AWLB-0MIL	Halogen	0	Miller
AWLB-1MIL	Halogen	1	Miller
AWLB-2MIL	Halogen	2	Miller
AWLB-2MCD	Halogen	2	Macintosh
AWLB-3MCD	Halogen	3	Macintosh
AWLB-4MCD	Halogen	4	Macintosh

Fibre optic

	Type	Size	Blade
AWLH-FO	Fibre optic Handle	-	-
AWLB-0MILFO	Fibre optic	0	Miller
AWLB-1MILFO	Fibre optic	1	Miller
AWLB-2MILFO	Fibre optic	2	Miller
AWLB-2MCDFO	Fibre optic	2	Macintosh
AWLB-3MCDFO	Fibre optic	3	Macintosh
AWLB-4MCDFO	Fibre optic	4	Macintosh

Guedel/Oral Airway

Key Features

- Rounded edges with smooth inner bore
- Reinforced bite block
- Colour codes and size clearly marked
- Single use



Product Specifications

	Size	Colour	Length
AWG-000D	000	Pink	30 mm
AWG-00D	00	Orange	40 mm
AWG-0D	0	Blue	50 mm
AWG-1D	1	Violet	60 mm
AWG-2D	2	White	70 mm

	Size	Colour	Length
AWG-3D	3	Green	80 mm
AWG-4D	4	Yellow	90 mm
AWG-5D	5	Red	100 mm
AWG-6D	6	Water green	110 mm

Intubation Stylet

Key Features

- Soft distal tip
- Flexible aluminium with plastic sheath
- Designed for difficult intubations
- Packaged for single use only

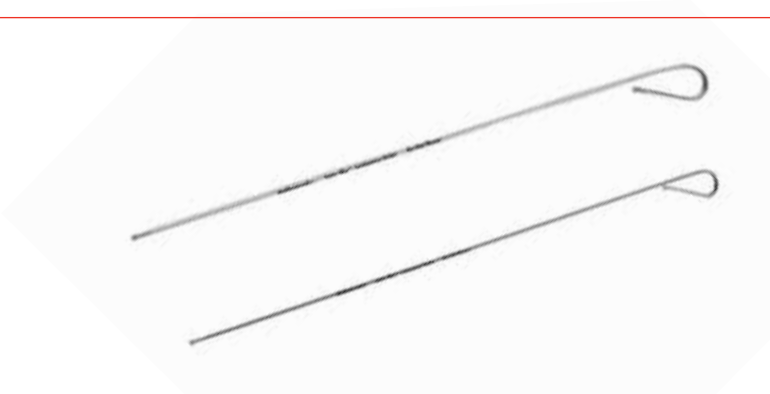

Product Specifications

	Size (Fr.)	Recommended Tube I.D. (Inside diameter)	Length
AWIS-S	6	2.5 mm – 4.5 mm	280 mm
AWIS-M	10	4 mm – 6 mm	350 mm
AWIS-L	14	5 mm	350 mm

Endotracheal Tubes Uncuffed

Key Features

- Smooth bevelled and moulded atraumatic hooded tip
- Graduation marks to aid correct positioning
- Standard 15 mm connector
- Clear material allows visualisation of condensed exhaled air

Product Specifications

	ID (Inside diameter)	OD (Outside diameter)	Length (including connector)
AWET-TU2	2 mm	2.9 mm	171 mm
AWET-TU2.5	2.5 mm	3.6 mm	171 mm
AWET-TU3	3 mm	4.3 mm	190 mm
AWET-TU3.5	3.5 mm	4.9 mm	213 mm
AWET-TU4	4 mm	5.6 mm	232 mm
AWET-TU4.5	4.5 mm	6.2 mm	253 mm



	ID (Inside diameter)	OD (Outside diameter)	Length (including connector)
AWET-TU5	5 mm	6.9 mm	274 mm
AWET-TU5.5	5.5 mm	7.5 mm	304 mm
AWET-TU6	6 mm	8.2 mm	317 mm
AWET-TU6.5	6.5 mm	8.8 mm	327 mm
AWET-TU7	7 mm	9.6 mm	337 mm

Endotracheal Tubes Cuffed

Key Features

- Thin-walled and flexible cuff
- Standard 15 mm connector
- Pilot balloon with self sealing valve
- Graduation marks to aid correct positioning

Product Specifications

	ID (Inside diameter)	OD (Outside diameter)	Length (including connector)
AWET-T3	3 mm	4.3 mm	190 mm
AWET-T3.5	3.5 mm	4.9 mm	213 mm
AWET-T4	4 mm	5.6 mm	232 mm
AWET-T4.5	4.5 mm	6.2 mm	253 mm
AWET-T5	5 mm	6.9 mm	274 mm
AWET-T5.5	5.5 mm	7.5 mm	304 mm
AWET-T6	6 mm	8.2 mm	317 mm
AWET-T6.5	6.5 mm	8.8 mm	327 mm



	ID (Inside diameter)	OD (Outside diameter)	Length (including connector)
AWET-T7	7 mm	9.6 mm	339 mm
AWET-T7.5	7.5 mm	10.2 mm	350 mm
AWET-T8	8 mm	10.9 mm	360 mm
AWET-T8.5	8.5 mm	11.5 mm	370 mm
AWET-T9	9 mm	12.1 mm	375 mm
AWET-T9.5	9.5 mm	12.8 mm	375 mm
AWET-T10	10 mm	13.5 mm	375 mm

Nasopharyngeal Airways

Key Features

- Soft thin walled construction
- Sterile

Product Specifications

	Size (Fr.)	ID (Inside diameter)	OD (Outside diameter)
AWNA-2.5	12	2.5 mm	4 mm
AWNA-3.0	14	3 mm	4.7 mm
AWNA-3.5	16	3.5 mm	5.3 mm
AWNA-4.0	18	4 mm	6 mm
AWNA-4.5	19	4.5 mm	6.3 mm
AWNA-5.0	20	5 mm	6.7 mm
AWNA-5.5	22	5.5 mm	7.3 mm



	Size (Fr.)	ID (Inside diameter)	OD (Outside diameter)
AWNA-6.0	24	6 mm	8.1 mm
AWNA-6.5	26	6.5 mm	8.7 mm
AWNA-7.0	28	7 mm	9.4 mm
AWNA-7.5	30	7.5 mm	10 mm
AWNA-8.0	32	8 mm	10.8 mm
AWNA-8.5	34	8.5 mm	11.4 mm
AWNA-9.0	36	9 mm	12 mm

Laryngeal Mask Airway - Supreme (LMA)

Key Features

- Integral bite block
- Drain tube
- Fixation tab ensures tip engagement with UOS
- Larger pre-curved cuff
- Epiglottic fins prevent epiglottis entering airway



Product Specifications

	Patients	Weight	Size
AWLM-1D	Neonates/infants	5 kg	1
AWLM-2D	Infants/children	10-20 kg	2
AWLM-3D	Children	30-50 kg	3
AWLM-4D	Adults	50-70 kg	4
AWLM-5D	Adults	70-100 kg	5

Oxygen Therapy & Suction Disposables

Code	Description
OXM-AO	Oxygen Mask Adult
OXM-AOT	Oxygen Mask Adult & 2m O ₂ tubing
OXM-CO	Oxygen Mask Child
OXM-COT	Oxygen Mask Child & 2m O ₂ tubing
OXC-N	Nasal Cannula & 2m O ₂ tubing
OXM-AN	Nebuliser Mask Adult
OXM-CN	Nebuliser Mask Child
OXM-AR	Non Rebreather Mask Adult
OXM-CR	Non Rebreather Mask Child
OXM-AV	Adult Venturi Mask Multiple %
OXT	Oxygen Tube per metre

OXT-C	Oxygen Tube with Connector 2 m
OSP-BS	Oxygen Bodok Seal
OSP-S	Oxygen Cylinder Spanner
OXT-S	Suction Tube per metre
OXSYS-P	Yankuer Suction Unit
OXSYS-06	Y Suction Catheter Size 6
OXSYS-08	Y Suction Catheter Size 8
OXSYS-10	Y Suction Catheter Size 10
OXSYS-12	Y Suction Catheter Size 12
OXSYS-14	Y Suction Catheter Size 14
OXSYS-16	Y Suction Catheter Size 16
OXSYS-18	Y Suction Catheter Size 18



Weinmann Corpuls³

The Corpuls³ is a new defibrillator and monitoring system which offers uninterrupted patient monitoring for emergency medical services and hospitals. The Corpuls³ consists of three devices: a monitoring unit, a patient box and a defibrillator which can be used all together, two at a time or each on its own. At an emergency site, ambulance or in the hospital, communication between the individual devices is guaranteed by wireless technology, so the operator can decide how to use Corpuls³ dependent on the situation. For the first time, uninterrupted patient monitoring is possible.

Monitor Module

The monitor module is the operating and switching centre of Corpuls³. The 21 cm screen can be read easily even in direct sunlight or from the side. An integrated defibrillation menu allows prompt operation at the scene of an emergency.



Defibrillator Module

Functions of the module

- Defibrillation
- Cardioversion
- Pacing

If defibrillation is not required, this module does not have to be attached to the other two modules (e.g. for transport within hospital). With less weight to carry, rescue personnel can be more mobile. If defibrillation is required the option for electrodes or traditional paddles can be used.

Each of the three Corpuls³ modules has a lithium-ion battery pack that will last for several hours at maximum charge. Corpuls³ can display battery power life to the minute. When operating as a complete device, each module battery pack can fall back on the reserves of the others. The battery packs can be charged by the battery charger, mains power unit or the mounting device.

Patient Module

The Patient Module is the core of Corpuls³ and always stays with the patient and ensures that patient data is always monitored without interruption. The Patient Module accessory bag allows for easy attachment to a stretcher frame or side rail or the slim, lightweight design allows the module to be placed with the patient

- Diagnostic 12-lead ECG
- Non-invasive blood pressure (NIBP)
- Masimo Pulse oxymetry (SpO₂)
- Temperature (TEMP)
- Capnography (CO₂)
- Invasive blood pressure (IBP)
- Electrodes are readily available from the storage compartment in the patient module transport bag



Mounting Options

- A mounting solution is provided for each or all of the modules

Code	AED & Manual Mode						
	12 Lead ECG	SpO ₂	NIBP	CO ₂	IBP	Temp	
WM-3GS011000	•	-	-	-	-	-	
WM-3GS012000	•	•	-	-	-	-	
WM-3GS013000	•	•	•	-	-	-	
WM-SGS014000	•	-	•	-	-	-	
WM-SGS015000	•	-	•	•	-	-	
WM-SGS016000	•	•	•	•	-	-	
WM-SGS017000	•	•	•	•	•	-	
WM-SGS018000	•	•	•	•	•	•	



Meducore Easy AED

Both lay people and trained rescue workers are impressed by the simplicity of Meducore Easy. Its unique operating concept permits the rescuer to concentrate on the patient and to stay calm even in hectic situations. Available in either disposable or rechargeable battery pack operation. Wall mounted holder and transport bags are also available.

Key Features

- Automatically turns on when cover is opened
- Very clear and complete spoken voice instructions
- Automatic adjustment of volume to ambient noise level
- Unmistakable, clear and bright traffic light indicators (red/green)
- Extras are stored in device: scissors, disposable razor, face shield
- Step-by-step instructions and positioning symbols on the electrode package
- Single-button operation
- Info key calls up elapsed time and number of shocks since device was started
- CPR guidance system ensures correct CPR is administered
- Automatic daily self-test ensures the device is always ready for use
- Disposable battery maintains charge for four years in stand-by mode
- Shelf life of electrodes: 30 months from date of manufacture
- Includes infra-red easy view software as standard



Supply Schedule

- | | |
|----------|--|
| WM-41005 | AED, non rechargeable battery, electrodes, scissors, razor, face shield and PC software "Easy View" (on CD) |
| WM-41000 | AED, rechargeable battery, electrodes, scissors, disposable razor, face shield and PC software "Easy View" (on CD) |
| WM-40116 | Replacement defibr electrodes |
| WM-40155 | Battery pack non rechargeable |
| WM-40150 | Battery pack rechargeable |
| WM-40300 | AED wall mount box |
| WM-40120 | Wall mount bracket |
| WM-40100 | AED transport bag |



Product Specifications

Width	Height	Depth	Weight
240 mm	93 mm	240 mm (including handles)	2.6 kg (including battery and electrodes)

Meducore Easy AED Trainer

The Meducore Easy Trainer provides realistic scenarios for users of the Meducore Easy AED without charging or discharging electrical energy.

Key Features

- Cost-saving training mode with rechargeable batteries
- Reusable training electrodes
- 10 m wireless remote control with ability to control simulated patient scenarios
- Elapsed training time is shown in the remote control display
- Eight typical usage scenarios are pre-configured; three of these scenarios can be programmed
- Training electrodes and battery are not interchangeable with live unit
- Device is clearly labelled 'Trainer'

Supply Schedule

- | | |
|----------|--|
| WM-41080 | AED Trainer, battery pack, charger, 2 pr electrodes & remote control |
| WM-40115 | Replacement training electrodes |
| WM-40084 | Battery pack rechargeable |



HeartStart HS1 First Aid Defibrillator

The HeartStart HS1 First Aid Defibrillator provides confidence in knowing that you can save a life, even before help arrives. The HeartStart HS1 First Aid Defibrillator is designed for use by anyone, any time, at any location. It is simple to operate; with minimal training required an individual could easily use this device to save a life. The clear and concise voice instructions prompt the user through the steps of first aid defibrillation and CPR. The HeartStart HS1 First Aid Defibrillator has a comprehensive automatic self-test that checks all the vital functions on a daily, weekly and monthly schedule.



Supply Schedule

LAER- M5066AABU	HS1 Defibrillator with battery pack, electrode set & slimline case
LAER-M5071A	Adult SMART defibrillator electrode set
LAER-5072A	Infant / Child SMART defibrillator electrode set
LAER-M5070A	Battery, lithium manganese dioxide
LAER-YC	Waterproof hard case

HeartStart HS1 First Aid Defibrillator Trainer

The HeartStart HS1 First Aid Defibrillator Trainer simulates how the HeartStart HS1 First Aid Defibrillator will operate during a real-life sudden cardiac arrest. Clear and concise voice instructions provide easy-to-follow directions for training emergency workers. The HeartStart HS1 First Aid Defibrillator Trainer provides a variety of simulations or training scenarios to help responders acquire and demonstrate the basic skills necessary to use the HeartStart HS1 in an emergency.



Supply Schedule

LAER- M5086A	HS1 Defibrillator trainer with adult training pad cartridge, manikin adapter strip and carry case
LAER-M5073A	Adult training pads with cartridge
LAER-M5074A	Infant / Child training pads
LAER-M5093A	Adult training pads without cartridge

HeartStart FRx Defibrillator

The HeartStart FRx Defibrillator is a semi-automatic external defibrillator that is rugged, reliable and designed to be easy to use for those first to arrive at an emergency situation. It incorporates a number of features to ensure readiness with minimum maintenance. The HeartStart FRx Defibrillator is simple to operate, with minimal training an individual could easily use this device to save a life. The clear and confident voice instructions coach the first aider through each steps of first aid defibrillation and CPR. The HeartStart FRx Defibrillator is always ready with comprehensive automatic self-tests of all vital functions on a daily, weekly and monthly schedule.

Supply Schedule

LAER-861304ABU	FRx defibrillator, battery pack, electrode set and carry case
LAER-989803139261	Smart pads defibrillator electrode set
LAER-989803139311	Infant/child key
LAER-989803139271	Training pads adult (one pair)
LAER-M5070A	Battery lithium manganese dioxide



Finger Tip Pulse Oximeter Code ZM-MD300D

The Finger Tip Pulse Oximeter combines monitor and sensor into one compact unit that provides accurate, reliable, SpO₂ rate and pulse rate (PR) measurements on patients ranging from paediatrics to adults. Ideal for use within any emergency, hospital or clinical setting. Powered by either two AAA rechargeable or alkaline batteries.



Product Specifications

Length	Height	Depth	Weight
58 mm	32 mm	34 mm	50 g (includes 2 x AAA 1.5V rechargeable batteries)

SmartOx Pulse Oximeter

Weinmann offers the pulse oximeter SmartOx for routine spot checks in doctor's offices and in rescue services. It provides precise, non-invasive measurement of arterial oxygen saturation effectively and quickly. A selection of interchangeable sensors is available.



Supply Schedule

WM 18000 Pulse oximeter
WM 18010 Finger clip sensor including cable

Product Specifications

Length	Width	Depth	Weight
136 mm	32 mm	24 mm	72 g (includes 2 x AAA Alkaline batteries)

Field Corpsman Kit (Basic and Deluxe) Code NARP-20-0001 (Basic) NARP-20-0002 (Deluxe)

The North American Rescue's Basic and Deluxe Field Corpsman Kit are lightweight, durable and portable diagnostic sets that offer corpsmen excellence & flexibility as they care for the eyes & ears of the troops they escort into battle. The fine array of tools in this kit includes a wide selection of high intensity lights & magnifiers for enhancing both day and night examinations. Weight: Basic 175 g, Deluxe 328 g.



Basic NSN
6515-01-458-6178
Deluxe NSN
6515-01-458-6057

Special Features

- Lightweight, portable kit
- Xenon examination lamp (batteries included)
- Red lens for night use
- Fibre optic light-bender/nasal head
- Spare batteries
- Soft mesh pouch

Ear Care

- Otoscopic head
- Reusable adult specula: For use with the otoscopic head
- Disposable adult specula: For use with the otoscopic head.
- Lighted stainless curette: Used to remove wax from the ear or to assist in debris removal from small wounds

** Exclusive to the Deluxe kit is a Heine Mini 3000 Ophthalmoscope (with batteries).

Eye Care

- Cobalt blue lens: Provides UV illumination to examine the eyes for corneal abrasions or small foreign bodies.
- High resolution eye loop: Designed to gently sweep foreign bodies from the surface of the eye. The lighted tip illuminates work area
- Illuminated magnifier: Use with both the clear and cobalt blue lens. The magnifier is preferred for examining the soft tissue of the eye. Also useful for locating splinters and examining wounds, rashes and other topical irritations
- Lighted eye magnet: For the removal of metal foreign bodies in the eye
- Fluor-I-Strips: For use with cobalt blue lens for identification of corneal abrasions or to locate small particles in the eye

Heine Otoscope Mini 3000 Code DEO-HMO

The Heine Otoscope Mini 3000 is a compact pocket otoscope with direct illumination. This unique pocket size otoscope can only be used with the Mini 3000 handle system.

Key Features

- Xenon halogen technology provides a concentrated white light for perfect illumination and a brilliant image
- Three-times magnification and optimised casing surface for razor sharp images and minimal reflection
- Swivelling viewing window built into instrument
- Attachment clip with integrated on/off switch that switches off automatically when returned to the pocket
- Two-piece handle and head which is flexible and easy to maintain
- High quality handle that is shockproof, sturdy and non-slip
- Replaceable AA batteries



Heine Ophthalmoscope Mini 3000 Code DEO-HM

The Heine Ophthalmoscope Mini 3000 is a high quality, pocket size ophthalmoscope with fixation star aperture. Ideal for clinics and pre-hospital use. This ophthalmoscope can only be used with the Mini 3000 handle system.

Key Features

- Attachment clip with integrated on/off switch that switches off automatically when returned to the pocket
- Enhanced XHL Xenon Halogen Technology provides a concentrated white light for perfect illumination and a brilliant image
- Five different apertures offering a full function instrument including fixation star
- Two-piece handle and head which is flexible and easy to maintain
- High quality handle that is shockproof, sturdy and non-slip
- Replaceable AA batteries



Sprague Rappaport Stethoscope Code DES-SR

The Sprague Rappaport Stethoscope is very versatile and is often the choice of medical students, paediatricians and cardiologists. Superior acoustics for high, medium and low frequencies is achieved by changing to the most appropriate of a selection of five interchangeable chest pieces. There are adult and paediatric diaphragms and three bells for accurate detection of high, middle and low frequency sounds in both children and adults.

Key Features

- 56 cm tubing
- Adjustable binaural
- Accessory pouch containing two spare diaphragms, one pair of mushroom eartips and one pair of silicon eartips



Littmann Classic II S.E. Stethoscope Code DES-LC2

Featuring a two-sided chest piece, the Littmann Classic II S.E. Stethoscope offers high acoustic sensitivity. A tuneable diaphragm on one side augments the traditional bell function of the opposite side.

Key Features

- Traditional bell combined with tuneable diaphragm technology that allows you to conveniently alternate between low and high frequency sounds without turning over the chest piece
- Excellent acoustic seal and comfortable fit with patented 3M Littmann Snap Tight Soft-Sealing Eartips
- Patient-friendly, non-chill rim and diaphragm
- Single-lumen tubing in a variety of popular colours



Deluxe Sphygmomanometer *Code DESP-SA*

The Deluxe Sphygmomanometer is a standard two tube sphygmomanometer suitable for home, office or emergency medical services use.

Key Features

- Black enamel manometer with maximum range 0 - 300 mm Hg
- D-Bar self adjusting velcro cuff for one handed application
- Chrome plated inflation valve
- Zipped leatherette case



One Hand Sphygmomanometer *Code DESP-IHSR*

The One Hand Sphygmomanometer provides fully flexible reading positions and ease of handling as it is designed for the convenient use of both left and right hand operators. The air control permits exact release of air pressure.

Key Features

- Velcro fastened
- Zipped leatherette case
- Low cost
- Push button valve which allows the user to deflate the sphygmomanometer gradually



Heine One Hand Sphygmomanometer *Code DESP-1H*

The Heine One Standard Sphygmomanometer has many desirable features.

Key Features

- Latex-free
- Exceptionally strong construction with triple-mounted, shockproof movement
- Impact-resistant housings crafted in special, shock-absorbing materials
- Microfilter to protect the valve and movement
- Oversized inflator speeds up cuff inflation
- The inflator spoon can be set for left and right handed users
- Cuffs and tube systems are interchangeable with most single-tube instruments



Wall Mount Sphygmomanometer *Code DESP-W6*

This Wall Mount Sphygmomanometer has many essential and sought after features.

Key Features

- Large easy to read 150 mm dial
- Maximum range 0 - 300 mm Hg
- Rear bracket storage compartment area
- 110° rotation for easy viewing
- Nylon velcro cuff
- Latex bladder and bulb
- Nickel plated air release valve
- 2.4 m (when extended) coil tubing



Thomas Heating Pack Code THOM-TT650 Thomas Heating Pack (Red)

The Thomas Heating Pack is the largest and most complete IV fluid and medication warmer in the EMS industry.

Features of the pack include three interior colour-coded pockets with elastics designed to hold medications or other IV supplies and two removable clear vinyl exterior pockets. The outside of the Thomas Heating Pack is constructed from 1000D water resistant fabric with protective foam and aluminum insulated polyethylene bubbles for maximum heat radiance and temperature maintenance. The exterior of the pack also includes reflective striping for improved visibility.

Features

- Adjustable, tuck-away backpack straps with chest connect
- Holds up to 3 L of IV fluids as well as all medications and trauma gear
- Includes 1 fully-insulated IV bag
- Includes a Redi-Splint that serves as the frame of the pack
- Pre-set 36.5° C temp while plugged in
- Fuse protected and easily removable heating element
- 12 volt operation
- Draws a maximum of 2 A
- 1 year electronics warranty

Product Specifications

Length	Width	Height
30 cm	35 cm	18 cm



Contents not included



THOM-TT520 Insulated IV Pressure Infusion Bag

Thomas EMS Temperature Controlled Soft Case Code THOM-TT460

The New Thomas EMS Temperature Controlled Soft Case is designed to allow you to confidently and accurately store all non-refrigerated EMS medications at the manufacturers recommended storage range. The internal temperature controlled compartment is large enough to store all of your medication and temperature sensitive supplies. The external, non-temperature controlled pockets allow for storage of all basic trauma and response items.

Key Features

- Maintains approximately 22°C off ambient temperature
- Automatically maintains + / - 1°C from set temperature
- 5 cm insulation in the main chamber keeps medications cool even when unplugged and on-scene
- External digital temperature display
- 12 Volt or 240 Volt power supply
- Draws a maximum of 6 A
- Interior section is lined with removable clear vinyl for easy cleaning and moisture containment
- Includes both shoulder strap & backpack straps
- Weight: 4 kg
- Main Body Internal: 41 cm L x 25 cm W x 23 cm D
- External Dimensins: 58 cm L x 48 cm W x 38 cm D
- Temperature Controlled Volume: 23.6 l
- Non-Temperature Contolled Volume: 29.8 l
- Total Volume: 53.4 l



LED readout



Main compartment

Thomas Chillcore Case Code THOM-TT450 Thomas ChillCore Case (Orange)

The Thomas Chillcore Case enables therapeutic hypothermic induction to begin immediately on-scene. The Chillcore Case keeps IV solutions at desired temperature (as low as -7°C) even in periods of extreme heat and will comfortably store up to 4 L of IV solution (or 3 L when stored with the Thomas EMS Insulated Drug case). The Chillcore Case automatically switches to battery power when removed from the vehicle and will operate on its own internal batteries for up to 90 minutes. A built in smart sensor increases the cooling power during extreme conditions. External digital temperature display for easy monitoring and precise temperature setting. Each ChillCore Case includes an insulated pressure infused 1000 mL IV bag which allows solution to remain cool during rapid infusion. The small insulated drug case stores perfectly into the Thomas EMS Chillcore case and keeps your key refrigerated medications at ideal storage temperatures.

Key Features

- Also heats to 46°C for IV warming
- Maintains constant set temperature $\pm 1^{\circ}$
- Interior LCD light illuminates the inside of the case in low visibility situations
- Housed in a durable plastic case
- 12 volt vehicle power standard
- Draws a maximum of 8 A
- Internal storage dimensions 24 cm W x 29 cm D x 8 cm H
- Exterior Dimensions : 39 cm W x 49 cm D x 19 cm H



THOM-TT520 Insulated IV Pressure Infusion Bag

Clima-Tech Climate Controlled EMS Case Code THOM-CLIMA1-Y

The Clima-Tech is a Portable Temperature Controlled Case designed specifically for the EMS Market. The Clima-Tech contents are securely packaged in a rugged Pelican case that is built with stainless steel hardware and padlock protectors for optimum security. The inside lid content layout is well organised with a double layer of elastic lined clear pockets that assist with fast and secure placement of pharmaceuticals and other supplies. The main storage compartment provides adequate space for medications that require room temperature storage.

Key Features

- Maintains 28°C off ambient temperature
- Automatically maintains $\pm 1^{\circ}\text{C}$ from set temperature
- Retractable extension handle/polyurethane wheels
- Smart sensor detects ambient temperature and predicts interior temperatures
- Will cool or heat up to 3 hours on battery power
- Automatically switches to battery power when removed from vehicle
- Draws a maximum of 8 A
- External digital temperature display
- Internal storage dimensions 36 cm W x 33 cm D x 15 cm H
- Exterior Dimensions : 56 cm W x 42 cm D x 28 cm H
- 12 volt vehicle power or 240 volt with optional power supply



Contents not included

Thomas ALS Hard Case

Code THOM-TT423 ALS Complete (Grey), THOM-TT434 ALS Complete (Yellow)

The Thomas ALS Hard Case features a large removable padded drug case attached via heavy-duty magnets to the inside lid. The use of fluid-resistant, heavy weight vinyl and closed cell foam adds additional protection and basic cleaning and decontamination quick and easy. The layout of the elastic drug securing system and pocket design allows for convenient storage. The drug case also contains a clear vinyl locking section for narstretcheric storage. The base of the Thomas ALS Hard Case consists of a modular, foam divider system plus two removable fold outs featuring clear vinyl, colour-coded pockets. The base of the hard case can easily accommodate up to 3 L of IV solution and accessories, your IO device, as well as additional medications. This design allows for all base contents to be quickly and easily viewed upon the opening of the case.

This combination of the drug case and divided foam base allows several users to work out of the same case in multiple victim situations. Includes galvanized steel plate and glue kit for lid mount. Complete Thomas ALS Hard Case includes THOM-TT321 (removable drug case lid), THOM-TT742 (foam divided base) and the Pelican 1550 Case.



Contents not included

Thomas Hard Case BLS

Code THOM-TT428 BLS Complete (Grey), THOM-TT430 BLS Complete (Yellow)

The Thomas BLS Hard Case features a removable lid section attached via magnets to the inside of the lid. Each removable lid section that contains six colour-coded pockets that are designed to hold all of your BLS response equipment. The use of fluid-resistant heavy weight vinyl on the outside of the intubation kit makes cleaning and decontamination easy.

The base of the Thomas BLS Hard Case consists of a modular, foam divider system plus 2 removable fold outs featuring clear vinyl, colour-coded pockets. This design allows for all base contents to be protected and quickly and easily viewed upon the opening of the case. The base of the Thomas BLS Hard Case can hold all of the contents that the lid can accommodate, allowing for two EMT's to work on separate patients simultaneously from the same case. Complete BLS Hard Case includes THOM-TT331 (BLS lid section), THOM-TT742 (foam divided base) and the Pelican 1550 Case.



Contents not included

Thomas Airway Hard Case

Code THOM-TT432 Airway Complete (Grey), THOM-TT433 Airway Complete (Yellow)

The Thomas Airway Hard Case features a large removable intubation kit attached via magnets to the inside of the lid. The Intubation Kit can be removed and used by several medics in a multiple victim scenario, or remain secured to the lid and still be fully functional. The Intubation Kit is designed to hold multiple intubation handles, Macintosh and Miller blades, ET Tubes, Magill forceps, airways, RSI medications, and all other needed intubation accessories. The use of fluid-resistant heavy weight vinyl on the outside of the intubation kit makes cleaning and decontamination easy.

The base of the Thomas Airway Case consists of a modular, foam divider system plus two removable fold outs featuring clear vinyl, colour-coded pockets. The base of the Airway Case is designed to accommodate multiple adult and paediatric BVM's. Complete Airway Hard Case includes THOM-TT341 (Removable intubation kit), THOM-TT742 (foam divided base) and the Pelican 1550 Case. Includes galvanised steel plate and glue kit for lid mount.



Contents not included

Ferno 5107 Professional Trauma Kit Code FAHAD-5107

The Ferno 5107 Professional Trauma Kit is designed to accommodate all the supplies used by today's emergency professional. It has easy access to various external pockets that are configured with elastic loops and multiple internal pouches for first response supplies. The layout of the main internal body compartment can be customised quickly. A low profile back also keeps the kit close to the attendant minimising pressure on the spine when transporting a fully loaded kit. As well as the ergonomic, non slip shoulder strap the 5107 Professional Trauma bag is fitted with a tuck-away backpack harness system and is mini-kit compatible. Available in red and blue.



Product Specifications

Length	Width	Height
57 cm	31 cm	37 cm

Ferno 5108 Professional ALS Kit Code FAHAD-5108

The Ferno 5108 Professional ALS Kit has the same features as the Ferno 5107 Professional Trauma Kit with the addition of four mini kits to provide the ultimate, compact advanced life support kit. Available in red and blue.

Kit Includes

- 1 x 5114 Medication Mini Kit
- 1 x 5115 Intubation Mini Kit
- 2 x 5116 Intravenous Mini Kits

Product Specifications

Length	Width	Height
57 cm	31 cm	37 cm



Ferno Trauma Responder II Kit 5103 Code FAHAD-5103

The Ferno 5103 Trauma Responder Kit has a full opening compartment with elastic loops, a clear faced internal pouch and various internal segments that can be customised to suit the owner requirements. The kit also features a large external pocket with additional elastic loops that enhance the functionality of the kit. The 5103 features moulded feet on the bottom of the bag, providing extra protection and strength. Available in red and blue.

Product Specifications

Length	Width	Height
43 cm	23 cm	39 cm



Ferno 5113 First-In Trauma Kit Code FAHAD-5113

The Ferno 5113 is a great basic first response kit. The kit features an external pocket on the lid and a large, deep internal compartment that can be customised to fit all your essential first response gear. The kit comes with a removable base complete with moulded feet. This kit is compatible with Ferno Mini Kits. Available in red and blue.

Product Specifications

Length	Width	Height
38 cm	29 cm	37 cm



Saver 2100 First Responder Kit *Code FAHAD-2100*

The Saver 2100 First Responder Kit is built for the functional storage of all medical supplies. In the padded main compartment, the divided full front pouch has two wing pockets.

Product Specifications

Length	Width	Height
48 cm	28 cm	20 cm



Thomas Emergency Responder Pack TT800 *Code THOM-TT800*

The Thomas Emergency Responder Pack TT800 (ER) is specifically designed for initial care of critically ill or injured patients. The ladder frame of the pack can also serve as a splint when needed. This Kit includes eight interior pockets and three exterior pockets. This pack is available in orange.

Product Specifications

Length	Width	Height
35 cm	15 cm	30 cm



Ferno Primary Response Kit R400 *Code FAPR400*

The Ferno Primary Response Kit R400 is an uncomplicated design that allows universal use. The internal layout of the Ferno Primary Response Kit is a combination of fixed, clear faced pockets and removable clear faced modules. A large external pocket further enhances the user's ability to customise the content layout. The well laid out design and bulky storage areas provide plenty of options for end users. The kit features a comfortable back harness and can also be carried by top mounted carry handle. This kit is available in red and blue.

Product Specifications

Length	Width	Height
31 cm	15 cm	50 cm



Ferno Paramedic Rescue Backpack R300 *Code FAPR300*

The Ferno Paramedic Rescue Backpack is a large kit with spacious internal and external storage options. There is a total of 5 external pockets of varying size. The internal layout is a combination of fixed, clear faced pockets and removable clear faced modules. The long body, uncomplicated design and bulky area provides enough space to stock gear for the largest of scenarios. The kit features a comfortable, tuck-away back harness and can also be carried by top mounted carry handle. This kit is available in red and blue.

Product Specifications

Length	Width	Height
31 cm	15 cm - plus pockets	60 cm



Thomas ALS Packs Code THOM-TT100 (ALS Pack), THOM-TTR100 (ALS Roller Pack)

The Thomas ALS Pack TT100 and TTR100 are designed to carry virtually all equipment and supplies needed by emergency medical teams to perform advanced cardiac and trauma life support. The colour-coded ABC configuration (Airway, Bleeding and Cardiac Medicine) helps responders with equipment location recall. In total, the ALS pack includes over 100 individual dividers, elastic and pouches. Includes adjustable backpack straps with chest connect strap. This pack comes standard in orange. The TTR100 eliminates the stress and strain of transporting paramedic gear with the addition of an internal frame, wheels and a telescoping handle.

Kit Includes

- 2 x large exterior pockets
- 3 x colour-coded airways pouches (intubation, airway, paediatric)
- 1 x soft drug box (holds over 50 separate drugs and vials)
- 3 x colour-coded IV pouches
- 4 x exterior removable clear vinyl pockets

Product Specifications

	Length	Width	Height
TT100	36 cm	19 cm	57.5 cm
TTR100	36 cm	20.5 cm	57.5 cm



Contents not included

Thomas ALS Pack Ultra Code THOM-TT150 (ALS Pack Ultra), THOM-TTR150 (ALS Ultra Roller Pack)

The Thomas ALS Pack Ultra TT150 and TTR150 has all of the same features as the TT100 and TTR100 as well as the capacity to carry an Australian 400 L 'C' size cylinder. They have an increased exterior pocket size to hold an additional pack, increased reflectivity and larger, removable, clear vinyl interior pockets.

Key Features

- Space for an Australian 400 L 'C' size cylinder
- Backpack straps with chest connect
- Increased exterior pocket size to hold an additional pack
- Increased reflectivity
- Larger, removable, clear vinyl interior pockets

Kit Includes

- 2 x large exterior pockets
- 1 x soft drug box (holds more than 50 drugs and vials)
- 3 x colour-coded IV pouches
- 4 x exterior removable clear vinyl pockets
- 3 x colour-coded airways pouches (intubation, airway, paediatric)

Product Specifications

	Length	Width	Height
TT150	36 cm	18 cm	57.5 cm
TTR150	36 cm	20.5 cm	57.5 cm



Contents not included

Traverse Kigali Patrol Pack *Code TRAV20-0045*

Designed as a medical pack for the ski patrol, the Traverse Kigali organises and carries equipment for anyone responding away from the roadside, whether on foot, skis, ATV or mountain bike. Multiple pockets organise equipment for efficient access. A large sleeve with a retaining strap safely holds a 'C' size oxygen cylinder. Full suspension system with aluminum stays, padded shoulder strap and waist belt lets the pack ride comfortably all day, even when fully loaded. Built-in rain cover protects contents from snow, rain or other wet conditions. A removable (hook & loop) white medic cross for identification is included.



Contents not included

Built-in Rain Cover



Ferno Airway Management/Oxygen Kit 5100 *Code FAHAD-5100*

The Ferno Airway Management/Oxygen Kit 5100 is very popular due to its ease of use and versatility. There are several external pockets that allow good storage options and oxygen can be accessed via the main compartment or through an external pocket. The internal compartment has room for a Australian 400 L 'C' size oxygen cylinder with enough space for additional oxygen or trauma gear. This kit includes one utility 5131 pouch and two 5134 utility pouches and is multi-kit compatible. This kit is conveniently fitted with a tuck-away harness system and is available in red and blue.



Product Specifications

Length	Width	Height
58 cm	24 cm	33 cm

Weinmann Rescue Emergency Pack *Code WM-9025*

The Weinmann Rescue-Pack successfully combines the advantages of a conventional emergency case with the benefits of a backpack. There is no need to open the main compartment of the backpack, just open the front two flaps for fast and efficient access to the things you need right away. Medicine module has room for 22 ampoules



Product Specifications

Length	Width	Height
56 cm	40 cm	25 cm

Ferno 5110 Professional Trauma/Air Management Kit II *Code FAHAD-5110*

The Ferno 5110 is a fully functional and convenient professional trauma and airway management kit which includes a tuck-away backpack harness system and the adjustable storage in the main compartment. Oxygen access is available through the end pocket and from the main compartment. The Ferno 5110 Professional Trauma/Air Management Kit II is compatible with Australian 400 L 'C' size oxygen cylinder. This kit is available in red and blue.



Product Specifications

Length	Width	Height
64 cm	28 cm	38 cm

Saver 2110 Trauma O₂ Kit Code FAHAD-2110

The storage in the Saver 2110 Trauma O₂ Kit ensures personnel are highly organised and prepared for emergency response situations. The removable shelf dividers, five full-sized outer pockets, front pockets, large open-trauma dressing pockets and two mesh pockets on the lid ensure that everything is easily accessible and stored. The elastic loops and zipped compartments guarantee that contents are securely positioned. This kit is available in red and blue.



Product Specifications

Length	Width	Height
67 cm	41 cm	25 cm

Saver 2140 O₂ Backpack Kit Code FAHAD-2140

The Saver 2140 O₂ Backpack Kit has numerous expandable mesh pouches and a main component lid with a full-size open pocket which is compatible with the 5117 Professional Trauma Mini-Kit. Two full length, zipped side pockets make the 2140 O₂ Backpack Kit very practical. This backpack conveniently holds an Australian 400 L 'C' size oxygen cylinder. This kit is available in red and blue.



Product Specifications

Length	Width	Height
47 cm	24 cm	47 cm

Ferno 5120 Oxygen Carry Kit Code FAHAD-5120

This carry kit is a single piece design that is made with a squared aluminium frame to prevent the bag from rolling to one side at emergency scenes or during transportation. This carry kit easily hangs from stretchers and is padded for protection. The Ferno 5120 Oxygen Carry Kit comes with a double zip opening to provide easy access to the regulator. The kit will carry an Australian 400 L 'C' size oxygen cylinder. This kit is available in red and blue.



Product Specifications

Length	Width	Height
55 cm	16 cm	22 cm

Weinmann Oxygen Therapy Kit Code WM-8AU10001

The Weinmann Oxygen Therapy Kit is simplistic in design and allows storage of all standard oxygen therapy gear. Incorporated into this exclusive, lightweight design is a carry handle and shoulder strap along with a stretcher attachment strap. All sides of the kit incorporates 10 mm foam padding that offers protection for the oxygen bottle and contents. A clear faced window provides vision to the oxygen regulator and additional cylinder straps ensure the cylinder is held securely. A piggy back module sits on the back of the pack for surplus therapy or resuscitation gear. Supplied standard with distinctive check reflective tape.



Product Specifications

Length	Width	Height
55 cm	13 cm	24 cm

Ferno Responder Vest 5104 Code FAHAD-5104

The Ferno Responder Vest 5104 is has numerous pockets and sleeves that allow hands free transportation of first response and medical supplies. On the front of the vest there are five, velcro closing, vacant, storage pockets as well as a radio and pen-flashlight holder. The back of the vest has a large double zipper entry sleeve area 51 cm x 29 cm as well as an additional storage area with zipper entry 30 cm x 17 cm that can attach, via velcro, reflective assignment tags.

On the inside front of the vest there are two additional concealed pockets 24 cm x 21 cm. The vest's adjustable straps ensure a comfortable fit for all body shapes while the reflective strips, located on both the back and front ensure visibility in emergency situations.



Ferno Responder II Vest 5105 Code FAHAD-5105

The Ferno Responder II Vest 5105 has various essential features that assist with emergency and rescue response situations. The front of the vest has a total of 5 pockets, 3 small top pockets and 2 large zipper pockets with multiple storage compartments. There is also a radio and pen-flashlight holder. The back of the vest has a large double zipper entry sleeve area 51 cm x 29 cm as well as an additional storage area with zipper entry 30 cm x 17 cm that can attach, via velcro, reflective assignment tags.

On the inside front of the vest there are two additional concealed pockets 24 cm x 21 cm. The vest's adjustable straps ensure a comfortable fit for all body shapes, while the reflective strips, located on both the back and front ensure visibility in emergency situations.



Ferno 5106 Responder II Mesh Vest Code FAHAD-5106

The main body of the Ferno 5106 Responder II Mesh Vest is made from breathable mesh material and has all the same features of the 5105 with the exception of the inside front, concealed pockets and large rear double zip entry sleeve.

Features

- Breathable mesh material
- 3 velcro closing front pockets
- 2 zipper closing front pockets with various elastic loops, open and zippered pouch
- Radio and pen-flashlight holder
- Rear storage area with zipper entry 30 cm x 17 cm
- Adjustable straps ensure a comfortable fit for all body shapes
- Front and rear reflective strips for night time visibility



CMC Rescue Radio Harness Code CMC240025

The CMC Rescue Radio Harness is a long time favourite amongst fire departments. The user does not have to remove the radio from the harness, simply press the talk button and speak. This radio harness will carry a wide range of a standard sized, hand-held radios on the user's chest in a position that protects the radio from the impact of weather. This harness works under coats, rain gear or turnouts. CMC's unique shape and strap system holds the harness tight to the body, keeping the radio in place regardless of activity. The mesh panel breathes to minimise perspiration.



CMC Rescue Radio Holster Harness Code CMC240027

This versatile holster enables a radio to be carried just about anywhere. The belt has loop slots for a conventional belt carry or loop through webbing for an over the shoulders carry. Dual velcro straps allow the radio holster to fit on the shoulder strap of a pack or full bodied harness. CMC's unique universal fit radio pocket is easy to adjust and securely holds a wide range of radio models while allowing easy access to all knobs, front mounted keypads and displays.



CMC Rescue Water Resistant Radio Harness

Code CMC240041 Harness and Aqua Pac Bag CMC421103 Aqua Pac Bag only

Decrease the risk of water damage to your radio due to inclement weather, over-spray from fire hoses or splashes. CMC's Water Radio Harness has been re-designed to take advantage of the watertight security of the Aqua Pac waterproof radio bag. The Aqua Pac bag attaches to a modified version of our CMC Rescue Radio Harness providing the same level of security and wearing comfort. Fits most radios up to 5 cm x 20 cm including antenna length.



Ferno Belt Holsters and Glove Pouches

Ferno manufactures and supplies a vast range of belt mounted holsters and pouches that are designed to securely hold instruments, torches, gloves and other commonly used tools of the trade. All items are made from heavy-duty nylon and guaranteed to perform.

- | | |
|-------------|---|
| 1. FAPH800 | Fits penlight or instrument (image not shown) |
| 2. FAPH600 | Fits penlight, instrument |
| 3. FAPH100 | Fits penlight, three additional instruments |
| 4. FAPH200 | Fits penlight, three additional instruments, stethoscope, glove pouch |
| 5. FAPH275 | Fits penlight, three additional instruments, window punch, stethoscope, glove pouch |
| 6. FAPH400 | Fits a resuscitation pocket mask |
| 7. FAPGP100 | Fits gloves (one pair) |
| 8. FAPGP200 | Fits gloves (five pair) |
| 9. FAPGP250 | Fits gloves plus resus shield |



Ferno 5115 Professional Intubation Mini Kit

Code FAHAD-5115

The Ferno 5115 Professional Intubation Mini-Kit stores your intubation and airway supplies for quick access and ease of use. The removable internal pouch is ideal for miscellaneous supplies and contains a removable card for additional storage. This kit is available in red and navy blue.

Product Specifications

Length	Width	Height
33 cm	8 cm	24 cm



Ferno 5130 Intubation Ultra Mini-Kit

Code FAHAD-5130

Designed to hold a variety of emergency airway supplies and accessories in an efficient compact layout that easily fits into larger kits. This kit is available navy blue only.

Product Specifications

Length	Width	Height
14 cm	5 cm	29 cm



Thomas Transport Airway Kit TT410

Code THOM-TT410

A complete, organised grab and go airway kit designed to carry all the equipment needed for a successful intubation. The outside of the TT410 includes a small pocket designed to hold gloves, Braslow tape or an ALS pocket guide. The other side of the kit includes the Thomas dry erase board and pen, which can be used for patient note taking or equipment replacement reminders. The inside section is designed to hold 8 laryngoscope blades and a medium or large handle, multiple size syringes and two Magill forceps and guide. There are also lockable vinyl pockets for drugs or other accessories. Additionally there are two pockets for storing up to 14 ET tubes and holders. The TT410 is small enough to fit within larger packs.

Product Specifications

Length	Width	Height
33 cm	23 cm	9 cm



Contents not included

Ferno 5116 Professional Intravenous Mini Kit

Code FAHAD-5116

The Ferno 5116 Professional Intravenous Mini-Kit allows storage and quick access to essential IV supplies. This mini-kit is easily stored inside larger kits and provides a billow pocket for small sharps containers. YKK zippers pulls provide lockable security. Available in red and navy blue.

Product Specifications

Length	Width	Height
11 cm	9 cm	23 cm



Ferno 5114 Professional Medication Mini Kit Code FAHAD-5114

The Ferno 5114 Professional Medication Mini-Kit offers a modern approach to organising drugs. The compact design enables storage within larger kits. The eight removable ampoule cards and lockable zipper ensures the safe storage of any drugs. This medication kit is available in red and blue.



Product Specifications

Length	Width	Height
23 cm	22 cm	8 cm

Thomas Drug Kit TT300 Code THOM-TT300

The Thomas Drug Kit TT300 is able to hold more than 50 separate drug vials in addition to syringe boxes. The Thomas Drug Kit TT300 includes a dry erase board, pen and a separate narstretcherics section which can be locked. The Thomas Drug Kit TT300 has a padded drug bag and has two vinyl windows for printed material. Numerous support sections are available in the form of clear vinyl support pockets and pouches that are ideal for carrying a wide variety of equipment and supplies. The clear pouches allow for rapid identification of supplies and quick restocking. This kit is available in orange.



Contents not included

Product Specifications

Length	Width	Height
23 cm	33 cm	9 cm

Thomas Insulated Drug Case Code THOM-TT305

The small insulated drug case assists in protection medications from extreme weather conditions. Ideal for use in any kit the Thomas Insulated Drug Case also stores perfectly into the Thomas EMS Chillcore case which keeps your key refrigerated medications at the manufacturers recommended storage temperatures.



Contents not included

Product Specifications

Length	Width	Height
23 cm	10 cm	4 cm

Ferno 5117 Professional Trauma Mini-Kit Code FAHAD-5117

This Ferno 5117 Professional Trauma Mini-Kit provides excellent storage space, enabling functional organisation of your essential trauma supplies. The bag utilises loops and durable mesh pockets to create an easily identifiable storage environment. The ferno 5117 is available in red and blue.



Product Specifications

Length	Width	Height
34 cm	8 cm	24 cm

Saver Belt First Aid Kits 200GR and 300GR

Codes FAHAD 200GR and FAHAD 300GR

Carrying basic personal first aid requirements for work or outdoors is made easy with the Saver Belt First Aid Kits 200GR and 300GR. The kits are available in green.

Product Specifications

	Length	Width	Height
FAHAD-200GR	10 cm	4 cm	14 cm
FAHAD-300GR	14 cm	8 cm	10 cm

FAHAD 300GR



Saver First Aid Kit 700GR Code FAHAD-700GR

The Saver First Aid Kit 700GR is ideal for home, work and outdoor activities. Numerous inner pouches and elastic loops store and organise a good supply of first aid items. This kit is available in green.

Product Specifications

Length	Width	Height
21.5 cm	7.5 cm	15 cm



Saver First Aid Kit 800GR Code FAHAD-800GR

The Saver First Aid Kit 800GR has numerous inner pouches and elastic loops, making it ideal for storing and organising a variety of first aid items. It is suitable for home, work and outdoor. This kit is available in green.

Product Specifications

Length	Width	Height
25.5 cm	10 cm	14 cm



Saver First Aid Hip Pack 1000GR Code FAHAD-1000GR

The Saver First Aid Hip Pack 1000GR was originally designed to carry airway equipment for lifeguards, but can also be used to carry first-responder supplies or personal gear. This kit is available in green.

Product Specifications

Length	Width	Height
35.5 cm	6.5 cm	5 cm



Saver Rescue Trauma Hip Pack 900 Code FAHAD-900GR

The Saver Rescue Trauma Hip Pack 900 is widely used by search and rescue personnel and ski patrollers. It has a surprising amount of storage space and the waist belt straps tuck away when not in use. Available in green.

Product Specifications

Length	Width	Height
36 cm	10 cm	18 cm



ULM Classic Cases

The ULM Classic Case with its semi-variable interior compartments offer a wide range of compartment divisions for practically any requirement. Its versatility, combined with its unmatched ruggedness, durability and sheer good looks, make the ULM Classic Cases indispensable in any emergency.



ULM Case 1

ULM Case 2

ULM Case 3



Product Specifications

Code	Description	Length	Width	Depth	Weight	Med Module
WM-8840	ULM CASE 1	52.5 cm	40 cm	17 cm	6.5 kg	26
WM-8730	ULM CASE 2	52.5 cm	40 cm	20 cm	6.7 kg	33*
WM-8830	ULM CASE 3	52.5 cm	40 cm	23 cm	8.3 kg	22 - 55

Available as accessory

Flambeau Orange Medical Kits

Codes FAFPM1872, FAFPM2072, FAFPM2272 and FAFPM2273

These highly durable medical kits are the perfect storage device, providing numerous compartments that are ideal for carrying a wide variety of medical supplies. Longevity is assured through the use of heavy duty copolymer lightweight material that is resistant to rust, dust, scratches and most common chemicals.

Product Specifications

	Length	Width	Depth
PM1872	44.5 cm	26 cm	21.6 cm
PM2072	48.5 cm	27.5 cm	26 cm
PM2272	49.5 cm	29 cm	30 cm
PM2273	49.5 cm	29 cm	30 cm

PM2273 & PM2272

PM2072

PM1872



Plano Medical Kit

Code FAMB747M

The Plano Medical Kit is the original trauma box that has been widely used in the ambulance industry for many years. The box allows all necessary equipment to be kept at your finger tips. The front panel drops down, allowing three trays to swing back or the three drawers to pull out. Features include an extra-deep bottom compartment.

Product Specifications

Length	Width	Height
52 cm	29 cm	32 cm



Saver First Aid Kits

Code FAF1672G, FAF1772G, FAF1872G

Ferno First Aid Boxes are not a re-badged fishing or tool box but a purpose-designed medical box for first aid use. Each box comes standard with a locking feature, making the kits tamper-proof if desired. Metal hinges demonstrate the quality of Ferno first aid boxes and are purpose-designed to make the boxes durable. Each box has an over-centre catch and a tongue and groove seal, which provides a tighter seal of the box, making them resistant to things such as dust and water. Another unique feature of the Ferno First Aid Boxes is the removable dividers in the white trays, which allow you to greater customise each compartment. The trays also have a generous depth for greater storage and a smooth surface for easy cleaning.



Features

- Removable dividers in trays
- Deeper trays purpose sized for first aid gear
- Tamper-proof lock system
- Over-centre catch and tongue and groove sealing
- Smooth surface on box lids for labelling
- Metal hinges
- Resistant to oil and most common chemicals



FAF1672G



FAF1772G



FAF1872G

Ferno Compact First Aid Boxes

Codes FAF1272G FAF1472G

The Ferno 1272 and 1472 first aid boxes are compact, lightweight and ideal for hiking, travelling or driving as they provide simple storage of your first aid equipment in the car, caravan or in your back pack. The Ferno Compact Kits feature a full length hinge and snap lock lid that ensures a tight and secure close.



FAF1472G

FAF1272G



FAF1472G

FAF1272G

Product Specifications

	Length	Width	Depth	Carton Qty
FAF1672G	32 cm	18.5 cm	14 cm	6
FAF1772G	42 cm	22 cm	18.5 cm	4
FAF1872G	45 cm	25 cm	22 cm	4
FAF1272G	25.5 cm	11 cm	4 cm	24
FAF1472G	35.5 cm	14 cm	6 cm	12



First Aid Cabinets

Ferno offers a range of first aid cabinets that come in a variety of sizes ensuring the right fit for all your first aid and medical supplies. They are durable and most can be utilised as either a portable or wall mountable unit, with carry handles and single door entry. These attractive cabinets are finished in white powder coated steel.

Product Specifications

	Product	Length	Width	Depth
FACHC	First Aid Box Handy Chest	250 mm	160 mm	80 mm
FACSF	First Aid Cabinet SF	380 mm	240 mm	120 mm
FAC1W	First Aid Cabinet 1W	380 mm	200 mm	120 mm
FAC2F	First Aid Cabinet 2F	440 mm	280 mm	150 mm
FAC2W	First Aid Cabinet 2W	440 mm	280 mm	150 mm
FACMWU	First Aid Cabinet MWU	460 mm	350 mm	170 mm
FAC3F	First Aid Cabinet 3F	590 mm	400 mm	170 mm



FACHC - First Aid Box Handy Chest



FACSF - First Aid Cabinet SF



FAC1W - First Aid Cabinet 1W



FAC2F - First Aid Cabinet 2F



FAC2W - First Aid Cabinet 2W



FACMWU - First Aid Cabinet MWU



FAC3F - First Aid Cabinet 3F

Burnshield

Burnshield works by halting the burn process, and physically protecting against further contamination. Burnshield's cooling and soothing effect results from its specially formulated Hydrogel and its active ingredient is Melaleuca Alternifolia (tea-tree). The sterile dressing keeps the wound clean and minimises the loss of body fluids. Burnshield is easy to apply, non-adhesive and easy to remove without causing further trauma to the patient. Burnshield is safe for use on children. For best results, Burnshield should be applied as soon as possible after the burn has occurred.

Burnshield Dressings

Burnshield Dressings cater for the most common areas for burns and are available in the following range of different packs and sizes.

Key Features

- Provides physical protection against contamination
- Non-adherent and does not stick to the wound
- Suitable for all kinds of burns and scalds
- Dressing is elastic, stretches and flexes
- Cools and moistens the burn area
- Water soluble and easily removed
- Sterile - bacteria static
- Draws out the heat
- Stops the burn progression
- Relieves pain
- Non-toxic, non-irritant
- Anti-bacterial action
- Five year shelf life



Available Sizes

- BTBS-D10 x 10 (10 cm x 10 cm)
- BTBS-D20 x 20 (20 cm x 20 cm)
- BTBS-D20 x 45 (20 cm x 45 cm)
- BTBS-D60 x 40 (60 cm x 40 cm)
- BTBS-D2.5 x 50 (2.5 cm X 50 cm)
- BTBS-D5 x 100 (5 cm x 100 cm)
- BTBS-D20 x 45F - face mask (20 cm x 45 cm)
- BTBS-D60 x 40F - face mask (60 cm x 40 cm)
- BTBS-DR100 x 100 (100 cm x 100 cm)
- BTBS-DR100 x 200 (100 cm x 200 cm)

Burnshield Hydrogel

Codes BTBS-H50ML (50 ml), BTBS-H125ML (125 ml spray back) and BTBS-SB (3.5 ml sachet)

Burnshield Hydrogel is a sterile, water-based solution that is anti-microbial, anesthetising and cooling. The gel can be applied directly to first, second and third degree burns including scalds, facial, chemical and electrical burns. The gel relieves pain by cooling, moisturising and soothing the skin while protecting the burned area from contamination. Burnshield Hydrogel has a two year shelf life.

Available Sizes

- BTBS-H50ML (50 ml)
- BTBS-H125ML (125 ml)
- BTBS-SB (3.5 ml)



Mini Burn Kit *Code BTBS-KM*

The Mini Burn Kit is conveniently packaged in a compact, sealed box and contains the basic everyday treatment. The Mini Burn Kit makes an ideal addition to any first aid kit.

Contents

Mini Burn Kit

- 1 x 10 cm x 10 cm
- 2 x Burn blotts 3.5 ml
- 1 x Soft cohesive foam bandage



Home Burn Kits

The Home Burn Kits come supplied in a handy, self contained, swing tag container that can either be hung on the wall or placed into a first aid kit ready for urgent attention. The container is clear faced and all contents are in full view.

Contents

Burn Kit 10 B (BTBS-K10B)

- 1 x 10cm x 10cm dressing
- 1 x Hydrogel bottle 50 ml
- 4 x Burn Blotts 3.5 ml
- 4 x Adhesive plasters
- 1 x Pamphlet

Burn Kit 20 B (BTBS-K20B)

- 1 x 20 cm x 20 cm dressing
- 1 x Hydrogel bottle 50 ml
- 4 x Burn blotts 3.5 ml
- 4 x Adhesive plasters
- 1 x Pamphlet



Easy Care Burn Kit *Code BTBS-KEC*

The EasyCare Burn Kit provides the basic content to treat a mild to moderate emergency burn in the workplace or home. All content is housed in a protective plastic case.

Contents

- 1 x Burnshield plastic box
- 2 x 10cm x 10cm dressing
- 1 x 20cm x 20cm dressing
- 3 x Burn Blotts 3.5 ml
- 3 x Adhesive plasters
- 1 x Paper tape 25 cm x 3 m
- 1 x Latex gloves pair
- 1 x Scissors
- 2 x Conform bandage 50 mm



Burnshield Rescue Burns Kit *Codes BTBS-KE*

The Burnshield Rescue Burns Kit is a moderate sized trauma kit that is used by basic, intermediate and advanced life support professionals who deal with first response and trauma cases.

Contents

- 2 x Burnshield Dressing (10 cm x 10 cm)
- 2 x Burnshield Dressing (20 cm x 20cm)
- 2 x Burnshield Dressing (60 cm x 40 cm)
- 1 x Burnshield Dressing (5 cm x 100 cm)
- 1 x Plastipore (2.4 cm x 5 m)
- 2 x Conforming bandage (5 cm)
- 1 x Burnshield Hydrogel (125 ml)
- 1 x Scissors
- 1 x Latex gloves (pair)
- 1 x Rescue blanket



Burnshield Responder Kit Codes BTBS-KR

The Burnshield Responder Kit is a trauma kit that is used by professionals who deal with trauma cases such as doctors, paramedics, nursing staff and ambulance personnel. This one bag caters for minor, moderate and severe burns.



Contents

- 8 x Burnshield Dressing (10 cm x 10 cm)
- 3 x Burnshield Dressing (20 cm x 20 cm)
- 2 x Burnshield Dressing (60 cm x 40 cm)
- 1 x Burnshield Dressing (2.5 cm x 50 cm)
- 1 x Plastipore (2.4 cm x 5 m)
- 2 x Conforming bandage (7.5 cm)
- 1 x Scissors
- 1 x Rescue Blanket (adult)
- 2 x Latex gloves (pair)
- 3 x Burnshield Hydrogel (125 ml)
- 2 x Sterile water ampoules
- 1 x Syringe (20 ml)

Burnshield Combi Trauma Pack Codes BTBS-KCT

The Burnshield Combi Trauma Pack is an advanced burns trauma bag for use by ambulance, fire, defence and industry personnel.

Contents

- 5 x Burnshield Dressing (10 cm x 10 cm)
- 5 x Burnshield Dressing (20 cm x 20 cm)
- 3 x Burnshield Dressing (60 cm x 40 cm)
- 2 x Burnshield Blanket (80 cm x 80 cm)
- 5 x Burnshield Dressing (2.5 cm x 50 cm)
- 3 x Burnshield Dressing (5 cm x 100 cm)
- 2 x Burnshield Hydrogel (1 L)
- 4 x Burnshield Hydrogel (125 ml)
- 2 x Crepe bandage (10 cm)
- 1 x Crepe bandage (15 cm)
- 1 x Rescue Blanket (adult)
- 2 x Purified water
- 1 x Scissors
- 1 x Syringe (20 ml)
- 2 x Latex gloves (pair)
- 1 x Plastipore (2.4 cm x 5 m)



Burnshield Fire/Trauma Blankets

Burnshield Fire/Trauma Blankets are made from pure wool inter-linking cellular structure that is impregnated with Hydrogel, which provides remarkable heat protection and extended burn-through times. Hydrogel draws the heat from burns and can be used with confidence as a fire and smoke shield to provide a means of escape, rescue and protection. The blankets are also ideal as a lifesaver as they can stifle flames or be placed over the burning victim to stop the flames, while at the same time providing a first aid treatment to the burns. Burnshield blankets are packaged in a portable hands-free bag and are available in a variety of sizes.

Available Sizes

- BTBS-B1x1 (1 m x 1 m)
- BTBS-B1.2x1.6 (1.2 m x 1.6 m)
- BTBS-B2.45x1.6 (2.45 m x 1.6 m)



Ferno ALS Kit Contents Codes FWE-ALSC

The Ferno ALS Kit contents provide a comprehensive range of product that can be supplied with either your choice of Ferno 5108 Professional ALS Kit or the R300 Paramedic Rescue Backpack. (kit contents supplied separately to bag)

Contents

Bandages & Dressings:

- 2 Triangular Bandages
- 1 Combine Dressing 20 cm x 75 cm
- 2 #15 Wound Dressing
- 1 Pkt 50 Fabric Adhesive Dressings
- 2 Algisite Dressing 5 cm x 5 cm
- 2 Burnshield Dressing 10 cm x 10 cm
- 1 Paraffin Gauze Dressing 10 cm x 10 cm
- 2 Conforming Gauze Bandage 7.5 cm
- 2 Conforming Gauze Bandage 15 cm
- 5 Pkt 5 Gauze Swabs 10 cm x 10 cm
- 1 Heavy Crepe Bandage 7.5 cm
- 1 Heavy Crepe Bandage 7.5 cm
- 5 Eye Pads
- 2 Leukoplast Adhesive Tape 2.5 cm
- 1 Leukoplast Adhesive Tape 1.25 cm
- 1 Disposable Basic Dressing Pack

Advanced Life Support:

- Advanced Life Support:
- 1 Disposable Resuscitator (Adult)
- 1 Set 6 Nasopharyngeal Airways
- 1 Set 5 Guedel Airways



Equipment & Supplies

- 1 Sphygmomanometer 1 Hand
- 1 Stethoscope
- 1 Ferno CPR Mask
- 1 Eye Wash
- 1 Sam Splint 36"
- 5 Pr Nitrile Gloves
- 1 Universal Shears
- 1 Bandage Scissors
- 1 Kelley Forceps
- 1 Splinter Tweezers
- 1 Space Blanket
- 1 Burn Dressing 70 cm x 75 cm
- 10 Povidone Iodine Prep Pads
- 10 Alcohol Prep Pads
- 10 Antiseptic Cream Satchets 1 ml
- 1 Stingose Gel 25 g
- 1 Instant Ice Pack
- 1 Oral Glucose Gel
- 1 Ipecac Syrup
- 1 Disposable Scalpel
- 1 No-Rinse Hand Gel

Ferno BLS Kit Contents Codes FWE-BLSC

The Ferno BLS Kit contents provide basic equipment and dressings required during a medical emergency. These contents can be supplied with the Ferno 5107 Professional Trauma Kit, Ferno 5103 Trauma Responder II Kit or the Ferno R400.Primary Response Kit (kit contents supplied separately to bag)

Contents

Bandages & Dressings:

- 2 Triangular Bandages
- 1 Combine Dressing 20 cm x 75 cm
- 1 #15 Wound Dressing
- 1 Pkt 50 Fabric Adhesive Dressings
- 2 Algisite Dressing 5 cm x 5 cm
- 2 Burnshield Dressing 10 cm x 10 cm
- 1 Paraffin Gauze Dressing 10 cm x 10 cm
- 2 Conforming Gauze Bandage 7.5 cm
- 2 Conforming Gauze Bandage 15 cm
- 5 Pkt 5 Gauze Swabs 10 cm x 10 cm
- 1 Heavy Crepe Bandage 7.5 cm
- 1 Heavy Crepe Bandage 7.5 cm
- 5 Eye Pads
- 2 Leukoplast Adhesive Tape 2.5 cm
- 1 Leukoplast Adhesive Tape 1.25 cm



Equipment & Supplies

- 1 Set 5 Guedel Airways
- 1 Space Blanket
- 1 Sphygmomanometer 1 Hand
- 1 Stethoscope
- 1 Eye Wash.
- 1 Sam Splint 36"
- 5 Pr Nitrile Gloves
- 1 Universal Shears
- 1 Bandage Scissors
- 1 Kelley Forceps
- 1 Splinter Tweezers
- 1 Space Blanket
- 1 Ferno CPR Mask
- 1 Burn Dressing 70 cm x 75 cm
- 10 Povidone Iodine Prep Pads
- 10 Alcohol Prep Pads
- 10 Antiseptic Cream Satchets 1 ml
- 1 Stingose Gel 25 g
- 1 Instant Ice Pack
- 1 No-Rinse Hand Gel

Flat-Packed Trolleys

Code CRT-FP1 (single drawer) CRT-FP2 (double drawer)

These trolleys are strong and durable and are an ideal, low cost alternative to stainless steel trolleys. Each Econo Trolley is shipped flat packed, unassembled with all the tools and instructions required to assemble.

Key Features

- Large 75 mm twin polyurethane wheels
- Hard edged whiteboard shelves and drawer front
- Charcoal powdercoat steel legs and cover panels
- Dimensions: L 550 mm, W 550 mm, H 900 mm



Medical/Instrument Trolleys (stainless steel)

The Stainless Steel Trolleys provide a clean and stylish storage solution. The stainless steel surface and construction ensures durability, resistance to corrosion and easy cleaning and disinfecting. Supplied with non-marking, 10 cm swivel wheels, with the option of varying number of drawers and drawer configurations.

Product Specifications

	Height	Width	Depth	Drawer
CRT-SSND-1	90 cm	50 cm	50 cm	No Drawer
CRT-SSND-2	90 cm	80 cm	50 cm	No Drawer
CRT-SS1D-1	90 cm	50 cm	50 cm	Single
CRT-SS1D-2	90 cm	60 cm	50 cm	Single
CRT-SS2D-H	90 cm	80 cm	50 cm	Double drawer - horizontal
CRT-SS2D-V	90 cm	50 cm	50 cm	Double drawer - vertical
CRT-SS4D	90 cm	80 cm	50 cm	4 draw; 2 horizontal, 2 vertical
CRT-SS5D	90 cm	60 cm	50 cm	5 drawer - vertical



Stainless Steel Pedal Bin Codes SWPB

The Stainless Steel Pedal Bin provides hygienic and convenient hands-free operation. The durable foot pedal mechanism and the non-slip, non-marking base ensures the longevity of this product. 12 ltr capacity.



Step-Up Stools Codes CRSS-SS (Single Step-Up Stool - chrome) and CRSS-ST (Double Step-Up Stool - chrome)

Step-Up Stools are made with rigid tubular steel frame with a non slip vinyl top and a protected rubber edge. They provide simple assistance for stepping up onto a raised platform or bed area. Available in two sizes.

Product Specifications

	Length	Depth	Height	SWL
Single Step	455 mm	265 mm	200 mm	140 kg
Double Step	455 mm	550 mm	470 mm	140 kg



Casualty Couch Code CRC-C (standard), CRC-CHD (heavy duty)

Casualty or examination couches are a basic essential of the consulting and treatment setting. The Casualty Couch is ideal for a stable examination environment with the comfort, stability, strength and aesthetic design ideal for any casualty room. Also available in heavy duty version with 250 kg SWL.

Key Features

- Sturdy 32 mm tubular steel frame
- Powder-coated finish
- Vinyl covered 40 mm foam padding
- Adjustable head rest
- Compatible with Casualty Couch accessories
- Dimensions: L 1820 mm, W 610 mm, H 780 mm



Mobile Casualty Couch Code CRC-CM

Patients and practitioners alike continue to appreciate the comfort, stability, strength and aesthetic design of this mobile couch. It provides many of the features of the standard Casualty Couch with the additional and often essential feature of mobility.

Key Features

- Sturdy chrome finish tubular frame
- 125 mm rubber castors, 2 with locks
- Fixed 75 mm thick foam padded top
- Upholstered in grey vinyl
- Adjustable head rest
- Compatible with Casualty Couch accessories to form the ideal patient trolley
- Dimensions: L 1820 mm, W 610 mm, H 780 mm



Accessories shown in image sold separately. See below

Casualty Couch Accessories

Safety Rails Code CRC-CMR

Available in a chrome finish these safety rails feature two upright locking positions as well as the down position. Easy to operate and bolt straight onto the Mobile Casualty Couch.

Wire Basket Code CRC-CWB

The removable wire basket fits the Standard Casualty Couch or Mobile Couch. It features a strong construction and powder-coated finish.



IV Poles & Accessory Clamp

Codes CRC-CRIS (Stainless Steel) and CRC-CI (chrome plated mild steel), Code CRC-CIC (Accessory Clamp)

These IV poles conveniently clamp on to the Casualty Couch. Accessory clamps are required for fitting the IV pole to the couch.

IV Pole Key Features

- Double hook welded IV pole
- Made from a 12 mm rod

Accessory Clamp Key Features

- Black powder-coat finish
- Attaches onto 32 mm tube or square section
- Height adjustable via a key wheel
- Accepts IV pole



Ferno Mobile Privacy Screen *Codes CRP-3M*

The Ferno Mobile Privacy Screen is a lightweight, stable and secure screen. Each panel is made with lightweight vinyl that is heat sealed and easy to clean. The rigid frame is constructed from anodised aluminium for easy manoeuvrability and the legs and castors are removable so the unit can be packed flat for storage or freight.

Product Specifications

	Width	Height
Folded	66 cm	158 cm
Extended	192 cm	158 cm



Magnifying Lamp *Codes CRL-ML*

Magnifying lamps produce high quality, shadowless lighting for intricate examination tasks.

Key Features

- 1.75 x magnification through a 120 mm diameter three dioptr lens
- 22 watt circular fluorescent tube produces 1250 lumens of shadowless 'daylight' illumination
- Angle poise spring balanced adjustable arm with a full extension of 1150 mm
- Comes complete with a table clamp

Mounting Options

- CRL-MWB: Wall mount (plastic moulded)
- CRL-D: Desk clamp (plastic moulded)
- CRL-T-S: Mobile base



JM 6 Wheelchair *Codes CRW-F*

The JM 6 Wheelchair is a low cost wheelchair that does not sacrifice practical application or convenience. This wheelchair features a dual use transit or can be self propelled. The swing away removable footrest and fold down back rest provide versatility in use and storage whilst the nylon upholstery ensures an easy to clean surface, supporting the sterile environment of casualty rooms. This wheelchair comes provided with quick release self propel wheels, with fixed arms and has a 90 kg weight capacity.

Key Features

- 20 cm solid front castors
- 60 cm solid rear castors
- Fixed or removable arms
- Removable and adjustable footrest
- Dual use transit or self propelled



Transit Configuration



Laerdal Little Anne

The Laerdal Little Anne manikin has been developed to provide affordable, effective, realistic adult CPR training without compromising realism or quality. The lightweight design makes it easy to transport and the durable construction provides unequalled long-term use.

Also available in a 4-pack with carry bag.

Key Features

- Oral and nasal passages for realistic nose pinch
- Natural obstruction of the airway
- Head tilt/chin lift and jaw thrust
- Realistic airway function
- Anatomically correct landmarks and sternal notch
- Audible feedback reinforces correct compression depth
- Realistic chest compression
- Economical disposable airways
- Removable and reusable faces



Little Anne Manikin Includes:

1 Manikin, Soft Pack/Training Mat, 2 Resusci Manikin Faces, 2 Little Anne Airways, Virkon Rapid Pack and Directions for Use.

Supply Schedule

LAER-02002015	Little Anne Light Skin	LAER-020300	Airways (pkt 24)
LAER-02002415	Little Anne Light Skin 4-Pack	LAER-020301	Airways (pkt 96)
LAER-02002515	Little Anne Dark Skin	LAER-310210	Faces Light Skin (pkt 6)
LAER-02002915	Little Anne Dark Skin 4-Pack	LAER-310215	Faces Dark Skin (pkt 6)
		LAER-15120103	Face Shields (6 rolls of 36)

Laerdal Resusci Anne Basic and Skillguide

The Resusci Anne Basic and Resusci Anne SkillGuide manikins offer optimal realism and quality to adult CPR education. With its modular construction, and use of the optional SkillGuide performance indicator, students can quickly sharpen their skills to perform adult quality CPR. Add first aid or rescue limbs to integrate first aid, trauma, and extrication to the training.

Key Features

- Natural obstruction of the airway
- Head tilt/chin lift and jaw thrust
- Occluded airway with hyperextension
- Realistic resistance for chest compression
- Anatomically correct landmarks and sternal notch
- Articulating arms, legs and head
- Carotid pulse simulation
- Disposable non-rebreathing airways
- Optional Skillguide CPR performance indicator
- Removable/reusable faces



Resusci Anne CPR Manikin Includes:

Torso/Full-Body Manikin, 4 Decorated Resusci Manikin Faces, 3 Disposable Manikin Airways, Carrying Case or Soft Pack, Track Suit (Full-Body Models) or Jacket (Torso Models), Directions for Use and Virkon Rapid Pack. Models listed as "SkillGuide" include the SkillGuide unit.

Supply Schedule

LAER-31000515	Resusci Anne Torso Basic with Hard Case	LAER-152250	Airways (pkt 24)
LAER-31000615	Resusci Anne Torso Basic with Soft Pack	LAER-310210	Faces (pkt 6)
LAER-31003515	Resusci Anne Full-Body Basic with Hard Case	LAER-15120103	Face shields (6 rolls of 36)
LAER-31001515	Resusci Anne Torso SkillGuide with Hard Case		
LAER-31001615	Resusci Anne Torso SkillGuide with Soft Pack		
LAER-31004515	Resusci Anne Full-Body SkillGuide with Hard Case		

Laerdal Little Junior

The Little Junior manikin meets your need for a low-cost, quality child CPR trainer and is the perfect supplement to the Resusci Junior manikin. Our package of four Little Junior manikins makes hands-on practice affordable for every student.

Key Features

- Realistic oral and nasal passages
- Anatomically correct landmarks and sternal notch
- Natural obstruction of the airway
- Head tilt/chin lift and jaw thrust
- Realistic airway function
- Audible feedback for chest compressions
- Realistic chest compression resistance
- Economical disposable airways
- Removable and reusable faces



Little Junior Manikin Includes:

1 Manikin, Soft Pack/Training Mat, 2 Junior Faces, 2 Junior Airways, Virkon Rapid Pack and Directions for Use.

Supply Schedule

LAER-18002015	Little Junior Light Skin	LAER-183010	Faces Light Skin (pkt 6)
LAER-18002515	Little Junior Dark Skin	LAER-183015	Faces Dark Skin (pkt 6)
LAER-18002215	Little Junior Light Skin 4-Pack	LAER-183210	Airways (pkt 25)
LAER-18002715	Little Junior 4-Pack Dark Skin	LAER-183211	Airways (pkt 100)
		LAER-15120103	Face Shields (6 rolls of 36)

Laerdal Resusci Junior Basic and Skillguide

The Laerdal Resusci Junior manikin offers realistic, high-quality child CPR education. It has full-body construction and use of an optional Skillguide performance indicator so that students can quickly sharpen their skills in performing child CPR. The Laerdal Resusci Junior comes with a durable hard case.

Key Features

- Natural obstruction of the airway
- Head tilt/chin lift and jaw thrust
- Realistic chest rise
- Realistic resistance for chest compressions
- Anatomically correct landmarks and sternal notch
- Life-like size and weight of a five year old child
- Bilateral carotid pulse simulation
- Disposable non-rebreathing airways
- Optional SkillGuide CPR performance indicator



Resusci Junior Manikin Includes:

Paediatric Manikin, Hard Plastic Carry Case (except where noted), Training Mat, Track Suit, 4 Junior Faces, 4 Junior Airways, Virkon Rapid Pack and Directions for Use. Model listed as "SkillGuide" includes the SkillGuide

Supply Schedule

LAER-18001015	Resusci Junior	LAER-183010	Faces (pkt 6)
LAER-18001115	Resusci Junior with SkillGuide	LAER-183210	Airways (pkt 25)
LAER-18001215	Resusci Junior with Water Rescue	LAER-183211	Airways (pkt 100)
		LAER-15120103	Face Shields (6 rolls of 36)

Laerdal Baby Anne

The Laerdal Baby Anne manikin was developed to provide effective, infant CPR training without compromising realism or quality. The convenient packaging of four Baby Anne manikins assists with easy transportation. The low price makes hands-on practice affordable for every student.

Key Features

- Oral and nasal passages
- Natural obstruction of the airway
- Head tilt/chin lift and jaw thrust
- Realistic chest compression
- Economical disposable airways
- Removable and reusable faces
- Foreign-body airway obstruction feature

Baby Anne Manikin Includes:

1 Manikin, Soft Pack, 6 Airways, 10 Foreign Body Practice Objects and Directions for Use.



Supply Schedule

LAER-050000	Baby Anne Light Skin	LAER-050100	Airways (pkt 24)
LAER-050002	Baby Anne Dark Skin	LAER-050200	Faces Light Skin (pkt 6)
LAER-050010	Baby Anne Light Skin 4-Pack	LAER-050202	Faces, Dark Skin (pkt 6)
LAER-050012	Baby Anne 4-Pack Dark Skin	LAER-050300	Foreign Objects (pkt 10)
		LAER-15120103	Face Shields (6 rolls of 36)

Laerdal Resusci Baby Basic and Skillguide

The Laerdal Resusci Baby manikin offers realism and quality to infant CPR education. Its full-body construction and use of the optional Skillguide performance indicator enables students to quickly sharpen their skills in performing infant CPR. The Laerdal Resusci Baby Basic and Skillguide comes supplied with a carry case.

Key Features

- Natural obstruction of the airway
- Head tilt/chin lift and jaw thrust
- Occluded airway with hyperextension
- Realistic chest rise and resistance
- Anatomically correct landmarks and sternal notch
- Articulating arms, legs and head
- Brachial pulse simulation
- Disposable non-rebreathing airways
- Optional Skill Guide CPR performance indicator



Resusci Baby Manikin Includes:

Infant Manikin, Hard Plastic Carry Case, 3 Baby Faces, 6 Baby Airways, Virkon Rapid Pack, Pulse Bulb, Tubing, and Directions for Use. Model listed as "SkillGuide" includes the SkillGuide unit.

Supply Schedule

LAER-14001015	Resusci Baby	LAER-143600	Faces (pkt 6)
LAER-14001115	Resusci Baby w/SkillGuide	LAER-143601	Faces (pkt 36)
LAER-143700	Airways (pkt 24)	LAER-15120103	Face Shields (6 rolls of 36)
LAER-143701	Airways (pkt 96)	CPRLA-FS36	Face Shields (1 roll of 36)

Ambu CPR Pal

The Ambu CPR Pal manikin is a simple and cost-effective tool for CPR training. Ambu CPR Pal has a unique hygienic system which allows simple decontamination of the mouth/nose pieces and protects users from cross contamination, eliminating internal cleaning. Each Pal comes complete with 5 mouth/nose pieces, 100 airway bags and carry case.



Supply Schedule

- CPRAP Ambu CPR Pal complete
- CPRAP-F25 Mouth/Nose Piece
- CPRAP-H Packet of 200 airways

Simulaids Rescue Manikins

The official manikins of the Firefighter Combat Challenge, Simulaids' manikins are the best way to maintain the reality of rescue training without using a live subject. Fully articulated, Rescue Randy can be positioned in every conceivable situation. The head and body are built of dense, flexible, life-like vinyl that is rugged and waterproof. The 1905 kg force breaking strength stainless-steel cables are coated. Rescue Randy has been designed to be a realistic 183 cm (6 ft) tall, 75 kg body-size manikin. Jennifer Juvenile is 121 cm (4 ft) tall; equivalent to a 7 or 8-year-old child. The Water Rescue Randy was developed for YMCA water safety courses and allows adjustment to its buoyancy by adding weight to the abdomen. It weighs 18 kg on dry land but will sink with about 4.5 kg added weight. I.A.F.F. Rescue Randy has additional reinforcement for even greater durability.

Note: Only the Water Rescue Manikin should be used in the water.



Product Specifications

	Model	Height	Weight
CMC781338	Rescue Randy	165 cm	25 kg
CMC781335	Rescue Randy	165 cm	48 kg
CMC781344	Rescue Randy Combat Challenge	183 cm	66 kg
CMC781345	Rescue Randy Combat Challenge	183 cm	75 kg
CMC781475	I.A.F.F. Rescue Randy	183 cm	75 kg
CMC781355	Jennifer Juvenile	121 cm	7 kg
CMC781326	Water Rescue Manikin	-	18 kg
CMC781373	Nylon Storage Bag 7, 25, 48kg Simulaids		
CMC782094	Nylon Storage Bag 66 or 75kg Simulaids		



Lifetec General Purpose Dummy

The Lifetec General Purpose dummies are suitable for common dry rescue scenarios such as height, confined space, USAR, RTA and general handling exercises. They are weighted to produce an anatomically correct weight distribution and the feel of an unconscious patient. These dummies are tough enough to be buried under concrete slabs, trees or have motor vehicles laid upon them to present realistic scenarios for rescuers. Machine washable, protective overalls keep the dummy clean, and greatly increase the lifespan of the dummy. For additional protection, all training dummies of 20 kg and over are supplied complete with gum boots. Also available with camouflage overalls.



Product Specifications

	Description	Height	Weight
LT-RL5	Baby training	0.69 m	5 kg
LT-RL10	Toddler training	0.87 m	10 kg
LT-RL20	Youth training	1.30 m	20 kg
LT-RL30	Light adult	1.83 m	30 kg
LT-RL50	Standard adult	1.83 m	50 kg
LT-RL70	Heavy adult	1.83 m	70 kg
LT-RL100	Very heavy adult	1.83 m	100 kg



Lifetec Water Rescue Dummy

The Lifetec Water Rescue Dummy perfectly simulates an unconscious casualty in water. They will float at an angle of approximately 45 degrees with just the head and shoulders visible. The overalls supplied have integral pockets that enable the user to add buoyancy or weight to the dummy. Additional use of a heavy-duty nylon mesh and closed cell foam allows water to flood out of the dummy as it is being recovered. The Lifetec Water Rescue Dummies can now be supplied in two models: 'man overboard' or 'search and rescue'. The man overboard dummy is supplied with bright orange overalls and reflective tape on the headband. The search and rescue model is supplied with black overalls with no reflective tape.



Product Specifications

	Description	Height	Weight
LT-RLWRMO	Water Rescue - Adult Man Overboard	1.83 m	40 kg
LT-RLWRSR	Water Rescue - Adult Search & Rescue	1.83 m	40 kg
LT-RLWRMO20	Water Rescue - Youth Man Overboard	1.30 m	20 kg
LT-RLWRSR20	Water Rescue - Youth Search & Rescue	1.30 m	20 kg



Lifetec Flame Retardant Dummy

The Flame Retardant Dummy is designed for high temperature snatch rescue scenarios with real flames and the chance of a flash-over. They are weighted to produce an anatomically correct weight distribution and the feel of an unconscious patient. The higher specification, flame retardant dummies demonstrate a good balance between temperature and abrasion resistance. The Flame Retardant dummy is similar to the general purpose dummy, but incorporates glass fibre for the outer carcass stitched with PTFE coated glass thread. The protective overalls are made using Kermel flame retardant fabric which provides excellent heat and abrasion resistance and each dummy is fitted with heat resistant fire-fighters safety boots. The dummies will easily withstand temperatures of 200-250° C and only starts to fail at temperatures in excess of 400° C. Flash-over temps greater than 1000° C are withstood by the dummy for short periods.

Product Specifications

	Description	Height	Weight
LT-RLFR30	Flame Retardant - light adult	1.83 m	30 kg
LT-RLFR50	Flame Retardant - standard adult	1.83 m	50 kg



Lifetec Multi-Trauma Rescue Training Dummy

The Lifetec Multi-Trauma Rescue Dummy is a general purpose rugged rescue dummy that can simulate an impaled torso, suspected neck injury and amputated arm or leg and allows the fitting of an extrication collar. The hole on the left of the torso allows a paling or a spike that is firmly held in place. The right arm and right leg are fully detachable to simulate an amputation, or by partially releasing the locking straps the limb can be weakly attached and will fall off. The dummy is supplied complete with sturdy gum boots that protect the legs if the dummy is dragged along the ground. The Multi-Trauma Rescue Dummy is tough enough to allow a vehicle or heavy girder to be laid on it without damage.



Product Specifications

	Description	Height	Weight
LT-RLMT30	Lifetec Multi-Trauma Manikin, Light Adult	1.83 m	30 kg
LT-RLMT50	Lifetec Multi-Trauma Manikin, Standard Adult	1.83 m	50 kg



Lifetec HazMat Dummy

The standard general purpose dummy is ideal for all the general rescue scenarios, but when you need to practice a rescue scenario where the dummy needs to be doused in water such as a chemical spillage, or lay for long periods in a constantly wet storm water drain, foul water or wet cave rescue then the HazMat Dummy is the one you need. The Lifetec HazMat Dummy has a carcass of nylon reinforced PVC which will withstand continuous wet conditions. It is supplied with a polyurethane coated polyester overall. At the end of the rescue exercise hose the dummy down with fresh water and hang up to dry.

Product Specifications

	Description	Height	Weight
LT-RLHM30	Light Adult	1.83 m	30 kg
LT-RLHM50	Standard Adult	1.83 m	50 kg
LT-RLHM70	Heavy Adult	1.83 m	70 kg



Lifetec Bariatric Dummy

The Lifetec Bariatric Dummy provides rescue teams with a realistic alternative for bariatric retrieval and enable realistic training to take place. The Bariatric dummy is based around a 100 kg general purpose dummy with a further 5 layers over the top, these being a mixture of the weighted layers and foam cushioning that enables the weight to slide from side to side. Supplied complete with a carrying sheet to assist in carrying and positioning the dummy.



Product Specifications

	Description	Height	Weight
LT-RLLG180	Obese Adult	1.8 m	180 kg



Toyota Landcruiser Personnel Carrier

Utilising the tried and tested Toyota Landcruiser PC (Troop Carrier) this vehicle is ideal for rugged off road and remote casualty recovery. Now available with dual air bags the Toyota PC conforms to relevant Australian Standards and other stringent regulations such as BHP Billiton's FRCP compliancy. This vehicle is available in a range of specifications tailored specifically to meet client requirements.



Features

- Rear facing attendant seat with storage compartment below
- Stretcher Lock
- Internal right hand side six compartment medical locker with lighting
- Internal Ferno EXL or Saver Scoop Stretcher locker
- Internal left hand side Oxy Resus, Defibrillator and Trauma Kit storage locker
- Dual wall mounted oxygen outlets and 'D' size oxygen bracket
- Glove and tissue holders
- Dual heavy duty roof racks
- Rear aluminium step
- Emergency red, blue and amber lighting beacon's
- 100 watt emergency siren
- Reflective emergency signage and livery
- Ambulance grade window tinting to rear
- Overhead radio console
- Warning aerial with integral light
- Halogen work lights
- Reversing alarm
- Lockable battery isolation switch
- Tow bar
- Rear plug and charge system



Mini Module Ambulance

The Mini Module Ambulance is compatible with Toyota Hilux and Ford Ranger cab chassis. Ample work space and independent rear air-conditioning ensure comfort and functionality during long distance casualty transfers while maintaining four wheel drive capability for extreme site conditions. The Mini Module features integrated roll over protection to meet relevant Australian standards and other stringent regulations such as BHP Billiton's FRCP compliancy. The all alloy construction ensures vehicle performance is not compromised.

Features

- Rear facing attendants seat with storage compartment below
- Stretcher Lock
- Internal right hand side, nine compartment medical locker with lighting
- Internal Ferno EXL or Saver Scoop Stretcher Locker
- Internal left hand side Oxy Resus, Defibrillator and Trauma Kit dual draw storage locker
- External rapid deployment Oxy Resus Kit and miscellaneous items storage locker
- Dual wall mounted oxygen outlets
- External Dual 'D' size oxygen cylinder storage locker
- Rear aluminium step
- Glove and tissue holders
- LED emergency light bar plus rear and side LED emergency strip lights
- Independent rear air conditioning unit
- Drug safe
- 100 watt emergency siren
- Reflective emergency signage and livery
- Ambulance grade window tinting to rear
- Warning aerial with integral light
- HID work lights
- Reversing alarm
- Lockable battery isolation switch
- Rear plug and charge system



Emergency Response and Rescue Trailer

Ideal for industrial sites or emergency services with limited vehicle resources the Emergency Response and Rescue Trailer is specifically designed to house a range of rescue equipment. Featuring a rugged treated steel sub frame, dual four wheel drive axles for added clearance and an all alloy upper construction this robust trailer will handle even the most extreme conditions.

Key Features

- Three gas strut operated and dust proof sealed doors
- Roll out vehicle extrication tool draws for easy access and reduced lifting hazard
- Rear breathing apparatus swing out davit housing six units for rapid donning with storage for an additional three cylinders
- Extra large under storage locker to house a basket stretcher and rope rescue equipment
- Spill response and HAZMAT storage
- LED internal lighting
- Twin telescopic HID work light poles and forward facing HID spot lights
- Deep cycle battery charged from the TNT vehicle extrication tool power pack (optional) giving 18 hours of lighting power
- LED tail and indicator lights
- Rear drop down stabilisation legs
- Reflective emergency signage and livery



Fire and Emergency Light Tanker

Used by Australian fire and emergency services, the Light Tanker is available to suit Toyota Landcruiser and Nissan Patrol cab chassis. The careful design and attention to detail ensure the upmost functionality while catering to a host of OH&S issues. Maximum locker space coupled with high volume water and foam capability ensures the Light Tanker is an ideal first response rescue vehicle and bush and asset fire protection appliance.

Key Features

- Roller shutter lockers (two in total) maximising storage space while or traditional box style lockers available
- Davey/Yanmar Diesel twin impellor pump delivering 450 L per minute at 5 bar (other options available)
- 500 or 600 L baffled fibre glass or custom aluminium tank
- Fully automated 'around pump' foam proportioning system
- Additional storage for 20 L foam containers
- Two 64 mm high-flow BIC outlets
- One 64 mm high-flow BIC inlet
- One 64 mm camlock suction inlet
- Automated or manual 25 mm hose reel
- Front spray bar
- Behind cab mounted scrub fire branch
- Storage for layflat hoses
- Fixed hand tool mounts
- LED light bar and LED emergency strip lights
- 100 watt siren
- Load speaker
- Spare wheel davit minimises OH&S lifting issues
- Drip torch and jerry can storage brackets
- Two x 4 m camlock suction hoses
- Emergency and rescue signage and livery
- Additional roll over protection



Hi-Safe Tripod Code HS-TP10

A simple, heavy duty tripod developed by industry professionals with years of field experience.

Key Features

- Compact head frame reduces weight and size
- Independently adjustable spring loaded legs minimise the risk of accidental closure.
- Galvanised steel construction
- 2.3 m head clearance
- 2.2 m foot print (at full extension)
- Single swivel bolt attachment point
- Supplied with foot tether
- SWL 180 kg with 7:1 safety factor
- Rated 2 person rescue - 1 person working



Hi-Safe Tripod Bag Code HS-TP CARRY BAG

A purpose made bag for the Hi-Safe Tripod. This bag is made from 1680 black cordura and has a full length zipper, reinforced ends, two carry straps and a full length shoulder strap with padding.



Hi-Safe Rescue Winch Code HS-RW20T (tripod), HS-RW20D (davit)

The rescue winch has been developed to be attached to either the Hi-Safe Tripod or Davit System. The Rescue Winch utilises a Weston Brake System with steel gears, back up brake and is supplied with 20 m of cable. It works on a basic wind up, wind down principle.

The Hi-Safe Rescue Winch is rated at 180 kg with a 7:1 safety factor. Developed for one person working or for two persons rescue.

Comes complete with a re-direct pulley.

Weight: 7 kg



Hi-Safe Davit System

Codes HS-DAV SYS (complete system), HS-DAV B (Davit Base) and HS-DAV A (Davit arm and body)

The complete Davit System is an ideal solution for scenarios lacking overhead anchor points or areas that cannot be straddled by a tripod.

Key Features

- Durable galvanised steel construction
- Simple to install and one man portable
- Collapsible design
- Individual bases can be installed at various work locations allowing a single davit arm to be used in various locations
- 34 kg arm and body
- 14 kg base - dimension: 300 mm²
- SWL 180 kg with 8:1 safety factor





arachnipod

The Ferno Arachnipod is the world's most versatile modular total edge management system (TEMS). Components can be added or removed as required so that the Arachnipod complements existing structural or natural features. The unique design of the patent-pending modular head means the Arachnipod can be constructed into many different configurations including a ginpole/monopole, bipod, tripod, quadpod, bridge system and handrail recovery monopole.

For heavy loads, four legs can be used to form a quadpod and increase the safe working load (SWL). Its versatility makes it an ideal system for workers in industries such as rescue and emergency services, construction, military, utility services, mining, film and maintenance.

Configurations



Gin Pole/Monopole



Handrail Recovery Monopole



A-Frame



Sideways A-Frame using pulley head



A-Frame with Lazy Leg and reverse head

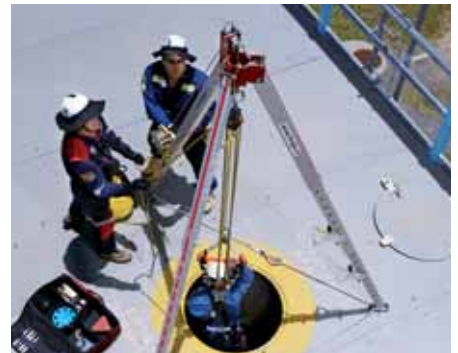

Tripod



Tripod as High Directional System



Bridge System



Quadpod

How It Works

The Arachnipod, in its most basic form, is a simple tripod with the three legs independently pivoting from an anodised aluminium head. The modular head has a similar design to a door hinge. Inserting or removing a pin through the centre of the head allows the quick and simple addition or removal of components to create a configuration to suit any edge management scenario. Each head section contains a shackle for guying while an optional in-built twin grooved stainless steel pulley is also available.

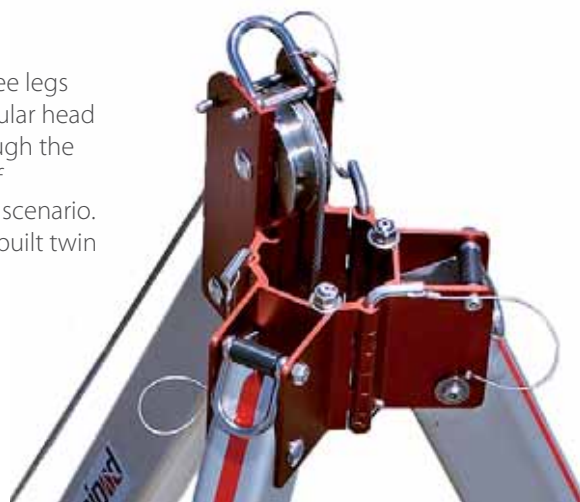

Accessories



Standard foot



Hold-down stake



Spike foot



Soft ground shoe



Arachnipod step



Winch and mount



Lazy leg extender kit



Type 3 fall arrest block with mount bracket



Gin head



Rigging plate

Quad plate



Reverse head



Equipment bracket



Accessory kit

Arachnipod Kits

The modular design of the Arachnipod offers customers the option to purchase a basic unit and upgrade to make a more advanced system. Minimal space is needed to store an Arachnipod as it flat packs for simple and convenient storage. There are five kits available for purchase, ranging from the basic tripod through to a total edge management system (TEMS).

Product Contents	Arachnipod Kits				
	Arachnipod Industrial	Industrial Plus	Arachnipod Rescue	Rescue Plus	Arachnipod TEMS
Basic tripod (without pulley)	1				
Tripod (with pulley head)		1	1	1	1
Foot rope & rope grab	1	1	1	1	1
Arachnipod bag			1	1	1
Rigging plate			1		
Spike feet			3		
Lazy leg kit inc. Reverse head & bag				1	1
Full accessory kit				1	1
2 m bridge kit					1

* Bridge kit includes extra leg, bag and foot rope

Full Accessory Kit Contents	Qty
Accessory bag	1
Spike feet	4
Gin head	1
Soft ground shoes	4
Hold-down stakes	4
M12 Tru-bolts	8
M12 masonry drill bit	2
Spare Qik-link head pins	2
Spare detent pins	2
Spare leg pin with detent pin	1
Steps	2
Equipment bracket	1
Rigging plate	1
Quad plate (shapekeeper)	1

Optional extras
3 m bridge kit
4 m bridge kit
Bridge kit stainless steel upgrade kit
Additional standard leg
Additional pulley leg
Gin head
Lazy leg extension kit
10 m winch and mount (6 mm cable)
20 m winch and mount (6 mm cable)
Type 3 fall arrest block and mount



Min-Evac 2P *Code UL-160-669-506*

The Min-Evac 2P is a controlled rate descent device suitable for self rescue evacuation for one or two persons. Best for use from structures such as towers, wind turbines, masts, high bay lift trucks and cranes. The length of rope required can be customised to each users requirements

Work height: Up to 160 m for 2 persons at a time. The length of rope supplied can be customised to each users requirements.

Rate of descent: 0.8 m per second

Rope: 11 mm A.S. approved, kernmantle rope *(Code UL-163-660-602)*

Standards: EN341 Class A, EN1496 Class A, ANSI Z359.4

Min-Evac Hub Type A *Code UL-160-669-505*

The Min-Evac Hub Type A is a controlled rate descent device with lifting capabilities that is suited for single person, self rescue evacuation from structures such as towers, wind turbines, masts, high bay lift trucks and cranes. The 15:1 geared recovery mechanism provides quick retrieval of a fallen or suspended person, minimising the potential for deadly suspension trauma. The hook is lowered and connected to the suspended persons harness fall arrest loops, the rescuer winds the person far enough to release the load on the lanyard. Once released the rescuer can lower or raise the person to safety. The rescue procedure is simple and does place the rescuer in any danger. The rope length can be customised to each users requirements.

Work height: Up to 160 m for 1 person at a time

Rate of descent: 0.8 m per second

Rope: 11 mm A.S. approved, kernmantle rope *(Code UL-163-660-602)*

Standards: EN341 Class A, EN1496 Class A, ANSI Z359.4

Min-Evac 2P Hub Type A *Code UL-160-669-507*

The Min-Evac Hub Type A is a controlled rate descent device with lifting capabilities that is suited for either one or two person, self rescue evacuation from structures such as towers, wind turbines, masts, high bay lift trucks and cranes. The 15:1 geared recovery mechanism provides quick retrieval of a fallen or suspended person, minimising the potential for deadly suspension trauma. The hook is lowered and connected to the suspended persons harness fall arrest loops, the rescuer winds the person far enough to release the load on the lanyard. Once released the rescuer can lower or raise the person to safety. The rescue procedure is simple and does place the rescuer in any danger. The rope length can be customised to each users requirements.

Work height: Up to 160 m for 2 persons at a time

Rate of descent: 0.8 m per second

Rope: 11 mm A.S. approved, kernmantle rope *(Code UL-163-660-602)*

Standards: EN341 Class A, EN1496 Class A, ANSI Z359.4



Mini-Evac 2P



Hub Type A



Mini-Evac Hub Type A



Lift-Evac Code UL-160-669-509

The Lift-Evac is a controlled rate evacuation and descent device that has the ability to raise or lower a worker or casualty. Ideal for work positioning over distances up to 20 m the Lift-Evac provides the user with high levels of safety combined with maximum flexibility for all rescue or rope access situations. Easy to anchor and control and intuitive to use due to its 'ratchet' style raise and lower facility. The ratchet handle is telescopic to give more leverage when required and a second handle provides stability and control during use. The Lift-Evac can be used to recover a casualty whilst the rescuer remains in a safe position, or if necessary the rescuer can descend to the casualty whilst maintaining complete control of the device. The length of rope supplied can be customised to each users requirements.

Work height: Up to 160 m for 2 persons at a time (200 kg)

Rate of descent: 0.8 m per second descent
0.2 m per second ascent
(dependent upon operator competence and fitness)

Rope: 11 mm A.S. approved, kernmantle rope (Code UL-163-660-602)

Standards: EN341 Class A, EN1496 Class B, ANSI Z359.4



Lift-Evac Double Code UL-160-669-510

The Lift-Evac Double is a controlled rate evacuation and descent device that has the ability to raise or lower a worker or casualty. Ideal for work positioning over distances up to 30 m the Lift-Evac Double provides the user with high levels of safety combined with maximum flexibility for all rescue or rope access situations. Easy to anchor and control and intuitive to use due to its double handle 'ratchet' style raise and lower facility. The ratchet handles are telescopic to give more leverage when required. This makes the raising of two persons very comfortable compared with other rescue products.

The Lift-Evac Double is ideal for situations where ascent off a taller structure is required or where a faster evacuation from a confined space may be beneficial. The length of rope supplied can be customised to each users requirements.

Work height: Up to 160 m for 2 persons at a time (200 kg)

Rate of descent: 0.8 m per second descent
0.4 m per second ascent
(dependent upon operator competence and fitness)

Rope: 11 mm A.S. approved, kernmantle rope (Code UL-163-660-602)

Standards: EN341 Class A, EN1496 Class B, ANSI Z359.4

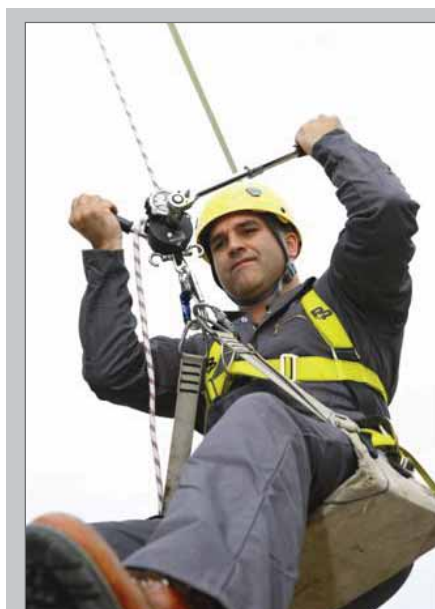

Hi-Safe Rescue Pulley System

Code FWE-CSRK (bag),
FWE-CSRD (drum)

Developed for backup and rescue situations the Hi-Safe Rescue Pulley System has a 4:1 lift advantage and a built-in lift and lock system which can be manually overridden. It comes standard with a tie off adapter and 50 m of rope allowing approximately 12 m of lift. Supplied standard with a heavy duty rope bag, also available with optional dust proof stowage drum.



Optional drum

Ferno Mini Haul Kit

Code VKIT MINI HAUL

The Ferno Mini Haul kit is an extremely compact haul kit that will provide a 6:1 mechanical advantage. It features a V-shaped cleat that if required, enables the operator to lock off the system during a hauling operation. The Ferno Mini Haul Kit is rated for one person rescue only.



CMC CSR Pulley Kit Code CMC500102

The CMC CSR Pulley Kit is 4:1 rescue system that is provided with a pulley that is easy to release under load. The new aluminium pulleys swivel at both ends of the system eliminating any potential twisting of the lines. The CMC CSR Pulley Kit is an excellent choice for confined space entry or rope access where a heavy duty pulley system is required. Supplied with 30 m CMC Rescue Static Pro Lifeline, 2 karabiners, 2 pulleys and rope bag



Res-Q-Link Recovery Pole Code FWE2090

The Res-Q-Link is a unique and multi functional rescue pole incorporating many features and benefits including:

- Large alloy double action hook compatible with most recovery systems and allowing two configurations to provide versatility when rescuing a fall victim
- Extendable from 150 cm to 280 cm.
- Fibreglass outer pole and rubber coated handle for maximum grip and control in long reach scenarios.
- Torch holder for low light scenarios which is compatible with most slim line torches
- Rope and web cutting knife to cut victim free once a recovery system is attached.
- Additional double action hook available (Code VCT L3536201)



Large alloy hook with torch and torch holder (torch not supplied)

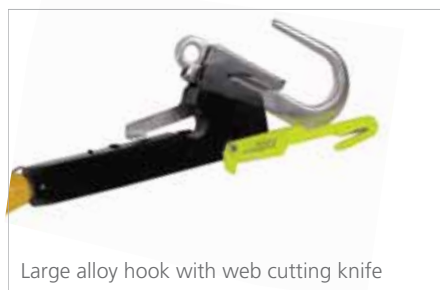

Large alloy hook with web cutting knife



Large alloy hook, knife in stored position

ResQmax Line Deployment Kit

Codes CMC564000 (with SCBA filler hose), CMC564001 (with SCUBA filler hose) and CMC564002 (with DIN filler hose)

The ResQmax Line Deployment Kit contains everything you need to launch a 3 mm messenger line up to 107 m. The Dacron line is 152 m in length and has a tensile strength of 500 lbf. Once you have the messenger line across, use it to pull across the rescue rope.

Kit Includes

- 1 x ResQmax launcher with folding stock
- 1 x Red streamline line projectile with two spare moulded projectile protectors
- 1 x 152 m dacron messenger line with compact line container
- 1 x Spares kit
- 1 x Corrosion block lubricant/rust inhibitor, 118 mL
- 1 x Streamline filler hose assembly
- 1 x Cordura kit carry bag, red/black
- 5 x Streamline nozzle protectors
- 1 x Operator's manual
- 1 x Training CD



Survivor FR Escape System Code CMC500300

The CMC top-of-the-line Escape Kit includes 15 m of the ProSeries Escape Line, Survivor FR Escape Bag, Double Brake Escape Artist descent control device and the Nars Escape Anchor for its combination of ease of use, light weight and versatility. The bag attaches to your belt or harness with velcro, or you can thread your belt through the tunnel loop. Use the included tether to connect the system to your escape belt or harness for immediate deployment. Weight 1.4 kg.



CMC Survivor RIT Kits Code CMC500345 (15 m), CMC500347 (45 m)

For many firefighters, the solution to navigation in an unknown structure with poor visibility is a small cord attached at the entrance and deployed as the firefighter moves through the building. Whether called a RIT line, guideline, or search line, the cord provides a means of retracing your steps to the entry point or for a Rapid Intervention Team to quickly locate you. With a karabiner on each end, your partner's line can be attached to yours to extend the distance. The 15 m length works well for residences and small structures. The 45 m length is a good choice for larger commercial buildings. Includes CMC ProSeries RIT Line and two bright orange manual lock karabiners with keeper pin. 765 g and 1.2 kg.



Ferno FDU

Code FWE-FDU 100 (with friction rack) FWE-FDU 200 (without friction rack)

The new Ferno FDU is designed for personal rescue, emergency escape, rescue operations or specialised rope work. It is a friction control, double stop, descending system, with a simple and soft moulded, operator handle. The system starts releasing its load when the handle is moved towards the central position. Should a panic grab take place and the handle is pulled past the central position, the system locks up into the double stop mode.

This mode will only be maintained with the force exerted by the operator, until a gentle release takes place. If the handle is let go, the system automatically locks. For rescue loads (2 persons) the Ferno FDU is available with an additional friction rack. The Ferno FDU has been extensively tested with Donaghys 11 mm Rescue Response Static Rope and Donaghys 11 mm Response XT Rope and when used with either of these ropes will conform to AS/NZS 4488.1:1997.



Dimensions taken with handle in stored position

	Length	Width	Depth	Weight
FDU100	250 mm	135 mm	45 mm	950 g
FDU200	250 mm	135 mm	45 mm	730 g



Sarab Descender Code VISC RP810E

The Sarab Descender is specifically designed for technical rope access and intervention purposes. It is ideal for use by height access technicians, special forces, rescue specialists and also for arborists and tower workers who are exiting via a long rope descent.

The Sarab Descender has a multi-use rope adjustment device that takes the load of two people and also features double stop capabilities. In technical rope access situations it must always be used in conjunction with a type A device or an EN353-2 backup device and safety line. Suitable for 10.5 to 11.5 mm rope.



Length	Width	Depth	Weight
193 mm	79 mm	35 mm	440 g

Anthron Lory Code ANTH-LORY

The Anthron Lory is a self locking belay device that is also suitable for descending, ascending and mechanical advantage hauling systems. Unlike other units the Anthron Lory automatically locks, both when the handle is released or pulled too far reducing the risk of panic pull.



Rope	Length	Width	Depth	Weight
9 mm - 11.4 mm	125 mm	70 mm	35 mm	365 g

Anthron Doublestop Descender Code ANTH-DSD-30

The Anthron Doublestop Descender is a robust and functional descender with great breaking power and two jamming positions for descending and rescue operations. Too much or too little handle pressure activates the descender's jamming position. Placing the handle in a central position or 'sweet spot' enables a smooth, controlled descent. Maximum working load is 150 kg however it has been rated by the manufacturer for 200 kg in a non-shock load rescue situation.



Rope	Length	Width	Depth	Weight
11 mm	190 mm	76 mm	25 mm	340 g

Rescue Figure 8 Code VCT L6170001 (Alloy), VCT I61700PO (Stainless Steel)

Available in alloy or stainless steel. Our Rescue Figure 8 with ears is ideal for rescue rappelling or lowering heavy loads.

	Length	Width	Depth	Weight	Break Load
Alloy	172 mm	172 mm	13 mm	250 g	40 kN
Stainless Steel	172 mm	160 mm	11 mm	543 g	40 kN



Exodus Escape Device Code HS-RE20

Forming the heart of the EPV kit this incredibly simple unit can be used for descent and belaying. Constructed from premium quality aircraft grade aluminium and tested in excess of 15 kN. Supplied with steel screw gate karabiner.

Rope	Length	Width	Depth	Weight
11 mm - 12 mm	160 mm	79 mm	29 mm	450 g*

*weight without karabiner



CT Chest Ascender Code VCT 2D640DO

It is commonly used as a chest ascender but can also be used for other applications. The design of the ascender ensures smooth and positive ascending as well as good jamming and a patented rope release device.

Rope	Length	Width	Depth	Weight
8 mm - 13 mm	104 mm	77 mm	36 mm	140 g



CT Ascender Simple Code VCT 2D642DO

The Climbing Technology Ascender Simple is designed to be fastened to the harness with a karabiner, maillon rapide or rope 8 mm to 13 mm. The design of the ascender ensures smooth and positive ascending as well as good jamming and a patented rope release device.

Rope	Length	Width	Depth	Weight
8 mm - 13 mm	110 mm	74 mm	30 mm	150 g



CT Handled Ascenders Code VCT 2D639S5 (left) and VCT 2D639D5 (right)

Each of the Climbing Technology Handled Ascenders has a large opening so they can be easily used with gloves. The handles are padded with a textured rubber compound which is comfortable but firm, providing a non-slip grip.

Rope	Length	Width	Depth	Weight
8 mm - 13 mm	190 mm	95 mm	35 mm	215 g



VCT 2D639S5 (left)

VCT 2D639D5 (right)



Traverse 540 Rescue Belay Code TRAV16-0100 (large) and TRAV16-0200 (small)

The Traverse 540 Rescue Belay is developed specifically to meet the needs of rescue system belays. It is a self-locking device that is able to hold falling loads quickly while limiting the peak force. This well engineered device is easy to rig and the systematic design reduces the risk of improper loading. A built-in release lever reduces the tension on the belay rope, eliminating the need for a release hitch. For use with kernmantle rescue rope. The BCCTR Belay Compliance Drop Test specifications require a 1 m drop of a 280 kg load onto 3 m of 12.7 mm kernmantle rescue rope, with less than 1 m of additional travel and less than 15 kN peak force.



Code	Rope Size	Weight	MBS
TRAV16-0200 (Small)	10.6 mm - 11.5 mm	624 g	40 kN
TRAV16-0100 (Large)	11.5 mm - 13 mm	624 g	40 kN

CMC Rescue MPD Code CMC333000

Developed and refined during four years of research & testing, the CMC Rescue MPD is the next major advance in technical hardware for professional rope rescuers. The MPD is a multi-purpose device that performs all functions for main lines, belay/safety lines, tag lines and hoisting lines. The MPD can also be used to tension high lines and guiding lines. Training and on-scene rigging can be greatly simplified by having a single device. Rescue system changeover from a lowering system to a raising system becomes faster and safer by eliminating the need to switch out and replace hardware.

UL Classified to NFPA 1983 - General Use Pulley - Auxiliary - Descent Control

- Variable-friction descent control device for rescue systems and rappels
- High efficiency pulley with an integral rope-locking mechanism for a haul system
- Rescue belay device
- Meets BCCTR Rescue Belay Competency Criteria
- Becket allows rigging cleaner and more efficient pulley systems
- For use with 1/2 in. (13mm*) rope
- Allows the main line and belay line rigging to be mirror images
- Functions as lowering brake and as ratcheting pulley for raising
- Rapid conversion to a retrieval line makes it ideal for confined space operations

*Designed for use with 12.5 mm-13 mm rope. Rope used for certification rounded up to 13 mm per NFPA 1983.



CMC ProSeries CSR Swivel Pulley

The CMC ProSeries CSR Swivel Pulley is a professional tool for confined space and other rescue applications. It has a proprietary locking system and can be unlocked while under load. By eliminating the cam, the pulley system is much more compact when fully collapsed.

The integral swivel reduces torque by aligning the pulley with the load. The built-in swivel is compact and eliminates the need for multiple connections to incorporate a separate swivel. The forged steel eye, high strength aluminium side plates, sealed ball bearings, and anodised aluminium sheaves all combine to provide exceptional strength.

Code	Sheave Diameter	Sheave Width	MBS	Weight
CMC300345	38 mm	11 mm	36 kN	513 g
CMC300344	38 mm	11 mm	36 kN	408 g
CMC300337	70 mm	13 mm	53.3 kN	1.4 kg
CMC300336	70 mm	13 mm	52.5 kN	1 kg



CMC Rescue S/S Swivel Pulleys

The rotating swivel aligns the rope with the direction of pull making these swivel pulleys ideal for high anchor points or tripods and the overall length is minimised by combining the swivel with the pulley. The stainless steel sheave on the single pulley permits use with either rescue rope or wire cable. The proprietary pivoting side plate can open without having to disconnect the pulley from the anchor, allowing rope to be quickly inserted or removed. Use the swivel double pulley when you need two ropes to run together.

A double detent button prevents accidental opening. Sheave size 51 mm x 13 mm.



Code	Sheave Diameter	Sheave Width	MBS	Weight
CMC300431	Single Stainless Steel	Light Use	32.7 kN	320 g
CMC300430	Single Stainless Steel	General Use	39.4 kN	320 g
CMC300432	Double Aluminium	General Use	43.5 kN	414 g

OG1 Prusik Minding Pulley *Code FWEOG1*

The OG1 Prusik Minding Pulley has an impressive 36 kN load rating, however its distinctive feature is the combination of a side opening plate with a unique stainless steel gate that allows you to access the sheave without having to disconnect the pulley from its anchor or karabiner. The OG1 Pulley can accommodate up to three 12 mm karabiners at its connection point. Researched and developed by our team in Australia, the Versa-OG1 Pulley is an invaluable aid for any heavy duty industrial rigging or rescue operations. Made from high grade anodized aluminium and stainless steel. Sheave size: 51 mm x 13 mm..



Rope	Length	Width	Depth	Weight
11 mm - 13 mm	180 mm	120 mm	47 mm	950 g

ISC Prusik Minding Pulleys

ISC Prusik Minding Pulleys are designed for heavy duty rescue, rigging and hauling systems. The full range consists of sizes small, medium and large. Each size is available in a single or double pulley configuration in aluminium or stainless steel.

Alloy Plate with Alloy Wheel

Code	Description	MBS	Rope	Sheave	Weight
VISC RP060A1	Small Single	40 kN	13 mm	50 mm	200 g
VISC RP061A1	Small Double	40 kN	13 mm	50 mm	340 g
VISC RP063A1	Medium Single	50 kN	13 mm	62 mm	280 g
VISC RP064A1	Medium Double	50 kN	13 mm	62 mm	500 g
VISC RP066A1	Large Single	70 kN	16 mm	75 mm	440 g
VISC RP067A1	Large Double	70 kN	16 mm	75 mm	760 g



Stainless Steel

Stainless Steel with Stainless Steel Wheel

Code	Description	MBS	Rope	Sheave	Weight
VISC RP060D1	Small Single	40 kN	13 mm	50 mm	398 g
VISC RP061D1	Small Double	40 kN	13 mm	50 mm	674 g
VISC RP063D1	Medium Single	50 kN	13 mm	62 mm	584 g
VISC RP064D1	Medium Double	50 kN	13 mm	62 mm	1036 g
VISC RP066D1	Large Single	70 kN	16 mm	75 mm	896 g
VISC RP067D1	Large Double	70 kN	16 mm	75 mm	1626 g



Alloy



Standard Stainless Steel Tandem Pulley Code VISC RP036

- Break strength: 40 kN
- Dimensions: L 154 mm, W 105 mm, D 40 mm
- Rope: 13 mm
- Approved standards: BS EN 12278
- Weight 942 g



CT Mobile Pulley Code VCT L6220003

A light alloy pulley with oscillating side plates. The sheave is mounted on self lubricating bushings. Rope 13mm.

Rope	Length	Width	Depth	Weight	Break Load
<13 mm	74 mm	44 mm	33 mm	94 g	22 kN



CT Twin Pulley Code VCT 2P62600

Light alloy double pulley with oscillating side plates. Twin sheaves mounted on heavy duty ball bearings. Up to three connectors can be hooked in to the large eyelet plus one connector in the smaller eyelet.

Rope	Length	Width	Depth	Weight	Break Load
<13 mm	152 mm	70 mm	48 mm	345 g	50 kN



CT Mobile Single Pulley Code VCT 2P62400

Large light weight alloy pulley with oscillating side plates. Twin sheaves mounted on heavy duty ball bearings. Up to three connectors can be hooked in to the large eyelet.

Rope	Length	Width	Depth	Weight	Break Load
<13 mm	124 mm	70 mm	28 mm	200 g	32 kN

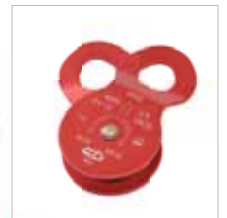

CT Mobile Double Pulley Code VCT 2P62500

Large light weight alloy pulley with oscillating side plates. Twin sheaves mounted on heavy duty ball bearings. Up to three connectors can be hooked in to the large eyelet plus one connector in the smaller eyelet.

Rope	Length	Width	Depth	Weight	Break Load
<13 mm	147 mm	70 mm	48 mm	210 g	32 kN



ISC Rope Grab with Pip Pin Code VISC RP209A

The ISC Rope Grab with Pip Pin is a high quality, lightweight rope grab that can be fitted to the rope at any point. The axle is fitted or detached by pushing on the thumb button to release the locking bearings. The ISC Rope Grab with Pip Pin is made from high quality, machined 6082 aluminium and is hard anodised. Suitable for use on 11 mm to 13 mm diameter semi-static ropes. The ISC Rope Grab with Pip Pin is EN353-2 rated.



Stop and Go Code VCT I70812PO

An openable Stop and Go fall device equipped with an anti-panic release lever. Suitable for 12 mm rope and certified for use with Donaghys 11 mm Response Static and Response XT Lines. EN353-2 Rated.



Length	Width	Depth	Weight
120 mm	95 mm	38 mm	480 g

Anchor Plates

Code VCT L6370303 (4 holes) and VCT L6370503 (8 holes)

Anchor Plates allow you to create and organise your anchor systems safely. These Anchor Plates are made from high grade aluminium alloy. Anchor Plates are available in four, eight or fifteen hole options.

	Length	Width	Weight	Breaking Load	Hole Diameter
4 Holes	96.5 mm	83 mm	63 g	36 kN	20 mm
8 Holes	149 mm	98 mm	136 g	45 kN	20 mm
15 Holes	249 mm	150 mm	471 g	55 kN	19 mm



Forged Alloy Swivel

Code VCT L7950003

This lightweight Forged Alloy Swivel with precision bearings helps in the prevention of severe rope twist. Each eyelet will fit three connectors up to 12mm diameter. Ideally used in tripod rescue scenarios or hauling systems.

Length	Width	Depth	Weight	Break Load
113 mm	57 mm	30 mm	170 g	40 kN





CMC Steel 72 kN Karabiner

Code CMC300110 (screw gate) and CMC300120 (triple action)

The ultimate general purpose CMC steel rescue karabiner with a 40 mm gate opening and a break strength of 72 kN. Available with screw gate or triple action gate.

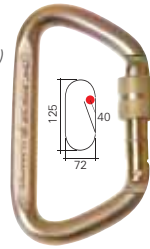

Weight	Diameter Bar	
287 g	13 mm	72 kN

Steel Screw Gate Karabiner

Code VAUA TP11A

The perfect rescue karabiner. Large symmetrical D-shape, steel screw gate with large offset gate opening and 60 kN strength.

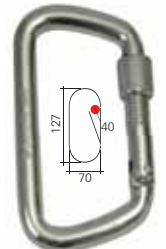

Weight	Diameter Bar			
320 g	13 mm	60 kN	15 kN	15 kN

Steel Screw Gate Karabiner

Code VAUA TN61A

A compact D-shape, steel screw gate karabiner. Slender design locking eye prevents rope snag when clipping in and out.

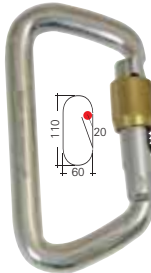

Weight	Diameter Bar			
220 g	12 mm	60 kN	12 kN	15 kN

Steel Triplock Karabiner

Code VISC KH202SSP1

Large D-shape steel karabiner with triple action gate opening. This steel karabiner is ideal for rescue and general industrial applications. Optional captive bar provided.

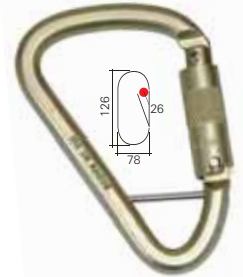

Weight	Diameter Bar	
269 g	12 mm	50 kN

Steel Triplock Karabiner

Code VCT A430TBZO

A compact, lightweight, hardened steel karabiner with a 50 kN rating and triple lock gate. New snag free nose and gate. Optional captive bar provided.

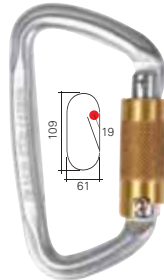

Weight			
195 g	50 kN	15 kN	15 kN

Steel Triplock Karabiner

Code VCT A595TBBZO

This steel karabiner is made of hardened zinc plated steel for high performance and enhanced safety. It has a triple action twist lock entry with wide opening gate and optional captive bar. New snag free nose and gate.

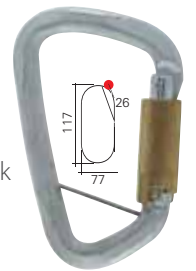

Weight	Diameter Bar			
267 g	13 mm	50 kN	15 kN	15 kN

Steel Screw Gate Karabiner

Code VCT A455TBZO

This high strength, hardened zinc plated steel karabiner has a useful wide opening screw gate entry. New snag free nose and gate. Optional captive bar provided.

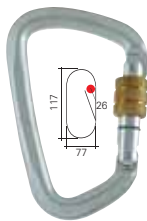

Weight	Diameter Bar			
253 g	13 mm	50 kN	15 kN	20 kN

Steel Screw Gate Karabiner

Code VCT A428TOZO

Classic screw gate karabiner with very high break strength and optional captive bar. Individually tested. New snag free nose and gate.

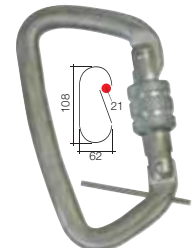

Weight	
178 g	50 kN

Steel Triplock Karabiner

Code VISC KH308SSP1

Our most popular triple action karabiner. It is perfect for secure connections to D-rings and anchors. Used widely in industrial applications. Optional captive bar.

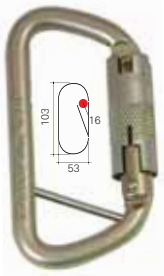

Weight	Diameter Bar	
170 g	10 mm	35 kN

Steel Screw Gate Karabiner

Code VAUA TM11A

Classic D-shape, steel screw gate karabiner. Perfect for most applications including rescue, industrial, caving, group use or setting anchors for climbing.

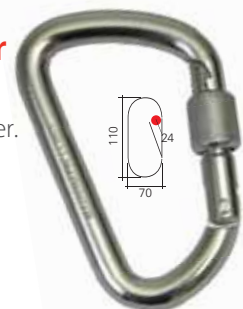

Weight	Diameter Bar			
230 g	12 mm	35 kN	10 kN	10 kN



Steel Screw Gate Karabiner

Code VAUA TX11S

Large pear shaped steel screw gate karabiner with captive bar and large offset gate opening. The large, easy to use gate opening is perfect for clipping scaffold or ladder steps.

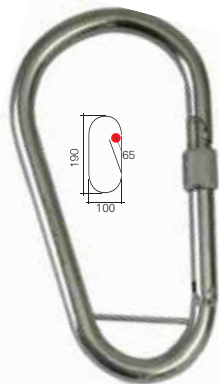

Weight	Diameter Bar			
460 g	13 mm	25 kN	12 kN	6 kN

Steel Triplock Karabiner

Code VISC 307SSP1 (steel), VISC 307SSP3 (stainless steel)

Large steel triplock karabiner with large gate opening. The large gate opening is ideal for attaching to larger anchors. Available in steel or stainless steel.

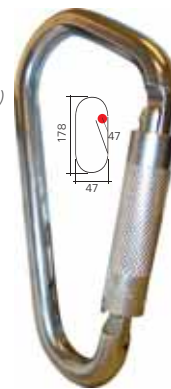

Weight	
steel 335 g stainless steel 395 g	40 kN

Steel Swivel Triplock Karabiner

Code VISC KH260SS11 (steel), VISC KH251SS11 (stainless steel)

Available in steel or stainless steel with a fall indicator. Swivel feature eliminates potential twisting of line.



Weight		
steel 225 g stainless steel 330 g	35 kN	19 kN

Alloy Triplock Karabiner

Code VCT 2C42300

A lightweight, c-shaped alloy karabiner with triplock gate opening. Ideal for situations where a three way load is exerted.

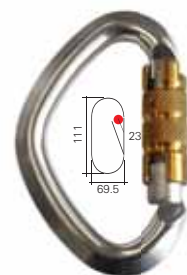

Weight		
133 g	20 kN	15 kN

Alloy Triplock Karabiner

Code VCT L530001

Extra light, drop forged alloy karabiner with triple action gate opening. Optional captive bar provided.

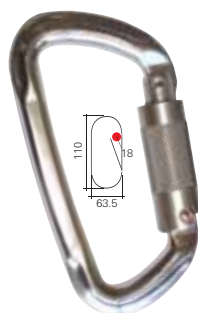

Weight	
79 g	30 kN

Alloy Triplock Karabiner

Code VCT L4131201

A lightweight, alloy, triple action karabiner with a pear shaped profile that allows a large 29 mm gate opening.

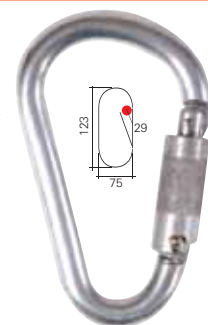

Weight			
98 g	27 kN	9 kN	7 kN

Alloy Screw Gate Karabiner

Code VAUA KX11AM

This is a great alloy rescue karabiner. Features lightweight alloy design, large D-shape with wide gate opening and large, easy to use screw gate barrel.

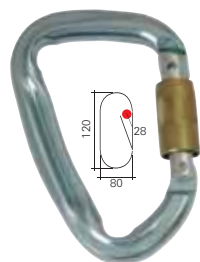

Weight			
110 g	36 kN	10 kN	16 kN

Wire Connectors

Code VCT I70908PO (80 mm), VCT I70910PO (100 mm), VCT I70914PO (140 mm)

Available in three different sizes to suit 80 mm, 100 mm or 140 mm scaffold or pipe. Constructed from one-piece stainless steel giving it a high overall strength 15 kN.



Maillon Rapide Standard

The Maillon Rapide Standard is extremely strong when loaded along the long axis. Suitable for anchor and rigging connections.



Code	Size mm	Length mm	Gate Opening mm	Thread Diameter mm	Work Load kg
Standard - Zinc Plated Steel					
VMR STS04	4	39.5	5.5	6	180
VMR STS06	6	57	7.5	9	400
VMR STS08	8	74	11	11	700
VMR STS10	10	89	12	13	1100
VMR STS12	12	104.5	15	15	1500
Standard - Stainless Steel					
VMR STSS08	8	74	11	11	1100
VMR STSS10	10	89	12	13	1800
VMR STSS12	12	104.5	15	15	2500
Standard - High Strength Alloy					
VMR STA10	10	89	12	13	2500

Maillon Rapide Large Opening

The wider mouth opening makes connecting easier. Suitable for anchor and rigging connections.



Code	Size mm	Length mm	Gate Opening mm	Thread Diameter mm	Work Load kg
Large Opening – Zinc Plated Steel					
VMR LOS07	7	79	16	10	500
VMR LOS08	8	88	17.5	11	650
VMR LOS10	10	105.5	20.5	13	1 000
VMR LOS12	12	124	23.5	15	1250
VMR LOS16	16	161	29.5	19	2500
Large Opening – Stainless Steel					
VMR LOSS08	8	88	17.5	11	980
VMR LOSS10	10	105.5	20.5	13	1600
VMR LOSS12	12	124	23.5	15	2200

Maillon Rapide C

Commonly used when connecting sit and chest harnesses.



Code	Size mm	Length mm	Gate Opening mm	Thread Diameter mm	Work Load kN
C Shape – Zinc Plated Steel					
VMR CS10	10	86	10	13	10 kN
C Shape - High Strength Alloy					
VMR CA10	10	86	10	13	10 kN

Maillon Rapide Delta

Ideal in situations where a three-way load is exerted. Also used for climbing rope, anchors and harness-to-chest harness connectors.



Code	Size mm	Width mm	Length mm	Gate Opening mm	Thread Diameter mm	Work Load kg
Delta - Zinc Plated Steel						
VMR DS04	4	35.5	40	5.5	6	100
VMR DS06	6	47	56	7.5	9	250
VMR DS08	8	56	73	10	11	550
VMR DS10	10	66	87	12	13	900
VMR DS12	12	75	104	15	15	1100
Delta - Stainless Steel						
VMR DSS04	4	35.5	40	5.5	6	200
VMR DSS08	8	56	73	10	11	770
VMR DSS10	10	66	87	12	13	1250
VMR DSS12	12	75	104	15	15	1750
Delta - High Strength Alloy						
VMR DA10	10	66	87	12	13	350

Maillon Rapide Pear

Ideal in situations where a three-way load is exerted. Also used for climbing rope, anchors and harness-to-chest harness connectors.



Code	Size mm	Width mm	Length mm	Gate Opening mm	Thread Diameter mm	Work Load kg
Pear Shaped – Zinc Plated Steel						
VMR PS08	8	53	100	17.5	11	480
VMR PS10	10	63	118	20.5	13	720

Maillon Rapide Twist

Fitted with a 90 degree twist, the Twist Maillon Rapide is ideal for smoother PPE connections in industrial safety, fall arrest systems, work restraint, work positioning, rope access as well as in mountaineering and climbing.



Code	Size mm	Width mm	Length mm	Gate Opening mm	Thread Diameter mm	Break Strength kN
Twist Zinc Plated Steel						
VMR STSTW07 (Standard)	7	33	66	16	10	27.5
VMR LOSTW08 (Large Opening)	8	36	88	17.5	11	32



Spreader Bar *Code VAI SPREADER SHA*

Used in confined space situations and rescue scenarios. Attaches to confined space pick up points on harness shoulder straps.

AS/NZS 1891.1:2007 approved.



Patient Lifting Sling *Code VRES PAT LIFT+*

Code VRES PAT LIFT+

Ideal for retrieval of victims trapped in locations where time and rescue is of the essence. Simple to apply and fully adjustable in confined and difficult situations. Seat and leg loops hold victim securely.



Vertical Rescue Triangular Harness *Code VRES TRI HARN*

The Vertical Rescue Triangular Harness is a simple yet robust patient lifting sling designed for all forms of rapid vertical extrications. The simple design allows the harness to be applied to the patient easily and quickly compared to other full body rescue harnesses. The Vertical Rescue Triangular Harness secures the patient during a lift. This harness is not suitable for patients with suspected spinal injuries.



Bauman Screamer Suit *Code CMC728101*

Designed for rapid extrication by hoist or short haul, the Screamer Suit dons quickly without the delay of putting on a full body harness designed for a rescuer. The Screamer Suit is easy to put on and holds the subject securely during lifting. The system adjusts from small patients to large patients up to 227 kg. Not intended for a patient with a spinal injury or other injury requiring a stretcher evacuation.



Paediatric Rescue Carrier *Code CMC724309*

The Paediatric Rescue Carrier was developed to safely protect paediatrics and infants during evacuations as a result of major flooding incidents. The Paediatric Rescue Carrier can be collapsed and folded for easy stowage and is designed to facilitate helicopter hoist rescue operations. The ends of the bag can be extended to accommodate most paediatric backboards. The bottom and sides are lined with 25 mm closed cell foam to provide structural rigidity and buoyancy. Made out of durable 1000 denier Cordura fabric, the Paediatric Rescue Carrier will provide protection to your most precious cargo in the harshest environments. Weight 3.2 kg



Product Specifications

Length	Width	Height
79 cm	41 cm	30 cm

Ferno Hardpoint Full Body Harness *Code VHI HP*

The Ferno Hardpoint provides all the comfort and benefits of the standard Centrepoint 2 range however the Ferno Hardpoint replaces the front web belay loop with a hard connection point. For even greater versatility there are an abundance of hard and soft connection points spaced across the waist and back pads to attach additional hardware and gear.

Features

- Front hard connection point
- Versatile design allows use for a multitude of applications
- Offset (cranked) pole strap attachment points
- Quick connect buckles on waist and legs
- Front and rear free fall arrest D-ring attachment points
- Limited free fall arrest attachment point
- 8 additional connection points for hardware and gear
- Extra wide, padded waist and leg straps for added comfort when hanging or working for long periods of time
- Removable moisture wicking 3D mesh back pad provides unrivalled shoulder and neck protection



Quick connect buckles

Ferno Hardpoint Ascender Full Body Harness *Code VHI HP ASC*

The Ferno Hardpoint Ascender is supplied with most of the features and comforts from the Centrepoint 2 range along with all the benefits found on the standard Hardpoint Full Body Harness. The Hardpoint Ascender also features an integrated chest ascender that provides increased mobility when ascending.

Features (additional)

- Integrated chest ascender for increased mobility when ascending
- Optional chest harness and backpad available to ensure chest ascender remains close to the body during operation



Integrated Chest Ascender



Quick connect buckles



Ferno Chest Strap Set *Code VAI AHCS*

Specifically designed for rope access workers utilising the Hardpoint and Centrepoint Harnesses. The Ferno Chest Strap Set prevents the harness front straps and associated hardware pulling away from the chest and body when attached to and hanging from this point. The strap is pre-attached to a back pad, just remove the existing back pad and replace with this set. The webbing straps can be tightened either over the front chest strap or fed through the front D-ring for extra stabilisation. There are side attachment straps to secure the entire set in place



Ferno Centrepoint 2 Full Body Harness

Code VHI CEN FB 2 (basic), VHI CEN FB 2 BS (with optional extra)

The Ferno Centrepoint 2 Full Body Harness is a versatile, comfortable harness that can be used for a multitude of rescue and industrial applications.

Features

- Versatile design allows use for a multitude of applications
- Offset (cranked) pole strap attachment points
- Confined space retrieval attachment points
- Quick connect buckles on waist and legs
- Front and rear free fall arrest D-ring attachment points
- Limited free fall arrest attachment point
- Gear loops for storing excess hardware and gear
- Extra wide, padded waist and leg straps for added comfort when hanging or working for long periods of time
- Removable moisture wicking 3D mesh back pad provides unrivalled shoulder and neck protection
- Fully adjustable rear leg risers to ensure best fit
- Australian Standards approved AS/NZS 1891.1:2007
- Available XS, S, M, L, XL. Conditions apply for XS and XL.



Quick connect buckles

Ferno Centrepoint 2 Ascender Full Body Harness

Code VHI CEN FB 2 A

The Ferno Centrepoint 2 Ascender Full Body Harness is based on our industry renowned Centrepoint 2. As well as being our most versatile and comfortable rescue harness it also features an integrated chest ascender that provides increased mobility when ascending.

Features (additional)

- Integrated chest ascender for increased mobility when ascending
- Optional chest harness and backpad available to ensure chest ascender remains close to the body during operation

Optional Features

- Battery and self rescuer attachment strap
- Flame-proof/anti-static webbing



Integrated Chest Ascender



Quick connect buckles



Ferno Centrepoint Full Body Harness

Code VHI CEN FB (basic), VHI CEN FB CS (con space), VHI CEN FB CS BS (batt strap)

Features

- Pole strap attachment points
- Front and rear free fall arrest D-ring attachment point
- Limited free fall arrest attachment point
- Rear free fall arrest attachment point
- Extra wide, padded, waist and leg straps for added comfort when hanging or working for long periods of time
- Gear loops around the waist for storing excess hardware and gear
- Fixed, elasticised leg risers
- Australian Standards approved AS/NZS 1891.1:2007
- Versatile design allows use for a multitude of applications
- Available XS, S, M, L, XL. Conditions apply for XS and XL

Optional Features

- Confined space retrieval attachment points
- Battery and self rescuer attachment strap



Hi-Safe FH17 SES Full Body Harness *Code HS-FH17-SES*

The Hi-Safe FH17 SES Full Body Harness is a comfortable, light weight harness that is easy to don. It is designed for industrial rigging, elevated work platforms and all general height safety scenarios.

Key Features

- Front free fall arrest attachment points
- Rear free fall arrest D-ring attachment point
- 2 Tool Loops attached to rear waist strap
- Thread through, adjustable leg straps
- Sub pelvic strap for extra protection
- Fully adjustable, multi size fit
- Easy to don jacket style design
- Australian Standards approved AS/NZS 1891.1:2007



Ferno Centrepont Sit Harness *Code VHI CEN SIT (basic), VHI CEN SIT BS (with optional accessories)*

The Ferno Centrepont Sit Harness is a fully adjustable, lightweight harness which has been designed to be easily worn and used. The Ferno Centrepont Sit Harness is particularly comfortable to wear due to its extra wide padded waist belt and leg loops. It is ideally suited for rescue work and rope access. Under AS/NZS 1891:1 guidelines, this harness is classified for limited free fall only and is ideal when combined with a chest harness. The harness also incorporates two side D-rings for pole strap restrained fall. This harness comes available in small, medium or large.



Ferno Flashpoint Sit Harness *Code VHI FLASHP*

The Ferno Flashpoint Sit Harness has been a favourite of State Emergency Services in Australia for many years. It is an extremely strong, lightweight and comfortable harness to hang in. This is due to its extra thigh/sit strap that spreads the load more evenly across the body, reducing the strain on the leg straps and waist belt. The twin belay loops provide strength and orientates the descender in line with the body, instead of at right angles. The Ferno Flashpoint Sit Harness can also be combined with a chest harness to provide extra support and security. One size fits all.



Ferno Rappel Belt *Code VAI RAPPEL*

The Ferno Rappel Belt is designed for situations where an instant evacuation or extrication is the only resort. It is manufactured from quality 44 mm webbing and plated steel components.

Key Features

- Secure sliding bar buckle for ultra fast donning
- Steel D-ring attachment point
- Velcro loop keeps D-ring stowed until required
- Velcro keeps the web belt end neatly secured, preventing any possibility of entanglement or slippage
- Rated to 6 kN - restraint fall



Ringers Barrier Extrinsication Glove Code Ring-327

The Ringers Barrier Extraction Glove is waterproof but features a breathable barrier that protect hands from micro-organisms such as TB, Hepatitis, Staph and HIV. The glove has boxed finger tip design for better fit and comfort, and the moulded thermal plastic rubber knuckle reduces impact. The glove is made from 3M reflective fabric that improves the visibility of hands. The elastic cuff and gaiter are designed specifically to keep out glass and debris. The glove has cut resistant Kevlar palm, thumb, side and finger panels and Kevlar stitching for added strength to high wear areas. Available in S, M, L, and XL.



Ringers Extrinsication Glove - Long Cuff Code RING-304

The Extrinsication Glove with a long cuff is made from durable Clarino material, which is tougher and more durable than leather. It features reinforced index finger and thumb joints and puncture resistant palm pads making them particularly resistant to abrasions. The elastic cuff keeps out glass and debris, reducing the chance of injury. Despite the toughness of these gloves, they still provide enough feel to palpate a pulse. Available in S, M, L, and XL.



Ringers Rope Rescue Glove Code RING-353

The Rope Rescue Glove is ideal for optimum grip and control in inclement weather and a snug fit that assists with effective dexterity. This glove features uniquely designed gel pads, which in conjunction with the finger and palm patches, ensure optimum rope control and hand protection. Available in S, M, L, and XL.



Ringers Authentic Glove Code RING-133

The Authentic Glove is a multi-purpose glove with velcro wrist straps and a snug fit design. The glove features a unique split palm, Clarino finger and palm patches, along with tough Spandex top material with hidden seams that improve the comfort, feel and durability of the glove. Available in S, M, L, and XL.



CMC Rescue Special-Ops Gloves Code CMC250412/3/4/5

CMC Rescue Special-Ops Gloves balance the need for finger tip dexterity with hand protection. These fingerless gloves will protect the hand from nicks, cuts, bruises and abrasions. The Clarino synthetic leather patches on the palm and the fingers provide added durability and protection for rope work. The 3 mm shock absorbing gel padding protects the palm from impacts and vibration. Spandex back and velcro wrist closure provide a snug fit without limiting dexterity. A karabiner loop is sewn into the wrist, allowing you to hang the gloves on your harness gear loop when not in use. Available in S, M, L and XL.



CT Glove Half and Full Finger

Code VCT 7X980 (AA, AB, AC, AD) M L XL XXL Half Finger, VCT 7X980 (OA, OB, OC, OD) M L XL XXL Full Finger

A comfortable leather glove that offers enhanced hand protection from rope friction. The moisture wicking properties are enhanced by the perforated top leather surface. Exposed fingers provide normal finger dexterity and feel. The full finger provides additional protection. Full Finger 108 g. Half Finger 100 g.



Response® XT

Access Line



Response XT has been designed with your ultimate safety in mind, certified to AS/NZS 4142.3, ANSI Z-133 and EN 1981 standards. Donaghys Response XT is the premium safety and rescue line and allows quick access for any emergency.

- Low stretch, high strength
- Heat Set
- Quick access
- Excellent knot holding

Working Load	80 kg	375 kg	3740 kg
Elastic Elongation	1.4%	6.1%	25%

Size (Dia)	Weight/100 m	Break Strength	SWL	Reel Length
11 mm	9 kg	3475 kg	347 kg	200 m
13 mm	11 kg	4750 kg	475 kg	200 m

Response® Static Line

Access Line



Response Static Line is characterised as supple for handling, coiling and providing superior feel and control when used with certified hardware in any abseil, belay or static descent application. AS/NZS 4142.3 and EN1891 compliant. Available in various colour options.

Size (Dia)	Weight/100 m	Break Strength	SWL	Reel Length
6 mm	3 kg	1100 kg	110 kg	100 m
9 mm	6 kg	2250 kg	225 kg	200 m
11 mm	9 kg	3475 kg	347 kg	200 m
13 mm	11 kg	4750 kg	475 kg	200 m
16 mm	16.5 kg	6900 kg	690 kg	100 m

Arresta Static Kernmantle Rope

Access Line



Narrowtex Static Kernmantle Rope is a fully imported, economical rope constructed with a braided polyester outer surrounding a nylon kernmantle core.

Available in 11.5 mm and 13 mm diameter
Meets AS 4142.3 and EN 1891:1998

Rhino

Rigging/Lowering Line



Rhino is a 100% polyester double braid. Designed for high strength with low stretch, Rhino offers the ultimate in rigging or lowering lines.

- Low stretch
- Easy to splice
- Excellent handling and abrasion resistance
- UV stable
- Designed to run easily through rigging hardware

% of Break Strength	10%	20%	30%
Elastic Elongation 12 mm	1.8%	2.6%	3.3%
Elastic Elongation 16 mm	1.8%	2.6%	3.3%

Size (Dia)	Weight/100 m	Break Strength	SWL	Reel Length
12 mm	10.4 kg	4570 kg	760 kg	100 m
16 mm	21 kg	5530 kg	920 kg	100 m

Three Strand Polyester Rope

Rigging/Lowering Line



A spliceable three strand, high tenacity, abrasion resistant polyester. This rope is suitable for a multitude of applications including roofing restraint, general lift and tie down purposes.

- AS4142:3 1993 compliant

Size (Dia)	Reel Length	Standard Breakforce	Base Colour	Marker Yarn	No. Strands
12 mm	250 m	2280 kg	Natural White	Blue	3
16 mm	250 m	4100 kg	Natural White	Blue	3

Spark

Climbing Rope



Constructed using a tough 16 strand braided polyester cover with a kernmantle core then stabilised to create an ideal hard wearing cost effective climbing line.

- Fully spliceable cover dependent construction
- Low stretch and highly visible
- Lightweight
- Wears well with high abrasion resistant low snag polyester cover
- Kernmantle core construction
- Meets ANSI Z-133 standards

% of Break Strength	10%	20%	30%
Elastic Elongation	2.5%	3.6%	5.2%

Size (Dia)	Weight/100 m	Break Strength	SWL	Reel Length
12 mm	9 kg	3204 kg	320 kg	200 m

NRG

Climbing Rope



NRG is a high performance 12 mm, 24 strand climbing line designed for use in sports climbing and professional arborist applications. NRG is lightweight with excellent knot holding abilities and allows easy access into trees with great foot locking capabilities.

- Knobby cover construction for easy handling
- Excellent bend ratio
- Lightweight
- Low stretch for excellent foot locking
- Kernmantle core construction
- Works well with hardware
- Meets ANSI Z-133 standards

% of Break Strength	10%	20%	30%
Elastic Elongation	2.5%	3.4%	4.5%

Size (Dia)	Weight/100 m	Break Strength	SWL	Reel Length
12 mm	8.3 kg	3523 kg	352 kg	100 m

Standard-Prus

Prusik Line



A double braided high tenacity nylon Prusik or accessory line which can be used in all general applications.

- Easy handling and knot holding
- Suitable for general applications

Spectra-Speed

Prusik Line



Approved for use as Prusik material climbing hitches. Spectra-Speed uses a high tenacity polyester braided cover over a braided Spectra® 900 core.

- Very lightweight with no stretch
- Easy to splice
- Meets ITCC climbing competition rules
- Certified to Australian Standard AS/NZS 4142.3

Armour-Prus

Prusik Line



At long last, a prusik line that will last. A unique cover blend of Technora and polyester acts like armour over a core of lightweight Spectra 900. Donaghys Spectra® core incorporates a world first safety feature of twin Kevlar strands preventing the core from being cut or melted completely in the unlikely event of a cover failure.

- Very low stretch and easy to splice
- Technora is rated 234°C higher than standard polyester

Product	Size (Dia)	Break Strength	Reel Length
Standard-Prus	6 mm	1100 kg	100 m
Standard-Prus	8 mm	1900 kg	100 m
Spectra-Speed	6 mm	1570 kg	100 m
Spectra-Speed	8 mm	2800 kg	100 m
Spectra-Speed	10 mm	4300 kg	100 m
Armour-Prus	8 mm	2800 kg	25 m
Armour-Prus	10 mm	4300 kg	25 m

CMC Rescue Prusik Cord and Load Release Hitch Cord

Code CMC293017, CMC293037, CMC293018, CMC293038 and CMC293039

The most important attribute of a cord used for prusik hitches is consistency in handling and diameter. Once you have determined the prusik hitch that works best on your host rope, it is important to achieve the same performance every time it is replaced. CMC Rescue Prusik Cord has the right balance of suppleness for reliable activation, but is not so soft that it wears out rapidly. Made of nylon with a torque-free kernmantle construction, it comes in solid colours to differentiate between cords designed for prusik hitches and climbers' accessory cords. Two colour choices in the 7 mm and 8 mm diameters allow separate colours for each length of prusik belay system. The 9 mm diameter is the size preferred by rescuers who use a load releasing hitch. These cords are available by the foot or spool.



Product Specifications

	Diameter	Colour	MBS	Spool Length
CMC293017	7 mm	Yellow	9 kN	366 m (1200 ft)
CMC293037	7 mm	Blue	9kN	366 m (1200 ft)
CMC293018	8 mm	Green	12 kN	366 m (1200 ft)
CMC293038	8 mm	Red	12 kN	366 m (1200 ft)
CMC293039	9 mm	Orange	16 kN	548 m (1800 ft)

CMC Rescue Lifeline

CMC Rescue Lifeline is an all nylon kernmantle rescue rope manufactured to our specifications by New England Ropes, which meet our demanding performance requirements. CMC Rescue Lifeline has the optimum balance of strength, handling, and durability with minimum sheath slippage. Whether you are a firefighter on a skyscraper, a mountain rescuer high on a cliff rescue, a responder to an industrial accident or a tactical officer on rappel, we feel that CMC Rescue Lifeline is your best choice for a life support rope.



Product Specifications

Light Use CMC Rescue Lifeline

	Diameter	Colour	MBS	kg per 100 ft
CMC272430	9.5 mm	Red	21 kN	2.2 kg
CMC272450	9.5 mm	Black	21 kN	2.2 kg
CMC272810	11 mm	Orange	29 kN	2.5 kg
CMC272820	11 mm	Blue	29 kN	2.5 kg
CMC272830	11 mm	Red	29 kN	2.5 kg
CMC272850	11 mm	Black	29 kN	2.5 kg

General Use CMC Rescue Lifeline

	Diameter	Colour	MBS	kg per 100 ft
CMC263200	12.5 mm	White	41 kN	3.2 kg
CMC273210	12.5 mm	Orange	41 kN	3.2 kg
CMC273220	12.5 mm	Blue	41 kN	3.2 kg
CMC273230	12.5 mm	Red	41 kN	3.2 kg
CMC273250	12.5 mm	Black	41 kN	3.2 kg
CMC273270	12.5 mm	Yellow	41 kN	3.2 kg
CMC274010	16 mm	Orange	47 kN	4.9 kg

Rope Finishing

Ferno can manufacture rope components to individual specifications including splicing of both standard and double braid synthetic rope along with quality sewing of kernmantle rope with an array of plastic, stainless steel and galvanised steel thimble fittings to ensure a perfect custom solution.



Ferno Rope Bags

Code *VBS HIVIS (Heavy-Duty)*, *VBS ROP BAG (Standard)*

The Ferno Heavy-duty Rope Bag keeps your rope conveniently stowed, ready for transportation and quick deployment. It comes with a carry handle, backpack straps, pull tight throat closure and is made from 1000 denier vinyl.

Available in 50 m, 100 m, 150 m and 200 m sizes.

The Standard Rope Bag is available in 50 m, 100 m, 150 m and 200 m sizes and is made from 1000 denier cordura. This version comes complete with a single shoulder strap only.

Bag	Height	Depth	Bag	Height	Depth
50 m	560 mm	240 mm	150 m	680 mm	300 mm
100 m	700 mm	240 mm	200 m	850 mm	300 mm



Ferno Heavy-duty Rope Bag

Ferno Standard Rope Bag

Multi Pouch

Code *VRES MULTI POUCH*

The Multi Pouch is an ideal bag for the convenient storage of all rope and rescue gear. The clear faced pouches provide an uninterrupted view of all equipment, assisting in quick identification and deployment. The Multi Pouch is made from tough 1000 denier nylon. Each Multi Pouch features integral carry handle and backpack straps. The Multi Pouch has been a favourite with emergency services personnel for many years.



All Purpose Grab Bag

Code *VBI CARRY*

This multi-purpose bag is ideal and large enough for storing your harness and all related gear to make up your own kit. A handy daisy chain is located inside the zipper opening for convenient storage of karabiners and other gear. Available in a variety of colours: maroon, black, red, yellow and blue.

Dimensions: L 580 mm x D 300 mm



Small Gear Bag

Code *VARB GB*

A universal, heavy-duty Cordura bag with robust handle and draw-string top. Self supporting but still capable of collapsing for storage.

Dimensions: L 150 mm, W 150 mm, D 150 mm



Expedition II Duffel Bag

Code *VBS EXP 2 HD*

The Expedition II Duffel Bag is a sizeable bag with a 75 L capacity that is made tough to carry rescue, industrial or climbing gear. This bag is made from 1680 denier nylon with integral shoulder and carry straps and is a favourite from our outdoor range.

Dimensions: L 750 mm x W 300 mm x H 200 mm



Ferno Haul Bag

Code *VBS HAUL 200 (cordura)*, *VBI HAUL IND (leather)*

The Ferno Haul Bag is a tough, hard wearing bag that has a safe working load of 50 kg with a 5:1 safety factor and an impressive 90 L gear capacity. It includes oversized easy to attach haul loops and heavy duty back pack straps. The bag also features two separate pull tight draw strings to secure its load as well a four D-rings around the base for stabilising the load during long distance hauling. Available in either leather or 1680 cordura.



CMC Rescue SRT Throwline Bag Sets

Codes CMC291250, CMC291275, CMC291650 and CMC291100

The CMC Rescue SRT Throwline Bag Sets feature CMC's SRT Throwline which is a multi-use water rescue line that comes in several lengths and types of bags. The handle makes for easy and accurate throwing and has a quick release buckle to attach the bag to a boat or a PFD. Pack cloth and mesh bags both have an ethafoam disk for added floatation. The unique EZ-Stuff bag has integral floatation properties, a side grommet and reflective stripe.



CMC191100

CMC291650

CMC291275

CMC291250

Product Specifications

	Rope Length	Weight	Bag Type	Bag Colour
CMC291250	15.25 m	0.91 kg	Pack Cloth	Orange
CMC291275	22.75 m	1.36 kg	Pack Cloth	Orange
CMC291650	15.25 m	0.91 kg	EZ-Stuff	Yellow
CMC291100	30.50 m	1.81 kg	Mesh	Yellow

Ferno Slings

Codes VSL R32KN (25 mm round), VSL S30KN (50 mm flat snake) and VSL S80KN (50 mm heavy duty flat snake)

Every Ferno Sling is made from high grade, abrasion resistant webbing and is available in a variety of colours and lengths. Slings are made for a versatile and handy adjunct for forming temporary anchor points. The Ferno Slings are manufactured in accordance to AS/NZS1891.



25 mm Round Sling



50 mm Heavy Duty Flat Snake Sling



50 mm Flat Snake Sling

Ferno Industrial Daisy Chain

Code Vai DAISY H/D BLK

The Ferno Industrial Daisy Chain is ideal for positioning the casualty during work operations and is a must for all Rope Access and Rescue Technicians. A total length of 1.1 m with an end to end rating between 15 kN to 20 kN (load angle dependent). Each unit comes with 10 x 60 mm attachment loops and is made from durable 25 mm flat polyester web. Each loop rated to 5 kN.



Girth Hitch Sling

Code Vsl G 30kN

The Girth Hitch Sling differs significantly in design and performance from other adjustable anchor straps, allowing it to handle a higher load before slipping. The D-ring on one side is larger than the other, so the other end can pass through, allowing the straps to be rigged in a girth hitch. Available in lengths from 30 cm to 2.5 m





Ferno Rescue Personal Lanyard (PAL) *Code Vas DAISY ADJ*

The Ferno Rescue Personal Lanyard allows a rescuer to quickly connect to a victim and then adjust the strap to the desired length. It works well for positioning the victim for a lowering or rappel-based pick off or for an assisted rappel. There is an added loop to the end for a more positive grip when pulling to adjust. Depending on how the buckle is loaded, it will begin to slip between 15 kN to 20 kN. Tying off the buckle will increase strength.



Etrier and Aider Four and Five Step *Code Vas ETRIER 4 & 5 and Vas AIDER 4 & 5*

Code Vas ETRIER 4 & 5 and Vas AIDER 4 & 5

The Etrier and Aider Four and Five Step are ideal for rescue, rope access and recreational aid climbing. The 25 mm tubular webbing and dense vinyl stiffening ribs remain rigid, ensuring ease of foot placement and superior abrasion resistance.



Ferno Shotbag *Code VKIT THROW BAG*

Code VKIT THROW BAG

The Ferno Shotbag consists of a dipped throw bag attached to 30 m of cord all housed in a convenient storage bag.



Tool Wrist Loops *Code HS-WL10, HS-WL15*

The Tool Wrist Loops reduce the risk of dropped tools and equipment. They are lightweight, flexible and comfortable to wear and have been developed to secure hand tools and other equipment in situations where work must be carried out over other workers or public spaces.



- Cord loop
- Adjustable wrist band
- Washable



- Metal snap clip
- Swivel hook
- Adjustable wrist band

Safe Spring Hook *Code EB-STL*

The Safe Spring Coil prevents tools accidentally falling when working at height. Coiled, plastic coated stainless wire extends from 430 mm to 1600 mm. Supplied with various fitting attachments for varying tools configurations. 5 kg load weight. Minimum order quantity of 12.



ISC Edge Roller *Code VISC ER100A*

The ISC Edge Roller protects ropes from damage when working over sharp or abrasive edges. The system is fully modular, consisting of edge roller boxes made from pressed and powder coated aluminium and steel oval maillons which can be easily and quickly linked together to form a chain of whatever length is appropriate for the task. Each box assembly weighs 460 g and consists of one box and two maillons. Each box has a series of rollers which protect ropes in three directions but allow the rope to run smoothly with minimal friction.



Rescuetech Multi-Unit Edge Roller

A low profile edge protection device featuring an alloy aluminium frame and rollers. The Rescuetech Multi-Unit Edge Roller may be used as a single unit or paired up with multiple units to provide large area protection. Units link together with the included rapid links or may be tied using flat webbing to provide long range protection.



Code	Description	Dimensions
RT-611111	Single unit	14.5 cm x 21 cm
RT-611112	Small 2 units	45 cm x 21 cm
RT-611113	Medium 3 units	67 cm x 21 cm
RT-611114	Medium 4 units	90 cm x 21 cm

Rope Protectors

Ferno provide various styles of rope protectors that prevent rope damage on sharp, abrasive or dirty edges and help prolong the life of your rope and slings. They are available in heavy-duty, flat or in a lighter duty wraparound. Ferno's Rope Protectors provide ideal protection for your ropes and slings.

- (1) VAS ROP PROT - Light duty
- (2) VAI ROP PROT IND FLAT - Flat
- (3) VAI ROP PROT IND WRAP - Wraparound



Ultra-Pro Edge Protector

Code CMC294042 (2 Edge Protector) and CMC294044 (4 Edge Protector)

The Ultra-Pro Edge Protector conforms to the edge but prevents sharp bends in the rope, reducing friction and wear. Ideal for edge protection during hauling operations. Holes in all four corners allow the Ultra-Pro to be tied off for safety or linked together for extended protection.



Bokat Rope Washer *Code CMC294060*

The Bokat Rope Washer cleans rope with a combination of water pressure and brushing action. The plastic body clamps over the rope and velcro closures allow adjustment to rope size for maximum efficiency. The inside is lined with Astroturf which scrubs the rope as it is pulled through the washer. For use with ropes up to 19 mm in diameter. For optimum rope cleaning, pre-soak rope in Ferno Rope and Harness Wash.



Ferno Rope and Harness Wash

Code VAS WASH (500 ml bottle) and VAS WASH 20 (20 L container)

A highly concentrated, blue liquid that is recommended for use with industrial harnesses, access, rigging and lowering ropes. Ferno Rope and Harness Wash is environmentally friendly, bio-degradable and does not contain any phosphates, bleaches or fragrances. It is low foaming, free rinsing with excellent soil removal properties. Available in a 500 ml bottle or 20 L bulk container.



Rope Measurer

Code DONA-PRP9058M

This rope measurer quickly and accurately measures cordage from 4 mm to 19 mm diameter. Counter reads up to 3050 m. Supplied with mounting bracket.



Engel Hot Knife

Code VDPS G4480000 (knife), VDPS G4480001 (blade)

A hot knife/rope cutter for rope and web. This electric handheld unit cuts and fuses the ends of polyester and nylon ropes and webbing. Blade sold separately.



Go Anywhere Toilet Kit Code MIR-D019W

The most sanitary, safe, environmentally-friendly, portable toilet solution available complete with toilet paper and hand sanitiser. Prevents spread of disease with no spills, splash backs or waste contact. Our toilet kit is the ONLY biodegradable solution that traps, encapsulates, deodorises and breaks down waste with a NASA-developed gelling agent.

Commonly used by emergency services, defence, remote outdoor programs, expedition adventure racing and ultra-marathon events. The Go Anywhere Toilet Kit can be used with the Go Anywhere Toilet System, non working toilets or by itself. Each waste kit includes a zip close disposal/transport bag, a waste collection bag preloaded with poo powder gelling agent, toilet paper and a hand sanitiser.



box of 12



individual kit

Pee-Wee Personal Unisex Urine Bag

GC-D449PW3 Pkt 3 GC-D455PW12 Pkt 12

Pee Wee Personal Unisex Urine Bags can provide freedom from planning lives, trips, outdoor recreational outings around the proximity to the toilet. Each bag contains NASA developed proprietary gelling agent that traps, encapsulates, breaks down and deodorises waste instantly, preventing spills, splash-backs and waste contact. Packs out without leaks or spills, in portable solidified and fully biodegradable form. Pee Wee personal urine bags are safe and sanitary for consumers and our environment.



Poo Powder Waste Treatment Code MIR-D105POW

The Poo Powder Waste Treatment container has 120 scoops of Poo Powder. Each scoop contains enough powder to treat up to 600 g of liquid and solid waste. Poo Powder can be used by itself or used to extend the Go Anywhere Toilet Kit, simply sprinkle a scoop over the waste. Weight: 1.9 kg.



Go Anywhere Toilet Code MIR-D119PET

The Go Anywhere Toilet structure is available separately and sets up in seconds with no assembling required. Designed to keep the outside of the waste bag clean, assisting with the hygienic transportation and removal of filled bags. The Go Anywhere Toilet is lightweight and conveniently folds into a briefcase. Comes supplied with 3 x Go Anywhere Toilet Kits. Weight: 3 kg

Dimensions: L 480 mm, H 35 mm, D 130 mm



The Go Anywhere Toilet System Code MIR-PETT

The easy to use Go Anywhere Toilet System provides privacy and a sanitary and odourless method of packing out and disposing of liquid and solid waste. It is ideal for remote locations or for disasters and emergencies. All items fit into a backpack, which contains additional Go Anywhere Toilet Kits to transport used waste bags. The pack weighs 8 kg with contents included.

Contents

- 1 x Go Anywhere Toilet
- 1 x Clean Waste Privacy Shelter
- 1 x Clean Waste Backpack
- 15 x Go Anywhere Toilet Kit



UniFold Shelter Code MIR-UNI-XX

The Ferno Emergency Shelter is a fast and easy to erect full enclosure structure. Once unpacked it takes only 30 seconds for the roof, sidewalls, floor and end walls with zippered doors and windows to form into a full size structural building ready for occupation by people, equipment or supplies. The Emergency Shelter can be supplied pre-assembled with options such as privacy undress compartments, decon shower stalls, collection basin, fixed shower heads and integral lighting. The only training required to erect the shelter is to follow the simple set-up instructions.



Advantages of the UniFold Structure

- **Toughness:** The resilience of the polypropylene rigid floor and walls are unmatched by any other fast structure system.
- **Water & Storm Resistant:** This is an insulated shelter that is made of material that will never soak or seep water even in the longest downpour and will withstand extreme temperature ranges and withstands winds up to 110 kph.
- **Mobility:** Only Ferno Emergency Shelter structures can be moved after they have been erected. The floor acts as a skid, simply pull and drag to a new location.

Product Specifications

All Ferno Emergency Shelters fold down into a flat structure for storage and transportation. The relative dimensions of the flat structure are shown as outlined boxes below. The depth or thickness of the flat structure ranges from 25 cm to 68 cm depending on the shelters length when deployed or erected. The weight for all models is less than 3.5 kg per square metre including the floor and walls and end structures.

The models are coded and named by section size, therefore a 10' x 22' Emergency Shelter is called a "1022."

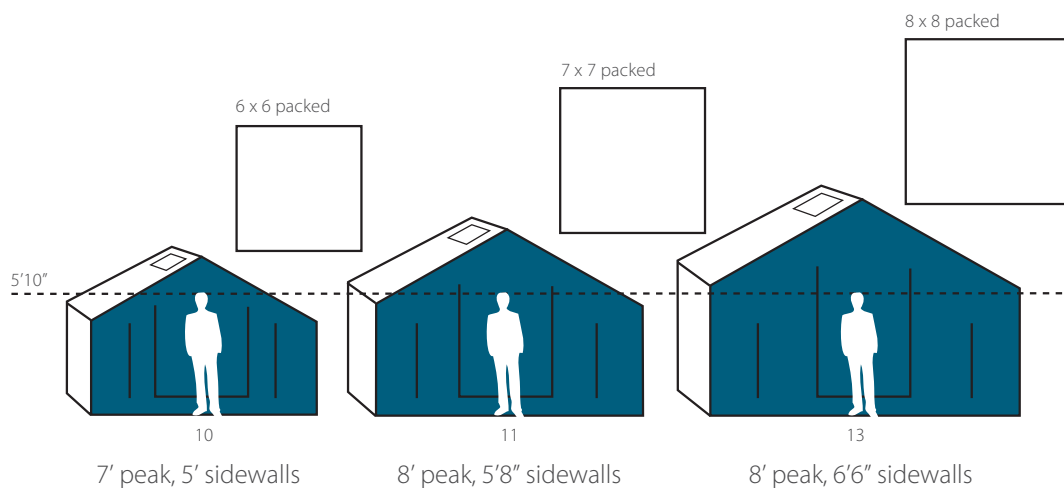

10' Model Options	10' x 6' 305 cm x 183 cm	10' x 10' 305 cm x 305 cm	10' x 14' 305 cm x 427 cm	10' x 18' 305 cm x 549 cm	10' x 22' 305 cm x 670 cm
12' Model Options	11' x 6' 335 cm x 183 cm	11' x 10' 335 cm x 305 cm	11' x 14' 335 cm x 427 cm	11' x 18' 335 cm x 549 cm	11' x 22' 335 cm x 670 cm
13' Model Options (min qty 10)	13' x 6' 396 cm x 183 cm	13' x 10' 396 cm x 305 cm	13' x 14' 396 cm x 427 cm	13' x 18' 396 cm x 549 cm	13' x 22' 396 cm x 670 cm

Ferno Triage Tags *Code MIR-FTT*

Designed for use at mass casualty incidents (MCI) the Ferno Triage Tags are water proof and have been designed with the most recent MCI management concepts. It is compatible with the START (Simple Triage And Rapid Treatment) triage system. Ferno Triage Tags come in a packet of 50.

Key Features

- Individual tag numbers and barcodes
- A tear off tag for tracking personal belongings
- A tear off section for the transportation group
- An area for noting patients who have been decontaminated

Product Specifications

Length	Width
115 mm	215 mm



First Response Triage Kit *Code MIR-AME-435*

The First Response Triage Kit is a versatile kit that allows first arriving emergency personnel to quickly initiate triage operation at a mass casualty incident. The First Response Triage Kit is packed in a durable, easy to clean nylon carry case which is small enough to be placed in a staff, ambulance or fire rescue vehicle.

Kit Includes

- Durable yellow triage vest with adjustable sides
- Triage officer checklist
- Red, yellow, green and black rolls of triage ribbon
- Metal clipboard and START (Simple Triage And Rapid Treatment) algorithm card
- Triage supply pouch for storage of tags, ribbon, markers, airways, trauma dressings, EMT scissors, pens and grease pencils
- EMT scissors
- Pens and grease pencils
- 25 Ferno Triage Tags



Body Bags *Codes DPBB and DPBB-H*

These Body Bags are a large size with a zipper on three sides for ease of body handling. The Body Bags are made from heavy duty PVC, and are available with or without eight integral handles for comfortable handling during transportation.

Product Specifications

Length	Width
2080 mm	900 mm



TNT Rescue Tools Start with Tested Designs

TNT Rescue Tools are designed with the end user and victim in mind. TNT Rescue tools are designed and engineered in association with in-house fire and EMS personnel and knowledgeable industry professionals.

Lifetime Warranty

When you purchase TNT Rescue Systems, Inc. products through Ferno Australia you can be sure you are getting the highest quality rescue tools in the market. So confident are TNT with the quality of their products they offer what no other rescue tool manufacturer can - a lifetime warranty*.

In the unlikely event your TNT product begins to wear, fails to perform as originally intended or even becomes accidentally damaged**, your product will be either replaced or repaired for the life of the product.

*Excludes engines, lifting bags and lifting bag accessories, which are not manufactured by TNT and have their own separate warranty.

**Contact Ferno Australia for full warranty terms and conditions

True Variable Speed Control (TVSC)

TVSC (Deadman Control) - Too important to not have on your rescue tools. In those crucial moments of metal displacement, control is a must. With our exclusive, True Variable Speed Control, tool movement can be varied in order to provide you with the most control in the industry.

Exceeding Industry Standards

TNT 2:1 Safety Factor

The safety factor relates to how much force a particular component can withstand before a failure can occur. At TNT all of our systems and components have a safety factor of 2 to 1, even though the industry standard is only 1.5 to 1. When the tool is in your hand, the higher safety factor is worth it.

System Safety Factor

In general, the system safety factor is the lowest safety factor of any individual component in the system. For example a system containing a tool with a safety factor of 1.5 to 1 and a hose with a safety factor of 4 to 1 the system will have an lowest overall safety factor of 1.5 to 1. The industry standard for systems and components is 1.5 to 1. All of TNT's systems and components have a safety factor of 2 to 1 exceeding industry standards.

NFPA 1936 Compliant and UL Classified Tools

TNT Rescue Systems, Inc. has obtained certification for their hydraulic rescue tools in accordance with NFPA 1936 standard on Powered Rescue Tool Systems. Certification has been obtained through Underwriters Laboratories, Inc.(UL) which have a long-standing reputation for the highest standards for quality, integrity and customer service. UL has been involved extensively since 1993 in developing safety and performance tests for rescue tools; methods that now serve as guidelines for the national standard (NFPA 1936).

ISO 9001:2008

TNT Rescue Systems, Inc. is certified as an ISO 9001:2008 registered organisation. This means you can be sure that TNT products are designed and manufactured to the high standards that our industry and the ISO demands.



TNT Rescue Cutters

TNT Rescue Cutter blades are made from high quality heat treated steel that creates a wear-resistant anodised surface. For manageability in critical areas, TNT Rescue Cutters have excellent True Variable Speed Control (TVSC) complete with deadman feature which increases manageability in critical situations. The cutters are well balanced for easy positioning and the D-shaped wraparound handle ensures easy operation in all positions for both left and right handed operators.

The Confined Space Cutter CSC-40 is the most advanced confined space cutter currently available. The new TNT BFC-320 Brute Force Cutter is the most powerful C-cutter in the industry, boasting an industry first of 320 000 lbs (1424 kN) of cutting force.

Key Features

- Internal safety bleed valve (relief valve) to prevent over pressurisation
- Anodised aluminium body
- Separate controller
- Optional hand pump operation
- Regrindable blades which extends blade life
- Lifetime warranty

Technologically Advanced Blade Design

There is more to a cut than slicing through metal. That is why TNT engineers use extensive lab testing, field testing and computer modelling to be sure their blades perform in five critical areas:

- **Blade trajectory:** In a cutting tool, the arc of the blade determines how well the blade wraps around and pulls the material into the strongest cutting area of the blade.
- **Initial cutting edge rake:** Through extensive testing and computer modelling, TNT's engineers have created the optimum angle to provide the widest range of reliable cutting capabilities.
- **Angle of deflection:** Once the blade has made the cut, the metal must be deflected away from the cutting edge. This angle is critical in making a clean separated cut.
- **Glass clean-outs:** Glass dust is extremely hard on the wear surface of blades. The blades are designed with clean out grooves where the glass dust is deposited as the tool is operated. This extends the life of the blade.
- **Blade thickness:** The blade thickness is an important aspect of the entire tool and its operation. The blade must be substantial enough to withstand the forces of the tool and yet thin enough to get into tight spots. TNT blades are force tested at twice the force that the cutter can achieve.

TNT's own rigorous standards enable them to offer an Unconditional Lifetime Warranty: TNT Rescue Tool blades are covered forever against breakage.



Product Specifications

Models	TNT-BFC-320	TNT-SLC-24	TNT-SLC-27	TNT-SLC-28	TNT-SLC-29	TNT-CSC-40
Max. operating PSI	10,500 psi/724 bar	10,500 PSI/724 bar	10,500 PSI/724 bar	10,500 PSI/724 bar	10,500 PSI/724 bar	10,500 PSI/724 bar
Max. blade opening	197 mm	127 mm	178 mm	193 mm	193 mm	38 mm
Max. cutting force	1424 kN	528 kN	528 kN	694 kN	1197 kN	155 kN
Deployment weight	22.5 kg	15.3 kg	15.3 kg	17.9 kg	18.4 kg	4.9 kg
Width	273 mm	228 mm	285 mm	285 mm	285 mm	81 mm
Height	178 mm	178 mm	178 mm	178 mm	178 mm	132 mm
Length	762 mm	723 mm	723 mm	711 mm	726 mm	304 mm
UL Classified	Yes	Yes	Yes	Yes	Yes	Yes
NFPA 1936 Compliant	Yes	Yes	Yes	Yes	Yes	Yes

*5500 PSI units also available. Please contact Ferno for more details

TNT Rescue Spreaders

The combination grabber jaw and automotive spreader tips are made of heat treated steel which enables better tool grip and relocation of metal. For manageability in critical situations TNT Rescue Spreaders have variable speed control complete with True Variable Speed Control (TVSC) and Deadman Control. The D-shape wraparound handle is well balanced for easy positioning and ensures easy operation in all positions for left or right handed operators. Dual pilot check valves are used for reliable and superior load holding. Extended working surface-serrations extend into the arms. The spreaders have a wear resistant anodised surface that protects the tool from corrosion. The spreaders can also be used with chain attachments/systems for pulling operations.



TNT-S-100-41

Spreader Arm and Tip

In the rescue industry, a failure can have drastic implications. A TNT spreader arm has never failed a rescuer. The arms on TNT spreaders are engineered to withstand extreme conditions and forces which are inherent in rescue operations.

I-Beam Design

The I-Beam Design provides superior strength-to-weight ratio in the construction industry. The rescue tool industry is no different. Through extensive computer modelling and testing TNT has designed a strong yet light I-Beam style spreader arm.

Advanced Super Grip Tip

In a spreader tip, aggressive equates to better grip. TNT tips have aggressive serrations on all potential gripping surfaces, including the sides. This helps minimise tool slippage and kick out. Additionally, the spread cup increases the holding power of the tip within the spread.



TNT-CSS-40

Lifetime Warranty

In the unlikely event your TNT product begins to wear, fails to perform as originally intended or even becomes accidentally damaged, your product will be either replaced or repaired for the life of the product.

Product Specifications

Models	TNT-S-100-24	TNT-S-100-28	TNT-S-100-32	TNT-CSS-40
Max. operating PSI	10,500 PSI/724 bar	10,500 PSI/724 bar	10,500 PSI/724 bar	10,500 PSI/724 bar
Max. opening	610 mm	711 mm	813 mm	203 mm
Max. spread force	286 kN	249 kN	225 kN	22.3 kN
Max. pulling force	130 kN	113 kN	102 kN	-
Deployment weight	18.7 kg	19.8 kg	20.6 kg	4.5 kg
Width	342 mm	342 mm	342 mm	83 mm
Height	165 mm	165 mm	165 mm	104 mm
Length	774 mm	830 mm	894 mm	406 mm
UL Classified	Yes	Yes	Yes	-
NFPA 1936 Compliant	Yes	Yes	Yes	-

*5500 PSI units also available. Please contact Ferno for more details.

TNT Rescue Combination Tools

Codes TNT-SLCC-20 (primary cutter/secondary spreader) and TNT-SLCC-30 (primary spreader/secondary cutter)

TNT Rescue Combination Tools Codes TNT-SLCC-20 (primary cutter/secondary spreader) and TNT-SLCC-30 (primary spreader/secondary cutter) TNT Rescue Combination Tools are a cutting and spreading tool in one. The spreader arm and cutter blades are made from high quality heat treated tool steel, which has a wear resistant, anodised surface and is covered by TNT's lifetime warranty. The unique blade profile and tough blade construction make these tools the choice for quick, one tool rescue operations. The cutting blades have a unique mini C-cutter design (parrot beak) close to the tool, which prevents tool slippage during cutting operations. The D-shape wraparound handle is well balanced for easy positioning and ensures simple operation in all positions for left or right handed operators. Dual pilot check valves are used for reliable and superior load holding in critical situations. The TNT-SLCC-20 has a cutting edge along the full length of the blade. The TNT-SLCC-30 Spreader can also be used with chain attachments/systems for pulling operations.

Product Specifications

Models	TNT-SLCC-20	TNT-SLCC-30
Max. operating PSI	10,500 psi/724 bar	10,500 psi/724 bar
Max. opening	393 mm	355 mm
Max. cut force	528 kN	528 kN
Max. spread force	93.3 kN	70.5 kN
Deployment weight	16.5 kg	17.6 kg
Width	228 mm	228 mm
Height	178 mm	178 mm
Length	838 mm	825 mm
UL Classified	Yes	Yes
NFPA 1936 Compliant	Yes	Yes

*5500 PSI units also available. Please contact Ferno for more details.



TNT Rescue Forcible Entry Tool Kit

Codes TNT-FE-5.0 (without handle), TNT-FE-9.0 (without handle), TNT-FE-5.0-H (with handle), TNT-FE-9.0-H (with handle)

The TNT Forcible Entry Tool Kit includes the TNT Forcible Entry Tool and TNT Hydraulic Hand Pump. Light and portable, the kit is ideal for situations where immediate action and quick access is critical. Designed to reduce pinch points, this light yet powerful tool has a maximum spread force of 37.4 kN (also available in tactical black).



Product Specifications

	TNT-FE-9.0	TNT-FE-5.0
Max. operating pressure	10,500 PSI/724 bar	10,500 PSI/724 bar
Max. spread force	37.4 kN	37.4 kN
Stroke	229 mm	127 mm

TNT Rescue Rams

The TNT Rescue Rams provide both pushing and pulling capabilities. They have a maximum push force in excess of 22 650 kg making them ideal for heavy equipment and machinery. The Ram tip and base plates have aggressive 'bear teeth' edges to ensure the rams penetrate metals, plastic and other materials for better grip strength. This provides greater control and increased safety during displacement of various structures or loads. The need for attachments to prevent slippage during operation is therefore negated. The True Variable Speed Control (TVSC) and Deadman Control increases manageability in critical situations. The dual pilot check valves provide reliable and superior load holding. The capability of rams can be increased with the addition of the optional extensions and push plates for increased surface area during operations. The TNT Rescue Rams can also be used with chain packages/systems for pulling operations.



Product Specifications

Models	TNT-R-20	TNT-R-30	TNT-R-40	TNT-R-50	TNT-R-60	TNT-TLS- 25	TNT-TLS-50
Max. operating PSI	10,500 PSI/724 bar	10,500 PSI/724 bar	10,500 PSI/724 bar	10,500 PSI/724 bar	10,500 PSI/724 bar	10,500 PSI/724 bar	10,500 PSI/724 bar
Closed length	462 mm	542 mm	673 mm	803 mm	927 mm	425 mm	546 mm
Extended length	630 mm	775 mm	1,029 mm	1,286 mm	1,538 mm	832 mm	1278 mm
Highest push force	147 kN	147 kN	147 kN	147 kN	147 kN	229 kN	229 kN
Highest pull force	79.6 kN	79.6 kN	79.6 kN	79.6 kN	79.6 kN	NA	NA
Stroke	178 mm	229 mm	336 mm	482 mm	610 mm	NA	NA
Deployment weight	12.2 kg	14.5 kg	16.8 kg	18.6 kg	21.3 kg	18.2 kg	21.5 kg
Height	188 mm	188 mm	188 mm	188 mm	188 mm	216 mm	216 mm
Width	89 mm	89 mm	89 mm	89 mm	89 mm	114 mm	114 mm
UL Classified	Yes	Yes	Yes	Yes	Yes	Yes	Yes
NFPA 1936 Compliant	Yes	Yes	Yes	Yes	Yes	Yes	Yes

*5500 PSI units also available. Please contact Ferno for more details

Ram Extension Kits *Codes TNT-TLS (TLS Kit), TNT-XR (XR-Kit) and TNT-R (R-Kit)*

There are three types of the Ram Extension Kit which include the following options:

XR-Kit

- Small standard saddle
- C-saddle
- Conical
- Wedge
- Cutting head
- Peeling/cutting head
- 9 cm push plate
- 14 cm push plate

TLS Kit

- 12.5 cm and 25 cm extensions
- Small standard saddle
- C-saddle
- Conical
- Wedge
- Cutting head
- 14 cm push plate
- Peeling/cutting heads

R-Kit

- 12.5 cm and 25 cm extensions
- Small standard saddle
- Conical
- 14 cm push plate



TNT Rescue Pumps

TNT Exclusive Pump Designs

The most complicated part of the hydraulic system is the pump. TNT Rescue Systems Inc. and Blanton and Co. have been building pumps for industrial, defence and rescue applications for more than four decades. The experience and knowledge gained over the years is engineered into every pump TNT builds.

Supercharged

TNT engineers have eliminated the potential problems in pumps caused by spring driven pistons. TNT pump pistons are supercharged through TNT's exclusive Oil Supercharging System (OSS). This system prevents piston short stroking and slap, common in pumps relying on spring operated pistons, which robs your rescue tools of speed and power.

Piston over Piston

The most efficient type of hydraulic pump is a piston pump. All TNT two-stage pumps use a TNT exclusive, piston-over-piston design. This allows TNT pumps to achieve higher first-stage pressure settings, giving the user greater tool speed and performance.



Accelerator *Code TNT-ATT-6.5*

Key Features

- 2 tool simultaneous operation, or single tool operation at twice the speed
- Supercharged hHydrostatic 2 stage radial piston pumps
- True Simo unit with 2 separate pumps sharing one reservoir
- Flip down handle for compact storage
- Optional roll cage
- Well balanced and single handle enable easy lifting
- Spark arrestor muffler standard
- Available with 6.5 Honda motor, Yanmar Diesel or Electric
- Hour meter standard on all Honda motors

Product Specifications

Model	ATT-6.5
Max. operating PSI	10,500 PSI/724 bar
Pump type	Radial Piston
Motor	6.5 hp (4.85kw) Honda Petrol
Displacement	196 cc
Fuel tank capacity	3.60 L
Approx. Fuel run time	2 hrs
Hydraulic oil	Mineral Base
Deployment weight	36.38 kg
Width	394 mm
Height	381 mm
Length	539 mm
UL classified	Yes
NFPA 1936 compliant	Yes

*Also available in 5,500psi



Twin Simo Power Unit

Code TNT-BT-6.5 (Honda 6.5 HP, OHV 4 cycle), TNT-DT-4.0 (Yanmar 4.0 HP Diesel Electric Start) and TNT-ET-4.0 (Electric 4.0 HP)

Key Features

- 2 tool simultaneous operation prevents the need for changing over to individual tools
- Supercharged hydrostatic two-stage radial piston pumps
- True simo unit with 2 separate pumps sharing 1 reservoir
- Flip down handle for compact storage on BT-6.5
- Optional roll cage on BT-6.5 (DT&ET 4.0 roll cage standard)
- Well balanced with single handle for easy lifting
- Spark arrester muffler standard
- Available with 6.5 HP Honda motor, Yanmar 4.0 HP Diesel or 4.0 HP Electric
- Hour meter standard on all Honda motors



Product Specifications

Models	TNT-BT-6.5	TNT-DT-4.0	TNT-ET-4.0
Max. operating PSI	10,500 PSI/724 bar	10,500 PSI/724 bar	10,500 PSI/724 bar
Pump type	Radial Piston	Radial Piston	Radial Piston
Motor	6.5 hp (4.9 kw) Honda petrol	4.0 hp (3 kw) Yanmar diesel	4.0 hp (2.3 kw) Leeson electric
Displacement	196 cc	219 cc	-
Fuel tank capacity	3.60 L	2.40 L	-
Approx. Fuel run time	2 hrs	2.6 hrs	-
Deployment weight	34.5 kg	51.3 kg	45.4 kg
Width	394 mm	447 mm	368 mm
Height	381 mm	508 mm	394 mm
Length	539 mm	566 mm	610 mm
UL classified	Yes	Yes	Yes
NFPA 1936 compliant	Yes	Yes	Yes

Quad Power Unit

Code TNT-DT-10.0

Key Features

- Electric and recoil start
- 4 tool simultaneous operation prevents the need for changing over to individual tools
- High flow

Product Specifications

Model	TNT-DT-10.0
Max. operating PSI	10,500 PSI/724 bar
Pump type	Radial Piston
Motor	10.0 hp (7.5 kw) Yanmar diesel
Displacement	418 cc
Fuel tank capacity	5.4 L
Approx. Fuel run time	4 hrs
Hydraulic oil	Mineral Base
Deployment weight	105.3 kg
Width	686 mm
Height	635 mm
Length	946 mm
UL classified	Yes
NFPA 1936 compliant	Yes



Bantam Pump Codes TNT-BT-3.0 (Honda 3.0 HP, OHV 4 cycle) and TNT-ET-2.0 (Electric 2.0 HP)

Key Features

- Lightweight with easy manoeuvrability
- Small and compact for convenient storage
- 2 tool connection allows alternate operation of tools
- 4 stroke overhead valve Honda engine
- Optional roll cage (ET 2.0 roll cage standard)
- Supercharged hydrostatic two-stage radial piston pumps
- Spark arrestor muffler standard
- Hour meter standard on all Honda motors
- Available with 3.0 HP Honda motor or Leeson electric motor



TNT-ET-2.0

Product Specifications

Models	TNT-BT-3.0	TNT-ET-2.0
Max. operating PSI	10,500 PSI/724 bar	10,500 PSI/724 bar
Pump type	Radial Piston	Radial Piston
Motor	3.0 hp (2.2 kw) Honda Petrol	1.2 hp (1.31kw) Leeson electric
Displacement	98 cc	N/A
Fuel tank capacity	1.21 L	N/A
Approx. Fuel run time	1.3 hrs	N/A
Deployment weight	24.2 kg	36.32 kg
Width	305 mm	305 mm
Height	435 mm	343 mm
Length	533 mm	610 mm
UL classified	Yes	N/A
NFPA 1936Compliant	Yes	N/A

*5500 PSI units also available. Please contact Ferno for more details



TNT-BT-3.0

Air Hydraulic Pump Codes TNT-ARP

Key Features

- Lightweight, high strength, corrosion resistant aluminium reservoir
- Internal dual stage pressure relief valve
- Able to operate from existing SCBA cylinders



TNT-ARP

Hydraulic Hand Pump Codes TNT-HDP

Key Features

- Two-stage operation
- Single-tool operation

Product Specifications

Models	TNT-ARP	TNT-HDP
Max. operating PSI	10,500 PSI/724 bar	10,500 PSI/724 bar
Pump type	Piston	Piston
Motor	air (90-175psi)	Hand operated
Engine type	Air hydraulic	Hand pump
Deployment weight	9.9 kg	13.1 kg
Width	147 mm	99 mm
Height	220 mm	296 mm
Length	330 mm	679 mm



TNT-HDP

TNT Rescue High Pressure Lifting Bags

TNT Rescue High Pressure Lifting Bags are durable bags made from SBR rubber, which is resistant to physical and chemical damage. These bags are strengthened by Kevlar cord reinforcement. Interlocking dimples provide superior gripping, therefore significantly reducing the possibility of slippage and making it safer to use a combination of lifting bags in one single lifting operation.



TNT High Pressure Lifting Bags

Key Features

- Operating Pressure: 118 psi (8 bar)
- Operating Temperature: -40° C to 110° C
- Thickness: 25 mm
- Test Pressure: 177 psi (12 bar)
- Surface: Interlocking dimples provide superior gripping
- Safety Factor: 4 to 1 or 472 psi (32 bar)



Product Specifications

Models	SLK 1/3	SLK 3/5	SLK 7/6	SLK 9/7	SLK 13/9	SLK 21/11	SLK 26/12	SLK 34/14	SLK 43/17	SLK 70/20
Size	15 x 15 cm	22.5 x 22.5 cm	30 x 30 cm	38 x 38 cm	45 x 45 cm	55 x 55 cm	61 x 61 cm	69 x 69 cm	78 x 78 cm	91 x 91 cm
Lifting Height	7 cm	13 cm	15 cm	18 cm	22 cm	27 cm	30 cm	36 cm	42 cm	51 cm
Capacity Lift	1,000 kg	2,800 kg	5,700 kg	9,600 kg	12,700 kg	20,300 kg	24,700 kg	31,500 kg	41,400 kg	66,100 kg
Individual Weight	0.60 kg	1.3 kg	2.4 kg	4 kg	5.3 kg	8.1 kg	11.2 kg	13.3 kg	18.2 kg	25.3 kg

TNT Rescue Medium Pressure Lifting Bags

Key Features

- Heavy duty Kevlar reinforced construction ensures excellent operation over time
- Over-pressure safety relief valve
- Can be inserted under objects with just 50 mm clearance
- Interior 25 mm terylene web restraints (1 US ton test)
- Claw type coupling inflation port for quick attachment
- Lifting capacities up to 11,902 kg
- Operating pressure 1 bar

Product Specifications

Models	SMP 24/17	SMP 30/23	SMP 36/24	SMP 48/40
Diameter	61 cm	76 cm	91 cm	122cm
Max. Lift capacity	2,976 kg	4,650 kg	6,694 kg	11,902 kg
Max. Lift	43 cm	59 cm	61 cm	100 cm
Volume	295 L	620 L	900 L	3,010 L
Weight	6 kg	7 kg	7 kg	10 kg



TNT Rescue Lifting Bags Flat Form

Key Features

- 2 or 3 bags may be stacked for greater lifting height
- Resists rolling and shifting. Will not round out as it is inflated
- Flat-form bags retain their flat surface for greater stability and greater lifting height
- High pressure means heavy lifting 116 PSI max
- About 25 mm in height per bag (deflated)

Product Specifications

Models	SFF-7/7	SFF-12/7	SFF-20/8	SFF-35/8
Bag dimension	55 x 55 cm	61 x 61 cm	78 x 78 cm	91 x 91 cm
Max. Lift capacity	7, 112 kg	12, 193 kg	20, 321 kg	35, 562 kg
Max. Lift height	8 cm	18 cm	20 cm	20 cm



TNT Rescue High Pressure Power Lift Programs

Codes TNT-ABSS42 (42 Ton Starter Set), TNT-ABMS110 (110 Ton Medium Duty Set) and TNT-ABAS162 (162 Ton Advanced Set)

The TNT Rescue High Pressure Power LIFT Program offers a kit system approach to your lifting bag needs.

42 Ton Starter Set

- 2 x SLK-21/11 Lifting Bags
- 1 x U-0450 Regulator (6000 psi)
- 1 x HD-2 Dual Deadman Controller
- 1 x HH-20' blue hose
- 1 x HH-20' red hose

110 Ton Medium Duty Set

- 2 x SLK-21/11 Lifting Bags
- 2 x SLK-34/14 Lifting Bags
- 1 x U-0450 Regulator (6000 psi)
- 1 x HD-2 Dual Deadman Controller
- 2 x HH-35' green and black hose
- 2 x HI-35' red and blue hose w/inline relief

162 Ton Advanced Set

- 1 x SLK-9/7 Lifting bag
- 2 x SLK-21/11 Lifting bags
- 2 x SLK-34/14 Lifting bags
- 1 x SLK-43/17 Lifting bag
- 2 x U-0450 Regulator (6000 psi)
- 2 x HD-2 Dual Deadman Controller
- 2 x HH-35' Green & black hose
- 2 x HI-35' Red & blue hose w/inline relief

TNT Rescue Tool Mounts Plastic and Steel

TNT Tool Mounts are designed to hold your TNT Rescue Hydraulic Tools securely in place while in a vehicle or in storage. TNT Tool Mounts are available in both plastic and steel.



Couplers

All TNT Rescue tools come with an option of couplers. Including our standard coupler, optional flat coupler or the new Nexus Shunt Valve Coupler.

The Nexus Coupler is the ultimate single connection coupler system designed with the ability to hot swap tools on over 100 feet of hose with no requirement for a special tool to release the pressure. The Nexus Coupler features a unique system that allows maximum flow to the tool, which reduces the temperature and allows for maximum speed and performance. A safety lock has been added for extra security to eliminate tool disconnect during use. We are so confident in this new technology that we back it with TNT's True Lifetime Service and Warranty.



Maglite D-Cell Flashlight Codes DET-MD2, DET-MD3, DET-MD4 and DET-MD5

Every Maglite D-Cell Flashlight embodies a precise balance of refined optics, efficient power, durability and quality. Each Maglite D-Cell Flashlight includes two high intensity White Star Krypton Gas Lamps for enhanced brilliance and extended range.

Key Features

- Self-cleaning rotary switch, three positions - on, off and signal
- High-intensity light beam
- Individually serial numbered
- Half turn, cam action focus, spot-to-flood
- Spare lamp safely secured in the tail cap
- High strength aluminium alloy cases
- O-ring sealed for water resistance
- Limited lifetime warranty



Product Specifications

	Code	Length	Barrel Diameter	Head Diameter	Weight With Batteries	Battery Required
2D-Cell Mag-Lite Flashlight	DET-MD2	254 mm	40 mm	57 mm	674 g	2 x D Size Alkaline
3D-Cell Mag-Lite Flashlight	DET-MD3	313 mm	40 mm	57 mm	856 g	3 x D Size Alkaline
4D-Cell Mag-Lite Flashlight	DET-MD4	374 mm	40 mm	57 mm	1043 g	4 x D Size Alkaline
5D-Cell Mag-Lite Flashlight	DET-MD5	434 mm	40 mm	57 mm	1233 g	5 x D Size Alkaline
6D-Cell Mag-Lite Flashlight	DET-MD6	495 mm	40 mm	57 mm	1423 g	6 x D Size Alkaline

Mag Charger Rechargeable Flashlight System Code DET-MBC (system) DET-MR (battery only)

Without question the Mag Charger Rechargeable Flashlight System is the ultimate lighting tool. Refined and enhanced over many years of dedicated service, the Mag Charger Rechargeable Flashlight System is chosen by professionals worldwide.

Key Features

- Solid-state electronics
- Limited lifetime warranty
- Individually serial numbered
- Up to 1000 hours of battery life
- Durable extra hard anodised finish
- Charger operates on A/C or D/C current
- Easily replaced high intensity halogen lamp
- One quarter turn, cam action focus, spot-to-flood
- Self-cleaning rotary switch, three positions - on, off and signal



Product Specifications

Length	Barrel Diameter	Head Diameter	Weight With Batteries	Peak Beam Candle Power	Battery Life Continuous On Time	Battery Required
320 mm	40 mm	59 mm	907 g	Up to 51,700 PBC	Up to 2 hours	Mag Charger Rechargeable NiCad Battery Pack

Mini Maglite Flashlight 2-Cell AA Code DET-MAA

The Mini Maglite Flashlight 2-Cell AA is a classic American design. Famous around the world for its brightness, quality, durability and dependability.

Key Features

- High-intensity light beam
- Half-turn, twist-focus, spot-to-flood
- Spare lamp safely secured in the tail cap
- High strength aluminium alloy case
- Limited lifetime warranty



Product Specifications

Length	Barrel Diameter	Head Diameter	Weight With Batteries	Break Down Candle Power	Battery Required
146 mm	18 mm	25 mm	107 g	Up to 2,952	2 x AA Size Alkaline

Mini Maglite Flashlight 2-Cell AAA Code DET-MAAAB

The Mini Maglite Flashlight 2-Cell AAA has all the same features and functions as the Mini Maglite Flashlight AA in a smaller, lighter version for ease of use and storage.

Key Features

- High-intensity light beam
- Half-turn, twist-focus, spot-to-flood
- Spare lamp safely secured in the tail cap
- High strength aluminium alloy case
- Limited lifetime warranty



Product Specifications

Length	Barrel Diameter	Head Diameter	Weight With Batteries	Break Down Candle Power	Battery Required
127 mm	13 mm	19 mm	49 g	Up to 488	2 x AAA Size Alkaline

Princeton Tec Blast Handheld Code OUTD-PRI10003

This little powerhouse delivers a surprising blast of light given its compact size. The Blast maintains waterproof integrity to 100 metres.

Key features

- Power: 14 Lumens
- Batteries: 2 x AAA Alkaline
- Weight: 44 g (with batteries)
- Burn time: 3 hrs



Princeton Tec AMP 3.0 Handheld Code OUTD-PRI100013

The AMP 3.0 defies size perceptions with 40 lumens of pure white light in a compact and rugged Xylex housing. The AMP 3.0 offers 30% greater lighting courtesy of the latest Princeton Tec LED technology. This combined with two output settings and a regulated circuit provides 90 hours of illumination.

Key features

- Power: 40 Lumens
- Batteries: 4 x AAA (included)
- Lamp: 4 x 5mm Ultrabright LED
- Burn time: 90 hours
- Weight: 122 g (with batteries)



Princeton Tec AMP 5.0 Handheld Code OUTD-PRI100015

The AMP 5.0 offers area lighting and long distance spot beam. The soft cycle push button switch offers instant access to the 3 ultrabright LEDs or the Maxbright Rebel LED, while regulated circuitry provides constant brightness and enough burn time to get you through 160 hours of darkness.

Key features

- Power: 65 Lumens
- Batteries: 4 x AA (included)
- Lamp: 3 x 5 mm Ultrabright LED
- 1 x Maxbright Rebel LED
- Burn time: 160 hours
- Weight: 213 g (with batteries)



Princeton Tec Fuel Code OUTD-PR100000

The Princeton Tec Fuel is designed to meet the widest range of applications while remaining small, lightweight and robust. Suitable for camp set-up, trekking, climbing and emergency signalling. An adjustable pivoting head allows you to shine light where you need it. Three ultrabright LEDs configured in a row provide even light that keeps shadows to a minimum. An electronically controlled switch system provides three levels of light output as well as two blinking emergency signalling modes. The ultra-light head strap provides plenty of adjustment for the perfect fit.

Key Features

- Power: 35 Lumens
- Batteries: 3 x AAA (included)
- Weight: 78 g (with batteries)



Princeton Tec EOS 2 Industrial Headlamp Code OUTD-PR100002

The Class I, Division 1 rating makes the EOS II the safest choice when working in hazardous environments because of its intrinsically safe rating, high performance and compact size. The single Maxbright Rebel LED puts out an incredible 50 lumens and has a running burn time of up to 60 hours. The EOS II comes with a rubber head band that really sticks to an industrial hard hat or rescue helmet. Waterproof to one meter, the EOS II is an excellent choice when swimming rivers or working in similar environments. Also comes with the standard elastic and Velcro mounting patch. UL Class I, Div 1, Groups A, B, C, D*

* When used with 3 alkaline batteries.

Key Features

- Power: 50 Lumens
- Batteries: 3 x AAA (included)
- Weight: 105 g (with batteries)



Princeton Tec APEX Headlamp Code DET-PTAP

The Princeton Tec APEX Headlamp is ideal for use at long and short distances with 130 lumens of light, regulated LEDs, five modes, heat regulation and a battery power meter. The APEX combines a regulated three watt Maxbright LED with four regulated Ultrabright LEDs for constant brightness on all modes. A dual switch system allows the user to switch modes and independently control the intense, smooth or long range lighting. Available in orange (as shown) or black.

Key Features

- Power: 60 Lumens
- Batteries: 4 x AA alkaline, lithium, NiMH recharge
- Weight: 279 g



Snap Lite Lightstick Safety Light Code CMC108016 (green) and CMC108017 (yellow)

The Snap Lite Lightstick Safety Light is a chemical lightstick that has proven to be the ideal safe alternative light source. Lightsticks are spark proof, non-flammable, non-toxic, non-corrosive and weather proof and have played an essential role in lighting everything from accident scenes to hell spots. These light sources are ideal for marking the location of access points, personnel and equipment. Snap Lite Lightstick Safety Lights are available in yellow and green and burn for up to 12 hours.



TFT Res-Q-Rench Code CMC635025

This versatile multi-purpose tool is designed for ground fire operations and rescue incidents. Manufactured from high strength nylon, the TFT Res-Q-Rench is lightweight at 142 g but rugged enough to provide years of reliable service.

Key Features

- Designed to work with rocker lug handline and supply line couplings
- Works with 10 cm - 12.5 cm Storz locking coupling
- Carbide tip window punch
- Heavy-duty seat belt cutter
- Pry bar for windows
- Door or window prop
- Fits many residential gas shut off valves
- Length: 21 cm (closed) and 31.5 cm (open)



CMC Rescue Seat Belt Cutter Code CMC294020

The CMC Rescue Seat Belt Cutter is an inexpensive, razor sharp seat belt cutter that should be kept in every vehicle and first aid kit. It can be easily and safely used by anyone to quickly cut seat belts, web or light cord. This is a lightweight tool that weighs only 28 g.



Guides Safety Knife Code CMC294013

The Guides Safety Knife is the safe way to cut rope and webbing without having an exposed blade. This knife will cut flat or tubular webbing up to 6 mm and most ropes up to 1.5 cm thick. For convenience and to ensure that you are never caught out with a blunt blade there is a handy set of replacement blades stored in the handle. This knife comes in vibrant yellow.



Res-Q-Me Rescue Tool Code CMC634007

The Res-Q-Me is the ideal personal rescue tool for vehicle accidents and emergencies. Small enough to fit on a key chain and weighing just 17g, the Res-Q-Me easily cuts through seat belts and breaks side and rear vehicle windows. Using a concealed spring, less than 5 kg of force is needed. The Res-Q-Me is safe and easy to carry in your pocket, bag or purse.



Pacific Folding Knife Code INK-PFK

This folding knife contains all the essential safety and functional features to ensure quick operation in emergency and rescue situations. The 8.5 cm curved, serrated and recessed blade has a rounded blunt tip to avoid accidents when dropped or if used within close proximity to the skin. Ideal for cutting webbing, rope and other items that may be hindering escape in an emergency or rescue situation. The sturdy handle is 12 cm in length and 2.5 cm wide making it easy to control the blade or the glass punch that is inserted into the base of the handle. The recessed webbing blade is ideally placed to achieve optimum control and safety while operating. This knife is fitted with a blade safety lock and belt clip. All knives come with a pouch that is fitted with a clip so that the knife can be kept on hand at all times.



Universal Scissor Code INS-U

The Universal Scissor is lighter and safer to use than a knife when cutting through the likes of clothes, seat belts and harnesses. The Universal Scissor is ideal for emergency situations and is made from stainless steel with polypropylene handles. These large utility scissors effortlessly fit within most Ferno belt holsters, clip on to a karabiner or easily fit into an emergency pack or kit so they are readily accessible in an emergency situation. Autoclaveable to 143° C.



Xcaper Smoke Filters and Masks

The Xcaper Smoke Filter is the world's first moist direct-contact smoke and particulate filtration mask. It uses patented technology combining a natural-based aloe gel extract and negatively charged styrene beads to attract and neutralise initially 100% of gases like Hydrogen Cyanide, Acrolein and Carbon Monoxide. It reduces 100% of dust and particulate matter down to 3/10th of one micron. The Xcaper technology is lab-verified, approved for use by the US Navy and has been proven in tens of thousands of live fire situations over the last six years by more than 75,000 professional firefighters. The unique features of this smoke mask provide it with unsurpassed ease-of-use, comfort, respiration, portability and unparalleled protection.

Xcaper Moist Filter *Codes XC-F-XF*

The revolutionary Xcaper Moist Filter delivers unparalleled protection by trapping particulate matter and absorbing hazardous gases common to smoke in bush fires, structural fires, overhaul, arson investigation and various SWAT situations. The cloth of the filter passes the California E117 burn test (direct flame for 38 seconds before the cloth will ignite). The contents of the filter include a combination of a proprietary, all-natural plant extract which is hypoallergenic, and styrene beads. This formula makes the Xcaper Moist Filter feel moist and cool to the touch. The gel will not steam, so there is no risk of steam burns. The styrene beads are used as a medium to trap the particulate matter and allow the filter to fit any shape or size face. Laboratory tests indicate that the Xcaper Moist Filter will trap anhydrite water-soluble gases such as Hydrogen Cyanide, Carbon Monoxide and Acrolein. The filter will last five to eight hours in a bush fire situation. For optimal performance, keep the Xcaper Moist Filter in its original vacuum sealed, airtight bag until ready to use. The Xcaper Moist Filter is lightweight at only 62 g.



Whiffs Brush-Pro Mask *Code XC-BPM-WHIFM*

Whiffs Brush Pro Mask is easier to put on and take off. We've replaced the Velcro head strapping system with an elastic band made of Nomex material, simply tie the elastic band behind your neck. The Whiffs Brush-Pro is also made of Advance Nomex, which carries a 565°C heat rating. The breathing port of the mask is made of Nomex knitted hood material which also carries a 565°C heat rating. The Whiffs Brush-Pro Mask is lined with blue Indura Ultra Soft cloth with a hydro lone finish. This material helps to wick moisture from the firefighter's face and prevents the transfer of radiant heat to the skin. It is excellent for bushfire fighting and is perfect for structural overhaul/mop-up. Its sleek design makes it comfortable to wear, even in hot climates. The black velcro attachment point at the bridge of the nose on the outside of the Whiffs Brush-Pro Mask should be used for attaching to goggles. The other three velcro attachment points on the outside of the mask are for attaching the optional neck shroud.



The Whiffs Tac-Air Pro Mask *Code XC-TAPM-WTAPM*

The Whiffs Tac-Air Pro Mask is easy to put on and take off with a new elastic band made of Nomex material, simply tie the elastic band behind your neck. The Whiffs Tac-Air Pro Mask was developed for police and SWAT departments. The mask and breathing port of the mask are made of black Nomex material which carries a 565°C heat rating. The Tac-Air Pro Mask is lined with blue Indura Ultra soft cloth with a hydro lone finish. This material helps to wick moisture from the user's face and prevents the transfer of radiant heat to the skin. The mask can also be used for bush firefighting and for structural overhaul/mop-up. Its sleek design makes it comfortable to wear, even in hot climates. The black velcro attachment point at the bridge of the nose on the outside of the mask can be used for attaching to goggles. Weight 57 g.



Whiffs Nomex Shroud *Code XC-BPS-WMSRD*

The Whiffs Nomex Shroud fits the Whiffs Nomex Mask and is made of Advance Nomex which carries a 565°C rating. The shroud is lined with blue Indura Ultra Soft cloth with a hydro lone finish. This material helps to wick moisture from the firefighter's face and prevents the transfer of radiant heat to the skin. It is the perfect accessory when more protection is needed. The three velcro attachment points on the inside of the mask should be used to attach to the Whiffs Nomex Mask. The Whiffs Nomex Shroud is machine washable in cold water and should be hung out to dry. Weighing only 73 g, this shroud is lightweight and easy to use.



Whiffs Manta *Code XC-WMX20, XC-WMX30*

The New Manta X20 and X30 are made of Carbon X material and Kevlar elastic with Nomex thread. The Manta X20 and X30 are easy to use just like a Bandana and is made with a stretchable material which makes it easy to pull down and up when needed. Used with an Xcaper Filter (which filters hazardous gases and vapors and 100% of particulate matter) you have the perfect combination of protection for 4 to 6 hours. The filter simply Velcro's to the inside of the bandana. Each Manta comes with one Xcaper Moist Filter. (The Manta X30 is a slightly larger version of the Manta X 20).



Alta Superflex Knee Pads Code CMC355413

Many emergency workers spend a lot of time working on their knees. This is particularly true on heavy rescue operations, confined space entries or tactical responses. Alta Superflex Knee Pads have a full 12 mm layer of foam padding which helps to reduce stress and fatigue to the knees, allowing you to work longer and more effectively. Alta pads are lightweight, weighing only 340 g. The rubber caps grip the surface to prevent sliding. The unique buckle fastening system is easy to use and allows a comfortable fit that minimises interference with circulation to the lower legs. Available in black.



Alta Flex Industrial Elbow Pads Code CMC355310

Alta Flex Industrial Elbow Pads are designed to protect your elbows when crawling and are valuable for horizontal confined space entries, cave rescue or tactical responses. The non-slip, rubber caps actually grip the surface, allowing for faster movement. The unique buckle fastening system is easy to use and allows a comfortable fit that minimises interference with circulation. Alta Flex Industrial Elbow Pads weigh only 170 g and are available in black.



Skylotec Sky Crown Helmet Code VSKY SKYCROWN ORA

An innovative and stylish helmet with an integrated venting system. A unique interior padding system combined with German engineering provides a very comfortable fit with superior safety and impact resistance. Further adjustment and comfort can be had via a unique adjustment dial at the rear of the helmet. Certified to EN 397. Weight 440 g. Contact Ferno for colour options.



Skylotec Skybowl Helmet Code VSKY BE-018-200

The Skybowl combines all the great functions of a lightweight climbing helmet with a unique adjustable ventilation system. The ventilation adjusting mechanism is easy to reach at the back of the helmet and is simple to handle even with gloves. At the same time the SkyBowl offers high comfort, a mesh spider strap, stage less quick-adjustment a head lamp holder and much more. Certified to European standard EN397. Weight 400 g. Contact Ferno for colour options.



The Vertical Sunbrero Code VAS SUNBRERO

Fits over your helmet and extends beyond the rim to block 100% of UV ray and to stop glare and sun from your face, ears and the back of your neck. Made of durable, cordura nylon, the Sunbrero has an elastic band that grips to the Skylotec helmets and secures to the headlamp retainer clips.



Fox 40 Whistle

Codes CMC180011 (orange), CMC180013 (red), CMC180021 (orange with Flex Coil)

The Fox 40 Whistle is a reliable whistle that works under almost any conditions and has a reputation for being one of the loudest whistles available. This whistle is made of a durable plastic and does not have a pea that will stick or swell when wet, nor will it rust or transfer cold like a metal whistle. The Fox 40 Flex Coil provides several options for wearing the Fox 40 Flex Coil Whistle. The coil can be attached to your PFD or radio chest harness to keep the whistle close at hand, but out of the way. If the whistle is needed frequently then the coil can fit over the wrist.



Rescue and Workplace Communication Systems from Con-Space

Con-Space full duplex hands-free Rescue and Workplace Communication Systems are designed for Urban Search and Rescue (USAR) disasters and hazardous workplace situations that permits controlled confined space entry when there is a vital communication need. Con-Space can provide various systems that are intrinsically safe, water and dust proof. Designed to interface with any type or style of breathing apparatus, gas tight chemical suits, high heat and clean room PPE, even in high-noise environments. Contact Ferno Australia for further product information.



Con-Space Victim Locator Kit 1



Con-Space Rescue Kit 1P

The Con-Space Two-Way Radio Accessory and Close Proximity Communication Solutions are a high performance, reliable and rugged solution that can interface with all types of respiratory equipment such as SCBA (Self Contained Breathing Apparatus), PAPR (Powered Air Purifying Respirator), SAR (Supplied Air Respirator) and APR (Air Purifying Respirator) and protective suits such as gas tight chemical, high heat close proximity, NBC (Nuclear Bacterial Chemical) and clean room. Designed and built for use in dangerous and hostile situations encountered by police, rescue, ambulance, fire and defence personnel, and in hazardous environments including oil and gas, explosive materials, mining and smelting industries. Each system has either a throat or boom microphone. The patented throat microphone delivers clear voice reproduction, eliminating air noise and significantly reducing ambient noise from high noise situations. The radio accessories large push to touch (PTT) switch works even through heavy clothing, bunker gear, or protective haz-mat suits. Contact us for a copy of Radio Accessory Guide.

Note: At time of ordering, Ferno will need to know the make and model of your two-way radio. Radio connectors are hard-wired to systems at time of manufacture to comply to intrinsically safe requirements and to ensure water and dust tight integrity.



Con-Space SR65M Intrinsically Safe Modular Radio Accessory



Con-Space SRVA Radio Accessory & Close Proximity Voice Amplifier

CMC Confined Space Entry & Rescue Training Manual

Code CMC993214

Newly revised, the CMC Confined Space Entry & Rescue Training Manual is the textbook for the confined space rescue course taught by the CMC Rescue School. It is the official textbook for the California State Fire Marshal's state-certified confined space rescue courses, and the training manual of choice for fire departments and industrial rescue teams worldwide. All chapters have been updated and expanded for the second edition, and three new chapters have been added: Communications, High Point Anchor Systems, and Permitting Confined Spaces. Color has been added to most of the more than 150 illustrations for improved clarity.

CMC's instructors are recognised experts in confined space entry and rescue training and operations. Their input in refining this manual ensures that it contains the most practical, up-to-date information on: laws and regulations for confined space entry in the USA; development of a rescue team; assessment and preparation for entry; organisation of an emergency response; monitoring for and managing atmospheric and other hazards; rescue equipment; and patient transport. Quality paperback, 282 pages.

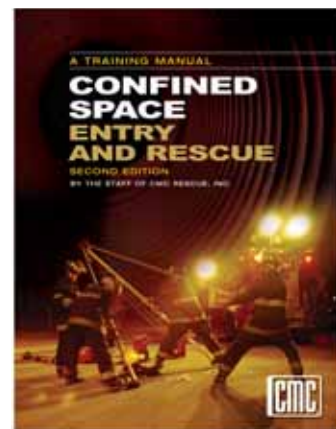

CMC Rope Rescue Manual 4th Edition

Code CMC993221

With over 45,000 copies sold, the CMC Rope Rescue Manual has become the standard reference for many departments and rope rescue training programs. The manual reflects what we have learned through many years of responding to rescues and teaching thousands of students. Now in its third edition, the manual has been updated and several new chapters have been added. The extensive use of illustrations and step-by-step procedures help the reader to develop or expand rope rescue knowledge and skills. Topics include: safety, equipment, rappelling, pick-offs, stretcher evacuations, patient packaging, improvised high anchor points, and organising the response. More than 240 illustrations and photos take you step-by-step through lowering and raising systems, mechanical advantage, and rappel-based rescues. Quality paperback, 208 pages.

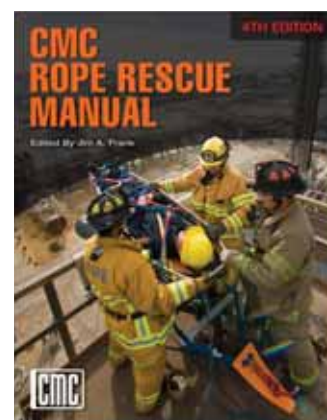

SAM OnScene Patient Assessment Guide

Code SAM-7000

Jotting down notes or taking a history can be next to impossible during a fast-paced, emergency call. To save precious seconds you write on medical tape, pillow cases, rubber gloves, or whatever is in your reach. The SAM OnScene Patient Assessment Guide is a durable, waterproof, write-and-wipe note pad containing essential assessment questions for the most common emergency calls. Many questions can be answered by checking yes-or-no boxes or by circling a selection. You write on the pad with a smear-proof fast drying Sharpie permanent marker which easily wipes clean with alcohol. For an inexpensive permanent record, you can photocopy your notes before its next use.

Size 10 cm x 20 cm



SAM OnScene Knee Board

Code SAM-7001 (Orange) SAM-7002 (Black)

The SAM OnScene Knee Board makes your OnScene Patient Assessment Guide immediately available. It secures the Guide to your thigh with a comfortable wide elastic band. When the use of both of your hands is crucial the SAM Knee Board is your best friend. It allows you to take notes quickly and easily while keeping your hands free for patient care.



Knee board supplied without assessment guide

FreeForm SE (Standard Examination) Nitrile Glove Code MFFF

The FreeForm SE Nitrile Glove is a super-soft nitrile formulation offering a latex-like fit and feel. The FreeForm SE Nitrile Glove offers comfortable strength in a relaxed fit examination glove. Unlike conventional nitrile gloves, the FreeForm SE Nitrile Glove works with your hands as they move. These gloves provide reliable protection against pathogens and are impervious to oil, grease and petrol. This glove features textured finger tips for a secure grip.

Product Specifications

Sizes	XS, S, M, L, XL	Elasticity/Elongation	500%
Gloves per box	100	Colour	Blue
Length	245 mm	Cuff	Beaded
Glove Exterior	Textured fingers		



FreeForm EC (Extended Cuff) Nitrile Glove Code MFFEC

The FreeForm EC has many of the features of the FreeForm SE with the additional feature of an extended cuff and a thicker cover for added protection and coverage.

Product Specifications

Sizes	S, M, L, XL, XXL	Elasticity/Elongation	500%
Gloves per box	50	Colour	Blue
Length	290 mm	Cuff	Extended, Beaded
Glove Exterior	Micro-textured fingertips		



Supreno Nitrile Glove Code MFSS

The Supreno Nitrile Glove is an odourless synthetic glove for high-risk areas. This nitrile glove is completely powder-free and textured for wet and dry gripping, offering a sensitive feel. These gloves are impervious to oil, grease and petrol.

Product Specifications

Sizes	XS, S, M, L, XL	Elasticity/Elongation	500%
Gloves per box	100	Colour	Blue
Length	245 mm	Cuff	Beaded
Glove Exterior	Textured fingers		



Supreno Plus Nitrile Glove Code MFSP

The Supreno Plus is an odourless synthetic glove for high-risk areas. This nitrile glove is completely powder-free and textured for reliable grip. It offers comfort and durability with an extended cuff for extra protection. The Supreno Plus is a sensitive synthetic glove designed to withstand rough handling. They are impervious to oil, grease and petrol.

Product Specifications

Sizes	XS, S, M, L, XL	Elasticity/Elongation	500%
Gloves per box	50	Colour	Blue
Length	290 mm	Cuff	Extended, Beaded
Glove Exterior	Textured fingers		



Midnight Black Nitrile Glove Code MFMK

The MidKnight glove is a black, powder free nitrile glove that offers the superior combination of durability and protection against day-to-day hazards. MidKnight provides an exceptional balance of performance, comfort and durability. Designed specifically with a distinctive black colour that resists stains.

Product Specifications

Sizes	S, M, L, XL, XXL	Elasticity/Elongation	550%
Gloves per box	100	Colour	Black
Length	245 mm	Cuff	Beaded
Glove Exterior	Fully Textured (XXL glove is fingertip textured only)		



Diamond Grip Plus Latex Glove Code MFDGP

For those who prefer powder-free protection and a secure grip, the Diamond Grip Plus glove is the glove of choice. It has textured fingers for exceptional wet and dry gripping. Perfect for every day use, the Diamond Grip Plus is a clean, low odour, high elasticity glove that minimises hand strain. The low modulus latex allows greater manual dexterity and lessened hand fatigue.

Product Specifications

Sizes	XS, S, M, L, XL	Elasticity/Elongation	711%
Gloves per box	100	Colour	White
Length	240 mm	Cuff	Beaded
Glove Exterior	Fully textured		



Synetron Plus Latex Glove Code MFSY

The Synetron Latex Glove is designed for hazardous work. An interior / exterior polymer coating system provide superior anti-sticking properties that assist with donning in wet, damp or dry conditions. The Synetron Plus offers great film stability and an extended, beaded cuff for greater protection over the wrist and arm, making the Synetron Plus glove technically superior.

Product Specifications

Sizes	S, M, L, XL	Elasticity/Elongation	700%
Gloves per box	50	Colour	Natural
Length	290 mm	Cuff	Extended, Beaded
Glove Exterior	Fully textured		



Safegrip Latex Glove Code MFSG

The Safegrip Latex Glove is a powder-free latex glove that has been made for hazardous environments. This glove is four times thicker than standard latex examination gloves. The extended cuff offers added protection against splashes and spills. If you work in a non-medical environment and need a glove with strength, durability and grip, the Safegrip is for you.

Product Specifications

Sizes	S, M, L, XL	Elasticity/Elongation	701%
Gloves per box	50	Colour	Blue
Length	290 mm	Cuff	Extended, Beaded
Glove Exterior	Textured fingertips		



Virkon Surface Disinfectant Solution Codes CPRL-VS (10 x 50 g sachets) and CPRL-VT (10 x 5 g tablets)

Virkon is the ultimate high level surface disinfectant and provides unequalled protection from infection. It is a working solution that has an exceptional safety profile and is compatible with a wide range of materials including stainless steel, plastics and rubber. Virkon Surface Disinfectant Solution is an easy to use product, which has a broad spectrum of activity; it can be used in a large number of applications and is biodegradable.



Cool Vest RPCM Technology

The RPCM (Renewable Phase Change Material) Cool Vests are suitable for anyone working in warm to hot temperatures for short or prolonged periods of time. The total weight of the RPCM Cool Vest is less than 2.3 kg, yet the Cool Vest maintain a constant dry 15°C for up to 2.5 hours in ambient temperature of up to 38°C. Cool packs are dry and do not sweat or produce condensation, leaving you cool, dry and comfortable. RPCM Cool Vests recharge in only 20 minutes in ice water or 30 minutes in the fridge or freezer. Keep a set of charged Cool Packs on site in a portable cooler for quick and easy changeovers. The chemical in the RPCM Cool Packs is completely non-toxic, non-flammable, safe and environmentally friendly. Should the RPCM Cool Packs rupture, it is easily washed off with mild soap and water.

Classic RPCM Cool Vest *Code GT-SCV-RB*

The Classic RPCM Cool Vest is suitable for anyone working in extreme temperatures for prolonged periods of time. The Classic RPCM Cool Vest is hard wearing blue cotton twill that features over-the-shoulder and side strap adjustability. In addition, this vest features a heavy-duty front zipper that assists with ease of wearability. The Classic RPCM Cool Vest provides the user with maximum ergonomic comfort.



High Visibility RPCM Cool Vest

Code GT-SCV-YR (lime green) and GT-SCV-OR (orange)

The High Visibility RPCM Cool Vest is ideal for use where high visibility garments are required and for anyone working in extreme temperatures for prolonged periods of time. This vest is ideal to wear in road gangs and construction sites. This Cool Vest conforms to AS-4602. The High Visibility RPCM Cool Vest features over-the-shoulder and side strap adjustability. In addition, this vest features a heavy-duty front zipper that assists with ease of wearability.



Fire Retardant RPCM Cool Vest *Code GT-SCV-FR*

The Fire Retardant RPCM Cool Vest is specifically constructed from fire retardant materials and is ideal for workers in environments where sparks or flames are present, making this garment ideal for firefighters and welders. The Fire Retardant RPCM Cool Vest is suitable for anyone working in extreme temperatures for prolonged periods of time. Made from hard wearing, fire retardant material and features over-the-shoulder and side strap adjustability. In addition, this vest features a heavy-duty front zipper that assists with ease of wearability.



RPCM Cool Pack Set of Four *Code GT-RSPS15XX*

RPCM cool packs come in sets of four and are easily rechargeable. They can be completely recharged in ice water in only twenty minutes or in a refrigerator or freezer in thirty minutes. It is easy to tell when the RPCM Cool Packs are completely charged, as the clear liquid inside turns a solid white colour. RPCM Cool Packs are an ideal source of temperature relief as they can maintain a 15°C temperature as long as any portion of the phase change material remains solid within the pack. All RPCM Cool Vests are supplied with rechargeable RPCM Cool Packs. Additional cool packs are sold separately.



RPCM Chilly Dog

Code GT-RCCD15XX-A (Chilli Dog Vest and RPCM Packs) and GT-RCCD15XX-B (Chilli Pup Vest and RPCM Packs)

The RPCM Chilly Dog is a powerful cooling device originally designed for defence and law enforcement working dogs. The RPCM Chilly Dog has adjustable buckles and strapping around the chest to ensure a secure and comfortable fit for all sizes of working and domestic dogs. It is available in two sizes.



Acknowledgements

Image on inside front cover, page 51, 57, 58 & 59 courtesy of Weinmann Medical Technology

Image on cover, inside front cover & page 103 courtesy of Highpoint Access & Rescue

Image on page 107 courtesy of CMC Rescue

Designer: Choice Creative

Emergency Rescue

Height Safety
Rock Climbing
Home Care
Mortuary

Ferno Australia

Head Office
11 Johnstone Road
Brendale Qld 4500
Australia

Call toll free
1800 804 647

p +61 7 3881 4999
f +61 7 3881 1125

VIC
18 Damosh Avenue
Carrum Downs VIC 3201
p +61 3 9775 1260
f +61 3 9775 1360

WA
22 Casella Place
Kewdale WA 6105
p +61 8 9353 2300
f +61 8 9353 1169

www.ferno.com.au

 **FERNO**
Australia

Distributor