

CATALOGUE | CATALOGO

2016



H.P. WATER CLEANERS › VACUUM CLEANERS

IDROPULTRICI › ASPIRATORI

MER

MERCURY

**MERCURY**

## ELECTRICAL COLD WATER H.P. CLEANERS IDROPULITRICI ELETTRICHE AD ACQUA FREDDA

R 1100	6
X-STAR	8
L	10
SM	12
S	14
T	16
A	18
FIXED 1700-1900	20
K 250 STATIC	22
M 250	24
M COMPACT	26
M PREMIUM	28
ETM	30
K 803 S , K 805 S , K 807 S , K 809 S	32
K 803 TS , K 805 TS , K 807 TS , K 809 TS	34
K 891 TS , K 991 TS	36
K 809 ECO , K 801 ECO , K 901 ECO	38
K 1001 TS , K 1251 TS , K 1501 TS	40
K XTREME	42

## GAS ENGINE H.P. CLEANERS IDROPULITRICI CON MOTORE ENDOTERMICO

FDX 2	44
FDX ELITE	46
FDX PRO	48
FDX 4	50
FDX XTREME	52
FDX WB	54
PTO	56
FDX HOT CUBE	58
HOT BOX	60

## ELECTRICAL HOT WATER H.P. CLEANERS IDROPULITRICI ELETTRICHE AD ACQUA CALDA

BORA 2	62
VENTO	64
JUPITER	66
JUPITER PRO	68
VENUS CLASSIC	70
VENUS EXTRA	72
E PREMIUM PLUS	74
F CLASSIC	76
F EXTRA	78

## VACUUM CLEANERS > ASPIRATORI

VACUUM CLEANERS > ASPIRATORI	80
------------------------------	----

## NEBULIZERS > NEBULIZZATORI

NEBULIZERS > NEBULIZZATORI	86
----------------------------	----

## DETERGENTS > DETERGENTI

DETERGENTS > DETERGENTI	88
-------------------------	----

## ACCESSORIES > ACCESSORI

ELECTRICAL COLD WATER H.P. CLEANERS IDROPULITRICI ELETTRICHE AD ACQUA FREDDA	90
GAS ENGINE H.P. CLEANERS IDROPULITRICI CON MOTORE ENDOTERMICO	108
ELECTRICAL HOT WATER H.P. CLEANERS IDROPULITRICI ELETTRICHE AD ACQUA CALDA	118
VACUUM CLEANERS ACCESSORIES	
ACCESSORI ASPIRATORI	126
NOZZLES > UGELLI	128
CHARTS > TABELLE	130

# LEGEND › LEGENDA



Cold water H.P. Cleaners - Idropulitrici ad acqua fredda



Hot water H.P. Cleaners - Idropulitrici ad acqua calda



bar - MPa = Max pressure - Pressione max



l/h = Max flow rate - Portata max



kW = Absorbed power - Potenza assorbita



HP / kW = Electric Motor power - Potenza Motore elettrico



Electrical power supply - Alimentazione da rete elettrica



HP = Engine Motor - Motore a scoppio



Fuel power supply - Alimentazione a carburante



°C = Outlet max water temperature - Temperatura max uscita acqua



lt = Diesel tank - Serbatoio gasolio



kg/h = Fuel consumption - Consumo combustibile



lt = Detergent tank - Serbatoio detergente



kg = Weight - Peso



cm = Dimensions - Dimensioni



RPM motor - Giri motore



RPM pump - Giri pompa

## TotalStop

Device that automatically stops the motor when the gun is closed.  
*Dispositivo che consente lo spegnimento automatico del motore alla chiusura della pistola.*

## EASY-START

Device that guarantees starting of the motor under any and all connection conditions, even if there is a drop in mains voltage.  
*Dispositivo che garantisce la partenza del motore in ogni condizione di allacciamento, anche in presenza di cali di tensione della rete elettrica.*

## PREMIUM



**EXCLUSIVE NO-OIL-LEAK SYSTEM**  
in the crankcase minimising wear of the piston oil seal (PATENTED)

### ESCLUSIVO SISTEMA DI TENUTA TRA CARTER E TESTATA

*che impedisce l'ingresso di polvere e sporizia nella zona di scorrimento pistoni pur permettendo la fuoriuscita dell'acqua (BREVETTATO)*



**EXCLUSIVE PACKING SYSTEM**  
New self lubricating double packing design with special bunatexile seals and bronze rings for an exceptional packing life.

### ESCLUSIVO SISTEMA DI TENUTE ACQUA

*AUTOLUBRIFICATO con doppio pacco di guarnizioni in gomma tela rinforzate con anelli in teflon/bronzo per una eccezionale durata delle guarnizioni*



**EXCLUSIVE SEALING SYSTEM BETWEEN CRANKCASE AND PUMP HEAD** that prevents dust and dirt getting inside where the pistons work but letting water out (PATENTED)

### ESCLUSIVO SISTEMA DI TENUTA OLIO

*nel carter che minimizza l'usura del paraolio pistoni (BREVETTATO)*

# BA10 BACKFLOW PREVENTER



*BA 10 · BackFlow Preventer is a special safety device that prevents water flowing back to the source, isolating the drinking water supply network from the circuit that supplies water to the cleaner.*

**BA 10 · BackFlow Preventer è uno speciale dispositivo di sicurezza che evita il riflusso d'acqua verso la fonte, isolando la rete idrica potabile dal circuito di alimentazione dell'idropulitrice.**



**MANDATORY BY LAW  
EN 60335 - 2 - 79 : 2010**

*According to the EU directives currently in force, the water that passes through a high-pressure cleaner is no longer considered fit for drinking. This is why it cannot be connected directly to the drinking water supply network unless a BA 10 Back Flow Preventer disconnecter has been installed.*

**OBBLIGATORIO PER LEGGE  
EN 60335 - 2 - 79 : 2010**

*Secondo le vigenti direttive comunitarie, l'acqua che attraversa un'idropulitrice non è più considerata potabile. Per tale motivo un'idropulitrice non può essere collegata direttamente alla rete d'acqua potabile senza aver prima installato il disconnettore BA 10 Back Flow Preventer.*



*The BA10 · BackFlow Preventer is easily fitted directly on the water tap.*

**BA10 · BackFlow Preventer si monta con estrema semplicità direttamente al rubinetto della rete idrica.**



*When the tap is turned on the flow of water hermetically closes the BA10 · BackFlow Preventer discharge valve that acts just like part of a straight hose.*

**All'apertura del rubinetto, il flusso d'acqua chiude ermeticamente la valvola di scarico del BA10 · BackFlow Preventer che si comporta come una porzione di tubo rettilineo.**



*The BA10 · BackFlow Preventer starts working when network pressure drops, cutting the drinking water supply network off from the circuit supplying the high-pressure cleaner, discharging the water externally.*

**BA10 · BackFlow Preventer entra in funzione quando la pressione di rete cala, isolando la rete idrica potabile dal circuito di alimentazione dell'idropulitrice, scaricando all'esterno l'acqua.**



*Horizontal fitting*  
**Installazione orizzontale**



*Vertical fitting*  
**Installazione verticale**



*Do not connect it directly to the high-pressure cleaner*  
**Non collegare direttamente all'idropulitrice**



# R 1100

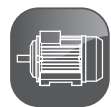

## GENERAL FEATURES

- Easy handling thanks to the 115 mm diameter wheels
- Quick water intake fitting
- Vertical electrical pump with pump at the bottom and an all-metal construction without any plastic used for the structural components
- TotalStop device
- Universal type motor
- Motor thermal protection

## CARATTERISTICHE GENERALI

- Facilità di movimento grazie alle ruote di diametro 115 mm
- Attacco rapido aspirazione acqua
- Elettropompa disposta in verticale con pompa in basso, costruzione interamente in metallo, senza materiale plastico nei componenti strutturali
- Dispositivo TotalStop
- Motore di tipo universale
- Protezione termica del motore
- Uso domestico

- Practical positioning of the power cable and delivery hose.
- *Pratico posizionamento cavo elettrico e tubo di mandata.*

- Ergonomic handle for easy handling
- *Comoda maniglia di presa ergonomica per facilitare la movimentazione dell'idropulitrice*







- Easy-to-fit accessories
- *Pratici alloggiamenti per gli accessori*



CODE CODICE	MODEL MODELLO	MOTORPUMP MOTO Pompa									
			Ph	V	Hz	bar	MPa	l/h	kW	kg	(L x W x H) cm
9054 1001	R 1100	-	1	230	50	120	12	360	1,6	10	82 x 28 x 26



STANDARD ACCESSORIES › DOTAZIONE STANDARD

	Gun with protection <i>Kit pistola con protezione</i>
	Lance with adjustable nozzle <i>Lancia con ugello regolabile</i>
	Lance with rotating nozzle <i>Lancia con ugello rotante</i>
	Foam lance <i>Lancia schiumogena</i>
	5 m delivery hose kit <i>Kit tubo mandata 5 m</i>
	Suction coupler <i>Raccordo aspirazione</i>
	Water filter <i>Filtro acqua</i>

# X-STAR



MTP KLR



## GENERAL FEATURES

- Vertical structure, designed for maximum ergonomics and ease of use
- Comet electrical pump with pump at the bottom and an all-metal construction without any plastic used for the structural components
- **EASY-START** device
- **TotalStop** device
- Motor thermal protection

## CARATTERISTICHE GENERALI

- *Struttura a sviluppo verticale concepita per la massima ergonomia e praticità d'uso*
- *Elettropompa Comet con pompa in basso e costruzione interamente in metallo, senza materiale plastico nei componenti strutturali*
- **Dispositivo EASY-START**
- **Dispositivo TotalStop**
- *Protezione termica del motore*
- *Uso domestico*



- Practical handle for easy handling
- Comoda maniglia per facilitare la movimentazione



- Quickfit coupling for connecting to the water mains
- Raccordo con attacco rapido per il collegamento alla rete idrica



CODE CODICE	MODELS MODELLI	MOTORPUMP MOTOPIOMPA									
			Ph	V	Hz	bar	MPa	l/h	kW	kg	(L x W x H) cm
9048 1001	X-STAR Classic	KLR	1	230	50	120	12	360	1,6	11	44 x 21 x 21
9048 1501	X-STAR Extra	KLR	1	230	50	120	12	360	1,6	11	44 x 21 x 21

**STANDARD ACCESSORIES › DOTAZIONE STANDARD**

CLASSIC	EXTRA
	Gun with protection <i>Kit pistola con protezione</i>
	Lance without nozzle head (securfix) <i>Lancia senza testina ugello (securfix)</i>
	Adjustable nozzle head (securfix) <i>Testina ugello regolabile (securfix)</i>
	 Rotating nozzle head (securfix) <i>Testina ugello rotante (securfix)</i>
	Foam lance <i>Lancia schiumogena</i>
	6 m delivery hose kit <i>Kit tubo mandata 6 m</i>
	 Fixed brush <i>Idrospazzola fissa</i>



# L

## 1300 - 1400 - 1600 GOLD 1680 GOLD PLUS



MTP KLR



MTP KLR Gold



### GENERAL FEATURES

- Vertical structure, designed for maximum ergonomics and ease of use
- Comet electrical pump with three axial pistons arranged vertically with pump at the bottom and an all-metal construction without any plastic used for the structural components
- Brass pump head for L Gold only
- **EASY-START** device
- **TotalStop** device
- Motor thermal protection
- Quick water intake fitting

### CARATTERISTICHE GENERALI

- *Struttura a sviluppo verticale concepita per la massima ergonomia e praticità d'uso*
- *Elettropompa Comet a tre pistoni assiali disposta in verticale con pompa in basso e costruzione interamente in metallo, senza materiale plastico nei componenti strutturali*
- *Testata pompa in ottone per L Gold*
- **Dispositivo EASY-START**
- **Dispositivo TotalStop**
- **Protezione termica del motore**
- **Attacco rapido aspirazione acqua**
- **Uso domestico**

- Easy-to-fit accessories
- Pratici alloggiamenti per gli accessori

- Hose reel at the back
- Avvolgitubo collocato nella parte posteriore

- Easy to handle thanks to the big wheels (rubber coated on L Gold models)
- Facilità di movimento grazie alle ruote di grandi dimensioni (rivestite in gomma nei modelli L Gold)

- Additional handle for lifting
- Maniglia supplementare per il sollevamento



CODE CODICE	MODELS MODELLI	MOTORPUMP MOTOPOMPA									
			Ph	V	Hz	bar	MPa	l/h	kW	kg	(L x W x H) cm
9046 1066	L 1300 Classic	KLR	1	230	50	130	13	360	1,7	12	82 x 30,8 x 31
9046 1003	L 1400 Classic	KLR	1	230	50	140	14	410	2,0	12	82 x 30,8 x 31
9046 1065	L 1600 Gold Classic	KLR	1	230	50	150	15	480	2,3	12	82 x 30,8 x 31
9046 1067	L 1300 Extra	KLR	1	230	50	130	13	360	1,7	13	82 x 30,8 x 31
9046 1004	L 1400 Extra	KLR	1	230	50	140	14	410	2,0	13	82 x 30,8 x 31
9046 1064	L 1600 Gold Extra	KLR	1	230	50	150	15	480	2,3	13	82 x 30,8 x 31
9046 1500	L 1680 Gold Plus	KLR	1	230	50	150	15	480	2,3	13	82 x 30,8 x 31

**STANDARD ACCESSORIES › DOTAZIONE STANDARD**

CLASSIC	EXTRA	PLUS
	Gun with protection <i>Pistola con protezione</i>	
Lance without nozzle head (securfix) <i>Lancia senza testina ugello (securfix)</i>		Lance with adjustable nozzle <i>Lancia con ugello regolabile</i>
	Adjustable nozzle head (securfix) <i>Testina ugello regolabile (securfix)</i>	Lance with rotating nozzle <i>Lancia con ugello rotante</i>
	Rotating nozzle head (securfix) <i>Testina ugello rotante (securfix)</i>	
	Foam lance <i>Lancia schiumogena</i>	
6 m delivery hose kit <i>Kit tubo mandata 6 m</i>	8 m delivery hose kit <i>Kit tubo mandata 8 m</i>	8 m R1-1/4" delivery rubber hose kit <i>Kit tubo gomma mandata 8 m R1-1/4"</i>
	Fixed brush <i>Idrospazzola fissa</i>	



# SM



## 1450 - 1480 GOLD



MTP KMR



MTP KMR Gold



### GENERAL FEATURES

- Comet electrical pump with three axial pistons arranged vertically with pump at the bottom and an all-metal construction without any plastic used for the structural components
- SM 1480 Gold equipped with a brass pump head
- EASY-START device
- TotalStop device
- Motor thermal protection
- Quick water intake fitting
- Supports for housing the accessories and power cable

### CARATTERISTICHE GENERALI

- Elettropompa Comet a tre pistoni assiali disposta in verticale con pompa in basso e costruzione interamente in metallo, senza materiale plastico nei componenti strutturali
- SM 1480 Gold dotata di testata pompa in ottone
- Dispositivo EASY-START
- Dispositivo TotalStop
- Protezione termica del motore
- Attacco rapido aspirazione acqua
- Supporti per l'alloggiamento degli accessori e del cavo di alimentazione
- Uso semiprofessionale

- Ergonomic handle for easy handling
- Comoda maniglia di presa per facilitare la movimentazione dell'idropultrice



- Easy to handle up and down steps thanks to the big wheels
- Facilità di movimento su gradini grazie alle ruote di grandi dimensioni



- Hose reel with 10 m high-pressure hose (for Extra models only)
- Avvolgitubo con tubo alta pressione 10 m (solo per modelli Extra)



CODE CODICE	MODELS MODELLI	MOTORPUMP MOTO Pompa									
			Ph	V	Hz	bar	MPa	l/h	kW	kg	(L x W x H) cm
9043 1001	SM 1450 Classic	KMR	1	230	50	145	14,5	480	2,3	17	89 x 32 x 38
9043 1052	SM 1480 Gold Classic	KMR	1	230	50	150	15	480	2,3	17	89 x 32 x 38
9043 1002	SM 1450 Extra	KMR	1	230	50	145	14,5	480	2,3	19	89 x 32 x 38
9043 1062	SM 1480 Gold Extra	KMR	1	230	50	150	15	480	2,3	19	89 x 32 x 38



STANDARD ACCESSORIES › DOTAZIONE STANDARD

CLASSIC		EXTRA	
	Gun with protection <i>Pistola con protezione</i>		Lance with adjustable nozzle <i>Tubo lancia con ugello regolabile</i>
	Foam lance <i>Lancia schiumogena</i>		Lance with rotating nozzle <i>Lancia con ugello rotante</i>
	7 m delivery hose kit <i>Kit tubo mandata 7 m</i>		10 m delivery hose kit (on Hose Reel) <i>Kit tubo mandata 10 m (su Avvolgitubo)</i>



S



1600 - 1700 GOLD



MTP KSR



GENERAL FEATURES

- Comet electrical pump with three axial pistons arranged vertically with pump at the bottom and an all-metal construction without any plastic used for the structural components
- S 1700 equipped with a brass pump head and detergent suction straight from a 1.8 litre capacity tank
- **EASY-START** device
- **TotalStop** device
- Manually resettable amperometric protection
- Pressure gauge
- Water inlet quick coupling



CARATTERISTICHE GENERALI

- *Elettropompa Comet a tre pistoni assiali disposta in verticale con pompa in basso e costruzione interamente in metallo, senza materiale plastico nei componenti strutturali.*
- *S 1700 dotata di testata pompa in ottone e aspirazione del detergente diretta da serbatoio capacità 1,8 lt*
- **Dispositivo EASY-START**
- **Dispositivo TotalStop**
- **Protettore amperometrico a riarmo manuale**
- **Manometro pressione**
- **Attacco rapido aspirazione acqua**
- **Usa semiprofessionale**

- Ergonomic handle for easy handling
- Comoda maniglia di presa per facilitare la movimentazione dell'idropultrice



- Easy to handle up and down steps thanks to the big wheels
- Facilità di movimento su gradini grazie alle ruote di grandi dimensioni



- Hose reel with 10 m rubber high-pressure hose (for Extra models only)
- Avvolgitubo con tubo gomma alta pressione 10 m (solo per modelli Extra)



CODE CODICE	MODELLI	MOTORPUMP MOTOPIOMPA										
			Ph	V	Hz	bar	MPa	l/h	kW	l	kg	(L x W x H) cm
9041 1001	S 1600 Classic	KSR	1	230	50	145	14,5	510	2,4	-	17	89 x 32 x 38
9041 1002	S 1700 Gold Classic	KSR	1	230	50	155	15,5	540	2,7	1,8	17	89 x 32 x 38
9041 1501	S 1600 Extra	KSR	1	230	50	145	14,5	510	2,4	-	19	89 x 32 x 38
9041 1502	S 1700 Gold Extra	KSR	1	230	50	155	15,5	540	2,7	1,8	19	89 x 32 x 38



STANDARD ACCESSORIES › DOTAZIONE STANDARD

CLASSIC	EXTRA
	GC 251 gun with protection <i>Pistola GC 251 con protezione</i>
	Bent lance, with adjustable nozzle <i>Lancia angolata, con ugello regolabile</i>
	Foam lance (for S1600 models only) <i>Lancia schiumogena (solo per modelli S 1600)</i>



# T



## 1750 GOLD - 1800 GOLD - 1900 GOLD



MTP KTR Gold



### GENERAL FEATURES

- Hose reel (Extra only) located at the bottom of the high-pressure water cleaner guaranteeing exceptional stability also when in use
- Low-pressure detergent suction from the internal tank
- Detergent suction kit from an external tank (on request)
- Power cable storage rear compartment
- Comet electrical pump with three axial pistons arranged vertically with pump at the bottom and an all-metal construction without any plastic used for the structural components
- Pump with brass head on all models
- **EASY-START** device
- **TotalStop** device
- Motor thermal protection



### CARATTERISTICHE GENERALI

- *Avvolgitubo (solo Extra) collocato nella parte inferiore della idropulitrice con garanzia di eccezionale stabilità della macchina anche durante il lavoro*
- *Aspirazione detergente in bassa pressione dal serbatoio interno*
- *Kit aspirazione detergente da serbatoio esterno (su richiesta)*
- *Vano posteriore per collocare il cavo elettrico*
- *Elettropompa Comet a tre pistoni assiali disposta in verticale con pompa in basso e costruzione interamente in metallo, senza materiale plastico nei componenti strutturali*
- *Pompa con testata in ottone su tutti i modelli*
- *Dispositivo **EASY-START***
- *Dispositivo **TotalStop***
- *Protezione termica motore*
- *Uso semiprofessionale*



- Easy handling thanks to the two big wheels (250 mm Ø)
- *Facilità di movimentazione grazie alle due ruote di grandi dimensioni (Ø 250 mm)*

- Handy lance and gun storage
- *Pratico alloggiamento della pistola della lancia*

- Hose reel  
*(Extra models only)*
- *Avvolgitubo (solo modelli Extra)*

- Additional handle for lifting the high-pressure cleaner
- *Maniglia supplementare per il sollevamento dell'idropultrice*



CODE CODICE	MODELS MODELLI	MOTORPUMP MOTOPOMPA										
			Ph	V	Hz	bar	MPa	l/h	kW	l	kg	(L x W x H) cm
9053 1005	T 1750 Gold Classic	KTR	1	230	50	150	15	510	2,4	1	22	40 x 41 x 91
9053 1001	T 1800 Gold Classic	KTR	1	230	50	160	16	550	2,7	1	22	40 x 41 x 91
9053 1003	T 1900 Gold Classic	KTR	1	230	50	160	16	600	2,9	1	22	40 x 41 x 91
9053 1006	T 1750 Gold Extra	KTR	1	230	50	150	15	510	2,4	1	25	40 x 41 x 91
9053 1002	T 1800 Gold Extra	KTR	1	230	50	160	16	550	2,7	1	25	40 x 41 x 91
9053 1004	T 1900 Gold Extra	KTR	1	230	50	160	16	600	2,9	1	25	40 x 41 x 91

**STANDARD ACCESSORIES › DOTAZIONE STANDARD**

CLASSIC	EXTRA
<p>GC 251 gun with protection <i>Pistola GC 251 con protezione</i></p>	
<p>Bent lance, with adjustable nozzle <i>Kit tubo lancia angolata, con ugello regolabile</i></p>	
<p>8 m rubber delivery hose kit <i>Kit tubo gomma mandata 8 m</i></p>	<p>Bent lance, with rotating nozzle <i>Lancia angolata, con ugello rotante</i></p>
	<p>Fixed brush <i>Idrospazzola fissa</i></p>
	<p>12 m rubber delivery hose kit (on Hose Reel) <i>Kit tubo gomma mandata 12 m (su Avvolgitubo)</i></p>



# A



## 2800 - 3000 - 3200 - 4000 - 5000



AXR / GXR



### GENERAL FEATURES

- Compact size for storing and practical to use thanks to its vertical design
- Simple to transport horizontally in the car
- Comet AXR pump with brass head and ceramic pistons (on KA 2800 GXR pump with brass head and stainless steel pistons)
- Pressure gauge
- Built-in professional unloader valve
- EASY-START device on single-phase models
- TotalStop device
- Rotary switch
- Regulated low-pressure detergent suction
- Motor thermal protection



### CARATTERISTICHE GENERALI

- Ingombro ridotto nella messa a riposo e praticità d'uso in condizioni di lavoro grazie allo sviluppo verticale
- Semplicità di trasporto su auto in posizione orizzontale
- Pompa Comet AXR con testata in ottone e pistoni in ceramica (su KA 2800 pompa GXR con testata in ottone e pistoni in acciaio)
- Manometro pressione
- Valvola di regolazione professionale integrata
- Dispositivo EASY-START sui modelli monofase
- Dispositivo TotalStop
- Interruttore rotativo
- Aspirazione detergente in bassa pressione con regolazione
- Protezione termica del motore
- Uso semiprofessionale gravoso

- Adjustable detergent suction device from an external tank with filter
- Dispositivo di aspirazione detergente da tanica esterna, regolabile con filtro



- 3 lt detergent tank, easily removed
- Serbatoio detergente 3 lt facilmente rimovibile



- Comet AXR/GXR pump, 3 axial plungers and brass pump head
- Pompa Comet AXR/GXR, 3 pistoni assiali e testata in ottone



- 15 m hose reel. Practical handle and stop device
- Avvolgitubo di 15 m. Comoda maniglia e dispositivo di fermo



CODE CODICE	MODELS MODELLI	MOTORPUMP MOTO Pompa	Electrical		Pressure		Flow	Power		Energy	Capacity	Weight	Dimensions	
			Ph	V	Hz	bar	MPa	l/h	HP	kW	kWh	l	kg	(L x W x H) cm
9037 1147	A 2800 M Classic	GXR	1	230	50	140	14	540	2,6	1,9	2,6	3,0	36	44 x 42 x 94
9037 1002	A 3000 M Classic	AXR	1	230	50	130	13	720	3,0	2,2	2,9	3,0	36	44 x 42 x 94
9037 1001	A 3200 M Classic	AXR	1	230	50	150	15	600	3,0	2,2	2,9	3,0	36	44 x 42 x 94
9037 1005	A 5000 T Classic	AXR	3	400	50	200	20	720	5,0	3,7	4,3	3,0	36	44 x 42 x 94
9037 1148	A 2800 M Excel	GXR	1	230	50	140	14	540	2,6	1,9	2,6	3,0	36	44 x 42 x 94
9037 1021	A 3000 M Excel	AXR	1	230	50	130	13	720	3,0	2,2	2,9	3,0	36	44 x 42 x 94
9037 1012	A 3200 M Excel	AXR	1	230	50	150	15	600	3,0	2,2	2,9	3,0	36	44 x 42 x 94
9037 1016	A 4000 T Excel	AXR	3	400	50	170	17	720	4,3	3,2	3,8	3,0	36	44 x 42 x 94
9037 1019	A 5000 T Excel	AXR	3	400	50	200	20	720	5,0	3,7	4,3	3,0	36	44 x 42 x 94

STANDARD ACCESSORIES › DOTAZIONE STANDARD

CLASSIC	EXCEL
	GC 251 gun with protection <i>Pistola GC 251 con protezione</i>
	Lance with adjustable jet, with nozzle (for the A 2800 model only) <i>Lancia getto regolabile con ugello (solo per modello A 2800)</i>
	Bent lance with detergent head, without nozzle <i>Lancia angolata con testina detergente, senza ugello</i>
	Fan shape nozzle 1/4" MEG connection <i>Ugello con getto a lama attacco 1/4" MEG</i>
	8 m rubber delivery hose kit <i>Kit tubo gomma mandata 8 m</i>
	 15 m rubber delivery hose kit (on Hose Reel) <i>Kit tubo mandata 15 m (su Avvolgitubo)</i>



# FIXED



## 1700 GOLD - 1900 GOLD



MTP KTR Gold



### GENERAL FEATURES

- Sturdy structure with tubular frame for wall mounting
- Equipped with a quick wall coupling system with safety lock
- Handy support for housing all the accessories
- Standard hose reel with rubber delivery hose
- Water inlet with cartridge filter
- **Comet electrical pump with three axial pistons arranged horizontally with pump at the bottom and an all-metal construction without any plastic used for the structural components.**
- **Pump with brass head on all models**
- **EASY-START** device
- **TotalStop** device
- Motor thermal protection

### CARATTERISTICHE GENERALI

- **Robusta struttura per applicazione a parete con telaio tubolare**
- **Equipaggiata con sistema di aggancio rapido a muro, con blocco di sicurezza**
- **Pratico supporto per alloggiare tutti gli accessori**
- **Avvolgitubo di serie con tubo mandata in gomma**
- **Ingresso acqua con filtro a cartuccia**
- **Elettropompa Comet a tre pistoni assiali disposta in orizzontale con pompa in basso e costruzione interamente in metallo, senza materiale plastico nei componenti strutturali.**
- **Pompa con testata in ottone su tutti i modelli**
- **Dispositivo EASY-START**
- **Dispositivo TotalStop**
- **Protezione Termica del motore**
- **Uso semiprofessionale**

## DUAL USE › DOPPIO USO

- Permanently fixed on the wall – always ready to use
- *Fissaggio statico a parete sempre pronta all'uso*
- Easily removable
- *Facilmente removibile*
- Easy to move to wherever else wanted
- *Facilmente trasportabile in altri posti di utilizzo*



CODE CODICE	MODELS MODELLI	MOTORPUMP MOTO Pompa									
			Ph	V	Hz	bar	MPa	l/h	kW	kg	(L x W x H) cm
9052 1001	FIXED 1700 Classic Gold	KTR	1	230	50	150	15	510	2,4	20	50 x 26 x 60
9052 1008	FIXED 1900 Classic Gold	KTR	1	230	50	160	16	600	2,9	21	50 x 26 x 60
9052 1002	FIXED 1700 Extra Gold	KTR	1	230	50	150	15	510	2,4	22	50 x 26 x 60
9052 1015	FIXED 1700 Extra Gold with blue food-industry hose / con tubo blu anti-macchia	KTR	1	230	50	150	15	510	2,4	22	50 x 26 x 60
9052 1009	FIXED 1900 Extra Gold	KTR	1	230	50	160	16	600	2,9	23	50 x 26 x 60

- Brass pump head that withstands pressure and is corrosion resistant
- *Pompa con testata in ottone resistente alla pressione ed alla corrosione*
- Hose reel with 10 or 20 meter high pressure hose
- *Avvolgitubo con 10 o 20 metri di tubo ad alta pressione*
- Hose cleaning guide kit (optional)
- *Kit guida - pulisci tubo (optional)*
- Accessory rack supplied with the high-pressure cleaner
- *Supporto per gli accessori in dotazione all'idropulitrice*



## STANDARD ACCESSORIES › DOTAZIONE STANDARD

GC 251 gun with protection  
*Pistola GC 251 con protezione*

Bent lance, with adjustable nozzle  
*Lancia angolata, con ugello regolabile*

Bent lance, with rotating nozzle (for Extra models only)  
*Lancia angolata con ugello rotante (solo per modelli Extra)*

Rack for accessory  
*Supporto accessori*

Rotating brush (for Extra models only)  
*Idrospazzola rotante (solo per modelli Extra)*

Hose reel with rubber high-pressure hose 10m (Classic models only) 20m (Extra models only)  
*Avvolgitubo con tubo gomma alta pressione 10m (solo modello Classic) 20m (solo modello Extra)*

Foam lance 11  
*Lancia schiumogena 11t*



# K 250 STATIC



LW-K



## GENERAL FEATURES

- Wall fixing or stationary use configuration
- Sturdy stainless steel casing
- Easy maintenance by simply removing the casing
- Low-pressure detergent suction
- Pressure gauge
- 4-pole motor (1400 rpm) well oversized and protected with paint
- Built-in professional unloader valve
- **TotalStop**
- Self-priming pumps with **EASY-START** device on single-phase models
- Rotary switch
- Motor thermal protection



## CARATTERISTICHE GENERALI

- **Configurazione per fissaggio a muro o per utilizzo stazionario**
- Robuste carenature in acciaio inossidabile
- Facile manutenzione con la semplice rimozione della carenatura
- Aspirazione detergente in bassa pressione
- Manometro di pressione
- **Motore a 4 poli (1400 giri/min) ampiamente sovradimensionato e protetto da verniciatura**
- Valvola di regolazione professionale integrata
- **TotalStop**
- Pompe autoadescanti con dispositivo **EASY-START** per modello monofase
- Interruttore rotativo
- Protezione termica motore
- Uso professionale

ON THE WALL › A PARETE

Dual use  
Doppio uso

ON THE FLOOR › A TERRA



CODE CODICE	MODELS MODELLI	PUMP POMPA											
			Ph	V	Hz	bar	MPa	l/h	HP	kW	kW	kg	(L x W x H) cm
9057 2001	K 250 Static 10/150 M	LW-K	1	230	50	150	15	600	3,0	2,2	2,9	40	55 x 35 x 35
9057 2003	K 250 Static 12/130 M	LW-K	1	230	50	130	13	720	3,0	2,2	2,9	40	55 x 35 x 35
9057 2002	K 250 Static 15/170 T	LW-K	3	400	50	170	17	900	5,5	4,0	5,0	40	55 x 35 x 35

STANDARD ACCESSORIES › DOTAZIONE STANDARD

	GH 301 gun with swivel Pistola GH 301 con swivel		Fan shape nozzle, 1/4" MEG connection Ugello con getto a lama attacco 1/4" MEG
	Bent lance with detergent head, without nozzle Lancia angolata con testina detergente, senza ugello		10 m rubber delivery hose kit with quick coupler M22x1,5 Kit tubo gomma mandata 10m, con attacco rapido M22x1,5
		Ejector kit Kit eiettore	

# M 250

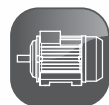

LW-K

**1** CAN BE USED VERTICALLY  
UTILIZZABILE IN VERTICALE

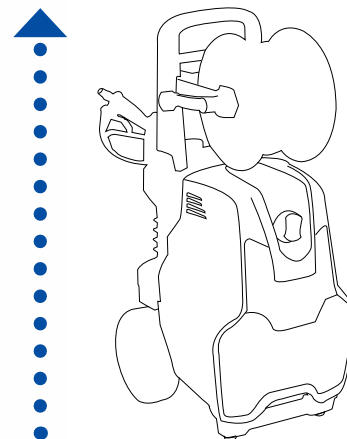

**2** CAN BE USED HORIZONTALLY  
UTILIZZABILE IN ORIZZONTALE

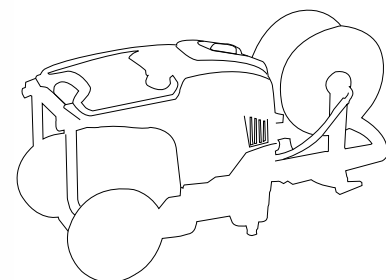

## GENERAL FEATURES

- Sturdy injection-moulded plastic casing
- Handy lance and gun storage
- Handle with supports for the power cable and delivery hose
- **Easy maintenance by simply removing the front casing**
- Big wheels (220 mm Ø) for easy movement up and down steps and over uneven ground
- Removable detergent tank with level visible from the outside
- Detergent adjustment with filter
- Regulated low-pressure detergent suction
- Pressure gauge
- 4-pole motor (1400 rpm) well oversized and protected with paint
- Built-in professional unloader valve
- **TotalStop**
- Self-priming pumps with **EASY-START** device on single-phase models
- Rotary switch
- Motor thermal protection

## CARATTERISTICHE GENERALI

- Robuste carenature in materiale plastico stampato ad iniezione
- Pratico alloggiamento della pistola e della lancia
- Manico con supporti di cavo alimentazione e tubo mandata
- **Facilità di manutenzione con la semplice rimozione della carenatura frontale**
- Ruote di grandi dimensioni (Ø220mm) per una facile movimentazione su gradini e terreni accidentati
- Serbatoio detergente estraibile con livello visibile esternamente
- Regolazione detergente con filtro
- Aspirazione detergente in bassa pressione con regolazione
- Manometro di pressione
- Motore a 4 poli (1400 giri/min) ampiamente sovradimensionato e protetto da verniciatura
- Valvola di regolazione professionale integrata
- **TotalStop**
- Pompe autoadescanti dispositivo **EASY-START** modelli monof.
- Interruttore rotativo
- Protezione termica motore
- Uso professionale



- COMET LW-K type pump with 3 integral ceramic pistons. Oil sight glass. Brass pump heads.
- Pompa COMET tipo LW-K 3 pistoni in ceramica integrale. Visore livello olio Testate in ottone.



- Removable detergent tank with externally visible level
- Serbatoio detergente estraibile con livello visibile esternamente



- Hose reel 15/20 m (for Extra models only)
- Avvolgitubo 15/20 m (solo per modelli Extra)



- M 250 Classic



CODE CODICE	MODELS MODELLI	PUMP POMPA	Electrical plug		Pressure gauge		Detergent container		Motor		Power		Weight		Dimensions	
			Ph	V	Hz	bar	MPa	l/h	HP	kW	kW	l	kg	(L x W x H) cm		
9057 1002	M 250 10/150 M Classic	LW-K	1	230	50	150	15	600	3,0	2,2	2,9	3,5	40	54 x 44 x 68		
9057 1004	M 250 12/130 M Classic	LW-K	1	230	50	130	13	720	3,0	2,2	2,9	3,5	40	54 x 44 x 68		
9057 1006	M 250 11/160 M Classic ★	LW-K	1	230	50	160	16	660	3,5	2,6	3,3	3,5	40	54 x 44 x 68		
9057 1008	M 250 13/190 T Classic	LW-K	3	400	50	190	19	780	5,5	4,0	5,0	3,5	40	54 x 44 x 68		
9057 1010	M 250 15/170 T Classic	LW-K	3	400	50	170	17	900	5,5	4,0	5,0	3,5	40	54 x 44 x 68		
9057 1012	M 250 11/210 T Classic	LW-K	3	400	50	210	21	660	5,5	4,0	5,0	3,5	40	54 x 44 x 68		
9057 1001	M 250 10/150 M Extra	LW-K	1	230	50	150	15	600	3,0	2,2	2,9	3,5	50	54 x 44 x 99		
9057 1003	M 250 12/130 M Extra	LW-K	1	230	50	130	13	720	3,0	2,2	2,9	3,5	50	54 x 44 x 99		
9057 1005	M 250 11/160 M Extra ★	LW-K	1	230	50	160	16	660	3,5	2,6	3,3	3,5	50	54 x 44 x 99		
9057 1007	M 250 13/190 T Extra	LW-K	3	400	50	190	19	780	5,5	4,0	5,0	3,5	50	54 x 44 x 99		
9057 1009	M 250 15/170 T Extra	LW-K	3	400	50	170	17	900	5,5	4,0	5,0	3,5	50	54 x 44 x 99		
9057 1011	M 250 11/210 T Extra	LW-K	3	400	50	210	21	660	5,5	4,0	5,0	3,5	50	54 x 44 x 99		

★ requires 4 kW single-phase electricity supply - richiede rete elettrica monofase da 4 kW



STANDARD ACCESSORIES › DOTAZIONE STANDARD

CLASSIC		EXTRA	
	GC 251 gun with protection Pistola GC 251 con protezione		GH 301 gun with swivel Pistola GH 301 con swivel
	Bent lance with detergent head, without nozzle Lancia angolata con testina detergente, senza ugello		
	15° spray nozzle, 1/4" MEG connection Ugello con getto a lama 15°, attacco 1/4" MEG		
	10 m rubber delivery hose kit Kit tubo gomma mandata 10 m		Lance with rotating nozzle Lancia con ugello rotante
			15 m rubber delivery hose kit (on Hose Reel - M 250 Extra models) Kit tubo gomma mandata 15 m (su Avvolgitubo - modelli M 250 Extra)



# M Compact



## MOBILE - PICK UP - STATIC Kit



### MOBILE



#### GENERAL FEATURES

- Easy maintenance by simply removing the front casing and taking the electrical pump unit out
- Big wheels (220 mm ø); easy to handle also up and down steps and over uneven ground
- Extractable 3.5 litre detergent tank with level that can be seen externally. Fitted with filter, adjustment knob and an external tank suction system
- **Pump with two oil sight glasses, with level visible from the outside and brass pump head**
- 4-pole motor (1400 rpm) well oversized and protected with paint
- Built-in professional unloader valve
- Self-priming pumps (with **EASY-START** device on single-phase models)
- Timed **TotalStop**
- Rotary switch
- Electrical panel with contactor and thermal relay
- Motor thermal protection



#### CARATTERISTICHE GENERALI

- *Facilità di manutenzione, con la semplice rimozione della carenatura frontale ed estrazione del gruppo elettropompa*
- *Ruote di grandi dimensioni (ø 220 mm); estrema maneggevolezza anche su gradini e terreno accidentato*
- *Serbatoio detergente da 3,5 litri estraibile, con livello visibile dall'esterno. Dotato di filtro, manopola di regolazione e sistema per aspirazione da serbatoio esterno*
- *Pompa con doppio visore olio (livello visibile all'esterno) e testata in ottone*
- *Motore a 4 poli (1400 giri/min) ampiamente sovradimensionato e protetto da verniciatura*
- *Valvola regolazione professionale integrata*
- *Pompe autoadescanti (con dispositivo **EASY-START** sui modelli monofase)*
- ***TotalStop** temporizzato*
- *Interruttore rotativo*
- *Quadro elettrico con Teleruttore e Relè termico*
- *Protezione termica del motore*
- *Uso professionale*

- Pressure unloader valve with a large and practical knob
- Valvola regolazione pressione, con comoda e grande manopola di presa



- Well balanced for easy handling
- Estrema maneggevolezza grazie alla favorevole posizione del baricentro



- Pump with two oil sight glasses and external level viewer
- Pompa con doppio visore olio, con livello visibile dall'esterno



- Comet ZW-K pump with 3 integral ceramic pistons and brass pump head
- Pompa Comet ZW-K con 3 pistoni in ceramica integrale con testata in ottone



CODE CODICE	MODELS MODELLI	PUMP POMPA	Electrical			Pressure		Flow	Power		Consumption	Weight	Dimensions	
			Ph	V	Hz	bar	MPa	l/h	HP	kW	kW	l	kg	(L x W x H) cm
<b>M Compact Pick-Up</b>														
9050 1007	M Compact 3.11 M	ZW-K	1	230	50	120	12	660	3,0	2,2	2,9	3,5	37	57 x 42 x 47
9050 1008	M Compact 5.15 T	ZW-K	3	400	50	160	16	900	5,5	4,0	5,0	3,5	38	57 x 42 x 47
<b>M Compact Mobile</b>														
9050 1003	M Compact 3.11 M	ZW-K	1	230	50	120	12	660	3,0	2,2	2,9	3,5	37	63 x 54 x 93
9050 1002	M Compact 5.13 T	ZW-K	3	400	50	180	18	780	5,5	4,0	5,0	3,5	38	63 x 54 x 93
9050 1001	M Compact 5.15 T	ZW-K	3	400	50	160	16	900	5,5	4,0	5,0	3,5	38	63 x 54 x 93
<b>M Compact Mobile con avvolgitubo - with hose reel</b>														
9050 1004	M Compact 3.11 M	ZW-K	1	230	50	120	12	660	3,0	2,2	2,9	3,5	37	63 x 54 x 93
9050 1005	M Compact 5.13 T	ZW-K	3	400	50	180	18	780	5,5	4,0	5,0	3,5	38	63 x 54 x 93
9050 1006	M Compact 5.15 T	ZW-K	3	400	50	160	16	900	5,5	4,0	5,0	3,5	38	63 x 54 x 93

## PICK-UP



- Configuration for stationary use (on a pallet, on a base, on the ground)
- Easy to handle thanks to the practical built-in steel handles
- Configurazione per utilizzo stazionario (su pianale, su base, su terreno)
- Di facile movimentazione grazie alle comode maniglie in acciaio integrate nel telaio della macchina

## STATIC Kit



- Wall application kit with heavy duty tubular structure and hose reel
- Configuration for fixed washing points
- Kit applicazione a parete con struttura tubolare robusta ed affidabile con avvolgitubo
- Configurazione per postazioni fisse di lavaggio



### STANDARD ACCESSORIES › DOTAZIONE STANDARD

	GH 351 gun with Swivel (n.2 o-ring) Pistola GH 351 con Swivel (n.2 o-ring)		Bent lance with detergent head, without nozzle Lancia angolata con testina detergente, senza ugello
	15° spray nozzle, 1/4" MEG connection Ugello con getto a lama 15° attacco 1/4" MEG		Hose reel with rubber hose (15m for MOBILE models) Avvolgitubo girevole con tubo gomma (15m per modelli MOBILE)
		Rubber delivery hose kit (8m for MOBILE models, 10m for PICK-UP models) Kit tubo gomma mandata (8m per modelli MOBILE, 10m per modelli PICK-UP)	



# M Premium



## MOBILE - PICK UP - STATIC Kit



### PREMIUM



## MOBILE



### GENERAL FEATURES

- Easy maintenance by simply removing the front casing and taking the electrical pump unit out
- Big wheels (220 mm ø); easy to handle also up and down steps and over uneven ground
- Extractable 3.5 litre detergent tank with level that can be seen externally. Fitted with filter, adjustment knob and an external tank suction system
- **Pump with two oil sight glasses, with level visible from the outside and brass pump head**
- 4-pole motor (1400 rpm) with double bearing, well oversized and protected with paint
- Banjo professional pressure unloader valve
- Timed **TotalStop**
- Rotary switch
- Electrical panel with contactor and thermal relay
- Motor thermal protection



### CARATTERISTICHE GENERALI

- *Facilità di manutenzione, con la semplice rimozione della carenatura frontale ed estrazione del gruppo elettropompa*
- *Ruote di grandi dimensioni (ø 220 mm); estrema maneggevolezza anche su gradini e terreno accidentato*
- *Serbatoio detergente da 3,5 litri estraibile, con livello visibile dall'esterno. Dotato di filtro, manopola di regolazione e sistema per aspirazione da serbatoio esterno*
- ***Pompa con doppio visore olio, con livello visibile dall'esterno e testata in ottone***
- *Motore a 4 poli (1400 giri/min) con doppio cuscinetto ampiamente sovradimensionato e protetto da verniciatura*
- *Valvola regolazione professionale flangiata*
- ***TotalStop*** temporizzato
- *Interruttore rotativo*
- *Quadro elettrico con Teleruttore e Relè termico*
- *Protezione termica del motore*
- *Uso professionale*

- Pressure unloader valve with a large and practical knob
- Valvola regolazione pressione, con comoda e grande manopola di presa



- Well balanced for easy handling
- Estrema maneggevolezza grazie alla favorevole posizione del baricentro



- Pump with two oil sight glasses and external level viewer
- Pompa con doppio visore olio, con livello visibile dall'esterno



- Comet RW Premium pump with 3 integral ceramic pistons and brass pump head
- Pompa Comet RW Premium con 3 pistoni in ceramica integrale e testata in ottone



CODE CODICE	MODELS MODELLI	PUMP POMPA	Ph		V		Hz		bar		MPa		l/h		HP		kW		kW		l		kg		(L x W x H) cm	
			Ph	V	Hz	bar	MPa	l/h	HP	kW	kW	l	kg	(L x W x H) cm												
<b>M Premium Pick-Up</b>																										
9050 1513	M Premium 6.13 T	RW	3	400	50	190	19	780	6.0	4.4	5.5	3.5	55	62 x 47 x 51												
9050 1514	M Premium 6.15 T	RW	3	400	50	170	17	900	6.0	4.4	5.5	3.5	55	62 x 47 x 51												
9050 1515	M Premium 8.15 T	RW	3	400	50	210	21	900	7.5	5.5	6.6	3.5	55	62 x 47 x 51												
9050 1540	M Premium 8.21 T	RW	3	400	50	160	16	1260	7.5	5.5	6.9	3.5	55	62 x 47 x 51												
9050 1528	M Premium 9.15 T	RW	3	400	50	230	23	900	9.0	6.6	7.3	3.5	55	62 x 47 x 51												
9050 1519	M Premium 9.21 T	RW	3	400	50	180	18	1260	9.0	6.6	7.5	3.5	55	62 x 47 x 51												
<b>M Premium Mobile</b>																										
9050 1501	M Premium 6.13 T	RW	3	400	50	190	19	780	6.0	4.4	5.5	3.5	55	63 x 59 x 96												
9050 1502	M Premium 6.15 T	RW	3	400	50	170	17	900	6.0	4.4	5.5	3.5	55	63 x 59 x 96												
9050 1503	M Premium 8.15 T	RW	3	400	50	210	21	900	7.5	5.5	6.6	3.5	55	63 x 59 x 96												
9050 1504	M Premium 8.21 T	RW	3	400	50	160	16	1260	7.5	5.5	6.9	3.5	55	63 x 59 x 96												
9050 1505	M Premium 9.15 T	RW	3	400	50	230	23	900	9.0	6.6	7.3	3.5	55	63 x 59 x 96												
9050 1506	M Premium 9.21 T	RW	3	400	50	180	18	1260	9.0	6.6	7.5	3.5	55	63 x 59 x 96												
<b>M Premium Mobile con avvolgitubo - with hose reel</b>																										
9050 1507	M Premium 6.13 T	RW	3	400	50	190	19	780	6.0	4.4	5.5	3.5	55	63 x 59 x 96												
9050 1508	M Premium 6.15 T	RW	3	400	50	170	17	900	6.0	4.4	5.5	3.5	55	63 x 59 x 96												
9050 1509	M Premium 8.15 T	RW	3	400	50	210	21	900	7.5	5.5	6.6	3.5	55	63 x 59 x 96												
9050 1510	M Premium 8.21 T	RW	3	400	50	160	16	1260	7.5	5.5	6.9	3.5	55	63 x 59 x 96												
9050 1511	M Premium 9.15 T	RW	3	400	50	230	23	900	9.0	6.6	7.3	3.5	55	63 x 59 x 96												
9050 1512	M Premium 9.21 T	RW	3	400	50	180	18	1260	9.0	6.6	7.5	3.5	55	63 x 59 x 96												

## PICK-UP



- Configuration for stationary use (on a pallet, on a base, on the ground)
- Easy to handle thanks to the practical built-in steel handles
- Configurazione per utilizzo stazionario (su pianale, su base, su terreno)
- Di facile movimentazione grazie alle comode maniglie in acciaio integrate nel telaio della macchina

## STATIC Kit



- Wall application kit with heavy duty tubular structure and hose reel
- Configuration for fixed washing points
- Kit applicazione a parete con struttura tubolare robusta ed affidabile con avvolgitubo
- Configurazione per postazioni fisse di lavaggio

## STANDARD ACCESSORIES › DOTAZIONE STANDARD



GH 351 gun with Swivel (n.2 o-ring)  
Pistola GH 351 con Swivel (n.2 o-ring)



Bent lance with detergent head, without nozzle  
Lancia angolata con testina detergente, senza ugello



25° spray nozzle, 1/4" MEG connection  
Ugello con getto a lama 25° attacco 1/4" MEG



Hose reel with rubber hose (15m for MOBILE models)  
Avvolgitubo girevole con tubo gomma (15m per modelli MOBILE)



Rubber delivery hose kit (solo versione MOBILE e PICK-UP)  
Kit tubo gomma mandata 10 m (MOBILE and PICK-UP version)



# ETM

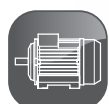

## GENERAL FEATURES

- Easy to transport thanks to a practical top grip and anti-vibration supports
- 2-pole motor (2800 rpm) for continuous use, 4-pole motor (1400 rpm) on ETM 150 model
- Built-in professional unloader valve with ejector (except ETM 71 model)
- **EASY-START** device (except ETM 71 model)
- **TotalStop** device (except ETM 71 model)
- Rotary switch
- Motor thermal protection
- Overheating thermostatic valve on ETM 71 model

## CARATTERISTICHE GENERALI

- *Semplicità di trasporto mediante confortevole impugnatura superiore ed appoggio su supporti antivibranti*
- *Motore a 2 poli (2800 giri/min) per uso continuo, motore a 4 poli (1400 giri/min) per modello ETM 150*
- *Valvola di regolazione professionale integrata con eiettore (eccetto modello ETM 71)*
- *Dispositivo **EASY-START** (eccetto modello ETM 71)*
- *Dispositivo **TotalStop** (eccetto modello ETM 71)*
- *Interruttore rotativo*
- *Protezione termica del motore*
- *Valvola termostatica di protezione da sovratemperatura su modello ETM 71*
- *Uso semiprofessionale gravoso (uso professionale per ETM 150)*

- Comet piston pumps with brass head
- Pompe a piston Comet con testata in ottone



- Brass quick coupling delivery fitting
- Attacco di mandata con innesto rapido in ottone









- Pressure regulating knob with anti-tampering device
- Manopola regolazione pressione con dispositivo antimanomissione



CODE CODICE	MODELS MODELLI	PUMP POMPA											
			Ph	V	Hz	bar	MPa	l/h	HP	kW	kW	kg	(L x W x H) cm
9055 0006	ETM 71	BWD-K	1	230	50	120	12	420	1,5	1,1	1,5	18	26 x 47 x 37
9055 0004	ETM 100	GXR	1	230	50	130	13	480	2,5	1,9	2,3	23	26 x 47 x 37
9055 0001	ETM 130	AXR	1	230	50	130	13	720	3,0	2,2	2,9	27	26 x 47 x 37
9055 0011	ETM 150	LW-K	1	230	50	150	15	600	3,0	2,2	2,9	35	26 x 47 x 37

 STANDARD ACCESSORIES › DOTAZIONE STANDARD

ETM 71		ETM 100 / ETM 130 / ETM 150	
	GC 251 gun with protection <i>Pistola GC 251 con protezione</i>		
	Bent lance with detergent head, without nozzle <i>Lancia angolata con testina detergente, senza ugello</i>		
	15° spray nozzle, 1/4" MEG connection <i>Ugello con getto a lama 15° attacco 1/4" MEG</i>		
	10 m thermoplastic delivery hose kit <i>Kit tubo termostatico 10 m</i>		8 m rubber delivery hose kit <i>Kit tubo mandata 8 m</i>
	Foam lance <i>Lancia schiumogena</i>		



# K 803-805-807-809 S



## GENERAL FEATURES

- Heavy duty structure with painted steel cover
- Handy and secure hose reel housing (when applicable) on top of the handle
- 4-pole motor (1400 rpm) well oversized and protected with paint
- Built-in professional unloader valve (**bolt-on K 809 only**)
- Self-priming ZW-K and FW2 pumps
- Exclusive pump-motor coupling system for intensive use (**K 809 only**)
- Contactor
- Motor thermal protection
- Overheating thermostatic valve



## CARATTERISTICHE GENERALI

- *Struttura robusta ed affidabile con cofano in acciaio verniciato*
- *Pratica e sicura collocazione dell'avvolgitubo (quando previsto) sul manubrio in posizione superiore*
- *Motore a 4 poli (1400 giri/min) ampiamente sovradimensionato e protetto da verniciatura*
- *Valvola regolazione professionale integrata (flangiata solo su K 809)*
- *Pompe autoadescanti ZW-K e FW2*
- *Esclusivo sistema accoppiamento pompa - motore per uso intensivo (solo K 809)*
- *Teleruttore*
- *Protezione termica motore*
- *Valvola termostatica di protezione da sovratemperatura*
- *Uso professionale*



- The hose reel can be mounted on the handle on request
- *A richiesta, possibilità di montaggio dell'avvolgitubo sul manubrio*



- Comet ZW-K pump with 3 integral ceramic pistons and brass pump head. Two oil sight glasses
- *Pompa Comet ZW-K con 3 pistoni in ceramica integrale con testata in ottone. Doppio visore livello olio*



- Comet FW2 pump with 3 integral ceramic pistons and brass pump head. Two oil sight glasses (K809 models only)
- *Pompa Comet FW2 con 3 pistoni in ceramica integrale con testata in ottone. Doppio visore livello olio (solo modelli K809)*



CODE CODICE	MODELS MODELLI	PUMP POMPA											
			Ph	V	Hz	bar	MPa	l/h	HP	kW	kW	kg	(L x W x H) cm
9024 4022	K 803 S 11/120 M	ZW-K	1	230	50	120	12	660	3,0	2,2	2,9	62	90 x 62 x 84
9024 4013	K 805 S 15/150 T	ZW-K	3	400	50	160	16	900	5,5	4,0	4,8	62	90 x 62 x 84
9024 4014	K 807 S 15/200 T	ZW-K	3	400	50	210	12	900	7,5	5,5	6,5	62	90 x 62 x 84
9024 4016	K 809 S 21/160 T	FW2	3	400	50	160	16	1260	7,5	5,5	7,0	66	90 x 62 x 84



STANDARD ACCESSORIES › DOTAZIONE STANDARD

 <p>GC 251 gun with protection <i>Pistola GC 251 con protezione</i></p>	 <p>Bent lance with detergent head, without nozzle <i>Lancia angolata con testina detergente, senza ugello</i></p>
 <p>25° spray nozzle, 1/4" MEG connection <i>Ugello con getto a lama 25° attacco 1/4" MEG</i></p>	 <p>10 m rubber delivery hose kit <i>Kit tubo gomma mandata 10 m</i></p>



# K 803-805-807-809 TS



## GENERAL FEATURES

- Heavy duty structure **with stainless steel cover**
- Handy and secure housing of the hose reel (when applicable) in back position on the handlebar
- Readily serviceable brass suction filter
- **Hot water seals**
- 4-pole motor (1400 rpm) well oversized and protected with paint
- Built-in professional unloader valve (**K 803- K 805 only**)
- Bolt-on professional unloader valve (**K 807 - K 809 only**)
- Timed **TotalStop**
- **Exclusive pump-motor coupling system for intensive use (K 807 - K 809 only)**
- Contactor
- Motor thermal protection



## CARATTERISTICHE GENERALI

- **Struttura robusta ed affidabile con cofano in acciaio inox**
- **Pratica e sicura collocazione dell'avvolgitubo (quando previsto) in posizione posteriore sul manubrio**
- **Filtro aspirazione in ottone ispezionabile**
- **Guarnizioni ad acqua calda**
- **Motore a 4 poli (1400 giri/min) ampiamente sovradimensionato e protetto da verniciatura**
- **Valvola regolazione pressione professionale integrata (solo K 803- K 805)**
- **Valvola regolazione professionale flangiata (solo K 807 - K 809)**
- **TotalStop temporizzato**
- **Esclusivo sistema accoppiamento pompa - motore per uso intensivo (solo K 807 - K 809)**
- Teleruttore
- Protezione termica motore
- **Uso professionale**

- Big pneumatic wheels (320 mm ø)
- Ruote pneumatiche di grandi dimensioni (ø320mm)



- Comet ZW-K pump with 3 integral ceramic pistons and brass pump head. Two oil sight glasses
- Pompa Comet ZW-K con 3 pistoni in ceramica integrale con testata in ottone. Doppio visore livello olio (solo modelli K803-K805)



- Comet FW2 pump with 3 integral ceramic pistons and brass pump head. Two oil sight glasses (K807-K809 models only)
- Pompa Comet FW2 con 3 pistoni in ceramica integrale con testata in ottone. Doppio visore livello olio (solo modelli K807-K809)



CODE CODICE	MODELS MODELLI	PUMP POMPA											
			Ph	V	Hz	bar	MPa	l/h	HP	kW	kW	kg	(L x W x H) cm
9024 4021	K 803 TS 11/120 M	ZW-K	1	230	50	120	12	660	3,0	2,2	2,9	63	90 x 62 x 84
9024 4023	K 805 TS 15/160 T	ZW-K	3	400	50	160	16	900	5,5	4,0	4,8	63	90 x 62 x 84
9024 4024	K 807 TS 15/210 T	FW2	3	400	50	210	21	900	7,5	5,5	6,5	67	90 x 62 x 84
9024 4025	K 809 TS 21/160 T	FW2	3	400	50	160	16	1260	7,5	5,5	7,0	67	90 x 62 x 84

**STANDARD ACCESSORIES › DOTAZIONE STANDARD**

	GH 351 gun with Swivel (n.2 o-ring) <i>Pistola GH 351 con Swivel (n.2 o-ring)</i>		Bent lance with detergent head, without nozzle <i>Lancia angolata con testina detergente, senza ugello</i>
	25° spray nozzle, 1/4" MEG connection <i>Ugello con getto a lama 25° attacco 1/4" MEG</i>		10 m rubber delivery hose kit <i>Kit tubo gomma mandata 10 m</i>
		Brass inlet water filter <i>Filtro aspirazione acqua in ottone</i>	



# K 891-991 TS



## PREMIUM



RW Premium



### GENERAL FEATURES

- Heavy duty structure **with stainless steel cover**
- Handy and secure housing of the hose reel (when applicable) in back position on the handlebar
- Readily serviceable brass suction filter
- **Hot water seals**
- 4-pole motor (1400 rpm) well oversized and protected with paint
- Professional unloader valve
- Timed **TotalStop**
- **Exclusive pump-motor coupling system for intensive use**
- Contactor
- Motor thermal protection

### CARATTERISTICHE GENERALI

- **Struttura robusta ed affidabile con cofano in acciaio inox**
- **Pratica e sicura collocazione dell'avvolgitubo (quando previsto) in posizione posteriore sul manubrio**
- **Filtro aspirazione in ottone ispezionabile**
- **Guarnizioni ad acqua calda**
- **Motore a 4 poli (1400 giri/min) ampiamente sovradimensionato e protetto da verniciatura**
- **Valvola regolazione pressione professionale**
- **TotalStop temporizzato**
- **Esclusivo sistema accoppiamento pompa - motore per uso intensivo**
- **Teleruttore**
- **Protezione termica motore**
- **Uso professionale**

- Pneumatic wheels
- Ruote pneumatiche



- Reversible handlebar for easy handling by pushing
- Manubrio reversibile per movimentazione a spinta



- Stainless steel cover
- Telaio in acciaio inox



- Stainless steel pressure gauge
- Manometro in acciaio inox



CODE CODICE	MODELS MODELLI	PUMP POMPA											
			Ph	V	Hz	bar	MPa	l/h	HP	kW	kW	kg	(L x W x H) cm
9024 4072	K 891 TS 15/230 T	RW	3	400	50	230	23	900	9,0	6,7	7,3	70	90 x 62 x 84
9024 4073	K 891 TS 21/180 T	RW	3	400	50	180	18	1260	9,0	6,7	7,3	70	90 x 62 x 84
9024 4071	K 991 TS 15/270 T	RW	3	400	50	270	27	900	10,0	7,4	8,5	89	115 x 60 x 88
9024 4057	K 991 TS 21/210 T	RW	3	400	50	210	21	1260	10,0	7,4	8,5	89	115 x 60 x 88

STANDARD ACCESSORIES › DOTAZIONE STANDARD

	GH 351 gun with Swivel (n.2 o-ring) <i>Pistola GH 351 con Swivel (n.2 o-ring)</i>		Bent lance with detergent head, without nozzle <i>Lancia angolata con testina detergente, senza ugello</i>
	25° spray nozzle, 1/4" MEG connection <i>Ugello con getto a lama 25° attacco 1/4" MEG</i>		10 m rubber delivery hose kit <i>Kit tubo gomma mandata 10 m</i>
	Brass inlet water filter <i>Filtro aspirazione acqua in ottone</i>		Ejector kit <i>Kit eiettore</i>

# K 801-901 ECO PREMIUM

## K 809 ECO



### GENERAL FEATURES

- Handle with supports for housing the gun, lance, power cable and delivery hose
- **Hot water seals**
- Handy and secure housing of the hose reel (when applicable)
- 4-pole three-phase asynchronous motor (1400 rpm)
- **Exclusive pump-motor coupling system for intensive use**
- Bolt-on professional unloader valve
- Contactor
- Stainless steel frame and casing
- Motor thermal protection
- Timed **TotalStop**

### CARATTERISTICHE GENERALI

- *Manico dotato di supporti per l'alloggiamento della pistola, della lancia, del cavo di alimentazione e del tubo mandata*
- **Guarnizioni ad acqua calda**
- *Pratica e sicura collocazione dell'avvolgitubo (quando previsto)*
- *Motore elettrico asincrono trifase 4 poli (1400 giri/min)*
- **Esclusivo sistema di accoppiamento pompa-motore per uso intensivo**
- *Valvola di regolazione flangiata professionale*
- *Teleruttore*
- *Telaio e carena in acciaio inox*
- *Protezione termica del motore elettrico*
- **TotalStop** temporizzato
- *Uso professionale*

- Big wheels in food-industry rubber
- Ruote di grandi dimensioni con rivestimento in gomma antitraccia



- Pressure gauge with stainless steel casing
- Manometro pressione con cassa in acciaio inox



- Comet FW2 and RW Premium pumps with 3 integral ceramic pistons and brass pump head (nickel head for RW).
- Pompe Comet FW2 e RW Premium con 3 pistoni in ceramica integrale con testata in ottone (testata in nickel per RW).



- The hose reel can be mounted on the handle on request
- A richiesta, possibilità di montaggio dell'avvolgitubo sul manubrio



CODE CODICE	MODELS MODELLI	PUMP POMPA											
			Ph	V	Hz	bar	MPa	l/h	HP	kW	kW	kg	(L x W x H) cm
9024 4725	K 809 ECO 21/150	FW2	3	400	50	150	15	1260	7,5	5,5	7,0	67	90 x 62 x 84
9024 4726	K 801 ECO 15/210	RW Premium	3	400	50	210	21	900	9,0	6,6	7,5	70	90 x 62 x 84
9024 4727	K 901 ECO 21/180	RW Premium	3	400	50	180	18	1260	9,0	6,6	7,5	70	90 x 62 x 84

 STANDARD ACCESSORIES › DOTAZIONE STANDARD

 <p>GH 351 stainless steel gun with Swivel and ball quick coupler <i>Pistola GH 351 inox con Swivel + attacco rapido a sfere</i></p>	 <p>Stainless steel bent lance, adjustable head, with ball quick coupler without nozzle <i>Lancia angolata inox, testina regolabile + attacco rapido a sfere senza ugello</i></p>
 <p>S. Steel fan shape nozzle 25°, 1/4" MEG connection <i>Ugello inox con getto a lama 25° attacco 1/4" MEG</i></p>	 <p>10 m BLUE food industry rubber delivery hose kit <i>Kit tubo gomma mandata 10 m BLU anti-traccia</i></p>
 <p>Brass inlet water filter <i>Filtro aspirazione acqua in ottone</i></p>	



# K 1001-1251-1501 TS



## PREMIUM



SW / TW Premium



### GENERAL FEATURES

- Heavy duty structure **with stainless steel cover**
- High filtering capacity cartridge self-cleaning suction filter
- Pressure gauge with stainless steel casing
- **Hot water seals**
- 4-poles (1400 rpm) motor well oversized and protected with paint
- Pneumatic wheels with steel hub and air chamber
- Highly professional unloader valve with external bypass
- Motor-pump coupling by means of a flexible joint
- FLOW-SENSITIVE timed **TotalStop**
- Low voltage control panel
- Contactor
- Thermal relay motor protection



### CARATTERISTICHE GENERALI

- **Struttura robusta ed affidabile con cofano in acciaio inox**
- **Filtro aspirazione autopulente a cartuccia di alta portata, con alto potere filtrante**
- **Manometro pressione con cassa in inox**
- **Guarnizioni ad acqua calda**
- **Motore a 4 poli (1400 giri/min) ampiamente sovradimensionato e protetto da verniciatura**
- **Ruote schiumate con mozzo in acciaio ad effetto pneumatico**
- **Valvola regolazione altamente professionale con by-pass esterno**
- **Accoppiamento motore-pompa mediante giunto elastico**
- **TotalStop temporizzato FLOW-SENSITIVE**
- **Quadri Comando in bassa tensione**
- **Teleruttore**
- **Protezione del motore con relè termico**
- **Uso professionale continuo**



- The stainless steel hose reel can be mounted on request, with 20-40-60 m hose.
- *A richiesta, possibilità di montaggio dell'avvolgitubo interamente in acciaio inox con tubo da 20, 40, 60 metri.*

- Practical and safe housing accessories, all with ball quick coupler
- *Pratico e sicuro alloggiamento degli accessori, tutti con attacco rapido a sfere*

- Valve and pressure accumulator
- *Valvola e accumulatore di pressione*

- Stainless steel frame on request. Protective panels version on request.
- *Versione con telaio inox fornibile su richiesta. Versione con pannelli protettivi fornibile su richiesta.*



CODE CODICE	MODELS MODELLI	PUMP POMPA	Electrical			Pressure		Flow	Power		Energy	Weight	Dimensions
			Ph	V	Hz	bar	MPa		HP	kW			
9059 0351	K 1001 TS 21/210	SW Premium	3	400	50	210	21	1260	10,0	7,3	8,5	158	90 x 75 x 95
9059 0352	K 1001 TS 28/160	TW Premium	3	400	50	160	16	1680	10,0	7,3	8,5	158	90 x 75 x 95
9059 0353	K 1251 TS 21/250	SW Premium	3	400	50	250	25	1260	12,0	8,8	10,0	161	90 x 75 x 95
9059 0354	K 1251 TS 33/160	TW Premium	3	400	50	160	16	1980	12,0	8,8	10,0	161	90 x 75 x 95
9059 0355	K 1501 TS 42/130	TW Premium	3	400	50	130	13	2520	15,0	11,0	12,0	163	90 x 75 x 95
9059 0357	K 1501 TS 18/350	TW Premium	3	400	50	350	35	1080	15,0	11,0	12,0	163	90 x 75 x 95

STANDARD ACCESSORIES › DOTAZIONE STANDARD

	RL51 gun with swivel and ball quick coupler <i>(RL56 gun on K1501 models)</i> <i>Pistola RL 51 con Swivel e attacco rapido a sfere (pistola RL56 su modelli K1501)</i>		Stainless steel double (single on 18/350 model) barrel lance with ball quick coupler, without nozzle <i>Lancia canna doppia (singola sul modello 18/350) inox con attacco rapido a sfere, senza ugello</i>
	25° spray nozzle, 1/4" MEG connection <i>Ugello con getto a lama 25° attacco 1/4" MEG</i>		Detergent nozzle for double barrel lance, 1/4" MEG connection (not on 18/350 model) <i>Ugello detergente per lancia canna doppia, attacco 1/4" MEG (non sul modello 18/350)</i>
	Self cleaning water filter <i>Filtro acqua autopulente</i>		10 mt delivery rubber hose kit, with quick coupler <i>Kit tubo gomma mandata 10 mt, con attacco rapido</i>



# K Xtreme



## PREMIUM



TW Premium



TW 500 Premium



### GENERAL FEATURES

- Sturdy frame painted with anti-corrosive treatment
- **Stainless-steel cover panel**
- Handy lance and gun storage
- High filtering capacity cartridge self-cleaning suction filter
- Pneumatic wheels with steel hub and air chamber
- Electric motor (1400 rpm) 20, 25 and 30 HP
- Comet TW Premium triplex pumps
- Motor-pump coupling by means of a flexible joint
- Automatic unloader valve with external by-pass and gradual pressure restoring
- Overheating thermostatic valve
- **Low voltage (24V) industrial start-up panel (star-delta on 25-30 HP models)**
- Remote switch and motor cut-out with thermal relay
- Emergency stop button
- Hour counter

### CARATTERISTICHE GENERALI

- **Robusto telaio verniciato con trattamenti anticorrosivi**
- **Pannello di rivestimento in acciaio inox**
- Pratico alloggiamento di pistola e lancia
- Filtro aspirazione autopulente a cartuccia ampiamente sovradimensionato, con alto potere filtrante
- Ruote schiumate con mozzo in acciaio ad effetto pneumatico
- Motore elettrico (1400 giri/min) 20, 25 e 30 HP
- Pompe triplex Comet TW Premium
- Accoppiamento motore pompa mediante giunto elastico
- Valvola automatica di regolazione con by-pass esterno e ripristino graduale della pressione
- Valvola termostatica di protezione da sovratemperatura
- **Quadro di avviamento diretto con comandi in bassa tensione (24V), (stella triangolo su modelli 25-30 HP)**
- Teleruttore e protezione del motore con relè termico
- Pulsante di arresto di emergenza
- Contatore
- **Uso altamente professionale**

- Motor-pump coupling with a flexible joint
- *Accoppiamento motore pompa mediante giunto elastico*



- Hose reel can be mounted on request
- *A richiesta, possibilità di montaggio dell'avvolgitubo*



- Protective panels version on request.
- *Versione con pannelli protettivi fornibile su richiesta.*



CODE CODICE	MODELS MODELLI	PUMP POMPA											
			Ph	V	Hz	bar	MPa	l/h	HP	kW	kW	kg	(L x W x H) cm
9059 0001	K Xtreme 15/500	TW Premium	3	400	50	500	50	900	20,0	14,7	15,0	175	100 x 75 x 85
9059 0002	K Xtreme 21/350	TW Premium	3	400	50	350	35	1260	20,0	14,7	15,0	175	100 x 75 x 85
9059 0003	K Xtreme 33/250	TW Premium	3	400	50	250	25	1980	20,0	14,7	15,0	175	100 x 75 x 85
9059 0004	K Xtreme 18/500	TW Premium	3	400	50	500	50	1080	25,0	18,4	18,5	185	100 x 75 x 85
9059 0005	K Xtreme 21/450	TW Premium	3	400	50	450	45	1260	25,0	18,4	18,5	185	100 x 75 x 85
9059 0006	K Xtreme 42/200	TW Premium	3	400	50	200	20	2520	25,0	18,4	18,5	185	100 x 75 x 85
9059 0014	K Xtreme 21/500	TW Premium	3	400	50	500	50	1260	30,0	22,1	23,0	200	100 x 75 x 85

On request, available 440V 60Hz models - *Disponibili su richiesta modelli a 440V 60Hz*

STANDARD ACCESSORIES › *DOTAZIONE STANDARD*

	GH 501 stainless steel spray gun with quick couplers <i>Pistola GH 501 inox con attacchi rapidi</i>		Straight stainless steel lance, with adjustable handle <i>Lancia inox dritta, con impugnatura regolabile</i>
	Flat stainless-steel spray nozzle (15° or 25°) with ceramic insert (available on request in s/s-tungsten material) <i>Ugello inox getto piatto 15° o 25° con inserto in ceramica (disponibile su richiesta in materiale inox/tungsteno)</i>		20 mt delivery hose kit with quick coupler M24x1,5 <i>Kit tubo mandata 20 mt con attacchi rapidi M24x1,5</i>
		Self cleaning water filter <i>Filtro acqua autopulente</i>	

# FDX 2

## 2 wheels - 2 ruote



### FDX 2 10/150 - VRX

#### GENERAL FEATURES - CARATTERISTICHE GENERALI

- Loncin G 160 F Engine
- **Comet VRX 3 axial piston pump with brass pump head**
- Readily serviceable suction filter
- Professional unloader valve
- No engine oil safety device (oil-alert)
- **Motore Loncin G 160 F**
- **Pompa Comet a 3 pistoni assiali VRX, con testata in ottone**
- **Filtro aspirazione ispezionabile**
- **Valvola regolazione professionale**
- **Dispositivo di sicurezza mancanza olio motore (oil-alert)**
- **Uso semiprofessionale**

### FDX 2 12/200 - BXD

#### GENERAL FEATURES - CARATTERISTICHE GENERALI

- Loncin G 200 F Engine
- **Comet BXD self-priming pump with 3 axial integral ceramic pistons and brass pump head**
- Regulated low-pressure detergent suction
- Readily serviceable suction filter
- Professional unloader valve
- No engine oil safety device (oil-alert)
- **Motore Loncin G 200 F**
- **Pompa Comet BXD autoadescante con 3 pistoni assiali in ceramica e testata in ottone**
- **Aspirazione detergente in bassa pressione con regolazione**
- **Filtro aspirazione ispezionabile**
- **Valvola regolazione professionale**
- **Dispositivo di sicurezza mancanza olio motore (oil-alert)**
- **Uso semiprofessionale**

### FDX 2 - BXD / AXD

#### GENERAL FEATURES - CARATTERISTICHE GENERALI

- Honda GP or GX series engine
- **No engine-oil safety device (oil-alert)**
- **Comet BXD-AXD self-priming pumps with 3 axial ceramic pistons and brass pump head**
- Regulated low-pressure detergent suction
- Readily serviceable suction filter
- Professional unloader valve
- No engine oil safety device (oil-alert)
- **Motore Honda serie GP o GX**
- **Dispositivo di Sicurezza mancanza olio motore**
- **Pompe Comet BXD-AXD autoadescanti con 3 pistoni assiali in ceramica e testata in ottone**
- **Aspirazione detergente in bassa pressione con regolazione**
- **Filtro aspirazione ispezionabile**
- **Valvola regolazione professionale**
- **Dispositivo di sicurezza mancanza olio motore (oil-alert)**
- **Uso semiprofessionale**

### FDX 2 - BWD-K / ZWD / ZWD-K

#### GENERAL FEATURES - CARATTERISTICHE GENERALI

- Honda GX series engine
- **No engine-oil safety device (oil-alert)**
- **Comet BWD, ZWD, ZWD-K self-priming triplex pumps, 3 ceramic pistons, brass pump head, bronze conrods**
- Regulated low-pressure detergent suction
- Readily serviceable suction filter
- Professional unloader valve
- No engine oil safety device (oil-alert)
- **Motore Honda serie GX**
- **Dispositivo di Sicurezza mancanza olio motore**
- **Pompe Comet BWD, ZWD, ZWD-K triplex autoadescanti, 3 pistoni in ceramica, testata ottone, bielle in bronzo**
- **Aspirazione detergente in bassa pressione con regolazione**
- **Filtro aspirazione ispezionabile**
- **Valvola regolazione professionale**
- **Dispositivo di sicurezza mancanza olio motore (oil-alert)**
- **Uso semiprofessionale**

- Easy to handle up and down steps and over uneven ground
- *Facilità di movimento su gradini e fondi sconnessi*

- Well balanced for easy handling
- *Estrema maneggevolezza grazie alla favorevole posizione del baricentro*



CODE CODICE	MODELS MODELLI	PUMP POMPE	Pressure		Flow rate	Power	Weight	Dimensions
			bar	MPa				
9020 1155	FDX 2 10/150 - Loncin G160 F	VRX	150	15	540	5,0	27	67 x 55 x 89
9020 1156	FDX 2 12/200 - Loncin G200 F	BXD	200	20	720	6,0	30	67 x 55 x 89
9020 1315	FDX 2 13/150 - Honda GP160	BXD	150	15	780	5,0	30	67 x 55 x 89
9020 1316	FDX 2 12/200 - Honda GP200	BXD	200	20	720	6,0	30	67 x 55 x 89
9020 1304	FDX 2 14/200 - Honda GX270	AXD	200	20	840	9,0	40	67 x 55 x 89
9020 1317	FDX 2 12/140 - Honda GP160	BWD-K	140	14	720	5,5	30	67 x 55 x 89
9020 1306	FDX 2 13/180 - Honda GX200	BWD-K	180	18	780	6,0	34	67 x 55 x 89
9020 1308	FDX 2 16/210 - Honda GX340	ZWD-K	210	21	960	11,0	48	67 x 55 x 89
9020 1309	FDX 2 16/250 - Honda GX390	ZWD	250	25	960	13,0	50	67 x 55 x 89
9020 1310	FDX 2 15/270 - Honda GX390	ZWD-K	270	27	900	13,0	50	67 x 55 x 89

STANDARD ACCESSORIES › DOTAZIONE STANDARD

FDX2 Loncin

	Gun GC 251 with protection <i>Pistola con protezione GC 251</i>
	Bent lance with detergent head, without nozzle <i>Lancia angolata con testina detergente, senza ugello</i>
	Fan shape nozzle 15°, 1/4" MEG connection <i>Ugello con getto a lama 15°, attacco 1/4" MEG</i>
	8 m rubber delivery hose kit <i>Kit tubo gomma mandata 8 m</i>
	Foam lance (only for 10/150 model) <i>Lancia schiumogena (solo per modello 10/150)</i>

FDX2 Honda

	GH 301 gun with Swivel <i>Pistola GH 301 con Swivel</i>
	Bent lance with detergent head, without nozzle <i>Lancia angolata con testina detergente, senza ugello</i>
	Fan shape nozzle 25°, 1/4" MEG connection <i>Ugello con getto a lama 25°, attacco 1/4" MEG</i>
	10 m rubber delivery hose kit (8 m for 13/150 - 12/200 - 12/140 models) <i>Kit tubo gomma mandata 10 m (8 m per modelli 13/150 - 12/200 - 12/140)</i>

# FDX ELITE

## 4 wheels - 4 ruote



AXD



LWD-K



ZWD-K



ZWD



### GENERAL FEATURES

- With 4 wheels 2 of which castors
- Painted stainless steel pump protection casing
- Handle with practical supports for housing the gun, lance and delivery hose
- Low-pressure detergent suction
- Readily serviceable water filter
- Honda GP or GX series engine
- No engine-oil safety device (oil-alert)
- Water suction from external tank option (self-priming pumps)
- Professional pressure unloader valve
- Overheating thermostatic valve

### CARATTERISTICHE GENERALI

- Con 4 ruote di cui 2 pivotanti
- Carenatura di protezione della pompa in acciaio verniciato
- Manico dotato di pratici supporti per l'alloggiamento della pistola, della lancia e del tubo mandata
- Aspirazione del detergente in bassa pressione
- Filtro acqua ispezionabile
- Motori Honda serie GP o GX
- Dispositivo di sicurezza mancanza olio motore (oil-alert)
- Possibilità di aspirare acqua da serbatoio esterno (pompe autoadescanti)
- Valvola di regolazione della pressione professionale
- Valvola termostatica di protezione da sovratemperatura
- Uso semiprofessionale

- Easy handling thanks to the big pneumatic wheels
- *Facilità di movimento grazie alle ruote pneumatiche di grandi dimensioni*



- Comet AXD, LWD-K and ZWD-K pumps with 3 ceramic pistons and brass pump head
- *Pompe Comet AXD, LWD-K e ZWD-K con 3 pistoni in ceramica e testata in ottone*



- The hose reel can be mounted on the handle on request
- *A richiesta, possibilità di montaggio dell'avvolgitubo sul manubrio*



CODE CODICE	MODELS MODELLI	PUMP POMPE	Pressure		Flow	Power	Weight	Dimensions
			bar	MPa	l/h	HP	kg	(L x W x H) cm
9020 1515	FDX ELITE 13/150 - Honda GP160	AXD	150	15	780	5,5	38	90 x 62 x 84
9020 1502	FDX ELITE 12/170 - Honda GX160	AXD	170	17	720	5,5	38	90 x 62 x 84
9020 1506	FDX ELITE 14/200 - Honda GX270	AXD	200	20	840	9,0	48	90 x 62 x 84
9020 1510	FDX ELITE 13/180 - Honda GX200	LWD-K	180	18	780	6,0	42	90 x 62 x 84
9020 1507	FDX ELITE 16/210 - Honda GX340	ZWD-K	210	21	960	11,0	58	90 x 62 x 84
9020 1508	FDX ELITE 16/250 - Honda GX390	ZWD	250	25	960	13,0	58	90 x 62 x 84
9020 1509	FDX ELITE 15/270 - Honda GX390	ZWD-K	270	27	900	13,0	58	90 x 62 x 84

**STANDARD ACCESSORIES › DOTAZIONE STANDARD**

	GH 301 gun with Swivel <i>Pistola GH 301 con Swivel</i>		Bent lance with detergent head, without nozzle <i>Lancia angolata con testina detergente, senza ugello</i>
	Fan shape nozzle 25°, 1/4" MEG connection <i>Ugello con getto a lama 25°, attacco 1/4" MEG</i>		10 m rubber delivery hose kit <i>Kit tubo gomma mandata 10 m</i>
	Thermostatic Valve (optimal functioning when supplied with tap water pressure) <i>Valvola termostatica (funzionamento ottimale solo se alimentata in pressione)</i>		



# FDX PRO

## 4 wheels - 4 ruote



**PREMIUM**



### GENERAL FEATURES

- With 4 wheels of which 2 castors
- Honda GX series engine (petrol models) or Yanmar L70 engine (Diesel model)
- No engine-oil safety device (oil-alert) (Honda engine only)
- **Automatic decelerator to reduce RPM in the bypass phase (Honda engine only)**
- **Gearbox (with 1560 rpm pump) (Honda engine only)**
- Regulated low-pressure detergent suction
- Readily serviceable brass suction filter
- Water suction from external tank option (self-priming pumps)
- Overheating thermostatic valve



### CARATTERISTICHE GENERALI

- Con 4 ruote di cui 2 pivotanti
- Motore Honda serie GX (modelli a benzina) o Yanmar L70 (modello Diesel)
- Dispositivo di Sicurezza mancanza olio motore (solo motore Honda)
- **Deceleratore automatico per la riduzione del numero di giri in fase di by-pass (solo motore Honda)**
- **Riduttore di giri (con pompa a 1560 rpm) (solo motore Honda)**
- Aspirazione del detergente in bassa pressione con regolazione
- Filtro aspirazione in ottone facilmente ispezionabile
- Possibilità di aspirare acqua da serbatoio esterno (pompe autoadescenti)
- Valvola termostatica di protezione da sovratemperatura
- Uso professionale



- Easy handling thanks to the big pneumatic wheels
- *Facilità di movimento grazie alle ruote pneumatiche di grandi dimensioni*



- Comet RW Premium, FW2 pumps with 3 ceramic pistons and brass pump head
- *Pompe Comet RW Premium, FW2 con 3 pistoni in ceramica e testata in ottone*



- The hose reel can be mounted on the handle on request
- *A richiesta possibilità di montaggio dell'avvolgitubo sul manubrio*



- RPM deceleration kit
- *Kit deceleratore di giri motore*



CODE CODICE	MODELS MODELLI	PUMP POMPA	Pressure		Flow rate l/h	Power HP	Weight kg	Dimensions (L x W x H) cm
			bar	MPa				
<b>Diesel Engines - Motori diesel</b>								
9020 1114	FDX PRO 15/150 - Yanmar L70	ZWD-K	150	15	900	7,5	60	116 x 62 x 71
<b>Petrol engines - Motori a benzina</b>								
9020 1087	FDX PRO 16/200 - Honda GX340	FW2	200	20	960	11,0	82	116 x 62 x 71
9020 1090	FDX PRO 16/200 - Honda GX340 + AVT	FW2	200	20	960	11,0	87	116 x 62 x 71
9020 1132	FDX PRO 15/270 - Honda GX390	RW	270	27	900	13,0	82	116 x 62 x 71
9020 1146	FDX PRO 15/270 - Honda GX390 + AVT	RW	270	27	900	13,0	87	116 x 62 x 71
9020 1144	FDX PRO 15/300 - Honda GX390	RW	300	30	900	13,0	82	116 x 62 x 71
9020 1145	FDX PRO 15/300 - Honda GX390 + AVT	RW	300	30	900	13,0	87	116 x 62 x 71
9020 1116	FDX PRO 16/250 - Honda GX390	RW	250	25	960	13,0	82	116 x 62 x 71
9020 1117	FDX PRO 16/250 - Honda GX390 + AVT	RW	250	25	960	13,0	87	116 x 62 x 71
9020 1118	FDX PRO 18/220 - Honda GX390	RW	220	22	1080	13,0	82	116 x 62 x 71
9020 1119	FDX PRO 18/220 - Honda GX390 + AVT	RW	220	22	1080	13,0	87	116 x 62 x 71

**STANDARD ACCESSORIES › DOTAZIONE STANDARD**

	GH 351 gun with Swivel (n.2 o-ring) <i>Pistola GH 351 con Swivel (n.2 o-ring)</i>		Double barrel lance, without nozzle <i>Lancia a canna doppia senza ugello</i>
	Fan shape nozzle 25°, 1/4" MEG connection <i>Ugello con getto a lama 25° attacco 1/4" MEG</i>		Detergent nozzle for double barrel lance, 1/4" MEG connection <i>Ugello detergente per lancia canna doppia, attacco 1/4" MEG</i>
	10 m rubber delivery hose kit <i>(for models without hose reel)</i> <i>Kit tubo gomma mandata 10 m</i> <i>(per modelli senza avvolgitubo)</i>		15 m hose reel <i>(for models with hose reel)</i> <i>Avvolgitubo 15 m</i> <i>(per modelli con avvolgitubo)</i>
	Brass inlet water filter <i>Filtro aspirazione acqua in ottone</i>		Thermostatic Valve (optimal functioning when supplied with tap water pressure) <i>Valvola termostatica (funzionamento ottimale solo se alimentata in pressione)</i>



# FDX 4

## 4 wheels - 4 ruote



**PREMIUM**



### GENERAL FEATURES

- With 4 pneumatic wheels
- Honda GX series engine (petrol models) or Yanmar L100 engine (Diesel model)
- **Electrical starting**
- No engine-oil safety device (oil-alert)
- **Automatic decelerator to reduce the number of revs in the bypass phase (on petrol engines)**
- **Gearbox (with 1560 rpm pump)**
- Regulated low-pressure detergent suction
- Big water filter at pump inlet
- Water suction from external tank option (self-priming pumps)
- Overheating thermostatic valve

### CARATTERISTICHE GENERALI

- Con 4 ruote pneumatiche
- Motore Honda Serie GX (modelli a benzina) o Yanmar L100 (modello Diesel)
- **Avviamento elettrico**
- Dispositivo di Sicurezza mancanza olio motore
- **Deceleratore automatico per la riduzione del numero di giri in fase di by-pass (su motori benzina)**
- **Riduttore di giri (con pompa a 1560 rpm)**
- Aspirazione detergente in bassa pressione con regolazione
- Filtro acqua di grande dimensione in ingresso pompa
- Possibilità di aspirare acqua da serbatoio esterno (pompe autoadescanti)
- Valvola termostatica di protezione da sovratemperatura
- **Uso professionale**

- Easy handling thanks to the big pneumatic wheels
- *Facilità di movimento grazie alle ruote pneumatiche di grandi dimensioni*



- Comet RW Premium, FW2 pumps with 3 ceramic pistons and brass pump head
- *Pompe Comet RW Premium, FW2 con 3 pistoni in ceramica e testata in ottone*



- RPM deceleration kit only for petrol engine models
- *Kit deceleratore di giri motore solo modelli motore a benzina*



CODE CODICE	MODELS MODELLI	PUMP POMPA	Pressure		Flow	Power	Weight	Dimensions
			bar	MPa				
<b>Diesel Engines - Motori diesel</b>								
9020 1057	FDX 4 16/200 - FW2 - Yanmar L100 - Diesel with electrical and battery starting con avviamento elettrico e batteria	FW2	200	20	960	11,0	124	89 x 77 x 86
9020 1070	FDX 4 21/160 - FW2 - Yanmar L100 - Diesel with electrical and battery starting con avviamento elettrico e batteria	FW2	160	16	1260	11,0	124	89 x 77 x 86
<b>Petrol engines - Motori a benzina</b>								
9020 1049	FDX 4 16/200 - FW2 - Honda GX340 with decelerator - con deceleratore	FW2	200	20	960	11,0	72	89 x 77 x 86
9020 1121	FDX 4 16/250 - RW - Honda GX390 with electrical and battery starting and decelerator - con avviam. elett., batteria e deceleratore	RW	250	25	960	13,0	82	89 x 77 x 86
9020 1120	FDX 4 18/250 - RW - Honda GX390 with decelerator - con deceleratore	RW	250	25	960	13,0	72	89 x 77 x 86
9020 1150	FDX 4 18/220 - RW - Honda GX390 with electrical and battery starting and decelerator - con avviam. elett., batteria e deceleratore	RW	220	22	1080	13,0	82	89 x 77 x 86
9020 1123	FDX 4 18/220 - RW - Honda GX390 with decelerator - con deceleratore	RW	220	22	1080	13,0	72	89 x 77 x 86
9020 1152	FDX 4 21/200 - RW - Honda GX390 with electrical and battery starting and decelerator - con avviam. elett., batteria e deceleratore	RW	200	20	1260	13,0	82	89 x 77 x 86
9020 1151	FDX 4 21/200RW - Honda GX390 with decelerator - con deceleratore	RW	200	20	1260	13,0	82	89 x 77 x 86

**STANDARD ACCESSORIES › DOTAZIONE STANDARD**

	GH 351 gun with Swivel (n.2 o-ring) <i>Pistola GH 351 con Swivel (n.2 o-ring)</i>		Double barrel lance, without nozzle <i>Lancia a canna doppia senza ugello</i>
	Fan shape nozzle 25°, 1/4" MEG connection <i>Ugello con getto a lama 25° attacco 1/4" MEG</i>		Detergent nozzle for double barrel lance, 1/4" MEG connection <i>Ugello detergente per lancia canna doppia, attacco 1/4" MEG</i>
	10 m rubber delivery hose kit <i>Kit tubo gomma mandata 10 m</i>		Brass inlet water filter <i>Filtro aspirazione acqua in ottone</i>
	Thermostatic Valve (optimal functioning when supplied with tap water pressure) <i>Valvola termostatica (funzionamento ottimale solo se alimentata in pressione)</i>		



# FDX Xtreme



## 4 wheels - 4 ruote

### PREMIUM



#### GENERAL FEATURES

- 4 wheels with foamed-acting pneumatic
- Engines: Honda GX 690 (petrol versions) or Kohler 12KD477/2 (diesel versions)
- Gearbox (with 1560 rpm pump)
- Electrical starting
- No engine-oil safety device (oil-alert)
- Hours meter
- Automatic decelerator to reduce the number of revs in the bypass phase
- Stainless steel gradual pressure restoration valve with EASY-START
- Thermostatic valve
- Big water filter at pump inlet, readily serviceable cartridge type
- Water suction from external tank option (self-priming pumps)
- Suitable for high professional use



#### CARATTERISTICHE GENERALI

- 4 ruote schiumate con effetto pneumatico
- Motori: Honda GX 690 (versioni benzina) oppure Kohler 12KD477/2 (versioni diesel)
- Riduttore di giri (con pompa a 1560 rpm)
- Avviamento elettrico
- Dispositivo di Sicurezza mancanza olio motore (oil-alert)
- Contatore
- Deceleratore automatico per la riduzione del numero di giri in fase di by-pass
- Valvola a ripristino graduale della pressione in acciaio inox con EASY-START
- Valvola termostatica
- Filtro acqua di grande dimensione in ingresso pompa a cartuccia ispezionabile
- Possibilità di aspirare acqua da serbatoio esterno (pompe autoadescanti)
- Uso altamente professionale

- Rear wheel with brake
- *Ruota posteriore dotata di freno*

- Comet TW, TW 500 bar Premium pump with 3 ceramic plungers and brass pump head
- *Pompa Comet TW, TW 500 bar Premium, con 3 pistoni in ceramica e testata in ottone*

- The hose reel can be mounted on request
- *A richiesta possibilità di montaggio dell'avvolgitubo*

- RPM deceleration kit only for petrol engine models
- *Kit deceleratore di giri motore solo modelli motore a benzina*



CODE CODICE	MODELS MODELLI	PUMP POMPA	Pressure		Flow l/h	Power HP	Weight kg	Dimensions (L x W x H) cm
			bar	MPa				
<b>Petrol Engines (Honda GX 690) - Motore benzina (Honda GX690)</b>								
9058 0001	FDX Xtreme 15/500	TW Premium 500	500	50	900	22,0	150	100 x 82 x 85
9058 0002	FDX Xtreme 18/400	TW Premium 500	400	40	1080	22,0	150	100 x 82 x 85
9058 0003	FDX Xtreme 21/350	TW Premium 500	350	35	1260	22,0	150	100 x 82 x 85
9058 0004	FDX Xtreme 30/280	TW Premium	280	28	1800	22,0	150	100 x 82 x 85
9058 0005	FDX Xtreme 36/230	TW Premium	230	23	2160	22,0	150	100 x 82 x 85
9058 0006	FDX Xtreme 42/180	TW Premium	180	18	2520	22,0	150	100 x 82 x 85
<b>Diesel Engines (Kohler 12KD477/2) - Motore diesel (Kohler 12KD477/2)</b>								
9058 0007	FDX Xtreme 15/500	TW Premium 500	500	50	900	22,8	190	100 x 82 x 85
9058 0008	FDX Xtreme 18/400	TW Premium 500	400	40	1080	22,8	190	100 x 82 x 85
9058 0009	FDX Xtreme 21/350	TW Premium 500	350	35	1260	22,8	190	100 x 82 x 85
9058 0010	FDX Xtreme 30/280	TW Premium	280	28	1800	22,8	190	100 x 82 x 85
9058 0011	FDX Xtreme 36/230	TW Premium	230	23	2160	22,8	190	100 x 82 x 85
9058 0012	FDX Xtreme 42/180	TW Premium	180	18	2520	22,8	190	100 x 82 x 85

**STANDARD ACCESSORIES › DOTAZIONE STANDARD**

	Stainless steel GH 501 spray gun with quick couplers <i>Pistola GH 501 inox con attacchi rapidi</i>		Straight stainless steel lance, with adjustable handle <i>Lancia inox dritta, con impugnatura regolabile</i>
	Flat stainless-steel jet nozzle (15° or 25°) with ceramic insert (available on request in s/s-tungsten material) <i>Ugello inox getto piatto 15° o 25° con inserto in ceramica (disponibile su richiesta in materiale inox/tungsteno)</i>		20 mt delivery hose kit with quick coupler M24x1,5 <i>Kit tubo mandata con attacchi rapidi M24x1,5</i>
		Self cleaning water filter <i>Filtro acqua autopulente</i>	



# FDX WB



LWD-K



BWD-K



## GENERAL FEATURES

- 120 l polyethylene tank
- Painted steel frame
- Wheels with puncture-proof tyres
- Honda GX160 and Loncin G200F engines
- Comet LWD-K and BWD-K self-priming triplex pumps, with ceramic pistons and brass pump head
- Professional unloader valve
- Suction filter (readily serviceable external filter at pump inlet)
- Regulated low-pressure detergent suction
- GH301 spray gun with swivel
- Hose reel with 15m G1/4 hose
- Semi-professional use

## CARATTERISTICHE GENERALI

- Cisterna 120 LT in polietilene
- Telaio in acciaio verniciato
- Ruote con gomma anti-foratura
- Motori Honda GX160 e Loncin G200F
- Pompe Comet LWD-K e BWD-K, triplex autoadescanti, a pistoni in ceramica e testata in ottone
- Valvola di regolazione professionale
- Filtro in aspirazione (filtro esterno ispezionabile in ingresso pompa)
- Aspirazione detergente in bassa pressione con regolazione
- Pistola GH301 con swivel
- Avvolgitubo con 15mt tubo G1/4
- Uso semiprofessionale

- Readily serviceable external suction filter
- *Filtro aspirazione esterno ispezionabile*

- 15 m hose reel
- *Avvolgitubo 15 m*

- Comet Triplex pump, ceramic pistons and brass head
- *Pompa Comet triplex, pistoni in ceramica e testata in ottone*



CODE CODICE	MODELS MODELLI	PUMP POMPA	Pressure		Flow	Power	Weight	Dimensions
			bar	MPa	l/h	HP	kg	(L x W x H) cm
9020 0801	FDX WB 8/160 Honda GX 160	LWD-K	160	16	480	5,5	70	120 x 80 x 110
9020 0802	FDX WB 8/160 Loncin G 200 F	BWD-K	160	16	480	6,0	70	120 x 80 x 110

**STANDARD ACCESSORIES › DOTAZIONE STANDARD**

<p>GH 301 gun with Swivel <i>Pistola GH 301 con Swivel</i></p>	<p>Bent lance with detergent head, without nozzle <i>Lancia angolata con testina detergente, senza ugello</i></p>
<p>Fan shape nozzle 25°, 1/4" MEG connection <i>Ugello con getto a lama 25°, attacco 1/4" MEG</i></p>	<p>15 m hose reel <i>Avvolgitubo 15 m</i></p>



# PTO



## PREMIUM



### GENERAL FEATURES

- Also available with compact closing frame (71x85x15 cm)
- RW pumps with 1450 rpm gearbox kit
- With TWN pump for direct application
- Water suction from external tank option (self-priming pumps)
- Professional pressure unloader valve
- Shield for cardan shaft
- Readily serviceable brass water suction filter
- Pressure Gauge



### CARATTERISTICHE GENERALI



- Disponibile anche completa di telaio richiudibile e di ridotte dimensioni (71x85x15 cm)
- Pompe RW con moltiplicatore a 1450 giri/min
- Con pompa TWN per applicazione diretta
- Possibilità di aspirare acqua da serbatoio esterno (pompe autoadescanti)
- Valvola di regolazione pressione professionale
- Protezione Albero Cardanico
- Filtro aspirazione acqua in ottone, facilmente ispezionabile
- Manometro di pressione
- Uso professionale



- 1 Coupling for tractor's 3rd linkage point, diam. 19 - 25 mm
  - 2 22 mm diameter pins for 3-point hitch
  - 3 Gearbox kit for 1450 rpm pumps (RW)
- 1 Attacco al terzo punto trattore diam. 19 - 25 mm  
2 Pini diametro 22 mm per attacco ai bracci del sollevatore  
3 Moltiplicatore per pompe a 1450 giri/min (RW)

- Comet TWN and RW Premium pumps with 3 integral ceramic pistons and brass pump head. Two oil sight glasses
- Pompe Comet TWN e RW Premium con 3 pistoni in ceramica integrale con testata in ottone. Doppio visore livello olio



CODE CODICE	MODELS MODELLI	PUMP POMPA				
			bar	MPa	l/h	HP
<b>PTO Premium with frame - con telaio</b>						
9045 0014 *	PTO 21/200	RW	200	20	1260	10,5
9045 0003 ●	PTO 23/200	TWN	200	20	1380	11,3
9045 0005 ●	PTO 30/170	TWN	170	17	1800	12,3
<b>PTO Premium without frame - senza telaio</b>						
9045 0017 *	PTO 15/150	RW	150	15	900	6,0
9045 0016 *	PTO 21/200	RW	200	20	1260	10,5
9045 0008 ●	PTO 23/200	TWN	200	20	1380	11,3
9045 0010 ●	PTO 30/170	TWN	170	17	1800	12,3

\* with gearbox kit (540 rpm PTO) - con moltiplicatore (PTO 540 giri/min)  
● without gearbox kit (1000 rpm PTO) - senza moltiplicatore (PTO 1000 giri/min)

 STANDARD ACCESSORIES › DOTAZIONE STANDARD

 <p>GH 351 gun with Swivel, n. 2 o-ring <i>Pistola GH 351 con swivel, n. 2 o-ring</i></p>	 <p>Bent double barrel lance, without nozzles <i>Lancia a canna doppia angolata, senza ugelli</i></p>
 <p>Detergent nozzle for double barrel lance, 1/4" MEG connection <i>Ugello detergente per lancia canna doppia, attacco 1/4" MEG</i></p>	 <p>Fan shape nozzle 25°, 1/4" MEG connection <i>Ugello con getto a lama 25° attacco 1/4" MEG</i></p>
 <p>10 m rubber delivery hose kit <i>Kit tubo gomma mandata 10 m</i></p>	 <p>Water suction filter <i>Filtro aspirazione acqua</i></p>



# FDX Hot Cube

PED  
97 / 23 / CE  
cat. II



## GENERAL FEATURES

- Professional hot water high pressure cleaner for uses without connection to electricity grid
- Honda GX 390 engine (petrol models) or Yanmar L100 engine (diesel models)
- **Electrical starting-up**
- No engine-oil safety device (oil-alert)
- **Automatic decelerator to reduce the number of revs in the bypass phase**
- **Gearbox**
- Fuel tank with level float and fill up filter
- Professional gradual pressure restoration unloader valve
- Double coil vertical boiler with stainless steel outer casing
- Electronic temperature setting system with constant water temperature
- **PED 97/23/CE cat. II certification**
- Flow-switch operated burner
- Safety valve
- Boiler thermal protection
- Flame control kit

## CARATTERISTICHE GENERALI

- *Idropulitrice professionale a caldo per utilizzo senza allacciamento alla rete elettrica*
- *Motore Honda GX 390 (modelli a benzina) o Yanmar L100 (modelli diesel)*
- **Avviamento elettrico**
- *Dispositivo di Sicurezza mancanza olio motore*
- **Deceleratore automatico per la riduzione del numero di giri in fase di by-pass**
- **Riduttore di giri**
- *Serbatoio gasolio con galleggiante livello e filtro di riempimento*
- *Valvola regolazione professionale a ripristino graduale della pressione*
- *Caldaia verticale con serpentina a doppia spirale*
- *Sistema elettronico di regolazione della temperatura, con basso pendolamento del valore impostato*
- **Certificazione PED 97/23/CE cat. II**
- *Bruciatore azionato da Flussostato*
- *Valvola di sicurezza*
- *Protezione termica della caldaia*
- *Kit comando controllo fiamma*
- *Uso professionale continuo*

- FW2 pump with 3 integral ceramic pistons and brass pump head
- Pompa FW2 con 3 pistoni in ceramica e testata in ottone

- Protective panels version (on request)
- Versione con pannelli protettivi (su richiesta)

- Water pumped from tank with filter and float, anti-scale dispenser with pump and 2.5 l capacity tank
- Aspirazione acqua da tanica con filtro e galleggiante, dosatore anticalcare con pompa e serbatoio da 2,5 lt

- High performance stainless steel boiler
- Caldaia ad elevato rendimento realizzata in acciaio inox



CAGE

TRAILER

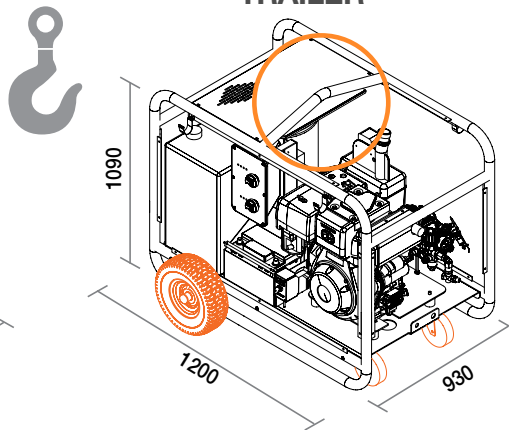
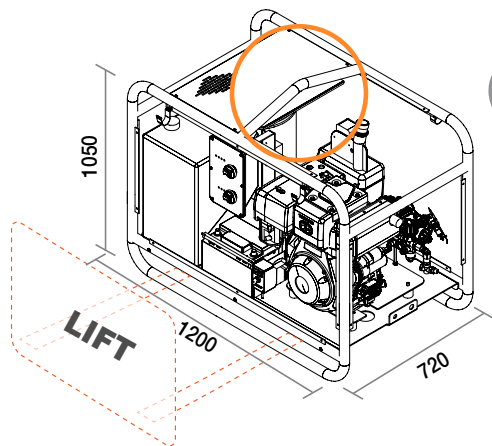

CODE CODICE	MODELS MODELLI	PUMP POMPA	Pressure		Flow l/h	Temperature °C	Power HP	Capacity l	Consumption kg/h	Weight kg	Dimensions (L x W x H) cm
			bar	MPa							
9058 0501 *	FDX Hot Cube 16/200 D Yanmar L 100 N	FW2	30 > 200	3 > 20	330 > 960	85 > 140	11,0	30	6,3	230	120x93x108
9058 0502 *	FDX Hot Cube 16/200 B Honda GX 390	FW2	30 > 200	3 > 20	330 > 960	85 > 140	13,0	30	6,3	200	120x93x108
9058 0503 *	FDX Hot Cube 21/160 D Yanmar L 100 N	FW2	30 > 160	3 > 16	560 > 1260	85 > 140	11,0	30	7,9	230	120x93x108
9058 0504 *	FDX Hot Cube 21/160 B Honda GX 390	FW2	30 > 160	3 > 16	560 > 1260	85 > 140	13,0	30	7,9	200	120x93x108

\* Code for Trailer Version / Codice per Versione Trailer (Cage Version on request / Versione Cage su richiesta)  
Protective panels kit available on request / Kit pannelli protettivi disponibile su richiesta

STANDARD ACCESSORIES › DOTAZIONE STANDARD

	GH 351 gun with Swivel (n.2 o-ring) Pistola GH 351 con Swivel (n.2 o-ring)		Double barrel lance, without nozzles Lancia a canna doppia senza ugelli
	Fan shape nozzle 25°, 1/4" MEG connection Ugello con getto a lama 25° attacco 1/4" MEG		10 m rubber delivery hose kit Kit tubo gomma mandata 10 m
	Brass inlet water filter Filtro aspirazione acqua in ottone		Detergent nozzle for double barrel lance, 1/4" MEG connection Ugello detergente per lancia canna doppia, attacco 1/4" MEG
	RPM deceleration kit Kit deceleratore di giri motore		Flame control kit Kit comando controllo fiamma



# HOT BOX



## HOT WATER MOBILE GENERATOR GENERATORE MOBILE DI ACQUA CALDA



**200 bar**



**350 bar > 500 bar**



### GENERAL FEATURES

- Hot water mobile generator up to 140°C for connection with cold water high pressure cleaners
- Connection hose to pressure cleaner (R2 3/8" - 2 mt)
- Fuel tank with level float and fill up filter
- Steam or hot water operation
- Flow-switch controlled burner
- Professional safety valve
- Boiler thermal protection
- Flame control
- Electronic temperature setting system with constant water temperature
- "Machine switched on" indicator
- "Steam shutdown" indicator
- "Check burner" indicator



### CARATTERISTICHE GENERALI

- Generatore mobile di acqua calda fino a 140°C per connessione con idropulitrici ad acqua fredda
- Tubo di collegamento all'idropulitrice (R2 3/8" - 2 mt)
- Serbatoio gasolio, con galleggiante di livello e filtro di riempimento
- Funzionamento a vapore o acqua calda
- Bruciatore azionato da Flussostato
- Valvola di sicurezza professionale
- Protezione termica della caldaia
- Controllo fiamma
- Sistema elettronico di regolazione della temperatura, con basso pendolamento del valore impostato
- Spia "Macchina sottotensione"
- Spia "Stop vapore"
- Spia "Controllo bruciatore"

- Stainless steel cover panels (on 350-500 bar models)
- Pannelli di rivestimento in acciaio inox (su modelli 350-500 bar)



- High performance boiler
- Caldaia ad alte prestazioni



- Boiler kit can also be sold separately
- Kit Caldaia vendibile anche separatamente.



**Cold water H.P. Cleaners**  
Idropultrici ad acqua fredda

**Boiler HotBox 200 bar**

**Hot water H.P. Cleaners**  
Idropultrici ad acqua calda

- X-STAR
- KR 1100
- KL
- KSM
- KS
- KT
- STATIC
- ETM
- KA
- K250
- K COMPACT
- FDX 2
- FDX ELITE
- FDX WB



**Cold water H.P. Cleaners**  
Idropultrici ad acqua fredda

**Boiler HotBox 350 / 500 bar**

**Hot water H.P. Cleaners**  
Idropultrici ad acqua calda

- K PREMIUM
- FDX PRO - FDX 4
- PTO
- K STEEL SERIES
- K 1001 - 1251 - 1501(42/130) TS
- FDX XTREME
- K XTREME
- K 1501(18/350) TS



350 bar  
500 bar



CODE CODICE	MODELLI MODELLI	Electrical		Pressure		Flow (l/h)	Power (kW)	Temperature (°C)	Capacity (l)	Weight (kg/h)	Weight (kg)	Dimensions (L x W x H) cm	
		Ph	V	Hz	bar								MPa
9040 0004	Hot Box 15/200	1	230	50	200	20	900	0,25	90 > 140	18	5,7	90	95 x 62 x 85
9040 0010	Hot Box 25/350	1	230	50	350	35	1500	0,25	90 > 140	20	8,3	110	76 x 77 x 96
9040 0005	Hot Box 25/500	1	230	50	500	50	1500	0,25	90 > 140	20	8,3	120	76 x 77 x 96
9040 0011	Hot Box 25/350	-	12	-	350	35	1500	0,25	90 > 140	20	8,3	110	76 x 77 x 96
9040 0009	Hot Box 25/500	-	12	-	500	50	1500	0,25	90 > 140	20	8,3	120	76 x 77 x 96

On request, available 110-115V / 50-60 Hz, 200V / 50-60 Hz. / Disponibili su richiesta modelli a 110-115V / 50-60 Hz, 200V / 50-60 Hz.

**STANDARD ACCESSORIES › DOTAZIONE STANDARD**

200 bar	350 bar	500 bar
<p>R2 5/16" 2 mt connection high pressure rubber hose kit Kit tubo gomma alta pressione 2 mt per collegamento</p>	<p>R2 3/8" 2 mt connection high pressure rubber hose kit Kit tubo gomma alta pressione 2 mt per collegamento</p>	<p>R2 3/8" 1,5 mt connection high pressure rubber hose kit Kit tubo gomma alta pressione 1,5 mt per collegamento</p>



# BORA 2

## 120 - 130 GOLD



MTP KMR Gold



### GENERAL FEATURES

- Comet electrical pump with three axial pistons arranged vertically with pump at the bottom and an all-metal construction without any plastic used for the structural components.
- Head in brass (**Gold version only**) or aluminium
- Fuel tank with level indicator
- **EASY-START** device
- **TotalStop** device
- **Combustion head with transparent flame viewer**
- Delayed burner start
- Safety valve
- Boiler thermal protection
- 3 positions switch (stop - cold water - hot water)
- Motor thermal protection



### CARATTERISTICHE GENERALI

- **Elettropompa Comet a tre pistoni assiali disposta in verticale con pompa in basso e costruzione interamente in metallo, senza materiale plastico nei componenti strutturali.**
- **Testa pompa in ottone (solo versione Gold) o alluminio**
- **Serbatoio gasolio con spia di livello**
- **Dispositivo EASY-START**
- **Dispositivo TotalStop**
- **Testa di combustione con oblò controllo fiamma**
- **Partenza ritardata del bruciatore**
- **Valvola di sicurezza**
- **Protezione termica della caldaia**
- **Interruttore a 3 posizioni (stop - acqua fredda - acqua calda)**
- **Protezione termica del motore**
- **Uso domestico**

- Big rubber wheels
- Ruote di grandi dimensioni



- Small, powerful and easy to use
- Piccola, potente e semplice da usare



- Safety valve
- Valvola di sicurezza



- Combustion head with transparent flame viewer
- Testa di combustione con oblo controllo fiamma



CODE CODICE	MODELS MODELLI	MOTORPUMP MOTOPOMPA	Ph		V		Hz		bar		MPa		l/h		kW		°C		l		kg/h		kg		(L x W x H) cm	
			Ph	V	Hz	bar	MPa	l/h	kW	°C	l	kg/h	kg	(L x W x H) cm												
9049 1002	BORA 2 120	KMR	1	230	50	120	12	450	2,0	90	25	2,45	55	68 x 50 x 80												
9049 1502	BORA 2 130 GOLD	KMR	1	230	50	130	13	450	2,2	90	25	2,45	55	68 x 50 x 80												

**STANDARD ACCESSORIES › DOTAZIONE STANDARD**

 <p>GH 251 gun with protection <i>Pistola GH 251 con protezione</i></p>	 <p>Bent lance with protection, without nozzle <i>Lancia angolata con protezione, senza ugello</i></p>
 <p>Fan shape nozzle 25°, 1/4" MEG connection <i>Ugello con getto a lama 25° attacco 1/4" MEG</i></p>	 <p>8 m rubber delivery hose kit <i>Kit tubo gomma mandata 8 m</i></p>
 <p>Foam lance <i>Lancia schiumogena</i></p>	



# VENTO



135 - 150



MTP KSR Gold



## GENERAL FEATURES

- Comet electrical pump with three axial pistons arranged horizontally with pump at the bottom and an all-metal construction without any plastic used for the structural components and brass pump head
- Pressure gauge
- Built-in fuel and detergent tanks
- Direct low-pressure suction of water with detergent
- **EASY-START** device
- **TotalStop** device
- Delayed burner start
- Safety valve
- Amperometric motor protection
- **Temperature setting thermostat**



## CARATTERISTICHE GENERALI

- *Elettropompa Comet a tre pistoni assiali disposta in orizzontale con pompa in basso e costruzione interamente in metallo, senza materiale plastico nei componenti strutturali e testata in ottone*
- Manometro pressione
- Serbatoio gasolio e detergente integrati
- Aspirazione acqua diretta con detergente in bassa pressione
- Dispositivo **EASY-START**
- Dispositivo **TotalStop**
- Partenza ritardata del bruciatore
- Valvola di sicurezza
- Protezione amperometrica del motore
- **Termostato di regolazione temperatura**
- *Uso semiprofessionale*



- Big rubber wheels
- Ruote di grandi dimensioni

- Practical lance and gun storage
- Pratico alloggiamento della pistola e della lancia

- Hose reel with 10 m high-pressure hose (for EXTRA models only)
- Avvolgitubo con tubo alta pressione in gomma 10 m. (solo per modelli EXTRA)



CODE CODICE	MODELS MODELLI	MOTORPUMP MOTOPOMPA	Electrical			Pressure		Flow	Power	Temperature	Consumption	Weight	Dimensions		
			Ph	V	Hz	bar	MPa							l/h	kW
9044 1001	VENTO CLASSIC 150	KSR	1	230	50	150	15	540	2,7	90	15	3,11	4,5	85	89 x 50 x 82
9044 1003	VENTO CLASSIC 135	KSR	1	230	50	135	13,5	600	2,7	90	15	3,11	4,5	85	89 x 50 x 82
9044 1002	VENTO EXTRA 150	KSR	1	230	50	150	15	540	2,7	90	15	3,11	4,5	85	89 x 50 x 82
9044 1004	VENTO EXTRA 135	KSR	1	230	50	135	13,5	600	2,7	90	15	3,11	4,5	85	89 x 50 x 82

**STANDARD ACCESSORIES › DOTAZIONE STANDARD**

CLASSIC	EXTRA
	GH 251 gun with protection <i>Pistola GH 251 con protezione</i>
	Bent lance with detergent head, without nozzle <i>Lancia angolata con testina detergente, senza ugello</i>
	Fan shape nozzle 15°, 1/4" MEG connection <i>Ugello con getto a lama 15° attacco 1/4" MEG</i>
8 m rubber delivery hose kit <i>Kit tubo gomma mandata 8 m</i>	10 m rubber delivery hose kit (on Hose Reel) <i>Kit tubo gomma mandata 10 m (su Avvolgitubo)</i>

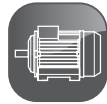

# JUPITER CLASSIC - EXTRA



AXR / GXR



## GENERAL FEATURES

- 15-litres capacity fuel tank with level float and fill up filter
- Regulated low-pressure detergent suction
- 2 poles (2800 rpm) motor with thermal protection
- Delayed **TotalStop** (instantaneous on JUPITER 3.10 model)
- **EASY-START** on single phase models
- Safety valve for boiler protection
- Boiler thermal protection
- Rotary On-Off switch
- Temperature setting thermostat
- Amperometric control (on three-phase models)
- Motor rotating control (on three-phase models)
- Phase control" indicator (on three-phase models)
- "No fuel" indicator



## CARATTERISTICHE GENERALI

- *Serbatoio gasolio di capacità 15 litri, con galleggiante di livello e filtro di riempimento*
- *Aspirazione detergente in bassa pressione con regolazione*
- *Motore con protezione termica a 2 poli (2800 rpm)*
- **TotalStop** temporizzato (istantaneo su modello JUPITER 3.10)
- **EASY-START** su modelli monofase
- *Valvola di sicurezza di protezione della caldaia*
- *Protezione termica della caldaia*
- *Interruttore rotativo per accensione*
- *Termostato di regolazione temperatura*
- *Controllo amperometrico (su modelli trifase)*
- *Controllo rotazione motore (su modelli trifase)*
- *Controllo fase (su modelli trifase)*
- *Spia "Mancanza gasolio"*
- *Uso semi-professionale gravoso*

- Hose reel with 15 m high-pressure rubber hose (Extra versions only)
- *Avvolgitubo con 15 mt tubo gomma alta pressione (solo versioni Extra)*



- Gun with pressure regulator (optional)
- *Pistola con regolatore di pressione (optional)*



- Front bumper
- *Paraurti anteriore*



- Closeable handles for transport operation
- *Maniglie richiudibili per operazioni di trasporto*



- Access to all inner parts, casing comes off in one piece
- *Accesso a tutte le parti interne rimuovendo la Carenatura in unico pezzo*



- Rear bumper
- *Paraurti posteriore*



CODE CODICE	MODELS MODELLI	MOTORPUMP MOTO Pompa	Ph		V		Hz		bar		MPa		l/h		HP		kW		kW		°C		l		kg/h		l		kg		(L x W x H) cm	
			1	3	1	3	1	3	1	3	1	3	1	3	1	3	1	3	1	3	1	3	1	3	1	3	1	3	1	3		
9061 1001	JUPITER Classic 3.10 10/140 M	GXR	1	230	50	140	14	600	3,0	2,2	2,9	110	15	3,5	3,5	95	94 x 62 x 84															
9061 1002	JUPITER Classic 5.12 12/180 T	AXR	3	400	50	180	18	720	5,0	3,7	4,8	110	15	4,2	3,5	100	94 x 62 x 84															
9061 1003	JUPITER Extra 3.10 10/140 M	GXR	1	230	50	140	14	600	3,0	2,2	2,9	110	15	3,5	3,5	100	104 x 62 x 84															
9061 1004	JUPITER Extra 5.12 12/180 T	AXR	3	400	50	180	18	720	5,0	3,7	4,8	110	15	4,2	3,5	105	104 x 62 x 84															



STANDARD ACCESSORIES › DOTAZIONE STANDARD

CLASSIC		EXTRA	
	GH 251 gun <i>Pistola GH 251</i>		Bent lance with detergent head, without nozzle <i>Lancia angolata con testina detergente, senza ugello</i>
	Fan shape nozzle 15°, 1/4" MEG connection <i>Ugello con getto a lama 15° attacco 1/4" MEG</i>		10 m rubber delivery hose kit <i>Kit tubo gomma mandata 10 m</i>
	Hose reel with 15 m rubber delivery hose <i>Avvolgitubo con 15 m tubo gomma mandata</i>		

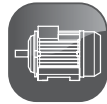

# JUPITER PRO

## CLASSIC - EXTRA



LW-K



### GENERAL FEATURES

- 15-litres capacity fuel tank with level float and fill up filter
- Regulated low-pressure detergent suction
- 4 poles (1400 rpm) motor with thermal protection
- Delayed **TotalStop**
- **EASY-START** on single phase models
- Safety valve for boiler protection
- Boiler thermal protection
- Rotary On-Off switch
- Temperature setting thermostat
- Amperometric control (on three-phase models)
- Motor rotating control (on three-phase models)
- Phase control" indicator (on three-phase models)
- "No fuel" indicator



### CARATTERISTICHE GENERALI

- Serbatoio gasolio di capacità 15 litri, con galleggiante di livello e filtro di riempimento
- Aspirazione detergente in bassa pressione con regolazione
- Motore con protezione termica a 4 poli (1400 rpm)
- **TotalStop** temporizzato
- **EASY-START** su modelli monofase
- Valvola di sicurezza di protezione della caldaia
- Protezione termica della caldaia
- Interruttore rotativo per accensione
- Termostato di regolazione temperatura
- Controllo amperometrico (su modelli trifase)
- Controllo rotazione motore (su modelli trifase)
- Controllo fase (su modelli trifase)
- Spia "Mancanza gasolio"
- Uso professionale

- Hose reel with 15 m high-pressure rubber hose (Extra versions only)
- Avvolgitubo con 15 mt tubo gomma alta pressione (solo versioni Extra)



- Gun with pressure regulator
- Pistola con regolatore di pressione



- Front bumper
- Paraurti anteriore



- Closeable handles for transport operation
- Maniglie richiudibili per operazioni di trasporto



- Access to all inner parts, casing comes off in one piece
- Accesso a tutte le parti interne rimuovendo la Carenatura in unico pezzo



- Rear bumper
- Paraurti posteriore



CODE CODICE	MODELS MODELLI	MOTORPUMP MOTOPIOMPA	Electrical		Pressure		Flow	Power		Temperature	Water	Chemical	Weight	Dimensions			
			Ph	V	Hz	bar	MPa	l/h	HP	kW	°C	l	kg/h	l	kg	(L x W x H) cm	
9061 1101	JUPITER PRO Classic 3.10 10/150 M	LW-K	1	230	50	150	15	600	3,0	2,2	3,0	110	15	3,5	3,5	95	94 x 62 x 84
9061 1102	JUPITER PRO Classic 5.12 12/200 T	LW-K	3	400	50	200	20	720	5,5	4,0	5,3	110	15	4,2	3,5	100	94 x 62 x 84
9061 1103	JUPITER PRO Extra 3.10 10/150 M	LW-K	1	230	50	150	15	600	3,0	2,2	3,0	110	15	3,5	3,5	100	104 x 62 x 84
9061 1104	JUPITER PRO Extra 5.12 12/200 T	LW-K	3	400	50	200	20	720	5,5	4,0	5,3	110	15	4,2	3,5	105	104 x 62 x 84



STANDARD ACCESSORIES › DOTAZIONE STANDARD

CLASSIC		EXTRA	
	GH 281 gun with Swivel and pressure regulator <i>Pistola GH 281 con Swivel e regolatore pressione</i>		
	Bent lance with detergent head, without nozzle <i>Lancia angolata con testina detergente, senza ugello</i>		
	Fan shape nozzle 15°, 1/4" MEG connection <i>Ugello con getto a lama 15° attacco 1/4" MEG</i>		
	10 m rubber delivery hose kit <i>Kit tubo gomma mandata 10 m</i>		Hose reel with 15 mt rubber delivery hose <i>Avvolgitubo con 15 m tubo gomma mandata</i>

# VENUS CLASSIC

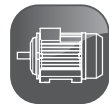

LW-K



ZW



FW2



- 2 swivel wheels in addition to the two fixed wheels
- 2 ruote girevoli in aggiunta alle due ruote fisse



- Practical and safe lance supports
- Pratici e sicuri supporti lancia



## GENERAL FEATURES

- 18-litre capacity fuel tank with level float and fill up filter
- Regulated high-pressure detergent suction **(only models with water tank)**
- Regulated low-pressure detergent suction **(only models without water tank)**
- 4-pole motor (1400 rpm) with Comet LW-K, ZW and FW2 with water tank and integrated valve on LW-K
- FW2 pump with flanged valve on 8.15 models
- Delayed **TotalStop**
- **EASY-START** on single-phase models
- Delayed burner start
- Professional safety valve
- Boiler thermal protection
- Rotary On-Off switch
- Contactor and motor protection with amperometric control
- Temperature setting thermostat
- "No fuel" indicator
- "Machine switched on" indicator
- "Phase control" indicator

## CARATTERISTICHE GENERALI

- Serbatoio gasolio di capacità 18 litri, con galleggiante di livello e filtro di riempimento
- Aspirazione detergente in alta pressione con regolazione **(solo modelli con tanica acqua)**
- Aspirazione detergente in bassa pressione con regolazione **(solo modelli senza tanica acqua)**
- Motore a 4 poli (1400 giri/min) con pompe Comet LW-K, ZW e FW2 con tanica acqua e valvola inglobata su LW-K
- Pompa FW2 con valvola flangiata su modelli 8.15
- **TotalStop** temporizzato
- **EASY-START** su modelli monofase
- Partenza ritardata del bruciatore
- Valvola di sicurezza professionale
- Protezione termica della caldaia
- Interruttore Rotativo per accensione
- Teleruttore e protezione del motore con controllo amperometrico
- Termostato di regolazione temperatura
- Spia "Mancanza gasolio"
- Spia "Macchina sottotensione"
- Spia "Controllo fase"
- Uso professionale

- Separate boiler fan unit
- Gruppo ventilazione caldaia indipendente



- Hose reel with 15 m high-pressure rubber hose
- Avvolgitubo con 15 mt tubo gomma alta pressione (optional)



- Water tank with anti-scale device
- Vaschetta acqua con dispositivo e serbatoio anticalcare



- Access to all inner parts, casing comes off in one piece
- Accesso a tutte le parti interne rimuovendo la Carenatura in unico pezzo



- Door for adjusting pump pressure and for inspecting and cleaning water filter
- Sportello per regolazione della pressione pompa e per ispezione e pulizia del filtro acqua



- Front bumper
- Paraurti anteriore



- Cover for :
  - a. adjustment and fill detergent tank, with external tank suction system
  - b. access to the crossbar for lifting
  - c. Casing lock screw
- Coperchio per :
  - a. regolazione e riempimento serbatoio detergente, con possibilità di aspirazione da serbatoio esterno
  - b. accesso al gancio di sollevamento della idropulitrice
  - c. vite di bloccaggio carenatura



- Comet LW-K, ZW and FW2, Triplex pump, ceramic pistons and brass head
- Pompa Comet LW-K, ZW e FW2, triplex, pistoni in ceramica e testata in ottone



CODE CODICE	MODELS MODELLI	PUMP POMPA	Ph		V		Hz		bar		MPa		l/h		HP		kW		°C		I		kg/h		I		kg		(L x W x H) cm	
			Ph	V	Hz	bar	MPa	l/h	HP	kW	°C	I	kg/h	I	kg	(L x W x H) cm														
<b>Without water tank and anti-scale tank - Senza vaschetta acqua e cisterna anticalcare</b>																														
9060 1301	VENUS Classic 3.11 - 11/120	LW-K	1	230	50	120	12	660	3,0	2,2	2,9	110	18	4,4	3,5	105	95 x 62 x 85													
9060 1302	VENUS Classic 5.13 - 13/180	LW-K	3	400	50	180	18	780	5,5	4,0	4,9	110	18	4,6	3,5	110	95 x 62 x 85													
9060 1303	VENUS Classic 5.15 - 15/160	LW-K	3	400	50	160	16	900	5,5	4,0	5,0	110	18	5,5	3,5	110	95 x 62 x 85													
9060 1305	VENUS Classic 8.15 - 15/200	FW2	3	400	50	200	20	900	7,5	5,5	6,5	110	18	5,7	3,5	125	95 x 62 x 85													
<b>With water tank and anti-scale tank - Con vaschetta acqua e cisterna anticalcare</b>																														
9060 1351	VENUS Classic 3.11 - 11/120	ZW	1	230	50	120	12	660	3,0	2,2	2,9	110	18	4,4	3,5	110	95 x 62 x 85													
9060 1352	VENUS Classic 5.13 - 13/180	ZW	3	400	50	180	18	780	5,5	4,0	4,9	110	18	4,6	3,5	115	95 x 62 x 85													
9060 1353	VENUS Classic 5.15 - 15/160	ZW	3	400	50	160	16	900	5,5	4,0	5,0	110	18	5,5	3,5	115	95 x 62 x 85													
9060 1355	VENUS Classic 8.15/15/200	FW2	3	400	50	200	20	900	7,5	5,5	6,5	110	18	5,7	3,5	128	95 x 62 x 85													

**STANDARD ACCESSORIES › DOTAZIONE STANDARD**

Without Water Tank and Anti-scale Tank Senza Vaschetta Acqua e Cisterna Anticalcare		With Water Tank and Anti-scale Tank Con Vaschetta Acqua e Cisterna Anticalcare	
	GH 301 gun with Swivel Pistola GH 301 con Swivel		Bent lance with detergent head, without nozzle Lancia angolata con testina detergente, senza ugello
	Bent lance with nozzle holder, without nozzle Lancia angolata con testa portaugello, senza ugello		Fan shape nozzle 25°, 1/4" MEG connection Ugello con getto a lama 25° attacco 1/4" MEG
	10 m rubber delivery hose kit Kit tubo gomma mandata 10 m		

# VENUS EXTRA

PED  
97 / 23 / CE  
cat. II

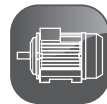

ZW



FW2



- 2 swivel wheels in addition to the two fixed wheels
- 2 ruote girevoli in aggiunta alle due ruote fisse



- Practical and safe lance supports
- Pratici e sicuri supporti lancia



## GENERAL FEATURES

- 18-litre capacity fuel tank with level float and fill up filter
- High pressure detergent suction with adjustment of the quantity from an inside tank, possibility of using an external detergent tank
- Water suction from a tank with an integrated and readily serviceable suction cartridge filter
- Anti-scale device with pump and tank (2.5 l)
- Professional 4-pole motor (1400 rpm) with Comet ZW pumps and professional unloader bolt-on valve
- FW2 pump on 8.15 model
- Timed **TotalStop**
- **General stop (when the machine is not used for a long time)**
- **EASY-START** on 1-230 models
- Steam operation
- Flow-switch controlled burner
- Professional safety valve
- Boiler thermal protection
- Electronic temperature setting system with constant water temperature
- **PED 97/23/CE cat. II certification**
- Delayed burner start

## CARATTERISTICHE GENERALI

- Serbatoio gasolio di capacità 18 litri, con galleggiante di livello e filtro di riempimento
- Aspirazione detergente in alta pressione con regolazione della quantità da serbatoio interno, possibilità di aspirare da tanica esterna
- Aspirazione acqua da cisterna integrata con filtro aspirazione a cartuccia ispezionabile
- Dispositivo anticalcare con pompa e serbatoio (2,5 lt)
- Motore a 4 poli professionale (1400 giri/min) con pompe Comet ZW e valvola regolazione pressione professionale flangiata
- Pompa FW2 su modello 8.15
- **TotalStop** temporizzato
- **Stop generale (in caso di prolungata inattività)**
- **EASY-START** su modelli 1-230
- Funzionamento a vapore
- Bruciatore azionato da Flussostato
- Valvola di sicurezza professionale
- Protezione termica della caldaia
- Sistema elettronico di regolazione della temperatura, con basso pendolamento del valore impostato
- **Certificazione PED 97/23/CE cat. II**
- Partenza ritardata del bruciatore
- **Uso professionale**



- Separate boiler fan unit
- Gruppo ventilazione caldaia indipendente

- Water tank with anti-scale device
- Vaschetta acqua con dispositivo e serbatoio anticalcare

- Door for adjusting pump pressure and for inspecting and cleaning water filter
- Sportello per regolazione della pressione pompa e per ispezione e pulizia del filtro acqua

- Cover for :
  - a. adjustment and fill detergent tank, with external tank suction system
  - b. anti-scale tank filling
  - c. access to the crossbar for lifting
  - d. Casing lock screw
- Coperchio per :
  - a. regolazione e riempimento serbatoio detergente, con possibilità di aspirazione da serbatoio esterno
  - b. riempimento serbatoio anticalcare
  - c. accesso al gancio di sollevamento della idropulitrice
  - d. vite di bloccaggio carenatura



- Hose reel with 15 m high-pressure rubber hose
- Avvolgitubo con 15 mt tubo gomma alta pressione (optional)

- Access to all inner parts, casing comes off in one piece
- Accesso a tutte le parti interne rimuovendo la Carenatura in unico pezzo

- Professional control panel
- Quadro comandi professionale

- Comet LW-K, ZW and FW2, Triplex pump, ceramic pistons and brass head
- Pompa Comet LW-K, ZW e FW2, triplex, pistoni in ceramica e testata in ottone



CODE CODICE	MODELS MODELLI	PUMP POMPA	Electrical		Pressure		Flow	Power	Power	Power	Temperature	Capacity	Capacity	Weight	Dimensions		
			Ph	V	Hz	bar										MPa	I/h
9060 1501	VENUS Extra 3.11 - 11/120	ZW	1	230	50	30 > 120	3 > 12	330 > 660	3,0	2,2	2,9	85 > 140	18	4,4	3,5	110	95 x 62 x 85
9060 1502	VENUS Extra 5.13 - 13/180	ZW	3	400	50	30 > 180	3 > 18	330 > 780	5,5	4,0	4,9	85 > 140	18	4,6	3,5	115	95 x 62 x 85
9060 1503	VENUS Extra 5.15 - 15/160	ZW	3	400	50	30 > 160	3 > 16	400 > 900	5,5	4,0	5,0	85 > 140	18	5,5	3,5	115	95 x 62 x 85
9060 1505	VENUS Extra 8.15 - 15/200	FW2	3	400	50	30 > 200	3 > 20	330 > 900	7,5	5,5	6,5	85 > 140	18	5,7	3,5	128	95 x 62 x 85

STANDARD ACCESSORIES › DOTAZIONE STANDARD

<p>GH 351 gun with Swivel (n. 2 o-ring) <i>Pistola GH 351 con Swivel (n. 2 o-ring)</i></p>	<p>Bent lance, with nozzle holder, without nozzle <i>Lancia angolata, testina portaugello, senza ugello</i></p>
<p>Fan shape nozzle 25°, 1/4" MEG connection <i>Ugello con getto a lama 25° attacco 1/4" MEG</i></p>	<p>10 m rubber delivery hose kit <i>Kit tubo gomma mandata 10 m</i></p>
<p>Flame control kit <i>Kit comando controllo fiamma</i></p>	



# E PREMIUM PLUS



**PREMIUM**

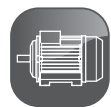

RW Premium



## GENERAL FEATURES

- Fuel tank with level floater and fill up filter
- Regulated high-pressure detergent suction **(only models with water tank)**
- Regulated low-pressure detergent suction **(only models without water tank)**
- Readily serviceable suction filter
- Professional 4-pole motor (1400 rpm) with double bearing
- Professional pressure unloader valve with external bypass
- Self Priming pumps
- Timed **TotalStop**
- Pressure gauge
- Safety valve
- Boiler thermal protection
- Delayed burner start
- Low voltage control panel
- Contactor
- Motor protected with a thermal relay
- Rotary On-Off switch
- **Temperature setting thermostat**
- "No fuel" indicator
- "Machine switched on" indicator



## CARATTERISTICHE GENERALI

- *Serbatoio gasolio con galleggiante livello e filtro di riempimento*
- *Aspirazione detergente in alta pressione con regolazione **(solo modelli con tanica acqua)***
- *Aspirazione detergente in bassa pressione con regolazione **(solo modelli senza tanica acqua)***
- *Filtro aspirazione ispezionabile*
- *Motore a 4 poli (1400 giri/min) professionale con doppio cuscinetto*
- *Valvola regolazione pressione professionale con by-pass esterno*
- *Pompe autoadescanti*
- ***TotalStop** temporizzato*
- *Manometro pressione*
- *Valvola di sicurezza*
- *Protezione termica della caldaia*
- *Partenza ritardata del bruciatore*
- *Quadro comandi in bassa tensione*
- *Teleruttore*
- *Protezione del motore con relè termico*
- *Interruttore Rotativo per accensione*
- ***Termostato di regolazione temperatura***
- *Spia "Mancanza gasolio"*
- *Spia "Macchina sottotensione"*
- *Uso professionale*

- Big solid wheels (260 mm ø)
- Ruote piene di grandi dimensioni (ø 260 mm)

- Highly professional motor pump unit with patented coupling between motor with double bearing and the Comet RW Premium pump with 3 integral ceramic pistons and brass pump head. External bypass valve
- Gruppo motopompa altamente professionale con accoppiamento brevettato, tra motore con doppio cuscinetto e pompa Comet RW Premium con 3 pistoni in ceramica integrale con testata in ottone. Valvola by-pass esterno

- Separate boiler fan unit
- Gruppo ventilazione caldaia indipendente



CODE CODICE	MODELS MODELLI	PUMP POMPA																
			Ph	V	Hz	bar	MPa	l/h	HP	kW	kW	°C	l	kg/h	l	kg	(L x W x H) cm	
<b>Without water tank - Senza vaschetta acqua</b>																		
9033 1901	E Premium Plus 15/200	RW Premium	3	400	50	200	20	900	8,0	5,9	7,0	110	13	6,4	13	130	103 x 71 x 86	
<b>With water tank - Con vaschetta acqua</b>																		
9033 1902	E Premium Plus 15/200	RW Premium	3	400	50	200	20	900	8,0	5,9	7,0	110	13	6,4	13	130	103 x 71 x 86	
<b>With water tank and anti-scale tank (2,5 lt) - Con vaschetta acqua e cisterna anticalcare (2,5 lt)</b>																		
9033 1906	E Premium Plus 15/200	RW Premium	3	400	50	200	20	900	8,0	5,9	7,0	110	13	6,4	13	130	103 x 71 x 86	



**STANDARD ACCESSORIES › DOTAZIONE STANDARD**

<b>Without Water Tank Senza Vaschetta Acqua</b>	<b>With Water Tank Con Vaschetta Acqua</b>
	<p>GH 351 gun with Swivel (n. 2 o-ring) <i>Pistola GH 351 con Swivel (n. 2 o-ring)</i></p>
<p>Bent lance with detergent head, without nozzle <i>Lancia angolata con testina detergente, senza ugello</i></p>	<p>Bent lance with nozzle holder, without nozzle <i>Lancia angolata con testa portaugello, senza ugello</i></p>
	<p>Fan shape nozzle 25°, 1/4" MEG connection <i>Ugello con getto a lama 25° attacco 1/4" MEG</i></p>
	<p>10 m rubber delivery hose kit <i>Kit tubo gomma mandata 10 m</i></p>

# F CLASSIC

## PREMIUM

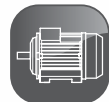

RW Premium



### GENERAL FEATURES

- Fuel tank with level floater and fill up filter
- Regulated high-pressure detergent suction (only models with water tank)
- Regulated low-pressure detergent suction (only models without water tank)
- Readily serviceable suction filter
- Professional 4-pole motor (1400 rpm)
- Professional pressure unloader valve
- Timed **TotalStop**
- Pressure gauge
- Flow-switch controlled burner
- Safety valve
- Boiler thermal protection
- Delayed burner start
- Low voltage control panel
- Contactor
- Motor protected with thermal relay
- Rotary On-Off switch
- **Temperature setting thermostat**
- "No fuel" indicator
- "Machine switched on" indicator

### CARATTERISTICHE GENERALI

- *Serbatoio gasolio con galleggiante livello e filtro di riempimento*
- *Aspirazione detergente in alta pressione con regolazione (solo modelli con tanica acqua)*
- *Aspirazione detergente in bassa pressione con regolazione (solo modelli senza tanica acqua)*
- *Filtro aspirazione ispezionabile*
- *Motore a 4 poli professionale (1400 giri/min)*
- *Valvola regolazione pressione professionale*
- **TotalStop** temporizzato
- *Manometro pressione*
- *Bruciatore azionato da Flussostato*
- *Valvola di sicurezza*
- *Protezione termica della caldaia*
- *Partenza ritardata del bruciatore*
- *Quadro comandi in bassa tensione*
- *Teleruttore*
- *Protezione del motore con relè termico*
- *Interruttore Rotativo per accensione*
- **Termostato di regolazione temperatura**
- *Spia "Mancanza gasolio"*
- *Spia "Macchina sottotensione"*
- *Uso professionale intensivo*

- Door for inspecting and cleaning the water filter
- Sportello ispezione e pulizia filtro acqua

- Separate boiler fan unit
- Gruppo ventilazione caldaia indipendente





- Glove compartment with handy access to check pump oil level
- Vano portaoggetti con pratico accesso controllo livello olio pompa



CODE CODICE	MODELS MODELLI	PUMP POMPA	Ph		V		Hz		bar		MPa		l/h		HP		kW		kW		°C		l		kg/h		l		kg		(L x W x H) cm	
			Ph	V	Hz	bar	MPa	l/h	HP	kW	kW	°C	l	kg/h	l	kg	(L x W x H) cm															
<b>Without a water tank - Senza vaschetta acqua</b>																																
9051 1301	F Classic 6.15	RW Premium	3	400	50	160	16	900	6,0	4,4	5,8	110	19	6,4	16	152	132 x 82 x 96															
9051 1302	F Classic 8.15	RW Premium	3	400	50	200	20	900	8,0	5,9	7,0	110	19	6,4	16	152	132 x 82 x 96															
<b>With a water tank - Con vaschetta acqua</b>																																
9051 1309	F Classic 6.15	RW Premium	3	400	50	160	16	900	6,0	4,4	5,8	110	19	6,4	16	152	132 x 82 x 96															
9051 1308	F Classic 8.15	RW Premium	3	400	50	200	20	900	8,0	5,9	7,0	110	19	6,4	16	152	132 x 82 x 96															
9051 1306	F Classic 9.18	RW Premium	3	400	50	200	20	1080	9,0	6,6	7,6	110	19	6,4	16	158	132 x 82 x 96															
9051 1307	F Classic 9.21	RW Premium	3	400	50	170	17	1260	9,0	6,6	7,6	110	19	6,4	16	158	132 x 82 x 96															
9051 1951	F Classic 10.18	RW Premium	3	400	50	220	22	1080	10,0	7,3	9,8	110	19	8,0	16	165	132 x 82 x 96															
9051 1952	F Classic 10.21	RW Premium	3	400	50	210	21	1260	10,0	7,3	10,3	110	19	8,0	16	165	132 x 82 x 96															



**STANDARD ACCESSORIES › DOTAZIONE STANDARD**

Without Water Tank Senza Vaschetta Acqua		With Water Tank Con Vaschetta Acqua	
 <p>GH 351 gun with Swivel (n. 2 o-ring) Pistola GH 351 con Swivel (n. 2 o-ring)</p>			
 <p>Bent lance with detergent head, without nozzle Lancia angolata con testina detergente, senza ugello</p>		 <p>Bent lance with nozzle holder, without nozzle Lancia angolata con testa portaugello, senza ugello</p>	
 <p>Fan shape nozzle 25°, 1/4" MEG connection Ugello con getto a lama 25° attacco 1/4" MEG</p>			
 <p>10 m rubber delivery hose kit Kit tubo gomma mandata 10 m</p>			



# F EXTRA



## PREMIUM

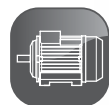

PED  
97 / 23 / CE  
cat. II



RW Premium



### GENERAL FEATURES

- Fuel tank with level floater and fill up filter
- Regulated high-pressure detergent suction
- Readily serviceable suction filter
- Big solid wheels (300 mm ø)
- **Anti-scale device with pump and tank (2.5 l)**
- Professional 4-pole motor (1400 rpm)
- Professional pressure-release unloader valve
- Timed **TotalStop**
- General stop (when the machine is not used for a long time)
- Double coil vertical boiler
- **Stainless steel outer casing**
- Electronic temperature setting system with constant water temperature
- **PED 97/23/CE cat. II certification**
- Flow-switch controlled burner
- Safety valve
- Boiler thermal protection
- Delayed burner start



### CARATTERISTICHE GENERALI

- **Serbatoio gasolio con galleggiante livello e filtro di riempimento**
- **Aspirazione detergente in alta pressione con regolazione**
- **Filtro aspirazione ispezionabile**
- **Ruote piene di grandi dimensioni (ø 300 mm)**
- **Dispositivo anticalcare con pompa e serbatoio (2,5 lt)**
- **Motore a 4 poli professionale (1400 giri/min)**
- **Valvola regolazione pressione professionale a rilascio pressione**
- **TotalStop temporizzato**
- **Stop generale (in caso di prolungata inattività)**
- **Caldaia verticale con serpentina a doppia spirale**
- **Corpo esterno caldaia in acciaio inox**
- **Sistema elettronico di regolazione della temperatura con basso pendolamento del valore impostato**
- **Certificazione PED 97/23/CE cat. II**
- **Brucciore azionato da Flussostato**
- **Valvola di sicurezza**
- **Protezione termica della caldaia**
- **Partenza ritardata del bruciore**
- **Uso professionale intensivo**

- Door for inspecting and cleaning the water filter
- Sportello ispezione e pulizia filtro acqua

- Separate boiler fan unit
- Gruppo ventilazione caldaia indipendente

- Glove compartment with handy access to check pump oil level
- Vano portaoggetti con pratico accesso controllo livello olio pompa

- Professional control panel
- Quadro comandi professionale



**CONTROL PANEL**

- Low voltage controls
- Contactor
- Motor protected with a thermal relay
- Rotary On-Off switch
- Electronic temperature setting
- “No fuel” indicator
- “Machine switched on” indicator
- “General Stop” indicator
- “Motor thermal cut-out triggered” indicator
- “Microleaks alarm” indicator
- “Steam shutdown” indicator
- “Check burner” indicator



**QUADRO COMANDI**

- Comandi in bassa tensione
- Teleruttore
- Protezione del motore con relè termico
- Interruttore Rotativo per accensione
- Regolazione elettronica temperatura
- Spia “Mancanza gasolio”
- Spia “Macchina sottotensione”
- Spia “Stop Generale”
- Spia “Intervento termico motore”
- Spia “Allarme microperdite”
- Spia “Stop vapore”
- Spia “Controllo bruciatore”

CODE CODICE	MODELLI MODELLI	PUMP POMPA	Electrical			Pressure		Flow	Power		Temperature	Water	Steam	Weight	Dimensions		
			Ph	V	Hz	bar	MPa		HP	kW						kW	°C
9051 1701	F Premium 6.15	RW Premium	3	400	50	30 > 160	3 > 16	400 > 900	6,0	4,4	5,8	85 > 140	19	6,4	16	152	132x82x96
9051 1703	F Premium 8.15	RW Premium	3	400	50	30 > 200	3 > 20	370 > 900	8,0	5,9	7,0	85 > 140	19	6,4	16	154	132x82x96
9051 1704	F Premium 9.18	RW Premium	3	400	50	30 > 200	3 > 20	450 > 1080	9,0	6,6	7,6	85 > 140	19	6,4	16	160	132x82x96
9051 1702	F Premium 9.21	RW Premium	3	400	50	30 > 170	3 > 17	550 > 1260	9,0	6,6	7,6	85 > 140	19	6,4	16	160	132x82x96
9051 1901	F Premium 10.18	RW Premium	3	400	50	30 > 220	3 > 22	400 > 1080	10,0	7,3	9,8	85 > 140	19	8,0	16	165	132x82x96
9051 1902	F Premium 10.21	RW Premium	3	400	50	30 > 210	3 > 21	540 > 1260	10,0	7,3	10,3	85 > 140	19	8,0	16	165	132x82x96



**STANDARD ACCESSORIES › DOTAZIONE STANDARD**

<p>GH 351 gun with Swivel (n. 2 o-ring) Pistola GH 351 con Swivel (n. 2 o-ring)</p>	<p>Bent lance, with nozzle holder, without nozzle Lancia angolata, testina portaugello, senza ugello</p>
<p>Fan shape nozzle 25°, 1/4" MEG connection Ugello con getto a lama 25° attacco 1/4" MEG</p>	<p>10 m rubber delivery hose kit Kit tubo gomma mandata 10 m</p>
<p>Flame control kit Kit comando controllo fiamma</p>	

**VACUUM CLEANERS • *ASPIRATORI***

---



## VACUUM CLEANERS • ASPIRATORI

### Cartridge filters • Filtro a cartuccia

- Suitable for dust with a grain size bigger than 5 µm. This does not include dust produced by tools used for honing, grinding or sanding, etc., which are usually fine and are smaller than 5 µm.
- *Adatti per polveri con granulometrie superiori ai 5 µm, sono escluse le polveri generate da utensili per levigazione, smerigliatura, carteggio, ecc., in quanto solitamente generano polveri (fini) inferiori ai 5 µm.*



### Hepa and BIA cartridge filter Filtro a cartuccia Hepa e BIA

- When working with tools for honing, grinding or sanding, etc., Law Decree 626/94 requires the use of Hepa and BIA filters which are capable of retaining dust particles as small as 0.3 µm (equivalent to a filtration efficiency of 99.97%). As a result, a standard filter is not enough.
- *La norma 626/94 impone, nelle lavorazioni con utensili per levigazione, smerigliatura, carteggio, ecc., l'utilizzo dei filtri Hepa e BIA, in quanto sono in grado di filtrare particelle di polvere fino a 0,3 µm (equivalente ad una percentuale di filtrazione del 99,97%), per questo motivo il filtro standard non basta*



### Polyester filter with ring and filter cage Filtro in poliestere con anello e tendifiltro

- It can be used with the cartridge filter installed or in place of it. By increasing the number of filtration stages the primary filter works more efficiently and requires less frequent cleaning. In this case the polyester fabric filter with ring serves as the first level filter. Using the polyester filter together with the cartridge filter brings the retention capacity of the filter down from 5 µm to 3 µm
- *Può essere utilizzato con il filtro a cartuccia montato o in alternativa ad esso. Aumentando gli stadi di filtrazione il filtro primario lavora meglio e necessita di essere ripulito con minor frequenza in questo modo il panno con anello assume il ruolo di filtro primo livello. Utilizzando il filtro poliestere, insieme al filtro a cartuccia si abbassa il valore da 5 µm fino a 3 µm.*



### Nylon filter with ring and filter cage Filtro in nylon con anello e tendifiltro

- This must always be used with the cartridge filter installed. With certain applications we recommend using it together with the BIA and Hepa cartridge filter rather than the standard one (car body shops, carpentry, marble works, etc.).
- *Deve sempre essere utilizzato con il filtro a cartuccia montato, in particolari settori è consigliabile impiegarlo con il filtro cartuccia Hepa e BIA anziché quello standard (carrozzerie, falegnamerie, marmmerie, ecc.).*



### Sponge filter • Filtro a mousse

- This must be fitted on the float mount (after removing the cartridge filter) every time the unit is to be used to aspirate liquids.
- *Deve essere montato sul portagalleggiante ogni volta che si devono aspirare liquidi (dopo aver rimosso il filtro a cartuccia).*



#### CAUTION

Never suck flammable, explosive, toxic or carcinogenic liquids.

#### ATTENZIONE

Evitare assolutamente l'aspirazione di liquidi infiammabili, esplosivi, tossici e cancerogeni.

**PROFESSIONAL SERIES WITH 1 MOTOR - SERIE PROFESSIONALE A 1 MOTORE**

## AS 20-P

Wet&amp; Dry



### GENERAL FEATURES - CARATTERISTICHE GENERALI

- Compact, designed to take up little room, they are particularly powerful, light, flexible, simple, easy to handle and use.
- *Di dimensioni contenute, studiati per essere poco ingombranti, sono particolarmente potenti, leggeri, versatili, semplici, maneggevoli e di facile uso.*

## AS 21-X

Wet&amp; Dry



### GENERAL FEATURES - CARATTERISTICHE GENERALI

- Compact, designed to take up little room, they are particularly powerful, light, flexible, simple, easy to handle and use.
- *Di dimensioni contenute, studiati per essere poco ingombranti, sono particolarmente potenti, leggeri, versatili, semplici, maneggevoli e di facile uso.*

## AS 31-X

Wet&amp; Dry



### GENERAL FEATURES - CARATTERISTICHE GENERALI

- Compact, designed to take up little room, they are particularly powerful, light, flexible, simple, easy to handle and use.
- *Di dimensioni contenute, studiati per essere poco ingombranti, sono particolarmente potenti, leggeri, versatili, semplici, maneggevoli e di facile uso.*

## AS 35 PRO-P



### GENERAL FEATURES - CARATTERISTICHE GENERALI

- Complete with a wide range of accessories. Powerful, versatile, easy to handle and particularly suitable for medium-sized areas.
- *Corredato da un'ampia gamma di accessori. Potente, versatile, maneggevole e particolarmente adatto alle medie superfici.*

CARATTERISTICHE TECNICHE - TECHNICAL SPECIFICATIONS		AS 20-P W&D	AS 21-X W&D	AS 31-X W&D	AS 35 PRO-P
CODICE - CODE		9350 0045	9350 0050	9350 0051	9350 0052
Peso • Weight	kg	7,6	7,8	8,5	12,6
Tensione Nominale (Frequenza) • Nominal Voltage (Frequency)	V (Hz)	230 (50-60)	230 (50-60)	230 (50-60)	230 (50-60)
Potenza Motore • Motor Power	W	1250	1250	1250	1250
Capacità nominale contenitore detriti • Nominal capacity of dirt container	lt	21	21	30	36
Contenitore realizzato in • Container made in		PP	ACCIAIO STEEL	ACCIAIO STEEL	PP
Depressione max • Maximum Vacuum power	kPa	19	19	19	22,5
Portata aria efficace • Airflow rate	m³/h	209	209	209	190
Lunghezza cavo alimentazione • Length of the power cable	m	3	3	3	8,5
Tipo motore (Grado di protezione) • Type of motor (Protection level)		by-pass (IPX4)	by-pass (IPX4)	by-pass (IPX4)	by-pass (IPX4)
Classe di isolamento • Insulation class		□	□	□	□
Numero Motori • Motors Number		1	1	1	1
Stadi Motori • Motors Stages		1	1	1	2
SISTEMA FILTRANTE - FILTERING SYSTEM		AS 20-P W&D	AS 21-X W&D	AS 31-X W&D	AS 35 PRO-P
		CODICE - CODE	CODICE - CODE	CODICE - CODE	CODICE - CODE
Sacco in carta • Paper bag		3050 0011	3050 0011	3050 0013	3050 0013
Sacco in poliestere • Polyester bag		3050 0012	3050 0012	3050 0014	3050 0014
Filtro a cartuccia poliestere • Polyester cartridge filter		1002 0249	1002 0249	1002 0249	1002 0248
Filtro in poliestere con anello • Polyester filter with ring		1002 0246	1002 0246	1002 0246	1002 0247
Filtro in poliestere con anello e tendifiltro • Polyester filter with ring and filter stretcher					
Cappuccio liquidi • Hood for liquids		1002 0166	1002 0166	1002 0166	1002 0166

PROFESSIONAL SERIES WITH 1 OR 2 MOTORS - SERIE PROFESSIONALE A 1 O 2 MOTORI

### AS 50 PRO-X



### AS 70 PRO-X



### AS 70 PRO-B2-X



#### ▶ GENERAL FEATURES - CARATTERISTICHE GENERALI

- Powerful, designed and built for demanding jobs. Perfect for big areas such as: workshops, labs, showrooms, hotels, etc. The stainless steel container is suitable for problem-free suction of corrosive liquids.
- *Potenti apparecchi, progettati e costruiti per lavori impegnativi. Adatti alle grandi superfici: officine, laboratori, aree espositive, hotels, etc. Il contenitore in acciaio inox è idoneo per aspirare senza problemi le sostanze liquide corrosive.*

## AS 37 VIBRA

FOR DUST ONLY  
DO NOT USE TO  
VACUUM LIQUIDS

**SOLO PER POLVERI**  
**DA NON UTILIZZARE**  
**PER ASPIRARE LIQUIDI**



#### ▶ GENERAL FEATURES - CARATTERISTICHE GENERALI

- Suitable for the suction of processing debris generally. Power-driven tool connection with microprocessor for automatic stop and start. The filter is cleaned automatically thanks to the Intelligent Cleaning Filter vibrating system. A pair of electromechanical vibrators start working only when the filter is dirty.
- *Idoneo nell'aspirazione di residui di lavorazione in genere. Attacco elettroutensili dotato di microprocessore che consente l'avviamento e lo stop automatico. La pulizia del filtro è automatica grazie al sistema vibrante Intelligent Cleaning Filter. Una coppia di vibratori elettromeccanici si attiva solo quando il filtro è sporco.*

CARATTERISTICHE TECNICHE - TECHNICAL SPECIFICATIONS		AS 50 PRO-X	AS 70 PRO-X	AS 70 PRO-B2-X	AS 37 VIBRA
CODICE - CODE		9350 0053	9350 0054	9350 0055	9350 0032
Peso • Weight	kg	13,5	21	23	12,8
Tensione Nominale (Frequenza) • Nominal Voltage (Frequency)	V (Hz)	230 (50-60)	230 (50-60)	230 (50-60)	230 (50-60)
Potenza Motore • Motor Power	W	1400	1400	2600	1400
Capacità nominale contenitore detriti • Nominal capacity of dirt container	lt	50	77	77	37
Contenitore realizzato in • Container made in		ACCIAIO INOX STAINLESS STEEL	ACCIAIO INOX STAINLESS STEEL	ACCIAIO INOX STAINLESS STEEL	PP
Depressione max • Maximum Vacuum power	kPa	24	24	24	24
Portata aria efficace • Airflow rate	m³/h	215	215	340	215
Potenza max disp. alla presa per elettroutensile • Max outlet power for power-driven tools	W				2000
Lunghezza cavo alimentazione • Length of the power cable	m	8,5	8,5	8,5	8,5
Tipo motore (Grado di protezione) • Motor type (Protection level)		by-pass (IPX4)	by-pass (IPX4)	by-pass (IPX4)	by-pass (IPX4)
Classe di isolamento • Insulation class		□	□	□	(I)
Numero Motori • Motors Number		1	1	2	1
Stadi Motori • Motors Stages		2	2	2	2
SISTEMA FILTRANTE - FILTERING SYSTEM		AS 50 PRO-X	AS 70 PRO-X	AS 70 PRO-B2-X	AS 37 VIBRA
Sacco in carta • Paper bag		3050 0007	3050 0007	3050 0007	3050 0007
Sacco in poliestere • Polyester bag		3050 0015	3050 0015	3050 0015	
Filtro a cartuccia poliestere • Polyester cartridge filter		1002 0248	1002 0186	1002 0186	
Filtro a cartuccia Hepa • Hepa cartridge filter			1002 0169	1002 0169	1002 0192
Filtro in poliestere con anello • Polyester filter with ring		1002 0247	1002 0184	1002 0184	
Filtro in poliestere con anello e tendifiltro • Polyester filter with ring and filter stretcher			1002 0167	1002 0167	1002 0247
Cappuccio liquidi • Hood for liquids		1002 0166	1002 0166	1002 0166	1002 0166

## AS 75 F2

### ▶ GENERAL FEATURES - CARATTERISTICHE GENERALI

- Professional vacuum cleaner and liquid cleaner with trolley, handles on the sides, emptying kit to facilitate emptying of the plastic container. Ideal for family businesses, industries and for cleaning large areas.
- *Aspirapolvere ed aspiraliquidi professionale equipaggiato di carrello con maniglie laterali e con kit di svuotamento per facilitare lo svuotamento del fusto in plastica. Ideale per aziende artigiane, industrie e pulizie di grandi superfici.*



## AS 77 B2

### ▶ GENERAL FEATURES - CARATTERISTICHE GENERALI

- Professional vacuum cleaner and liquid cleaner with handle and tilting trolley to make transporting and emptying the plastic container easier. Ideal for family businesses, industries and for cleaning large areas.
- *Aspirapolvere ed aspiraliquidi professionale equipaggiato di maniglione e carrello basculante, per facilitare gli spostamenti e lo svuotamento del fusto in plastica, ideale per aziende artigiane, industrie e pulizie di grandi superfici.*



## AS 78 B3



CARATTERISTICHE TECNICHE - TECHNICAL SPECIFICATIONS		AS 75 F2	AS 77 B2	AS 78 B3
CODICE - CODE		9350 0025	9350 0026	9350 0027
Peso • Weight	kg	21	25	27
Tensione Nominale (Frequenza) • Nominal Voltage (Frequency)	V (Hz)	230 (50-60)	230 (50-60)	230 (50-60)
Potenza Motore • Motor Power	W	2600	2600	3300
N. motori • No. of motors		2	2	3
Capacità nominale contenitore detriti • Nominal capacity of dirt container	lt	77	77	77
Contenitore realizzato in • Container made in		PP	PP	PP
Depressione max • Maximum Vacuum power	kPa	22	24	22
Portata aria efficace • Airflow rate	m <sup>3</sup> /h	340	430	510
Lunghezza cavo alimentazione • Length of the power cable	m	8,5	8,5	8,5
Tipo motore (Grado di protezione) • Motor type (Protection level)		by-pass (IPX4)	by-pass (IPX4)	by-pass (IPX4)
Classe di isolamento • Insulation class		□	□	□
Stadi Motori • Motors Stages		2	2	2
SISTEMA FILTRANTE - FILTERING SYSTEM		AS 75 F2	AS 77 B2	AS 78 B3
Filtro a cartuccia poliestere • Polyester cartridge filter		1002 0186	1002 0186	1002 0186
Filtro-mousse per aspirare sostanze liquide • Sponge filter for vacuuming up liquids		1002 0166	1002 0166	1002 0166
Filtro a cartuccia Hepa • Hepa cartridge filter		1002 0169	1002 0169	1002 0169
Filtro in poliestere con anello e tendifiltro • Polyester filter with ring and filter stretcher		1002 0167	1002 0167	1002 0167
Sacchetto di carta • Paper bag		3050 0007	3050 0007	3050 0007
Filtro in poliestere con anello • Polyester filter with ring		1002 0184	1002 0184	1002 0184

PROFESSIONAL SERIES WITH 2 OR 3 MOTORS - SERIE PROFESSIONALE A 2 O 3 MOTORI

# AS 76-2

## GENERAL FEATURES - CARATTERISTICHE GENERALI

- Extractor model (liquid cleaner) for cleaning armchairs, carpets and rugs, using the right fitting to supply the detergent. A 20-litre capacity tank guarantees good autonomy (water or water mixed with detergent). Use of the detergent is essential while vacuuming up dust is possible with the optional dust kit. Equipped with handle and tilting trolley.
- *Modello estrattore (aspiraliquidi) utilizzabile per la pulizia di poltrone, moquette e tappeti, utilizzando la bocchetta adatta per erogare il detergente, grazie ad un serbatoio da 20 L garantisce una buona autonomia (acqua o acqua mista con detergente). È fondamentale l'utilizzo del detergente, mentre l'aspirazione delle polveri è consentita con il kit polveri, optional. Equipaggiato di maniglione e carrello basculante.*



# AS 81-B3 Metaloil

## GENERAL FEATURES - CARATTERISTICHE GENERALI

- For vacuuming specific materials such as metal swarfs, wood and glass residues not to mention oils, lubricants and everything else deriving from mechanical manufacturing waste. The suction filter which has a high filtering surface is protected against the direct impact of materials by a cyclone effect barrier.
- *Per l'aspirazione di materiali particolari quali i trucioli di metallo, residui di legno e vetro, nonché oli, lubrificanti e quant'altro derivante dagli scarti della produzione meccanica. Il filtro di aspirazione ad elevata superficie filtrante, è protetto dall'urto diretto dei materiali per mezzo di una barriera che favorisce l'effetto ciclone.*



- "Cyclone" filter protection
- Proteggi filtro "ciclone"

CARATTERISTICHE TECNICHE · TECHNICAL SPECIFICATIONS		AS 76-2	AS 81 METALOIL
CODICE · CODE		9350 0029	9350 0033
Peso · Weight	kg	31	30
Tensione Nominale (Frequenza) · Nominal Voltage (Frequency)	V (Hz)	230 (50-60)	230 (50-60)
<b>Potenza Motore · Motor Power</b>	<b>W</b>	<b>3600</b>	<b>3600</b>
N. motori · No. of motors		2	3
<b>Capacità nominale contenitore detriti · Nominal capacity of dirt container</b>	<b>lt</b>	<b>77</b>	<b>77</b>
<b>Contenitore realizzato in · Container made in Stainless Steel</b>		<b>PP</b>	<b>PP</b>
<b>Depressione max · Maximum Vacuum power</b>	<b>kPa</b>	<b>24</b>	<b>24</b>
Portata aria efficace · Airflow rate	m³/h	460	645
Lunghezza cavo alimentazione · Length of the power cable	m	8,5	8,5
Tipo motore (Grado di protezione) · Motor type (Protection level)		by-pass (IPX4)	by-pass (IPX4)
Classe di isolamento · Insulation class		□	□
Stadi Motori · Motors Stages		2	2
<b>SISTEMA FILTRANTE · FILTERING SYSTEM</b>		<b>AS 76-2</b>	<b>AS 81 METALOIL</b>
		<b>CODICE · CODE</b>	<b>CODICE · CODE</b>
Filtro a cartuccia poliestere · Polyester cartridge filter			1002 0165
Filtro-mousse per aspirare sostanze liquide · Sponge filter for vacuuming up liquids		1002 0166	1002 0166
Proteggi filtro "ciclone" · "Cyclone" filter protection			2416 0147
Filtro a cartuccia Hepa · Hepa cartridge filter		1002 0169	
Filtro in poliestere con anello e tendifiltro · Polyester filter with ring and filter stretcher		1002 0167	1002 0167
Sacchetto di carta · Paper bag		3050 0007	
Filtro in poliestere con anello · Polyester filter with ring		1002 0184	1002 0184

## NEBULISATION EQUIPMENT · APPARECCHI PER LA NEBULIZZAZIONE

# SPRAY

- Equipment for nebulising low density liquids, detergents and disinfectants.
- *Apparecchi per la nebulizzazione di liquidi detergenti e disinfettanti a bassa densità.*

24 Lt  
INOX



24 Lt



50 Lt



## GENERAL FEATURES

- Filled with liquid and loaded with air at 6 bar, they work automatically without having to be connected continuously to compressed air.

## CARATTERISTICHE GENERALI

- *Riempiti di liquido e caricati d'aria a 6 bar, funzionano autonomamente senza bisogno del collegamento continuo all'aria compressa.*

	SP 24 SPRAY	SX 24 SPRAY INOX	SP 50 SPRAY
Codice / Code	9360 0001	9360 0003	9360 0005
Capacità / Capacity	24 Lt	24 Lt	50 Lt
Serbatoio / Tank	Acciaio Verniciato Painted Steel	Acciaio INOX Stainless Steel	Acciaio Verniciato Painted Steel
Valvola di Sicurezza Safety Valve	8 bar -MPa 0,8	8 bar - MPa 0,8	8 bar - MPa 0,8
Kit pistola-lancia Gun Lance kit	600 mm	600 mm INOX	900 mm
Tubo / Hose	6 m - RILSAN	6 m - RILSAN	6 m - RILSAN
Ugelli / Nozzles	No. 1 (Ottone - Brass)	No. 1 (Ottone - Brass)	No. 1 (Ottone - Brass)
Manometro / Gauge	SI / YES	SI / YES	SI / YES
Indicatore Livello Level viewer	SI / YES	SI / YES	SI / YES

## FOAM

- Equipment for nebulising liquids and detergents with a solution foaming device.
- *Apparecchi per la nebulizzazione di liquidi detergenti con dispositivo soluzione schiumogena.*

24 Lt  
INOX



24 Lt



50 Lt



### GENERAL FEATURES

- Filled with liquid and loaded with air at 6 bar they need to be connected continuously to compressed air.

### CARATTERISTICHE GENERALI

- Riempi di liquido e caricati d'aria a 6 bar, necessitano del collegamento continuo all'aria compressa.

	SP 24 FOAM	SX 24 FOAM INOX	SP 50 FOAM
Codice / Code	9360 0002	9360 0004	9360 0006
Capacità / Capacity	24 Lt	24 Lt	50 Lt
Serbatoio / Tank	Acciaio Verniciato Painted Steel	Acciaio INOX Stainless Steel	Acciaio Verniciato Painted Steel
Valvola di Sicurezza Safety Valve	8 bar - MPa 0,8	8 bar - MPa 0,8	8 bar - MPa 0,8
Kit pistola-lancia Gun Lance kit	600 mm	600 mm INOX	900 mm
Tubo / Hose	10 m - PVC	10 m - PVC	10 m - PVC
Ugelli / Nozzles	No. 4 (Ottone - Brass)	No. 4 (Ottone - Brass)	No. 4 (Ottone - Brass)
Manometro / Gauge	SI / YES	SI / YES	SI / YES
Indicatore Livello Level viewer	SI / YES	SI / YES	SI / YES

DETERGENTI › SOLO PER IL MERCATO ITALIANO - ONLY FOR ITALIAN MARKET

## HAND NEUTRO

 Autovetture  
e veicoli  
industriali

Motori



Edilizia

 Macchinari e  
attrezzature  
industriali

 Statue, fontane,  
restauro

### CARATTERISTICHE GENERALI

- *Uso Hobbystico*
- Hand Neutro è un detergente neutro, costituito da una miscela di tensioattivi anionici ad alto potere lavante.
- È adatto alle pulizie manuali di tutte le superfici lavabili, in particolare facilita l'eliminazione di ogni tipo di sporco, anche il più tenace, dalle superfici delle autovetture.
- Negli impianti di lavaggio automatico, viene usato per un ulteriore ripasso manuale delle zone più sporche.

### CARATTERISTICHE TECNICHE

- Hand neutro si usa solitamente diluito in acqua in rapporto da 1:100 a 2:100 (1-2%) a seconda dello sporco. Quando utilizzato con idropulitrice, diluire al 4:100 a 5:100 (4-5%).
- PH 6.0
- Biodegradabilità 100%
- Confezioni:  
It 1x12 **0609 0007**  
It 5x4 **0609 0008**  
It 10 **0609 0009**

## BASIC AUTO

 Autovetture  
e veicoli  
industriali

Motori



Edilizia

 Veicoli e  
attrezzature  
agricole

 Macchinari e  
attrezzature  
industriali

### CARATTERISTICHE GENERALI

- Basic Auto è un detergente liquido alcalino, specifico per il lavaggio degli autoveicoli con idropultrici ad acqua calda o acqua fredda.
- Ottimo per la pulizia di macchinari ed attrezzature agricole ed industriali.

### CARATTERISTICHE TECNICHE

- Basic Auto si usa solitamente diluito in acqua in rapporto da 3:100 a 5:100 (3-5%) per utilizzo manuale o con nebulizzatori.
- Quando utilizzato con idropultrice, diluire al 5:100 a 6:100 (5-6%).
- PH 6.0
- Biodegradabilità 90%
- Confezioni:  
It 1x12 **0609 0010**  
It 5x4 **0609 0011**  
It 10 **0609 0012**

## ECO MOTO

 Autovetture  
e veicoli  
industriali

Motori



Edilizia

 Veicoli e  
attrezzature  
agricole

Moto

 Statue, fontane,  
restauro

### CARATTERISTICHE GENERALI

- Eco Moto è un detergente universale idoneo per la pulizia di ogni tipo di superficie, specifico per il lavaggio di motori, automezzi e attrezzature con particolari in alluminio e di leghe leggere.
- Ottimo per la pulizia di moto e biciclette, per la pulizia di piazzali e pavimenti industriali, idoneo al lavaggio delle tende.

### CARATTERISTICHE TECNICHE

- Eco Moto si usa solitamente diluito in acqua in rapporto da 2:100 a 20:100 (2-20%) 2-4% per superfici dure con sporco grasso non penetrato, 2-3% per motocicli e biciclette con telai in alluminio, 5-6% per cisterne ed autocarri con particolari in alluminio, 10-20% per motori di auto, camion e barche.
- Quando utilizzato con idropultrice, diluire del 10-20%.
- PH 12.0
- Biodegradabilità 90%
- Confezioni:  
It 1x12 **0609 0013**  
It 5x4 **0609 0014**  
It 10 **0609 0015**

## TENAX FORTE

 Autovetture  
e veicoli  
industriali

 Veicoli e  
attrezzature  
agricole

### CARATTERISTICHE GENERALI

- *Uso Professionale*
- Tenax Forte è un detergente molto energetico a base alcalina, autolucidante, specifico per il lavaggio con idropultrice ad acqua calda o ad acqua fredda di carrozzerie d'autovetture, veicoli industriali e macchine agricole.

### CARATTERISTICHE TECNICHE

- Tenax Forte si usa solitamente diluito in acqua in rapporto da 1:100 a 2:100 (1-2%) se utilizzato con nebulizzatori. Quando utilizzato con idropultrice, diluire al 5:100 a 6:100 (5-6%).
- PH 13.0
- Biodegradabilità 90%
- Confezioni:  
It 5x4 **0609 0016**  
It 10 **0609 0017**



DETERGENTI › SOLO PER IL MERCATO ITALIANO - ONLY FOR ITALIAN MARKET

## EDIL DET



Edilizia

Statue, fontane,  
restauroAttrezzature  
sanitariAttrezzature  
industria  
alimentare

### CARATTERISTICHE GENERALI

- *Uso Professionale*
- *Edil Det è un detergente disincrostante specifico per l'industria alimentare e l'industria edilizia.*
- *Particolarmente indicato per togliere lo smog da muretti e da statue, per togliere il calcare dalle piscine e dalle fontane, per pulire i sanitari.*
- *Non dà luogo ad esalazioni.*

### CARATTERISTICHE TECNICHE

- *Edil Det si usa solitamente diluito in acqua in rapporto da 5:100 a 10:100 (5-10%).*
- *Quando utilizzato con idropulitrice, diluire al 10:100 (10%).*
- *PH 2.5*
- *Biodegradabilità 90%*
- *Confezioni:*  
It 5x4 **0609 0018**  
It 10 **0609 0019**

## TESSIL DET

Per bidoni aspiratutto con lancia lavamoquette



### CARATTERISTICHE GENERALI

- *Tessil Det è un detergente industriale costituito da una miscela di sostanze attive a bassa schiumosità.*
- *Particolarmente efficace per la pulizia di poltrone, tappeti, moquette, tappezzeria, interni auto.*
- *Lascia un delicato e gradevole odore di profumo fresco.*

### CARATTERISTICHE TECNICHE

- *Tessil Det si usa solitamente diluito in acqua in rapporto da 10:100 (10%).*
- *PH 12.7*
- *Biodegradabilità 90%*
- *Confezioni:*  
It 5x1 **0609 0026**

SPECIAL PRODUCTS FOR H.P. CLEANERS - PRODOTTI SPECIALI PER IDROPULTRICI AD ACQUA CALDA

## ACID SER disincrostante



### CARATTERISTICHE GENERALI

- *Acid Ser è un disincrostante per eliminare i depositi calcarei nelle serpentine delle idropultrici, senza danneggiare il materiale a contatto con il liquido.*

### CARATTERISTICHE TECNICHE

- *Acid Ser si usa diluito con acqua al 10%.*
- *Lasciare agire il prodotto per 12-16 ore nella*
- *PH < 1*
- *Confezioni:*  
It 10 **0060 0002**

## NO KAL anticalcare



### CARATTERISTICHE GENERALI

- *No Kal è un anticalcare liquido che previene la formazione di calcare nelle serpentine delle idropultrici.*

### CARATTERISTICHE TECNICHE

- *No Kal si usa nella tanica anticalcare delle idropultrici.*
- *PH < 7*
- *Confezioni:*  
It 5 **0060 0006**  
It 10 **0060 0005**  
It 20 **0060 0003**

## Sabbia



### CARATTERISTICHE GENERALI

- *Sabbia silicea.*

### CARATTERISTICHE TECNICHE

- *Sabbia silicea grani 0,6 - 1,2*
- *Confezioni:*  
Kg 25 **3048 0001**

## Bicarbonato di Sodio























### CARATTERISTICHE GENERALI

- *Bicarbonato di Sodio per lance sabbianti.*

### CARATTERISTICHE TECNICHE

















- *Bicarbonato di Sodio per lance sabbianti.*
- *Confezioni:*  
Kg 25 **3048 0003**

ELECTRICAL COLD WATER H.P. CLEANERS > IDROPULITRICI ELETTRICHE AD ACQUA FREDDA















			X STAR		R	L						SM				S			
			CLASSIC	EXTRA	1100	CLASSIC 1300	EXTRA 1300	CLASSIC 1400	EXTRA 1400	CLASSIC 1600	EXTRA 1600	PLUS 1680	CLASSIC 1450	EXTRA 1450	CLASSIC 1480	EXTRA 1480	CLASSIC 1600	EXTRA 1600	
<b>Accessories • Accessori</b>																			
<b>Gun kit with guard • Kit pistola con protezione</b>																			
	Gun • Pistola		2410 0103	•	•		•	•	•	•	•	•		•	•	•	•		
	GC 251	G1/4M	2410 0119															•	•
	GC 251	G3/8M	2410 0121																
	GH 281 + pressure unloader valve GH 281 + regolatore pressione	G1/4M	2410 0225				*	*	*	*	*	*	*	*	*	*	*	*	*
		G3/8M	2410 0222																
	Gun • Pistola		2410 0171			•													
	GH 301 + Swivel	G3/8M	2410 0165																
<b>Lance kit without nozzle • Kit lancia senza ugello</b>																			
	Adjustable jet Getto regolabile	mm 500	3301 0936																
	Securfix		3301 1119	•	•		•	•	•	•	•	•							
<b>Lance kit with nozzle • Kit lancia con ugello</b>																			
	Diritta • Straight	ø 0,9	3301 0851										•	•	•	•			
		ø 1,05	3301 1428									•							
	Angolata • Bent	ø1,1	3301 1055																
	Angolata • Bent	ø1,2	3301 0928																
	Angolata • Bent	ø1,15	3301 0934															•	•
	Angolata • Bent	ø1,3	3301 1017																
	Angolata • Bent	ø1,25	3301 1065																
	Diritta • Straight		3301 1210			•													
<b>Lance nozzle • Ugello lancia</b>																			
		028	3400 0721																
		025	3400 0507																
		033	3400 0726																
		030	3400 0469																
		028	3400 0509															•	•
		037	3400 0725																
		033	3400 0511																
		043	3400 0726																
		045	3400 0698																
		035	3400 0513																
		050	3400 0704																
<b>Lance hose kit with rotating nozzle • Kit tubo lancia con ugello rotante</b>																			
	Straight • Diritta	035	3301 0830																
	Straight • Diritta	04	3301 0826																
	Straight • Diritta	050	3301 0893																
	Straight • Diritta	045	3301 0782																
	Straight • Diritta	022	3301 0852										*	•	*	•			
		025	3301 1429									•							
	Bent • Angolata	028	3301 1152															*	•
	Bent • Angolata	033	3301 1053																
	Bent • Angolata	037	3301 1025																
	Straight • Diritta		3301 1212			•													
<b>Securfix nozzle head kit • Kit testina ugello Securfix</b>																			
		ø 1,0	3217 0251				•	•											
		ø 1,05	3217 0253	•	•				•	•									
		ø 1,15	3217 0257							•	•								
<b>Securfix rotating nozzle head kit • Kit testina ugello rotante Securfix</b>																			
		022	3217 0247	*	•		*	•	*	•									
		028	3217 0249							*	•								
<b>Foam lance kit • Kit lancia schiumogena</b>																			
			3301 0815																
			3301 0843										•	•	•	•	•	•	•
			3301 1062	•	•		•	•	•	•	•	•							
			3301 1128																
			3301 1214			•													



ELECTRICAL COLD WATER H.P. CLEANERS > IDROPULITRICI ELETTRICHE AD ACQUA FREDDA



















			X STAR		R	L						SM				S			
			CLASSIC	EXTRA	1100	CLASSIC 1300	EXTRA 1300	CLASSIC 1400	EXTRA 1400	CLASSIC 1600	EXTRA 1600	PLUS 1680	CLASSIC 1450	EXTRA 1450	CLASSIC 1480	EXTRA 1480	CLASSIC 1600	EXTRA 1600	
<b>Accessories • Accessori</b>																			
<b>Rotating brush • Idrospazzola rotante</b>																			
	l/min 8 ÷ 11	1413 0034																	
		1413 0036	*	●		*	●	*	●	*	●		*	*	*	*	*	*	
		1413 0037	*	*		*	*	*	*	*	*		*	*	*	*	*	*	
<b>Professional solar panels washing kit • Kit professionale lavaggio pannelli solari</b>																			
	G3/8 M	1603 0101	*	*	*	*	*	*	*	*	*	*	*	*	*	*	*	*	
<b>Drain cleaning kit • Kit sonda spurgatubi</b>																			
	m 8	3045 0031	*	*		*	*	*	*	*	*	*	*	*	*	*	*	*	
	m 15	3045 0032											*	*	*	*	*	*	
	m 25 6 ÷ 9 l/min	3045 0035																	
	m 25 10÷15 l/min	3045 0042																	
<b>Floor cleaning lance kit • Kit tubo lancia pavimenti</b>																			
	SC 155	3301 0710											*	*	*	*	*	*	
	SC 147	3301 1407	*	*		*	*	*	*	*	*	*	*	*	*	*	*	*	
<b>Double barrel lance kit • Kit lancia canna doppia</b>																			
	mm 700	3301 0942																	
	+ nozzle + ugello ø4 2540	3400 0444																	
<b>Sand/Soda blasting kit • Kit lancia sabbicante/bicarbonato</b>																			
	Ø 1,2	3301 0820																	
	Ø 1,4	3301 0821																	
		3301 0849								*	*	*	*	*	*	*	*		
<b>Delivery hose kit • Kit tubo mandata</b>																			
	m 15 R1-1/4"	3208 0971																	
	m 8 R1-1/4"	3208 1028																	
	m 8 R1-1/4"	3208 1300										●							
	m 10 R1-1/4"	3208 1050																	
	m 10 R1-1/4"	3301 0689																	
	m 8 R1-1/4"	3301 0818																	
	m 8 R1-1/4"	3301 0816					●		●		●						●		
	m 10 R1-1/4"	3301 0842																●	
	m 10 R1-1/4"	3301 0854												●		●			
	m 6 R1-1/4"	3301 1036	●	●		●		●		●									
	m 7 R1-1/4"	3301 1049											●		●				
	m 20 R1-1/4"	3301 1102																	
	m 12 R1-5/16"	3301 1134																	
	m 20 R1-1/4"	3301 1185																	
	m 5 R1-1/4"	3301 1208			●														
<b>Delivery hose kit • Kit tubo mandata speciale</b>																			
	m 8 R1-1/4"	3301 0612																	
	m 8 R1-1/4"	3301 0833																*	
	m 8 R1-5/16"	3301 1218																	
<b>Delivery hose extension kit • Kit prolunga tubo mandata</b>																			
	m 8	3301 0836	*	*		*	*	*	*	*	*		*	*	*	*	*	*	
	m 8 R1-1/4"	3301 0855												*		*		*	
	m 8 R1-1/4"	3301 1316																*	
	m 4	3301 1047	*	*		*	*	*	*	*	*		*	*	*	*	*	*	
	m 10 R1-1/4"	3301 1125																	

		T						A						FIXED					K 250 STATIC						
CLASSIC 1700	EXTRA 1700	CLASSIC 1750	EXTRA 1750	CLASSIC 1800	EXTRA 1800	CLASSIC 1900	EXTRA 1900	CLASSIC 2800	CLASSIC 3000	CLASSIC 3200	CLASSIC 5000	EXTRA 2800	EXTRA 3000	EXTRA 3200	EXTRA 4000	EXTRA 5000	CLASSIC 1700	EXTRA 1700	EXTRA 1700 T.A.	CLASSIC 1900	EXTRA 1900	10/150 M	12/130 M	15/170 T	
								*	*	*	*	*	*	*	*							*	*	*	
*	*	*	●	*	●	*	●										*	*	*	*	*				
*	*	*	*	*	*	*	*										*	●	●	*	●				
*	*	*	*	*	*	*	*	*	*	*	*	*	*	*	*	*	*	*	*	*	*	*	*	*	*
*	*	*	*	*	*	*	*										*	*	*	*	*				
				*	*	*	*					*													
				*	*	*	*		*	*	*	*	*	*	*	*							*	*	*
*	*	*	*	*	*	*	*	*	*	*	*	*	*	*	*	*	*	*	*	*	*	*	*	*	*
*	*	*	*	*	*	*	*										*	*	*	*	*				
								*	*	*	*	*	*	*	*	*							*	*	*
								*	*	*	*	*	*	*	*	*							*	*	*
*	*	*	*	*	*	*	*			*	*		*	*		*							*	*	*
										*	*	●	●	●	●	●									
								*	*	*	*											●	●	●	
								*	*	*	*						●			●		*	*	*	
●																									
	●																								
*		●		●																					
*	*	*	*	*	*	*	*																		
																	*	*	*	*	*				

			X STAR		R	L						SM				S			
			CLASSIC	EXTRA	1100	CLASSIC 1300	EXTRA 1300	CLASSIC 1400	EXTRA 1400	CLASSIC 1600	EXTRA 1600	PLUS 1680	CLASSIC 1450	EXTRA 1450	CLASSIC 1480	EXTRA 1480	CLASSIC 1600	EXTRA 1600	
<b>Accessories • Accessori</b>																			
<b>Hose reel kit • Kit avvolgitubo girevole</b>																			
	m 10	R1-1/4"	7002 0265															*	
	m 10	R1-1/4"	7002 0273										*		*				
	m 15	R1-1/4"	7002 0330																
	m 20	R1-5/16"	7002 0332																
	m 12	R1-1/4"	7002 0292																
<b>Spiral suction hose kit • Kit tubo aspirazione spiralato</b>																			
	m 8		3299 0019																
<b>Suction hose kit with quick coupling • Kit attacco rapido aspirazione acqua</b>																			
			5002 0022	*	*		*	*	*	*	*	*	*	*	*	*	*	*	*
<b>Suction hose with quick coupling • Attacco rapido aspirazione acqua</b>																			
			2803 3389																
<b>Suction hose kit with quick coupling kit • Kit tubo aspirazione con kit attacco rapido</b>																			
			3208 0783	*	*								*	*	*	*	*	*	*
<b>Ejector Kit - Kit eiettore</b>																			
			3410 0381																
<b>Regulated detergent suction cap kit • Kit tappo aspirazione regolazione detergente</b>																			
			3312 0014																
<b>Back-flow preventer kit BA 10 • Kit disconnettore idrico BA 10</b>																			
	G3/4M G3/4M		0608 0049	*	*	*	*	*	*	*	*	*	*	*	*	*	*	*	*
	Garden hose quick couplers Kit raccordi attacco rapido	G3/4F G3/4F	5002 0024	*	*	*	*	*	*	*	*	*	*	*	*	*	*	*	*
<b>Suction coupling kit • Kit raccordo aspirazione</b>																			
			2803 3430																
<b>Water filter • Filtro acqua</b>																			
			1002 0232																
<b>Accessory rack • Supporto accessori</b>																			
			3002 0688																
<b>Hose cleaning guide kit • Kit guida tubo</b>																			
			5018 0084																
<b>Sludge pump kit • Kit lancia aspirafango</b>																			
	030		3410 0373										*	*	*	*	*	*	*
	050		3410 0375																









ELECTRICAL COLD WATER H.P. CLEANERS > IDROPULTRICI ELETTRICHE AD ACQUA FREDDA

			M 250											M COMPACT			M PREMIUM							
Accessories • Accessori			EXTRA 10/150	CLASSIC 10/150	EXTRA 12/130	CLASSIC 12/130	EXTRA 11/160	CLASSIC 11/160	EXTRA 13/190	CLASSIC 13/190	EXTRA 15/170	CLASSIC 15/170	EXTRA 11/210	CLASSIC 11/210	3.11 M	5.13 T	5.15 T	6.13 T	6.15 T	8.15 T	8.21 T	9.15 T	9.21 T	
<b>Gun kit with guard • Kit pistola con protezione</b>																								
	GH 351 + swivel		2410 0115																					
	GC 251		2410 0121	•		•		•		•		•												
	GC 251 + prolunga + swivel		2410 0174																					
	GH 281 + pressure unloader valve GH 281 + regolatore pressione	G 3/8 M	2410 0222	*	*	*	*	*	*	*	*	*	*	*	*	*	*	*	*	*	*	*	*	*
	GH 301 + Swivel		2410 0183	•	*	•	*	•	*	•	*	•	*											
	GH 351 + revolving lance GH 351 + lancia girevole		2410 0125												*	*	*	*	*	*	*	*	*	
	GH 351 + fixed lance GH 351 + lancia fissa		2410 0127												*	*	*	*	*	*	*	*	*	
	GH 351 INOX + Swivel		2410 0184																					
	RL51 + Swivel + ball quick coupler RL51 + Swivel + attacco rapido a sfere		2410 0194																					
	RL56 + Swivel + ball quick coupler RL56 + Swivel + attacco rapido a sfere		2410 0201																					
	GH 501 con attacchi rapidi GH 501 with quick couplers		2410 0195																					
<b>Bent lance hose kit, detergent head, without nozzle • Kit tubo lancia angolata testina detergente senza ugello</b>																								
	mm 500	3301 0936	•	•	•	•	•	•	•	•	•	•	•											
	mm 700	3301 0977												•	•	•	•	•	•	•	•	•	•	•
	mm 900 INOX	3301 1225																						
	mm 500 INOX	3301 1244																						
	mm 1200 INOX	3301 1245																						
<b>Straight stainless steel lance with ball quick coupler, without nozzles • Lancia dritta inox con attacco rapido a sfere, senza ugelli</b>																								
		3301 1362																						
<b>Double barrel lance kit • Kit tubo lancia canna doppia</b>																								
	mm 700	3301 0942	*	*	*	*	*	*	*	*	*	*	*	*	*	*	*	*	*	*	*	*	*	*
	mm 700 INOX	3301 1222																						
	mm 800	3301 1323																						
	+det.nozzle + ugello det.	ø 4	3400 0444	*	*	*	*	*	*	*	*	*	*	*	*	*	*	*	*	*	*	*	*	*
<b>Stainless-steel lance with rotating nozzle with quick coupler M24x1,5 (600 bar) • Lancia inox con ugello rotante con attacchi rapidi M24x1,5 (600 bar)</b>																								
	030 inox	3301 1324																						
	035 inox	3301 1332																						
	045 inox	3301 1326																						
	050 inox	3301 1328																						
	090 ottone	3301 1329																						
	15 ottone	3301 1331																						
<b>Lance hose kit with rotating nozzle • Kit tubo lancia con ugello rotante</b>																								
	Straight • Dritta 040	3301 0826	•	*			•	*										*						
	Straight • Dritta 035	3301 0830																						
	Straight • Dritta 045	3301 0831								•	*					*	*			*		*		
	Straight • Dritta 050	3301 0894			•	*																		
	Straight • Dritta 055	3301 0896								•	*						*		*					
	Straight • Dritta 070	3301 0900																						*
	Straight • Dritta 080	3301 1004																				*		
	Bent • Angolata 028	3301 1151																						
	Bent • Angolata 037	3301 1024																						
<b>Stainless steel straight rotating nozzle lance with ball quick coupler • Lancia dritta inox ugello rotante con attacco rapido a sfere</b>																								
	045	3301 1305																						
	050	3301 1306																						
	060	3301 1307																						
	070	3301 1308																						
	080	3301 1309																						
	10	3301 1310																						
	13	3301 1311																						
	20	3301 1312																						

























ELECTRICAL COLD WATER H.P. CLEANERS > IDROPULITRICI ELETTRICHE AD ACQUA FREDDA

		M 250										M COMPACT			M PREMIUM							
		EXTRA 10/150	CLASSIC 10/150	EXTRA 12/130	CLASSIC 12/130	EXTRA 11/160	CLASSIC 11/160	EXTRA 13/190	CLASSIC 13/190	EXTRA 15/170	CLASSIC 15/170	EXTRA 11/210	CLASSIC 11/210	3.11 M	5.13 T	5.15 T	6.13 T	6.15 T	8.15 T	8.21 T	9.15 T	9.21 T
<b>Accessories • Accessori</b>																						
<b>Lance hose jet kit • Kit tubo lancia getto</b>																						
	ø 1,40	3301 0910															*					
	ø 1,50	3301 0912												*	*				*		*	
	ø 1,62	3301 0916														*		*				
	ø 1,80	3301 1086																				*
	ø 2,0	3301 1088																		*		
<b>Stainless steel rotating nozzle head • Testina ugello rotante inox 0°</b>																						
	030	3217 0279																				
	050	3217 0281																				
	035	3217 0283																				
	090	3217 0287																				
	15	3217 0286																				
	045	3217 0294																				
<b>Sand/Soda blasting lance kit • Kit lancia sabbiane/bicarbonato</b>																						
	ø 1,2	3301 0820	*	*							*	*										
	ø 1,4	3301 0821			*	*	*	*	*	*	*	*	*	*	*	*	*	*		*		
	ø 0,85	3301 0863																				
	ø 1,8	3301 0973																	*		*	
<b>Sand/Soda blasting lance kit, with ball quick coupler + rubber suction hose + 15° nozzle • Kit lancia sabbiane/bicarbonato, con attacco</b>																						
	055 500 bar	3301 1318																				
	050 500 bar	3301 1320																				
	080 500 bar	3301 1321																				
	09 500 bar	3301 1322																				
	040 500 bar	3301 1333																				
	050 500 bar	3301 1334																				
09 500 bar	3301 1336																					
<b>Professional sand/soda blasting lance kit • Kit lancia sabbiane/bicarbonato professionale</b>																						
	055	3301 0864														*	*	*		*		
	090	3301 0865																	*		*	
	040	3301 1219																				
	080	3301 1228																				
<b>Fan shape nozzle 15° or 25°, 1/4" MEG connection (max 350 bar) • Ugello con getto a lama 15° o 25°, attacco 1/4" Meg (max 350 bar)</b>																						
	15 025	3400 0546																				
	15 028	3400 0709																				
	15 033	3400 0722									•	•										
	15 037	3400 0725	•	•			•	•														
	15 043	3400 0726							•	•				•								
	15 050	3400 0728			•	•																
	25 045	3400 0736											•					•		•		
	25 040	3400 0735															•					
	25 050	3400 0737																				
	25 053	3400 0747								•	•			•								
	25 055	3400 0738															•					
	25 060	3400 0739																				
	25 065	3400 0710																				
	25 070	3400 0601																				
	25 075	3400 0742																			•	
	25 075	3400 0600																				
	25 080	3400 0743																	•			
	25 10	3400 0486																				
	25 13	3400 0487																				
	25 20	3400 0647																				













ETM				K STEEL S				K STEEL TS						K STEEL ECO			K STEEL						K Xtreme									
ETM 71	ETM 100	ETM 130	ETM 150	803	805	807	809	803	805	807	809	891 15/230T	891 21/180T	991 15/270T	991 21/210T	809 21/150T	801 15/210	901 21/180	1001		1251		1501		15/500	21/350	33/250	18/500	21/450	42/200	21/500	
																			21/210	28160	21/250	33/160	42/130	18/350								
																									*							
																										*						
																											*					
																												*				
																													*			
																														*		
																															*	
																																*
																																*
																																*
																																*
																																*
																																*
																																*
																																*
																																*
																																*
																																*
																																*
																																*
																																*
																																*
																																*
																																*
																																*
																																*
																																*
																																*
																																*
																																*
																																*
																																*
																																*
																																*
																																*
																																*
																																*
																																*
																																*
																																*
																																*
																																*
																																*
																																*
																																*
																																*
																																*
																																*
																																*
																																*
																																*
																																*
																																*
																																*
																																*
																																*
																																*
																																*
																																*
																																*
																																*
																																*
																																*
																																*
																																*
																																*
																																*
																																*
																																*
																																*
																																*
																																*
																																*
																																*
																																*
																																*
																																*
																																*

Accessories • Accessori		M 250												M COMPACT			M PREMIUM					
		EXTRA 10/150	CLASSIC 10/150	EXTRA 12/130	CLASSIC 12/130	EXTRA 11/160	CLASSIC 11/160	EXTRA 13/190	CLASSIC 13/190	EXTRA 15/170	CLASSIC 15/170	EXTRA 11/210	CLASSIC 11/210	3.11 M	5.13 T	5.15 T	6.13 T	6.15 T	8.15 T	8.21 T	9.15 T	9.21 T
<b>Washing lance with ball quick coupler, without nozzle • Lancia lavaggio con attacco rapido a sfere, senza ugello</b>																						
		1603 0133																				
		1603 0134																				
<b>Fan shape nozzle 0°, 1/4" MEG connection (max 350 bar) • Ugello con getto a lama 0°, attacco 1/4" Meg (max 350 bar)</b>																						
	0 030	3400 0619																				
	0 035	3400 0621																				
	0 045	3400 0380																				
	0 050	3400 0622																				
	0 070	3400 0633																				
	0 075	3400 0411																				
	0 090	3400 0645																				
	0 15	3400 0626																				
<b>Flat stainless-steel jet nozzle (15° or 25°) with ceramic insert • Ugello inox getto piatto 15° o 25° con inserto in ceramica</b>																						
	15 030	3400 0614																				
	15 035	3400 0615																				
	15 040	3400 0616																				
	15 045	3400 0699																				
	25 050	3400 0618																				
	25 090	3400 0644																				
	25 15	3400 0611																				
<b>Nozzle for soda blasting head • Ugello per testa sabbiante</b>																						
	15° - 040	3400 0578																				
	15° - 050	3400 0594																				
	15° - 090	3400 0483																				
<b>Fan-shape nozzle for washing lance and foam lance (M15x1) • Ugello ventaglio per lancia lavaggio e schiumogena (M15x1)</b>																						
	1,5 mm	3400 0662																				
	2,0 mm	3400 0663																				
	2,3 mm	3400 0664																				
	3,0 mm	3400 0665																				
<b>Rotating Brush • Idrospazzola rotante</b>																						
	8+ 11 l/min	1413 0034	*	*	*	*	*	*	*	*	*	*	*	*	*							
	13+ 18 l/min	1413 0035														*	*	*	*	*	*	*
<b>Professional solar panels washing kit • Kit professionale lavaggio pannelli solari</b>																						
	G3/8 M	1603 0101	*	*	*	*	*	*	*	*	*	*	*	*	*							
<b>Foam lance kit with regulator • Kit lancia schiumogena con regolatore</b>																						
		3301 0795																				
		3301 0902														*	*	*	*	*	*	*
		3301 0815	*	*	*	*	*	*	*	*	*	*	*	*	*							
<b>Foam lance with ball quick coupler • Lancia schiumogena con attacco rapido a sfere</b>																						
		3301 1303																				
<b>Floor cleaning lance kit • Kit tubo lancia lavapavimenti</b>																						
	SC 155	3301 0710	*	*	*	*	*	*	*	*	*	*	*	*	*							
<b>Stainless steel floor cleaning lance kit (gun not supplied) • Lancia lavapavimenti inox (pistola non fornita)</b>																						
		3301 1253																				
<b>Professional stainless steel floor cleaning lance • Lancia lavapavimenti professionale inox</b>																						
		3301 1252																				
<b>Drain cleaning kit, 25 m • Kit sonda spurgatubi m 25</b>																						
	16+21 l/min	3045 0037																		*	*	
	10+15 l/min	3045 0041	*	*	*	*	*	*	*	*	*	*	*	*	*	*	*	*	*	*	*	*





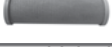

		M 250											M COMPACT			M PREMIUM							
Accessories • Accessori		EXTRA 10/160	CLASSIC 10/160	EXTRA 12/130	CLASSIC 12/130	EXTRA 11/160	CLASSIC 11/160	EXTRA 13/190	CLASSIC 13/190	EXTRA 15/170	CLASSIC 15/170	EXTRA 11/210	CLASSIC 11/210	3-11 M	5-13 T	5-15 T	6-13 T	6-15 T	8-15 T	8-21 T	9-15 T	9-21 T	
<b>Drain cleaning kit, 25 m with ball quick coupler • Kit sonda spurgatubi m 25 con attacco rapido a sfere</b>																							
	16+21 l/min	3045 0047																					
	22+33 l/min	3045 0048																					
	10+15 l/min	3045 0050																					
	16+29 l/min	3045 0051																					
	30+42 l/min	3045 0052																					
<b>Rubber delivery hose kit • Kit tubo gomma mandata</b>																							
	m 10 R1-1/4"	3301 0806																					
	m 15 R1-1/4"	3208 0971	•		•		•		•		•		•										
	m 8 R1-1/4"	3208 1028													•	•	•						
	m 10 R1-1/4"	3208 1051		•		•		•		•		•		•									
	m 10 R2-5/16"	3301 0825																					
	m 10 R2-3/8"	3301 0945																					
	m 10 R1-5/16"	3301 0988																					•
	m 20 R2-3/8" 600 bar	3301 1226																					•
	m 20 R2-1/2" 310 bar	3301 1268																					
	m 20 R2-1/2" 310 bar	3301 1269																					
	m 20 R2-3/8" 400 bar	3301 1270																					
	m 20 R2-3/8" 400 bar	3301 1271																					
	m 10 R2-1/2"	3301 1286																					
	m 10 R2-3/8"	3301 1314																					
	m 10 R2-3/8"	3301 1361																					
<b>Food-industry rubber delivery hose kit • Kit tubo gomma mandata anti-traccia</b>																							
	m 10 R1-5/16"	3301 0559																					
	m 10 R2-5/16"	3301 0599																					
	m 10 R2-3/8"	3301 1247																					
<b>Rubber delivery hose extension kit • Kit prolunga tubo gomma mandata</b>																							
	m 8 R1-1/4"	3301 0818	*	*	*	*	*	*	*	*	*	*	*	*									
	m 10 R1-5/16"	3301 0823													*	*	*	*	*	*	*		*
	m 10 R2-3/8"	3301 0947																					
	m 10 R2-5/16"	3301 0986																				*	
	m 20 R2-3/8"	3301 1271																					
	m 30 R2-1/2"	3301 1278																					
<b>Food-industry rubber delivery hose extension kit • Kit prolunga tubo gomma mandata antitraccia</b>																							
	m 10 R2-5/16"	3301 1249																					
	m 10 R1-5/16"	3301 1248																					
	m 10 R2-3/8"	3301 1250																					
<b>Hose reel with rubber hose • Avvolgitubo girevole con tubo gomma</b>																							
	m 15 R1-1/4"	7002 0241												•	•	•							
	m 15 R1-5/16"	7002 0279																•	•	•	•		•
	m 15 R1-1/4"	7002 0280													*	*	*						
	m 15 R1-5/16"	7002 0281																*	*	*	*		*
	m 15 R2-5/16"	7002 0285																				•	
	m 15 R2-3/8"	7002 0287																				*	
	m 15 R1-5/16"	7002 0315																					
	m 15 R2-5/16"	7002 0316																					
	m 15 R2-3/8"	7002 0317																					
	stainless steel with blue food-industry hose, 20 m inox con tubo blu anti-tr.	m 20 R2-5/16"	7002 0304																				
	stainless steel without rubber hose inox senza tubo gomma	max 30 m R2-5/16"	7002 0329																				
	max 40 m R1-5/16"	7002 0329																					
m 15 R1-1/4"	7002 0399		*		*		*		*		*		*										
m 20 R1-1/16"	7002 0400		*		*		*		*		*		*										

ETM				K STEEL S				K STEEL TS						K STEEL ECO			K STEEL						K Xtreme									
ETM 71	ETM 100	ETM 130	ETM 150	803	805	807	809	803	805	807	809	891 16/230T	891 21/180T	991 16/270T	991 21/210T	809 21/150T	801 15/210	901 21/180	1001		1251		1501		15/500	21/350	33/250	18/500	21/450	42/200	21/500	
																			21/210	28160	21/250	33/160	42/130	18/350								
																*	*	*	*		*		*									
																				*		*	*	*	*							
																										*						
																										*						
																										*						
																										*						
																										*						
																										*						
																										*						
																										*						
																										*						
																										*						
																										*						
																										*						
																										*						
																										*						
																										*						
																										*						
																										*						
																										*						
																										*						
																										*						
																										*						
																										*						
																										*						
																										*						
																										*						
																										*						
																										*						
																										*						
																										*						
																										*						
																										*						
																										*						
																										*						
																										*						
																										*						
																										*						
																										*						
																										*						
																										*						
																										*						
																										*						
																										*						
																										*						
																										*						
																										*						
																										*						
																										*						
																										*						
																										*						
																										*						
																										*						
																										*						
																										*						
																										*						
																										*						
																										*						
																										*						
																										*						
																										*						
																										*						
																										*						
																										*						
																										*						
																										*						
																										*						
																										*						
																										*						
																										*						
																										*						
																										*						
																										*						
																										*						
																										*						
																										*						
																										*						
																										*						
																										*						



















		M 250												M COMPACT			M PREMIUM						
		EXTRA 10/150	CLASSIC 10/150	EXTRA 12/130	CLASSIC 12/130	EXTRA 11/160	CLASSIC 11/160	EXTRA 13/190	CLASSIC 13/190	EXTRA 15/170	CLASSIC 15/170	EXTRA 11/210	CLASSIC 11/210	3.11 M	5.13 T	5.15 T	6.13 T	6.15 T	8.15 T	8.21 T	9.15 T	9.21 T	
<b>Accessories • Accessori</b>																							
<b>Stainless steel hose reel kit with rubber hose • Kit avvolgitubo inox con tubo gomma blu</b>																							
	m 20 R2-3/8" 600 bar	7002 0339																					
	max m 20 R2-5/16" without rubber hose senza tubo gomma	7002 0343																					
	max m 30 R1-5/16" without rubber hose senza tubo gomma																						
<b>Inox hose reel kit complete with Blue hose • Kit avvolgitubo inox con tubo Blu anti-macchia</b>																							
	m 20 R2-1/2"	7002 0345																					
	m 20 R2-3/8"	7002 0346																					
	m 20 R2-1/2" 310 bar	7002 0359																					
	m 20 R2-3/8" 600 bar	7002 0360																					
	m 40 R2-1/2"	7002 0366																					
	m 60 R1-1/2"	7002 0367																					
<b>Static kit complete with on-wall mounting frame • Kit Static completo di telaio e fissaggio a muro</b>																							
	m 20 R1-1/4"	5018 0076												*	*								
	m 20 R1-5/16"	5018 0077															*	*	*		*	*	
	m 20 R2-5/16"	5018 0105															*	*	*		*	*	
<b>Mobile kit complete with internal metal frame, handle and wheel kit • Kit Mobile completo di telaio supporto, manico e kit ruote</b>																							
		5018 0078												*	*								
		5018 0079															*	*	*		*	*	
<b>Protective panels kit • Kit pannellatura protettiva</b>																							
		5018 0126																					
<b>Spiral suction hose kit • Kit tubo aspirazione spiralato</b>																							
	m 8	3299 0019	*	*	*	*	*	*	*	*	*	*	*	*	*	*	*	*	*	*	*	*	*
<b>Suction hose with quick coupling • Attacco rapido aspirazione acqua</b>																							
		2803 3389	*	*	*	*	*	*	*	*	*	*	*										
<b>Detergent tank bracket • Supporto tanica detergente</b>																							
	lt 5	3002 0751																					
<b>Injector kit • Kit eiettore</b>																							
	ø 2,7	3410 0333																					
	ø 2,7	3410 0372																					
<b>Back-flow preventer kit BA 10 • Kit disconnettore idrico BA 10</b>																							
	G3/4M G3/4M	0608 0049	*	*	*	*	*	*	*	*	*	*	*	*	*	*	*	*	*	*	*	*	*
	Garden hose quick coupler kit 3/4 Kit raccordi attacco rapido 3/4	G3/4F G3/4F	5002 0024	*	*	*	*	*	*	*	*	*	*	*	*	*	*	*	*	*	*	*	*
<b>Water suction filter in brass • Filtro aspirazione acqua</b>																							
	G3/4F G3/4F	1002 0159																					
<b>Water filter • Filtro acqua</b>																							
	80 Mesh	1002 0241																					
<b>100 mesh cartridge for water filter • Cartuccia 100 mesh per filtro acqua</b>																							
	80 Mesh	1002 0242																					
<b>Foot pedal valve • Valvola pedale</b>																							
	G 3/8 M	0608 0071																					
	G 3/8 M	0608 0097	*	*	*	*	*	*	*	*	*	*	*	*	*	*	*	*	*	*	*	*	*





Accessories • Accessori			M 250												M COMPACT			M PREMIUM							
			EXTRA 10/150	CLASSIC 10/150	EXTRA 12/130	CLASSIC 12/130	EXTRA 11/160	CLASSIC 11/160	EXTRA 13/190	CLASSIC 13/190	EXTRA 15/170	CLASSIC 15/170	EXTRA 11/210	CLASSIC 11/210	3.11 M	5.13 T	5.15 T	6.13 T	6.15 T	8.15 T	8.21 T	9.15 T	9.21 T		
<b>Quickfit kit • Kit attacco rapido</b>																									
	M22	0011 0026																							
<b>Stainless steel lance hose kit with foam nozzle + quick kit M22 • Kit tubo lancia inox con ugello schiuma + kit attacco rapido M22</b>																									
	mm 500 M22	3301 1275																							
<b>Stainless steel foam system device • Dispositivo sistema schiuma inox</b>																									
		0608 0076																							
<b>Protective clothing kit • Kit abbigliamento protettivo</b>																									
		0608 0070																							
<b>Sludge pump • Lancia aspirafango</b>																									
	030	3410 0373	*	*			*	*					*	*			*								
	050	3410 0375			*	*			*	*	*	*			*	*	*		*	*		*			
	085	3410 0377																			*		*		
	050	3410 0378																							
	095	3410 0379																							
	075	3410 0380																							
	15	3410 0374																							

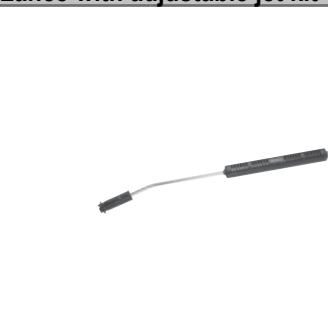

			FDX 2										FDX Elite						
			Axial Pumps / Pompe Assiali					Triplex					Axial Pumps / Pompe Assiali			Triplex			
			10/150	12/200	13/150	12/200	14/200	12/140	13/180	16/210	16/250	15/270	13/150	12/170	14/200	13/180	16/210	16/250	15/270
<b>Accessories • Accessori</b>																			
<b>Gun kit • Kit pistola</b>																			
	<b>Gun with guard</b> <i>Pistola con protezione</i>		2410 0103	●															
	<b>GH 351 + fixed lance (n. 2 o-ring)</b>		2410 0115																
	<b>GC 251</b>		2410 0121		●														
	<b>GH 351 + revolving lance</b> <i>GH 351 + lancia girevole</i>		2410 0125																
	<b>GH 351 + fixed lance</b> <i>GH 351 + lancia fissa</i>		2410 0127																
	<b>GH 281 + pressure unloader valve</b> <i>GH 281 + regolatore pressione</i>	G 3/8 M	2410 0222	*	*	*	*	*	*	*	*	*	*	*	*	*	*	*	*
	<b>GH 301 + Swivel</b>		2410 0183			●	●	●	●	●	●	●	●	●	●	●	●	●	●
	<b>GH 501</b>		2410 0195																
<b>Lance hose kit • Kit tubo lancia</b>																			
	<b>Straight with nozzle</b> <i>Dritta con ugello</i>		3301 1010	●															
	<b>Bent + det. head without nozzle</b> <i>Angolata + testina det. senza ugello</i>		3301 0936		●														
	<b>Bent + det. head without nozzle</b> <i>Angolata + testina det. senza ugello</i>		3301 0835			●	●	●	●	●	●	●	●	●	●	●	●	●	●
	<b>Bent + det. head without nozzle</b> <i>Angolata + testina det. senza ugello</i>		3301 0977																
	<b>Double barrel lance kit</b> <i>A canna doppia senza ugello</i>		3301 0942			*	*	*	*	*	*	*	*	*	*	*	*	*	*
		mm 800	3301 1323																
<b>Nozzle • Ugello</b>																			
	<b>Per lancia • for lance</b>	ø 1,15	3400 0470	●															
	<b>Detergente • detergent</b>	ø4 2540	3400 0444			*	*	*	*	*	*	*	*	*	*	*	*	*	*
<b>Lance with adjustable jet kit • Kit tubo lancia getto regolabile</b>																			
	ø 1,2 03	3301 0906																	
	ø 1,3 035	3301 0908																	
	ø 1,4 04	3301 0910				*					*		*					*	
	ø 1,5 045	3301 0912					*	*			*		*					*	
	ø 1,55 05	3301 0914			*				*	*		*			*	*			
	ø 1,62 055	3301 0916																	
	ø 1,65 06	3301 1095																	
	ø 1,8 06	3301 1086																	
ø 2,0 08	3301 1088																		
<b>Lance hose kit with rotating nozzle • Kit tubo lancia ugello rotante</b>																			
	033	3301 1053	*	*															
	035	3301 1240																	
	04	3301 0826				*					*		*					*	
	04	3301 1113																	
	03	3301 0829																	
	045	3301 0831					*	*	*		*		*				*		
	05	3301 0894		*			*	*	*		*		*		*	*		*	
	055	3301 0896																	
	06	3301 0898																	
	070	3301 0900																	
	1,00	3301 0996																	
080	3301 1004																		

FDX Pro							FDX 4					FDX XTREME						FDX WB		PTO				FDX HOT CUBE				
15/270	15/300	16/200	16/250	16/220	15/150	16/200 FW2 Yanmar	21/160 FW2 Yanmar	16/200 FW2 Honda	16/250 RW Honda	16/220 RW Honda	21/200 RW Honda	Petrol Engine / Motore Benzina				Diesel Engine / Motore Diesel		8/160 LWD-K	8/160 BWD-K	15/150	21/200	23/200	30/170	16/200 D	16/200 B	21/160 D	21/160 B	
15/500	18/400	21/350	30/280	36/230	42/200	15/500	18/400	21/350	30/280	36/230	42/200	15/500	18/400	21/350	30/280	36/230	42/200	8/160 LWD-K	8/160 BWD-K	15/150	21/200	23/200	30/170	16/200 D	16/200 B	21/160 D	21/160 B	
●	●	●	●	●	●	●		●	●	●	●									●	●	●	●	●	●	●	●	
*	*	*	*	*	*	*		*	*	*	*														*	*	*	*
*	*	*	*	*	*	*		*	*	*	*														*	*	*	*
																		*	*									
												●	●	●	●	●	●	●	●	●								
*	*	*	*	*	*	*		*	*	*	*							●	●						*	*	*	*
●	●	●	●	●	●	●		●	●	●	●							*	*	●	●	●	●	●	●	●	●	●
												●	●	●	●	●	●											
●	●	●	●	●	●	●		●	●	●	●							*	*	●	●	●	●	●	●	●	●	●
*	*																	*	*									
		*						*																	*	*		
			*						*																			
				*						*																		
					*						*																*	*
	*																											
*																		*	*									
		*						*																	*	*		
			*						*													*						
				*						*													*					
					*						*													*				
						*																				*	*	

**FDX 2**

**FDX Elite**

**Accessories • Accessori**

Axial Pumps / Pompe Assiali					Triplex					Axial Pumps / Pompe Assiali					Triplex				
10/150	12/200	13/150	12/200	14/200	12/140	13/180	16/210	16/250	15/270	13/150	12/170	14/200	13/180	16/210	16/250	15/270			

**Stainless-steel lance with rotating nozzle with quick coupler M24x1,5 (600 bar) • Lancia inox con ugello rotante con attacchi rapidi M24x1,5 (600 bar)**



030 inox	3301 1324															
040 inox	3301 1325															
050 inox	3301 1327															
075 ottone	3301 1328															
12 ottone	3301 1330															
15 ottone	3301 1331															

**Fan shape nozzle 15° or 25°, 1/4" MEG connection • Ugello con getto a lama 15° or 25° attacco 1/4" MEG**



15 033	3400 0722	●														
15 037	3400 0725		●	●							●					
15 043	3400 0726						●	●							●	
25 030	3400 0606															
25 035	3400 0701															
25 040	3400 0735															●
25 045	3400 0736					●			●			●				
25 050	3400 0737		●			●	●			●		●	●			
25 050	3400 0652															
25 055	3400 0738															
25 060	3400 0739															
25 065	3400 0740															
25 070	3400 0711															
25 075	3400 0742															
25 080	3400 0743															
25 10	3400 0524															

**Concentrated stainless-steel jet nozzle 0° with ceramic insert • Ugello inox getto concentrato 0° con inserto in ceramica**



0 030	3400 0619															
0 040	3400 0620															
0 050	3400 0622															
0 080	3400 0625															
0 11	3400 0624															
0 15	3400 0626															

**Flat stainless-steel jet nozzle (15° or 25°) with ceramic insert • Ugello inox getto piatto 15° o 25° con inserto in ceramica**















15 030	3400 0614															
15 040	3400 0616															
25 050	3400 0618															
25 080	3400 0612															
25 11	3400 0613															
25 15	3400 0611															

**Nozzle soda blasting head and tungsten carbide • Ugello per testa sabbiante in carburo di tungsteno**



15° - 040	3400 0578															
15° - 050	3400 0594															
15° - 080	3400 0595															
15° - 090	3400 0483															

FDX Pro						FDX 4						FDX XTREME						FDX WB			PTO				FDX HOT CUBE					
15/270	15/300	16/200	16/250	18/220	15/150	16/200 FW2 Yanmar	21/160 FW2 Yanmar	16/200 FW2 Honda	16/250 RW Honda	18/220 RW Honda	21/200 RW Honda	Petrol Engine / Motore Benzina				Diesel Engine / Motore Diesel				8/160 LWD-K	8/160 BWD-K	15/150	21/200	23/200	30/170	16/200 D	16/200 B	21/160 D	21/160 B	
15/500	18/400	21/350	30/280	36/230	42/200	15/500	18/400	21/350	30/280	36/230	42/200	15/500	18/400	21/350	30/280	36/230	42/200	8/160	8/160	8/160	15/150	21/200	23/200	30/170	16/200 D	16/200 B	21/160 D	21/160 B		
											*		*				*													
											*		*				*													
											*		*				*													
											*		*				*													
											*		*				*													
											*		*				*													
											*		*				*													
											*		*				*													
											*		*				*													
											*		*				*													
											*		*				*													
											*		*				*													
											*		*				*													
											*		*				*													
											*		*				*													
											*		*				*													
											*		*				*													
											*		*				*													
											*		*				*													
											*		*				*													
											*		*				*													
											*		*				*													
											*		*				*													
											*		*				*													
											*		*				*													
											*		*				*													
											*		*				*													
											*		*				*													
											*		*				*													
											*		*				*													
											*		*				*													
											*		*				*													
											*		*				*													
											*		*				*													
											*		*				*													
											*		*				*													
											*		*				*													
											*		*				*													
											*		*				*													
											*		*				*													
											*		*				*													
											*		*				*													
											*		*				*													
											*		*				*													
											*		*				*													
											*		*				*													
											*		*				*													
											*		*				*													
											*		*				*													
											*		*				*													
											*		*				*													
											*		*				*													
											*		*				*													
											*		*				*													
											*		*				*													
											*		*				*													
											*		*				*													
											*		*				*													
											*		*				*													
											*		*				*													
											*		*				*													
											*		*				*													
											*		*				*													
											*		*				*													
											*		*				*													
											*		*				*													
											*		*				*													
											*		*				*													
											*		*				*													
											*		*				*													
											*		*				*													
											*		*				*													
											*		*				*													
											*		*				*													
											*		*				*													
											*		*				*													
											*		*				*													
											*		*				*													
											*		*				*													
											*		*				*													
											*		*				*													
											*		*				*													
											*		*				*													
											*		*				*													
											*		*				*													













Accessories • Accessori			FDX 2								FDX Elite								
			Axial Pumps / Pompe Assiali				Triplex				Axial Pumps / Pompe Assiali				Triplex				
			10/150	12/200	13/150	12/200	14/200	12/140	13/180	16/210	16/250	15/270	13/150	12/170	14/200	13/180	16/210	16/250	15/270
<b>Stainless steel rotating nozzle head • Testina ugello rotante 0°</b>																			
	030 inox	3217 0279																	
	040 inox	3217 0280																	
	050 inox	3217 0281																	
	075 ottone	3217 0284																	
	12 ottone	3217 0278																	
15 ottone	3217 0286																		
<b>Sand/Soda blasting lance kit • Kit lancia sabbiate/bicarbonato</b>																			
		3301 0849	*	*															
	ø 1,4	3301 0821			*	*	*	*	*	*	*	*	*	*	*	*	*	*	*
	055	3301 0864																	
	ø 1,8	3301 0973																	
	040 500 bar	3301 1219																	
	050 500 bar	3301 1227																	
	080 500 bar	3301 1228																	
<b>Sand/Soda blasting lance kit, with ball quick coupler + rubber suction hose + 15° nozzle • Kit lancia sabbiate/bicarbonato, con attacco</b>																			
	15° - 040	3301 1333																	
	15° - 050	3301 1334																	
	15° - 080	3301 1335																	
	15° - 090	3301 1336																	
<b>Rotating brush • Idrospazzola rotante</b>																			
	8÷ 11 l/min	1413 0034				*		*					*						
	13÷ 18 l/min	1413 0035			*		*		*	*	*	*	*	*	*	*	*	*	*
		1413 0036	*	*															
		1413 0037	*	*															
<b>Professional solar panels washing kit • Kit professionale lavaggio pannelli solari</b>																			
	G3/8 M	1603 0101	*	*	*	*	*	*	*	*	*	*	*	*	*	*	*	*	*
<b>Kit foam lance kit • Kit lancia schiumogena</b>																			
		3301 0843	●																
		3301 0902		*	*	*	*	*	*	*	*	*	*	*	*	*	*	*	*
<b>Drain cleaning kit • Kit sonda spurgatubi</b>																			
	6÷ 9 l/min	3045 0035																	
	16÷ 21 l/min	3045 0037							*	*						*	*		
	10÷ 15 l/min	3045 0042	*	*	*	*	*	*	*		*	*	*	*	*	*		*	*
	22÷ 33 l/min	3045 0045																	
	10÷ 15 l/min	3045 0050																	
	16÷ 29 l/min	3045 0051																	
30÷ 42 l/min	3045 0052																		
<b>Rubber delivery hose kit • Kit tubo gomma mandata</b>																			
	m 8 R1-1/4"	3208 1028		●	●	●													
	m 8 R1-1/4"	3208 1031	●																
	m 10 R2-3/8"	3301 0945																	
	m 10 R2-5/16"	3301 0825								●	●							●	●
	m 10 R1-5/16"	3301 0988					●	●	●	●		●	●	●	●	●	●	●	●
m 10 R2-3/8"	3301 0658																		
<b>Rubber delivery hose kit with quick coupling M24x1,5 • Kit tubo gomma mandata con innesti rapidi M24x1,5</b>																			
	m 20 R2-3/8" 600 bar	3301 1226																	
	m 20 R2-3/8" 400 bar	3301 1270																	
	m 20 R2-1/2" 310 bar	3301 1268																	



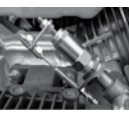











FDX Pro						FDX 4						FDX XTREME						FDX WB			PTO				FDX HOT CUBE						
15/270	15/300	16/200	16/250	18/220	15/150	16/200 FW2 Yanmar	21/160 FW2 Yanmar	16/200 FW2 Honda	16/250 RW Honda	18/220 RW Honda	21/200 RW Honda	Petrol Engine / Motore Benzina					Diesel Engine / Motore Diesel					8/160 LWD-K	8/160 BWD-K	15/150	21/200	23/200	30/170	16/200 D	16/200 B	21/160 D	21/160 B
15/500	18/400	21/350	30/280	36/230	42/200	15/500	18/400	21/350	30/280	36/230	42/200	15/500	18/400	21/350	30/280	36/230	42/200	8/160 LWD-K	8/160 BWD-K	15/150	21/200	23/200	30/170	16/200 D	16/200 B	21/160 D	21/160 B				
												*					*														
													*				*														
														*			*														
															*		*														
																*		*													
												</																			













FDX Pro						FDX 4						FDX XTREME						FDX WB			PTO				FDX HOT CUBE						
15/270	15/300	16/200	16/250	18/220	15/150	16/200 FW2 Yanmar	21/160 FW2 Yanmar	16/200 FW2 Honda	16/250 RW Honda	18/220 RW Honda	21/200 RW Honda	Petrol Engine / Motore Benzina				Diesel Engine / Motore Diesel				8/160 LWD-K	8/160 BWD-K	15/150	21/200	23/200	30/170	16/200 D	16/200 B	21/160 D	21/160 B		
15/500	18/400	21/350	30/280	36/230	42/200	15/500	18/400	21/350	30/280	36/230	42/200	15/500	18/400	21/350	30/280	36/230	42/200	8/160 LWD-K	8/160 BWD-K	15/150	21/200	23/200	30/170	16/200 D	16/200 B	21/160 D	21/160 B				
*	*	*			*			*		*	*							*	*												
			*	*		*		*	*													*	*	*	*			*	*		
								*	*			*	*											*	*						
														*	*																
														*	*																
																*	*														

















Accessories • Accessori			FDX 2										FDX Elite						
			Axial Pumps / Pompe Assiali					Triplex					Axial Pumps / Pompe Assiali			Triplex			
			10/150	12/200	13/150	12/200	14/200	12/140	13/180	16/210	16/250	15/270	13/150	12/170	14/200	13/180	16/210	16/250	15/270
<b>Thermostatic valve • Valvola termostatica</b>																			
	G 3/8M	1215 0359		*	*	*	*						●	●	●				
	G 1/2M	1215 0360						*	*	*	*	*				●	●	●	●
	G 1/2M	1215 0389																	
<b>Spiral suction hose kit • Kit tubo aspirazione spirato</b>																			
	m 8	3299 0019			*	*	*	*	*	*	*	*	*	*	*	*	*	*	*
<b>Injector kit • Kit eiettore</b>																			
	ø 2,1	3410 0372																	
	ø 2,7	3410 0333																	
<b>Water suction filter • Filtro aspirazione acqua</b>																			
		1002 0159																	
	50 mesh 70 l/min	1002 0238																	
	cartuccia cartridge 50 mesh	1002 0239																	
<b>Engine rev decelerator kit • Kit deceleratore giri motore</b>																			
		0608 0069																	
<b>Flame control kit • Kit comando controllo fiamma</b>																			
		5018 0081																	
<b>Suction strainer kit • Kit cestina di fondo</b>																			
	ø 25 mm	0401 0038																	
<b>PTO frame kit • Kit telaio PTO</b>																			
		3206 0295																	
<b>Foot pedal valve • Valvola pedale</b>																			
	G 3/8"	0608 0071																	
	G 3/8"	0608 0097	*	*	*	*	*	*	*	*	*	*	*	*	*	*	*	*	*
<b>Protective clothing kit • Kit abbigliamento protettivo</b>																			
		0608 0070																	
<b>Sludge pump kit • Kit lancia aspirafango</b>																			
	030	3410 0373	*			*													
	050	3410 0375			*		*	*	*	*	*								
	060	3410 0376																	
	085	3410 0377																	
	050	3410 0378																	
	095	3410 0379																	



			BORA 2		VENTO			
Accessories • Accessori			120	GOLD 130 G	CLASSIC 150 C	EXTRA 150 E	CLASSIC 135 C	EXTRA 135 E
<b>Gun kit with guard • Kit pistola con protezione</b>								
	GH 251	2410 0102	●	●	●	●	●	●
	GH 281 + pressure unloader valve GH 281 + regolatore pressione	G 1/4 M 2410 0225			*	*	*	*
<b>Bent lance hose kit without nozzle • Kit tubo lancia angolata senza ugello</b>								
	mm 700	3301 0835			●	●	●	●
	mm 500	3301 1144	●	●				
<b>Lance with adjustable jet kit • Kit tubo lancia getto regolabile</b>								
	ø 1,2	3301 0928					*	*
	ø 1,1	3301 1055			*	*		
<b>Lance with rotating nozzle kit • Kit tubo lancia con ugello rotante</b>								
	04	3301 0826					*	*
	035	3301 0829	*	*	*	*		
<b>Double barrel lance kit • Kit tubo lancia canna doppia</b>								
	mm 700	3301 0942	*	*	*	*	*	*
	+det. nozzle + ugello det.	ø 4 3400 0444	*	*	*	*	*	*
<b>Fan shape nozzle 15° attacco 1/4" MEG • Ugello con getto a lama 15° attacco 1/4" MEG</b>								
	ø 1,04 15 028	3400 0721			●	●		
	ø 1,19 15 04	3400 0350					●	●
	25° ø 1,0 15 025	3400 0547	●	●				
<b>Sandblasting lance kit • Kit lancia sabbiante</b>								
	ø 1,2	3301 0990	*	*	*	*	*	*
<b>Foam lance kit • Kit lancia shiumogena</b>								
		3301 0815			*	*	*	*
		3301 0843	●	●				
<b>Rotating brush max 60° • Idrospazzola rotante max 60°</b>								
	13+ 18 l/min	1413 0037	*	*	*	*	*	*

Accessories • Accessori			BORA 2		VENTO			
			120	GOLD 130 G	CLASSIC 150 C	EXTRA 150 E	CLASSIC 135 C	EXTRA 135 E
<b>Drain cleaning kit • Kit sonda spurgatubi</b>								
	m 8 6 ÷ 9 l/min	3045 0031	*	*	*	*		
	m 15 6 ÷ 9 l/min	3045 0032	*	*	*	*		
	m 25 10 ÷ 15 l/min	3045 0042					*	*
<b>Rubber delivery hose kit • Kit tubo gomma mandata</b>								
	m 8 R1-1/4"	3208 1031	●	●	●		●	
	m 10 R1-1/4"	3208 1032				●		●
<b>Rubber delivery hose extension kit • Kit prolunga tubo gomma mandata</b>								
	m 10 R1-5/16"	3301 0823			*		*	
	m 8 R1-1/4"	3301 0855	*	*		*		*
<b>Kit tubo aspirazione spiralato • Spiral suction hose kit</b>								
	m 8	3299 0019	*	*	*	*	*	*
<b>Back-flow preventer kit BA 10 • Kit disconnettore idrico BA 10</b>								
	G3/4M G3/4M	0608 0049	*	*	*	*	*	*
 Garden hose quick coupler kit 3/4 Kit raccordi attacco rapido 3/4	G3/4F G3/4F	5002 0024	*	*	*	*	*	*
<b>Anti-scale device • Dispositivo anticalcare</b>								
		0608 0048	*	*	*	*	*	*
<b>Water suction filter • Filtro aspirazione acqua</b>								
		1002 0129			*	*	*	*
<b>Flame control kit • Kit comando controllo fiamma</b>								
		5018 0114	*	*	*	*	*	*
<b>Sludge pump kit • Kit lancia aspirafango</b>								
	030	3410 0373	*	*	*	*	*	*











ELECTRICAL HOT WATER H.P. CLEANERS > IDROPULITRICI ELETTRICHE AD ACQUA CALDA

Accessories • Accessori			JUPITER				JUPITER PRO				VENUS CLASSIC							
			3-10 Classic	5-12 Classic	3-10 Extra	5-12 Extra	3-10 Classic	5-12 Classic	3-10 Extra	5-12 Extra	3-11	5-13	5-15	8-15	with Water tank and Anti-scale tank con Vasch. acqua e Anticalcare			
														3.11	5.13	5.15	8.15	
<b>Gun kit with guard • Kit pistola con protezione</b>																		
	GH 251 with protection GH 251 con protezione		2410 0096	•	•	•	•											
	GH 281 + pressure unloader valve GH 281 + regolatore pressione	G 3/8 M	2410 0222	*	*	*	*	•	•	•	•	*	*	*	*	*	*	*
	GH 351 + Swivel (n. 2 o-ring)		2410 0115															
	GH 351 + revolving lance + det. head GH 351 + lancia girevole + testa det.		2410 0125	*	*	*	*	*	*	*	*	*	*	*	*	*	*	*
	GH 351 + fixed lance + det. head GH 351 + lancia fissa + testa det.		2410 0127	*	*	*	*	*	*	*	*	*	*	*	*	*	*	*
	GH 351 + fixed lance + nozzle holder head GH 351 + lancia fissa + testa portaugello		2410 0129															
	GH 351 + swivel lance+nozzle holder head GH 351 + lancia girevole + testa portaugello		2410 0131															
	GH 301 with Swivel GH 301 con Swivel		2410 0183									•	•	•	•	•	•	•
<b>Bent lance + detergent head without nozzle • Lancia angolata con testina detergente senza ugello</b>																		
		mm 700	3301 0835	•	•	•	•	•	•	•	•	•	•					
		mm 700	3301 0977															
<b>Bent lance, with nozzle holder (without nozzle) • Lancia angolata, testa portaugello(senza ugello)</b>																		
		mm 700	3301 1353														•	•
		mm 700	3301 0975															
<b>Lance with adjustable jet kit • Kit tubo lancia getto regolabile</b>																		
	ø 1,3	3301 0908	*		*													
	ø 1,4	3301 0910		*		*	*	*	*	*	*							
	ø 1,5	3301 0912										*			*			
	ø 1,55	3301 0914										*		*	*		*	
	ø 1,62	3301 0916											*			*		
	ø 1,8	3301 1086												*			*	
	ø 1,65	3301 1095																
<b>Lance hose kit with rotating nozzle • Kit tubo lancia con ugello rotante</b>																		
	035	3301 0830	*		*													
	040	3301 0826		*		*	*	*	*	*								
	045	3301 0831										*			*			
	050	3301 0894									*		*	*	*		*	
	055	3301 0896										*			*		*	
	060	3301 0898															*	
	070	3301 0900																
<b>Double barrel lance kit • Kit tubo lancia canna doppia</b>																		
		mm 700	3301 0942	*	*	*	*	*	*	*	*	*	*	*	*	*	*	*
	+det. nozzle + ugello det.	ø 4	3400 0444	*	*	*	*	*	*	*	*	*	*	*	*	*	*	*
<b>Fan shape nozzle 15°, 1/4" MEG connection • Ugello con getto a lama 15°, attacco 1/4" MEG</b>																		
	15 035	3400 0677	•		•													
	15 037	3400 0715						•		•								
	15 040	3400 0690		•		•			•		•							
	25 045	3400 0736										•			•			
	25 050	3400 0737									•		•	•	•			•
	25 055	3400 0738											•				•	
	25 060	3400 0739																
	25 070	3400 0741																
25 065	3400 0740																	











VENUS EXTRA				E PREMIUM PLUS 15/200			F CLASSIC <i>without water tank senza vaschetta acqua</i>		F CLASSIC <i>with water tank con vaschetta acqua</i>						F EXTRA						
3.11	5.13	5.15	8.15	STD	Water tank <i>vasch. acqua</i>	Anti-scale tank <i>Anticalcare</i>	6.15	8.15	6.15	8.15	9.18	9.21	10.18	10.21	6.15	8.15	9.18	9.21	10.18	10.21	
●	●	●	●	●	●	●	●	●	●	●	●	●	●	●	●	●	●	●	●	●	●
				*			*	*													
				*			*	*													
*	*	*	*		*	*			*	*	*	*	*	*	*	*	*	*	*	*	*
*	*	*	*		*	*			*	*	*	*	*	*	*	*	*	*	*	*	*
				●			●	●													
●	●	●	●		●	●			●	●	●	●	●	●	●	●	●	●	●	●	●
*	*		*	*	*	*				*					*	*			*		*
		*						*	*			*		*		*		*		*	*
							*				*		*			*		*		*	*
*	*		*	*	*	*			*	*	*	*	*	*	*	*	*	*	*	*	*
*	*	*	*	*	*	*	*	*	*	*	*	*	*	*	*	*	*	*	*	*	*
●	●		●	●	●	●			●	●			●		●	●			●		●
		●					●	●	●		●		●		●		●		●		●
												●						●			●
														●							●

ELECTRICAL HOT WATER H.P. CLEANERS > IDROPULITRICI ELETTRICHE AD ACQUA CALDA

			JUPITER				JUPITER PRO				VENUS CLASSIC								
Accessories • Accessori			3-10 Classic	5-12 Classic	3-10 Extra	5-12 Extra	3-10 Classic	5-12 Classic	3-10 Extra	5-12 Extra	3-11	5-13	5-15	8-15	with Water tank and Anti-scale tank con Vasch. acqua e Anticalcare				
																3.11	5.13	5.15	8.15
<b>Sand/Soda blasting lance kit • Kit lanca sabbicante/bicarbonato</b>																			
	ø 1,4	3301 0821	*	*	*	*	*	*	*	*	*	*	*	*	*	*	*	*	*
	ø 1,8	3301 0973										*					*		
<b>Foam lance kit with regulator • Kit lancia schiumogena con regolatore</b>																			
		3301 0902	*	*	*	*	*	*	*	*	*	*	*	*	*	*	*	*	*
<b>Rotating brush max 60° • Idrospazzola rotante max 60°</b>																			
	8÷ 11 l/min	1413 0034	*		*		*		*		*		*		*		*		*
	13÷ 18 l/min	1413 0035		*		*		*		*		*		*		*		*	
<b>Professional solar panels washing kit (max 60°C) • Kit professionale lavaggio pannelli solari (max 60°C)</b>																			
	G3/8 M	1603 0101										*	*	*	*	*	*	*	*
<b>Drain cleaning kit, 25 m • Kit sonda spurgatubi m 25</b>																			
	15÷ 21 l/min	3045 0037																	
	10÷ 15 l/min	3045 0042	*	*	*	*	*	*	*	*	*	*	*	*	*	*	*	*	*
<b>Rubber delivery hose kit • Kit tubo gomma mandata</b>																			
	m 10 R1-1/4"	3208 1051	●					●				●				●			
	m 10 R2-5/16"	3301 0825											●						●
	m 10 R2-3/8"	3301 0945																	
	m 10 R1-5/16"	3301 0988		●				●				●	●			●	●		
<b>Rubber delivery hose extension kit • Kit prolunga tubo gomma mandata</b>																			
	m 8 R1-1/4"	3301 0844									*				*				
	m 10 R1-5/16"	3301 0823	*	*			*	*			*	*			*	*		*	*
	m 10 R2-3/8"	3301 0947																	
	m 10 R2-5/16"	3301 0986											*						*
	m 15 R2-5/16"	3301 0992																	
<b>Spiral suction hose kit • Kit tubo aspirazione spiralato</b>																			
	m 8	3299 0019	*	*	*	*	*	*	*	*	*	*	*	*	*	*	*	*	*
<b>Hose reel • Avvolgitubo</b>																			
	m 15 R1-1/4"	7002 0241			●				●										
	m 15 R1-5/16"	7002 0279				●				●									
<b>Hose reel with rubber hose • Avvolgitubo girevole con tubo gomma</b>																			
	m 20 R2-5/16"	7002 0382																	
	m 20 R2-3/8"	7002 0383																	
	m 20 R1-5/16"	7002 0381																	
	m 15 R1-5/16"	7002 0385								*	*	*		*	*	*		*	*
	m 15 R2-5/16"	7002 0386								*	*	*	*	*	*	*	*	*	*
<b>Steam nozzle kit with curved lance • Kit ugello vapore con lancia curva</b>																			
	mm 700	3301 1101																	







VENUS EXTRA				E PREMIUM PLUS 15/200			F CLASSIC <i>without water tank senza vaschetta acqua</i>		F CLASSIC <i>with water tank con vaschetta acqua</i>						F EXTRA					
3.11	5.13	5.15	8.15	STD	Water tank <i>vasch. acqua</i>	Anti-scale tank <i>Anticalcare</i>	6.15	8.15	6.15	8.15	9.18	9.21	10.18	10.21	6.15	8.15	9.18	9.21	10.18	10.21
*	*		*	*	*	*		*	*	*			*		*	*			*	
		*					*				*	*		*			*	*		*
*	*	*	*	*	*	*	*	*	*	*	*	*	*	*	*	*	*	*	*	*
*																				
	*	*	*	*	*	*	*	*	*	*	*		*		*	*	*		*	
*	*	*	*																	
				*	*	*					*	*	*	*			*	*	*	*
*	*	*	*				*	*	*	*					*	*				
●																				
			●	●	●	●		●		●						●				
	●	●					●		●		●	●	●	●	●		●		●	●
*																				
	*	*					*		*						*				*	*
											*	*	*	*			*	*	*	*
			*	*	*	*		*		*						*				
				*	*	*														
*	*	*	*	*	*	*	*	*	*	*	*	*	*	*	*	*	*	*	*	*
				*	*	*		*		*						*				
							*		*		*	*	*	*			*	*	*	*
*	*	*																		
*	*	*	*																	
*	*	*	*												*	*	*	*	*	*









ELECTRICAL HOT WATER H.P. CLEANERS > IDROPULITRICI ELETTRICHE AD ACQUA CALDA

			JUPITER				JUPITER PRO				VENUS CLASSIC							
Accessories • Accessori			3.10 Classic	5.12 Classic	3.10 Extra	5.12 Extra	3.10 Classic	5.12 Classic	3.10 Extra	5.12 Extra	3.11	5.13	5.15	8.15	with Water tank and Anti-scale tank con Vasch. acqua e Anticalcare			
															3.11	5.13	5.15	8.15
Exhausted fumes conveyor • Convogliatore di fumi esausti camino																		
		0466 0055	*	*	*	*	*	*	*	*	*	*	*	*	*	*	*	*
Kit disconnettore idrico BA 10 • Back-flow preventer kit BA 10																		
	G3/4M G3/4M	0608 0049	*	*	*	*	*	*	*	*	*	*	*	*	*	*	*	*
	Kit raccordi attacco rapido 3/4 Garden hose quick couplers G3/4F G3/4F	5002 0024	*	*	*	*	*	*	*	*	*	*	*	*	*	*	*	*
Dispositivo anticalcare • Anti-scale device																		
		0608 0048	*	*	*	*	*	*	*	*	*	*	*	*	*	*	*	*
Kit elettrovalvola detergente • Detergent solenoid valve kit																		
	24 V	0802 0015																
Kit comando controllo fiamma • Flame control kit																		
		5018 0081																
		5018 0114	*	*	*	*	*	*	*	*	*	*	*	*	*	*	*	*
		5018 0115																
Kit serbatoio anticalcare • Anti-scale tank kit																		
		5018 0092																
Valvola pedale • Foot pedal valve																		
	G 3/8"	0608 0097								*	*	*	*	*	*	*	*	*
Sludge pump kit • Kit lancia aspirafango																		
	030	3410 0373								*	*	*	*	*	*	*	*	*
	050	3410 0375								*	*		*	*			*	*
	060	3410 0376										*				*		
	085	3410 0377																

VENUS EXTRA				E PREMIUM PLUS 15/200			F CLASSIC <i>without water tank senza vaschetta acqua</i>		F CLASSIC <i>with water tank con vaschetta acqua</i>						F EXTRA					
3.11	5.13	5.15	8.15	STD	Water tank <i>vasch. acqua</i>	Anti-scale tank <i>Anticalcare</i>	6.15	8.15	6.15	8.15	9.18	9.21	10.18	10.21	6.15	8.15	9.18	9.21	10.18	10.21
*	*	*	*	*	*	*	*	*	*	*	*	*	*	*	*	*	*	*	*	*
				*	*	*	*	*												
				*	*	*	*	*												
				*			*	*												
									*	*	*	*	*	*	*	*	*	*	*	*
●	●	●	●												*	*	*	*	*	*
							*	*	*	*	*	*	*	*						
					*	●			*	*	*	*	*	*	●	●	●	●	●	●
*	*	*	*	*	*	*	*	*	*	*	*	*	*	*	*	*	*	*	*	*
*	*	*	*	*	*	*									*					
							*	*	*	*						*	*		*	
																		*		*

## ACCESSORIES - ACCESSORI

Modello Model	Codice Code	Tubo flessibile Flexible hose		Prolunga / Extension tube			Bocchetta / Attachment
		bocchetta attachment	tubo standard standard hose	dritta plastica straight plastic	curve acciaio cromato bent chrome-plated steel	dritte acciaio cromato straight chrome-plated steel	lancia lance
							
AC 18 ASPIRACENERE	9350 0038	3208 1131					0219 0024
AS 20-P	9350 0045		3208 1275	2417 0096			0219 0027
AS 21-X	9350 0050		3208 1275	2417 0096			0219 0027
AS 31-X	9350 0051		3208 1275	2417 0096			0219 0027
AS 35 PRO-P	9350 0052		3208 1045		3208 1047	3208 1046	0219 0006
AS 50 PRO-X	9350 0053		3208 1045		3208 1047	3208 1046	0219 0006

Modello Model	Codice Code	Tubo flessibile / Flexible hose				Bocchetta / Attachment				
		tubo standard standard hose	elettrot. power-driven	idrolitico hydrolytic	antistatico antistatic	curve acciaio cromato bent chrome- plated steel	dritte acciaio cromato straight chrome- plated steel	lancia lance	lava moquette carpet cleaning	lava poltrone couch cleaning
										
AS 70 PRO-X	9350 0054	3208 1045								
AS 70 PRO-B2-X	9350 0055					3208 1047	3208 1046	0219 0006		
AS 37 VIBRA	9350 0032	3208 1045	3208 1048			3208 1047	3208 1046	0219 0006		
AS 75 F2	9350 0025	3208 1045				3208 1047	3208 1046	0219 0006		
AS 77 B2	9350 0026	3208 1045				3208 1047	3208 1046	0219 0006		
AS 78 B3	9350 0027	3208 1045				3208 1047	3208 1046	0219 0006		
ASL 76-2	9350 0029	3208 1045		3208 1049		3208 1047	3208 1046	0219 0006	0219 0007	0219 0008
ASL 81-B3 METALOIL	9350 0033	3208 1112			3208 1111	3208 1113		0219 0012 0219 0014 0219 0015 0219 0016		

Bocchetta / Attachment		Spazzola pennello <i>Brush attachment</i>	Telaio per spazzola combin. <i>Support for combi-brush</i>	Racla		Spazzola / Brush		
per imbottiti <i>for soft furnishings</i>				polveri / liquidi <i>dust / liquids</i>	moquette <i>carpet</i>	liquidi <i>liquids</i>	polveri <i>dust</i>	pulisci griglia <i>grill cleaner</i>
								3046 0036
0219 0028		3046 0037	3206 0370	3046 0038				
0219 0028		3046 0037	3206 0370	3046 0038				
0219 0028		3046 0037	3206 0370	3046 0038				
		3046 0027			3046 0030	3046 0029	3046 0028	
		3046 0027			3046 0030	3046 0029	3046 0028	

Bocchetta / Attachment		Spazzola pennello <i>Brush attachment</i>	Telaio per spazzola combin. <i>Support for combi-brush</i>	Racla			Spazzola / Brush			Cestello / Basket	
per detriti <i>for dirt-intake</i>	ventosa ondulata <i>corrugated squeegee</i>			moquette <i>carpet</i>	liquidi <i>liquids</i>	polveri <i>dust</i>	moquette <i>carpet</i>	liquidi <i>liquids</i>	polveri <i>dust</i>	porta accessori <i>accessories storage</i>	inferiore porta accessori <i>lower accessories storage</i>
		3046 0027					3046 0030	3046 0029	3046 0028	3002 0625	
		3046 0027	3206 0318	3046 0032		3046 0031	3046 0030	3046 0029	3046 0028		
		3046 0027					3046 0030	3046 0029	3046 0028		
		3046 0027					3046 0030	3046 0029	3046 0028	3002 0625	3002 0628
		3046 0027					3046 0030	3046 0029	3046 0028	3002 0625	3002 0628
		3046 0027					3046 0030	3046 0029	3046 0028		3002 0628
0219 0017	0219 0013	3046 0035	3206 0319		3046 0034	3046 0033				3002 0625	

**NOZZLES**  
UGELLI

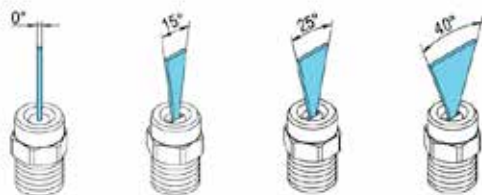

**STAINLESS STEEL 350 BAR PACKED NOZZLE**  
UGELLO INOX 350 BAR CONFEZIONATO



DIAMETER DIAMETRO	JET ANGLE ANGOLO GETTO	CODE CODICE
030	0°	3400 0457
035	0°	3400 0451
040	0°	3400 0449
045	0°	3400 0433
050	0°	3400 0437
055	0°	3400 0434
060	0°	3400 0718
065	0°	3400 0436
070	0°	3400 0719
075	0°	3400 0464
085	0°	3400 0448
090	0°	3400 0720

025	15°	3400 0547
028	15°	3400 0721
030	15°	3400 0667
033	15°	3400 0722
035	15°	3400 0723
037	15°	3400 0725
040	15°	3400 0724
043	15°	3400 0726
045	15°	3400 0727
050	15°	3400 0728
060	15°	3400 0729
065	15°	3400 0438
070	15°	3400 0730
075	15°	3400 0465
085	15°	3400 0458
090	15°	3400 0731

DIAMETER DIAMETRO	JET ANGLE ANGOLO GETTO	CODE CODICE
025	25°	3400 0732
030	25°	3400 0733
035	25°	3400 0734
040	25°	3400 0735
045	25°	3400 0736
050	25°	3400 0737
053	25°	3400 0747
055	25°	3400 0738
060	25°	3400 0739
065	25°	3400 0740
070	25°	3400 0741
075	25°	3400 0742
080	25°	3400 0743
085	25°	3400 0744
090	25°	3400 0745
10	25°	3400 0486
11	25°	3400 0544
13	25°	3400 0487

030	40°	3400 0454
035	40°	3400 0435
040	40°	3400 0452
045	40°	3400 0446
00	40°	3400 0443
055	40°	3400 0431
065	40°	3400 0447
075	40°	3400 0467
085	40°	3400 0460

• Nozzles flow chart on page 130. / Tabella portate ugelli a pagina 130.



**NOZZLES**  
UGELLI

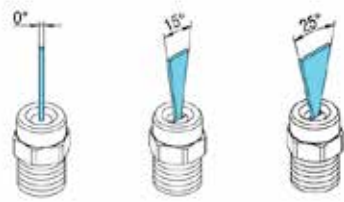

**CERAMIC 350 BAR**  
**UNPACKED NOZZLE**  
UGELLO CERAMICA 350 BAR  
NON CONFEZIONATO



**CERAMIC 500 BAR**  
**UNPACKED NOZZLE**  
UGELLO CERAMICA 500 BAR  
NON CONFEZIONATO



DIAMETER DIAMETRO	JET ANGLE ANGOLO GETTO	CODE CODICE
075	0°	3400 0623
080	0°	3400 0625
090	0°	3400 0645
11	0°	3400 0624
15	0°	3400 0626

080	15°	3400 0697
090	15°	3400 0696



035	25°	3400 0642
040	25°	3400 0628
050	25°	3400 0618
075	25°	3400 0617
080	25°	3400 0612
090	25°	3400 0644
10	25°	3400 0643
11	25°	3400 0613
15	25°	3400 0611

DIAMETER DIAMETRO	JET ANGLE ANGOLO GETTO	CODE CODICE
030	0°	3400 0619
035	0°	3400 0621
040	0°	3400 0620
050	0°	3400 0622

025	15°	3400 0627
030	15°	3400 0614
035	15°	3400 0615
040	15°	3400 0616
045	15°	3400 0659
050	15°	3400 0689
055	15°	3400 0695

• Nozzles flow chart on page 130. / Tabella portate ugelli a pagina 130.

**NOZZLES FLOW CHART**  
TABELLA PORTATE UGELLI

	 <b>bar</b> <b>MPa</b> <b>Psi</b>															 <b>l/min</b> <b>US gpm</b>
	<b>50</b> <b>5</b> <b>725</b>	<b>70</b> <b>7</b> <b>1015</b>	<b>100</b> <b>10</b> <b>1450</b>	<b>120</b> <b>12</b> <b>1740</b>	<b>150</b> <b>15</b> <b>2176</b>	<b>180</b> <b>18</b> <b>2611</b>	<b>200</b> <b>20</b> <b>2901</b>	<b>220</b> <b>22</b> <b>3191</b>	<b>250</b> <b>25</b> <b>3626</b>	<b>280</b> <b>28</b> <b>4061</b>	<b>300</b> <b>30</b> <b>4351</b>	<b>350</b> <b>35</b> <b>5076</b>	<b>400</b> <b>40</b> <b>5802</b>	<b>450</b> <b>45</b> <b>6527</b>	<b>500</b> <b>50</b> <b>7252</b>	
<b>010</b>	1,6 0,43	1,9 0,50	2,3 0,60	2,5 0,66	2,8 0,74	3,1 0,81	3,2 0,85	3,4 0,89	3,6 0,95	3,8 1,01	3,9 1,04	4,3 1,13	4,6 1,20	4,8 1,28	5,1 1,35	
<b>015</b>	2,4 0,64	2,9 0,76	3,4 0,90	3,7 0,99	4,2 1,11	4,6 1,21	4,8 1,28	5,1 1,34	5,4 1,43	5,7 1,51	5,9 1,56	6,4 1,69	6,8 1,81	7,3 1,92	7,6 2,02	
<b>020</b>	3,2 0,85	3,8 1,01	4,6 1,20	5,0 1,32	5,6 1,47	6,1 1,62	6,4 1,70	6,8 1,79	7,2 1,90	7,6 2,02	7,9 2,09	8,5 2,25	9,1 2,41	9,7 2,55	10,2 2,69	
<b>022</b>	3,5 0,94	4,2 1,11	5,0 1,32	5,5 1,45	6,1 1,62	6,7 1,78	7,1 1,87	7,4 1,96	7,9 2,09	8,4 2,22	8,7 2,29	9,4 2,48	10,0 2,65	10,6 2,81	11,2 2,96	
<b>025</b>	4,0 1,06	4,8 1,26	5,7 1,51	6,2 1,65	7,0 1,84	7,6 2,02	8,1 2,13	8,5 2,23	9,0 2,38	9,5 2,52	9,9 2,61	10,7 2,82	11,4 3,01	12,1 3,19	12,7 3,37	
<b>028</b>	4,5 1,19	5,3 1,41	6,4 1,69	7,0 1,85	7,8 2,06	8,6 2,26	9,0 2,38	9,5 2,50	10,1 2,67	10,7 2,82	11,1 2,92	11,9 3,15	12,8 3,37	13,5 3,58	14,3 3,77	
<b>030</b>	4,8 1,28	5,7 1,51	6,8 1,81	7,5 1,98	8,4 2,21	9,2 2,42	9,7 2,55	10,1 2,68	10,8 2,86	11,4 3,02	11,8 3,13	12,8 3,38	13,7 3,61	14,5 3,83	15,3 4,04	
<b>033</b>	5,3 1,41	6,3 1,66	7,5 1,99	8,2 2,18	9,2 2,43	10,1 2,67	10,6 2,81	11,2 2,95	11,9 3,14	12,6 3,33	13,0 3,44	14,1 3,72	15,0 3,97	16,0 4,22	16,8 4,44	
<b>035</b>	5,6 1,49	6,7 1,76	8,0 2,11	8,7 2,31	9,8 2,58	10,7 2,83	11,3 2,98	11,8 3,13	12,6 3,33	13,3 3,53	13,8 3,65	14,9 3,94	16,0 4,22	16,9 4,47	17,8 4,71	
<b>037</b>	6,0 1,58	7,1 1,86	8,4 2,23	9,2 2,44	10,3 2,73	11,3 2,99	11,9 3,15	12,5 3,30	13,3 3,52	14,1 3,73	14,6 3,86	15,8 4,17	16,9 4,46	17,9 4,73	18,9 4,98	
<b>040</b>	6,4 1,70	7,6 2,02	9,1 2,41	10,0 2,64	11,2 2,95	12,2 3,23	12,9 3,41	13,5 3,57	14,4 3,81	15,3 4,03	15,8 4,17	17,1 4,51	18,2 4,82	19,3 5,11	20,4 5,39	
<b>042</b>	6,8 1,79	8,0 2,12	9,6 2,53	10,5 2,77	11,7 3,10	12,8 3,39	13,5 3,58	14,2 3,75	15,1 4,00	16,0 4,23	16,6 4,38	17,9 4,73	19,1 5,06	20,3 5,36	21,4 5,66	
<b>045</b>	7,3 1,92	8,6 2,27	10,3 2,71	11,2 2,97	12,6 3,32	13,8 3,64	14,5 3,83	15,2 4,02	16,2 4,28	17,2 4,53	17,8 4,69	19,2 5,07	20,5 5,42	21,8 5,75	22,9 6,06	
<b>050</b>	8,1 2,13	9,5 2,52	11,4 3,01	12,5 3,30	14,0 3,69	15,3 4,04	16,1 4,26	16,9 4,47	18,0 4,76	19,1 5,04	19,7 5,21	21,3 5,63	22,8 6,02	24,2 6,39	25,5 6,73	
<b>053</b>	8,5 2,26	10,1 2,67	12,1 3,19	13,2 3,50	14,8 3,91	16,2 4,28	17,1 4,51	17,9 4,73	19,1 5,05	20,2 5,34	20,9 5,53	22,6 5,97	24,2 6,38	25,6 6,77	27,0 7,14	
<b>055</b>	8,9 2,34	10,5 2,77	12,5 3,31	13,7 3,63	15,4 4,06	16,8 4,44	17,7 4,68	18,6 4,91	19,8 5,24	21,0 5,54	21,7 5,74	23,5 6,20	25,1 6,62	26,6 7,03	28,0 7,41	
<b>006</b>	9,7 2,55	11,4 3,02	13,7 3,61	15,0 3,96	16,8 4,42	18,3 4,85	19,3 5,11	20,3 5,36	21,6 5,71	22,9 6,05	23,7 6,26	25,6 6,76	27,4 7,23	29,0 7,66	30,6 8,08	
<b>065</b>	10,5 2,77	12,4 3,27	14,8 3,91	16,2 4,29	18,1 4,79	19,9 5,25	21,0 5,54	22,0 5,81	23,4 6,19	24,8 6,55	25,7 6,78	27,7 7,32	29,6 7,83	31,4 8,30	33,1 8,75	
<b>070</b>	11,3 2,98	13,3 3,53	16,0 4,22	17,5 4,62	19,5 5,16	21,4 5,66	22,6 5,96	23,7 6,25	25,2 6,66	26,7 7,05	27,6 7,30	29,9 7,89	31,9 8,43	33,8 8,94	35,7 9,43	
<b>075</b>	12,1 3,19	14,3 3,78	17,1 4,52	18,7 4,95	20,9 5,53	22,9 6,06	24,2 6,39	25,4 6,70	27,0 7,14	28,6 7,56	29,6 7,82	32,0 8,45	34,2 9,03	36,3 9,58	38,2 10,10	
<b>080</b>	12,9 3,41	15,3 4,03	18,2 4,82	20,0 5,28	22,3 5,90	24,5 6,46	25,8 6,81	27,0 7,15	28,8 7,62	30,5 8,06	31,6 8,34	34,1 9,01	36,5 9,63	38,7 10,22	40,8 10,77	
<b>085</b>	13,7 3,62	16,2 4,28	19,4 5,12	21,2 5,61	23,7 6,27	26,0 6,87	27,4 7,24	28,7 7,59	30,6 8,09	32,4 8,56	33,6 8,87	36,2 9,58	38,8 10,24	41,1 10,86	43,3 11,44	
<b>090</b>	14,5 3,83	17,2 4,53	20,5 5,42	22,5 5,94	25,1 6,64	27,5 7,27	29,0 7,66	30,4 8,04	32,4 8,57	34,3 9,07	35,5 9,39	38,4 10,14	41,0 10,84	43,5 11,50	45,9 12,12	
<b>10</b>	16,1 4,26	19,1 5,04	22,8 6,02	25,0 6,60	27,9 7,37	30,6 8,08	32,2 8,52	33,8 8,93	36,0 9,52	38,1 10,08	39,5 10,43	42,6 11,27	45,6 12,04	48,4 12,77	51,0 13,46	
<b>12</b>	19,3 5,11	22,9 6,05	27,4 7,23	30,0 7,92	33,5 8,85	36,7 9,69	38,7 10,22	40,6 10,72	43,2 11,43	45,8 12,09	47,4 12,52	51,2 13,52	54,7 14,45	58,0 15,33	61,2 16,16	
<b>15</b>	24,2 6,39	28,6 7,56	34,2 9,03	37,5 9,89	41,9 11,06	45,9 12,12	48,4 12,77	50,7 13,40	54,1 14,28	57,2 15,11	59,2 15,64	64,0 16,90	68,4 18,06	72,5 19,16	76,5 20,20	
<b>20</b>	32,2 8,52	38,1 10,08	45,6 12,04	49,9 13,19	55,8 14,75	61,2 16,16	64,5 17,03	67,6 17,86	72,1 19,04	76,3 20,15	79,0 20,86	85,3 22,53	91,2 24,09	96,7 25,55	101,9 26,93	

NOZZLE SIZE / MISURA UGELLO

## PRESSURE DROPS IN RUBBER HOSES



### PERDITE DI CARICO NEI TUBI ALTA PRESSIONE

Pressure drops expressed in bar per 1 meter length of linear hose without fittings.

Specific gravity: 0,85 - Viscosity: 20 centistokes (cs) at 21 °C (70 °F).

Perdite di pressione in bar per una lunghezza del tubo flessibile di 1 m. lineare senza raccordi.

Peso specifico del fluido: 0,85 - Viscosità cinematica: 20 centistokes (cs) a 21 °C.

		 inch mm											
		3/16" 4,8	1/4" 6,4	5/16" 7,9	3/8" 9,5	1/2" 12,7	5/8" 15,9	3/4" 19	1" 25,4	1"1/4 31,8	1"1/2 38,1	2" 50,8	3" 76,2
 l/min	1	0,242	0,075										
	2	0,466	0,146	0,066									
	4	0,996	0,293	0,133	0,058								
	8	2,433	0,613	0,250	0,117								
	10	3,540	0,880	0,335	0,144	0,045							
	15		1,776	0,660	0,273	0,068	0,027						
	20		3,080	1,129	0,462	0,116	0,041	0,018					
	30			2,159	0,887	0,228	0,082	0,032					
	40					0,379	0,144	0,050	0,014				
	50					0,555	0,192	0,075	0,021				
	60					0,756	0,263	0,111	0,029	0,009			
	70					0,970	0,373	0,154	0,037	0,013			
	80					1,250	0,475	0,200	0,049	0,016	0,007		
	90					1,531	0,560	0,237	0,066	0,021	0,008		
	100						0,653	0,274	0,073	0,025	0,010	0,003	
	125						0,964	0,393	0,103	0,036	0,014	0,004	
	150							0,567	0,147	0,050	0,019	0,005	
	175							0,735	0,186	0,060	0,026	0,007	
	200							0,920	0,228	0,083	0,033	0,009	
	250								0,347	0,124	0,050	0,013	
300								0,475	0,162	0,068	0,017	0,002	
400								0,832	0,303	0,118	0,032	0,004	
500								1,159	0,425	0,164	0,043	0,006	
600									0,562	0,222	0,057	0,008	
700									0,733	0,301	0,078	0,011	
800									0,924	0,383	0,098	0,014	
900									1,144	0,468	0,118	0,016	
1000										0,553	0,140	0,019	







**MERCURY**



Download  
Comet Spa  
App

Follow us on



[www.comet-spa.com](http://www.comet-spa.com)



**MERCURY**  
BY COMET

Comet Spa › via G. Dorso, 4 - 42124 Reggio Emilia › Italy  
phone + 39 0522 386111 › [www.comet-spa.com](http://www.comet-spa.com)  
Italia: [vendite@comet.re.it](mailto:vendite@comet.re.it) › Fax + 39 0522 386300  
Export: [export@comet.re.it](mailto:export@comet.re.it) › Fax + 39 0522 386280