

## DS-2CD1323G0-IU 2 MP IR Fixed Turret Network Camera



- 1/2.7" Progressive Scan CMOS
- 1920 × 1080@30fps
- 2.8/4 mm fixed lens
- Color: 0.028 Lux @ (F2.0, AGC ON), 0 Lux with IR
- H.265+/H.265/H.264+/H.264
- BLC/3D DNR/ROI
- IR range: Up to 30 m
- 3-Axis adjustment
- IP66
- Built-in microphone



## Specifications

Camera	
Image Sensor	1/2.7" Progressive Scan CMOS
Min. Illumination	Color: 0.028 Lux @ (F2.0, AGC ON), 0 Lux with IR
Shutter Speed	1/3 s to 1/100,000 s
Slow Shutter	Yes
Day & Night	IR Cut Filter
WDR	DWDR
Angle Adjustment	Pan: 0° to 360°, tilt: 0° to 75°, rotate: 0° to 360°
Lens	
Lens Type	Fixed lens, 2.8/4 mm
Aperture	F2.0
FOV	2.8mm: Horizontal FOV: 114°, vertical FOV: 62°, diagonal FOV: 135° 4 mm: Horizontal FOV: 86°, vertical FOV: 46°, diagonal FOV: 102°
Lens Mount	M12
Illuminator	
IR Range	Up to 30 m
Wavelength	850 nm
Video	
Max. Resolution	1920 × 1080
Main Stream	50Hz: 25fps (1920 × 1080, 1280 × 960, 1280 × 720) 60Hz: 30fps (1920 × 1080, 1280 × 960, 1280 × 720)
Sub Stream	50Hz: 25fps (640 × 480, 640 × 360, 320 × 240) 60Hz: 30fps (640 × 480, 640 × 360, 320 × 240)
Video Compression	Main stream: H.265+/H.265/H.264+/H.264 Sub-stream: H.265/H.264/MJPEG
H.264 Type	Baseline Profile/Main Profile/High Profile
H.265 Type	Main Profile
Video Bit Rate	32 Kbps to 8 Mbps
Audio(-U)	
Audio Compression	G.711/G.722.1/G.726/MP2L2/PCM
Audio Bit Rate	64Kbps(G.711)/16Kbps(G.722.1)/16Kbps(G.726)/32-192Kbps(MP2L2)
Smart Feature-Set	
Basic Event	Motion detection, video tampering alarm, exception (illegal login)
Linkage Method	Upload to FTP, notify surveillance center, send email, trigger capture
Region of Interest	1 fixed region for main stream and sub-stream
Image	
Image Enhancement	BLC, 3D DNR
Image Setting	Rotate mode, saturation, brightness, contrast, sharpness, AGC and white balance adjustable by client software or web browser

Day/Night Switch	Day/Night/Auto/Schedule
<b>Network</b>	
Protocols	TCP/IP, ICMP, HTTP, HTTPS, FTP, DHCP, DNS, RTP, RTSP, RTCP, NTP, IGMP, QoS, UDP
API	ONVIF (PROFILE S, PROFILE G), ISAPI, SDK
Simultaneous Live View	Up to 6 channels
User/Host	Up to 32 users, 3 levels: administrator, operator and user
Client	iVMS-4200, iVMS-4500, iVMS-5200, Hik-Connect
Web Browser	IE8+, Chrome 41.0-44, Firefox 30.0-51, Safari 8.0-11
<b>Interface</b>	
Communication Interface	1 RJ45 self-adaptive Ethernet port
Audio	1 audio input (built-in microphone), mono sound
Interface Style	Pigtail style interface
<b>General</b>	
Firmware Version	5.5.83
General Function	One-key reset, heartbeat, mirror, password protection, privacy mask, watermark, IP address filter
Reset	Reset via web browser and client software
Startup and Operating Conditions	-30 °C to 60 °C (-22 °F to 140 °F), humidity 95% or less (non-condensing)
Storage Conditions	-30 °C to 60 °C (-22 °F to 140 °F), humidity 95% or less (non-condensing)
Power Supply	12 VDC ± 25%, Φ 5.5 mm coaxial power plug; PoE (802.3af, class 0)
Power Consumption and Current	12 VDC, 0.4 A, max. 5 W; PoE (802.3af, 36 V to 57 V), 0.20 A to 0.10 A, max. 6.5 W
Material	Camera body: metal, bottom base : plastic
Dimensions	Camera: 94.4 × Φ110 mm (3.7" × Φ4.3") With package: 150 × 150 × 141 mm (5.9" × 5.9" × 5.6")
Weight	Camera: Approx. 354 g (0.8 lb.) With package: Approx. 681 g (1.5 lb.)
<b>Approval</b>	
EMC	47 CFR Part 15, Subpart B; EN 55032: 2015, EN 61000-3-2: 2014, EN 61000-3-3: 2013, EN 50130-4: 2011 +A1: 2014; AS/NZS CISPR 32: 2015; ICES-003: Issue 6, 2016; KN 32: 2015, KN 35: 2015
Safety	UL 60950-1, IEC 60950-1:2005 + Am 1:2009 + Am 2:2013, EN 60950-1:2005 + Am 1:2009 + Am 2:2013, IS 13252(Part 1):2010+A1:2013+A2:2015, IEC/EN 60950-1
Chemistry	2011/65/EU, 2012/19/EU, Regulation (EC) No 1907/2006
Protection	Ingress protection: IP66 (IEC 60529-2013)

\* Listed resolutions are only selectable options. It does not mean that all streams can work at their maximum resolution at the same time.

## Available Model

DS-2CD1323G0-IU (2.8/4 mm)

**Dimension**

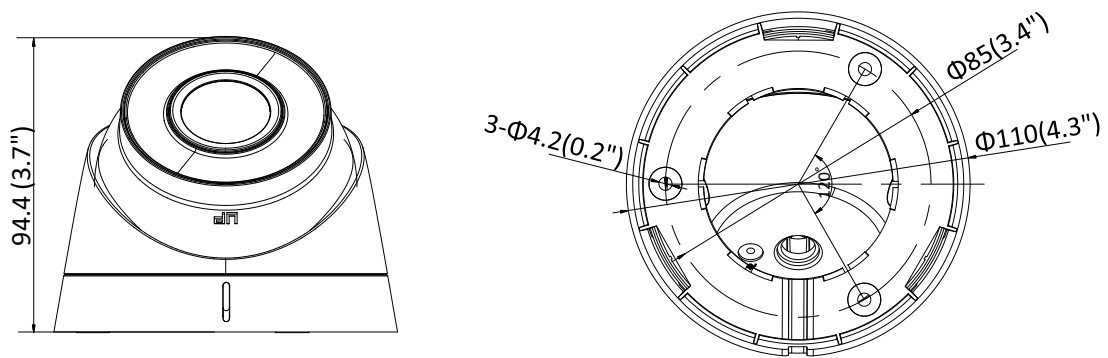

Unit: mm (inch)

**Accessory**



**DS-1272ZJ-110-TRS**  
Wall Mount



**DS-1275ZJ-SUS**  
Vertical Pole Mount



**DS-1276ZJ-SUS**  
Corner Mount



**DS-1280ZJ-S**  
Junction Box

Distributed by

**HIKVISION®****Headquarters**

No.555 Qianmo Road, Binjiang District,  
Hangzhou 310051, China  
T +86-571-8807-5998  
overseasbusiness@hikvision.com

**Hikvision USA**  
T +1-909-895-0400  
sales.usa@hikvision.com

**Hikvision Australia**  
T +61-2-8599-4233  
salesau@hikvision.com

**Hikvision India**  
T +91-22-28469900  
sales@pramahikvision.com

**Hikvision Canada**  
T +1-866-200-6690  
sales.canada@hikvision.com

**Hikvision Thailand**  
T +662-275-9949  
sales.thailand@hikvision.com

**Hikvision Europe**  
T +31-23-5542770  
sales.eu@hikvision.com

**Hikvision Italy**  
T +39-0438-6902  
info.it@hikvision.com

**Hikvision Brazil**  
T +55 11 3318-0050  
Latam.support@hikvision.com

**Hikvision Turkey**  
T +90 (216)521 7070- 7074  
sales.tr@hikvision.com

**Hikvision Malaysia**  
T +601-7652-2413  
sales.my@hikvision.com

**Hikvision UK & Ireland**  
T +01628-902140  
sales.uk@hikvision.com

**Hikvision South Africa**  
Tel: +27 (10) 0351172  
sale.africa@hikvision.com

**Hikvision France**  
T +33(0)1-85-330-450  
info.fr@hikvision.com

**Hikvision Kazakhstan**  
T +7-727-9730667  
nikia.panfilov@hikvision.ru

**Hikvision Vietnam**  
T +84-974270888  
sales.vt@hikvision.com

**Hikvision UAE**  
T +971-4-4432090  
salesme@hikvision.com

**Hikvision Singapore**  
T +65-6684-4718  
sg@hikvision.com

**Hikvision Spain**  
T +34-91-737-16-55  
info.es@hikvision.com

**Hikvision Tashkent**  
T +99-87-1238-9438  
uzb@hikvision.ru

**Hikvision Hong Kong**  
T +852-2151-1761  
info.hk@hikvision.com

**Hikvision Russia**  
T +7-495-669-67-99  
sateru@hikvision.com

**Hikvision Korea**  
T +82-[0]31-731-8817  
sales.korea@hikvision.com

**Hikvision Poland**  
T +48-22-460-01-50  
info.pl@hikvision.com

**Hikvision Indonesia**  
T +62-21-2933759  
Sales.Indonesia@hikvision.com

**Hikvision Colombia**  
sales.colombia@hikvision.com