

# HG

## Molded Case Circuit Breakers & Earth Leakage Circuit Breakers

<b>Overview and Characteristics</b>		4
<b>Technical Data</b>	External Structure and Indications	16
	Technical Data	20
	Technical Data (HGP)	34
	Operation Characteristic Curve	59
<b>Model Selection Table</b>		70
<b>Accessories</b>	HGM General Type	98
	HGP High Breaking Type	100
	Internal Accessories	102
	External Accessories	110
	Order Code of Accessories	136
<b>Dimensions</b>		146
<b>Order Code</b>		210
<b>Handling and Maintenance Inspection</b>		214
<b>Acquired Standards</b>		220

## HG Series

# Molded Case Circuit Breakers & Earth Leakage Circuit Breakers

Maximized selectivity and safety with wide product range and reinforced breaking performance!



## Rated Short-Circuit Current by AF, (Ics = 100 % Icu at 440/460 V)

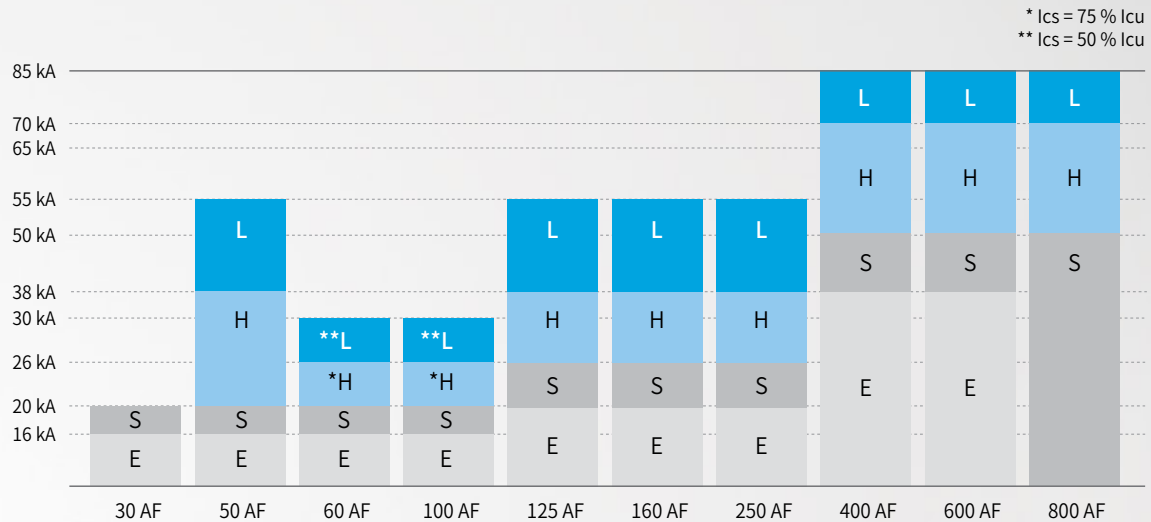

### Wide Product Range

HGM/HGE 32 AF ~ 800 AF

### Best Breaking Capacity

16 kA ~ 85 kA (at 460 V), Ics = 100 % Icu

### Rated Insulation Voltage of 1,000 V

### Reinforcement of Protective Coordination

It enables selective breaking.

### Adjustable Rated Current (Molded Case Circuit Breaker)

32 ~ 250 AF : 0.8 - 0.9 - 1 Times the Rated Current  
400 ~ 800 AF : 0.63 - 0.8 - 1 Times the Rated Current

### Adjustable Residual Current (Earth Leakage Circuit Breaker)

100 - 300 - 500 - 1,000 (mA)

### Adjustable Residual Current's Non-Operation Hour (Earth Leakage Circuit Breaker)

0 - 200 - 500 - 1,000 (ms)



Molded Case Circuit Breakers



Earth Leakage Circuit Breakers

## Overview and Characteristics

### Enhanced Performance and Various Selectivity

Various Range of Products : 10 Frames, 32 ~ 800 AF

Compatible MCCB, ELCB Dimensions and Common use of Accessories

Standardization of Product Depth per Frame : 32 ~ 250 AF (68 mm), 400 ~ 800 AF (110 mm)



32, 50, 63, 100 AF

50, 125 AF

160, 250 AF



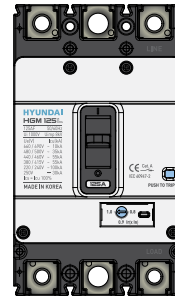

MCCB

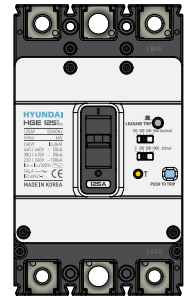

ELCB



400 AF



630, 800 AF

Unit : mm

VCB

ACB

MCCB

MS

RELAY

# Overview and Characteristics

## HGM Type of Molded Case Circuit Breaker

### Maximized Insulation Performance

The safety of the product has been maximized through enhanced insulation voltage

- Rated Insulation Voltage,  $U_i$  : 1,000 V
- Rated Impulse Withstand Voltage,  $U_{imp}$  : 8 kV

### High Breaking Capacity

Maximum domestic breaking capacity was realized with high breaking capacity.

- 16 ~ 30 kA at 460 V (100 AF)
- 20 ~ 55 kA at 460 V (125 ~ 250 AF)
- 38 ~ 85 kA at 460 V (400 ~ 800 AF)

### Cable Insulation Performance Suitability

In case there is a presence of abnormal condition such as welding of the main contact after tripping of the circuit breaker by realizing the cable insulation performance in accordance with IEC 60947-2, the handle does not move from ON to OFF position. This makes it safe by preventing the operation of circuit breaker caused by the operator's negligence.

### Adjustable Rated Current in all Frames

The adjustable rated current of up to 800 AF provides optimal protection for load variations in customer's equipment.

- Long Time ( $\leq 250$  AF) :  
3-step adjusting, 80 % - 90 % - 100 % of rated current
- Long Time (400 AF, 800 AF) :  
3-step adjusting, 63 % - 80 % - 100 % of rated current

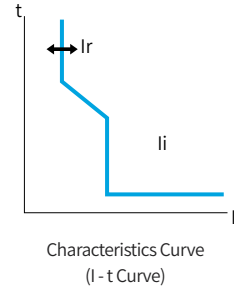

### Sealing Structure (Option) Applied

Dial sealing structure was applied to prevent arbitrary change of the current set value using a protection cover (Prevent operation of thermal magnetic adjustment knob) (Option).

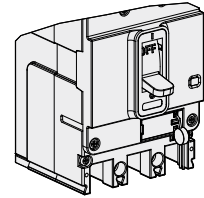

**HYUNDAI**  
**HGM 125H**

125AF	50/60Hz
$U_i$ 1000V	$U_{imp}$ 8kV

CE Cat. A  
IEC 60947-2

**PUSH TO TRIP**

$U_e$ (V)	$I_{cu}$ (kA)
660 / 690V	~ 8kA
480 / 500V	~ 26kA
440 / 460V	~ 38kA
380 / 415V	~ 38kA
220 / 240V	~ 85kA
250V	~ 20kA
$I_{cs} = I_{cu}$ 100%	



1.0 ← 0.8

**0.9  $I_r(x I_n)$**

### Service Breaking Capacity ( $I_{cs} = 100\% \times I_{cu}$ )

100 % service breaking capacity has been realized by significantly improving the breaking capacity by restricting accidental current using an internal current limiting device in case of short-circuit accidents.

- 32 ~ 800 AF
  - 16 ~ 55 kA @ 460 Vac (Below 250 AF)
  - 38 ~ 85 kA @ 460 Vac (400 ~ 800 AF)
- (HGM60, 100 H Type  $I_{cs} = 75\% I_{cu}$ , HGM60, 100 L Type  $I_{cs} = 50\% I_{cu}$ )

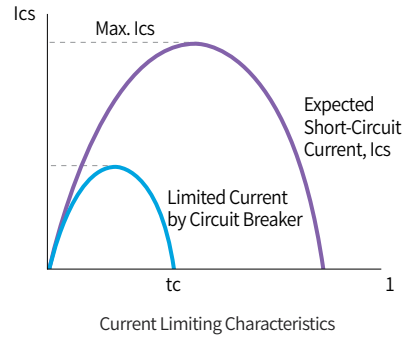

### Various Low Voltage System Protections

HGM Type MCCB realizes current limiting characteristics and outstanding breaking performance and enables various low voltage system protections such as discrimination and cascading.

#### Discrimination

It is a protection method in which when an accident occurs during load, the downstream circuit breaker that is directly related to the accident circuit operates first so that the other sound branch circuit breaker and the upstream main circuit breaker can feed continuously. It is a low voltage system protection method that can minimize the fault point by selectively preventing faults.

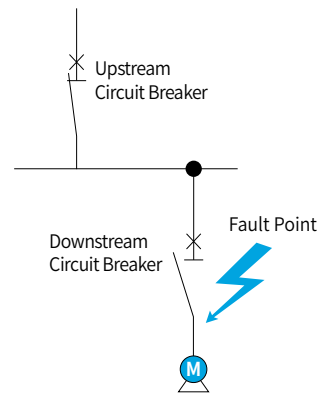

#### Cascading

In case an accident occurs during load, the upstream main circuit breaker operates earlier than the downstream circuit breaker of the accident circuit for back-up protection. It is an economic protection method. Thus, a circuit breaker with lower breaking capacity than the estimated short-circuit current can be applied.

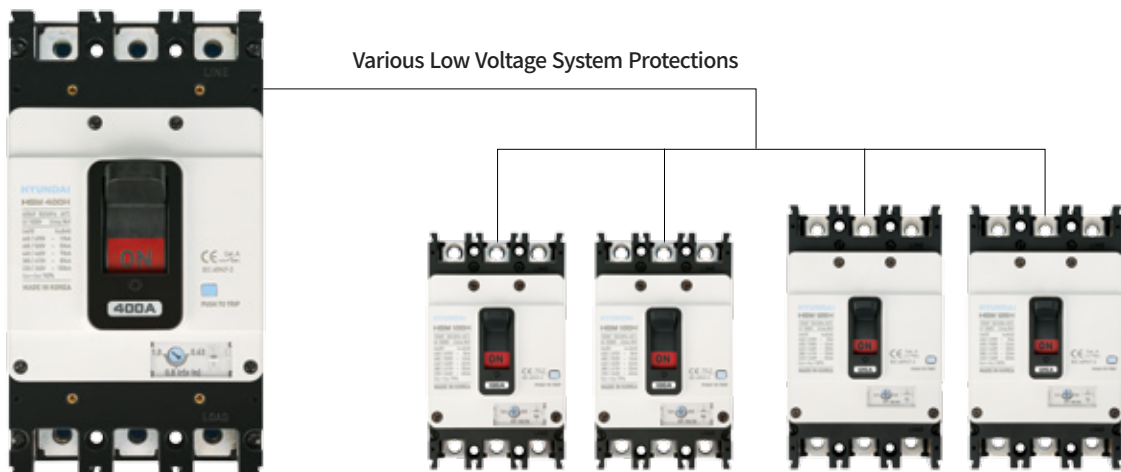

## Overview and Characteristics

### HGE Type of Earth Leakage Circuit Breaker

#### Secures Equivalent Breaking Performance with MCCB, Maintains Compatibility with Dimensions and Accessories

- Service Breaking Current,  $I_{cs} = 100\% I_{cu}$
- Rated Impulse Withstand Voltage,  $U_{imp} : 6 \text{ kV}$

#### Characteristics of Earth Leakage Protection

- Prevention function of damage caused by reverse connection : A circuit capable of preventing damage in PCB and Trip Coil has been applied to prevent damage despite usage during reserve connection caused by the misuse of user.
- The device is safe as it is equipped with a function that prevents unnecessary malfunction of earth leakage circuit breaker caused by temporary drop of voltage and noise signal.
- With the 3-phase power supply method, it safely breaks even during abnormal system voltage caused by open phase.
- By deploying filter circuit in IC, it safely protects the inverter load from grounding.

#### Adjustable Residual Current / Operating Time

Item	Adjustable Residual Current				Cut-Off Time				
	30 mA	100 mA	300 mA	500 mA	1,000 mA	0 ms	200 ms	500 ms	1,000 ms
Previous (U-ELCB)	Fixed	Adjustable (3 Steps)			-	Fixed	-	-	-
New Product (HG-ELCB)	Fixed	Adjustable (4 Steps)				Adjustable (4 Steps)			

- With adjustable leakage current sensitivity (4 stages), prompt action can be taken without replacing the product depending on the load status.
- Selective protection coordination between upstream circuit breaker and downstream circuit breaker is possible through adjustable residual current and operating time, protecting the circuit safely

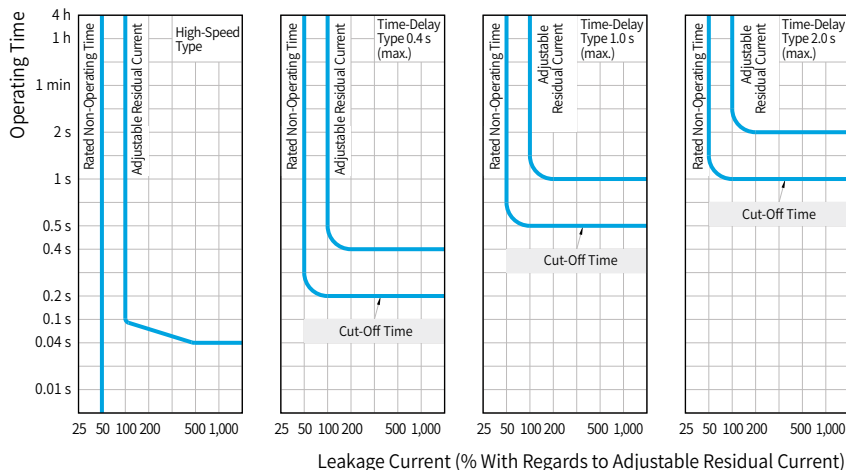
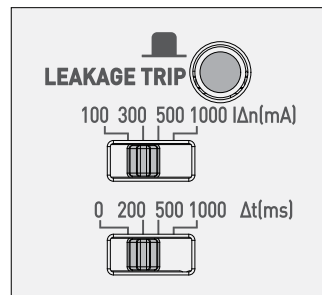

## Applicable standards and certifications

### Applicable Standards

#### Domestic Standards

**KS C 8321 Molded Case Circuit Breaker for Industrial Uses**  
(Molded Case Circuit Breaker for Industrial Uses)

**KS C 4613 Circuit Breaker Incorporating Residual Current Protection for Industrial Uses (CBR)**  
(Circuit Breaker Incorporating Residual Current Protection for Industrial Uses (CBR))

#### International Standards

**IEC 60947-1**  
Low Voltage Switchgear and Controlgear, Part 1 (General Rules)

**IEC 60947-2**  
Low Voltage Switchgear and Controlgear, Part 2 (Circuit Breakers)



### Approvals and Certifications

HG-Series MCCB has acquired the testing/certification from certified testing institutes registered in STL in accordance with the IEC standard and domestic safety certifications (K 60747-2) and can be installed and applied depending on the usage environment and condition permitted in the standard.

- CB Certification (Certifying Institute, DEKRA)
- Safety Certification
- KS Certification
- Marine Approvals (8 Classifications)

#### Vibration/Shock-Proof Test Certification Acquired

Our product has qualified the vibration/shock-proof test in accordance with the IEC 60068-2-6 which is a requirement of IACS, an international vessel inspection institute.

- 5 ~ 13.2 Hz : Displacement (1 mm)
- 13.2 ~ 100 Hz : Acceleration (0.7 g)

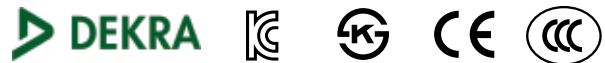

#### Our services

Testing, Inspections, Certification DEKRA provides certification of management systems as well as technical support, testing and certification of a wide range of products throughout the life cycle.

## HG Series

# Molded Case Circuit Breakers (HGP Type)

Realizes optimal protection performance regardless of changes in load situation with rated adjustment design!



## Rated Short-Circuit Current by AF (Ics = 100 % Icu at 440/460 V)

150 kA	50DX	125DX	160DX	250X	400X	630X	800X
85 kA	50DH	125DH	160DH	250H	400H	630H	800H
70 kA	50DS	125DS	160DS	250S	400S	630S	800S
65 kA							
	50D AF	125D AF	160D AF	250 AF	400 AF	630 AF	800 AF

### Wide Product Range

HGP 50 AF ~ 800 AF

### Realizes Maximum Domestic Breaking Capacity

150 kA (at 460 V)

### Reinforcement of Protective Coordination

It enables selective breaking.

### Acquisition of Various Certifications

DEKRA, marine and KS certifications have been acquired.

### Adjustable Operating Characteristics

#### Rated Current

3-Steps, 0.8 - 1 Times the Rated Current  
(Thermal Magnetic Type)

9-Steps, 0.4 - 1 Times the Rated Current  
(Electronic Type)

#### Instantaneous Current

6-Steps, 5 - 6 - 7 - 8 - 9 - 10 Times the Rated Current  
(Thermal Magnetic Type)

7-Steps, 1.5 - 11 Times the Rated Current  
(Electronic Type)



## Overview and Characteristics (HGP)

### Perfect Protection Coordination and Maximized Breaking Capacity

Simplified Dimension with 4 Types from 50 ~ 800 AF

Adjustable Rated Currents in all Models

Owens the Best Domestic Breaking Capacity in all Frames : 150 kA at 460 V

Various Breaking Coordination such as Selective Breaking and Others

Guaranteed Breaking Capacity in Reverse Connection



Trip Device : Thermal Magnetic Type

Trip Device : Thermal Magnetic Type, Electronic Type

50D, 125D, 160D AF

250 AF





Trip Device : Thermal Magnetic Type, Electronic Type

Trip Device : Thermal Magnetic Type, Electronic Type

400, 630 AF

800 AF

Unit : mm

VCB

ACB

MCCB

MS

RELAY

# Overview and Characteristics (HGP)

## HGP Type of Molded Case Circuit Breaker

### Maximized Insulation Performance

The safety of the product has been maximized through improved insulation voltage

- Rated Insulation Voltage,  $U_i$  : 1,000 V
- Rated Impulse Withstand Voltage,  $U_{imp}$  : 8 kV

### Best Breaking Capacity

Best domestic breaking capacity has been realized with regards to all frames with the best breaking capacity.

- 150 kA at 460 V (Same performance secured in all frames)

### Cable Insulation Performance Suitability

In case there is presence of abnormal condition such as welding of the main contact after tripping the circuit breaker by realizing the cable insulation performance in accordance with IEC 60947-2, the handle does not move from ON to OFF position, making it safe by preventing the operation of circuit breaker caused by the operator's negligence.

### Adjustable Rated Current in all Frames

The adjustable rated current of up to 800 AF provides optimal protection for load variations in customer's equipment.

- Rated Current  
 Thermal Magnetic Type : 0.8 - 1 times the rated current (3 Step)  
 Electronic Type : 0.4 - 1 times the rated current (9 Step)
- Instantaneous Current  
 Thermal Magnetic Type : 5 - 6 - 7 - 8 - 9 - 10 times the rated current (6 Step)

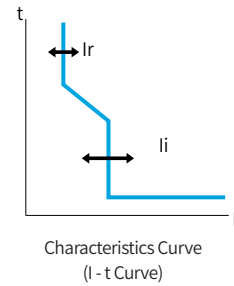

### Sealing Structure (Option) Applied

Dial sealing structure was applied to prevent arbitrary change of the current set value using a protection cover (Prevent operation of thermal magnetic adjustment knob) (Option).

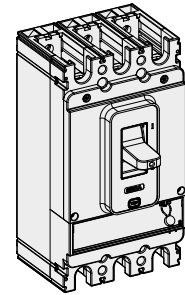

**HYUNDAI**  
**HGP 630S**

630AF	50/60Hz
$U_i$ 1000V	$U_{imp}$ 8kV

CE Cat. A  
 IEC 60947-2

$U_e$ (V)	$I_{cu}$ (kA)
660 / 690V	~ 10kA
480 / 500V	~ 50kA
440 / 460V	~ 70kA
380 / 415V	~ 85kA
220 / 240V	~ 100kA
240V	65kA

$I_{cs} = I_{cu} 100\%$

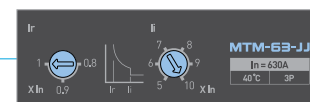

**Service Breaking Capacity ( $I_{cs} = 100\% \times I_{cu}$ )**

100 % service breaking capacity has been realized by significantly enhancing the breaking capacity by restricting accidental current using an internal current limiting device in case of short-circuit accidents.

- 50 ~ 800 AF
- 36 ~ 150 kA @ 460 Vac

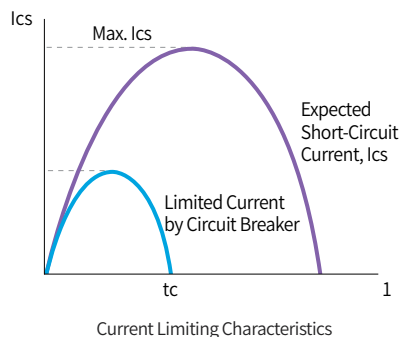

**Guaranteed Breaking Capacity in Reverse Connection**

The same breaking performance is guaranteed even if the device is used by mixing LINE (Line side)/LOAD (Load side).

- Realizes integrated barrier circuit breaker that reinforces phase to phase insulation
- Realizes fast breaking operating characteristics by applying instantaneous mechanism part

**Various Low Voltage System Protections**

HGP Type MCCB realizes current limiting characteristics and outstanding breaking performance and enables various low voltage system protections such as discrimination and cascading.

**Discrimination**

It is a protection method in which when an accident occurs during load, the downstream circuit breaker that is directly related to the accident circuit operates first so that the other sound branch circuit breaker and the upstream main circuit breaker can feed continuously. It is a low voltage system protection method that can minimize the fault point by selectively preventing faults.

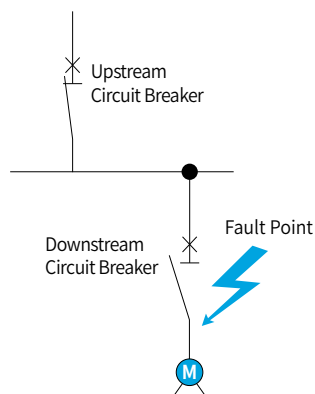

**Cascading**

In case an accident occurs during load, the upstream main circuit breaker operates earlier than the downstream circuit breaker of the accident circuit for back-up protection. It is an economic protection method that enables circuit breaker with lower breaking capacity than the estimated short-circuit current to be applied.



## External Structure and Indications

### Molded Case Circuit Breaker (MCCB)

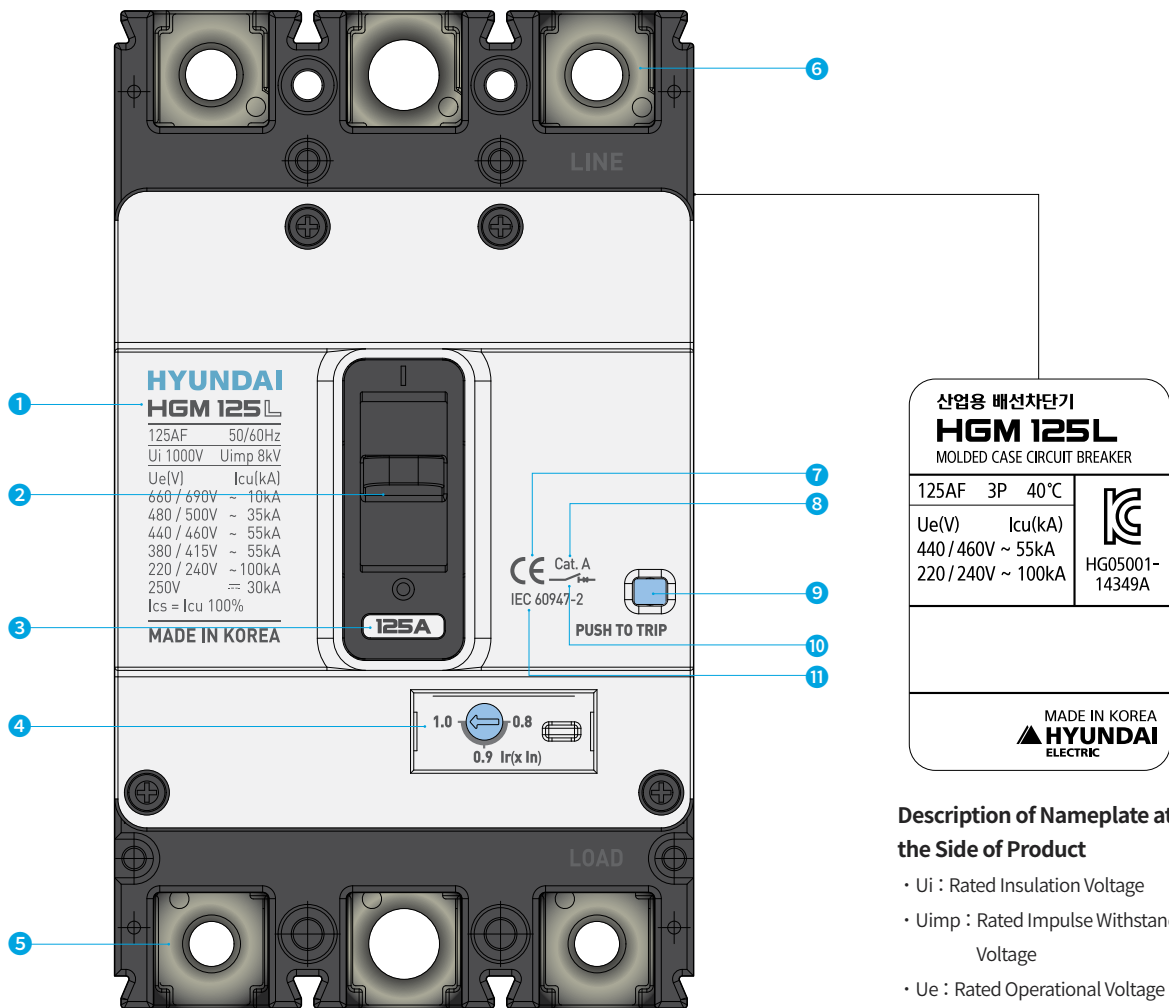

#### Description of Nameplate at the Side of Product

- U<sub>i</sub> : Rated Insulation Voltage
- U<sub>imp</sub> : Rated Impulse Withstand Voltage
- U<sub>e</sub> : Rated Operational Voltage
- I<sub>cu</sub> : Rated Ultimate Short-Circuit Breaking Capacity (o-co)
- I<sub>cs</sub> : Rated Service Short-Circuit Breaking Capacity (o-co-co)

#### Molded Case Circuit Breaker (MCCB)

- |                                 |                        |  |
|---------------------------------|------------------------|--|
| ① Manufacturer and Product Name | ⑤ Load Side Terminal   | ⑨ Trip Button                              |
| ② Operating Handle              | ⑥ Line Side Terminal   | ⑩ Cable Insulation Performance Suitability |
| ③ Rated Current Nameplate       | ⑦ CE Marking           | ⑪ Reference Standard                       |
| ④ Rated Current Adjusting Dial  | ⑧ Utilization Category |  |

## Earth Leakage Circuit Breakers (ELCB)

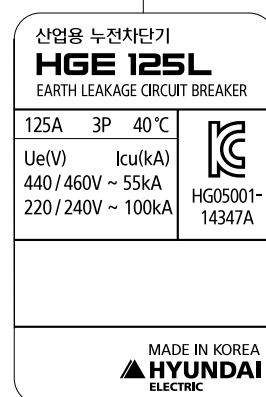
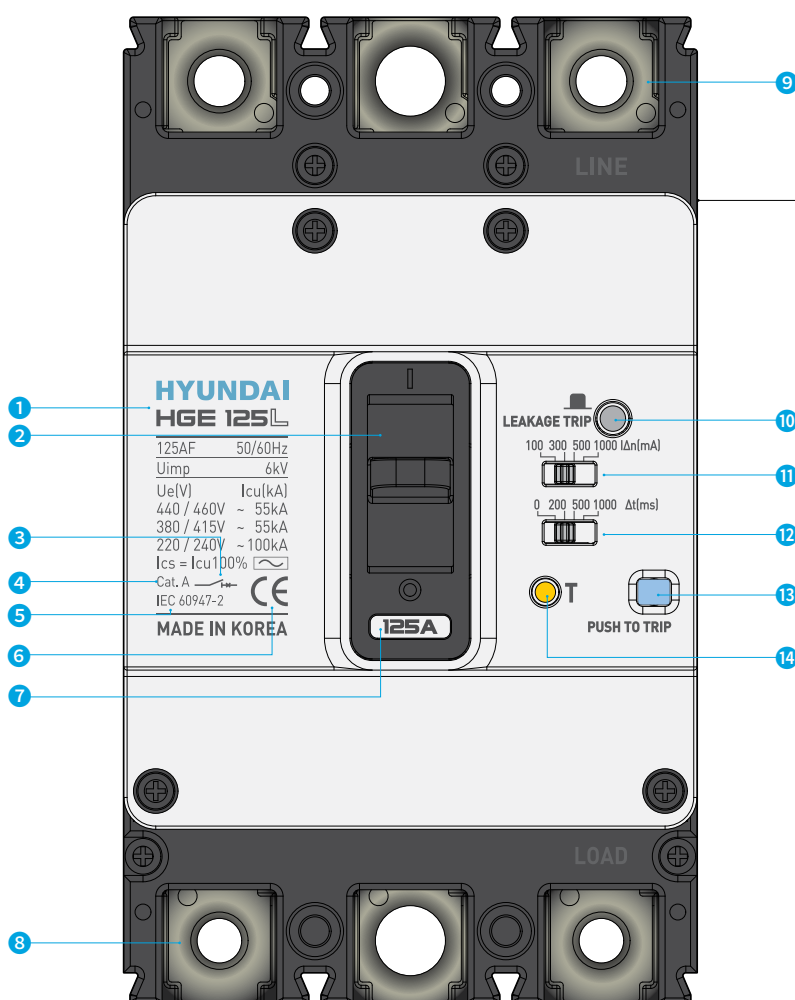

### Description of Nameplate at the Side of Product

- Ui : Rated Insulation Voltage
- Uimp : Rated Impulse Withstand Voltage
- Ue : Rated Operational Voltage
- Icu : Rated Ultimate Short-Circuit Breaking Capacity (o-co)
- Ics : Rated Service Short-Circuit Breaking Capacity (o-co-co)

### Earth Leakage Circuit Breakers (ELCB)

- |  |                           |   |  |
|--|---------------------------|---|--|
| 1 Manufacturer and Product Name            | 4 Utilization Category    | 9 Line Side Terminal                          | 12 Rated Non-Operating Time Setting Switch |
| 2 Operating Handle                         | 5 Reference Standard      | 10 Leakage Trip Indication Device             | 13 Trip Button                             |
| 3 Cable Insulation Performance Suitability | 6 CE Marking              | 11 Adjustable Residual Current Setting Switch | 14 Leakage Test Button                     |
|  | 7 Rated Current Nameplate |   |  |
|  | 8 Load Side Terminal      |   |  |

## External Structure and Indications

### Molded Case Circuit Breaker (HGP Type)

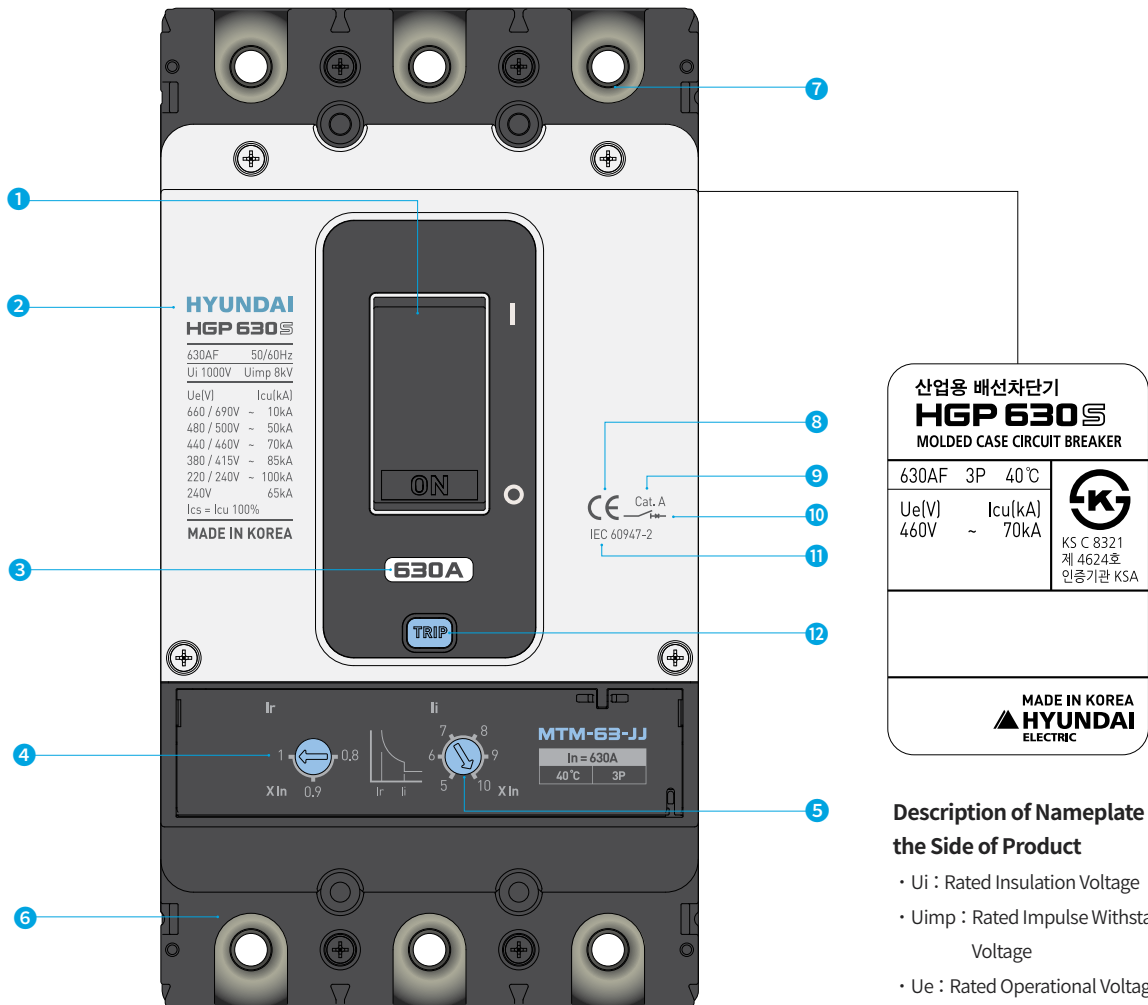

#### Description of Nameplate at the Side of Product

- Ui : Rated Insulation Voltage
- Uimp : Rated Impulse Withstand Voltage
- Ue : Rated Operational Voltage
- Icu : Rated Ultimate Short-Circuit Breaking Capacity (o-co)
- Ics : Rated Service Short-Circuit Breaking Capacity (o-co-co)

#### Molded Case Circuit Breaker (HGP Type)

- |   |  |   |
|---|--|---|
| 1 Operating Handle                      | 5 Instantaneous Operating Current Adjusting Dial | 9 Utilization Category                      |
| 2 Manufacturer and Product Name         | 6 Load Side Terminal                             | 10 Cable Insulation Performance Suitability |
| 3 Rated Current Nameplate               | 7 Line Side Terminal                             | 11 Reference Standard                       |
| 4 Long Operating Current Adjusting Dial | 8 CE Marking                                     | 12 Trip Button                              |

VCB

ACB

**MCCB**

MS

RELAY

# Technical Data

## Environmental Operating Conditions

### Temperature Derating

The overcurrent characteristic of MCCB has been set to the ambient temperature of 40 °C. If the ambient temperature is less or more than 40 °C, the overcurrent characteristics may differ.

#### If the Ambient Temperature is less than 40 °C

In order to ensure that the circuit breaker’s overcurrent meet the derating curve at the given ambient temperature, the real current (Ir) has to be adjusted. The temperature correction ratio or each MCCB is shown in the circuit breaker’s characteristics curve.

#### If the Ambient Temperature is more than 40 °C

As the internal temperature of MCCB is a sum of increased temperature due to current flow and the ambient temperature, if the ambient temperature exceeds 40 °C, thermal damage of internal insulation material of MCCB may occur causing the circuit breaker to trip at an early stage. When applying ambient temperature higher than 40 °C, the rated current must be adjusted as shown in the following rated current correction table.

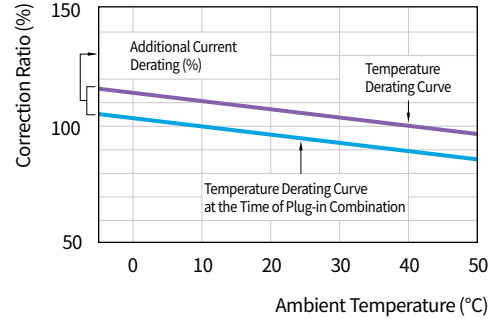

In (Rated Current) :  
Circuit breaker’s rating at ambient temperature of 40 °C  
Ir (Real Current) :  
Circuit breaker’s rating at the given temperature  
 $I_r = \text{Correction Ratio (\%)} \times I_n$

Rated Current Derating Table : HG Type/Standard Mounting

Model	Rated Current (A)	Ambient Temperature (°C)									
		10	20	30	40	45	50	55	60	65	70
HGM/HGE 30, 50E/S, 60, 100	16	18.9	18.6	17.8	16	15.2	14.6	14.1	13.6	13.2	12.8
	20	23.58	23.3	22.2	20	19.1	18.3	17.6	17.0	16.5	16.0
	25	26.8	26.2	25.6	25	24.7	24.4	24.1	23.8	23.5	23.2
	32	34.3	33.5	32.8	32	31.6	31.3	30.9	30.5	30.1	29.7
	40	42.9	41.9	41.0	40	39.5	39.0	38.6	38.1	37.6	37.1
	50	53.6	52.4	51.2	50	49.4	48.8	48.2	47.6	47.0	46.4
	63	67.5	66.0	64.5	63	62.2	61.5	60.7	60.0	59.2	58.5
	75	80.4	78.6	76.8	75	74.1	73.2	72.3	71.4	70.5	69.6
	80	85.8	83.8	81.9	80	79.0	78.1	77.1	76.2	75.2	74.2
HGM/HGE 50H/L, 125	100	107.2	104.8	102.4	100	98.8	97.6	96.4	95.2	94.0	92.8
	16	18.9	18.6	17.8	16	15.2	14.6	14.1	13.6	13.2	12.8
	20	23.6	23.3	22.2	20	19.1	18.3	17.6	17.0	16.5	16.0
	25	27.3	26.6	25.8	25	24.6	24.2	23.8	23.4	23.0	22.6
	32	35.0	34.0	33.0	32	31.5	31.0	30.5	30.0	29.5	29.0
	40	43.8	42.5	41.3	40	39.4	38.8	38.1	37.5	36.8	36.2
	50	54.7	53.1	51.6	50	49.2	48.4	47.7	46.9	46.1	45.3
	63	68.9	66.9	65.0	63	62.0	61.0	60.1	59.1	58.0	57.0
	75	82.0	79.7	77.3	75	73.8	72.7	71.5	70.3	69.1	67.9
HGM/HGE 160, 250	80	87.5	85.0	82.5	80	78.8	77.5	76.3	75.0	73.7	72.4
	100	109.4	106.3	103.1	100	98.4	96.9	95.3	93.8	92.1	90.5
	125	136.7	132.8	128.9	125	123.1	121.1	119.1	117.2	115.1	113.1
	100	107.8	105.2	102.6	100	96.0	94.0	92.0	88.0	85.5	83.0
	125	134.8	131.5	128.3	125	120.0	117.5	115.0	110.0	106.9	103.8
	150	161.7	157.8	153.9	150	144.0	141.0	138.0	132.0	128.3	124.5
	160	172.5	168.3	164.2	160	153.6	150.4	147.2	140.8	136.8	132.8
	175	188.7	184.1	179.6	175	168.0	164.5	161.0	154.0	149.6	145.3
	200	215.6	210.4	205.2	200	192.0	188.0	184.0	176.0	171.0	166.0
225	242.6	236.7	230.9	225	216.0	211.5	207.0	198.0	192.4	186.8	
250	269.5	263.0	256.5	250	240.0	235.0	230.0	220.0	213.8	207.5	



Rated Current Derating Table : HG Type/Standard Mounting

Model	Rated Current (A)	Ambient Temperature (°C)									
		10	20	30	40	45	50	55	60	65	70
HGM/HGE 400	250	269.5	263.0	256.5	250	246.8	243.5	240.2	237.0	233.6	230.3
	300	324	316.5	309	300	291	282	273	264	255	246
	350	378	369.25	360.5	350	340	330	320	310	300	290
	400	432	422	412	400	388	376	364	352	340	328
	500	540	527.5	515	500	485	470	455	440	425	410
HGM/HGE 630, 800	630	680.4	664.65	648.9	630	611	592	573	554	535	516
	700	756	738.5	721	700	679	658	637	616	595	574
	800	864	844	824	800	776	752	728	704	680	656

Rated Current Derating Table : HG Type/Plug-in Method

Model	Rated Current (A)	Ambient Temperature (°C)									
		10	20	30	40	45	50	55	60	65	70
HGM/HGE 30, 50E/S, 60, 100	16	18.5	18.3	17.4	16	14.9	14.3	13.8	13.3	12.9	12.5
	20	23.1	22.8	21.8	20	18.7	17.9	17.2	16.7	16.1	15.7
	25	26.3	25.7	25.1	25	24.2	23.9	23.6	23.3	23.0	22.7
	32	33.6	32.9	32.1	31	31.0	30.6	30.2	29.9	29.5	29.1
	40	42.0	41.1	40.1	39	38.7	38.3	37.8	37.3	36.8	36.4
	50	52.5	51.4	50.2	49	48.4	47.8	47.2	46.6	46.1	45.5
	63	66.2	64.7	63.2	62	61.0	60.3	59.5	58.8	58.0	57.3
	75	78.8	77.0	75.3	74	72.6	71.7	70.9	70.0	69.1	68.2
	80	84.0	82.2	80.3	78	77.5	76.5	75.6	74.6	73.7	72.8
	100	105.1	102.7	100.4	98	96.8	95.6	94.5	93.3	92.1	90.9
HGM/HGE 50H/L, 125	16	18.5	18.2	17.4	16	14.9	14.3	13.8	13.3	12.9	12.5
	20	23.1	22.8	21.8	20	18.7	17.9	17.2	16.7	16.1	15.7
	25	26.8	26.0	25.3	25	24.1	23.7	23.4	23.0	22.6	22.2
	32	34.3	33.3	32.3	31	30.9	30.4	29.9	29.4	28.9	28.4
	40	42.9	41.7	40.4	39	38.6	38.0	37.4	36.8	36.1	35.5
	50	53.6	52.0	50.5	49	48.2	47.5	46.7	45.9	45.1	44.4
	63	67.5	65.6	63.7	62	60.8	59.8	58.8	57.9	56.9	55.9
	75	80.4	78.1	75.8	74	72.4	71.2	70.1	68.9	67.7	66.5
	80	85.8	83.3	80.9	78	77.2	76.0	74.7	73.5	72.2	71.0
	100	107.2	104.1	101.1	98	96.5	94.9	93.4	91.9	90.2	88.7
HGM/HGE 160, 250	125	134.0	130.2	126.3	123	120.6	118.7	116.8	114.8	112.8	110.9
	100	103.5	101.0	98.5	96	92.2	90.2	88.3	84.5	82.1	79.7
	125	129.4	126.2	123.1	120	115.2	112.8	110.4	105.6	102.6	99.6
	150	155.3	151.5	147.8	144	138.2	135.4	132.5	126.7	123.1	119.5
	160	165.6	161.6	157.6	154	147.5	144.4	141.3	135.2	131.3	127.5
	175	181.1	176.7	172.4	168	161.3	157.9	154.6	147.8	143.6	139.4
	200	207.0	202.0	197.0	192	184.3	180.5	176.6	169.0	164.2	159.4
HGM/HGE 400	225	232.9	227.3	221.6	216	207.4	203.0	198.7	190.1	184.7	179.3
	250	258.7	252.5	246.2	240	230.4	225.6	220.8	211.2	205.2	199.2
	250	261.4	255.1	248.8	242.5	239.3	236.2	233.0	229.9	226.6	223.4
	300	314.3	307.0	299.7	291.0	282.3	273.5	264.8	256.1	247.4	238.6
	350	366.7	358.2	349.7	339.5	329.8	320.1	310.4	300.7	291.0	281.3
HGM/HGE 630, 800	400	405.2	395.8	387.6	378	373.7	367.9	363.2	357.9	352.6	347.3
	500	523.8	511.7	499.6	485.0	470.5	455.9	441.4	426.8	412.3	397.7
	630	660.0	644.7	629.4	611.1	592.7	574.2	555.8	537.4	519.0	500.5
	700	725.8	709.0	692.2	672.0	651.8	631.7	611.5	591.4	571.2	551.0
800	777.8	759.7	744.1	726	717.4	706.3	697.3	687	676.9	666.7	

VCB

ACB

MCCB

MS

RELAY

## Technical Data

### Environmental Operating Conditions

#### Altitude Derating

The characteristics of the circuit breaker is not affected at an altitude of less than 2,000 m Characteristics of insulation and air cooling of the circuit breaker are reduced at an altitude of more than 2,000 m and the rated current and rated voltage must be adjusted as shown in the table below However, there is no change in the characteristics of breaking capacity.

Circuit Breaker	Altitude	2,000 m	3,000 m	4,000 m	5,000 m
HGM Type MCCB 32 ~ 800 AF	Withstand Voltage (V)	3,000	2,500	2,100	1,800
	Insulation Voltage (V) $U_i$	1,000	850	750	600
	Maximum Operational Voltage (V) $U_e$	690	590	520	460
	Average Through-Current (A), at 40 °C $I_n \times$	1	0.96	0.93	0.9
HGE Type ELCB 32 ~ 800 AF	Withstand Voltage (V)	3,000	2,500	2,100	1,800
	Insulation Voltage (V) $U_i$	800	700	600	500
	Maximum Operational Voltage (V) $U_e$	460	390	345	275
	Average Through-Current (A), at 40 °C $I_n \times$	1	0.96	0.93	0.9

#### Vibrations

The excessive vibration may cause problems such as decrease of breaking capacity, lower dynamic, strength, reduction of electric current conductivity or compromising safety of operating characteristics. Therefore, proper consideration is required with regards to these environmental stresses when it comes to designating the circuit breakers. These stresses are generated by the vibration during transportation, magnetic impact during opening and closing operation and influence of adjacent devices. Our circuit breaker has been verified in accordance with the standards with regards to vibration resistance.

#### Vibration test

Vibration test is verified with the standard requested by the shipping certification institute in compliance with IEC 60068-2-6. Out of the vibration test items, resonance test and vibration Endurance test were verified based on the following standard.

#### Vibration Endurance test

A sinusoidal wave with frequency of 30 Hz is applied for 90 minutes to check for abnormalities.

- 30 Hz : 0.7 g Acceleration

#### Resonance test

It confirms whether vibration is generated in the characteristics part of MCCB by slowly changing the frequency in the frequency sector of the following sinusoidal wave.

- 5 ~ 13.2 Hz : 1 mm Displacement
- 13.2 ~ 100 Hz : 0.7 g Acceleration

#### Seismic Performance and Shock Tolerance Table

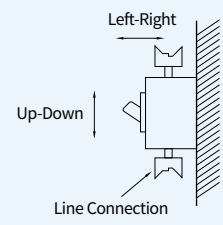
Item	Seismic
Test Condition Mounting Posture Direction of Vibration, Shock	<ul style="list-style-type: none"> <li>• Vertical mounting</li> <li>• Up-down, left-right, front-back</li> </ul> 
Test Result	<ul style="list-style-type: none"> <li>• Non-conduction (ON of OFF status)</li> <li>• Status where rated current has been conducted on until the temperature of MCCB becomes constant and continuous</li> <li>• If it is ON, it should not turn OFF</li> <li>• If it is OFF, it should not turn ON</li> <li>• No abnormal status such as damage, deformation or loosened screw part</li> <li>• The characteristics of switch and trip after the test must be normal</li> </ul>

## Degree of Protection

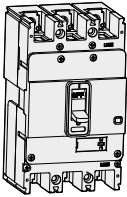
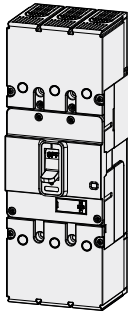
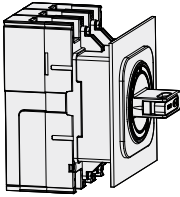
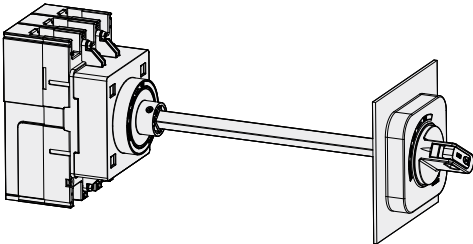

By stipulating the IP Grade of MCCB based on IEC 60529 standard, the IP degree is changed according to the product condition.

Condition	Circuit Breaker	Circuit Breaker + Terminal Cover	Circuit Breaker + Terminal Cover + Rotary Handle (Surface Placement Type)	Circuit Breaker + Terminal Cover + Rotary Handle (Extension Type)
Appearance				
Protection Degree	IP20	IP40	IP40	IP54



# Technical Data

## Power Losses / Resistance

### HGM Type MCCB

Type	Rated Current (A)	HGM30, 50E/S, 60, 100		HGM50H/L, 125		HGM160, 250		HGM400		HGM630, 800	
		R/Pole (mΩ)	P/Pole (W)	R/Pole (mΩ)	P/Pole (W)	R/Pole (mΩ)	P/Pole (W)	R/Pole (mΩ)	P/Pole (W)	R/Pole (mΩ)	P/Pole (W)
 Fixed / Adj	16	16.0	4.10	17.0	4.35						
	20	16.0	6.40	17.0	6.80						
	25	4.0	2.50	4.3	2.69						
	32	4.0	4.10	3.0	3.07						
	40	2.9	4.64	1.9	3.06						
	50	2.3	5.75	1.6	3.90						
	63	1.2	4.88	0.9	3.37						
	75	0.7	4.11	0.6	3.38						
	80	0.9	5.76	0.6	3.84						
	100	0.7	7.30	0.6	5.60	0.6	5.60				
	125			0.5	7.97	0.4	6.72				
	150					0.4	8.55				
	160					0.3	8.70				
	175					0.3	9.80				
	200					0.3	10.80				
	225					0.3	13.67				
	250					0.2	13.75	0.2	14.38		
	300							0.2	18.90		
	350							0.2	23.28		
	400							0.2	27.20		
	500									0.1	30.00
	630									0.1	39.60
	700									0.1	53.90
	800									0.1	64.00
 Plug-in	16	16.1	4.12	17.1	4.37						
	20	16.1	6.43	17.1	6.83						
	25	4.1	2.55	4.4	2.74						
	32	4.1	4.18	3.1	3.15						
	40	3.0	4.77	2.0	3.18						
	50	2.4	5.95	1.6	4.10						
	63	1.3	5.20	0.9	3.69						
	75	0.8	4.56	0.7	3.83						
	80	1.0	6.27	0.7	4.35						
	100	0.8	8.10	0.6	6.40	0.6	6.40				
	125			0.6	9.22	0.5	7.97				
	150					0.5	10.35				
	160					0.4	10.75				
	175					0.4	12.25				
	200					0.4	14.00				
	225					0.4	17.72				
	250					0.3	18.75	0.3	19.38		
	300							0.3	26.10		
	350							0.3	33.08		
	400							0.3	40.00		
	500									0.2	50.00
	630									0.2	68.40
	700									0.2	93.10
	800									0.2	115.20

### HGE Type ELCB

Type	Rated Current (A)	HGE30, 50E/S, 60, 100		HGE50H/L, 125		HGE160, 250		HGE400		HGE630, 800	
		R/Pole (mΩ)	P/Pole (W)	R/Pole (mΩ)	P/Pole (W)	R/Pole (mΩ)	P/Pole (W)	R/Pole (mΩ)	P/Pole (W)	R/Pole (mΩ)	P/Pole (W)
Fixed 	16	14.3	3.66	12.9	3.30						
	20	14.3	5.72	12.9	5.16						
	25	4.9	3.04	4.2	2.63						
	32	4.9	4.98	3.9	4.00						
	40	2.9	4.64	2.3	3.75						
	50	2.4	6.03	1.7	4.14						
	63	1.7	6.62	1.2	4.80						
	75	0.8	4.49	0.7	4.15						
	80	1.0	6.65	0.7	4.72						
	100	0.8	8.07	0.8	7.52	0.5	5.44				
	125			0.7	10.16	0.5	7.32				
	150					0.4	8.10				
	160					0.3	8.67				
	175					0.3	10.06				
	200					0.3	11.37				
	225					0.3	14.65				
	250					0.2	15.13	0.3	16.25		
	300							0.2	21.60		
	350							0.2	26.95		
	400							0.2	32.00		
500									0.2	40.00	
630									0.2	54.00	
700									0.1	68.60	
800									0.1	83.20	
Plug-in 	16	14.3	3.66	12.9	3.30						
	20	14.3	5.72	12.9	5.16						
	25	4.9	3.04	4.4	2.75						
	32	4.9	4.98	3.9	4.00						
	40	2.9	4.64	3.0	4.85						
	50	2.4	6.03	1.8	4.49						
	63	2.1	8.49	1.7	6.59						
	75	1.3	7.14	1.1	6.40						
	80	1.0	6.65	1.1	7.28						
	100	1.0	9.77	0.8	8.42	0.5	5.44				
	125			0.7	11.56	0.5	7.32				
	150					0.4	8.10				
	160					0.3	8.67				
	175					0.3	10.06				
	200					0.3	11.37				
	225					0.3	14.65				
	250					0.2	15.13	0.3	21.25		
	300							0.3	28.80		
	350							0.3	36.75		
	400							0.3	44.80		
500									0.2	60.00	
630									0.2	82.80	
700									0.2	107.80	
800									0.2	134.40	

VCB

ACB

MCCB

MS

RELAY

# Technical Data

## Cascading Table

### AC 220/240 V

Upstream Circuit Breaker : HGM30, HGM50, HGM60, HGM100, HGM125, HGM160, HGM250, HGM400

Downstream Circuit Breaker : HiBD63, HiBD125, HGM30, HGM50, HGM60, HGM100

Upstream Circuit Breaker	HGM30		HGM50				HGM60				HGM100			
	E	S	E	S	H	L	E	S	H	L	E	S	H	L
Breaking Capacity [Icu] (kA r.m.s.)	35	50	35	50	85	100	35	50	50	50	35	50	50	50
Downstream Breaking Capacity [Icu] (kA r.m.s.)	Enhanced Breaking Capacity													
HiBD63E 10	15	15	15	15	15	15	15	15	15	15	15	15	15	15
HiBD63S 15	20	20	20	20	20	20	20	20	20	20	20	20	20	20
HiBD63N 20			35	40	40	40	35	40	40	40	35	40	40	40
HiBD63H 25			35	50	50	50	35	40	40	40	35	40	40	40

Upstream Circuit Breaker	HGM125				HGM160				HGM250			
	E	S	H	L	E	S	H	L	E	S	H	L
Breaking Capacity [Icu] (kA r.m.s.)	50	65	85	100	50	65	85	100	50	65	85	100
Downstream Breaking Capacity [Icu] (kA r.m.s.)	Enhanced Breaking Capacity											
HiBD63E 10	15	15	15	15	15	15	15	15	15	15	15	15
HiBD63S 15	20	20	20	20	20	20	20	20	20	20	20	20
HiBD63N 20	40	40	40	40	40	40	40	40	40	40	40	40
HiBD63H 25	40	50	50	50	40	50	50	50	40	50	50	50
HiBD125 25	40	40	40	40	40	40	40	40	40	40	40	40

Upstream Circuit Breaker	HGM30		HGM50				HGM60				HGM100			
	E	S	E	S	H	L	E	S	H	L	E	S	H	L
Breaking Capacity [Icu] (kA r.m.s.)	35	50	35	50	85	100	35	50	50	50	35	50	50	50
Downstream Breaking Capacity [Icu] (kA r.m.s.)	Enhanced Breaking Capacity													
HGM30E 35		50		50	65	65		50	50	50		50	50	50
HGM50E 35				50	65	70		50	50	50		50	50	50
HGM50S 50					70	85								
HGM50H 85						100								
HGM60E 35								50	50	50		50	50	50
HGM100E 35												50	50	50

Upstream Circuit Breaker	HGM125				HGM160				HGM250				HGM400			
	E	S	H	L	E	S	H	L	E	S	H	L	E	S	H	L
Breaking Capacity [Icu] (kA r.m.s.)	50	65	85	100	50	65	85	100	50	65	85	100	50	75	100	125
Downstream Breaking Capacity [Icu] (kA r.m.s.)	Enhanced Breaking Capacity															
HGM30E 35	50	65	65	65	50	65	65	65	50	65	65	65	50	65	65	65
HGM30S 50		65	65	65		65	65	65		65	65	65		65	65	65
HGM50E 35	50	65	65	70	50	65	65	70	50	65	65	70	50	65	65	70
HGM50S 50		65	70	85		65	70	85		65	70	85		65	70	85
HGM50H 85				100				100				100				100
HGM60E 35	50	65	70	70	50	65	70	70	50	65	70	70	50	65	70	70
HGM60S 50		65	70	70		65	70	70		65	70	70		65	70	70
HGM60H 50		65	70	70		65	70	70		65	70	70		65	70	70
HGM60L 50		65	70	70		65	70	70		65	70	70		65	70	70
HGM100E 35	50	65	70	70	50	65	70	70	50	65	70	70	50	65	70	70

Upstream Circuit Breaker : HGM125, HGM160, HGM250, HGM400, HGM630, HGM800

Downstream Circuit Breaker : HGM100, HGM160, HGM250, HGM400, HGM630, HGM800

Upstream Circuit Breaker	HGM125				HGM160				HGM250				HGM400				
	E	S	H	L	E	S	H	L	E	S	H	L	E	S	H	L	
Breaking Capacity [Icu] (kA r.m.s.)	50	65	85	100	50	65	85	100	50	65	85	100	50	75	100	125	
Downstream Breaking Capacity [Icu] (kA r.m.s.)	Enhanced Breaking Capacity																
HGM100S	50		65	70	70		65	70	70		65	70	70		65	70	70
HGM100H	50		65	70	70		65	70	70		65	70	70		65	70	70
HGM100L	50		65	70	70		65	70	70		65	70	70		65	70	70
HGM125E	50		65	85	100		65	85	100		65	85	100		65	85	100
HGM125S	65			85	100			85	100			85	100			85	100
HGM125H	85				100				100				100				100

Upstream Circuit Breaker	HGM160				HGM250				HGM400				
	E	S	H	L	E	S	H	L	E	S	H	L	
Breaking Capacity [Icu] (kA r.m.s.)	50	65	85	100	50	65	85	100	50	75	100	125	
Downstream Breaking Capacity [Icu] (kA r.m.s.)	Enhanced Breaking Capacity												
HGM160E	50		65	85	100		65	85	100		75	85	100
HGM160S	65			85	100			85	100			85	100
HGM160H	85				100				100			100	125
HGM160L	100												125
HGM250E	50						65	85	100		75	85	100
HGM250S	65							85	100			85	100
HGM250H	85								100			100	125
HGM250L	100												125

Upstream Circuit Breaker	HGM630				HGM800			
	E	S	H	L	S	H	L	
Breaking Capacity [Icu] (kA r.m.s.)	50	75	100	125	75	100	125	
Downstream Breaking Capacity [Icu] (kA r.m.s.)	Enhanced Breaking Capacity							
HGM250E	50		75	85	100	75	85	100
HGM250S	65			85	100		85	100
HGM250H	85			100	125		100	125
HGM250L	100				125			125
HGM400E	50		75	85	100	75	85	100
HGM400S	75			85	100		85	100
HGM400H	100				125			125
HGM630E	50		75	85	100	75	85	100
HGM630S	75			85	100		85	100
HGM630H	100				125			125
HGM800S	75						70	85
HGM800H	100							85

# Technical Data

## Cascading Table

### AC 440/460 V

Upstream Circuit Breaker : HGM30, HGM50, HGM60, HGM100, HGM125, HGM160, HGM250, HGM400

Downstream Circuit Breaker : HiBD63, HiBD125, HGM30, HGM50, HGM60, HGM100

Upstream Circuit Breaker	HGM30		HGM50				HGM60				HGM100			
	E	S	E	S	H	L	E	S	H	L	E	S	H	L
Breaking Capacity [Icu] (kA r.m.s.)	16	20	16	20	38	55	16	20	26	30	16	20	26	30
Downstream Breaking Capacity [Icu] (kA r.m.s.)	Enhanced Breaking Capacity													
HiBD63E	6	10	10	10	10	10	10	10	10	10	10	10	10	10
HiBD63S	7.5	14	14	14	14	14	14	14	14	14	14	14	14	14
HiBD63N	10			16	20	20	20	16	20	20	20	16	20	20
HiBD63H	15			16	20	26	26	16	20	20	20	16	20	20

Upstream Circuit Breaker	HGM125				HGM160				HGM250			
	E	S	H	L	E	S	H	L	E	S	H	L
Breaking Capacity [Icu] (kA r.m.s.)	20	26	38	55	20	26	38	55	20	26	38	55
Downstream Breaking Capacity [Icu] (kA r.m.s.)	Enhanced Breaking Capacity											
HiBD63E	6	10	10	10	10	10	10	10	10	10	10	10
HiBD63S	7.5	14	14	14	14	14	14	14	14	14	14	14
HiBD63N	10	16	20	20	20	16	20	20	20	16	20	20
HiBD63H	15	16	20	26	26	16	20	26	26	16	20	26
HiBD125	15	16	20	26	26	16	20	26	26	16	20	26

Upstream Circuit Breaker	HGM30		HGM50				HGM60				HGM100			
	E	S	E	S	H	L	E	S	H	L	E	S	H	L
Breaking Capacity [Icu] (kA r.m.s.)	16	20	16	20	38	55	16	20	26	30	16	20	26	30
Downstream Breaking Capacity [Icu] (kA r.m.s.)	Enhanced Breaking Capacity													
HGM30E	16	20		20	26	30		20	20	20		20	20	20
HGM30S	20				30	30			26	26			26	26
HGM50E	16			20	26	30		20	20	20		20	20	20
HGM50S	20				30	38			26	26			26	26
HGM50H	38					55								
HGM60E	16							20	20	20		20	20	20
HGM60S	20								26	26			26	26
HGM60H	26									30				30
HGM100E	16											20	20	20
HGM100S	20												26	26
HGM100H	26													30

Upstream Circuit Breaker	HGM125				HGM160				HGM250				HGM400			
	E	S	H	L	E	S	H	L	E	S	H	L	E	S	H	L
Breaking Capacity [Icu] (kA r.m.s.)	20	26	38	55	20	26	38	55	20	26	38	55	38	50	70	85
Downstream Breaking Capacity [Icu] (kA r.m.s.)	Enhanced Breaking Capacity															
HGM30E	16	20	26	30	20	26	26	30	20	26	26	30	26	26	30	30
HGM30S	20	26	30	30		26	30	30		26	30	30		30	30	30
HGM50E	16	20	26	30	20	26	30	30	20	26	30	30	20	26	30	30
HGM50S	20	26	30	38		26	30	38		26	30	38	20	30	38	38
HGM50H	38			55				55				55		50	70	70
HGM50L	55													70	70	
HGM60E	16	20	26	30	20	26	26	30	20	26	26	30	26	26	30	30
HGM60S	20	26	30	30		26	30	30		26	30	30	26	30	30	30
HGM60H	26		30	38			30	38			30	38	30	38	38	38
HGM60L	30			38				38				38		38	38	38
HGM100E	16	20	26	30	20	26	26	30	20	26	26	30	26	26	30	30
HGM100S	20	26	30	30		26	30	30		26	30	30	26	30	30	30
HGM100H	26		30	38			30	38			30	38	30	38	38	38
HGM100L	26			38				38				38		38	38	38



Upstream Circuit Breaker : HGM125, HGM160, HGM250, HGM400, HGM630, HGM800

Downstream Circuit Breaker : HGM100, HGM160, HGM250, HGM400, HGM630, HGM800

Upstream Circuit Breaker	HGM125				HGM160				HGM250				HGM400			
	E	S	H	L	E	S	H	L	E	S	H	L	E	S	H	L
Breaking Capacity [Icu] (kA r.m.s.)	20	26	38	55	20	26	38	55	20	26	38	55	38	50	70	85
Downstream Breaking Capacity [Icu] (kA r.m.s.)	Enhanced Breaking Capacity															
HGM125E	20	26	30	38		26	30	38		26	30	38	26	30	38	38
HGM125S	26		38	38			38	38			38	38		38	50	50
HGM125H	38			55				55				55		50	70	70
HGM125L	55														70	70
HGM160E	20					26	30	38		26	30	38	26	30	38	38
HGM160S	26						38	50			38	50	30	38	50	50
HGM160H	38							55				55		50	70	70
HGM160L	55														70	70

Upstream Circuit Breaker	HGM250				HGM400				HGM630				HGM800			
	E	S	H	L	E	S	H	L	E	S	H	L	S	H	L	
Breaking Capacity [Icu] (kA r.m.s.)	20	26	38	55	38	50	70	85	38	50	70	85	50	70	85	
Downstream Breaking Capacity [Icu] (kA r.m.s.)	Enhanced Breaking Capacity															
HGM250E	20	26	30	38	26	30	38	38	26	30	38	38	30	38	38	
HGM250S	26		38	50	30	38	50	50	30	38	50	50	38	50	50	
HGM250H	38			55		50	70	70		50	70	70	50	70	70	
HGM250L	55						70	70			70	70		70	70	
HGM400E	38					50	70	70		50	70	70	50	70	70	
HGM400S	50						70	85			70	85		70	85	
HGM400H	70							85				85			85	
HGM630E	38									50	70	70	50	70	70	
HGM630S	50										70	85		70	85	
HGM630H	70											85			85	
HGM800S	50													70	85	
HGM800H	70														85	

# Technical Data

## Installation

### Insulation Distance (Safety Clearance)

For safety, insulation distance must be secured at installation. In case of installing a circuit breaker, safety clearances must be secured between breakers or between the circuit breaker and panel, bus bar and other adjacent devices. When the circuit breaker interrupts a short circuit, high temperature ionized gas is generated and the gas is discharged through the discharge outlet from the circuit breaker. As this gas can cause short-circuit accidents and grounding accidents, sufficient insulation distance is required between the circuit breaker and the panel.

※ In case insulation barrier is not installed between the circuit breaker terminals, secondary short-circuit accident may occur so it must be used. The insulation barrier must be installed towards the direction of the circuit breaker's line indication part.

Separation distance in case the circuit breaker is installed side by side

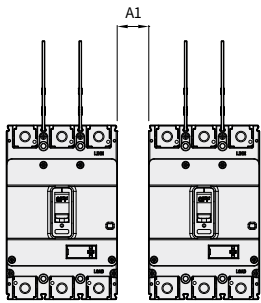

Up/down/left/right distance in case of metallic panel

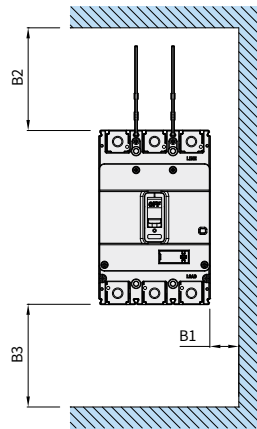

Front/back distance in case of metallic panel

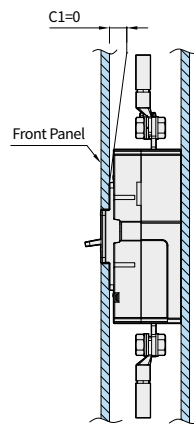

Distance with circuit breaker in case the live part is exposed

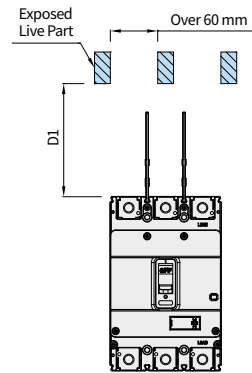

※ In case of using the minimum separation distance (A1 = 0), terminal cover and phase to phase barrier must be assembled between the product.

※ If the distance between the live parts is less than 60 mm, the exposed part must be insulated.

### HGM/HGE Type's Minimum Insulation Distance

Type	Minimum Clearance (mm)											
	460 V						240 V					
	A1	B1	B2	B3	C1	D1	A	B1	B2	B3	C1	D1
HGM30 E/S	0	25	50	25	0	85	0	15	50	25	0	70
HGM50 E/S	0	25	50	25	0	85	0	15	50	25	0	70
HGM100 E/S/H/L	0	25	50	25	0	85	0	15	50	25	0	70
HGM50 H/L	0	25	50	25	0	85	0	15	50	25	0	70
HGM125 E/S/H/L	0	25	50	25	0	85	0	15	50	25	0	70
HGM160 E/S	0	25	80	40	0	140	0	15	80	40	0	110
HGM160 H/L	0	40	80	40	0	140	0	20	80	40	0	110
HGM250 E/S	0	25	80	40	0	140	0	15	80	40	0	110
HGM250 H/L	0	40	80	40	0	140	0	20	80	40	0	110
HGE30 E/S	0	25	50	25	0	85	0	15	50	25	0	70
HGE50 E/S	0	25	50	25	0	85	0	15	50	25	0	70
HGE100 E/S/H/L	0	25	50	25	0	85	0	15	50	25	0	70
HGE50 H/L	0	25	50	25	0	85	0	15	50	25	0	70
HGE125 E/S/H/L	0	25	50	25	0	85	0	15	50	25	0	70
HGE160 E/S	0	25	80	40	0	140	0	15	80	40	0	110
HGE160 H/L	0	40	80	40	0	140	0	20	80	40	0	110
HGE250 E/S	0	25	80	40	0	140	0	15	80	40	0	110
HGE250 H/L	0	40	80	40	0	140	0	20	80	40	0	110
HGM400 E/S	0	60	120	60	0	200	0	30	120	60	0	160
HGM400 H/L	0	80	120	60	0	200	0	40	120	60	0	160
HGM630, 800 E/S	0	60	120	60	0	200	0	30	120	60	0	160
HGM630, 800 H/L	0	80	120	60	0	200	0	40	120	60	0	160
HGE400 E/S	0	60	120	60	0	200	0	30	120	60	0	160
HGE400 H/L	0	80	120	60	0	200	0	40	120	60	0	160
HGE630, 800 E/S	0	60	120	60	0	200	0	30	120	60	0	160
HGE630, 800 H/L	0	80	120	60	0	200	0	40	120	60	0	160

### Installation Angle

It can be installed vertically or horizontally without changing any characteristics of the HGM/HGE Type of circuit breakers and as for the detailed installation direction, please refer to the figure below.

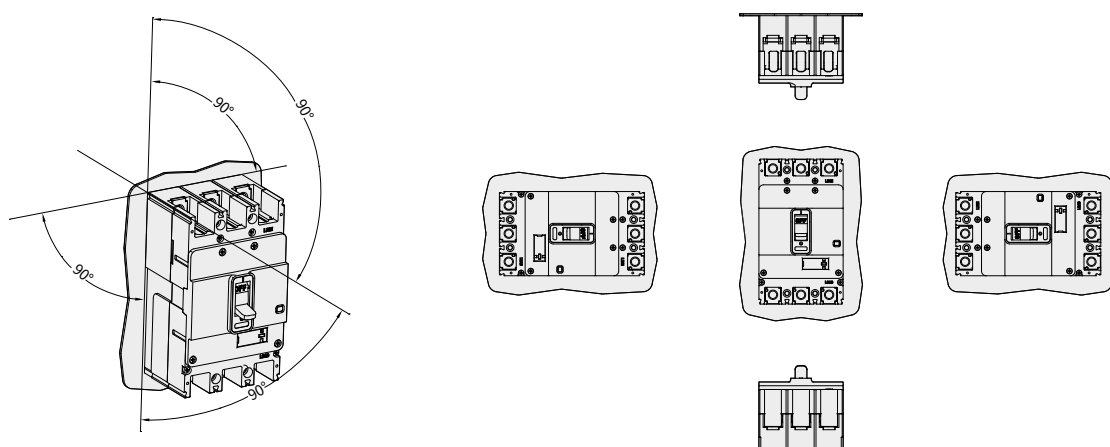

### Direction of Power Supply

#### HGM/HGE Type

When wiring the terminal between breakers, the LINE, LOAD mark in front of the product's cover must be checked.

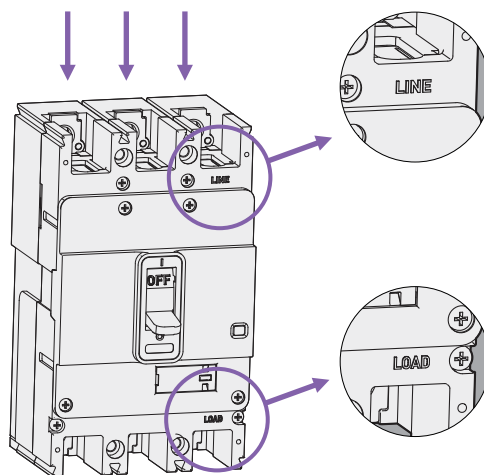





# Technical Data

## Standard Configuration

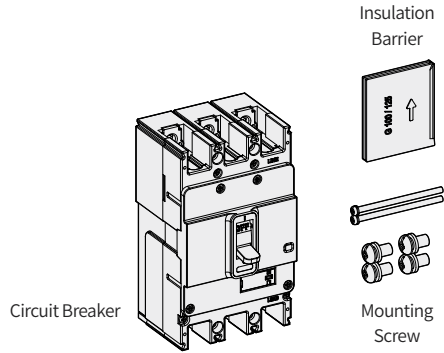
### HGM/HGE Type

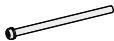



#### HGM/HGE30 ~ 250

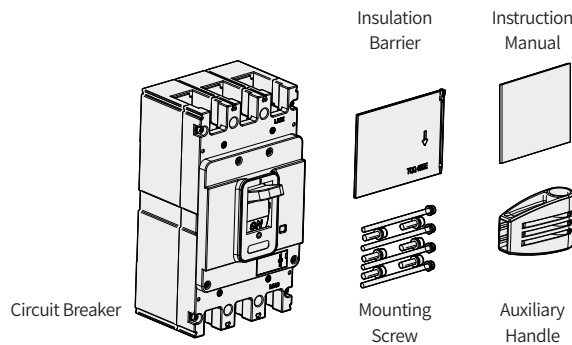

Type	Part					
HGM/HGE 30, 50E/S, 60, 100	2P	2 EA (M4×L70)	4 EA	(M5×L15) (15 ~ 50 A)	(M8×L15) (60 ~ 100 A)	1 EA
	3P	2 EA (M4×L70)	6 EA			2 EA
	4P	4 EA (M4×L70)	8 EA	3 EA		
HGM/HGE 50H/L, 125	2P	2 EA (M4×L70)	4 EA (M8×L15)		1 EA	
	3P	2 EA (M4×L70)	6 EA (M8×L15)		2 EA	
	4P	4 EA (M4×L70)	8 EA (M8×L15)		3 EA	
HGM/HGE 160, 250	2P	2 EA (M4×L70)	4 EA (Hex Socket M8×L18)		1 EA	
	3P	2 EA (M4×L70)	6 EA (Hex Socket M8×L18)		2 EA	
	4P	4 EA (M4×L70)	8 EA (Hex Socket M8×L18)		3 EA	

#### HGM/HGE400 ~ 800



Type	Part				
HGM/HGE 400	2P	4 EA (M6×L103)	4 EA (M10×L30)	1 EA	1 EA
	3P	4 EA (M6×L103)	6 EA (M10×L30)	2 EA	1 EA
	4P	6 EA (M6×L103)	8 EA (M10×L30)	3 EA	1 EA
HGM/HGE 630, 800	2P	4 EA (M6×L103)	4 EA (M12×L30)	1 EA	1 EA
	3P	4 EA (M6×L103)	6 EA (M12×L30)	2 EA	1 EA
	4P	6 EA (M6×L103)	8 EA (M12×L30)	3 EA	1 EA

## MCCB/ELCB Assembly and Terminal Mounting Specification

### HGM/HGE Type

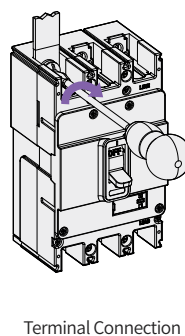
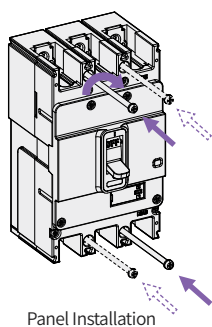

No	Type	Panel Mounting		Connection Terminal		
		Screw Specification	Terminal (mm)	Mounting Torque	Conductor	Tightening Torque
1	HGM/HGE 30, 50E/S, 60, 100	M4 : 13 kgf.cm		 M5 x L15 (≤50) M8 x L15 (>50)		M5 : 28.5 kgf.cm M8 : 110 kgf.cm
2	HGM/HGE 50H/L, 125	M4 : 13 kgf.cm		 M8 x L15		M8 : 110 kgf.cm
3	HGM/HGE 160, 250	M4 : 13 kgf.cm		 Hex Socket Bolt M8 x L15		Hex M8 : 110 kgf.cm
4	HGM/HGE 400	M6 : 45 kgf.cm		 Hex Socket Bolt M10 x L30		Hex M10 : 270 kgf.cm
5	HGM/HGE 630, 800	M6 : 45 kgf.cm		 Hex Socket Bolt M12 x L30		Hex M12 : 470 kgf.cm

## Technical Data (HGP)

### Environmental Operating Conditions

#### Temperature Derating

The overcurrent characteristic of MCCB has been set to the ambient temperature of 40°C. If the ambient temperature is less or more than 40°C, the overcurrent characteristics may differ.

#### If the Ambient Temperature is less than 40 °C

In order to ensure that the circuit breaker’s overcurrent meet the derating curve at the given ambient temperature, the real current (Ir) has to be adjusted. The temperature correction ratio or each MCCB is shown in the circuit breaker’s characteristics curve.

#### If the Ambient Temperature is more than 40 °C

As the internal temperature of MCCB is a sum of increased temperature due to current flow and the ambient temperature, if the ambient temperature exceeds 40 °C, thermal damage of internal insulation material of MCCB may occur causing the circuit breaker to trip at an early stage. When applying ambient temperature higher than 40 °C, the rated current must be adjusted as shown in the following rated current correction table.

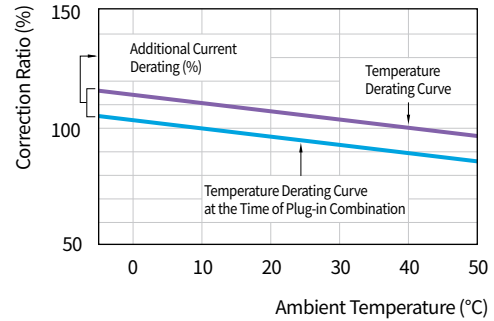

In (Rated Current) :  
Circuit breaker’s rating at ambient temperature of 40 °C  
Ir (Real Current) :  
Circuit breaker’s rating at the given temperature  
 $I_r = \text{Correction Ratio (\%)} \times I_n$

Rated Current Derating Table : HGP Type/Standard Mounting (Fixed Type)

Model	Rated Current (A)	Ambient Temperature (°C)									
		10	20	30	40	45	50	55	60	65	70
HGP160D	16	18	17	17	16	16	15	15	14	14	13
	20	22	22	21	20	19	19	18	18	17	16
	25	28	27	26	25	24	24	23	22	22	21
	32	36	35	33	32	31	30	29	28	27	26
	40	45	43	42	40	39	38	36	35	34	33
	50	56	54	52	50	49	47	46	44	43	41
	63	71	68	66	63	61	59	57	55	53	51
	80	90	87	83	80	78	75	73	70	68	65
	100	112	108	104	100	97	94	91	88	85	82
	125	141	135	130	125	121	117	113	109	105	101
	150	169	162	156	150	145	140	135	130	125	120
HGP250	160	180	173	166	160	155	150	145	140	135	130
	100	109	106	103	100	97	94	91	88	85	82
	125	137	133	129	125	121	117	113	109	105	101
	150	164	159	155	150	145	140	135	130	125	120
	160	175	170	165	160	155	150	145	140	135	130
	175	191	186	180	175	175	175	175	175	175	175
	200	219	212	206	200	194	188	182	176	170	164
HGP400 HGP630	225	246	239	232	225	218	210	203	195	188	180
	250	274	266	258	250	243	235	228	220	213	205
	300	323	315	308	300	291	282	273	264	255	246
	350	376	368	359	350	340	330	320	310	300	290
	400	430	420	410	400	388	376	364	352	340	328
HGP800	500	538	525	513	500	485	470	455	440	425	410
	630	677	662	646	630	611	592	573	554	535	516
	700	753	735	718	700	679	658	637	616	595	574
	800	860	840	820	800	776	752	728	704	680	656

Rated Current Derating Table : HGP Type/Plug-in Method

Model	Rated Current(A)	Ambient Temperature (°C)									
		10	20	30	40	45	50	55	60	65	70
HGP 160D	16	16	16	15	14	14	14	13	13	12	12
	20	20	19	19	18	17	17	16	16	15	15
	25	25	24	23	23	22	21	21	20	19	19
	32	32	31	30	29	28	27	26	25	24	23
	40	40	39	37	36	35	34	33	32	31	30
	50	51	49	47	45	44	42	41	40	38	37
	63	64	61	59	57	55	53	51	50	48	46
	80	81	78	75	72	70	68	65	63	61	59
	100	101	97	94	90	87	85	82	79	77	74
	125	126	122	117	113	109	105	102	98	95	91
	150	152	146	140	135	131	126	122	117	113	108
	160	162	156	150	144	140	135	131	126	122	117
HGP250	100	103	100	97	94	91	88	86	83	80	77
	125	129	125	121	118	114	110	106	102	99	95
	150	154	150	145	141	136	132	127	122	118	113
	160	165	160	155	150	146	141	136	132	127	122
	175	180	175	169	165	165	165	165	165	165	165
	200	206	200	194	188	182	177	171	165	160	154
	225	231	225	218	212	204	197	190	183	176	169
250	257	250	242	235	228	221	214	207	200	193	
HGP400 HGP630	300	284	277	271	264	256	248	240	232	224	216
	350	331	323	316	308	299	290	282	273	264	255
	400	378	370	361	352	341	331	320	310	299	289
	500	473	462	451	440	427	414	400	387	374	361
	630	596	582	568	554	538	521	504	488	471	454
HGP800	700	696	680	664	648	628	609	589	570	550	531
	800	796	777	759	740	718	696	673	651	629	607

## Technical Data (HGP)

### Environmental Operating Conditions

#### Altitude Derating

The characteristics of the circuit breaker is not affected at an altitude of less than 2,000 m Characteristics of insulation and air cooling of the circuit breaker are reduced at an altitude of more than 2,000 m and the rated current and rated voltage must be adjusted as shown in the table below However, there is no change in the characteristics of breaking capacity.

Circuit breaker	Altitude	2,000 m	3,000 m	4,000 m	5,000 m
HGP Type MCCB HGP160D HGP250 ~ 800	Withstand Voltage (V)	3,000	2,500	2,100	1,800
	Insulation Voltage (V) $U_i$	1,000	850	750	650
	Maximum Operational Voltage (V) $U_e$	690	590	520	460
	Average Through-Current (A), at 40 °C $I_n \times$	1	0.96	0.93	0.9

#### Vibrations

The excessive vibration may cause problems such as decrease of breaking capacity, lower dynamic, strength, reduction of electric current conductivity or compromising safety of operating characteristics. Therefore, proper consideration is required with regards to these environmental stresses when it comes to designating the circuit breakers. These stresses are generated by the vibration during transportation, magnetic impact during opening and closing operation and influence of adjacent devices. Our circuit breaker has been verified in accordance with the standards with regards to vibration resistance.

#### Vibration Test

Vibration test is verified with the standard requested by the shipping certification institute in compliance with IEC 60068-2-6. Out of the vibration test items, resonance test and vibration Endurance test were verified based on the following standard.

#### Vibration Endurance Test

A sinusoidal wave with frequency of 30 Hz is applied for 90 minutes to check for abnormalities.

- 30 Hz : 0.7 g Acceleration

#### Resonance Test

It confirms whether vibration is generated in the characteristics part of MCCB by slowly changing the frequency in the frequency sector of the following sinusoidal wave.

- 5 ~ 13.2 Hz : 1 mm Displacement
- 13.2 ~ 100 Hz : 0.7 g Acceleration

### Seismic Performance and Shock Tolerance Table

Item	Seismic
Test Condition Mounting Posture Direction of Vibration, Shock	<ul style="list-style-type: none"> <li>• Vertical mounting</li> <li>• Up-down, left-right, front-back</li> </ul>
Test Result Status of MCCB Judgment Condition	<ul style="list-style-type: none"> <li>• Non-conduction (ON or OFF status)</li> <li>• Status where rated current has been conducted on until the temperature of MCCB becomes constant and continuous</li> </ul> <ul style="list-style-type: none"> <li>• If it is ON, it should not turn OFF</li> <li>• If it is OFF, it should not turn ON</li> <li>• No abnormal status such as damage, deformation or loosened screw part</li> <li>• The characteristics of switch and trip after the test must be normal</li> </ul>



## Degree of Protection

By stipulating the IP Grade of MCCB based on IEC 60529 standard, the IP degree is changed according to the product condition.

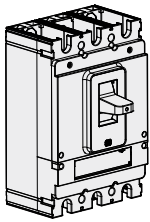
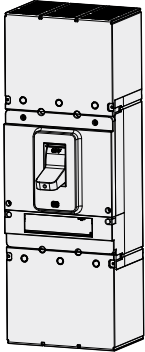
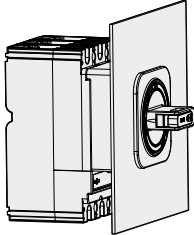
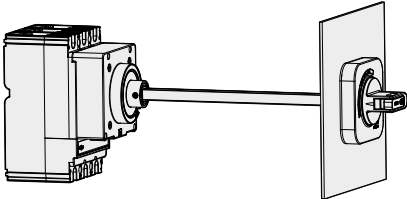
Condition	Circuit Breaker	Circuit Breaker + Terminal Cover	Circuit Breaker + Terminal Cover + Rotary Handle (Surface Placement Type)	Circuit Breaker + Terminal Cover + Rotary Handle (Extension Type)
Appearance				
Protection Degree	IP20	IP40	IP40	IP54

## Technical Data (HGP)

### Power Losses / Resistance

#### HGP Type MCCB

Type	Rated Current (A)	HGP50D		HGP125D		HGP160D		HGP250		HGP400		HGP630		HGP800		
		R/Pole (mΩ)	P/Pole (W)	R/Pole (mΩ)	P/Pole (W)	R/Pole (mΩ)	P/Pole (W)	R/Pole (mΩ)	P/Pole (W)	R/Pole (mΩ)	P/Pole (W)	R/Pole (mΩ)	P/Pole (W)	R/Pole (mΩ)	P/Pole (W)	
Fixed	16	14.4	3.69	14.4	3.69	14.4	3.69									
	20	14.4	5.76	14.4	5.76	14.4	5.76									
	25	6.372	3.98	6.372	3.98	6.372	3.98									
	32	4.056	4.15	4.056	4.15	4.056	4.15									
	40	2.544	4.07	2.544	4.07	2.544	4.07									
	50	2.544	6.36	2.544	6.36	2.544	6.36									
	63			1.488	5.91	1.488	5.91									
	80			1.188	7.60	1.188	7.60									
	100			1.044	10.44	1.044	10.44	0.88	8.80							
	125			0.924	14.44	0.924	14.44	0.61	9.53							
	150					0.792	17.82	0.46	10.35							
	160					0.792	20.28	0.46	11.78							
	175							0.39	11.94							
	200							0.39	15.60							
	225							0.3	15.19							
	250							0.3	18.75							
	300									0.215	19.35					
	350									0.215	26.34					
	400									0.185	29.60					
	500											0.155	38.75			
630											0.125	49.61				
700													0.11	53.90		
800													0.08	51.20		



Type	Rated Current (A)	HGP50D		HGP125D		HGP160D		HGP250		HGP400		HGP630		HGP800		
		R/Pole (mΩ)	P/Pole (W)	R/Pole (mΩ)	P/Pole (W)	R/Pole (mΩ)	P/Pole (W)	R/Pole (mΩ)	P/Pole (W)	R/Pole (mΩ)	P/Pole (W)	R/Pole (mΩ)	P/Pole (W)	R/Pole (mΩ)	P/Pole (W)	
 Plug-in	16	14.48	3.71	14.48	3.71	14.48	3.71									
	20	14.48	5.79	14.48	5.79	14.48	5.79									
	25	6.452	4.03	6.452	4.03	6.452	4.03									
	32	4.136	4.24	4.136	4.24	4.136	4.24									
	40	2.624	4.20	2.624	4.20	2.624	4.20									
	50	2.624	6.56	2.624	6.56	2.624	6.56									
	63			1.568	6.22	1.568	6.22									
	80			1.268	8.12	1.268	8.12									
	100			1.124	11.24	1.124	11.24	0.94	9.40							
	125			1.004	15.69	1.004	15.69	0.67	10.47							
	150					0.872	19.62	0.52	11.70							
	160					0.872	22.32	0.52	13.31							
	175							0.45	13.78							
	200							0.45	18.00							
	225							0.36	18.23							
	250							0.36	22.50							
	300									0.255	22.95					
	350									0.255	31.24					
	400									0.225	36.00					
	500											0.195	48.75			
	630											0.165	65.49			
	700													0.13	63.70	
	800													0.1	64.00	

VCB

ACB

MCCB

MS

RELAY

# Technical Data (HGP)

## Cascading Table

### AC 220/240 V

Upstream Circuit Breaker : HGP50D, HGP125D, HGP160D, HGP250, HGP400, HGP630

Downstream Circuit Breaker : HiBD63\*, HiBD125\*, HGM30, HGM50

Upstream Circuit Breaker	HGP50D				HGP125D			
	F*	S	H	X	F*	S	H	X
Breaking Capacity [Icu] (kA r.m.s.)	65	100	130	200	65	100	130	200
Downstream Breaking Capacity [Icu] (kA r.m.s.)	Enhanced Breaking Capacity							
HiBD63E*	10	20	20	20	20	20	20	20
HiBD63S*	15	30	30	30	30	30	30	30
HiBD63N*	20	40	60	60	40	60	60	60
HiBD63H*	25	40	60	60	40	60	60	60
HiBD125*	25	40	60	60	40	60	60	60

Upstream Circuit Breaker	HGP160D				HGP250			
	F*	S	H	X	F*	S	H	X
Breaking Capacity [Icu] (kA r.m.s.)	65	100	130	200	65	100	130	200
Downstream Breaking Capacity [Icu] (kA r.m.s.)	Enhanced Breaking Capacity							
HiBD63E*	10	20	20	20	20	20	20	20
HiBD63S*	15	30	30	30	30	30	30	30
HiBD63N*	20	40	60	60	40	60	60	60
HiBD63H*	25	40	60	60	40	60	60	60
HiBD125*	25	40	60	60	40	60	60	60

Upstream Circuit Breaker	HGP50D				HGP125D				HGP160D				
	F*	S	H	X	F*	S	H	X	F*	S	H	X	
Breaking Capacity [Icu] (kA r.m.s.)	65	100	130	200	65	100	130	200	65	100	130	200	
Downstream Breaking Capacity [Icu] (kA r.m.s.)	Enhanced Breaking Capacity												
HGM30E	35	65	70	70	70	65	70	70	70	65	70	70	70
HGM30S	50	65	70	70	70	65	70	70	70	65	70	70	70
HGM50E	35	65	85	100	100	65	85	100	100	65	85	100	100
HGM50S	50	65	100	130	130	65	100	130	130	65	100	130	130
HGM50H	85		100	130	150		100	130	150		100	130	150
HGM50L	100			130	150			130	150			130	150

Upstream Circuit Breaker	HGP250				HGP400				HGP630				
	F*	S	H	X	F*	S	H	X	F*	S	H	X	
Breaking Capacity [Icu] (kA r.m.s.)	65	100	130	200	65	100	130	200	65	100	130	200	
Downstream Breaking Capacity [Icu] (kA r.m.s.)	Enhanced Breaking Capacity												
HGM30E	35	65	70	70	70	65	70	70	70	65	70	70	70
HGM30S	50	65	70	70	70	65	70	70	70	65	70	70	70
HGM50E	35	65	85	100	100	65	85	100	100	65	85	100	100
HGM50S	50	65	100	130	130	65	100	130	130	65	100	130	130
HGM50H	85		100	130	150		100	130	150		100	130	150
HGM50L	100			130	150			130	150			130	150

※ \* F Type and HiBD Type products are dedicated overseas products.

Upstream Circuit Breaker : HGP125D, HGP160D, HGP250, HGP400, HGP630

Downstream Circuit Breaker : HGM60, HGM100, HGM125, HGM160, HGM250

Upstream Circuit Breaker	HGP125D				HGP160D				
	F*	S	H	X	F*	S	H	X	
Breaking Capacity [Icu] (kA r.m.s.)	65	100	130	200	65	100	130	200	
Downstream Breaking Capacity [Icu] (kA r.m.s.)	Enhanced Breaking Capacity								
HGM60E	35	65	70	70	70	65	70	70	70
HGM60S	50	65	70	70	70	65	70	70	70
HGM60H	50	65	70	70	70	65	70	70	70
HGM60L	50	65	70	70	70	65	70	70	70
HGM100E	35	65	70	70	70	65	70	70	70
HGM100S	50	65	70	70	70	65	70	70	70
HGM100H	50	65	70	70	70	65	70	70	70
HGM100L	50	65	70	70	70	65	70	70	70
HGM125E	50	65	85	100	100	65	85	100	100
HGM125S	65		100	130	130		100	130	130
HGM125H	85		100	130	150		100	130	150
HGM125L	100			130	150			130	150

Upstream Circuit Breaker	HGP250				HGP400				HGP630				
	F*	S	H	X	F*	S	H	X	F*	S	H	X	
Breaking Capacity [Icu] (kA r.m.s.)	65	100	130	200	65	100	130	200	65	100	130	200	
Downstream Breaking Capacity [Icu] (kA r.m.s.)	Enhanced Breaking Capacity												
HGM60E	35	65	70	70	70	65	70	70	70	65	70	70	70
HGM60S	50	65	70	70	70	65	70	70	70	65	70	70	70
HGM60H	50	65	70	70	70	65	70	70	70	65	70	70	70
HGM60L	50	65	70	70	70	65	70	70	70	65	70	70	70
HGM100E	35	65	70	70	70	65	70	70	70	65	70	70	70
HGM100S	50	65	70	70	70	65	70	70	70	65	70	70	70
HGM100H	50	65	70	70	70	65	70	70	70	65	70	70	70
HGM100L	50	65	70	70	70	65	70	70	70	65	70	70	70
HGM125E	50	65	85	100	100	65	85	100	100	65	85	100	100
HGM125S	65		100	130	130		100	130	130		100	130	130
HGM125H	85		100	130	150		100	130	150		100	130	150
HGM125L	100			130	150			130	150			130	150

Upstream Circuit Breaker	HGP160D				HGP250				
	F*	S	H	X	F*	S	H	X	
Breaking Capacity [Icu] (kA r.m.s.)	65	100	130	200	65	100	130	200	
Downstream Breaking Capacity [Icu] (kA r.m.s.)	Enhanced Breaking Capacity								
HGM160E	50	65	85	100	100	65	85	100	100
HGM160S	65		100	130	130		100	130	130
HGM160H	85		100	130	150		100	130	150
HGM160L	100			130	150			130	150
HGM250E	50				65	85	100	100	
HGM250S	65					100	130	130	
HGM250H	85					100	130	150	
HGM250L	100						130	150	

\* F Type products are dedicated overseas products.

## Technical Data (HGP)

### Cascading Table

#### AC 220/240 V

Upstream Circuit Breaker : HGP400, HGP630, HGP800

Downstream Circuit Breaker : HGM160, HGM250, HGM400, HGM600, HGM800

Upstream Circuit Breaker	HGP400				HGP630				HGP800				
	F*	S	H	X	F*	S	H	X	F*	S	H	X	
Breaking Capacity [Icu] (kA r.m.s.)	65	100	130	200	65	100	130	200	65	100	130	200	
Downstream Breaking Capacity [Icu] (kA r.m.s.)	Enhanced Breaking Capacity												
HGM160E	50	65	85	100	100	65	85	100	100				
HGM160S	65		100	130	130		100	130	130				
HGM160H	85		100	130	150		100	130	150				
HGM160L	100			130	150			130	150				
HGM250E	50	65	85	100	100	65	85	100	100	65	85	100	100
HGM250S	65		100	130	130		100	130	130		100	130	130
HGM250H	85		100	130	150		100	130	150		100	130	150
HGM250L	100			130	150			130	150			130	150

Upstream Circuit Breaker	HGP400				HGP630				HGP800				
	F*	S	H	X	F*	S	H	X	F*	S	H	X	
Breaking Capacity [Icu] (kA r.m.s.)	65	100	130	200	65	100	130	200	65	100	130	200	
Downstream Breaking Capacity [Icu] (kA r.m.s.)	Enhanced Breaking Capacity												
HGM400E	50	65	100	130	150	65	100	130	150	65	100	130	150
HGM400S	75		100	130	150		100	130	150		100	130	150
HGM400H	100			130	200			130	200			130	200
HGM400L	125			130	200			130	200			130	200
HGM600E	50					65	100	130	150	65	100	130	150
HGM600S	75						100	130	150		100	130	150
HGM600H	100							130	200			130	200
HGM600L	125							130	200			130	200
HGM800S	75										100	130	150
HGM800H	100											130	200
HGM800L	125											130	200

※ \* F Type products are dedicated overseas products.

Upstream Circuit Breaker : HGP50D, HGP125D, HGP160D, HGP250, HGP400, HGP630, HGP800

Downstream Circuit Breaker : HGP50D, HGP125D, HGP160D, HGP250, HGP400, HGP630, HGP800

Upstream Circuit Breaker	HGP50D				HGP125D				HGP160D			
	F*	S	H	X	F*	S	H	X	F*	S	H	X
Breaking Capacity [Icu] (kA r.m.s.)	65	100	130	200	65	100	130	200	65	100	130	200
Downstream Breaking Capacity [Icu] (kA r.m.s.)	Enhanced Breaking Capacity											
HGP50D/125D/160DF*	65	100	130	150		100	130	150		100	130	150
HGP50D/125D/160DS	100		130	200			130	200			130	200
HGP50D/125D/160DH	130			200				200				200

Upstream Circuit Breaker	HGP250			
	F*	S	H	X
Breaking Capacity [Icu] (kA r.m.s.)	65	100	130	200
Downstream Breaking Capacity [Icu] (kA r.m.s.)	Enhanced Breaking Capacity			
HGP50D/125D/160DF*	65	100	130	150
HGP50D/125D/160DS	100		130	200
HGP50D/125D/160DH	130			200
HGP250 F*	65	100	130	150
HGP250 S	100		130	200
HGP250 H	130			200

Upstream Circuit Breaker	HGP400				HGP630				HGP800			
	F*	S	H	X	F*	S	H	X	F*	S	H	X
Breaking Capacity [Icu] (kA r.m.s.)	65	100	130	200	65	100	130	200	65	100	130	200
Downstream Breaking Capacity [Icu] (kA r.m.s.)	Enhanced Breaking Capacity											
HGP50D/125D/160DF*	65	100	130	150		100	130	150		100	130	150
HGP50D/125D/160DS	100		130	200			130	200			130	200
HGP50D/125D/160DH	130			200				200				200
HGP250 F*	65	100	130	150		100	130	150		100	130	150
HGP250 S	100		130	200			130	200			130	200
HGP250 H	130			200				200				200
HGP400/630 F*	65	100	130	150		100	130	150		100	130	150
HGP400/630 S	100		130	200			130	200			130	200
HGP400/630 H	130			200				200				200
HGP800 F*	65									100	130	150
HGP800 S	100										130	200
HGP800 H	130											200

\* F Type products are dedicated overseas products.

# Technical Data (HGP)

## Cascading Table

### AC 440/460 V

Upstream Circuit Breaker : HGP50D, HGP125D, HGP160D, HGP250, HGP400, HGP630

Downstream Circuit Breaker : HiBD63\*, HiBD125\*, HGM30, HGM50

Upstream Circuit Breaker		HGP50D				HGP125D			
		F*	S	H	X	F*	S	H	X
Breaking Capacity [Icu] (kA r.m.s.)		36	65	85	150	36	65	85	150
Downstream Breaking Capacity [Icu] (kA r.m.s.)		Enhanced Breaking Capacity							
HiBD63-E*	6	10	15	15	15	10	15	15	15
HiBD63-S*	7.5	14	15	20	20	15	20	20	20
HiBD63-N*	10	20	26	26	26	20	26	26	26
HiBD63H*	15	20	30	30	30	20	30	30	30
HiBD125*	15	20	30	30	30	20	30	30	30

Upstream Circuit Breaker		HGP160D				HGP250			
		F*	S	H	X	F*	S	H	X
Breaking Capacity [Icu] (kA r.m.s.)		36	65	85	150	36	65	85	150
Downstream Breaking Capacity [Icu] (kA r.m.s.)		Enhanced Breaking Capacity							
HiBD63-E*	6	10	15	15	15	10	15	15	15
HiBD63-S*	7.5	15	20	20	20	15	20	20	20
HiBD63-N*	10	20	26	26	26	20	26	26	26
HiBD63H*	15	20	30	30	30	20	30	30	30
HiBD125*	15	20	30	30	30	20	30	30	30

Upstream Circuit Breaker		HGP50D				HGP125D				HGP160D			
		F*	S	H	X	F*	S	H	X	F*	S	H	X
Breaking Capacity [Icu] (kA r.m.s.)		36	65	85	150	36	65	85	150	36	65	85	150
Downstream Breaking Capacity [Icu] (kA r.m.s.)		Enhanced Breaking Capacity											
HGM30 E	16	26	38	38	38	26	38	38	38	26	38	38	38
HGM30 S	20	30	38	38	38	30	38	38	38	30	38	38	38
HGM50 E	16	26	38	38	38	26	38	38	38	26	38	38	38
HGM50 S	20	30	38	38	38	30	38	38	38	30	38	38	38
HGM50 H	38		50	70	85		50	70	85		50	70	85
HGM50 L	55		65	70	85		65	70	85		65	70	85

Upstream Circuit Breaker		HGP250				HGP400				HGP630			
		F*	S	H	X	F*	S	H	X	F*	S	H	X
Breaking Capacity [Icu] (kA r.m.s.)		36	65	85	150	36	70	85	150	36	70	85	150
Downstream Breaking Capacity [Icu] (kA r.m.s.)		Enhanced Breaking Capacity											
HGM30 E	16	26	38	38	38	26	38	38	38	26	38	38	38
HGM30 S	20	30	38	38	38	30	38	38	38	30	38	38	38
HGM50 E	16	26	38	38	38	26	38	38	38	26	38	38	38
HGM50 S	20	30	38	38	38	30	38	38	38	30	38	38	38
HGM50 H	38		50	70	85		50	70	85		50	70	85
HGM50 L	55		65	70	85		65	70	85		65	70	85

※ \* F Type and HiBD Type products are dedicated overseas products.



Upstream Circuit Breaker : HGP125D, HGP160D, HGP250, HGP400, HGP630

Downstream Circuit Breaker : HGM60, HGM100, HGM125, HGM160, HGM250

Upstream Circuit Breaker	HGP125D				HGP160D			
	F*	S	H	X	F*	S	H	X
Breaking Capacity [Icu] (kA r.m.s.)	36	65	85	150	36	65	85	150
Downstream Breaking Capacity [Icu] (kA r.m.s.)	Enhanced Breaking Capacity							
HGM60 E	16	26	38	38	38	26	38	38
HGM60 S	20	30	38	38	38	30	38	38
HGM60 H	26	36	50	50	55	36	50	55
HGM60 L	30	36	50	50	55	36	50	55
HGM100 E	16	26	38	38	38	26	38	38
HGM100 S	20	30	38	38	38	30	38	38
HGM100 H	26	36	50	50	55	36	50	55
HGM100 L	30	36	50	50	55	36	50	55
HGM125 E	20	36	50	50	50	36	50	50
HGM125 S	26	36	50	50	50	36	50	50
HGM125 H	38		50	70	85		50	70
HGM125 L	55		65	70	85		65	70

Upstream Circuit Breaker	HGP250				HGP400				HGP630				
	F*	S	H	X	F*	S	H	X	F*	S	H	X	
Breaking Capacity [Icu] (kA r.m.s.)	36	65	85	150	36	70	85	150	36	70	85	150	
Downstream Breaking Capacity [Icu] (kA r.m.s.)	Enhanced Breaking Capacity												
HGM60 E	16	26	38	38	38	26	38	38	38	26	38	38	38
HGM60 S	20	30	38	38	38	30	38	38	38	30	38	38	38
HGM60 H	26	36	50	50	55	36	50	50	55	36	50	50	55
HGM60 L	30	36	50	50	55	36	50	50	55	36	50	50	55
HGM100 E	16	26	38	38	38	26	38	38	38	26	38	38	38
HGM100 S	20	30	38	38	38	30	38	38	38	30	38	38	38
HGM100 H	26	36	50	50	55	36	50	50	55	36	50	50	55
HGM100 L	30	36	50	50	55	36	50	50	55	36	50	50	55
HGM125 E	20	36	50	50	50	36	50	50	50	36	50	50	50
HGM125 S	26	36	50	50	50	36	50	50	50	36	50	50	50
HGM125 H	38		50	70	85		50	70	85		50	70	85
HGM125 L	55		65	70	85		65	70	85		65	70	85

Upstream Circuit Breaker	HGP160D				HGP250			
	F*	S	H	X	F*	S	H	X
Breaking Capacity [Icu] (kA r.m.s.)	36	65	85	150	36	65	85	150
Downstream Breaking Capacity [Icu] (kA r.m.s.)	Enhanced Breaking Capacity							
HGM160 E	20	36	50	50	50	36	50	50
HGM160 S	26	36	50	50	50	36	50	50
HGM160 H	38		50	70	85		50	70
HGM160 L	55		65	70	85		65	70
HGM250 E	20					36	50	50
HGM250 S	26					36	50	50
HGM250 H	38						50	70
HGM250 L	55						65	70

\* F Type products are dedicated overseas products.

## Technical Data (HGP)

### Cascading Table

#### AC 440/460 V

Upstream Circuit Breaker: HGP400, HGP630, HGP800

Downstream Circuit Breaker : HGM160, HGM250, HGM400, HGM600, HGM800

Upstream Circuit Breaker	HGP400				HGP630				HGP800				
	F*	S	H	X	F*	S	H	X	F*	S	H	X	
Breaking Capacity [Icu] (kA r.m.s.)	36	70	85	150	36	70	85	150	36	70	85	150	
Downstream Breaking Capacity [Icu] (kA r.m.s.)	Enhanced Breaking Capacity												
HGM160 E	20	36	50	50	50	36	50	50	50				
HGM160 S	26	36	50	50	50	36	50	50	50				
HGM160 H	38		50	70	85		50	70	85				
HGM160 L	55		65	70	85		65	70	85				
HGM250 E	20	36	50	50	50	36	50	50	50	36	50	50	50
HGM250 S	26	36	50	50	50	36	50	50	50	36	50	50	50
HGM250 H	38		50	70	85		50	70	85		50	70	85
HGM250 L	55		65	70	85		65	70	85		65	70	85

Upstream Circuit Breaker	HGP400				HGP630				HGP800				
	F*	S	H	X	F*	S	H	X	F*	S	H	X	
Breaking Capacity [Icu] (kA r.m.s.)	36	70	85	150	36	70	85	150	36	70	85	150	
Downstream Breaking Capacity [Icu] (kA r.m.s.)	Enhanced Breaking Capacity												
HGM400 E	38		70	85	100		70	85	100		70	85	85
HGM400 S	50		70	85	100		70	85	100		70	85	85
HGM400 H	70			85	100			85	100			85	100
HGM400 L	85				100				100				100
HGM600 E	38						70	85	100		70	85	85
HGM600 S	50						70	85	100		70	85	85
HGM600 H	70							85	100			85	100
HGM600 L	85								100				100
HGM800 S	50										70	85	85
HGM800 H	70											85	100
HGM800 L	85												100

※ \* F Type products are dedicated overseas products.

Upstream Circuit Breaker : HGP50D, HGP125D, HGP160D, HGP250, HGP400, HGP630, HGP800

Downstream Circuit Breaker : HGP50D, HGP125D, HGP160D, HGP250, HGP400, HGP630, HGP800

Upstream Circuit Breaker	HGP50D				HGP125D				HGP160D			
	F*	S	H	X	F*	S	H	X	F*	S	H	X
Breaking Capacity [Icu] (kA r.m.s.)	36	65	85	150	36	65	85	150	36	65	85	150
Downstream Breaking Capacity [Icu] (kA r.m.s.)	Enhanced Breaking Capacity											
HGP50D/125D/160D F*	38	65	85	100		65	85	100		65	85	100
HGP50D/125D/160D S	70		85	150			85	150			85	150
HGP50D/125D/160D H	85			150				150				150

Upstream Circuit Breaker	HGP250			
	F*	S	H	X
Breaking Capacity [Icu] (kA r.m.s.)	36	65	85	150
Downstream Breaking Capacity [Icu] (kA r.m.s.)	Enhanced Breaking Capacity			
HGP50D/125D/160D F*	36	65	85	100
HGP50D/125D/160D S	65		85	150
HGP50D/125D/160D H	85			150
HGP250 F*	36	65	85	100
HGP250 S	65		85	150
HGP250 H	85			150

Upstream Circuit Breaker	HGP400				HGP630				HGP800			
	F*	S	H	X	F*	S	H	X	F*	S	H	X
Breaking Capacity [Icu] (kA r.m.s.)	36	70	85	150	36	70	85	150	36	70	85	150
Downstream Breaking Capacity [Icu] (kA r.m.s.)	Enhanced Breaking Capacity											
HGP50D/125D/160D F*	36	65	85	100		65	85	100		65	85	100
HGP50D/125D/160D S	65		85	150			85	150			85	150
HGP50D/125D/160D H	85			150				150				150
HGP250 F*	36	65	85	100		65	85	100		65	85	100
HGP250 S	65		85	150			85	150			85	150
HGP250 H	85			150				150				150
HGP400/630 F*	36	65	85	100		65	85	100		65	85	100
HGP400/630 S	70		85	150			85	150			85	150
HGP400/630 H	85			150				150				150
HGP800 F*	36									65	85	100
HGP800 S	70										85	150
HGP800 H	85											150

\* F Type products are dedicated overseas products.

# Technical Data (HGP)

## Discrimination Table

Ue < AC 460 V

Upstream Circuit Breaker : HGP50D ~ HGP800

Downstream Circuit Breaker : HiBD63\*, HiBD125\*

Model	Trip Unit Rated Current (A)	HGP160D F*/S/H/X												
		Thermal Magnetic												
		16	20	25	32	40	50	63	75	80	100	125	150	160
HiBD63* - NS B, C, D Curve	1	0.19	0.32	0.32	0.32	0.32	0.4	0.5	0.6	0.64	0.8	1	T	T
	3	0.19	0.32	0.32	0.32	0.32	0.4	0.5	0.6	0.64	0.8	1	T	T
	5	0.19	0.32	0.32	0.32	0.32	0.4	0.5	0.6	0.64	0.8	1	T	T
	6	0.19	0.32	0.32	0.32	0.32	0.4	0.5	0.6	0.64	0.8	1	T	T
	10	0.19	0.32	0.32	0.32	0.32	0.4	0.5	0.6	0.64	0.8	1	T	T
	16		0.32	0.32	0.32	0.32	0.4	0.5	0.6	0.64	0.8	1	T	T
	20			0.32	0.32	0.32	0.4	0.5	0.6	0.64	0.8	1	T	T
	25				0.32	0.32	0.4	0.5	0.6	0.64	0.8	1	T	T
	32					0.32	0.4	0.5	0.6	0.64	0.8	1	T	T
	40						0.4	0.5	0.6	0.64	0.8	1	T	T
HiBD63* - H/N/S/E B, C, D Curve	1	0.19	0.32	0.32	0.32	0.32	0.4	0.5	0.6	0.64	0.8	1	T	T
	2	0.19	0.32	0.32	0.32	0.32	0.4	0.5	0.6	0.64	0.8	1	T	T
	3	0.19	0.32	0.32	0.32	0.32	0.4	0.5	0.6	0.64	0.8	1	T	T
	4	0.19	0.32	0.32	0.32	0.32	0.4	0.5	0.6	0.64	0.8	1	T	T
	5	0.19	0.32	0.32	0.32	0.32	0.4	0.5	0.6	0.64	0.8	1	T	T
	6	0.19	0.32	0.32	0.32	0.32	0.4	0.5	0.6	0.64	0.8	1	T	T
	10	0.19	0.32	0.32	0.32	0.32	0.4	0.5	0.6	0.64	0.8	1	T	T
	13		0.32	0.32	0.32	0.32	0.4	0.5	0.6	0.64	0.8	1	T	T
	15		0.32	0.32	0.32	0.32	0.4	0.5	0.6	0.64	0.8	1	T	T
	16		0.32	0.32	0.32	0.32	0.4	0.5	0.6	0.64	0.8	1	T	T
	20			0.32	0.32	0.32	0.4	0.5	0.6	0.64	0.8	1	T	T
	25				0.32	0.32	0.4	0.5	0.6	0.64	0.8	1	T	T
	32					0.32	0.4	0.5	0.6	0.64	0.8	1	T	T
	40						0.4	0.5	0.6	0.64	0.8	1	T	T
	50							0.5	0.6	0.64	0.8	1	T	T
63								0.6	0.64	0.8	1	T	T	
HiBD125* B, C, D Curve	63								0.64	0.8	2.4	2.4	2.4	
	80									0.8	2.4	2.4	2.4	
	100										2.4	2.4	2.4	
												2.4	2.4	
	125												2.4	

- T Total Discrimination, Up to the Breaking Capacity of the Downstream Circuit Breaker
- 4 Discrimination Limit = 4 kA
- No Discrimination

※ \* F Type and HiBD Type products are dedicated overseas products.

Upstream Circuit Breaker : HGP50D ~ HGP800  
 Downstream Circuit Breaker : HiBD63 \*, HiBD125 \*

Model	Trip Unit	HGP250 F*/S/H/X								HGP400 F*/S/H/X		HGP630 F*/S/H/X		HGP800 F*/S/H/X			
		Thermal Magnetic															
		Rated Current (A)	100	125	150	160	175	200	225	250	300	350	400	500	630	700	800
HiBD63*-NS B, C, D Curve	1	T	T	T	T	T	T	T	T	T	T	T	T	T	T	T	
	3	T	T	T	T	T	T	T	T	T	T	T	T	T	T	T	
	5	T	T	T	T	T	T	T	T	T	T	T	T	T	T	T	
	6	T	T	T	T	T	T	T	T	T	T	T	T	T	T	T	
	10	T	T	T	T	T	T	T	T	T	T	T	T	T	T	T	
	16	T	T	T	T	T	T	T	T	T	T	T	T	T	T	T	
	20	T	T	T	T	T	T	T	T	T	T	T	T	T	T	T	
	25	T	T	T	T	T	T	T	T	T	T	T	T	T	T	T	
	32	T	T	T	T	T	T	T	T	T	T	T	T	T	T	T	
	40	T	T	T	T	T	T	T	T	T	T	T	T	T	T	T	
HiBD63*- H/N/S/E B, C, D Curve	1	T	T	T	T	T	T	T	T	T	T	T	T	T	T	T	
	2	T	T	T	T	T	T	T	T	T	T	T	T	T	T	T	
	3	T	T	T	T	T	T	T	T	T	T	T	T	T	T	T	
	4	T	T	T	T	T	T	T	T	T	T	T	T	T	T	T	
	5	T	T	T	T	T	T	T	T	T	T	T	T	T	T	T	
	6	T	T	T	T	T	T	T	T	T	T	T	T	T	T	T	
	10	T	T	T	T	T	T	T	T	T	T	T	T	T	T	T	
	13	T	T	T	T	T	T	T	T	T	T	T	T	T	T	T	
	15	T	T	T	T	T	T	T	T	T	T	T	T	T	T	T	
	16	T	T	T	T	T	T	T	T	T	T	T	T	T	T	T	
	20	T	T	T	T	T	T	T	T	T	T	T	T	T	T	T	
	25	T	T	T	T	T	T	T	T	T	T	T	T	T	T	T	
	32	T	T	T	T	T	T	T	T	T	T	T	T	T	T	T	
	40	T	T	T	T	T	T	T	T	T	T	T	T	T	T	T	
	50	T	T	T	T	T	T	T	T	T	T	T	T	T	T	T	
63	T	T	T	T	T	T	T	T	T	T	T	T	T	T	T		
HiBD125* B, C, D Curve	63	2.4	2.4	2.4	2.4	T	T	T	T	T	T	T	T	T	T	T	
	80	2.4	2.4	2.4	2.4	T	T	T	T	T	T	T	T	T	T	T	
	100	2.4	2.4	2.4	2.4	T	T	T	T	T	T	T	T	T	T	T	
	125	2.4	2.4	2.4	2.4	T	T	T	T	T	T	T	T	T	T	T	

- T Total Discrimination, Up to the Breaking Capacity of the Downstream Circuit Breaker
- 4 Discrimination Limit = 4 kA
- No Discrimination

※ \* F Type and HiBD Type products are dedicated overseas products.

# Technical Data (HGP)

## Discrimination Table

Ue < AC 460 V

Upstream Circuit Breaker : HGP50D ~ HGP800  
 Downstream Circuit Breaker : HGM30 ~ HGM800

Model	Trip Unit	HGP160D F*/S/H/X												
		Thermal Magnetic												
		16	20	25	32	40	50	63	75	80	100	125	150	160
HGM30 E/S HGM50 E/S HGM60 E/S/H/L HGM100 E/S/H/L	Rated Current (A)													
	16							0.5	0.6	0.64	0.8	1	1.25	1.25
	20							0.5	0.6	0.64	0.8	1	1.25	1.25
	25							0.5	0.6	0.64	0.8	1	1.25	1.25
	32							0.5	0.6	0.64	0.8	1	1.25	1.25
	40									0.64	0.8	1	1.25	1.25
	50									0.64	0.8	1	1.25	1.25
	63										0.8	1	1.25	1.25
	75											1	1.25	1.25
	80											1	1.25	1.25
100													1.25	
HGM125 E/S/H/L	16							0.5	0.6	0.64	0.8	1	1.25	1.25
	20							0.5	0.6	0.64	0.8	1	1.25	1.25
	25							0.5	0.6	0.64	0.8	1	1.25	1.25
	32							0.5	0.6	0.64	0.8	1	1.25	1.25
	40									0.64	0.8	1	1.25	1.25
	50									0.64	0.8	1	1.25	1.25
	63										0.8	1	1.25	1.25
	75											1	1.25	1.25
	80											1	1.25	1.25
	100													1.25
HGM160 E/S/H/L HGM250 E/S/H/L	125													
	100													
	125													
	150													
	160													
	175													
	200													
	225													
HGM400 E/S/H/L	250													
	300													
	350													
	400													
HGM630 E/S/H/L HGM800 S/H/L	500													
	630													
	700													
	800													

- T Total Discrimination, Up to the Breaking Capacity of the Downstream Circuit Breaker
- 4 Discrimination Limit = 4 kA
- No Discrimination

※ \*F Type products are dedicated overseas products.

Upstream Circuit Breaker : HGP50D ~ HGP800

Downstream Circuit Breaker : HGM30 ~ HGM800

Model	Trip Unit	HGP250 F*/S/H/X								HGP400 F*/S/H/X		HGP630 F*/S/H/X		HGP800 F*/S/H/X			
		Thermal Magnetic															
		Rated Current (A)	100	125	150	160	175	200	225	250	300	350	400	500	630	700	800
HGM30 E/S HGM50 E/S HGM60 E/S/H/L HGM100 E/S/H/L	16	0.8	1	1.25	1.25	1.4	1.6	1.8	2	T	T	T	T	T	T	T	
	20	0.8	1	1.25	1.25	1.4	1.6	1.8	2	T	T	T	T	T	T	T	
	25	0.8	1	1.25	1.25	1.4	1.6	1.8	2	T	T	T	T	T	T	T	
	32	0.8	1	1.25	1.25	1.4	1.6	1.8	2	T	T	T	T	T	T	T	
	40	0.8	1	1.25	1.25	1.4	1.6	1.8	2	T	T	T	T	T	T	T	
	50	0.8	1	1.25	1.25	1.4	1.6	1.8	2	T	T	T	T	T	T	T	
	63	0.8	1	1.25	1.25	1.4	1.6	1.8	2	T	T	T	T	T	T	T	
	75		1	1.25	1.25	1.4	1.6	1.8	2	T	T	T	T	T	T	T	
	80		1	1.25	1.25	1.4	1.6	1.8	2	T	T	T	T	T	T	T	
	100					1.25	1.4	1.6	1.8	2	T	T	T	T	T	T	
HGM125 E/S/H/L	16	0.8	1	1.25	1.25	1.4	1.6	1.8	2	T	T	T	T	T	T	T	
	20	0.8	1	1.25	1.25	1.4	1.6	1.8	2	T	T	T	T	T	T	T	
	25	0.8	1	1.25	1.25	1.4	1.6	1.8	2	T	T	T	T	T	T	T	
	32	0.8	1	1.25	1.25	1.4	1.6	1.8	2	T	T	T	T	T	T	T	
	40	0.8	1	1.25	1.25	1.4	1.6	1.8	2	T	T	T	T	T	T	T	
	50	0.8	1	1.25	1.25	1.4	1.6	1.8	2	T	T	T	T	T	T	T	
	63	0.8	1	1.25	1.25	1.4	1.6	1.8	2	T	T	T	T	T	T	T	
	75		1	1.25	1.25	1.4	1.6	1.8	2	T	T	T	T	T	T	T	
	80		1	1.25	1.25	1.4	1.6	1.8	2	T	T	T	T	T	T	T	
	100					1.25	1.4	1.6	1.8	2	T	T	T	T	T	T	
HGM160 E/S/H/L HGM250 E/S/H/L	125					1.4	1.6	1.8	2	T	T	T	T	T	T	T	
	100				1.25	1.4	1.6	1.8	2	2.4	2.8	3.8	4	5	T	T	
	125						1.6	1.8	2	2.4	2.8	3.8	4	5	T	T	
	150								2	2.4	2.8	3.8	4	5	T	T	
	160								2	2.4	2.8	3.8	4	5	T	T	
	175									2.4	2.8	3.8	4	5	T	T	
	200									2.4	2.8	3.8	4	5	T	T	
	225										2.8	3.8	4	5	T	T	
HGM400 E/S/H/L	250										3.8	4	5	T	T		
	250											4	5	5.6	6.4		
	300											4	5	5.6	6.4		
	350												5	5.6	6.4		
HGM630 E/S/H/L HGM800 S/H/L	400												5	5.6	6.4		
	500													5.6	6.4		
	630														6.4		
	700																
800																	

※ \* F Type products are dedicated overseas products.

# Technical Data (HGP)

## Discrimination Table

Ue < AC 460 V

Upstream Circuit Breaker : HGP50D ~ HGP800

Downstream Circuit Breaker : HGP50D ~ HGP800

Model	Trip Unit Rated Current (A)	HGP160D F*/S/H/X												
		Thermal Magnetic												
		16	20	25	32	40	50	63	75	80	100	125	150	160
HGP50D F*/S/H/X HGP125D F*/S/H/X HGP160D F*/S/H/X	16							0.5	0.6	0.64	0.8	1	1.25	1.25
	20							0.5	0.6	0.64	0.8	1	1.25	1.25
	25							0.5	0.6	0.64	0.8	1	1.25	1.25
	32							0.5	0.6	0.64	0.8	1	1.25	1.25
	40									0.64	0.8	1	1.25	1.25
	50									0.64	0.8	1	1.25	1.25
	63									0.8	1	1.25	1.25	
	75										1	1.25	1.25	
	80										1	1.25	1.25	
	100													1.25
HGP250 F*/S/H/X	100													
	125													
	150													
	160													
	175													
	200													
HGP400 F*/S/H/X HGP630 F*/S/H/X	225													
	250													
	300													
	350													
HGP800 F*/S/H/X	400													
	500													
	630													
	700													
	800													

- T Total Discrimination, Up to the Breaking Capacity of the Downstream Circuit Breaker
- 4 Discrimination Limit = 4 kA
- No Discrimination

※ \*F Type products are dedicated overseas products.



Upstream Circuit Breaker : HGP50D ~ HGP800

Downstream Circuit Breaker : HGP50D ~ HGP800

Model	Trip Unit Rated Current (A)	HGP250 F*/S/H/X								HGP400 F*/S/H/X		HGP630 F*/S/H/X		HGP800 F*/S/H/X			
		Thermal Magnetic															
		100	125	150	160	175	200	225	250	300	350	400	500	630	700	800	
HGP50D F*/S/H/X HGP125D F*/S/H/X HGP160D F*/S/H/X	16	0.8	1	1.25	36	36	36	36	36	T	T	T	T	T	T	T	
	20	0.8	1	1.25	1.25	36	36	36	36	T	T	T	T	T	T	T	
	25	0.8	1	1.25	1.25	1.4	36	36	36	T	T	T	T	T	T	T	
	32	0.8	1	1.25	1.25	1.4	36	36	36	T	T	T	T	T	T	T	
	40	0.8	1	1.25	1.25	1.4	36	36	36	T	T	T	T	T	T	T	
	50	0.8	1	1.25	1.25	1.4	36	36	36	T	T	T	T	T	T	T	
	63	0.8	1	1.25	1.25	1.4	36	36	36	T	T	T	T	T	T	T	
	75		1	1.25	1.25	1.4	36	36	36	T	T	T	T	T	T	T	
	80		1	1.25	1.25	1.4	36	36	36	T	T	T	T	T	T	T	
	100				1.25	1.4	1.6	36	36	T	T	T	T	T	T	T	
	125						1.6	1.8	36	T	T	T	T	T	T	T	
	150							1.8	2	T	T	T	T	T	T	T	
	160								2	T	T	T	T	T	T	T	
	HGP250 F*/S/H/X	100				1.25	1.4	1.6	1.8	2	36	36	36	T	T	T	T
125							1.6	1.8	2	36	36	36	T	T	T	T	
150									2	36	36	36	T	T	T	T	
160									2	2.4	36	36	T	T	T	T	
175										2.4	2.8	36	36	36	T	T	
200										2.4	2.8	3.8	36	36	T	T	
225											2.8	3.8	36	36	T	T	
250												3.8	4	36	T	T	
HGP400 F*/S/H/X HGP630 F*/S/H/X	300											4	5	36	36		
	350												5	36	36		
	400												5	5.6	36		
	500													5.6	6.4		
	630														6.4		
HGP800 F*/S/H/X	700																
	800																

**T** Total Discrimination, Up to the Breaking Capacity of the Downstream Circuit Breaker

**4** Discrimination Limit = 4 kA

No Discrimination

※ \* F Type products are dedicated overseas products.

# Technical Data (HGP)

## Type 2 Coordination (IEC 60947-4-1)

### AC 440V

Performance : Ue = 440 V

Circuit Breakers	F*	S	H
HGP100/250	36	65	85
HGP400/630	36	65	85
HGP800	36	65	85

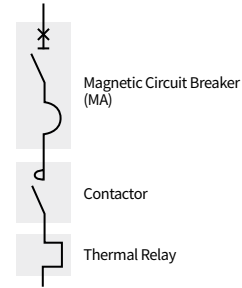

Motor			Circuit Breakers			Contactors	Thermal o/l relays	
P (kW)	I (A) 440 V	Ie Max (A)	Type	Rating (A)	Ii (A)	Type	Type	Irth (A)
0.37	1.1	1.6	HGP100	2.5	32.5	HGC18	HGT18 <sup>1)</sup>	0.8 ~ 1.2
0.55	1.4	1.6	HGP100	2.5	32.5	HGC18	HGT18 <sup>1)</sup>	1.1 ~ 1.6
0.75	1.7	2.5 <sup>2)</sup>	HGP100	2.5	32.5	HGC18	HGT18 <sup>1)</sup>	1.5 ~ 2.1 <sup>2)</sup>
1.1	2.4	2.5	HGP100	3.2	41.6	HGC18	HGT18 <sup>1)</sup>	2 ~ 3
1.5	3.1	4	HGP100	6.3	81.9	HGC40	HGT18 <sup>1), 4)</sup>	2.8 ~ 4.2
2.2	4.5	6	HGP100	6.3	81.9	HGC40	HGT18 <sup>1), 4)</sup>	4 ~ 6
3	5.8	6	HGP100	6.3	81.9	HGC40	HGT18 <sup>1), 4)</sup>	5.6 ~ 8
4	8	8	HGP100	12.5	163	HGC65	HGT65 <sup>1), 4)</sup>	6 ~ 9
5.5	10.5	12.5 <sup>3)</sup>	HGP100	12.5	163	HGC65	HGT65 <sup>1), 4)</sup>	8 ~ 12 <sup>3)</sup>
7.5	13.7	18	HGP100	32	416	HGC65	HGT65 <sup>1)</sup>	12 ~ 18
10	19	25	HGP100	32	416	HGC65	HGT100 <sup>1)</sup>	17 ~ 25
11	20	25	HGP100	32	320	HGC100	HGT100 <sup>1)</sup>	17 ~ 25
15	26.5	32	HGP100	50	650	HGC100	HGT100	22 ~ 32
18.5	33	40	HGP100	50	650	HGC100	HGT100	28 ~ 40
22	39	40	HGP100	50	650	HGC100	HGT100	34 ~ 50
30	52	63	HGP100	100	1300	HGC115	HGT150	48 ~ 80
37	63	63	HGP100	100	1300	HGC130	HGT150	48 ~ 80
45	76	80	HGP250	125	1250	HGC150	HGT150	48 ~ 80
55	90	100	HGP250	160	1600	HGC150	HGT150	69 ~ 115
75	125	150	HGP250	200	2000	HGC150	HGT150	90 ~ 150
90	140	150	HGP250	200	2000	HGC150	HGT150	111 ~ 185
110	178	185	HGP250	250	2500	HGC185	HGT265	135 ~ 225
132	210	265	HGP400	350	3500	HGC265	HGT265	180 ~ 300
160	256	265	HGP400	350	3500	HGC265	HGT265	180 ~ 300
200	310	320	HGP630	400	4000	HGC400	HGT500	240 ~ 400
220	353	400	HGP630	630	6300	HGC400	HGT500	300 ~ 500
250	400	500	HGP630	700	7000	HGC500	HGT500	300 ~ 500
300	460	500	HGP800	700	7000	HGC500	HGT800	378 ~ 630
		630	HGP800	800	8000	HGC630	HGT800	378 ~ 630
335	540	630	HGP800	800	8000	HGC800	HGT800	378 ~ 630
375	575	630	HGP800	800	8000	HGC800	HGT800	378 ~ 630

※ 1) Iq < 50 kA  
 2) TOR Thermal Maximum Rating 2.1 A  
 3) TOR Thermal Maximum Rating 12 A  
 4) Type 1 Only for Thermal Relay  
 \* F Type products are dedicated overseas products.

## Installation

### Insulation Distance (Safety Clearance)

For safety, insulation distance must be secured at installation. In case of installing a circuit breaker, safety clearances must be secured between breakers or between the circuit breaker and panel, bus bar and other adjacent devices. When the circuit breaker interrupts a short circuit, high temperature ionized gas is generated and the gas is discharged through the discharge outlet from the circuit breaker. As this gas can cause short-circuit accidents and grounding accidents, sufficient insulation distance is required between the circuit breaker and the panel.

※ In case insulation barrier is not installed between the circuit breaker terminals, secondary short-circuit accident may occur so it must be used. The insulation barrier must be installed towards the direction of the circuit breaker's line indication part.

Separation distance in case the circuit breaker is installed side by side

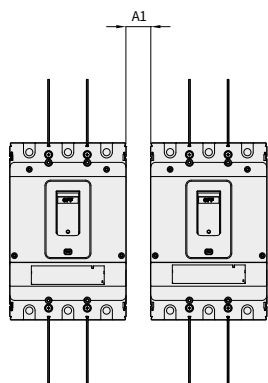

Up/down/left/right distance in case of metallic panel

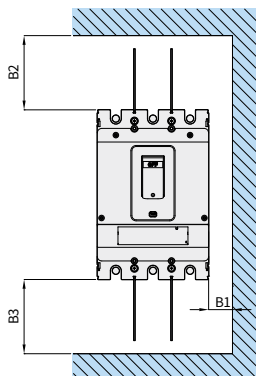

Front/back distance in case of metallic panel

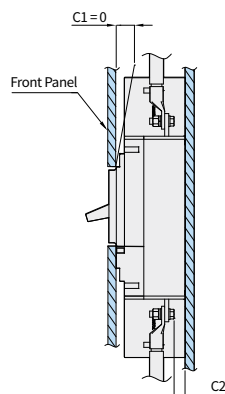

Distance with circuit breaker in case the live part is exposed

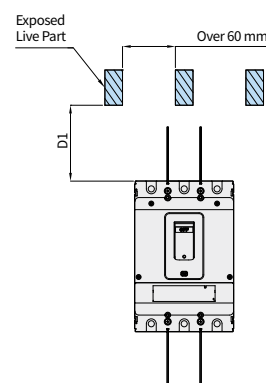

※ In case of using the minimum separation distance (A1 = 0), terminal cover and phase to phase barrier must be assembled between the product.

※ If the distance between the live parts is less than 60 mm, the exposed part must be insulated.

### HGP Type's Minimum Insulation Distance

Type	Minimum Clearance (mm)													
	460 V							240 V						
	A1	B1	B2	B3	C1	C2	D1	A1	B1	B2	B3	C1	C2	D1
HGP50D F*/S	0	10	50	50	0	8	350	0/50	10	50	50	0	8	350
HGP50D H/X	0	10	50	50	0	8	350	0/50	10	50	50	0	8	350
HGP125D F*/S	0	10	50	50	0	8	350	0/50	10	50	50	0	8	350
HGP125D H/X	0	10	50	50	0	8	350	0/50	10	50	50	0	8	350
HGP160D F*/S	0	10	50	50	0	8	350	0/50	10	50	50	0	8	350
HGP160D H/X	0	10	50	50	0	8	350	0/50	10	50	50	0	8	350
HGP250 F*/S	0	10	100	100	0	8	350	0/50	10	100	100	0	8	350
HGP250 H/X	0	10	100	100	0	8	350	0/50	10	100	100	0	8	350
HGP400 F*/S	0	40	116	116	0	8	350	0/50	15	116	116	0	8	350
HGP400 H/X	0	40	116	116	0	8	350	0/50	15	116	116	0	8	350
HGP630 F*/S	0	40	116	116	0	8	350	0/50	15	116	116	0	8	350
HGP630 H/X	0	40	116	116	0	8	350	0/50	15	116	116	0	8	350
HGP800 F*/S	0	45	115	115	0	8	350	0/50	20	115	115	0	8	350
HGP800 H/X	0	45	115	115	0	8	350	0/50	20	115	115	0	8	350

※ \* F Type products are dedicated overseas products.

## Technical Data (HGP)

### Installation

#### Installation Angle

The HGP Type of circuit breakers can be installed vertically or horizontally without changing any characteristics and as for the detailed installation direction, please refer to the figure below.

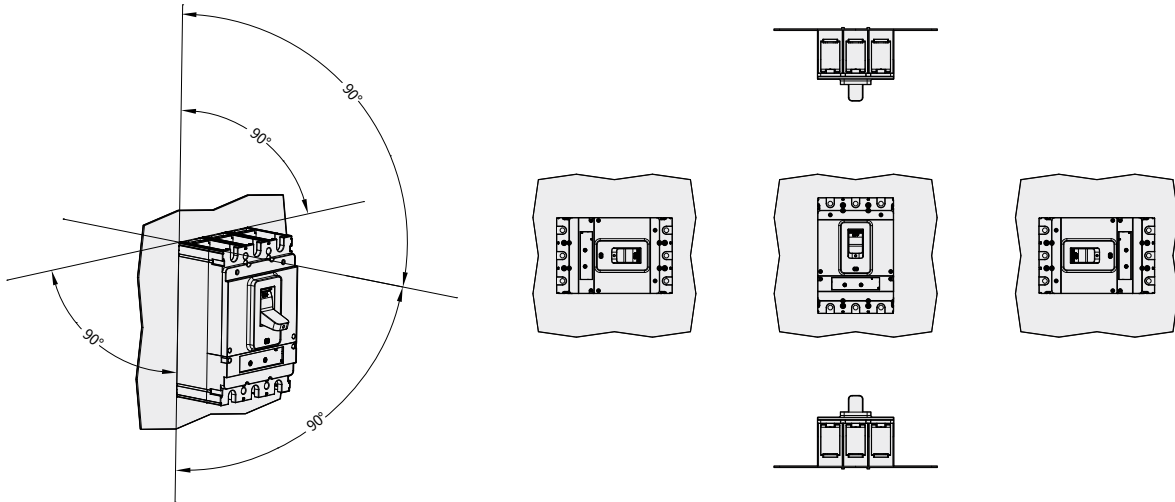

#### Direction of Power Supply

As for the HGP Type circuit breaker, the breaking power of circuit breaker does not drop even if power is supplied to the load side so power can be supplied to any direction regardless of the line side/load side for use. With regards to the use in reverse connection, DEKRA certification has been obtained based on IEC 60947-2.

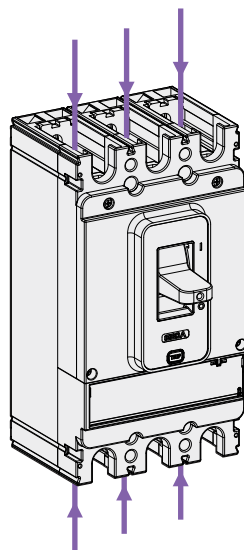



## Standard Configuration

### HGP Type

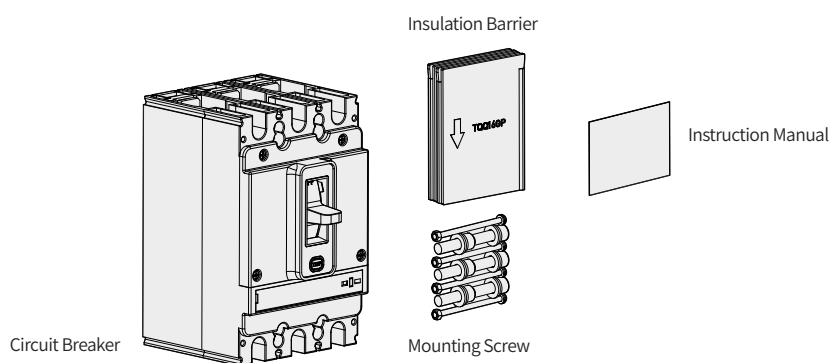

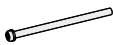

HGP50D, HGP125D, HGP160D, HGP250

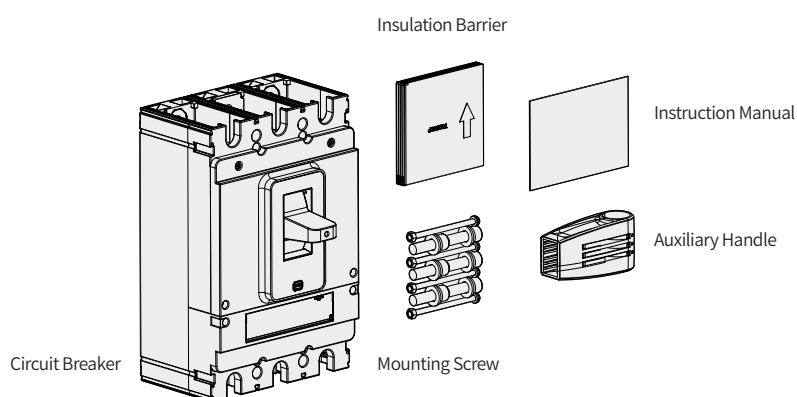

MCCB	Part			
HGP50D, HGP125D, HGP160D	3P	4 EA (M4×L85)	6 EA (PH Screw P·S/W M8×L18)	4 EA
	4P	6 EA (M4×L85)	8 EA (PH Screw P·S/W M8×L18)	6 EA
HGP250	3P	4 EA (M4×L85)	6 EA (Hex Socket P·S/W M8×L20)	4 EA
	4P	6 EA (M4×L85)	8 EA (Hex Socket P·S/W M8×L20)	6 EA

HGP400, HGP630, HGP800



MCCB	Part				
HGP400, HGP630	3P	4 EA (M5×L98)	6 EA (Hex Socket P·S/W M10×L30)	4 EA	1 EA
	4P	4 EA (M5×L98)	8 EA (Hex Socket P·S/W M10×L30)	6 EA	1 EA
HGP800	3P	4 EA (M6×L110)	6 EA (Hex Socket P·S/W M12×L35)	4 EA	1 EA
	4P	4 EA (M6×L110)	8 EA (Hex Socket P·S/W M12×L35)	6 EA	1 EA

# Technical Data (HGP)

## MCCB Assembly and Terminal Mounting Specification

### HGP Type

HGP Type circuit breaker can be mounted directly on the panel by using a screw. In case there is a bus bar or terminal at the back of the panel, attention is required with regards to the insulation distance. The wire and bus bar have to be wired according to the terminal part's specification for power supply of circuit breaker and fastened according to the specified tightening torque.

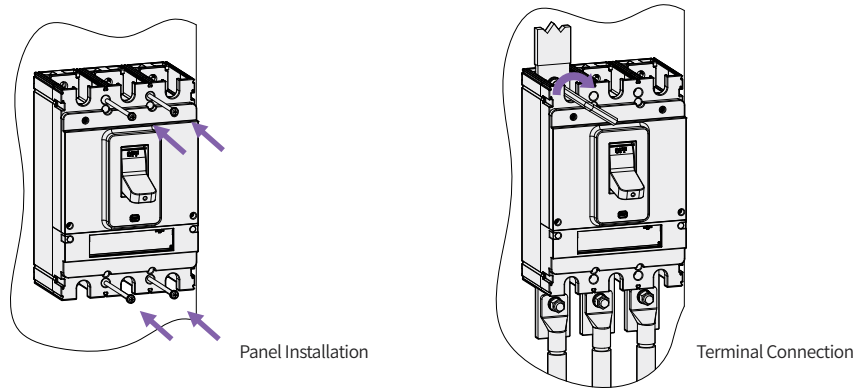

No	MCCB Type	Connection Terminal		
		Terminal Connection Method and Dimensions (mm)	Conductor Processing	Tightening Torque
1	HGP50D HGP125D HGP160D			M8 : 80 ~ 136 kgf.cm
2	HGP250	<p>Height of Terminal (A) 1) Below 100 A LINE : 24 mm, LOAD : 24 mm 2) Exceeding 100 ~ Below 250 A LINE : 26 mm, LOAD : 24 mm</p>		M8 : 80 ~ 136 kgf.cm
3	HGP400 HGP630			M10 : 140 ~ 270 kgf.cm
4	HGP800			M12 : 350 ~ 470 kgf.cm

# Operation Characteristic Curve

HGM/HGE100 (16 ~ 32 A)

• HGM/HGE30, 50E/S, 60, 100

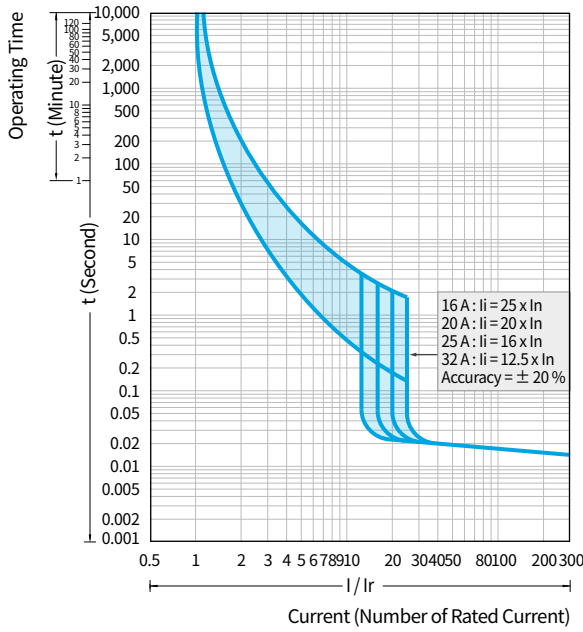

Ambient Temperature Derating Curve

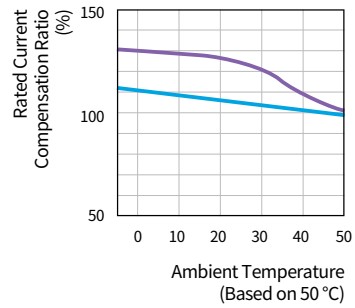
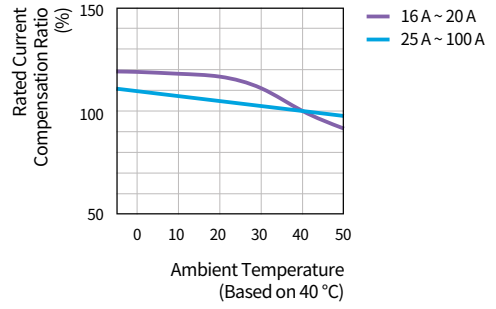

HGM/HGE100 (40 ~ 100 A)

• HGM/HGE50E/S, 60, 100

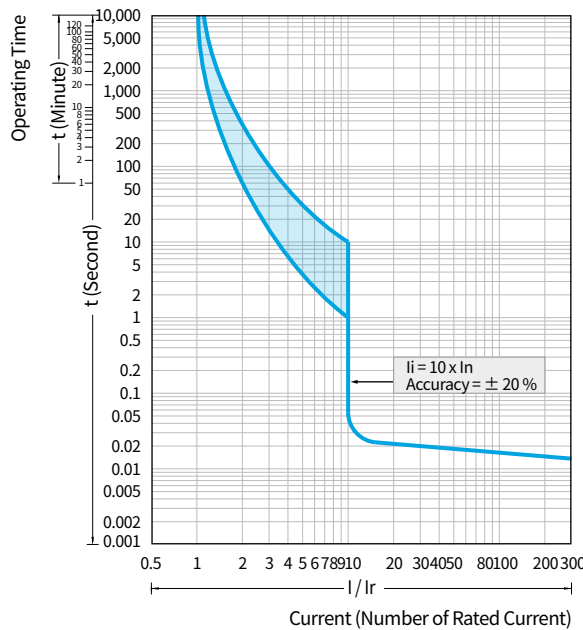

Ambient Temperature Derating Curve

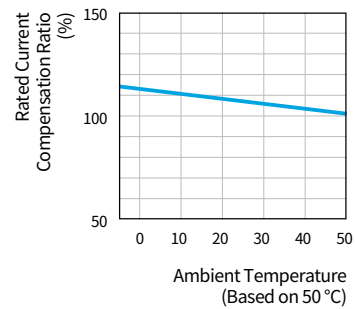
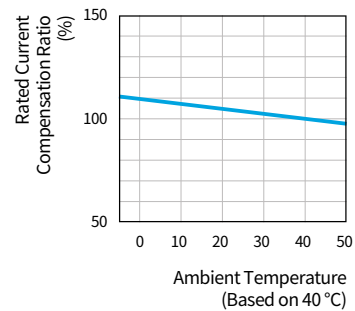

# Operation Characteristic Curve

HGM/HGE125 (16 ~ 32 A)

• HGM/HGE50H/L, 125

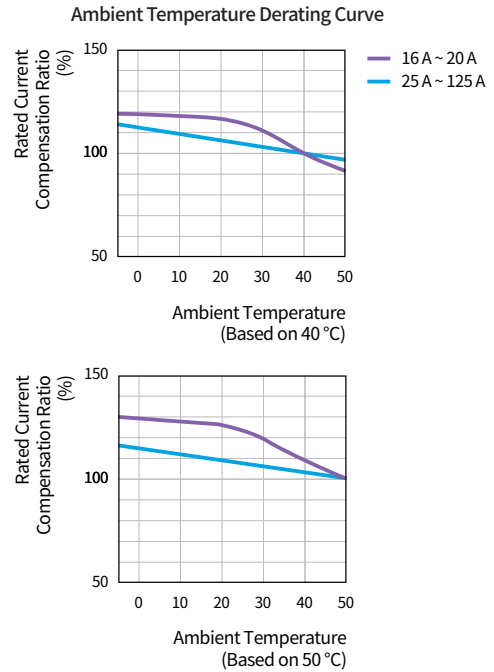
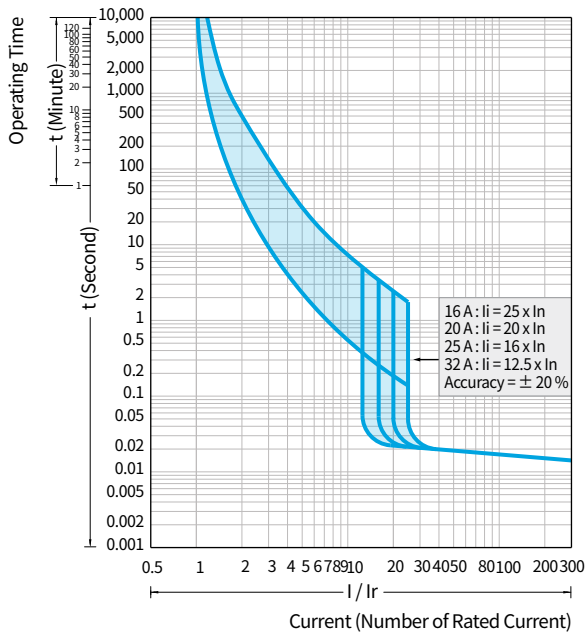

HGM/HGE125 (40 ~ 125 A)

• HGM/HGE50H/L, 125

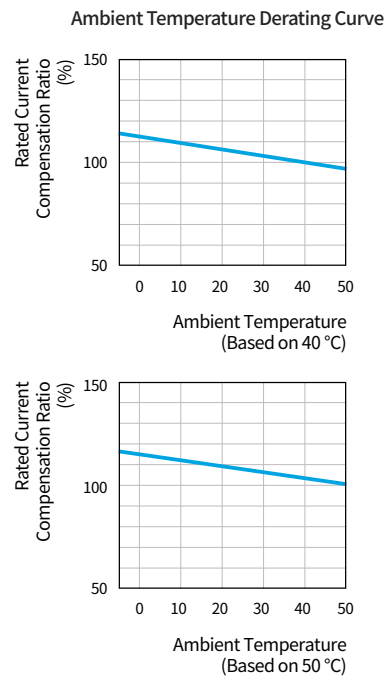
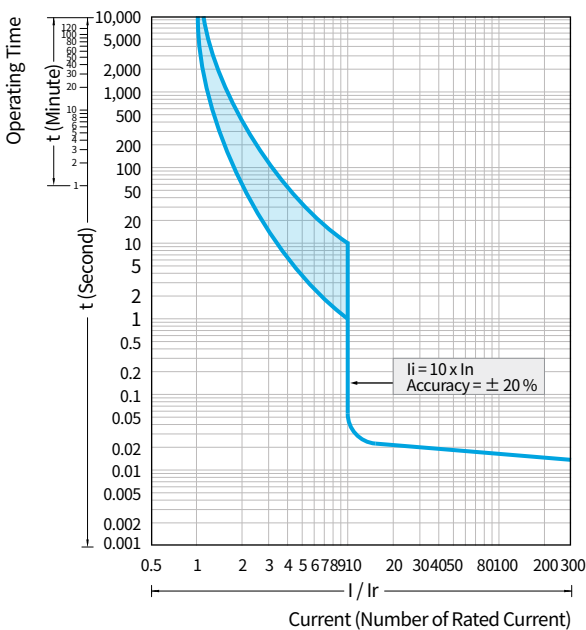



HGM/HGE250 (100 ~ 250 A)

• HGM/HGE160, 250

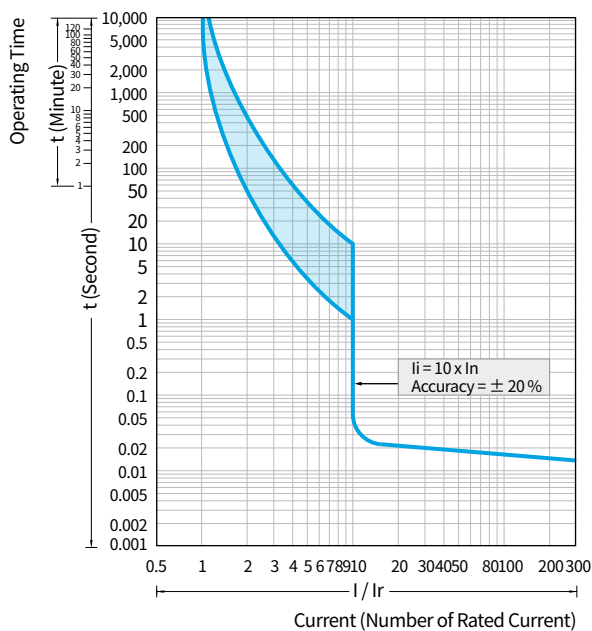

Ambient Temperature Derating Curve

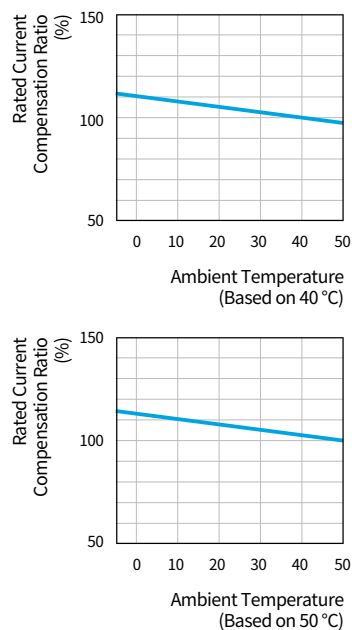

HGM400

• HGM400

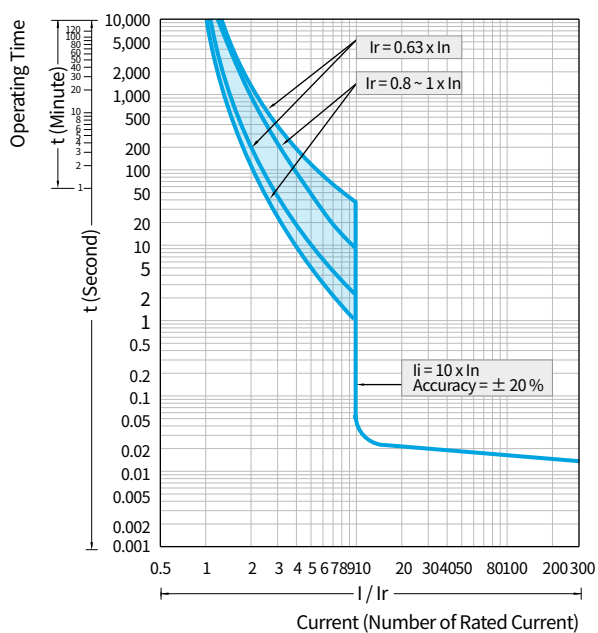

Ambient Temperature Derating Curve

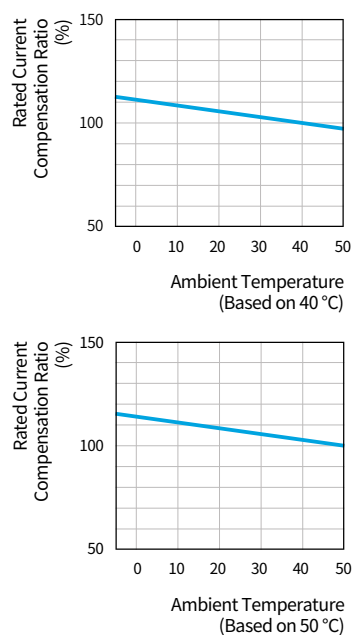

# Operation Characteristic Curve

HGM800 (500 ~ 800 A)

• HGM630, 800

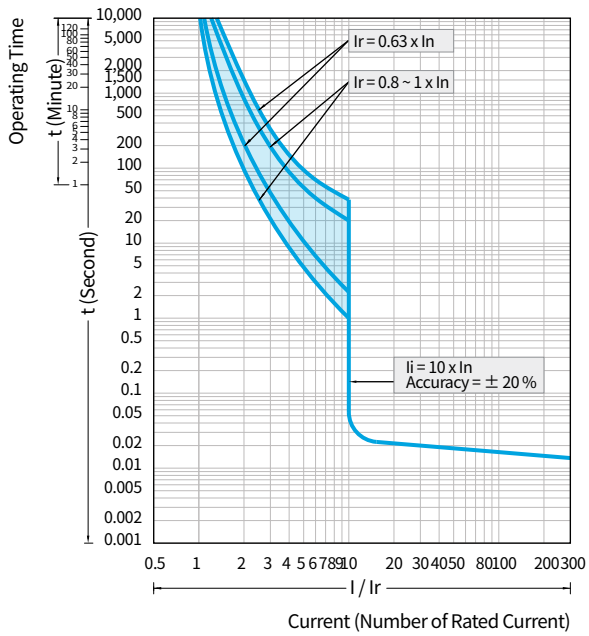

Ambient Temperature Derating Curve

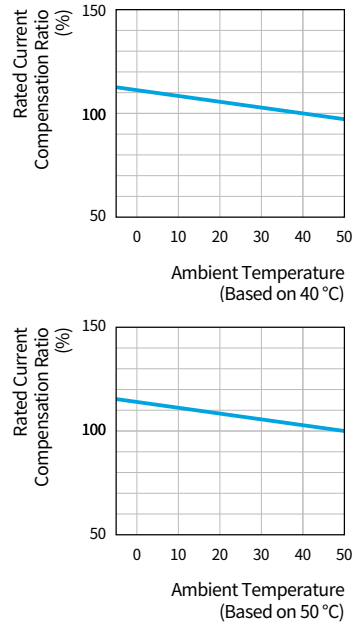

HGE400

• HGE400

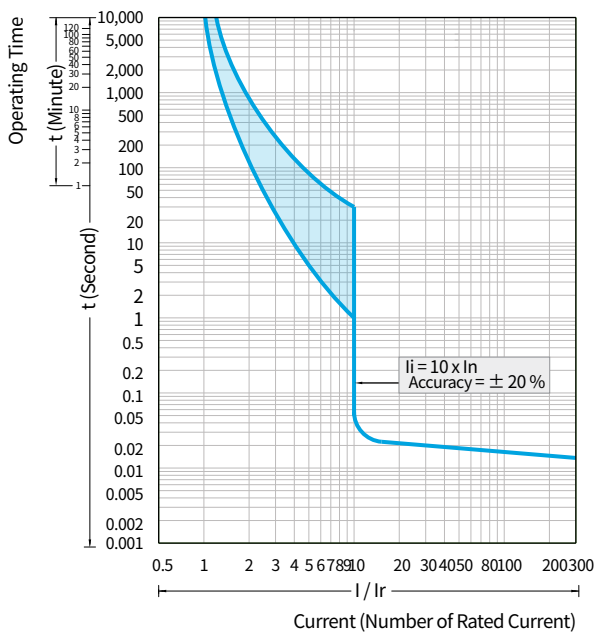

Ambient Temperature Derating Curve

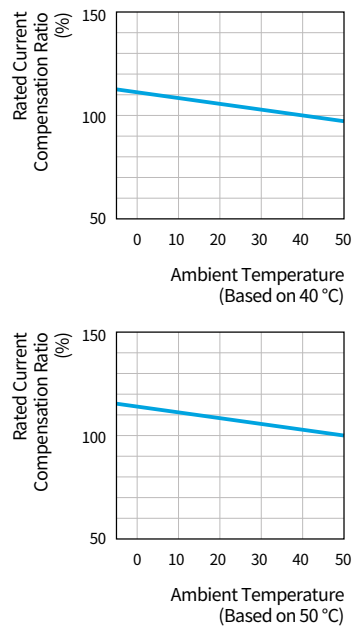

HGE800 (630 ~ 800 A)

• HGE630, 800

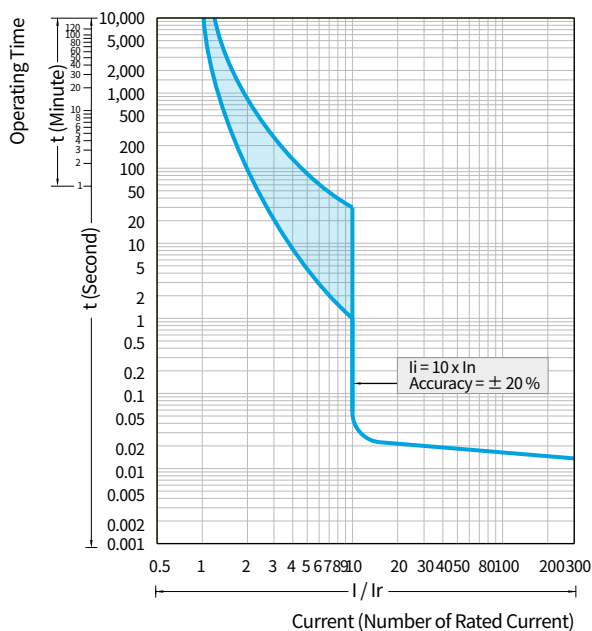

Ambient Temperature Derating Curve

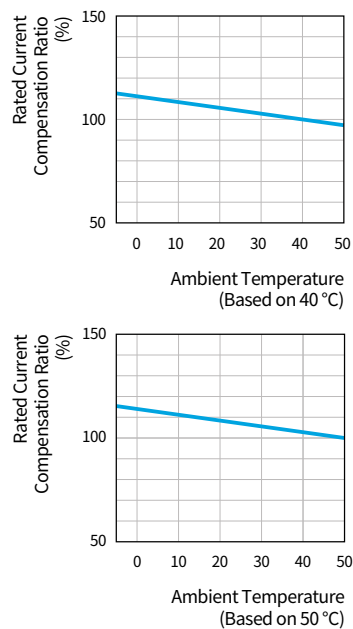

# Current & Energy-Limiting Characteristic Curve

## Current-Limiting Characteristic Curve

• Based on 400/460 V

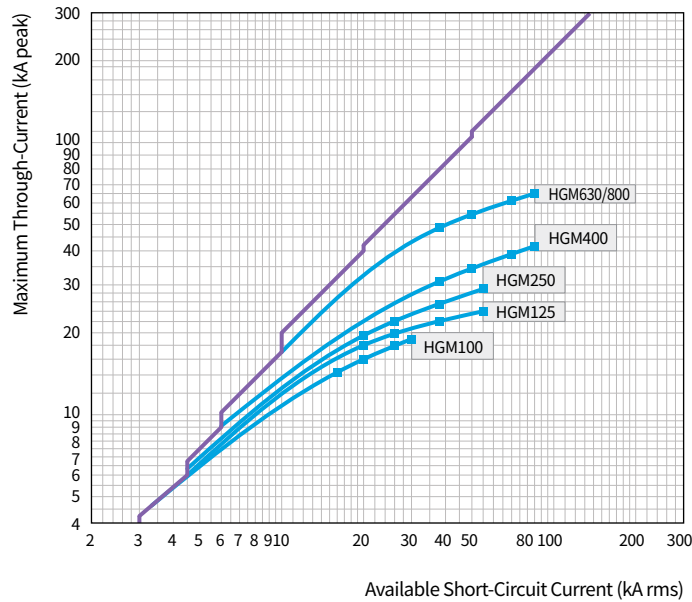

## Energy-Limiting Characteristic Curve

• Based on 400/460 V

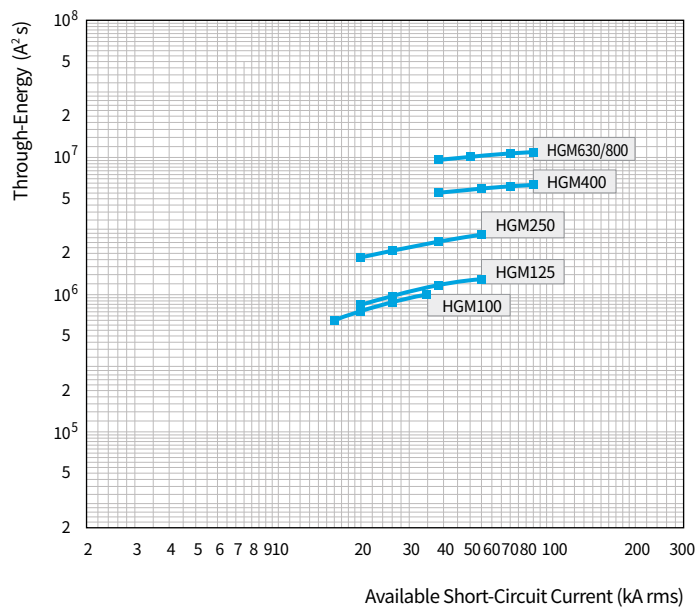

# Operation Characteristic Curve (HGP)

## HGP160D (16 ~ 32 A)

• HGP50D, 125D, 160D

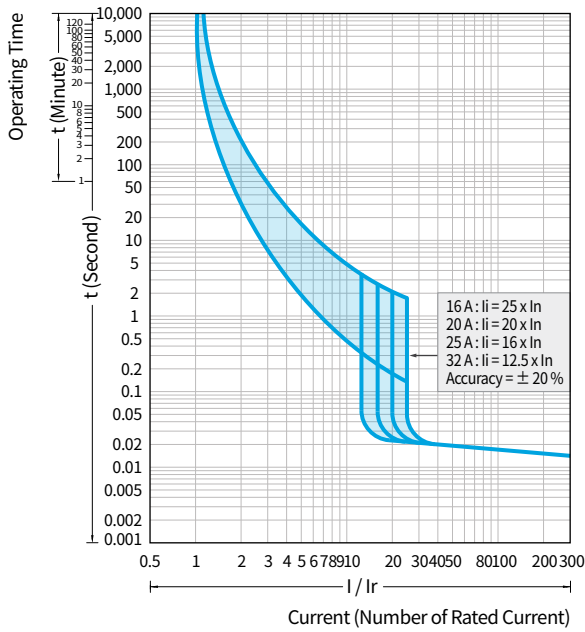

Ambient Temperature Derating Curve

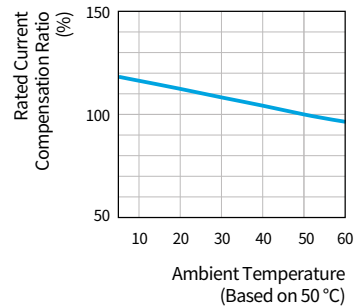
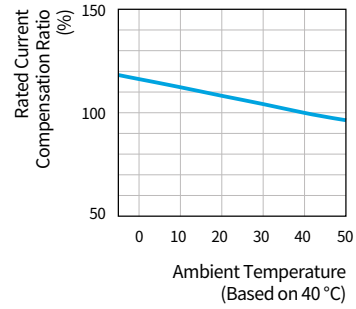

## HGP160D (40 ~ 160 A)

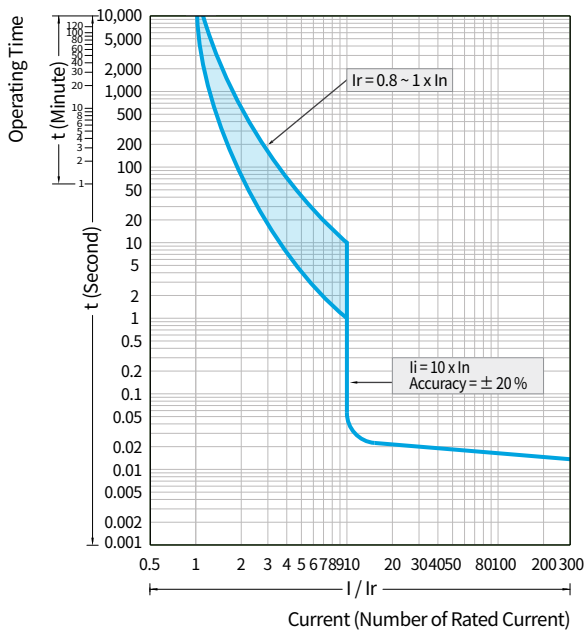

Ambient Temperature Derating Curve

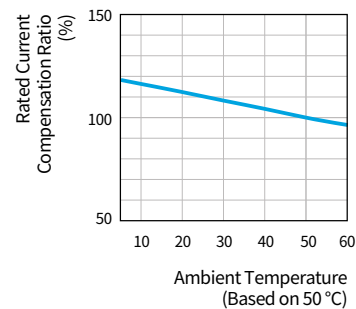
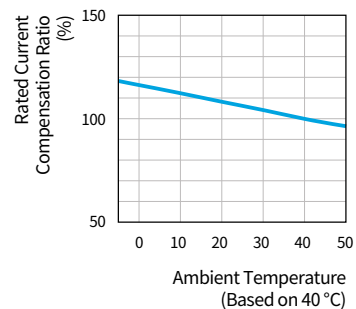

# Operation Characteristic Curve (HGP)

HGP250 (100 ~ 250 A)

• HGP250

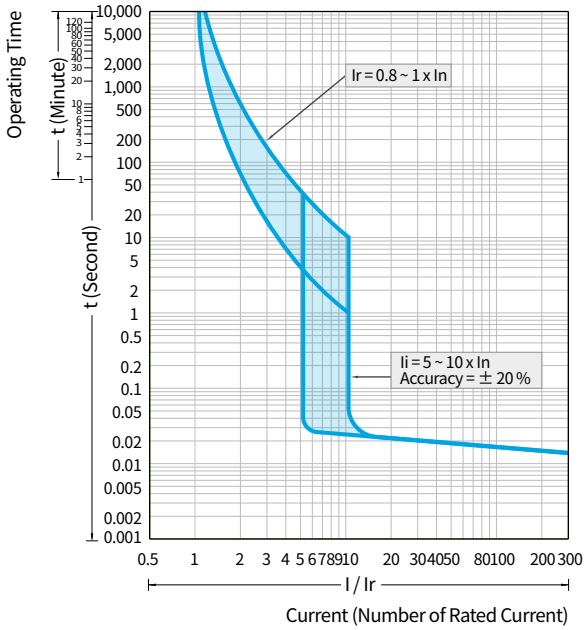

Ambient Temperature Derating Curve

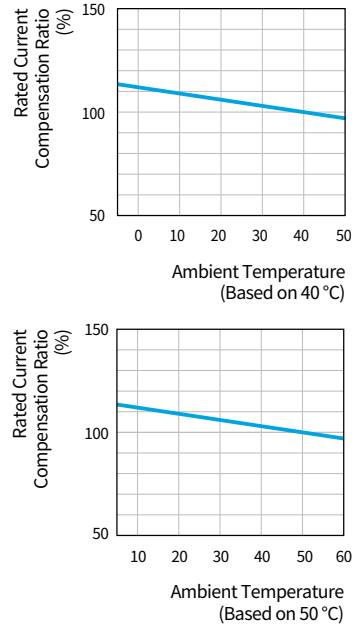

HGP630 (300 ~ 630 A)

• HGP400, 630

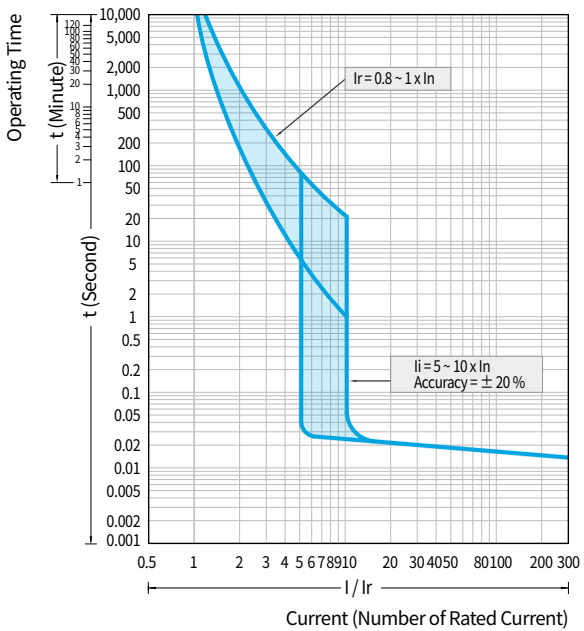

Ambient Temperature Derating Curve

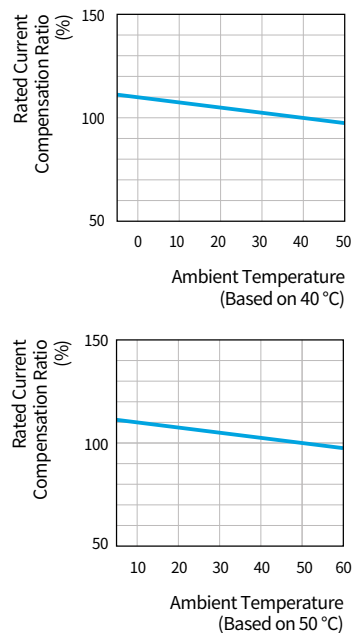

HGP800 (700 ~ 800 A)

• HGP800

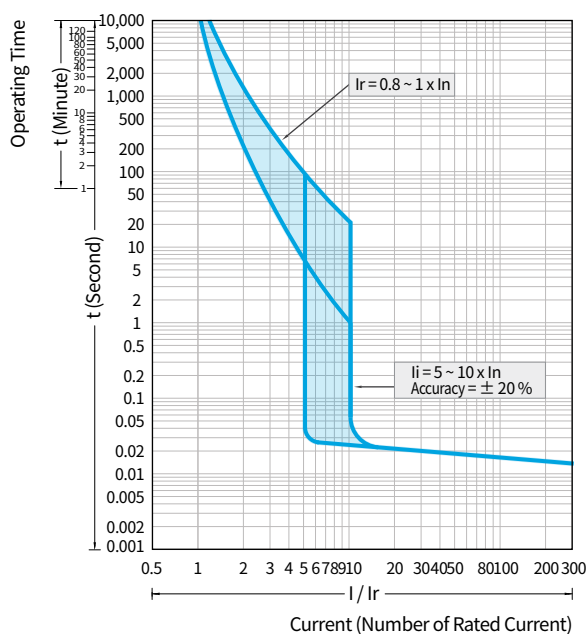

Ambient Temperature Derating Curve

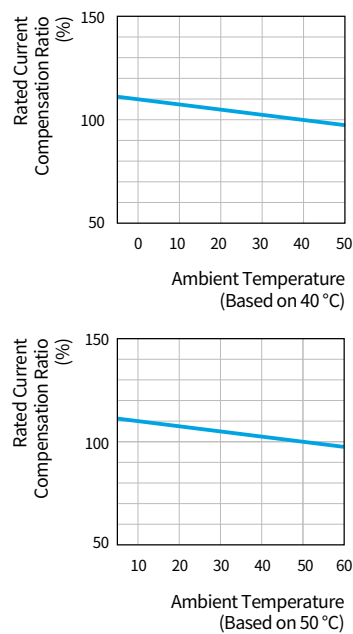

# Current & Energy-Limiting Characteristic Curve (HGP)

## Current-Limiting Characteristic Curve

• Based on 400/460 V

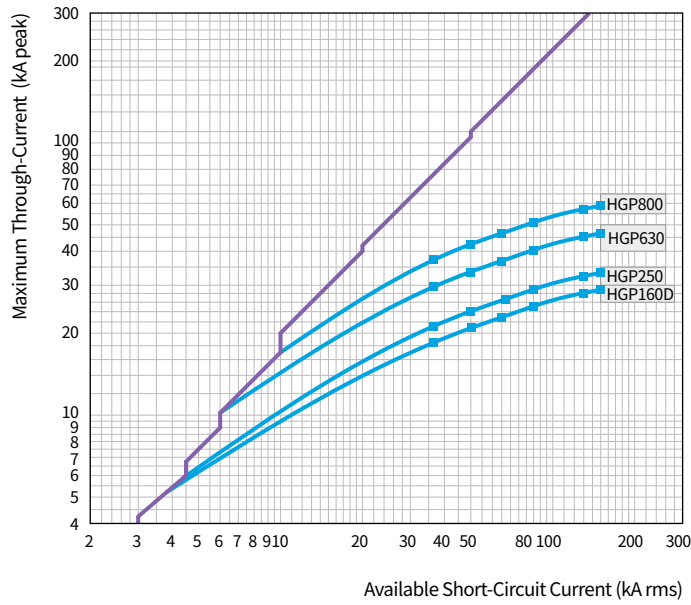

## Energy-Limiting Characteristic Curve

• Based on 400/460 V

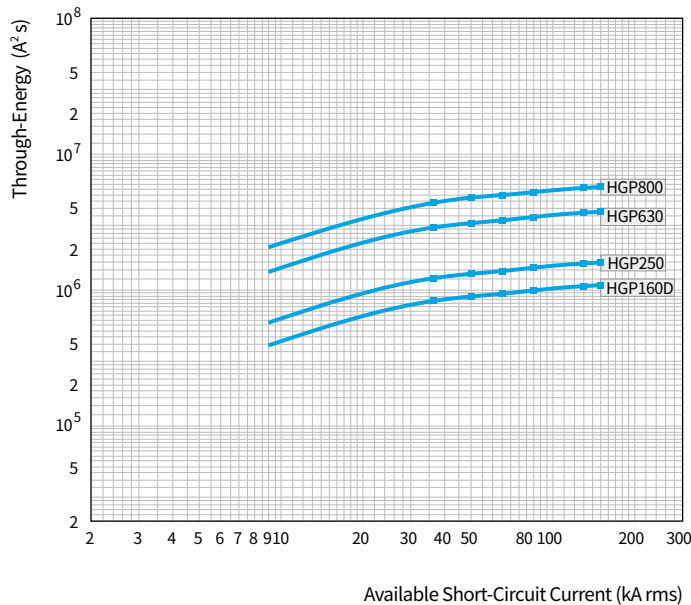



VCB

ACB

**MCCB**

MS

RELAY

# Model Selection Table

## Molded Case Circuit Breaker (HGM Type) : 32 ~ 250 AF

### Common Ratings

Rated Insulation Voltage, Ui	1,000 V	Suitability for Isolation	Yes
Rated Operational Voltage, Ue	690 V	Utilization Category	A
Rated Impulse Withstand Voltage, Uimp	8 kV	Pollution Degree	3
Protection Function	Overload, Instantaneous, Short-Circuit Protection	Reference Standard	IEC 60947-2

Model Name		HGM30	HGM50				HGM60					
Frame	(AF)	32	50				63					
Number of Poles	(P)	2, 3, 4 <sup>1)</sup>	2, 3, 4 <sup>1)</sup>				2, 3, 4 <sup>1)</sup>					
Rated Current, at 40 °C	(A)	16, 20, 25, 32	16, 20, 25, 32, 40, 50				16, 20, 25, 32, 40, 50, 63					
Rated Ultimate Short-Circuit Breaking Capacity [Icu] (kA rms)												
Short-Circuit Breaking Category Code		E	S	E	S	H	L	E	S	H	L	
AC 660/690 V		2.5	5	2.5	5	8	10	2.5	5	7.5	8	
AC 480/500 V		7.5	10	7.5	10	26	35	7.5	10	14	26	
AC 440/460 V		16	20	16	20	38	55	16	20	26	30	
AC 380/415 V		16	20	16	20	38	55	16	20	26	30	
AC 220/240 V		35	50	35	50	85	100	35	50	50	50	
DC 250 V (2P)		5	10	5	10	20	30	5	10	15	15	
Service Breaking Capacity [Ics = % Icu]		100	100	100	100	100	100	100	100	75	50	
Endurance [times] (Durability)												
Mechanical		30,000		30,000				30,000				
Electrical (at 460 V)		10,000		10,000				10,000				
Trip Device												
Thermal Magnetic	Long Time [LT]	Fixed	(1.0) × In		(1.0) × In				(1.0) × In			
		Adjustable	(0.8 - 0.9 - 1.0) × In		(0.8 - 0.9 - 1.0) × In				(0.8 - 0.9 - 1.0) × In			
	Instantaneous [INST]	400 A		16 ~ 32 A : 400 A, 40 ~ 50 A : 10 × In				16 ~ 32 A : 400 A, 40 ~ 63 A : 10 × In				
Accessory												
Internal	Auxiliary Switch		AUX	●	●				●			
	Alarm Switch		ALT	●	●				●			
	Shunt Trip		SHT	●	●				●			
	Under-Voltage Trip		UVT	●	●				●			
External	Rotary Handle	Front Contact	TFG	●	●				●			
		Extended	TFH	●	●				●			
	Mechanical Open/Close Device		MOT	●	●				●			
	Mechanical Interlock		MIF	●	●				●			
	Handle Locking Device		PLD	●	●				●			
	Plug-in	TDM (LINE/LOAD)			● (3P Only)	● (3P Only)	● (3P Only)		● (3P Only)			
		TDM (LINE Only)			● (3P Only)	● (3P Only)	● (3P Only)		● (3P Only)			
		TDF (LINE Only)			● (3P Only)	● (3P Only)	● (3P Only)		● (3P Only)			
		TDA (1 row)			● (3P Only)	● (3P Only)	● (3P Only)		● (3P Only)			
		TDA (2 rows)			● (2, 3P Only)	● (2, 3P Only)	● (3P Only)		● (2, 3P Only)			
Cage Terminal Block		CTB	●	●				●				
Terminal Cover		TCF	●	●				●				
Insulation Barrier		TQQ	●	●				●				
Terminal Bus Bar		TBB	-	-				-				
Installation and Dimensions												
Connection/ Installation	Front Connection		Terminal Screw									
	Rear Connection		Horizontal/Vertical									
	Plug-in		Switchgear (Line & Load, Line Only), Switchboard									
Dimension (mm)	DIN Rail Installation		Possible if DIN Rail adaptor is be used			-			Possible if DIN Rail adaptor is be used			
	a (2/3/4P)		50/75/100	50/75/100	60/90/120		50/75/100					
	b		130	130	155		130					
	c		68	68	68		68					
Weight (kg)	2/3/4P		0.6/0.8/1.0	0.6/0.8/1.0	0.8/1.0/1.3		0.6/0.8/1.0					
Detailed Rating and Selection		228 Page			228 Page			228 Page				
Characteristic Curve and Appearance		59 / 158 Page			59 / 158 Page			59 / 158 Page				

※ 1) 4 Pole Arrangement : Basic specification of R-S-T-N (N-R-S-T is optional).

2) As for 2P products, only the neutral pole in the 3P product has been eliminated so the dimension is equivalent to the 3P product.

HGM100				HGM125				HGM160				HGM250			
100				125				160				250			
2, 3, 4 <sup>1)</sup>				2, 3, 4 <sup>1)</sup>				2 <sup>2)</sup> , 3, 4 <sup>1)</sup>				2 <sup>2)</sup> , 3, 4 <sup>1)</sup>			
16, 20, 25, 32, 40, 50, 63, 75, 80, 100				16, 20, 25, 32, 40, 50, 63, 75, 80, 100, 125				100, 125, 150, 160				100, 125, 150, 160, 175, 200, 225, 250			
E	S	H	L	E	S	H	L	E	S	H	L	E	S	H	L
2.5	5	7.5	8	5	7.5	8	10	7.5	8	8	10	7.5	8	8	10
7.5	10	14	26	10	14	26	35	14	20	26	35	14	20	26	35
16	20	26	30	20	26	38	55	20	26	38	55	20	26	38	55
16	20	26	30	20	26	38	55	20	26	38	55	20	26	38	55
35	50	50	50	50	65	85	100	50	65	85	100	50	65	85	100
5	10	15	15	10	15	20	30	10	15	20	30	10	15	20	30
100	100	75	50	100	100	100	100	100	100	100	100	100	100	100	100
30,000				30,000				25,000				25,000			
10,000				10,000				10,000				10,000			
(1.0)×In				(1.0)×In				(1.0)×In				(1.0)×In			
(0.8 - 0.9 - 1.0)×In				(0.8 - 0.9 - 1.0)×In				(0.8 - 0.9 - 1.0)×In				(0.8 - 0.9 - 1.0)×In			
16 ~ 32 A : 400 A, 40 ~ 100 A : 10×In				16 ~ 32 A : 400 A, 40 ~ 125 A : 10×In				10×In				10×In			
●				●				●				●			
●				●				●				●			
●				●				●				●			
●				●				●				●			
●				●				●				●			
●				●				●				●			
●				●				●				●			
●				●				●				●			
● (3P Only)				● (3P Only)				● (3P Only)				● (3P Only)			
● (3P Only)				● (3P Only)				● (3P Only)				● (3P Only)			
● (3P Only)				● (3P Only)				-				-			
● (3P Only)				● (3P Only)				-				-			
● (2, 3P Only)				● (3P Only)				-				-			
●				●				●				●			
●				●				●				●			
●				●				●				●			
-				-				●				●			
Terminal Screw Horizontal/Vertical								Terminal Screw, Terminal Bus Bar Horizontal/Vertical							
Switchgear (Line & Load, Line Only), Switchboard								Switchgear (Line & Load, Line Only)							
Possible if DIN Rail adaptor is be used								-							
50/75/100				60/90/120				105/105/140				105/105/140			
130				155				165				165			
68				68				68				68			
0.6/0.8/1.0				0.8/1.0/1.3				1.1/1.3/1.7				1.1/1.3/1.7			
228 Page				228 Page				228 Page				228 Page			
59 / 158 Page				60 / 159 Page				61 / 160 Page				61 / 160 Page			

# Model Selection Table

## Molded Case Circuit Breaker (HGM Type) : 400 ~ 800 AF

### Common Ratings

Rated Insulation Voltage, Ui	1,000 V	Suitability for Isolation	Yes
Rated Operational Voltage, Ue	690 V	Utilization Category	A
Rated Impulse Withstand Voltage, Uimp	8 kV	Pollution Degree	3
Protection Function	Overload, Instantaneous, Short-Circuit Protection	Reference Standard	IEC 60947-2

Model Name		HGM400				HGM630				HGM800					
Frame	(AF)	400				630				800					
Number of Poles	(P)	2 <sup>2)</sup> , 3, 4 <sup>1)</sup>				2 <sup>2)</sup> , 3, 4 <sup>1)</sup>				2 <sup>2)</sup> , 3, 4 <sup>1)</sup>					
Rated Current, at 40 °C	(A)	250, 300, 350, 400				500, 630				700, 800					
Rated Ultimate Short-Circuit Breaking Capacity [Icu] (kA rms)															
Short-Circuit Breaking Category Code		E	S	H	L	E	S	H	L	S	H	L			
AC 660/690 V		5	8	10	14	5	8	10	14	8	10	14			
AC 480/500 V		18	35	50	65	25	45	50	65	45	50	65			
AC 440/460 V		38	50	70	85	38	50	70	85	50	70	85			
AC 380/415V		45	65	85	100	45	65	85	100	65	85	100			
AC 220/240 V		50	75	100	125	50	75	100	125	75	100	125			
DC 250 V (2P)		20	25	40	40	20	25	40	40	25	40	40			
Service Breaking Capacity [Ics = % Icu]		100	100	100	100	100	100	100	100	100	100	100			
Endurance [times] (Durability)															
Mechanical		4,000				2,500				2,500					
Electrical (at 460 V)		1,000				500				500					
Trip Device															
Thermal Magnetic	Long Time [LT]	Fixed	(1.0) × In				(1.0) × In				(1.0) × In				
		Adjustable	(0.63 - 0.8 - 1.0) × In				(0.63 - 0.8 - 1.0) × In				(0.63 - 0.8 - 1.0) × In				
	Instantaneous [INST]	10 × In				10 × In				10 × In					
Accessory															
Internal	Auxiliary Switch	AUX	●				●				●				
	Alarm Switch	ALT	●				●				●				
	Shunt Trip	SHT	●				●				●				
	Under-Voltage Trip	UVT	●				●				●				
External	Rotary Handle	Front Contact	●				●				●				
		Extended	●				●				●				
	Mechanical Open/Close Device		MOT	●				●				●			
	Mechanical Interlock		MIF	●				●				●			
	Handle Locking Device		PLD	●				●				●			
	Plug-in	TDM (LINE/LOAD)		● (3P Only)				● (3P Only)				● (3P Only)			
		TDM (LINE Only)		● (3P Only)				● (3P Only)				● (3P Only)			
		TDF (LINE Only)		-				-				-			
		TDA (1 row)		-				-				-			
		TDA (2 rows)		-				-				-			
Cage Terminal Block		CTB	●				●				●				
Terminal Cover		TCF	●				●				●				
Insulation Barrier		TQQ	●				●				●				
Terminal Bus Bar		TBB	●				●				●				
Installation and Dimensions															
Connection/ Installation	Front Connection	Terminal Screw				Terminal Screw, Terminal Bus Bar									
	Rear Connection	Horizontal/Vertical Cable				Horizontal/Vertical Cable									
	Plug-in	Switchgear (Line & Load, Line Only)				Switchgear (Line & Load, Line Only)									
Dimension (mm)		a (2/3/4P)	140/140/184				210/210/280				210/210/280				
		b	257				280				280				
		c	110				110				110				
Weight (kg)	2/3/4P	4/4.5/5.4				8.7/9.5/12.5				8.7/9.5/12.5					
Detailed Rating and Selection		228 Page				228 Page				228 Page					
Characteristic Curve and Appearance		61 / 161 Page				62 / 162 Page				62 / 162 Page					

※ 1) 4 Pole Arrangement : Basic specification of R-S-T-N (N-R-S-T is optional).

2) As for 2P products, only the neutral pole in the 3P product has been eliminated so the dimension is equivalent to the 3P product.

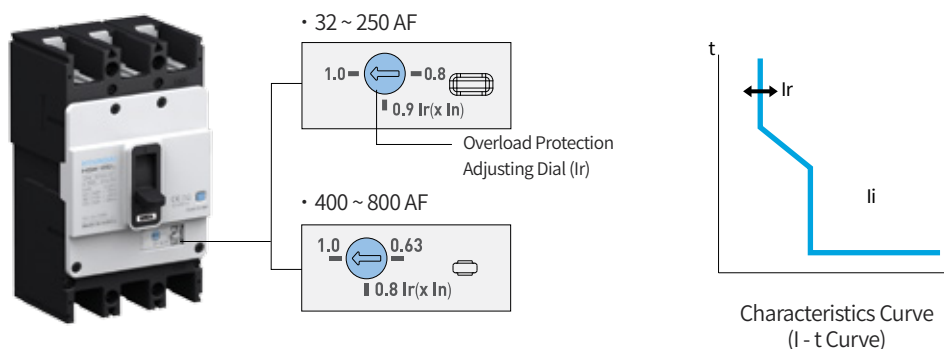

### Trip Unit Characteristics – Thermal Magnetic

Rated Current (A) In		16	20	25	32	40	50	63	75	80	100	125
MCCB	HGM30	●	●	●	●							
	HGM50	●	●	●	●	●	●					
	HGM60	●	●	●	●	●	●	●				
	HGM100	●	●	●	●	●	●	●	●	●	●	
	HGM125	●	●	●	●	●	●	●	●	●	●	●
Moment Characteristics Ir												
Setting Value (A)	Fixed	16	20	25	32	40	50	63	75	80	100	125
	0.8×In	12.8	16	20	25.6	32	40	50.4	60	64	80	100
	0.9×In	14.4	18	22.5	28.8	36	45	56.7	67.5	72	90	112.5
	1.0×In	16	20	25	32	40	50	63	75	80	100	125
Instantaneous Characteristics li												
Setting Value (A)	10×In			400		400	500	630	750	800	1,000	1,250
	Max. Non-Tripping Current (A)			320		320	400	504	600	640	800	1,000
	Min. Tripping Current (A)			480		480	600	756	900	960	1,200	1,500
Neutral Pole Protection												
4P3D	Unprotected											
4P4D	-											

Rated Current (A) In		100	125	150	160	175	200	225	250	300	350	400	500	630	700	800
MCCB	HGM160	●	●	●	●											
	HGM250	●	●	●	●	●	●	●	●							
	HGM400								●	●	●	●				
	HGM630												●	●		
	HGM800														●	●
Moment Characteristics Ir																
Setting Value (A)	Fixed	100	125	150	160	175	200	225	250	300	350	400	500	630	700	800
	0.63×In									189	221	252	315	397	441	504
	0.8×In	80	100	120	128	140	160	180	200	240	280	320	400	504	560	640
	0.9×In	90	112.5	135	144	157.5	180	202.5	225							
	1.0×In	100	125	150	160	175	200	225	250							
10×In								250	300	350	400	500	630	700	800	
Instantaneous Characteristics li																
Setting Value (A)	10×In	1,000	1,250	1,500	1,600	1,750	2,000	2,250	2,500	3,000	3,500	4,000	5,000	6,300	7,000	8,000
	Max. Non-Tripping Current (A)	800	1,000	1,200	1,280	1,400	1,600	1,800	2,000	2,400	2,800	3,200	4,000	5,040	5,600	6,400
	Min. Tripping Current (A)	1,200	1,500	1,800	1,920	2,100	2,400	2,700	3,000	3,600	4,200	4,800	6,000	7,560	8,400	9,600
Neutral Pole Protection																
4P3D	Unprotected															
4P4D	-															

## Model Selection Table

### Switch - Disconnecter (HGM NA Type) : 50 ~ 800 AF

Switch - disconnecter is a switch for disconnection without protective function and as the appearance is equivalent to the circuit breaker, all accessories of the circuit breaker can be shared.

#### Common Ratings

Rated Insulation Voltage, Ui	1,000 V	Suitability for Isolation	Yes
Rated Operational Voltage, Ue	690 V	Utilization Category	AC 22 A/AC 23 A - DC 22 A/DC 23 A
Rated Impulse Withstand Voltage, Uimp	8 kV	Pollution Degree	3
		Reference Standard	IEC 60947-3

Model Name		HGM50NA	HGM100NA	HGM125NA	HGM160NA		
Frame	(AF)	50	100	125	160		
Number of Poles	(P)	3, 4 <sup>1)</sup>	3, 4 <sup>1)</sup>	3, 4 <sup>1)</sup>	3, 4 <sup>1)</sup>		
Conventional Free Air Thermal Current, Ith at 60 °C	(A)	50	100	125	160		
<b>Rated Operational Current [Ie]</b>							
AC 440/480 V (50/60 Hz)		50	100	125	160		
DC 250 V (1 Pole Connection)		50	100	125	160		
DC 250 V (2 Pole Connection)		50	100	125	160		
Rated Short Circuit Making Current [Icm] (kA Peak @ AC 460)		0.8	1.7	2.1	2.7		
Rated Short Time Withstand Current [Icw] (kA rms)		1	1	1	2		
<b>Endurance [times] (Durability)</b>							
Mechanical		30,000	30,000	30,000	25,000		
In @ 440 V		10,000	10,000	10,000	10,000		
<b>Accessory</b>							
Internal	Auxiliary Switch	AUX	●	●	●	●	
	Alarm Switch	ALT	●	●	●	●	
	Shunt Trip	SHT	●	●	●	●	
	Under-Voltage Trip	UVT	●	●	●	●	
External	Rotary Handle	Front Contact	TFG	●	●	●	●
		Extended	TFH	●	●	●	●
	Mechanical Open/Close Device		MOT	●	●	●	●
	Mechanical Interlock		MIF	●	●	●	●
	Handle Locking Device		PLD	●	●	●	●
	Plug-in	TDM (LINE/LOAD)		● (3P Only)	● (3P Only)	● (3P Only)	● (3P Only)
		TDM (LINE Only)		● (3P Only)	● (3P Only)	● (3P Only)	● (3P Only)
		TDF (LINE Only)		● (3P Only)	● (3P Only)	● (3P Only)	-
TDA (1 row)		● (3P Only)	● (3P Only)	● (3P Only)	-		
TDA (2 rows)		● (3P Only)	● (3P Only)	● (3P Only)	-		
Cage Terminal Block		CTB	●	●	●	●	
Terminal Cover		TCF	●	●	●	●	
Insulation Barrier		TQQ	●	●	●	●	
Terminal Bus Bar		TBB	-	-	-	●	
<b>Installation and Dimensions</b>							
Connection/ Installation		Front Connection	Terminal Screw		Terminal Screw, Terminal Bus Bar		
		Rear Connection	Horizontal/Vertical		Horizontal/Vertical		
		Plug-in	Switchgear (Line & Load, Line Only), Distribution Panel		Switchgear (Line & Load, Line Only)		
		DIN Rail Installation	Possible if DIN Rail adaptor is be used		-	-	
Dimension (mm)	a (3/4P)	75/100	75/100	90/120	105/140		
	b	130	130	155	165		
	c	68	68	68	68		
Weight (kg)	3/4P	0.8/1.0	0.8/1.0	1.0/1.3	1.3/1.7		
Detailed Rating and Selection		228 Page	228 Page	228 Page	228 Page		
Characteristic Curve and Appearance		158 Page	158 Page	159 Page	160 Page		

※ 1) 4 Pole Arrangement : Basic specification of R-S-T-N (N-R-S-T is optional.)

### Applicable Field of Switch – Disconnectors

- Bus bar connection and disconnection
- Disconnection of switchgear and control panel
- Switch for emergency power switchover (ATS)

HGM250NA	HGM400NA	HGM630NA	HGM800NA
250	400	630	800
3, 4 <sup>1)</sup>	3, 4 <sup>1)</sup>	3, 4 <sup>1)</sup>	3, 4 <sup>1)</sup>
250	400	630	800
250	400	630	800
250	400	630	800
250	400	630	800
4.2	6.8	10.7	13.6
2	1	2	2
25,000	4,000	2,500	2,500
10,000	1,000	500	500
●	●	●	●
●	●	●	●
●	●	●	●
●	●	●	●
●	●	●	●
●	●	●	●
●	●	●	●
●	●	●	●
●	●	●	●
● (3P Only)	● (3P Only)	● (3P Only)	● (3P Only)
● (3P Only)	● (3P Only)	● (3P Only)	● (3P Only)
● (3P Only)	-	-	-
-	-	-	-
-	-	-	-
●	●	●	●
●	●	●	●
●	●	●	●
●	●	●	●
Terminal Screw, Terminal Bus Bar	Terminal Screw	Terminal Screw, Terminal Bus Bar	Terminal Screw, Terminal Bus Bar
Horizontal/Vertical	Horizontal/Vertical Cable	Horizontal/Vertical Cable	Horizontal/Vertical Cable
Switchgear (Line & Load, Line Only)	Switchgear (Line & Load, Line Only)	Switchgear (Line & Load, Line Only)	Switchgear (Line & Load, Line Only)
-	-	-	-
105/140	140/184	210/280	210/280
165	257	280	280
68	110	110	110
1.3/1.7	4.5/5.4	9.5/12.5	9.5/12.5
228 Page	228 Page	228 Page	228 Page
160 Page	161 Page	162 Page	162 Page

# Model Selection Table

## Motor Protection Circuit Breakers (HGM MO Type) : 50 ~ 250 AF

### Common Ratings

Rated Insulation Voltage, Ui	1,000 V	Suitability for Isolation	Yes
Rated Operational Voltage, Ue	690 V	Utilization Category	A
Rated Impulse Withstand Voltage, Uimp	8 kV	Pollution Degree	3
Protection Function	Instantaneous, Short-Circuit Protection	Reference Standard	IEC 60947-2

Model Name		HGM50				HGM60				
Frame	(AF)	50				63				
Number of Poles	(P)	3				3				
Rated Current, at 40 °C	(A)	40, 50				40, 50, 63				
<b>Rated Ultimate Short-Circuit Breaking Capacity [Icu] (kA rms)</b>										
Short-Circuit Breaking Category Code		E	S	H	L	E	S	H	L	
AC 660/690 V		2.5	5	8	10	2.5	5	7.5	8	
AC 480/500 V		7.5	10	26	35	7.5	10	14	26	
AC 440/460 V		16	20	38	55	16	20	26	30	
AC 380/415 V		16	20	38	55	16	20	26	30	
AC 220/240 V		35	50	85	100	35	50	50	50	
DC 250 V (2P)		5	10	20	30	5	10	15	15	
Service Breaking Capacity [Ics = % Icu]		100	100	100	100	100	100	75	50	
<b>Endurance [times] (Durability)</b>										
Mechanical		30,000				30,000				
Electrical (at 460 V)		10,000				10,000				
<b>Trip Device</b>										
Magnetic	Instantaneous [INST]	10×In				10×In				
<b>Accessory</b>										
Internal	Auxiliary Switch	AUX	●				●			
	Alarm Switch	ALT	●				●			
	Shunt Trip	SHT	●				●			
	Under-Voltage Trip	UVT	●				●			
Rotary Handle	Front Contact	TFG	●				●			
	Extended	TFH	●				●			
Mechanical Open/Close Device		MOT	●				●			
Mechanical Interlock		MIF	●				●			
Handle Locking Device		PLD	●				●			
External	Plug-in	TDM (LINE/LOAD)	● (3P Only)		● (3P Only)		● (3P Only)		● (3P Only)	
		TDM (LINE Only)	● (3P Only)		● (3P Only)		● (3P Only)		● (3P Only)	
		TDF (LINE Only)	● (3P Only)		● (3P Only)		● (3P Only)		● (3P Only)	
		TDA (1 row)	● (3P Only)		● (3P Only)		● (3P Only)		● (3P Only)	
		TDA (2 rows)	● (2, 3P Only)		● (3P Only)		● (3P Only)		● (2, 3P Only)	
Cage Terminal Block		CTB	●				●			
Terminal Cover		TCF	●				●			
Insulation Barrier		TQQ	●				●			
Terminal Bus Bar		TBB	-				-			
<b>Installation and Dimensions</b>										
Connection/Installation	Front Connection	Terminal Screw				Terminal Screw				
	Rear Connection	Horizontal/Vertical				Horizontal/Vertical				
	Plug-in	Switchgear (Line & Load, Line Only), Distribution Panel								
	DIN Rail Installation	Possible if DIN Rail adaptor is be used		-		Possible if DIN Rail adaptor is be used				
Dimension (mm)		a	75		90		75			
		b	130		155		130			
		c	68		68		68			
Weight (kg)	3P	0.8		1.0		0.8				
Detailed Rating and Selection		228 Page				228 Page				
Characteristic Curve and Appearance		59 / 158 Page				59 / 158 Page				



HGM100				HGM125				HGM160				HGM250			
100				125				160				250			
3				3				3				3			
40, 50, 63, 75, 80, 100				40, 50, 63, 75, 80, 100, 125				100, 125, 150, 160				100, 125, 150, 160, 175, 200, 225, 250			
E	S	H	L	E	S	H	L	E	S	H	L	E	S	H	L
2.5	5	7.5	8	5	7.5	8	10	7.5	8	8	10	7.5	8	8	10
7.5	10	14	26	10	14	26	35	14	20	26	35	14	20	26	35
16	20	26	30	20	26	38	55	20	26	38	55	20	26	38	55
16	20	26	30	20	26	38	55	20	26	38	55	20	26	38	55
35	50	50	50	50	65	85	100	50	65	85	100	50	65	85	100
5	10	15	15	10	15	20	30	10	15	20	30	10	15	20	30
100	100	75	50	100	100	100	100	100	100	100	100	100	100	100	100
30,000				30,000				25,000				25,000			
10,000				10,000				10,000				10,000			
10×In				10×In				10×In				10×In			
●				●				●				●			
●				●				●				●			
●				●				●				●			
●				●				●				●			
●				●				●				●			
●				●				●				●			
●				●				●				●			
●				●				●				●			
● (3P Only)				● (3P Only)				● (3P Only)				● (3P Only)			
● (3P Only)				● (3P Only)				● (3P Only)				● (3P Only)			
● (3P Only)				● (3P Only)				-				-			
● (3P Only)				● (3P Only)				-				-			
● (2, 3P Only)				● (3P Only)				-				-			
●				●				●				●			
●				●				●				●			
●				●				●				●			
-				-				●				●			
Terminal Screw Horizontal/Vertical								Terminal Screw, Terminal Bus Bar Horizontal/Vertical							
Switchgear (Line & Load, Line Only), Distribution Panel								Switchgear (Line & Load, Line Only)							
Possible if DIN Rail adaptor is be used				-				-				-			
75				90				105				105			
130				155				165				165			
68				68				68				68			
0.8				1.0				1.3				1.3			
228 Page				228 Page				228 Page				228 Page			
59 / 158 Page				60 / 159 Page				61 / 160 Page				61 / 160 Page			

# Model Selection Table

## Motor Protection Circuit Breakers (HGM MO Type) : 400 ~ 800 AF

### Common Ratings

Rated Insulation Voltage, Ui	1,000 V	Suitability for Isolation	Yes
Rated Operational Voltage, Ue	690 V	Utilization Category	A
Rated Impulse Withstand Voltage, Uimp	8 kV	Pollution Degree	3
Protection Function	Instantaneous, Short-Circuit Protection	Reference Standard	IEC 60947-2

Model Name		HGM400				HGM630				HGM800			
Frame	(AF)	400				630				800			
Number of Poles	(P)	3				3				3			
Rated Current, at 40 °C	(A)	250, 300, 350, 400				500, 630				700, 800			
Rated Ultimate Short-Circuit Breaking Capacity [Icu] (kA rms)													
Short-Circuit Breaking Category Code		E	S	H	L	E	S	H	L	S	H	L	
AC 660/690 V		5	8	10	14	5	8	10	14	8	10	14	
AC 480/500 V		18	35	50	65	25	45	50	65	45	50	65	
AC 440/460 V		38	50	70	85	38	50	70	85	50	70	85	
AC 380/415 V		45	65	85	100	45	65	85	100	65	85	100	
AC 220/240 V		50	75	100	125	50	75	100	125	75	100	125	
DC 250 V (2P)		20	25	40	40	20	25	40	40	25	40	40	
Service Breaking Capacity [Ics = % Icu]		100	100	100	100	100	100	100	100	100	100	100	
Endurance [times] (Durability)													
Mechanical		4,000				2,500				2,500			
Electrical (at 460 V)		1,000				500				500			
Trip Device													
Magnetic	Instantaneous [INST]	10×In				10×In				10×In			
Accessory													
Internal	Auxiliary Switch	AUX	●			●				●			
	Alarm Switch	ALT	●			●				●			
	Shunt Trip	SHT	●			●				●			
	Under-Voltage Trip	UVT	●			●				●			
External	Rotary Handle	Front Contact	TFG	●		●				●			
		Extended	TFH	●		●				●			
	Mechanical Open/Close Device		MOT	●			●				●		
	Mechanical Interlock		MIF	●			●				●		
	Handle Locking Device		PLD	●			●				●		
	Plug-in	TDM (LINE/LOAD)			● (3P Only)		● (3P Only)				● (3P Only)		
		TDM (LINE Only)			● (3P Only)		● (3P Only)				● (3P Only)		
		TDF (LINE Only)			-		-				-		
TDA (1 row)			-		-				-				
TDA (2 rows)			-		-				-				
Cage Terminal Block		CTB	●			●				●			
Terminal Cover		TCF	●			●				●			
Insulation Barrier		TQQ	●			●				●			
Terminal Bus Bar		TBB	●			●				●			
Installation and Dimensions													
Connection/ Installation	Front Connection	Terminal Screw				Terminal Screw, Terminal Bus Bar							
	Rear Connection	Horizontal/Vertical Cable				Horizontal/Vertical Cable							
	Plug-in	Switchgear (Line & Load, Line Only)				Switchgear (Line & Load, Line Only)							
Dimension (mm)	a (3P)	140				210		210					
	b	257				280		280					
	c	110				110		110					
	3P	4.5				9.5		9.5					
Detailed Rating and Selection		228 Page				228 Page				228 Page			
Characteristic Curve and Appearance		61 / 161 Page				62 / 162 Page				62 / 162 Page			



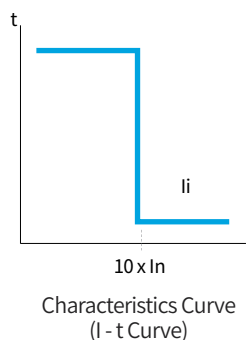

### Trip Unit Characteristics - Thermal Magnetic

Rated Current (A) In		40	50	63	75	80	100	125
MCCB	HGM50	●	●					
	HGM60	●	●	●				
	HGM100	●	●	●	●	●	●	
	HGM125	●	●	●	●	●	●	●
Instantaneous Characteristics li								
Setting Value (A)	10× In	400	500	630	750	800	1,000	1,250
	Max. Non-Tripping Current (A)	320	400	504	600	640	800	1,000
	Min. Tripping Current (A)	480	600	756	900	960	1,200	1,500

Rated Current (A) In		100	125	150	160	175	200	225	250	300	350	400	500	630	700	800
MCCB	HGM160	●	●	●	●											
	HGM250	●	●	●	●	●	●	●								
	HGM400								●	●	●	●				
	HGM630												●	●		
	HGM800														●	●
Instantaneous Characteristics li																
Setting Value (A)	10× In	1,000	1,250	1,500	1,600	1,750	2,000	2,250	2,500	3,000	3,500	4,000	5,000	6,300	7,000	8,000
	Max. Non-Tripping Current (A)	800	1,000	1,200	1,280	1,400	1,600	1,800	2,000	2,400	2,800	3,200	4,000	5,040	5,600	6,400
	Min. Tripping Current (A)	1,200	1,500	1,800	1,920	2,100	2,400	2,700	3,000	3,600	4,200	4,800	6,000	7,560	8,400	9,600

## Model Selection Table

### ZCT Embedded Molded Case Circuit Breaker (HGM Type) : 32 ~ 250 AF

As a model with a built-in ZCT in MCCB, it is a device that detects grounding when connected to an external ELR (Earth Leakage Relay) that can enhance reliability.

#### Common Ratings

Rated Insulation Voltage, Ui	1,000 V	Suitability for Isolation	Yes
Rated Operational Voltage, Ue	690 V	Utilization Category	A
Rated Impulse Withstand Voltage, Uimp	8 kV	Pollution Degree	3
Protection Function	Overload, Instantaneous, Short-Circuit Protection	Reference Standard	IEC 60947-2

Model Name		HGM30	HGM50				HGM60					
Frame	(AF)	32	50				63					
Number of Poles	(P)	2 <sup>2)</sup> , 3, 4 <sup>1)</sup>	2 <sup>2)</sup> , 3, 4 <sup>1)</sup>				2 <sup>2)</sup> , 3, 4 <sup>1)</sup>					
Rated Current, at 40°C	(A)	16, 20, 25, 32	16, 20, 25, 32, 40, 50				16, 20, 25, 32, 40, 50, 63					
Rated Ultimate Short-Circuit Breaking Capacity [Icu] (kA rms)												
Short-Circuit Breaking Category Code		E	S	E	S	H	L	E	S	H	L	
AC 660/690 V		2.5	5	2.5	5	8	10	2.5	5	7.5	8	
AC 480/500 V		7.5	10	7.5	10	26	35	7.5	10	14	26	
AC 440/460 V		16	20	16	20	38	55	16	20	26	30	
AC 380/415 V		16	20	16	20	38	55	16	20	26	30	
AC 220/240 V		35	50	35	50	85	100	35	50	50	50	
Service Breaking Capacity [Ics = % Icu]		100	100	100	100	100	100	100	100	75	50	
Endurance [times] (Durability)												
Mechanical		30,000		30,000				30,000				
Electrical (at 460 V)		10,000		10,000				10,000				
ZCT Output Characteristics		200 mA/100 mV		200 mA/100 mV				200 mA/100 mV				
Trip Device												
Thermal Magnetic	Long Time [LT]	(1.0) × In		(1.0) × In				(1.0) × In				
	Instantaneous [INST]	400 A		16 ~ 32 A : 400 A, 40 ~ 50 A : 10 × In				16 ~ 32 A : 400 A, 40 ~ 63 A : 10 × In				
Accessory												
Internal	Auxiliary Switch	AUX	●	●				●				
	Alarm Switch	ALT	●	●				●				
	Shunt Trip	SHT	●	●				●				
	Under-Voltage Trip	UVT	●	●				●				
External	Rotary Handle	Front Contact	TFG	●	●				●			
		Extended	TFH	●	●				●			
	Mechanical Open/Close Device		MOT	●	●				●			
	Mechanical Interlock		MIF	●	●				●			
	Handle Locking Device		PLD	●	●				●			
	Plug-in	TDM (LINE/LOAD)		● (3P Only)	● (3P Only)	● (3P Only)	● (3P Only)	● (3P Only)	● (3P Only)	● (3P Only)	● (3P Only)	● (3P Only)
		TDM (LINE Only)		● (3P Only)	● (3P Only)	● (3P Only)	● (3P Only)	● (3P Only)	● (3P Only)	● (3P Only)	● (3P Only)	● (3P Only)
		TDF (LINE Only)		● (3P Only)	● (3P Only)	● (3P Only)	● (3P Only)	● (3P Only)	● (3P Only)	● (3P Only)	● (3P Only)	● (3P Only)
		TDA (1 row)		● (3P Only)	● (3P Only)	● (3P Only)	● (3P Only)	● (3P Only)	● (3P Only)	● (3P Only)	● (3P Only)	● (3P Only)
		TDA (2 rows)		● (2, 3P Only)	● (2, 3P Only)	● (3P Only)	● (3P Only)	● (3P Only)	● (3P Only)	● (2, 3P Only)	● (2, 3P Only)	● (2, 3P Only)
Cage Terminal Block		CTB	●	●				●				
Terminal Cover		TCF	●	●				●				
Insulation Barrier		TQQ	●	●				●				
Terminal Bus Bar		TBB	-	-				-				
Installation and Dimensions												
Connection/ Installation	Front Connection	Terminal Screw										
	Rear Connection	Horizontal/Vertical										
	Plug-in	Switchgear (Line & Load, Line Only), Distribution Panel										
Dimension (mm)	DIN Rail Installation	Possible if DIN Rail adaptor is be used		-	Possible if DIN Rail adaptor is be used							
	a (2/3/4P)	75/75/100	75/75/100	90/90/120	75/75/100							
	b	130	130	155	130							
	c	68	68	68	68							
Weight (kg)	2/3/4P	0.7/0.8/1.0	0.7/0.8/1.0	0.9/1.0/1.3	0.7/0.8/1.0							
Detailed Rating and Selection		228 Page		228 Page								
Characteristic Curve and Appearance		59 / 158 Page		59 / 158 Page								

※ 1) 4 Pole Arrangement : Basic specification of R-S-T-N

2) As for 2P products, only the neutral pole in the 3P product has been eliminated so the dimension is equivalent to the 3P product.

HGM100				HGM125				HGM160				HGM250			
100				125				160				250			
2 <sup>2)</sup> , 3, 4 <sup>1)</sup>				2 <sup>2)</sup> , 3, 4 <sup>1)</sup>				2 <sup>2)</sup> , 3, 4 <sup>1)</sup>				2 <sup>2)</sup> , 3, 4 <sup>1)</sup>			
16, 20, 25, 32, 40, 50, 63, 75, 80, 100				16, 20, 25, 32, 40, 50, 63, 75, 80, 100, 125				100, 125, 150, 160				100, 125, 150, 160, 175, 200, 225, 250			
E	S	H	L	E	S	H	L	E	S	H	L	E	S	H	L
2.5	5	7.5	8	5	7.5	8	10	7.5	8	8	10	7.5	8	8	10
7.5	10	14	26	10	14	26	35	14	20	26	35	14	20	26	35
16	20	26	30	20	26	38	55	20	26	38	55	20	26	38	55
16	20	26	30	20	26	38	55	20	26	38	55	20	26	38	55
35	50	50	50	50	65	85	100	50	65	85	100	50	65	85	100
100	100	75	50	100	100	100	100	100	100	100	100	100	100	100	100
30,000				30,000				25,000				25,000			
10,000				10,000				10,000				10,000			
200 mA/100 mV				200 mA/100 mV				200 mA/100 mV				200 mA/100 mV			
(1.0)×In				(1.0)×In				(1.0)×In				(1.0)×In			
16 ~ 32 A : 400 A, 40 ~ 100 A : 10×In				16 ~ 32 A : 400 A, 40 ~ 125 A : 10×In				10×In				10×In			
●				●				●				●			
●				●				●				●			
●				●				●				●			
●				●				●				●			
●				●				●				●			
●				●				●				●			
●				●				●				●			
●				●				●				●			
● (3P Only)				● (3P Only)				● (3P Only)				● (3P Only)			
● (3P Only)				● (3P Only)				● (3P Only)				● (3P Only)			
● (3P Only)				● (3P Only)				-				-			
● (3P Only)				● (3P Only)				-				-			
● (2, 3P Only)				● (3P Only)				-				-			
●				●				●				●			
●				●				●				●			
●				●				●				●			
-				-				●				●			
Terminal Screw Horizontal/Vertical								Terminal Screw, Terminal Bus Bar Horizontal/Vertical							
Switchgear (Line & Load, Line Only), Distribution Panel								Switchgear (Line & Load, Line Only)							
Possible if DIN Rail adaptor is be used								-							
75/75/100				90/90/120				105/105/140				105/105/140			
130				155				165				165			
68				68				68				68			
0.7/0.8/1.0				0.9/1.0/1.3				1.1/1.3/1.7				1.1/1.3/1.7			
228 Page				228 Page				228 Page				228 Page			
59 / 158 Page				60 / 159 Page				61 / 160 Page				61 / 160 Page			

# Model Selection Table

## ZCT Embedded Molded Case Circuit Breaker (HGM Type) : 400 ~ 800 AF

### Common Ratings

Rated Operational Voltage, Ue	AC 220/460 V	Suitability for Isolation	Yes
Usable Voltage Range	AC 187 ~ 506 V	Utilization Category	A
Rated Impulse Withstand Voltage, Uimp	6 kV	Pollution Degree	3
Protection Function	Current Leakage, Overload, Instantaneous, Short-Circuit Protection	Reference Standard	IEC 60947-2

Model Name		HGM400	HGM630	HGM800	
Frame (AF)		400	630	800	
Number of Poles (P)		2 <sup>2)</sup> , 3, 4 <sup>1)</sup>	2 <sup>2)</sup> , 3	2 <sup>2)</sup> , 3	
Rated Current, at 40 °C (A)		250, 300, 350, 400	500, 630	700, 800	
<b>Rated Ultimate Short-Circuit Breaking Capacity [Icu] (kA rms)</b>					
Short-Circuit Breaking Category Code		E S H L	E S H L	E S H L	
AC 660/690 V		5 8 10 14	5 8 10 14	5 8 10 14	
AC 480/500 V		18 35 50 65	25 45 50 65	45 50 65 65	
AC 440/460 V		38 50 70 85	38 50 70 85	50 70 85 85	
AC 380/415 V		45 65 85 100	45 65 85 100	65 85 100 100	
AC 220/240 V		50 75 100 125	50 75 100 125	75 100 125 125	
Service Breaking Capacity [Ics = % Icu]		100 100 100 100	100 100 100 100	100 100 100 100	
<b>Endurance [times] (Durability)</b>					
Mechanical		4,000	2,500	2,500	
Electrical (at 460 V)		1,000	500	500	
ZCT Output Characteristics		200 mA/100 mV	200 mA/100 mV	200 mA/100 mV	
<b>Trip Device</b>					
Thermal	Long time [LT]	(1.0)×In	(1.0)×In	(1.0)×In	
Magnetic	Instantaneous [INST]	10×In	10×In	10×In	
<b>Accessory</b>					
Internal	Auxiliary Switch	AUX	●	●	
	Alarm Switch	ALT	●	●	
	Shunt Trip	SHT	●	●	
	Under-Voltage Trip	UVT	●	●	
External	Rotary Handle	Front Contact	TFG	●	
		Extended	TFH	●	
	Mechanical Open/Close Device	MOT	●		
	Mechanical Interlock	MIF	●		
	Handle Locking Device	PLD	●		
	Plug-in	TDM (LINE/LOAD)	● (3P Only)	● (3P Only)	● (3P Only)
		TDM (LINE Only)	● (3P Only)	● (3P Only)	● (3P Only)
		TDF (LINE Only)	-	-	-
TDA (1 row)		-	-	-	
TDA (2 rows)		-	-	-	
Cage Terminal Block	CTB	●	●		
Terminal Cover	TCF	●	●		
Insulation Barrier	TQQ	●	●		
Terminal Bus Bar	TBB	●	●		
<b>Installation and Dimensions</b>					
Connection/ Installation	Front Connection	Terminal Screw	Terminal Screw, Terminal Bus Bar		
	Rear Connection	Horizontal/Vertical Cable	Horizontal/Vertical Cable		
	Plug-in	Switchgear (Line & Load, Line Only)	Switchgear (Line & Load, Line Only)		
Dimension (mm)	a (2/3/4P)	140/140/184	210/210	210/210	
	b	257	280	280	
	c	110	110	110	
Weight (kg)	2/3/4P	4/4.5/5.4	8.7/9.5	8.7/9.5	
Detailed Rating and Selection		228 Page	228 Page	228 Page	
Characteristic Curve and Appearance		61 / 161 Page	62 / 162 Page	62 / 162 Page	

※ 1) 4 Pole Arrangement : Basic specification of R-S-T-N

2) As for 2P products, only the neutral pole in the 3P product has been eliminated so the dimension is equivalent to the 3P product.

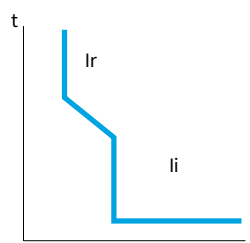

Characteristic Curve (I - t Curve)

### Trip Unit Characteristics - Thermal Magnetic

Rated Current (A) In		16	20	25	32	40	50	63	75	80	100	125							
MCCB	HGM30	●	●	●	●														
	HGM50	●	●	●	●	●	●												
	HGM60	●	●	●	●	●	●	●											
	HGM100	●	●	●	●	●	●	●	●	●	●								
	HGM125	●	●	●	●	●	●	●	●	●	●	●							
Moment Characteristics I <sub>r</sub>																			
Setting Value (A)	1.0 × I <sub>n</sub>	16	20	25	32	40	50	63	75	80	100	125							
Instantaneous Characteristics I <sub>i</sub>																			
Setting Value (A)	10 × I <sub>n</sub>		400		400		400		500		630		750		800		1,000		1,250
	Max. Non-Tripping Current (A)		320		320		320		400		504		600		640		800		1,000
	Min. Operational Current (A)		480		480		480		600		756		900		960		1,200		1,500
Neutral Pole Protection																			
4P3D		Unprotected																	
4P4D		-																	

Rated Current (A) In		100	125	150	160	175	200	225	250	300	350	400	500	630	700	800
MCCB	HGM160	●	●	●	●											
	HGM250	●	●	●	●	●	●	●								
	HGM400								●	●	●	●				
	HGM630												●	●		
	HGM800															●
Moment Characteristics I <sub>r</sub>																
Setting Value (A)	1.0 × I <sub>n</sub>	100	125	150	160	175	200	225	250	300	350	400	500	630	700	800
Instantaneous Characteristics I <sub>i</sub>																
Setting Value (A)	10 × I <sub>n</sub>	1,000	1,250	1,500	1,600	1,750	2,000	2,250	2,500	3,000	3,500	4,000	5,000	6,300	7,000	8,000
	Max. Non-Tripping Current (A)	800	1,000	1,200	1,280	1,400	1,600	1,800	2,000	2,400	2,800	3,200	4,000	5,040	5,600	6,400
	Min. Operational Current (A)	1,200	1,500	1,800	1,920	2,100	2,400	2,700	3,000	3,600	4,200	4,800	6,000	7,560	8,400	9,600
Neutral Pole Protection																
4P3D		Unprotected														
4P4D		-														

# Model Selection Table

## Earth Leakage Circuit Breaker (HGE Type) : 32 ~ 250 AF

### Common Ratings

Rated Operational Voltage, Ue	AC 220/460 V	Suitability for Isolation	Yes
Usable Voltage Range	AC 187 ~ 506 V	Utilization Category	A
Rated Impulse Withstand Voltage, Uimp	6 kV	Pollution Degree	3
Protection Function	Earth Leakage, Overload, Instantaneous, Short-Circuit Protection	Reference Standard	IEC 60947-2

Model Name		HGE30	HGE50	HGE60	
Frame	(AF)	32	50	63	
Number of Poles	(P)	2 <sup>2)</sup> , 3, 4 <sup>1)</sup>	2 <sup>2)</sup> , 3, 4 <sup>1)</sup>	2 <sup>2)</sup> , 3, 4 <sup>1)</sup>	
Rated Current, at 40 °C	(A)	16, 20, 25, 32	16, 20, 25, 32, 40, 50	16, 20, 25, 32, 40, 50, 63	
<b>High Speed Type</b>					
Adjustable Residual Current	(mA)	30	30	30	
Max. Operational Time	(s)	0.1	0.1	0.1	
<b>Time Delay Type</b>					
Adjustable Residual Current	(mA)	100 - 300 - 500 - 1,000 Adjustable	100 - 300 - 500 - 1,000 Adjustable	100 - 300 - 500 - 1,000 Adjustable	
Maximum Operational Time	(s)	0.1 - 0.4 - 1.0 - 2.0	0.1 - 0.4 - 1.0 - 2.0	0.1 - 0.4 - 1.0 - 2.0	
Inertial Delay Time	(ms)	0 - 200 - 500 - 1,000 Adjustable	0 - 200 - 500 - 1,000 Adjustable	0 - 200 - 500 - 1,000 Adjustable	
<b>Rated Ultimate Short-Circuit Breaking Capacity [Icu] (kA rms)</b>					
Short-Circuit Breaking Category Code		E S	E S H L	E S H L	
AC 440/460 V		16 20	16 20 38 55	16 20 26 30	
AC 380/415 V		16 20	16 20 38 55	16 20 26 30	
AC 220/240 V		35 50	35 50 85 100	35 50 50 50	
Service Breaking Capacity [Ics = % Icu]		100 100	100 100 100 100	100 100 75 50	
<b>Endurance [times] (Durability)</b>					
Mechanical		30,000	30,000	30,000	
Electrical (at 460 V)		10,000	10,000	10,000	
<b>Trip Device</b>					
Thermal	Long Time [LT]	(1.0) × In	(1.0) × In	(1.0) × In	
Magnetic	Instantaneous [INST]	400 A	16 ~ 32 A : 400 A, 40, 50 A : 10 × In	16 ~ 32 A : 400 A, 40 ~ 63 A : 10 × In	
<b>Accessory</b>					
Internal	Auxiliary Switch	AUX	●	●	
	Alarm Switch	ALT	●	●	
	Shunt Trip	SHT	-	-	
	Under-Voltage Trip	UVT	-	-	
External	Rotary Handle	Front Contact	TFG	●	
		Extended	TFH	●	
	Mechanical Open/Close Device	MOT	●		
	Mechanical Interlock	MIF	●		
	Handle Locking Device	PLD	●		
	Plug-in	TDM (LINE/LOAD)	● (3P Only)	● (3P Only)	● (3P Only)
		TDM (LINE Only)	● (3P Only)	● (3P Only)	● (3P Only)
		TDF (LINE Only)	● (3P Only)	● (3P Only)	● (3P Only)
		TDA (1 row)	● (3P Only)	● (3P Only)	● (3P Only)
		TDA (2 rows)	● (2, 3P Only)	● (2, 3P Only)	● (3P Only)
Cage Terminal Block	CTB	●	●		
Terminal Cover	TCF	●	●		
Insulation Barrier	TQQ	●	●		
Terminal Bus Bar	TBB	-	-		
<b>Installation and Dimensions</b>					
Connection/ Installation	Front Connection	Terminal Screw			
	Rear Connection	Horizontal/Vertical			
Dimension (mm)	Plug-in	Switchgear (Line & Load, Line Only), Distribution Panel			
	DIN Rail Installation	Possible if DIN Rail adaptor is be used	-	Possible if DIN Rail adaptor is be used	
	a (2/3/4P)	75/75/100	75/75/100	90/90/120	75/75/100
	b	130	130	155	130
Weight (kg)	c	68	68	68	68
	2/3/4P	0.8/0.9/1.3	0.8/0.9/1.3	1.0/1.1/1.4	0.8/0.9/1.3
Detailed Rating and Selection	228 Page		228 Page		
Characteristic Curve and Appearance	62 / 163 Page		62 / 163 ~ 164 Page		

※ 1) 4 Pole Arrangement : Basic specification of R-S-T-N

2) As for 2P products, only the neutral pole in the 3P product has been eliminated so the dimension is equivalent to the 3P product.



HGE100				HGE125				HGE160				HGE250			
100				125				160				250			
2 <sup>2)</sup> , 3, 4 <sup>1)</sup>				2 <sup>2)</sup> , 3, 4 <sup>1)</sup>				2 <sup>2)</sup> , 3, 4 <sup>1)</sup>				2 <sup>2)</sup> , 3, 4 <sup>1)</sup>			
16, 20, 25, 32, 40, 50, 63, 75, 80, 100				16, 20, 25, 32, 40, 50, 63, 75, 80, 100, 125				100, 125, 150, 160				100, 125, 150, 160, 175, 200, 225, 250			
30				30				30				30			
0.1				0.1				0.1				0.1			
100 - 300 - 500 - 1,000 Adjustable				100 - 300 - 500 - 1,000 Adjustable				100 - 300 - 500 - 1,000 Adjustable				100 - 300 - 500 - 1,000 Adjustable			
0.1 - 0.4 - 1.0 - 2.0				0.1 - 0.4 - 1.0 - 2.0				0.1 - 0.4 - 1.0 - 2.0				0.1 - 0.4 - 1.0 - 2.0			
0 - 200 - 500 - 1,000 Adjustable				0 - 200 - 500 - 1,000 Adjustable				0 - 200 - 500 - 1,000 Adjustable				0 - 200 - 500 - 1,000 Adjustable			
E	S	H	L	E	S	H	L	E	S	H	L	E	S	H	L
16	20	26	30	20	26	38	55	20	26	38	55	20	26	38	55
16	20	26	30	20	26	38	55	20	26	38	55	20	26	38	55
30	50	50	50	50	65	85	100	50	65	85	100	50	65	85	100
100	100	75	50	100	100	100	100	100	100	100	100	100	100	100	100
30,000				30,000				25,000				25,000			
10,000				10,000				10,000				10,000			
(1.0)×In				(1.0)×In				(1.0)×In				(1.0)×In			
16 ~ 32 A : 400 A, 40 ~ 100 A : 10×In				16 ~ 32 A : 400 A, 40 ~ 125 A : 10×In				10×In				10×In			
●				●				●				●			
●				●				●				●			
-				-				-				-			
●				●				●				●			
●				●				●				●			
●				●				●				●			
●				●				●				●			
● (3P Only)				● (3P Only)				● (3P Only)				● (3P Only)			
● (3P Only)				● (3P Only)				● (3P Only)				● (3P Only)			
● (3P Only)				● (3P Only)				-				-			
● (3P Only)				● (3P Only)				-				-			
● (2, 3P Only)				● (3P Only)				-				-			
●				●				●				●			
●				●				●				●			
●				●				●				●			
-				-				●				●			
Terminal Screw Horizontal/Vertical								Terminal Screw, Terminal Bus Bar Horizontal/Vertical							
Switchgear (Line & Load, Line Only), Distribution Panel								Switchgear (Line & Load, Line Only)							
Possible if DIN Rail adaptor is be used								-							
75/75/100				90/90/120				105/105/140				105/105/140			
130				155				165				165			
68				68				68				68			
0.8/0.9/1.3				1.0/1.1/1.4				1.3/1.5/1.9				1.3/1.5/1.9			
228 Page				228 Page				228 Page				228 Page			
62 / 163 Page				62 / 164 Page				62 / 165 Page				62 / 165 Page			

# Model Selection Table

## Earth Leakage Circuit Breaker (HGE Type) : 400 ~ 800 AF

### Common Ratings

Rated Operational Voltage, Ue	AC 220/460 V	Suitability for Isolation	Yes
Usable Voltage Range	AC 187 ~ 506 V	Utilization Category	A
Rated Impulse Withstand Voltage, Uimp	6 kV	Pollution Degree	3
Protection Function	Earth Leakage, Overload, Instantaneous, Short-Circuit Protection	Reference Standard	IEC 60947-2

Model Name		HGE400	HGE630	HGE800									
Frame	(AF)	400	630	800									
Number of Poles	(P)	2 <sup>2)</sup> , 3, 4 <sup>1)</sup>	2 <sup>2)</sup> , 3	2 <sup>2)</sup> , 3									
Rated Current, at 40 °C	(A)	250, 300, 350, 400	500, 630	700, 800									
<b>High Speed Type</b>													
Adjustable Residual Current	(mA)	30	30	30									
Max. Operational Time	(s)	0.1	0.1	0.1									
<b>Time Delay Type</b>													
Adjustable Residual Current	(mA)	100 - 300 - 500 - 1,000 Adjustable	100 - 300 - 500 - 1,000 Adjustable	100 - 300 - 500 - 1,000 Adjustable									
Max. Operational Time	(s)	0.1 - 0.4 - 1.0 - 2.0	0.1 - 0.4 - 1.0 - 2.0	0.1 - 0.4 - 1.0 - 2.0									
Inertial Delay Time	(ms)	0 - 200 - 500 - 1,000 Adjustable	0 - 200 - 500 - 1,000 Adjustable	0 - 200 - 500 - 1,000 Adjustable									
<b>Rated Ultimate Short-Circuit Breaking Capacity [Icu] (kA rms)</b>													
Short-Circuit Breaking Category Code		E	S	H	L	E	S	H	L	S	H	L	
AC 440/460 V		38	50	70	85	38	50	70	85	50	70	85	
AC 380/415 V		45	65	85	100	45	65	85	100	65	85	100	
AC 220/240 V		50	75	100	125	50	75	100	125	75	100	125	
Service Breaking Capacity [Ics = % Icu]		100	100	100	100	100	100	100	100	100	100	100	
<b>Endurance [times] (Durability)</b>													
Mechanical		4,000				2,500				2,500			
Electrical (at 460 V)		1,000				500				500			
<b>Trip Device</b>													
Thermal	Long Time [LT]	(1.0) × In				(1.0) × In				(1.0) × In			
Magnetic	Instantaneous [INST]	10 × In				10 × In				10 × In			
<b>Accessory</b>													
Internal	Auxiliary Switch	AUX	●			●				●			
	Alarm Switch	ALT	●			●				●			
	Shunt Trip	SHT	●			●				●			
	Under-Voltage Trip	UVT	●			●				●			
External	Rotary Handle	Front Contact	TFG	●		●				●			
		Extended	TFH	●		●				●			
	Mechanical Open/Close Device		MOT	●			●			●			
	Mechanical Interlock		MIF	●			●			●			
	Handle Locking Device		PLD	●			●			●			
	Plug-in	TDM (LINE/LOAD)			● (3P Only)		● (3P Only)				● (3P Only)		
		TDM (LINE Only)			● (3P Only)		● (3P Only)				● (3P Only)		
		TDF (LINE Only)			-		-				-		
		TDA (1 row)			-		-				-		
		TDA (2 rows)			-		-				-		
Cage Terminal Block		CTB	●			●				●			
Terminal Cover		TCF	●			●				●			
Insulation Barrier		TQQ	●			●				●			
Terminal Bus Bar		TBB	●			●				●			
<b>Installation and Dimensions</b>													
Connection/Installation	Front Connection	Terminal Screw		Terminal Screw, Terminal Bus Bar									
	Rear Connection	Horizontal/Vertical Cable		Horizontal/Vertical Cable									
	Plug-in	Switchgear (Line & Load, Line Only)		Switchgear (Line & Load, Line Only)									
Dimension (mm)	a (2/3/4P)	140/140/184		210/210									
	b	257		280									
	c	110		110									
Weight (kg)	3/4P	4/4.5/5.4		8.7/9.5									
Detailed Rating and Selection		228 Page		228 Page									
Characteristic Curve and Appearance		62 / 166 Page		63 / 167 Page									

※ 1) 4 Pole Arrangement : Basic specification of R-S-T-N

2) As for 2P products, only the neutral pole in the 3P product has been eliminated so the dimension is equivalent to the 3P product.

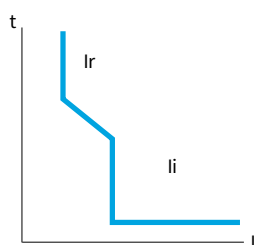

Over-Current Protection Characteristics

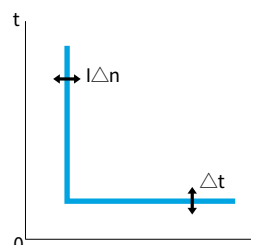

Earth Leakage Protection Characteristics (Time Delay Type)

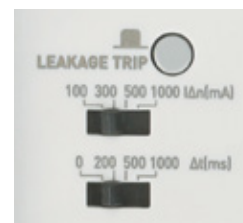

### Trip Unit Characteristics - Thermal Magnetic

Rated Current (A) In		16	20	25	32	40	50	63	75	80	100	125
ELCB	HGE30	●	●	●	●							
	HGE50	●	●	●	●	●	●					
	HGE60	●	●	●	●	●	●	●				
	HGE100	●	●	●	●	●	●	●	●	●	●	
	HGE125	●	●	●	●	●	●	●	●	●	●	●
Moment Characteristics Ir												
Setting Value (A)	1.0 × In	16	20	25	32	40	50	63	75	80	100	125
Instantaneous Characteristics Ii												
Setting Value (A)	10 × In	400		400		400	500	630	750	800	1,000	1,250
	Max. Non-Tripping Current (A)	320		320		320	400	504	600	640	800	1,000
	Min. Operational Current (A)	480		480		480	600	756	900	960	1,200	1,500
Rated Non-Operational Time IΔn												
High-Speed Type		Fixed : 30 mA										
Time Delay Type		Adjustable : 100 - 300 - 500 - 1,000 mA										
Inertial Propagation Time Δt												
High-Speed Type		Fixed : 0 ms										
Time Delay Type		Adjustable : 0 - 200 - 500 - 1,000 ms										
Neutral Pole Protection												
4P3D		Unprotected										
4P4D		-										

Rated Current (A) In		100	125	150	160	175	200	225	250	300	350	400	500	630	700	800
ELCB	HGE160	●	●	●	●											
	HGE250	●	●	●	●	●	●	●	●							
	HGE400								●	●	●	●				
	HGE630												●	●		
	HGE800														●	●
Moment Characteristics Ir																
Setting Value (A)	1.0 × In	100	125	150	160	175	200	225	250	300	350	400	500	630	700	800
Instantaneous Characteristics Ii																
Setting Value (A)	10 × In	1,000	1,250	1,500	1,600	1,750	2,000	2,250	2,500	3,000	3,500	4,000	5,000	6,300	7,000	8,000
	Max. Non-Tripping Current (A)	800	1,000	1,200	1,280	1,400	1,600	1,800	2,000	2,400	2,800	3,200	4,000	5,040	5,600	6,400
	Min. Operational Current (A)	1,200	1,500	1,800	1,920	2,100	2,400	2,700	3,000	3,600	4,200	4,800	6,000	7,560	8,400	9,600
Rated Non-Operational Time IΔn																
High-Speed Type		Fixed : 30 mA														
Time Delay Type		Adjustable : 100 - 300 - 500 - 1,000 mA														
Inertial Propagation Time Δt																
High-Speed Type		Fixed : 0 ms														
Time Delay Type		Adjustable : 0 - 200 - 500 - 1,000 ms														
Neutral Pole Protection																
4P3D		Unprotected														
4P4D		-														

## Model Selection Table

### High Breaking Capacity Type of Molded Case Circuit Breaker (HGP Type) : 50 ~ 800 AF

#### Common Ratings

Rated Insulation Voltage, Ui	1,000 V	Suitability for Isolation	Yes
Rated Operational Voltage, Ue	690 V	Utilization Category	A
Rated Impulse Withstand Voltage, Uimp	8 kV	Pollution Degree	3
Protection Function	Overload, Instantaneous, Short-Circuit Protection	Reference Standard	IEC 60947-2

Model Name		HGP50D			HGP125D			HGP160D		
Frame (AF)		50			125			160		
Number of Poles (P)		3, 4 <sup>1)</sup>			3, 4 <sup>1)</sup>			3, 4 <sup>1)</sup>		
Rated Current, at 40 °C (A)		16, 20, 25, 32, 40, 50			16, 20, 25, 32, 40, 50, 63, 75, 80, 100, 125			100, 125, 150, 160		
Rated Ultimate Short-Circuit Breaking Capacity [Icu] (kA rms)										
Short-Circuit Breaking Category Code		S	H	X	S	H	X	S	H	X
AC 660/690 V		8	8	10	8	8	10	8	8	10
AC 480/500 V		50	65	100	50	65	100	50	65	100
AC 440/460 V		65	85	150	65	85	150	65	85	150
AC 380/415 V		85	100	150	85	100	150	85	100	150
AC 220/240 V		100	130	200	100	130	200	100	130	200
DC 250 V		65	85	100	65	85	100	65	85	100
Service Breaking Capacity [Ics = % Icu] (kA rms)		100	100	100	100	100	100	100	100	100
Short-Circuit Making [Icm] (kA rms)										
AC 660/690 V		14	14	17	14	14	17	14	14	17
AC 480/500 V		105	143	220	105	143	220	105	143	220
AC 440/460 V		143	187	330	143	187	330	143	187	330
AC 380/415 V		187	220	330	187	220	330	187	220	330
AC 220/240 V		220	286	440	220	286	440	220	286	440
Endurance [times] (Durability)										
Mechanical		25,000			25,000			25,000		
In @ 440 V		10,000			10,000			10,000		
Trip Device										
Thermal		●			●			●		
Magnetic		(0.8 - 0.9 - 1.0) × In			(0.8 - 0.9 - 1.0) × In			(0.8 - 0.9 - 1.0) × In		
Instantaneous [INST]		16 ~ 32 A : 400 A, 40 ~ 50 A : 10 × In			16 ~ 32 A : 400 A, 40 ~ 125 A : 10 × In			10 × In		
Electronic		-			-			-		
Long Time [LTD]		-			-			-		
Short Time [STD]		-			-			-		
Instantaneous [INST]		-			-			-		
Accessory										
Internal		●			●			●		
Auxiliary Switch		AUX			AUX			AUX		
Alarm Switch		ALT			ALT			ALT		
Shunt Trip		SHT			SHT			SHT		
Under-Voltage Trip		UVT			UVT			UVT		
External		●			●			●		
Rotary Handle		TFG			TFG			TFG		
Extended		TFH			TFH			TFH		
Mechanical Open/Close Device		MOT			MOT			MOT		
Mechanical Interlock		MIF			MIF			MIF		
Handle Locking Device		PLD			PLD			PLD		
Plug-in		● (3P Only)			● (3P Only)			● (3P Only)		
TDM (LINE/LOAD)		● (3P Only)			● (3P Only)			● (3P Only)		
TDM (LINE Only)		● (3P Only)			● (3P Only)			● (3P Only)		
Cage Terminal Block		CTB			CTB			CTB		
Terminal Cover		TCF			TCF			TCF		
Insulation Barrier		TQQ			TQQ			TQQ		
Terminal Bus Bar		TBB			TBB			TBB		
Installation and Dimensions										
Connection/Installation		Front Connection			Terminal Screw					
		Rear Connection			Horizontal/Vertical Cable					
		Plug-in			Switchgear (Line & Load, Line Only)					
Dimension (mm)		a (3/4P)			90/120			90/120		
		b			140			140		
		c			86			86		
Weight (kg)		3/4P			1.5/1.8			1.5/1.8		
Detailed Rating and Selection		232 Page			232 Page			232 Page		
Characteristic Curve and Appearance		69 / 174 Page			69 / 174 Page			69 / 174 Page		

※ 1) 4 Pole Arrangement : Basic specification of R-S-T-N

HGP250			HGP400			HGP630			HGP800		
250			400			630			800		
3, 4 <sup>1)</sup>			3, 4 <sup>1)</sup>			3, 4 <sup>1)</sup>			3, 4 <sup>1)</sup>		
100, 125, 150, 160, 175, 200, 225, 250			300, 350, 400			500, 630			700, 800		
S	H	X	S	H	X	S	H	X	S	H	X
8	8	10	10	20	35	10	20	35	10	20	35
50	65	100	50	70	100	50	70	100	50	70	100
65	85	150	70	85	150	70	85	150	70	85	150
85	100	150	85	100	150	85	100	150	85	100	150
100	130	200	100	130	200	100	130	200	100	130	200
65	85	100	65	85	100	65	85	100	65	85	100
100	100	100	100	100	100	100	100	100	100	100	100
14	14	17	17	40	74	17	40	74	17	40	74
105	143	220	105	154	220	105	154	220	105	154	220
143	187	330	154	187	330	154	187	330	154	187	330
187	220	330	187	220	330	187	220	330	187	220	330
220	286	440	220	286	440	220	286	440	220	286	440
25,000			20,000			20,000			10,000		
10,000			6,000			4,000			3,000		
●			●			●			●		
(0.8 - 0.9 - 1.0) × In			(0.8 - 0.9 - 1.0) × In			(0.8 - 0.9 - 1.0) × In			(0.8 - 0.9 - 1.0) × In		
(5 - 6 - 7 - 8 - 9 - 10) × In			(5 - 6 - 7 - 8 - 9 - 10) × In			(5 - 6 - 7 - 8 - 9 - 10) × In			(5 - 6 - 7 - 8 - 9 - 10) × In		
-			-			-			-		
-			-			-			-		
-			-			-			-		
-			-			-			-		
●			●			●			●		
●			●			●			●		
●			●			●			●		
●			●			●			●		
●			●			●			●		
●			●			●			●		
●			●			●			●		
●			●			●			●		
●			●			●			●		
● (3P Only)			● (3P Only)			● (3P Only)			● (3P Only)		
● (3P Only)			● (3P Only)			● (3P Only)			● (3P Only)		
●			●			●			●		
●			●			●			●		
●			●			●			●		
●			●			●			●		
●			●			●			●		
Terminal Screw, Terminal Bus Bar			Terminal Screw, Terminal Bus Bar			Terminal Screw, Terminal Bus Bar			Terminal Screw, Terminal Bus Bar		
Horizontal/Vertical Cable			Horizontal/Vertical Cable			Horizontal/Vertical Cable			Horizontal/Vertical Cable		
Switchgear (Line & Load, Line Only)			Switchgear (Line & Load, Line Only)			Switchgear (Line & Load, Line Only)			Switchgear (Line & Load, Line Only)		
105/140			140/186.5			140/186.5			210/280		
165			260			260			320		
86.5			110			110			135		
2/2.6			5.4/7.2			5.4/7.2			15.1/19.6		
232 Page			232 Page			232 Page			232 Page		
70 / 175 Page			70 / 176 Page			70 / 176 Page			71 / 177 Page		



### Trip Unit Characteristics – Thermal Magnetic HGP250, 400, 630, 800

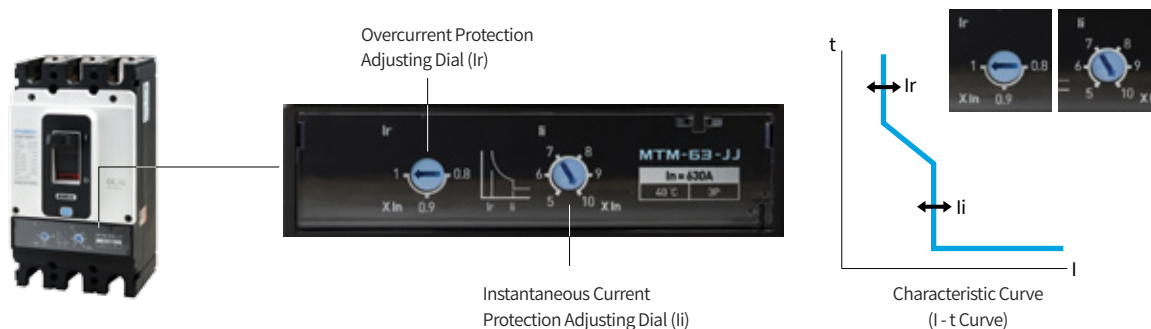

Rated Current (A) In		100	125	150	160	175	200	225	250	300	350	400	500	630	700	800	
MCCB	HGP250	●	●	●	●	●	●	●	●								
	HGP400									●	●	●					
	HGP630												●	●			
	HGP800														●	●	
<b>Moment Characteristics Ir</b>																	
Fixed (FF)	1.0×In	100	125	150	160	175	200	225	250	300	350	400	500	630	700	800	
Adjustable (JF, JJ)	0.8×In	80	100	120	128	140	160	180	200	240	280	320	400	504	560	640	
	0.9×In	90	112.5	135	144	157.5	180	202.5	225	270	315	360	450	567	630	720	
	1.0×In	100	125	150	160	175	200	225	250	300	350	400	500	630	700	800	
<b>Instantaneous Characteristics Ii</b>																	
Fixed (FF, JF)	10×In	1,000	1,250	1,500	1,600	1,750	2,000	2,250	2,500	3,000	3,500	4,000	5,000	6,300	7,000	8,000	
	Max. Non-Tripping Current (A)	800	1,000	1,200	1,280	1,400	1,600	1,800	2,000	2,400	2,800	3,200	4,000	5,040	5,600	6,400	
	Min. Tripping Current (A)	1,200	1,500	1,800	1,920	2,100	2,400	2,700	3,000	3,600	4,200	4,800	6,000	7,560	8,400	9,600	
Adjustable (JJ)	5×In	-	625	750	800	875	1,000	1,125	1,250	1,500	1,750	2,000	2,500	3,150	3,500	4,000	
	Max. Non-Tripping Current (A)	-	500	600	640	700	800	900	1,000	1,200	1,400	1,600	2,000	2,520	2,800	3,200	
	Min. Tripping Current (A)	-	750	900	960	1,050	1,200	1,350	1,500	1,800	2,100	2,400	3,000	3,780	4,200	4,800	
	6×In	-	750	900	960	1,050	1,200	1,350	1,500	1,800	2,100	2,400	3,000	3,780	4,200	4,800	
	Max. Non-Tripping Current (A)	-	600	720	768	840	960	1,080	1,200	1,440	1,680	1,920	2,400	3,024	3,360	3,840	
	Min. Tripping Current (A)	-	900	1,080	1,152	1,260	1,440	1,620	1,800	2,160	2,520	2,880	3,600	4,536	5,040	5,760	
	7×In	-	875	1,050	1,120	1,225	1,400	1,575	1,750	2,100	2,450	2,800	3,500	4,410	4,900	5,600	
	Max. Non-Tripping Current (A)	-	700	840	896	980	1,120	1,260	1,400	1,680	1,960	2,240	2,800	3,528	3,920	4,480	
	Min. Tripping Current (A)	-	1,050	1,260	1,344	1,470	1,680	1,890	2,100	2,520	2,940	3,360	4,200	5,292	5,880	6,720	
	8×In	-	1,000	1,200	1,280	1,400	1,600	1,800	2,000	2,400	2,800	3,200	4,000	5,040	5,600	6,400	
	Max. Non-Tripping Current (A)	-	800	960	1,024	1,120	1,280	1,440	1,600	1,920	2,240	2,560	3,200	4,032	4,480	5,120	
	Min. Tripping Current (A)	-	1,200	1,440	1,536	1,680	1,920	2,160	2,400	2,880	3,360	3,840	4,800	6,048	6,720	7,680	
	9×In	-	1,125	1,350	1,440	1,575	1,800	2,025	2,250	2,700	3,150	3,600	4,500	5,670	6,300	7,200	
	Max. Non-Tripping Current (A)	-	900	1,080	1,152	1,260	1,440	1,620	1,800	2,160	2,520	2,880	3,600	4,536	5,040	5,760	
	Min. Tripping Current (A)	-	1,350	1,620	1,728	1,890	2,160	2,430	2,700	3,240	3,780	4,320	5,400	6,804	7,560	8,640	
10×In	-	1,250	1,500	1,600	1,750	2,000	2,250	2,500	3,000	3,500	4,000	5,000	6,300	7,000	8,000		
Max. Non-Tripping Current (A)	-	1,000	1,200	1,280	1,400	1,600	1,800	2,000	2,400	2,800	3,200	4,000	5,040	5,600	6,400		
Min. Tripping Current (A)	-	1,500	1,800	1,920	2,100	2,400	2,700	3,000	3,600	4,200	4,800	6,000	7,560	8,400	9,600		
<b>Neutral Pole Protection</b>																	
4P3D (Neutral Unprotected)		●	●	●	●	●	●	●	●	●	●	●	●	●	●	●	
4P4D (Neutral Protected 100 % Ir)										●	●	●	●	●	●	●	

# Model Selection Table

## Motor Protection Type of Molded Case Circuit Breaker (HGP Type) : 100 ~ 800 AF

The circuit breaker for motor protection is a circuit breaker for instantaneous trip (magnetic only) equipped with instantaneous and short circuit protection functions only, it is suitable for protecting the motor by assembling it together with the overcurrent relay/ electronic connector.

### Common Ratings

Rated Insulation Voltage, Ui	1,000 V	Suitability for Isolation	Yes
Rated Operational Voltage, Ue	690 V	Utilization Category	A
Rated Impulse Withstand Voltage, Uimp	8 kV	Pollution Degree	3
Protection Function	Instantaneous, Short-Circuit Protection	Reference Standard	IEC 60947-2

Model Name	HGP100			HGP250			
Frame (AF)	100			250			
Number of Poles (P)	3			3			
Rated Current, at 40 °C (A)	2.5, 3.2, 6.3, 12.5, 20, 32, 50, 63, 80, 100			125, 150, 175, 200, 225			
<b>Rated Short-Circuit Breaking Capacity [Icu](kA rms)</b>							
Short-Circuit Breaking Category Code	S	H	X	S	H	X	
AC 660/690 V	8	8	10	8	8	10	
AC 480/500 V	50	65	100	50	65	100	
AC 440/460 V	65	85	150	65	85	150	
AC 380/415 V	85	100	150	85	100	150	
AC 220/240 V	100	130	200	100	130	200	
Service Breaking Capacity [Ics = % Icu]	100	100	100	100	100	100	
<b>Rated Short-Circuit Making Capacity [Icm](kA rms)</b>							
AC 660/690 V	14	14	17	14	14	17	
AC 480/500 V	105	143	220	105	143	220	
AC 440/460 V	143	187	330	143	187	330	
AC 380/415 V	187	220	330	187	220	330	
AC 220/240 V	220	286	440	220	286	440	
<b>Endurance [times] (Durability)</b>							
Mechanical	25,000			25,000			
In @ 440 V	10,000			10,000			
<b>Trip Device</b>							
Thermal	●			●			
Magnetic	●			●			
	Long Time [LT]	-		-		-	
	Instantaneous [INST]	(6 - 7 - 8 - 9 - 10 - 11 - 12 - 13) × In		(5 - 6 - 7 - 8 - 9 - 10) × In		-	
Electronic	-			-			
	Long Time [LTD]	-		-		-	
	Short Time [STD]	-		-		-	
	Instantaneous [INST]	-		-		-	
<b>Accessory</b>							
Internal	Auxiliary Switch	AUX	●			●	
	Alarm Switch	ALT	●			●	
	Shunt Trip	SHT	●			●	
	Under-Voltage Trip	UVT	●			●	
External	Rotary Handle	Front Contact	TFG			●	
		Extended	TFH			●	
		Mechanical Open/Close Device	MOT			●	
		Mechanical Interlock	MIF			●	
		Handle Locking Device	PLD			●	
	Plug-in	TDM (LINE/LOAD)		● (3P Only)			● (3P Only)
		TDM (LINE Only)		● (3P Only)			● (3P Only)
		Cage Terminal Block	CTB	●			●
		Terminal Cover	TCF	●			●
		Insulation Barrier	TQQ	●			●
	Terminal Bus Bar	TBB	●			●	
<b>Installation and Dimensions</b>							
Connection/ Installation	Front Connection	Terminal Screw, Terminal Bus Bar		Terminal Screw, Terminal Bus Bar			
	Rear Connection	Horizontal/Vertical Cable		Horizontal/Vertical Cable			
	Plug-in	Switchgear (Line & Load, Line Only)		Switchgear (Line & Load, Line Only)			
Dimension (mm)		a	105		105		
		b	165		165		
		c	86.5		86.5		
Weight (kg)	3/4P	2/2.6		2/2.6			
Detailed Rating and Selection		232 Page		232 Page			
Characteristic Curve and Appearance		69 / 175 Page		70 / 175 Page			



HGP400			HGP630			HGP800		
400			630			800		
3			3			3		
350, 400			500, 630			700, 800		
S	H	X	S	H	X	S	H	X
8	8	35	10	20	35	10	20	35
50	65	100	50	70	100	50	70	100
65	85	150	70	85	150	70	85	150
85	100	150	85	100	150	85	100	150
100	130	200	100	130	200	100	130	200
100	100	100	100	100	100	100	100	100
17	40	74	17	40	74	17	40	74
105	154	220	105	154	220	105	154	220
154	187	330	154	187	330	154	187	330
187	220	330	187	220	330	187	220	330
220	286	440	220	286	440	220	286	440
20,000			20,000			10,000		
6,000			4,000			3,000		
●			●			●		
-			-			-		
(5 - 6 - 7 - 8 - 9 - 10) × In			(5 - 6 - 7 - 8 - 9 - 10) × In			(5 - 6 - 7 - 8 - 9 - 10) × In		
-			-			-		
-			-			-		
-			-			-		
●			●			●		
●			●			●		
●			●			●		
●			●			●		
●			●			●		
●			●			●		
●			●			●		
●			●			●		
●			●			●		
●			●			●		
● (3P Only)			● (3P Only)			● (3P Only)		
● (3P Only)			● (3P Only)			● (3P Only)		
●			●			●		
●			●			●		
●			●			●		
●			●			●		
Terminal Screw, Terminal Bus Bar			Terminal Screw, Terminal Bus Bar			Terminal Screw, Terminal Bus Bar		
Horizontal/Vertical Cable			Horizontal/Vertical Cable			Horizontal/Vertical Cable		
Switchgear (Line & Load, Line Only)			Switchgear (Line & Load, Line Only)			Switchgear (Line & Load, Line Only)		
140			140			210		
260			260			320		
110			110			135		
5.4/7.2			5.4/7.2			15.1/19.6		
232 Page			232 Page			232 Page		
70 / 176 Page			70 / 176 Page			71 / 177 Page		

## Model Selection Table

### Trip Unit Characteristics



Rated Current (A) In		2.5	3.2	6.3	12.5	20	32	50	63	80	100
MCCB	HGP100	●	●	●	●	●	●	●	●	●	●
Instantaneous Setting Current (A)											
8 Step Adjustable	6×Ir	15	19.2	37.8	75	120	192	300	378	480	600
	7×Ir	17.5	22.4	44.1	87.5	140	224	350	441	560	700
	8×Ir	20	25.6	50.4	100	160	256	400	504	640	800
	9×Ir	22.5	28.8	56.7	112.5	180	288	450	567	720	900
	10×Ir	25	32	63	125	200	320	500	630	800	1,000
	11×Ir	27.5	35.2	69.3	137.5	220	352	550	693	880	1,100
	12×Ir	30	38.4	75.6	150	240	384	600	756	960	1,200
	13×Ir	32.5	41.6	81.9	162.5	260	416	650	819	1,040	1,300
Accuracy		Within - 20 % ~ + 30 %									

Rated Current (A) In		125	150	175	200	225	350	400	500	630	700	800
MCCB	HGP250	●	●	●	●	●						
	HGP400						●	●				
	HGP630								●	●		
	HGP800										●	●
Instantaneous Setting Current (A)												
6 Step Adjustable	5×Ir	625	750	875	1,000	1,125	1,750	2,000	2,500	3,150	3,500	4,000
	6×Ir	750	900	1,050	1,200	1,350	2,100	2,400	3,000	3,780	4,200	4,800
	7×Ir	875	1,050	1,225	1,400	1,575	2,450	2,800	3,500	4,410	4,900	5,600
	8×Ir	1,000	1,200	1,400	1,600	1,800	2,800	3,200	4,000	5,040	5,600	6,400
	9×Ir	1,125	1,350	1,575	1,800	2,025	3,150	3,600	4,500	5,670	6,300	7,200
	10×Ir	1,250	1,500	1,750	2,000	2,250	3,500	4,000	5,000	6,300	7,000	8,000
Accuracy		Within - 20 % ~ + 30 %										

# Model Selection Table

## Switch Disconnectors (HGP NA Type) : 50 ~ 800 AF

Switch disconnector is a short circuit switch without protection function and as the appearance is equivalent to the circuit breaker, all accessories can be shared with the circuit breaker.

### Common Ratings

Rated Insulation Voltage, Ui	1,000 V	Suitability for Isolation	Yes
Rated Operational Voltage, Ue	690 V	Utilization Category	AC 22 A/AC 23 A - DC 22 A/DC 23 A
Rated Impulse Withstand Voltage, Uimp	8 kV	Pollution Degree	3
		Reference Standard	IEC 60947-3

Model Name		HGP50DNA	HGP125DNA	HGP160DNA		
Frame	(AF)	50	125	160		
Number of Poles	(P)	3, 4 <sup>1)</sup>	3, 4 <sup>1)</sup>	3, 4 <sup>1)</sup>		
Conventional Thermal Current, I <sub>th</sub> at 60 °C	(A)	50	125	160		
<b>Rated Operational Current [I<sub>e</sub>]</b>						
AC 440/480 V (50/60 Hz)		50	125	160		
DC 250 V (1 Pole)		50	125	160		
DC 250 V (2 Pole in Series)		50	125	160		
Rated Short-Circuit Making Capacity [I <sub>cm</sub> ] (kA Peak)		2.1	2.8	3.6		
<b>Rated Short-Time Withstand Current [I<sub>cw</sub>]</b>						
1 s	(A rms)	1,800	2,200	2,200		
3 s	(A rms)	1,800	2,200	2,200		
20 s	(A rms)	690	960	960		
<b>Endurance [times] (Durability)</b>						
Mechanical		(A rms)	25,000	25,000	25,000	
In @ 440 V		(A rms)	10,000	10,000	10,000	
<b>Accessory</b>						
Internal	Auxiliary Switch	AUX	●	●	●	
	Alarm Switch	ALT	●	●	●	
	Shunt Trip	SHT	●	●	●	
	Under-Voltage Trip	UVT	●	●	●	
External	Rotary Handle	Front Contact	TFG	●	●	●
		Extended	TFH	●	●	●
	Mechanical Open/Close Device		MOT	●	●	●
	Mechanical Interlock		MIF	●	●	●
	Handle Locking Device		PLD	●	●	●
	Plug-in	TDM (LINE/LOAD)	● (3P Only)	● (3P Only)	● (3P Only)	
		TDM (LINE Only)	● (3P Only)	● (3P Only)	● (3P Only)	
	Cage Terminal Block		CTB	●	●	●
	Terminal Cover		TCF	●	●	●
	Insulation Barrier		TQQ	●	●	●
Terminal Bus Bar		TBB	-	-	-	
<b>Installation and Dimensions</b>						
Connection/ Installation	Front Connection	Terminal Screw				
	Rear Connection	Horizontal/Vertical Cable				
Dimension (mm)	Plug-in	Switchgear (Line & Load, Line Only)				
	a (3/4P)	90/120	90/120	90/120		
	b	140	140	140		
	c	86	86	86		
Weight (kg)	3/4P	1.5/1.8	1.5/1.8	1.5/1.8		
Detailed Rating and Selection		232 Page	232 Page	232 Page		
Characteristic Curve and Appearance		174 Page	174 Page	174 Page		

※ 1) 4 Pole Arrangement : Basic specification of R-S-T-N

### Applicable Field of Switch – Disconnectors

- Bus bar connection and disconnection
- Disconnection of switchgear and control panel
- Switch for emergency power switchover (ATS)

HGP250NA	HGP400NA	HGP630NA	HGP800NA
250	400	630	800
3, 4 <sup>1)</sup>	3, 4 <sup>1)</sup>	3, 4 <sup>1)</sup>	3, 4 <sup>1)</sup>
250	400	630	800
250	400	630	800
250	400	630	800
250	400	630	800
4.9	7.1	8.5	12
3,500	5,000	6,300	8,000
3,500	5,000	6,300	8,000
1,350	1,920	2,320	2,560
25,000	20,000	20,000	10,000
10,000	6,000	4,000	3,000
●	●	●	●
●	●	●	●
●	●	●	●
●	●	●	●
●	●	●	●
●	●	●	●
●	●	●	●
●	●	●	●
●	●	●	●
● (3P Only)	● (3P Only)	● (3P Only)	● (3P Only)
● (3P Only)	● (3P Only)	● (3P Only)	● (3P Only)
●	●	●	●
●	●	●	●
●	●	●	●
●	●	●	●
Terminal Screw	Terminal Screw	Terminal Screw	Terminal Screw
Horizontal/Vertical Cable	Horizontal/Vertical Cable	Horizontal/Vertical Cable	Horizontal/Vertical Cable
Switchgear (Line & Load, Line Only)	Switchgear (Line & Load, Line Only)	Switchgear (Line & Load, Line Only)	Switchgear (Line & Load, Line Only)
105/140	140/186.5	140/186.5	210/280
165	260	260	320
86.5	110	110	135
2/2.6	5.4/7.2	5.4/7.2	15.1/19.6
232 Page	232 Page	232 Page	232 Page
175 Page	176 Page	176 Page	177 Page

## Accessory

### HGM General-Type

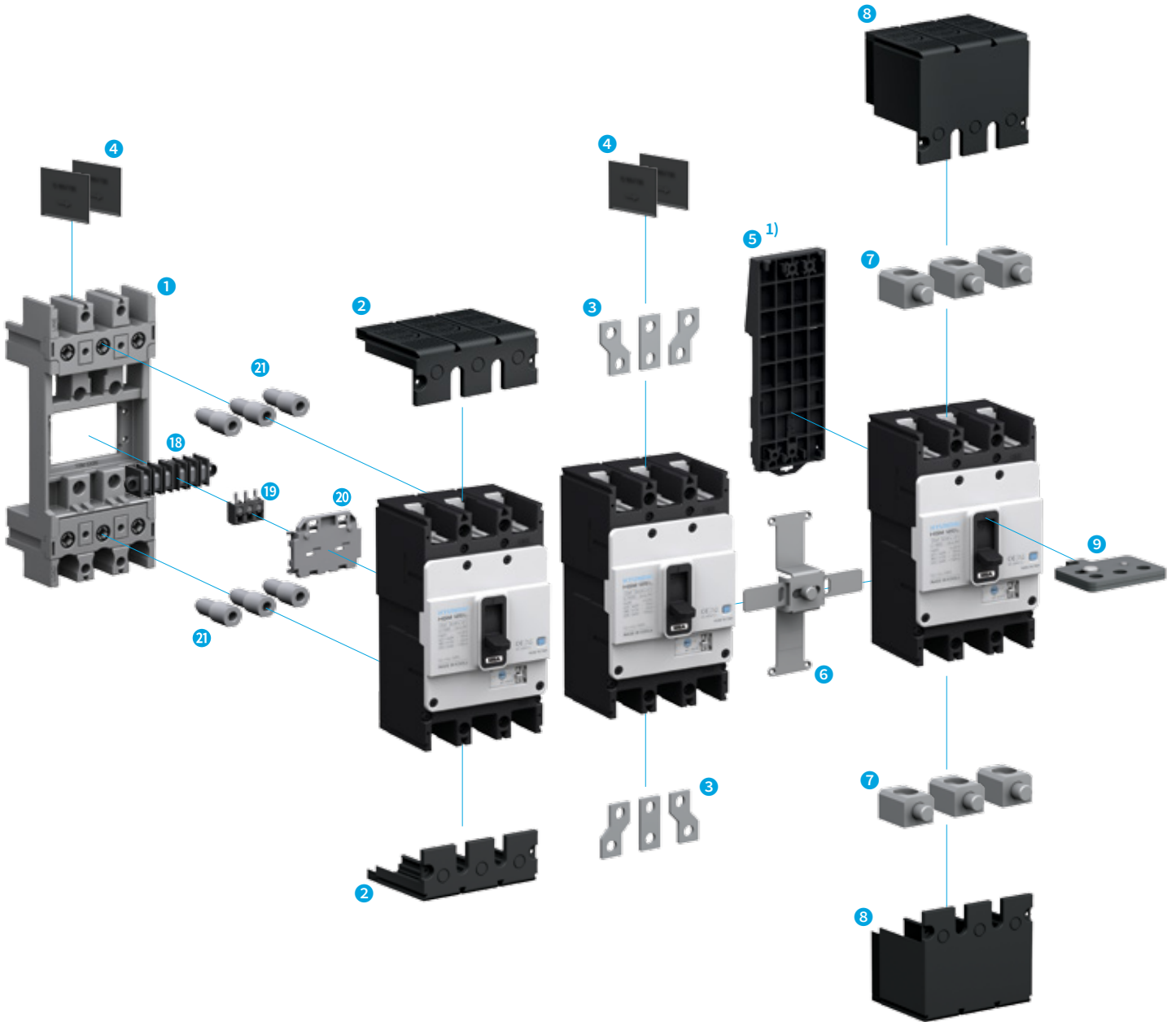

※ 1) DIN Rail Adaptor (DRA) : For HGM/HGE100

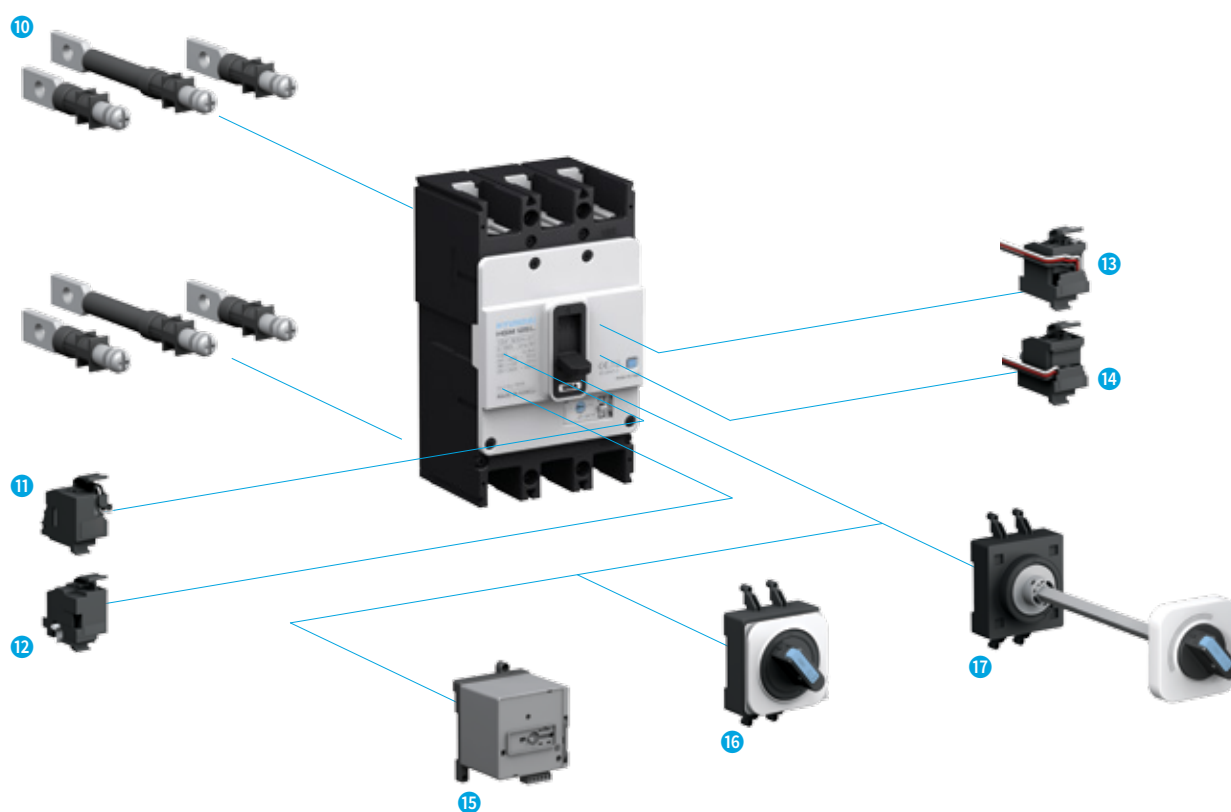

### HGM Type MCCB

- |                                      |                                       |  |
|--------------------------------------|---------------------------------------|--|
| 1 Plug-in Device (TDA, TDM, TDF)     | 8 Terminal Cover (General-Type) (TCF) | 15 Motor Operator (MOT)                    |
| 2 Terminal Cover (For Plug-in) (TCF) | 9 Padlock (PLD)                       | 16 Direct Rotary Handle (TFG)              |
| 3 Bus Bar (TBB)                      | 10 Rear Connection Terminal (RCT)     | 17 Extended Rotary Handle (TFH)            |
| 4 Insulation Barrier (TQQ)           | 11 Shunt Trip Switch (SHT)            | 18 Plug-in Terminal Block (CBM)            |
| 5 DIN Rail Adaptor (DRA)             | 12 Under-Voltage Trip Switch (UVT)    | 19 Plug-in Terminal Block (CBB BLOCK UNIT) |
| 6 Mechanical Interlock (MIF)         | 13 Auxiliary Switch (AUX)             | 20 Plug-in Terminal Block (CBB PLATE)      |
| 7 Lug Terminal (CTB)                 | 14 Trip Alarm Switch (ALT)            | 21 Plug-in Terminal (PC MALE)              |

## Accessory

### HGP High Breaking Capacity

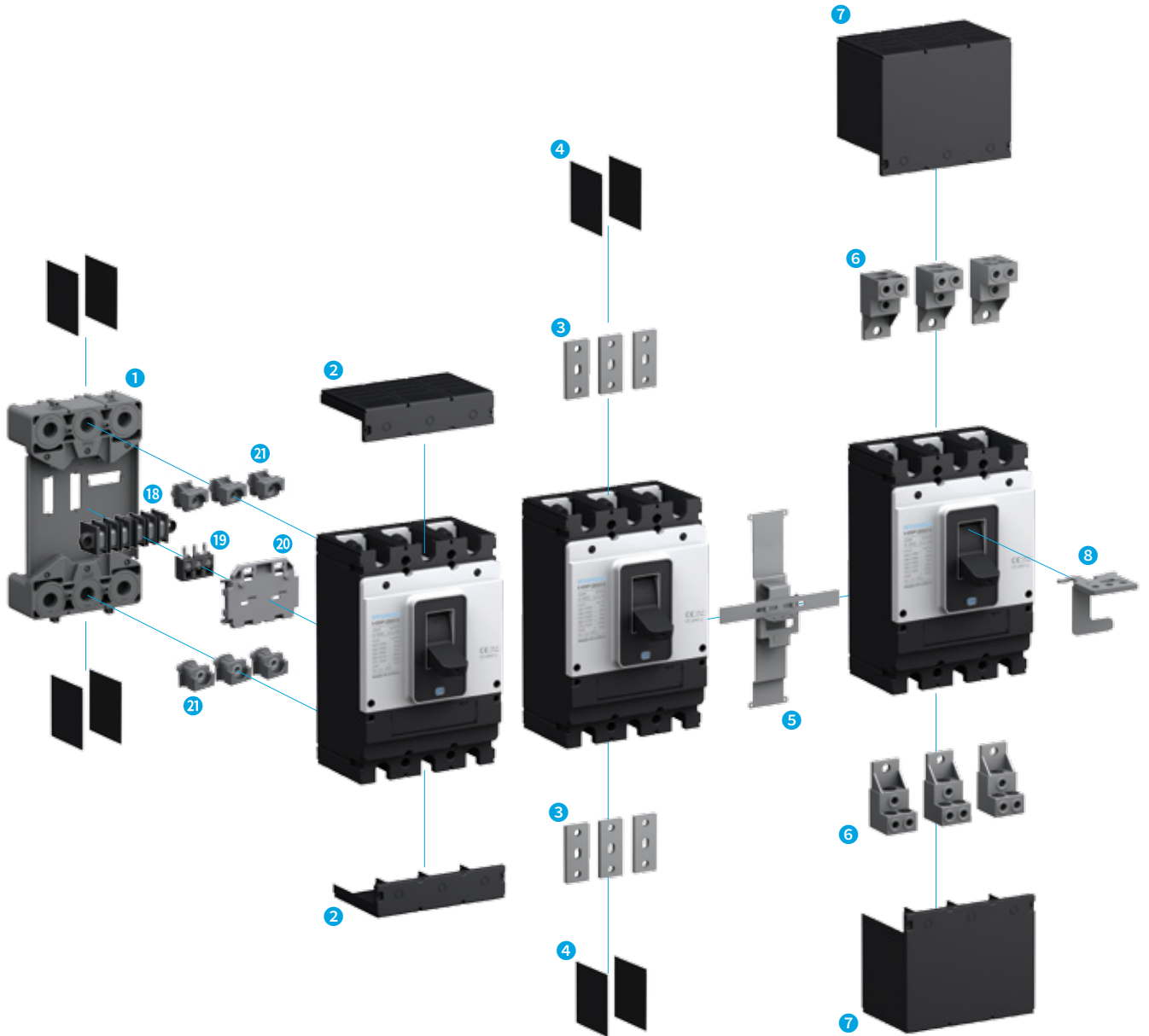



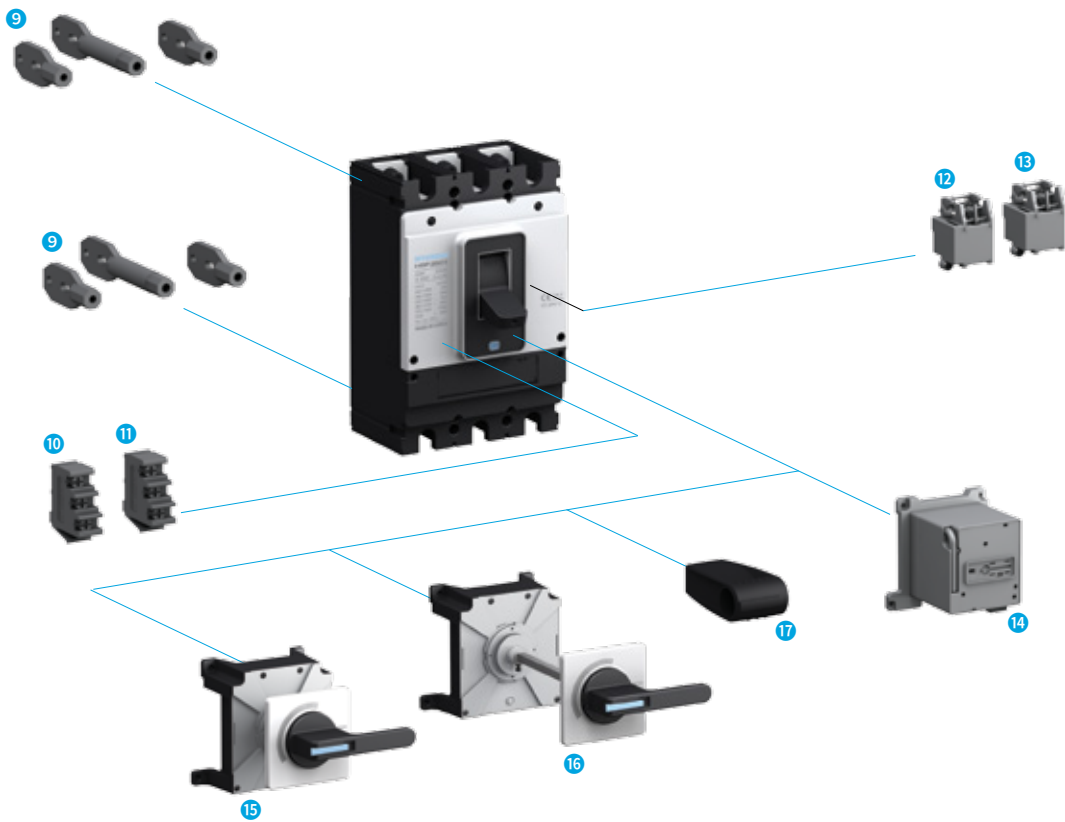

### HGP Type MCCB

- |   |                                    |  |
|---|------------------------------------|--|
| 1 Plug-In Device (TDM)                          | 8 Padlock (PLD)                    | 15 Direct Rotary Handle (TFG)              |
| 2 Terminal Cover (For Plug-in) (TCF Short Type) | 9 Rear Connection Terminal (RCT)   | 16 Extended Rotary Handle (TFH)            |
| 3 Bus Bar (TBB)                                 | 10 Auxiliary Switch (AUX)          | 17 Auxiliary Handle (THA)                  |
| 4 Insulation Barrier (TQQ)                      | 11 Trip alarm Switch (ALT)         | 18 Plug-in Terminal Block (CBM)            |
| 5 Mechanical Interlock MIF)                     | 12 Shunt trip Switch (SHT)         | 19 Plug-in Terminal Block (CBB BLOCK UNIT) |
| 6 Lug Terminal (CTB)                            | 13 Under-Voltage Trip Switch (UVT) | 20 Plug-in Terminal Block (CBB PLATE)      |
| 7 Terminal Cover (General-Type) (TCF Long Type) | 14 Motor Operator (MOT)            | 21 Plug-in Terminal (PC MALE)              |

## Internal Accessories (HGM)

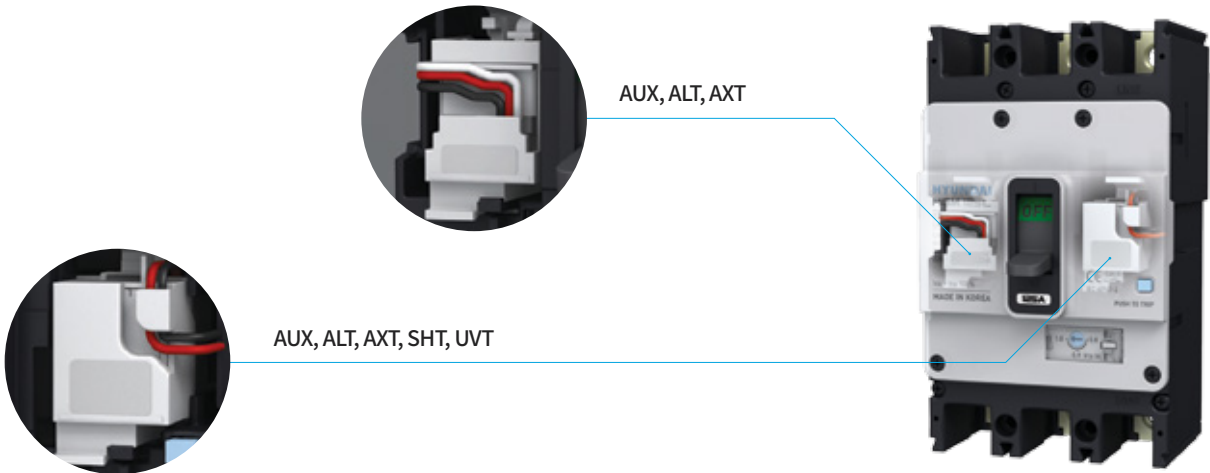

HGM30, 50E/S, 60, 100

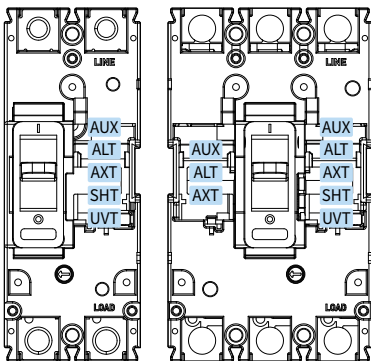

HGM50H/L, 125

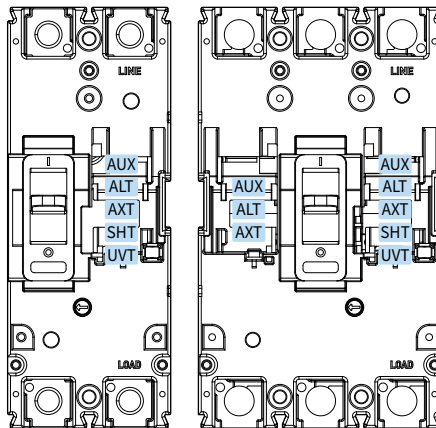

HGM160, 250

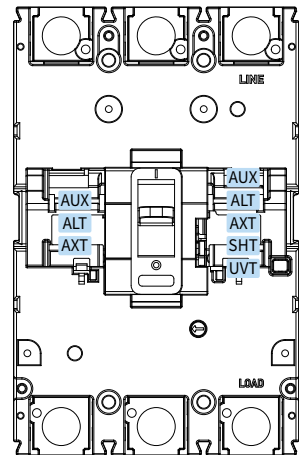

### Possible Installation Combinations (Below 250 AF)

Type	Pole	AUX	ALT	SHT	UVT	AXT	AUX	AUX	SHT	UVT	SHT	UVT	SHT	UVT
							ALT	ALT	AUX	AUX	ALT	ALT	AXT	AXT
HGM30 ~ HGM125	2													
HGM30 ~ HGM250	3/4													
HGE30 ~ HGE250	2/3/4													

※ AUX : Auxiliary Switch □ / ALT : Alarm Switch ■ / SHT : Shunt Trip ▨ / UVT : Under-Voltage Trip ▩ / AXT : Auxiliary Alarm Switch ◼ (AUX/ALT Integrated Type)

## HGM Type's Internal Accessories and Possible Location for Installation

- Auxiliary Switch (AUX)
- Alarm Switch (ALT)
- Auxiliary + Trip Alarm Switch (AXT)
- Shunt Trip Coil (SHT)
- Under-Voltage Trip Coil (UVT)

HGM400

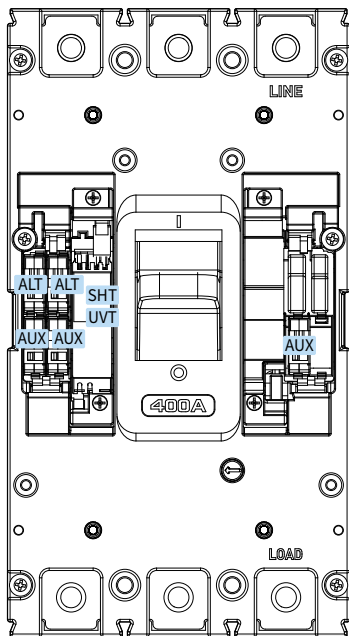

HGM630, 800

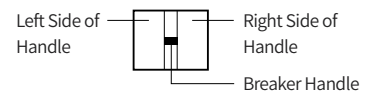
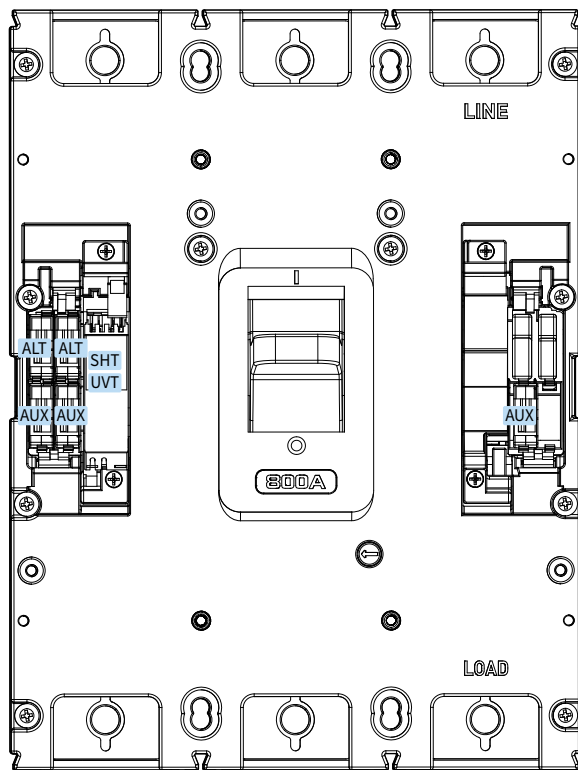

Possible Installation Combinations (400 ~ 800 AF)

Type	Pole	AUX	ALT	SHT	UVT	AUX	SHT	UVT	SHT	UVT	SHT	UVT
						ALT	AUX	AUX	ALT	ALT	AUX	AUX
HGM400	2/3/4											
HGM630 HGM800	2/3 4RSTN											
HGM630 HGM800	4NRST											
HGE400	2/3/4											
HGE630 HGE800	2/3											

※ AUX : Auxiliary Switch □ / ALT : Alarm Switch ■ / SHT : Shunt Trip □ / UVT : Under-Voltage Trip □  
 HGM Type's ZCT embedded type of product can be combined equally as HGE Type.

## Internal Accessories (HGM)

### Auxiliary Switch (AUX) / Trip Alarm Switch (ALT)

It is a contact for indicating the status of the circuit breaker in a remote position.

This contact can be used to realize not only the indication function but also electrical functions such as electrical lock and relay.

#### Auxiliary Switch (AUX)

- Indicates the ON/OFF status of the circuit breaker contact.
- Status is OFF during TRIP.
- It is comprised of C contact.

#### Trip Alarm Switch (ALT)

- It is only activated when the circuit breaker has tripped due to an overload, short circuit or operation of shunt trip switch and does not operate during general ON/OFF.
- Returns to original state when circuit breaker has been reset.
- It is comprised of C contact.

#### Auxiliary + Trip Alarm Switch (AXT)

- This switch is an integrated combination of auxiliary switch and trip alarm switch.



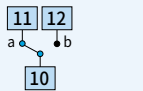
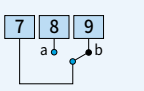
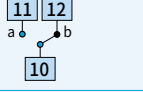
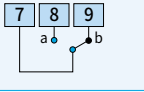
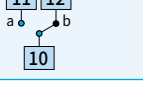
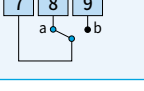













#### Contact Circuit Diagram

	Auxiliary Switch (AUX)	Trip Alarm Switch (ALT)
MCCB ON		
MCCB OFF		
MCCB TRIP		

#### Rating of Contact

Rated Conventional Thermal Current	5 A		
Minimum Load	160 mA, 5 VDC		
Rated Operation Current	Resistive Load	Inductive Load	
	AC 125 V	5 A	3 A
	AC 250 V	3 A	2 A
	DC 30 V	4 A	3 A
	DC 125 V	0.4 A	0.4 A
	DC 250 V	0.2 A	0.2 A

#### Possible Location for Installation

Type	Pole	AUX	ALT	AXT
HGM30 ~ HGM125	2			
HGM30 ~ HGM250	3/4			
HGE30 ~ HGE250	2/3/4			
HGM400	2/3/4			
HGE400	2/3/4			
HGM630 HGM800	2/3/4			
HGE630 HGE800	2/3			

※ AUX : Auxiliary Switch

ALT : Alarm Switch

AXT : Auxiliary Alarm Switch   (AUX/ALT Integrated Type)



AUX

## Shunt Trip Device (SHT)

Shunt trip device (SHT) is a device that remotely trips the circuit breaker by applying voltage to both terminals of the coil.

### Operating Condition

- $U \geq 0.7 \times U_n$  (More than 70 % of rated voltage applied)
- As for impulse type voltage, more than 20 ms applied

### Rated Voltage and Characteristics (100 ~ 250 AF)

Rated voltage (Un)	Power Consumption		
	VA (W)	A (A)	
DC	24 V	50.2	2.1
	48 V	94.6	1.97
	60 V	91.2	1.52
	100 ~ 120 V	11.8	0.1
	125 V	58.1	0.47
AC (50/60 Hz)	100 ~ 120 V	75.2	0.63
	200 ~ 250 V	64.8	0.26
	380 ~ 480 V	131	0.27
Rated Operational Voltage	0.7 ~ 1.1 × Un		
Operating Time	50 ms		

### Wiring

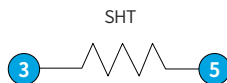

### Possible Location for Installation

Type	Pole	SHT	UVT
HGM30 ~ HGM125	2		
HGM30 ~ HGM250	3/4		
HGE30 ~ HGE250	2/3/4		
HGM400	2/3/4		
HGE400	2/3/4		
HGM630 HGM800	2/3/4		
HGE630 HGE800	2/3		

※ SHT : Shunt Trip   
 UVT : Under-Voltage Trip



SHT

## Internal Accessories (HGM)

### Under-Voltage Trip Device (UVT)

In case the circuit voltage drops to less than 35 % of the rated voltage ( $U_n$ ), UVT automatically initiates a trip in the circuit breaker to prevent damage to the load.

#### Opening Conditions

- Operating characteristics are guaranteed to conform to the IEC 60947-2 standard criteria.
- Trip Condition of Circuit Breaker :  $U \leq 0.35 \times U_n$
- Fixed Type : 50 ms (400 ~ 800 AF)
- Time Delay Type : 500 ~ 1,000 ms (Below 250 AF)
- No Trip Condition of Circuit Breaker :  $U \geq 0.7 \times U_n$
- In the  $U = 0.35 \sim 0.7 \times U_n$  interval, the circuit breaker can be tripped but the operation is not guaranteed.

#### Time Delay Function

Malfunction is prevented during a short momentary voltage drop of below 500 ms. (Below 250 AF)

#### Wiring

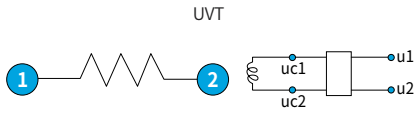

#### Closing Conditions

- In case of circuit breakers assembled with UVT, the circuit breaker cannot be ON (Closing) when voltage is not applied to the UVT.
- The reset operation after the circuit breaker's trip caused by UVT operation may differ depending on the circuit breaker's type and UVT structure.
- In order to close the circuit breaker, Voltage must be applied to UVT.
- Closing Condition :  $U \geq 0.85 \times U_n$

#### Rated Voltage and Characteristics (Below 250 AF)

Rated Voltage ( $U_n$ )		Power Consumption	
		VA (W)	A (mA)
DC	24 V	0.96	40
	48 V	1.1	22.7
	100 ~ 110 V	2.2	20
AC (50/60 Hz)	100 ~ 120 V	5.1	42
	200 ~ 230 V	6	26
	380 ~ 415 V	9.6	23
	440 ~ 480 V	12.5	26
Starting Voltage	Opening	0.35 ~ 0.7 $\times U_n$	
	Closing	0.85 $\times U_n$	
Rated Operational Voltage		0.85 ~ 1.1 $\times U_n$	
Operating Time		500 ~ 1,000 ms	

※ Do not use UVT for electrical interlocking system.



UVT



UVT Controller

# Internal Accessories (HGP)

## HGP Type's Internal Accessories and Possible Location for Installation

- Auxiliary Switch (AUX)
- Alarm Switch (ALT)
- Shunt Trip Coil (SHT)
- Under-Voltage Trip Coil (UVT)

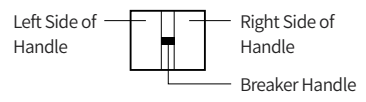
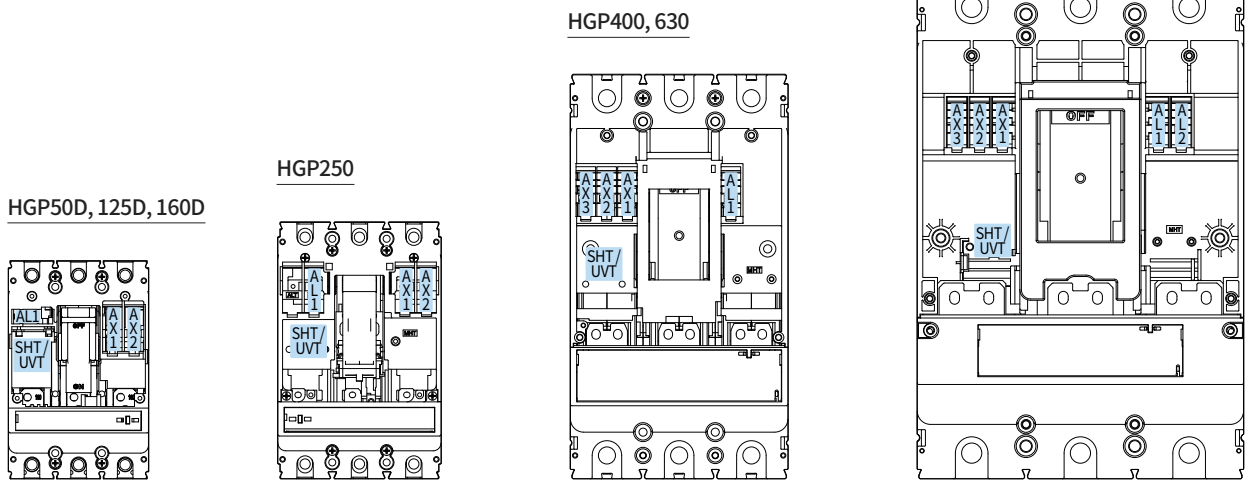
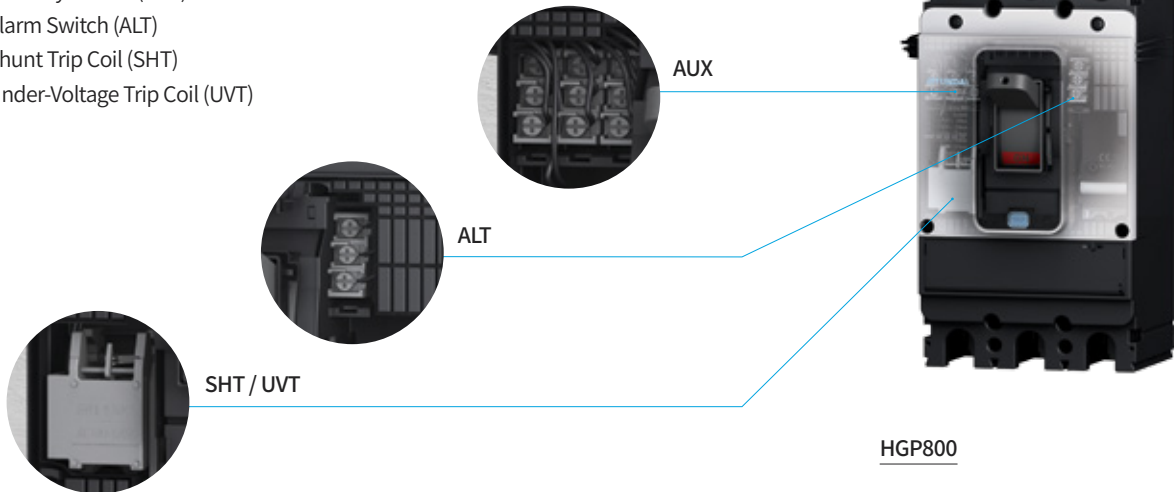

### Possible Location for Installation

Type	Pole	AUX	ALT	SHT	UVT	SHT	SHT	UVT	UVT	SHT	UVT
						AUX	ALT	AUX	ALT	AUX	ALT
HGP50D HGP125D HGP160D	3/4										
HGP250	3/4										
HGP400 HGP630	3/4										
HGP800	3/4										

※ AUX : Auxiliary Switch □ / ALT : Alarm Switch ■ / SHT : Shunt Trip □ / UVT : Under-Voltage Trip □ / AXT : Auxiliary Alarm Switch □ (AUX/ALT Integrated Type)

VCB

ACB

MCCB

MS

RELAY

## Internal Accessories (HGP)

### Auxiliary Switch (AUX)/ Trip Alarm Switch (ALT)

It is a contact for indication to inform the status of the circuit breaker in a remote position.

This contact can be used to realize not only the indication function but also electrical functions such as electrical lock and relay.

#### Auxiliary Switch (AUX)

- Indicates the ON/OFF status of the circuit breaker contact.
- Status is OFF during TRIP.
- It is comprised of C contact.







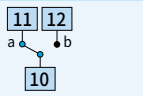
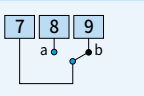
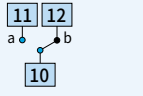
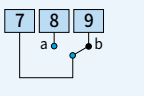
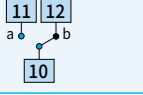
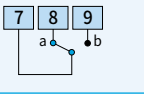

#### Trip Alarm Switch (ALT)

- It is only activated when the circuit breaker has tripped due to an overload, short circuit or operation of shunt trip switch and does not operate during general ON/OFF.
- Returns to original state when circuit breaker has been reset.
- It is comprised of C contact.

#### Contact Circuit Diagram

	Auxiliary Switch (AUX)	Trip Alarm Switch (ALT)
MCCB ON		
MCCB OFF		
MCCB TRIP		

#### Possible Location for Installation

Type	AUX	ALT
HGP50D HGP125D HGP160D		
HGP250		
HGP400 HGP630		
HGP800		

#### Rating of Contact

Rated Conventional Thermal Current	5 A		
Minimum Load	160 mA, 5 VDC		
Rated Operation Current	Resistive Load	Inductive Load	
AC	125 V	5 A	3 A
	250 V	3 A	2 A
DC	30 V	4 A	3 A
	125 V	0.4 A	0.4 A
	250 V	0.2 A	0.2 A



HGP630 - AUX - ALT



HGP250 ~ 800 ALT  
HGP160 ~ 800 AUX



HGP160D ALT



## Shunt Trip Device (SHT) / Under-Voltage Device (UVT)

SHT/UVT is installed inside the circuit breaker and it offers the function of remote tripping the circuit breaker by controlling the voltage applied to both terminals of the coil.

### Shunt Trip Device (SHT)

It is able to remotely trip the circuit breaker by applying voltage to the shunt trip device installed in the circuit breaker.

#### Operating Condition

- $U \geq 0.7 \times U_n$  (More than 70 % of rated voltage applied)
- As for impulse type voltage, more than 20 ms applied

#### Rated Voltage and Characteristics

Rated Voltage (Un)	Power Consumption	
	W or VA	A (mA)
DC	24 V	1.2
	100 ~ 125 V	2.8
	100 ~ 120 V	3.3
AC (50/60 Hz)	200 ~ 230 V	5.2
	380 ~ 415 V	13.9
	440 ~ 480 V	10.9
Rated Operational Voltage	0.7 ~ 1.1 × Un	
Operating Time	50 ms	

#### Possible Location for Installation

Type	SHT	UVT
HGP50D HGP125D HGP160D		
HGP250		
HGP400 HGP630		
HGP800		

#### Wiring

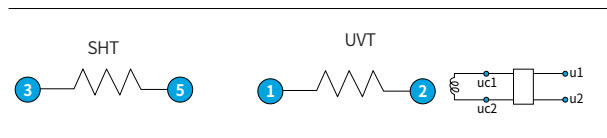

### Under-Voltage Device (UVT)

If the under-voltage trip device is installed in the circuit breaker, the circuit breaker is tripped or is not closed in case the circuit voltage is below the reference value.

In case the circuit voltage drops to less than 35 % of the rated voltage ( $U_n$ ), UVT automatically initiates a trip in the circuit breaker to prevent damage to the load.

#### Opening Conditions

- Operating characteristics are guaranteed to conform to the IEC 60947-2 standard criteria.
- Trip Condition of Circuit Breaker :  $U \leq 0.35 \times U_n$
- No Trip Condition of Circuit Breaker :  $U \geq 0.7 \times U_n$
- In the  $U = 0.35 \sim 0.7 \times U_n$  interval, the circuit breaker can be tripped but the operation is not guaranteed.

#### Closing Conditions

- In case of circuit breakers assembled with UVT, the circuit breaker can be OFF/RESET when voltage is not applied but the circuit breaker cannot be ON (Closing).
- In order to close the circuit breaker, Voltage must be applied to UVT.
- Closing Condition :  $U \geq 0.85 \times U_n$

#### Rated Voltage and Characteristics

Rated Voltage (Un)	Power Consumption	
	W or VA	A (mA)
DC	24 V	2.6
	100 ~ 125 V	5
	100 ~ 120 V	4.5
AC (50/60 Hz)	200 ~ 230 V	5.6
	380 ~ 415 V	10.8
	440 ~ 480 V	12.5
Starting Voltage	Opening	0.35 ~ 0.7 × Un
	Closing	0.85 × Un
Rated Operational Voltage	0.85 ~ 1.1 × Un	
Operating Time	50 ms	

※ Do not use UVT for electrical interlocking system.



HGP50D ~ HGP160D



HGP250



HGP400 ~ 800



UVT Controller



HGP630\_SHT

## External Accessories (HGM)

### Locking Device

#### Handle Locking Device Using Padlock (PLD)

This device is used for locking the handle of circuit breaker to the OFF position by using a padlock. Padlock is not provided separately and up to 3 can be used. The applicable specifications of padlocks are as below.

Type	Application	Padlock Diameter <sup>1)</sup>
PLD 10GM	HGM30 ~ HGM250	5 mm
	HGE30 ~ HGE250	
PLD 40GM	HGM400 ~ HGM800	6 mm
	HGE400 ~ HGE800	

#### Mechanical Interlock

This device interlocks two circuit breakers by using a mechanical interlock.

#### Key Features

- It prevents two breakers from closing at the same time.
- All circuit breakers are turned OFF. The applicable specifications of padlocks are as below.

Type				Application	Padlock Diameter <sup>1)</sup>
2P	3P	4P (RSTN)	4P (NRST)		
MIF 10GM 2	MIF 10GM 3	MIF 10GM R4	MIF 10GM N4	HGM/HGE30, 50E/S, 60, 100	5 mm
MIF 12GM 2	MIF 12GM 3	MIF 12GM R4	MIF 12GM N4	HGM/HGE50H/L,125	
-	MIF 25GM 3	MIF 25GM R4	MIF 25GM N4	HGM/HGE160, 250	
-	MIF 40GM 3	MIF 40GM R4	MIF 40GM N4	HGM/HGE400	6 mm
-	MIF 80GM 3	MIF 80GM R4	MIF 80GM N4	HGM/HGE630, 800	



PLD

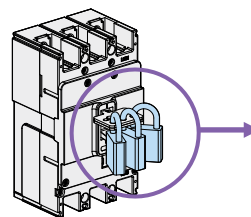
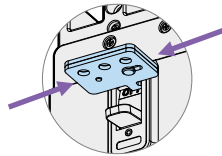

Padlock Diameter  
(Refer to Table)



MIF

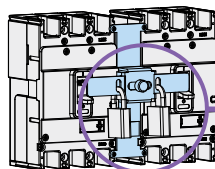

Padlock Diameter  
(Refer to Table)

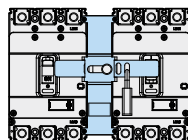

Right Off Lock

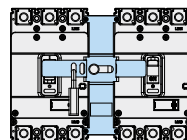

Left Off Lock

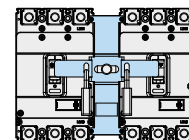

Double Off Lock

※ 1) Padlock not included

## Terminal Cover

As a part that insulates the circuit breaker's live and load side of terminal area from the outside, it prevents electric shock and short-circuit accidents that may occur due to direct contact of people's hand or tools such as drivers with the live current part. When the terminal cover is used, the protection grade of IP40 is applied to the power part. Based on the connection method of the circuit breaker, it can be classified into long or short type for use and various handles and interlock devices can be combined for use.

### Short Type

It is suitable for plug-in or rear connection.

### Long Type

It is suitable for front connection by using wires, bus bar or lug terminals.

Type						Application	Pitch (mm)
2P		3P		4P			
Short	Long	Short	Long	Short	Long		
TCF 10GM S2	TCF 10GM L2	TCF 10GM S3	TCF 10GM L3	TCF 10GM S4	TCF 10GM L4	HGM30, 50E/S, 60, 100 HGE30, 50E/S, 60, 100	25
TCF 12GM S2	TCF 12GM L2	TCF 12GM S3	TCF 12GM L3	TCF 12GM S4	TCF 12GM L4	HGM50H/L, 125 HGE50H/L, 125	30
TCF 25GM S3	TCF 25GM L3	TCF 25GM S3	TCF 25GM L3	TCF 25GM S4	TCF 25GM L4	HGM160, 250 HGE160, 250	35
TCF 40GM S3	TCF 40GM L3	TCF 40GM S3	TCF 40GM L3	TCF 40GM S4	TCF 40GM L4	HGM400 HGE400	44
TCF 80GM S3	TCF 80GM L3	TCF 80GM S3	TCF 80GM L3	TCF 80GM S4	TCF 80GM L4	HGM630, 800 HGE630, 800	70
TCF 10HD S2	-	TCF 10HD S3	-	-	-	HDB30, 50, 100 HDG30, 50, 100	25



Short Type



Long Type

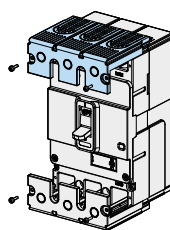

Assembly Diagram

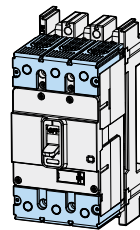

Short Type  
(Plug-in Connection)

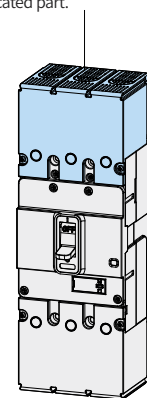

Long Type  
(Front Connection)

※ In case of using as front connection, please use it after removing the indicated part.

## External Accessories (HGM)

### Insulation Barrier

As a part used to prevent accidents with regards to insulation and conductive foreign substance between the circuit breaker terminals, it improves the performance of phase-to-phase insulation by installing it in the groove between the circuit breaker's terminals. It can easily be assembled even if the circuit breaker has already been installed and in case the two circuit breakers have been installed side by side, it can also be assembled in the gap between the two circuit breakers. In addition, it is used in the terminal cover and plug-in base.

※ In case insulation barrier is not mounted between the circuit breaker's terminal, it may cause secondary short-circuit accidents so it must be used.  
Insulation barrier must be installed towards the direction of the circuit breaker's line indication part.

Type			Application	No. of Parts (EA/Set)		
2P	3P	4P		2P	3P	4P
TQQ 10GM 2	TQQ 10GM 3	TQQ 10GM 4	HGM30, 50E/S, 60, 100 HGE30, 50E/S, 60, 100	1	2	3
TQQ 10GM 2	TQQ 10GM 3	TQQ 10GM 4	HGM50H/L, 125 HGE50H/L, 125	1	2	3
TQQ 25GM 2	TQQ 25GM 3	TQQ 25GM 4	HGM160, 250 HGE160, 250	1	2	3
TQQ 63GP 2	TQQ 63GP 3	TQQ 63GP 4	HGM400 HGE400	1	2	3
TQQ 63GP 2	TQQ 63GP 3	TQQ 63GP 4	HGM630, 800 HGE630, 800	1	2	3
TQQ 10HD 2	TQQ 10HD 3	-	HDB30, 50, 100 HDG30, 50, 100	2	4	-

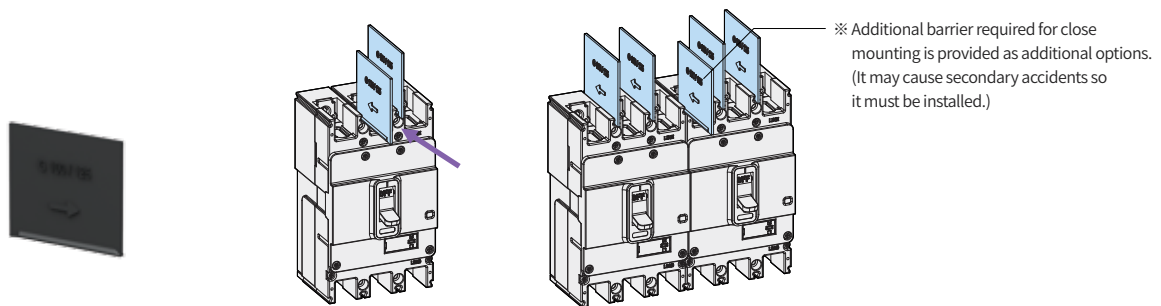

## Rotary Handle

Rotary handle is a product that can check and operate MCCB's ON/OFF/TRIP even when the panel door is closed by installing the circuit breaker in enclosed switchgear or on MCCB panel and others. There are two types of rotary handle, direct type and extended type and all the rotary handles offer panel door locking function and handle locking function. The rotary handle can be rotated clockwise to turn the circuit breaker "ON" and according to the mounting direction of MCCB, it is categorized into the upper line, the right line and the left line. The IP rating of the handle is IP40.

### Direct Rotary Handle

- 32 ~ 250 AF : The handle is attached directly to the circuit breaker.
- 400 ~ 800 AF : The handle attached to the door of the panel.

### Extended Rotary Handle

It is suitable in case the distance between the circuit breaker and the panel door is long. The handle is attached to the door of the panel and there is no trip-button function.

Type			Application
Upper Line	Right Line	Left Line	
TFG 10GM U	TFG 10GM R	TFG 10GM L	HGM/HGE30, 50E/S, 60, 100
TFG 12GM U	TFG 12GM R	TFG 12GM L	HGM/HGE50H/L, 125
TFG 25GM U	TFG 25GM R	TFG 25GM L	HGM/HGE160, 250
TFG 40GM U	TFG 40GM R	TFG 40GM L	HGM/HGE400
TFG 80GM U	TFG 80GM R	TFG 80GM L	HGM/HGE630, 800

Type	Application
TFH 10GM	HGM/HGE30, 50E/S, 60, 100
TFH 12GM	HGM/HGE50H/L, 125
TFH 25GM	HGM/HGE160, 250
TFH 40GM	HGM/HGE400
TFH 80GM	HGM/HGE630, 800



Direct Rotary Handle  
(TFG-HGM)

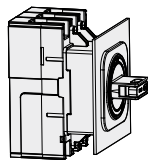

HGM30 ~ HGM250

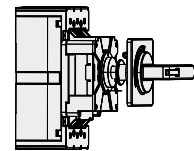

HGM400 ~ HGM800



Extended Rotary Handle  
(TFH-HGM)

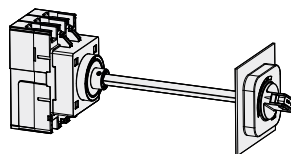

HGM30 ~ HGM250

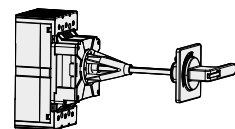

HGM400 ~ HGM800

## External Accessories (HGM)

### Rotary Handle

#### Types of Handle Depending on the Circuit Breaker's Installation Type

Rotary handle is divided into the following three types depending on the circuit breaker's direction of power supply.

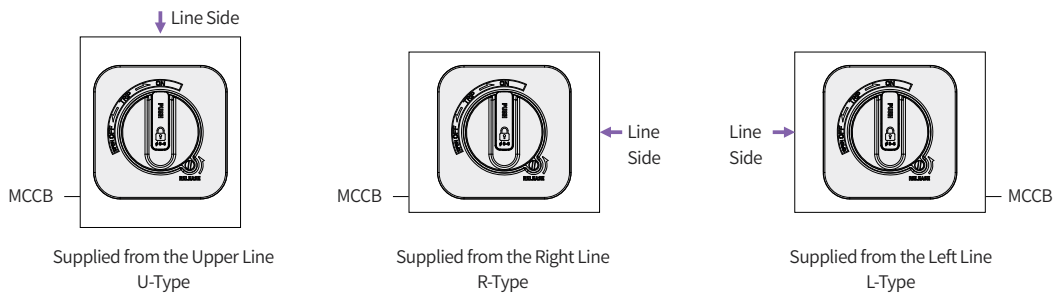

#### How to Operate the Handle

Operating Direction : If the handle is rotated clockwise, the circuit breaker is ON.

- Circuit Breaker ON : Rotate the handle to ON position. (Figure 1)
- Circuit Breaker OFF : Rotate the handle to OFF position. (Figure 2)
- Circuit Breaker TRIP : If the circuit breaker is tripped, the handle will automatically return to TRIP position. (Figure 3)
- After the circuit breaker is tripped, rotate the handle to the RESET position first (Figure 4) then rotate to the ON position and the circuit breaker will turn ON (Figure 1).
- If you need to open the door when the handle is in the ON state, rotate the RELEASE screw to the direction of the arrow then open the door (Figure 5).

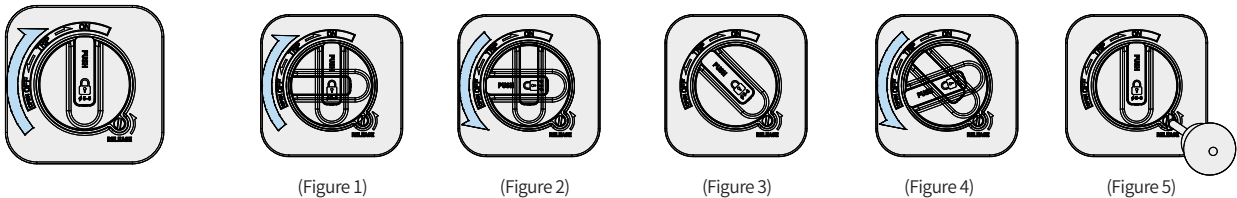

#### Handle Locking Device

Locking Function	OFF State Door Lock	ON State Door Lock	Reverse Interlock	Handle Padlock
Details	<ul style="list-style-type: none"> <li>• Impossible to open the panel door when the circuit breaker is in the OFF state.</li> <li>• Possible at RESET position</li> <li>• Possible to open the panel door after rotating the handle to RESET</li> </ul>	<ul style="list-style-type: none"> <li>• Impossible to open the panel door when the circuit breaker is in the ON state</li> <li>• Possible to open the panel door after rotating the RELEASE screw</li> </ul>	<ul style="list-style-type: none"> <li>• Impossible to close the circuit breaker (ON) in case the panel door is open</li> </ul>	<ul style="list-style-type: none"> <li>• Padlocking function which locks using a padlock to prevent handle operation.</li> <li>• Padlock is not provided separately and the number of padlocks depends on the padlock diameter. (Refer to the table below)</li> <li>• As for the specifications of the applicable padlocks, refer to the table below.</li> </ul>
Direct Type (TFG)	●	●	● (100/125/250 AF Only)	●
Extended Type (TFH)	●	●	-	●

※ For TFG 250 AF or less, The handle remains ON when the circuit breaker is tripped after padlocking in on position

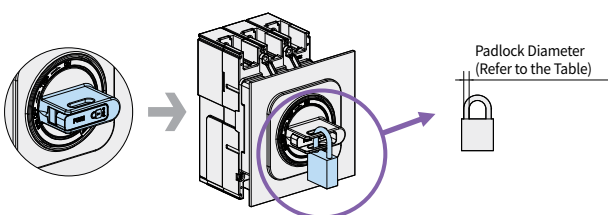

Application	Padlock Diameter <sup>1)</sup>	No. of Padlocks that can be Used
HGM/HGE30 ~ 250	6 ~ 8 mm	Ø6,Ø7 : 2 EA Ø8 : 1 EA
HGM/HGE400 ~ 800	5 ~ 7 mm	3 EA

※ <sup>1)</sup> Padlock not included

## Front Connection of Fixed Devices

Straight/spreader bus bar can be or lug terminal can be selected for use depending on the size specification of the cable or bus bar to be connected to the circuit breaker.

### Insulated Bar Connection

In case the bus bar pitch of the switchgear is equal to the circuit breaker, it can be connected directly to the circuit breaker by using an insulation tube. Refer to the following connection bus bar specification for connection. The insulation barrier between phases and terminal cover must be used.

Application	Connection Bus Bar Dimensions (mm)				Applicable Bolt and Tightening Torque	
	A	B	C	D	Bolt Spec.	Max. Tightening Torque (kgf×cm)
HGM/HGE 30, 50E/S, 60, 100	< 7.5	< 17	$\varnothing \geq 5.5$ ( $\leq 50$ A)	A + 7.5	M5 Screw ( $\leq 50$ A)	28.5
	< 7.5	< 17	$\varnothing \geq 9$ ( $> 50$ A)	A + 7.5	M8 Screw ( $> 50$ A)	110
HGM/HGE50H/L, 125	< 7.5	< 20	$\varnothing \geq 9$	A + 7.5	M8 Screw	110
HGM/HGE160, 250	< 10	< 27	$\varnothing \geq 9$	A + 10	M8 Hex Socket	110
HGM/HGE400	< 12.5	< 30	$\varnothing \geq 11$	A + 12.5	M10 Hex Socket	270
HGM/HGE630, 800	< 12.5	< 45	$\varnothing \geq 13$	A + 12.5	M12 Hex Socket	470

### Crimped Terminal

The terminal that conforms to the specification (crimped/copper tubing terminal) must be used and the insulation barrier between phases and the terminal cover must be used. The terminal that conforms to the cable's material and specification must be selected for use according to the rating of the circuit breaker. Also the terminal is not provided separately. For the cable specifications, refer to the table below.

Application Type	Rated Current	Cu Cable Size (mm <sup>2</sup> )	Applicable Terminal Dimensions (mm)	
			A	B
HGM/HGE 30, 50E/S, 60, 100	32	6	$\varnothing \geq 5.5$	< 18
	50	10	$\varnothing \geq 5.5$	
	63	16	$\varnothing \geq 9$	
	100	35	$\varnothing \geq 9$	
HGM/HGE50H/L, 125	50	10	$\varnothing \geq 9$	< 21
	125	50	$\varnothing \geq 9$	
HGM/HGE160, 250	160	70	$\varnothing \geq 9$	< 28
	250	120	$\varnothing \geq 9$	
HGM/HGE400	400	240	$\varnothing \geq 11$	< 30
HGM/HGE630, 800	800	240×2	$\varnothing \geq 13$	< 45

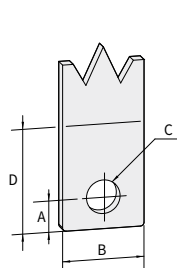

Connection Bus Bar

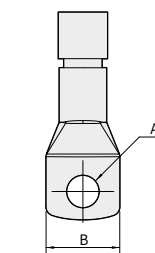
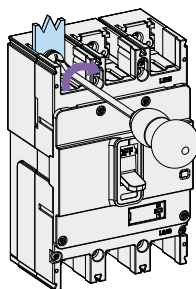

Crimped Terminal

## External Accessories (HGM)

### Front Connection of Fixed Devices

#### Busbar

##### Straight Busbar

It is used to meet the cable and standards of the switchgear.  
(Pitch between the poles maintained)

##### Spreader Busbar

It is used to extend the internal insulation distance of the switchgear. (Pitch between the poles extended)

Application		Straight		Spreader	
Type	Pole	Type	Pitch	Type	Pitch
HGM/HGE 160, 250	2	TBB 25GP 2S	35 mm	-	45 mm
	3	TBB 25GP 3S		TBB 25GP 3E45	
	4	TBB 25GP 4S		TBB 25GP 4E45	
HGM/HGE 400	2	TBB 40GM 2S	44 mm	-	59 mm
	3	TBB 40GM 3S		TBB 40GM 3E59	
	4	TBB 40GM 4S		TBB 40GM 4E59	
HGM/HGE 630	2	TBB 63GM 2S	70 mm	-	-
	3	TBB 63GM 3S		-	
	4	TBB 63GM 4S		-	
HGM/HGE 800	2	TBB 80GM 2S	70 mm	-	-
	3	TBB 80GM 3S		-	
	4	TBB 80GM 4S		-	

#### LUG Terminal

As a part that connects the cable to the circuit breaker so that the cable can be used without crimped terminal, it must be selected according to the product's rating and size of cable.

Application		LUG Terminal		Application				Tightening Torque (kgf×cm)
Type	Pole	Type	Material	EA	Material	S (mm <sup>2</sup> )	L (mm)	
HGM/HGE 30, 50E/S, 60, 100 (≤ 50 A)	2	CTB 10GM 2S50	Al	1	Cu/Al	2.5 ~ 16	14	60
	3	CTB 10GM 3S50						
	4	CTB 10GM 4S50						
HGM/HGE 60, 100 (> 50 A)	2	CTB 10GM 2S100	Al	1	Cu/Al	16 ~ 50	14	60
	3	CTB 10GM 3S100						
	4	CTB 10GM 4S100						
HGM/HGE 50H/L, 125	2	CTB 12GM 2S	Al	1	Cu/Al	2.5 ~ 70	14	60
	3	CTB 12GM 3S						
	4	CTB 12GM 4S						
HGM/HGE 160, 250	2	CTB 25GM 2S	Al	1	Cu/Al	50 ~ 180	19	140
	3	CTB 25GM 3S						
	4	CTB 25GM 4S						
HGM/HGE 400	3	CTB 40GM 3S1H	Al	1	Cu/Al	60 ~ 240	30 ~ 60	353
	4	CTB 40GM 4S1H				60 ~ 125		
HGM/HGE 400	3	CTB 40GM 3S	Al	2	Cu/Al	60 ~ 240	30 ~ 60	353
	4	CTB 40GM 4S						
HGM/HGE 630, 800	3	CTB 80GM 3S	Al	3	Cu/Al	60 ~ 185	30 ~ 60	353
	4	CTB 80GM 4S						

※ Quantity per Set : 2P - 2 EA, 3P - 3 EA, 4P - 4 EA

The type concerned is an inch-type and in case of HGM100 ~ 250, ISO type (mm) is also available.



Straight Busbar



Spreader Busbar

LUG Terminal



HGM/HGE30 ~ 250



HGM400



HGM/HGE630, 800



Wire



## Plug-in Connection Devices

If the plug-in connection method is used, the circuit breaker can be replaced quickly and accurately without separating the power cable during a malfunction of a circuit breaker. Therefore, if the plug-in method of circuit breaker is installed in important electrical facilities such as shipping, broadcast station and others, the circuit breaker can be replaced and maintained quickly and conveniently without disconnecting the bus bar.

- Applicable to 32 ~ 800 AF.
- Offers convenient maintenance of switchgear.
- Convenient and relaxed installation after manufacture of the switchgear.
- Circuit breaker can be removed or replaced quickly without touching the terminal connection area.
- Connection block can be made by connecting the internal accessory to the circuit breaker.
- Type : For switchboard (TDM/TDF), for distribution board (TDA)
- Composition : Plug-in devices, plug-in MCCB, terminal cover or insulation barrier (Option).

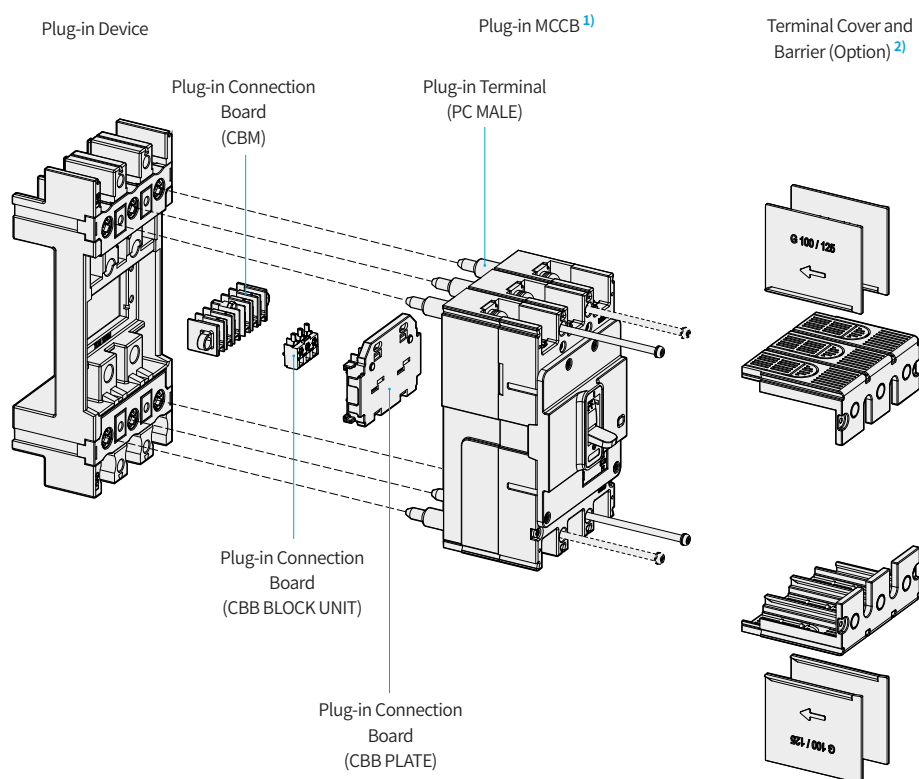

※ 1) Plug-in MCCB must be used to apply the plug-in connection method.

2) If case the terminal cover is not used, the barrier between phases must be installed.

## External Accessories (HGM)

### HG-MCCB Plug-in CBM Wiring Position (TDM Front Side)

Option	HGM30, 50E/S, 60, 100/2P	HGM30, 50E/S, 60, 100	HGM50H/L, 125, 160, 250	HGM400, 630, 800	HGP50D, 125D, 160D	HGP250	HGP630	HGP800
AUX								
AUX2								
AUX3								
ALT								
SHT/UVT								
AUX+ALT								
AUX2+ALT								
AUX3+ALT								
AUX+SHT/UVT								
AUX2+SHT/UVT								
AUX3+SHT/UVT								
ALT+SHT/UVT								
AUX+ALT+SHT/UVT								
AUX+ALT+SHT/UVT Max. Mounting Combination								

## Plug-in Connection Block

As a connection block capable of realizing the plug-in connection method, it can be connected to the internal and external accessory of the circuit breaker.

### Application

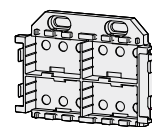
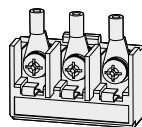
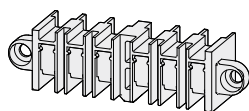

HGM100 ( $\leq 50$ A)	CBM 10GM 2PUNIT (2P) CBM 10GM UNIT (3P)	CBB BLOCK UNIT	CBBPLATE 10GM
HGM100 ( $> 50$ A)			
HGM125			
HGM250			CBBPLATE 40GM
HGM400			CBBPLATE 80GM
HGM800			
Quantity per Set	1	1	1

## Plug-in Terminal

It is a part that can realize the plug-in MCCB.

### Application

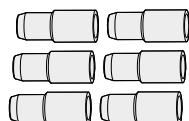

HGM100 ( $\leq 50$ A)	PCMALE 10GM 50 A
HGM100 ( $> 50$ A)	PCMALE 10GM 100 A
HGM125	PCMALE 12GM
HGM250	PCMALE 25GM
HGM400	PCMALE 40GM
HGM800	PCMALE 80GM
Quantity per Set	6

## External Accessories (HGM)

### Plug-in Devices



As a connection block for plug-in MCCB installation, it is available for applicable panel and the purpose of use.

#### TDM Type

- TDM-P : It is comprised of plug-in terminal for both line/load for convenient use of connection block depending on the structure of the switchgear.
- TDM-F : Only plug-in parts of the line terminal are provided in TDM-P products.

#### TDF Type

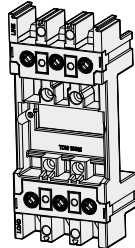
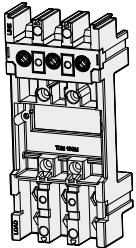
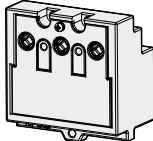
- Only the line terminal is comprised of plug-in terminal but the plug-in device can be fixed to the switchgear using the same method as TDM-P.

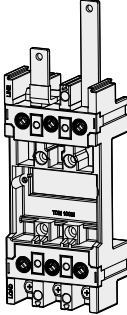
Applied Panel	Switchgear			Distribution Board	
Type	TDM-P	TDM-F	TDF	TDA (2 row)	TDA (1 row)
Composition					
Purpose	Line/Load Side	Line Side	Line Side	Duble Base	Single Base
HGM/HGE Type	32 ~ 800 AF	32 ~ 800 AF	32 ~ 125 AF	32 ~ 125 AF	32 ~ 125 AF
Pole	3P	3P	3P	2P (100 AF Only), 3P	3P

### Specification of Connection Busbar

The bus bar of the switchgear can directly be connected to the plug-in device. The specifications of the applicable bus bar are as below and the insulation barrier or terminal cover must be used.

Unit : mm

Product	A	B	C	D	Remark
HGM/HGE30, 50E/S, 60, 100	< 10	< 21	$\varnothing \geq 6.5$	< 17.5	
HGM/HGE50H/L, 125	< 10	< 21	$\varnothing \geq 6.5$	< 19.5	
HGM/HGE160, 250	< 17.5	< 25	$\varnothing \geq 8.5$	< 27.5	
HGM/HGE400	< 22	< 32	$\varnothing \geq 10.5$	< 38	
HGM/HGE630, 800	< 30	< 40	$\varnothing \geq 17$	< 48.5	

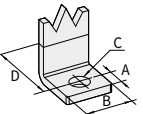
Product	A	B	C	D	Remark
HGM/HGE30, 50E/S, 60, 100	< 7.5	< 15	$\varnothing \geq 7$	< 13	
HGM/HGE50H/L, 125	< 7.5	< 15	$\varnothing \geq 7$	< 13	
HGM/HGE160, 250	-	-	-	-	
HGM/HGE400	-	-	-	-	
HGM/HGE630, 800	-	-	-	-	

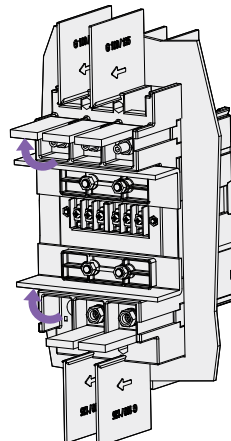

## Rear Connection Terminal

It is a part for rear connection instead of front connection requirement it applies the fixed type of circuit breaker to the switchgear. The bus bar of the switchgear can be wired vertically or horizontally depending on the assembly direction of the connection.

### Flat Type

Application		Rear Terminal		Quantity per Set	
Type	Pole	Line Side	Load Side	Short Terminal	Long Terminal
HGM/HGE 30, 50E/S, 60, 100 (≤ 50 A)	2	RCT 05GM F2		1	1
	3	RCT 05GM F3		2	1
	4	RCT 05GM F4		2	2
HGM/HGE 60, 100 (> 50 A)	2	RCT 10GM F2		1	1
	3	RCT 10GM F3		2	1
	4	RCT 10GM F4		2	2
HGM/HGE 50H/L, 125	2	RCT 12GM F2		1	1
	3	RCT 12GM F3		2	1
	4	RCT 12GM F4		2	2
HGM/HGE 160, 250	2	RCT 25GM F2		2	0
	3	RCT 25GM F3		2	1
	4	RCT 25GM F4		2	2
HGM/HGE 400	3	RCT 40GM F3 LINE	RCT 40GM F3 LOAD	2	1
	4	RCT 40GM F4 LINE	RCT 40GM F4 LOAD	2	2
HGM/HGE 630, 800	3	RCT 80GM F3 LINE	RCT 80GM F3 LOAD	2	1
	4	RCT 80GM F4 LINE	RCT 80GM F4 LOAD	2	2

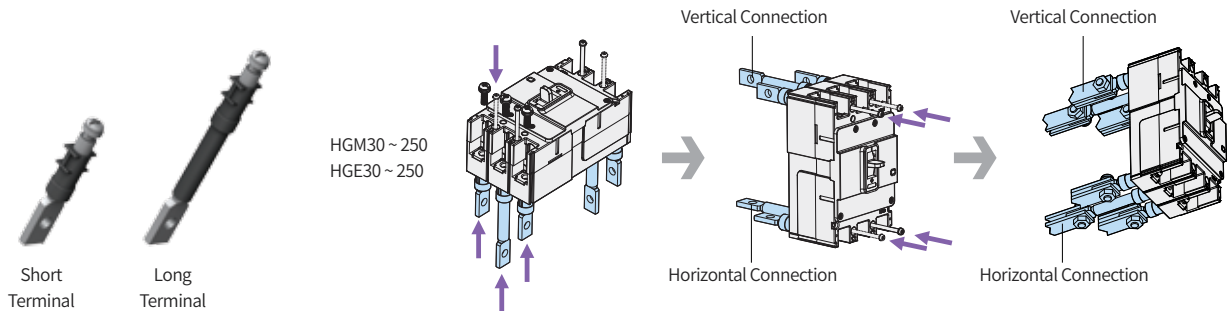

※When assembling the RCT, remove the back barrier in advance.

## DIN Rail Adaptor

This is a part that enables a separate adaptor to be assembled and mounted for rear connection with the circuit breaker when the circuit breaker is mounted on the DIN Rail. (HGM/HGE100 Only)

Application		Din Rail Adaptor	Quantity
Type	Pole		
HGM/HGE 30, 50E/S, 60, 100	2	DRA 10GM	1
	3	DRA 10GM	1
	4	DRA 10GM	2

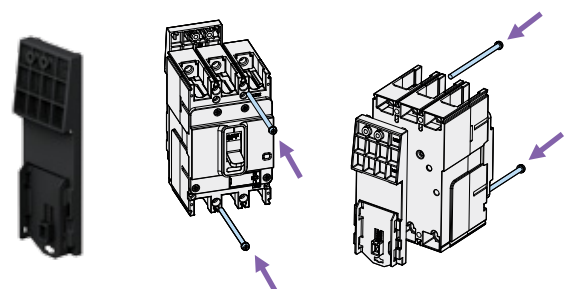

※ When assembling the DRA, remove the back barrier beforehand.

## External Accessories (HGM)

### Motor Operator

This device is used for turning the circuit breaker ON/OFF in remote position.

It is convenient for establishing automation system for low-voltage system and for selecting load when operating under emergency power.

Application		MOT	Voltage
Type	Pole		
HGM30, 50E/S, 60, 100	3, 4	MOT 10GM	DC 24 V AC/DC 110 V AC/DC 240 V
HGM50H/L, 125	3, 4	MOT 12GM	
HGM160, 250	3, 4	MOT 25GM	
HGM400	3, 4	MOT 40GM	
HGM630, 800	3, 4	MOT 80GM	

### Rating and Characteristics

Format	Mechanical Lifespan	Operational Voltage	Operational Current (A)	Operating Time (ms)		Power Consumption (W)
				Closing	Opening	
MOT 10GM	10,000	DC 24 V	≤ 2.5	310	200	14
		AC/DC 110 V	≤ 0.5			
		AC/DC 240 V	≤ 0.5			
MOT 12GM	10,000	DC 24 V	≤ 2.5	350	230	14
		AC/DC 110 V	≤ 0.5			
		AC/DC 240 V	≤ 0.5			
MOT 25GM	8,000	DC 24 V	≤ 2.5	350	230	14
		AC/DC 110 V	≤ 0.5			
		AC/DC 240 V	≤ 0.5			
MOT 40GM	5,000	DC 24 V	≤ 6.0	500	350	14
		AC/DC 110 V	≤ 3.0			
		AC/DC 240 V	≤ 2.0			
MOT 80GM	5,000	DC 24 V	≤ 6.0	500	350	35
		AC/DC 110 V	≤ 3.0			
		AC/DC 240 V	≤ 2.0			

※ Range of Operational Voltage : 85 ~ 110 % (DC 24 V : 95 ~ 110 %)

### Circuit and Wiring Drawing

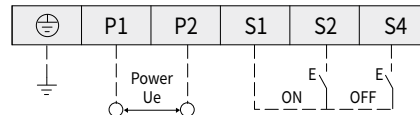
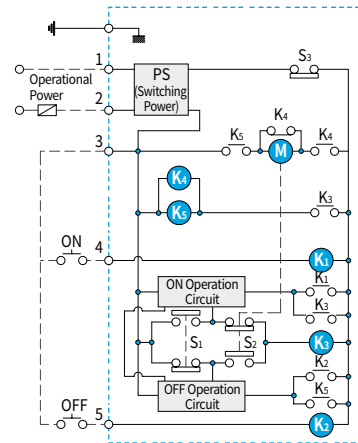

- : Motor
- : ON Relay
- : OFF Relay
- : Relay for Motor
- S1 : ON Limit Switch
- S2 : OFF Limit Switch
- S4 : Auto/Manual Limit Switch

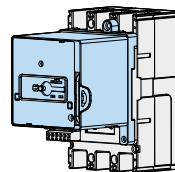

### ※ Precaution for mounting

When mounting the motor operator on MCCB, it must be mounted when the MCCB's handle position is in OFF position. Mounting the motor operator in other positions (ON, TRIP) may cause damage to the motor.

## External Accessories (HGP)

### Locking Device

#### Padlocking Device (PLD)

This device is used for locking the handle of circuit breaker to the OFF position by using a padlock. Padlock is not provided separately and up to 3 can be used. The applicable specifications of padlocks are as below.

#### Mechanical Interlock

This device interlocks two circuit breakers by using a mechanical interlock.

#### Key Features

- It prevents two breakers from closing at the same time.
- All circuit breakers are open. The applicable specifications of padlocks are as below.

Type	Application	Padlock Diameter <sup>1)</sup>
PLD 16GP	HGP50D, HGP125D, HGP160D	5 ~ 6 mm
PLD 25GP	HGP250 (HGP100/MCP)	
PLD 63GP	HGP400, HGP630	
PLD 80GP	HGP800	

Type		Application	Padlock Diameter <sup>1)</sup>
3P	4P		
MIF 16GP 3	MIF 16GP R4	HGP50D, HGP125D, HGP160D	5 ~ 7 mm
MIF 25GP 3	MIF 25GP R4	HGP250 (HGP100/MCP)	
MIF 63GP 3	MIF 63GP R4	HGP400, HGP630	
MIF 80GP 3	MIF 80GP R4	HGP800	

※ 1) Padlock not included

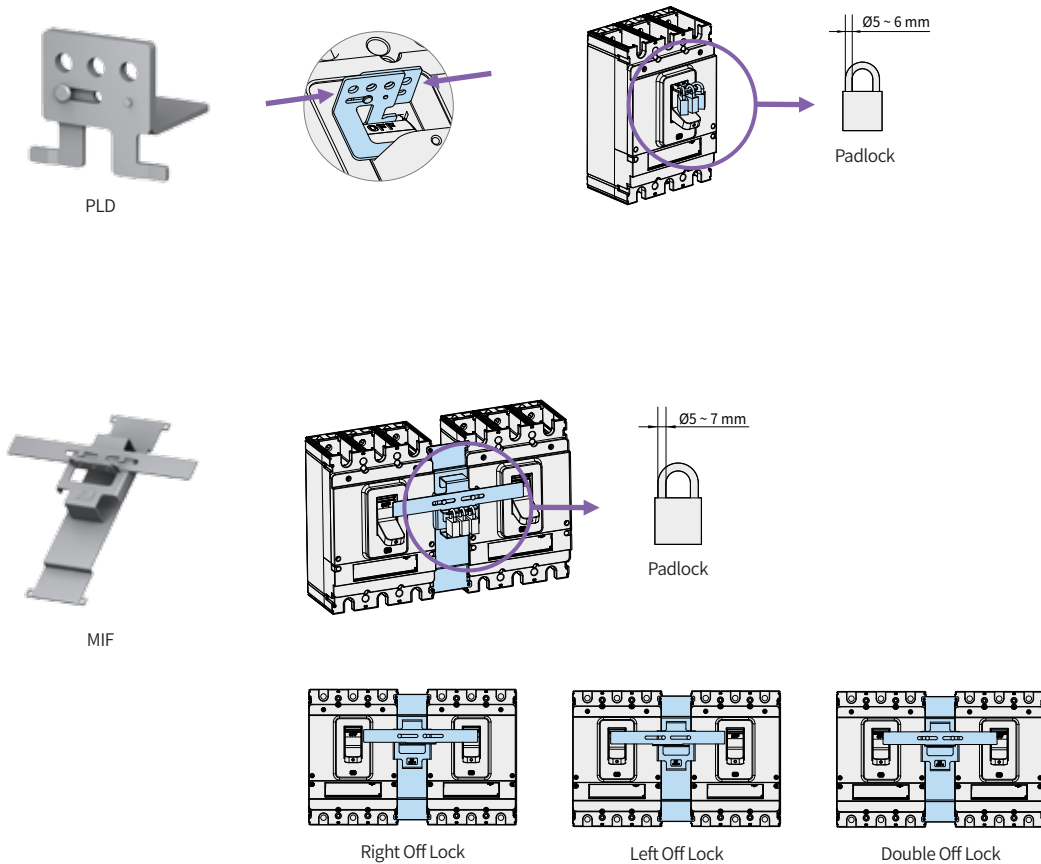

## External Accessories (HGP)

### Terminal Cover / Insulation Barrier

#### Terminal Cover

It is our insulation part of circuit breaker for live and load side of terminal area from the outside and it prevents electric shock and short-circuit accidents that may occur due to direct contact of people's hand or tools with the live current part. When the terminal cover is used, the protection degree of IP40 is applied to the conductor part. Based on the connection method of the circuit breaker, it can be classified into long or short type for use and various handles and interlock devices can be combined for use.

#### Short Type

It is suitable for plug-in or rear connection.

#### Long Type

It is suitable for front connection by using wires, bus bar or lug terminals.

#### Insulation Barrier

As a part used to prevent accidents with regards to insulation and conductive foreign substance between the circuit breaker terminals, it improves the performance of phase-to-phase insulation by installing it in the groove between the circuit breaker's terminals. It can easily be assembled even if the circuit breaker has already been installed and in case the two circuit breakers have been installed side by side, it can also be assembled in the gap between the two circuit breakers. In addition, it is used in the terminal cover and plug-in base. In case insulation barrier is not mounted between the circuit breaker's terminal, it may cause secondary short-circuit accidents so it must be used.

Type			Application	Pitch (mm)	No. of Parts (EA/Set)
3P Short (Plug-in)	3P Long (3P)	4P Long (4P)			
TCF 16GP S3	TCF 16GPL L3	TCF 16GPL L4	HGP50D, HGP125D, HGP160D	30	1
TCF 25GP S3	TCF 25GPL L3	TCF 25GPL L4	HGP250 (HGP100/MCP)	35	1
TCF 63GP S3	TCF 63GPL L3	TCF 63GPL L4	HGP400, HGP630	46.5	1
TCF 80GP S3	TCF 80GPL L3	TCF 80GPL L4	HGP800	70	1

Type			No. of Parts (EA/Set)	
3P	4P	Application	3P	4P
TQQ 16GP 3	TQQ 16GP 4	HGP50D, HGP125D, HGP160D	4	6
TQQ 25GP 3	TQQ 25GP 4	HGP250 (HGP100/MCP)	4	6
TQQ 63GP 3	TQQ 63GP 4	HGP400, HGP630	4	6
TQQ 80GP 3	TQQ 80GP 4	HGP800	4	6



Terminal Cover Short Type



Terminal Cover Long Type



Insulation Barrier

※ In case of using as front connection, please use it after removing the indicated part.

※ Additional barrier required for close mounting is provided as additional options. (It may cause secondary accidents so it must be installed.)

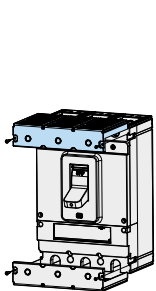

Assembly Diagram

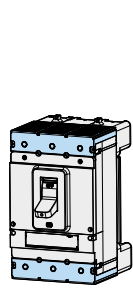

Short Type (Plug-in Connection)

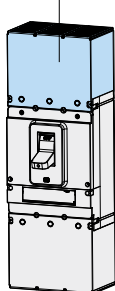

Long Type (Front Connection)

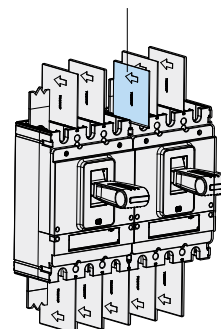
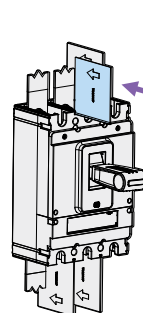



## Rotary Handle

Rotary handle is a product that can check and operate MCCB's ON/OFF/TRIP even when the panel door is closed by installing the circuit breaker in enclosed switchgear or on MCCB panel and others. There are two types of rotary handle, direct type and extended type and all the rotary handles offer panel door locking function and handle locking function. The rotary handle can be rotated clockwise to turn the circuit breaker "ON" and according to the mounting direction of MCCB, it is categorized into the upper line, the right line and the left line. The IP grade of the handle is IP40.

### Direct Rotary Handle

- 160 ~ 250 AF : The handle is installed directly to the circuit breaker.
- 630 ~ 800 AF : The handle is installed to the door of the panel.

Type			Application
Upper Line	Right Line	Left Line	
TFG 16GP U	TFG 16GP R	TFG 16GP L	HGP50D, HGP125D, HGP160D
TFG 25GP U	TFG 25GP R	TFG 25GP L	HGP250 (HGP100/MCP)
TFG 63GP U	TFG 63GP R	TFG 63GP L	HGP400, HGP630
TFG 80GP U	TFG 80GP R	TFG 80GP L	HGP800

### Extended Rotary Handle

It is suitable if the distance between the circuit breaker and the panel door is long. The handle is installed to the door of the panel and there is no trip-button function.

Type	Application
TFH 16GP	HGP50D, HGP125D, HGP160D
TFH 25GP	HGP250 (HGP100/MCP)
TFH 63GP	HGP400, HGP630
TFH 80GP	HGP800

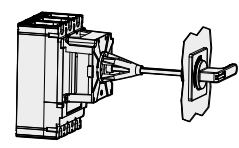
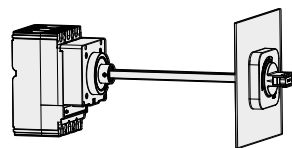
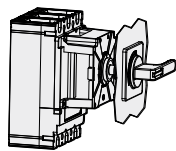
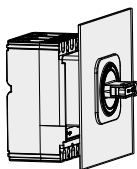

HGP50D, HGP125D  
HGP160D, HGP250

HGP400, HGP630  
HGP800

HGP50D, HGP125D  
HGP160D, HGP250

HGP400, HGP630  
HGP800

## External Accessories (HGP)

### Rotary Handle

#### Types of Handle by the Circuit Breaker's Installation Type

Rotary handle is divided into the following three types by the circuit breaker's direction of power supply.

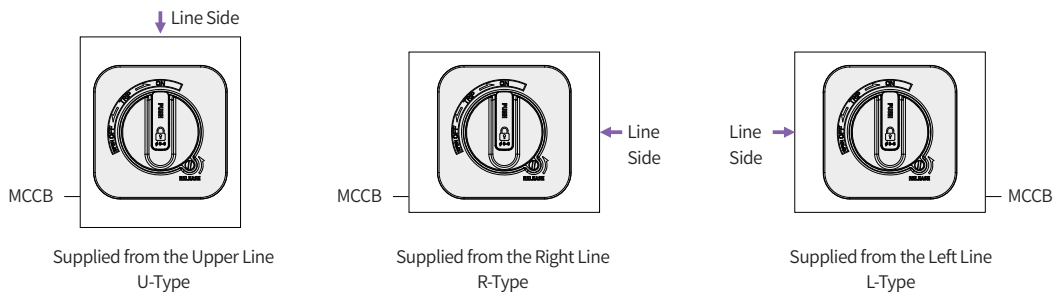

#### How to Operate the Handle

Operating Direction : If the handle is rotated clockwise, the circuit breaker is ON.

- Circuit Breaker ON : Rotate the handle to ON position. (Figure 1)
- Circuit Breaker OFF : Rotate the handle to OFF position. (Figure 2)
- Circuit Breaker TRIP : If the circuit breaker is tripped, the handle will automatically return to TRIP position. (Figure 3)
- After the circuit breaker is tripped, rotate the handle to the RESET position first (Figure 4) then rotate to the ON position and the circuit breaker will turn ON (Figure 1).
- If you need to open the door when the handle is in the ON state, rotate the RELEASE screw to the direction of the arrow then open the door (Figure 5).

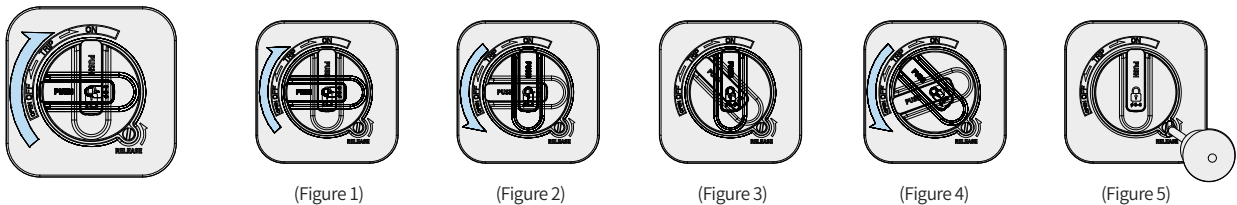

#### Handle Locking Device

Locking Function	OFF State Door Lock	ON State Door Lock	Reverse Interlock	Handle Padlock
Details	<ul style="list-style-type: none"> <li>• Impossible to open the panel door when the circuit breaker is in the OFF state.</li> <li>• Possible at RESET position</li> <li>• Possible to open the panel door after rotating the handle to RESET</li> </ul>	<ul style="list-style-type: none"> <li>• Impossible to open the panel door when the circuit breaker is in the ON state</li> <li>• Possible to open the panel door after rotating the RELEASE screw</li> </ul>	<ul style="list-style-type: none"> <li>• Impossible to close the circuit breaker (ON) in case the panel door is open</li> </ul>	<ul style="list-style-type: none"> <li>• Padlocking function which locks using a padlock to prevent handle operation.</li> <li>• Padlock is not provided separately and the number of padlocks depends on the padlock diameter. (Refer to the table below)</li> <li>• As for the specifications of the applicable padlocks, refer to the table below.</li> </ul>
Direct Type (TFG)	●	●	● (160/250 AF Only)	●
Extended Type (TFH)	●	●	-	●

※ For TFG 250 AF or less, The handle remains ON when the circuit breaker is tripped after padlocking in on position

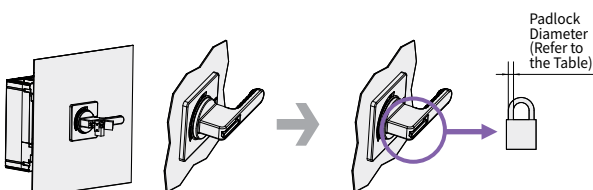

Application	Padlock Diameter <sup>1)</sup>
HGP50D, HGP125D, HGP160D, HGP250	6 ~ 8 mm
HGP400, HGP630, HGP800	5 ~ 7 mm

※ 1) Padlock not included

## Front Connection of Fixed Devices

Straight/spreader bus bar or lug terminal can be selected according to the size and specification of the cable or bus bar to be connected to the circuit breaker.

### Insulated Bar Connection

In case the bus bar pitch of the switchgear is equal to the circuit breaker, it can be connected directly to the circuit breaker by using an insulation tube. Refer to the following connection bus bar specification for connection and the insulation barrier between phases and terminal cover must be used.

Application	Connection Bus Bar Dimensions (mm)				Applicable Bolt and Tightening Torque	
	A	B	C	D	Bolt Spec.	Max. Tightening Torque (kgf×cm)
50 ~ 160 AF	< 9	< 22	Ø9	A + 9	M8 Screw	136
250 AF	< 9	< 25	Ø9	A + 10	M8 Hex Socket	136
400 ~ 630 AF	< 15	< 32	Ø10.5	A + 15	M10 Hex Socket	270
800 AF	< 15.5	< 50	Ø13	A + 16.5	M12 Hex Socket	470

### Crimped Terminal

Standard terminals (crimped/copper tubing terminal) must be used and the insulation barrier between phases and the terminal cover must be used. Standard terminals must be selected for use according to the rating of the circuit breaker and the terminal is not provided separately. As for the cable specifications with regards to important ratings, refer to the table below.

Application		Cu Cable Size (mm <sup>2</sup> )	Applicable Terminal Dimensions (mm)		
AF	Rated Current		A	B	C
50 ~ 160 AF	100 A	35	Ø9	< 22	< 9
	160 A	70			
250 AF	160 A	70	Ø9	< 25	< 9
	250 A	120			
400 ~ 630 AF	400 A	240	Ø10.5	< 32	< 15
	630 A	185×2			
800 AF	800 A	240×2	Ø13	< 50	< 15.5

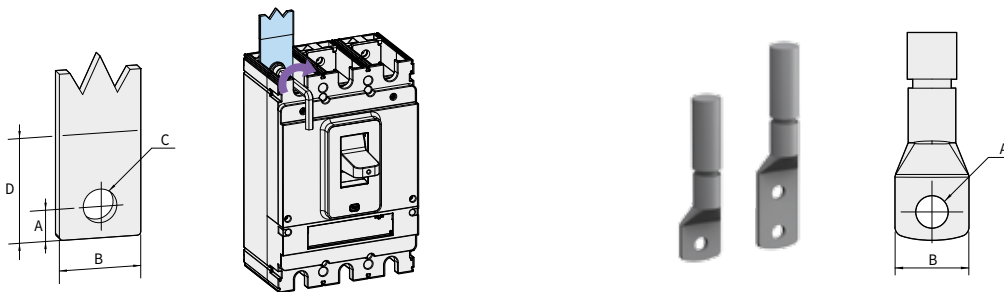

### Busbar

#### Straight Busbar

It is used to meet the cable and standards of the switchgear. (Pitch between the poles maintained)

#### Spreader Busbar

It is used to extend the internal insulation distance of the switchgear. (Pitch between the poles extended)

Application	Straight			Spreader	
	Type	Pole	Pitch	Type	Pitch
HGP250	TBB 25GP 3S	3	35 mm	TBB 25GP 3E45	45 mm
	TBB 25GP 4S	4		TBB 25GP 4E45	
HGP630	TBB 63GP 3S	3	46.5 mm	TBB 63GP 3E61.5	61.5 mm
	TBB 63GP 4S	4		TBB 63GP 4E61.5	
HGP800	TBB 80GP 3S	3	70 mm	-	-
	TBB 80GP 4S	4		-	-



※ Quantity per Set : 3P - 3 EA, 4P - 4 EA

## External Accessories (HGP)

### LUG Terminals

As a cable connection to the circuit breaker the cable can be used without crimped terminal, it must be selected according to the product's rating and size of cable.

Application		LUG Terminal		Application				Tightening Torque (kgf×cm)
Type	Pole	Type	Material	EA	Material	S (mm <sup>2</sup> )	L (mm)	
HGP50D HGP125D HGP160D	3 4	CTB 16GP 3 CTB 16GP 4	Steel	1	Cu/Al	1.5 ~ 95	19	140
HGP250 (HGP100/MCP)	3 4	CTB 25GP 3 CTB 25GP 4	Al	1	Cu/Al	14 ~ 185	19	
HGP400 HGP630	3 4	CTB 63GP 3 CTB 63GP 4	Al	2	Cu/Al	60 ~ 240	30 ~ 60	353
HGP800	3 4	CTB 80GP 3 CTB 80GP 4	Al	3	Cu/Al	60 ~ 185	30 ~ 60	

※ Packaging Quantity per Set : Provided in the composition quantity of line or load side (3P - 3 EA, 4P - 4 EA)



HGP50D  
HGP125D  
HGP160D



HGP250



HGP400  
HGP630



HGP800

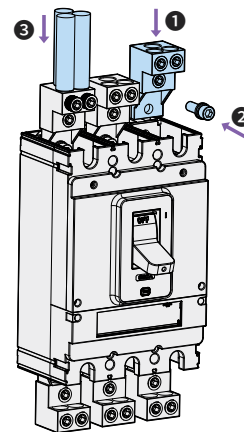
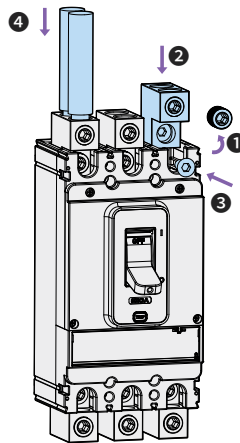
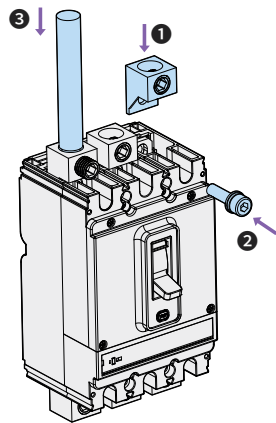
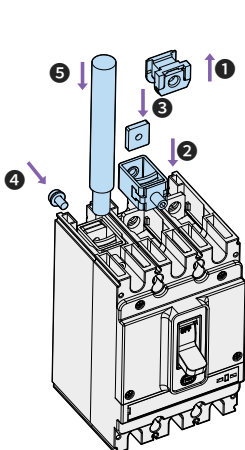
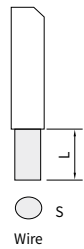

## Plug-in Connection Devices

When the plug-in connection method is used, the circuit breaker can be replaced quickly and accurately without power off during a malfunction of a circuit breaker. Therefore, in case the plug-in method of circuit breaker is installed in important electrical facilities such as shipping, broadcast station and others, the circuit breaker can be replaced and maintained quickly and conveniently without disconnecting the bus bar.

- Applicable to 50 ~ 800 AF, up to 3P.
- Offers convenient maintenance of switchgear.
- Convenient and relaxed installation after manufacture of the switchgear.
- Circuit breaker can be removed or replaced quickly without touching the terminal connection area.
- Type : For switchboard (TDM/TDF)
- Composition : Plug-in devices, plug-in MCCB, terminal cover or insulation barrier (Option)

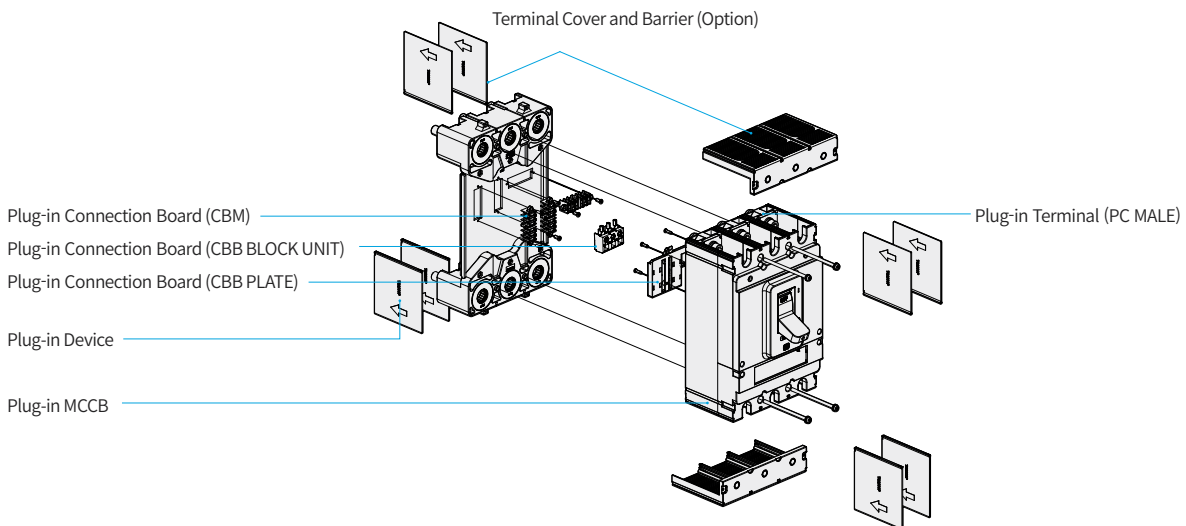

## Plug-in MCCB (For HGP)

In order to apply the plug-in connection method, the plug-in MCCB must be used instead of the general type, even for the MCCB. The product covers various breaking capacity up to the rated current of 800 A so this product conforms to the switchgear standard. Connection board (Connector) can be added to connect internal accessories to the circuit breaker.

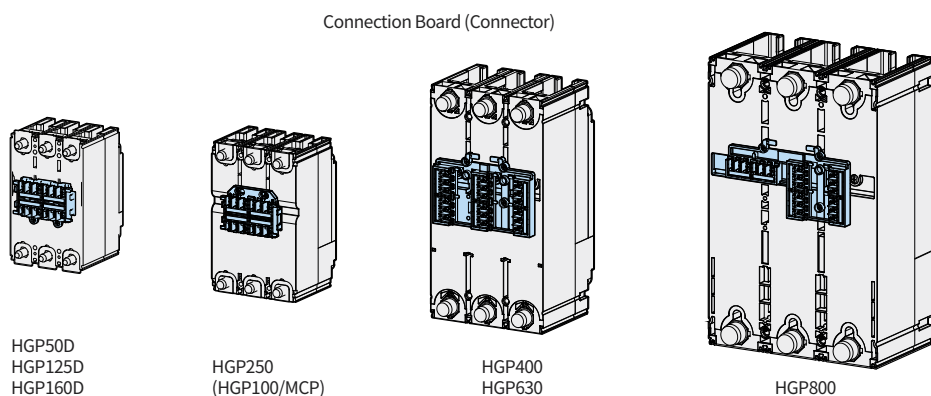

## External Accessories (HGP)

### Plug-in Connection Devices

#### Plug-in Devices

As a connection block in which plug-in MCCB can be installed, it is available according to the applied panel and the purpose.

#### TDM Type

- TDM-P : It is comprised of plug-in terminal for both line/load for convenient use of connection block depending on the structure of the switchgear.
- TDM-F : Only plug-in parts of the line terminal are provided in TDM-P products.

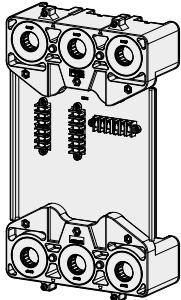
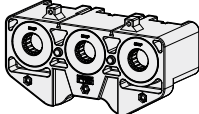
Applied Panel	For Switchgear	
Type	TDM-P	TDM-F
Composition		
Purpose	Line/Load Side	Line Side
Applicable MCCB	HGP50 ~ 800 AF 3P	

#### Specification of Connection Busbar

The bus bar of the switchgear can directly be connected to the plug-in device.

The specifications of the applicable bus bar are as below and the insulation barrier or terminal cover must be used.

Unit : mm

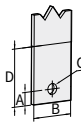
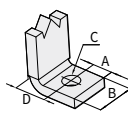
Product	A	B	C	D	Remark	Product	A	B	C	D	Remark
50 ~ 160 AF	< 12	< 21	$\varnothing \geq 8.5$	A + 18		50 ~ 160 AF	< 12	< 21	$\varnothing \geq 8.5$	< 12	
250 AF	< 18	< 25	$\varnothing \geq 8.5$	A + 17		250 AF	< 18	< 25	$\varnothing \geq 8.5$	< 18	
400 ~ 630 AF	< 34	< 35	$\varnothing \geq 10.5$	A + 26		400 ~ 630 AF	< 25	< 35	$\varnothing \geq 10.5$	< 25	
800 AF	< 30	< 40	$\varnothing \geq 16.5$	A + 30		800 AF	< 30	< 40	$\varnothing \geq 16.5$	< 30	

※ The insulation barrier for plug-in device is an option

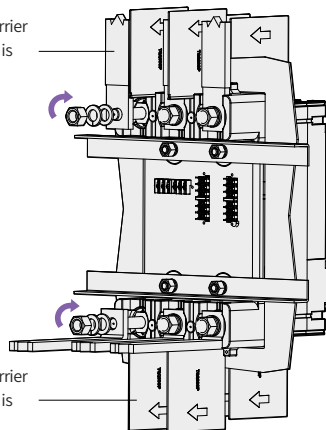

※ The insulation barrier for plug-in device is an option.

### HG-MCCB Plug-in CBM Wiring Position (TDM Front Side)

Option	HGP50D, HGP125D, HGP160D	HGP250 (HGP100/MCP)	HGP400, HGP630	HGP800
AUX				
AUX2				
AUX3				
ALT				
SHT/UVT				
AUX+ALT				
AUX2+ALT				
AUX3+ALT				
AUX+ SHT/UVT				
AUX2+ SHT/UVT				
AUX3+ SHT/UVT				
ALT+ SHT/UVT				
AUX+ALT+ SHT/UVT				
AUX+ALT+ SHT/UVT Max. Mounting Combination				

## External Accessories (HGP)

### Plug-in Connection Block

In order for the plug-in connection method, it can be connected to the internal and external accessory of the circuit breaker.

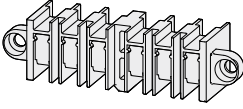
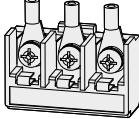
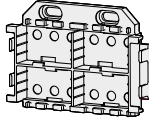
Application			
HGP160D	CBM 10GM UNIT (3P)	CBB BLOCK UNIT	CBBPLATE 16GP
HGP250			CBBPLATE 10GM
HGP630			CBBPLATE 63GP
HGP800			CBBPLATE 80GP
Quantity per Set			1

### Plug-in Terminal

It is a part that can realize the plug-in MCCB.

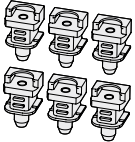
Application	
HGP160D	PCMALE 16GP
HGP250	PCMALE 25GP
HGP630	PCMALE 63GP
HGP800	PCMALE 80GP
Quantity per Set	6



## Rear Connection Terminal

It is a part that is used in case there is a need for rear connection instead of front connection by applying the fixed type of circuit breaker to the switchgear. The bus bar of the switchgear can be wired vertically or horizontally depending on the assembly direction of the connection.

### Flat Type

Application Type	Pole	Rear Terminal		Quantity per Set	
		Line Side	Load Side	Short Terminal	Long Terminal
HGP50D, HGP125D, HGP160D	3	RCT 16GP F3		2	1
	4	RCT 16GP F4		2	2
HGP250 (HGP100/MCP)	3	RCT 25GP F3		2	1
	4	RCT 25GP F4		2	2
HGP400 HGP630	3	RCT 63GP F3 LINE	RCT 63GP F3 LOAD	2	1
	4	RCT 63GP F4 LINE	RCT 63GP F4 LOAD	2	2
HGP800	3	RCT 80GP F3 LINE	RCT 80GP F3 LOAD	2	1
	4	RCT 80GP F4 LINE	RCT 80GP F4 LOAD	2	2

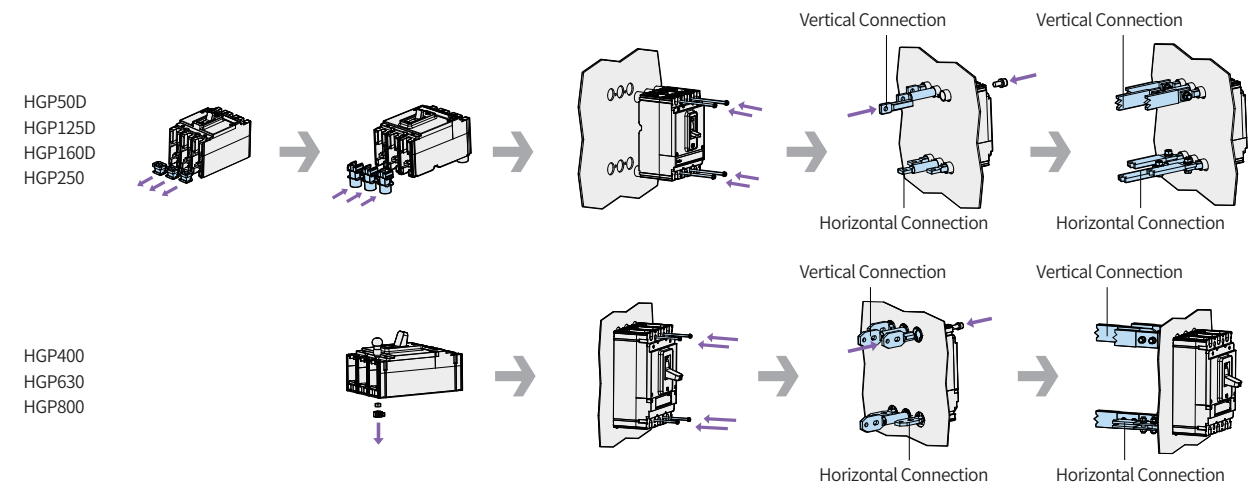
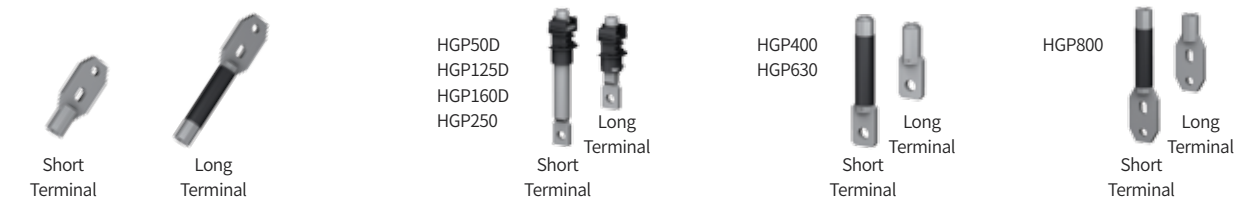

### Auxiliary Handle (THA)

As an auxiliary handle used to reduce the operating force of ON, OFF, RESET in large capacity circuit breaker (400 ~ 800 AF), it is a standard product provided. It comes together with a holder for storing auxiliary handle that can be fixed to the switchboard panel.

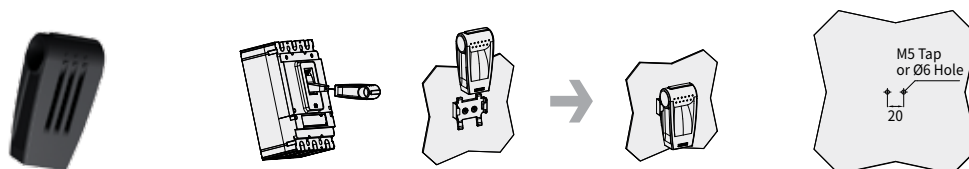

## External Accessories (HGP)

### Motor Operator

This device is used for turning the circuit breaker ON/OFF from remote position. It is convenient for establishing automation system for low-voltage load system and for selecting load when operating under emergency power.

Application		Pole	MOT	Voltage
Type				
HGP50D, HGP125D, HGP160D		3, 4	MOT 16GP	DC 24 V AC/DC 110 V AC/DC 240 V
HGP250 (HGP100/MCP)		3, 4	MOT 25GP	
HGP400, HGP630		3, 4	MOT 63GP	
HGP800		3, 4	MOT 80GP	

### Rating and Characteristics

Format	Operational voltage	Operational Current (A)	Operating Time (ms)		Power Consumption (W)	Endurance
			Closing	Opening		
MOT 16GP	DC 24 V	≤ 2.5	500	500	14	10,000
	AC/DC 110 V	≤ 0.5				
	AC/DC 240 V	≤ 0.5				
MOT 25GP	DC 24 V	≤ 2.5	500	500	14	10,000
	AC/DC 110 V	≤ 0.5				
	AC/DC 240 V	≤ 0.5				
MOT 63GP	DC 24 V	≤ 6.0	1,000	1,000	35	5,000
	AC/DC 110 V	≤ 3.0				
	AC/DC 240 V	≤ 2.0				
MOT 80GP	DC 24 V	≤ 6.0	1,000	1,000	35	5,000
	AC/DC 110 V	≤ 3.0				
	AC/DC 240 V	≤ 2.0				

※ Range of Operational Voltage : 85 ~ 110 % (DC 24 V : 95 ~ 110 %)

### Circuit and Wiring Drawing

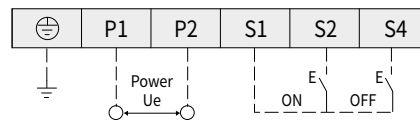
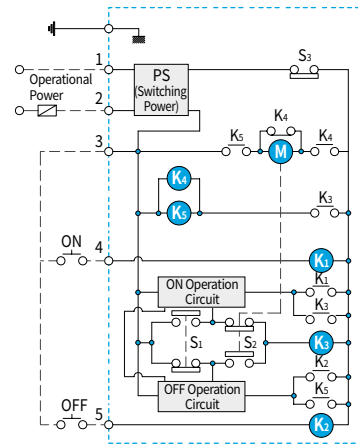

- : Motor
- : ON Relay
- : OFF Relay
- : Relay for Motor
- S1 : ON Limit Switch
- S2 : OFF Limit Switch
- S3 : Auto/Manual Limit Switch

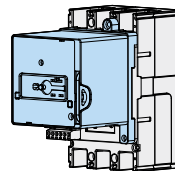

#### ※ Precaution for mounting

When mounting the motor operator on MCCB, it must be mounted when the MCCB's handle position is at in position. Mounting the motor operator in other positions (ON, TRIP) may cause damage to the motor.

VCB

ACB

**MCCB**

MS

RELAY

## Order Code of Accessories

### HGM/HGE Type of Accessory Unit

#### HGM/HGE30, 50E/S, 60, 100

##### Connection Method

		2 Pole	3 Pole	4 Pole
Plug-in	TDM (LINE/LOAD)	-	TDM 10GM P3	-
	TDM (LINE Only)	-	TDM 10GM F3	-
	TDF (LINE Only)	-	TDF 10GM 3	-
	TDA (1 row)	-	TDA 10GM S3	-
	TDA (2 rows)	TDA 10GM D2	TDA 10GM D3	-
Conn. Block (CBM)		CBM 10GM 2P UNIT	CBM 10GM UNIT	-
CBB BLOCK UNIT		-	CBB BLOCK UNIT	-
CBB PLATE		-	CBBPLATE 10GM	-
PC MALE		-	PCMALE 10GM 50 A (≤ 50 A) PCMALE 10GM 100 A (> 50 A)	-
Terminal Busbar (TBB)	Straight Busbar	-	-	-
	Spreader Busbar	-	-	-
Rear Connection Terminal (RCT)	LINE/LOAD (≤ 50 A)	RCT 05GM F2	RCT 05GM F3	RCT 05GM F4
	LINE/LOAD (> 50 A)	RCT 10GM F2	RCT 10GM F3	RCT 10GM F4
Cage Terminal (CTB)	≤ 50 A) inch	CTB 10GM 2S50	CTB 10GM 3S50	CTB 10GM 4S50
	> 50 A) inch	CTB 10GM 2S100	CTB 10GM 3S100	CTB 10GM 4S100
	≤ 50 A) mm	CTB 10GM 2S50-MM	CTB 10GM 3S50-MM	CTB 10GM 4S50-MM
	> 50 A) mm	CTB 10GM 2S100-MM	CTB 10GM 3S100-MM	CTB 10GM 4S100-MM
Din Rail Adaptor (DRA)		DRA 10GM	DRA 10GM	DRA 10GM

##### Internal Accessory

	Auxiliary Switch (AUX)	Alarm Switch (ALT)	Auxiliary/Alarm (AXT)
Indication Contacts	AUX 10GM C1	ALT 10GM L1	AXT 10GM L1
	AUX 10GM C2	ALT 10GM R1	AXT 10GM R1
Remote Tripping	Shunt Trip (SHT)		Under-Voltage Trip (UVT)
	SHT 10GM DC 24 V		UVT 10GM DC 24 V
	SHT 10GM DC 100 - 120 V		UVT 10GM DC 100 - 110 V
	SHT 10GM DC 48 V		UVT 10GM DC 48 V
	SHT 10GM DC 60 V		UVT 10GM AC 100 - 120 V
	SHT 10GM DC 125 V		UVT 10GM AC 200 - 230 V
	SHT 10GM AC 100 - 120 V		UVT 10GM AC 380 - 415 V
	SHT 10GM AC 200 - 250 V		UVT 10GM AC 440 - 480 V
SHT 10GM AC 380 - 480 V		-	

##### External Accessory

		Front Contact (TFG)	Extended (TFH)	
Rotary Handle	Upper Line	TFG 10GM U	TFH 10GM	
	Right Line	TFG 10GM R	TFH 10GM	
	Left Line	TFG 10GM L	TFH 10GM	
Motor Operator <sup>1)</sup>	2 Pole		3 Pole	4 Pole
	-		MOT 10GM DC 24 V	
	-		MOT 10GM AC/DC 110 V	
	-		MOT 10GM AC/DC 240 V	
Terminal Cover	Short	TCF 10GM S2	TCF 10GM S3	TCF 10GM S4
	Long	TCF 10GM L2	TCF 10GM L3	TCF 10GM L4
Locking Device	2 Pole		3 Pole	4 Pole RSTN / NRST
	Padlock	PLD 10GM	PLD 10GM	PLD 10GM
Mechanical Interlock	MIF 10GM 2	MIF 10GM 3	MIF 10GM R4 / MIF 10GM N4	
Interpole Barrier	2 Pole		3 Pole	4 Pole
	TQQ 10GM 2		TQQ 10GM 3	TQQ 10GM 4
Auxiliary Handle		-		

※ 1) For HGM only.

**HGM/HGE50H/L, 125****Connection Method**

		2 Pole	3 Pole	4 Pole
Plug-in	TDM (LINE/LOAD)	-	TDM 12GM P3	-
	TDM (LINE Only)	-	TDM 12GM F3	-
	TDF (LINE Only)	-	TDF 12GM 3	-
	TDA (1 row)	-	TDA 12GM S3	-
	TDA (2 rows)	-	TDA 12GM D3	-
Conn. Block (CBM)		-	CBM 10GM UNIT	-
CBB BLOCK UNIT		-	CBB BLOCK UNIT	-
CBB PLATE		-	CBBPLATE 10GM	-
PC MALE		-	PCMALE 12GM	-
Terminal Busbar (TBB)	Straight Busbar	-	-	-
	Spreader Busbar	-	-	-
Rear Connection Terminal (RCT)	LINE/LOAD	RCT 12GM F2	RCT 12GM F3	RCT 12GM F4
Cage Terminal (CTB)	inch	CTB 12GM 2S	CTB 12GM 3S	CTB 12GM 4S
	mm	CTB 12GM 2S-MM	CTB 12GM 3S-MM	CTB 12GM 4S-MM
Din Rail Adaptor (DRA)		-	-	-

**Internal Accessory**

	Auxiliary Switch (AUX)	Alarm Switch (ALT)	Auxiliary/Alarm (AXT)
Indication Contacts	AUX 10GM C1	ALT 10GM L1	AXT 10GM L1
	AUX 10GM C2	ALT 10GM R1	AXT 10GM R1
Remote Tripping	Shunt Trip (SHT)		Under-Voltage Trip (UVT)
	SHT 10GM DC 24 V		UVT 10GM DC 24 V
	SHT 10GM DC 100 - 120 V		UVT 10GM DC 100 - 110 V
	SHT 10GM DC 48 V		UVT 10GM DC 48 V
	SHT 10GM DC 60 V		UVT 10GM AC 100 - 120 V
	SHT 10GM DC 125 V		UVT 10GM AC 200 - 230 V
	SHT 10GM AC 100 - 120 V		UVT 10GM AC 380 - 415 V
	SHT 10GM AC 200 - 250 V		UVT 10GM AC 440 - 480 V
	SHT 10GM AC 380 - 480 V		-

**External Accessory**

		Front Contact (TFG)	Extended (TFH)	
Rotary Handle	Upper Line	TFG 12GM U	TFH 12GM	
	Right Line	TFG 12GM R	TFH 12GM	
	Left Line	TFG 12GM L	TFH 12GM	
Motor Operator <sup>1)</sup>		2 Pole	3 Pole	4 Pole
		-	MOT 12GM DC 24 V	
		-	MOT 12GM AC/DC 110 V	
Terminal Cover	Short	TCF 12GM S2	TCF 12GM S3	TCF 12GM S4
	Long	TCF 12GM L2	TCF 12GM L3	TCF 12GM L4
Locking Device	Padlock	PLD 10GM	PLD 10GM	PLD 10GM
	Mechanical Interlock	MIF 12GM 2	MIF 12GM 3	MIF 12GM R4 / MIF 12GM N4
Interpole Barrier		TQQ 10GM 2	TQQ 10GM 3	TQQ 10GM 4
Auxiliary Handle				

※ 1) For HGM only.

## Order Code of Accessories

### HGM/HGE Type of Accessory Unit

#### HGM/HGE160, 250

##### Connection Method

		2 Pole	3 Pole	4 Pole
Plug-in	TDM (LINE/LOAD)	-	TDM 25GM P3	-
	TDM (LINE Only)	-	TDM 25GM F3	-
	TDF (LINE Only)	-	-	-
	TDA (1 row)	-	-	-
	TDA (2 rows)	-	-	-
Conn. Block (CBM)		-	CBM 10GM UNIT	-
CBB BLOCK UNIT		-	CBB BLOCK UNIT	-
CBB PLATE		-	CBBPLATE 10GM	-
PC MALE		-	PCMALE 25GM	-
Terminal Busbar (TBB)	Straight Busbar	TBB 25GP 2S	TBB 25GP 3S	TBB 25GP 4S
	Spreader Busbar	-	TBB 25GP 3E45	TBB 25GP 4E45
Rear Connection Terminal (RCT)	LINE/LOAD	RCT 25GM F2	RCT 25GM F3	RCT 25GM F4
Cage Terminal (CTB)	inch	CTB 25GM 2S	CTB 25GM 3S	CTB 25GM 4S
	mm	CTB 25GM 2S-MM	CTB 25GM 3S-MM	CTB 25GM 4S-MM
Din Rail Adaptor (DRA)		-	-	-

##### Internal Accessory

	Auxiliary Switch (AUX)	Alarm Switch (ALT)	Auxiliary/Alarm (AXT)
Indication Contacts	AUX 10GM C1	ALT 10GM L1	AXT 10GM L1
	AUX 10GM C2	ALT 10GM R1	AXT 10GM R1
Remote Tripping	Shunt Trip (SHT)		Under-Voltage Trip (UVT)
	SHT 10GM DC 24 V	UVT 10GM DC 24 V	
	SHT 10GM DC 100 - 120 V	UVT 10GM DC 100 - 110 V	
	SHT 10GM DC 48 V	UVT 10GM DC 48 V	
	SHT 10GM DC 60 V	UVT 10GM AC 100 - 120 V	
	SHT 10GM DC 125 V	UVT 10GM AC 200 - 230 V	
	SHT 10GM AC 100 - 120 V	UVT 10GM AC 380 - 415 V	
	SHT 10GM AC 200 - 250 V	UVT 10GM AC 440 - 480 V	
SHT 10GM AC 380 - 480 V	-		

##### External Accessory

		Front Contact (TFG)	Extended (TFH)	
Rotary Handle	Upper Line	TFG 25GM U	TFH 25GM	
	Right Line	TFG 25GM R	TFH 25GM	
	Left Line	TFG 25GM L	TFH 25GM	
Motor Operator <sup>1)</sup>	2 Pole		3 Pole	4 Pole
	-		MOT 25GM DC 24 V	
	-		MOT 25GM AC/DC 110 V	
Terminal Cover	Short	TCF 25GM S3	TCF 25GM S4	
	Long	TCF 25GM L3	TCF 25GM L4	
Locking Device	2 Pole		3 Pole	4 Pole RSTN / NRST
	Padlock	PLD 10GM	PLD 10GM	PLD 10GM
	Mechanical Interlock	MIF 25GM 3		MIF 25GM R4 / MIF 25GM N4
Interpole Barrier	2 Pole		3 Pole	4 Pole
Auxiliary Handle	TQQ 25GM 2		TQQ 25GM 3	TQQ 25GM 4
			-	

※ 1) For HGM only.

## HGM/HGE400

## Connection Method

		2 Pole	3 Pole	4 Pole
Plug-in	TDM (LINE/LOAD)	-	TDM 40GM P3	-
	TDM (LINE Only)	-	TDM 40GM F3	-
Conn. Block (CBM)		-	CBM 10GM UNIT	-
CBB BLOCK UNIT		-	CBB BLOCK UNIT	-
CBB PLATE		-	CBBPLATE 40GM	-
PC MALE		-	PCMALE 40GM	-
Terminal Busbar (TBB)	Straight Busbar	TBB 40GM 2S	TBB 40GM 3S	TBB 40GM 4S
	Spreader Busbar	-	TBB 40GM 3E59	TBB 40GM 4E59
Rear Connection Terminal (RCT)	LINE/LOAD	-	RCT 40GM F3	RCT 40GM F4
Cage Terminal (CTB)	1 Hole	-	CTB 40GM 3S1H	CTB 40GM 4S1H
	2 Hole	-	CTB 40GM 3S	CTB 40GM 4S

## Internal Accessory

	Auxiliary Switch (AUX)	Alarm Switch (ALT)
Indication Contacts	AUX 40GM C1	ALT 40GM L1
	Shunt Trip (SHT)	Under-Voltage Trip (UVT)
Remote Tripping	SHT 40GM DC 24 V	UVT 40GM DC 24 V
	SHT 40GM DC 100 - 125 V	UVT 40GM DC 100 - 110 V
	SHT 40GM AC 100 - 120 V	UVT 40GM AC 100 - 125 V
	SHT 40GM AC 200 - 230 V	UVT 40GM AC 220 - 230 V
	SHT 40GM AC 380 - 415 V	UVT 40GM AC 380 - 415 V
	SHT 40GM AC 440 - 480 V	UVT 40GM AC 440 - 480 V

## External Accessory

		Front Contact (TFG)	Extended (TFH)	
Rotary Handle	Upper Line	TFG 40GM U	TFH 40GM	
	Right Line	TFG 40GM R	TFH 40GM	
	Left Line	TFG 40GM L	TFH 40GM	
		2 Pole	3 Pole	4 Pole
Motor Operator <sup>1)</sup>		-	MOT 40GM DC 24 V	
		-	MOT 40GM AC/DC 110 V	
		-	MOT 40GM AC/DC 240 V	
Terminal Cover	Short	TCF 40GM S3		TCF 40GM S4
	Long	TCF 40GM L3		TCF 40GM L4
Locking Device	Padlock	PLD 40GM	PLD 40GM	PLD 40GM
	Mechanical Interlock	MIF 40GM 3		MIF 40GM R4 / MIF 40GM N4
Interpole Barrier		-	TQQ 40GM 3	TQQ 40GM 4
Auxiliary Handle			THA 48GM	

※ 1) For HGM only.

## Order Code of Accessories

### HGM/HGE Type of Accessory Unit

#### HGM/HGE630, 800

##### Connection Method

		2 Pole	3 Pole	4 Pole
Plug-in	TDM (LINE/LOAD)	-	TDM 80GM P3	-
	TDM (LINE Only)	-	TDM 80GP F3	-
Conn. Block (CBM)		-	CBM 10GM UNIT	-
CBB BLOCK UNIT		-	CBB BLOCK UNIT	-
CBB PLATE		-	CBBPLATE 80GM	-
PC MALE		-	PCMALE 80GM	-
Terminal Busbar (TBB)	Straight Busbar	TBB 63GM 2S (HGM/HGE630) TBB 80GM 2S (HGM/HGE800)	TBB 63GM 3S (HGM/HGE630) TBB 80GM 3S (HGM/HGE800)	TBB 63GM 4S (HGM/HGE630) TBB 80GM 4S (HGM/HGE800)
	Spreader Busbar	-	-	-
Rear Connection Terminal (RCT)	LINE/LOAD	-	RCT 80GM F3	RCT 80GM F4
Cage Terminal (CTB)		-	CTB 80GM 3S	CTB 80GM 4S

##### Internal Accessory

	Auxiliary Switch (AUX)	Alarm Switch (ALT)
Indication Contacts	AUX 40GM C1	ALT 40GM L1
	Shunt Trip (SHT)	Under-Voltage Trip (UVT)
Remote Tripping	SHT 40GM DC 24 V	UVT 40GM DC 24 V
	SHT 40GM DC 100 - 125 V	UVT 40GM DC 100 - 110 V
	SHT 40GM AC 100 - 120 V	UVT 40GM AC 100 - 125 V
	SHT 40GM AC 200 - 230 V	UVT 40GM AC 220 - 230 V
	SHT 40GM AC 380 - 415 V	UVT 40GM AC 380 - 415 V
	SHT 40GM AC 440 - 480 V	UVT 40GM AC 440 - 480 V

##### External Accessory

		Front Contact (TFG)	Extended (TFH)	
Rotary Handle	Upper Line	TFG 80GM U	TFH 80GM	
	Right Line	TFG 80GM R	TFH 80GM	
	Left Line	TFG 80GM L	TFH 80GM	
		2 Pole	3 Pole	4 Pole
Motor Operator <sup>1)</sup>		-	MOT 80GM DC 24 V	
		-	MOT 80GM AC/DC 110 V	
		-	MOT 80GM AC/DC 240 V	
Terminal Cover	Short	TCF 80GM S3		TCF 80GM S4
	Long	TCF 80GM L3		TCF 80GM L4
Locking Device	Padlock	PLD 40GM	PLD 40GM	PLD 40GM
	Mechanical Interlock	MIF 80GM 3		MIF 80GM R4 / MIF 80GM N4
Interpole Barrier		-	TQQ 40GM 3	TQQ 40GM 4
Auxiliary Handle		THA 48GM		

※ 1) For HGM only.



VCB

ACB

**MCCB**

MS

RELAY

## Order Code of Accessories

### HGP Type of Accessory Unit

#### HGP50/125/160D

##### Connection Method

Plug-in		3 Pole	4 Pole
TDM (LINE/LOAD)		TDM 16GP P3	-
TDM (LINE Only)		TDM 16GP F3	-
Conn. Block (CBM)		CBM 10GM UNIT	-
CBB BLOCK UNIT		CBB BLOCK UNIT	-
CBB PLATE		CBBPLATE 16GP	-
PC MALE		PCMALE 16GP	-
Terminal Busbar (TBB)	Straight Busbar	-	-
	Spreader Busbar	-	-
Rear Connection Terminal (RCT)	LINE/LOAD	RCT 16GP F3	RCT 16GP F4
Cage Terminal (CTB)		CTB 16GP 3	CTB 16GP 4

##### Internal Accessory

	Auxiliary Switch (AUX)	Alarm Switch (ALT)
Indication Contacts	AUX 16GP R1	ALT 16GP L1
	Shunt Trip (SHT)	Under-Voltage Trip (UVT)
	SHT 16GP DC 24 V	UVT 16GP DC 24 V
	SHT 16GP DC 100 - 110 V	UVT 16GP DC 100 - 110 V
Remote Tripping	SHT 16GP AC 100 - 120 V	UVT 16GP AC 100 - 120 V
	SHT 16GP AC 200 - 230 V	UVT 16GP AC 200 - 230 V
	SHT 16GP AC 380 - 415 V	UVT 16GP AC 380 - 415 V
	SHT 16GP AC 440 - 480 V	UVT 16GP AC 440 - 480 V

##### External Accessory

		Front Contact (TFG)	Front Contact (TFG)
Rotary Handle	Upper Line	TFG 16GP U	TFH 16GP
	Right Line	TFG 16GP R	TFH 16GP
	Left Line	TFG 16GP L	TFH 16GP
		3 Pole / 4 Pole	
Motor Operator		MOT 16GP DC 24 V	
		MOT 16GP AC/DC 110 V	
		MOT 16GP AC/DC 240 V	
		3 Pole	4 Pole
Terminal Cover	Short	TCF 16GP S3	-
	Long	TCF 16GP L3	TCF 16GP L4
Locking Device	Padlock	PLD 16GP	PLD 16GP
	Mechanical Interlock	MIF 16GP 3	MIF 16GP R4
Interpole Barrier		TQQ 16GP 3	TQQ 16GP 4
Auxiliary Handle		-	

**HGP250 (HGP100/MCP)****Connection Method**

Plug-in		3 Pole	4 Pole
TDM (LINE/LOAD)		TDM 25GM P3	-
TDM (LINE Only)		TDM 25GM F3	-
Conn. Block (CBM)		CBM 10GM UNIT	-
CBB BLOCK UNIT		CBB BLOCK UNIT	-
CBB PLATE		CBBPLATE 10GM	-
PC MALE		PCMALE 25GP	-
Terminal Busbar (TBB)	Straight Busbar	TBB 25GP 3S	TBB 25GP 4S
	Spreader Busbar	TBB 25GP 3E45	TBB 25GP 4E45
Rear Connection Terminal (RCT)	LINE/LOAD	RCT 25GP F3	RCT 25GP F4
Cage Terminal (CTB)		CTB 25GP 3	CTB 25GP 4

**Internal Accessory**

	Auxiliary Switch (AUX)	Alarm Switch (ALT)
Indication Contacts	AUX 16GP R1	ALT 25GP L1
	Shunt Trip (SHT)	Under-Voltage Trip (UVT)
Remote Tripping	SHT 25GP DC 24 V	UVT 25GP DC 24 V
	SHT 25GP DC 100 - 110 V	UVT 25GP DC 100 - 110 V
	SHT 25GP AC 100 - 120 V	UVT 25GP AC 100 - 120 V
	SHT 25GP AC 200 - 230 V	UVT 25GP AC 200 - 230 V
	SHT 25GP AC 380 - 415 V	UVT 25GP AC 380 - 415 V
	SHT 25GP AC 440 - 480 V	UVT 25GP AC 440 - 480 V

**External Accessory**

		Front Contact (TFG)	Extended (TFH)
Rotary Handle	Upper Line	TFG 25GP U	TFH 25GP
	Right Line	TFG 25GP R	TFH 25GP
	Left Line	TFG 25GP L	TFH 25GP
		3 Pole / 4 Pole	
Motor Operator		MOT 25GP DC 24 V	
		MOT 25GP AC/DC 110 V	
		MOT 25GP AC/DC 240 V	
		3 Pole	4 Pole
Terminal Cover	Short	TCF 25GP S3	-
	Long	TCF 25GP L3	TCF 25GP L4
Locking Device	Padlock	PLD 25GP	PLD 25GP
	Mechanical Interlock	MIF 25GP 3	MIF 25GP R4
Interpole Barrier		TQQ 25GP 3	TQQ 25GP 4
Auxiliary Handle		-	

## Order Code of Accessories

### HGP Type of Accessory Unit

#### HGP400/630

##### Connection Method

Plug-in		3 Pole	4 Pole
TDM (LINE/LOAD)		TDM 63GP P3	-
TDM (LINE Only)		TDM 63GP F3	-
Conn. Block (CBM)		CBM 10GM UNIT	-
CBB BLOCK UNIT		CBB BLOCK UNIT	-
CBB PLATE		CBBPLATE 63GP	-
PC MALE		PCMALE 63GP	-
Terminal Busbar (TBB)	Straight Busbar	TBB 63GP 3S	TBB 63GP 4S
	Spreader Busbar	TBB 63GP 3E61.5	TBB 63GP 4E61.5
Rear Connection Terminal (RCT)	LINE	RCT 63GP F3 LINE	RCT 63GP F4 LINE
	LOAD	RCT 63GP F3 LOAD	RCT 63GP F4 LOAD
Cage Terminal (CTB)		CTB 63GP 3	CTB 63GP 4

##### Internal Accessory

	Auxiliary Switch (AUX)	Alarm Switch (ALT)
Indication Contacts	AUX 63GP L1	ALT 63GP R1
	Shunt Trip (SHT)	Under-Voltage Trip (UVT)
Remote Tripping	SHT 63GP DC 24 V	UVT 63GP DC 24 V
	SHT 63GP DC 100 - 110 V	UVT 63GP DC 100 - 110 V
	SHT 63GP AC 100 - 120 V	UVT 63GP AC 100 - 120 V
	SHT 63GP AC 200 - 230 V	UVT 63GP AC 200 - 230 V
	SHT 63GP AC 380 - 415 V	UVT 63GP AC 380 - 415 V
	SHT 63GP AC 440 - 480 V	UVT 63GP AC 440 - 480 V

##### External Accessory

		Front Contact (TFG)	Extended (TFH)
Rotary Handle	Upper Line	TFG 63GP U	TFH 63GP
	Right Line	TFG 63GP R	TFH 63GP
	Left Line	TFG 63GP L	TFH 63GP
		3 Pole/ 4 Pole	
Motor Operator		MOT 63GP DC 24 V	
		MOT 63GP AC/DC 110 V	
		MOT 63GP AC/DC 240 V	
		3 Pole	4 Pole
Terminal Cover	Short	TCF 63GP S3	-
	Long	TCF 63GP L3	TCF 63GP L4
Locking Device	Padlock	PLD 63GP	PLD 63GP
	Mechanical Interlock	MIF 63GP 3	MIF 63GP R4
Interpole Barrier		TQQ 63GP 3	TQQ 63GP 4
Auxiliary Handle		THA 63GP	

**HGP800****Connection Method**

Plug-in		3 Pole	4 Pole
TDM (LINE/LOAD)		TDM 80GP P3	-
TDM (LINE Only)		TDM 80GP F3	-
Conn. Block (CBM)		CBM 10GM UNIT	-
CBB BLOCK UNIT		CBB BLOCK UNIT	-
CBB PLATE		CBBPLATE 80GP	-
PC MALE		PCMALE 80GP	-
Terminal Busbar (TBB)	Straight Busbar	TBB 80GP 3S	TBB 80GP 4S
	Spreader Busbar	-	-
Rear Connection Terminal (RCT)	LINE	RCT 80GP F3 LINE	RCT 80GP F4 LINE
	LOAD	RCT 80GP F3 LOAD	RCT 80GP F4 LOAD
Cage Terminal (CTB)		CTB 80GP 3	CTB 80GP 4

**Internal Accessory**

	Auxiliary Switch (AUX)	Alarm Switch (ALT)
Indication Contacts	AUX 63GP L1	ALT 63GP R1
	Shunt Trip (SHT)	Under-Voltage Trip (UVT)
Remote Tripping	SHT 63GP DC 24 V	UVT 63GP DC 24 V
	SHT 63GP DC 100 - 110 V	UVT 63GP DC 100 - 110 V
	SHT 63GP AC 100 - 120 V	UVT 63GP AC 100 - 120 V
	SHT 63GP AC 200 - 230 V	UVT 63GP AC 200 - 230 V
	SHT 63GP AC 380 - 415 V	UVT 63GP AC 380 - 415 V
	SHT 63GP AC 440 - 480 V	UVT 63GP AC 440 - 480 V

**External Accessory**

		Front Contact (TFG)	Extended (TFH)
Rotary Handle	Upper Line	TFG 80GP U	TFH 80GP
	Right Line	TFG 80GP R	TFH 80GP
	Left Line	TFG 80GP L	TFH 80GP
		3 Pole / 4 Pole	
Motor Operator		MOT 80GP DC 24 V	
		MOT 80GP AC/DC 110 V	
		MOT 80GP AC/DC 240 V	
		3 Pole	4 Pole
Terminal Cover	Short	TCF 80GP S3	-
	Long	TCF 80GP L3	TCF 80GP L4
Locking Device	Padlock	PLD 80GP	PLD 80GP
	Mechanical Interlock	MIF 80GP 3	MIF 80GP R4
Interpole Barrier		TQQ 80GP 3	TQQ 80GP 4
Auxiliary Handle		THA 80GP	

# Dimensions

## Front Connection HGM100

• HGM30, 50E/S, 60, 100

### External Dimension

Unit : mm

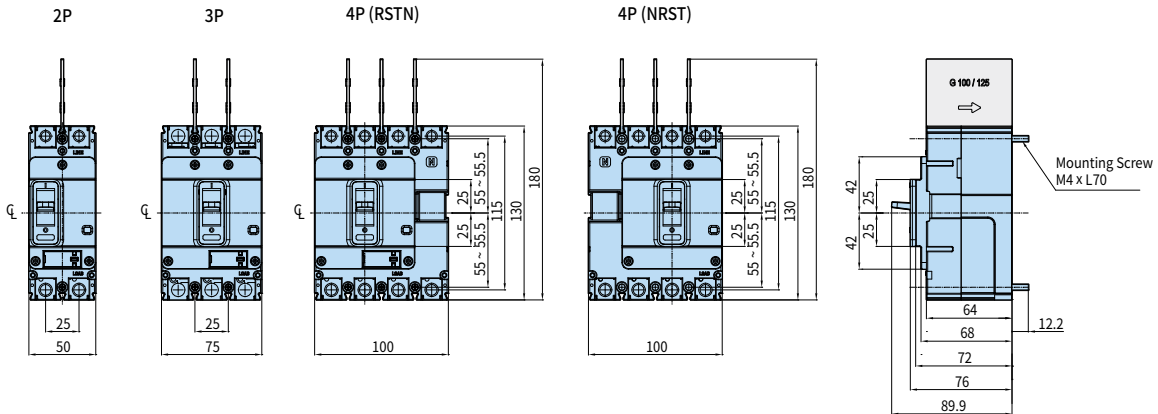

※ The insulation barrier at the live side is provided as standard product.

### Panel Installation Dimension

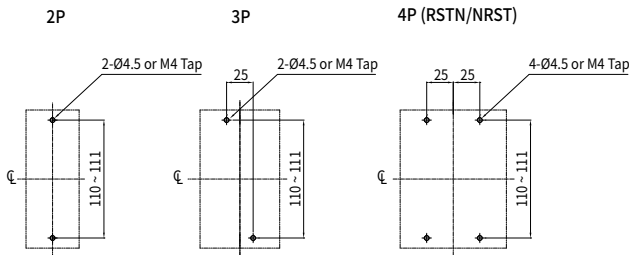

### Detail Drawing of Terminal Part/ Connecting Conductor

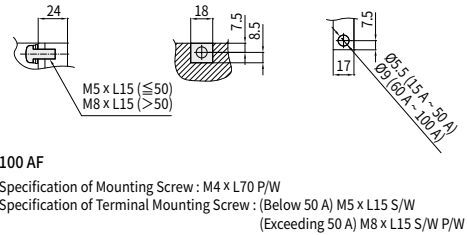

### Dimension of Panel Cover Cutting - Handle Exposure

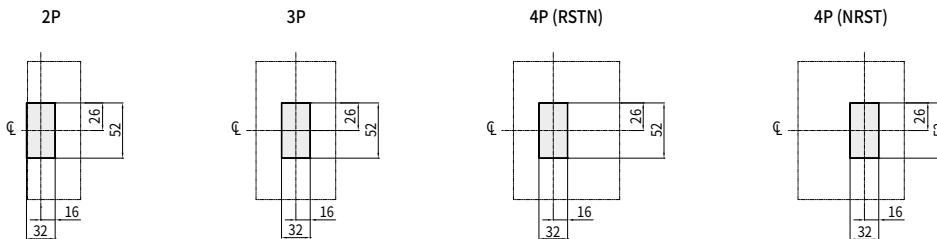

### Dimension of Panel Cover Cutting - Handle/Test Button Exposure

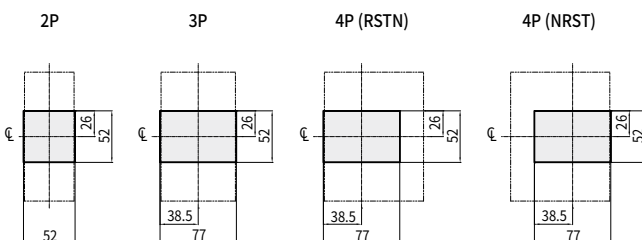

### Dimension of Panel Cover Cutting - Handle/Trip Unit Exposure

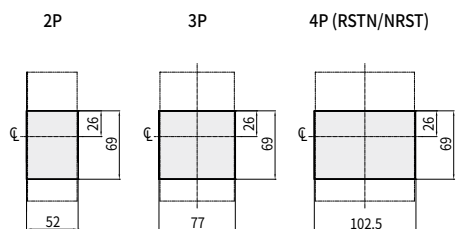

## Front Connection HGM125

• HGM50H/L, 125

### External Dimension

Unit: mm

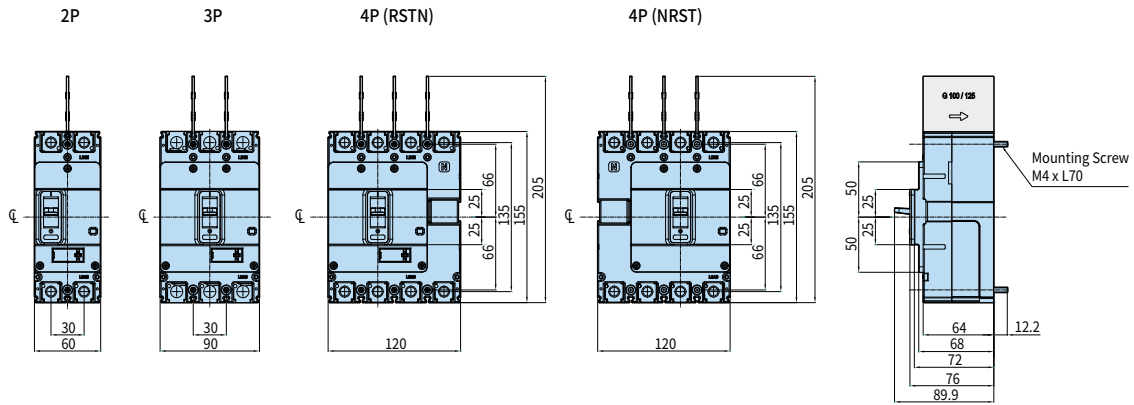

※ The insulation barrier at the live side is provided as standard product.

### Panel Installation Dimension

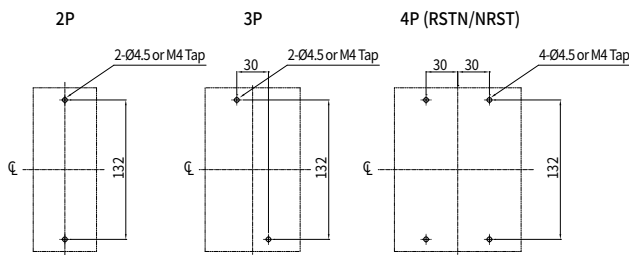

### Detail Drawing of Terminal Part/ Connecting Conductor

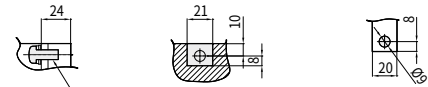

125 AF

Specification of Terminal Mounting Screw : M4 x L70 P/W  
Specification of Mounting Screw : M8 x L15 S/W P/W

### Dimension of Panel Cover Cutting - Handle Exposure

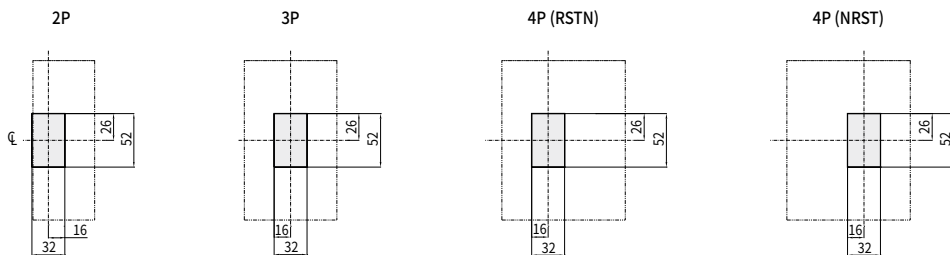

### Dimension of Panel Cover Cutting - Handle/Test Button Exposure

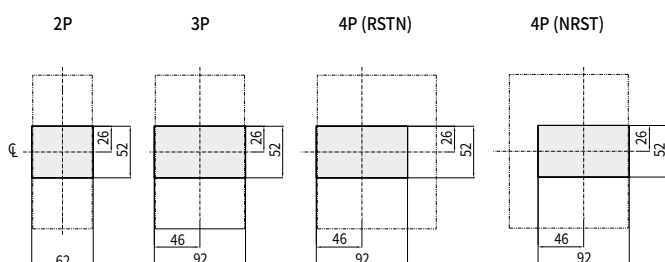

### Dimension of Panel Cover Cutting - Handle/Trip Unit Exposure

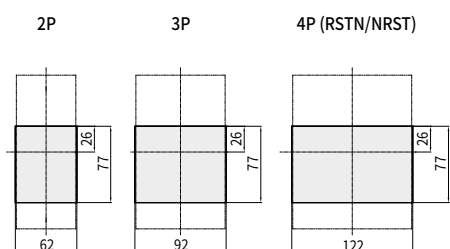

# Dimensions

## Front Connection HGM250

• HGM160, 250

### External Dimension

Unit : mm

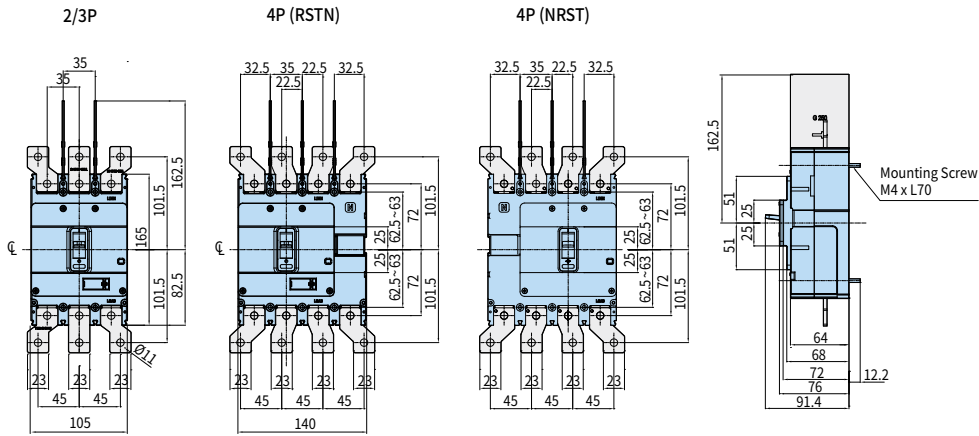

※ The insulation barrier at the live side is provided as standard product.

### Panel Installation Dimension

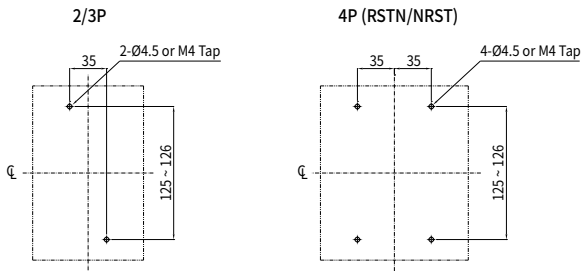

### Detail Drawing of Terminal Part/ Connecting Conductor

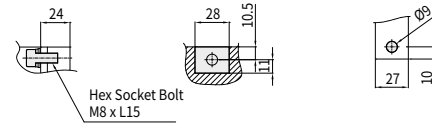

250 AF

Specification of Mounting Screw : M4 x L70 P/W

Bus Screw Specification : Hex Socket Bolt M8 x L18 W/W

### Dimension of Panel Cover Cutting - Handle Exposure

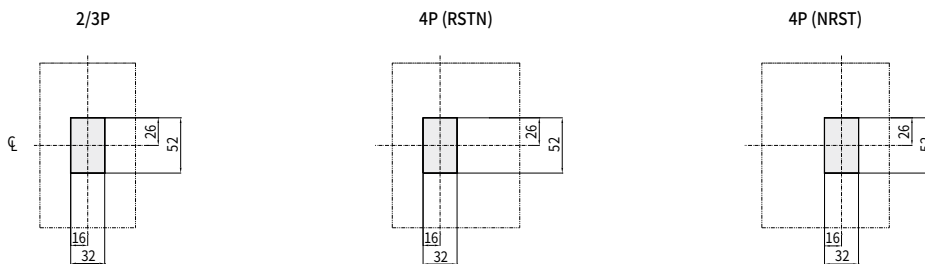

### Dimension of Panel Cover Cutting - Handle/Test Button Exposure

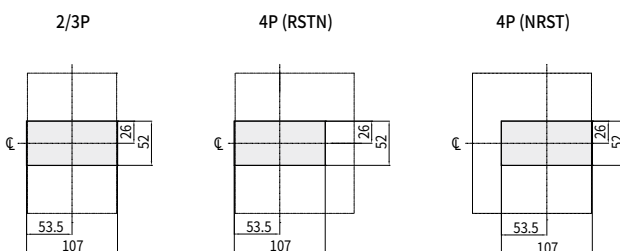

### Dimension of Panel Cover Cutting - Handle/Trip Unit Exposure

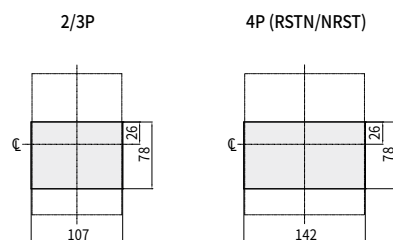



## Front Connection HGM400

• HGM400

### External Dimension

Unit: mm

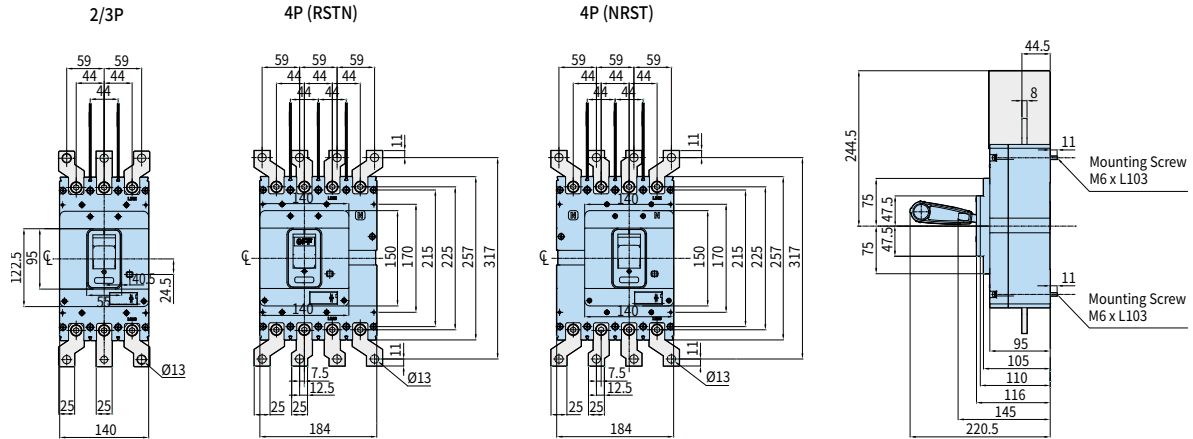

※ The insulation barrier at the live side is provided as standard product.

### Panel Installation Dimension

### Detail Drawing of Terminal Part/Connecting Conductor

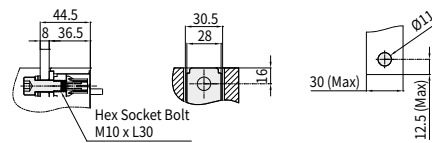
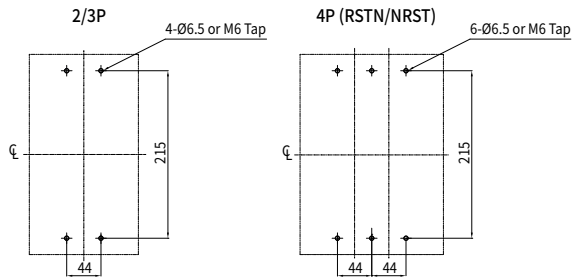

### Dimension of Panel Cover Cutting - Handle Exposure

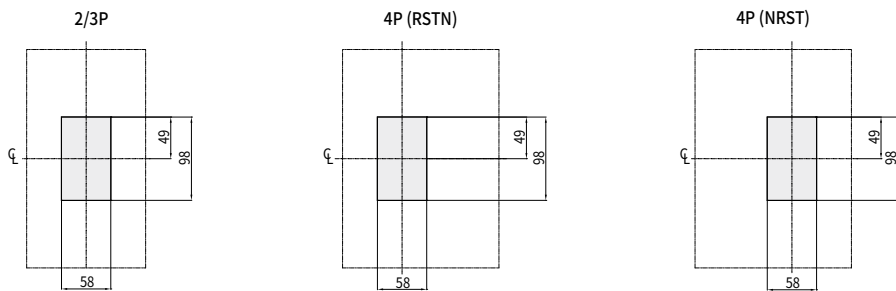

### Dimension of Panel Cover Cutting - Handle/Test Button Exposure

### Dimension of Panel Cover Cutting - Handle/Trip Unit Exposure

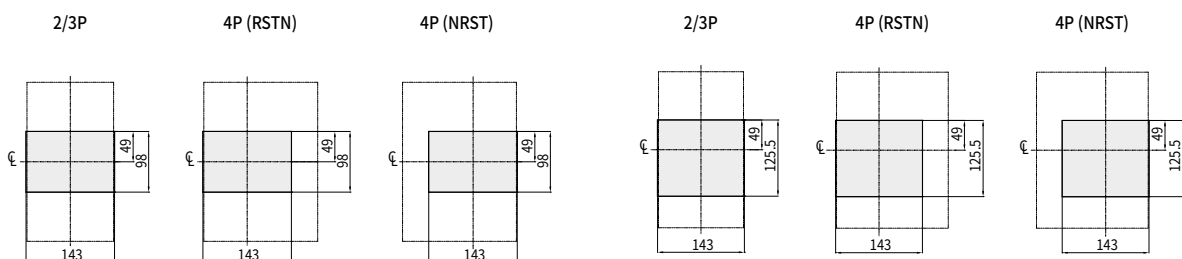

# Dimensions

## Front Connection HGM800

• HGM630, 800

### External Dimension

Unit : mm

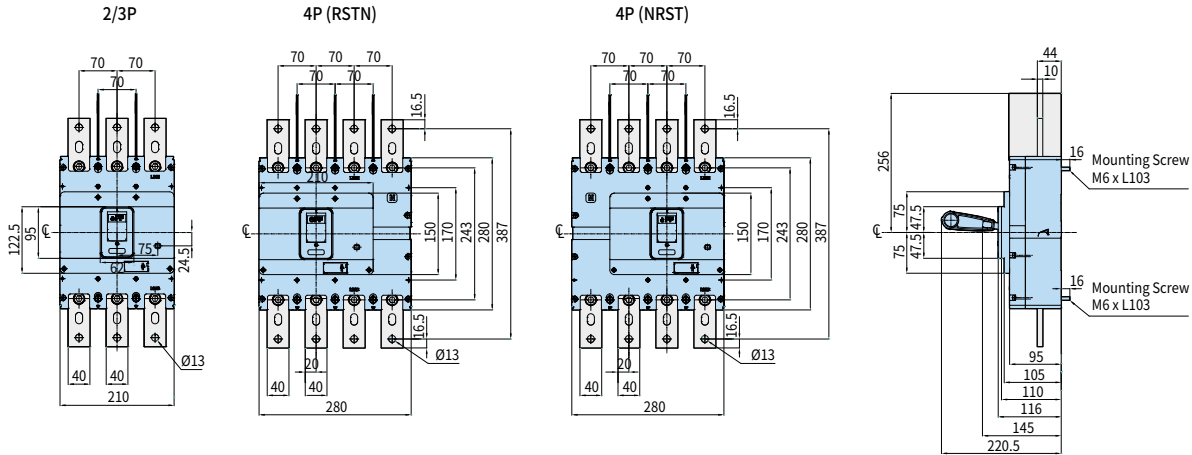

※ The insulation barrier at the live side is provided as standard product.

### Panel Installation Dimension

### Detail Drawing of Terminal Part/Connecting Conductor

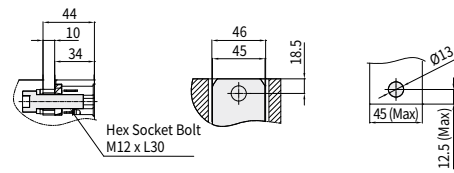
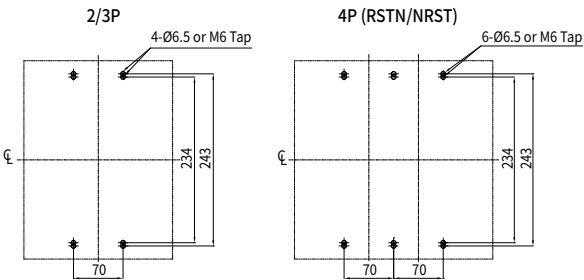

### Dimension of Panel Cover Cutting - Handle Exposure

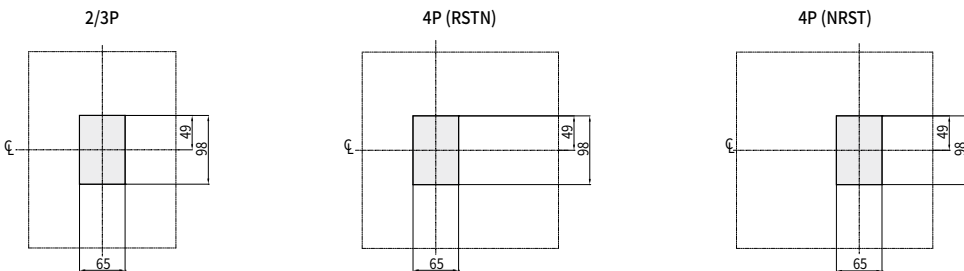

### Dimension of Panel Cover Cutting - Handle/Test Button Exposure

### Dimension of Panel Cover Cutting - Handle/Trip Unit Exposure

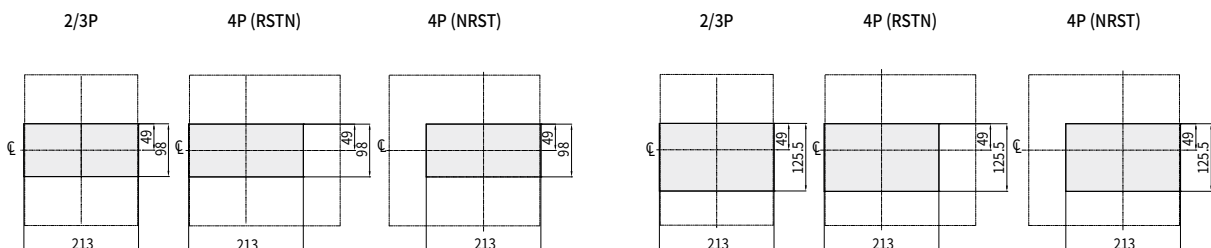

## Front Connection HGE100

• HGE30, 50E/S, 60, 100

### External Dimension

Unit: mm

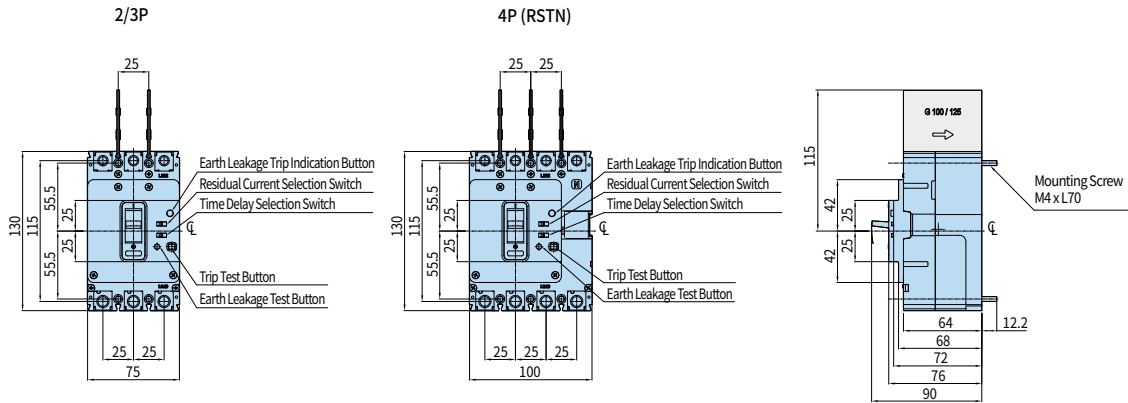

※ The insulation barrier at the live side is provided as standard product.

### Panel Installation Dimension

### Detail Drawing of Terminal Part/Connecting Conductor

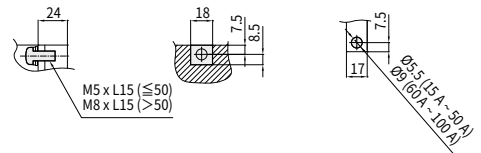
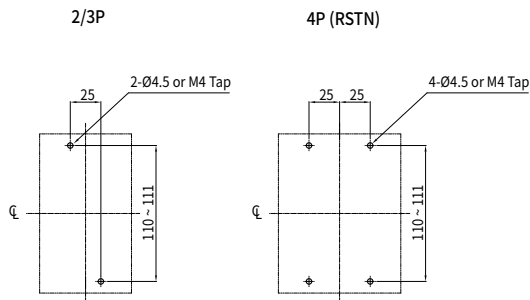

**100 AF**  
 Specification of Mounting Screw : M4 x L70 P/W  
 Specification of Terminal Mounting Screw : (Below 50 A) M5 x L15 S/W  
 (Exceeding 50 A) M8 x L15 S/W P/W

### Dimension of Panel Cover Cutting - Handle Exposure

### Dimension of Panel Cover Cutting - Handle/Test Button Exposure

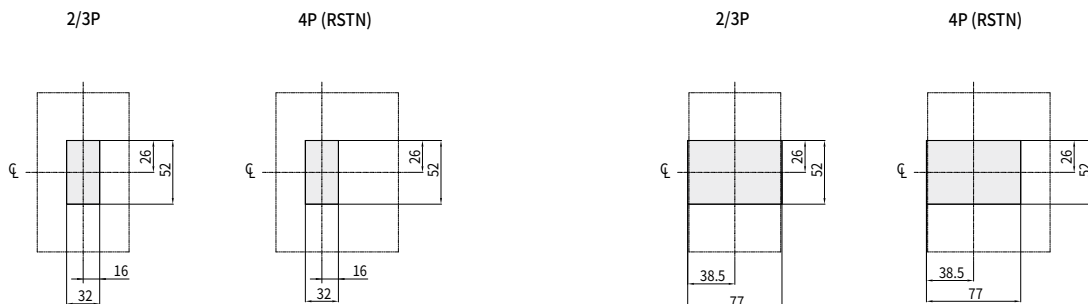

# Dimensions

## Front Connection HGE125

• HGE50H/L, 125

### External Dimension

Unit : mm

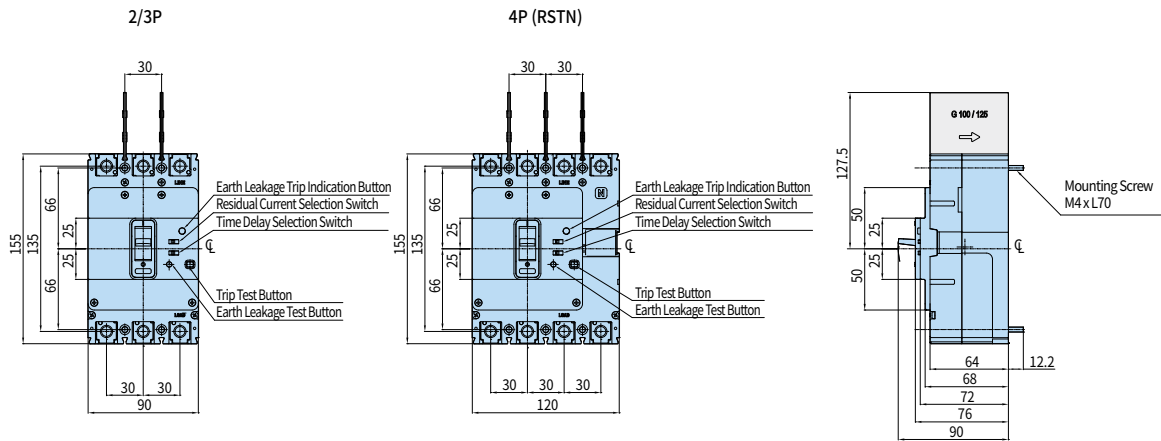

※ The insulation barrier at the live side is provided as standard product.

### Panel Installation Dimension

### Detail Drawing of Terminal Part/Connecting Conductor

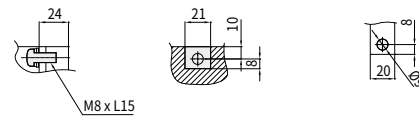
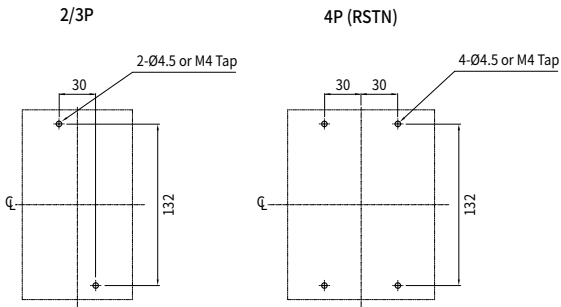

125 AF

Specification of Mounting Screw : M4 x L70 P/W

Specification of Terminal Mounting Screw : M8 x L15 S/W P/W

### Dimension of Panel Cover Cutting - Handle Exposure

### Dimension of Panel Cover Cutting - Handle/Test Button Exposure

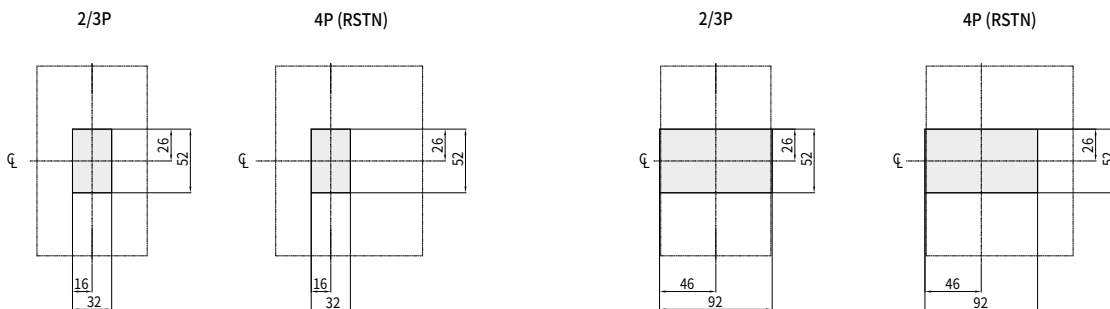

## Front Connection HGE250

• HGE160, 250

### External Dimension

Unit: mm

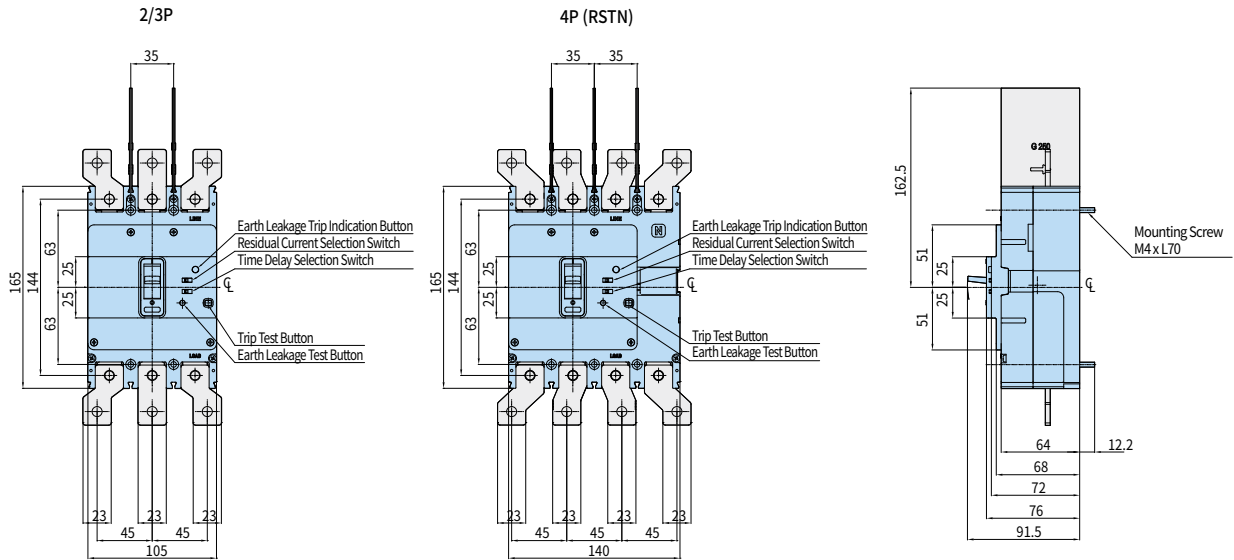

※ The insulation barrier at the live side is provided as standard product.

### Panel Installation Dimension

### Detail Drawing of Terminal Part/Connecting Conductor

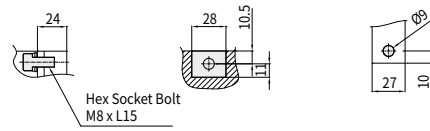
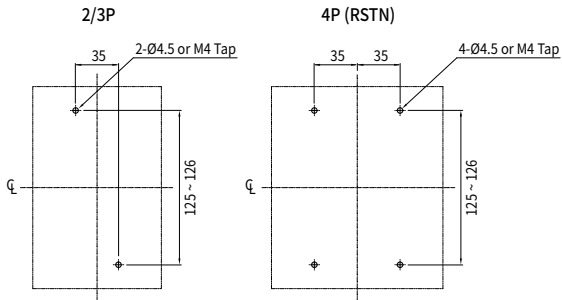

250 AF

Specification of Mounting Screw : M4 x L70 P/W

Specification of Terminal Mounting Screw : Hex Socket Bolt M8 x L18 W/W

### Dimension of Panel Cover Cutting - Handle Exposure

### Dimension of Panel Cover Cutting - Handle/Test Button Exposure

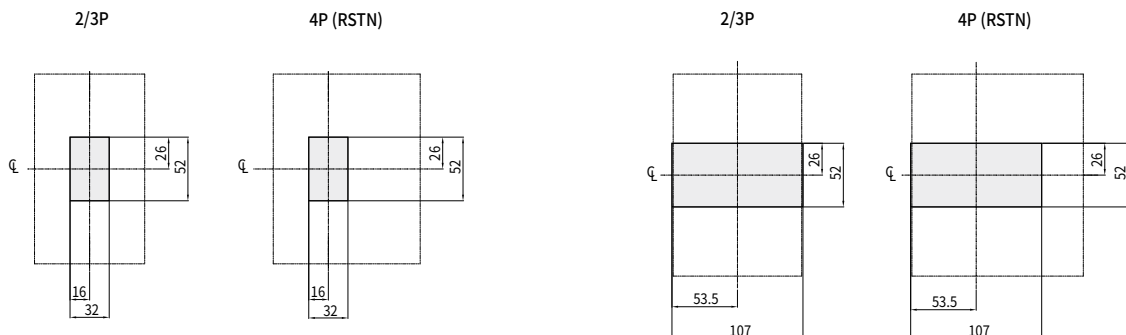

# Dimensions

## Front Connection HGE400

• HGE400

### External Dimension

Unit : mm

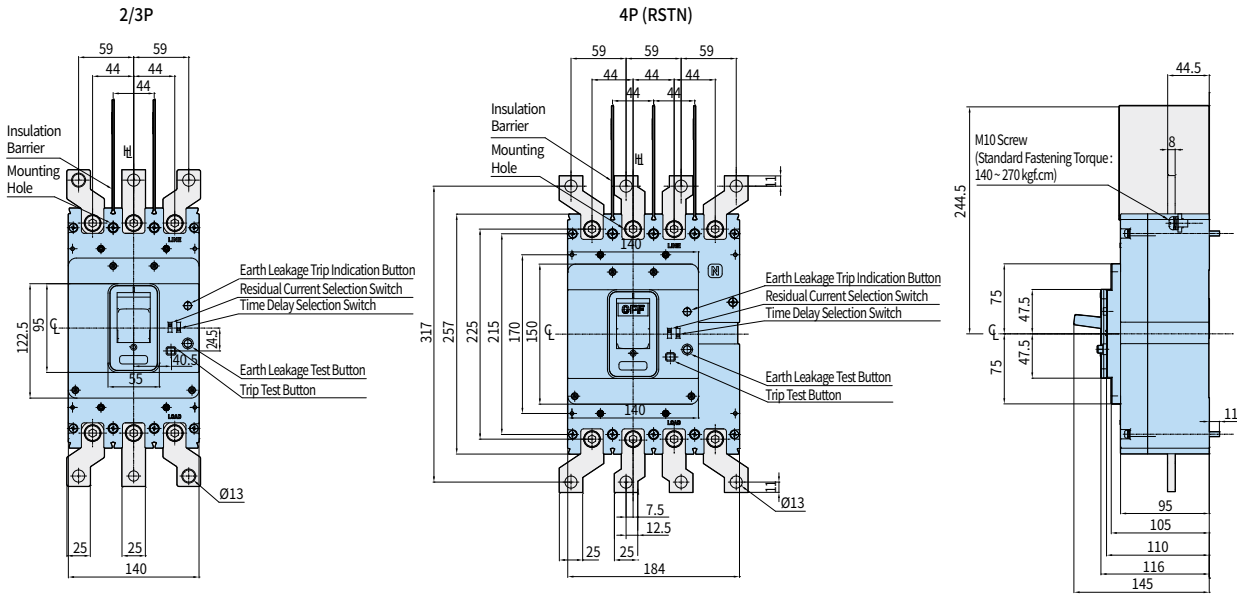

※ The insulation barrier at the live side is provided as standard product.

### Panel Installation Dimension

### Detail Drawing of Terminal Part/Connecting Conductor

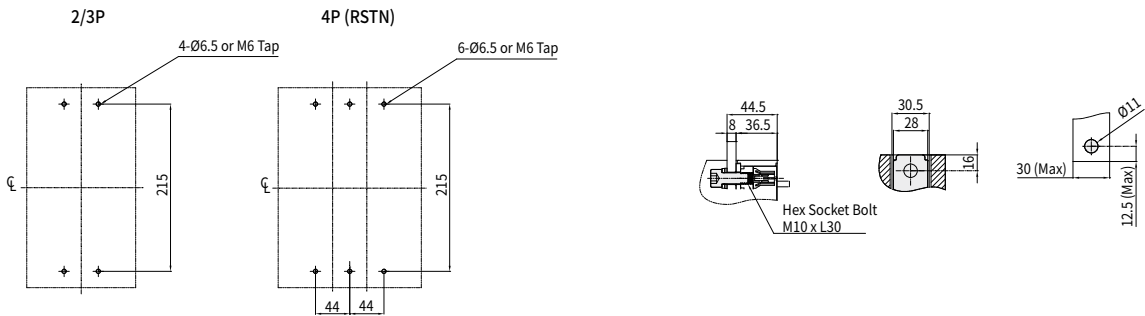

### Dimension of Panel Cover Cutting

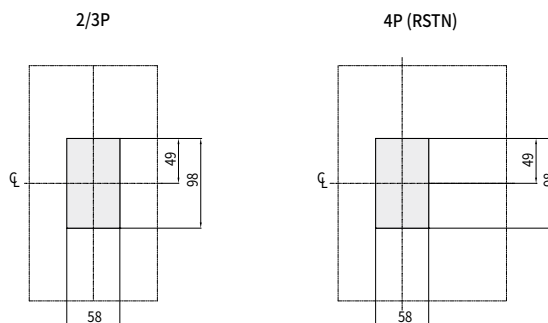

## Front Connection HGE800

• HGE630, 800

### External Dimension

Unit: mm

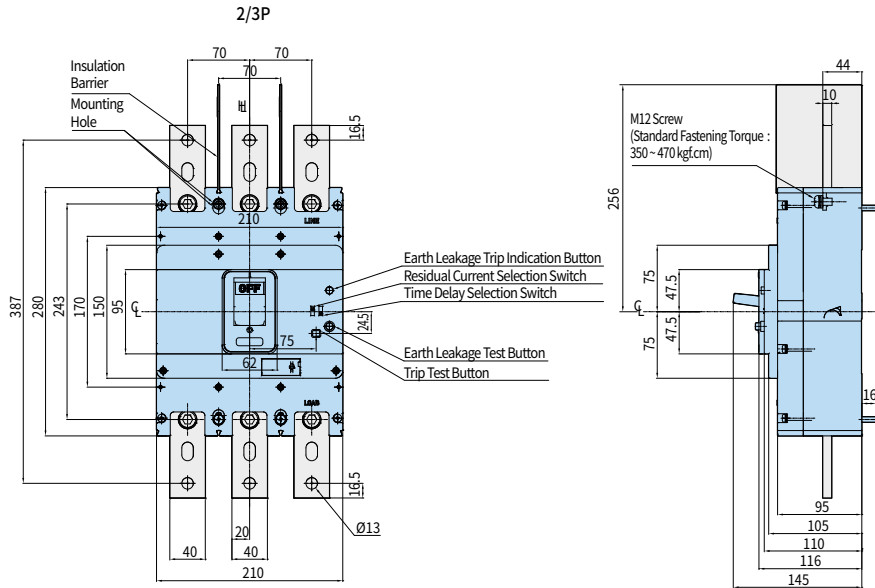

※ The insulation barrier at the live side is provided as standard product.

### Panel Installation Dimension

### Detail Drawing of Terminal Part/Connecting Conductor

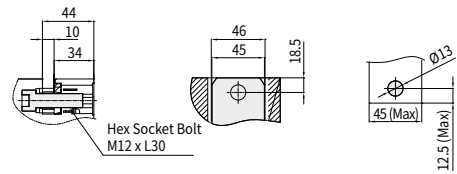
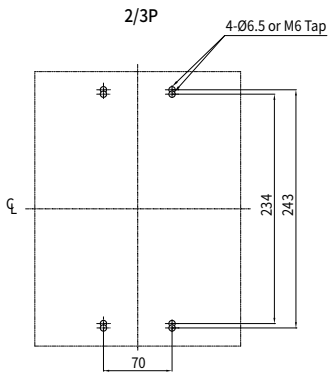

### Dimension of Panel Cover Cutting

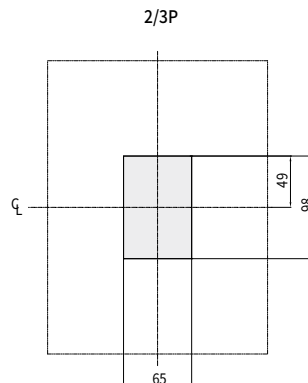

# Dimensions

## Front Connection HGP160D

• HGP50D, 125D, 160D

### External Dimension

Unit : mm

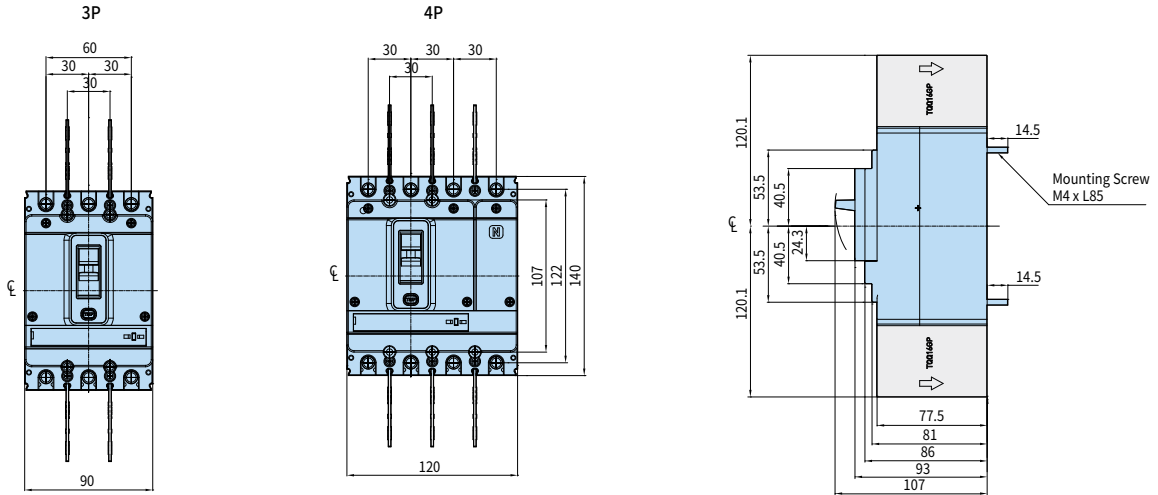

### Panel Installation Dimension

### Detail Drawing of Terminal Part/Connecting Conductor

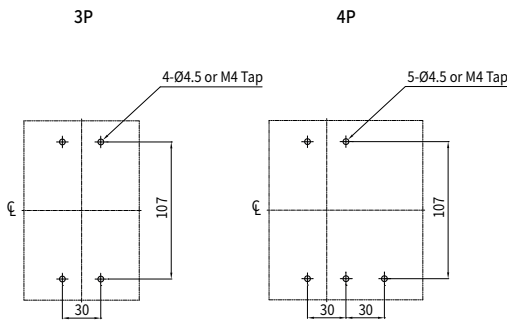

### Connecting Conductor

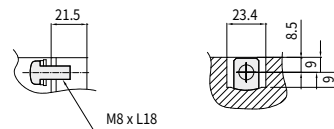

### Terminal Part



### Dimension of Panel Cover Cutting

#### Handle/Test Button Exposure

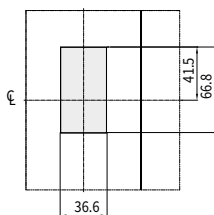

#### Handle/Trip Unit Exposure

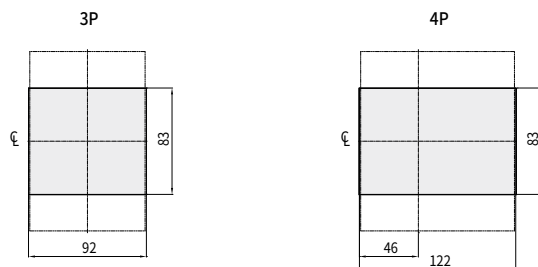



## Front Connection HGP250 (HGP100/MCP)

• HGP100, 250

### External Dimension

Unit: mm

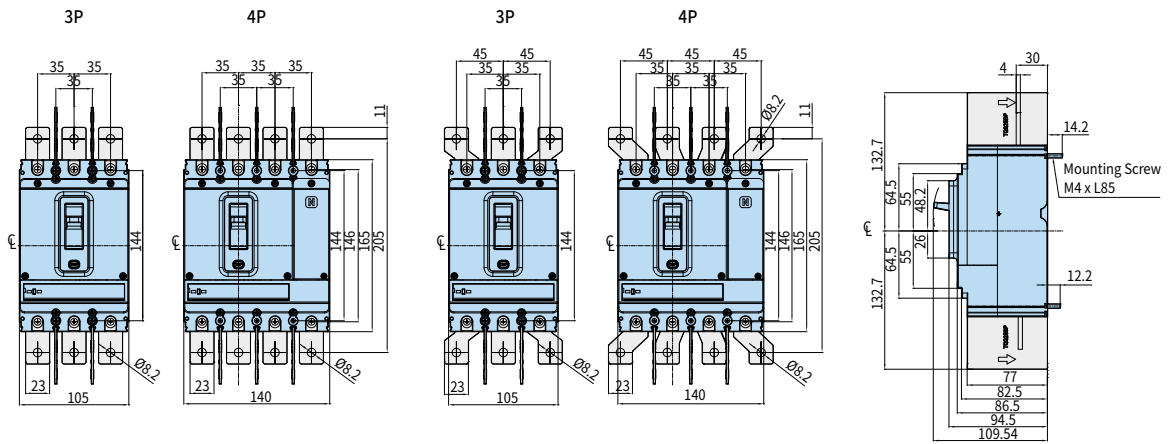

### Panel Installation Dimension

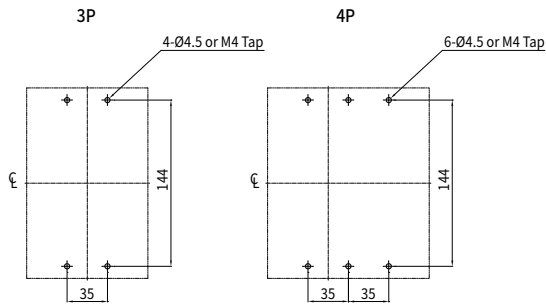

※ Screw Applied : M4 × L85 S/W (For Circuit Breaker Mounting),  
M8 × L18 S/W P/W (For Terminal Mounting)

### Detail Drawing of Terminal Part/Connecting Conductor

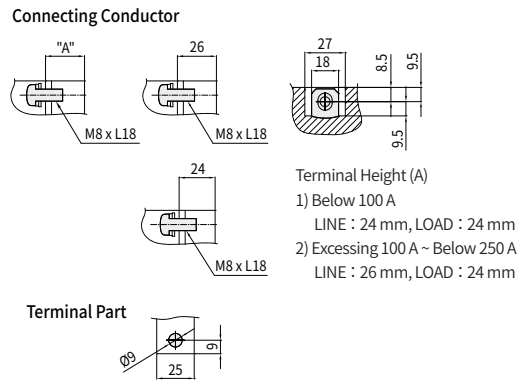

### Dimension of Panel Cover Cutting

#### Handle/Test Button Exposure

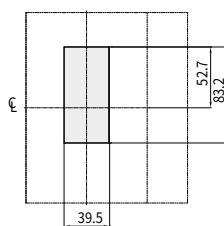

#### Handle/Trip Unit Exposure

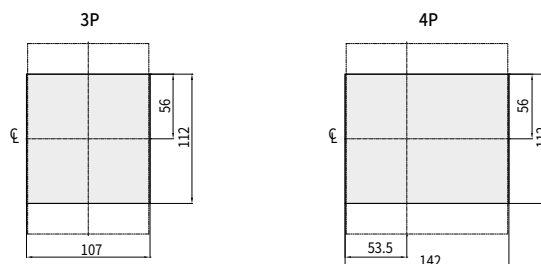

# Dimensions

## Front Connection HGP630

• HGP400, 630

### External Dimension

Unit : mm

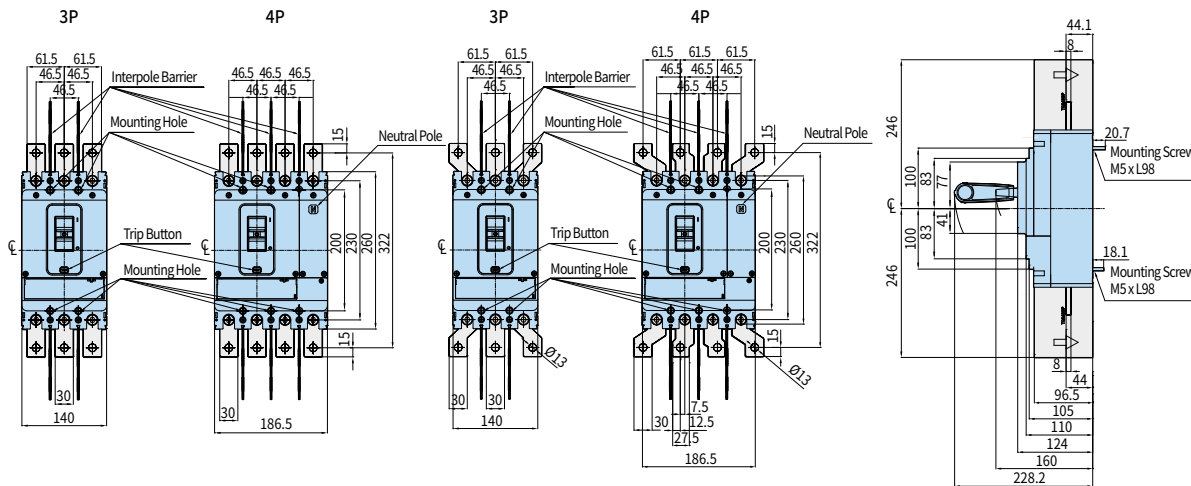

### Panel Installation Dimension

### Detail Drawing of Terminal Part/Connecting Conductor

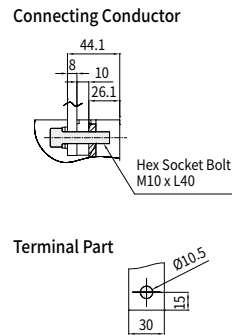
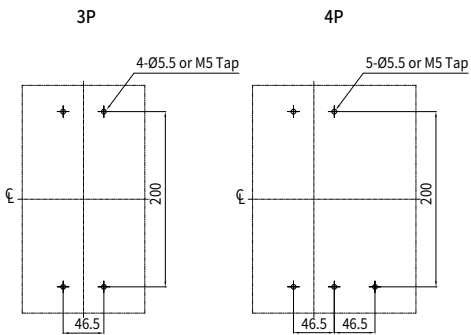

### Dimension of Panel Cover Cutting

#### Handle/Test Button Exposure

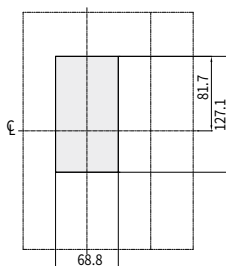

#### Handle/Trip Unit Exposure

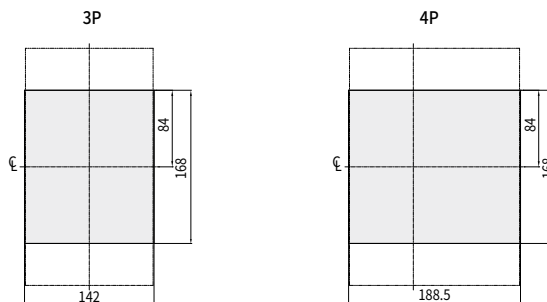

## Front Connection HGP800

• HGP800

### External Dimension

Unit: mm

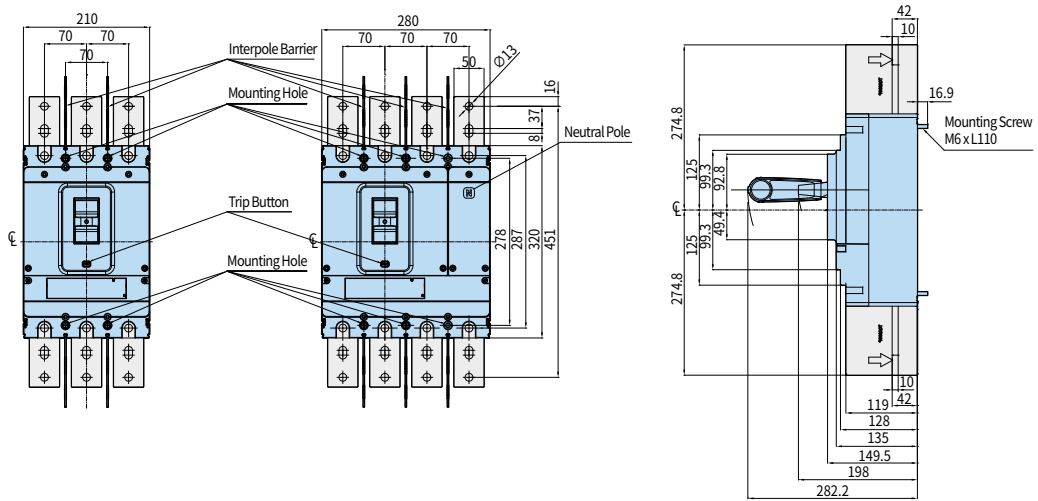

### Panel Installation Dimension

### Detail Drawing of Terminal Part/Connecting Conductor

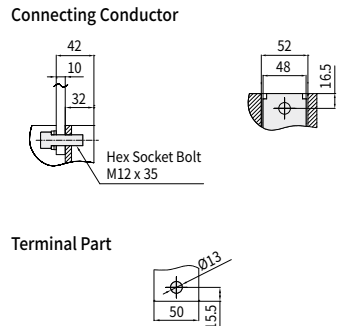
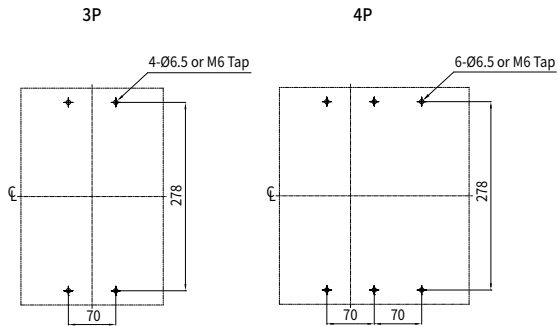

### Dimension of Panel Cover Cutting

#### Handle/Test Button Exposure

#### Handle/Trip Unit Exposure

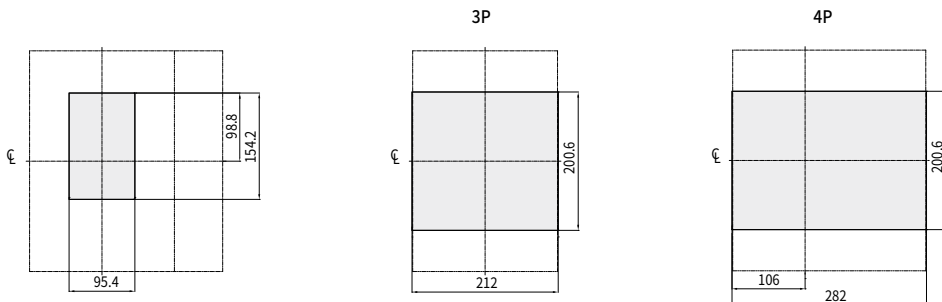

# Dimensions

## Rear Connection (Flat Type) HGM100

• HGM30, 50E/S, 60, 100

### External Dimension

Unit: mm

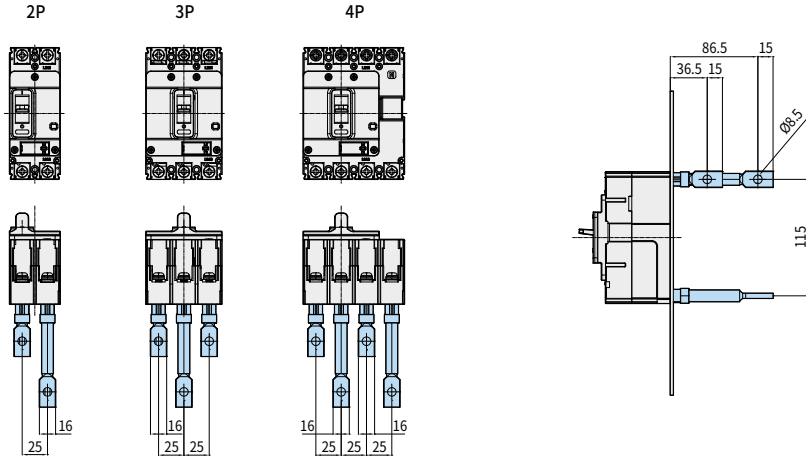

### Panel Installation Dimension

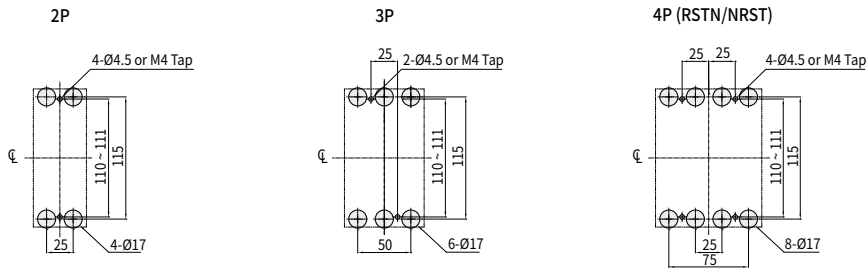

### Dimension of Panel Cover Cutting - Handle/Test Button Exposure

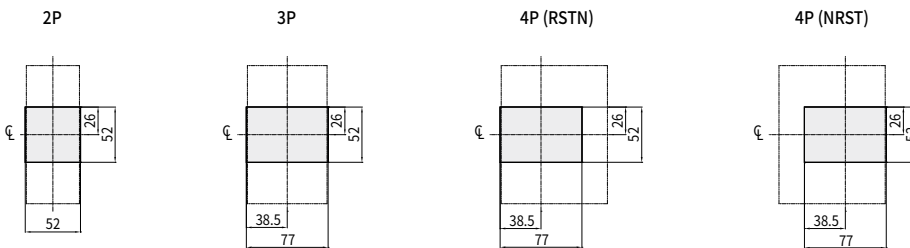

### Dimension of Panel Cover Cutting - Handle/Trip Unit Exposure

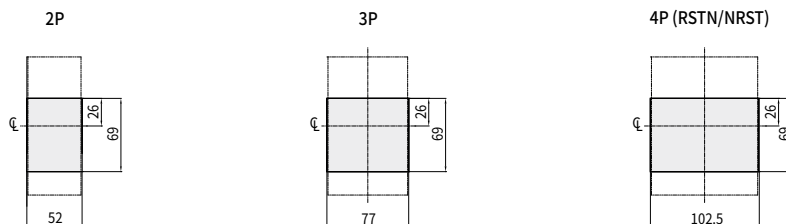

※ When assembling the RCT, remove the back barrier beforehand.

## Rear Connection (Flat Type) HGM125

• HGM50H/L, 125

### External Dimension

Unit: mm

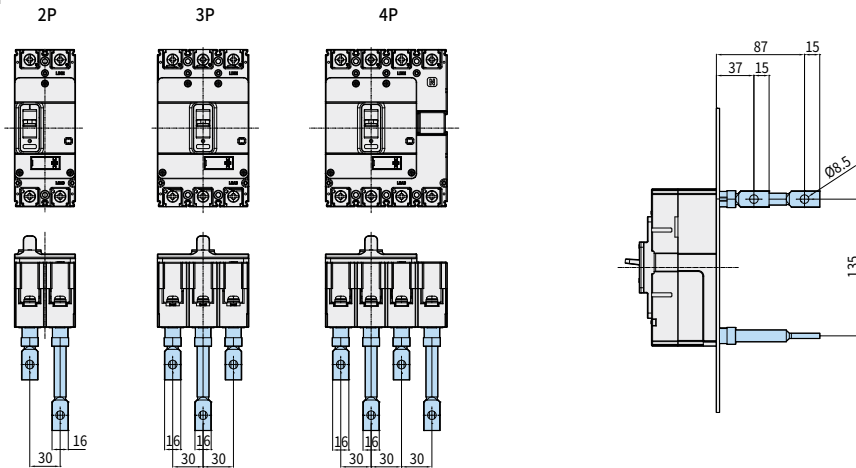

### Panel Installation Dimension

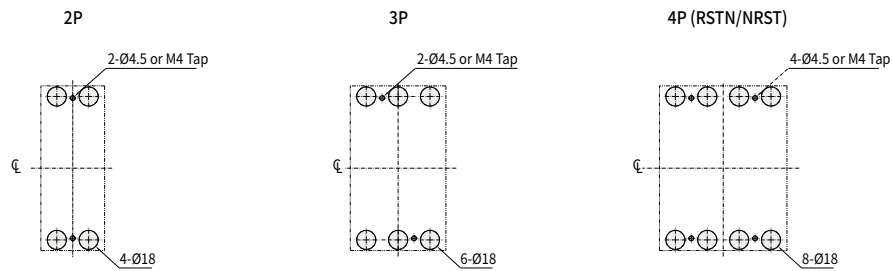

### Dimension of Panel Cover Cutting - Handle/Test Button Exposure

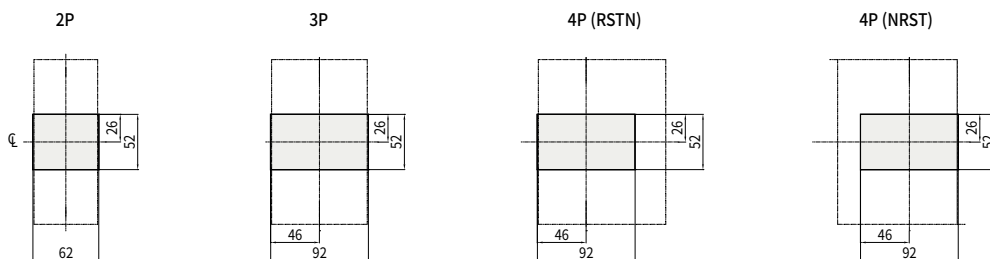

### Dimension of Panel Cover Cutting - Handle/Trip Unit Exposure

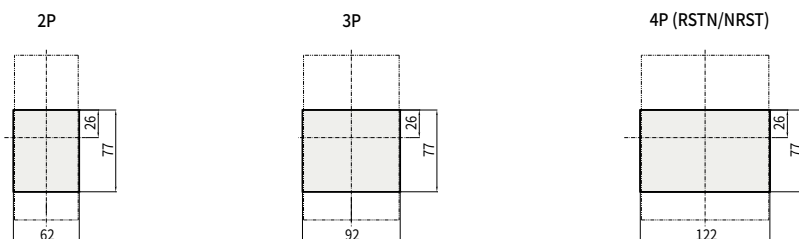

※ When assembling the RCT, remove the back barrier beforehand.

# Dimensions

## Rear Connection (Flat Type) HGM250

• HGM160, 250

### External Dimension

Unit : mm

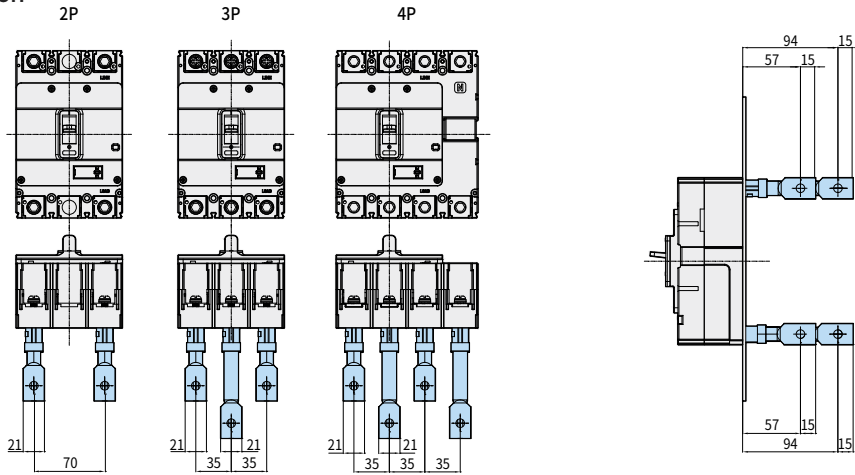

### Panel Installation Dimension

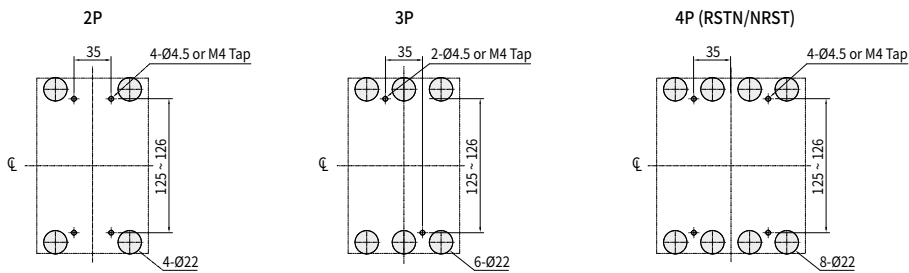

### Dimension of Panel Cover Cutting - Handle/Test Button Exposure

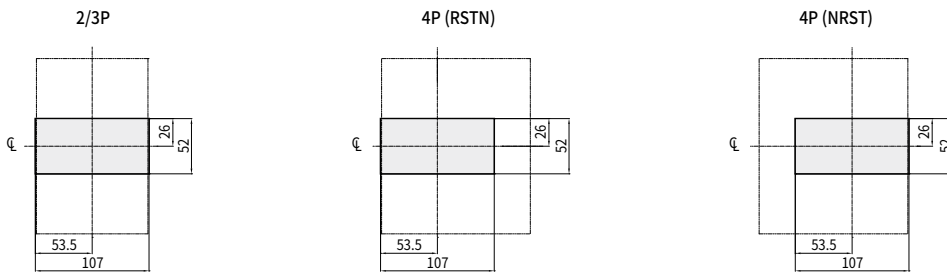

### Dimension of Panel Cover Cutting - Handle/Trip Unit Exposure

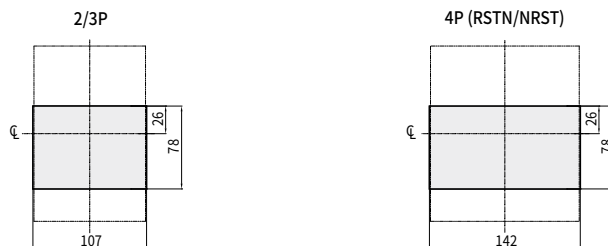

※ When assembling the RCT, remove the back barrier beforehand.

## Rear Connection (Flat Type) HGM400

• HGM400

### External Dimension

Unit: mm

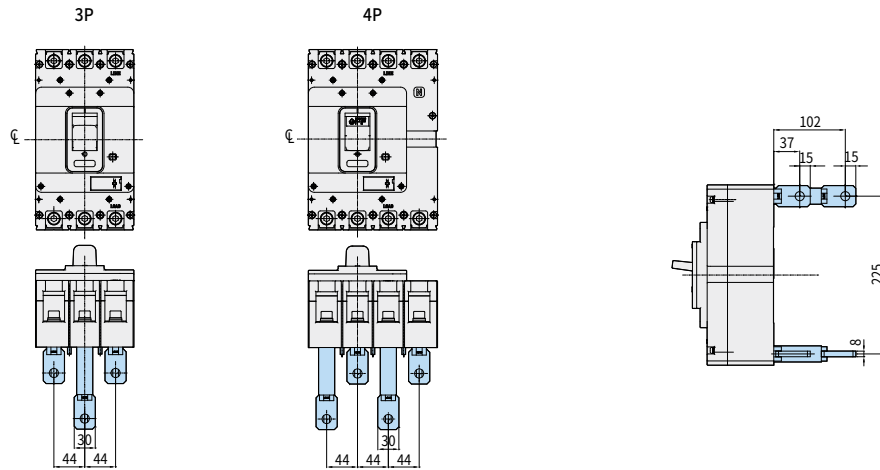

### Panel Installation Dimension

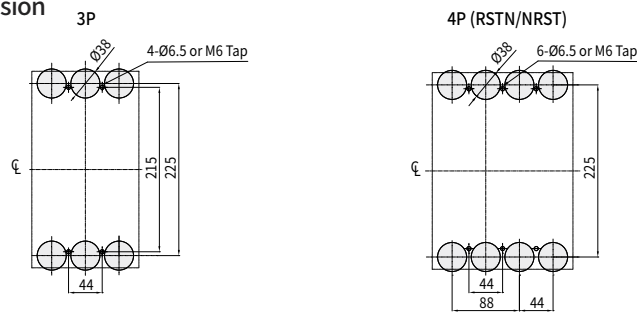

### Dimension of Panel Cover Cutting - Handle/Test Button Exposure

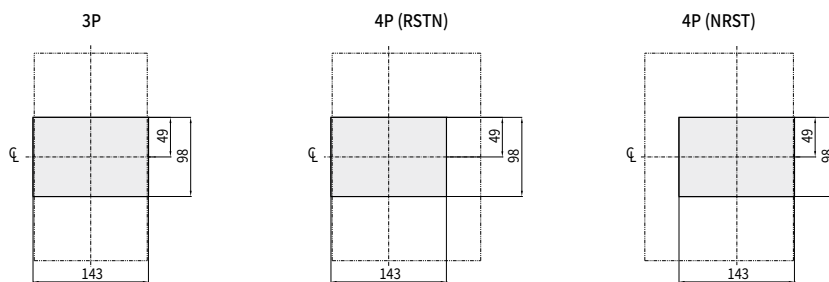

### Dimension of Panel Cover Cutting - Handle/Trip Unit Exposure

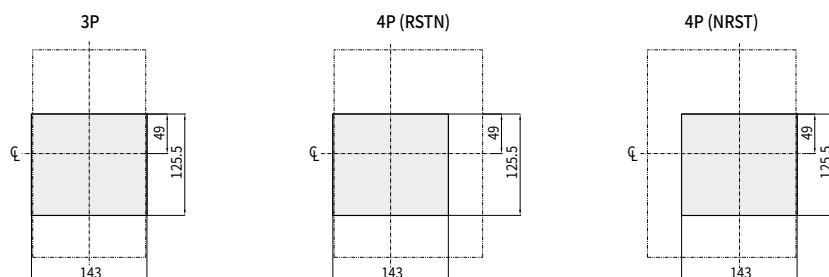

※ When assembling the RCT, remove the back barrier beforehand.

## Dimensions

### Rear Connection (Flat Type) HGM800

• HGM630, 800

#### External Dimension

Unit : mm

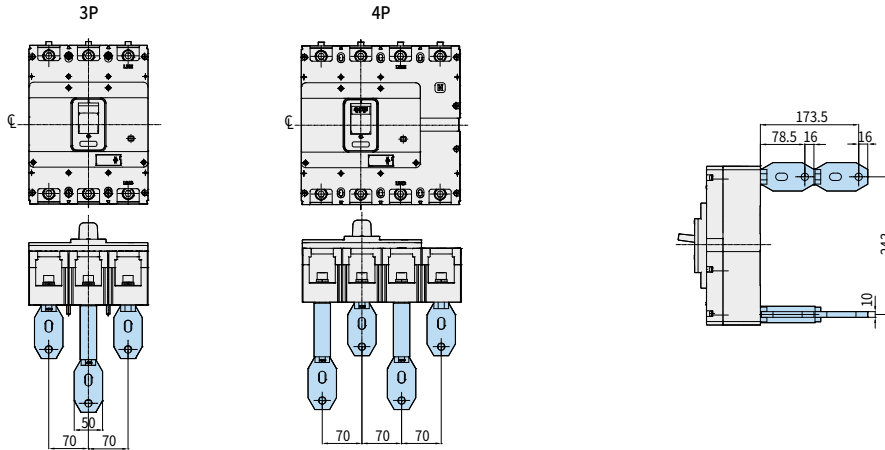

#### Panel Installation Dimension

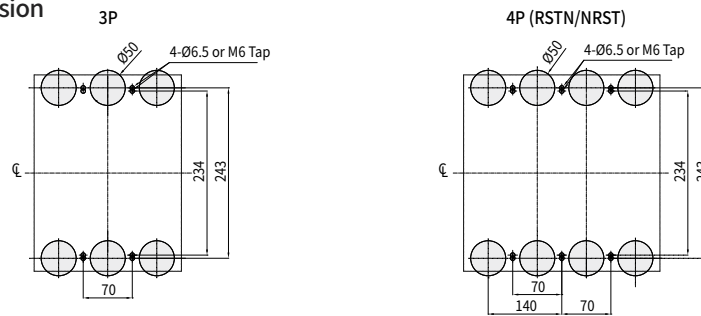

#### Dimension of Panel Cover Cutting - Handle/Test Button Exposure

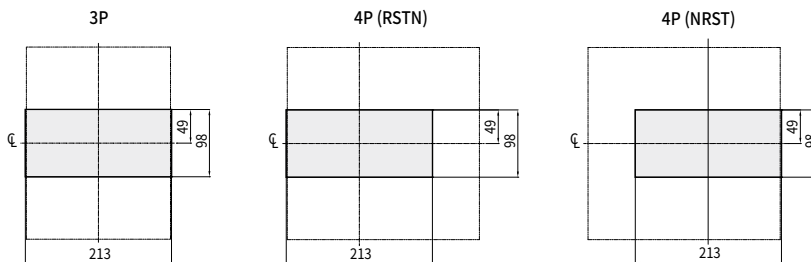

#### Dimension of Panel Cover Cutting - Handle/Trip Unit Exposure

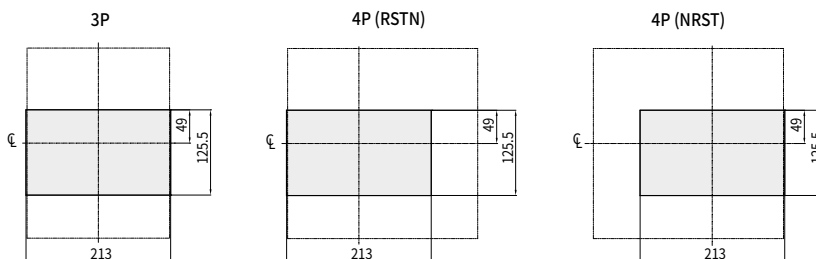

※ When assembling the RCT, remove the back barrier beforehand.



## Plug-in Type HGM100

• HGM30, 50E/S, 60, 100

### External Dimension (TDM Type)

Unit: mm

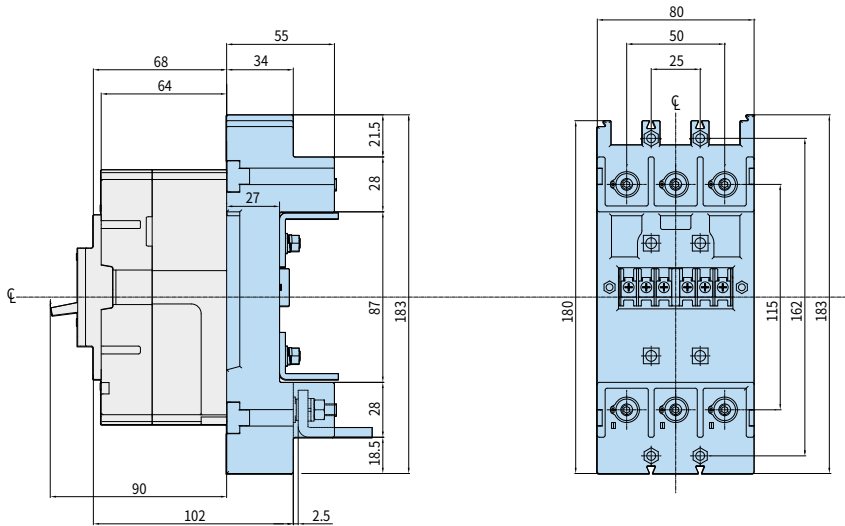

### Panel Installation Dimension and Cover Cutting Dimension

Detailed Drawing of Connection

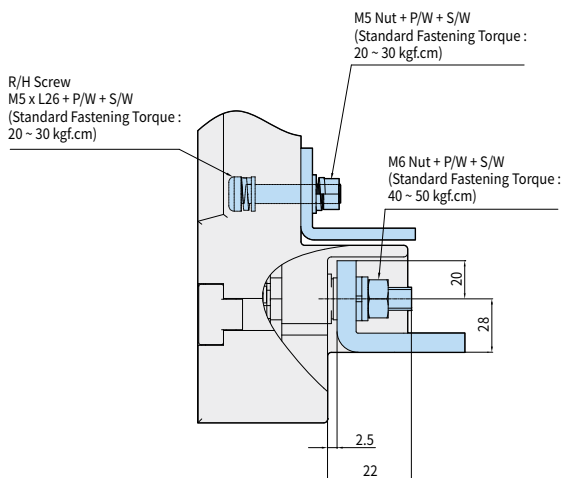

Mounting Drawing

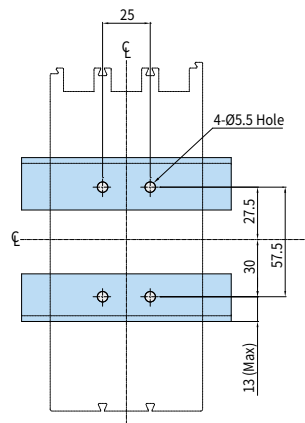

Process Criterion of Connecting Conductor

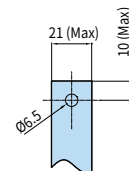

# Dimensions

## Plug-in Type HGM100

• HGM30, 50E/S, 60, 100

### External Dimension (TDA D Type)

Unit : mm

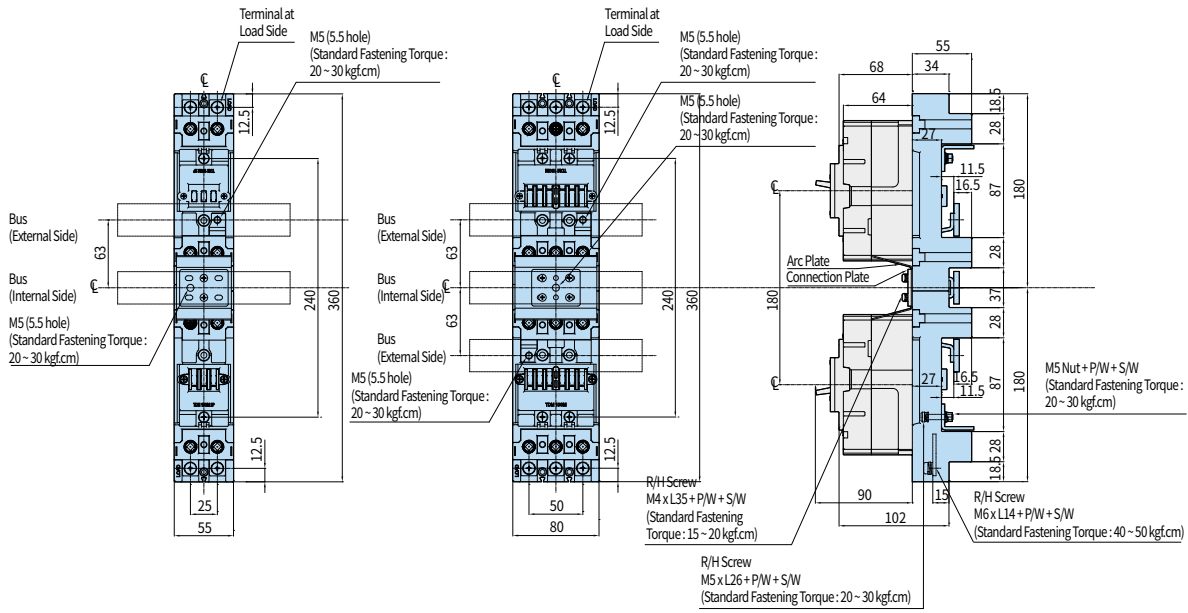

### Panel Installation Dimension and Cover Cutting Dimension

Mounting Drawing

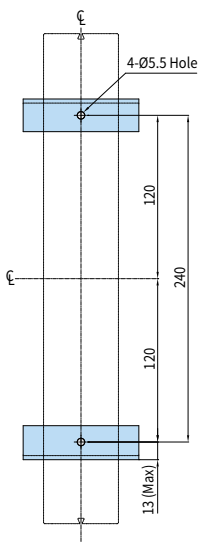

Mounting Drawing

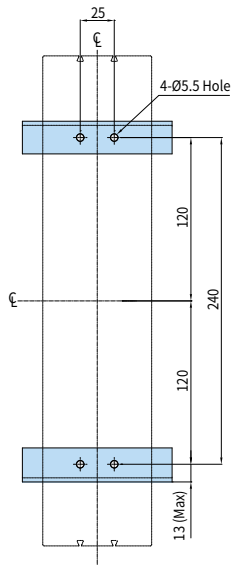

Process Criterion of Connecting Conductor

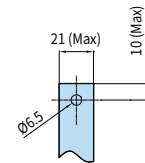

### Plug-in Type HGM100

• HGM30, 50E/S, 60, 100

#### External Dimension (TDA S Type)

Unit: mm

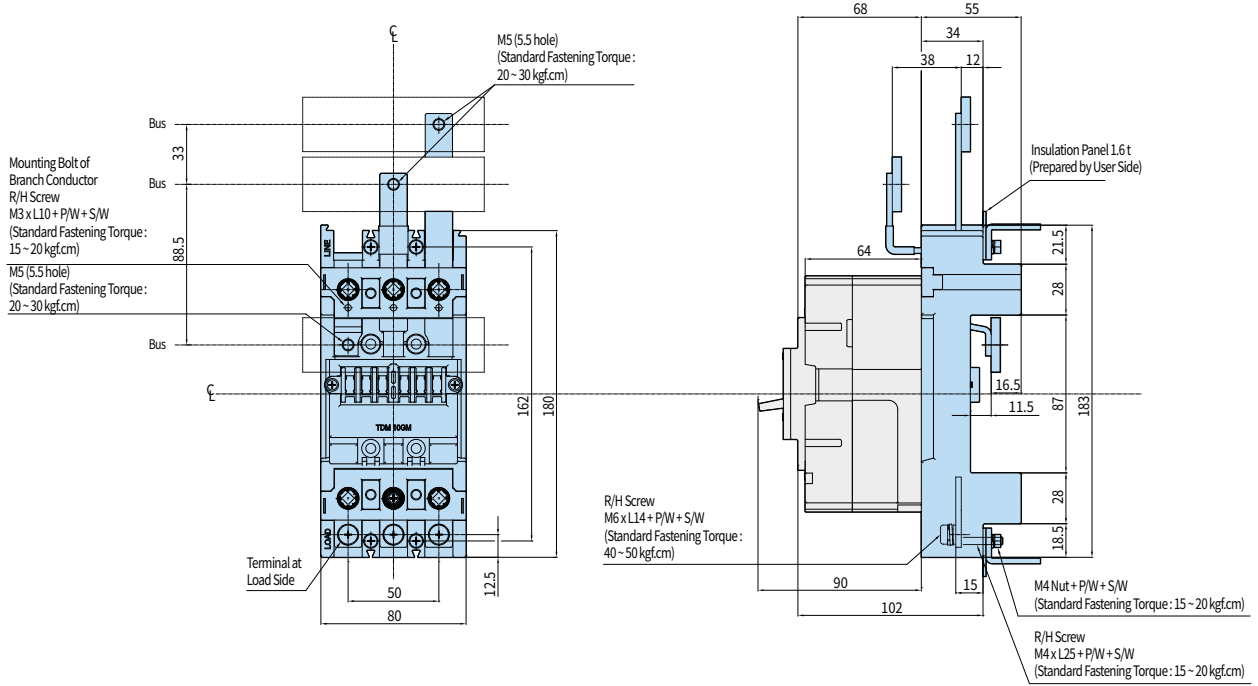

#### Panel Installation Dimension and Cover Cutting Dimension

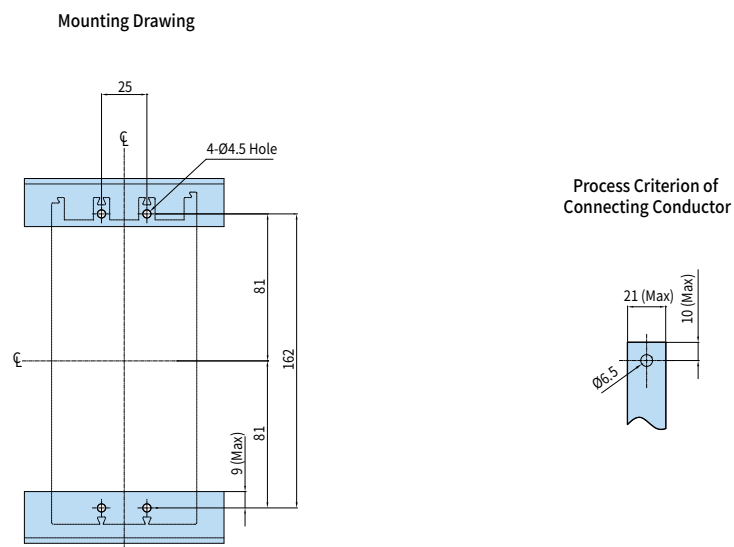

# Dimensions

## Plug-in Type HGM100

• HGM30, 50E/S, 60, 100

External Dimension (TDF Type)

Unit : mm

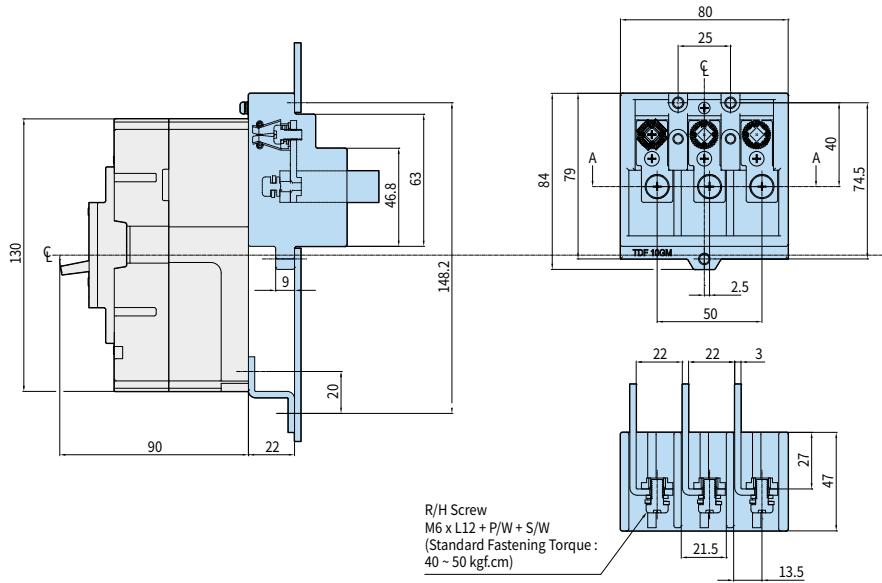

## Panel Installation Dimension and Cover Cutting Dimension

Mounting Drawing

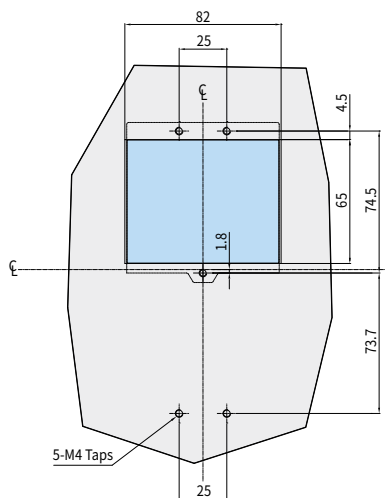

Process Criterion of Connecting Conductor

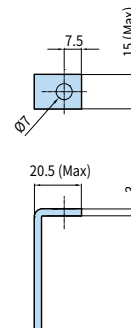

## Plug-in Type HGM125

• HGM50H/L, 125

### External Dimension (TDM Type)

Unit: mm

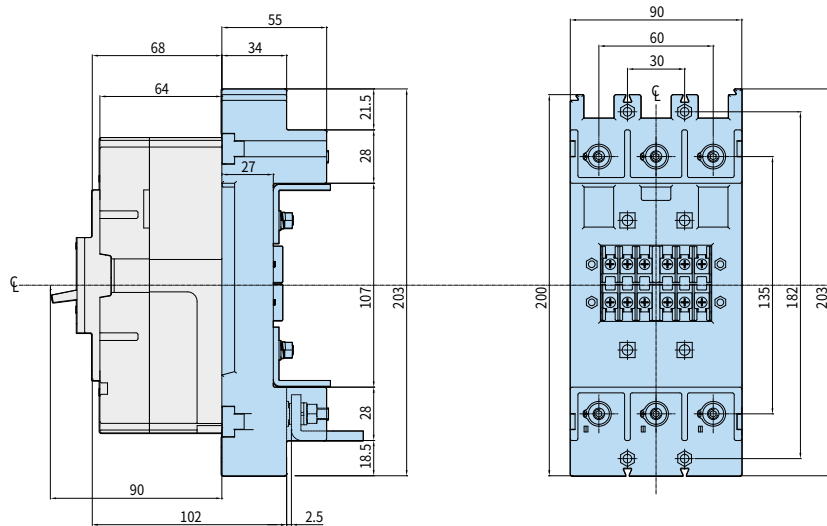

### Panel Installation Dimension and Cover Cutting Dimension

Detailed Drawing of Connection

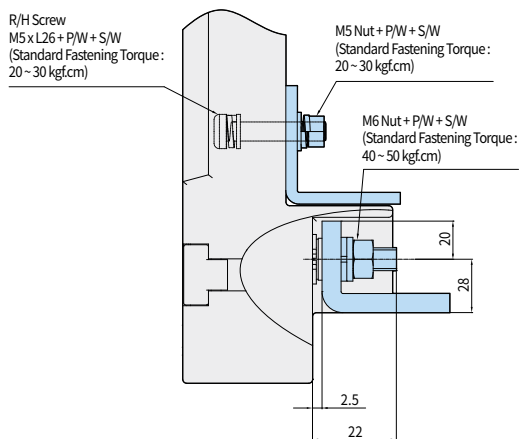

Mounting Drawing

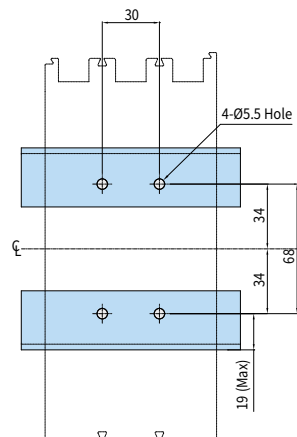

Process Criterion of Connecting Conductor

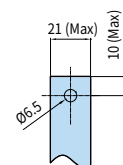

# Dimensions

## Plug-in Type HGM125

• HGM50H/L, 125

### External Dimension (TDA D Type)

Unit : mm

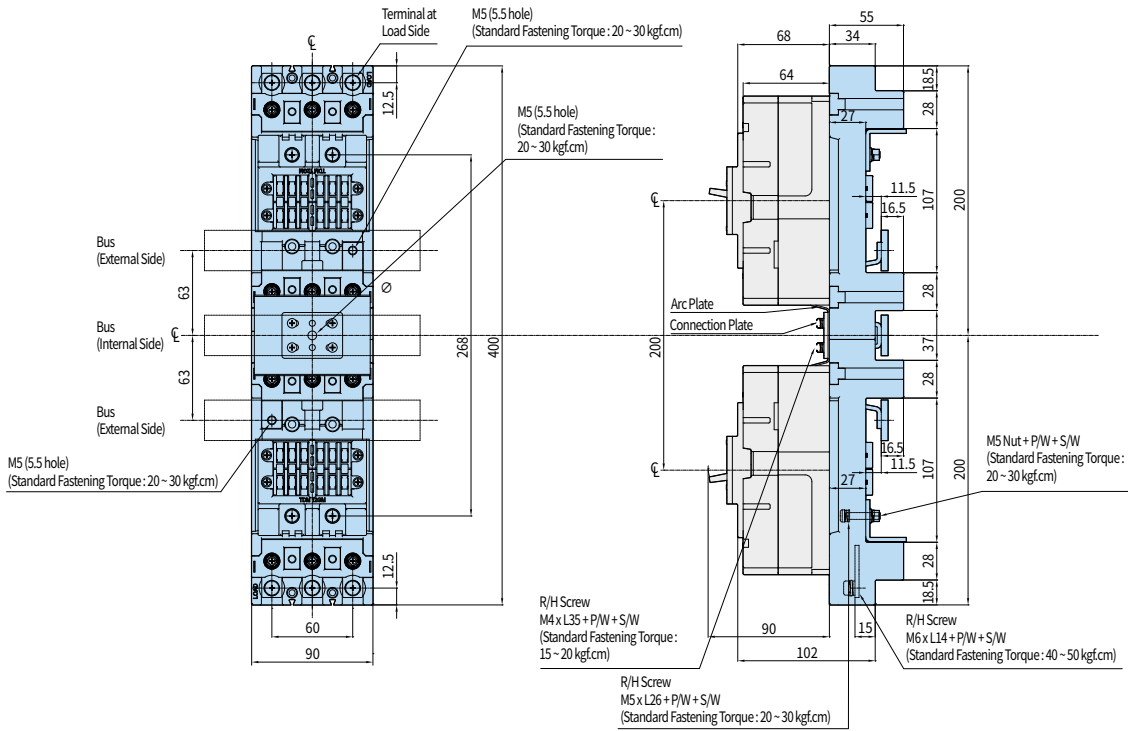

### Panel Installation Dimension and Cover Cutting Dimension

#### Mounting Drawing

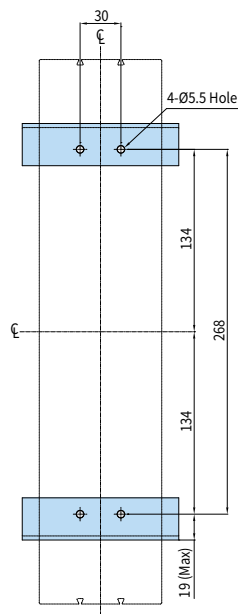

#### Process Criterion of Connecting Conductor

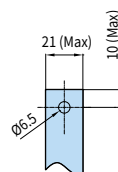

### Plug-in Type HGM125

• HGM50H/L, 125

#### External Dimension (TDA S Type)

Unit: mm

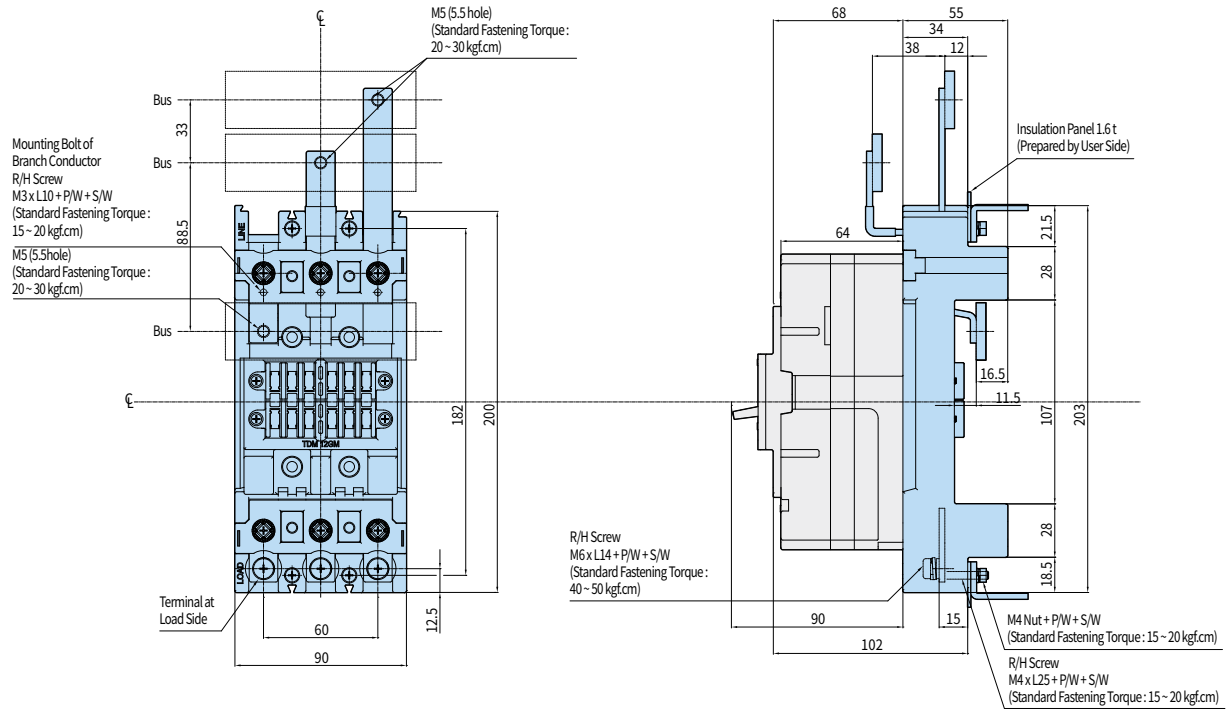

#### Panel Installation Dimension and Cover Cutting Dimension

##### Mounting Drawing

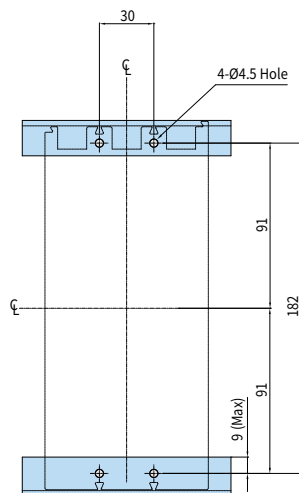

##### Process Criterion of Connecting Conductor

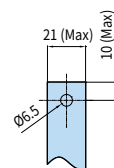

# Dimensions

## Plug-in Type HGM125

• HGM50H/L, 125

External Dimension (TDF Type)

Unit : mm

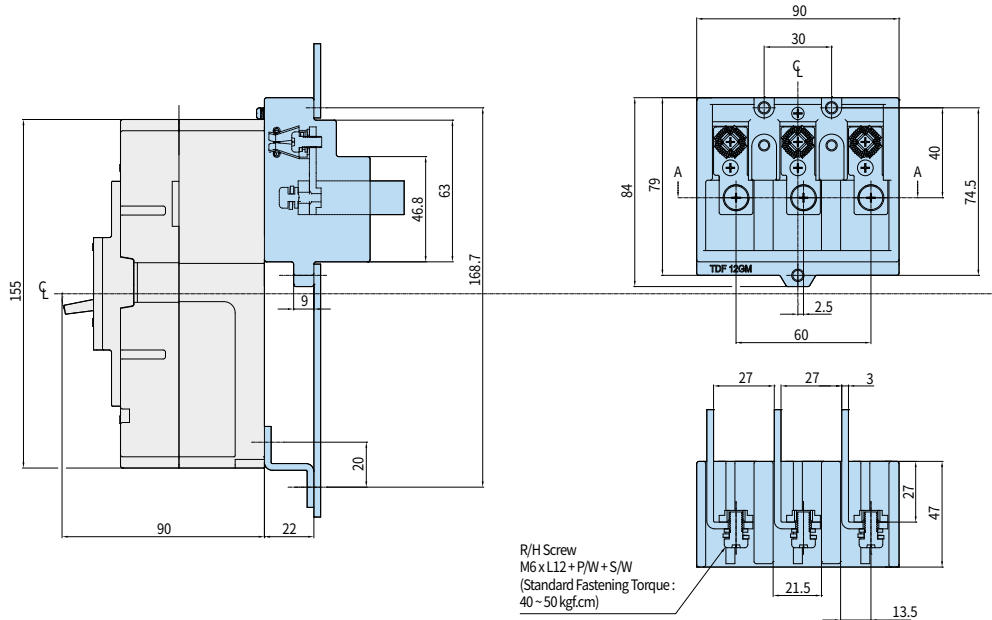

## Panel Installation Dimension and Cover Cutting Dimension

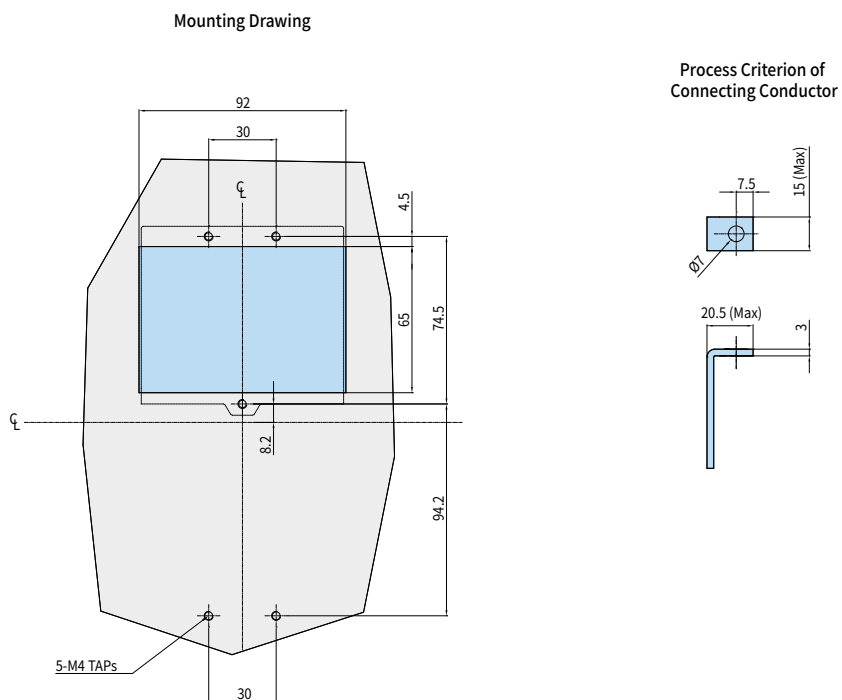



## Plug-in Type HGM250

• HGM160, 250

### External Dimension (TDM Type)

Unit: mm

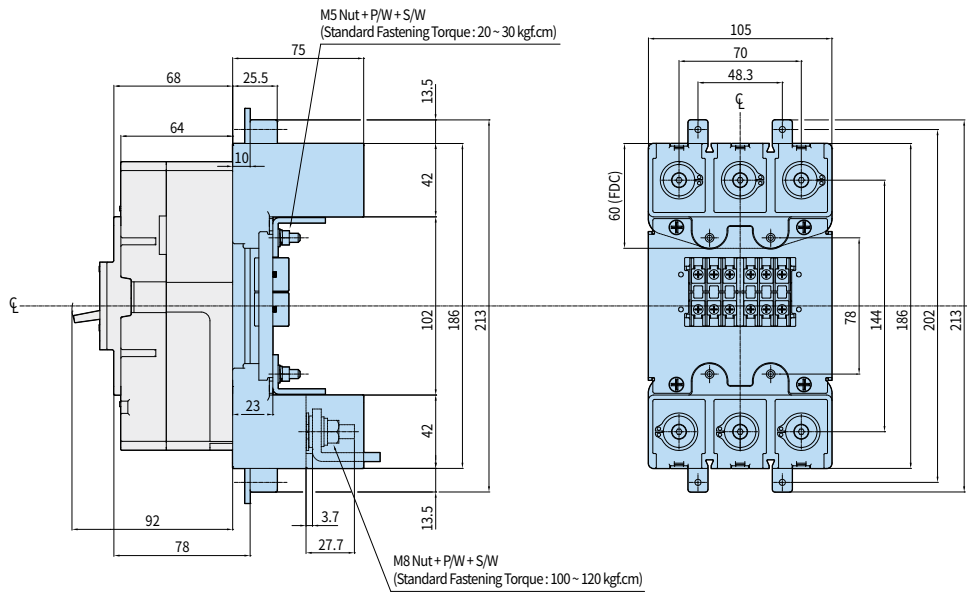

### Panel Installation Dimension and Cover Cutting Dimension

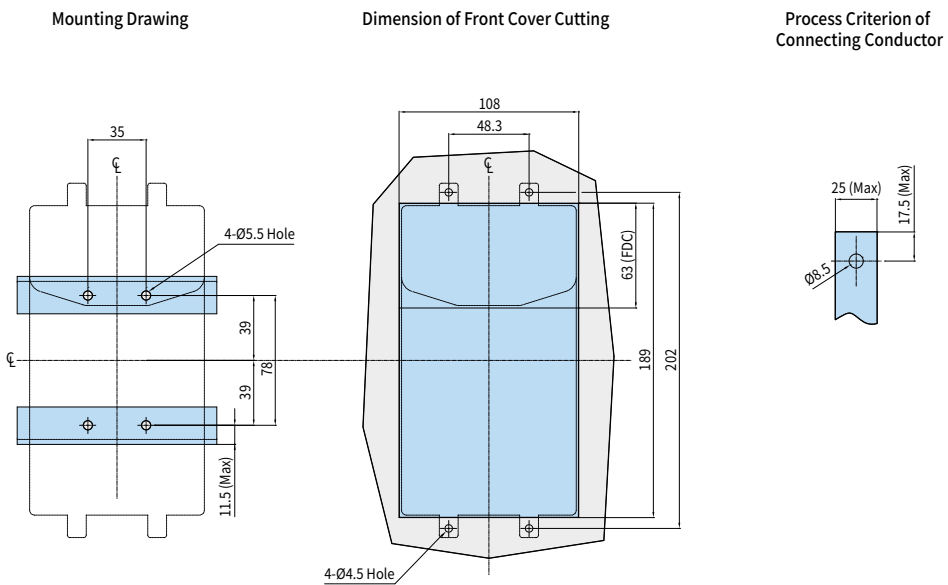

# Dimensions

## Plug-in Type HGM400

• HGM400

External Dimension (TDM Type)

Unit : mm

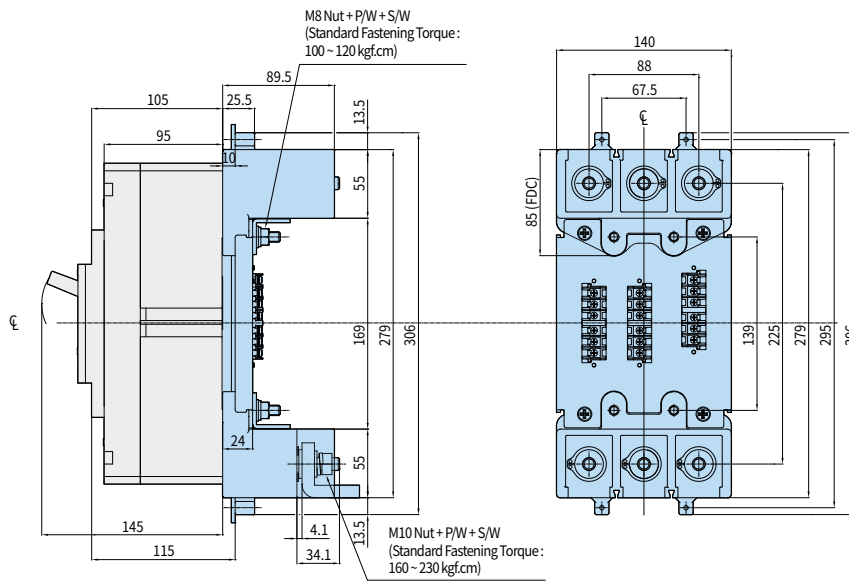

## Panel Installation Dimension and Cover Cutting Dimension

Mounting Drawing

Dimension of Front Cover Cutting

Process Criterion of Connecting Conductor

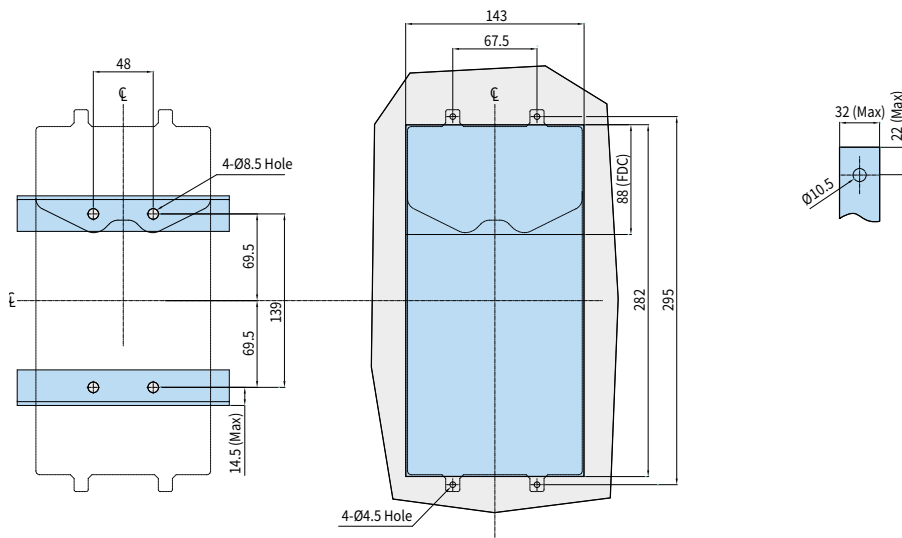

## Plug-in Type HGM800

• HGM630, 800

### External Dimension (TDM Type)

Unit: mm

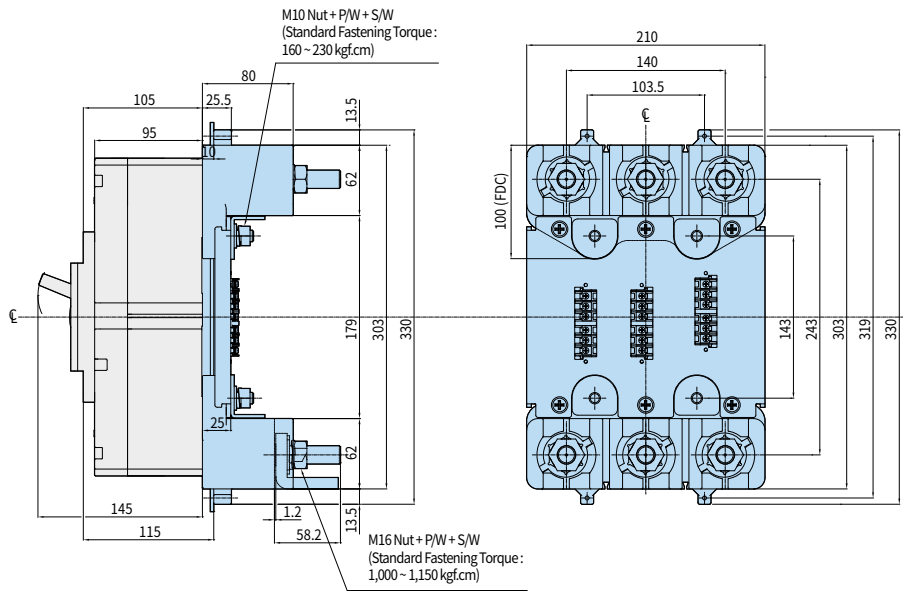

### Panel Installation Dimension and Cover Cutting Dimension

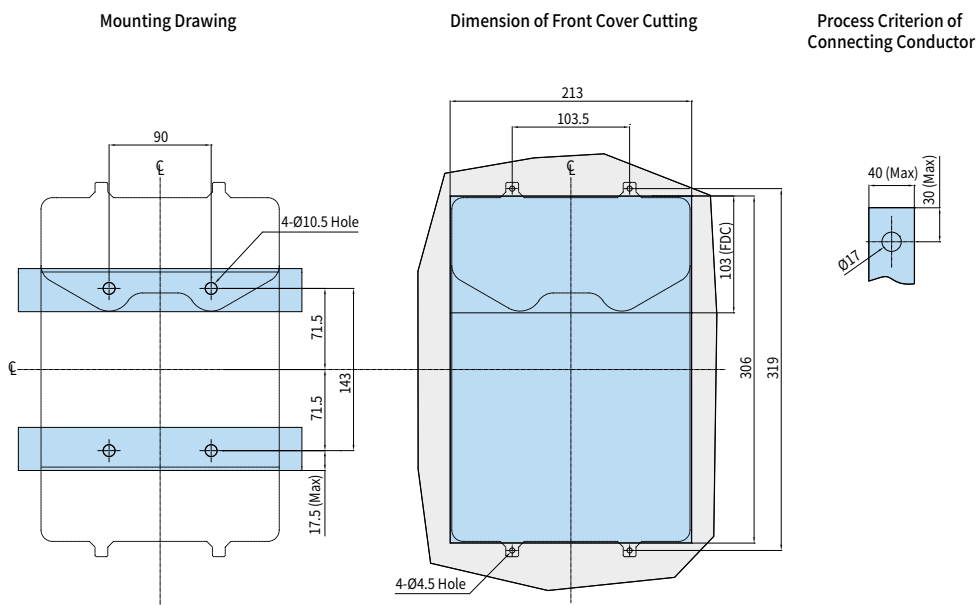

# Dimensions

## Plug-in Type HGP160D

• HGP50D, 125D, 160D

### External Dimension

Unit : mm

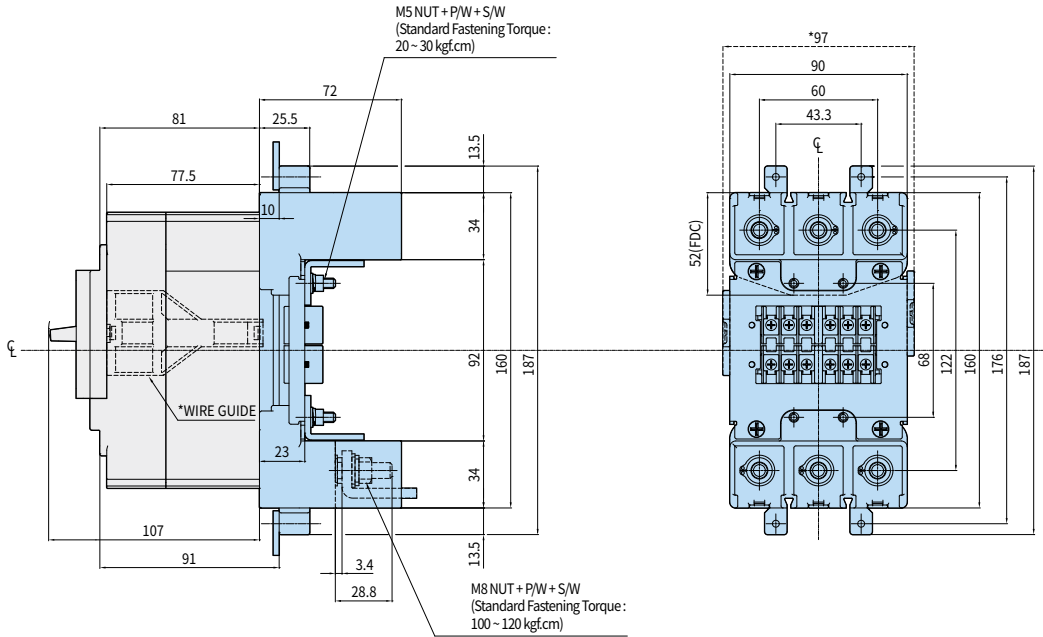

### Panel Installation Dimension and TDM Cover Cutting Dimension

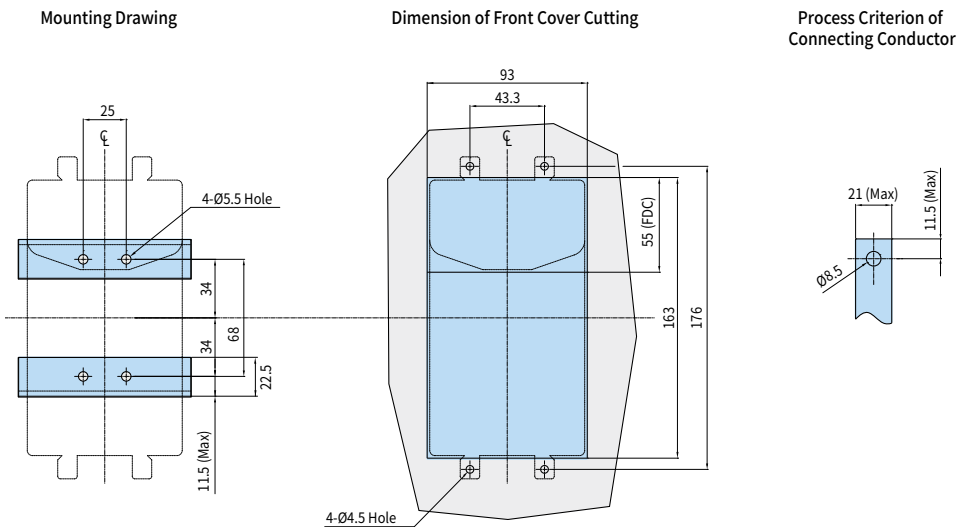

## Plug-in Type HGP250 (HGP100/MCP)

• HGP100, 250

### External Dimension

Unit: mm

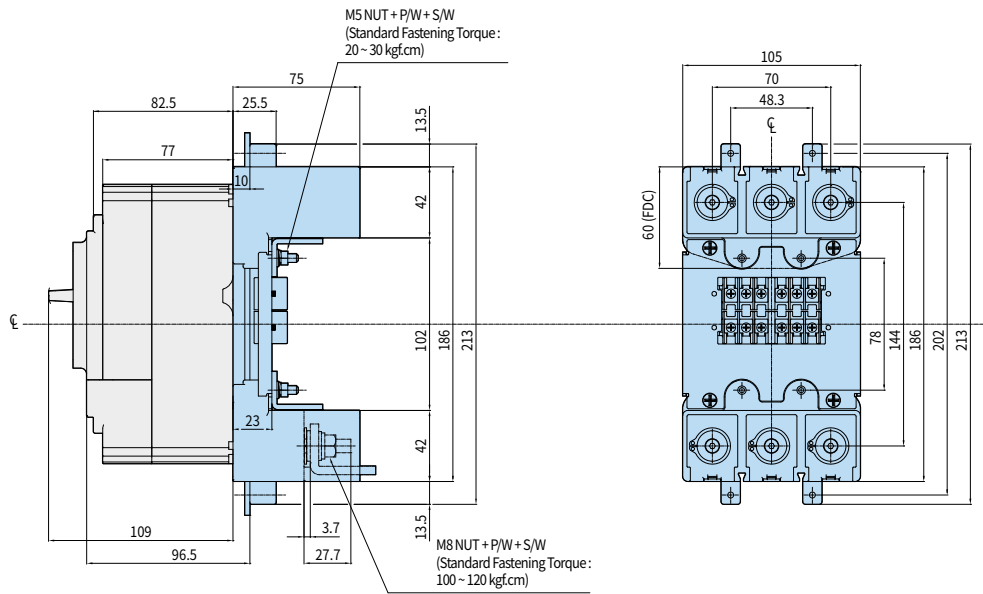

### Panel Installation Dimension and TDM Cover Cutting Dimension

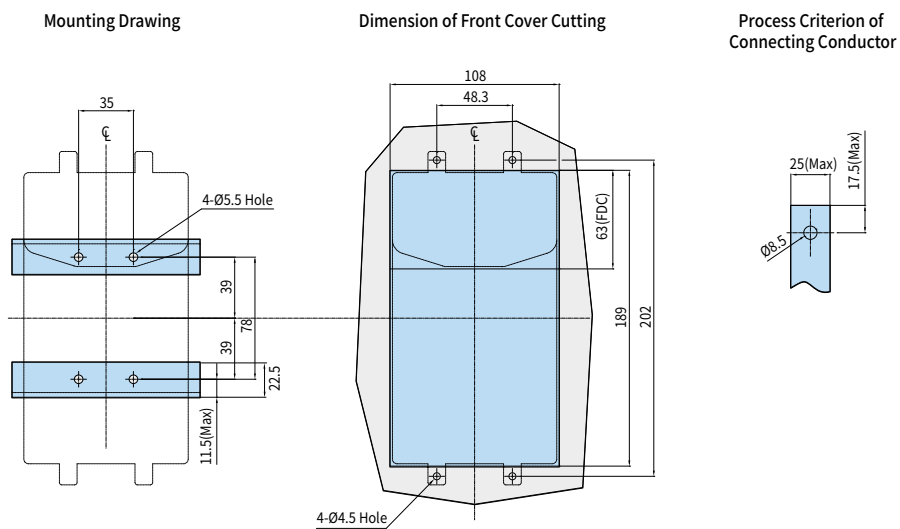

# Dimensions

## Plug-in Type HGP630

• HGP400, 630

### External Dimension

Unit: mm

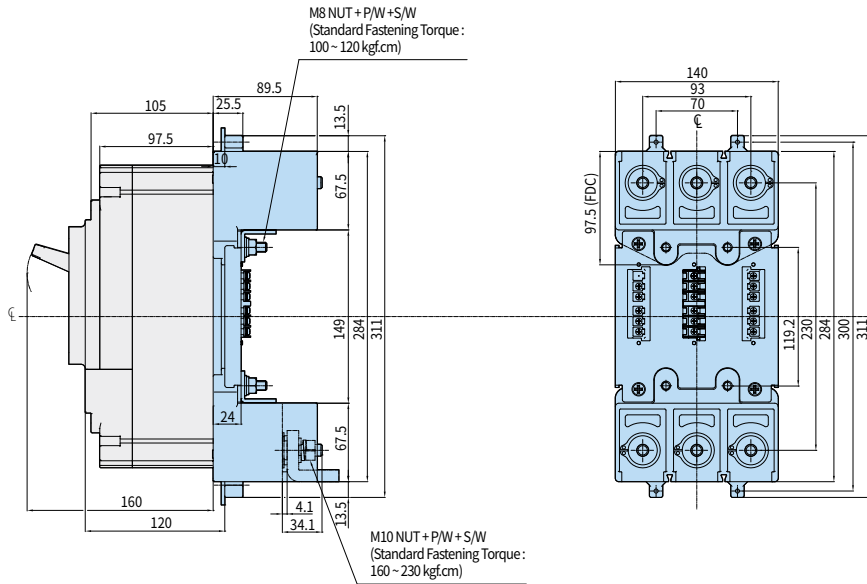

### Panel Installation Dimension and TDM Cover Cutting Dimension

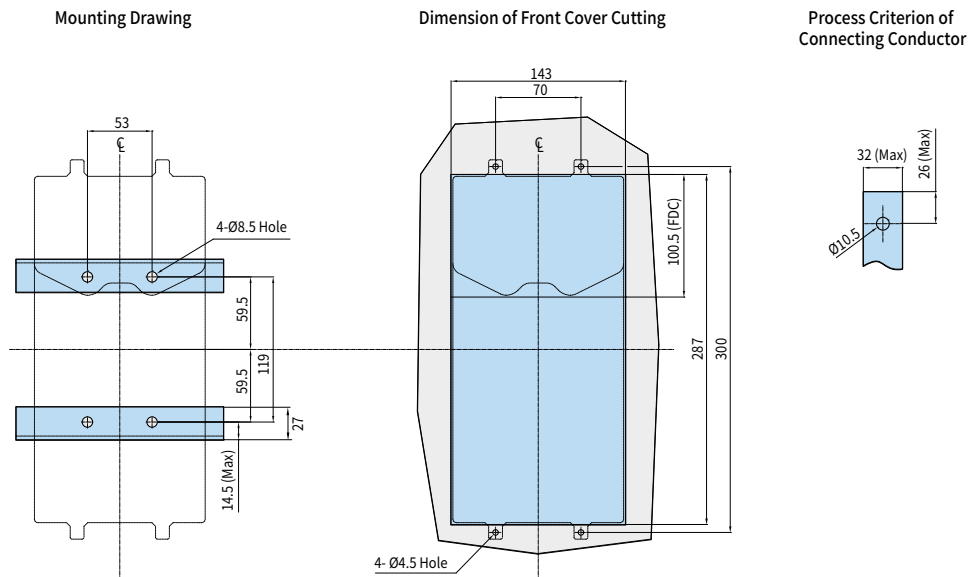

## Plug-in Type HGP800

• HGP800

### External Dimension

Unit: mm

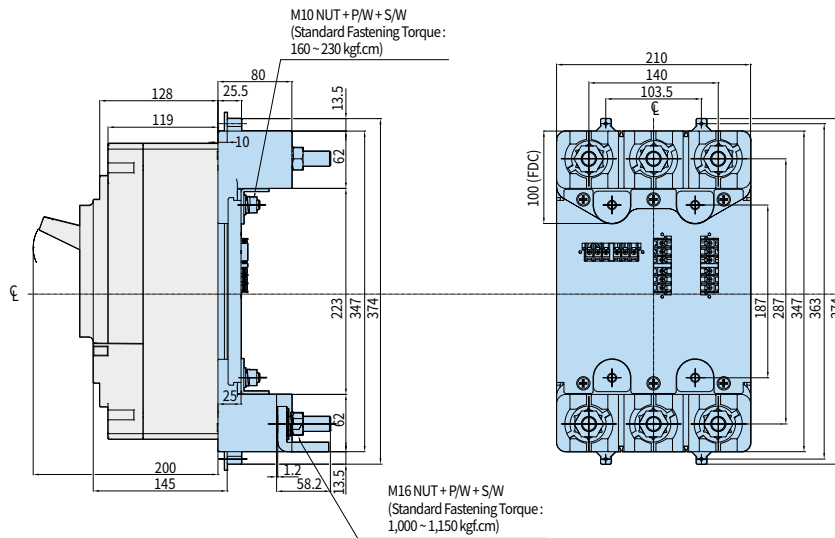

### Panel Installation Dimension and TDM Cover Cutting Dimension

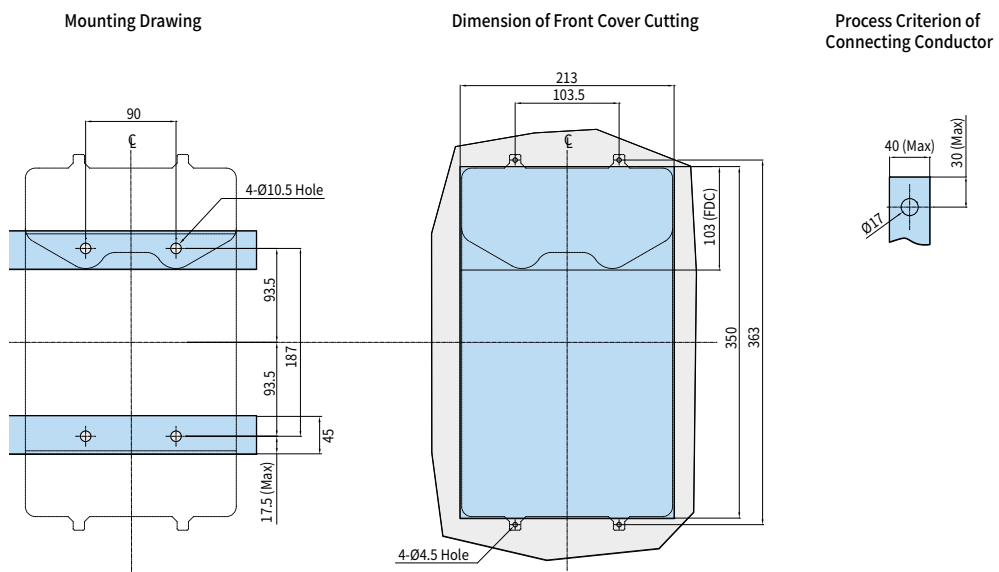

## Dimensions

### External Rotary Handle HGM100

• HGM30, 50E/S, 60, 100

#### External Dimension - Front Contact Type

Unit : mm

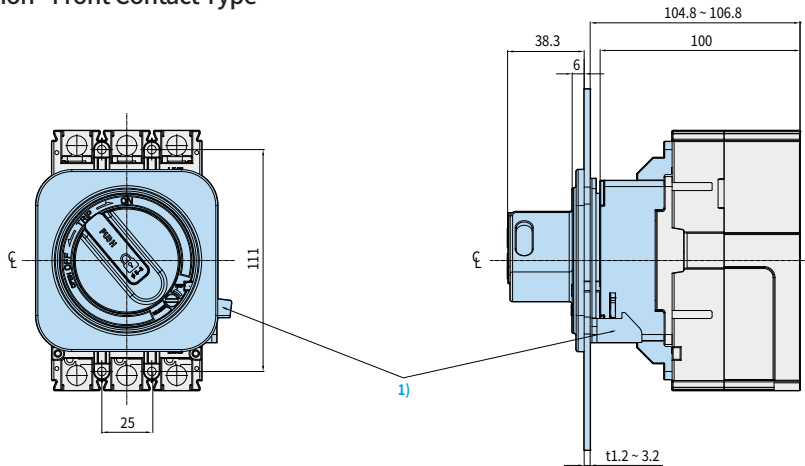

※ 1) Note that the LOCK PLATE may need to be positioned for combined operation with the handle.

#### External Dimension - Extended Type

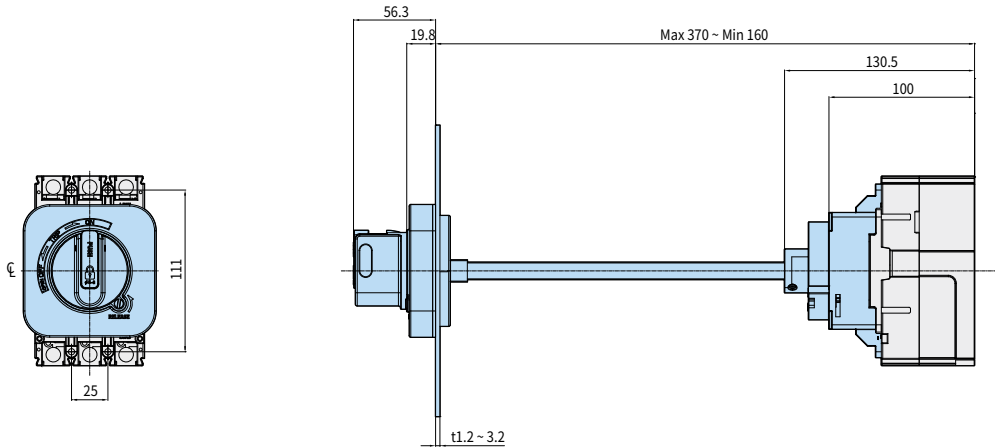

#### Panel Installation Dimension

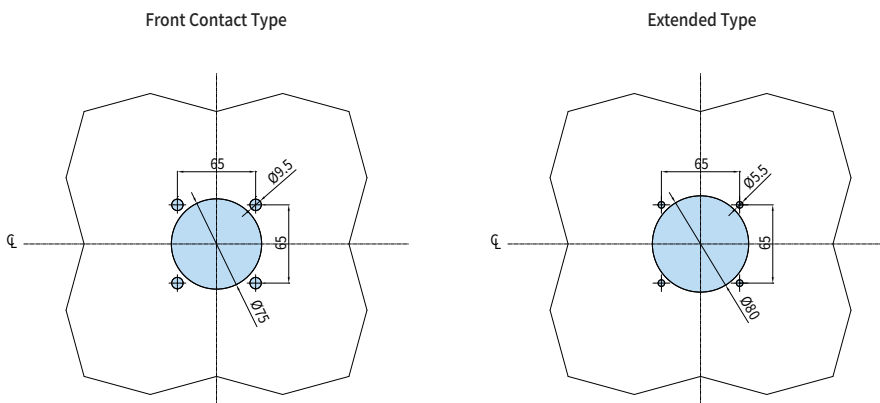



## External Rotary Handle HGM125

• HGM50H/L, 125

### External Dimension - Front Contact Type

Unit: mm

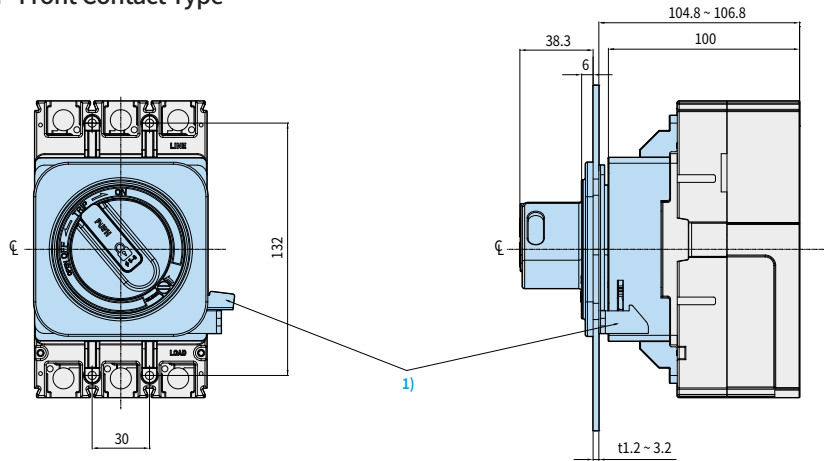

※ 1) Note that the LOCK PLATE may need to be positioned for combined operation with the handle.

### External Dimension - Extended Type

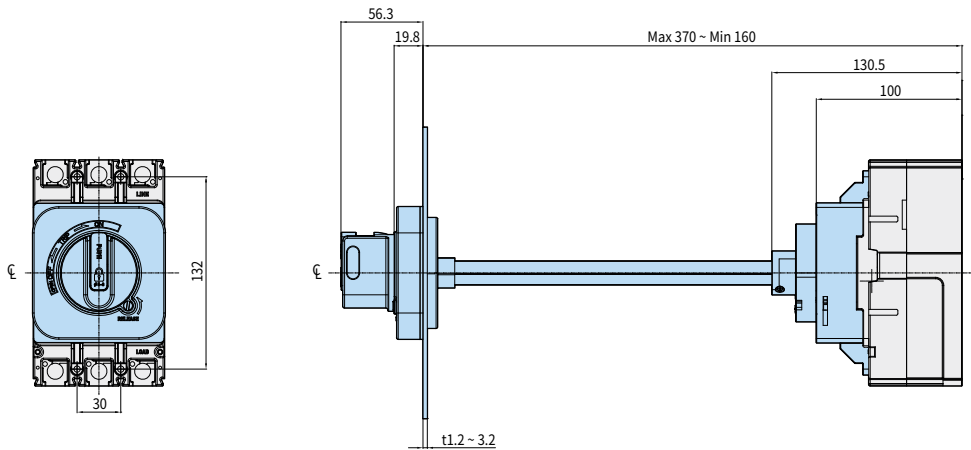

### Panel Installation Dimension

Front Contact Type

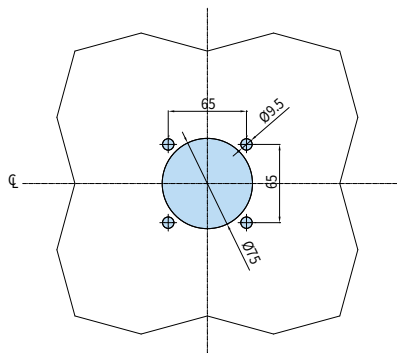

Extended Type

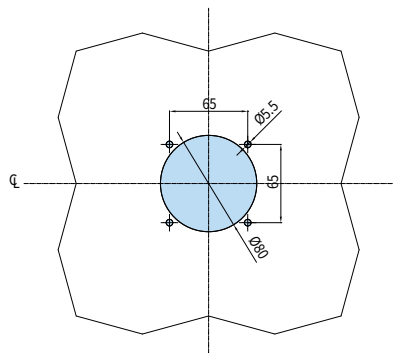

# Dimensions

## External Rotary Handle HGM250

• HGM160, 250

### External Dimension - Front Contact Type

Unit : mm

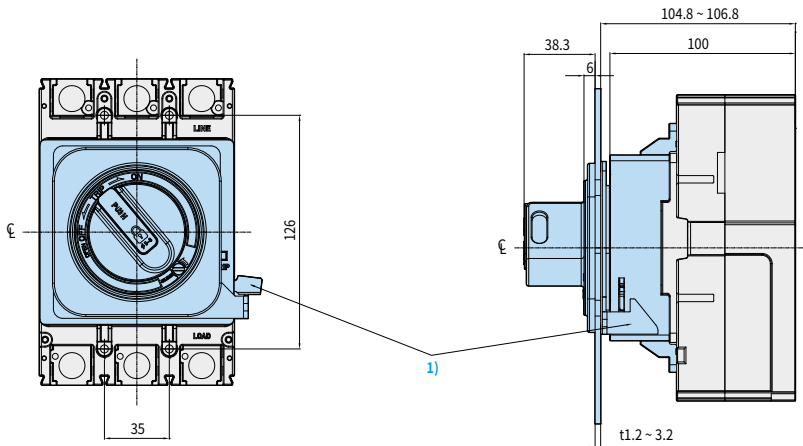

※ 1) Note that the LOCK PLATE may need to be positioned for combined operation with the handle.

### External Dimension - Extended Type

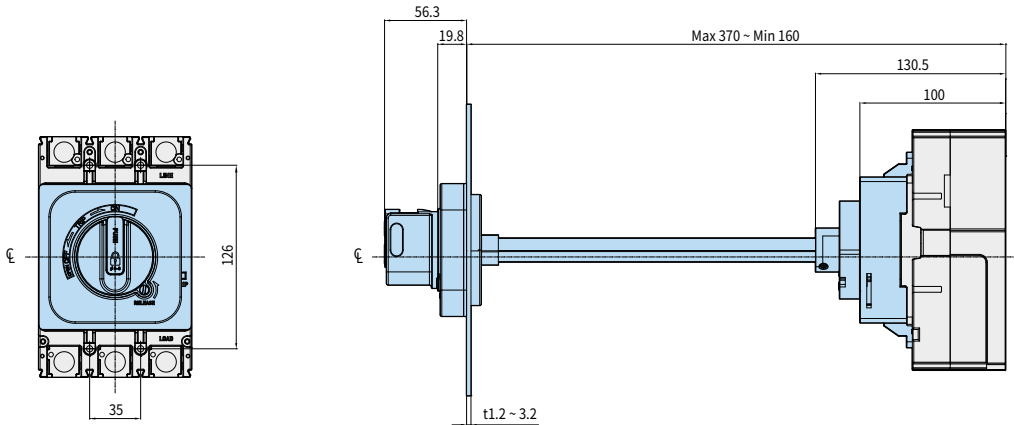

### Panel Installation Dimension

Front Contact Type

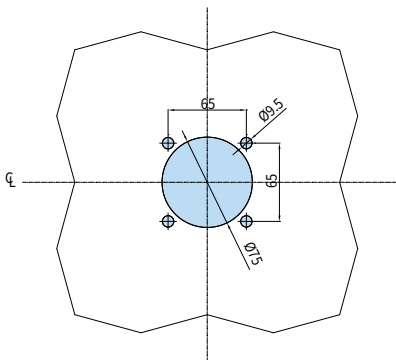

Extended Type

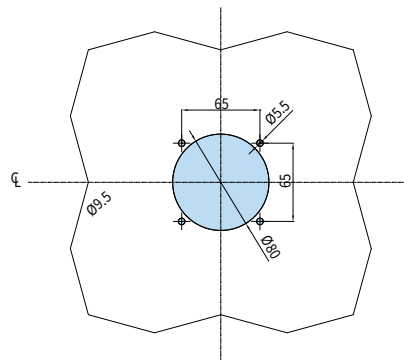

## External Rotary Handle HGM400

• HGM400

### External Dimension - Front Contact Type

Unit: mm

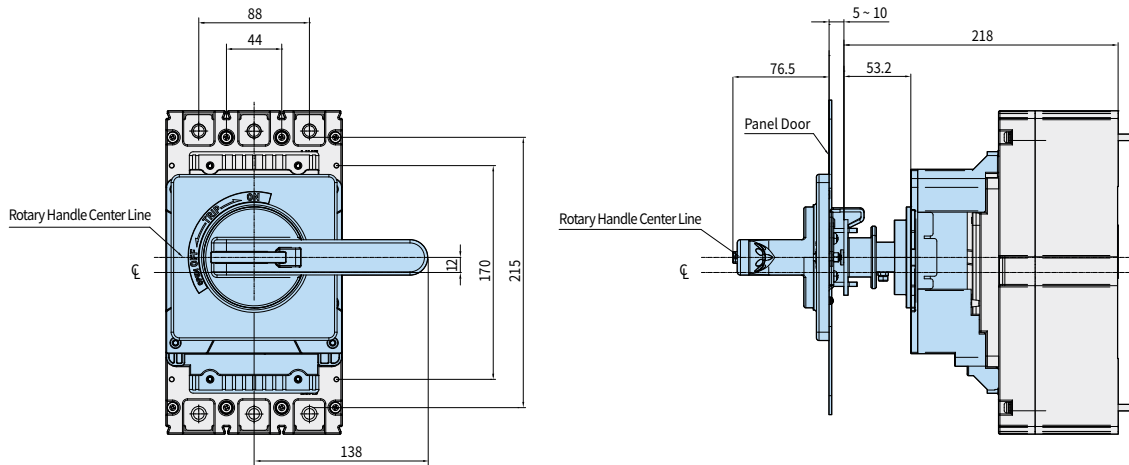

### External Dimension - Extended Type

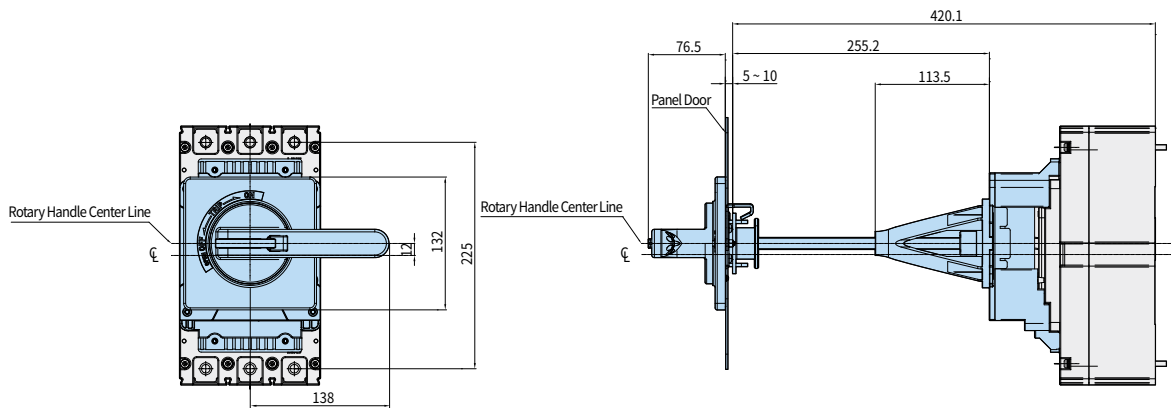

### Panel Installation Dimension

Front Contact Type

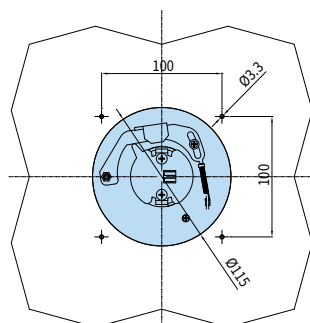

Extended Type

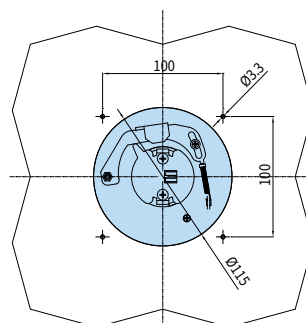

## Dimensions

### External Rotary Handle HGM800

• HGM630, 800

#### External Dimension - Front Contact Type

Unit : mm

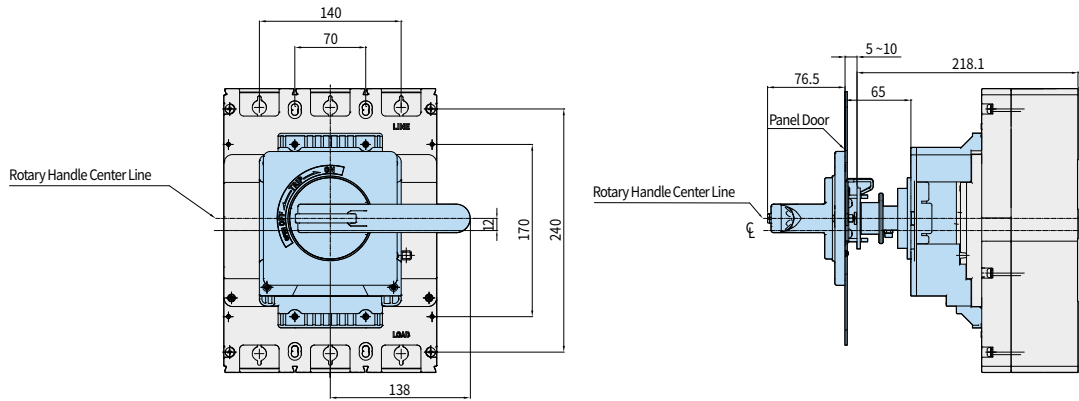

#### External Dimension - Extended Type

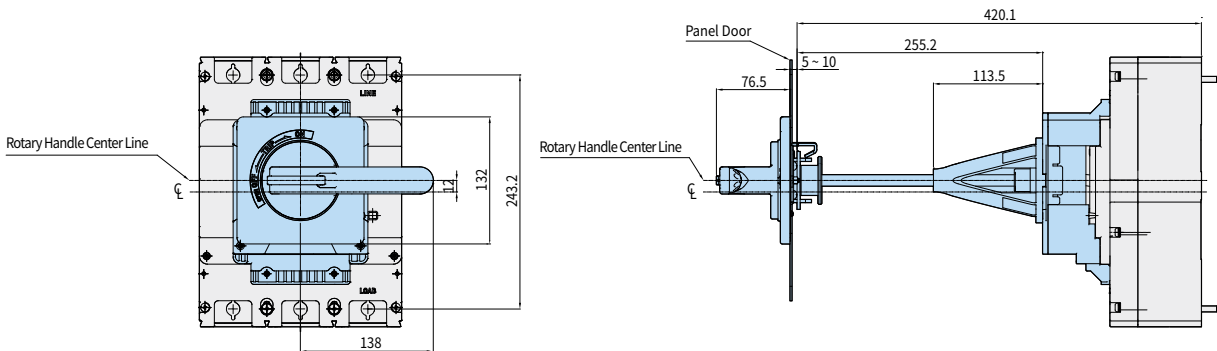

#### Panel Installation Dimension

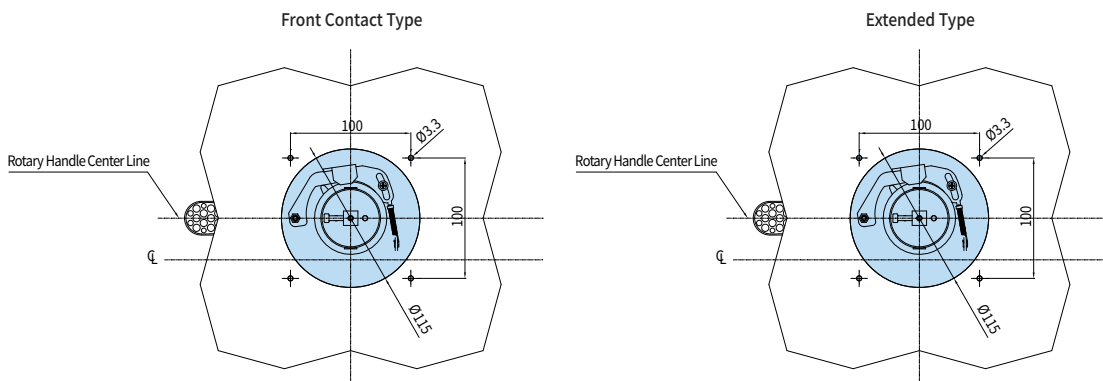

## External Rotary Handle HGP160D

• HGP50D, 125D, 160D

### External Dimension - Front Contact Type

Unit: mm

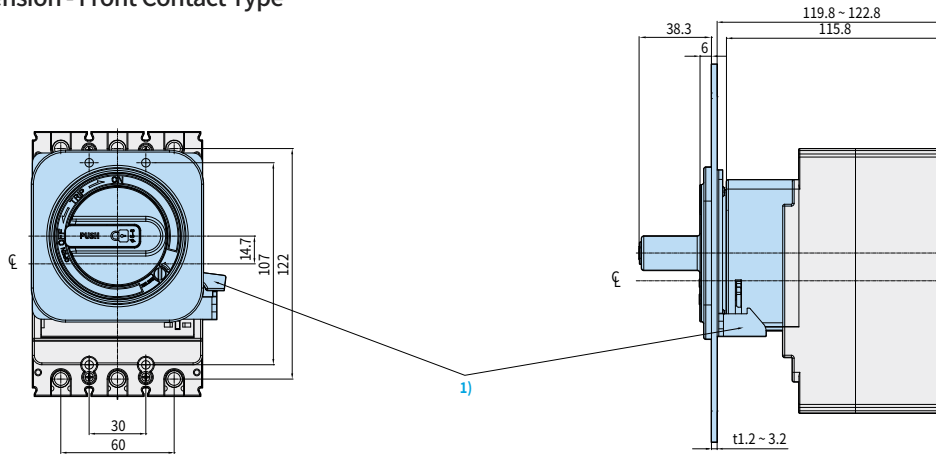

※ 1) Note that the LOCK PLATE may need to be positioned for combined operation with the handle.

### External Dimension - Extended Type

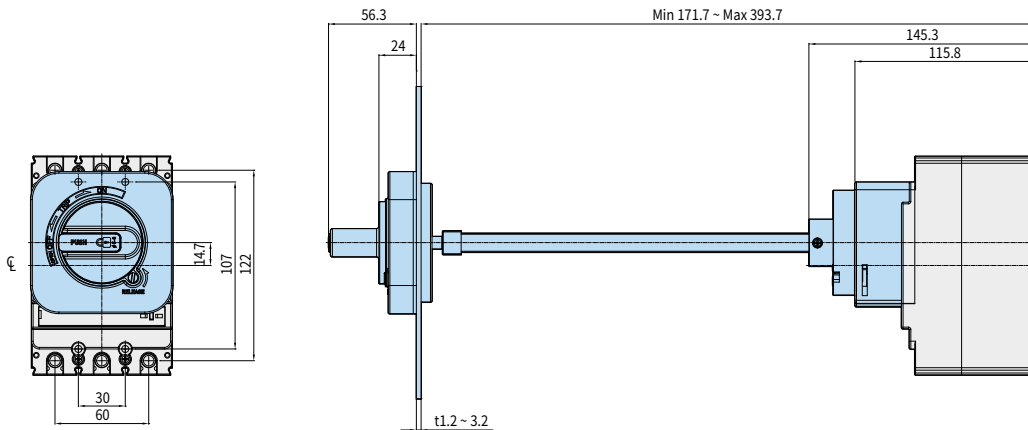

### Panel Installation Dimension

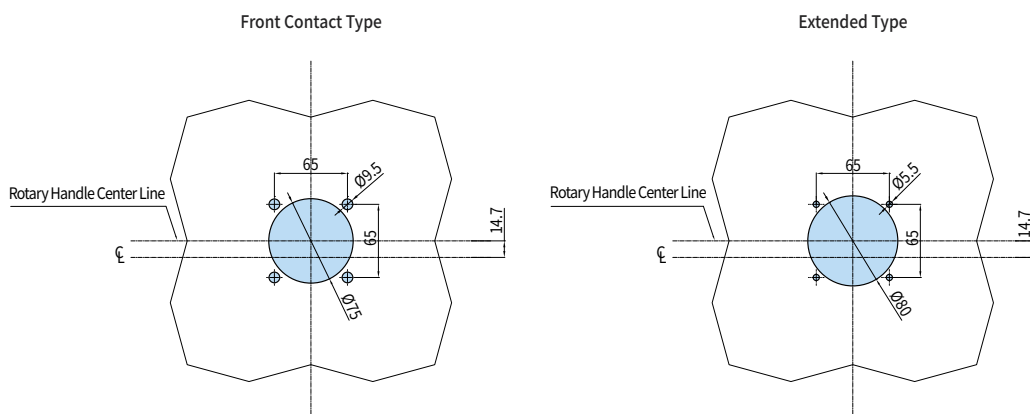

## Dimensions

### External Rotary Handle HGP250 (HGP100/MCP)

• HGP100, 250

#### External Dimension - Front Contact Type

Unit : mm

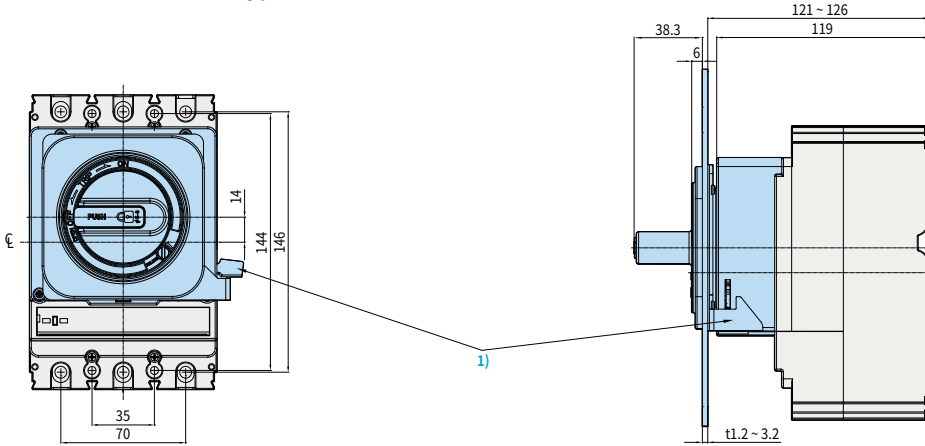

※ 1) Note that the LOCK PLATE may need to be positioned for combined operation with the handle.

#### External Dimension - Extended Type

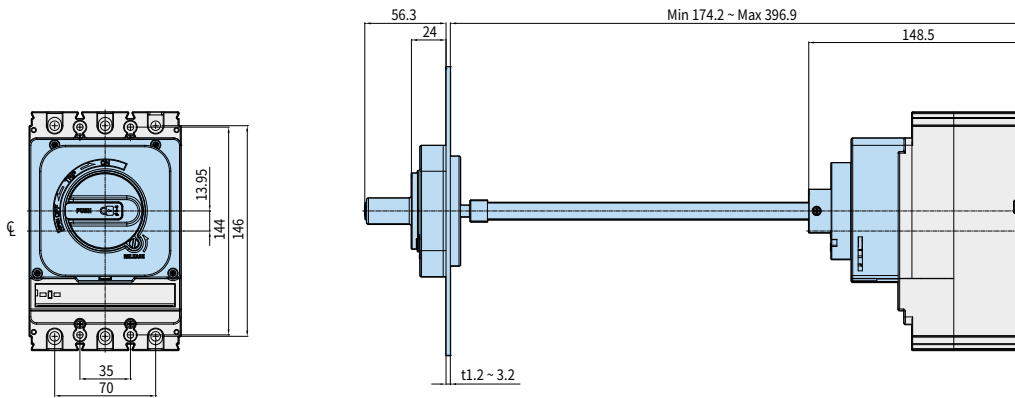

#### Panel Installation Dimension

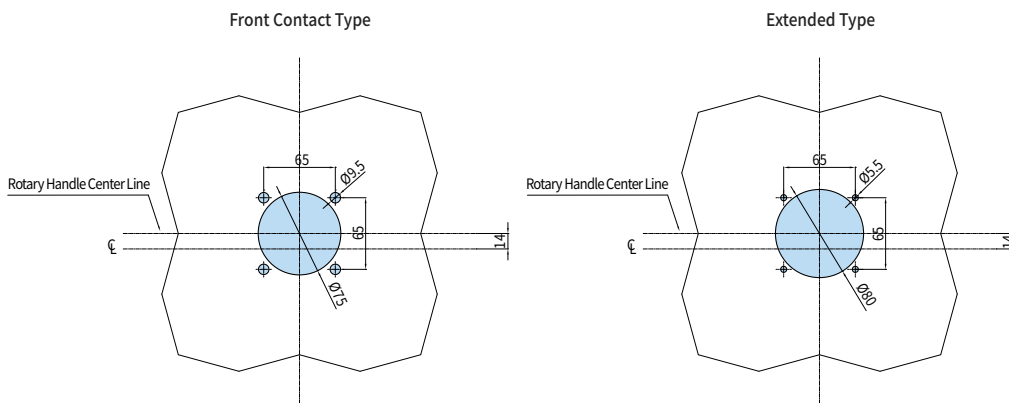

## External Rotary Handle HGP630

• HGP400, 630

### External Dimension - Front Contact Type

Unit: mm

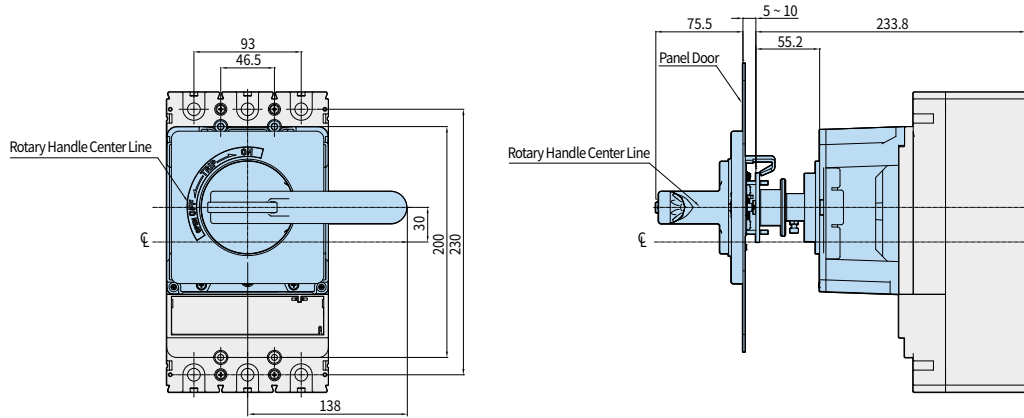

### External Dimension - Extended Type

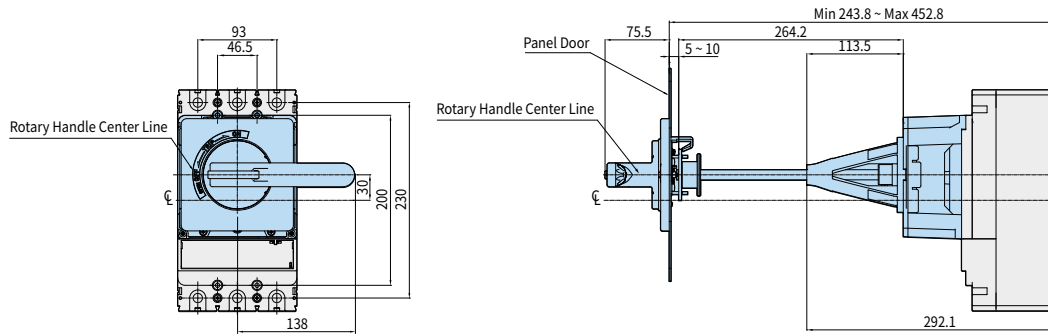

### Panel Installation Dimension

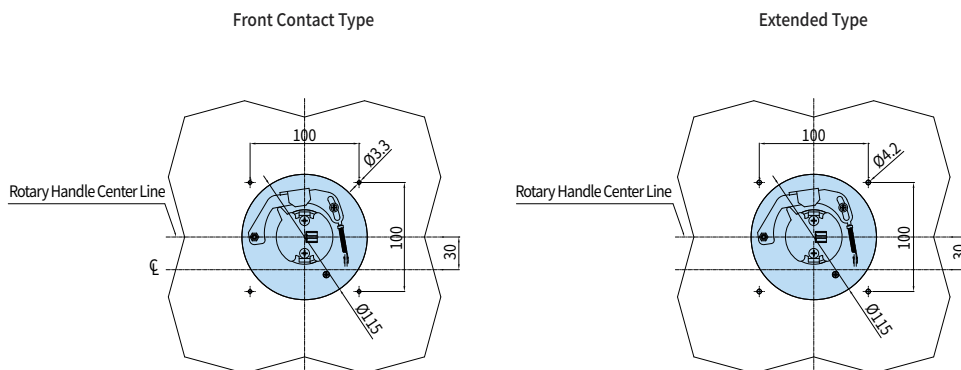

# Dimensions

## External Rotary Handle HGP800

• HGP800

### External Dimension - Front Contact Type

Unit : mm

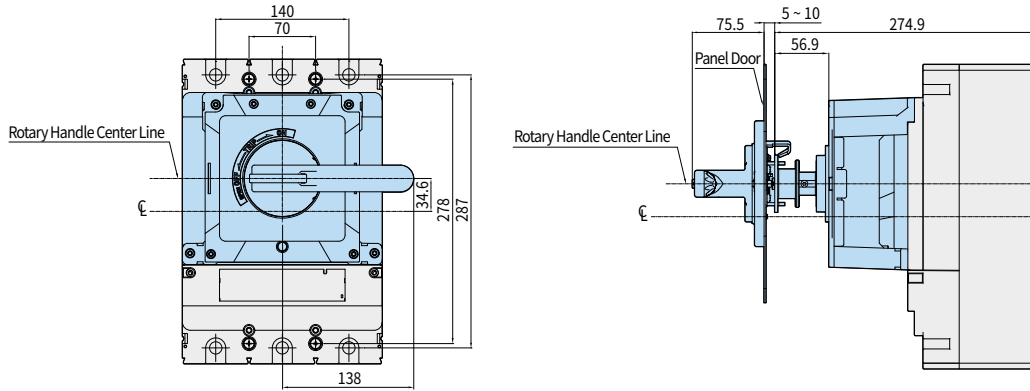

### External Dimension - Extended Type

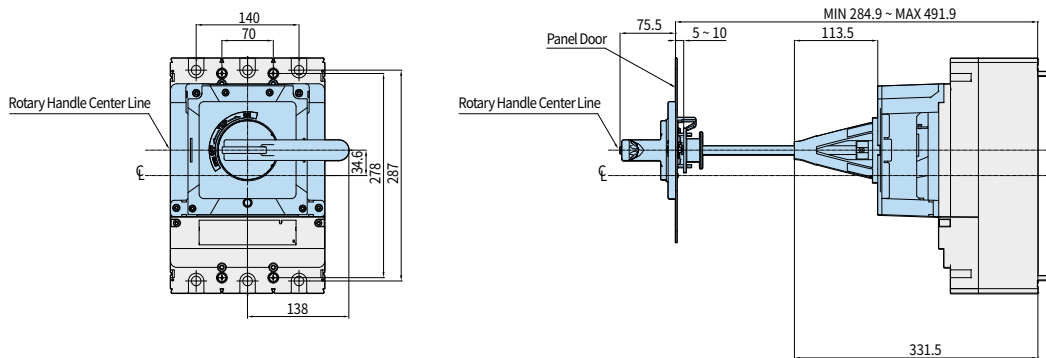

### Panel Installation Dimension

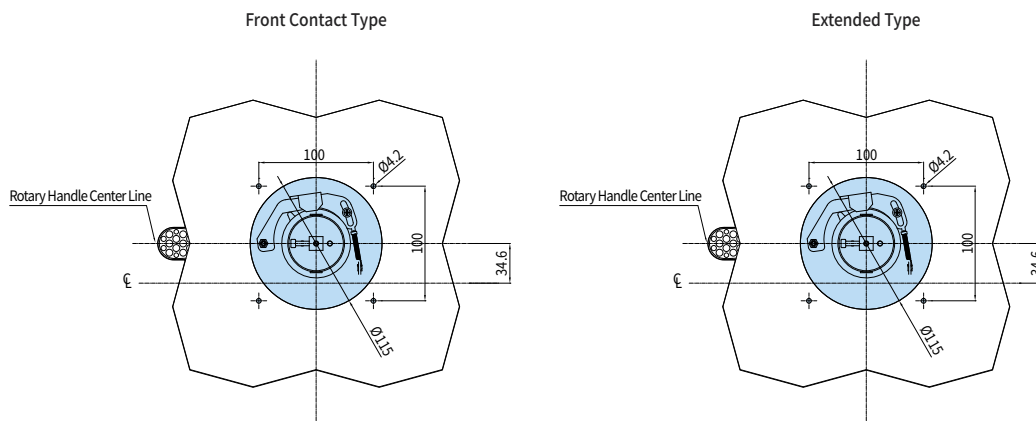



## Mechanical Interlock HGM100

• HGM30, 50E/S, 60, 100

### External Dimension

Unit: mm

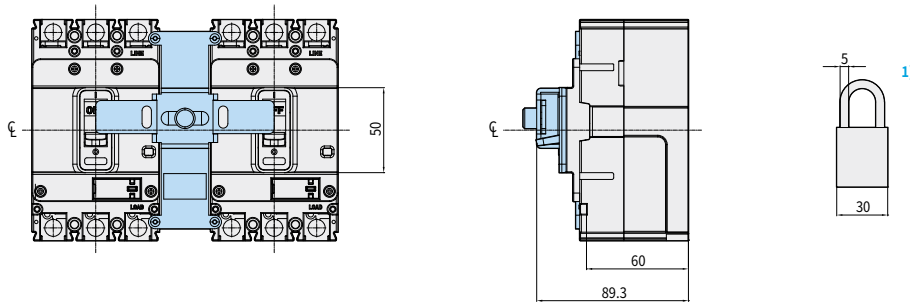

### Panel Installation Dimension

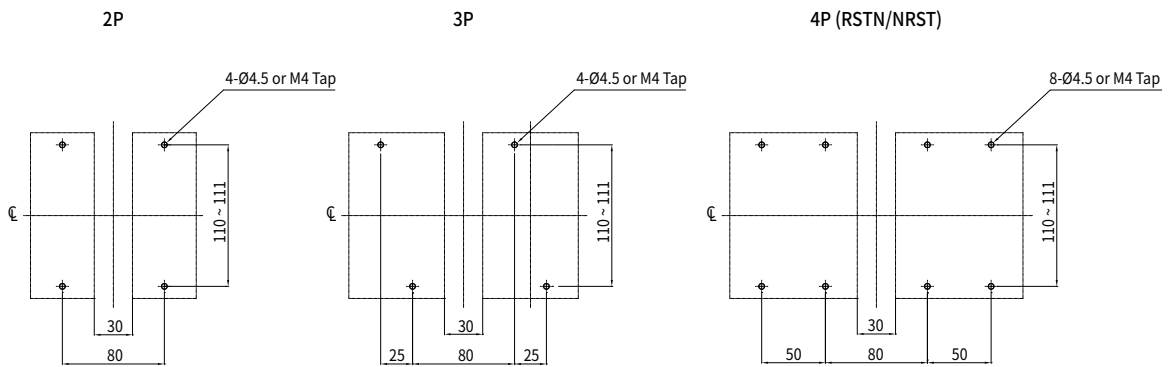

### Dimension of Panel Cover Cutting

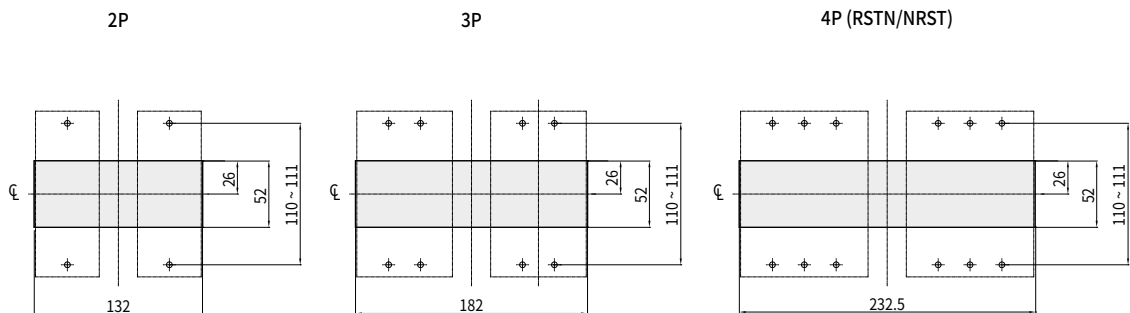

※ 1) Padlock not included.

# Dimensions

## Mechanical Interlock HGM125

• HGM50H/L, 125

### External Dimension

Unit: mm

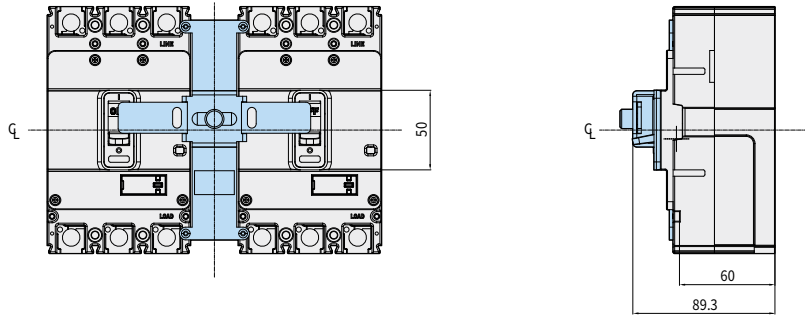

### Panel Installation Dimension

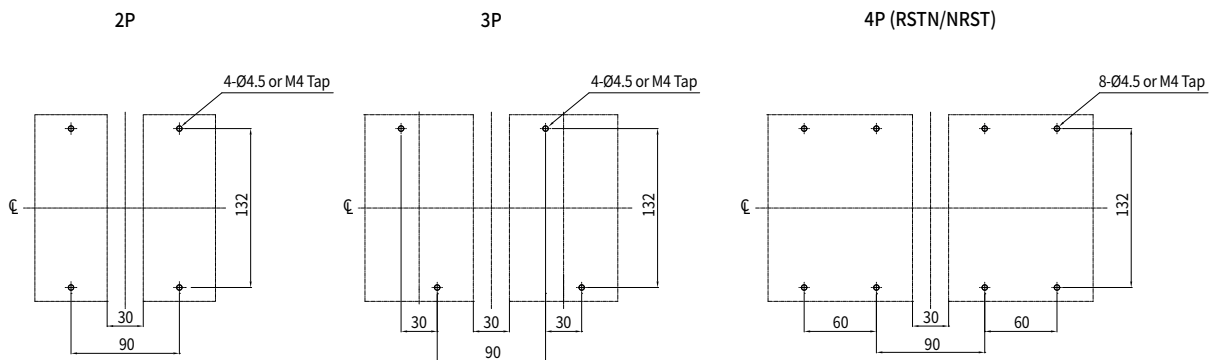

### Dimension of Panel Cover Cutting

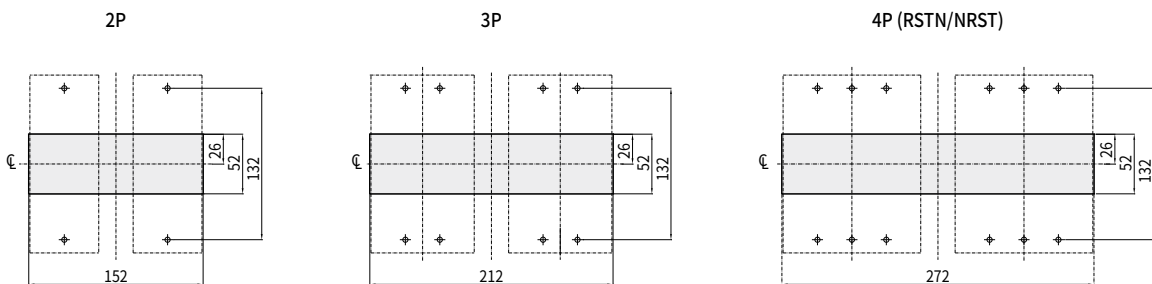

## Mechanical Interlock HGM250

• HGM160, 250

### External Dimension

Unit: mm

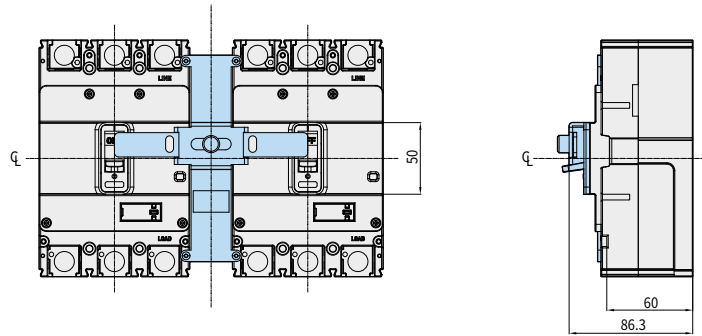

### Panel Installation Dimension

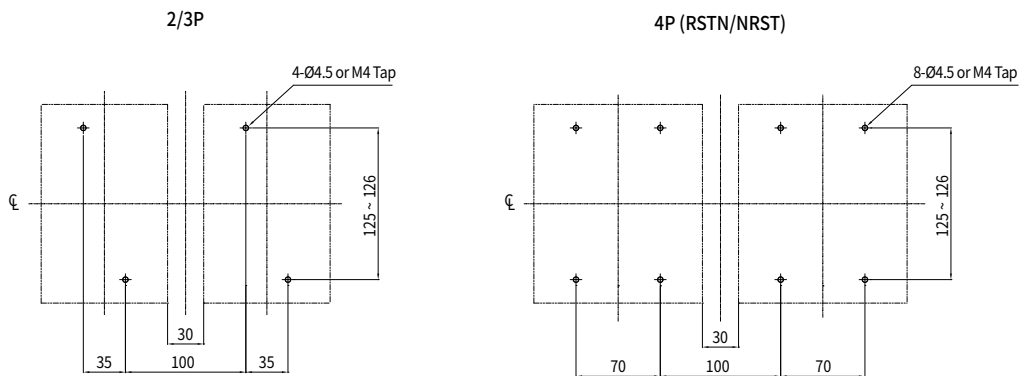

### Dimension of Panel Cover Cutting

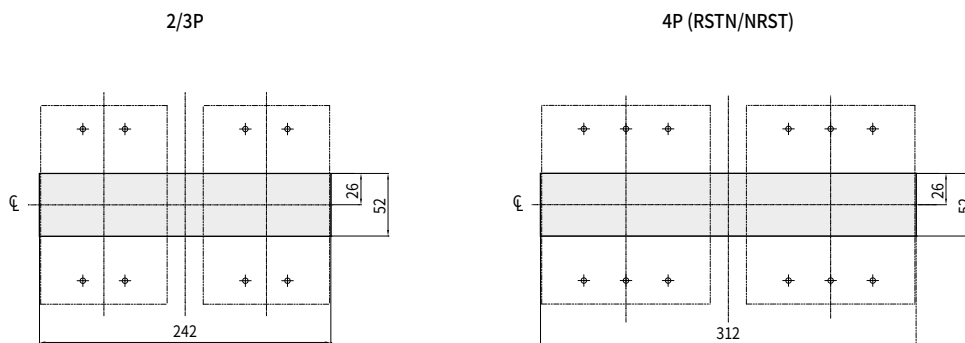

# Dimensions

## Mechanical Interlock HGM400

• HGM400

### External Dimension

Unit : mm

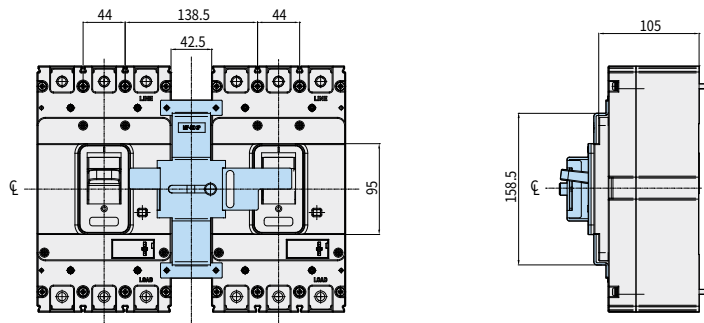

### Panel Installation Dimension

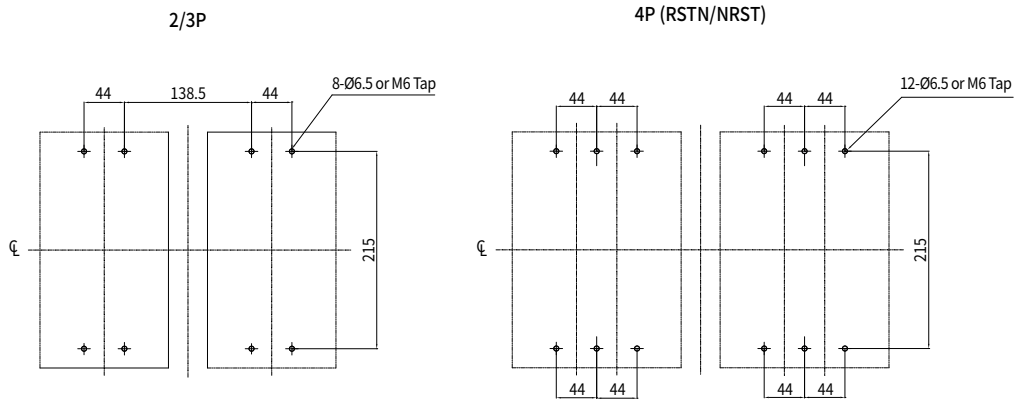

### Dimension of Panel Cover Cutting

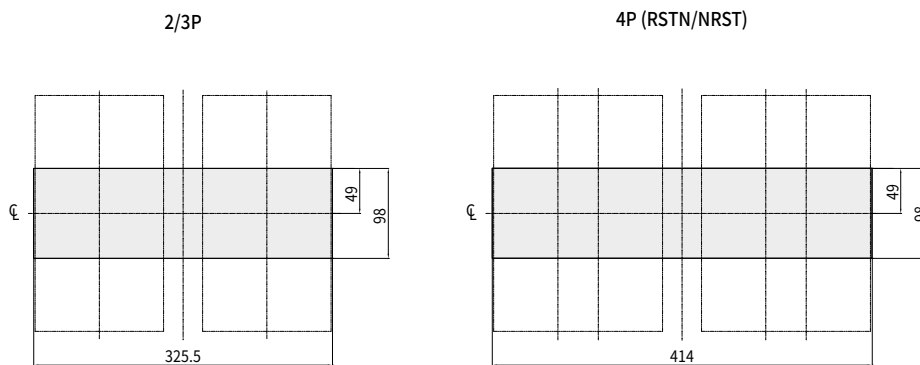

## Mechanical Interlock HGM800

• HGM630, 800

### External Dimension

Unit: mm

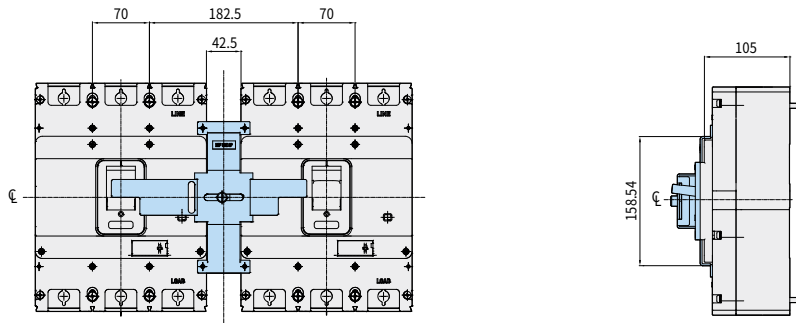

### Panel Installation Dimension

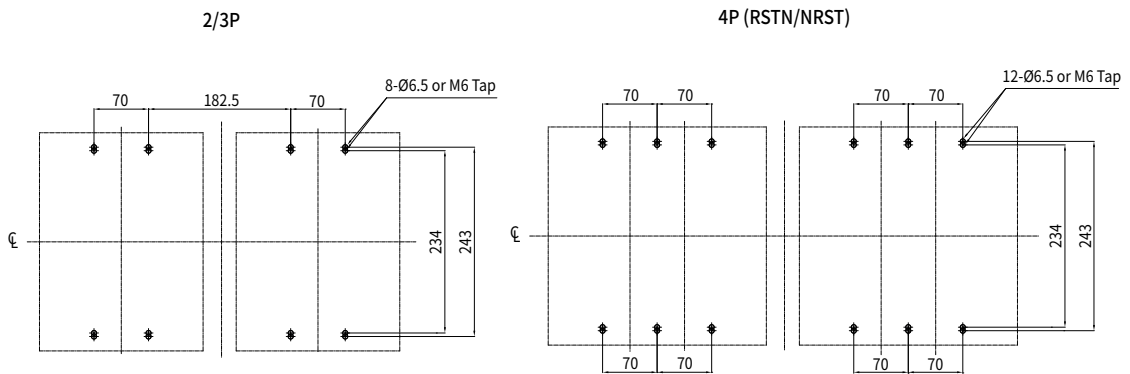

### Dimension of Panel Cover Cutting

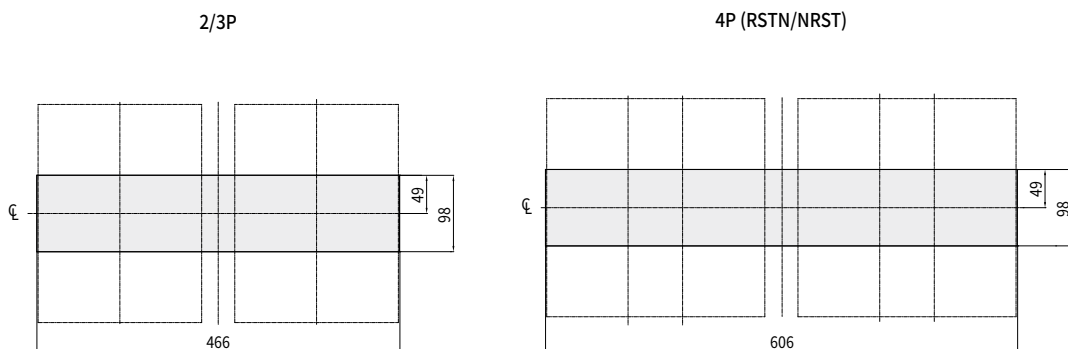

# Dimensions

## Mechanical Interlock HGP160D

• HGP50D, 125D, 160D

### External Dimension

Unit: mm

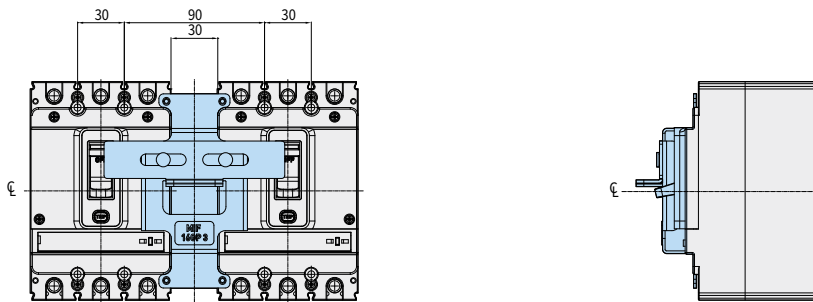

### Panel Installation Dimension

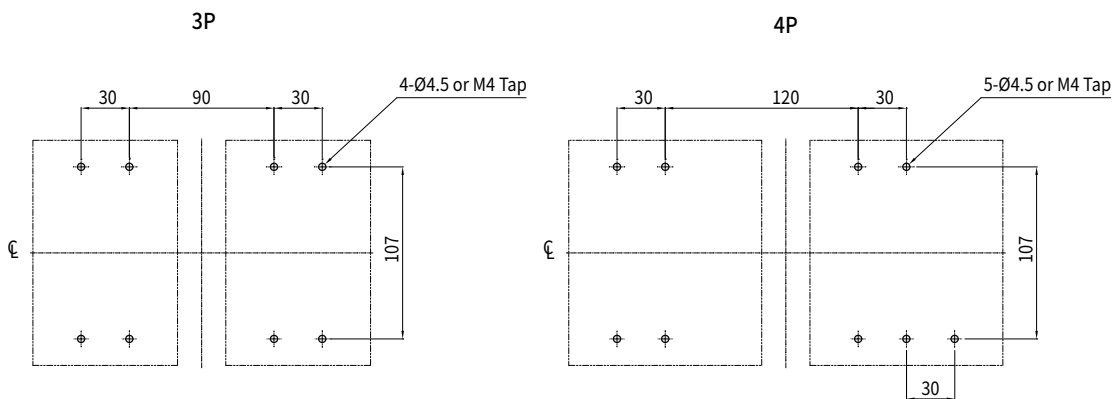

### Dimension of Panel Cover Cutting

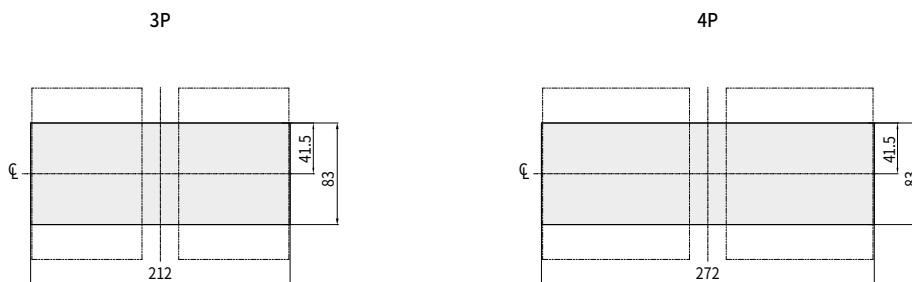

## Mechanical Interlock HGP250 (HGP100/MCP)

• HGP100, 250

### External Dimension

Unit: mm

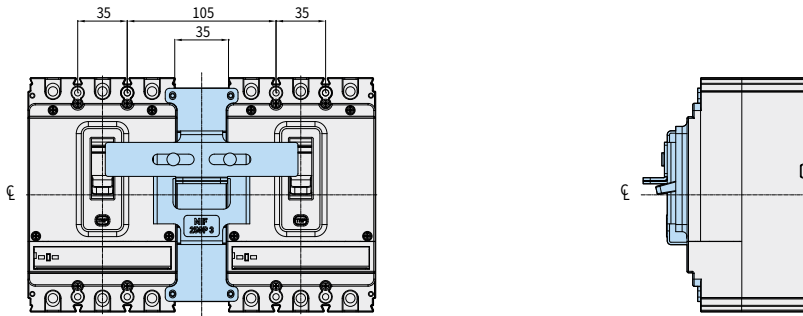

### Panel Installation Dimension

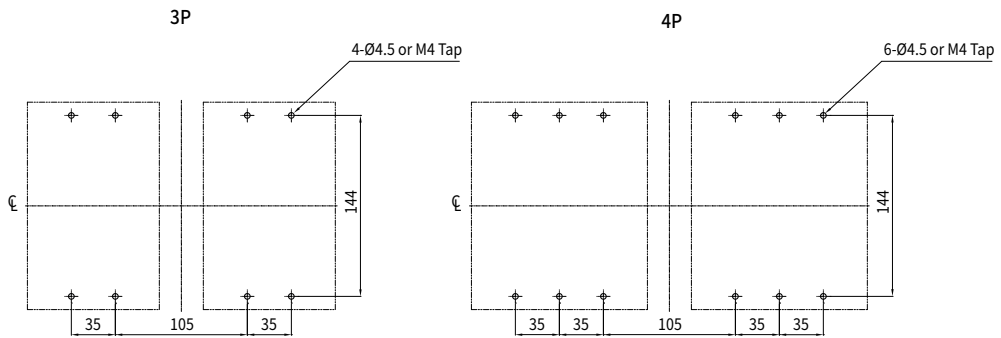

### Dimension of Panel Cover Cutting

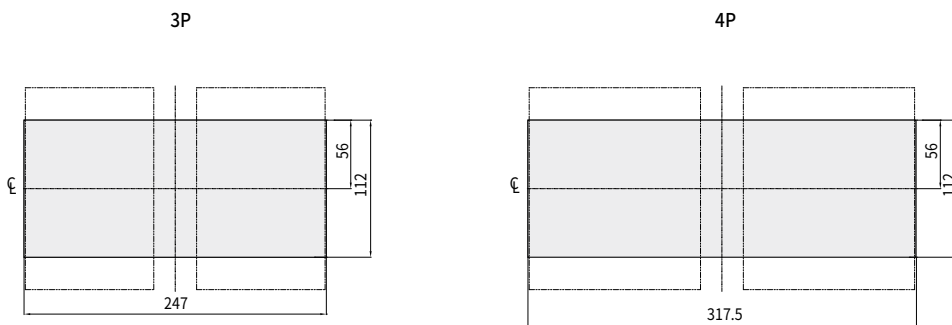

## Dimensions

### Mechanical Interlock HGP630

• HGP400, 630

#### External Dimension

Unit : mm

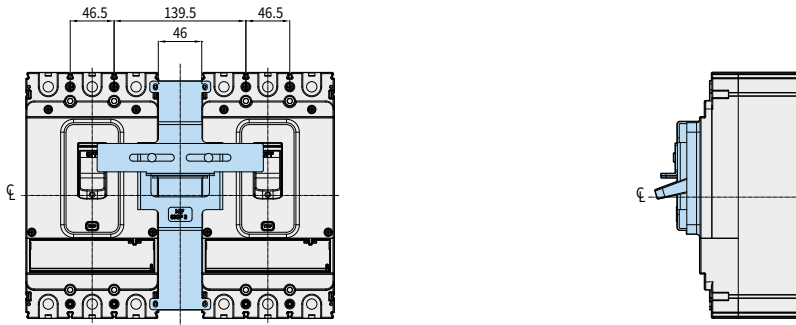

#### Panel Installation Dimension

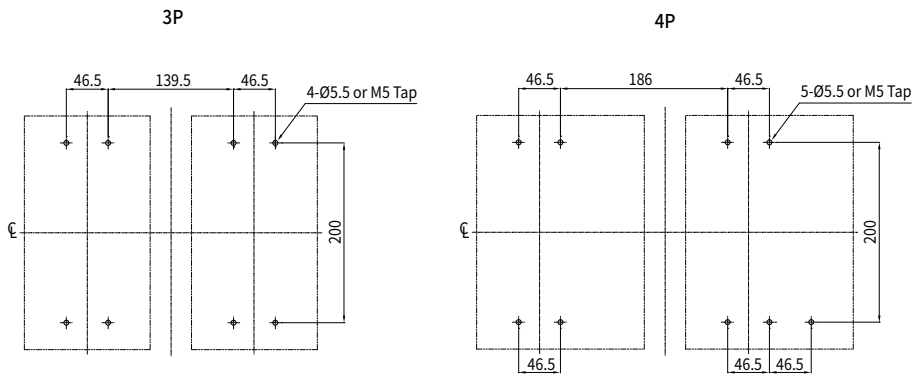

#### Dimension of Panel Cover Cutting

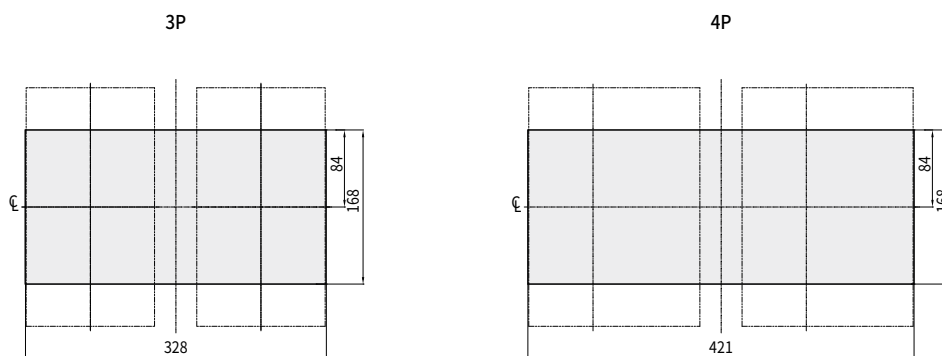



## Mechanical Interlock HGP800

• HGP800

### External Dimension

Unit: mm

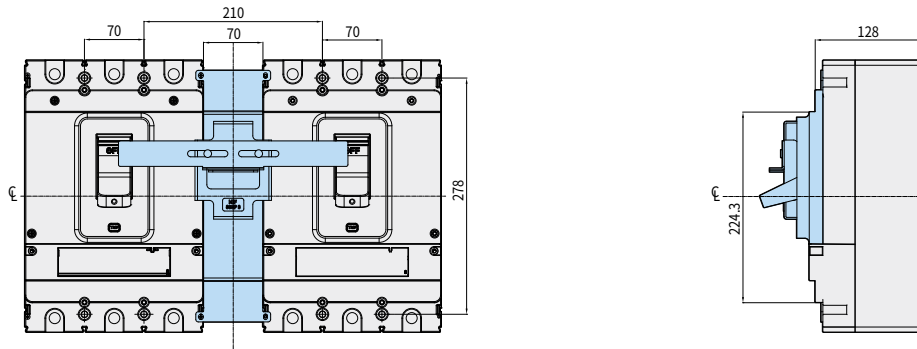

### Panel Installation Dimension

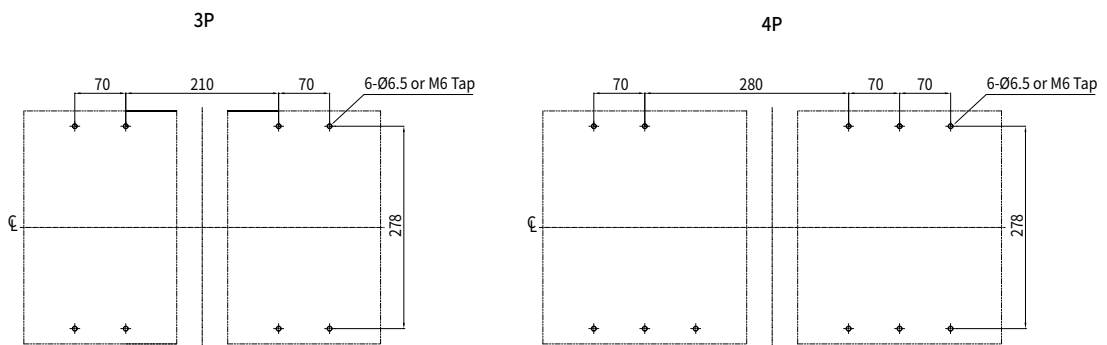

### Dimension of Panel Cover Cutting

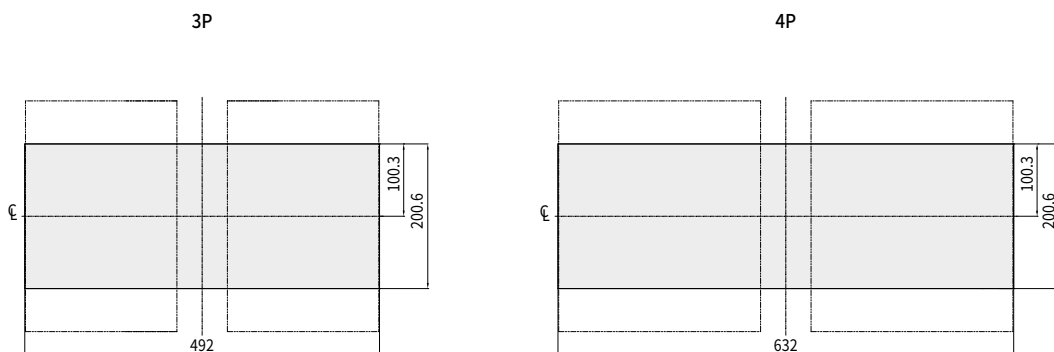

## Dimensions

### Terminal Cover HGM100

• HGM30, 50E/S, 60, 100

Long Type

Short Type

Unit : mm

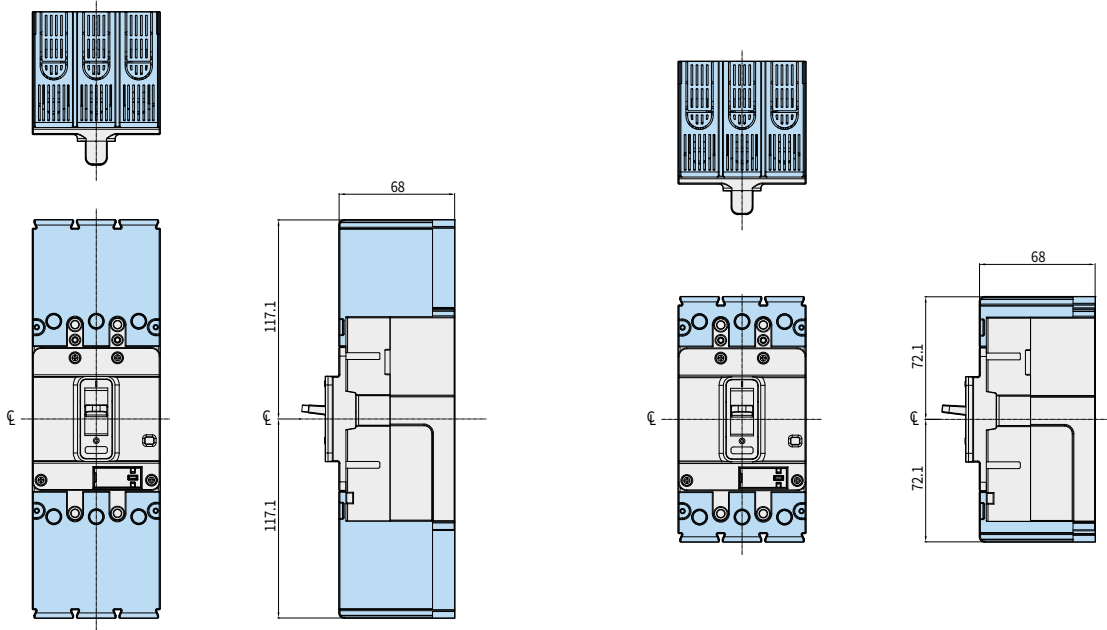

### Terminal Cover HGM125

• HGM50H/L, 125

Long Type

Short Type

Unit : mm

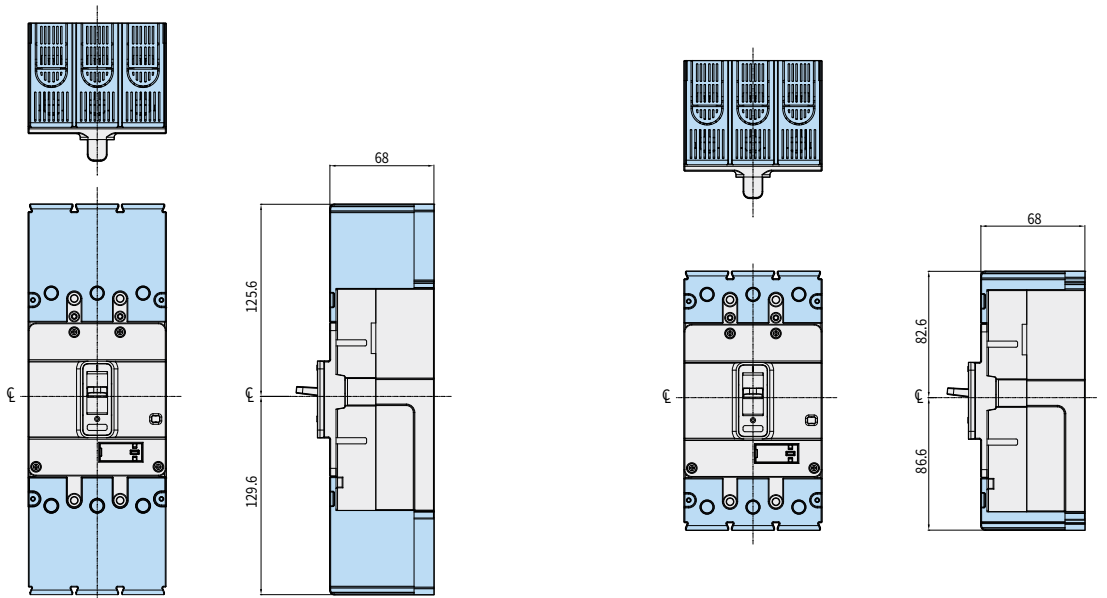

### Terminal Cover HGM250

• HGM160, 250

Long Type

Short Type

Unit: mm

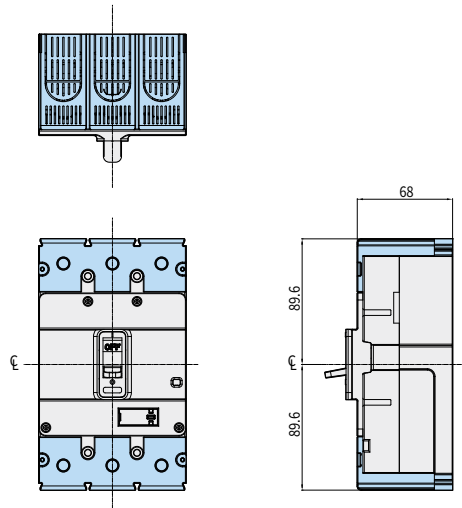
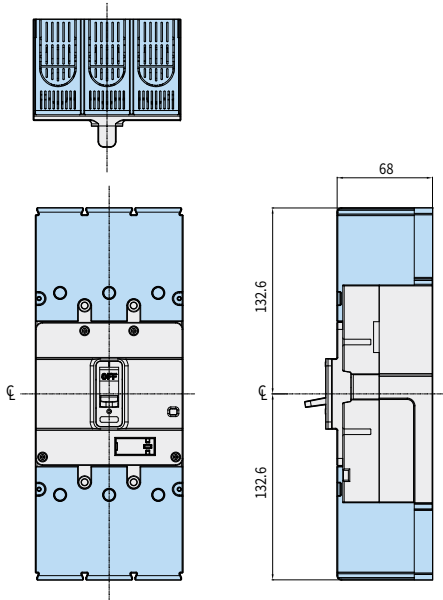

### Terminal Cover HGM400

• HGM400

Long Type

Short Type

Unit: mm

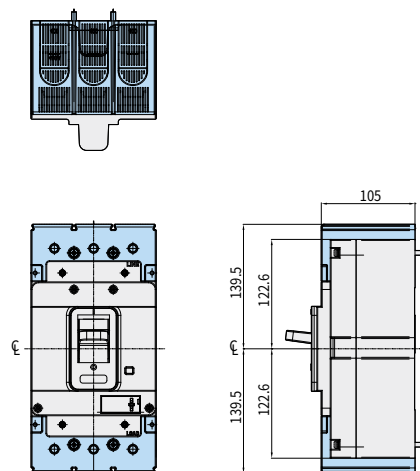
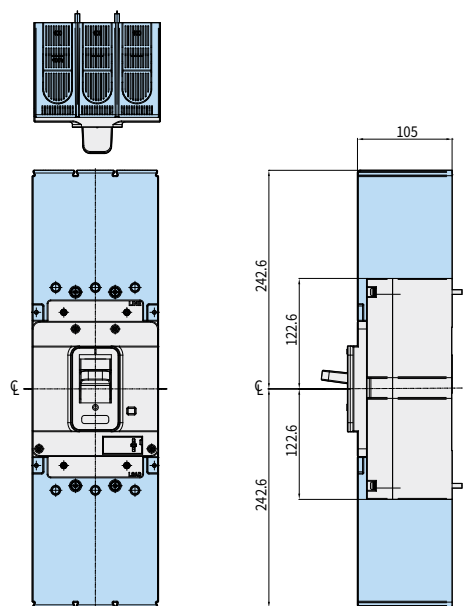

# Dimensions

## Terminal Cover HGM800

• HGM630, 800

Long Type

Short Type

Unit : mm

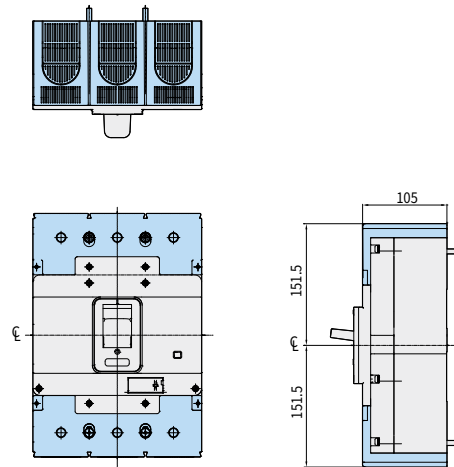
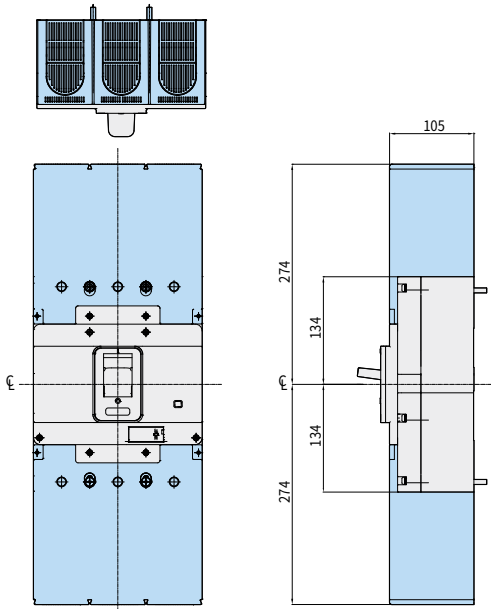

### Terminal Cover HGP50D, 125D, 160D

• HGP50D, 125D, 160D

Long Type 3P/4P

Short Type 3P

Unit: mm

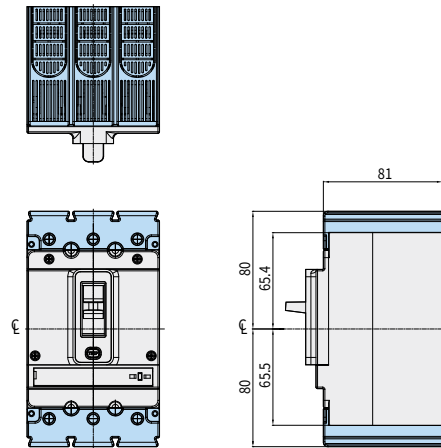
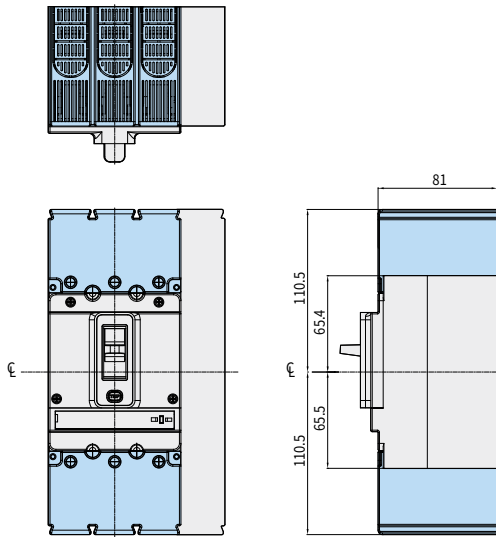

### Terminal Cover HGP250 (HGP100/MCP)

• HGP100, 250

Long Type 3P/4P

Short Type 3P

Unit: mm

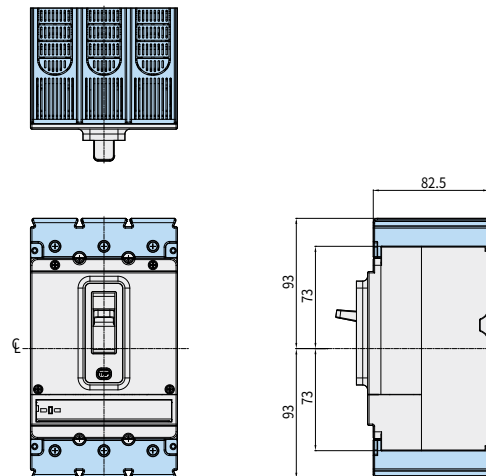
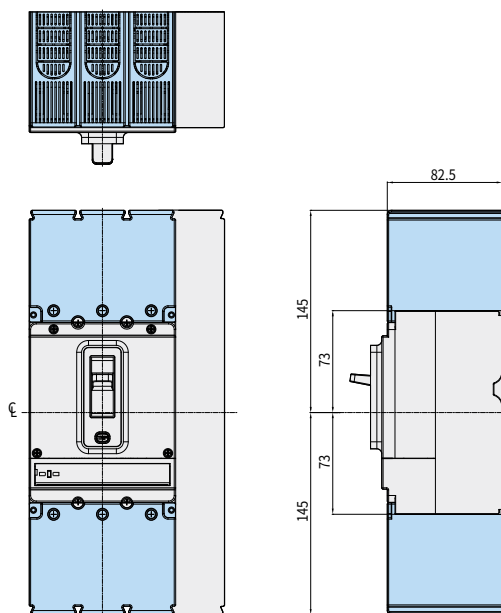

## Dimensions

### Terminal Cover HGP400, 630

• HGP400, 630

Long Type 3P/4P

Short Type 3P

Unit: mm

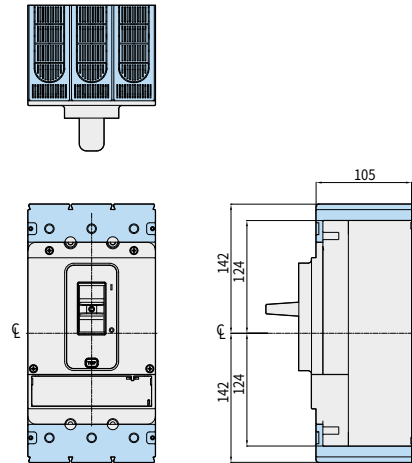
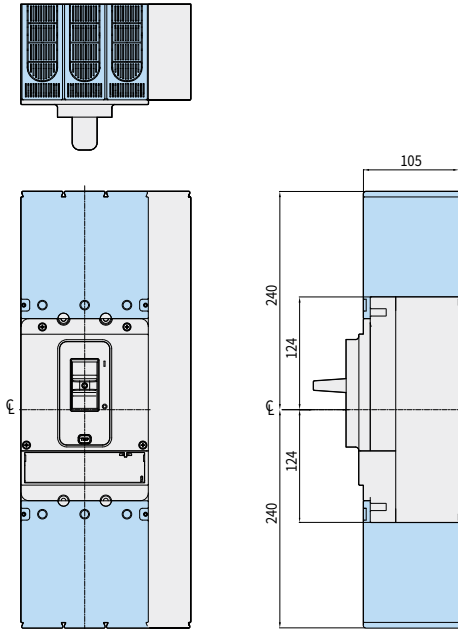

### Terminal Cover HGP800

• HGP800

Long Type 3P/4P

Short Type 3P

Unit: mm

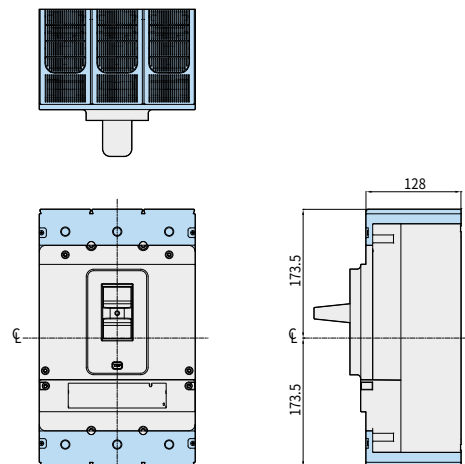
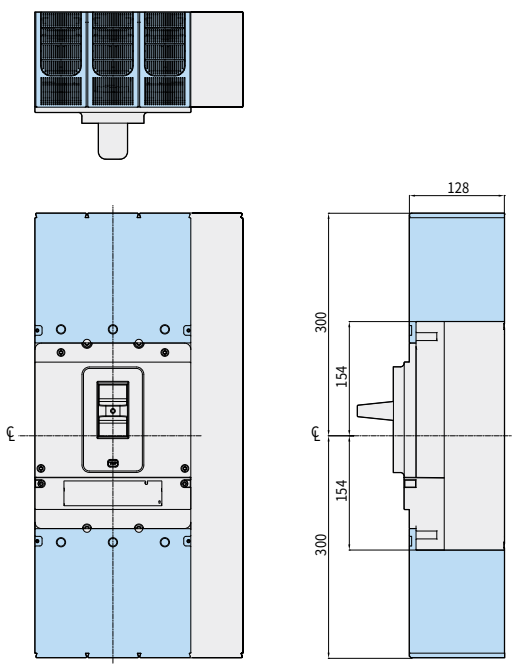

## Motor Operator

HGM30, 50E/S, 60, 100

Unit: mm

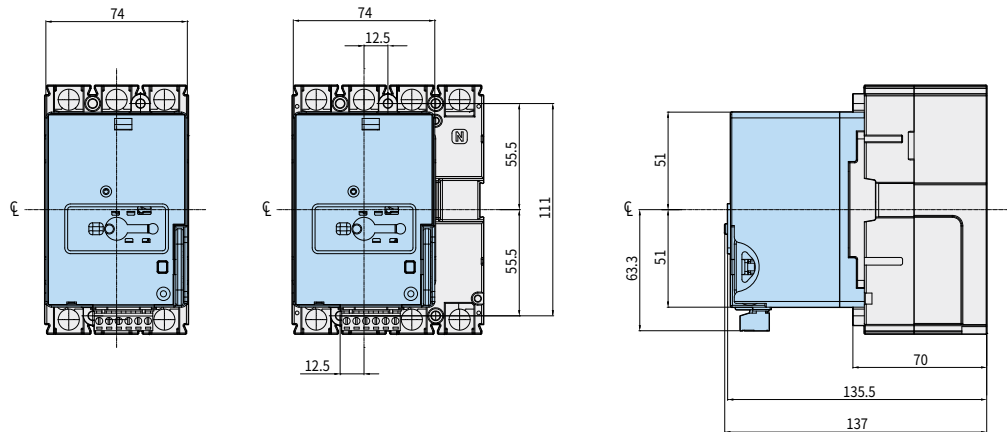

HGM50H/L, 125

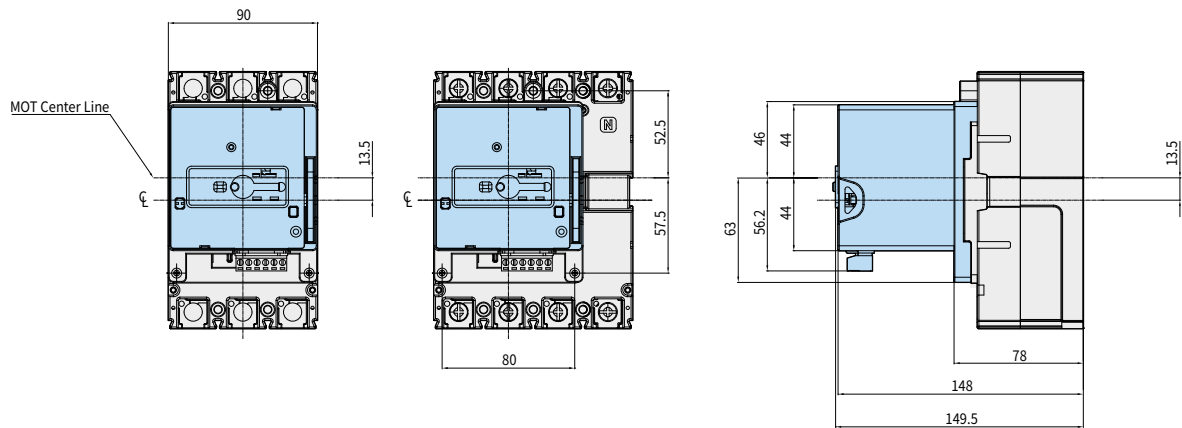

HGM160, 250

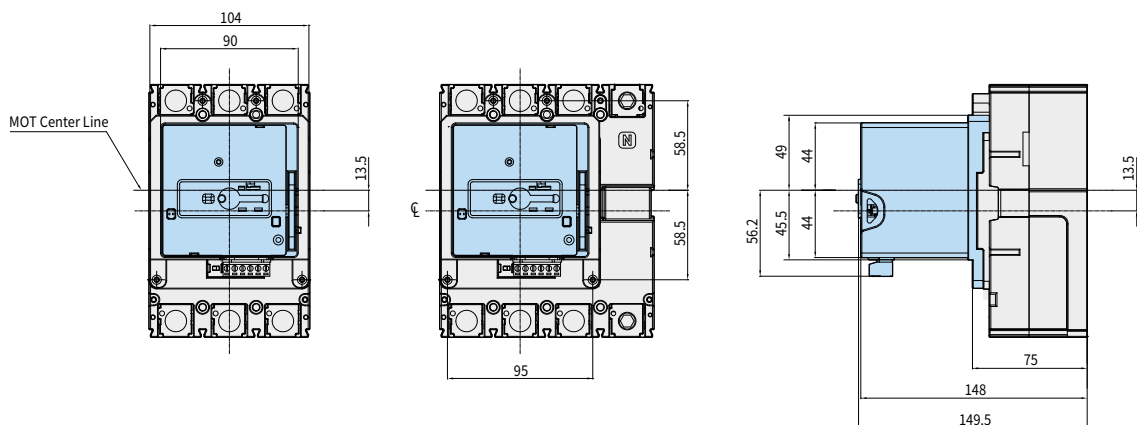

# Dimensions

## Motor Operator

HGM400

Unit : mm

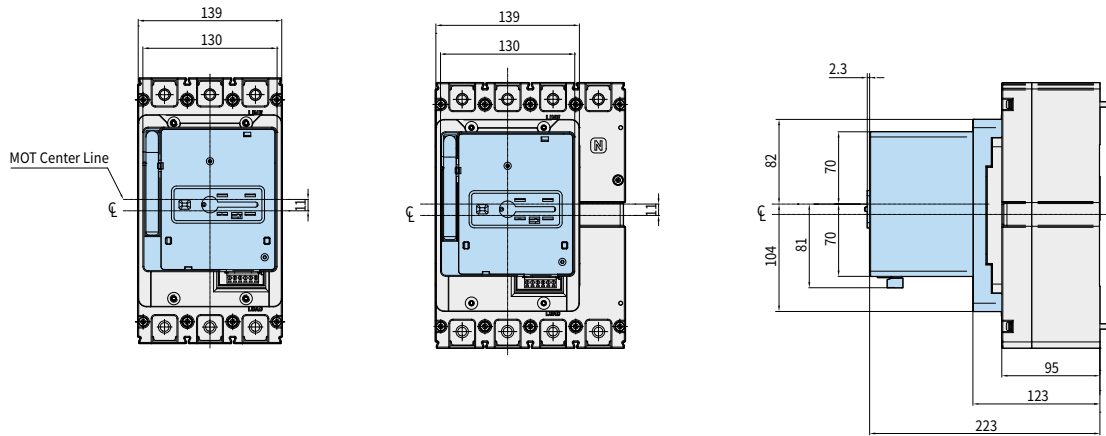

HGM630, 800

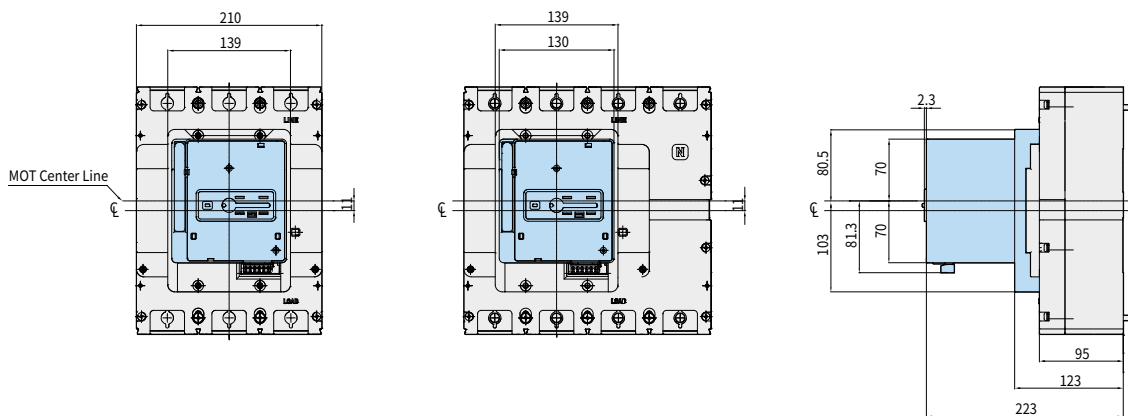



HGP50D, 125D, 160D

Unit: mm

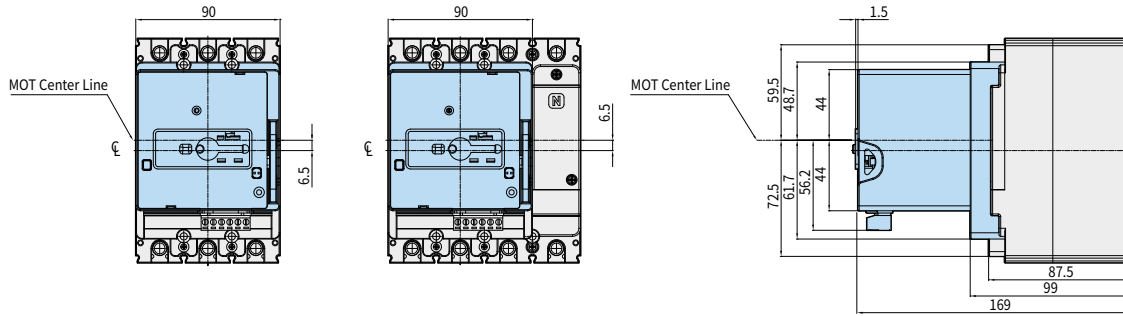

HGP250 (HGP100/MCP)

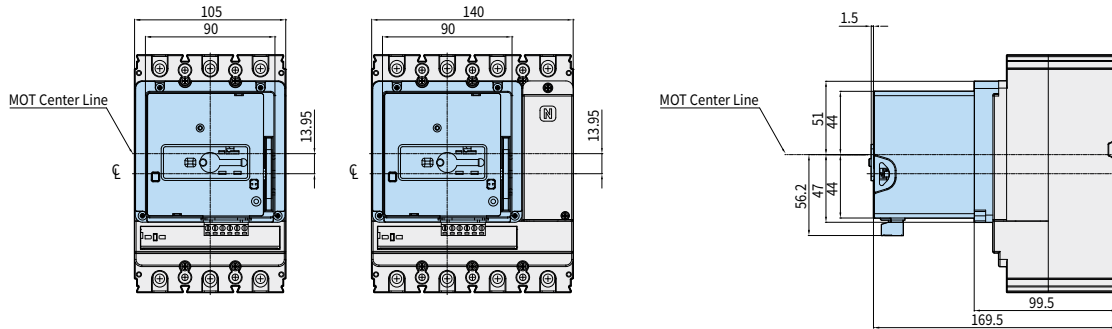

HGP400, 630

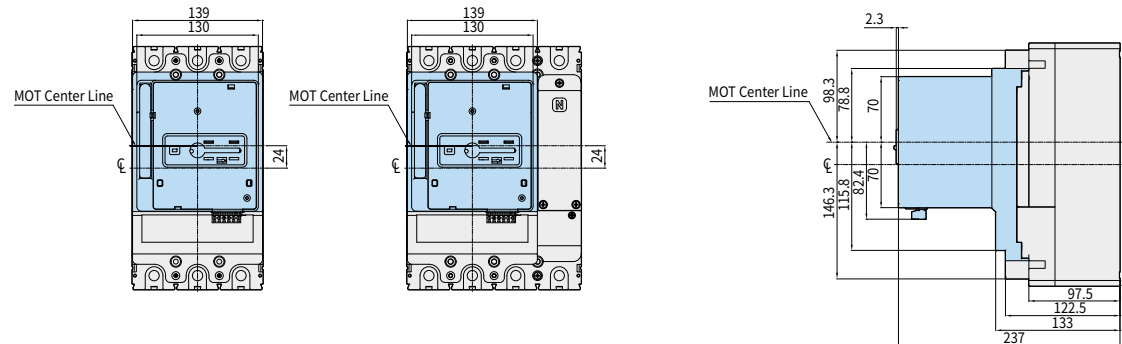

HGP800

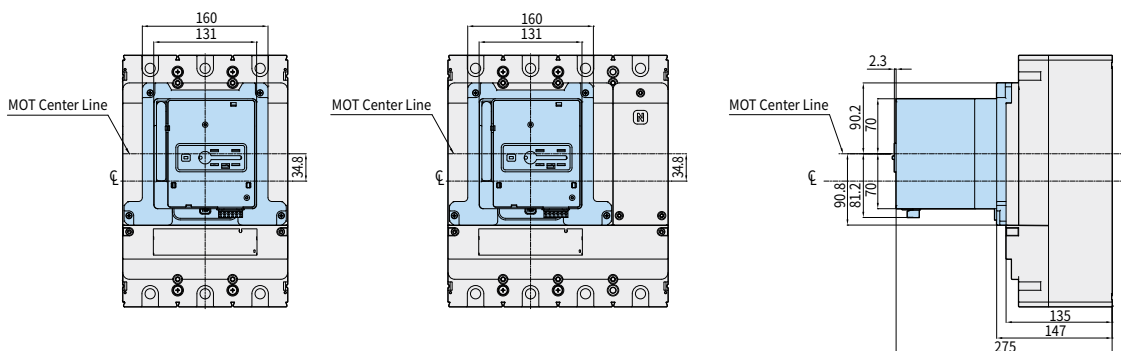

## Dimensions

### LUG Terminal

HGM30, 50E/S, 60, 100

Unit : mm

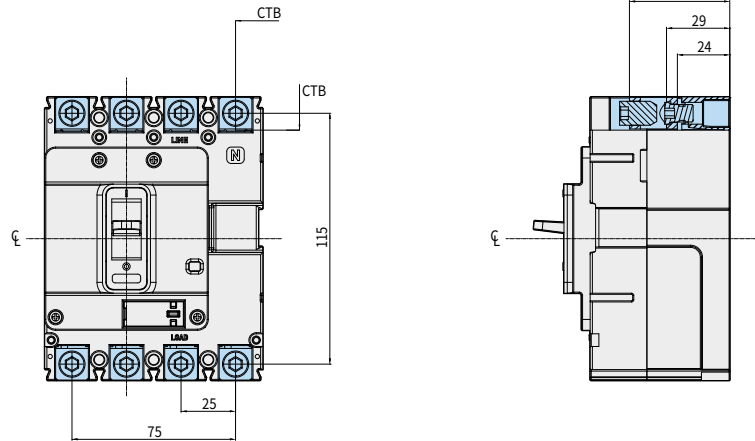

HGM50H/L, 125

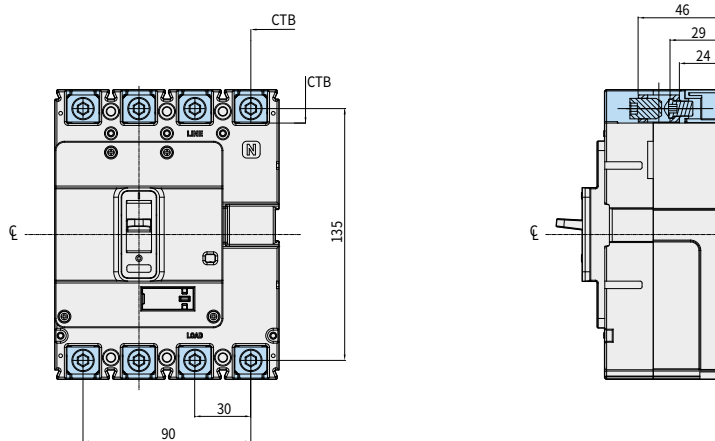

HGM160, 250

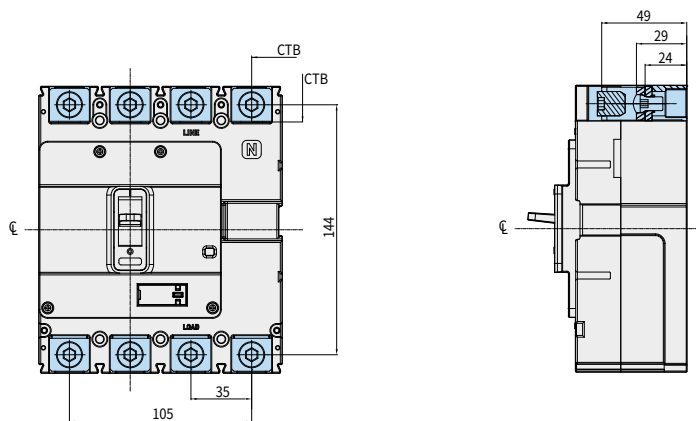

※ When using CTB, in case the Line/Load Insulation Barrier is not mounted, insulation tube or insulation tape does not provide complete insulation between bare conductors which may cause secondary short-circuit accidents so it must be used.

HGM400

Unit: mm

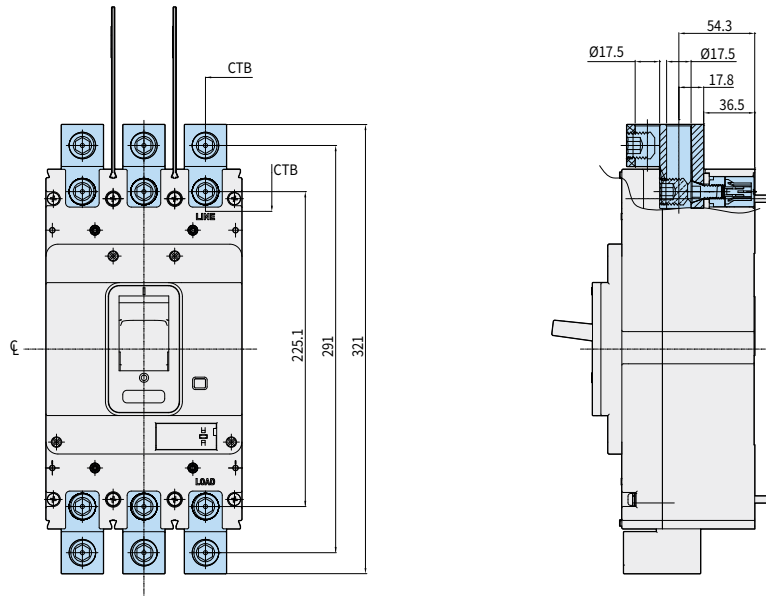

HGM630, 800

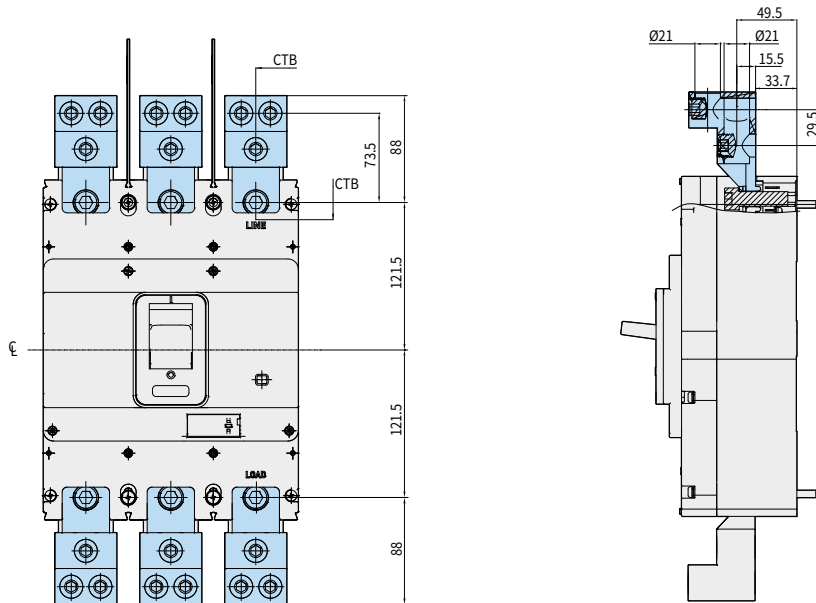

※ When using CTB, in case the Line/Load Insulation Barrier is not mounted, insulation tube or insulation tape does not provide complete insulation between bare conductors which may cause secondary short-circuit accidents so it must be used.

## Dimensions

### LUG Terminal

HGP50D, 125D, 160D

Unit: mm

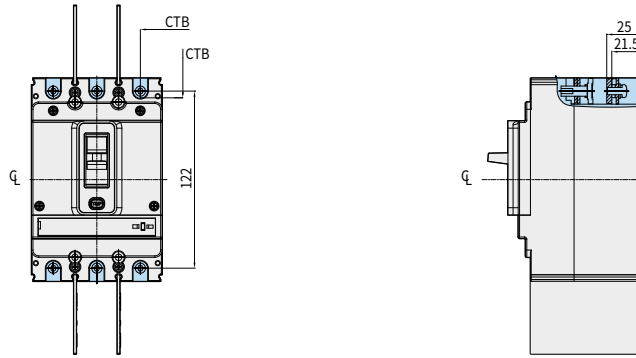

HGP250 (HGP100/MCP)

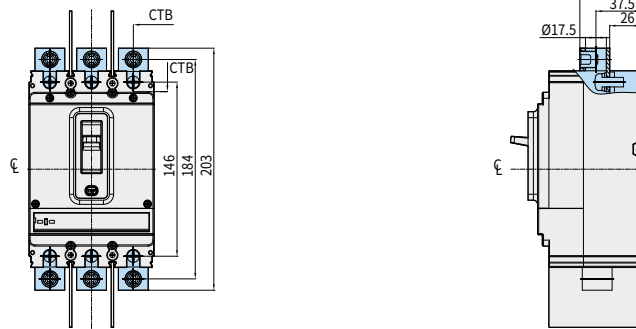

HGP400, 630

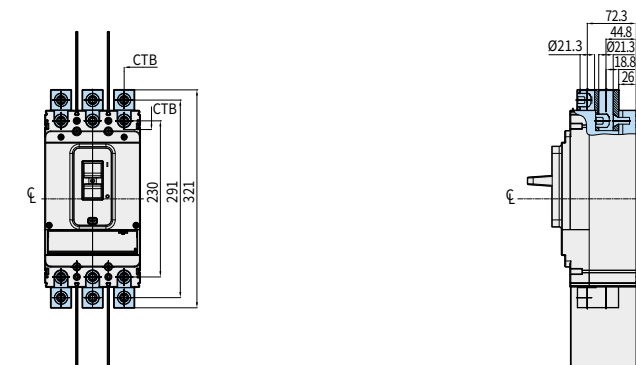

HGP800

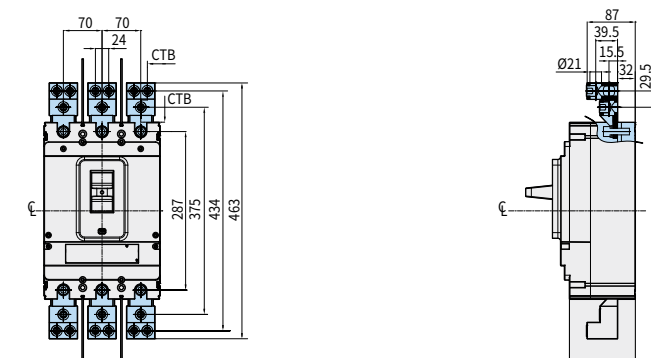

## DIN Rail Adaptor

• HGM100

### Dimension of DIN Rail Mounting Hole

Unit: mm

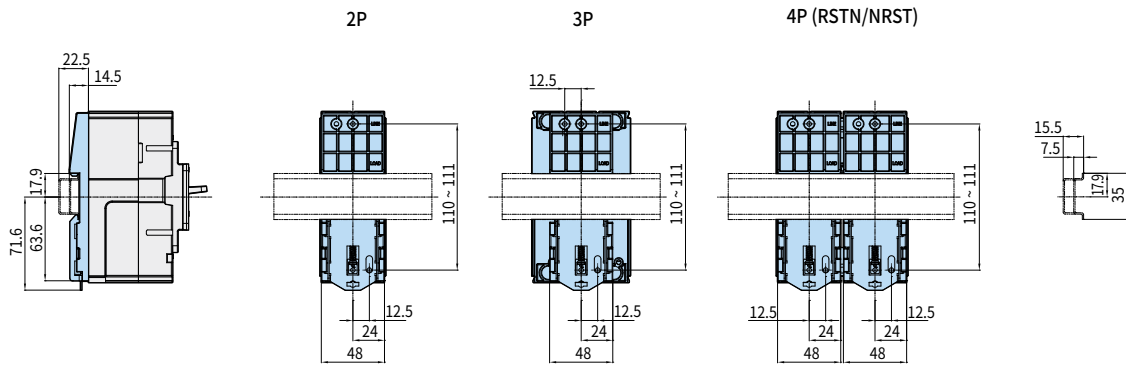

※ When assembling the DRA, remove the back barrier beforehand.

## Order Code

### HG Type of Molded Case Circuit Breaker, Earth Leakage Circuit Breaker

HGM		50		E		3P		T4		S			
Model Name		Frame Size		Short-Circuit Breaking Category Code		No. of Poles (Category per Circuit Breaker)		Product Category		Connection Method			
HGM	Molded Case Circuit Breaker	30	32 AF	E	E Type	General Type of MCCB/ELCB		MCCB : Ambient Temperature		S	Front Connection		
	HGE	Earth Leakage Circuit Breaker	50	50 AF	S	S Type	2P	2 Pole	T4	40/45 °C	BS <sup>3)</sup>	Terminal Bus Bar (Straight Type)	
60			63 AF	H	H Type	3P	3 Pole	T5	50 °C	BE <sup>4)</sup>	Terminal Bus Bar (Spreader Type)		
100			100 AF	L	L Type	4P	4 Pole (RSTN)	ELCB : Adjustable Residual Current				P	Plug-in
125			125 AF	NA	Switch-Disconnecter	4PN	4 Pole (NRST)	ZCT Embedded Type of MCCB		G4	30 mA	F	Live Side : Plug-in Load Side : Front Connection
160			160 AF			2Z	2 Pole	Instantaneous Circuit Breaker		G5 <sup>1)</sup>	100 mA		
250			250 AF			3Z	3 Pole	Switch-Disconnecter		MO <sup>2)</sup>	Instantaneous		
400			400 AF			4Z	4 Pole	Switch-Disconnecter		DS	Switch-Disconnecter		
630			630 AF										
800	800 AF												

※ 1) In case of 100/300/500/1,000 mA adjustable and time delay type, place order as 100 mA.

2) As for instantaneous products, only 3P can be ordered.

3) Only for 400 ~ 800 AF.

4) Only for 400 AF.

5) HGM32 ~ 250 AF is AC 380 ~ 480 V.

6) Only for HGM32 ~ 250 AF.

7) Rated current of instantaneous products : Deployed above 40 A.

00		00		C	00016		F
Auxiliary Contact Composition (AUX/ALT)		Shunt Trip Device Rating (SHT/UVT)		Frequency	Rated Current <sup>7)</sup>		Trip Device Characteristics (Applicable To MCCB Only)
00	Not Attached	0	Not Attached	C	00016	16 A	For Protecting Overload Short-Circuit
10	AUX 1C	S1	SHT AC 100 - 120 V		00020	20 A	
20	AUX 2C	S2	SHT AC 200 - 230 V				- Thermal Fixed/ Instantaneous Fixed
01	ALT 1C	S3 <sup>5)</sup>	SHT AC 380 - 415 V				
11	AUX 1C + ALT 1C	S4 <sup>5)</sup>	SHT AC 440 - 480 V				F Thermal Adjustable/ Instantaneous Fixed
21	AUX 2C + ALT 1C	S5	SHT DC 24 V		00800	800 A	Instantaneous
		S6	SHT DC 100 - 125 V				B Instantaneous Fixed (10×In)
		S7 <sup>6)</sup>	SHT DC 48 V				Switch-Disconnecter
		S8 <sup>6)</sup>	SHT DC 60 V				- No Protection Function
		U1	UVT AC 100 - 120 V				
		U2	UVT AC 200 - 230 V				
		U3	UVT AC 380 - 415 V				
		U4	UVT AC 440 - 480 V				
		U5	UVT DC 24 V				
		U6	UVT DC 100 - 110 V				
		U7 <sup>6)</sup>	UVT DC 48 V				

## Order Code

### HGP Type of Molded Case Circuit Breaker / Switch Disconnecter

HGP		50D		S		3P		T4		S			
Model Name		Frame Size		Short-Circuit Breaking Category Code <sup>1)</sup>		No. of Poles		Product Category		Connection Method			
HGP	Molded Case Circuit Breaker / Earth Leakage Circuit Breaker	50D	50 AF	S	65 kA	2P	2 Pole	Molded Case Circuit Breaker	T4	Ambient Temperature of 40 °C	S	Front Connection	
		125D	125 AF	H	85 kA	3P	3 Pole				BS <sup>2)</sup>	Straight Type of Bus Bar Packaging	
		160D	160 AF	X	150 kA	Switch-Disconnecter		Circuit Breaker for Motor Protection	T5	Ambient Temperature of 50 °C	BE <sup>2)</sup>	Spreader Type of Bus Bar Packaging	
		100	100 AF/MCP	NA							P	Plug-in PC/CBM Not Attached	
		250	250 AF					MP	For Motor Protection	F	Live Side : Plug-in Load Side : Front Connection		
		400	400 AF					Switch-Disconnecter		DS	Switch-Disconnecter	X	Plug-in PC/CBM Not Attached
		630	630 AF										
		800	800 AF										

※ 1) Based on AC 440/460 V

2) B/E : Applicable to both live part/load part

3) Applicable to HGP400 ~ 800

4) Applicable to HGP800

The order format above is to describe the order code. As for detailed specification per circuit breaker type, please refer to the relevant page upon order.



00		00		C	00016		F		
Auxiliary Contact Composition (AUX/ALT)		Shunt Trip Device Rating (SHT/UVT)		Frequency (Category per MCCB)	Rated Current (Category per MCCB)		Trip Device Characteristics		
00	Not Attached	0	Not Attached	C	00016	16 A	For Protecting Overload Short-Circuit		
10	AUX 1C	S1	SHT AC 110 V		00020	20 A	-	Thermal Fixed/Instantaneous Fixed (MTM - FF)	
20	AUX 2C	S2	SHT AC 220 V					F	Thermal Adjustable/Instantaneous Fixed (MTM - JF)
01	ALT 1C	S3	SHT AC 380 V					H	Thermal Adjustable/Instantaneous Adjustable (MTM - JJ)
11	AUX 1C + ALT 1C	S4	SHT AC 440 V					N	Thermal Fixed/Instantaneous Fixed (MTM - FF) + 4P N Phase Protection
21	AUX 2C + ALT 1C	S5	SHT DC 24 V					FN	Thermal Adjustable/Instantaneous Fixed (MTM - JF) + 4P N Phase Protection
31 <sup>3)</sup>	AUX 3C + ALT 1C	S6	SHT DC 110 V					HN	Thermal Adjustable/Instantaneous Adjustable (MTM - JJ) + 4P N Phase Protection
32 <sup>4)</sup>	AUX 3C + ALT 2C	U1	UVT AC 110 V						For Motor Protection
		U2	UVT AC 220 V					-	No Thermal/Instantaneous Adjustable (MCP - OJ)
		U3	UVT AC 380 V						Switch-Disconnecter
		U4	UVT AC 440 V					-	No Protection Function (DSU)
		U5	UVT DC 24 V						
		U6	UVT DC 110 V						

# Handling and Maintenance Inspection

## Storage and Transportation

### Storage Precaution

- | Ambient Temperature | - 20 ~ + 60 °C
- | Altitude | Below 1,000 m above sea level
- | Relative Humidity | Within 45 % ~ 85 %

The surrounding environment may affect the insulation function and Endurance of the molded case and earth leakage circuit breakers so the environment condition for usage must accurately be checked before application.

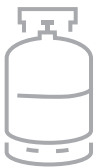

- Do not store in places with corrosive gas  
Do not leave it around gas containing sulfurous gas or sulfur or ammonia gas and others.



- Do not store in places with high humidity for a long period of time



- Do not leave under direct sunlight for a long period of time.



- Avoid places with a lot of dust  
Do not store in exposed places and use cover or packing material to prevent dust from piling up on the circuit breaker.



- Avoid storage in high or low temperature  
Storage temperature must be maintained between - 20 °C ~ + 60 °C.

### Transportation Precautions

#### ▲ Caution

- Do not apply impact during transportation. Dropping or applying strong impact may cause defect.
- Do not handle while holding the circuit breaker's accessory or the external plug-in wire of the accessory. It may cause injury in the handler or a malfunction of the circuit breaker.

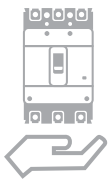

- Hold the main unit of the circuit breaker during transportation  
Do not handle while holding the external guide line of the accessory or the terminal bar.



- Pay attention when handling metal accessories  
Sharp planes or edges in the metal accessory may cause injury.



- Do not apply impact during transportation  
Dropping or applying strong impact may cause defect.



- Pay attention to the packaging of the circuit breaker before transportation  
Inappropriate packaging may cause damage in the circuit breaker during transportation.

## Installation

As for the detailed dimension of each part required for installation, refer to the external structure.

### ⚠ Caution

- Electrical works shall only be conducted by a person qualified for electrical works.
- For wiring works, the upper circuit breaker must be cut off (OFF) and execute the work after checking that it is not charged.
- In case of disconnecting cable or terminal bar, tighten the terminal screw firmly at the standard tightening torque.  
In case the terminal screw is tightened loosely, it may cause damage and fire due to overheating.
- Strictly insulate up to the circuit breaker's portion with terminal barrier, insulating tube, insulating tape and others between bare conductors with regards to the front connection of the circuit breaker.  
In case it is not insulated, it may cause short circuit.

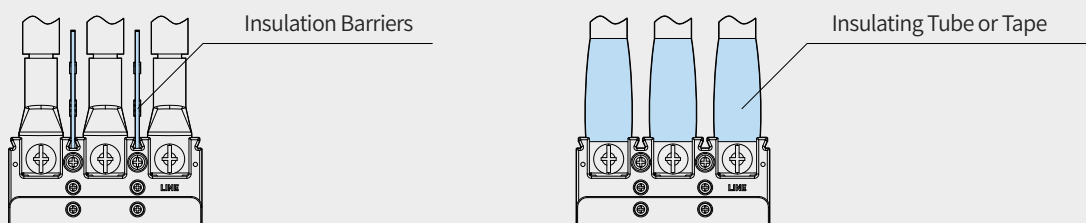

- Secure sufficient arc space (Insulation distance) so that the arc gas discharge outlet is not blocked.  
In case this discharge outlet is blocked, the current may not be blocked.
- Do not install the circuit breaker in abnormal environment such as high temperature, high humidity, dust, corrosive gas, vibration, impact and others. It may cause fire or abnormal trip.
- Install so that foreign substances (Metal powder, concrete powder etc.), rainwater and others do not enter the circuit breaker.  
Such foreign substances in the circuit breaker may cause fire or malfunction.
- In case of 4 pole circuit breaker, the neutral wire of 3 phase 4 wire must be connected to the N phase (Right end part of the circuit breaker).
- When mounting the product, the live part (LINE) signal must be connected to the live part and the load part (LOAD) signal must be connected to the load part. Wrong connection may cause damage in product and electric shock.
- In case the insulation barrier is not mounted between the circuit breaker terminals, it may cause secondary short-circuit accidents so it must be used.

# Handling and Maintenance Inspection

## Installation

### Installation Precautions

- Install the circuit breaker in a place that satisfies the following environment conditions

Installing the circuit breaker in places and environment other than the following may cause malfunction of circuit breaker, fire and others.

- Ambient temperature of - 5 °C to + 40 °C  
(However, the 24-hour average temperature must not exceed 35 °C.)
- Relative humidity to be within 45 ~ 85 %
- Excessive vibration or impact to be avoided
- True height to be below 2,000 m
- To be used in an environment without excessive water vapor, oil vapor, smoke, dust, alkaline, corrosive material and others
- To avoid direct sunlight



- Arc gas exhaust hole must not be blocked  
It may drop the breaking capacity.



- Attention to be paid to dust, metal fragments and others  
After installation, protection cover and covers to be covered during work



- The insulation plate attached to the bottom of the circuit breaker must not be separated  
It may destroy insulation and drop the insulation performance.

### Connection Precautions



- When fastening the terminal screw, it should be fastened according to the specified torque  
Incomplete fastening of terminal screw may cause overheating so each terminal screw must be fastened completely according to the specified torque. In addition, excessive fastening torque may cause damage in the terminal screw and the circuit breaker case.



- Use of lubricant at the terminal screw part is prohibited  
Lubricant reduces the friction of the screw, causing the screw to loosen, ultimately leading to an increase in temperature.



- Exposed conductor must be insulated  
Insulating tube or insulating tape must be used for complete insulation between the bare conductors of the MCCB.  
In case the terminals are not insulated, it may cause secondary short-circuit during short-circuit accidents.

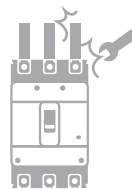

- Stud must not be deformed  
Excessive force must not be applied to the stud at the conductor connecting part of the rear connection type.  
In addition, stud must not be deformed during wiring.



- In case of 4 pole circuit breaker, the neutral wire of 3 phase 4 wire must be connected to the N phase.  
It may not function in overcurrent which may cause fire.



- The conductor must be fixed firmly on a flat state.  
As for the connecting conductor, electromagnetic force between conductors is generated by extremely big fault current so it must be fixed firmly.

### Connection Precautions

The following table is the impact electromagnetic force generated by fault current.

#### Impact Electromagnetic Force per 1 m Conductor

Regulated Short-Circuit Current kA ( ) Power Factor	Electromagnetic Force (In Case of 3 Phase Short Circuit) N (kgf)	
	10 cm Conductor Interval	20 cm Conductor Interval
10 (0.4)	490 (50)	245 (25)
18 (0.3)	1,863 (190)	932 (95)
25 (0.2)	4,412 (450)	2,206 (225)
35 (0.23)	8,630 (880)	4,315 (440)
42 (0.2)	12,455 (1,270)	6,277 (635)
50 (0.2)	17,652 (1,800)	8,826 (900)
65 (0.2)	29,910 (3,050)	14,955 (1,525)
85 (0.2)	51,190 (5,220)	25,595 (2,510)
100 (0.2)	70,804 (7,220)	35,402 (3,610)
125 (0.2)	110,815 (11,300)	55,408 (5,650)

- **Contact surface must be clean**

Dust and others must be removed from the contact surface to prevent increase in connection resistance at the contact surface.

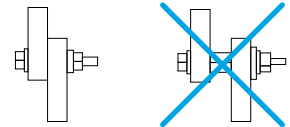

- **Conductor must be connected so that it has direct contact with the contact surface**

Do not use bolt or nut between the contact surfaces of the conductor. If there is no direct contact between conductors, it may cause increase in temperature and fire.

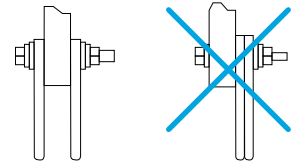

- **Do not overlap the conductors**

When numerous conductors are connected to the terminal bar, do not overlap and assemble. Assemble at both ends of the terminal bar.

### Maintenance Inspection

#### Initial Inspection

- Residues of steel plate, grinded materials of the wire, other conductor's foreign substances and others must not be left around the terminal of the circuit breaker
- There must be no crack and damage in the cover and base
- The fastening status of the terminal fastening part must be checked
- Check must be made if the rated voltage and breaking capacity of the circuit breaker are correct
- When the insulation resistance is measured using a 500 V insulation-resistance tester, it must be above 5 MΩ

#### Withstand Voltage

Main Circuit		Auxiliary Circuit or Control Circuit <sup>1)</sup>	
Rated Insulation Voltage	Test Voltage (Effective Value of Interchange)	Rated Insulation Voltage of Operational Circuit	Test Voltage (Effective Value of Interchange)
$U_i \leq 300$ V	2,000 V for 1 min	$U_{is} \leq 60$ V	1,000 V for 1 min
$300 < U_i \leq 600$ V	2,500 V for 1 min	$60 < U_{is} \leq 600$ V	$2 \cdot U_{is}$ 1,000 V (최소 1,500 V) for 1 min

※ Based on the abovementioned table, do not conduct withstand voltage test above it.

1) Between terminal and grounding

# Handling and Maintenance Inspection

## Installation

### Regular Inspection

Inspection shall be conducted once in 1 month before/after the commencement of the equipment operation in order to maintain the performance of the circuit breaker and to prevent unexpected accidents. After that, regular inspection is required depending on the environment.

### Standard of Inspection Period

Extent	Environment	Standard of Inspection Period
Standard Usage State	Clean and dry state of air	Less than 10 years after installation - Once in 2 ~ 3 years
		More than 10 years after installation - Once a year
		More than 15 years after installation - Once in 6 months
	Place without corrosive gas even though there is dust inside	Less than 10 years after installation - Once a year
		More than 10 years after installation - Once in 6 months
		More than 15 years after installation - Once a month
Bad Environment	Place containing sulfurous acid, hydrogen sulfide, salinity, vapor and others	Less than 5 years after installation - Once in 6 months
		More than 5 years after installation - Once a year
	Places with specially more corrosive gas	Once a month

### Regular Inspection Item

Inspection Item	Procedure	Countermeasure
Tightening of Terminal Screw	<ul style="list-style-type: none"> <li>Inspect tightening of terminal screw, conductor connecting screw</li> </ul>	<ul style="list-style-type: none"> <li>Tighten according to the specified torque</li> <li>Ensure that it is not tightened excessively</li> </ul>
Dust and Foreign Substance	<ul style="list-style-type: none"> <li>Check for foreign substance such as dust on the circuit breaker's surface, especially the top of the live part. There must be no dust or foreign substance to secure insulation distance</li> </ul>	<ul style="list-style-type: none"> <li>Remove dust, foreign substance and others using cloth with clean surface types (Do not use thinner or detergent)</li> </ul>
Damage in Mold Case	<ul style="list-style-type: none"> <li>Check for damage or crack on the circuit breaker's cover and base</li> </ul>	<ul style="list-style-type: none"> <li>Replace circuit breaker</li> </ul>
Arc Exhaust Hole	<ul style="list-style-type: none"> <li>Check for pollution in the arc exhaust hole</li> </ul>	<ul style="list-style-type: none"> <li>If there are burns or excessive pollution due to melted metal particles and others, replace the circuit breaker</li> </ul>
Switch Operation	<ul style="list-style-type: none"> <li>If the circuit breaker was maintained at closed state at normal times, operate the switch multiple times. Friction caused by hardened grease and others will be reduced and the contact resistance can be stabilized</li> <li>Press the trip button to trip the circuit breaker multiple times</li> </ul>	<ul style="list-style-type: none"> <li>If there is a problem in the switch operation of the circuit breaker, replace or contact the nearest store</li> <li>If the specified limit value of the switch operation has exceeded, replace</li> </ul>
Discoloration of Terminal Part	<ul style="list-style-type: none"> <li>Check for severe discoloration in the terminal part or conductor part</li> <li>If there is severe discoloration in the copper conductor or silver coated part, check the insulation performance caused by thermal damage</li> </ul>	<ul style="list-style-type: none"> <li>Slight discoloration in the silver coated part is not a problem. If there is a problem in insulation due to thermal damage, replace the circuit breaker</li> </ul>
Insulation Resistance	<ul style="list-style-type: none"> <li>Separate all conductors connected to the circuit breaker and measure the insulation resistance between the poles, terminals and groundings</li> </ul>	<ul style="list-style-type: none"> <li>If the insulation resistance is not more than 5 MΩ, replace</li> </ul>

### Inspection and Processing after Blocking Fault Current

In case the circuit breaker has blocked the fault current, determine whether it can be re-used or whether it has to be replaced with a new product depending on the size of the fault current.

- In case the arc exhaust hole is not polluted or there are no other abnormalities, it can be reused.
- In case there is pollution such as dark burns around the arc exhaust hole and in case the insulation resistance is above 5 MΩ, there is no dielectric breakdown when the specified withstand voltage is applied and in case there is no excessive temperature increase in the terminal part, it can be reused.
- If there are burns at the handle part, severe pollution around the arc exhaust hole, melted metal particles and others, replace the circuit breaker immediately.

### Countermeasures with Regards to Abnormal Phenomenon





In case there is abnormal phenomenon during the use of circuit breakers, take appropriate action according to the following table.

Type of Abnormality	Phenomenon	Assumed Cause	Action to be Taken
Abnormal Heating	Heating at terminal part	• Loose terminal screw, conductor connecting screw	Re-tighten according to the specified torque
		• Increased resistance of contact	Replace circuit breaker
	Damage in insulation material at terminal part	• Loose terminal screw, conductor connecting screw • Defect in contact between circuit breaker's terminal and terminal bar or cable lugs due to loose screw tightening and interference caused by foreign substance	Replace circuit breaker
Defect in Current Flow	Abnormal heating in the circuit breaker's external case	• Increased resistance of contact	Replace circuit breaker
		• Loosening at the internal connection part	
		• Increased current density due to disconnection	
Does Not Function	Abnormal voltage at load side	• Big consumption at contact	Replace circuit breaker
		• Foreign substance between contacts	
		• Fusing at conductive part (Excessive opening/closing and corrosion due to corrosive gas)	
Does Not Function	ON does not function	• No reset in trip state	ON after reset
		• Damage in trip mechanism due to excessive opening/closing	Replace circuit breaker
		• Demagnetized state of under-voltage trip device	Apply specified voltage
	OFF does not function	• Fusing at contact	Replace circuit breaker
		• Demagnetized state of under-voltage trip device	Apply specified voltage
	RESET does not function	• Bimetal has not been cooled sufficiently	Reset after sufficient cooling
		• Corrosion or deformation of bimetal	Replace circuit breaker
• Abnormality in mechanism			
• Can't be used due to excessive opening/closing			
Frequent Breaking	Trip under rated current	• Damage in mechanism due to excessive breaking current	Lower the ambient temperature using wind and others
		• High ambient temperature (Above 40 °C)	
		• Abnormal heating due to loosening of screw at terminal part	
	Trip in running current	• Internal heating at the circuit breaker	Re-tighten according to the specified torque
		• In case the cross sectional area of connecting conductor is smaller than the regulation	Replace circuit breaker
		• Trip in running inrush current	Change the connecting conductor or change the circuit breaker's rated current
		• Trip during switching at Y-Δ operation	Change the instantaneous trip current setting or replace with circuit breaker with bigger rated current
Overcurrent does Not Function	Does not function above specified operational current	• Trip during switching in reversible operation	Replace with circuit breaker with bigger rated current
		• Trip in big running current	
		• Trip in long running current	
Abnormality in Accessory	Abnormal operation of shunt trip device (SHT)	• Short circuit between motor layer	Repair or replace motor
		• Wrong connection of SHT/UVT's operational circuit	Inspect wiring
		• When current limiting breaking of upper fuse or cooperation with upper circuit breaker is low	Review cooperation again
	Abnormal operation of under-voltage trip device (UVT)	• When the ambient temperature is significantly low	Check the compensating current
		• Inappropriate rated current	Check the rated current
		• Abnormal voltage of operational circuit	Check the rated voltage
		• Does not function due to voltage drop in operational circuit	Maintain the rated voltage
Abnormal operation of auxiliary switch (AUX) and alarm switch (ALT)	Abnormal operation of auxiliary switch (AUX) and alarm switch (ALT)	• Coil damage due to difference in the coil's rated voltage, non-operation of damage prevention switch and others	Replace accessory
		• Defect in mechanism	Replace accessory
	Abnormal operation of under-voltage trip device (UVT)	• Difference in voltage used	Check the rated voltage
• Damage in UVT controller		Replace and check disconnection	
Abnormal operation of auxiliary switch (AUX) and alarm switch (ALT)	Abnormal operation of auxiliary switch (AUX) and alarm switch (ALT)	• Contact damage due to excessive micro switch rating	Replace and check the micro switch load
		• Defect in mechanism	Replace and repair accessory

## Current Status of Acquired Standards

### Approvals & Certificates









#### MCCB

Type of Certification		Approvals				Certificates
Type of Standard	Safety Certificate	KS	IEC	GB	DEKRA	
Mark						
Testing Institute	KETI	KS	CE	GB 1984	DEKRA	
Certification Country	Korea	Korea	Europe	China	Netherlands	
HGM30	E	●	●	●	●	
	S	●	●	●	●	
HGM50	E	●	●	●	●	
	S	●	●	●	●	
	H	●	●	●	●	
	L	●	●	●	●	
HGM60	E	●	●	●	●	
	S	●	●	●	●	
	H	●	●	●	●	
	L	●	●	●	●	
HGM100	E	●	●	●	●	
	S	●	●	●	●	
	H	●	●	●	●	
	L	●	●	●	●	
HGM125	E	●	●	●	●	
	S	●	●	●	●	
	H	●	●	●	●	
	L	●	●	●	●	
HGM160	E	●	●	●	●	
	S	●	●	●	●	
	H	●	●	●	●	
	L	●	●	●	●	
HGM250	E	●	●	●	●	
	S	●	●	●	●	
	H	●	●	●	●	
	L	●	●	●	●	
HGM400	E	●	●	●	●	
	S	●	●	●	●	
	H	●	●	●	●	
	L	●	●	●	●	
HGM630	E	●	●	●	●	
	S	●	●	●	●	
	H	●	●	●	●	
	L	●	●	●	●	
HGM800	S	●	●	●	●	
	H	●	●	●	●	
	L	●	●	●	●	



## Approvals & Marine Certificates





### MCCB

Type of Certification		Vessel							
Type of Standard		Korea	U.K	France	U.S.A	Germany	Russia	Italy	Japan
Mark									
Testing Institute		KR	LR	BV	ABS	DNV-GL	RMRS	RINA	NK
Certification Country		Korea	U.K	France	USA	Germany	Russia	Italy	Japan
HGM30	E	●	●	●	●	●	●	●	●
	S	●	●	●	●	●	●	●	●
HGM50	E	●	●	●	●	●	●	●	●
	S	●	●	●	●	●	●	●	●
	H	●	●	●	●	●	●	●	●
	L	●	●	●	●	●	●	●	●
HGM60	E	●	●	●	●	●	●	●	●
	S	●	●	●	●	●	●	●	●
	H	●	●	●	●	●	●	●	●
	L	●	●	●	●	●	●	●	●
HGM100	E	●	●	●	●	●	●	●	●
	S	●	●	●	●	●	●	●	●
	H	●	●	●	●	●	●	●	●
	L	●	●	●	●	●	●	●	●
HGM125	E	●	●	●	●	●	●	●	●
	S	●	●	●	●	●	●	●	●
	H	●	●	●	●	●	●	●	●
	L	●	●	●	●	●	●	●	●
HGM160	E	●	●	●	●	●	●	●	●
	S	●	●	●	●	●	●	●	●
	H	●	●	●	●	●	●	●	●
	L	●	●	●	●	●	●	●	●
HGM250	E	●	●	●	●	●	●	●	●
	S	●	●	●	●	●	●	●	●
	H	●	●	●	●	●	●	●	●
	L	●	●	●	●	●	●	●	●
HGM400	E	●	●	●	●	●	●	●	●
	S	●	●	●	●	●	●	●	●
	H	●	●	●	●	●	●	●	●
	L	●	●	●	●	●	●	●	●
HGM630	E	●	●	●	●	●	●	●	●
	S	●	●	●	●	●	●	●	●
	H	●	●	●	●	●	●	●	●
	L	●	●	●	●	●	●	●	●
HGM800	S	●	●	●	●	●	●	●	●
	H	●	●	●	●	●	●	●	●
	L	●	●	●	●	●	●	●	●

## Current Status of Acquired Standards







### Approvals & Certificates

#### ELCB

Type of Certification	Approvals			Certificates
Type of Standard	Safety Certificate	KS	IEC	IEC
Mark				
Testing Institute	KETI	KS	CE	DEKRA
Certification Country	Korea	Korea	Europe	Netherlands
HGE30	E	●	●	●
	S	●	●	●
HGE50	E	●	●	●
	S	●	●	●
	H	●	●	●
HGE60	L	●	●	●
	E	●	●	●
	S	●	●	●
HGE100	H	●	●	●
	L	●	●	●
	E	●	●	●
HGE125	S	●	●	●
	H	●	●	●
	L	●	●	●
HGE160	E	●	●	●
	S	●	●	●
	H	●	●	●
HGE250	L	●	●	●
	E	●	●	●
	S	●	●	●
HGE400	H	●	●	●
	L	●	●	●
	E	●	●	●
HGE630	S	●	●	●
	H	●	●	●
	L	●	●	●
HGE800	S	●	●	●
	H	●	●	●
	L	●	●	●

## Approvals & Certificates

### MCCB









Type of Certification	Approvals					Certificates
Type of Standard	Safety Certificate	KS	IEC	GB		IEC
Mark						
Testing Institute	KETI	KS	CE	GB	Gosstandart	DEKRA
Certification Country	Korea	Korea	Europe	China	Russia	Netherlands
HGP50D	F*		●			●
	S	●	●			●
	H	●	●			●
	X	●	●	●		●
HGP125D	F*		●			●
	S	●	●			●
	H	●	●			●
	X	●	●	●	●	●
HGP160D	F*		●			●
	S	●	●			●
	H	●	●			●
	X	●	●	●		●
HGP250	F*		●			●
	S	●	●		●	●
	H	●	●			●
	X	●	●	●		●
HGP400	F*		●			●
	S	●	●			●
	H	●	●			●
	X	●	●	●		●
HGP630	F*		●			●
	S	●	●			●
	H	●	●			●
	X	●	●	●		●
HGP800	F*		●			●
	S		●			●
	H		●			●
	X		●	●		●

※ \* F Type products are dedicated overseas products.

## Current Status of Acquired Standards

### Approvals & Marine Certificates

#### MCCB

Type of Certification		Vessel							
Type of Standard	Korea	U.K	France	U.S.A	Germany	Italy	Japan	Russia	
Mark									
Testing Institute	KR	LR	BV	ABS	DNV-GL	RINA	NK	RMRS	
Certification Country	Korea	U.K	France	USA	Germany	Italy	Japan	Russia	
HGP50D	F*	●	●	●	●	●	●	●	
	S	●	●	●	●	●	●	●	
	H	●	●	●	●	●	●	●	
	X	●	●	●	●	●	●	●	
HGP125D	F*	●	●	●	●	●	●	●	
	S	●	●	●	●	●	●	●	
	H	●	●	●	●	●	●	●	
	X	●	●	●	●	●	●	●	
HGP160D	F*	●	●	●	●	●	●	●	
	S	●	●	●	●	●	●	●	
	H	●	●	●	●	●	●	●	
	X	●	●	●	●	●	●	●	
HGP250	F*	●	●	●	●	●	●	●	
	S	●	●	●	●	●	●	●	
	H	●	●	●	●	●	●	●	
	X	●	●	●	●	●	●	●	
HGP400	F*	●	●	●	●	●	●	●	
	S	●	●	●	●	●	●	●	
	H	●	●	●	●	●	●	●	
	X	●	●	●	●	●	●	●	
HGP630	F*	●	●	●	●	●	●	●	
	S	●	●	●	●	●	●	●	
	H	●	●	●	●	●	●	●	
	X	●	●	●	●	●	●	●	
HGP800	F*	●	●	●	●	●	●	●	
	S	●	●	●	●	●	●	●	
	H	●	●	●	●	●	●	●	
	X	●	●	●	●	●	●	●	

※ \*F Type products are dedicated overseas products.