

System Fenders

Floating Fenders

Arch Fenders

Other Fenders

Accessories

Pipes & Lining

Other Products

Rubber Fender

MARINE FENDERING SYSTEM





History

A company specializing in developing and delivering marine products and services; as well as an established provider of a wide range of high quality North American construction materials.

- Sourcing products, researching and identifying suppliers according to contract specifications resulting in dealerships and sales agreements.
- Promoting, procuring and supplying miscellaneous marine parts and products.
- Solidifying and developing relationships with existing and new vendors in the US marine industry.
- Preparing, participating and processing bids according administrative requirements.
- Exporting pre-owned yachts and managing necessary licensing and documentation.
- Administering purchases of canoes, rowing boats and equipment.
- Coordinating finances and overseas shipments.

Contents

System Fenders

SSP-Type Fender	4
HSP-Type Fender	7
STR-Type Fender	10
TR-Type Fender	13
TRS-Type Fender	16
Pad	17
Panel	18

Floating Fenders

Pneumatic Fender	19
Foam Filled Fender	22

Arch Fenders

AOV-Type Fender	23
ACV-Type Fender	25
NV-Type Fender	27

Other Fenders

CYL-Type Fender	29
BP-Type Fender	31
BC-Type Fender	32
RC, RD, DC, DD-Type Fender	34
MC-Type Fender	35
W-Type Fender	36
SBP-Type Fender	•
Roller-Type Fender	37
Composite-Type Fender	39
SM-Type Fender	40
Lord-Type Fender	•
Corner-Type Fender	•
Seal	•
Criteria for Designing Fender System	41
Rubber Properties	42
Standard Size of Vessel and Berthing Energy	43

Accessories

Resin-Type Anchor Bolt	45
I-Type Anchor Bolt	46
J-Type Anchor Bolt	•
Stud-Type Anchor Bolt	47
HS Chemical-Type Anchor Bolt	•
Washer	48
Chain & U-Anchor	•
Template	•

Pipes & Lining

Expansion Joint	49
Sleeve Hose	54
Lining	55

Other Products

Rubber Railroad Pad	57
Ladder	58
Bollard	59
Car Stopper	•
Corner Protector	•
Trench Cover Belt	•

System Fenders



System fender was specially developed for use in harbours used by larger vessels. These larger vessels, in order to keep their weight to the minimum in pursuit of efficiency, are normally constructed with hulls of relatively thin sheet steel. System Fender has a large surface contact area which will absorb a great amount of kinetic energy but will provide a low hull pressure so that the vessel may not be damaged during berthing operations. The System Fender is also used worldwide for large vessels where there's excessive difference between the rise and fall of the tide.

■ SSP-Type Fender

Super spool fender (SSP) has been improved over the ordinary spool fender at the buckling point and in the shape of the edge of the leg. Its wider dispersion of stress has been corroborated by the FEM (finite element method)

The wider dispersion of stress makes it possible to increase the design deflection from 45% to 52.5%, resulting in superior performance of the super spool fender, as well as being durable.

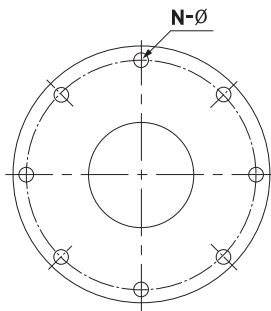
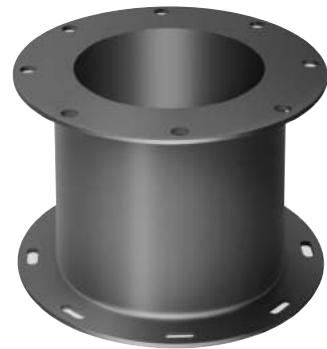

Panel Side

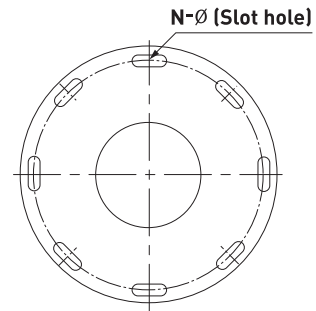
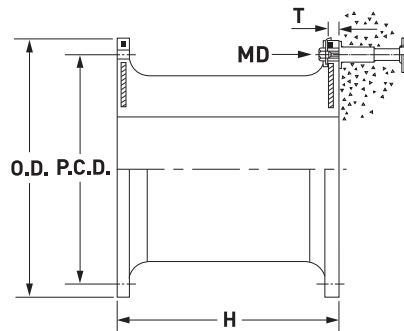

Wharf Side(Slot)

● Dimension

(Unit:mm)

Dimension Height	MD	O.D.	P.C.D.	N-Ø	N-Ø (Slot Hole)	T
300H	M20 (3/4)	400	340	4-25	4-25×35	15
500H	M24 (1)	650	550	4-32	4-32×40	25
630H	M27 (1 1/8)	840	700	4-39	4-39×49	25
650H	M27 (1 1/8)	870	730	4-39	4-39×49	25
800H	M30 (1 1/4)	1050	900	6-40	6-40×50	30
1000H	M36 (1 1/2)	1300	1100	6-47	6-47×58	35
1150H	M42 (1 3/4)	1500	1300	6-50	6-50×65	37
1200H	M42 (1 3/4)	1550	1350	6-53	6-53×65	38
1250H	M42 (1 3/4)	1650	1450	6-53	6-53×65	35
1400H	M48 (2)	1800	1600	6-60	6-60×75	37
1450H	M48 (2)	1850	1650	6-60	6-60×75	37
1600H	M48 (2)	2000	1800	8-60	8-60×75	45
1700H	M56 (2 1/4)	2100	1900	8-66	8-66×80	40
2000H	M64 (2 1/2)	2200	2000	8-74	8-74×95	50
2250H	M64 (2 1/2)	2550	2300	10-74	10-74×95	52
2500H	M64 (2 1/2)	2950	2700	10-74	10-74×95	70

- MD : Anchor Size See Page 45~47

● **Compression Test**

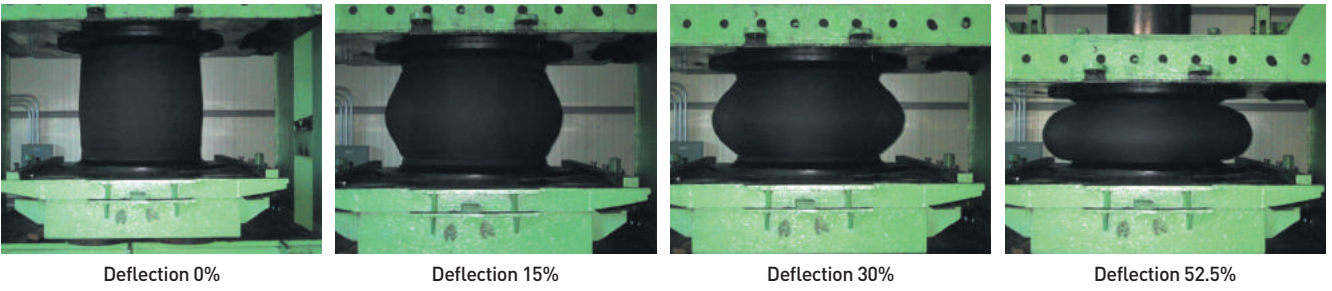

● **Performance Curve**

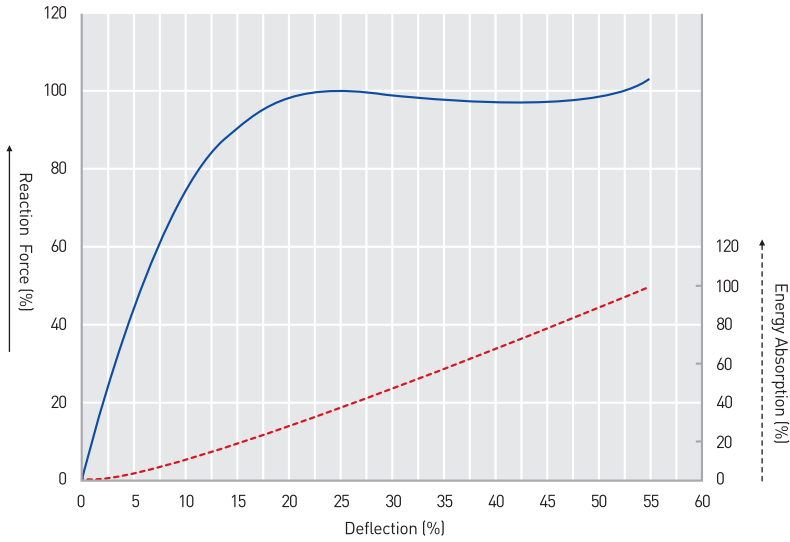

● **Performance of Intermediate Deflection**

Deflection(%)	R · F(%)	E · A(%)
0	0	0
5	44	3
10	74	9
15	91	18
20	99	29
25	100	40
30	99	51
35	98	62
40	97	73
45	98	84
50	99	95
52.5	100	100
55	104	106

● **Clearances**

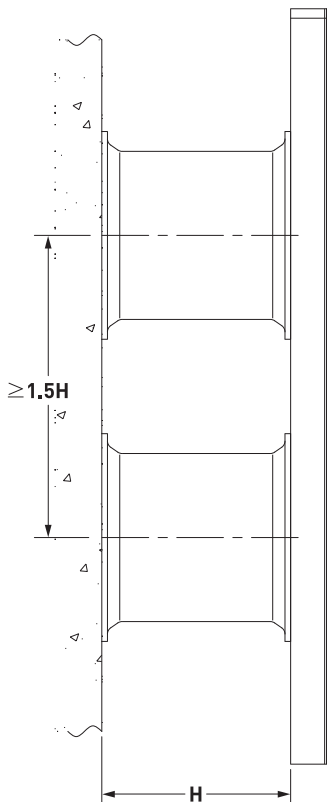

● **3D Model**

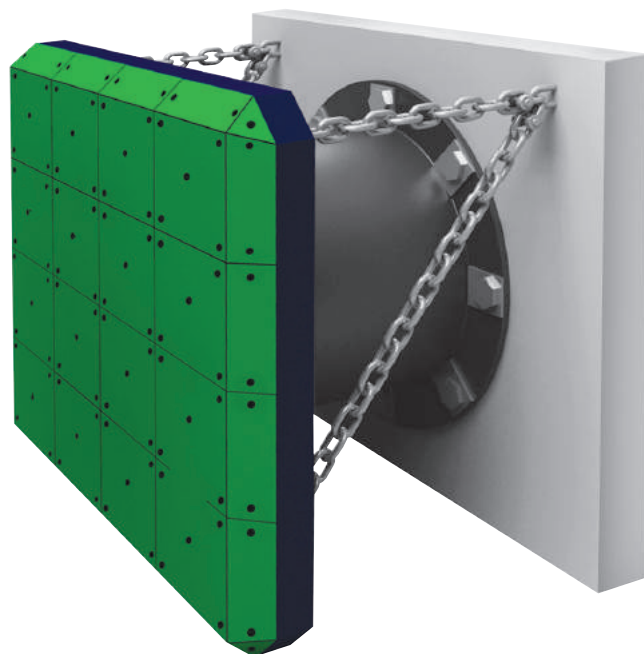

● Performance Table

Size Performance		300H	500H	630H	650H	800H	1000H	1150H	1200H	1250H	1400H	1450H	1600H	1700H	2000H	2250H	2500H
		R170	R • F(kN)	65.8	183	290	309	468	731	966	1052	1141	1432	1536	1870	2111	2922
	E • A(kJ)	8.8	41.3	82.6	90.7	169	330	502	571	645	906	1007	1353	1622	2642	3761	5159
R165	R • F(kN)	63.9	177	281	300	458	709	938	1021	1108	1390	1491	1815	2049	2836	3589	4431
	E • A(kJ)	8.6	40.1	80.1	88.0	164	321	487	554	626	879	977	1313	1575	2564	3651	5008
R160	R • F(kN)	61.9	172	273	291	440	688	909	990	1074	1348	1445	1760	1987	2750	3480	4297
	E • A(kJ)	8.3	38.8	77.7	85.3	159	311	473	537	607	853	948	1273	1527	2486	3540	4856
R155	R • F(kN)	60.0	167	264	281	426	666	881	959	1041	1305	1400	1705	1925	2664	3372	4163
	E • A(kJ)	8.1	37.6	75.3	82.7	154	301	458	520	588	826	918	1233	1479	2409	3429	4704
R150	R • F(kN)	58.1	161	256	272	413	645	852	928	1007	1263	1355	1650	1863	2578	3263	4028
	E • A(kJ)	7.8	36.4	72.9	80.0	149	291	443	504	569	800	888	1193	1431	2331	3319	4553
R145	R • F(kN)	56.1	156	247	263	399	623	824	897	974	1221	1310	1595	1801	2492	3154	3894
	E • A(kJ)	7.5	35.2	70.4	77.3	144	282	428	487	550	773	859	1154	1384	2253	3208	4401
R140	R • F(kN)	54.2	150	239	254	385	602	796	866	940	1179	1265	1540	1739	2406	3045	3760
	E • A(kJ)	7.3	34.0	68.0	74.7	139	272	414	470	531	746	829	1114	1336	2176	3098	4249
R135	R • F(kN)	52.2	145	230	245	371	580	767	835	906	1137	1220	1485	1676	2320	2937	3625
	E • A(kJ)	7.0	32.8	65.6	72.0	134	262	399	453	512	720	799	1074	1288	2098	2987	4097
R130	R • F(kN)	50.3	140	222	236	358	559	739	804	873	1095	1174	1430	1614	2234	2828	3491
	E • A(kJ)	6.8	31.6	63.1	69.3	129	253	384	436	493	693	770	1034	1241	2020	2876	3946
R125	R • F(kN)	48.4	134	213	227	344	537	710	773	839	1053	1129	1375	1552	2148	2719	3357
	E • A(kJ)	6.5	30.3	60.7	66.7	124	243	369	420	474	666	740	995	1193	1942	2766	3794
R120	R • F(kN)	46.4	129	205	218	330	516	682	743	806	1011	1084	1320	1490	2063	2610	3223
	E • A(kJ)	6.2	29.1	58.3	64.0	119	233	355	403	455	640	711	955	1145	1865	2655	3642
R115	R • F(kN)	44.5	124	196	209	316	494	654	712	772	969	1039	1265	1428	1977	2502	3088
	E • A(kJ)	6.0	27.9	55.9	61.3	114	223	340	386	436	613	681	915	1097	1787	2544	3490
R110	R • F(kN)	42.6	118	188	200	303	473	625	681	739	926	994	1210	1366	1891	2393	2954
	E • A(kJ)	5.7	26.7	53.4	58.7	109	214	325	369	417	586	651	875	1050	1709	2434	3339
R105	R • F(kN)	40.6	113	179	191	289	451	597	650	705	884	949	1155	1304	1805	2284	2820
	E • A(kJ)	5.5	25.5	51.0	56.0	104	204	310	352	398	560	622	835	1002	1632	2323	3187
R100	R • F(kN)	38.7	107	171	182	275	430	568	619	671	842	903	1100	1242	1719	2175	2686
	E • A(kJ)	5.2	24.3	48.6	53.3	99.4	194	295	336	379	533	592	796	954	1554	2213	3035
R95	R • F(kN)	36.8	102	162	173	261	408	540	588	638	800	858	1045	1180	1633	2067	2551
	E • A(kJ)	4.9	23.1	46.1	50.7	94.5	185	281	319	360	506	563	756	907	1476	2102	2883
R90	R • F(kN)	34.8	96.7	154	163	248	387	511	557	604	758	813	990	1118	1547	1958	2417
	E • A(kJ)	4.7	21.9	43.7	48.0	89.5	175	266	302	341	480	533	716	859	1399	1991	2732
R85	R • F(kN)	32.9	91.3	145	154	234	365	483	526	571	716	768	935	1056	1461	1849	2283
	E • A(kJ)	4.4	20.6	41.3	45.3	84.5	165	251	285	323	453	503	676	811	1321	1881	2580
R80	R • F(kN)	31.0	85.9	136	145	220	344	455	495	537	674	723	880	993	1375	1740	2148
	E • A(kJ)	4.2	19.4	38.9	42.7	79.6	155	236	269	304	426	474	637	763	1243	1770	2428

- R • F : Reaction Force(kN) - E • A : Energy Absorption(kJ) - Tolerance : ±5% or ±10% - Rated Deflection : 52.5% - Maximum Deflection : 55%

● PIANC Factor

Angle Factor		Velocity Factor		Temperature Factor	
Angle(°)	Factor	Time(sec)	Factor	Temp.(°C)	Factor
0	1.000	1	1.007	-30	1.205
3	0.976	2	1.004	-20	1.165
5	0.951	3	1.002	-10	1.128
8	0.911	4	1.001	0	1.092
10	0.885	5	1.000	10	1.054
15	0.807	6	1.000	23	1.000
20	0.655	8	1.000	30	0.975
		≥10	1.000	40	0.945
				50	0.935

■ HSP-Type Fender

Hyper spool fender (HSP) is a new circular type fender which is based on super spool fender.

It is high-performance marine fender with superior durability.

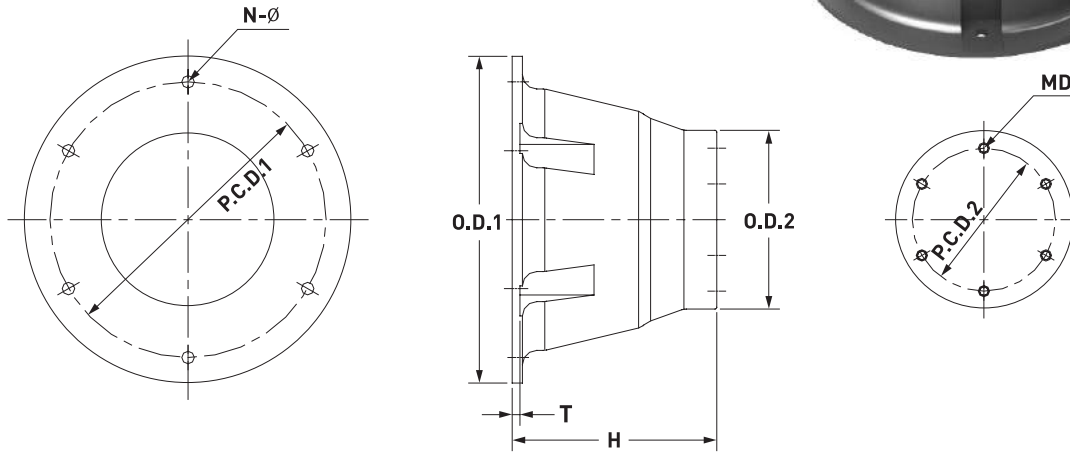

● Dimension

(Unit:mm)

Dimension Height	MD	O.D.1	P.C.D.1	O.D.2	P.C.D.2	T	N-ø
300H	M20(3/4)	500	440	262	210	18	4-26
350H	M20(3/4)	575	510	306	245	20	4-26
400H	M20(3/4)	650	585	350	280	20	4-26
500H	M24(1)	820	730	436	350	22	4-30
600H	M24(1)	900	810	525	420	23	4-30
700H	M30(1 1/4)	1120	1020	615	490	26	4-38
800H	M36(1 1/2)	1250	1165	700	560	31	6-44
900H	M36(1 1/2)	1450	1313	785	630	36	6-44
1000H	M42(1 3/4)	1600	1460	875	700	38	6-50
1150H	M42(1 3/4)	1850	1550	1000	805	41	6-50
1200H	M42(1 3/4)	1920	1750	1050	840	46	8-50
1300H	M48(2)	2080	1900	1140	910	50	8-60
1400H	M48(2)	2240	2040	1230	980	53	8-60
1600H	M48(2)	2500	2330	1400	1120	80	8-60
1800H	M56(2 1/4)	2880	2620	1575	1260	90	10-70
2000H	M56(2 1/4)	3200	2920	1700	1400	100	10-70

- MD : Anchor Size See Page 45~47

● **Compression Test**

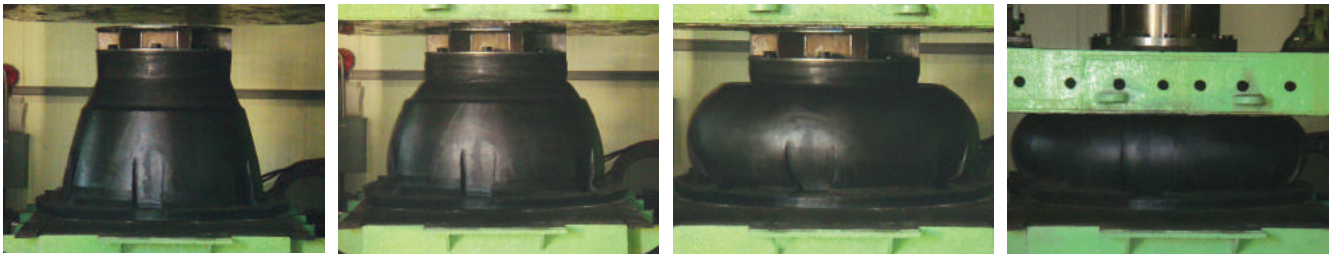

Deflection 0%

Deflection 30%

Deflection 50%

Deflection 70%

● **Performance Curve**

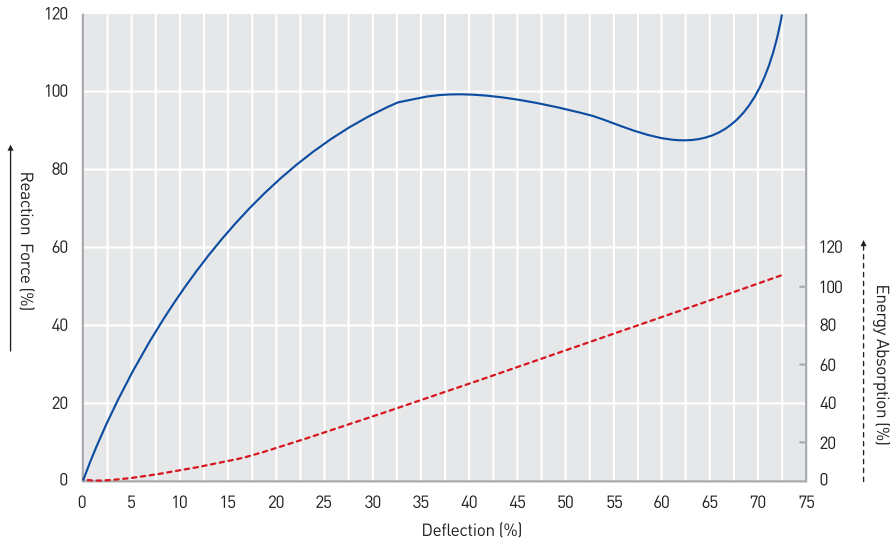

● **Performance of Intermediate Deflection**

Deflection(%)	R · F(%)	E · A(%)
0	0	0
5	27	1
10	48	5
15	65	10
20	78	16
25	88	24
30	95	32
35	99	40
40	100	49
45	99	58
50	96	67
55	93	75
60	89	84
65	89	92
70	100	100
72.5	121	105

● **Clearances**

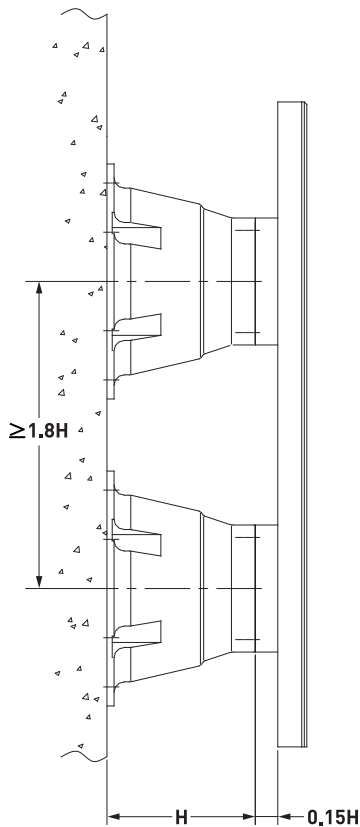

● **3D Model**

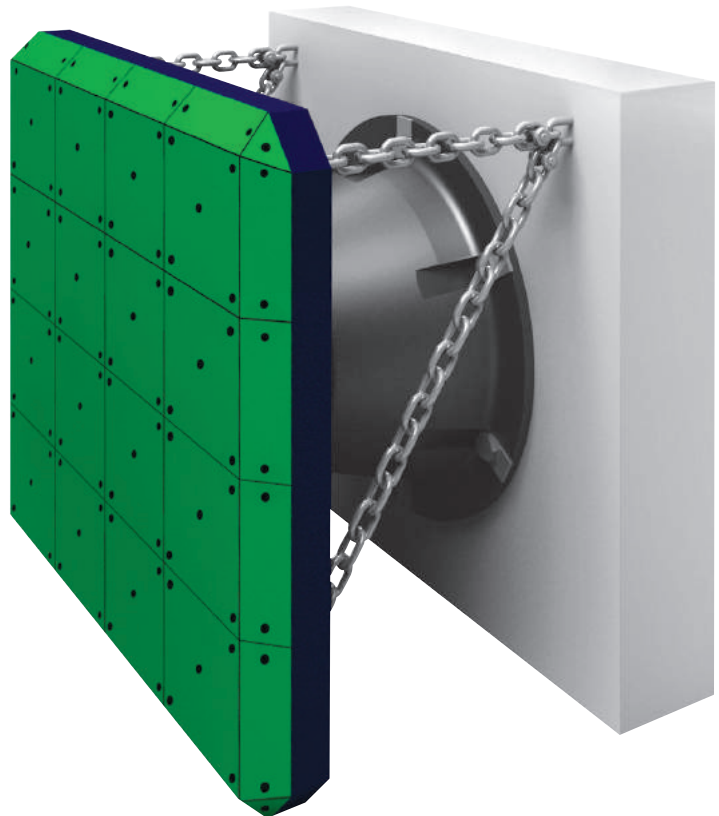

● Performance Table

Size		300H	350H	400H	500H	600H	700H	800H	900H	1000H	1150H	1200H	1300H	1400H	1600H	1800H	2000H
Performance																	
R150	R • F(kN)	109	149	194	305	437	596	778	984	1216	1607	1750	2054	2382	3112	3938	4862
	E • A(kJ)	17.7	28.1	42.7	85.3	146	233	347	493	677	1030	1170	1488	1857	2772	3948	5415
R145	R • F(kN)	105	144	188	294	423	576	753	952	1175	1553	1691	1986	2303	3009	3807	4700
	E • A(kJ)	17.1	27.2	41.3	82.5	141	225	336	477	654	996	1131	1438	1795	2680	3816	5235
R140	R • F(kN)	102	139	181	284	408	556	727	919	1134	1500	1633	1917	2224	2905	3675	4538
	E • A(kJ)	16.5	26.3	39.8	79.7	136	217	324	460	632	961	1092	1389	1733	2588	3685	5054
R135	R • F(kN)	98.0	134	175	274	393	536	701	886	1094	1446	1575	1849	2144	2801	3544	4376
	E • A(kJ)	15.9	25.3	38.4	76.8	131	209	313	444	609	927	1053	1339	1671	2495	3553	4874
R130	R • F(kN)	94.4	129	168	264	379	517	675	853	1053	1393	1516	1780	2065	2697	3413	4214
	E • A(kJ)	15.3	24.4	37.0	74.0	126	202	301	427	587	893	1014	1289	1609	2403	3422	4693
R125	R • F(kN)	90.7	124	162	254	364	497	649	820	1013	1339	1458	1712	1985	2594	3281	4052
	E • A(kJ)	14.7	23.4	35.6	71.1	121	194	289	411	564	858	975	1240	1548	2310	3290	4513
R120	R • F(kN)	87.1	119	155	244	350	477	623	788	972	1286	1400	1643	1906	2490	3150	3890
	E • A(kJ)	14.1	22.5	34.1	68.3	117	186	278	394	542	824	936	1190	1486	2218	3158	4332
R115	R • F(kN)	83.5	114	149	234	335	457	597	755	932	1232	1341	1575	1827	2386	3019	3727
	E • A(kJ)	13.5	21.6	32.7	65.4	112	178	266	378	519	790	897	1141	1424	2125	3027	4152
R110	R • F(kN)	79.9	109	142	223	321	437	571	722	891	1178	1283	1506	1747	2282	2888	3565
	E • A(kJ)	12.9	20.6	31.3	62.6	107	171	255	362	496	755	858	1091	1362	2033	2895	3971
R105	R • F(kN)	76.2	104	136	213	306	417	545	689	851	1125	1225	1438	1668	2179	2756	3403
	E • A(kJ)	12.4	19.7	29.9	59.7	102	163	243	345	474	721	819	1041	1300	1941	2764	3791
R100	R • F(kN)	72.6	99.1	130	203	291	397	519	656	810	1071	1166	1370	1588	2075	2625	3241
	E • A(kJ)	11.8	18.8	28.4	56.9	97.1	155	232	329	451	687	780	992	1238	1848	2632	3610
R95	R • F(kN)	69.0	94.1	123	193	277	377	493	624	770	1018	1108	1301	1509	1971	2494	3079
	E • A(kJ)	11.2	17.8	27.0	54.1	92.3	147	220	312	429	652	741	942	1176	1756	2500	3430
R90	R • F(kN)	65.3	89.2	117	183	262	358	467	591	729	964	1050	1233	1429	1867	2363	2917
	E • A(kJ)	10.6	16.9	25.6	51.2	87.4	140	208	296	406	618	702	893	1114	1663	2369	3249
R85	R • F(kN)	61.7	84.2	110	173	248	338	441	558	689	911	991	1164	1350	1764	2231	2755
	E • A(kJ)	10.0	15.9	24.2	48.4	82.6	132	197	279	384	584	663	843	1052	1571	2237	3069
R80	R • F(kN)	58.1	79.3	104	163	233	318	415	525	648	857	933	1096	1271	1660	2100	2593
	E • A(kJ)	9.4	15.0	22.8	45.5	77.7	124	185	263	361	549	624	793	990	1479	2106	2888

- R • F : Reaction Force(kN) - E • A : Energy Absorption(kJ) - Tolerance : ±5% or ±10% - Rated Deflection : 70% - Maximum Deflection : 72.5%

● PIANC Factor

Angle Factor		Velocity Factor		Temperature Factor	
Angle(°)	Factor	Time(sec)	Factor	Temp.(°C)	Factor
0	1.000	1	1.048	-30	1.205
3	1.000	2	1.025	-20	1.165
5	1.000	3	1.014	-10	1.128
8	0.991	4	1.006	0	1.092
10	0.982	5	1.000	10	1.054
15	0.935	6	1.000	23	1.000
20	0.876	8	1.000	30	0.975
		≥10	1.000	40	0.945
				50	0.935

■ STR-Type Fender

Super TR(STR) is an improved model from previous TR Fender, developed since highly efficient fender was in need of developing. And, this fender can also be used in a vessel upgrade when there is lack of space for setting up.

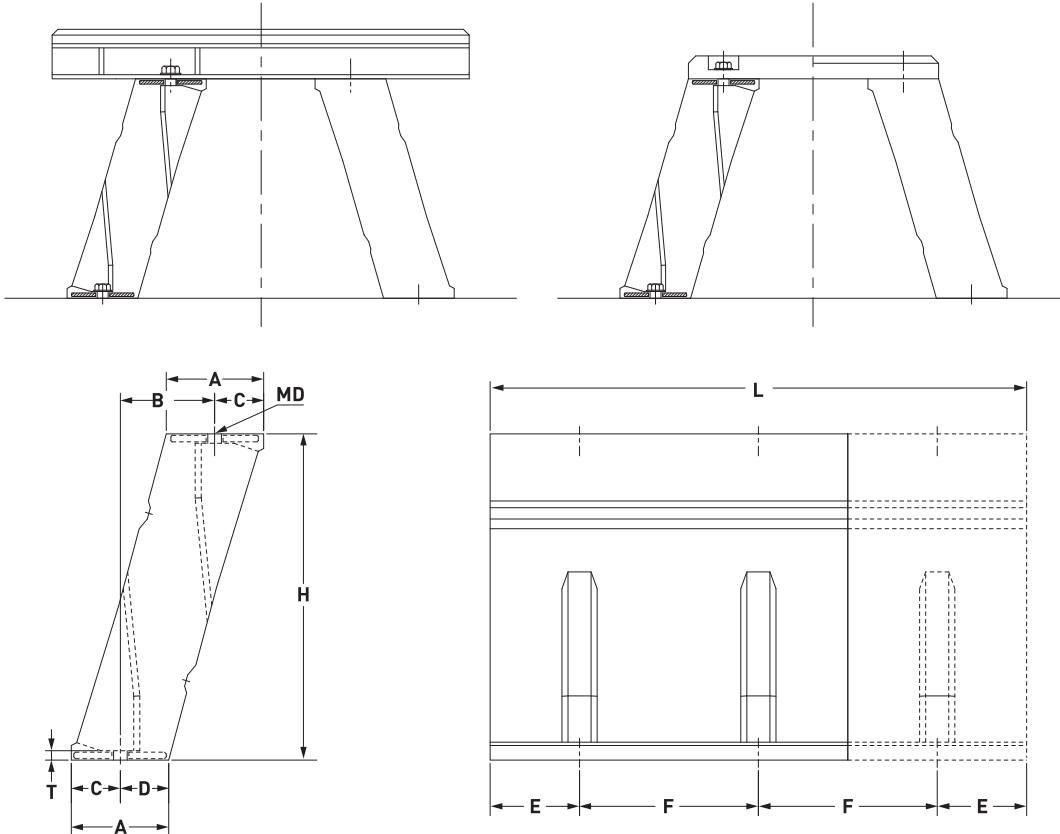
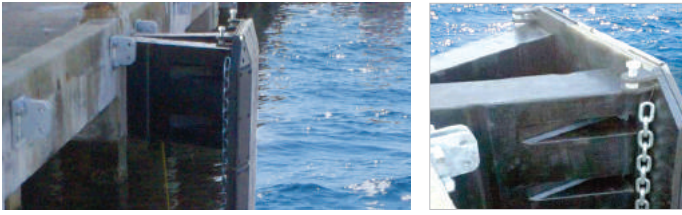

● Dimension

(Unit:mm)

Dimension	MD	T	A	B	C	D	E	F
Height								
250H	M20(3/4)	17	80	78	40	40	150	300
300H	M20(3/4)	17	94	93	47	47	150	300
400H	M24(1)	17	125	124	63	62	250	500
500H	M30(1 1/4)	20	158	142	87	71	250	500
600H	M30(1 1/4)	20	188	199	87	101	250	500
750H	M36(1 1/2)	26	235	230	118	117	250	500
800H	M36(1 1/2)	26	250	240	129	121	250	500
1000H	M42(1 3/4)	31	322	310	162	160	250	500
1250H	M48(2)	36	401	388	202	199	250	500
1450H	M48(2)	41	454	445	228	226	250	500
1600H	M56(2 1/4)	50	507	480	261	246	250	500

- MD : Anchor Size See Page 45~47

● **Compression Test**

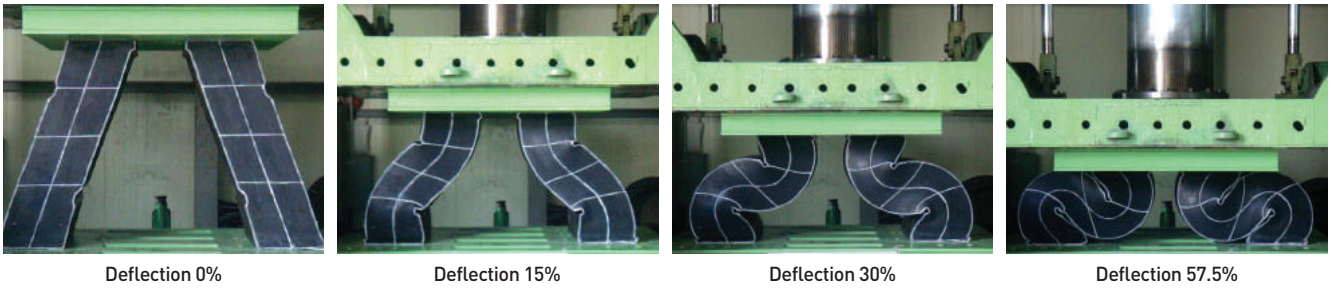

● **Performance Curve**

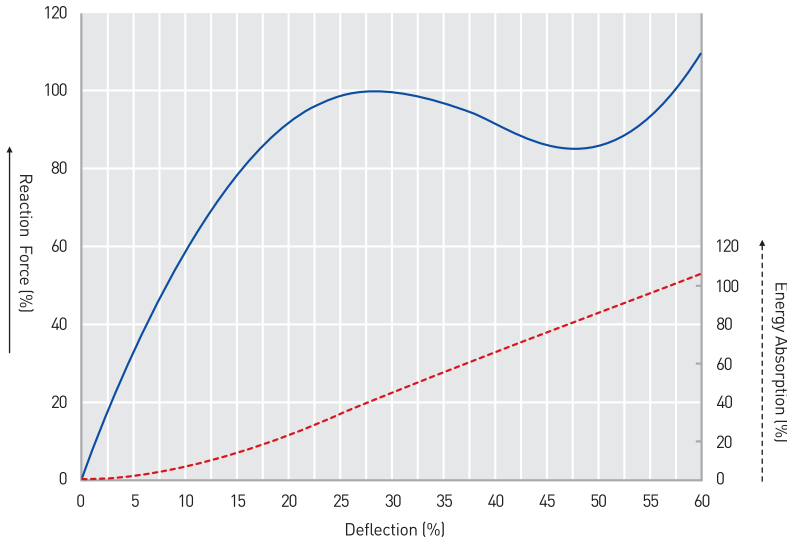

● **Performance of Intermediate Deflection**

Deflection(%)	R • F(%)	E • A(%)
0	0	0
5	32	2
10	60	7
15	79	14
20	92	24
25	99	34
30	100	45
35	97	56
40	92	66
45	86	76
50	85	86
55	94	95
57.5	100	100
60	110	106

● **Clearances**

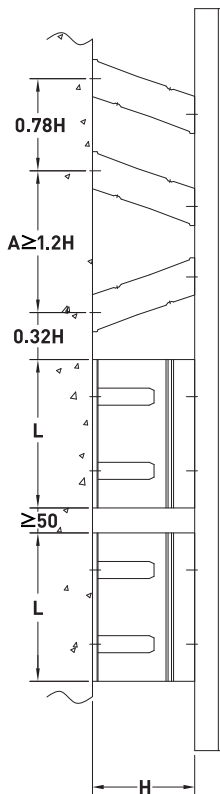

● **3D Model**

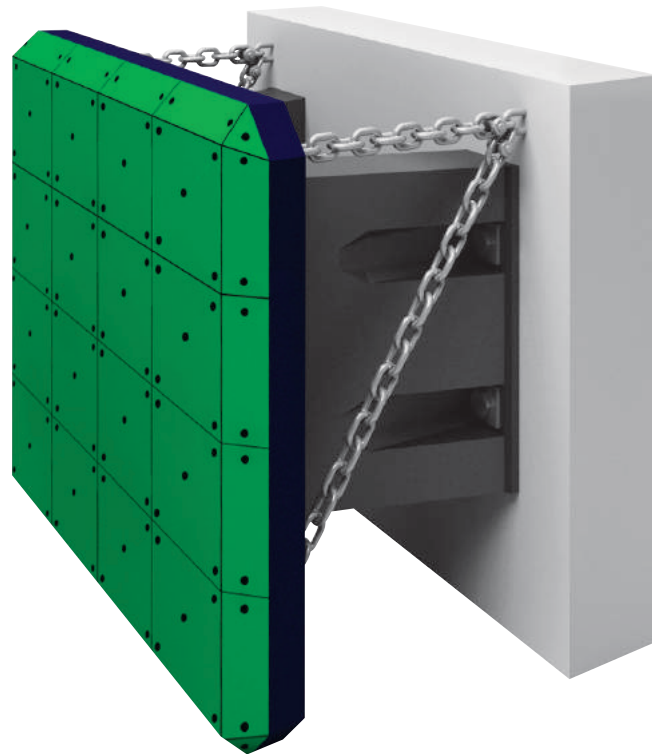

● Performance Table

(1m Length)

Size		250H	300H	400H	500H	600H	750H	800H	1000H	1250H	1450H	1600H
Performance												
R165	R • F(kN)	295	353	471	589	706	882	942	1177	1471	1706	1883
	E • A(kJ)	34.0	48.6	85.8	136	194	304	346	541	845	1136	1384
R160	R • F(kN)	286	342	457	571	684	855	914	1141	1427	1654	1825
	E • A(kJ)	33.0	47.1	83.2	132	188	295	336	524	819	1102	1342
R155	R • F(kN)	277	332	443	554	663	829	885	1105	1382	1603	1768
	E • A(kJ)	31.9	45.6	80.6	128	183	286	325	508	794	1067	1300
R150	R • F(kN)	268	321	428	536	642	802	856	1070	1338	1551	1711
	E • A(kJ)	30.9	44.1	78.0	124	177	277	315	492	768	1033	1258
R145	R • F(kN)	259	310	414	518	620	775	828	1034	1293	1499	1654
	E • A(kJ)	29.9	42.7	75.4	120	171	267	304	475	743	999	1216
R140	R • F(kN)	250	299	400	500	599	749	799	999	1248	1448	1597
	E • A(kJ)	28.8	41.2	72.8	115	165	258	294	459	717	964	1174
R135	R • F(kN)	241	289	385	482	577	722	771	963	1204	1396	1540
	E • A(kJ)	27.8	39.7	70.2	111	159	249	283	442	691	930	1132
R130	R • F(kN)	232	278	371	464	556	695	742	927	1159	1344	1483
	E • A(kJ)	26.8	38.3	67.6	107	153	240	273	426	666	895	1090
R125	R • F(kN)	223	267	357	446	535	668	714	892	1115	1293	1426
	E • A(kJ)	25.8	36.8	65.0	103	147	231	262	410	640	861	1048
R120	R • F(kN)	214	257	343	429	513	642	685	856	1070	1241	1369
	E • A(kJ)	24.7	35.3	62.4	98.9	141	221	252	393	615	826	1007
R115	R • F(kN)	205	246	328	411	492	615	657	820	1026	1189	1312
	E • A(kJ)	23.7	33.8	59.8	94.8	135	212	241	377	589	792	965
R110	R • F(kN)	196	235	314	393	471	588	628	785	981	1137	1255
	E • A(kJ)	22.7	32.4	57.2	90.6	130	203	231	360	563	758	923
R105	R • F(kN)	188	225	300	375	449	561	600	749	936	1086	1198
	E • A(kJ)	21.6	30.9	54.6	87	124	194	220	344	538	723	881
R100	R • F(kN)	179	214	286	357	428	535	571	713	892	1034	1141
	E • A(kJ)	20.6	29.4	52.0	82.4	118	184	210	328	512	689	839
R95	R • F(kN)	170	203	271	339	406	508	542	678	847	982	1084
	E • A(kJ)	19.6	28.0	49.4	78.3	112	175	199	311	487	654	797
R90	R • F(kN)	161	193	257	321	385	481	514	642	803	931	1027
	E • A(kJ)	18.5	26.5	46.8	74.2	106	166	189	295	461	620	755
R85	R • F(kN)	152	182	243	304	364	454	485	606	758	879	970
	E • A(kJ)	17.5	25.0	44.2	70.0	100	157	178	279	435	585	713
R80	R • F(kN)	143	171	228	286	342	428	457	571	713	827	913
	E • A(kJ)	16.5	23.5	41.6	65.9	94.2	148	168	262	410	551	671

- R • F : Reaction Force(kN) - E • A : Energy Absorption(kJ) - Tolerance : ±5% or ±10% - Deflection : 57.5%

● PIANC Factor

Angle Factor

Angle(°)	Factor(A=1.2H)	Factor(A=1.5H)
0	1.000	1.000
3	0.995	0.986
5	0.989	0.968
8	0.975	0.934
10	0.960	0.897
15	0.900	0.801
20	0.830	0.705

Velocity Factor

Time(sec)	Factor
1	1.017
2	1.009
3	1.004
4	1.002
5	1.001
6	1.000
8	1.000
≥10	1.000

Temperature Factor

Temp.(°C)	Factor
-30	1.205
-20	1.165
-10	1.128
0	1.092
10	1.054
23	1.000
30	0.975
40	0.945
50	0.935

■ TR-Type Fender

TR fender consists of two independent legs of solid rubber bolted to a wide steel-framed rubbing board protected with square pads of high quality plastic material.

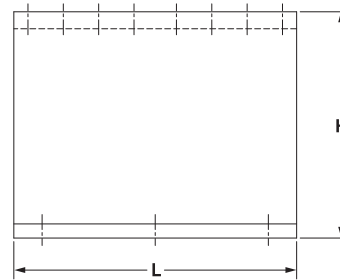
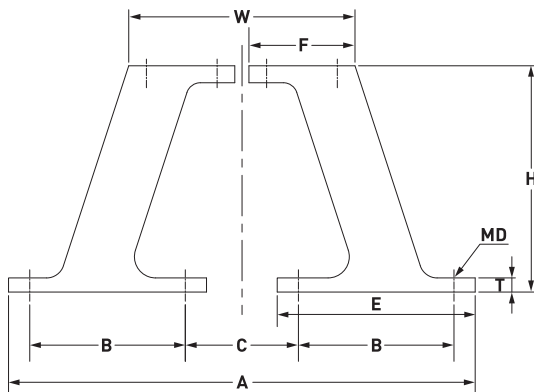
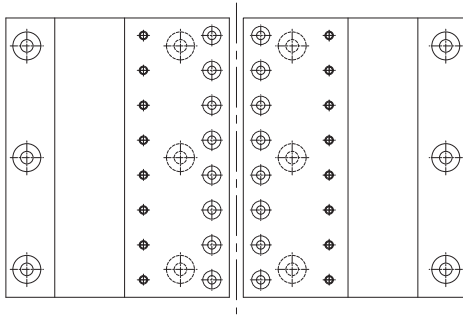

● Dimension

(Unit:mm)

Dimension	MD	A	B	C	E	F	T	W	L
Height									
600H	M48(2)	1435	450	375	592.5	180	50	965	1000 ~ 3000
800H	M64(2 1/2)	1850	585	480	765	240	60	800	
1000H	M64(2 1/2)	2180	685	610	890	300	65	1000	
1150H	M64(2 1/2)	2500	800	650	1005	345	65	1150	
1300H	M76(3)	2740	880	750	1115	395	65	1300	
1450H	M76(3)	3100	1000	800	1300	675	100	1450	
1600H	M76(3)	3300	1100	800	1400	750	100	1600	
1800H	M76(3)	3670	1200	970	1500	830	110	1800	
2000H	M76(3)	4050	1300	1150	1600	880	120	2000	
2250H	M76(3)	4400	1400	1300	1700	945	130	2250	
2500H	M76(3)	4860	1500	1560	1800	1000	140	2500	

- MD : Anchor Size See Page 45~47



● **Compression Test**

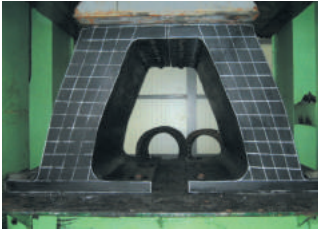

Deflection 0%

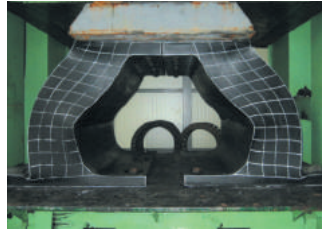

Deflection 15%

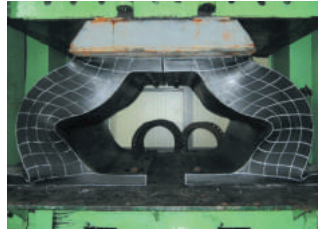

Deflection 30%

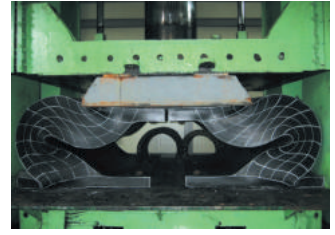

Deflection 57.5%

● **Performance Curve**

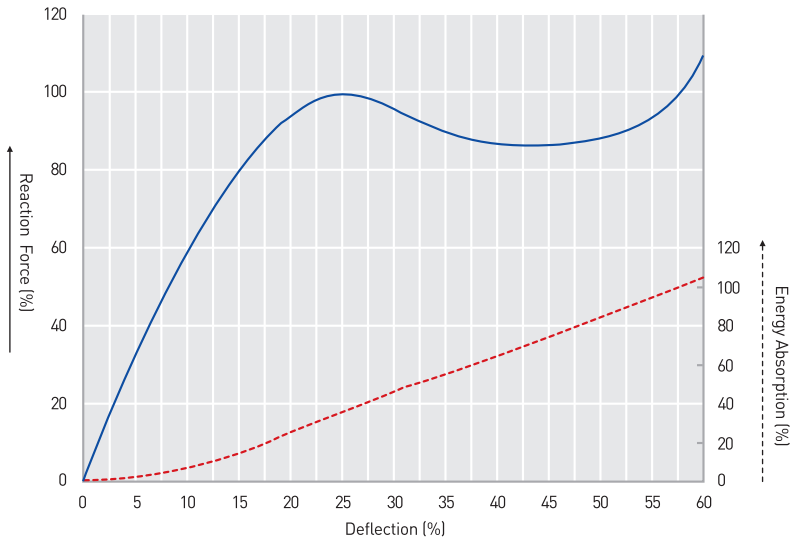

● **Performance of Intermediate Deflection**

Deflection(%)	R · F(%)	E · A(%)
0	0	0
5	33	2
10	58	7
15	80	14
20	94	24
25	100	35
30	96	45
35	90	56
40	87	65
45	86	75
50	89	85
55	94	95
57.5	100	100
60	110	106

● **3D Model**

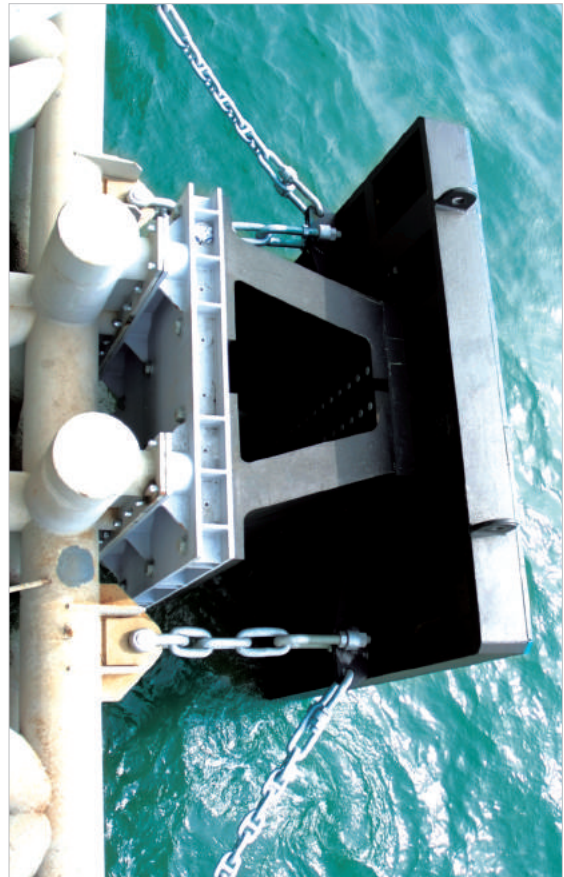
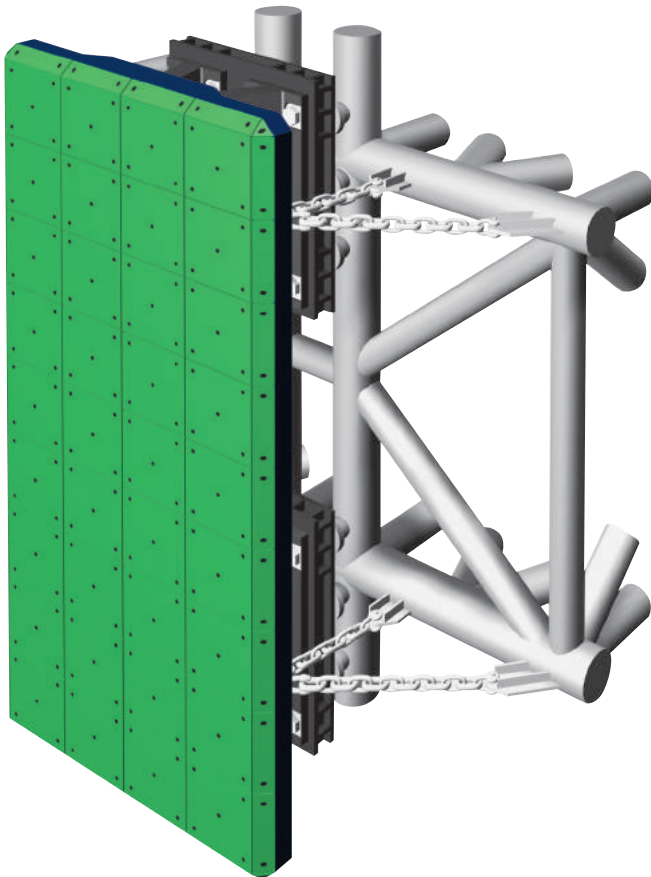

● Performance Table

Size		600H	800H	1000H	1150H	1300H	1450H	1600H	1800H	2000H	2250H	2500H
Performance												
R150	R • F(kN)	645	859	1074	1236	1397	1558	1719	1934	2148	2418	2686
	E • A(kJ)	175	311	486	642	821	1021	1243	1573	1942	2459	3036
R145	R • F(kN)	623	831	1038	1195	1350	1506	1661	1869	2077	2337	2596
	E • A(kJ)	169	300	469	620	794	987	1202	1521	1878	2377	2935
R140	R • F(kN)	602	802	1003	1154	1303	1454	1604	1805	2005	2257	2507
	E • A(kJ)	163	290	453	599	766	953	1161	1468	1813	2295	2833
R135	R • F(kN)	580	773	967	1113	1257	1403	1547	1740	1934	2176	2417
	E • A(kJ)	158	279	437	577	739	919	1119	1416	1748	2213	2732
R130	R • F(kN)	559	745	931	1071	1210	1351	1490	1676	1862	2095	2327
	E • A(kJ)	152	269	421	556	712	885	1078	1363	1683	2131	2631
R125	R • F(kN)	537	716	895	1030	1164	1299	1432	1611	1790	2015	2238
	E • A(kJ)	146	259	405	535	684	851	1036	1311	1619	2049	2530
R120	R • F(kN)	516	688	859	989	1117	1247	1375	1547	1719	1934	2148
	E • A(kJ)	140	248	389	513	657	817	995	1258	1554	1967	2429
R115	R • F(kN)	494	659	824	948	1071	1195	1318	1482	1647	1854	2059
	E • A(kJ)	134	238	372	492	630	783	953	1206	1489	1885	2327
R110	R • F(kN)	473	630	788	906	1024	1143	1260	1418	1576	1773	1969
	E • A(kJ)	128	228	356	471	602	749	912	1154	1424	1803	2226
R105	R • F(kN)	451	602	752	865	978	1091	1203	1354	1504	1692	1880
	E • A(kJ)	123	217	340	449	575	715	870	1101	1360	1721	2125
R100	R • F(kN)	430	573	716	824	931	1039	1146	1289	1432	1612	1790
	E • A(kJ)	117	207	324	428	547	681	829	1049	1295	1639	2024
R95	R • F(kN)	408	544	680	783	884	987	1089	1225	1361	1531	1701
	E • A(kJ)	111	197	308	406	520	647	788	996	1230	1557	1923
R90	R • F(kN)	387	516	645	742	838	935	1031	1160	1289	1451	1611
	E • A(kJ)	105	186	291	385	493	613	746	944	1165	1475	1821
R85	R • F(kN)	365	487	609	700	791	883	974	1096	1217	1370	1522
	E • A(kJ)	99.2	176	275	364	465	579	705	891	1101	1393	1720
R80	R • F(kN)	344	458	573	659	745	831	917	1031	1146	1289	1432
	E • A(kJ)	93.4	166	259	342	438	545	663	839	1036	1311	1619
R75	R • F(kN)	322	430	537	618	698	779	859	967	1074	1209	1343
	E • A(kJ)	87.6	155	243	321	411	511	622	787	971	1229	1518
R70	R • F(kN)	301	401	501	577	652	727	802	902	1003	1128	1253
	E • A(kJ)	81.7	145	227	299	383	477	580	734	906	1148	1417

- R • F : Reaction Force(kN) - E • A : Energy Absorption(kJ) - Tolerance : ±5% or ±10% - Rated Deflection : 57.5% -Maximum Deflection : 60%

● Angular Berthing

Fender System 1 (Transversal Angular Berthing)

Fender System 2 (Longitudinal Angular Berthing)

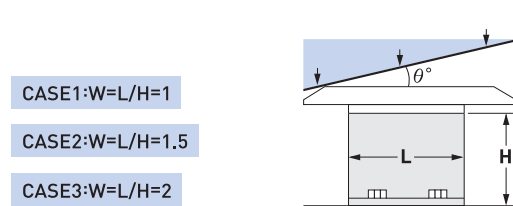
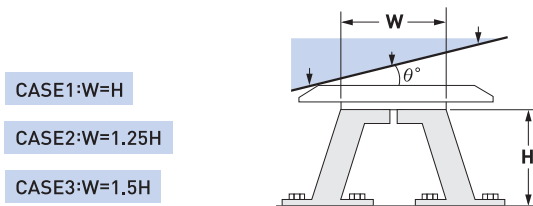

● Angular Performance Factor

Angle (Deg)		0		3		6		9		12		15	
Performance		R • F	E • A	R • F	E • A	R • F	E • A	R • F	E • A	R • F	E • A	R • F	E • A
Transversal Angular	Case1 (W=H)	1.00	1.00	0.95	0.94	0.93	0.88	0.92	0.82	0.91	0.76	0.90	0.70
	Case2 (W=1.25H)	1.00	1.00	0.94	0.92	0.92	0.85	0.90	0.78	0.88	0.70	0.86	0.63
	Case3 (W=1.5H)	1.00	1.00	0.93	0.90	0.91	0.82	0.88	0.74	0.85	0.65	0.82	0.56
Longitudinal Angular	Case1 (L/H=1)	1.00	1.00	0.97	0.94	0.94	0.89	0.92	0.85	0.90	0.80	0.88	0.75
	Case2 (L/H=1.5)	1.00	1.00	0.94	0.92	0.93	0.85	0.90	0.78	0.86	0.72	0.80	0.65
	Case3 (L/H=2)	1.00	1.00	0.94	0.89	0.92	0.80	0.89	0.72	0.89	0.65	0.90	0.58

■ TRS-Type Fender

TRS fender is an improved V type fender which has high energy absorption. R/E ratio is smaller than other Fenders. It is reinforced by an embedded steel plate across the entire bottom as well as the top of the fender. Resin board is attached on the top of the fender in order to protect the rubber body, to gain better performance and to decrease friction force.

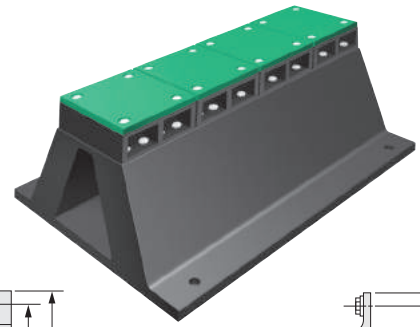

TRS-A Type : This type has a synthetic resin board installed on its top.

TRS-B Type : This type has a synthetic resin board, which is not of one piece but divided into separate piece as many as required, installed on its top.

TRS-C Type : This type is the one which has a synthetic resin board installed on top of the I.S. joint (steel made) already fixed.

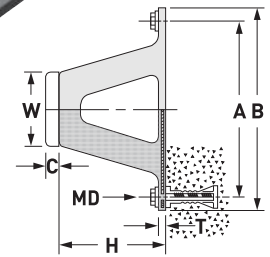
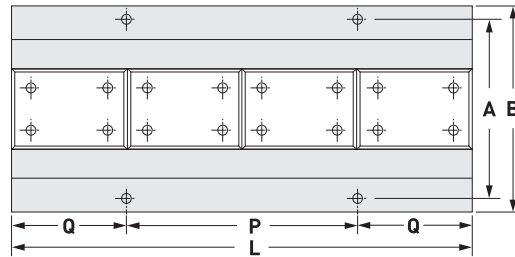

● Dimension

(Unit:mm)

Dimension Height	MD	A	B	P	Q	T	W
150	M18 (3/4)	260	320	500	250	20	100
200	M24 (1)	310	380	500	250	25	130
250	M24 (1)	400	500	500	250	30	160
300	M30 (1 1/4)	530	645	500	250	35	190
400	M36 (1 1/2)	710	840	500	250	40	250
500	M42 (1 3/4)	860	1000	500	250	45	320
600	M48 (2)	1050	1210	500	250	50	380
800	M64 (2 1/2)	1350	1550	500	250	60	500
1000	M64 (2 1/2)	1600	1800	500	250	70	640

- C : 30~100mm - MD : Anchor Size See Page 45~47

● Performance Curve

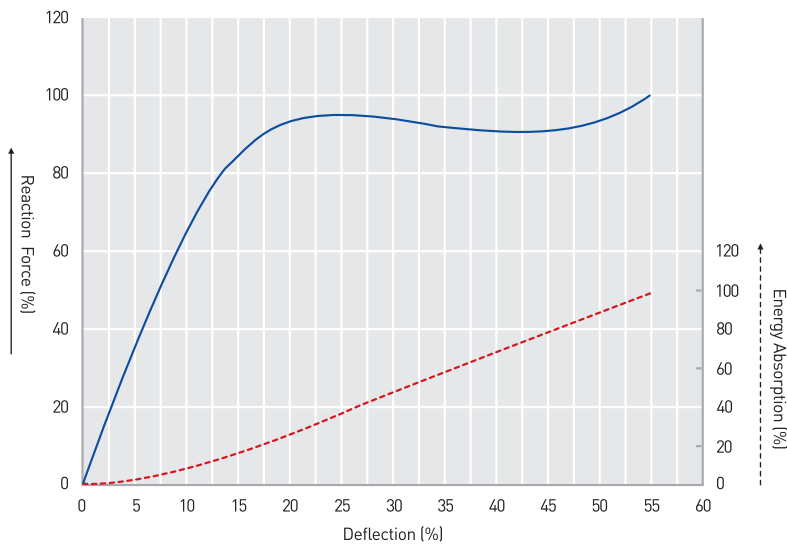

● Performance of Intermediate Deflection

Deflection(%)	R · F(%)	E · A(%)
0	0	0
5	36	2
10	65	8
15	84	16
20	93	26
25	95	37
30	93	48
35	92	58
40	90	68
45	91	79
50	93	89
55	100	100

● Performance Table

(1m Length)

Size		150H	200H	250H	300H	400H	500H	600H	800H	1000H
Performance										
RH	R · F(kN)	129	172	215	257	343	429	515	686	859
	E · A(kJ)	7.8	14.7	23.5	33.3	59.8	94.1	135	241	376
RM	R · F(kN)	108	143	179	215	286	358	429	572	715
	E · A(kJ)	6.9	12.7	19.6	28.4	50.0	78.4	113	201	314
RL	R · F(kN)	88.2	114	143	172	228	286	343	458	572
	E · A(kJ)	4.9	9.0	15.7	22.5	39.2	62.7	90.2	161	251

- R · F : Reaction Force(kN) - E · A : Energy Absorption(kJ) - Tolerance : ±5% or ±10% - Deflection : 55%

■ Pad

Some types of fenders have pads on its steel frame. The pad is attached to the fender to minimise scraping on a vessels hull due to the friction coefficient between vessel and fender.



Applicable color

Colors above may be differed from actual products

● Resin Pad (HDPE)

Physical Properties	Testing Standard	Requirement
Density	ASTM D 1505, JIS K 7112	0.92 ~ 1.05 g/cm ³
Tensile Strength	ASTM D 638, JIS K 7113	Min. 20 MPa
Elongation		Min. 500 %
Compression Strength	ASTM D 695a, JIS K 7181	Min. 30 MPa
Friction Coefficient	ASTM D 1894	Max. 0.2

● Resin Pad (UHMW-PE)

Physical Properties	Testing Standard	Requirement
Density	ISO 1183	0.922~0.942 g/cm ³
Wear resistance	DIN 58836	100 ± 10%
Yield stress	ISO 527	Min. 17 Mpa
Tensile strain	ISO 527	Min. 8 %
Modulus of elasticity	ISO 527	Min. 700 Mpa
Impact strength	ISO 179 (double-notched)	Min. 170 kJ/m ²
	ISO 179 (single-notched)	No fracture



■ Panel

System fenders can be fitted with frontal panel to obtain wide contact area with the vessel, reducing pressure against the vessel hulls as much as required.



Example of Structure Analysis

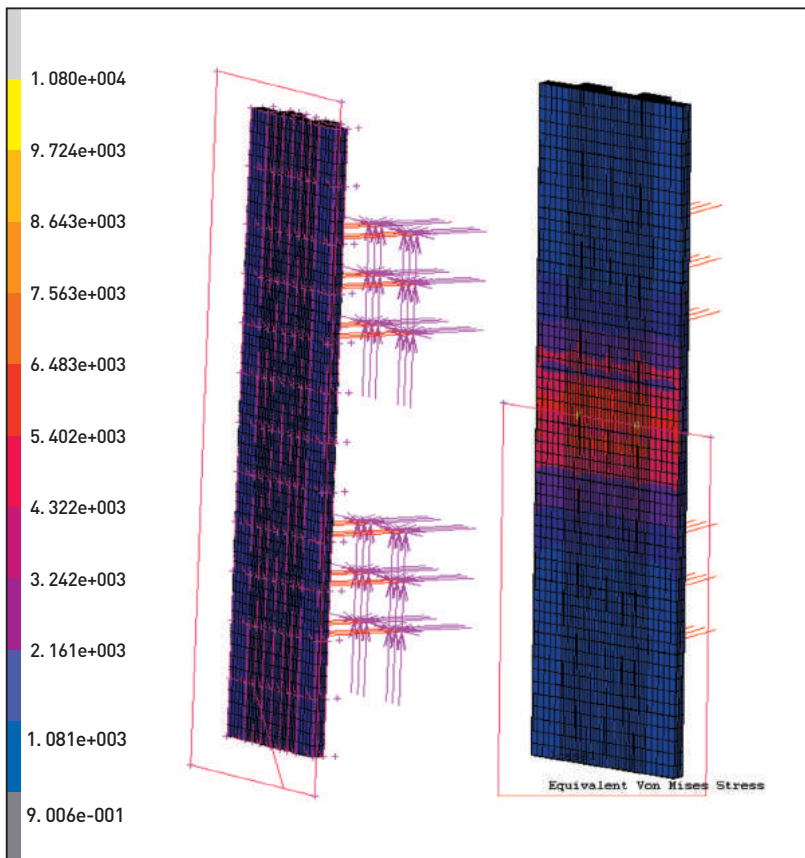
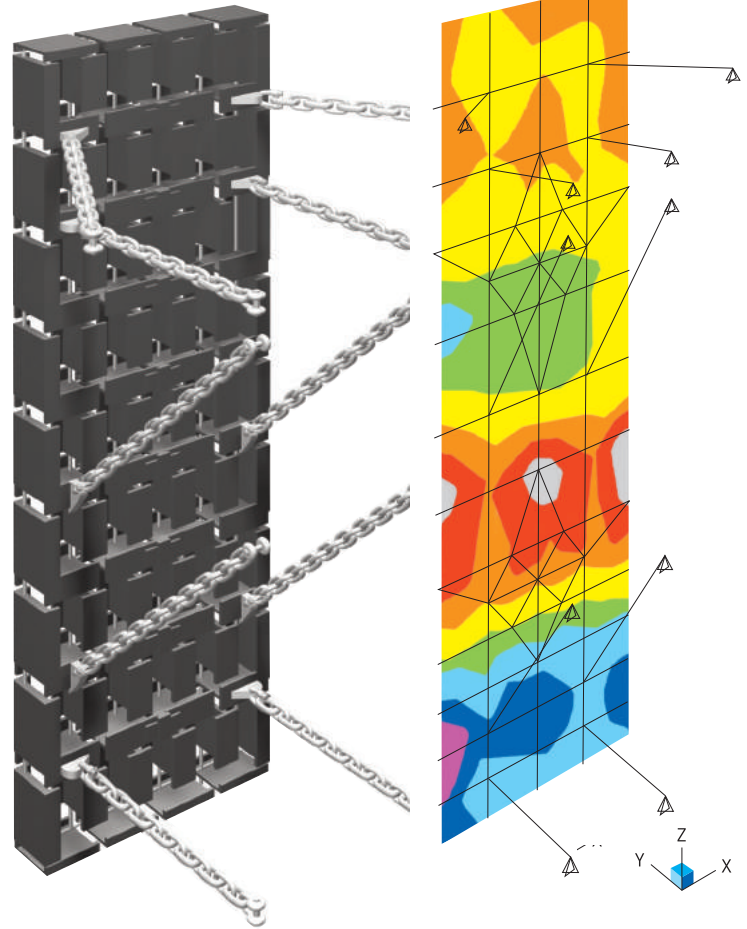



Floating Fenders

Excellent compressibility and elasticity

Unlike the general rubber fender using the elasticity of rubber, this one utilizes the compressibility and elasticity of air. Therefore, the shock absorption rate is substantially upgraded.

Good buoyancy and simplified handling

Floating fenders are buoyant, and they do their job at best possible position without being affected by tides. Moreover they are much lighter and easier to handle than the conventional solid rubber models due to their hollow construction.

Low reaction and high absorption energy fender with low surface pressure

Easy of installation and repair / Maximum permissible service life

■ Pneumatic Fender

Light-weight and easy to handle, pneumatic fenders enable the large stand-off required for offshore cargo transfer between tankers or between factory ships and trawlers. Heavy-duty construction withstands both impact and aggressive environments, so that pneumatic fenders are a cost-effective option for intensive long-term use.

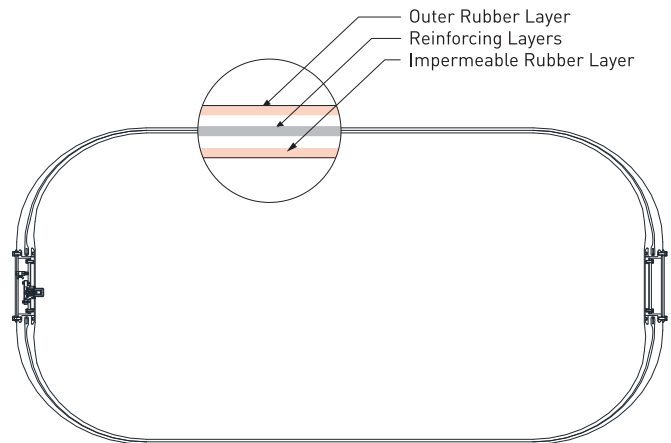

● Compression Test

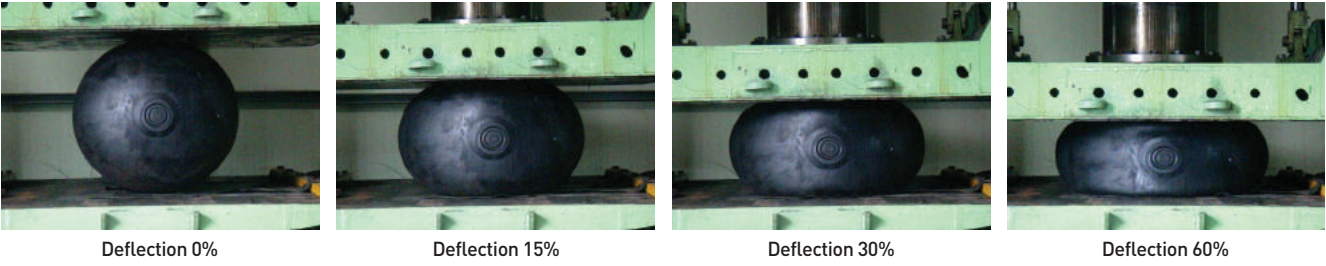

● Performance Curve

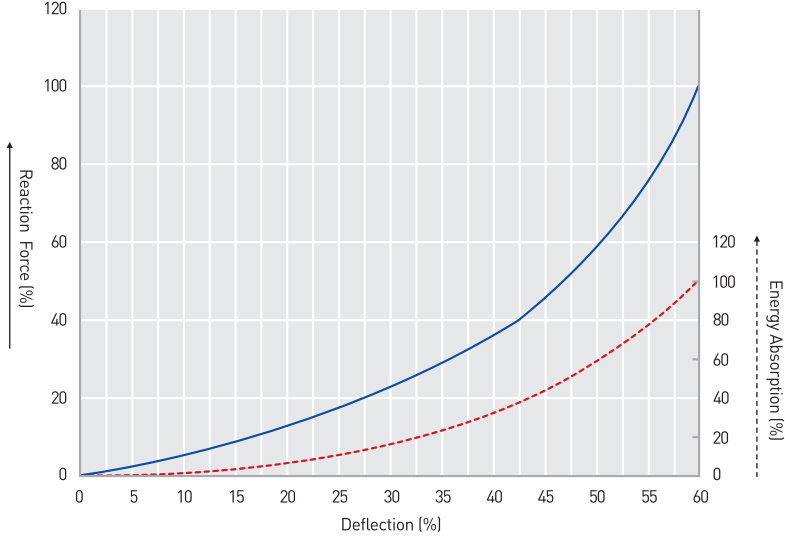

● Performance of Intermediate Deflection

Deflection(%)	R · F(%)	E · A(%)
0	0	0
5	3	0
10	6	1
15	9	4
20	13	7
25	18	11
30	23	16
35	29	24
40	36	32
45	45	44
50	58	58
55	75	76
60	100	100

● Performance Table

[Unit:mm]

Diameter	300		500		600	700	800		1000		1200		1350	1500		1700	2000		2500		3000	3300				4500		
Length	500	600	800	1000	1000	1500	1200	1500	1500	2000	1800	2000	2500	2500	3000	3000	3000	3500	6000	4000	5500	5000	4500	6500	10600	13000	7000	9000
Initial Inner Pressure of 30 kPa																												
R·F(kN)	19.6	23.5	52.9	66.6	79.9	146	127	167	196	265	294	323	441	500	588	664	798	931	1596	1274	1752	1960	2038	2940	4753	5627	4106	5292
E·A(kJ)	1.0	1.2	4.1	5.1	7.7	14.1	15.7	19.6	31.4	41.2	53.9	58.8	99.0	118	137	181	235	274	470	490	674	980	1019	1470	2372	3397	2960	3802
Initial Inner Pressure of 50 kPa																												
R·F(kN)	22.5	26.5	58.8	73.5	88.2	163	141	186	222	295	320	354	496	554	658	755	882	1029	1764	1480	2035	2205	2195	3165	5165	6331	4655	5998
E·A(kJ)	1.3	1.5	5.7	7.2	8.5	15.8	21.6	27.4	40.2	53.9	69.6	77.4	125	152	182	233	323	377	647	674	927	1225	1323	1911	3116	3822	3812	4949
Initial Inner Pressure of 80 kPa																												
R·F(kN)	29.4	35.3	78.4	98.0	118	206	187	235	280	373	404	449	631	697	836	953	1121	1313	2244	1862	2558	2783	2764	3989	6497	7977	5860	7536
E·A(kJ)	1.7	2.0	7.4	9.1	11.4	19.9	27.4	34.3	51.9	69.6	90.2	101	160	196	235	304	421	491	842	871	1196	1568	1705	2470	4028	4938	4939	6350

● Weight

[Unit:mm, kg]

Diameter	300		500		600	700	800		1000		1200		1350	1500		1700	2000		2500		3000	3300				4500		
Length	500	600	800	1000	1000	1500	1200	1500	1500	2000	1800	2000	2500	2500	3000	3000	3000	3500	6000	4000	5500	5000	4500	6500	10600	13000	7000	9000
Fender Body	10	15	25	35	45	80	75	95	140	170	180	200	270	300	350	500	550	650	950	1100	1350	1700	1800	2250	3000	3700	4100	4950
Chain Net	-	-	-	-	-	-	100	110	170	200	210	220	260	400	440	510	880	920	1220	1510	1620	2620	2360	3120	4700	5800	5100	6200
Total	10	15	25	35	45	80	175	205	310	370	390	420	530	700	790	1010	1430	1570	2170	2610	2970	4320	4160	5370	7700	9500	9200	11150

● Dimension of Jetty at Installation

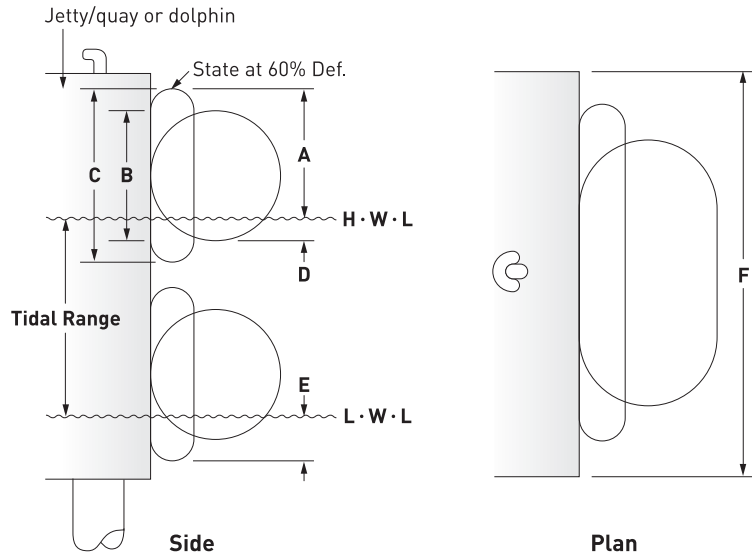

● Installation Dimension

(Unit:mm)

Size	A	B	C	D	E	(F)
1000Ø×1500L	975	950	1350	200	375	2000
1200Ø×2000L	1200	1140	1620	220	430	2600
1500Ø×2500L	1525	1420	2050	250	525	3250
2000Ø×3500L	2050	1900	2700	300	650	4500
2500Ø×4000L	2490	2380	3380	450	890	5200
3300Ø×6500L	3380	3140	4460	500	1080	8500
4500Ø×9000L	4710	4270	6180	800	1470	12000

● Typical Fender Arrangement for Submarine

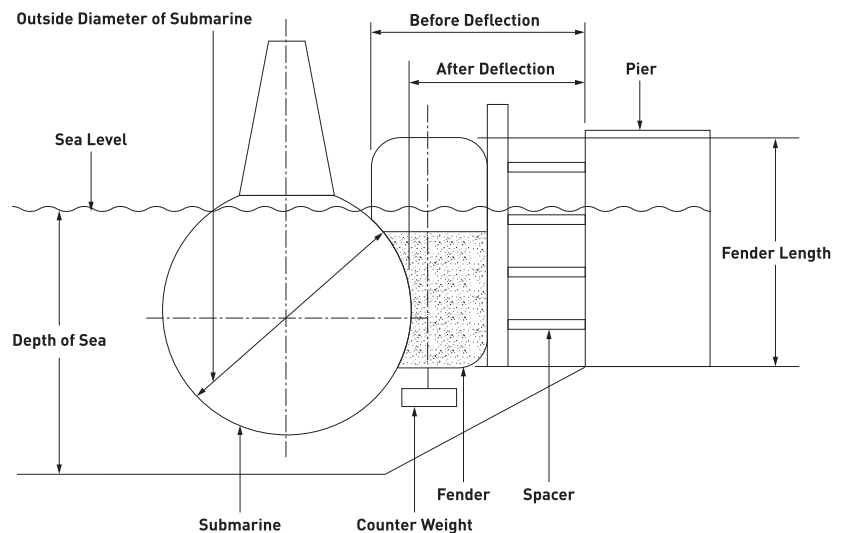

● Submarine Type Fender Performance Table (Initial Pressure : 50kPa)

Size	Ø1700×7200L		Ø2000×6000L		Ø2500×5500L		Ø3300×6500L		Ø3300×10600L		Ø4500×9000L		
	DEF(%)	60	45	60	45	60	45	60	45	60	45	60	35
Water Ratio(%)	0.0	65.0	0.0	65.0	0.0	65.0	0.0	60.0	0.0	54.5	0.0	65.0	
R · F(kN)	1811	611	1764	599	2035	686	3165	1246	5165	1275	5998	2191	
E · A(kJ)	561	134	647	155	927	223	1911	615	3116	589	4949	865	

- R · F : Reaction Force(kN) - E · A : Energy Absorption(kJ) - Tolerance : ±5% or ±10%

■ Foam Filled Fender

Foam filled fenders are appropriate for virtually any type of vessel. A closed cell foam core makes these fenders unsinkable and allows for long maintenance intervals. The core is encased in a heavily reinforced elastomer skin that withstands sunlight, seawater and abrasion. Additional reinforcement for large foam fenders are provided by a standard chain and tire net.

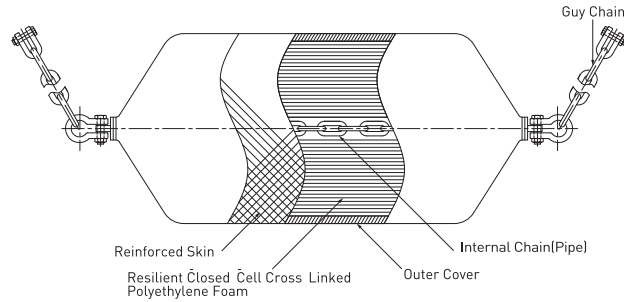
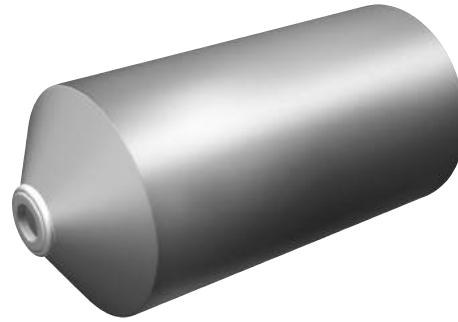

● Performance Curve

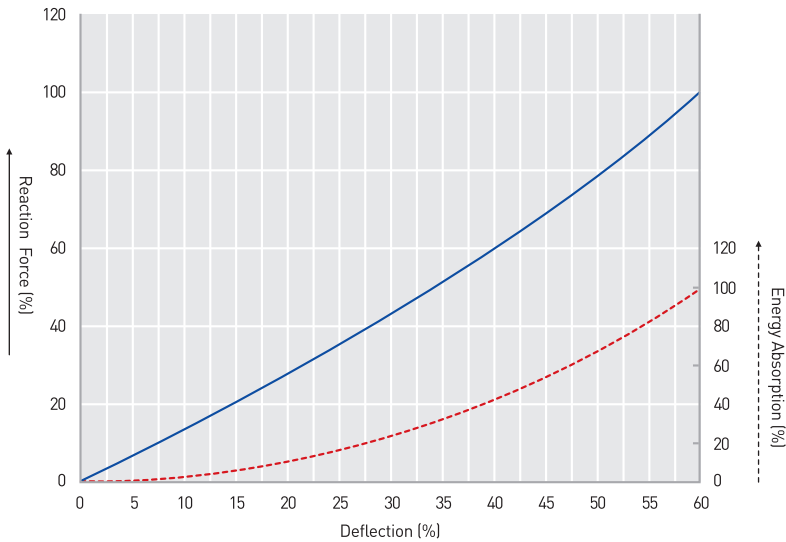

● Performance of Intermediate Deflection

Deflection[%]	R • F[%]	E • A[%]
0	0	0
5	7	1
10	15	3
15	21	6
20	28	10
25	36	16
30	43	24
35	52	32
40	59	42
45	69	54
50	79	68
55	89	83
60	100	100

● Performance Table

(Unit:mm)

Diameter	700		1000		1200		1350		1500		1700		2000			2500			3000		3300	
	Length	1500	2000	1500	2000	2000	2500	2500	2500	3000	3000	3500	4000	4500	4000	4500	5500	4900	6000	4500	6500	
LOW REACTION																						
R•F(kN)	82.3	118	106	153	171	229	253	318	347	370	506	606	694	717	806	1070	906	1376	1011	1641		
E•A(kJ)	17.6	23.5	29.4	41.2	52.9	76.4	88.2	118	141	171	271	323	376	482	541	717	859	1111	900	1452		
STANDARD CAPACITY																						
R•F(kN)	137	196	176	255	284	382	421	529	578	617	843	1009	1156	1196	1343	1784	1509	2293	1686	2734		
E•A(kJ)	29.4	39.2	49.0	68.6	88.2	127	147	196	235	284	451	539	627	804	902	1196	1431	1852	1499	2421		
HIGH CAPACITY																						
R•F(kN)	176	235	225	333	363	451	539	647	755	804	1098	1303	1509	1558	2107	2323	2303	2979	2195	3548		
E•A(kJ)	29.4	49.0	58.8	88.2	118	147	196	235	304	363	588	706	813	1039	1421	1558	1862	2401	1950	3146		
EXTRA HIGH CAPACITY																						
R•F(kN)	255	333	333	480	529	666	794	951	1098	1176	1607	1911	2205	2274	3087	3401	3371	4361	3205	5184		
E•A(kJ)	49.0	68.6	88.2	127	176	216	284	343	441	539	862	1029	1186	1519	2068	2283	2715	3518	2842	4596		
SUPER HIGH CAPACITY																						
R•F(kN)	343	461	549	657	725	911	1088	1303	1499	1607	2195	2617	3018	3107	4224	4645	4606	5968	4390	7095		
E•A(kJ)	68.6	88.2	127	176	235	294	392	470	608	735	1176	1401	1617	2087	2832	3116	3714	4812	3891	6292		

- RReaction Force(kN) - E•A : : Energy -Absorption(kj) -Tolerance: ±±5% or or ±10% - Deflection : 60%



Arch Fenders

Arch types are the first buckling type fenders. They are the most versatile fender in the world and reinforced by an embedded steel plate across the entire bottom of the fender. They have been installed at the berthing facilities for various sizes of vessels and have shown satisfactory results after usage for long periods.

■ AOV-Type Fender

AOV fender is highlighted with its features of high energy absorption, low reaction force. Its arch shape serves well to reduce concentration of stress when the fender is compressed. They are in good quality with four rubber grade. They also have a wide selection of sizes and energy capacities, and equipped with steel mounting plates at the fender bottom and open legs make it easy install fenders at any berthing facility.

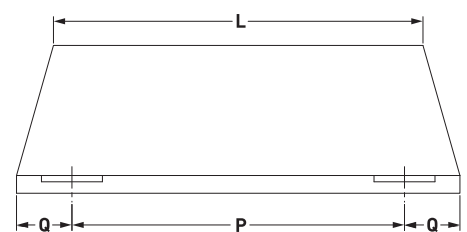
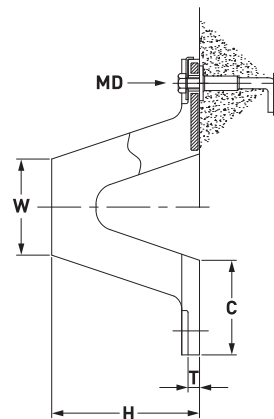
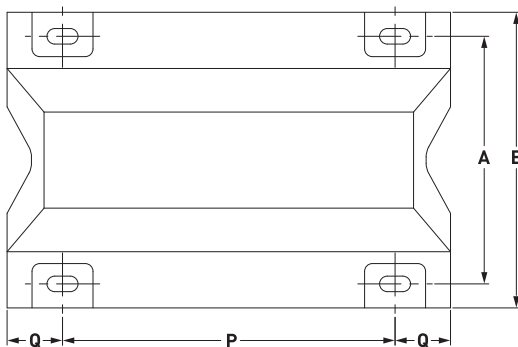
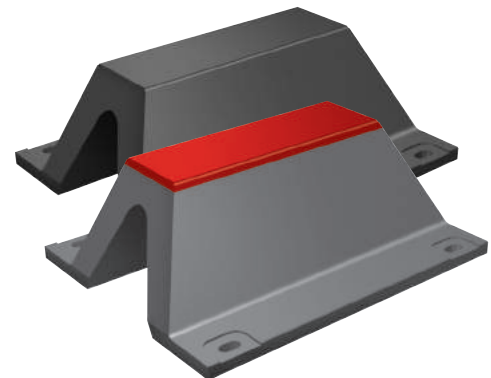

● Dimension

(Unit:mm)

Dimension Height(H)	MD	A	B	C	T	W	1000L		1500L		2000L		2500L		3000L		3500L	
							P	Q	P	Q	P	Q	P	Q	P	Q		
150H	M22 (7/8)	240	300	96	17	97.5	855	110	675×2	112.5	620×3	107.5	785×3	110	715×4	107.5	671×5	110
200H	M24 (1)	320	400	128	17	130	860	120	680×2	120	620×3	120	785×3	122.5	715×4	120	672×5	120
250H	M27 (1 1/8)	410	500	160	22	162.5	865	130	680×2	132.5	620×3	132.5	790×3	127.5	715×4	132.5	673×5	130
300H	M30 (1 1/4)	490	600	192	23	195	870	140	685×2	140	625×3	137.5	790×3	140	715×4	145	674×5	140
400H	M36 (1 1/2)	670	800	256	31	260	900	150	700×2	150	635×3	147.5	800×3	150	725×4	150	680×5	150
500H	M42 (1 3/4)	840	1,000	320	34	325	930	160	715×2	160	645×3	157.5	810×3	160	730×4	165	686×5	160
600H	M48 (2)	1,010	1,200	384	40	390	960	170	730×2	170	655×3	167.5	820×3	170	740×4	170	692×5	170
800H	M64 (2 1/2)	1,340	1,600	501	45	525	1,040	180	770×2	180	680×3	180	845×3	182.5	760×4	180	-	-
1000H	M64 (2 1/2)	1,680	2,000	640	49	650	1,100	200	800×2	200	700×3	200	865×3	202.5	775×4	200	-	-

- MD : Anchor Size See Page 45~47

● **Compression Test**

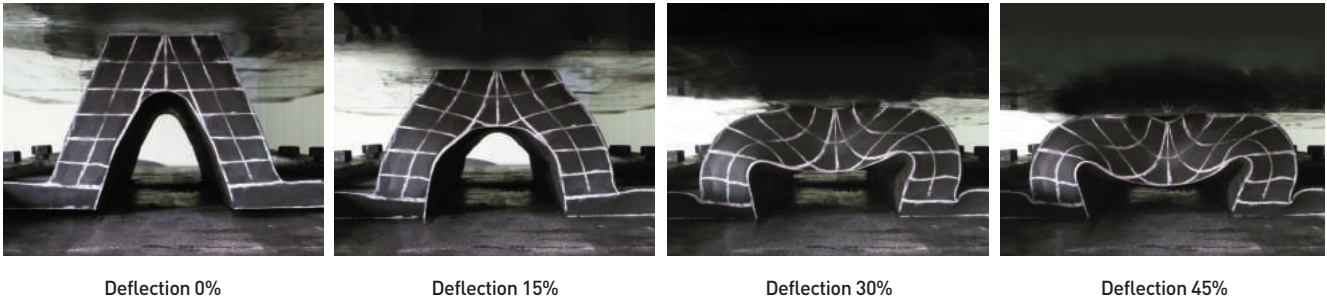

● **Performance Curve**

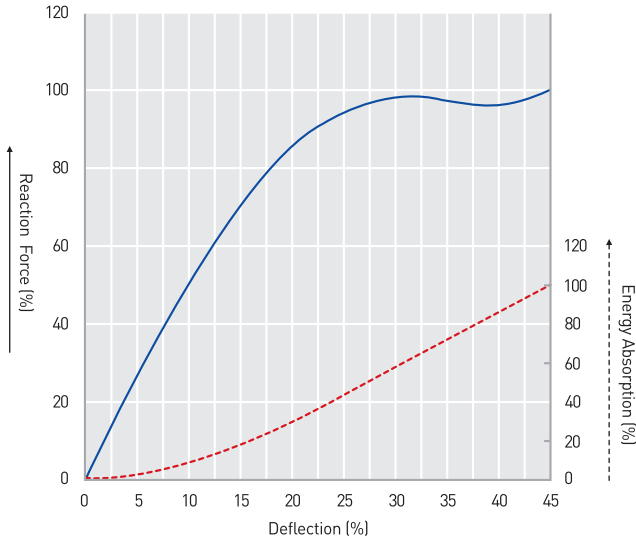

● **Performance of Intermediate Deflection**

Deflection(%)	R · F(%)	E · A(%)
0	0	0
5	26	2
10	50	8
15	69	17
20	85	28
25	96	42
30	100	56
35	97	71
40	96	85
45	100	100

● **Performance Table**

Size		(1m Length)								
Performance		150H	200H	250H	300H	400H	500H	600H	800H	1000H
R1	R · F(kN)	127.4	176.4	215.6	254.8	343.0	421.4	509.6	676.2	842.8
	E · A(kJ)	5.9	11.8	17.6	25.5	45.1	70.6	101.9	180.3	281.3
RH	R · F(kN)	107.8	147.0	186.2	225.4	294.0	372.4	441.0	588.0	735.0
	E · A(kJ)	4.9	9.8	15.7	22.5	39.2	61.7	88.2	156.8	244.0
RM	R · F(kN)	88.2	117.6	137.2	166.6	225.4	284.2	333.2	450.8	558.6
	E · A(kJ)	3.9	7.8	11.8	16.7	30.4	47.0	66.6	120.5	186.2
RL	R · F(kN)	58.8	78.4	98.0	117.6	156.8	186.2	225.4	303.8	372.4
	E · A(kJ)	2.9	4.9	7.8	11.8	20.6	30.4	45.1	80.4	124.5

- R · F : Reaction Force(kN) - E · A : Energy Absorption(kJ) - Tolerance : ±5% or ±10% - Deflection : 45%

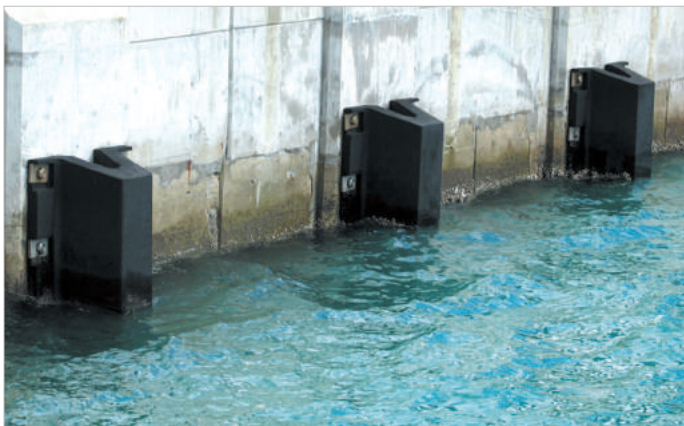

■ ACV-Type Fender

ACV fender is the most versatile fender in the world. It is the first fender to be reinforced by an embedded steel plate across the entire bottom of the fender, and the first dynamically stable type fender against outer force in various directions. It is easy in handling and maintaining.

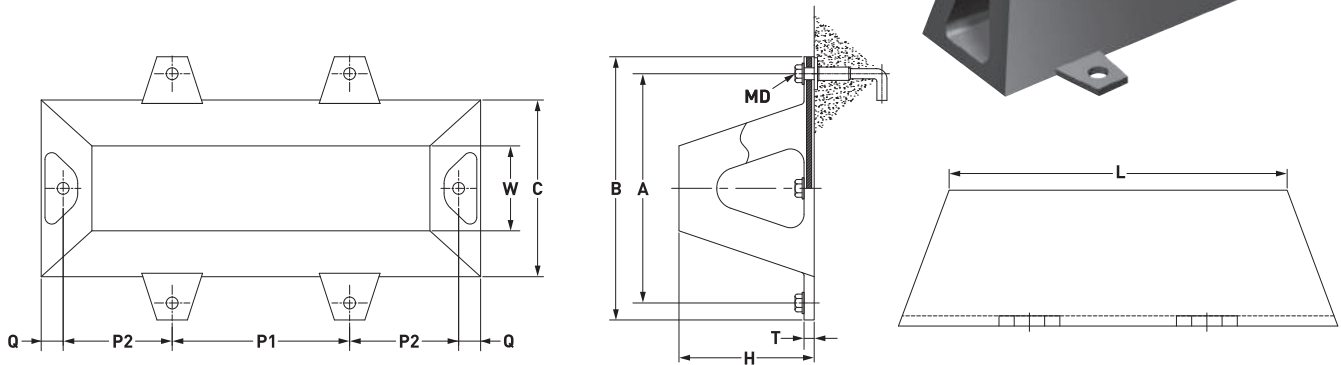

● Dimension

(Unit:mm)

Dimension Height	MD	A	B	C	T	W	1000L		1500L		2000L			2500L			3000L			3500L		
							P2	Q	P2	Q	P1	P2	Q	P1	P2	Q	P1	P2	Q	P1	P2	Q
200H	M24 (1)	350	445	250	25	125	555	70	805	70	900	605	70	900	855	70	900×2	655	70	900×2	905	70
300H	M30 (1 1/4)	530	645	375	35	188	600	75	850	75	1000	600	75	1000	850	75	1000×2	600	75	1000×2	850	75
400H	M36 (1 1/2)	710	840	500	40	250	640	85	890	85	1200	540	85	1200	790	85	1200×2	440	85	1200×2	690	85
500H	M42 (1 3/4)	860	1000	625	40	315	675	100	925	100	1000	675	100	1000	925	100	1000×2	675	100	1000×2	925	100
600H	M48 (2)	1050	1210	750	50	375	710	115	960	115	1020	700	115	1020	950	115	1020×2	690	115	1020×2	940	115
700H	M48 (2)	1180	1380	880	55	450	635	115	885	115	1000	635	115	1000	885	115	1000×2	635	115	-	-	-
800H	M64 (2 1/2)	1350	1550	1000	60	500	670	130	920	130	1050	645	130	1050	895	130	1050×2	620	130	-	-	-
1000H	M64 (2 1/2)	1600	1800	1250	65	625	700	150	950	150	1200	600	150	1200	850	150	1200×2	500	150	-	-	-
1300H	M76 (3)	2030	2250	1625	65	815	-	-	975	200	900	775	200	900	1025	200	900×2	825	200	-	-	-

- MD : Anchor Size See Page 45~47



● **Compression Test**

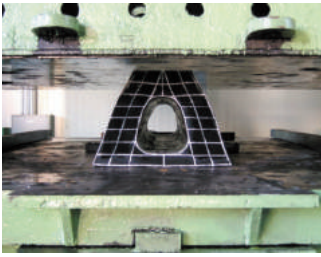

Deflection 0%

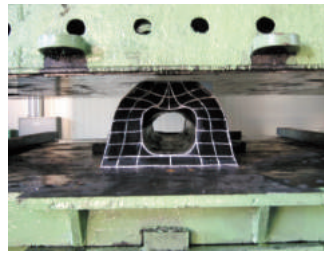

Deflection 15%

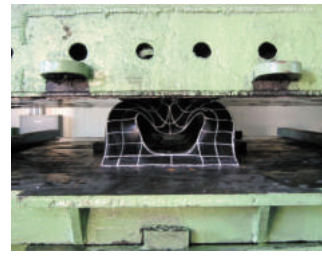

Deflection 30%

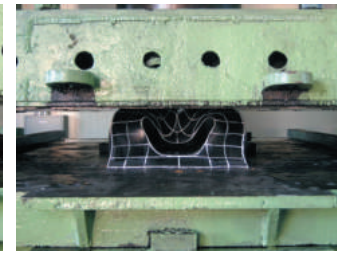

Deflection 45%

● **Performance Curve**

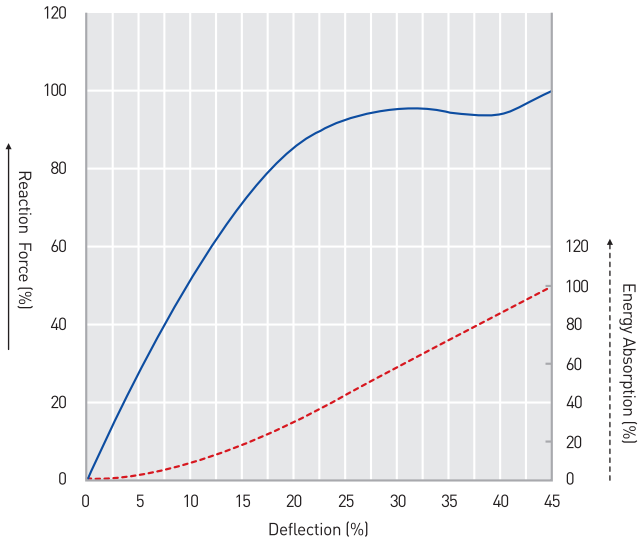

● **Performance of Intermediate Deflection**

Deflection(%)	R • F(%)	E • A(%)
0	0	0
5	27	2
10	51	8
15	72	17
20	86	29
25	96	42
30	100	57
35	95	71
40	94	85
45	100	100

● **Performance Table**

(1m Length)

Size		200H	300H	400H	500H	600H	800H	1000H	1300H
Performance									
RH	R•F(kN)	147.0	225.4	294.0	372.4	441.0	588.0	735.0	960.4
	E•A(kJ)	9.8	21.6	39.2	60.8	88.2	156.8	245.0	411.6
RM	R•F(kN)	117.6	166.6	235.2	294.0	333.2	470.4	588.0	764.4
	E•A(kJ)	6.9	15.7	29.4	45.1	63.7	117.6	176.4	303.8
RL	R•F(kN)	78.4	117.6	156.8	186.2	235.2	313.6	372.4	480.2
	E•A(kJ)	4.9	9.8	19.6	29.4	39.2	78.4	117.6	196.0

- R • F : Reaction Force(kN) - E • A : Energy Absorption(kJ) - Tolerance : ±5% or ±10% - Deflection : 45%



■ NV-Type Fender

NV fender is newly designed with 15% increased energy absorption capacity when it is compared to other type of fenders of same size with same rubber grades. With the most suitable structures and shape design, compression capacity has been increased from 45% to 52.5%. It is easy to install and replace because it has simple structure and same Anchor bolts holes location as AOV. 17% of reaction force and 32% of surface reaction force have been decreased when NV is compared to existing arch type fenders with same energy absorption capacity.

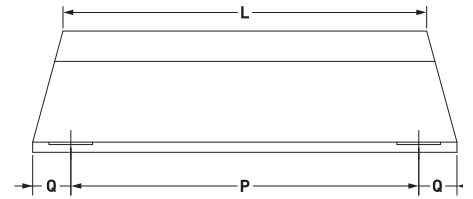
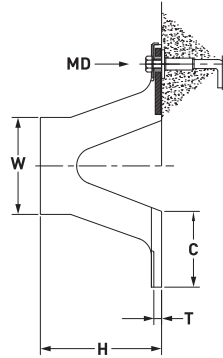
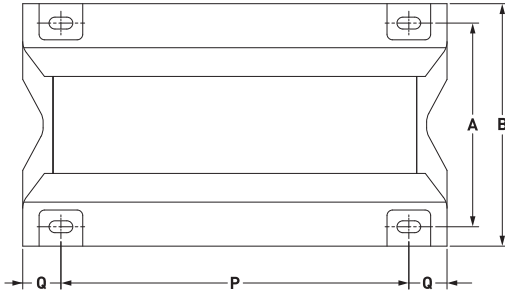
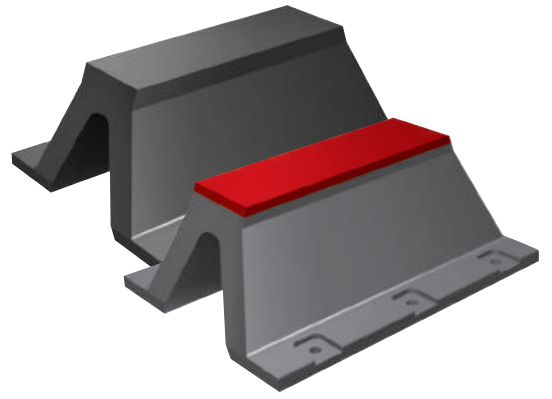

● NV-B Type

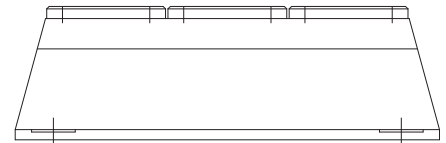
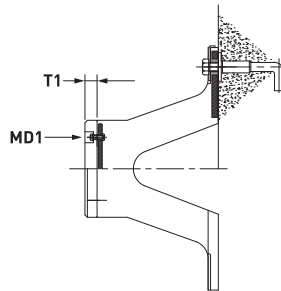
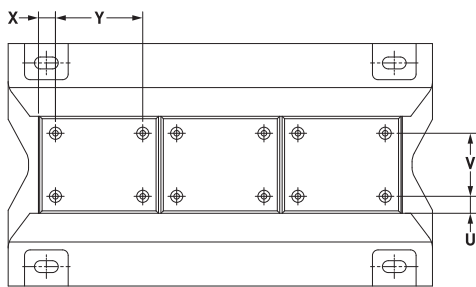

● Dimension

(Unit:mm)

Dimension Height	MD	A	B	C	T	W	NV-B Type					1000L		1500L		2000L		2500L		3000L		
							MD1	X	Y	U	V	T1	P	Q	P	Q	P	Q	P	Q	P	Q
150H	M22 (7/8)	240	300	93.5	17	120	M16	60~70	330~410	60	0	30	855	110	675×2	112.5	620×3	107.5	785×3	110	715×4	107.5
200H	M24 (1)	320	400	125	17	160	M16	60~70	330~410	80	0	30	860	120	680×2	120	620×3	120	785×3	122.5	715×4	120
250H	M27 (1 1/8)	410	500	156	22	200	M16	70~85	330~410	45	110	30	865	130	680×2	132.5	620×3	132.5	790×3	127.5	715×4	132.5
300H	M30 (1 1/4)	490	600	187.5	23	240	M16	70~85	330~410	50	140	40	870	140	685×2	140	625×3	137.5	790×3	140	715×4	145
400H	M36 (1 1/2)	670	800	250	28	320	M16	70~85	330~410	60	200	40	900	150	700×2	150	635×3	147.5	800×3	150	725×4	150
500H	M42 (1 3/4)	840	1000	312.5	32	380	M20	70~85	330~410	65	250	50	930	160	715×2	160	645×3	157.5	810×3	160	730×4	165
600H	M48 (2)	1010	1200	375	40	480	M20	70~85	330~410	65	350	50	960	170	730×2	170	655×3	167.5	820×3	170	740×4	170
800H	M64 (2 1/2)	1340	1600	500	45	640	M24	70~85	330~410	100	440	60	1040	180	770×2	180	680×3	180	845×3	182.5	760×4	180
1000H	M64 (2 1/2)	1680	2000	625	49	800	M24	70~85	330~410	100	600	60	1100	200	800×2	200	700×3	200	865×3	202.5	775×4	200

- MD : Anchor Size See Page 45~47

● **Compression Test**

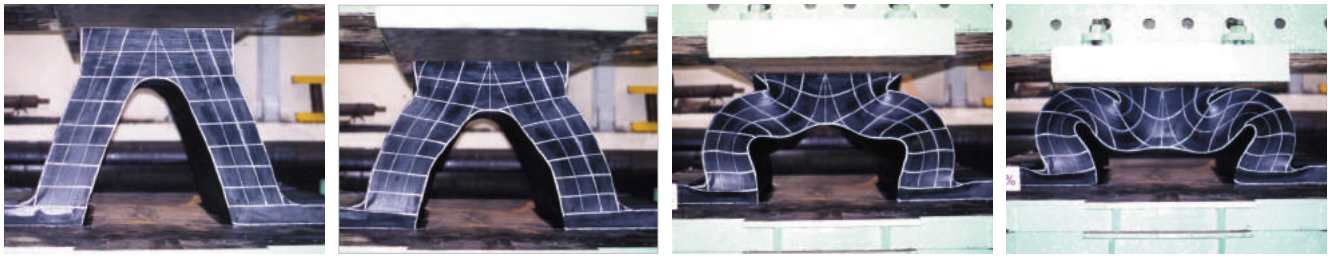

Deflection 0%

Deflection 15%

Deflection 30%

Deflection 52.5%

● **Performance Curve**

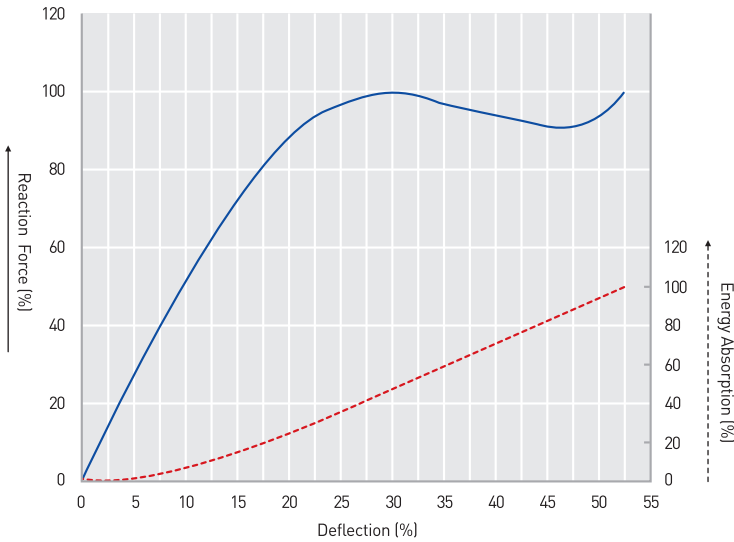

● **Performance of Intermediate Deflection**

Deflection(%)	R • F(%)	E • A(%)
0	0	0
5	26	2
10	52	6
15	73	14
20	88	24
25	97	35
30	100	47
35	97	60
40	94	71
45	91	83
50	93	94
52.5	100	100

● **Performance Table**

(1m Length)

Size		150H	200H	250H	300H	400H	500H	600H	800H	1000H
Performance										
R1	R • F(kN)	161.7	205.8	264.6	323.4	426.3	529.2	632.1	852.6	1058.4
	E • A(kJ)	8.8	16.7	26.5	38.2	67.6	105.8	152.9	271.5	426.3
RH	R • F(kN)	117.6	166.6	205.8	245.0	323.4	411.6	490.0	646.8	813.4
	E • A(kJ)	6.9	12.7	20.6	29.4	51.9	81.3	117.6	209.7	327.3
RM	R • F(kN)	107.8	137.2	176.4	215.6	284.2	352.8	421.4	568.4	705.6
	E • A(kJ)	5.9	10.8	17.6	25.5	45.1	70.6	101.9	181.3	284.2
RL	R • F(kN)	88.2	117.6	147.0	166.6	225.4	284.2	343.0	450.8	568.4
	E • A(kJ)	4.9	8.8	13.7	20.6	36.6	56.8	81.3	145.0	226.4

- R • F : Reaction Force(kN) - E • A : Energy Absorption(kJ) - Tolerance : ±5% or ±10% - Deflection : 52.5%

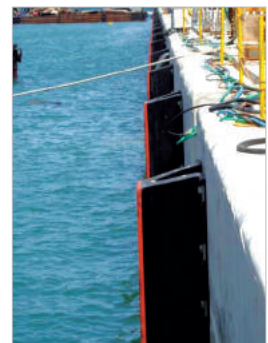



Other Fenders

■ CYL-Type Fender

It is simply cylindrical construction, and is able to withstand large compressive deformation with low reaction load. It is also freely secured without the necessity of precise anchor bolt arrangements.

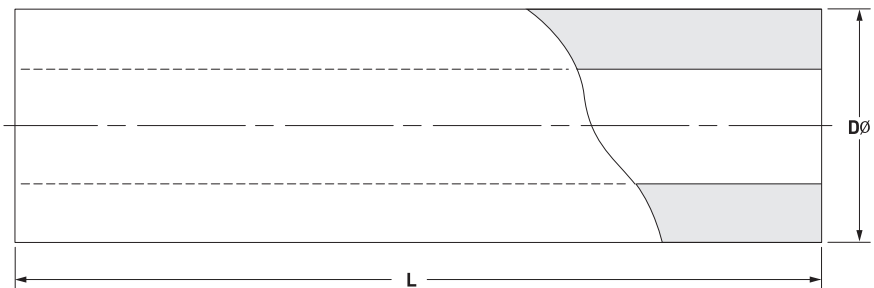
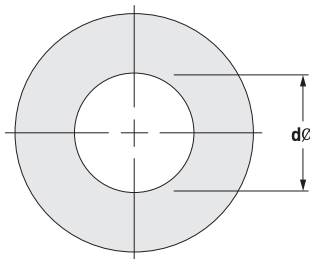

● Dimension

(Unit:mm)

Size	$\varnothing 150$ $\times \varnothing 75$	$\varnothing 200$ $\times \varnothing 100$	$\varnothing 250$ $\times \varnothing 125$	$\varnothing 300$ $\times \varnothing 150$	$\varnothing 400$ $\times \varnothing 200$	$\varnothing 500$ $\times \varnothing 250$	$\varnothing 600$ $\times \varnothing 300$	$\varnothing 700$ $\times \varnothing 350$	$\varnothing 800$ $\times \varnothing 400$	$\varnothing 900$ $\times \varnothing 450$	$\varnothing 1000$ $\times \varnothing 500$	$\varnothing 1100$ $\times \varnothing 550$	$\varnothing 1200$ $\times \varnothing 600$	$\varnothing 1400$ $\times \varnothing 700$	$\varnothing 1500$ $\times \varnothing 750$	$\varnothing 1600$ $\times \varnothing 800$	$\varnothing 1800$ $\times \varnothing 900$	$\varnothing 2000$ $\times \varnothing 1000$
$\varnothing D$	150	200	250	300	400	500	600	700	800	900	1000	1100	1200	1400	1500	1600	1800	2000
$\varnothing d$	75	100	125	150	200	250	300	350	400	450	500	550	600	700	750	800	900	1000

● Installation Example

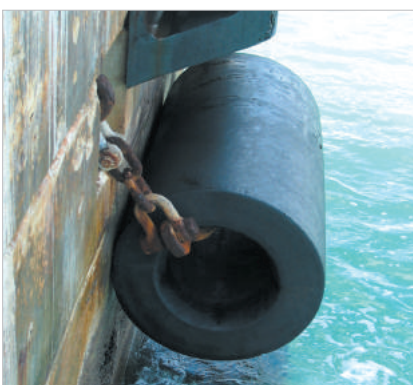

● Fitting chain and bar

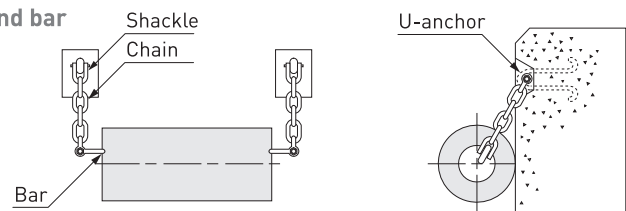

● Fitting chain

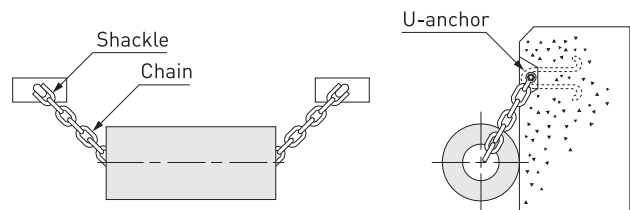

● Ladder

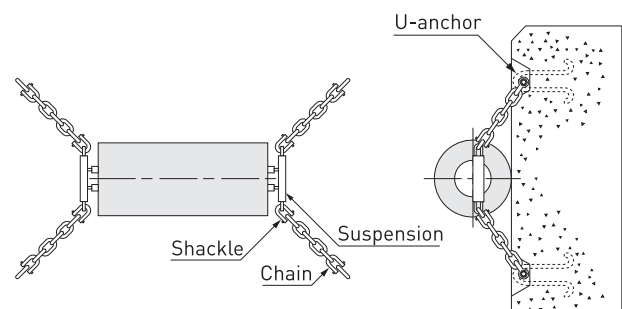

● **Compression Test**

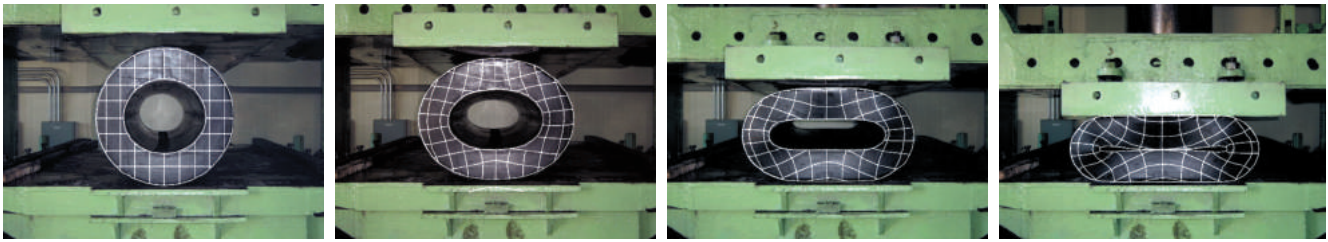

Deflection : 0%

Deflection : 15%

Deflection : 30%

Deflection : 50%

● **Performance Fender Curve**

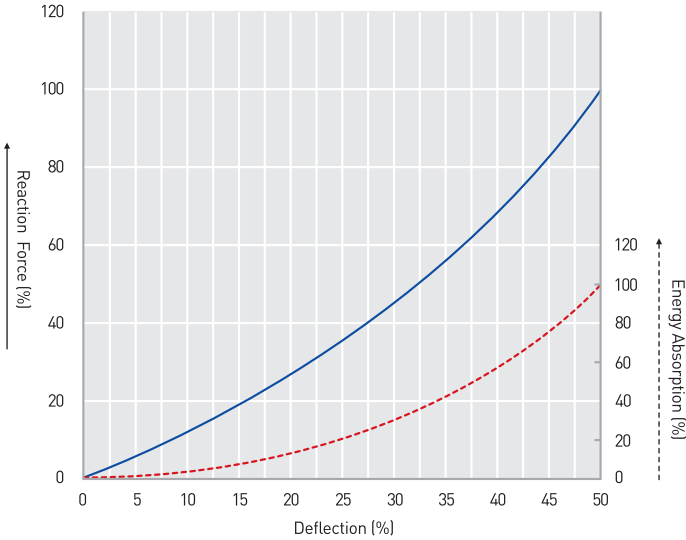

● **Performance of Intermediate Deflection**

Deflection(%)	R • F(%)	E • A(%)
0	0	0
5	5	1
10	12	3
15	19	7
20	27	12
25	35	20
30	45	30
35	56	42
40	69	58
45	83	77
50	100	100

● **Performance Table**

(1m Length)

Size		Ø150 × Ø75	Ø200 × Ø100	Ø250 × Ø125	Ø300 × Ø150	Ø400 × Ø200	Ø500 × Ø250	Ø600 × Ø300	Ø700 × Ø350	Ø800 × Ø400	Ø900 × Ø450	Ø1000 × Ø500	Ø1100 × Ø550	Ø1200 × Ø600	Ø1400 × Ø700	Ø1500 × Ø750	Ø1600 × Ø800	Ø1800 × Ø900	Ø2000 × Ø1000
Performance																			
R1	R • F(kN)	88.2	113.2	139.7	176.4	235.2	279.3	338.1	411.6	441.0	529.2	558.6	617.4	676.2	793.8	845.3	896.7	1058	1117
	E • A(kJ)	2.6	4.7	7.1	10.7	19.1	29.4	42.6	57.3	76.4	95.6	120.5	135.2	172.0	233.7	254.3	305.8	380.7	446.9
RH	R • F(kN)	73.5	98.0	122.5	147.0	196.0	245.0	294.0	343.0	392.0	441.0	490.0	539.0	588.0	686.0	735.0	784.0	882.0	980.0
	E • A(kJ)	2.2	3.9	6.2	8.8	15.7	24.5	35.3	48.0	62.7	79.5	98.0	118.6	141.1	192.1	220.5	250.9	317.5	392.0
RM	R • F(kN)	58.8	75.5	93.1	117.6	156.8	186.2	225.4	274.4	294.0	352.8	372.4	411.6	450.8	529.2	563.5	597.8	705.6	744.8
	E • A(kJ)	1.8	3.1	4.7	7.2	12.7	19.6	28.4	38.2	51.0	63.7	80.4	90.2	114.7	155.8	169.5	203.8	253.8	297.9
RL	R • F(kN)	40.2	52.9	63.7	78.4	107.8	127.4	156.8	176.4	205.8	235.2	254.8	284.2	313.6	362.6	387.1	411.6	470.4	509.6
	E • A(kJ)	1.2	2.1	3.2	4.7	8.2	12.9	18.6	24.5	33.3	42.1	51.9	62.7	74.5	101.9	116.6	132.3	169.5	203.8

- R • F : Reaction Force(kN) - E • A : Energy Absorption(kJ) - Tolerance : ±5% or ±10% - Deflection : 50%

■ BP-Type Fender

Bumper fender (BP) is suitable for protecting port facilities from lateral berthing load. It keeps the damage of fender at minimum due to an unbreakable shape, and has large contact area with vessel hull. It is suitable for gravity type quay.

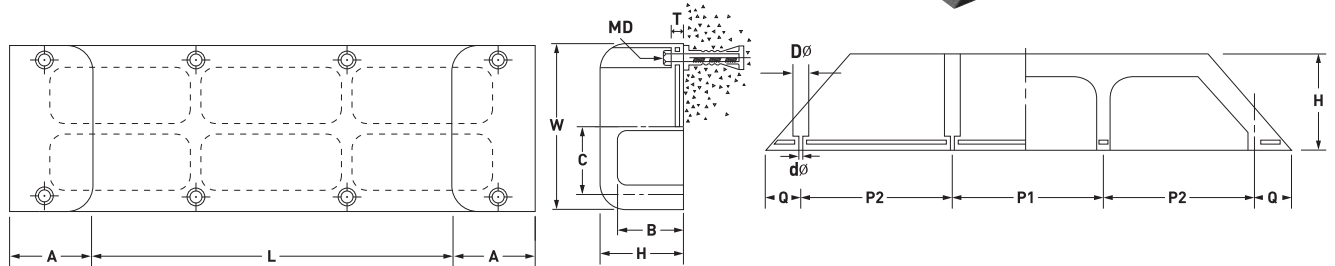
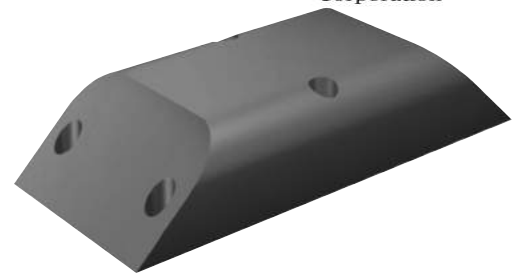

● Dimension

(Unit:mm)

Dimension Height	MD	A	B	C	Dø	dø	Q	T	W	1000L		1500L		2000L		2500L		3000L	
										P1	P2	P1	P2	P1	P2	P1	P2	P1	P2
150H	M24 (1)	150	110	100	65	30	75	25	300	-	575	-	825	710	720	880	885	785×2	790
200H	M30 (1 1/4)	200	150	145	75	40	100	30	400	-	600	-	850	730	735	900	900	800×2	800
250H	M30 (1 1/4)	250	190	190	80	40	125	35	500	-	625	-	875	750	750	910	920	810×2	815
300H	M36 (1 1/2)	300	230	235	90	45	150	35	600	-	650	-	900	760	770	930	935	825×2	825
400H	M36 (1 1/2)	400	310	320	90	45	200	40	800	-	700	-	950	800	800	960	970	850×2	850
500H	M42 (1 3/4)	500	380	410	110	55	250	50	1000	-	750	-	1000	830	835	1000	1000	875×2	875
600H	M48 (2)	600	460	490	125	60	300	60	1200	-	800	-	1050	860	870	1030	1035	900×2	900
800H	M64 (2 1/2)	800	620	670	145	75	400	80	1600	-	900	-	1150	930	935	1100	1100	950×2	950
1000H	M64 (2 1/2)	1000	780	850	160	75	500	80	2000	-	1000	-	1250	1000	1000	1160	1170	1000×2	1000
1200H	M76 (3)	1200	935	1000	200	90	600	90	2400	-	1100	-	1350	1100	1050	1300	1200	1050×2	1050

- MD : Anchor Size See Page 45-47

● Performance Curve

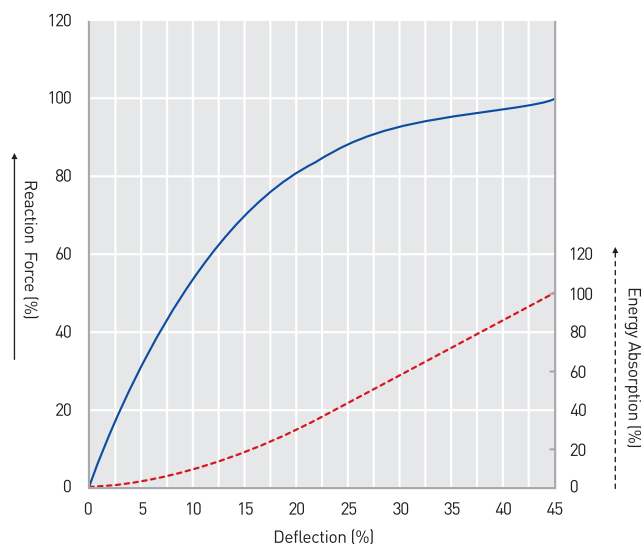

● Performance Table

(1m Length)

Size Performance		150H	200H	250H	300H	400H	500H	600H	800H	1000H	1200H
Def.45%	R • F(kN)	125.4	166.6	208.7	249.9	333.2	416.5	499.8	666.4	833.0	999.6
	E • A(kJ)	6.3	11.1	17.3	24.9	44.3	68.6	100.0	177.4	276.4	397.9

- R • F : Reaction Force(kN) - E • A : Energy Absorption(kJ) - Tolerance : +20% ~ -10% - Deflection : 45%

■ BC-Type Fender



BC fender has no damage to the paint as well as ship hull due to low face pressure and it is adjustable to any variety of shape with the flexibility. It is easy to install the grooved body with simple chain, wire or rope.

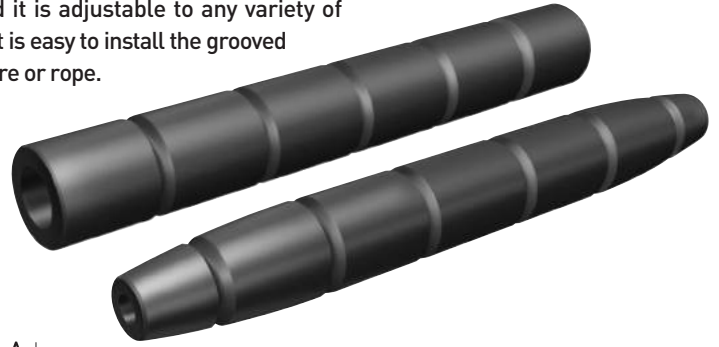

Straight Type

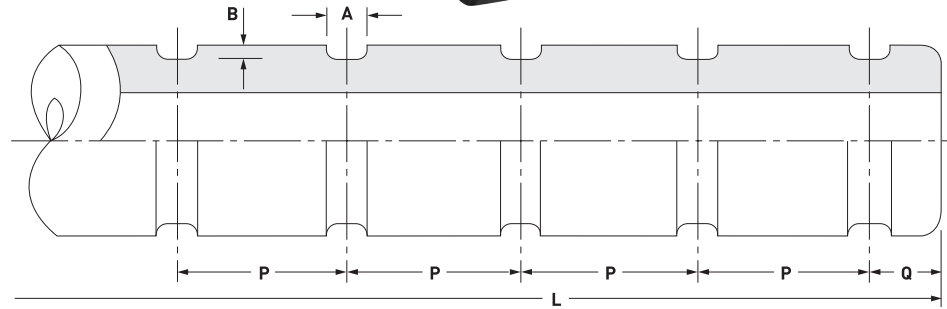
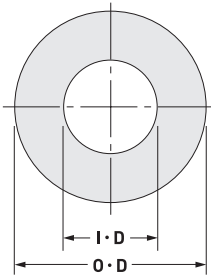

● Dimension (Use:For Side)

(Unit:mm)

Size	∅100×∅50	∅150×∅75	∅200×∅100	∅250×∅125	∅300×∅150	∅350×∅175	∅400×∅200	∅500×∅250	∅600×∅300	∅700×∅350
O·D	100	150	200	250	300	350	400	500	600	700
I·D	50	75	100	125	150	175	200	250	300	350
A	30	30	50	50	50	70	70	70	85	85
B	10	10	15	15	15	20	20	30	30	40
P	600~900	600~900	600~900	600~900	600~900	600~900	600~900	600~900	600~900	600~900
Q	100	100	150	150	200	200	200	250	250	300

- Maximun length available is 20m.

Taper Type

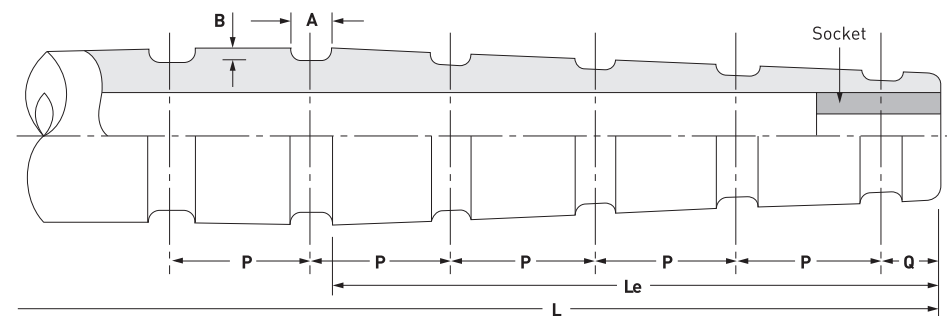
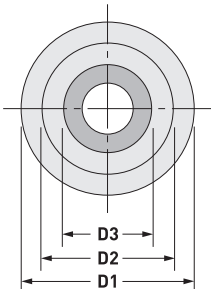

Le=1/4L

● Dimension (Use:For Bow and Stern)

(Unit:mm)

Size	∅200×∅100	∅250×∅125	∅300×∅150	∅350×∅175	∅400×∅200	∅500×∅250	∅600×∅300	∅700×∅350	∅800×∅400
D1	200	250	300	350	400	500	600	700	800
D2	150	190	225	260	300	375	450	525	600
D3	100	125	150	175	200	250	300	350	400
A	50	50	50	70	70	70	85	85	85
B	15	15	15	20	20	30	30	40	40
P	600~900	600~900	600~900	600~900	600~900	600~900	600~900	600~900	600~900
Q	150	150	200	200	200	250	250	300	300
Socket	O·D	-	-	-	202	252	303	354	404
	I·D	-	-	-	100	100	150	150	150
	Length	-	-	-	-	300	350	400	400

- Maximun length available is 20m.



Method of Installation-Inside

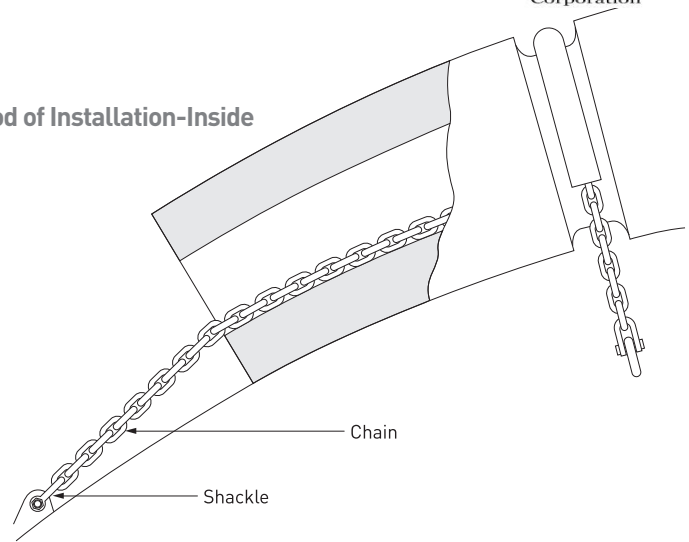

Method of Installation-Groove

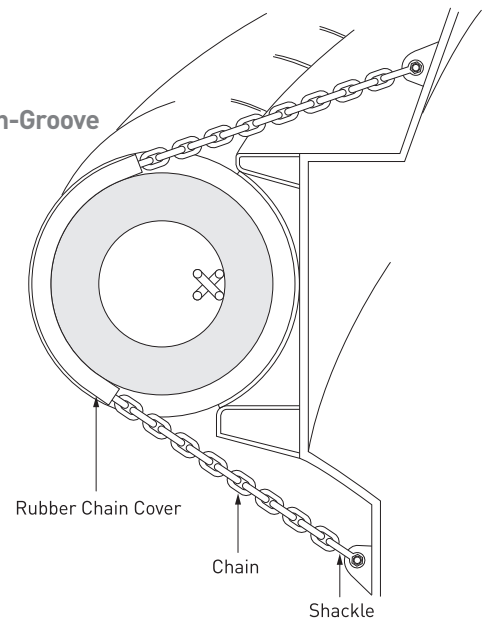

● Size of Fitting

Size of Fender	Chain		Shackle	Turnbuckle
	For Inside	For Groove		
Less than $\varnothing 600$	$\varnothing 16$	$\varnothing 16$	SC-16	$\varnothing 19$
Including and over $\varnothing 600$	$\varnothing 19$	$\varnothing 19$	SC-20	$\varnothing 22$

- SC : Straight shackle with screwed bolt - Fittings are to be galvanized



● Bending Radius(R) should not over 4 times of outer diameter

(Unit:mm)

O.D	$\varnothing 200$	$\varnothing 300$	$\varnothing 400$	$\varnothing 500$	$\varnothing 600$	$\varnothing 800$
Permissible Bending Radius(R)	800	1200	1600	2000	2400	3200

RC, RD, DC, DD-Type Fender

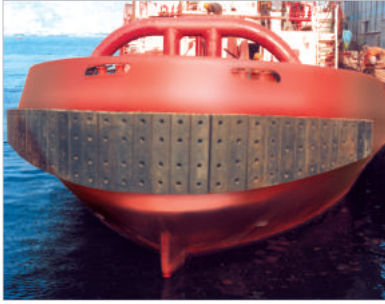

The volumes of energy absorption and reaction force of this fender are greater than those of hollow cylindrical fender. The side for attachment is flat so that it can be secured more firmly than cylindrical fender.



Vertical Fitting Bolt Method

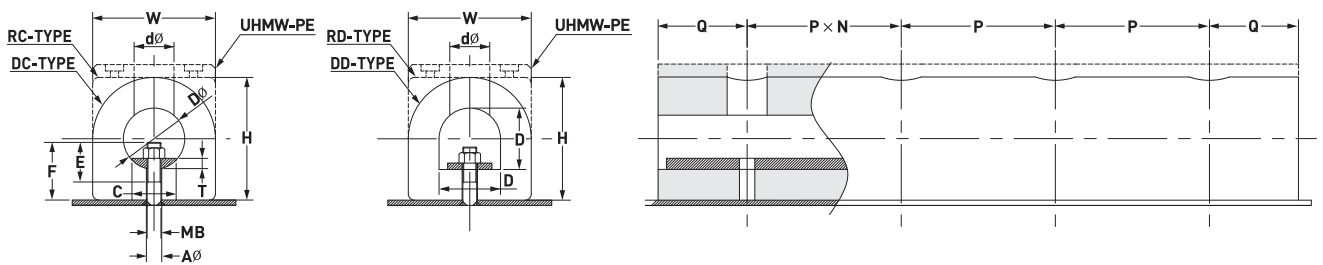

Cross Fitting Bolt Method

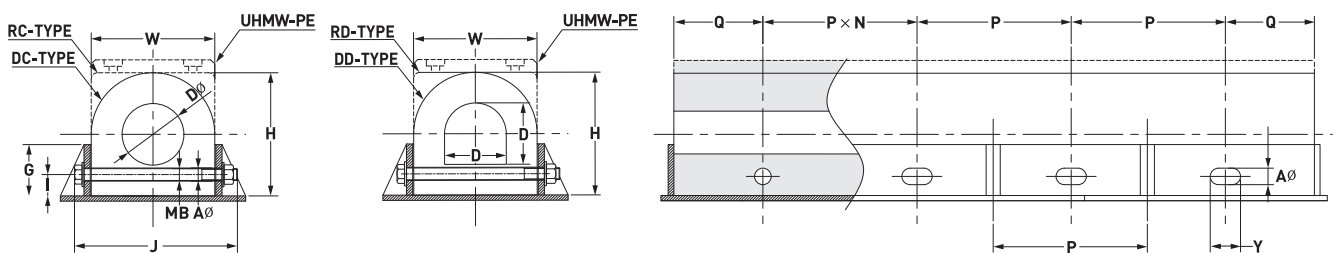

● Dimension

(Unit:mm)

Size	DC 150H × φ75	DC 200H × φ100	DC 250H × φ125	DC 300H × φ150	DC 400H × φ200	DC 500H × φ250	
Fender	Dφ	75	100	125	150	200	250
	dφ	55	65	70	70	90	100
	C	50	65	80	90	100	120
	G	60	75	100	125	150	175
	H	150	200	250	300	400	500
	I	22	30	43	52	70	88
	J	220	280	350	400	520	640
	T	16	19	22	25	28	32
	W	150	200	250	300	400	500
Frame	Aφ	20	25	28	28	36	42
	MB	M16 (5/8)	M20 (3/4)	M24 (1)	M24 (1)	M30 (1 1/4)	M36 (1 1/2)
	E	40	50	60	70	80	90
	F	80	95	112	132	180	210
	Y	32	38	42	48	54	62
	P	250 ~ 350					
	Q	150 ~ 200					

- MB : Anchor Size See Page 45~47

● Performance Table

(1m Length)

Size			150H × ϕ 75	200H × ϕ 100	250H × ϕ 125	300H × ϕ 150	400H × ϕ 200	500H × ϕ 250
Performance								
DC-Type (DD)	RH	R • F(kN)	102.9	137.2	171.5	205.8	274.4	343.0
		E • A(kJ)	2.8	5.1	7.8	11.4	20.2	31.6
	RL	R • F(kN)	48.8	65.0	81.3	97.5	130.0	162.5
		E • A(kJ)	1.3	2.4	3.7	5.4	9.6	14.9
RC-Type (RD)	RH	R • F(kN)	164.6	219.5	274.4	329.3	439.0	548.8
		E • A(kJ)	5.2	9.2	14.4	20.8	36.9	57.7
	RL	R • F(kN)	78.0	104.0	130.0	156.0	208.0	260.0
		E • A(kJ)	2.4	3.8	6.0	8.6	15.2	23.8

 - R • F : Reaction Force(kN) - E • A : Energy Absorption(kJ) - Tolerance : $\pm 5\%$ or $\pm 10\%$ - Deflection : 50%

■ MC-Type Fender

MC fender is installed on the side of the tugboat, and makes it possible towing and berthing with the fender only.

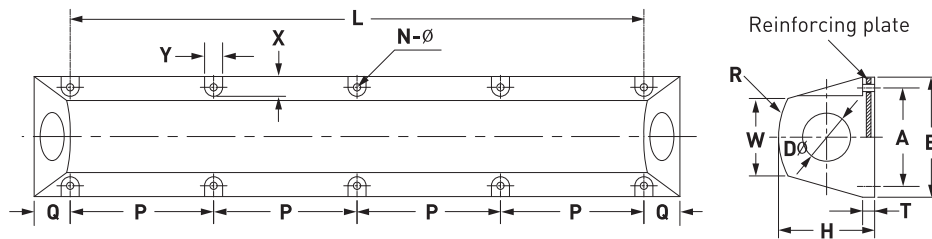
● Dimension

(Unit:mm)

Fender	MD	A	B	D ϕ	L	N- ϕ	P	Q	R	T	W	X	Y
400H	M24(1)	410	500	200	Max. 3000	10-30	500	150	350	50	300	80	75

- MD : Anchor Size See Page 45~47

■ W-Type Fender



W-type fenders have been developed for use as push-pads for tugboats, and are also ideal for fendering the berthing section of a pontoon or protecting bridge piles. These are installed in rows to provide a continuous resilient fender face.

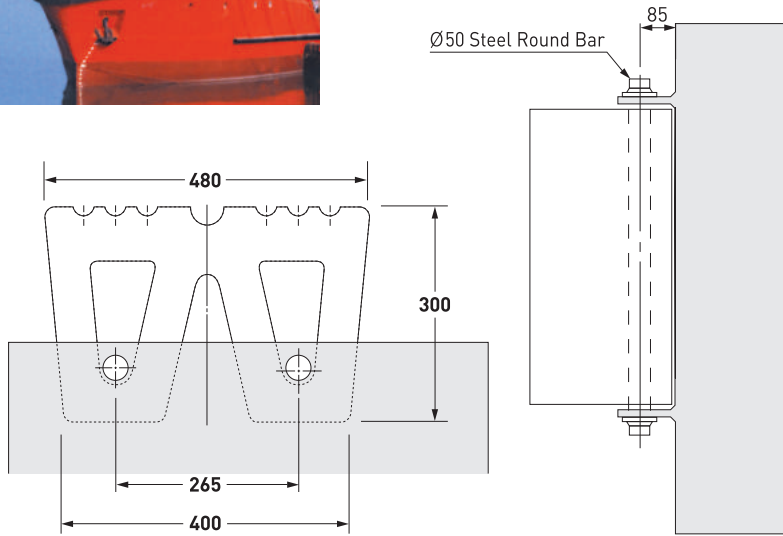

■ SBP-Type Fender



Super bumper fender (SBP) is improved from existing Bumper type, and it is specialized to minimize damages, caused by the impact of crash, to the bridges and hulls. Also it has superior energy absorption capacity with outstanding compression deformation ratio of the fender body. Also this type can be installed on any curved surface of the bridges.



For plane surface

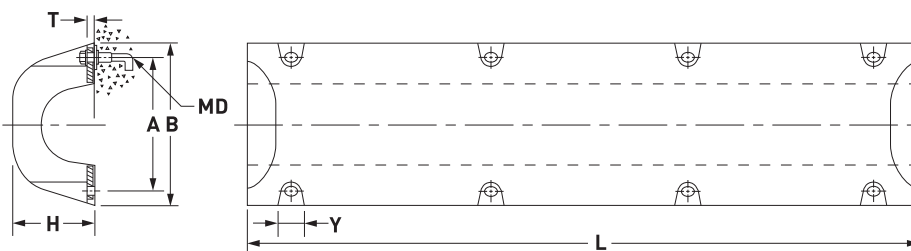

For curver surface

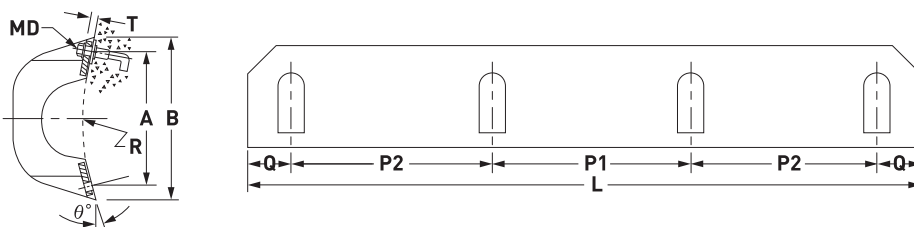

● Dimension

(Unit:mm)

Size Height	MD	A	B	T	Y	R		1000L		1500L		2000L		2500L		3000L		
						4°	8°	P2	Q	P2	Q	P2	Q	P2	Q	P1	P2	Q
250H	M30 (1 1/4)	410	500	25	130	over 3m	under 3m	560	220	560×2	190	560×3	160	700×3	200	700×2	560×2	240
300H	M36 (1 1/2)	490	600	30	140	over 3m	under 3m	560	220	560×2	190	560×3	160	700×3	200	700×2	560×2	240
400H	M36 (1 1/2)	660	800	40	140	over 4m	under 4m	560	220	560×2	190	560×3	160	700×3	200	700×2	560×2	240
500H	M42 (1 3/4)	820	1000	50	170	over 4m	under 4m	560	220	560×2	190	560×3	160	700×3	200	700×2	560×2	240
600H	M48 (2)	990	1200	60	180	over 5m	under 5m	560	220	560×2	190	560×3	160	700×3	200	700×2	560×2	240

- MD : Anchor Size See Page 45-47

● Performance Curve

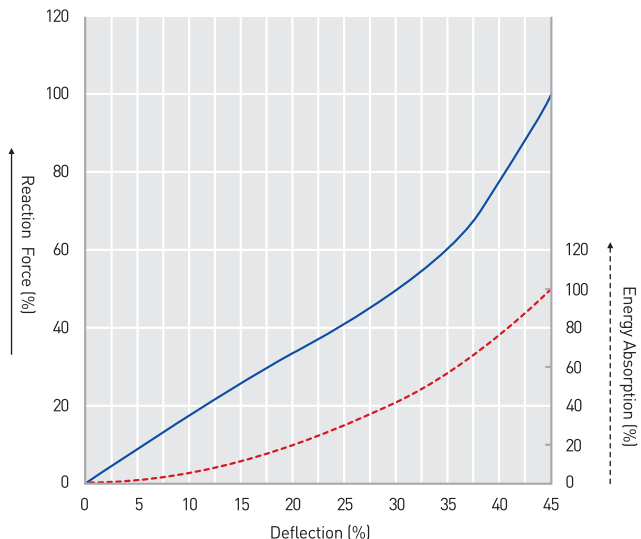

● Performance of Intermediate Deflection

Deflection(%)	R • F(%)	E • A(%)
0	0	0
5	9	1
10	17	5
15	25	11
20	33	19
25	41	29
30	49	42
35	61	57
40	77	76
45	100	100

● Performance Table

Size	250	300	400	450	500	600
R • F(kN)	427.3	513.5	684.0	769.3	855.5	1026
E • A(kJ)	19.4	27.9	49.7	62.9	77.6	111.8

(1m Length)

- R • F : Reaction Force(kN) - E • A : Energy Absorption(kJ) - Tolerance : ±5% or ±10% - Deflection : 45%

■ Roller-Type Fender

The fixed axle roller is a simple and effective fender suitable for high reactive loads with moderated deflection, and limited kinetic energy absorption characteristics. It is designed specifically for assisting in maneuvering vessels in confined spaces such as dry docks and pontoon. Units of this type are installed in building and dry docks which are in exposed conditions. With a pattern of simple rollers, the ships are allowed to positively contact one fenders, and the ship can then be rolled out safely with very little friction resistance.

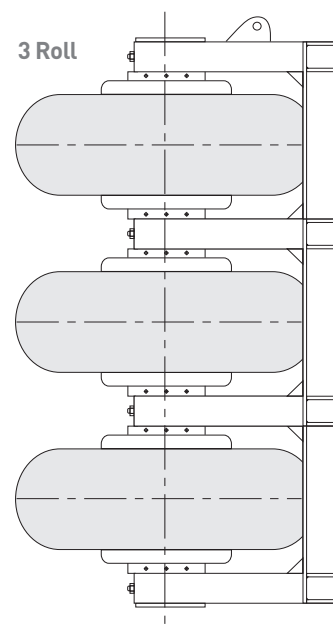
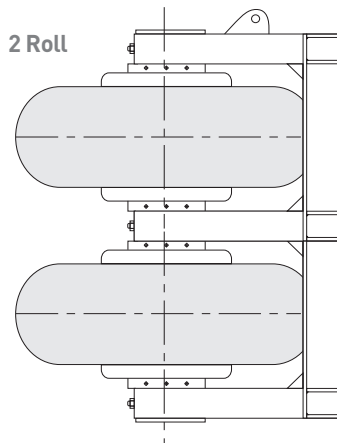
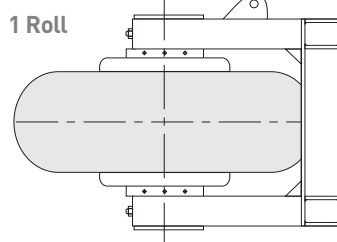
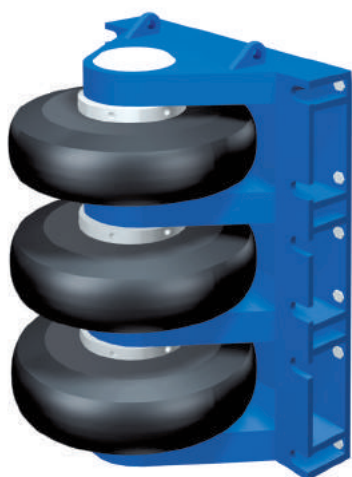

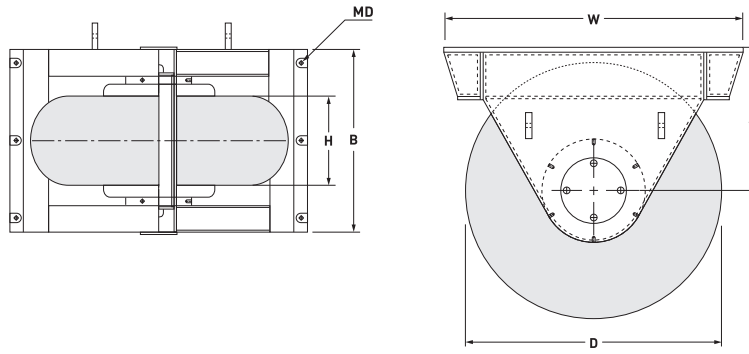

● Dimension

(Unit:mm)

Type Size	MD	Roller Fender		Frame				
		D	H	A	W	1 Roll-B	2 Roll-B	3 Roll-B
R600	M22 (7/8)	600	200	350	695	420	780	1120
R750	M22 (7/8)	750	250	420	870	510	935	1360
R900	M24 (1)	900	300	520	1040	610	1120	1630
R1200	M27 (1 1/8)	1200	400	670	1380	820	1500	2180
R1400	M30 (1 1/4)	1400	400	772	1400	820	1500	2180
R1500	M30 (1 1/4)	1500	500	850	1740	1010	1850	2690
R1800	M36 (1 1/2)	1800	600	960	2080	1210	2215	3220
R2100	M42 (1 3/4)	2100	700	1155	2440	1410	2590	3770
R2400	M48 (2)	2400	800	1280	2770	1610	2950	4290
R2700	M56 (2 1/4)	2700	900	1440	3130	1810	3300	4790
R3000	M64 (2 1/2)	3000	1000	1600	3480	2010	3660	5310

- MD : Anchor Size See Page 40~42

● Performance Curve

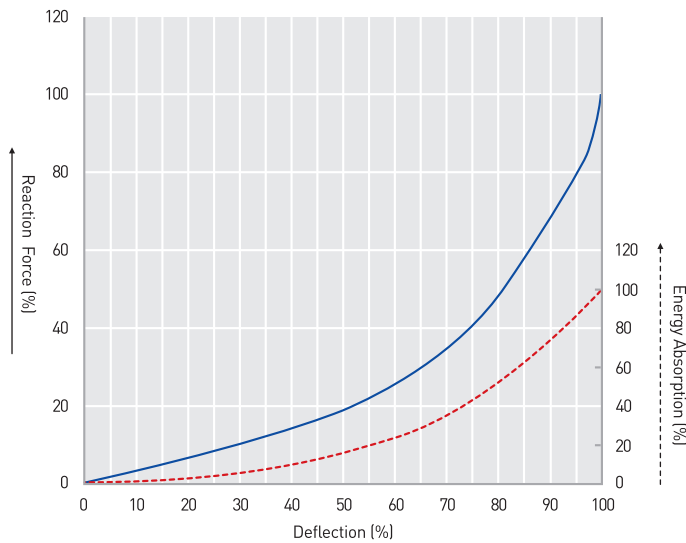

● Performance Table

Size	R600	R750	R900	R1200	R1400	R1500	R1800	R2100	R2400	R2700	R3000	
Deflection(mm)	125	157	185	260	300	325	390	455	510	578	640	
Performance												
1 Roll	R · F(kN)	68.6	107.8	147.0	264.6	392.0	421.4	607.6	823.2	1078	1362	1676
	E · A(kJ)	2.5	4.8	8.2	19.6	33.0	38.3	66.2	104.9	156.8	223.4	305.8
2 Roll	R · F(kN)	137.2	215.6	294.0	529.2	784.0	842.8	1215	1646	2156	2724	3352
	E · A(kJ)	4.9	9.6	16.5	39.2	66.1	76.6	132.3	209.7	313.6	446.9	611.5
3 Roll	R · F(kN)	205.8	323.4	441.0	793.8	1176	1264	1823	2470	3234	4087	5027
	E · A(kJ)	7.4	14.4	24.7	58.8	99.0	115.0	198.5	314.6	470.4	670.3	917.3

- R · F : Reaction Force(kN) - E · A : Energy Absorption(kJ) - Tolerance : ±5% or ±10%

■ Composite-Type Fender

Composite fenders are applicable to installation on workboats and narrow waterways. The benefit of composite fender is a great energy absorption with low friction properties owing to the fact that rubber body and UHMW-PE are made into a single moulded product. The special manufacturing technique is applied to make strong adhesion between the elastomer section and UHMW-PE during vulcanization process. Therefore no more mechanical fixings are needed.

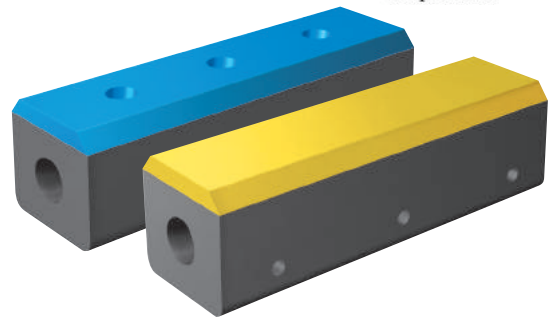

Vertical Fitting Bolt Method

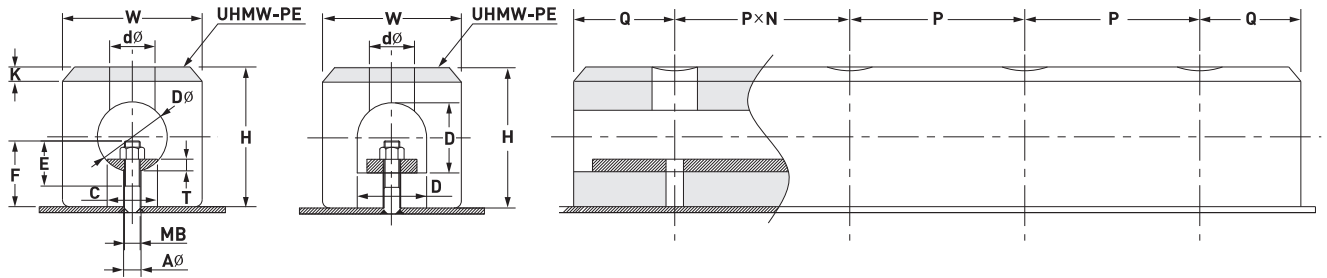

Cross Fitting Bolt Method

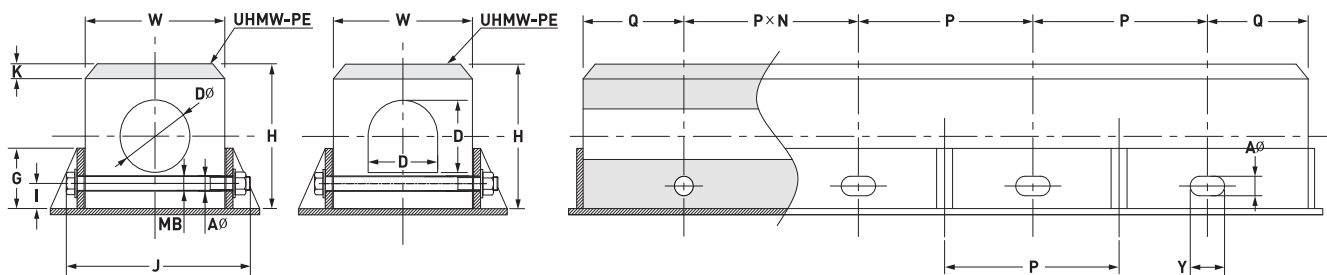

● Dimension

(Unit:mm)

Size	Fender											Frame					
	C	D \varnothing	d \varnothing	G	H	I	K	P	Q	T	W	A \varnothing	MB	E	F	J	Y
150H×75 \varnothing	50	75	60	60	150	26	20	250~350	150~200	16	150	22	M16 (5/8)	40	80	220	32
200H×100 \varnothing	65	100	65	75	200	35	25			19	200	25	M20 (3/4)	50	95	280	38
250H×125 \varnothing	80	125	70	100	250	43	30			22	250	28	M24 (1)	60	112	350	42
300H×150 \varnothing	90	150	80	125	300	52	30			25	300	32	M24 (1)	70	132	400	48

■ SM-Type Fender

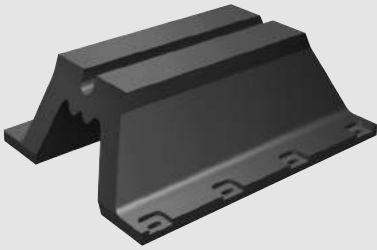

■ Lord-Type Fender



■ Turtle-Type Fender



■ Corner-Type Fender

It is to be installed at the corner of the structure, and to be used as a protector fender for vessels and the structure. This type is reinforced by an embedded steel plate at the entire bottom of a fender.

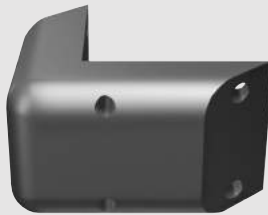

BP-Type

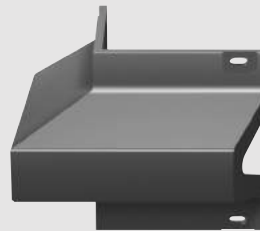

AOV-Type

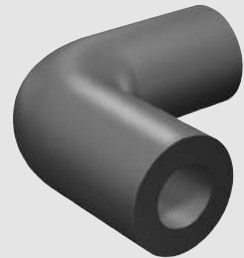

CYL-Type

■ Seal



Meeting Face



D Shaped Seal



P-Type Seal



Bearing Pad



Soft Type Seal



Bottom Seal



Omega Seal



Water Stop

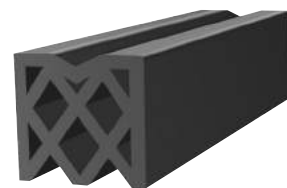

Water Seal



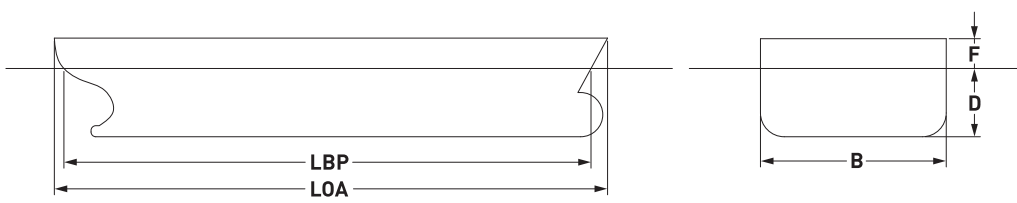
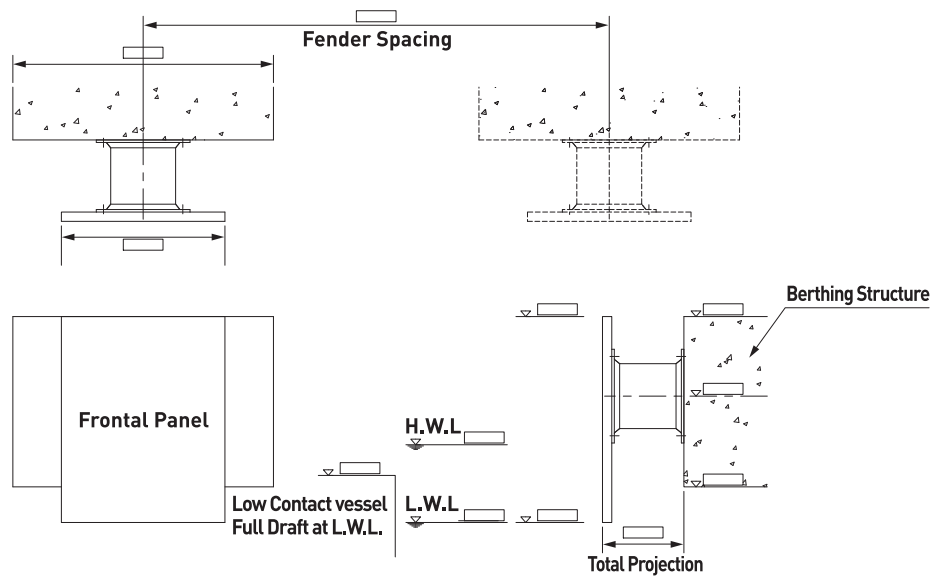

■ Criteria for Designing Fender System

Item		Design Criteria		
GENERAL	Project			
	Consultant and / or Contractor			
	Port & Country			
VESSEL	Type	<input type="checkbox"/> General Cargo Ship <input type="checkbox"/> Oil Tanker <input type="checkbox"/> Ferry	<input type="checkbox"/> Bulk Carrier <input type="checkbox"/> Ro / Ro <input type="checkbox"/> Gas Carrier	<input type="checkbox"/> Container Ship <input type="checkbox"/> Passenger Ship <input type="checkbox"/> Other()
	Weight : DeadWeight Tonnage (D.W.T)	Largest	Smallest	
	Displacement Tonnage (D.T)	Largest	Smallest	
	Dimension : Length Overall (m) (LOA)	Largest	Smallest	
	Length Between Perps (m) (LBP)	Largest	Smallest	
	Breadth (m) (B)	Largest	Smallest	
Maximum Draft (m) (D)	Largest	Smallest		
Freeboard (m) (F)	Largest	Smallest		
Hull Pressure (Ton/m ² or kN/m ²) (P)				
BERTHING CONDITIONS	Speed (m/s)			
	Angle(degree)			
	Berthing Method	1/4 point or others()		
	Abnomal Impact Factor			
	Effective Berthing Energy (Ton-m or kN-m)			
BERTH	Structure	<input type="checkbox"/> Wharf <input type="checkbox"/> Flexible pile <input type="checkbox"/> Concrete	<input type="checkbox"/> Dolphin <input type="checkbox"/> New <input type="checkbox"/> Steel structure	<input type="checkbox"/> Gravity structure <input type="checkbox"/> Existing
	Length(m)			
	Depth of Water(m)			
	Tidal Level :	H.W.L(m) L.W.L(m)		
	Area for installing Fender :	Height(m) Width(m)		
	Elevation for installing Fender :	Top(m) Bottom(m)	(+ or -)	
	Spacing of Fender(m)			
	Allowable Reaction Force(Ton or kN)			
OTHER SPECIAL REQUIREMENTS				
VESSEL LAYOUT				
BERTH LAYOUT				





■ Rubber Properties

Property	Testing Standard	Condition	Requirement
Tensile Strength	DIN 53504 ASTM D 412 Die C AS 1180.2 BS ISO 37 JIS K 6251	Original	16.0 MPa(Min.)
		Aged for 96 hours at 70°C	12.8 MPa(Min.)
Elongation at Break	DIN 53504 ASTM D 412 Die C AS 1180.2 BS ISO 37 JIS K 6251	Original	350%
		Aged for 96 hours at 70°C	280%
Hardness	DIN 53505 ASTM D 2240 AS 1683.15.2 JIS K 6253	Original	78° Shore A (Max.)
		Aged for 96 hours at 70°C	Original +8° Shore A (Max.)
Compression Set	ASTM D 395 Method B AS 1683.13 Method B BS 903 A6 ISO 815 JIS K 6259	22 hours at 70°C	30% (Max.)
Tear Resistance	ASTM D 624 Die B AS 1683.12 BS ISO 34-1 JIS K 6252	Original	70kN/m (Min.)
Ozone Resistance	DIN 53509 ASTM D 1149 AS 1683-24 BS ISO 1431-1 JIS K 6259	50pphm at 20% strain, 40°C, 100 hours	No cracks
Seawater Resistance	BS ISO 1817 ASTM D 471	28 days at 95°C	Hardness : ±10° Shore A (Max.) Volume : ±10/-5% (Max.)
Abrasion	ASTM D 5963-04 BS ISO 4649 : 2002	Original	100mm ³ (Max.)
	BS 903 A9, Method B	3000 revolution	1.5cc (Max.)
Bond Strength	ASTM D 429, Method B BS 903.A21 Section 21.1	Rubber to steel	7N/mm (Min.)

■ Standard Size of Vessel and Berthing Energy

Confidence Limit : 75%												
Type	Dead Weight Tonnage (t)	Displacement (t)	Length Overall (m)	Length P.P (m)	Breath (m)	Depth (m)	Maximum Draft (m)	Wind Lateral Area (m ²)		Wind Front Area (m ²)		Berthing Energy (kJ) 0.15m/sec
								Full Load Condition	Ballast Condition	Full Load Condition	Ballast Condition	
General Cargo Ship 	1,000	1,690	67	62	10.8	5.8	3.9	278	342	63	93	16.7
	2,000	3,250	83	77	13.1	7.2	4.9	426	541	101	142	32.6
	3,000	4,750	95	88	14.7	8.1	5.6	547	708	132	182	48.0
	5,000	7,690	111	104	16.9	9.4	6.6	750	993	185	249	78.6
	7,000	10,600	123	115	18.6	10.4	7.4	922	1,240	232	307	109.3
	10,000	14,800	137	129	20.5	11.6	8.3	1,150	1,570	294	382	153.7
	15,000	21,600	156	147	23	13.1	9.5	1,480	2,060	385	490	226.4
	20,000	28,400	170	161	24.9	14.3	10.4	1,760	2,490	466	585	299.2
	30,000	41,600	193	183	27.8	16.2	11.9	2,260	3,250	611	750	443.2
	40,000	54,500	211	200	30.2	17.6	13.0	2,700	3,940	740	895	582.1
Bulk Carrier * 	5,000	6,920	109	101	15.5	8.6	6.2	689	910	221	245	71.5
	7,000	9,520	120	111	17.2	9.5	6.9	795	1,090	250	287	98.5
	10,000	13,300	132	124	19.2	10.6	7.7	930	1,320	286	340	137.6
	15,000	19,600	149	140	21.8	11.9	8.6	1,100	1,630	332	411	201.3
	20,000	25,700	161	152	23.8	13.0	9.4	1,240	1,900	369	470	264.0
	30,000	37,700	181	172	27.0	14.7	10.6	1,480	2,360	428	569	386.3
	50,000	61,100	209	200	32.3	17.1	12.4	1,830	3,090	518	723	620.0
	70,000	84,000	231	221	32.3	18.9	13.7	2,110	3,690	586	846	891.1
	100,000	118,000	255	246	39.2	21.1	15.2	2,460	4,460	669	1,000	1202.5
	150,000	173,000	287	278	44.5	23.8	17.1	2,920	5,520	777	1,210	1756.1
200,000	227,000	311	303	48.7	25.9	18.6	3,300	6,430	864	1,380	2298.2	
250,000	280,000	332	324	52.2	27.7	19.9	3,630	7,240	938	1,540	2832.5	
Container Ship ** 	7,000	10,700	123	115	20.3	9.8	7.2	1,460	1,590	330	444	105.0
	10,000	15,100	141	132	22.4	11.3	8.0	1,880	1,990	410	535	148.6
	15,000	22,200	166	156	25.0	13.3	9.0	2,490	2,560	524	663	219.2
	20,000	29,200	186	175	27.1	14.9	9.9	3,050	3,070	625	771	290.1
	25,000	36,100	203	191	28.8	16.3	10.6	3,570	3,520	716	870	359.7
	30,000	43,000	218	205	30.2	17.5	11.1	4,060	3,950	800	950	428.2
	40,000	56,500	244	231	32.3	19.6	12.2	4,970	4,730	950	1,110	569.3
	50,000	69,900	266	252	32.3	21.4	13.0	5,810	5,430	1,090	1,250	724.2
60,000	83,200	286	271	36.5	23.0	13.8	6,610	6,090	1,220	1,370	838.7	
Oil Tanker 	1,000	1,580	61	58	10.2	4.5	4.0	190	280	86	85	16.2
	2,000	3,070	76	72	12.6	5.7	4.9	280	422	119	125	31.3
	3,000	4,520	87	82	14.3	6.6	5.5	351	536	144	156	45.9
	5,000	7,360	102	97	16.8	7.9	6.4	467	726	184	207	74.4
	7,000	10,200	114	108	18.6	8.9	7.1	564	885	216	249	103.2
	10,000	14,300	127	121	20.8	10.0	7.9	688	1,090	255	303	144.4
	15,000	21,000	144	138	23.6	11.6	8.9	860	1,390	309	378	211.4
	20,000	27,700	158	151	25.8	12.8	9.6	1,010	1,650	355	443	277.3
	30,000	40,800	180	173	29.2	14.8	10.9	1,270	2,090	430	554	409.0
	50,000	66,400	211	204	32.3	17.6	12.6	1,690	2,830	548	734	678.5
	70,000	91,600	235	227	38.0	19.9	13.9	2,040	3,460	642	884	910.4
	100,000	129,000	263	254	42.5	22.5	15.4	2,490	4,270	761	1,080	1277.0
	150,000	190,000	298	290	48.1	25.9	17.4	3,120	5,430	920	1,340	1879.6
200,000	250,000	327	318	52.6	28.7	18.9	3,670	6,430	1,060	1,570	2466.1	
300,000	368,000	371	363	59.7	33.1	21.2	4,600	8,180	1,280	1,970	3612.4	

■ Standard Size of Vessel and Berthing Energy

Confidence Limit : 75%												
Type	Dead Weight Tonnage (t)	Displacement (t)	Length Overall (m)	Length P.P (m)	Breath (m)	Depth (m)	Maximum Draft (m)	Wind Lateral Area (m ²)		Wind Front Area (m ²)		Berthing Energy (kJ) 0.15m/sec
								Full Load Condition	Ballast Condition	Full Load Condition	Ballast Condition	
RoRo Ship 	1,000	2,190	73	66	14.0	6.2	3.5	880	970	232	232	18.9
	2,000	4,150	94	86	16.6	8.4	4.5	1,210	1,320	314	323	36.7
	3,000	6,030	109	99	18.3	10.0	5.3	1,460	1,590	374	391	54.7
	5,000	9,670	131	120	20.7	12.5	6.4	1,850	2,010	467	497	89.8
	7,000	13,200	148	136	22.5	14.5	7.2	2,170	2,350	541	583	124.3
	10,000	18,300	169	155	24.6	17.0	8.2	2,560	2,760	632	690	175.1
	15,000	26,700	196	180	27.2	20.3	9.6	3,090	3,320	754	836	261.4
	20,000	34,800	218	201	29.1	23.1	10.7	3,530	3,780	854	960	346.6
	30,000	50,600	252	233	32.2	27.6	12.4	4,260	4,550	1,020	1,160	514.1
Passenger Ship 	1,000	1,030	64	60	12.1	4.9	2.6	464	486	187	197	08.5
	2,000	1,910	81	75	14.4	6.3	3.4	744	770	251	263	16.1
	3,000	2,740	93	86	16.0	7.4	4.0	980	1,010	298	311	23.6
	5,000	4,320	112	102	18.2	9.0	4.8	1,390	1,420	371	386	37.9
	7,000	5,830	125	114	19.8	10.2	5.5	1,740	1,780	428	444	52.1
	10,000	8,010	142	128	21.6	11.7	6.4	2,220	2,250	498	516	73.2
	15,000	11,500	163	146	23.9	13.7	7.5	2,930	2,950	592	611	107.4
	20,000	14,900	180	160	25.7	15.3	8.0	3,560	3,570	669	690	138.8
	30,000	21,300	207	183	28.4	17.8	8.0	4,690	4,680	795	818	191.1
	50,000	33,600	248	217	32.3	21.7	8.0	6,640	6,580	990	1,010	288.4
70,000	45,300	278	243	35.2	24.6	8.0	8,350	8,230	1,140	1,170	378.2	
Ferry 	1,000	1,230	67	61	14.3	5.5	3.4	411	428	154	158	10.4
	2,000	2,430	86	78	17.0	6.8	4.2	656	685	214	221	20.8
	3,000	3,620	99	91	18.8	7.7	4.8	862	903	259	269	31.4
	5,000	5,970	119	110	21.4	9.0	5.5	1,220	1,280	330	344	51.9
	7,000	8,310	134	124	23.2	10.0	6.1	1,530	1,600	387	405	72.8
	10,000	11,800	153	142	25.4	11.1	6.8	1,940	2,040	458	482	104.0
	15,000	17,500	177	164	28.1	12.6	7.6	2,550	2,690	555	586	154.8
	20,000	23,300	196	183	30.2	13.8	8.3	3,100	3,270	636	673	207.2
	30,000	34,600	227	212	33.4	15.6	9.4	4,070	4,310	771	819	310.4
	40,000	45,900	252	236	35.9	17.1	10.2	4,950	5,240	880	940	413.2
Gas Carrier 	1,000	2,480	71	66	11.7	5.7	4.6	390	465	133	150	25.4
	2,000	4,560	88	82	14.3	7.2	5.7	597	707	195	219	47.0
	3,000	6,530	100	93	16.1	8.4	6.4	765	903	244	273	67.3
	5,000	10,200	117	109	18.8	10.0	7.4	1,050	1,230	323	361	104.6
	7,000	13,800	129	121	20.8	11.3	8.1	1,290	1,510	389	434	140.9
	10,000	18,900	144	136	23.1	12.9	9.0	1,600	1,870	474	527	193.0
	15,000	27,000	164	154	26.0	14.9	10.1	2,050	2,390	593	658	275.4
	20,000	34,800	179	169	28.4	16.5	11.0	2,450	2,840	696	770	354.5
	30,000	49,700	203	192	32.0	19.0	12.3	3,140	3,630	870	961	504.6
	50,000	78,000	237	226	37.2	22.8	12.3	4,290	4,940	1,150	1,270	743.8
	70,000	105,000	263	251	41.2	25.7	12.3	5,270	6,050	1,390	1,530	962.5
	100,000	144,000	294	281	45.8	29.2	12.3	6,560	7,510	1,690	1,860	1270.5

* Full Load Condition of Wind Lateral / Front Areas of log carrier don't include the areas of logs on deck

** Full Load Condition of Wind Lateral / Front Areas of Container Ships include the areas of containers on deck

Accessories

Anchor bolt, chain & U-anchor are used in installing fender to quay or marine structures, As a material, mild steel galvanised or stainless steel are used.

Resin-Type Anchor Bolt

TR Unit (1000H~1300H), TR-S (150H~1000H), ACV (200H~1300H)

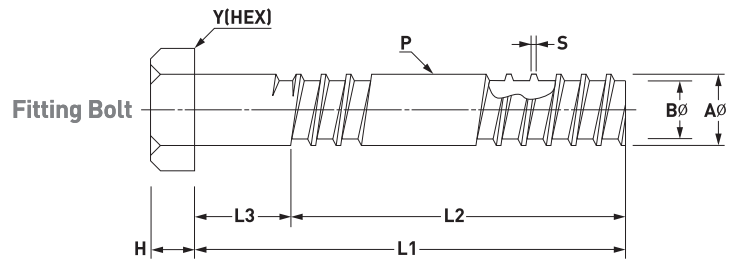
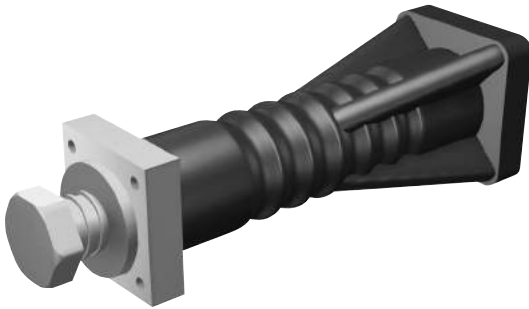

Parts	Material	Remarks
Fitting Bolt	Stainless Steel	-
Plug	Resin	-

Fitting Bolt Dimension

(Unit:mm)

WD"	H	Y	L1	L2	L3	AØ	BØ	S	P (pitches/inch)
3/4	13	30	160	105	55	19	14	2.0	2 3/4
1	18	41	210	145	65	25	18	2.0	2 1/2
1 1/4	22	50	270	185	85	32	24	2.5	2
1 1/2	27	58	330	235	95	38	30	2.5	2
1 3/4	32	67	330	235	95	44	35	3.0	1 3/4
2	36	77	395	265	130	50	40	3.5	1 1/2
2 1/2	45	95	410	275	135	65	53	4.0	1 1/4
3	55	110	440	305	135	76	62	4.5	1

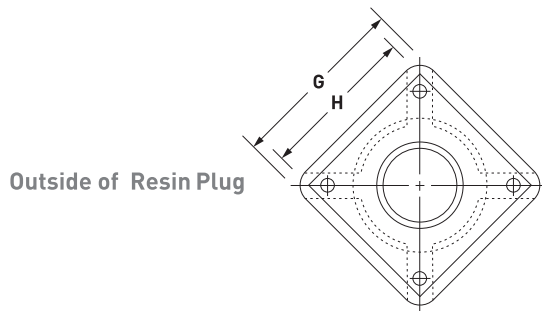

Outside of Resin Plug

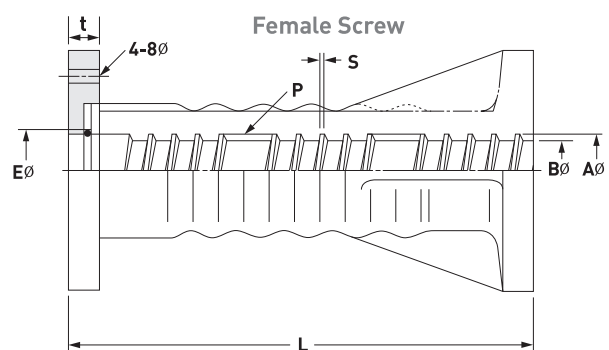

Resin Plug Dimension

(Unit:mm)

WD"	Outside of Resin Plug Body					Female Screw			
	EØ	G	H	t	L	AØ	BØ	S	P (pitches/inch)
3/4	27.0	60	55	25	150	21	16	3	2 3/4
1	35.5	63	75	25	200	26	19	3	2 1/2
1 1/4	42.5	100	80	30	250	33	25	3	2
1 1/2	50.0	120	110	30	300	40	31	3.5	2
1 3/4	57.0	120	110	30	300	46	36	3.5	1 3/4
2	63.0	160	150	30	360	53	41.5	4	1 1/2
2 1/2	78.0	160	150	30	360	68	54.5	4.5	1 1/4
3	88.0	180	170	30	400	79	64	5	1

I-Type Anchor Bolt

SSP Fender / General, Especially AOV, NV & SBP Fender

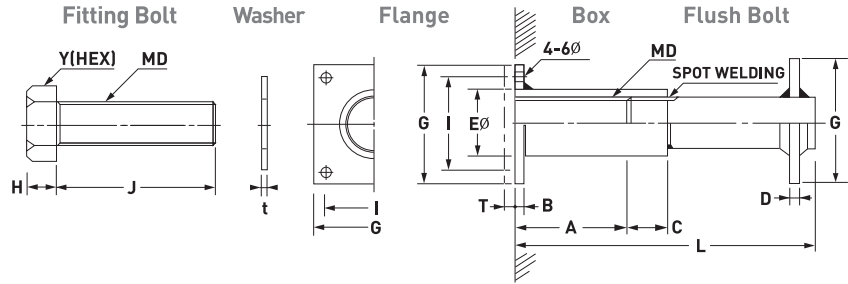
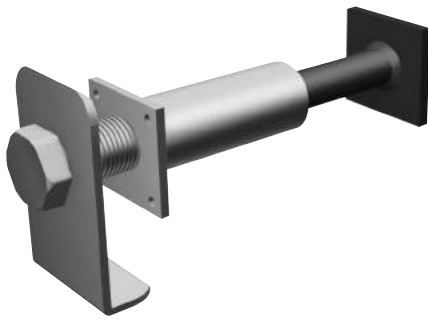

Parts	Material	Remarks
Fitting Bolt, Flange, Box	Stainless Steel	-
Flush Bolt	Rolled Steel	-

Dimension

(Unit:mm)

MD	Fitting Bolt				Flange, Box, Flush Bolt							
	H	Y	Z	J	A	B	C	D	E∅	G	I	L
M22 (7/8)	14(15)	32(35)	30	t+T+Z (round up to nearest 5mm)	50	6	25	6	28	65	50	165
M24 (1)	15(18)	36(41)	35		55	6	25	6	32	70	55	175
M27 (1 1/8)	17(20)	41(46)	37		60	6	30	9	35	75	60	200
M30 (1 1/4)	19(22)	46(50)	40		65	6	30	9	38	75	60	225
M36 (1 1/2)	23(27)	55(58)	45		70	6	35	9	45	85	70	270
M42 (1 3/4)	26(32)	65(67)	50		75	6	40	12	55	90	75	325
M48 (2)	30(36)	75(77)	60		85	6	45	12	65	120	95	360
M56 (2 1/4)	35(40)	85(85)	70		90	6	55	16	75	125	100	435
M64 (2 1/2)	40(45)	95(95)	75		100	6	60	16	80	130	105	475
M76 (3)	45(55)	110(110)	80	120	6	75	19	95	155	120	550	

- T : Clamping thickness of fender or bracket - t : See page 48

J-Type Anchor Bolt

SSP Fender / General, Especially AOV, NV & SBP Fender

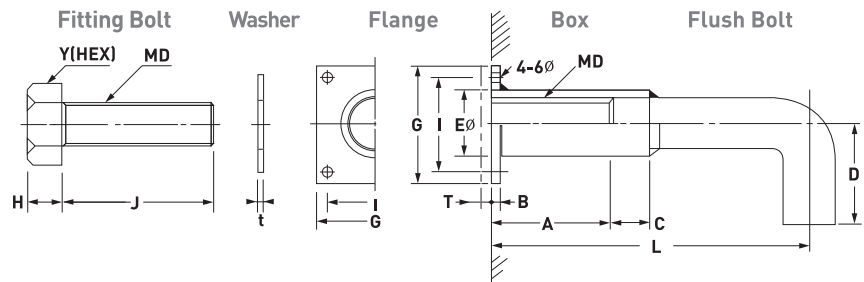

Parts	Material	Remarks
Fitting Bolt, Flange, Box	Stainless Steel	-
Flush Bolt	Rolled Steel	-

Dimension

(Unit:mm)

MD	Fitting Bolt				Flange, Box, Flush Bolt							
	H	Y	Z	J	A	B	C	D	E∅	G	I	L
M22 (7/8)	14(15)	32(35)	30	t+T+Z (round up to nearest 5mm)	50	6	25	50	28	65	50	175
M24 (1)	15(18)	36(41)	35		55	6	25	50	32	70	55	185
M27 (1 1/8)	17(20)	41(46)	37		60	6	30	75	35	75	60	210
M30 (1 1/4)	19(22)	46(50)	40		65	6	30	85	38	75	60	230
M36 (1 1/2)	23(27)	55(58)	45		70	6	35	100	45	85	70	255
M42 (1 3/4)	26(32)	65(67)	50		75	6	40	100	55	90	75	290
M48 (2)	30(36)	75(77)	60		85	6	45	120	65	120	95	325
M56 (2 1/4)	35(40)	85(85)	70		90	6	55	140	75	125	100	350
M64 (2 1/2)	40(45)	95(95)	75		100	6	60	160	80	130	105	375
M76 (3)	45(55)	110(110)	80	120	6	75	160	95	155	120	450	

- T : Clamping thickness of fender or bracket - t : See page 48

■ Stud-Type Anchor Bolt

General, Especially AOV, NV & SBP Fender

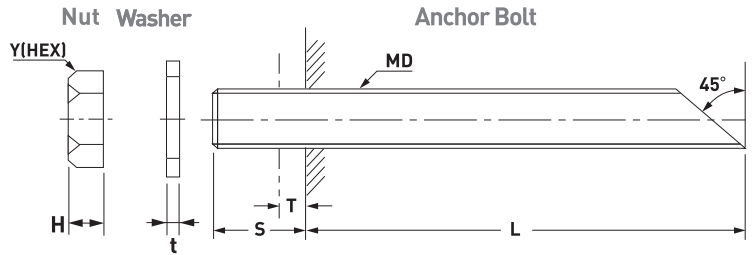
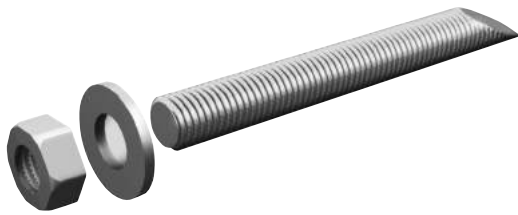

Parts	Material	Remarks
Anchor Bolt	Stainless Steel	-

● Dimension

(Unit:mm)

MD	Nut			Anchor Bolt	
	H	Y	Z	L	S
M22 (7/8)	18(18)	32(35)	8	145	H+t+T+Z (Rounded up to nearest 5mm)
M24 (1)	19(20)	36(41)	10	175	
M27 (1 1/8)	22(22)	41(46)	10	210	
M30 (1 1/4)	24(25)	46(50)	11	210	
M36 (1 1/2)	29(30)	55(58)	12	250	
M42 (1 3/4)	32(35)	65(67)	13	320	
M48 (2)	38(40)	75(77)	15	320	
M56 (2 1/4)	45(45)	85(85)	18	400	
M64 (2 1/2)	51(50)	95(95)	20	450	
M76 (3)	61(62)	110(110)	20	550	

- T : Clamping Thickness of Fender or Bracket - t : See page 48 - Anchor Bolt shall be fixed on the Hole by using the mixed Acrylate Resin & Hardner

■ HS Chemical-Type Anchor Bolt

General, Especially AOV, NV & SBP Fender

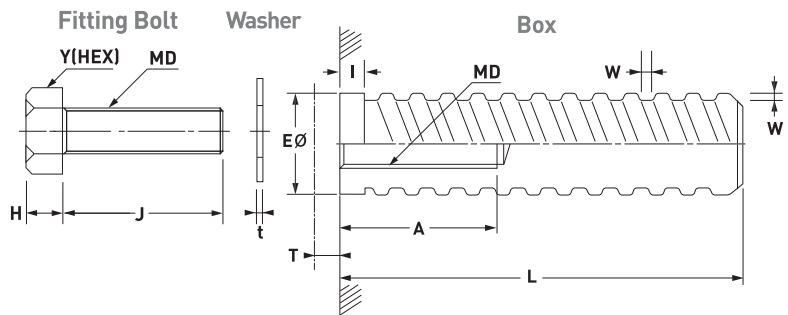
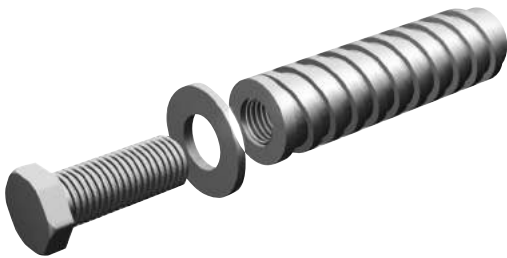

Parts	Material	Remarks
Fitting Bolt	Stainless Steel	-
Box		

● Dimension

(Unit:mm)

MD	Fitting Bolt				Box				
	H	Y	Z	J	A	I	E	L	W
M22 (7/8)	14(15)	32(35)	30	t+T+Z (round up to nearest 5mm)	100	15	32	200	2
M24 (1)	15(18)	36(41)	35		100	15	35	250	2
M27 (1 1/8)	17(20)	41(46)	37		100	15	40	250	2
M30 (1 1/4)	19(22)	46(50)	40		100	15	45	250	2
M36 (1 1/2)	23(27)	55(58)	45		120	15	55	300	2.5
M42 (1 3/4)	26(32)	65(67)	50		120	15	60	350	2.5
M48 (2)	30(36)	75(77)	60		120	15	65	350	2.5
M56 (2 1/4)	35(45)	85(85)	70		120	15	70	400	2.5
M64 (2 1/2)	40(45)	95(95)	75		120	15	80	450	2.5
M76 (3)	45(55)	110(110)	80		150	15	95	450	2.5

- T : Clamping Thickness of Fender or Bracket - t : See page 48

■ Washer

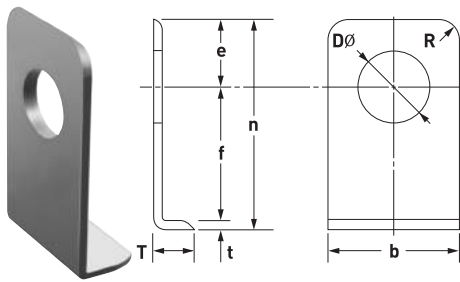

● L-Type Washer Dimension

(Unit:mm)

MD	AOV, NV Fender								
	Size	b	D	e	f	n	R	T	t
M22 (7/8)	150H	68	25	23	32	59.5	10	12	4.5
M24 (1)	200H	74	29	33	42	79.5	10	14	4.5
M27 (1 1/8)	250H	88	34	42	48	94.5	10	16	4.5
M30 (1 1/4)	300H	100	37	47	58	109.5	10	19	4.5
M36 (1 1/2)	400H	119	43	52	68	126	10	22	6
M42 (1 3/4)	500H	127	49	56	83	145	10	25	6
M48 (2)	600H	139	56	61	98	165	10	28	6
M64 (2 1/2)	800H	195	70	100	134	242	10	32	8
	1000H	215	70	110	164	282	10	36	8

● Round Washer Dimension

(Unit:mm)

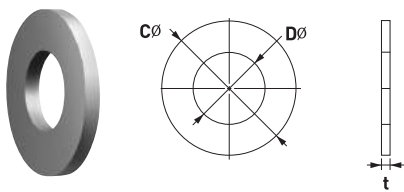

MD	General			TR Unit, TR-S, ACV		
	C	D	t	C	D	t
M20 (3/4)	-	-	-	80	24	6
M22 (7/8)	44	26	5	-	-	-
M20 (1)	52	28	5	90	28	6
M27 (1 1/8)	58	31	5	-	-	-
M30 (1 1/4)	62	35	5	90	35	6
M36 (1 1/2)	72	41	8	130	41	9
M42 (1 3/4)	82	47	8	140	47	9
M48 (2)	95	54	8	160	54	12
M64 (2 1/2)	115	70	10	180	70	12
M76 (3)	135	82	10	180	82	12

● Rectangle Washer Dimension

(Unit:mm)

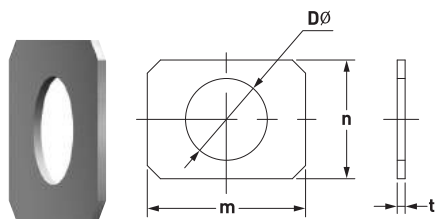

MD	General				SSP-TYPE Fender			
	m	n	D	t	m	n	D	t
M20 (3/4)	50	45	24	5	45	40	22	5.5
M22 (7/8)	70	50	26	5	-	-	-	-
M24 (1)	75	55	28	5	65	50	28	5.5
M27 (1 1/8)	85	60	31	5	85	60	31	5.5
M30 (1 1/4)	100	65	35	5	85	60	35	5.5
M36 (1 1/2)	115	75	41	8	100	65	41	8
M42 (1 3/4)	140	90	47	8	105	90	47	8
M48 (2)	165	100	54	8	130	110	54	8
M56 (2 1/2)	185	125	62	8	120	100	62	8
M64 (2 1/2)	210	135	70	10	140	110	70	10
M64 (2 1/2)	-	-	-	-	160	120	70	10
M76 (3)	230	150	80	10	-	-	-	-

■ Chain & U-Anchor



■ Template

● Template can be used for all type of fenders. This can be imbedded in a newly constructed dock. This would ensure precise fitting of the fenders.

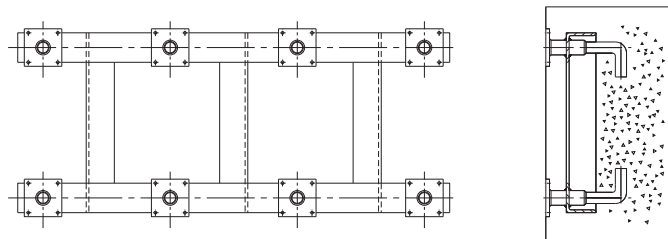
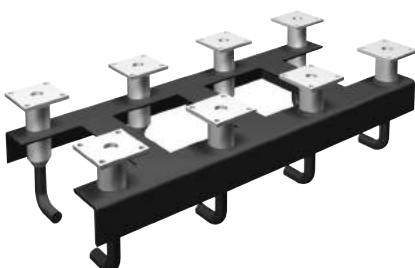

Pipes & Lining

Expansion Joint

Rubber Expansion Joints which are designed to avoid excessive stress and to absorb vibration plus eliminate noises on pipe connections are made of a high quality rubber compound for the maximum in flexibility, plus the cover rubber is oil and ozone resistant. This compound is combined with a strong synthetic fabric for vacuum and the carcass of the joint is reinforced with steel wire. All Expansion joints are made of superior quality rubber and the steel reinforcement is resistant to corrosion, abrasion and water with good flexibility, maintaining high pressure resistance.

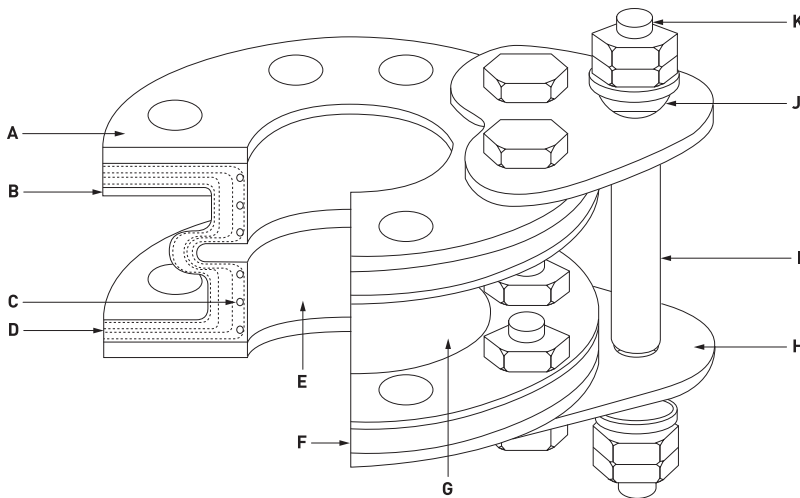
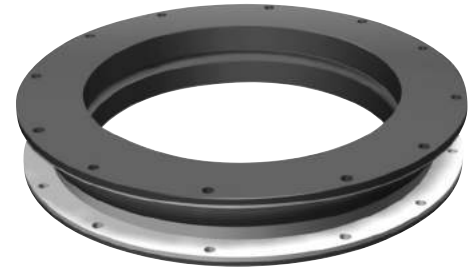

- A : Matching Flange
- B : Split Metal Retaining Ring
- C : Carcass Metal Reinforcing
- D : Carcass Fabric Reinforcing
- E : Tube
- F : Rubber Expansion Joint
- G : Cover
- H : Control Rod Plate
- I : Pipe Sleeve
- J : Ball Seat
- K : Control Rod Stud Bolt

Tube

A protective, leak proof lining made of synthetic or natural rubber as the application dictates. This is a seamless tube that extends through the bore to the outside edges of the flanges. Its purpose is to eliminate the possibility of the materials being handled penetrating the carcass and weakening the fabric.

Cover

The exterior surface of the joint is formed from natural or synthetic rubber, depending on service requirements.

Reinforcing Fabric

The carcass reinforcing fabric is the flexible and supporting member between the inner tube and outer cover. Standard constructions normally utilize high quality synthetic fabric.

Reinforcing Wire

Reinforcing Wire imbedded in the carcass are frequently used as strengthening member of the joint. The use of metal sometimes raises the rated working pressure and can supply rigidity to the joint for vacuum service.

• Rubber

Rubber		Hardness (HS)		Tensile strength (kg/cm ²)		Elongation (%)	
Cover	Tube	Cover	Tube	Cover	Tube	Cover	Tube
CR	CR	Max.70	Max.70	Min.120	Min.120	Min.400	Min.400
CR	NR	Max.70	Max.70	Min.120	Min.160	Min.400	Min.400
CR	NBR	Max.70	Max.70	Min.120	Min.80	Min.400	Min.350
CIIR	CIIR	Max.70	Max.70	Min.100	Min.100	Min.350	Min.350
EPDM	EPDM	Max.70	Max.70	Min.80	Min.80	Min.300	Min.300
CR	FDA-NBR	Max.70	Max.70	Min.120	Min.100	Min.400	Min.400

• Reinforcing Fabric

Nominal Size I · D (Inch)	Fabric	Density (E · P · I)	Tensile Strength (kg/cm)	Elongation (%)	Shrinkage 150°C × 30min(%)	Weight (g/m ²)
18 ~	Polyester T/C 1000D/3	26	Min.180	Min.15	Max.6	430

● Retaining Ring & Control Unit

Item	KS	Comparison	
		JIS	ASTM
Heavy Hex Bolt & Control Rod Stud Bolt	D3755.SN B7	G41007.SN B7	A193.B7
	D3503.3SS400	G3101.SS400	A307.B
	D3706.STS304	G4303.SUS304	A276.304
	D3706.STS316	G4303.SUS316	A276.316
	- -	- -	A193.B8(304)
Heavy Hex Nut & Jam Nuts	D3752.SM 45C	G4051.S45C	A194.2H
	D4101.SC42	G5101.SC42	A563.A
	D3706.STS304	G4303.SUS304	A276.304
	D3706.STS316	G4303.SUS316	A276.316
	- -	- -	A194.8N(304N)
Pipe Sleeve	D3562.SPPS42	G3454.STPG42	A53.B
	D3570.SPHT42	G3456.STPT42	A106.B
	D3576.STS316TP	G3456.SUS316TP	A358.316
	D3576.STS304TP	G3459.SUS304TP	A358.304
	- -	- -	A194.8MN(316N)
Control Rod Plate & Ball Seat & Retaining Ring	D3503.SS400	G3101.SS400	A36
	D3706.STS304	G4303.SUS304	A276.304
	D3706.STS316	G4303.SUS316	A276.316

● Anticorrosive Coating

Item	Coating	KS	Comparison	
			JIS	ASTM
Retaining Ring & Pipe Sleeve	ZINC Hot Dip Galvanizing	D8308.HDZ40 (MIN. 400g/m ²)	H8641.HDZ40 (MIN. 400g/m ²)	A123 (MIN. 458g/m ²)
Other Steel Part	Electroplated Coating of Zinc on Iron and Steel	D8304.ZP3 (THK. MIN. 8μm)	H8610.ZP3 (THK. MIN. 8μm)	B633 (THK. MIN. 8μm)

● Pressure Characteristics of Rubber Expansion Joint

EXP-J Nominal Size I · D (Inch)		42~66	68~96	98~108	114	
Design of Expansion Joint Construction	Positive	PSIG	80	70	60	50
		kg/cm ²	5.6	4.9	4.2	3.5
	Negative	In. of Hg	26	26	26	26
		mmHg	660.4	660.4	660.4	660.4

● Minimum Face-To-Face Dimension

Nominal Size I · D (Inch)	Single Arch (mm)	Nominal Size I · D (Inch)	Double Arch (mm)	Nominal Size I · D (Inch)	Triple Arch (mm)
42 ~ 114	305 (12")	22 ~ 78	356 (14")	22 ~ 96	457 (18")
		84 ~ 108	406 (16")	102 ~ 114	508 (20")

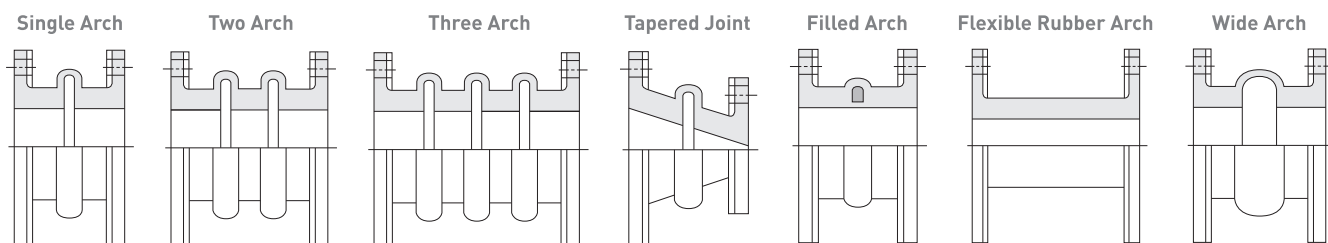

● Expansion Joint Dimension

Size		L		I · D	B.C.D		O.D		N		H			A	B	C	D
					ANSI & AWWA	JIS	ANSI & AWWA	JIS	ANSI & AWWA	JIS	ANSI & AWWA CL.D	AWWA CL.B	JIS				
mm	inch	mm	inch	mm	mm	mm	mm	mm			mm	mm	mm	mm	mm	mm	mm
25	1.0	152	6	25	79	90	108	125	4	4	16	-	19	14	32	12	10
32	1.25	152	6	32	89	100	118	135	4	4	16	-	19	14	32	12	10
40	1.5	152	6	38	98	105	127	140	4	4	16	-	19	14	32	12	10
50	2	152	6	51	121	120	152	155	4	4	19	-	19	14	32	12	10
65	2.5	152	6	64	140	140	178	175	4	4	19	-	19	14	32	12	10
75	3	152	6	76	152	-	191	-	4	-	19	-	-	14	32	12	10
90	3.5	152	6	89	178	160	216	195	8	8	19	-	19	14	32	12	10
100	4	152	6	102	191	175	229	210	8	8	19	19	19	14	32	12	10
125	5	152	6	127	216	210	254	250	8	8	22	19	23	16	32	12	10
150	6	152	6	152	241	240	279	280	8	8	22	19	23	19	32	12	10
200	8	152	6	203	298	290	343	330	8	12	22	19	23	19	38	19	10
250	10	203	8	254	362	355	406	400	12	12	25	19	25	19	38	19	10
300	12	203	8	305	432	400	483	445	12	16	25	19	25	22	38	19	10
350	14	203	8	356	476	445	533	490	12	16	29	22	25	22	51	19	10
400	16	203	8	406	540	510	597	560	16	16	29	22	28	25	51	19	10
450	18	254	10	457	578	565	635	620	16	20	32	22	27	28	51	19	10
500	20	254	10	508	635	620	699	675	20	20	32	22	27	28	51	22	10
550	22	254	10	559	692	680	749	745	20	20	35	22	33	28	51	22	10
600	24	254	10	610	749	730	813	795	20	24	35	22	33	28	51	22	10
650	26	254	10	660	806	780	870	845	24	24	35	22	33	28	57	25	10
700	28	254	10	711	864	840	927	905	28	24	35	22	33	28	57	25	10
750	30	254	10	762	914	900	984	970	28	24	35	25	33	28	57	25	10
800	32	254	10	813	978	950	1060	1020	28	28	41	25	33	28	57	25	10
850	34	254	10	864	1029	1000	1111	1070	32	28	41	25	33	28	57	25	10
900	36	254	10	914	1086	1050	1168	1120	32	28	41	25	33	28	57	25	10
950	38	254	10	965	1149	-	1238	-	32	28	41	25	-	28	57	25	10
1000	40	254	10	1016	1200	1160	1289	1235	36	28	41	25	39	28	57	25	10
1050	42	305	12	1067	1257	-	1346	-	36	-	41	29	-	30	64	28	10
1100	44	305	12	1118	1314	-	1403	-	40	-	41	29	-	30	64	28	10
1150	46	305	12	1168	1365	-	1454	-	50	-	41	29	-	30	64	28	10
1200	48	305	12	1219	1422	-	1511	-	44	-	41	29	-	30	64	28	10
1250	50	305	12	1270	1480	-	1568	-	44	-	48	32	-	30	64	28	10
1300	52	305	12	1321	1537	-	1626	-	44	-	48	32	-	32	64	28	10
1350	54	305	12	1372	1594	-	1683	-	44	-	48	32	-	32	64	28	10
1400	56	305	12	1422	1651	-	1746	-	48	-	48	32	-	32	64	28	10
1450	58	305	12	1473	1708	-	1803	-	48	-	48	32	-	32	64	28	10
1500	60	305	12	1524	1759	-	1854	-	52	-	48	35	-	32	64	28	10
1550	62	305	12	1575	1823	-	1924	-	52	-	48	35	-	32	64	28	10
1650	66	305	12	1676	1930	-	2032	-	52	-	48	35	-	32	64	28	10
1700	68	305	12	1727	1988	-	2089	-	56	-	48	35	-	32	64	28	10
1800	72	305	12	1829	2096	-	2197	-	60	-	48	35	-	34	64	28	15
2000	78	305	12	1981	2261	-	2362	-	64	-	54	41	-	34	64	28	15
2150	84	305	12	2134	2426	-	2534	-	64	-	54	41	-	34	64	28	15
2300	90	305	12	2286	2591	-	2705	-	68	-	60	48	-	38	64	28	15
2450	96	305	12	2438	2756	-	2877	-	68	-	60	48	-	38	64	28	15
2600	102	305	12	2591	2908	-	3048	-	72	-	67	54	-	45	70	28	15
2750	108	305	12	2743	3067	-	3219	-	72	-	67	54	-	45	70	28	15
2900	114	305	12	2896	3220	-	3391	-	76	-	73	60	-	45	70	28	15

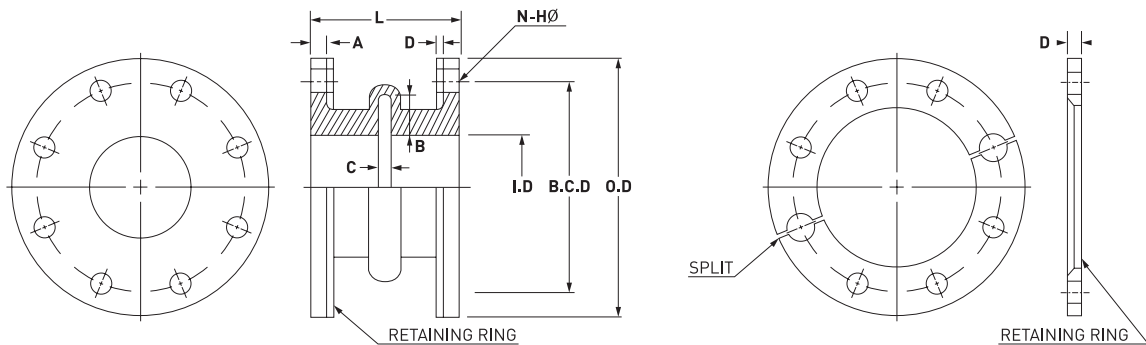

● Tolerance

(Unit:mm)

Nominal Size I · D (mm)	I · D	B · C · D	O · D	A	H	L			
						0"~6" (0~152)	7"~12" (178~305)	14"~18" (356~457)	20"~ (508~)
24"~46" (600~1150)	±9	±7	±12	±2	±1	±4	±4	-6 ~ +4	±6
48"~70" (1200~1778)	-12 ~ +9	±9	-12 ~ +19	±2	±1	±6	±9	±9	±9
72"~ & (1800~)	-15 ~ +9	±12	-19 ~ +25	±2	±1	±6	±9	±9	±9

● Expansion Joint Movement/Force/Spring Rate

Size		L		Movement					Force				Spring Rate			
				A.C	A.E	L.D	A.M	T.M	A.C	A.E	L.D	A.M	A.C	A.E	L.D	A.M
mm	inch	mm	inch	mm	mm	mm	deg.	deg.	kg	kg	kg	kg.m	kg/mm	kg/mm	kg/mm	kg.m/deg.
25	1.0	152	6	12	6	12.7	27.5	3	50.4	32.4	78.7	0.2	4.2	5.4	6.2	0.006
32	1.25	152	6	12	6	12.7	22.5	3	62.4	40.8	99.1	0.3	5.2	6.8	7.8	0.014
40	1.5	152	6	12	6	12.7	18.5	3	75.6	49.2	119.4	0.4	6.3	8.2	9.4	0.021
50	2	152	6	12	6	12.7	14.5	3	91.2	59.4	158.4	0.6	7.6	9.9	12.5	0.041
65	2.5	152	6	12	6	12.7	11.5	3	114	73.8	172.7	0.8	9.5	12.3	13.6	0.069
75	3	152	6	12	6	12.7	10.0	3	135.6	88.8	186.7	1.1	11.3	14.8	14.7	0.11
90	3.5	152	6	12	6	12.7	8.3	3	158.4	103.2	201.9	1.5	13.2	17.2	15.9	0.18
100	4	152	6	12	6	12.7	7.5	3	181.2	118.2	215.9	2.0	15.1	19.7	17.0	0.26
125	5	152	6	12	6	12.7	6.0	3	226.8	147.6	247.7	3.1	18.9	24.6	19.5	0.51
150	6	152	6	12	6	12.7	5.0	3	272.4	177	297.4	4.4	22.7	29.5	22	0.88
200	8	152	6	19	9.5	12.7	5.5	3	478.8	311.6	341.6	9.6	25.2	32.8	26.9	1.75
250	10	203	8	19	9.5	12.7	4.5	3	598.5	389.5	367	14.9	31.5	41	28.9	3.3
300	12	203	8	19	9.5	12.7	3.75	3	718.2	467.4	430.5	21.8	37.8	49.2	33.9	5.8
350	14	203	8	19	9.5	12.7	3.25	2	628.9	408.5	506.7	8.5	33.1	43	39.9	2.6
400	16	203	8	19	9.5	12.7	2.75	2	718.2	467.4	582.9	28.9	37.8	49.2	45.9	10.5
450	18	254	10	19	9.5	12.7	2.5	1	807.5	526.3	643.9	35.8	42.5	55.4	50.7	14.3
500	20	254	10	22	11	12.7	2.5	1	1041	675.4	720.1	52.5	47.3	61.4	56.7	21.0
550	22	254	10	22	11	12.7	2.25	1	1144	743.6	746.8	63.7	52	67.6	58.8	28.3
600	24	254	10	22	11	12.7	2.0	1	1247	810.7	773.4	75.6	56.7	73.7	60.9	37.8
650	26	254	10	25	12.5	12.7	2.0	1	1365	888.8	829.3	92.7	54.6	71.1	65.3	40.3
700	28	254	10	25	12.5	12.7	2.0	1	1470	956.3	885.2	139.4	58.8	76.5	69.7	52.7
750	30	254	10	25	12.5	12.7	2.0	1	1578	1025	941.1	120.6	63.1	82	74.1	60.3
800	32	254	10	25	12.5	12.7	1.8	1	1683	1094	1106	137.9	67.3	87.5	87.1	76.6
850	34	254	10	25	12.5	12.7	1.75	1	1788	1250	1270	155.8	71.5	100	100	89.0
900	36	254	10	25	12.5	12.7	1.5	1	1893	1230	1435	174.8	75.7	98.4	113	116.5
950	38	254	10	25	12.5	12.7	1.5	1	1998	1299	1475	195.2	79.9	103.9	116.1	130.1
1000	40	254	10	25	12.5	12.7	1.5	1	2103	1366	1514	215.7	84.1	109.3	119.2	143.8
1050	42	305	12	28	14	12.7	1.5	1	2227	1446	1552	240.8	79.5	103.3	122.2	160.5
1100	44	305	12	28	14	12.7	1.5	1	2332	1513	1619	263	83.3	108.1	127.5	175.3
1150	46	305	12	28	14	12.7	1.3	1	2436	1584	1687	301.3	87	113.2	132.8	231.8
1200	48	305	12	28	14	12.7	1.25	1	2542	1652	1752	314.9	90.8	118	138	251.9
1250	50	305	12	28	14	12.7	1.25	1	2649	1721	1820	339.5	94.6	122.9	143.3	271.6
1300	52	305	12	28	14	12.7	1.25	1	2755	1791	1885	368.8	98.4	127.9	148.4	295
1350	54	305	12	28	14	12.7	1.25	1	2862	1858	1952	398.1	102.2	132.7	153.7	318.5
1400	56	305	12	28	14	12.7	1.25	1	2968	1929	2017	425	106	137.8	158.8	340
1450	58	305	12	28	14	12.7	1.0	1	3074	1998	2083	456.8	109.8	142.7	164	456.8
1500	60	305	12	28	14	12.7	1.0	1	3181	2092	2148	488.1	113.6	149.4	169.1	488.1
1550	62	305	12	28	14	12.7	1.0	1	3287	2162	2219	555.8	117.4	154.4	174.7	555.8
1650	66	305	12	28	14	12.7	1.0	1	3497	2274	2317	591.7	124.9	162.4	182.4	591.7
1700	68	305	12	28	14	12.7	1.0	1	3604	2342	2386	740.4	128.7	167.3	187.9	740.4
1800	72	305	12	28	14	12.7	0.9	1	3816	2481	2481	705.6	136.3	177.2	195.6	784
2000	78	305	12	28	14	12.7	0.9	1	4133	2687	2699	872.1	147.6	191.9	212.5	969
2150	84	305	12	28	14	12.7	0.8	1	4452	2894	2913	954	159	206.7	229.4	1193
2300	90	305	12	28	14	12.7	0.75	1	4771	3101	3122	1304	170.4	221.5	245.8	1739
2450	96	305	12	28	14	12.7	0.7	1	5088	3307	3345	1298	181.7	236.2	263.4	1855
2600	102	305	12	28	14	12.7	0.66	1	5404	3514	3360	1545	193	251	280.3	2341
2750	108	305	12	28	14	12.7	0.62	1	3723	3720	3776	1870	204.4	265.7	297.3	3016
2900	114	305	12	28	14	12.7	0.59	1	6042	3927	3985	2311	215.8	280.5	313.8	3916

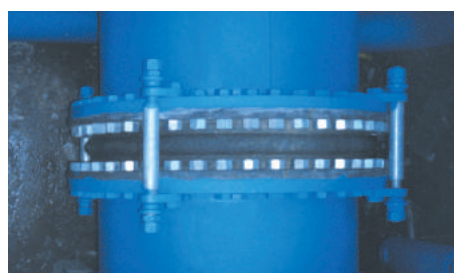
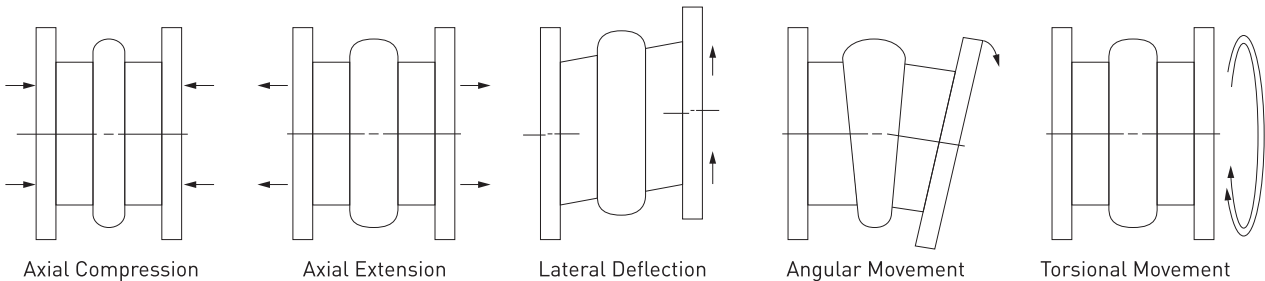

● Control Rod/Pipe Sleeve

EXP-J		Control Unit				Control Rod Numbers				
		PlateTHK. (mm)	Rod DIA. (Inch)	Control Unit Numbers		Test Pressure(Kg/cm ²)				
mm	Inch			Rods	Plate	2	3	4	6	8
50	2	10	5/8	2	4	46.3	-	-	-	-
65	2.5	10	5/8	2	4	37.0	-	-	-	-
75	3	10	5/8	2	4	30.9	-	-	-	-
100	4	10	5/8	2	4	21.0	32.7	43.5	-	-
125	5	10	5/8	2	4	16.5	24.7	32.9	-	-
150	6	13	5/8	2	4	13.0	19.5	26.0	-	-
200	8	13	3/4	2	4	11.4	17.1	22.8	-	-
250	10	19	7/8	2	4	11.4	17.1	22.8	34.2	-
300	12	19	1	2	4	11.2	16.8	22.4	33.7	-
350	14	19	1	2	4	7.8	11.7	15.6	23.5	-
400	16	19	1 1/8	2	4	7.9	11.9	15.9	23.8	31.7
450	18	19	1 1/8	2	4	6.6	9.9	13.1	26.7	26.3
500	20	19	1 1/8	2	4	5.5	8.3	11.1	16.5	22.1
600	24	25	1 1/4	2	4	5.1	7.7	10.4	15.5	20.6
700	28	32	1 3/8	2	4	4.6	6.9	9.1	13.7	18.3
800	32	32	1 1/2	2	4	4.4	6.6	8.8	13.2	17.6
850	34	38	1 5/8	2	4	5.0	7.5	10.0	15.1	20.0
900	36	38	1 3/4	2	4	4.8	7.2	9.7	14.5	19.3
1000	40	38	1 1/2	3	6	2.9	4.4	6.0	8.9	11.8
1100	44	38	1 5/8	3	6	3.1	4.6	6.2	9.3	12.4
1200	48	38	1 3/4	3	6	2.8	4.2	5.7	8.5	11.3
1300	52	38	1 3/4	3	6	2.5	3.7	4.9	7.4	9.8
1350	54	38	2	3	6	3.0	4.5	6.0	9.0	12.0
1500	60	45	2	3	6	2.5	3.7	5.0	7.4	9.9
1550	62	45	2	4	8	2.3	3.5	4.6	7.0	9.3
1650	66	48	2	4	8	2.1	3.1	4.1	6.2	8.3
1800	72	48	2	4	8	1.8	2.7	3.5	5.3	7.1
2000	78	51	2 1/4	4	8	2.0	2.9	3.9	5.9	7.4
2150	84	57	2 1/4	4	8	1.7	2.6	3.4	5.1	6.7
2300	90	64	2 1/2	4	8	1.8	2.8	3.7	5.5	7.4
2450	96	64	2 3/4	4	8	2.0	3.0	4.1	6.0	8.1
2600	102	64	2 3/4	4	8	1.8	2.3	3.8	5.3	7.1
2750	108	64	2 3/4	4	8	1.6	2.4	3.2	5.3	6.4
2900	114	64	2 3/4	6	12	1.5	2.2	1.8	2.9	5.9

■ Sleeve Hose

Dredging sleeve Hose for transporting liquids, slurries and dry materials. This hose is used as a flexible connection in dredging applications.

Inner Rubber

Black NR/SBR rubber blend. This material is resistant to wear, cutting, weathering and seawater.

Reinforcement

Synthetic high tensile tire cord resistant to high pressure

Outer Cover Black NR/SBR rubber blend. This cover protects the reinforcement from seawater, solar radiation and mechanical damage.

Steel Flange

These include parts of nipples, flanges and suction ring. All are sandblasted to be free from rust and then chemically treated to ensure complete bonding with the rubber.

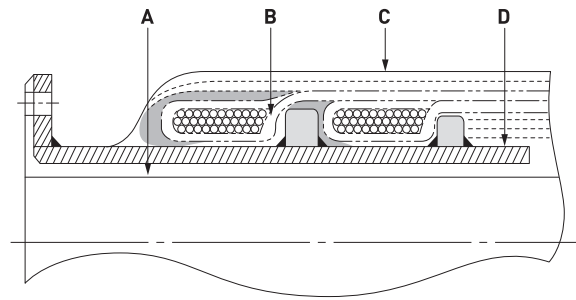

- A : Inner Rubber (Synthetic Rubber)
- B : Reinforcement
- C : Outer Cover (Synthetic Rubber)
- D : Steel Flange



● Sleeve Hose Standard Dimension

(Unit:mm)

Inside Diameter	Overall Length	Inner Tube Thickness	Outer Cover Thickness	Flange Thickness	Nipple Thickness
450	1300	15	5	19	9
500	1300	15	5	19	9
600	1500	20	5	22	9
650	1600	20	5	22	9
685	1600	20	5	25	9
700	1700	20	5	28	9
750	1900	20	5	28	9
800	2000	25	5	32	12
850	2000	25	5	32	12
900	2000	25	5	32	12

● Sleeve Hose Performance Table

Item		Standard	Test Condition
Resisting Pressure	Longitudinal Elongation	± 10%	Working Pressure
		± 15%	Test Pressure
	Circumferential Elongation	± 5%	Working Pressure
		± 7.5%	Test Pressure
Bending Angle (θ)		Min. 10°	-

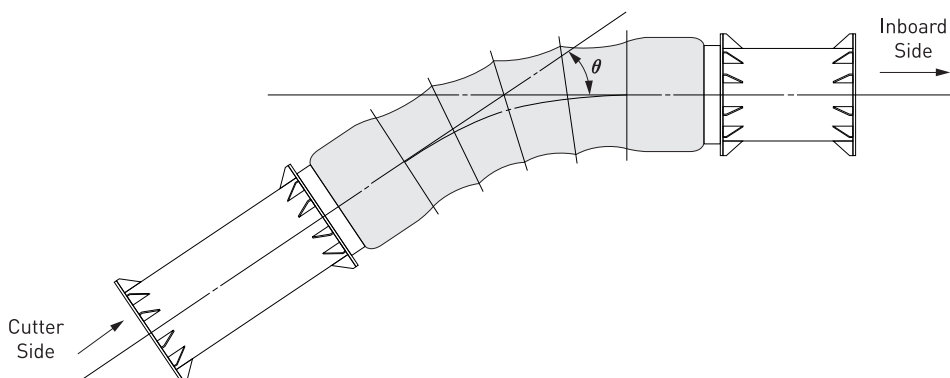

■ Lining

Lining is a rubber covering which can be applied to most surfaces. The purpose of the lining is mostly a rust preventive and or a barrier between two products (chemical & steel). It is being used to improve the life of a TANK or PIPELINE. There are also Rubber, Plastic, Ceramic & Metal etc., linings available.

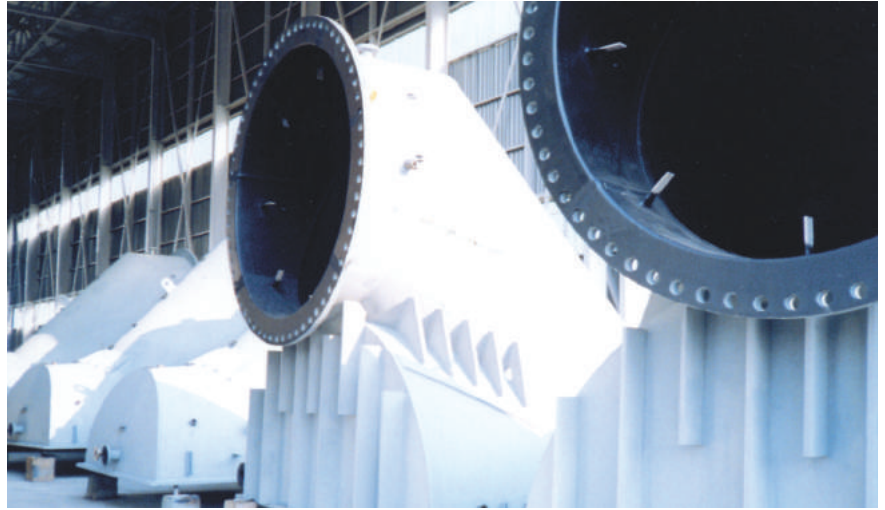

● Characteristics of Lining

Superior to chemical resistance	It's superior to endurance to Acid, Alkali & Mineral dyes (Except for the oxidization, acetic acid, sulfic acid etc)
Superior to adhesion	It is easy to adhere to the parent metal, has large adhesive strength & able to adhere to not only metal but also Concrete.
Superior to impact resistance	Soft rubber has excellent physical property to endure from impact. Contrary to Plastic, there is no creaking from external force.
Superior to abrasion	Generally it has good abrasion property. However, hard rubber has poor abrasion at high temperature.
Easiness at working	It can be worked with complicated shaped products or large size product. And also, thickness can be changed.
Remarks	It has small specific gravity and so the product is light, easy for inspection & can be mending & repaired.

- However, it can't be used at high temperature & can be used generally at 120~130°C.
And also weak from oxidized substance which Oraganic chemicals & Organic compounded.

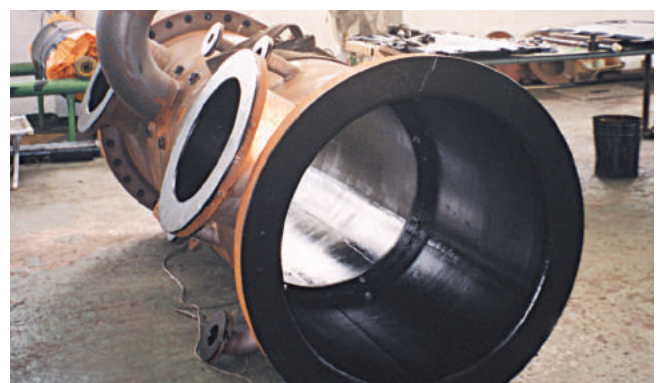

● Chemical Resistance Chart

Chemicals	Kind of Rubber	Natural Rubber						Neoprene (CR)		Butyl (IIR)	
		Soft		Hard		S + H + S		RT	70°C	RT	70°C
		RT	70°C	RT	70°C	RT	70°C				
Acetic acid	10%	×	×	○	○	○	×	×	×	○	○
Acetone		△	×	△	△	△	×	△	×	○	△
Ammonium carbonate		○	△	○	○	○	○	○	○	○	○
Ammonium chloride		○	△	○	○	○	○	○	○	○	○
Calcium chloride		○	△	○	○	○	○	○	○	○	○
Carbonic acid		○	△	○	○	○	○	○	○	○	○
Caustic potash	25%	○	○	○	○	○	○	○	○	○	○
Caustic Soda	48%	○	○	○	○	○	○	○	○	○	○
Chlorine gas-wet		×	×	○	○	○	×	×	×	×	×
Chromic acid	1%	×	×	△	×	△	×	×	×	○	×
Ethanol		○	×	○	○	○	△	○	△	○	△
Ethyl glycol		○	△	○	○	○	○	○	△	○	△
Ferric chloride		○	△	○	○	○	○	○	○	○	○
Formaldehyde		○	×	○	○	○	○	○	×	○	×
Fomic acid	90%	○	×	○	○	△	×	○	△	○	×
Glycerine		○	△	○	○	○	○	○	○	○	△
Hydrochloric acid	10%	○	×	○	○	○	○	△	×	○	△
	35%	○	×	○	○	○	△	×	×	○	×
Hydrobromic acid	40%	○	×	○	○	○	△	△	×	○	×
Hydrofluoric acid	1%	×	×	○	○	○	×	○	×	○	○
	48%	×	×	△	×	×	×	×	×	○	×
Hydrogen sulfide		○	△	○	○	○	△	○	△	○	○
Nitric acid	1%	×	×	×	×	×	×	×	×	△	×
Phosphoric acid		○	○	○	○	○	○	○	○	○	○
Potassium chlorate		○	△	○	○	○	○	○	○	○	○
Potassium chloride		○	△	○	○	○	○	○	○	○	○
Propyl alcohol		○	×	○	○	○	△	○	△	○	○
Sodium chlorate		○	△	○	○	○	○	○	○	○	○
Sodium chloride		○	△	○	○	○	○	○	○	○	○
Sodium phosphate		○	△	○	○	○	○	○	○	○	○
Sodium sulfate		○	△	○	○	○	○	○	○	○	○
Sodium sulfide		○	△	○	○	○	○	○	○	○	○
Stannous chloride		○	△	○	○	○	○	○	○	○	○
	10%	○	×	○	○	○	○	○	△	○	○
Sulfuric acid	50%	○	×	○	○	○	○	○	△	○	○
	70%	×	×	○	×	△	×	△	×	○	×
Sulfurous acid		×	×	○	○	○	△	○	×	△	×
Zinc chloride		○	△	○	○	○	○	○	○	○	○

○: Good △: Fair ×: Unsatisfactory

Other Products

■ Rubber Railroad Pad

Existing wooden, Asphalt or Concrete railway crossings may cause accidents and severe damage on passing vehicles and people because of its unsafe rugged surface. In addition these existing types of crossings cost a lot of money to maintain and repair. However with Rubber railroad pad, which is made of superior rubber properties, do not have an uneven surface when installed with railway crossing and does not necessitate any guard rail. With this special feature, Rubber railroad pad brings a safe driving environment with an improved sense of driving and low cost of maintenance.

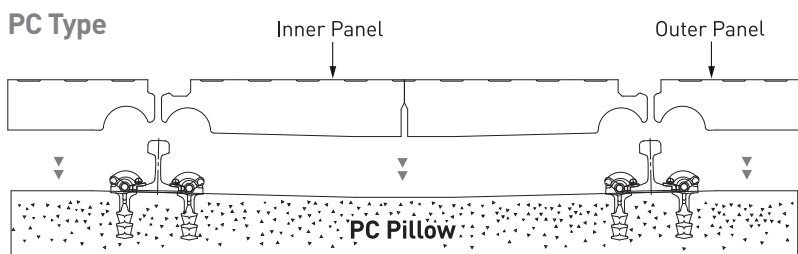
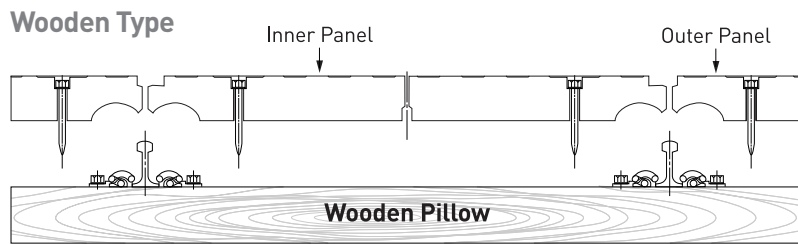
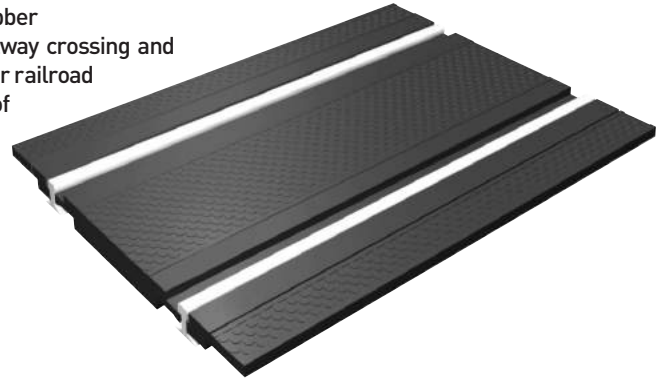
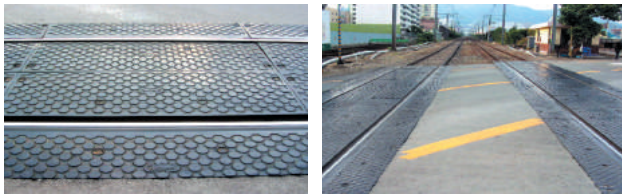

Patent taken out for the rubber rail road



● Dimension

(Unit:mm)

Unit	Wooden Type		PC Type	
	Inner Panel	Outer Panel	Inner Panel	Outer Panel
Size	1834 × 742 × 178	1834 × 488 × 178	1250 × 742 × 174	1250 × 440 × 154

● Rubber Characteristics

Physical Properties	MD	O.D.	P.C.D.
Gravity	-	Min. 1.073	
Hardness(Shore-A)	Point	65 ± 5	60 ± 5
Elongation	%	Min. 450	
Tensile Strength	kg/cm ²	Min. 150	
Elastic Modulus	psi	-65°C 23,048	
		18°C 924	

■ Ladder

● Rubber Ladder

Rubber ladders are flexible, corrosion resistant and can withstand most accidental impacts from smaller vessels. Therefore, rubber ladder is completely free from maintenance. The rubber ladders are combined with extensions and a variety of optional handrails to suit many applications.

● Specifications

Total Width	730mm
Length of Rungs	450mm
Interval of Rungs	300mm

● Dimension

Slope Type Ladder			
A (Main) Length(mm)	B (Joint) Length(mm)	Number of Rungs	Number of Anchors
1200	600	4	2 X 3
1500	900	5	2 X 3
1800	1200	6	2 X 3
2100	1500	7	2 X 4
2400	1800	8	2 X 4
2700	2100	9	2 X 4
3000	2400	10	2 X 5

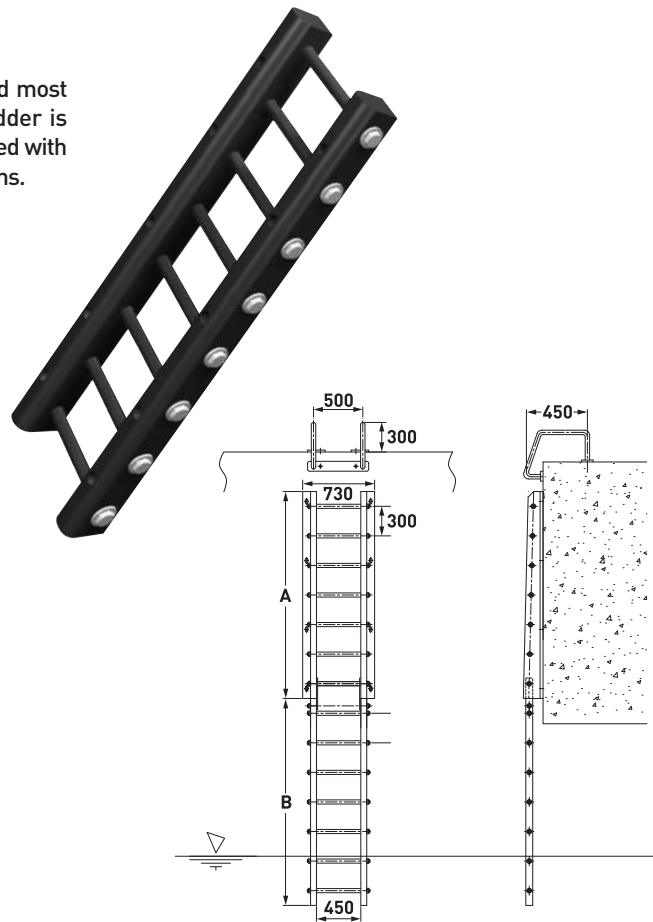

● Other Type Ladder

Height 150H

A (Main) Length(mm)	B (Joint) Length(mm)
600	600
900	900
1200	1200
1500	1500
1800	1800
2100	
2400	
2700	
3000	

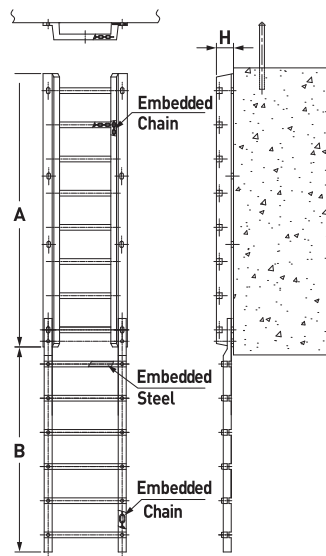

Height 200H

A (Main) Length(mm)	B (Joint) Length(mm)
900	600
1200	900
1500	1200
1800	1500
2100	1800
2400	
2700	

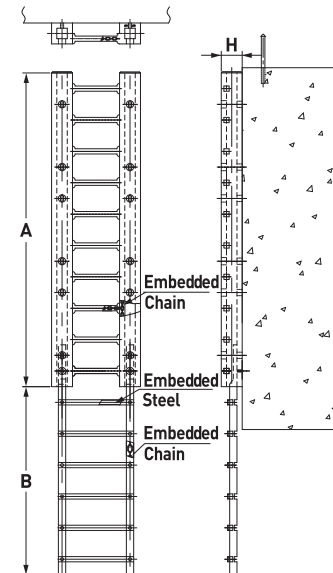

■ Bollard

• Bollard

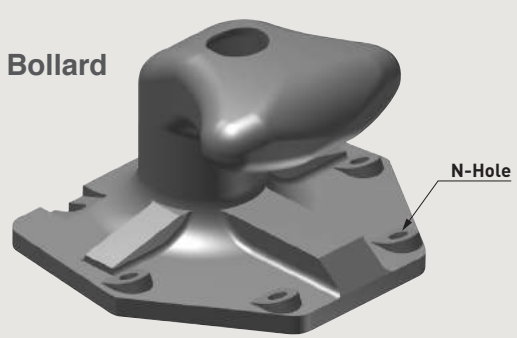

ton	5	10	15	25	35	50	70	100	150	200
N	4	4	4	4	6	6	6	6	6	6

• BITT

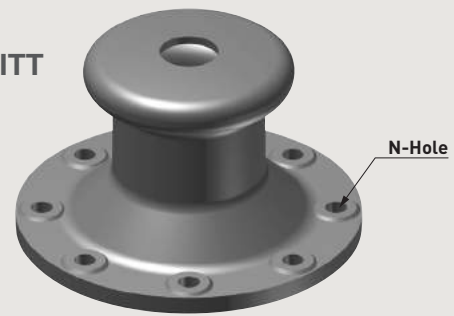

ton	15	25	35	50	70	100	150	200
N	4	6	6	6	6	8	8	8

• Horn-Type

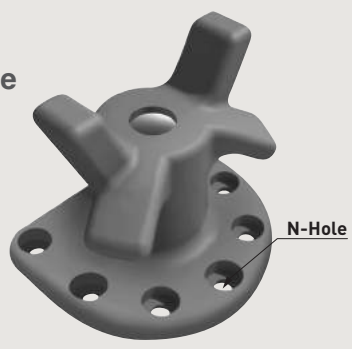

ton	10	15	20	30	50	75	100	125	150	200
N	4	4	5	5	5	6	7	7	7	8

• Tee-Type

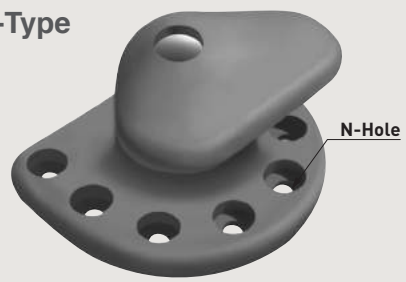

ton	10	15	20	30	50	75	100	125	150	200
N	4	4	5	5	5	6	7	7	7	8

■ Finite Element Analysis

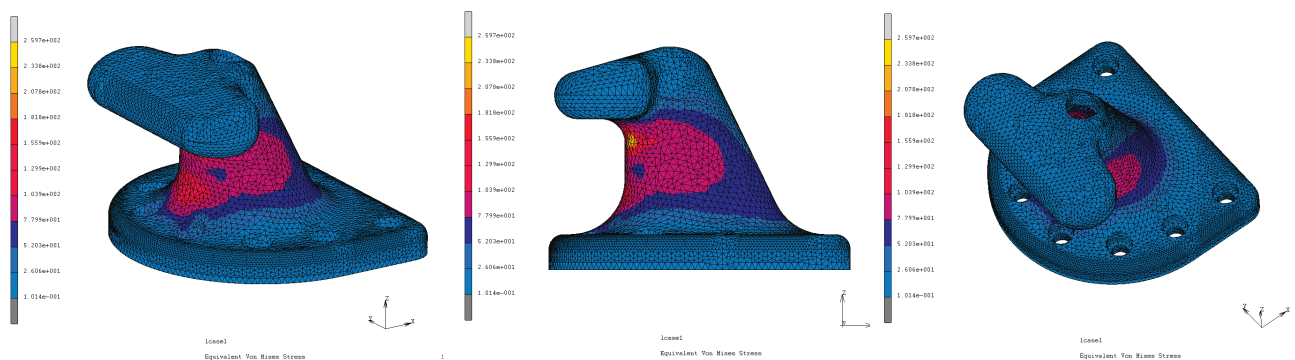

■ Bollard Loading test





HEAD OFFICE
2275 Research Blvd.
Suite 500
Rockville, Maryland 20850
U.S.A.

Tel: 1-240-413-3314
Fax: 1-240-547-5460

info@anchorbridge.com

