

**SERVICE MANUAL**  
**SKID STEERS**  
85XT  
90XT  
95XT

---

7-52254

1. Trim along dashed line.
2. Slide into pocket on Binder Spine.

TYPE 1-4

**SERVICE MANUAL**  
**SKID STEERS**  
85XT  
90XT  
95XT

---

7-52254

1. Trim along dashed line.
2. Slide into pocket on Binder Spine.

TYPE 1-4

**SERVICE MANUAL**  
**SKID STEERS**  
85XT  
90XT  
95XT

---

7-52254

1. Trim along dashed line.
2. Slide into pocket on Binder Spine.

TYPE 1-4

**SERVICE MANUAL**  
**SKID STEERS**  
85XT  
90XT  
95XT

---

7-52254

1. Trim along dashed line.
2. Slide into pocket on Binder Spine.

TYPE 1-4

# 85XT/90XT/95XT Skid Steers

## Service Manual

### 7-52254

## Table of Contents

Description	Section No.	Form No.
<b>General</b>		
<b>Tab 1</b>		
Section Index - General		7-52922
Standard Torque Specifications	1001	7-52930
Fluids and Lubricants	1002	7-52943
Metric Conversion Chart	1003	7-52950
Loctite Product Chart		8-98902
<b>Engines</b>		
<b>Tab 2</b>		
Section Index - Engines		7-52982
Engine and Radiator Removal and Installation	2000	7-53000
Aftercooler	2411	7-43512
Cylinder Head and Valve Train	2415	8-24175
Cylinder Block	2425	8-24185
Lubrication System	2445	8-24195
Cooling System	2455	8-24205
Turbocharger	2465	8-25552
Turbocharger Failure Analysis	2565	9-78235
<b>Fuel System</b>		
<b>Tab 3</b>		
Section Index - Fuel System		7-53020
Fuel System and Filters	3410	8-24213
Fuel Injectors	3413	8-24235
Bosch Model VE Fuel Injection Pump	3415	7-37143
<b>Electrical</b>		
<b>Tab 4</b>		
Section Index - Electrical		7-53032
Electrical "How It Works"	4000	7-53043
Electrical "How It Works" (85XT Machines With P.I.N. JAF0352234 And After) (90XT Machines With P.I.N. JAF0320050 And After) (95XT Machines With P.I.N. JAF0311357 And After)	4000	6-75150
Removal and Installation of Electrical Components	4001	7-53050
Electrical Specifications and Troubleshooting	4002	7-53562
Electrical Specifications, Troubleshooting, and Schematics	4002	6-75160

**Reprinted**

# 85XT/90XT/95XT Skid Steers

## Service Manual

### 7-52254

## Table of Contents

Description	Section No.	Form No.
Battery	4005	7-51310
Starter and Starter Solenoid	4006	7-53090
Alternator	4007	7-53100
<b>Power Train</b>		<b>Tab 6</b>
Section Index - Power Train		7-53113
Hydrostatic How It Works	6000	7-53123
Removal and Installation of Power Train Components	6001	7-53131
Removal and Installation of Power Train Components (85XT Machines With P.I.N. JAF0352234 And After) (90XT Machines With P.I.N. JAF0320050 And After) (95XT Machines With P.I.N. JAF0311357 And After)	6001	6-75230
Hydrostatic Troubleshooting	6002	7-53582
Drive Coupling	6003	7-53141
Piston Pumps - Tandem Pump (M51)	6004	7-53151
Drive Motors - 90XT and 95XT	6005	7-53160
Drive Motors - 85XT	6005	7-53171
Gear Box	6006	7-52890
Sprockets, Chains, and Axle Assemblies	6007	7-52732
Solenoid Valve for Two Speed Drive Motor	6008	7-52900
Accumulator for Charge Circuit	6009	7-53331
Accumulator for Charge Circuit (90XT Machines With P.I.N. JAF0298607 And After) (95XT Machines With P.I.N. JAF0299000 And After)	6009	6-75220
Wheels and Tires	6011	7-53181
<b>Brakes</b>		<b>Tab 7</b>
Section Index - Brakes		7-53192
How It Works	7000	7-54861
Brake - 85XT (Machines Before PIN JAF0273132)	7003	7-54771
Brake - 85XT (Machines With PIN JAF0273132 And After)	7003	6-41380
Brake - 90XT and 95XT	7003	7-52882
Brake Pump	7004	7-54710
<b>Hydraulics</b>		<b>Tab 8</b>
Section Index - Hydraulics		7-53213
"How It Works"	8000	7-53222

# 85XT/90XT/95XT Skid Steers

## Service Manual

### 7-52254

## Table of Contents

Description	Section No.	Form No.
Hydraulic System "How It Works" (85XT Machines With P.I.N. JAF0352234 And After) (90XT Machines With P.I.N. JAF0320050 And After) (95XT Machines With P.I.N. JAF0311357 And After)	8000	6-74410
Hydraulic System Troubleshooting	8001	7-53230
Hydraulic System Troubleshooting (85XT Machines With P.I.N. JAF0352234 And After) (90XT Machines With P.I.N. JAF0320050 And After) (95XT Machines With P.I.N. JAF0311357 And After)	8001	6-75180
Cleaning the Hydraulic System and Hydrostatic System	8002	7-53240
Removal and Installation of Hydraulic Components	8003	7-53250
Removal and Installation of Hydraulic Components (85XT Machines With P.I.N. JAF0352234 And After) (90XT Machines With P.I.N. JAF0320050 And After) (95XT Machines With P.I.N. JAF0311357 And After)	8003	6-75200
Gear (Equipment) Pump	8004	7-53261
Loader Control Valve	8005	7-53280
Loader Control Valve (2 Spool Valve) (85XT Machines With P.I.N. JAF0352234 And After) (90XT Machines With P.I.N. JAF0320050 And After) (95XT Machines With P.I.N. JAF0311357 And After)	8005	6-74400
Loader Control Valve (Bi-Directional Self Leveling Valve) (85XT Machines With P.I.N. JAF0352234 And After) (95XT Machines With P.I.N. JAF0311357 And After)		
Cylinders	8006	7-53291
Optional High Pressure High Flow Pump (Piston Pump)	8007	7-53300
Optional Low Pressure High Flow Pump (Gear Pump)	8008	7-53310
Control Valve for Low Pressure High Flow System	8009	7-53320
Self-Leveling Valve	8010	7-53780
<b>Hydraulics, Cont.</b>	<b>Tab 8</b>	
Solenoid Valve for Hydraulic Coupler System	8011	7-54700
D125 Backhoe Control Valve - North American Only	8012	7-54690
Accumulator for Ride Control	8013	7-53060
Flat Faced Couplers	8014	7-54740
Solenoid Valve for High Pressure High Flow System (Piston Pump)	8020	7-53790
<b>Mounted Equipment</b>	<b>Tab 9</b>	
Section Index - Mounted Equipment		7-53343
Pedals and Levers	9001	7-53611
Loader	9002	7-53360
Attachment Coupler	9003	7-53370

**85XT/90XT/95XT Skid Steers  
Service Manual  
7-52254  
Table of Contents**

Description	Section No.	Form No.
ROPS Canopy, Seat, Seat Belts, and Operators Compartment	9004	7-53380
Heater	9006	7-53401
Backhoe (D125 Backhoe)	9007	7-54660
Trencher	9008	7-54870
Steel Track	9009	7-54880
Rubber Track	9010	7-54890
Air Conditioning Troubleshooting - For Systems With R134A Refrigerant	9011	6-41330
Air Conditioner System Gauges and Testing - For Systems With R134A Refrigerant	9012	6-41340
Air Conditioner System Service - For Systems With R134A Refrigerant Refrigerant Recovery, Compressor Removal and System Evacuation and Recharging	9013	6-41350
Air Conditioner Component Service - For Systems With R134A Refrigerant	9014	6-41360
<b>Hydraulic and Electrical Schematic Foldout</b>	<b>In Rear Pocket</b>	<b>7-53623</b>

**NOTE:** Case, LLC. reserves the right to make improvements in design or changes in specifications at any time without incurring any obligation to install them on units previously sold.

# SECTION INDEX - GENERAL

## Section Title

## Section Number

Standard Torque Specifications ..... 1001

Fluids and Lubricants ..... 1002

Metric Conversion Chart..... 1003

Loctite Product Chart

**CASE CORPORATION**  
700 State Street  
Racine, WI 53404 U.S.A.

**CASE CANADA CORPORATION**  
3350 SOUTH SERVICE ROAD  
BURLINGTON, ON L7N 3M6 CANADA

Bur 7-52922

© 1999 Case Corporation  
Printed in U.S.A.  
February, 1999

# Section 1001

## STANDARD TORQUE SPECIFICATIONS

85XT - 90XT - 95XT

CASE CORPORATION  
700 State Street  
Racine, WI 53404 U.S.A.

CASE CANADA CORPORATION  
450 Sherman Avenue  
Hamilton, ON L8N 4C4 CANADA

Bur 7-52930

© 1997 Case Corporation  
Printed in U.S.A.  
September, 1997

## TABLE OF CONTENTS

TORQUE SPECIFICATIONS - DECIMAL HARDWARE .....	3
Grade 5 Bolts, Nuts, and Studs .....	3
Grade 8 Bolts, Nuts, and Studs .....	3
TORQUE SPECIFICATIONS - METRIC HARDWARE .....	4
Grade 8.8 Bolts, Nuts, and Studs .....	4
Grade 12.9 Bolts, Nuts, and Studs .....	4
Grade 10.9 Bolts, Nuts, and Studs .....	4
TORQUE SPECIFICATIONS - STEEL HYDRAULIC FITTINGS .....	5
37 Degree Flare Fitting .....	5
Straight Threads with O-ring .....	5
Split Flange Mounting Bolts .....	6
O-Ring Face Seal End .....	6
O-Ring Boss End .....	6
Fitting or Lock Nut .....	6
Pipe fittings .....	7

## TORQUE SPECIFICATIONS - DECIMAL HARDWARE

Use the torques in this chart when special torques are not given. These torques apply to fasteners with both UNC and UNF threads as received from suppliers dry, or when lubricated with engine oil. Not applicable if special graphities, Molydisulfide greases, or other extreme pressure lubricants are used.

Grade 5 Bolts, Nuts, and Studs		
		
Size	Newton metres	Pound-Inches
1/4 inch	10 to 12	91 to 103
5/16 inch	21 to 24	188 to 212
3/8 inch	38 to 43	336 to 378
		Pound-Feet
7/16 inch	61 to 69	45 to 51
1/2 inch	94 to 104	68 to 76
9/16 inch	132 to 149	98 to 110
5/8 inch	183 to 210	138 to 155
3/4 inch	325 to 370	242 to 270
7/8 inch	530 to 595	390 to 435
1.0 inch	790 to 890	585 to 655
1-1/8 inch	980 to 1100	725 to 805
1-1/4 inch	1385 to 1555	1020 to 1145
1-3/8 inch	1810 to 2030	1335 to 1495
1-1/2 inch	2400 to 2700	1770 to 1990

Grade 8 Bolts, Nuts, and Studs		
		
Size	Newton metres	Pound-Inches
1/4 inch	15 to 16	130 to 145
5/16 inch	30 to 34	268 to 301
3/8 inch	54 to 60	474 to 534
		Pound-Feet
7/16 inch	86 to 97	63 to 71
1/2 inch	132 to 149	96 to 110
9/16 inch	191 to 213	140 to 155
5/8 inch	260 to 293	190 to 215
3/4 inch	480 to 515	340 to 380
7/8 inch	745 to 835	550 to 615
1.0 inch	1120 to 1280	825 to 925
1-1/8 inch	1585 to 1785	1170 to 1315
1-1/4 inch	2215 to 2235	1650 to 1855
1-3/8 inch	2930 to 3295	2160 to 2430
1-1/2 inch	3895 to 4375	2870 to 3225

**NOTE:** Use thick nuts with Grade 8 bolts.

## TORQUE SPECIFICATIONS - METRIC HARDWARE

Use the following torques when specifications are not given.

These values apply to fasteners with both coarse and fine threads as received from supplier, plated or unplated, or when lubricated with engine oil. These values do not apply if graphite or Molydisulfide grease or oil is used. Use of a click type torque wrench, or better is required.

Grade 8.8 Bolts, Nuts, and Studs		
		
Size	Newton metres	Pound-Inches
M4	3 to 4	31 to 35
M5	5 to 6	49 to 55
M6	10 to 11	84 to 94
M8	23 to 26	229 to 277
M10	46 to 51	408 to 460
		Pound-Feet
M12	80 to 90	59 to 66
M14	128 to 145	94 to 106
M16	200 to 220	149 to 161
M20	400 to 450	293 to 330
M24	690 to 780	510 to 575
M30	1375 to 1545	1010 to 1140
M36	2400 to 2700	1770 to 1990

Grade 10.9 Bolts, Nuts, and Studs		
		
Size	Newton metres	Pound-Inches
M4	5 to 6	44 to 49
M5	8 to 9	71 to 79
M6	14 to 15	120 to 136
M8	33 to 37	293 to 329
		Pound-Feet
M10	65 to 74	48 to 54
M12	114 to 128	85 to 94
M14	183 to 205	136 to 153
M16	285 to 320	208 to 235
M20	555 to 620	406 to 460
M24	955 to 1075	705 to 790
M30	1900 to 2140	1400 to 1580
M36	3315 to 3730	2445 to 2750

## Grade 12.9 Bolts, Nuts, and Studs



Usually the torque values specified for grade 10.9 fasteners can be used satisfactorily on grade 12.9 fasteners.

# Section 2000

## ENGINE REMOVAL AND INSTALLATION

**CASE CORPORATION**  
700 State Street  
Racine, WI 53404 U.S.A.

**CASE CANADA CORPORATION**  
3350 SOUTH SERVICE ROAD  
BURLINGTON, ON L7N 3M6 CANADA

Bur 7-53000

© 1999 Case Corporation  
Printed in U.S.A.  
February, 1999

2000

## TABLE OF CONTENTS

REMOVAL .....	3
INSTALLATION .....	12

## REMOVAL

**NOTE:** The photos in this procedure are for reference only.

### STEP 1

Park the machine on a level surface. Remove the bucket or attachment from the loader arms. Raise the loader arms and lock the loader arms into the raised position. Tilt the cab forward.

### STEP 2

Turn the ignition switch and the master disconnect switch (if equipped) to the OFF position.

### STEP 3

Disconnect the negative battery cable from the battery.

### STEP 4

Open the rear access door on the machine.

### STEP 5

Open the hood.

### STEP 6

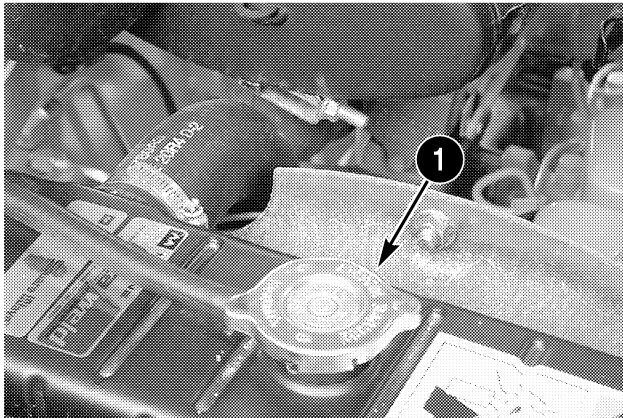

BD99E028

Slowly loosen the radiator cap (1). Install a hose on the drain valve and drain the radiator into a clean container that holds approximately 19 litres (5 gallons).

**NOTE:** During installation, fill the radiator and coolant reservoir completely. See Section 1002 for coolant specifications. Start and run the engine until the coolant is at operating temperature. Stop the engine and check for leakage. When the coolant is cold, check the coolant reservoir level. Add coolant as required.

### STEP 7

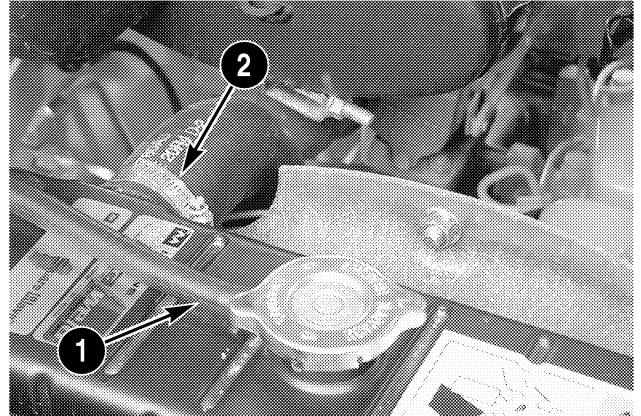

BD99E028

Disconnect the overflow hose (1) from the radiator neck.

### STEP 8

Connect acceptable lifting equipment to the rear access door.

### STEP 9

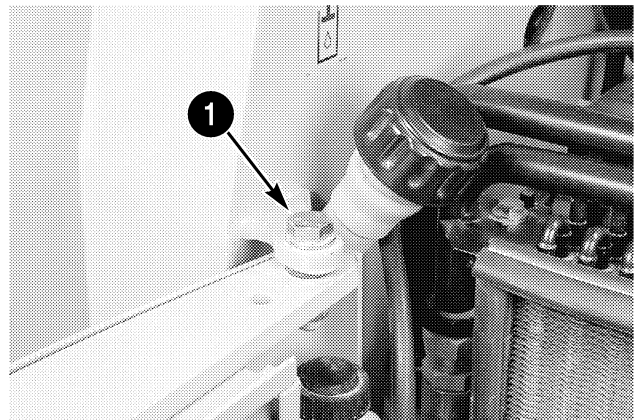

BD99E040

Loosen and remove the hardware (1) that fastens the top of the door to the frame.

### STEP 10

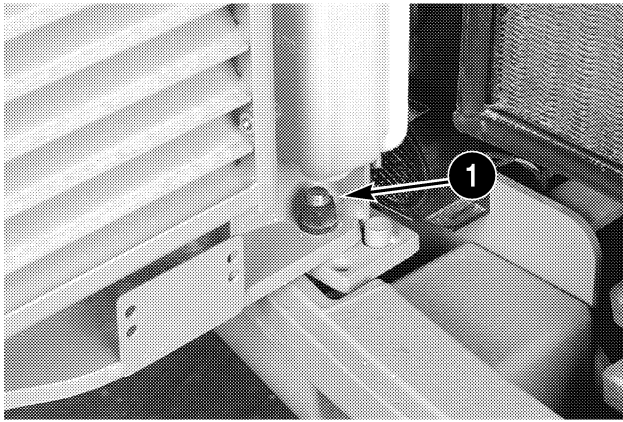

BD99E042

Loosen and remove the hardware (1) that fastens the bottom of the door to the frame.

### STEP 11

If the machine is equipped with a high flow high pressure system. Place acceptable lifting equipment under the rear bumper. Loosen and remove the mounting hardware. Lower the bumper and remove the bumper from the machine.

### STEP 12

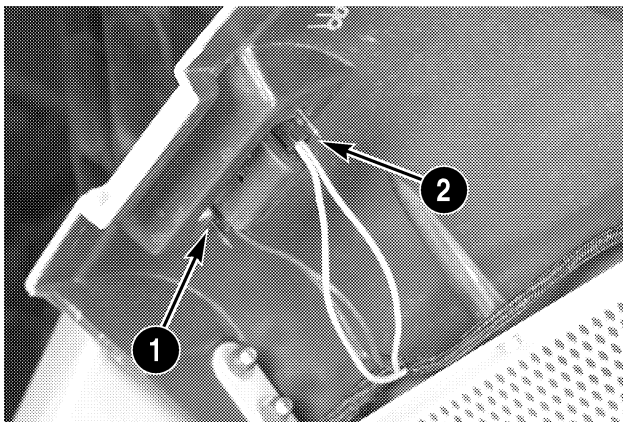

BD99E038

Disconnect the electrical connectors (1 and 2) from the rear tail lamps on both sides of the hood.

### STEP 13

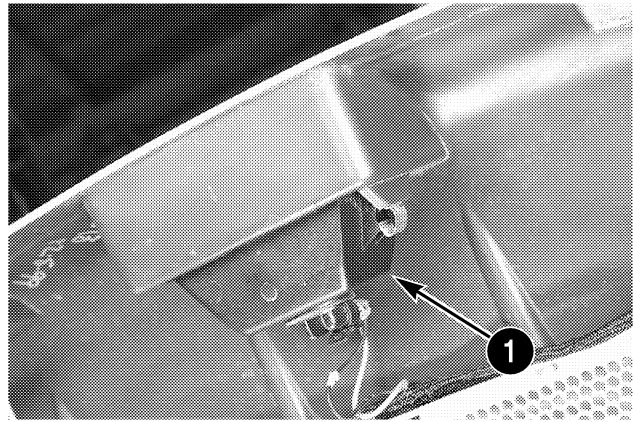

BD99E039

Disconnect the rear work lamp (1) from the hood.

### STEP 14

Remove the electric harness and rear work lamp from the hood. Put the electrical harness and rear work lamp out of the way.

### STEP 15

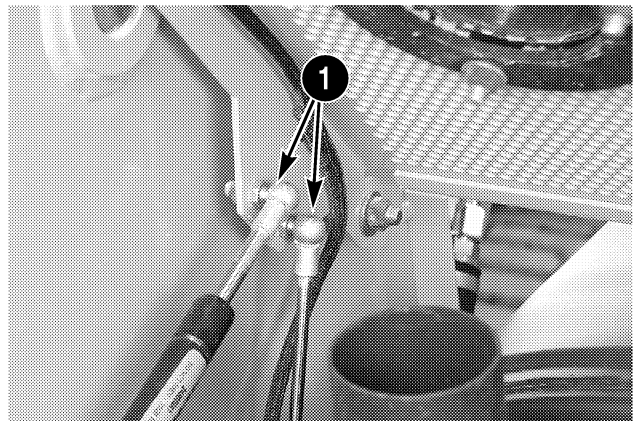

BD99E029

Disconnect the clip from the ball joint at the hood end of the cylinder (1). Remove the cylinder from the ball joint.

### STEP 16

Count the number of washers on each side of the hood. Make a record of the number and location of the washers for use during assembly.

**STEP 17**

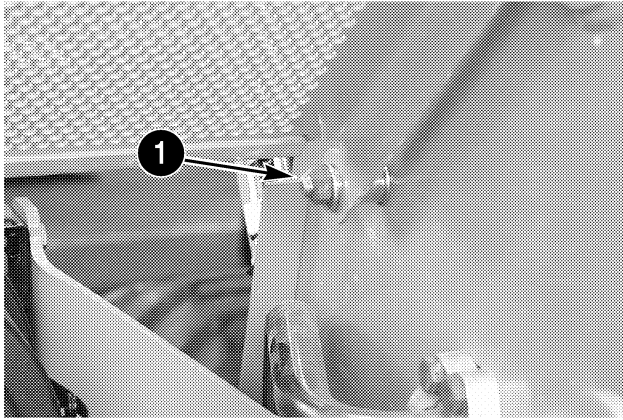

BD99E035

Loosen and remove the lock nuts and washers from the studs (1) on each side of the hood.

**STEP 18**

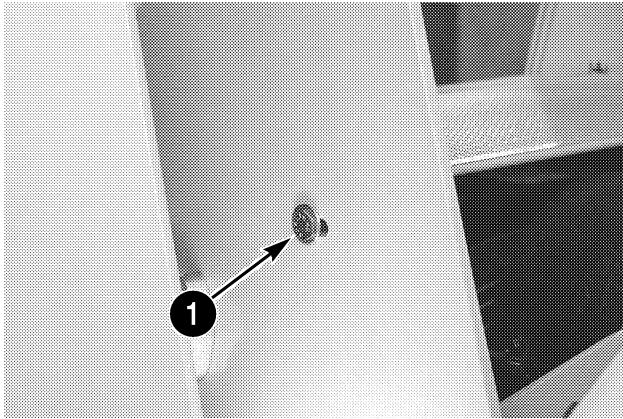

BD99E045

Loosen and remove the stud (1) and hardware from one side of the hood.

**STEP 19**

Remove the hood from the stud on the other side of the machine. Remove the hood from the machine.

**STEP 20**

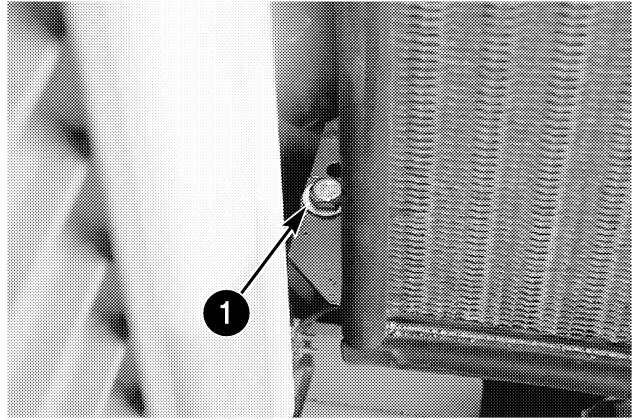

BD99E043

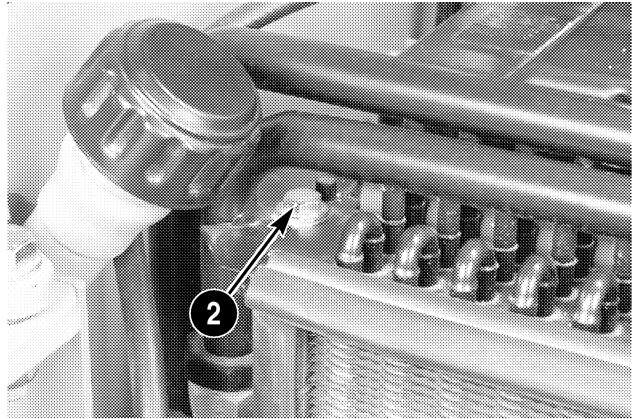

BD99E041

Loosen and remove the hardware that fastens the oil cooler to the radiator (1 and 2). Remove the oil cooler from the radiator and move the oil cooler out of the way. Be careful not to damage the oil cooler.

**STEP 21**

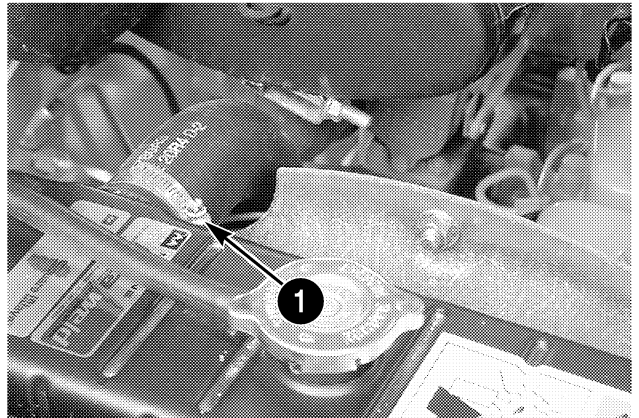

BD99E028

Loosen the hose clamps (1) on the upper and lower radiator hoses.

**STEP 22**

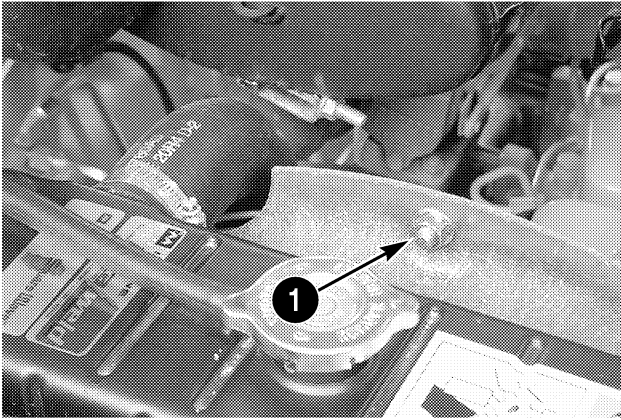

BD99E028

Loosen and remove the cap screws, washers, and lock nuts that fasten the fan guard to the radiator shroud. Remove the fan guard from the machine.

**STEP 23**

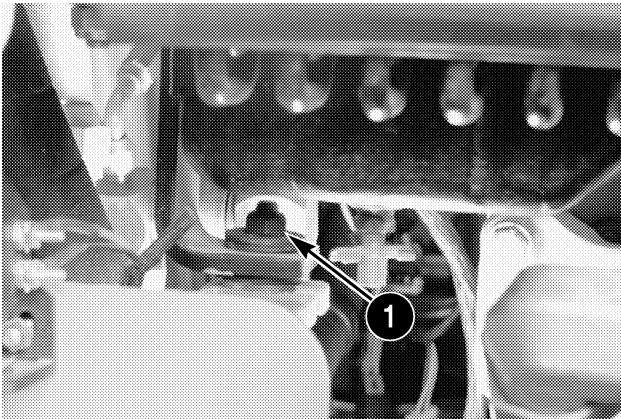

BD99E044

Loosen and remove the hardware (1) that fastens the bottom of the radiator to the frame.

**STEP 24**

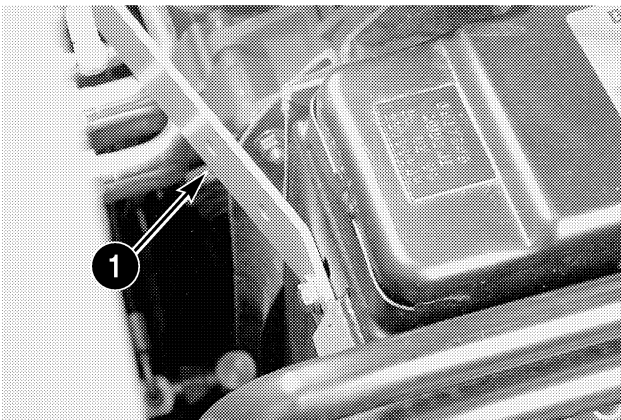

BD99E036

Loosen and remove the hardware and bracket that fasten the left side of the radiator to the frame.

**STEP 25**

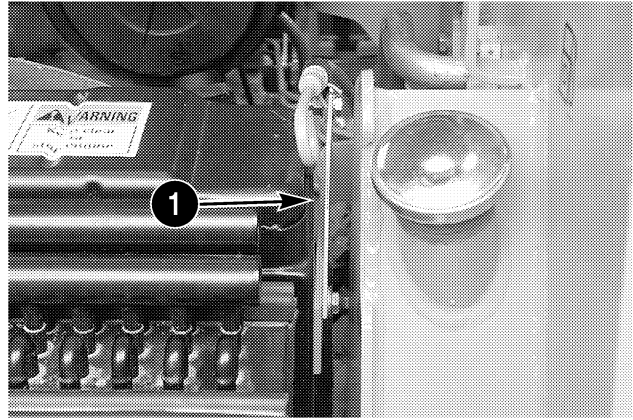

BD99E034

Loosen and remove the hardware and bracket (1) that fasten the right side of the radiator to the engine oil dipstick tube and the frame.

**STEP 26**

Move the radiator away from the upper and lower radiator hoses. Remove the radiator from the machine.

**STEP 27**

Remove the guard and fan blade from the engine.

**STEP 28**

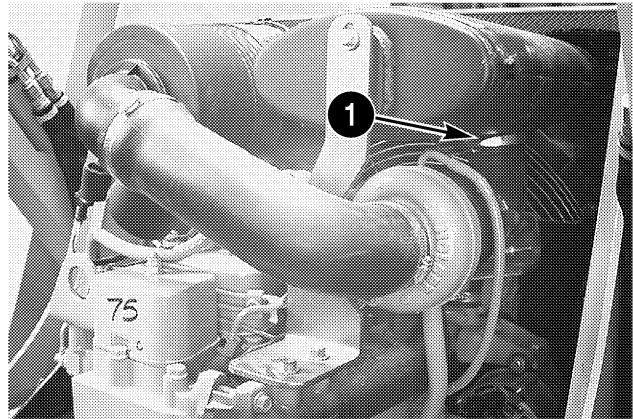

BD99E024

Loosen the clamp on the muffler intake.

**STEP 29**

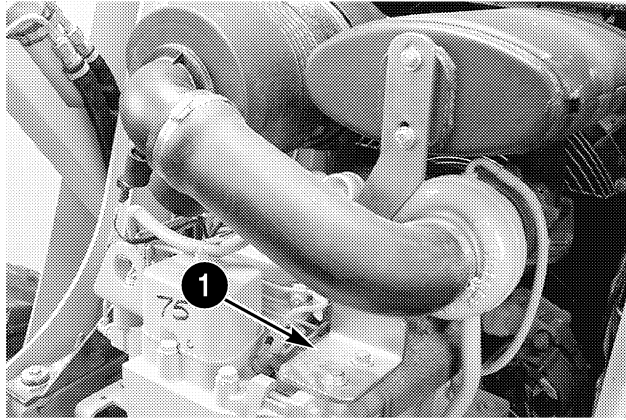

Loosen and remove the cap screws that fasten the muffler mounting bracket (1) to the exhaust manifold.

**STEP 30**

Remove the muffler from the machine.

**STEP 31**

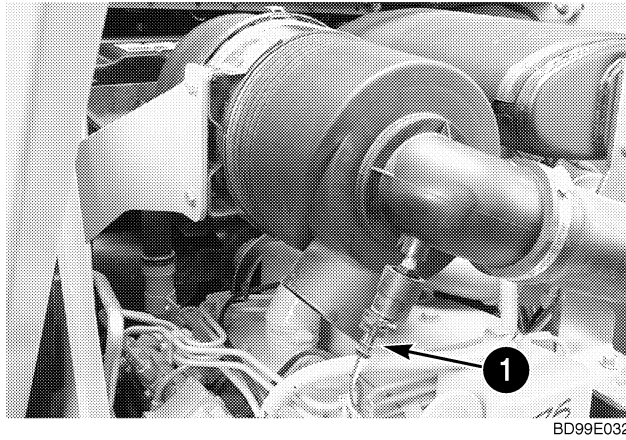

Disconnect the electrical connector (1) from the air filter restriction indicator switch.

**STEP 32**

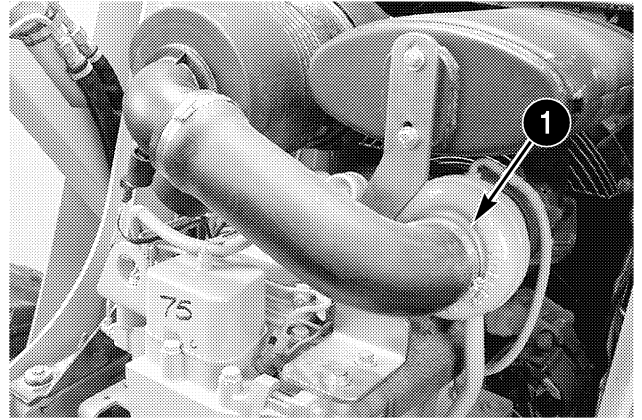

Loosen the hose clamp (1). Loosen the hose on the turbocharger.

**NOTE:** The following step shows removing the mounting bracket for the air cleaner. On the 85XT and 95XT make sure not to remove the hardware for the loader arm locking pin.

**STEP 33**

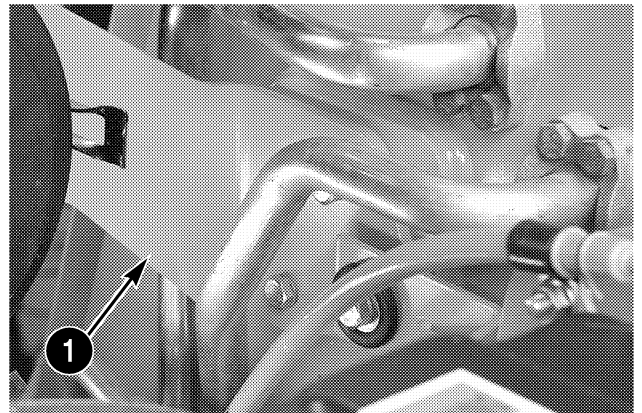

Loosen and remove the cap screws that fasten the air cleaner mounting bracket (1) to the frame.

**STEP 34**

Remove the air cleaner, mounting bracket, and hose from the machine.

**NOTE:** Fasten identification tags to the wires as they are removed from the engine for use during installation.

### STEP 35

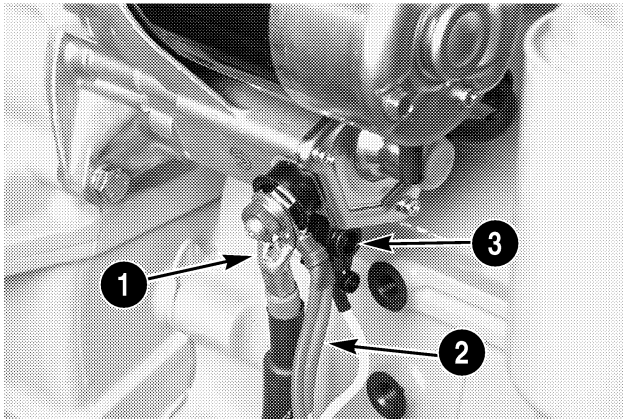

BD99E019

Disconnect the cable (1) and wires (2 and 3) from the starter solenoid.

**NOTE:** During assembly, after wire (3) is connected to the starter solenoid apply a small amount of RTV to the screw head and then close the cover on the screw.

### STEP 36

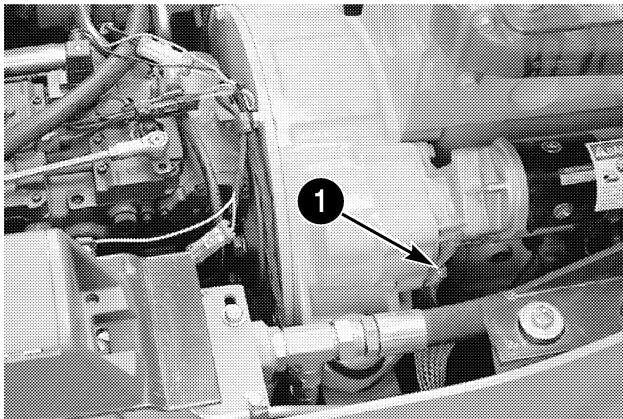

BD99E031

Find the ground strap from the starter mounting bolt to the machine frame. Loosen and remove the starter mounting bolt and washer that holds the ground strap. Remove the ground strap from the bolt. Install the washer and starter mounting bolt.

### STEP 37

Find the ground wires on the side of the engine. Loosen and remove the cap screws that fastens the ground wires to the engine. Keep all ground wires together.

### STEP 38

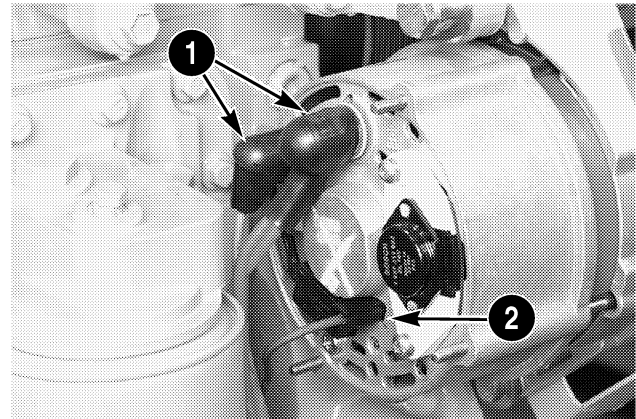

BD99E017

Disconnect the wires (1 and 2) from the alternator.

### STEP 39

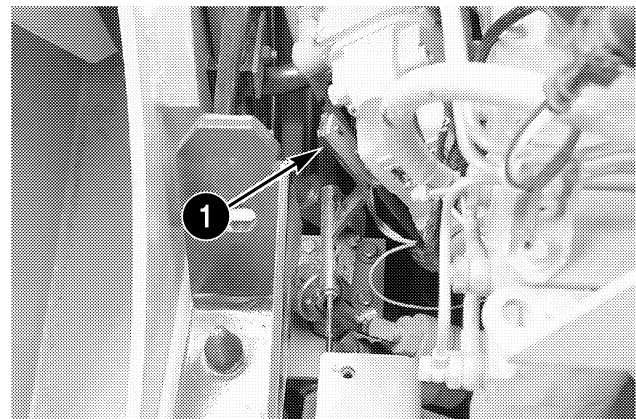

BD99E033

Loosen and remove the two cap screws and lock washers that fasten the throttle linkage bracket (1) to the fuel injection pump.

### STEP 40

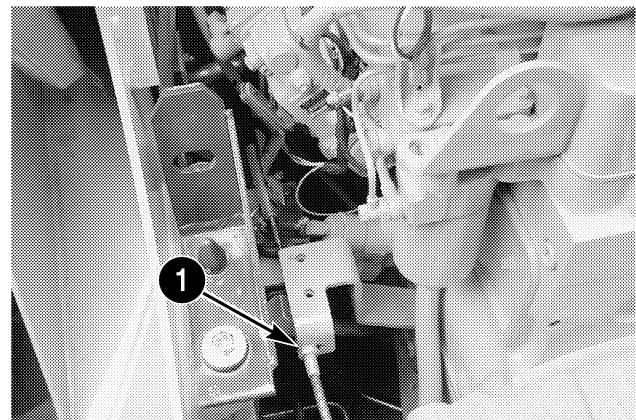

BD99E031

Loosen the jam nut (1) on the throttle cable mounting bracket. Remove the throttle cable from the mounting bracket. Move the throttle cable out of the way.

**Thank you very much for  
your reading. Please Click  
Here. Then Get COMPLETE  
MANUAL. NO WAITING**



**NOTE:**

**If there is no response to  
click on the link above,  
please download the PDF  
document first and then  
click on it.**

**STEP 41**

Disconnect the wire connector from the engine coolant temperature switch.

**STEP 42**

Disconnect the wire connector for the fuel injection pump solenoid.

**STEP 43**

Disconnect the electrical connector for the fuel injection pump solenoid.

**STEP 44**

Loosen and remove the cap screw that fastens the wiring harness to the right side of the engine.

**STEP 45**

Remove all tie straps that fasten the engine harness to the engine. Make a record of the location for use during installation.

**STEP 46**

Move the wiring harness out of the way.

**STEP 47**

Disconnect the fuel lines from the engine.

- A. Loosen the clamp on the fuel line at the fuel injection pump.
- B. Pull the hose from the fitting.
- C. Install a bolt in the fuel line to keep the fuel in the line.
- D. Repeat steps A, B, and C for the fuel line on the hand pump.

**STEP 48**

If the machine is equipped with a high pressure gear pump and control valve:

- A. Find the gear pump mounted on the timing gear cover. Loosen and remove the bolts (1) that fasten the high pressure gear pump to the timing gear cover. Remove the gear pump from the timing gear cover. Fasten the gear pump out of the way.

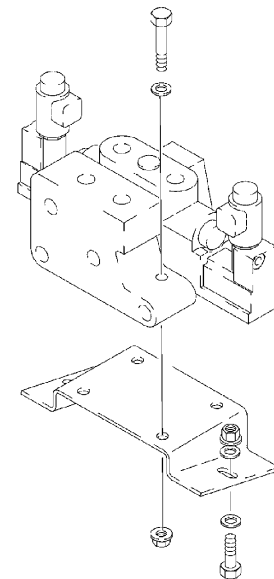
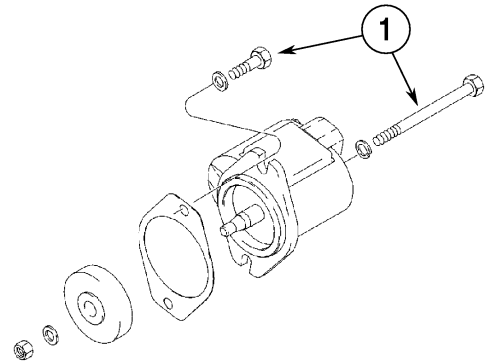

BS99G156

- B. Locate the high flow control valve (1). Find the cap screws that fasten the mounting bracket for the high flow control valve to the frame. Loosen and remove the bolts, washers and self-locking nuts (2). Move the high flow control valve toward the rear of the machine and out of the way.

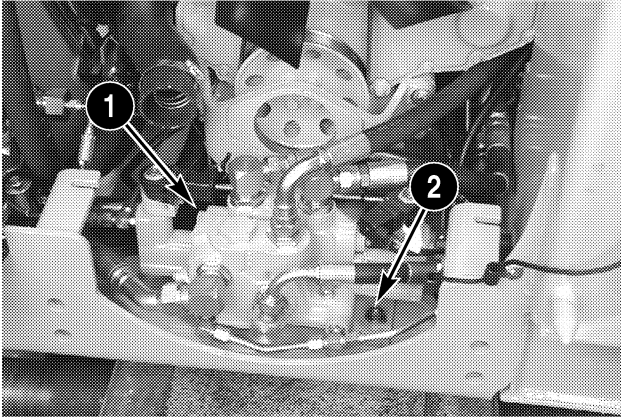

BD99E021

**STEP 49**

If the machine is equipped with a high pressure piston pump:

- A. Find the high pressure piston pump mounted on the rear of the engine.

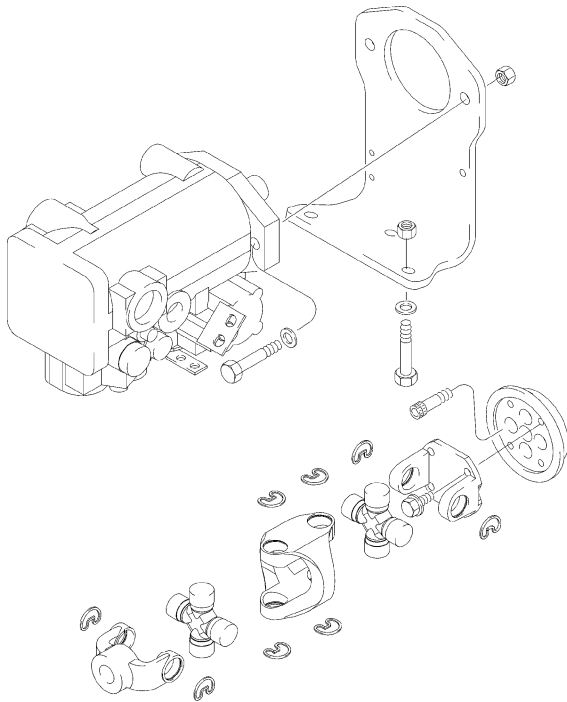

BS99G157

- B. Loosen and remove the bolts (1), washers, and self-locking nuts that fasten mounting bracket for the piston pump to the frame.

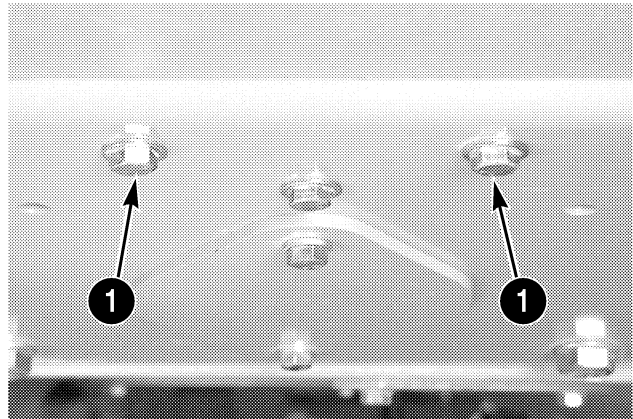

BD99E046

- C. Move the piston pump away from the engine until the splined shaft on the piston pump disengages the coupling. Fasten the piston pump out of the way.

**STEP 50**

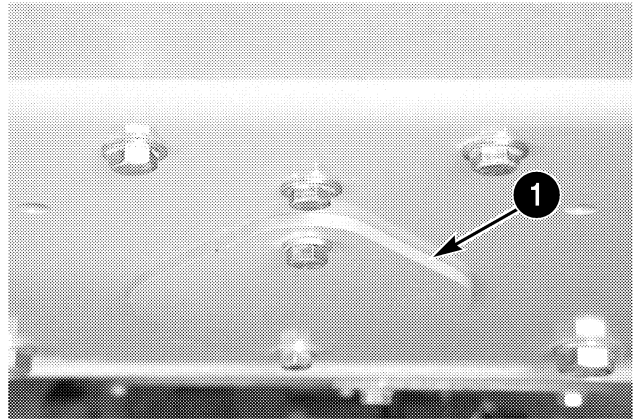

BD99E046

Loosen and remove the cap screws and washers that fasten the cover plate to the frame. Remove the cover plate (1) for access to the rear motor mount.

**STEP 51**

Connect lifting equipment capable of lifting 272 kg (600 pounds) to the lifting eyes on the engine.

**NOTE:** Clean the hydraulic filter and the area around the hydraulic filter. Install caps and/or plugs in all fittings that are disconnected.

**STEP 52**

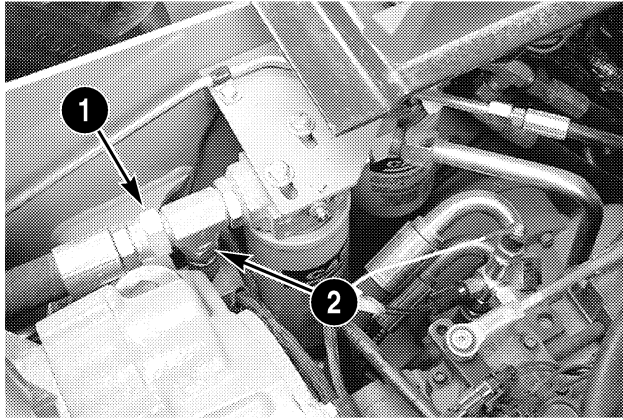

BD99E030

Disconnect the hoses (1 and 2) from the fitting on the hydraulic filter.

**STEP 55**

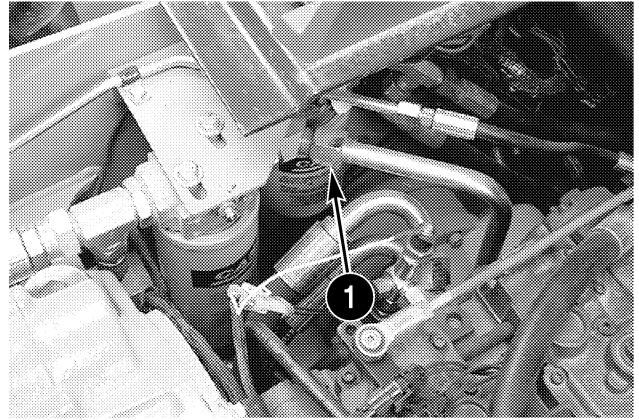

BD99E030

Remove the tube (1) from the fitting on the hydraulic filter.

**STEP 53**

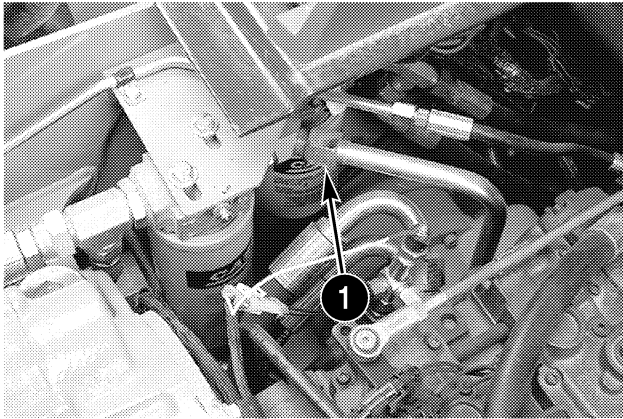

BD99E030

Disconnect the tube (1) from the fitting on the hydraulic filter.

**STEP 56**

Remove the hydraulic filter assembly.

**STEP 57**

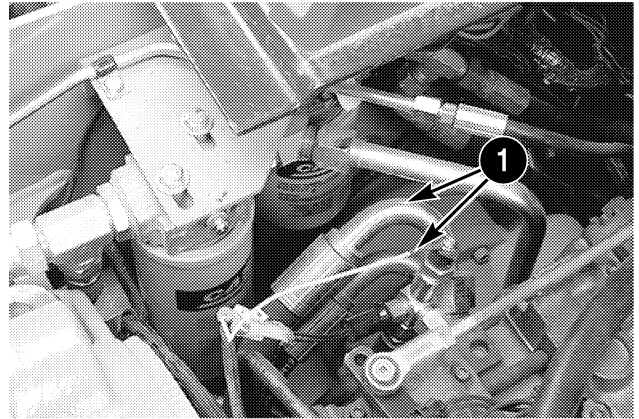

BD99E030

Disconnect the hydraulic lines (1) shown from the left side of the tandem pump.

**STEP 54**

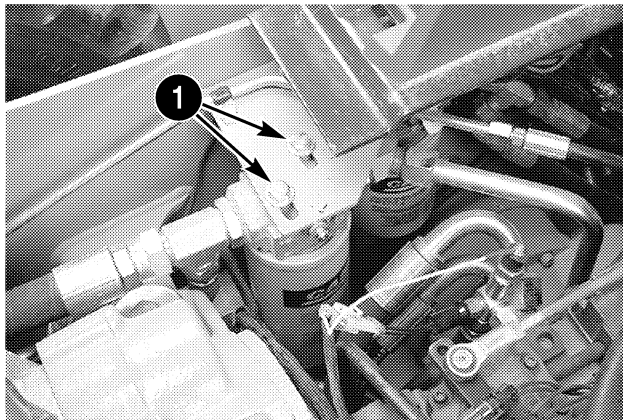

BD99E030

Loosen and remove the cap screws (1) and flat washers that fasten the hydraulic filter head to the mounting bracket.

### STEP 58

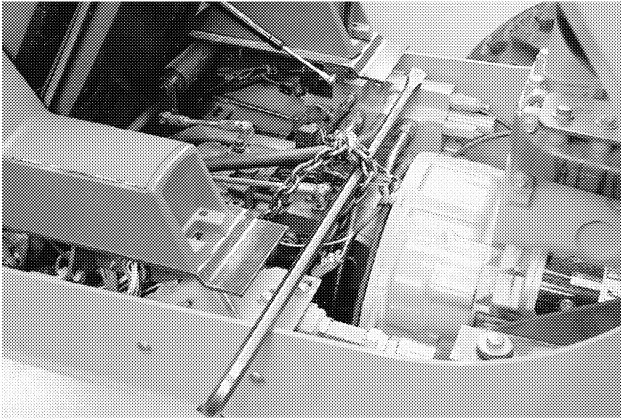

Connect equipment to the tandem pump that will hold the tandem pump in position when the engine is removed.

### STEP 59

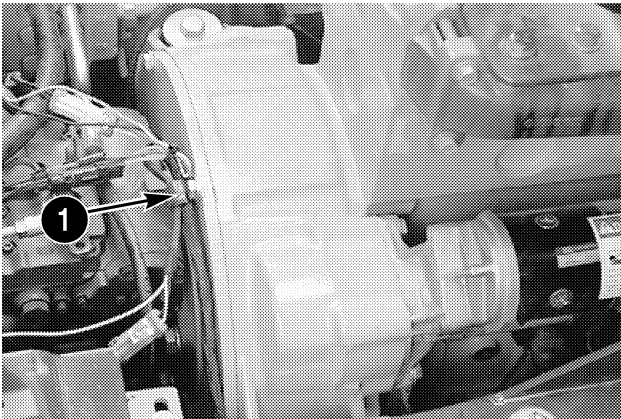

Loosen and remove the cap screw (1) and washer that fastens the clamp and wiring harness to the tandem pump mounting plate. Move the wiring harness out of the way. Remove the five remaining cap screws and washers that fasten the tandem pump mounting plate to the engine.

### STEP 60

Move the engine away from the tandem pump mounting plate until the splined shaft on the tandem pump disengages the coupling.

**NOTE:** *During assembly apply anti-seize compound to the splined shaft on the tandem pump before engaging the splined shaft in the coupling.*

### STEP 61

Remove the engine from the machine.

## INSTALLATION

### STEP 62

Installation of the engine is the reverse of removal.