

NTX 1.2 SETUP SHEET

NAME _____
 DATE _____
 TRACK _____

TRACK CONDITION

SURFACE SMOOTH MEDIUM BUMPY
SIZE TIGHT MEDIUM FAST
TRACTION LOW MEDIUM HIGH

TRANSMISSION

PINION 1st: _____ 2nd: _____
SPUR GEAR 1st: _____ 2nd: _____

DRIVE TRAIN

	FRONT	REAR
GEAR DIFF OIL (cst)		
RIGID AXLE		

CLUTCH SETTINGS

STANDARD

TYRES

	SHORE
FRONT	
REAR	

SHOCKS SETTINGS

	FRONT	REAR
SPRINGS		
OIL		
PISTON HOLES		

FRONT ARM BUSHES ORIENTATION

5 9 10 100 15 91

ANTI-ROLL BAR

FRONT	
REAR	

REAR ROLL CENTER

5 5 100 100 15 15

ACKERMAN

1 1 2 2

FRONT

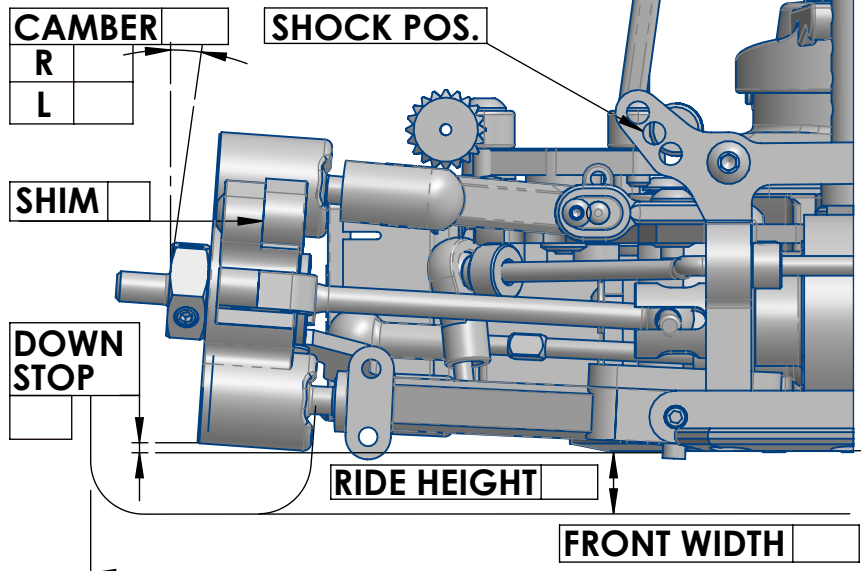

REAR

