



The International Journal

AOL Keyword: Racecar Engineering

# Racecar engineering



### THE PERFECT PROFILE

Our expert's practical guide to choosing the optimum wing shape



### PUTTING A DAMPER ON IT

Latest developments from the world's top suspension specialists

March 2006 · Vol 16 No 03

www.racecar-engineering.com

UK £4.60 · USA \$9.25

# Porsche RS Spyder

## Serial Le Mans winner's new prototype

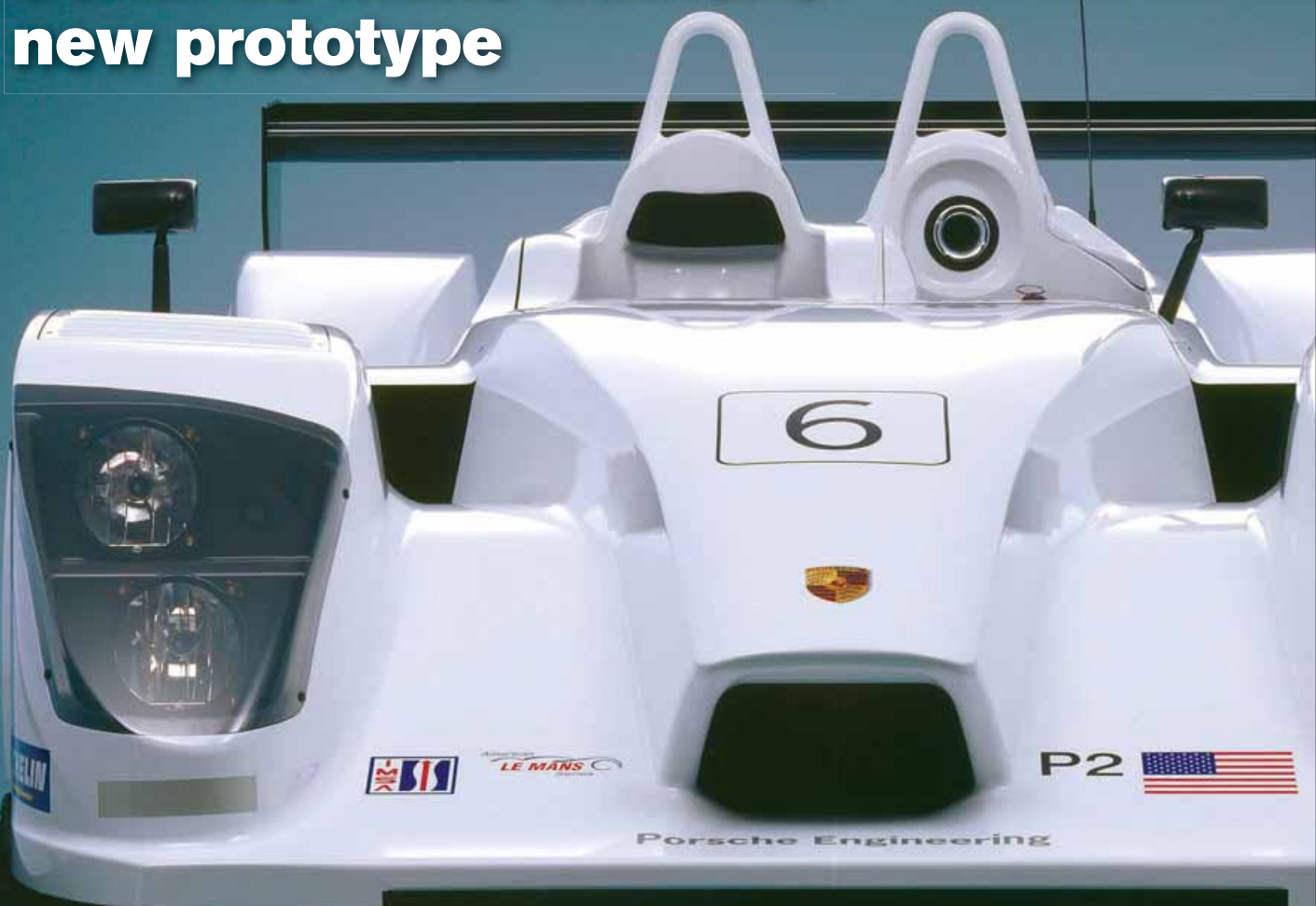

**Formula Atlantic**  
Stalwart North American  
race series revamped

**Revealing rig**  
Do you know what shape  
your racecar is on track?

YYePG Proudly Presents, Thx for Support



# Clamshell Quick Disconnects ...Simply A Snap!

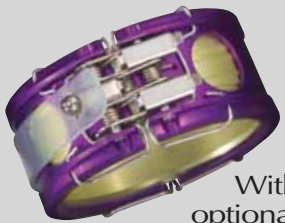

With optional safety strap

## SMARTER

Saves Time, Space, Weight and Headaches  
Threadless Fixed Cavity Design  
Full Flow - No Restrictions  
Double O-Ring Sealing on Hose Ends  
Fully Exchangeable with Wiggins® Style

## FASTER

Snaps Off/On; No Tools Needed  
Double Swivel Hinge For Easier Assembly  
Aerospace Quality Race Proven



Largest stock of hose ends, adapters, weld-ons, caps and plugs

## SECURE

Flexible, Secure Connections For Hose or Tube  
Axial Tube Movement Up to 1/4" And  $\pm 4^\circ$  Angularity  
Triple-Latch Finger Closure for Security  
Optional Safety Strap Makes Visual Inspection Easy And Sure

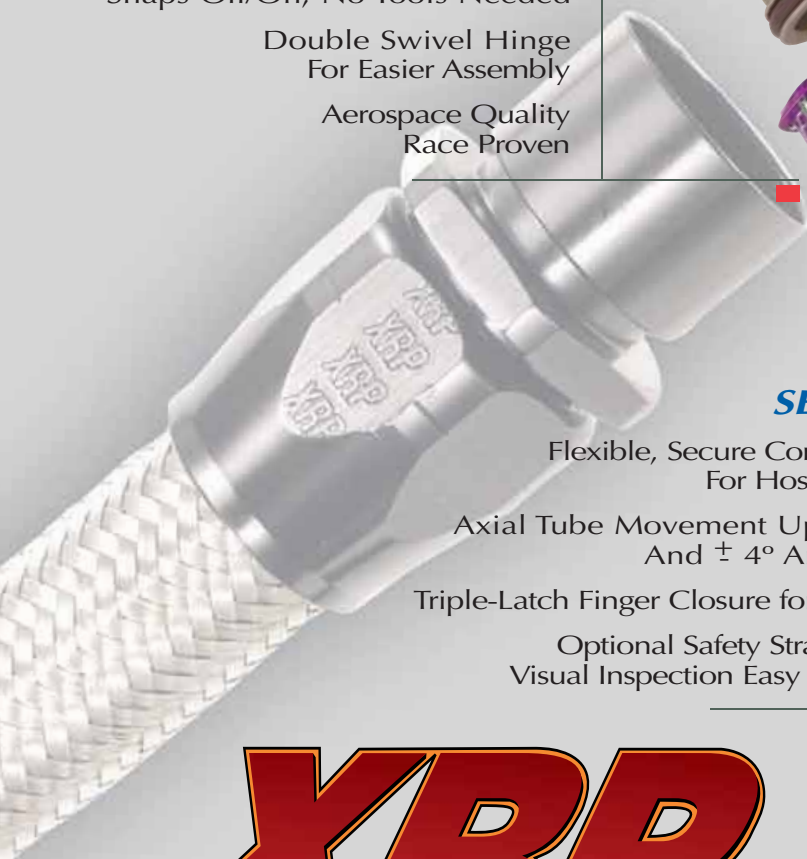

# XRP®

**THE XTREME IN RACING PLUMBING**

® Registered Trademark of Transdigm, Inc.

**XRP, INC.** 5630 Imperial Hwy. South Gate, CA 90280  
sales@xrp.com tel 562 861 4765 fax 562 861 5503

**EUROPE** James Lister & Sons motorsport@lister.co.uk  
tel 44 (0) 121 525 5800 fax 44 (0) 121 525 4833

XRP Proudly Presents, The for Support

# Contents

## Features

### Cover story

- 30 Autosport Engineering 2006**  
Report from Europe's premier industry show
- 36 Porsche LMP**  
The long awaited new Spyder from Zuffenhausen examined
- 42 New Atlantics**  
Long in the tooth junior series revamped
- 46 Winging it**  
Aerofoil guru Simon McBeath discusses wing profile selection and optimisation
- 54 Motorsport in Paradise**  
Cluster spotlight on Barbados
- 60 Lotus SKMS rig**  
Investigating the shape of cars under load

## Raceworld

- 05 Write line** – Has motorsport lost its sense of theatre to corporate image control?
- 06 Debrief** – F1 is changing, diesels are going to Le Mans and news from the Birmingham show
- 18 Race people** – Keith Duckworth obituary
- 21 V-Angles** – Paul Van Valkenburgh worries about the future and military robots
- 25 Column** – Sergio Rinland despairs of one make monotony and its effect on engineers
- 21 Forum** – The editor stirred things up in V15N12, here's the fallout

## Raceshop

- 69 Buyers' insight** – This month, dampers
- 75 Tech Spotlight** – Performance Friction's new carbon brake disc
- 77 Racegear** – All the latest products
- 83 Database** – Full motorsport supplier listings
- 93 Aerobytes** – Simon McBeath on the influence of a front wing on downstream aerodynamics
- 97 The Consultant** – Mark Ortiz discusses tyre pressures on snow

### Subscriptions

**FOR SUBSCRIPTION DETAILS TURN TO  
PAGE 67  
Or visit [www.racecar-engineering.com](http://www.racecar-engineering.com)**



**36**

Porsche



**42**

Swift

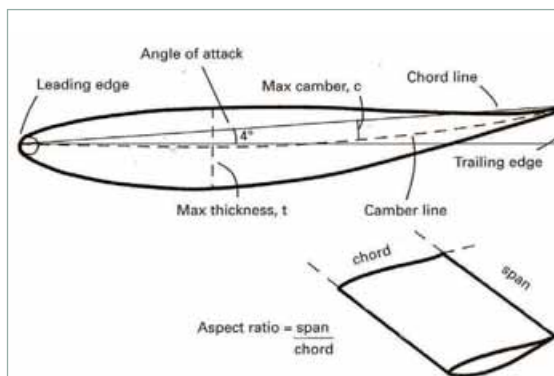

**46**

McBeath



**60**

Clarke

YYePG Proudly Presents, Thx for Support

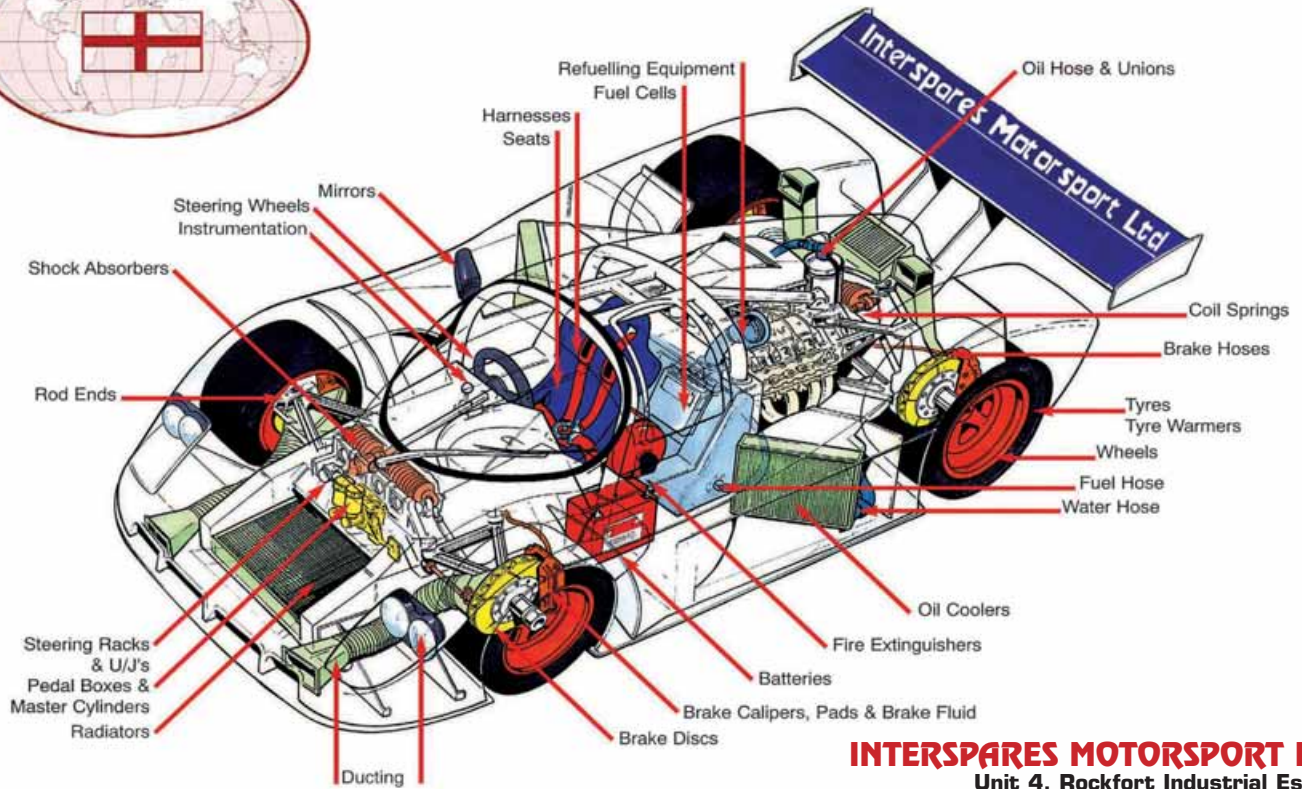

**Export Specialists**

**INTERSPARES MOTORSPORT LTD**

Unit 4, Rockfort Industrial Estate  
Wallingford, Oxfordshire OX10 9DA

Tel: +44 (0)1491 827460 fax: +44 (0)1491 827469

Email: [export@intmsport.com](mailto:export@intmsport.com)

**THE GLOVES  
PROFESSIONALS  
TRUST.**

**MECHANIX WEAR**

*Mechanix Gloves are used by more race mechanics than any other brand.  
Mechanix Gloves. The tool that fits like a glove.®  
Mechanix Europe Via dell'industria, 31  
31041 Cornuda (Treviso) Italy  
[info@europe.mechanix.com](mailto:info@europe.mechanix.com)  
[www.mechanix.com/international](http://www.mechanix.com/international)*

ORIGINAL    M-PACT™    M-PACT 2    FASTFIT™

# Write Line

**H**as motorsport lost its sense of showmanship under the oppressive pressure of its major manufacturer paymasters? I found myself asking this question thanks to a flippant comment from a racing driver at a car launch late last year. The launch in question was the new Audi Rio diesel sports prototype in Paris last year. For the event, the company had gained permission for the new racecar to be driven slowly round the Jardins du Trocadero in the shadow of the Eiffel Tower. When the new car rolled to a standstill, driver Tom Kristensen hopped out to be met by an attractive female interviewer with a microphone. 'How was the drive?' she asked. 'Not bad,' replied Kristensen, 'the Paris traffic was bad but the run up the autoroute was fine.'

Did he... we asked ourselves. Surely not. He hadn't just driven it all the way from Inglostadt had he? Is that possible? Why not? Wind up the ground clearance to clear bumps, register the car for the road – easy. Audi does it with production car prototypes all the time. Wow, what a fantastic stunt. And fuel? Could they even have driven it all the way on one tank? Surely not. But why not? 90 litres, the car running off boost most of the way, cruising at the legal maximum, except of course in Germany where a zoomph squirt would have made the performance point. What a superb way of driving home the synergy with the diesel road cars on both economy and performance.

'Of course, we should point out,' said the pretty interviewer, 'that you are only joking.' And puff, the whole sense of theatre was blown out like a candle flame. At the risk of getting Mr Kristensen into trouble, I have to say the launch seemed rather flat after that.

But it does make the point that too often we expect people to love motorsport for its mind and we are inclined to deny it a revealing dress or seductive make-up. However, we live in an age where there is a mass of entertainment fighting for people's attention. If something wants to get noticed it needs to make itself stand out. And that doesn't mean compromising the purity of the racing on the track. The two activities are not mutually exclusive. Look back 30 or 40 years and publicity stunts went hand in hand with good racing. Granted, in those days it often involved the politically incorrect use of women, but it didn't have to.

Today, the sport seems to have lost its sense of fun. It has become rather sober, responsible and respectable. When did you last see motorsport grabbing headlines on the front page? The most recent occasion I can recall was a couple of years ago when they ran F1 cars through London's streets. Crowds turned out in hundreds of thousands and headlines were grabbed everywhere. But such events are all too rare. Is that because the sport we love has become too serious and self important? Or is it that major manufacturers can't reconcile the wow factor with their carefully-crafted, squeaky-clean public images?

Let's face it, you can't imagine a manufacturer backed F1 team doing something crazy like taking one of its cars to Bonneville, can you? Er, hang on...

“THE SPORT SEEMS TO HAVE LOST ITS SENSE OF FUN”

**Editor**

Charles Armstrong-Wilson



YyPG Proudly Presents, Thx for Support

The International Journal  
**Racecar**  
engineering

**Pit Crew**

**Vol 16 No.3**

**Editor**

Charles Armstrong-Wilson

**Deputy Editor**

Sam Collins

**Art Editor**

Barbara Stanley Borrás

**Chief Sub Editor**

Mike Pye

**Editorial Assistant**

Katie Power

**Contributing Editors**

Paul Van Valkenburgh, Allan Staniforth

**Technical Consultant**

Peter Wright

**Group Art Editor**

Patrick Morrissey

**Contributors**

George Bolt Jr, Pete Knivett, Charles Clarke, Dave Hancock, Simon McBeath, Mark Ortiz, Martin Sharp, Ian Wagstaff, Dan Carney

**Photography**

LAT, Tony Tobias, justbajan.com

**Business Development Manager**

Tony Tobias +44 (0) 20 8726 8328

Mobile 07768 244880 Fax +44 (0) 20 8726 8399

tony\_tobias@ipcmedia.com

**Advertisement Sales Executive**

Andy King +44 (0) 20 8726 8329

andy\_king@ipcmedia.com

**Group Advertisement Manager**

Nick Lee

**Publisher**

Gavin de Carle

**General Manager**

Niall Clarkson

**Managing Director**

Paul Williams

**Editorial & Advertising**

Racecar Engineering, Focus Network,

Leon House, 233 High Street,

Croydon, Surrey CR9 1HZ, UK

**Tel** +44 (0)20 8726 8364

**Fax** +44 (0)20 8726 8399

**E-mail** racecar@ipcmedia.com

**Back Numbers** Back issues department,

PO Box 772, Peterborough PE2 6WJ, UK

**Tel** +44 (0)1733 385170

**Website** mags-uk.com/ipc

**Worldwide News Trade Distribution**

Marketforce (UK) 5th Floor, Low Rise, Kings Reach

Tower, Stamford Street, London SE1 9LS, UK

**Tel** +44 (0)20 7633 3300

**Worldwide Subscriptions** Racecar Engineering

Subscriptions, PO Box 272, Hayward's Heath,

West Sussex, RH16 3FS, UK

**Typesetting & Repro** CTT Limited

**Print Text** Benham Goodhead Print

**Cover** BR Hubbard Printers

**Printed in England** ISSN No 0961-1096

USPS No 007-969

**Racecar Engineering**

is a Focus Network publication, published by

IPC Country & Leisure Media Ltd

A part of IPC Media, a TimeWarner company

**Racecar Engineering, incorporating**

**Cars & Car Conversions and Rallysport,**

is published 12 times per annum and is available

on subscription. Although due care has been

taken to ensure that the content of this publication

is accurate and up-to-date, the publisher can

accept no liability for errors and omissions. Unless

otherwise stated, this publication has not tested

products or services that are described herein,

and their inclusion does not imply any form of

endorsement. By accepting advertisements in

this publication, the publisher does not warrant

their accuracy, nor accept responsibility for their

contents. The publisher welcomes unsolicited

manuscripts and illustrations but can accept no

liability for their safe return.

© 2006 IPC Media. All rights reserved.

Reproduction (in whole or in part) of any text,

photograph or illustration contained in this

publication without the written permission of the

publisher is strictly prohibited. *Racecar Engineering*

(USPS 007-969) is published 12 times per year by

IPC Media Ltd in England. Periodicals postage paid

at Green Brook NJ 08812. US subscriptions cost

\$79.00 from EWA, 205 US Highway 22, Green

Brook, NJ 08812, tel: 800 272 2670. Postmaster:

send address changes to *Racecar Engineering*,

205 US Hwy 22, Green Brook NJ 08812 USA

[www.racecar-engineering.com](http://www.racecar-engineering.com)

# Formula One revolution

New regulations issued by the FIA mean that 2008 will see massive change in Formula 1. Control parts, the controversial CDG wing, rev limits and restrictions on development will all hit the grid this season.

As predicted in last month's issue, green solutions will also start to make an appearance in 2008 as all F1 fuel will have at least 5.5 per cent of its content from biological sources. Customer cars will also make a return, as independent teams will be able to purchase complete cars from works teams.

The stated objective of the new regulations is to make substantial reductions in the cost of going grand prix racing. An independent team with a \$100 million (£57 million) budget should now be able to compete with a manufacturer team prepared to spend more than three times that amount.



Once again F1 is changing the regulations in an attempt to reduce costs and encourage independent teams to compete

LAT

Comments made by Max Mosley reveal the financial motivation behind these fairly drastic changes: 'the real argument in Formula 1 is about costs,

the world championship must remain financially viable for independent teams. Against this, two or three manufacturers want to win by spending unlimited

amounts of money. This approach has caused great damage to motorsport, most recently to the Indy Racing League and we don't want it in F1.'

## 2006 rule change round-up

### Technology

New technologies such as front torque transfer or 'brake steer' which give a team a competitive advantage for one season, but which are then adopted by all teams for subsequent seasons at significant expense, will be banned at the end of the first season.

The reason for this is to reduce costs, so a team that develops a

new technology still feels the benefit of it, albeit only for the rest of the season. However, this does still allow teams to spend large sums on developing technologies, only to see them banned if it is felt they have no value to the sport. If they are banned, the teams will be obliged to publish full details of the system. Racecar will likely publish any such details.

5.5 per cent of the fuel mix must come from biological sources, and from 2009 regenerative power systems will be permitted, meaning F1 is likely to become hybrid drive. This should increase the relevance of Formula 1 to the development of road car technology.

### Aerodynamics

The centreline downwash

generating (CDG) wing will become mandatory from 2008. There will be other significant bodywork changes to reduce downforce and keep drag at current levels. Substantial changes to the front of the cars will also be made to make them handle better in traffic. From 2009 the teams will only make two changes to the cars' bodywork after the start of the season. What constitutes a



LAT



LAT

Early '90s' F1 cars could give an insight into what 2008 cars may look like

Simplified aerodynamics and wide slick tyres should help to improve racing

YEPG Proudly Presents, Thx for Support

# set for 2008

Many of the changes are aimed at reducing the costs of grand prix racing, though previous attempts to do this have, according to some, had the opposite effect, something Mosley counters: 'It must not be forgotten that the new engine rules were originally drawn up and proposed by the car manufacturers to reduce costs. Although some of these manufacturers now claim

that costs have risen, it has become clear that for a properly managed engine supplier costs have fallen substantially.'

Formula 1 seems to be looking forward, and all 10 teams have agreed to allow Super Aguri F1 to enter, even though the Japanese outfit still has some very major uncertainties to resolve – a prime example being the construction of a chassis. It's likely the

team will start the season with a modified Arrows design, though the team admits that it does not expect to be on the pace until mid season. However, there are still question marks over the very future of the sport, and a rival series organised by a group of manufacturers known as the GPMA still looks likely to go ahead. This would leave Formula 1 with only half its teams.

## F1 calendar 2006

12 March – Bahrain  
 19 March – Malaysia  
 2 April – Australia  
 23 April – San Marino  
 7 May – Europe  
 (Germany)  
 14 May – Spain  
 28 May – Monaco  
 11 June – Great Britain  
 25 June – Canada  
 2 July – USA  
 16 July – France  
 30 July – Germany  
 6 August – Hungary  
 27 August – Turkey  
 10 September – Italy  
 17 September – Belgium  
 1 October – China  
 8 October – Japan  
 22 October – Brazil



Super Aguri F1 will be the first of a new breed of independent teams, using aged Arrows chassis and Honda V8s

change is not yet clear, be it a new winglet or a fully re-worked aero package. There will also be limitations on some 'interesting' areas of aerodynamic research.

No car may produce more than 12,500N of downforce at any time. The purpose of some of these changes is to ensure the cars create a wake and can draft each other. Any aerodynamic device that avoids

the purpose will be banned. Winglets and flip-ups have effectively been banned

### Chassis

Cars will shed 55kg of weight, bringing the minimum weight to 550kg, to save on teams buying and carrying ballast. Maximum car width has been increased to 2000mm with a minimum width of

1950mm. Restrictions on materials are also in place.

### Engine

Engines will be little changed from the current 2.4-litre V8 specification, though the restricted 3.0-litre V10s will be outlawed. One significant change is the adoption of a rev limit of 19,000rpm again to keep costs under control. Although not yet confirmed it is likely that engines will have to last three full race meetings, making it more likely that teams will look to circumvent testing limits by running their units in LMP2 sportscars.

### Electronics

Every car will carry a control ECU built by an FIA-selected single supplier, and it may only be connected to the cars' loom, sensors and actuators in a specified fashion. All components of the engine and transmission must be

controlled only by this ECU. Digital instrumentation will also be a control part. These measures are supposed to stop any driver aids being used, but a number of industry sources have voiced concern to *Racecar* that teams will still be able to use their own sensors for acquisition purposes, although their loom cannot be connected in any way with the FIA control loom.

### Transmission

To reduce costs gear ratios must be made of steel and no thinner than 12mm. It is also likely that transmissions will have to last four race meetings.

### Tyres

Control slicks will be supplied by a single manufacturer, known not to be Michelin. Drivers will also be able to adjust tyre pressures during a race for safety reasons.



Complex aerodynamic devices, including winglets, have now been outlawed

YyEPG Proudly Presents, Thx for Support



## Diesel power for Le Mans

Diesel power has returned to sportscar racing with two new projects breaking cover and, as has long been rumoured, Audi's successor to the dominant R8 – the R10 – is diesel powered. The new car was unveiled in Paris shortly before Christmas, some believe as a taunt to Peugeot which is itself constructing a diesel racer for Le Mans. Compared to the R8, the R10 has a longer wheelbase to accommodate the longer V12 engine and wider front tyres. In profile the car has a strong family resemblance to the almost unbeatable R8, but the front end is strikingly different and some say even aesthetically displeasing. The shrouded front suspension improves airflow, claims Audi, and is reminiscent of Bentley's 2003 Le Mans winner.

A major difference are the twin roll hoops, or 'blades', as they are totally different to any other prototype yet constructed and give much cleaner airflow to the rear of the car.

Audi claims the new, all-aluminium, V12 TDi engine produces 650bhp and a massive 1100Nm (811lb.ft) of torque. This gives rise to a whole new set of challenges, not least in the transmission. The Xtrac gearbox developed for the R10 is lighter than Ricardo's R8 unit, even though it has to handle a 55 per cent increase in torque. Tyres too will be developed with Michelin to cope with the extra loading.

Fuel efficiency has been increased over the petrol R8 with the R10 able to run an extra lap at Le Mans between stops. Already the Audi is the favourite to win this year's Le Mans 24 Hours.

Meanwhile in England, Ian Dawson's



Audi



Audi

**Diesel-engined R10 is firm favourite for outright victory at Le Mans this year**



Tom Wilcock

**GroupBio's Lola will run on bio-diesel this season, the first LMP to do so**

Le Mans diesel dream is back on track. Having entered the first diesel-fuelled car at La Sarthe for over 50 years in 2004 – beating Audi by two years – he plans to be back this year with a further development.

Dawson's Taurus Sports team was

unable to finance a further season after 2004 and a rescue plan by consultants ARP proved ill conceived. But Dawson has now received support from bio-diesel producer D1 Oils, meaning that he can once again bring something new to Le Mans. Even in 2004 he was already

looking beyond the horizon and was talking of using bio-diesel (like the bio-ethanol used by Nasamax, a product made from renewable energy crops). The new team will be known as groupBio team.

Late last year Dawson's Lola B2K/10 was converted by Mountune to run on a mixture of regular diesel and bio-diesel, with the hope of an entry for this year's 24 Hours. The calorific value of bio-diesel is very close to mineral diesel, and the change is mainly down to engine mapping. A new engine has been purchased to replace the old one that was taken from a Volkswagen SUV with turbocharging now courtesy of KKK rather than Garrett. At the time of writing the car had been, said Dawson, 'half hybridised.' This should have been completed in time for the Lola to comply with the 2006 regulations and to be able to enter for the Sebring 12-hour race.

The new sponsor, D1 Oils, is a UK-based global producer of bio-diesel. There are, says Dawson, 'a lot of things it can learn' from the new project. 'What we learn about how different bio-diesel blends perform in our engine is going to be of immense value,' adds D1 CEO Philip Wood. It is also intended to give D1 the opportunity to build up its brand as it plans to expand its planting and refining business. One country in particular where there is interest in bio-diesel is Japan, which means that the team could take advantage of the new Japanese Le Mans Endurance Series.

Ricardo Judd's diesel engine project is also believed to be making progress with help from government money.

## Take Courage

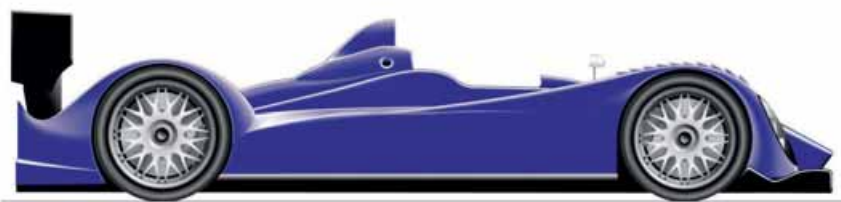

Courage

Courage has revealed an artist's impression of the overall look of its new LC70 LMP chassis. This will be the Le Mans-based firm's first top-class prototype fully compliant with current LMP rules.

YYePG Proudly Presents, Thx for Support

# moment of truth

Racing doesn't only depend on how fast you go but also how quickly you slow down. Every corner demands a unique response in how, when and where you brake. And at these moments, the engineering decisions you've made will decide whether it's going to be a hot lap or not.

But if you've fitted AP Racing brakes, you'll know your driver has the confidence to brake deeper at every corner – from start to finish.

That's because AP Racing have spent over 60 years honing their art to perfection – supplying brakes to over 250 GP winners and numerous championships in the process.

And that's simply the truth.

*For a catalogue detailing the AP Racing range brakes, clutches, actuation products and ancillaries call our technical sales team or visit our website.*



AP RACING  
WHEELER ROAD  
COVENTRY  
CV3 4LB  
ENGLAND  
TEL +44 (0)24 7663 9595  
FAX +44 (0)24 7663 9559  
EMAIL: sales@apracings.co.uk



the science of friction

YyPG Proudly Presents, Thx for Support

[www.apracings.com](http://www.apracings.com)





Worldwide distributor for many famous manufacturers.  
Discover our ranges of high performance engine parts  
and don't hesitate to contact us for further informations.



Visit our web site !!



JE Forged Pistons  
Cars - Bikes



Forged Rods  
SAENZ



Forged & Titanium  
Valves MPI



Fasteners ARP



Camshafts  
KENT CAMS



Forged Pistons  
IASA



Throttle bodies  
TWM



Headgaskets  
COMETIC



Insulating Products  
COOL-IT



Valves Springs  
EIBACH



Pistons rings  
NPR

**JACQUEMIN TUNING**

233, Avenue de La République

59110 La Madeleine

France

Tél: 00 33 [0]3 20 74 64 80

Fax: 00 33 [0]3 20 74 64 89

YVEPC Proudly Presents, Thx for Support

[www.jacquemintuning.com](http://www.jacquemintuning.com)

## Dome's modular concept

Dome has released concept sketches of a new modular prototype racer, adaptable from LMP1 and 2 to GT format with only minor changes. Whilst the idea is new and exciting, sources in Japan say it is unlikely the car will ever be built.



# The Motorsport Foundation

The Motorsport Industry Association unveiled a brand new initiative to help the sport in the UK. Called the Motorsport Foundation, it will be a fund aimed at assisting the recruitment of new competitors and audiences, thereby growing the demand for UK motorsport businesses, services and equipment.

In the first instance, the initiatives the Foundation intends to tackle will be focused on marketing to increase the profile of motorsport and establishing a 'National Motorsport Week' in 2006. There will also be a 'kick start' scheme to nurture emerging talent.

The MIA's chief executive, Chris Aylett, said 'I have always believed that creating such a foundation would be very beneficial for the sport and, thereby, the industry. The timing is now right for our industry to help itself from within rather than hoping and waiting for external support.'

MIA chairman, Peter Digby, echoed the sentiments: 'I'm personally delighted that the MIA and its members have

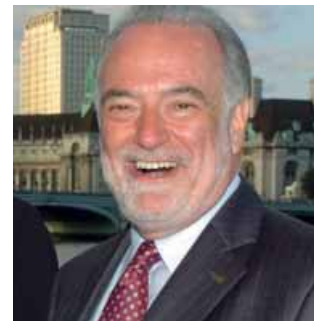

'The timing is now right...' says MIA chief executive Chris Aylett

taken this initiative. It will deliver new business and improve the profile and reputation of UK motorsport and its industry at a crucial time.

To raise the resources the MIA plans to solicit support through partnerships with industry, wealthy individuals, government, governing bodies, charities, covenants, annual appeals and special events. A company limited by guarantee, the Foundation will initially form part of the MIA with a charitable subsidiary being developed in due course.

# Prototypes dominate Autosport launches

There were plenty of new cars on display at January's Autosport Show in the UK. Of interest was an all-new spaceframe V8 concept racer in the form of the VERC0 XV8R.

Meanwhile, Lola made a surprise announcement of its intent to return to amateur racing with its first foray into the LMP3 market, the B06/90.



The car is initially being built for Sports 2000.

Other new prototypes from Juno, Gloria, Norma, Kelforms and Lynx were also on display.

■ See show report on page 30 for more details.



# Control the race

Bosch Motorsport ECU MS 3.1



## High Tech for Engine Control Units from Bosch Motorsport

The ECU MS 3.1 is a management system for engines from 4 up to 6 cylinders. It is covered by an extremely flat aluminium housing. The innovative hybrid technology makes the 0.55 lb light unit very easy to handle and resistant. The ECU MS 3.1 is a successful component of the Formula 3 and the Porsche Cup. Do you want to be part of the success? Find more information at [www.bosch-motorsport.com](http://www.bosch-motorsport.com)



**BOSCH**  
Invented for life

# NASCAR TV deal announced

NASCAR has announced its TV deal for 2007 and beyond. The contract involves ESPN and ABC, Fox Speed Channel and TNT and is worth \$4.48 billion over an eight-year period. Wall Street however didn't look upon the deal favourably and stocks in the two major NASCAR track operators, Speedway Motorsports and International Speedway Corporation, fell 10 per cent when the news broke, despite the deal being worth 40 per cent more than the current contract. Beginning in 2007, each NASCAR season will be launched on Fox with the telecast of the Daytona 500. Fox will then also carry NASCAR Speedweek's events, including the Budweiser Shootout and Daytona Pole Qualifying, and will broadcast the 12 NASCAR Nextel Cup races following the Daytona 500. TNT will broadcast six consecutive Nextel Cup Series races (races 14-19), while the final 17 Cup Series points races will



Minor rule changes for 2006 mainly revolve around fuel and refuelling systems

be broadcast on ABC or ESPN. The final 10 races, the Chase for the Nextel Cup, will be broadcast on ABC. The NASCAR Busch Series will be broadcast on ABC, ESPN or ESPN 2, with no less than four events on ABC. Speed will televise the NASCAR Craftsman Truck Series, with the exception of two events that will be

broadcast by Fox.

NASCAR pocket 10 per cent of the TV purse, while the tracks take 65 per cent and the remaining 25 per cent is added to the race purse. NASCAR also announced that only five races in 2006 will be impound races, where teams practice and qualify then impound the

cars. Last year 21 of the 36 races were impound events but changes were made after lobbying from TV networks needing more airtime and track operators wanting more gate money from the cars on track. Both Talladega and Richmond races, plus the July Daytona night race will be impound races.

A number of technical rule changes were also revealed prior to the start of the 2006 season. These include a downsizing of the outlets on the 11-gallon fuel dump cans used during pit stops from two inches to 1 3/4 inches in an effort to slow pit stops and take pressure off the wheel changers. This only applies to the Busch Series and Craftsman Trucks. The tops of fuel cells must also now be level with the top of the rear chassis rails they mount between (in the past teams would lower the cell and frame thus lowering the centre of gravity). *George Bolt Jr*

## Citroën C4 back on track

While rumours proliferated last year (many emanating from France) that Citroën Sport's development of the C4 WRC had not ceased, they remained unsubstantiated. *Racecar* reported on the rumours, and the evident frustration of chief engineer Xavier Mestelan-Pinon at not being allowed to get into the C4 project. *RE* can now reveal the full story.

The first, running, C4 WRC prototype was ready for its first test in September 2004. This was a short tarmac shakedown, followed shortly after by a more substantial test on gravel stages in the south of Spain. Then, the following month, Jean-Martin Folz, president of PSA, the parent company of Peugeot and Citroën, dropped the bombshell, announcing that both companies would withdraw their official involvement in the WRC from the end of 2005.

Another dictum from Folz that October was that all work on the C4

WRC must cease forthwith, and it did. Citroën Sport's engineering development emphasis then concentrated entirely on the Xsara WRCar.

Then, at the Catalonia Rally on the final weekend of October 2005, Folz announced that Citroën would make an official return to the 2007 WRC with the C4 WRC. The project was on again, and only then did any work resume on the C4.

Before last Christmas, it was back testing. Dusted off, the car was essentially still in its



Citroën's latest WRC challenger will be based on the current C4 road car

September 2004 specification, but this is set to change. The initial 2007-specification car is scheduled to be ready for March and its first test is to be between then and May this year.

In contrast to the entirely revised 2006-specification Ford Focus WRC, the C4 WRCs' running gear is largely similar to that of the Xsara WRC. The current plan configures essentially similar suspension with improved friction, while it is hoped that work on the Xsara's XU7JP4 engine - which, in common with all WRC engines, is devoid of water injection - will bring outputs to above those when it had water injection. This unit is also in the C4, but under-bonnet restrictions mean it cants back about its crank centreline by 25 degrees, while in the Xsaras it is at 30 degrees.

Gearboxes are identical, save for a unique C4 bellhousing to cater for the 'lost' five degrees. Mestelan

considers the C4 will continue with six forward ratios, believing there is not enough evidence of an advantage in choosing five speeds.

The C4 retains an hydraulic circuit to power the gear change and active centre diff, which Mestelan believes to be a good solution - heavier perhaps than alternatives, but a simple system providing good actuating power. The new passive front and rear differentials offer a facility to externally adjust their pre-loads by the crew through their casings between stages.

At present, Folz has dictated that this new World Rally Car will be first seen in action in the 2007 WRC, and this is what Mestelan is working toward, in the full knowledge however that match practice is crucial to the development of a car: 'We will be at the World Championship for the test - and alone!' he said. *Martin Sharp*

# Hats off to Bowler

With no fewer than 21 of its current Wildcat 200 desert racers entered in this year's Dakar, Bowler Off Road has set its sights on greater goals. Boss of the Derbyshire, UK-based operation, Drew Bowler, describes the Wildcat as a clubman car that carries the potential to be a top privateer car – something the proliferation of Wildcat entries on Dakar would seem to justify. Bowler's next project is a machine that private drivers can buy as a new car and which can effectively be made into a specification similar to that of a works off-road racer: 'The chassis and body designs have to be of a higher quality and of a good enough design that by putting in trick gearboxes and suspension you can actually push it on to the next level. But it's got to be available at a cost that the customer can afford,' says Bowler.

With styling based on the shorter and squatter Range Rover Sport shape, development work on this, as yet unnamed, new car has been under way for over a year, and preparation for production is well in hand. The Wildcat carries similar styling cues to a Land Rover and, indeed, some mechanical system componentry is carried over from that Solihull-made machine.



As yet un-named Range Rover-based racer has its sights set on Dakar 2007

Bowler's relationship with Land Rover has been strengthening over the years and, with the new vehicle nearing completion, the bond between the two operations is now very strong. Land Rover is offering engineers, simulation equipment and production engineering expertise to assist in getting this groundbreaking new car right first time.

Bowler has chosen to ensure this by, 'spending the money at the right end of the job. You look at the long-term result, rather than what it's costing you on the first hit.' Accordingly, from Bowler's original CAD designs by designer Jez Siddall, a 1/6th scale model has been made in MDF, and this is being scanned by Simpack to come up with the digital design data to provide an FE model.

From this a complete stress and strain simulation can be carried out.

Much of the running gear will be from the Range Rover Sport, as will components such as lights, door handles etc. Land Rover has a tradition of eschewing some (more economical) mass production engineering designs such as locating the front differential in the sump, as favoured by some 4X4 manufacturers. As such, much of the Range Rover Sport's componentry are eminently suitable for rally raids.

With wider, unique wishbones the track will be at the FIA maximum for rally raids, but other suspension parts such as hubs, differentials and gearboxes will be Range Rover Sport, although it is envisaged that when the

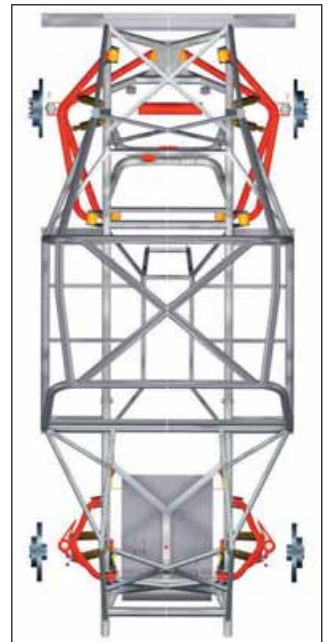

top level FIA racer comes on stream, a Sadev gearbox could be used. Engines will either be the Range Rover Sport's supercharged 4.2-litre V8 or the normally aspirated 4.4-litre V8, but for the FIA racer it plans to bring the 4.2 down to 4.0-litres, enabling the car to run at 1825kg minimum weight, despite the vehicle being built to run at 1600kg.

Early models are expected to be built with the 600bhp, 4.4-litre blown V8 and used on non-FIA events to test the car's ruggedness. The target is for the new Bowler to contest Dakar 2007.

# Mitsubishi falls on its own WRC sword

Mitsubishi has axed its world rally programme due to budget cuts. With the Monte-Carlo Rally starting in late to mid-January 2006, and this decision arriving just four weeks before the first round, this verdict was very late indeed.

As a motor corporation Mitsubishi is not alone in experiencing financial difficulties, but the split from former parent company DaimlerChrysler last year has worsened the situation. In its last-minute call the Mitsubishi board decided that 2006 WRC budget demands were excessive and scrapped the programme, announcing that it must 'focus management resources on



Despite making progress with its Lancer WRC, Mitsubishi is now out of the running, leaving just two full-time manufacturers to contest the 2006 series continued promotion of its revivalisation plan.' It is 'hoped' the team will return in 2008, although there is no firm commitment to this. Mitsubishi's Dakar operation, however, will continue.

The irony is that with the Peugeot and Citroën works teams absent from next year's WRC, Mitsubishi could have been looking at regular podiums this year. Since Andrew Cowan won the 1974 Safari Rally, Mitsubishi has maintained a role in world championship rallying and last year it looked to be coming good again. The Lancer WRC had been running to 2006's 'simplified' World Rally Car specification for most of the past two years and was certainly showing progress, as a strong second place in Australia last year demonstrated.

An extremely cohesive bunch of rally technicians and mechanics are now looking for jobs...



A range of 2-4 way adjustable dampers

Light-weight construction

RCS modular clutch system consisting of:

- Central release bearing
- Racing clutch kit
- Lightweight flywheel

Very low weight and mass of inertia FEM optimized

Engine response is clearly increased leading to faster acceleration

# Racing

**Motorsport Matrix Systems.**

***"If I'm pushing the envelope  
I don't need limits."***

For optimum performance you need components as perfect as your driving. Our proposal: Sachs Racing Clutch System RCS, a modular system of clutch building blocks. And the Racing Damper System RDS: no-compromise contact with the grid in extreme racing situations. Developed with the know-how and experience of the world's most demanding race series. And bearing a name that stands for race technology without limits: ZF Sachs Race Engineering. Driving technology to win.



 BERU

F1 SYSTEMS

# precision speed



For every major professional motorsport formula, BERU F1 Systems engineers accurate, robust solutions – fast.

**Electrical Connectors** – Shortest lead times from in-house manufacture of the Souriau Autosport range. Ultra compact Size Two connector up to 48% lighter available now.

**Tyre Pressure Monitoring** – F1 to Rally Raids and now the world's fastest road car, accurate, configurable systems for safety and performance.

**Composites** – Novel design and manufacturing processes provide significant weight reductions for a range of components on road and track.

**Wiring Harness** – From design to installation, bespoke solutions for winners in F1, WRC, Sportscars and IRL.

**Stress Measurement** – Integrated load cells reveal a host of performance gains in chassis, powertrain and suspension applications.

Precision Speed from BERU F1 Systems.

BERU F1 Systems,  
Technical Centre,  
Owen Road,  
Diss, Norfolk,  
IP22 4ER.

+44 (0)1379 646200

Visit our website  
[www.f1systems.com](http://www.f1systems.com)



**SOURIAU**  
Connection Technology

Preferred Status Distributor

Y&P Brands Presents, Thx for Support

# MIA Awards

For valuable contributions to motorsport. This year the winners were...

BY CHARLES ARMSTRONG-WILSON

On the Thursday evening of Autosport International the great and the good of motorsport converged on the Motorsport Industry for the MIA Awards. This annual event not only provides a focus for the European industry each year but also honours those that the MIA members feel have made an exceptional contribution to the sport. This year's winners were:

**The Business of the Year Award**

*(sponsored by Xtrac)*

**Winner: Goodridge**

Received by Stuart Goodridge

**The Teamwork Award**

*(sponsored by TAC Europe)*

**Winner: Renault F1**

Received by Pat Symonds

**The Small Business of the Year Award**

*(sponsored by Performance Racing Industry)*

**Winner: RML Group**

Received by Ray Mallock

**The Export Achievement Award**

*(sponsored by Autosport International)*

**Winner: Caterham Cars**

Received by Jez Coates

**The Rally Business of the Year Award**

*(sponsored by MIRA)*

**Winner: International Sportsworld Communications**

Received by David Richards

**The Technology and Innovation Award**

*(sponsored by Ricardo UK)*

**Winner: Beru F1 Systems**

Received by John Bailey

**The Service to the Industry Award**

*(sponsored by the WDA Motorsport Initiative)*

**Winner: A1 Grand Prix**

Received by John Wickham



Above: all the winners and sponsors gathered together at the end of the award's ceremony



Above left: David Richards holds court

Above: Todd Cope - Stasis Engineering and Alessandro Lesma - Ferrari SPA



Above: the MIA president's table  
Right: Richard Barnes - SPA group, Rodolfo Alcocer - Pro Car Auto Tecnica and Lynda Randall - SCCA Pro Racing



YYePG Proudly Presents, Thx for Support



**Jonathan Wheatley**

● Red Bull Racing continues to poach more staff from up and down the F1 pitlane. Former Renault chief mechanic **Jonathan Wheatley** has joined the team, as have ex-Toyota men **Humphrey Corbett** and **Gianfranco Fantuzzi**.

● **Fantuzzi's** departure from his post as logistics manager at Toyota means that the Toyota test team organiser **Andy Beaven** fills his position.

● **Gustav Brunner** has made a surprise departure from his role at Toyota F1. The team has been re-structuring internally and his position of chief designer has been made obsolete. Brunner, however, is likely to stay within Formula 1.

● **Len O'Hagan** has been appointed chairman of the new Rockingham



**Gustav Brunner**

Performance Park in Northampton, UK.

● Former Kraco Racing/Kraco-Galles team owner **Maurice Kraines** has died. His team won the Champ Car title and Indy 500 in the early '90s.

● **Todd Parrott**, who was released from Robert Yates Racing as crew chief for Dale Jarrett, has relocated to Petty Enterprises as the head wrench for Bobby Labonte. Parrott joins other veteran crew chiefs **Paul Andrews** and **Robbie Loomis** who returns as team manager of the team.

● **Roy McCauley**, chief engineer with Penske Racing South, has taken over the role of crew chief for the number two Miller-sponsored Penske Dodge, replacing Larry Carter who was removed from the position during December. Carter was offered another



**Todd Parrott**

position within the Penske organisation, but instead made the move to Bill Davis Racing in a different role. McCauley had six wins crew chiefing Ryan Newman in just nine starts in the Busch Series during 2005, McCauley was previously with PPI Motorsports.

Penske Racing South also laid off more than 20 employees in a shake up that included closing the 77 Kodak team.

● Crew chief **Kevin Hamlin** has moved with driver Dave Blaney from Richard Childress Racing to the Bill Davis Racing CAT Dodge team that will switch to Toyota in 2007.

● **Ken Schrader** took his former BAM Racing crew chief, **David Hyder**, with him when he left the team for the Woods



**Kevin Hamlin**

Brothers. Former BAM car chief, **Ron Otto**, has been named as crew chief for rookie driver Brent Sherman in 2006 with BAM.

● **Kate Millar**, an engineer with the WPS Racing V8 Supercar team, has been given the inaugural 'Excellence in studies and achievement' award by the Queensland state section of CAMS. Millar joined the team in early 2005.

● **Gavin D. Ireland** has won the 2005 Renault MSA Young Photographer of the Year award for his work with Scuderia Ecosse and on the Autodrome project with *Racecar Engineering* deputy editor Sam Collins. Ireland's work in *Racecar* was also part of the submission.

Send your company and personnel news direct to the **Racecar Engineering** team: tel: +44 (0)20 8726 8363; fax: +44 (0)20 8726 8399 or email [racecar@ipcmedia.com](mailto:racecar@ipcmedia.com)

## Keith Duckworth 1933–2005

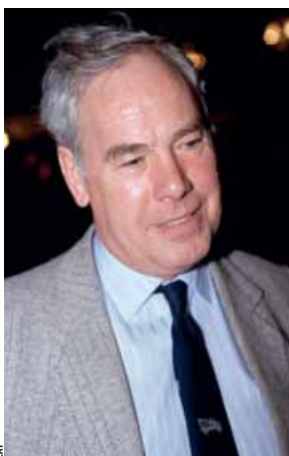

**Keith Duckworth – the man who put the 'worth' in Cosworth**

In 1967 a film entitled *Nine Days in Summer* charted a revolution in motorsport engineering. The Lotus 49 and the creation of its now legendary powerplant – the Cosworth DFV. Featuring heavily in the film is an enthusiastic engine designer and Yorkshireman by the name of Keith Duckworth, the man who put the 'worth' in Cosworth.

After compulsory service in the UK Royal Air Force, Duckworth attended Imperial College in London to study engineering. After finishing his studies in 1957 he joined Colin Chapman's growing firm – Lotus – as a transmission development engineer. Soon after starting there he met Mike Costin and Cosworth was born.

Duckworth's DFV engine went on

to win 154 grands prix and had success in countless other formulas in numerous guises. The DFV will be Duckworth's lasting legacy, along with Cosworth – a company still

supplying engines to top teams in Formula 1 today.

An online book of condolence has been set up at [www.keithduckworth.co.uk](http://www.keithduckworth.co.uk)



**Legends together – Graham Hill, Keith Duckworth and the Lotus 49 in 1967**

YYePG Proudly Presents, Thx for Support

# More Championships than any other.

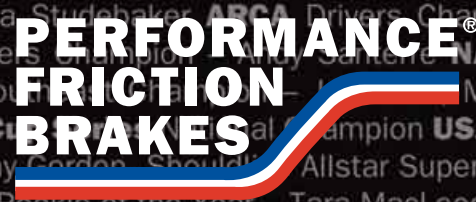

Performance Friction, USA | 866.392.9936 | Fax 803.222.8134 | [www.PerformanceFriction.com](http://www.PerformanceFriction.com) | © copyright Performance Friction 2005

# MANUFACTURERS OF HIGH PERFORMANCE SILICONE HOSE



## SFS Performance is one of the world's leading hose manufacturing companies for Motorsport applications.

We cater for the ultra-high specification and time-sensitive demands of race teams which enables us to provide unique services and bespoke products with low tooling costs for our customers.

One of our greatest assets is our ability to offer bespoke hoses, designed to meet your exact requirements, with low-cost tooling, and rapid turn-around from conception through to production.

We produce elbows, reducers, straight lengths and hump hoses, in a range which is so comprehensive our customers are able to plumb in any configuration.

Our products have been proven at the highest levels of racing, and are used by some of the most prestigious teams and manufacturers including:

- PEUGEOT WRC • FORD MOTORSPORT • ROUSH
- PRODRIVE TICKFORD • RALLIART • NOBLE AUTOMOTIVE



T: 44 (0)1582 488040 F: 44 (0)1582 412277

E: [sales@sfsperformance.co.uk](mailto:sales@sfsperformance.co.uk)

W: [www.sfsperformance.co.uk](http://www.sfsperformance.co.uk)

Unit E, Kingsway Industrial Estate, Kingsway, Luton, Beds LU1 1LP UK



For further details please call or email us, or visit our website: [www.sfsperformance.co.uk](http://www.sfsperformance.co.uk)

## No.1 in Motorsport? Makes sense then to choose the No.1 in motorsport safety



### Fit the best

*We're not just saying that. Lifeline products are specified and used by many of the world's leading teams and constructors. Our cutting edge design ensures that you have the most innovative motorsport safety products available.*

### Lifeline for

- Zero 360 Gas Extinguishers
- Zero 2000 Foam Extinguishers
- Quick release steering bosses
- LED Rain lights

## Motorsport safety means

Tel: 024 7671 2999  
**Lifeline**  
Fire & Safety Systems Ltd.

Lifeline Fire & Safety Systems Ltd Burnsall Road Coventry CV5 6BU

Fax: 024 7671 2998 Email: [sales@lifeline-fire.co.uk](mailto:sales@lifeline-fire.co.uk) Web: [www.lifeline-fire.co.uk](http://www.lifeline-fire.co.uk)

YEPG Proudly Presents, Thx for Support

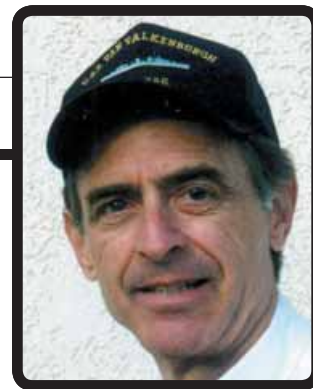

## Military technology transfer

Has electronic vehicle control has progressed to such levels that drivers could soon become redundant?

**A** really good engineer in any discipline is always watching for new breakthroughs in technology, even seemingly unrelated ones. And always in the back of his mind is the evaluation, 'how might I use that in my own applications?' My brother, also an engineer, says that when he gets stumped for a solution he wanders through random aisles in a surplus electronics store, and often sees something that triggers an answer. While I was covering the DARPA Challenge entrants last month, I kept wondering how their engineers might handle an 'on-road' challenge like an oval or road racing course. Could professional racers improve their performance by talking with the programmers about their vehicle control logic? That might seem ridiculous, but consider this: after active suspensions were banned, I heard that the engineers who had researched and developed them were able to make conventional suspensions work almost as well.

Granted, the very greatest current

computing power is way short of human capacity, but for repeating laps on a closed course, the task really isn't that complex – to me it's almost boring – with the exception of negotiating a pass. Otherwise, alone on the track – as in qualifying – the driver is just a conversion system, sensing a finite number of inputs, integrating (and differentiating) them, and responding with three control modifications: steer, throttle, brake.

So the key question is, how would you compare the sensitivity of a driver to that of electronic sensors, such as those used to control vehicles in the DARPA race? Based on my experience with data acquisition instrumentation, I'd say that in most cases, the best drivers would be pretty poor in comparison.

The obvious exception would be vision, →

**“ON TRACK, THE DRIVER IS JUST A CONVERSION SYSTEM”**



especially object recognition, where both engineers and neuroscientists are stumped by the abilities of the most primitive organism. Outside of a narrow two-degree 'tunnel vision' cone, human acuity is pretty poor, yet we can easily identify objects in a wide angle of peripheral vision. And our relative depth perception is very good, partly due to other cues, especially using vision for the mental calculus of the interception of two moving objects. Consider, for example, the task of catching a pop fly, or hitting a running receiver with a football. And yet, visual accuracy in distance is really poor compared to a laser rangefinder or GPS,

Let's look at other sensor comparisons, one by one, by the feedback stimulus to be sensed, such as velocity, gs and yaw angle.

## “COMPARED TO ELECTRONICS, HUMANS DON'T SENSE ANYTHING VERY PRECISELY”

Velocity is usually determined by instantaneous changes in distance. Ever try to judge your speed out on the open road without looking at the speedometer? Plus or minus 10mph at 80? That's not very precise when compared to the cheapest speedometer, much less GPS, radar, or lidar. During acceleration, even the mathematical integration of the 'g' signal from an accelerometer, as done by inexpensive electronic 'power meters', is far more accurate.

Cornering or braking in gs? Most humans are fairly imprecise in measuring g loading, compared to simple accelerometers, much less a six-degree-of-freedom Inertial Measurement Unit. On the other hand, we are sometimes overly sensitive to 'jerk', or the change of gs with time, as with ride quality, and elevator stops and starts, and all sorts of vibration inputs.

Acceleration perception is so poor that race drivers seem to actually pay more attention to steering wheel force feedback, like the tug to one side when a braked wheel locks up, or the drop-off in steering wheel force when the front tyres go over their traction limit in cornering and understeer. Drivers also seem to use their observation of the extremes of steering angle. But again, even existing data acquisition sensors are more accurate.

Vehicle yaw angle, the driver senses as relative to the vehicle vector path. Yaw gyros have been controlling fighter aircraft better than pilots for decades, although they do have a tendency to drift over time. But two GPS receivers placed at extreme ends of the body worked really well for DARPA entrants, and gyros just supplemented them. Yaw acceleration, like 'jerk', is probably a better feedback, in its sudden instantaneous change, such as when the car loses traction at one end, especially the rear.

When you come right down to it, compared to electronics, it seems like humans don't sense much of anything very precisely, other than images and sound frequencies — and at that, not even intensity to within ten per cent accuracy. There ought to be a great opportunity for cybernetics to supplement those poor skills, if racing rules allowed. Or is it possible to present more precise feedbacks to the driver in legal or concealed ways?

It seems like it would be relatively easy for a computer to steer a racecar around a race track, with previously well-mapped road boundaries, using differential GPS feedbacks that are accurate to a few centimeters. Driving at the limit of traction would then require an IMU with three-axis accelerometers to control cornering and braking at the limit (the vertical accelerometer for adjusting to road roughness). Then a single yaw gyro would manage the heading angle, and fine control of the oversteer/understeer balance that results from changing brake and throttle, and constantly changing front/rear surface coefficients. It is possible all this is already being done in stability control in production passenger cars, where the control is via minor brake applications at each of the individual four wheels.

Running against other vehicles seems a lot more complex. This is closer to the challenge of street traffic, where currently there are very good autonomous vehicle following algorithms, but without the lateral vehicle awareness that would allow it to swerve to avoid an obstacle. You need proximity sensors, and the ability to predict other vehicle's vector path — actually probably like the mission of 'Star Wars Defense' killer missile intercepts, but without the intention of impacting.

Wait a minute! Hasn't all this logic already been analysed by computer race gaming developers? I'm not into that, so you tell me. When you drive against other computer-generated drivers, aren't they driving some realistic optimum lines, and aren't your car boundaries compared to theirs, so that interference (collisions) can be determined, or predicted and avoided? I've heard that you can even input the opposition's skill level of car control. If these programmers' knowledge of vehicle dynamics is really as good as it is as their game simulations indicate, then they must be very close to being able to handle the logic in the real world. And the gaming industry might also have someone with the financial justification to go to the effort to transfer this technology to a real racecar. Think of the publicity! And the potential effect on sales of their games. If I were going to be around in this business very much longer, that's a challenge I'd jump on.

The first run-off between a human qualifying lap and one by an autonomous race car would be a sensational event. Like the challenge when World Chess Champion Garry Kasparov lost to IBM's 'Deep Blue'. I hope I live to see the day when vehicle dynamics racing engineers out drive the best of those overpaid Formula 1 and NASCAR celebrities.

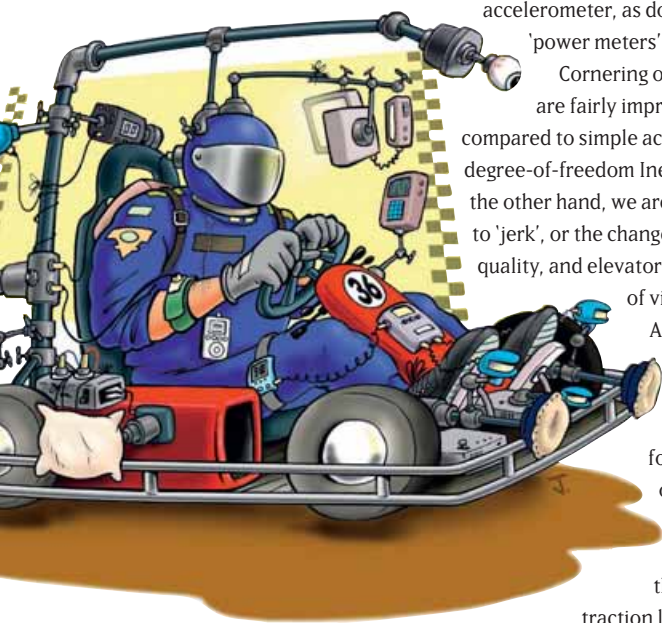

YePG Proudly Presents, Thx for Support



At the heart  
of the world's  
most powerful  
engines...

[www.arrowprecision.com](http://www.arrowprecision.com)

**Arrow** are at the **International Historic Motorsport Show** 24th-26th Feb, Hall 2 **Stoneleigh Park**, where we will be introducing our new web site to historic racecar enthusiasts. The new site includes Arrow's full range of stock items plus a huge selection of ARP fastener kits, bolts and studs. Fully searchable databases will be available to browse online and includes technical data on all our products.

Items available from **Arrow** will include

- Steel Connecting Rods •
- Cam Followers •
- Valve Guides •
- Pre Ground Shims •

Items available from **ARP** will include

- Replacement Rod Bolts •
- Main Studs and Bolts •
- Head Studs and Bolts •
- Stretch gauges •
- Assembly Lubes •
- Specialist Kits, Porsche etc •

Plus much more.

From custom to production, from vintage to LeMans,  
you need Arrow at the heart of your engine.



YYePG Proudly Presents, Thx for Support



[www.arrowprecision.com](http://www.arrowprecision.com)

tel: 01455 234200

fax: 01455 233545



## electrical problems?

### need a custom made wiring harness

We can provide competitively priced hardware for all leading manufacturers of data acquisition and engine management systems

Specialists in:

- Carbon Control Panels
- Electronic Power Steering
- LED Rain Lights

We have a Mobile Workshop and can provide Track-side Support

Custom made wiring looms for all of our products can be provided.

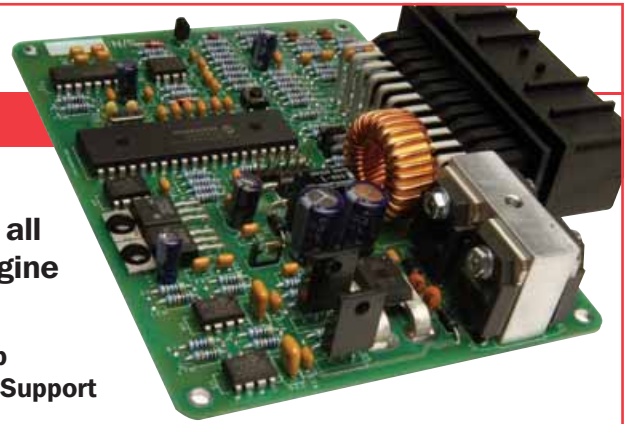

**dc**  
**electronics**  
*Motorsport Specialist*

Unit 1, Quayside Industrial Park  
 Maldon, Essex CM9 5FA  
 T: +44(0)1621 856451  
 F: +44(0)1621 842237  
 E: sales@wiringlooms.com



**Designers and Manufacturers of Professional Electrical Systems for all type of Motorsport Vehicles**



## Call us first...



Unit 31 Silverstone Circuit Towcester Northants NN12 8TN  
 T: 01327 857822 F: 01327 858096 [www.tridentracing.co.uk](http://www.tridentracing.co.uk)

YYePG Proudly Presents, Thx for Support



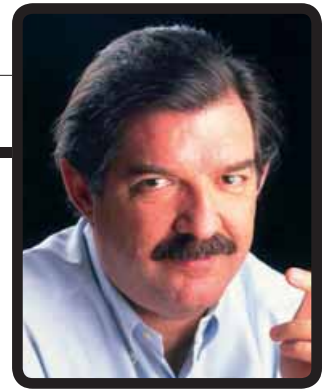

# The uncompetitive edge

Has the role of the racecar designer in the intermediate formulae become obsolete as price outweighs performance?

**W**hen I left Argentina to design racing cars I came to the UK because it was the world leader. It had numerous racecar manufacturers, most of the Formula 1 teams and a world-leading edge in racecar know how and technology. It was the place to be, and for anyone with ambitions to be a racecar designer there was no contest. I fulfilled my ambitions working for the country's leading manufacturers and F1 teams, but in recent years I have seen the UK's lead slip away to other areas of Europe. Dallara has taken over Formula 3, GP2, WSBK and Indy Cars, Toyota has set up its Formula 1 team in Germany and specialist suppliers are flourishing in the US, Western and Eastern Europe. Meanwhile, the UK has lost many F1 teams and seen its wealth of racecar manufacturers and suppliers whittled down to a shadow of its former self.

Why is this a concern? We can't claim that the UK has a god given right to this business. The problem is, that the reasons why this business is slipping out of the UK will also make it slip out of Europe. In the future, Eastern Europe, India, China and other emerging economies will be taking whole chunks of the business away from the UK and Western Europe.

The cost of manufacturing in these countries is already legendary. Low labour rates and low overheads, coupled with a steadily rising capability, make it uneconomic to not manufacture parts in these territories. Already some major names in motorsport are having components made in China and India in the full and certain knowledge that if they don't, they won't be around for very long.

Does that mean the whole motorsport industry will move to the east? Not necessarily. It doesn't have to and, to discover why, we need to look at the reasons it is leaving the UK now. In my view it is a failure of the governing bodies and the industry associations to create rules within which the industry can flourish. Right now there is no competition and creativity in single seaters apart from Formula SAE and Formula 1.



Are control formulae such as Formula BMW (left) killing the competitive edge? Rinland suggests replacing them with an open formula such as Formula 4

Hard to believe? Let's take a look at the single seater spectrum today.

Entry level these days is Formula BMW, or maybe Formula Renault – both car manufacturer controlled formulae with one chassis mandated for each series and very tight rules. Above that is Formula 3, an open-chassis formula but dominated by one manufacturer. However, I'll come back to that later. Then above F3 is GP2, again a car manufacturer controlled formula. Also, consider this. Alongside GP2 are AIGP, Superfund, Formula Nippon, Indy Lights, Renault World Series and even GP Masters – seven series with similar levels of power, grip and performance and all with one chassis devoted to each series.

**“THE REASONS WHY THIS BUSINESS IS SLIPPING OUT OF THE UK WILL ALSO MAKE IT SLIP OUT OF EUROPE”**

Yes, most of them are made by different manufacturers, but none of them are competing against each other. The only competition is when they pitch for the contract and it's not a battle of performance but a battle of price. The company that can promise to deliver for the lowest price gets the contract. And as soon as the winning bidder has the →

YyPG Proudly Presents, Thx for Support

Rinland suggests an open set of rules to encourage competition, bring technical prowess back into motor racing and promote the free market for racecar manufacturers



signed paperwork in hand he goes back to the factory and says, 'here's the price, now start cutting costs to guarantee a profit that keeps us in business.' There's no danger of the cars being uncompetitive because they will all be the same. If they turn out to be too slow, then the manufacturer just needs to negotiate a bigger wing, more power or wider tyres with the sanctioning body to compensate the deficit.

What all this amounts to is no real motivation to learn and improve for racecar designers. Yes, there are people designing cars for racing but, without the need to build a better car and beat other design teams, you don't need the best resources, human and technical, to create those machines. If you don't have designers designing racecars in a competitive environment, the industry quickly loses the ability to do it and the gap with F1 widens on a regular basis.

Is all this such a problem? If you have competent engineers building cars that only have to compete with themselves, then why make things more

be replaced with a single set of rules called, let's say, Formula 2. I'm not re-inventing the wheel here, it is just a case of creating an open set of rules where technical prowess can help win races.

I know we have that in Formula 3, yet the series is dominated by one manufacturer and, as promised, I've come back to that. The engine rules for F3, with them breathing through a restrictor, were fine in the 1970s and 1980s. It was the best solution available for controlling performance. But in the 21st century it has become impossibly expensive to develop those engines, to the point where Opel has to pull out. The investment is too great to justify the return. That leaves Mercedes Benz and Honda, and the price of their engines is so high it dominates the budget of the teams to the point where they can't afford to take a risk on the chassis. Technology has moved on since the '70s and with modern electronics we have better ways of restricting power outputs on engines. The amount of money that is spent on engines could be massively reduced, making more budget available for chassis choice and technical developments.

Below Formula 3, the logical thing would be to get rid of single-make formulae and replace them with something like Formula 4. All these series could have mandated maximum prices for chassis and parts without affecting the free market principle and ensuring competition keeps the engineering moving forward. With this technical edge it would be hard for anyone, with nothing to recommend them other than low labour costs, to steal the industry away. A bi-product of this philosophy will be constant developments of young, talented engineers and technicians that can then move up the ladder to get to the top of the business with solid foundations.

We live in a free world, and for more than 100 years motor racing has been the standard bearer of the free world. The defining characteristic of a free world is competition and the victory of excellence over mediocrity. Today in motor racing we have some sort of communism with no competition. Just make it cheap. It's ludicrous, but unless something changes it will be very difficult to sustain this motorsport industry so dear to many of us.

## “TODAY IN MOTOR RACING WE HAVE SOME SORT OF COMMUNISM”

complicated? Simply because, if you are only having to compete on price, then the West is guaranteed to lose against the emerging economies. The price competitiveness of India or China will ensure they always win the contract and western racecar manufacturers will only exist in history books. This is why the UK's technical ability ceased to be a factor in its industry lead and the business went to other countries. It is also why the same crisis will strike the European industry if the organisers carry on the way they are going.

Unless the FIA takes back control of its racing series, this culture of controlled formulae in the name of (false) economy will guarantee the collapse of the western racecar industry.

Change needs to be made, and I'm willing to stick my neck out to say what that change should be. Those seven single-seater formulae below Formula 1 should

YePG Proudly Presents, Thx for Support

The Competitive Edge



www.lister.co.uk/motorsport

Union Street, West Bromwich, West Midlands. B70 6DG  
Tel 0121 525 5800 Fax 0121 525 4833 Email motorsport@lister.co.uk

**JLS** James Lister & Sons  
**MOTORSPORT**

"...Race Technology lead the industry with their advanced GPS dataloggers. The GPS is used to calculate higher accuracy speeds and track maps."

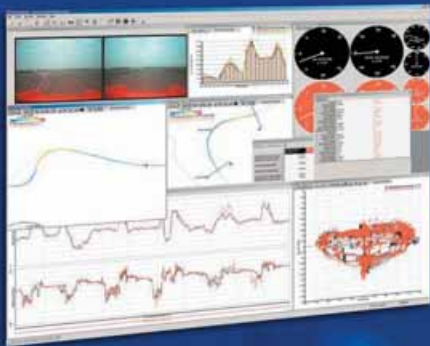

**Compare**  
Drivers, Races,  
Laps & Sectors

**High Accuracy**  
**Track Maps**  
**and Speeds**

**Unique**  
**20Hz GPS**  
**technology**

**Installed in**  
**Minutes**  
**no Beacons**

Complete systems  
from **£500**

**Full Video**  
**Integration**

The UK leaders in data logging  
www.Race-Technology.com



Contact us on:  
**0115 9061111**  
sales@Race-Technology.com

*Race Technology*  
www.Race-Technology.com

**V8 POWER** from

**POWERtec**



Race proven  
RP range of  
lightweight  
V8 engines

**THE MOST SIGNIFICANT RACE ENGINE**  
**SINCE THE COSWORTH DFV.** CIRCUIT DRIVER

Full warranty available with each engine  
30 racing hours between rebuilds  
Prices start at £17,750 +VAT  
F1 style four pump oil scavenge system  
Twin counter-rotating balance shafts  
Outright Brands Hatch GP lap record holder, in Radical SR8

**PHASE 2 ENGINES**  
**NOW AVAILABLE:**  
2,016 - 320bhp  
2,516 - 390bhp  
2,616 - 380/430bhp  
3,016 - 470bhp

**POWERtec**  
ENGINEERING

24 IVATT WAY BUSINESS PARK, WESTWOOD, PETERBOROUGH PE3 7PG.  
**CALL NOW +44 (0)1733 331919**  
sales@POWERTECENGINEERING.COM

**ATL**

# Cell-ebration!

## Fuel Cells for Every Motor Sport!



**INDY CELLS**  
IRL/CART  
Methanol  
CRFS-102

**LMP CELLS**  
FT3.5, FT5  
LMP Sports Prototypes,  
Grand Am, ALMS, GT, GTS



**X-CELLS**  
FT5  
F1, F3000,  
F3, GP2



**SAVER CELLS®**  
FT3  
Saloons, Sports, Stocks,  
Touring, Rally Raid, Off-Road



**RACELLS**  
FT3  
Mini Stock,  
Legends, Hill Climb,  
Drag, Midgets



**CUSTOM CELLS**  
FT3, FT3.5  
WRC Rally, Touring,  
Saloon, Formulas,  
Rally Raid



**SUPER CELLS**  
FT3.5, FT5  
NASCAR, CASCAR, ASCAR,  
ASA, AUSCAR

visit

**ATL**  
Fuel Cells  
at  
[atlinc.com](http://atlinc.com)

**Aero Tec Laboratories Ltd.**  
One Patriot Drive, Rooksley Park  
Milton Keynes MK13 8PU England  
Tel: +44 (0) 1908 351700  
Fax: +44 (0) 1908 351750  
e-mail: [atl@atlltd.com](mailto:atl@atlltd.com)

**Aero Tec Laboratories Inc.**  
Spear Road Industrial Park  
Ramsey, New Jersey 07446-1251 USA  
Tel: (001) 201-825-1400  
Fax: (001) 201-825-1962  
e-mail: [atl@atlinc.com](mailto:atl@atlinc.com)

**ATL**



Valvetrain Component Cells



Short Run Valve Cells



Engineering



Heat Treat



Coatings



Quality Control



Rapid Prototype



Valve Inspection



©2004 XcelDyne LLC

### Because Every Part is Critical...

In racing, you should never rest on past accomplishments. What worked yesterday may not be what wins tomorrow. From F1 and LeMans to World Rally, CART, IRL, GP2, BTCC, DTM, World Superbike, Moto GP and more – leading teams from across Europe and around the world are making the switch to XcelDyne Technologies.

#### Short Run Production is Our Specialty

- World class manufacturing facility utilizing automation, robotics and computerized controls for maximum quality and repeatability
- Quick turnaround times through dedicated manufacturing cells for optimal process specialization
- Proprietary coating technologies for wear and impact resistance - thermal spray, PVD, and CVD technologies
- Environmentally controlled, metrology lab with sub micron measuring capabilities
- Superior Materials - All mil. spec aerospace certified - Optimized by in-house heat treating



[xcelDyne.com](http://xcelDyne.com) 42 High Tech Boulevard Thomasville, NC 27360 USA  
888.481.2310 (Inside USA) (01) 336.472.8281 (01) 336.472.2405 Fax

## Green meanie

Regarding the editor's 'Write Line' article in V15N12, I feel I must pass comment. I'm sorry, but stringing together a series of unconnected statements is considerably less than I have come to expect from Racecar Engineering. Indeed, it had all the spin and bad science we have, sadly, come to expect from politicians like Mr Blair and the social meddlers 'advising' him.

Yes, there is climate change, however, considerable scientific data does not link it to increasing CO<sub>2</sub> levels [Caillon, N, Severinghaus, JP, Jouzel, J, Barnola, JM, Kang, J and Lipenkov, VY 2003. *Timing of atmospheric CO<sub>2</sub> and Antarctic temperature changes across Termination III. Science* 299: 1728-1731 (2003)]. The Oregon Petition, signed by 18,000 scientists, states: 'There is no convincing scientific evidence that human release of carbon dioxide, methane, or other greenhouse gasses is causing or will, in the foreseeable future, cause catastrophic heating of the Earth's atmosphere and disruption of the Earth's climate.'

There is significant correlation between climate change and sunspot activity – the 'Little Ice Age' of 1645 - 1715 coincided exactly with the 'Maunder Minimum' when sunspot activity was almost nil. Chris Folland, from the UK Meteorological Office stated: 'The data doesn't matter. We're not basing our recommendations [for reductions in carbon dioxide emissions] upon the data. We're basing them upon the climate models.' These are climate models

**Email the Editor: [racecar@ipcmedia.com](mailto:racecar@ipcmedia.com)**  
or send your letters to: The Editor, Racecar Engineering, IPC Media, Leon House,  
233 High Street, Croydon, CR9 1HZ, England Fax: +44 (0)20 8726 8399  
Visit [www.racecar-engineering.com](http://www.racecar-engineering.com) and submit your project for a feature online



**The debate over alternative fuels in racing rages on**

that are so inaccurate that, up until recently, didn't include clouds. Mankind is responsible for just 3.5 per cent of global carbon cycle CO<sub>2</sub> emissions and cars 1/7th of that. Automotive Advisers and Associates of Hilden, Germany showed that energy consumption per capita of travelling public is 60 per cent higher for public transport than for private cars.

On the subject of alternative fuels, an under-load diesel engine produces what Kyoto University described as 'possibly the most carcinogenic substance currently known' and so-called 'green fuels' produce the same quantity of CO<sub>2</sub> and other by-products as ordinary ones. Current fashionable fuels such as bio-diesel and bio-ethanol are, quite simply, no different from ordinary diesel and ordinary ethanol if nothing is planted to replace the biomass used in their production.

So please, let's try to keep RE's climate and environmental

comment on the same high level as its engineering content.

**Tim Lawrence, UK**

## Bio futures?

In 'Write Line' V15N12, you worry that in a world threatened by global warming, motorsports emissions will make motorsports as socially unacceptable as smoking. But what you rightly see as a problem might also be looked at as an opportunity. It is through the challenges of racing that the world has developed quicker, stronger and more reliable cars. Today, the rules keep changing but race teams continue to find ways to make cars even better. The racing industry should approach global warming as just another rule change. If it mandates that a race vehicle cannot be powered by an internal combustion engine, it must still find a way to race and it will still have suspensions, aero, tyres etc. The powertrain guys are

just going to have to learn some new tricks, but it is still about converting stored energy into motion. Our race team has a head start on this already. ProEV's Electric Imp powered by Kokam's lithium polymer batteries is already competing. The 235bhp, 370ft.lbs torque (at zero rpm), AWD Subaru Impreza chassis is undefeated in SCCA D modified autocross. Our best finish in sprint (around 30 miles) road racing is a rather lucky second place but we expect an honest victory against gas-powered competition in 2006.

Walk around a typical paddock and look at all the intelligence and creativity focused on dropping that extra 10th of a second. Are these not the people who can take the electric car and make it as fast as today's gas-powered cars? Is this not the challenge that can make racing relevant again?

**Clifford Rassweiler**  
by email



Preview the online edition of  
**The International Journal of Racecar engineering** in your browser

Go to 'This issue' at [www.racecar-engineering.com](http://www.racecar-engineering.com)

YiePG Proudly Presents, Thx for Support

AUTOSPORT  
ENGINEERING

# Autosport International 2006

Birmingham once again played host to one of the most established events on the motorsport engineering calendar. **Racecar** was there to report on the highlights

Words	Racecar Engineering
Photos	Sam Collins; Tony Butler; LAT

Once again Autosport Engineering provided a focus for the industry at this key point in the season. For two days the aisles were packed with buyers from across the industry and much business was conducted. However, genuinely new products seemed to be thin on the ground, although there were plenty of revised and updated versions of established products. *Racecar* trawled the show and this is what caught our eyes.

Pace Products was showing off its new dry sump system developed for the forthcoming Formula Ford rules – designed in cooperation with Ford, engine builder Mountune and leading chassis builders in the series. It incorporates a cast aluminium sump pan and Pace-designed oil pump, with the aim of keeping costs down and

easing installation of the new 1.6 Duratec engine into established and forthcoming chassis designs. The system will be distributed by Sky Ford.

Developments from friction specialist AP Racing included a new strap drive design for mounting discs to hubs. Torque loadings are transmitted using 11 stacks of three spring-steel strips loaded linearly. These offer a degree of lateral movement for the disc in relation to the hub, accommodating heat expansion and realigning the disc automatically, thereby reducing knock off of the pads.

The company was also displaying its new range of high-spec flywheels. Made from high-grade chrome molybdenum steel they offer increased strength and durability with low weight and greatly reduced inertia. For competition

applications AP Racing has so far launched versions for the Rover K-Series and Vauxhall/Opel 2.0-litre engines.

ZF Sachs displayed its new range of Porsche racing flywheels that have the unique feature of being detachable from the crank. They are engaged during the start-up procedure then disengaged once the engine is running, reducing the collective inertia of the engine's rotational masses. The company also revealed that its new Formula 1 clutch is 83mm in diameter, reduced from 97mm previously. It has a new steel alloy for the diaphragm spring that is claimed to retain its shape and tension up to 600degC. This is designed to retain the same biting point through repeated starts. Three and four-plate versions will be offered to customers.

Creasey Castings was showing off a casing it produced for the Japanese GT Championship-winning Nissan Skyline. This exceptionally large item is cast in magnesium – a particularly tricky operation incorporating numerous thicknesses of material with different cooling rates.

Frits Altorf, Koni's product manager, OE & Racing, disclosed at Autosport International that his company's FSD (frequency selective damping) technology is currently under test with a Formula 1 team. FSD was launched last year for the road market as a non-electronic answer to the damper manufacturers' age-old problem of whether to offer better road holding or comfort. It features a special valve (the anti-roll chamber) that is added to the damper and is able to control a parallel oil flow next to the one going through the piston. This parallel flow is closed by the FSD feature, resulting in a rise in damping force. Put simply, the FSD feature is a hydraulic amplifier that delays the build up of pressure. It first appeared as original equipment on the Lamborghini Gallardo.

Altorf points out that 'there are other frequencies that you have to take care of,' as well as those that cause problems for road cars. If testing is successful, the concept may find its way into the likes of GP2, where Koni is the mandated damper supplier. It is possible that instead of a four-way damper the company may offer a three-way damper with FSD which, says Altorf, will be 'something unique for racing.'

Fellow shock absorber manufacturer Öhlins also had new product at the show in the form of a range of 46mm piston-type off-road/rally raid dampers with remote reservoirs. These come with a protective sleeve for spring wear and circlips.

Deutsch's Dave Watters described his company's latest products as 'an exciting new step in connector technology.' He points out that the density of a connector package has not changed for about 20 years, which could be why Formula 1 teams were asking at the show how soon they could see a sample of the company's latest double density connector, the 12-41. Watters describes this as the 'new little brother' for the 14-64 that was launched late last year. Like the 14-64, it offers more connectors than a standard shell, thus significantly reducing the weight of the wiring harness in the vehicle. As its name suggests, the 12-41 double density autosport connector allows 41 connectors in a size 12 connector shell. Further connectors within this family are due to be launched later in the year.

Beru Fi continues to target the North American market, with one of its new products at the show being Digi Tyre DT – a dual tyre pressure monitoring systems for NASCAR. Testing of the product has already been taking place in the UK with production parts scheduled for release in the spring. Understanding what is really happening to both the inner and outer tyre has always been a

challenge to NASCAR, but Beru Fi managing director John Bailey says that with Digi Tyre DT it will be possible to accurately measure the pressure and temperature of both the inner liner and outer tyre. Because of the minimal air gap between the two it has previously been impossible to install a conventional system. However, what is described as innovative electronics packaging and a 'radical' new battery technology that will last the full season have made this breakthrough feasible. Beru Fi also used the show to launch Digi Tyre Lite, a

transaxle gearbox, is looking to expand. Managing director Mark Bloor stated that his small family company wishes to grow into the Continental market; last year's Essen Show having been its first foray into this region. It is his belief that there is nobody in Germany that manufacturers similar transmissions to Elite.

Representatives from Clemson University and the CUICAR project were making their fifth appearance at Autosport International. The University's Graduate Engineering Centre is now fully funded and the main building will be



**Left: new dry sump system from Pace Products designed for 1.6-litre Duratec engines used in Formula Ford**

**Below left: new from ZF Sachs was an 83mm F1 clutch with a diaphragm spring capable of withstanding temperatures up to 600degC**

**Below right: also from ZF Sachs came this detachable racing flywheel for GT racing Porsches that can be disengaged after start-up, massively reducing the rotational mass of the engine**



cost-effective tyre monitoring system suitable for national sports, GT, saloon and single seaters.

Hoses for motorsport come in two types – the more flexible, fully convoluted type and the smooth bore version with its better flow rates. In the past it has been easier to swage, rather than crimp, onto a fully convoluted hose. Goodridge illustrated at the show that it has now developed a style of collar that enables it to crimp onto a fully convoluted hose. The main advantage of crimping is that the teams can do it themselves.

Elite Racing, which was showing its new TXL-300 6S mid-torque, sequential, six-speed

complete by the summer, with the first class scheduled for August this year. The first of five Technology Neighbourhoods is also nearly finished, while the BMW research centre was opened last summer. Each of the neighbourhoods will have what is being described as a 'Clemson magnet facility.' The planned wind tunnel is to act as this feature for Technology Neighbourhood 3. A fully-funded package has still to be put together for the tunnel, though a plan is expected in April.

The SAE also announced it is to establish a new strategic office centre on the campus. Sam Konduros, the University's acting motorsports →



## IMPORTANT DATE FOR YOUR DIARY!

**Autosport Engineering expo** January 11-12 2007

Pole Position starts here!

For information on Europe's fastest growing motorsport trade show contact Tony Tobias on:

expo [tonytobias.com](http://tonytobias.com)

+44 (0)7768 244 880

# For Winners Only!



## Want to WIN business?

**Autosport International is the world's largest motorsport show.** With over 840 exhibitors, let them tell you the reasons why you should join this award winning show:

The quality and variety of visitors that Autosport International attracts makes us believe that the show is unmatched in its value as a marketing tool and productive business showcase. If you're serious about the motorsport business, you just can't afford not to be seen there.

Sharon Quaife, Quaife Engineering

It was a great opportunity for us to meet with customers, new and existing - and the response following the show has been fantastic. Roll on Autosport 2006!

Andrea Rodney, Hone-all Precision

Autosport International is the ultimate racing show catering to the European markets.

Oscar Romano, Ferrea Racing Components

- 25,000 trade visitors
- Over £400 million worth of business will be influenced by trade buyers attending Autosport International
- 84% of trade visitors rate the show as an important place to do business
- 54% do not visit any other trade show



To reserve your stand space at Autosport Engineering / Manufacturing Technology

contact the Sales Team on: +44 (0) 20 8267 8300

or Tony Tobias on: +44 (0) 7768 244 880, [expo@tonytobias.com](mailto:expo@tonytobias.com)

[www.autosport-international.com](http://www.autosport-international.com)

Supported by:

YyPG Proudly Presents, Thx for Support





**Clockwise from above:** new prototypes were out in force at the Racing Car Show, many it seems competing for the same customer business: Juno SSV6, soon to be eligible for CN and Sports 2000; Lynx LR1, aimed at Bikesports and SCCA D Sports; Spead's re-vamped RMO6, again a Bikesports contender; Lola's glorious homage to its classic T70 – the Mk3B; and Kelforms Retoga, another prototype coupé aimed at Bikesports and D Sports



Ligier showed its JS49 (see V16N2) for the first time in Britain to try and capture some of the lucrative Britsports market, while Sparco founder, Enrico Gloriso's Gloria company, unveiled its new B6S baby prototype racecar. The Turin, Italy-based firm has based the new car on its already successful B5 open wheel, with a steel, spaceframe chassis able to accept a wide range of motorcycle powerplants that should suit the UK's new Bikesports series and the USA's SCCA D Sports category perfectly.

Pitched squarely against the Gloria is Lynx AE's new LR1 coupe, which is designed for exactly the same applications as the Italian car. The Lynx has been designed and constructed in the heart of Britain's so-called Motorsport Valley cluster, and the first chassis raced with promising results in late 2005. The firm used the show to reveal details of the customer car plans, with both sale and rental versions likely. Of particular interest is the cars' gearshift system, developed alongside the LR1. Racecar has been invited to track test the car and gearshift system in the next few months so see future issues for more details.

Also on display at the show was the Kelforms Retoga, which was very similar in design and concept to the Lynx.

A surprise announcement saw Lola return to its roots with an all-new addition to its prototype range – the Bo6/90. With it the company enters the now ultra competitive market for small

director, hopes a cluster of trade associations will eventually take advantage of the site including, he'd like to think, perhaps the MIA and SEMA.

Further evidence of the importance of the UK racecar industry to the USA was illustrated in a NASCAR seminar headed by Robbie Weiss, managing director of NASCAR International. The presence of both team boss Richard Childress and his new director of engine R&D – former Cosworth man Nick Hayes – underlined the connection. 'The Motorsport Valley has brought a lot of new technology and new opportunities,' said Childress, 'and we are open to business with European companies.' He also said, 'we're here to look at what Evernham and Yeates have already done here,' although he denied that this meant Childress would be establishing a UK operation.

Dodge's John Fernandez pointed out that his company has been coming to Europe now for three years, looking for new technology. Evernham Engines' boss, Mark McArdle, added to

this that his company's UK venture, AET, 'is now beginning to do a significant amount of manufacturing.'

Racecar Engineering's stand at the show was the venue for the launch of Simon McBeath's new book *Competition Car Aerodynamics*. As a long-time contributor to the magazine and a wing manufacturer, Simon has been the author of the title's aerodynamics column, Aerobytes, for two years. His new publication is based on his previous book *Competition Car Downforce*, published in 1998, but has drawn heavily on the Aerobytes column to create a title with more scope. The book is in the shops now priced £25 and comes with an accompanying DVD.

Alongside the more serious Autosport Engineering show is the Racing Car Show – traditionally a popular place for manufacturers to unveil new racecars. And this year was no different, with the explosion of small prototype racing showing no signs of slowing down.

YEPG Proudly Presents, Thx for Support

prototypes. Lola, who's recent heritage resides in mass producing cars for high-class series such as A1 Grand Prix and F3, designed the Bo6/90 chassis after identifying a growing space in the market, though it was the organisers of Sports 2000 in the UK and general enthusiasm for that series that originally directed Lola to design the car. The aluminium monocoque chassis has also been designed to be easily adapted to fit engines suited to VdeV Racing and similar, such as the 2.0-litre Honda. The opportunity to make such modifications allows the chassis to become a concept aimed at more than one market and Lola has no doubt the Bo6/90 will eventually appear in various other series beyond Sports 2000.

The chassis has been built to withstand up to 400bhp, with the Nissan V6 being an appropriate example of a suitable engine. Lola will be running the car on the track in the next few weeks to make its official announcement, with orders being taken early this season.

Interestingly, this now makes Lola the only racecar manufacturer to supply cars to the complete prototype spectrum – LMP1, 2 and 3. Racecar will watch with interest to see if Courage, Ligier, Dome or other similar outfits follow suit.

The current car to beat in Britsports is the Ewan Baldry-designed Juno SSV6, but the Northern England constructor's cars are not yet eligible for the smaller capacity and lower-cost series such as CN in Europe, but that looks set to change with its new Juno. Aimed once again at the CN/Sports 2000/trackday market, Baldry has used his F1 expertise once again to create a very competent looking machine.

The buzz at the show did seem to be prototype racing, and this appears to be reflected in the industry in general, with both Juno and Gloria announcing moves to larger premises to cope with demand and Norma opening a UK sales arm to market is M20 Evo 3 – also unveiled at the show. Of the international prototype scene there was only one topic of conversation, and that was diesels. The progress of Ricardo, Mountune and Audi projects was widely discussed, but the promised project from Peugeot Sport has become something of a mystery. A number of very significant and well-known firms (who one might expect such a project to outsource at least some components to) approached Racecar enquiring about the French oil burner. This suggests the project may have been quietly cancelled just over six months after being announced at last year's Le Mans 24 Hours.

Meanwhile, away from the world of sports prototypes, another new car was being showcased, though it was received with sceptical comments by some. The VERC0 (Vee Eight Racing Company) XV8R supersaloon is the fourth attempt unveiled over the years at the show to try and introduce a spaceframe silhouette,

## Stand and deliver



**Racecar's Tony Tobias presents the awards for the best presented stands to Caress Precision's John Caress for single unit and to Mountune's Roger Allen for multi unit**



V8-powered racecar to the British market. What makes the VERC0 different is the fact that its constructors are not proposing launching a new series into an already over saturated market. Instead, it proposes to build a car that will fit within existing classes – a move that could revolutionise the British and even European racing scene. Available with 650bhp naturally-aspirated or 900bhp twin-turbo power options with supplied or leased engine programmes, the cars are designed and engineered to be identical in chassis, engine installation, transmission and running gear, with only bodyshell and driver settings as variables. Power is supplied by Nicholson McLaren's XB V8 powerplant, via Xtrac transmission, to the rear wheels.

The car is available to order in a number of variations and is priced from £195,000 (\$345,000) plus lease engine programme and VAT. Both 650bhp and 900bhp variants are also available to purchase outright, complete with engine units. At each recognised race series official test day and race events, engine, transmission and technical services will be provided.

The cars' design allows the fitting of a wide range of bodyshells and external parts from original manufacturer production steel components from popular, mid-range, four-door saloon cars such as the Peugeot

**Racecar's own Simon McBeath was on hand to launch his new book on racecar aerodynamics**



407. Around 20 different production models can be used as basis for the cars' silhouettes, including the Ford Mondeo, Honda Accord and Vauxhall Vectra.

The sceptics say the VERC0 follows in the footsteps of the ill thought out and over publicised failures of the Supercar V8, SCV8 and Touring One championships. At £195,000 the VERC0 is moving into a market for serious budgets only and whether the struggling British professional motorsport scene can accommodate it is debatable. It will also be going head to head with proven cars such as the Ford Falcon and Holden Monaro. However, to see big powerful cars like this on British circuits could bring spectators back to the tracks.

Professor Sid Watkins, the now retired F1 chief doctor, managed to persuade his good friend Bernie Ecclestone to make himself available for the 2006 Watkins Lecture. Organised by the Motorsport Safety Fund, this is an event open to marshals and race officials who give their time freely to make motorsport in the UK possible. Last year it was delivered by Ferrari technical director Ross Brawn and the promise of an audience with Mr F1 himself filled the room this year.

In the event, Ecclestone elected not to give a traditional-style talk, instead preferring to be interviewed, in this case by Dr Watkins wife, Susan. Although a journalist and biographer herself, and having collaborated with him on a biography, Mrs Watkins appeared unable to press Ecclestone on major questions of interest. Meanwhile, he wisecracked his way through the interview, dismissing many questions with one-word answers. At one point he aroused the hostility of the audience when he professed himself ignorant of the role of an incident officer.

At the end, the man seemed relieved, while the audience regarded the event as one of the less memorable Watkins lectures.



**24 hours.**  
**2.2 million openings.**  
**2.2 million closings.**  
**1 victory.**  
**Ready to go again.**

Del West titanium valves are central to the performance of the vast majority of today's high-revving racing engines. Their low mass is remarkable. Also particularly prized by everyone from NASCAR engine builders to Formula 1 engine designers are Del West's proprietary alloys, machining to tolerances previously thought impossible, and our unique, low-friction coatings.

Performance gets you to the front of the grid, but durability gets you to the finish line. Del West valves have durability to throw away.

In the Le Mans 24 Hour race, Del West valves not only stood the test of millions of openings, closings and thermal cycles, but on disassembly, proved to be ready to do it all again. They now live on in dyno test and development engines.

**Del West valves.**  
**Good to go.**  
**Good to go again.**

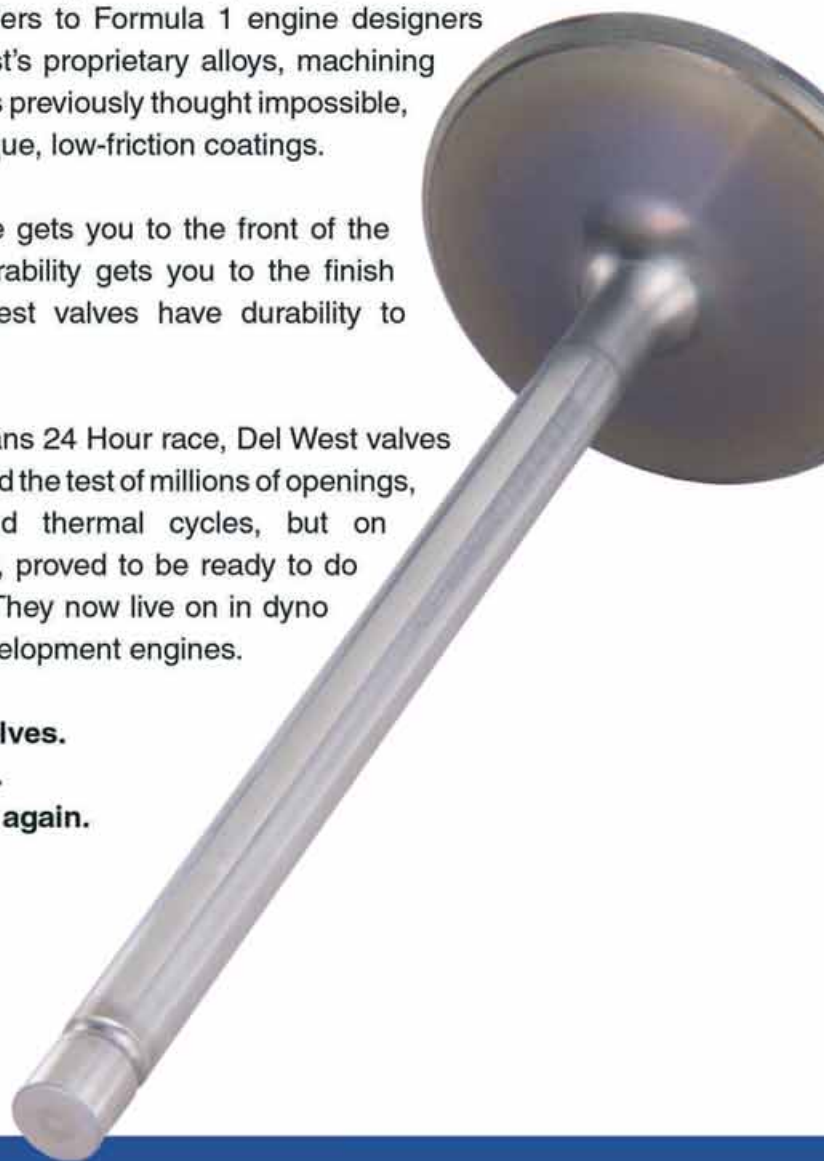

**Del West USA**

Sales/Tech Support (800) 990-2779  
28128 W. Livingston Avenue  
Valencia, CA 91355  
(661) 295-5700 Fax (661) 295-8300  
[www.delwestusa.com](http://www.delwestusa.com)



YYePG Proudly Presents, Thx for Support  
**Lightweight valve train components.**  
*Because nothing else even comes close.*

**Del West Europe**

ZI Les Vernes  
1852 Roche, Switzerland  
0041 21 967 21 21  
Fax 0041 21 967 21 27  
[www.delwesteurope.com](http://www.delwesteurope.com)

# Along came a



Words	Jonathan Ingram
Photos	Porsche, LAT

**P**orsche has become part of the legend of the Le Mans 24 Hours, with more victories than any other manufacturer bar none. However, the last time a Porsche was in the running for overall victory at Le Mans was in 1998 with the 911 GT1. Since then it has been content to supply customer GT2 class 911s. Although it toyed with the idea of going to Le Mans with an all-new LMP1 in 2000 the development car was mothballed and left to become obsolete in a secret corner of its Weissach R&D centre. But pressure from the USA has changed all that and in early 2005 rumours started circulating that Porsche was developing a new car in secret, and last summer the RS Spyder (type 9R6) LMP2 was revealed.

The first mission of the RS Spyder is to win the LMP2 category of the 2006 American Le Mans Series championship in the hands of factory-supported Penske Racing. In 2007, the Spyder is scheduled to become a customer car for LMP2 privateers in North America, as well as in Europe's Le Mans-based series and possibly in Japan, too.

The cars' 3.4-litre V8 engine is purpose-built for the Spyder, but also

happens to be very close to the configuration used by the Indy Racing League, raising speculation that Porsche may return to unfinished business at the Indy 500. As for sportscar racing, more than a few engineers have speculated about the right sort of 750kg configuration winning overall at Le Mans, in the race where Porsche first made a name for itself with smaller, lighter-weight vehicles before the brutish 917 scored the company's first of 16 overall victories in 1970.

It is unlike Porsche to build a prototype that, in its present configuration for the LMP2 category, cannot compete for the overall win at Le Mans, and it seems equally unlikely the highly successful Roger Penske is going sportscar racing just to win the North American LMP2 category. More likely is that Penske is lining up a future engine supplier for Indy or a return to the Le Mans 24 Hours in search of an overall win.

Despite horsepower reduced by the LMP2 category's air restrictor, it is worth noting that the new Spyder ran among the LMP1 leaders during the entire four-hour ALMS race on its debut at Laguna Seca Raceway last

YEPG Proudly Presents, Thx for Support

# Spyder

The arrival of Porsche's 9R6 Spyder prototype at Laguna Seca last October has prompted speculation about the company's future in motorsport



## Tech spec

Car	Porsche 9R6 RS Spyder
Chassis	carbon monocoque
Engine	Porsche MR6 3.4-litre V8 (with 44mm restrictor)
Power	480bhp
Torque	370Nm at 7500rpm
Cams	twin overhead
Gearbox	Porsche GR6 six-speed sequential
Clutch	ZF Sachs triple plate carbon
Suspension	wishbone, ZF Sachs dampers
Weight	750kg
Aerodynamics	twin plane rear wing, ACO spec floor
Length	4650mm
Width	2000mm
Height	1086mm

**“OVERALL DESIGN IS AN EFFORT TO PERFECT THE CURRENT RULES PACKAGE”**

October. Driver Lucas Luhr set the race's third fastest lap time versus the winning Zytek o4S, the brace of Audi R8s of Champion Racing and the two Lola B01/60s of Dyson Racing. So maybe this car is already in a position to compete for overall victory on tracks such as the narrow, slippery Laguna.

Adding further mystery to the RS Spyder — besides the refusal of Porsche officials to unveil any of the car's mechanicals at Laguna — are the origins of the rapidly designed and built prototype. Officially, the car was commissioned by Porsche Cars North America, although a rumour has circulated that ALMS founder and pharmaceutical magnate Don Panoz paid for the design of the RS Spyder as part of an effort to boost factory and team participation in his series. However, this has been flatly denied by CEO of the group, Scott Atherton, and Don Panoz who stated, 'the only manufacturer who has received financial support from me is the Panoz Esperante GTLM team.'

At a time when the ALMS is under heavy assault from the rival Grand American series, a new prototype from Porsche should work well at the box office, especially in the hands of Penske Racing. No doubt Panoz further understands the ticket sale importance of having a Le Mans-winning car →



The RS spyder is typical of LMP2 design with its twin roll hoops, though it has a low rear deck and dual element rear wing on double struts

YYePG Proudly Presents, Thx for Support



in his fields in light of the past appeal of Porsche's GT1-98 coupé, the BMW V12 LMR and the all-conquering Audi R8s. Is it enough for the ALMS just to have a Porsche prototype designed for North American participation in a secondary category, not a Le Mans contender?

The car's development, meanwhile, and presumably Penske's participation has been underwritten by the major DHL sponsorship, with partial participation by Mobil 1 and Michelin. The German-owned DHL is not only looking to expand its business footprint in North America but also to expand its logistics business with Porsche. Taken together, that justifies a substantial multi-million dollar budget even without the Le Mans angle.

If there is more than meets the eye to Porsche's newest Spyder, we'll have to wait and see, both on the track and in media announcements. The officials

### “AN INTENSE PROGRAMME OF CFD HAS BEEN APPLIED TO EVERY SQUARE INCH”

at the German company are anxious to keep their latest prototype strictly on eye level, refusing to unveil anything beneath the bodywork and, at the time of writing, declining to discuss any specifics on its technical capacities. Since then, the car has remained under the notoriously effective cloak of Penske's private testing programme, run out of the enormous Penske Racing South factory in Mooresville, North Carolina.

While the car or engine's future prospects are tantalising, there is no doubt the current programme is configured for profits from privateer car and parts sales starting in 2007. That alone puts the emphasis on a relatively affordable, reliable prototype that can be counted on to beat the 'garagistas' running Courage and Lola chassis mated to a variety of powerplants. 'It's important for a customer programme that you do not put in very expensive technology,' said Hartmut Kristen, who organised the 60-man team that built the RS Spyder.

Much of the crew came from the Carrera GT project – an ironic twist since the use of carbon fibre for both strength and weight savings gleaned from the road car was used to create the racecar. 'A lot of the know how we gained from the Carrera GT we could use very efficiently for the chassis of (the Spyder),' said Kristen, 'particularly since the safety regulations are much, much tighter than they were five or 10 years ago. Our regulations are very close to what you have to fulfil for a street legal car today.'

Instead of a blank sheet of paper, emphasised Kristen, the project started with a 'blank screen' and was done entirely by computer. 'The main thing



The 9R6 has undergone an extensive testing and development programme, including sessions at Estoril (above)

Unlike many other LMP2s, 9R6 has a symmetrical appearance, suggesting a genuine two seater

was that everything was calculated. There was nothing hand crafted.'

Given the fast turnaround demanded by the project and its destination as a user-friendly customer car, ie one that is reliable, the car's overall design is an effort to perfect the current rules package more so than break new ground. As such it carries many of the usual design cues of the current generation of prototypes.

### Aerodynamic optimum

'If you compare the last 10 years, the cars will not look any different,' said Kristen. 'They're always getting closer and closer to the aerodynamic optimum. You have the package and you have to get the bits and pieces in the car and fight with the air as efficiently as possible.'

YEPG Proudly Presents, Thx for Support

The standardisation of prototype sportscar designs arose from back-to-back seasons at Le Mans in 1999-2000. The frightful blow-overs and crashes of the Mercedes CLK-LMs in 1999 brought renewed focus on safety concerning front and rear overhangs and underbody configurations, as well as eventual structural changes including cockpit designs.

The next step came in 2000 with the arrival of the highly successful Audi R8. A re-design of the original R8R, the all-conquering R8 in fact incorporated some of the better features of its rivals from the previous 1999 season.

Those key elements included a centrally located low front air intake for brake cooling/aerodynamic benefits, combined with an extended front splitter (whose effectiveness is enhanced by the central opening for the brake ducts) that first appeared on the Panoz LMP-1. Also, the new Audi R8 featured a switch to side-mounted radiators and intakes similar to BMW's LMR, plus the latter's controversial, but approved, single roll hoop.

The new prototype designs that have followed, with the exception of the Bentley coupé, have had slight variations on these themes and the RS Spyder is no exception. But while the carefully crafted undulations of the Spyder follow the usual pattern on a large scale, it's clear an intense programme of computational fluid dynamics has been applied to every square inch of detail, as well as to proportions.

The standard aerodynamic features start with a high nose fronted by the centrally located intake for brake cooling. The choice to evacuate that air on either side is a vertical sidepod opening cut into an otherwise unbroken flank. Located about a foot behind the front wheel, the configuration and location for the exit of air are unique to Porsche. Both the arched nose and the wide intake on the snout are similar to the new

Courage C65, although the lower nose and front air intake for the Porsche are noticeably larger than any of its predecessors. Meanwhile, at Laguna the team used a deep-set insert to modify the actual opening.

The splitter is stepped up across the central portion of the front end according to the new regulations to prevent excessive lift suddenly developing under the nose (the problem with Mercedes' notorious accidents). The underside must now be flat from the centreline of the front axle all the way to a taper under the gearbox and the groundeffect tunnels are fixed. Kick-ups on the sides where the floor meets the bodywork, as well as a plank are mandatory. In summary, there's no fiddling with the underside to gain an advantage.

Uniquely to the Spyder, there are no raised bodywork bubbles in front of the driver or notional passenger like the C65 or the new Lola-MG LMP2 at Le Mans. The latter two's choices are assumed to get air more efficiently over

the newly mandated double-staged supports behind the driver/'passenger'. Porsche's choice is to use the steadily rising broad arch of the nose that concludes in a relatively flat plane in front of the open portion of the cockpit – both an interesting and elegant solution.

Porsche's Spyder is also distinguished by two open roll hoops, versus the single hoop used by Courage or the two solid promontories in the new Lola-MG LMP2 entry. In addition to dual roll hoops, the Porsche cockpit has the symmetrical appearance of literally accommodating two people. On the

side of the 'passenger', the engine's air intake is located at head level. As usual, the space given to the 'passenger' is not enough for a person the same size as the driver.

Was there any consideration given to a closed cockpit car? 'It was always the question of what would suit the situation of one given race better than the other solution,' said Kristen. 'At the moment I think definitely there is no question because aerodynamically the [open cockpits] actually do not have a disadvantage. But you have a lot of advantages for the driver in that it's not so hot inside the car. Driver changes are easier and there are safety regulations you have to conform to. So it was never a question about an open cockpit.'

Some designers still believe the effect of less tumbling air over the roof of a closed car overcomes the frontal drag penalty, and it makes for efficient delivery of air to the rear wing as well. But these same designers also concede the engine for a coupé must be a four-cylinder configuration if one hopes to meet the 750kg weight limit, an engine option definitely not considered practical by Porsche. As it is, there's still some question whether the Spyder actually makes weight at 750kg with its customer V8.

Despite a normally aspirated engine, the RS Spyder's radiator

openings in the sidepods are ample – a good idea for racing in America, where historically designers have underestimated the demands of cooling on a continent quite a few latitudes south of Europe. There's also a bit of intrigue: what would be the cooling demands of a twin turbo V8 should the car be reconfigured in the future as a 900kg LMP1?

In the rear, the Porsche engineers have succeeded in getting a very low rear deck. The dual-element rear wing is centrally mounted by double struts and the end plates are the dog-eared style that extend down to the kick-up at the back of the dovetailed rear bodywork. All in all, the new Porsche is easy on the eye and aesthetically well balanced.

But what about the internals? If the past is prologue, the drivetrain is where the customers will really get their money's worth. Porsche's entry in the stakes for the all-time most successful endurance racer, the 956/962 series, derived much of its success from the inaugural Bosch Motronic →



**“AERODYNAMICALLY THE [OPEN COCKPITS] ACTUALLY DO NOT HAVE A DISADVANTAGE”**



Wind tunnel work was done in both full scale and model tunnels at Weissach





**A rare look under the skin of the Spyder at Road Atlanta shows brake ducts, front suspension and the crash box design. The car was repainted for its race debut in the distinctive colours of DHL. MoTeC dash is evident in cockpit shot**

engine management system and the horsepower of the flat six engines. In the more modern era of air restriction, Audi's claim to having built the greatest endurance racer rests squarely on the mating of the R8's electronically controlled sequential gearbox to its twin turbo V8. In an air-restricted formula, the car that gets off the corners most efficiently gets to top speed sooner and stays there longer – a major advantage cited by many of the Audi R8's early victims. The Audi's strongest suit was often overlooked in place of the ability to quickly exchange gearboxes to replace damaged rear suspensions during the company's initial Le Mans victories.

Porsche no doubt is counting on success from its drivetrain. It relies on a 90-degree V8 whose pitch sounds very much like an engine with a flat crank. The water-cooled V8 has single-cylinder throttle valves and is managed by the Bosch MS 4.2 system. It is mated to a Porsche-engineered, paddle-operated, six-speed, sequential transmission with constant mesh straight

cut gears. Rumour has it that the gears themselves were the cause of the RS Spyder's three gearbox failures during a 12-hour test at Road Atlanta. This setback forced a cancellation of its debut in the 1000-mile Petit Le Mans at Don Panoz's track, in favour of the four-hour season finale at Laguna two weeks later.

Whatever the problem, Porsche's Kristen

said the gearbox failures resulted from the usual development, without going into any detail, other than to tout Porsche's V8. 'From my point of view, the gearbox has one disadvantage compared to all other parts. The better the engine becomes, the closer the gearbox comes to its limits. That's why we had gearbox problems.' Another scenario would include problems from a lighter weight drivetrain needed to reach the 750kg minimum.

With an eye on reducing weight, the suspension is an adaptation of the LMP1 designed by Norbert Singer in 2000 – the V10 prototype that helped develop the Carrera GTs' engine without ever seeing competition. Instead of racing the LMP1 at Le Mans, the company decided to concentrate its resources on the Cayenne, its very successful entry into the SUV market.

Will the LMP2 category Spyder be the launching point for a return to overall victory contention for Le Mans? Porsche refuses to be drawn on this question, although Kristen acknowledges the current LMP2's air restrictor will prevent it from being competitive on the straights at Le Mans against new LMP1 entries. As for the Indy question, Kristen simply shrugs his shoulders: 'We haven't done the regulations, either for the ACO or for Indianapolis. If these engines are pretty close, it happened...'

With the RS Spyder, Porsche once again is concentrating on efficient use of resources, keeping a crack design team at its research facilities in Weissach engaged in a new project that is fully expected to sustain the

company's reputation for technical excellence. All this on the heels of a development programme aimed at privateer owner drivers.

There may be no clear design breakthroughs apparent in the new Spyder, but it's likely to set at least one new standard in another area, given the amount of customer interest already established for the 2007 season. 

**“THE BETTER THE ENGINE BECOMES, THE CLOSER THE GEARBOX COMES TO ITS LIMITS”**

**Kristen Hartmut, RS Spyder design team**  
YYePG Proudly Presents, Thx for Support

# i2 is here.

[motec.com.au](http://motec.com.au)



Race smart.

**MoTeC Research Centre**  
Tel: +61 3 9761 5050

AUSTRALIA

**MoTeC Europe Ltd**  
Tel: +44 8700 119 100

EUROPE

**MoTeC Systems USA**  
Tel: +1 714 895 7001

USA

**MoTeC Systems East**  
Tel: +1 704 799 3800

Over 50 Countries

YvePG Proudly Presents, Thx for Support

ASIA

# A new era for Formula Atlantic

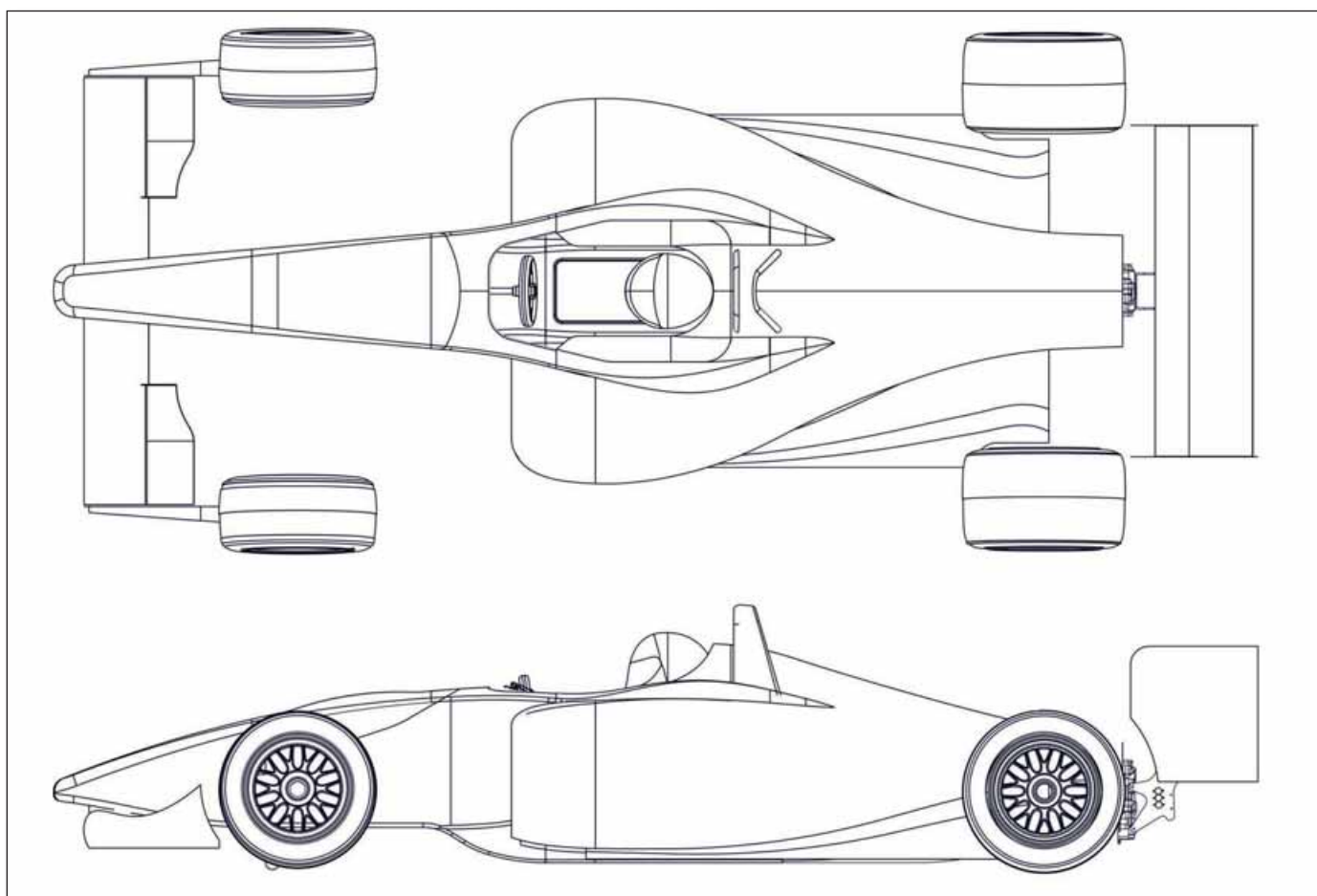

After 17 years of sponsorship and engines by Toyota, Formula Atlantic enters a new phase, with a bigger, faster and more powerful car than ever

Words	Dan Carney
Images	LAT

**T**he 2006-spec Champ Car Atlantic Championship car will still be constructed by Swift Engineering Inc, but engine power will be courtesy of Cosworth, with a 2.3-litre DOHC I-4 employing the Ford Duratec 23 production engine as its foundation.

The new Swift 016a Formula Atlantic car will be bigger, with a longer wheelbase, larger cockpit to accommodate larger drivers and a larger cockpit opening for easier driver extraction. The large displacement Cosworth engine is tuned to reliably

produce 300 tractable, driver-friendly horsepower for a lifespan of 2000 racing miles.

These changes reposition Formula Atlantic, moving it closer to its parent Champ Car series in power, and providing some separation from alternative development series such as Pro Formula Mazda, whose cars are very similar in size and speed to the previous Atlantic cars.

The loss of Toyota and the engine supply deal with Cosworth of course means that the series loses a significant revenue stream and marketing

partner. But the Cosworth engine deal doesn't preclude an automaker signing on as the title sponsor, asserts Vicki O'Connor, managing director of the Champ Car Atlantic Championship. 'Engines can be badged, so there is always the opportunity for another manufacturer to come in,' she said.

With a Ford corporate engine providing the block and head castings used by Cosworth, the roster of potential sponsor candidates might seem limited to the Ford family of companies, but

with Cosworth's assembly of the engines from mostly dedicated racing parts, 'that is not necessarily the case,' O'Connor said. Which, considering that the Pro Formula Mazda series is seen as a competitor to Champ Car's Atlantic series, it might be difficult to convince Ford marketeers that the company's brands should be competing against one another.

### Upping the power

An output of 300bhp boosts Atlantic closer to the power level of the defunct Indy Lights series, the previous direct stepping stone into Champ Cars. With Indy Lights gone, there was a desire to boost the performance of Atlantic cars to a level closer to that of Champ Cars. 'We wanted to re-establish that Atlantic is the top of the heap for training series in North America,' said Steve Sewell, manager, technology, Champ Car.

## “IMPROVED ACCESS FOR PERIODIC MAINTENANCE”

The engine is available in a range of displacements, but Champ Car and Cosworth chose the largest available displacement because it enables the engine to make more power with less strain, for a longer life and reduced operating expenses. The Cosworth's \$39,000 (£22,300) price tag is comparable to the \$40,000 bill for the 2005 Toyota 4A-GE engine, but the new engine is designed to last 2000 miles, rather than the 900-1000 miles of the Toyota.

That endurance means teams should be able to complete the season with three rebuilds, which would cost about \$35,000 (£20,000), Sewell said. Rebuilds and other engine services will be provided by Cosworth through the same support structure that is already in place for the Champ Car series. This existing infrastructure probably gave Cosworth an advantage in the competition for the engine supply contract. Its ownership by the same partners who own the Champ Car series probably didn't hurt its chances either. Likewise, Pi Research, another member of the Gerald Forsythe/Kevin Kalkhoven/Paul Gentilozzi empire, supplies its Sigma Elite Junior data system for the new car.

The engine's brawny size also makes it easier for Cosworth to build an engine that not only lasts the predicted distance, but that does so with no significant degradation in performance. Of course, a nearly 50 per cent increase in displacement — from 1.6 litres to 2.3 litres — also produces an increase in physical size. The Cosworth engine uses an aluminum Ford block and head, while the Toyota engine's block was iron, so the engine isn't much heavier than

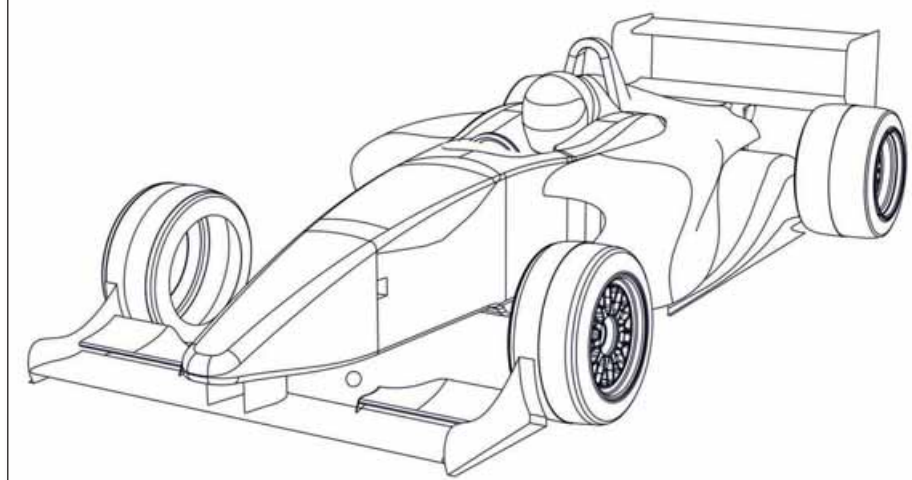
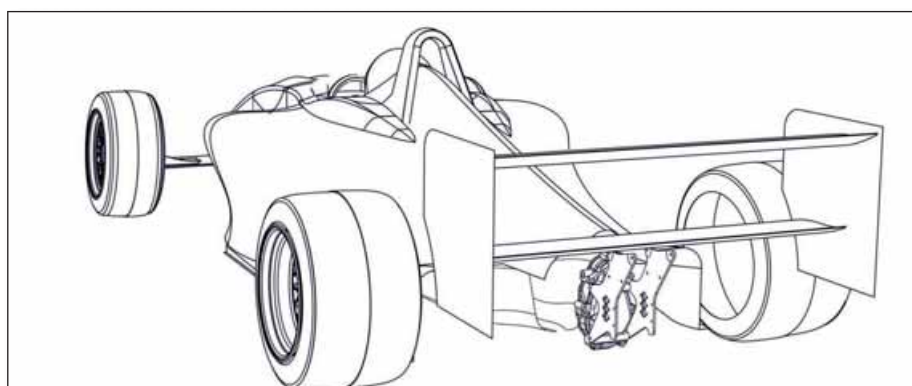
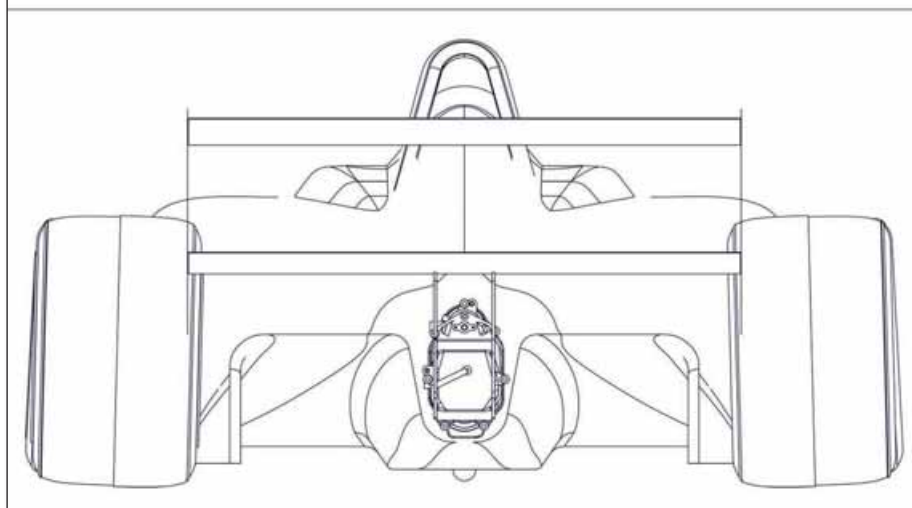
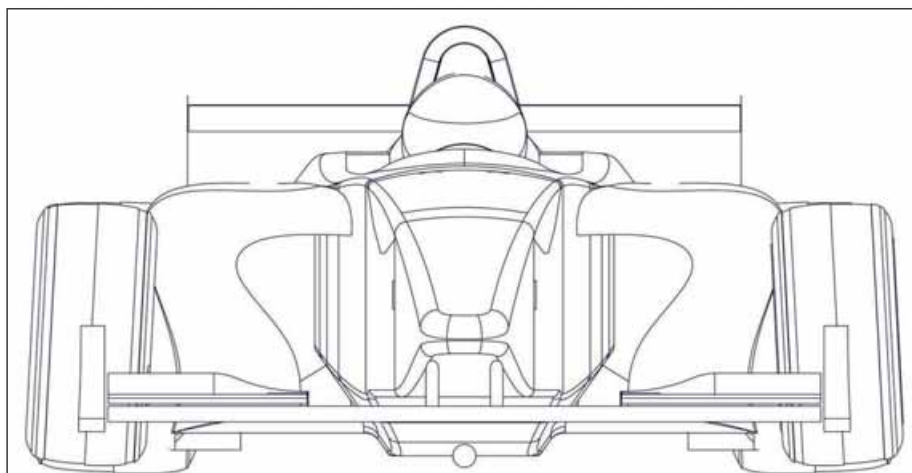

→ **Swift Q16a has longer wheelbase, larger cockpit and, with resultant downforce increase, will be faster, too**  
 YEPG Proudly Presents, Thx for Support

the outgoing powerplant, according to Cosworth. But the engine is both long and tall. This could present packaging challenges, but with the car itself growing for improved comfort and safety, squeezing in the engine was not as difficult as it might have been.

A predictable roster of bidders turned out to pitch for the contract of the new Atlantic car, with Swift ultimately prevailing over Dallara, Lola, Mygale and Don Panoz's Elan Motorsports Technologies conglomerate of Van Diemen, G-Force and Panoz.

Swift held the advantage of not suffering from the unfavorable exchange rate, shipping costs and import duties endured by the European contenders, but it also prevailed over fellow American constructor Elan. 'Several manufacturers were able to meet the price criteria,' said Sewell, 'but Swift wanted to partner with us on this.' The company also seemed to have the attitude of wanting to prove itself after a rocky launch for its 008a Atlantic, he said.

The 016a will cost \$79,500 (£45,300) for a chassis and \$175,000 (£100,000) for a race-ready car complete with engine and the sealed series-spec Dynamic Suspension DSSV dampers. BBS wheels and Yokohama tyres continue to be the specified suppliers of those components.

Swift's nine years of experience supplying first the 008a and then the 014a Atlantic cars to the series gave the company some idea of areas where they could save money building the new car, said Chris Norris, director of engineering for Swift. 'We've gained experience with how these cars are run and what teams expect of them.'

By re-shaping the car's monocoque, designers were able to produce an easier-to-manufacture structure. 'The 008a monocoque [carried over for the 014a] was a compound surface, which makes it difficult to get the monocoque built,' said Norris. The flat, planar surfaces popular today in F1 are easier to make, so the new Atlantic is both more contemporary looking and cheaper to build.

The larger monocoque of course adds drag, but it also provides the opportunity for increased downforce from ground effects, so the result is a car that will be faster than its predecessor, Norris said. 'Our target is for the car to be quicker in every track segment,' he said.

### Improved reliability

The Swift SG3 gearbox is largely carried over from the 014a, but with some changes for improved serviceability and reliability. 'We've improved the strength of the differential,' Norris said. Designers also improved access for periodic maintenance. 'There were a couple of tasks they had to do rarely, but when they did, they were quite fiddly. It wasn't to do with the day-to-day running, it was the six month or yearly service when they were changing bearings.'

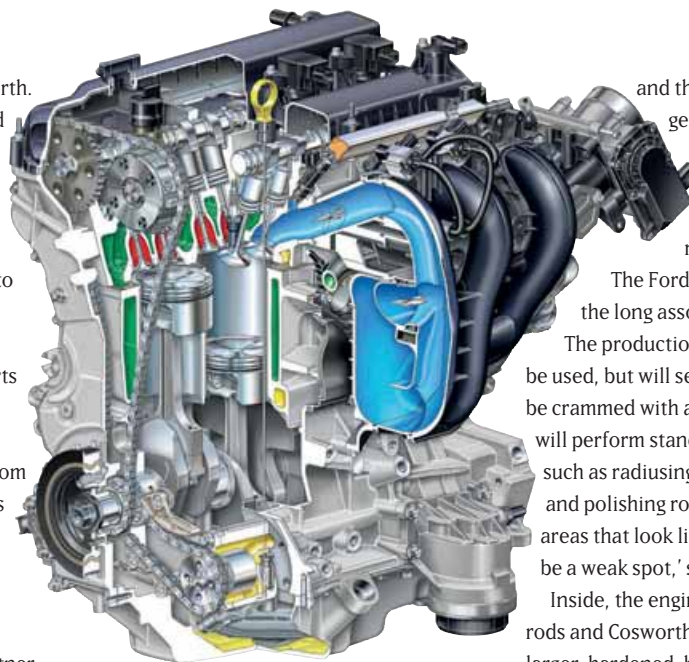

**2.3-litre Cosworth engine uses modified Duratec block and head castings, but with all new internals**

The company also altered the design of the reverse gear, going to a constant engagement layout using dog rings. There is some parasitic loss in this arrangement that is undesirable in an open series, but in a spec series that doesn't matter. The new design lets teams replace dog rings when the engagement teeth are damaged by a rough shift, rather than having to replace an entire reverse gear set, as was the case before.

The Cosworth engine supply, of course, echoes the series' foundation, when it ran the Cosworth BDA until Toyota took over. This connection has sparked significant interest and curiosity among the racing community, according to Ian Bisco, vice president, Cosworth Inc. 'People think of the past

and the Cosworth BDA, and that generated a lot of excitement,' he said. 'I think Swift and ourselves were surprised and very happy that there was so much interest.'

The Ford production connection echoes the long association of the two companies.

The production block and head castings will be used, but will see significant attention and will be crammed with all-new moving parts. Cosworth will perform standard block preparation services such as radiusing corners, relieving stress spots and polishing rough areas. 'We'll machine any areas that look like they are suspect, that could be a weak spot,' said Bisco.

Inside, the engine gets a steel crankshaft and rods and Cosworth pistons. The head receives larger, hardened, high-endurance valve seats, bronze valve guides and larger valves. Valve ports are machined for improved flow, and high performance cams replace the standard items. An more sophisticated barrel-type throttle replaces the traditional butterfly, eliminating the obstruction of the throttle shaft during wide-open throttle conditions. Cosworth also casts a dry-sump pan and cam cover that are designed to tie the engine into the car as a stressed unit.

In the interest of longevity, the engine has an 8500rpm redline. 'It has a pretty long stroke,' said Bisco. 'If there were any negatives, it is the long stroke and pretty high piston speed.' However, Cosworth already has track experience with a slightly less powerful version of this engine, in the Caterham racing series, which uses the same engine in a 260bhp state of tune.

Atlantic teams will get a warranty with their engine similar to that on the Champ Car engines, said Bisco. Customers will get a free replacement if an engine fails through no fault of the team in the first 200 miles, and will get a pro-rata discount on the replacement for engines with between 200 and 1400 miles. After 1400 miles, customers will simply exchange a failed engine for a fresh one, the same as if they were buying a replacement. RE

**“AN INNOVATIVE BARREL-TYPE THROTTLE REPLACES THE TRADITIONAL BUTTERFLY”**



**Giles Villeneuve using the power of the original Cosworth BDA engine in Formula Atlantic in the 1 70s**  
YYPG Proudly Presents, Thx for Support



**World leaders in the manufacture of driveline components**  
**The only manufacturer to specialise in both motorcycle**  
**and car transmissions**



**For FREE brochure and info: Tel 0845 1307400**  
**info@quaife.co.uk • www.quaife.co.uk**

Quality Accredited  
 ISO 9001-2000 and  
 ISO QS9000-TS16949



## **Ole Buhl Racing Ltd.**



**Ole Buhl Racing** is a world wide supplier of **EFI engine management systems**

*Supplying engine management solutions for Grass Track to Le Mans  
 Prototypes we can help you maximise your engine's potential.*

*Our top level engine management systems offer a wide range of control features.  
 Just a few are listed below*

- Variable Cam Timing
- Traction Control
- Advanced Power Shift Control
- Multiple Run Maps
- Knock Control
- Self Learn and Closed Loop Lambda Control
- Launch Control
- In- Built Logging

**We also provide**

- Engine and Chassis Wiring
- Engine and Chassis Sensors
- Data Logging and Displays

**Measure It, Control It, Log It and Display It**

Ole Buhl Racing Ltd, Roughwood House, Highwood, Nr Ringwood, Hampshire BH24 3LE, England

Tel: +44 (0) 1425 47 88 22

Fax: +44(0) 1425 47 88 66

Email: [sales@efitechnology.co.uk](mailto:sales@efitechnology.co.uk)

YyPG Proudly Presents, Thx for Support



In the second of a new series we look at the need-to-know information in particular aspects of racecar engineering. This month we look at rear wings – how to choose the correct style and profile for your application and what to consider in making this choice

# Spoiler for choice

Wondering how to select a racecar wing set-up? Here's one practical approach to a complex problem

**T**he question of what wing design to use on a racecar arises not just at the initial design stages, but also quite possibly at each track visited. While not everybody has the budget to select a different wing set-up for each type of track, is the best compromise always being utilised? So, assuming technical regulations allow any choice, how do you figure out the configuration of wings you should run, and where do you find suitable wing profiles?

The general idea is to attain the best lap or run time by achieving the right downforce to drag compromise, usually known as optimising aerodynamic efficiency. As wings play a significant role in this quest, it pays to seek the best solution available. The search for the right

wing set-up has to begin with clear knowledge of the rules relating to the number of wing elements permitted, and any constraints on dimensions and position of wings. In many restricted categories these go a long way to defining most of the key criteria, although there are often still degrees of freedom that can be explored and exploited. In other categories there are so few restrictions that many more decisions have to be made as to what will work. So, assuming you have some freedom of choice, where do you start?

## What configuration?

There is an empirical method for calculating a first approximation of the wing configuration – that is, single element, dual element or whatever – that

Words	Simon McBeath
Images	Advantage CFD; LAT; McBeath

YePG Proudly Presents, Thx for Support

your racecar will need. A version of this approach is detailed, with examples, in the writer's latest book, *Competition Car Aerodynamics*. The approach originally appeared as an article in *Racecar Engineering* in V7N4 in 1997. In a nutshell, the method is based on assigning a drag budget to the rear wing, given that rear wings can create significant drag while front wings create relatively little. This wing drag budget is then used to estimate what kind of rear wing is appropriate. The front is then chosen to provide a balance.

The process is not going to be repeated in full here, but it's useful to recap the outline, shown here to the right, for a single seater with front and rear wings. For a racecar without front wings, the rear wing obviously has to be balanced with alternative downforce generating devices. The process is as follows:

1. Measure (if you can find the space) maximum speed without wings. To calculate this requires

## “THE RIGHT DOWNFORCE TO DRAG COMPROMISE”

values for the frontal area, the maximum power available at the wheels, the wingless drag coefficient,  $C_D$  (quite probably a guesstimate in this instance, but likely to be in the range 0.5 to 0.7 for single seaters without wings), and the equation relating power absorbed to speed and drag. In 'semi-metric' form this is

$$\text{bhp absorbed} = C_D \times A, \text{sq.m} \times (\text{max.speed, m/s})^3$$

1225

which rearranges to

$$V_{\text{max, m/s}} = \sqrt[3]{(\text{bhp available} \times 1225) / (C_D \times A, \text{sq.m})}$$

[Note that power to overcome drag is related to speed cubed because drag force is proportional to velocity squared, and power is force multiplied by velocity] Figures 1 and 2 show power absorption plots for high and medium speed ranges for a representative range of  $C_D.A$  values.

2. Decide by how much you are prepared to reduce that top speed by the addition of a rear wing.
3. Calculate the difference in power absorption figures between the top speed without wings and the reduced top speed you are prepared to accept with wings.
4. The difference between these power absorption figures is the power you 'donate' to the rear wing to overcome its additional drag, which we'll call 'wing bhp'.
5. Calculate the maximum wing  $C_D$  value that this represents. This requires values for the wingspan and chord dimensions to work out the plan area of the wing, and the power

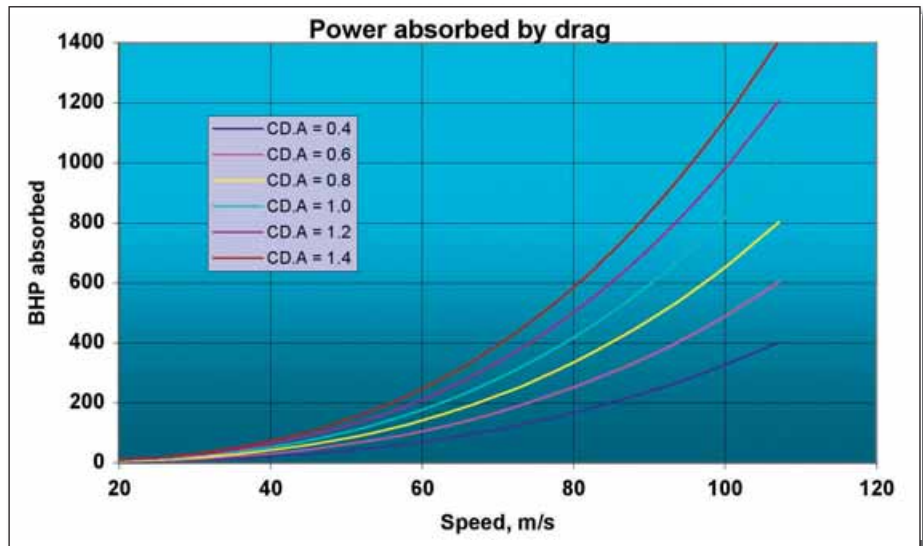

Figure 1: aerodynamic drag absorbs considerable power at higher racecar speeds (McBeath)

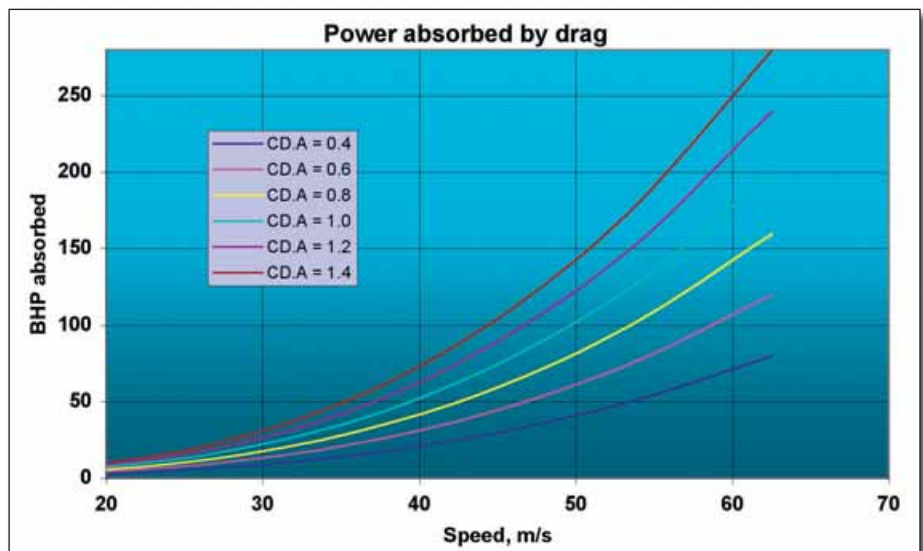

Figure 2: power absorbed by the aerodynamic drag of less rapid racecars (McBeath)



The search for the right wing set-up has to start with a clear understanding of the regulations in any given class

absorption equation rearranged to

$$\text{Wing } C_{D\text{max}} =$$

$$\frac{\text{'wing bhp' } \times 1225}{\text{wing plan area, sq.m} \times (\text{selected top speed, m/s})^3}$$

6. Using figure 3, based on published racecar wing data, work out what  $C_L$  figure corresponds with the calculated maximum wing  $C_D$  value. Then from figure 4, which shows approximate lift coefficient ranges for three basic wing configurations, work out what basic configuration wing (that is, whether it is single, dual or possibly triple element) ought to provide this  $C_L$  value.

YEPG Proudly Presents, Thx for Support

7. Calculate the theoretical downforce figure that the rear wing will give using the following basic 'lift' equation:

$$\text{'lift' (downforce, N)} = 0.5 \times \text{air density} \times \text{wing plan area, sq.m} \times \text{wing } C_L \times V^2, \text{m/s}$$

(air density = 1.225kg/m<sup>3</sup>).

Then calculate the downforce required at the front to balance this value (in proportion to the static weight distribution for want of a better starting point, probably with slightly more rearward bias). The front wing dimensions will be needed next, as will the wings' ground clearance so that ground effect can be allowed for in →



determining the requisite  $CL_{(front)}$  value (figure 5 shows a generic plot of 'ground effect amplification'). Then work out what configuration will be needed to attain this  $CL_{(front)}$ .

8. Finally, determine suitable profiles, or sets of profiles, that will meet the calculated requirements.

This process generally requires a few iterations to produce a practical solution, and it only gives a starting point – a balanced set-up will still have to be attained in testing. You will need to run the calculations for different  $CD$  guesstimates, different acceptable top speeds, and different wing dimensions and overhangs, to name but a few of the variables. It is also necessary to take into account that rear wings never work as well in practice as they do in theory, but a rear wing 'inefficiency factor' can be applied.

## “REAR WINGS NEVER WORK AS WELL IN PRACTICE AS IN THEORY”

But fundamentally this, and any other method that might try to determine the basic wing configuration you're going to need, always leaves one key question hanging – to fulfil the final stage of the eight-point plan above, where can you find suitable wing profiles?

### Profile hunting

There are actually various sources of potentially suitable profiles, assuming we gloss over the possibility of copying someone else's existing design (rife though this practice may be, it's nothing less than theft if the designer's permission has not been granted). The 'traditional' method is to look in the small number of aeronautical textbooks that provide profile catalogues (see the reference list at the end of this article). Although none of these profiles were intended for use on a racecar, among their merits is that they are published, proven, and plottable (ordinates for many of them are readily available). These are two-dimensional profiles, so a decision on the three-dimensional shape of the wing will still be required.

Another useful resource nowadays is the internet, and specifically some of the aerofoil simulation packages to be found there. Some basic ones can be used at no cost, but more advanced ones must be purchased. And while they generally also appear to concentrate on two-dimensional aeronautical profiles, some show simulated flows and allow limited interactive manipulation of fundamental parameters, such as thickness and camber, while displaying the changes to forces or coefficients. And very

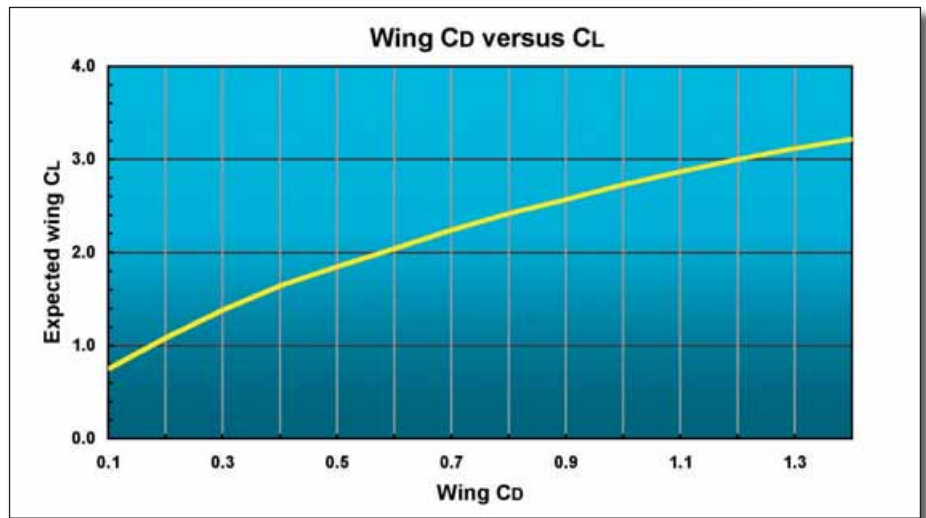

Figure 3: approximate correlation between wing  $CD$  and  $CL$ , based on published data on racecar wings (Competition Car Aerodynamics, McBeath)

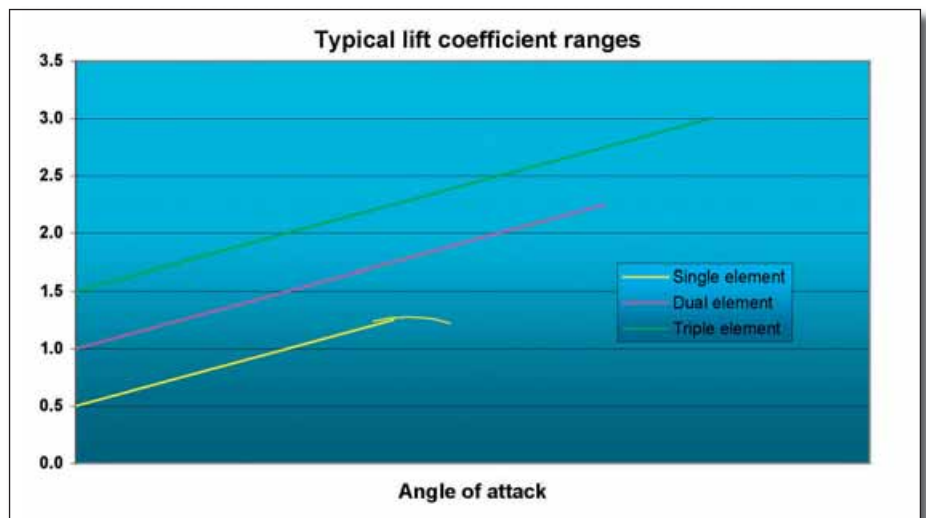

Figure 4: indication of the likely  $CL$  ranges for three basic wing configurations (McBeath)

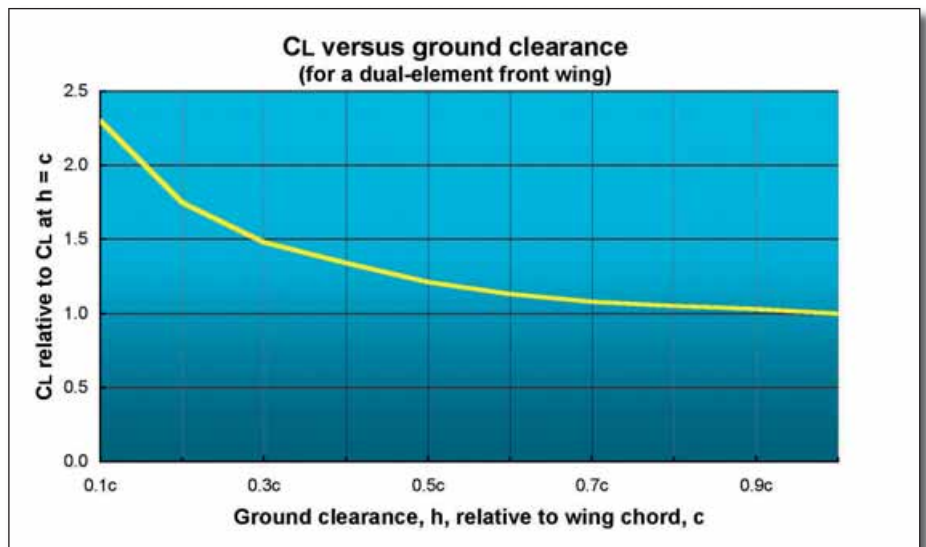

Figure 5: a generic plot, based on dual-element front wing data, of ground effect 'amplification' of downforce prior to viscous blockage at very small ground clearances (Competition Car Aerodynamics, McBeath)

usefully, ordinates of the shape you decide upon can then be plotted and used for manufacturing your own design of wing. Again, see the references list for a small selection of websites offering these facilities.

But even after consulting these valuable YEPG Proudly Presents, Thx for Support

resources there are still some unknowns. For example, although some of the aeronautical textbooks and one (hard to find) racecar wing text provide information and data on multi-element wings, there is little to guide the profile seeker on shapes that are suitable as dual or triple-element

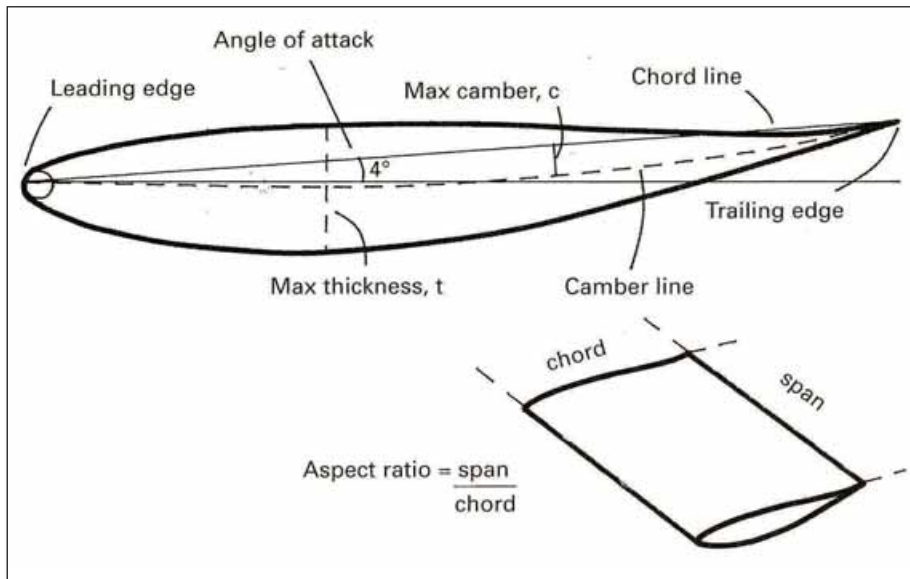

Figure 6 (above): single-element wing terminology (McBeath)

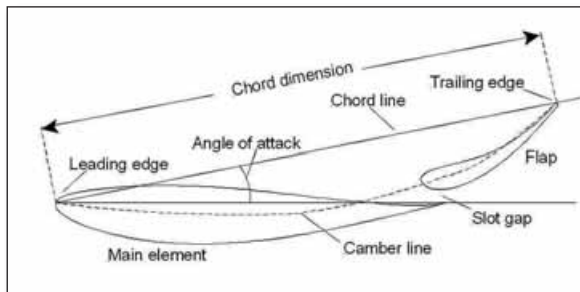

Figure 7 (left): dual-element wing terminology (McBeath)



If a digital model of your car exists, a professional can optimise a wing profile for a specific car using CFD

racecar wings. And more fundamentally, what characteristics does a profile require in order to generate the required performance, possibly over a wide range of angle settings? This type of information is essential if the right choice from a potentially bewildering selection is to be made.

**Profile selection**

Followers of the Aerobytes series in this magazine will recall that we ran a number of articles on the influence of the basic characteristics of single-element wings in issues V14N6 to V14N8. We also looked at dual-element wings in V14No. From

these and other references it is possible to draw up a list of selection criteria to begin to whittle down the choice.

For a single element wing that will be adjusted over a range of angles the aerodynamic parameters (see figure 6) are likely to include:

1. Thin section thickness for a low downforce, low drag set-up – 14 to 16 per cent maximum thickness for best efficiency across the widest range of angles, and 18 to 20 per cent maximum thickness for maximum downforce.
2. Small amounts of camber, perhaps in the range four to six per cent for low downforce, low drag and high efficiency; possibly in excess of 10 per cent camber or so for high downforce. Front wings generally need less camber because of ground effect 'amplification'.
3. Low angle of attack for low downforce and low drag; high angle of attack, up to a maximum of

**“THERE ARE VARIOUS SOURCES OF POTENTIALLY SUITABLE PROFILES”**

around 14 to 16 degrees relative to the airflow for greater downforce, with inherent drag penalty.

4. Leading edge radius probably in the range one to three per cent of chord, although this parameter is to an extent governed by the thickness and camber distributions. A bigger leading edge radius would be more suitable if the wing is to be run at steeper angles.

Indeed, before settling on a shape, judgements – probably intuitive – have to be made on the location of maximum thickness and camber, and the distributions of those two key parameters along the profile. Typically maximum thickness location would be about one third the way along the chord from the leading edge, with maximum camber located about half way along the profile. But there is still theoretically an infinite range of distributions available. In all honesty, the most likely and pragmatic action at this point will be to eyeball and select a profile that fits the basic criteria, and which 'looks right'.

For dual and triple-element profiles, some of the criteria for a single-element wing will still apply to the mainplane design. However, it is said that a thicker mainplane section with a more rounded leading edge radius can work better with flaps. And if the flap chord is at the higher end of the preferred range, say 30 to 40 per cent of overall chord (see figure 7), then a mainplane thickness as high as 20 per cent is said to give a significant increase in downforce compared



Designer and Manufacturer of Wiring Harness assemblies and components to Motor Sport.

[www.zica.uk.com](http://www.zica.uk.com)



- First class personnel, facilities, systems and infrastructure allow Zica to provide first class customer service combined with the most open book competitive pricing in the Industry.



- Fully ISO 9001-2000 compliant Quality System with state of the art inspection and automated testing procedures. latest material and component technology.
- For further information or to receive a quotation please contact Steve Crabtree, Business Development Manager. E-mail [steve.crabtree@zica.uk.com](mailto:steve.crabtree@zica.uk.com) Tel +44 (0) 8700 272089.

- Zica Consultancy Limited, 21 Angelvale, Top Angel, Buckingham, Buckinghamshire MK18 1TH.
- Tel +44 (0) 8700 272072, e-mail [sales@zica.uk.com](mailto:sales@zica.uk.com), Fax +44 (0) 8700 272042.



Power Steering  
Power Steering  
Power Steering  
Power Steering

# WOODWARD

**The Elegant Solution.**

...You say your front end geometry plants the tyres like crazy, but nobody can drive the car longer than ten minutes without calling it a pig?  
Imagine the design freedom you'd gain if driver effort weren't an issue.  
No, we're not talking about some lashup made from OEM parts, but a race-proven system with the versatility to cope with the most unanticipated requirements. Field-interchangeable response rates and highly predictable performance: the elegant solution to any steering problems.

[www.woodwardsteering.com](http://www.woodwardsteering.com)

1.307.472.0550; fax 1.307.233.1551

# Setrab

**Pro Line**

**Oil coolers for high performance cars**

Reliability  
Flexibility  
Know-how

Visit [www.setrab.com](http://www.setrab.com)

A number of aerofoil simulation packages can be found for free on the internet, though more comprehensive advanced ones generally have to be purchased. These can be useful in early planning stages



to a mainplane of around 10 per cent thickness. The amount of camber in the mainplane will depend on downforce requirement, and is likely to be in the range of five to 15 per cent of chord, and quite possibly 20 per cent or more for high downforce applications, positioned perhaps slightly forward of or around halfway along the mainplane chord. The adjustment to the angle of the flap(s) will have the effect of altering the rearward bias of the camber of the overall wing, which is one of the fundamental means by which the addition of the flap alters downforce.

As for the flaps, as has already been stated, flap chord will most likely be around 30 per cent of mainplane chord, and the flap thickness may need to be, relatively speaking, slightly thicker than the mainplane thickness. The position of the flap's maximum thickness is often fairly well forward, say at around 20 per cent of its chord – this can help to create a beneficial converging slot shape between the flap and the mainplane by producing fairly rapid curvature from the flap's leading edge onto its lower surface. The flap profile does not seem to be overly critical in order that it will perform a useful function. But logic dictates that the same criteria that apply to a single-element

mainplane ought to be applicable to the shape of a flap. So it would seem to be a reasonable assumption that a more cambered flap will help to generate more downforce than a less cambered one. Furthermore, the use of a flap with more camber can make it easier to achieve the desired convergent slot shape than if the flap has a flatter profile.

**“THERE IS, THEORETICALLY, AN INFINITE RANGE OF DISTRIBUTIONS AVAILABLE”**

The maximum angle of inclination of the flap relative to the mainplane chord line can be determined in track testing, but for a dual element will probably not exceed 40 degrees. For triple-element wings a typical configuration might see the second flap perhaps 30 degrees steeper than the first flap, giving second flap angles of 60 degrees or more. Indeed when categories like

Formula 1 and ChampCar were permitted to use triple-element wings, second flaps were sometimes run more or less vertical. However, while downforce increases with steeper flap angles, the incremental gains become smaller and increases in drag become larger, so efficiency (lift divided by drag) tails off.

A further consideration with multi-element wings is the relative positioning of the flap(s) and the mainplane, and the flaps with respect to each other if there is more than one. In an article entitled 'Wings and flaps' in V10N2 we covered current theory on the mechanisms involved in the interaction between the mainplane and flap for a dual-element wing. In essence, the main element and the flap modify the flow on each other beneficially to reduce the likelihood of flow separation on both, and to enable the development of greater pressure differentials between their upper and lower surfaces. Needless to say the slot gap and overlap are important in this respect.

The aeronautical texts are of limited use in determining efficient, let alone optimum, slot gaps and overlaps for racecar wings, and in any case this parameter would ideally be optimised for any given wing and set of operating conditions. As a start point again though, a vertical gap approximating three to five per cent of mainplane chord, and an overlap of perhaps five to seven per cent of mainplane chord will enable a beneficial interaction between the flap and mainplane. The gap between the first and second flaps will more than likely be a little smaller than this.

### Scaling to size

To meet the dimensional requirements of either the rules or your own specification it will be necessary to scale the selected wing profiles to full size. Sometimes the technical regulations mandate a maximum permitted chord, but if they do not, what chord dimension should be used?

Maximum wingspan is almost universally →



Despite all the science, initial judgement on thickness and camber often begins with intuitive guesswork  
YePG Proudly Presents, Thx for Support

limited by the relevant technical regulations. But should the maximum permitted span be utilised? We have seen that downforce is related to plan area, and so is drag. But we must also look at the 'aspect ratio', AR, the ratio of span to chord.

How does aspect ratio influence wing performance? The high-pressure area above a racecar wing and the low-pressure area below it induce some air to flow around the wing tips, from the high to the low-pressure region. This forms the characteristic tip vortices we sometimes 'see' with high downforce wings on damp or humid days as the humidity condenses in the low-pressure core of the vortices (figure 8 is a CFD visualisation). The flow around the tips decreases downforce by reducing the pressure differential between top and bottom surfaces, and the effect is felt proportionately more with a narrow wing (low AR) than with a wide one (high AR).

The 'spillage' around the tips is also associated with induced drag,  $C_{Di}$ , now referred to as vortex drag, because the wing feels drag from the low pressure in the vortices trailing it. This force is felt proportionately more with a narrow wing.

It follows then that a wider wing will perform better in both respects, and this is too good a bonus to pass up. So there are two conclusions on AR. First, utilise the maximum permitted span. And second, don't assume that using the maximum permitted chord, or indeed the maximum chord that will fit on the car, is necessarily the right choice. A theoretical check on this can be made using the following pair of formulae:

$$C_L \text{ is proportional to } \frac{1}{1 + (2/AR)} \quad (\text{see also figure 9})$$

$$\text{and } C_{Di} \text{ is proportional to } \frac{C_L^2}{\pi AR}$$

Comparing two wings with the same area but different aspect ratios using these two formulae demonstrates that the wing with the bigger aspect ratio has a higher lift coefficient and a smaller induced drag coefficient. Note too that using suitably large end plates increases the effective aspect ratio of a wing by reducing spillage around the wing tips (see figure 10), as discussed in Aerobytes V15N4.

**Profile variations**

Of course, an alternative to all of the above is to go to a commercial provider of aerodynamic analysis and consultancy services and ask them to provide an optimised wing design for your application. This could either be done on a wing in isolation from the car, or if a digital model of the car exists then the wings could be optimised, using CFD, for the flow around the specific car. It is very apparent when looking at any top category racecar nowadays that, for example, wings rarely maintain the same profile right across their span, and this stems from on-car optimisation effort. However, to alter either the chord or the angle across the span with any hope of making gains requires information on the flow structure around the wing. This can only really come from CFD simulations or perhaps detailed wind tunnel work with the racecar to visualise the flow in the vicinity of the wing, and hence make informed changes to the wing itself. And although those facilities are more cost effective than is generally thought, they aren't financially available to all. Furthermore, to manufacture a wing with variable chord or angle ('twist') may also require CNC pattern or mould creation capability, which would pre-suppose the availability of a 3D CAD model – again, not a facility available to all.

But if digital models, CFD analysis, CNC manufacturing and wind tunnel verification are beyond your team's budget, the methods outlined here should get you in the ballpark. RE

**References**

Abbott, IH and von Doenhof, AJ – *The Theory of Wing Sections*, Dover, 1959 (the classic aeronautical wing text)  
 Althaus, D and Wortmann, FX – *Stuttgarter Profilkatalog*, Vieweg, 1981  
 Benzing, E – *Ali / Wings*, Automobilia, 1991 (very difficult to locate, but based on racecar wings)  
 Katz, J – *Race Car Aerodynamics*, 1995 (more theory)  
 McBeath, S – *Competition Car Aerodynamics*, Haynes, 2006 (more theory and practice)  
 Simons, M – *Model Aircraft Aerodynamics*, Argus, third edition, 1989 (very useful source of profiles and theory, in spite of the word 'model' in the title)

**Websites**

- [www.pdas.com/aerosoft.htm](http://www.pdas.com/aerosoft.htm) – Public Domain Aeronautical Software (PDAS), at which links to the following can be found:
- [www.aerologic.com](http://www.aerologic.com) – design and analysis of streamlined bodies
- [www.compufoil.com](http://www.compufoil.com) – airfoil design software
- [www.dreeseocode.com](http://www.dreeseocode.com) – DesignFOIL design and analysis of simple wings
- [www.grc.nasa.gov/WWW/K-12/aerosim/index](http://www.grc.nasa.gov/WWW/K-12/aerosim/index) – FoilSim II, version 1.5 now available, simplified 2D computational models allowing visualisation of the effects of parameter changes, and plotting of ordinates
- [www.tdmsoftware.com/afd](http://www.tdmsoftware.com/afd) – 'Airfoil Design Workshop'

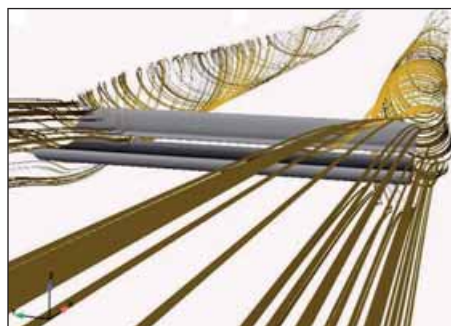

“**MAXIMUM WINGSPAN IS LIMITED BY THE TECHNICAL REGULATIONS**”

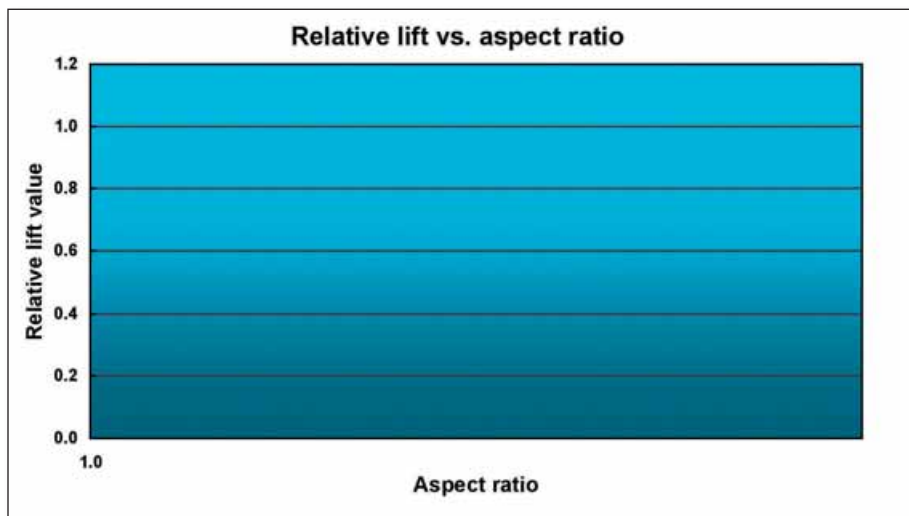

**Figure 8 (top): wing tip vortices have a greater proportional influence on a low aspect wing** (Advantage CFD)

**Figure 9 (above): increasing the aspect ratio leads to increased lift, or downforce in our context** (Competition Car Aerodynamics, McBeath)

**Figure 10 (right): end plates increase the effective aspect ratio by lessening the effect of the tip vortices** (Advantage CFD)



YYePG Proudly Presents, Thx for Support

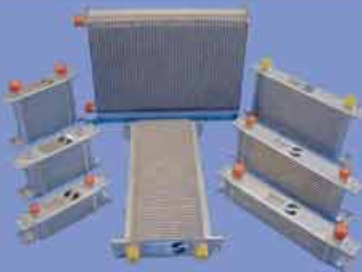

**MOCAL** High performance air to oil coolers



Oil cooler installation kits



Remote filter heads & take offs



Electric water pumps, release engine power



Dashboard gauges



Oilstats control oil temperature for more power & mpg



**LAMINOVA** oil to water coolers



Electric oil pumps for transmission cooling



Holley & Facet fuel pumps



Custom hoses for oil, fuel, brakes & coolant, Aeroquip, ProGold, Moquip & Speedflow



World biggest filler cap distributor



Early warning switches & bulbs

Manufacturers of **MOCAL** & Moquip oil cooling equipment. Distributors of automotive fluid control products. Online shop @ [www.thinkauto.co.uk](http://www.thinkauto.co.uk) Catalogue £2 refundable.

# Think Automotive

[www.thinkauto.co.uk](http://www.thinkauto.co.uk)

292 Worton Road, Isleworth, Middlesex, TW7 6EL  
Tel 0208 568 1172 Fax 0208 847 5338  
Email [ccc@thinkauto.co.uk](mailto:ccc@thinkauto.co.uk)

Cam and valve train

## Research & Development Services

for the Performance Motor Industry & Race Engine Builders



The specialists in prototype and small batch high performance camshaft design and manufacture.

- In-house profile design
- Small batch prototypes
- Confidentiality assured
- Quick response times
- Sensible costings
- Superfinishing
- Landis 3L CNC Cam Grinder
- Extensive database of profiles available



# PIPER CAMS

<http://www.pipercams.co.uk>

Piper RS Ltd. 2 St. John's Court, Ashford Business Park, Ashford, Kent TN24 0SJ United Kingdom  
Telephone: (+44) 1233 500 200 Fax: (+44) 1233 500 300

# Motorsport's island paradise

Sun, sand, rum and rallying sums up Barbados' motorsport ethos. But underneath there's an untapped pool of motorsport knowledge and enthusiasm, just waiting to shine

Words	Sam Collins
Photos	Collins; Martin Sharp

Situated on the southern edge of the Caribbean, Barbados is at first glance totally unremarkable, at least from an automotive point of view. The holiday destination of choice for wealthy Britons is mainly notable as an exporter of rum and laid-back living. It rarely features on the radar of the motorsport industry, but this looks set to change.

This is a nation that has gone, or perhaps always has been, motorsport crazy, and it was estimated that around 10 per cent of the population attend at least two motorsport events a year. 'Motorsport is the biggest spectator sport in this country. Other sports struggle to get crowds,' explained Noel Lynch, the island's minister for tourism. 'But with this the organisers struggle to get all the fans into the circuit in time,' he continued. 'What a fantastic situation for a sport to be in.'

As with any motorsport area with a large fan base, there is a huge aftermarket sector inspired by the on-track antics, and everyone talks about the sport on a fairly constant basis. Antonio 'Stones' Da Silva, one of the people behind the island's biggest motorsport event, Rally Carnival, reveals why: 'People in Barbados are proud of their cars, it is very much a car culture. Although not everyone can afford the best or newest cars, they make the best of what they can get.'

'Rally Carnival' is the island's biggest event, with competitors from Europe and the Caribbean gathering to compete on the island's challenging asphalt rally stages. 'Rallying is what we do best here at the moment,' reasons Da Silva. 'Rally Carnival is just that – a two-week combination of motorsport and partying. Our roads are perfect for rallying, partly because we probably have too many of them. The Barbados road network is very

dense in comparison to the rest of the Caribbean; every plantation used to be bordered by roads so they run everywhere.' Crowds of up to 25,000 spectators turn out to see local entries take on the top amateur crews from Europe – helped by the event organisers striking a deal with a shipping line to transport competitors' cars to Barbados. 'A lot of professionals, or those who chase championships, don't do it because they effectively lose their car for three months,' said Da Silva. 'But we attract a lot of amateurs who just compete for fun. For them, it's the ideal holiday – sun, sea, sand, rum and rallying.'

Motorsport in Barbados is not just limited to rallying on the country's numerous closed roads, there are also two permanent facilities: Vaucluse Raceway Park and Bushy Park. However, of these, Bushy Park is currently the only race circuit on the island. It is a small, basic facility, similar in

Rorty, production-based saloons are extremely popular with the enthusiastic crowds

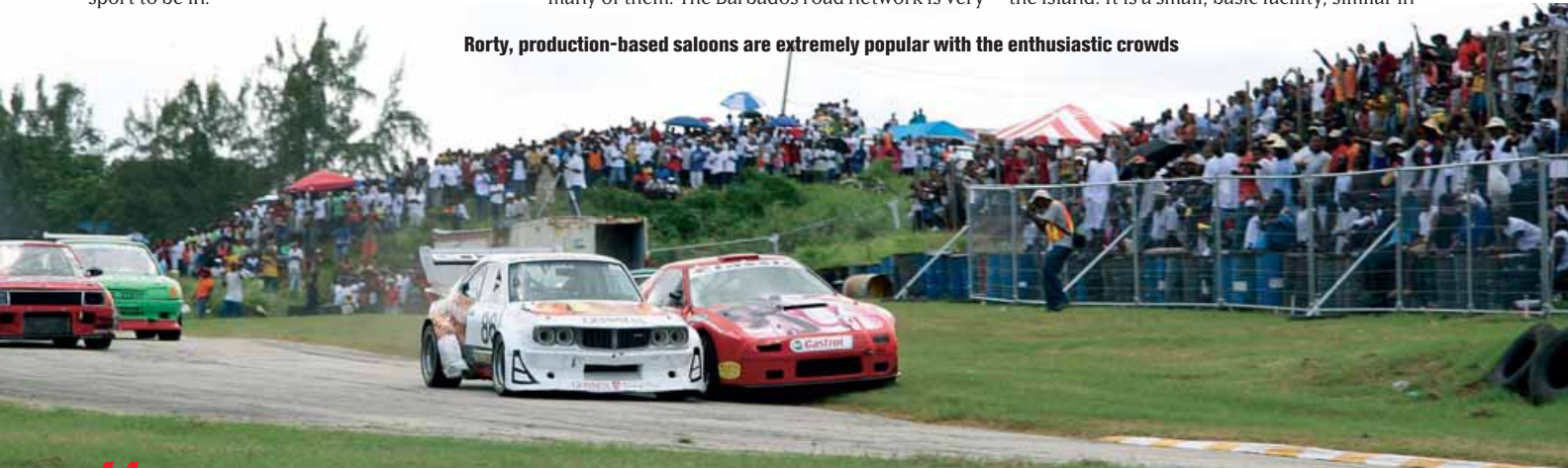

**“MOTORSPORT IS THE BIGGEST SPECTATOR SPORT IN THIS COUNTRY”**

YyPG Proudly Presents, Thx for Support



**Nowhere else in the world has quite the same attitude to motorsport...**

character and size to Lydden Hill in England. Safety measures are almost non-existent: small unsupported tyre walls in key spots, allied to some empty oil drums on the starting grid. There are no physical barriers between the track and pit area, and in places nothing between the action and the spectators other than common sense.

The pit garages are just wooden frames. Any international entries (who mainly come from Guyana) have their car's shipping crate in addition to act as covered garages. It is an aged venue and its 0.8-mile layout, whilst challenging, is under developed, due to a prolonged period of inactivity that ended a few years ago. The surface is very rough, crazed and broken up in places, and nature has reclaimed some of the circuit's width where the edges have crumbled away to nothing. But the circuit has a strong spectator following and a lot of charm. A lively open saloon car series

entertains at every opportunity, with the enthusiastic crowd cheering audibly over the noise of the unsilenced racers. RE visited the Bushy Park circuit on a day when it was 'closed', and was surprised to see a good number of spectators in the track's only grandstand. A handful of the international entries had organised an impromptu test session and were running just under race pace – shaking down their cars and learning the track. Yet locals were turning out just

to watch the unofficial testing. Motorsport it seems is a very popular thing amongst the black contingent of the island who make up 95 per cent of the total population.

There are local heroes to cheer on in highly modified and spectacular fire-spitting machines. During the recent 'International Show Down' at the track the real passion that Bajans hold for motorsport was demonstrated. A record crowd witnessed the circuit champion and the Guyanan lap record holder play out a high-speed grudge match on track, driving the spectators into a frenzy that only a high speed drifting demonstration and a new car launch could pacify. It was the stuff that made series like NASCAR and the BTCC famous and attractive to spectators and sponsors alike.

Because there are few rules, the cars range from humble Minis and Volkswagens to flame- →

**“OUR FANS LIKE SALOONS, BECAUSE THEY CAN ASPIRE TO THEM”**



**Rallying in Barbados has reached an international level with a number of ex-works World Rally Cars currently active on the island's rough asphalt road courses**  
 YEPG Proudly Presents, Thx for Support



# DOCKING

Advanced Cooling Systems

**Water Radiators  
Intercoolers  
Oil Coolers  
Heat Exchangers  
System Design  
Ancillary Products**

Manufactured to your requirements by the UK's leading supplier.

Tel 00 44 (0) 1327 857164  
Fax 00 44 (0) 1327 858011  
Website [www.dockingengineering.com](http://www.dockingengineering.com)

Unit 15 Silverstone Circuit • Silverstone Northants • NN12 8TL • United Kingdom



DESIGN • FABRICATION • RACING SERVICES

Our production knowledge, racing experience and design innovation ensure that our components fit and perform to the highest standard.

Prototype development and technical project management are available as are consultation and track support for formula and sports car teams.



Supplier for:



[www.snapdragonms.com](http://www.snapdragonms.com)

53 South Prospect St., Amherst, MA 01002 USA  
413.256.0861 Fax: 413.253.0936



## S60 PRO

DTAfast is proud to announce the all new S60 PRO - a race engine management system newly designed from first principles in both software and hardware

Performance	exceptional under all conditions
Reliability	absolute
Software	approachable and intuitive in the DTA tradition
Features	comprehensive

*Engine management in the digital age*



DTAfast, 10 Boston Court, Kansas Avenue, Salford M50 2G  
Tel: +44 (0)161 877 1419 Fax: +44 (0)161 877 7086  
Email: [office@dtafast.co.uk](mailto:office@dtafast.co.uk) Website: [www.dtafast.co.uk](http://www.dtafast.co.uk)

## PIT TO CAR RADIO

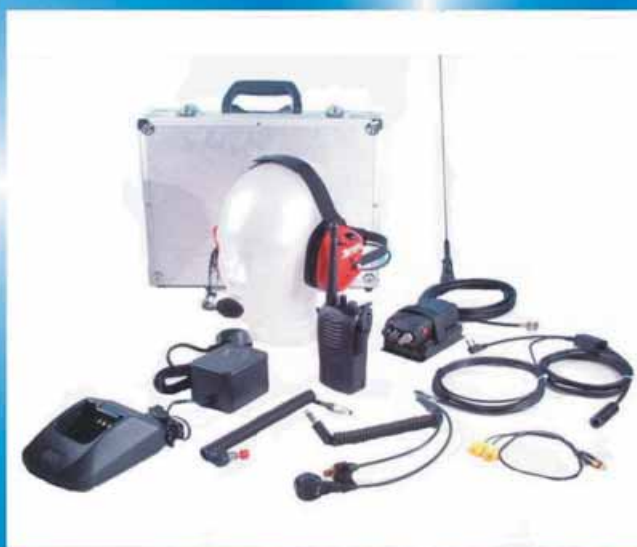

**SYSTEMS FOR ALL TYPES OF RACE CAR**

0044(0)1508 528837

[Sales@autotel.co.uk](mailto:Sales@autotel.co.uk)



[www.raceradio.co.uk](http://www.raceradio.co.uk)

YYePG Proudly Presents, Thx for Support

**Bushy Park is the island's premier but undeveloped venue**



**Safety standards are almost non-existent, allowing spectators to really get involved with the thrill of the sport**



**Vaucluse Raceway Park, currently a rally sprint course, has the potential to be developed into a good standard facility**



**The pits at Bushy Park are spartan at best, but with tropical weather who needs walls?**



YYePG Proudly Presents, Thx for Support

belching, rotary-engined beasts, and some homegrown engineering talent is starting to show through. Looking over the cars in the paddock reveals that a Barbados motorsport industry, although still embryonic, is starting to grow. Yet seemingly no European or US-based racing supplies firm is making a serious effort to trade with the islanders.

Vaucluse Raceway Park is situated on one of the island's high points, not far from the affluent west coast of the island. Developed by rally carnival organisers, it is currently a 2.8km rally sprint course, but has real development potential, and its current operators are keen to make it a significant motorsport complex. Like Bushy Park, the facilities are basic, and further development must be undertaken to sustain activity. Currently the venue closes for six months of the year.

Greg Cozier is one of the men behind Vaucluse Park, and has some ideas about how to further the sport on the island: 'We are currently at a bit of a turning point. Between this year and next year, some decisions have to be made.' He continues to

**“SOME HOME-GROWN ENGINEERING TALENT IS STARTING TO SHOW THROUGH”**

pass opinion on the state of the nation, 'As far as rallying is concerned I think we have gone as far as we can go. Circuit racing hasn't got near that level yet, but unfortunately it is very difficult to sustain both. We are still a small island with a relatively small amount of active drivers,' he warns. 'I would like to see rallying continue at the level it is, with the Rally Carnival doing as well as it has done for the last five years. We need to settle on a single formula for some kind of circuit racing that wouldn't eat into the size of the rallying scene – something that wouldn't take away drivers, cars or sponsors. That's where we are and we want to see how best to do that.'

One plan is to build a half-mile oval track at Vaucluse Park to attract NHRPA Hot Rods and Legends from Europe, and perhaps even a number of cars from the USA for some kind of international championship event, as well as developing a domestic NHRPA-style class. Cozier expands: 'We are thinking about something that is preferably rear-wheel drive, loud and quick. Also something that can be supported by all the dealers because we don't really have any dealer support here. That's why the whole idea of the National Hot Rods came up because the cars are exciting, light and fast. They are cheap and easy to maintain and run, and whilst contact is frequent, they are very easy to repair. Also they are marketable and sponsor friendly. We can →

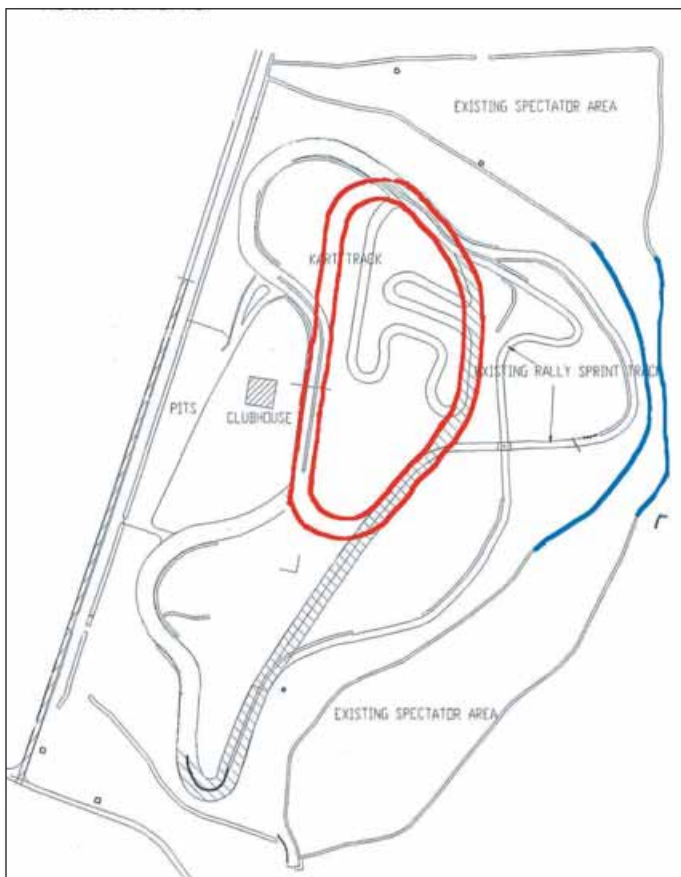

Plans for the development of Vacluse could include a half mile tri oval (shown here in red), as well as a drag strip and kart circuit. Event organisers are particularly keen to attract more competitors from Europe and the USA

**“WE HAVE ALL THE FACILITIES IN BARBADOS”**

get local dealers involved and they can fit any plastic body on they want over the spaceframe.’

Stock car racing seems to fit with the Barbados scene as there is apparently ‘little interest in bringing single-seat or prototype racing to the island, our fans like saloons or what look like road-based cars, because they aspire to them.’

So, on an island where even the minibus taxis are fitted with aftermarket spoilers, perhaps UK-style National Hot Rods are the logical answer, especially as they have been described by some publications as ‘Europe’s answer to NASCAR’ and ‘a boy racer’s wet dream.’

Cozier continues: ‘The oval track idea came about because motorsport on the island has to be sustainable locally, and around here competitors come from very varied levels of society. Some of them are a lot wealthier than others so it’s important to find a formula where people can compete fairly at a reasonable budget. At the same time, the spectators are very knowledgeable and sensitive to what’s going on in the rest of the motorsport world. They also like the spectacle of driving so it’s got to be an exciting formula.’

Vacluse Park is an ideal location for a stock car circuit as it forms a natural bowl, so offers the good spectator viewing that is essential for oval racing to be a success. The current format of Bushy Park could also accept the oval track cars, allowing for at least a two-circuit championship to take place on the island.

Other ideas include creating drag strips and a race circuit somewhere on the island to attract

series like international Formula 3 – an idea popular with some of the local competitors, including golf club groundsman and driver of a racing Volkswagen Beetle, Henief Gooding: ‘In five years time I would like to see a very international-type circuit here, with a drag strip, and perhaps even able to accommodate Formula 1 cars. We have all the facilities in Barbados: good health facilities, good housing and incredible hotel accommodation. I think the crowds are only going to increase.’ It is clear that Barbados could become a good destination for a motorsporting holiday, both for the engineer or driver and also their family.

West Surrey Racing’s circuit designer, Clive Bowen, spent time on the island during the international race week, flown in by local businessman and motorsport enthusiast Bizzy Williams, to see what ideas are feasible for the future development of the sport in Barbados. Whilst no firm plans were made, these are certainly moves in the right direction.

Whatever the future holds for Bajan motorsport, it is certain that it will continue to grow, and there seems unlikely to be a shortage of amateur racers and rallyists willing to journey there from Europe to compete on what is fast becoming motorsport’s paradise island. RE

## Bolt-on goodies

Aftermarket is a huge sector on the island of Barbados. Everything from minibuses to Subarus has some kind of non-standard bit on it from ‘go faster, get noisy’ exhausts to spoilers and racing seats. And there is huge enthusiasm for any kind of performance car.

Looking over the Bajan and Guyanan competition cars in action at Bushy Park is like reading a who’s who of motorsport engineering firms, including everyone from ATL to Zircotec. It appears, however, that few of these

firms have noticed this rapidly-growing market. There are no speed shops here, no Demon Tweaks, Atech or similar. Performance exhausts are sold in electrical equipment shops and almost everything else is imported. Whilst the market is small, it is vibrant and active, with a good amount of competitors and a seemingly limitless amount of aftermarket customers, there is a real opportunity for an EU or US-based competition car supplies company to set up shop here.

YYEPG Proudly Presents, Thx for Support



**NORTON MOTOR SPORTS**  
SERVING THE MOTOR SPORTS INDUSTRY

3D CAD-CAM  
WIRE EROSION  
SPARK EROSION  
CNC MILLING  
CNC TURNING  
CNC HARD MACHINING  
UNIVERSAL GRINDING  
SURFACE GRINDING  
BENCH POLISHING & ASSEMBLY  
INSPECTION

DIRECT TEL: +44 (0)1327 811597  
DIRECT FAX: +44 (0)1327 811539  
EMAIL: PETER@NORTONMOTORSPORT.CO.UK

HIGH PRECISION MACHINED PARTS FOR  
FORMULA 1 • WORLD RALLY • TOURING CAR • HISTORIC



34-36 BURNERS LANE, KILN FARM, MILTON KEYNES MK11 3HB  
TEL: +44 (0)1908 561444 • Fax: +44 (0)1908 307519

DESIGNER AND MANUFACTURER  
FOR THE MOTORSPORT INDUSTRY



**PERFECT BORE**  
Race pistons & liners

- Design Engineering
- Precision Forgings
- Forged Pistons
- Performance Cylinder Liners
- Block Conversions
- Bore Coating

Perfect Bore Ltd  
+44 (0)1264 774330  
e-mail sales@perfectbore.com  
www.perfectbore.com



**THE racing crankshaft manufacturer**

*Finest art for finest engine tuners*

**Chambon**

**CRANKSHAFTS**

Race proven in Formula 1,  
Nascar, WRC, DTM,  
F3, A1, WTCC, Le Mans,  
ALMS, NHRA,  
Formula Nippon,  
S1600, Historic,  
GP1, Superbike ...



**Chambon**  
CRANKSHAFTS

81, rue de la Tour  
BP 640  
42042 Saint-Etienne Cedex 01  
France  
Tel. : +33477 92 34 92  
Fax : +33477 74 33 58  
sales@chambon.com

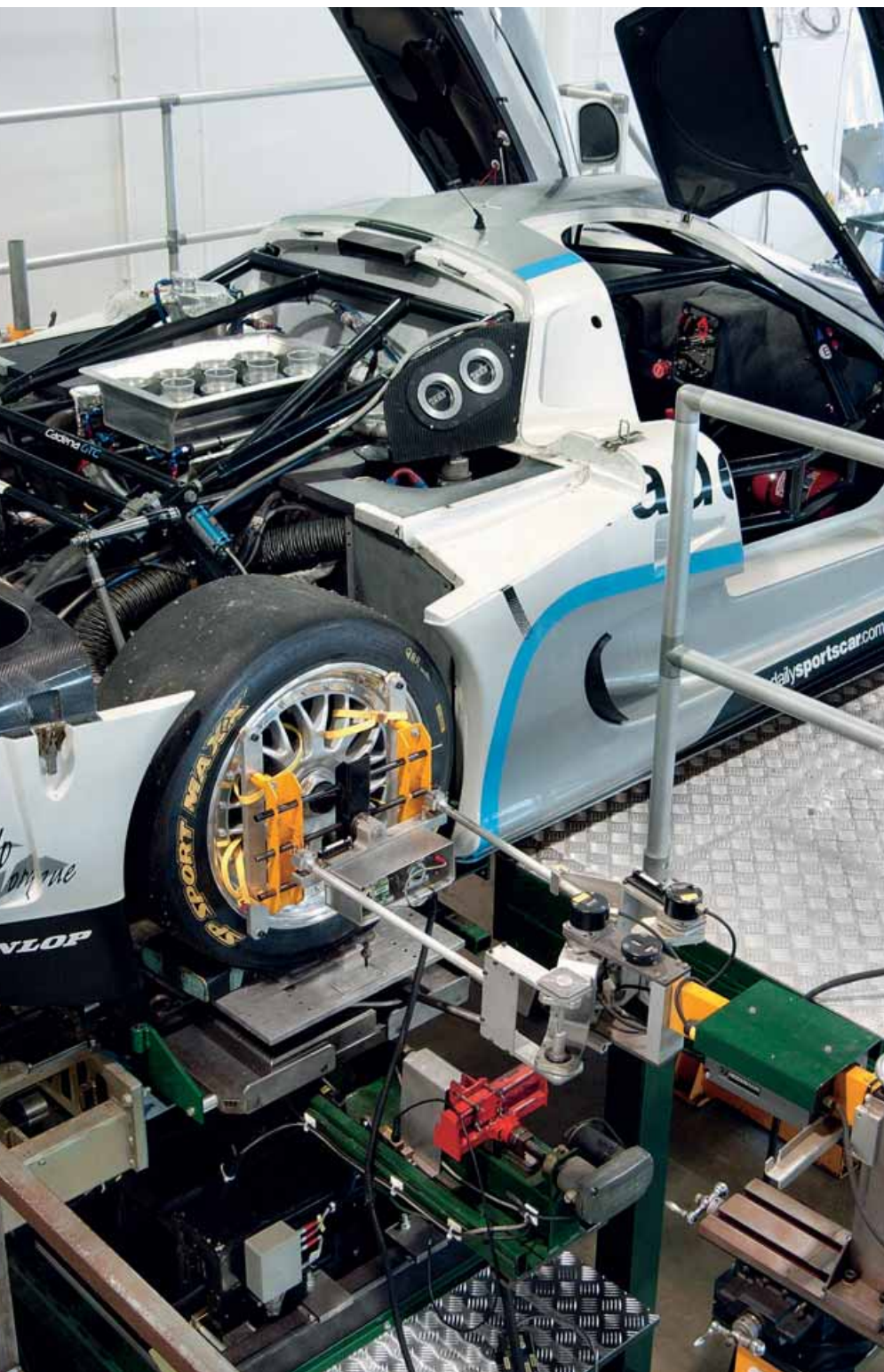

Kinematics and compliance testing are key to extracting the best performance from a chassis. Lotus Engineering explains how it works

Words	Charles Clarke
-------	----------------

Photos	LAT
--------	-----

**S**KCMS is Lotus Engineering speak for Suspension Kinematics and Compliance Measurement System. This in turn is a fancy name for a custom vehicle measurement rig designed, developed and made in-house by Lotus Engineering.

'We did some early kinematics and compliance tests about 14 years ago, really before anybody was looking at K and C measurements,' says Ray Hill, vehicle testing validation area manager at Lotus Engineering. 'We had a small test rig, which we used for our own in-house measurements. This development preceded our kinematic software development by about a year or two. We'd had the rig for about five years before PCs had developed to the extent that they could do anything useful with kinematic lab data.'

When Lotus started this work the 386 was the popular PC, which just about had enough puff to handle spreadsheets and word processing. The 386 and 486 were only marginally capable of controlling the test machine and simple data logging. 'For our first machine the test results populated an Excel spreadsheet which you could use to get x, y plots with slopes,' says Hill.

As computers developed, standard software like MatLab took over the results capture, display and interpretation. Data was presented to MatLab from the machine in the way that the software required. Around the same time, because of the greater general availability of computer power, Lotus Engineering started to develop its own kinematics and compliance analysis software (see *Racecar Engineering* V15N2).

'It all started with a notion to try and quantify some of the ride and handling characteristics of the vehicle,' says Hill. 'When the rig was first developed, there were only three similar rigs throughout the world – one in the US, one in Germany and one in France. These were mainly owned by the tyre companies who used them to gain quantitative information about their tyres.'

Because of the type of development and consultancy work done by Lotus Engineering it needed something to measure vehicle kinematics

# Character of deformation

YYePG Proudly Presents, Thx for Support

and compliance parameters. Initially it rented time on the tyre company machines on a project-by-project basis, but it soon became clear that it would be much more convenient to have a machine in-house.

'We would be doing a development project with Goodyear or Michelin and would have to go to their machine to run tests,' say Hill. 'Also, generally speaking, the information we got from these machines was not always in the right format and in many situations it was a case of the data being appropriate for tyres but not for suspensions. So we decided to build our own machine. At the time the Shark (kinematic) software suite was being developed so we had a fairly good idea of the kinds of data we needed the rig to capture. We knew the kinds of characteristics that were important and needed to be measured and the kinds of things we needed to change to improve the vehicle performance.'

Based on discussions with the suspension analysis department and the ride and handling engineers a detailed specification for the rig was put together. 'In terms of the design process, we examined the measurements we needed to take and basically designed the rig around these requirements,' says Hill. 'To some extent the initial design was influenced by the kinds of machines that were in use by the tyre companies, although their machines operated in a slightly different way.'

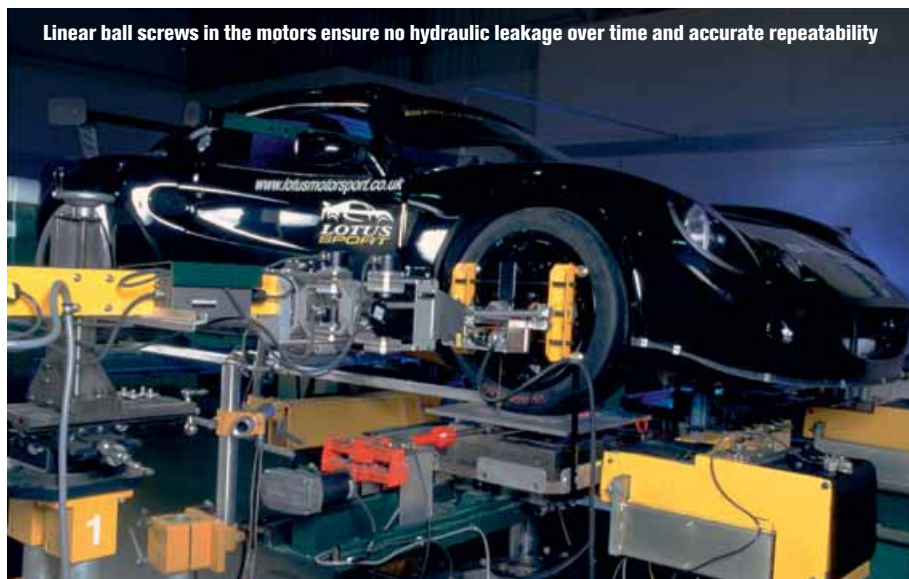

Linear ball screws in the motors ensure no hydraulic leakage over time and accurate repeatability

**“YOU ARE NOT FORCED TO ASSUME THAT COMPONENTS ARE PERFORMING TO SPECIFICATION”**

The Lotus SKCMS machine can be split into four basic areas:

1. A system to measure the movement of each wheel in all directions (six degrees of freedom
- three translational and three rotational).
2. A system that measures the deflection of the body relative to ground in six degrees of freedom. (When a test is performed these values are subtracted to produce absolute values so the test results are not influenced by the fixing of the vehicle to the test machine.)
3. There is a force measuring system that mechanically splits the x, y and z forces without any cross coupling, which means that no mathematical corrections are necessary on the force measurement system. The vertical →



The Lotus rig measures the movement of each wheel in all directions – three translational and three rotational. It also measures deflection relative to the ground

YEPG Proudly Presents, Thx for Support

load cells only measure vertical load, the lateral load cells only the lateral loads and likewise the fore and aft cells. This was one of the objectives of the initial design.

4. The machine has an electro-mechanical drive system which uses high response servo motors with linear balls screws – these are very quiet, reliable and the big advantage is that when the drive stops the system remains in that position indefinitely. (If the drive mechanism were hydraulic, like a traditional four-post rig, you would get leakage over time and the system would eventually settle.)

'If you hit the emergency stop for any reason the mechanism is locked and it stays in that position,' says Hill. 'By that token the results are repeatable and accurate. We also have a very simple mechanism for clamping the vehicle in place.'

Gavan Kershaw, a senior ride and handling engineer at Lotus Engineering, is a talented sportscar racer in his own right. His current weapon of choice is a GT2-specification Mosler MT900R that has been spending some time on the SKCMS rig. 'The work we were doing on Gavan's Mosler fits squarely into the category of suspension refinement,' says Hill. 'Gavan is an experienced ride and handling engineer and has a very good idea of how he wants the geometry to behave under load. With racecars you can quantify things like anti-roll bar stiffness so that if the anti-roll bar is adjustable you know exactly the level of stiffness that each level of adjustment provides. You can get true wheel rates and it

allows you to ensure that the theoretical situation is as close as you could possibly get to the physical one.'

There have been instances in the past where Lotus Engineering has been testing racecars with so-called 'adjustable components' that were not providing the level of adjustment originally specified. This generally helped to explain why the appropriate performance changes were not experienced when adjustments were made based on the initial specifications. 'It's not necessarily a case of the manufacturers misleading the

### “IT CAN FILTER THE MASS OF INFLUENCES ON RIDE AND HANDLING PERFORMANCE”

customer, other things can be happening with other components to negate the adjustment,' says Hill. 'Things like the anti-roll bar supports deflecting in an undesirable fashion when maximum anti-roll bar stiffness is applied. Only when you get the car on a rig where you can isolate and identify the contribution of all components can you identify these problems with any level of certainty and you know exactly what's happening when particular adjustments are made.'

You can also use the rig to set up certain suspension characteristics. 'In the case of the

Mosler we were setting up the rear bump steer,' says Hill. 'This is adjustable on the toe link for height so we were able to quantify how each increment changed the bump steer and exactly the extent of the toe-in for each increment. We can then set the bump steer to match required values that we get from the kinematics software.'

Once you've done an analysis like this you are much better able to postulate behaviours from what you know about the vehicle. 'It's far easier than sticking a wet finger in the air in the circuit garage,' says Hill. 'For people like Gavan, because of his experience he's got a pretty good idea of what sort of compliant steer and bump steer curves he's expecting, to give the response in the vehicle that he likes. For him, supplying the curves is enough, effectively calibrating his car. When he goes out and experiences a certain behaviour, because he knows so much about the kinematics and compliance of the whole car, he's got a better chance of tuning the behaviour to his liking than someone using a trial and error process in isolation.'

For other clients the information from the test machine can be used with Lotus' kinematics and compliance software to help diagnose problems – this is a bit more time consuming and expensive but it provides the whole package.

In an ideal world, on a new project you would probably end up with a mule-type car. You would do some measurements and see how they compared to what you believed you'd designed. Hopefully they would be close, and then from the results of the test machine they can be used in the



'Quasi-static, low-speed testing' eliminates interference from rubber bushes and dampers which could otherwise affect test results

YYePG Proudly Presents, Thx for Support



**The ability to isolate every individual component means subjective track test results can be confirmed and specific parameters quantified and investigated**

kinematics and compliance software to predict how you would expect that vehicle to behave on the road or test track. Or you could find out how to correct the mule vehicle to make it behave the way you wanted it to.

'Recently a manufacturer came to us for us to assess their new car,' says Hill. 'Initially we gave them a subjective opinion of the car and identified some issues with the steering just from taking it around the track and on public roads. We then put the car on the rig to quantify the front and rear suspension characteristics and from that we identified some parameters that were probably contributing to some of the steering issues. Things like rear axle lateral stiffness that was not really appropriate to the type of vehicle. We then did a short exercise to address these issues through various component changes – different rate rubbers and bushings, different wheel bearings and some other things. We verified the changes on the rig and then drove the vehicle and the customer went away happy.'

The whole duration of this exercise was probably about three weeks. 'Chances are that the problems would not have been identified in this relatively short period of time using trial and error techniques. Also, trial and error would have taken a very long time to identify some other more discreet and obscure component interactions, if they could be found at all. The beauty of SKCMS analysis is that every component can be isolated and measured and its effect on performance can be quantified with software.'

Also, you are not forced to assume that components are performing to specification – if you have no way of measuring the lateral stiffness of a wheel bearing in situ you may be erroneously assuming it's okay.'

The rig is only designed to measure suspension kinematics and compliance characteristics. According to Hill, 'If you take some measurements and identify some small changes that you think will help and still don't solve the problem, perhaps it's an issue with the overall basic torsional stiffness of the vehicle. In which case, as

**“THE RESULTS ARE REPEATABLE AND ACCURATE”**

long as the client agrees, we would use our body torsion test rig to calibrate the torsional characteristics of the vehicle and to look at what we need to do to improve them.'

From the measurements on the SKCMS rig you will normally have a very good idea of what other systems could be contributing to the poor performance (other than the suspension and steering). This will usually direct attention to other test equipment.

Many ride and handling issues can be addressed with different shock absorber settings and spring rates. 'It could even be a problem with the design of the shock absorber itself, which is

limiting what you can achieve with the vehicle,' notes Hill. 'This is quite common with vehicles at the economy end of the market.'

Where there are complex interactions taking place it is sometimes very difficult to identify the offending components without detailed SKCMS data, and without the data it is very difficult to come up with remedial actions. It is doubly difficult for the weekend racer who does not have extensive ride and handling engineering experience to attempt any kind of rigorous remedial trial and error programme that has any hope of success.

If a particular vehicle has some undesirable characteristics and these are not being addressed by reasonable trial and error then, rather than continue the unsatisfactory experience, a visit to an SKCMS rig could probably yield beneficial results relatively quickly.

'Normally the first order of business is a brief assessment on the test track by our ride and handling engineers,' says Hill. 'This will identify issues and from there we would do a fairly short exercise to quantify the suspension on the SKCMS machine,' says Hill. Based on previous experience, this kind of exercise can be done in as little as two days. 'We've done a number of short racecar projects of the order of two days and generally speaking the customer goes away happier (you'll never satisfy racers 100 per cent of the time). Also, there are usually some things that cannot be fixed under the regulations, even if we find a problem.'





Lotus Engineering developed its rig in stages as its knowledge and requirements for data acquisition and processing increased. 'We had the basics of our current machine when we were approached by a Japanese bus manufacturer to do some tests on his vehicles,' Hill told us. 'This required us to dismantle and re-configure our machine to take a 10,000kg test load. We found a fundamental problem in this particular case that was fixed relatively easily and, because of the experience, the manufacturer asked us if we could supply them with a test machine. So we designed a 10,000kg machine especially for them. This led us to supply machines for other clients. All the time we were doing this work we were evolving the technology of the basic SKCMS machine so that our own equipment benefited from the development of the concept for other clients. Since then we've sold another two machines to other locations around the world.'

## “EVERY COMPONENT CAN BE ISOLATED AND MEASURED AND ITS EFFECT ON PERFORMANCE CAN BE QUANTIFIED WITH SOFTWARE”

When Lotus was first thinking about developing its own machine a lot of the early ideas came from the machine tool industry. Things like linear ball screws are fairly commonplace on machine tools. 'We went for this kind of technology because it has proven to be inherently reliable over the years and is readily available,' says Hill. 'This is why we decided to make the machine an electromechanical device. This kind of technology

for controlling machine motion with motors was in its infancy when we started, and since then it has become much more mainstream.'

'Our current tests we describe as "body static at low speed". We do this for two reasons – we don't want to excite the shock absorbers (which we test separately) and, when you're testing rubber-bushed suspension, it is essential to test at a constant loading velocity because of the inherent damping characteristics of the rubber in the bushes. Rubber has a dynamic performance which responds to changes in frequency so we concentrate on quasi-static, low-speed tests.'

'The purpose of the quasi-static SKCMS testing is to check out the "as built" situation against the "as designed",' says Hill. 'Chasing down problems is much easier in the static environment.'

Most of the dynamic testing will be done on a four-post 'shaker' rig to examine damper settings and things that can affect the overall dynamic characteristics of the vehicle. 'Gavan uses a four-post rig to check the damper settings for different tyres (wets, intermediates and drys). We are looking at getting one of these rigs next year,' explains Hill.

Shock absorber adjustment and testing is a science in its own right,' he continues. 'It is a common fallacy that if you buy adjustable shock absorbers then all your bases are covered – this could not be further from the truth. Firstly, buying cheap adjustable shock absorbers is not a very cost effective way of solving the problem and secondly, shock absorbers have ranges of adjustment some or all of which may not be suitable for addressing the particular problems of your vehicle.'

Alongside the SKCMS machine Lotus Engineering has a number of specific shock absorber testing machines. Usually, if a client wanted a 'total test package', that would involve rating the shock absorbers at every valve setting to suit the application. 'And,' says Hill, 'from there you can get a good idea of what type of settings would suit the particular vehicle and particular racing conditions.'

This goes a long way to taking the guesswork out of the set-up process. If the vehicle is fully calibrated you can start the set-up process with parameters that are very close to the optimum for the particular conditions, the fuel loads and the tyres. It is interesting to observe that even an experienced racer like Kershaw recognises the importance of continually testing on the SKCMS rig. Even with his experience he relies on the hard data gathered from test measurement, as well as the subjective feel of the test track.

The beauty of SKCMS analysis is that it can filter the mass of influences on ride and handling performance. It identifies problems and you can come away with more problems fixed than the ones you thought existed before you went in. RE

## Gavan Kershaw

Cadena GTC Team in its previous guise as Gavan Kershaw Racing won the 2004 British GT Cup Class Dunlop Superpole Award at its first attempt. Gavan and team mate Barrie Whight claiming three race wins, four podiums and the majority of fastest race laps in the process.

For 2004 the team thoroughly re-worked a Lotus Motorsport Elise, making it the most advanced example of its type in the world, and it will approach the preparation and running of its newly acquired GT2-specification Mosler MT900R in exactly the same way.

The team, now re-named Cadena GTC, is made up of highly skilled and motivated personnel, all of whom have the desire to win.

Kershaw's racing career started at a young age, winning several karting championship titles. He then progressed to stock cars where he won multiple British championships. More recently, he has been crowned 2003 Lotus Roadsports Series Champion and 2004 British GT Cup Dunlop Superpole Champion.

Kershaw is also principal vehicle dynamics engineer for Lotus Cars. His role is to extract the best out of Lotus cars to make them the fantastic drivers' cars they are famous as. He was involved in the development of the Mark 2 Elise/



Kershaw (left) with team mate Barrie Whight

Exige, the VX220 and the Motorsport Elise.

Away from the racing circuit, Kershaw has appeared on BBC Top Gear, as well as other television programmes and magazines. He has also won the Autocar Oversteer Challenge four years running, beating F1 and rally stars in the process.

Website: [www.cadena-gtc.com](http://www.cadena-gtc.com)

### Team results:

- 2005** Tag Heuer GT250 winners
- 2004** British GT Cup Class Dunlop Superpole Award winner; dailysportscar.com National Motorsport Car of The Year; Gavan Kershaw voted British GT Driver of The Year; British GT Cup Class – three race wins
- 2003** Lotus Roadsports Series Champion

YYPG Proudly Presents, Thx for Support



**ENGINEERED TO PERFORM**  
world leaders in high performance pistons



**POWERING WINNERS IN MOTOGP, WORLD SBK, AMA,  
BRITISH SBK, SPEEDWAY, LE MANS, BTCC AND MORE...  
OFFICIAL SUPPLIERS FOR ALL A1GP ENGINES**



**Omega Pistons**

Oak Barn Road, Halesowen  
West Midlands B62 9DW

Tel: 0121 559 6778  
Fax: 0121 559 6779

info@omegapistons.com  
www.omegapistons.com

YYePG Proudly Presents, Thx for Support

**RACE PROVEN  
TECHNOLOGY**

Performance Fluid Transfer Systems

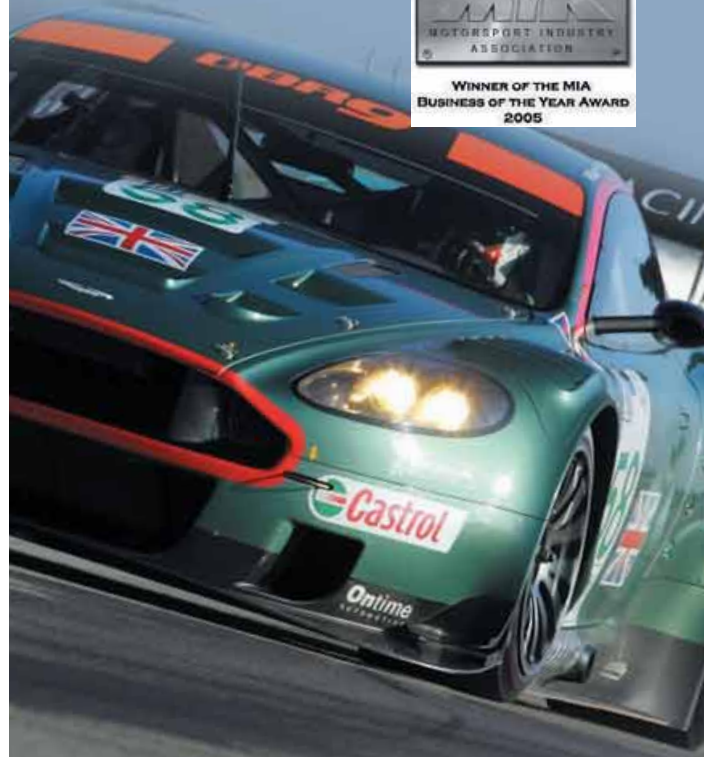

Tried, tested and used by the world's  
leading motorsport teams



**GOODRIDGE**

**PUSH THE LIMITS**

GOODRIDGE (UK) LTD GROUP HQ. EXETER AIRPORT EXETER, EX5 2UP ENGLAND  
Tel: +44(0)1392369090 Fax: +44(0)1392441780 email: uksales@goodridge.net  
HOSE AND FITTINGS GUARANTEED FOREVER



LA (310) 533 1924 FRANCE (1) 64 38 44 44 GERMANY (0) 6321 60 168 SILVERSTONE (01327) 858799 BENELUX (15) 256 5232 JAPAN (3) 5716 4795 SPAIN (96) 3355306

www.goodridge.net

# The one in the middle wins races



## DS1.11 & DS2.11

SILOXANE TECHNOLOGY

BRAKE PADS



RACING

FEDERAL MOGUL

The best brands in the business

### Relative Performance Characteristics of Ferodo Racing Range Under Heavy-Duty Conditions

	Pad Life	Disk Life	Average $\mu$	Fade	Pedal Travel	Release
DS 2500	Excellent	Moderate	Moderate	Moderate	Moderate	Moderate
DS 3000	Good	Moderate	Moderate	Moderate	Moderate	Moderate
DS 3000+03	Good	Moderate	Excellent	Good	Moderate	Moderate
DS 3000E	Good	Moderate	Excellent	Good	Moderate	Moderate
FER 4003	Good	Moderate	Excellent	Good	Moderate	Excellent
DS 1.11	Good	Excellent	Excellent	Good	Moderate	Excellent
DS 2.11	Good	Excellent	Excellent	Good	Moderate	Excellent

Excellent  
Good  
Moderate

www.federal-mogul.com/ferodoracing

### Race Proven

- DS1.11 - suffix "W"
- A1GP
  - FIA FT
  - Touring Cars
  - Formula Cars
  - Group N
  - Stock Cars
- DS2.11 - suffix "X"
- WRC
  - Rally Group N
  - Touring Cars

YyPG Proudly Presents, Thx for Support



Circuit Supplies (UK) Ltd

Unit 22, Harmill Industrial Estate, Grovebury Road,

Leighton Buzzard, Beds LU7 4FF

Tel: 01525 385 888 Fax: 01525 385 898

info@circuitsupplies.com www.circuitsupplies.com

# EXCLUSIVE subscription offer



## Get 3 FREE issues

### GREAT REASONS TO SUBSCRIBE:

- 3 issues absolutely FREE\*
- SAVE a further 20% off the cover price after your trial period with Direct Debit, paying only £3.68 an issue
- Spread your payments with Direct Debit, only £11.04 a quarter
- FREE delivery direct to your door by priority mail, anywhere in the world
- Don't rely on reading someone else's copy – make sure you stay one step ahead
- An essential read for all motorsport professionals, amateurs, students and enthusiasts alike

**Call our hotline now! +44 (0)845 6767778**  
**or go online [www.racecar-engineering.com](http://www.racecar-engineering.com)**

Lines are open 9am–9pm, UK time. Please have your details ready when you call, quoting code **28R**. Please note, offers vary online

#### SUBSCRIPTION PRICES

UK 3-monthly direct debit	£11.04	<b>Save 20%</b>
USA annual	\$106.87	<b>Save 15%</b>
UK annual cheque/credit card	£46.92	<b>Save 15%</b>
Europe annual	€80.38	<b>Save 15%</b>
Rest of World annual	£66.90	<b>Save 15%</b>

\*If you are not completely satisfied, you can cancel your subscription on receipt of your second issue and pay nothing. To keep receiving your subscription, you don't have to do anything – the subscription will automatically continue at a discounted low rate. The 3 free issues are yours to keep whatever you decide. Offer ends 24 February 2006.

YEPG Proudly Presents. Thx for Support.

www.reigersuspension.com



info@reigersuspension.com



Reiger Racing Suspension  
Molenenk 5a  
NL-7255 AX Hengelo (Gld.)  
Tel.: + 31 (0)575-462077  
Fax: + 31 (0)575-463316

U.K. sales:  
Octave Engineering Consultancy  
Chestnut Cottage \* The Green  
NN11 3AF BADBY Northants  
marc@octaveengineering.com



**AURORA**  
BEARING COMPANY

QUALITY SYSTEM  
REGISTERED TO  
ISO 9001:2000  
(WITH AS9100)

The **Motion-Transfer Specialists**  
The widest range of styles  
and configurations of  
**Rod Ends** and **Spherical Bearings**  
in the industry,  
for all your racing needs.

*Now available:*

Aurora Bearing CAD drawings, 3-D models,  
and catalog on line at

[WWW.AURORABEARING.COM](http://WWW.AURORABEARING.COM)

Contact us for free catalog and free CAD drawing library CD

**Aurora Bearing Company**  
970 South Lake Street  
Aurora Il. 60506  
U.S.A

Phone: ++ 630-859-2030  
Fax: ++ 630-859-0971

e-mail: [aurora\\_rodends@aurora.com](mailto:aurora_rodends@aurora.com)



RACE CAR ENGINEERING AND FABRICATION.

MANUFACTURES OF ALL RACE CAR  
COMPONENTS.



THE HIGHEST STANDARD OF WORKMAN SHIP  
GUARANTEED.

SDW LIGHT FABRICATIONS LIMITED  
UNITS 5 & 6 OVERTHORPE ROAD  
BANBURY, OXFORDSHIRE  
OX16 8SX

TEL. (01295) 270710

FAX. (01295) 273254

E-MAIL. [info@sdwlightfabrications.co.uk](mailto:info@sdwlightfabrications.co.uk)

[www.sdwlightfabrications.co.uk](http://www.sdwlightfabrications.co.uk)

**Raceshop** is a section of *Racecar Engineering* written for people who are in the process of designing, building or running racecars. **Raceshop** is designed to be interactive. We want you, our readers, to let us know about your company, your new products and your engineering problems. **Raceshop** can provide you with a showcase for your products or the answers to your engineering questions.

Send your details to those listed below for each of **Raceshop's** sections. You can either send material direct to the Leon House address on Page 5, or to the email addresses below...

**Racegear:** racecar@ipcmedia.com

**Database:** Tony Tobias  
tony\_tobias@ipcmedia.com

**The Consultant:** Mark Ortiz  
markortiz@vnet.net

**Aerobytes:** Simon McBeath  
via: racecar@ipcmedia.com

## 69 Dampers

Ian Wagstaff looks at the latest developments in damper technology

## 77 Racegear

Our review of the latest products and components for racecar engineers

## 83 Database

*Racecar's* comprehensive, easy to use directory of contact details for motorsport engineering companies, manufacturers, suppliers, teams and much, much more – exclusive to **Raceshop**

## 93 Aerobytes

Simon McBeath looks at front wings and their effect on single-seater dynamics

## 97 The Consultant

Chassis guru Mark Ortiz on tyre pressure, with regard to winter driving conditions



# Shocks away!

Damper suppliers in top-level motorsport is often kept secret, but here is **Racecar's** rundown of the major players in this fiercely competitive market

Words | Ian Wagstaff

**Choosing the right damper is critical to extracting the optimum performance from a racecar, but knowing how to set them up is another skill altogether**

The shock absorber, or more correctly, damper market is a highly competitive one with a large number of players. Some, like Penske, specialises in performance and motorsports, while others, such as ZF Sachs, are major original equipment suppliers to the passenger car market. Included are names like Öhlins, Showa, Dynamics (MTCE), Extremtech, Koni, Moton, Bilstein, AVO, Spax and Leda, with the specialists and major component suppliers competing at all levels.

Penske Racing Shocks, which were first developed for Indy Car in the USA, have been used in virtually all forms of racing throughout the world, including Formula 1, NASCAR, Champ Car, Le Mans and IRL. The latest from the company is the 8770 series 4, which is said to feature relatively recent Formula 1 technology and is suitable for sportscar, touring car and, indeed,

## “IT IS UNUSUAL FOR A SUPPLIER TO DECLARE ITS CUSTOMERS IN FORMULA 1”

anywhere that needs true four-way damping. The need for this has, says Penske, presented itself during the last few seasons with teams requesting more adjustment from their dampers because of the limited amount of testing possible during race weekends.

Penske's first four-way damper was introduced for Formula 1 in 1990 and was successful in its first appearance. Since then the design has been upgraded and re-packaged and has now been on the winners of 75 grands prix. The 8770 is an evolution of this. By offering high and low-speed compression and rebound, it is said to offer the most versatility with external adjustment, reducing the need for re-valves. With four clearly defined adjusters, two affecting bleed, the others high-speed forces, chassis tuning is reckoned to be simpler.

Penske is also expanding into the historic market with a range that debuted at the 2006 Autosport International show. It will also display at the Historic Motor Sport Show in the UK, through its distributor for Europe and Japan, Penske Racing Shocks UK – a division of SPA Designs. →

YePG Proudly Presents, Thx for Support



www.spaxperformance.com



### Motorsport Gas Dampers

- Rebuildable - rapid rebuild service
- Re-valvable - suitable for all applications
- Steel or Alloy Bodies

Bespoke applications a speciality

Krypton Gas filled for greater stability and durability



TrakSPAX Double & Single Adjustable Dampers



CSX Bespoke Dampers



For more details contact your authorised SPAX dealer. To talk directly to a SPAX engineer call 0906 3027729\*

# SPEED IS EVERYTHING



### With Jiffy-tite® Quick-Connect Fluid Fittings

Jiffy-tite Quick-Connect Fittings are made to connect or disconnect in seconds without tools. Absolutely no wrenching is required. That's why racers from every major series – NHRA, IHRA, SCCA, SPRINT and more are seeking out these lightweight fittings with the 100% leak proof seal. Their patented valve technology in both the socket and plug assembly allows the fluid to be interrupted without any mess or spills. For engine swaps, water recirculation or any plumbing that requires a speedy response – Jiffy-tite Quick-Connects are the perfect choice.

- Now available in popular AN/NPT sizes
- Radius port o-ring fittings also available
- NHRA, IHRA approved, SCCA accepted



Made in U.S.A.  
Better By Design

www.jiffy-tite.com 888-605-7788

**Penske Racing Shocks has been manufacturing four-way adjustable dampers since 1990. Its 8770 series 4 is the latest evolution, suitable for many different forms of motorsport**



**MTCE, under the name Dynamic Suspension, offers a complete, four-way adjustable suspension programme called DSSV**

**German supplier ZF Sachs revolutionised F1 damping with its rotational damper (below), as documented in Racecar V15N5**



Öhlins is another supplier to Formula 1, and its dampers have also been used on the all-conquering Audi R8 and on around 30 of the competitors in the Paris Dakar. Another reasonably new four-way-adjustable shock absorber is its twin tube TTX40. This has a 40mm piston and a through-rod shaft without any external gas reservoir. The top eye can be re-locked without opening the damper. The controls for the external adjustment of this have been collected in a single location, while compression and rebound ranges have been kept separate so each adjustment affects only the parameter it is intended to affect. The number of positions (40 on the low-speed adjusters and 50 on the high-speed adjusters) has also been increased relative to earlier products. The weight has also been reduced compared to Öhlins' TT40 damper. For example, the weight of a TTX40 (not including end eye and spring platforms) with 56mm of stroke is about 850g. A number of the NASCAR teams and Indy Racing League currently run on TTX dampers.

MTCE (Multimatic Technical Centre Europe) introduced its DSSV (dynamic suspensions spool valve) technology to a wider market last year, having developed the concept in Champ Car racing with the Newman-Haas team. Until 2005 it had only been available through exclusive arrangements, but now it has been used on such as the Panoz Elan GT car, as well as in the British GT series and both the Japanese Formula 3 and Formula Nippon series.

The P1 Formula 3 Lola team of Danilo Dirani was one to switch to the product during the course of the season. Dirani reckoned that they were particularly responsive to change, especially during a long test session. Following the partnership with Lola that resulted from this, MTCE has designed an SSV specifically targeted at the Formula 3 market for 2006. This will be suitable for Dallaras as well as Lolas. In addition, MTCE

dampers are to be supplied to the new Champ Car Atlantic series.

DSSV is another pure four-way damper which features independent high and low speed valves for control of both bump and rebound. It includes linear indexed adjusters, matched from damper to damper to optimise the symmetry rating across each axle. The external, cartridge-based configuration of the valves means they can be replaced on the damper without the need to disassemble, re-build or bleed the unit.

MTCE, which operates using the Dynamic Suspensions brand, claims that DSSV is more than just a damper, being rather a complete programme that incorporates hardware, software and engineering services.

Koni's shock absorbers have been standard on the GP2 series during its fledgling year. The product used has been its 2822 MkII series four-way adjustable damper, which has a wide damping adjustment range in both high and low piston speeds, in both rebound as well as bump. Koni was also the damper supplier to the Red Bull Formula 1 cars last year. While it will not be seen on the first team's racecars in 2006, it will be a supplier to the second string Toro Rosso team.

It is unusual for a supplier to declare its customers in Formula 1, commercial conditions dictating whether it does or does not name names. ZF Sachs has, in recent years, made much of its association with Ferrari and in May last year, *Racecar Engineering* carried details of the collaboration between the Italian race team and its German supplier that resulted in a re-think over rear dampers. Its concept, first seen on the F2003-GA grand prix car, dispenses with telescopic dampers and replaces them with non-adjustable rotational units. These not only reduce weight but also allow for a smaller gearbox to be used. Instead of the three conventional dampers of the rear suspension, two rotational dampers integrated in the rocker handle the bulk of the work, replacing two of

**“KRYPTON GAS IS SAID TO BE ALMOST IMPOSSIBLE TO DESTABILISE”**

YEPG Proudly Presents, Thx for Support



## Dampers

the conventional dampers. The pivoted rocker is a type of triangular lever arm that diverts bounce and rebound motion from the wheel to the spring and anti-roll bar. The idea subsequently found its way on to other Formula 1 cars and during 2005 Sauber, Toyota and Minardi all used ZF Sachs product, although the latter had conventional dampers all round.

Ferrari and Sauber also last year used ZF Sachs' TRD (through-rod dampers) at the front. Unlike conventional dampers these have a titanium rod running all the way through the aluminium cylinder barrel with the damper elements, protruding at both ends of the damper. A TRD damper weighs just 200g and is claimed to absorb the shocks of a bumpy track faster than a conventional unit.

In addition to those who operate at the rarefied altitudes of Formula 1, there are a number who specialise more in national and club racing. Leda Suspension, which now exports to over 40 countries, will be launching a new monoshock, shimstack damper this year manufactured from aerospace specification aluminium that uses a new method of hard anodising from Germany. Sales director John Stubbs says that the product will be of high quality, very adjustable and suitable for such as British Touring Car Championship teams. A number of electronic 'add ons' will be featured which, even though they may be unable to be used during a race, will be suitable for setting up the car. Stubbs denies that the setting up of

### “SPAX HAS A PARTICULAR FOLLOWING ON THE HISTORIC SCENE”

dampers is a 'black art' and says that the new product will be sold with guidelines on how to operate it.

Last July Spax launched a new range of steel bodied, gas-pressurised dampers designed specifically for clubman and historic racing. The basic principle of the CSX range, as it is known, is that it allows competitors to create their own specification of damper from a menu of options. The customer specifies the end fittings (spherical bearing, stem, rubber bush), damper length, rebound to bump ratio, spring fittings and options. All CSX dampers are pressurised with inert krypton gas, which is said to be almost impossible to destabilise, thus producing more stable valving. Spax's older aluminium-bodied TrackSPAX range has also been revamped. Single (SA) and double adjustable (DA) versions are available, the former with 25 points of adjustment in bump, the latter with 25 adjustment points each for bump and rebound.

Adjustable bump and rebound damping on the CSX are fixed by means



Leda offers a range of touring car and rally dampers, like this three-way unit

UK manufacturer Spax has recently revamped its aluminium-bodied Trakspax range, available in single and double adjustable formats



New from Spax is its rebuildable, steel-bodied, krypton-filled CSX range, aimed primarily at clubman and historic racers

of an adjuster knob, while ride height can be altered via an extra long thread on the damper body. The range has also been designed so that it can be serviced, re-valved and repaired, if required, using Spax's three-day rebuild service.

Spax has a particular following on the historic scene and is a supplier to Classic Team Lotus. It also points out that it supplies dampers for such as the John Cooper Mini Challenge and has product on several cars in the Nürburgring 24-hours. Product is purchased direct from the factory.

Over the past year AVO has introduced monotube coilover and telescopic dampers specifically for competition use. These can be single, double or triple adjustable and all are gas pressurised with remote canisters. The company also still offers twin-tube dampers, indeed reckons to be the only one to sell a twin-tube damper with independent bump and rebound without a remote canister. Currently the company deals more in rallying and is to supply the Rover Challenge during 2006. It also runs its own Escort Cosworth Group A car and its products are to be found in such UK national race championships as those for Ginettas and Mazda MX5s.

YEPG Proudly Presents, Thx for Support

# Eibach<sup>®</sup> THE WILL TO WIN SPRINGS



ISO 9001 QS 9000

For more than 50 years, Eibach Springs has dedicated itself to one simple quest: building the finest springs in the world. When other springs sag, or need frequent replacement, top race teams, from F1 to WRC, from Le Mans to NASCAR, inevitably turn to Eibach. And, also inevitably, wonder why they didn't choose Eibach in the first place.

- Ultra-Lightweight for Reduced Unsprung Mass
- Maximum Deflection in Combination with Smallest Block Heights
- Exceptional Block Resistance and Durability
- Lowest Side Loads with Load Center Ideally Located Relative to Spring Axis
- Guaranteed Rate Consistency and Linearity

**Performance Perfected.**

## Germany

Eibach Federn  
Am Lennedamm 1  
57413 Finnentrop  
☎ 49 (0) 2721 / 511-0  
☎ 49 (0) 2721 / 511-111  
@ eibach@eibach.de

## USA

Eibach Springs, Inc.  
264 Mariah Circle  
Corona, CA 92879  
☎ (1) 909-256-8300  
☎ (1) 909-256-8333  
@ eibach@eibach.com

## England

Eibach Suspension Technology Ltd.  
Unit 25, Swannington Rd.  
Broughton Astley  
Leicestershire LE9 6TU  
☎ 44 (0) 1455-286524  
☎ 44 (0) 1455-285853  
@ eibach@eibach.co.uk

## Japan

Eibach Japan Co., Ltd.  
14-1 Kamiikedai 2-chome,  
Ohta-ku,  
Tokyo, 145-0064  
☎ 81 (0) 3-5499-6342  
☎ 81 (0) 3-3726-7605  
@ trading1@eibach.uec-group.com

## Australia

Eibach Suspension Technology P.T.Y. Ltd.  
3-4 Prosperity Parade  
Warriewood 2102 NSW  
☎ 61 (0) 2-9999-3655  
☎ 61 (0) 2-9999-3855  
@ eibach@eibach.com.au



eibach.com

aero sensing - circuit protection - complete vehicle wiring - CAN

**SAKATA**  
MOTORSPORT ELECTRONICS  
Engine Management Systems • Data Acquisition & Sensors • Performance Wiring Solutions

NEW! M400 ECU      M880 ECU      NEW! M600 ECU

M880 ECU

Sakata Motorsport Electronics is one of North America's largest **MoTeC** Systems dealers, specializing in complete motorsport solutions from design and manufacturing to trackside support. Contact Us Today!

Professional Lambda Meter

NEW! Mini Digital Display

MoTeC ADL Advanced Dash Logger

SAKATA MOTORSPORT ELECTRONICS Tel: +1-714-448-9473  
689 S. State College Blvd, Unit K Fax: +1-714-448-9247  
Fullerton, CA 92631 USA info@sakatamotorsport.com

multi-pulse injection - staged injection - individual cylinder mapping

celebratory - strain-gauging - servo/stepper/PID - variable intake - variable cam control - drive-by-wire - lap timing - photo/vide

## physicaldigitallimited

Brookside, Jacob's Well, Guildford, Surrey, GU4 7NS  
Tel: +44 (0) 1483 857537 Mob: 07880 703010  
www.physicaldigital.com info@physicaldigital.com

physical digital limited Offer a Mobile 3 Dimensional Non-Contact Optical Digitising Service

- **Quality Inspection**  
Cad Comparison, First Article Inspection and Route Cause Analysis
- **Computer Aided Engineering**  
Aero & Fluid Dynamics, Finite Element Analysis - Requiring Accurate Scan Data to Compare 'As Built' to the Computation
- **3D Design**  
Capture Free Form Surfaces, Hand Made or Hand Modified Designs to CAD and Packaging of Components
- **Deformation**  
Under Load, Temperature Change, Stress & Strain and Deterioration through Life

Utilising the Latest Generation of GOM Optical Measuring Techniques Giving you the Leading Edge

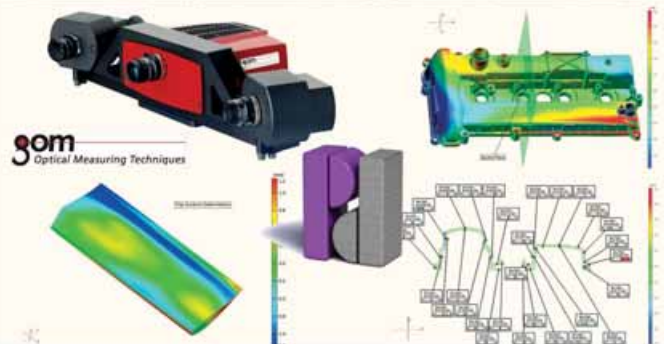

For all your physical to digital needs



# SHOCK ABSORBER DYNAMOMETERS



>CLUBMAN 04

This machine is designed to bring features of higher end machines to racers with limited budgets. The standard windows based software supplied with this machine enables the user to access data of both velocity and displacement. The machine is an economy evolution of the wide range of capabilities available with SPA Dynamometers.



>BTP 4000

The SPA BTP4000 is the latest in a line of successful Dynamometers which runs all software options. This new level Bench Top Portable has all the features of our world leading BTP2000 but now with a 4" stroke option, and with further updated features it offers the Race Engineer an unrivalled degree of accuracy and flexibility, in its' class, in Shock Absorber Data Acquisition



>PSD 04

This advanced Dynamometer from SPA is specially designed both for the experienced Engineer and for anyone utilising the many benefits to be gained, by owning a Dynamometer for the first time. The standard software package with the PSD 04 has a range of graphical analysis allowing simple measurement of Velocity and Displacement. A wide range of upgrade options are available

SPA Aerofoils Ltd  
Common Barn, Tamworth Road  
Packington, nr Lichfield  
Staffordshire, WS14 9PX, UK  
Tel: +44 (0)1827 300150  
Fax: +44 (0)1827 300151  
Email: sales@spa-uk.co.uk

SPA Technique  
1209 Indy Way, Indianapolis  
IN 46214, USA  
Tel: (317) 271 7941  
Fax: (317) 271 7951

e-mail: patrick@spatechnique.com  
website: www.spatechnique.com

[www.spa-uk.co.uk](http://www.spa-uk.co.uk)

AS USED BY



SUCCESS BY DESIGN...

**The ultimate range of lightweight hose and fittings for the professional racer**

**BMRs**

**Brown & Miller Racing Solutions Ltd**  
Unit 77A, Langley House  
Manselman Trading Estate  
Langley, Slough SL3 6DF  
England  
Tel: 01753 630110  
Fax: 01753 574277  
e-mail: sales@bmrsltd.com

**Brown & Miller Racing Solutions LLC**  
8095 Debarbie Place NW  
Concord, North Carolina 28027  
USA  
Tel: 704 793 4319  
Fax: 704 793 4321  
e-mail: sales@bmrsltd.com

[www.bmrsltd.com](http://www.bmrsltd.com)

**'MASTER SWITCH' 'BATTERY CUT-OUT' 'KILL SWITCH'**  
Whatever you call it, don't ignore it. If it fails your race is over!

**SOLID STATE BATTERY ISOLATOR**  
from  
**CARTEK**  
AUTOMOTIVE ELECTRONICS

Developed specifically for motor-sport applications the Solid State Battery Isolator from Cartek is a major advance in the safety and reliability of race vehicles.

Fully electronic with no moving parts and cemented into an aluminium shell makes this system highly resistant to shock, vibration, moisture and dirt.

Using the latest MOSFET technology this system provides safe, spark free isolation of the vehicle's battery and engine electrics in accordance with FIA and MSA rules.

Designed to be chassis mounted close to the vehicle's battery. Microprocessor controlled incorporating false trigger detection, internal temperature monitoring and short-circuit protection offer unprecedented safety. Small size and at just 140g this Isolator is also incredibly light.

**WWW.CARTEK.BIZ**  
**CARTEK AUTOMOTIVE ELECTRONICS LTD**  
Wildern House, Goodalls Lane  
Hedge End, Southampton  
SO30 4QR, ENGLAND  
Email: info@cartek.biz  
Tel: +44(0)1489 799905 Fax: +44(0)1489 787392

# Black magic

Performance Friction believes it has taken a leap forward in carbon/carbon brake technology with its new continuous fibre disc

Words | Charles Armstrong-Wilson



Performance Friction carbon discs are the first to feature continuous fibres running across the thickness of the disc, dramatically improving heat dissipation toward the core

“WOUND FROM A CONTINUOUS FIBRE IN THREE DIRECTIONS”

The carbon/carbon disc and pad combination is nothing new on a racecar. Developed for racing in the 1980s, it offers light weight, good wear properties and legendary retardation. The technology is reasonably described as mature and advances are rare and incremental in nature.

Performance Friction, by comparison, is still something of a new kid on the block in the brake market. However, it has characterised its approach by endeavouring to bring something new to every product market it enters. Starting with brake pads, it followed with discs and calipers. Now it has eyed the carbon/carbon brake market, but to tackle it in the company's traditional style the company needed to find an advantage to set its product apart from the rest.

Despite all its benefits, carbon/carbon does have one weakness as a braking medium. Carbon fibres are very good at conducting heat down their length, but

they are not very efficient at conducting heat between fibres. Most carbon brakes are produced from chopped strand or woven fabric laid in layers and compressed before being baked to reduce the material to carbon. This produces fibres lying in the X and Y directions but none in the Z direction across the thickness of the disc.

The result is, under braking, the surface of the disc becomes very hot, but the heat does not conduct easily away from the surface to the core of the disc. Obviously this means the surface can easily become overheated and start breaking down.

Some manufacturers have experimented with ways of creating fibres in the Z direction to aid heat conduction across the disc with varying degrees of success.

Performance Friction looked at the problem slightly differently. Rather than trying to connect the layers of carbon with bridging fibre, it wound its disc from a continuous fibre in three directions. This creates a blank with unbroken heat paths in all directions allowing heat to conduct through to the core of the disc. It results in a higher heat capacity as the temperature soaks through to the core and less extreme readings on the surface.

In early testing the disc has demonstrated greater longevity and more stable braking performance as illustrated by the accompanying graphs. Early examples of the disc have even been able to dispense with cooling holes around their perimeter, aiding structural integrity. Applications will begin in sportscars and, at the time of writing, work was beginning with American Le Mans Series teams.

Early tests have exhibited improved longevity and more stable braking potential

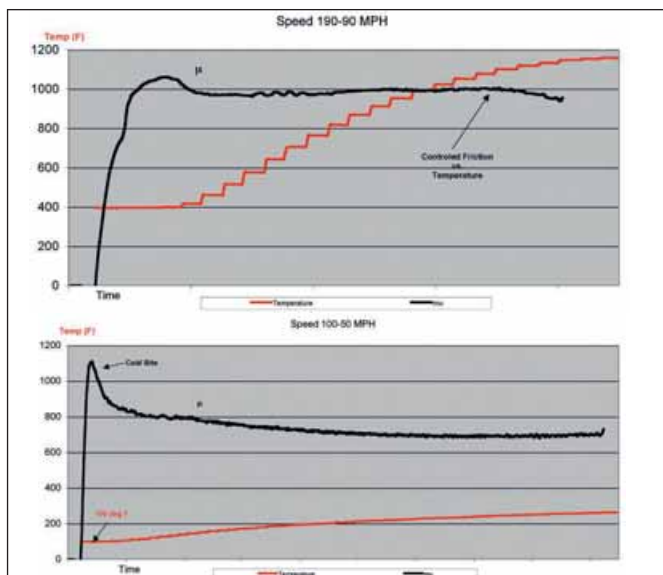

Performance Friction Corporation  
83 Carbon Metallic Highway  
Clover, SC 29710, USA  
Telephone: +(1) 800 521 8874  
Fax: +(1) 803 222 8134  
www.performancefriction.com

YYePG Proudly Presents, Thx for Support

# ACCRALITE

performance **forged**  
pistons

[www.accralite.com](http://www.accralite.com)



With Accralite's experience you can design, build and win!

British



Manufacturers



Tel: +44(0)121 525 6450

Email: [pistons@accralite.com](mailto:pistons@accralite.com)

Fax: +44 (0)121 553 5951

Web: [www.accralite.com](http://www.accralite.com)

Spon Lane South, Smethwick, West Midlands. B66 1QJ

**TORQline**<sup>TM</sup>

Japanese GT - ALMS - LMES - WRC - Super 2000

Lightweight Composite and  
Metallic Driveline  
Products

Liberate your Driveline  
[www.TORQline.com](http://www.TORQline.com)

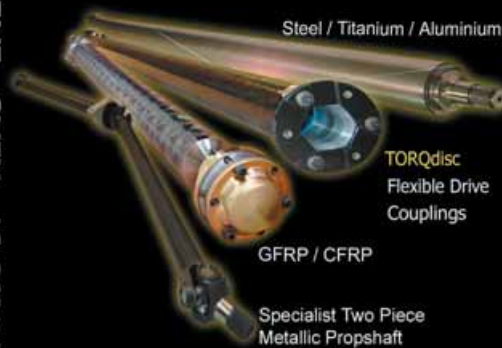

Steel / Titanium / Aluminium

TORQdisc  
Flexible Drive  
Couplings

GFRP / CFRP

Specialist Two Piece  
Metallic Propshaft

CTG Ltd Banbury Oxfordshire UK  
t +44 (0)1295 220130 f +44 (0)1295 220138  
[motorsport@ctgltd.co.uk](mailto:motorsport@ctgltd.co.uk) [www.TORQline.com](http://www.TORQline.com)



# NEWMAN CAMS

**THE ENGINE BUILDERS CHOICE**

- Performance Camshaft Manufacturer for over 30 years.
- All Performance and Race Cams Ground on CNC Cam Grinder.
- UKs Most Technically Advance Performance Camshaft Manufacture.
- Cams, Followers, Valve Springs, Cam Kits.

Farnborough Way, Farnborough,  
Kent BR6 7DH  
Tel: 01689 857109  
Fax: 01689 855498  
E-mail: [info@newman-cams.com](mailto:info@newman-cams.com)  
[www.newman-cams.com](http://www.newman-cams.com)

Contact: Gordon Riseley

email: [griseley@ringspann.co.uk](mailto:griseley@ringspann.co.uk)

Come and see us at  
The Historic Motor Sports Show  
Stand E68



High Performance

Motorsport

Gearshift & Throttle Cables



**RCS**

[www.RCScables.com](http://www.RCScables.com)  
Tel 01234 342511

**RCS - Cables and Controls**

YYePG Proudly Presents, Thx for Support

## Rolling levellers

Longacre Racing Products has released its new roll-off levellers, made from 6061 T6 aluminium.

Designed for dead flat accuracy, the roll offs allow the user to move the vehicle on and off scales easily to release tyre bind and side loads. The billet aluminium levellers are manufactured with six different swivel adjusters for added ease.

Each leveller kit comes with four individual roll offs and with an option for low-profile 2.5in (6.35cm) pads or 4in (10.16cm) pads.

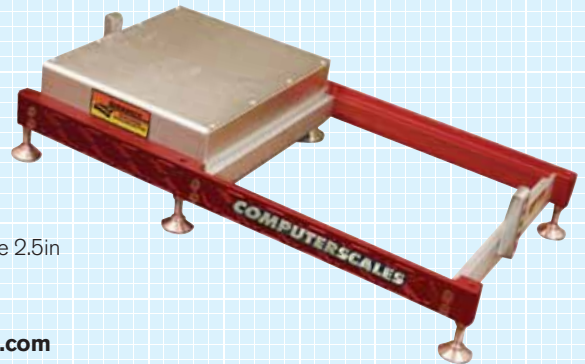

● For more information call +(1) 360 453 2030 or visit [www.longaceracing.com](http://www.longaceracing.com)



## Shock control

Koni has introduced a new control system and wiring for its electric drag racing shock absorber.

Via a laptop or MSD controller, the new system allows racers to set, map and save timed, shock-damping adjustments. After each pass shock data can be downloaded to observe velocity and suspension motion. The system has an internal timer, as well as burnout control settings and hosts an independent control for left and right shocks as well as rebound and compression damping.

Kits can be purchased either complete with Koni's electric drag shocks or as a separate controller and wiring kit to fit existing Koni drag shocks.

● For more information visit [www.koni.com](http://www.koni.com)

## Da Video dash

A new extensive video and data logging system has been developed by Aim Sports LLC.

The DaVid data logger expands on Aim's experience in this field by introducing new video technology. It combines two cameras to channel separate video signals to the dash display where the user can then examine crucial statistics such as speed, rpm and brake/throttle positions from earlier driving sessions.

Easy connection technology (ECT) allows DaVid to be connected to many commonly used ECUs by selecting from a custom database. Even if an ECU does not provide a serial connection, the DaVid flexible analogue inputs allow sensors to work without compatibility problems in any situations.

As with many other Aim products, the DaVid also provides the option of configuring the dash display according to personal taste.



● For more information call +(1) 951 674 9090 or visit [www.aimsports.com](http://www.aimsports.com)

## Leading loggers



Race Technology has recently announced the release of its new data acquisition system, the DL2.

The British manufacturer of racing data logger systems has developed the DL2 to be the next generation of its already successful DL1 system. The unit has been custom designed for automotive data acquisition where speed, acceleration and vehicle position is recorded via a mixture of GPS and accelerometers.

Race Technology's 20Hz GPS solution has been combined with 16 analogue sensor input channels and four wheel/shaft speed inputs. Recorded data can be graphed, combined or analysed through 30 various channels using either the included analysis software or exported to an external source.

● For more information email [sales@race-technology.com](mailto:sales@race-technology.com) or visit [www.race-technology.com](http://www.race-technology.com)

YYePG Proudly Presents, Thx for Support

# RACE GEAR

New products and services for racecar engineers

## Winning software

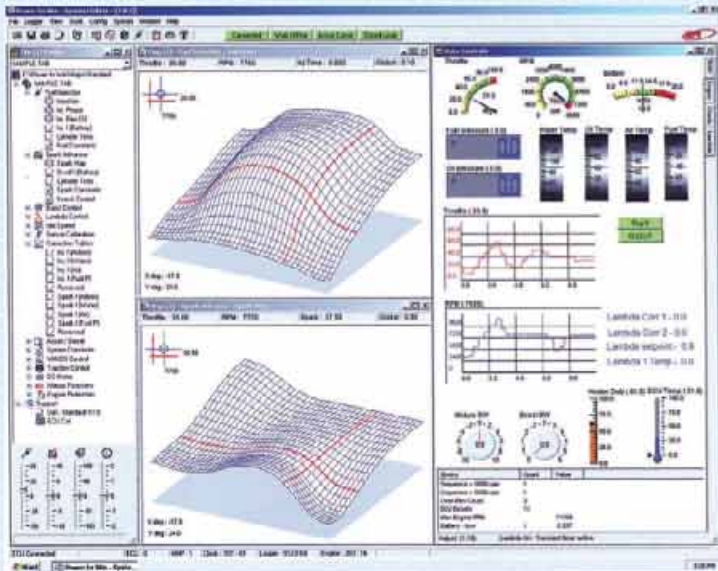

Power to Win version 7.0 is the new engine software from EFI Technology Inc that provides current maps in the ECU to be edited in real time.

The software is a fully integrated systems editor and communications application that, when connected, instantly updates any modifications made to the maps to be changed directly in the ECU.

The data control window comprises 16 various user pages to store all engine channel data. User defined controls allow the information to be displayed according to preference and all maps can be edited to be either graphic or numeric displays.

All previous 6.0 engine maps and loggers are compatible with the new 7.0 software.

● For more information call +(1) 310 793 2505 or visit [www.efitechnology.com](http://www.efitechnology.com)



**ARP** automotive Racing products America's Leading Performance Bolts and Fixings  
Now available for Japanese and European cars - at far less than you may think!

**Don't Risk That Expensive Engine! Insist on only the VERY BEST!**

Rod Bolts • Head Studs & Bolts • Main Studs & Bolts • Rocker Arm Studs & Adjusters • Valve Cover Studs & Bolts  
Exhaust Manifold Studs & Bolts • Inlet Manifold Studs & Bolts • Cam & Engine Component Fixings  
Engine Fixing Kits • Flywheel & Driveline Studs & Bolts • Bulk Metric Fasteners • Piston Ring Compressors & other tools

#### CONROD BOLT KITS

BMC A Series, 3/8"	£62.64
BMC A/B Series, 11/32"	£54.82
BMC B Series, 3/8" Cap	£22.38
BMC K Series	£48.98
Cosworth Sierra/Escort	£43.04
Ford BDA, Pro series	£38.98
Ford CVH	£39.41
Ford Pinto	£29.80
Ford Zetec 1.6 8mm	£43.79
Mitsubishi 3000GT	£44.98
Mitsubishi Evolution	£47.20
Opel 1.4/1.6 8v	£37.98
Opel 2litre 16v XE	£42.31
Opel 9mm Pro Wave	£52.13
Nissan SR20 DET	£40.91
Peugeot 205/306/309/406	£63.61
Porsche 944	£101.59
Renault Clío 16v 9mm	£50.85
Toyota 4AGE 16v	£35.80
Toyota Supra 2JZA80	£54.45
VW 1.8 water cooled	£98.66
VW 1.6 air cooled	£98.63
Formula Vee 9mm cap	£41.67

#### HEAD STUD KITS

BMC A Series 9 stud	£85.54	Mitsubishi V6 6G72	£269.68
BMC A Series 11stud	£93.65	Opel 2litre 16v XE	£89.90
A Series 11 stud, shaved	£65.99	Porsche 911/930T	£422.04
BMC B Series	£87.66	Subaru Impreza	£145.42
BMW2002/320i/318i	£111.00	Toyota Supra	£96.39
BMW M3/E46/S54	£118.70	Toyota 4AG 16v	£105.54
Cosworth Sierra/Escort	£96.50	Toyota 3SGTE	£105.54
Ford Escort 1600cc 10mm	£81.10	Triumph Spitfire	£41.91
Honda H22A4 VTEC	£114.56	TR4	£83.47
Mitsubishi Evolution	£95.61	TR7	£50.44
Mitsubishi Evo.Undercut	£99.13	VW Golf/Jetta 2.0/1.8 16v	£91.58

#### MAIN STUD KITS

Ford Pinto 2000	£76.32
Mitsubishi Evolution	£76.52
Opel 2litre 16v	£75.73
Toyota 3SGTE	£71.71
Toyota 4AG 16v	£69.41

#### FLYWHEEL BOLT SETS

Ford 2000cc	£8.82
Ford 1.8/2.0 Duratec	£27.95
Ford 2.0 Zetec	£16.19
Opel 2litre	£25.85
Toyota 3SGTE	£35.04
Toyota 4AG	£19.75

Metric bolt packs, assembly lube and special tools also available, call for details  
All prices are plus VAT



An Appointed ARP Distributor  
**Telephone: 01384 216102**

New stockists required - Export Enquires Welcome - Large range for Japanese & European vehicle applications  
Massive stocks of ARP products held in the UK - ready for next day delivery

\*For orders received before 11.00am - subject to performance of courier, which is beyond our control

Fax: 01384 216109  
e-mail: [sales@coordsport.com](mailto:sales@coordsport.com)  
[www.coordsport.com](http://www.coordsport.com)

YYePG Proudly Presents, Thx for Support

## A new breed

The 8860 ECU from EMS is the leader of the company's new engine management computer generation, offering a user friendly and practical service aimed at reducing the time spent on tuning an engine.

The 8860 ECU examines and re-calculates each engine parameter over 600 times per second enabling each individual cylinder to be analysed and optimised before firing the ignition and injectors.

In instances when engines may have two load measuring devices, any two sensors can be programmed for use and has the flexibility to read almost any type of sensor by hosting easy-to-use calibration tables.

Accuracy is claimed to be 100 per cent as trigger inputs are filtered for noise, plus engine speeds are always precisely timed by means of an advanced auto signal tracking system.



● For more information call +(1) 877 936 7872 or visit [www.emsnorthamerica.com](http://www.emsnorthamerica.com)

**Ferrea**  
RACING COMPONENTS

**TITANIUM  
STRENGTH  
ENGINEERED TO WIN**

### Ferrea Racing Components

proudly offers the finest Chrome Nitride (CrN) coated titanium valve line for the race market.

- **Forged** from special high-temperature titanium alloy ensures greater molecular density and increased resistance to higher levels of fatigue and tensile stresses.
- **Proprietary Chrome Nitride (CrN) coating** introduced by Ferrea a decade ago has set the standard for today's industry valve manufacturers. Our unique CrN coating is applied uniformly to the entire valve forming a protective insulating barrier from high engine temperatures, which also increases heat dissipation to the valve guide surface and reduces friction and wear without delaminating or flaking.
- Extensive **multi-staged heat treatment** and **stress-relieving** process to ensure molecular integrity and prolong valve cycle life.
- Ferrea works with many engine suppliers to Aerospace, Cart, Formula 1, IRL, ALMS, Le Mans, Nascar, USAC, NHRA and IHRA, World Rally, and other forms of professional motorsports, all in strict confidence.
- Industry leader in manufacturing turn around time on all custom valves.
- Certified ISO 9001 / QS 9000, TS 16949, ISO 14001.

Call for your complete Ferrea valve train solutions or inquiries.

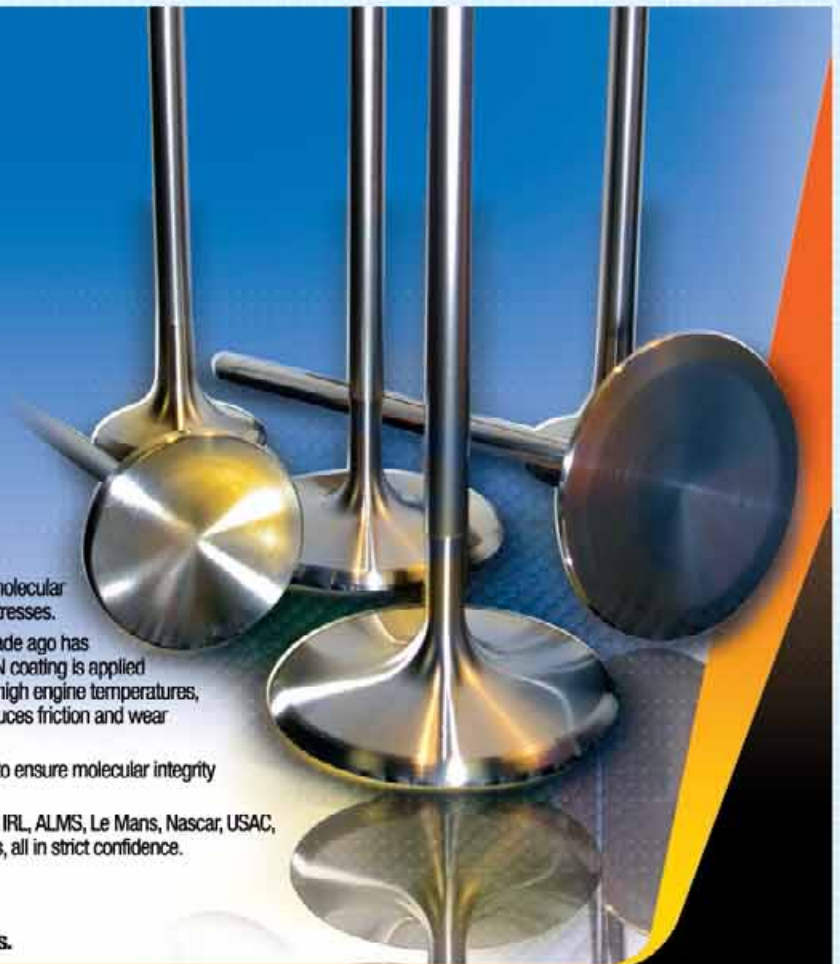

Tech Line: 954-733-2505 • Toll Free: 888-733-2505 • Fax: 954-735-2179 • 2600 NW 55th Court, Suite 238 • Ft. Lauderdale, FL 33309, USA • [www.ferrea.com](http://www.ferrea.com) • Email: [Ferrea@ferrea.com](mailto:Ferrea@ferrea.com)

YYePG Proudly Presents, Thx for Support



## Multi-task display

The multi-function Race Pro IIID dash display is now available from SenDEC Racing Products. Offering a variety of features, including ultra large LCD display characters and a bar graph tachometer, along with simple menus, long life and reliability.



It comes with SenDEC's patented and programmable tachometer input, up to two temperature inputs and is compatible with CHT sensors, EGT sensors and water temperature sensors. It can be programmed for temperature over limit warnings and includes lap timers that can be adapted to different track splits and hide times, as well as session run times, total engine run time and available memory.

● For more information call +(1) 315 986 1812 or visit [www.sendcracing.com](http://www.sendcracing.com)

## Engine detective

Engine Analyzer Pro V3.3 is a detailed software package from Performance Trends Inc that allows the professional engineer to simulate engine builds or adjustments on the computer prior to building them for real.

The software prevents wearing out the engine on the dyno and the excess costs involved by enabling users to investigate and experiment with various engine combinations on the computer whilst attempting to find maximum power.

All applications are included, whether it be turbocharged, nitrous oxide injected, naturally aspirated or restricted. Spark advance on detonation, ring leakage on blow-by and cam profiles are just some of the detailed calculations included in the investigation process which assists the user to gain a better insight into engine theory.

● For more information call +(1) 248 473 9230 or visit [www.performancetrends.com](http://www.performancetrends.com)

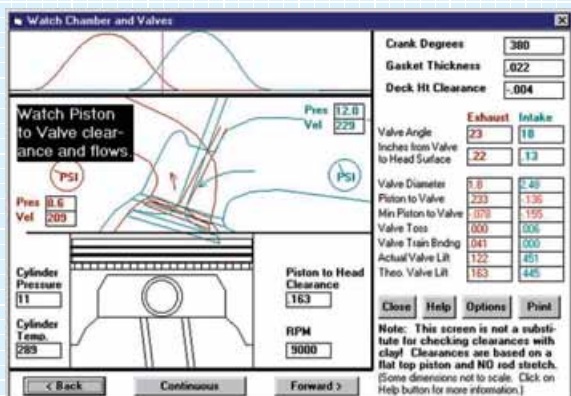

YYePG Proudly Presents, Thx for Support

## Rallycourse 2005-2006

Edited by David Williams

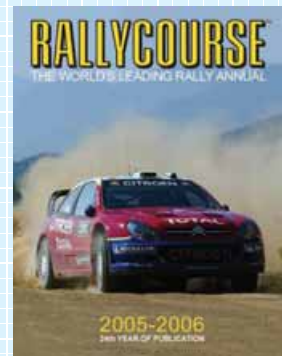

*Rallycourse* is the final work of David Williams who died unexpectedly last year and, as usual, is the essential blow-by-blow account of the World Rally year. 2005 could be one of the most significant years in the history of the WRC – the loss of Richard Burns to illness and Michael Park in a crash will no doubt call for changes in the sports safety provisions. *Racecar's* own WRC correspondent, Martin Sharp, examines the development of shock absorbers and suggests improvements to side impact protection in some detail.

Whilst at first glance light on technical content, what there is in *Rallycourse* is excellent.

● Published by: Crash Media Group ([www.crashmediagroup.com](http://www.crashmediagroup.com)); ISBN 1-905334-06-0; £30.00 (\$49.95)

## Pirelli World Rallying 28

By Martin Holmes

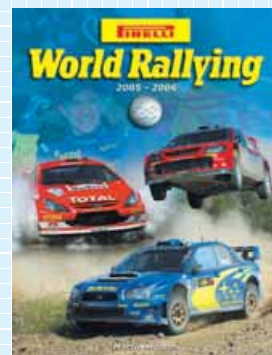

Rally fans will probably have hoped for a DVD for Christmas, with action images of an action sport. Rally enthusiasts will have hoped for the 28th edition of *World Rallying*. Its 200 plus pages allow for a calmer, more reflective review of the 2005 season. There's a WRC round-by-round account with statistics and informative sidebars. There are also plenty of photographs and some detailed tables to pore over.

But what about *Racecar Engineering* technophiles? It's good news – *Pirelli World Rallying 28* also has chapters to grab your attention. There's an informative WRC specification table plus an overview of technical developments (including Group N, Super 1600 and Super 2000 cars). And Pierre Genon, principal engineer at Subaru World Rally Team, explains about aerodynamics although, sadly, gives little away.

Background chapters on, for example, Suzuki Sport and rally control technology are interesting if frustratingly short. Many of the photographs are also worth close scrutiny, although it's a pity chief photographer, Maurice Selden, doesn't point his lenses in and around the interesting parts of the cars more often.

Is *Pirelli World Rallying 28* worth buying? Yes it is, but not if it means sacrificing your subscription to *Racecar Engineering*.

● Published by: Vinehouse UK?? ([www.vinehouseuk.co.uk](http://www.vinehouseuk.co.uk)); ISBN 0-9545433-2-7; £24.95

**ARP** manufactures fasteners used in:

**Formula 1**  
**IRL**  
**NASCAR**  
**NHRA**  
**British SuperBike**



Honda Indy V8 (HI5R)  
Winner of the 2005  
IRL Manufacturers' Championship  
and Indy 500 using ARP Fasteners

***The very same quality fasteners  
are available for your application***

**ARP**  
**automotive *Racing* products**

YYePG Proudly Presents, Thx for Support

Automotive Racing Products, 1863 Eastman Ave., Ventura, California. 805.525.1497 [www.arp-bolts.com](http://www.arp-bolts.com)

Toolmakers + Precision Engineers

# M&B Tools Technical Services

3D Design

CNC Milling

CMM Inspection

Wire Erosion

Spark Erosion

Grinding



Pickerings Road, Halebank Industrial Estate,  
Widnes, Cheshire, WA8 8XW, UK

Tel: +44 (0) 151 423 6455 Fax: +44 (0) 151 423 6388

email: [info@mbtools.org](mailto:info@mbtools.org)

[www.mbtools.org](http://www.mbtools.org)

## D.A.T.A.S LTD.

Data Analysis Tools And Simulation

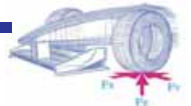

## RaceSim version 2.7

- **Expert:** Steady state, transient, 4 post, optimisation, strategy, etc
- **Standard:** Low cost lap simulation
- **NasCar:** Stock cars with live axle
- **F3 Lite:** Incl. Dallara F3 car model
- **Mitchell Geometry:** European agents, Now includes **RaceSim** data exchange

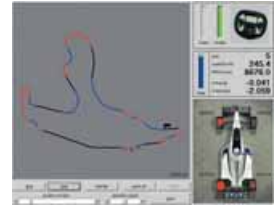

## Consultancy

- Vehicle Dynamics
- Racetrack Support
- Software Development

## Multi Media

- Photo realistic virtual animations
- Technical features for TV
- Animated walk through grid



D.A.T.A.S LTD. The Old Chapel, Norfolk IP21 4XP

Tel: +44(0)1603 506 526 Fax: +44(0)1603 504 907

[www.datas-ltd.com](http://www.datas-ltd.com) - [chris.murphy@datas-ltd.com](mailto:chris.murphy@datas-ltd.com)



**...sample data at least once every engine rev for the whole of the Le Mans 24 hour race and still have memory to spare...**

The new **FD20 Flash Data Logger** from Farrington uses removable **SD Flash Memory** cards as the storage medium. Not only does this give the system a huge memory, it also dispenses with download leads and the need to take a laptop into the pit lane.

The FD20 has a variable sampling rate up a maximum of 500 samples per second, 19 channels and a memory of up to 1 Gbyte.

In addition to the data logging the FD20 drives the **SWIS10 Steering Wheel Instrument System** (illustrated) complete with lap timing.

**To be released at the Autosport Engineering Show January 12th and 13th - see us on stand E284**

### Outline Specification

**Pre-assigned Channels:**  
Oil Pressure, oil temperature, water temperature, fuel pressure/level, lateral G, longitudinal G, gear, battery voltage, control box temperature, wheel speed and engine speed.

**User Channels:**  
8 single ended ratiometric or 0 to 5 volts input.

**Sampling Rate:**  
4 to 500 samples per second

**Memory:**  
Up to 1 Gbyte.

**Data Analysis Software:**  
*Podium Flash* is video enabled and has powerful database facilities for exploring very large data files.



PolyLogic

Prices:  
*Much less than you might think.*



Farrington Instruments Limited - Unit 9 Oriel Court - Omega Park - Alton - Hampshire - GU342YT  
T: 01263 822222 [www.farrington.co.uk](http://www.farrington.co.uk)

# Database

**Section 1** lists manufacturers of Brand-Name Racecars.

**Sections 2-3** list component manufacturers. Section 2 is dedicated to Chassis Components, Section 3 to Engine and Transmission Components

**Sections 4-5-6** list equipment manufacturers. Section 4 is dedicated to Factory Equipment. Section 5 to Circuit Equipment. Sections 6 to Driver Equipment

**Sections 7-8-9-10** list companies that supply services. Section 7 is devoted to Chassis Engineering Services, Section 8 to Engine / Transmission / Suspension Services. Section 9 to Testing Services. Section 10 to Non-Engineering Services

To get your company listed in the racecar database please contact Andy King - 0208 726 8329 andy\_kings@ipcmedia.com

Costs listed below:

Name and number £50 - 12 issues

Name and number bold £70 - 12 issues

Logo and full company details £420 - 12 issues including web, address, email etc etc

£210 - 6 issues

**www.**

**racecareengineering.com**

**Andy King on  
Tel: +44 (0)20 8726 8329**

**andy\_king@ipcmedia.com**

RACECAR DATABASE is compiled by IPC Media for publication only in RACECAR ENGINEERING magazine. RACECAR has not tested products, equipment or services that are listed, and this listing does not imply any form of endorsement. Although every care is taken to ensure that RACECAR DATABASE is accurate and up-to-date, the publisher can accept no responsibility for errors or omissions.

© IPC MEDIA 2003. All rights reserved. Reproduction (in whole or in part) of any text contained in RACECAR DATABASE (including reproduction by photocopying), without the written permission of the publisher, is strictly prohibited.

# Database 1

## RACECAR MANUFACTURERS

### 1.1

#### Racecar Manufacturers

A-MAC	USA (1) 408 727 9288 Fax (1) 408 988 8998 A-Mac Fabrication, 1745 Grant Street, Suite 2, Santa Clara, CA 95050, USA
ASCARI	Tel 01295 254800 Fax 01295 255944 Overthorpe Road, Banbury, Oxfordshire OX16 4PN England
APOLLO RACING DESIGN LTD	Tel 01280 835800 Fax 01280 823015 Email info@apolloracingdesign.com Website www.apolloracingdesign.com Millgate Barn, Radcliffe, Bucks MK18 4AB, England
BARRELLI	Italy (39) 02 782427 Fili Barrelli, Via La Spezia 5, 20156 Milan, Italy
BRD Race Cars Inc.	Tel (1) 716 637 9467 16 Hollybrook Road, Brockport, NY 14420, USA
BODOLA	Tel Sweden 46 171 27690 Fax Sweden 46 171 27690 Bodin Chassiteknik, Skalbogatan 8, 745 37 Enköping, Sweden
BREDA	Italy (39) 049 9004895 Fax (39) 049 900 2821 Breda Racing s.r.l. via Buonarroti 10a, 35035 Mestrino, PD, Italy
BRYTEC	Tel 01772 786500 Fax 01772 786500 Lower College, Hotherhall Lane, Longridge, Preston, Lancashire PR3 2XB
CARBIR	USA (1) 262 377 2850 Fax (1) 262 375 1602 Carbir Race Cars Inc, 1220 Falls Road, Grafton, WI 53024, USA
CHEEK	Norway (47) 90 78 70 32 Fax (47) 69 19 02 55 Cheek Racing Cars, Flatebavn 3, 1792 Tistedal, Norway
CHEETAH	USA (1) 408 492 1331 Fax USA (1) 408 492 1333 Omni Fab, 380 Martin Avenue, Santa Clara, CA 95050
CHEVRON	Tel 01300 348499 The Chevron Centre, Piddle Trenthide, Nr Dorchester, Dorset DT12 2RF, England
US Importer Continental Crosslé	Tel (1) 513 777 4545 9000 Debbie Drive, West Chester, OH 45069, USA
DALLARA	Italy (39) 050 525 50711 Fax (39) 050 525 53478 Dallara Automobili, Via Provinciale 33, 43040 Varano Melegari, Parma, Italy
DEBORA	France (33) 381 51 18 51 Fax (33) 381 51 18 51 bis Rue du Docteur Moras, 25000 Besancon, France
DAN GURNEY'S ALL AMERICAN RACERS, INC	Tel USA 714 540 1771 Fax USA 714 540 3749 2334 South Broadway PO BOX 2186, Santa Ana, CA 92707, USA
DJ RACECARS	Tel 01663 734518 Fax 01663 732 130 Email del@djracecars.fsnet.co.uk Unit 10, Britannia Rd Est, Buxworth, Nr Whaley Bridge, High Peak, SK23 7NF
DOME CO. LTD	Tel 81 (0)75744-3131 Fax 81 (0)75744-3035 Roebuck House Cox Lane, Chessington, Surrey KT9 1DG England
DOME CARS, LTD	Tel 0208 397 9999



#### MODULAR + ERGONOMIC

- WORKBENCHES
- TOOL STORAGE
- RACKING

STATIC or MOBILE

www.gwssystems.com

01403 276 445

DOWNES ENGINEERING	Fax 0208 397 6830 Tel USA 707 938 1001 Fax USA 707 935 0481 19564 8th St. East, Sonoma, CA 95476 USA
DRAGON	USA (1) 413 267 0904 Small Fortune Racing, 77 Stafford Hollow Road, Monson, MA 01057, USA
ELISE	France (33) 1 47 49 15 66 1 Rue Pierre Cassin, 92500 Rueil Malmaison, Paris, France
EUROCAR	Tel 0353 861668 Fax 0353 861877 SHP Motorsport, Unit 7 Farraday Business Park, Littleport, Ely, Cambridgeshire CB6 1SE, England
EXTREME CARS	Australia (61) 396 822225 (61) 396 821119 (61) 396 900809 Email mrp007@tpg.com.au King Way House, 188-190 Kings Way, South Melbourne, Victoria 3205 Aus.
FABCAR	USA (1) 317 872 3664 Fax (1) 317 872 3835 4148 West 99 Street Carmel Indiana Tel/Fax 01823 69817
FORCE RACING CARS	Clyse Farm, Stathie, Nr Bridgewater TA7 0JN England 001 562 596 9242 Tel 01635 44466 Fax 01635 30056
GRAN TOURING CLASSICS GOULD	Tel 01933 440774 Gould Engineering Services, Unit 7, Arrhem Road, Newbury, Berks, RG14 5RU
ICP/CITATION	USA (1) 317 273 0089 Indianapolis Competition Products, 1717 Expo Lane, Indianapolis, IN 46214, USA
JADE	Tel 01883 744 443 Fax 01883 744 443 Address Jade Motorsport Engineering, Unit 2 Pendell Farm, Pendell Road Bletchingley Surrey RH1 4QH
JEDI	Tel 01933 440774 John Corbyn Motors, 36A Stanley Road, Wellingborough, Northamptonshire NN8 1DY, England
KBS	USA (1) 909 355 4800 Fax (1) 909 355 5933 KBS Engineering, 8296 Fremontia, Suite B, Fontana, CA 91040, USA
KUDZU	USA (1) 404 457 6300 Fax (1) 404 458 6188 5096 Peachtree Road, Atlanta, GA 30341, USA
LAZER	USA (1) 906 863 5003 Campbell Motorsport, W7719 Fernwood Drive, Menominee, MI 49858, USA
LOLA	Tel 01480 453101 Fax 01480 456722 Lola Cars International, Glebe Road, St Peters Hill, Huntingdon, Cambridgeshire PE18 7DS, England
LUCCHINI	Italy (39) 0376 391271 Fax (39) 0376 391200 Lucchini Engineering, via Valleggio 2, 45100 Mantova, Italy
LYNCAR ENGINEERING	Tel 01635 860066 Fax 01635 860066 Email: lyncar001@btopenworld.com Briff Lane, Bucklebury, Reading, Berkshire RG7 6SN
MAGNUM	Italy (39) 0376 32552 Fax 0376 32552 141 Laurence Leyland Industrial Estate, Wellingborough, Northamptonshire NN8 1RA, England
MALLOCK	Tel 01604 863504 Fax 01604 863807 Mallock Racing, Rowley Wood Lane, Hartwell, Northamptonshire NN7 2JT, England
MARK BAILEY RACING	Tel 01380 850130 Fax 01380 850140 MBR Building, 8A Jockey Lane Bromham, Chippingham, Wiltshire, SN15 2EZ
MATT WATERMAN MOTORSPORT DESIGN	Tel 0408 216357 Fax 0408 216357
MYGALE	Tel France 33 3 8621 8621 Fax France 33 3 8621 8622 Technopole du Circuit, 58470 Magny-Cors, France
OSELLA S.R.L.	Tel 0972 715852 Fax 0972 715391 Z.I Valle di Vitalba, 85020 Atella, (PZ)
PANOZ	Tel USA (1) 770 967 2310 Fax USA (1) 770 965 8762 5294 Winder Highway, Braselton, GA 30517, USA

PHOENIX USA	USA (1) 813 655 1199 Phoenix Race Cars, 364 Hairpin Drive, Sebring, FL 33870, USA Fax (1) 813 665 1199
PICCHIO S.p.A	Tel 0039 0861 86105/16 Fax 0039 0861 86246/80561 Email: picchio@picchio.com or picchiospa@email.it Website: www.picchio.com Zona Industriale Ancarano 64010 - Ancarano (Teramo) Italy
PILBEAM	Tel 01778 424838 Fax 01778 393032 Pilbeam Racing Design, Graham Hill Way, Cherry Halt Road, Bourne, Lincolnshire, PE10 9PJ
PIPER	USA (1) 708 365 5334 Piper Engineering, 5N461 Meadowview Lane, St Charles, IL 60175, USA
PREDATOR	USA (1) 313 681 1377 Fax (1) 248 681 1377 Crossroads Fabrication, 265 Hillcliff, Waterford, MI 48328, USA
PROTECH COMPOSITES LTD	Tel: +44(0) 1420 471 400 Fax: +44 (0) 1420 487 047 www.protechcomposites.co.uk Unit 62, Woolmer Trading Estate Bordon, Hampshire, GU35 9QF, UK
PROTOFORM	USA (1) 607 739 7345 Protoform Race Engineering, 51 Ponderosa Drive, Horseheads, NY 14845, USA
RACEFAB	USA (1) 313 694 8335 Fax (1) 313 694 8335 8307 Beauman Road, Houston, TX 77022, USA
RALT	01865 883354 Fax 01865 883789 Ralt Engineering, Sutton Farm House, Sutton, Witney, Oxfordshire OX29 5RD, England
RAPTOR	US Importer Tel (1) 310 533 1144 Fax (1) 310 530 0139 Ralt American, 2310 Kashiwa Court, Torrance, CA 90505, USA
RAY	USA (1) 215 775 1938 Performance Engineering, RD5 Box 5435, Mohnton, PA 19540, USA
RILEY & SCOTT	Tel 0208 680 9418 Fax 0208 688 4026 15 Silverwing Industrial Park, Croydon, Surrey CR0 4RU, England



RML LTD	Tel 01933 402440 Fax 01933 676519 www.rmlmallock.co.uk 6-10 Whittle Close, Park Farm Ind Est, Wellingborough, Northants NN8 6TJ England
SABRE	USA (1) 714 693 0296 USA Race Cars, 1535 Harmony Circle, Anaheim, CA 92807, USA Fax (1) 714 693 3164
SCCA	USA (1) 303 693 2111 Fax (1) 303 680 5633 Spec Racer, 7476 South Eagle Street, Unit 5, Englewood, CO 80112, USA
SCARAB	Tel 01656 822033R RS Racing & Specialised Services, High House, Kirton Road, Egmanton, Newark, Nottinghamshire NG22 0HF, England
SEZIO FLORIDA RACING	SEZIO FLORIDA RACING Tel: 001 776 878145 USA (1) 310 538 2914 Fax (1) 310 538 0126
SHELBY	Shelby Can-Am, Shelby Technologies Inc, 19021 South Figueroa, Gardena, CA 90248, USA
SPECTRUM	Australia (61) 3 95 80 52 36 Fax (61) 3 95 80 53 31 Spectrum Racing Cars, Borland Racing Developments, 39 Industrial Drive, Braeside, Victoria, Australia 3105
STRYX	Tel 01789 750567 Fax 01789 292183 Minerva Developments, Grafton Lodge, Binton, Stratford-on-Avon, Warwickshire CV37 9TX, England
SPICE RACING CARS LTD	Tel 01483 203956 Fax 01483 203956 Int House, 31 Church Road, Hendon, NW4 4EB, England
SWIFT	US Importer International Racing Products Tel (1) 800 793 0496 1034 Riva Ridge, Great Falls, VA 22066, USA
SYMBOL	Italy (39) 0362 903967 Symbol Team srl, via Fiume 17, Carate Brianza, 20048 MI, Italy
TAMPOLLI	Italy (39) 055 8873268 Fax (39) 055 8825777 Tampolli Engineering, via degli Artigiani 44-46, Calenzano, 50041 FI, Italy
TOM'S	Japan (81) 3370 46801 Fax (81) 3370 46805 6-13-10 Todoroki Setagaya-ku, Tokyo, Japan 158
TPG	0039 682 32225 Tel 01953 888195 Fax 01953 888198
VAN DIEMEN	Van Diemen International Racing Services, Chalk Road, Snetterton, Norfolk NR16 2JZ, England US Importer Primus Racing Tel (1) 813 522 7544 Fax (1) 813 522 7417 3608 Morris Street, St Petersburg, FL 33407, USA

# RCS - Cables and Controls

High Performance

Gearshift & Throttle Cables

Motorsport



www.RCScables.com  
Tel 01234 342511

YyPG Proudly Presents, Thx for Support



# Database 2

## COMPETITION CAR CHASSIS COMPONENTS

### 2.1 Chassis/BodyWork Ancillaries

**AEROFOILS**  
ACTIVE ENG USA (0) 714 637 055



**AERODINE COMPOSITES GROUP, LLC**  
Tel: 317 271 1207 Fax: 317 271 4455  
www.aerodinecomposites.com  
8201 Indy Lane, Indianapolis, Indiana 46214

**ANDREAM LTD CUSTOMIZED COMPOSITE WINGS**  
Tel: 01953 885775 / Fax: 01953 884176  
Email: dave.greenwood@andream.co.uk  
Unit 12 Norwich Road Industrial Estate, Wotton, Norfolk IP25 6DR

**CGB CONSULTANTS** (0) 1202 673666  
**DJ RACECARS LTD** 01661 731518  
**JANUS TECHNOLOGY** 0753 860996

**PROTECH COMPOSITES LTD**  
Tel: +44(0) 1420 471 400 Fax: +44 (0) 1420 487 047  
www.protechcomposites.co.uk  
Unit 62, Woolmer Trading Estate, Bordon, Hampshire, GU35 9GF, UK



**LOLA** Tel: 01480 451301 / Fax 01480 456722  
Lola Cars International, Liebe Road, St Peters Hill, Huntingdon, Cambridgeshire PE8 7DS, England  
US Importer  
Tel (0) 317 244 2277 / Fax (0) 317 390 2121  
Lola Cars Inc, Suite B, 2809 Fortune Circle East, Indianapolis, IN 46241, USA  
01214 844066

**ROAD & STAGE M/SPORT** France (33) 1 60 01 03 67  
**SARDOU** Tel: 01258 860716  
**THE WING SHOP** Fax: 01258 860716  
E-mail: info@wingshop.co.uk  
Web: www.wingshop.co.uk

**SPA AEROFOILS LTD** 01827 260026  
**UNI OF MARYLAND** USA (0) 410 495 6861  
**QINETIQ** 02700 100942  
**ZEUS MOTORSPORT** 01604 878101



**ABC AUTOSPORT BEARINGS & COMPONENTS**  
Tel: +44(0)932 225777 Fax: +44(0)932 222295  
Unit 3 Shepperton Business Park, Shepperton, Middlesex TW17 8AA

**ALL WAYS FORWARD** 01242 222811  
**ARP** USA (0) 805 225 5752  
**ARROW SUPPLY** USA (0) 2124 840404  
**CLARENDON** 01455 841200  
**COAST FABRICATION** USA (0) 714 842 2603  
**DATUM ENGINEERING** 02426 383032  
**DZUS FASTENERS EUROPE** 01254 744422  
**FASTENER FACTORY** 01327 310188  
**FLUID CONTROL PRODUCTS INC** USA (0) 217 324 3737  
Fax (0) 217 324 3717

**PROTEC FASTENERS LTD** 01527 63231  
**SPECIALTY FASTENERS** 08003 866771  
**STAUBILI** France (33) 4 50 45 60 60  
**TRIDENT RACING SUPPLIES** TEL: 01327 857812  
FAX: 01327 857812

Unit 31, Silverstone Circuit, Northants NN12 8TN

**FIRE EXTINGUISHERS**



**LIFELINE** 02476 712999  
**INREAD NORTHBRIDGE MOTORSPORT** 01662 572924  
**RALLY DESIGN** 0795 531871  
**SAFETY DEVICES** 01353 724202  
**SPA DESIGN** 01827 288328  
**SPA TECHNIQUE** USA (0) 317 271 7941  
USA (0) 201 825 1400 Fax (0) 201 825 1962  
Aero Tec Laboratories Inc.  
Spear Road Industrial Park, Ramsey, NJ 07446-1221, USA

**FUEL CELLS**  
ATL UK 01908 321700 Fax 01908 351750  
Aero Tec Laboratories Ltd (Europe),  
1 Patriot Drive, Rooksley, Milton Keynes MK13 8PU  
USA (0) 714 842 2211

**FUEL SAFE SYSTEMS** USA (0) 714 842 2211  
**GOMM METAL DEVELOPMENTS** 01483 764876  
**KS MOTORSPORT** Germany (49) 2271 44905  
**PRONALS** France (33) 320 99 75 10  
**TRANSAUTOSPORT** 01772 454647  
**ACTIVE ENG** USA 001 714 637 055

**GARTRAC** 01428 682263  
**ROLLCENTRE** 01480 464052  
**SAFETY DEVICES** 01353 724202  
**SIGMA** Switzerland (41) 61 9717600  
**CORBEAU** 01424 854499  
**GRAND PRIX RACEWEAR** 020 8987 5500  
**MONO** 01825 433773  
**EARS MOTORSPORTS** USA 001 714 637 055  
**KS MOTORSPORT** Germany (49) 2271 44905  
**OMP** USA (0) 973 361 0508  
**MONO** USA 001 714 637 055  
**LUKE** 01213 844791  
**Total Restraint Systems** 01722 326080  
**TRW SABELT** 020 7736 2881  
**WILLANS** 01264 810712

**RUBBER & ELASTOMERIC COMPONENTS**  
BUTSER RUBBER LTD Tel: 0730 894034

### 2.2 Electrical Systems



**REDLINE MOTORSPORT** Tel: 01606 737500  
Fax: 01606 737683

**ALTERNATORS**  
**BOSCH** 01895 834466  
Germany (49) 711 8111 USA (0) 312 865 5200  
**BRISE AUTO ELECTRICS** 01322 277622  
**MM COMPETITION** 08707 444666  
**McCLAREN ELECTRONICS** 01483 261400

**CABLES**  
**CENTURY CABLES** Tel: 0733 216000 / Fax: 0733 216082  
Email: kw@centurycables.com / web: www.centurycables.com  
**IS MOTORSPORT** USA (0) 317 244 6643  
**PERFORMANCE WIRING SOLUTIONS** +44 (0)1954 253620  
**RINGSPIRAN** 01234 342511  
**SPEEDY CABLES** 020 7226 0228  
**SPOT ON CONTROL** 0188 979 0682  
**TRIDENT RACING** 01327 857822  
**CONTINENTAL** USA (0) 511 459 8861

**CONNECTORS**  
**BERU FI SYSTEMS** 01379 646200  
**DEUTSCH** 01424 852721  
**IS MOTORSPORT** USA (0) 317 244 6643  
**MAGNETI MARELLI** Italy (39) 02 972 27570  
**MM COMPETITION** 08707 444666  
**PERFORMANCE WIRING SOLUTIONS** +44 (0)1954 253620  
**SAKATA MOTORSPORT ELEC. INC** 01797 322500  
**SERVO & ELECTRONIC SALES LTD** 01801 868677  
**SPECIALTY FASTENERS** 01793 572217  
**RAYCHEM** 01793 572217

**DISTRIBUTORS**  
**IS MOTORSPORT** USA (0) 317 244 6643  
**MM COMPETITION** 08707 444666  
**PALLAS CONNECTIONS** 01869 277053  
**PAD RACING** NZ (64) 1 3186 288

**IGNITION SYSTEMS**  
**BOSCH** UK 01895 834466  
Germany (49) 711 8111 USA (0) 312 865 5200  
**SBD MOTORSPORT** 02081 391 0121  
**EFI TECH** USA (0) 310 793 2505  
**HELLA UK** 01295 272233  
**LUMINATION** 020 7403 4334  
**MAGNETI MARELLI** Italy (39) 02 972 27570  
**MM COMPETITION** 08707 444666  
**MOTEC** Australia (61) 3 9781 5050  
UK 08700 119100  
**MOTEC (EUROPE)** UK 08700 119100  
**MOTEC JAPAN** Japan (81) 489 46 1734  
**MOTEC SYSTEMS USA** USA (0) 714 897 6804  
**MSD IGNITION** USA (0) 915 857 5200  
**PI RESEARCH** 01934 842812  
**PIA (UK)** 01869 241044  
**STACK** 01483 261400  
**McCLAREN ELECTRONICS** 01483 261400

**THE STRAIN GAUGING CO** 01256 320666

**LIGHTS**  
**HELLA** 01295 272233  
**PIAA** 01934 848 430  
**PRODRIVE** 01295 254100

**LOAD CELLS**  
**NOVATECH MEASUREMENTS** 01424 852 744

**SPARKPLUGS**  
**BERU** 01295 272233  
**BOSCH** Germany (49) 711 8111  
UK 01895 834466 USA (0) 312 865 5200  
0151 522 3000  
Germany (49) 2271 44905  
Italy (39) 02 972 27570  
UK 0208 202 2151

**SPARKPLUG LEADS**  
**MAGNETI MARELLI** Italy (39) 02 972 27570  
**MM COMPETITION UK** 08707 444666

**WIRING HARNESSSES**  
**A.N. MOTORSPORT DESIGN** 01628 776320  
**COMPETITION DATA SYS** USA (0) 716 631 2880  
**DC ELECTRONICS** 01621 856451  
**SBD MOTORSPORT** 0208 301 0121  
**EFI TECH** USA (0) 310 793 2505  
**BERU FI SYSTEMS** 01379 646200  
**MAGNETI MARELLI** Italy (39) 02 972 27570  
**MM COMPETITION** 08707 444666  
**MOTEC** Australia (61) 3 9781 5050  
**MOTEC (EUROPE)** UK 08700 119100  
**MOTEC JAPAN** Japan (81) 489 46 1734  
**MOTEC SYSTEMS USA** USA (0) 714 897 6804  
**PALLAS CONNECTIONS** 01869 277053  
**PERFORMANCE WIRING SOLUTIONS** +44 (0)1954 253620  
**RAYCHEM** 01793 572217

**SAKATA MOTORSPORT ELEC. INC.** Tel: (714) 446 9473  
Fax: (714) 446 9427  
Website: www.sakatomotorsport.com  
689 S. State College Blvd, Unit F Fullerton, CA 92831

**SERVO & ELECTRONIC SALES LTD** 01797 322500  
**DAVID BROWN** 01706 872644  
**THE STRAIN GAUGING CO** 0256 320666  
**TONY JAMES** 01379 854485

**ZICA CONSULTANCY LIMITED** Tel: +44 (0) 8700 270272  
Email: sales@zica.com Website: www.zica.co.uk  
21 Anglevale, Top Angel, Buckingham, Buckinghamshire, MK08 1TH

### 2.3 Controls

**GEARSHIFT SYSTEMS**  
**CENTURY CABLES** Tel: 0733 216000 / Fax: 0733 216082  
Email: kw@centurycables.com / web: www.centurycables.com  
**DAVID BROWN** 01706 872644  
**SBD MOTORSPORT** 02081 391 0121  
**HEWLAND ENG** 01628 137600  
**JACK KNIGHT** 01481 764126  
**PRODRIVE** 01295 273355  
**QUAIFE ENGINEERING** 01732 741144  
**RICARDO MIDLANDS TECHNICAL CENTRE** 01926 319399  
**RINGSPIRAN** 01234 342511  
**THE STRAIN GAUGING CO** 0256 320666  
**STONE FOUNDRIES** 020 8853 4648

**HYDRAULIC VALVES**  
**A.N. MOTORSPORT DESIGN** 01628 776320  
**LEE PRODUCTS** 0753 886664  
**MOOG CONTROLS** 01684 296600

**INSTRUMENTATION**  
**ACTIVE SENSORS** 01202 480620  
**CRAWFIELD IMPACT CENTRE** 01234 750944  
**LPI STACK** USA 001 714 637 055  
**LUMINATION** 020 7403 4334  
**MAGNETI MARELLI** Italy (39) 02 972 27570  
**MM COMPETITION** 08707 444666  
**MOTEC** Australia (61) 3 9781 5050  
UK 08700 119100  
**MOTEC (EUROPE)** UK 08700 119100  
**MOTEC JAPAN** Japan (81) 489 46 1734  
**MOTEC SYSTEMS USA** USA (0) 714 897 6804  
**PENNY & GILES** 01202 409409  
**PI RESEARCH** 01934 253600  
**QINETIQ** 08700 100942  
**SPA DESIGN** 01827 288328  
**STACK** 01869 241044  
**McCLAREN ELECTRONICS** 01483 261400  
**THE STRAIN GAUGING CO** 0256 320666  
**VARIOHM** 01217 351004

**MIRRORS**  
**GRAND PRIX RACEWEAR** 0208 987 5500  
**SPA DESIGN** 01827 288328

**PEDALS**  
**AP RACING** 02476 63595  
**CHEVRON RACING** 01956 773795  
**LOLA** Tel: 01480 451301  
Fax: 01480 456722

**TILTON** USA (0) 805 688 2353  
**WILWOOD ENG** USA (0) 805 388 1188

**STEERING SYSTEMS**  
**FLAMING RIVER** USA (0) 440 826 4188  
**MOBILIS** Canada (1) 450 647 8900  
**RALLY DESIGN** 01795 531871  
Germany (49) 7541 773541  
UK 0195 9816921

**WOODWARD MACHINE CORP** TEL: USA (0) 307 472 0550  
FAX: USA (0) 307 235 1551  
Website: www.woodwardsteering.com  
PO Box 4479, 3592 Burd Road, Casper, WY82604, USA

**STEERING WHEELS**  
**DEMON TWEETS** 01978 664466  
**MOUNTINE** 01255 383055

**SWITCHES & KILL-SWITCHES**  
**IS MOTORSPORT** USA (0) 317 244 6643  
**MAGNETI MARELLI** Italy (39) 02 972 27570  
**MM COMPETITION** 08707 444666  
**SAKATA MOTORSPORT ELEC. INC.** (714) 446 9473  
**TONY JAMES** 01379 854485  
**TRIDENT RACING** 01536 770777

**THROTTLE CABLE**  
**CENTURY CABLES** Tel: 0733 216000 / Fax: 0733 216082  
Email: kw@centurycables.com  
Web: www.centurycables.com

**JLS MOTORSPORT** 0121 525 7733  
**KINSLER** USA (0) 800 362 4115  
**LUMINATION** 020 7403 4334  
**RALLY DESIGN** 01795 531871  
**SPOT ON CONTROL** 0188 9790682  
**RINGSPIRAN** 01234 342511

### 2.4 Suspension Systems

**DEREK BENNETT ENG** 01565 777433  
**DON FOSTER RACING** France (33) 4 70 58 0308

**DYNAMIC SUSPENSIONS** USA (0) 916 638 7888  
**GROUND CONTROL** Tel: 01480 451301  
Fax: 01480 456722  
**LOLA** USA (0) 916 638 7888

**PROFLEX UK** 01200 442345  
**RICARDO MIDLANDS TECHNICAL CENTRE** 01926 477208  
**ROD MILLEN MOTORSPORT** USA (0) 714 847211

### 2.5 Suspension Components

**ANTIROLL BARS**  
**COIL SPRINGS** 01142 758733  
**COMPTECH USA** USA (0) 916 933 1080  
**DEREK BENNETT ENG** 01565 773795  
**DON FOSTER RACING** France (33) 4 70 58 0308  
**DTM CONSULTANTS UK** 01865 407726  
**GROUND CONTROL** USA (0) 916 638 7888  
**KIC INT MOTORSPORTS** USA (0) 604 559 3354  
**HARROP** Australia (61) 3 9499 7413  
**PRECISION** USA (0) 708 766 4432

**BEARINGS & BUSHES**  
**ABC AUTOSPORT BEARINGS & COMPONENTS**  
Tel: +44(0)932 225777 Fax: +44(0)932 222295  
Unit 3 Shepperton Business Park, Shepperton, Middlesex TW17 8AA

**AURORA BEARING** USA (0) 630 859 2030  
**FASTENER FACTORY** 01217 310188  
**GETECNO** Italy (39) 010 835 6016  
**QINETIQ** 08700 100942

**Goldline Bearings Ltd**  
Tel: +44(0)932 225777 Fax: +44(0)932 222295  
Unit 3 Shepperton Business Park, Shepperton, Middlesex TW17 8AA

**GOLDLINE BEARINGS** Tel: 01932 294401  
Fax: 01932 294403  
Stafford Park 17, Telford, TF3 3DG  
USA (0) 916 638 7888  
USA (0) 630 859 2030  
01217 310188  
08700 100942

**GROUND CONTROL** USA (0) 916 638 7888  
**RESB** 0121 520 1871  
**ROSE BEARINGS** 01522 500933

**COILSPRINGS**  
**COIL SPRINGS** 01142 758 5733  
**COMPTECH USA** USA (0) 916 933 1080  
**EBACH** USA 015 283850  
Germany (49) 271 512200  
**GROUND CONTROL** USA (0) 916 638 7888  
**HYPERCOILS** USA (0) 574 753 6622  
**HERBERT TERRY** 01527 64261  
**PERFORMANCE SPRINGS** 01253 716900  
**WOODHEAD** 011 244202

**DAMPERS**  
**DTM CONSULTANTS UK** 01865 407726  
**DYNAMIC SUSPENSIONS** 01842 755744  
**PROFLEX UK** 01200 442345  
**GROUND CONTROL** USA (0) 916 638 7888  
**IRZ SUSPENSION** -314 0260955  
**NONROE AUTO EQUIPMENT** 01904 631441  
**MORRIS DAMPERS INC** USA (0) 586 826 9411  
**MOTON** Netherlands (31) 413 259838  
**OHLINS RACING** UK 0208 974 1615  
USA (0) 215 375 0180  
**PENSKER RACING SHOCKS** UK 01827 288328  
USA (0) 336 431 1827

**ROEHRIG**

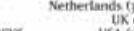

**SPAX UK (Worldwide HQ)** Tel: 01869 244771  
Tel: 01869 240536 e-mail: sales@spaxperformance.com  
Website: www.spaxperformance.com

**SPAX USA** Tel: (443) 557 0086  
Website: www.spaxusa.com

**SPAX Deutschland** Tel: 01801 7729 33 (01801 SPAX DE)  
Tel: 01801 7729 00 (01801 SPAX 00)  
e-mail: spaxde@spaxperformance.com  
Website: www.spaxperformance.com

**SPAX France** Tel: 0478 9042 43  
Website: www.spaxfrance.com

**RODS & ROD-ENDS**  
**AURORA BEARING CO** USA (0) 630 859 2030

**76 Lifeline** REVERE BRISE ADA INSTRUMENTS

**Parc Fermé Racing**  
Global Motorsport Mailorder  
Brands Hatch Warehouse  
+44 (0)1474 850 666  
www.parcfermeracing.com

**DMS technologies** **RACETECH** **MOCAL**  
Engineering with Energy

**Proflex UK Ltd** **proflex** SHOCK ABSORBERS Sole UK Sales & Service

Thorn Street Garage, Thorn Street, Clitheroe BB7 2LJ

phone: 01200 442345 for 01200 443050

Yeeps Proudly Presents, The Hot Support

**FASTENER FACTORY** 01327 310108  
**GOLDLINE BEARINGS** 01952 292401  
**GROUND CONTROL** USA (4) 916 638 7888  
**KINSLER** USA (4) 810 362 1145  
**RESB INTERNATIONAL** 0208 390 8070  
**ROSE BEARINGS** 01522 500933  
**SPECIALITY FASTENERS** 01803 866371

**SEALS**  
**SPECIALITY FASTENERS** 01803 866371  
**WALTHER** 01442 891929

**STRUT BRACES**  
**DEMON TWEETS** 01978 664466  
**EIBACH** Germany (39) 2721 5110  
 UK 0455 285850  
 USA (4) 714 727 3700  
 01327 310108  
 UK 0208 390 8070

**FASTENER FACTORY**  
**HILNERS RACING** UK 0208 974 1615

**FLUIDS**  
**ALCON COMPS** 01827 312500  
**AP RACING** 02476 639595  
**BENDIX** France (33) 14 972 2305  
 UK 01942 743888  
 0793 512712  
 Malaysia (603) 245 2642  
 USA (4) 305 270 9433  
 USA (4) 973 305 3912  
 USA (4) 805 222 2141  
 01280 843390  
 USA (4) 805 688 2353  
 USA (4) 805 388 1188

**TILTON**  
**WILWOOD**

**PADS**  
**ALCON COMPS** 01827 312 500  
**AP RACING** 02476 639595  
**BT BRAKE TECHNOLOGY** Germany (49) 6003 82919  
 USA (4) 239 772 4261  
 France (33) 14 972 2305

**CARBONE INDUSTRIE**

**DUCKHAMS OILS** 0208 290 0600  
**ELF** France (33) 1 4744 4546  
 UK 0208 902 8820  
 01372 222000  
 01484 712101  
 08700 100942  
 01476 861095

**ESSO OIL**  
**MILLERS OILS**  
**QUINETIQ**  
**RED LINE OILS**  
**REPSOL** Spain (34) 91 456 53 00  
 UK 0207 581 1933  
 UK 016 288522  
 USA (4) 713 932 9954  
 USA (4) 305 771 1010  
 UK 01488 682655  
 USA (4) 919 480 0905  
 0207 719 3000  
 USA (4) 606 264 7222

**SUCK SO**  
**STP**

**TECH-LINE**  
**TEXACO UK**  
**VALVOLINE**

**JACQUEMIN TUNING**  
**SAENZ EUROPE-JACQUEMIN TUNING**  
 France Tel: +33(0)320746480  
 Fax: +33(0)320746489  
 Email: jmjacquemin@nordnet.fr  
 Website: www.jacquemintuning.com

**SAENZ**  
**SCHIRCK** USA (4) 305 27 3422  
**SWINDON RACING ENGINES** Germany (49) 21 91 9500  
 0793 533121

**CONROD BOLTS**  
**ARIAS FORGED PISTONS** USA (4) 310 532 9737

**ARP**  
 automotive products  
 MADE IN USA  
 USA Tel: (4) 805 339 2200  
 Fax: (4) 805 650 0742  
 Website: www.arp-bolts.com  
 1863 Eastman Avenue, Ventura 93003

**ARROW**  
 precision engineering ltd  
 Tel: +44 (0) 1455 234200  
 Fax: +44 (0) 1455 233545  
 Website: www.arrowprecision.co.uk  
 Email: enquiries@arrowprecision.co.uk  
 12 Barleyfield, Hinckley, Leicestershire LE10 1YE  
 France (33) 395 68 33 39  
 USA (4) 949 498 1800  
 COAST FABRICATION USA (4) 714 842 2601  
 COSWORTH 01604 752444  
 USA (4) 310 534 1390  
 USA (4) 213 543 1390  
 0208 391 0121

**ARROW PRECISION ENGINEERING LTD**  
 Tel: +44 (0) 1455 234200  
 Fax: +44 (0) 1455 233545  
 Website: www.arrowprecision.co.uk  
 Email: enquiries@arrowprecision.co.uk  
 12 Barleyfield, Hinckley, Leicestershire LE10 1YE  
 France (33) 395 68 33 39  
 USA (4) 949 498 1800  
 COAST FABRICATION USA (4) 714 842 2601  
 COSWORTH 01604 752444  
 USA (4) 310 534 1390  
 USA (4) 213 543 1390  
 0208 391 0121

**BLANC AERO** France (33) 395 68 33 39  
**CARRILLO INDUSTRIES** USA (4) 949 498 1800  
**COAST FABRICATION** USA (4) 714 842 2601  
**COSWORTH** 01604 752444  
 USA (4) 310 534 1390  
 USA (4) 213 543 1390  
 0208 391 0121

**CROWER** USA (4) 310 534 1390  
**SBD MOTORSPO** USA (4) 213 543 1390  
**0208 391 0121**

**LINREAD NORTHBRIDGE MOTORSPO**  
 Tel: 0162 572924, Fax: 0162 572901  
 Viking Road, Wigston, Leicestershire, LE18 2BL  
 Austria (43) 386 251 2500  
 USA (4) 330 630 0888

**PANKL**  
**ATECH MOTORSPORTS** USA (4) 330 630 0888

**Co-ordsport**  
**CO-ORD SPORT**  
**ARP, FIDANZA, ROSS & OLIVER DISTRIBUTORS**  
 Tel: +44 (0)1384 216102  
 Fax: +44 (0)1384 216109  
 Email: sales@coordsport.com  
 Kings Street, Dudley, West Midlands DY2 8PX, UK  
 01455 273738  
 USA (4) 901 345 6886  
 02476 366910  
 01902 324460  
 01902 457189

**DKE** 01455 273738  
**EAGLE** USA (4) 901 345 6886  
**FARNDON ENG** 02476 366910  
**GRAINGER & WORRALL** 01902 324460  
**LAYSTALL ENGINEERING** 01902 457189

**NORTHBRIDGE**  
**MOTORSPORT**

**LINREAD NORTHBRIDGE MOTORSPO** Tel: 0162 572924, Fax: 0162 572901  
 Viking Road, Wigston, Leicestershire, LE18 2BL  
 01746 782668  
 0793 533121

**MILLINGTON** 01746 782668  
**SWINDON RACING ENGINES** 0793 533121

**CRANKSHAFTS**  
**CUSTOM CRANK** Tel: 01902 422144, Fax: 01902 422133  
 Web: www.customcrank.co.uk  
 Email: markchenry.rigg@btinternet.com

**THE CRANKSHAFT PEOPLE**

**CRANKSHAFT DAMPERS**  
**VIBRATECH** USA (4) 716 895 8000

**FLYWHEELS**  
**ALVIS ATL** 02476 539111  
**ARROW PRECISION ENGINEERING LTD**  
 Tel: +44 (0) 1455 234200  
 Fax: +44 (0) 1455 233545  
 USA 001 916 931 1080  
 02476 366910  
 Australia (61) 39 499 7433  
 USA (4) 714 220 2227  
 USA (4) 847 540 8999  
 0793 533121

**COMPTECH USA** 02476 366910  
**FARNDON ENG** 02476 366910  
**HARROP** Australia (61) 39 499 7433  
**KAITEN PRODUCTS** USA (4) 714 220 2227  
**QUARTERMASTER** USA (4) 847 540 8999  
**SWINDON RACING ENGINES** 0793 533121

**GASKETS**  
**COMETIC BY JT** FRANCE (33) 03207 46480  
**GOETZ** Germany (49) 221 21 74909  
**GORE-TEX** USA (4) 310 392 3200

**HEADS**  
**INTEGRAL POWERTRAIN** 01908 278600  
**DUNNELL ENGINES** 01449 677226  
**KENT AEROSPACE** 0793 533121

**INJECTORS**  
**ASNU** 0208 420 4494  
**HOLLEY PERFORMANCE** USA (4) 502 781 9274  
**KINSLER** USA (4) 810 362 1145  
**KS MOTORSPORT** Germany (49) 1271 44995  
**MARREN** USA (4) 203 732 4585

**INTAKE MANIFOLDS**  
**SBD MOTORSPO** 0208 391 0121  
**DUNNELL ENGINES** 01449 677226  
**EDELBROCK** USA (4) 310 281 2222  
**GRAINGER & WORRALL** 01902 324460

**2.6 Braking Systems**

**ALCON COMPONENTS** 01827 312500  
**AP RACING** 02476 639595  
**ATE** 0208 8054 8836  
**CARBONE INDUSTRIE** France (33) 0472 355700

**Circuit Supplies (U.K.) LTD**  
 Tel: 01525 395888  
 Fax: 01525 395898  
 Unit 22, Harmill Ind Est, Grovebury Road,  
 Leighton Buzzard, Beds, LU6 8FF  
 Email: info@circuitsupplies.com  
 Web: www.circuitsupplies.com

**BT BRAKE TECHNOLOGY** Germany (49) 6003 82919  
 USA (4) 239 772 4261

**DELPHI BRAKE SYSTEMS** 01926 472472  
**EBC BRAKES** 01604 583344  
**ENDLESS BRAKES** Japan (81) 267 68 0071

**brembo**

**GRANDPRIX RACEWEAR**  
 Tel: 01908 220777  
 Email: info@grandprixwear.com  
 Web: www.grandprixwear.com  
 Unit 3 Fitzhamon Court, Featherstone Road,  
 Wolverton Mill, Milton Keynes MK12 6LB

**GOODRIDGE** UK 01392 369090  
 USA (4) 310 533 1924 USA (4) 317 244 1000 USA (4) 704 662 9095  
**MOSA FREIN** Belgium (32) 01 71 32 73

**PERFORMANCE FRICTION** (4) 800 521 8874  
**EUROPE +44 (0) 1280 843 390**

**REDLINE MOTORSPORT** Tel: 01606 737500  
 Fax: 01606 737683  
 E-mail: info@redlinemotorport.co.uk

**WILWOOD ENG** USA (4) 805 388 1188

**THE RIG SHOP LTD**  
 Tel/Fax: +44(0) 2380 338347  
 Ocean Village, Marina Service area,  
 Maritime Walk, Southampton SO14 3TL

**futurefibres**

**FUTURE FIBRES** Specialists in Flexible Composite Wheel Tethers  
 Tel: 023 8066 1160 Fax: 023 8066 1161  
 Unit 4dd Marchwood Industrial Park,  
 Southampton SO40 4PB

**2.7 Brake Components**

**CALIPERS**  
**ALCON COMPONENTS** 01827 312500  
**AP RACING** 02476 639595  
**BREMBO** Italy (39) 035 605111  
 UK 02476 679668

**BT BRAKE TECHNOLOGY** Germany (49) 6003 82919  
 USA (4) 239 772 4261  
 01952 244321  
 USA (4) 805 222 2141  
 01280 843390

**PROFESSIONAL M/SPORTS** EUROPE +44 (0) 1280 843 390  
**QUINETIQ** 01626 332889  
**RACE BRAKES** 08700 100942  
**TAR.OX** New Zealand (64) 9377 2000  
**WILWOOD** Italy (39) 039 587814  
 USA (4) 805 388 1188

**DISCS**  
**ALCON COMPS** 01827 312500  
**AP RACING** 02476 639595  
**ATE** 020 8054 8836  
**BREMBO** Italy (39) 2 240 9631  
 UK 01280 700664

**BT BRAKE TECHNOLOGY** Germany (49) 6003 82919  
 USA (4) 239 772 4261

**CARBONE INDUSTRIE** France (33) 0472 355700

**HAWK**

**GRANDPRIX RACEWEAR**  
 Tel: 01908 220777  
 Email: info@grandprixwear.com  
 Web: www.grandprixwear.com  
 Unit 3 Fitzhamon Court, Featherstone Road,  
 Wolverton Mill, Milton Keynes MK12 6LB

**PERFORMANCE FRICTION** USA (4) 805 222 2141  
 EUROPE +44 (0) 1280 843 390  
 01327 878 006

**MARDI GRAS M/SPORTS** USA (4) 815 361 9000  
**RAYBESTOS** Italy (39) 039 587814  
**TAR.OX** USA (4) 805 688 2353  
**TILTON** USA (4) 805 388 1188  
**WILWOOD** USA (4) 805 388 1188

**Carbon Metallic®**

**PERFORMANCE FRICTION** (4) 805 222 2141  
**EUROPE +44 (0) 1280 843 390**

**EBC BRAKES** 01604 583344  
**ENDLESS BRAKES** Japan (81) 267 68 0071  
**FERODO** 01298 812520  
**FR** 01885 400639  
**MINTEX** 01274 854000  
**PAGID MOTORSPORTS** USA (4) 941 772 4284  
**PERFORMANCE FRICTION** USA (4) 805 222 2141  
 01280 843390  
 USA (4) 815 361 9000  
 Italy (39) 039 587814  
 USA (4) 805 688 2353  
 USA (4) 805 388 1188

**RAYBESTOS** USA (4) 815 361 9000  
**TAR.OX** Italy (39) 039 587814  
**TILTON** USA (4) 805 688 2353  
**WILWOOD** USA (4) 805 388 1188

**VALVES**  
**ALCON COMPS** 01827 312 500  
**AP RACING** 02476 639595  
**TILTON** USA (4) 805 688 2353  
**WILWOOD USA** (4) 805 388 1188

**2.8 Wheels**

**DYNAM RACING UK** 01249 655481  
**HILLGARD** Sweden (46) 300 60590  
**KINESIS MOTORSPORT** USA (4) 760 598 5300  
**MOMO** Italy (39) 0276 11072  
**SPARCO** Italy (39) 011 470 2343

**WHEEL TETHERS**

**TRIS LIMITED**  
 THE RIG SHOP LTD  
 Tel/Fax: +44(0) 2380 338347  
 Ocean Village, Marina Service area,  
 Maritime Walk, Southampton SO14 3TL

**futurefibres**

**FUTURE FIBRES** Specialists in Flexible Composite Wheel Tethers  
 Tel: 023 8066 1160 Fax: 023 8066 1161  
 Unit 4dd Marchwood Industrial Park,  
 Southampton SO40 4PB

**2.9 Tyres**

**AVON RACING** 01225 703101  
**CO-ORD SPORT** 01884 216102  
**DUNLOP** 0121 306 6000  
 Australia (61) 330 59333  
 Ireland (353) 178 3599

**VINTAGE TYRES LTD** (Distributor of Dunlop Race Tyres in North America)  
 Tel Canada (416) 902 228 2335  
 Fax Canada (416) 902 2282427  
 Email vintyre@aol.com  
 255 Southwest Cove Road, Hubbards,  
 Nova Scotia, Canada, B0J 1T0

**GOODYEAR** Germany (49) 2234 82031  
 USA (4) 216 796 2121  
 Canada (416) 416 684 7418  
 07572 401284  
 France (33) 73 90 77 341  
 01933 41444  
 05482 613339  
 Japan (81) 33 432 7111

**MICHELIN**

**TOYO**

**YOKOHAMA**

**2.10 Fuels & Lubricants**

**AGIP** Italy (39) 65 0981  
**BP** 01442 232323  
 0793 519521  
 01372 380532  
 0793 512712

**CASTROL** Malaysia (603) 245 2642  
**CASTROL** USA (4) 305 270 9433  
**CASTROL** USA (4) 973 305 3912  
**CENTURY** 01782 202521

**AGIP** Italy (39) 65 0981  
**BP** 01442 232323  
 0793 519521  
 01372 380532  
 0793 512712

**CASTROL** Malaysia (603) 245 2642  
**CASTROL** USA (4) 305 270 9433  
**CASTROL** USA (4) 973 305 3912  
**CENTURY** 01782 202521

**CIRCUIT SUPPLIES (U.K.) LTD**

Circuit Supplies are the main UK distributor for Ferodo Racing brake pads including the new DS2500 material - developed especially for track day and high performance road use.

**ALSO AP RACING MAIN DISTRIBUTOR**

Unit 22, Harmill Industrial Estate, Grovebury Road, Leighton Buzzard, Beds LU7 4FF, England

Telephone: 01525 385 888 (International +44 1525 385 888)  
 Fax: 01525 385 898 (International +44 1525 385 898) Mobile: 07774 689600  
 Email: info@circuitsupplies.com

**FERODO RACING** Main UK Distributors **AP RACING** Main Distributors

**JENVEY DYNAMICS** 01746 768810  
**KINSLER** USA (0) 800 362 1145  
**LINGENFELTER** USA (0) 219 724 2552  
**SCHRIK** Germany (49) 21 91 9500  
**SWINDON RACING ENGINES** 01793 531321

**LINEARS**  
**AE PISTONS** 01274 7299595  
**APPERLEY HONING** 01242 525868  
**DATRON SLEEVES** USA (0) 760 601 9895  
**GKN SQUEEZEFORM** 01952 244321  
**LAYSTALL ENG** 01902 457899  
**MAHLE** Germany (49) 277 4690

**OIL SEALS**  
**RACETEC NAK** 02380 246986

**PISTONS**  
**ACCALITE PISTONS** Tel 0121 525 6450  
 Fax 0121 551 5951  
**Accralite Piston Division, Spon Lane South,**  
**Smethwick, West Midlands B66 4JF**  
**AE PISTON PRODUCTS** 01274 7299595  
**ARIAS** 01403 784022  
**ARIAS FORGED PISTONS** USA (0) 310 532 9737  
**BATTEN PERFORMANCE** USA (0) 313 946 9850  
**COSWORTH** 01604 752444  
 USA (0) 100 534 1390  
 USA (0) 714 898 9793  
**JE PISTONS** USA (0) 804 971 01658  
**MALVERN RACING** USA (0) 732 905 3366  
**MANLEY PERFORMANCE** 0121 559 6778  
**OMEGA PISTONS**



**PERFECT BORE** +44 (0) 1264 774319



**ROSS PISTON STOCKISTS** Tel 01384 26102 Fax 01384 26109  
 Website: www.coorsport.com  
 Email: sales@coorsport.com  
**Kings Street, Dudley West Midlands DY2 8PX**  
**SWINDON RACING ENGINES** 01793 531321  
**TOTAL SEAL** USA (0) 602 678 4977  
**WISCO PISTON** USA (0) 216 976 6600  
 Canada 800 265 1029

**PISTON RINGS**  
**AE PISTON PRODUCTS** 01274 7299595  
**ARIAS FORGED PISTONS** USA (0) 310 532 9737  
**CORDS PISTON RING** 0208 998 9923  
**FORD AUTO ENG** USA (0) 805 2981785  
**GOETZ** Germany (49) 221 277 4690  
**HI-TECH** USA (0) 801 972 8766  
**TOTAL SEAL** USA (0) 602 678 4977  
**TWR ENGINES** 01993 879000

**RUBBER & ELASTOMERIC COMPONENTS**



**BUTSER RUBBER LTD** Tel: 01793 894034 / Fax: 01793 894344  
 Website: www.butserrubber.com  
 Email: butserrubber@btinternet.com  
**Mint Road, Liss, Hampshire GU33 7BQ**

**VALVES**



**DEL WEST ENG** USA Tel: (0) 661 295 5700  
 Fax: (0) 661 295 8300  
**28128 West Livingston, Valencia CA 91355, USA**  
**FERREA** USA (0) 954 733 2505  
**GES VALVES LTD** 01483 415444  
**QUINETO** 08700 100942  
**MANLEY PERFORMANCE** USA (0) 732 905 3366  
**RACING ENGINE VALVES** USA (0) 954 772 8060  
**SCHRIK** Germany (49) 21 91 9500  
**SUPERTECH PERFORMANCE** USA (0) 408 448 2001  
**SWINDON RACING ENGINES** 01793 531321  
**VALVE TECHNICS** 01604 706541  
**XCELZYNE TECHNOLOGIES** USA (0) 336 472 8281

**VALVE SEATS**

**ARROW PRECISION ENGINEERING LTD**  
 Tel +44 (0) 1455 234200  
 Fax +44 (0) 1455 233545  
 Tel (0) 805 499 8885  
 Fax (0) 805 499 7880  
**2640 Lavery Ct, Unit C, Newbury Park, CA 91320, USA**  
**SERDI** 01895 232215  
**SWINDON RACING ENGINES** 01793 531321

**VALVESPRINGS**  
**CONNAUGHT** 01795 843802  
**DIAMOND** USA (0) 113 792 6620  
**EDELBROCK** USA (0) 213 781 2222  
**HERBERT TERRY & SONS** 01527 62284  
**KENT CAMS** 01101 248666  
**KURT KAUFFMANN** Germany (49) 71 538300  
**MANLEY PERFORMANCE** USA (0) 732 905 3366  
**PERFORMANCE SPRINGS** 01253 716900  
**SCHMITTHIEL** Germany (49) 62 2176060  
**VALVE SPRING RETAINERS**  
**GES VALVES LTD** 01483 415444

**VALVE GUIDES**

**ARROW PRECISION ENGINEERING LTD**  
 Tel +44 (0) 1455 234200  
 Fax +44 (0) 1455 233545  
 USA (0) 714 220 2227  
 01895 232215

**KAITEN PRODUCTS**  
**SERDI** 01795 843802

### 3.2 Engine Ancillaries

**AIR FILTERS**



**INDUCTION TECH GROUP** Tel 02476 30386  
 Fax 02476 309999  
**Unit 8, Quinn Close, Seven Stars Industrial Estate,**  
**Whitley, Coventry CV3 4LH**  
**K&N ENGINEERING** USA (0) 909 481 3816  
**K&N FILTERS (EUROPE)** UK 01925 636950  
**KINSLER** USA (0) 248 362 1145  
**PIPERCROSS** 01604 671100

**CARBURETTORS**  
**BO FUEL SYSTEMS** USA (0) 706 864 8544  
**CARBURETOR SHOP** USA (0) 909 481 3816  
**SOLEX** France (33) 14 759 7771  
**WEBER** Italy (39) 52 479995  
**WEBCON** 01932 787100

**EXHAUST SYSTEMS**  
**ACTIVE ENGINEERING** USA (0) 714 637 0155  
**BURNS STAINLESS** USA (0) 949 631 5120



**GDS EXHAUSTS** Tel: 01280 702510 / Fax: 01280 702225  
 Email: sales@gds-exhausts.co.uk  
 Website: www.gds-exhausts.co.uk  
**Unit 8C Boundary Road, Brackley NN13 7ES**



**GOOD FABRICATIONS LTD**  
 Tel: +44 (0)1844 202850 / Fax: (0)1844 202833  
 Email: info@goodfabs.com www.goodfabs.com  
**Unit 3a, Drakes Farm, Drakes Drive, Long Grendon,**  
**Aylesbury, Bucks HP8 9BA England**  
**FLOWMASTER** USA (0) 646 461 4113  
**JETEX EXHAUSTS** 01789 298089  
**MARK ORTIZ** USA (0) 716 835 3242  
**PIPER CAMS** 01233 500200  
**SPECIALISED EXHAUST** 0208 648 4786

**FUEL FILTERS**  
**AN MOTORSPORT DESIGN** 01628 776320  
**CONNAUGHT** 01795 843802  
**EARL'S PERFORMANCE** UK 01217 858221  
 Fax 01217 858473  
**Unit 17 Silverstone Circuit, Towcester,**  
**Northamptonshire NN12 8TL, England**  
**ED PINK RACING ENGINES** USA 808 785 6740  
**EXACT ENGINEERING** 01803 866464  
**FHS MOTOR RACING** 01753 513080  
**FLUID CONTROL PRODUCTS INC** USA (0) 217 324 3737  
 01413 223000  
**KINSLER** USA (0) 248 362 1145  
**LEE PRODUCTS** 01753 886664  
**SPV RACING** Australia (61) 2 791 9899  
**THINK AUTOMOTIVE** 0208 568 1172  
**TJ FILTERS** 01752 667675  
**WEBCON** 01932 287100

**FUEL INJECTION**  
**AC ROCHESTER** USA (0) 716 359 6361  
**ASNU** Tel 0208 420 4194  
**BGC MOTORSPORT** 0208 880 4205  
**BOSCH** 01805 534166  
 Germany (49) 711 8111  
 USA (0) 312 865 5200  
**CONNAUGHT** 01795 843802  
**SBD MOTORSPORT** 0208 591 0121  
**FLUID CONTROL PRODUCTS** Tel (0) 34 291 9221  
**GENESIS ELECTRONIC SYSTEMS** 01635 582255  
**INDUCTION TECHNOLOGY** 02476 303886  
**JENVEY DYNAMICS** 01746 768810  
**JOHN WILCOX COMPETITION** 01455 230576



**KINSLER FUEL INJECTION** Tel: USA (0) 248 362 1145  
 Fax: USA (0) 248 362 1032  
 Website: www.kinsler.com  
**LINGENFELTER** USA (0) 219 724 2552  
**MAGNETI MARELLI** Italy (39) 2 6181 331  
**MM COMPETITION SYSTEMS** 08707 444666  
**MARREN** USA (0) 201 732 4565  
**MILLINGTON** 01746 789268  
**MOTEC** Australia (61) 3 9761 5050  
**UK 08700 101000**  
**MOTEC (EUROPE)** Japan (81) 489 46 1734  
**MOTEC SYSTEMS USA** UK 0208 591 7200  
**NIIPPON DENSO** +44 (0)1954 253610  
 (714) 440 9471  
 USA (0) 805 967 9478

**PECLET CONTROL SYSTEMS**  
**SAKATA MOTORSPORT ELEC. INC.**  
**TWM INDUCTION** USA (0) 805 967 9478

**FUEL LINES**  
**AERQUIP** USA (0) 419 238 1190  
**AN MOTORSPORT DESIGN** 01628 776320

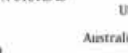

**ATL** USA (0) 201 825 1400  
 Fax (0) 201 825 1962  
**Aero Tec Laboratories Inc, Spear Road Industrial Park,**

**ATL** Ramsey, NJ 07446-1221, USA  
 UK 01908 357700 / Fax 01908 357570  
**Aero Tec Laboratories Ltd (Europe), 1 Patriot Drive,**  
**Rooksley, Milton Keynes, MK13 8PU**

**BROWN AND MILLER** UK 01753 553610  
 USA 704 793 4319  
 0795 843802  
**CONNAUGHT** 01803 866464  
**EXACT ENGINEERING** USA 317 243 3092  
**FAE MACHINE** 01684 891898  
**FLEXOLITE** UK 01795 541955  
**FUEL SAFE** USA (0) 714 841 2311  
 USA (0) 310 531 1924  
 USA (0) 317 244 1000  
 USA (0) 704 662 9095

**GOODRIDGE CA**  
**GOODRIDGE INDY**  
**GOODRIDGE EAST**

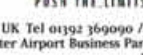

**GOODRIDGE UK** Tel 01392 369090 / Fax 01392 441780  
**Exeter Airport Business Park, Exeter, EX5 2TP**  
**HENRY'S ENG** USA (0) 410 535 4142  
**JLS MOTORSPORT** Tel 0121 525 7733



**KRONTEC MASCHINENBAU GmbH**  
 Fitting & Hose Systems  
**Pommernstraße 33 93073 Neutraubling**  
**Germany (49) 2271 44905**  
**France (33) 320 99 75 10**  
**Australia (61) 2 791 9899**  
**USA 0208 568 1172**  
**01684 891898**  
**01392 369090**  
**France 33 3 209 97510**  
**01327 359512**  
**USA (0) 218 233 2282**

**KS MOTORSPORTS**  
**PRONAL'S**  
**SPECIALTY FASTENERS**  
**SPV RACING** Australia (61) 2 791 9899  
**THINK AUTOMOTIVE** 0208 568 1172  
**FLEXOLITE** 01684 891898  
**GOODRIDGE** 01392 369090  
**PRONAL'S** France 33 3 209 97510  
**RACETECH** 01327 359512  
**WELDON RACING PUMPS** USA (0) 218 233 2282



**XRP INC** Tel USA (0) 562 861 4765  
 Fax USA (0) 562 861 5503  
**5630 Imperial Highway, South Gate, CA 90280, USA**

**FUEL VALVES**  
**AN MOTORSPORT DESIGN** 01628 776320  
**ATL** USA (0) 201 825 1400  
 UK 01908 357700  
 01803 866464  
 USA (0) 248 362 1145  
 France 33 3 20 997510  
 01803 866371

**EXACT ENG**  
**KINSLER**  
**PRONAL'S**  
**SPECIALTY FASTNERS**

**HOSES & HOSE-ENDS**  
**AERQUIP** USA (0) 419 238 1190  
**AN MOTORSPORT DESIGN** 01628 776320

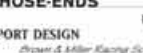

**BROWN AND MILLER** UK Tel: 01753 553610  
 Fax: 01753 574777  
**Unit 7-A, Langley House, Middle Green Trading Estate,**  
**Langley, SL3 6DP USA Tel: 704 793 4319**  
 Fax: 704 793 4319  
**4005 Dearborn Place NW, Concord, NC 28027**  
**DELPHI BRAKES SYSTEMS** 01926 474772  
 USA (0) 310 609 1602  
**EXACT ENG** 01803 866464  
**FASTENER FACTORY** 01327 311018  
**FHS MOTOR RACING** 01753 570865  
**FLUID CONTROL PRODUCTS INC** USA (0) 217 324 3737  
 Fax (0) 217 324 3717  
 01392 369090  
**GOODRIDGE UK** USA (0) 310 531 1924  
**GOODRIDGE CA** USA (0) 317 244 1000  
**GOODRIDGE INDY** USA (0) 704 662 9095  
**GOODRIDGE EAST** 01282 419192  
**HCL FASTENERS** USA (0) 410 135 4142  
**HENRY'S ENG** 0121 525 7733  
**JLS MOTORSPORT** USA (0) 248 362 1145  
**KINSLER** 01443 238464  
**SAMCO SPORT**

**DELPHI BRAKES SYSTEMS** 01926 474772  
 USA (0) 310 609 1602  
**EXACT ENG** 01803 866464  
**FASTENER FACTORY** 01327 311018  
**FHS MOTOR RACING** 01753 570865  
**FLUID CONTROL PRODUCTS INC** USA (0) 217 324 3737  
 Fax (0) 217 324 3717  
 01392 369090  
**GOODRIDGE UK** USA (0) 310 531 1924  
**GOODRIDGE CA** USA (0) 317 244 1000  
**GOODRIDGE INDY** USA (0) 704 662 9095  
**GOODRIDGE EAST** 01282 419192  
**HCL FASTENERS** USA (0) 410 135 4142  
**HENRY'S ENG** 0121 525 7733  
**JLS MOTORSPORT** USA (0) 248 362 1145  
**KINSLER** 01443 238464  
**SAMCO SPORT**



**SFS PERFORMANCE** Tel: 01582 488040  
 Fax: 01582 412277  
 Website: www.sfsperformance.co.uk  
**Unit E Kingsway Industrial Estate, Kingsway**  
**Luton LU1 1LP**  
**SPECIALTY FASTNERS** 01803 866371  
**SPEED FLOW** 0208 530 6664  
**THINK AUTOMOTIVE** 0208 568 1172  
**UNCLIP AUTOMOTIVE** 01932 355277  
**XRP INC** USA (0) 562 861 4765

**INTERCOOLERS**  
**AH FABRICATIONS** 01432 354704  
**ALLARD MOTOR CO** 01425 500 331  
**FLUID CONTROL PRODUCTS INC** USA (0) 217 324 3737  
 Fax (0) 217 324 3717  
 01440 760690  
 0208 965 2151  
 01582 412 697

**PAPE PRODUCTS**  
**SERCK MARSTON**  
**SFS PERFORMANCE**

**OIL COOLERS**

**AERQUIP** USA (0) 419 238 1190  
**CV PRODUCTS** USA (0) 910 883 4096  
**DOCKING & CO** 01372 857614  
**EARL'S** USA (0) 310 609 1602  
**EXACT ENGINEERING** 01803 866464  
**FAE MACHINE** USA 317 243 3092  
**FLUID CONTROL PRODUCTS INC** USA (0) 217 324 3737  
 Fax (0) 217 324 3717  
 01392 369090  
**GOODRIDGE UK** USA (0) 310 531 1924  
**GOODRIDGE CA** USA (0) 317 244 1000  
**GOODRIDGE INDY** USA (0) 704 662 9095  
**GOODRIDGE EAST** Sweden (46) 85 907 4045  
**LAMINOVA** 0121 550 3258  
**PROCOMP** 020 8966 2151  
**SECAN** France (33) 14 790 6712  
**SERCK MARSTON** Sweden (46) 40 158080  
**SETRAB** 01803 866371  
**SPECIALTY FASTNERS** Australia (61) 2 791 9899  
**SPV RACING** 020 8568 1172  
**THINK AUTOMOTIVE** 01547 530289  
**TREVOR MORRIS ENG**

**OIL FILTERS**  
**AN MOTORSPORT DESIGN** 01628 776320  
**COSWORTH** 01604 752444  
 USA (0) 310 534 1390  
 USA (0) 310 609 1602  
 USA 818 785 6740  
 01803 866464  
 01573 570863  
 01443 223000  
 USA (0) 248 362 1145

**OIL PUMPS**  
**ED PINK RACING ENGINES** USA 818 785 6740  
**KENT CAMS** 01303 248666  
**PACE PRODUCTS** 01440 760960  
**PACET** 01628 526754  
**SPV RACING** Australia (61) 2 791 9899  
**SWINDON RACING ENGINES** 01793 531321  
**TITAN MOTORSPORT** 01480 474402

**OILS & LUBRICANTS**  
**OLD HALL PERFORMANCE LTD** +44 (0) 24 7671 7100  
 Fax +44 (0) 24 7671 7400  
 email sales@redlineoil-europe.com  
 www.redlineoil-europe.com

**OIL SEALS**  
**RACE-TEC NAK** 02380 246986  
**PIONEER WESTON (WYKO)** 0161 703 2011

**OIL SUMPS**  
**AH FABRICATIONS** 01432 354704

**ARE RACING ENGINE SYSTEMS**  
 USA (0) 916 987 7629  
 www.drysump.com  
 01795 843802  
 01746 768810  
 USA (0) 808 497 1211  
 01440 760960  
 0208 853 4648  
 01793 531321  
 01480 474402  
 01547 530289

**CONNAUGHT**  
**JENVEY DYNAMICS**  
**KINSLER**  
**PACE PRODUCTS**  
**STONE FOUNDRIES**  
**SWINDON RACING ENGINES**  
**TITAN MOTORSPORT**  
**TREVOR MORRIS ENG**

**TURBOCHARGERS**  
**GARRETT AUTOMOTIVE** 01695 22391  
**HOSET ENG** 01484 412244  
**INTERPRO ENGINEERING** 01454 412777  
**QUINETO** 08700 100942  
**TURBO TECHNICS** 01604 764005  
**ALLARD MOTOR CO** 01425 500 331

**WATER COOLERS**  
**AH FABRICATIONS** 01432 354704  
**DOCKING & CO** 01372 857614  
**DENSO MARSTON** 01573 526266  
**NIIPPON DENSO** Japan (81) 56 625 5511  
 UK 0208 591 7700  
 01440 760960  
 0208 965 2151

**WATER INJECTION**  
**ERI** 01273 581007

**WATER PUMPS**  
**DAVIES, CRAIG** Australia (61) 39 499 7433  
**ED PINK RACING ENGINES** USA 818 785 6740  
**EDELBROCK** USA (0) 213 781 2222  
**TREVOR MORRIS ENG** 01547 530289

**Buy autosport bearings on-line**  
**All from stock. Lowest prices**



**T: +44 (0) 1932 225777**  
**F: +44 (0) 1932 222215**

YyPG Proudly Presents, Thx for Support

### 3.3 Engine Electronics

#### COMPUTER SUPPLIERS

ACES 01206 395224  
 ADVANCED AUTOMOTIVE 01753 642019  
 COMPETITION DATA USA (0) 716 631 2880  
 FUELTRONICS Australia (61) 985 21 2109  
 PAD RACING New Zealand (64) 3 3386 2881  
 PERFORMANCE TRENDS USA (0) 248 473 9230  
 RACELOGIC 01280 812803

#### DATA-ACQUISITION

ACTIVE SENSORS Tel 01202 480620  
 Fax 0120 2480664  
 ADVANCED AUTOMOTIVE 01753 642019  
 B&G RACING USA (0) 602 274 2537  
 BOSCH 01895 834266  
 Germany (49) 711 8111  
 USA (0) 312 865 5200  
 Australia (61) 985 21 2109  
 USA 800 870 8383  
 01905 796900  
 USA (0) 311 761 1545  
 Germany (49) 721 944850  
 0208 463 9222  
 01908 261655  
 Canada (0) 604 984 9437  
 USA (0) 404 448 9550



INTERCOMP USA Tel (0) 763 476 2531  
 Fax (0) 763 476 2641  
 14465 23rd Avenue N, Minneapolis, MN 55447, USA  
 ISAAC INSTRUMENTS INC. Tel: (450) 658 7520  
 Fax: (450) 658 3322  
 Email: isaac@isaac.ca  
 Website: www.isaac.ca  
 25 Robert, Chamby, Quebec, Canada J3L 1S2

LONGACRE USA (0) 425 485 0620  
 McLAREN ELECTRONICS 01483 261000  
 MM COMPETITION SYSTEMS 08707 441666  
 MOTEC Australia (61) 3 9761 5050  
 MOTEC (EUROPE) UK 08700 191010  
 MOTEC JAPAN Japan (81) 489 46 1734  
 MOTEC SYSTEMS USA USA (0) 714 897 6804  
 MOTEC USA (0) 804 973 1399  
 MOTOR SPORT ELEC Australia (61) 7 3290 1309  
 MOTORSPORTS INTERFACE 0127 31011  
 MTS Powertrain Tech Tel 01932 351516  
 Fax 01932 351517

7 Glen Court, Canada Road, Byfleet, Surrey KT14 7JL  
 NIPPON DENSO Japan (81) 50 625 9051  
 PECTEL CONTROL SYSTEMS +44 (0)1924 253100  
 PENNY & GILES 01202 409409  
 PERFORMANCE TRENDS USA (0) 248 473 9230  
 PI RESEARCH 01954 253600  
 POLY LOGIC 01462 620366  
 QINETIQ 08700 100942  
 QUANTUM SUSPENSION 01241 865950  
 RACE DATA ENGINEERING USA (0) 714 449 1445  
 SAKATA MOTORSPORT ELEC. INC. (714) 446 9473  
 STACK Tel 01869 240404  
 Fax 01869 245500  
 email: sales@stackfwd.com

Wedgewood Road, Bicester Oxfordshire, OX26 4JL  
 STEVE BUNKHALL 01223 301025  
 VARIOHM 01327 351094

#### ENGINE MANAGEMENT SYSTEMS

ADVANCED AUTOMOTIVE 01753 642019  
 ASNU 0208 420 4494  
 BOSCH 01895 834266  
 Germany (49) 711 8111  
 USA (0) 312 865 5200  
 Australia (61) 985 21 2109  
 CONNAUGHT 0208 463 9229  
 DATAPARES 0208 463 9229  
 SBD MOTORSPORT 0208 301 0121  
 McLAREN ELECTRONICS 01483 261000  
 MM COMPETITION 08707 441666



MOTEC PTY LTD Aus Tel: 613 9761 9090  
 Aus Fax: 613 9761 5021  
 Japan +81 489 461 734  
 121 Merringdale Drive  
 Croyston South Victoria Australia  
 UK +44 8700 191000  
 USA +1 714 895 7001

PECTEL CONTROL SYSTEMS 01924 253100  
 PRECISION RACE SERVICES USA (0) 248 473 9230  
 SAKATA MOTORSPORT ELEC. INC. (714) 446 9473  
 STACK 01869 240404  
 SUPERCHIPS 01280 812803  
 TERRY SHEPHERD TUNING 01606 574254  
 WALBRO ENGINE MANAGEMENT USA (0) 909 872 7091  
 ZYTEK SYSTEMS 0121 323 2323

#### ENGINE SENSORS

ACTIVE SENSORS Tel 01202 480620  
 Fax 0120 2480664  
 Unit 12, Wilberly Rd, Chischurch, Dorset, Bt21 3BU England  
 (49) 6134 7179-0  
 AVL DEUTSCHLAND  
 GmbH Germany  
 DATAPARES 0208 463 9229  
 ENTRAN 01923 893 999  
 KESTLER INSTRUMENTS 01420 544477



KULITE SENSORS Tel 01256 466646  
 Kulite House, Stroudley Road, Denismole, RG24 8UG, England

MAGCANICA INC USA 858 454 8950  
 McLAREN ELECTRONICS 01483 261000  
 THE STRAIN GAUGING CO 01256 300666  
 VARIOHM 01327 351094

#### REV-LIMITERS

LUCAS ELECTRICAL 0121 536 5050  
 LUMINATION 020 7403 4344  
 MM COMPETITION 08707 441666

### 3.4 Transmission Components

#### CLUTCHES



ALCON Tel +44 (0) 1827 723700  
 Fax +44 (0) 1827 723701  
 Email info@alcon.co.uk  
 www.alcon.co.uk  
 Apollo, Tamworth, Staffordshire B79 7JN



#### AP RACING

(0)24 7663 9595  
 Fax (0) 24 7663 9599  
 Wheeler Road, Coventry, CV3 4LB  
 0208 654 8835  
 01392 369090  
 Tel 01480 451301  
 Fax 01480 450722  
 QUARTER MASTER USA (0) 847 540 8999  
 Fax (0) 847 540 0526  
 510 Teles Road, Lake Zurich, IL 60047, USA  
 UK 01926 812136  
 Germany (49) 9725 5975



#### SACHS RACE ENGINEERING GmbH

Tel +49 9721-984300  
 Fax +49 9721-984299  
 Email service.sachs-race-engineering.de  
 Website www.sachs-race-engineering.de  
 Ernst-Sachs-Strasse 62, 97424 Schweinfurt, Germany  
 SACHS BOGE UK 01788 822153  
 TILTON ENGINEERING USA (0) 805 688 2353  
 Fax (0) 805 688 2745  
 25 Easy Street, Buellton, CA 93427 USA  
 Fax (0) 805 388 4938  
 USA (0) 805 388 1168  
 416 Calle San Pablo, Camarillo, CA 93012, USA

#### COMPLETE TRANSMISSIONS



RICARDO MIDLANDS TECHNICAL CENTRE  
 Tel: 01926 447152  
 Fax: 01926 393152  
 Email: latin.wght@ricardo.com  
 Website: www.ricardo.com  
 Southam Road, Radford Semele,  
 Leamington Spa CV31 1FQ

#### CWP'S

DAVID BROWN 01484 422800  
 DTS USA (0) 311 778 0540  
 JCM TRANSEXLES USA (0) 303 695 6093  
 MARK BAILEY RACING 01380 850130  
 XTRAC LTD 01635 293800

#### DIFFERENTIALS

AJEC INDUSTRIES 01242 222739  
 GEARACE LIMITED 01869 277563  
 GKN AXLES 0207 930 2424  
 HEWLAND ENG USA (0) 1628 827600  
 JCM TRANSEXLES USA (0) 303 695 6093  
 MARK BAILEY RACING 01380 850130  
 QUAFIE ENGINEERING 01732 741444  
 RICARDO 01273 455011  
 RICARDO MIDLANDS TECHNICAL CENTRE 01926 393999  
 TOM'S DIFFERENTIALS USA (0) 310 634 8431  
 TRAN-X GEARS LTD 02476 659061  
 XTRAC LTD 01635 293800  
 ZEXEL-GLEASON USA (0) 716 464 5000

#### DRIVESHAFTS



CTG Tel: +44 (0)1295 220130  
 Fax: +44 (0)1295 220138  
 Email: motorsport@ctgpld.co.uk  
 www.ctgpld.co.uk  
 Thorpe Park, Thorpe Way, Banbury, Oxfordshire  
 OX16 4SU United Kingdom



GKN MOTOR SPORT Tel 0121 313 1664  
 Fax 0121 313 2074  
 Unit 5, Kingsbury Business Park,  
 Kingsbury Road, Minworth, Sutton Coldfield,  
 Birmingham B76 9DL, England

METALORE USA (0) 310 643 0360  
 PANKL 0043 3862 33999  
 TEX RACING USA (0) 910 428 9522  
 TRAN-X GEARS LTD 02476 659061

#### GEARS



BGM 001 808 882 6422  
 www.bmrac.com  
 Chatsworth CA 9711 USA  
 COLLEGE & MORLEY 02476 462328  
 COMPUTECH USA (0) 916 933 1080  
 DAVID BROWN 01484 422800  
 GEARACE LIMITED 08169 277563  
 HEWLAND ENG 01628 827600  
 JCM TRANSEXLES USA (0) 303 695 6093  
 KERSCHBAUMER Ger (49) 6074 47 663  
 MARK BAILEY RACING 01380 850130  
 PANKL 0043 3862 33999  
 TEX RACING USA (0) 910 428 9522  
 RICARDO MIDLANDS TECHNICAL CENTRE 01926 393999  
 TRAN-X GEARS LTD 02476 659061  
 XTRAC LTD 01635 293800

#### UNIVERSAL JOINTS

FLAMING RIVER USA (0) 440 826 4488  
 GEARACE LIMITED 01869 277563

## Database 4

### FACTORY EQUIPMENT

#### 4.1 Factory Hardware

##### AIR LINES & FITTINGS

A.N. MOTORSPORT DESIGN 01628 776320  
 EARL'S UK 01327 858221  
 EXACT ENGINEERING 01803 866464  
 Fhs Motor Racing Ltd 01753 313080  
 GOODRIDGE UK 01392 369090  
 GOODRIDGE CA USA (0) 310 533 1924  
 GOODRIDGE INDY USA (0) 317 244 1000  
 GOODRIDGE EAST USA(0) 704 661 9095  
 INGERSOLL RAND 01204 696060  
 JLS MOTORSPORT 0121 525 7733  
 KRONTEC Germany (49) 9401 703062  
 REGENT 09908 612602  
 ROTOTEST Sweden 46 8532 55800  
 THINK AUTOMOTIVE 0208 568 1722

##### AIR TOOLS

DESOUTTER AUTOMOTIVE 0208 205 4884



DINO PAOLI S.R.L. Tel: +390 522 300828  
 Fax: +390 522 304864  
 email: info@dinopaoli.com  
 Website: www.dinopaoli.com  
 Via Guido Dorso, 54200, Reggio Emilia, Italy

FACOM 01912 956099  
 INGERSOLL RAND 01204 696060  
 JLS MOTORSPORT 0121 525 7733

##### CNC MACHINING CENTRES

ABSOLUTE MACHINE TOOL USA (0) 440 324 5133  
 BOSTON DIGITAL USA (0) 508 473 4561  
 BRIDGEPORT MACHINE USA (0) 248 299 1750  
 DEREK ROBINSON 016 266 2222  
 DEWCO USA (0) 765 962 7201  
 MACHINERY SALES USA (0) 510 490 4000  
 MAKINO USA (0) 800 552 3288  
 MEDDINGS MACHINES 01752 893277  
 MILLS ENGINEERING 01601 745533  
 MILSITE ENGINEERING USA (0) 304 273 5353  
 JCS PERFORMANCE USA (0) 716 434 2509  
 RMT MECHATRONICS 01895 222215  
 SERDI 01895 222215  
 SOUTHWESTERN IND USA (0) 310 608 4422  
 SPA AEROFOILS LTD 01827 260026  
 T65 USA (0) 920 668 1000  
 TOYODA EUROPE 02476 547200

#### CRACK DETECTION

ABS PRODUCTS USA (0) 714 671 0728  
 DCM TECH USA (0) 800 533 5319  
 KRAUTKRAMER BRANSON USA (0) 717 242 0327

#### CRYOGENIC TEMPERING

FROZEN SOLID 01449 674914

#### DUST EXTRACTION EQUIP

DENCER 01789 470908

#### DYNAMOMETERS: CHASSIS

FROUDE CONSOLE 01905 856800  
 International Dynamometers LTD/Dynapack  
 001 559 292 3800 New Zealand 64 4587 0484  
 USA (0) 603 329 5645  
 LAND & SEA UK 01842 757544  
 KISTLER Instruments Ltd 01420 544477  
 ROTOTEST Sweden (46) 8 532 55800  
 SUPERFLOW USA (0) 800 471 7701  
 Belgium 325 216300  
 UNICO (UK) LTD 01908 260000

#### DYNAMOMETERS: DAMPER

BEHRENS SPEED CENTER USA (0) 914 651 7389  
 CZECH MATE USA (0) 800 809 2223  
 DYNAMIC SUSPENSIONS Can (0) 905 470 8778  
 UK 01842 757544  
 ND TECH SHOCK DYNOS USA (0) 520 616 7942  
 SCHMITT EUROPE UK 02476 697922  
 SPA DESIGN 01827 260026  
 SPA TECHNIQUE USA (0) 317 271 7941  
 TAT Germany (49) 7252 84258

#### DYNAMOMETERS: ENGINE

AVL Germany (49) 61 34 71 790  
 DSP TECHNOLOGY 0932 351516  
 DYNAMIC TEST SYSTEMS 01842 757544  
 ENGINE & DYNAMOMETER 01708 857088  
 FROUDE CONSOLE 01905 856800  
 JRM AUTOMOTIVE USA (0) 508 966 2531  
 LAND & SEA USA (0) 603 329 5645  
 LOTUS ENGINEERING 01953 608000  
 MOTORSPORTS INTERFACE 01788 890412  
 TAT Germany (49) 7252 84258

#### DYNAMOMETER INSTRUMENTATION

ACQUIRED DATA SYSTEMS USA (0) 810 566 0131  
 DEPAZ DYNO SYSTEMS USA (0) 315 339 1265  
 DYNOLAB USA (0) 206 243 8977  
 FROUDE CONSOLE 01905 856800  
 LAND & SEA USA (0) 603 329 5645  
 KISTLER Instruments Ltd 01420 544477  
 PERFORMANCE TRENDS USA (0) 248 473 9230  
 QUADRANT SCIENTIFIC USA (0) 303 666 8414  
 ROEHRIG ENGINEERING USA (0) 336 431 1827  
 SUPERFLOW USA (0) 800 471 7701  
 Belgium 325 216300  
 TAT Germany (49) 7252 84258

#### ENGINE BALANCING EQUIP

ABS PRODUCTS USA (0) 714 671 0728  
 BC GEROLYMI USA (0) 916 638 9008  
 POWERHOUSE PRODUCTS USA 800 872 2223  
 SCHMITT EUROPE 02476 697922  
 SUNNEN PRODUCTS USA (0) 800 732 2878  
 WINONA VAN Canada (0) 800 831 4870

#### ENGINE HOISTS

MR GASKET PERFORMANCE USA (0) 216 398 8300  
 SILVER SEAL USA (0) 800 521 2936

#### ENGINE STANDS

ABS PRODUCTS USA (0) 714 671 0728  
 BLUEBIRD USA (0) 800 808 2473  
 C-LINE USA (0) 800 645 7677  
 DYNAMIC TEST SYSTEMS USA (0) 800 243 3966  
 GOODSON USA (0) 507 452 1830  
 JIGS USA (0) 614 294 5451  
 MOROSO PERFORMANCE USA (0) 203 453 6571  
 MR GASKET PERFORMANCE USA (0) 216 398 8300  
 RACER COMPONENTS USA (0) 901 581 9976  
 SCRIBNER USA (0) 916 638 1935

#### FLOW BENCHES

ASNU 0208 420 4494  
 AUDIE TECHNOLOGY USA (0) 610 630 5805  
 CV PRODUCTS USA (0) 800 448 1223  
 South Africa (27) 11 963128  
 CLO-FLOW USA (0) 315 339 1265  
 DEPAZ DYNO SYSTEMS USA (0) 714 671 0728  
 FLOWDATA USA (0) 800 262 4634  
 HONEY MFG USA (0) 248 473 9230  
 PERFORMANCE TRENDS USA (0) 248 473 9230  
 ROEHRIG ENGINEERING USA (0) 336 431 1827  
 SUPERFLOW USA (0) 800 471 7701  
 Belgium 325 216300  
 TAT Germany (49) 7252 84258

## Dynamometer Services Group Ltd

Contact DSG (Formerly EDS)

**Sales of New & Second-hand Dynamometers**

**Engine Test Equipment incl. Computer Control & Data Logging**

**Refurbishment & Updating of Dynamometers & Ancillaries**

**Fabrication of Engine Test Stands**

**Dynamic Balancing & CARRILLO Con-Rods**

**Dynamometer Services Group Ltd.,**  
 P.O. Box 163, Upminster RM14 3WL  
 Tel/Fax: 01708-857108

## Getecno

MOTORSPORT QUALITY  
 ROD ENDS  
 SPHERICAL BEARINGS



## INTERNATIONAL DISTRIBUTORS - WIDE STOCK

**AURORA** • **RODOBAL** • **Seals-it**

inch sizes      widest range in Europe  
 metric sizes

ROD ENDS ACCESSORIES:  
 lateral seals  
 protection boots,  
 jam-nuts  
 right-hand, left-hand

**Getecno srl**  
 16141 GENOVA - Italy  
 fax +39 010 835.66.55  
 phone +39 010 835.60.16

internet: [www.getecno.com](http://www.getecno.com)  
 e-mail: [info@getecno.com](mailto:info@getecno.com)

YyPG Proudly Presents TheXforSupport  
 Français, Italiano



**GENERATORS: PORTABLE**  
 HANCO GENERATING USA (t) 800 411 6688  
 LINCOLN ELECTRIC USA (t) 216 481 8100

**HORIZONTAL/VERTICAL MACHINING CENTRES**  
 MAKINO USA (t) 800 552 3288  
 MILLS 01603 745511  
 MITSUBISHI-YAMAZEN 0208 749 9161  
 RGS PERFORMANCE USA (t) 716 434 2509  
 TOYODA 02476 542200

**LATHES**  
 RMT MECHATRONICS 01565 650411  
 LOCK-N-STITCH USA (t) 800 736 8264  
 MAGNAFLUX USA (t) 847 657 5300  
 THE STRAIN GAUGING CO 01256 320666

**RAPID PROTOTYPING**  
 CRP TECHNOLOGY Italy (39) 059 821355  
 3D SYSTEMS UK 04442 282600

**TOOL CABINETS**  
 DURA 01205 712800



**GWS Systems Oy** Tel: 01403 276445  
 Fax: 01403 276434  
 Email: sales@gwsystems.co.uk  
 Website: gwsystems.co.uk

Units 10-12 Horsham Court, City Business Centre, 6  
 Brighton Road, Horsham, West Sussex RH13 5BA  
 LISTA 01908 222333  
 MAC TOOLS USA (t) 614 755 7000

**WELDING EQUIPMENT**  
 AMILLER ELECTRIC MFG USA (t) 800 426 4553

## 4.2 Factory Software

### CAD & CAM SOFTWARE

BRIDGEPORT MACHINE USA (t) 248 299 1750  
 DASSAULT SYSTEMS USA (t) 888 673 2134  
 DELCAM 0121 766 5544  
 EXA USA (t) 781 676 8551  
 MITUTOYO UK 01264 353123  
 PARAMETRIC TECHNOLOGY 01252 817000  
 QimacIQ 08700 100942

### PARTS USE LIFING

ADVANCED RACING SYSTEMS USA (t) 513 893 2773  
 LIFECHECK 01285 720665  
 KINETIC RACING TECHNOLOGIES USA (t) 248 245 2330  
 NOSKECOMP Australia 07 32 88 3195

### PERF. SIMULATION

D.A.T.S 01603 506526  
 PI RESEARCH 01954 253600  
 PERFORMANCE TRENDS USA (t) 248 473 9230  
 RICARDO USA (t) 734 197 6666  
 SERVOTEST 0208 707 1400  
 VEHICLE DYNAMICS PERFORMANCE USA (t) 512 450 1035

# Database 5

## CIRCUIT EQUIPMENT

### 5.1 Pits Equipment

#### AIR COMPRESSORS

COMPAIR UK 01494 465000  
 COMPAIR UK 01473 602222  
 ROTOTEST Sweden 46 8532 55 890

#### AIR LINES & FITTINGS

EXACT ENGINEERING 01803 866464  
 FASTENER FACTORY 01327 31018  
 FHS Motor Racing Ltd 01753 510880  
 GOODRIDGE UK 01392 369090  
 GOODRIDGE CA USA (t) 310 533 1924  
 GOODRIDGE INDY USA (t) 317 244 1000  
 GOODRIDGE EAST USA (t) 704 662 9095  
 JLS MOTORSPORT 0121 525 7733  
 KRONTEC Germany (49) 9401 703062

Berliner Straße 31, 93073 Neutraubling, Germany  
 MOTORSPORTS NZ NZ 0604 2566 5599  
 THINK AUTOMOTIVE 0208 518 1172

#### BATTERY CHARGERS

POWER TRANS SOLUTIONS -Tel 01722 332226  
 Fax 01722 333 522  
 www.wynall.com  
 Stephens Road, Church Fields  
 Salisbury, Wiltshire, SP2 7NX  
 01327 857822

#### TRIDENT

**CAMBER GAUGES**  
 DEMON TWEETS 01978 664466  
 75 Ash Road South, Wrexham Industrial Estate,  
 Wrexham, Clwyd LL13 9UG, Wales

HARRISON AUTO USA (t) 602 254 0024  
 LONGACRE RACING USA (t) 425 885 3823  
 OMS RACING 0113 2575956  
 PACE PRODUCTS 01284 850960



**REDLINE MOTORSPORT** Tel 01606 737500  
 Fax 01606 737683  
 E-mail: info@redlinemotorsport.co.uk  
 01327 857822

#### TRIDENT

#### CHASSIS STANDS

DEMOM TWEETS 01978 664466  
 SMR COMPONENTS USA (t) 708 949 9100

#### COMPUTER HARDWARE

ADVANCED AUTOMOTIVE 01753 642019  
 CALEX INSTRUMENTATION 01255 373128  
 CRANFIELD 01234 751361  
 DYNOLAB USA (t) 206 243 8877  
 FASTER SYSTEMS USA (t) 415 332 6064  
 FUELTRONICS Australia (61) 08816321999  
 FUJITSU 0208 571 4444  
 GENESIS 01635 582255  
 KISTLER Switzerland (41) 52 224 111  
 NOVA USA (t) 615 832 6355  
 OLIVETTI 0208 785 6666  
 PERFORMANCE TRENDS USA (t) 248 473 9230  
 RACING CAR COMPUTERS 01279 812496  
 STACK 08169 240404

#### CORNER SCALES

A.R.T. USA (t) 914 889 4499  
 DEMON TWEETS 01978 664466  
 LONGACRE RACING USA (t) 206 885 3823  
 NOVATECH 0124 852744  
 REDLINE MOTORSPORT Tel 01606 737500  
 ROLLCENTRE 01480 464052

#### DAMPER DYNAMOMETERS (PORTABLE)

DYNAMIC SUSPENSIONS 01842 755744  
 ROEHRIG ENGINEERING USA (t) 313 344 8120  
 SERVOTEST LTD 020 8907 1400  
 SPA DESIGN 01827 288328  
 SPA TECHNIQUE USA (t) 317 271 7941

#### EAR DEFENDERS

DEMOM TWEETS 01978 664466  
 FASTENER FACTORY 01327 31018  
 RACING RADIOS USA (t) 404 366 3796  
 REDLINE MOTORSPORT Tel 01606 737500

#### ELECTRIC STARTERS

POWER TRANS SOLUTIONS 01722 332226

#### ENGINE HOISTS

DUNLOP AUTOMOTIVE 0121 384 4444  
 FACOM UK 01932 566099

#### ENGINE STANDS

GUYON RACING Canada (t) 493 277 6020  
 TITAN MOTORSPORT 01480 474402

#### FIRE EXTINGUISHERS

CHUBB 01932 785588



**FEV** Tel 01243 555566 Fax 01234 555660  
 Email sales@f-e-v.co.uk  
 www.f-e-v.co.uk  
 Unit 10 Ford Lane Business Park,  
 Ford, West Sussex BN18 0UZ

#### FIREMASTERS

LIFELINE FIRE SYSTEMS 02028 852 8585  
 Mardi Gras Motorsports 02476 712999  
 OMP 01327 858 006  
 Italy (39) 10 680 851

#### QINETIQ

SILVERSTONE RACE SERVICES 08700 100942  
 SPA DESIGN 01327 828411  
 SPA TECHNIQUE 01827 288328  
 TRIDENT USA (t) 317 271 7941  
 01327 857822

#### FLOOR CRANES

ANRICK TRADING NZ (04) 5809371  
 FASTNER FACTORY 01327 31018  
 SLINGSBY 01274 721591

#### FUME EXTRACTORS

DENCER 01789 470188  
 INGERSOLL RAND 01204 690690

#### HAND PUMPS

EXACT ENGINEERING 01803 866464  
 FACOM 01932 566099  
 SILVERSTONE RACE SERVICES 01327 828411  
 SNAP-ON USA (t) 414 656 5372  
 0161 969 0126  
 0208 310 6666

#### WURTH UK

#### HAND TRUCKS

OMS RACING 0132 575956  
 SILVERSTONE RACE SERVICES 01327 828411

#### HEAD TORCHES

ESSEX RACING USA (t) 404 889 4096  
 HELLA 01295 272323

#### JACKS

ARGO MANUFACTURING USA (t) 630 377 1750  
 DEMON TWEETS 01978 664466  
 DUNLOP AUTOMOTIVE 02476 667738  
 FACOM UK 01932 566099  
 01327 31018  
 FASTENER FACTORY 0121 525 7733  
 JLS MOTORSPORT Germany (49) 2271 449095  
 PADDY HOPKIRK LTD 01525 850800  
 PERFORMANCE MACHINE USA (t) 301 828 4546  
**REDLINE MOTORSPORT** Tel 01606 737500  
 SLINGSBY 01274 721591  
 DEMON TWEETS 01978 664466  
 KS MOTORSPORT Germany (49) 2271 449095  
 MARDI GRAS MOTORSPORTS 01327 858 006  
 MECHANIX WEAR USA (t) 661 257 0474  
 RALLY DESIGN 01795 531871  
 SILVERSTONE RACE SERVICES 01327 858441

#### NOISE METERS

CIRRUS RESEARCH 01723 891655

#### PIT BARRIERS

KAISER & KRAFT 01923 233312  
 SLINGSBY 01274 721591

#### PIT BOARDS

ACTIVE ENGINEERING USA 001 714 637 1155  
 DEMON TWEETS 01978 664466  
 GRAND PRIX RACEWEAR 0208 987 5500  
 KS MOTORSPORT Germany (49) 2271 449095  
**REDLINE MOTORSPORT** Tel 01606 737500  
 TRIDENT 01327 857822

#### PIT CANOPIES

PIT BITS 01727 858297

#### PIT LANE MARKERS

KAISER & KRAFT 01923 233312  
 SLINGSBY 01274 721591

#### PIT TROLLEYS

CHAMPION 01953 888664  
 DEMON TWEETS 01978 664466  
 GTC COMPETITION 01483 272151  
 LISTA 01908 222333  
**REDLINE MOTORSPORT** Tel 01606 737500  
 OMS RACING 0113 2575956

#### PYROMETERS



AP RACING Tel 02476 639595  
 Fax 02476 639559  
 Wheeler Road, Coventry, CV1 4LB

#### RADIO SCANNERS

QINETIQ 08700 100942  
 RACING RADIOS USA (t) 404 366 3796

#### RADIO SYSTEMS/INTERCOMS

AUTOCOM 01926 431249  
 AUTOTEL RACE RADIO 01508 528837  
 MRT 0150 981 2610  
 QINETIQ 08700 100942  
 STRODE SOUND 01761 419248

#### RAIN SUITS

DEMOM TWEETS 01978 664466  
 GRAND PRIX PROMOTIONS 01474 879524  
 JAYBRAND 0733 68247  
**REDLINE MOTORSPORT** Tel 01606 737500

#### REFUELLING LINES & VALVES

DUNLOP 01235 863863  
 EXACT ENGINEERING 01803 866464  
 GTC COMPETITION 01483 272151  
 KRONTEC Germany (49) 9401 703062  
 PREMIER FUEL SYSTEMS 01332 850515  
**THE STRAIN GAUGING CO** 01256 320666

#### REFUELLING RIGS

DEMOM TWEETS 01978 664466  
 GTC COMPETITION 01483 272 151  
 PREMIER FUEL SYSTEMS 01332 850515  
**REDLINE MOTORSPORT** Tel 01606 737500  
 SPA DESIGN 01827 288328  
 THE STRAIN GAUGING CO 01256 320666

#### SCISSOR PLATFORMS

SLINGSBY 01274 721591

#### SETUP FLOORS

ACTIVE ENGINEERING USA 001 714 637 1155  
 4-PATCH 01376 342463  
 KS MOTORSPORT Germany (49) 2271 449095  
 ME MOTORSPORT 01884 253070  
 RML 01933 402440  
**THE STRAIN GAUGING CO** 01256 320666  
 SPA AEROFOLS LTD 01827 260026  
 UNIVERSITY OF HERTFORDSHIRE 01707 284270

#### SETUP GAUGES

A.R.T. USA (t) 914 889 4499  
 CYBER DYNAMICS 01869 347812  
 DEMON TWEETS 01978 664466  
 LONGACRE RACING USA (t) 206 885 3823  
 ME MOTORSPORT 01884 253070

#### REDLINE MOTORSPORT THE STRAIN GAUGING CO

Tel 01606 737500  
 01256 320666

#### SPACE HEATERS

FASTENER FACTORY 01327 31018

#### STOPWATCHES

CASIO 0208 450 9131  
 DEMON TWEETS 01978 664466  
 GRAND PRIX RACEWEAR 020 8987 5500  
 KS MOTORSPORT Germany (49) 2271 449095  
 RACING RADIOS USA (t) 404 366 3796  
**REDLINE MOTORSPORT** Tel 01606 737500  
 TRIDENT 01327 857822

#### STORAGE SYSTEMS

KAISER & KRAFT 01923 233312  
 LISTA (UK) LTD 01908 222333  
 POLSTORE STORAGE 01403 750000  
 PRONALS France (33) 3201 997510

#### TAPE

DEMOM TWEETS 01978 664466  
 CLARENDON 01455 841200  
 DRC RACE CAR USA (t) 609 397 4455  
 FASTENER FACTORY 01327 31018  
 KS MOTORSPORT Germany (49) 2271 449095  
 RALLY DESIGN 01795 531871  
**REDLINE MOTORSPORT** Tel 01606 737500  
 TRIDENT 01327 857822

#### TIMING SYSTEMS

CASIO 0208 450 9131  
 CONTINENTAL SPORT USA (t) 513 459 8888  
 ME MOTORSPORT 01884 253070  
 MOTEC Australia (61) 3 9761 5050  
 MOTEC (EUROPE) UK 08700 119100  
 MOTEC JAPAN Japan (81) 489 46 1734  
 MOTEC SYSTEMS USA USA (t) 714 897 6804  
 MST SPORTS TIMING 01684 573479  
 PI RESEARCH 01954 253600  
 PIT BITS 01727 858297  
 STACK 01869 240404  
 UNISYS 0208 453 5562  
 VULCAN ENTERPRISES USA (t) 602 759 7926

#### TOOL CABINETS

FACOM UK 01932 566099  
 KAISER & KRAFT 01923 233312  
 POLSTORE STORAGE 01403 750000  
 SLINGSBY 01274 721591

#### TORQUE WRENCHES

FACOM UK 01932 566099  
 NORBAR TORQUE TOOLS 01295 270331  
 RALLY DESIGN 01795 531871

#### TRACKING GAUGES

A.R.T. USA (t) 914 889 4499  
 DEMON TWEETS 01978 664466  
 GMD COMPUTRACK Austr (61) 2 9644 1946  
**REDLINE MOTORSPORT** Tel 01606 737500  
 THE STRAIN GAUGING CO 01256 320666

#### TYRE PRESSURE GAUGES

BERU Fi SYSTEMS 01379 646200  
 GRAND PRIX RACEWEAR 0208 987 5500  
 THE STRAIN GAUGING CO 01256 320666  
 TRIDENT 01327 857822

#### TYRE TEMPERATURE GAUGES

THE STRAIN GAUGING CO 01256 320666  
 TRIDENT 01327 857822

#### TYRE TROLLEYS

OMS RACING 01132 575956

#### TYRE WARMERS

BANDIT Australia (61) 3 9318 0644  
 DEMON TWEETS 01978 664466  
 GRAND PRIX RACEWEAR 020 8987 5500  
 JAYBRAND 0733 68247  
**REDLINE MOTORSPORT** Tel 01606 737500  
 SEEKERS 0151 524 0919

## 5.2 Paddock Equipment

#### AWNINGS

ALFRED BULL 01483 575492  
 ALFORSFORD TECTONICS 01962 736316  
 AWNING COMPANY 01204 363463  
 BARKERS 020 8653 1988  
 DEANS AWNINGS 01942 241399  
 MAYFLOWER 01494 712131  
 PIT BITS 01727 858297  
 TOP MARQUEES 01623 749777

#### MOTORHOME HIRE

ATLANTIC COAST 01297 552222  
 DAVID WILSON'S TRAILERS 01825 740696  
 DUDLEYS 01993 703774  
 MIDLAND INTERNATIONAL 02476 336411  
 SPIRES OF OXFORD 01805 875539  
 WESTCROFT AMERICAN 01902 731244



YyPG Proudly Presents, Thx for Support

# Database 6

## COMPETITION CAR CHASSIS COMPONENTS

### 6.1 Driver's Equipment

#### ANTI MIST FLUIDS

**DEMON TWEETS** Tel 01978 664466 / Fax 01978 664467  
Hugmore Lane, Llan-y-Pwll, Wrexham, Clwyd LL13 9YE, Wales  
**GRAND PRIX RACEWEAR** Tel 0208 987 5500  
Fax 0208 742 8999  
Power Road, Chiswick, London, W4 5PY, England



**REDLINE MOTORSPORT** Tel 01606 737500  
Fax 01606 737583  
E-mail info@redlinemotorsport.co.uk

#### BOOTS & GLOVES

**DEMON TWEETS** 01978 664466  
**GRAND PRIX RACEWEAR** 0208 987 5500  
**MECHANIKWEAR** USA (i) 805 357 0474  
**REDLINE MOTORSPORT** Tel 01606 737500

#### COOL CAPS & SUITS

**DEMON TWEETS** 01978 664466  
**GRAND PRIX RACEWEAR** 020 8987 5500  
**REDLINE MOTORSPORT** Tel 01606 737500

#### DRIVING SUITS & ACCESSORIES

**DEMON TWEETS** 01978 664466  
**GRAND PRIX RACEWEAR** 020 8987 5500  
**REDLINE MOTORSPORT** Tel 01606 737500

#### HELMETS & ACCESSORIES



**QINETIQ** Tel 44 (0) 8700 100942  
www.QinetiQ.com  
Cody Technology Park,  
Ively Road, Farnborough, Hampshire, GU14 0LX

# Database 7

## CHASSIS ENGINEERING SERVICES

### 7.1 Chassis Services

#### BODYWORK SPECIALISTS

**ABBEY PANELS** 02476 644999  
**ADVANCED COMPOSITES** 01773 763441  
**ANDY ROUSE ENGINEERING** 02476 635182  
**AERO APPLICATIONS** USA (i) 562 597 0001  
**AERODINE COMPOSITES** USA (i) 317 271 1207  
**AERODYNAMIC CONSULTANTS** (66) 729 5628  
**APPLIED FIBREGLASS** 01842 765339  
**ASQUITH THOMAS** 01924 402001  
**CBG CONSULTANTS AERODYNAMICS** (0) 1202 673666  
**CML GROUP** 0151 647 5531  
**COMPOSITE DESIGN** USA (i) 727 539 0605  
**CRANFIELD UNIVERSITY** 01234 754512  
**CROPREYD BRIDGE GARAGE** 01295 758444  
**DEREK PALMER ENGINEERING** 01555 893315  
**DON FOSTER** France (33) 470 580308  
**EARS MOTORSPORT** 01625 433773  
**FIBRESPORTS** 01268 527331  
**GRAHAM HATHAWAY RACING** 01621 856956  
**GTC COMPETITION** 01483 272151  
**GTI ENGINEERING** 01280 700800  
**HAMLIN MOTOR SERVICES** 01582 841284  
**HEDDINGTON COACHWORKS** 01380 850198  
**INTAPORSCH** 01273 834241  
**LOTUS ENGINEERING** 01953 608000  
**LYNX MOTORS** 01424 851277  
**MERLIN BODYCRAFT** 01280 705156  
**MITCHELL** NZ (64) 78236188  
**PODIUM DESIGN** 07000 763486  
**SPA COMPOSITES** 01543 432904

#### COMPOSITES SPECIALISTS

**Active engineering** USA 001 714 637 1155  
**ACTIVA TECHNOLOGY** 020 8974 1651  
**AELIUS TECHNOLOGY** USA (i) 970 472 1288  
**AERODINE COMPOSITES** USA (i) 317 271 1207  
**APPLIED FIBREGLASS** 01842 765339  
**ASTEC** 01332 875451  
**B&K RESINS** 0208 464 7734  
**CBG CONSULTANT AERODYNAMICS** (0) 1202 673666  
**CARBON FIBRE TECHNOLOGY** 01508 488257  
**CARBONE INDUSTRIE** France (33) 14 972 2305  
**COMPOSITE AUTOMOTIVE TECH** 01249 443438  
**COMPOSITE DESIGN** USA (i) 727 539 0605  
**COMPOSITE WINGS** 01953 885478

# Cranfield UNIVERSITY

**CRANFIELD UNIVERSITY** Tel 01234 754902  
Fax 01234 756171  
Cranfield, Bedfordshire, MK43 0AL  
www.motorsportcranfield.ac.uk  
motorsportcranfield.ac.uk

**CROSBY GRP** 01327 857042  
**CTG** 44 (0)1295 220130  
**CTS** 01480 459378  
**DELTA COMPOSITES** 01280 824498  
**DEREK BENNETT** 01565 777395  
**ELAM COMPOSITES** USA (i) 706 658 2853  
**DU PONT** UK 01438 734000  
Switzerland (41) 22 717 5111  
USA (i) 302 774 1000

**FIBREGLASS FABRICATIONS**  
**G FORCE COMPOSITES** 0208 568 0293  
**HEYES ENGINEERING** 01243 544192  
**HITCO** 01453 750491  
**JANUS TECHNOLOGY** USA (i) 213 516 5707  
01753 869996

# KOMPRESX

**KOMPRESX** Tel 0191 416 8200 Fax 0191 415 5962  
Website www.kompresx.com  
Email sales@kompresx.com  
58-59 Hutton Close, Crowther Ind Est,  
Tyne & Wear NE58 0AH

**LOTUS ENGINEERING** 01953 608000  
**MICRO CRAFT** USA (i) 909 947 1843  
**MIRA** 0247 6355 0090  
**NERO** 01254 202085  
**PANKL** Austria (4) 37862 512500  
**PODIUM DESIGN** 07000 763486  
**PRONAL'S** France (33) 320 99 75 10  
**QINETIQ** 08700 100942  
**RICHARD HINTON RACING** 01279 717667  
**RMCS (CRANFIELD)** 01793 785359  
**SAMCO sport** 01443 238 464  
**SCART** USA (i) 203 798 6698  
**SCOTT BADER** 01933 663100  
**SPA COMPOSITES** 01543 432904  
**SQUARE ONE MOTORSPORT** 01825 723425  
**STRAND GLASSFIBRE** 0208 568 7191  
**TAG EQUIPMENT** 01787 477990  
**TECHFLEX** USA (i) 201 279 6253  
01480 523811  
**TECHNICAL RESIN BONDERS** 01664 812454  
**TONY THOMPSON RACING** 01535 664902  
**TURBO HEAT** 01707 284270  
**UNIVERSITY OF HERTFORDSHIRE** 01565 777395  
**VIN MALKIE RACING** 01604 878101  
**ZEUS M/SPORT ENG LTD**

#### DESIGN AND ANALYSIS



**ENABLING TECHNOLOGIES CONSULTING ENGINEERS LTD**  
Tel +44 (0)1983 550480 Fax +44 (0)1983 550489  
Email office@enablingtechnologies.co.uk  
Web enablingtechnologies.co.uk  
Innovation Centre, St Cross Business Park,  
Monks Brook, New Port, Isle of Wight PO30 5WB, England  
LOLA Tel 01480 451301  
Fax 01480 456722



**RICARDO MIDLANDS TECHNICAL CENTRE**  
Tel 01926 477152 Fax 01926 319352  
Email pmarkwick@mtc.ricardo.com  
Website: www.ricardo.com  
Southam Rd, Radford Semele, Leamington Spa CV31 1FQ

#### FABRICATION

**ABBEY PANELS** 02476 644999  
**A-MAC FABRICATION** USA (i) 408 727 9288  
**ANDY ROUSE ENGINEERING** 02476 635182  
**ANEX SYSTEMS** 01869 345038



**AUTOMOTIVE FABRICATION** Tel/Fax 001 214 745 1148  
Email weld666@airmail.net  
1027 Levey Street Dallas, Texas 75207

**ASTEC** 01332 875451  
**AZTEK** 01509 261299  
**BBW** 01483 722 713  
**BOB SPARSHOTT ENGINEERING** 01908 618080  
**BRADY FABRICATIONS** 01869 252750  
**BRISE ALLOY FABRICATIONS** 01322 223431  
**BSS PARTS** 01772 601602  
**CHEVRON RACING** 01565 777395  
**CHIP GANASSI RACING** 01243 544192  
**CML GROUP** 0151 647 5531  
**COLMET PRECISION** 01206 681658  
**COMPOSITE DESIGN** USA (i) 727 539 0605  
**COMPETITION FABRICATIONS** 01953 454573  
**CRANFIELD UNIVERSITY** 01234 754512  
**CTG RACING** 01202 871102  
**DEREK BENNETT** 01565 777395  
**DJ RACECARS** 01663 734518  
**DOCKING ENGINEERING** 01327 857164

**EUROTECH MOTORSPORT** 0121 3314944  
**FOXCRIFT ENGINEERING** 01264 810110  
**B Y G FORCE PRECISION ENG** 01243 544192  
**GOMM METAL DEVELOPMENTS** 01483 764876  
**GRAHAM HATHAWAY RACING** 01621 856956  
**GTC COMPETITION** 01483 272151  
**HAMLIN MOTOR SERVICES** 01582 600745  
**HAUS OF PERFORMANCE** USA (i) 714 545 2755  
**JAGO DEVELOPMENTS** 01243 789366  
**KRONTEC MASCHINENBAU** (49) 9401 700352  
**LOTUS ENGINEERING** 01953 608000  
**LYNX MOTORS** 01424 851277  
**MACDONALD RACE ENG** 0208 889 1633  
**MATRIX ENGINEERING** USA (i) 888 249 0013  
**MASON ENGINEERING** USA (i) 805 527 6624  
**MICRO CRAFT** USA (i) 909 947 1843  
**MIKE TAYLOR DEVELOPMENTS** 01609 780123  
**MIRKO RACING** USA (i) 408 776 0073  
**POLSON** 01440 820371  
**PREMIER AEROSPACE** 01332 850515  
**QinetiQ** 08700 100942  
**RACEPREP 3001** 01903 734499  
**RBS** 01788 543094  
**RETRO TRACK & AIR UK** 01453 545360  
**RICARDO MIDLANDS TECHNICAL CENTRE** Tel: 01926 477152  
Fax: 01926 319352  
Email: iain.wight@ricardo.com  
USA (i) 317 248 9470  
Tel 01933 422040  
Fax 01933 676519  
www.rmmallock.co.uk

**RILEY & SCOTT**  
**Ray Mallock LTD (RML)** Tel 01933 676519  
www.rmmallock.co.uk

**6-10 Whittle Close, Park Farm Industrial Estate,**  
**Wellingborough, Northants NN8 6TY England**  
**SNAPDRAGON MOTORSPORTS** USA (i) 413 2560821  
01827 260026  
**SOUTH AEROLIFTS LTD** 01285 860295  
**SPA CERNEY ENGINEERING** 01932 355277  
**UNICLIP AUTOMOTIVE** USA (i) 714 847 4417  
**VAN DYNE ENGINEERING** 01565 777395  
**VIN MALKIE RACING**

#### MOULDING

**ADVANCED COMPOSITES** 01773 763441  
**AERODINE COMPOSITES** USA (i) 317 271 1207  
**ASTEC** 01332 875451  
**BENTLEY CHEMICAL TRADING** 01562 515121  
**BUTSER RUBBER** 01730 894034  
**CML GROUP** 0151 647 5531  
**COMPOSITE DESIGN** USA (i) 727 539 0605  
**COMPOSITE WINGS** 01953 885478  
**CROSBY GRP** 01327 857042  
**CROMPTON TECH GROUP** 01295 220130  
**CTG** 44 (0)1295 220130  
**G FORCE COMPOSITES** 01243 544192  
**GRIFITHS ENGINEERING** 01582 600629  
**JANUS TECHNOLOGY** 01753 869996  
**MICRO CRAFT** USA (i) 909 947 1843  
**PROTECH COMPOSITES LTD** Tel: +44(0) 1420 471 000  
Fax: +44 (0) 1420 487 047  
www.protechcomposites.co.uk  
Unit 62, Woolmer Trading Estate  
Bordon, Hampshire, GU35 9QF, UK  
**ROSS COURTNEY** 01384 291919  
**STARTLINE UK LTD** 01933 665752  
**SECART ENGINEERING** 001 203 798 6698

#### SPACEFRAME DESIGN

**AELIUS TECHNOLOGY** USA (i) 970 472 1288  
**ENABLING TECHNOLOGIES LTD** 01983 550483  
**COSINE TECHNOLOGY** 01706 378851  
**CRANFIELD UNIVERSITY** 01234 754512  
**DAVID POTTER CONSULTING** 0033(0) 494 339090  
**DEREK BENNETT ENGINEERING** 01565 777395  
**MAGNUM CARS** 01933 442861  
**Ray Mallock LTD (RML)** Tel 01933 402440  
Fax 01933 676519  
www.rmmallock.co.uk  
**6-10 Whittle Close, Park Farm Industrial Estate,**  
**Wellingborough, Northants NN8 6TY England**  
**STARTLINE UK LTD** 01933 665752

# Database 8

## DRIVETRAIN & SUSPENSION ENGINEERING SERVICES

### 8.1 Engine Services

#### RACE PREPARATION

**ALDON** 01384 572553  
**ANDY ROUSE ENGINEERING** 02476 635182  
**AUTOKRAFT** 0121 777 2083  
**AZTEK** 01509 261299  
**BJ MOTOR ENGINEERS** 0161 748 8663  
**BR MOTORSPORT** 01926 451454  
**DAVE CROSS MOTOGY** 01246 477566  
**SBD MOTORSPORT** 0208 391 0121  
**CLEM COMPETITION** USA (i) 214 503 8044  
**CONCEPT MOTORSPORTS** 0208 568 0293  
**CONTINENTAL M/SPORT** USA (i) 513 459 8888  
**DBR MotorSport** Tel 0161 627 4189 Fax 0161 627 4189  
Unit 4 Forge Ind Estate, Green Acres Road,  
Oldham Lancashire, 014 7LE  
**DJ RACECARS** 01663 734518  
**DTM POWER** 01865 407726  
**DUNNELL ENGINES** 01449 677226  
**EARS MOTORSPORT** 01625 433773

**EDS** 01708 857108  
**ELABORAZIONE COLASUNO** 0207 738 8331  
**ENGINE DATA ANALYSIS** 01977 561622  
**ENGINE SHOP** 02380 812199  
**FISCHER ENGINEERING** USA (i) 818 767 8840  
**FORWARD ENGINEERING** 01676 523256  
**GEMINI ENGINEERING** 01474 534779  
**GEOFF RICHARDSON ENGINEERING** 01480 861599  
**GF BECK MOTORSPORT PREPARATION** 01646 621814  
**GOLDFLOW** 01491 875554  
**GOODMAN RACING ENGINES** 01327 300422  
**GRAHAM HATHAWAY RACING** 01621 856956  
**GRIFFIN MOTORSPORT** 01793 771802  
**HARPERS PERFORMANCE** 01642 818188  
**HARTWELL** 01020 556566  
**HAUS OF PERFORMANCE** USA (i) 714 545 2755  
**HT RACING** 01474 872888  
**IRMSCHER** 01543 414466  
**IVAN DUTTON** 01923 816277  
**JANSPEED MOTORSPORT** 01722 321833  
**J MATTIS ENGINE TECH** Greece 003 019 512 761  
**JOHN WILCOX COMPETITION ENG** 01455 230576  
**JONDEL** 01933 411993  
**KENT AUTO DEVELOPMENTS** 01303 874082  
**KREMER RACING** Germany (49) 221 171025  
**LE SPORT** France (33) 14 582 4400  
**LIGHTNING PERFORMANCE** USA (i) 904 439 5283  
**LINGENFELTER** USA (i) 219 724 2552  
**MARDI GAS MOTORSPORTS** 01327 858 006  
**MATHWALL ENGINEERING** 0152 703191  
**MATRIX ENGINEERING** USA (i) 888 249 0013  
**MAXSYM ENGINE TECH** 01660 681555  
**MERLIN DEVELOPMENTS** 01283 518184  
**MILLINGTON** 01746 789268  
**MINERVA MOTORSPORT** 01509 233970  
**MINISTER RACING ENGINES** 01634 682577  
**MIRKO RACING** USA (i) 408 776 0073  
**MIS M/SPORTTECHNIK GERMANY** (49)263680394  
**MOUNTUNE RACE ENGINES** 01251 854029  
**NEIL BROWN ENGINEERING** 01775 723052  
**PHIL JONES ENGINE DEV** 01564 824869  
**PHIL MARKS ENGINE DEV** 0182 546 4220  
**PRIME MOTORSPORT** USA (i) 812 546 4220  
**PRIMA RACING** 015 9491903  
**PRODRIVE** 01295 273355  
**QUICKSILVER RACE** USA (i) 301690 9009  
**QUORN ENGINE DEVELOPMENTS** 01509 41237  
**RACE ENGINE DEVELOPMENT** USA (i) 760 630 0450  
**RACEPEC** 01925 636959  
**RACE TECHNIQUES** 01242 245640  
**RACING BENT** USA (i) 714 779 8677  
**RANDLINGER** Germany (49) 761 16373  
**ROAD & STAGE MOTORSPORT** 01524 844066  
**ROADSPEED PERFORMANCE** 01453 750864  
**RPM FRANCE** (33) 3 86 66 00 08  
**SCARBOROUGH** Canada (i) 416 759 9309  
**SEARLE** 0208 305 2250  
**STEVE CARBONE RACING** USA (i) 918 835 6596  
**SWAYMAR** 01932 868377  
**SWINDON RACING ENGINES** 01993 531321  
**TECNO** 01268 764047  
**TERRY SHEPHERD TUNING** 01695 574454  
**THINK AUTOMOTIVE** Tel 0208 568 1172  
Fax 0208 847 5338  
Email matt@thinkauto.co.uk  
292 Worton Road, Isleworth, Middlesex, TW7 6EL  
**THUNDERBIRD RACING INT LTD** 01623 622848  
**VAN DYNE ENGINEERING** USA (i) 714 847 4417  
**WARRIOR** 01825 764833  
**ZYTEK ENGINEERING** 01332 48974  
**ZEUS MOTORSPORT ENGINEERING LIMITED**  
Tel 01604 878101 Fax 01604 878111  
The Racing Stables, Blisworth Hill Farm,  
Stoke Road, Blisworth, Northants NN7 3DB

### 8.2 Engine Services

#### REBUILDS

**ANDREASON RACING** 01300 348499  
**ANEX SYSTEMS** 01869 345038  
**BTR PREPARATIONS** 01977 523448  
**EARS MOTORSPORT** 01625 433773  
**GTC COMPETITION** 01483 272151  
**HAUS OF PERFORMANCE** USA (i) 714 545 2755



**HEWLAND ENGINEERING** Tel 01628 827600  
Fax 01628 829708  
Waltham Road, Maidenhead, Berks, SL6 3LR  
**JACK KNIGHT** 01483 764326  
**JP RACE CENTRE** 01327 858151  
**KREMSPEED EQUIPMENT INC. USA** (1)814 724 4086  
**MARK BAILEY RACING** 01380 850130  
**MATRIX ENGINEERING** USA (i) 888 249 0013  
**ME MOTORSPORTS** 01884 253070  
**QUAIFE ENGINEERING** Tel 01732 741444  
Fax 01732 741555  
Email info@quaife.co.uk  
www.quaife.co.uk  
Vestry Road, Sevenoaks, Kent, TN14 5EL  
**ROADSPEED PERFORMANCE** 01453 750864  
**TONY THOMPSON RACING** 01664 812454  
**ZF** Germany (49) 7541 77 2543  
UK 015 9869211

# How are you fastening your bonnet?



- MORE AERODYNAMIC
- MORE SECURE, MORE CONVENIENT
- FASTER TO USE AND SAFER

SFC LTD • TOTNES • DEVON • TQ9 5AL • UK

T +44 (0)1803 868677 • F +44 (0)1803 868678

YyePG Proudly Presents, Thx for Support



PANEL FASTENING  
BROUGHT  
UP-TO-DATE

www.aerocatch.com

## 8.3 Suspension Services

### SETUP SPECIALISTS

ACTIVE ENGINEERING USA (i) 714 637 1155  
 ANDREASON RACING 01300 348499  
 ATHON MOTORSPORT 014 2490 272  
 AZTEK 01509 261299  
 BEAUFORT RESTORATION 01795 830288  
 DAVID POTTER CONSULTING 0013101494 139090  
 BRADY FABRICATIONS 01869 252750  
 CRANFIELD UNIVERSITY 01234 754152  
 DON FOSTER France (33) 470 580308  
 FILBEAM RACING DESIGNS 01925 433773  
 GEOSCAN (G.L.L. Design) 01225 790258  
 LOLA Tel 01480 451301  
 Fax 01480 450722  
 HAUS OF PERFORMANCE USA (i) 714 545 2755  
 INTERPO ENGINEERING 01454 412777  
 LOTUS ENGINEERING 01951 608000  
 MARDI GRAS MOTORSPORT 01327 858006  
 MARK ORTIZ USA (i) 704 933 8876  
 PILLBEAM RACING DESIGNS 01778 424938  
 PODIUM DESIGNS 07000 761 486  
**Ray Mallock LTD (RML)** Tel 01933 402440  
 Fax 01933 676519  
 www.rmlmallock.co.uk

6-10 Whittle Close, Park Farm Industrial Estate,  
 Wellingborough, Northants NN8 6TY England  
 FSUSPENSION TECHNOLOGY 01327 851958

### Shock Box

SHOCKBOX DAMPER SERVICES Tel: 07919 340590  
 Website: www.shockbox.co.uk  
 Email: ghibj@compuserve.com  
 67 Blackthorn Road, Attleborough, Norfolk, NR17 1YJ UK  
 THE STRAIN GAUGING CO 0256 320066  
 UNIVERSITY OF HERTFORDSHIRE 01707 284270

ENGINEERING SERVICES  
 RACING INDUSTRY TECHNICAL SERVICES  
 USA (i) 248 645 1724

## 8.4 Metal Services

### BEAD & SAND BLASTING

BLAST-IT-ALL USA (i) 800 353 2642  
 CAMCOAT PERFORMANCE COATINGS 01925 445001  
 COMPAIR AUTOPOWER 01494 465000  
 HANKOE MOTORSPORT 0753 522779  
 MACDONALD RACE ENG 0208 889 1633  
 SWAYMAR CASTING 01795 415000  
 AEROMET 017 985 9964  
 GM DESIGN 02582 600629  
 GRIFFITHS ENGINEERING Sweden (46) 300 60590  
 HILLGARD 01746 768810  
 JENVEY DYNAMICS 01795 475333  
 KENT AEROSPACE CASTINGS 01312 868177  
 PANKL Austria (43) 3862 512500  
 QUAIFF ENGINEERING 01734 741444  
 QDF COMPONENTS 01312 868177  
 QUARTMASTER USA (i) 847 510 8099  
 QINETIQ Tel 08700 100942  
 www.QinetiQ.com  
 Cody Technology Park, Ively Road, Farnborough,  
 Hampshire, GU14 0LX  
 ZEUS ALUMINIUM 01384 482222

### balzers

BALZERS LTD Tel 01908 372727 Fax 01908 361362  
 www.balzers.co.uk  
 Bradbourne Drive, Tilbrook, Milton Keynes, MK7  
 BAT, UK  
 CAMCOAT PERFORMANCE COATINGS 01925 445001



CTG Tel: +44 (0)1295 220130 Fax: +44 (0)1295 220138  
 E-mail: motorsport@ctgfd.co.uk  
 www.ctgfd.co.uk

Thorpe Park, Thorpe Way, Banbury, Oxfordshire  
 OX16 4SU United Kingdom

LURO COTE USA (i) 909 885 3233  
 KENT MOTORSPORT CASTINGS 01795 662888  
 POITON 01452 300500  
 POLYMER DYNAMICS USA (i) 713 694 3256  
 QINETIQ 0 8700 100942  
 SWAIN TECH USA (i) 716 889 2786  
 WALLWARK HEAT TREATMENT 0161 797911



ZIRCOTEC PERFORMANCE COATINGS  
 Tel: 0870 190 8480 Fax: 0870 190 8488  
 E-mail: enquiries@zircotec.co.uk  
 www.zircotec.com  
 528.10 Unit 2 Harwell business Centre,  
 Didcot, Oxfordshire OX11 0QJ United Kingdom

FINISHING  
 ALUMINIUM SPECIAL 01384 291900  
 APPERLEY HONING 01242 525868  
 ARMORALL PRODUCTS 01799 513130  
 CML GROUP 012 647 5531  
 GRIFFITHS ENGINEERING 02582 600629  
 HEPWORTH INTERNATIONAL 01484 70720  
 JENVEY DYNAMICS 01746 768810  
 KENT AEROSPACE CASTINGS 01795 476133  
 QUAIFF ENGINEERING 01732 741144

QINETIQ 0 8700 100942  
 RICHARD BARRETT MOULDS USA 351 282 9842  
 ZEUS ALUMINIUM PRODUCTS 01384 482222

### FOUNDRIES

AEROMET 01795 415000  
 BA HARRISON 01676 2769351  
 GM DESIGN 017 985 9964



FINECAST 01903 765821  
 H GRIFFITHS ENGINEERING 01582 600629  
 JENVEY DYNAMICS 01746 768810  
 KENT AEROSPACE CASTINGS 01795 476133  
 KENT MOTORSPORT CASTINGS 01795 662888  
 QUALCAST 01312 760200  
 UK RACING CASTINGS 01247 750877

### HEAT TREATMENT

AR CORNELL 01245 268098  
 AUTOSPRINT 01675 464857  
 AVONBAR 01932 840058  
 BEAUFORT RESTORATION 01795 830288  
 JENVEY DYNAMICS 01746 768810  
 PANKL Austria (43) 3862 512500  
 QUANTUM HEAT TREATMENT 01908 642242  
 TECMAC 01954 337900  
 ZEUS MOTORSPORT 01604 878910

### MACHINING

ABBEY PANELS 02476 644999  
 ACTIVE ENGINEERING USA (i) 714 637 1155  
 APPERLEY HONING 01242 525868  
 ATHENA MANUFACTURING LP USA (i) 352 928 2693  
 AVONBAR 01932 840058  
 AZTEK 01509 261299  
 BEAUFORT RESTORATION 01795 830288  
 CML GROUP 01927 868177  
 COLEMAN MACHINE USA (i) 606 863 8945  
 DATUM ENGINEERING 02476 381221  
 FORMULA FABRICATIONS 01953 605190  
 DONCASTERS LTD 01312 864900  
 JENVEY DYNAMICS 01746 768810



KRONTEC GMBH Tel Germany (49) 9401 5253-0  
 Fax Germany (49) 9401 5253-10  
 Pommerstrasse 31, 93073 Neutraubling, Germany

LANGSTONE ENGINEERING LTD 01292 454230  
 LINGENEELER USA (i) 219 724 2552  
 LOTUS ENGINEERING 01951 608000  
 MACDONALD RACE ENG 0208 889 1633  
 MASON ENGINEERING USA (i) 805 527 6624  
 METAL SPINNERS 0191 267 101  
 MILSPEC PRODUCTS USA (i) 407 814 8997  
 QINETIQ 0 8700 100942  
 PANKL AUSTRIA (43) 3862 512500  
 PERFORMANCE MACHINE 01312 850515  
 PREMIER AEROSPACE 01732 850515  
 PREMIER FUEL SYSTEMS 01732 850515  
 QUAIFF ENGINEERING 01734 741444  
 RICARDO INC USA (i) 734 397 6666  
 RICHARD BARRETT MOULDS USA 351 282 9842  
 TITAN MOTORSPORTS 01480 474402  
 TREVOR MORRIS ENGINES 015474 289  
 TRICK MACHINING 01493 751666  
 VIN MALKIE 01565 777395

### METAL MATRIX COMPOSITES

BP METAL COMPOSITES 01252 37



CRANFIELD UNIVERSITY Tel 01234 754902  
 Fax 01234 752671  
 Email motorsport@cranfield.ac.uk  
 www.motorsport.cranfield.ac.uk  
 Motorsport Group, Cranfield University,  
 Cranfield, Bedfordshire, MK43 0AL

GM DESIGN 017 985 9964  
 MMCK USA (i) 617 893 4449  
 PANKL Austria (43) 3 8625 12500

### METAL SUPPLIERS

ADVANCED METALS INTERNAT 01923 202500  
 AIRCO METALS LTD 0188 973 0509  
 ALUMINIUM SPECIAL 01384 291900  
 APPERLEY HONING 01242 525868  
 BRADY FABRICATIONS 01869 252750  
 BRITISH ALCAN ALUMINIUM 01753 888773  
 AVESTOPLART LTD 0114 241331  
 BYWORTH MATERIAL SERVICES 01453 821609  
 COLUMBIA METALS 01864 810091  
 CROMPTON TECH GROUP 01295 229130  
 MASON ENG USA (i) 805 527 6624  
 RICHARD BARRETT MOULDS USA 351 282 9842  
 RGB STAINLESS 0121 558 311  
 SMITHS HIGH PERFORMANCE 01767 604780  
 SPA AEROFOLDS LTD 01827 260026



Tel: +44 (0)1908 260707 Fax: +44 (0)1908 260404  
 Email: sales@superalloys.co.uk  
 Number 1 Garamonde Drive, Wymbsay  
 Milton Keynes MK9 9DF UK

### TITANIUM SPECIALISTS

AIRCO METALS LTD 0188 973 0509  
 A.N. MOTORSPORT DESIGN 01628 776320  
 APPERLEY HONING 01242 525868  
 ATHENA MANUFACTURING LP USA (i) 352 928 2693  
 CML GROUP 0151 647 5531

COAST FABRICATION USA (i) 714 842 2603  
 DATUM ENGINEERING 02476 383032  
 DONCASTERS LTD 01312 864900  
 PANKL Austria (43) 3 8625 12500  
 QINETIQ 0 8700 100942  
 SPA AEROFOLDS LTD 01827 260026



TITANIUM INTERNATIONAL Tel: 0121 789 5764  
 Fax: 0121 784 8054  
 Email: rnhoskinson@titltd.co.uk  
 Keys House, Granby Avenue, Garretts Green,  
 Birmingham B33 0SP

### TUBE FORMING

CONTRACT MFG & ASM USA (i) 920 720 4225  
 MALVERN AIRCRAFT 01684 892600  
 SPA AEROFOLDS LTD 01827 260026

## 8.5 Race Preparation

### CHASSIS

ACTIVE ENGINEERING USA (i) 714 637 1155  
 AMS 0831 501931  
 AMT MOTORSPORT 01444 483477  
 ANEX SYSTEMS 01869 345018  
 AUTOMECH 0161 775 851  
 AVONBAR 01932 840058  
 BARWELL MOTORSPORT 0208 197 4411  
 BR MOTORSPORT 01926 452545  
 BRR MOTORSPORT 01232 858095  
 CHRIS LEWIS MOTORSPORT 01677 422633  
 DEREK BENNET ENG 01565 777395  
 PRO MOTORSPORT 01555 893315  
 DOME CARS LTD Japan (81) 75 744 3131  
 DON FOSTER France (33) 470 580308  
 FOXKRAFT ENGINEERING 01264 801010  
 FRP RACING 01234 779699  
 GRAHAM WISEMAN 01278 685439  
 HAUS OF PERFORMANCE USA (i) 714 545 2755  
 HAWKINS RACING 0208 579 1438  
 INTERPO ENGINEERING 01454 412777  
 JACK CRONE RACING USA (i) 909 371 6090  
 JOHN VILLAGE AUTOMOTIVE 01246 495980  
 K2 RACE ENGINEERING 01825 760728  
 MACDONALD RACE ENG 020 889 1633  
 MARDI GRAS MOTORSPORT 01237 852426  
 MARK BAILEY RACING 01380 850110  
 MARK DUNHAM RACE ENG 01351 648922  
 MATRIX ENGINEERING USA (i) 888 249 0013  
 MELTUNE PX MOTORSPORT 01923 242536  
 MIRRO CONSULTING Tel USA (i) 408 776 0073  
 Fax USA (i) 317 218 9470  
 1680 Church Street, Building no.14, Morgan Hill, CA 95037, USA  
 0101 809553  
 07000 761486  
 QINETIQ 0 8700 100942  
 RACECRAFT INTERNATIONAL 01789 290000  
 RACE TEC DESIGN & ENGINEERING 01386 812192  
 RFX & SCOTT USA (i) 317 218 9470  
**Ray Mallock LTD (RML)** Tel 01933 402440  
 Fax 01933 676519  
 www.rmlmallock.co.uk

6-10 Whittle Close, Park Farm Industrial Estate,  
 Wellingborough, Northants NN8 6TY England

ROY KENNEDY RACING 01327 858055  
 SCHENK USA (i) 909 371 6090  
 SHENPAR PRODUCTS Germany (49) 8654 2034  
 STARTLINE UK LTD 01312 862969  
 STORM MOTORSPORT 01933 666572  
 TECH-CRAFT MOTORSPORT 01474 85 4367  
 TOLLBAR RACING 01926 490675  
 TT AUTOMOTIVE RACING 01433 631698  
 VIN MALKIE 0142 495 3456  
 ZAKSPEED 01565 777395  
 Germany (49) 2636 87923

## Database 9

### TESTING SERVICES

## 9.1 Chassis Testing

### CALIBRATION SERVICES

RICARDO INC USA 001 734 397 6666  
 THE STRAIN GAUGING CO 01256 320666  
 TORQUE FAST CALIBRATION 01782 744212  
 UNIVERSITY OF HERTFORDSHIRE 01707 284270

### CRASH TESTING

CRANFIELD UNIVERSITY 01234 754152  
 OCA DATA SYSTEMS 01234 751361  
 KISTLER INSTRUMENTS LTD 01908 641474  
 MIRA LTD 0247 635 5000  
 QINETIQ 0 8700 100942  
**Ray Mallock LTD (RML)** Tel 01933 402440  
 Fax 01933 676519  
 www.rmlmallock.co.uk  
 6-10 Whittle Close, Park Farm Industrial Estate,  
 Wellingborough, Northants NN8 6TY England  
 THE STRAIN GAUGING CO 01256 320666

### MEASUREMENT EQUIPMENT

AUTOSPRINT 01675 464857  
 BEAUFORT RESTORATION 01795 832888  
 BERU F3 SYSTEMS 01379 646200  
 OCA DATA SYSTEMS 01234 751361  
 CRANFIELD INSTITUTE 01908 641474  
 GENESIS ELECTRONIC SYSTEMS 01923 893 999  
 INSTRON SCHENK 01494 456789  
 INTERCOMP USA 763 476 2531

KISTLER INSTRUMENTS LTD 01420 544477  
 LONGACRE USA (i) 425 485 0620  
 LOTUS ENGINEERING 01953 608000  
 MICROLEASE 0208 427 8822  
 MIRA LTD 0247 635 5000  
 MOTORSPORTS INTERFACE 01788 809412  
 QINETIQ 0 8700 100942  
 ROEHRIG ENGINEERING Tel USA (i) 336 431 1827  
 ROTO TEST AB Sweden (46) 85 325 5890  
 THE STRAIN GAUGING CO 01256 320666

### ROLLING ROADS

ALDON AUTOMOTIVE 01384 785088  
 AUTOMECH 0164 775 8851  
 AUTOSPRINT 01842 766226  
 AUTOSPRINT 01675 464857  
 BD ENGINEERING 01795 843980  
 PIT STOP 01909 850654  
 BEJ MOTOR ENGINEERS 0161 748 8663  
 BOSCH 01895 814466  
 BBR GTI LTD 01280 702389  
 BRUNO HANSON Denmark (45) 65 99 1616  
 CARBURETTOR CENTRE 0208 340 5057  
 CHAMPION MOTORS 01908 664134  
 CRANFIELD INSTITUTE 01332 671491  
 DERBY AUTO ACCESSORIES 01865 407726  
 DTM CONSULTANTS (UK) 0207 738 8131  
 ELABORAZIONE COLASUNDO 01885 400639  
 FGR 01905 856800  
 FROUDE CONSINE 01454 412777  
 INTERPO ENGINEERING 01922 321813  
 JANSPEED MOTORSPORT 01923 260788  
 MACHTECH USA (i) 888 249 0013  
 MATRIX ENGINEERING 0247 635 5000  
 MIRA LTD 01609 780555  
 MOTORSCOPE USA (i) 614 292 5491  
 OHIO STATE UNIVERSITY 01865 248100  
 OSELLI ENGINEERING 0161 761 1177  
 RE PERFORMANCE CENTRE 01202 486599  
 RICHARD LONGMAN RACING 01453 750864  
 ROADSPED PERFORMANCE France (33) 16 00 10 367  
 SARDOU 01869 32111  
 SCHENK 01703 585044  
 SOUTHAMPTON UNIVERSITY T1M STILES RACING 01278 453036  
 TIPTON GARAGE 0104 812091

### STRESS ANALYSIS

COSINE TECHNOLOGY 01706 378859  
 LOLA Tel 01480 451301  
 Fax 01480 456722

### WELD TESTING

C & B CONSULTANTS AERODYNAMICS LTD  
 C & B CONSULTANTS, AERODYNAMICS LTD  
 Tel +44 (0) 1202 673666 / Fax +44 (0) 1202 673776  
 Email candbaero\_uk@candbconsultants.com  
 www.candbconsultants.com

194 Stanley Green Road, Poole, Dorset BH15 3AH  
 C & B INTERNATIONAL INC Tel +1 317 291 0978 / Fax +1 317 536 0656  
 email candbaero\_indy@aol.com  
 6210 La Pas Trail, Indianapolis, Indiana 46268

KISTLER INSTRUMENTS LTD 01420 544477  
 WIND TUNNELS ACTIVA TECH 0208 974 1615  
 AIOLOS ENG Canada (i) 416 674 3017  
 CRANFIELD INSTITUTE 01908 664134  
 CRANFIELD UNIVERSITY 01234 754152  
 DOME CARS LTD Japan (81) 75 744 3131  
 IMPERIAL COLLEGE LONDON 0207 589 5111  
 LANGLEY FULL-SCALE USA (i) 757 766 2266  
 MARCH 01280 704160  
 MICRO CRAFT USA (i) 909 947 1843  
 MIRA LTD 0247 635 5000  
 OHIO STATE UNIVERSITY USA (i) 614 292 5491  
 RMCS (ICRANFIELD) 01793 783559  
 QINETIQ 0 8700 100942  
 SARDOU SA France (33) 16 00 10 367  
 UNIVERSITY OF MARYLAND USA(i) 301 405 6861  
 WESTLAND HELICOPTERS 01935 702190

### WIND TUNNEL MODELS

ADVANCED COMPOSITES 01773 761441  
 AERODINE COMPOSITES USA (i) 317 271 1207  
 CAPITAL PATTERNS 0208 977 0276  
 COMPOSITE DESIGN USA (i) 227 539 0605  
 DOME CARS LTD Japan (81) 75 744 3131  
 MARTIN FELDWICK 01603 71201  
 MICRO CRAFT USA (i) 909 947 1843  
 MIRA 0247 635 5000  
 SARDOU SA France (33) 16 00 10 367  
 THE STRAIN GAUGING CO 01256 320666

## 9.2 Engine Testing

### COMBUSTION ANALYSIS

AM TEST SYSTEMS 01253 780780  
 AUTOSPRINT 0121 236 5133



AVL DEUTSCHLAND GmbH GERMANY (49) 634 379-0  
 CRANFIELD INSTITUTE 01908 664134  
 CRANFIELD UNIVERSITY 01234 754152  
 INTEGRAL POWERTRAIN 01908 278600  
 KISTLER Instruments Ltd 01420 544477  
 LOTUS ENGINEERING 01953 608000  
 MACHTECH 01923 260788



Tel: 08707 450584 Fax: 08707 450585

e-mail: sales@questmead.co.uk

website: www.questmead.co.uk

YyEPG Proudly Presents. Thanks for Support

MIRA LTD 0247 635 5000  
 MOTORSPORTS INTERFACE 01788 890412  
 MTS Powertrain Tech Tel 01932 351516  
 PETROCHEM CARLESS LTD 01372 360000  
 PRECISION AUTOMOTIVE USA (1) 708 266 4402  
 RICARDO 01273 794144  
 RICARDO INC USA (1) 734 397 6666  
 QINETIQ 0 8700 100942  
 RICARDO 01273 45561  
 TREVOR MORRIS ENGINES 0154 74289

#### DYNAMOMETER SUPPLIERS



**AVL DEUTSCHLAND GmbH GERMANY** (49) 6134 7179-0  
 BEAUFORT RESTORATION 01795 83288  
 CRANFIELD UNIVERSITY 01234 754152  
 DYPAC DYNO USA (1) 315 339 1265  
 DYNAMIC TEST USA (1) 800 243 3966  
 DYNOMITE USA (1) 603 329 5645  
**ENGINE & DYNAMOMETER** 01708 857108  
 FROUDE CONSINE 01905 856800  
 LOTUS ENGINEERING 01953 608000  
 MACHTECH 01923 269788  
 MIS M/SPORTSTECHNIK Germany (49)263680394  
 MOTORSPORTS INTERFACE 01788 890412  
 Ricardo Inc USA (1) 734 397 6666  
 ROTOTEST Sweden (46) 8 532 55890  
 SUPERFLOW USA (1) 219 471 1746  
 BELGIUM 32 15 216300  
 TAT Germany (49) 7252 84258

#### DYNAMOMETER SERVICES

ACCURATE ENGINEERING USA (1) 216 232 1156  
 CELTIC PERFORMANCE ENG 01362 696729  
 AIRFLOW RESEARCH USA (1) 888 890 0616  
 ALDON AUTOMOTIVE 01384 78508  
 AMG MOTORENBAU Germany (49) 7144 3020  
 ANDY ROUSE ENGINEERING 02476 615282  
 ARIAS 01403 784022  
 ATKINSONS MOTORSPORT 01539 732500  
 AUTOKRAFT 0121 777 2083  
 AUTOTECH 0161 7551851  
 AUTO SPECIALISTS USA (1) 704 786 0977  
 AVONBAR 01932 840058  
 EVOLUTION ENGINEERING 0207 703 2225  
 BERTHUS ENGINES USA (1) 908 395 4244  
 BJ MOTOR ENGINEERS 0164 748 8663  
 BOB WIRTH RACING USA (1) 510 487 3279  
 BRAYTON ENGINEERING USA (1) 517 279 8458  
 BR MOTORSPORT 01926 45545  
 BRODIE BRITAIN (BBR) 02280 202389  
 CAMBRIDGESHIRE SPORTS 01954 210248  
 CARBONE RACING USA (1) 948 835 6596  
 CENTRAL AUTO TECH 0121 4558392  
 COMPETITION ENGINE 02206 435289  
 CONCEPT MOTORSPORT 0208 568 0293  
 CONNAUGHT 01795 841802  
 DAVE CROFTS 01246 477566  
 DAWSON AUTO DEVELOPMENT 0127 852729  
 DESIGN & DEVELOPMENT 06095 574454  
**DRAGON PROJECT RACING** TEL 018 974 4875  
 DUNNELL ENGINES 01449 677266  
 DYNOMITE USA (1) 603 329 5645  
 EAGLE ENGINE CO USA (1) 805 373 6806  
 ELABORAZIONE COLASUNO 0207 738 8331  
 ELLIOTT & SON 01206 71275  
 EDS 01708 857108  
 ENGINE DATA ANALYSIS 01977 516622  
 FAST CAR CLINIC 01274 579564  
 FISCHER ENGINEERING USA (1) 888 504 0100  
 FONTANA AUTOMOTIVE USA (1) 310 538 2505  
 FROUDE CONSINE 01905 856800  
 GAERTJE ENGINES USA (1) 219 223 3016  
 GEMINI ENGINEERING 01474 534779  
 GEOFF RICHARDSON ENG 01480 861599  
 GMH ENGINEERING USA (1) 801 225 8970  
 GOODMAN RACING ENGINES 01327 300422  
 GRAHAM HATHAWAY RACING 01621 856056  
 HARPERS PERFORMANCE 01642 888888  
 GEORGE HARTWELL 01202 556566  
 HASSELGREN ENGINES USA (1) 510 524 2485  
 HAUS OF PERFORMANCE USA (1) 714 545 2755  
 HIGHGATE ENGINEERING 0208 951 4923  
 HODSON ENGINEERING 01732 463658  
 HODSON ENGINEERING 01473 623000  
 HOLBAY RACE ENGINES USA (1) 704 394 2151  
 HOLMAN AUTOMOTIVE 01270 665495  
 HUDDART 01908 278690  
 INTEGRAL POWERTRAIN 01454 417777  
 INTERPRO ENGINEERING 01273 473 624 216  
 INTER-TUNING 01923 816277  
 IVAN DUTTON 01722 321833  
 JANSPEER ENGINEERING 01903 891776  
 JENNETTS ENGINES 01491 680719  
 JF ENGINES 01903 771022  
 JOHN BROWN ENGINEERING 01903 771022  
 KREMER RACING Germany (49) 221 17 1025  
 LANGFORD & PECK 01933 441664  
 LINGENFELTER USA (1) 219 724 2552  
 LISTER CARS 01372 37474  
 LOTUS ENGINEERING 01953 608000  
 LYNX MOTORS 01424 85277  
 MRE 0208 889 1633  
 MAXSYM ENGINE TECHNOLOGY 01608 685155  
 MACHTECH 01923 269788  
 MATHWALL ENGINEERING 01252 703191  
 MERLIN DEVELOPMENTS 01283 510814

MICKY MAROLLO USA (1) 607 734 2148  
 MINERVA MOTORSPORT 01509 231970  
 MINISTER RACING ENGINES 01634 682577  
 MOUNTUNE 01621 854029  
 NEIL BROWN ENGINEERING 01775 721052  
 NELSON ENGINE SERVICES 01249 815929  
 OSSELY ENGINEERING 08665 248000  
 PAUL PFAFF RACE USA (1) 714 804 7573  
 PHIL JONES ENGINE DEVELOPMENTS 01454 310 936  
 01564 824869  
 01233 7327377  
 PIPER FM USA (1) 812 546 4220  
 PRICE MOTORSPORT 015 9499901  
 PRIMA RACING USA (1) 626 847 5000  
 PRO/CAM 01295 273355  
 PRODRIVE 01732 74144  
 QUAFIE ENGINEERING USA (1) 301 698 9009  
 QUICKSILVER 01509 41237  
 QUORN ENGINE DEVELOPMENTS USA (1) 714 397 8677  
 RACING BENT USA (1) 734 397 6666  
 RICARDO INC 01273 794144  
 RICARDO 01524 844066  
 ROAD & STAGE MOTORSPORT Sweden (46) 8 532 55890  
 ROTO TEST Canada (1) 416 759 9109  
 SCARBOROUGH 0208 305 2250  
 SEARLE USA (1) 248 689 9000  
 SCHENCK PEGASUS 01285 860295  
 SOUTH CERNEY ENGINEERING 01375 378606  
 SPECIALISED ENGINES USA (1) 209 207 5081  
 STERLING ENGINES 0191 586731  
 SWIFT MOTORSPORT 01793 53121  
 SWINDON RACING ENGINES 0154 74289  
 TREVOR MORRIS ENGINES USA (1) 714 847 447  
 VAN DYNE ENGINEERING 01825 764833  
 WARRIOR 01797 224000  
 WESLAKE DEVELOPMENTS

#### ENGINE BALANCING

AUTOMOTIVE BALANCING USA (1) 562 861 5344

#### FLOWBENCH ANALYSIS

ADVANTEC NEW TECHNOLOGY (49) 2261 61901  
 AM TEST SYSTEMS 01253 780780  
 BOB WIRTH RACING USA (1) 510 487 3279  
 CRANFIELD UNIVERSITY 01234 754152  
 HAUS OF PERFORMANCE USA (1) 714 545 2755  
 INTEGRAL POWERTRAIN 01908 278600  
 LINGENFELTER USA (1) 219 724 2552  
 LOTUS ENG 01953 608000  
 MAXSYM ENGINE TECH 01608 685155  
 MOBILIS LAB CANADA (1) 450 647 1890  
 NEIL BOLD ENGINEERING 01204 71636  
 RACE ENGINE DEV USA (1) 760 630 0450  
 RACE TECHNIQUES 01242 245640  
 RICARDO INC USA (1) 734 397 6666  
 RICARDO 01273 794144  
 TREVOR MORRIS ENGINES 0154 74289  
 U.M.P.S. 01784 439771

#### FUEL ANALYSIS

AM TEST SYSTEMS 01253 780780  
 BOB WIRTH RACING USA (1) 510 487 3279  
 CRANFIELD INSTITUTE 01908 694134  
 LOTUS ENGINEERING 01953 608000  
 QINETIQ 0 8700 100942

#### INJECTION ANALYSIS

ASNU 0208 420 4494

#### OIL ANALYSIS

AM TEST SYSTEMS 01253 780780  
 BOB WIRTH RACING USA (1) 510 487 3279  
 CRANFIELD INSTITUTE 01908 694134  
 LOTUS ENGINEERING 01953 608000  
 QINETIQ 0 8700 100942  
 RICARDO 01273 794144

#### RACE ENGINE DESIGN



**RICARDO CONSULTING ENGINEERS**  
 Tel 01273 794144 Fax 01273 794572  
 Email: dave.morrison@ricardo.com  
 Website: www.ricardo.com  
 Shoreham by Sea, West Sussex, BN43 5FG

#### TEMPERATURE MONITORING

AM TEST SYSTEMS 01253 780780  
 BOB WIRTH RACING USA (1) 510 487 3279  
 CALEX ELECTRONICS 01525 373178  
 CCA DATASYSTEMS 01525 378938  
 CONNAUGHT ENGINES 01795 843802  
 INTEGRAL POWERTRAIN 01908 278600  
 LOTUS ENGINEERING 01953 608000  
 MACHTECH 01923 269788  
 MIRA LTD 0247 635 5000  
 MOTOR SPORT ELE AUS 01758 890412  
 MOTORSPORTS INTERFACE 0 8700 100942  
 QINETIQ 01491 6742  
 RACEPARTS 01273 794144  
 RICARDO 01236 320666  
 THE STRAIN GAUGING CO 0154 74289  
 TREVOR MORRIS ENGINES

#### TEST BED SUPPLIERS



**AVL DEUTSCHLAND GmbH GERMANY** (49) 6134 7179-0

#### TEST CELL DESIGN

MARTYR TEST TECHNOLOGY 01386 792125

#### 9.3 Transmission Testing

#### TESTING SERVICES

ANEX SYSTEMS 01809 345038  
 ANTHONY BEST DYNAMICS 01225 867575



**AVL DEUTSCHLAND GmbH GERMANY** (49) 6134 7179-0  
 AVONBAR 01932 840058  
 BEAUFORT RESTORATION 01795 83288  
 CRANFIELD INSTITUTE 01908 694134  
 DAVID BROWN VEHICLE TRANS 04284 422890  
 EUROTECH MOTORSPORT 02476 672959  
 HALIBRAND USA (1) 800 824 7947  
 UK 01928 36176  
 HAUS OF PERFORMANCE USA (1) 714 545 2755  
 HEWLAND ENGINEERING 01628 827600  
 LOTUS ENGINEERING 01953 608000  
 MACHTECH 01923 269788  
 MARK BAILEY RACING 01264 860014  
 MIRA LTD 0247 635 5000  
 PDS RACING 01977 61922



**QUAIFE ENGINEERING** Tel 01732 74144  
 Fax 01732 74555  
 Email info@quaife.co.uk www.quaife.co.uk  
 Vestry Road, Sevenoaks, Kent, TN14 5EL

RICARDO 01273 794144  
 RICARDO 01926 319399  
**ROADSPEED PERFORMANCE** 01453 750864  
 SCHENCK PEGASUS CORP (1) 248 689 9000  
 SERVOTEST LTD 020 8707 1400  
 SIEMENS AG Germany (49) 941 790 5313  
**THE STRAIN GAUGING CO** 01256 320666  
 ZF Germany (49) 7541 37 2543  
 UK 015 4869221

#### 9.4 Suspension Testing

#### TESTING SERVICES

ANDY ROUSE ENGINEERING 02476 635182  
 CRANFIELD INSTITUTE 01908 694134  
 EUROTECH MOTORSPORT 02476 672959  
 HAUS OF PERFORMANCE USA (1) 714 545 2755  
 INSTRON SCIENK 01494 457079  
 JENVEY DYNAMICS 07246 768810  
 LOLA Tel 01480 451301  
 Fax 01480 450722  
 MARDI GRAS MOTORSPORT 01327 858006  
 MIRA LTD 0247 635 5000  
 PILBEAM RACING DESIGNS 01778 424838  
 RACE TEC DESIGN & ENG 01386 87292  
 RACRAFT MOTORSPORT 01707 45946  
 RATRACE MOTORSPORT 0208 203 8700  
 RICARDO 01273 794144  
 RICHARD HINTON RACING 01279 77667  
 RMCS (CRANFIELD) 01793 785359  
**Ray Mallock LTD (RML)** Tel 01933 402440  
 Fax 01933 676519  
 www.rmlmallock.co.uk  
 6-10 Whittle Close, Park Farm Industrial Estate,  
 Wellingborough, Northants NN8 6TY England

ROEHRIG ENGINEERING USA (1) 336 431 1827  
 SERVOTEST LTD 020 8707 1400  
 SCHENCK PEGASUS USA (1) 248 689 9000  
 SPA DESIGN LTD 01827 288328  
 STARTLINE UK LTD 01933 665752

#### 9.5 Brake Testing

#### DYNAMOMETER SUPPLIERS

BOSCH 01895 834466  
 MTS POWERTRAIN TECHNOLOGY 01932 351516  
 DYNOMITE USA (1) 603 329 5645  
**KISTLER INSTRUMENTS AG** Tel 01273 40 52 224 111  
 Fax 01273 40 52 224 144  
 Email info@kistler.com  
 PO Box, CH-8408 Winterthur, Switzerland  
 MIRA LTD 0247 635 5000  
 WILWOOD ENG USA USA (1) 805 388188  
 UNICO (UK) LTD 01908 260000

#### TESTING SERVICES

HAUS OF PERFORMANCE USA (1) 714 545 2755  
 EUROPEAN FRICTION 017 9714837  
 MIRA LTD 0247 635 5000  
 RICARDO 01273 45561  
 SIEMENS AG Germany (49) 941 790 5313  
**THE STRAIN GAUGING CO** 01256 320666

#### 9.6 Metal Testing

#### CRACK TESTING

BEAUFORT RESTORATION 01795 83288  
 CML GROUP 0151 647 5531  
**CRANFIELD UNIVERSITY** 01234 754152  
 GM DESIGN 017 985 9964  
 MIRA LTD 0247 635 5000  
 ORANGE COUNTY USA (1) 800 359 8378  
 QINETIQ 0 8700 100942  
 RICARDO 01273 45561  
 RMCS (CRANFIELD) 01793 785359  
 SCHENCK PEGASUS USA (1) 248 689 9000  
 SPA AEROFOLIOS LTD 01827 260026  
 STRAIN GAUGING CO 01256 320666  
 SWINDON RACING ENGINES 01793 53121  
 UNIVERSITY OF HERTFORDSHIRE 01707 284290  
 VIN MALKE RACING 01565 777395  
 WESTLAND HELICOPTERS 01955 702190

#### STRENGTH TESTING

AR CORNELL 01245 268080  
 ARMOR-ALL PRODUCTS 07999 53130  
 AVONBAR 01932 840058  
 BA HARRISON 016 2769331  
 CML GROUP 0151 647 5531  
 CRANFIELD UNIVERSITY 01234 754152  
 GRIFFITHS ENGINEERING 01582 600629  
 HIGH TECH PERFORMANCE USA (1) 818 908 0943  
 DONCASTERS 01322 864900  
 MRE 0208 889 1633  
 MIRA LTD 0247 635 5000  
 NITRIDING SERVICES 01952 677372  
 ORANGE COUNTY USA (1) 800 359 8378  
 RICARDO 01273 45561  
 QINETIQ 0 8700 100942  
 RMCS (CRANFIELD) 01793 785359  
 ROUSH RACING USA (1) 315 591 4184  
 SCHENCK PEGASUS USA (1) 248 689 9000  
**THE STRAIN GAUGING CO** 01256 320666  
 UNIVERSITY OF HERTFORDSHIRE 01707 284290  
 ZEUS MOTORSPORT 01604 878101

## Database 10

SERVICES - GENERAL

#### 10.2 Paddock Services

#### AIR FREIGHT FORWARDERS

ALL WAYS FORWARD 01242 228111  
 EMO AIR CARGO 0208 577 5100  
 FIRSTAIR 01784 424551  
 JIM RUSSELL FREIGHT 01332 819331  
 MSAS 0208 890 1355  
 MW FREIGHT SERVICES 01895 446442  
 RAPID INTERNATIONAL 0161 436 7074  
 UNION AIR TRANSPORT Australia (61) 2 522 4618  
 WINWEST

#### MOTORHOME

ATLANTIC COAST 01297 552222



#### CHESHIRE AMERICAN MOTORHOMES

Tel +44(0) 161 427 6868  
 Fax +44(0) 161 426 0010  
 Website www.americancarmotorhomes.co.uk  
 Email sales@americancarmotorhomes.co.uk  
 Lomberhay Farm, Andrawane,  
 Highlane Village, Stockport SK6 8HY

#### DAVID WILSON'S TRAILERS

DUDLEYS 01825 740696  
 MIDLAND INTERNATIONAL 01919 701274  
 SPIRES OF OXFORD 02476 13641  
 ULTRA INTERNATIONAL 01865 875539  
 WESTCROFT AMERICAN 01766 770011  
 01902 731324

#### TRAILER HIRE

11/56 MOTORSPORT 01543 480309  
 BRIAN JAMES TRAILERS 01247 260733  
 DAVID WILSON'S TRAILERS 01815 740696  
 DC TRAILERS 01406 380224  
 ELLIS ENGINEERING 01277 631274  
 HOPKINS MOTORSPORT 0117 9509294  
 MOBILE PROMOTIONS 01832 731460  
 NEIL BAINBRIDGE RACING 01296 714547  
 TON HIRE 0892 816555  
 WARWICK TRAILERS 01692 732681  
 WARWICKSHIRE TRAILERS 01564 792317

## A.H. FABRICATIONS FOR THE FOLLOWING

- ALUMINIUM PETROL TANKS,
- DRY SUMP TANKS,
- OIL COOLERS,
- WATER RADIATORS,
- INTERCOOLERS,
- HEAT EXCHANGERS,

Visit the new website  
[www.ahfabrications.co.uk](http://www.ahfabrications.co.uk)

TEL +44 (0) 1432 354704 FAX +44(0) 1432 359762

ALEXANDER FAIRBairn Ltd

A.H. FABRICATIONS, UNIT 6H, THORN BUSINESS PARK, ROTHERWAS, HEREFORD, HR2 6JT, ENGLAND

We're Proudly Presents, Tnx for Support

**SUPER FLEX**  
POLYURETHANE

ADVANCED POLYURETHANE SUSPENSION BUSHES

[www.superflex.co.uk](http://www.superflex.co.uk)

Unrivalled Quality, Realistically Priced - Upgrade to SuperFlex

01749 678152  
Mon-Fri 9-6

**RACEPARTS (UK) LTD**  
Motor racing parts, spares & equipment

**2006 MOTORSPORT CATALOGUE**

PLEASE CALL FOR A FREE COPY

TEL: +44 (0) 1491 822000  
FAX: +44 (0) 1491 822009  
EMAIL: SALES@RACEPARTS.CO.UK  
WWW.RACEPARTS-DIRECT.COM  
UNIT 3 ROCKFORT IND EST, WALLINGFORD, OXON. OX10 8DA

Butser Rubber specialises in custom rubber mouldings and high quality components and is ISO 9001:2000 certified.

**Butser Rubber**

We manufacture any product from one off prototypes to volume production.

Butser Rubber Limited, Mint Road, Liss, Hampshire, GU33 7BQ.  
Tel: +44 (0) 1730 894034  
Fax: +44 (0) 1730 894344  
[www.butser-rubber.com](http://www.butser-rubber.com)  
butser@btinternet.com

Our range includes rubber-to-metal bondings, gaskets, extrusion and mouldings.

Medical Defence Motor Sport Maritime Aerospace  
Formula 1

## We're precise about what we do.

CNC Honing  
CNC Gundrilling  
EDM Drilling  
CNC Milling  
Deep Hole Boring  
CNC Turning

Whatever your requirements for quality precision machined components, single source manufacture offers the most reliable and cost-effective solution.

At Hone-All we provide a wide variety of industries with a complete service to meet all their manufacturing needs - from sourcing raw materials to producing quality machined components.

We constantly invest in our highly skilled teams, the latest industry systems, new CNC machine tools and state of the art inspection technology to ensure business excellence.

As all procedures are carried out within our own facilities we are able to continuously improve controls over cost, quality and lead times. This guarantees the most competitive rates and a faster, more effective service that not only meets, but exceeds your production demands.



FM 38790



**Hone-All. From start to perfect finish. HoneAll**

YYePG Proudly Presents, Thx for Support

**Hone-All Precision Limited** Frenchs Avenue, Dunstable, Bedfordshire LU6 1BH Telephone 01582 477721 Fax 01582 477728 E.mail [sales@hone-all.co.uk](mailto:sales@hone-all.co.uk) Website [hone-all.co.uk](http://hone-all.co.uk)



## Integrating the details

The influence of a single-seater front wing on downstream aerodynamics around the car

Last month we looked at the distribution of static pressures – and the aerodynamic forces arising – around a full model of a 2001 Reynard Champ Car. Examining static pressure plots it was possible to visualise the dominant sources of 'pressure drag' (that element of drag arising from overall pressure differences) and downforce. This month we look at the area of the car around the front wing to see its influence in its immediate vicinity and some way downstream. Figure 1 shows the model, with static pressures mapped on the upper surfaces.

CFD enables various methods of visualising aerodynamic properties. In particular, it is possible to look at properties along single planes in any of the three directions, defined usually as x, y and z. In this way, 'slices' through the air surrounding a racecar can be examined. To enable us to study the influence of the front wing we're going to utilise predominantly transverse slices in the vertical plane at stations along the length of the car.

The majority of these plots, such as figure 2, show two different properties.

### “SLICES THROUGH THE AIR SURROUNDING A RACECAR”

On the left is 'total pressure', which is a measure of the energy in the airflow at any particular point. As air passes over the surfaces of a body like a racecar it loses energy due to viscous effects (eg skin friction) and flow separation (where there are changes in surface shape that prevent the airflow from remaining attached). Total pressure is therefore high in areas where viscous effects or flow separation have not 'stolen' energy. But where energy losses have occurred because of one or both of these mechanisms, total pressure decreases. These plots use red for maximum total pressure (total pressure coefficient,  $C_pT = 1$ ), through yellows, greens and blues ( $C_pT = 0$ ) showing decreasing total pressure.

On the right is static pressure, which is the form of pressure that exerts forces on the racecar surfaces. In conditions where Bernoulli's Equation applies, static pressure decreases as velocity increases (and vice versa). Positive static pressures are shown as red and orange and negative static pressures are shown by green and blue.

Figure 1: the Reynard 011 model, with static pressures plotted

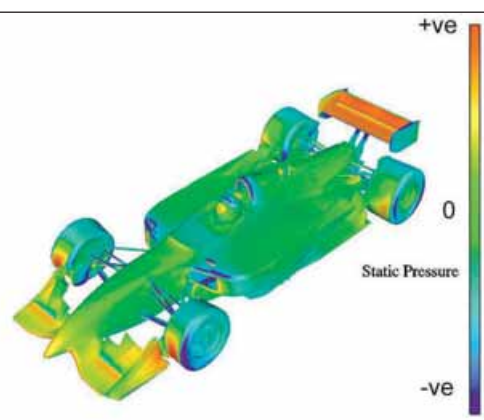

Illustrations courtesy: Advantage CFD

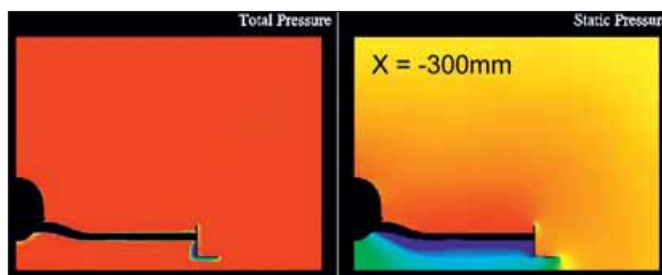

Figure 2: cross section, looking rearwards, of the nosecone and left side front wing, 150mm aft of the leading edge

Figure 2 is a slice looking rearwards, taken about 150mm back from the front wing mainplane leading edge (at  $x = -300\text{mm}$ , where  $x = 0\text{mm}$  at the front of the chassis tub, 300mm aft of this slice). Only the left side of the car is shown – the black half oval on the left is the nosecone. The static pressure plot shows negative static pressure below the wing and positive static pressure above it that jointly contribute to downforce. The total pressure plot reveals only minor losses in energy near the wing and nose surfaces, and under the end plate 'footplate'.

Moving 400mm downstream to just aft of the front wing flap trailing edge, at  $x = 100\text{mm}$  (figure 3) and things have developed. The different static pressures that developed above and below the wing have now merged to virtually the same level, and the total pressure plot shows the wing's wake. The red area in the static pressure plot is where the airflow has slowed ahead of the front wheel – hence the high static pressure, which produces pressure drag on the wheel. Static pressure is also high above the end plate footplate and low beneath it, creating an increment of downforce. Most obvious though is the circular (blue) wing tip vortex. The air in the vortex →

Produced in association with Advantage CFD

**advantage** CFD

Tel: +44 (0)1280 846806

Email: [cfid@advantage-cfd.co.uk](mailto:cfid@advantage-cfd.co.uk)

Web site: [www.advantage-cfd.co.uk](http://www.advantage-cfd.co.uk)

YYePG Proudly Presents, Thx for Support

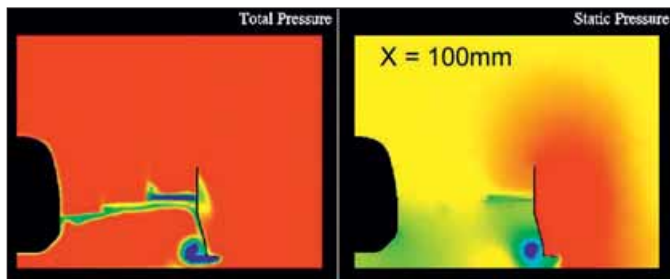

Figure 3: cross section in line with the front wing flap trailing edge

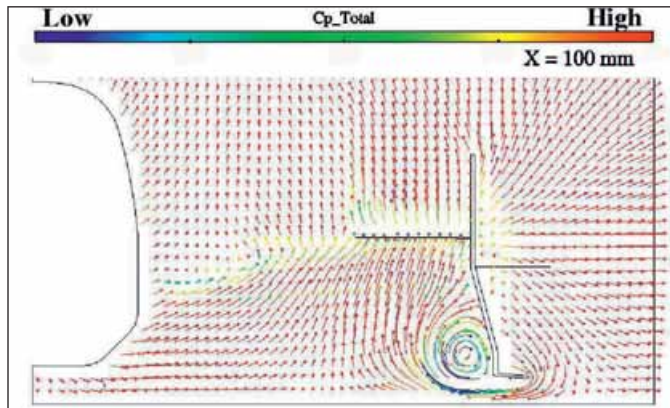

Figure 3a: in plane velocity vectors show the wing tip vortex

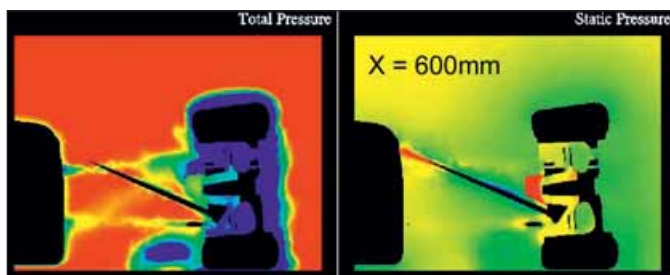

Figure 4: cross section in line with the front wheel centre

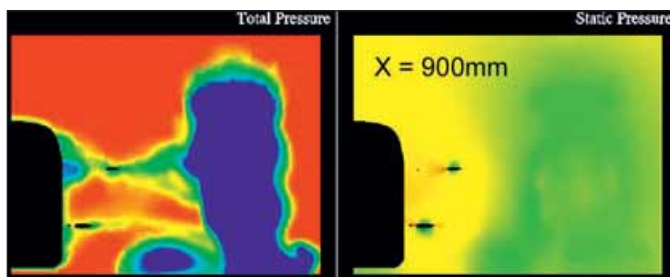

Figure 5: cross section just aft of the front wheel

has lost significant total pressure (energy), which is also associated with low static pressure. The vortex is initiated by air flowing from the high static pressure area outboard of the wing to the low static pressure area beneath, the flow then separating at the bottom of the end plate. Figure 3a, showing in-plane velocity vectors, confirms this. Notice the end plate has been angled outwards to 'accommodate' the vortex.

Figure 4 (x = 600mm) is in line with the wheel centre. Static pressure is low above the wheel, leading to aerodynamic lift, and high in the brake cooling duct. The total pressure plot shows substantial energy losses within and around the wheel, and smaller losses in the wakes of the forward suspension links. The faint yellow diagonal from the centre to the lower left of the total pressure plot is the residual front wing wake. The wing tip vortex is still in evidence in the total pressure plot, but less so in the static pressure plot.

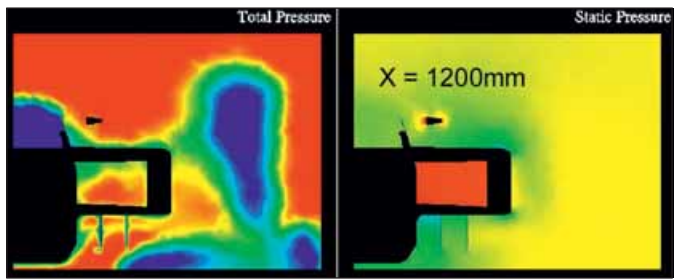

Figure 6: cross section in line with the front of the sidepod

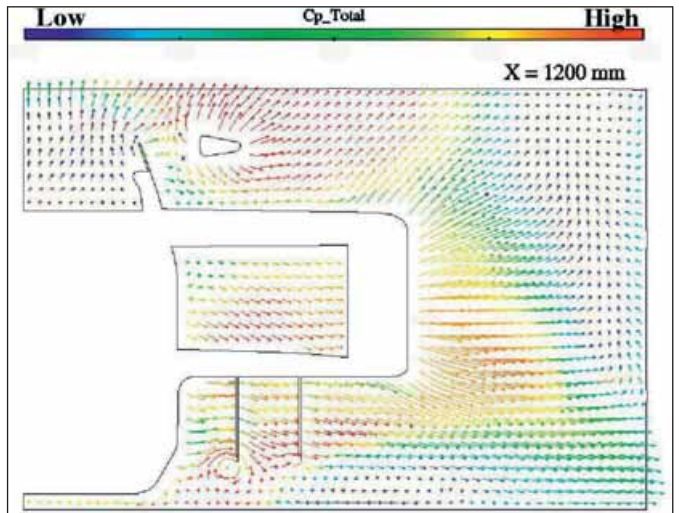

Figure 6a: in plane velocity vectors in line with the front of the sidepod

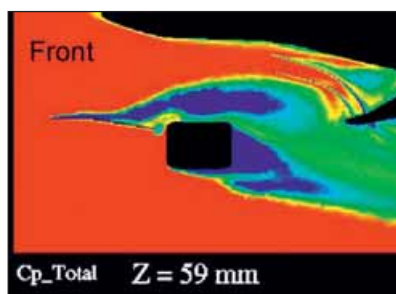

Figure 7: cross section, viewed from above, of total pressure at sidepod base height around the front, left corner of the car

At x = 900mm (figure 5) static pressure is slightly negative immediately behind the wheel, adding pressure drag. The total pressure plot shows the large wake from the wheel, and the wing tip vortex is still very apparent, but it has flattened and shifted inboard slightly.

At x = 1200mm (figure 6) the cockpit, mirror, sidepod, radiator inlet duct and the 'vortex generators' (the curved turning vanes) in the front of the underbody are visible. Static pressure is high in the radiator inlet duct, as it needs to be to drive cooling air through the system, but has started to reduce in the underbody. The total pressure plot shows the wheel wake to be well outboard of the sidepod. The low total pressure 'residue' of the wing tip vortex is also still apparent (bottom centre) but figure 6a shows the circulation has virtually ceased. There is, however, a new vortex being formed – by the vortex generators – which influences the forces generated by the underbody.

Figure 7, looking from above at sidepod base height, illustrates that the wing tip vortex has in fact been steered outboard by the vortex generators – as it might be by a bargeboard, or a front endplate extension such as Formula 1 outlawed in 1994. The air flowing into the underbody is therefore at higher energy than if the now 'tired' wing tip vortex were allowed to enter that area, to the improvement of underbody and diffuser performance. In this way, the front wing has positive and potentially negative influences.

Next month we'll see what happens in the underbody.

# KAITEN®

PERFORMANCE PRODUCTS

THE SPECIALIST IN FORGED CHROMOLY FLYWHEELS

FORGED • INTEGRAL RING GEAR  
FULL CNC MACHINED FOR EXACT TOLERANCE  
WIDE RANGE OF FORGING DIES

DESIGNED FOR USE WITH:  
RACE CLUTCH SIZES 4.5", 5.5", 7.25", 8.5"  
& STANDARD FACTORY STYLE CLUTCHES

CUSTOM DESIGN AND MANUFACTURING AVAILABLE



KAITEN PERFORMANCE PRODUCTS  
4431 CORPORATE CENTER DRIVE, UNIT 131 LOS ALAMITOS, CALIFORNIA 90720  
TEL: +1 714 220 2227 FAX: +1 714 220 2819  
EMAIL: SALES@KAITENPRODUCTS.COM

WWW.KAITENPRODUCTS.COM

New from Rowley Race Dynamics

2nd Edition

## An Introduction To Race Car Engineering Book 1



With the help of powerful software packages, this exciting new book provides the race engineer with considerable insight into the possible performance envelopes of a modern race car.



TO ORDER:  
www.rowleyrace.com

Wm. C. Mitchell Software - Racing by the Numbers

Introducing version 4.0 of the WinGeo3 Suspension Geometry program with Force-based Roll Centers



www.MitchellSoftware.com  
800-844-7296 from USA and Canada  
125 East Plaza Drive, Suite 117

704-660-0330 voice  
704-663-0085 fax  
Mooresville, NC 28115 USA



# CAT CAMS

**PRODUCTS:**

- CAMSHAFTS
- RACE TAPPETS
- VALVE SPRINGS
- RETAINERS
- LASH CAPS
- CAM PULLEYS
- CRANKSHAFTS
- STEEL RODS
- ROD BOLTS

## CAMSHAFTS & VALVE TRAIN COMPONENTS

- ▶ CNC machine shop (incl. cam grinding) & CMM quality control
- ▶ continuous inhouse development of cam design software
- ▶ the widest camshaft range on the web
- ▶ steel billet cams for any application
- ▶ 'true lock' nonius cam pulleys
- ▶ forged steel conrods

(PEUGEOT / CITROEN 1.6L 16V)

info@[www.catcams.be](http://www.catcams.be) tel: +32 (0)3/320.25.60  
fax: +32 (0)3/322.36.77



# KINSLER FUEL INJECTION

- Monster Mesh™ Series of Filters
- K-140 Pressure Relief Valve
- Throttle Bodies
- Electronic Fuel Injectors
- Chevrolet LS1 High Port
- Lite Weight Mechanical Pumps
- Indy Racing League Fuel Rail & Components
- #1 Weldon Distributor Since 1997
- EFI Chevrolet
- Electronic Engine Management
- Diaphragm High Speed
- High Flow Bypasses
- Quick Disconnect Bypass
- Precision Nozzles and Jets

This Is Just A Sampling...

## We Are THE Linkage Source !!!

Manufacturing, Sales, & Service. Constant flow, Electronic, and Lucas mechanical fuel injection. Tel: +1-248-362-1145

*Kinsler Fuel Injection, Inc.* Fax: +1-248-362-1032  
1834-RCE Thunderbird Street Troy, MI 48084 USA [www.kinsler.com](http://www.kinsler.com)

Techn. Manual/Catalog \$12.00 US \$15.00 non-US



# KENT CAMS

- ★ In house profile design
- ★ Prototype production & development
- ★ One off & small batch production
- ★ Used from Touring Cars to Formula 1 - by the championship winners!

## CAMSHAFTS - VERNIER CAM WHEELS - CAM FOLLOWERS

**Kent Performance Camshafts Ltd**  
Units 1-4 Military Road, Sharncliffe Ind. Estate, Folkestone, Kent CT20 3SP  
England Tel: 01 303 248666 Fax: 01 303 251374



# ORLANDO

## ONE MILLION SQUARE FEET

### More New Racing Technology Than Anywhere On Earth



- **1,400 Exhibiting Companies • 4,000 Booths**
- **45,000 Buyers From 40 Countries**
- **Discover The Latest Advances In Motorsport Engineering**



**19<sup>TH</sup> ANNUAL** **Performance Racing Industry**  
**TRADE SHOW**

**DECEMBER 14-16, 2006**

**ORLANDO, FLORIDA • USA**

Orange County Convention Center • North/South Buildings

**FOR MORE INFORMATION**

**[www.performanceracing.com](http://www.performanceracing.com)**

31706 South Coast Hwy

Laguna Beach, CA 92651-6974, USA

Tel: +1 949.499.5413 • Fax: +1 949.499.9521

©Laguna Coast Publishing, Inc. November 2005 TS4242-K

YEPG Proudly Presents, Thx for Support

Mark Ortiz is

# THE CONSULTANT

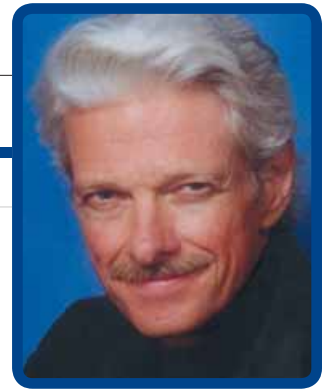

## Tyre pressures in the snow

**Tyres do not cut through the snow, at any inflation pressure, rather they compact it vertically and ride over it. Traction comes from the action of the tyre interlocking with the snow itself**



**Q** I have heard two schools of thought on tyre pressure for winter driving, in particular driving on snow-covered roads. The first is that tyres should be kept at the upper end of the manufacturers' specifications to help in cutting through the snow — the thinking being that the contact patch is smaller, hence more weight per square inch, as well as less sidewall deflection — which may decrease the potential for hydroplaning on the snow. The other is that running the pressure at the lower end allows for better bite for the tread in the snow and more stability. What do you think?

**A** I'm with the low-pressure school. It's said that one measurement is worth a thousand expert opinions and really, you'd think this might be measurable. Surely somebody has tried measuring, say, how steep a hill a vehicle can climb at various tyre pressures? I would be willing to defer to any actual measurement that contradicts my expert opinion. That said, I offer my expert opinion, based on a lot of time spent in Wisconsin, where there are long, snowy winters.

Mark Ortiz Automotive is a chassis consulting service primarily serving oval track and road racers. In these pages Mark answers your queries on chassis set-up and handling. If you have a question to put to him, email to [markortiz@vnet.net](mailto:markortiz@vnet.net), call 704-933-8876 or write to **Mark Ortiz, 155 Wankel Dr., Kannapolis, NC 28083-8200 USA**

First, tyre pressure effects in snow are surprisingly subtle compared to other variables, and effects due to other variables are surprisingly large. That explains why there is controversy about inflation pressures.

One reason tyre testing was moved indoors, with rollers or belts substituting for pavement, is that even on hard, dry pavement, weather, surface contamination, pavement temperature, pavement age, and other factors make enough difference that small variations in tyre performance are hard to measure repeatably.

**“COMPARED TO SNOW, PAVEMENT IS SIMPLE AND CONSISTENT”**

When we're dealing with snow, we have similar variability, exaggerated at least tenfold. Snow and ice come in dozens of different varieties and depths, and all of these have properties that are highly temperature sensitive. Compared to snow, pavement is simple and consistent.

The explanation I have heard from sources that advocate high tyre →  
YYePG Proudly Presents, Thx for Support

pressures is that the tyre needs to penetrate the snow and get to the pavement, where it can find traction. But clearly, in most snow conditions that never happens, at any inflation pressure. If it did, we'd see bare pavement where the tyre passed.

Instead, we see compacted snow, with an imprint of the tyre tread. Or at least we see that if the tyre is rolling, and not spinning or sliding – and if we are dealing with snow that has not already been compacted. We also usually see a small area alongside the track where the snow appears slightly raised, apparently having been pushed out of the way, perhaps just by the sidewall. This is not a lot of snow, however. Most of the snow stays put horizontally, and gets compacted vertically. The tyre evidently gets traction by packing the snow into a relatively solid form, and simultaneously interlocking with it. To break traction, the compacted snow projections residing in the tread grooves must be sheared off, and the layer of snow lying under the tread blocks must also fail in some manner.

The failure of the snow in the grooves is easily visualised as simple breakage. The failure of the snow under the tread blocks is a bit harder to visualise. It appears that the snow under the tread blocks contributes more to traction than one would imagine, because the tyre's grip is greatly improved by siping (cutting small slits or grooves into) the tread blocks. It also helps to roughen the surface of the tread blocks.

I do not claim to perfectly understand the mechanics of structural failure of snow in a tyre contact patch, but I do know that it is normally a combination of breakage and melting. Ice (and snow is ice crystals) can be melted by mechanical pressure – or, stating it differently, the melting point of ice is lowered by mechanical stress, either compressive or shear stress. Any place snow or ice liquefies, its mechanical strength disappears and it turns into a lubricant. The closer the ice or snow is to its melting point, the less mechanical stress is required to turn it to liquid.

So, when we compact snow, we make it stronger, but only up to the point where we start to get localised melting. The unit loading required to reach this point depends on how cold the snow or ice is. Moreover, short of the point where we encounter melting by compression alone, we see an increased likelihood of melting by the combination of compression and shear. In other words, as unit loading increases, we gain hardness but lose melt resistance. The hardness gain is fairly independent of temperature. The melt resistance loss is heavily affected by temperature, or at least its importance is.

### Contact patch size

From this, we might logically expect that the ideal contact patch size would be smaller in really cold weather than when we're near thaw temperature. I suspect that this is academic, however. I think the optimum contact patch size is far bigger than we can ever get with a tyre. Consider the transportation devices that people have devised specifically for snow: snow cats; snowmobiles; snowshoes; cross-country skis etc. All of these operate by compacting the snow minimally over a large area, and then trying to get maximum purchase on that large interface. For best performance on snow, or any other soft surface, we really want a belt or track, not a tyre at all.

It would seem to follow that the more we can get a tyre to act like a track, the better it should work. That would suggest a radial tyre, at low pressure. Note that it does not necessarily follow that we want a wide tyre. It is generally agreed that for most winter conditions, a tyre should be narrow. I think, based on the reasoning above, there will be winter conditions where a wide tyre may be preferable. These may include bare ice and hard-packed snow, probably even shallow soft snow. But in snow of significant depth, narrow tyres are better. The reason for this doesn't have to do with an increase in traction when the tyre is narrow, as such. It has to do with the force required to move the tyres, which is less when the tyres are narrow.

As the tyre rolls forward, it is resisted by the snow in front of it. To advance, the tyre must, in effect, climb a ramp of snow. The ramp of snow is not strong enough to support the tyre, and it is continually collapsing under the weight of the car. The amount of collapse is fairly similar regardless of the width of the tyre. For any practical tyre size, we will compact the snow to a pretty solid state, no matter what. Yet the snow has substantial resistance to this compaction, and this translates to a resistance to the wheel's forward motion. The taller and wider the mass of snow, the greater the resistance to motion. The height of the snow we must compact depends on the snow's depth. The width we must compact depends on the width of the tyre. It would also seem that a narrow tyre should provide more directional control, since it is better shaped to act like a blade or rudder.

From this reasoning, we might expect that the ideal tyre for deep snow would resemble a bicycle tyre. Such a tyre would be easy to push along, and should have good directional stability. However, it doesn't quite work that way with really narrow tyres, as anybody who has tried riding a bicycle in deep snow will attest. The problem is that the ramp of compacted snow that the tyre rides on is so narrow that the tyre is forever sliding off the side of it into the soft snow alongside. As soon as the tyre moves forward again, another narrow compacted ramp is formed beneath it, and again it slides off one side or the other – no predicting which side. The result is that the tyre absolutely will not run straight.

So there is such a thing as too narrow. The tyre needs to be wide enough to sit on top of the compacted ramp it is making for itself. A square-shouldered profile, or one with concave shoulders that compact a sort of retaining berm along the side of the main ramp can be expected to help

Returning to the question of inflation pressure, this also affects resistance to forward motion. And even this relationship is not as straightforward as one might think. Based on our experience with tyres on pavement, on a smooth, hard surface, the higher the inflation pressure, the easier the tyre rolls (within practical limits). But on a rough surface, a

softer pressure can actually roll more easily. For this to be so, the surface must have roughness as opposed to waviness – that is, the ups and downs must be fairly close together. The tyre rolls easier because it can yield to the bumps rather than having to climb over them. This was realised early in the history of the pneumatic tyre. John Dunlop noticed that his new pneumatic tyre would roll further across his bumpy back yard than a solid tyre.

This has relevance to driving in snow because often the situation that gets us stuck is one where one or more wheels are in a fairly modest-sized depression, and we have to move the tyre over the lip of the depression with the meager traction available. In at least some such situations, soft inflation will make getting over that lip easier.

It will be apparent that I am writing here from a mixture of practical experience and inference. I invite readers with further experience, or contradictory experience, to comment.

## “THE TYRE GETS TRACTION BY PACKING THE SNOW INTO A RELATIVELY SOLID FORM”



A tyre's grip on snow can be greatly improved by siping the tread blocks

YEPG Proudly Presents, Thx for Support

# DON'T SACRIFICE THE WIN

The difference between WINNING and LOSING is STAYING CONNECTED...  
**Get Connected!**

**ADEL WIGGINS** Flexible Tube Connectors  
GROUP

## SECURE YOUR WIN

Stay connected with Adel Wiggins Flexible Tube Connectors! The difference between winning and losing is in the connection. Do not sacrifice a win to a simple hose blowout or burst. This occurs when conventional hose clamps or barbs fail to secure the hose located between the connections or components. Adel Wiggins Flexible Tube Connectors eliminates these failures. This is why they have caught the attention of so many professional racers today. One of the main reasons for its popularity is its ability to be removed or installed with only one hand quickly and easily, whether they are being used with tubing or hose. Adel Wiggins Flexible Tube Connectors are offered standard in lightweight aluminum and are available in stainless steel or titanium upon special order. They have an operating temperature range from -120° F to 800° F and are able to withstand boost excess of 125 PSI.



## SAFETY-LOCKING, ONE HAND INSTALLATION

The locking latch design eliminates troublesome and time-consuming installation of safety-wire or the necessity of tools to make the connection. The electrical bonding feature eliminates the external clamps, fasteners and jumper wire required in some applications. Elimination of lock wire holes, bolt-on bars, grounding clamps, snake clamps and jumper wires removes what can be a cumbersome and unattractive connection. The W900 series minimizes weight and unit cost, while retaining the proven performance and reliability of other WIG-O-FLEX connectors.



## APPLICATIONS

### RADIATOR CONNECTIONS



### OIL COOLER CONNECTIONS



### TURBO CONNECTIONS



### THROTTLE BODY CONNECTIONS



### INTERCOOLER CONNECTIONS



## FEATURES: Lightest of all flexible tube connectors

- Saves installation and tear down costs • Full range of stocked sizes: 1/2" to 4"
- Saves time, space, and weight • Easy, one-hand installation • Design flexibility

**FCP**  
Fluid Control Products, Inc.

Australia  
C.A.P.A. 088 582 3499

England  
Goodridge UK 01392 369090  
BMRS 0175 355 3610  
Earls UK 0132 785 8221

Germany  
Goodridge Deutschland 06321 60168  
Kroner: 09401 52530

Italy  
Tecnauto SRL 02 738 8773  
Japan  
Siro Corporation 03 9420 4154  
New Zealand  
Turbo Vehicles Ltd. 09 525 6696

YYePG Proudly Presents, Thx for Support

Toll Free in NA: 800-541-2345  
Worldwide: 217-324-3737  
[www.fluidcontrol.net](http://www.fluidcontrol.net)