

RED STAR



VOLUME 34

Mikoyan MiG-25

Foxbat

Guardian on the Soviet Borders



Yefim Gordon

Mikoyan MiG-25 *Foxbat*

Guardian of the Soviet Borders



Yefim Gordon

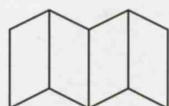

MIDLAND

An imprint of
Ian Allan Publishing

Mikoyan MiG-25 Foxbat:

Guardian of the Soviet Borders

© 2007 Yefim Gordon and Dmitry Komissarov
ISBN (10) 1 85780 259 4
ISBN (13) 978 1 85780 259 7

Published by Ian Allan Publishing
Riverdene Business Park, Hersham, Surrey
KT12 4RG
Visit the Ian Allan Publishing website at
www.ianallanpublishing.com

Midland Publishing is an imprint of
Ian Allan Publishing Ltd

Worldwide distribution (except North America):
Midland Counties Publications
4 Watling Drive, Hinckley, LE10 3EY, England
Telephone: 01455 254 450 Fax: 01455 233 737
E-mail: midlandbooks@compuserve.com
www.midlandcountiessuperstore.com

North American trade distribution:
Specialty Press Publishers & Wholesalers Inc.
39966 Grand Avenue, North Branch, MN 55056, USA
Tel: 651 277 1400 Fax: 651 277 1203
Toll free telephone: 800 895 4585
www.specialtypress.com

© 2007 Midland Publishing
Design concept and layout
by Polygon Press Ltd. (Moscow, Russia)
Line drawings by Oleg Put'makov
Colour artwork by Vasily Zolotov (pp 110-111) and
Valentin Vetlitskiy

This book is illustrated with photos by Yefim Gordon, Victor Drushlyakov, the late Sergey Skrynnikov, the late Boris Vdovenko, Vasilii Koonyayev, Mikhail Sedel'nikov, Chris Lofting, Sanjay Simha, ITAR-TASS, as well as from the archives of RSK MiG, MiGRemont, *Mir Aviatsii* magazine, Yefim Gordon, Victor Kudryavtsev and the Russian Aviation Research Trust, plus internet sources, including www.bharat-rakshak.com.

Printed in England by
Ian Allan Printing Ltd
Riverdene Business Park, Molesey Road,
Hersham, Surrey, KT12 4RG

All rights reserved. No part of this publication may be reproduced, stored in a retrieval system, transmitted in any form or by any means, electronic, mechanical or photocopied, recorded or otherwise, without the written permission of the publishers.

Contents

Introduction.....	3
1. A (Red) Star is Born.....	5
2. The Foxbat Family.....	15
3. Foxbat Anatomy.....	65
4. Foxbats in Action.....	97
5. MiG-25 Operators.....	107
Line drawings.....	121
Colour artwork.....	138

Title page: A Russian Air Force/4th Combat & Conversion Training Centre MiG-25RU takes off on a training sortie from Lipetsk-2 AB. Note the contrast between the dark paintwork on the cockpit section, which is under wraps when the aircraft is parked, and the sun-bleached finish on the rest of the airframe.
This page: Mechanics perform pre-flight checks on a 47th Guards Independent Reconnaissance Regiment MiG-25RBT coded '76 Red'.

Front cover: '06 Blue' – the sixth MiG-25P interceptor prototype (Ye-155P-6), the first example to feature the definitive vertical tail.
Rear cover, top: '37 White', a camouflaged MiG-25BM SEAD aircraft; **bottom:** MiG-25RBT '76 Red' and MiG-25RU '32 Red' are prepared for a sortie at Shatalovo AB, with an APA-5D ground power unit and a TZ-22 articulated fuel bowser parked alongside.



Introduction

The West always kept a close watch on new Soviet aircraft. Until the early 1960s, however, there were few aircraft that could create a sensation. Of course, there were the Myasishchev M-4 (NATO reporting name *Bison*) and Tupolev Tu-95 *Bear* strategic bombers and Mikoyan/Gurevich Ye-2A *Faceplate* and Ye-4/Ye-5 *Fishbed* fighters. These aircraft caused a bit of a stir but did not cause the West to worry too much. (Note: The Ye prefix means *yedinitsa* ('unit'), that is, a 'one-off' aircraft. It was used to designate Mikoyan prototypes up to and including the MiG-31.)

The first signs of trouble came in the summer of 1961 when the Soviet Union unveiled the Myasishchev M-50 *Bounder* and Tu-22 *Blinder* bombers, the Ye-152A *Flipper* high-speed interceptor and the Tu-28P (Tu-128) *Fiddler* long-range interceptor. Besides, an intruding Lockheed U-2B high-altitude reconnaissance aircraft flown by Francis Gary Powers was shot down by a surface-to-air missile (SAM) near Sverdlovsk on 1st May 1960, in an incident that put an end to the type's almost unhindered overflights of Soviet territory.

Until then the West did not rate the Soviet Air Defence Force (PVO – *Protivovozdooshnaya oborona*) too highly. The S-25 SAM designed and fielded in the early 1950s had limited range and 'kill' altitude and was used on a small scale. The backbone of the PVO

was formed of obsolete day interceptors of early/mid-1950s vintage. True, there were attempts to boost the capability of these aircraft. The OKB-155 design bureau headed by Artyom Ivanovich Mikoyan and Mikhail Iosifovich Gurevich and the OKB-115 bureau led by Aleksandr Sergeyevich Yakovlev brought out experimental versions of the MiG-19 *Farmer* and the Yak-27 *Flashlight* respectively fitted with liquid-propellant rocket boosters to expand the altitude and speed envelope. Yet these 'Rocket Riders' never achieved operational status. (OKB = *opytno-konstruktorskoye byuro* – experimental design bureau; the number is a code allocated for security reasons.)

OKB-51 led by Pavel Osipovich Sukhoi had better luck; the all-new Su-9 *Fishpot-A* interceptor entered production in 1958 and achieved initial operational capability (IOC) in 1959. The Su-9 was capable of destroying supersonic targets at altitudes up to 20,000 m (65,620 ft) but had very limited range.

Since the potential adversary had large numbers of strategic bombers capable of delivering nuclear weapons (including stand-off air-to-ground missiles), the Soviet government urged the enforced development of long-range, high-altitude and high-speed air defence systems to counter the bomber threat. State leader Nikita Sergeyevich

Khrushchov maintained a close interest in anti-aircraft missile systems. Thus, the S-75 Tunguska SAM (NATO SA-2 *Guideline*) was developed and fielded in the late 1950s. Incidentally, it was this missile that blasted Powers' U-2 out of the sky.

Meanwhile, by the early 'sixties the aircraft designers had created a new class of fighters – the so-called heavy interceptors. These aircraft lacked the customary cannon armament and were not designed for dogfighting. Their mission was to destroy the enemy's strategic bombers with medium/long-range air-to-air missiles (AAMs) a long way off from the state border or, failing that, from key targets. The first major effort in this direction came from OKB-301 led by Semyon Alekseyevich Lavochkin, which developed the La-250 (dubbed *Anaconda* by its pilots). The production La-250A was to carry two newly developed K-15 medium-range AAMs. The *Anaconda* entered flight testing, but the advent of the S-75 SAM system and Khrushchov's bias towards rocketry killed off the aircraft.

In the late 'fifties, various Mikoyan designs – the I-75, Ye-150 and Ye-152/Ye-152A/Ye-152M – suffered the same ignominious fate. These were remarkable aircraft capable of destroying almost any target at altitudes up to 22,000 m (72,180 ft) and up to 1,000 km (621 miles) range shortly after take-off. Yet



The appropriately marked first prototype of the single-engined Mikoyan/Gurevich Ye-152 all-weather heavy interceptor, shown here with centreline drop tank and two Mikoyan K-9-155 missiles on wingtip launch rails. Though ill-starred, the Ye-152 helped greatly to develop the future MiG-25 – in particular, its powerplant.



Above: The Ye-152A powered by two Tumanskiy R11F-300 turbojets was created as an insurance policy in case of possible development problems with the R15-300 engine. It carried the K-9-155 AAMs on underwing pylons.

they, too, did not progress beyond the prototype stage. The S-75's success on 1st May 1960 was undoubtedly a major contributing factor. The Sukhoi T-37 heavy interceptor, an innovative design making use of titanium alloys and all-welded assemblies, was even less lucky: the prototype was scrapped without ever being flown.

Still, the threat posed by the USA's large strategic bomber force led the Soviet leaders in 1965 to field the Tu-128 twin-engined heavy interceptor armed with R-4 long-range AAMs. The Tu-128's top speed of 1,665 km/h (1,034 mph) with a full complement of missiles was not a very impressive figure, and the main rea-

son why the aircraft was to see service with the PVO was its great range in excess of 2,500 km (1,552 miles). The R-4's performance and special missile launch tactics enabled the Tu-128 to destroy targets flying way above the aircraft's service ceiling. Besides, the crew included a navigator/weapons systems officer, which reduced the pilot workload and increased efficiency.

The development of heavy interceptors in the late 1950s/early 1960s proved invaluable for the Soviet aircraft industry. The Tumanskiy R15B-300 afterburning turbojet with a reheat thrust of 10,150 kgp (22,380 lbst), which had been put through its paces on the Ye-152,

finally entered production. This mighty powerplant had taken the Ye-152 to a number of world speed records. (The ill-starred T-37 was designed around the same engine.) The RP-S Smerch (Tornado) fire control radar installed on the Tu-128 had an impressive target detection and missile guidance range. (RP-S stood for *rahdiopritsel* 'Smerch' – literally 'Tornado' radio sight.)

Thus, many of the technological prerequisites for the birth of a high-speed long-range interceptor were in place by 1960. What actually triggered its appearance was yet another lap in the arms race.



The Ye-152M – the ultimate development of the Ye-150/Ye-152 family – reverted to wingtip missile carriage but was armed with Bisnovat K-80 (R-4) AAMs. It also featured a fatter spine housing additional fuel, a revised cockpit canopy and provisions for canard foreplanes.

A (Red) Star is Born

As the Convair B-58 Hustler supersonic bomber became operational with the US Air Force and the Lockheed YF-12A/SR-71 Blackbird programme was launched (incidentally, Soviet intelligence got wind of this highly classified programme nearly two years before the Blackbird's A-12 prototype made its first flight), the Soviet government felt compelled to give an adequate answer to these threats. The design bureaux led by Vladimir Mikhaïlovich Myasishchev (OKB-23) and Andrey Nikolayevich Tupolev (OKB-156) persisted with supersonic bomber and missile carrier projects – and in so doing were influenced by US aircraft design practices to a certain extent. The Mikoyan OKB was tasked with developing a multi-role supersonic aircraft suitable for the interceptor and reconnaissance roles.

Preliminary design (PD) work had started as early as 1958, when the Ye-150/Ye-152 interceptor series was under development and testing. In this instance, however, an aircraft possessing exceptional flight performance (particularly speed) and a comprehensive avionics and equipment suite was required.

Rumour has it that the story of the MiG-25 began with a conversation between Chief Designer Artyom Ivanovich Mikoyan, who had just returned from the 1959 Paris Air Show, and project designer Yakov I. Seletskiy. Mikoyan ran into Seletskiy as he was passing along a corridor of the OKB-155 office and suggested

that Seletskiy should 'draw an interceptor along the lines of the [North American RA-5] Vigilante but powered by two R15-300 engines, designed to fly at 300 km/h (186 mph) and without all-too-sophisticated high-lift devices'. At the time, such a phrase from the OKB chief was tantamount to an official go-ahead.

Other sources state that the aircraft's general arrangement was drawn up unofficially *before* any information on the Vigilante became available. The sketches were shown to PD section chief Rostislav Apollosovich Belyakov (who later succeeded Mikoyan as OKB-155 head), then to Nikolay Z. Matyuk and finally to Mikoyan. However, actual work did not begin until mid-1959. Other sections of the OKB were called on to help the PD section with the aircraft's unusual layout.

After a few weeks' hard work a design was born that obviously had good potential. However, it was immediately apparent that the development of this aircraft called for a new approach to designing the airframe, avionics and weaponry and, most importantly, new manufacturing technologies.

The project aroused the interest of the PVO command, which needed a high-speed high-altitude interceptor, and the Soviet Air Force (VVS – *Voyenno-vozdooshnyye seely*), which wanted a new reconnaissance platform. Besides, a strike version armed with a ballistic missile was proposed.

Since the requirements stated by the PVO and the VVS for the interceptor and reconnaissance aircraft respectively were broadly similar (a top speed of circa Mach 3 and a service ceiling in excess of 20,000 m/65,620 ft), it was decided to design a joint-service aircraft to fill both roles. An agreement on this had been reached in 1960. In February 1961 the Communist Party of the Soviet Union (CPSU) Central Committee issued a joint directive with the Soviet Council of Ministers, tasking the Mikoyan OKB with developing the Ye-155 high-speed high-altitude aircraft, the interceptor and reconnaissance versions of which were designated Ye-155P (*perekhvatчик*) and Ye-155R (*razvedchik*) respectively. On 10th March 1961, Artyom I. Mikoyan signed an order formally launching the design work on the Ye-155. Meanwhile, the VVS and PVO each issued a general operational requirement for the two main versions.

By the time the work really got started the designers had amassed a wealth of experience. The only suitable engine – the R15B-300 axial-flow afterburning turbojet designed by Aleksandr A. Mikulin and his closest aide Sergey K. Tumanskiy at OKB-300 – was well developed. The R15B-300 was a derivative of the earlier KR15-300 (*izdeliye* 15K) expendable turbojet designed for the Tupolev '121' (Tu-121) theatre-strategic cruise missile (hence the K for *korotkoroosnyy* – with a short service life). (*Izdeliye*

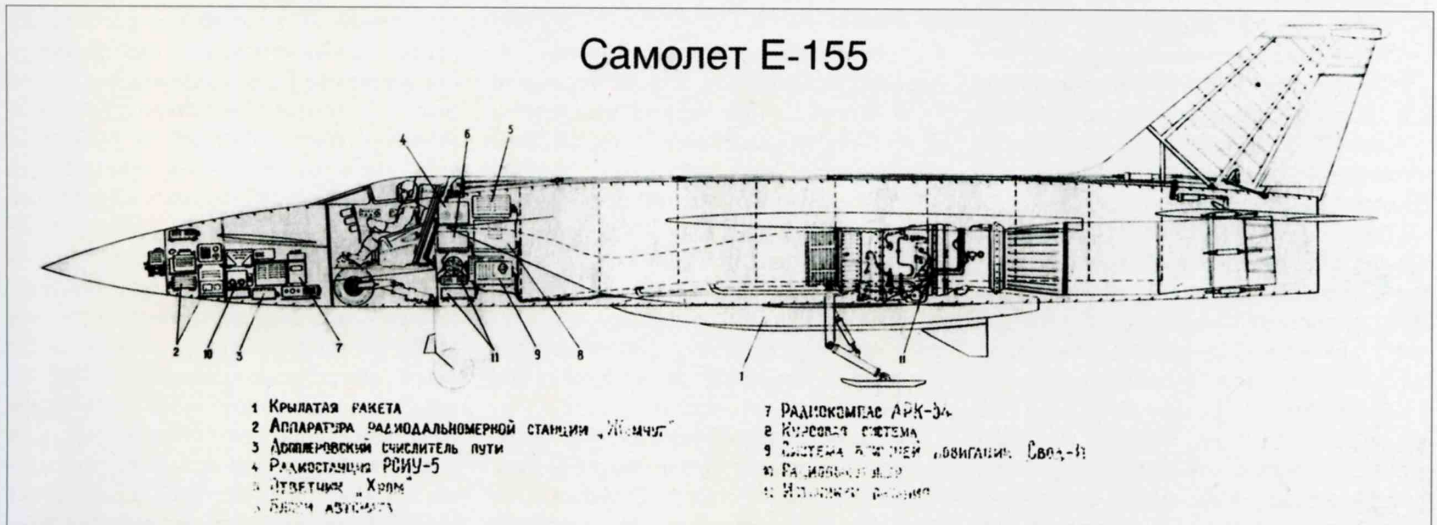

A cutaway of an early project version of the Ye-155's cruise missile carrier version. Note the canard foreplanes, high-set tailplanes, single nosewheel and main landing gear with skids. The figures denote: 1. Cruise missile. 2. Zhemchug ranging radar. 3. Doppler sensor system. 4. RSIU-5 radio. 5. Khrom IFF transponder. 6. (avionics modules). 7. ARK-54 ADF. 8. Compass system. 9. Svod-4 SHORAN. 10. DME.

(product) such and such was a common code for Soviet/Russian military hardware items.) Thus the R15B-300 reversed the usual trend, since expendable turbojets are usually based on 'normal' fighter engines, not vice versa. Within a short time, the engine designers altered the compressor, combustion chamber and afterburner, increasing the gas temperature throughout, and incorporated a new variable-area nozzle. The hydromechanical fuel control unit of the original version was replaced by an electronic FCU.

Actually the R15B-300 was *not* the only suitable engine. Concurrently, the Rybinsk Engine Design Bureau (RKBM – *Rybinskoye konstruktorskoye byuro motorostroyeniya*) led by Pyotr A. Kolesov was testing the even more powerful RD17-16 turbojet developed under Prokofiy F. Zoobets. But that was built in a handful of examples and intended chiefly for supersonic heavy bombers (including the Myasishchev M-52 that never flew). The design bureau headed by Arkhip M. Lyul'ka (OKB-165) was also working on an engine in the same thrust class but their contender was still on the drawing board.

Apart from the engine, the Ye-150/Ye-152 family had helped to refine other items that would go into the future Ye-155, such as analogue computers, communications, identification friend-or-foe (IFF) and command link equipment, ejection seats, air conditioning systems and so on. Also, they had provided valuable data on aerodynamics, engine gas dynamics, flight controls, aircraft stability and controllability at high Mach numbers and kinetic heating/airframe thermal loads.

The design team worked enthusiastically. Before long, three possible general arrangements were devised, all three envisaging a twin-engined aircraft. One had the engines located side-by-side, as on the MiG-19 and Ye-152A. The second had a stepped-tandem arrangement reminiscent of the Mikoyan I-320 experimental fighter (that is, with one engine amidships, exhausting under the fuselage, and another in the rear fuselage). The third project utilised an arrangement identical to the BAC (English Electric) Lightning with vertically paired engines located in the rear fuselage.

The second and third options were rejected because the powerful R15 turbojet had a large diameter and a vertically staggered arrangement would increase the aircraft's height appreciably, complicating removal and replacement of engines in service conditions. The idea of placing the engines in underwing nacelles was also rejected because of the dangerously strong thrust asymmetry if an engine or an afterburner failed on take-off. Moreover, the designers decided to drop the single nose-mounted air intake and circular fuselage

cross-section so characteristic of earlier Mikoyan jet fighters.

As the scope of work increased it became necessary to appoint a chief project engineer, as was customary at the OKB. General Designer Artyom I. Mikoyan offered this job to his first deputy A. G. Broonov but the latter refused. While the reason behind this refusal remains uncertain to this day, it could probably be poor health... or perhaps Broonov just didn't believe in the Ye-155.

At the moment the branch of OKB-155 responsible for unmanned aerial vehicles (UAVs), led by Aleksandr Ya. Bereznyak, was becoming increasingly powerful and was about to become a separate design bureau. In that case Mikhail Iosifovich Gurevich, who led another design group also tasked with UAVs, potentially would be out of business since the breakaway Bereznyak group was likely to take his staff away with it.

Mikoyan opted for an unusual but highly effective solution to this crisis by assigning two of the OKB's three Chief Designers to the Ye-155 programme as project chiefs. Mikhail I. Gurevich was responsible for the airframe (while still 'doing UAVs', mind you), while the weapons and equipment integration were the responsibility of Nikolay Z. Matyuk, since the latter had been project chief of the I-75 and Ye-150 interceptors and was well versed in dealing with avionics and weaponry. Gurevich had the lead at first; however, he could do less and less design work due to advanced age and failing health, and finally he retired, leaving Matyuk with the entire responsibility for the project.

In addition to this, leading specialists for various design areas were appointed. These were L. G. Shengelaya (equipment); Yuriy F. Polooshkin (efficiency planning and reconnaissance systems design); Yakov I. Seletskiy (aircraft systems integration); A. A. Choomachenko (aerodynamics); Gleb Ye. Lozino-Lozinskiy and V. A. Lavrov (powerplant and air conditioning system); Rostislav A. Belyakov, V. M. Iezuitov, A. A. Nefyodov and A. V. Minayev (flight controls and landing gear); D. N. Koorgoozov and Z. Ye. Bersoodskiy (structural engineering); L. P. Voynov (gas dynamics and thermal load calculations); D. A. Gringauz (chief engineer of the interceptor version); V. A. Shoomov (missile strike version project); I. V. Froomkin (chief engineer of the reconnaissance version); Ye. V. Lyubomirov (reconnaissance equipment); and finally, A. A. Sorokin and B. L. Kerber (aircraft systems).

A design group responsible for the Ye-155 project was created in the design section, reporting to project chief N. Z. Matyuk. One Mikoyan OKB employee, V. Stepanov, recalled that 'Mikoyan selected engineers with progressive views and the ability and

aptitude to find unconventional solutions'. The work of defining and refining the general arrangement of the aircraft went on.

After the retirement of Mikhail I. Gurevich, Nikolay Z. Matyuk remained the aircraft's project chief for the 35 years that followed. He was assisted by Deputy Chief Designers P. Ye. Syrovoy and V. P. Syrovoy, L. G. Shengelaya, A. V. Minayev and Ya. G. Kokushkin; Shengelaya took over responsibility as the aircraft's programme chief in 1998.

During the PD and advanced development project (ADP) stages the following features were incorporated into the Ye-155's design and duly substantiated. The airframe was largely made of stainless steel accounting for up to 80% of the structural weight (primarily VNS-2, VNS-4 and VNS-5 grades; VNS = *vysokoprochnaya nerzhavayushchaya stahl'* – high-strength stainless steel). Titanium alloys making up about 8% of the structural weight were used in the area of the engine bays; another 11% was accounted for by heat-resistant grades of duralumin used for non-stressed airframe parts. The choice of steel as the principal structural material turned out to be correct. Neither Soviet aircraft designers nor their US counterparts at Lockheed developing the SR-71 were able to overcome the cracking problem affecting welded titanium structures with thin walls, not to mention the fact that steel was a lot cheaper. On the other hand, this decision necessitated large-scale reequipment of the Mikoyan OKB's experimental production facility and, later, the production plant; new welding, coating and thermal treatment technologies had to be mastered and a lot of personnel had to be retrained to use them.

The OKB decided to design highly efficient cooling systems and heat insulation technologies and test the future aircraft's fuel system and hydraulics at the high temperatures that would be typical of its operations. In order to solve the problems associated with the strong kinetic heating it was decided to use the special T-6 jet fuel with a high boiling point (which would be nitrogenated prior to refuelling, giving off gaseous nitrogen in flight) and pressurise the fuel tanks with nitrogen at supersonic speeds to reduce the danger of explosion. A high-capacity liquid cooling system using more than 200 litres (44 Imp gal) of coolant – a 40/60 methanol/water mixture – was developed, catering primarily for the generators, the powerful radar set, the active electronic countermeasures (ECM) equipment and the VHF radio. A multi-stage air conditioning system comprising a cooling turbine and air/air and air/fuel heat exchangers was designed. Also, large-scale use was made of heat-insulating and reflective coatings, including silver plating and heat-dissipating paints.

Originally the Ye-155P was to carry two (later four) K-9M air-to-air missiles (AAMs) developed by the UAV section of the Mikoyan OKB. This was a version of the Ye-150/Ye-152 family's intended K-9-155 missile adapted to be guided by the Smerch radar instead of the TsP radar fitted to the Ye-150/Ye-152. However, as the work progressed, the OKB-4 'Molniya' (Lightning) design bureau led by Matus R. Bisnovat proposed arming the Ye-155P with their all-new K-40 high-altitude AAM. (OKB-4 is now called GMKB *Vympel* – 'Pennant' State Machinery Design Bureau; GMKB = *Gosoodarstvennoye mashinostroitel'noye konstruktorskoye byuro.*) The missile was developed in close cooperation with several other research and development establishments, including the State Research Institute of Aircraft Systems (GosNII AS – *Gosoodarstvennyy naoochno-issledovatel'skiy institoot aviatsionnykh sistem*).

The K-40 had a titanium body giving a weight saving and better resistance to kinetic heating at high Mach numbers (up to Mach 3 when on the wing and in excess of Mach 4 in free flight). Good high-altitude performance was ensured by the large cruciform wings of delta planform, as well as by the long-burn solid-propellant rocket motor, the explosive charge divided into two sections spaced fore and aft, and the self-designed guidance and flight control system.

The missile came in two versions with different guidance systems – the K-40R semi-active radar homing (SARH) version (for *rahdiolokatsionnaya [golovka samonavedeniya]* – radar seeker head) and the infrared homing. K-40T (for *teplovaya [golovka samonavedeniya]* – IR seeker head). The former version featured a PARG-12 semi-active radar seeker head (*poluaktivnaya rahdiolokatsionnaya golovka*); the radar and the missile's seeker head were to have two guidance channels, the back-up channel being activated automatically if the main one was jammed by enemy ECM.

The heat-seeking version was very promising, since the Ye-155P was to destroy supersonic targets with a high IR signature. Heat-seeking missiles allowed the aircraft to attack the target from any angle. Besides, a mixed complement of SARH and IR-homing missiles made the weapons system more effective against enemy countermeasures. A built-in cannon was also proposed at various times but the idea was eventually dismissed.

The Ye-155R reconnaissance version was to be equipped with the all-new *Peleng* (Beating) navigation suite with course correction from an inertial navigation system (INS) with a digital processor, which would be linked to an autopilot. The aircraft would also carry new types of reconnaissance equipment in several optional combinations.

The Flight Research Institute named after Mikhail M. Gromov (LII – *Lyotno-issledovatel'skiy institoot*) in the town of Zhukovskiy, south of Moscow, and the All-Union Electronics and Automatic Equipment Research Institute (VNIIRA – *Vsesoyooznyy naoochno-issledovatel'skiy institoot rahdioelektroniki i avtomahtiki*) in Leningrad initiated the development of the *Polyot* (Flight) unified flight/navigation suite. The ground part of the suite consisted of Svod (Arch) and *Doroga* (Road) azimuth-rangefinder radio beacons and a *Katet* (Cathetus) combined localiser/glideslope beacon. The on-board components included a navigational computer; an automatic flight control system (advanced autopilot); an air data system; an attitude & heading reference system (AHRS) serving the radio navigation equipment and air traffic control/identification friend-or-foe (ATC/IFF) transponders; and an antenna/feeder set.

The Polyot suite enabled the aircraft to follow a planned course, then return to base and make an automatic approach. Besides, it provided inputs to other systems, triggering the aerial cameras and the like.

The absence of the hitherto traditional single forward air intake and the side-by-side engine placement meant that the fuselage could be shortened and the cross-section area and wetted area could be reduced while still leaving enough internal volume for fuel. Instead, two-dimensional lateral air intakes with horizontal airflow control ramps were used – and proved to be very successful.

The designers opted for trapezoidal wings with a straight trailing edge. These passed wind tunnel tests at the Central Aerodynamics and Hydrodynamics Institute named after Nikolay Ye. Zhukovskiy (TsAGI – *Tsentral'nyy aero- i gidrodinamicheskii institoot*) and were found to have an adequate lift/drag ratio at speeds between Mach 2 and Mach 3. The wing structure was relatively lightweight and provided adequate fuel tankage.

The shoulder-mounted wing arrangement was selected because it tied in conveniently with the lateral air intakes and enabled the aircraft to carry large air-to-air missiles, which would have been impossible with a low-wing arrangement. A mid-wing arrangement was ruled out for structural reasons (the high-wing layout permitted, in effect, the use of a one-piece wing).

The first projects envisaged a tail unit with a single fin and rudder and canard foreplanes (known as 'destabilisers' in Russian parlance) to augment the all-moving stabilisers (stabilators) for pitch control.

Designing the main landing gear units proved a bit tricky. A complex layout had to be developed in order to give a sufficiently wide

wheel track while still enabling the oleo legs and mainwheels to fit into a rather small space in the fuselage when retracted.

The Tu-128's Smerch radar developed by a design team under Fyodor F. Volkov was selected for the interceptor version, being the most suitable option among available fire control radars. The radar was specially upgraded for the Ye-155P by adding a 2-cm waveband channel for added ECM resistance, the resulting version being designated Smerch-A. It was larger and heavier than the *Oryol* (Eagle) radar capable of tracking targets and guiding R-8 medium-range missiles. (This radar was developed for the initial production version of the Su-15 Flagon interceptor fitted originally with the Oryol-D version and later with the Oryol-DM.) However, it offered longer detection range (up to 100 km/62 miles) with a scan azimuth of $\pm 60^\circ$. The parabolic antenna dish of the Smerch radar had nearly twice the horizontal emission angle of contemporary Soviet airborne radars. On the minus side, the radar set was based on vacuum tubes, which didn't do much for reliability.

The interceptor version was to operate within the *Vozdukh-1* (Air-1) ground-controlled intercept (GCI) system – the first Soviet system of the kind to enter production. (This system saw service with the air defence of the USSR and other Warsaw Pact countries for a good many years.)

The Ye-155R reconnaissance version was radically different from the Yak-25RV *Mandrake*, Yak-27R *Mangrove* and Tu-16R *Badger* making up the backbone of the VVS reconnaissance force. The high-flying subsonic Yak-25RV provided adequate intelligence but was becoming increasingly vulnerable. Sure enough, attempts had been made to create a high-altitude high-speed reconnaissance vehicle that could penetrate enemy defences with impunity, but all of them proved unsuccessful. Thus, the VVS showed a great interest in the reconnaissance version of the new aircraft, proposing its first equipment fit as early as May 1960.

The proposed defensive equipment comprised the following:

- a cannon firing special rounds filled with chaff to create a cloud of chaff ahead of the aircraft;
- ASO-2I chaff dispensers (*avtomaht sbrosa otrazhateley* – automatic chaff dispenser) firing thirty-two 26-mm (1.02-in) chaff bundles apiece;
- *Zarevo* (Glow) infrared countermeasures (IRCM) bombs to decoy heat-seeking missiles;
- a *Sirena-3* (Siren) radar warning receiver (RWR);
- a *Rezeda* (Mignonette) ECM package (active jammer);

• an SRZO-2 IFF interrogator/transponder (*samolyotnyy rahdiolokatsionnyy zaproschik-otvetchik* – aircraft-mounted radar [IFF] interrogator/responder).

The avionics suite included an *Initsiativa-2* (Initiative) ground-mapping radar, a *Strela* (Arrow) Doppler speed and drift sensor system, a KSI compass system coupled with an STsGV vertical gyro, an RSBN-2S Svod short-range radio navigation system (RSBN = *rahdiotekhnicheskaya sistema blizhney navigatsii* – SHORAN), an air data system, an autopilot and a Put' (Track) flight director.

The navigation equipment was to work as an integrated system built around either an analogue processor or a *Plamya-VT* (Flame) computer, one of the first Soviet digital airborne computers. This was to ensure a maximum course deviation of ± 5 km (3.1 miles), a target approach accuracy of 1-2 km (0.62-1.24 miles) and determine the airspeed and heading with a 0.5% error margin. Aircraft-to-ground communication was by means of an RSIU-5 VHF radio set.

Eight interchangeable reconnaissance suites were proposed initially. Version 1 was intended for photo reconnaissance (PHOTINT) and general-purpose signals intelligence (SIGINT). The mission equipment comprised five cameras and an SRS-4A SIGINT pack (*stahntsaya razvedki svyazi*). The cameras included three AFA-44s, two of which were mounted obliquely and one vertically, and two AFA-42s (AFA = *aerofotoapparat* – aerial camera). The AFA-42s were fitted due to the other cameras' limited film capacity to make sure the entire route would be covered.

Version 2 was fitted with four AFA-45 cameras, one AFA-44 and two AFA-42s for oblique and vertical photography. It also carried the SRS-4A SIGINT pack.

Version 3 carried an ASchAFA-5 or ASchAFA-6 slot camera (*avtomaticheskii shchelevoy aerofotoapparat*) for continuous shooting, working in a way similar to a movie camera, plus one AFA-44 and two AFA-42s. A *Bariy-1* (Barium) television system could also be fitted.

Version 4 was intended for topographic reconnaissance. It carried an AFA-41 camera on a TAU mount (*topograficheskaya aerofotoustanovka*), one AFA-44, two AFA-42s and the *Bariy-1* TV system.

Version 5 was configured for night reconnaissance and featured two NAFA-MK or NAFA-100 night cameras (*nochnoy aerofotoapparat*). It carried 12 FotAB-100 flare bombs (*fotograficheskaya aviabomba*, literally 'photo bomb') or 60 FotAB-MG flares for target illumination and could also be fitted with the SRS-4A SIGINT pack.

Version 6 was another night recce aircraft fitted with a NAFA-Ya-7 camera coupled with

a *Yavor-7* (Sycamore) airborne flash unit and the SRS-4A SIGINT pack.

Version 7 was to carry thermal imaging equipment.

Finally, version 8 was a dedicated electronic intelligence (ELINT) aircraft equipped with SRS-4A, SRS-4B and Romb-3 (Rhombus, or Diamond) general-purpose SIGINT packs and a Koob-3 (Cube) pack for detailed SIGINT.

All versions could be fitted with an FARM photo adapter, an MIZ-9 cockpit voice recorder and an optical tracker. Some avionics items were optional; thus, the Put' flight director could be replaced with a *Priboy* (Surf) FD, the RSIU-5 radio with a *Pero* (Feather) or *Lotos* (Lotus) set. The reconnaissance version could be equipped with *Looga* (the name of a Russian river) and Polyot navigation aids. The SRS-4A and SRS-4B SIGINT packs were meant to be easily interchangeable. In general, the range of mission equipment proposed for the Ye-155R was much the same as that carried by contemporary Soviet reconnaissance aircraft.

In the strike version, the aircraft was to carry an air-launched ballistic missile.

The reconnaissance suite originally proposed promptly earned criticism from the VVS, being branded as inefficient. Hence in March 1961 the VVS came up with a specific operational requirement for the Ye-155R. The range of targets included missile launch pads, ammunition depots, naval bases and harbours, ships, railway stations, airfields, command, control, communications and intelligence (C³I) centres, soft-skinned and armoured vehicles, and bridges. The equipment suite was specified more clearly, more stringent requirements applying. Now the location of small targets such as bridges had to be pinpointed with a 100... 150-m (330... 500-ft) error margin; for large-area targets (such as factories) the error margin was 300-400 m (990-1,300 ft). Intelligence was to be transferred via data link within three to five minutes after passing over the target.

The navigation suite was to operate with an error margin of 0.8-1% in areas devoid of landmarks, ensuring a target approach accuracy of ± 200 -300 m (660-990 ft) and landmark following with a maximum deviation of 500-1,000 m (0.31-0.62 miles). The equipment providing this performance comprised a SHORAN set working with RSBN-4N Doroga beacon, a KSI compass system, a *Privod* (Drive) marker beacon receiver, an airspeed and altitude reference unit, a *Strela-B* Doppler speed and drift meter, an ANS central navigation computer and a Polyot autopilot.

The Air Force also asked the Mikoyan OKB to consider fitting the aircraft with the Puma radar (developed for the early versions of the Sukhoi Su-24 *Fencer* tactical bomber),

the FARM-2 adapter for taking pictures from the radar screen, a camera programming module and an RV-25 radio altimeter. The *Droozhba* (Friendship) radar intended for Pavel V. Tsybin's ill-fated RS supersonic reconnaissance aircraft was proposed as a possible alternative to the Puma. In a nutshell, the VVS proposed three basic reconnaissance versions: a PHOTINT and general-purpose ELINT version, a detailed SIGINT version and a radar imaging version.

The PHOTINT/ELINT version was to carry an SRS-4A or SRS-4B SIGINT pack (with quick-change capability) and seven interchangeable camera sets intended respectively for (a) high-altitude general daylight recce, (b) high-altitude detailed daylight recce, (c) low-level day recce, (d) topographic daylight recce, (e) high-altitude night recce, (f) medium-altitude night recce and (g) low-level night recce. The detailed SIGINT version was fitted with a Koob-3 centimetre- and decimetre-waveband side-looking airborne radar (SLAR) and a *Voskhod* (Sunrise) metre-waveband SLAR. Finally, the third version had an *Igla* (Needle) SLAR and a TV system based on the *Bariy* set. Air-to-ground communication in each case was provided by a *Prizma-2* (Prism) HF radio and an RSIU-5 VHF radio coupled to a *Leera* (Lyre) cockpit voice recorder. No changes were made to the defensive equipment.

This proposal was accepted – however, with major revisions. The designers did some homework and pointed out that the chances of penetrating the enemy air defences at medium altitudes would be virtually nil. With no clouds to hide it from view at altitudes between 10 and 20 km (32,810-65,620 ft), the Ye-155R would be a sitting duck. Thus, the principal reconnaissance mode would be high-altitude supersonic flight; this, in turn, necessitated an increase in the cameras' focal lengths.

In 1961 someone suggested creating a 'mother ship' carrying a drone that could be fitted with a limited number of equipment suites, in a similar manner to the Lockheed A-12/D-21 combination. However, this idea was quickly discarded.

In the early 1960s, the Krasnogorsk Optics and Machinery Plant (KOMZ – *Krasnogorskiy optiko-mekhanicheskiy zavod*) located in Krasnogorsk a short way northwest of Moscow brought out a hitherto unseen piece of hardware – the AFA-70 four-lens aerial camera. It comprised two modules with asymmetrical optical axes. The design was heavily influenced by N. Beshenov and Yu. Ryabushkin, the two chiefs of the design group.

Another group under O. V. Uspenskiy produced two versions of the SAU-155 automatic control system (*sistema avtomaticheskovo*

opravleniya) – the SAU-155R for the reconnaissance version and the SAU-155P for the interceptor. An equally interesting piece of equipment, the Peleng navigation suite, was devised by the Ramenskoye Instrument Design Bureau (RPKB – *Ramenskoye priborno-konstruktorskoye byuro*), then headed by S. V. Zelenkov. In addition to navigation tasks, it allowed automatic and semi-automatic flight along a preset route (working in conjunction with the SAU-155) and provided inputs for the reconnaissance suite.

The Peleng system was to include an INS (corrected by a Tropic pulse-phased hyperbolic navigation system designed by VNIIRA) and a digital mainframe computer based on the Plamya unit, developed by the Elektroavtomatika design bureau under P. A. Yefimov and V. I. Lanerudin. The Ye-155 was the first aircraft of its class to carry a digital computer linked to the automatic flight control system. After considering the merits and shortcomings of analogue and digital processors, the designers opted for the digital type for being more lightweight, reliable and precise.

While the mission equipment was being finalised, the designers compared the Soviet reconnaissance equipment with the American items salvaged from the wreckage of Powers' Lockheed U-2B (56-6693) that had been shot down near Sverdlovsk on 1st May 1960. The probability of penetrating the potential adversary's (that is, NATO's) air defences was also analysed and eventually found to be acceptably high.

The Mikoyan OKB gave some recommendations as to the reconnaissance, ECM and communications suites. On 20th January 1962 the State Committee for Aviation Hardware (GKAT – *Gosoodarstvennyy komitet po aviatsionnoy tekhnike*), the State Committee for Electronics (GKRE – *Gosoodarstvennyy komitet po radioelektronike*) and the State Committee for Defence Materiel (GKOT – *Gosoodarstvennyy komitet po oboronnoy tekhnike*) issued a unique joint order concerning the range of equipment to be fitted to the Ye-155. The order was signed by the chairmen of the three committees (Pyotr V. Dement'yev, G. Kazanskiy and Sergey A. Zverev respectively) and by Ye. Shkoorko, Chairman of the High Economic Council.

(Note: In 1957 several Soviet ministries, including those of aircraft industry, electronics and defence industry, lost their ministerial status and were 'demoted' to state committees because of the Soviet leader Nikita S. Khrushchov's disdainful attitude to manned weapons systems and predilection towards missiles. In 1965, however, they regained their original names and 'rank' when Khrushchov was unseated.)

Meanwhile, preliminary design work on the Ye-155P interceptor and the Ye-155R

reconnaissance aircraft proceeded apace. A long row of configurations was tried and discarded before the design was finalised; these included unconventional layouts with variable geometry wings and lift engines. Three versions of wing structural design were contemplated, two of them being rejected upon failing the stringent static tests. The reconnaissance version was originally to have a crew of two, with a navigator's station in the extreme nose; this was discarded later, giving way to additional ELINT equipment.

A few of the layouts considered at the PD stage are described below.

Ye-155R VG high-altitude high-speed recon aircraft (Ye-158) (project)

In one of the PD studies the Mikoyan OKB attempted to marry the Ye-155R to variable geometry (VG) wings. In addition to the 'swing-wing' layout, the aircraft – also known as the Ye-158 – was characterised by having a crew of two; a navigator's station with small rectangular lateral windows admitting some daylight was located in the nose ahead of the pilot's cockpit. The shape of the wings and horizontal tail was reminiscent of the General Dynamics FB-111A tactical bomber. At maximum sweepback the wing panels together with the stabilizers effectively formed a delta wing, improving the aircraft's speed capabilities. At minimum sweep the aircraft's manoeuvrability, endurance and especially field performance were improved considerably.

The Ye-158 was intended primarily for high-speed high-altitude PHOTINT and ELINT, with a secondary tactical bomber role. In the latter capacity it was also capable of delivering tactical nuclear bombs at high speed from high altitude. However, the 'swing-wing' arrangement further increased the aircraft's MTOW. Besides, the good manoeuvrability conferred by VG wings was of little use with regard to the aircraft's primary mission. Nor was short take-off and landing (STOL) performance called for; originally it was envisioned that the aircraft would operate from unpaved tactical airstrips but the Ye-158 turned out to be too heavy for that. Finally, the navigator was considered unnecessary and a single-seat configuration was adopted for the recon version. Eventually, after analysing various options, the designers dropped the 'swing-wing' layout.

The table on the following page gives the Ye-158's design performance.

This series of stills from a promotional film (for official use) shot by the Mikoyan OKB shows a model of the projected Ye-158 'swing-wing' reconnaissance aircraft with the wings in (top to bottom) cruise (top two pictures), manoeuvring (centre) and take-off/landing (lower two) settings.

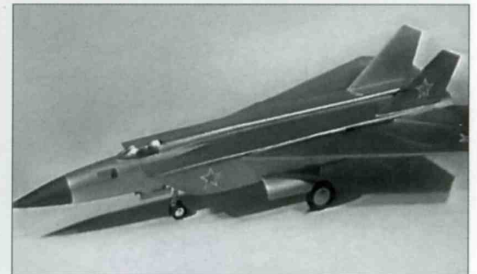

Ye-158 design performance

Take-off weight, kg (lb)	40,000-45,000 (88,180-99,200)
Maximum speed, km/h (mph):	
at sea level	1,400-1,500 (869-931)
at high altitude	3,000-3,500 (1,863-2,173)
Maximum range, km (miles):	
at sea level	1,600 (993)
at high altitude, supersonic	2,500 (1,552)
at high altitude, subsonic	5,000 (3,105)
Take-off run on dirt runway, m (ft)	400 (1,310)

Ye-155N high-altitude high-speed missile carrier (project)

The early 1960s saw several Soviet aircraft design bureaux begin development of various UAVs. The projects under consideration at that time included such exotic ones as

using a ballistic missile as a launch vehicle for delivering a manned or unmanned interceptor speedily to the air combat zone (!) and creating a space vehicle that was to destroy enemy satellites in orbit (who says President Ronald Reagan's 'Star Wars' ideas were



Above: The Ye-158 model with the wings at maximum sweep. Note how the wings effectively form a common lifting surface with the tailplanes set high up on the fuselage.



The same model with the wings at minimum sweep. Note the conical radome and the symmetrically located windows of the navigator's station aft of it. The small vertical tails are also noteworthy.

new?). More mundane programmes envisaged the creation of intercontinental ballistic missiles (yes, during the Khrushchov era aircraft OKBs also had to take on such 'odd jobs' to suit the Soviet leader's 'missile itch') and unmanned combat aerial vehicles (UCAVs) designed for combating small targets, such as ships and air defence radars.

In 1961 OKB-155 considered developing a version of the basic Ye-155 capable of carrying a strategic air-to-surface missile. The project was designated Ye-155N (for *nositel'* – 'carrier', or mother ship). The single- or two-stage missile weighing up to 7.5 tons (16,530 lb) was to have a liquid-propellant rocket motor and carry a fairly powerful warhead over an intercontinental range. Depending on whether the aircraft was to carry a pure ballistic or an aeroballistic missile the Mikoyan OKB was to cooperate with the Moscow Thermal Equipment Institute or the *Raduga* (Rainbow) Machinery Design Bureau respectively.

The idea of a MiG-25 toting a ballistic missile was soon shelved. However, two attempts to revive it were made in the late 1970s (see Chapter 2).

Composite reconnaissance aircraft (Ye-155RD drone carrier and Kh-155DR reconnaissance drone) (project)

As work progressed on the Ye-155R reconnaissance version, the general belief was that the main reconnaissance mission profile would be high-altitude supersonic flight (a 'hi-hi' mission profile), since the aircraft stood little chance of penetrating enemy air defences at medium altitude. However, the medium-altitude reconnaissance mission was still there. Therefore, a composite reconnaissance system was evolved in 1961 in parallel with the Ye-155N missile carrier. It comprised the Ye-155RD high-altitude reconnaissance aircraft carrying a Kh-155DR expendable reconnaissance drone (the DR suffix stood for *dorazvedchik* – lit. 'reconnaissance mission completion aircraft' or auxiliary reconnaissance aircraft) in lieu of a missile for close-in work.

If the target was well protected by strong air defences or obscured by overcast, the drone would be released at a safe distance and glide towards the target, descending below the clouds. Even before the Kh-155DR reached the target area, the 'mother ship' would make a U-turn and head towards a designated area, picking up intelligence from the RPV via data link. The intelligence could then be further relayed to ground C³I centres or saved in a data recorder on board the Ye-155DR after the drone impacted. A recoverable UAV was also contemplated; after making its reconnaissance run it would escape to the recovery zone at low level.

The drone could be configured with four different equipment packages, including daylight cameras, night cameras, low light level television (LLLTV) and SLAR. The 'mother ship' could also carry three different equipment fits for daylight PHOTINT, general and detailed PHOTINT and SIGINT. However, the drone carrier version was also abandoned.

Composite reconnaissance aircraft (Ye-155R drone carrier and Krechet reconnaissance RPV) (project)

A while later the Mikoyan OKB dusted off the composite reconnaissance system idea. This time a remotely piloted vehicle (RPV) was envisioned which, like the project itself, was named *Krechet* (Gyrfalcon); I. V. Froomkin was the project chief. The Krechet RPV was to have ground and air launch modes and operate either as a reconnaissance UAV or as aUCAV.

Ye-155R high-speed reconnaissance aircraft with auxiliary lift engines (project)

In contemplating possible configurations of the Ye-155R project the Mikoyan designers tried making use of the small RD36-35 turbojet developed in the Rybinsk engine design bureau (RKBM, or OKB-36) under Pyotr A. Kolesov. The engine was a lift-jet intended to improve the field performance of combat aircraft.

In the early 'sixties, work on the MiG-23 multi-role tactical fighter was proceeding in the Mikoyan OKB in parallel with the Ye-155 programme. The MiG-23's first version, a delta-winged development aircraft designated *izdeliye* 23-01 (NATO reporting name *Faithless*), made use of RD36-35 lift-jets installed in the fuselage. To test the feasibility of this composite powerplant, a production MiG-21PFM fighter was converted into a technology demonstrator called *izdeliye* 23-31. The strengths and weaknesses of the composite powerplant concept were not yet fully studied at the time, and it was then that this concept was applied to the Ye-155R.

In this project the RD36-35 lift jets were located almost vertically on both sides of the Ye-155R's fuselage spine. Two locations were considered (tandem or staggered tandem with the port group being shifted slightly aft). The engines breathed through intakes with aft-hinged doors; the intakes and the exhaust ports closed flush with the fuselage skin in cruise flight.

Like the 'swing-wing' version, the STOL version had a crew of two, with the navigator sitting ahead of the pilot in a compartment with small rectangular windows. In general, however, the lift jets were of little use to the aircraft's reconnaissance mission. In fact, they reduced range appreciably because they ate



This upper view of the Ye-158 model shows that the wingtips were parallel to the fuselage centreline when the wings were fully deployed.

up internal volume, leaving less for fuel; hence the STOL version was dropped as impractical.

Ye-155Sh attack aircraft (project)

This was a dedicated low-level ground-attack version, the Sh suffix standing for *shtoormovik* (attack aircraft). Since the Ye-155 was ill suited for low-altitude missions, the project was quickly abandoned.

Ye-155ShR attack/reconnaissance aircraft (project)

This was a proposed dual-role version optimised for ground attack and low-altitude reconnaissance duties (ShR = *shtoormovik-razvedchik*). Like the versions described above, it never went further than the drawing board.

Supersonic business jet derivative of MiG-25 (project)

Perhaps the most unusual and unlikely of the many spin-offs of the Ye-155 design was a proposed supersonic business jet (SSBJ) derivative (even though the term 'business jet'

was unknown in the USSR). No separate designation is known. Preliminary design work on this aircraft started in 1963 and continued well into 1965. The aircraft was to carry five to seven passengers or 700-1,000 kg (1,540-2,204 lb) of cargo and be capable of operating from second-class airfields (that is, with runways up to 2,600 m/8,530 ft long).

The idea came first as a memorandum addressed to the OKB's leaders. They approved the idea and gave the go-ahead for a more detailed project. The VVS also showed some interest, but generally the designers worked on the SSBJ at their own risk.

The main thrust of the project was maximum commonality with the existing fighter. In effect, only the forward fuselage was all-new, being much longer and wider. Behind the flightdeck was a passenger cabin with one-abreast seating for six and an aisle, with a portside entry door immediately aft of the flightdeck. The cabin could be converted for cargo carriage by removing the seats. The wider fuselage necessitated an increase in the fuel load in order to extend the range to 3,000-3,500 km (1,863-2,173 miles) at a cruise



ing speed of Mach 2.35 (2,500 km/h, or 1,552 mph). The modified wings had extended tips, greater aspect ratio and small leading-edge root extensions (LERXes). The main landing gear units were new, featuring bogies with tandem wheels of smaller diameter.

The relatively short range, limited usage of the aircraft and the large amount of design work needed all conspired against the Mikoyan biz-jet and the project was abandoned. This was probably the world's first SSBJ design.

The PD stage was followed by the ADP stage where various design aspects and systems could be dealt with in detail. At this stage, the interceptor's MTOW grew, approaching that of the reconnaissance version. Artyom I. Mikoyan pressured his design team into completing the advanced design stage in six months. As early as 1962 a mock-up review commission convened to inspect the Ye-155R, since the prototype of the reconnaissance version was to be built first.

The aircraft was a twin-engined shoulder-wing monoplane with twin tails and twin engines; the twin-engined configuration was selected on account of the aircraft's large weight. An integral welded steel fuel tank holding more than 10 tons (22,000 lb) of fuel formed the centre fuselage; more fuel was carried in cigar-shaped wingtip tanks. This huge quantity of fuel was necessary for prolonged flight at high Mach numbers. The forward fuselage housed radar and reconnaissance equipment. The engines were located side-by-side in the rear fuselage, breathing through large two-dimensional air intakes with raked lips and movable horizontal airflow control ramps flanking the fuselage. Such intakes later found use on both Soviet and Western combat aircraft.

Calculations showed that a single fin and rudder could not provide adequate directional stability, except by making the fin overly large. Therefore, twin tails slightly canted outwards were used, augmented by ventral strakes on the aft fuselage and small fins (or winglets) at the wingtips.

As previously mentioned, the choice of suitable structural materials was a singularly important issue. The immense kinetic heating at high Mach numbers ruled out aluminium alloys. The fuselage and wing centre section were designed as a huge fuel tank. In theory, they could just as well be made of aluminium

Top: A model showing a proposed STOL version of the Ye-155R with tandem lift-jets.

Centre and above: A different version of the STOL project with lift engines in a staggered arrangement. Note the low-set tailplane.

Left: A comparison of the VG and STOL versions.

alloy, since they would be cooled by fuel and would only be subject to dangerous overheating after fuel burnoff. However, in this case the structure had to be riveted and sealed with special heat-resistant sealants, which were lacking in the USSR.

It seemed the only alternative was titanium. Or was it? Titanium was difficult to machine and had the annoying tendency to crack after it was welded. That left steel, which could be welded without undue problems and, incidentally, obviated the need for special sealants and the labour-intensive riveting process. The automated welding methods developed by Yevgeniy O. Paton were widely used in various branches of industry, especially in weaponry production.

The engineers had their share of doubts about using steel. Many of them believed that the welded integral tanks would be incapable of absorbing the flight loads and would crack after each landing. Fortunately, numerous static tests showed that this was not the case.

Indeed, the choice of materials was perhaps the worst problem facing the engineers. Plexiglas, for one, could not be used for the cockpit canopy because of the high temperatures. Existing hydraulic fluids would decompose, and tyres and other rubber parts become hard and brittle in these conditions.

In early 1962 the CPSU Central Committee and the Council of Ministers issued another directive, ordering the construction of several prototypes. This document specified general operational requirements, construction and test commencement schedules, the order of cooperation with other design bureaux and the amount of state financing. After that, specific operational requirements (SORs) for the two versions were drawn up. In September 1962, the CofM Presidium's Commission for Defence Industry Matters finalised the equipment suite to be fitted to the reconnaissance version. The SOR for the interceptor version was endorsed on 15th June 1963.

Many equipment items were put through their paces on various testbeds. Earlier, the only systems development aircraft used by OKB-155 had been engine testbeds and those for testing UAV equipment. With the advent of the Ye-155 this range was vastly increased. The Ye-150, Ye-152 and Ye-152M helped refine the R15B-300 turbojet. Two Tupolev Tu-104 *Camel* twin-turbojet medium-haul airliners were converted into avionics testbeds for the Peleng navigation suite, the *Anis* (Aniseed) INS, the Strela Doppler air-speed/drift sensor system, the receiver of the Tropic navigation system and the main digital computer (of which several versions were tested). Another Tu-104 and one of the two Tu-110 four-turbojet airliner prototypes were converted into testbeds for the Smerch-A radar and SARH guidance system for the



Above: A model of the proposed supersonic business jet derivative of the Ye-155 showing the all-new forward fuselage and main gear units. The number of cabin windows appears too large.



This view of the same model shows the modified wings of greater aspect ratio with LERXes and the large vertical tails.

R-40 missile respectively. The long pointed radome replacing the Tu-104's glazed nose gave rise to the nickname *Bu ratino* (the Russian equivalent of Pinocchio); this sobriquet was coined by Air Marshal Yevgeniy Ya. Savitskiy. One MiG-21 fighter served as testbed for the Polyot navigation suite (the RSBN-2S SHORAN, the Romb-1K analogue processor, the SKV-2N AHRS and the air data system).

The LII and the design bureaux developing the various equipment items for the Ye-155 had an important part in performing these tests and analysing their results. The assorted testbeds of the Ye-155 programme served on for a considerable time, equipment tests continuing even as the first prototypes were being flown. Anatoliy V. Lyapidevskiy, the one-time Polar Aviation pilot and the very first person to receive the Hero of the Soviet Union (HSU) title, and A. V.

Minayev made themselves prominent in creating the test rigs and testbeds (Minayev was later appointed Mikoyan's deputy in this area).

Besides the Mikoyan OKB, a variety of organisations had a hand in making the Ye-155 fly. These included the RPKB, GosNI- IAS, the Siberian Aviation Research Institute (SibNIA – *Sibeerskiy naoochno-issledovatel'skiy instiitoot aviahtsiï*) in Novosibirsk, LII, the Moscow Research Institute of Instrument Engineering named after Vladimir V. Tikhomirov (MNIIP – *Moskovskiy naoochno-issledovatel'skiy instiitoot priborostroyeniya*), NPO Avionika (= 'Avionics' Research & Production Association; NPO = *naoochno-proizvodstvennoye obyedineniye*), the Voskhod (Sunrise) Machinery Design Bureau, the Kursk industrial automation design bureau, the Soyuz engine design



Above: An early model of the Ye-155P interceptor. Note the four K-40 AAMs under the wings.

bureau, VNIIRA, NPO Pal'ma, the All-Union Technology Research Institute, the State Radio Communications Research Institute (GNIIRS – *Gosudarstvennyy naoochno-issledovatel'skiy institoot rahdiosvyazi*), the Moscow Radio Communications Research Institute (MNIIRS), the optomechanical plants in Kazan' and Krasnogorsk, the *Ekrahn* (Screen) plant in Kuibyshev (now renamed back to Samara), the *Detahl'* (Detail or Part) design bureau in Kamensk-Ural'skiy, the 'Mars' Machinery Design Bureau, TsAGI, the All-Union Aviation Materials Institute (VIAM – *Vsesoyooznyy institoot aviatsionnykh materi-*

ahlov), the Central Aero Engine Institute (TsIAM – *Tsentral'nyy institoot aviatsionno-motorostroyeniya*) and many more.

Metallurgical institutes and specialised laboratories produced new grades of high-strength heat-resistant stainless steel, titanium and aluminium alloys (the latter were used in relatively 'cold' areas of the airframe). Tools and jigs for casting, extruding, welding and assembling parts made of these alloys were developed. Tests were run to determine the behaviour of various alloys during welding, their propensity to cracking during heating/cooling cycles and the compatibility of

primary and secondary structural materials. The crystallisation laws in the welding area were studied, resulting in methods of controlling crystallisation when alloys with different properties were welded together.

Artyom I. Mikoyan and Rostislav A. Belyakov, who superseded the retired Mikhail I. Gurevich as First Deputy General Designer, handled all matters concerning the Ye-155. Besides, the design team under project chief Nikolay Z. Matyuk included his deputy P. Ye. Syrovoy (responsible for the design documents development), A. V. Minayev, V. A. Arkhipov (engineer in charge of the first prototype) and the chiefs of some of the Mikoyan OKB's other sections.

A major contribution was also made by GKAT (later renamed the Ministry of Aircraft Industry, or MAP – *Ministerstvo aviatsionnoy promyshlennosti*) and its Chairman (later Minister) Pyotr V. Dement'yev, as well as by the VVS and PVO Commanders-in-Chief.

Meanwhile, the Gor'kiy aircraft factory No. 21 named after Sergo Ordzhonikidze, a long-standing manufacturer of MiGs, was earmarked for production of the Ye-155 and began upgrading its shops to cope with the new technologies. New technologies of working with heat-resistant alloys and composites had to be mastered, welding and thermal treatment of major airframe assemblies had to be automated. The Soviet aircraft industry was poised to jump its own hurdle by creating the fastest third-generation combat aircraft.

Work on the Ye-155 prototype and technical documents proceeded at a fast rate, and by late 1963 the first prototype was largely complete.



Models of the (left to right) Ye-155P interceptor, Ye-155U two-seat trainer and Ye-155R reconnaissance aircraft.

The Foxbat Family

Ye-155R-1 and Ye-155R-2 reconnaissance version prototypes

Designated Ye-155R-1, the first prototype was rolled out at MMZ No. 155 'Zenit' (*Moskovskiy mashinostroitel'nyy zavod* – Moscow Machinery Plant No. 155 'Zenith', as the Mikoyan OKB and its experimental factory were euphemistically referred to in those days) in December 1963 and trucked to the OKB's flight test facility at Zhukovskiy. It had taken a whole year to complete the aircraft. The Ye-155R-1 represented the reconnaissance version but carried a rather incomplete equipment fit, lacking the cameras (the camera ports were faired over with sheet metal), the ECM gear, the Peleng LORAN and Romb-1K

SHORAN systems, the HF radio set and automatic route-following system.

The first prototype had a few peculiarities distinguishing it from later examples. The vertical tails looked disproportionately small for such a large aircraft and had horizontally cropped tips; the port fin had a small cigar-shaped fairing with a dielectric tip at the top, while the other fin had a large full-chord dielectric cap. In contrast, the ventral fins were quite large. The Ye-155R-1 had a wing incidence of 0° and no yaw dampers on the rudders. It further differed from production aircraft in having a double-curvature nosecone

incorporating narrow lateral dielectric panels. A 'towel rail' aerial associated with a data link system (part of the test equipment) was mounted under the nose.

Two 600-litre (132 Imp gal) non-jettisonable fuel tanks were fitted to the wingtips, doubling as anti-flutter weights. Small trapezoidal fins canted slightly outwards were attached to the lower rear portions of the tanks; they increased longitudinal stability while decreasing lateral stability (in other words, they had the effect of an inverted wing). Mathematical analysis and wind tunnel tests showed that these 'inverted winglets'

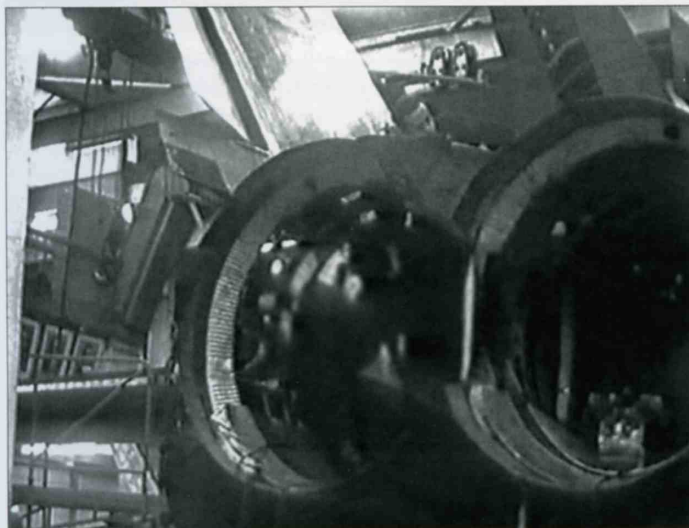
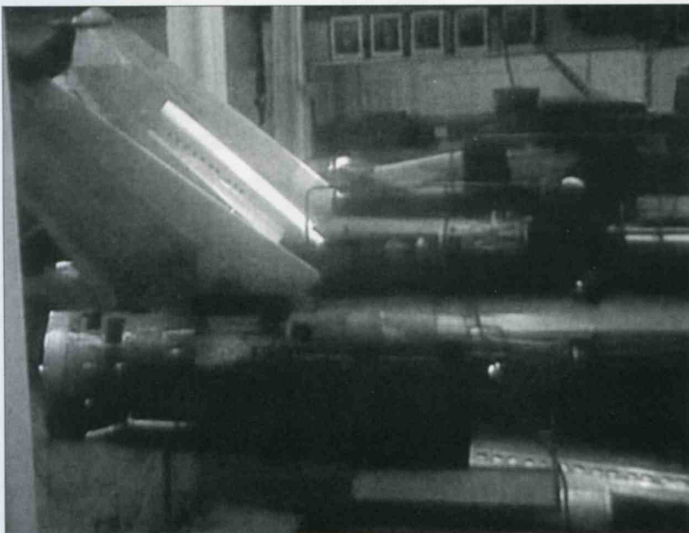

These pictures show one of the Ye-155 prototypes (not the first one, as indicated by the raked fin tips) taking shape at the Mikoyan OKB's experimental plant. Note how the circumferences of the engine bays intersect in the nozzle area. The lower right picture shows the internal structure of one of the fuselage fuel tanks.



Four views of the Ye-155R-1 ('1155 Red'), showing the double-curvature nose with narrow dielectric panels, the tip tanks with downward-canted 'winglets', the horizontally cropped small fins, large ventral fins and low-set tailplanes. Note the closed nosewheel well doors and the star insignia on the fuselage.

made up for the zero incidence of the wings. It was also believed that they could enhance the aerodynamic efficiency of the wings (though tests showed this belief was wrong).

Like other MiG-25 prototypes, the Ye-155R-1 had small flat airfoil-shaped fairings and removable panels on the sides of the air intake trunks; these allowed the installation of movable canard foreplanes meant to enhance pitch control at high Mach numbers. (The idea was dropped later in the test phase and the canards were never installed.) The first prototype was intended for exploring the flight envelope, refining the aerodynamic layout, checking the manual control system and certain other systems.

By the time the aircraft received its engines the R15B-300 turbojets had been uprated to 11,200 kgp (24,690 lbst) in full afterburner. The prototype was painted silver overall; the greater part of the nose ahead of the cockpit was black, disguising the aforementioned dielectric panels. The unusual four-digit serial '1155 Red' (that is, first prototype of the Ye-155) was carried below the cockpit in italics. Unusually, Soviet Air Force insignia were carried not only on the tails but also on the fuselage (to be precise, the air intake trunks) – a practice that had been discontinued in 1955.

The aircraft was prepared for its first flight under the auspices of engineer-in-charge V. A. Arkhipkin and his assistant L. G. Shengelaya. In addition to General Designer (OKB chief) Artyom I. Mikoyan and the two chief project engineers (Mikhail I. Gurevich and Nikolay Z. Matyuk), the test programme was monitored by Gheorgiy A. Sedov and Konstantin K. Vasil'chenko who headed the OKB's flight test section, being responsible for the flying personnel and the test process respectively. (Vasil'chenko later quit OKB-155 and became director of LII.)

Ground checks and systems tests proceeded until the spring of 1964. Test equipment sensors and data recorders were installed and calibrated, and the necessary paperwork was completed. Finally, on 6th March the Ye-155R-1 took to the air for the first time, flown by OKB-155's new chief test pilot Aleksandr V. Fedotov. (He had superseded Gheorgiy K. Mosolov as chief test pilot after Mosolov was injured while ejecting from the stricken Ye-8/1 fighter prototype.) Thus began the manufacturer's flight tests. Soon afterwards, Pyotr M. Ostapenko joined the test programme; along with Fedotov he bore the brunt of the early test flying.

At subsonic speeds all went smoothly, but as transonic tests began an immediate problem arose. As it approached the speed of sound, the prototype would start banking of its own accord; this phenomenon, called *val'ozhka* in Russian, could not be countered

even by full aileron deflection. The Mikoyan OKB was familiar with this phenomenon, having encountered it on earlier aircraft with more sharply swept wings – the MiG-15 *Fagot*, the MiG-17 *Fresco* and the MiG-19.

As a temporary remedy, the pilots devised a special tactic, initiating a slow roll in the opposite direction before going transonic. As the aircraft slipped through the sound barrier the bank angle decreased automatically, in spite of the pilot's actions. Later, as the Ye-155 accelerated further, roll lateral control was regained. Still, the message was clear: the wing design needed modifications.

The next snag was excessive wing vibration caused by fuel sloshing to and fro in the wingtip tanks as it was burned off. The problem was solved by the simple expedient of eliminating the tip tanks.

A spate of problems surfaced at near-maximum speeds. The aircraft's static stability deteriorated as speed grew; the afterburners tended to flame out at high altitude, increasing fuel consumption and shortening the service life of the engines and other mechanisms located in the aft fuselage due to excessive vibration. A so-called 'mist' (plainly visible condensation caused by boundary layer turbulence) appeared in the air intakes at high Mach numbers and high alpha, increasing drag and vibration and spoiling the intake's characteristics.

Fuel consumption during climb was rather higher than anticipated. So was the MTOW, both of which caused the first prototype's range to fall short of the target figure.

In 1965 MMZ No. 155 completed the second prototype; this was also a reconnaissance aircraft and was thus designated Ye-155R-2. This allowed the scope of the flight test programme to be expanded appreciably. Unlike the first prototype, the Ye-155R-2 lacked the tip tanks and winglets from the start. Meanwhile, the Gor'kiy aircraft factory No. 21 was preparing to commence production of the new aircraft. Soon two Ye-155P interceptor prototypes (see below) joined the test programme to speed up the 'debugging' of the airframe, engines and avionics. The principal avionics and weapons systems were tested on the Tu-104, Tu-110 and MiG-21 testbeds mentioned earlier. LII and Red Banner State Research Institute of the Air Force (GNIKI VVS – *Gosoo-darstvennyy krasnoznamyonnyy naoochno-issledovatel'skiy institoot Voyenno-vozdooshnykh seel*) test pilots also started flying the prototypes, as did pilots from the Gor'kiy factory.

Problems of varying complexity and urgency had to be dealt with during the early tests. For example, heat-resistant paints were required, as ordinary paint would be so scorched after a few high-speed flights with

intense kinetic heating that the colour of the national markings became indiscernible. Therefore, a high-reflectivity heat-resistant grey paint was specially developed for the Ye-155; suitable black and white paints were also selected.

The VVS was generally pleased with the Ye-155's performance during the manufacturer's tests, which comprised about 200 flights. The aircraft's speed and altitude envelope had been determined and the engineers succeeded in attaining adequate stability and controllability.

Ye-155R-3, Ye-155R-4, Ye-155R-5 and Ye-155R-6 pre-production aircraft

Since the State acceptance trials programmes developed for the Ye-155's reconnaissance and interceptor versions differed considerably, it was decided that the two versions would be tested in parallel by separate teams. Each version was to make several hundred flights before it could be found satisfactory and taken on strength.

More prototypes were needed to expedite the tests. However, the Mikoyan OKB's experimental plant in Moscow was not in a position to start building the '23-01' and '23-11' prototypes of the MiG-23 *Flogger* fighter. Hence it was decided to build pre-production batches of both MiG-25 versions at the Gor'kiy factory. This brought about a re-equipment of the plant; of course, it involved a lot of trouble but paid off by shortening the learning curve.

Pre-production interceptors and reconnaissance jets started rolling off the Gor'kiy assembly line before the end of 1965. The black-nosed third reconnaissance prototype, Ye-155R-3, '3155 Red', was the first to come. However, the airframe components were manufactured in Moscow and delivered by boat via Doobna (Moscow Region) to Gor'kiy for study and assembly. The Ye-155R-3 carried a complete camera fit and avionics suite (the camera ports were functional and their number was increased) and was intended for testing various daylight recce camera arrangements.

Quite a few changes based on input from the early flight tests of the Ye-155R-1 were incorporated into the third prototype. The wingtip tanks were replaced by anti-flutter weights in slender cigar-shaped fairings (sometimes referred to as 'balance booms'). The wings were set at 2° incidence. The fins were marginally taller and had raked tips; this necessitated a relocation of the aerials housed in the fin tip fairings, both of which now had dielectric inserts. The forward fuselage had structural changes made in order to permit installation of the reconnaissance equipment. Finally, the third prototype introduced an enormous ventral drop tank holding

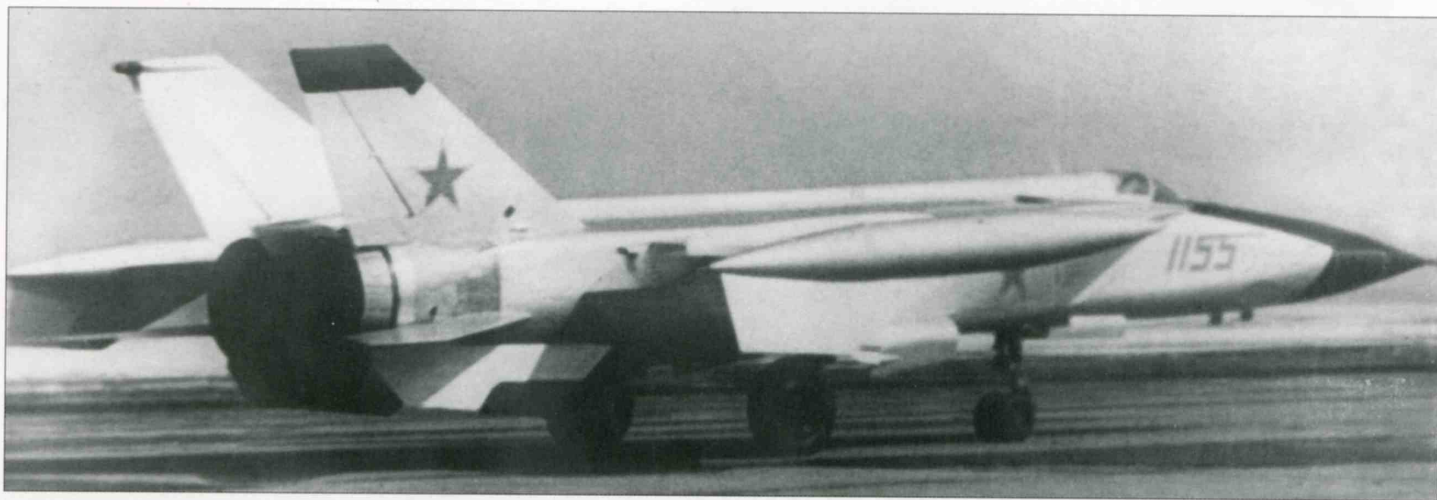

**ПЕРВЫЙ ВЫЛЕТ
И ПОЛЕТЫ
САМОЛЕТА
Е-155**

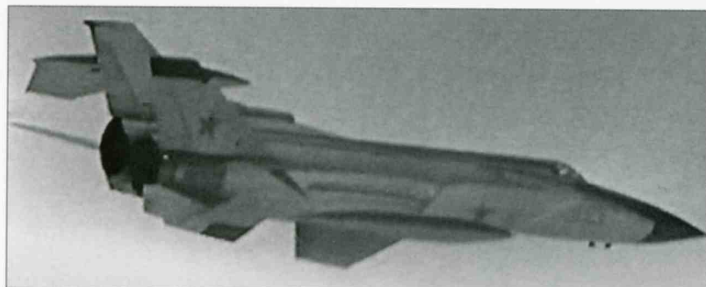
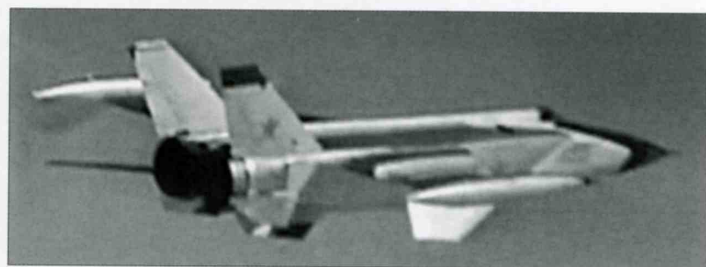
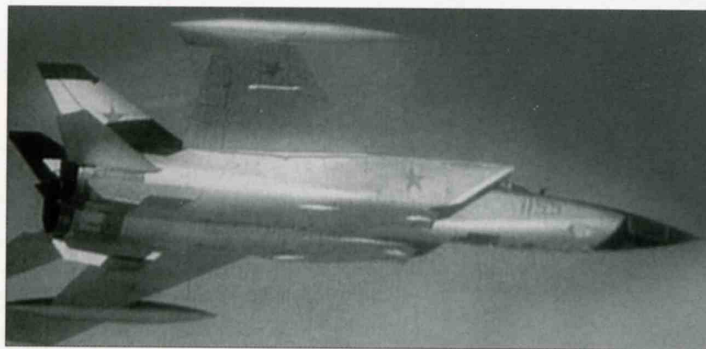

This page: These stills from a Mikoyan OKB cine film for Those Who Need To Know show the Ye-155R-1 during its maiden flight on 6th March 1964 and during subsequent test flights in which the landing gear was retracted. Noteworthy details include the two faired-over oblique camera ports, the fairings on the air intake trunks intended for would-be canard foreplanes, the asymmetrically located dielectric portions of the fins and the 'towel rail' aerial of a data link system forming part of the test instrumentation. Note that the nosewheel well doors are now open when the gear is down.

Right and far right: Front and rear views of the third prototype of the reconnaissance version, the Ye-155R-3 ('3155 Red'), with the drop tank attached.



Above: The moment of triumph: Aleksandr V. Fedotov climbs out of the Ye-155R-1 after the successful completion of the maiden flight.

5,300 litres (1,166 Imp gal), more than half as long as the aircraft itself. Never before had such huge reservoirs been carried externally by Soviet aircraft.

The Ye-155R-3 was rolled out on 6th May 1966 and the factory's flight test department took charge of it. Ground checks lasted two months; finally, on 6th July 1966 the aircraft took to the air with Mikoyan OKB pilot Aleksandr V. Fedotov at the controls. It may be noted that this aircraft and other pre-production machines were completed in the cramped old assembly shop of the Gor'kiy aircraft factory. Hence each aircraft had to be tilted nose-up as it was rolled out in order for the fins to clear the low door of the shop.

The joint State acceptance trials – that is, performed jointly by the manufacturer (OKB-155) and the customer (the Air Force) – were carried out chiefly by GNIKI VVS at the institute's main facility, Vladimirovka AB in Akhtobinsk, Astrakhan' Region, in southern Russia. The GNIKI VVS test team under Col. Roomyantsev included project test pilot Col. Aleksandr S. Bezhevets and military engineers B. Klimov, V. Tokarev and A. Klyagin. The latter was responsible for evaluating the combat efficiency of the Ye-155.

The designers and engineers responsible for the aircraft's systems were to find out how the boundary layer, shock waves and vibrations affected the quality of pictures generated by the cameras, whether the airframe

heating/cooling cycles made the camera port glazing excessively brittle, whether the heat from the aircraft's skin affected the cameras, whether glass heated to 250°C (482°F) would distort the pictures and so on. Any one of these questions could pose a problem, significantly impairing the resolution of the long-range cameras with a focal length ranging from 750 to 1,200 mm (29½ to 47¼ in). The designers had every reason to be apprehensive. On the Yak-27R tactical reconnaissance aircraft the cameras mounted in the forward fuselage had a resolution of only about 10 lines to a millimetre, which was three times lower than in static ground conditions.

To find the answers to these questions a comprehensive research programme was arranged. It included temperature and vibration measurements in the camera bay and flights over a special test range near Serpukhov, a town in the Moscow Region, with accurate navigation using geodetical markers. The cameras' field of view was divided into four zones by gluing special glass squares of varying thickness to the camera port glazing, emulating four lenses with different focal lengths; this helped to select the lens giving maximum picture sharpness. To ensure a stable thermal environment, on the ground the camera was kept in a special capsule in which a preset temperature between 35°C and 50°C (95-122°F) was automatically maintained. The cameras incorporated rods made of a special alloy called invar with a thermal expansion quotient equal to that of glass, meant to reduce dangerous tensions in the lenses.

Fortunately, the tests showed that the designers had no reason to worry about picture quality. In flight, the lenses offered a resolution of about 30 lines to a millimetre. In practice this meant that at a flight level of 20,000 m (65,620 ft) the A-72 and A-70M cameras had a resolution of 30 cm (11¼ in) and 40 cm (15¼ in) respectively, with a contrast quotient of 0.4. This made it possible to make out objects measuring 1.5 x 1.5 m (4 ft 11 in x 4 ft 11 in) for the A-72 camera or 2-2.5 x 2-2.5 m (6 ft 6 in ... 8 ft 2 in x 6 ft 6 in ... 8 ft 2 in) for the



Above: Mikoyan OKB chief test pilot Aleksandr V. Fedotov, Hero of the Soviet Union. He was the Ye-155's project test pilot.

A-70M, or even smaller objects if the contrast quotient was higher.

Engineer V. K. Khomenko suggested a flexible attachment for the optically flat camera port glass, which eliminated tensions in the glass caused by heating. This and the location of the cameras in the nose, so that they fired through a relatively thin boundary layer with no appreciable turbulence to distort the picture, helped to complete the camera tests successfully. A carefully selected flight mode (flight level 20 km, airspeed in excess of Mach 2.35) and the Ye-155's relatively rigid airframe ensured an acceptable vibration level. Later, photography at subsonic speeds and lower levels was successfully tried. The A-70M and A-72 cameras gave acceptable results at altitudes of 6,000 m (19,685 ft) and 10,000 m (32,810 ft) respectively with no need for adjustment.

The A/E-10 topographic camera designed by the Peleng Central Design Bureau in Minsk and the SRS-4A/SRS-4B SIGINT packs were put through their paces with no major complications. The SRS-4A was capable of detect-





Three views of the Ye-155R-3, showing the lack of tip tanks (replaced by anti-flutter weights), the functional camera ports and the relocated data link aerial.

ing centimetre- and decimetre-waveband radars. Its aerials were located on the forward fuselage sides behind dielectric panels. After being picked up, the enemy radar signal was amplified, classed by frequency, converted and recorded on film by a photographic registrator unit. The alternative SRS-4B SIGINT pack differed only in the range of detectable frequencies.

The Ye-155R-3 was flown by Mikoyan test pilots Aleksandr V. Fedotov, Pyotr M. Ostapenko, Boris A. Orlov, Oleg V. Goodkov, A. Kravtsov, Aleksandr S. Bezhevets, Igor' I. Lesnikov and others. It was this aircraft that the greater part of the test program for the reconnaissance version was completed on.

The second pre-production machine, designated Ye-155R-4 (construction number

020SA01, or 020CA01 in Cyrillic characters; fuselage number 0101), was the first example built in Gor'kiy from the outset. It was eventually coded '024 Red' – that is, *izdeliye* 02, airframe No. 4 – and represented the 'production standard' configuration, featuring a number of changes. First of all, it had the redesigned tail unit introduced earlier on the MiG-25P (Ye-155P-6, see below). Secondly,



These three views of '3155 Red' illustrate well the redesigned fins with raked tips and the huge drop tank. Note also the difference in national insignia placement.

the extreme nose had an almost conical shape instead of double curvature and featured a dielectric tip; the lateral dielectric panels had a trapezoidal shape and were moved aft. Thirdly, the root fairings for the proposed canards were eliminated from the air intake trunks. The aircraft served for performance testing and reconnaissance suite calibration. Several new items were also tested on this

machine, namely the Peleng-S and Polyot-11 navigation systems, interchangeable liquid-cooled pallet-mounted ECM sets and the Prizma HF radio. A. Ya. Ishchenko was the engineer in charge of this aircraft.

(A note must be made here on MiG-25 construction numbers. Two systems were used, and both were meant to throw outsiders (read: hypothetical spies) off track. Since air-

craft production in the Soviet Union (and now Russia) usually was/is broken down into production batches containing more or less the same number of airframes, a system was devised to conceal the batch number and hence how many aircraft had been built. It was based on a code word, *samolyotchik*; depending on the context, this slang word can mean either 'member of flight or ground



Above: Mikoyan OKB test pilot Pyotr M. Ostapenko, HSU, who flew the Ye-155R-1 and Ye-155R-3, among other things.

crew operating fixed-wing aircraft' (as opposed to *vertolyotchik* – ditto but operating helicopters) or 'airframer' (as opposed to the engine/avionics/weapons makers). A number from 0 to 9 corresponded to each letter of the code word (in Cyrillic characters):

С	А	М	О	Л	Ё	Т	Ч	И	К
S	A	M	O	L	Yo	T	Ch	I	K
0	1	2	3	4	5	6	7	8	9

Thus the batch numbers were substituted by letter combinations. Batch 01 equalled SA (CA), Batch 02 equalled SM (CM), Batch 04 equalled SL (CЛ), Batch 05 equalled SE (CE; the letter Ё was not used) and so on. Hence the construction number consisted of the air-

craft's in-house product code (*izdeliye* 84 = MiG-25P, *izdeliye* 02 = MiG-25R and *izdeliye* 39 = MiG-25RU) to which a zero was added, then the batch code and the number of the machine within the batch. Examples are MiG-25P c/n 840SCh09, MiG-25R c/n 020SL02 and MiG-25RU c/n 390SA01.

In 1974 the factory switched to a different system devised in 1973 to make life even harder for spies and used by most Soviet aircraft factories. In this system the product code and extra zero are followed by five digits which do not signify *anything at all*. The first two digits of these 'famous last five', as they are often called, change independently from the final three. The digits are prefixed by an N (actually the number sign). Examples are MiG-25P '09 Red' (c/n N84049608) manufactured on 21st December 1977, MiG-25RBV '55 Red' (c/n N02016375) manufactured in November 1974, MiG-25PU '90 Blue' (c/n N22040418) and MiG-25RU '34 Red' (c/n N39017407) manufactured on 23rd July 1981.

Additionally, MiG-25s have four-digit fuselage numbers (f/ns) or line numbers consisting of the batch number and the number of the machine in the batch; security is all very well but the manufacturer has to keep track of production, after all. Most of the Soviet/CIS aircraft design bureaux use the term 'sereyny nomer' for fuselage numbers; this is derived from the word *seriya* in the meaning 'production batch'. The Mikoyan OKB, however, invented its own term, referring to the f/n as 'nomer komplekta agregatov' ('subassembly set number') in similar manner to the set numbers used by Hawker Siddeley for the Andover transport. Thus, the aforementioned MiG-25P c/n 840SCh09 is f/n 0709 and MiG-25P c/n N84019175 is f/n 1710.



Above: Boris A. Orlov, HSU – another Mikoyan test pilot who was heavily involved in the MiG-25 programme.

The c/n is normally stencilled on the front wall of the nosewheel well, though some early MiG-25s with construction numbers in the alphanumeric system carried the c/n externally on the nose. The f/n appears only in Mikoyan OKB documents and is not found anywhere on the aircraft.)

The test programme lasted several years, during which the prototypes made several hundred flights. Finally, in 1967 the State Commission signed the Act of Acceptance for Stage A (that is, preliminary) tests of the reconnaissance version and recommended the aircraft for production.

The toughest part was the testing of the Polyot-11 and Peleng-S navigation systems, the latter comprising an INS, a Strela Doppler

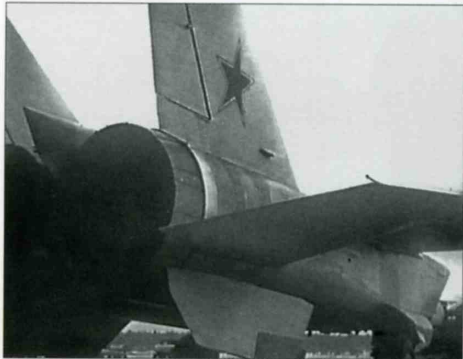

Above left: The rear fuselage and tail unit of the Ye-155R-3, showing the convergent-divergent engine nozzles and the brake parachute housing in between.

Above centre and above: '3155 Red' taxis out and becomes airborne on a test mission. Note that the nosewheel well doors are closed.

Left: A poor-quality but rare photo of the Ye-155R-3 in flight.

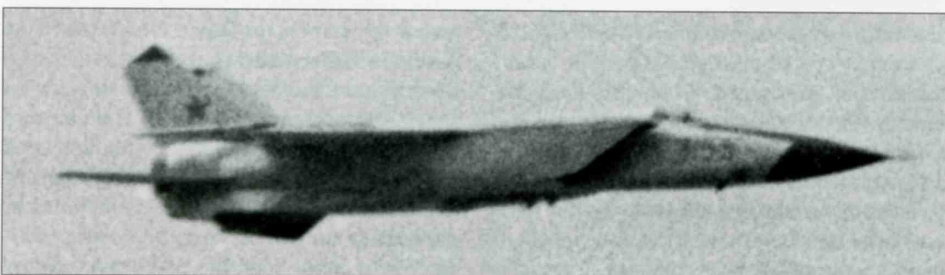

airspeed/drift meter and an Orbita digital computer. (RPKB assigned a representative, G. N. Boorov, to the tests.) The former system didn't cause too many problems, but a good many flights were necessary to check out the various operational modes, obtain statistical data and make adjustments (for example, to the autopilot gear ratios). The Peleng-S, however, turned into a 'can of worms', as the navigation computer proved very unreliable and needed debugging.

Had the designers chosen to 'go by the book', the Peleng-S system would be turned down as failing to meet the Air Force's reliability criteria. However, Gheorgiy A. Sedov, L. G. Shengelaya, Konstantin K. Vasil'chenko, A. V. Minayev (Mikoyan OKB), S. V. Zelenkov, V. S. Magnusov (RPKB), V. I. Lanerdin and R. A. Shek-lovsipyants (Elektroavtomatika design bureau) managed to persuade the VVS that reliability could be improved in service conditions – and were later proven right. The need for a new reconnaissance aircraft was so dire that A. A. Pol'skiy, chief of the Avionics Test Department, made the risky but correct decision to clear the Ye-155R for production with the controversial Peleng-S suite. The State Commission was not even put off by the crash of the third pre-production aircraft, Ye-155R-5, in its acceptance flight in Gor'kiy on 30th August 1965, in which test pilot L. I. Minenko was injured.

A total of four development reconnaissance aircraft participated in the manufacturer's flight tests and State acceptance trials. The fourth pre-production aircraft, the Ye-155R-6, was stationed at the Mikoyan OKB's test facility in Zhukovsky (the LII airfield). One more airframe was completed for static testing. Finally, in late 1969, the State Commission under Maj. Gen. Silin, the Soviet Air Force's chief of reconnaissance, signed the Act of Acceptance and the reconnaissance version entered production as the MiG-25R.

Ye-155P-1 and Ye-155P-2 interceptor prototypes

Wearing no tactical code, the first prototype of the interceptor version – the Ye-155P-1 – was completed in Moscow in the summer of 1964 and made its first flight on 9th September at the hands of test pilot Pyotr M. Ostapenko. It was basically similar to the Ye-155R-3 (all the refinements introduced on the latter aircraft were incorporated into the interceptor prototype). However, the forward fuselage was different; the 'camera case' nose of the Ye-155R gave way to an ogival radome which housed the Smerch-A fire control radar – or, rather, was to house (the radar set and dish were replaced by test instrumentation on the first prototype). The two pylons positioned well outboard (the inboard ones didn't come until

later) carried dummy K-40 missiles painted bright red. As on the Ye-155R-1, a small 'towel rail' aerial for the data link system that was part of the test instrumentation was mounted under the forward fuselage. Like the Ye-155R-1, the aircraft wore red star insignia both on the tails and on the fuselage.

The second prototype, the Ye-155P-2, was also built in Moscow, arriving at the flight test facility a year later. It was almost identical to the Ye-155P-1, right down to the lack of radar. The only visible differences were the data link aerial repositioned to the centre fuselage underside and the lack of star insignia on the air intake trunks.

The Ye-155P-1 was used to complete the greater part of the manufacturer's tests and also claimed a few world records. The first prototype took no part in the State acceptance trials.

Ye-155P-3 through Ye-155P-11 pre-production interceptors

Even as the manufacturer's flight trials of the two interceptor prototypes progressed it became obvious that the aircraft had record-breaking potential. A major effort was launched to develop the State acceptance trials programme jointly with the VVS and PVO top brass.

The trials programme took rather long to receive the official go-ahead. The complexity of the new interceptor system and the stringent demands of the military (the PVO wanted 'kill' probability statistics, navigational accuracy data and so on) meant that more test flights than usual were needed. This, in turn, called for more prototypes and an extended flight test period.

A new approach to test flight planning was needed. Problems arose with procuring the necessary test instrumentation. One major issue was safety during live missile launch trials, especially when the interceptor and the target drone closed in head-on at supersonic speed. The missile would blow the drone



Top and above: Attired in a pressure suit and a GSh-4 full-face pressure helmet, Pyotr Ostapenko discusses a test flight with OKB engineers.

apart and the debris would be scattered in an area hundreds of miles long and dozens of miles wide, which was much larger than the affordable area of the firing ranges.

A pre-production batch of nine aircraft, designated Ye-155P-3 through Ye-155P-11, was laid down; these were intended chiefly for State acceptance trials. These aircraft, too, carried test instrumentation – either in a ventral pod or in lieu of certain avionics items, such as the radar.

After the two interceptor prototypes had made their first few test flights, the joint State acceptance trials held by the Mikoyan OKB, the VVS and the PVO began in November 1965 in keeping with a ruling passed by the



Refitted with production-style nose and tails, the Ye-155R-3 is now in the Central Russian Air Force Museum in Monino as '25 Red'. Note that MiG-25P missile pylons have been fitted in error.



Three views of the Ye-155P-1 prototype fitted with a data link aerial and carrying inert K-40R AAMs on the as-yet two pylons. Note provisions for canards.

CofM Presidium's Commission on defence industry matters (VPK – *Voyenno-promyshlennaya komissiya*). The trials proceeded in two stages; Stage A involved general flight tests, while Stage B was devoted to testing and evaluating the aerial intercept weapons system as a whole. The State Commission was chaired by Air Marshal Yevgeniy Yakovlevich Savitskiy, twice HSU, deputy C-in-C of the PVO.

As early as 1966 the first two Gor'kiy-built interceptors – the Ye-155P-3 and Ye-155P-4 (appropriately coded '03 Red' and '04 Red') – joined the two prototypes in the State acceptance trials, which had been underway since December 1965. Unlike the Ye-155P-1 and

Ye-155P-2, these aircraft had four underwing missile pylons – a feature that became standard on subsequent interceptors.

As mentioned earlier, the Smerch-A radar tailored for the Ye-155 differed slightly from the original RP-S Smerch developed for the Tu-128. Later, when the MiG-25 entered production, the radar was designated RP-25 (= 'radio sight for MiG-25'). The Smerch-A radar and the K-40 missile were put through their paces on the LM-104 avionics/weapons test-bed – a modified Tu-104A *Camel* twin-turbojet medium-haul airliner registered CCCP-42326 (c/n 66600102). This aircraft had the radar installed on a special adapter supplanting the usual glazed navigator's sta-

tion in the nose and missile pylons under the wings.

The Ye-155P-3 was the first example to have the radar fitted. Yet, like the fourth and fifth interceptors, this machine had an incomplete avionics fit.

Coded '05 Red', the fifth interceptor used in the test programme (the Ye-155P-5) was completed in the summer of 1967. This aircraft and both interceptor prototypes took part in a flypast during a grand airshow at Moscow-Domodedovo airport on 9th July 1967 together with the Ye-155R-3. All four jets were flown by GNIKI VVS pilots taking part in the State acceptance trials because Mikoyan OKB test pilots were otherwise engaged. Igor'



Top: Two pre-production or LRIP MiG-25Ps featuring cropped-delta wing endplates combined with the anti-flutter weights.

Above: The Ye-155P-2 seen from a chase plane during an early test flight.

Top right and above right: The Ye-155P-2 extends its undercarriage. Like the other early development aircraft, it had small nosewheels with no mudguard.

I. Lesnikov and Grigoriy A. Gorovoy flew the first and second prototypes respectively, G. B. Vakhmistrov was at the controls of the Ye-155P-5, while Vadim I. Petrov flew the reconnaissance machine. All three interceptors carried conformal ventral containers with test instrumentation on the centreline.

During rehearsals before the show one of the Ye-155s was replaced by a standard MiG-21F-13 *Fishbed-C* fighter – according to some sources, because the Ye-155 in question had crashed and a replacement aircraft was not available until a few days before the event. The Ye-155R-4 featuring the new nose and tails also took part in the rehearsal of the airshow but not in the actual event, apparently being considered too ‘sensitive’.

After the show the Ye-155P-3, Ye-155P-4 and Ye-155P-5 were fitted with wing endplates of cropped-delta planform integrated with the wingtip anti-flutter booms. These aerodynamic surfaces, immediately dubbed *lasty* (webbed feet) because of their shape, were meant to improve directional stability, which turned out to be inadequate when the aircraft carried a full complement of missiles.

In 1967 the Gor’kiy factory completed four more aircraft of the pre-production batch (Ye-155P-6 through Ye-155P-9) and turned them over for flight testing. These aircraft introduced a redesigned vertical tail that became standard for production examples. The fins were significantly enlarged and recontoured, featuring a slight leading edge kink at the roots and reduced trailing-edge sweep; the port fin had a dielectric leading

edge blending into a large dielectric cap. Each fin/rudder assembly now had an area of 8 m² (86.02 sq ft). Conversely, the ventral fins were downsized, tapering towards the rear, which reduced the risk of scraping them along the runway during rotation. The slab stabilisers (stabilators), which until then had been used only for pitch control, could now be deflected differentially to assist roll control; they could thus be called tailerons (more of this later). Wing anhedral was increased to 5°. The overall effect of these changes was to increase the maximum indicated airspeed (IAS) and improve stability, allowing the wing endplates to be dispensed with.

The final two aircraft of the pre-production batch (Ye-155P-10 and Ye-155P-11) followed in 1968. The first fully equipped interceptor, the Ye-155P-6, became the pattern aircraft for full-scale production. All of the ‘big-tailed’ pre-production interceptors participated in the State acceptance trials along with the first four production machines – ‘501 Blue’, ‘502 Blue’, ‘503 Blue’ and ‘504 Blue’ (c/ns 840SE01 through 840SE05, f/ns 0501 through 0504). The Ye-155P-3, Ye-155P-4, Ye-155P-5, Ye-155P-6, Ye-155P-10 and Ye-155P-11 operated from the GNIKI VVS test centre in Akhtobinsk most of the time; the remaining three aircraft were operated by the Mikoyan OKB and based in Zhukovskiy.

Mastering MiG-25 production was a major technological challenge for the plant. A lot of new technologies for working with high-strength stainless steel and titanium had to be introduced, including hydraulic forming and

explosive forming. New tools, primarily welding equipment and computer-controlled machine tools, had to be designed and manufactured. The first Gor’kiy-built examples were extremely complicated and labour-intensive to build. At the suggestion of Ye. I. Mindrov (the factory’s chief designer) MAP issued a decision whereby several aircraft were set aside for perfecting the manufacturing process. These aircraft were retained by the plant, and the efforts to make the design better suited for mass production lasted from 1968 to 1974. As compared to the prototypes, the pattern aircraft for series production featured 568 design changes of varying scale; as a result, empty weight was reduced by 120 kg (265 lb), mission preparation time was reduced by 35 minutes and turnaround time by 25 minutes.

A number of design deficiencies were discovered during the trials – and they were discovered the hard way when a series of fatal accidents took place. For example, when the pilot pulled 5 Gs during a manoeuvre, the wingtips flexed nearly 70 cm (2 ft 3³⁵/₆₄ in) from the normal position, which could result in aileron reversal and loss of control. Rather than change the wing design, the designers imposed a Mach 2.83 speed limit for the MiG-25. Controllability remained inadequate, and breaking the Mach 2.83 speed limit could cause serious trouble or even prove fatal. On 30th October 1967 GNIKI VVS project test pilot Igor’ I. Lesnikov, one of the participants of the Domodedovo flypast, was killed in a crash in the Ye-155P-1 while trying to set a

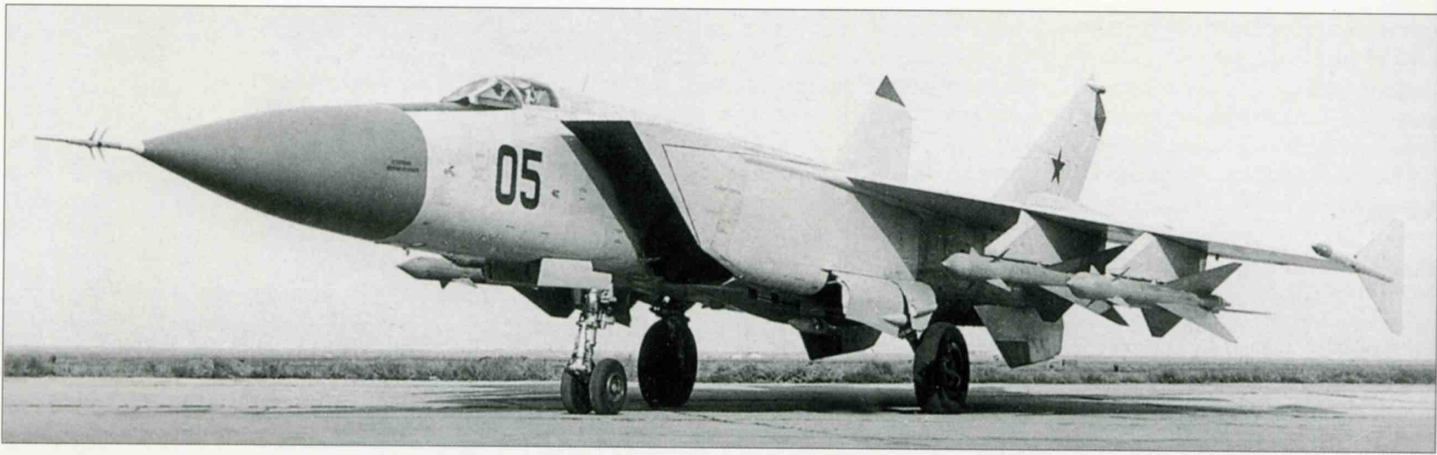

Above: '05 Red', the Ye-155P-5, after the addition of wingtip endplates. The air intakes' lower lips are fully deflected. Note the four wing pylons, the pale blue trim on the air intakes (which lack provisions for canards) and the 'Caution, fibreglass' stencil on the radome.

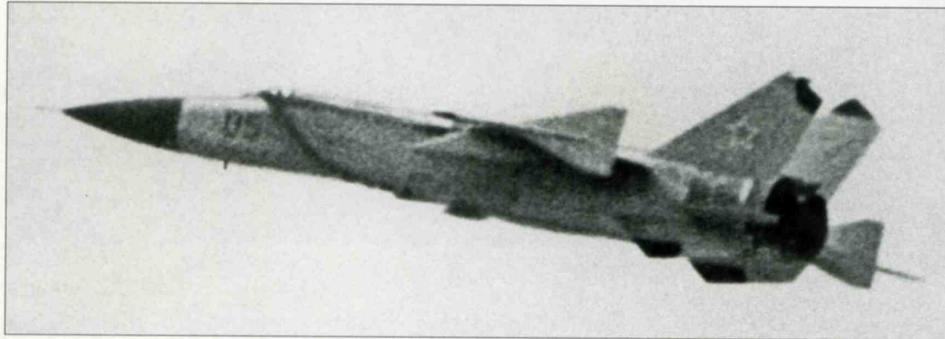

Left: The modified Ye-155P-5 in flight with no external stores.

Below/bottom and below left/bottom left: Four more views of '05 Red' with a full load of dummy K-40R AAMs. Note that the air intake outer walls are canted outwards.

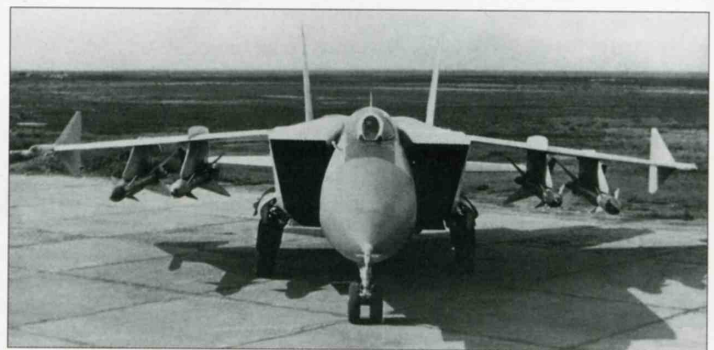
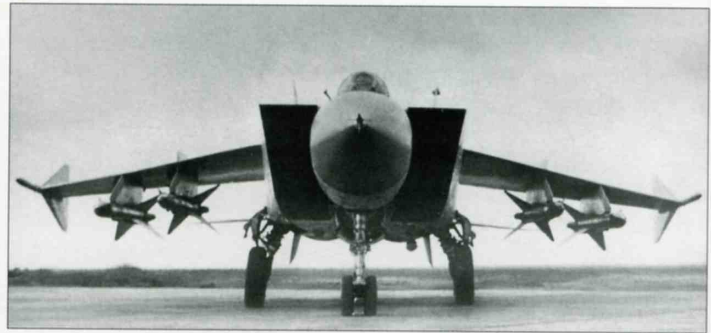

time-to-height world record. The cause of the crash was traced to aileron reversal when the aircraft exceeded the speed limit. It was this accident that led the OKB to redesign the roll control circuit and introduce differential stabilator deflection; roll control efficiency improved dramatically, allowing the never-exceed speed to be increased from 1,000 to 1,200 km/h (from 621 to 745 mph).

Another dangerous phenomenon, which also contributed to the decision to redesign

the control system, manifested itself during live weapons tests. Two Air Force test pilots, Norair Kazaryan and later Aleksandr V. Kuznetsov, found themselves in a predicament after launching missiles asymmetrically – that is, both missiles on one wing – at an altitude of 15,000 m (49,210 ft) and high speed. The aircraft rolled inverted, ignoring aileron inputs, and entered a vertical dive, recovering with difficulty at less than 8,000 m (26,250 ft); this situation was even dubbed

'the Kazaryan effect'. Once the differentially controllable tailplanes had been introduced, the 'Kazaryan effect' was cured completely.

Stage B of the Ye-155P's State acceptance trials was split into two halves. The first of these (stage B-0) ended in 1968, resulting in a tentative go-ahead for full-scale production. The second half was completed in the autumn of 1969; during this stage the test aircraft made 161 flights from Akhtobinsk and 51 flight from Zhukovskiy. A further 116 flights

were made to calibrate the aircraft's systems and simulate missile launches, with the Ye-155P-10 and Ye-155P-11 posing as 'targets'. The latter two aircraft were also used to train service pilots.

In addition to the interceptor prototypes, several support aircraft took part in the trials programme. These included three Tu-104A navigation system and radar testbeds, a Tu-110 *Cooker* four-turbojet airliner converted into a missile guidance system testbed, a MiG-21US *Mongol* trainer and a Su-9 interceptor converted into avionics testbeds, and an Il'yushin IL-14 *Crate* piston-engined airliner outfitted as a command relay and guidance aircraft. Various ground equipment and simulators were also used. In addition to some of the Ye-155Ps, a number of Su-9s, MiG-17 and MiG-21 fighters, Yak-25RV reconnaissance aircraft and Tu-16, Tu-22 and IL-28 bombers served as targets during simulated missile launches.

All in all, the Ye-155Ps made 1,291 test flights from Akhtoobinsk, including 693 under the State acceptance programme (the latter figure included 353 'official' flights). During live missile launch tests, 105 missiles were fired at 33 assorted target drones – M-28s, M-21s, M-16s, Yak-25RV-IIs and KRMs. (Note: The M-28, M-21, M-16 (aka Tu-16M) and KRM are target drone conversions of the IL-28 *Beagle* bomber, MiG-21, Tu-16 and KSR-2 anti-shiping cruise missile respectively. M = *mishen'* – target; *krylataya raketa-mishen'* – cruise missile/target [conversion].) Eight more target drones were destroyed during other trials. The development interceptors based at Zhukovsky made 170 flights, the mixed bag of support aircraft making some 600 flights in all.

On 26th April 1969, IA PVO Commander Gen. Anatoliy L. Kadomtsev made his first flight in the Ye-155P-11 – which was to be his last. Shortly after take-off from Akhtoobinsk the starboard engine tossed a turbine blade, rupturing a hydraulic line and causing a massive fire. On hearing the fire/hydraulic system failure warning, Kadomtsev asked the tower for instructions and was ordered to eject. However, just then the control system became unserviceable; the aircraft rolled and plunged into an arm of the Volga River, killing the pilot. It was never found out with certainty why he did not eject; perhaps he had operated the seat incorrectly, being used to Sukhoi aircraft with a different ejection algorithm (although test pilot Stepan A. Mikoyan wrote that Kadomtsev knew the ejection technique), or perhaps the ejection mechanism was also damaged somehow. When the cause of the accident was discovered, the Tumanskiy OKB redesigned the turbine of the R15B-300 turbojet and imposed a temporary limit on the turbine temperature.



Above: '03 Red' (the Ye-155P-3) takes off with a full load of missiles. The wing endplates are just discernible.



The Ye-155P-4 ('04 Red') breaks formation with the camera ship, showing the ventral fairing housing test equipment.

Kadomtsev's death in harness, which caused quite a commotion, was a sore loss to the Air Force, because he was a competent commander and looked certain to become the next Air Force C-in-C. It was also a severe blow for General Designer Artyom I. Mikoyan, who had flown in from Moscow to participate in the investigation of the crash. He suffered a massive heart attack on returning to Moscow and passed away a year later, on 9th December 1970.

On 28th April 1970 the interceptor version completed its State acceptance trials and was cleared for production, notwithstanding the crashes. The Acceptance protocol was signed by VVS C-in-C Air Marshal Pavel S. Kutakhov, PVO C-in-C P. F. Batitskiy, Minister of Aircraft Industry Pyotr V. Dement'yev, Minister of Electronics Industry Valeriy D. Kalmykov, Minister of Defence Industry Sergey A. Zverev and Minister of Machinery Production Vyacheslav V. Bakhirev and approved by VVS Deputy C-in-C (Armament) A. N. Ponomaryov. OKB-155 Deputy General Designer Rostislav A. Belyakov signed the Act on behalf of Mikoyan. The protocol read:

'The S-155 missile interceptor system generally meets the requirements of the CPSU Central Committee and the Council of

Ministers of the USSR. As compared with other interceptor systems in service with the PVO it has better command and control capabilities at high and medium altitude, better ECM resistance, longer radar detection range and missile 'kill' range and more modern avionics enabling it to operate in adverse weather.'

In 1971 the interceptor entered production as the MiG-25P. As compared to the prototypes, the production version incorporated quite a few changes aimed at improving aerodynamic efficiency, such as the enlarged and recontoured fins and rudders, the smaller and likewise recontoured ventral fins, differentially movable tailplanes and 2° wing incidence. The rudders had special dampers added to the hinges. The triangular wing endplates were definitively deleted. Moreover, the airframe structure was reinforced and the service durability of the integral fuel tanks (that is, their resistance to cracking during normal heating/cooling cycles) was increased to an acceptable level; also, a technique was developed for repairing (welding) hairline cracks in the fuel tanks in service conditions.

The landing gear was modified after a case of intercrystalline corrosion on Ye-155P-3 that caused a main gear strut to fail

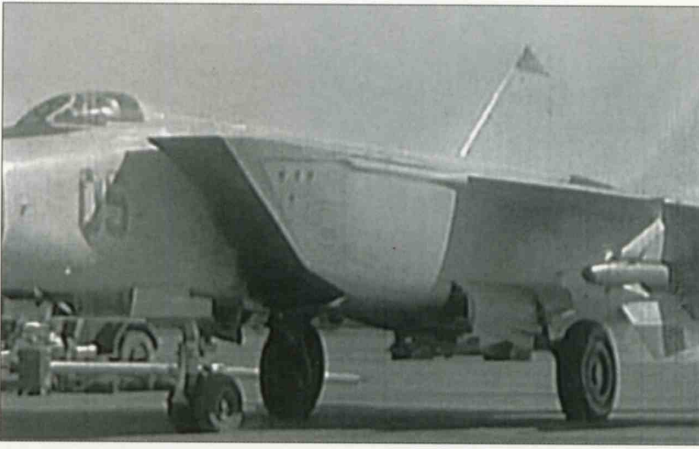

Above, left and right: Showing signs of wear and tear, the Ye-155P-5 taxis with K-40T heat-seeking missiles on the pylons during the State acceptance trials. The port air intake carries four 'kill' stars denoting successful test launches. Note that the large ventral fins have been replaced by the definitive tapered version.

when the aircraft was refuelled and left overnight. Also, the nose gear unit had larger wheels and the nosewheel well doors were slightly bulged to accommodate them. The engines' electric starters were replaced by S3 jet fuel starters (small gas turbines with an output of 150 shp) and the automatic electric engine controls were refined.

The reliability of many avionics and electronic equipment items, including the radio altimeter and the SHORAN/approach system, was improved. The radar set had an increased output and was less sensitive to jamming and clutter (at low level). A wave guide link was established between the radar and the missiles' SARH seeker heads to keep them 'in tune' with the radar until launched. The SAU-155 automatic flight control system was also refined.

The modifications increased the MiG-25's top speed to 1,300 km/h (812.5 mph) IAS. Several issues concerning intercept tactics, flight safety and test data processing were resolved and steps were taken to improve serviceability and ease of maintenance.

Generally the aircraft met the Government's main requirements as to the types of targets, service ceiling (in sustained level flight) and dynamic ceiling (in a zoom climb), maximum speed, intercept range, 'kill' probability, G limits, radar and missile launch range, the target's altitude above the interceptor's own flight level, scramble time and so on. It also partly met the rough-field requirement (the MiG-25 could use dirt strips in the summer but not in the spring and autumn seasons when the surface was soft – with a full fuel and ordnance load, the runway loading on the main gear units was too high). The required mean time between failures (MTBF) and mission preparation time were not reached yet.

Air Force test pilots Vadim I. Petrov, Norair Kazaryan, Grigoriy A. Gorovoy, Aleksandr V. Kuznetsov, Nikolay I. Stogov, Stepan A. Mikoyan and OKB test pilots Aleksandr V. Fedotov and Boris A. Orlov signed the pilot assessment section of the protocol. This section said, among other things:

'The aircraft has markedly superior performance as compared to existing interceptors.

The powerful engines enable it to reach high speeds and altitudes quickly. The aircraft is equipped with an up-to-date navigation suite and automatic flight control system which enhance its capabilities as compared to existing interceptors.'

The Acceptance protocol contained the following conclusions based on test results:

1. [...]

2. *The aircraft is capable of following a preset route and making an automatic landing approach down to 50 m (164 ft).*

3. *Piloting techniques at subsonic speeds are quite similar to existing interceptors, except for high stick forces in the pitch channel. Take-off and landing is easy.*

4. *The aircraft can be mastered by pilots with flying experience on contemporary interceptors after taking a transition course to become acquainted with the avionics.'*

An incident that occurred in late 1970 proved the MiG-25's superiority to contemporary Soviet interceptors. A group of high-ranking VVS officers arrived at an airbase to take proficiency training. The final flights were to



Left: The Ye-155R-3 (left) shares a hardstand with the Ye-155P-2 loaded with two dummy missiles.

Below: A scene from the 9th July 1967 airshow at Moscow-Domodedovo as the Ye-155R-3 flown by Vadim Petrov heads a V formation with the Ye-155P-1 (flown by Igor Lesnikov) on the port wing and the Ye-155P-2 (flown by Grigoriy Gorovoy) on the starboard wing. The Ye-155P-5 flown by G. Vakhmistrov is hot on their heels.





The test pilots who participated in the MiG-25's State acceptance trials. Upper row, left to right: Lt. Col. Igor I. Lesnikov, Lt. Col. Vadim I. Petrov, Lt. Col. Grigoriy A. Gorovoy, Gen. Stepan A. Mikoyan. Lower row: Capt. Nikolay I. Stogov, Maj. Aleksandr V. Kuznetsov, Lt. Col. Norair V. Kazaryan and Oleg V. Goodkov.

be at night and in IFR conditions. Four MiG-25Ps and three Su-15s took off. Immediately afterwards the weather deteriorated sharply; as a result, only the MiG pilots were able to find the runway and land successfully. All three Su-15s lost their way and crashed, killing the pilots.

The acceptance protocols for the reconnaissance and interceptor versions were the culmination of many years' hard work by the Mikoyan design bureau, the factories and test personnel, especially the pilots. Project engineers S. G. Polyakov, V. V. Novikov, Arkadiy B. Slobodskoy, O. T. Ryazanov, M. M. Proshin, A. Ya. Ishchenko, I. A. Solodov, V. P. Syrovoy and A. Ya. Shcheblykin were highly commended in the protocols.

Upon completion of the tests some of the development aircraft were transferred to service units so that the new MiG could become operational quicker.

Record breakers

The Ye-155 prototypes claimed an impressive series of world records that bore testimony to the aircraft's enormous potential and the high class of Soviet test pilots. They took the aircraft beyond the limits originally set for it, and these record-breaking flights yielded invaluable

information for the designers as to what their brainchild was actually capable of (short of killing the pilot). The Ye-155's records generated unique data on the aircraft's stability and handling, engine operation in supersonic flight at low IAS, airframe heat resistance during prolonged flight at Mach 2.75-2.83, the functioning of life support systems at altitudes in excess of 35,000 m (114,830 ft) – that is, 10,000-12,000 m (32,800-39,370 ft) higher than the design ceiling, and so on.

The aircraft's unique performance, the availability of highly skilled pilots (notably

Aleksandr V. Fedotov) and engineers and the LI's trajectory tracking capabilities all contributed to the impressive number of records (29 in all) set by the future MiG-25. The records were set by development aircraft with minimum modifications, such as the addition of an oxygen bottle for high-altitude flights.

Most flights were preceded by a lot of calculations (the choice of an optimum trajectory, heat dissipation figures and so on) using computers. Engineer Yu. S. Vygodskiy made a major contribution to selecting the correct trajectories.

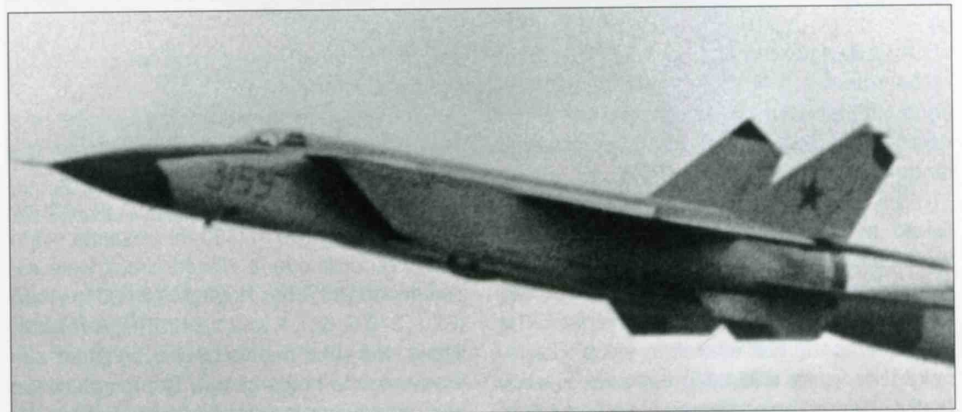

Another shot of the Ye-155R-3 as it flies at Moscow-Domodedovo on 9th July 1967.

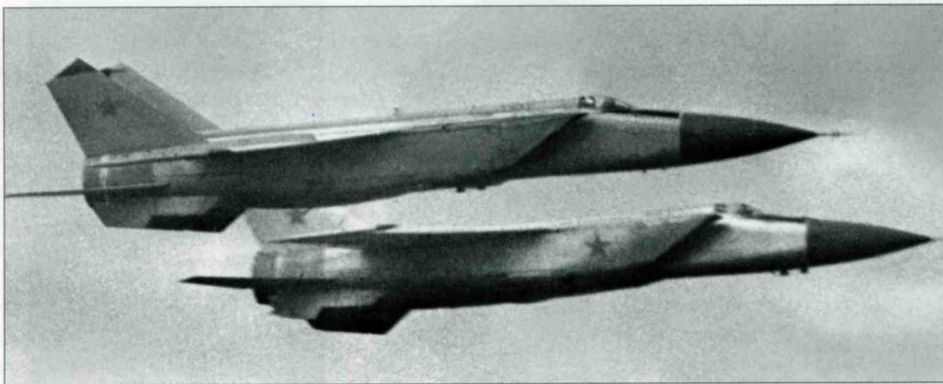
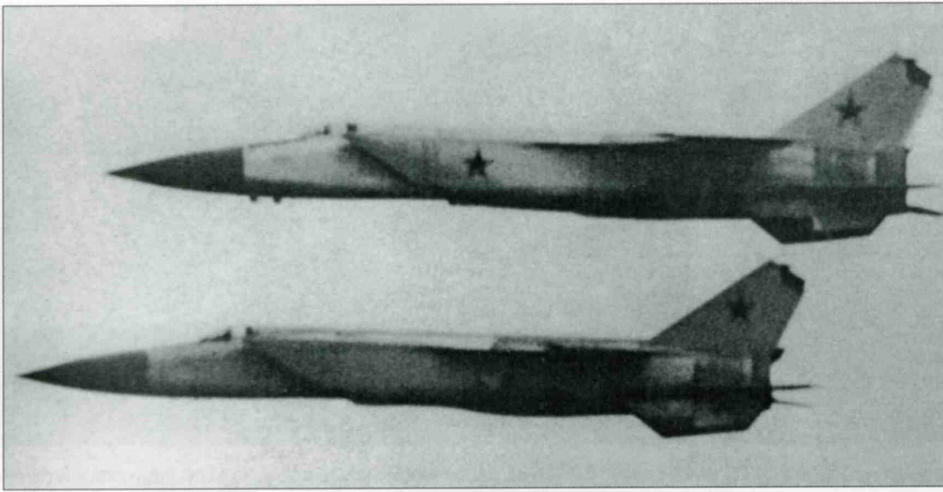

Top and above: The Ye-155P-1 (with stars on the air intake trunks) and Ye-155P-2 shot from different angles at Domodedovo. Both aircraft have had the missile pylons removed for the occasion.

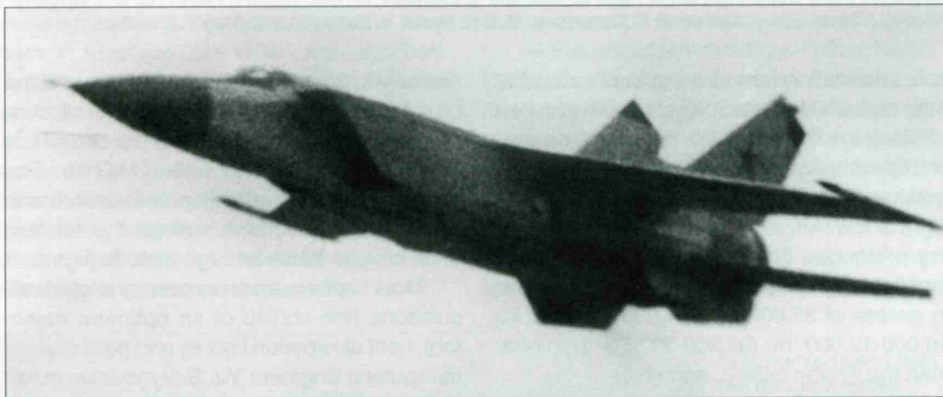

Another view of the Ye-155P-2 at Domodedovo. Only examples with the original tail unit design took part in the flypast; MiG-25s with the definitive large tails were apparently considered too 'sensitive'.

According to the International Federation of Aeronautics (FAI – *Fédération d'Aéronautique Internationale*) classification the Ye-155 belonged to Class C1 (III), that is, jet-powered landplanes with unlimited MTOW.

The seven all-time world records established by different versions of the MiG-25 were particularly impressive. These included altitude, speed and time-to-height for altitudes of 20,000 m (65,620 ft) and higher. The Ye-155 was the first aircraft to set a time-to-height record for a 35,000-m altitude. The aircraft's remarkable speed and altitude envelope, excellent stability and handling,

and high thrust/weight ratio were all contributing factors.

The absolute speed records were set on a 3-km (1.863-mile) stage at low level (not more than 100 m/330 ft) or on a 15... 25-km (9.31... 15.52-mile) stage with a variance in altitude not exceeding 100 m (330 ft). Absolute world speed records over a closed circuit were set on circuits 100; 500; 1,000 and 2,000 km long (62.1; 310.5; 621.1; and 1,242.2 miles respectively), the pilot maintaining a constant altitude over the entire circuit. The length of the triangular circuit was measured by adding up the lengths of the three sides; hence in reality

the distance covered by the aircraft was slightly longer, demanding a higher speed.

The closed-circuit flights entailed high G loads and sharp bank angles, the aircraft and pilot being subjected to these flight modes for considerable periods. On the 100-km circuit, for instance, flight at 75° bank with the aircraft pulling 4 Gs totalled about 2.5 minutes. Total time on the 500-km circuit was about 10 minutes and twice as much on the 2,000-km circuit. During this time the aircraft experienced peak thermal loads.

One year after the Ye-155's first flight, the FAI received official documents from the USSR claiming that on 16th March 1965, pilot Aleksandr V. Fedotov had set world speed records with payloads of 1 and 2 tons (2,205 and 4,410 lb). The aircraft in question was stated as a 'Ye-266 powered by two R-266 turbojets'. These spurious designations, however, left no doubts as to the origin of the aircraft and its powerplant – the engines' stated thrust (10,000 kgp/22,045 lbst) was the giveaway. Western experts knew that in 1962 the FAI had registered a number of world records set by the 'Ye-166' (which was actually the specially modified Ye-152M experimental heavy interceptor) powered by an 'R-166' turbojet with an identical rating.

Thus, it was clear that the aircraft was designed by Mikoyan and the engines by Tumanskiy. And the subject of the claim – an average speed of 2,319.12 km/h (1,440.44 mph) over a 1,000-km circuit – was but a taste of things to come.

Whatever doubts the West may have had about the MiG-25's capabilities were dispelled when the type made its first public appearance at the 1967 Domodedovo flypast. No photographs or other information had been published before. The aircraft's looks showed clearly that the new MiG was a potent piece of hardware. After that, the aircraft was allocated the NATO reporting name *Foxbat*.

The performance displayed by the development aircraft during the trials made it possible to set a new series of world records. Three months after the sensational flypast, Mikoyan test pilot Mikhail M. Komarov averaged 2,982.5 km/h (1,852.48 mph) over a 500-km closed circuit. The same day, Aleksandr V. Fedotov took a 1,000-kg (2,204-lb) payload to an altitude of 29,977 m (98,349.7 ft). These impressive records gave the West a clearer idea of the new MiG's performance.

The prototypes' test flights continued for some considerable time even after the MiG-25 became operational with the Soviet Air Force. A new spate of speed, altitude and time-to-height records followed in 1973. On 8th April Fedotov attained an average speed of 2,605.1 km/h (1,618 mph) on a 100-km closed circuit. The difficulty of sustaining a high speed on a short course accounted for

the lower result than on the 1,000-km course.

On 4th June 1973, Boris A. Orlov climbed to 20,000 m (65,620 ft) in 2 min 49.8 sec. That same day Pyotr M. Ostapenko reached 25,000 m (82,020 ft) in 3 min 12.6 sec and 30,000 m (98,425 ft) in 4 min 3.86 sec in the same aircraft – a Ye-155P prototype suitably lightened by removing non-essential items.

Moreover, the same aircraft was used to set new altitude records. Reaching the aircraft's dynamic ceiling in a zoom climb demanded considerable courage and skill from the pilots. On 25th July 1973 Fedotov made two sorties, achieving remarkable results. With a 1,000-kg payload he reached 35,230 m (115,584 ft), bettering his own result of 1967 by 5,253 m (17,234 ft); in the other flight he attained 36,240 m (118,897.6 ft) with no payload – an absolute world record. The aircraft moved by inertia over a substantial part of the trajectory after the engines flamed out in the thin air of the stratosphere. At the apogee the IAS dropped to a mere 75 km/h (46.5 mph), which was five times lower than the minimum set in the flight manual. The mission was complicated by very limited allowable elevator inputs, the need to follow the prescribed trajectory very closely, and extremely high AoAs and vertical speeds (the latter reached 300-400 m/sec, or 59,040-78,720 ft/min).

Until recently, the identity of the aircraft used to set the records was classified. Now we know that the aircraft in question were the Ye-155R-1, Ye-155R-3 and Ye-155P-1 stripped of some equipment items to cut weight. The Ye-155R-3 survived and is now on display in the Central Russian Air Force Museum in Monino near Moscow, fitted with production-standard tails and nose and painted as '25 Red'. Visitors who are familiar with the MiG-25 will immediately notice a curious discrepancy: the aircraft has both the 'camera nose' characteristic of the reconnaissance version and the missile pylons of the interceptor! The pylons were added erroneously after the aircraft was put on display.

Ye-155P weapons testbed

The Ye-155P-10 interceptor was modified in 1973 to serve as a testbed for the K-33 semi-active radar homing long-range AAM – the prototype form of the R-33 (NATO code name AA-9 Amos) created by GMKB Vympel for the MiG-31 *Foxhound* heavy interceptor. This large missile required AKU-410-1 pyrotechnically actuated pantographic ejector racks (*aviatsionnaya katapool'tnaya oostanovka* – aircraft-mounted ejector rack) propelling the weapon a safe distance away before the rocket motor was ignited. It was these ejector racks and launch technique that were tested on the Ye-155P-10.

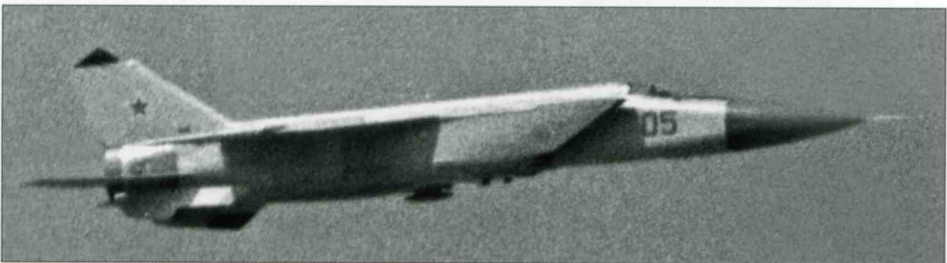
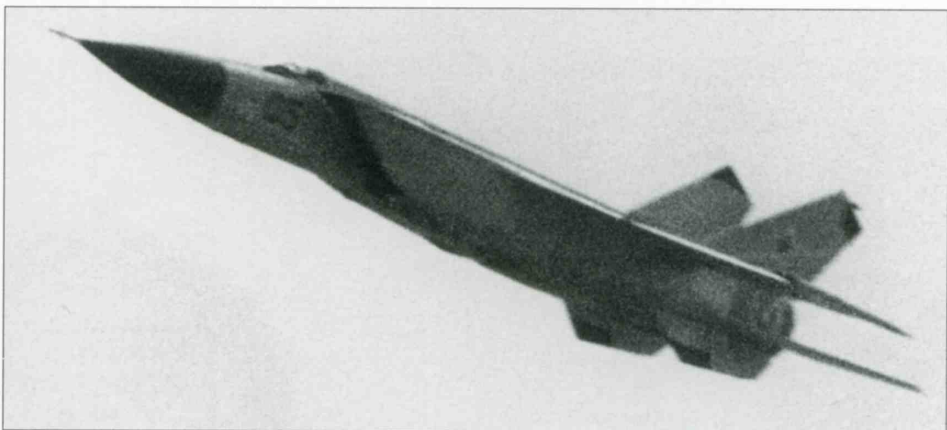
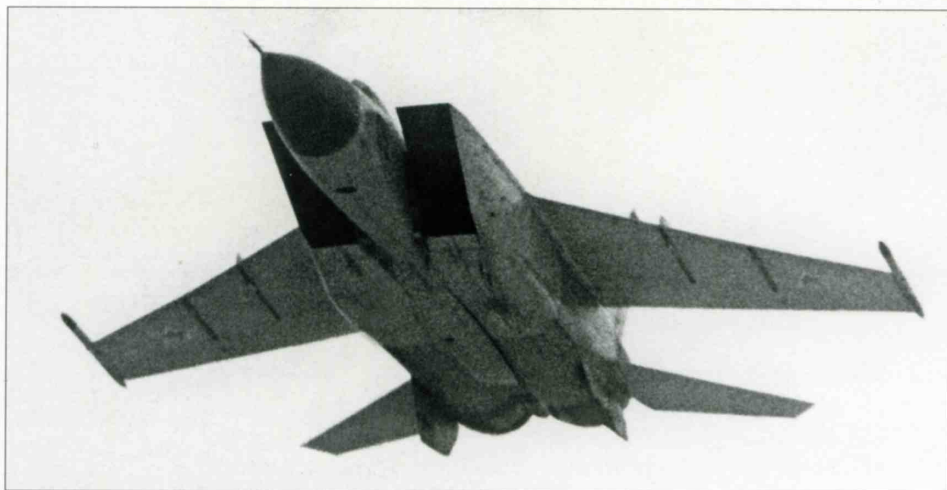

This series of pictures shows the Ye-155P-5 during the 9th July 1967 Domodedovo flypast. The aircraft still lacks the endplate fins. Note the ventral camera pod – presumably for recording missile launches.

Early-production MiG-25P interceptor (*izdeliye 84*)

The pre-production batch intended for State acceptance trials was followed by a low-rate initial production (LRIP) batch. These were the first aircraft to bear the official service des-

ignation MiG-25P; the in-house product code at the plant was *izdeliye 84*. The LRIP MiG-25Ps were almost identical to the development interceptors – that is, they had the old small vertical tails and sported endplate fins at the wingtips.



Left: '06 Blue', the Ye-155P-6 development aircraft, was the first MiG-25 to feature the production-standard large vertical tails.

Below left: Front view of MiG-25P '501 Blue', the first interceptor of the full-scale production run.

Below and centre left: These views of '501 Blue' sharing a hardstand with several Su-15s shows well the new shape of the vertical tails with larger dielectric portions.

Centre right: The MiG-25P's inboard and outboard missile pylons have a different shape.

Bottom left and right: MiG-25P '502 Blue' was the first to have redesigned nose gear doors, one section of which doubles as a mudguard.



The SR-71 strategic reconnaissance aircraft with remarkable speed and altitude performance was then completing flight tests. The MiG-25P was the only real means of countering the Blackbird threat; therefore, the PVO top command wanted major industrial centres and important military bases, especially in the eastern and northern regions of the USSR, to be protected by MiG-25Ps.

In April 1969 the PVO's 148th TsBP i PLS (*Tsentr boyevoy podgotovki i pere- oochivaniya lyotnovo sostava* – Combat & Conversion Training Centre) at Savasleyka AB near Gor'kiy took delivery of the first production MiG-25Ps in order to train pilots and ground crews and refine combat tactics. So did, concurrently, one of the first-line PVO fighter regiments based in Pravdinsk near Gor'kiy. This initial delivery was effectively for evaluation purposes. The convenient location of the interceptor unit allowed spares to be delivered quickly; factory specialists could be summoned fast if need arose, and crew training could be organised at the factory airfield (Gor'kiy-Sormovo).

The servicing manuals were still far from perfect at the time, some structural details and equipment items needed redesigning, and the tech staff grew increasingly vocal in their complaints. The pilots were more tolerant, though they, too, had their share of trouble mastering the aircraft.

This was a singularly important point in the aircraft's career as the service tests began and the MiG-25P achieved IOC. The evaluation included live weapons training with missile launches being made at the GNIKI VVS test range. For the first time R-40 missiles were fired successfully in head-on and pursuit modes at targets flying at 20,000 m and speeds of up to 2,700 km/h (1,677 mph). This proved that the MiG-25P was actually capable of intercepting and destroying the SR-71. In general, the service tests went well and the 'bugs' that came up were quickly ironed out.

The MiG-25P's NATO reporting name was *Foxbat-A*.

Late-production MiG-25P interceptor (izdeliye 84)

In 1971 the MiG-25P entered full-scale production at the Gor'kiy aircraft factory. The basic production version differed from LRIP aircraft in having the enlarged and recon-toured fins, the smaller ventral fins and wings with 5° anhedral and no endplates. The nose gear had bigger wheels and redesigned doors, one of which acted as a debris guard.

The weapons control system was built around the Smerch-A1 radar (aka RP-25 or *izdeliye 720*) and the K-10T sight. The radar could scan the airspace and track aerial targets either autonomously or using ground inputs relayed via the Vozdukh-1 GCI system.



An air-to-air of MiG-25P '501 Blue' shows the silhouette of the production-standard interceptor.

After that, target lock-on, aircraft guidance towards the launch point and data feed to the missiles' warheads occurred automatically.

The weapons load consisted of four R-40 AAMs (aka *izdeliye 46*; NATO AA-6 *Acrid*) – two R-40R (*izdeliye 46R*) missiles with SARH seeker heads and two R-40T (*izdeliye 46T*) IR-homing missiles. The missiles were carried on underwing pylons, one of each type per side.

The MiG-25P was fitted with the *Lazoor'* (Prussian Blue) command link system and the Polyot-11 flight control system which automated flying a great deal. The command link system was linked with the weapons control system, enabling the aircraft to be directed to the target area automatically or semi-automatically. The flight control system provided automatic climb and acceleration to a preset speed and autostabilisation in all three channels, maintained a constant speed and altitude, and limited G loads and alpha.

Apart from the radar and sight, the basic avionics suite included an IFF set (an SRO-2M transmitter and an SRZM-2 receiver) mounted on the starboard fin, a Sirena-3 RWR with antennas located at the top of the starboard fin and in the anti-flutter weight fairings at the wingtips. The aircraft was also fitted with an RV-UM (RV-4) low-range radio altimeter, an ARK-10 ADF, an MRP-56P marker beacon receiver, an SP-50 ILS, an RSBN-6S SHORAN set, R-832M and Prizma radios and the SAU-155P1 automatic control system.

Apart from the forward fuselage design (the MiG-25P had a large ogival dielectric nosecone instead of the MiG-25R's conical metal nose with camera ports and dielectric inserts), the interceptor differed in having marginally greater wing span and a wing leading edge kinked in line with the boundary layer fences, with greater sweep on the inboard portions. Early-production aircraft had a KM-1 ejection seat developed in-house (KM = [*katapool'tnoye*] *kreslo Mikoyana* – 'Mikoyan [ejection] seat'); this model permitted safe ejection at up to 1,300 km/h (807 mph). Later this was replaced by a KM-1M seat with an expanded operational envelope. Unlike the reconnaissance version, the interceptor had no provisions for a drop tank.

The aircraft's structural strength and thrust/weight ratio enabled it to reach high indicated airspeeds. The main limiting factor was inadequate aileron authority. Igor' I. Lesnikov's fatal crash in the Ye-155R-1 proved it, since he had exceeded the IAS limit by a considerable margin while trying to set a world record. Yet, as the Acceptance protocol pointed out, an increase in IAS could make the interceptor a more effective weapon.

A way of improving roll control at high IAS had been successfully tried on the MiG-23 in the late 1960s. It involved using differentially movable stabilators (tailerons) and an additional control servo. Differential stabilator deflection was the main means of roll control at high speeds.

As mentioned earlier, this feature was also introduced on the pre-production MiG-25s. The first results were encouraging – the modified aircraft showed good roll control characteristics at up to 1,300 km/h (that is, 200 km/h (124 mph) better than with the original tailplanes). Production MiG-25s also had differentially movable stabilators. But then, a series of fatal accidents followed at indicated airspeeds around 1,000 km/h (621 mph), puzzling the designers and the Air Force mightily.

148th TsBP i PLS pilot Maystrenko was the first to lose his life in these circumstances, crashing at Kubinka airbase on 30th June 1969 while training for a flying display. The aircraft rolled inverted and dived into the ground during a low-level pass over the airfield. The Mikoyan OKB immediately started searching for the cause of the crash, but inspection of the wreckage showed no mechanical failures. Various theories were tried, from wind shear to pilot error. Soon, however, reports of brief roll control failures started coming in from MiG-25 units. On 31st (some sources say 30th) May 1973 the experienced Air Force test pilot Aleksandr V. Kuznetsov was killed in similar circumstances while flying a sortie from Akhtobinsk in MiG-25P f/n 0808 (the first example with differentially controllable stabilators). Pilot Kolesnikov had a near-accident as well.

To find the reason a special flight test programme was initiated by LII and performed by

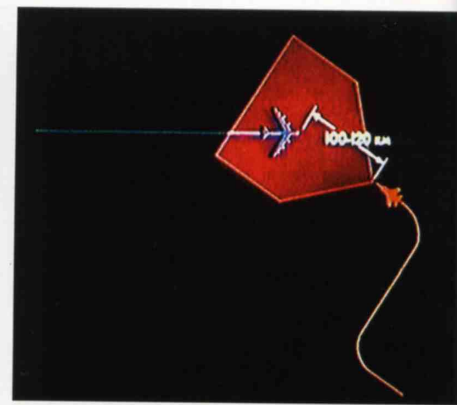
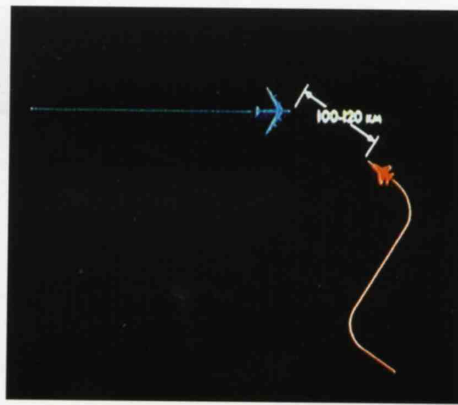
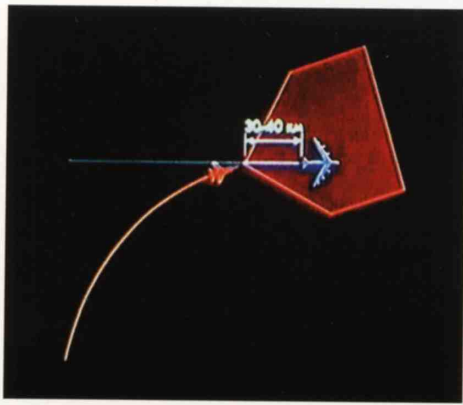

Above: These schematic drawings show the MiG-25P's intercept range when attacking a bomber-type target in pursuit and head-on modes

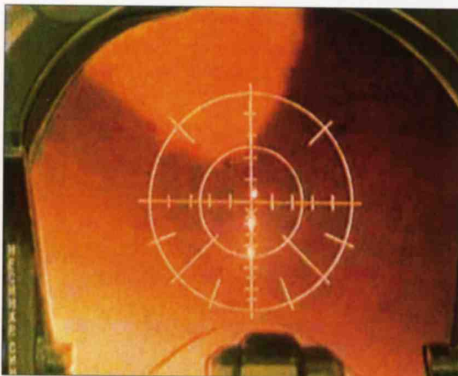
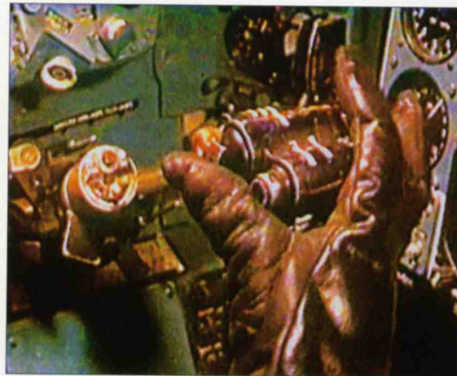
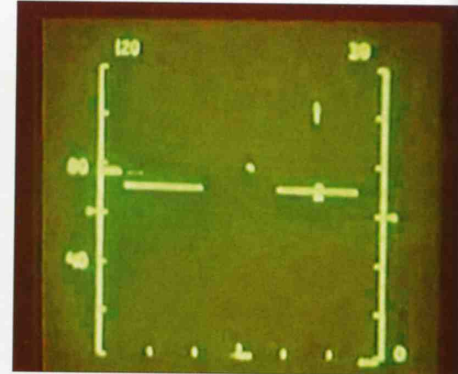

These pictures show live weapons test episodes from the MiG-25P's State acceptance trials.

Top row, left to right: A grim-faced test pilot looks at the radar screen. The Mach meter shows a true airspeed of Mach 2.9 – the interceptor is going flat out as it closes in on its prey. The radar screen features range and altitude bars; the target is depicted in the centre as a 'blip'.

Centre row: The pilot looks up from the instruments, trying to make visual contact with the target. The missile launch button is pushed and an R-40 missile leaves the MiG-25P's starboard outer pylon.

Bottom row: The target is seen by the gun camera as it leaves contrails across the sky. Next, a missile streaks away from the interceptor.



Above: A number of small-tailed initial production MiG-25Ps with wing endplates found their way into VVS service. Here such aircraft are seen at rest (left) and on final approach. The tactical code is almost illegible but appears to be '83' or '89'.

Oleg V. Goodkov, one of the institute's most experienced test pilots. A MiG-25 was fitted out with test instrumentation and telemetry equipment, and special safety precautions (altitude limits) were taken.

However, the precautions proved insufficient. On the fateful day of 4th October 1973 Goodkov managed to detect the flight mode leading to loss of control but it was too late to eject. During a high-speed run at 500 m (1,640 ft) the aircraft started rolling uncontrollably and crashed into a textile factory warehouse in Ramenskoye not far from the ILL airfield in Zhukovskiy, killing the pilot. It was the purest luck that no one was killed on the ground, except a police dog sitting in the sidecar of a police motorcycle when the policeman stopped on hearing the thunder of the diving jet.

This time the cause of the crash was established with certainty. It turned out that the stabilator actuators were not powerful enough to counteract the torque when stabilator deflection exceeded a certain angle at high speed, since the tailplane axes were located well aft, leading to overcompensation. To correct this, the hinges were moved forward by 140 mm (55 in), extending the actuator arm. Within six months all MiG-25Ps in service with PVO units had been appropriately modified.

Speaking of units, soon after the regiment in Gor'kiy the MiG-25P was issued to PVO units stationed near Moscow, Kiev, Perm', Baku, Rostov and in the High North and Soviet Far East. Overhaul shops were set up at Nasosnaya AB near Baku and at the existing military aircraft overhaul plant in Dnepropetrovsk.

Generally the type's service introduction went smoothly, though, of course, there were incidents – sometimes unique ones. On one occasion a young pilot stationed in Kotlas took off to intercept a target drone. While manoeuvring to get a target lock-on, he rolled the aircraft more than 90° and the radar got a lock-on on the ground (!). Instead of climbing, the aircraft entered a steep dive in full afterburner, going automatically after the 'target' and exceeding the speed limit in doing so. Realising he was in deep trouble, the pilot ini-



Top and above: This very early MiG-25P coded '83 Blue' was an instructional airframe at the (now closed) Junior Technical Specialists' School in Sointsevo just outside Moscow.



A brand-new MiG-25P makes a pre-delivery test flight in Gor'kiy. Though still unpainted and devoid of insignia, it carries dummy AAMs (to use a Russian jocular expression, it is 'trouserless but wearing a hat').



'07 Blue', an operational Soviet Air Force MiG-25P, toting a typical ordnance load – two IR-homing R-40Ts inboard and two semi-active radar homing R-40Rs outboard.

tiated a recovery but pulled the stick back too hard. At 1,600 km/h (993 mph) IAS, the aircraft was subjected to 11 or 12 Gs when pulling out of the dive, causing *g-loc* (G-induced loss of consciousness). After regaining consciousness, the pilot immediately saw the real target on the radar screen, destroyed it with a missile and landed safely. The airframe was bent quite badly, being stressed for 5 Gs as it was, but remained in one piece thanks to the double structural strength reserve.

In Rostov-on-Don, a pilot displayed extraordinary courage, managing to land safely in adverse weather when nearly all flight instruments died because of a short circuit in a defective distribution bus. This would have been impossible if the chief project engineer had not foreseen this and insisted on installing back-up instruments (airspeed indicator, altimeter and sideslip indicator) not using electric power.

Over the years, the designers and engineers of the Mikoyan OKB, the Gor'kiy factory and the VVS did a colossal job, extending the MiG-25's time between overhauls (TBO) from an initial 50 hrs (!) to 800, 900 and eventually 1,000 hrs. Engine TBO increased from just 25 hrs to 750 hrs. As the pilots and ground crews

grew more qualified and familiar with the aircraft, the number of complaints about defects and failures dropped markedly. In due course the interceptor earned a reputation as a simple and reliable aircraft.

The MiG-25P remained in production at the Gor'kiy aircraft factory until 1982, by which time just over 460 had been manufactured. On 13th April 1972 the Council of Ministers issued a directive officially clearing the MiG-25P for service. By the mid-1970s the type made up the backbone of the Soviet Air Defence Force's interceptor inventory. After converting to the MiG-25P, PVO units stationed near the Soviet borders successfully intercepted SR-71As prowling along the borders, the weapons control system indicating 'Ready for launch'. This input is only given if the SARH seeker head of a missile on the wing gets a lock-on and if speed, altitude, G load, triangulation errors and target range are OK. In a nutshell, the Blackbirds *could* have been shot down (despite the US Air Force's allegations to the contrary), and the only reason that they weren't is that the actual order to fire had not been given. Anyway, the SR-71s and Lockheed U-2s stayed clear of the areas where MiG-25Ps were based; in contrast, these types continued their reconnaissance

missions over other parts of the USSR and its allies, such as Cuba and North Korea, for quite some time.

As the aircraft entered service the designers set to work refining it. A new Vozdukh-1M ground-based GCI system entered service, replacing the Vozdukh-1 and expanding the interceptor's tactical capabilities. In the mid-1970s the MiG-25P received an upgraded Smerch-A2 radar (aka *izdeliye* 720M) offering higher reliability, as well as upgraded command link and automatic flight control systems and improved communications equipment. Later this radar was supplanted by the Smerch-A3 featuring a spatial selection mode that gave the interceptor 'look-down/shoot-down' capability; yet this method was deemed insufficiently effective and the Smerch-A3 gave place to a different radar, the S-25. A further refined version, the Smerch-A4, was under development; by then, however, fire control radars had to be capable of picking out targets among ground clutter, which a monopulse low-PRF radar was incapable of doing.

The table at the foot of the page provides a performance comparison of Soviet and US interceptors.

MiG-25P avionics testbed with Parol'-2 IFF

A production MiG-25P coded '76' served as a testbed for the new *Parol'-2* (Password) IFF system comprising the *izdeliye* 632-1 interrogator and *izdeliye* 620-20P transponder. The presence of the new equipment was revealed by the distinctive triangular blade aerials replacing the equally characteristic triple rod aerials of unequal length that had given rise to the NATO code name Odd Rods.

MiG-25PA (Ye-155PA) interceptor (project)

In the mid-1960s the Mikoyan OKB was working on a projected interceptor version known as the Ye-155PA. The aircraft was to be capable of engaging targets flying at up to 3,500-4,000 km/h (2,173-2,484 mph) within an altitude range of 100-30,000 m (330-98,425 ft). Provisions were made for semi-autonomous operation – that is, without relying entirely on GCI centres for locating the target. To this end the Ye-155PA was to feature a new Smerch-100 weapons control system (WCS), which subsequently evolved into the *Zaslou* (Barrier) WCS fitted to the MiG-31 *Foxhound* interceptor and be armed with new R-100 AAMs. The aircraft was to be powered by modified R15BV-300 engines giving it a top speed of Mach 3.5 (the V suffix stood for *vysoznyy* – high-altitude). However, when the project was in the midst of development the Air Force handed down new operational requirements for interceptors (in particular,

Performance comparison of Soviet and US interceptors

	MiG-25P	MiG-23M	Su-15TM	McDD* F-15A	GD** F-16A
Thrust/weight ratio	0.66	0.85	0.7	1.15	1.4
Maximum speed, km/h (mph):					
at sea level	1,200 (745)	1,350 (838)	1,300 (807)	1,470 (913)	1,490 (925)
at 11,000 m (36,090 ft)	3,000 (1,863)	2,500 (1,552)	2,230 (1,385)	2,650 (1,646)	2,100 (1,304)
Maximum Mach number	2.83	2.35	2.1	2.5	2.0
Service ceiling, m (ft)	20,500 (67,260)	17,800 (58,400)	18,000 (59,055)	19,200 (62,990)	18,000 (59,055)
Minimum control speed, km/h (mph)	400 (248)	400/450 (248/279)	450 (279)	350 (217)	350 (217)

* McDonnell Douglas has now been taken over by Boeing

** General Dynamics is now part of Lockheed Martin

these concerned the maximum speed) and the Ye-155PA was abandoned.

Ye-155P superfast interceptor with Vikhr' WCS

A projected derivative of the Ye-155P interceptor (no separate designation has been quoted) was to have a maximum speed increased to 3,700 km/h (2,298 mph). The aircraft had a new WCS based on the Vikhr' (Whirlwind) fire control radar with a target detection range of 120-150 km (74.5-93 miles); the armament consisted of four K-44 medium-range AAMs with a maximum launch range of 45 km (28 miles).

LL-1104 avionics testbed

In 1977 a standard production MiG-25P (f/n 1104) was converted into an avionics testbed designated LL-1104. The LL prefix denoted *letayuschchaya laboratoriya* – literally 'flying laboratory'; this Russian term is used indiscriminately for any kind of testbed, research or survey aircraft. The LL-1104 served for verifying the SAU-155PD automatic flight control system, the updated GCI guidance system and other avionics intended for the upgraded MiG-25PD interceptor (see next entry).

MiG-25PD interceptor (*izdeliye 84D*)

After Lt. V. I. Belenko's notorious defection to Japan in September 1976 (see Chapter 4) the Soviet PVO found itself in a predicament. The specially appointed government commission did some homework and reported that the Americans had studied the MiG-25P in detail. It was clear that, unless the design and avionics were drastically and urgently upgraded, the type's combat efficiency would be negated. As a remedy, it was decided to develop a new WCS for new-build MiG-25s and retrofit it to existing ones.

In a joint effort with the Ministry of Aircraft Industry and military experts, the Mikoyan OKB developed a comprehensive upgrade programme in a remarkably short time. The Smerch-A radar gave place to a Sapfeer-25 (Sapphire) quasi-continuous emission radar which was to be a derivative of the MiG-23's recently debugged Sapfeer-23. An infrared search & track (IRST) system coupled with the radar would be added to make the weapons system less susceptible to enemy ECM and enable the aircraft to make 'sneak attacks' without switching on the radar. An all-new ground-based GCI system including a more modern jam-proof aircraft-mounted receiver was to replace the Vozdukh-1M. Likewise, a new IFF set was to be fitted.

The aircraft was to carry upgraded missiles having almost twice the 'kill' range thanks to more effective seeker heads (both SARH and IR) and higher-capacity storage batteries. New weapons loads were sug-



This MiG-25P coded '76' was a testbed for the Parol'-2 IFF system, as revealed by the small 'bump' below the radome.

gested; for example, two of the R-40 missiles could be replaced by a quartet of R-60 or R-60M (NATO AA-8 *Aphid*) short-range IR-homing AAMs. Unlike its predecessor, the Sapfeer-25 radar operated on three-phase AC power, requiring modifications to the electric system and engine accessory gearboxes in order to install new AC generators.

An appropriate Council of Ministers and CPSU Central Committee joint directive appeared on 4th November 1976. This document tasked the Mikoyan OKB and its partners with creating the MiG-25-40D aerial intercept weapons system based on the MiG-25PD aircraft (D stood for *dorabotannyy* – modified or upgraded). The new model was to enter production as soon as possible, and all existing MiG-25Ps were to be progressively updated to MiG-25PD standard by the Air Force's aircraft repair plants.

The MiG-25-40D weapons system was required to intercept aerial targets within a wider range of speeds and altitudes; target detection and tracking range was to be increased as well. The aircraft was to have 'look-down/shoot-down' and dogfight capability, mission avionics with higher ECM resistance and the aforementioned stealth attack capability in IRST mode.

Before long, the Mikoyan OKB and its 'subcontractors' had come up with appropriate design solutions. Specifications were issued to aircraft factories, electronics plants and other defence industry factories for production of new components.

Work on the new interceptor, designated MiG-25PD or *izdeliye 84D*, progressed very quickly. This was largely thanks to the carefully prepared test programme developed and supervised by project chief Nikolay Z. Matyuk and L. G. Shengelaya.

As predicted, the new WCS was built around a suitably modified Sapfeer-23 (alias S-23 or N-003) radar and designated Sapfeer-25 (S-25, or N-005). The new version developed by Yu. Kirpichnikov's design bureau differed in having a larger antenna dish and was capable of detecting targets with a radar cross-section (RCS) of 16-19 m² (172.0-204.3 sq ft) at more than 100 km (62.1 miles) range.

The new radar was also better at picking out targets among ground clutter. The R-40R and R-40T missiles were also modified to permit integration with the new radar, becoming the R-40RD and R-40TD respectively; once again the D stood for *dorabotannyy*.

As mentioned earlier, some of the MiG-25PD's avionics were put through their paces on the LL-1104 testbed. Next, three production MiG-25Ps were converted as the MiG-25PD prototypes. Appropriately coded '305 Blue', the first prototype (c/n N84042474, f/n ...305) performed its maiden flight on 19th November 1977 with Mikoyan OKB chief test pilot Valeriy Ye. Menitskiy at the controls. The second prototype (c/n N84042608, f/n ...306) and the third aircraft (f/n ...307) were coded '306 Blue' and '307 Blue' respectively; they arrived at Zhukovskiy and entered flight testing in 1978.

The MiG-25PD was equipped with the new BAN-75 target indication and guidance system acting in concert with the ground-based Looch-1 (Ray of light, or Beam) guidance system. The latter aligned the aircraft's radar scanner with the target, making the radar less sensitive to jamming.

Instead of the two R-40TD missiles, the MiG-25PD could carry four R-60 short-range IR-homing AAMs on APU-60-2 twin missile rails on the outboard pylons. Production aircraft were fitted with an *izdeliye 26Sh-1* IRST unit.

Outwardly the MiG-25PD differed from its predecessor in having a modest fuselage stretch ahead of the cockpit to accommodate the new radar set, with recontoured skin panels and relocated maintenance access hatches. The small angular IRST fairing on the underside of the nose (just aft of the radome) was another obvious identification feature. Since the electric system had been revised to cater for the new avionics, the MiG-25PD was powered by R15BD-300 engines (the D again stood for *dorabotannyy*). This version had the same rating as the R15B-300 but featured a modified accessory gearbox to take the new AC generator. Like the MiG-25R (and unlike the MiG-25P), the upgraded interceptor could carry a 5,300-litre (1,166 Imp gal) drop tank.



Above: '305 Blue', one of the MiG-25PD prototypes. The IRST fairing under the nose is clearly visible.



MiG-25PD '305 Blue' seen on final approach to Zhukovskiy. The aircraft has been modified for some test work (note the absence of the IRST).

Stage A of the joint State acceptance trials was completed in 1978. Stage B lasted from September 1978 to February 1979. That year the State commission endorsed the Act of Acceptance, confirming that tests had been successfully completed. The MiG-25PD had a normal take-off weight of 34,920 kg (76,980 lb) and a MTOW of 36,720 kg (80,950 lb). Cruising at Mach 2.35, the aircraft had a range of 1,250 km (776 miles) on internal fuel with four R-40 missiles; in subsonic flight the range was 1,730 km (1,074 miles). The drop tank extended the range to 2,400 km (1,490 miles). With no drop tank the aircraft could climb to

19,000 m (62,336 ft) in 6.6 minutes; the service ceiling was increased to 20,700 m (67,910 ft).

Even as the test programme went ahead, in 1978 the Gor'kiy aircraft factory launched production of the MiG-25PD. In the technical manuals the aircraft's new radar was referred to as the RP-25M and the missiles were called *izdeliye* 46TD and *izdeliye* 46RD. MiG-25PD production continued into 1984, with 104 new-build examples being manufactured (including export aircraft). Some of them indeed were exported (see page 39). After that, in 1984 the Gor'kiy aircraft factory switched to full-scale

production of the MiG-31 interceptor. The NATO codename was *Foxbat-E*.

The MiG-25PD proved to be a singularly reliable aircraft. Only a single machine was lost due to structural failure when the radome disintegrated at high speed, rendering the aircraft uncontrollable. MiG-25PDs were very successful in destroying practice targets, but once a reckless missile launch ended in a tragic 'friendly fire' incident. A pair of MiG-25PDs was intercepting a target drone and the flight leader crossed the path of an R-60 missile fired by his wingman. The missile locked on the new target and destroyed the MiG.

The table on the opposite page gives a performance comparison of some Soviet third-generation interceptors.

MiG-25PD testbed

Upon completion of the trials MiG-25PD '305 Blue' was converted under an unidentified test and development programme. The radar and IRST were removed (in so doing the dielectric radome was replaced by an identically shaped metal nosecone), and small antenna fairings appeared on the fuselage spine and ahead of the port mainwheel well.

MiG-25PDS mid-life update (*izdeliye* 84DS)

Due to the substantial improvement in the combat capabilities of the MiG-25PD over its predecessor, the Mikoyan OKB made the unprecedented decision (in the OKB's history, that is) to upgrade all early production MiG-25Ps to MiG-25PD standard. The mid-life update (MLU) programme began in 1979; the aircraft were progressively returned to the Gor'kiy aircraft factory for conversion when they were due for an overhaul. The MLU included replacing the Smerch-A (Smerch-A2) radar with the Sapfeer-25 (this involved cutting up the nose section and inserting a small plug), installing the IRST module and the new BAN-75 command link equipment, and reengining the fighter with R15BD-300 turbojets. The upgraded aircraft were redesignated MiG-25PDS (for *perekhvatchik, dorabotanny v stroyoo* – field-modified interceptor, or interceptor updated in service) and were almost identical to new-production MiG-25PDs. The only external difference was that the MiG-25PDS retained the old-style short conical brake parachute housing, whereas the new-build MiG-25PD had the later parabolic one. Another difference was the lack of provisions for a drop tank.

Actually the first two conversions were undertaken by an Air Force aircraft repair plant, not by the manufacturer. The MLU programme was completed in 1982, just as MiG-25PD production ended. Thus, the capabilities of the PVO's MiG-25 fleet were not only retained but enhanced.

Basic specifications of the Sapfeer-25 radar.

	Pursuit mode	Head-on mode
Detection range for a target with a 19-m ² (204 sq ft)		
RCS at medium/high altitude, km (miles)	63-80 (39.1-49.6)	105-115 (65.2-71.42)
Target lock-on range, km (miles)	50-60 (31-37.2)	76-80 (47.2-49.6)
Detection range in look-down mode, km (miles):		
RCS = 19 m ²	14-25 (8.7-15.5)	27-30 (16.7-18.6)
RCS = 0.1 m ² (1.07 sq ft)	3-6 (1.86-3.72)	9-11 (5.59-6.83)
Target lock-on range in look-down mode, km (miles):		
RCS = 19 m ²	12-23 (7.45-14.28)	25-27 (15.5-16.7)
RCS = 0.1 m ²	3.5-5 (2.17-3.1)	5-7 (3.1-4.34)
Scan sector:		
azimuth	±56°	±56°
elevation	-42°/+52°	-42°/+52°

MiG-25PD interceptor (export version)

Originally the MiG-25P interceptor was not even considered for export, being, as it were, the most sophisticated Soviet interceptor of the early 1970s. Unlike other Soviet fighters, these aircraft were not even deployed to the Soviet Union's Warsaw Pact allies so as not to tempt them; the Soviet political and military leaders were not always eager to share the latest military technology with their 'brothers in arms'.

Belenko's defection brought about a change in policy – or, at any rate, was a major factor behind this change. Since the cat (or the *Foxbat*) was out of the bag anyway and the potential adversary had had a close look at the situation and earn money by selling the MiG-25 to a few selected foreign customers? All the more so since a new version of the interceptor had entered production.

Hence an export version was developed to meet a request by several Middle Eastern and African nations. It was something of a hybrid between the MiG-25P and the MiG-25PD, combining the long-nosed airframe of the latter with the outdated WCS based on the Smerch-A2 radar; yet, like the MiG-25PD, the export version could carry R-60 AAMs. Appropriate changes were also made to the IFF system. The export version was supplied to Libya, Iraq, Syria and Algeria. In 1984 alone, 38 MiG-25PDs were exported.

The foreign MiG-25PDs are said to have seen action in several local wars and skirmishes. Thus, during the Gulf War (Operation *Desert Storm*) the US military command revealed in the winter of 1991 that a US Air Force McDonnell Douglas F-15C Eagle had shot down two Iraqi Air Force MiG-25Ps with Raytheon AIM-7M Sparrow missiles after the *Foxbats* had behaved very aggressively, trying to attack a USAF Lockheed Martin F-16 Fighting Falcon. However, this was by no means a one-sided game; in September 1992 the New York Times quoted a US Navy intelligence officer as saying that on 17th January 1991, the second day of the war, an Iraqi MiG-25P had shot down a US Navy McDonnell Douglas F/A-18C Hornet. Before that, the Iraqi *Foxbats* had seen action during the Iran-Iraq War of 1980-89. Libyan Arab Republic Air Force MiG-25Ps were active over the Mediterranean, especially when the US Navy's 6th Fleet was exercising close at hand.

MiG-25PDSG development aircraft

Operational experience with the MiG-25P/PD showed that these aircraft might well have to intercept low-level targets (and were quite capable of doing so). Hence ECM and IRCM systems were needed to make the aircraft less vulnerable to enemy fire. To this end, in 1982 a single MiG-25PDS ('94 Red', c/n

Performance of Soviet third-generation interceptors

	Su-15TM	Su-15	MiG-25PD
Maximum thrust/weight ratio	0.82	0.63	0.7
Wing loading, kg/m ² (lb/sq ft)	397 (81.39)	395 (80.98)	490 (100.46)
Maximum indicated airspeed at sea level, km/h (mph)	1,300 (807)	1,100 (683)	1,200 (745)
Maximum true airspeed at 11,000 m (36,090 ft), km/h (mph)	2,230 (1,385)	2,230 (1,385)	3,000 (1,863)
Service ceiling, m (ft)	18,000 (59,055)	17,650 (57,910)	20,500 (67,260)
Patrol altitude, m (ft):			
head-on mode	17,000 (55,770)	15,000 (49,210)	20,000 (65,620)
pursuit mode	16,000 (52,490)	n.a.	n.a.
Climb time to patrol altitude, min	n.a.	n.a.	9.7
Maximum range, km (miles)	1,380 (857)	1,120 (695)	1,320 (820)
Endurance	1 hr 41 min	1 hr 27 min	1 hr 37 min
G limit	6.5	6.0	4.4

N84037011) was fitted experimentally with a *Beryoza-LE* (Birch) radar homing and warning system (RHAWS), a *Gherahn'* (Geranium) active jammer in a ventral pod and KDS-155 IRCM flare dispensers (*kassetnyy derzhahtel' spetsial'nyy* – special cassette-type rack). These provided protection against radar-homing and heat-seeking surface-to-air missiles and AAMs both for the individual aircraft and for other aircraft in a flight.

Designated MiG-25PDSG (the G was a reference to the *Gherahn'* ECM pod), the aircraft was tested successfully in 1983. Yet it remained a one-off because the jammer could not be produced in sufficient quantities. The MiG-25PDSG was relegated to a tech school in Kazan' as an instructional airframe.

MiG-25PDSL development aircraft

A similarly modified aircraft coded '94' was designated MiG-25PDSL, entering flight testing in 1985; the L stood for [*letayuschchaya*] *laboratoriya* – testbed. It differed from the MiG-25PDSG in having an L-006LM *Beryoza-LM* RHAWS and a *Gardeniya-1FU* (*Gardenia*) podded active jammer; the chaff/flare dispensers were the same.

MiG-25PDZ development aircraft

In the late 1980s, Soviet aircraft designers returned to the issue they had been trying intermittently to resolve for the last forty years – providing tactical aircraft with in-flight refuelling (IFR) capability. The first experiments involving MiG-15, MiG-17 and Yak-15 fighters



Two views of '306 Blue', another MiG-25PD prototype. Note the black anti-glare panel ahead of theIRST.



Above: '52 Blue', an operational MiG-25PD armed with two R-40RD medium-range AAMs and four R-60M short-range AAMs on twin adapters.

dated back to the late 1940s and early 1950s. A second series followed in the late 1960s with an IL-28 tactical bomber and a MiG-19 (SM-10) fighter fitted with IFR probes. The advent of the IL-78 *Midas* tanker (a derivative of the IL-76MD *Candid-B* transport), the UPAZ-A standardised podded hose drum unit (HDU) and retractable refuelling probes meant that tactical fighters and interceptors could finally enjoy IFR capability.

Soviet research and development work on IFR systems for tactical fighters was conducted mainly by the USSR's two competing 'fighter makers' – the Sukhoi and Mikoyan design bureaux. In the late 'eighties the Mikoyan OKB fitted three MiG-25s experimentally with refuelling probes and launched a trials programme. One of the aircraft in question, converted from a production MiG-25PD ('45 Blue'), was used to examine the possibility of extending the intercept range and operating jointly with MiG-31 interceptors. The modified aircraft was designated MiG-25PDZ, the Z standing for *zapravka* (refuelling).

The conversion was performed by one of the Air Force's aircraft repair plants in 1985

and the MiG-25PDZ entered flight test in early 1986. The retractable L-shaped refuelling probe was located ahead of the cockpit windshield and slightly offset to starboard. A plug had to be inserted in the nose à la MiG-25BM to accommodate the probe and associated equipment. After the first few test flights the probe was shortened.

About the same time, Mikoyan and Sukhoi were working on fitting IFR probes to fourth-generation fighters (the MiG-29 *Fulcrum* light tactical fighter and the Su-27 *Flanker* interceptor). For commonality reasons, the probes on both aircraft were offset to port; therefore, the designers considered moving the probe to the port side on the MiG-25PDZ as well. This called for major modifications, including more pipelines, changes to the fuel metering system, additional SHORAN equipment ensuring rendezvous with the tanker and special lights for illuminating the probe and the tanker's drogue during night refuelling.

The flight tests were a complex and dangerous affair, since the hose and drogue could hit the fighter's cockpit if the fighter pilot

misjudged his position; a broken hose could douse the fighter with fuel, with an ensuing massive fire more than probable. To simplify flying the MiG-25PDZ and make refuelling easy enough for average service pilots, a micro-control system was proposed and tested successfully. It involved engine thrust vectoring by slightly moving the petals of the variable nozzles.

Despite its complexity, the IFR system tested on the MiG-25PDZ in its definitive form was clearly efficient enough, and a proposal was drafted to retrofit existing MiG-25s with it. However, the Air Force was short of IL-78 tankers to fill the PVO's needs, since the type was primarily intended to work with Tu-95MS *Bear-H* and Tu-160 *Blackjack* heavy bombers and the Il'yushin/Beriyev A-50 *Mainstay* AWACS (another spin-off of the IL-76MD). Hence the PVO dropped the idea of refitting MiG-25s with the IFR system, deciding to fit it only to the more modern MiG-31.

MiG-25PDM interceptor (project)

After analysing experience gained in various local wars, in 1985 the Mikoyan OKB came up



A Russian Air Force MiG-25PD coded '72 Red' in the static display during an 'open house' at the 929th State Flight Test Centre (the former GNIKI VVS) in Akhtobinsk. Of note are the rudders painted in Russian flag colours, the red-painted nose gear doors and the red trim on the air intakes.

with the idea of a massive upgrade. The MiG-25PD was to be retrofitted with the weapons and WCS of the Su-27 or the MiG-29. This was, specifically, the *Flanker's* RLPK-27 radar targeting system (*rahdiolokatsionnyy pritsel'nyy kompleks*) based on the N001 Mech (Sword) fire control radar or the *Fulcrum's* RLPK-29 built around the N019 Topaz radar. The radar would have to be modified by fitting a new antenna of larger diameter. Some other avionics items would also be replaced by more modern ones.

However, the Vympel R-27 (NATO AA-10 *Alamo*) medium-range AAMs carried by the MiG-29 and Su-27 were not designed to withstand the intense kinetic heat at the high Mach numbers typical of the *Foxbat*. This would place a restriction on the MiG-25's speed, and the project was abandoned.

MiG-25R high-speed high-altitude reconnaissance aircraft (*izdeliye 02*)

The first production MiG-25R reconnaissance aircraft (known at the Gor'kiy factory as *izdeliye 02*) started rolling off the production line in 1969. The deficiencies noted in the course of the State acceptance trials and the initial service period were quickly corrected, and the OKB kept introducing more refinements. As the Gor'kiy factory re-equipped with more up-to-date machinery and tooling, production became less labour-intensive and costly, and the production rate started to grow.

The equipment suite of the production MiG-25R comprised four oblique A-70M cameras for general-purpose PHOTINT and one A/E-10 topographic camera with a 1,300-mm (51 3/8 in) lens. These cameras were developed by the Krasnogorsk 'Zenit' Optics and Machinery Plant (KOMZ) under A. Beshenov and enabled pictures to be taken at flight levels of up to 22,000 m (72,180 ft). The cameras fired through five optically flat windows in the



Above: MiG-25PD '305 Blue' after conversion under an unknown R&D programme. Note the metal nosecone replacing the dielectric radome.



MiG-25PDS '08 Blue' (c/n N84018081) on display at the open-air museum at Moscow-Khodyinka. This view shows the original short brake parachute housing that was retained after the PDS upgrade.

underside of the nose, four of which were arranged in a chequerboard pattern.

The reconnaissance version differed from the interceptor in having integral fuel tanks in the fins to extend range. For self-protection the MiG-25R featured a built-in Siren' (Lilac,

pronounced *seeren'*) active ECM pack; any of three interchangeable jammers – the SPS-141 Siren'-1F, SPS-142 Siren'-2F or SPS-143 Siren'-3F – could be fitted. (SPS = *stahntsiya pomekhovykh signahlov* – jammer.) As was the case with the MiG-25P, early



'45 Blue', the MiG-25PDZ in-flight refuelling system testbed. The retracted IFR probe is just visible ahead of the cockpit.

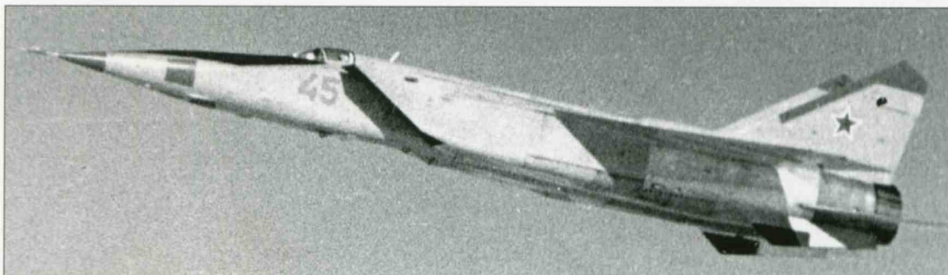
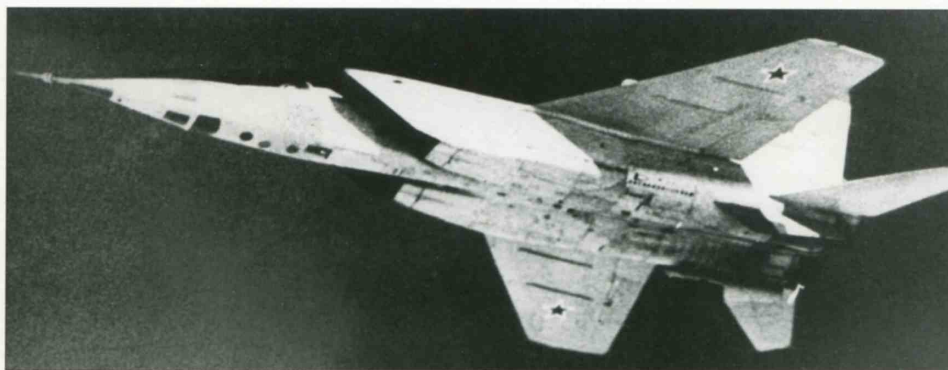

Top and above: A MiG-25R coded '45 Blue' shows the camera windows and the dielectric panels associated with SIGINT. The lack of wingtip anti-flutter weights shows this is a very early aircraft.

aircraft had the KM-1 ejection seat which was later replaced by the improved KM-1M.

In keeping with VVS plans, the first few production aircraft (production batches 3 and 4) were delivered to the Lipetsk training centre to be used for evolving conversion training techniques (since the two-seat trainer version was still in prototype form), reconnaissance efficiency assessment and operational evaluation. The majority, however, went to the Moscow Military District – specifically, to the

Guards Independent Reconnaissance Air Regiment operating out of Shatalovo AB, Smolensk Region. This unit, which began operating the type in June-July 1969, was tasked with the service test programme.

As MiG-25Rs were delivered to the independent (that is, direct reporting) reconnaissance regiments of the VVS's Air Armies, each unit initially operated a mixed bag of types. One squadron in the regiment was equipped with the new MiGs used for high-

altitude clear-weather day reconnaissance, the other flew outdated Yak-27Rs used chiefly for night and low-level day reconnaissance. For evaluation purposes the number of MiGs per regiment was temporarily increased to 17.

Pilot training proved to be a problem. Mikoyan test pilots (especially CTP Aleksandr V. Fedotov), Gor'kiy aircraft factory pilots and VVS test pilots provided assistance to the first-line units, speeding up conversion to the type. However, the problem of staffing the units with computer technicians qualified to work with the MiG-25R was even worse. Hasty changes had to be made to the educational programme at the Air Force Engineering Academy named after Nikolay Ye. Zhukovskiy, and some students were reprofiled right in the middle of the semester. Still, despite these difficulties the service tests were completed successfully and the MiG-25R became one of the principal reconnaissance aircraft of the Soviet tactical aviation. The NATO reporting name was *Foxbat-B*.

Meanwhile, successive improvements were incorporated into the aircraft as production grew. MiG-25Rs up to c/n 020ST03 (020CT03 in Cyrillic characters; f/n 0603) had ordinary wingtips; later aircraft were fitted with anti-flutter 'balance booms'. All early MiG-25Rs later had bombing capability added and were thus upgraded to MiG-25RB standard (which see).

MiG-25RB high-speed high-altitude recce/strike aircraft (*izdeliye 02B*)

After defeating the Arab states in the Six-Day War of 1967, Israel resorted to systematic



'024 Red', the MiG-25RB prototype (Ye-155R-4B), with a full load of eight FAB-250M-62 low-drag bombs. The aircraft has the original nose gear door design but has been retrofitted with wingtip anti-flutter weights.

strike missions against Egyptian military bases and industrial centres so as to maintain military superiority. When Israeli aircraft bombed a transformer station near Cairo and knocked out all the power in the city, the Egyptian government decided they had had enough and approached the USSR, requesting technical and military assistance for the air defence, reconnaissance and strike missions.

Supporting Egypt and Syria was an important political issue for the Soviet Union at the time, since the Arab states were perpetually at war with Israel, which was backed by the USA. The Soviet military leaders, notably the Defence Minister Marshal Dmitriy F. Ustinov, decided to use the MiG-25 in the Middle East in the reconnaissance and tactical bomber roles (the MiG-25R could carry flare bombs for night reconnaissance missions, so in theory there was no reason why it could not carry general-purpose bombs). Test pilot Stepan A. Mikoyan gives a slightly different story: it was Minister of Aircraft Industry Pyotr V. Dement'yev who, inspired by the navigation suite's high accuracy, came up with the idea of using the MiG-25 as a high-altitude bomber. Thus, in late 1969 the Mikoyan OKB and a number of partner organisations were tasked with converting the pure reconnaissance MiG-25R to a dual-role aircraft within three or four weeks.

The designers set to work immediately. To increase bombing accuracy the inputs from the RSBN-6S SHORAN set were fed into the Peleng navigation system. Since the aircraft had no bomb sight, bomb release would be triggered automatically by the navigation computer as the aircraft approached the target, whose coordinates were entered in the computer; hence bomb travel calculation software was devised and installed in the navigation computer. A bomb release system was fitted; the bomb shackles were made heat-resistant, safe bomb temperatures were calculated, drop modes devised, and multiple ejector racks (MERs) designed and manufactured. Meanwhile, an inter-department group was formed to assess the aircraft's chances of survival in the bomber role. The group included A. G. Zaytsev representing GosNII AS and Yu. F. Polooshkin representing the Mikoyan OKB.

As early as February 1970 conversion work started at the GNIKI VVS test facility in Akhtobinsk. The subject of the conversion was the fourth prototype of the reconnaissance variant, Ye-155R-4 ('024 Red', c/n 020SA01, f/n 0101). In March 1970 Mikoyan OKB test pilot Aviard G. Fastovets made the first bomb drop at 20,000 m (65,620 ft) and 2,500 km/h (1,552 mph) in this aircraft – a world's first, in fact. Later, Air Force test pilots Aleksandr S. Bezhevets and Nikolay I. Stogov



Top and above: The same aircraft as originally flown (the Ye-155R-4), seen here during the rehearsal for the 1967 Domodedovo airshow in company with a MiG-21F-13 and a Ye-155P. Note the new-style tails.

took over the main part of the flight testing. A. V. Minayev (a senior Mikoyan official who went on to become Deputy Minister of Aircraft Industry) supervised the test programme.

Various defects and nasty surprises popped up during the test programme, ranging from primitive mistakes like electrical connectors attached with wrong-grade solder (which melted in high-speed flight due to the intense heat) to serious problems, such as 'lapses' in the navigation system when following ground beacons in high-altitude flight. The area where the pyrotechnical multiple ejector racks were located under the wings proved to be hotter than anticipated. On one occasion in April 1970 Bezhevets switched to an alternate test mission when the Peleng navigation system went down, rendering the

primary mission impossible. The alternate mission involved prolonged supersonic flight; in the course of it the actuating cartridges in the MERs overheated and exploded, causing an uncommanded bomb release.

To prevent similar incidents in the future the bomb racks were moved to a colder area under the fuselage; this meant only four bombs could be carried, limiting the bomb load to 2,000 kg (4,410 lb). New cartridges with a higher blast point were developed later and the designers added the wing pylons again, doubling the bomb load. The tests showed that the specially developed FAB-500M-62T heat-insulated 500-kg (1,102-lb) low-drag HE bombs (the T suffix denoted *termostoykaya* – heat-resistant) and the new cartridges could be used throughout the air-



A brand-new and still-unpainted MiG-25RB makes a test flight from Gor'kiy, showing off the camera ports.

craft's speed range. Other types of bombs, including heavier-calibre bombs, could also be carried.

At the early stage of the tests the bombing accuracy turned out to be unsatisfactory. The reason was that at altitudes around 23,000 m (75,460 ft) and speeds around 2,500 km/h (1,552 mph) the aircraft would yaw slightly and imperceptibly for the pilot, obeying the autopilot's commands. Even though the bombs would be released at the right moment, even a slight deviation from the intended flight path would cause major aiming errors. Much effort was spent on curing this defect; as a result, the error margin was

reduced to 1 km (0.62 miles) – that is, the bomb would drop anywhere within a 2 x 2 km (1.24 x 1.24 mile) square. This was acceptable for nuclear bombs but no good for conventional weapons.

When the aircraft was bombed-up the service ceiling decreased slightly. To make up for this the area of the air intakes' upper surface was increased. The modification was tested successfully on the Ye-155R-4: with a full bomb load, the aircraft's service ceiling was increased by 500-700 m (1,640-2,300 ft) without affecting speed and range.

After that it was decided to modify a number of production MiG-25Rs urgently to the

same standard as '024 Red' for service tests in which regular VVS pilots would participate along with test pilots. The aircraft were modified in Gor'kiy; after that, new MiG-25Rs were to be manufactured as dual-role aircraft. To increase bombing accuracy, a new Peleng-D navigation suite was developed. It included a new and more accurate INS with float gyros (the old Anis INS used special ball bearings), a vertical accelerometer for registering the aircraft's vertical speed at the bomb release point and making corrections, and a correction system receiving inputs from a hyperbolic LORAN system. Additionally, the MiG-25RB and subsequent reconnaissance/strike versions had a Polyot-11 navigation suite comprising the Romb-1K SHORAN/approach system (later renamed Klystron), an attitude & heading reference system (AHRS) and an air data system.

A massive crew training and systems debugging effort began at GNIKI VVS in Akhtobinsk. The test pilots succeeded in finding optimum climb-to-cruise transition modes causing no appreciable oscillation and an optimum turn trajectory after bomb release with minimum fuel consumption, altitude and speed loss.

Quite a few bugs had to be eliminated, as it turned out. The navigation computer and INS failed at regular intervals. There were flight incidents, too. One of the service pilots, Krasnogorskiy, undershot on landing and struck the runway verge, bending the aircraft a bit but managing to keep it on the runway. Pilot Uvarov had an uncommanded nose gear extension caused by an improperly set



An atmospheric shot of two blue-coded MiG-25RBs taxiing out for a night sortie. Note the attachment fittings for the wing pylons.

gear uplock but managed to land safely. Generally the service tests went well.

Concurrently with the tests, in 1970 the Gor'kiy aircraft factory started producing the dual-role MiG-25RB, or *izdeliye* 02B (the RB suffix denoted *razvedchik-bombardirovshchik* – reconnaissance aircraft/bomber). The production aircraft was intended for clear-weather day/night PHOTINT, general-purpose and detailed SIGINT, day/night radar imaging in VFR and IFR conditions and day/night bomb attacks in VFR and IFR conditions. Reconnaissance was possible at flight levels of up to 23,000 m (75,460 ft) and speeds of 2,500-3,000 km/h (1,552-1,863 mph) within a combat radius of 920 km (571 miles). It was possible to deliver bombs at up to 21,000 m (68,900 ft) and 2,500 km/h within a combat radius of 650 km (403 miles) while performing all kinds of reconnaissance tasks. After dropping the bombs the pilot was supposed to maintain a speed of at least Mach 2.25, performing the getaway manoeuvre with 60° bank in daylight conditions and 45° bank at night. Should the Peleng-D navigation suite fail during the bombing run, the bomb strike could be performed in manual mode, making use of the Polyot-11 navigation suite.

The baseline camera fit was identical to the MiG-25R, consisting of four A-70M cameras and one A/E-10. Alternate fits comprised two A-72 cameras with 150-mm (5.9 in) lenses for detail reconnaissance of a narrow strip of terrain or a single A-87 with a 650-mm (25.6 in) lens. For electronic intelligence duties, an SRS-4A (*izdeliye* 30A) or SRS-4B (*izdeliye* 30B) general-purpose SIGINT set was fitted; alternatively, the SRS-4V (*izdeliye* 30V) version could be fitted. The aircraft also carried an SPS-141 Siren'-1F (*izdeliye* 141) ECM pack.

The MiG-25RB became operational in December 1970 and was the first of the *Foxbat's* reconnaissance/strike versions. Early production aircraft had a bomb load restricted to 2,000 kg (4,410 lb) and carried four FAB-500M-62 low-drag bombs under the fuselage. Later, wing pylons were added, doubling the bomb load. Four MBD3-U2 racks with twin side-by-side DZU-1 shackles were fitted – two in tandem on the fuselage centreline and one under each wing. (MBD = *mnogozamkovyy bahlochnyy derzhahtel'* – multiple beam-type rack; U = *oonifitseerovanny* – standardised. Thus, MBD3-U2 means 'MER, Group 3 (that is, capable of carrying ordnance up to 500 kg/1,102 lb calibre), standardised, two-bomb version'.) They could carry various combinations of bombs: four to eight 80-kg (176-lb) FotAB-100-80 flare bombs or 250-kg (551-lb) FAB-250 high-explosive bombs, or eight FAB-500M-62 (regular) or FAB-500M-62T (the heat-insulated variety customised for the MiG-25) HE

Basic performance of the MiG-25RB

Take-off weight, kg (lb):	
with drop tank, no bombs	39,830 (87,810)
without external stores ('clean')	35,060 (77,290)
with four FAB-250 bombs	37,210 (82,030)
Internal fuel load, kg (lb)	15,000 (33,070)
Fuel load in drop tank, kg (lb)	4,450 (9,810)
Top speed at altitudes exceeding 18,000 m (59,055 ft), km/h (mph)	3,000 (1,863)
Top speed in 'clean' condition, km/h (mph)	2,500 (1,552)
Maximum indicated airspeed, km/h (mph):	
at altitudes up to 5,000 m (16,400 ft)	1,000 (621)
at 5,000-18,200 m (16,400-59,710 ft)	1,100 (683)
Maximum Mach number above 18,200 m (59,710 ft)	2.83
Maximum IAS with drop tank, km/h (mph):	
at altitudes up to 11,000 m (36,090 ft)	1,000 (621)
above 11,000 m	Mach 1.5
Maximum IAS with four FAB-500 bombs, km/h (mph):	
at altitudes up to 5,000 m	1,000 (621)
at 5,000-15,800 m (16,400-51,840 ft)	1,100 (683)
above 15,800 m	Mach 2.35 (15 minutes only)
Maximum cruising speed with FAB-500 bombs, km/h (mph):	2,500 (1,562.5)
Climb time, min:	
to 10,000 m (32,810 ft)	1.33
to 20,000 m (65,620 ft)	6.7
Climb time to minimum combat altitude (20,200 m/66,270 ft) with four FAB-250 bombs, min:	8.2
Cruise altitude, m (ft)	19,000-21,000 (62,340-68,900)
Altitude over target with four FAB-250 bombs, m (ft)	20,700 (67,913)
Service ceiling, m (ft):	
TOW 22,600 kg (49,820 lb), 'clean'	23,000 (75,460)
TOW 30,100 kg (66,360 lb), four FAB-500 bombs, Mach 2.35 cruise	20,200 (66,270)
Service ceiling in sustained level flight, m (ft)	26,000 (85,300)
Combat radius (reconnaissance mission), km (miles):	
on internal fuel	675 (419)
with drop tank	920 (571)
Maximum base-to-target distance on strike mission (with allowance for FAB-500 bomb ballistic travel), km (miles)	560 (347)
Maximum range, km (miles):	
with drop tank at 9,000-12,000 m (29,260-39,370 ft) and 1,000 km/h (621 mph)	2,900 (1,801)
with drop tank at 19,000-21,000 m (62,335-68,900 ft) and 2,500 km/h (1,552 mph)	2,610 (1,621)
on internal fuel at 19,000-21,000 m and 2,500 km/h	2,120 (1,316)
Range at Mach 2.35, km (miles):	
on internal fuel (TOW 35,060 kg/77,290 lb, fuel load 14,900 kg/32,850 lb)	2,045 (1,270)
with drop tank (TOW 39,830 kg/87,810 lb, fuel load 19,350 kg/42,660 lb)	2,560 (1,590)
Range at Mach 0.92, km (miles):	
on internal fuel	2,280 (1,416)
with drop tank	2,810 (1,745)
Range at 1,000 m (3,280 ft) and 800 km/h (496 mph) IAS, km (miles):	
on internal fuel, 'clean'	1,243 (772)
with drop tank	1,504 (934)
with four FAB-500 bombs	1,017 (631)
Range with FAB-500 bombs if dropped halfway along the route, km (miles):	1,090 (677)
Endurance at Mach 2.35:	
on internal fuel (TOW 35,060 kg, fuel 14,900 kg)	1 hr 7 min
with drop tank (TOW 39,830 kg, fuel 19,350 kg)	1 hr 21 min
Endurance at 1,000 m and 800 km/h IAS:	
on internal fuel, 'clean'	1 hr 32 min
with drop tank	1 hr 50 min
with four FAB-500 bombs	1 hr 15 min
Endurance at Mach 0.92:	
on internal fuel	2 hrs 26 min
with drop tank	3 hrs 00 min

Field performance

TOW, kg (lb)	33,500 (73,850) 'clean'	39,000 (85,980) with drop tank	n.a. (with four FAB-500 bombs)
Take-off run, m (ft)	1,050 (3,440)	1,400 (4,590)	1,250 (4,100)
Unstick speed, km/h (mph)	350 (217)	375 (233)	375 (233)
Take-off run time, seconds	n.a.	n.a.	24
Landing weight, kg (lb)	22,000 (48,500)	n.a.	23,000 (50,705)
Landing run with brake parachutes, m (ft)	830 (2,720)	n.a.	800 (2,620)
Landing run time, seconds	n.a.	n.a.	22

Take-off data

	'clean'	with drop tank	with four FAB-500 bombs
Taxi weight, kg (lb)	35,060 (77,290)	39,830 (87,810)	37,210 (82,030)
TOW, kg (lb)	34,560 (76,190)	39,330 (86,710)	36,710 (80,930)
Fuel load, kg (lb)	15,000 (33,070)	19,450 (42,880)	15,000 (33,070)
Rotation speed, km/h (mph)	285 (177)	300 (186)	300 (186)
Unstick speed, km/h (mph)	350 (217)	380 (236)	360 (223)
Take-off run, m (ft)	1,100 (3,610)	1,400 (4,590)	1,200 (3,940)
Take-off run time, seconds	21	26	24
Take-off distance to 25 m (82 ft), m (ft)	2,100 (6,890)	2,700 (8,860)	2,300 (7,545)

Landing data

	'clean'	with four FAB-500 bombs
Landing weight, kg (lb)	23,000 (50,705)	24,000 (52,910)
Fuel weight, kg (lb)	3,000 (6,613)	1,800 (3,968)
Touchdown speed, km/h (mph)	280 (175)	290 (181)
Landing run, m (ft):		
with brake parachutes	750 (2,460)	800 (2,620)
without brake parachutes	1,450 (4,760)	1,500 (4,920)
Landing run time, seconds:		
with brake parachutes	23	24
without brake parachutes	35	37

bombs. For combined reconnaissance/strike missions the aircraft carried four FAB-250 bombs on the belly MERs; no drop tank could be carried in this case.

Late-production MiG-25RBs, starting with c/n N02022077, had the bomb load increased to 5,000 kg (11,020 lb) and could carry ten FAB-500M-62s (four in tandem pairs under the wings and six under the fuselage on modified MBD3-U2T MERs, the T standing for 'tandem'). However, it soon became obvious that this ordnance load was excessive, impairing speed and service ceiling drastically because of the added drag and all-up weight. Besides, wing loading was excessive at subsonic speeds and the air intake walls were subject to added loads at speeds in excess of Mach 0.9, which could cause fatigue problems.

The fin tanks were deleted on late production aircraft in the mid-1970s, restricting the fuel tankage to the wings and fuselage. The

5,280-litre (1,173 Imp gal) drop tank also impaired performance a good deal; still it was rarely jettisoned when it ran dry. No bombs could be carried when the drop tank was fitted.

For pinpoint bomb aiming and automatic bomb release using preset target coordinates, the MiG-25RB and later reconnaissance/strike models were equipped with a Peleng-D or Peleng-DR navigation/bombing system. The more accurate Peleng-DM was retrofitted later. The MiG-25RB also had the Polyot-11 navigation/flight control system.

The aircraft's manoeuvrability and the thrust of its massive turbojets enabled it to perform sustained level flight, albeit with deceleration, at altitudes exceeding its nominal service ceiling. The effective maximum level flight ceiling in full afterburner with 3,300 kg (7,275 lb) of fuel remaining at the end of the flight mode was 26,000-27,000 m (85,300-

88,580 ft). The MiG-25RB could exceed Mach 2.4 for 15 minutes; a Mach 2.65-2.83 dash was also possible but was not to exceed five minutes. Cruising time at speeds below Mach 2.4 was unlimited.

MiG-25RB deliveries to units stationed in the Ukraine commenced in 1970. Some aircraft were delivered to the Air Force's 4th TsBP i PLS in Lipetsk. Five MiG-25RB regiments were deployed in Poland and East Germany. Later the aircraft saw service with VVS units of the Belorussian, Trans-Caucasian, Central Asian, Siberian and Leningrad Military Districts.

The MiG-25RB stayed in production for two years until superseded by more sophisticated versions in 1972. The first reconnaissance/strike version received its baptism of fire on the Middle Eastern theatre of operations. In 1971, a Soviet Air Force Antonov An-22 *Antey* (Antheus; NATO *Cock*) heavy transport airlifted four dismantled MiG-25RBs to Cairo-West airbase, Egypt. There the MiGs were reassembled and successfully flew reconnaissance missions over Israeli-held territory, piloted by six Soviet airmen (three regular VVS pilots, two NII VVS test pilots and one MAP test pilot).

The MiG-25RB and its versions were popular with their crews due to their exceptional performance: high speed, the excellent picture quality provided by the cameras, the ability to reconnoitre large areas in a single sortie and low vulnerability to enemy fire. The aircraft was sometimes used for civilian purposes (for example, defining areas engulfed by forest fires, snow-covered or flooded areas). Using the MiG-25 to get this kind of data was quicker and cheaper than if surveillance satellites or topographic reconnaissance aircraft (the An-30 *Clank* photo survey aircraft and the like) were used.

MiG-25RBK reconnaissance/strike aircraft (*izdeliye 02K, izdeliye 51*)

To meet VVS requirements, a version of the basic MiG-25RB fitted with a Koob-3 detailed SIGINT suite was developed, receiving the designation MiG-25RBK (*razvedchik-bombardirovshchik s apparatooroy 'Koob'*). Work on this version started concurrently with the MiG-25R, since the SIGINT equipment carried by the latter could detect pulse-Doppler radars but could not transmit data to ground command centres. In contrast, the Koob-3 suite could pinpoint the location of enemy transmitters (both pulsed and continuous), define their class and relay intelligence immediately by data link while recording it digitally on board the aircraft for later analysis.

The 'cube' weighed several hundred kilos and was too bulky to install on an interchangeable pallet, like the SRS-4 packs. Hence the aircraft's nose had to be

redesigned; some of the cameras were deleted and the camera ports faired over.

The MiG-25RBK prototype, '305 Blue' (c/n 020 SO 05, f/n 0305), was converted from a very early MiG-25R in the summer of 1970. The aircraft underwent rigorous testing in 1971-1973. After passing State acceptance trials successfully the MiG-25RBK was produced in Gor'kiy from 1973-1980; the product code was initially *izdeliye* 02K but was later changed to *izdeliye* 51 to enhance security. The NATO code name was again *Foxbat-B*.

Production aircraft had an upgraded Koob-3M (*izdeliye* K-3M) SIGINT suite, an SPS-143 Siren'-3F (*izdeliye* 143) active jammer and similar armament to the MiG-25RB. Late-production MiG-25RBKs featured air intake upper walls of greater area, a redesigned brake parachute housing, an SPO-15 Beryoza RHAWs (aka L006 or *izdeliye* 006; SPO = *sistema predooprezhdeniya ob obloochenii* – lit. 'irradiation warning system'). The SPO-15 didn't merely tell the pilot that he was being 'painted' by enemy radars but also displayed the bearing and type of the radar and its operating mode, helping to assess the threat. Starting in 1981, MiG-25RBKs were retrofitted with more modern reconnaissance equipment.

MiG-25RBK export version

Concurrently with the downgraded export model of the MiG-25PD interceptor the Mikoyan OKB developed a similarly downgraded export version of the MiG-25RBK for 'friendly nations' featuring less sophisticated guidance and weapons control systems. According to press reports, more than 30 MiG-25Rs (*sic*) were delivered to Algeria, eight to Iraq, five to Libya, eight to Syria and six to India. Three aircraft saw service with the Bulgarian Air Force but were eventually exchanged for MiG-23BN *Flogger-H* fighter-bombers. The reason was ostensibly problems with spares procurement, but in reality Bulgaria had no real use for Mach 2+ reconnaissance/strike aircraft.

The Iraqi MiG-25RBs saw action during the Iran-Iraq War, making high-altitude supersonic bombing raids against Iranian oil rigs in the Persian Gulf. Several aircraft were reported as lost in accidents or 'due to poor tactical planning'.

MiG-25RBS reconnaissance/strike aircraft (*izdeliye* 02S, *izdeliye* 52)

Back in the early 1960s the possibility arose to obtain radar imagery of comparable quality to traditional photo imagery when the synthetic aperture radar was invented. The basic design principles of a side-looking airborne radar (SLAR) utilising the synthetic aperture principle were verified on Antonov An-12 *Cub* transports and Il'yushin IL-18 *Coot* airliners



Above: A MiG-25RBK (right) and a MiG-25RBS line up for take-off. The different placement of the dielectric panels is obvious. Note the MiG-25RBK's enlarged dielectric nosecone.

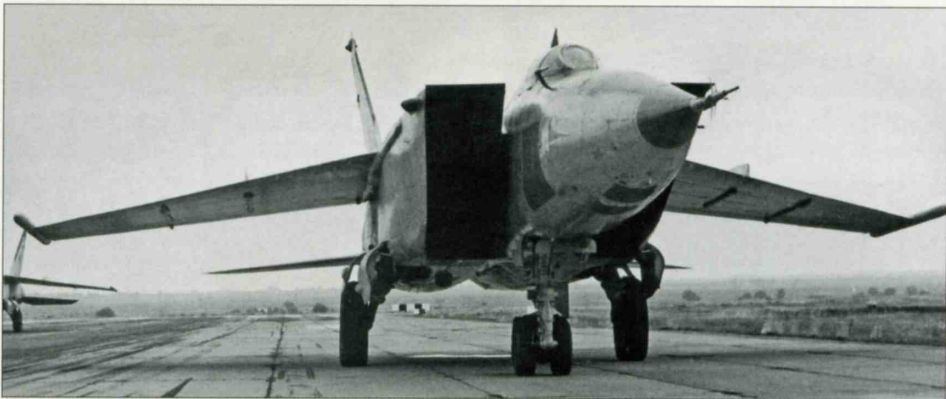

Above: Front view of a MiG-25RBS. Note the ECM blisters on the air intake trunks.



A MiG-25RBS heading a line-up of reconnaissance/strike MiG-25s shows off its characteristic large dielectric panels concealing SLAR antennas.

converted into avionics testbeds. This allowed the Moscow Research Institute of Instrument Engineering named after Vladimir V. Tikhomirov (MNIIP – *Moskovskiy naoochno-issledovatel'skiy institoot priborostroyeniya*) to come up with the idea of developing a SLAR tailored to the design of the Ye-155R as early as 1963. It took two years for the idea to ripen, and at length in 1965 the Air Force issued an SOR for a SLAR-equipped interceptor.

Development of the *Sablya E* (Sabre E) SLAR, aka *izdeliye* 122, lasted nearly seven years. The radar was a monobloc unit utilising an advanced modular design. The reconnais-

sance/strike version equipped with the Sablya E radar was designated, quite logically, MiG-25RBS (*razvedchik-bombardirovshchik s apparaturoy 'Sablya'*).

Again, the prototype, '304 Blue' (c/n 020 SO 04, f/n 0304), was converted from a MiG-25R in the summer of 1970 concurrently with the MiG-25RBK prototype. The new version could be identified by two much-enlarged dielectric panels positioned well aft on the forward fuselage sides. The MiG-25RBS was equipped with an SPS-142 Siren'-2F (*izdeliye* 142) jammer and had identical armament to the earlier strike version. No aerial cameras were fitted.



Above: This MiG-25RBS coded '09 Red' serves as an instructional airframe at the Russian Air Force's Tambov Aviation Engineers' College (TVVAIU).



Above: MiG-25RBV '08 Red' is also used for instructional purposes at Tambov. This version reverted to small lateral dielectric panels positioned well forward.



The later MiG-25RBT (illustrated by '40 Red', c/n N02008115 at Shatalovo AB) looks very similar to the MiG-25RBV, the late-style brake parachute housing being the main identification feature.

The picture generated by the radar was processed on the ground in a specially equipped van. The SLAR could detect parked aircraft, trains and ships and visualise the condition of bridges and similar structures.

After passing State acceptance trials in 1972-73 the MiG-25RBS entered production in 1973 as *izdeliye* 02S; this code was later changed to *izdeliye* 52. The MiG-25RB, 'RBK' and 'RBS' officially entered service in keeping with two Council of Ministers directives issued on 13th April and 18th December 1972. The NATO code name was *Foxbat-D*.

Production of the MiG-25RBS continued into 1977; some aircraft were later refitted with new ELINT gear. It may be said now that more than 220 reconnaissance/strike MiG-25s were manufactured in various versions, the last machines rolling off the line in 1982.

MiG-25RBV reconnaissance/strike aircraft (*izdeliye* 02V)

Another reconnaissance/strike version that came into being concurrently with the two versions described above had the standard SRS-4A and SRS-4B SIGINT packs replaced

with a more modern SRS-9 *Virazh* (Turn) general-purpose SIGINT set (*izdeliye* 31). Hence the aircraft was designated MiG-25RBV. Several optional camera fits were available for this model. The NATO name was again *Foxbat-B*.

Once again the prototype, '303 Blue' (c/n 020 SO 03, f/n 0303), was converted from a MiG-25R in the summer of 1970, passing State acceptance trials in 1971-1972. New from 1973-1979 as *izdeliye* 02V. Late-production aircraft had a new SPS-151 *Lyutik* (Buttercup) active jammer replacing the SPS-141 Siren'.

Confusingly, from the mid-1970s onwards the remaining unupdated aircraft with SRS-4 SIGINT sets were also referred to in service as MiG-25RBVs. However, their factory code (*izdeliye* 02B) remained unchanged.

MiG-25RBN night reconnaissance/strike aircraft

In keeping with the Air Force's specific operational requirements the Mikoyan OKB had made provisions for high-altitude night PHOTINT missions when developing the Ye-155R. Two NAFA-MK-75 cameras (*nochnoy aerofotoapparat* – aerial camera for night operations) designed by the Kazan' Optical & Mechanical Plant – which, like the Krasnogorsk plant, was abbreviated as KOMZ – could be installed in the standard camera nose with the optical axes slightly tilted aft. Four to ten FotAB-100-80 or FotAB-100-140 flare bombs were carried on underfuselage racks.

The flare bombs were released over the target by the Peleng navigation system, the initial flash triggering a sensor that opened the camera shutters. The burn time of a single bomb was sufficient for two exposures. The NAFA-MK-75 camera had a lens with a high aperture ratio (1:3.5) and shutter speeds between 1/25 and 1/80. When extra sensitive film was loaded it was possible to shoot in dusk without the benefit of flare bombs.

Yet it was clear from the start that the night PHOTINT version offered no great advantage. Firstly, the results simply weren't worth the effort. The very complicated mission yielded just 16 exposures of rather poor quality, and photography was only possible in clear weather. Secondly, in peacetime, night photography was only possible over sparsely populated areas because the bright flashes of the exploding flare bombs could cause panic among unsuspecting civilians, to say nothing of the massive splinters that could cause death and destruction. Therefore, the night PHOTINT version was excluded from the State acceptance trials programme.

In the course of the trials programme the shutter operating logic was changed. The shutters opened in advance and closed right after the flash; thus, the burn time of the flare

bombs was better used. Despite being scheduled to begin right after the State acceptance trials of the basic MiG-25R and be finished as soon as possible, the 'night eyes' test programme was not completed until the advent of the MiG-25RB. The night PHOTINT version was designated MiG-25RBN, the N standing for *nochnoy* – night (used attributively).

The aircraft could also be fitted with the SRS-9 Virazh SIGINT suite. The principal data of the MiG-25RB/MiG-25RBV equipped for night PHOTINT duties as the MiG-25RBN are given in the table on this page.

MiG-25RBT reconnaissance/strike aircraft (*izdeliye 02T*)

In 1979 the Mikoyan OKB and GNIKI VVS began State acceptance trials of yet another reconnaissance/strike version – the MiG-25RBT. It differed from the MiG-25RBV mainly in having the Virazh SIGINT pack replaced by a *Tangazh* (Pitch, as an aircraft's motion) general-purpose SIGINT pack, hence the T. The *Tangazh* module (*izdeliye 33*) was lighter and more reliable; it also had a wider range of detectable radars and their location could be pinpointed when the recorded intelligence was processed post-flight. Outwardly the MiG-25RBT could be identified by the new-style brake parachute housing.

Known in-house as *izdeliye 02T*, the MiG-25RBT was in production at the Gor'kiy aircraft factory in 1980-1982. This version was equipped with the new SRO-1P Parol' (*izdeliye 62*) IFF transponder and the SPO-15 (L006) Beryoza RHAWs replacing the earlier SPO-10 Sirena-3M RWR.

MiG-25RBSh reconnaissance/strike aircraft (*izdeliye 02Sh*)

An upgrade programme for the MiG-25RBS was launched in 1981. The extremely trouble-

Below: Camouflaged *Foxbats* were relatively rare. This MiG-25RBSh coded '76 Red' was operated by GNIKI VVS in Akhtobinsk.

Right: The same aircraft banks away from the camera ship, showing off its undersides.

MiG-25RBN specifications

MTOW, kg (lb):	
with four FotAB-100 flare bombs	35,740 (78,790)
with eight FotAB-100 bombs	36,420 (80,290)
Fuel load, kg (lb)	15,000 (33,068)
Maximum cruising speed, km/h (mph):	
with flare bombs	2,390 (1,484)
'clean'	2,500 (1,552)
Unstick speed with eight FotAB-100 bombs, km/h (mph)	355 (220)
Combat radius, km (miles):	
with four FotAB-100 bombs	530 (329)
with eight FotAB-100 bombs	505 (313)
Cruise altitude on night PHOTINT mission, m (ft)	19,700-20,700 (64,630-67,910)
Service ceiling with a 29,800-kg (65,700-lb) TOW (including eight bombs) at Mach 2.25, m (ft)	19,700 (64,630)
Range with bombs if dropped halfway along route, km (miles):	
with four FotAB-100 bombs	1,145 (711)
with eight FotAB-100 bombs	1,085 (673)
Take-off run with eight FotAB-100 bombs, m (ft)	1,200 (3,937)
Take-off run time with eight FotAB-100 bombs, seconds	23
Take-off distance with eight FotAB-100 bombs, m (ft)	2,300 (7,545)

some Sablya SLAR gave place to a new-generation *Shompol* (Ramrod) SLAR; hence the updated aircraft were redesignated MiG-25RBSh or *izdeliye 02Sh*, and part of the MiG-25RBS fleet was modified in due course.

Outwardly the MiG-25RBSh could be identified by the new-style brake parachute housing. The NATO name was again *Foxbat-D*.

The *Shompol* had a resolution two to three times better than the old SLAR. Besides,





Top: MiG-25RBF '58 Red' (c/n N02024819) is one of several operated by the 931st GvORAP.

Above: MiG-25RBF '28 Red' (c/n N02024311) of the 47th GvORAP in the static display at Kubinka AB on 8th August 2002. The small dielectric panels characteristic of this version are well visible.

Left: '20 Red' (c/n N02032208), a rare camouflaged MiG-25RBF, at Shatalovo AB.

it allowed the aircraft to work at any altitude between 300 and 23,000 m (980-75,460 ft), whereas the Sablya could not operate below 17,000 m (55,770 ft). Finally, the new SLAR had a moving target selection (MTS) mode and a combined mapping/MTS mode.

MiG-25RBF reconnaissance/strike aircraft (*izdeliye* 02F)

In 1981 it was the MiG-25RBK's turn to get an MLU. The Koob-3M SIGINT suite was replaced by an up-to-date Shar-25 (Ball, or Balloon) detailed SIGINT system (*izdeliye* F-25S). The aircraft could also carry panoramic cameras and was fitted with active jammers and chaff/flare dispensers.

The word 'shar' begins with a Sh. However, this suffix letter was by then allocated to the Shompol-equipped MiG-25RBSh and

could not be used; therefore, the latest version received the 'out-of-sequence' designation MiG-25RBF, or *izdeliye* 02F; the F was borrowed from the mission system's product code.

Curiously, many Western publications misidentify the Soviet/Russian Air Force MiG-25RBFs stationed in (former East) Germany and Poland as MiG-25RBSh's, despite the fact that the two versions differ markedly in appearance! The key to this puzzle is that the Russian technicians, when asked by Western spotters about the aircraft type in the days of the Russian pullout, said these aircraft were MiG-25RBSh's – earnestly believing they were RBSh's because they had the Shar-25 system! Even the people operating the actual aircraft don't take the trouble to find out the correct designation sometimes...

The MiG-25RBF was readily identifiable by the two small dielectric panels located low on each side of the nose in lieu of camera ports. The Shar-25 suite was speedy and could work in a jumbled radio signal environment, picking out assorted transmitters. It could detect state-of-the-art radars with a complex emission spectrum and quickly relay data to ground command centres.

The MiG-25RBK to RBF and MiG-25RBS to RBSh upgrades were done by VVS aircraft repair plants as the aircraft came in for overhaul.

MiG-25RBVDZ and MiG-25RBShDZ development aircraft

As mentioned earlier, the in-flight refuelling system fitted to the MiG-25PDZ interceptor was also tested on two reconnaissance/strike versions of the *Foxbat*. On these aircraft the IFR probe was offset to starboard (as originally on the interceptor) but was located much further forward and was non-retractable (this was dictated by the mission equipment

installed in the nose). As on the MiG-25PDZ, a slight stretch of the nose section was necessary to accommodate the probe and associated equipment.

Two aircraft – a MiG-25RBV coded '68 Blue' and a MiG-25RBSh coded '34' – were modified and redesignated MiG-25RBVDZ and MiG-25RBShDZ respectively (the DZ suffix stood for *dorabotannyy dlya zaprahvki* – modified for refuelling). The IL-78 tanker prototype (CCCP-76556) was used during the tests; however, the aircraft could also receive fuel from other tankers, including Su-24M *Fencer-D* tactical bombers carrying a UPAZ-A HDU as a 'buddy' refuelling pack.

At that time, however, the Su-24MR *Fencer-E* tactical reconnaissance aircraft entered flight testing. Like the basic Su-24M, it had an IFR probe as standard and was considered more advanced. Hence the VVS quickly dropped the idea of extending the MiG-25RB's range and, as with the interceptor version, the proposed MLU programme never materialised.

MiG-25MR weather reconnaissance aircraft

A handful of MiG-25s was built in a specialised weather reconnaissance version designated MiG-25MR (*meteorazvedchik*). The MiG-25MR had the cameras and the SRS-4 SIGINT pack replaced with specialised mission equipment.

MiG-25RR radiation reconnaissance aircraft

A small batch of eight MiG-25RBVs was fitted out for radiation reconnaissance (RINT) duties. Previously, RINT duties had been performed by Yak-25RR (*radiatsionny razvedchik* – RINT aircraft) and Yak-25RRV (*radiatsionny razvedchik vysotnyy* – high-altitude RINT aircraft), both based on the single-seat straight-wing Yak-25RV *Mandrake* reconnaissance aircraft, and later the Yak-28RR *Brewer*. The MiG-25RR had a higher service ceiling than either of these aircraft and, importantly, could slip through the high radiation area quicker, reducing pilot exposure.

Designated MiG-25RR, these aircraft carried a *Vysota* (Altitude) mission equipment suite, including a FUKA air sampling pod intended for detecting radioactive particles in the atmosphere at high altitude. This equipment had originally been designed by the Yakovlev OKB for the abovementioned types; Mikoyan OKB engineers modified it, adapting the equipment to the Foxbat.

In the 1970s and 1980s the MiG-25RRs repeatedly flew sorties along the Soviet-Chinese border, monitoring Chinese nuclear tests. These aircraft were later fitted with upgraded RINT equipment.

MiG-25R IRINT aircraft (project)

A version of the MiG-25R did not progress beyond the preliminary design stage was optimised for infrared reconnaissance (IRINT) and fitted with a thermal imager. No separate designation is known, since that would probably depend on the model of the mission equipment.

MiG-25PP ECM aircraft (project)

Another projected version based on the MiG-25RB was an ECM aircraft designated MiG-25PP (*postanovshchik pomekh* – ECM aircraft). This aircraft was evidently intended to provide ECM cover for groups of sister ships performing a *recce*/strike mission.

Ye-155F tactical bomber (project)

At an early stage of the MiG-25 programme the Mikoyan OKB proposed a tactical bomber version designated Ye-155F (for *frontovoy bombardirovshchik*) – tactical bomber). The aircraft had a redesigned forward fuselage accommodating a crew of two – a pilot and a navigator/weapons systems officer (WSO) – seated side-by-side and a Puma navigation/attack radar system; both features were shared with the competing Su-24 tactical bomber. However, the Air Force evinced a greater interest for the Su-24 and the Mikoyan project was abandoned.

Ye-155B high-speed high-altitude bomber (project)

Inspired by the first successful bombing tests conducted on the MiG-25RB in the early 1970s, the Mikoyan OKB proposed a pure bomber version designated Ye-155B (for *bombardirovshchik*). The aircraft was to be fitted with an *Ivolga* (Golden Oriole) electro-optical bombing sight capable of detecting small targets any time of day/night and a radar for detecting surface ships and other targets with a large RCS. Again, the crew consisted of a pilot and a navigator/WSO. The Ye-155B never got even as far as the drawing board.

MiG-25RB high-speed high-altitude bomber derivative (project)

Another project envisaged transforming the MiG-25RB into a pure bomber by installing an extra fuel tank in the extreme nose instead of the reconnaissance equipment.

Ye-155VK satellite interceptor/suborbital launch vehicle (project)

In the 1970s the Mikoyan OKB envisaged a version of the MiG-25 optimised for suborbital launch of low-Earth orbit ballistic missiles, including anti-satellite ballistic missiles. The missile was to be capable of engaging satellites, as well as maritime targets with a large RCS or radar pulse emitting targets at long

range up to the radio horizon. To this end, the carrier aircraft designated Ye-155VK (the suffix probably stands for *vozdooshno-kosmicheskii* – air/space, used attributively as a reference to the missile's launch mode) was to be fitted with a specialised and rather unconventional WCS featuring lateral active and passive antenna arrays. Having detected the target, the aircraft was to turn head on to it and launch the missile equipped with an appropriate seeker head. Maximum launch range was to 600 km (372 miles); with over-the-horizon (OTH) capability the maximum range increased to 700 km (434 miles).

Three ways of destroying satellites in orbit were considered – detonating a powerful warhead in close proximity, scoring a direct hit with a suborbital ballistic kinetic kill vehicle (SBKKV) and even blasting the satellite with cannon fire (!).

Some of the Mikoyan OKB's best engineering talent was involved in the development of the Ye-155VK; these included Nikolay Z. Matyuk, K. K. Vasil'chenko, Anatoliy A. Belosvet, V. N. Shoomov, L. F. Nazarov, Yu. F. Polooshkin *et al.* The project did not materialise but it paved the way for the specialised MiG-31D 'satellite killer' aircraft.

Ye-155K SEAD aircraft (project)

As the MiG-25R and MiG-25RB reconnaissance aircraft were developed, penetrating enemy air defences became a major issue. This could be attained by either of three means: higher speed and agility plus evasive manoeuvres to escape incoming missiles; sophisticated active and passive ECM and IRCM equipment; or suppression of enemy air defences (SEAD) by means of anti-radar missiles (ARMs).

Speaking of manoeuvrability, a low-level target approach followed by a zoom climb to about 25,000 m (82,020 ft) and prolonged high-altitude flight proved a very effective tactic. The reconnaissance version had a dynamic ceiling in excess of 30,000 m (98,425 ft) but this could only be reached by specially lightened aircraft. Besides, the engines would flame out in a zoom climb and had to be relit at a much lower altitude.

A MiG-25 flying at top speed and altitude was pretty hard to shoot down. Yet it was by no means immune, especially deep behind enemy lines and considering the enemy's sophisticated air defence systems. Also, it was hard to speak about ECM requirements without knowing the true performance of the air defence systems that the adversary might deploy. Thus, an aircraft armed with ARMs – a 'Wild Weasel', to use an unofficial US term – was clearly the best bet.

The first ARMs designed in the 1960s weighed tons and could only be carried by heavy bombers. In the 1970s, however,

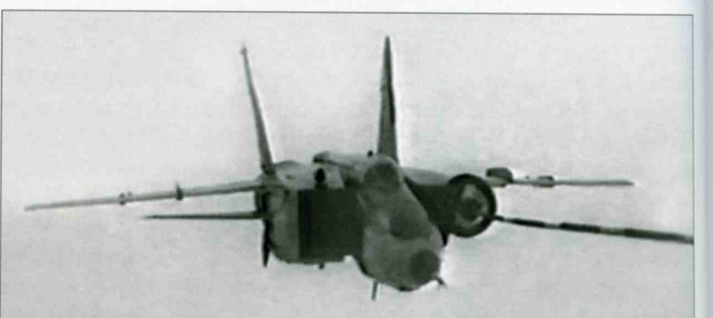
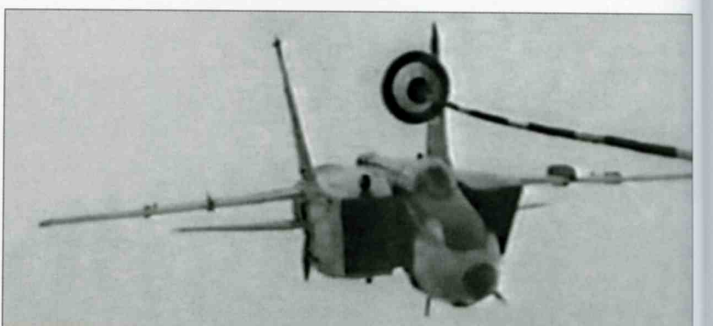
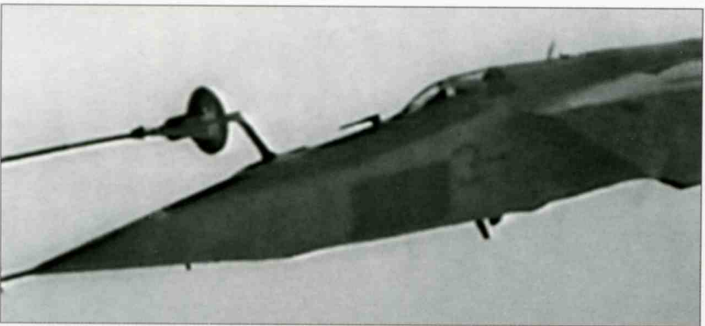
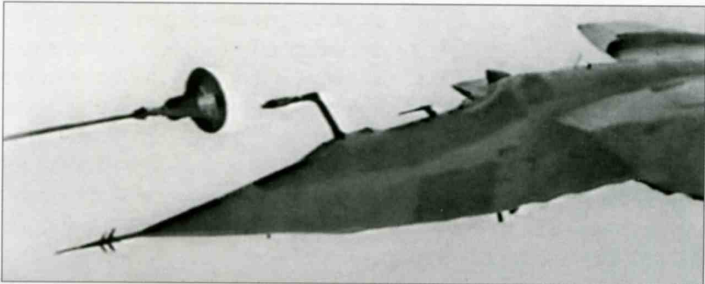

Left: The MiG-25RBVDZ and a Su-24M bomber take on fuel from the IL-78 prototype, CCCP-76556.

Left row, top: The MiG-25RBVDZ on final approach.

Right row, top & upper centre: The MiG-25RBShDZ and another Su-24M make contact with the IL-78.

Left row, upper & lower centre: The MiG-25RBShDZ is seen from the IL-78's refuelling systems operator station as it approaches the starboard drogue.

Left row, bottom: The same scene from the MiG driver's perspective.

Right row, lower centre & bottom: The same aircraft makes contact with the tanker's port drogue. Note the test equipment camera on the starboard air intake of the MiG-25RBShDZ.

smaller and lighter missiles became available, albeit they were designed to be launched mostly from low and medium altitude. One of these, the Kh-58 (NATO AS-11 Kilter) developed by the MKB Raduga (Rainbow) design bureau, could be carried by the MiG-25 after some minor modifications.

Contemporary Western air defence systems, such as the Nike Hercules SAM, had a single-channel guidance system, and the Soviet designers put this to good use. After considering various tactics a zigzag manoeuvre was devised which enabled the ARM to knock out the enemy guidance radar before the SAM could nail the aircraft. The Kh-58 could be fitted with various homing systems and destroy all components of the enemy air defence system. Hence, the joint CPSU Central Committee/Council of Ministers directive clearing the MiG-25RB for service included a clause about fitting it with Kh-58 missiles.

The first 'Wild Weasel *Foxbat*' project had the form of an engineering proposal and was designated Ye-155K, the K standing for *kompleks* [vo'oroozheniya] (weapons system – a

designation often used for Soviet air-to-surface missile systems). The aircraft was to be fitted with two powerful *Landysh* (Lily of the Valley) jammers and carry two Kh-58U ARMs while retaining the reconnaissance and bombing capability. However, the project failed to attract interest.

MiG-25B high-speed reconnaissance/strike aircraft (project)

In 1977 a new reconnaissance/strike version was proposed under the designation MiG-25B. It had an *Espadron* (Backsword) avionics and weapons suite consisting of a Shompol SLAR, a new SIGINT set, a thermal imaging system, a data link system and ARMs. At the same time some thought was given to fitting ARMs to PHOTINT aircraft.

MiG-25BM SEAD aircraft (*izdeliye* 02M, *izdeliye* 66)

The Mikoyan OKB persisted with the ideas first defined in the Ye-155K project and continued working on a 'Wild Weasel' MiG-25, now designated MiG-25BM. However, this version took its time coming – for two reasons. Firstly, the OKB had agreed with the VVS to develop separate projects for the reconnaissance and SEAD missions. The latter would be fulfilled by a specialised version carrying four Kh-58 missiles and fitted with sophisticated ECM gear (a range of powerful active jammers covering a wide frequency spectrum). Such an aircraft could not only bite a hole in enemy defences to enable MiG-25RB reconnaissance aircraft to get through but also fulfil tactical aviation missions with a wider scope – such as hunting enemy radars on a specified section of the frontline.

Secondly, the Kh-58 missile required much more extensive modifications than the

designers anticipated. To ensure faultless operation after repeated no-launch flights the missile was fitted with a new rocket motor. The empennage had to be modified so as to permit carriage by other aircraft types. The resulting one-size-fits-all missile was designated Kh-58U or *izdeliye* 112U (for *oonifitseerovanny* – standardised).

Special equipment had to be developed to enable a tactical 'wolf pack' to operate above a territory measuring several thousand square miles. Its functions included threat selection and threat priority allocation, destruction of targets with known coordinates, definition of launch zones for the Kh-58 missiles and monitoring the missile's flight programme along the entire trajectory. This integrated equipment package was designated *Yaguar* (Jaguar) and, like the missile, took a lot of time to define, produce and test. It included a Sych-M (Barn Owl) target designator providing target coordinates to the missiles' seeker heads, a Beryoza-L RHAWs and Siren'-1D-OZh and Lyutik jammers. The ECM gear operated in the 2-cm and 3-cm wavebands, enhancing the aircraft's protection against SAMs and enemy fighters.

The MiG-25BM's principal armament consisted of four Kh-58U ARMs carried on AKU-58 ejector racks; however, provisions for carrying free-fall bombs were retained. The navigation suite was suitably upgraded.

It took a while to evolve the weapons system's philosophy. Launching the missiles safely from the ejector racks was a complex task. Another problem was electromagnetic compatibility (EMC) of the avionics components and compensation of possible targeting errors (especially with long-wave radars) when the enemy was using 'decoy transmitters' located close at hand. To test the equipment for EMC and accumulate statistical data



MiG-25RB '401 Blue' was one of several *Foxbat*-Bs modified under the MiG-25BM's development programme. The Kh-58U anti-radar missiles are well visible, as are the radar detection system antenna blisters low on the sides of the nose.



The penultimate step towards the creation of the MiG-25BM was the MiG-25RBM development aircraft. It is seen here at parked Zhukovskiy after transfer to LII.

a further Tu-104 airliner was converted into an avionics testbed by LII. Finally, the software for the 'Peleng' navigation system was also updated.

The new version had a 720-mm (2 ft 4 $\frac{1}{2}$ in) 'plug' inserted into the nose section to accommodate the ECM and missile guidance equipment. The four missiles were carried on underwing pylons in the same fashion as on the MiG-25P; iron bombs could also be carried, as on the MiG-25RB. The cockpit interior differed from the latter version in lacking reconnaissance equipment control panels; the electric and air conditioning systems were also modified.

A curious feature was the self-contained missile cooling system located in each of the pylons to which the AKU-58 ejector racks were fixed. The system used an alcohol/water mixture as a cooling agent.

The MiG-25BM prototype ('408 Red') made its first flight on 27th January 1977, flown by OKB test pilot Shchelkoonov. State acceptance trials began that year, continuing until 1980, and showed virtually no deterioration in flight performance.

In general the tests went smoothly, despite a few unpleasant surprises. To check out the operation of the targeting system a certain number of radar targets had to be provided. Real radars were used for want of expendable 'simulator' transmitters; they were switched off as the missile came too close for comfort, and 'kill' confirmation was given by telemetry equipment which the missiles carried in lieu of warheads. Many missiles, however, refused to be fooled and went all the way in, scoring direct hits and knocking out the radars completely.

The tests showed that the decision to separate the reconnaissance and air defence suppression missions had been correct. Hence, the dual-role MiG-25B project of 1977 was abandoned in favour of the dedicated 'Wild Weasel' MiG-25BM version fitted with the Yaguar system.

The MiG-25BM stayed in production from 1982 to 1985; at the Gor'kiy factory it was known initially as *izdeliye* 02M and later as *izdeliye* 66. A mere 40 examples were built; to simplify conversion training they were delivered to independent tactical aerial reconnaissance units operating the MiG-25RB and its versions. The 'Wild Weasel' could be identified by dielectric blisters enclosing radar homing antennas low on the sides of the nose (which was painted dark grey or olive drab) and by the AKU-58 missile adapters on the pylons.

The missile's high launch impulse and highly sensitive guidance system made it possible to increase the maximum launch range. In one trial launch the missile destroyed a target located at 50% longer range than usual. In reality, however, the missile's endurance was restricted by the capacity of its batteries; besides, at maximum range the missile heated up dangerously and could blow up before reaching the target. Thus, more modifications were needed; however, the MKB Raduga design bureau had higher-priority projects to take care of, and no one really demanded an increase in the Kh-58U's range anyway.

Following successful trials the MiG-25BM entered service, but not before 1988, three years after production had terminally ended. The delay was due to a lengthy pilot and

ground crew conversion training course completed at the Air Force's testing grounds.

MiG-25RBM and other testbeds

The MiG-25RBV prototype ('303 Blue', c/n 020 SO 03, f/n 0303) and a MiG-25RB coded '401 Blue' (c/n 020SL01, f/n 0401) were converted for testing the MiG-25BM's mission equipment; flight tests took place in 1974-1976. A further MiG-25RBV converted under this programme ('47 Blue', c/n N02022047) bore the unofficial designation MiG-25RBM. It was later transferred to LII for development work.

MiG-25M (Ye-155M) experimental interceptor

The 13th April 1972 directive ordering the MiG-25RB, MiG-25RBK and MiG-25RBS into service also elaborated on the upgrade possibilities of the basic design. The military wanted an increase in range at low and medium altitude and an increase in service ceiling and maximum speed.

The Mach 2.83 speed limit imposed on the MiG-25 was purely theoretical, since the aircraft had the potential to go faster from the very start. High speeds reduced lateral stability and service life, but there were cases of pilots exceeding the speed limit without harming the aircraft. Therefore, the designers intended to reach a Mach 3.0-3.2 top speed so that the MiG-25 could outperform its arch-rival, the SR-71A – the world's fastest reconnaissance aircraft. This could be achieved by fitting the MiG-25 with more powerful and fuel-efficient engines.

As far back as the early 1960s a group of engine designers led by Shookhov and Rotmistrov proposed a comprehensive upgrade

of the R15B-300 turbojet. The idea materialised as the uprated R15BF2-300, aka *izdeliye* 65M. The improvement in performance was achieved by adding a compressor stage and increasing the combustion chamber and turbine temperatures. As compared to the basic R15B-300, the R15BF2-300 had a lower specific fuel consumption (SFC), a higher thrust (10,000 kgp/22,045 lbst dry and 13,230-14,500 kgp/29,170-31,970 lbst reheat) and a higher engine pressure ratio (4.95 versus 4.75).

The two engines were perfectly interchangeable, having identical dimensions and mountings. Providing the airframe was made more heat-resistant because of the new engine's higher turbine temperature, the R15BF2-300 offered a substantial increase in rate of climb, service ceiling, range and speed (up to 3,500 km/h, or 2,173 mph).

Teaming up with other aircraft industry enterprises and establishments, the Mikoyan OKB started a massive research effort with a view to increasing the MiG-25's top speed, concentrating mainly on aerodynamic stability and airframe/engine thermal limits. The aircraft's principal structure was made of steel and thus was heat-resistant enough. Some airframe components, however (such as the radome and forward fuselage, wingtips, flaps and ailerons), were made of duralumin and composites. They were not subjected to significant structural loads but experienced high temperatures and had to be replaced with steel or titanium honeycomb structures. This, in turn, called for new technologies. Therefore the Mikoyan OKB suggested to split the work into two stages – that is, test and refine the engine on a structurally standard MiG-25 first and come back to the speed issue later.

Both the VVS and MAP went along with this approach and gave the go-ahead for Stage 1. In September 1964 the Ministry of Aircraft Industry issued an order detailing the test programme of the reengineered MiG-25. Yet



Above: '43 White', an operational Russian Air Force MiG-25BM.



Above: This view shows clearly the MiG-25BM's four missile pylons fitted with AKU-58 missile adapters.

the theoretical part, as well as the manufacturing and bench testing of the R15BF2-300 prototypes, took longer than predicted; development work was completed in 1971-1972 but the flight tests did not begin until 1973.

The development aircraft was converted from a standard MiG-25P manufactured in the summer of 1973 (c/n N84019175, f/n 1710); the modification was performed by the manufacturer in accordance with OKB documents. Still powered by standard R15B-300 engines

and equipped with a Smerch-A2 radar, the machine made its first flight on 12th June 1973 with Pyotr M. Ostapenko at the controls. Later it was flown by Aleksandr V. Fedotov, Aviard G. Fastovets, Boris A. Orlov and other OKB test pilots. On 30th August 1973 the aircraft was fitted with the intended R15BF2-300 engines, receiving a new non-standard c/n (841710) and the appropriate tactical code '710 Blue'. From then on the aircraft bore the unofficial designation MiG-25M (*modifit-*

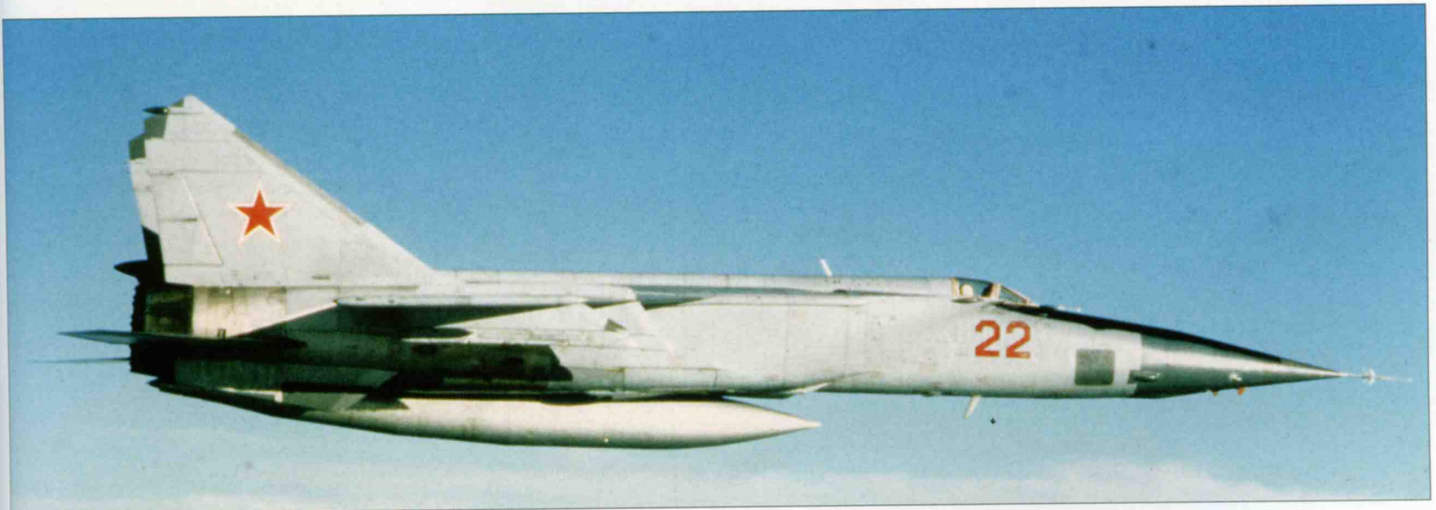

As this photo shows, the MiG-25BM was able to carry a drop tank. The SEAD version's colour scheme included a distinctive dark grey nose.



Above: '710 Blue', one of the two 'MiG-25M' development aircraft, in the open-air museum at Moscow-Khodynka. The 'solid' nozzle shrouds of the R15BF2-300 engines are well visible from this angle.

seerovanny – modified); in official paperwork, however, it was referred to simply as 'MiG-25P No. 710'.

Flight tests of the re-engined interceptor began in 1974. In 1975 a tentative conclusion was issued, recommending the aircraft for production. That year '710 Blue' was subjected to further modifications, receiving a set of wings taken from a modified MiG-25RB coded '601 Blue' (see below) and the horizontal tail of an initial-production MiG-25P coded '502 Blue' (c/n 840SE02, f/n 0502). More updates followed in 1976, this time to the aircraft's control system and electric system.

MiG-25M '710 Blue' underwent State acceptance trials in 1976. Meanwhile, in keeping with a VPK ruling issued on 17th April 1974 the ministries of aircraft, electronics and defence industries were working on the MiG-25-40M aerial intercept weapons system comprising the Ye-155M interceptor powered by R15BF2-300 engines, the upgraded Smerch-A4 radar and the improved K-40M

AAM. The longer detection/tracking range of the radar (which had 'look-down/shoot-down' capability) and the longer launch range of the missiles should allow the interceptor to destroy targets within a wider range of speeds and altitudes, including the destruction of fast low-flying targets. For close-in engagements the Ye-155M interceptor was to be armed with K-60 or K-60M short-range IR-homing AAMs (the future R-60/R-60M) and a 23-mm (.90 calibre) Gryazev/Shipunov GSh-23L twin-barrel fast-firing cannon.

Yet eventually the 'Powers That Be' decided against launching production of the Ye-155M. The reason was that the more advanced and promising Ye-155MP interceptor (*izdeliye* 83/1) – the prototype of the future MiG-31, which lies outside the scope of this book – and the MiG-25P/*izdeliye* 99 engine testbed (see below) were actively undergoing tests at the time, starting in 1975. Both of these aircraft were powered by the advanced and fuel-efficient Solov'yov D-30F (PS-30F) afterburning turbofans with a similar rating but

a lower SFC. Moreover, at the time the Soviet aero engine plants were shouldering a considerable workload, and launching production of the R15BF2-300 could have been a problem. Finally, the PVO top command was more interested in the new MiG-31 than in upgrading the existing MiG-25. Hence the R15BF2-300 was not built in quantity, and '710 Blue' remained a one-off.

Upon completion of the State acceptance trials the aircraft was used as a testbed until withdrawn from use in April 1977. After sitting idle at the OKB's flight test facility at Zhukovskiy for a while the interceptor was transferred to one of the Air Force's Junior Aviation Specialists Schools (ShMAS – *Shkola mlahdshikh aviatsionnykh spetsialistov*) as a ground instructional airframe. Later, '710 Blue' ended up in the open-air aviation museum at Moscow-Khodynka established in 1994 (incidentally, displaying its original construction number). Regrettably, the museum is now closed and the aircraft, like all the other exhibits, is in serious danger.

MiG-25M (Ye-155M) experimental reconnaissance/strike aircraft

The Ye-155M development programme also involved three MiG-25RBs refitted with more powerful and fuel-efficient R15BF2-300 engines and the upgraded Peleng-2 navigation suite. The maximum bomb load of these aircraft was increased to 5,000 kg (11,020 lb).

The first of the three (f/n 0703) was coded '703 Blue', entering flight test in February 1976. The R15BF2-300 engines were also verified on MiG-25RB '401 Blue' (c/n 020SL01, f/n 020401), which had previously served as a testbed for some of the MiG-25M's equipment items, and MiG-25RB '601 Blue' (c/n 020ST01, f/n 020601), which was one of the four *Foxbats* temporarily deployed to Egypt in 1971. After the latter aircraft had been reengined, its c/n in the record card was changed to 02-601.

The conversion work was completed very quickly but refining the engine took much longer. Still, it was worth the trouble: the engine did produce the claimed performance. The service ceiling exceeded 24,200 m (79,396 ft) and supersonic cruise range was 1,920 km (1,200 miles) in clean condition or 2,530 km (1,581 miles) with a 5,300-litre (1,177 Imp gal) drop tank.

The modified MiG-25RB was used to set a number of world time-to-height and altitude records. In the documents submitted to the FAI for registration purposes the aircraft was referred to under the fake designation Ye-266M. On a single day (17th May 1975) Aleksandr V. Fedotov and Pyotr M. Ostapenko set three time-to-height records, reaching 25,000 m (82,020 ft), 30,000 m (98,425 ft) and 35,000 m (114,830 ft) in 2 min 23.2 sec, 3 min 9.85



The remains of the second *izdeliye* 99 engine testbed ('992 Blue') serve as a teaching aid at the Moscow Aviation Institute. Note the nose section on the right clearly indicating the machine's MiG-25R lineage.

sec and 4 min 11.7 sec respectively. For these record flights all non-essential equipment was removed to reduce weight.

In the summer of 1977 Fedotov bettered his own altitude world records. On 22nd June he took the aircraft to 37,800 m (121,653 ft) with a 2,000-kg (4,410-lb) payload, and reached 37,650 m (123,523 ft) on 31st August with no payload. However, soon after the record flights, a pressure valve in the fuel system failed in a regular flight, causing one of the fuselage fuel tanks to become overpressurised and burst. A good-sized chunk of the upper fuselage skin came off in mid-air; test pilot Aviard G. Fastovets displayed considerable skill and bravery, managing to land safely. The aircraft was repaired but test flights did not resume.

The test flights of the reengined MiG-25Ms confirmed the possibility of improving the aircraft's performance considerably. In lightened form for the record-breaking flights the aircraft had a thrust to weight ratio better than 1.0 – for the first time in Mikoyan OKB history. As a result, the brakes couldn't hold the aircraft in full afterburner, and a special mobile detent had to be developed (a heavy vehicle with a jet blast shield to which the aircraft was connected by a strong steel cable and lock).

MiG-25 cruise missile control system testbed

A single MiG-25P was converted into a testbed for verifying the control systems of cruise missiles developed under the guidance of General Designer Vladimir N. Chelomey.

MiG-25 development aircraft with D-30F (PS-30F) engines (*izdeliye 99*)

The production MiG-25P interceptor fulfilled all design requirements except range. To increase range one MiG-25P was experimentally re-engined with Solov'yov D-30F (aka PS-30F) afterburning turbofans rated at 15,500 kgp (34,170 lbst) – both for the purpose of verifying the engine itself and as part of the new Ye-155MP's development pro-

gramme. This engine was a derivative of the 'pure' D-30 commercial turbofan rated at 6,800 kgp (14,990 lbst) powering the Tu-134 short-haul airliner, not the later and much larger D-30KU/D-30KP turbofan which is a totally different engine. The testbed was designated *izdeliye 99* and appropriately coded '991 Blue', receiving the new c/n 990001 (*izdeliye 99*, batch 00, 01st aircraft in the batch). The conversion was completed in April 1976 and the aircraft was delivered to the Zhukovskiy flight test facility in June. Later, a MiG-25R was similarly converted and coded '992 Blue' (c/n 990002).

Unlike the MiG-25M described above, the new engines required major modifications to the airframe. Still, outwardly the aircraft differed little from standard MiG-25s and the internal fuel capacity remained unchanged at 19,700 litres (4,377 Imp gal). The new turbofan was expected to improve rate of climb and especially range (particularly at subsonic speed) thanks to its lower SFC.

A short while earlier, several MiG-25M (Ye-155M) testbeds powered by Tumanskiy R15BF2-300 turbojets had been tested, but there was no knowing if and when this engine would enter production. The new and fairly complex MiG-31 fighter weapons system could also take a long time testing. Thus, a MiG-25 fitted with the new fuel-efficient engines could supplant the standard MiG-25PD on the Gor'kiy production line for a while until the MiG-31 would be ready.

The scope of the *izdeliye 99* programme was much larger than with the MiG-25M. Yet, with assistance from the Gor'kiy aircraft factory and due largely to the insistence of lead engineer M. Proshin, the technical problems were solved quickly enough. Shortly after test flights commenced, a subsonic cruise range of 3,000 km (1,863 miles) on internal fuel was achieved. Supersonic flight, though, caused more problems.

Normal take-off weight during tests was 37,750 kg (83,220 lb), including 15,270 kg (33,660 lb) of internal fuel; MTOW with drop tank was 42,520 kg (93,740 lb). Range was increased to 2,135 km (1,326 miles) in supersonic cruise or 3,310 km (2,068 miles) at transonic speed, and service ceiling was boosted to 21,900 m (71,850 ft); rate of climb was also improved.

Tests of the *izdeliye 99* continued until 1978. However, the MiG-31 was designed around the D-30F engine from the outset. And when the Ye-155MP (the MiG-31 prototype) entered flight testing in the autumn of 1975, interest in the MiG-25/D-30F reengining project waned. In fact, no one took the trouble to study the aircraft's performance completely. The two modified aircraft were relegated to the role of engine testbeds under the MiG-31 development programme. Moreover, '992 Blue', which was transferred to LII and was to be flown by LII test pilot A. A. Shcherbakov, never flew, being used only for ground engine runs (right on the runway) in 1978. After being



Top: At the end of its flying career the MiG-25PD prototype '306 Blue' was converted into the *izdeliye 84-20* engine testbed. The longer nozzle of the AL-41F development engine is visible in the upper photo. The lower photo shows the machine languishing at the RSK MiG flight test facility in Zhukovskiy.

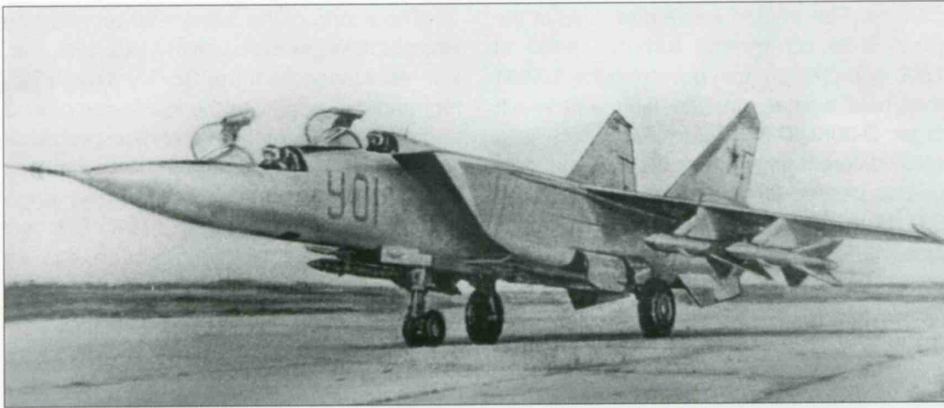

Above: A heavily retouched photo of the MiG-25PU prototype, 'U01 Blue'.

struck off charge this aircraft became a cut-away instructional airframe at the Moscow Aviation Institute.

MiG-25PD engine testbed (*izdeliye 84-20*)

In 1991-1992 the second prototype MiG-25PD interceptor, '306 Blue' (c/n N84042680, f/n ...306), was used by the Mikoyan OKB as a testbed for the experimental Lyul'ka-Saturn AL-41F afterburning turbofan (*izdeliye 20*). This engine was intended for Russia's fifth-generation multi-role fighters, including the projected Mikoyan '1.42' and its demonstrator version, the '1.44'. The development engine supplanted the port R15BD-300 turbojet. The modified MiG-25 was designated

izdeliye 84-20 (that is, '*izdeliye 84* modified for testing *izdeliye 20*') and used for testing the AL-41F in various flight modes, including supersonic flight.

The test programme was a rather complex one, since the new engine had a totally different control system (FADEC – full authority digital engine control) and was much more powerful than the standard R15BD-300, delivering about 17,700 kgp (39,020 lbst) versus 11,200 kgp (24,690 lbst) in full afterburner, which had its adverse effect on the aircraft's handling. Therefore, much thought was given to safety measures in case the development engine or its air intake control system should fail, especially on take-off and in supersonic flight up to Mach 2.



Above: '91 Red' (c/n N22018746), a MiG-25PU operated by LII, taxis at Zhukovskiy.



A Russian Air Force MiG-25PU operated by the 929th State Flight Test Centre in Akhtobinsk.

Stage A of the flight test programme (including supersonic flight) was completed without major difficulties. Aircraft 84-20 made more than 30 test flights, some of which proceeded at high supersonic speeds and high altitudes; some of the missions involved in-flight engine shutdown and restarting. The tests yielded invaluable data, allowing Lyul'ka-Saturn to make the necessary changes to the design of the AL-41F. The *izdeliye 84-20* was post-Soviet Russia's first supersonic engine testbed.

MiG-25PU interceptor trainer (*izdeliye 22*)

A two-seat trainer version of the MiG-25 was developed in the late 1960s to facilitate pilot training. This wasn't envisaged by the initial operational requirements, nor required by government directives. However, VVS test pilots and instructors pressured the Mikoyan OKB into designing such an aircraft to fit both the interceptor and reconnaissance roles.

The designers decided to use a stepped-tandem arrangement with the instructor's cockpit in a redesigned nose, ahead of and slightly lower than the trainee's cockpit. This simple but effective solution afforded an excellent field of view for the instructor and the trainee alike and had been used before by Tupolev (on the Tu-128UT) and Yakovlev (on the Yak-28U). The extreme nose ahead of fuselage frame 1 was designed anew, with no room for a radar or reconnaissance equipment. The instructor's cockpit was fitted with a complete set of controls and flight instruments, a failure simulation panel (so that the instructor could provide 'bad news' for the trainee and see how the latter would cope); an intercom was provided for both cockpits.

Since the trainer had no radar, the R-40RD SARH missile was excluded from the weapons range. The aircraft could still carry IR-homing R-40TD AAMs, though.

Officially the trainer was developed pursuant to a VPK ruling dated 7th July 1965. The advanced development project work proceeded in 1967-69. Since the trainer was needed first and foremost by the PVO, the prototype was built by cutting up a standard MiG-25P interceptor (c/n 840SL05, f/n 0405), retaining the missile pylons. It was completed in August 1969, receiving the very non-standard code 'Y01 Blue' (that is, U01 in Cyrillic characters), the U denoting *oochebnyy* – trainer. The interceptor trainer version was designated MiG-25PU (for *perekhvatchik oochebnyy*). Arkadiy B. Slobodskoy was appointed lead engineer for the trainer versions.

Mikoyan OKB chief test pilot Aleksandr V. Fedotov made the MiG-25PU's maiden flight on 28th October 1969. State acceptance trials began in September 1970, lasting until July

1971. The flight test programme was completed without major problems, except for some buffeting experienced at high Mach numbers. The OKB chose the line of least resistance and imposed a Mach 2.65 speed limit rather than make design changes.

Upon completion of the trials the MiG-25PU entered production in Gor'kiy with the factory code *izdeliye 22*; nearly 180 examples had been built when production of this model ended in 1982. Except for the weapons controls, the MiG-25PU's cockpit equipment was identical to the MiG-25PD. The wings with the kinked leading edge came straight from the interceptor, including the four pylons which could carry R-40 missiles (chiefly dummy versions). As already mentioned, the instructor's cockpit in the nose left no room for a radar; therefore, radar operation was emulated.

In 1977 one MiG-25PU was specially modified for setting female world records. Svetlana Ye. Savitskaya, aerobatics world champion and daughter of Marshal Yevgeniy Ya. Savitskiy (he, as the reader remembers, chaired the State commission holding the MiG-25's trials), had a chance to train on the MiG-25PU after graduating from the Test Pilots' School in Zhukovskiy. The results exceeded by far every record set to date by female pilots, so it was decided to let her have a crack at the records without transitioning to the single-seat MiG-25.

On 31st August 1977, Savitskaya reached an altitude of 21,209.9 m (69,586.2 ft). On 21st October she averaged 2,466.31 km/h (1,541.44 mph) over a 500-km (312.5 miles) closed circuit. Finally, on 12th April 1978 she clocked 2,333 km/h (1,458.125 mph) over a 1,000-km (625 miles) closed circuit. Typically, the aircraft was registered in the FAI records under the disguise designation Ye-133.

MiG-25RU reconnaissance trainer (*izdeliye 39*)

Quite predictably, the need arose for a reconnaissance/strike trainer fitted with reconnaissance equipment emulators. Development of such an aircraft was completed in 1970. The reconnaissance trainer prototype (c/n 390SA01) made its first flight at Gor'kiy-Soromovo on 20th March 1971 with factory test pilot El'kinbard at the controls. After completing the test programme the aircraft entered production in 1972 as the MiG-25RU (*razvedchik oochebnyy* – reconnaissance aircraft, trainer) or *izdeliye 39*; the production run was much smaller, totalling 50 examples. The only visible difference from the MiG-25PU was the absence of missile pylons (unlike the 'real-life' reconnaissance version, the reconnaissance trainer had the kinked 'interceptor wings'). The MiG-25RU also lacked the Peleng navigation system.



A Russian Air Force/4th TsBP i PLS MiG-25RU takes off from Lipetsk-2 AB, showing the lack of pylons.

The two trainer versions were widely used by VVS and PVO combat and conversion training centres (the 4th TsBP i PLS and 148th TsBP i PLS respectively) for advanced training for many years to come. They were also used by first-line units for pilot checkout, proficiency training, weather reconnaissance and so on. Both versions received the NATO reporting name *Foxbat-C*.

As compared with the single-seat versions, the trainers cracked the sound barrier more often in the same number of flight hours and hence suffered bigger airframe loads, which caused fatigue cracks in the wings – a problem the Mikoyan OKB had never encountered before. To cure the problem, changes had to be made to the manufacturing technology and overhaul procedures, and the trainers' service life was suitably increased.

The trainers were supplied to major foreign operators of the MiG-25's single-seat versions. For example, India took delivery of two MiG-25RUs.

Several trainers were converted to testbeds and research aircraft described separately.

MiG-25RB avionics testbed (Project *Trapetsiya*)

The MiG-25RB proved a very convenient aircraft for conversion into various electronic equipment and systems testbeds by virtue of the access hatches in the forward fuselage.

These could be used to replace the standard SIGINT gear and cameras by experimental avionics and test instrumentation.

The Flight Research Institute (LII) used MiG-25RBs in various trials programmes. The first of these was Project *Trapetsiya* (Trapeze) under which the aircraft was used to test the navigation system of a new cruise missile.

MiG-25 testbeds in the Buran space shuttle programme

Three aircraft (a MiG-25RU, a MiG-25PU and a MiG-25RB) were used as testbeds and support aircraft under the Buran (Snowstorm; pronounced *boorahn*) space shuttle programme. The two latter aircraft were also used as Buran pilot trainers for practicing the shuttle's characteristic steep landing approach. They are described below.

MiG-25RU ejection seat testbed

The MiG-25RU prototype was transferred to LII by the Mikoyan OKB after completing its flight test programme. The new owner converted it into a testbed for the Zvezda K-36RB zero-zero ejection seat – a version of the standard Soviet ejection seat modified for use in the Buran space shuttle. The seat was fired from the rear cockpit, which was suitably modified with a cutaway metal fairing in lieu of the standard canopy. A ciné camera was installed in a dorsal fairing on the nose to record ejection seat separation.

MiG-25RU brief specifications

Fuselage length	19.431 m (63 ft 9 in)
Wing span	14.015 m (45 ft 11 in)
Take-off weight, kg (lb):	
with drop tank	39,200 (86,420)
without drop tank (full fuel load)	34,460 (75,970)
with 80% fuel load (all tanks except No. 1 fuselage tank)	32,100 (70,770)
with 50% fuel load (Nos. 3 & 4 fuselage tanks and wing tanks)	26,700 (58,860)
Top speed	Mach 2.65

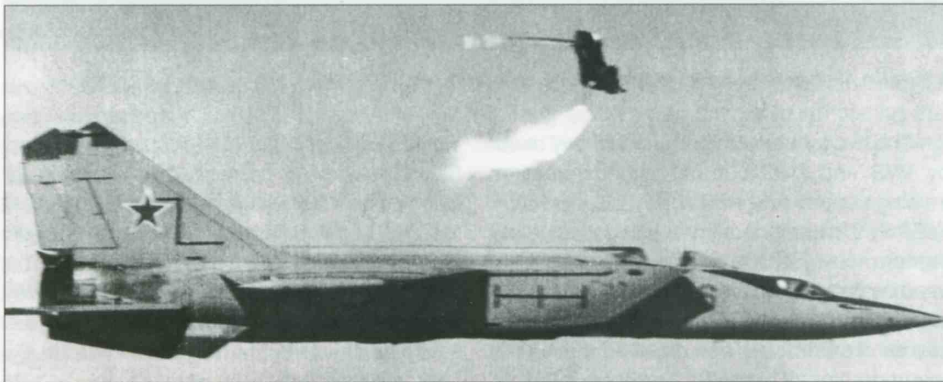

Top and above: Shown here with the original tactical code '46 Red', LII's MiG-25RU ejection seat testbed had a modified rear cockpit and wore photo calibration markings on the fuselage and fins.

Initially the aircraft was coded '46 Red'; later it was recoded '01 Blue'. When the Buran programme was terminated the MiG-25RU was used for testing other ejection seats – such as the K-93 seat developed for the MiG-AT advanced trainer. On 22nd-27th August 1995 the ejection seat testbed was in the static display at the MAKS-95 airshow in Zhukovskiy.

MiG-25PU-SOTN TV tracker aircraft

In order to calculate trajectory guidance algorithms for the Buran space shuttle, LII converted a MiG-25PU ('22 Blue', c/n N22040578) into a research aircraft designated MiG-25PU-SOTN (*samolyot optiko-televizionno nablyudeniya* – optical/TV surveillance aircraft). Its missions included:

- advanced research of trajectory guidance algorithms for the Buran at altitudes below 20,000 m (65,620 ft) as part of the shuttle's total in-flight simulation complex (which also included three Tu-154LL control system testbeds/approach trainers – CCCP-85024, CCCP-85083 and CCCP-85108);
- checking out monitoring techniques for the shuttle's automatic flight control system;
- training space shuttle pilots and navigators/system operators;
- acting as a chase plane for the Buran during flight tests.

The aircraft was fitted with a KRL-78 radio command link system (*komahndnaya rahdi-olinyi*) integrated with the standard SAU-155 automatic control system, a B-218 data link system, test instrumentation (data recorders) and a TV tracking system for videotaping the aircraft being shadowed. This equipment suite had been jointly developed for the MiG-25PU-SOTN by the Molniya Research & Production Association (the creator of the Buran) and the Institute of TV systems.

The TV tracking system included a Sony DXM-3P video camera, a 3800PS video tape recorder, a DX-50 video monitor, a KL-108 transmitter and an MB-10 transmit antenna. The ground control room was equipped with a KL-123 receiver, short-range and long-range receiving antennas and control and data recording gear. The front cockpit housed the video camera and associated equipment. External identification features were the extra aeriels under the nose and on the fuselage spine.

Lining up on the 'target aircraft', the pilot of the MiG-25PU-SOTN extended the landing gear and flaps and throttled back the engines



Seen here with the new tactical code '01 Blue' and the LII logo on the nose, the testbed fires a Zvezda K-36RB ejection seat. The seat's distinctive stabilising booms tipped with drogue parachutes are deployed.

at about 18,000 m (59,055 ft) in order to follow the same steep glide path, get the 'target' in his viewfinder and start shooting. Until the real thing flew, the aircraft which acted as 'stand-ins' for the Buran were a specially modified MiG-25RB ('02 Blue'), a similarly modified MiG-31 ('97 Red') and the BTS-002 (registered CCCP-3501002) – a full-scale Buran fitted with four Lyul'ka AL-31 turbofans and a lengthened nosewheel leg for taking off under its own power. (BTS = *bol'shoye trahnsportnoye soodno* – 'big transport ship' (!). Another designation of the same aircraft is GLI-Buran GLI standing for *gorizontahl'nyye lyotnyye ispytaniya* – 'horizontal flight tests'.)

Stage A of the programme comprised 15 flights for checking the TV tracking system's



Above: Here the ejection seat testbed has a special cover placed over the rear cockpit. Note the non-standard fat wingtip pods.



Above and below: '02 Blue', the MiG-25PU modified for verifying the Buran space shuttle's control system. It is seen here at Zhukovskiy, its home base.

function, range and sensitivity to interference. It turned out that signals from the aircraft reached the ground control room undistorted in about 85% of the cases and the worst interference was caused by the radio altimeters of other aircraft flying nearby.

Stage B was held in September-October 1986 and served to optimise the data link transmission parameters and to determine the effect of the 'target aircraft' on picture quality. The optimum distance to the target was judged at about 10 m (33 ft). Therefore, an additional TV screen was installed in the rear cockpit; the front cockpit canopy was modified and a Betacam video camera used.

Finally, Stage C was held near Yevpatoria on the Crimea Peninsula on 11th-16th October 1986 and included ten flights with the updated and complete equipment suite. Yet the heyday of the aircraft was yet to come: it was when the 'real' Buran lifted off on its one and only unmanned space mission on 15th November 1988. Test pilot Magomed Tolboyev flying the MiG-25PU-SOTN intercepted the shuttle on its subsequent reentry and flew chase during its glide and automatic approach all the way to touchdown at Baikonur, videotaping the entire sequence.



'22 Blue', the MiG-25PU-SOTN, whizzes past the Buran space shuttle which has just touched down at Baikonur-Yoobileyyny airfield after its sole orbital flight on 15th November 1988.

1190 - number built and years of production

- family development

- mid-life update

the right-hand edge of the silhouette is in line with the first flight date

hatchet lines denote projected versions

MiG-25

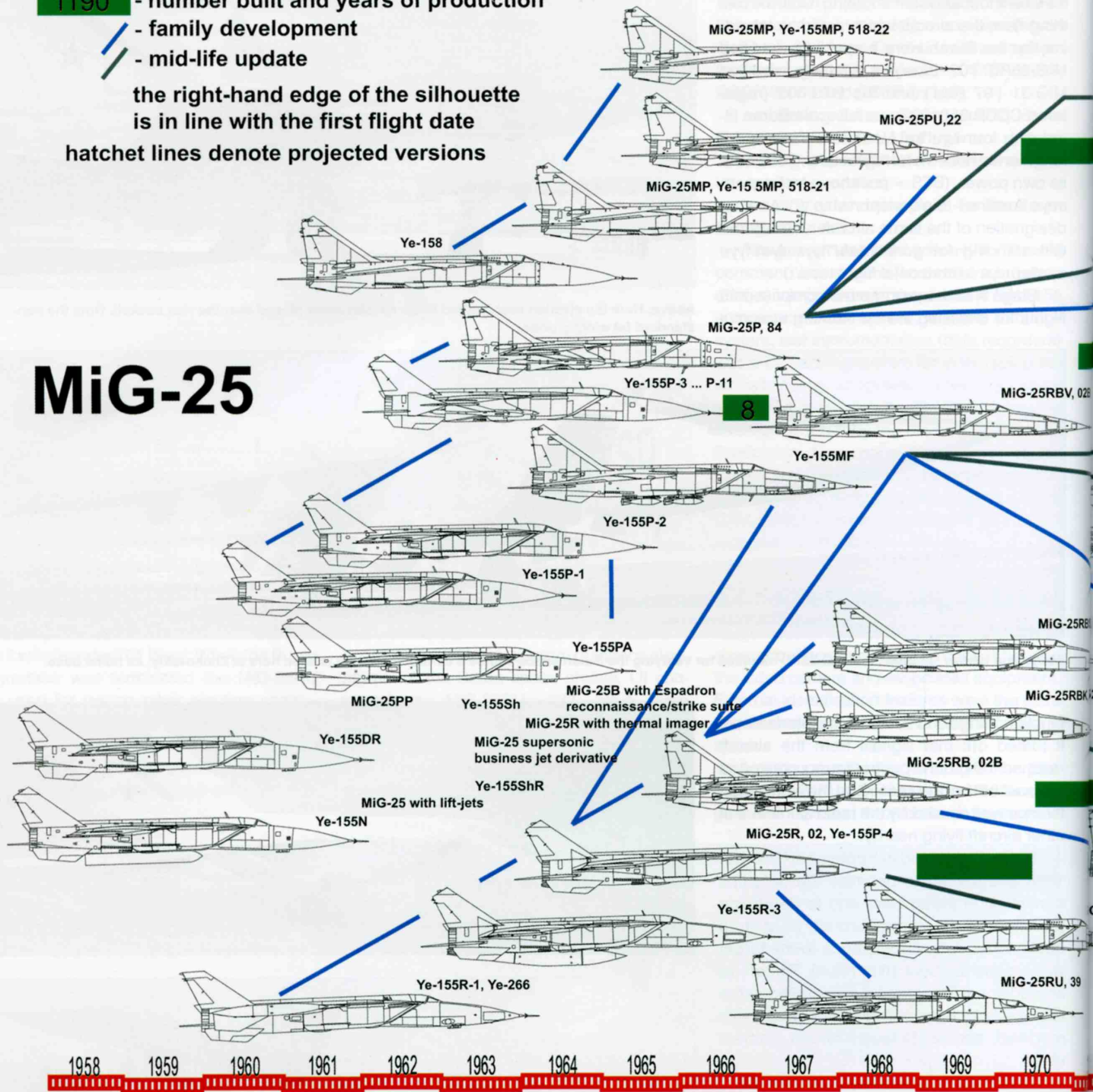

MiG-25PU Buran control system testbed

Another MiG-25PU coded '02 Blue' (c/n N22044011) was also used by LII as a research aircraft under the Buran space shuttle development programme. Specifically, this aircraft served for evolving methods of checking the operation of the shuttle's automatic flight control system and training Buran crews.

MiG-25RBK research aircraft

The abovementioned MiG-25RBK coded '02 Blue' (c/n N02029210) was likewise modified for the Buran test programme. The reconnaissance equipment and navigation/attack computer was replaced by additional communications gear, data link and other specialised equipment. The aircraft could also carry test instrumentation containers on the underwing hardpoints. '02 Blue' could be

identified as a research vehicle by the additional dielectric panels on the sides of the air intake trunks.

MiG-25PU avionics testbed

Another MiG-25PU was modified in 1975 for testing the SAU-155MP automatic flight control system and KN-25 navigation suite (*kompleks navigatsii*) intended for the MiG-31.

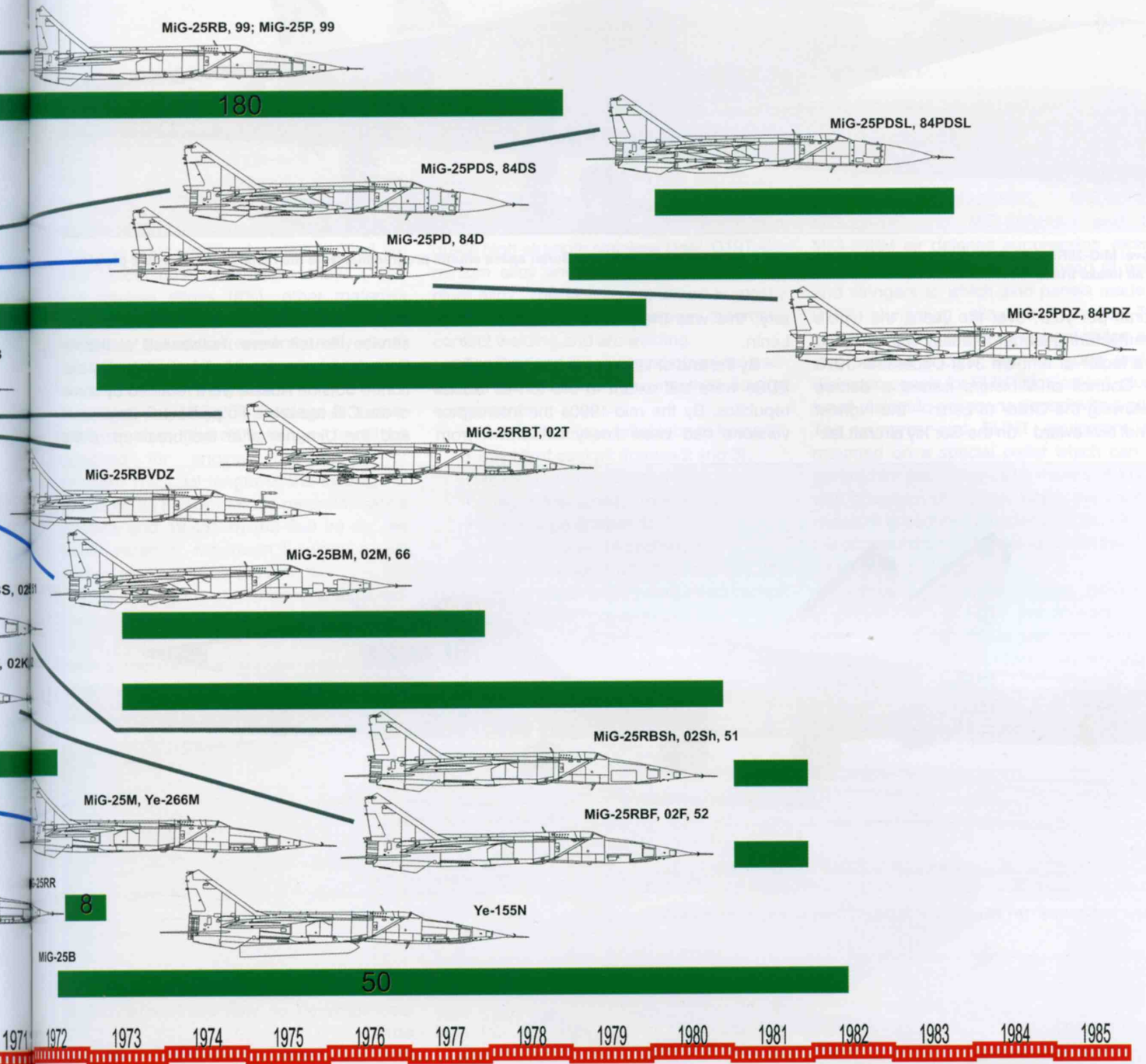

High gross weight reconnaissance version (project)

The MiG-25R was evolved into a high-gross weight version featuring various structural and system changes, the most obvious of which was the main units equipped with twin-wheel bogies borrowed from the MiG-31. These utilised an unorthodox staggered-tandem arrangement, the front wheels being mounted inboard of the oleo and the rear

wheels outboard (unlike, for example, the SAAB JA/AJ 37 Viggen where the wheels were situated in line).

High gross weight launch platform version (project)

Concurrently, a version intended for launching heavy missiles (such as suborbital launch ballistic missiles) was under consideration. This version, too, had MiG-31 main gear units.

The MiG-25 remained in production at the Gor'kiy aircraft factory from 1969 to 1982 – quite an impressive period; the final aircraft were delivered to the customer in 1984. The production run totalled 1,116 aircraft – 1,112 Gor'kiy-built machines and four prototypes manufactured by MMZ No. 155 in Moscow (the Ye-155P-1, Ye-155P-2, Ye-155R-1 and Ye-155R-2). MiG-25 production peaked at 90



Above: MiG-25RBK '02 Blue' (c/n N02029210) served as an avionics testbed under the Buran space shuttle programme. Note the rectangular dielectric panel on the air intake trunk.

aircraft per year; over the years, the type's manufacturing labour intensity was reduced by a factor of ten. On 31st December 1970 the Council of Ministers issued a decree bestowing the Order of Lenin – the highest Soviet civil award – on the Gor'kiy aircraft fac-

tory; this was the plant's second Order of Lenin.

By the end of 1991 some 550 MiG-25PDs/PDSs were still extant in the former Soviet republics. By the mid-1990s the interceptor versions had been finally withdrawn from

Russian PVO service; aircraft with still some service life left were mothballed at the Air Force's storage depots. A few examples stationed outside Russia were retained by some of the CIS republics (in particular, Belorussia and the Ukraine) after the break-up of the



Above: MiG-25RBS '701 Blue' (c/n N02048127) used as a systems testbed.



The same aircraft preserved in front of the MKB Raduga weapons design bureau in Doobna, Moscow Region, wearing the spurious tactical code '001 Blue' and sporting Kh-58U anti-radar missiles on MiG-25BM style pylons under the wings.

USSR. The reconnaissance/strike versions also soldiered on with the Russian/CIS air arms.

From 1979 onwards the type was exported to Algeria, India, Iraq, Libya and Syria. As already mentioned, four MiG-25RBs were briefly operated by Bulgaria but then traded in for MiG-23BNs.

In the late 1980s the Mikoyan OKB was considering MLU programmes for the MiG-25 that were to boost its combat efficiency, including the addition of IFR capability. However, the demise of the USSR and the resulting defence spending cutbacks made short work of these plans.

Foxbat Anatomy

Type: Twin-engined single-seat supersonic interceptor or reconnaissance/strike aircraft. The fuselage is of all-metal construction, a one-piece structure formed mainly by a fuel tank. The main structural materials used are steel (about 80%), aluminium alloys (11%) and titanium alloys (8%); other materials account for 1% of the structure. The various versions of the aircraft are structurally identical, except the forward fuselage.

Fuselage: The MiG-25's fuselage is a one-piece structure (the aft fuselage cannot be detached for engine maintenance or change). The total length of the fuselage is 19.581 m (64 ft 2½ in) for the reconnaissance versions and 19.431 m (63 ft 9 in) for the trainer versions. Maximum fuselage cross-section area is 5.54 m² (59.6 sq ft).

The fuselage is of monocoque stressed-skin construction with 57 frames, 15 of which (some sources say 14) are principal load-bearing frames, plus supplementary lower longerons and beams. The forward fuselage with the cockpit is made of aluminium alloys.

The centre fuselage is formed by a welded fuel tank made of steel and split into several cells. The main structural materials are VNS-2, VNS-5, EI-878, SN-3, EI-703 and VL-1 grade high-strength stainless steel, D19T aluminium alloy and OT4-1 heat-resistant titanium alloy. The fuselage structure is mostly assembled by automatic and semi-automatic contact welding and arc welding.

The fuselage is composed of various panels and can be broken down into the following components:

- forward fuselage (pitot tube to frame 2);
- bay aft of cockpit (frames 2 and 3);
- air intake trunks (frames 2-6);
- integral fuel tank (frames 3-12);
- aft fuselage (frames 12-14);
- tailcone (frame 14 and beyond).

Fuselage frames 1 and 2 form a bay, the upper half of which is the pressurised cockpit and the lower half houses avionics.

The *forward fuselage* up to frame 2 is of monocoque structure and is structurally different in the interceptor, reconnaissance/strike and trainer versions.

In the reconnaissance and reconnaissance/strike versions (MiG-25R, MiG-25RB, MiG-25RBK, MiG-25RBS, MiG-25RBV, MiG-25RBF and MiG-25RBSH) and the MiG-25BM air defence suppression version the forward fuselage is composed of webs and stringers to which skin panels made of D19T aluminium alloy are riveted. The extreme nose is of almost conical shape and incorporates circular camera ports and/or dielectric panels for ELINT equipment, plus a small dielectric nosecone tipped with a pitot. The cameras and ELINT equipment are mounted on a special pallet which can be lowered for maintenance by means of a hoist with a system of cables. When the pallet is raised, it is secured by special bolts, closing the access hatch and forming part of the load-bearing structure.

In the interceptor versions (MiG-25P, MiG-25PD/MiG-25PDS) the forward fuselage houses the radar set and antenna dish; the latter is enclosed by an ogival dielectric radome carrying a pitot. The radome can be slid forward for radar main-



This overall view of a MiG-25PD flying above heavy overcast shows clearly the aircraft's layout with massive air intake trunks flanking the forward fuselage to blend into the centre fuselage.

Foxtrot Anatomy

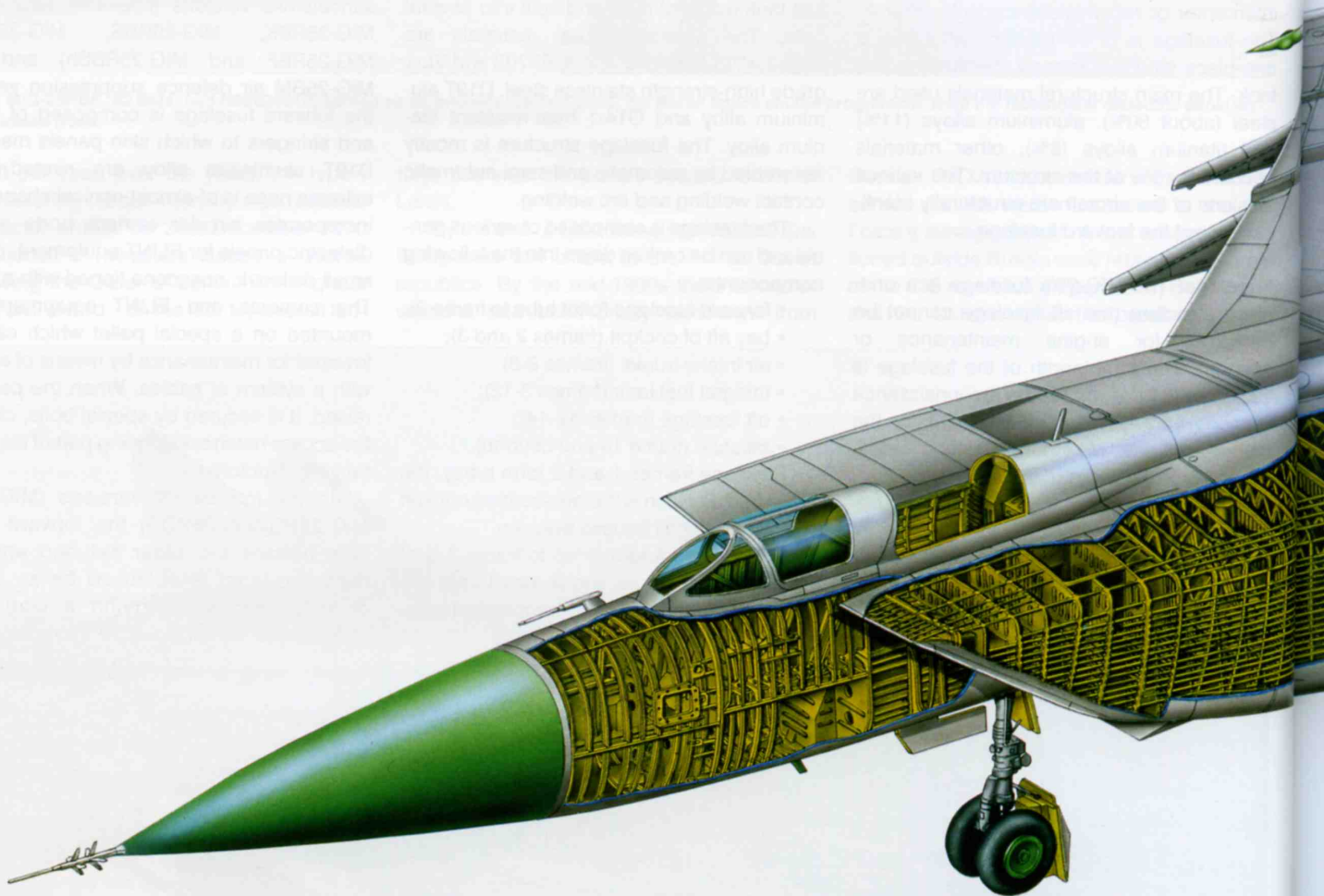

A cutaway drawing of the early-model MiG-25P interceptor illustrating the airframe structure. The port engine is not shown.

tenance and is attached by bolts on a flange mounting.

In the trainer versions (MiG-25PU, MiG-25RU) the forward fuselage has no dielectric panels and houses the pressurised instructor's cockpit, which is located ahead of and below the structurally similar main cockpit (occupied by the trainee).

The pressurised cockpit located between frames 1 and 2 has a framework of metal profiles (auxiliary frames identified by letters in

Russian alphabetical sequence – A-B-V-G-D etc.). The two-piece canopy faired into the upper fuselage contour is attached to a supporting panel and the glazing is made of E-2 heat-resistant Plexiglas. The fixed windshield has an optically flat elliptical forward panel 20 mm (0.79 in) thick and curved triangular sidelights; these and the blown glazing of the main portion hinged to starboard are 12 mm (0.47 in) thick. The canopy is opened and closed manually by means of an external

handle and an internal folding strut. It is held in the open position by the abovementioned strut forward and a retaining bar aft and secured in the closed position by four locks. Pressurisation is ensured by an inflatable perimeter seal. The cockpit glazing is equipped with de-icers.

Fitting for guide rails for the KM-1 ejection seat are attached to the cockpit floor at the bottom portion of frame 2. The canopy is faired into a tapering fuselage spine of semi-



circular cross-section that continues aft along the entire fuselage, terminating in the brake parachute housing (see Landing gear).

The forward fuselage skin panels and access hatch covers, canopy support frame and cockpit floor are all attached to fuselage frame 1.

The cockpit's sloping rear bulkhead serves as an attachment for the canopy support frame and cockpit floor. Frame 2 has a recess for the nose landing gear unit.

The bay aft of the cockpit connects the forward fuselage and the *centre fuselage* (the fuel tank bay). It is an oval-section semi-monocoque structure tapering towards the rear in accordance with the area rule. The upper and side parts of the bay house avionics while the lower part is the nosewheel well. The bay is composed of panels made mainly of D19T duralumin. The skin panels are spot-welded to frames 2A and 2B, web-frames 2V, 2G and 2D, longerons and

stringers and incorporate a number of access panels.

The avionics bay is separated from the wheel well by a pressure bulkhead riveted to a square-section longitudinal beam assembled from metal angles. This hollow beam carries the nose gear actuator and downlock mounting and also houses control runs accessible via the removable top section of the beam. The nose gear fulcrum is located on frame 3 and the actuator fitting is between

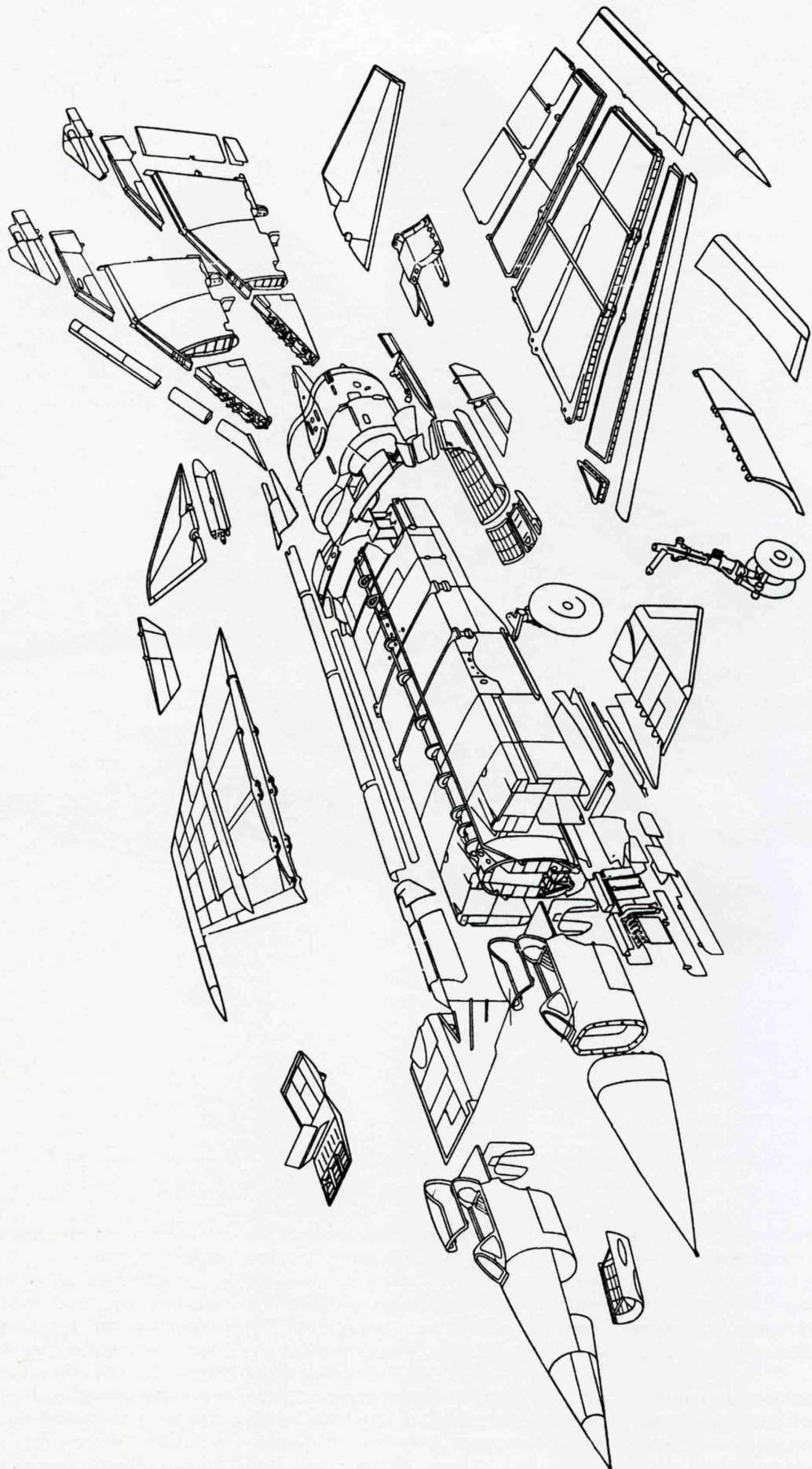

An exploded view of the MiG-25P, with the alternative nose section of the MiG-25R shown alongside.

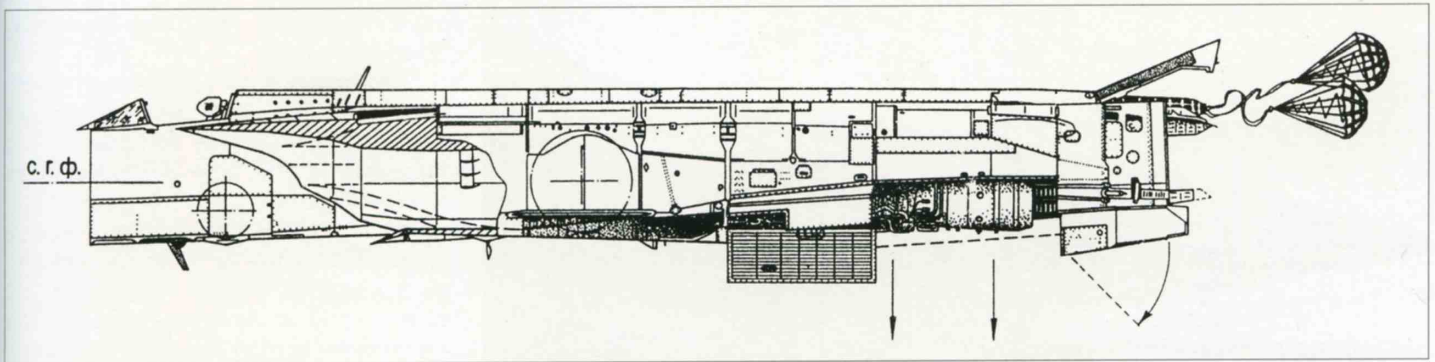

Above: A schematic drawing showing the layout of the fuselage (less the extreme nose ahead of frame 1). The mainwheels are stowed almost vertically. Note the lower airbrake. The engines are extracted downwards. Note the drogue parachutes extracting the twin brake parachutes.

Right: The nose of a MiG-25PD. Note the IRST fairing (with a black anti-glare panel on the underside of the radome ahead of it) and the retractable landing/taxi lights.

Below right: The nose of a MiG-25RBV, showing the dielectric panels for the Virazh SIGINT set and the window of the port oblique camera further aft.

Bottom right: The nose of a MiG-25RBS, showing the port dielectric panel for the Sablya SLAR.



frames 2V and 2G. The bay is pressurised and the bay walls are heat-insulated by means of bonded ATAZ mats faced with ANT-7 fabric. The access hatches have rubber perimeter seals and are secured by quick-release fasteners.

The air intake trunks are stressed-skin structures with frames and access panels absorbing part of the load. The inlet ducts run along the fuselage sides from frame 2, connecting to the engine inlets at frame 6. The air intakes are two-dimensional and have a sharp leading edge slanting sharply aft in side view. Between frames 6 and 7 the inlet duct cross-section changes to circular. The flat inner faces of the intakes stand proud from the fuselage sides, acting as boundary layer splitter plates, and are attached to the fuselage by hinges and bolts; V-shaped fairings spilling the boundary layer connect the splitter plates to the fuselage. The upper panels incorporate boundary layer spill outlets. The boundary layer air is directed into the engine bays via auxiliary intakes at frame 9 for engine cooling.

The integral fuel tank delimited by frames 3-12 is a one-piece monocoque structure welded from VNS-2, VNS-4, VNS-5 and SN-3 high-strength stainless steel (VNS = *vysokoprochnaya nerzhaveyushchaya stahl'*; SN = *stahl' nerzhaveyushchaya* – stainless steel). The bottom part of the tank section and some internal webs in the tank are made of D19T heat-resistant duralumin. The structural elements of this section are mostly connected by argon-arc and spot welding.





Above: The nose of the MiG-25RBT is similar to that of the MiG-25RBV – unsurprisingly, since only the equipment inside is different. The forward camera ports are hard to spot from this angle.



The MiG-25RBF has a similar nose shape but a large MiG-25RBK-style dielectric nosecone and additional dielectric panels low on the sides instead of camera ports.

The centre fuselage tank section is the main load-bearing element of the fuselage, absorbing the structural loads from the wings, the tail unit (via the aft fuselage), the engines and the landing gear, plus the external aerodynamic loads and the pressure loads in the air intake ducts and pressurised

fuel tanks. It has eleven principal load-bearing frames and is separated into six bays by bulkheads.

Technologically, the centre fuselage consists of four parts: the Nos. 1 and 2 tanks (frames 3-6), the No. 3 tank (frames 6-7), the Nos. 4 and 5 tanks (frames 7-11) and the No.

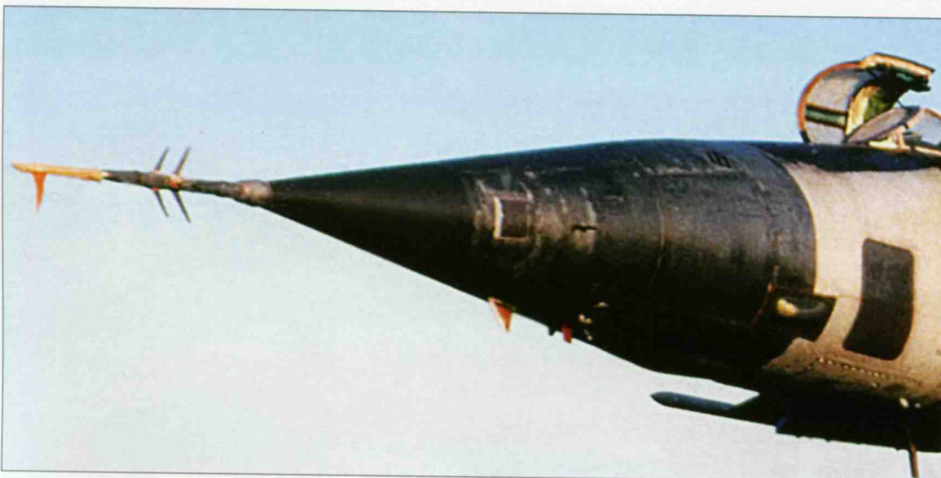

The nose of a MiG-25BM, showing the distinctive dielectric blisters and square-shaped dielectric panels of the radar detection suite.

6 tank (frames 11 and 12). These are made up of separate panels.

The mainwheel wells are located between frames 6-9. The main gear fulcrums are attached to the fuselage keel beam and to frame No. 8, the downlock struts being attached to frame 9.

The *aft fuselage* (frames 12-14) is a mono-coque structure with two principal load-bearing frames (Nos. 13 and 14) made of VL-1 steel and built-up skin panels. It incorporates the stabilator booster bays with access covers made of SN-3 steel and stabilator mounting beams made of VL-1 steel.

Frames 13 and 14 serve as attachment points for the vertical tails, ventral fins and stabilator mounting beams. In addition, frame 14 carries the upper and lower airbrake actuators and the rudder bellcranks. The upper airbrake has an area of 1.3 m² (13.97 sq ft) and a maximum deflection of 45°; the lower airbrake has an area of 1.0 m² (10.76 sq ft) and a maximum deflection of 43° 30'.

The tailcone consists of several panels. The internal structure is made of steel and spot-welded. The external skin and webs are made of titanium and likewise spot-welded, then riveted to the steel internal structure. The upper part of the tailcone begins with the upper airbrake recess, continuing into the brake parachute housing with a duralumin cover and fittings. The lower part of the tailcone incorporates the lower airbrake recess. The tailcone is attached to frame No. 14 with a double row of rivets.

The lower fuselage between frames 9 and 13 incorporates removable cowling panels for engine maintenance and removal/installation. The engines are extracted downwards.

Wings: Cantilever shoulder-mounted wings of trapezoidal planform. Wing span is 14.015 m (45 ft 11⁹/₁₆ in) or 14.062 m (46 ft 1¹/₂ in) for the interceptor and trainer versions, depending on what type of wingtips is fitted, and 13.38 m (43 ft 10⁹/₁₆ in) for the reconnaissance/strike versions. Wing area for the reconnaissance/strike versions is 61.4 m² (660.66 sq ft), including centre section, or 41.0 m² (441.16 sq ft) without centre section. Reconnaissance/strike versions have constant 41° 02' leading edge sweep from roots; interceptor and trainer versions have a kinked leading edge with 42° 30' sweep inboard of the inner pylons and 41° 02' outboard. Trailing edge sweep 9° 29' for all versions; aspect ratio 2.94, taper 3.1, anhedral 5° from roots, incidence 2°. The wings are cambered.

The wings utilise TsAGI P-44M airfoil section at the roots, with a relative thickness of 3.7%, and TsAGI P-101M section at the tips with a thickness/chord ratio of 4.76%. Root chord is 6.943 m (22 ft 9¹/₂ in), tip chord is 2.237 m (7 ft 4 in); mean aerodynamic chord

Below: The small dielectric nosecone as fitted to most reconnaissance versions of the MiG-25 (except the MiG-25RBK and MiG-25RBF).

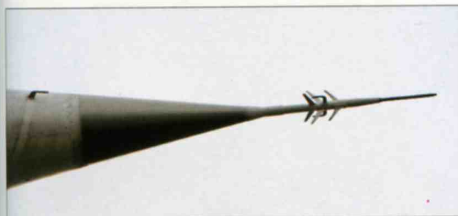

(MAC) is 4.992 m (16 ft 4¹⁷/₃₂ in). The greater part of the trailing edge is occupied by one-piece flaps and two-section ailerons, with fixed portions outboard of the latter; there are no leading-edge devices.

Each wing panel is attached to the fuselage by five bolts. The wings are of three-spar construction and are made largely of welded VNS-2, VNS-5 steel and OT4-1 titanium sheet. The main longitudinal structural elements are the front, middle and rear spars and the front and rear stringers. The leading edge and wing torsion box ribs are punched from VNS-4 sheet. Most of them are attached to the wing skin by means of 'spacer boxes'; however, ribs 21, 22, 23 and 26 are attached directly to the skin. The trailing edge ribs are made of OT4-1 titanium. Each rib is thus made in two parts and spot-welded during assembly.

The detachable leading edge is welded from OT4-1 titanium sheet. It houses fuel lines and cable runs. The trailing edge assembly is riveted and welded. At the root it incorporates attachments for the flaps and the aileron bellcranks.

Each wing panel has four attachments for two weapons pylons, with reinforcement plates made of 30KhGSNA steel. Special deflectors are installed on the wing leading



Above: The forward fuselage of a MiG-25PU, showing the stepped-tandem cockpits and the all-metal nosecone.



Above: The canopy of a MiG-25. Note the colour of the sealant around the edges of the transparencies.

edge to keep water from seeping into the pylons. The upper surface of each wing has a single boundary layer fence in line with the inboard hardpoint (riveted and welded from D19T sheet) and a shallow fairing above each hardpoint. The ailerons' centre and outer attachment brackets are made of 30KhGSNA steel and AK4-1 aluminium alloy respectively.

The rear end of rib No. 22 serves as the outboard attachment point for the flap and the inboard attachment point for the aileron.

The wingtips are welded and riveted structures fitted with anti-flutter weights, radar warning receiver aerials and static discharge wicks. The MiG-25 was fitted with two types of wings featuring detachable or per-



Another view of a trainer's forward fuselage (this time a MiG-25RU). The canopies open to starboard. With the nose gear unit positioned well aft, the MiG-25 requires a long towbar for ground handling.



Top left: The port air intake of a MiG-25PD. Note the protective sheath on the lower intake lip preventing injuries to ground personnel.

Top right: The starboard air intake of a MiG-25BM. The intake blanks are positioned well inside the inlets and hence feature long handles to facilitate removal and installation.

Above: This view shows how the intake's inner wall, which has a complex curvature, stands apart from the fuselage side to act as a boundary layer splitter. Note the small intakes scooping up the boundary layer for engine bay cooling. The lower lip is at maximum deflection.

Above left and left: The air intake trunks feature removable panels (originally intended for access to the actuators of the canard foreplanes that were never fitted). Note the ECM antenna blisters.

Right: This view shows the faired actuators of the air intakes' lower lips. Most MiG-25s have the landing/taxi lights buried in the undersides of the air intake trunks as shown here.

Below and centre: The MiG-25's air intakes feature distinctive tree-like airflow stabilisers when the ducts' cross-section changes from two-dimensional to circular.

Bottom: A view of the segmented airflow control ramp with boundary layer suction apertures.

Below right: The upper side of the air intake trunks, showing the boundary layer spill outlets. Note the retaining rod keeping the cockpit canopy open.

Bottom right: The upper centre fuselage and fuselage spine; the brake parachute housing is just visible.

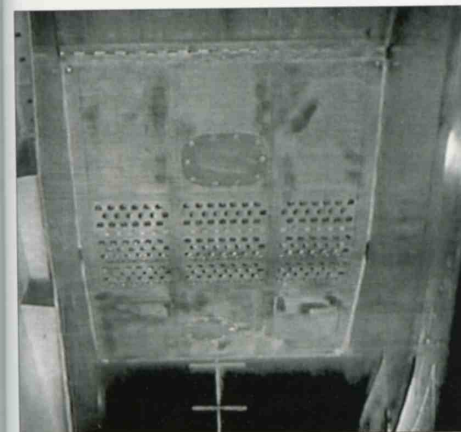
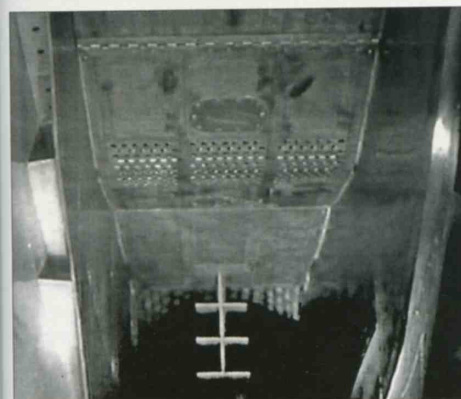
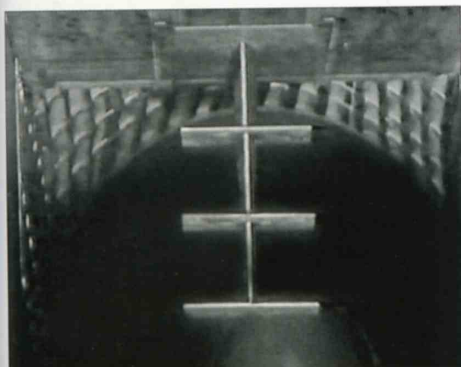

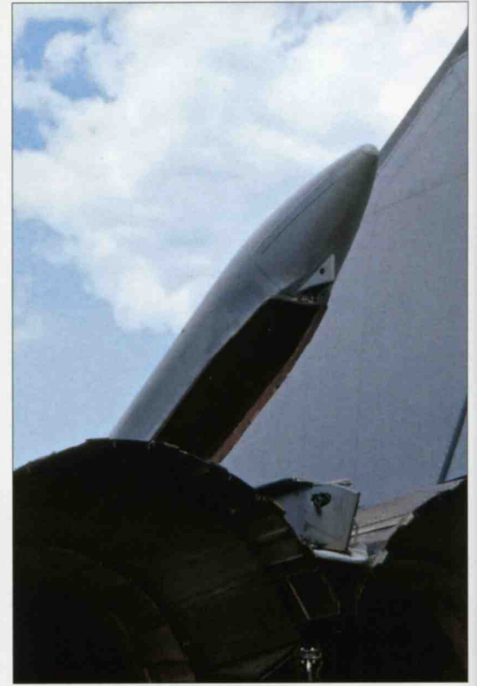
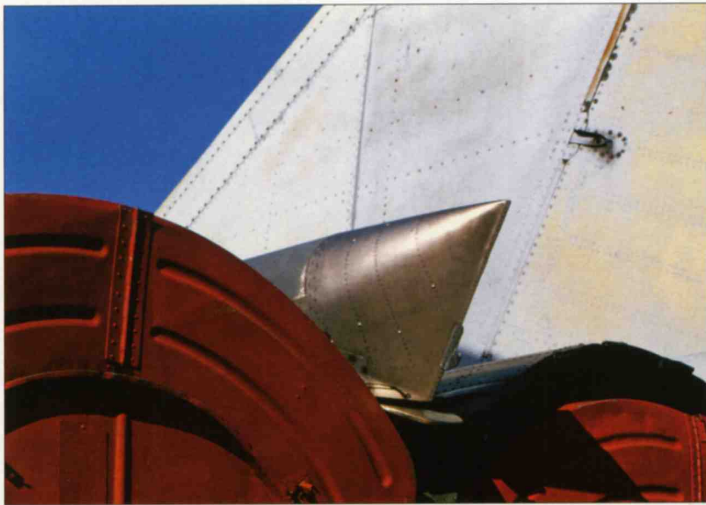

Top left: The original style of the brake parachute housing with a short pointed end.

Top and above: The later-style brake parachute housing mounted on a short 'pylon'. The housing tilts up bodily when the parachutes are deployed.

Above left: The port wing of a MiG-25RB, showing the boundary layer fence and the wing/fuselage joint.

Left and below: The pylons of a MiG-25BM fitted with AKU-58 ejector racks.





Above, left and right: The fins of the MiG-25 incorporate various navigation and communications antennae. The configuration of the dielectric portions on the port and starboard fins differs.

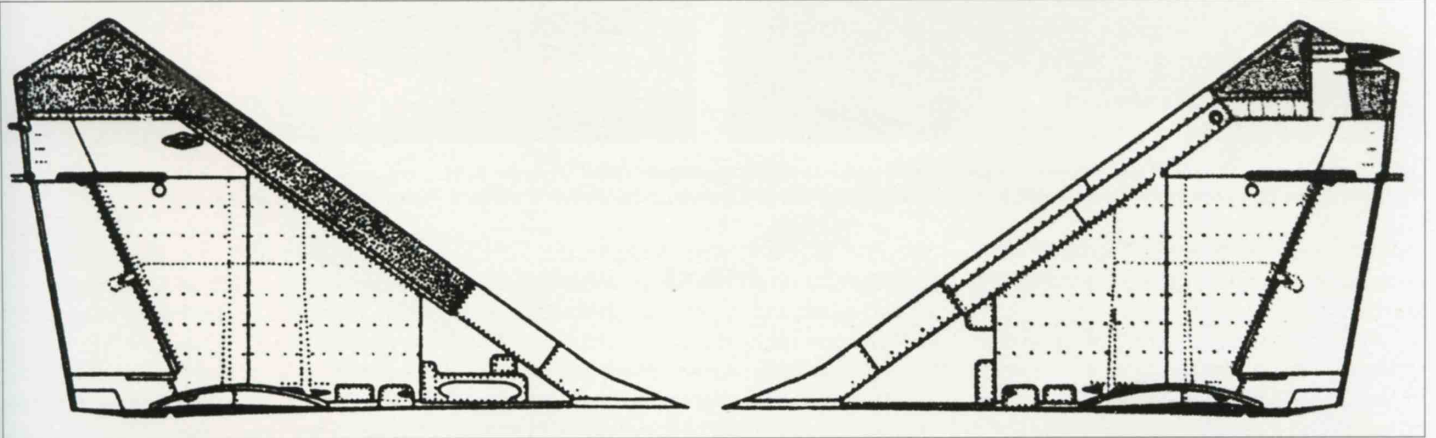

Above: The inboard faces of the port fin (left) and the starboard fin.

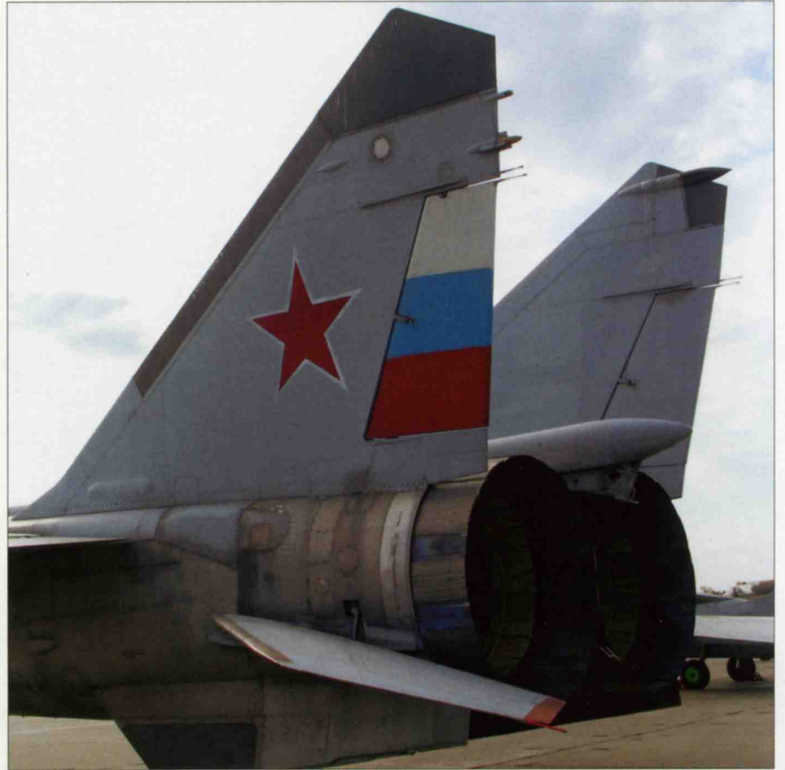

Left: The fins of the MiG-25 are canted slightly outward. Note the open brake parachute housing. Right: The tail unit of a MiG-25PD.

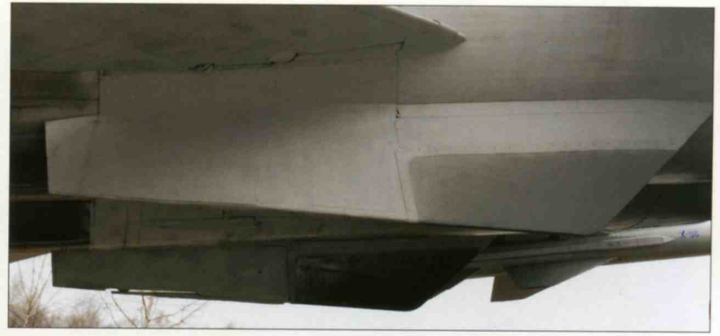
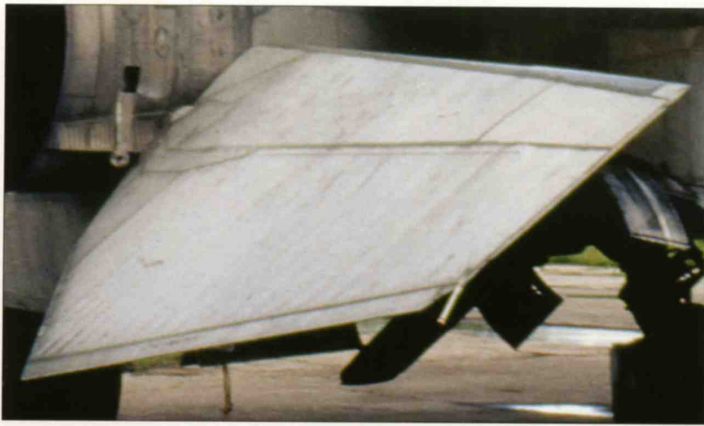

Left and above left: The MiG-25 has differentially controllable slab stabilisers; the tips are raked for better flutter resistance. Right and above right: The fins are augmented by trapezoidal ventral fins which incorporate dielectric portions enclosing more antennae.

manently attached wingtips. The detachable ones are connected to the wing panels by four bolts.

The wing/fuselage fairing is a riveted structure with subframes and skin panels made of D19T. It is detachable and held by bolts with self-locking nuts.

The wing torsion box forms integral fuel tanks divided by hermetic bulkheads into forward and aft sections. The forward tanks are

delimited by the forward stringer, the front spar, the root rib and rib 30. The aft tanks are located along the entire span between the front and rear spars, the root rib and rib 33. All joints are carefully welded to seal them.

The two-section ailerons are made chiefly of D19T duralumin and have riveted skins and a honeycomb core. Anti-flutter weights are incorporated into the nose sections of the ailerons. Each aileron is 1.7 m (5 ft 7 in) long;

total aileron area is 2.72 m² (29.26 sq ft), maximum deflection is $\pm 25^\circ$ (at low speeds).

The flaps, too, have riveted skins and a honeycomb core and move on two hinges. Each flap is 1.932 m (6 ft 4 in) long; total flap area is 4.3 m² (46.26 sq ft), maximum deflection is 25°. Early-production aircraft (interceptors up to c/n 840SCh09 (f/n 0709) and recce aircraft up to c/n 020SL04 (f/n 0404)) had blown flaps with a landing setting of 47°.

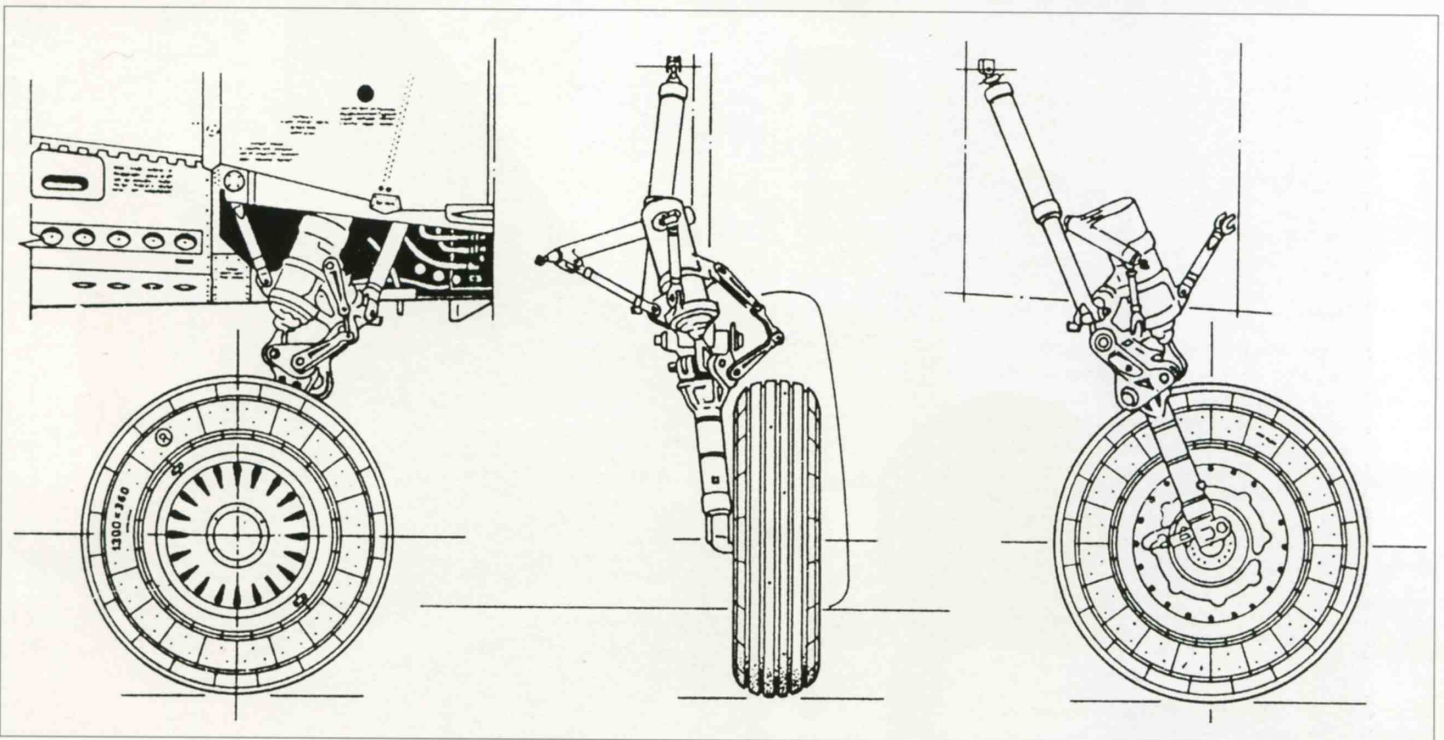

Three views of the starboard main gear unit. The outline in the rear view shows the wheel at maximum oleo compression.

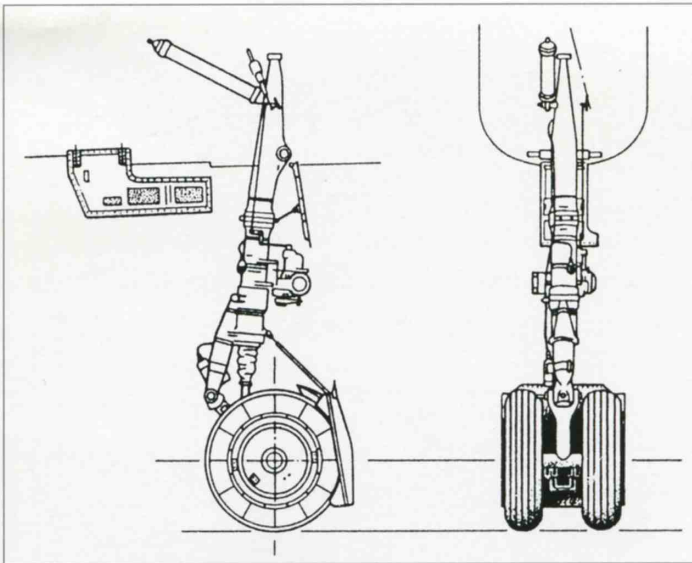

Far left: The port main gear unit seen from behind.

Left and above: The nose gear unit of a typical MiG-25 with a nose gear door segment doubling as a mud/snow/slush guard.



Above: Another view of a typical MiG-25's nose gear unit, showing the levered suspension and the steering mechanism/shimmy damper. Note the locally made 'hedgehog' strategically placed ahead of the nosewheels to puncture them in the event of unauthorised taxiing – a lesson learned from several hijackings of Soviet combat aircraft. Also of note are the red lines painted on the wheel rim and tyre to show instantly whether the tyre sits tight on the rim as it should.



Above right: The landing gear of a MiG-25BM. The 'knee joints' of the levered-suspension main units are visible from this angle.

Right: This view shows the lightning holes in the MiG-25's massive mainwheels.



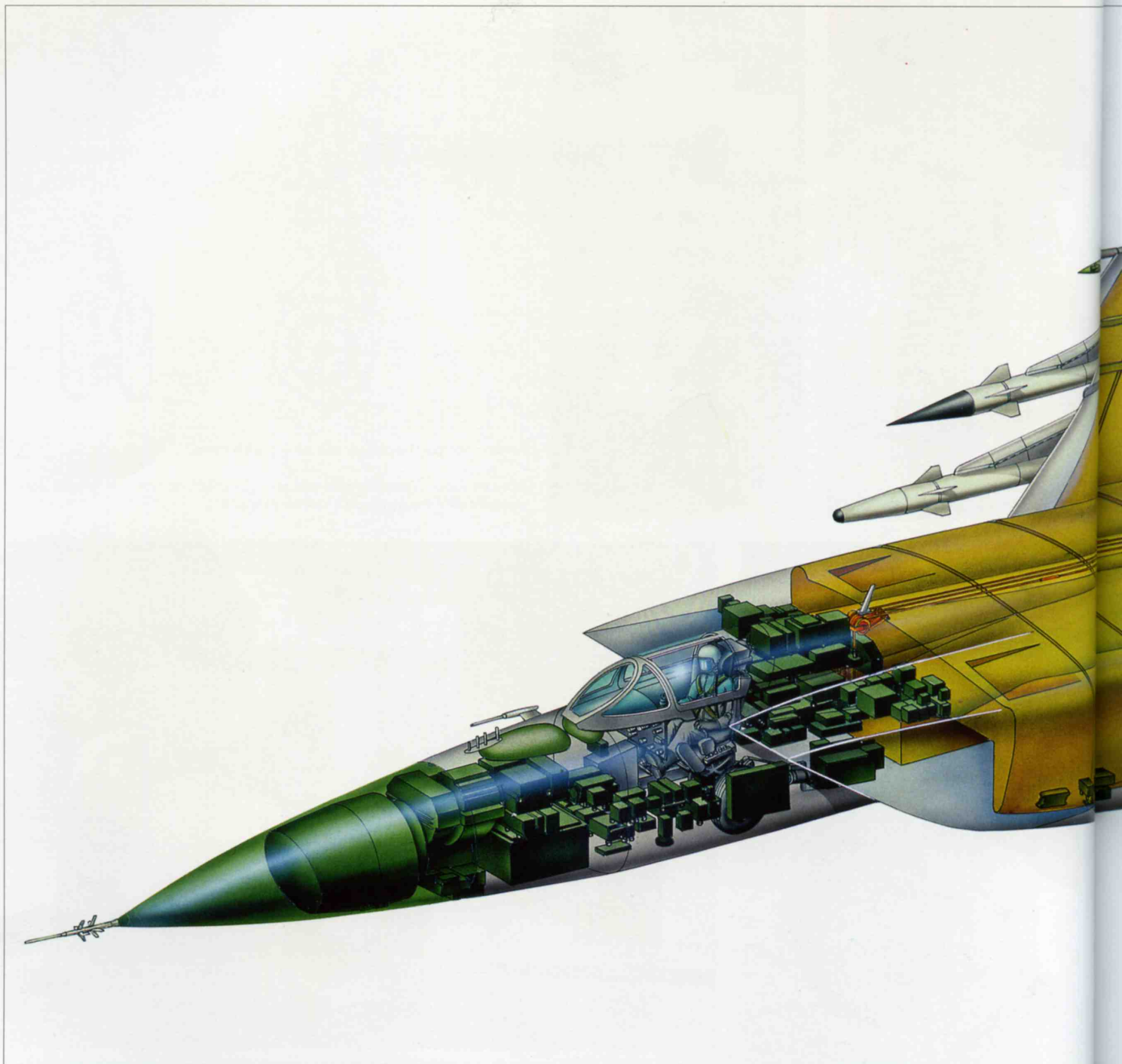

Another cutaway drawing of the MiG-25P, this time showing the powerplant, the fuel system and the location of various avionics components.

Tail unit: The *vertical tail* comprises twin fins with one-piece inset rudders; the tails have a basically trapezoidal planform with raked tips. Leading-edge sweepback 54° , trailing-edge sweepback $4^\circ 18'$, aspect ratio 0.996, taper 4.66; the fins are canted 8° outboard. The vertical tails have an airfoil thickness/chord ratio ranging from 4 to 4.5%.

The fins are three-spar structures featuring spars, stringers and ribs of VNS5 steel and AK-4 duralumin and skins of D19AT duralumin. Each fin is 3.05 m (10 ft 0 in) tall and 4.76 m (15 ft 7 $\frac{1}{2}$ in) long measured at the base, with a 3.22 m (10 ft 6 $\frac{3}{4}$ in) MAC. Total vertical tail

area is 16.0 m² (172.16 sq ft). The fins have structural differences: the port fin has a dielectric leading edge blended with a large dielectric fin cap, both of which house navigation and communications antennas, while the starboard one has a metal leading edge and two small dielectric inserts at the tip. The fins are attached to four fuselage frames (Nos. 11A, 12, 13 and 14).

The rudders have skins riveted to ribs and stringers. They move on three hinges and have bellcranks at the bottom for push/pull rod connection. Total rudder area is 2.12 m² (22.8 sq ft). Maximum rudder

deflection is $\pm 25^\circ$.

Two ventral fins of trapezoidal planform with riveted skins and ribs are located symmetrically under the aft fuselage. The lower forward portion of each fin is dielectric and can be folded sideways for maintenance access; normally it is attached to the aft portion by bolts. The aft portion is attached to the fuselage frames by two bolts. The port ventral fin incorporates a brake parachute deployment sensor actuated by impact on touchdown. Each ventral fin is 3.6 m (11 ft 9 $\frac{1}{4}$ in) long; total area is 3.55 m² (38.2 sq ft).

The Ye-155 prototypes and the initial-pro-

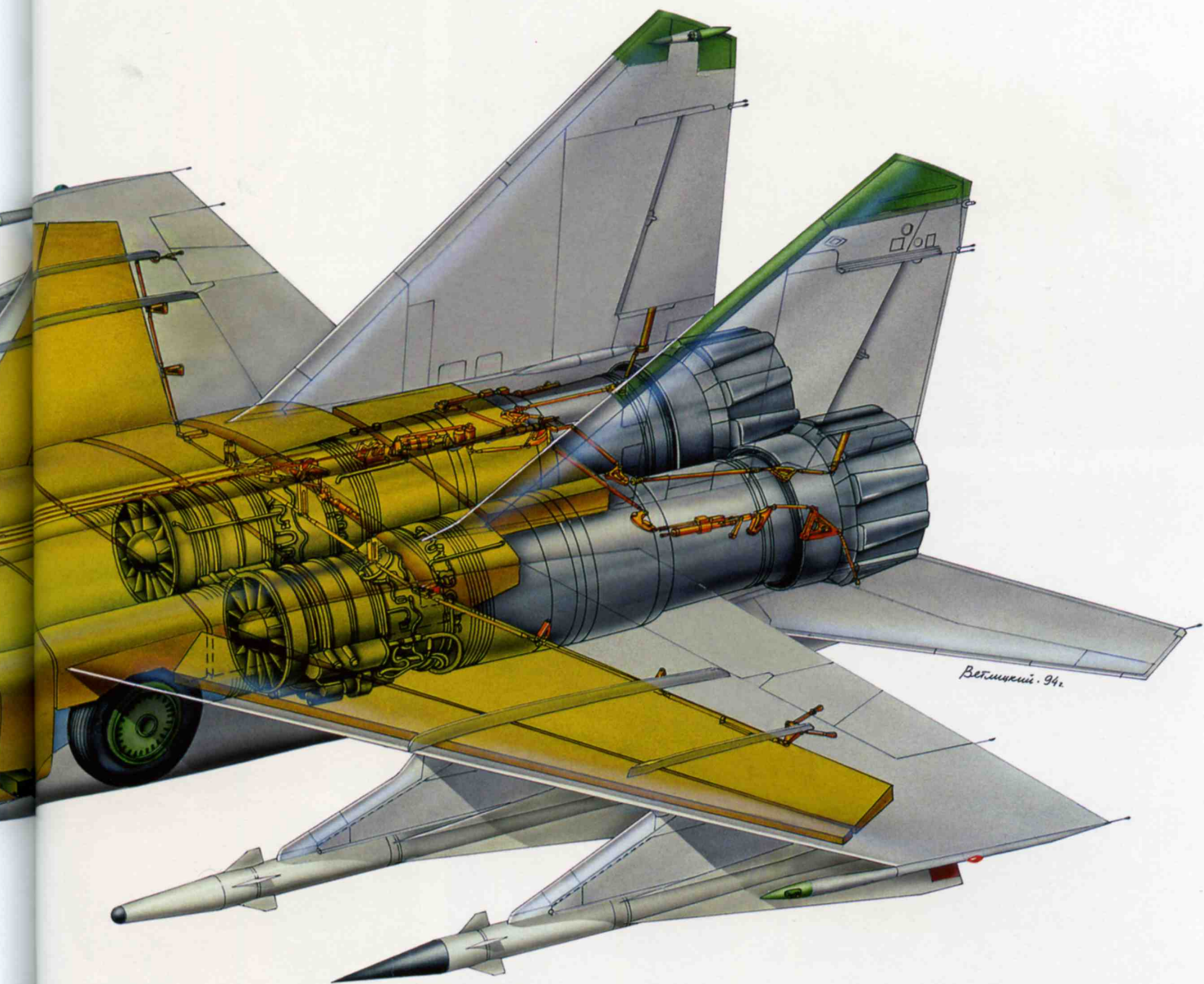

duction MiG-25P interceptors built in 1970 had smaller fin/rudder assemblies with metal leading edges and small dielectric fin caps but featured larger ventral fins.

The *horizontal tail* consists of cantilever slab stabilisers (stabilators), which are deflected together for pitch control and differentially for roll control. Leading-edge sweep-back $50^{\circ} 22'$, aspect ratio 3.1, taper 2.96. Span is 8.74 m (28 ft 8 in), though some sources state 8.8 m (28 ft 10½ in); area is 9.81 m² (105.5 sq. ft). The stabilators are carried on longitudinal beams in the aft fuselage. On MiG-25s built from 1973 onwards the stabila-

tor axles were moved approximately 140 mm (5½ in) forward along the chord to prevent elevator overcompensation and loss of control.

The stabilator axles are located at 33% MAC. The stabilator trailing edges are angled 2° upwards. Deflection range is $-32^{\circ}/+13^{\circ}$ on take-off and landing, diminishing to $-12^{\circ} 30'/+5^{\circ}$ in cruise flight.

Landing gear: Hydraulically retractable tricycle type. All three units retract forward, the mainwheels stowing beside the engines' inlet ducts. All three units have levered suspension and oleo-pneumatic shock absorbers. Wheel

track 3.85 m (12 ft 7½ in), wheelbase 5,144 m (16 ft 10½ in), though some documents quote the wheelbase as 5.138 m (16 ft 10¼ in).

The nose unit is fitted with twin 700x200 mm (27.55x7.87 in) KT-112/2 or KT-112A brake-equipped wheels (KT = *koleso tormoznoye*). The main units have single 1,300x360 mm (51.18x14.17 in) KT-111/2A or KT-111A brake wheels. All three units are fitted with automatic anti-lock brakes. The steerable nose unit has two turn limits (for low-speed and high-speed taxiing).

Retraction and extension is provided by a single hydraulic system, with pneumatic

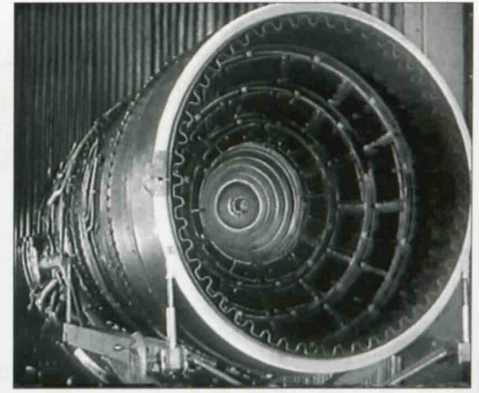
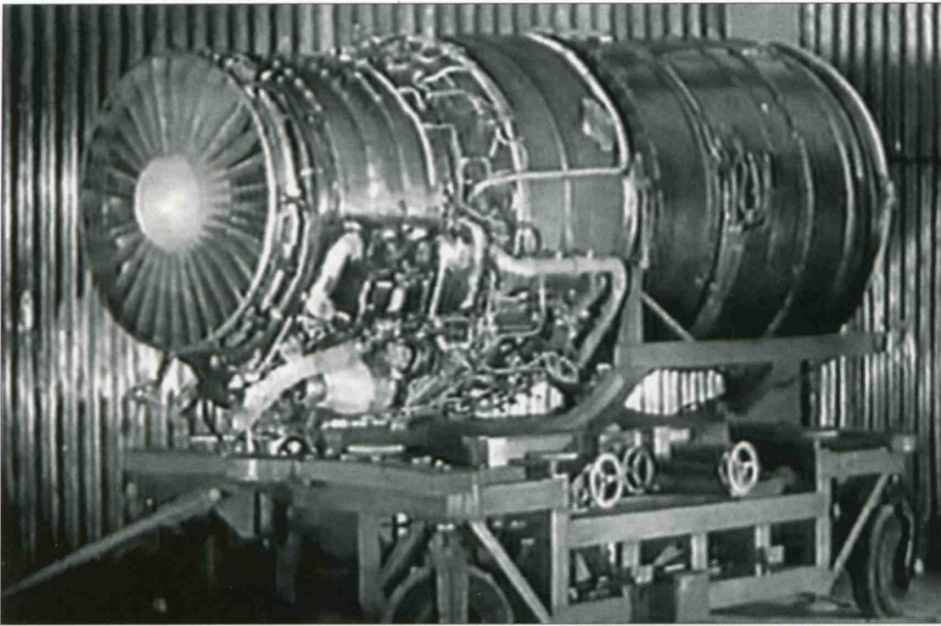

Left: A Tumanskiy R15B-300 turbofan (minus afterburner) on a ground handling dolly. The ventrally located accessory gearbox is visible.

Above: The R15B-300 seen from the rear.

Left: A cutaway R15B-300 engine used as a teaching aid.

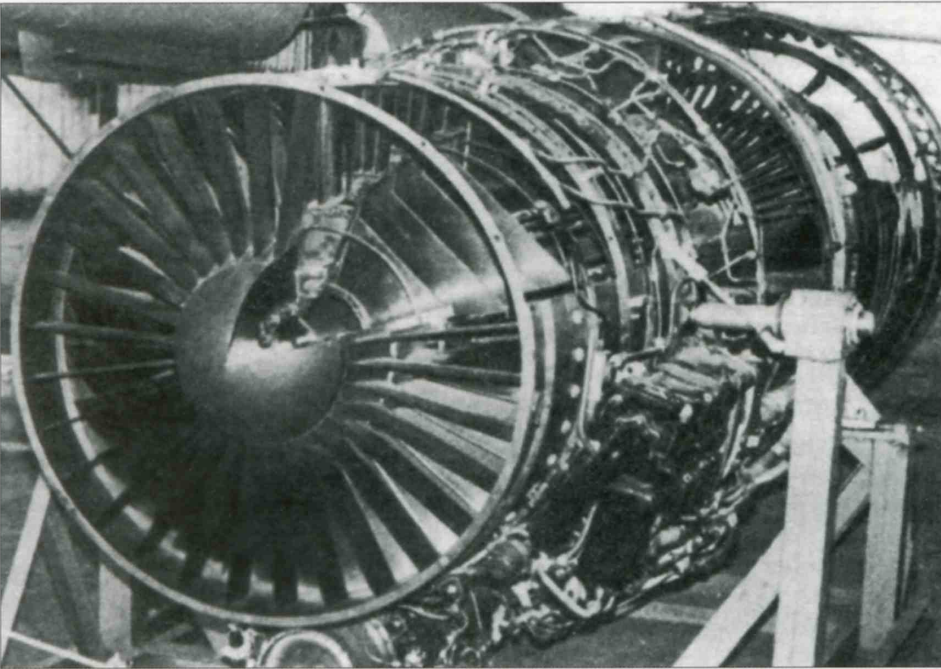

Below: The MiG-25's engine nozzles are located so close together that their contours intersect and the outer nozzle petals at the intersection are removed.

Bottom: An R15B-300 engine and its afterburner and extension jetpipe on their respective ground handling dollies.





Above: The 5,280-litre drop tank suspended beneath a MiG-25RB. Note the short pylon at the front.

emergency extension in the event of a hydraulics failure. All three units have mechanical locks; the nose unit is additionally secured in the down position by a hydraulic system cock preventing the fluid from escaping from the actuator.

The design of the nose gear doors varies from version to version. The only feature common to all versions is the small door segment aft of the gear fulcrum (mechanically linked to the strut). Apart from that, on the Ye-155R, Ye-155P and MiG-25PU prototypes the nose-wheel well is closed by two full-length clamshell doors bulged to accommodate the wheels. On most production aircraft these are replaced by smaller L-shaped clamshell doors, a bulged full-width door segment attached to the strut to double as a mud/snow/slush guard (fitting into a position further forward) and a narrow transverse door hinged at the front end (closed by mechanical linkages with which the wheels come into contact). On some aircraft the door/mud-guard segment is extended aft and given a T shape, supplanting the lateral doors. Each main gear unit has two large tandem doors; the rear doors are mechanically linked to the oleo struts. All wheel well doors remain open when the gear is down, except on the Ye-155 prototypes where the lateral nose gear doors opened only when the gear was in transit.

Two cruciform brake parachutes with a total area of 50 m² (538 sq ft) are used to shorten the landing run. They are stowed in an upward-hinged housing at the aft extremity of the fuselage spine, above and between the engine nozzles. On aircraft built up to early 1977 the brake parachute housing was close to the engine nozzles and had a short conical rear end; on later versions utilising a different type of parachutes it is raised higher and features a parabolic tip. The parachute



Rear view of the MiG-25's drop tank.

container is made of *tekstolit* (a cheap composite material).

The brake parachutes are deployed automatically on touchdown, triggered by a sensor in the port ventral fin.

Powerplant: Early-production MiG-25s were powered by two Tumanskiy R15B-300 axial-flow afterburning turbojets (*izdeliye 15B*) rated at 7,500 kgp (16,530 lbst) dry or 11,200 kgp (24,690 lbst) in full afterburner. The MiG-25PD and MiG-25PDS were fitted with identically rated R15BD-300 engines having modified accessory gearboxes.

The R15B-300 (R15BD-300) is a single-shaft turbojet with a five-stage compressor, a can-annular combustion chamber, a single-stage turbine, an afterburner and a variable (three-position) axisymmetrical ejector nozzle. The air intake assembly has a fixed spinner and 30 cambered inlet guide vanes. The compressor has an automatically controlled bleed strip aft of the third stage and part-span shrouds on the fifth stage. A ventral accessory gearbox is provided.

The R15B-300 (R15BD-300) is started by an S3 jet fuel starter (*S = startyor*) – a small turbine engine delivering 150 shp. The starters have individual air intakes closed by hydraulically operated doors when not in use. Each engine has a separate electronic control system with an RRD-15B electronic mode regulator (*regoolyator rezhima dvigatelya*) and a separate fire extinguishing system.

Maximum turbine speed at full military power 7,000 rpm. Engine pressure ratio at take-off power 4.75. Mass flow at take-off 144 kg/sec (317 lb/sec). Turbine temperature 1,230° K. Specific fuel consumption (SFC) in full afterburner 2.45 kg/kgp-hr (5.4 lb/lbst-hr); cruise SFC 1.12 kg/kgp-hr (2.47 lb/lbst-hr).

Length overall 4.1 m (13 ft 5½ in) in 'clean' condition and 6.3 m (20 ft 8 in) with inlet duct, maximum diameter 1.74 m (5 ft 8½ in). Dry weight 2,680 kg (5,910 lb). (Note: Some sources give different figures: length overall 6.65 m (21 ft 9¾ in), maximum diameter 1.64 m (5 ft 4¾ in), dry weight 2,590 kg (5,710 lb).

The engines are installed in fuselage bays aft of frame 9 which are separated by a

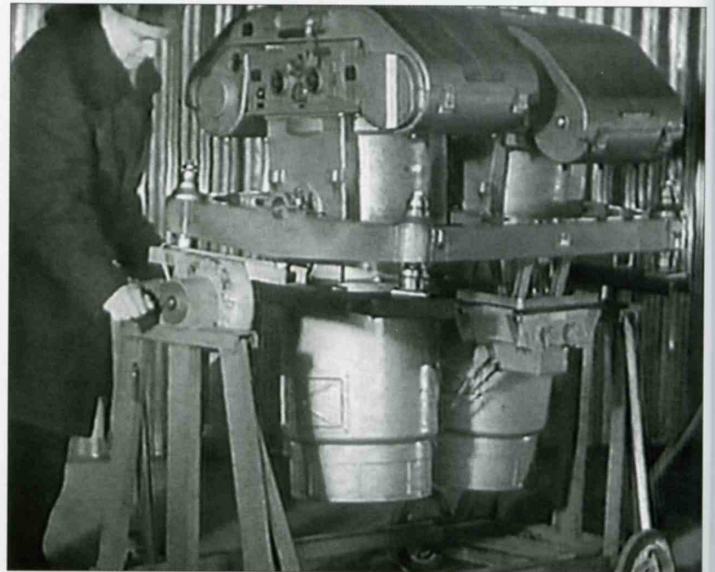
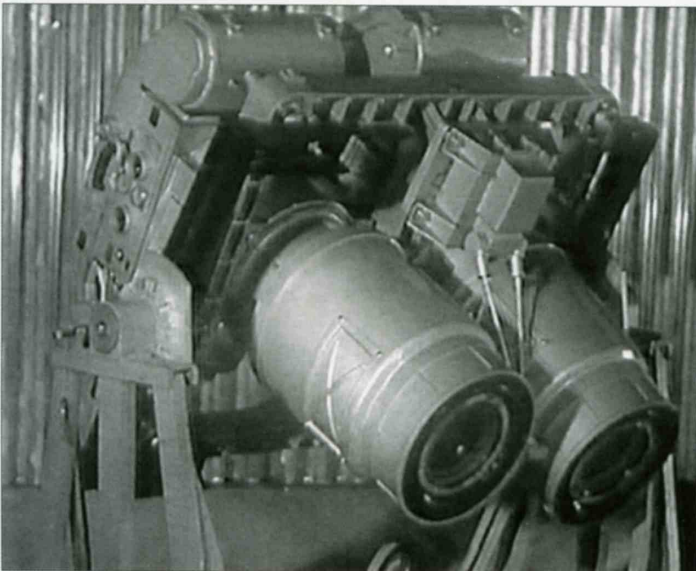
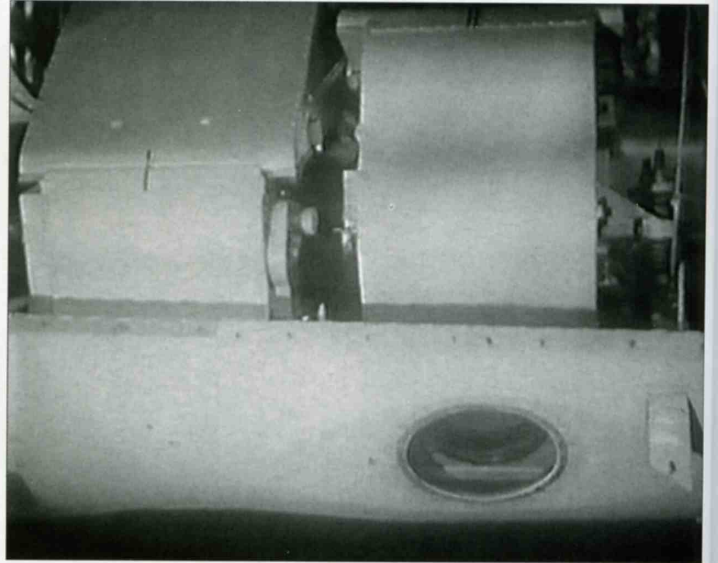
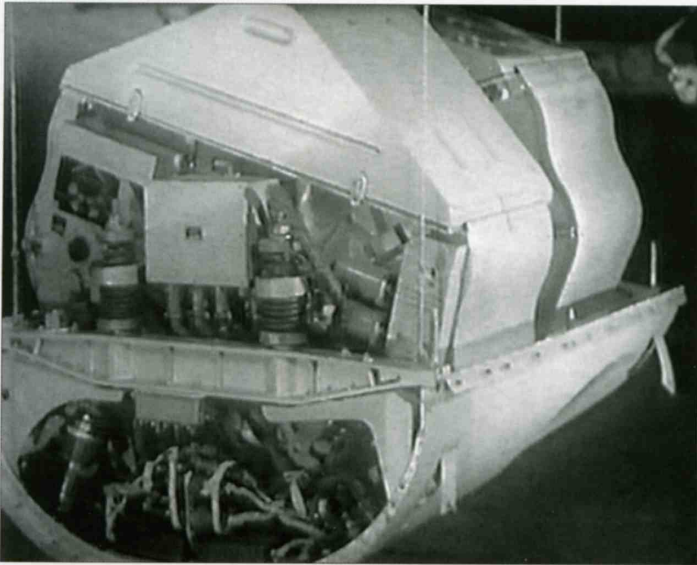
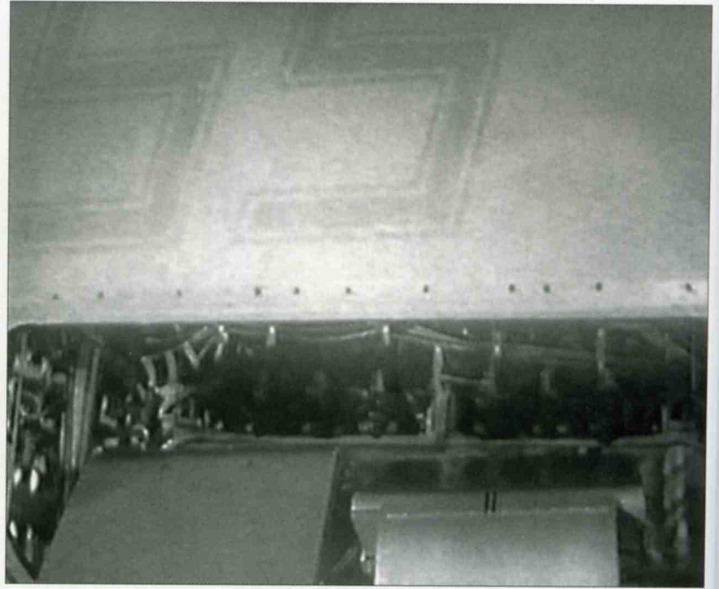
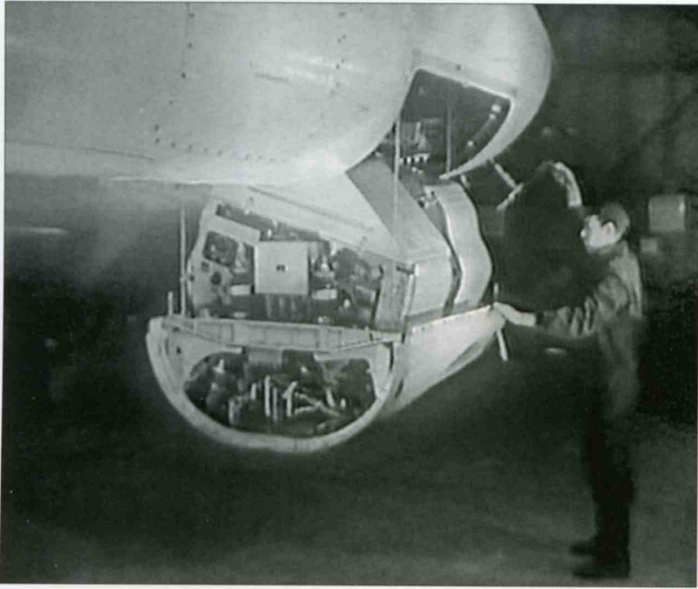

Top left and right: A technician lowers the camera pallet of the Ye-155R-3 reconnaissance prototype by means of a hoist.

Centre left and right: Close-ups of the lowered camera pallet, showing the cameras and their ancillary systems.

Above left and right: One of two modules of the A-70 camera, showing the twin bodies with film drives and the twin lenses with diverging optical axes.



Top left: The underside of a MiG-25RBT's nose, showing the five camera ports.

Top right, above left/right and below left: Lowering the camera pallet of a MiG-25RBT at Shatalovo AB. The hinged covers provide access to the retaining bolts.



Centre and right: A technician loads a film cassette into one of the cameras as the pallet rests on the ground.

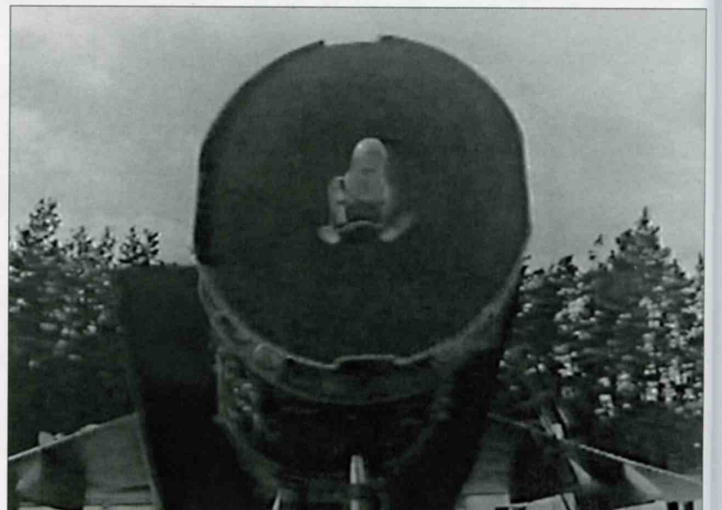
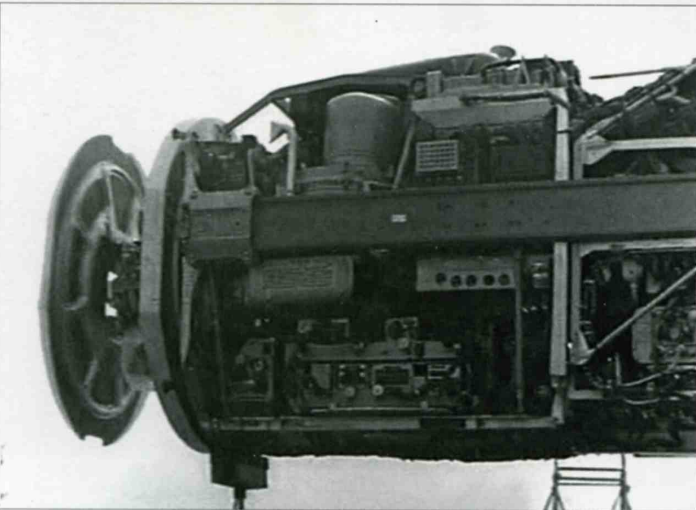
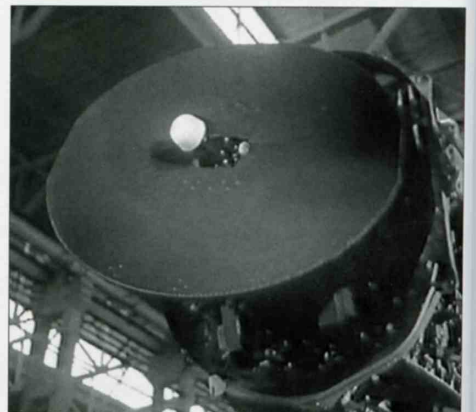
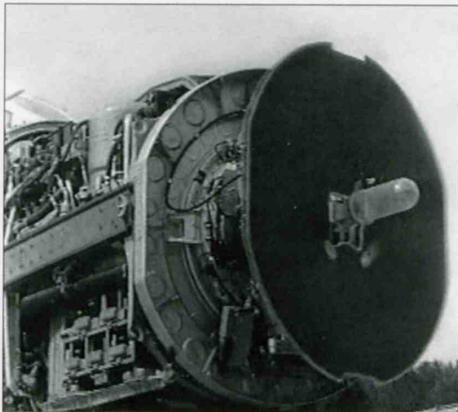
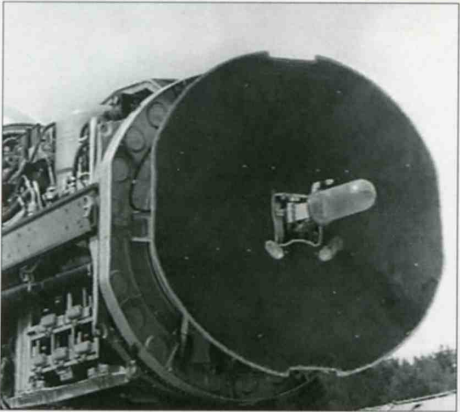
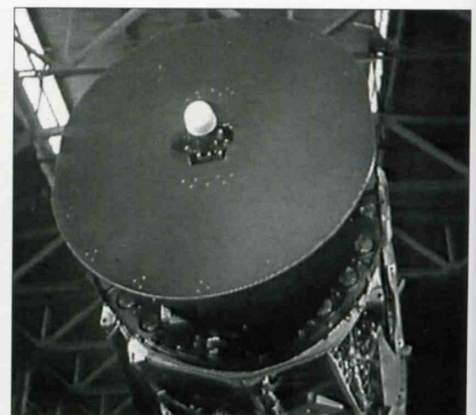
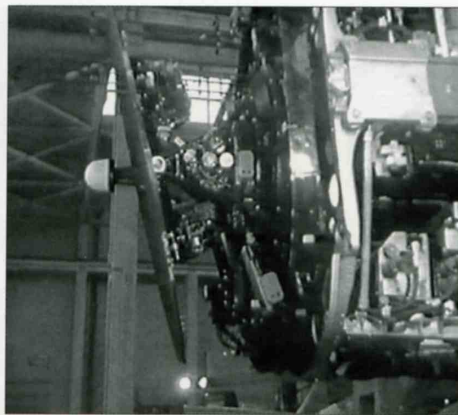
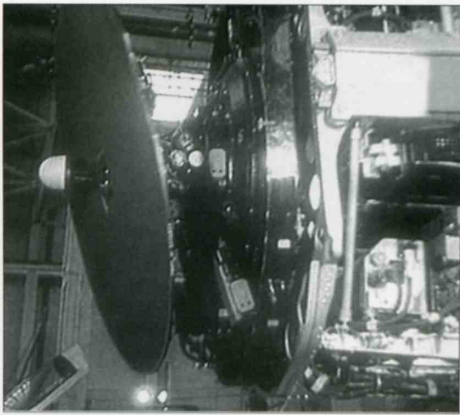

Top row and centre right: The Smerch-A fire control radar fitted to a Ye-155P prototype; this series of pictures shows the motion of the radar scanner. Centre row: A later version of the same radar with a slightly different antenna dish. Above left and right: The radar set can be exposed completely for maintenance.

longitudinal firewall; the engines mounting struts are attached to fuselage frames 10 and 11. For ease of maintenance the engines are rotated 13° outboard so that the accessory gearboxes face away from each other. The engine bays are cooled by boundary layer bleed air to protect the airframe and engine-mounted accessories from overheating.

The engine nozzles are inclined $2^\circ 30'$ upwards and $1^\circ 46'$ inwards for aerodynamic reasons. To reduce cross-section area the nozzles are placed so close together that the

distance between their centres is smaller than the nozzle diameter (the nozzles effectively overlap). Therefore, three inboard segments of each nozzle are removed and a fixed boat-tail fairing is installed in between so that the nozzle contours are slightly 'flattened' but unbroken.

The engines breathe through two-dimensional variable supersonic air intakes with raked leading edges and two-segment horizontal airflow control ramps. The forward segment of each ramp is perforated for boundary layer suction; the aft segment is fitted with vor-

tex generators to energise the airflow. In order to minimise losses in the inlet ducts the intakes have three-position movable lower lips. The intakes are controlled by the SRVMU-2A air intake automatic/manual control system.

Control system: Conventional fully powered flight controls, with irreversible twin-chamber hydraulic actuators in all three channels. Each actuator is powered by both hydraulic systems at once, one system per chamber. The control runs from the stick and rudder

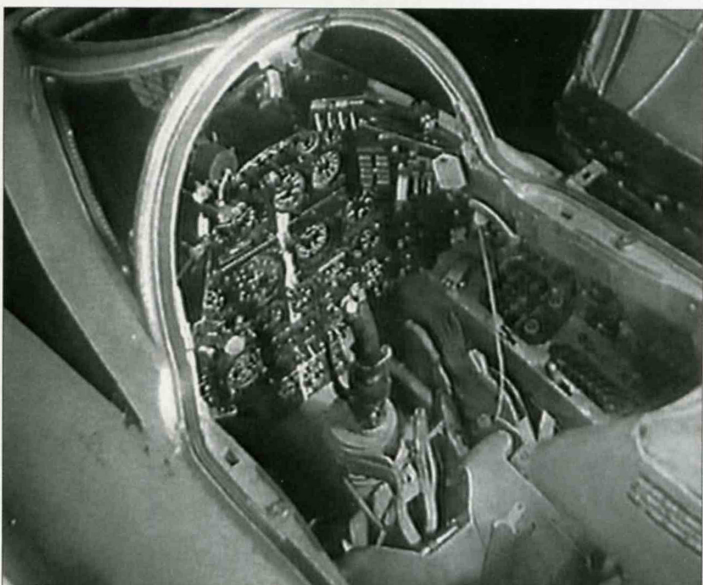
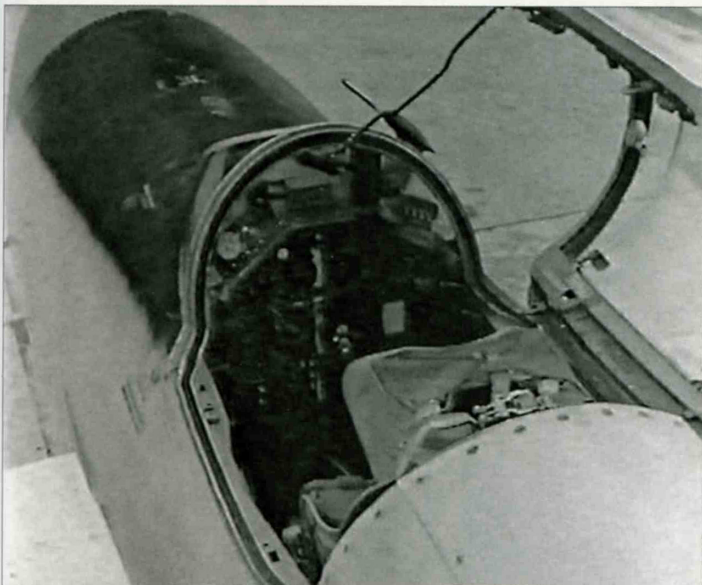
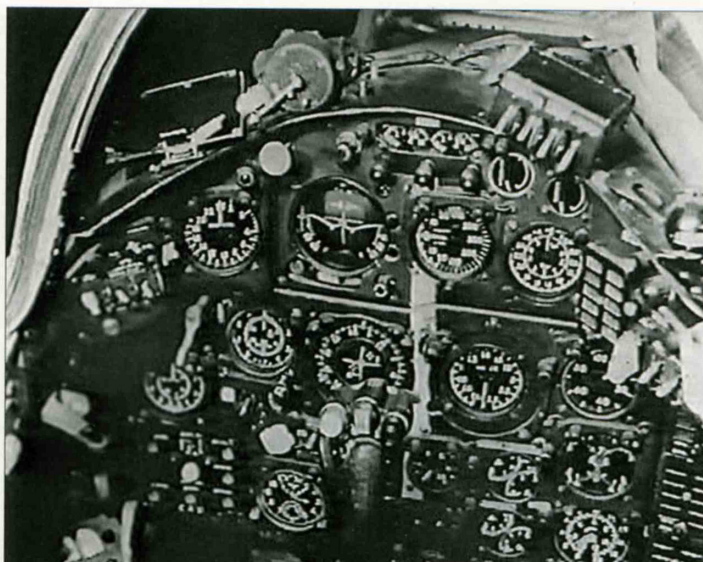
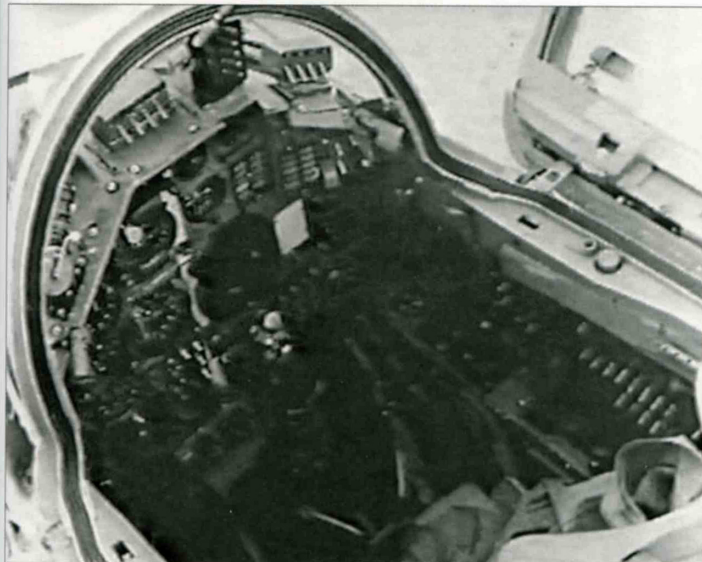

Four views of a Ye-155P prototype's cockpit. The instrument panel features conventional electromechanical instruments, a rectangular radarscope (low on the right) and a bank of caution/warning lights. The white line down the middle is for aligning the control stick to set the ailerons neutral during spin recovery.

pedals to the actuators are of mixed type, with dual cables in the fuselage spine and push-pull rods elsewhere.

Directional control is provided by twin rudders of single-spar construction. Both rudders are powered by a single BU-190 actuator (BU = 'booster'). Pitch control is provided by concerted deflection of the stabilators. Roll control is provided by the ailerons, assisted by differential deflection of the stabilators (tailerons). Each stabilator is controlled by a separate BU-170 actuator, the ailerons are operated a common BU-170E actuator (E = *eleron*).

The stick and pedals are spring-loaded for 'artificial feel'. Tailplane deflection is limited by an ARU-90A regulator changing the tailplane actuator ratio to prevent excessive elevator inputs at low altitude and high IAS. The same regulator also alters the stick forces proportionately with speed. Trimming to

reduce stick and pedal loads is made by means of an MP-100M mechanism substituting for trim tabs. Lateral stability is enhanced by differential stabilator deflection, with a special system countering the yaw arising during asymmetrical missile launch.

The MiG-25 is equipped with an SAU-155 automatic flight control system – specifically, the SAU-155R1 on the reconnaissance/strike models and the SAU-155P1 on the interceptors. It enhances combat efficiency, reducing pilot fatigue, increasing flight safety and permitting all-weather operation. The system operates the control surfaces by means of RAU-107A servos (*roolevoy agregat oopravleniya*) with telescopic push-pull rods.

Fuel system: On the interceptor variants, internal fuel is carried in ten integral tanks – six in the fuselage and four in the wings.

Reconnaissance versions built before the mid-1970s had two additional integral tanks in the fins. The wing tanks are split into front and rear groups by the middle spar, occupying almost the entire internal volume of the wings. All of the fuselage tanks have a complex shape.

The total internal fuel capacity is 16,580 litres (3,647.6 Imp gal) for the interceptors and 17,780 litres (3,911.6 Imp gal) for the reconnaissance/strike versions. The Nos. 1 through 6 fuselage tanks hold 2,810 litres (618.2 Imp gal), 3,220 litres (708.4 Imp gal), 3,060 litres (673.2 Imp gal), 2,340 litres (514.8 Imp gal), 2,370 litres (521.4 Imp gal) and 730 litres (160.6 Imp gal) respectively. The front wing tanks hold 550 litres (121 Imp gal) each, the rear ones 1,910 litres (420.2 Imp gal). The fin tanks on the reconnaissance aircraft hold 600 litres (132 Imp gal) each. The accumulator tank holds a further 150 litres (33 Imp gal)

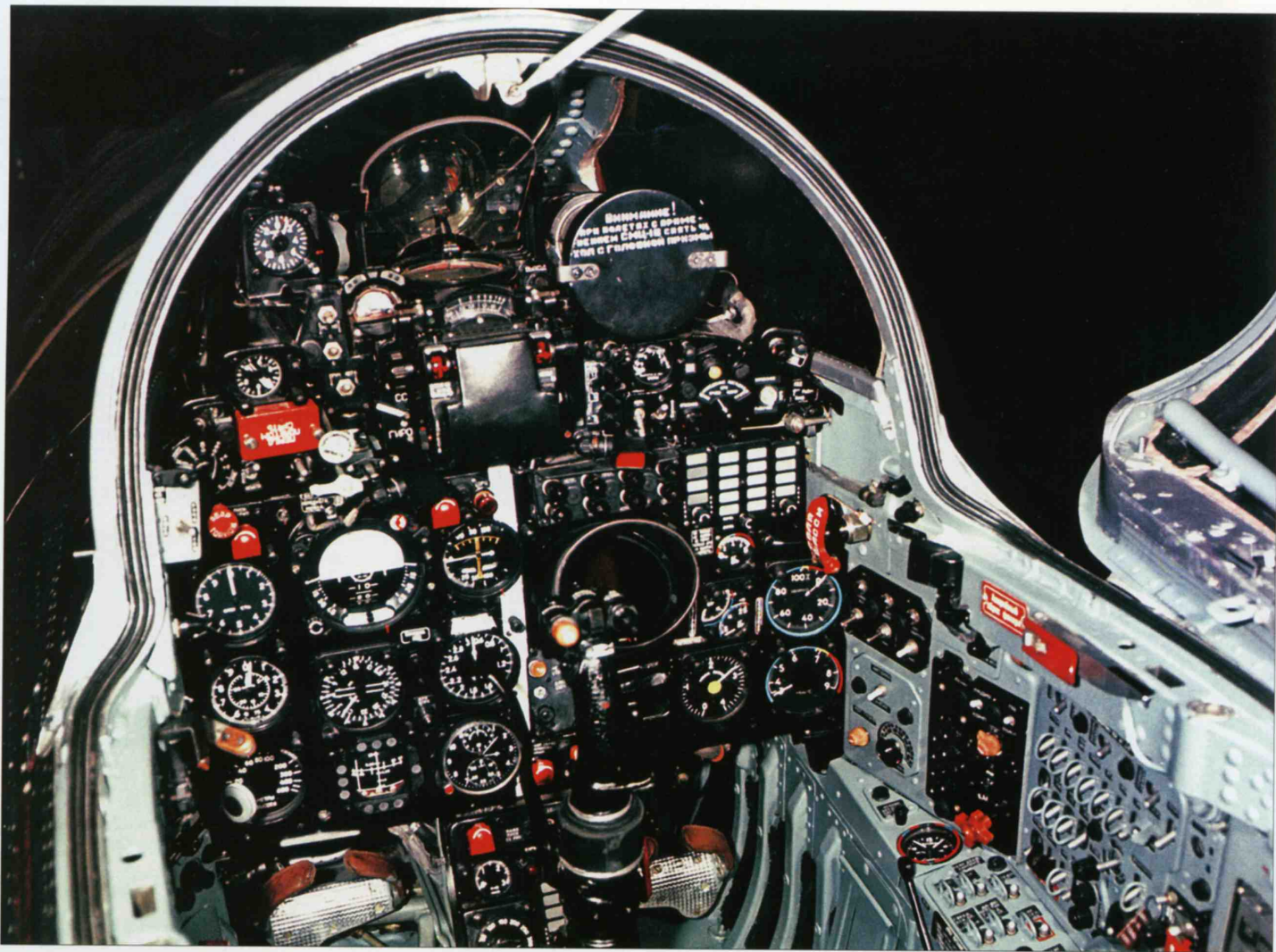

Above: The cockpit of the MiG-25P, showing the optical sight at the top of the panel and the radarscope on the right.

and the fuel lines another 40 litres (8.8 Imp gal). The interceptors carried 14,570 kg (32,120 lb) of fuel and the reconnaissance versions 15,000 kg (33,070 lb).

A 5,280-litre (1,161.6 Imp gal) drop tank holding 4,450 kg (9,810 lb) of fuel can be fitted on the fuselage centreline. The tank is 11.05 m (36 ft 3 in), with a maximum diameter of 1 m (3 ft 3 in), and increases the total fuel load to 19,450 kg (42,880 lb). Early production MiG-25Ps and MiG-25PDSs had no pro-

visions for a drop tank but the MiG-25PD can carry it on long-range intercept missions in maximum TOW configuration.

The main fuel grade was initially T-6 kerosene (T = *toplivo* – fuel), with T-7P as a substitute; RT (*reaktivnoye toplivo* – jet fuel) grade kerosene was later found acceptable.

Electrical system: AC and DC systems. Main power (28V DC) is produced by two GSR-12KIS generators feeding separate cir-

cuits. Each circuit includes a 15STsS-45B silver-zinc battery as a back-up. Each engine drives an SGK-11/1.5KIS (or SGK-11/1.5KIS-M) generator producing 200/215 V (400 Hz) three-phase AC via a PPO-20 constant-speed drive (*privod postoyannykh oborotov* – CSD), also feeding two circuits. Early MiG-25Ps and reconnaissance versions have a single-phase AC system.

Part of the equipment requires 36 V/400 Hz three-phase AC; therefore, each circuit

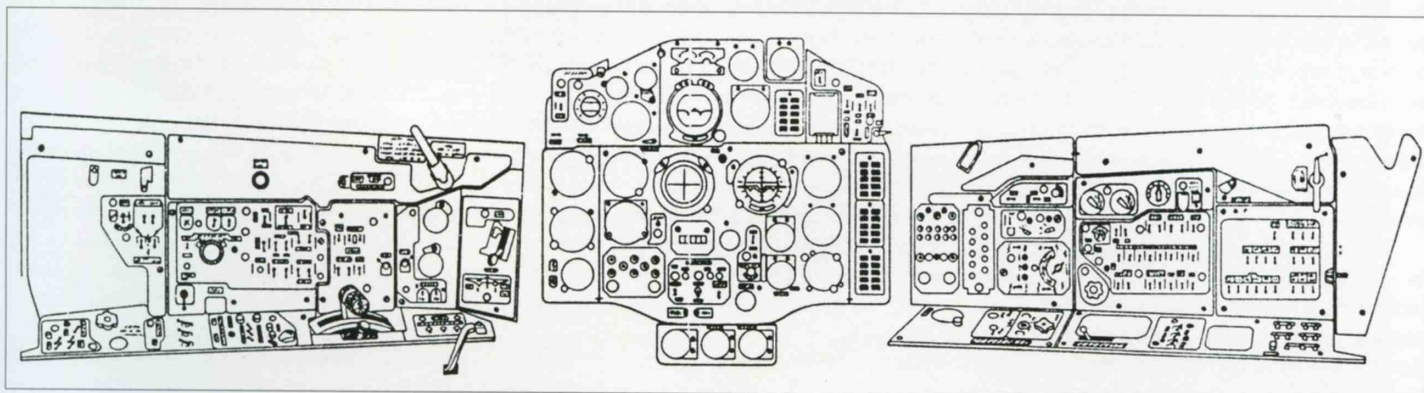

The main instrument panel and side cockpit consoles of the MiG-25RBV.

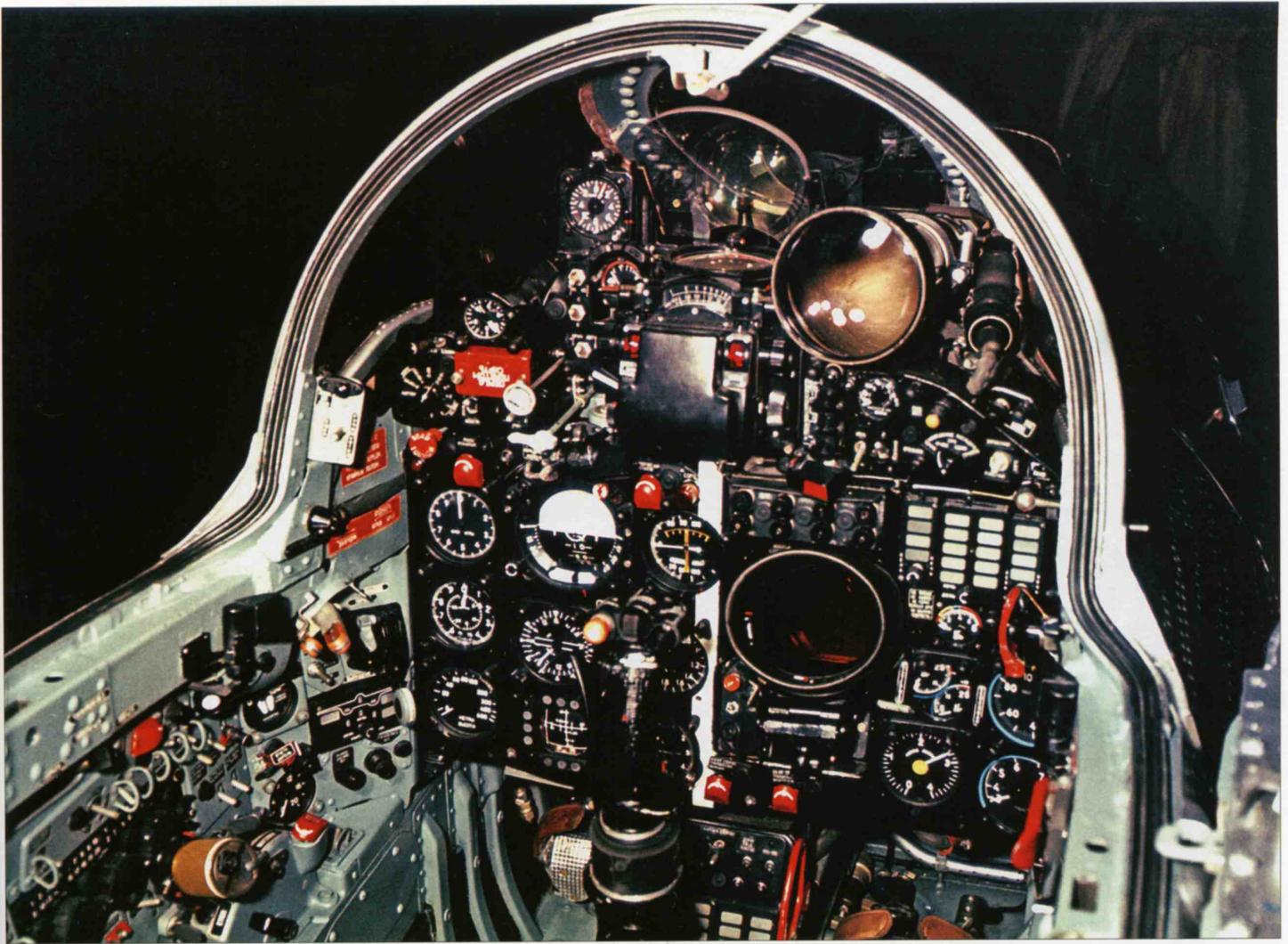

Above: Another view of the MiG-25P's cockpit with the protective cover removed from the radarscope.

includes a T-1.5/02 transformer. If the port circuit fails, all equipment can be powered by the starboard transformer; if the starboard circuit fails, 120 V AC is supplied by an emergency PTO-100/1900 AC converter. A failure indication system is fitted and big-time power consumers are shut down automatically if a circuit fails (to ensure that enough power is

available for vital equipment for at least 15 minutes during landing).

Hydraulic system: The MiG-25 has two independent hydraulic systems (general and flight control actuator feed systems).

The *general system* powers one chamber of each twin-chamber actuator control-

ling the stabilators (BU-170), ailerons (BU-170E) and rudders (BU-190). It is also responsible for landing gear, flap and air-brake operation, normal wheel braking, wheel braking when the aircraft is towed, mainwheel auto braking during gear retraction, air intake ramp operation and emergency retraction, intake lower lip operation,



Two views of the cockpit of a MiG-25RB flight simulator. The lurid turquoise colour typical of Soviet aircraft is meant to reduce pilot fatigue.



nosewheel steering and jet fuel starter air intake closure after engine start-up.

The *control actuator feed system* powers the other chamber of each control actuator. It also caters for emergency wheel braking along with the general system.

The systems use grade 7-50S-3 silicone-based hydraulic fluid. The general and control actuator feed systems have a capacity of 53 litres (11.7 Imp gal) and 30 litres (6.6 Imp gal) of fluid respectively.

Hydraulic power is supplied by NP-70A engine-driven variable-discharge rotary-piston hydraulic pumps coupled with fluid reservoirs. Nominal pressure is 180-210 kg/cm² (2,570-3,000 psi). The pumps are driven via fixed-ratio drives and the output is in direct proportion to engine rpm. For added reliability, each system features two pumps driven by different engines; this makes sure that both systems stay operational in the event of an engine failure. Thus, the intake ramp of the failed engine remains operational, enabling a relight (unless, of course, there is a catastrophic engine failure and restarting is out of the question).

Pneumatic system: The pneumatic system includes three subsystems (main, emergency

Left and below: The cockpit of a MiG-25RBF reconnaissance/strike aircraft. The starboard console carries controls for the communications equipment and ancillary systems. Note the twin ejection handles of the KM-1M ejection seat.

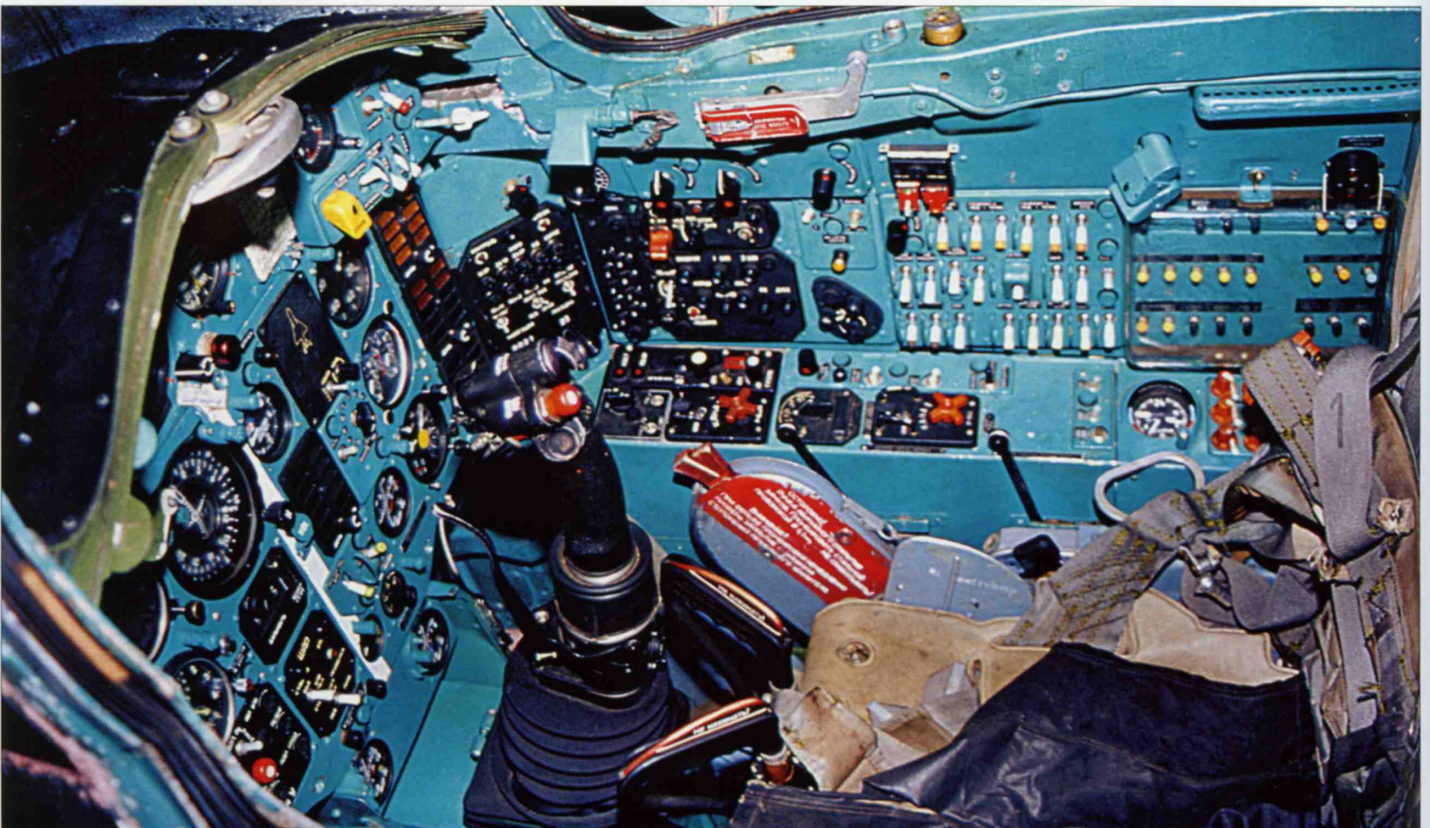



Above: The main instrument panel of a MiG-25BM SEAD aircraft. The basic instrumentation is somewhat different (in particular, the vertical strip gauges for the engines on the right are noteworthy).

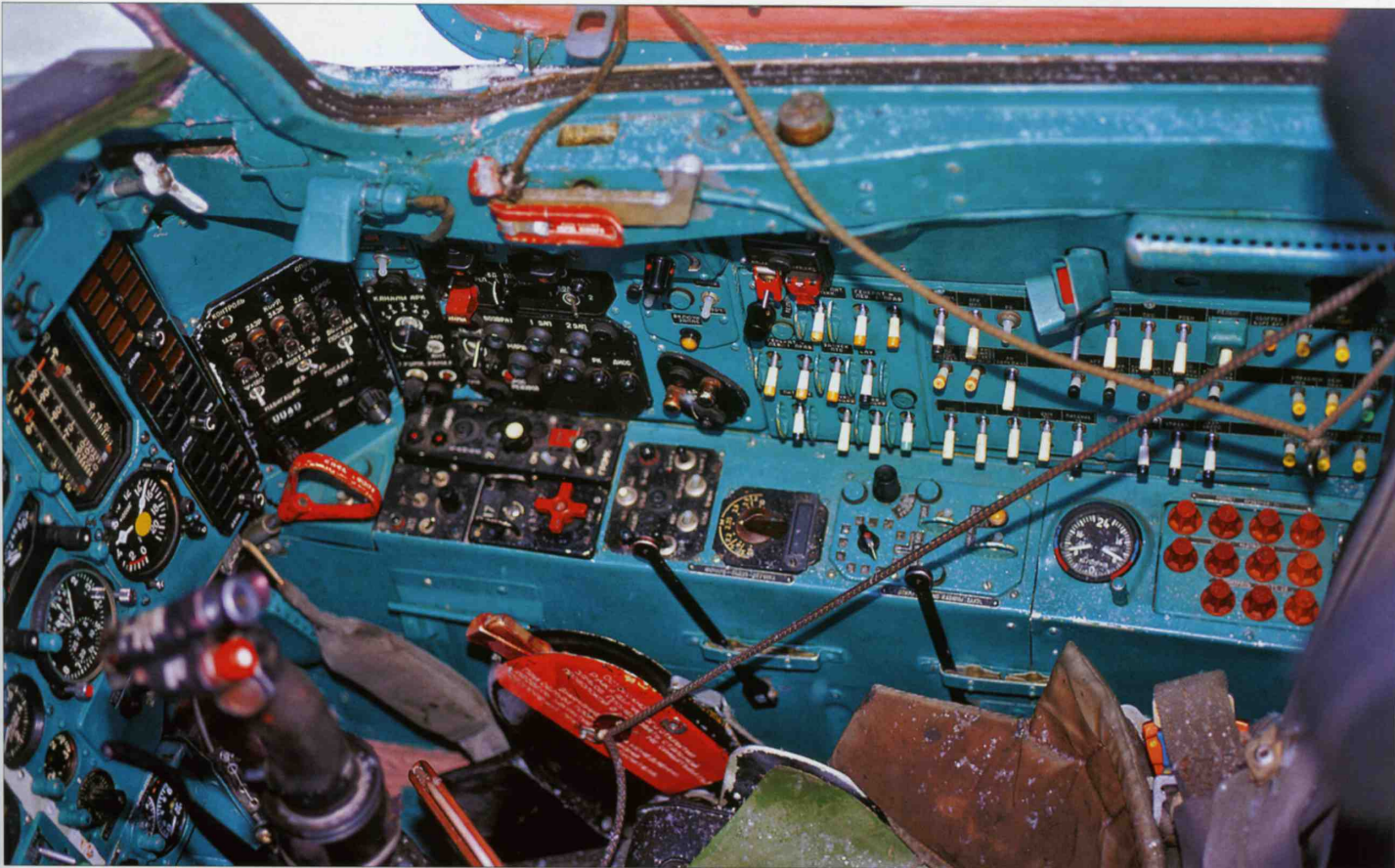

The starboard cockpit console of a MiG-25BM undergoing maintenance (hence the odd cables that can be seen here).



and avionics bay pressurisation). The *main system* pressurises the cockpit, controls the wheel brakes, canopy de-icing, fuel dump lines, generator cooling vents, automatic and manual brake parachute deployment, manual parachute release and engine starter air intake opening. It also operates the hoist lowering and raising the mission equipment pallet (on the reconnaissance versions) and controls nitrogen pressurisation of the fuel tanks.

The *emergency system* is responsible for emergency landing gear extension and adjusting the intake ramps for landing. The third system pressurises the avionics bays and radar (or, on reconnaissance/strike versions, SIGINT set) cooling water tank.

Compressed air for all three systems is stored in bottles – 14 litres (3.08 Imp gal) in the main system, 10 litres (2.2 Imp gal) in the emergency system and 2 litres (0.44 Imp gal) in the avionics bay pressurisation system.

Air conditioning system: The air conditioning system maintains the required air pressure and temperature in the cockpit and avionics bays. The system uses air bled from the engine compressors at about 400°C (752°F) and 1.1 kg/cm² (15.7 psi), supplied at a rate of about 800 kg/hr (1,763 lb/hr). The air

Left: The cockpit of MiG-25BM '37 White' features a very different instrument panel.

Below: The starboard console of the MiG-25M development aircraft ('710 Blue') preserved at Moscow-Khodynka.

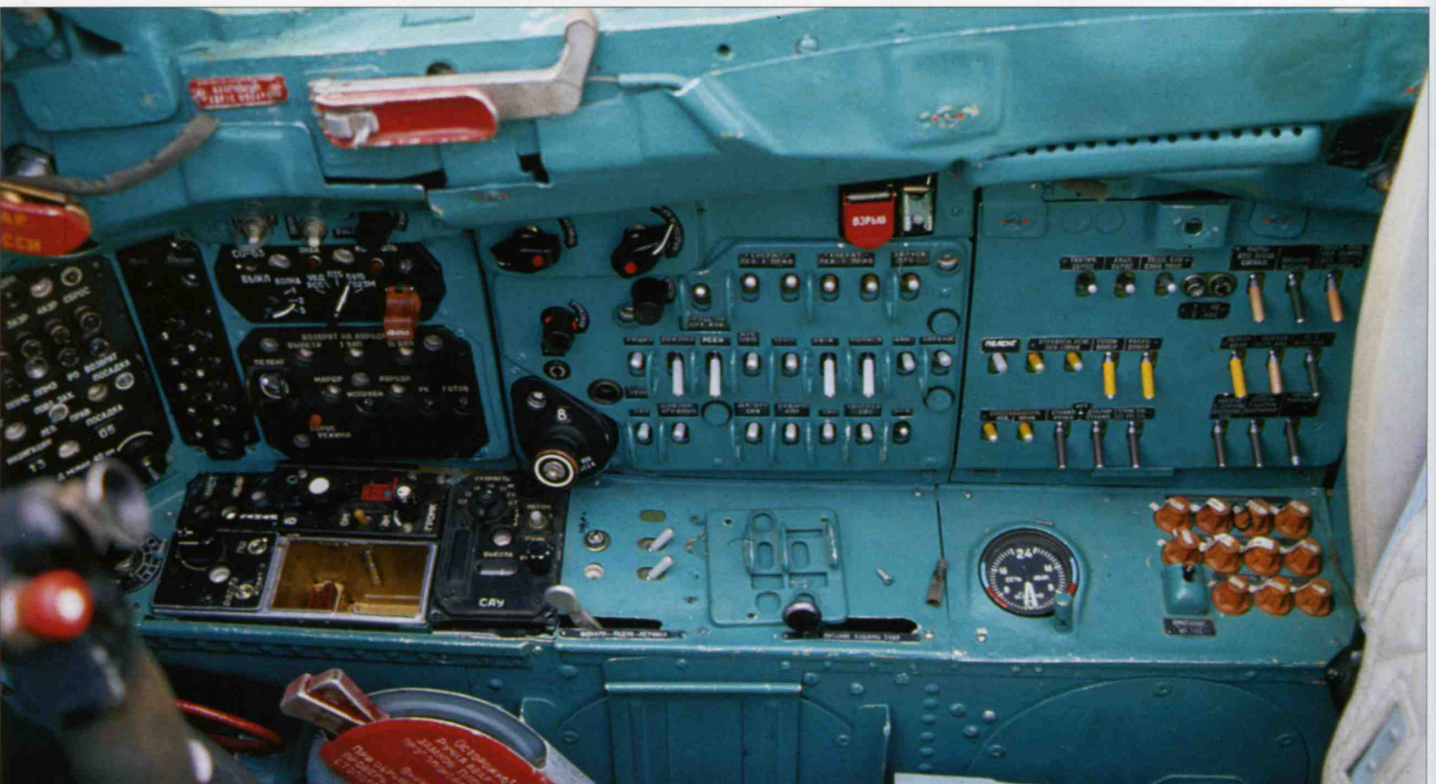

is cooled in primary air-to-air heat exchangers and a water radiator and then fed to two subsystems, one for the cockpit and one for the avionics bays, at a rate of about 240 kg/hr (529 lb/hr) and 560 kg/hr (1,234 lb/hr) respectively.

In each subsystem the air is further cooled. The cockpit subsystem uses another air-to-air heat exchanger and a cooling turbine; the avionics subsystem has a cooling turbine installed on the starboard engine. Cockpit air conditioning air is supplied at -7°C ($+19^{\circ}\text{F}$) and 0.45 kg/cm^2 (6.4 psi), while avionics cooling air comes at -20°C (-4°F) and about 0.075 kg/cm^2 (1.07 psi). The capacity of the air conditioning system is enough to keep cockpit temperature at an agreeable 20°C (68°F).

De-icing system: The cockpit canopy has ethyl alcohol de-icing. The de-icing system is actuated by a push-button. Two or three seconds are usually enough to melt the ice; if not, longer operation is possible.

Oxygen system and life support equipment: The MiG-25 is equipped with a KKO-5LP oxygen system (*komplekt kislorodnovo oboroodovaniya* – oxygen equipment set) which supports the pilot throughout the

Right: The main instrument panel of MiG-25M '710 Blue'. Part of the instruments have been removed after preservation. Note the list of navigation beacon frequencies on a card on the right.

Below: The port cockpit console of '710 Blue'.



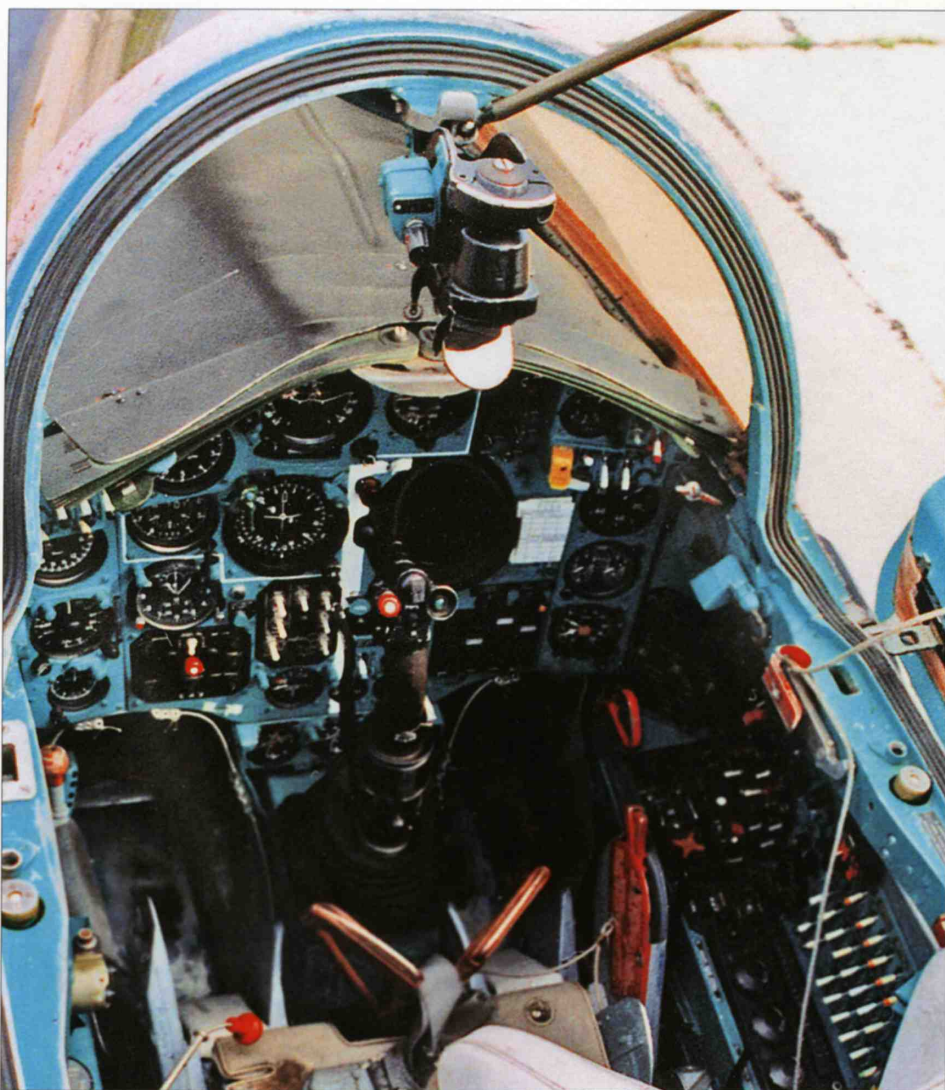

The rear (trainee's) cockpit of a MiG-25PU trainer.

altitude envelope if the cockpit remains pressurised, or up to 11,000 m (36,090 ft) in the event of decompression. During ejection the system automatically switches to the KP-27M portable breathing apparatus (*kislородnyy pribor*) with an adequate oxygen supply to last the pilot all the way down.

The pilot's flight gear includes a GSh-6 full-face pressure helmet (*ghermoshlem* – 'hermetic helmet') for high-altitude operations or a ZSh-5 or ZSh-7 'bone dome' flying helmet (*zashchitnyy shlem* – protective helmet) for lower altitudes), a VKK-6M pressure suit (*vysochno-kompenseeruyushchiy kostyum*) or a VK-3 ventilated flight suit. For over-water operations a VMSK-4 or VMSK-2M maritime high-altitude rescue suit (*vysochnyy morskoy spasahtel'nyy kostyum*), an ASP-74 lifebelt (*avareeyno-spasahtel'nyy poyas*) or ASZh-58 lifejacket (*avareeyno-spasahtel'nyy zhilet*) and a pair of gloves is provided. If the aircraft was to operate in an NBC-contaminated environment the pilot wore a *Komplekt-L* (Set L) NBC protection suit. The KM-1M ejection seat houses a survival kit, including an inflatable

dinghy, a *Komar* (Mosquito) emergency radio beacon and the usual signal flares, food rations, hunting knife, fishing gear and so on.

Fire extinguishing system: The port and starboard engine have separate fire warning systems with ionisation sensors and separate fire extinguishers. Each fire extinguisher bottle holds 6.75 kg (14.88 lb) of 114V₂ grade chlorofluorocarbon extinguishing agent.

Avionics and equipment: Except for the special mission equipment (including nav aids), the interceptor and reconnaissance versions have identical avionics.

Flight/navigation equipment: ARK-10 automatic direction finder, RV-19 (later RV-18) high-range radio altimeter, an RV-4 (RV-4A) low-range radio altimeter, MRP-56P marker beacon receiver, RSBN-6S *Korall* (Coral) SHORAN, Pion-3P (Peony; pronounced 'pee on') antenna feeder system. Recce/strike versions have a DISS-7 Doppler speed/drift sensor system (*Doplerovskiy izmeritel' skorosti i snosa*).

All versions are fitted with the Polyot-11 automatic navigation and flight control system including a Romb-1K SHORAN/automatic landing system, a SAU-155P1 (interceptors) or SAU-155R1 (reconnaissance versions) automatic flight control system, an SKV-2N-1 (reconnaissance versions) or SKV-2N-2 (interceptors; later replaced by SKV-2NL-2) attitude and heading reference system (*sistema koorsovertikahli*) and an SVS-PN-5 navigation data link system.

Operating in concert with ground DME/DF and localiser/glideslope beacons, the Polyot-11 ensures automatic climb with subsequent transition to cruise at preset altitude and speed, auto route following (using reference points, including four airfields which could also be used as staging points), auto return to home base or one of three reserve bases, manual diversion to an airfield not programmed for the flight, auto landing approach down to 50 m (164 ft), go-around and homing in on a marker beacon.

Throughout the sortie the pilot sees his position relative to the airfield or waypoints (given in coordinates). The Polyot-11 system is connected with the radar and the weapons aiming system and thus can direct the aircraft to the area where the target is. The system enables the MiG-25 to operate day and night in VFR and IFR conditions in automatic, semi-automatic and manual modes.

Communications equipment: R-832M *Evkalipt* (Eucalyptus) UHF radio, R-802 HF radio, R-847RM (later R-864) HF radio and (two-seaters only) SPU-7 intercom.

Targeting equipment: The interceptors' avionics suite is built around the weapons control system (WCS), ensuring the aircraft can intercept and destroy targets with missiles day and night in VFR and IFR conditions. The MiG-25P's WCS is based on the RP-25 *Smerch-A* radar (*izdeliye 720*) superseded in the mid-1970s by the improved *Smerch-A2* (*izdeliye 720M*). The MiG-25PD/PDS is fitted with an S-25 *Sapfeer-25* radar, aka RP-25M or RP-25MN. Its radar can detect a medium-sized target at more than 100 km (62.5 miles) range.

Besides the radar, the WCS of the MiG-25PD/PDS includes the TP-62Sh IRST (*teplopelengahtor*), the AVM-25 analogue computer and the PAU-473 pilot actions monitoring system (the modern equivalent of a gun camera). The WCS enables the aircraft to detect targets by means of radar, regardless of enemy ECM or ground clutter and covertly attack targets in pursuit mode without switching on the radar (or switching it on very briefly), using the IRST set. The WCS is connected with the IFF system.

The interceptors are fitted with a command link system receiving, decoding and indicating instructions coming in from ground control centres. The system could also work

the other way around, relaying messages to ground control. The MiG-25P had the old Lazoor' system, whereas the MiG-25PD/PDS was fitted with the BAN-75 system integrated with the ground-based Looch-1 guidance system.

Reconnaissance/strike versions are equipped with the Peleng-D navigation/bombing system (later replaced by the Peleng-DR and still later by the Peleng-DM), comprising the Anis-8 INS, the DISS-3S Doppler slip/drift meter, the TsVM-10-155 *Orbita*-155 digital computer and so on.

The MiG-25BM has a Yaguar targeting system.

Reconnaissance equipment: The mission equipment of the reconnaissance/strike versions included A-70M, A/E-10, A-72 and S45-ARE day cameras and the NA-75 night camera (chiefly on the MiG-25R, RB, RBN and RBT), the Romb-1K SIGINT pack, the SRS-4A or SRS-4B SIGINT pack (*izdeliye* 30A or 30B) on the MiG-25RB, the SRS-9 Virazh SIGINT pack (*izdeliye* 31) on the MiG-25RBV, the Koob-3M SIGINT pack on the MiG-25RBK, the Sablya E SLAR (*izdeliye* 122) on the MiG-25RBS, the Shompol SLAR on the MiG-25RBSH and the Shar-25 SIGINT pack (*izdeliye* F-25S) on the MiG-25RBF.

IFF system: SRO-2P (NATO *Odd Rods*) IFF transponder with aerials on the nose and tail; an SO-63B ATC transponder was also fitted (later replaced by the SO-69).

ECM/ESM equipment: Sirena-3M radar warning receiver (later replaced by the SPO-15 (L006) *Beryozha* RHAWs). Reconnaissance/strike versions have an SPS-141, SPS-142, SPS-143 or SPS-151 active jammer (depending on the aircraft model).

Data recording equipment: Tester-UZL flight data recorder, P-591 cockpit voice recording system with an RI-65 voice annunciator (capable of transmitting failure messages and distress signals automatically to ground control centres), MS-6 Leera (Lyre) tape recorder.

Armament: The MiG-25P was armed with four R-40 (*izdeliye* 46) medium-range AAMs – two R-40R semi-active radar homing (SARH) missiles and two R-40T IR-homing missiles. The missiles could hit targets pulling up to 4 Gs in an evasive manoeuvre and were carried on underwing pylons, one of a kind under each wing. The pylons were fitted with APU-84-46 launchers (APU = *avtomaticheskoye pooskovoye oostroystvo* – automatic launcher for aircraft '*izdeliye* 84' and missile '*izdeliye* 46'). The upgraded MiG-25PD/PDS carries updated R-40RD, R-40RD1 and R-40TD missiles. It can also carry two R-60 or R-60M short-range IR-homing AAMs on twin APU-60-11 racks on each outboard pylon instead of a single R-40. In this case only

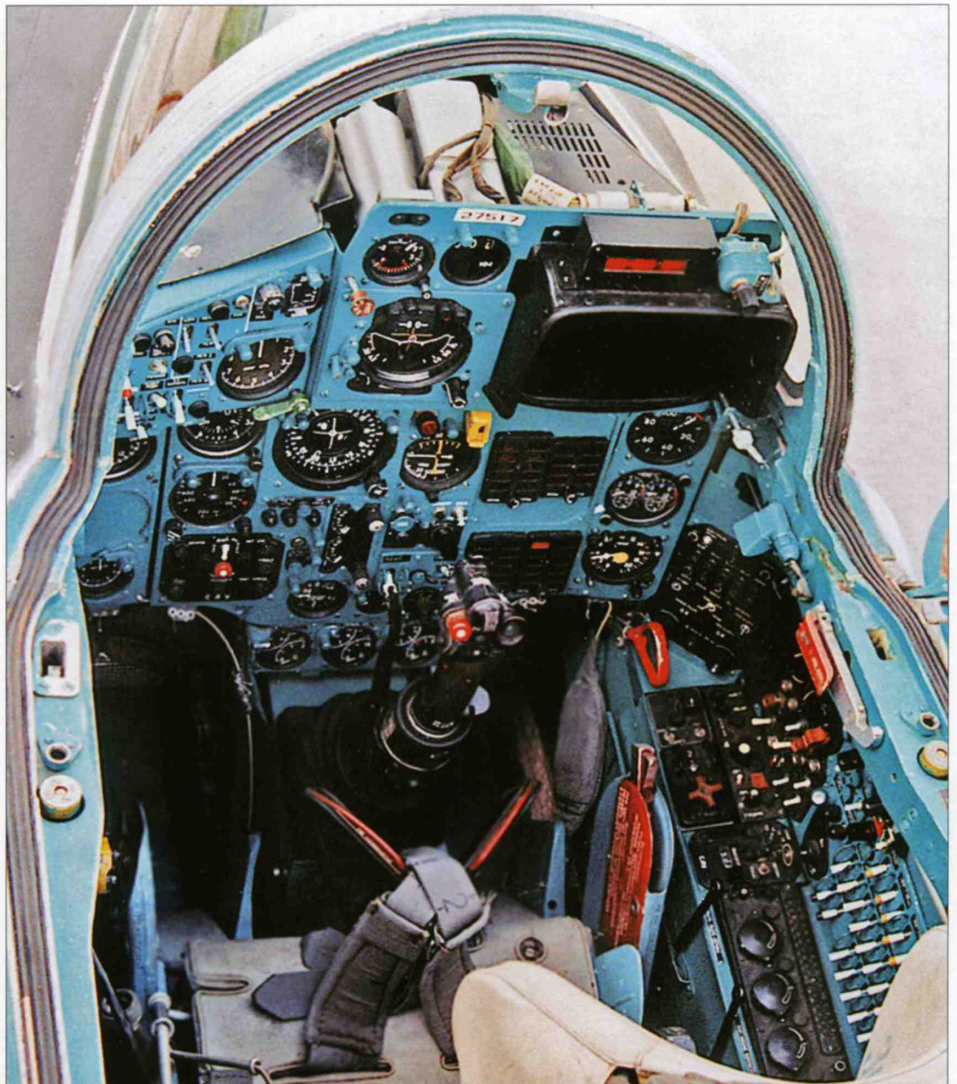

Above: The rear cockpit of the MiG-25PU-SOTN chase plane developed under the Buran space shuttle programme. Note the TV display on the right.



The front cockpit of the same aircraft. Note the special control panel on top of the instrument panel.

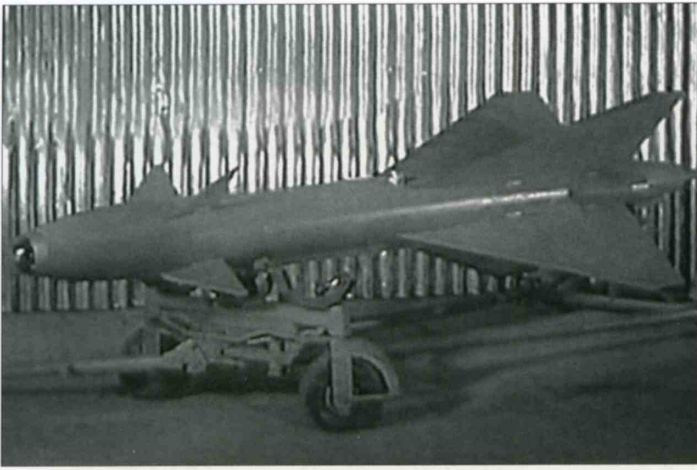

Left: A prototype K-40T medium-range IR-homing missile on a ground handling dolly.
 Right: A production R-40T (inboard) and a semi-active radar homing R-40R under the port wing of a MiG-25P.

SARH missiles are carried on the inboard pylons.

The reconnaissance/strike versions (MiG-25RB/RBK/RBS/RBV/RBSh/RBF) can carry up to 4,000 kg (8,820 lb) of free-fall

bombs; starting from c/n 02022077 the bomb load was increased to 5,000 kg (11,020 lb). The following combinations are possible:

- four FotAB-100-80 flare bombs in pairs under the wings;

- eight FotAB-100-80 flare bombs in pairs under the wings and fuselage;
- eight FAB-500M-62 high-explosive bombs in pairs under the wings and in tandem pairs under the fuselage;
- eight FAB-500M-62 bombs in tandem pairs under the wings and in tandem under the fuselage;
- ten FAB-500M-62 bombs in tandem pairs under the wings and in tandem pairs under the fuselage;
- ten FAB-500M-62 bombs in tandem pairs under the wings and in triplets under the fuselage.

Heat-insulated FAB-500M-62T HE bombs could be used instead of regular ones for high-speed missions. Small-calibre nuclear charges could also be carried.

The bomb armament of the air defence suppression MiG-25BM is similar to the reconnaissance/strike versions. For combating enemy radars the aircraft can carry four Kh-58U anti-radar missiles with a range in excess of 40 km (25 miles).

Crew escape system: The ejection system includes the canopy jettison mechanism and the ejection seat proper. Early MiG-25s had a Mikoyan KM-1 seat, replaced by the KM-1M on late production aircraft. The KM-1M seat permits ejection at up to 20,000 m (65,620 ft) and 1,200 km/h (750 mph). It could be operated on take-off and landing at speeds not less than 130 km/h (81 mph).

Top right: This view shows clearly the bifurcated rocket motor nozzle of the R-40 AAM – a necessity because the tailcone carries the guidance antenna (which is closed by a protective cap until immediately before take-off).

Above right: Eight FAB-500M-62 low-drag bombs suspended on MBD3-U2 racks under a MiG-25RB.

Right: The MiG-25BM carries Kh-58U ARMs.



Above: An R-40TD and two R-60M short-range IR-homing AAMs on an APU-60-2 paired launcher under the port wing of a MiG-25PD.

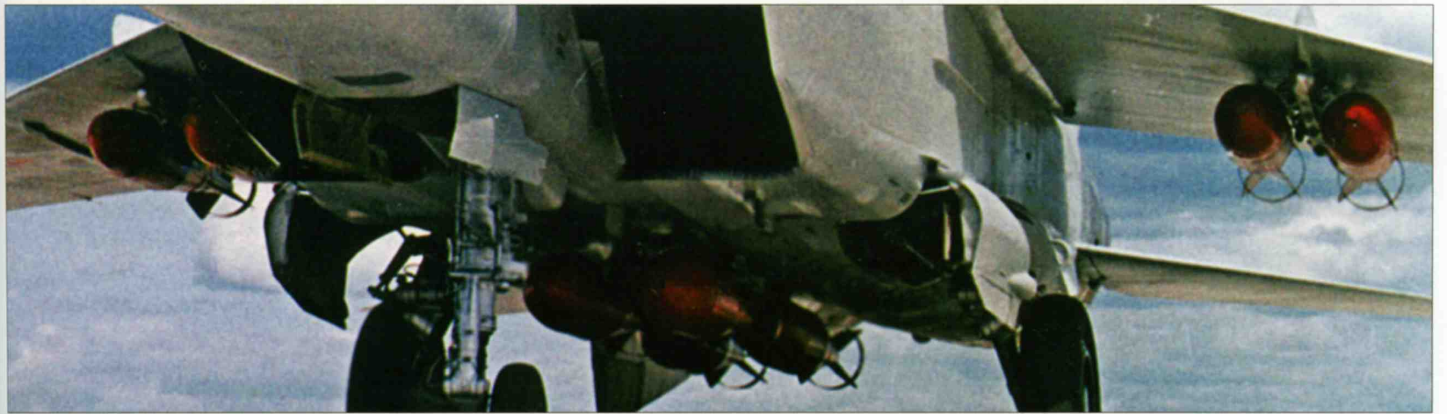
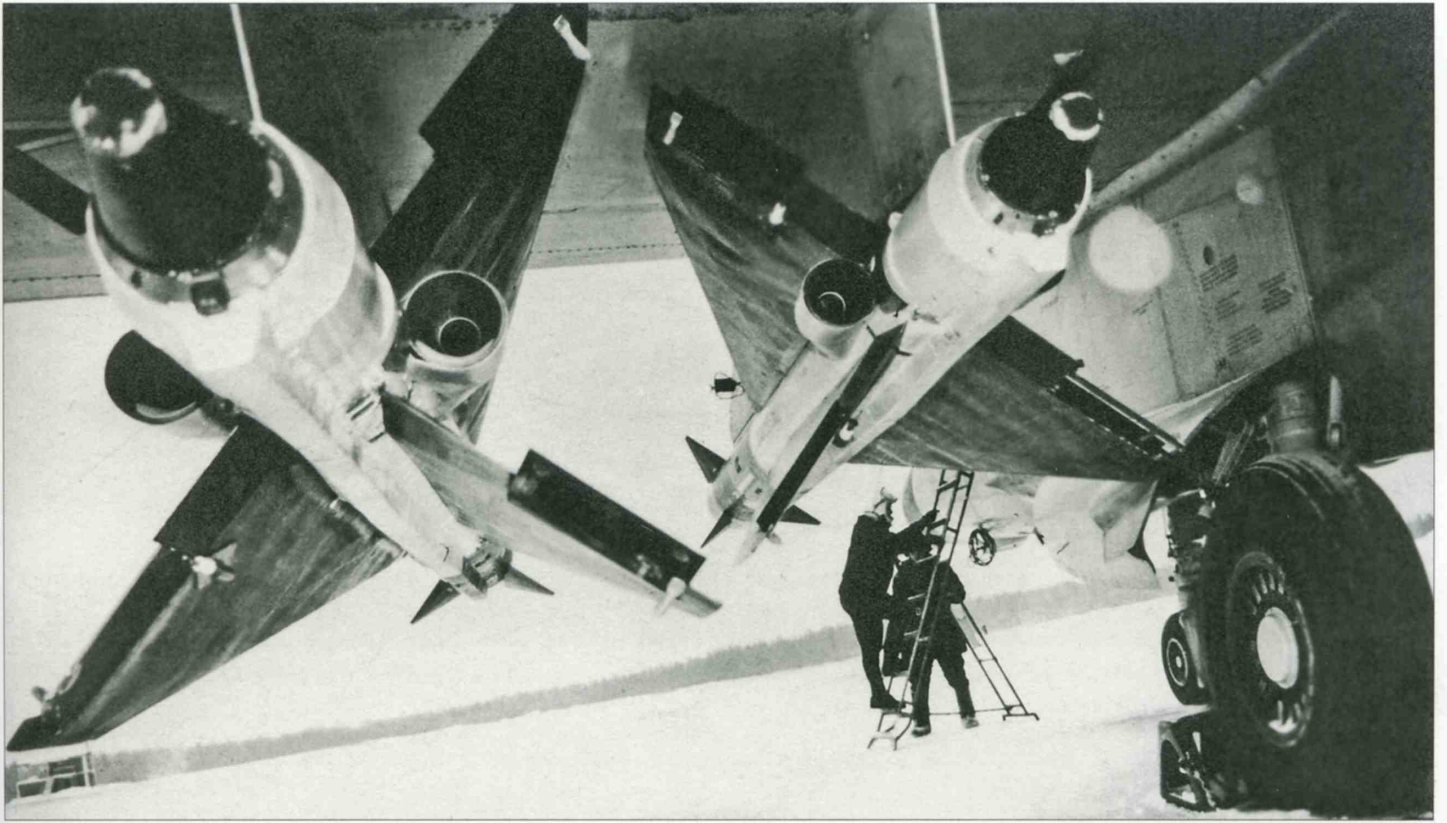



A Kh-58U anti-radar missile on an AKU-58 ejector rack fitted for show purposes to a MiG-25RBS preserved as a gate guard. This weapon is normally carried by the MiG-25BM.

MiG-25 main dimensions and data

	MiG-25PD	MiG-25RB	MiG-25RBN	MiG-25RU
Length excluding nose probe	19.75 m (64 ft 9½ in)	21.55 m (70 ft 8¾ in)	21.55 m (70 ft 8¾ in)	n/a
Fuselage length	n.a.	19.581 m (64 ft 2¼ in)	19.581 m (64 ft 2¼ in)	19.431 m (63 ft 9 in)
Height on ground	6.5 m (21 ft 4 in)	6.5 m (21 ft 4 in)	6.5 m (21 ft 4 in)	6.5 m (21 ft 4 in)
Wing span	14.015 m (45 ft 11¾ in)	13.38 m (43 ft 10¾ in)	13.38 m (43 ft 10¾ in)	14.015 m (45 ft 11¾ in)
Wing area w. centre section, m² (sq ft)	61.40 (660.66)	58.90 (633.76)	58.90 (633.76)	61.40 (660.66)
TOW, kg (lb):				
normal	34,920 (76,984)	37,100 (81,790)	35,740 (78,791)	32,100 (70,767)
maximum	36,720 (79,960)*	41,200 (90,828)**	36,420 (80,291)	39,200 (86,419)
Top speed, km/h (mph):				
at sea level	1,200 (750)	1,200 (750)	1,200 (750)	1,200 (750)
at 13,000 m (42,650 ft)	3,000 (1,875)	3,000 (1,875)	3,000 (1,875)	Mach 2.65
Landing speed, km/h (mph)	290 (181)	290 (181)	290 (181)	290 (181)
Unstick speed, km/h (mph)	360 (225)	360 (225)	355 (222)	350 (218)
Climb to 20,000 m (65,616 ft), minutes	8.9	8.2	n.a.	n.a.
Service ceiling, m (ft)	20,700* (67,913)	23,000 (5,459)	19,700 (64,632)	n.a.
Range, km (miles)				
above Mach 1.0	1,250* (781)	1,635/2,130 (1,021/1,331)†	1,085 (678)	n.a.
below Mach 1.0	1,730* (1,081)	1,865/2,400 (1,165/1,500)†	n.a.	n.a.
Take-off run, m (ft)	1,200 (3,937)	1,200 (3,937)	1,200 (3,937)	n.a.
Landing run, m (ft)	800 (2,624)	800 (2,624)	800 (2,624)	n.a.
G limit	+4.5	+4.5	n.a.	n.a.
Armament:				
bombs	none	4... 8 x FAB-500	4... 8 x FotAB-100	none
missiles	2xR-40RD 2xR-40TD or 1xR-40RD 1xR-40TD 2... 4xR-60M	none	none	dummy missiles

Notes:

Data for the MiG-25RBN is with eight FotAB-100 flare bombs suspended

* with four R-40 missiles

** with 5 tons (11,022 lb) of bombs

† MiG-25R with drop tank

Foxbats in action

After the Ye-155 had made its public *début* at the 1967 Domodedovo airshow, the aircraft was allocated the NATO reporting name *Foxbat* and promptly dubbed 'MiG-23' in the belief that it was next in line to the MiG-21. This 'educated guesswork', however, was proved to be wrong when the real MiG-23 was unveiled, and another year passed before the Ye-155's actual service designation became known in the West.

Many Soviet aircraft remained highly classified for a long time – perhaps none more so than the MiG-25. A turning point in the aircraft's career came when it actually saw combat on the Middle Eastern theatre of operations. Being on friendly terms with the Arab nations, the Soviet Union could not remain unperturbed when Israel defeated Egypt in the Six-Day War of June 1967.

In late January 1970 Egyptian President Gamal Abdul Nasser paid a secret visit to Moscow, asking for assistance in re-equipping the Egyptian armed forces. Specifically this included training military specialists, particularly SAM crews, and building up an effective air defence system.

Nasser's request was granted immediately. As early as February 1970 Egyptian troops began arriving in the USSR by the brigade to take their training, and deliveries of the latest Soviet military equipment commenced. The headquarters of all Egyptian Army units, right down to battalion level, had Soviet military advisors attached.

In March-April 1970 Soviet SAM battalions and fighter units moved into Egypt to provide protection for targets of importance, such as the Aswan dam, the seaport of Alexandria, air bases, army depots and factories. However, the USSR did not stop there; Soviet military experts took part in planning the operations aimed at liberating Arab territories annexed by Israel. The Egyptian Army was to breach Israeli defences, cross the Suez Canal and move on into the Sinai Desert. However, a thorough reconnaissance of enemy forces was necessary, since the Israelis had established a mighty defence along the Suez – the supposedly impregnable Bar-Lev line.

A new Arab-Israeli war was brewing. The Soviet leaders were well aware that the Egyptian armed forces were in no shape to take on the Israelis alone, even though they had been

rebuilt by 1971 with massive Soviet aid. However, direct Soviet involvement in a Middle Eastern conflict (the way many Arab leaders would like it!) was out of the question, as it was guaranteed to kick off the Third World War. Therefore, another unconventional decision was taken: a special reconnaissance task force flying MiG-25Rs would be dispatched to Egypt. The Ministry of Aircraft Industry was instrumental to this decision.

By then, the MiG-25 was veritably in a predicament. The test programme was dragging out with many problems requiring urgent solution, and the PVO Aviation C-in-C Gen. Anatoliy Kadomtsev's fatal crash in a MiG-25 in April 1969 certainly did not help. The PVO and VVS were getting pessimistic about the MiG-25, and the decision whether it was going to be accepted was nowhere in sight. It was then that Deputy Minister of Aircraft Industry A. V. Minayev (who, being an ex-Mikoyan man, had taken part in the development of the MiG-25 and cared about the new aircraft) suggested trying it out in the Middle East. The military were also interested in finding out what the MiG-25 could do ('seeing is believing', they say!) and jumped at the rare opportunity to test it in actual combat instead of the customary test ranges.

In the summer of 1970 a task force of 70 men headed by Minayev was formed at the GNIKI VVS test facility in Akhtoobinsk. This included the cream of the specialists from GNIKI VVS, the Air Force's 4th Combat & Conversion Training Centre in Lipetsk and a handful of first-line VVS units which were by then operating the type. Mikoyan OKB and aircraft industry employees who had participated in refining the aircraft and knew it well were also included. The task force also included six experienced pilots (mostly VVS pilots); the Mikoyan OKB was also represented by MiG-25 deputy project chief L. G. Shengelaya, Ishchenko and Yu. F. Polooshkin.

The group of test engineers included highly experienced men like Tokarev and Mishchok, some engineers from the Gor'kiy plant (headed by Goryunov) and engine experts from the Tumanskiy design bureau (headed by Groozdev) and the plant producing the R15B-300 turbojet. RPKB responsible for the Peleng navigation system sent engineer Boorov, and VNIIRA was represented by

radio navigation systems expert Andjian. The real rank and status of each man in the team was kept secret, and the group was closely guarded by Egyptian commandos at all times after arriving in Egypt.

A few words need to be said about the pilots involved in the mission. Test pilot V. Gordiyenko (the Gor'kiy factory's CTP) test-flew nearly all production MiG-25s and taught service pilots to handle the aircraft. GNIKI VVS test pilot Col. Nikolay I. Stogov, pilot V. Uvarov of the 4th TsBP i PLS and service pilots N. Borshchov, Yu. Marchenko, Choodin and Krasnogorskiy were all experienced airmen. Test pilot (1st Class) Col. Aleksandr S. Bezhevets, a man renowned for his resolve and command skills, was put in charge of the flying group. Also, he was second to none in knowing the MiG-25, having flown the first Ye-155 prototypes back in 1965.

Bezhevets was faced with the daunting task of keeping the large and motley team organised. In the first days of the task force's stay in Egypt it was directed by Air Marshal Aleksandr N. Yefimov (First Deputy C-in-C of the VVS who later went on to become C-in-C) and Lt. Gen. Dol'nikov, deputy chief Air Force advisor in Egypt.

There was no point in sending the MiG-25P heavy interceptor to the Middle East. First, one or two aircraft could not save the Egyptian air defence force, and the USSR could not afford to send more since it was guaranteed to attract attention in the West and be regarded as direct intervention. Second, the MiG-25P was most effective at long range and high altitude because of its remarkable performance, and the Middle Eastern theatre of operations was just too cramped for it.

Besides, there was the question of enemy tactics; the situation called for numerous highly manoeuvrable light fighters, rather than a handful of heavy interceptors, to counter the Israeli aircraft. Thus, the Soviet leaders decided that sending four reconnaissance aircraft would do a lot more good, since they could furnish tactical information rapidly and, importantly, boost the morale of the Egyptian forces.

Two 'pure reconnaissance' MiG-25Rs (f/ns 020501 and 020504) and two machines converted to MiG-25RB reconnaissance/strike configuration (f/ns 020402 and 020601)

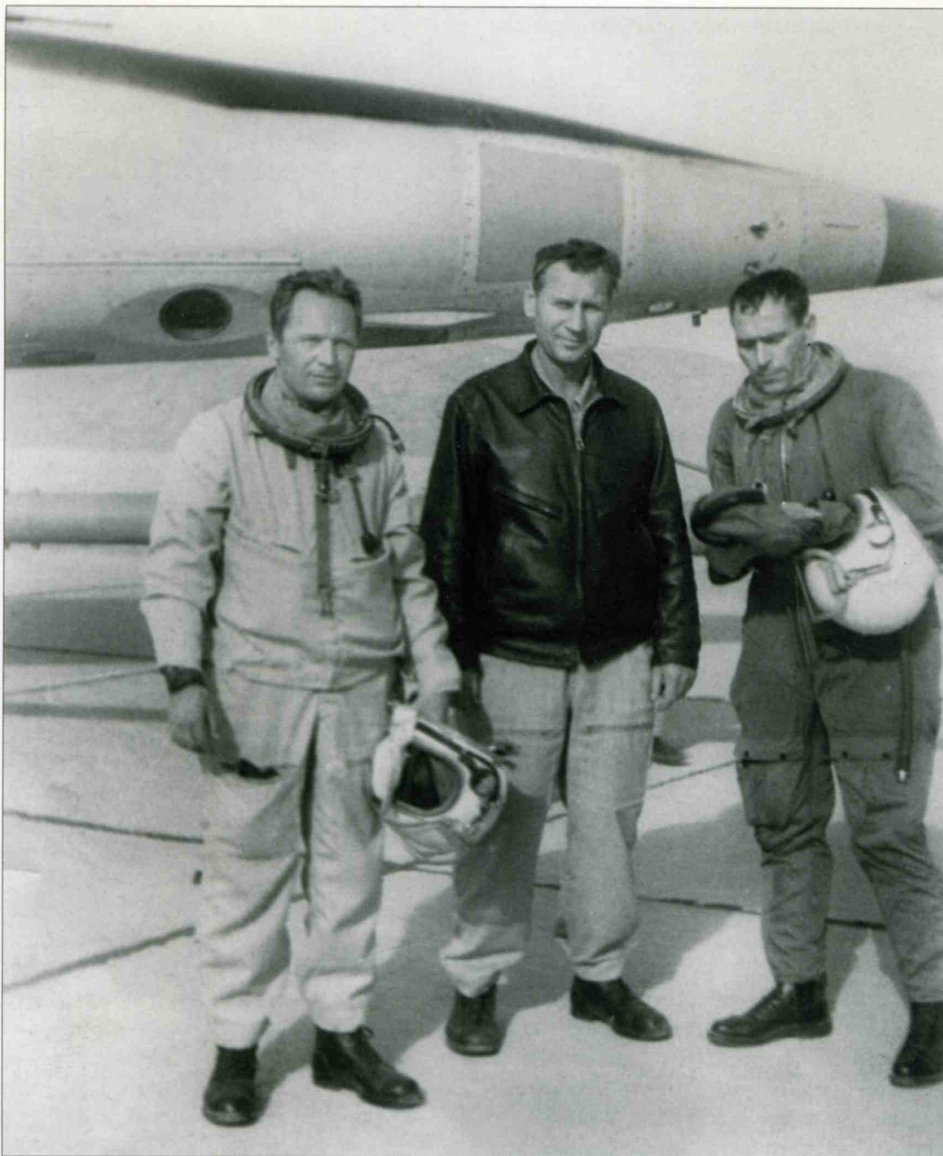

Soviet pilots who took part in the MiG-25RB's Egyptian deployment in March 1971 (with Aleksandr Bezhevets in the middle) pose before one of the four aircraft involved.

were selected among the early production aircraft undergoing tests at NII VVS. The tech staff was familiar with these aircraft, which simplified maintenance. For PHOTINT duties the aircraft could carry two different camera sets composed of A-72, A-87 and A/E-10 cameras, as well as interchangeable SRS-4A/SRS-4B SIGINT packs. The MiG-25RBs differed in having provisions for bomb racks and being fitted with the Peleng navigation/bombing computer.

The location where the group was to operate was kept secret until the last moment. The first clue was the medical examination which all the pilots had to pass to make sure they were fit for service in hot and dry climatic zones. The 'hot and dry' bit suggested Africa; this was soon confirmed when the top brass informed that the group was to 'extend international help' to the Arab Republic of Egypt.

Training was completed and everything set to go by late September 1970. But then

Nasser died on 28th September; Anwar Sadat, his successor, seemed more intent on negotiating than waging a war. A change in Egypt's political course seemed probable, and the trip was postponed. However, Sadat confirmed that Egypt was firm in its resolve to win back the land seized by Israel, and the programme went ahead as planned.

In March 1971 the group was ordered to pack their bags and redeploy to Egypt on the double. To save precious time the personnel and the four aircraft were to be airlifted by Soviet Air Force An-12 and An-22 Antey transports. But even with the wings, tail units and engines removed the MiGs would not fit into the An-22's cargo cabin – they were a couple of inches too wide and too high. The fuselage width was OK but the mainwheels got stuck in the Antey's cargo door.

Thinking fast, someone suggested reversing the main gear struts so that the mainwheels faced inboard instead of out-

board; that took care of the problem. Someone else suggested temporarily fitting MiG-21 mainwheels. They were strong enough to hold the stripped-down aircraft but much smaller than the MiG-25's own mainwheels, enabling the aircraft to go through the cargo door, though it was a very tight squeeze.

The group, designated the 63rd Independent Air Detachment (Det 63), was based at Cairo-West airport. For security reasons all members of the group wore Egyptian uniforms with no insignia of rank. Det 63 reported directly to Col. Gen. Okunev, the top Soviet military advisor in Egypt; Maj. Gen. Kharlamov, HSU, was responsible for tactical planning and objective setting. A. V. Minayev and L. G. Shengelaya monitored the group's operations from the manufacturer's side.

The Egyptians had already built huge hardened aircraft shelters (HASs) for the MiGs. Using these shelters, the highly skilled Soviet technicians managed to reassemble the aircraft in a few days. In the meantime Israeli Defence Force/Air Force (IDF/AF) aircraft attacked the airfield several times, which caused the air defences at Cairo-West to be reinforced with S-75 and S-125 SAM batteries. The shelters containing the MiGs were further protected by five ZSU-23-4 Shilka quadruple 23-mm (.90 calibre) self-propelled AA guns manned by Soviet crews. The airfield itself was guarded by Soviet soldiers who built machine-gun emplacements and put up barbed wire fences around the perimeter; as it were, the Egyptians were only responsible for guarding the outskirts of the field. Finally, the assembled and checked aircraft were wheeled over to the revetments previously occupied by Egyptian Air Force Tu-16KS-1 cruise missile carriers.

It was just as well that the task force was so painstaking about security measures. It turned out that the locals, for all their friendly attitude, could not be trusted to keep their mouths shut. Egyptian officers never gave security a second thought, and having them participate in mission planning and support meant that the Israelis were aware of the group's plans almost before the meeting adjourned. A few days after the task force moved to Cairo the local paper *Al-Akhrām* raised a ballyhoo, carrying a banner headline 'New aircraft at Cairo-West air base!' For sheer effect the paper labelled the aircraft 'X-500', but the accompanying pictures left no doubts as to their identity (and origin).

The Soviet task force was very worried indeed by how fast the Israelis got news of its planned sorties. This forced a change in the cooperation procedures with the Egyptians to stop possible breaches of security. A meeting chaired by Gen. Okunev resolved that from then on all work of Det 63 would be done only by Soviet personnel.

Ensuring flight safety turned out to be a major difficulty, too. To avoid encounters with IDF/AF aircraft special air routes had to be developed, ensuring that the MiG-25s were protected by SAMs at all times during climb and descent. The pilots also perfected a steep landing approach (not unlike the 'Khe Sanh tactical approach' used by the USAF in Vietnam) and devised evasive manoeuvres for escaping missiles. During descent the MiG-25 boasted a thrust/weight ratio better than 1; in contrast, Israeli McDonnell F-4E Phantom IIs and Dassault Mirage IIICJs had a ratio of 0.6 to 0.7.

The first trial flights over Egyptian territory began in late April. During this period, mission profiles were drawn up, cameras tried out and navigation computers adjusted and programmed. Test pilot V. Gordiyenko was the first to go up. During that sortie the SIGINT pack recorded that, in addition to Israeli radars located in the Sinai Peninsula, the aircraft had been 'painted' by a US Navy destroyer's radar and a British surveillance radar located on a mountain top on Crete. Later, Yu. Marchenko and A. Bezhevets also started flying sorties. These sorties had one curious feature. To ensure the best possible picture quality the automatic flight control system had to follow the predetermined route very closely, using landmarks – which were unavailable in the desert. Hence, the famous pyramids of Giza were used as landmarks, causing the pilots to refer to these missions jocularly as 'scenic tours'.

For security reasons the MiGs would take off without warning before some Egyptian could run off at the mouth that a sortie was planned. Cairo-West ATC would be 'officially' advised that nothing more serious than a routine engine check or taxi trials was cooking. As a result, the first unexpected (and unauthorised) take-off caused real panic among the Egyptians.

Sorties over Israeli-held territory involved cruising at full military power for about 40 minutes. The air temperature in the engine inlet ducts peaked at 320°C (608°F); the aircraft skin was not much colder either (303°C/577°F). By then, the Tumanskiy OKB had extended engine running time in full afterburner from three to eight minutes and then to 40 minutes. Thus, virtually all sorties could be flown at maximum thrust; the R15B-300 turbojets proved reliable enough and gave no problems in the hot Egyptian climate.

The MiG-25 used special T-6 grade jet fuel with a high boiling point which was unavailable in Egypt. To supply Det 63 with this exotic fuel, Soviet tankers would sail from Soviet seaports to Alexandria, whence the fuel was delivered to Cairo by KrAZ-214 tanker lorries.

The preparations were finally completed in May 1971 and the group was all set to start combat sorties. Missions were planned painstakingly. The pilot would start the engines while the aircraft was still in the HAS, then run a systems check and taxi out for take-off. Then he carefully positioned the aircraft on the runway because the holding position ('X marks the spot') was clearly defined and entered into the SAU-155R1 automatic flight control system. This was the starting point of the mission; from there the pilot proceeded, strictly observing radio silence – the pilots were allowed to go on air only in an emergency.

The reconnaissance aircraft always operated in pairs. This increased mission success probability while giving the pilots that extra bit of confidence 'in case I don't make it back'. If one aircraft went down because of a critical systems failure (or was shot down – war is war, after all) the other pilot could report the crash and indicate the whereabouts, helping the SAR group.

The Israelis were infuriated by the MiG-25's overflights and started a veritable hunt for the aircraft, but the prey invariably got away. Yet the Israelis had an excellent SIGINT operation running, and calling in Egyptian fighters by radio to provide air cover would be an open invitation for the enemy to come in and try to shoot the MiG down. Since the Soviet pilots maintained radio silence, the Israelis had no alternative but to circle over Cairo-West, waiting for the *Foxbats* to line up for take-off.

Even then, they were out of luck. As the Israeli fighters moved in to attack, they were immediately counterattacked by a flight of Egyptian MiG-21MFs flying top cover (these were summoned in advance from another airbase). After receiving word that the Soviet pilots were ready two of the MiG-21s streaked over the runway, followed immediately by the MiG-25s, a second pair of MiG-21s protecting the rear. In a few minutes the *Foxbats* would accelerate to Mach 2.5 and go 'up, up and away'.

Missions were flown at maximum speed and 17,000-23,000 m (55,770-75,460 ft). At this rate, no one could keep up with the MiG-25, and it was just as well because the reconnaissance aircraft were unarmed. The fuel was burned off at a rate of 500 kg (1,102 lb) per minute, reducing all-up weight, and the aircraft would gradually accelerate to Mach 2.8. Pilots recalled that the canopy became so hot it burned your fingers if you touched it. As the aircraft approached the target area the vertical and oblique cameras were operated automatically, photographing a strip of land 90 km (56 miles) wide on either side of the aircraft. To prevent malfunctioning of the delicate equipment the camera bay was

air-conditioned with a temperature variance of no more than 7°C (12.6°F).

Apart from high temperatures, photography at high Mach numbers involved another difficulty – the camera moved rapidly with respect to the object. In a single second the MiG-25 would travel almost 1,000 m (3,280 ft); thus, very high shutter speeds were needed to get clear pictures. To compensate for camera movement special adapters with movable prisms were developed, allowing the object to be kept in focus.

Certain photo and cine shooting modes required the camera ship to keep a constant speed. Another complication was that the MiG-25 was constantly climbing as fuel burnoff reduced weight, reaching 22,000 m (72,180 ft) at the end of its target run. In addition to taking pictures, the MiG-25Rs and MiG-25RBs pinpointed Israeli radars, communications centres and ECM facilities.

The entire flight from Suez to Port Said took just 1.5 or 2 minutes. On the approach to Cairo-West the reconnaissance aircraft were met by the MiG-21MFs, which escorted them all the way down, patrolling over the airfield until the Soviet aircraft were safely in their shelters.

After losing several aircraft to SAMs the Israelis gave up trying to bomb the base, but the confrontation continued. In September 1971 an IDF/AF aircraft flying combat air patrol near Cairo-West was shot down by an Egyptian SAM. The Israelis retaliated by raiding the SAM sites, knocking out two of them with Shrike ARMs; the Soviet men and officers manning the sites were killed. This led the Soviet command to take additional protective measures for Det 63. In October 1971 special underground hangars were built for the MiG-25s at Cairo-West. These shelters could survive a direct hit of a 500-kg (1,102-lb) bomb and were fitted with all necessary communications and equipment. Pre-flight checks and routine maintenance, including engine run-up, were done underground and the aircraft only left the shelter immediately before take-off.

The MiG-25s flew two sorties per month. As they covered all of the Suez Canal and went on to explore the Sinai Peninsula, the sorties grew longer, requiring a drop tank to be carried occasionally; with drop tank the aircraft's range exceeded 2,000 km (1,242 miles). The MiGs brought back hundreds of yards of film with valuable information, which was developed and sent to the intelligence section of the chief military advisor's HQ for analysis. The excellent pictures snapped from 20,000 m (65,620 ft) showed not only buildings and structures but also vehicles and even groups of people. Camouflaged materiel dumps and shelters were also visible. The SIGINT equipment helped to reveal a



Above : This shot of the pyramids at Giza, with the outskirts of Cairo in the background, testifies to the capabilities of the MiG-25R and its mission equipment.
 Below: Soviet technicians pose for a photo on the air intake trunk of MiG-25R '41 Red', one of the four deployed to Egypt.



camouflaged ECM facility near Jebel Umm-Mahas and pinpoint Israeli air defence radars and SAM sites.

Det 63 continued to operate successfully. The MiG-25s ventured still farther afield – that is, farther east, and by the winter of 1971 their routes took them over Israel. The Soviet pilots were not afraid of Israeli jets scrambling to intercept them, having encountered them before over the Sinai Desert – the F-4E and Mirage IIICJ were simply no match for the MiG-25. The Phantom was inferior in speed and ceiling; trying to line up for an attack it would often stall and flick into a spin. The Mirage did even worse, and at best the Israeli pilots managed only to get a glimpse of the intruder.

The Raytheon Hawk SAMs used by Israel were no great threat to the MiG-25 either, since the aircraft operated beyond their altitude range (12,200 m/40,030 ft). The MiGs' radar warning receiver often detected that the jet was being 'painted' by enemy radars but no missile warning ensued. On discovering a Hawk launcher the pilot would simply switch on the Siren' jammer and carry on with his business. The deep penetration flights continued into March 1972. The Israeli ambassador to the United Nations lodged a formal complaint

after each occurrence but no action on this issue was ever taken by the UN.

The Israelis did have a reason to be nervous. Among the support equipment and other paraphernalia Det 63 had brought with them were bomb racks for the two MiG-25RBs and FAB-500M-62T low-drag bombs specially developed for supersonic bombing. Each aircraft could carry up to eight such bombs; after being released at high altitude they could sail through the air for miles and miles. However, the Soviet pilots' missions did not include bomb strikes.

As an excuse for their inability to intercept the elusive MiGs the Israeli air defences stated that 'the object was clocked at Mach 3.2!' However, the flight recorders of the MiGs showed there were no major deviations from the prescribed mission profile. Well, yes, the aircraft were not always flown 'by the book'. On one occasion Aleksandr Bezhevets exceeded the speed limit to get away from pursuing Phantoms; the flight data recorder showed that the Mach limit had been more than tripled (!). Other sources state that it was VVS pilot Krasnogorskiy who should walk away with the record (and get the ticket), as he reached 3,400 km/h (2,111 mph) in one of the sorties. This was dangerous because the airframe could be damaged by overheating, but careful inspection of the aircraft showed no apparent damage. Still, the pilots received an unambiguous 'debriefing' after this incident.

The new MiGs had a good reliability record, with very few failures despite the fact that the aircraft still had its share of bugs. Still, each aircraft came complete with a double set of spares – just in case.

Nasty surprises did happen, after all. On one occasion Nikolay Stogov's aircraft suffered an engine flameout and began decelerating rapidly, forcing the pilot to radio for help. He was ordered to return to base immediately or land at the alternate airfield from where escort fighters scrambled. However, seconds later the engine revived spontaneously and Stogov proceeded with the mission as

planned. The trouble was traced to a faulty fuel flow control unit which the electronic engine control system somehow managed to correct.

A more serious incident happened to Bezhevets when he was flying the first machine reassembled on arrival in Egypt. A main gear breaker strut failed on landing approach and the strut would not lock down. Bezhevets decided to make a two-point landing. Touching down at 290 km/h (180 mph), he kept the aircraft's weight off the damaged strut as long as possible. Finally the strut collapsed and the aircraft slewed, scraping a wingtip along the ground and coming to rest against the runway. The landing was made so skilfully that the aircraft suffered only superficial damage to the wingtip and was soon flying again after the wingtip and landing gear had been repaired. (Some sources claim that, minor as the damage was, the aircraft was nevertheless returned to the USSR for repairs and a substitute MiG-25R sent in.)

There were other failures, too. For example, Uvarov's aircraft suffered a cockpit air conditioner failure during the descent, which caused the cockpit to get unbearably hot. Still, the bravery and skill of the pilots and technicians and the availability of spares accounted for the fact that no lives or aircraft were lost in the course of the deployment.

The original staff of Det 63 returned to the USSR in April 1972; the aircraft stayed and were operated successfully by new pilots dispatched from VVS units. The accident rate remained very low. On one occasion the cockpit glazing of the aircraft flown by VVS pilot Yashin failed at high altitude during deceleration; the cockpit decompressed but the pressure suit and oxygen system performed flawlessly, enabling Yashin to land safely.

In all, about twenty flights were made over Israeli-held territory while the MiG-25s were stationed in Egypt; all but one of them were made by pairs of aircraft. The pictures brought back by the MiGs showed clearly the positions of Israeli troops along the Suez. The Egyptian high command was very

impressed by the quality of the photos because their own MiG-21RFs had cameras with a narrow field of view and much valuable detail was lost.

The only sortie flown by a single aircraft was flown by Aleksandr Bezhevets over the Mediterranean along the boundary of Israeli territorial waters. Bezhevets fired his cameras in a banking turn, a reconnaissance practice hitherto unknown. The good lighting conditions, very clear air and highly sensitive film enabled a shutter speed of 1/800 which, together with the high contrast of the image, made for excellent results.

According to the mission profile the aircraft was not to come within 10-20 km (6.21-12.4 miles) of the Israeli border. However, the navigation specialists had forgotten about the high salinity of the Mediterranean and failed to make corrections to the Doppler speed and drift sensor inputs when programming the navigation computer. As a result the navigation error amounted to several kilometers (usually it doesn't exceed 1 km/0.62 miles) and the aircraft flew directly over the border for 3 nautical miles (5.5 km). According to Soviet military advisors, this flight impressed the Israeli leaders greatly, showing all too clearly that their air defence was too weak.

The MiG-25's combat success in the Middle East was excellent testimony to the aircraft's unique capabilities and operational reliability. The designers and the military now had all the proof they needed, and in December 1972 the aircraft was officially taken on strength by the VVS and PVO.

As time passed, however, the Egyptian leaders grew at odds with the Soviet Union. The MiG-25's excellent performance made Egypt want to buy the type, but their request was turned down. As a result, the tension escalated, with Egyptian troops exercising uncomfortably close to the hangars where the MiG-25s were parked. It was decided to move the aircraft back to the USSR (the Crimean Peninsula or the Caucasus region). In July 1972 President Sadat banished all Soviet military staff from the country, thus putting an end to Det 63's operations. After some negotiating it was decided to airlift the MiGs out of the country by An-22s, the way they had come. The Israelis never managed to shoot down a MiG-25 and thus prove that the USSR was involved.

In October 1973 Sadat unleashed the Yom Kippur war. At first the Egyptians did very well, penetrating the Bar-Lev line and advancing into Israeli territory on the Sinai Peninsula. But then the tables were turned as Israel launched a counteroffensive, securing a beachhead on the Egyptian side of the Suez Canal. Having no reliable information about the enemy, Egypt had no choice but to turn to the USSR for help again.

On 19th and 20th October the first An-12s and An-22s brought new MiG-25RBs, personnel, spares, support equipment and even fuel to Cairo-West AB again; the task force was now called Det 154. The industry group headed by MAP representative Ryabenko included Ryazanov and Polooshkin (Mikoyan OKB), Lenivtsev (RPKB), Chief Designers Andjian and Nalivayko (VNIIRA), reps from Tumanskiy OKB and the Gor'kiy aircraft factory. Lt. Col. V. Uvarov of the Lipetsk training centre was commander of the flying group.

The situation was very different from the previous deployment, with Israeli tanks advancing on Cairo at an average 10 km (6.2 miles) per day. Cannon fire could be heard in Heliopolis, a suburb of Cairo, in the morning hours. Thus, as the MiGs were reassembled, flying them back to the USSR was considered as an emergency option in case the Israelis got too close for comfort. (As a last-ditch possibility the aircraft could be blown up to prevent them from falling into enemy hands if Cairo-West was overrun. The personnel would be evacuated by road to the Libyan border.)

This time the Soviet contingent, apart from the MiG-25 pilots and support staff, included only a handful of SAM crews, military advisors working under contract with the Egyptians and small logistics groups responsible for organising airlifts and restoring ties with the Egyptian top command.

A few days later Egypt and Israel began truce talks. By the time hostilities ended one MiG-25 was flying and another had been assembled. Now, considering the possible threat from Soviet-built S-75 SAMs captured by the Israelis, it was decided to send a pair of MiG-25s on a reconnaissance sortie one hour before the truce took effect; one aircraft was to reconnoitre the Suez Canal, the other flying in a more easterly direction.

The mission was successful; developing the film and printing the pictures took the rest of the day and all of the night. By dawn the Egyptian command had learned the worst: in some places their brigades were having trouble fighting back a *single Israeli platoon* that put on a show like it was attacking in battalion strength! In a nutshell, the Egyptians had missed the chance to win a solid combat victory. After that, the Soviet SAM crews pulled out speedily but the MiGs of Det 154 stayed for another year, leaving for home in late 1974. This was the last Soviet involvement in a Middle Eastern conflict.

The successful combat tests of the MiG-25R/25RB boosted the morale of the aircraft industry as well, giving rise to the spate of reconnaissance/strike versions with new ELINT equipment which enhanced the aircraft's capabilities considerably. The engines' TBO was extended and their fuel efficiency

improved. The modified R15BD-300 engines were also retrofitted by repair shops in some cases to replace R15B-300s that had run out of service life. Improved Smerch-A2 and Smerch-A3 radars were fitted to the interceptors, replacing the older Smerch-A1.

As already mentioned, the MiG-25P interceptor was officially included into the PVO inventory on 13th April 1972. The type saw service with fighter regiments stationed near Moscow, Kiev, Perm', Baku, Rostov and in the High North and Soviet Far East. Once the *Foxbat* had been deployed, the flights of the US Air Force's SR-71A strategic reconnaissance aircraft along the Soviet borders became much less frequent. Occasionally the Blackbirds were in real danger – the MiG-25's missiles had achieved a lock-on and the target was within range; the only reason why the order to fire had not been given was that there was no incursion – the SR-71s stayed over international waters.

By the mid-1970s the MiG-25 had become the mainstay of the PVO's fighter arm. It was popular with flight and ground crews alike; the pilots liked its docile handling and willingness to forgive minor piloting errors, while the tech staff appreciated the MiG-25's ease of maintenance. In due course the interceptor earned such affectionate nicknames as *chemodahn* (suitcase) and *gastronom* (food store). While the former sobriquet was derived from the MiG-25's angular and massive appearance, the other nickname was due to the fact that alcoholic drinks are sold in food stores – and the MiG-25P's radar and generator cooling systems contained 200-plus litres (44 Imp gal) of methanol/water mixture (in effect, vodka).

As for active duty, MiG-25P operations were quite intensive, especially in the High North and the Far East, involving round-the-clock quick-reaction alert (QRA) duty and occasional scrambles. This placed high demands on the crews.

The big defection

On 6th September 1976, an unfortunate event occurred which had a profound effect on the MiG-25's development and service career. A MiG-25P piloted by Lt. Viktor I. Belenko and belonging to a PVO unit based at Chugoyevka AB (some sources say Sakharovka AB) north of Vladivostok failed to return from a sortie over the Sea of Japan. His superiors naturally assumed that he had crashed into the sea; but soon they learned the worst. The news that Belenko had landed at Hakodate International airport, Japan, came as a much more severe shock.

It is not known if Belenko contacted the US intelligence agencies on his own or was hired by them (there is even a theory that 'Viktor Belenko' was just a cover name for a

trained agent inserted for the purpose of stealing the latest Soviet military aircraft). What was established with certainty, however, is that the defection was not an impulsive action of a disgruntled officer – Belenko was awaited in Japan and had made preparations for the flight. Belenko was in a hurry and hotfooted it to Japan the very first time he had a full fuel load, taking the classified technical manuals with him (taking the manuals on a sortie was expressly forbidden).

Nobody at the base suspected that a defection was afoot. The mission profile included low-level flight during which the aircraft would be undetectable by ground radars. Only when Belenko failed to return at the planned time did the ATC start calling him on the radio and fighters were sent up to look for the crash site. The message from the border guards that an aircraft had crossed the frontier and was making for Japan came too late: Belenko was already approaching Japanese airspace, with Japanese Air Self-Defence Force (JASDF) fighters waiting to escort him.

The MiG-25P's navigation equipment could not guide the aircraft accurately during prolonged low-level flight unless RSBN-4N SHORAN beacons were available – and of course they weren't in Japan. The ADF could be helpful, but again the pilot had to enter the

marker beacon frequency at Hakodate, which the personnel at Chugooeyvka AB did not know. As it were, Belenko was so nervous that he misjudged his landing and overran, damaging the landing gear and making the aircraft unairworthy. Upon landing Belenko made a statement for the press and requested political asylum in the US. A large group of experts arrived from the US to examine the aircraft but Japanese engineers also took part in some stages of the work.

The Soviet government put pressure on Japan, demanding the return of the pilloined plane pronto. Since there were no legal reasons not to return the aircraft, the MiG-25 was returned – but, alas, in dismantled and crated condition. The Japanese did it on purpose to cover up for the fact that they and the US intelligence experts had tampered with the MiG.

When the Soviet delegation led by Gen. Dvornikov arrived in Japan the Japanese officials resorted to procrastination and bureaucratic snags. For example, when the crates with the dismantled aircraft were trucked to the pier for loading aboard a Soviet freighter the Soviet representatives demanded that the crates be opened for inspection (to make sure nothing was missing). The Japanese deliberately gave them only a few hours, hoping that 'the Russians' would not manage to check everything and repack the crates in time – but they were in for a disappointment.

The Soviet experts were quick to find out how much the West actually knew. When the MiG-25 was returned to the USSR it was determined that the Americans had run the engines and measured the aircraft's heat signature; they had also made a detailed analysis of the systems and avionics, including the radar, and the structural materials. Not knowing how to operate the equipment, the Americans had damaged some of it and had to make hasty repairs (foreign fuses and resistors were discovered in the radar set).

The incident got the world press going

wild with stories about the MiG-25. Aviation journalists derided the design as 'crude' and 'engineering archaeology' but conceded that the steel airframe worked well at high temperatures and could be manufactured and repaired easily without requiring any great skill from the repair personnel. The Smerch radar's electronic components were deemed outdated; on the other hand, the radar impressed the West by having two wavebands, which made it virtually jam-proof – something no US fire control radar featured at the time. In fact, USAF C-in-C Robert Siemens said that 'the MiG-25 is the only aircraft scaring all the world'. US Defence Secretary Schlesinger stated that the new Soviet interceptor was a sufficiently potent weapon to bring about drastic changes to the Western weapons systems and strategies, should it be fielded in substantial numbers.

The shock suffered by the Soviet political and military leaders and the defence industry at large defies description. The West had laid hands on the Soviet Union's most secret aircraft! Worse, Belenko's statements published by the world press made it clear that Western intelligence agencies had preliminary information on the latest two-seat version designated MiG-25MP (the future MiG-31). The potential adversary was now in a position to develop countermeasures and largely neutralise the MiG-25 in a short while.

This forced the Soviet government, the Ministry of Defence and MAP to take resolute action, which was later proven correct. The rigid and clear lines of command under the Soviet system got the design bureaux and defence industry working hard, and the much-improved MiG-25PD entered production just two and a half years after the notorious defection. Another year later the Soviet Air Force's aircraft repair plants began upgrading operational MiG-25Ps to MiG-25PDS standard at a fast rate. By the end of 1982 the capabilities of the PVO had been not merely restored but actually improved thanks to the higher-performance MiG-25PD/MiG-25PDS and the new MiG-31 interceptor which had achieved IOC by then.

The MiG-25 was of special importance to the Soviet air defence, since (until the MiG-31 entered service) it was the only aircraft capable of intercepting the SR-71As prowling over the Barents Sea and especially the Baltic Sea. When Poland was in turmoil in the early 1980s the West feared a possible Soviet invasion. The data provided by surveillance satellites on Soviet forces stationed along the western borders apparently proved insufficient for the Americans, and the SR-71As began their sorties over the Baltic. The MiG-25PDs and 'PDSs' stationed in the area bore the brunt of dealing with these snoopers.

Like any aircraft in active service, the Fox-

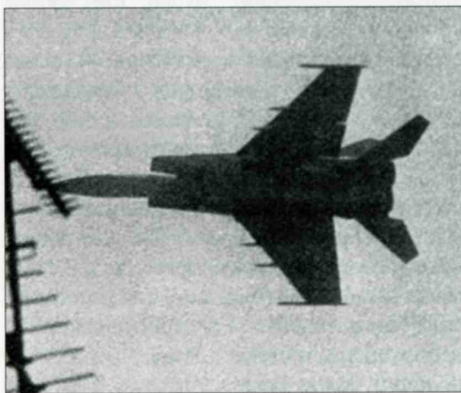

Top and above: Redolent with Cold War spirit, these shots show Viktor Belenko's MiG-25P '31 Red' as it comes in to land at Hakodate on 6th September 1976.

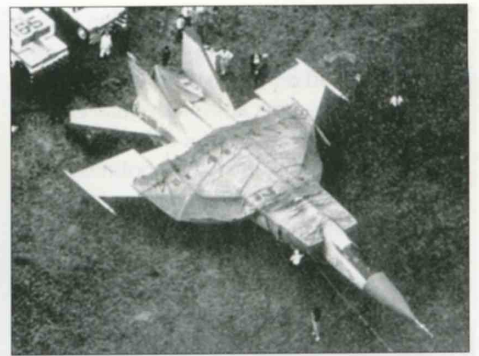

Top: Belenko's MiG-25P sits on the grass after overrunning at Hakodate, with curious locals swarming over it like ants.

Above, top right, centre right and right: Steps were promptly taken to hide the MiG from casual observers. The first, and rather futile, step was to drape it in orange cloth.

Right: The MiG-25P is dismantled with the help of a heavy-duty crane.

Below right and bottom right: In order to hide the fighter from view and let the intelligence services work without undue attention, a makeshift hangar was erected around the MiG on the apron at Hakodate.

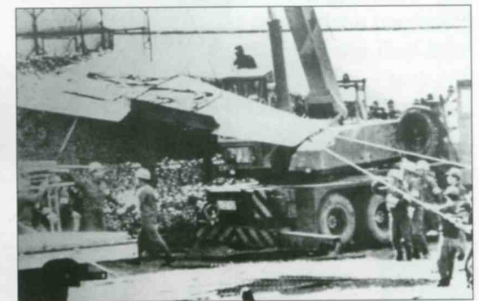

Above: Carefully wrapped to disguise the shape, the fuselage of Belenko's MiG-25P is loaded into a US Air Force Lockheed C-5A Galaxy which took it to the USA for study.

Right: Here, other components of the Foxbat are loaded into a JASDF Kawasaki C-1 transport.

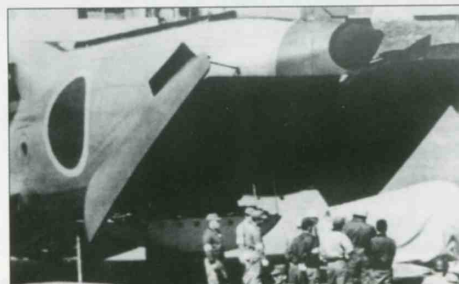

bat had its share of incidents. One young MiG-25PDS pilot, who was fresh from pilot college and had only recently gained his type rating, misjudged his approach while landing at Nasosnaya AB near Baku in fog. Touching down with 30° bank, the fighter bounced from one mainwheel to the other, rocking from side to side. Luckily there was no structural deformation (only the tyre on the wheel that touched down first had to be replaced).

On another occasion described earlier a young pilot operating out of Kotlas in the High North got so carried away while chasing the a practice target that, neglecting to watch the artificial horizon, he put the aircraft into a 90°

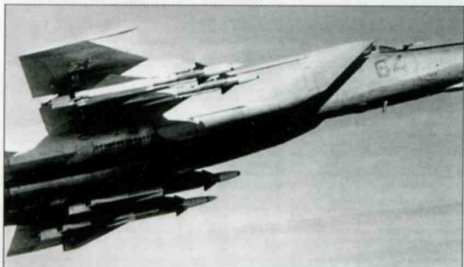

bank. The radar locked onto the ground and the machine dived earthwards in full afterburner, quickly exceeding the speed limit. Realising this, the pilot yanked the control stick sharply to initiate a recovery – and blacked out as the fighter pulled 12 Gs. Regaining consciousness a while later, he saw the target on his radarscope and fired a missile, completing his mission as planned. This time the aircraft was bent quite badly, yet it had stayed in one piece.

A practice mission involving live missile launches at a target range near Astrakhan' in southern Russia nearly ended in disaster; an R-40T missile failed to leave the pylon as the rocket motor ignited, causing strong yaw. The pilot, who was his unit's deputy CO, did his best to counter the yaw during the motor's eight-second burn time – guessing all the while whether the missile would self-destruct after burnout and blow the aircraft to pieces. Luckily there was no explosion.

In April 1984 a flight of MiG-25PDSs from Nasosnaya AB scrambled to intercept a drifting reconnaissance balloon launched from

across the border (these balloons had been a real nuisance since the 1950s). Drifting at 25,000 m (82,020 ft), the balloon was out of reach for any Soviet fighter except the MiG-25. After several abortive attempts one of the pilots succeeded in scoring a direct hit with a missile almost at point-blank range; the missile did not explode but tore a good-sized hole through several sections of the balloon's envelope (such balloons were made up of multiple sections like an orange for greater survivability). Losing some of its buoyancy, the balloon descended to 16,000 m (52,490 ft) where MiG-23 fighters summoned for help finished it off with cannon fire.

In the late 1970s/early 1980s Iranian airliners flying one particular weekly service used a route that took them a bit too close to the Soviet border. Hence once a week Soviet interceptor pilots would spend the day sitting in their fighters on QRA duty and waiting for the Iranian aircraft to appear, ready to 'escort' it and prevent a possible incursion. Finally the Soviet command decided it had had enough and gave orders to deploy two MiG-25PDs to an airbase in Armenia right next to the Iranian border. The pilots chosen for the flight were not given full details of the mission; they were simply ordered to take off and follow the headings they were given, maintaining radio silence all the while. At the last moment one of the pilots smelled a rat and made a U-turn just short of the border. The other pilot, who was not so quick on the uptake, continued across the border and strayed nearly 100 km (62 miles) into Iranian airspace before realising he was in deep trouble and turning back.

An incongruous and embarrassing incident occurred in a fighter unit stationed in Pravdinsk when a MiG-25P 'shot down' an innocent cow. As the fighter came in to land after a training sortie, it lost a dummy missile, which scored a direct hit. RIP cow.

Every cloud has a silver lining. However damaging it was, Belenko's defection had its positive effects, too; apart from the long-term effect of the ensuing MiG-25PD/PDS upgrade, it promoted new weapons sales. Exports of the *Foxbat* began in 1979. The slightly downgraded export versions of the MiG-25PD and MiG-25RBK were acquired by Algeria, Libya, Iraq, India, Syria and Bulgaria (though the latter soon gave up using the type). That, if anything, was an unconventional way of finding customers abroad – the aircraft had to be stolen to get exports going!

Israel had apparently sworn vengeance on the elusive MiG-25s – and actually succeeded in destroying two of them. On 13th February 1981, two IDF/AF RF-4Es acted as bait, intruding into Syrian airspace and luring a Syrian Air Force MiG-25P into pursuing them. The interceptor was then ambushed by



Top: A fully armed MiG-25PD flying a practice sortie.

Above: A typical Soviet-era publicity shot of a self-assured MiG-25 pilot in full flying attire.



MiG-25RBT '04 Red' (c/n N02008115), a 164th GvORAP (Guards Independent Reconnaissance Air Regiment) aircraft, awaits the next mission on a wintry hardstand at Krzywa AB, Poland.

two McDonnell Douglas F-15A Eagles hiding from Syrian radars behind a mountain range. One F-15 popped up behind a cloud of chaff, approaching the MiG from below so its pilot could not see the Israeli jet, and fired a Raytheon AIM-7M Sparrow missile which hit the MiG's port wing. Syrian ground controllers were unable to warn the pilot because the Israelis were heavily using ECM.

Shortly afterwards the roles in the cat-and-mouse game were reversed. Two Syrian MiG-21s provoked a couple of Israeli F-15s, which gave chase. Two MiG-25Ps took off to intercept the Eagles; one attacked the F-15

head on, the other tried for a flank attack. The first MiG-25 failed to fire its missiles after losing target lock-on and was shot down by the F-15 flight leader. The other MiG, however, got a good lock-on and destroyed the Israeli wingman with two R-40 missiles at about 40 km (25 miles) range. That was the last time Syrian MiG-25Ps engaged in combat.

The Iraqi Air Force used its eight MiG-25RBs with some success for bombing raids on Iranian oil rigs and Tehran during the Iran-Iraq War of 1980-1988. One aircraft fell victim to an Iranian Hawk missile; another was lost when an engine tossed a turbine

blade, forcing the pilot to eject. One more newly refurbished aircraft crashed on landing after a checkout flight in December 1987. No Iraqi MiG-25Ps were lost in the Iran-Iraq War. Soviet military experts visiting Iraq noted that Iraqi pilots were well pleased with the aircraft.

16th January 1991 marked the beginning of Operation Desert Storm in the Gulf War. The very next day, an Iraqi MiG-25P destroyed a US Navy McDonnell Douglas F/A-18 Hornet strike aircraft. However, that was all the good luck the Iraqi pilots had. On the opening day, two USAF F-15Cs (58th



MiG-25BM '24 Red' taxis at Krzywa with two Kh-58U ARMs on the outer wing stations.



Left and above left: This MiG-25P coded '42 Blue' overran the runway when returning home from a practice sortie and was totalled, collapsing the nose and starboard main gear units and snapping the fuselage in the cockpit area. Note that the brake parachutes were not deployed.

Above: Another wrecked MiG-25 at the scene of the crash landing.

TFS/33rd TFW) each destroyed one MiG-25P with Sparrow missiles. On 25th December 1992, two USAF General Dynamics F-16s used AIM-120 AMRAAM missiles for the first time ever, shooting down an Iraqi MiG-25. Two hours later an F-15E had a brush with a MiG-25, neither side scoring a 'kill'. On 2nd January 1993, a MiG-25 trying to intercept a Lockheed U-2R high-altitude reconnaissance aircraft was attacked by an F-15C, again with no losses on either side.

Azerbaijan took over several MiG-25s after the collapse of the Soviet Union, since the type was overhauled in Baku. Some reports state that Azeri MiG-25s destroyed a number of Armenian tanks with R-60M high-maneuvrability AAMs (!) during the war over the disputed Nagornyy Karabakh enclave. The Azeris also used MiG-25RBs for strike missions a lot but mostly without success, since the bombing computers were out of

order on most aircraft.

MiG-25 production peaked at 100 aircraft per year. Initially a MiG-25 required a little more than three times the number of man-hours to build than a MiG-21, though this number was reduced by an order of magnitude over the years. Interceptor production for the VVS was stopped in 1979 as the more capable MiG-31 entered production, the MiG-25PD being produced on a small scale for export only.

All models, especially the MiG-25PD, enjoyed a good reliability record and a long service life, with no serious defects and few bad accidents being recorded. More than 90% of the aircraft in service were kept flyable, with an MTBF of 66 hours (the prescribed minimum was 8 hours!). Average flying time per failure in the first half of 1992 was 450 hrs.

New combat tactics were developed per-

petually. For example, MiG-25PDs and MiG-25PDSs could be guided to the target by an Il'yushin/Beriyevev A-50 *Mainstay* airborne warning & control system (AWACS) or a MiG-31 (which can act as a 'mini-AWACS' in its own right). Work continued on service life extension, improving serviceability and reparability.

Many aviation experts believe that the MiG-25 influenced Western aircraft design practices to a certain extent. Similar aerodynamic solutions and layouts are to be found on some West European and American fighters. Western experts gave the MiG-25 credit (despite that 'engineering archaeology' stuff). Regrettably, the aircraft was often used at medium altitude or versus fighters when it couldn't use its capabilities to advantage.

The MiG-25 was a landmark in boosting Soviet defensive capability. Very few incursions were reported in areas where MiG-25Ps and MiG-25PDs/PDSs were stationed; the aircraft proved an effective means of deterring potential aggressors. Besides, it served as a basis for the even more effective MiG-31 interceptor. And even though it wasn't a mass-produced aircraft, it did its job well.

The design group responsible for the Foxbat received various state awards. Six people were awarded the prestigious Lenin Prize. They were General Designer Rostislav A. Belyakov, project chief Nikolay Z. Matyuk, the Gor'kiy aircraft factory's Director Ivan S. Silayev (who later became Minister of Aircraft Industry), engine project chief F. Shookhov, radar project chief F. F. Volkov and Deputy Minister of Aircraft Industry A. V. Minayev who headed the Egyptian task force.



Nose art was rarely seen on the Foxbat, which makes this MiG-25PD sporting a gorgeous sharkmouth all the more interesting.

MiG-25 Operators

As of now the MiG-25 has seen service in 13 nations, including seven of the former Soviet republics. Known operators of the type are listed in this chapter, and the USSR and the CIS republics are dealt with first.

Soviet Union/Russia

Until the 1980s the Soviet Union was the sole operator of the MiG-25 family. The interceptor versions were operated by the PVO, while the recce/strike variants and the MiG-25BM saw service with the tactical aviation arm of the Soviet Air Force (FA – *Frontovaya aviatsiya*).

Units operating the MiG-25 included the 764th IAP (*istrebitel'nyy aviapolk* – fighter regiment) at Perm'-Bol'shoye Savino, 458th IAP in Kotlas, 530th IAP at Chugooyevka, 712th IAP in Kansk, 98th GvORAP (*Gvardeyskiy otdel'nyy razvedyvatel'nyy aviapolk* – Guards independent recce air regiment) in Monchegorsk, 47th GvORAP at Shaykovka AB, the 4th TsBP i PLS in Lipetsk, the 148th TsBP i PLS at Savasleyka AB (now merged with the 4th TsBP i PLS) and the 929th State Flight Test Centre in Akhtobinsk. Until the mid-1990s the recce versions were deployed

abroad – with the 16th Air Army in (former East) Germany (931st ORAP in Werneuchen and 11th ORAP in Neu-Welzow) and with the 4th Air Army in Poland (164th GvORAP in Krzywa). As of now only the recce versions remain in service, the interceptors having been withdrawn.

Known **Russian Air Force** examples are listed below. Due to the Russian system of tactical codes the list is in c/n order. Some Soviet Air Force MiG-25s are also included for the sake of completeness; such aircraft are marked *.

C/n	F/n	Version	Tactical code	Notes
840 SE 01	0501	MiG-25P	501 Blue*	Mikoyan OKB
840 SE 02	0502	MiG-25P	502 Blue*	Mikoyan OKB
840 SE 03	0503	MiG-25P	503 Blue*	Mikoyan OKB
840 SE 04	0504	MiG-25P	504 Blue*	Mikoyan OKB
?	0808	MiG-25P	not known*	Crashed 31-5-1973
?	1104	MiG-25P	not known*	Mikoyan OKB, LL-1104 avionics testbed
N84008895			49 Red*	Preserved central Armed Forces Museum, Moscow
N84015270		MiG-25P	45 Blue*	Mikoyan OKB
N84018081		MiG-25PDS	08 Blue*	Preserved Moscow-Khodynka museum
N84019175	1710	MiG-25P	?	Converted to, see next line
841710		MiG-25M	710 Blue*	Mikoyan OKB, new c/n issued. Preserved Moscow-Khodynka museum with c/n still applied as N84019175
N84027607		MiG-25P	34 Red	Preserved Riga-Spilve museum
N84028605		MiG-25P	38 Red	Preserved Moscow-Khodynka museum
N84037011		MiG-25PDSG	94 Red	Mikoyan OKB. To Kazan' as instructional airframe
N84037054		MiG-25PD	74 Red	787th IAP. Dumped Rangsdorf AB, Germany, 1992
N84042415	...304	MiG-25PD	304 Blue	Mikoyan OKB
N84042474	...305	MiG-25PD	305 Blue	Mikoyan OKB, prototype
N84042680	...306	MiG-25PD	306 Blue	Mikoyan OKB, prototype. Converted to, see next line
		<i>Izdelye 84-20</i>		Mikoyan OKB, engine testbed
N84042.???	...307	MiG-25PD	307 Blue	Mikoyan OKB, prototype
N84049608		MiG-25P	09*	Mfd 21-12-1977. Converted to, see next line
		MiG-25PDS		Based Dnepropetrovsk; possibly to Ukrainian AF
020 SA 01	0101	MiG-25RB	024 Red	Mikoyan OKB, prototype (Ye-155R-4B)
020 SM 03	0203	MiG-25R	30 Blue	Preserved Riga-Spilve
020 SO 03?	0303	MiG-25RBV	303 Blue	Mikoyan OKB, prototype. Later converted to MiG-25BM systems testbed
020 SO 04?	0304	MiG-25RBS	304 Blue?	Mikoyan OKB, prototype
020 SO 05?	0305	MiG-25RBK	305 Blue	Mikoyan OKB, prototype
020 SL 01	0401	MiG-25RB	401 Blue	Mikoyan OKB, prototype. Converted to, see next line
		MiG-25M		Converted to MiG-25BM systems testbed
020 SL 02	0402	MiG-25R	02 Blue	Mikoyan OKB. Preserved Central Russian Air Force Museum, Monino
0205 SE 01	0501	MiG-25R	40 Red	Mfd 7-1970. 47th GvORAP/1st Sq
0205 SE 04	0504	MiG-25R	41 Red	Mfd 7-1970. 47th GvORAP/1st Sq
0205 SE 05	0505	MiG-25R	42 Red	Mfd 7-7-1970. 47th GvORAP/1st Sq; crashed 22-7-1971
020 ST 01	0601	MiG-25RB		Converted to, see next line
02-601		MiG-25M	601 Blue	Mikoyan OKB
020 ST 02	0602	MiG-25RB	not known	Mfd 18-6-1970. 511th ORAP; to 47th GvORAP 5-12-1988, to 39th ORAP 5-11-1990

020 ST 05	0605	MiG-25RB	not known*	Mfd 3-1972. 511th ORAP; to 47th GvORAP 5-12-1988. Struck off charge 27-10-1989, to ground trainer
N02007007		MiG-25RB	not known*	Mfd 1-10-1973. 293rd ORAP; to 47th GvORAP 7-1990; to Gor'kiy aircraft factory 15-6-1992
N02007033		MiG-25RB	55 Red	Preserved Moscow-Khodynka museum
N02008067		MiG-25RB	not known*	Mfd 25-12-1972. 293rd ORAP; to 47th GvORAP 7-1990; to Gor'kiy aircraft factory 15-6-1992
N02045037		MiG-25RB	18 Red	931st GvORAP
N02045187		MiG-25RB	not known*	Mfd 23-11-1976. 511th ORAP; to 47th GvORAP 5-12-1988; to 39th ORAP 16-11-1990
N020*0703		MiG-25RB		Converted to, see next line
		MiG-25M	703 Blue*	Mikoyan OKB
N02008094		MiG-25RBV	77 Red*	47th GvORAP/2nd Sqn; crashed 10-6-1982
N02016605		MiG-25RBV	79 Red*	47th GvORAP/2nd Sqn; crashed 7-8-1975
N02017745		MiG-25RBV	54 Red	Mfd 3-1978. 931st GvORAP
N02022047		MiG-25RBV	not known*	Converted to, see next line
		MiG-25RBM	47 Blue	Mikoyan OKB, testbed under MiG-25BM programme. Later transferred to LII
N02007033		MiG-25RBT	55 Red	Preserved Moscow-Khodynka museum
N02008115		MiG-25RBT	04 Red	Mfd 10-10-1973. 164th GvORAP. To 713th Aircraft Repair Plant; became, see next line
			40 Red	47th GvORAP, transferred 2-11-1993
N02010145		MiG-25RBT	03 Red	Mfd 29-10-1973. 164th GvORAP; became, see next line
			41 Red	47th GvORAP, transferred 16-5-1995
N02010181		MiG-25RBT	05 Red	Mfd 12-11-1973. 164th GvORAP; became, see next line
			42 Red	47th GvORAP, transferred 2-11-1993
N02010302		MiG-25RBT	43 Red	Mfd 19-1-1974. 164th GvORAP; to 47th GvORAP 7-12-1993
N02014137		MiG-25RBT	53 Red?	Mfd 30-9-1974. 11th ORAP; became, see next line
			18 Red	47th GvORAP, transferred 24-7-1991
N02014146		MiG-25RBT	57 Red	Mfd 9-7-1979. 931st GvORAP
N02014171		MiG-25RBT	53 Red	931st GvORAP
N02016108		MiG-25RBT	56 Red	Mfd 10-12-1974. 931st GvORAP. Recoded as, see next line
			29 Red	47th GvORAP/2nd Sqn, transferred 13-1-1989
N02016375		MiG-25RBT	55 Red	Mfd 29-11-1974. 931st GvORAP. To Aircraft Repair Plant No. 713; became, see next line
			16 Red	47th GvORAP/2nd Sqn, received 18-8-1992; named <i>Anatoliy Popov, HSU</i>
N02017620		MiG-25RBT	01 Red	Mfd 29-12-1977. 164th GvORAP. Became, see next line
			45 Red	47th GvORAP, transferred 17-11-1993; named <i>Yefim Melakh, HSU</i>
N02019907		MiG-25RBT	19 Red	Mfd 31-10-1978. 293rd ORAP; to 47th GvORAP 27-8-1990
N02019919		MiG-25RBT	07 Red	Mfd 5-12-1978. 164th GvORAP. Became, see next line
			46 Red	47th GvORAP/2nd Sqn, transferred 2-11-1993; named <i>Valentin Soogrin, HSU</i>
N02019925		MiG-25RBT	26 Red	Mfd 15-2-1979. 193rd GvORAP; to 47th GvORAP 18-9-1989
N02020305		MiG-25RBT	61 Red?	Mfd 9-1974. 931st GvORAP? Reported as such but see next line
			38 Red	968th OIISAP (4th TsBP i PLS, Lipetsk); to 47th GvORAP 30-5-1997
N02020731		MiG-25RBT	36 Red	968th OIISAP; to 47th GvORAP 30-5-1997
N02043081		MiG-25RBS	30 Red	Mfd 19-2-1976. 47th GvORAP, received 2-6-1989
N02043105		MiG-25RBS	15 Red	Mfd 2-1976. 164th GvORAP. Became, see next line
			53 Red	47th GvORAP, transferred 9-11-1993
N02043405		MiG-25RBS	24 Red	Mfd 23-3-1976. 511th ORAP; to 47th GvORAP 5-12-1988
N02045021		MiG-25RBS	52 Red?	931st GvORAP? Reported as such but see next line
			37 Red	968th OIISAP; to 47th GvORAP 30-5-1997
N02048127	...701	MiG-25RBS	701 Blue	Mikoyan OKB, development aircraft. Became, see next line
			'001 Blue'	Gate guard in front of MKB Raduga, Doobna, Moscow Region, fitted with pylons and Kh-58U missiles!
N02048240		MiG-25RBS	50 Red	931st GvORAP
N02048607		MiG-25RBS	09 Red	Mfd 10-1980. 164th GvORAP. Became, see next line
			55 Red	47th GvORAP, transferred 2-11-1993
N02050740		MiG-25RBS	26 Red	931st GvORAP. Same c/n quoted for '025 Red' preserved Tampere-Pirkkala
?		MiG-25RBS	09 Red	Recoded. previous code unknown. Ground instructional airframe at Tambov Tech School
N02029095		MiG-25RBSH	60 Red	Mfd 13-4-1981. 931st GvORAP; c/n possibly misquoted as N02029695
N02029105		MiG-25RBSH	62 Red	339th GvORAP, 931st GvORAP
N02047407		MiG-25RBSH	25 Red	Mfd 17-2-1977. 511th GvORAP; to 47th GvORAP 5-12-1988; to 713th Aircraft Repair Plant 8-9-1992
N02048205		MiG-25RBSH	51 Red	Mfd 22-4-1978. 931st GvORAP. To Aircraft Repair Plant No. 713; became, see next line
			17 Red	47th GvORAP, received 18-8-1992; named <i>Ivan Golubnichiy, HSU</i>
N02048510		MiG-25RBSH	54 Red	Mfd 21-4-1978. 164th GvORAP; to 47th GvORAP 26-11-1993
N02048649		MiG-25RBSH	56 Red	Mfd 18-4-1978. 164th GvORAP; to 47th GvORAP 7-12-1993
N02050010		MiG-25RBSH	08 Red	Mfd 4-1978. 164th GvORAP. Became, see next line
			57 Red	47th GvORAP, transferred 2-11-1993
N02050047		MiG-25RBSH	11 Red	Mfd 3-1978. 164th GvORAP. Became, see next line
			58 Red	47th GvORAP, transferred 2-11-1993
N02016375		MiG-25RBK	55 Red	Mikoyan OKB
N02029210		MiG-25RBK	02 Red	Mikoyan OKB; avionics testbed under Buran space shuttle programme

N02016445		MiG-25RBF	44 Red	Mfd 29-10-1974. 164th GvORAP; to 47th GvORAP 26-11-1993
N02021027		MiG-25RBF	47 Red	Mfd 23-7-1975. 164th GvORAP; to 47th GvORAP 26-11-1993
N02023145		MiG-25RBF	27 Red	Mfd 1-8-1977. 193rd GvORAP; to 47th GvORAP 18-9-1989
N02024311		MiG-25RBF	28 Red	Mfd 18-4-1978. 193rd GvORAP; to 47th GvORAP 18-9-1989
N02024604		MiG-25RBF	59 Red	931st GvORAP
N02024705		MiG-25RBF	48 Red	Mfd 3-1978. 164th GvORAP; to 47th GvORAP 2-11-1993
N02024819		MiG-25RBF	58 Red	Mfd 5-1978. 931st GvORAP
N02026209		MiG-25RBF	14 Red	Mfd 3-1978. 164th GvORAP; became, see next line
			49 Red	47th GvORAP, transferred 2-11-1993
N02028205		MiG-25RBF	23 Red	Mfd 22-5-1980. 511th ORAP; to 47th GvORAP 5-12-1988
N02028314		MiG-25RBF	50 Red	Mfd 9-9-1980. 164th ORAP; to 47th GvORAP 7-12-1993
N02028494		MiG-25RBF	82 Red	Mfd 9-10-1980. 164th GvORAP. Became, see next line
			51 Red	47th GvORAP, transferred 12-10-1993
N02029408		MiG-25RBF	22 Red	Mfd 21-4-1981. 293rd ORAP; to 47th GvORAP 7-1990
N02032208		MiG-25RBF	20 Red	Mfd 7-4-1981. 293rd ORAP; to 47th GvORAP 29-7-1990; named <i>Rostislav Yashchuk, HSU</i>
N02032317		MiG-25RBF	38 Red???	Mfd 30-4-1981. Reportedly 931st GvORAP; also reported as 36 Red. Became, see next line
			21 Red	11th ORAP; to 47th GvORAP 24-7-1991
N02032484		MiG-25RBF	52 Red	Mfd 30-5-1981. 164th GvORAP; to 47th GvORAP 26-11-1993
N66005125		MiG-25BM	70 Red	931st ORAP
N66005204		MiG-25BM	71 Red	931st ORAP
N66005246		MiG-25BM	72 Red	931st ORAP
N66005289		MiG-25BM	73 Red	931st ORAP
N66005304		MiG-25BM	74 Red	931st ORAP
N66005306?		MiG-25BM	not known	Mikoyan OKB
N66005382		MiG-25BM	75 Red	931st ORAP
N66005398		MiG-25BM	76 Red	931st ORAP
N66005407		MiG-25BM	77 Red	931st ORAP
N66005444		MiG-25BM	79 Red	931st ORAP
N66005521		MiG-25BM	80 Red	931st ORAP
N66005545		MiG-25BM	81 Red	931st ORAP
N660...	...408	MiG-25BM	408 Red	Mikoyan OKB, prototype
?		MiG-25PU	U01 Blue	Mikoyan OKB, prototype
N22018746		MiG-25PU	91 Red	LII
N22040418		MiG-25PU	90 Blue	Preserved Moscow-Khodyinka museum
N22040578		MiG-25PU	22 Blue	LII, MiG-25PU-SOTN
N22044011		MiG-25PU	02 Blue	LII, testbed under Buran space shuttle programme
390 SA 01	0101	MiG-25RU	46 Blue	Mikoyan OKB, prototype. To LII. converted to ejection seat testbed; later recoded as, see next line
			01 Blue	
N39002005		MiG-25RU	60 Red	Mfd 31-3-1976. 164th GvORAP; to 47th GvORAP 26-11-1993; struck off charge 1-4-97 as time-expired
N39003027		MiG-25RU	41 Red	339th GvORAP
N39003040		MiG-25RU	not known	Mfd 3-1973. 511th GvORAP; to 47th GvORAP 5-12-1988; to 39th ORAP 16-11-1990
N39003115		MiG-25RU	61 Red	Mfd 14-8-1973. 164th GvORAP. To Aircraft Repair Plant No. 713, later to 47th GvORAP 28-4-1994
N39004205		MiG-25RU	not known	Mfd 28-9-1973. 47th GvORAP, received 18-9-1989; to 39th ORAP 16-11-1990
N39005211		MiG-25RU	35 Red	Mfd 22-2-1974. 193rd GvORAP; to 47th GvORAP 18-9-1989
N39005315		MiG-25RU	01 Red	931st GvORAP
N39005333		MiG-25RU	02 Red	Mfd 6-9-1974. 931st GvORAP. Became, see next line
			not known	11th ORAP; to 47th GvORAP/2nd Sqn 24-7-1991; to 39th ORAP 9-12-1990; rep. to 47th GvORAP as 59 Red!
N39005411		MiG-25RU	03 Red	931st GvORAP
N39006131		MiG-25RU	40 Blue	Mikoyan OKB
N39008117		MiG-25RU	32 Red	Mfd 30-12-1975. 98th GvORAP; to 47th GvORAP 6-2-1989
N39008305		MiG-25RU	35 White	Mfd 18-11-1976. 968th OIISAP; to 47th GvORAP 30-5-1997. Became, see next line
			63 Red	
N39008407		MiG-25RU	62 Red	Mfd 26-11-1976. 164th GvORAP; to 47th GvORAP 17-11-1993
N39012441		MiG-25RU	63 Red	931st GvORAP
N39012587		MiG-25RU	64 Red	931st GvORAP
N39015266		MiG-25RU	33 White	Mfd 29-4-1978. 293rd ORAP; to 47th GvORAP/2nd Sqn 29-7-1990
N39015705		MiG-25RU	31 Red	Mfd 6-5-1978. 293rd ORAP; to 47th GvORAP 29-7-1990
N39017407		MiG-25RU	34 Red	Mfd 23-7-1981. 511th GvORAP; to 47th GvORAP 5-12-1988
990001		<i>Izdeliye 99</i>	991 Blue	Mikoyan OKB, prototype, converted MiG-25P
990002		<i>Izdeliye 99</i>	992 Blue	Mikoyan OKB, prototype, converted MiG-25R; ground instructional airframe at Moscow Aviation Institute

Note: OIISAP = *otdel'nyy instroktorsko-issledovatel'skiy smeshanny aviapolk* - Independent Instructional & Research Composite Air Regiment

'57 Blue', one of the 154th Independent Air Detachment MiG-25RBs deployed to Egypt in 1974. Note the lack of national insignia.



47th GvORAP MiG-25RBSH '17 Red' named *Ivan Golubnichiy*, HSU (c/n N02048205), Shaykovka AB. Like the unit's other aircraft, it displays the unit's Red Banner and Kutuzov Orders and honorary appellation *Borisovskiy*.



47th GvORAP/2nd Sqn MiG-25RBT '16 Red' *Anatoliy Popov*, HSU (c/n N02016375). Note the 27 mission markers and the squadron badge.



Another 47th GvORAP/2nd Sqn MiG-25RBT, '45 Red' *Yefim Melakh*, HSU (c/n N02017620), wears 15 mission markers.



One more 47th GvORAP/2nd Sqn MiG-25RBT, '46 Red' *Valentin Soogrin*, HSU (c/n N02019919), with 39 mission markers.



37

Russian Air Force MiG-25BM '37 White' with an 'Excellent aircraft' maintenance award badge.



РОСТИСЛАВ
ЯЩУК

БОРИСОВСКИЙ 20



Two views of 47th GvORAP/2nd Sqn MiG-25RBF '20 Red' Rostislav Yashchuk, HSU (c/n N02032208).



47th GvORAP MiG-25RU '33 White' (c/n N39015266). Note the starboard flap taken from a cannibalised camouflaged machine to replace the original flap which had been damaged.

Starboard side view of MiG-25RBT '46 Red' depicted on the opposite page.





Above: The only known Armenian Air Force MiG-25PD parked at Gyumri in company with several Su-25 attack aircraft.

Belorussian Air Force MiG-25s

C/n	Version	Tactical code	Notes
N39002037	MiG-25RU	64 Red	
N39003024	MiG-25RU	30 Red	
N39012108	MiG-25RU	25 Blue	
N39012214	MiG-25RU	30 Blue	
N39012587	MiG-25RU	65 Red	
N39018884	MiG-25RU	35 Blue	
N66002012	MiG-25BM	18 Blue	
N66002045	MiG-25BM	16 Blue	
N66002104	MiG-25BM	17 Blue	
N66005425	MiG-25BM	78 Red	Ground instructional airframe Minsk
N02026591	MiG-25RB	02 Blue	



Above: '49 Red', a Ukrainian Air Force MiG-25PD or PDS (it is hard to say from this angle), 'cleans up' after take-off.



Blue tactical codes are more common in the UAF nowadays. This MiG-25PD or PDS wears a Soviet-style Guards badge and the gold and black band associated with the Glory Order.

Armenia

After the break-up of the Soviet Union, some of the MiG-25s stationed in the other constituent republics (that is, outside the Russian Federation) were taken over by the air forces of the new nations forming the Commonwealth of Independent States (CIS). Armenia was one of them; the nascent **Armenian Air Force** (officially established in October 1992) had at least one (according to some sources, just one) MiG-25PD based at Gyumri, a town 130km (80 miles) north of Yerevan.

Azerbaijan

A number of MiG-25s based at Nasosnaya AB near Baku were taken over by the **Azerbaijan Air Force**. Available sources say Azerbaijan had eight MiG-25PDs, fourteen MiG-25RBs and six trainers.

Azeri *Foxbats* saw action during the war with Armenia over the Nagornyy Karabakh enclave. In so doing even the MiG-25PDs flew strike missions, firing R-60 heat-seeking AAMs at Armenian tanks! The MiG-25RBs were used as bombers, but bombing accuracy was poor due to unserviceable navigation/attack computers.

Belarus (Belorussia)

Following the collapse of the Soviet Union, the newly independent Republic of Belarus (Belorussia) took possession of up to fifty MiG-25s, which were taken on strength by the **Belarus Air Force**. This total included thirteen MiG-25PD interceptors; the others were reconnaissance/strike and trainer variants. By 1995 the type had been withdrawn, much of the fleet being concentrated in storage at Baranovichi AB.

Known Belorussian MiG-25s are listed in the table on this page. Again, since Belorussia continues using the Soviet tactical code system, the list is in c/n order.



Above: A line-up of red-coded Ukrainian Air Force MiG-25PDs

Kazakhstan

The **Kazakh Air Force** reportedly inherited some 30 MiG-25s (MiG-25PD interceptors and MiG-25PU trainers) after the collapse of the Soviet Union. None are currently on the inventory.

Turkmenistan

Established in October 1993, the **Turkmenistan Air Force** took over the former Soviet Air Force units based in the republic, including the 107th IAP based at Aktepe. This unit reportedly operated 24 MiG-25PDs and MiG-25PUs.

The Ukraine

The newly-independent Ukraine was the second-largest MiG-25 operator in the CIS; the **Ukrainian Air Force** (UAF, or VPS – *Viys'kovo-povitryany seely*; now PS ZSU – *Povitryany seely Zbroynykh seel Ookrainsy* – Air Component of the Ukrainian Armed Forces) took over a total of 79 after the break-up of the Soviet Union. Interceptor, reconnaissance and trainer versions were on strength; the MiG-25PDs and 'PDSs' were based at Dnepropetrovsk airport; the recon versions (including the MiG-25RBS) were operated by the 48th GvORAP.

More or less positively identified aircraft are listed on this page.



This Ukrainian MiG-25PU coded '001 Black' has been painted in a striking special colour scheme for an airshow performance.

Ukrainian Air Force MiG-25s

C/n	Version	Tactical code	Notes
N84030345	MiG-25PD	60 Blue	
N84046180	MiG-25PD	87 Red	
N02045127	MiG-25RBS	17 Red	
N22030345	MiG-25PU	60 Blue	
N220****	MiG-25PU	001 Black	Special colour scheme
	MiG-25PD	48 Red	
	MiG-25PD	49 Red	
	MiG-25PD	56 Blue	
	MiG-25PD	68 Red	
	MiG-25PD	79 Red	

Ukrainian Air Force MiG-25PD '56 Blue'.





Left: A trio of Algerian Air Force MiG-25PDs, including FU85 and FU56.

Below left: An Algerian MiG-25PD is prepared for handover to the customer in the Ukraine.

Below: An Algerian MiG-25PD takes off.

Bottom: MiG-25PD FU-75 streams its twin brake parachutes after landing.

Centre left: Freshly overhauled by the Ukrainian company MiGRemont, MiG-25PD FU-31 looks immaculate in Algerian markings.

Bottom left: Algeria also bought a few reconnaissance jets, including MiG-25RBV FG-78.



Soon, however, the MiG-25s were phased out and placed in storage. According to some sources, part of the Ukrainian MiG-25 fleet was sold to third-world countries (such as Algeria).

Non-CIS operators are listed next.

Algeria

The **Algerian Air Force** (*Al Quwwat al Jawwiya al Jaza'eriya/Force Aérienne Algérienne*) reportedly purchased 48 MiG-25PDSs, MiG-25RBVs, MiG-25PUs and MiG-25RUs (the proportion is unknown) – apparently from surplus Ukrainian stocks. They saw service with an unidentified *Escadre de Chasse* (Fighter Wing) at Ain Oussera AB, the interceptors being operated by the 110e and 120e *Escadron de Chasse* (Fighter SqN) and the recce/strike version by 510e *Escadron de Chasse*.

Known examples are MiG-25PDs serialled FU-31/3701, FU56 (sic – no hyphen), FU-75, FU85 and possibly FU-94, as well as MiG-29RBVs serialled 503, 689 and FG-78/3310. The aircraft wearing alphanumeric serials have been refurbished by the Ukrainian agency MiGRemont.

Bulgaria

In November 1982 the **Bulgarian Air Force** (*Bolgarski Voenno Vozdooshni Seeli*) took delivery of three MiG-25RBT spyplanes seri-





Above right: '754 Red', one of the Bulgarian Air Force's three MiG-25RBT reconnaissance aircraft, takes off on a practice mission.

Above, right and below right: Bulgaria's sole MiG-25RU trainer was serialised '51 Red'.



alled '731 Red' (c/n N02020731), '736 Red' (c/n N02020736), '754 Red' (c/n N02020754) and one MiG-25RU trainer serialised '51 Red' (c/n N39018801). With the exception of '736 Red', which crashed on 12th April 1984, they were returned to Russia in May 1991 in exchange for five MiG-23MLD fighters, as Bulgaria had no chance to use the MiG-25's potential to the full in the country's limited air-space.

India

In 1981 the **Indian Air Force** (*Bharatiya Vayu Sena*) took delivery of six MiG-25RBKs serialised KP351 through KP356 (the latter machine crashed on 3rd August 1994) and two MiG-25RU trainers serialised DS361 and DS362. The serials KP 312 and KP3106 have



One of the Indian Air Force's six MiG-25RBKs at rest. Note the badge of No. 102 Sqn 'Trisonics' on the nose.



Above: India's MiG-25s (illustrated here by MiG-25RBK KP351) were rarely seen in public and good images of them were scarce, appearing only when the type was due for retirement.

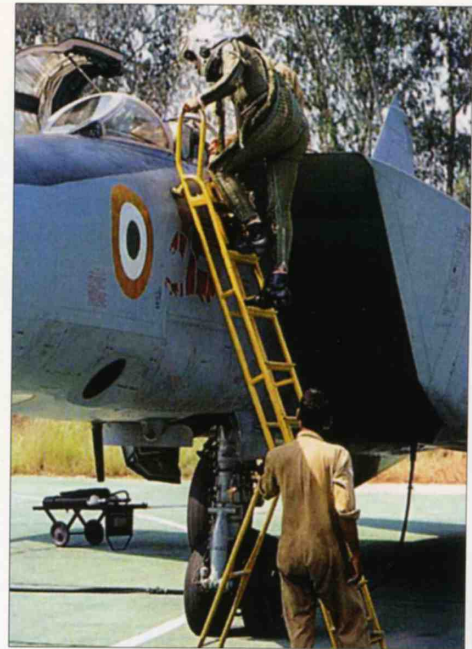

Above: An Indian pilot climbs into his MiG-25RBK at Bareilly AB.



Above: A fine view of KP351 flying over the Indian Ocean.

also been reported (though an available photo shows KP306) – probably in error, though KP 3106 was possibly delivered as an attrition replacement for KP 356. The aircraft were operated by No. 102 Squadron 'Trisonics' based at Bakshi-ka-Talab AB in Bareilly, Uttar Pradesh.

The MiG-25s were the IAF's only aircraft capable of Mach 3 flight and were considered an extra important strategic asset, being used to provide valuable intelligence on Pakistani and Chinese military developments, notably armoured divisions and strategic reserves close to the border. Therefore they were one of the IAF's most closely guarded secrets and were rarely, if ever, shown in public.

In May 1997 one of the MiG-25RB intruded into Pakistani airspace. A MiG-25 pilot says the mission would have remained a secret if the pilot had not accelerated to supersonic speed, the sonic boom immediately 'waking up' the ground surveillance staff. But the *Foxbat's* altitude and speed still

DS362, the Indian Air Force's second and final MiG-25RU.

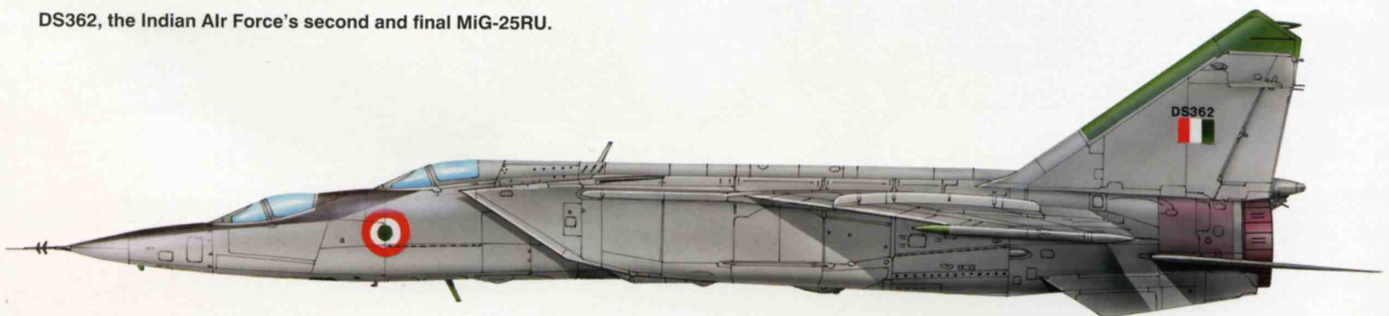



Above, left and right: DS362, the second of two MiG-25RUs delivered to the IAF, in its element and on the ground, awaiting the next sortie.

allowed the aircraft to evade Pakistani F-16s and plunge back into Indian airspace.

In May 2006 the IAF phased out the MiG-25. Its strategic reconnaissance functions have now been taken over by the IAF's Aerospace Command using satellites. The retired aircraft will serve on as instructional airframes at the Indian Air Force Academy at Dundigal.

Iraq

Starting in the early 1980s, the **Iraqi Air Force** (*al Quwwat al Jawwiya al Iraqiya*) took delivery of at least 18 *Foxbats* in interceptor, reconnaissance and trainer versions. The majority of these were MiG-25PDs and MiG-25PDSs operated by No. 96 Sqn at Qadisiyah (al-Taqaddum AB). Some sources say the interceptors belonged to the elite No. 1 FRS (Fighter/Reconnaissance Squadron); Flight A was manned by Iraqi personnel while the aircraft of Flight B were allegedly operated by Soviet pilots. The reconnaissance versions (initially MiG-25RBs, augmented since 1985 or 1986 by MiG-25RBTs) were concentrated in the No. 17 FRS since 1983.

The Iraqis first used the type operationally in the spring of 1981 during the Iran-Iraq War.

Iraqi Air Force MiG-25s

Serial	Version	Notes
25001	MiG-25PU	Derelict Qadisiyah, damaged
25002	MiG-25PU	Derelict Qadisiyah, damaged
25101*	MiG-25RB	
25102*	MiG-25RB	
25103	MiG-25RB	Wfu Tammuz
25104	MiG-25RB	Wfu Tammuz
25105	MiG-25RBT	Captured intact at Qadisiyah, to USAF Museum
25106	MiG-25RBT	Wfu Qadisiyah, captured by US forces
25107	MiG-25RBT	Wfu Tammuz, captured by US forces
25108*	MiG-25RBT	
25109	MiG-25RBT	Wfu Qadisiyah
25201	MiG-25PD	Destroyed by air raid at Qadisiyah
25202*	MiG-25PD	
25203*	MiG-25PD	
25204*	MiG-25PD	
25205*	MiG-25PD	
25206*	MiG-25PD	
25207*	MiG-25PD	
25208*	MiG-25PD	
25209*	MiG-25PD	
25210*	MiG-25PD	
25211	MiG-25PD	Wfu Ballad, captured by US forces



The Iraqis' ploy to bury their combat aircraft in the desert in order to save them from destruction failed. Here, US troops have unearthed a couple of MiG-25s, including MiG-25RBT '25107' (right).



Above: Captured in almost intact condition, MiG-25RBT '25105' was shipped to the USA to become an exhibit of the USAF Museum.



Left: Sister ship '25106' captured during Operation Desert Storm looks somewhat the worse for wear.
Right: A US soldier poses with the wreckage of an Iraqi MiG-25PD shot down by a USAF fighter.



Left: The badly damaged hulk of Iraqi MiG-25RU '25002' at Qadisiyah.



Right: MiG-25PD '25211' did not require exhumation because the Iraqis had not had time to bury it.

In the 1990s the Iraqi MiG-25RBTs flew several missions over Jordan and Saudi Arabia.

There are unconfirmed reports that the Soviet Union deployed several MiG-25BMs in Iraq in 1986-88 for evaluation in actual combat conditions; the aircraft were manned by Soviet crews and armed with Kh-58U and

Kh-25MP anti-radar missiles. According to Air Combat Intelligence Group (ACIG), at least two were shot down by Iranian Grumman F-14A Tomcat fighters.

The Iraf lost at least four MiG-25s during the Gulf War of 1991; some were shot down by USAF fighters, others were destroyed on

the ground by Allied air strikes. In an attempt to save at least some of the *Foxbats*, the Iraqis resorted to burying them in the sand (!) – a gesture of despair, since apparently no attempt had been made to seal them against ingress of sand. This did not stop the machines from being – literally – unearthed by

An Iraqi Air Force MiG-25PD captured during Operation Allied Force.



Allied ground forces that overran their hiding places.

In keeping with IrAF practice the MiG-25s had serials prefixed with the aircraft type (see table on previous page).

Libya

The **Libyan Arab Republic Air Force** (LAAF, or *al Quwwat al Jawwiya al-Libiya*) operated a sizeable number of MiG-25PDs, MiG-25RBKs, MiG-25PUs and MiG-25RUs; some sources say more than 60 were delivered in all. The aircraft were assigned to the Air Defence Command, serving with the No. 1025 Sqn at al Jufra-Hun, No. 1055 Sqn at Ghurdabiya and an unidentified squadron at Sabqa.

Known aircraft include MiG-25RBKs '485', '499', '504', MiG-25PDs '702', '731', '994', '2145', '6716', '7003', '7029', '7706', '7708', '7811' and MiG-25PU '207'. The version of MiG-25s serialled '127', '903', '6001', '6008', '6012', '6015' and '2708' is not known.

Syria

The **Syrian Air Force** (*al Quwwat al Jawwiya al Arabiya as-Souriya*) took delivery of approx-

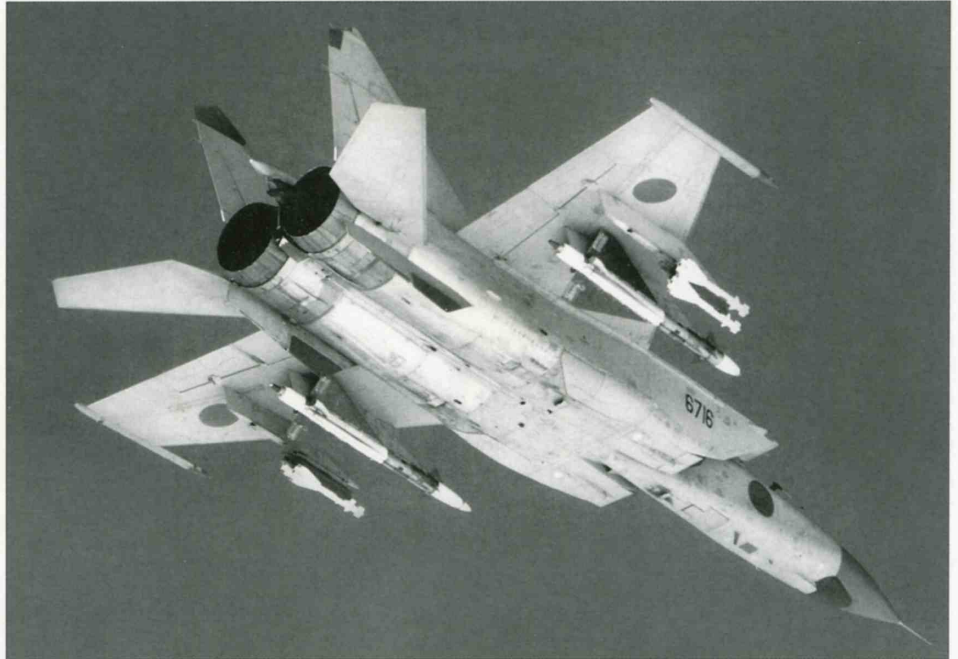

Right and above right: Excellent shots of an immaculate Libyan MiG-25PD ('6716') intercepted over the Mediterranean. The aircraft carries R-40TD and R-60M AAMs.



Top: Looking rather weathered and worn, LAAF MiG-25PD '7708' is pictured at Tripoli-Mitiga in company with several Aero L-39ZA Albatros trainers.

Above: MiG-25RBK '499' is shown at the same location – and in similar condition.



Above: Surrounded by Albatrosses and Let L-410UVP-T transports, LARAF MiG-25PU '207' is shown at Mitiga. Two more Foxbats – MiG-25PDs '994' and '7811' – are visible beyond.

Libyan Arab Republic Air Force MiG-25PD '6716'.

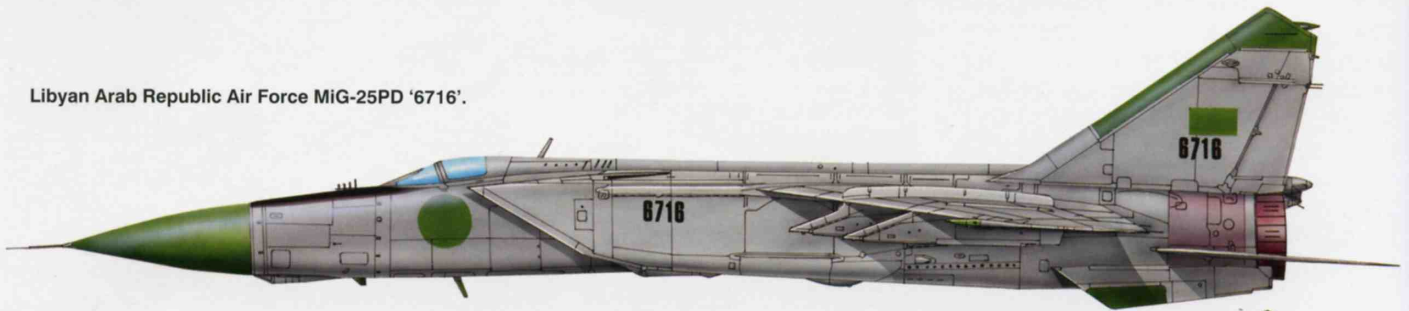

Libyan Arab Republic Air Force MiG-25RBK '499'.



imately sixteen MiG-25PD interceptors, eight MiG-25RBs and two trainers. The aircraft saw service with the No. 7 Sqn at Shayrat, Nos. 1 and 5 Sqns at Tiyas and an unidentified squadron at Dumayr. Only three machines

serialled 808, 2519 (a MiG-25PD) and 4101 have been identified.

Syrian MiG-25s have been used to intercept Israeli aircraft on many occasions but with scant success; this was largely due to

lack of experience on the part of the Syrian airmen and ground controllers. At least two MiG-25PDs have been destroyed by IDF/AF F-15s for the loss of one of their own.



A rare picture of a Syrian Air Force MiG-25PD serialled '2519'.

The Ye-155R-1

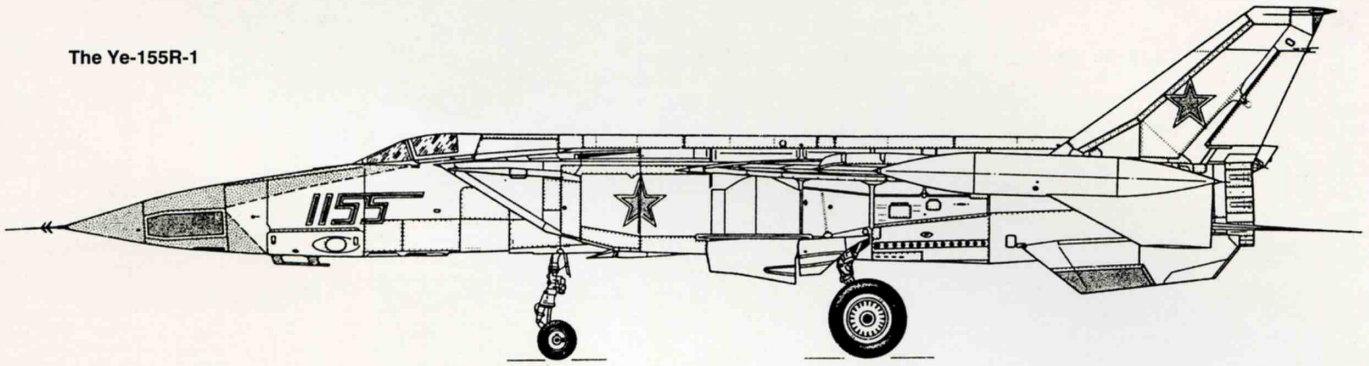

The Ye-155R-3 with drop tank attached

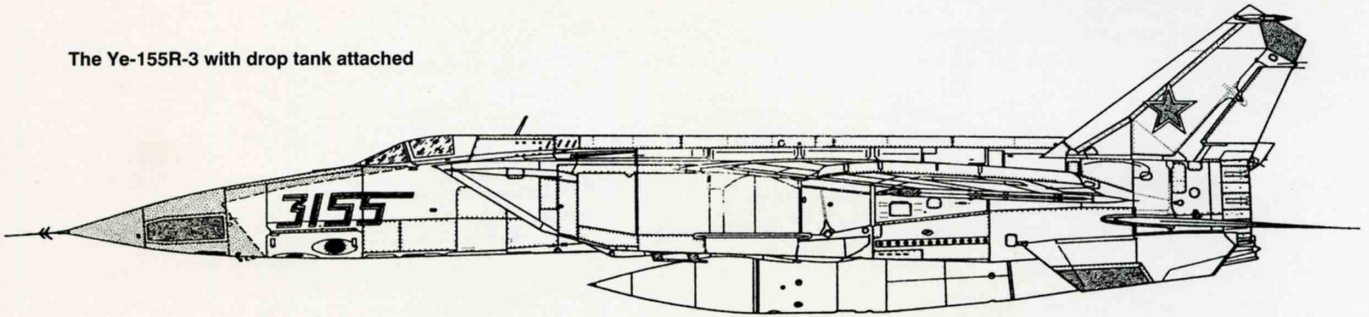

The Ye-155P-1 with K-40R AAMs

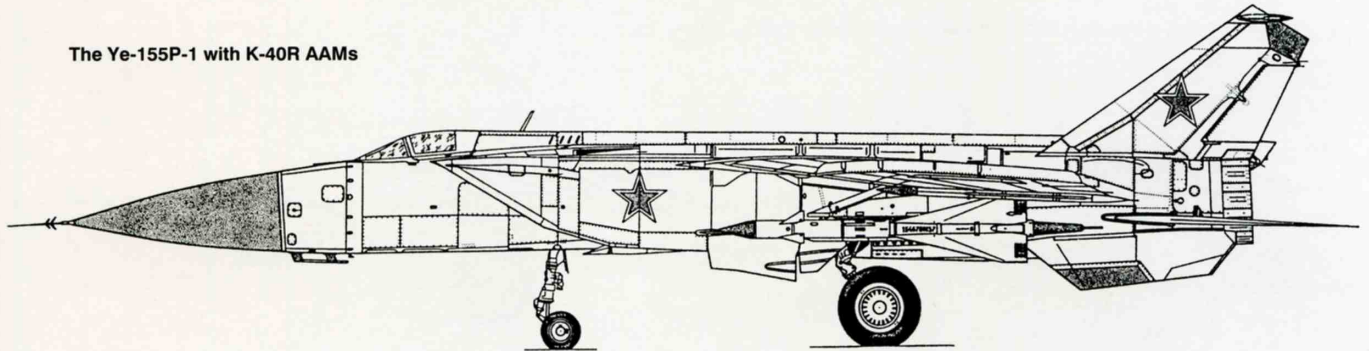

The Ye-155P-1 minus wing pylons and with ventral test equipment fairing
(as flown at the 1967 Moscow-Domododovo airshow)

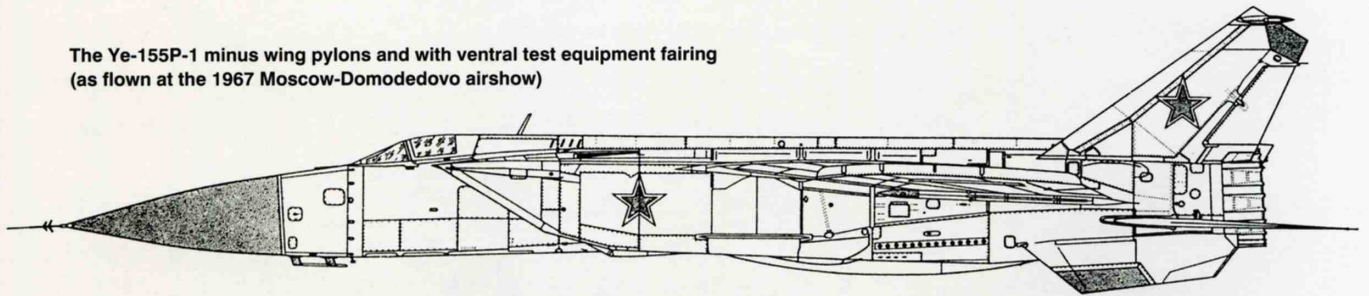

The Ye-155P-2 with test equipment fairing

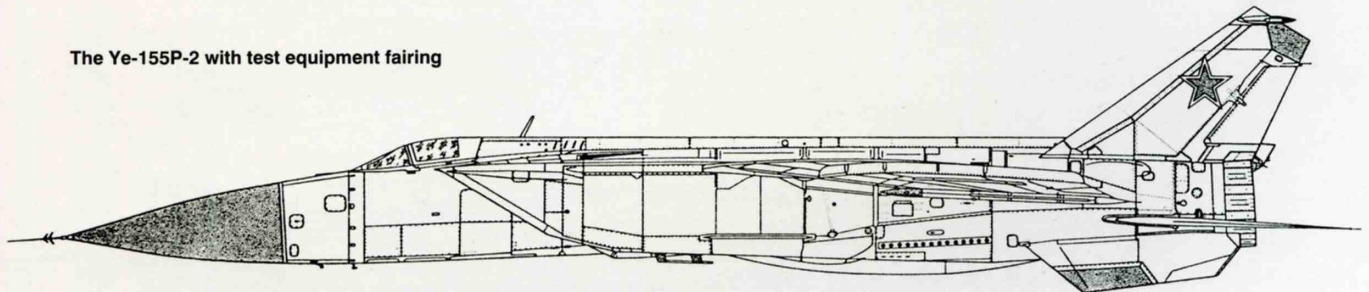

The Ye-155P-5 as flown at the Domodedovo airshow (with normal wingtips)

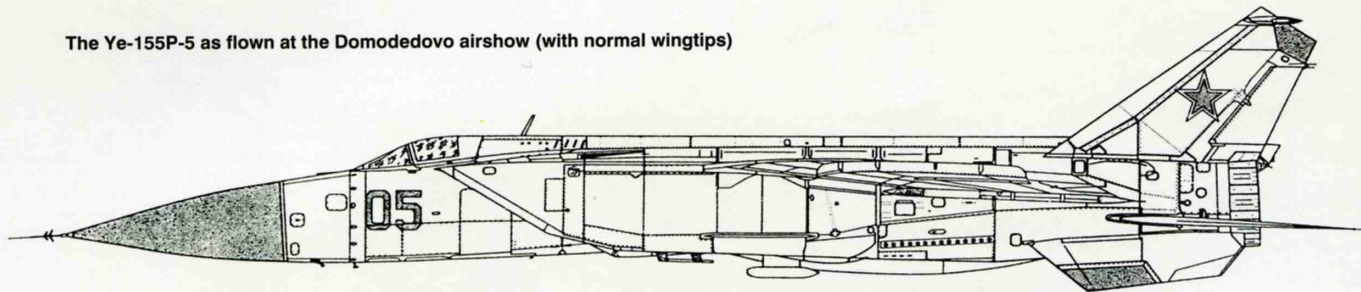

The Ye-155P-5 with wing endplates added

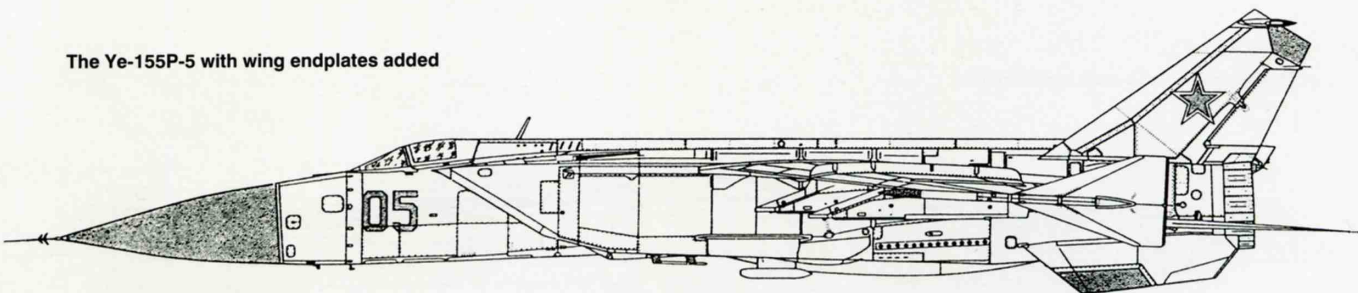

Low-rate initial production MiG-25P with wing endplates (*izdeliye 155P*), 1970

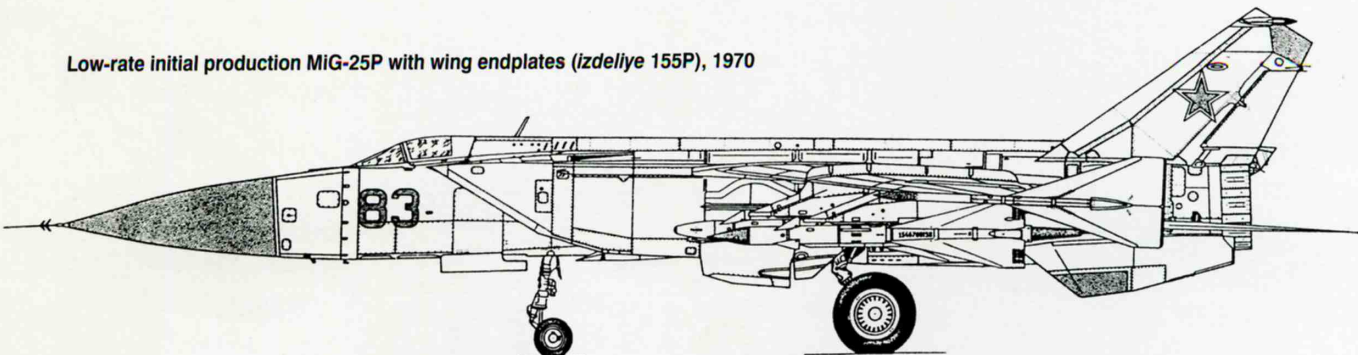

The Ye-155R-3 in modified form as preserved at the Central Russian Air Force Museum



The MiG-25RB prototype (Ye-155R-4B)

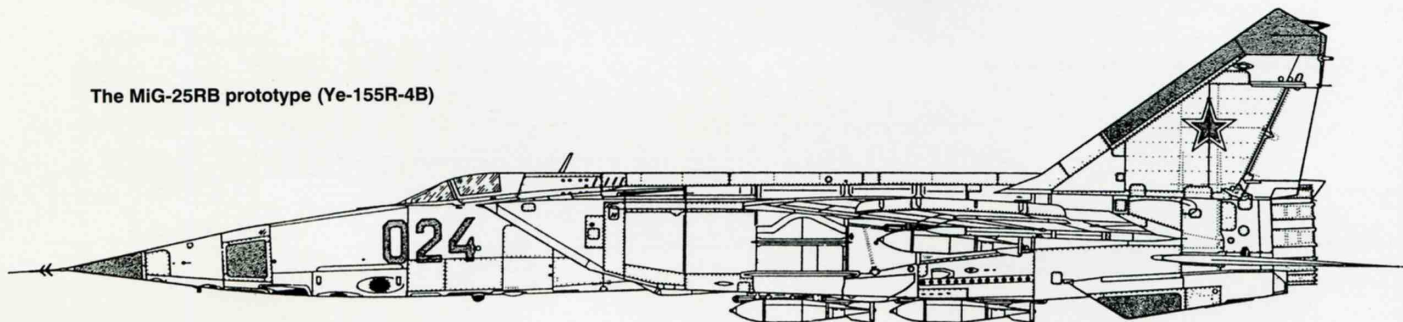

Initial production MiG-25R (*izdeliye 155R*), 1970

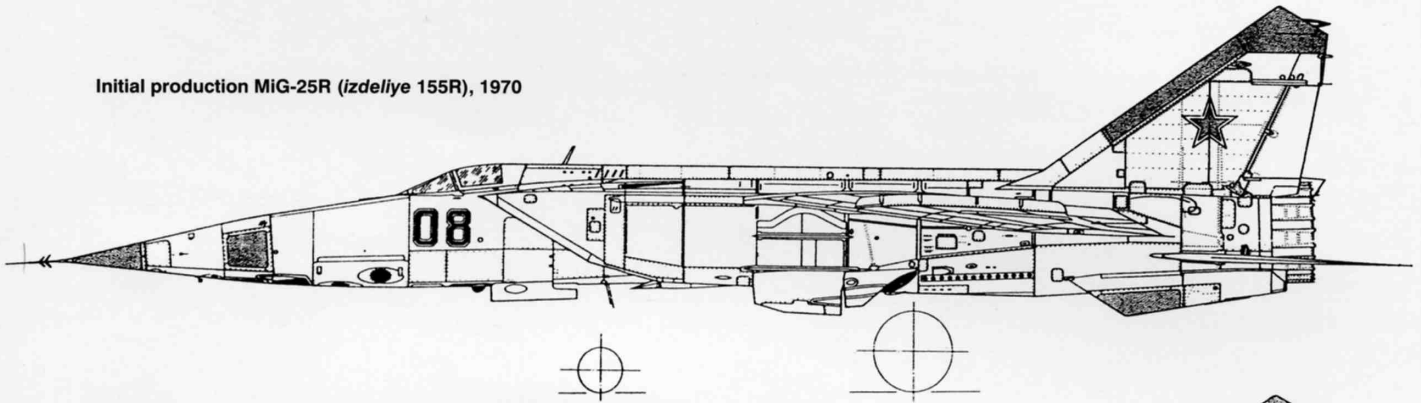

MiG-25R with A-72 camera installation

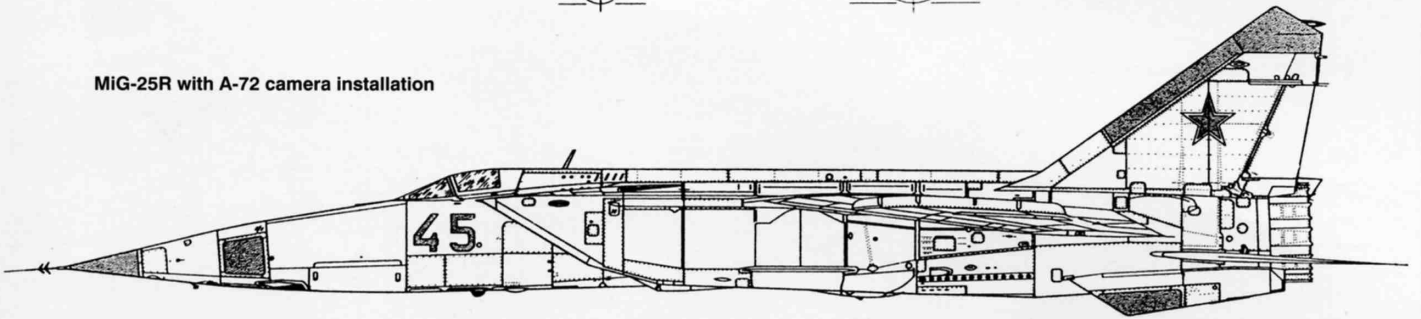

A modified MiG-25R with wing pylons, 1977

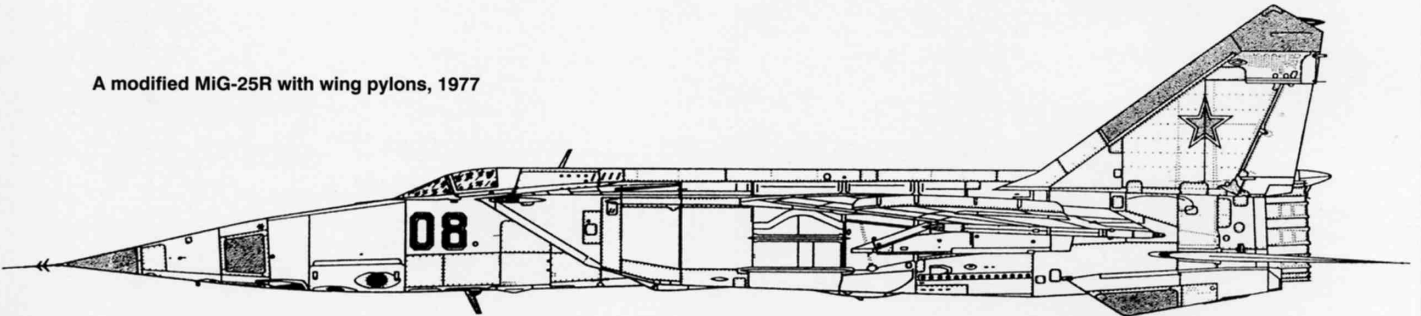

Production MiG-25RB (*izdeliye 02B*), 1971

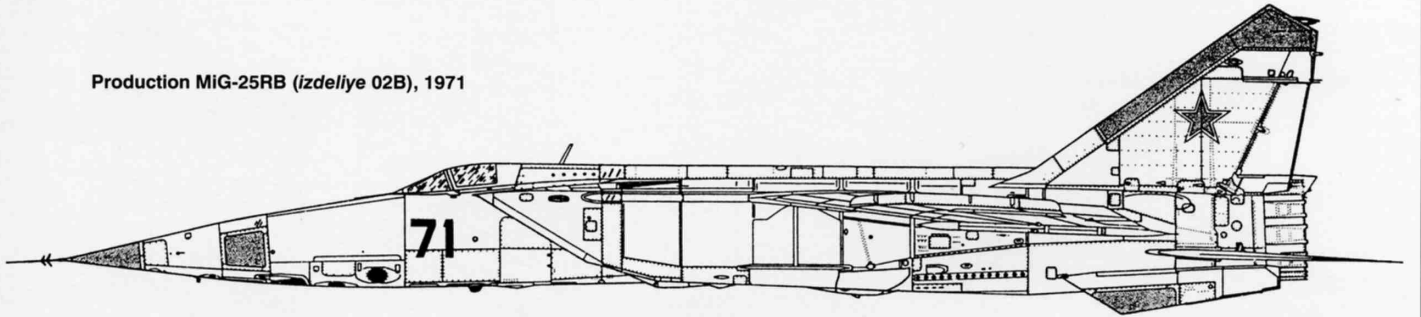

MiG-25RBV (*izdeliye 02V*), 1972

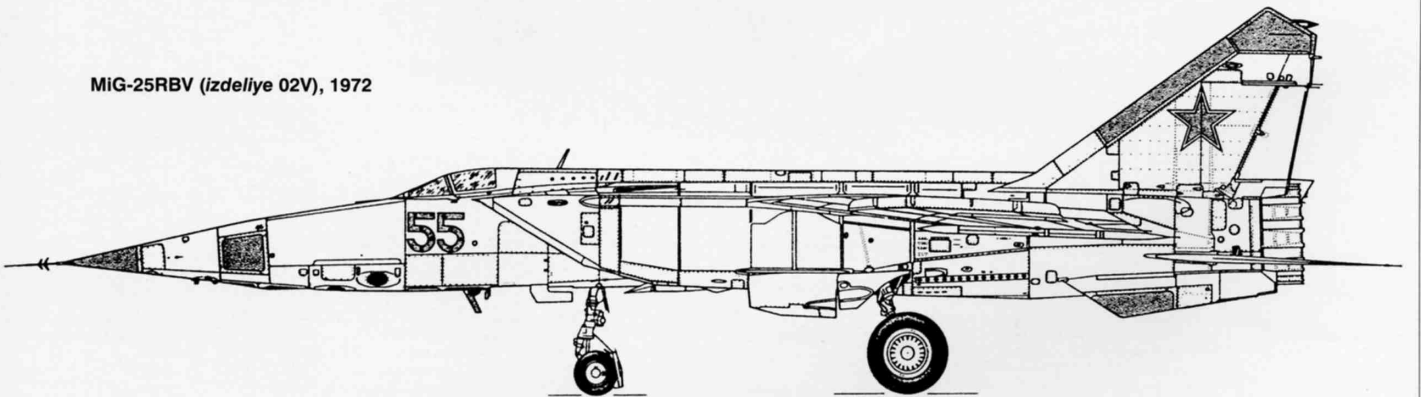

MiG-25RBV, 1974 standard

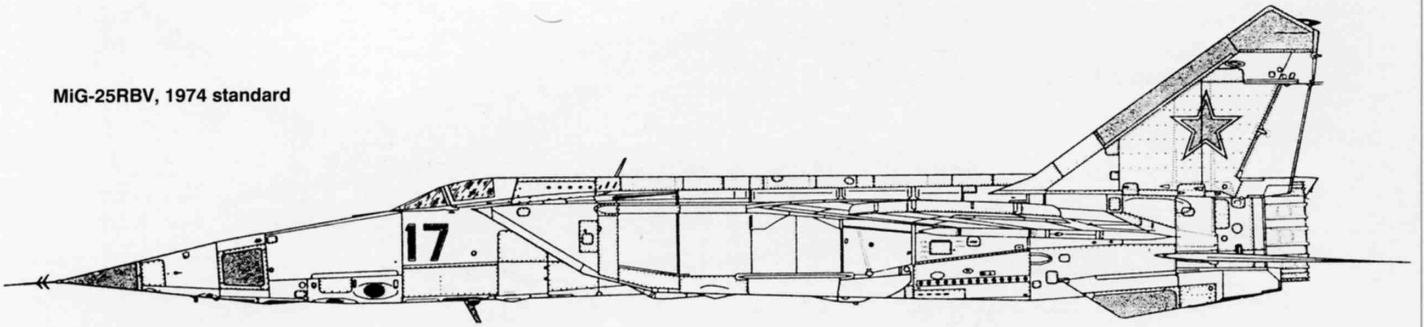

MiG-25RBK, 1971 standard

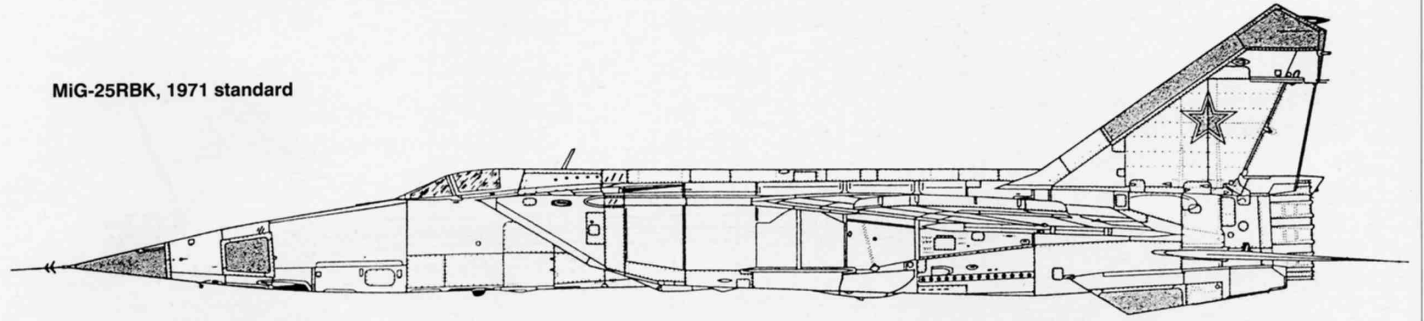

MiG-25RBK, 1974 standard

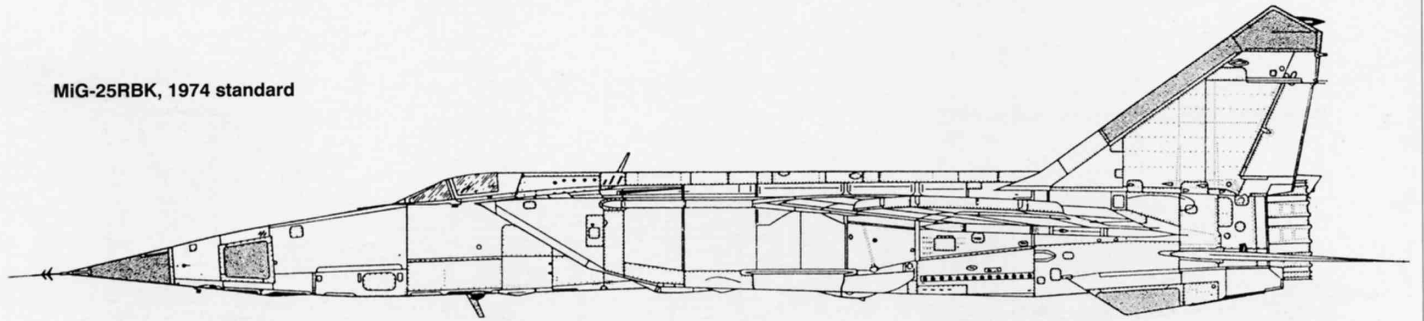

MiG-25RBK, 1976 standard

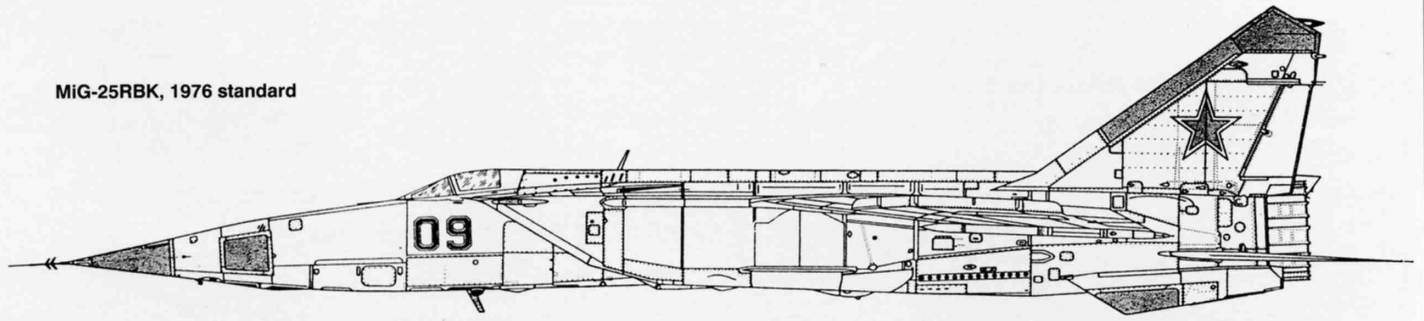

MiG-25RBK, 1980 standard

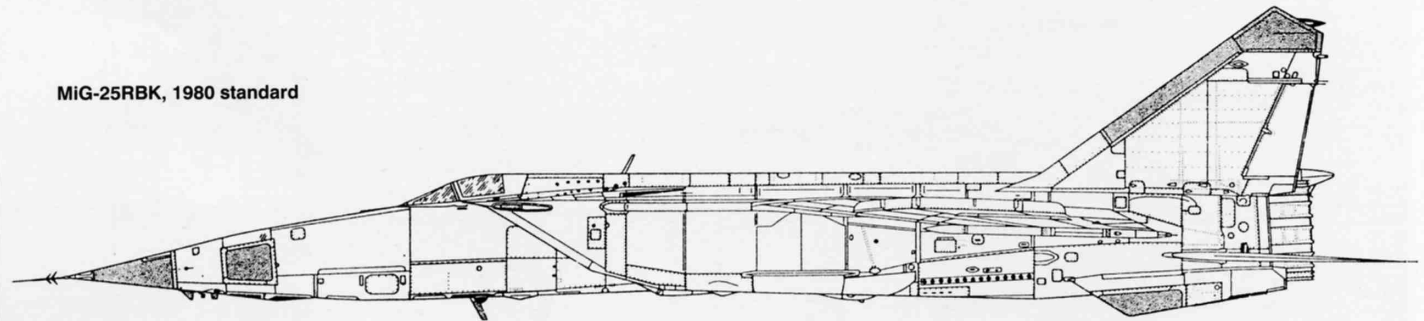

MiG-25RBS, 1972 standard

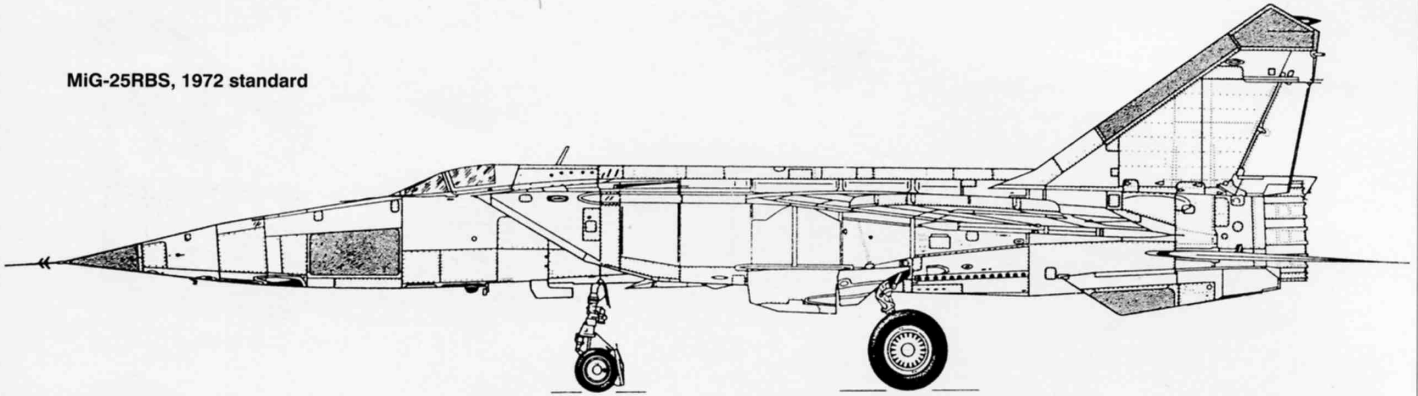

MiG-25RBS, 1974 standard

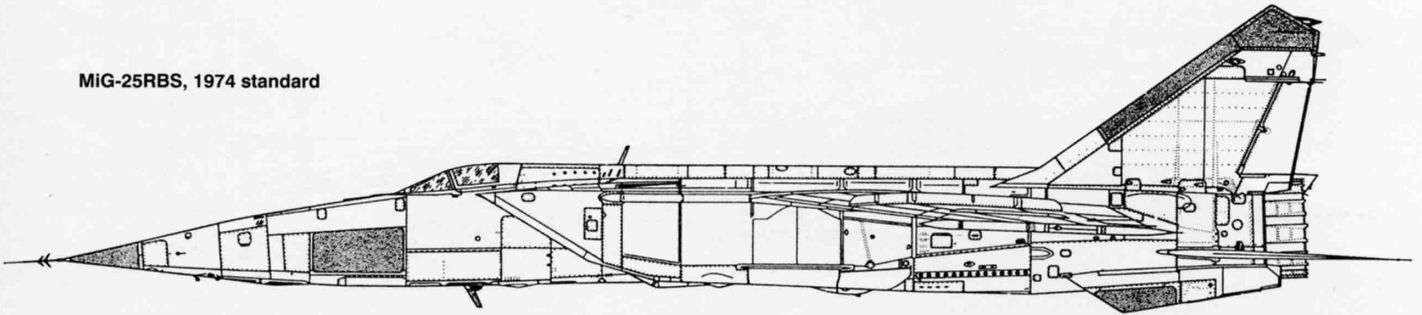

MiG-25RBS, 1978 standard

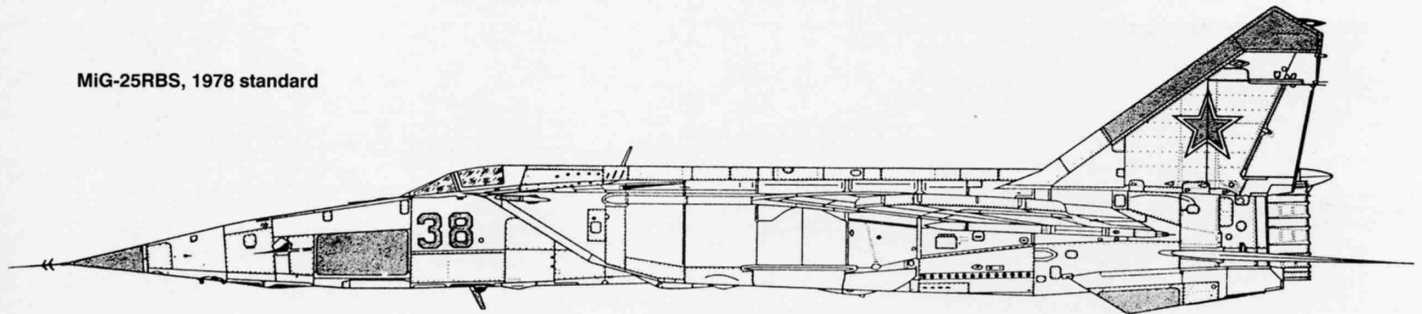

MiG-25RBS equipment testbed ('701 Blue', c/n N02048127), 1977

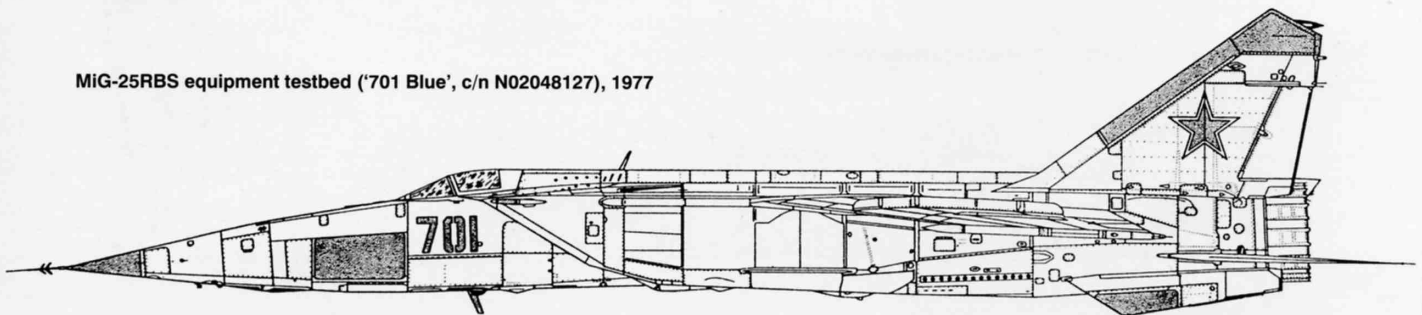

MiG-25RBT, 1978 standard

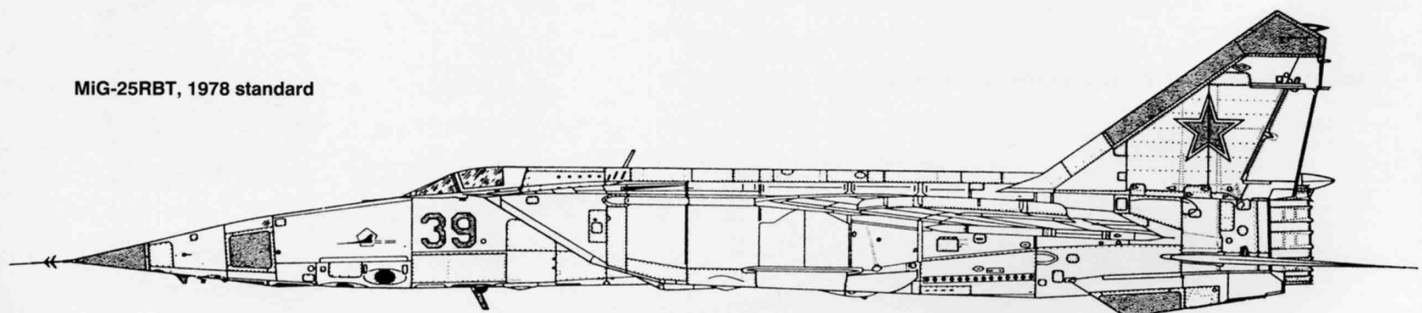

MiG-25RBT with a full load of bombs, 1980

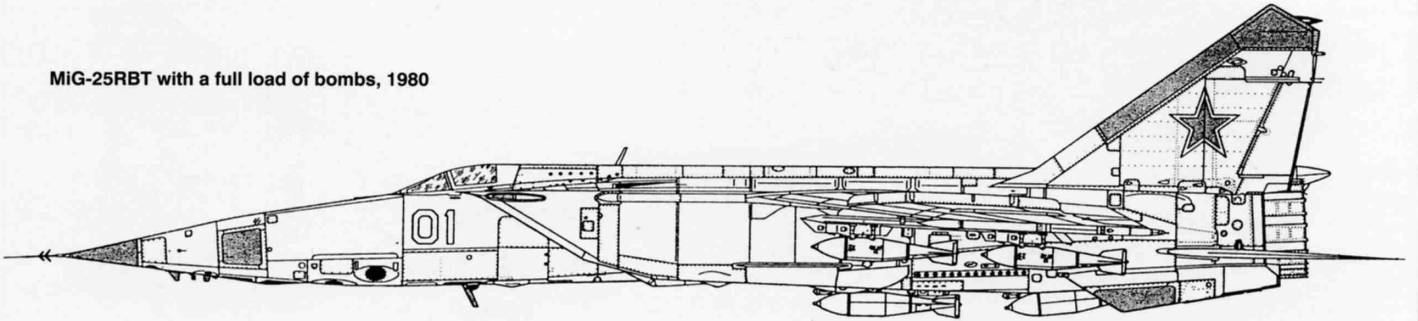

MiG-25RBF, 1981 standard

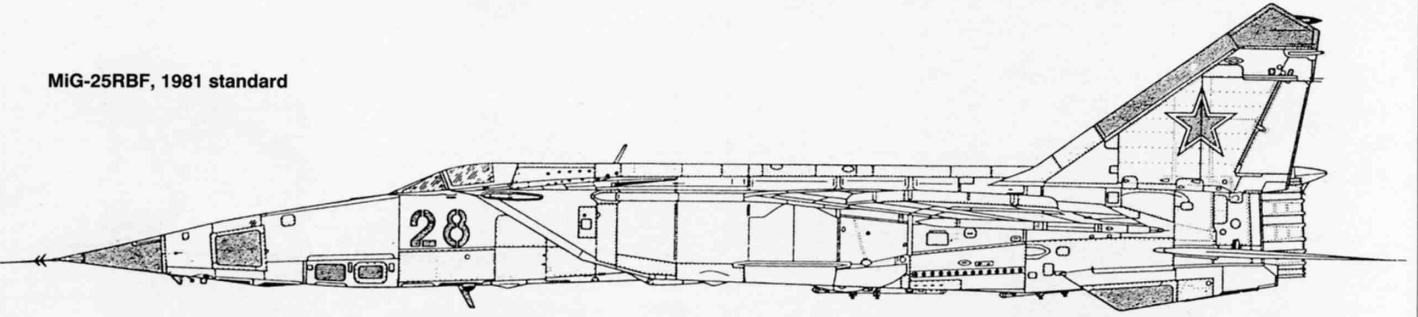

MiG-25RBSH, 1982 standard

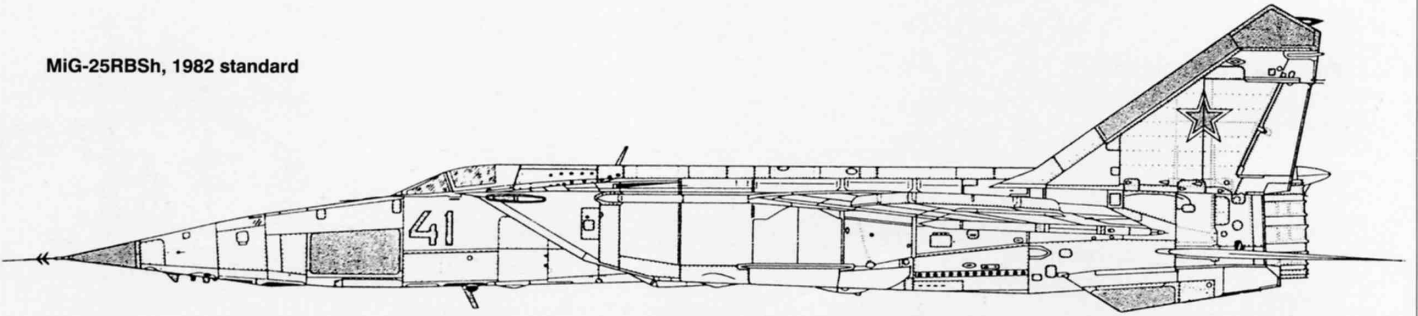

MiG-25RBK '02 Blue' (c/n N02029210) avionics testbed for Buran space shuttle

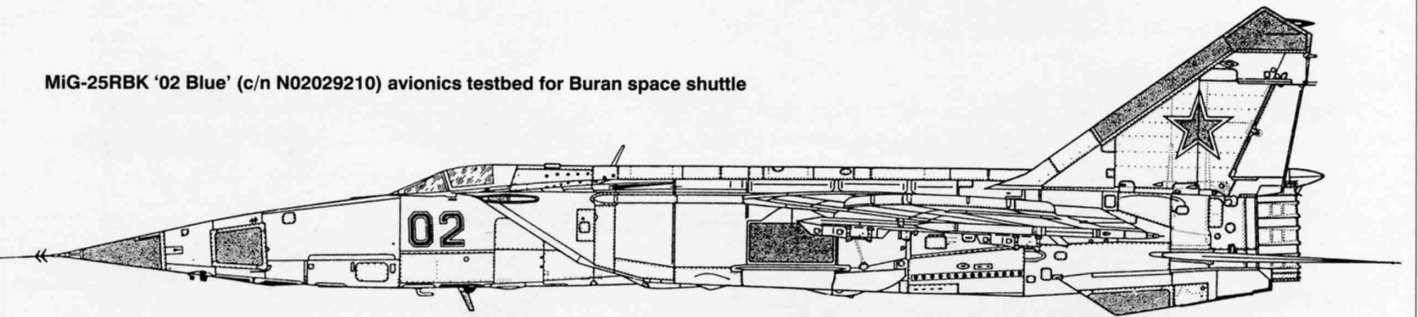

MiG-25M development aircraft based on MiG-25RB ('601 Blue', c/n 02-601)

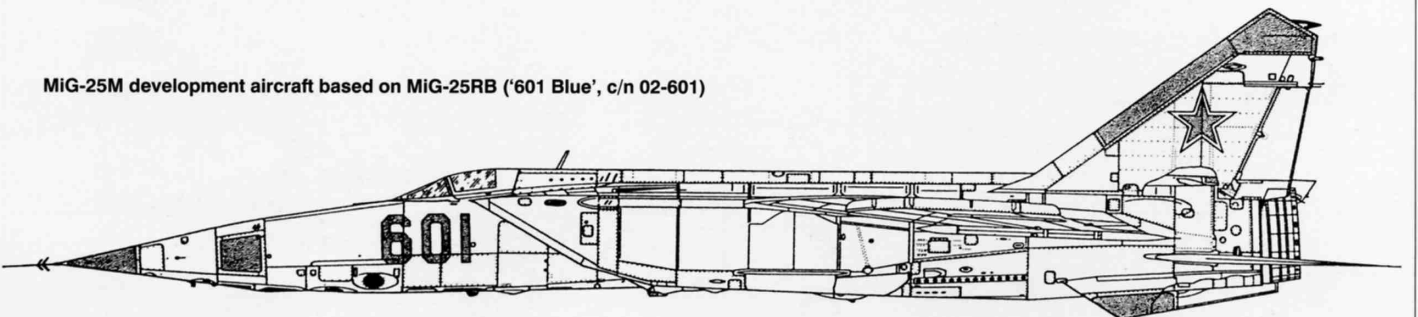

MIG-25RBSHDZ

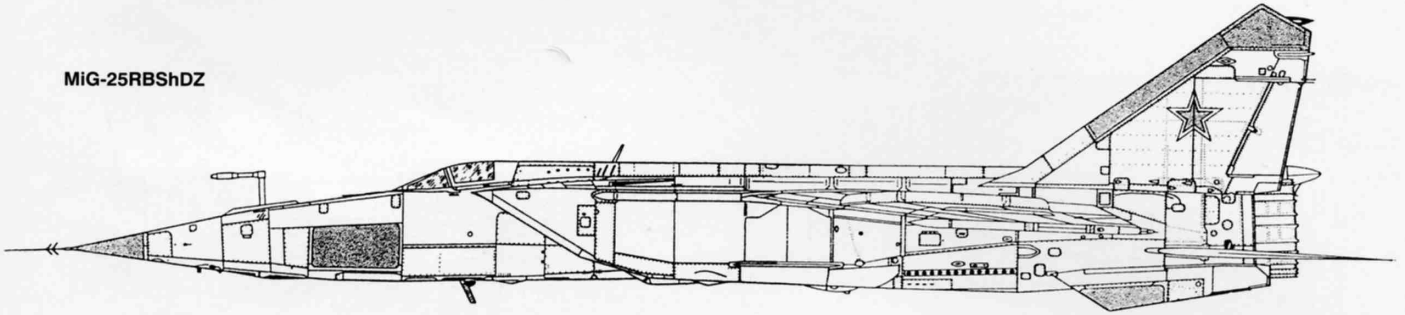

MIG-25RBM ('47 Blue', c/n N02022047)

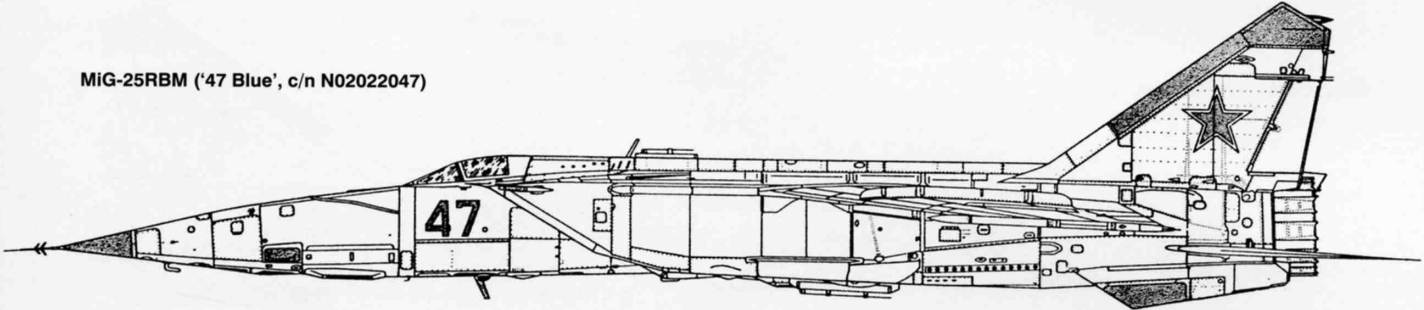

Production MiG-25BM, 1982

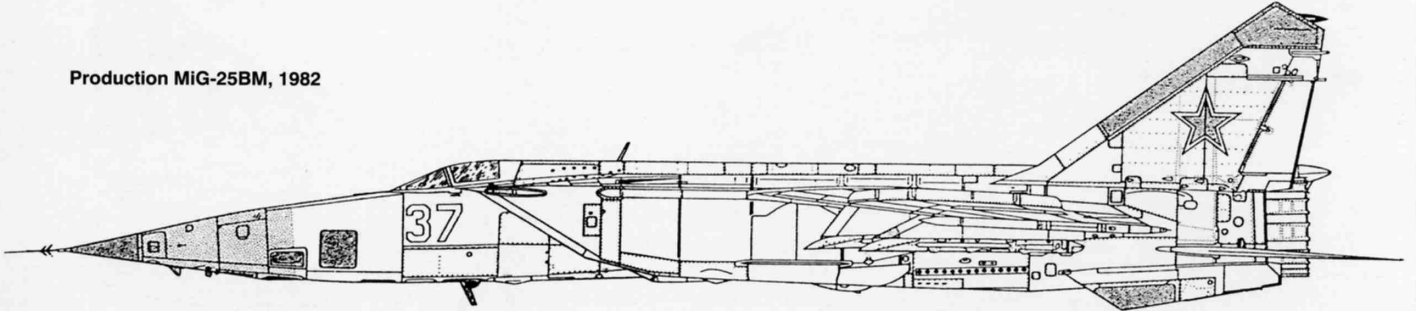

Production MiG-25BM with Kh-58U ARMs, 1984

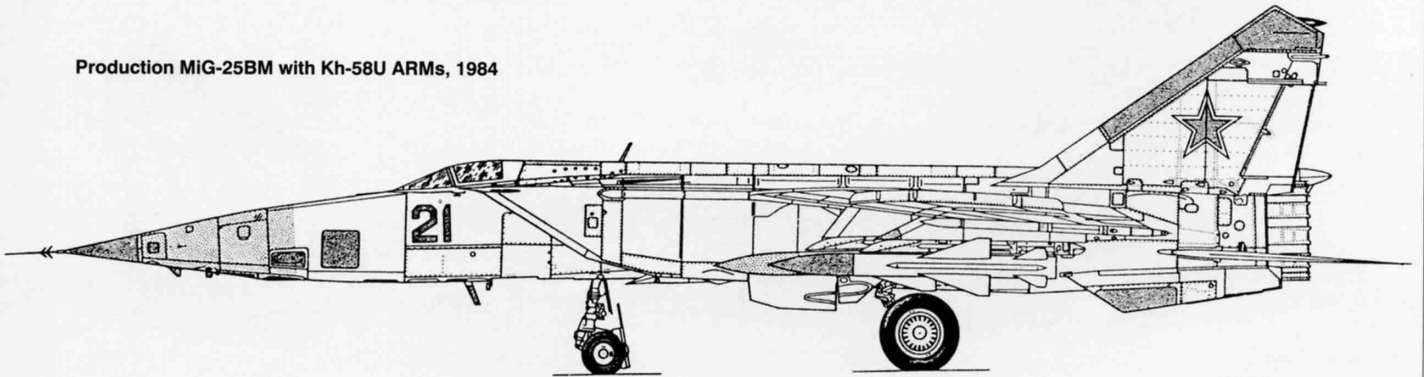

Early-production MiG-25P (izdeliye 84), 1971

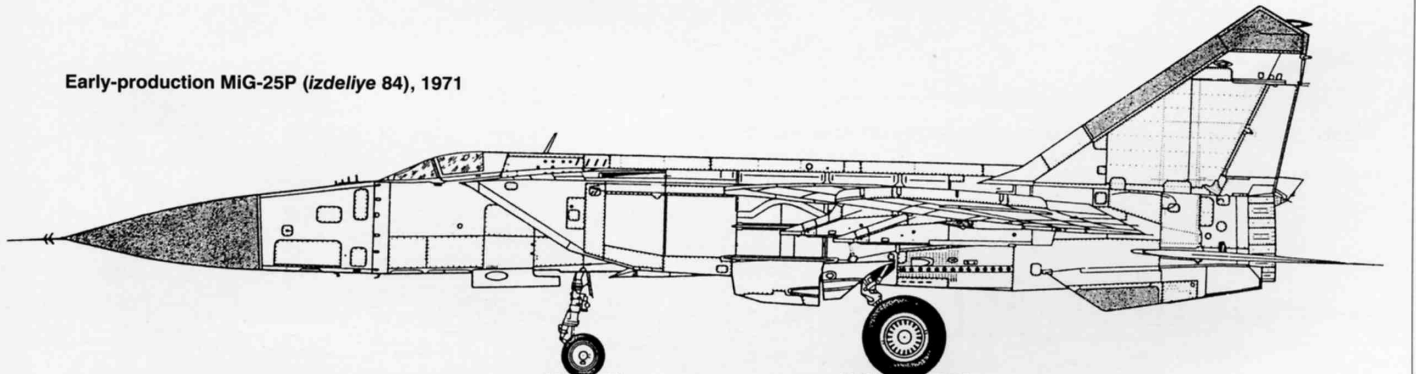

MiG-25P, 1971/72 standard

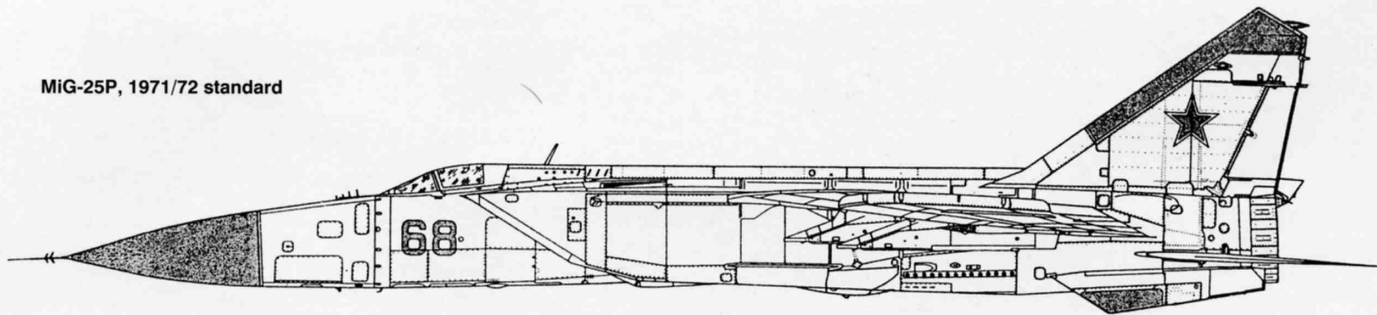

MiG-25P, early 1972 standard

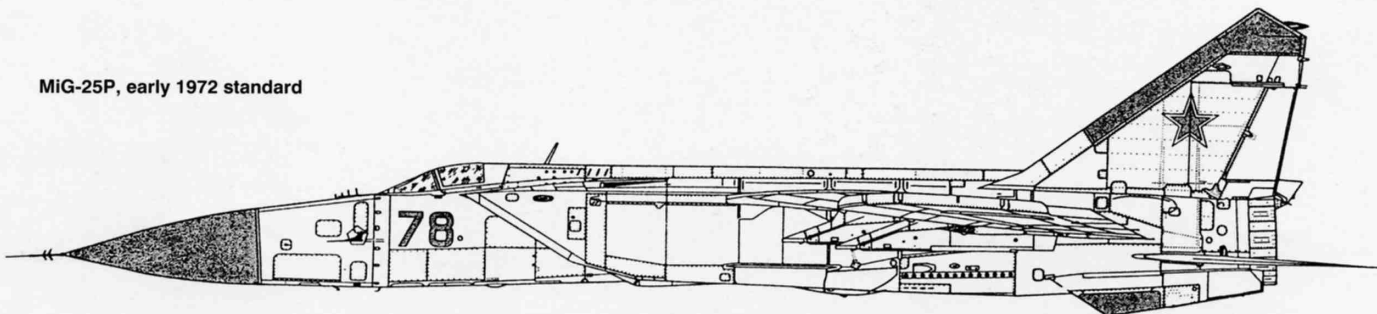

MiG-25P, late 1972 standard

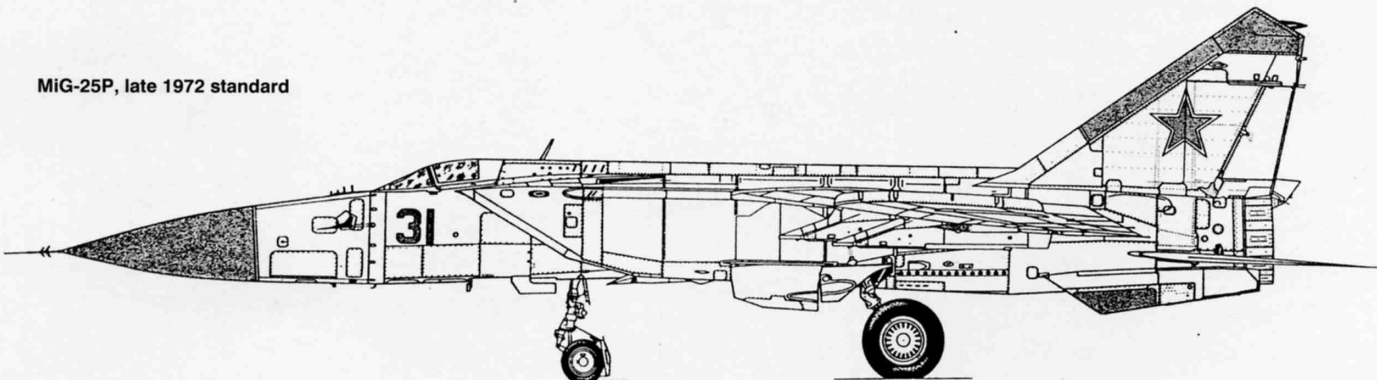

MiG-25P, 1974 standard

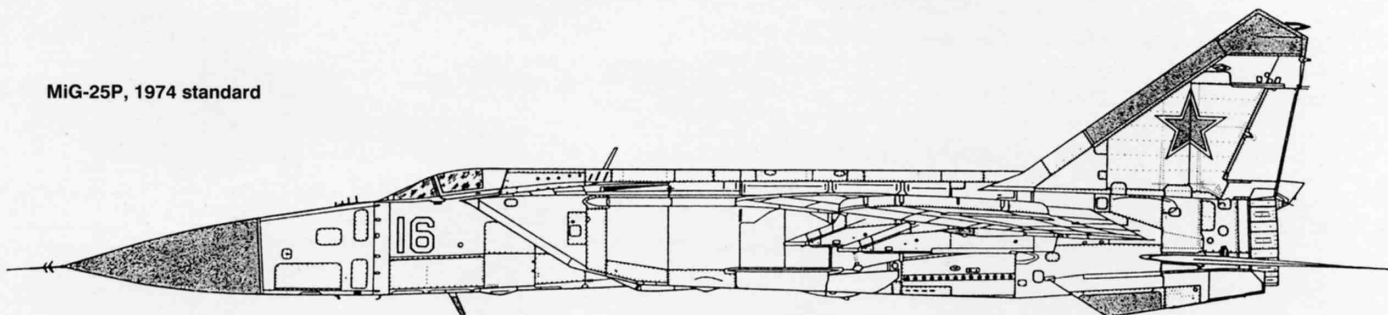

MiG-25P, 1975 standard

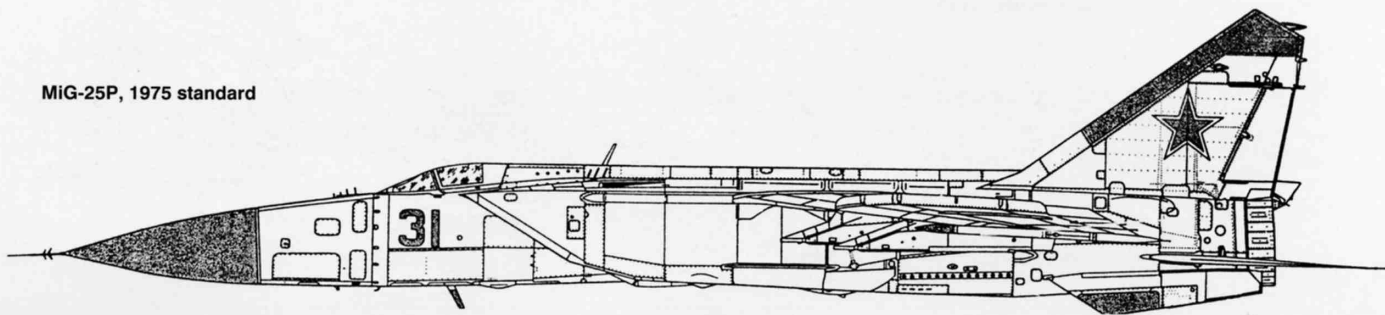

MiG-25P, 1977 standard

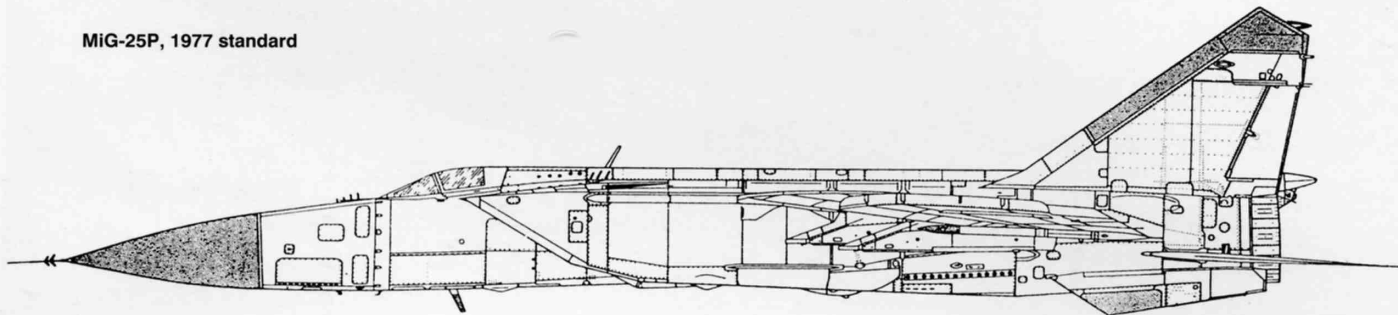

MiG-25P avionics testbed for Parol'-2 IFF system

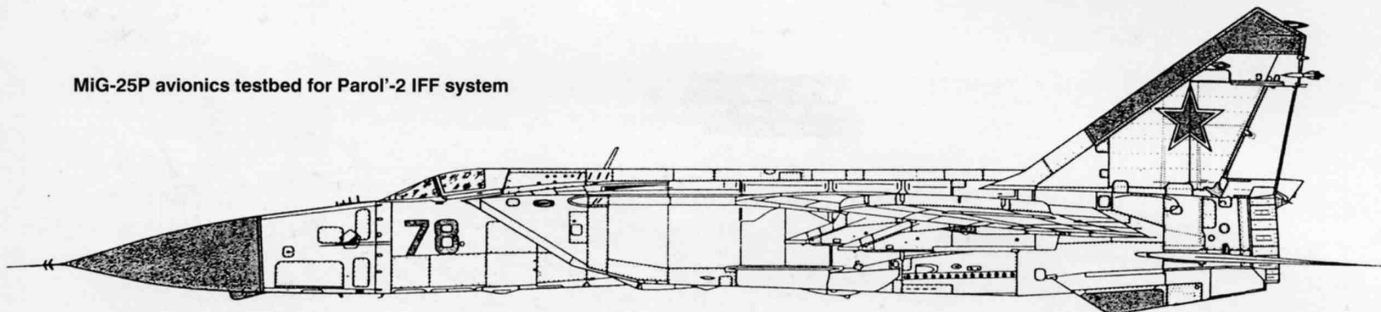

MiG-25M development aircraft based on MiG-25P ('710 Blue', c/n N84019175)

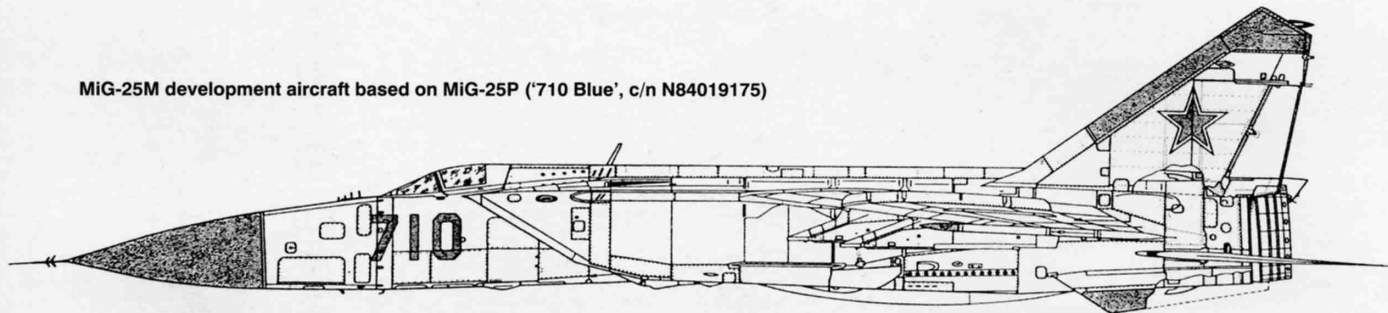

MiG-25P systems testbed

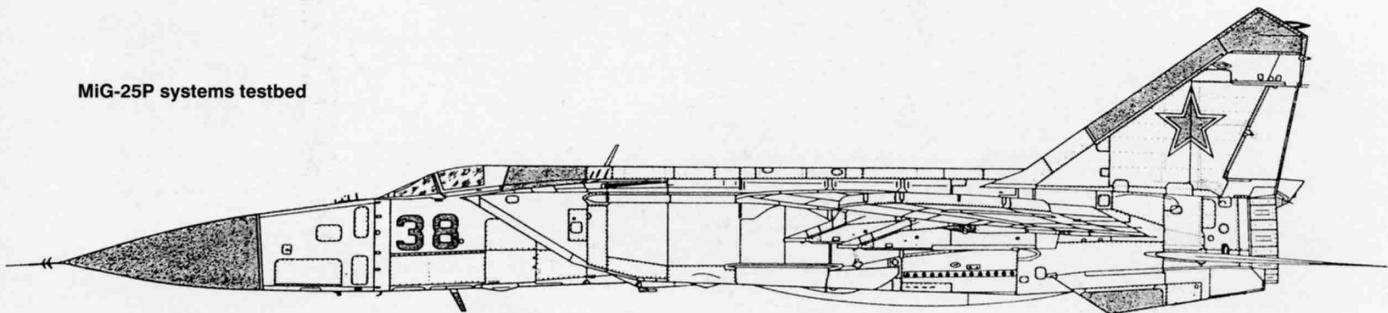

MiG-25P-LL engine testbed

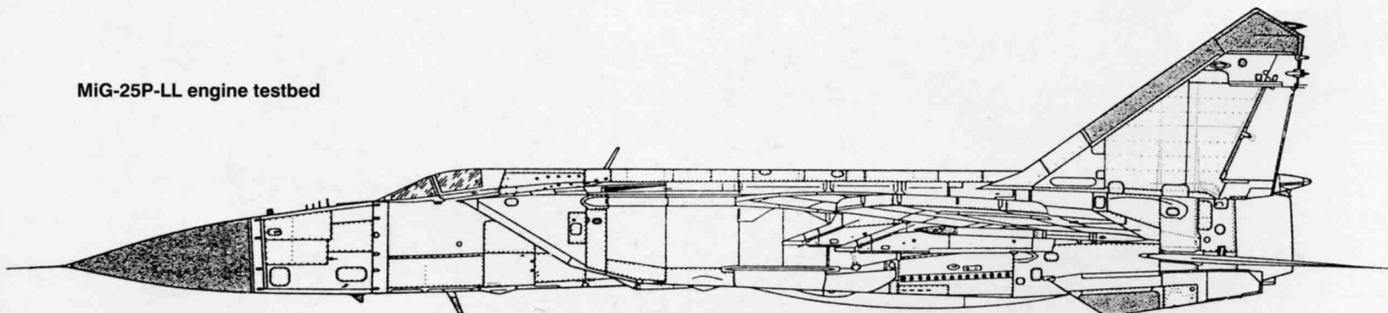

MiG-25PD prototype ('305 Blue', c/n N84042474)

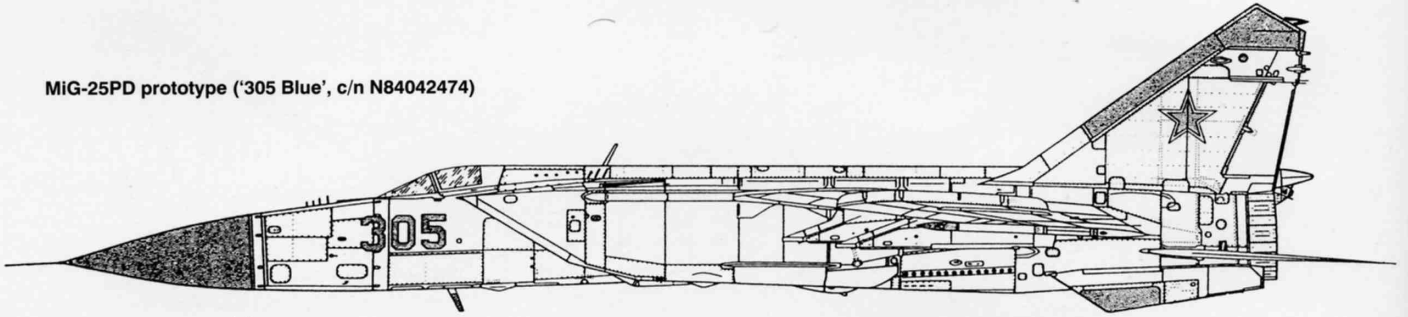

MiG-25PD prototype ('306 Blue', c/n N84042680)

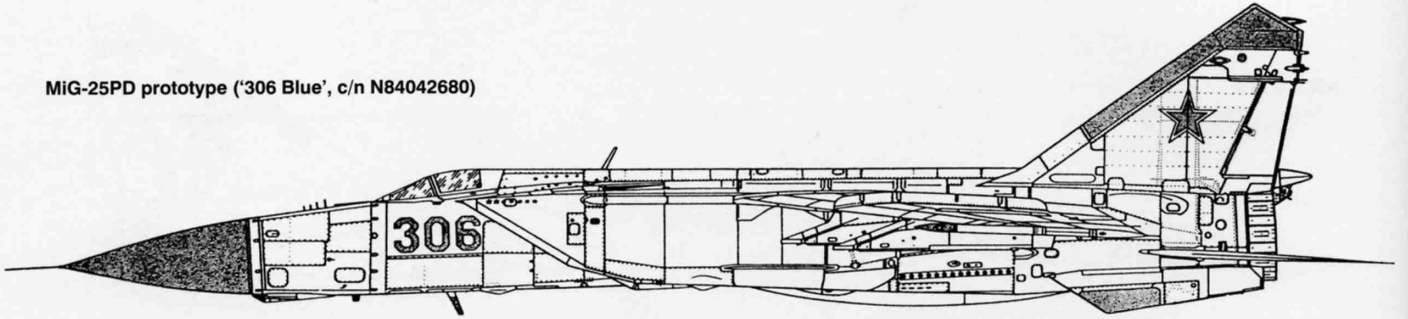

Production MiG-25PD, 1979

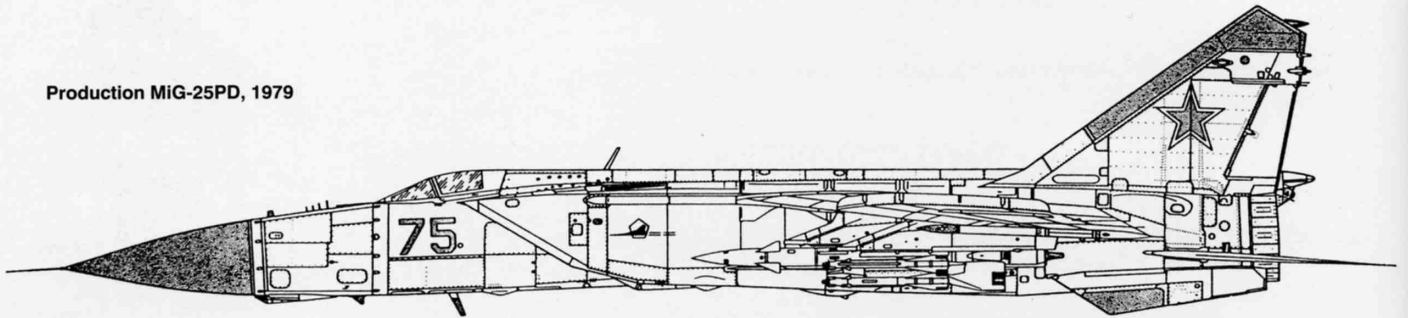

MiG-25PD, 1982 standard

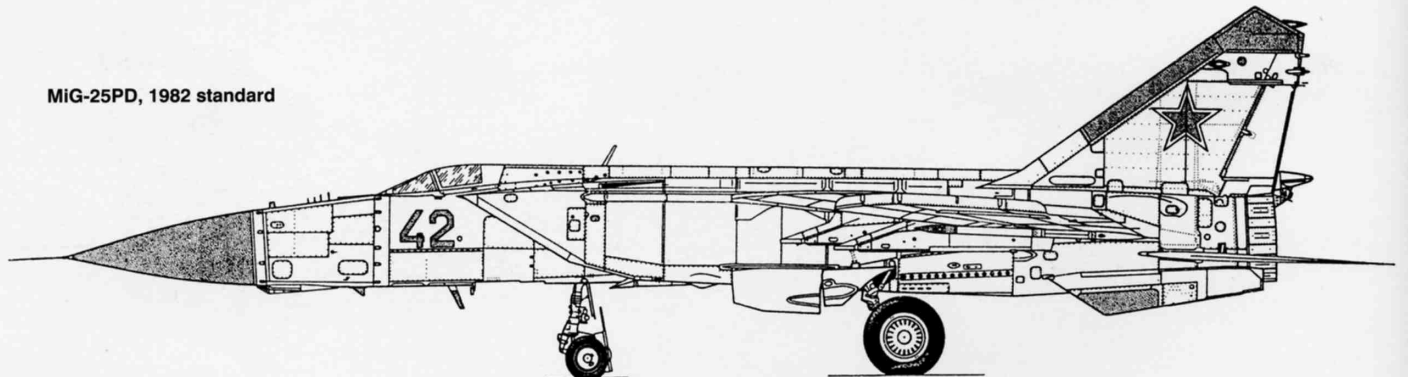

MiG-25PD, 1983 standard

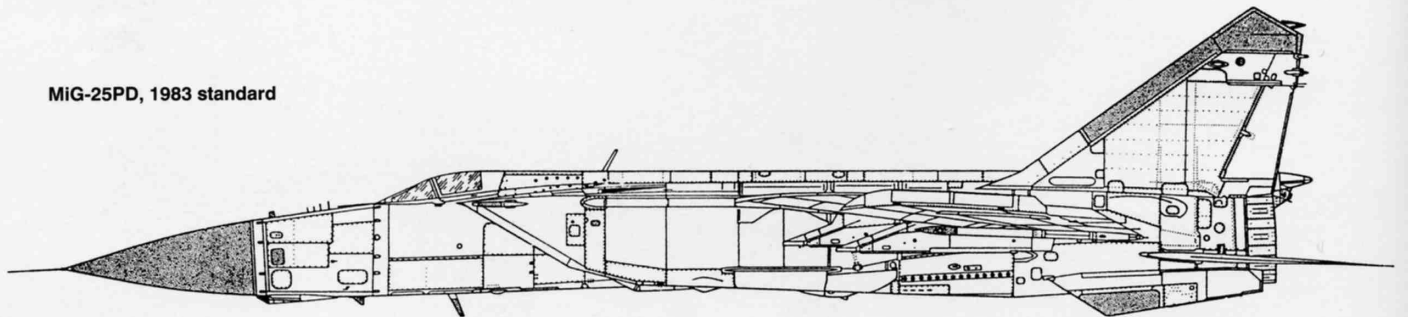

MIG-25PDS, 1980

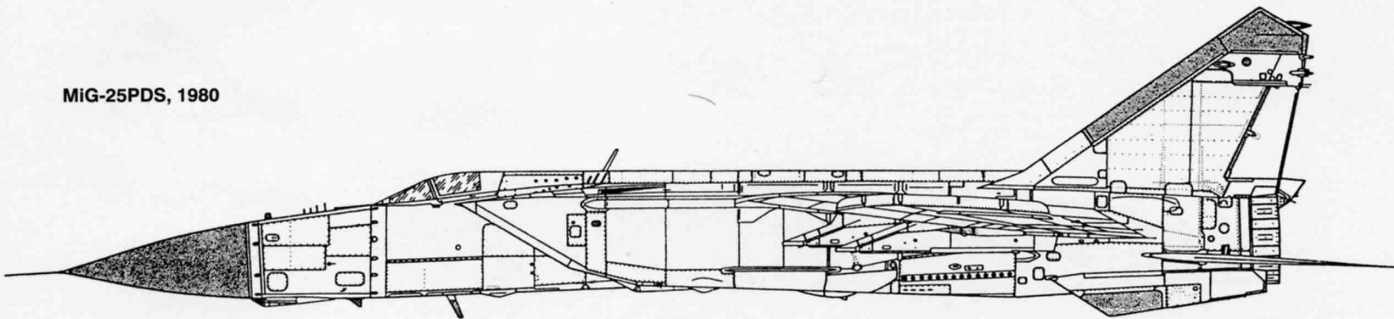

MIG-25PDZ

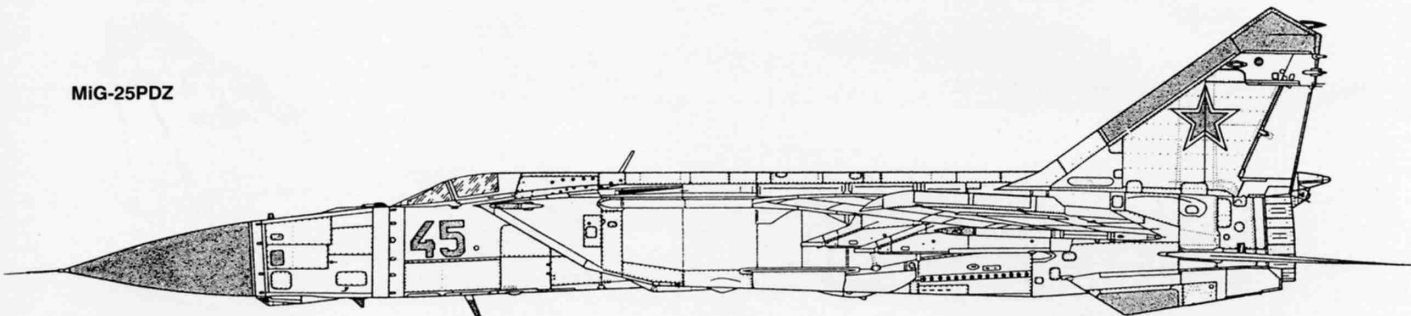

MIG-25PU prototype

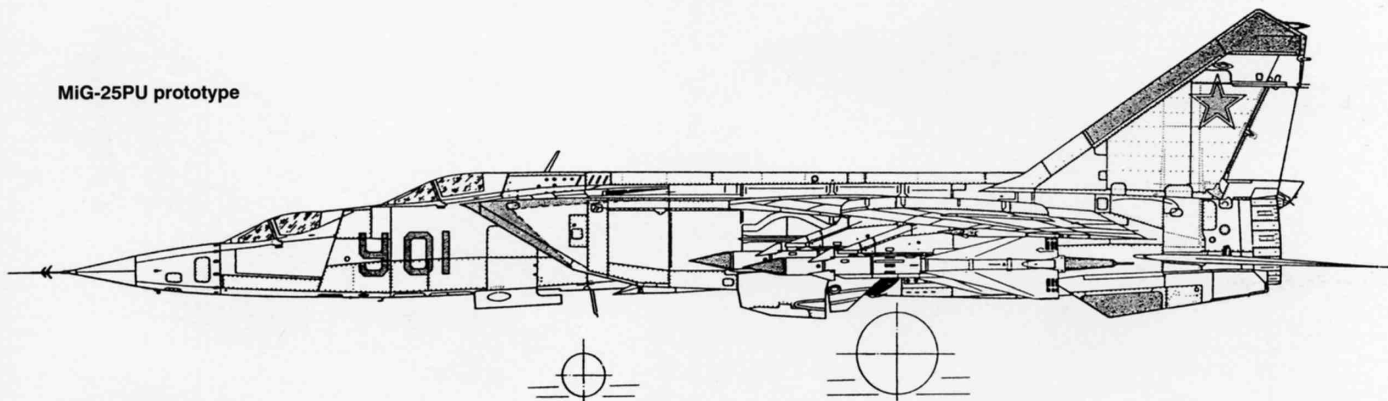

Production MiG-25PU, 1972

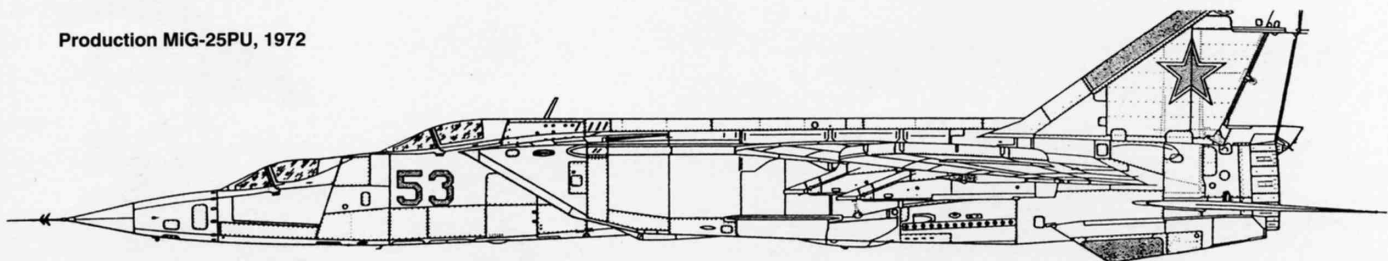

Production MiG-25RU, 1973

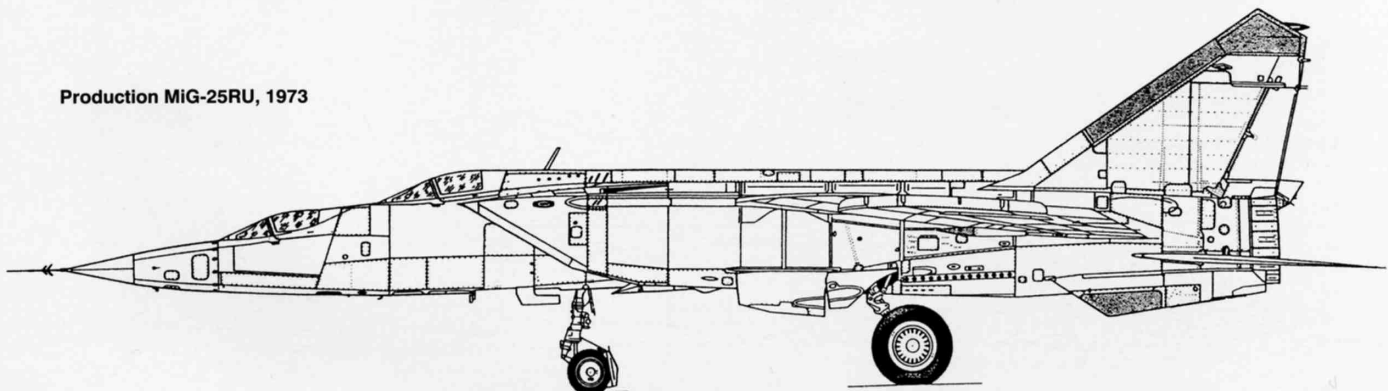

MiG-25RU, 1974 standard

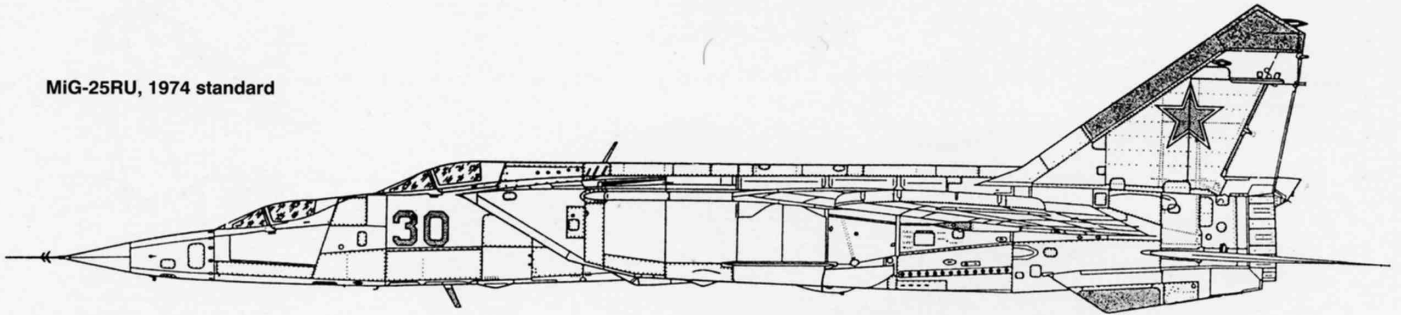

MiG-25PU, 1976 standard

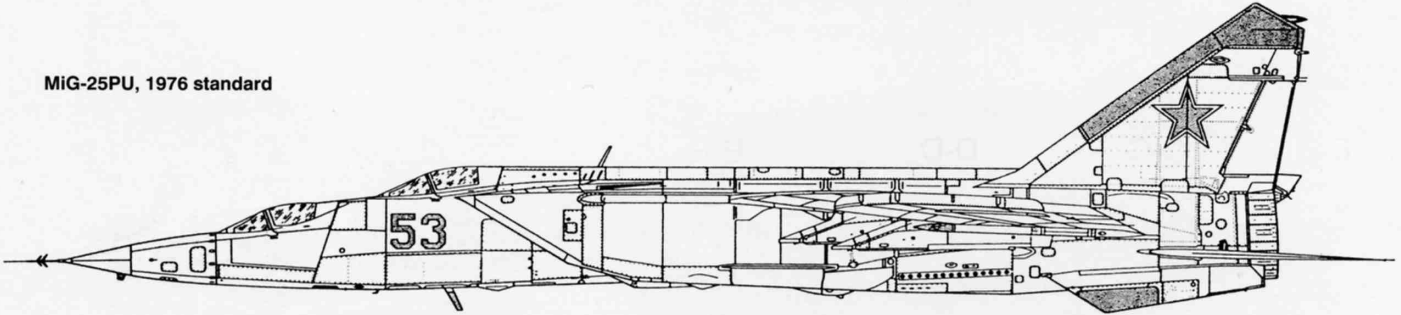

The last production MiG-25PU, 1983

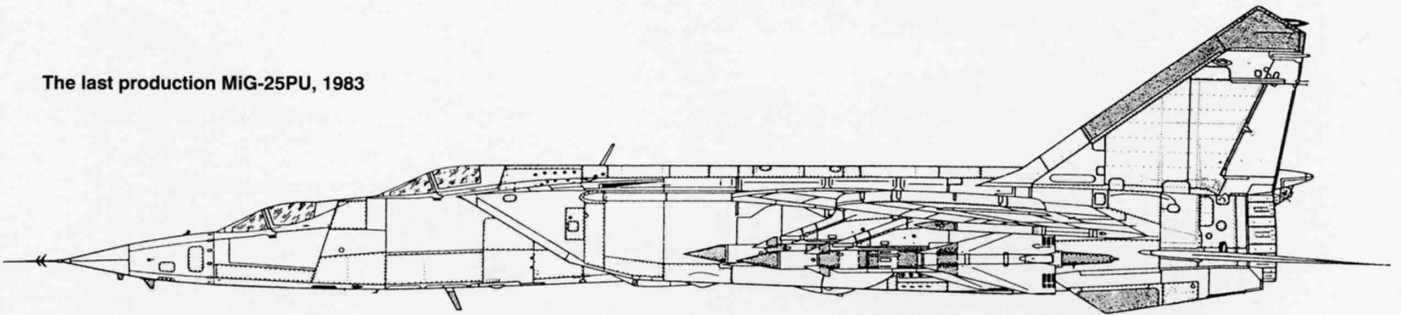

MiG-25PU-SOTN chase aircraft

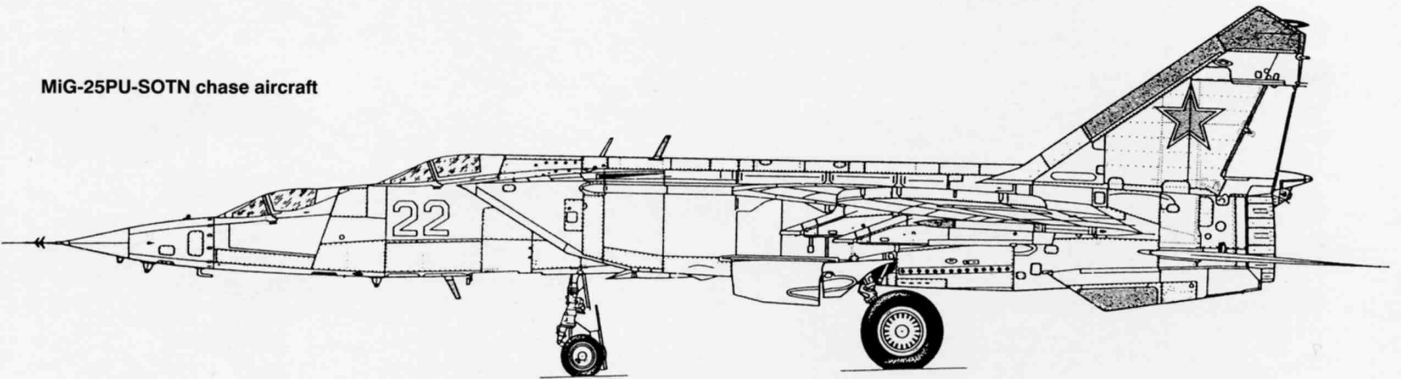

MiG-25RU ejection seat testbed

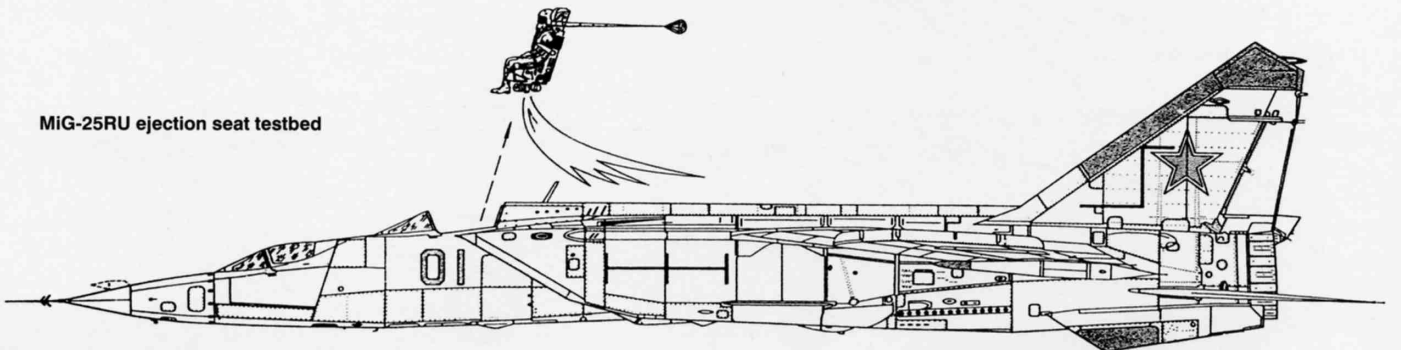

Front view of the MiG-25PU/MiG-25RU with airbrakes deployed

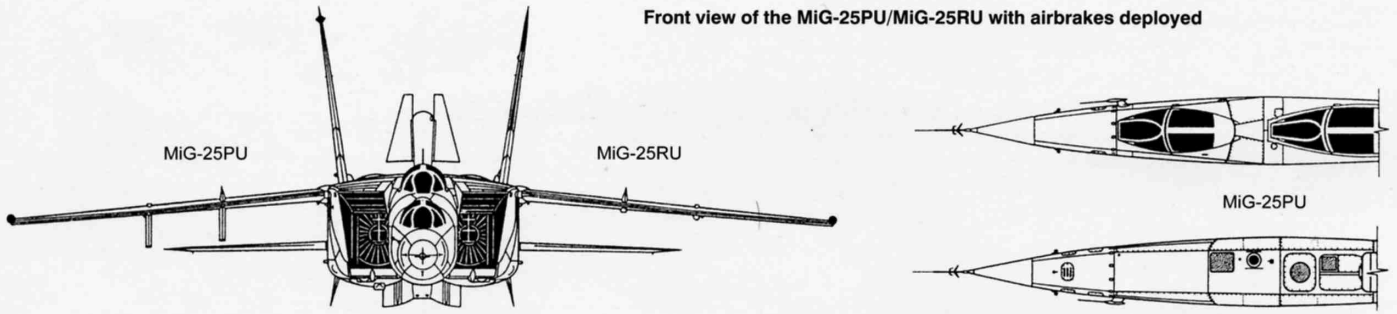

B-B

C-C

D-D

E-E

F-F

G-G

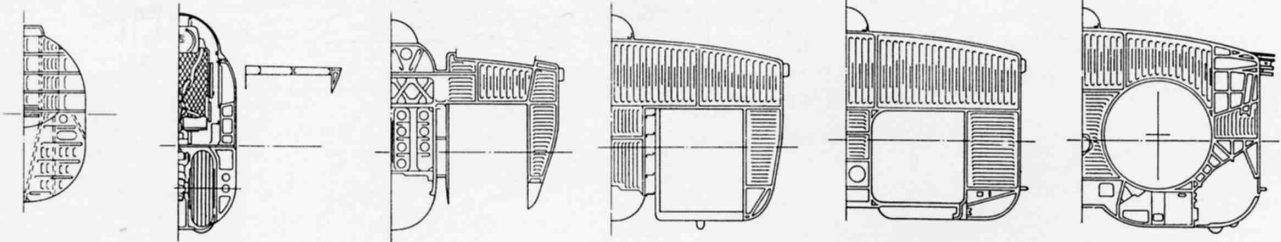

H-H

J-J

K-K

L-L

M-M

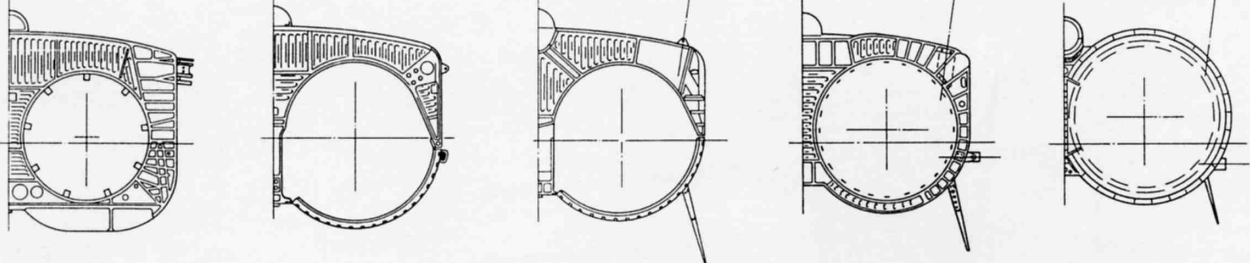

A-A

A-A



MiG-25R/RB
all versions



MiG-25P/PD/PDS

MiG-25 fuselage cross-sections

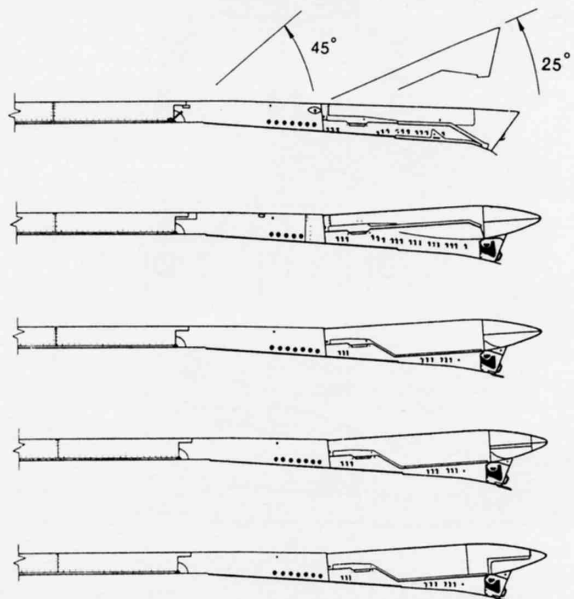
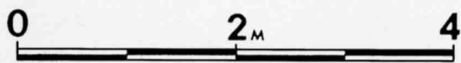

Different versions of the MiG-25's brake parachute housing

Upper view of MiG-25P. Scrap views show the starboard taileron (unobstructed by the fin), the optional chaff/flare dispensers and alternative ECM antenna blisters

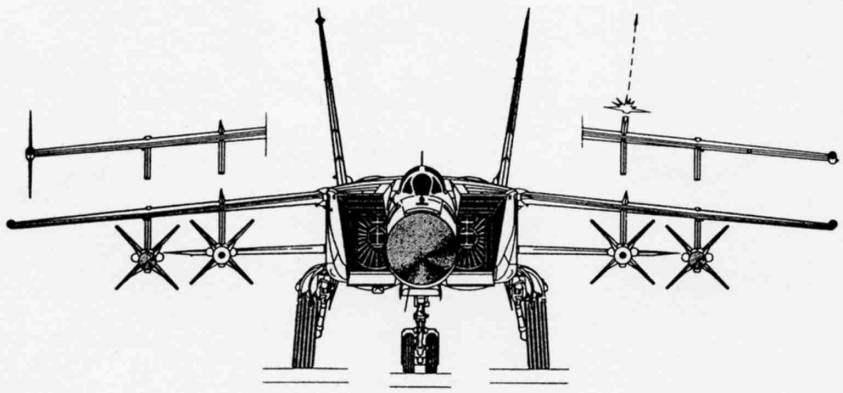
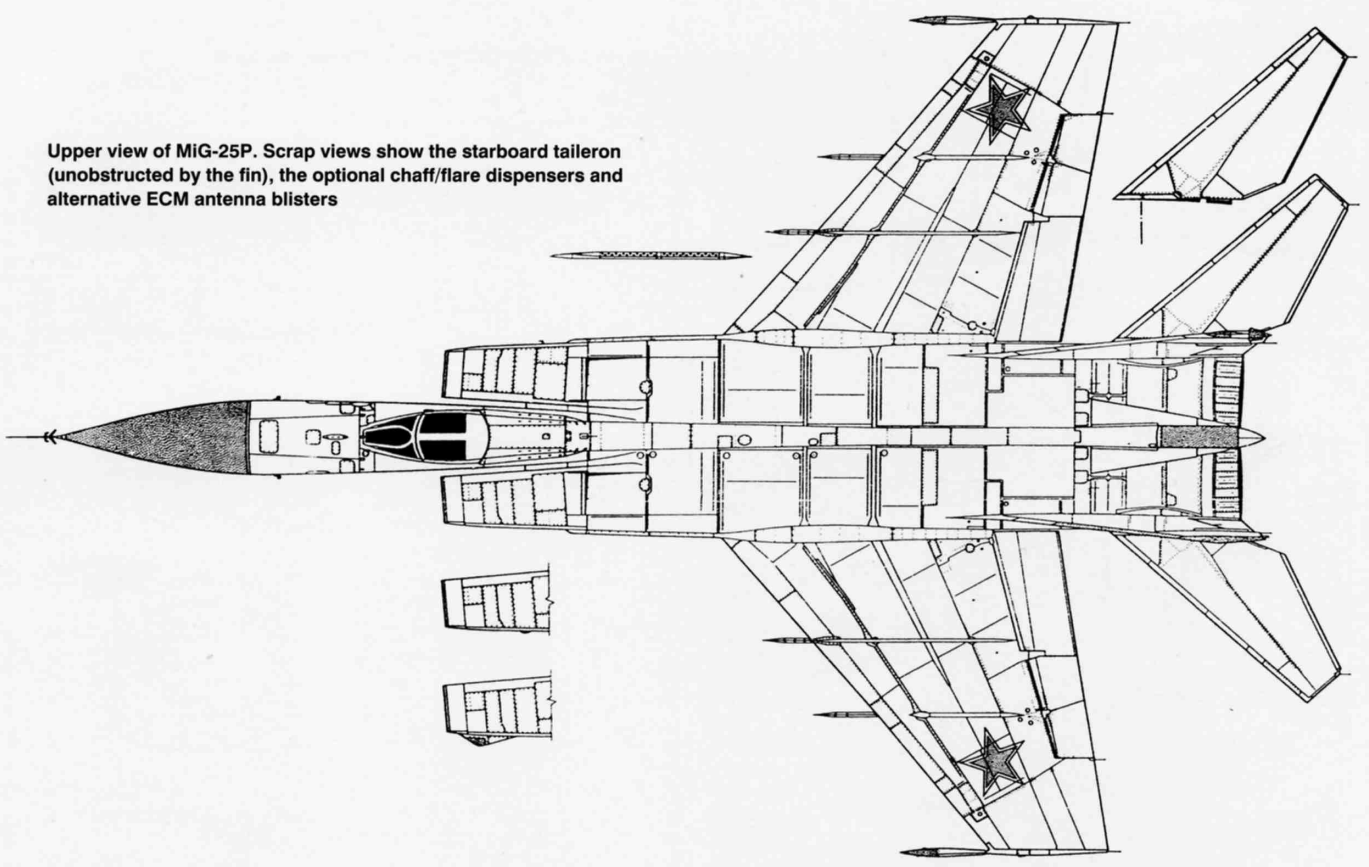

Front view of MiG-25P. Scrap views show the wing endplates of 1970-standard aircraft and the optional chaff/flare dispensers

B | C | D | E | F | G | H | J | K |

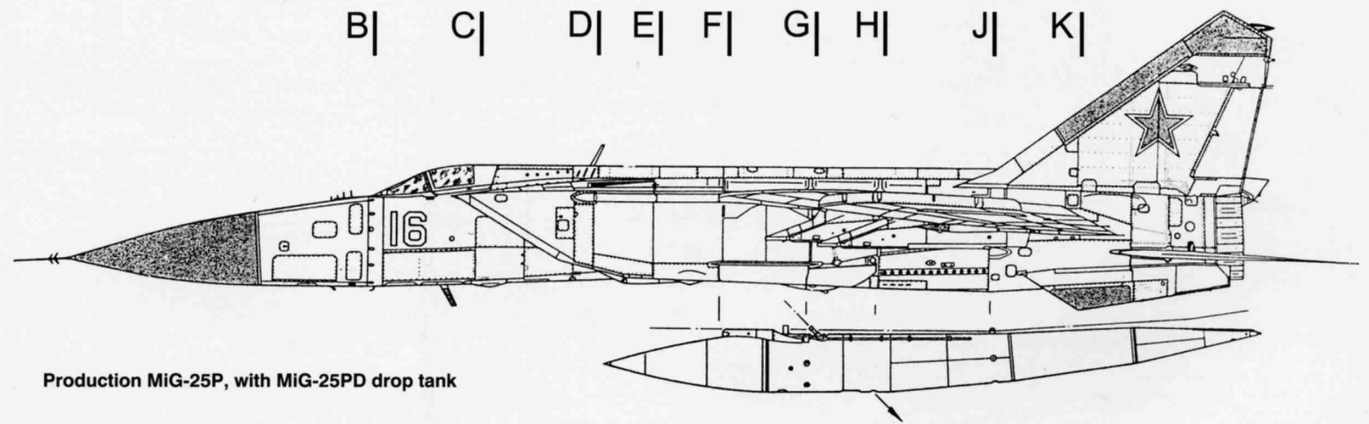

Production MiG-25P, with MiG-25PD drop tank

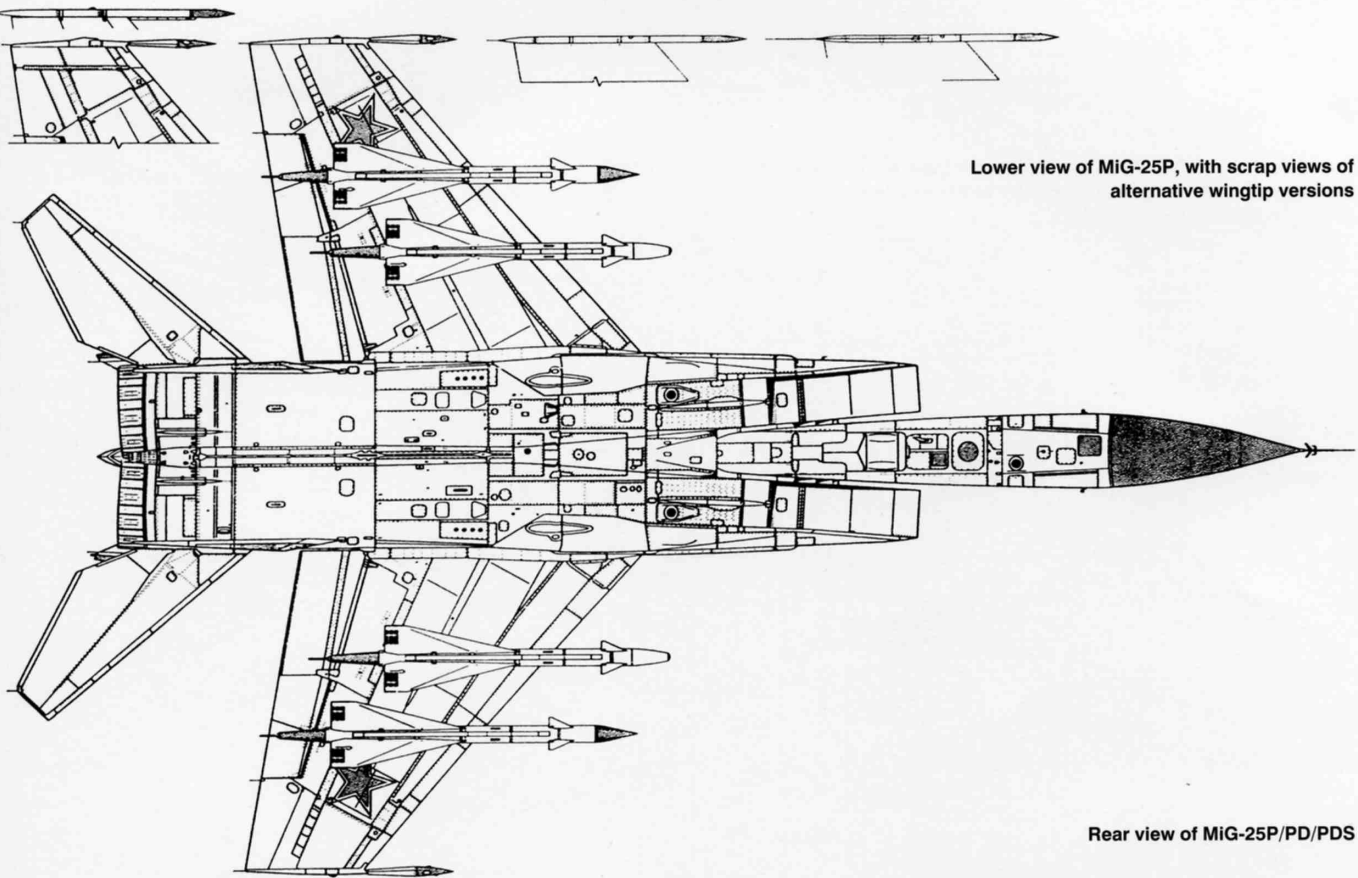

Lower view of MiG-25P, with scrap views of alternative wingtip versions

Rear view of MiG-25P/PD/PDS

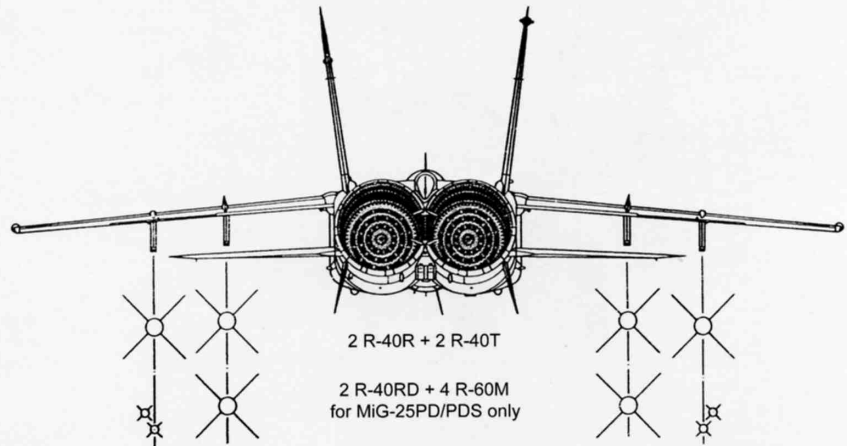

2 R-40R + 2 R-40T
 2 R-40RD + 4 R-60M
 for MiG-25PD/PDS only

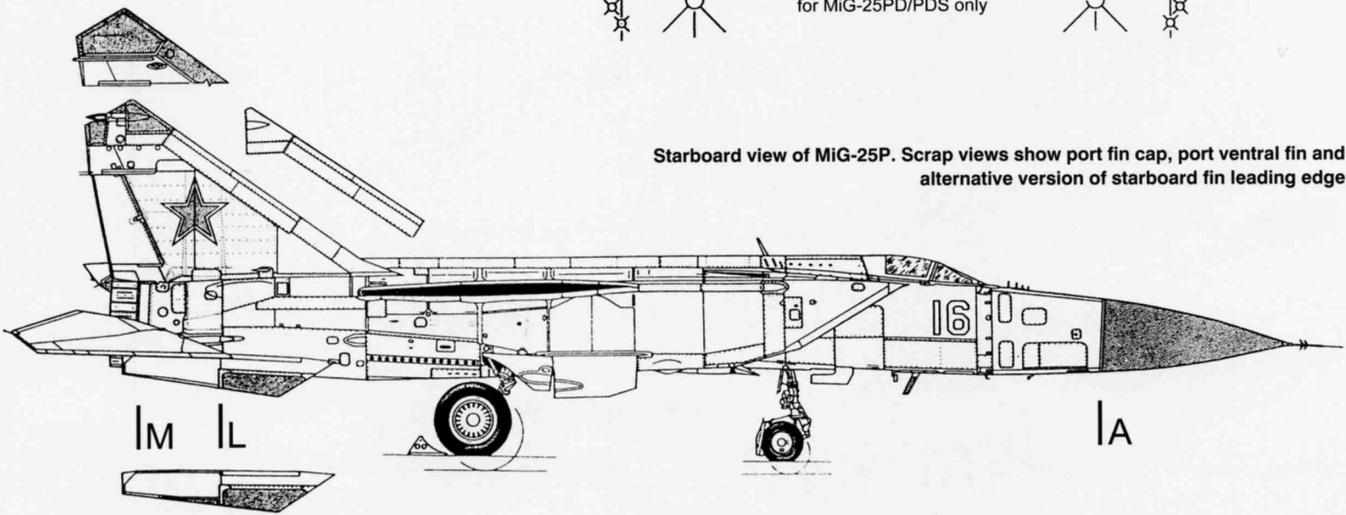

Starboard view of MiG-25P. Scrap views show port fin cap, port ventral fin and alternative version of starboard fin leading edge

IM IL

IA

Upper view of MiG-25RBV. Scrap views show the starboard taileron (unobstructed by the fin) and alternative ECM antenna blisters

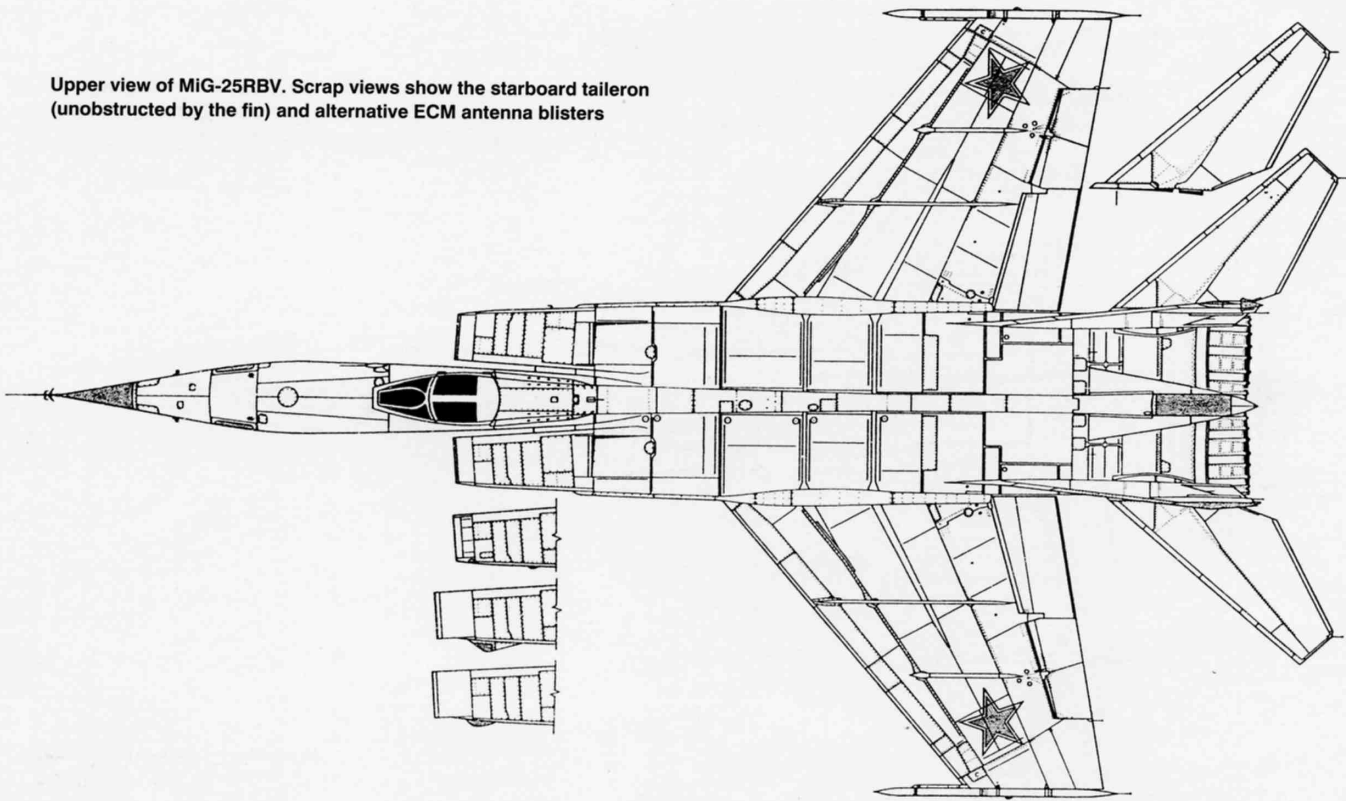

Front view of MiG-25RBV

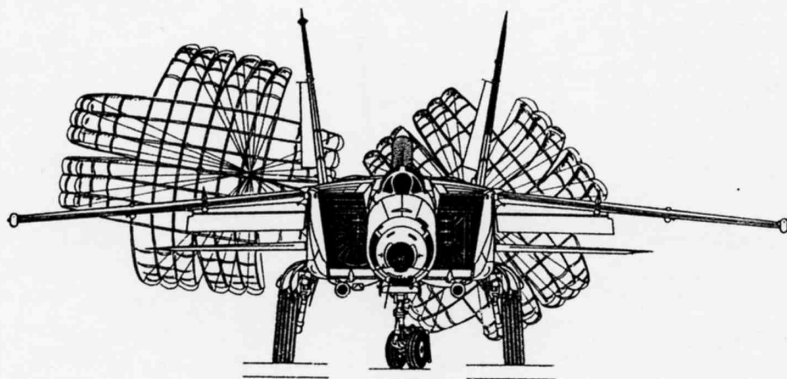

Port side view of MiG-25RBV with alternative weapons racks (left, wing installation; right, centreline installation). The fitting on the bottom drawing to the right is for the drop tank.

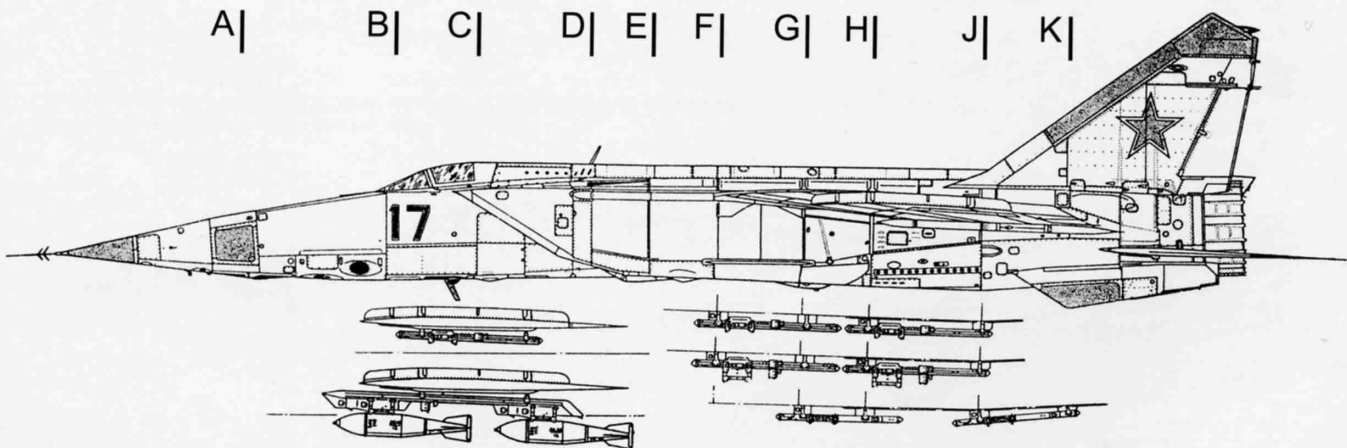

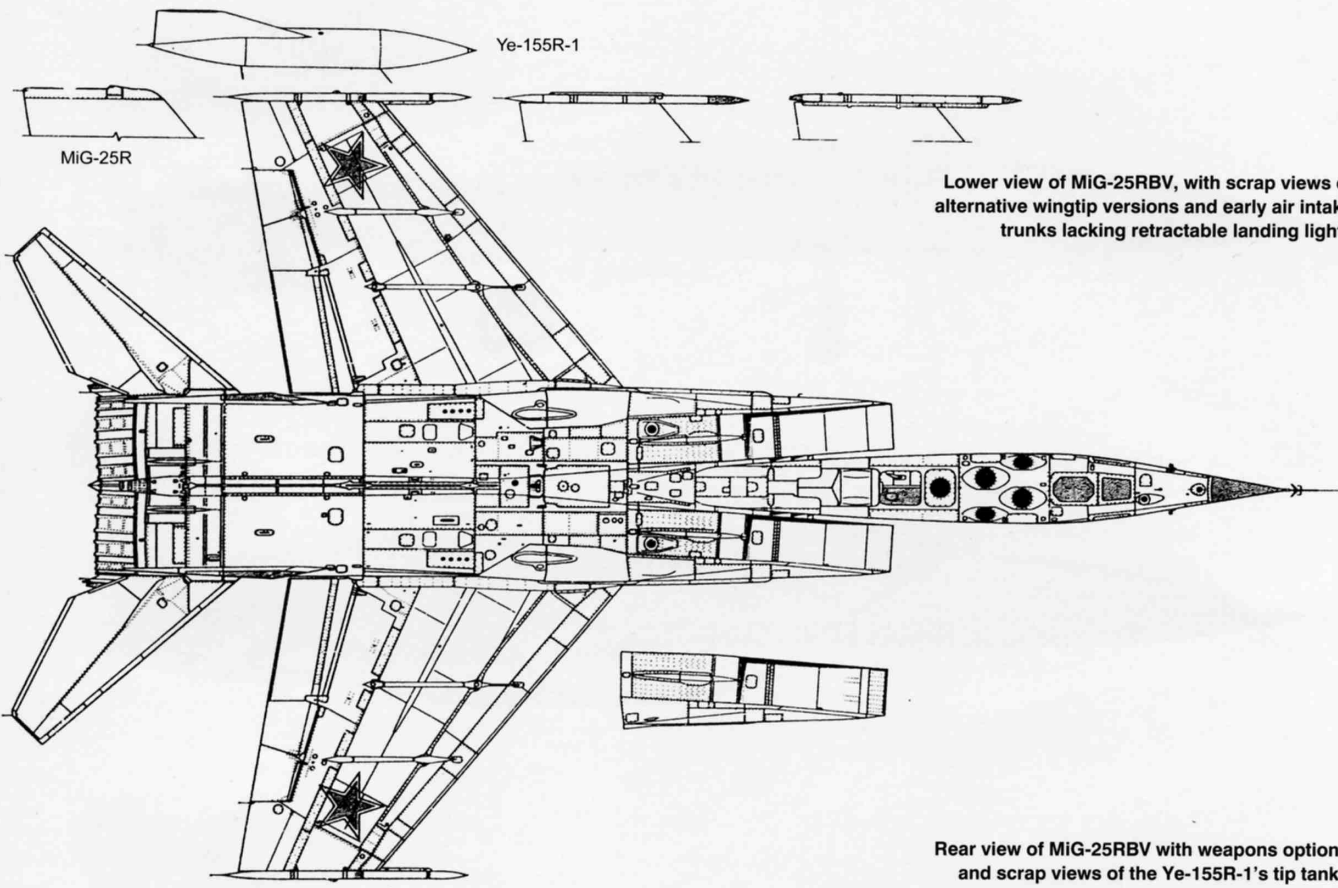

Lower view of MiG-25RBV, with scrap views of alternative wingtip versions and early air intake trunks lacking retractable landing lights

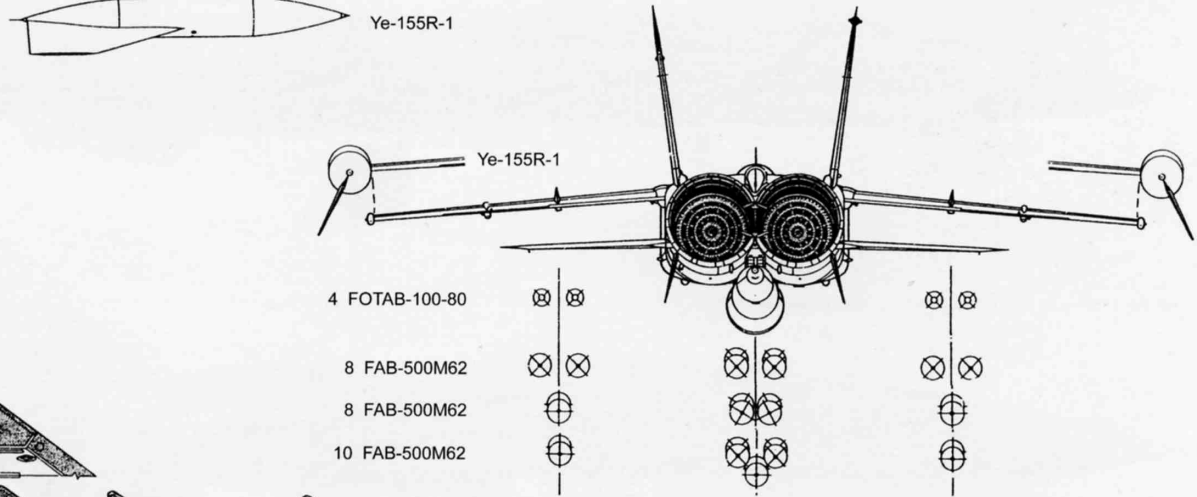

Rear view of MiG-25RBV with weapons options and scrap views of the Ye-155R-1's tip tanks

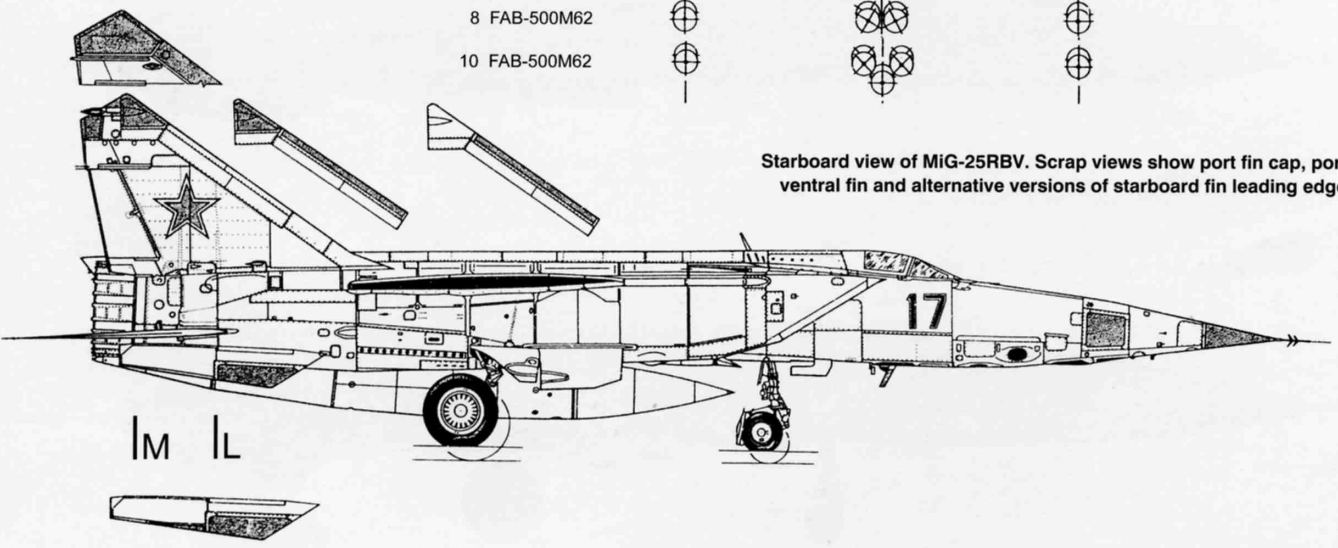

Starboard view of MiG-25RBV. Scrap views show port fin cap, port ventral fin and alternative versions of starboard fin leading edge

The Ye-155R-1



The Ye-155R-3 with drop tank attached



The Ye-155P-1 with K-40R AAMs



The Ye-155P-5 in late configuration with wing endplates

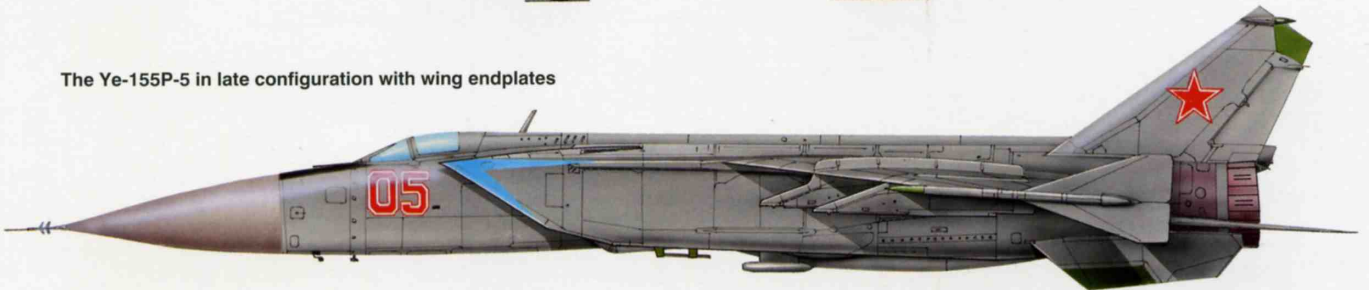

1970-model initial production MiG-25P with wing endplates, Solntsevo Junior Air Tech Staff School



The MiG-25RB prototype (Ye-155R-4B, c/n 020SA01)

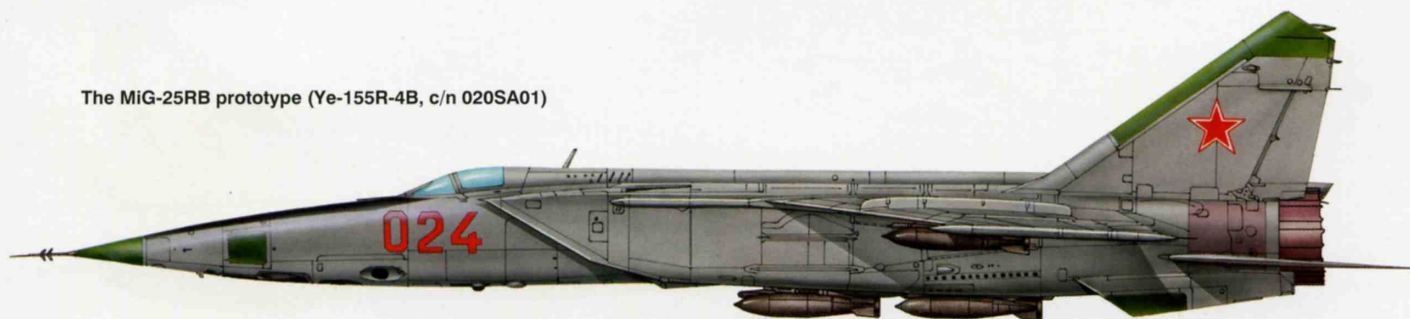

Early-production MiG-25R



MiG-25RB

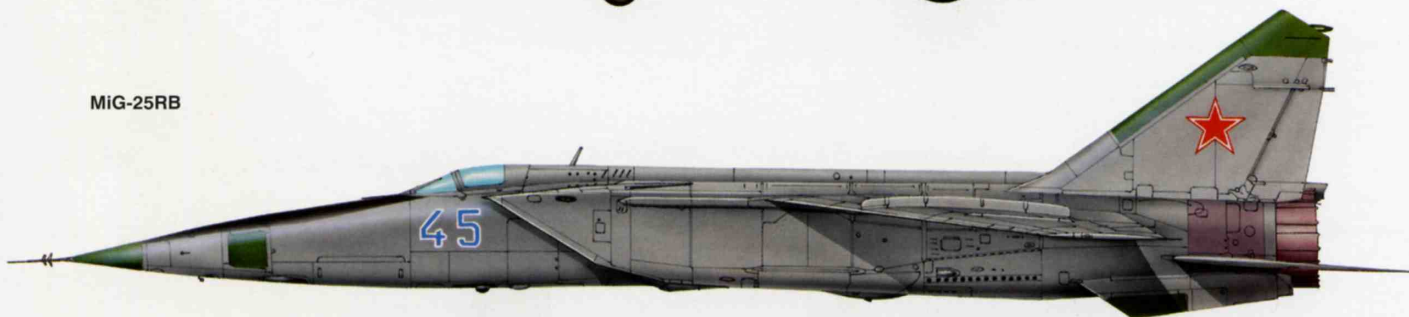

MiG-25RBS equipment testbed (c/n N02048127), 1977

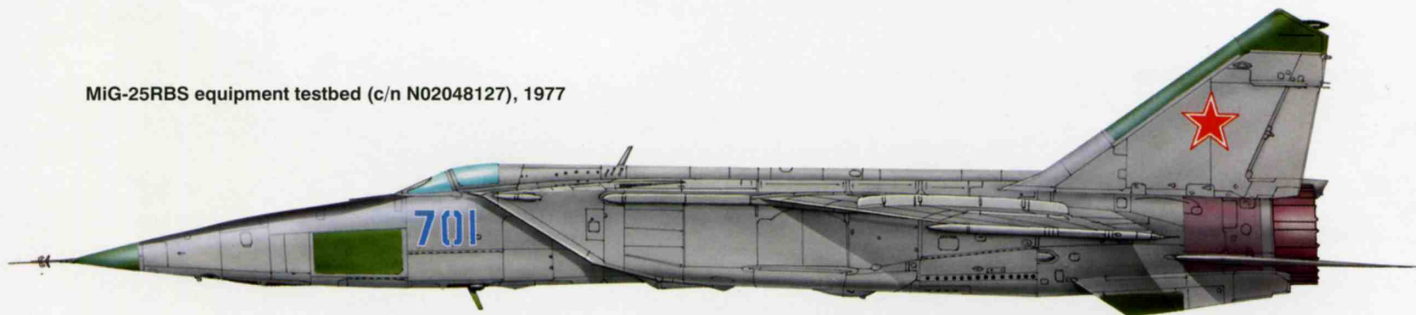

MiG-25RBT with 'Excellent aircraft' maintenance award badge

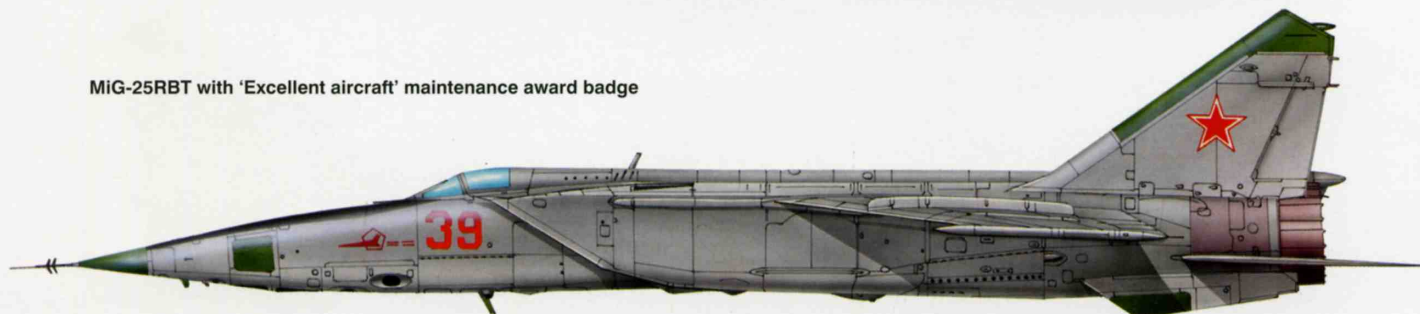

MiG-25RBSH, 1982

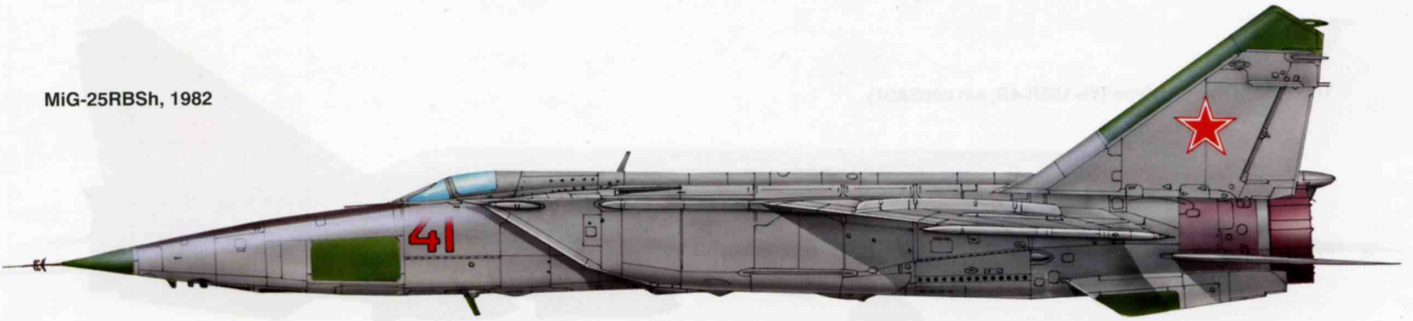

MiG-25BM, 1982

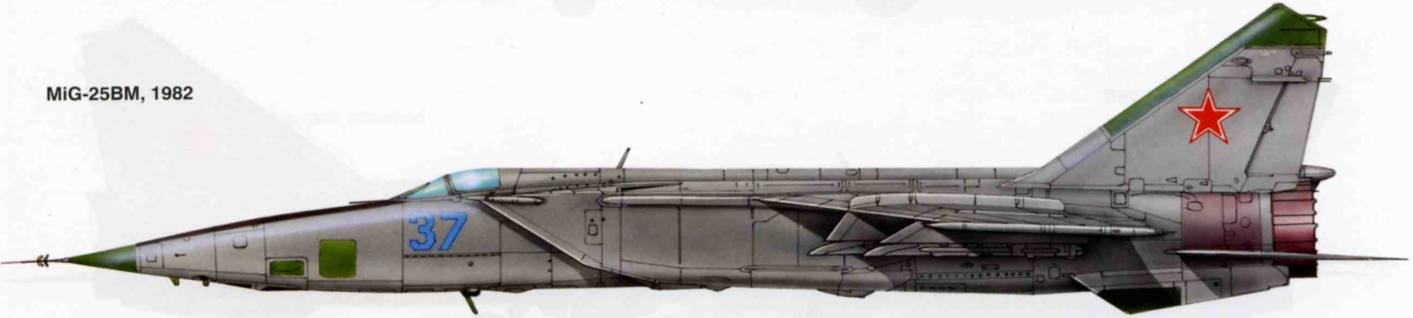

MiG-25BM with Kh-58U ARMs, 1984



MiG-25P, 1971/72 standard

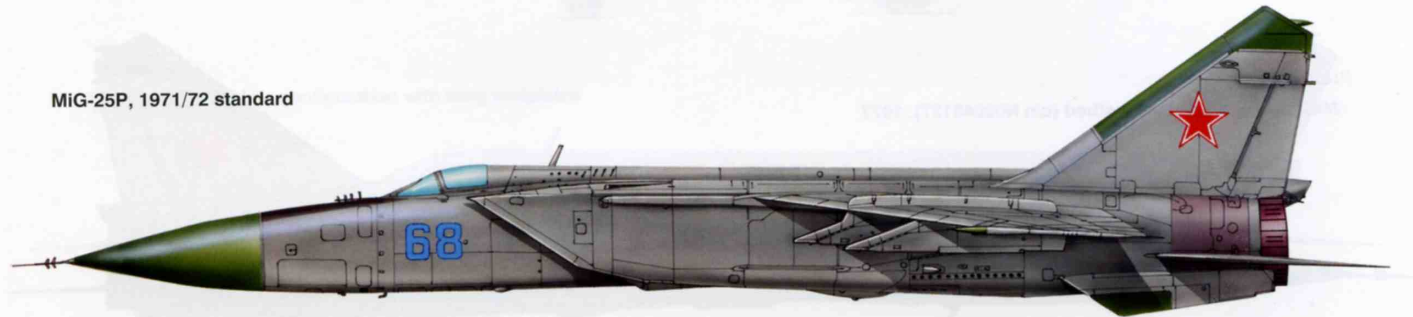

MiG-25PDS



MiG-25PD prototype (c/n N84042474)



Production MiG-25PD with 'Excellent aircraft' badge, 1979



MiG-25PU prototype



Production MiG-25PU with 'Excellent aircraft' and Mikoyan OKB badges



Production MiG-25RU in non-standard three-tone camouflage

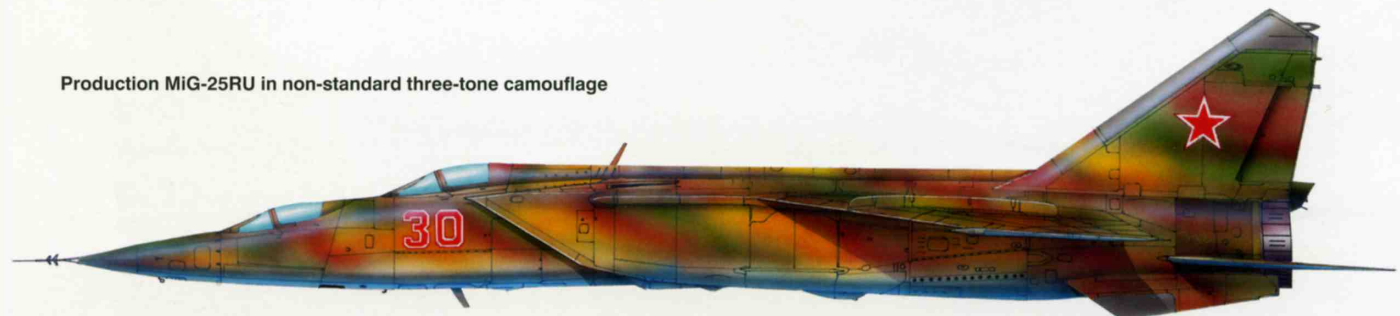



Six views of a typical MiG-25P. The drop tank is shown to indicate its position on the MiG-25PD.



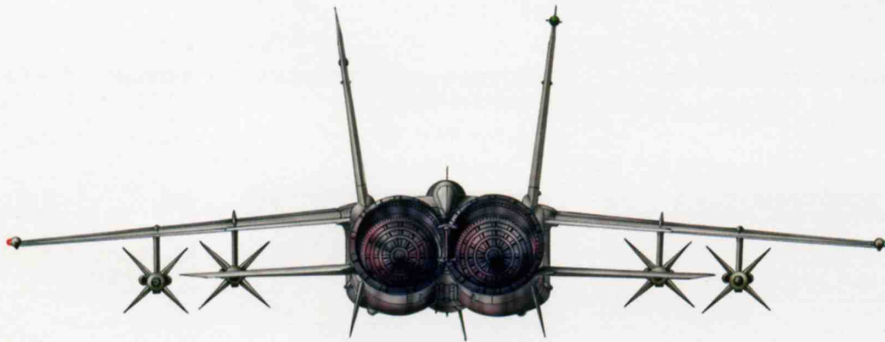

**We hope you enjoyed
this book . . .**

Midland Publishing titles are edited and designed by an experienced and enthusiastic team of specialists.

We always welcome ideas from authors or readers for books they would like to see published.

In addition, our associate, Midland Counties Publications, offers an exceptionally wide range of aviation, military, naval and transport books and videos for sale by mail-order worldwide.

For a copy of the appropriate catalogue, or to order further copies of this book, and any other Midland Publishing titles, please write, telephone, fax or e-mail to:

Midland Counties Publications

4 Watling Drive, Hinckley,
Leics, LE10 3EY, England
Tel: (+44) 01455 254 450
Fax: (+44) 01455 233 737
E-mail: midlandbooks@compuserve.com
www.midlandcountiesuperstore.com

AVRO VULCAN
Britain's Famous Delta-Wing V-Bomber
Phil Butler and Tony Buttler

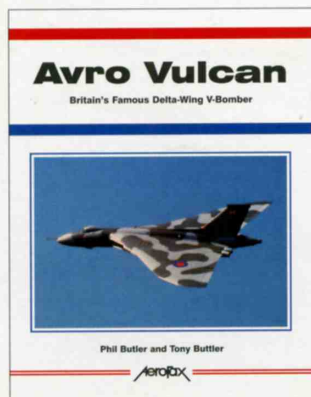

Alongside the Valiant and Victor, part of Britain's V-bomber fleet which projected the country's independent nuclear deterrent, the Avro Vulcan was one of the most famous aircraft designed and built in the United Kingdom in the post-war years. Between 1952 and 1964, 136 of the delta-winged aircraft were built by Avro. This thorough and well illustrated study in the highly successful 'Aerofax' series will attract the interest of military aviation enthusiasts across the country and beyond.

Softback, 280 x 215 mm, 176 pages
c300 b/w & colour photographs
978 1 85780 256 6 **£19.99**

TSR.2
Britain's Controversial Cold War Bomber
Joe Cherrie

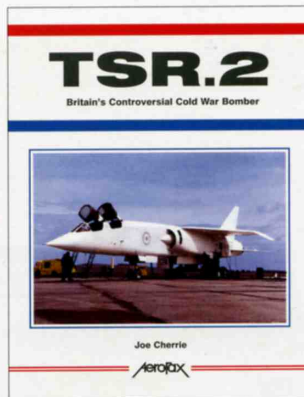

Although only flown as a prototype, the TSR.2 has become a popular and controversial subject. This book will provide an in-depth and balanced view of the project. Contains new drawings for modellers, many photographs and colour artwork and much new material, which has recently been declassified, on this beautiful, ill-fated British aircraft. This includes coverage of flight trials and other technical aspects of the programme. Competing designs from around the world, including the F-111, are also examined.

Softback, 280 x 215 mm, 176 pages,
c300 b/w & colour photographs
978 1 85780 266 5 **£19.99**

GLOSTER METEOR
Britain's Celebrated First-Generation Jet
Phil Butler and Tony Buttler

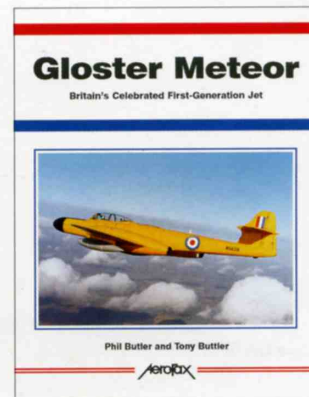

This is a celebration of one of the most successful British aircraft of all time. The Gloster Meteor first flew during World War Two and served with 16 overseas air forces as well as the RAF.

The book has a strong emphasis on the design and development of the aircraft and its initial flight testing. There are numerous data tables and details of the serials carried by the aircraft, plus many previously unpublished or relatively unknown photographs, including some rare early colour shots.

Softback, 280 x 215 mm, 144 pages
181 b/w, 71 colour photographs
978 1 85780 230 6 **£19.99**

MIKOYAN MIG-25 FOXBAT
Guardian of the Soviet Borders
Yefim Gordon

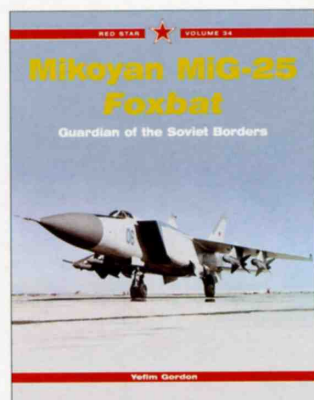

This latest 'Red Star' title examines the history, development and operational career of the MiG-25 'Foxbat', which first flew in the spring of 1964, with both the air forces of the Soviet Union and also in the many countries to which the aircraft was exported. It includes a superb range of illustrations and line drawings which supplement the author's well-informed text to provide a detailed analysis of one of the most potent and important Russian aircraft of the Cold War era.

Hardback, 280 x 215 mm, 128 pages
c250 b/w & colour illustrations.
978 1 85780 259 7 **£19.99**

LAVOCHKIN'S LAST JETS
Tony Buttler

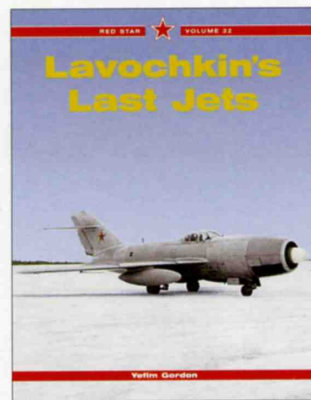

This book deals with all known variants of the later jet aircraft designs that were produced by the Lavochkin bureau, one of the less well known of the design teams who were at the forefront of the Soviet supersonic jet fighter programme from the late 1940s. Well illustrated with numerous photos and line drawings, this will be sought by all those interested in Soviet jet aircraft design era and by aviation modellers keen for unique source material.

Hardback, 280 x 215 mm, 128 pages
c250 b/w & colour illustrations.
978 1 85780 253 5 **£19.99**

BRITISH SECRET PROJECTS
Hypersonics, Ramjets & Missiles
Chris Gibson and Tony Buttler



Deals with the advanced projects through which the aviation industry sought to further high-speed flight, to prolong the effectiveness of the V-bomber force in defending the country against nuclear attack, or to develop increasingly sophisticated missiles to counter the latest threat. The book includes a detailed rundown of colour codes such as Blue Danube, Green Satan and Red Beard, used when Cold War deception was at its height.

Hardback, 282 x 213 mm, c192 pages
c300 b/w and colour illustrations,
plus drawings
978 1 85780 258 0 **£24.99**

BRITISH SECRET PROJECTS
Fighters & Bombers 1935-1950
Tony Buttler

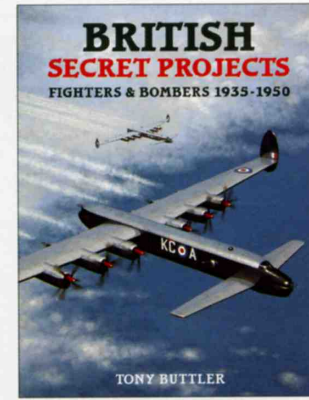

This volume again places the emphasis on unbuilt designs that competed with those that flew, and covers aircraft influenced by World War Two - projects that were prepared from the mid-1930s in the knowledge that war was coming through to some which appeared after the war was over. The latter includes early jets such as the Attacker, Sea Hawk and Venom which all flew post-war but to wartime or just post-war requirements.

Hardback, 282 x 213 mm, 240 pages
205 b/w, 16 colour photos,
plus line drawings
978 1 85780 179 8 **£29.99**



MIDLAND

An imprint of
Ian Allan Publishing

www.ianallanpublishing.co.uk

ISBN 978-1-85780-259-7



9 781857 802597

USA \$36.95 UK £19.99

Printed in England