

# THE PATEREK MANUAL

For Bicycle Framebuilders

## SUPPLEMENTED VERSION

Written by: Tim Paterek

Photography by: Kelly Shields, Jens Gunelson, and Tim Paterek

Illustrated by: Tim Paterek

Photolabwork by: Jens Gunelson

Published by: Kermesse Distributors Inc.

464 Central Avenue — Unit #2, Horsham, PA 19044 216-672-0230

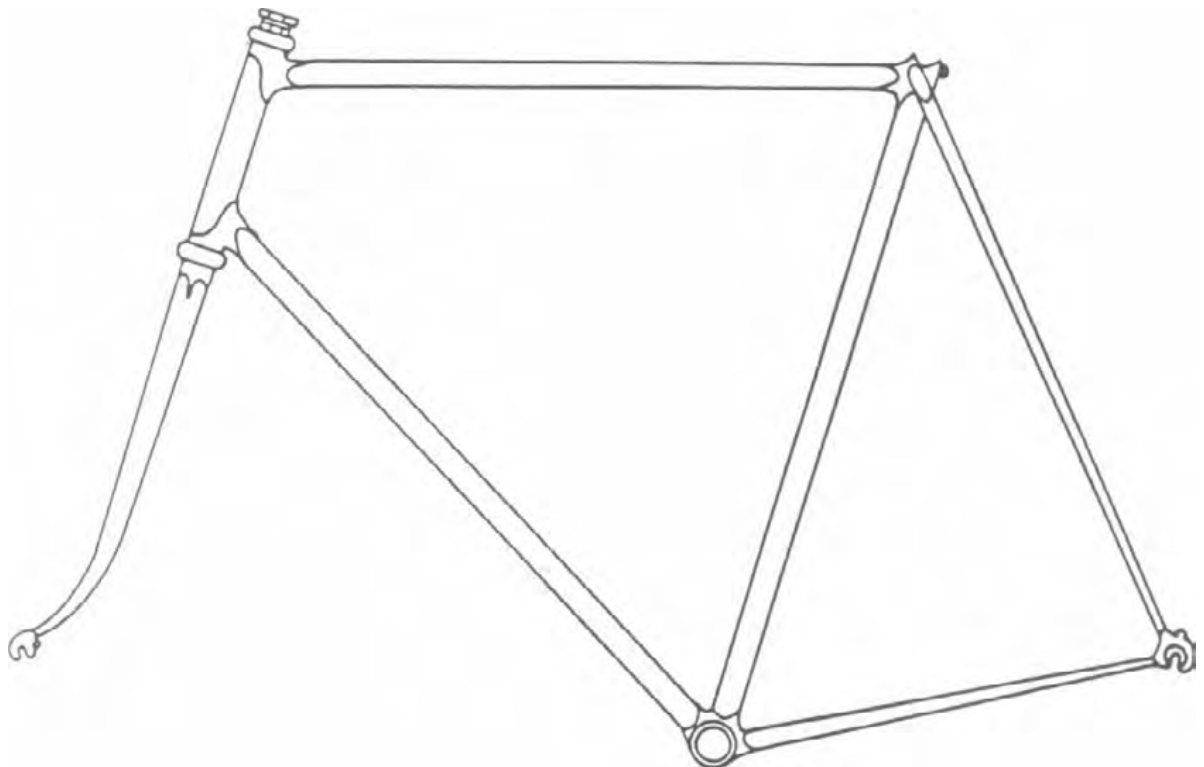

## ACKNOWLEDGEMENTS

This book would not have been possible without help from the following people:

Terry Osell  
Roy Simonson  
Kelly Shields  
Dr. Josephine Paterek  
Ginny Szalai

Chris Kvale  
Cecil Behringer  
Jens Gunelson  
John Corbett  
Steve Flagg

Special thanks must also go to:

Dr. Hank Thomas  
Dr. Joseph Hesse  
Ron Storm  
Laura Orbach  
Mary Rankin  
Todd Moldenhauer  
Susan Burch  
Alan Cambronne  
Martha Kennedy  
Bill Lofgren

Dr. James Collier  
John Temple  
Paul Speidel  
Marty Erickson  
Terry Doble  
Jay Arneson  
Harvey Probst  
Laurel Hedeem  
Bill Farrell  
Andy Bear

The following companies were particularly help ful during the writing of this book:

T.I. Sturmey-Archer of America  
Bicycle Research  
Blackburn Design  
Handy & Harmon  
New England Cycling Academy  
Island Cycle Supply  
Primo Consorzio  
Quality Bicycle Products  
True Temper Cycle Products  
Shimano Sales Corp.  
Modern Machine and Engineering

Phil Wood  
Binks  
Dynabrade  
Henry James  
Strawberry  
Ten Speed Drive  
G.P. Wilson  
Zeus Cyclery  
East side Quick Print  
Santana Cycles  
3M

## AUTHOR'S FOREWORD

There are many types of bicycle framebuilders and they can be easily categorized in the following way:

1. They offer custom geometrical specifications for each individual customer.
2. They offer any frame components the customer requests. i.e. tubing, lugs, dropouts, crown, shell, etc.
3. They offer custom finishing with a wide range of color choices.
4. They also offer the customer the option of building up a complete bike with any gruppo the customer wants.
5. Each frameset is individually built and is not in any way a mass produced unit.

It is my contention that a builder who meets all 5 of the above criteria can be considered a "comprehensive custom builder". Many builders will eliminate the number 2 option above. They find a set of lugs, tubes, crown, etc. that they like and stick with them. This usually gives their line more of a look of continuity. However, it is also the first step toward mass production. These builders I would call "limited custom builders". In addition, some builders may severely curtail options 1 and 3 as well. These builders I would call "Quasi custom builders". A builder that offers none of the above options could be called a "non custom builder". I am a comprehensive custom builder. Each frame I build is totally unique and takes 25 to 30 hours of meticulous work to build. I have close to 100 such frames on the road to date.

I know what works and what won't work in a bicycle frame. Knowledge of this sort cannot be gotten out of a book. It must be gained through trial and error and much experience. I have tried the best I know how to supply as much of this information as possible. Yet, I can't hope to get across to other builders just what a joint feels like when it initially gives during coldsetting. Nor, can I easily convey those feelings that "something just isn't right." Books cannot really get concepts like these across to people. However, books are still the most efficient way to program the human mind and we must rely on them to do so until something better comes along. There seems to be an attitude today that as soon as you read information about some subject, you are knowledgeable on that subject. In many instances, this is very far from the truth. A book is merely a jumping off point or launching pad for gaining real knowledge. Reading a book and not following it up with some practical experience is a dead end alley. What I am getting at

is - Don't read this book and then proclaim yourself an authority on framebuilding. You must build some frames before doing that. **For** most framebuilders, the first ten frames are a disaster. This book should alleviate a lot of that. No doubt, it will take about 25 frames or more for most of you to develop a level of credibility. Keep one thing in mind; each frame is easier than the one before. Here are a few ideas on how to keep your nose clean in a career of frame building.

- Don't do major work without a downpayment.
- Don't do work on a low bid.
- Don't work when you're tired or frustrated.
- Don't cut corners.
- Ride one of your own frames.
- Guarantee your own work.
- Don't withhold knowledge from someone else who wants to learn.
- Don't badmouth other builders.

Before going on to read the book, there are some basic premises laid out within it. They are:

- Silver brazed joints are superior to brass.
- Cold setting is necessary to good frame alignment.
- Investment castings are superior to stampings.
- Butted tubes are superior to plain gauge tubes.

Another item that should be mentioned at this time is that there are certain discrepancies that may appear in the book. Two come to my mind at this time:

1. On several occasions mock-ups had to be setup for the photographer. If the text is referring to working on a surface plate and the surface shown is clearly plywood or cardboard, please let it slip by.
2. A technical manual usually has the models wearing official looking work clothes with sleeves rolled up and flaps on the pockets. The photos in this book were taken in the winter in the upper midwest. My shop was rather cold at the time so please pardon the fact that I always appeared with a sweater on in the photographs.

Keeping these things in mind, you may now go on to read the book. I hope this book launches you off to as satisfying an experience as the one I have had over the last six years.

This book is dedicated to

Terry Osell

## FRAME GEOMETRY

The following is a detailed description of bicycle frame geometry. It deals with how to compute angles, clearances, and tube lengths and how those variables will affect the handling and riding qualities of a bike. This information could be of use to a framebuilder designing a frame, a salesperson selling a top quality frame, or a customer buying a top quality frame. The information that follows is based on certain standards of the industry such as; 27" or 700c wheel diameter, 1" diameter top tube, 5 to 8 cm of bottom bracket drop, and standard quill style pedals. In the case of off-road, tandem, or recumbant bicycles the rules and specs which follow may have to be modified or broken. In the case of using the following information to build frames, a high degree of precision is required. Use of a stone surface plate, vernier height gage, bevel protractor, V-blocks, and dial indicators is highly recommended. In the case of checking out one's own bike for self satisfaction, less precise tools may be used such as; strings, straight edges, carpenters' level, and an inexpensive level/protractor.

IMPORTANT:

Before starting, it is important to note two things; 1-Distances on frames will always be computed from center to center in this book. 2-An entire bicycle frame can be broken down into right triangles so that the Pythagorean theorem can be applied to find all unknowns.

SEAT TUBE LENGTH:

This is probably the most commonly used indicator to decide whether a frame is the correct size for a rider. Most often, a rider is asked to straddle a bike and lift the front wheel off the ground. On a busy Saturday, during the spring rush at the local bike shop, this will usually suffice to sell a \$200.00 machine. But when selling a top quality frame or building a custom frame, a higher degree of precision and a higher level of credibility is necessary. Tight fitting clothes or thick soled shoes will tend to cause great error with this technique. For that reason, I have developed the following simple procedure and formula to figure out seat tube length:

- A = Inseam length in centimeters with stocking feet
- B = Bottom bracket height in centimeters
- C = Crotch Clearance 4 centimeters for touring and 6 centimeters for racing
- D =  $A - (B + C)$
- E = Seat tube angle
- F = Complement of angle E

After measuring the rider's inseam and finding the other variables (B & E will be covered later), 2 sides and three angles will be known. With that knowledge, the Pythagorean theorem can be applied to find the seat tube length. The following formula will give the seat tube length. All that is needed is a hand held scientific calculator:

$$D [\sec (F)] = \text{Seat Tube Length}$$

OR:

$$D [\operatorname{cosec} (E)] = \frac{\quad}{\sin(E)} = \text{Seat Tube Length}$$

The following diagram should clarify any question which may arise:

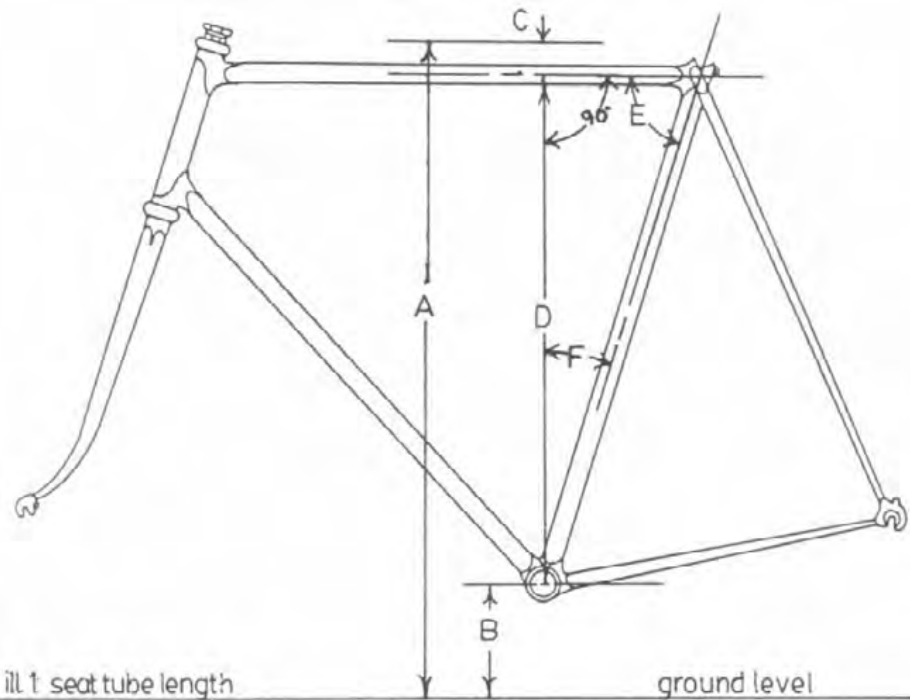

ill 1 seat tube length

ground level

It is a common practice of bicycle sales personnel to measure the seat tube length from the center of the bottom bracket to the top of the top tube (point X). In the designing of bicycle frames, it is more convenient and probably more accurate to measure from the center of the bottom bracket to the intersection of the centerlines of the seat and top tubes (point Y). Measuring to point X will make it sound as though the frame is larger than if the measurement is taken at point Y. There is a difference of about 13mm between the two ways of measuring. As long as this difference is taken into account, both methods are acceptable.

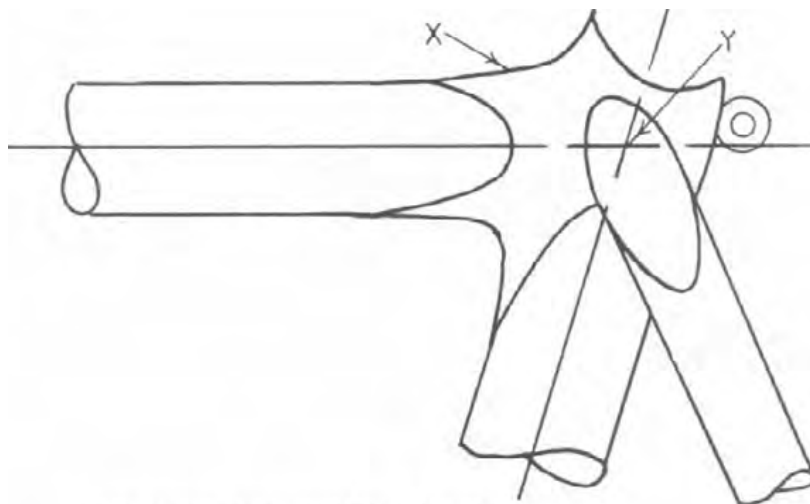

ill 2: measuring seat tube length

TOP TUBE LENGTH:

Top tube length and seat tube length go hand-in-hand. There isn't **really a neat formula to** give top tube length because of what is trying to be accomplished with that measurement. In the case of smaller bikes, with a seat tube length of about 49 cm, too short of a top tube would give far too much pedal overlap with the front wheel. Overlap of 2 to 3 cm. is nothing to worry about. Ideally, no overlap is preferred which is easily achieved in bikes with seat tubes of 55 cm or more. However, if the top tube grows in length at the same rate as the seat tube, a 65 cm frame has such **a long wheel** base that a very "whippy" bike is the result. Hence, on smaller bikes, the top tube is made long for safety and on taller bikes, the top tube is kept short for a more solid feeling in handling. The difference in the rider's reach can be compensated for with a longer or shorter stem. That is the reason a short stem is usually seen on a small bike and a long stem is usually seen on a tall bike. The following chart shows the top tube length to use for **the seat tube** length being used:

<u>S.T.</u> <u>LENGTH</u>	<u>T.T.</u> <u>LENGTH</u>	<u>S.T.</u> <u>LENGTH</u>	<u>T.T.</u> <u>LENGTH</u>
49.5 cm	51.5 cm	58.0 cm	57.3 cm
51.0	52.7	59.0	57.9
52.0	53.8	60.0	58.5
53.0	54.3	61.0	59.1
54.0	54.7	62.0	59.5
55.0	55.4	63.0	60.1
56.0	56.1	64.0	60.5
57.0	56.7	65 & up	60.8

The figures in the chart can be altered a centimeter in each direction and a very rideable bike will result. Some riders may request a radical variation from this chart due to an extremely short or long torso in relation to the legs or due to extremely long or short arms in relation to the rest of the body. If the difference cannot be compensated for in stem length, then modifications in the above chart becomes necessary.

It should be mentioned here that the length of the top tube can be altered a centimeter **or more in each** direction while **keeping** the wheelbase the same. This can be done by altering the seat tube and head tube angles and at the same time, changing the rake to match the new head angle.

STEM LENGTH:

A comfortable balance between stem length and top tube length is necessary. If the frame is prebuilt,



picking a stem is easy. If the frame is going to be built for the rider, then top tube length and stem length must be juggled. By taking the measurement of 1 cubit (the distance from the rider's elbow to the fingertips) and superimposing this onto a full size drawing of the bike to be built, the stem length can be found. The following diagrams should help clarify this:

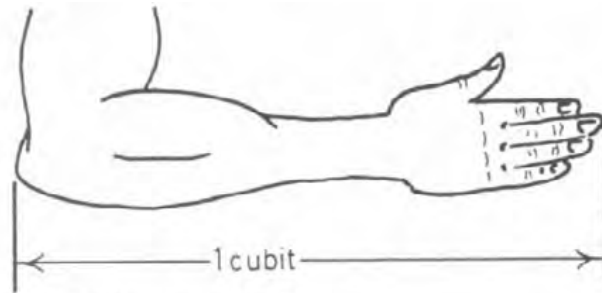

ill. 3: measuring a cubit

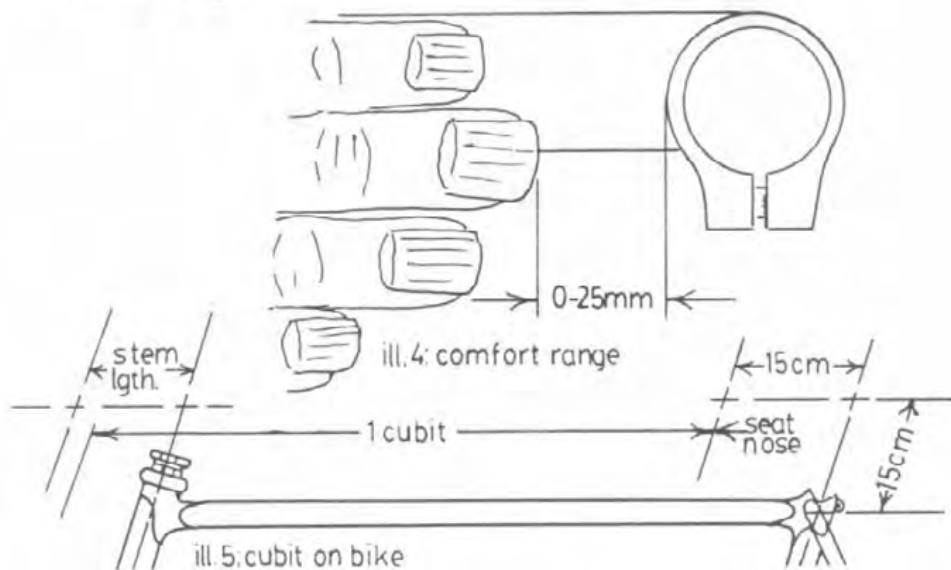

The comfort range for most riders will be to have the fingertip of the middle finger fall 0 to 25 millimeters behind the back surface of the handlebars. Generally a racer or a taller person may want to go for 25mm and a tourist or shorter person may want to go for the 0 measurement.

To further check for the correct distance from the saddle to the bars, the rider can mount the bike. While sitting on the saddle and hands gripping the drops, a plumb line can be dropped from the bridge of the nose. This vertical line should fall approximately in the center of the bar to be in the comfort range.

#### STEM LENGTH AND TOP TUBE LENGTH

The combination of stem length and top tube length can be computed by a simple formula. Note in the illustration how to find the torso measurement (TM) and the arm measurement (AM). The formula is very simple:

TM + AM

2.3

This will give a starting point to work from. By using a combination of the seat/top tube length chart, the cubit method, the above mentioned formula, and rider preference, a happy medium should be able to be found. Keep in mind that all of these methods only give starting points from which to work and should not be considered absolutes.

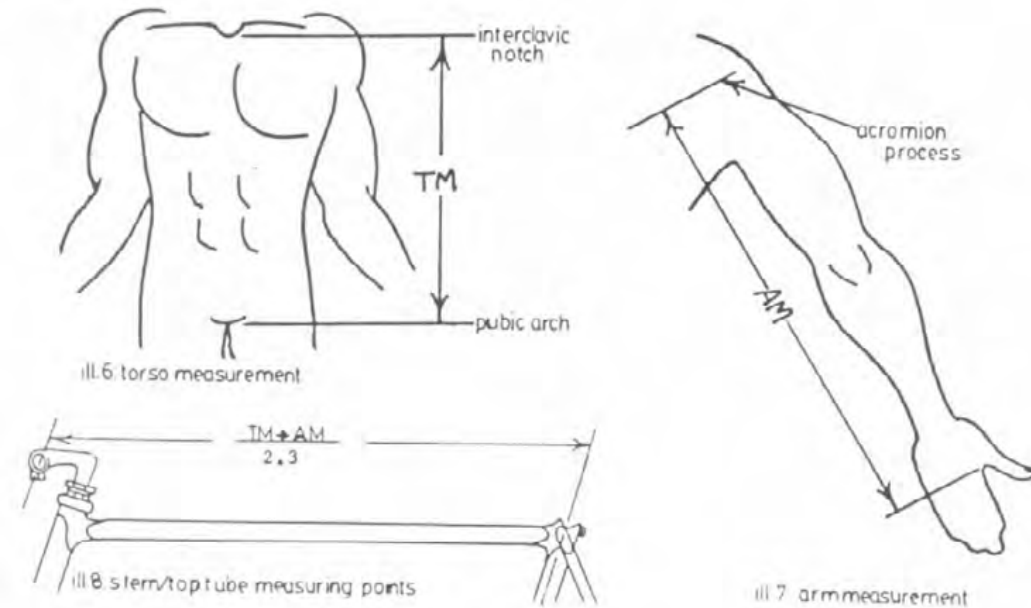

CRANK LENGTH/SEAT TUBE ANGLE/FORE & AFT SADDLE  
ADJUSTMENT RELATIONSHIP

This is a delicate arrangement and when set up correctly will give the rider a proper power stroke. With the cranks in a horizontal position, feet in toe clips, and rider on drops - a plumb line can be dropped from just below the rider's knee. If all adjustments are correct, the plumb line will drop through the ball of the foot and the center of the pedal. For more information of sizing, see The New England Cycling Academy - THE FIT KIT in the resource list in the back of the book.



ill 9. accommodating thigh length

#### STEERING GEOMETRY:

Steering geometry is very complex and was not really understood for many years. Not until our bike boom, computerized society and high tech world did people start to research out why bicycles steered the way they did. For decades bicycles were built by trial and error. People didn't really know why some bikes steered poorly and others handled well. But, when they hit on a bike that worked, they stuck with it. Today we know that the careful balance of the head tube angle and the fork rake will give us a measurement called "trail". It is this trail measurement that builders of decades ago were striving for without knowing it.

#### HEAD TUBE ANGLE:

This is the measurement off the horizontal plane that the head tube sits at. Head tube angles usually occur in the narrow range of 70 to 75 degrees with anything more or less being rather undesirable. The head tube angle must be matched to the amount of rake on the fork to produce a bike with desirable handling.

Head tube angles in the lower ranges (70 to 72 degrees) are considered to be good for off-road use or touring. They produce a softer ride and a more resilient front end. Head tubes in the mid-range (73 degrees) are considered to be good for general purpose or sport/touring. Head tube angles in the upper range (74 to 75 degrees) are considered to be good for racing because of the stiff feeling they produce in the handling. Most bikes are built with head tube angles in 1 degree increments but some builders with more patience, better equipment and a better eye build in 1/2 degree increments.

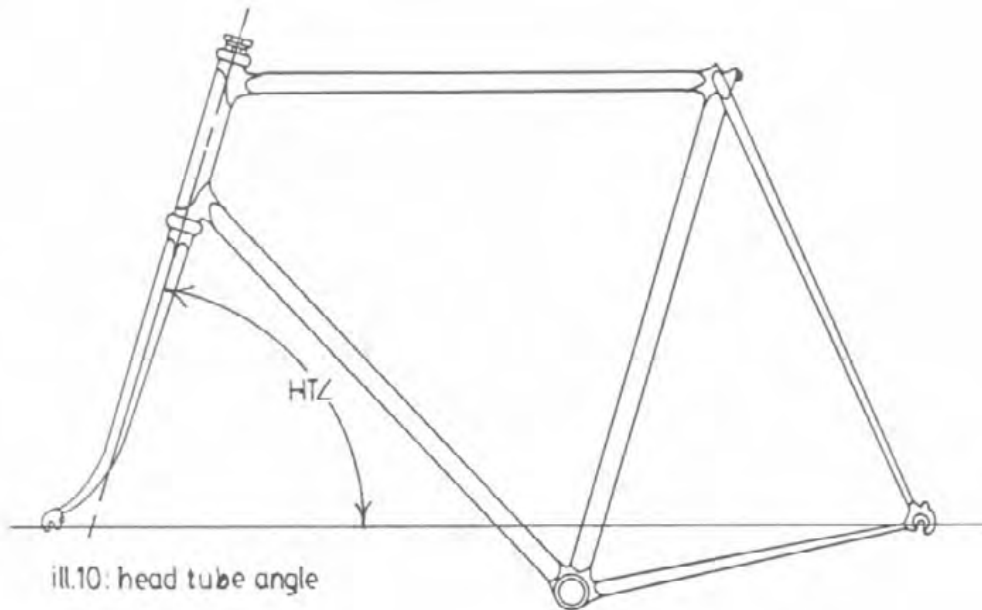

**FORK RAKE:**

This is the distance in front of the head tube center line that the front axle will set. In simple terms, it is the amount of offset in the fork. The diagram below should help explain rake better:

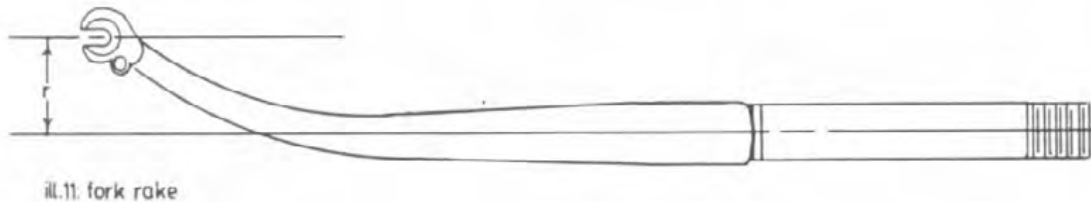

Fork rake must be carefully matched to the head tube angle to produce a bike with desirable handling characteristics. Generally speaking, forks with more rake are considered better for touring because of their ability to absorb more road shock. Forks with less rake are considered better for racing because of the more sensitive feel of the road they afford.

**TRAIL:**

Trail can be found by supporting the bike on a flat surface in an upright position for measuring purposes. A centerline is run down through the head tube until it hits the flat surface. A vertical line is then dropped

from the front axle until it hits the ground. The distance between these 2 points on the ground is the trail. The comfort range of trail is 50 to 70 millimeters. Beyond these limits in either direction would be considered less desirable. The diagram which follows shows in more detail how to find trail:

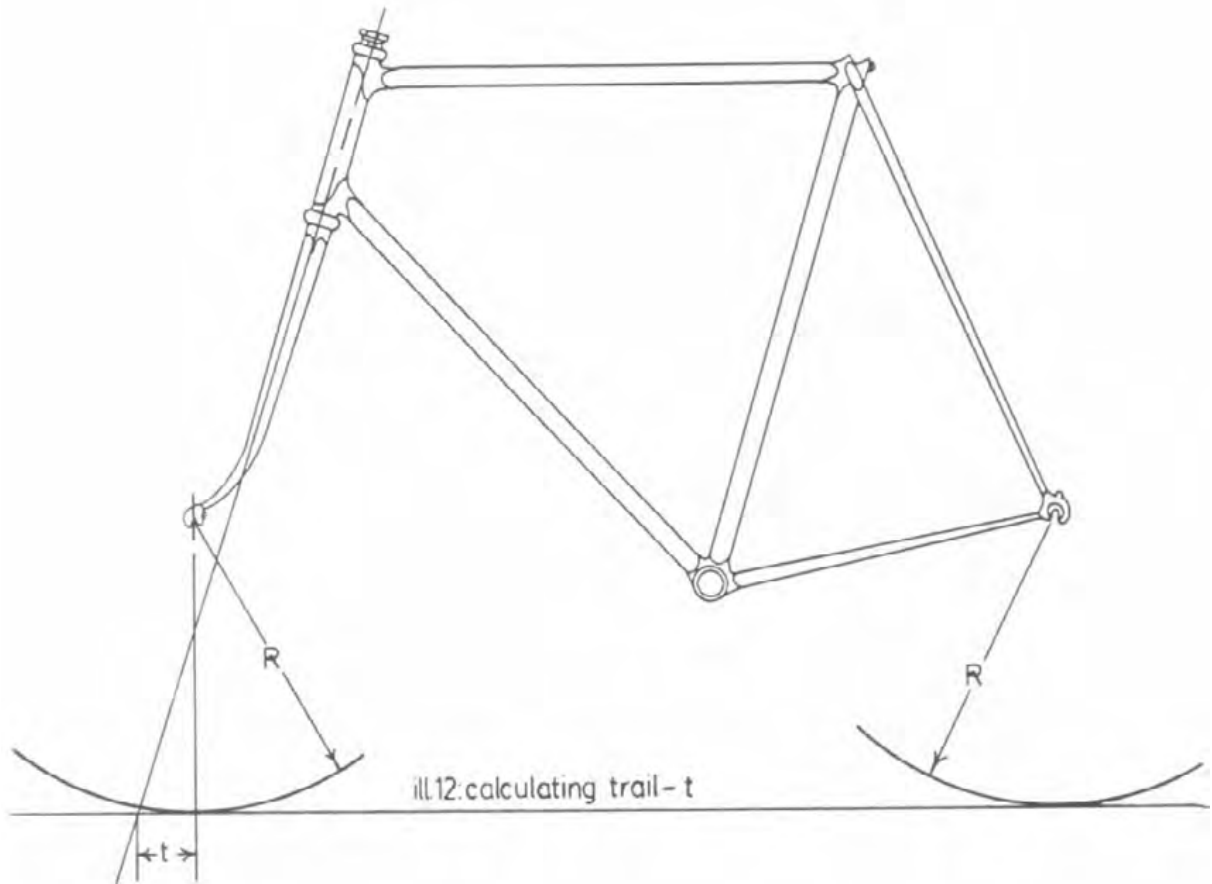

The following formulae will give the trail if rake, head angle, and wheel radius are known:

R = Wheel Radius  
 r = Rake  
 t = Trail  
 α = Head Angle

$$t = \frac{R \cos (\alpha) - r}{\sin (\alpha)}$$

$$r = R \cos (\alpha) - t \sin (\alpha)$$

Both formulae can be easily worked out on a scientific calculator. By experimenting, one can see that many combinations of wheel radius, rake, and head angle will give trail readings in the comfort range. By further checking one can find that, often, highly successful bikes in the past had trail readings in the comfort range. This was accomplished through trial and error and by continuing the manufacture of something that worked well.

## SOME MISCONCEPTIONS ABOUT TRAIL

### RISING AND FALLING OF THE HEAD TUBE:

One theory in existence only a few years ago was that the head tube on some bikes would drop as the rider turned to the side and other bikes would rise as the rider turned to the side. And further still, other bikes were supposed to stay level as the rider turned from side to side. The theory goes further to state that the first type described was hard to keep going in a straight line, the second was hard to turn and, of course, the third was a bike with desirable handling. In actuality, all bikes will drop as you turn to the side until you reach about 60 degrees in your turning, then they rise sharply. Apparently it was only a theory that no one did any research on for quite a while.

### POSITIVE-NEUTRAL-NEGATIVE STEERING

Another theory was developed during the time that knowledge about trail was still being formulated. This theory stated that bikes with less than 50mm of trail were quick or skittish. Bikes with over 50mm of trail were soft or sluggish. And, of course, bikes with 50mm of trail were supposed to be neutral bikes that had ideal steering characteristics. In actuality, trail is more on a continuum with the comfort range happening to occur at 50mm to 70mm.

### \*THE DAVISON FORMULA:

According to the Davison formula, a good handling bike had to have rake and trail equal each other. He even had the following formula to back him up:

$$\text{if } r = t$$

$$r = \frac{R \cos \alpha - r}{\sin \alpha}$$

$$r \sin \alpha = R \cos \alpha - r$$

$$r (1 + \sin \alpha) = R \cos \alpha$$

$$r = \frac{R \cos \alpha}{1 + \sin \alpha}$$

His formula was closely associated with the rising and falling theory stated above. In actuality, the theory that bikes with desirable handling must have rake and trail equal only works in a limited number of

\*A.C. Davison was active in the bicycle community in the mid 1930's.

combinations and cannot be used to work for all situations.

#### SEAT TUBE ANGLE:

The seat tube angle is probably one of the less critical factors in frame geometry. It is true that a rider placed more directly over the bottom bracket will have a better power stroke than one that is placed further back. However, sliding the saddle forward on the rails can have the same affect as using a steeper seat tube angle. Moving the saddle horizontally 1cm approximately equals 1 degree. In some cases a rider may have an unusually long or short thigh in relation to the rest of the body. In this case putting the saddle back or using a shallower seat tube angle could make up for a longer thigh. Conversely, moving the saddle forward or using a steeper seat tube angle could make up for a shorter thigh. Seat tube angles normally occur in the range of 72 to 74 degrees. An angle of 73 degrees could be considered average for general purpose use. Exceeding the 72-74 range should only be attempted in the case of a rider with leg anatomy that is beyond the normal range.

Generally speaking, a framebuilder is safe to build all bikes with a seat tube angle of 73 degrees. The following diagram shows how seat tube angle is measured.

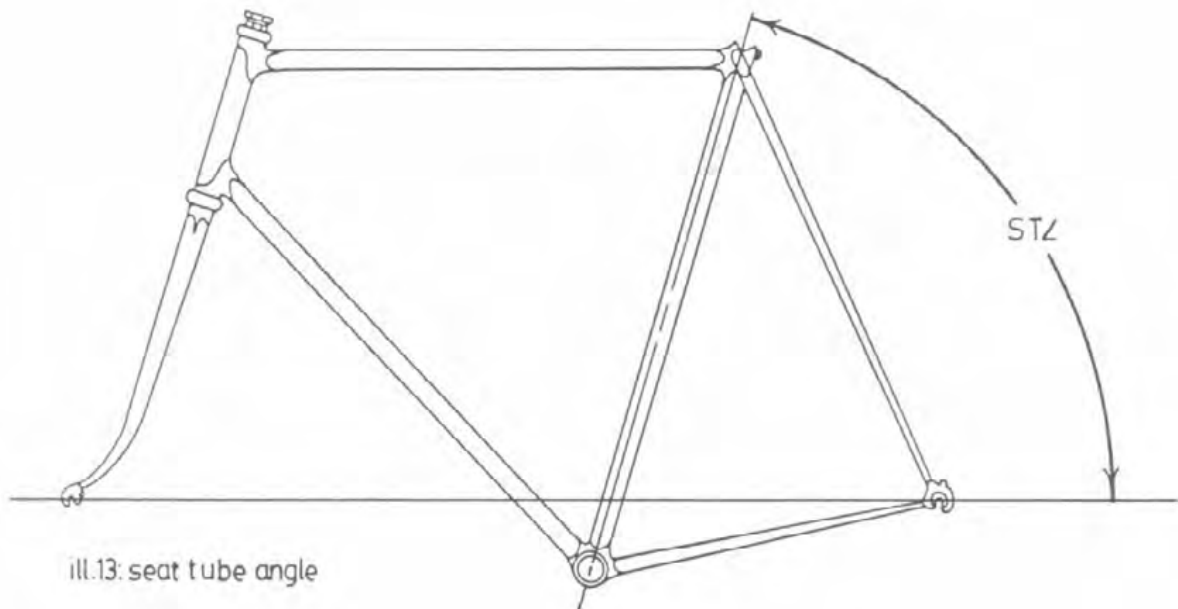

## FRONT CENTER:

This is the measurement from the center of the bottom bracket to the **center of the front axle**. It is this measurement that will tell if there will be overlap between the front tire **and the toeclip**. An ideal front center measurement is around 58cm. At 58cm there is usually no overlap and the bike still has a relatively short wheelbase (depending on chainstay length). Of course, it is harder to maintain a front center of 58cm on shorter and taller bikes due to what has to be done with top tube length. Bikes with a seat tube length of 55 cm to 58cm will often turn out having a front center of approximately 58cm - unless something drastic is done with top tube length and head tube angle. Another factor to consider is weight distribution. Normally, 55% of a rider's weight is over the rear wheel and 45% over the front wheel. A short front center will alter this a small amount and will change the ratio to slightly more weight over the front wheel whereas a longer front center will put slightly less weight over the front wheel. What does this say? There is a slight possibility that a rider with more massive shoulders and arms may have a little trouble with an extremely short front center and a rider with a very slight upper body build may have a little trouble with a longer front center measurement. However, it is the feeling of the author that this might be getting in to a hairsplitting situation and that the front center might not be that much worth worrying about. The sketch below shows how to measure front center:

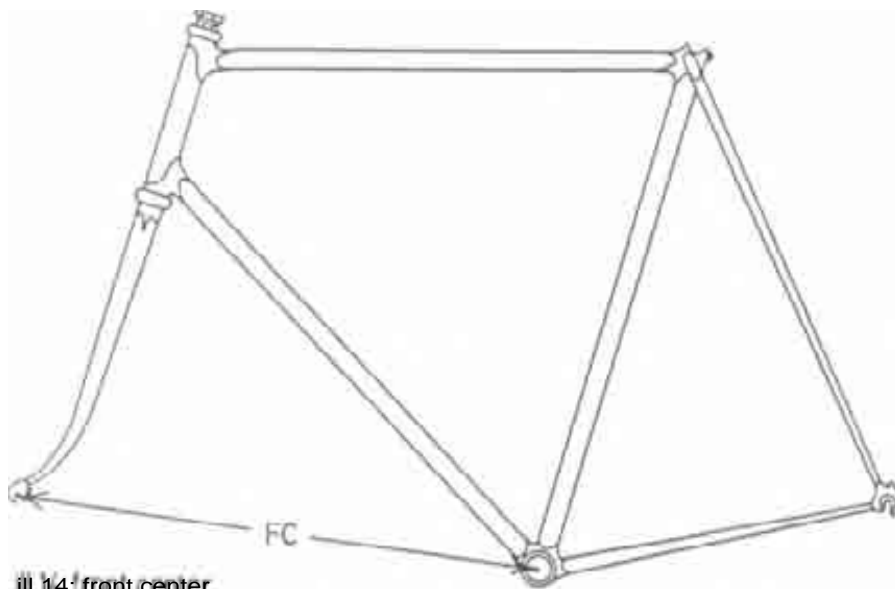



It should also be mentioned that moderate pedal overlap is not really critical. Even with significant pedal overlap, the toe cannot come in contact with the tire unless the rider is making a U-turn in the road or at least going very slow.

#### BOTTOM BRACKET DROP:

While looking at a bike frame it is easy to see that the center of the bottom bracket is located at a lower height than the center of the axles. This difference in height is called bottom bracket drop. (Some manufacturers refer to it as bottom bracket height. In this case, the reference point is the ground not the axles) Typically bottom bracket drop is between 5cm and 8cm and most builders will stay within a closer range still (5.5cm to 7.5cm). Generally speaking, high bottom brackets are more desirable for racing and low bottom brackets are more desirable for touring. \*Since maneuverability and cornering ability are of importance in racing, a rider does not want a factor to keep the bike from executing a corner at a critical moment. Pedaling into a corner would be one such critical moment. If the pedal on the inside of the turn is down while leaning heavily into the turn, the pedal could scrape the ground. Scraping the ground at such a time could be totally disastrous! For this reason a high bottom bracket is important for racing (particularly in criteriums where maneuverability can mean winning or not and in the case of track racing where the angle of the banked track can be difficult to judge for some riders). A high bottom bracket can allow a racer to lean 1 or 2 degrees more while cornering (A shorter set of cranks would also allow this). Since a tourist does not have to worry as much about maneuverability, a high bottom bracket is not necessary. Tourists usually go at a more relaxed pace and while executing a corner, have time to position the inside pedal in an upward position. This being the case, scraping pedals should almost never occur while touring. On the other hand, a tourist may even desire a lower bottom bracket. A lower bottom bracket would lower the load on the bike by as much as 2cm and hence, lower the center of gravity significantly. This would produce a more stable bike that would "cruise" down the road more comfortably. Average bottom bracket drop could be considered to be 7cm and a builder could be safe in building most bikes with that amount of drop. The diagram following shows how bottom bracket drop is measured:

\*Criterium and track bikes should be built with high bottom brackets. Bikes used for long road races, time trialing and touring should have low bottom brackets.

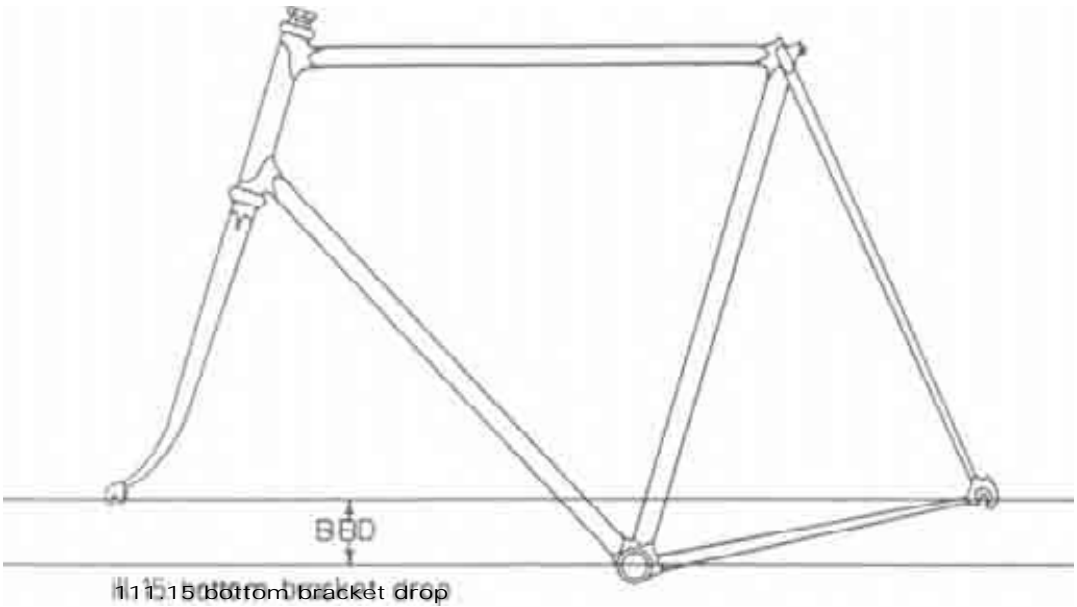

CHAINSTAY LENGTH:

Chainstay length is measured from the center of the bottom bracket to the center of the rear axle and the range is usually from 40cm to 47cm. Typically short chainstays are seen on racing frames and long chainstays are seen on touring bikes. In figuring chainstay length, things are not critical when using longer stays for touring. However, a builder must be careful when building **racing frames with short stays**. Some frames have such short stays that only low profile silk sew-ups can be used for two reasons; 1-The tire might hit the backside of the front derailleur clamp, 2- If not using vertical dropouts, the tire may have to be deflated to install or remove the wheel.

The following breakdown of advantages and disadvantages of long and short chainstays for racing and touring should help the reader understand this variable better.

	ADVANTAGES	DISADVANTAGES
SHORT STAYS	<p><b>Shorter bike</b> for better maneuverability particularly in a close pack of riders. Less energy lost in frame flex. A very small weight savings can be noticed. Better for climbing steep grades.</p>	<p>Wheel removal and installation can be hampered with really short stays. Ovaled or crimped stays <b>absolutely</b> necessary for side-to-side tire clearance. Problems with cross-over gears are accentuated.</p>

---

ADVANTAGES

DISADVANTAGES

Use of wide ratio triples is almost out of the question. Dissipates road shock poorly.

---

LONG STAYS Less trouble with cross-over gears. Absorbs road shock well. Handles wide ratio triples well. Allows room for use of fenders. Tracks well on the road. Weight spread over greater area better for loading.

Makes bike long and "whippy". Adds a very small amount of weight. Some energy loss due to frame flex. Poor maneuverability.

---

The following diagram shows how chainstay length is measured:



ill. 16: chainstay length

TIRE CLEARANCE:

This is the amount of clearance between the top of the tire and the bottom side of the crown in front and the clearance between the tire and the bridges in the rear. This has no effect on the handling of the bike unless a longer fork replaces a shorter fork or vice-versa. In that case, altering the height of the

head tube can change the head tube angle. Raising or lowering the head tube m can alter the angle by approximately 1 degree. A large amount of tire clearance would be necessary for the use of fenders and/or expedition tires. This would preclude the use of short reach brakes. On the other hand, a small amount of tire clearance would be necessary in order to use short reach brakes which would eliminate the use of fenders (AGC brakes have the shortest reach on the market and may even eliminate the future use of standard short reach brakes!).

#### TOP TUBE ANGLE:

The top angle should usually be 0 degrees. In other words, the top tube should usually lie in the horizontal plane. Only in the case of tandems and/or lugless building should there be any variation in this angle. The only reasons for departing from this angle on a single bike frame is for someone with back problems who still has the perseverance to ride a bike or for a person so short that a standard design doesn't allow enough length in the head tube.

#### FACTORS AFFECTING FRONT END GEOMETRY

##### HEADSET LOWER STACK HEIGHT:

A majority of the high quality headsets on the market have an overall stack height of 40mm. Stack height is simply how much room the headset will use up on the steering column. The amount of stack height available on a frameset can be figured out as follows; (length of steering column in millimeters) - (length of head tube in millimeters). The lower portion of these headsets have a stack of 14mm out of that total of 40mm. Some headsets have stack heights of 35mm or less and of course, that lower stack height is also less. (Tange-Aero, and Campagnolo-Gran Sport are headsets with short stack heights.) If going from a high quality headset with a stack height of 40mm to a shorter stack height, the head tube could drop 3 to 4mm This could alter the head tube angle almost 1/4 degree. Why anyone would do such a dastardly thing, is unknowable! (It is worth mentioning here that the above mentioned headsets can be used on framesets that are short of room for a **high** quality headset.) Headsets **with** 40mm stack heights are Campagnolo NR & SR, Specialized, Zeus, Shimano Dura-Ace & Dura-Ace EX, Spidel, Avocet, and Chris King.

##### REPLACING A FORK WITH ANOTHER WITH DIFFERENT CLEARANCE:

It is important when buying or building a replacement fork, that the same amount of clearance is maintained. Altering that tire clearance will raise or

lower the head tube as much as 1cm in some cases.

#### REPLACING A CROWN WITH DIFFERENT THICKNESS:

The thickness of a crown is measured from the crown race seat to the underside of the crown. Some of the taller crowns, like Henry James, measure 19 to 20mm. Some of the shorter crowns, like Zeus measure 16 to 17mm. In building or buying a replacement fork, that measurement should be maintained or compensated for via the tire clearance. An alteration here can result in an error of 3 or 4mm. The diagram below shows more clearly what fork crown thickness is:

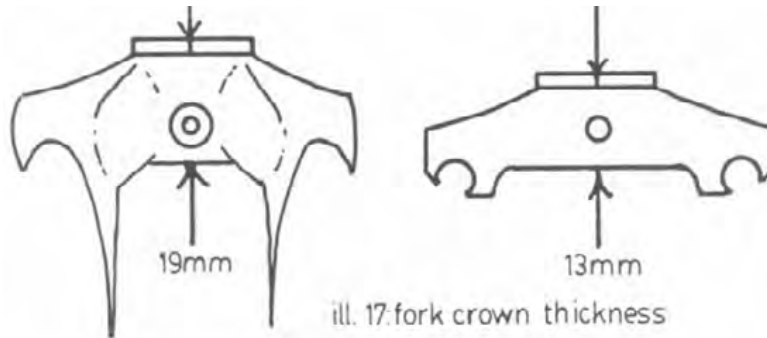

#### HEAD TUBE/DOWN TUBE INTERCEPT POINT: (Of framebuilder's concern only)

In building a frame from the full size working drawing, the same bottom head lug must be used as the one depicted in the drawing. Some bottom head lugs have the bottom of the down tube intercepting the back of the head tube rather low (Cinelli - about 2 or 3mm above the bottom of the head tube). Others are higher at that point (Henry James - About 9 to 10mm). This can result in an error of 5 to 7mm. See the diagram below:

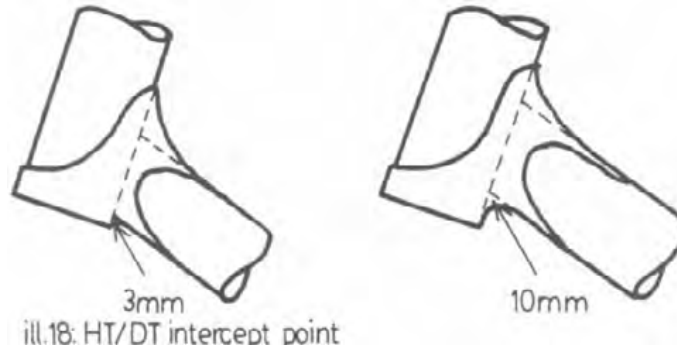

#### REPLACING A FORK WITH ONE OF DIFFERENT RAKE:

When building or buying a replacement fork, it should go without saying that a variation in the amount of rake between the two forks could affect the handling of the bike drastically. Always replace with original equipment or build replacement parts to original specs.

#### RUNNING A DIFFERENT SIZED TIRE ON THE FRONT:

Using a 700c on the front while having a 27" on the rear or vice-versa will have a minute effect on the angle at which the head tube sits. Even changing the size of both wheels at once will affect trail a small amount.

#### STRESSING A POINT:

It is rather obvious that, in the 6 previous subheadings, the amount of error was minute -in each case. But, consider this possible series of events which follow:

A builder designs a bike with Henry James lugs and crown but finds out that the lug sets will not be available for 2 weeks. Since he is on a tight schedule, he opts for a Cinelli set but does not bother to change the drawing. Since the fork crown was available, he decides to use that. Six months later the customer comes back after a bike accident. The fork is ruined but, the frame is undamaged. The builder says that he is out of Henry James crowns but, he has some really nice Zeus 2000 crowns. The customer goes along with that and then adds that he is no longer going to use fenders and regular reach brakes and could the builder set the new fork up for AGC brakes? The builder says that would be OK and asks if there is anything else. The customer says that the ride was always too stiff on the old fork and could the new one have some rake? Of course, the builder is more than willing to oblige. Two weeks later the fork is shipped to the customer and he takes the frame and new fork down to his favorite bike shop and asks the mechanic to install a headset as his old one was worn. He says that there are no Campagnolo Record headsets available for 2 weeks and would he settle for a Campagnolo Gran Sport this time? He agrees and when he picks the bike up remembers that the old front wheel is ruined. Before going on the ride he borrows a 700c front wheel from a friend to replace his old 27". The thing is so screwed up that he has another accident and wipes out his new fork.\*

That series of events was, of course, the worst that could have befallen the poor gentleman. From the original drawing (which we will assume was geometrically correct) to the time the bike is rebuilt, the front end has dropped approximately 23mm which would be approximately 2 degrees steeper on the head tube. A fork to match should have been raked less not more. Through this scenario it was easy to demonstrate \*The brand names were used to stress a point. The quality of those items is not in question.

how several factors can compound into a rather large error factor. The same holds true for an entire bike frame. If one small factor is slightly off, it may be imperceptible. However, a whole series of factors being off can make a bike very undesirable or in some cases, nearly unridable. This is what the reader should be looking for in scrutinizing a frameset. How many factors hold true to proper frame design? If some are in error, how many are there and what effect might they have on the bike overall.

A WORD OF WARNING: Unless you are working on a precision ground surface plate with a bevel protractor, dial indicators, vernier height gage, precision holding fixtures, and maintaining readings of + .005 " -- don't jump to conclusions!

## FRAMEBUILDER'S VARIATIONS

This is a detailed description of several variables that can make each bike built different from another. Those variables can be broken down as follows:

- 1 - Braze-ons
- 2 - Bridges
- 3 - Seat clusters
- 4 - Lugs
- 5 - Bottom brackets
- 6 - Fork crowns
- 7 - Dropouts
- 8 - Tube sets

Considering the choices within each of these variables, it is nearly possible to build an infinite number of totally unique frame sets--each noticeably different from the last. The builder who is aware of all of these variables can truly build custom frame sets which the rider knows someone else will not be riding. However, most builders will choose one or two items from each of the eight variables and stick with those. This list will cover most of what can be seen at any national bike show. There are two other sources for making frames truly unique:

- 1 - Check your history books, often there were fittings or embellishments which were used decades ago that have been forgotten.
- 2 - Your imagination.



## BRAZE-ONS:

Braze-ons are small fittings that are attached directly to the frame by means of brazing or spot welding. Due to the fact that silver brazing is the preferred method of the author, this section will be written with that in mind. By using braze-ons, instead of clips, several things can be accomplished:

- 1 - Use of clips and brackets can be eliminated
- 2 - A very small amount of weight can be saved
- 3 - A very clean looking frame set can be produced
- 4 - Rusting and chipping which occurs around clips and brackets can be nearly eliminated
- 5 - Equipment which could not be normally installed due to odd tube diameters can be used.

One major draw back of braze-ons is that they are permanently attached to the frame before it is painted. This makes it rather difficult to change one's mind after the work has been done.

## WATER BOTTLE FITTINGS:

These are very popular and are usually installed on the seat tube, down tube and the under side of the down tube. It's possible to install them on the under side of the top tube but leakage from the water could possibly occur. (On one occasion I even saw a water bottle mounted to the head tube.) There are three major types of water bottle fittings. They are sketched below:

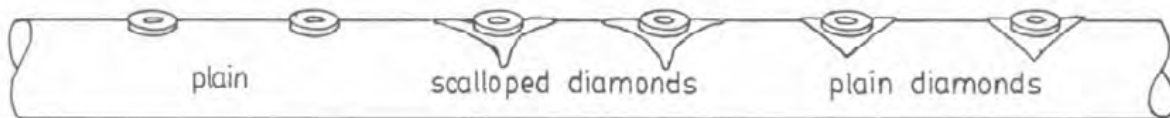

ill. 19: water bottle fittings

The following is a list of possibilities for locating water bottle fittings and problems which could occur by choosing a poor location:

- 1 - The most popular location for a bottle is mid down tube.
- 2 - If a bottle is mounted too high on the seat tube, the rider could have a difficult time pulling the bottle out past the top tube. This can be a possible problem on small frames.
- 3 - If a pump is mounted under the top tube, make sure the bottle will squeeze past the pump when

it's in place.

- 4 - If mounting a bottle under the down tube, make sure it is mounted low so that it will not interfere with the front tire or fender.
- 5 - When mounting two inline bottles on the down tube, make sure there is enough clearance to pull the lower bottle out past the upper one. (This problem does not exist with Velcro mounted bottles.)
- 6 - When mounting two inline bottles on the down tube, make sure there is enough room for the upper bottle to be pulled out when both shift levers are pulled all the way back. (This problem doesn't occur when using Barcons or stem mounted shifters.)
- 7 - Make sure neither of the holes drilled for the fittings are slightly rotated around the tube. This would make the cage sit rather askew.
- 8 - Nearly all water bottle fittings go into a 1/4" hole.
- 9 - Nearly all water bottle fittings should be spaced 63mm (2 1/2") on centers. (A few of the older European cages were set up for 65mm, but the holes in those cages can easily be elongated to fit the 63mm pattern.)
- 10 - Don't mount a seat tube water bottle low enough to interfere with the smooth operation of the front derailleur.

#### BRAZED-ON FRONT DERAILLEUR:

A limited selection of front derailleurs are available in a brazed-on model. Two of the most popular are Campagnolo and Dura-Ace EX. (There is a brazed-on Simplex that is not widely used.) Generally speaking, these derailleurs are for a close ratio set of gears such as those found on racing bikes. They will not work well for wide ratio gearing for three reasons; 1 - the cage is not long enough and the chain will drag on the bottom of the cage while a "granny" gear is being used, 2 - The inner cage plate is not wide enough to efficiently lift the chain off of a very small inner sprocket and into the middle position, 3 - These derailleurs do not hug the seat tube like a good wide ratio-triple one will. Below are examples of the three fittings to braze-on to use these derailleurs:



ill. 20: brazed-on front derailleurs

Here are some suggestions for proper location and installation of these fittings:

- 1 - The three fittings are not interchangeable.
- 2 - The Shimano is by far, the **easiest to** install. It is a casting that has sufficient surface area so that it doesn't need to be held in an intricate manner.
- 3 - The Campagnolo is harder to install. It is a stamping that must be held exactly while silver brazing. SRC **sells a jig to** hold them in place during brazing.
- 4 - The Campagnolo fitting has to be cocked back a couple of degrees or the tail of the derailleur cage will sit too high.
- 5 - These fittings should be checked for location by installing a crank set and **derailleur after** silver brazing. (NOTE: Wait for the fitting to cool before installing the derailleur!)
- 6 - The Shimano has **more swivel** adjustment.
- 7 - Unless specified differently by the rider, it **is best to set the derailleur** to be in the middle of its adjustment while using a 52 tooth chainwheel.

#### SHIFT LEVER BOSSES:

There are three popular lever bosses on the market. They are Campagnolo, Shimano and Zeus. Any of them can be modified to double as a cable stop so that Barcons or stem shifters can be used. The drawings below show them in detail:

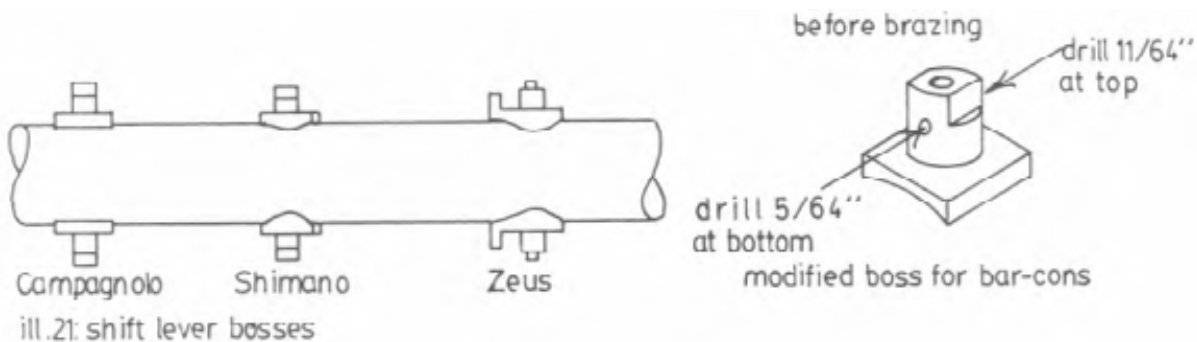

Some companies have a little square braze-on that sits on top of the down tube. This allows the mounting of Aero style levers. Suntour makes one and a separate company makes one to accommodate Campagnolo levers in this manner.

Here are some suggestions for mounting lever bosses:

- 1 - Lever bosses should be mounted so that the center point of the boss is 10-13cm down from the point at which the down tube meets the head tube.

- 2 - Campagnolo lever bosses are interchangeable with Suntour Superbe, Suntour VX, Rino and Simplex Super L.J.
- 3 - Suntour Blueline braze-on lever bosses are not interchangeable with anything else.
- 4 - Zeus braze-on lever bosses are not interchangeable with anything else.
- 5 - Make absolutely sure that both lever bosses are at the same height on the down tube. (Looking from the rider's point of view, this would be very noticeable.)
- 6 - Make sure that neither lever boss is rotated a few degrees around the tube. (This can be checked by sighting down the down tube on both sides at once from a head-on position.)
- 7 - See to it that a down tube water bottle does not interfere with the levers when they are pulled all the way back.
- 8 - If installing a set of lever bosses on an already built bike, make sure to remove the clamp stop if one has been brazed on.
- 9 - Overheating while installing lever bosses can be devastating! The down tube is one of the most heavily stressed tubes on the bike.
- 10 - After the flux is cleaned run a bottoming tap in the bosses to clean them out. (Campagnolo has 5 x .8 metric threads and Shimano has 4.5 x .75 metric threads.)

#### CANTILEVER BRAKE SETS:

Cantilevers have some advantages over standard brakes; they provide bigger clearances around the wheel for easier installation of fenders. In the case of off-road bikes -- mud build-up is less of a problem to the efficient operation of the brakes. They can be mounted in numerous locations which is very advantageous in the case of tandems. Mountain style cantilevers provide much more leverage and finally, cantilever brakes can be removed and replaced in nice little units. Cantilever braze-on studs are the same for all brands. They are pictured below:

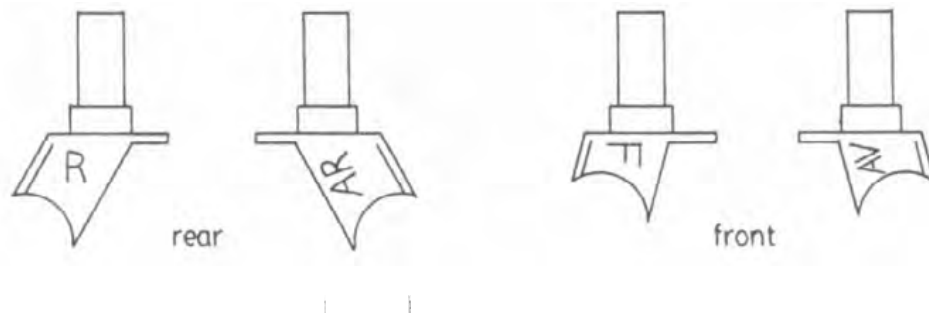

Here are some suggestions and warnings for mounting cantilever studs:

- 1 - There are two major styles of cantilevers; short ones which have been used for many years on single bikes, long ones which are used on mountain bikes and tandems.
- 2 - Long cantilevers give much more braking power
- 3 - The studs must be brazed-on at different heights for long or short cantilevers. (See the diagram that follows)
- 4 - Wheel size must be considered when locating cantilevers.
- 5 - If mounting cantilever studs on a chromed area, sand through the chrome so that they are attached to the steel underneath.
- 6 - If you only install a few cantilever studs a year, always assemble the brake unit and install a wheel to see how things line up before painting.
- 7 - Installing a rear brake hanger at the same time is a good idea.
- 8 - Rear studs are usually marked with an R or AR and front studs are marked with an F or an AV.
- 9 - Use of front studs on the rear may be required on short bikes with fastback seatstays.
- 10 - Use of rear studs may be required on a mountain fork.

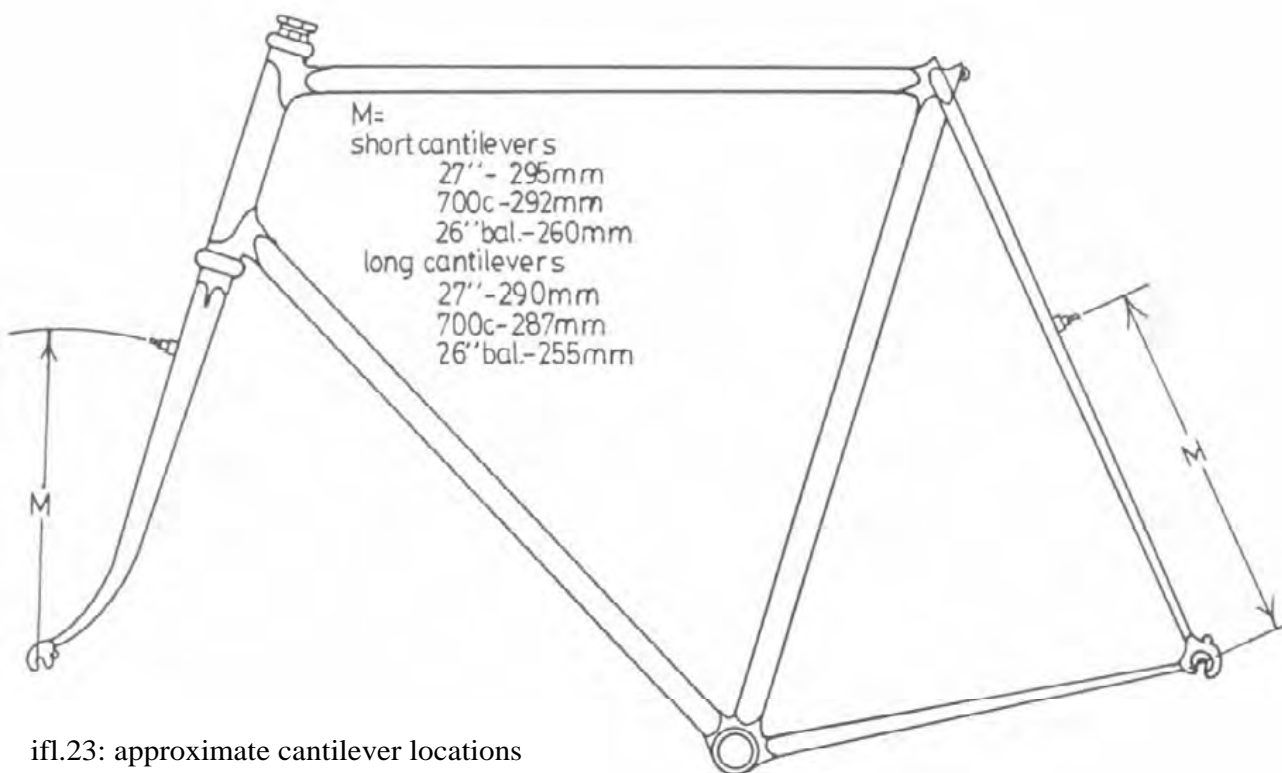

ifl.23: approximate cantilever locations

The previous figures are very close approximations. However, it is strongly advised that things be assembled for final checking before painting.

#### REAR RACK FITTINGS:

For the most part, the Blackburn style racks are the most preferred today. There are some less expensive, poorer quality copies that are made to the same specifications. For the sake of simplicity, all these racks can be lumped into one bunch which will be referred to as "Blackburn style racks". These racks come in several types:

- 1 - Braze-on mount for short bikes -- These have extra long struts going to the seatstays and fit 48-52cm frames. (This is a Blackburn C-SS-3.)
- 2 - Braze-on mount for medium sized bikes -- These fit bikes 53-59cm (SS-1)
- 3 - Braze-on mount for tall bikes -- These have extra long and bent forward struts going to the dropout eyelets and fit frame sizes 60-67cm. (C-SS-2)
- 4 - Brake mount/adjustable -- These fit a wide range of sizes.
- 5 - Seat stay mount/adjustable (heavy duty) -- These are primarily designed for off road use but will fit a wide range of sizes.

Numbers 1, 2, 3, & 5 can be mounted on the frame by use of a brazed-on fitting. Pictures of some popular style fittings can be seen below:

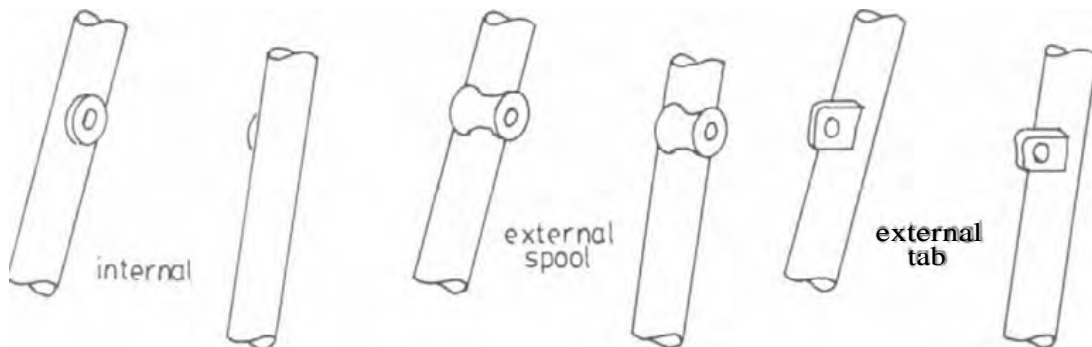

ill. 24 rear rack braze-ons, 5X.75metric threads

Here are some suggestions for mounting carrier fittings:

- 1 - Use fittings with 5 x .8 metric threads.
- 2 - Mount the carrier so that it is in the horizontal plane.
- 3 - Don't use the rack as a holding device while silver brazing. It will melt!
- 4 - The location for carrier fittings can be found by using the measurement from the center of the hole for the dropout eyelet to the center of

the hole for the seatstay carrier fitting. For small bikes using the C-SS-3 style carrier, this measurement is 39.5cm. For mid range bikes using an SS-1 style carrier, this measurement is 39.5cm. For tall bikes using the C-SS-2 style carrier, this measurement is 40.5cm. (A small amount of bending of the struts may be required when installing the carrier.)

- 5 - External braze-ons can be held in place by sliding a piece of 1/8" stainless welding rod through them. (See drawing)

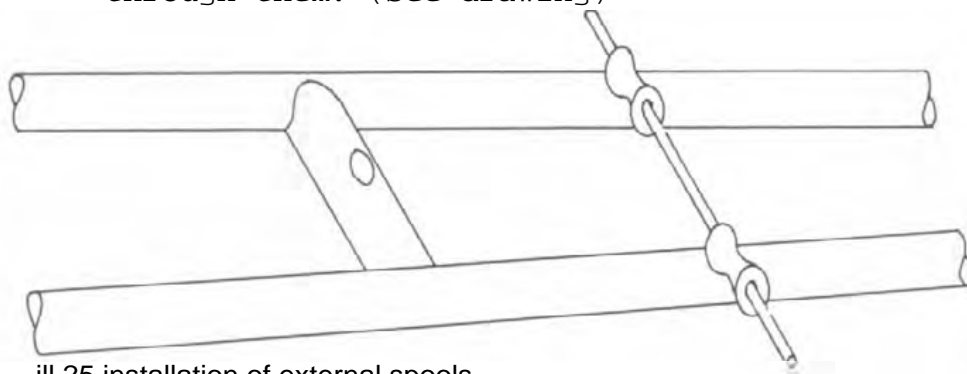

ill.25 installation of external spools

LOW RIDER MOUNTS:

The use of a low rider style rack can be beneficial in that it lowers the load of the front panniers by about 6" and consequently lowers the center of gravity. This has a stabilizing effect on the bike. Below are some methods of installing brazed-on fittings for low rider type racks:

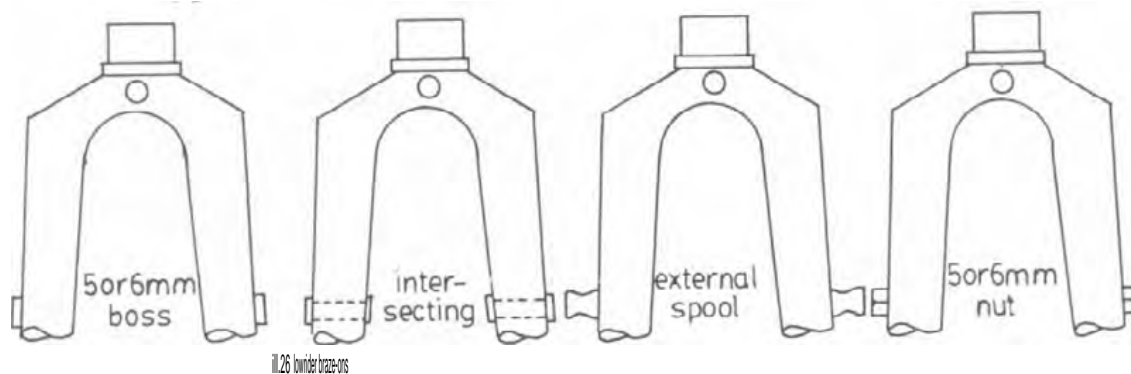

Here are some suggestions for mounting low rider type braze-ons:

- 1 - The 6mm threaded boss will provide the most strength.
- 2 - To mark the location of the braze-ons, the bike must be leveled, the rack mounted in the dropout holes and the rack leveled. Then the location on the fork blade may be marked. There is no easy way to locate these braze-ons and have the rack turn out level each time. Variations in front end geometry from bike to

bike can change the location of the braze-ons up to a full centimeter.

- 3 - After the braze-ons are finished, the rack must be jacked out from the fork blades about 1cm. This can be done easily by using bushings.

#### TOP TUBE CABLE GUIDES:

By installing top tube cable guides, the use of clips can be eliminated. One of the major drawbacks of using clips is that they tend to collect the perspiration that falls from the rider's face. Consequently, rust often occurs around the area that clips are installed. The following illustrations show different styles of top tube cable guides:

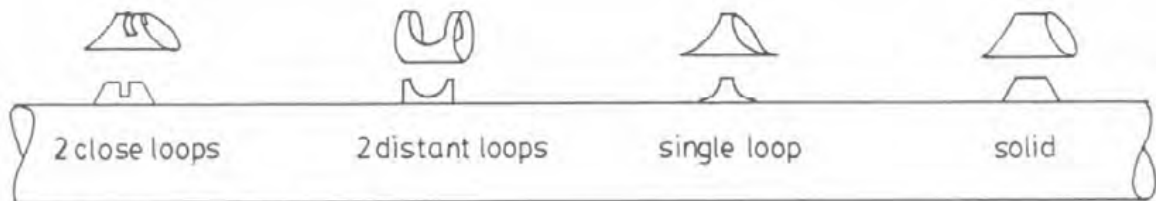

ill.27: top tube cable guides

Here are some suggestions for installing top tube cable guide sets:

- 1 - Two close loops are the strongest.
- 2 - Use a heat sync or hold them by the tops to prevent overheating.
- 3 - Locate the end ones about 5cm from the point of the lugs and locate the center one halfway between the other two.
- 4 - Racers may opt for only two guides for weight savings.
- 5 - Sight down the top of the top tube to check for alignment.
- 6 - The loops are quite fragile during the silver brazing process.
- 7 - Homemade guides out of 5/16" x .28" chrome-moly tubing will accommodate oversized housing.

#### CABLE STOPS:

Cable stops are probably the most commonly used fitting on a bike. A very high percentage of bikes on the road have a chainstay cable stop. Cable stops can also be silver brazed on the top tube for the rear brake cable, at the top of the down tube for barcons, at the bottom of the down tube for gear cable routing or on center pull brake hangers. Use of cable stops (and other braze-ons) is particularly useful on tandems and mountain bikes. Due to the oversized tubing used



on these bikes, standard clips cannot be used. The illustrations below show different styles of cable stops that are available:

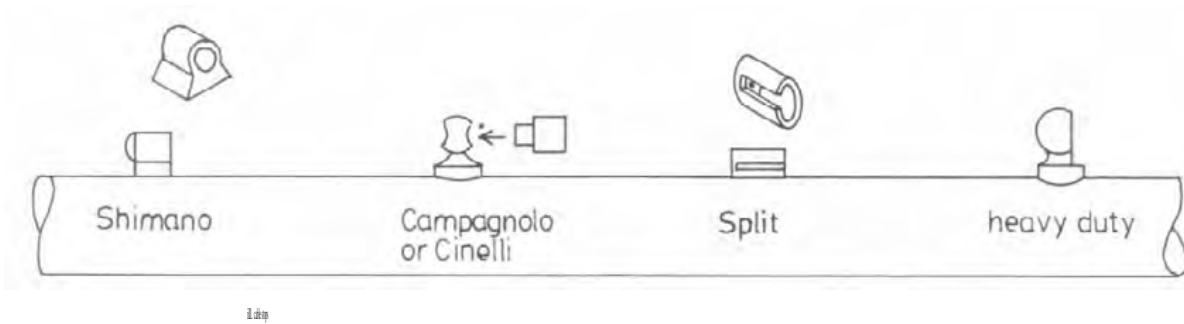

Here are some suggestions for mounting cable stops:

- 1 - Mount Barcon stops quite close to the head tube. This will cut down the amount that the cables rub against the head tube.
- 2 - Mount top tube brake cable stops along the side of the tube. Mounting them on the right side will be compatible with more brands of brakes.
- 3 - When mounting a chainstay cable stop, rotate it outward about 10 degrees.

#### PUMP PEGS:

Using a pump peg can have a couple of advantages:

- 1 - Elimination of a clip is possible.
- 2 - The pump can be carried under the top tube (with clips; this is difficult to do as top tubes are 1" in diameter and nearly all pump clips are made for 1 1/8").

However, a pump peg limits you to using one size and maybe even one brand of pump. Below are some pictures illustrating some different pump pegs:

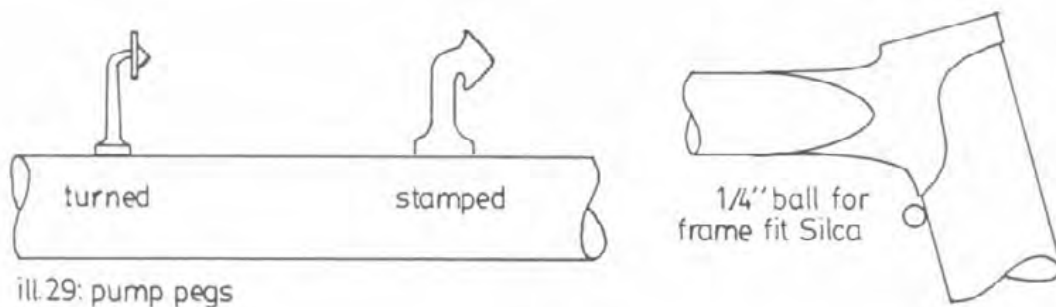

Here are some suggestions for installing a brazed-on pump peg:

- 1 - Installing a pump peg under the top tube frees the other tube for use of other accessories.

- 2 - Install the longest pump possible. A longer pump has a better compression stroke.
- 3 - A tight fitting pump will have less tendency to fall off the bike.

#### CLAMP STOP:

A clamp stop is simply a little tab which is usually brazed-on the underside of the down tube. It keeps a lever clamp from sliding down the tube and a tunnel clip from sliding up the tube. They can be triangular, heart shaped, square or even a little peg sticking down.

#### CHAIN HANGER:

A chain hanger can be mounted on the inside face of the right seatstay. This fitting allows the rider to remove the rear wheel and hang the chain on the chainhanger. By doing this the chain will stay on the chainwheels and reinstallation of the wheel is a lot easier. When transporting the bike, this also keeps the chain from falling off and getting grease all over the interior of the vehicle. Below are examples of different ways to braze-on chainhangers:

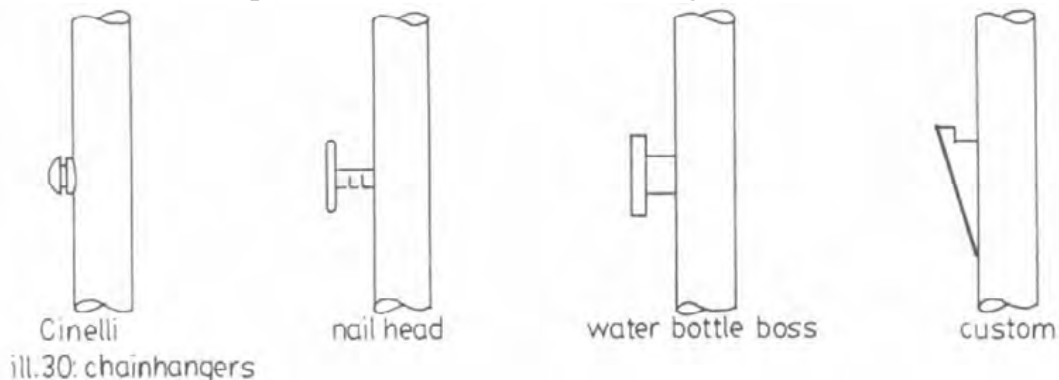

ill.30: chainhangers

Here are some suggestions for installing chainhangers:

- 1 - The chainhanger should be located about 6 to 10cm above the rear axle.
- 2 - If installing a chainhanger on a chromed stay, sand off the chrome in that spot as to be anchored to the steel underneath when finished.
- 3 - If installing a chainhanger on chromed stays, mount it a little high so that it can be painted over.

#### BOTTOM BRACKET GUIDES:

Bottom bracket cable guides are an excellent way to eliminate the use of cable clips. These guides are particularly useful on tandems and off-road bikes where oversized tubing is used. Bottom bracket guides are of two major types; 1 - Topside guides, 2 - Underneath

style. Below are some pictures showing the different kinds:



Campagnolo,

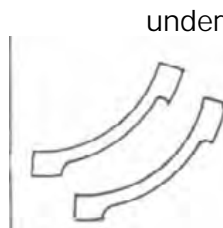

Shimano Cinelli 413

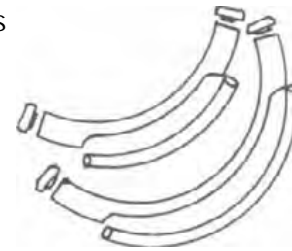

Cinelli 312/313

#### 11: 31: bottom bracket cable guides

Here are some suggestions for installing bottom bracket guides:

- 1 - Underneath style catches a lot more dirt.
- 2 - Underneath style may prohibit the use of certain display stands.
- 3 - Underneath style may prohibit the use of certain exercise trainers.
- 4 - Underneath style stands a better chance of getting crushed or misshapened.
- 5 - Cables can be routed under the bottom bracket simply by filing little grooves in the bottom bracket shell.
- 6 - The TREK company mounts a plastic guide plate with one screw on some models.
- 7 - The TREK company has an underneath style cast right into the bottom bracket shell on some models.
- 8 - A good position for topside guides is to have the fronts just slightly below the center line of the downtube.
- 9 - Most high quality derailleurs require a bottom bracket guide of some sort.
- 10 - Use of bottom bracket guides eliminates use of cable housing around the bottom bracket.
- 11 - It would be a good idea to retap and face the bottom bracket after installing bottom bracket guides. (Wait for the shell to cool!)

#### BARCON STOPS:

See cable stops and lever bosses on preceding pages.

#### EXTRA EYELETS FOR FENDERS:

Five or Six millimeter nuts can be silver brazed directly onto the dropouts to allow extra attachments for fenders or racks. Following are some diagrams to show where extra eyelets can be placed:

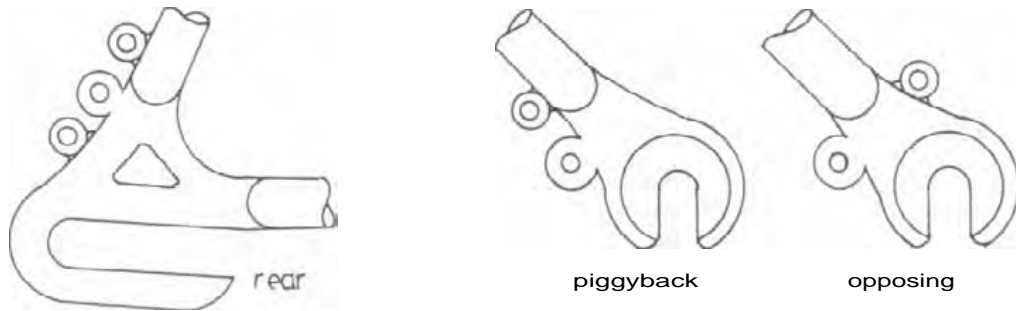

ill.32: extra eyelets

Here are some suggestions for installing eyelets:

- 1 - Five millimeter nuts would be more compatible with the things to be installed on the eyelets.
- 2 - After silver brazing the nut on round the edges with a file so it won't look so much like a nut.
- 3 - The TREK company makes an eyelet that can be brazed on. It looks very much like the original eyelets.
- 4 - If putting eyelets on a chromed area, sand through the chrome in the spot where the eyelet will be put.
- 5 - Some companies put 1/4" untapped holes in their dropouts. A water bottle fitting can be put into one of these holes.
- 6 - Piggyback eyelets are more compatible with a lowrider/fender combination.
- 7 - A water bottle fitting can be put in near the bottom of the seatstay as an eyelet.
- 8 - The reverse of an eyelet, a bolt, can also be brazed on to the frame.
- 9 - Leave enough room between eyelets so that accessories don't run into each other.

#### BRAKE BRIDGE REINFORCING SLEEVE:

Some bikes come with a simple brake bridge that has no reinforcing sleeve brazed into it. When the brake center bolt is tightened down, this type of bridge can collapse and deform. For this reason, the brake bridge hole should be drilled out large enough to accept a reinforcing sleeve. The sleeve is silver brazed in and the bridge becomes much stronger as a result. Following are some pictures to clarify what such a sleeve looks like:

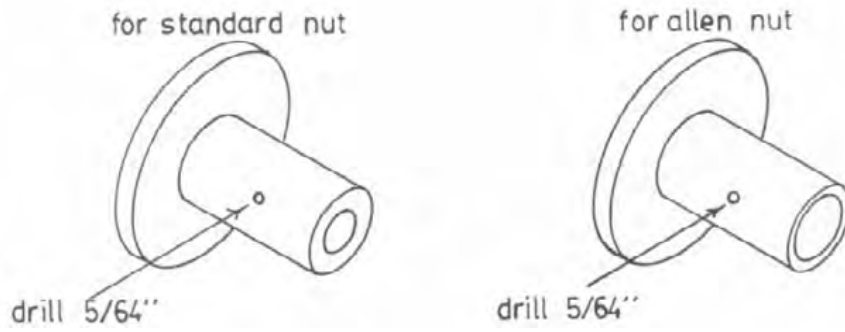

ill.33: broke bridge reinforcing sleeve

Here are some suggestions for installing reinforcing sleeves:

- 1 - Make sure the hole is drilled straight in both planes.
- 2 - Have enough clearance for silver to flow into.
- 3 - Make sure the hole is centered along the length of the bridge.

More on brake bridges will be covered in the next section of Framebuilders' Variations.

SPOKE CARRIER/CHAINSTAY GUARD:

A handy option that is being offered on many high quality touring bikes these days is a spoke carrier mounted on the top of the right hand chainstay. Because of its location and positioning, it doubles as a chainstay protector also. They can be made to hold as many as 5 spokes at once. Imagination is the key to designing these as they are not readily available to the framebuilding market yet. Here is an illustration to clarify what one of these fittings looks like:

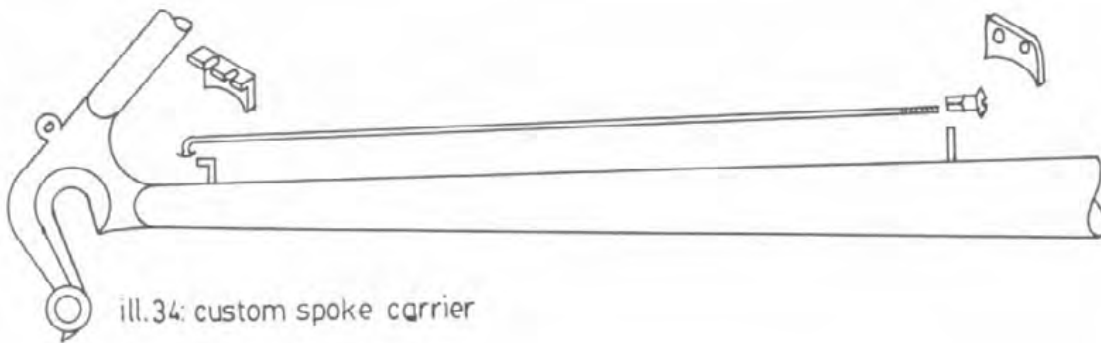

ill.34: custom spoke carrier

Here are some suggestions for installing a spoke carrier:

- 1 - Cable routing should be under the bottom bracket if the spoke carrier is to be mounted on the right chainstay.

- 2 - Several spoke carriers may be mounted on a frame.
- 3 - Decide on the length of spoke that will fit both wheels and spoke carrier.
- 4 - The spoke carrier should be mounted about two centimeters in front of the dropout and rotated outward about 10 degrees to keep it from hitting the chain in the upper gears.

#### CENTER PULL HANGERS:

Mounting a center pull hanger directly to the upper portion of the seatstays tends to be much cleaner and more efficient than bolting one to the seat lug. There is not the problem of the hanger rotating when adjusting the pinch bolt. A high quality, alien type pinch bolt can be used more easily. There are many ways to set up a center-pull hanger. Here are two ways which look good and are relatively easy to do:

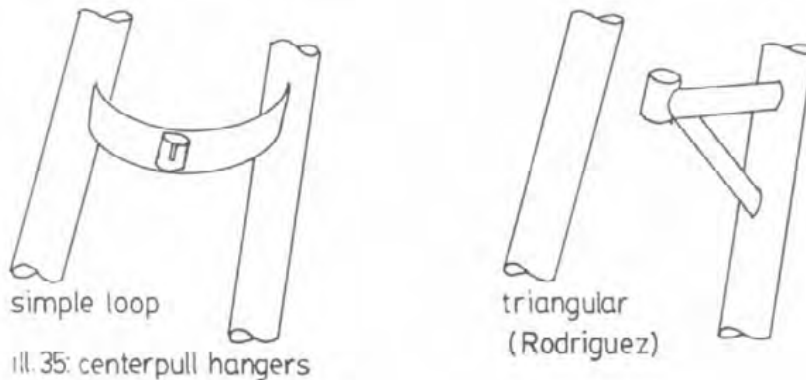

Here are some suggestions for installing a center-pull hanger:

- 1 - Mount it far enough away from the brake unit so that good leverage is obtained but the carrier clip does not hit the hanger. (This may be difficult to do on smaller frames.)
- 2 - Use only chrome-moly or equivalent to make the hanger. Mild steel could flex or bend under the load of braking.
- 3 - Be sure that the hole in the center of the hanger points to a location halfway between the brake shoes.

#### CRESTS, EMBELLISHMENTS AND CUTOUTS:

In the case of striving for a totally distinct and unique frame a builder can create all types of embellishments. The possibilities are as limitless as the builder's imagination. Here are just a few ideas for crests and embellishments:

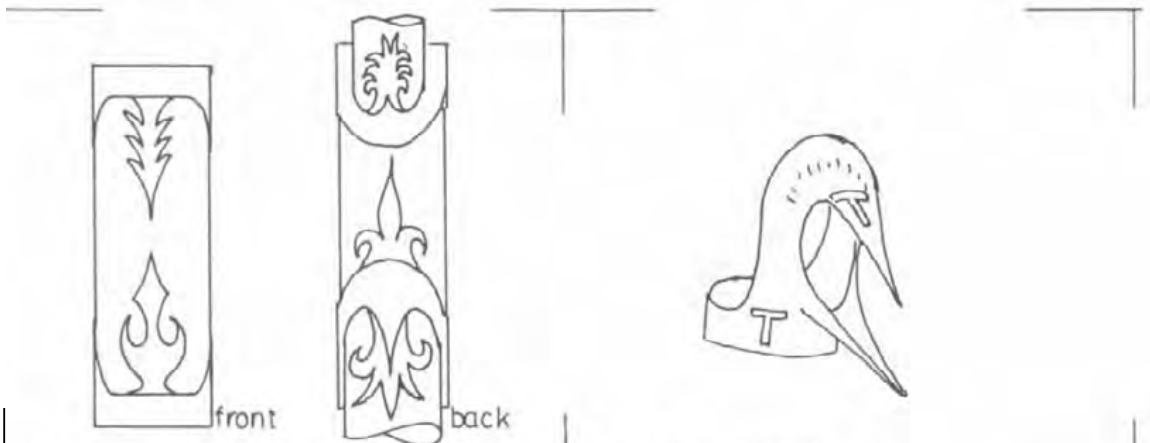

ill.36: head tube embellishments

ill.37: lug cutouts

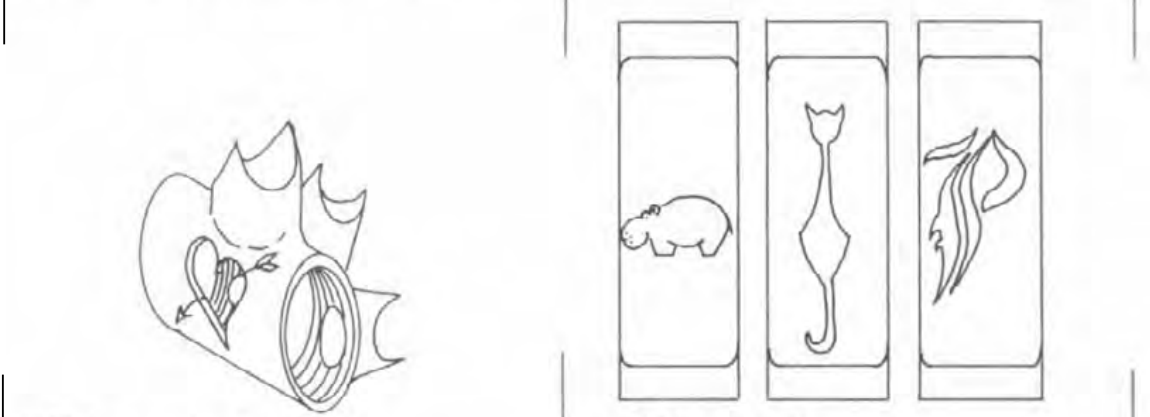

ill.38: bottom bracket cutouts

ill.39: headcrests

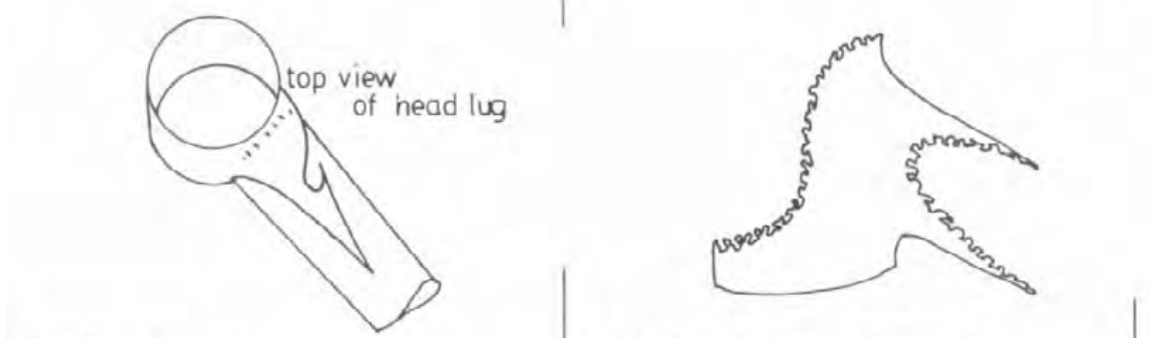

ill.40: asymmetrical lugs

ill.41: serrated lugs (Pauley)

These are some of the things I have done in the past. Of course, the possibilities are limitless. This sort of work takes a steady hand and a lot of patience. The beginning framebuilder may want to approach this sort of work with caution.

## BRIDGE VARIATIONS

### CHAINSTAY BRIDGES:

Chainstay bridges are of importance for two main reasons; 1 - They add a noticeable amount of stiffness in the rear triangle, 2 - They provide a way to attach a rear fender. Another use which is of very little importance is that of providing a stop for a kickstand to brace against. There are several variations that are possible in chainstay bridges. They are as follows:

#### STANDARD

This is the type seen on most frames. It is simple and easy to install. Since there is no outlet for air expansion in this type of bridge, air expansion holes must be drilled in the bridge itself or in the stays.

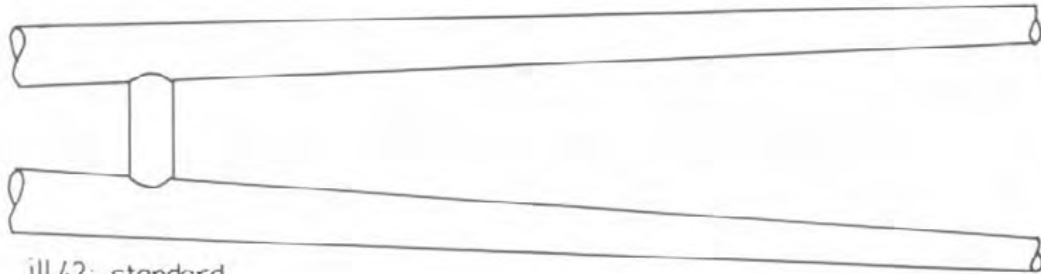

ill.42: standard

#### STANDARD-THREADED

Using a water bottle fitting in the back of the bridge for mounting fenders is a nice touch for touring frames. The threaded fitting also serves as a built-in air expansion hole. Drill a second vent hole in the front of the bridge.



ill.43: standard-threaded

#### STANDARD-SMALL DIAMETER

A piece of .250" to .375" O.D. material can be used to make a smaller diameter bridge. When using a smaller diameter like this, it is a good idea to use something with a thicker wall to try to gain some



strength back. A smaller diameter piece of tubing is not as strong as a larger diameter piece with the same wall thickness. Air expansion holes are still necessary.

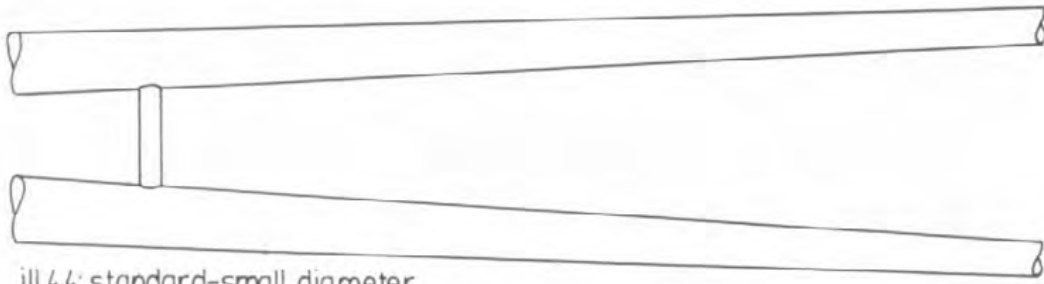

ill.44: standard-small diameter

#### U-SHAPED

A piece of thick walled .250" O.D. tubing can be heated up and bent into a U-shaped bridge. This would work out better on a racing frame as fastening fenders to it would be rather difficult.

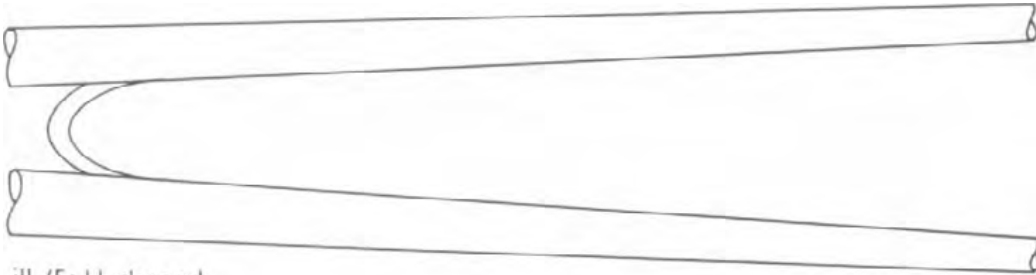

ill.45: U-shaped

#### CONCAVE

Several of the high quality European builders use this style. It is attractive and, since it is prefabricated, easy to fit and install. It is hollow though and, therefore, needs air expansion holes also.

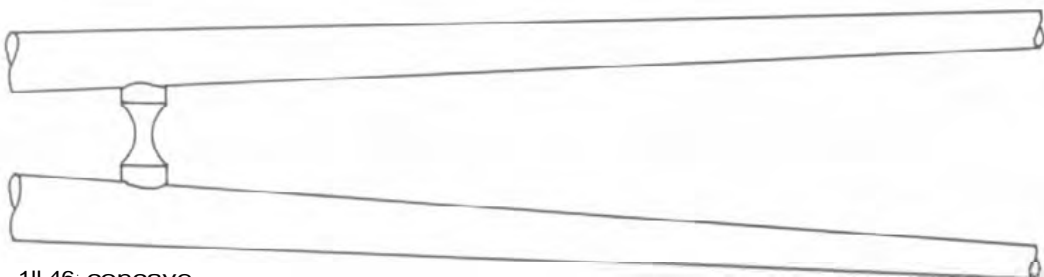

ill.46 concave

#### DRILLED THROUGH

This is a rather bold approach. The first impression is that it is weak. However, since this

large hole through the chainstays is filled by the bridge tubing, lost strength is added back again. Air expansion holes are unnecessary for this type of bridge.

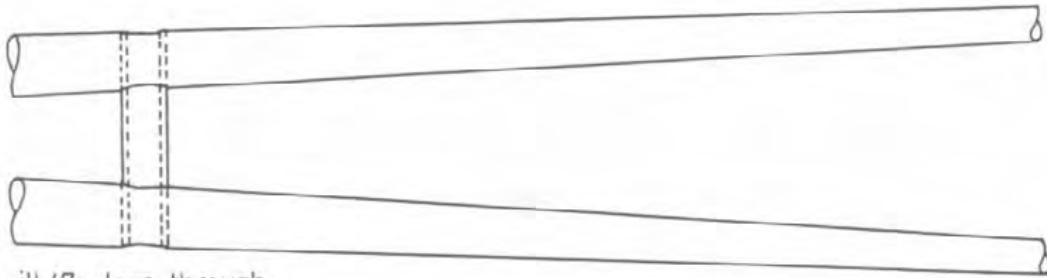

ill.47: clear through

#### NO BRIDGE

Even though the bridge is a useful addition it can be eliminated altogether. If one chooses not to use a bridge between the chainstays, it must be remembered that if the wheel is not in the rear triangle a weakness exists. In transporting such a frame a dummy axle should be kept in the rear dropouts.

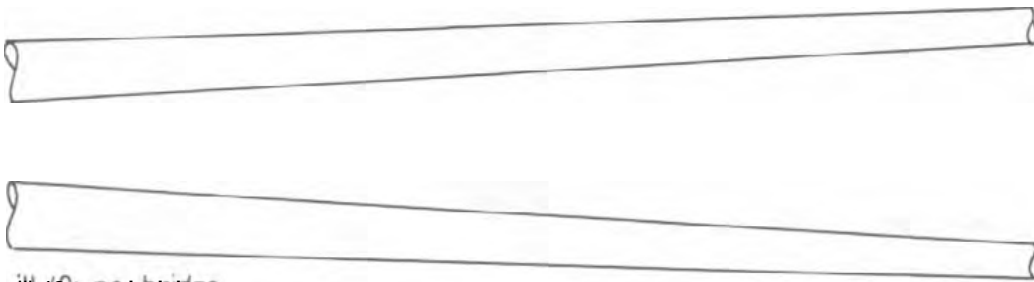

ill.48: no bridge

#### BRIDGE STIFFENERS

There are a few styles of bridge stiffeners on the market. These are decorative pieces that fit between the bridge and the chainstay. They do add strength to the joint by increasing the surface for the silver alloy to occupy. However, often they are difficult to fit because immediately behind the bridge is where there is either a crimp in the chainstay or where the chainstay starts its oval cross section. If installing chainstay bridge stiffeners, don't opt to use brake bridge stiffeners as a substitute. They are too long and bent to a different radius. Chainstay bridge stiffeners can be used with any 1/2" diameter bridge.

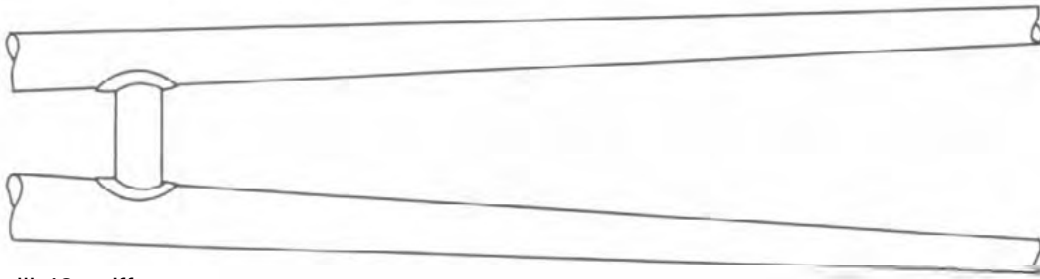

ill 49: stiffeners

### BRAKE BRIDGES

#### STANDARD - NOT REINFORCED

Many production line bikes, in order to cut costs, do not have a reinforced hole in the brake bridge. This is not a good idea! Tightening the brake center bolt too tight can crush such a bridge. No air expansion holes are necessary in this bridge.

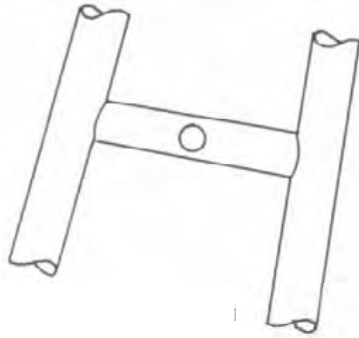

#### STANDARD-SIMPLE REINFORCEMENT

In order to eliminate the problem of crushed bridges the brake hole can be drilled out to 5/16" and a piece of 5/16" x .028" tubing can be silver brazed in place. A transverse air expansion hole should be drilled through the reinforcing sleeve. When assembling the brake caliper, radius bushings must still be used.

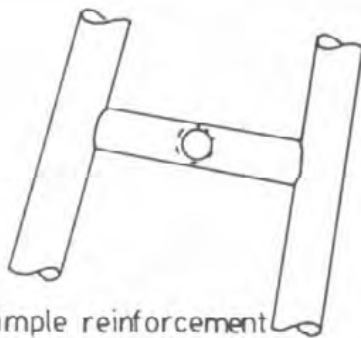

ill.51:simple reinforcement

## STANDARD-FLANGED REINFORCEMENT

Prefabricated reinforcing sleeves can be purchased to fit into a standard brake bridge. The plate or flange on the back side allows the elimination of the use of radius bushings. These also must have a transverse air expansion hole drilled into the sleeve. This type of sleeve is also available in an alien style.

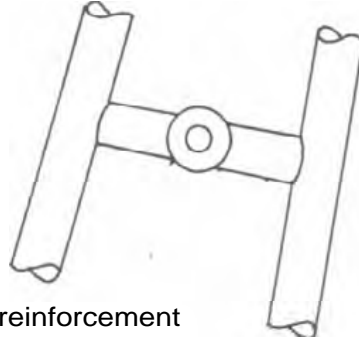

ill.52: flanged reinforcement

## STANDARD-WITH CYLINDRICAL BOSS

These have been used a lot on British bikes in particular. It is an attractive style and quite strong. However, it must be preassembled before installed and positioning of the hole can be somewhat of a challenge. No air expansion hole is necessary for this bridge.

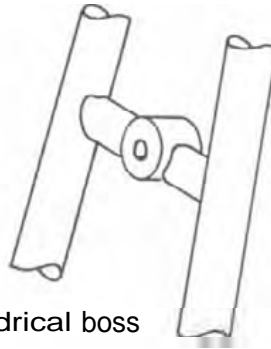

cylindrical boss

## V-SHAPED

Standard 1/2" diameter bridge material can be cut and modified to get the effect pictured below. A flanged reinforcement must be used and air expansion holes are necessary. This style of bridge is truly a challenge even for the experienced frame builder.

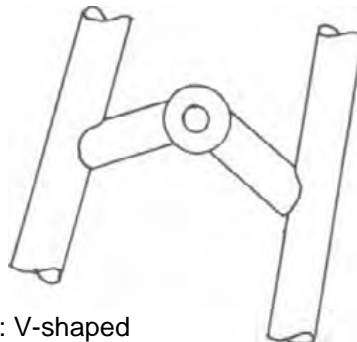

ill.54: V-shaped

## PREFABRICATED BRIDGES

### OLD STYLE CINELLI

If available, this is a fairly inexpensive bridge which is made to accept an alien style brake nut. A transverse air expansion hole in the sleeve is necessary.

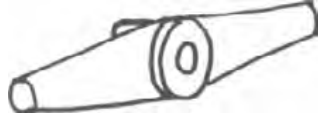

ill.55: old style Cinelli

### NEW STYLE CINELLI

This is a very attractive prefabricated bridge which accepts an alien type brake nut. It requires preassembly before installing which can prove a bit of a challenge for the beginner. It does not require air expansion holes.

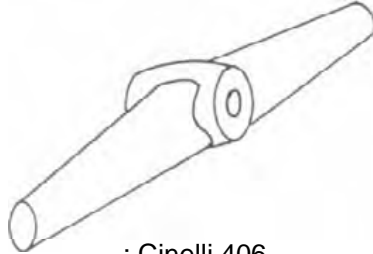

ill56

: Cinelli 406

### SQUARE CENTER CINELLI

This is a very easy to install prefabricated bridge which accepts an alien type brake nut. It requires no preassembly and no air expansion holes. A word of warning - often times the brass center will drop out of these after heat is applied for silver brazing! Another version of this bridge has a minute impression of a bicycle rider. Still another has an impression of the Cinelli logo.



ill.57: Cinelli 506

### AERO STYLE CINELLI

An easy to install prefabricated brake bridge which requires no preassembly and no air expansion holes. They accept an alien type of brake nut.



ill.59: Cinelli aero designs

## SOLID STYLE CINELLI

Sometimes it's hard to be totally unbiased. This *is* one of those times. This is an easy to install, prefabricated bridge which requires no preassembly and no air expansion holes. It accepts an alien type brake nut and is absolutely the heaviest piece of bridging on the market!

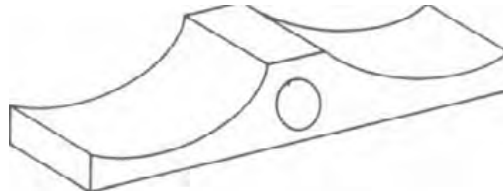

Cinelli solid

## DIAMOND STIFFENERS

Diamond shaped stiffeners can be used on almost any style bridge. They definitely have a strengthening effect on the joints where the bridge meets the seatstay. The increased surface area is what gives the added strength. Stiffeners should be used on all prefabricated bridges (with the exception of the Aero and Solid styles).

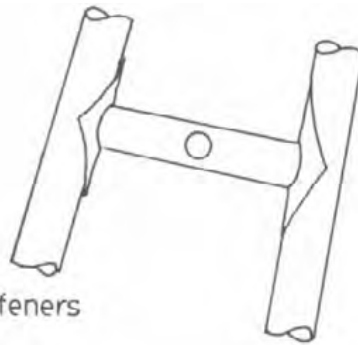

ill.60: stiffeners

## HELPFUL HINTS

Here are some helpful hints for installing chainstay and brake bridges:

- 1 - The brake hole must be centered exactly between the stays and great care must be taken in doing this.
- 2 - The brake hole must be perpendicular to the centerline of the bridge. When sighting through the brake hole, you should be able to sight in on the centerline of the seat tube.
- 3 - Although not as critical, the brake hole should be perpendicular to the plane of the seatstays. If not perpendicular, the brake caliper will be rotated slightly upward or downward.
- 4 - The chainstay and brake bridges should be the same distance from the outside radius of the tire on touring bikes. Having a rear fender that doesn't run concentrically with the rear wheel looks pretty unsightly.

- 5 - Air expansion holes must be used when called for. If they are not used, a poor joint is produced and unsightly spatter marks can occur. The holes can be drilled into the bridge, the reinforcing sleeve, or into the stay.
- 6 - If fenders will be used, plain bridges without an alien type hole, should be used. However, fenders can be mounted on an alien type bridge by putting the L-bracket between the bridge and the caliper.
- 7 - The fit for a bridge must be exact and should be rather tight. A sloppy fit or loose fit will tend to draw the stays together and prevent the wheel from sliding easily into place.

#### SEAT CLUSTERS

This is one of the areas that a builder can make the frame truly unique. For example, Falcon has long been known for the style of wrap around seatstays they use. Trek is known for their seatstays that have their name stamped in them. Raleigh Professional fastback seatstays are truly unique. Older Cinellis were known for the way they incorporated the seat post binder into the top of the seatstays. Unlike any other variation on the frame, the seat cluster can tend to become a trademark or even a signature for a builder. There are a great number of possibilities for finishing up a seat cluster. Following are about a dozen major ways to do it. The builder can branch off from there.

#### STANDARD-CONCAVE

A large majority of the frames on the market use this style. It is relatively easy and inexpensive to do. It can be done by two methods:

- 1 - Fitting a piece of 1" diameter tubing into the top of the stays and trimming off the excess. (This is the hard way.)
- 2 - Insert prefabricated slugs into the tops of the stays.

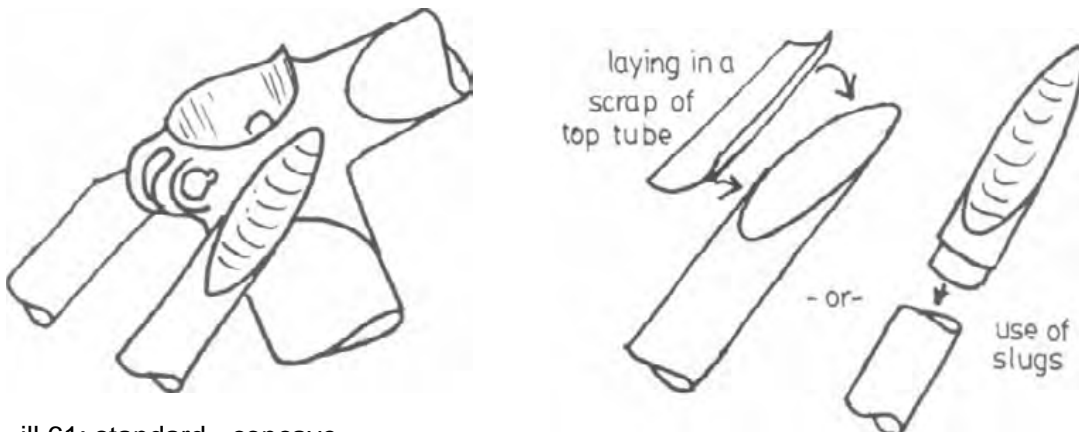

ill.61: standard - concave

### STANDARD-FLAT

This method is also used a lot in the industry. It is also easy and inexpensive to do. Two methods can also be done to accomplish this style:

- 1 - Silver brazing a flat plate onto the top of the stay and cleaning off the excess.
- 2 - Insert prefabricated slugs into the tops of the stays. Both ways are equally as easy.

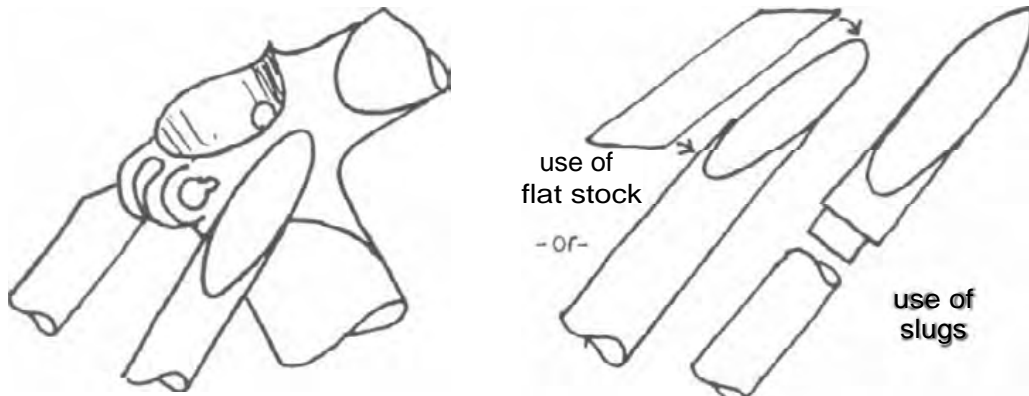

### PARTIAL WRAP AROUND

Some builders do this style. There is one main reason for adopting this style - the increased area for the silver adds appreciable strength to the joint.

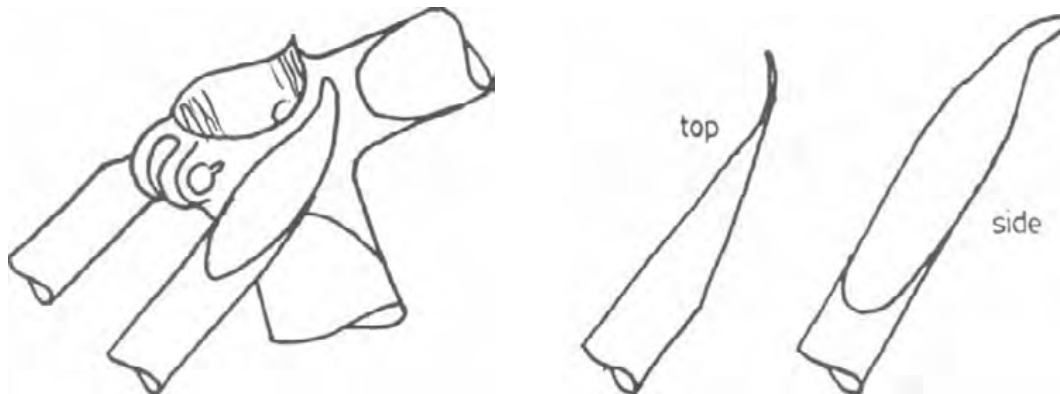

ill.63 partial wrap around

### FULL WRAP AROUND-FLAT

This is by far the strongest seat cluster that can be done. The surface area for the silver to occupy is at a maximum. However, if one is extremely weight conscious, this is also the heaviest seat cluster.



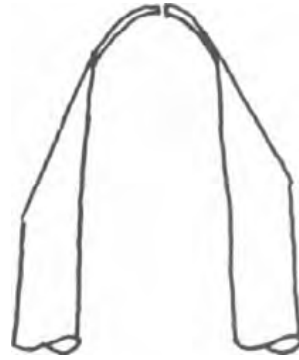
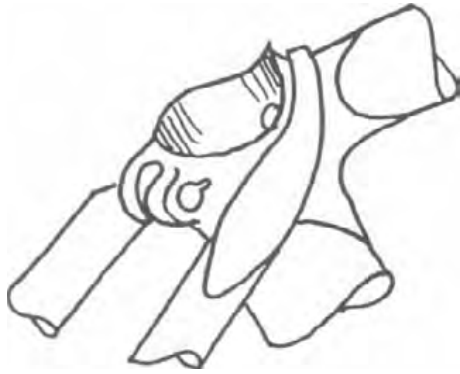

ill. 64: full wrap around-flat

#### **FULL WRAP AROUND-ROUND**

This has the same advantages as the flat style. However, it requires the fabrication of a special piece to connect the seatstays together.



ill.65:full wrap around- round

#### **FAST BACK-WITH EAR ON LUG**

Fast back seat clusters have two advantages:

- 1 - They are quite easy to do.
- 2 - The open area on the side of the seat lug can be dressed up with a cutout.

The main disadvantage of this style is the lack of strength. Since a fast back seat cluster is the narrowest part of a bike frame, a fair amount of lateral strength and stability is lost. (The previously mentioned styles attach to the sides of the seat lug and for that reason have greater strength.)



ill 66 fastback with ear on lug



modification of slug

#### FAST BACK-WITH ALLEN STYLE BINDER

These have the same advantages and disadvantages as the aforementioned cluster. They also have an additional disadvantage--a delicate balancing act is necessary during silver brazing. The beginning **builder** should have a fair amount of practice before attempting this style seat cluster.

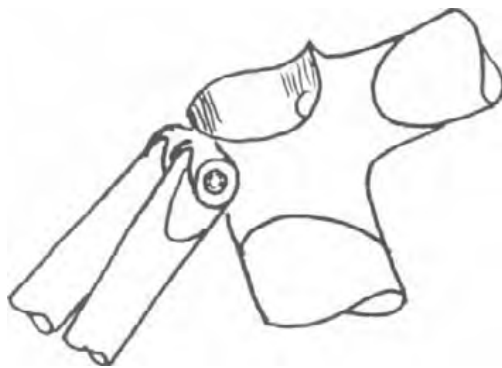

1167: fastback with allen binder

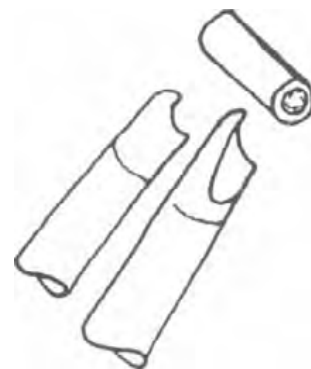

modified slugs

#### FAST BACK-RALEIGH PRO STYLE

These have the same strength factor **disadvantage as** the other fast backs. They also require the use of a seat lug with ample space below the binder in back. Further, some rather fancy mitering and delicate fillet building are required. These should be attempted by the experienced framebuilder.



ill 68: fastback - Raleigh Pro style



This joint requires compound miters and fillet brazing.

#### SEMI-FAST BACK

Cinelli makes a prefabricated slug that fits the top of the seatstays. They are machined out on the inside surface so that the slugs lie in close to the sides of the seat lug. This gives the appearance of a seat cluster that is neither standard nor fast back.

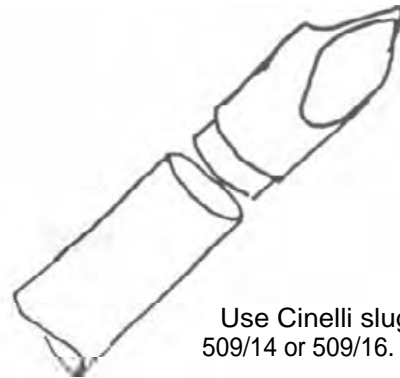

Use Cinelli slug 509/14 or 509/16.

#### OPEN TOP

A standard style seat cluster can be assembled without the caps or slugs at the top of the stays. This leaves the tops of the seatstays wide open. There is a substantial amount of strength lost by this method. It should only be done for extremely light riders or for time trial bikes where weight is of utmost importance. A drain hole should also be provided at the bottom of the stay as the stays could carry up to 6 fluid ounces of water on a rainy day. (Approximately 1/4 lb.)

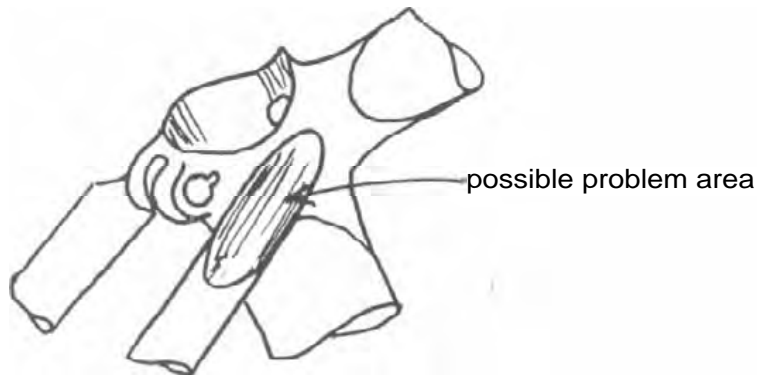

70: open top

### RAMJET AFTERBURNER STYLE

This is really quite a unique style that will make the frame stand out in a crowd. It requires a lot of modification of the lug before the front triangle is even assembled. Before attempting this style seat cluster, the builder should have developed some expertise in low temperature fillet brazing.

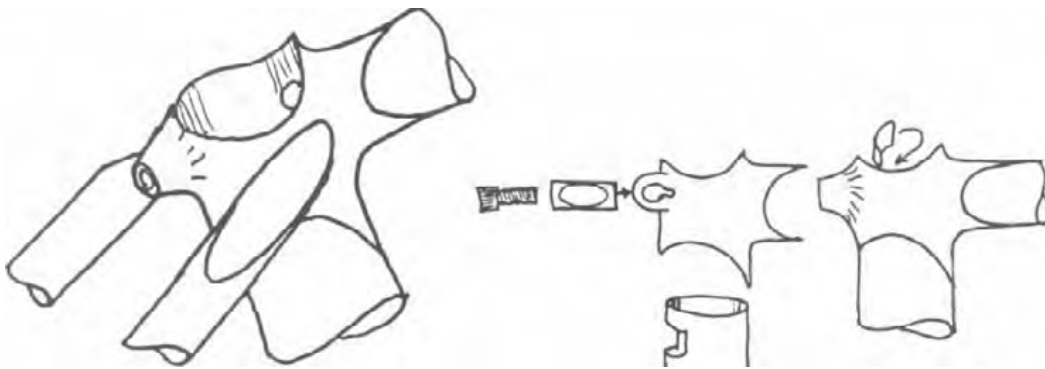

111.71. afterburner style

### TEARDROP EFFECT

A little bit of a nub can be left on the bottom of the seatstay cap. It can be kind of a nice little touch for someone who likes detail work.

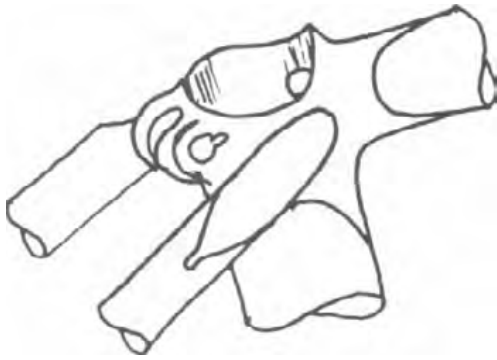

111.72: teardrop

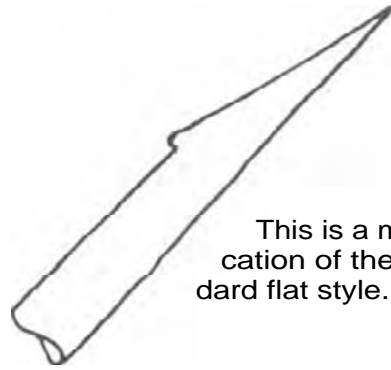

This is a modification of the standard flat style.

### STRESS RELIEF HOLES

After the seat cluster is fully assembled the slot should be cut in the back of the seat lug before the brake bridge goes in. (The brake bridge often becomes an obstacle that makes cutting the slot quite a chore.) The bottom of the slot should always have a stress relief hole. This hole will greatly reduce the chances of a circular crack developing at the bottom of the slot. Below are some examples of stress relief holes.

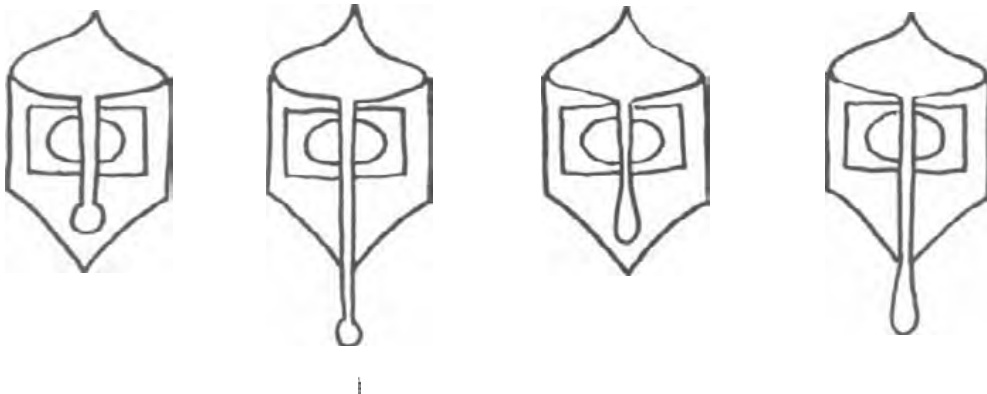

### SEAT CLUSTERS NOT AVAILABLE TO THE GENERAL MARKET

Many companies and independent builders have seatstay slugs and even complete seat clusters manufactured for them. Some examples are Masi, Colnago and Trek who all have their name or logo incorporated into their seat clusters. If you want to build a frame with one of their patented seat clusters--lots of luck. Those are their signature and they guard those very closely. Also, making facsimilies of another builder's seat cluster could easily be an infringement of a patent.

The best bet is either use one of the previously described types or have your own seatstay slugs or seat cluster manufactured.

#### SEAT STAY SLUGS

Cinelli has the best and most available selection of slugs in either 13mm, 14mm or 16mm sizes. Some of their styles are pictured below.

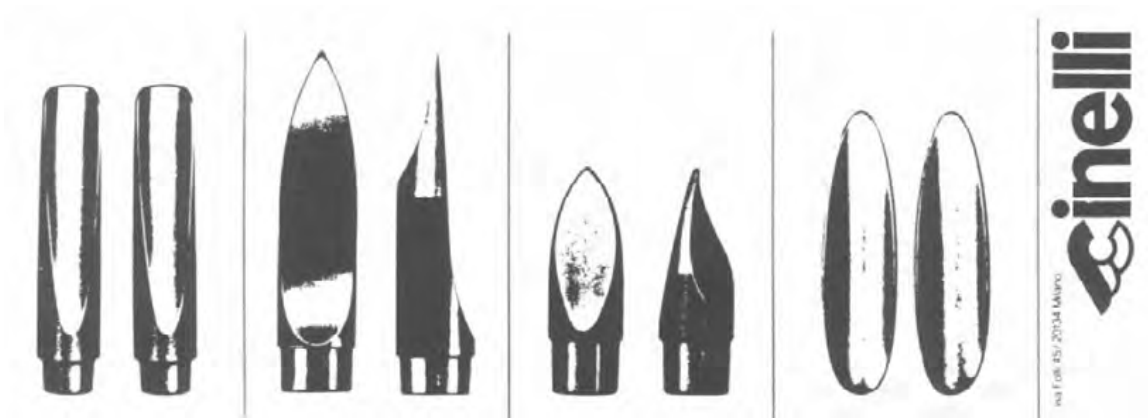

ill.74. Cinelli slugs- from 1984 Cinelli catalogue

#### LUG VARIATIONS

##### STAMPED LUGS

Lugs are available in two major types;

- 1 - Stamped lug sets
- 2 - Investment cast sets

The stamped lug sets are also sometimes called sheet metal lugs. They start out as a flat piece of sheet metal stock. The first step is to put the piece into a press and stamp out the rough shape necessary to make a lug. Then the piece is stamped into the contour of the lug. Since there will be a seam after this step, it must be welded before continuing. After the seam is welded, another stamping process chops off excess material to create the points. This is followed by another step that comes in from the side and cuts out the rounded bases in the lugs. Fancy cutouts can also be stamped out in one of these steps. The final step for stamped lugs is to bore the inside diameter,

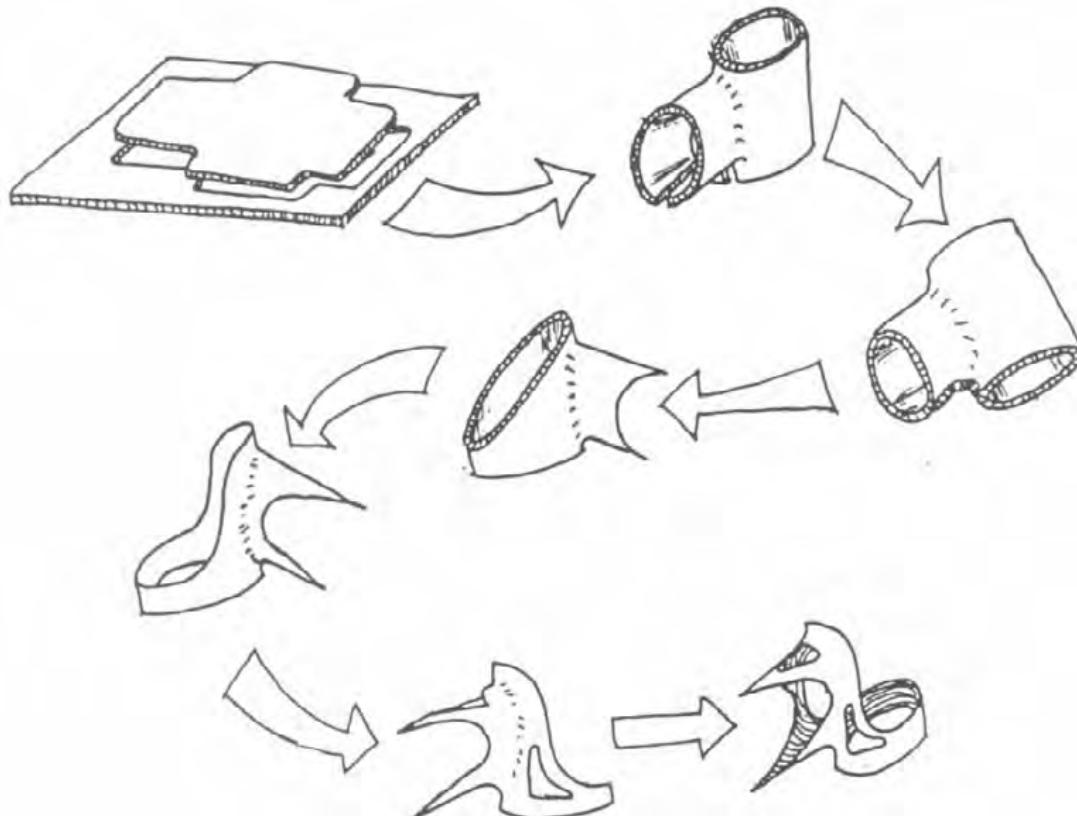

41.75 production steps in making a stamped lug

#### INVESTMENT CAST LUGS

Investment cast lugs are sometimes referred to as being made by the lost wax process. With investment cast lugs an actual full sized copy of the lug is made out of wax. This wax copy (It is not a mold) has all of the characteristics built into it (e.g. tolerances, finish, shape). The wax copy is then attached to a "tree" with other wax copies. Through a two week process, the tree is "invested" in a ceramic case. By putting the whole assembly into an oven, the wax is melted away, leaving only hollow cavities in the shape of the desired parts. The porosity of the ceramic mold allows air to escape while molten steel is being poured into it. After the castings are cool the ceramic mold is broken away to leave the cast pieces on the tree. The individual parts are cut away and then heat treated.

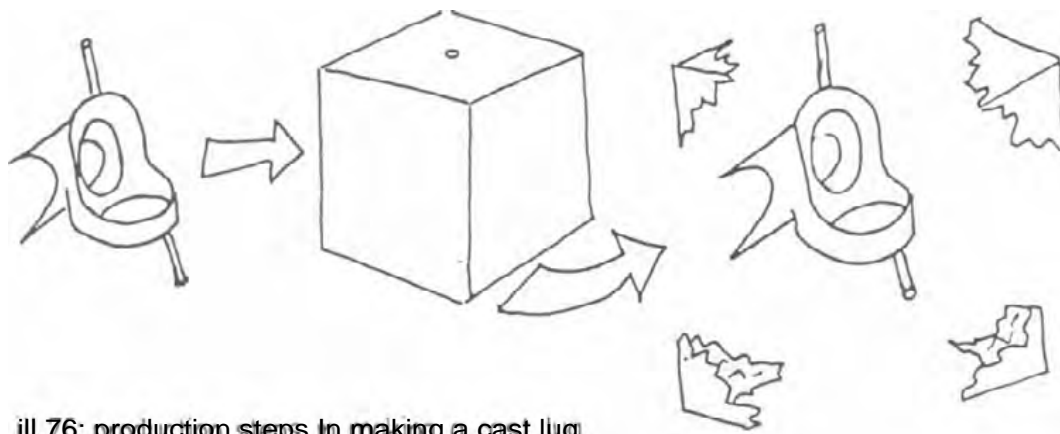

ill.76: production steps in making a cast lug

COMPARISONS OF INVESTMENT CAST AND STAMPED LUGS

Below is a table making comparisons of the two different styles of lugs. It shows advantages and disadvantages of each.

	ADVANTAGES	DISADVANTAGES
CAST LUGS	Harder materials such as Chrome-moly or stainless can be used. Inside diameters can be cast to be very close to necessary tolerances. A finer finish can be cast on the surface of the lug. Less preparation for silver brazing is necessary. Lugs can be cast to more exactly match frame angles. Because of close tolerances less silver solder is needed for a joint.	Cast lugs are usually quite stubby as long points are difficult to cast. Cutouts are also difficult to cast into a lug. Bending cast lugs is difficult and almost out of the question. Often lug sets have to be purchased with angles to match the working drawing. Cast lugs are quite expensive.
STAMPED LUGS	Longer points can be designed into the lug. Fancy cutouts can be designed into the lug. The lug is softer and	Preparation and clean up are time consuming. Sheet metal lugs can draw much more silver



---

ADVANTAGES

DISADVANTAGES

---

modifications can be made more easily. The lug can be bent up to a couple of degrees if necessary. Stamped lugs are much cheaper.

than cast lugs. Extensive reaming is often required for a good fit with the tube. Welded seams are often unsightly and may need special attention. Tabs on the seat lug should be reinforced internally.

---

There are a large number of lug sets available on the market today. Here is a discussion of the ones that are more readily available or more notable for some particular reason:

HENRY JAMES

These are investment cast out of chrome-moly by Henry James in California. They are extremely hard and need a minimum of prep work to get them ready for silver brazing. They cannot be altered very much and therefore, come in 1 degree increments and each lug can be ordered separately to make up a set. They have short points and no cutouts. Expect to pay about \$25.00 per set of 3.

CINELLI

These are investment cast but tend to be quite a bit softer than others thus allowing for some bending to meet individual needs. They are quite light and rather petite. They have no cutouts and short points. They require a bare minimum of prep work. Older Cinelli lugs were stamped lugs and not very attractive. Be careful when ordering not to end up with one of the old stamped sets. Expect to pay about \$25.00 per set.

PRUGNAT

These are stamped lugs and are quite simple in design. They can be bent to individual needs. They are available in about 4 different styles ranging from plain to having different styles of cutouts. They usually require a lot of reaming to prepare them for use. Cleanup will be rather time consuming also. Expect to pay about \$7.00 to \$9.00 per set.

## TANGE

These are stamped lugs and are also quite simple in design. They can be bent to individual needs. They are available in plain or with diamond shaped cutouts. They require little reaming to prepare them for use but external clean up can be time consuming. Expect to pay \$7.00 to \$9.00 per set.

## HADEN

These are stamped lugs and are also quite simple in design. They can be bent to individual needs. They are available in four styles - two of which have a separate alien style binder for the seat lug. They have cutouts in three styles. They require little reaming and little exterior clean up. Expect to pay \$7.00 to \$9.00 per set.

Of course there are literally dozens of brands and styles of lugs on the market. The ones mentioned above are ones I have used extensively or have personally sought out information about. For further questions about other brands and styles contact either the factory or a distributor of framebuilding supplies.

## BOTTOM BRACKET VARIATIONS

As with lug sets there are two major types of bottom bracket shells:

- 1 - Stamped
- 2 - Cast

To go over production of the two different types would be redundant as the processes are nearly identical to those used in the manufacture of lug sets. Also the comparison chart showing the advantages and disadvantages of stampings and castings readily applies to bottom brackets. That leaves a simple discussion of the different bottom bracket shells available on the market.

## CINELLI

These are investment cast with finely machined threads and faces. They require little preparation for silver brazing aside from moderate reaming. They are extremely stiff and are difficult to cold set. It is not necessary to remove much metal during the final facing procedure. They are readily available in both English and Italian specs. Expect to pay \$15.00 to \$20.00

HENRY JAMES

These are investment cast out of chrome-moly. They require little preparation for silver brazing aside from moderate reaming. They are extremely stiff and difficult to cold set. The manufacturer provides an extra millimeter of width so that if it is necessary to remove a lot during the facing procedure there is little risk of going under size. They are available in English specs. Expect to pay \$15.00 to \$20.00

RGF

This is one of the best stamped bottom bracket shells available. It is even sandblasted to give a genuine cast look. It requires a lot of reaming. (Good shell to use for French tubing) Some clean up is necessary to remove blemishes and ripples on the exterior of the shell. Be careful when facing. They come at exactly 68mm wide and it is easy to go undersize. They are readily available in English specs. Expect to pay \$7.00 to \$10.00

HADEN

This is a good practice bottom bracket for using on your first five bikes. It's a stamping. The welded seam is pretty rough and needs a lot of cosmetic work. Some numbers are stamped in the bottom surface and are somewhat unsightly. Some of these shells will actually come undersized and will be drastically undersized after facing. It all sounds pretty bad but the price is right. A Haden lug and bottom bracket set is so reasonable--it's almost like getting a free bottom bracket shell to play with.

All of the aforementioned bottom bracket shells come in English specs. Some come in Italian specs. If an Italian threaded bottom bracket is needed, ream and retap an English one. The necessity of using an Italian bottom bracket is questionable for two reasons:

- 1 - If an English or French shell strips out or is cross threaded, it can always be reamed and retapped to Italian. With an Italian bottom bracket that is not possible.
- 2 - The use of a left hand thread on the right side of the bike is definitely a superior concept. This is used on English and Swiss\* bottom brackets to prevent loosening of the fixed cup.

\*Swiss has the same thread as French but has a left hand thread on the right side.

Use of the French bottom bracket is also questionable for two reasons:

- 1 - The French, like the Italians, do not use a left hand thread on the right side.
- 2 - Such a small percentage of the American market is French that there will always be at least a little hassle in obtaining parts to fit French specs.

Generally bottom bracket shells are available in two widths; 68 and 70 millimeter. The 68mm is preferable since there are more bikes on the road with that width bottom bracket shell. Hence, parts are more easily obtainable. However, a 70mm shell always has the option of facing off 2mm if a problem arises. Besides, good luck finding a good reliable source for 70mm bottom bracket shells.

There is very little need to give much argument for Swiss bottom bracket shells. Admittedly, they do use a left hand thread on the right side. But, they comprise such a small portion of the market, bottom bracket cups will be difficult to obtain.

Some brands of the bottom bracket shells come with the option of choosing different geometrical specs (see picture). The variation of the angles around the bottom bracket is so little that a little reaming of the orifices is usually enough to do the trick. That which can't be accomplished by reaming can be taken care of by slight cold setting.

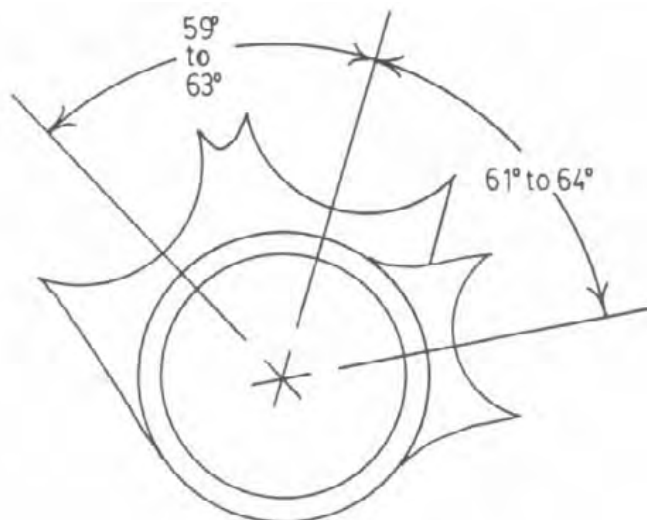

ill.77: bottom bracket angles

## FORK CROWN VARIATIONS

Fork crowns can be divided into two groups three times over:

- 1 - Stamped or Cast
- 2 - British or Continental oval cross sections
- 3 - Inserted or Overlapping configuration (Further divisions of Track, Tandem and Mountain crowns could be added too but to lessen the confusion will not be discussed).

On one hand, the earlier diagrams and table comparing and contrasting cast and stamped lugs apply to fork crowns. On the other hand, stamped fork crowns are almost archaic. They are state of the art of ten years ago. Cast crowns are so superior to stamped crowns that stamped crowns can only be recommended to make a quick and cheap replacement fork.

Fork blade cross sections are an ongoing controversy. Today the fatter, beefier continental blade is enjoying a lot of popularity. Ten years ago the thinner British blade was very popular. Both blades have a definite place in the bicycle industry. The British blade makes a good touring fork. Although it has less lateral stability due to its thin cross section, it has more strength from front to back. This means that cornering ability may be at a bit of a loss but forward stability when braking with a heavy load is improved. The Continental blade makes a better racing fork. Because of its wider cross section it has more lateral stability for better cornering. Since the racer doesn't carry a heavy load, forward stability is not that important.

### FORK BLADE CROSS SECTIONS

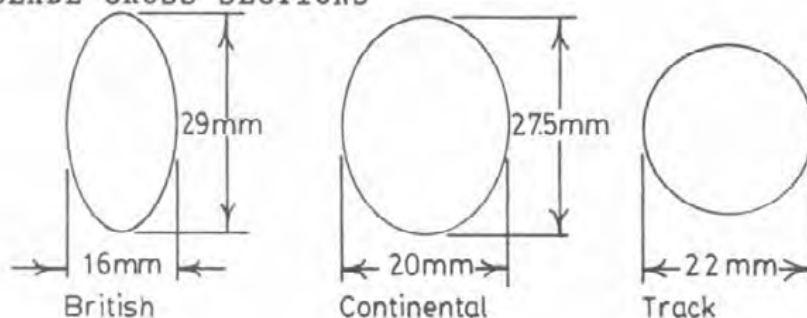

ill. 78: fork blade cross-sections.

The third division is in the way in which the crown and the blade are attached. With the inserted crown, the crown fits inside the blade. With the overlapping, the blade fits inside the crown. Both are of about the same strength. One would tend to think that the inserted crown would not be as strong. However, the one factor that would be of concern in this case is accounted for. Since the portion that is

inserted is of a smaller diameter, it is given a thicker wall. This makes the inserted crown as strong as the overlapping crown.

With three sets of two variables in fork crowns, the number of brands of crowns can be cubed. This will give a rough estimation of the great number of fork crowns on the market today. There are literally dozens and dozens of fork crowns to choose from. For that reason, only a few favorites will be discussed.

Some other minor variations that can be found in fork crowns are:

- 1 - Slope: refers to the angle at which the crown goes down to meet the blades. Full-sloping, semi-sloping, and non-sloping are the different types.
- 2 - Stiffeners or tangs: are decorative pieces of sheetmetal stock that are silver brazed to the inside face of the fork blade immediately below the crown. They add a very noticeable amount of lateral strength to the fork.
- 3 - Counterboring for allen nuts: counterboring of the brake hole can be done in order to use an allen type brake nut. This can be done to any crown by the builder.

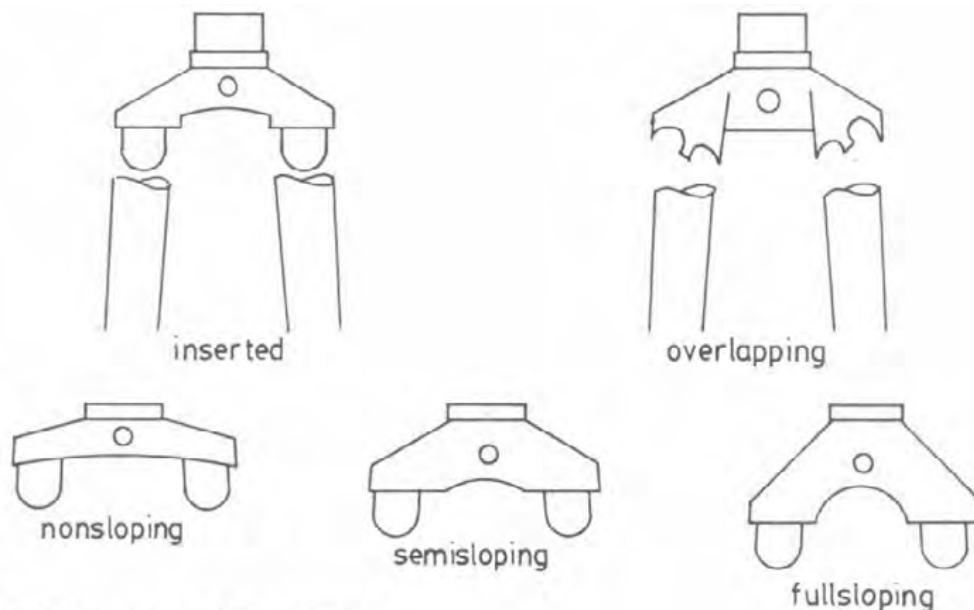

ill.79: styles of fork crowns

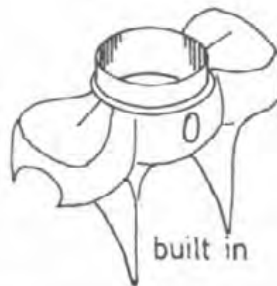
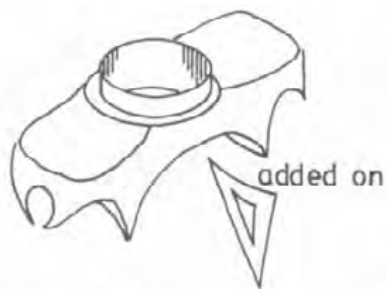

ill.80: fork stiffeners or tangs

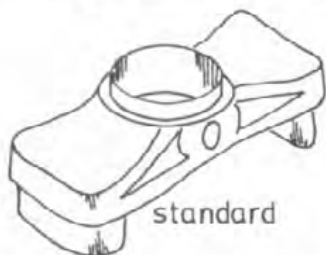

ill.81: front brake center bolt hole

#### CINELLI

Cinelli has a wide range of crowns to choose from. They make all types except stamped and overlapping for the British blades. They make crowns with all slope patterns. Their crowns require moderate reaming for a good fit on the steering column and a minimum clean up (One exception is the full-sloping inserted British crown which requires massive prep work). They have a large diameter at the site of the crown race so that their crowns can be milled for 26.4mm or 27.2mm. Several of the crowns in the Cinelli line have the option of using stiffeners. Expect to pay \$12.00 to \$16.00.

#### HENRY JAMES

These are some of the nicest crowns on the market. They have hidden air expansion holes and built in fork tangs. Sometimes the seams are rather rough in the casting and require a little extra clean up. They are out of chrome-cooly and are difficult to cold set after the fork is built. They also have a special dimple cast into the crown which automatically locates the drill bit when drilling the brake hole. These are about the thickest crowns on the market so if using one make sure the thickness is accounted for in the working drawing. Expect to pay \$19.00 to \$23.00.

## ZEUS

Zeus makes three crowns:

- 1 - Inserted, cast, British, non-sloping
- 2 - Inserted, cast, Continental, non-sloping
- 3 - Overlapping, cast, track, non-sloping

They are easy to clean up and prepare for silver brazing. They are one of the thinnest crowns and if using one this should be designed into the working drawing. Expect to pay \$9.00 to \$12.00.

## DROPOUT VARIATIONS

Basically there are three major styles of dropouts:

- 1 - Standard road dropouts
- 2 - Vertical dropouts
- 3 - Track or rear loading dropouts.

Any other types of dropouts are an offshoot from these three. There are some brands of dropouts that are simply stamped out of 3/32" mild steel sheet stock. These are of inferior quality and will be discussed no further. Most high quality dropouts are forged out of a fairly high quality steel. The better ones are then given raised faces where the quick release comes in contact with the dropout.

## STANDARD ROAD DROPOUTS

These have long (nearly horizontal) slots for the axle to slide into. This allows the wheel to be jockeyed back and forth between the chainstays to get the tire centered properly. Some of the more expensive road dropouts have small adjustment screws called chain adjusters screwed in from the back. There is a gross misconception about the purpose of chain adjusters. Many bikers think that they are for adjusting the wheel base on the bike. Chain adjusters were not designed for that purpose. They were designed for the company or person building frames who could not hold tight tolerances on chainstay length. By using dropouts with chain adjusters the builder really didn't have to worry so much about the chainstay length on both sides matching. A difference of 6mm could be taken up with the chain adjusters. Standard road dropouts with chain adjusters have one major drawback -- the threaded hole where the chain adjuster goes through is inherently weak. If the bike crashes or the rear derailleur goes into the spokes, the right dropout could shear off through the threaded hole.



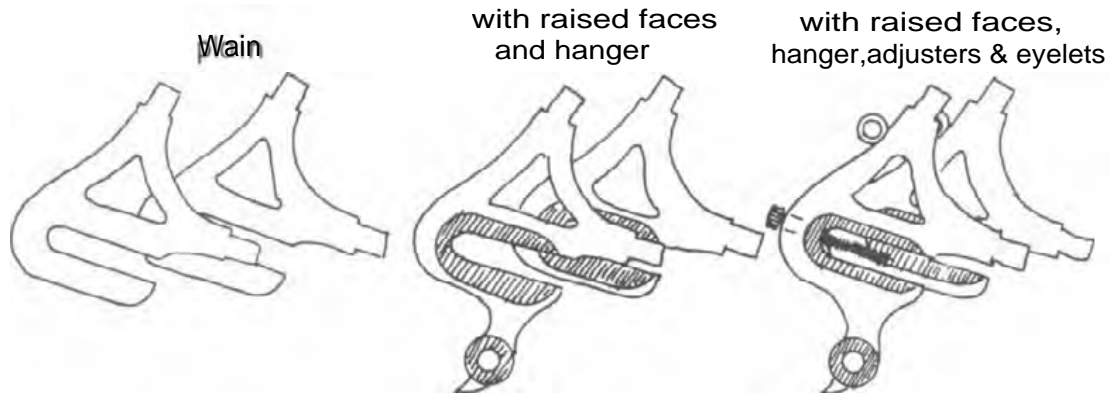

ill.82: wide range of dropout quality

#### VERTICAL DROPOUTS

Due to the fact that many framebuilders can hold better tolerances today the vertical dropout is widely used now. Rear triangles must be built with exacting accuracy when using verticals. Since the axle simply bottoms out in the dropout with verticals, they must be positioned so that a properly dished wheel sits in the middle of both chainstays as well as seatstays. This can be quite trying for the beginning frame builder. Vertical dropouts have four advantages:

- 1 - Pulling a tire into a chainstay due to a loose quick release never occurs.
- 2 - They are more compact and lighter as a rule.
- 3 - Since there is no threaded hole for a chain adjuster, they are much sturdier and have little or no tendency to shear off.
- 4 - Extremely tight clearances can be used between the rear tire and the seat tube.



Suntour

Shimano

G.P Wilson

ill.83: vertical dropouts

## TRACK OR REAR LOADING DROPOUTS

The rear loading dropouts are used for two major reasons:

- 1 - Due to the way they are attached to the stays they are stronger and can stand up to frequent and powerful sprints better.
- 2 - Since the wheel loads from the rear, there can be very tight clearances between the rear tire and the seat tube.

As a general rule, rear loading dropouts are only used on track bikes.



ill.84: track dropouts

## FRONT DROPOUTS

There is not much to be said about front dropouts. They simply come with rear dropouts in the set. Framebuilders seldom buy sets of dropouts based on what the front ones look like. Front dropouts either come with no fender eyelets, one eyelet or two eyelets. If eyelets are not present and desired, they can be silver brazed on. If there are eyelets and they are not desired, they can be cutoff.

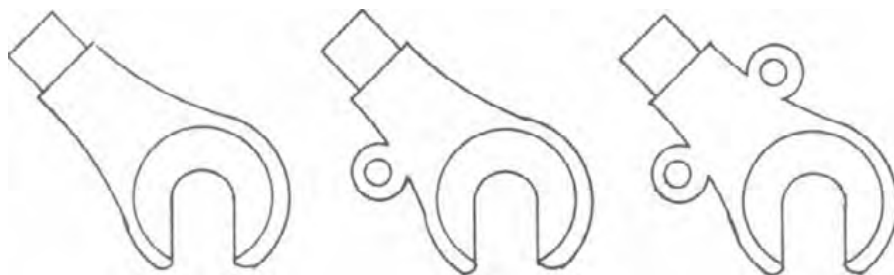

ill.85: factory positioning of front eyelets

Following is a brief discussion of some of the more popular dropouts on the market. There are quite a few available and this will be a fairly complete list.

# THE PATEREK MANUAL FOR BICYCLE FRAMEBUILDERS

## DROPOUT COMPARISON TABLE

BRAND AND MODEL	STANDARD ROAD - SHORT	STANDARD ROAD - LONG	VERTICAL	TRACK	CHAIN ADJUSTERS	RAISED FACES	OFFSET	CUTOUPS	DERAILLEUR HANGER	EYELETS	WEIGHT IN GRAMS	MATERIAL	COMMENTS
CAMPAGNOLO 1010	X			X	X	X	X	X	4	238	FS		
CAMPAGNOLO 1010/A	X			X	X	X	X	X	0	217	FS		
CAMPAGNOLO 1010/B	X			X	X	X	X	X	0	205	FS		
CAMPAGNOLO 1010/1	X			X	X	X	X	X	0		STS		
CAMPAGNOLO 1053		X							0	261	FS		
CAMPAGNOLO 1060		X							4		STS		
SUNTOUR EF-170 GS-III	X			X	X	X	X	X	4	225	FS	weight includes EP-101 front dropouts at 65grams	
SUNTOUR EF-200 GT-III	X			X	X	X	X	X	6	235	FS		"
SUNTOUR EF-210 SDG		X		X	X	X	X	X	6	194	FS		"
SUNTOUR EF-180 GS-VI	X			X	X	X	X	X	4	225	FS		"
SUNTOUR EF-140 GT-IV	X			X	X	X	X	X	4	225	FS		"
SUNTOUR EF-220 SDH		X		X	X	X	X	X	4	186	FS		"
SUNTOUR EF-150 SUPERBE	X			X	X	X	X	X	0	223	FS		
SUNTOUR EF-100 GS	X			X	X	X	X	X	4	229	FS		
SUNTOUR EP-120 SD		X		X	X	X	X	X	8	193	FS		
SUNTOUR EF-110 GS-II		X		X	X	X	X	X	4	226	FS		"
SUNTOUR EF-120 SDB		X		X	X	X	X	X	0	157	FS		
SUNTOUR EP-100 GT		X		X	X	X	X	X	4	233	FS		
SUNTOUR EF-130 SDC		X		X	X	X	X	X	8	198	FS		
SUNTOUR EP-110 GTW	X			X	X	X	X	X	4	230	FS		"



## ATTACHING DROPOUTS

Dropouts can be attached in several ways. Of primary concern in attaching them is the chainstay/dropout joint. This joint is under tension during riding and runs a higher risk of failure than the seatstay/dropout joint which is under compressive forces. The following are options for attaching dropouts.

### SIMPLE BRAZE

In the case of domed stays, brazing is more than adequate. The continuous line along the dome gives more surface area for brazing alloy to bond with. Silver or Brass are ok. However, brass will exceed the critical temperature of steel.

### BRAZE FILLED

With the milled (see pg. 2-56) style stayends, a rather large gap has to be filled. Low temperature brass, nickel-silver, or nickel-bronze are good for joining and filling at the same time.

### SPLIT CYLINDER INSERTS

As is the case in any other joint on the frame, increased surface area is desirable. This gives the silver more area to occupy. Hence, more holding power. G.P. Wilson of San Diego, California advises insertion of split cylinders before silver brazing.

### PINNING

**Drilling** a transverse hole through the stay end and dropout tab can be done before brazing. A steel pin is inserted prior to brazing. After brazing, the pin is filed flush. This method can be done in addition to any of the three previous methods.

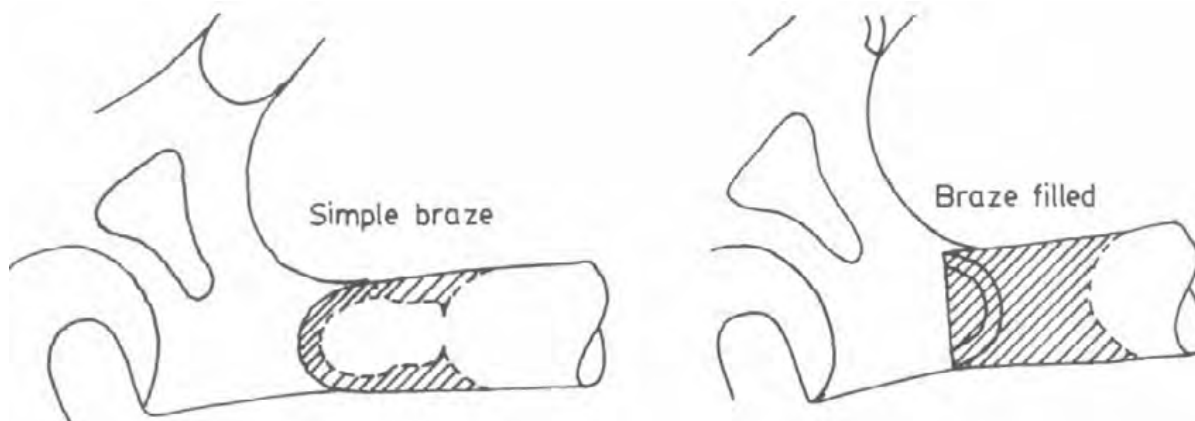

Dropout joints - brazing alloy roughly occupies crosshatched area

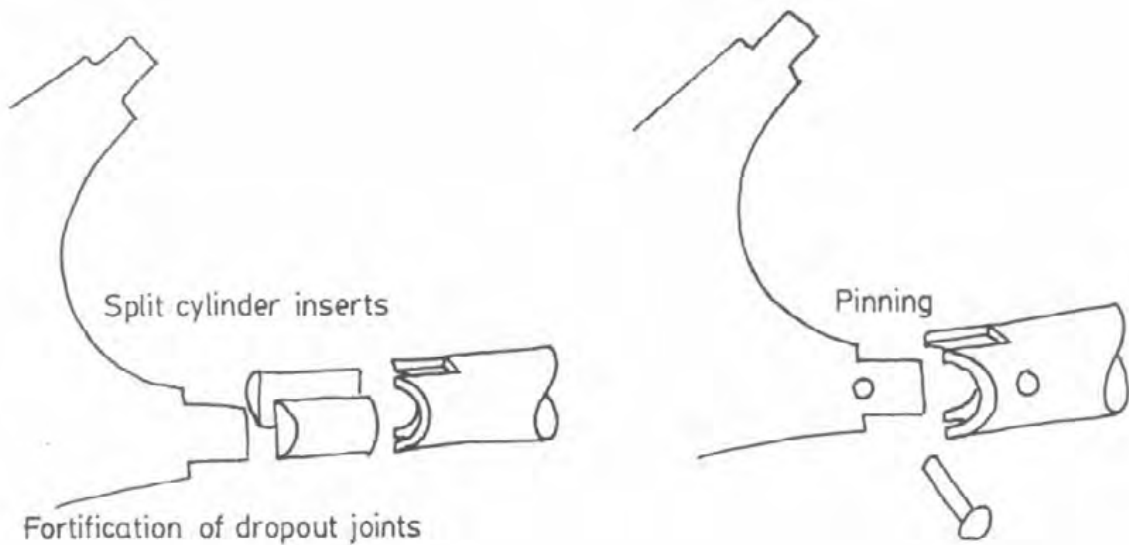

#### TUBING VARIATIONS

There are several major manufacturers of bicycle frame tubing in the world today. Some of the more popular ones are; Reynolds, Columbus, Ishiwata, Tange-Champion, Vitus, Durafort, True Temper and Oria. There are also brands of tubing that are made exclusively for a particular bicycle company and are not available to independent framebuilders. A good example of this would be Fuji's Valite tubing. The only tubing that will be discussed in this section will be the brands that are available to builders.

Tubing is available in either French specifications or British specifications. The main differences between these two are the wall thicknesses and the outside diameters of the tubes. The British tubes are manufactured to the nearest even increment in the English measuring system, i.e. 1", 1/8", 1 1/4", etc. French tubes are made to the nearest metric increment, i.e. 26mm, 28mm, 32mm etc. This makes French top tubes slightly larger in diameter than British top tubes (This is why it is very difficult to put top tube brake cable clips on a French bike). The British seat and down tubes are slightly larger in diameter than French (This is why a standard front derailleur will tend to twist on a French frame). Differences between French and British tubing dictate the use of specially made lugs and bottom bracket shells to match the nationality of the tube sets. For this reason, only British tube sets will be discussed in this section.

Tubing sets come with a variety of wall thicknesses and tapers. Some are plain gauge tubing and others are "butted" tubes which change in wall thickness from one end of the tube to the other. Since high quality frames should usually be built with butted tubes and taper gauge blades and stays, those will be the tube sets that will be discussed the most in this section.

#### THE DOWN TUBE

The down tube which connects the bottom head lug and the bottom bracket is one of the only two tubes that is double butted. The wall thickness at the ends of the tube is a heavy gauge and the wall thickness at the center of the tube is a light gauge. Yet the overall outer diameter from one end of the tube to the other remains uniform at 1 1/8". This means that all of the alterations to the tube have been done to the inside surface. This way, it is undetectable that anything special has been done to the tube (For a more complete description of how butted tubes are formed, a booklet called "TOP TUBES" can be ordered from TI Reynolds).

Of special concern to the framebuilder are mitering and cutting of the down tube. Cutting too much of the butted end off could eliminate the butt altogether. This would mean that where the tube is joined with a lug, only a thinwall tube is present. Such a condition would mean a substantially weakened frame from the start. For this reason, the major tube manufacturers have made special provisions so that the whole butted area is not cut off. Reynolds provides a long butt at one end. By cutting the excess off the long butt, a builder can avoid cutting off the entire butted area. The short butt is the end on which the Reynolds name is stamped. The short butted end should be mitered first but do not cut any more off. Opposite the end where the name is stamped is the long butt. During the final fitting of the tube, any excess can be cut from this end. Columbus offers three size ranges in nearly all of their tube sets. For a smaller rider, an A set should be ordered. For a middle sized rider, a B set should be ordered. For a tall rider a C set should be ordered. Excess may be cut off either end of the down tube in any Columbus set since the length desired will so closely match the A, B, or C set ordered. A few sets come with single butted down tubes. Put the butt at the head tube.

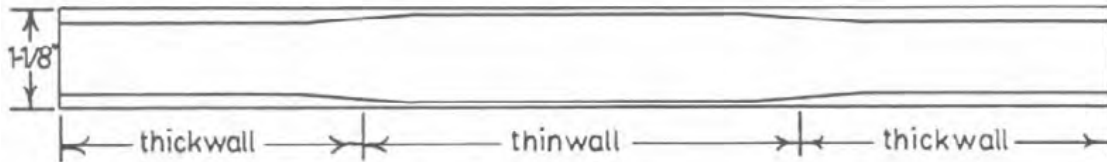

ill.86: cross section of double butted down tube

#### THE TOP TUBE

The top tube which connects the top head lug and the seat lug is the only other double butted frame tube in the tube set. Other than the fact that it has an outer diameter of 1", all other pertinent information is the same as that for the down tube. See the previous subheading for any cutting or mitering recommendations. A few sets come with single butted top tubes. Put the butt at the head tube.

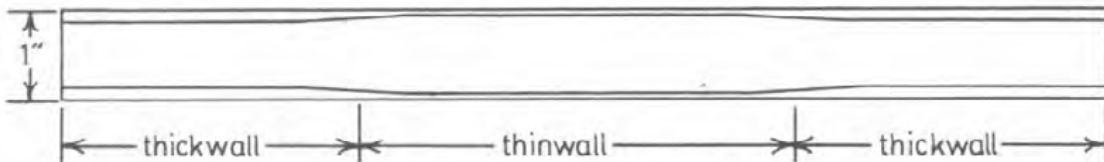

ill.87: cross section of double butted top tube

#### THE SEAT TUBE

The seat tube is only single butted. This is to allow for the insertion of the seat post in the thinwall end of the tube. IF the seat tube were double butted, it would be difficult to tell what diameter seat post would be necessary. Furthermore, if the seat post were to be inserted into a double butted tube which was cut at a location just before the butt, the seat post would rock and start to ream the top of the seat tube. With a single butted seat tube, several inches can be cut off and the same size seat post will still fit. The outer diameter of the seat tube is 1 1/8".

In cutting and mitering the seat tube it is very important to miter the butted end to come in contact with the bottom bracket shell. There are three ways to tell which is the butted end:

- 1 - Reynolds stamps their name in the butted end while Columbus stamps their logo in the butted end.



- 2 - Since a vast majority of tube sets accept a 27.2mm diameter seat post, keep one on hand to see which end of the seat tube it can be pushed into.
- 3 - Compare the wall thickness of each end of the tube either by eye or with a tubing micrometer to see which end is the butted end. When the butted end is determined, wrap a band of masking tape around the opposite end. This will eliminate any confusion as to which end is which later and also distinguish the seat tube from the down tube as well. Any excess in length should be removed from the thinwall end of the seat tube.

The length of the seat tube, as it comes in the tube set, is critical in determining how big of a frame can be built out of that particular tube set. Take the overall length of the seat tube as it comes in the kit. Add 25 millimeters to that length. The resulting figure will give the largest size that can be built from this kit (More experienced builders develop subtle ways to cheat by nearly a centimeter. By slightly altering the miter at the bottom bracket and doing a 1cm splice within the seat lug, a whole centimeter can be gained in seat tube length). Columbus Tubing comes in A, B, and C sets. The A set is for bikes with short seat tubes. The B set is for bikes with medium length seat tubes. The C set is for tall bikes. If a frame in excess of 64cm must be built, order the Reynolds tall set. This set comes with extra long tubes for the front triangle. However, stays and blades must be ordered separately. A few sets come with double butted seat tubes. Do not use these for extremely small bikes.

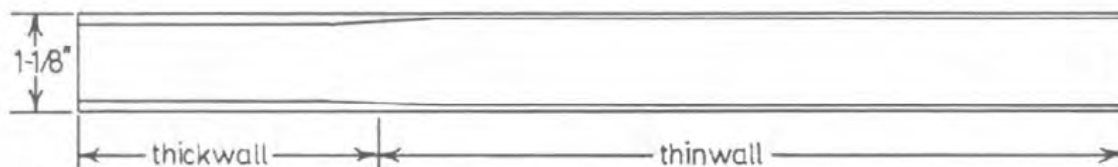

ill.88: cross section of single butted seat tube

#### THE HEAD TUBE

The head tube is not butted at all. It has an outside diameter of 1 1/4" and usually has a wall thickness of 1mm. Since the head tube is not butted in any way and neither end is mitered, there are no really important cutting procedures. Either end can be cut and any amount can be cut off. Again, for longer or

shorter head tubes, Columbus offers A, B, and C sets. Reynolds has extra long head tubes that are either stocked by jobbers or can be ordered from Reynolds.

A word about wall thicknesses of head tubes-- Columbus head tubes have a slightly thicker wall than Reynolds. This has advantages as well as disadvantages. The main advantage of a thicker wall in the head tube is that a stronger front triangle is the direct result. The main disadvantage of thicker walls on the head tube is in the milling and reaming procedure. Hand milling with a Campagnolo #733 tool or equivalent is very difficult on Columbus head tubes.



ill.89: cross section of non butteted head tube

#### THE STEERING COLUMN

The steering column is single-butteted and threaded at the thinwall end. The outer diameter of the column is 1". The butteted end of the steering column is 50mm long and the thinwall end is threaded to 50mm. Cutting of the steering column is very critical! If too much is cut off of the butteted end, there is no reinforcement where the steering column goes through the fork crown. Cutting off too much of the threaded portion does not leave enough threads to install a headset. Never cut more than 3cm off of the butteted end of the steering column! Never cut more than 3cm off of the threaded end of the steering column. With these guidelines, a steering column can be as much as 6cm longer than necessary and still be suitable for use. In case of a toss-up on how much to cut off of each end--try to cut less off the butteted end.

If the steering column is more than 6cm too long, do one of the following:

- 1 - If using Columbus tubing, see if the correct A, B or C set has been ordered. Order accordingly.
2. If using Reynolds, different length steering columns can be ordered from either the jobber or directly from Reynolds.
- 3 - If the builder has steering column dies, tap additional threads onto the steering column and cut excess off of the threaded portion of the column.

NOTE: If steering column dies are on hand, it is always more desirable to add more threads to the steering column and leave the butted end intact if possible.

Problems can arise if the steering column is being used in a very small frame set. The main problem that can occur in this case is having too long of a butt. If the butt is too long, the stem will be prevented from being inserted far enough. For really short bikes, there must be at least 50mm of thinwall in the steering column. In some cases, this may require that the butted end be cut shorter than previously recommended.

Some steering columns are fancier than others. Columbus provides a butted steering column which has internal splines along the length of the butt. These ridges are on the inside surface and form a gradual spiral. They not only have the effect that's the same as using a thicker butt--they also provide a torsional strength not present in regular butted steering columns. Furthermore, they add some class to the frameset. Ishiwata also offers the same option in a few selected tube sets.

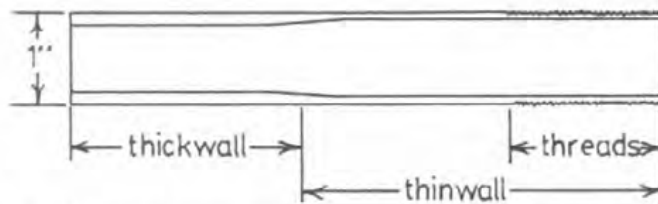

ill.90: cross section of butted steering column

## FORK BLADES

Fork blades either come as plain gauge or taper gauge. Taper gauge is different from butted tubes. In the case of butted tubes, there is a sudden and almost radical change in the gauge of the tubing along the length of the tube. In the case of tapered tubes, the gauge gradually changes from heavy to light over the entire length of the tube. By looking through the tube at a light source, one can actually see the beginning of the butted section of a butted tube. This is not possible with a tapered tube. Tapered fork blades are made by a four or five step process:

- 1 - A round tube with a tapered gauge is produced. This is thickwalled at one end and thinwalled at the other.

- 2 - The taper gauge tube is then swaged to form the external taper that typifies fork blades. After swaging the taper gauge is almost imperceptible or even gone altogether. At this point the fork appears to have a uniform wall thickness from top to bottom. This is because swaging decreases the outer diameter and at the same time increases the wall thickness.
- 3 - Optional step -- The ends may be domed and slotted at this point.
- 4 - The top of the fork blade is formed into an oval cross section.
- 5 - The bend (rake) is put in the fork at this time. This may be done in mass at the factory or individually by the independent builder.

Plain gauge forks are made by a slightly different process:

- 1 - A round, plain gauged tube is produced. This has uniform wall thickness over the entire length of the tube.
- 2 - The plain gauged tube is then swaged to form the external taper that typifies fork blades. After swaging the fork appears to have a reverse taper than that which would be desirable. This is because the swaging has decreased the outer diameter at the fork tips and at the same time increased the wall thickness at the tips. Now the blades are thinwalled at the tops and thickwalled at the tips.
- 3 - Optional step -- The ends may be domed and slotted at this point.
- 4 - The top of the fork blade is formed into an oval cross section.
- 5 - The bend is usually put in at the factory on plain gauge blades as most kits do not have plain gauge fork blades.

Cutting of fork blades is usually fairly simple. After the blade is bent and the dropouts are brazed into place, the excess is cut off of the tops. There are some instances in which some excess may need to be cut off of the tips before the dropouts are attached. If the blade is prebent and has more rake than is desired, cut no more than a centimeter off of the tips to alter the rake somewhat. Some mountain bike kits and tandem kits use the same specs for fork blades and chainstays. This sometimes leaves the builder with fork blades that are far too long. Cutting all of the excess off of the tops could put the crown too close to the point where the external taper starts. In such a case, some excess should be cut off of the tips and the rest should be cut off of the tops.

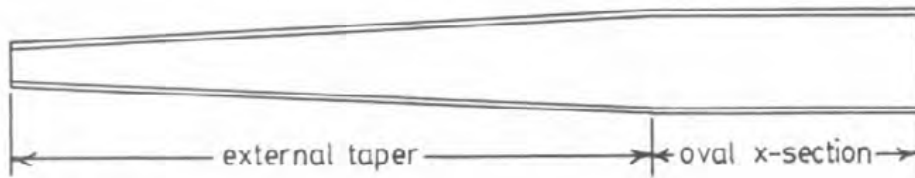

ill.91: breakdown of fork blade

## CHAINSTAYS

All of the information regarding taper gauges and plain gauges in forks is applicable to chainstays as well. Steps 1, 2, and 3 in the production of chainstays are the same as in the production of fork blades. For step 4, the forward portion of the chainstays are flattened, fluted or oveled to allow for proper clearances between the tire and chainstays and sprocket and chainstays. Step 5 is, of course, eliminated. Chainstays will come in one of several configurations:

- 1 - Round-oval-round -- Some chainstays are round where they are inserted into the bottom bracket shell. Moving away from the shell, they gradually become oval in cross section for about 5cm. They then go back to a round cross section for the rest of the length. The oveled area allows for necessary clearances. The round-oval-round configuration leaves less chance of stress fractures as there are no dimples or creases in the chainstay.
- 2 - Flattened -- Some chainstays come with a small flat area which is for tire and sprocket clearance. The flattened areas are just enough to provide the proper amount of clearance. These areas are somewhat abrupt and tend to be more visible than R-O-R.
- 3 - Fluted -- Some chainstays come with extremely deep indentations for the tire clearance. Deep flutes like this are seldom necessary and create an inherently weak spot in the chainstay. Fluted chainstays are highly susceptible to stress cracks. Unless excessive tire clearance is necessary, avoid using fluted chainstays.
- 4 - Round Some chainstays come with no provisions for clearances at all. These must be indented or oveled by the builder.

Cutting of chainstays is rather simple. There is seldom, if ever, any reason to cut anything off of the small diameter end of the chainstays. Excess should

usually be cut off of the large diameter end after the dropouts have been silver brazed in.

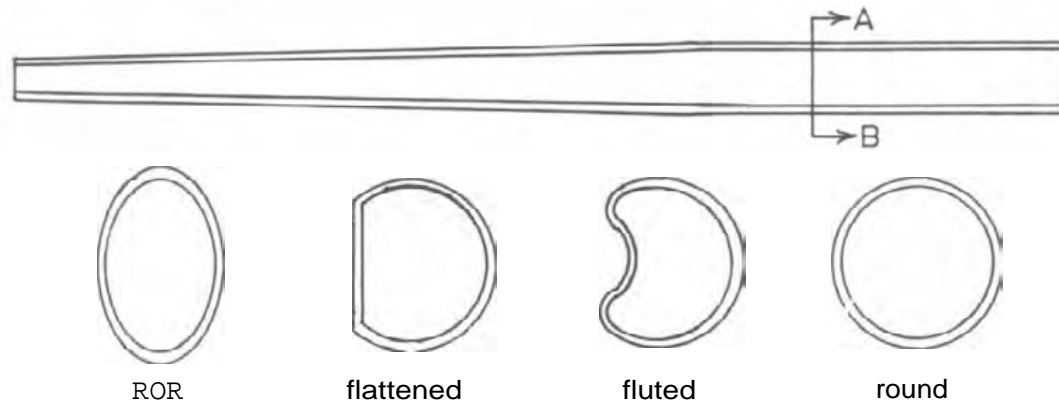

ill.92: transverse cross sections (AB) of chainstays

### SEAT STAYS

Seat stays can also come as taper gauge or plain gauge. Production of seat stays is rather simple. A taper gauge or plain gauge tube is swaged to create the desired external taper. Then the small diameter end may be domed and slotted. Information on the production of fork blades also applies to seat stays.

Basically, the only thing to watch for in seat stays is the outside diameter. Some are a 14mm seat stay which makes a lighter rear triangle. Some are a 16mm seat stay which produces a stronger rear triangle. Reynolds has recently introduced a double taper.

Cutting seat stays is rather simple. After the small end is slotted to fit the tabs on the dropout, the excess should be cut off the larger end.

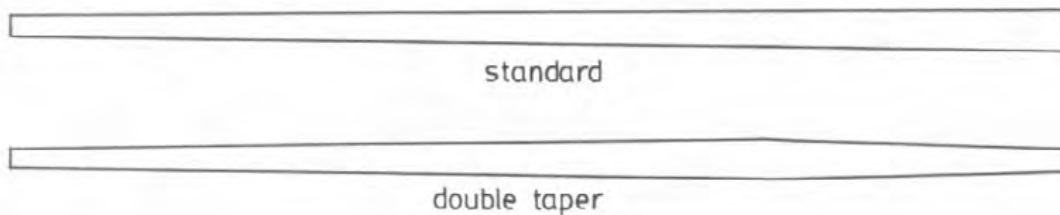

11.93: external tapers of seat stays

### BRIDGE MATERIAL

Some tube sets come with a piece of 1/2" diameter tubing about 7cm long. This is meant to be used for brake bridges. Sometimes this little piece is packed into one of the seat stays. When starting the building of the frame, look inside all of the blades and stays

to see if there is a little piece of bridge material hidden inside. If the frame is assembled with this piece inside, the noise can drive the rider crazy. If prefabricated bridges are to be used, don't throw the bridge material away. Short scraps of tubing like that come in handy quite often.

#### STAY AND BLADE ENDS

The ends or tips of seat stays, chainstays, and fork blades may or may not be altered at the factory. Reynolds usually provides a dome and a slot on their tips. Columbus provides a bevel on their tips and the builder must cut the slots. Some companies leave their tips plain and the builder must use imagination.



111.91.: blade and stay ends

Here are three popular ways of finishing the tips of stays and blades:



ill.95: popular ways of finishing tips

#### TUBE SUBSTITUTIONS

A builder does not have to use a tube set as it comes in the box. Any tube can be replaced with another brand or another gauge. A builder could build a frame with tandem chainstays and fork blades, a 1 1/8" x .065" chrome--cooly down tube, Columbus head tube and steering column, and 16mm seat stays. Such a bike would be very sturdy and extremely heavy. On the other hand a builder could just put a set of Columbus SP

chainstays and down tube into a Columbus SL tube set. This would make a nice light weight frame for someone who is just a little too heavy to ride an SL frame set. Chrome-moly aircraft tubing is an excellent source for tube substitutions. Aircraft tubing allows a builder to build a frame set to almost any size desired.

One problem arises with tube substitutions. Bicycle frame tubing manufacturers will not warranty materials in a frame set that mixes and matches different brands.

#### TUBING COMPARISON CHARTS

The following charts have been compiled from brochures put out by the four main cycle tubing companies; Columbus, Ishiwata, Reynolds, and Tange. A great deal of time was taken to put all units in one measuring system (METRIC), and also to put all information in the same format. This allows the builder to scan all tube sets on the market at a glance and make judgments on which set to use. Following is a brief description of how to read the charts:

TUBE LENGTHS -- All tube lengths are given in millimeters.

TUBE DIAMETERS -- All tube diameters are given in millimeters. A majority of the tube diameters are constant throughout the industry. The main differences which come up are in the French specifications. Reynolds is the only one of the tube companies which markets French diameter tubes in addition to British. French specs are listed on the last line of the Reynolds chart.

--In the case of chainstay diameters, two numbers are given. Since they are tapered, a diameter is given for the large end and another diameter is given for the small end.

--In the case of seatstay diameters, two or three numbers are given. Since they are tapered, a diameter is given for the large end and another number is given for the small end. In the case of Reynolds, some seatstays are double tapered. This means that both ends are small and the portion at the location of the brake bridge is a large diameter. Hence, three numbers.

--In the case of fork blades, not only are they tapered, but they are ovaled at the top as well. The first set of numbers (example 28 x 19) indicate the outer measurements of the oval



taken at right angles to each other. The last number is the Outer Diameter (O.D.) where the dropout goes in. Track fork blades are round at the top and will only have two numbers in the square.

WALL THICKNESS -- All wall thicknesses are given in tenths of a millimeter. If one number appears in the square, this indicates a plain gauge tube. Two numbers in a square indicates a butted tube. Tange offers one seat tube that is "triple butted"; this appears with three numbers in the square. Tange also has one double butted seat tube that has a different wall thickness at each end. This also appears with three numbers in the square. A small lower case letter may also appear in the square in which case; s = single butted, d = double butted, t = triple butted, p = plain gauge. In the case of some blades and stays that have a taper in their gauge, a capital T = taper gauge. Reynolds gives the Internal Diameter (I.D.) on all of their steering columns. I.D. is actually only a theoretical measurement in the manufacture of tubing and for this reason that column on the Reynolds chart has been left blank. However, Reynolds' British columns take a 22.2mm stem as do almost all other steering columns in these charts (Their French steering columns take a 22mm stem). An X in the steering column square indicates internal splines.

TOTAL WEIGHT -- The total weight of all sets is given in grams. Since Columbus puts out an A set for short riders, a B set for medium height riders, and a C set for tall riders, it is assumed that the weights given are for A sets. Weight figures on the A sets would appear more alluring in the market place. No weight has been given for the Reynolds Tall set or the 453 TECH as they are incomplete sets that require additional tubes before being complete.

NATIONALITY -- This appears on the Reynolds chart only. It simply indicates if a tube is available in French (F), British (B), or both (F&B).

RECOMMENDED USES -- It was difficult to designate definite uses for individual tube sets as rider weight, rider experience, and intended use all have to be juggled to get a happy medium. Many of the recommended uses are straight from the

brochures word-for-word. Others needed to be changed a little. Still others were reworded altogether. As they are in the charts, the intended uses will keep the builder out of trouble. In other words, the recommended uses are all modest and conservative. This gives the builder a starting point. **It** is up to the individual builder whether he wants to risk putting a heavy rider on SL tubing or if he wants to build a touring bike out of KL. Heavy riders should not be put on thin tubes. Inexperienced riders should not be put on thin tubes. Touring, commuting, and city bikes should not be built out of thin tubes. After the recommended use there will appear 2 abbreviations. The first tells whether the set is recommended for light, medium, or all riders. The second abbreviation tells whether the set is recommended for experienced, all, or beginning riders.

#### **TENSILE STRENGTH CHART**

The tensile strength chart was also compiled from information given in manufacturers' brochures. Here again, time had to be taken to put all values in the same units. Tensile strengths appear as kilograms per square millimeter. However, three of the four manufacturers gave figures in  $\text{kg/mm}^2$  and one gave figures in PSI. Hence, it was easier to convert the remaining one to  $\text{kg/mm}^2$ . Furthermore, converting mass figures to force figures is only theoretical. Therefore, converting these values to  $\text{Newtons/mm}^2$  lacks some credibility. To eliminate these discrepancies all tubes should have been tested by one unbiased testing agency and all values should have been expressed in  $\text{Newtons/mm}^2$ .

#### **COMPOSITION CHART**

Only two companies gave **the** composition of their alloys. Therefore, a complete comparison cannot be made between all four companies. However, the information is interesting **to** take note of.

#### **MISCELLANEOUS DISCREPANCIES**

Occasionally there was a misprint in the manufacturers' brochures. In these cases a little bit of interpolation was utilized to record a reasonable value in the charts.

**FORK BLADE RAKE --** Fork blade rake was not included in these charts as not enough information was available to make it meaningful.

As a general rule; All Columbus blades come straight and must be bent by the builder. Reynolds blades can be ordered bent or straight. On most Reynolds sets they are raked 45mm for racing sets or 50mm for touring sets.

CHAINSTAY CROSS-SECTION -- Here again it was difficult to put something meaningful together. As a general rule; You get what the specs call for with Reynolds and there's no telling what will pop out of the box with Columbus.

BLADE AND STAY TIPS -- This is just a too miniscule item to include in the charts.

COLUMBUS STEERING COLUMN/HEAD TUBE LENGTHS -- As near as can be determined, the A, B, and C sets each have a size range that can be expected for steering column and head tube lengths. Therefore, an exact value cannot be put in those squares.

COLUMBUS TENSILE STRENGTH -- The figures on tensile strength appearing in the 1984 Columbus brochure were very difficult to interpret. The figure that appears in the chart had to be taken from last year's brochure.

#### PREMIER TUBE SETS

Reynolds 753 - An ultralight weight tube set that is heat treated. It is only sold to builders certified by Reynolds. These builders must submit a sample of their work for destruction testing.

Tange Prestige - A special heat treated tubing with extremely high tensile strength. It can be ordered with ultralight specs or in the same specs as Tange 1, 2, 3, 4 or 5.

Columbus SLX - This is a lightweight tube set that has internal splines at the bottom bracket end of the seat tube, down tube, and chainstays.

Ishiwata 015 - This is probably the lightest tubing set made.

# TUBING COMPARISON CHART... DIMENSIONS

copyright 1984

COLUMBUS



	TUBE LENGTHS in mm												TUBE DIAMETERS in mm				WALL THICKNESS in mm				RECOMMENDED USES						
	SEAT	DOWN	TOP	HEAD	COLUMN	CHAINS	SEATS	BLADES	SEAT	DOWN	TOP	HEAD	COLUMN	CHAINS	SEATS	BLADES	TOTAL WGT gm	USES									
SLX A	600	600	600	180	180	410	500	390	28.6	28.6	25.4	31.7	25.4	22.2	14	28.4	6.9	d	d	d	1	2.5	.7	.7	1.9	1950	PROFESSIONAL TYPE USE: PARTICULARLY GOOD IN TIGHT FORMATIONS OR CRITERIUMS WHERE THE MANEUVERABILITY OF STIFF BUT LIGHT FRAME IS DESIRABLE
SLX B	620	620	600	180	220	410	550	390	28.6	28.6	25.4	31.7	25.4	22.2	14	28.4	6.9	d	d	d	1	2.5	.7	.7	1.9		
SLX-C	650	650	600	220	280	410	580	390	28.6	28.6	25.4	31.7	25.4	22.2	14	28.4	6.9	d	d	d	1	2.5	.7	.7	1.9		
SL-A	600	600	600	150	180	410	500	390	28.6	28.6	25.4	31.7	25.4	22.2	14	28.4	6.9	d	d	d	1	2.5	.7	.7	1.9	1925	UNIVERSAL ROAD RACING USE: IN-LINE HILLY, AND NORMAL RACES GOOD FOR EXPERIENCED MIDWEIGHT OR LIGHTER RIDERS
SL-B	620	620	600	180	220	410	550	390	28.6	28.6	25.4	31.7	25.4	22.2	14	28.4	6.9	d	d	d	1	2.5	.7	.7	1.9		
SL C	650	650	600	220	280	410	580	390	28.6	28.6	25.4	31.7	25.4	22.2	14	28.4	6.9	d	d	d	1	2.5	.7	.7	1.9		
SP-A	600	600	600	150	180	410	500	390	28.6	28.6	25.4	31.7	25.4	22.2	14	28.4	7.1	d	d	d	1	2.5	1	1	1.05	2296	IDEAL FOR IN-LINE AND STAGE RACES OVER ROUGH TERRAIN AND SPORT TOURING SOME LIGHT DUTY TOURING SUITABLE FOR ALL RIDER TYPES
SP-B	620	620	600	180	220	410	550	390	28.6	28.6	25.4	31.7	25.4	22.2	14	28.4	7.1	d	d	d	1	2.5	1	1	1.05		
SP-C	650	650	600	220	280	410	580	390	28.6	28.6	25.4	31.7	25.4	22.2	14	28.4	7.1	d	d	d	1	2.5	1	1	1.05		
PL-A	600	600	600	150	180	410	500	390	28.6	28.6	25.4	31.7	25.4	22.2	14	28.4	p	p	p	p	.8	2.5	.7	.7	1	1845	TRACK USE ONLY: PURSUIT EXPERIENCED LIGHTWEIGHT RIDERS
PL-B	620	620	600	180	220	410	550	390	28.6	28.6	25.4	31.7	25.4	22.2	14	28.4	p	p	p	p	.8	2.5	.7	.7	1		
PS-A	600	600	600	150	180	390	500	390	28.6	28.6	25.4	31.7	25.4	22.2	14	24	7.1	d	d	d	1	2.5	1.05	1	1.05	2255	
PS-B	620	620	620	180	220	390	550	390	28.6	28.6	25.4	31.7	25.4	22.2	14	24	7.1	d	d	d	1	2.5	1.05	1	1.05		
PS-C	650	650	650	220	280	390	580	390	28.6	28.6	25.4	31.7	25.4	22.2	14	24	7.1	d	d	d	1	2.5	1.05	1	1.05		
RECORD-A	600	600	600	150	180	410	500	390	28.6	28.6	25.4	31.7	25.4	22.2	14	28.4	p	p	p	p	.8	2.5	.5	.5	1.9	1610	FOR TRACK RECORD ATTEMPTS, POSSIBLY FOR LIGHTWEIGHT TIMETRIALERS EXPERIENCED RIDERS ONLY
RECORD-B	620	620	600	180	220	410	550	390	28.6	28.6	25.4	31.7	25.4	22.2	14	28.4	p	p	p	p	.8	2.5	.5	.5	1.9		
KL-A	600	600	600	150	180	410	500	390	28.6	28.6	25.4	31.7	25.4	22.2	14	28.4	5.7	d	d	d	.8	2.5	.5	.5	1.9	1670	
KL-B	620	620	600	180	220	410	550	390	28.6	28.6	25.4	31.7	25.4	22.2	14	28.4	5.7	d	d	d	.8	2.5	.5	.5	1.9		
GT A	600	600	600	150	180	410	500	390	28.6	28.6	25.4	31.7	25.4	22.2	16	28.4	6.9	d	d	d	1	2.5	1	.8	1.1	2257	HEAVY DUTY TOURING OR CITY BIKING SUITABLE FOR ALL RIDER TYPES
GT-B	620	620	600	180	220	410	550	390	28.6	28.6	25.4	31.7	25.4	22.2	16	28.4	6.9	d	d	d	1	2.5	1	.8	1.1		
GT-C	650	650	600	220	280	410	580	390	28.6	28.6	25.4	31.7	25.4	22.2	16	28.4	6.9	d	d	d	1	2.5	1	.8	1.1		
AELLE R-A	600	600	600	150	180	410	500	390	28.6	28.6	25.4	31.7	25.4	22.2	14	28.4	7.9	d	d	d	1	2.3	.9	.8	1.05	2257	GENERAL PURPOSE TUBING FOR THE BEGINNING RACER
AELLE R-B	620	620	600	180	220	410	550	390	28.6	28.6	25.4	31.7	25.4	22.2	14	28.4	7.9	d	d	d	1	2.3	.9	.8	1.05		
AELLE R-C	650	650	600	220	280	410	580	390	28.6	28.6	25.4	31.7	25.4	22.2	14	28.4	7.9	d	d	d	1	2.3	.9	.8	1.05		
AELLE-A	600	600	600	150	180	410	500	390	28.6	28.6	25.4	31.7	25.4	22.2	14	28.4	p	p	p	p	1	2.3	.9	.9	1	2345	GENERAL PURPOSE TUBING FOR THE BEGINNER
AELLE-B	620	620	600	180	220	410	550	390	28.6	28.6	25.4	31.7	25.4	22.2	14	28.4	p	p	p	p	1	2.3	.9	.9	1		
AELLE-C	650	650	600	220	280	410	580	390	28.6	28.6	25.4	31.7	25.4	22.2	14	28.4	p	p	p	p	1	2.3	.9	.9	1		

# THE PATEREK MANUAL FOR BICYCLE FRAMEBUILDERS

## TUBING COMPARISON CHART... DIMENSIONS

copyright 1984

ISHIWATA



	TUBE LENGTHS in mm										TUBE DIAMETERS in mm					WALL THICKNESS in mm					RECOMMENDED USES							
	SEAT	DOWN	TOP	HEAD	COLUMN	CHAINS	SEATS	BLADES	SEAT	DOWN	TOP	HEAD	COLUMN	CHAINS	SEATS	BLADES	SEAT	DOWN	TOP	HEAD		COLUMN	CHAINS	SEATS	BLADES	TOTAL WEIGHT gm		
015 Alpha	610	610	580	180	200	410	610	400	28.6	28.6	25.4	31.7	25.4	22.2	14.5	29 x 16	.7	.6	.6	1	2.2	.8	.8	1	1595	ROAD RACING - TIME TRIALS	LT	EXP
017 Record Breaker	610	610	580	180	200	410	610	400	28.6	28.6	25.4	31.7	25.4	22.2	14.5	29 x 16	.7	.7	.7	1	2.2	.8	.8	1	1895	ROAD RACING	MD	EXP
019 Glories Victory	610	610	580	180	200	410	610	400	28.6	28.6	25.4	31.7	25.4	22.2	14.5	29 x 16	.8	.8	.8	1	2.2	.8	.8	1	2015	RACING OR SPORT TOURING	ALL	ALL
022 Speed Gallant	610	610	580	180	200	410	610	400	28.6	28.6	25.4	31.7	25.4	22.2	14.5	29 x 16	.9	.9	.9	1	2.2	.8	.8	1	2185	TOURING - COMMUTING - BEG RACING	ALL	ALL
024 Ultra Strong	610	610	500	180	200	410	610	400	28.6	28.6	25.4	31.7	25.4	22.2	14.5	29 x 16	1.0	1.0	1.0	1	2.2	.8	.8	1	2360	HEAVY DUTY TOURING	ALL	ALL
025 Super Cyclist	610	610	580	180	200	410	610	400	28.6	28.6	25.4	31.7	25.4	22.2	14.5	29 x 16	.8	.9	.8	1	2.7	1.8	1.1	1.2	2470	TOURING - CITY BIKING	ALL	BEG
Magny X	610	610	580	180	200	410	610	400	28.6	28.6	25.4	31.7	25.4	22.2	14	29 x 16	.9	.9	.9	1	2.5	.8	.8	1	2235	ROAD & TOURING	ALL	ALL
Magny V	610	610	580	180	200	410	610	400	28.6	28.6	25.4	31.7	25.4	22.2	14	29 x 16	1.0	1.0	1.0	1	2.5	.8	.8	1	2420	ROAD & TOURING	ALL	BEG

\* internally splined column

# THE PATEREK MANUAL FOR BICYCLE FRAMEBUILDERS

## TUBING COMPARISON CHART... DIMENSIONS

REYNOLDS 

TUBE LENGTHS in mm     TUBE DIAMETERS in mm     WALL THICKNESS in mm

Model	SEAT DOWN	TOP	HEAD	COLLUM	CHAINS	SEATS	BLADES	SEAT DOWN	TOP	HEAD	COLLUM	CHAINS	SEATS	BLADES	SEAT DOWN	TOP	HEAD	COLLUM	CHAINS	SEATS	BLADES	SEAT DOWN	TOP	HEAD	COLLUM	CHAINS	SEATS	BLADES	RECOMMENDED USES
753 Track	635	635	600	220	280	400	555	370	28	28	28	28	28	28	32	25.4	22	13	11	10	11	13	13	13	13	13	13	13	753 Track
753 Race	635	635	600	220	780	400	555	370	28.6	28.6	25.4	31.7	25.4	22.2	13	11	16	16	16	16	16	16	16	16	16	16	16	16	753 Race
531 Professional	635	635	600	220	240	400	555	400	28.6	28.6	25.4	31.7	25.4	22.2	13	12	12	12	12	12	12	12	12	12	12	12	12	12	531 Professional
531 Competition	635	635	600	220	240	400	555	400	28.6	28.6	25.4	31.7	25.4	22.2	13	13	13	13	13	13	13	13	13	13	13	13	13	13	531 Competition
531 Special Tourist	635	635	600	220	740	440	600	400	28.6	28.6	25.4	31.7	25.4	22.2	13	14	14	14	14	14	14	14	14	14	14	14	14	14	531 Special Tourist
531 Club Sport	635	635	600	220	240	400	580	370	28.6	28.6	25.4	31.7	25.4	22.2	13	13	13	13	13	13	13	13	13	13	13	13	13	13	531 Club Sport
531 Special Lightweight	635	635	600	220	240	440	600	397	28.6	28.6	25.4	31.7	25.4	22.2	11	10	10	10	10	10	10	10	10	10	10	10	10	10	531 Special Lightweight
501 Chromalloy M	635	635	600	220	240	400	580	370	28.6	28.6	25.4	31.7	25.4	22.2	13	11	11	11	11	11	11	11	11	11	11	11	11	11	501 Chromalloy M
531 Tall Set	760	760	760	320	380	-	-	-	28.6	28.6	25.4	31.7	25.4	-	-	-	-	-	-	-	-	-	-	-	-	-	-	-	531 Tall Set
453 Tech	635	635	600	-	-	-	-	-	28.6	28.6	25.4	-	-	-	-	-	-	-	-	-	-	-	-	-	-	-	-	-	453 Tech
SMS	635	650	600	220	X	400	600	400	28.6	28.6	25.4	31.7	X	22.2	13	11	14	14	14	14	14	14	14	14	14	14	14	14	SMS
SPEC CHANGES IF ORDERED IN FRENCH																													
753 Track	F	1750	10	5	6	5	5	6	9	9	8	7	7	7	7	7	7	7	7	7	7	7	7	7	7	7	7	7	753 Track
753 Race	FAB	1800	10	5	5	5	5	6	9	9	8	7	7	7	7	7	7	7	7	7	7	7	7	7	7	7	7	7	753 Race
531 Professional	FAB	1900	10	5	5	5	5	6	9	9	8	7	7	7	7	7	7	7	7	7	7	7	7	7	7	7	7	7	531 Professional
531 Competition	FAB	2050	10	5	5	5	5	6	9	9	8	7	7	7	7	7	7	7	7	7	7	7	7	7	7	7	7	7	531 Competition
531 Special Tourist	FAB	2200	12	8	9	8	8	9	9	9	8	7	7	7	7	7	7	7	7	7	7	7	7	7	7	7	7	7	531 Special Tourist
531 Club Sport	B	2250	9	9	9	9	9	9	9	9	9	9	9	9	9	9	9	9	9	9	9	9	9	9	9	9	9	9	531 Club Sport
531 Special Lightweight	FAB	1995	5	5	5	5	5	6	9	9	8	7	7	7	7	7	7	7	7	7	7	7	7	7	7	7	7	7	531 Special Lightweight
501 Chromalloy M	FAB	2300	9	9	9	9	9	9	9	9	9	9	9	9	9	9	9	9	9	9	9	9	9	9	9	9	9	9	501 Chromalloy M
531 Tall Set	B	-	-	-	-	-	-	-	-	-	-	-	-	-	-	-	-	-	-	-	-	-	-	-	-	-	-	-	531 Tall Set
453 Tech	FAB	-	-	-	-	-	-	-	-	-	-	-	-	-	-	-	-	-	-	-	-	-	-	-	-	-	-	-	453 Tech
SMS	F+B	2100	-	-	-	-	-	-	-	-	-	-	-	-	-	-	-	-	-	-	-	-	-	-	-	-	-	-	SMS
ORDER REMAINING TUBES TO FIT ANY SPECIFIC NEEDS																													
FOR FRAMESETS OVER 65cm																													
TOURING - CITY BIKING																													
ALL BEG																													

RECOMMENDED USES

NATIONALITY

TOTAL WEIGHT

COPYRIGHT 1984

# THE PATEREK MANUAL FOR BICYCLE FRAMEBUILDERS

## TUBING COMPARISON CHART... DIMENSIONS

copyright 1984

TANGE



	TUBE LENGTHS in mm										TUBE DIAMETERS in mm					WALL THICKNESS in mm					RECOMMENDED USES								
	SEAT	DOWN	TOP	HEAD	COLUMN	CHAINS	SEATS	BLADES	SEAT	DOWN	TOP	HEAD	COLUMN	CHAINS	SEATS	BLADES	SEAT	DOWN	TOP	HEAD		COLUMN	CHAINS	SEATS	BLADES	TOTAL WGT gm			
*PRESTIGE	650	650	600	200	254	420	600	420	28.6	28.6	25.4	31.7	25.4	22.2	14	23	1.2	.7	.7	1	2.5	.8	.8	.9	1987	TRACK & ROAD RACING	Pursuit or time trialing	LT	EXP
No.1	610	650	600	200	254	420	600	420	28.6	28.6	25.4	31.7	25.4	22.2	14	23	.9	.8	.8	1	2.5	.8	.8	1	2220	TRACK & ROAD RACING		MD	EXP
No.2	610	650	600	200	254	420	600	420	28.6	28.6	25.4	31.7	25.4	22.2	14	23	.9	.9	.9	1	2.5	.8	.8	1	2290	TRACK, ROAD & TOURING		ALL	ALL
No.3	610	650	600	200	254	420	600	420	28.6	28.6	25.4	31.7	25.4	22.2	14	23	.9	1.0	1.0	1	2.5	.8	.8	1	2360	HEAVY DUTY TOURING		ALL	ALL
No.4	610	620	600	200	254	420	600	420	28.6	28.6	25.4	31.7	25.4	22.2	14	23	.9	.9	.9	1	2.5	.8	.8	1	2270	TOURING - COMMUTING		ALL	ALL
No.5	610	650	600	200	254	420	600	420	28.6	28.6	25.4	31.7	25.4	22.2	14	23	.9	.9	.9	1	2.5	.8	.8	1	2460	TOURING - CITY BIKING		ALL	BEG
Mangaloy 2001	610	620	600	200	254	420	600	420	28.6	28.6	25.4	31.7	25.4	22.2	14	23	1.0	1.0	1.0	1	2.7	.9	.9	1	2415	ROAD & TOURING		ALL	ALL
Mangaloy 200IS	610	620	600	200	254	420	600	420	28.6	28.6	25.4	31.7	25.4	22.2	14	23	1.0	1.0	1.0	1	2.7	.9	.9	1	2320	ROAD & TOURING		ALL	BEG

\* Specify track or road use when ordering Prestige.  
 If track, specify 23mm or 24mm round blades.  
 Seat tube comes single, double, or tripla butted.

23: 28.6 x 16.4  
 24: 27.4 x 20.6

# THE PATEREK MANUAL FOR BICYCLE FRAMEBUILDERS

## TUBING COMPARISON CHART... DIMENSIONS

copyright 1984

		RECOMMENDED USES		TUBE THICKNESS in mm																					
				TUBE LENGTHS in mm		TUBE DIAMETERS in mm		SEAT BLADES		SEAT		HEAD		COL UMN		CHAINS		SEARS		BLADES		TOTAL WGT in gm			
				DOWN	TOP	DOWN	TOP	DOWN	TOP	DOWN	TOP	DOWN	TOP	DOWN	TOP	DOWN	TOP	DOWN	TOP	DOWN	TOP	DOWN	TOP		
T <sub>1</sub> SP A	571	618	583	140	254	450	600	387	28.6	28.6	25.4	31.7	25.4	22.2	13	22.2	13	22.2	13	22.2	13	22.2	13	22.2	13
T <sub>1</sub> SP B	598	664	597	184	254	450	600	387	28.6	28.6	25.4	31.7	25.4	22.2	14	22.2	14	22.2	14	22.2	14	22.2	14	22.2	14
T <sub>1</sub> SP C	664	666	635	222	254	450	600	387	28.6	28.6	25.4	31.7	25.4	22.2	16	22.2	16	22.2	16	22.2	16	22.2	16	22.2	16
T <sub>1</sub> RC A	559	610	559	140	254	450	600	387	28.6	28.6	25.4	31.7	25.4	22.2	13	22.2	13	22.2	13	22.2	13	22.2	13	22.2	13
T <sub>1</sub> RC B	597	650	600	184	254	450	600	387	28.6	28.6	25.4	31.7	25.4	22.2	14	22.2	14	22.2	14	22.2	14	22.2	14	22.2	14
T <sub>1</sub> RC C	635	685	635	222	254	450	600	387	28.6	28.6	25.4	31.7	25.4	22.2	16	22.2	16	22.2	16	22.2	16	22.2	16	22.2	16
T <sub>1</sub> TR A	559	610	559	140	254	450	600	387	28.6	28.6	25.4	31.7	25.4	22.2	13	22.2	13	22.2	13	22.2	13	22.2	13	22.2	13
T <sub>1</sub> TR B	597	648	597	184	254	450	600	387	28.6	28.6	25.4	31.7	25.4	22.2	14	22.2	14	22.2	14	22.2	14	22.2	14	22.2	14
T <sub>1</sub> TR C	635	689	635	222	254	450	600	387	28.6	28.6	25.4	31.7	25.4	22.2	16	22.2	16	22.2	16	22.2	16	22.2	16	22.2	16
T <sub>1</sub> AT A	559	610	559	140	254	450	600	387	28.6	28.6	25.4	31.7	25.4	22.2	13	22.2	13	22.2	13	22.2	13	22.2	13	22.2	13
T <sub>1</sub> AT B	597	648	597	184	254	450	600	387	28.6	28.6	25.4	31.7	25.4	22.2	14	22.2	14	22.2	14	22.2	14	22.2	14	22.2	14
T <sub>1</sub> AT C	635	689	635	222	254	450	600	387	28.6	28.6	25.4	31.7	25.4	22.2	16	22.2	16	22.2	16	22.2	16	22.2	16	22.2	16
		HEAVY DUTY TOURING+MTN ALL		1.2		1.0		1.2		1.0		1.2		1.0		1.2		1.0		1.2		1.0		1.2	
		TOURING & COMMUTING ALL		1.0		.8		1.0		.8		1.0		.8		1.0		.8		1.0		.8		1.0	
		ROAD RACING		1.0		.8		1.0		.8		1.0		.8		1.0		.8		1.0		.8		1.0	
		SPORT TOURING		1.0		.8		1.0		.8		1.0		.8		1.0		.8		1.0		.8		1.0	
		ALL		1.0		.8		1.0		.8		1.0		.8		1.0		.8		1.0		.8		1.0	
		ALL		1.2		1.0		1.2		1.0		1.2		1.0		1.2		1.0		1.2		1.0		1.2	





# TUBING COMPARISON CHART

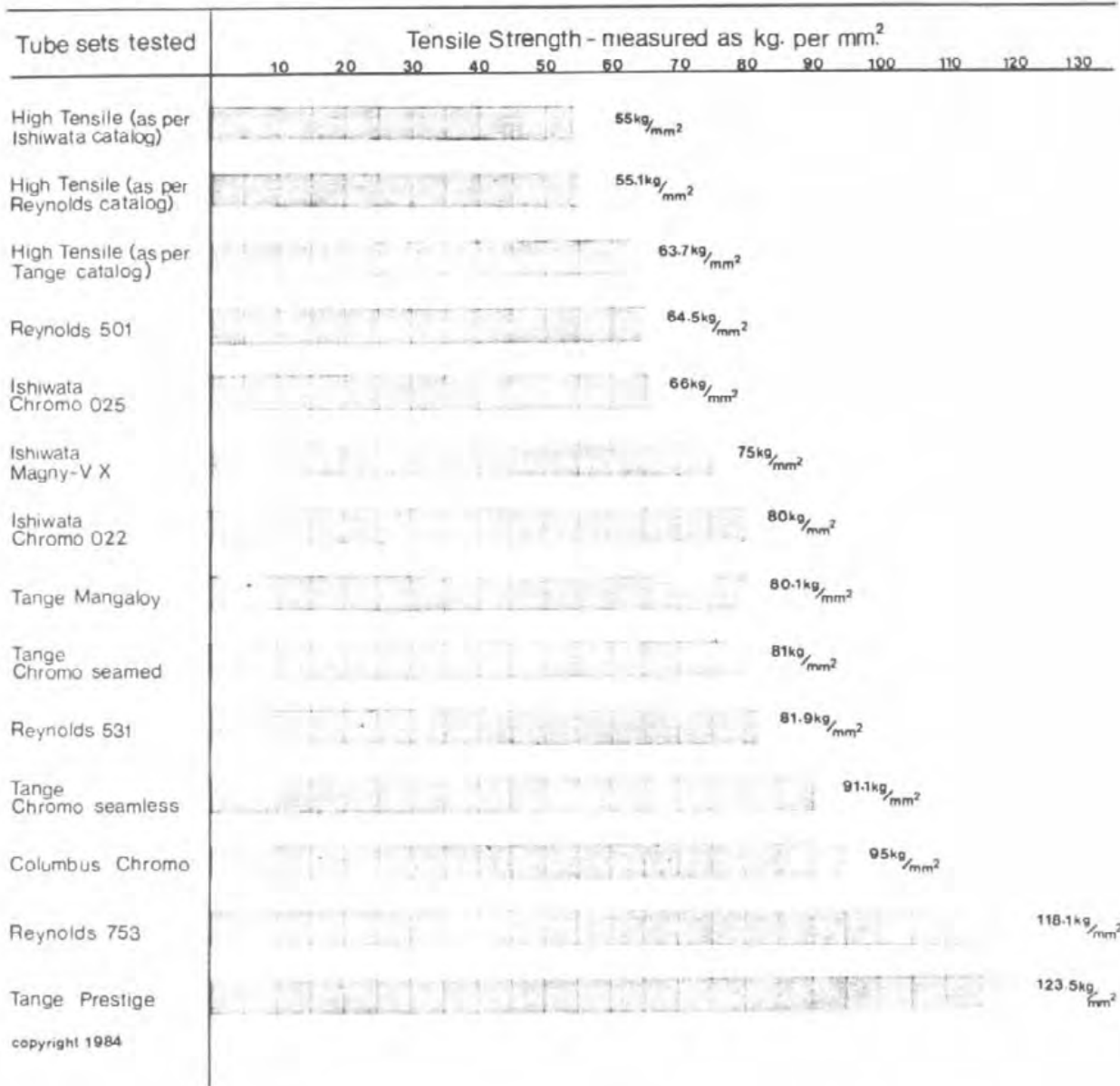

## TUBING COMPOSITION CHART

REYNOLDS	PERCENTAGES OF TRACE ELEMENTS								
	C	Si	Mn	Mo	S	P	Cr	Cu	Ti
531 Professional	.23 - .29	.15 - .35	1.25 - 1.45	.15 - .25	.045	.045			
531 Competition	.23 - .29	.15 - .35	1.25 - 1.45	.15 - .25	.045	.045			
531 Special Tourist	.23 - .29	.23 - .35	1.25 - 1.45	.15 - .25	.045	.045			
TANGE									
Chromo	.33	.35	.85	.25	.03	.03	1.2		
Mangaloy	.12	.15 - .35	.90		.035	.06		.25 - 4.5	.15
High Tensile	.09	.23	.67		.02	.06		.29	.04

## FRAMEBUILDER'S CHECKLIST

The following is a detailed step-by--step checklist to be used by the beginning framebuilder. It outlines every step from the beginning to the end of custom frame construction. This list serves two purposes:

- 1 - The builder will not have problems with accidentally skipping a process that should have been done.
- 2 - The framebuilder will be aware of all processes necessary to build a custom frame. By using this list the builder will never have to say, "Oh no! I forgot such and such!" OR "Gee, I never knew you had to do that."

Even the more experienced framebuilder will benefit from this checklist. It has taken me six years of framebuilding, Machine school and the teaching of numerous people how to build frames to be able to compile a clear and concise list such as this. There are items of interest which I have included in this list which I have picked up by touring ten bicycle factories in the U.S. and Europe and talking for many hours with at least a dozen other builders. I sincerely doubt if many other framebuilders have had such exposure and are willing to pass this exposure on.

This list is set up similarly to those used by machine school teachers. A pair of blanks is provided in the left hand margin for each step. The first blank (CO.) is to be checked off when the step is completed. The second blank (IN.) is to be checked off when the builder or teacher inspects the step for quality, tolerances and alignment. After both blanks are checked off the builder would continue on with the next step.

Do not proceed with this checklist until you have read the frame geometry section.

Immediately following the framebuilder's checklist is an extensive picture story. This picture story can be referred to at any time while going through the checklist by using the cross reference numbers given. Together, the checklist and picture story should thoroughly answer all questions.

This is what the working drawing will look like after following the directions in the first section of the framebuilder's checklist. It is not necessary to spend a lot of time on this drawing.

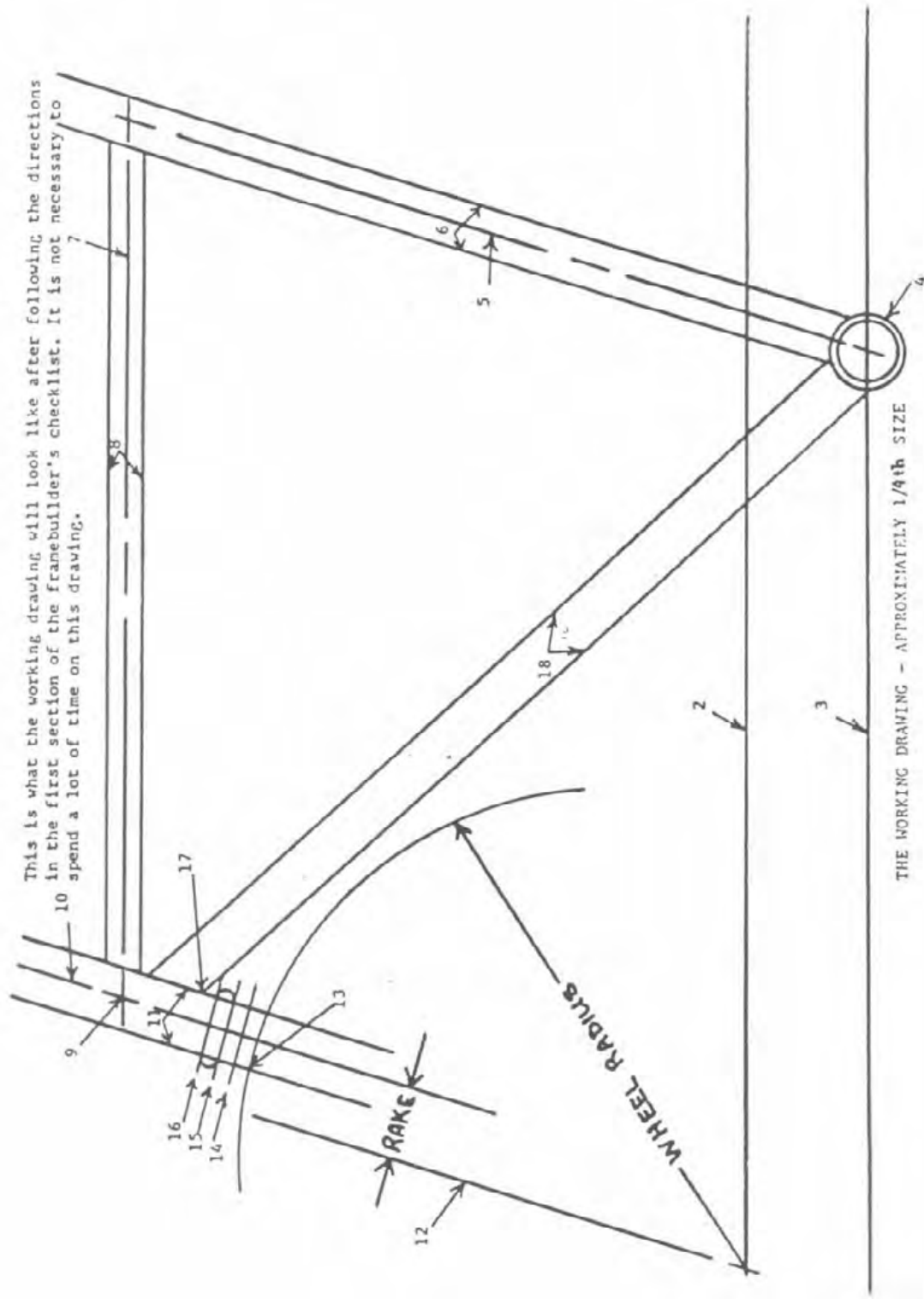

THE WORKING DRAWING - APPROXIMATELY 1/4th SIZE

- CO. IN. 1. THE DRAWING - Lugs and crown must be purchased by this time.
1. Mount a piece of paper measuring 30" x 30" on a drawing board. (See Fig. 1)
  2. Draw a horizontal centerline about 15cm up from the bottom of paper. This is the centerline of the axles and is the reference point for levelness.
  3. Calculate the amount of bottom bracket drop necessary and draw another horizontal centerline that distance below the first line. This is the centerline that goes through the bottom bracket.
  4. Find a point on the bottom bracket centerline about 20cm from the right edge of the paper. At this point scribe two concentric circles  $1 \frac{3}{8}$ " and  $1 \frac{5}{8}$ " in diameter. This is the bottom bracket shell.
  5. Calculate the seat tube angle that will be used and draw a centerline up out of the bottom bracket center at that angle. (This line should point slightly to the right as it rises out of the bottom bracket.) This is the centerline for the seat tube.
  6. Draw two lines parallel to this line. One line on each side and each  $\frac{9}{16}$ " away from the centerline. The  $1 \frac{1}{8}$ " diameter seat tube has just been drawn.
  7. Calculate the length of the seat tube and mark a point on the upper portion of the seat tube centerline exactly this distance from the center of the bottom bracket shell. Draw a horizontal centerline across the paper that intercepts that point. The centerline of the top tube has just been drawn.

CO. IN.

8. Draw two horizontal lines parallel to the top tube centerline, one will be 1/2" above it and the other 1/2" below it. The top tube has just been drawn.
9. Calculate the top tube length. Start at the point where the top tube and seat tube centerlines meet. From that point and moving to the left, mark a point on the top tube centerline at the proper length for the top tube. The head tube center point has just been located.
10. Calculate the head tube angle. Drop a centerline from the head tube center point downward at that angle. (This line goes slightly to the left as it goes downward.) The head tube centerline has just been drawn in.
11. Draw a pair of lines parallel to the head tube centerline, one 5/8" on one side of it and the other 5/8" on the other side. The head tube has now been drawn.
12. Calculate the fork rake. Draw a centerline parallel to the head tube centerline. This line will be to the left of the head tube centerline in the amount of the rake that will be used. The point at which this new line crosses the axle centerline is the center of the front axle.
13. Drop down to the front axle center. (This is the new reference point to finish the rest of the drawing.) Using the front axle center strike an arc with the radius of the wheel size to be used. This arc must cross the head tube centerline. This is the point at which the top of the tire passes between the fork blades and should be labeled "top of tire".

14. Calculate the amount of clearance desired between the top of the tire and the bottom of the crown. That distance should be found along the front edge of the head tube by measuring up from the top of the tire and marking it on the front edge of the head tube. Draw a line through that point perpendicular to the head tube centerline. Label this "Bottom of crown".
15. Measure the thickness of the crown that will be used and mark another point on the front edge of the head tube that distance above the previous line. Again draw a line through this point perpendicular to the head tube centerline. Label this line "Top of crown and bottom of headset". (See Fig. 2)
16. Locate another point on the front edge of the head tube 14mm up from the previous line. Again draw a line through this point perpendicular to the head tube centerline. Label this line "Top of the headset and bottom of the head tube". (See Fig. 3)
17. Calculate the HEAD TUBE/DOWN TUBE INTERCEPT POINT. Now move to the back edge of the head tube and measure up from the previous line to the head tube/down tube intercept point and mark that point. (See Fig. 4)
18. Locate the down tube by using the frame designer's straight edge described in the Fixtures section. This can be done by putting the center notch of the straight edge directly on the center of the bottom bracket and laying bottom edge of the straight edge against the head tube/down tube intercept point. The straight edge is now lying exactly where the down tube is supposed to be. Draw the down tube by scribing lines along the top and bottom edges of the

straight edge.

CO. IN.

19. Materials can be listed directly on the drawing as well as on the Frameset order form provided in the Framebuilder's labor and price schedule. (See Fig. 5)
20. The frame specifications can also be listed directly on the drawing as well as on the Frameset Order Form provided in the Framebuilder's Labor and Price Schedule. (See Fig. 5)
21. If working on more than one bike frame at once, write the customer's name in big letters with black magic marker in the middle of the drawing.
22. The drawing may now be transferred to a flat working surface and taped down. This surface should either be a stone surface plate or a piece of blanchard ground steel at least 3/4" thick.

II. GENERAL PREPARATION -- The tube set, dropouts, bottom bracket shell, lugs, and fork crown should have been purchased by this time. (See Figs. 6, 7, & 8)

1. Ream the inside diameters of the lugs for a proper fit with the corresponding frame tubes. A proper fit for a silver brazed joint should have about .004" of clearance. This will be a slightly sloppy fit. This procedure can be done with a combination of an 8" half round file and a high speed die grinder with cylindrical stone. (See Figs. 22 & 23)
2. Ream the inside diameter of the bottom bracket shell where the down and seat tubes are inserted. Strive for the same fit as with the lugs. When clamping the bottom bracket shell in a vice make sure to use soft jaws in the vise so as not to damage the faces or any of the threads.

(The chainstay orifices will be reamed later.) (See Fig. 22 & 23)

CO. IN.

3. Ream the fork crown for the proper fit with the steering column. This can be done by carefully clamping the crown in the soft jaws of the vise and running a #28 Chadwick adjustable hand reamer through the hole. (See Fig. 29 & 30)
4. File and sand the outside edges of the lugs, fork crown, and bottom bracket shell. All deformities, **burrs**, irregularities, and forming marks should be removed during this procedure. Do not touch the bottom bracket faces, the fork crown race seat or the head set seats on the lugs at this time! It is not necessary to do anything to the top surface of the seat lug at this time either. To produce a high quality custom frame set expect to spend four or five hours on this step alone. (See Figs. 24 - 28)
5. If the fork blades are not prebent, they must be bent to the correct amount of rake. When bending blades, bend the first one to specs and bend the second to match. They can be checked for how well they match by checking the height of their arc on the surface plate with a height gauge. Laying them on the drawing to check how well they match the desired rake should be done too. This is tricky work and the beginner should probably opt for ordering prebent blades or finding an experienced builder who will do the bending. When the blades are bent, the arc of the bend must lie in the same plane as flattened oval at the top of the fork blade!!! If this is not accomplished, the fork blades will have fork swoop and will not even come close to matching each other in appearance. This particular



CO. IN.

problem will be a source of constant annoyance to the rider as this is exactly where the rider is looking a lot of the time. (See Figs. 31, 32, & 33)

6. If the fork blades do not already have notches for the dropouts to fit into, they must be cut and filed. These notches must also lie in the same plane as the flattened oval at the top of the blade. The notches should be cut about a 6mm deep and the width of the notches should be carefully matched to the dropouts being used. After cutting both notches and fitting both dropouts in place, line up both blade/dropout sets and sight across them to make sure the dropouts are not cocked differently from each other. If that is the case, file one of the notches to correct this problem. After the dropouts have been fitted, file a tiny nick at the top of one dropout and the top of its matching blade so as not to get them switched around with the other set. (See Fig. 34 to 39)
7. If the fork blades have domed ends go on to step 8. If not, the tips of the blades should be scalloped out for looks as well as obtaining good clearance around the area of the front axle.
8. Repeat all of step 6 for the chainstays and rear dropouts. (See Fig. 34-39)
9. If the chainstays do not have domed ends, repeat step 7 for the chainstays.
10. A 3cm long flat should be filed on the inside face of the right side chainstay where it meets the dropout. This is to allow for clearance between the chain and the chainstay. (See arrow, Fig. 134)

11. Miter the butted end of the seat tube where it fits into the bottom bracket shell. The best way to find the butted end of the seat tube is to find which end a 27.2mm seat post will easily fit into. The other end is the butted end. (With Reynolds, the butted end is the end stamped with the name and gauge of the tubing.) Wrap the non-butted end with a ring of masking tape so as not to get confused later on. Marking for mitering can be done by inserting the butted end of the seat tube into the corresponding hole of the bottom bracket shell so it protrudes into the shell at least 3/4". A carbide scribe can then be used to scribe a line where excess can be filed away so there will be a flush fit inside the bottom bracket shell. The miter can be roughed in with a grinding wheel and cleaned up with a file. During this procedure, the tube should either be held in a Park clamp or a pair of aluminum or wooden Framebuilder's tube clamps. (See Fixtures.) (See Figs. 9, 10, 14, 15 & 21)
  
12. Miter the end of the down tube where it hits the backside of the head tube. (It will be mitered to an angle of 57 to 62 degrees.) In the case of Reynolds, the end being mitered now should be the "short butt." This is the end stamped with the name and gauge. In the case of Columbus, be sure to purchase the A, B, or C set to match the size of the frame being built and cut either end. Marking for mitering can be done by inserting the short butted end of the down tube into the corresponding hole in the bottom head lug. The tube should protrude to about the center of the lug. With a carbide scribe,

scribe a line around the tube where the excess will be cut off. The miter can be roughed in on a grinding wheel and the finer work can be done with a file. Again the tube should be held in a Park clamp or tubing blocks. The miter should be checked with three devices as follows:

1. The angle of the miter must be checked with a bevel protractor frequently during mitering. The correct angle may be taken off the drawing with the protractor. (If this angle is not between 57 and 62 degrees, something is wrong.)
2. The proper fit must be checked with a piece of head tube. The head tube must nestle into the miter with an absolute minimum of light showing through between the two tubes.
3. To see if the miter falls directly along the centerline of the down tube, a machinist's square can be laid across the two peaks of the miter. Both peaks should be the same height. (See Figs. 11, 13, 14, 15, 16, 17, 18, 19, 20)

Normally, in the bicycle industry, mitering is done on a \$10,000.00 Bridgeport mill. A hundred tubes will be mitered in one run and it takes about 30 to 45 seconds to do each one. Of course, this is out of the question for the average custom framebuilder. So the custom builder must do this by hand. After practice this procedure can be executed in about 15 minutes.

13. Miter the short butted end of the top tube where it meets the backside of the head tube. This will be mitered at about 72 to 75

CO. IN.

degrees. Again the angle can be taken directly off the drawing. Aside from the angle necessary, the procedure is identical to the mitering of the downtube. It is very important to wrap a piece of masking tape around the top tube close to the short butted end to be able to remember which end was mitered first. If this is not done, it is possible to put the top tube in backwards from how it was mitered. This is because the radii of the miters at both ends of the top tube are too close to each other to be able to tell the difference between them easily. However, the miters are different enough to throw off the front triangle by .5mm from the drawing. (See Figs, 12-20)

14. If eyelets are not desired, they may be cut off of the dropouts at this time.
15. If stamped lugs are being used, it is a good idea, at this time, to braze in a little sleeve to strengthen the binder assembly in the seat lug. It should be done with brass so it won't melt when final silver brazing is done on the joint later.
16. If any cutouts are desired in the lugs or dropouts or bottom bracket shell, they should be fashioned at this time.

III. **THE FRONT TRIANGLE** - At this point no silver brazing has been done and no more than one end of each tube has been worked with. Materials on hand at this point should include the prepped frameset, 2 oz. of Easy-Flo 30 silver brazing alloy, water soluble silver brazing flux, mild HCl acid solution, course/medium/fine emery cloth strips.

1. Prepare the bottom bracket shell and the butted end of the seat tube for silver brazing. This is done by thoroughly cleaning both surfaces of the joint with 150

that contains 45-55% Ag. Higher percentages are for jewelry work and lower percentages are for low cost work. Neither of which will have the correct flow characteristics or the right strength properties.

grit emery cloth and/or a wire wheel. The pieces can also be washed with an alkaline cleaner and dipped in and scrubbed with a mild HCl acid solution. They should be immediately rinsed with water and blown dry with a compressor. The most important factor in silver brazing is cleanliness. The pieces should be totally devoid of any grease, oil, metal treatment or foreign particles of any sort. Do not touch them after they have been prepared for silver brazing. Silver brazing should be done within a couple hours of this preparation as rust sets in quickly on cleaned untreated metal like this. (See Fig. 40)

WARNING - If the builder chooses to use a mild HCl acid solution for clean-up purposes, it should be done with the best ventilation possible and while wearing heavy duty rubber gloves. The acid vapor produced by this cleaning process can cause permanent lung damage and any acid getting into open cuts will eat away at body tissues for several days before being neutralized by the body. When not in use, the solution should be covered or sealed. If allowed to evaporate into the air, even a light concentration in the atmosphere **will cause** anything made of steel to rust at a greatly accelerated rate. In the case of cleaning up silver brazed joints after the joints are finished, the acid must be thoroughly rinsed off and blown clean. The smallest amount of acid residue can destroy a silver brazed joint in just a few days time. Acid residue left inside the tubes can eat right through the walls of the tubing in a

CO. IN.

matter of months. If using HCl acid solutions, follow all recommendations and cautions listed in this publication! (Sno-Bol toilet bowl cleaner is the best and most readily accessible source of an HCl acid solution.)

2. Apply flux generously to both surfaces to be joined and assemble them. Flux should be applied shortly after clean-up to keep surface rust from starting. Use plenty of flux as a lot of it will drip off during the pre-heat. (See Fig. 41)

WARNING - Silver solder flux contains fluorides and is acidic. It is extremely irritating to the eyes, mucous membranes, and any open sores. Do not let the flux come in contact with any of these areas. Wash your hands frequently while using this flux and speak to your doctor about first aid procedures before an accident occurs. Read all cautions on the side of the container and keep out of reach of children.

3. Fasten the seat tube and bottom bracket lightly into the bottom bracket jig. (Make sure the seat tube enters the center hole.) To be sure the seat tube comes out of the bottom bracket squarely, rotate the bottom bracket one way then the other. Find a position half way between the two extremes. Now clamp the bottom bracket tightly in the jig.
4. Make sure the seat tube is flush with the inside of the bottom bracket shell and the miter is not rotated at all. Now clamp down the seat tube in the jig.
5. The joint is now ready for silver brazing. Bottom bracket preheat

is important. It will take approximately 5 to 7 minutes to heat up the joint to the right temperature with oxy-acetylene. While heating, have the silver in one hand and ready to scoop up flux that falls and glop it back onto the joint. Save as much flux as possible. Use this preheat time to make sure the whole joint is evenly covered with flux. Use the silver to smear the flux around. Keep the flame moving at all times or the risk of overheating increases greatly. In the case of approaching the level of overheating, pull back with the flame for a couple of seconds. (A slightly carburizing flame should be used.) The flux should be used as a temperature indicator. It will be applied as a wet paste. As it heats up it will turn into a dry crust. As it heats up more it will appear to be a wet fluid with a lot of bubbling activity taking place. Watch the bubbles. As the flux gets to the right temperature, the bubbles will get smaller and smaller. When the bubbles get so small that they seem ready to disappear altogether, the joint is hot enough to start silver brazing. (It is not possible to get the whole joint hot enough all at the same time without a hearth process so as you work around the joint with the silver, just watch those bubbles as you go.) The best procedure is to braze the tips "peaks" first and then do the "valleys" of the joint. By looking inside the bottom bracket shell the builder can see if good penetration is being accomplished by looking for the silver as it comes through. (See Fig. 42)

**WARNING** Tinted glasses should always be worn while using the torch. However, use of tinted lenses increases the danger of overheating. The tint of the

lenses will change the color perception of the builder enough to not be able to detect mild overheating. While silver brazing in a well lit room, the builder should not even be able to pick out the least amount of reddish color of the metal. In a very dark room a very dull red can be perceived at silver brazing temperatures. (Do not confuse the reddish color of hot flux with the metal. Sometimes the flux will become red while the metal is still the right temperature. Flux will break down and get a muddy appearance if it is overheated.) If you choose to work without tinted lenses, you do so at your own risk.

6. After the work has cooled sufficiently, it can be removed from the jig. It should then be soaked in hot water long enough to remove the flux. Do not immerse a hot joint in water. Heat distortion will be greatly increased by doing this. While soaking the joint, the flux can be chipped off with a sharp implement to speed up the process. Do not chip off pieces of flux with your fingers! Those pieces of flux are as sharp as shattered glass! If HCl acid clean-up is done, thoroughly rinse and blow dry the joint.
7. Clamp the seat tube in the Park clamp or blocks. The bottom bracket should now be retapped with Campagnolo tool #721 or equivalent. (See Sutherland's Manual for proper use of bottom bracket taps.) (See Fig. 43)
8. While still clamped up the bottom bracket shell should be faced with Campagnolo tool #725 or equivalent. (See Sutherland's Manual for the proper procedure



CO. IN.

for bottom bracket facing.) (See Figs. 44 & 45).

9. The joint should now be checked for deflection due to heat distortion. This can be done by clamping the top of the seat tube and laying the bottom bracket micrometer against the faces of bottom bracket on each side. One half of the difference between the two sides is the amount of error. A difference in the readings of more than 1mm over a span of 50cm is unacceptable. If cold setting is necessary, the bottom bracket faces should be clamped tightly in the soft jaws of the vise and the joint must be bent to specs. If doing this with SL tubing or lighter, insert a 1" diameter steel rod down the entire length of the seat tube for reinforcement before cold setting. (Cold setting is a necessary evil of frame building and will be necessary on nearly 75% of all the joints in the frame.) (See Figs. 46 & 47)
10. A final cosmetic clean-up should now be done before going on to the next joint. Unsightly splotches of silver can be removed with jewelers' files and 120 grit emery cloth. (See Figs. 48 & 49)
11. Clean-up one end of the head tube and the bottom head lug and prep them for silver brazing. (See Fig. 50)
12. Apply flux.
13. Place the bottom head lug on the end of the head tube with about 1mm protruding through the bottom of the lug. Make sure the inner surface of the lug is tight against the back face of the head tube.
14. Lightly clamp the head tube in the soft jaws of the vise so that

CO. IN.

the lug is several centimeters away from the vise and the points of the lug sticking straight up in the air. (See Fig. 51)

15. Silver braze the joint now. Preheat will be much faster on this piece. Add silver to the 1mm of head tube sticking past the bottom of the lug and draw it through to the other side. More silver can be added to the back side of the head tube right above the lug and drawn down through in the other direction. After finishing the joint, inspect it for good penetration. Note if silver has come through the area where the down tube will be inserted. (See Fig. 51)
16. Clean-up (Step 6)
17. An air expansion hole must be drilled at the center point of where the down tube will intercept the back of the head tube. (In other words, right between the points of the lug and into the head tube.) A large hole is desirable. This will allow for easy flushing of the tubes during the final metal treatment. (drill this hole 1/2" in diameter.)
18. Before silver brazing the down tube into the bottom head lug, the angle of that joint must be checked. If using Henry James lugs, the fit is so precise that after using a lug with a designated angle, the joint should fall within tolerances. If using another brand of lug, some prebending of the lug will be necessary to be sure that the joint will be the correct angle. Before doing any of the necessary bending, the angle of the joint should be checked with the bevel protractor to see how much bending is required. After

CO. IN.

bending the lug to the proper angle, it must be checked again with the bevel protractor. If the angle has been achieved, the joint is ready for silver brazing. (This is, without a doubt, the most important joint of the whole bike. If this joint is off by any amount, steering geometry will be affected as well as the general configuration of the entire front triangle.; (See Fig. 52)

19. Clean-up the top of the down tube and bottom head lug and prep them for silver brazing.
20. Apply flux.
21. Assemble parts and clamp in Park clamp or blocks so that the head tube is horizontal and at about eye level. (No jig is necessary for this joint.) A long 1" diameter steel bar can be put through the head tube as a counterbalance in order to hold the head tube at the desired angle. (See Fig. 53)
22. After the preheat, tack the points of the lug and let it cool for a few minutes.
23. Use the bevel protractor to check the angle of the joint. If bending is necessary, insert 1" steel bars through the head tube and up the down tube for reinforcement. Bend to specs. Check with bevel protractor and bend more if necessary. (See Fig. 54)
24. After making sure the desired angle is reached, continue with the silver brazing and finish up the joint.
25. It may be necessary to repeat step 23 again at this point.
26. If working on a surface plate, the head tube/down tube

CO. IN.

configuration can be suspended above the drawing with V-blocks and the angle can be checked with a machinist's square by transferring the lines directly up to the edges of the tubes. (See Figs. 55 to 60)

27. Clean up the joint and repeat step 10.
28. Insert the down tube into the bottom bracket and suspend the head tube/down tube/seat tube (HT/DT/ST) configuration above the drawing with V-blocks. Use a machinist's square to get the head tube and down tube directly over the drawing. Now figure out where to make a rough cut at the bottom of the down tube so that about 1cm of tube will be sticking into and past the inside of the bottom bracket shell. (See Fig. 55)
29. Cut the tube off at the mark.
30. Again suspend the HT/DT/ST configuration above the drawing with V-blocks. This time make sure that all three tubes are directly above the drawing by using the machinist's square to transfer lines of the drawing up to the edges of the tubes. Some cold setting may be necessary to achieve the correct angle of the down and seat tubes.
31. When the frame is in position above the drawing, measure the distance from the top front of the seat tube to the top front of the head tube. Make note of this measurement. (See Fig. 59 & 60)
32. With a carbide scriber, scribe for the miter of the lower end of the down tube inside the bottom bracket but do not take the frame off the V-blocks yet! (See Fig. 56)
33. With the scriber, scribe a line on the down tube where it enters

CO. IN.

the outside of the bottom bracket also. (See Fig. 57)

34. Carefully pick up the frame disturbing as little as possible and scribe the other side of the down tube where the miter will be made.
35. Pull the two frame pieces apart and make a little file nick where the down tube is entering the outside of the bottom bracket. (Same mark as the one in step III-33)
36. Rough in the miter with the grinding wheel.
37. Finish the miter with an 8" half round file. (See Fig. 58)
38. Clean up the down tube/bottom bracket joint and prepare it for silver brazing.
39. Apply flux.
40. Mount the seat tube and bottom bracket in the bottom bracket jig as before. (See Fig. 61)
41. Insert the head tube into the head tube stabilizer bar (See Fixtures.) and insert down tube into bottom bracket shell while attaching the head tube stabilizing bar to the bottom bracket jig. (See Fig. 61)
42. Find the tiny file nick in the down tube and line it up with the point at which the down tube enters the bottom bracket shell. Temporarily tighten down the head tube stabilizing bar so the nick doesn't move.
43. Drill a small hole through the bottom bracket and down tube to insert a steel peg. (A 4d nail or smaller makes a good peg.) (See Fig. 62)

CO. IN.

44. Loosen the head tube stabilizer bar again and make sure the measurement from the top front of the Seat tube to the top front of the head tube is the same as the one taken in step #31. When this measurement is set correctly, tighten down the head tube stabilizer bar again. (See Fig. 61)
45. Silver braze the joint. This is a long preheat again due to the mass of the bottom bracket. (Take your phone off the hook for a while.) (See Fig. 63)
46. After the joint has cooled sufficiently, clean up as in step 111-6.
47. Deflection of the down tube should be checked the same as it was in step 111-9. (See Figs. 46 & 47)
48. Cold set as necessary to be within the tolerances described in step #9. If working with lighter tubing, there is a definite danger of crimping the down tube during this procedure. To safeguard against this a down tube protecting sheath can be placed around the down tube before cold setting. (See Fixtures.)
49. Check the measurement from the top front of the seat tube to the top front of the head tube. During heating and cooling this measurement may have been lost due to distortion, expansion and contraction. If cold setting is necessary, insert a long 1" diameter steel bar down the seat tube and put the protecting sheath around the down tube. Cold set as needed. (See Figs. 59, 60 & 61)
50. Again suspend the frame above the drawing with V-blocks and check with a machinist's square to see that all tubes are directly above

CO. IN.

the corresponding lines of the drawing. If further cold bending is necessary, do so. An error of the thickness of a line is acceptable over a span of 50 or 60 centimeters.

51. While the frame is still suspended above the drawing, find the point where the bottom of the top tube hits the back side of the head tube on the drawing. With a machinist's square, transfer this point up to the corresponding point on the back side of the actual head tube. Make a file nick at the point. (See Fig. 64 & 65)
52. Find the point on the drawing at which the bottom of the top tube hits the front of the seat tube. Transfer this point up to the actual seat tube and make a file nick at that point. (See Fig. 66)
53. Find the point on the drawing where the centerline of the top tube hits the back of the head tube. Transfer this point up to the head tube and mark that point with a carbide scribe. This will be the location of an air expansion hole. (See Fig. 65)
54. Find the point on the drawing where the top tube centerline hits the front of the seat tube. Transfer this point up to the actual seat tube and mark that point with a carbide scribe. This is the location for another air expansion hole. (See Fig. 66)
55. Clamp the frame in the Park clamp or blocks and leave it there till needed again.
56. Find the distance from the point found in step 111-51 to the point found in step 111-52. Make note of that measurement. (See Figs. 67 & 68)

57. Take the top tube and find the top surface of it. (The top head lug will be useful in doing this.) Mark with a magic marker on the piece of masking tape which surface is the top of the top tube. (Step 11-13 of the general prep had you install a piece of tape around the short butted end of the top tube.)
58. Take the measurement from step 111-56 and transfer it to the top surface of the top tube. Make a file nick at that point. (See Fig. 69)
59. Cut the top tube 15mm longer than indicated by that mark. (See Fig. 69)
60. Now use the seat lug to scribe where the miter will be at the seat tube end of the top tube. Make sure the top of the seat lug is on the top surface of the top tube! The scribe mark should go right through the file nick made in step 111-58.
61. Rough in the miter with the grinding wheel. (Don't forget that the miters at both ends of the top tube will be roughly parallel. If they are not parallel, something is wrong!) To be on the safe side, do the roughing work about 1mm longer than the file nick. (See Fig. 70)
62. The miter can now be finished with the 8" half round file. This is definitely the most tedious joint to miter on the entire frame. The beginner can expect to take 45 minutes or more to do this job. Set the original miter (short butt with masking tape) against the back side of the head tube. Make sure the bottom surface of the top tube hits the file nick on the back side of the head tube. **Now** carefully drop the back of the top tube into place against the



CO. IN.

seat tube. At first the top tube will be nearly 3cm above the file nick on the seat tube. The miter must now be carefully and gradually filed so that the top tube finally drops into place. The top tube must drop into place! This cannot be a force fit!!!! A force fit will throw off the entire geometry of the front triangle. It would be a good idea to recheck the measurement from step 111-31. (See Figs. 71, 72, & 73)

63. After the top tube is cut and mitered to the correct length, install the top head lug and the seat lug on the correct ends and slide them all down on the head tube and seat tube. Put the entire front triangle on the V-blocks above the drawing. Use the Square to get the frame in the right position. Slide the top tube down to the position it should be on the head and seat tubes by using the square. At this time the machinist's square should transfer all lines directly up to all edges of the front triangle. (Only transfer lines up from the interior of the front triangle. You'll go nuts trying to transfer lines up around the inside edges of the front triangle as well as the inside edges.) (See Fig. 74)
64. If all inside edges of the drawing transfer up to the frame with the least amount of error, (See 111-50) then make a file nick on the head tube where the top of the top head lug is. Then make another file nick where the top of the seat lug is.
65. Slide the top tube off again and cut the head tube 1cm longer than the file nick indicates. Then cut the seat tube 1cm longer than necessary. (If there is a spear point at the top of the seat lug, make sure to allow for that.)

66. Prick punch, center punch, pilot drill and drill the air expansion holes that were located in steps 111-53 & 111-54. Again 1/2" diameter holes will allow for more efficient flushing of the tubes during the final acid treatment. (See Fig. 66)
67. Clean and prep the two lugs for silver brazing.
68. Clean and prep the two ends of the top tube for silver brazing.
69. Clean and prep the tops of the head and seat tubes for silver brazing.
70. Apply flux to all surfaces.
71. Assemble all parts for final silver brazing. Align file nicks. (See Fig. 75)
72. Install a modified C-clamp #2 to keep the head lug from creeping down the head tube. (See Fig. 77)
73. Install a modified C-clamp #2 to keep the seat lug from creeping up the seat tube.
74. Install the modified bar clamp to make sure the seat and head tubes come in contact with the ends of the top tube. Tighten it snugly. Don't torque it down! (See Fig. 75)
75. If the points of the lugs are sticking up, the modified C-clamp #1 can be used to hold them down. (See Fig. 76)
76. Silver braze the seat lug and head lug in either order using the silver brazing techniques described earlier. Clamps can be removed as they are no longer needed. Try to safeguard against interruptions. The beginner will be silver brazing for over an hour during this step.

**WARNING** Some type of charcoal filter mask should be worn during silver brazing. Particularly when silver brazing for long periods of time. The fluorides in the flux and the cadmium fumes given off by the silver are both quite harmful. If dizziness or nausea are experienced during silver brazing get fresh air immediately and contact a physician for any further treatment necessary. Always have good ventilation.

77. Allow the joints to cool before cleaning off the flux with water and acid. Clean in the same manner as previously described.
78. Grind and file away the excess seat tube protruding through the top of the seat lug. Do the final filing with a half round jewelers' file.
79. Clean up the seat lug as described in step III-10.
80. Clean up the top head lug as described in step III-10.
81. Face mill and ream the top of the head tube with a Campagnolo #733 tool or equivalent. (See Sutherland's Manual for the proper use of cutting tools.) (See Fig. 78)
82. Face mill and ream the bottom of the head tube as in step III-81.

IV. **THE FORK** - All materials needed for the construction of the fork have already been listed.

1. Clean and prep the fork blade tips and dropouts for silver brazing.
2. Apply **flux**.
3. Set both fork blades upright in the vise with the dropouts in

CO. IN.

place. (Make sure the correct blades are with the correct dropouts.) Gently tighten down the soft jaws of the vise just enough to hold the fork blades for silver brazing. (See Fig. 96)

4. While doing the preheat, concentrate approximately 60 to 70 percent of the heat on the dropouts. This is because the dropouts are considerably thicker than the blades. They will require more heat during the preheat. (See Fig. 96)
5. If the blades have domed ends, silver brazing will be very easy. Just add the silver behind the eyelet and draw it around. Then add it to the top portion of the dropout and draw it around the other way. If large scallops were cut out in step II-7 of the general prep, there will be large crescent shaped holes to fill. This is a difficult trick to do with silver. To do this the metal must be kept very close to the melting temperature of the silver. Beginning framebuilders may opt for brass to attach scalloped dropouts. However, use of brass is not highly recommended. (See Fig. 96)
6. After the joints have cooled sufficiently, clean the area with hot water and acid. Rinse thoroughly and blow dry with the compressor.
7. There will more than likely be excessive dropout material to be filed away to have a smoothly finished joint. While filing be careful not to cut into the fork blade. This will cause unsightly undercutting. Be careful to file away only dropout material. Final filing should be done with a half round jeweler's file. The joint should then be sanded with a 120 grit emery cloth strip. Set aside the blades.

CO. IN.

8. Insert the threaded portion of the steering column into the larger sleeve of the dummy headset. The top of the steering column should be flush with the top of the dummy headset. Tighten the set screw.
9. Insert the butted end of the steering column into the head tube. Slide the smaller sleeve of the dummy headset onto the bottom of the steering column. Now slide the fork crown into place. (See Fig. 80)
10. If less than 2cm protrudes beyond the bottom of the fork crown, scribe the steering column for a rough cut and cut off the unneeded portion off the column. (See Fig. 80 & 81)
11. If 2 to 6cm protrudes beyond the bottom of the fork crown, cut half of the excess off of the top threaded part of the column. Then remeasure and cut the rest of the excess off of the bottom of the steering column. (See Fig. 80 & 81)
12. If more than 6cm of excess steering column protrudes beyond the bottom of the fork crown, one of two things can be done:
  - 1 - A shorter steering column can be ordered from the supplier.
  - 2 - Don't cut anything off of the bottom of the column and add 5cm of threads to the top of the column so that the excess can be cut off the top later. (If there is over 6cm of excess, the first option should be used.) (See Fig. 80 & 81)
13. Clean and prep the fork crown and steering column for silver brazing. (See Fig. 82)
14. Apply flux. (See Fig. 83 & 84)
15. The threaded end of the column can be held in the soft jaws of the vise so that the column is in

CO. IN.

a horizontal plane. No other jigging is necessary for this joint. (See Figs. 83, 84, 85 & 86)

16. Both parts being silver brazed at this time are equally massive and both are rather thick. It is really difficult to ruin this joint. Add the silver onto the small amount of excess protruding through the bottom of the crown and draw it up till it appears around the fork crown race seat. Be more forceful with the flame to draw the silver onto the sides of the joint. The flame can also be aimed up inside the bottom of the steering column to draw the silver around the sides. The brake bolt hole is a good spot to watch to see if adequate penetration is being accomplished. (See Fig. 85)
17. Allow the joint to cool sufficiently before cleaning up with hot water and acid. Do not hold your hand over the top of the steering column while dunking it in the water. If the joint is still quite hot, scalding hot steam will shoot out of the top of the steering column like a smoke stack.
18. File down any excess steering column protruding through the - fork crown. Final filing should be done with a jeweler's file. Sanding should be done with a 120 grit emery cloth strip. (See Figs. 87 & 88)
19. If the steering column still has to be cut to length, do so at this time. The dummy headset can be installed to find the proper length. (If a dummy headset is not available, the steering column from the top of the threaded portion to the base of the crown race seat should measure 40mm longer than the head tube.) After cutting the steering column to length,

CO. IN.

carefully file a small bevel around the top to be sure the first threads are cleared so a headset nut will screw on.

20. File a flat on the back side of the top of the steering column. (This will be the back side of the fork when it is finished.) Be careful not to file through the wall of the steering column. The flat should extend 1cm down from the top of the steering column. A keyed headset washer can be used to check for fit while the filing is being done. (See Fig. 94 & 95)
21. Drill out the brake hole to 1/4". Unless this step is being done on a mill, the brake hole should be drilled through one side and then through from the other side. This will assure that the brake hole goes through depressions, dimples or pre-drilled holes in the crown. (See Fig. 89)
22. If a counterbored hole suitable for flush mount alien brake bolt nut is desired, this is the time to do it. Don't forget, the counterbore will be on the back side of the crown. (This will be the same side that the flat on the steering column has been filed.) Mount a 13/32" counterbore with a 1/4" pilot in a drill press. (If a hand drill is used for this procedure, the risk of breaking off the 1/4" pilot is quite high.) Counterbore the 1/4" hole in the backside of the crown to a depth of 2mm. Go easy on the feed as the counterbore will be an extremely sharp cutting tool and will go clear through the crown in short order. (Don't forget the cutting oil!) After the counterboring is finished, the remaining 1/4" hole in the back of the crown must be drilled out to 21/64" (See Fig. 90)

23. The fork crown race seat must be milled next. Clamp the crown in the soft jaws of the vise so that the steering column is in a vertical position. Mill with Campagnolo tool #718 or equivalent. (See Sutherland's Manual for the proper use of cutting tools.) (See Figs. 91, 92 & 93)

24. Check now to see if the fork blades will fit easily into the crown. The fit will usually be tight. Here again a .004" clearance is required for silver brazing. If the fit is tight, the first thing that must usually be done is to flatten the oval cross section of the blades in the soft jaws of the vise by nearly a millimeter. If this doesn't do the trick, then do as follows:

1 - If using an overlapping crown, carefully enlarge the oval hole in the crown with a 3/8" diameter cylindrical stone mounted in the chuck of a die grinder. DO NOT TAKE MATERIAL OFF THE OUTSIDE OF THE FORK BLADES!!

2 - If using an inserted crown, file down the outer surface of the insertions on the bottom of the crown. DO NOT REAM THE INSIDE OF THE FORK BLADES!! (See Figs. 99, 100 & 101)

25. The fork blades must now be cut to length. Assemble the fork. (It will be about 5cm too long at this point.) Mount the dummy brake in the brake hole. Put the wheel that will be used in the dropouts but do not clamp the quick release. Measure the distance from the mark on the dummy brake (There will be one mark for short reach brakes and another mark for regular reach brakes.) down to the center of the rim where the brake shoes should hit. This is the amount



CO. IN.

that needs to be cut off the blades. (See Figs. 102, 103, & 104)

26. Cut one millimeter less than the necessary amount off the fork blades. (After filing and final fitting that millimeter will easily be lost.) (See Fig. 104)
27. Clean the burr out of the top of the blades.
28. Assemble the fork again. Put in the wheel again. Do not tighten the quick release. Look to see if the wheel sits closer to one blade. If the wheel sits closer to one blade, that blade is longer. It must be filed shorter. When both blades appear to be equidistant from the wheel, there is another final check to be made. Look down through the steering column to see if the wheel is centered from that view also. If the wheel is centered, go on to the next step.

NOTE - Tightening the quick release during this procedure will throw off alignment due to twist or caster in the dropouts which is more than likely present at this time.

NOTE - The wheel used during this procedure should be in excellent true and dished perfectly. Many builders keep a special set of wheels on hand for this purpose.

NOTE - When finished with this step, the fork must nearly fall together. There can be no force fits in the fork. Force fits will cause problems during and after brazing.

NOTE - There can be no gaps between the tops of the blades and the bottom of the fork crown. These gaps will

CO. IN.

actually close themselves up during the silver brazing process and throw off alignment elsewhere. (See Fig. 105, 106 & 107)

29. Any twist or caster must be removed from the dropouts at this time. Assemble the fork and front wheel again. See if the dropouts lie flat against the locknuts. If they don't, bend the dropouts so they do lie flat. (See Figs. 108 & 109)
30. Drill two air expansion holes into the inside faces of each blade. One hole should be about 15mm from the top of the blade. The other should be about 15mm from the bottom. 5/64" is a good size to use for these air expansion holes. Having two holes in each blade makes the final metal prep much easier. DO NOT DRILL THE HOLES IN THE SAME SIDE THAT THE NAME IS STAMPED IN THE DROPOUTS! Some fork crowns make provisions for hidden air expansion holes. In that case a set of holes near the dropouts need to be drilled. The second set must be drilled at the top of the inside faces of the blades and 1/4" in diameter. (See Fig. 97)
31. Clean and prep the crown and tops of the blades for silver brazing.
32. Apply flux.
33. Set the fork jig for the correct amount of rake. Make sure that both dropouts will be sitting at the same rake. If one side is higher than the other, there will be twist in the fork. (See Fig. 110)
34. Put the fork into the jig and moderately tighten down the clamp on the steering column.

35. Before clamping down on the dropouts, tap them with a brass hammer to be sure they are seated in place. Clamp them down. (See Fig. 112)
36. Before clamping the steering column fully, tap the top of it to be sure the blades bottom out in the crown. (See Fig. 111)
37. Set the fork twist indicator down across the tops of blades and take a reading. Flip-flop the indicator and take another reading. Both readings should be the same. If not, twist the crown as necessary and take the readings again. **This will probably have to be done several times before arriving at a good set of readings.** (Twisting the crown can be done quite easily by inserting a 1/4" diameter rod through the brake hole and using it as a lever.) When the two readings are the same, tighten down the steering column clamp. Take the readings again to make sure twisting did not occur during tightening. (See Figs. 113, 114 & 115)
38. If tangs are being used with the crown, they should be clamped against the blades with the modified C-Clamp #1.
39. The fork is now ready for silver brazing. Due to the mass of the crown, this is a long preheat so take the phone off the hook before starting. (See Figs. 116 & 117)
40. Allow the fork to cool thoroughly before cleaning it up with hot water and acid. Immersing a hot fork in water can have a serious effect on alignment.
41. If an inserted crown has been used, it must now be filed to be flush with the surface of the blades. Final filing should be

CO. IN.

done with a jeweler's file and final sanding should be done with a 120 grit emery cloth strip.

By this time you are probably fed up with the jeweler's file and sandpaper routine. However, it is necessary. Any file marks that are present can develop into stress cracks. The smaller the file marks or sanding marks the less there is a chance of stress cracks developing.

42. Fork alignment should be checked in the park fork alignment jig and tips should be aligned with figure "Ii" tools. (See Fig. 118)

#### V. THE REAR TRIANGLE

1. Slide the shorter portion of the dummy headset onto the steering column. Slide the steering column up through the head tube and then put the taller portion on the top of the steering column. Tighten down the thumbscrew on the dummy headset to a snug fit. The partially finished frameset is ready to put into the rear end jig. (See Fig. 119)
2. Mount the rear end jig (See Fixtures.) in the vise and level it using the long base as a reference. If using a Park stand, "Donuts" can be ordered from Park Tool so that the rear end jig can be fastened to and mounted in the Park stand.
3. Fasten the seat tube into the seat tube clamp of the jig but do not tighten all the way yet.
4. Rest the dropouts of the fork on the T-bar on the front of the jig.
5. With a 12" steel rule, scrape the sides of the forward portion of

CO. IN.

the down tube and the forward portion of the top tube at the same time. This will etch centerlines on the sides of the two tubes. (See Fig. 120)

6. With the 12" steel rule, scrape the sides of the rear portion of the top tube and the top portion of the seat tube at the same time. This will etch centerlines along the sides of these two tubes. (Fig. 121)
7. Using the reference surface from the leveling procedure, measure straight up to the centerline etched at the forward portion of the top tube. Make note of that measurement. (See Fig. 123)
8. Using the same reference surface, measure straight up to the line etched on the rear portion of the top tube. Make note of that measurement. (See Fig. 122)
9. Compare the two measurements just taken. If one is higher than the other, loosen the seat tube clamp assembly and raise or lower it as necessary to level the top tube. After this step is completed the top tube and the long base of the jig should be parallel with each other.
10. Check to see that the angle bar is touching both seat tube and down tube. Check to see if the bottom bracket shell is resting on the peg in the seat tube clamp assembly. If these items are in order, tighten the seat tube clamp.

If the original drawing was made with a horizontal top tube, allowances were made for a dummy headset & the fork has been built as specified in the drawing then, at this point, the head tube angle, seat tube angle

and bottom bracket drop will automatically find themselves. Success in achieving this is greatly dependent on how close to the drawing the front triangle corresponds. At this time seat tube, head tube, and top tube angles can be checked against the drawing. Bottom bracket drop can also be checked now. (See Figs. 124, 125, 126, 127, & 128)

11. Clean and prep the ends of the chainstays and rear dropouts for silver brazing.
12. Apply flux.
13. Silver braze the dropouts into the chainstays.

i

sufficiently, clean them up with hot water and HCl acid.

15. Excess dropout material will be protruding beyond the slot in the chainstays. This must be filed down to be flush with the chainstays. Rough in carefully with the grinder. Clean up with an 8" half round file. (Be very careful not to take material away from the chainstays, the only material that should be filed away is the actual dropout.) Finish the clean up with a half round jeweler's file and 120 grit emery cloth.
16. Set the sliding rear axle post of the rear end jig for the correct chainstay length. (See Fig. 129)
17. Rough cut the chainstays one centimeter longer than necessary and file the burr off the end. (See Fig. 130 & 131)
18. If the chainstays will not easily slide into corresponding holes of the bottom bracket shell and easily drop into place on the

CO. IN.

sliding rear axle post, then those holes must be reamed. (See Fig. 132)

19. To ream the holes for the chainstays, mount a 5/8" diameter cylindrical stone in a high speed die grinder and ream till the chainstay/dropout assemblies will slide into place. (See Fig. 132)
20. Clean up the burr around the chainstay holes in the bottom bracket with a jeweler's file.
21. Insert one chainstay into place and scribe where the miter should be on the inside surface of the bottom bracket shell. (Due to the way the jig is constructed, only one side of the chainstay can be scribed. A little guess work will be necessary on the back side.) (See Fig. 133)
22. Do this miter on the grinding wheel. It does not have to be a really neat miter as the bottom bracket taps will eventually cut straight across it.
23. Repeat steps V-21 & V-22 for the remaining chainstay.
24. Clean and prep the ends of the chainstays and the chainstay holes for silver brazing. (It would be wise to tip the jig upside down to keep the acid from getting all over the jig.)
25. Apply flux. (This joint is ready but will not be brazed for at least an hour or more.)
26. Raise the seatstay rest so that when a seatstay is pushed on to the rear dropout, the top of the seatstay will fall along the side of the seat lug. Tighten the rest in the correct position.

27. Repeat step 11-6 from the general preparation for the seatstays now. After the slots in the seatstays match the tabs on the dropouts, there should be no gaps between the top of the dropout tabs and the bottom of the seatstay slots when the seatstay is put into place. (See Fig. 134)
28. File a flat on the inside face of the bottom of the right seatstay. This will allow for sprocket/chain clearance. (See Arrow, Fig. 134)
29. Wrap bands of masking tape around each seatstay. Mark the left one with an L and the right one with an R. Put these letters on the outside surfaces of both stays. This will lessen the chance of rotating the stays while doing future operations. (Don't forget, the slots in the seatstays had to be filed at an angle and rotation of the stay can cause problems up at the seat cluster.)
30. Choose the style of seat cluster that will be used from the variations section of this manual. (Beginning builders should try starting out with the use of slugs.) (See Fig. 135)
31. If the slugs will not insert, into the seatstays with a proper silver braze fit, file down their diameter so that they will fit easily.
32. Put the seatstays into place with the slugs inserted. Since the seatstays have not been cut to length yet, they will be at least 6 to 8cm too long now.



33. Measure how much too long the seatstay/slug assemblies are. Remove the slugs and cut this amount off the seatstays. (If in doubt, cut off 2mm less than what's called for.)
34. Some final filing may be necessary to bring the two seatstay/slug assemblies to the right length.
35. Square up the tops of the seatstays with an 8" flat file.
36. Remove the burr from the inside of the tops of the seatstays. Do not remove the burr from the outsides of the seatstays.
37. Clean and prep the tops of the seatstays and the slugs for silver brazing.
38. Apply flux.
39. Reinstall the seatstay/slugs. The slugs should be silver brazed into the seatstays while everything is in place. This way an unsightly rotation of the slug can be detected before brazing is done. When there is no detectable rotation in the slugs, braze them in place. Use a little extra amount of silver for this joint so that any seam will be totally covered up.

IMPORTANT -- You are not brazing the slugs to the sides of the seat lug at this time!

40. After the joints have cooled sufficiently, clean them with water and acid.
41. File the seams that are left between the slug and the seatstays. Do this with a fine toothed 8" flat file. A definite

CO. IN. technique must be mastered for doing this type of filing on a curved surface. As the file goes around the tube, the builder's hands should follow in an arc-like motion. If done properly, there will be a minimum of facets in the filing work.

42. Remove any file marks with an 80 grit emery cloth strip. Finish up with 120 grit.
43. Drill 5/64" air expansion holes in both ends of each seatstay. The holes should be on the inside faces so they are out of view. Drill one hole at the seam of the slug. Drill the other hole 2cm up from the slot. Repeat for the other stay.
44. Clean and prep both ends of both stays for silver brazing.
45. Clean and prep the seat lug for silver brazing. (Do this with the jig upside down so as not to get acid on the jig. It is no longer necessary to keep the jig level.)
46. While the jig is still upside down, clean and prep the tabs on the dropouts for silver brazing.
47. Apply flux.
48. Starting at the bottom bracket, tack the chainstays into the bottom bracket shell. (Just tack them. The joint will be finished up later.) (See Fig. 136)
49. Silver braze the seatstays into the dropouts. (See Fig. 137)
50. Silver braze the slugs to the sides of the seat lug. (This may require some fillet building with the silver.) (See Fig. 138)
51. Remove the frame from the rear end jig.

CO. IN.

52. Finish the brazing of the chainstays into the bottom bracket shell. (See Fig. 139)
53. File the excess dropout material from where it protrudes beyond the surface at the bottom of the seatstays. (This is a repeat of step V-15.)
54. The seat tube should be reamed with a Chadwick #28 adjustable reamer to attain an easy slide fit with the seatpost. Follow this by honing lightly with a brake cylinder hone. (See Fig. 140)
55. Drill a  $7/32$ " stress relief hole where the bottom of the binder slot will fall. (See Fig. 142)
56. Cut the binder slot. This slot should be 1 to 2mm wide. To achieve this width, either sandwich 2 blades in a hacksaw or use an abrasive cut off wheel. (See Fig. 143)

#### VI. BRIDGES AND BRAZE-ONS

1. After the rear triangle was assembled and brazed in place, the dropouts more than likely pulled together so that a standard rear hub cannot be put in place without forcing it into the dropouts. That being the case, the rear end must be spread open to the right width. To do this, you must be certain that the rear triangle and front triangle are in the same plane. If they are not in the same plane, they should be after this cold setting procedure. Measure the distance between the inside faces of the rear dropouts. The distance should be 120mm for a five speed rear end and 125mm for a six speed rear end. Take note of how much the rear end has to be spread. (The rear end usually pulls in 2 to 4mm during the

CO. IN.

silver brazing process.) (See Fig. 141)

2. Use the Park FAG-1 tool or a string with rubber bands at each end to check if both triangles are in the same plane. Use the Park tool as per the directions. If the string method is used, attach one end of an eyelet in the rear dropout, run it up around the head tube and attach the other end to the other dropout eyelet. Now measure the distance between the string and the seat tube on both sides and cold set as follows: (See Fig. 141)
  - A. If the width measurement is OK between the dropouts but the rear triangle is out of plane with the front triangle, put a rear hub or axle set in the rear dropouts and bend both sides at once with the rear triangle persuader (See Fixtures) until both triangles are the same plane.
  - B. If the width measurement is too close between the dropouts and the rear triangle is out of plane with the front triangle, pull outward on the correct dropout to bring the triangle into plane and get the correct width at the same time.
  - C. If the width measurement between the dropouts is too close but the triangles are both in the same plane, pull on both dropouts to get the correct width and still stay in plane.

If the rear triangle persuader is not available for problem A, clamp the bottom bracket faces in the soft jaws of the vise and

pull on each dropout at a time.  
Pull them in the same direction.

3. Put the frame, dummy headset and fork together. Put a set of framebuilder's wheels in the dropouts. (If also desired, put in a seat post, saddle, bars and stem.) The frameset should now be scrutinized to see how well it will track and how well the wheels set in the dropouts. The most critical item to be looking for at this time is to see if the rear wheel comes closer to one chainstay than the other or if it comes closer to one seatstay than the other. If there is a problem, do as follows:

- A. If the wheel sits closer to the right chainstay, heat up the joint where the left chainstay joins the dropout and pull the joint apart slightly until the desired alignment is achieved. (Vice-versa for the other side) Cosmetic work will be necessary after this procedure. If dropouts with chain adjusters have been used, the adjusters will probably be able to take up any difference. In that case it is not necessary to pull the joint apart.
- B. If the wheel sits closer to the right seatstay, heat up the joint where the left seatstay joins the dropout and pull the joint apart slightly until the desired alignment is achieved. (Vice-versa for the other side) Cosmetic work will probably be necessary after this procedure. This type of aligning may be necessary regardless of whether standard road dropouts or vertical dropouts have been used.

IT IS UNACCEPTABLE TO ALTER THE SLOT IN THE DROPOUT TO ACHIEVE CORRECT ALIGNMENT. ANYONE WHO FILES THE DROPOUT SLOTS WITH A ROUND FILE IS PRACTICING STONE-AGE STYLE FRAMEBUILDING TECHNIQUES!!!

4. Disassemble the bike down to the bare frame again.
5. Set the dummy rear wheel for correct hub width. (125mm for 6 speed and 120mm for 5 speed) (See Fig. 145)
6. Set the dummy wheel for the correct tire radius. (33.7cm for 700c and 34cm for 27") (See Fig. 145)
7. Put the dummy rear wheel in place between the dropouts with the point between the seatstays. (See Fig. 145)
8. There should be marks on the dummy wheel where the brake shoes should hit sides of a 700c wheel and/or a 27" wheel. Choose the correct mark to work with.
9. Decide if short reach or regular reach brakes will be used. The brake bridge hole center will be 47mm above the chosen mark on the dummy wheel for short reach brakes. (52mm for regular reach brakes)
10. Miter the brake bridge to fit between the stays at the correct distance from the mark on the dummy wheel that was chosen. This is meticulous mitering work. The miters on each end of the bridge must be in the same plane. The angles filed on the ends of the bridge must match the slight angle of the seatstays. If there is any gap whatsoever between the bridge and seatstays, the dropouts will pull together again. The bridge must be a very snug fit as it is pushed up into

CO. IN.

place or, again, the dropouts will pull together during silver brazing.

11. If a standard bridge is being used, an air expansion hole must be drilled. To have the hole totally hidden, drill one hole in each seatstay where the bridge will be brazed into place. When the bridge is pushed up into place, the holes will be covered up. If another style of bridge is being used, see the section on brake bridge variations for recommendations on air expansion holes.
12. If a standard brake bridge is being used, do not drill the brake hole yet. If a standard brake bridge with a cylindrical boss or any of the Cinelli bridges are being used, bridge pieces must be preassembled, aligned, and silver brazed before the bridge is brazed to the stays. (See Fig. 146)
13. If diamond stiffeners are to be used, go back to step 10 and miter the bridge shorter on both sides to allow for the thickness of the stiffeners.
14. Before silver brazing, assemble the bridge parts and slide them into place. Check to see if the brake hole (if predrilled) sits in the exact center, see if the bridge is cocked in any plane, and see that the bridge is not rotated forward or backward. If everything checks out, go to the next step. If not, make alterations or make a new bridge. (Do not throw a bad bridge away. It could be used on a smaller frame at a later date.)
15. Clean and prep all of the bridge parts for silver brazing.
16. Clean and prep the seatstays for silver brazing.

17. Apply flux.
18. Assemble bridge parts and slide into place. It may be necessary to jiggle the assembly to squeeze excess flux out from under the stiffeners.
19. Tip the frame upside-down before brazing the bridge in. This will keep it from falling out when the flux becomes liquid. (See Fig. 147)
20. After the joints have cooled adequately, clean up with hot water and acid and blow it dry.
21. Some cosmetic clean up may be necessary.
22. If using a standard bridge, drill the brake hole at this time. First drill a small pilot hole. Make sure the hole is centered along the length of the bridge. Make sure the hole goes through perpendicular to the plane that the seatstays lie in. Having a helper sight in from the side helps in drilling a straight hole. Enlarge the pilot hole to the necessary size as follows:
  - A. If no sleeve will be used, drill 1/4"
  - B. If using 5/16" x .028" tube for reinforcing, drill the hole to 5/16".
  - C. If using a flanged reinforcement, drill the hole to the correct size so that the reinforcement will slide in easily.
23. Drill a 1/16" air expansion hole transversely through the middle of the sleeve.
24. Clean and prep the bridge and sleeve for silver brazing.
25. Apply flux.



CO. IN.

26. Silver braze the sleeve into place.
27. After the bridge has cooled adequately, clean up the flux with hot water and acid.
28. If a simple reinforcement was used, the ends must be rounded to be flush with the outside diameter of the bridge.
29. If a neat job was done, little or no clean up will be necessary on flanged reinforcements. Do not file the excess off the backside of the flanged reinforcement. There should be a flat for the washer and nut to hit against later.
30. Take out the dummy wheel to see if the width between the dropouts is satisfactory. If they have pulled together, repeat steps 1 and 2 of this section.
31. Put the dummy wheel back in. This time have the point between the chainstays. (See Fig. 148)
32. Cut, fit and miter the chainstay bridge and silver braze it in. There is no need to elaborate here as all the steps will be the same as those for the brake bridge. Some steps will be eliminated for obvious reasons.
33. At this time rear triangle alignment can be checked by the string method. If the string technique is used, three criteria must be met.
  - 1 - The seat and down tubes as they radiate from the bottom bracket shell must have no left or right deflection.
  - 2 - The head tube and seat tube must be in the same plane.
  - 3 - Use a very fine string such as monofilament fishing line.

Having met these three criteria

CO. IN.

the string method is extremely accurate. (See Fig. 141)

34. Check the measurement between the dropouts and dropout alignment with the Figure "H" tools. Cold setting may be necessary at this time. (See Fig. 149)
35. At this time the braze-ons will be applied. Braze-on work takes lots of practice and a personal technique must be developed. (See Figs. 150, 151, 152, 153, 154, 155, 157, 158, 159)

NOTE: My favorite way of attaching braze-ons is to flux both surfaces, apply a spot of silver to the frame, hold the braze-on with a cheap set of needle nose pliers, heat up the braze-on, hold the braze-on in place and reheat both the spot of silver and the braze-on. The silver will melt and bond the two surfaces together. Small fixtures can be made for some braze-ons.

36. A seam of silver should be laid around the diameters of the seat tube, down tube and chainstays where they poke into the bottom bracket shell. This seam is being applied to the inside surface of the bottom bracket shell. This seam will further insure good quality joints in the region of the bottom bracket shell. It is a good idea to attach bottom bracket guides immediately after laying the seam. This utilizes only one preheat of the bottom bracket. Follow these steps: (See Fig. 156)
  - A. Clean and prep the bottom bracket shell and cable guides for silver brazing.
  - B. Apply flux to the inside of the shell as well as the places where the cable guides

CO. IN.

will be brazed to the outside.

- C. Preheat the bottom bracket shell and make sure all of the flux does not run off the outside of the shell.
  - D. Lay the bead around the inside face of the shell where the tubes poke through. (See Fig. 156)
  - E. Put a spot of silver where the right side bottom bracket guide will go.
  - F. Heat up the right side guide, hold it in place and reheat the spot of silver till the guide "nestles" into place. (See Fig. 159)
  - G. Repeat steps E & F for the left side guide. (See Figs. 157 & 158)
37. After the bottom bracket has cooled sufficiently, clean it up with hot water and acid.
38. The bottom bracket should now be retapped with Campagnolo tool #721 or equivalent. (See Sutherland's Manual for proper use of cutting tools.) (See Fig. 160)
39. The bottom bracket should now be face milled with Campagnolo tool #725 or equivalent. (See Sutherland's Manual for proper use of cutting tools.) (See Fig. 161)
40. A serial number should now be stamped in the bottom bracket shell. Before stamping the number, screw a set of bottom bracket cups into the bottom bracket shell. With the cups in place, the shell will not deform from hitting it with the number stamps. (Use imagination for the serial number. Put the date that the frame is ready for painting

CO. IN.

or the number of framesets built to date. Some customers like the idea of stamping their Social Security number or driver's license on the frame.) (See Fig. 162)

41. OPTIONAL - Stamp a duplicate serial number on the steering column just above the fork crown race seat. This not only eliminates confusion if several frames are being painted at once but also provides a hidden serial number in case of theft. (See Fig. 163)
42. If the frame goes to a paint shop within the next 48 hours, nothing else has to be done. If there will be a longer wait, etch the surface of the frame (both inside & outside) with phosphoric acid. (See Fig. 164)

FIG #1

The bare essentials for making the drawing include; suitable flat surface, straight-edge, pencils, ruler, eraser, compass, protractor, calipers, fork crown to be used, bottom head lug to be used, and bottom 1/2 of dummy headset. (See Step I-1)

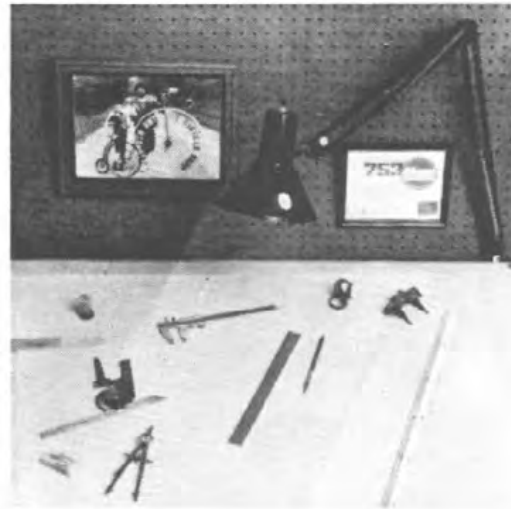

FIG #2

The thickness of the fork crown must be transferred onto the working drawing. This can be critical to front end geometry. (See Step 1-15)

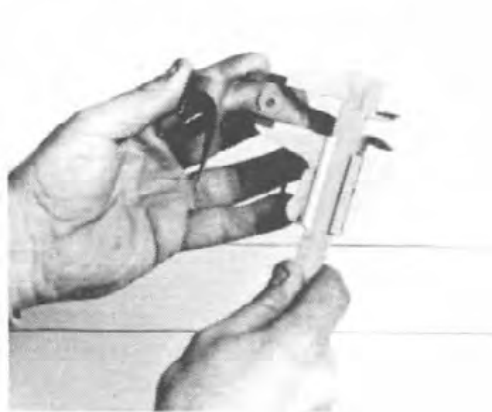
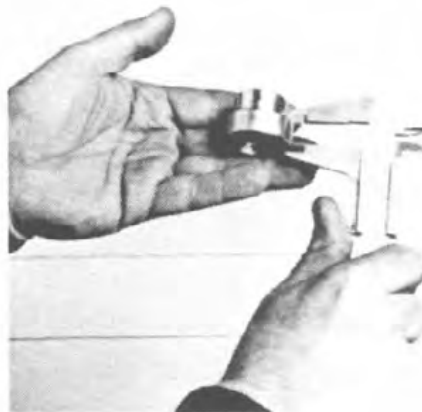

FIG #3

Transferring the stack height of the lower part of the headset onto the drawing is important to the front end geometry.

Most high quality headsets will measure 14mm for the lower stack height. (See Step 1-16)



The head tube/down tube intercept point must be measured and transferred to the drawing. Different brands of lugs can vary as much as 6mm on this measurement. (See Step 1-17)



The final drawing should be kept simple. Any time spent on sketching in lugs, dropouts, or even dimensions is wasted effort. The notations here are only for the benefit of the reader. (See Steps 1-19 & 20)

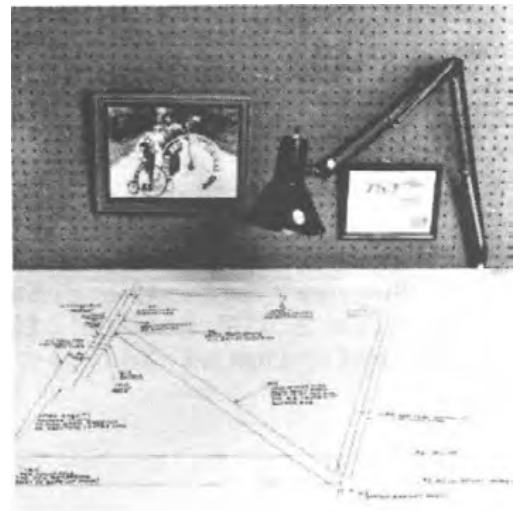

Pictured here are the bare essentials for doing the General Prep. Not pictured, but also necessary would be some sort of holding device to secure tubes while cutting, filing, or mitering them. A vise and tubing clamps or a Park stand would suffice. (See Beginning of Section II)

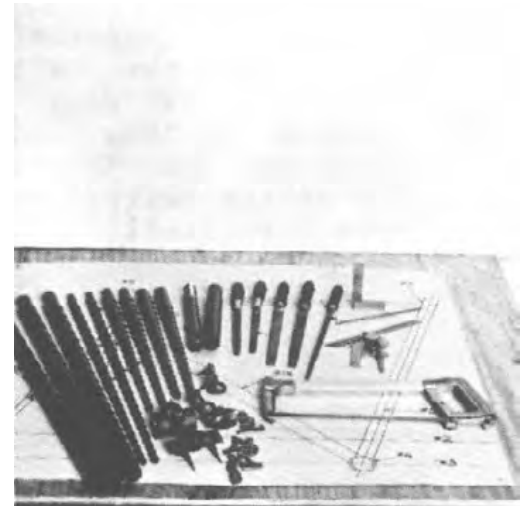

Before beginning the General Prep., the tube set should be thoroughly cleaned with mineral spirits. This will remove the greasy film (cosmoline) used to prevent rust during storage. (Beginning of Section II)

FIG. #7



The insides of the tubes should also be cleaned. After the tubes are cleaned they can rust rather readily. The frame should be built within two weeks from this time. If the building process is to take longer, oil the tubes down with a 10W motor oil. (See Beginning of Section II)

FIG. #8



Scribing "rough-cut" lines at the bottom of the seat tube can be done with a carbide scribe. This is done at the butted end of the single butted seat tube. (See Step II-11)

FIG. #9

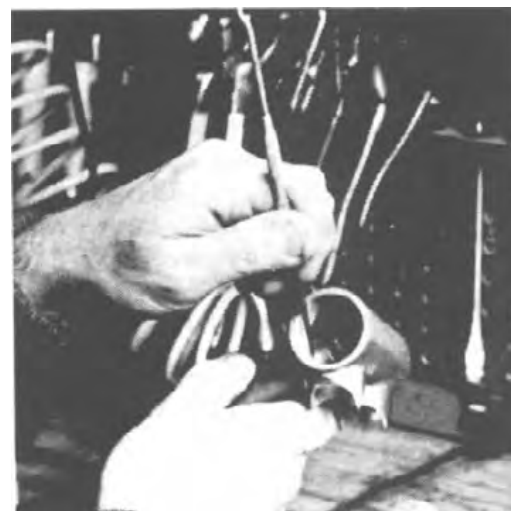

Before beginning the General Prep., the tube set should be thoroughly cleaned with mineral spirits. This will remove the greasy film (cosmoline) used to prevent rust during storage. (Beginning of Section II)

FIG. #7



The insides of the tubes should also be cleaned. After the tubes are cleaned they can rust rather readily. The frame should be built within two weeks from this time. If the building process is to take longer, oil the tubes down with a LOW motor oil. (See Beginning of Section II)

FIG. #8



Scribing "rough-cut" lines at the bottom of the seat tube can be done with a carbide scribe. This is done at the butted end of the single butted seat tube. (See Step II-11)

FIG. #9

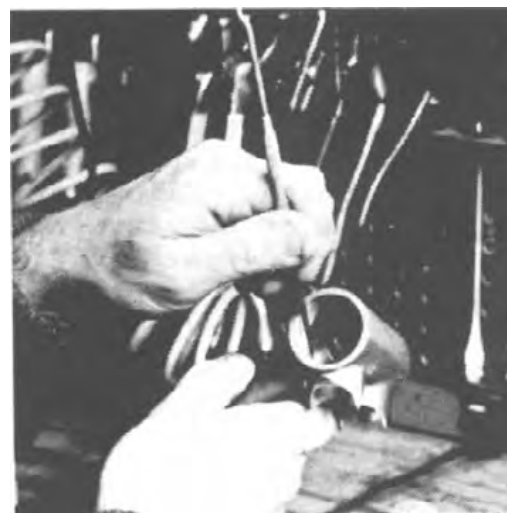



The bottom of the seat tube must also be mitered so that the down tube can be inserted later. Rough mitering can be done on a grinding wheel that has rounded edges. (See Step II-11)



Scribing on the bottom head lug is also meant for roughing-in work. Blue layout dye can be used if a clearer line is desired. (See Step 11-12)



Scribing a rough-cut line on the top head lug is also done with a carbide scribe. These scribed lines are meant only for rough mitering and probably will not be very close to the actual angles desired. (See Step 11-13)



FIG #13

Angles can be lifted directly off the drawing and transferred to the miter being filed. This will eventually get the angle of the miter to within 1/2 degree of the desired angle. (See Step 11-12 & 13)

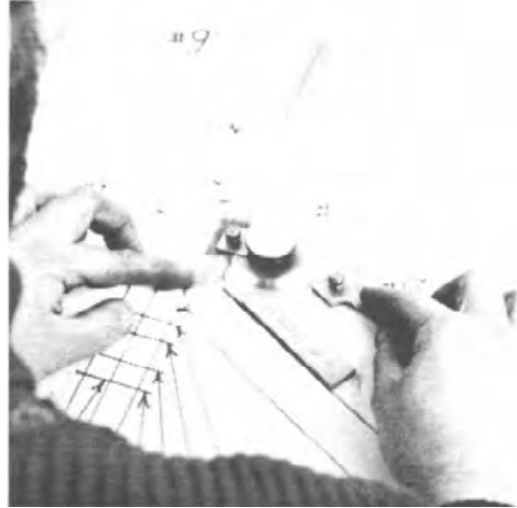

FIG #14

Note the use of frame blocks to hold a piece of tubing in a vise without denting. These can be made by a machine shop of brass or aluminum or be homemade easily out of hard maple or oak. (See Step II-11, II-12 & 11-13)

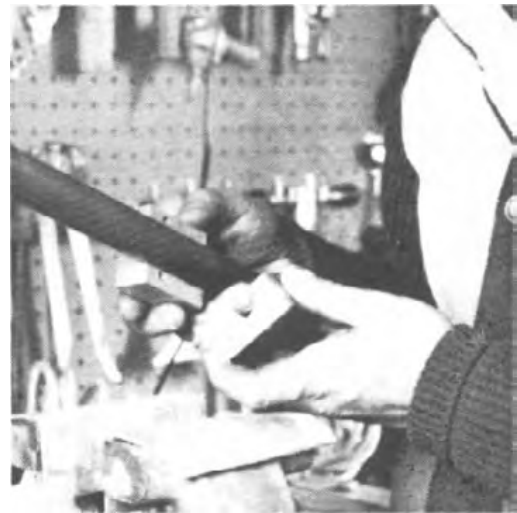
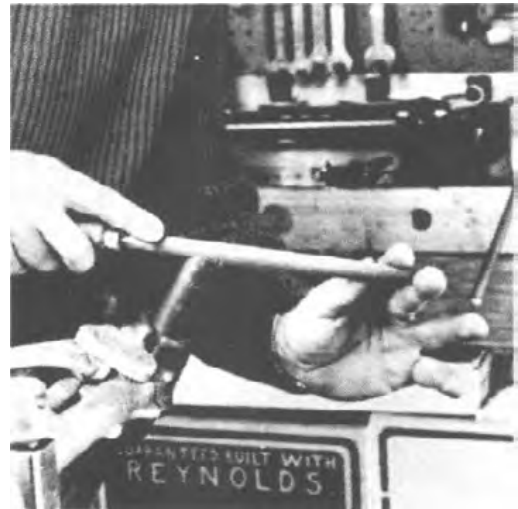

FIG #15

The miters in the front triangle can all be done by hand with an 8 inch half-round file. At factories this is usually done on a Bridgeport mill with costly fixturing. (See Step II-11, 12 & 13)



Rotating the file while making a forward cut will help make a more uniform curve in the miter. Note how the tube is set at about 60 degrees so the file can be held horizontally. (See Step 11-12 & 13)



The angle of the miter can now be checked with a bevel protractor. This could also be checked with a less expensive instrument. Craftsman makes a #9 GT 3868 angle finder that suffices nicely. (See Step 11-12 & 13)



A machinist's square can be used to see if the peaks of the miter are at the same height. If one is lower, that means the mitered tube will intersect the other tube slightly to one side or the other. (See Step 11-12 & 13)



A very important check is to see if light shines through the finished joint. Gaps are one of the biggest causes of distortion and deflection in the silver brazing process. (See Step 11-12 & 13)

FIG #19



The final check for a miter is to see if the desired angle is attained when the joint is assembled. With a lot of practice, a nearly perfect miter can be done in about 15 minutes. (See Step 11-12 & 13)

FIG #20



The bottom of the seat tube should be checked for any unusually high spots in the miter when finished. This miter is not as critical since the bottom bracket taps can easily cut off any high spots that protrude as much as 1mm. (See Step II-11)

FIG #21



FIG #22 All three lugs and the bottom bracket shell must be reamed for a proper silver braze fit. There should be about .004" to .006" of clearance between the inside surface of the lugs and the outer surface of the tubes. Here the reaming is being done with a cylindrical stone mounted in a die grinder. (See Step II-1 & 11-2)



FIG #23 Lugs may also be reamed with an 8" half round file. The only real problem that arises is in securely holding the lugs during reaming. (See Step II-I & 11-2)



FIG #24 After reaming, the outsides of the lugs can be prepared. All blemishes must be removed to give the frame a professional look. Rough work can be done on a grinder but a 6" half round file is preferred. Finish filing is done with a needle file as pictured. (See Step 11-4)



Final sanding should be done with 80 to 120 grit emery cloth. It can be purchased in 1" wide rolls or 9" x 12" sheets and torn to the desired width. Expect to spend at least 90 minutes on each lug before they are ready for silver brazing. (See Step 11-4)



A Dynaflex can greatly speed up the process of finishing lugs, crown and bottom bracket. Be careful! It goes through metal at an incredible speed. Do not touch the faces of the bottom bracket shell. (See Step 11-4)



Use a very light touch if the lugs are to be finished with a Dynaflex. It is not necessary to finish the top of the seat lug at this time. Don't squish the binder portion of the seat lug in the vise! (See Step 11-4)



When finishing the head lugs, do not touch the faces where the bearing cups will seat. Always use soft jaws when clamping the lugs, bottom bracket, or fork crown in the vise. (See Step 11-4)



The fork crown must be reamed so the steering column can be inserted with the proper clearance for silver brazing. This can be done with a half round file. The preferred method is to use a #28 Chadwick adjustable reamer as pictured. (See Step 11-3)



After reaming the steering column should easily slide into the fork crown and wiggle back and forth slightly. The clearance should be .004" to .006". (See Step 11-3)

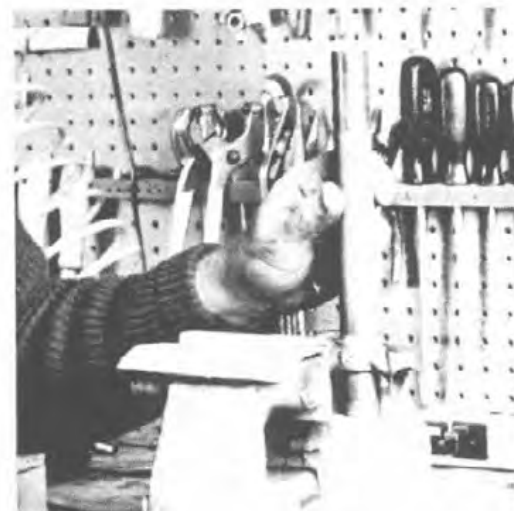

If the fork blades are not prebent, they should be bent in a fork blade bender.

FIG #31 Bend the first one to specs and carefully bend the second to match. A homemade bender can be made out of maple or oak. (See Step 11-5)



The most accurate way to check to see if the bend in fork blades match is on the surface table with a vernier height gauge. (See Step 11-5)

FIG #32



The first blade can be laid on the drawing to check for the correct amount of bend. Slight discrepancies can be adjusted later with the fork jig. (See Step 11-5)

FIG #33

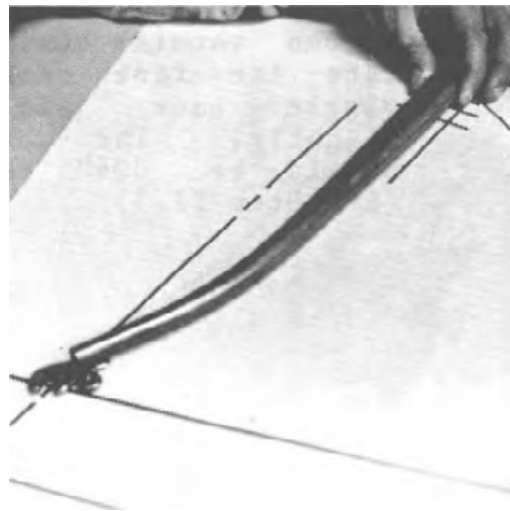



FIG #34 If the fork blades and chainstays are not already slotted to accept the dropouts, this should be done at this time. Two parallel cuts should be made with a hack saw. The little spurs that stick up between the cuts can be broken out with a pair of needle nose pliers. These slots should not be wide enough to accept the dropouts yet! (See Step 11-6 & 8)



FIG #35 The slots should now be widened carefully so that the dropouts will slide snugly into place. A sloppy fit is not necessary here as the silver will form a fillet along the edges of this joint. (See Step 11-6 & 8)



FIG #36 If the dropouts don't fit into the slotted ends, the tabs on the dropouts must be rounded or filed smaller. (See Steps 11-6 & 8)



When in place, the dropouts should be loose enough to push in place with the fingers but tight enough to hold the dropout in position during silver brazing. (See Steps 11-6 & 8)



The fork blades with the dropouts in them should be held up next to each other and sighted across to see if either dropout is cocked one way or the other. Corrections should then be made by filing the base of one of the slots. At this point file a small nick in one dropout tab and a nick in the top of the blade that matches it. (See Steps 11-6 & 8)

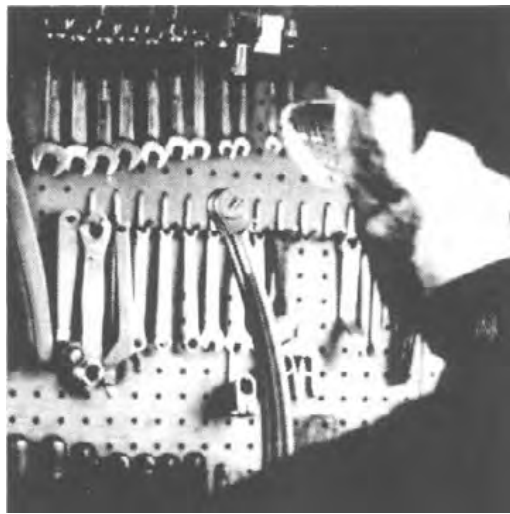

Sight across the rear dropouts in the same manner as the front dropouts. It is not necessary to mark them since the right dropout is different and the right chainstay has also been prepared differently. (See Step 11-6 & 8)

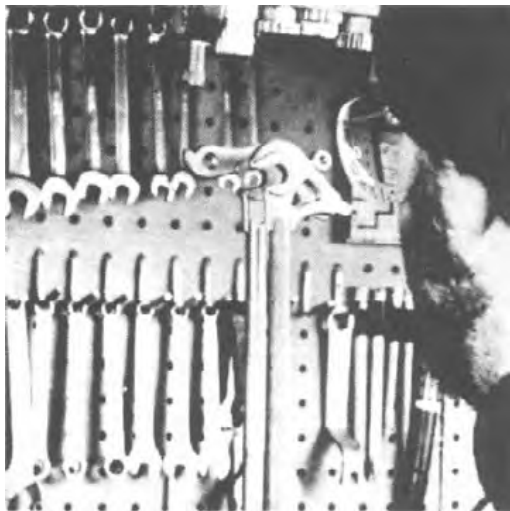

The first joint to be done in the building of the front triangle is the seat tube into the bottom bracket. Before silver brazing this joint, it must be thoroughly cleaned of dust, oil & rust. First clean with an alkylin cleaner (Shaklee Basic I is a good one) then clean with a 10% HCl acid solution (Sno-Bol works well). Blow dry. Acid clean up is not recommended for ultra light tubes in which case, simply sand. (See Step III-1)



A generous amount of flux should be applied to the surfaces to be silver brazed. Make sure to use water soluble silver brazing flux. Brass brazing flux will not work! (See Step 111-2)

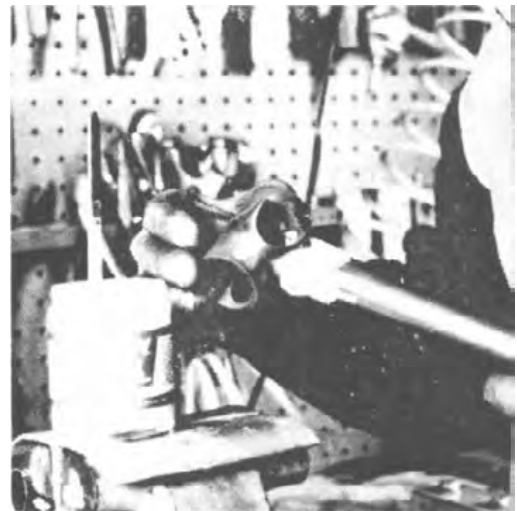

After the bottom bracket/seat tube joint has been cleaned and fluxed it is put into the bottom bracket jig and silver brazed. This jig doesn't have to be of high precision as cold setting will still be necessary on at least 7 out of 10 joints done on this jig. (See Step 111-5)



The bottom bracket must now be tapped with a set of line taps. Make sure the left and right sides don't get confused when using British bottom bracket shells. (See Step 111-7)



Face the bottom bracket before checking for tube deflection. Campagnolo and Gippiemme make the best hand operated bottom bracket face millers. (See Step 111-8)



Use a generous amount of cutting oil during any type of cutting procedures. Cutting oil contains chlorine and sulphur. Regular motor oil will not do the job properly. (See Step 111-8)



Deflection of the seat tube as it leaves the bottom bracket shell can be checked on a stone surface table or blanchard ground steel plate. One reading is taken close to the bottom bracket shell. Another is taken at the end of the tube. An error of 1mm over a span of 1 meter is acceptable. (See Step III-9 & 47)

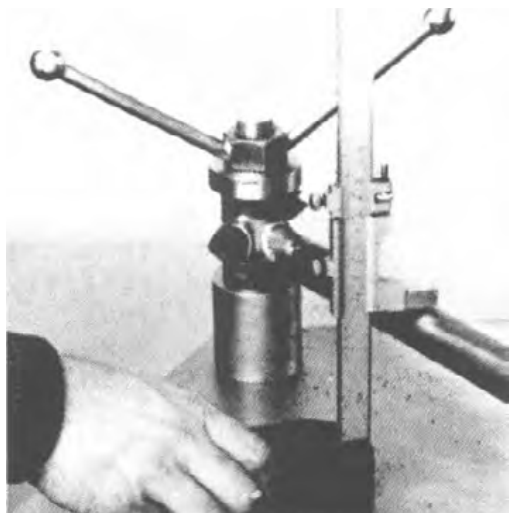

A less costly method of checking for deflection is with a bottom bracket micrometer. A reading is taken on each side of the tube at the same distance from the bottom bracket. Since this is a flip-flop method the amount of error is only half of the difference of the two readings. (See Step III-9 & 47)



A needle file can now be used to do final clean up of the joint. All excess silver should be filed away from the joint. Any blobs of silver will show through the paint job. (See Step III-10)



Note how a piece of emery cloth can be braced with a needle file. This gives the emery cloth a stiff backing which allows sanding in tight places. This technique is much more affordable than the use of expensive riffler files. (See Step III-10)



The bottom head lug and head tube should be cleaned thoroughly before silver brazing as do all of the other joints. Clean any oil off with mineral spirits or laquer thinner. Then the two pieces should be cleaned in hot water and a mild HCl acid solution. Proper ventilation is a must! (See Step III-11)



About 1mm of the head tube should protrude through the bottom head lug. This provides a slight rim which silver can be dropped onto. With practice, almost all of the silver necessary for this joint can be pulled up from this rim. (See Step III-14 & 15)



Put the mitered down tube into the finished joint. See how close the complete joint will come to the drawing. Cold setting may be necessary before doing the final brazing on this joint. When the angle is correct, clean and flux the pieces. (See Step 111-18)

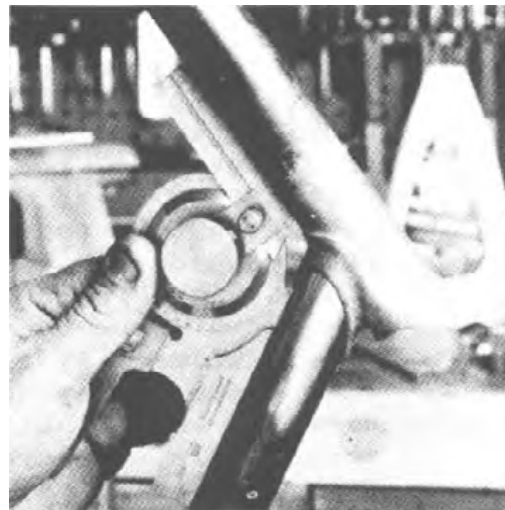

Tack the points of the lugs first. After checking the angle against the drawing and cold setting as necessary, finish the joint. (See Step III-21)



After the bottom head lug joint is completed, it must be checked for the proper angle again. If cold setting is necessary, reinforce the down tube with a solid steel bar to keep it from kinking. This is the most important joint in the bike. If it's not accurate, the front end will be geometrically incorrect. (See Step 111-23)



Before proceeding with the bottom bracket/down tube joint, the down tube will usually have to be rough cut to about 2cm too long so that the head tube/seat tube/down tube configuration can be loosely assembled. Finding the rough length of the down tube can be most easily found by suspending the frame tubes above the drawing on V blocks and transferring measurements up from the drawing. (See Step III-28)

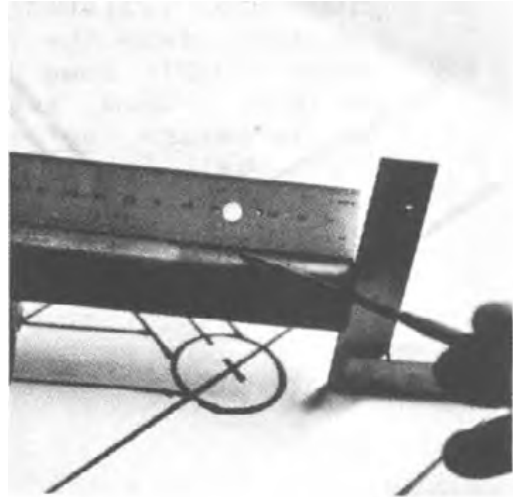

Assemble the head tube/down tube/seat tube (HT/DT/ST) configuration and situate it directly above the drawing. V blocks and a machinist's square can be used to get the proper location. Now mark the down tube for the miter with a carbide scribe. (See Step 111-32)

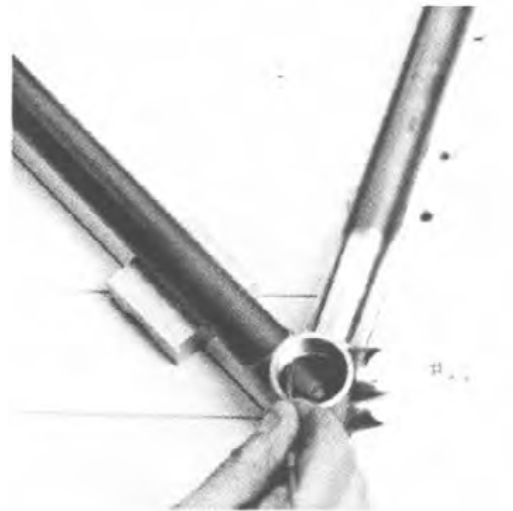

Another mark must be made along the outside of the bottom bracket shell. This mark is necessary because when the HT/DT/ST is in the bottom bracket jig, the inside of the bottom bracket shell will not be visible to check for flush. When elevating the frame above the drawing, be sure to allow for the different diameter of the head tube. (See Step 111-33)

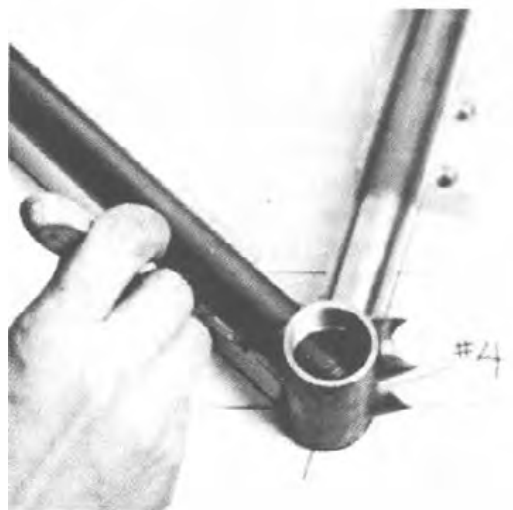



After the joint is mitered and cleaned it may be elevated above the drawing again. The machinist's square is then used to see if all lines of the drawing line up with the edges of the frame tubes. Tolerances for lining this **up** would be the thickness of a line over a span of 50cm. (See Step 111-37 & 49)



When the HT/DT/ST is in **position** above the drawing, take a measurement from the front of the top of the seat tube to the front of the top of the head tube. It's a **good** idea to have a helper at this point to stabilize the frame while measuring. (See Step 111-31 & 49)

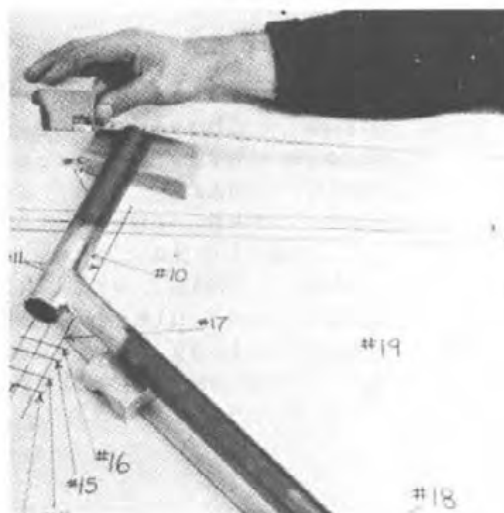

Make note of the measurement just taken. Do not cut the tops of these tubes off till this measurement has been utilized! (See Step 111-31 & 49)

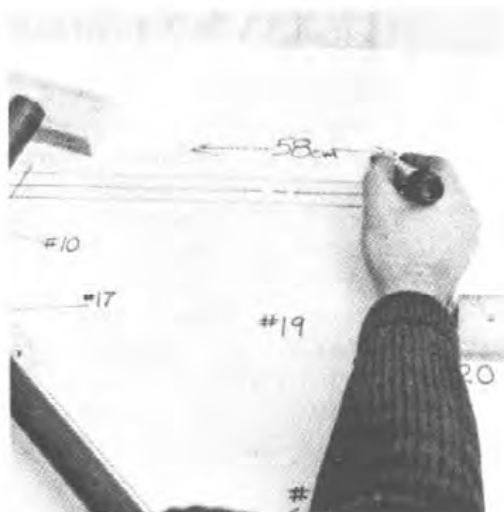

The HT/DT/ST may now be cleaned at the joint and assembled into the bottom bracket jig. Note the use of the head tube stabilizer bar now. This is also when the 58cm measurement from the last step is utilized. (58cm merely being this particular example) (See Steps 111-40, 41 & 44)



The down tube/bottom bracket joint should be pinned before silver brazing. A small nail is suitable. Just make sure the fit of the nail in the hole is tight. This will keep the mark in place that was etched along the outside of the bottom bracket shell. (See Step 111-43)

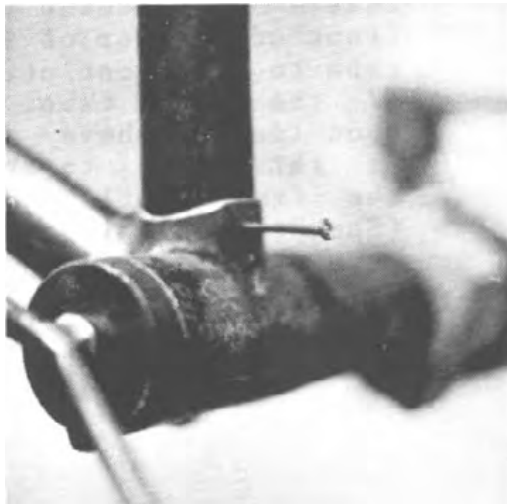

After clean up and fluxing, the joint can be silver brazed. After this joint cools, it must be checked for alignment with the bottom bracket micrometer and cold set as necessary. Use the down tube protector sheath to prevent kinking. Head tube twist CANNOT be removed at this point!!! (See Step 111-45)

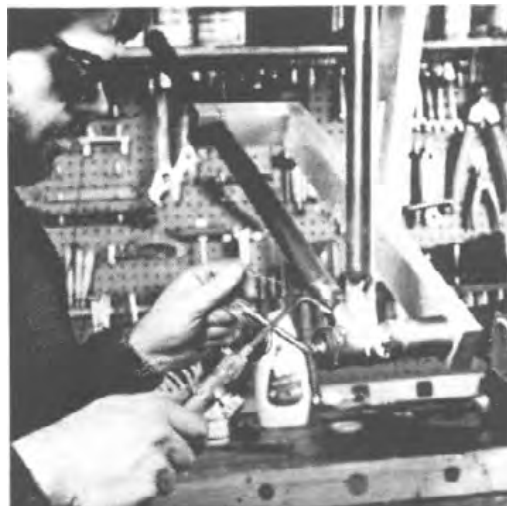

After any necessary cold setting elevate the frame over the drawing. At this time transfer the location of the top tube up from the drawing onto the backside of the head tube. This mark should be made with a carbide scribe. (See Step 111-51)

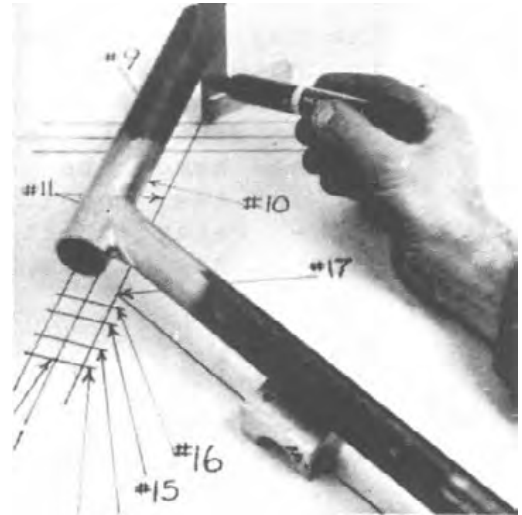

After locating the top tube on the backside of the head tube, mark the location for the air expansion hole. This can be either transferred up from the drawing or the lug can be centered on the previous marks to eyeball the location. (See Step 111-53)

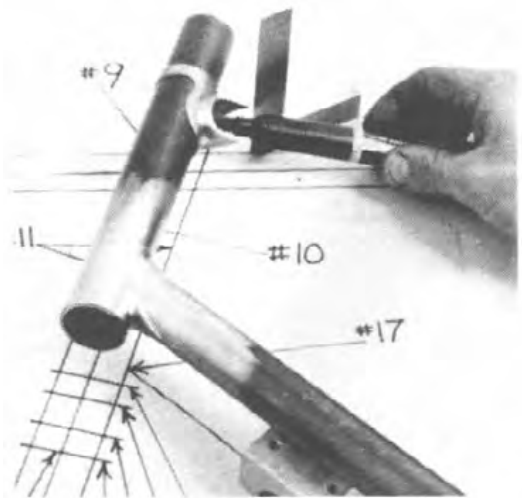

Here is a close-up shot of the 1/2" air expansion hole and the two marks which show the location of the top tube. A 1/2" air expansion hole is an absolute must to insure good circulation on the insides of the tubes during metal treatment. There should be one at each end of the top tube. (See Step 111-52, 54 & 66)

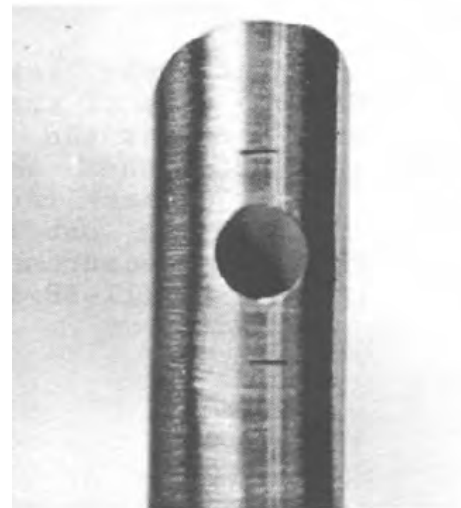

The top tube must now be cut to rough length. Measure the distance from the front of the seat tube to the back of the head tube along the top of the top tube. (The frame being built in this picture has a 49cm ST.)

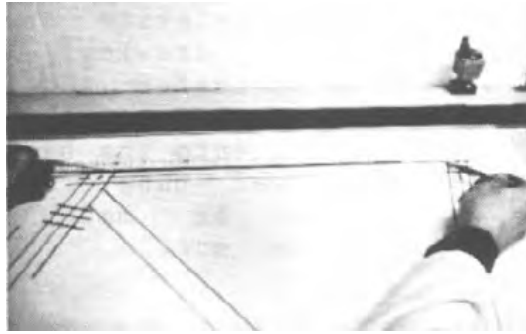

Here the scribe is indicating where the measurement should be taken from. (The frame being built in this picture has a 56cm ST.) (See Step 111-56)

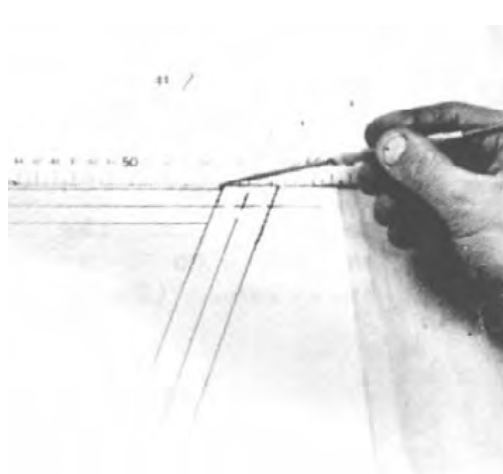

Lay the meter stick along the top edge of the top tube with zero at the crotch of the miter that was already done. Now mark for the cut. It must be cut 1cm longer than the measurement taken. (See Steps 111-58 & 59)

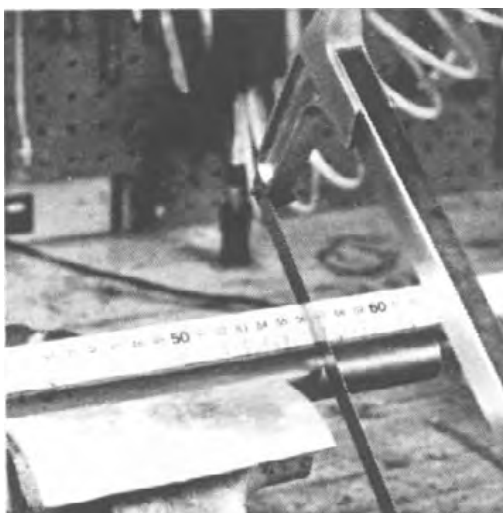

The miters can be checked to see if they are both in the same plane by holding a 1/4" tube at one end and a 1/8" tube at the other end. Then sight down the tube to see if both pieces are in one plane. The top tube is the most difficult tube to fit in the entire frame. (See Step III-61)

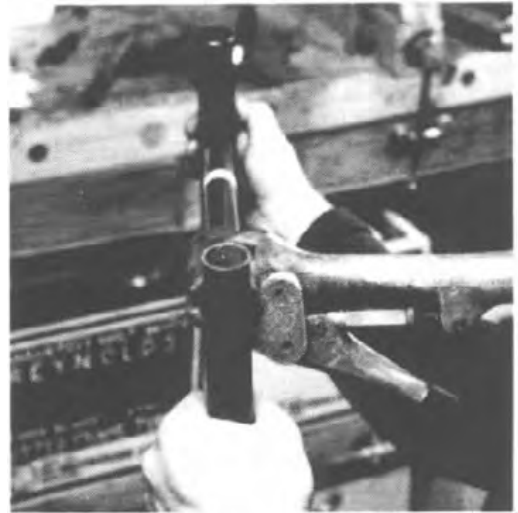

The top tube should just drop into place without any force at all. Any force used to put the top tube in place will push the head tube and seat tube apart, thus altering the geometry of the front triangle. (See Step 111-62)



This is the joint that was mitered during the general preparation. It should not be altered at all as the top tube is being fitted. (Note the piece of masking tape. It was put in place during the gen. prep. to show which end was mitered first.) (See Step 111-62)

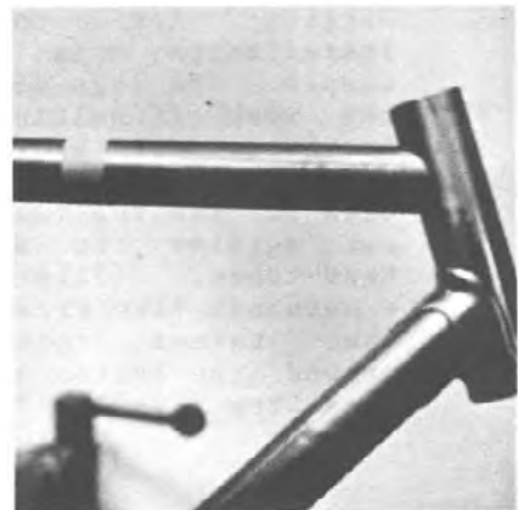

The seat tube/top tube miter is now finished. It must be a close and clean fit and cannot be forced into place. Fitting a top tube by an experienced builder should take 20-30 minutes. (See Step 111-62)

FIG #73

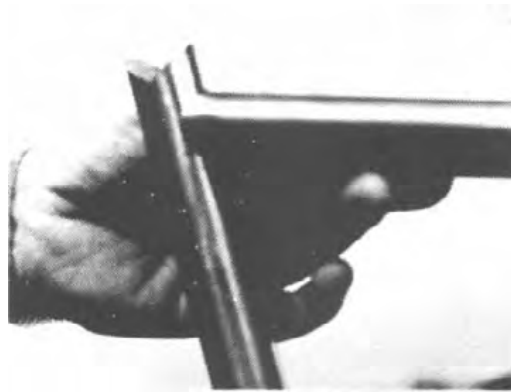

Rough cutting the tops of the seat and head tubes can be done any time after the HT/DT/ST comes out of the bottom bracket jig. About 5mm should protrude beyond the top of the lugs after rough cutting. **This** protruding rim is a handy area to drop silver onto during the silver brazing. (See Step 111-63)

FIG #74

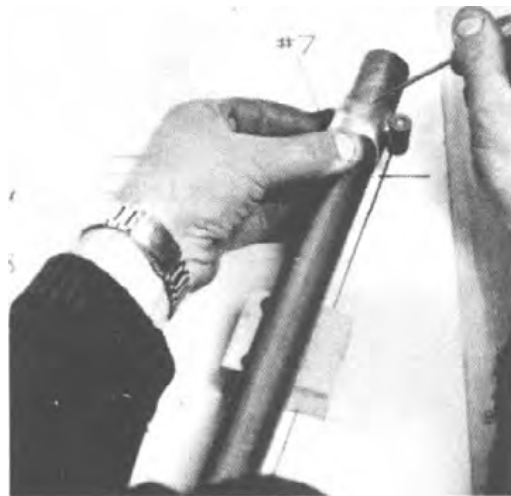

Jigging for top tube installation is rather simple. The lugs do most of the work of holding things in place. The modified bar clamp is used to make the ends of the top tube bottom out against the seat and head tubes. (This frame is a mountain bike frame. Note the lugless construction around the bottom bracket.) (See Step 111-71 & 74)

FIG #75

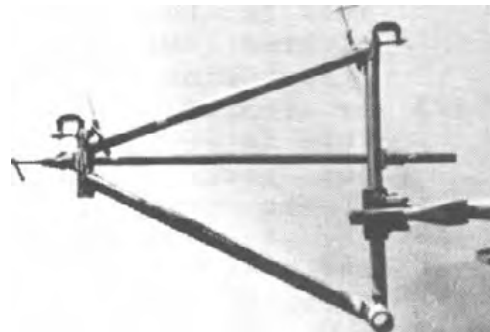

Here is a close-up of modified C-clamp #1. Note FIG #76 how it holds the points of the lug against the top tube. (See Step 111-75)

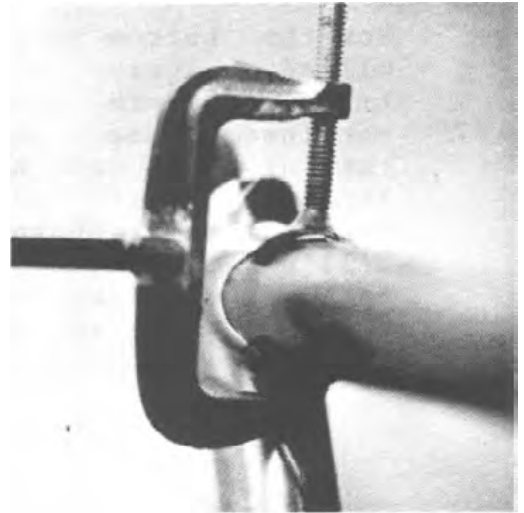

Here is a close-up of modified C-clamp #2. Note FIG #77 how it holds the top tube in place so it won't creep up the seat tube. (See Steps 111-72)



After the top tube is installed, the head tube is reamed and face milled. It is recommended to face the poorer of the two ends first. That would be the top as the bottom is a factory finished end. This allows the centering cone of the tool to locate on a semi-finished face. Mill only till a smooth surface is obtained. (See Step 111-81)



Now the bottom face can be milled. Again, mill only till a smooth surface is obtained. Use plenty of cutting oil and take only light cuts with the spring tension set light to medium. Milling too much off the bottom head lug can alter front end geometry slightly. (See Step 111-82)



The first step in building a fork is to mark the steering column at a rough cut length. This can be done by installing the dummy headset, column, and crown in the newly completed front triangle and scribing a line as shown. (See checklist for amounts that can be safely cut off.) (See Steps IV-9, 10, 11, & 12)



When cutting the column for rough length, cut about 2mm below the line. This will leave a little rim to drop silver on during silver brazing. (See Step IV-10, 11 & 12)

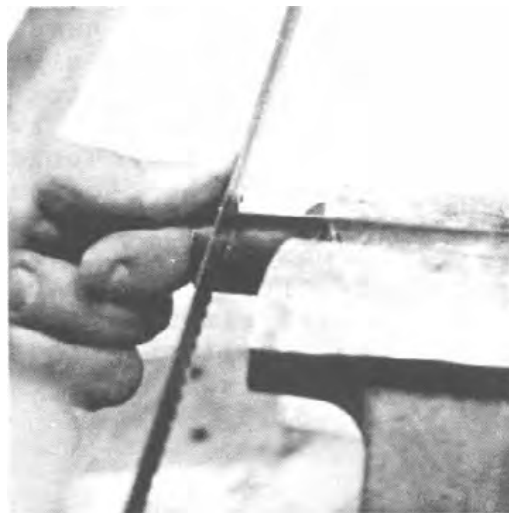



The column and crown must be cleaned for silver brazing. Blue layout dye is being removed here by sanding. The pieces should then be cleaned in acid as other joints are. (See Step IV-13)

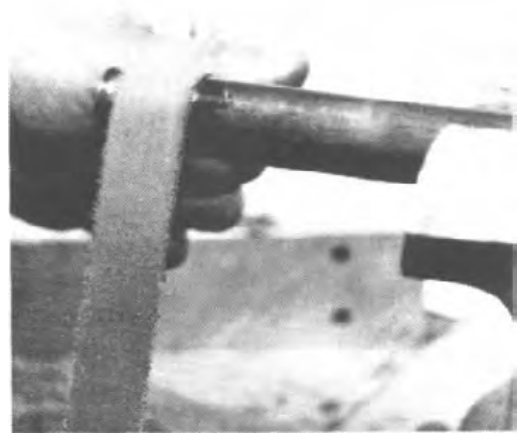

Flux both pieces generously. Since this is a massive (thick) joint, a lot of flux will probably drip off during the longer preheat. (See Step IV-14 & 15)



Place a generous amount of flux right on top of the crown as well. This will give a reserve of flux to draw upon as other flux drips and is lost. (See Step IV-14 & 15)



During silver brazing add silver to the small rim protruding beyond the bottom of the crown. If the crown has a predrilled brake hole, do not add silver there as surface tension can hold the silver at that point and it will not draw properly. (See Steps III-15 & 16)



When silver has drawn clear through the joint and a ring of silver can be seen all around the top of the bearing seat, the joint is done. Allow it to cool before cleaning the flux off with water. (Don't hold your hand over the top of the steering column when submerging in water) (See Steps III-15 & 17)

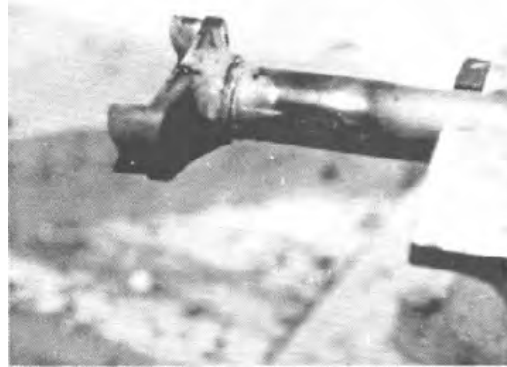

A 10" half round file will remove the 2mm rim around the bottom of the crown. Then switch to a 6" half round to remove the large file marks. A grinding wheel is not highly recommended for this job as it will tend to grind facets that will have to be removed afterwards. (See Step IV-18)



Finish filing can be done with a half round needle file. After this, sanding can be done as an optional step. (See Step IV-18)

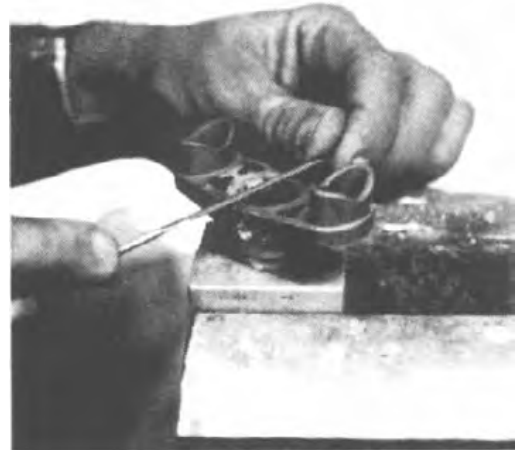

If a predrilled crown was used, locating the brake hole is simple. Do not settle for an undrilled crown unless a brake hole will not be drilled. Some crowns are dimpled for the brake hole which is also acceptable. (See Step IV-21)

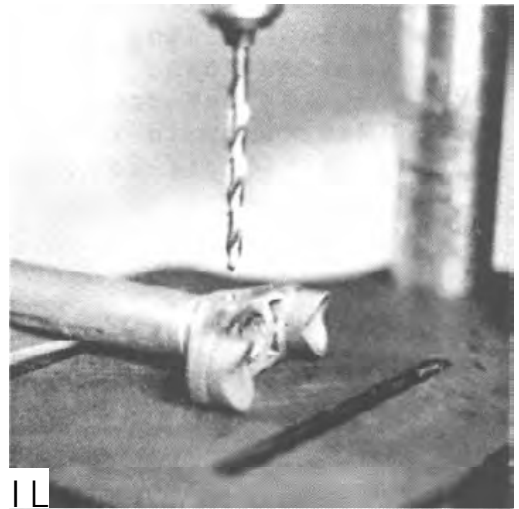

If an alien style brake bolt will be used, the backside of the 1/4" brake hole needs to be counterbored with a 13/32" counterbore with a 1/4" pilot. Counterbore to a depth of 2mm. The 1/4" hole in the backside must now be drilled out to 21/64". Do not drill the 1/4" hole in the front of the crown! Do this operation on a drillpress or preferably a milling machine. (See Step IV-22)

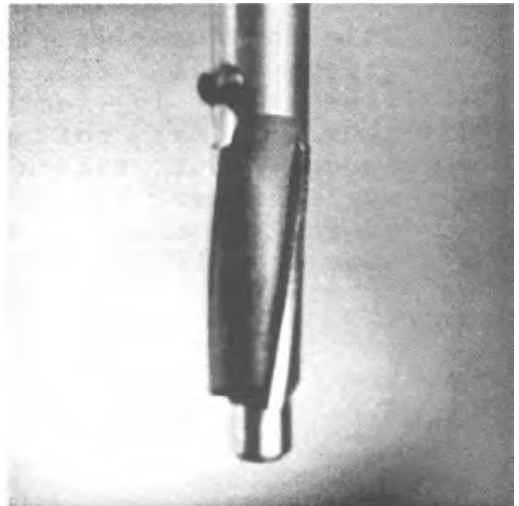

Install a forkcrown race milling tool as pictured.

FIG #91 Note how part of the dummy headset can be used to get extra spacing. (See Step IV-23)



While holding the assembly upside down, apply cutting oil to the crown race area. Then clamp in vise as shown. (See Step IV-23)

FIG #92

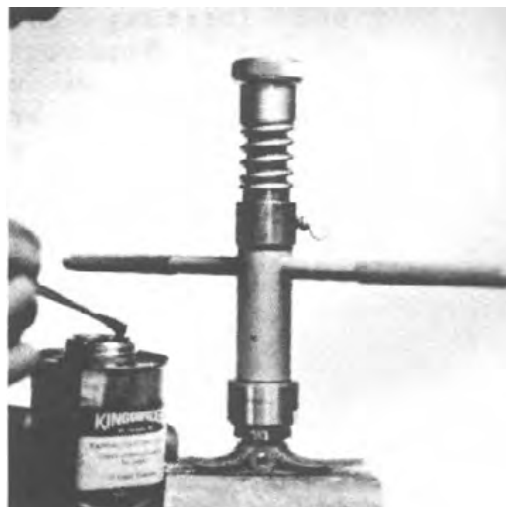

This tool usually requires a great deal of downward pressure. In fact, spring pressure may not even be enough. Cut till a smooth surface can be seen all around the crown race area. (See Step IV-23)

FIG #93

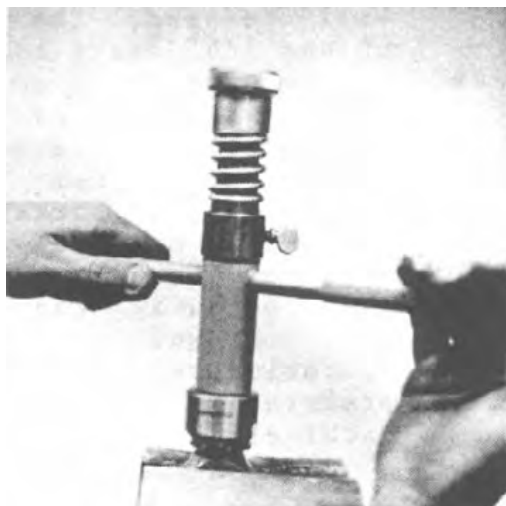

A flat must be filed on the back side of the top of the threaded portion of the steering column. Most crowns are reversible so the flat will determine which side of the crown/column is the back. Aero crowns have the sharp trailing edge at the back. Counterbored crowns have the counterbore at the back. (See Step IV-20)



A washer with a flat (Not a key) should be kept on hand for fitting. Zeus makes an excellent alloy washer with a flat on it for this purpose. The fit should be snug (almost a force fit). (See Step IV-20)



The fork tips may be silver brazed in place next. They should have been already fit to the blades in the gen. prep. Since the dropout is far thicker than the blade about 60 to 70 percent of the heat should be on the dropout. (See Step IV-3, 4, & 5)

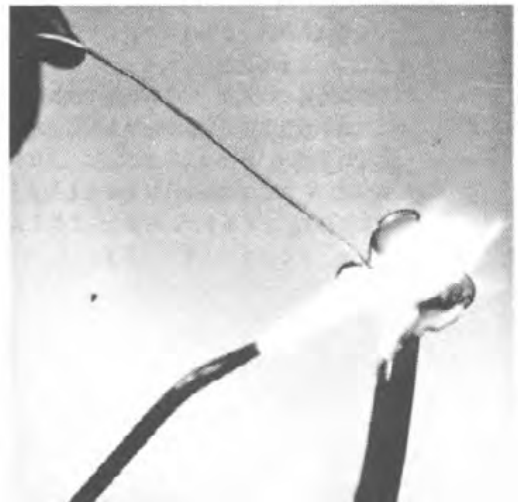

Each blade must have two air expansion holes. One is drilled about 1cm up from the dropout on the inside face of the fork blade. Drill it on the opposite side of the name printed on the dropout! (See Step IV-30)

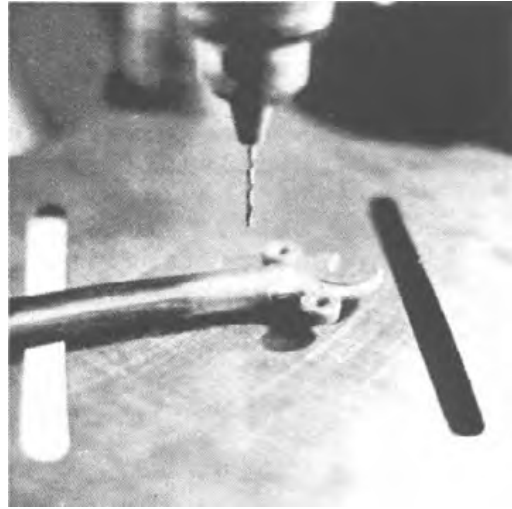

Some crowns, like the American made Henry James, integrate air expansion holes into the crown itself. If using a crown without these holes, the other air hole should be drilled about 2cm down from the crown on the inside face of the blade. These holes should be drilled after the blades are cut to length.

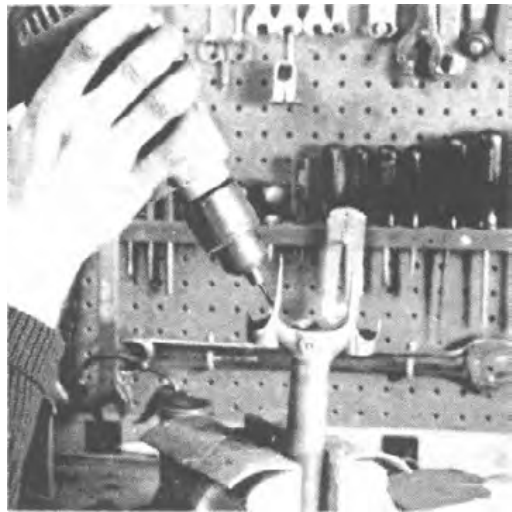

Test the blades for a proper fit with the crown. It should be the same .004" clearance as with all other joints so far. Investment cast crowns usually have a better fit at this point. (See Step IV-24)

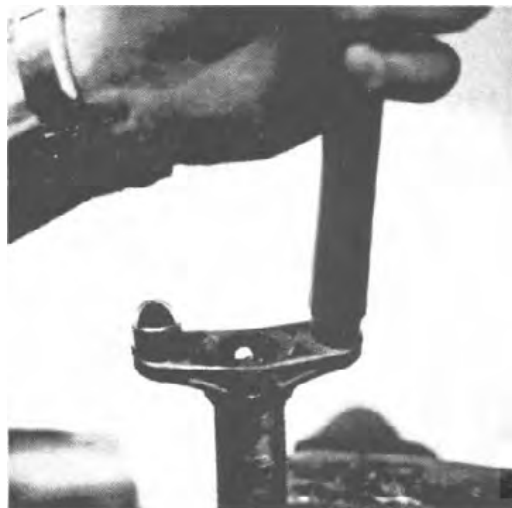

Many times the oval cross section of the fork blade is not quite right to fit properly onto the crown. If this is the case, squeeze the blades very slightly in the soft jaws of the vise. (See Step IV-24)



If the blades still don't fit properly on the crown, then file the crown at the contact area. In the case of overlapping crowns, carefully grind the inside of the opening. NEVER grind material off the blades to obtain the proper fit!!! (See Step IV-24)

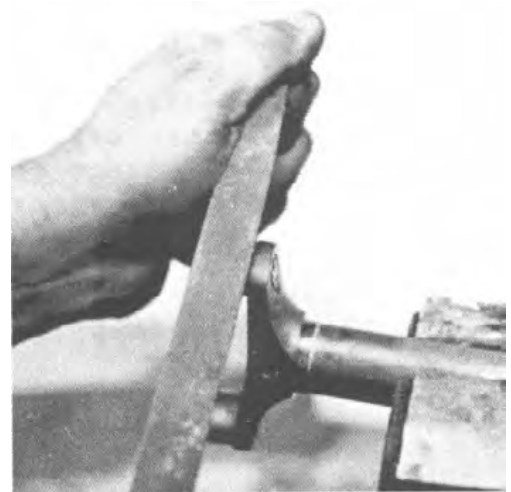

The dummy brake may be used to calculate how much should be cut off the fork blades. Simply measure from the desired hole in the dummy brake to the center of the rim sidewall. That is the amount to cut off the blades. Important: Regular or short reach brakes should have been designed into the drawing and not changed at this point. This can have a considerable effect on front end geometry. (See Step IV-25)

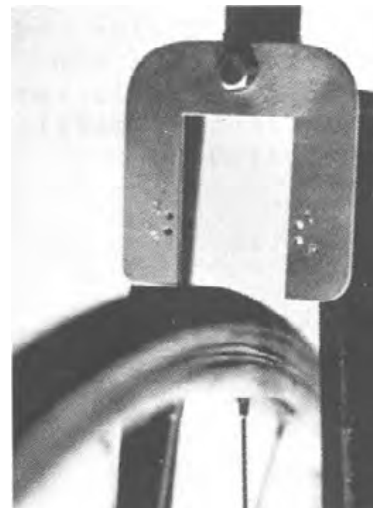

Another way to figure out how much to cut off the blades is to measure from the under side of the crown to be used to the top of the tire to be used. From that measurement subtract the clearance that was figured into the drawing. That leaves the amount to be cut off. This amount of clearance cannot be changed from that which appears on the drawing. (See Step IV-25)

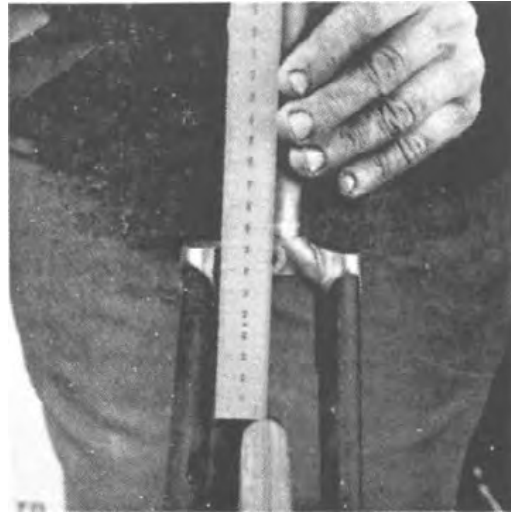

Mark the location for the cut on the side of the blade. Cut the blades from side to side not front to back. This will give the saw less chance to wander. It may be necessary to give the cut a little upward slant on some inserted crowns to insure a good fit. (See Step IV-25 & 26)

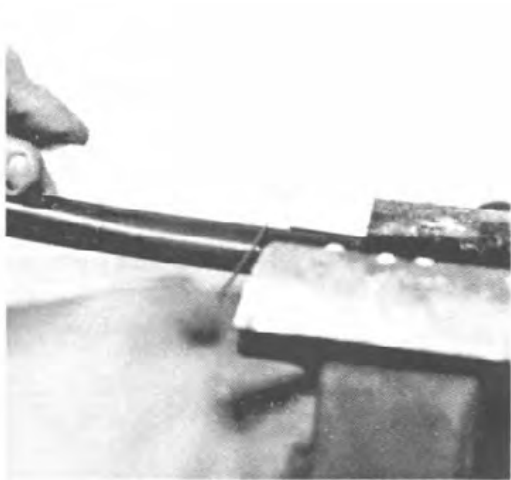

Here the blades are cut to length. Note how the tire and rim easily set in the dead center position. (See Step IV-28)

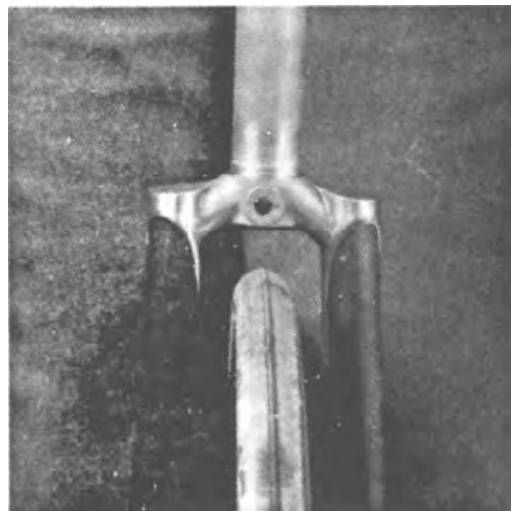



If using an inserted crown, the fit of the tops of the blades against the crown is critical. With a gap, as shown, hot shortness will cause the gap to close. This will throw off lateral alignment of the tips by as much as 5mm. (See Step IV-28)

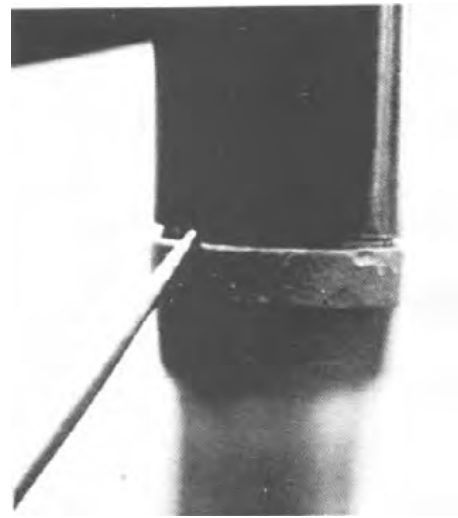

This picture shows a good fit. (See Step IV-28)

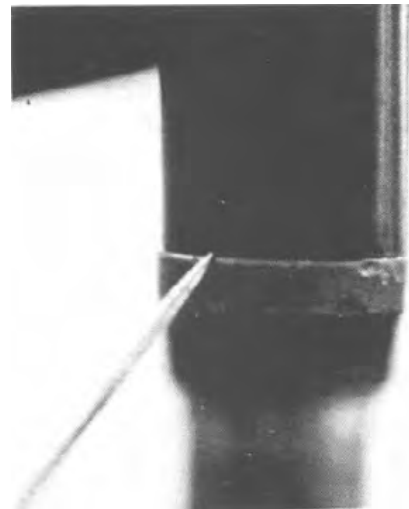

Before the fork goes into the jig, it must have a good fit between the dropout and the hub. A poor fit, as shown, will put spring tension on the fork while it is in the jig. When released, it will seek the shape it wants. (See Step IV-29)

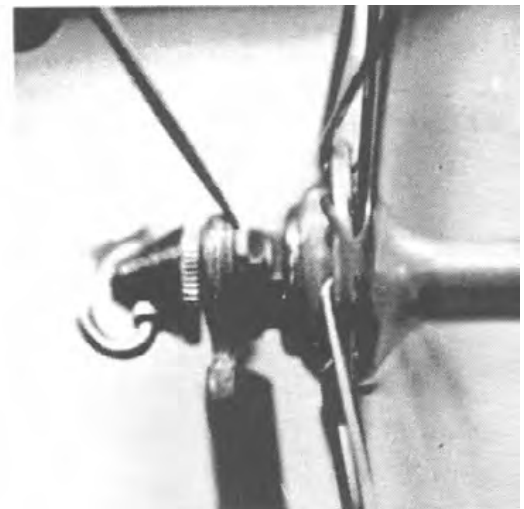

FIG #109 This picture shows a good fit after cold setting. (See Step IV-29)

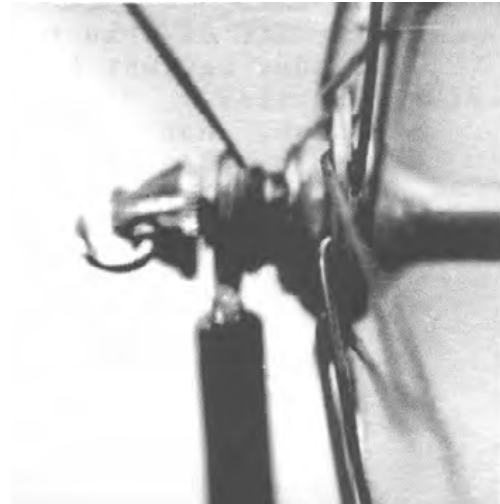
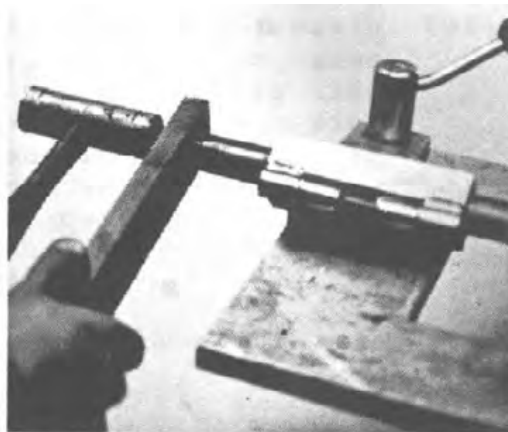

FIG #110 Set the fork jig for the correct amount of rake. To get the right height for the top of the axle add up the following values: 1-Height of centerline of column above the surface of the jig, 2-Amount of rake desired, 3-Radius of axle. This will give the reading to set the vernier height gauge at. (See Step IV-33)



FIG #111 After the joints to be done have been cleaned and fluxed, install the fork in the jig. With a brass hammer and a block of wood set the crown/column firmly against the tops of the blades as pictured. (See Step IV-36)



The dropouts should be lightly tapped with a brass hammer before the quick release is tightened. This will insure that they are fully in place. (See Step IV-35)



Now rest the fork twist gauge across the fork blades close to the crown. Do not put it on the tapered portion of the blades. Zero out the indicator dial and take a reading. Now flip the gauge over and take another reading. (See Step IV-37)

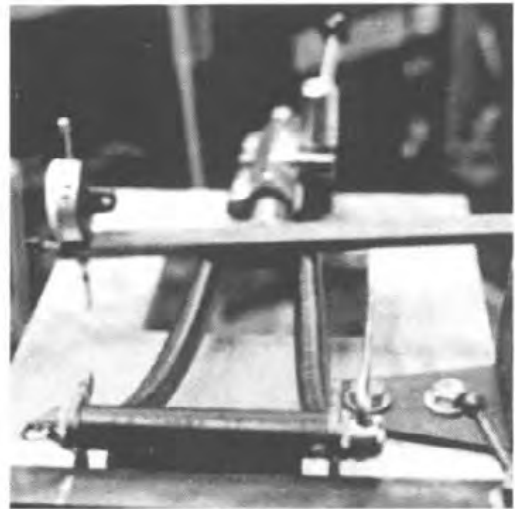

Here the face of the fork twist gauge can be seen. Note how close to the crown the gauge is placed. For the sake of clarity, many of these photos don't have flux applied yet. (See Step IV-37)

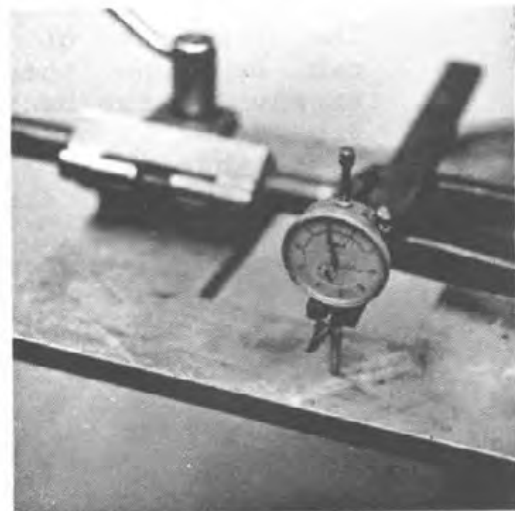

To get the same reading on both sides of the fork, the crown must be twisted.

FIG #115 This can be done with a Phillips screwdriver which has a 1/4" shaft. Put the screwdriver shaft through the brake hole, loosen the clamp on the column, twist as necessary, and tighten the clamp. (See Step IV-37)



FIG #116 The fork is now ready for silver brazing. Keep a majority of the heat on the crown--not the blades. (See Step IV-39)

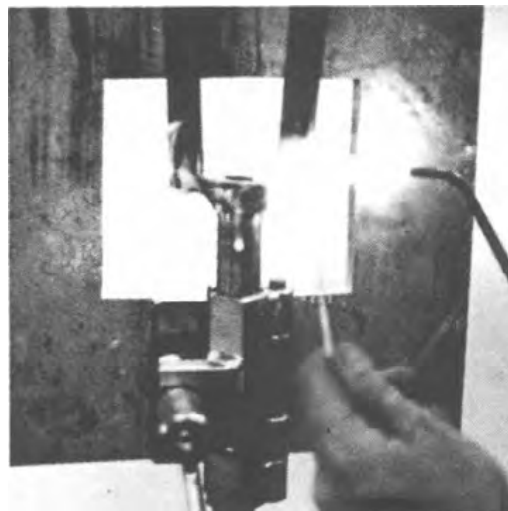
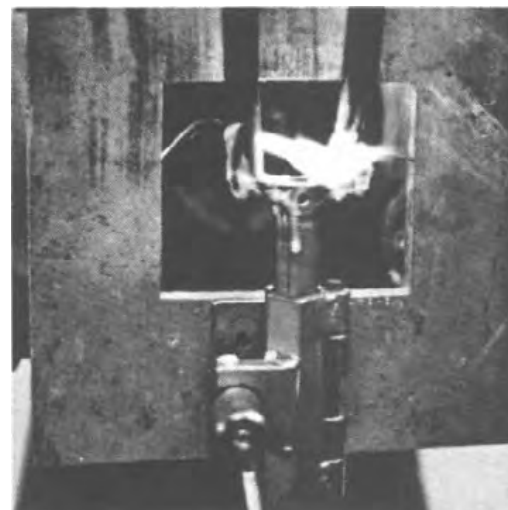
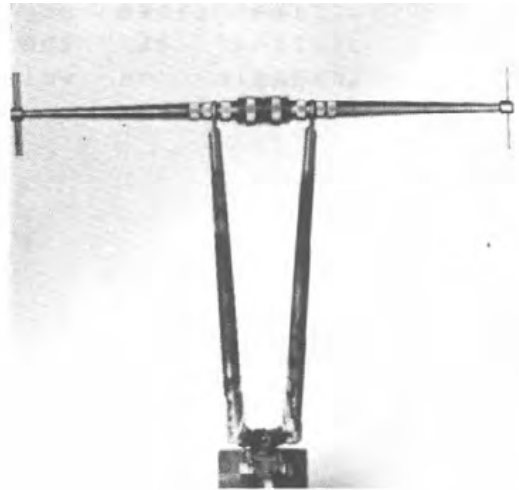

FIG #117 The backside of the fork can be done through the window in the back of the jig. Use of any material less than 1/2" aluminum plate or 3/8" steel plate for this jig is not advised. (See Step IV-39)



When the fork is removed from the jig, it should be checked for alignment by installing a framebuilder's wheel. Look for a difference in clearance between the rim and blades on each side. Sometimes cold setting in a Park fork jig is necessary. The dropout alignment should be checked with a set of figure "H" tools (pictured here) (See Step IV-42)



The rear end jig is pictured here. In order to use it, the front triangle and fork must be completed. A dummy headset must be available, and if the top tube has not been designed level -- the exact slope as per the drawing must be able to be measured. Before beginning work with this jig, it should be leveled. (See Step V-1)

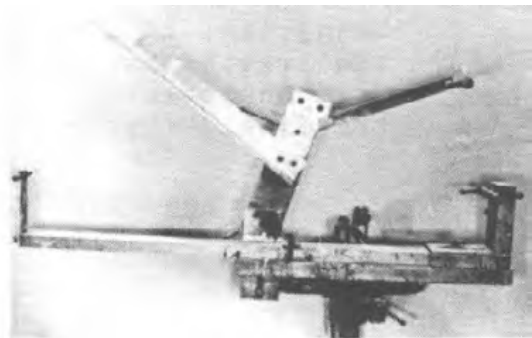

When the partially completed frame is installed in the rear end jig, a straight-edge can be used on edge to scribe center lines on the tubes. This will be used to locate the top tube in the leveled jig. Blue layout dye can be used to make the lines more legible. (See Step V-5)

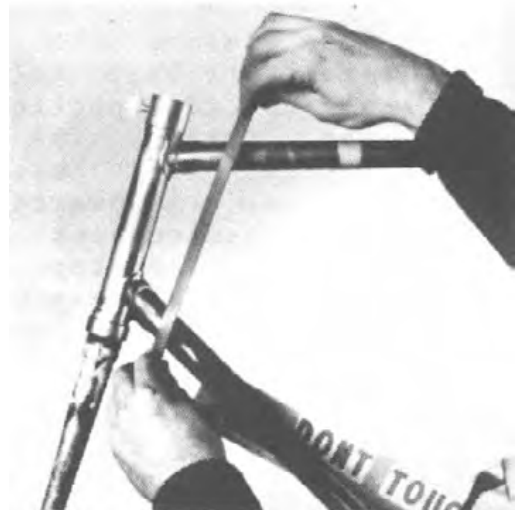

FIG #121 Scribe lines on the rear portion of the front triangle as well. (See Step V-6)

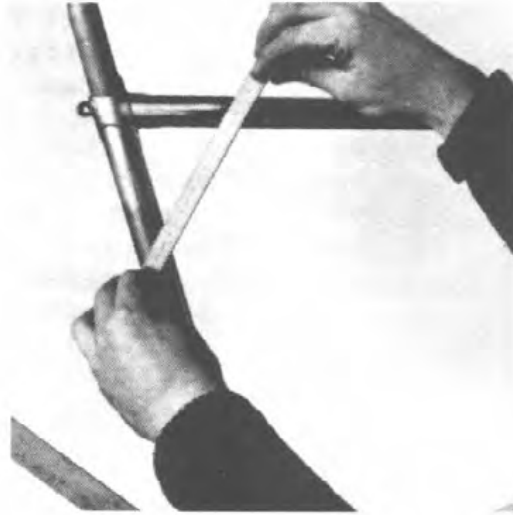

FIG #122 Using the line scribed in the previous step, measure from the base of the jig to the line. (See Step V-8)



FIG #123 Now measure the distance from the base to the line at the front portion of the top tube. The bottom bracket will have to be raised or lowered to get the measurements at each end of the top tube to match. This may take 3 or 4 tries before both readings are the same. (See Step V-7)



A string can be drawn tight between the dummy axles on the jig to locate the axle line. Now the bottom bracket drop can be measured. See that it matches the drawing. If minor mistakes have been made in the construction of the frame, some error can be taken up at this location. (See Step V-10)

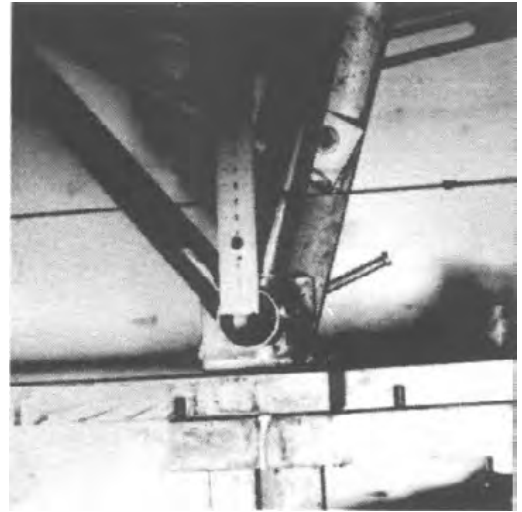

Before checking the tube angles, make sure the jig is level. A simple protractor level with a magnetic base is sufficient. (See Step V-10)



Using the same protractor level, check the top tube angle. This measurement is only for self satisfaction. If the angles are off from the drawing, it is too late to change things. (See Step V-10)

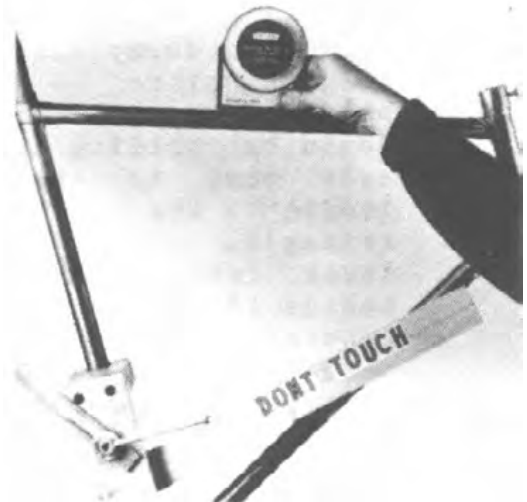

Here again these  
FIG #127 measurements are just a  
spot check. (See Step  
V-10)



This is the critical angle.  
It must be within 1/2  
degree of what was set out  
for. As before, this is  
FIG #128 really too late to change  
things. HOWEVER, a quick  
fix way to try to adjust an  
incorrect head angle would  
be to raise or lower the  
bottom bracket. This is a  
last ditch method and is  
somewhat frowned upon by  
the author! (See Step  
V-10)

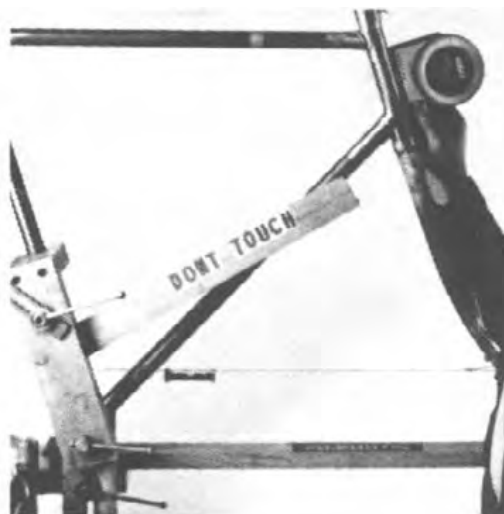

When the front triangle,  
fork, and dummy headset are  
all in place -- work can  
FIG #129 begin on the rear triangle.  
Begin by sliding the rear  
axle post to the desired  
length for the rear  
triangle. **IMPORTANT:**  
Check for tire clearance  
behind the seat tube. As a  
general rule; 27" tires  
have a radius of 34cm and  
700c tires have a radius of  
33.7cm. (See Step V-16)

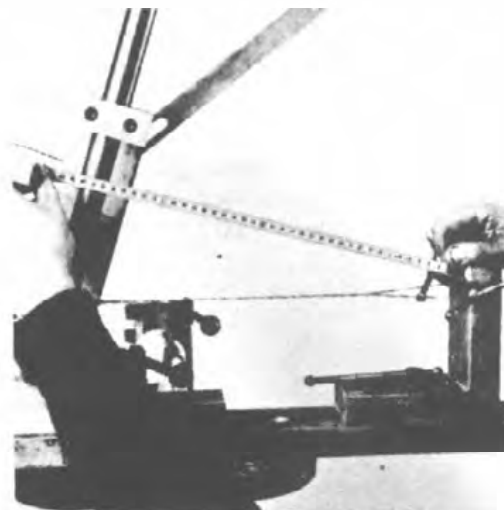



Measure the rough length for the chainstays. This should be measured from about 1/3 of the way into the bottom bracket shell to the center point of the rear axle. (See Step V-17)

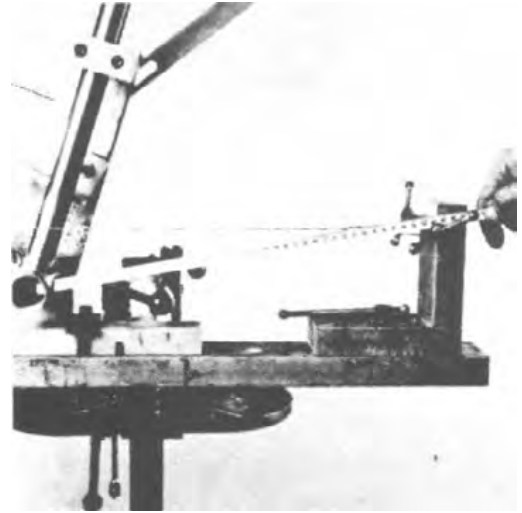

The rough cut chainstay length is then transferred to the chainstay with the dropout brazed into place. Allow some leeway -- cut the chainstays about 1cm longer than necessary. (See Step V-17)



The chainstays probably will not fit into the openings of the bottom bracket shell yet. Reaming with a 5/8" cylindrical stone will be necessary. A die grinder is the best tool for the job. Aim the tail of the die grinder toward the dropout and try not to "rock" the stone too much. (See Step V-18 & 19)

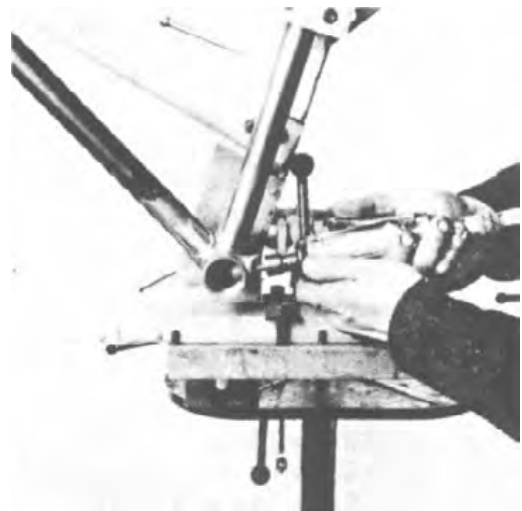

Here the chainstays are being scribed for the finishing cut. The finishing cut can be done on the bench grinder. A really fine miter is not necessary here as the bottom bracket taps will remove as much as 1mm of excess that protrudes into the shell. (See Step V-21)

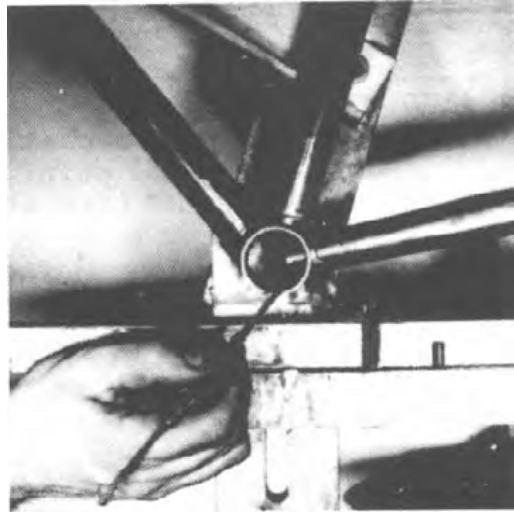

FIG #133

The seatstays must be prepared for installation. If the ends are not already domed and slotted, this must be done as pictured. Note how the stay on the sprocket side has a shortened tip on one side. This is done for added chain clearance. It would be a good idea to wrap a piece of masking tape around each stay and mark them R & L and note which is the inside face of each. (See Step V-27, 28 & V-10)

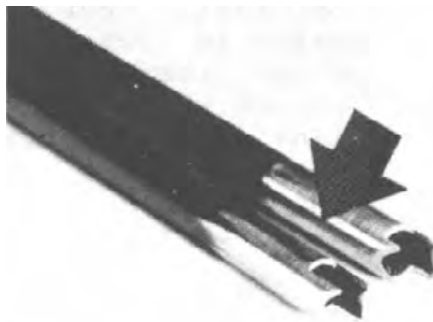

FIG #134

There are a multitude of ways to finish the tops of the stays. The easiest way is to use the ready made slugs as pictured. This particular bike will have the slugs modified into a fastback configuration. The seatstays must be completely finished products with 2 air expansion holes in each before they can be installed. A good fit without slop is critical. (See Step V-30)

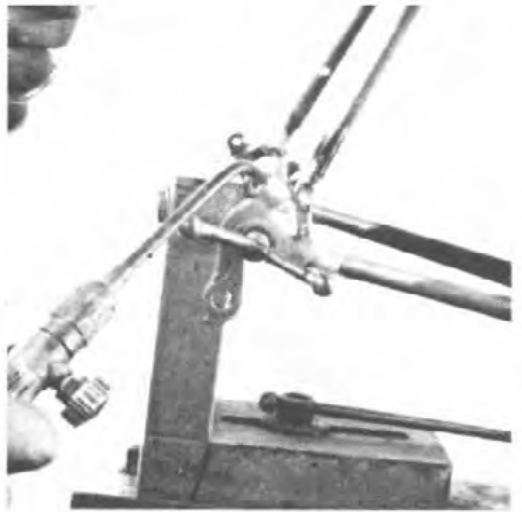

FIG #135

When the seatstays are in place and all joints FIG #136 cleaned and fluxed, brazing can begin. First "tack" the chainstays. (See Step V-48)



Next, move to the dropout/ seatstay joints. Keep FIG #137 60-70% of the heat on the dropout due to the difference in thickness of the two metals. (See Step V-49)



Attach seatstays to the seat lug. For variations in seat cluster FIG #138 configurations see the variations section of this book. Neat clean brazing is necessary on the seat cluster. Due to all of the contours in this area, clean up with files and emery cloth is difficult. (See Step V-50)



FIG #139 After removing the nearly completed frame from the rear end jig, the brazing of the chainstays can be finished. (See Step V-52)



FIG #140 The seat tube must be cleaned out thoroughly and then reamed for an easy slide fit of the seat post with a Chadwick #28 adjustable reamer. A finishing touch can be done by honing the seat tube with a brake cylinder hone. Be careful not to go oversized on this operation!!! Use a 27.2 seat post as a gauge to check for fit. (See Step V-54)



FIG #141 If a surface table and necessary fixtures are not available, the alignment of the front and rear triangle planes can be checked by attaching a string to one dropout, wrapping it tightly around the head tube and attaching it to the other dropout. Measure the gap between the string and seat tubes on both sides. Error is doubled. .5mm is acceptable. (See Steps VI-1, 2 & 33)

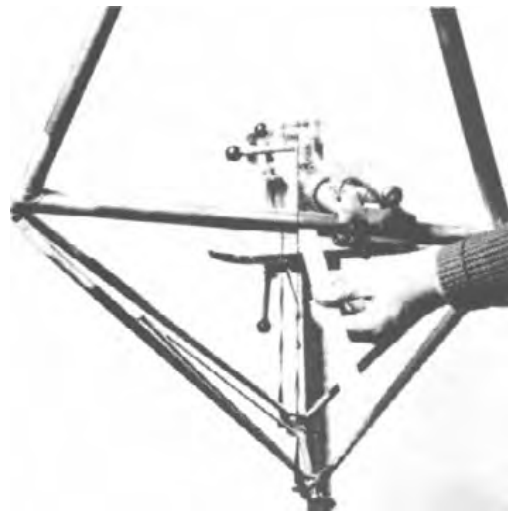

After reaming the seat tube, a stress relief hole should be drilled where the bottom of the binder slot will come. 7/32" is a good size to use. (See Step V-55)



The binder slot can be cut with an abrasive cut-off wheel mounted on an arbor and chucked in a die grinder. These cut-off wheels are available at many auto supply stores. IMPORTANT: Be sure the RPM rating of the wheel matches or exceeds the RPM of the die grinder. USE SAFETY GLASSES DURING THIS OPERATION!!! (See Step V-56)



Bridges and braze-ons can now be installed. Here is an array of pieces to go on a standard racing or sport touring frame. Touring frames often require many more braze-ons. (See Beginning of Section VI)



First the brake bridge is installed. Note the use of the dummy rear wheel to locate the position for the bridge. This fit must be a very snug fit with a minimum of gaps. A loose fit or gaps will allow the dropouts to pull together during cooling. (See Step VI-5, 6 & 7)



Some brake bridges must be brazed together before installation. Some are designed so that no assembly is needed before installing. Make sure that whatever kind is being used, allowance is made for hot air to escape through air expansion holes. (See Step VI-12)



It is a good idea to braze in the bridges in an upside-down position. This eliminates the need for jiggling and prevents the bridge from falling out of place while heating. (See Step VI-19)

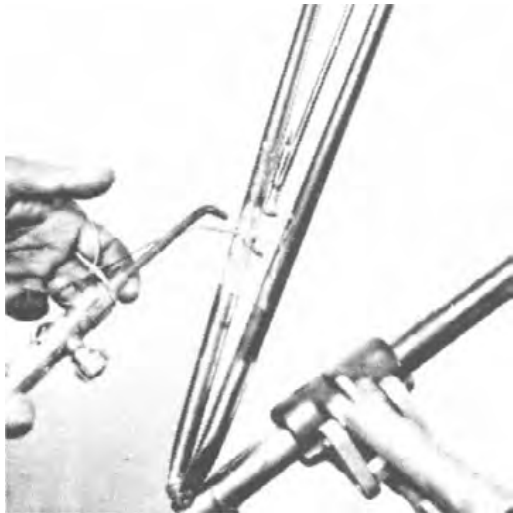

The chainstay bridge is the next item to be silver brazed on. Here again, a very snug fit with a minimum of gaps is necessary. Again the dummy wheel is used to find the location of the bridge. (See Step VI-31)

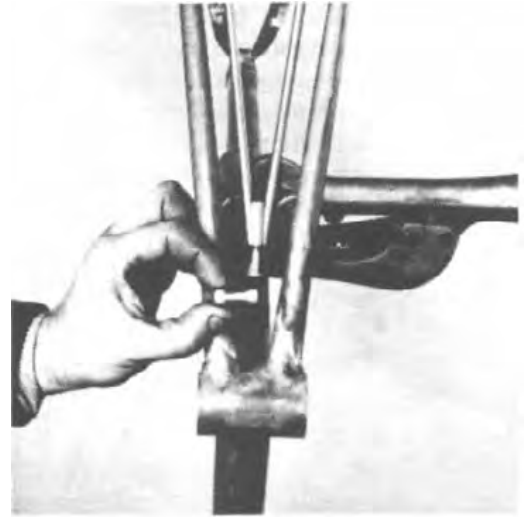

After the bridges are in place, the dropout alignment can be checked with the "H" tools. Make sure the "H" tools are tight before using them to bend the dropouts. If the dropouts pulled together due to gaps or sloppy fit, the rear end must be spread or the bridges must be reinstalled. (See Step VI-34)



When installing water bottle bosses, look out for several factors; 1-Get the holes the correct distance apart. 2-Don't mount two bottles too close together. 3-Don't mount a seat tube bottle too high or too close to the derailleur. 4-Mount underside bottles as close as possible to the bottom bracket. (See Step VI-35)



Water bottles are, by all standards, the easiest braze-ons to install. The personal record for the author is 7 sets in one hour on a tandem frame. Be careful not to get silver in the threaded hole. (See Step VI-35)

FIG #151



The easiest way to locate top tube cable guides is to place the fore and aft ones 5cm from the points of the lugs. Then split the distance between those two for the location of the middle one. (See Step VI-35)

FIG #152

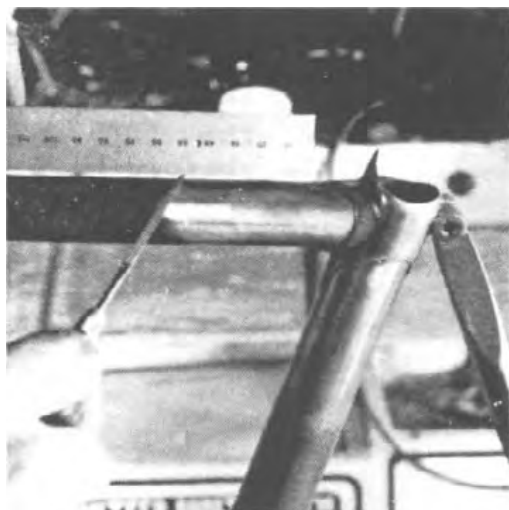

First a tiny dab of silver is applied to the location where the guide will be installed. (See Step VI-35)

FIG #153

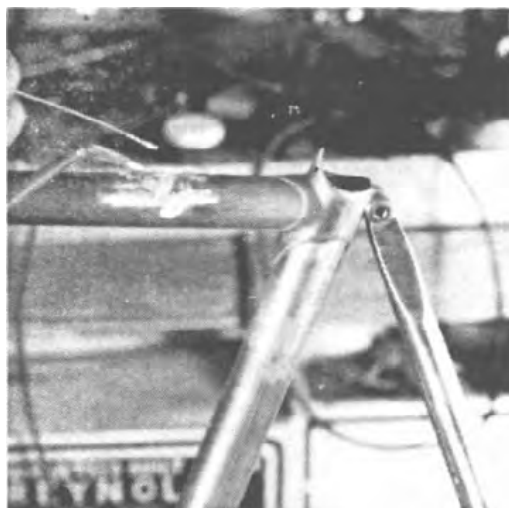



Hold the guide with a pair of worn out pliers as the heating and cooling will ruin a good pair. Gently preheat the fluxed braze-on. Hold it in place on the tube and remelt the silver. If done properly, the braze-on will nestle into place. After applying, sight down the top of the tube with one eye closed to check for alignment. (See Step VI-35)

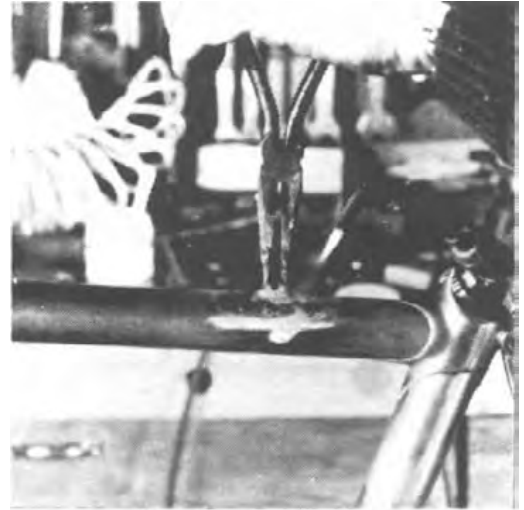

Lever bosses can be applied in the same manner. Great care must be taken to get these aligned in both planes. Jigs can be made to make installation of braze-ons a great deal easier for the beginner. However, with experience, the builder becomes far more agile at handling these small pieces. (See Step VI-35)



Before installing bottom bracket cable guides, a small bead of silver should be laid around the perimeters of the tubes where they protrude into the bottom bracket shell. This will insure a more solid joint. (See Step VI-36)



Here the left side bottom bracket cable guide is being preheated for installation. The pliers make an excellent heat sink to keep the piece from getting too hot. Always hold the braze-ons with the pliers while applying heat. (See Step VI-35 & 36)

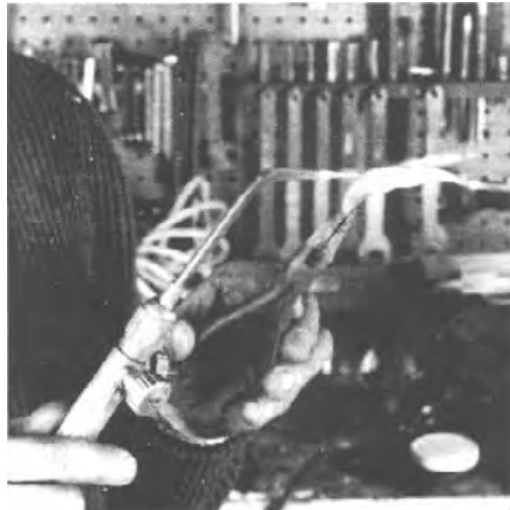

Here the bottom bracket guide is being installed. Make sure to get a good film of silver under this one as it constantly has upward pressure being exerted on it during riding. (See Step VI-35 & 36)



Here the right side bottom bracket cable guide is being installed. The bottom bracket cable guides should be installed so that the shift cables enter the braze-ons below the center line of the down tube. Note how the left braze-on has been bent inward at the back. (See Step VI-35 & 36)

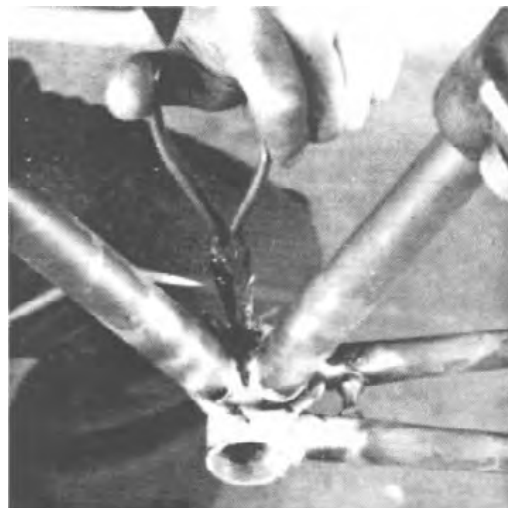

After cleaning the flux and oxidation away from the bottom bracket area, the threads must be cleaned out with bottom bracket line taps. NEVER run taps through threads that still have flux in them. (See Step VI-38)



The bottom bracket must be faced again. Be careful not to take too heavy of a cut and go undersized. (See Step VI-39)



All frames should have a serial number. Not only is it necessary for identification in case of theft, but it can also be used to tell when the frame was built, who built it, how many have been built etc. Note the rigid clamping necessary to stamp numbers. See how a bottom bracket cup prevents distortion of the shell during stamping. (See Step VI-40)



A duplicate serial number on the steering column is a good idea. This spot is hidden from view and may be overlooked by a would be thief. (See Step VI-41)



Here is the completed frame ready for painting. If there will be a lengthy wait for the paint job, the frame and fork should be scrubbed and flushed with Dupont 5717S metal prep to prevent rusting. Use heavy rubber gloves while handling 5717S1 Avoid breathing the fumes also. (See Step VI-42)



## FRAMEBUILDER'S LABOR AND PRICE SCHEDULE

This framebuilder's labor/price manual is designed for the builder who has built at least 10 successful frames and wants to continue on a small scale. In setting up this price schedule it was taken into consideration that most of those using it would be working out of their garage or basement and their overhead costs are buried within their home/living expenses. If this is not the case with you, an "our price" column is given to allow a greater margin of profit. It is not highly recommended to go below the prices too much as the low profit margin would be prohibitive.

In choosing the repairs to be listed the following factors have been considered; you have a good supplier of braze-ons, you do your own painting or have a reliable source to do it for you, you have a solid workbench with a firmly anchored vise mounted on it, you have a repair stand, you own an oxy-acetylene torch, you have a small compressor, you have an adequate selection of hand tools, files, drill and grinding wheel, you own a mechanics' tool case (Campagnolo, Zeus, Gippiemi, VAR or Bicycle Research will do) and have put some amount of time into making some usable framebuilding fixtures. If you fall short of these requirements, you will have problems when you invite potential customers over for your services as your capabilities will fall short of this manual. If, on the other hand, you are far better equipped than the above requirements call for, you may want to purchase a copy of the PATEREK catalogue and use that as your own manual.

Here are some words of caution for the beginning framebuilder; don't accept full payment for a job till it is completed, don't promise to get an item you are not sure where to obtain, don't let a job out the door till it is fully paid for, guarantee your work--and don't do any work which you feel you could not guarantee. Finally, don't do a job on a "low bid."

There are two pages in this manual which you have permission to make copies of in a limited manner. They are the Frameset Order Form and the Component Sheet.

BRAZE-ON PRICE LIST

	Sugg. Price	Our Price
1. Water Bottle Mounts		
A. Plain .....	\$ 9.00	
B. Scalloped Diamond Stiffeners .....	10.00	
C. Plain Diamond Stiffeners .....	10.00	
2. Brazed on Front Derailleur (includes Derailleur)		
A. Campagnolo .....	44.95	
B. Shimano Dura Ace .....	34.95	
3. Shift Lever Bosses		
A. Campagnolo (Fits Campy, Simplix S.L.J., Rino, Suntour) . . .	12.50	
B. Modified Campagnolo (allows for use of Barcons) .....	18.50	
C. Shimano .....	12.50	
4. Cantilever Brake sets (specify regular, tandem or mountain use) Levers and cables not included		
A. Mafac .....	44.95	
B. Dia Compe .....	44.95	
C. Shimano .....	44.95	
5. Rear Rack Fittings		
A. Internal (using water bottle boss) .....	10.00	
B. External .....	10.00	
6. Low Rider Mounts .....	10.00	
7. Top Tube Cable Guides		
A. 2 Close Loops .....	10.00	
B. 2 Distant Loops .....	10.00	
C. 1 Loop .....	10.00	
8. Cable Stop (3.50 if done with 2 other items)		
A. Shimano .....	5.00	
B. Campagnolo .....	5.00	
C. Split .....	5.00	
D. Heavy Duty .....	5.00	
9. Pump Peg (3.50 if done with 2 other items) - Specify brand and length and which frame tube to be installed on.		
A. Standard .....	5.00	
1/4" ball bearing to mount Silca frame-fit under top tube .	5.00	
10. Clamp stop (3.50 if done with 2 other items) .....	5.00	_ _ _
11. Chain Hanger (3.50 if done with 2 other items) .....	5.00	
12. Bottom Bracket Guides		
A. Campagnolo (top side) .....	13.00	
B. Shimano (top side) .....	13.00	
C. Cinelli (top side) .....	13.00	
D. Under Side .....	13.00	
13. Barcon stops - Specify style to be used (see #8) .....	7.50	
14. Extra Eyelets for fenders .....	7.50	.pr
15. Brake bridge reinforcing sleeve		
A. Standard .....	10.00	
E. Allen Type .....	10.00	
16. Spoke Carrier/Chainstay Guard .....	17.50	
17. Center Pull Hanger		
A. Simple Loop .....	10.00	
B. Triangular .....	18.00	

PAINTING PRICE LIST

	Sugg. Pri ce	Our Pri ce
Overhaul for painting; includes repacking bottom bracket & head and removing & replacing all components. (Repacking of hubs and cleaning up the drive train is extra) .....	\$45.00	
Stripping old paint .....	15.00	
Masking chrome:		
Seat stays, chainstays, and fork blades .....	5.00	
Head lugs and/or crown .....	5.00	
Single color paint job .....	60.00	
Two tone paint job .....	90.00	
Decal work (minimum charge) .....	10.00	
Pinstri ping (minimum charge) .....	15.00	
Clear coat (must go over the top of decals and pinstri ping .....	10.00	

FRAME REPAIR PRICE LIST

BOTTOM BRACKET:		
Clean out or straighten out threads .....	6.50	
Face milling (light cut) .....	7.50	
Face milling from 70mm to 68mm (heavy cut) .....	12.50	
Fill damaged threads with brass and retap to original specs. . . .	25.00	
Reinsert and rebraze an existing frame tube which has pulled out of the bottom bracket shell:		
Silver brazed .....	20.00	
Brass brazed .....	15.00	
HEAD:		
Mill top and bottom of head tube (without reaming) .....	8.00	
Mill and ream top and bottom of head tube (light cut) .....	10.00	
Mill head tube shorter to gain more threads on the steering column (heavy cut) minimum charge .....	15.00	
FORK:		
Align fork tips .....	2.50	
Reattach dropout (send old dropout along with fork) .....	7.00	
Replace dropouts .....	25.00	
Replace Blades:		
British cross section .....	40.00	
Continental oval .....	50.00	
Mill for fork crown race (light cut) 26.4mm .....	4.50	
Mill for fork crown race to gain 1 or 2 threads on the steering column (heavy cut) .....	6.00	

FRAME REPAIR LIST (continued)

	Sugg. Price	Our Price
Tap steering column to fit smaller frame:		
First centimeter . . . . .	3.00	
Each additional centimeter . . . . .	.75	
Fill damaged threads with brass and retap to original specs. . . . .	15.00	
REAR TRIANGLE:		
Replace dropouts (Camoy NR) - each . . . . .	\$40.00	
pair . . . . .	60.00	
Replace chainstays (REY 531) - each . . . . .	50.00	
pair . . . . .	75.00	
Replacement of chainstays includes a bridge and cable stop.		
Replace seatstays (REY 531) - each . . . . .	40.00	
- pair . . . . .	65.00	
Replacement of seatstays includes a brake bridge.		
Replace or relocate brake bridge - Standard type . . . . .	15.00	
- Allen style with stiffeners . . . . .	25.00	
Straighten seatstay with no kink . . . . .	5.00	
Straighten seatstay and fill & smooth out kink . . . . .	25.00	
Fill derailleur hanger threads with brass and retap . . . . .	15.00	
Clean out chain adjuster threads . . . . .	5.00	
Align tips . . . . .	2.50	
Align derailleur han <sup>g</sup> er . . . . .	2.50	
Open rear triangle to accommodate a 6 speed		
Cold bend (not highly recommended) . . . . .	5.00	
Install longer brake bridge--see above		
FRONT TRIANGLE:		
Replace head tube . . . . .	75.00	
Replace down tube and bottom head lug . . . . .	150.00	
Replace top tube and top head lug . . . . .	150.00	
Replace bottom bracket shell . . . . .	150.00	
Replace down tube, head tube and top tube . . . . .	250.00	
Splice a cracked frame tube back together . . . . .	25.00	
DRESSING A FRAME:		
Since many new factory frames are not cleaned up very well at the factory, the dealer must see to it that the bottom bracket is tapped and faced, the head tube is milled and reamed, the fork crown is milled, the seat tube is reamed for a proper fit, the tips are aligned, and small threaded holes are cleaned out.		
(This should also be done after a paint job) . . . . .	25.00	

CUSTOM FRAME PRICE LIST

LEVEL-1:

These are available as touring, sport/touring, or racing frames. Materials used for level -1 frames consist of .6mm/.9mm double butted frame tube sets, stamped lugs, medium quality bottom bracket shell and, standard road dropouts. Braze-ons include one water bottle mount, bottom bracket guides, top tube guides, chainstay stop, and chainhanger. A polyurethane finish is then applied. Decals are optional . . . . . 400.00



CUSTOM FRAME PRICE LIST (continued)

Sugg.      Our  
 Price      Price

LEVEL-2s

These are available as touring, sport/touring, or racing frames. Materials used for level -2 frames consist of .8mm/.9mm or .6mm/.8mm (5L) double butted frame tube sets, investment cast lugs-fork crown-bottom bracket and, high quality dropouts. Braze-ons include two water bottle mounts, bottom bracket guides, top tube guides, chainstay stop, chain hanger, pump peg, lever bosses or Barcon stops and, alien bolt bridges. A polyurethane finish is then applied. Dry transfer decals are optional. A final polyurethane clear coat is then applied ..... 500.00

SIZE AND WEIGHT RECOMMENDATIONS

Regular double butted tubing sets can usually be built as tall as 64cm and should not be ridden by a rider over 225 lbs.

SL double butted tubing sets can usually be built no bigger than 61cm and should not be ridden by a rider over 160 lbs.

Ultra-light double butted tubing sets can usually be built no bigger than 58cm and should not be ridden by a rider over 150 lbs. for time trialing or 125 lbs. for general racing.

For very tall riders the Reynolds "Tall Set" is available and can be built as tall as 76cm. This would add about \$50.00 to the cost of the frameset.

For riders between 160 and 195 lbs. who want to ride SL, the down tube and chainstays can be replaced with the next heavier gage tubing. This would add about \$35.00 to the cost of the frameset.

FRAMESET ORDER FORM/SPEC SHEET

Today's Date \_\_\_\_\_  
 Target Date \_\_\_\_\_

Name \_\_\_\_\_  
 Address \_\_\_\_\_  
 Phone \_\_\_\_\_  
 Height \_\_\_\_\_ Weight \_\_\_\_\_  
 Inseam \_\_\_\_\_ Arm Length \_\_\_\_\_  
 Cubit Length \_\_\_\_\_  
 Frame Type \_\_\_\_\_

-NOTES-

GEOMETRIC SPECS:

Seat tube length \_\_\_\_\_  
 Top tube length \_\_\_\_\_  
 Front center \_\_\_\_\_  
 Chainstay length \_\_\_\_\_  
 Seat tube angle \_\_\_\_\_  
 Head tube angle \_\_\_\_\_  
 Bottom bracket drop \_\_\_\_\_  
 Fork rake \_\_\_\_\_  
 Estimated trail \_\_\_\_\_  
 Bridge clearance \_\_\_\_\_  
 Crown/tire clearance \_\_\_\_\_  
 Rear hub width \_\_\_\_\_  
 Tire size \_\_\_\_\_

BRAZE-ONS:

add \$

MATERIALS SPECS:

L. H. BB guide \_\_\_\_\_ Tubing \_\_\_\_\_  
 R. H. BB guide \_\_\_\_\_ Lugs \_\_\_\_\_  
 Chainstay stop \_\_\_\_\_ Bottom bracket \_\_\_\_\_  
 W. B. #1 \_\_\_\_\_ Fork crown \_\_\_\_\_  
 W. B. #2 \_\_\_\_\_ Drop outs \_\_\_\_\_  
 W. B. #3 \_\_\_\_\_ Paint \_\_\_\_\_  
 W. B. #4 \_\_\_\_\_ Brazing Material \_\_\_\_\_

Top tube stops \_\_\_\_\_  
 Top tube guides \_\_\_\_\_  
 Lever bosses \_\_\_\_\_  
 Barcon stops \_\_\_\_\_  
 Pump peg \_\_\_\_\_  
 Rear rack mounts \_\_\_\_\_  
 Low rider mounts \_\_\_\_\_  
 Spoke carrier \_\_\_\_\_  
 Cantilevers \_\_\_\_\_  
 Cut-outs \_\_\_\_\_  
 Headcrest \_\_\_\_\_  
 Other \_\_\_\_\_

COST OF FRAMESET:

Base price of frame \$ \_\_\_\_\_

Extra braze-ons \_\_\_\_\_

Special requests \_\_\_\_\_

Subtotal \_\_\_\_\_

Tax \_\_\_\_\_

Total \_\_\_\_\_

Braze-on total \_\_\_\_\_

Downpayment \_\_\_\_\_

Balance Due \_\_\_\_\_

DESCRIPTION

Drive Train:

Cranks \_\_\_\_\_  
 BB \_\_\_\_\_  
 Chainrings  
 Pedals \_\_\_\_\_  
 Toe clips  
 Toe straps  
 Chain  
 Freewheel

Wheels:

Hubs  
 Spokes \_\_\_\_\_  
 Rims  
 Rimstrips  
 Tubes \_\_\_\_\_  
 Tires

Shifting system:

Fr. derailleur  
 R. derailleur  
 Levers \_\_\_\_\_  
 Cables \_\_\_\_\_  
 Clamps \_\_\_\_\_

Brake system:

Running gear:

Headset --  
 Seatpost  
 Saddle  
 Bars  
 Stem  
 Bar Wrap \_\_\_  
 Plugs  
 Pinch bolt

Accessories:

Pump  
 Carrier  
 Lights  
 Bottle rack  
 Bottle  
 Speedo  
 Lock

Other:

Name	Component	Group	Total
Address			Tax
			Total
Phone ___			Down Payment
Bike Type			Balance Due

## FIXTURES

There are many items necessary for frame building that are not generally available on the open market. These things must either be made for the builder by a machine shop or must be made by the framebuilder. To simplify matters, any of these items which must be specifically made for the builder will be referred to as "fixtures" from now on.

Fixtures can be divided into three main categories:

- 1 - Measuring fixtures
- 2 - Holding fixtures
- 3 - Bending fixtures

Each of the jigs in the three main categories will be discussed and diagrams will be used to show the fixtures in detail.

A set of detailed plans for the following fixtures are available on request from the author at a cost of \$10.00. Send to THE FRAMEBUILDER'S GUILD, R.T. 2, BOX 234, RIVER FALLS, WISCONSIN 54022

### MEASURING FIXTURES

#### DUMMY HEADSET

The dummy headset is made up of two bushings. When assembled on the steering column, they represent the actual stack height of a real headset. The small bushing is the bottom part of the headset and the larger bushing is the top part of the headset. The smaller bushing is dropped onto the steering column. The head tube of the frame is then lowered onto the steering column until it rests on the bushing. Then the larger bushing drops onto the steering column and snugs up against the head tube. The larger bushing has a set screw in the side which, when tightened down, will hold the fork and frame together. The dummy headset has four important functions:

- 1 - It measures the length at which to cut the steering column. Scribe the mark for the cut at the very top of the dummy headset.
- 2 - It holds the fork crown and the bottom of the head tube the correct distance apart while the rear end jig is being used.
- 3 - It allows the quick and easy assembly of the frameset for inspection purposes.
- 4 - It can be useful in storage and transportation of the frameset.

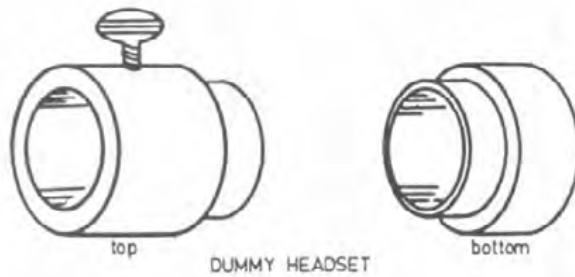

## DUMMY REAR WHEEL

The dummy rear wheel is a triangular-shaped device that acts as a rear wheel while the bridges are being installed in the rear triangle. Use of the dummy rear wheel lessens the risk of ruining the hub parts or tire on a set of framebuilder's wheels during brazing. A properly constructed dummy rear wheel has four functions in frame building:

- The tip of the triangle on the dummy rear wheel represents the outer diameter of the tire. When screwed in, it's set for 700c. When screwed out, it's set for 27".
- The small marks that appear about 2 or 3 centimeters from the end show where on the rim the brake shoes should hit. The upper mark is for 27" and the lower mark is for 700c.
- The distance between the locknuts can be set for five speed (120mm) or six speed (125mm). This will hold the dropouts the correct distance apart while silver brazing the bridges in place.
- The dummy will show if either stay is longer by being off center between the seatstays if a problem exists.

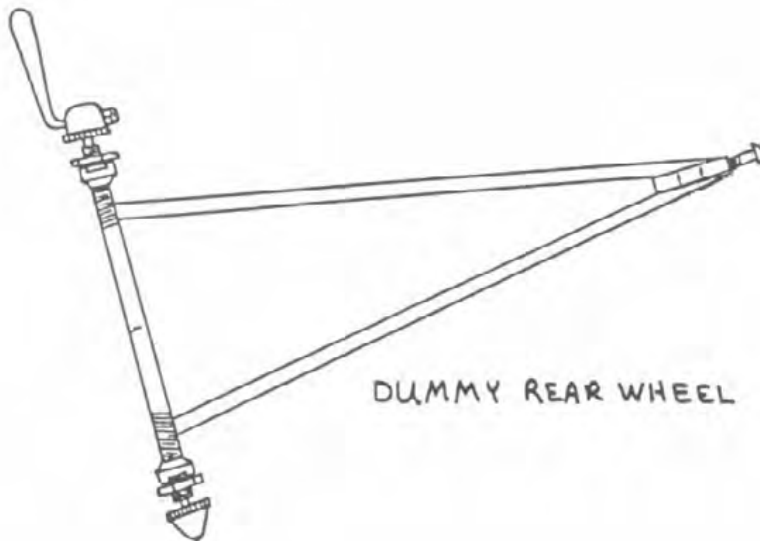

## DUMMY BRAKE

The dummy brake is an upside-down, u-shaped, flat piece of sheet stock that simulates the brake while cutting fork blades. Using the dummy brake is quicker and simpler than installing an actual brake caliper during this operation. The dummy brake has one main function--it shows what the distance should be between the brake center bolt and the middle adjustment for the brake shoes. The marks at two levels will give this distance for both short reach and regular reach Campagnolo brakes. The dummy brake should be used in conjunction with a set of framebuilder's wheels.

### DUMMY BRAKE.

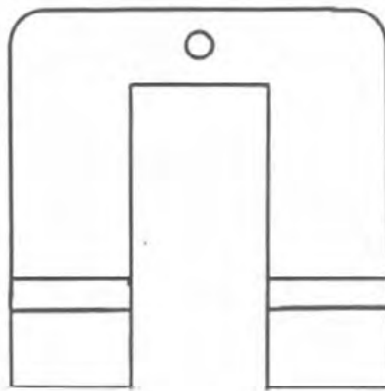

BOTTOM BRACKET MICROMETER

The bottom bracket micrometer (B.B. Mike for short) is used to measure the amount of deflection that has occurred in the down or seat tubes as they leave the bottom bracket shell. It is used in a fashion similar to a wheel dishing tool in that it is laid along the faces of a cleanly-faced bottom bracket shell. A reading is taken out at the micrometer head. It is then flipped around to the opposite face of the shell and another reading is taken. The amount of deflection that has occurred is half of the difference between the two readings. The B.B. Mike can be considered to be the poor man's surface table. If it is made out of high quality materials, it is extremely accurate.

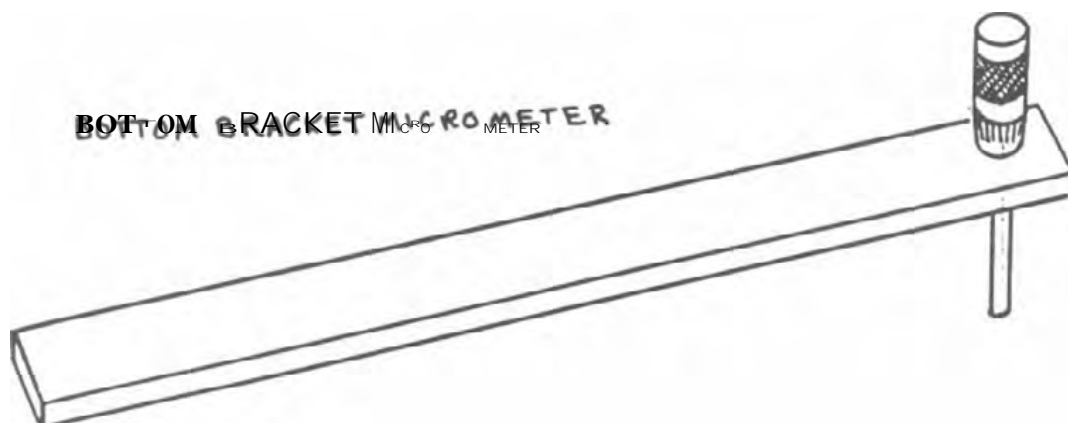

## FRAME DESIGNER'S STRAIGHT EDGE

To make the designing and drawing of the working drawing faster and easier, a special straight edge can be used. It is exactly 1 1/8" wide and can be laid on the drawing exactly where the seat or down tubes are to be drawn in place. Drawing the tubes can then be done quickly by scribing both sides of the tubes on each side of the straight edge. One end of the straight edge has a notch in the exact center. This notch helps locate where the down tube goes through the center of the bottom bracket shell.



FRAME DESIGNER'S STRAIGHT EDGE (30" X 1 1/8" X 1/4")

## FORK TWIST INDICATOR

When the fork is jugged up in the fork jig, the fork twist indicator can be laid across the upper part of the fork blades. A reading is then taken to find the distance between the indicator and the surface of the fork jig. The indicator is then flip-flopped and another reading is taken on the opposite side. If the readings are different, the crown must be twisted to compensate for the difference. This is done till there is no difference between the two readings.

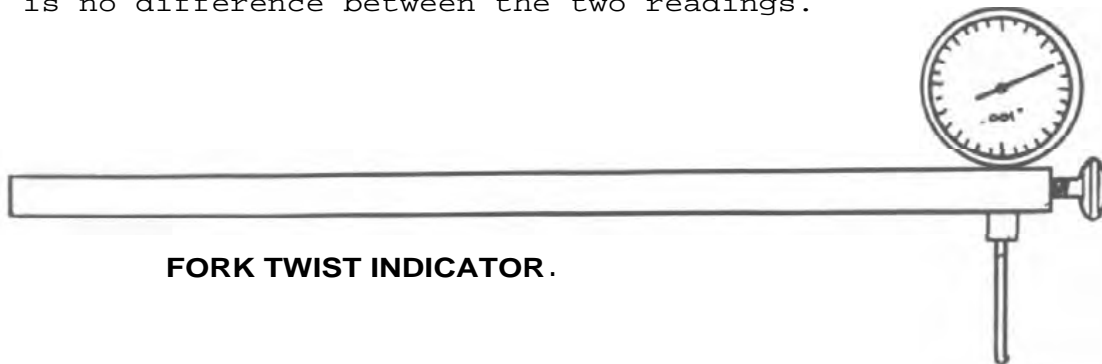

**FORK TWIST INDICATOR.**

## HOLDING FIXTURES

### TUBING CLAMPS OR FRAMEBUILDER'S BLOCKS

Clamping thinwall tubing in a vise can be rather risky business. The sides of the tube can be flattened and the tube consequently ruined. To eliminate the risk of this problem, a set of blocks can be fashioned to match the diameter of the tubes. When the tubes are clamped in such a set of blocks, there is no risk of flattening the tube. The blocks can be made of aluminum by a machine shop or even homemade out of hardwood.

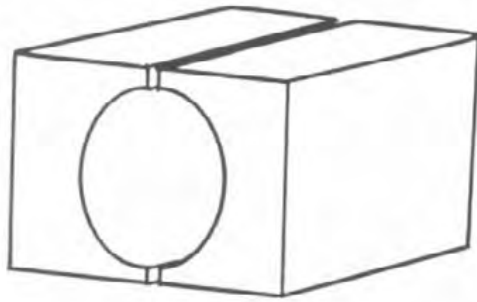

## TUBING CLAMPS

### REAR END JIG

The rear end jig is used to hold the front triangle, dummy headset, and fork in place while the rear triangle is constructed. The jig is made up of six main parts:

- A - The seat tube clamp assembly (8, 9 & 11)
- B - The stay rest (6 & 7)
- C - The angle bar (10)
- D - Rear axle post assembly (3, 4 & 5)
- E - Front axle post assembly (1, 3 & 4)
- F - Base.

This is a very expensive fixture and no expense should be spared in the production of this fixture. By all means, it must be straight and true.

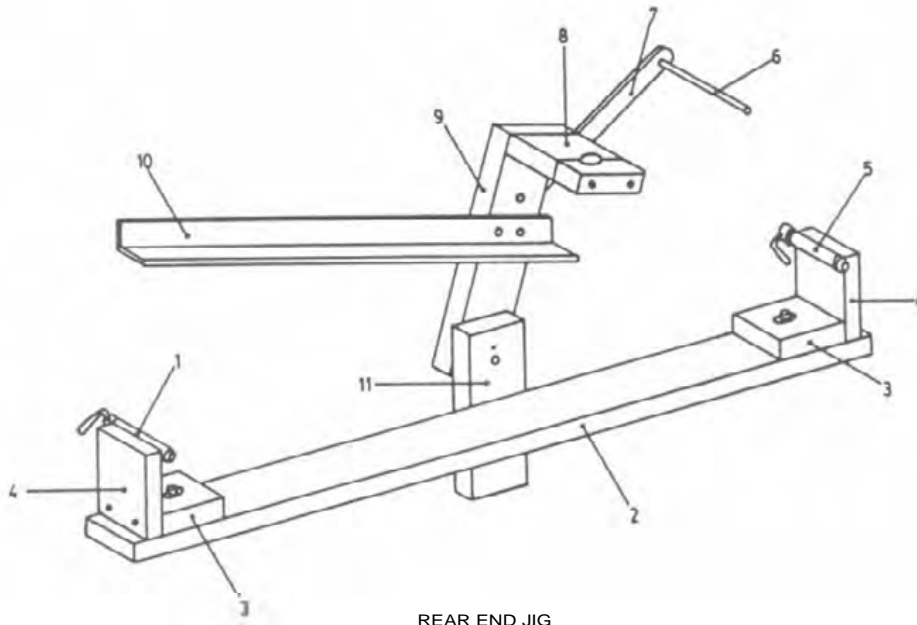

REAR END JIG



### MODIFIED BAR CLAMP

A regular furniture clamp can be taken and modified in such a way that it will clamp the head and seat tubes and pull them toward each other. This must be done so that the ends of the top tube come into contact with the back side of the head tube and the front side of the seat tube. This is necessary while silver brazing the seat lug and top head lug in place.

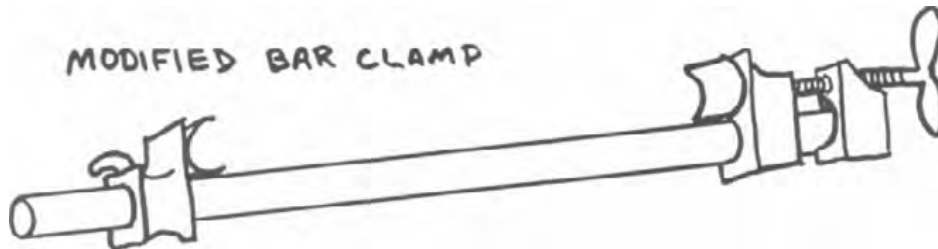

### SOFT JAWS FOR THE VISE

A pair of soft jaws can be fashioned out of 1/8" thick brass or aluminum sheet. Simply cut two pieces of the material to the same width as the jaws of the vise by about three inches. Clamp one piece in the vise so it's sticking about 1 1/2" straight up in the air. Take a big hammer and bend the piece over to conform to the shape of the top of the vise. Do the same with the other piece. These soft jaws can now be used to clamp a variety of pieces in the vise without

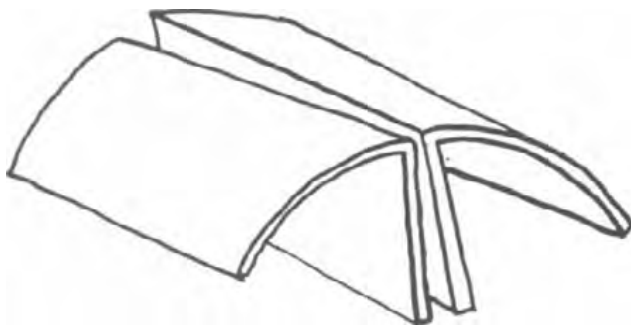

**SOFT JAWS**

## FORK JIG

The fork jig is designed to hold the blade/dropout and crown/column pieces in place while silver brazing the blades to the crown. The fork jig can be broken down into three main parts:

- 1 - The table (A)
- 2 - The steering column clamp (C)
- 3 - The rake adjustment assembly (B, D, E)

This fixture is a very expensive piece to produce and should definitely be made straight and true.

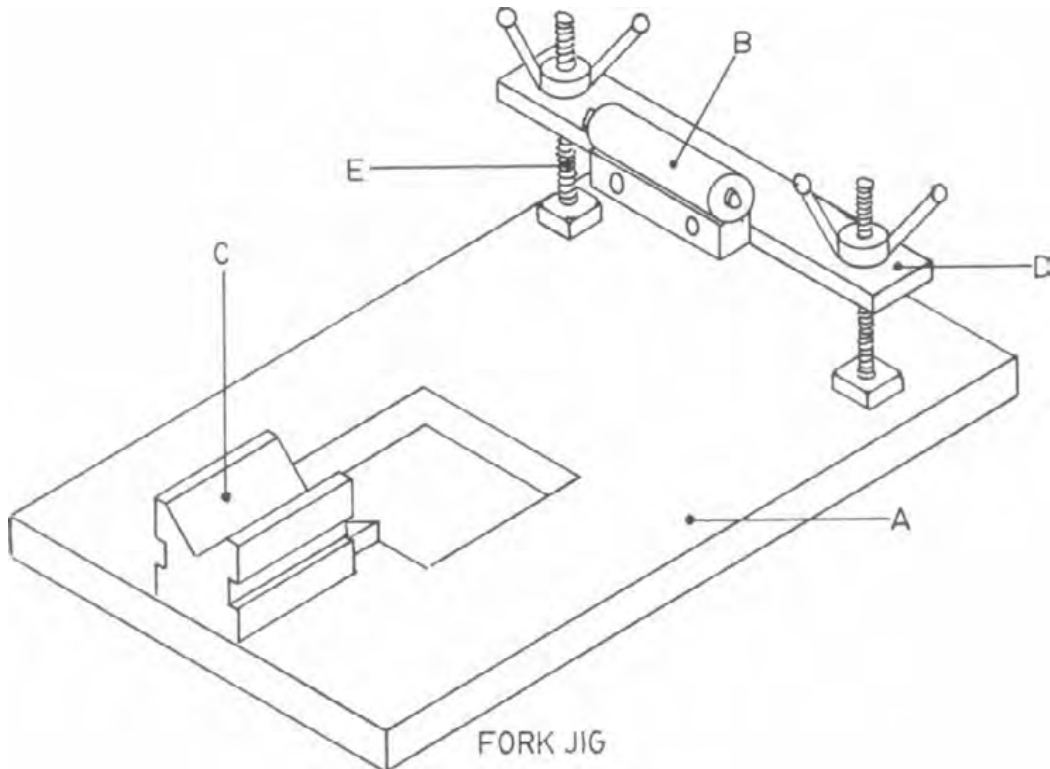

### MODIFIED C-CLAMP (#1)

When silver brazing the top tube into place, care must be taken so that the seat lug doesn't creep upward and the top head lug doesn't creep downward. To prevent this, modified C-clamps can be used to clamp those two lugs to the tubes. The rounded anvil on the C-clamp will prevent the tube and lug from deforming under heat and pressure.

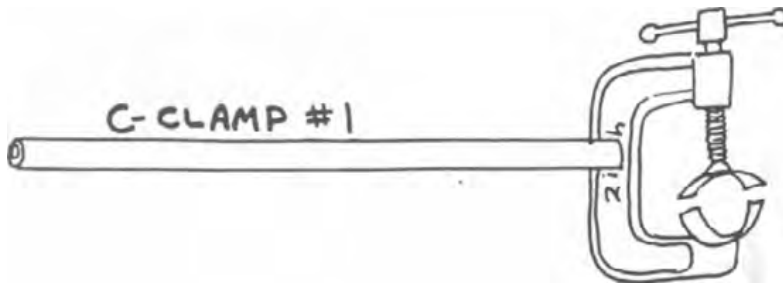

#### MODIFIED C-CLAMP (#2)

When silver brazing any of the lugs, sometimes the points stick up and do not lie flat against the tube. If this is the case, a modified C-clamp can be used to hold the points of the lug down.

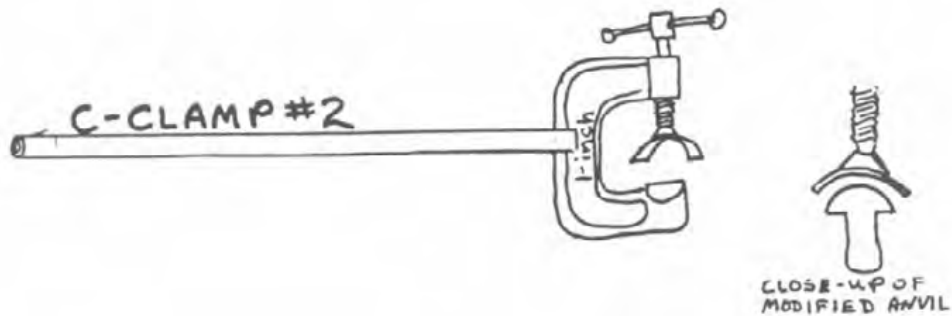

#### BOTTOM BRACKET JIG

When silver brazing the down tube or seat tube into the bottom bracket shell, the pieces must be held in place. The B.B. jig clamps the bottom bracket shell and either the down or seat tube. The B. B. Jig also makes sure that the shell and tube centerlines are perpendicular to each other.

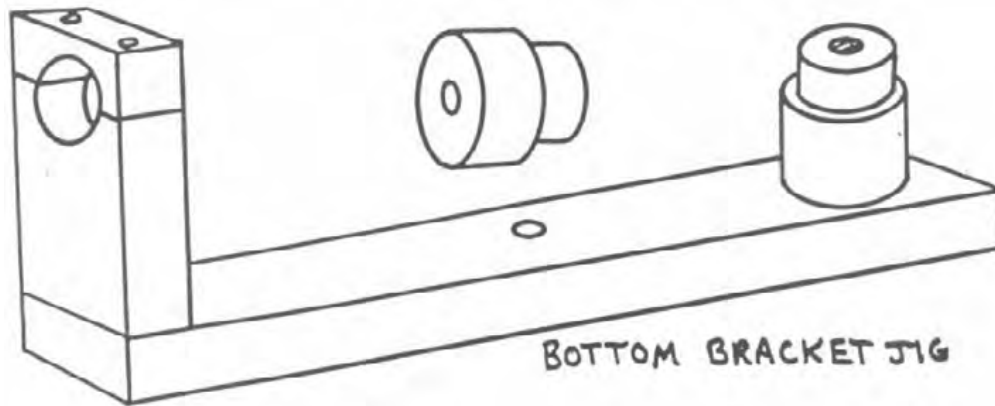

#### HEAD TUBE STABILIZER ARM

The head tube stabilizer arm is an optional device that makes sure the head tube and seat tube are in the same plane while down tube is silver brazed into the bottom bracket shell.

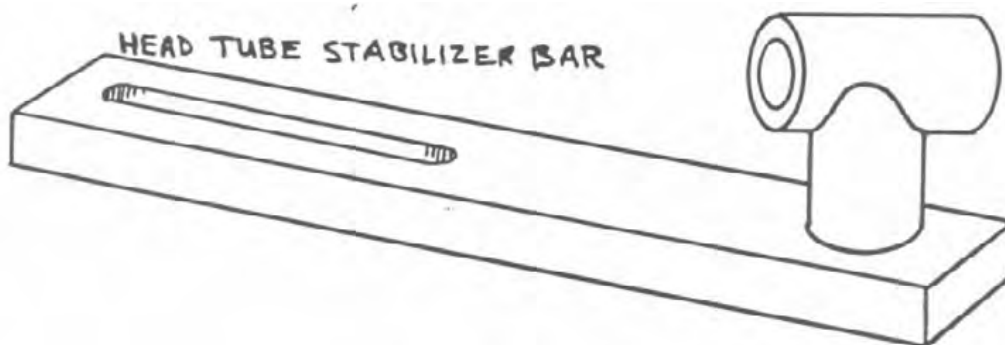

#### BENDING FIXTURES

##### DOWN TUBE PROTECTOR SHEATH

The down tube protector sheath is a piece of 1 1/4" tubing that is split up the middle along the entire length. It can be put around the down tube before cold setting the joint coming out of the bottom bracket shell. Using the sheath greatly reduces the risk of crimping the down tube during cold setting.

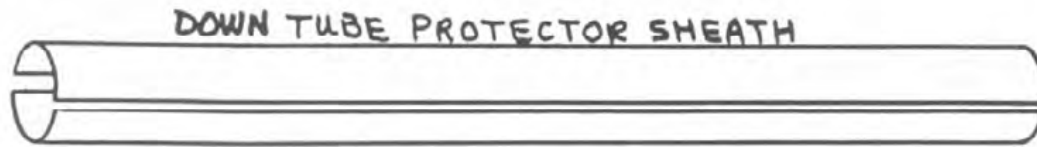

#### 1 1/8" STEEL BAR

A 1 1/8" diameter steel bar 1 meter long should be kept on hand. It is an excellent reinforcement to slide inside the head tube during cold setting of the bottom head joint. It also comes in handy for leverage.

#### 1" STEEL BAR

A 1" diameter steel bar should be kept on hand. It is an excellent reinforcement to slide inside the seat and down tubes during cold setting. It also comes in handy for leverage.

#### REAR TRIANGLE PERSUADER

This fixture is handy for moving the rear triangle to the left or right at the time the bridges are ready to be installed. It gives a tremendous amount of leverage in doing this cold setting procedure.

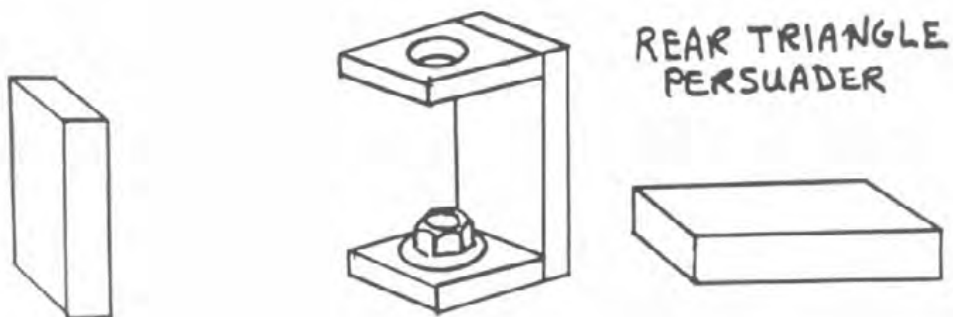

## FORK BLADE BENDER

The fork blade bender will bend fork blades to the correct radius without making unsightly crimps. Aluminum is the best material for this fixture. It is a costly fixture but, half a dozen ruined fork blades are quite costly also.

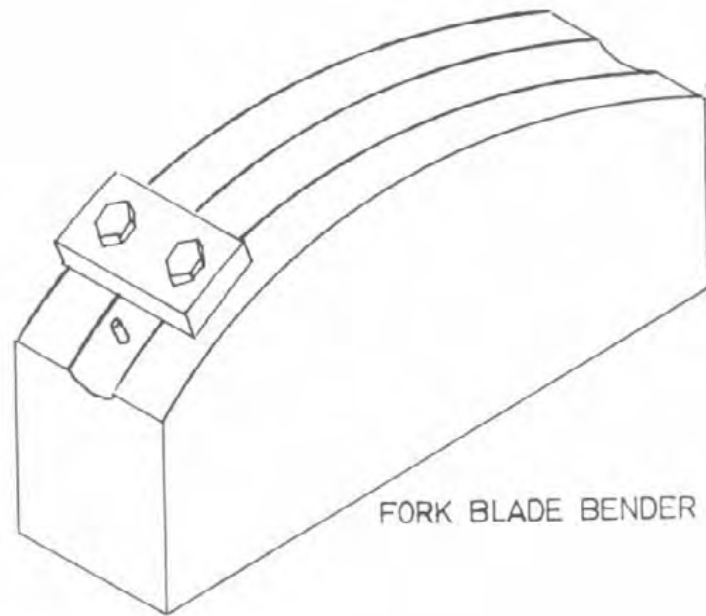

Frame and fork building fixtures are available from Andrew Hague in Great Britain. These fixtures are fully compatible with the PATEREK method of framebuilding with minor alterations to the procedure outlined in the CHECKLIST section of this book. These fixtures can be purchased from Phil Wood (see the resource section at the end of the book.) or can be ordered directly from Andrew Hague (See the resource section at the end of the book.).

## FRAME JIG

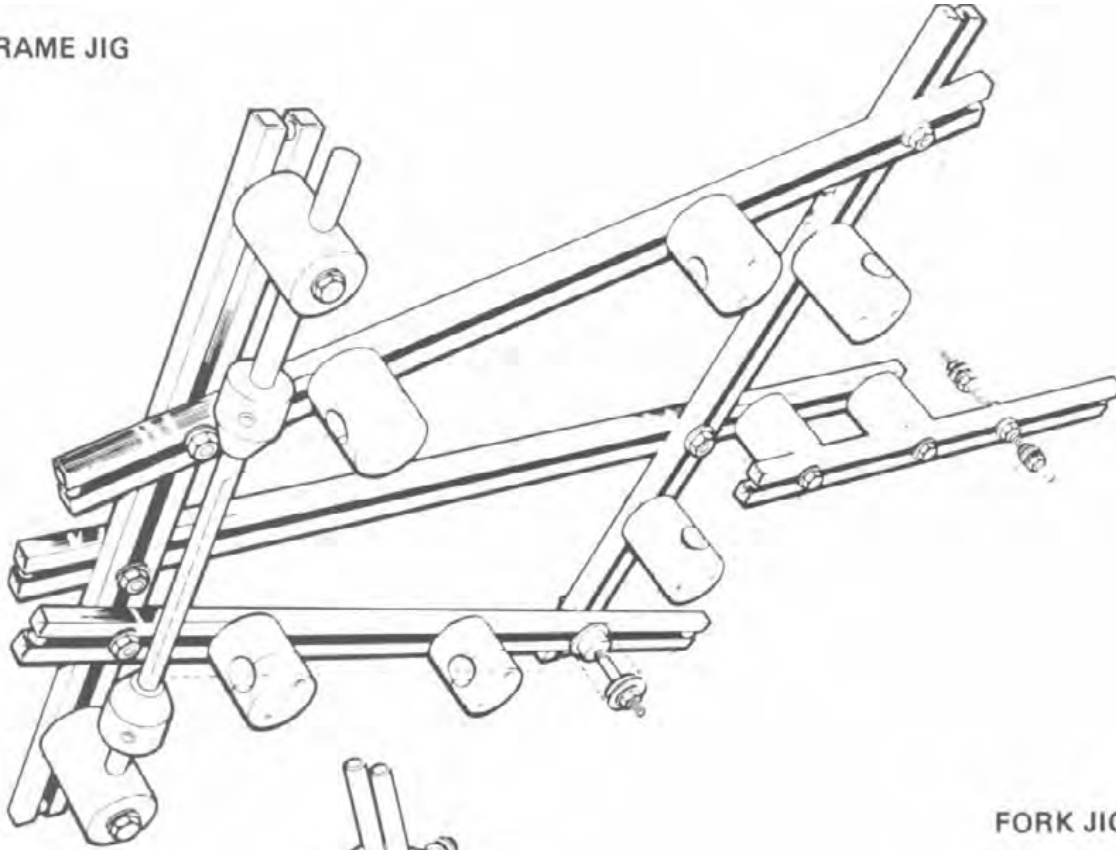

## FORK JIG

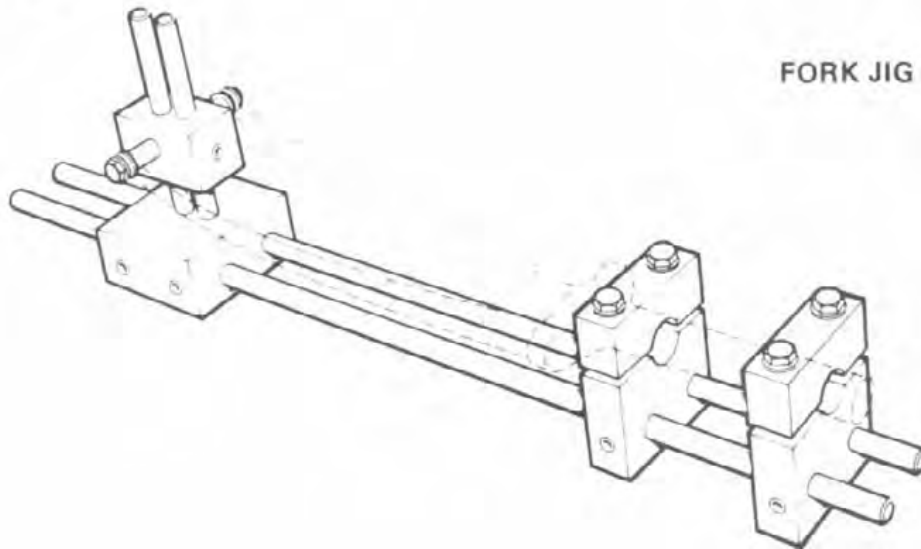

- Adjusts to any angle and size of frame
- Specify whether for imperial or metric size tubes.
- Made for 68mm, long bottom bracket shells.
- The tube supports also serve as heat sinks to protect the tube when brazing in the jig.
- With this jig you can make a lugless frame as easily as a lugged frame,

- Can be used on a bench or suspended from the ceiling.
- Easily dismantled for storage.
- All steel construction in bare metal finish.
- The fork jig can be supplied separately if required.

## TOOLS

Tools are different from fixtures in that they can be readily purchased from suppliers. Of course there are literally thousands of different tools that are particularly necessary for framebuilding. The following pages will discuss tools that are necessary for framebuilding with particular attention paid to those that are favorites of the author.

### MECHANICS TOOL CASE

The mechanic's tool case has within it all the tools necessary to tap & mill bottom brackets, mill & ream head tubes, align fork dropouts, tap steering columns, and mill fork crown race seats. These tools are absolutely essential to building quality framesets. If it is not possible to own a mechanic's tool case, at least arrange for another builder to do any necessary tapping, milling, and reaming.

Several companies manufacture and sell mechanics' tool cases. They range in price from \$500.00 for a somewhat incomplete, lesser quality set to \$1200.00 for a more complete top quality set. These companies are; Campagnolo, Gipiemme, Zeus, Bicycle Research, and VAR. They are all listed in the resource list at the end of the book.

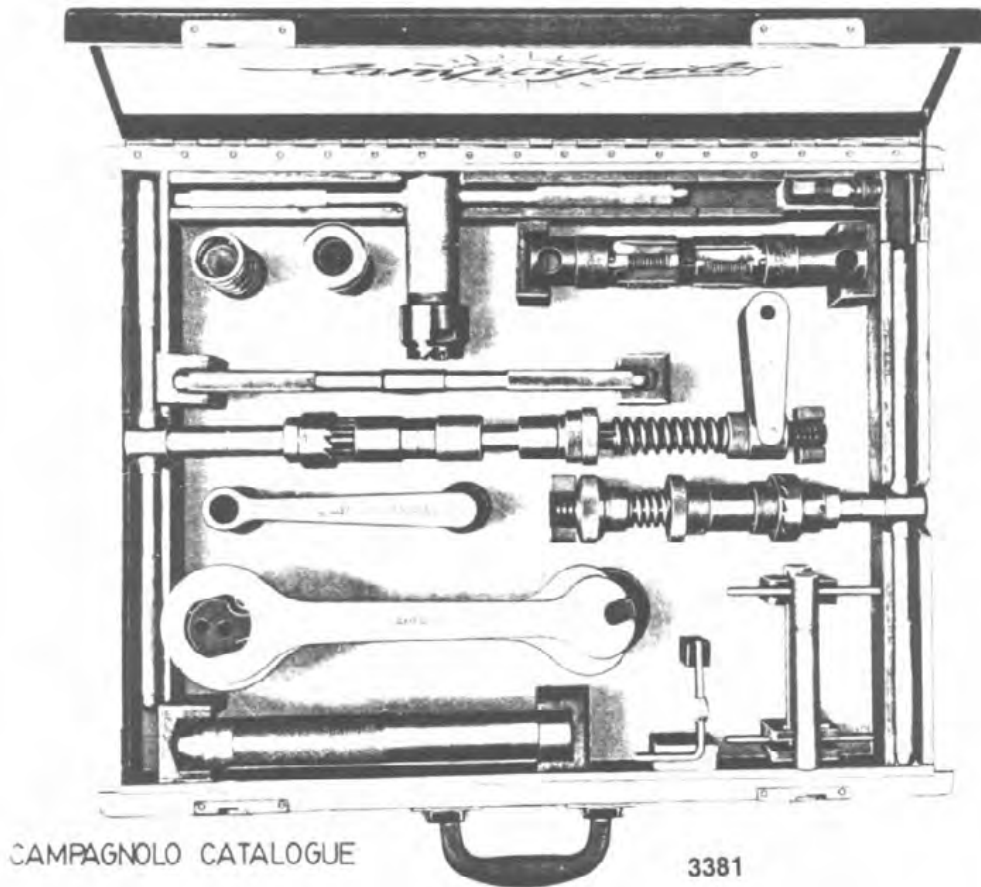



## WELDING TANKS AND APPARATUS

There are several combinations of gasses that can be used for silver brazing. MAPP gas, Propane, Hydrogen, and Oxy-Acetylene are just a few. Oxy-Acetylene is by far the most versatile and easiest to work with. Refilling is also easy. It provides a hot enough flame for welding when desired. Preheat is quick. Hoses, tips, goggles, gauges and strikers can be purchased as a set. There are several manufacturers to choose from. In choosing a brand of welding equipment, make certain to choose one that has service parts readily available, has fittings that are compatible with the rest of the industry and a place that is close by for refills. Tanks can be rented on a month-to-month basis or "purchased" on a contract basis. (The tanks are not actually purchased, but with a contract arrangement, demurrage fees can be avoided.) Do not waste time with tanks smaller than 70 cubic feet. Refilling becomes a real bother with smaller tanks. About two or three framesets can be built with a set of 70 cu. ft. tanks before refilling is necessary.



## WISE

A good quality vise is absolutely essential to framebuilding. There are a multitude of vises on the market with many options to choose from. In choosing a vise look for the following:

- 1 - At least 4" jaws--A smaller vise just doesn't have enough mass.
- 2 - Replaceable jaws--Framebuilding is hard on vise jaws.
- 3 - A swivel base--There are times that things must be held in an awkward position and swiveling helps a lot.

- 4 - Moveable front jaw--A vise with a moveable rear jaw will not allow a piece of tubing to be held vertically with the excess sticking down toward the floor.
- 5 - An American vise--The quality **of the** alloys used in American made vises is far better than the ones coming out of the Orient. Make sure the vise is mounted to a very sturdy base and that that base is securely mounted to either the wall or the floor.

#### Utility Vises

3 1/2", 4", 5 Jaw Widths

**Nos. 013 1/2, 014, 015**

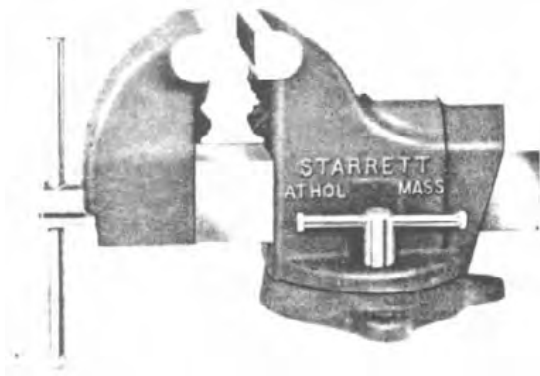

STARRETT CATALOGUE

Starrett

MACHINISTS' VISES



#### Brass Vise Jaw Caps

Designed to cover serrated jaw faces snugly to prevent marking of soft materials when held rigidly. Speedily attached and removed

## FILES

Files are the heart of framebuilding. The frame almost could not be built without them, A good selection of files must be kept on hand. The following are recommendations for files to buy:

- 10" flat, course, mill file for roughing work on outside corners and flat surfaces.
- 8" flat, bastard or 2nd cut, mill file for work on outside corners and flat surfaces.
- 6" flat, smooth, mill file for semi-finishing work.
- 10" half round, course file for doing roughing work or filing larger radii.
- 8" half round, bastard or 2nd cut file for filing the proper radii in the front triangle.
- 6" half round, smooth file for filing brake bridges.
- 8" and 10" round file for filing smaller radii.
- Triangular files are optional.

- One complete set of needle files for doing the finishing work.  
Rifflers are optional. They are excellent for tight spots but very expensive items.

"Dead" files must be replaced on a regular basis. In cutting hard metals like Chro-Mo steel, files wear out fast. The 8" files will be ready to be scrapped after ten frames.

Keep handles on all files at all times. The tange of a file is sharp and hazardous.

Buy American files. They are definitely made of superior material.

#### GRINDING WHEELS

The best grinding wheel set-up to buy is a motor with an arbor coming out of each end. Make sure all safety devices work properly, i.e. electrical ground, eye shields and tool rests. To make the grinder particularly useful to framebuilding, lower one of the tool rests all the way and raise the eye shield on that same side as far as possible. Now dress the wheel so it has a rounded contour. This is very useful for roughing in miter joints.

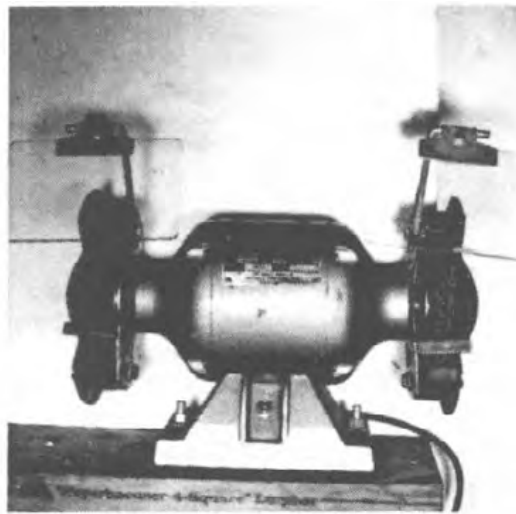

#### HAND OPERATED ELECTRIC DRILL

A hand drill is necessary for drilling air expansion holes and also for operating any rotary devices such as hones, wire wheels or sanding units. In choosing a hand drill look for the following options:

- 1 - 3/8" chuck or bigger to allow use of larger bits. A larger chuck is also easier to tighten and loosen.
- 2 - Variable speed switch -- Chro-Mo steel should be drilled at a very slow speed.

## DRILL BITS

A complete set of drill bits in a drill bit index is a good idea. Drill bits banging around in a box or drawer tend to get dull fairly fast. Buy only American made drill bits from a reputable source. NO 99c SPECIALS! A 1/16" to 1/4" set of bits with selected larger bits is satisfactory.

## PARR STAND

Park Tool of White Bear Minnesota makes the best bicycle stand in the world. Not only does it hold bicycles, but it also makes an excellent tubing jig to hold tubes while filing miters. The rotation of the clamp also allows for a multitude of positions in holding work.

Also made by Park is the frame alignment stand. This clamps and locates off the bottom bracket and allows fairly precise alignment checking. The stand can also be used for certain cold setting operations. The frame alignment stand can also be ordered with a bicycle stand mounted to the top of it.

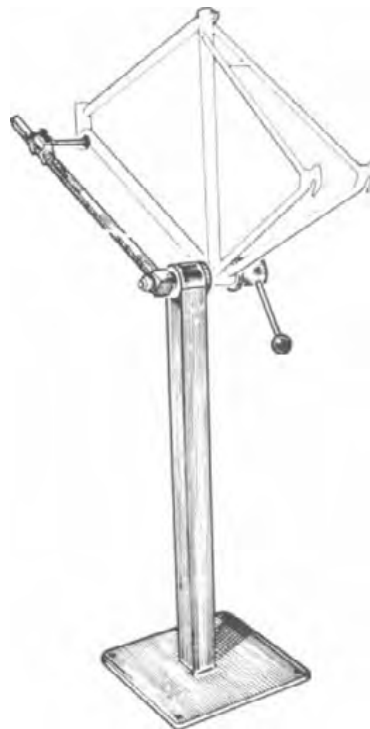

PARK CATALOGUE

## PRECISION TOOLS

Five precision tools are worth mentioning here.  
They are:

### THE MACHINIST'S SQUARE

The machinist's square can be used to check squareness of miters and for transferring lines and measurements up from a surface plate.

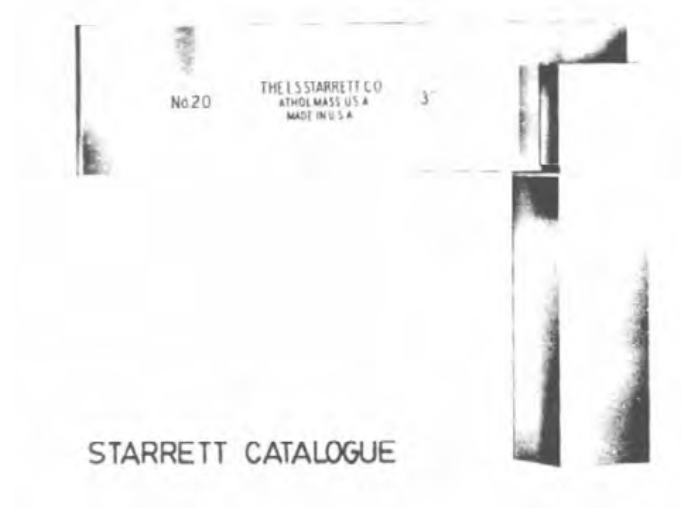

### THE VERNIER CALIPER

The vernier caliper is good for fine measurements in many instances. Buy one with both Metric and English scales.



### THE BEVEL PROTRACTOR

The bevel protractor can be used to check miter angles.

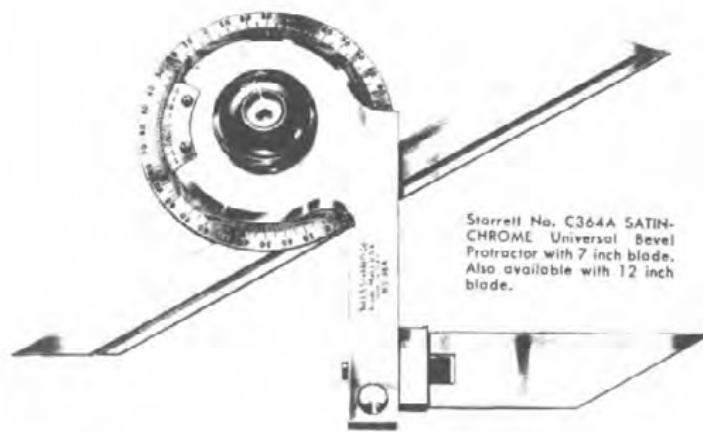

STAR R E T CATALOGUE

THE COMBINATION SQUARE WITH LEVELING BUBBLE

The combination square with leveling bubble can be used to check frame angles on a built up bike as well as leveling the rear end jig and double checking angles on an incomplete frame.



BROWN & SHARP  
CATALOGUE

V-BLOCKS

V-blocks can be used to suspend work above the drawing as it sits on a surface plate.

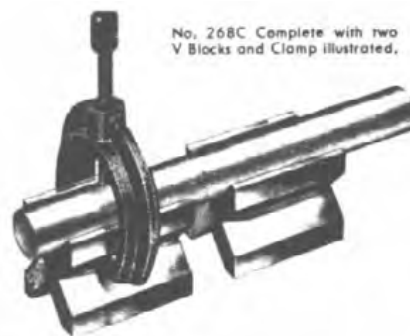

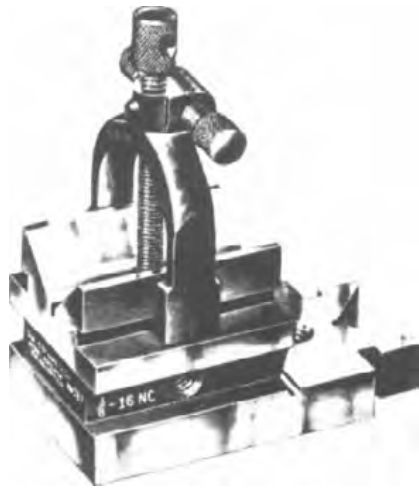

### V Block and Clamp

Hardened *and Ground*

*1/8 Inch*

No. 567

No. 567 V Block and Clamp shown above

## STARRETT CATALOGUE

### DIE GRINDER

Die grinders are very useful for high speed cutting of extremely hard material. Grinding inside tight places like inside the bottom bracket shell is possible with a die grinder. An abrasive disc can be mounted in the arbor to create an abrasive cut-off wheel. This is particularly useful in cutting the seat post binder slot. In buying stones and wheels for the die grinder, be sure to get ones with ratings for 25,000 rpm or faster.



### DRAWING BOARD

A satisfactory drawing board can be made for under \$20.00. All that is needed is flat drawing surface and a means of drawing consistent horizontal lines. The board can be made out of 3/4" AC plywood measuring 3' x 4'. A T-square can be used to draw the horizontal lines. All other lines can be located with a larger

protractor and drawn with a steel straight edge. The other end of the spectrum is to spend hundreds of dollars on a very exquisite drafting table and accessories.

#### DRILL PRESS

A drill press is definitely a luxury that most beginning framebuilders can get along without. However, if buying one, either a bench or floor model is fine. A 6" to 10" drill press is large enough for framebuilding work. A tilting head or table is useful but not necessary.



#### AIR COMPRESSOR

An air compressor is not a necessity for framebuilding but the advantages it offers oftentimes cannot easily be passed up. The most immediate use of the air compressor is for fast and thorough cleaning and drying of parts in preparation for silver brazing. The air compressor allows them to be blown dry before rust sets in. It also dries without contaminating the surface with oil or more dirt. For this type of use look for a compressor with a 110 volt motor, a smaller tank, and a single cylinder. The compressor can be used to run several air powered tools such as; die grinders, drills, Dynabrade sanders, etc. If using a compressor to this extent, look for one with a 220 volt motor, two cylinders, and at least a 25 gallon tank. Last of all, a compressor can be used for painting. In choosing a compressor for painting purposes, make sure it has separate gauges for tank and line pressures,



moisture filter, and can deliver enough cubic feet per minute to satisfy paint gun specs. (Note: If using the compressor to run air tools and paint, run separate lines for both operations so oil doesn't back-up into the paint line.)

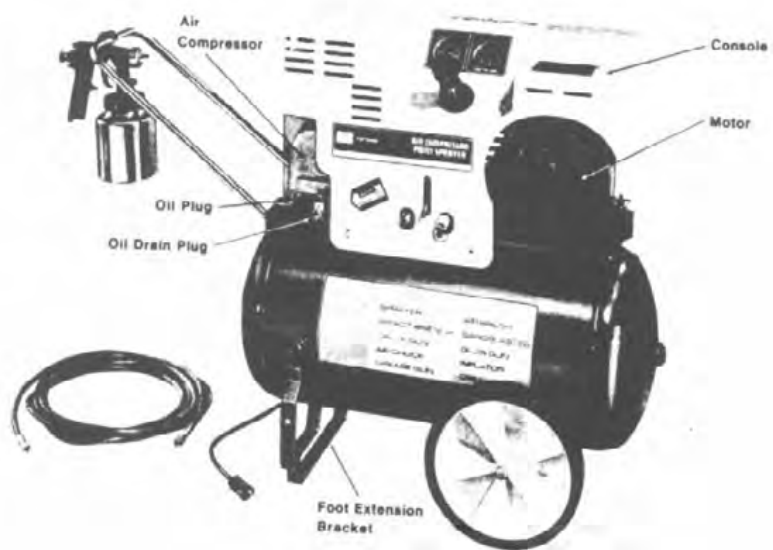

SEARS CATALOGUE

#### BELT SANDER

A belt sander is definitely a luxury. It can speed up several clean-up operations as well as chew up metal and spit it out faster than anything. This is a hint. Only the most experienced framebuilders should be using a belt sander. A piece of metal can be ruined in a matter of seconds on the belt sander. If purchasing one, buy a bench mount model which can be adjusted to vertical as well as horizontal work.

Another option in belt sanders is the narrow belt, hobby type sander. This would be better for the beginner to experiment with. It doesn't remove metal nearly as fast.

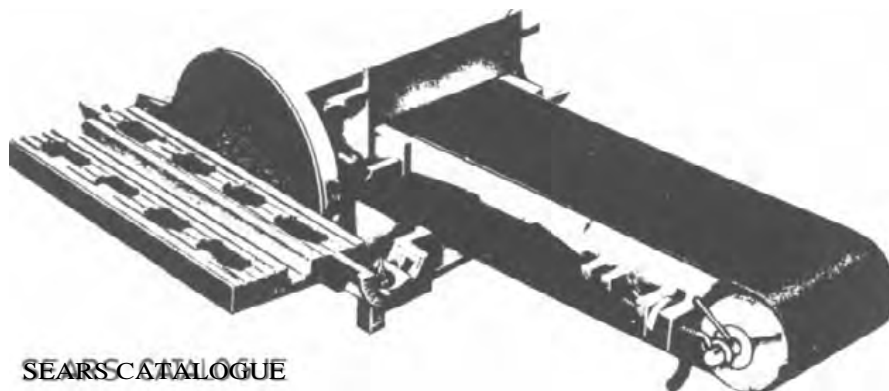

SEARS CATALOGUE

## DYNABRADE BELT SANDER

The Dynabrade belt sander uses a tiny 1/4" wide belt that can get into the tightest of places. It is good for doing contour work on inside and outside corners. It is an expensive unit (\$300.00) that should only be used by a skilled craftsman. It too is a "metal eater" that can do a lot of damage in the wrong hands. However, used by a skilled hand it has capabilities of doing excellent finish work. It comes in air-powered or electrical-powered.

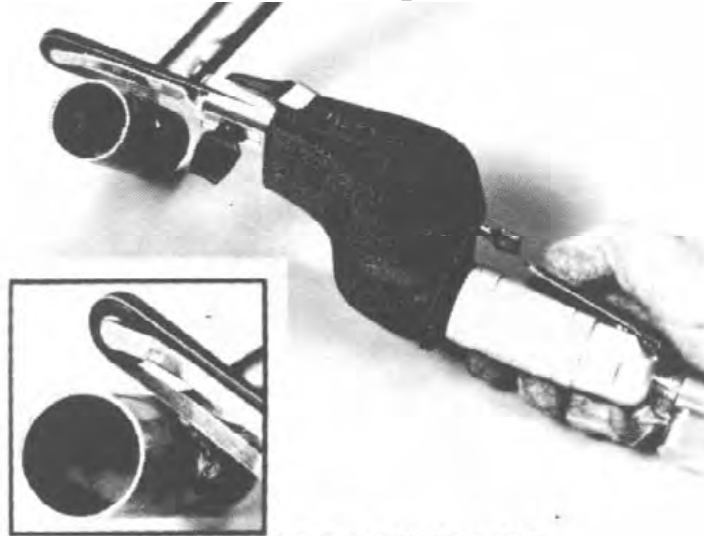

COMPLIMENTS OF DYNABRADE

## THE FIT KIT

Produced and marketed by the New England Cycling Academy (NECA), this kit answers all sizing questions pertaining to a good match between bike and rider. In addition, the Rotational Adjustment Devices (RAD) provided allow the most exacting adjustment of cleated shoes. (See NECA in the resource section.)



COMPLIMENTS OF NECA

## THE FRAME ALIGNMENT SYSTEM

This portable, high precision system will detect and measure all critical frame alignment using the central movement as a reference. It works well on new frames and forks as well as damaged ones. (See NECA in the reference -tion.



## TWO FINAL ITEMS

No shop should be without a fire extinguisher and a first aid kit. Make sure the fire extinguisher is up-to-date and has an A-B-C rating. Always keep the first aid kit replenished with particular attention paid to supplies for burns and minor cuts. Fire, Police and Ambulance phone numbers should be posted next to the phone.

## FRAMEBUILDER'S RESOURCE LIST

The following resource list has been made with the framebuilder specifically in mind. Only suppliers of the raw materials necessary for bicycle framebuilding have been included in this list. The suppliers are listed in 4 categories as follows:

- M These are manufacturers of products and seldom, if ever, deal with customers at the retailer or retail level. In dealing with these manufacturers, it is best just to request a brochure and the name of the nearest outlet which can handle the needs of the independent frame builder.

These are companies who bring products in from other countries in large quantities. They deal primarily with wholesalers. In dealing with these outfits, it is best just to request the name of the nearest outlet which can handle the needs of the independent framebuilder.

- W These are wholesalers or "jobbers". They usually deal directly with manufacturers and importers and sometimes import items themselves. Many wholesalers are more than happy to handle the specific needs of independent framebuilders. However, they will have some expectations of the builder.

- 1 -- Be ready with a business phone listing.
- 2 -- Have a state Retailer's Permit from the state Revenue Department.
- 3 -- Be ready to buy things in quantity.
- 4 -- Be prepared to pay on a C.O.D. basis for as long as the first year of doing business with them.
- 5 -- A Profit and Loss statement or a financial statement may be requested.

Other items that may help in dealing with wholesalers are:

- 1 -- Have a business card.
- 2 -- Have professional stationery.
- 3 -- Maintain a business checking account.

- R These are retailers. They sell to anyone who walks in off the street. They seldom, if ever, require minimum purchases. A good retailer will go to great lengths to get a product for a preferred customer. The retailer charges full retail price for goods sold and should be paid that price. (If the builder balks at paying

retail prices, then he should go through the hassles necessary to deal with the wholesaler.)

In the following list the proper letter classification **will** follow the business name in parentheses. If the firm desires business from framebuilders in particular, a letter "F" **will** appear also. Since some of the following businesses may fall under more than one classification, there may be more than one letter listed.

#### FRAMEBUILDER'S RESOURCE LIST

BENOTTO BICYCLES U.S.A. (I, W, F)  
544 W. LASTUNAS DRIVE  
SAN GABRIEL, CA 91776  
1-818-576-2222

Importers of the Benotto frame sizing stand (#008038). This mock-up of a bicycle is fully adjustable to fit any prospective customer. It's a good unit to use while making the working drawing.

BICYCLE RESEARCH (M, W)  
1300 GALINDO STREET  
CONCORD, CA 94520  
1-415-825-4223

Manufacturers of bicycle tools including taps, tap holders, and hand milling tools for head and bottom bracket. Also offer sharpening service for other brand cutters. (See Phil Wood)

BILL DAVIDSON CYCLES (I, W, F)  
2116 WESTERN AVE.  
SEATTLE, WA 98121  
1-206-682-8226

Importers of a line of high quality investment cast lugs, bottom bracket shells and fork crowns. Minimum order - 10 sets.

BINKS (M)  
9201 WEST BELMONT AVE.  
FRANKLIN PARK, IL 60131  
1-312-671-3000

Manufacturers of spray painting equipment - the Binks model #115 gun in particular. Also manufacturers of safety breathing units.

BLACKBURN DESIGN, JIM (M, F)  
75 CRISTICH LANE  
CAMPBELL, CA 95008  
1-408-371-0992

Blackburn is the designer/manufacturer of the highly-regarded line of carriers. They have a long-standing policy of co-operating closely with professional custom framebuilders. The extent of the services that they provide range from technical specifications to braze-on bits to original equipment (O.E.M.) sale of their products. All this with the goal of matching the best rack to the best bike. Professional framebuilders are encouraged to call or write.

BROWN & SHARP (M)  
PRECISION PARK  
NORTH KINGSTON, RI 02852  
1-401-886-2000

Manufacturers of high precision tools. Most notably for framebuilding are V-blocks, dial indicators, vernier calipers, height gages, micrometers, precision ground flat stock, and bevel protractors.

CAMPAGNOLO USA, INC. (I)  
P.O. BOX 37426  
HOUSTON, TX 77036

American distributors of Italian made bicycle components. Most notably for framebuilding are their line of braze-ons and dropouts.

COMPONENT COMPANY (W)  
801 W. MADISON STREET/ P.O. BOX 95  
WATERLOO, WI 53594  
1-800-558-0146

Distributors of bicycle parts and components. For framebuilders they have a limited selection of lugs, bottom brackets, tube sets and braze-ons.

CONSORIZIO PRIMO ( I )  
10250 BISSIIONNET - SUITE 330  
HOUSTON, TX 72036  
1-713-981-1934

Importers of the complete line of Columbus and Cinelli bicycle framebuilding components as well as Cinelli framebuilding fixtures.

CYCLE GOODS (R, F)  
2735 HENNEPIN AVE. S.  
MINNEAPOLIS, MN 55408  
1-800-328-5213

Cycle Goods sells Columbus, Cinelli, Reynolds, Tange, and Campagnolo framebuilding supplies including tube sets, lugs, bottom bracket shells, crowns, dropouts, and braze-ons. They ship UPS C.O.D. or accept major credit cards.

DITZLER AUTOMOTIVE FINISHES PPG INDUSTRIES INC. (M)  
P.O. BOX 3510  
TROY, MI 48084

Manufacturers of polyurethane enamels, acrylic enamels, acrylic lacquers and other painting products.

DUPONT DE NEMOURS & CO., INC. (M)  
WILMINGTON, DL 19898  
1-800-323-6004 OR 1-800-400-9475

Manufacturers of polyurethane enamels, acrylic enamels, acrylic lacquers, epoxy primers and other painting products.

DYNABRADE INC. (M)  
72 E. NIAGARA STREET  
TONAWANDA, NY 14150  
1-716-694-4600 OR 1-800-828-7333

Unique portable abrasive belt machines for grinding, blending, and polishing in normally inaccessible areas. The Dynaflex offers exceptional versatility, accepting over twenty different contact arms to match the needs of a particular application.

EUTECTIC  
40-40 172nd STREET  
FLUSHING, NY 11358  
1-800-323-4845

Manufacturers of brazing, welding, and soldering alloys as well as other compounds for special metallurgical uses.

FISHER MOUNTAIN BIKES (M, W, F)  
1501 SAN ANSELMO AVENUE  
SAN ANSELMO, CA 94960  
1-415-459-2247

Builders of the Fisher line of mountain bikes. Also wholesalers of mountain bike framebuilding supplies.

FRAME BUILDER'S GUILD (F)  
RT. 2, BOX 234  
RIVER FALLS, WI 54022

Presently working on framebuilding certification, group insurance for framebuilders and design and manufacture of fixtures.

FUTURE METALS (W)  
905 W. NORTH CARRIER PARKWAY  
GRAND PRAIRIE, TX 75050  
1-800-527-1631

Distributors and sellers of chrome-moly aircraft tubing.

HANDY & HARMON (M, W, F)  
850 3rd AVE.  
NEW YORK, NY 10022  
1-212-752-3400

Manufacturers of welding, brazing and soldering alloys-Easy Flo 30 and Handy Flux in particular.

HENRY JAMES BICYCLES, INC. (M, F)  
704-P ELVIRA AVE.  
REDONDO BEACH, CA 90277  
1-213-540-1552

Henry James offers American-made investment cast frame components. Lugs and bottom bracket shells are offered in a full range of angles. Road, Tandem and mountain crowns are sized for Columbus and New Reynolds ovals. Lightweight dropouts are a new addition in both alloy and stainless steel. Most components are available in stainless steel. Send self-addressed stamped envelope for literature and prices.

HIGH BRIDGE - TAKAHASKI PRESS CO. LTD. (M)  
30-9 HIGASHI NIPPORI 1-CHOME  
ARAKAWAKU  
TOKYO, 116 JAPAN  
TEL: 03 (807) 3187

Manufacturers of a complete line of fork crowns, dropouts and braze-ons.

ISLAND CYCLE SUPPLY CO. (W, F)  
425 WASHINGTON AVE.  
MINNEAPOLIS, MN 55401  
1-612-333-7771

Wholesalers and retailers of the complete line of Cinelli, Columbus, Reynolds, and Campagnolo framebuilding supplies as well as many other top quality bicycle products.



J.W. HARRIS CO. INC. (M)  
CINCINNATI, OH 45242

Manufacturers of Stay Silv silver brazing alloys and  
Safe Silv cadmium free silver brazing alloy.

LEE KATZ (W, I, F)  
1015 DAVIS STREET  
EVANSTON, IL 60201  
1-800-227-2453

Wholesalers of a complete line of Campagnolo, Reynolds,  
Vitus, Durafort, Micro Fusione, Columbus and Cinelli  
framebuilding supplies including tube sets, lugs,  
bottom bracket shells, crowns, and braze-ons. They  
also sell the SAPO frame alignment system.

MITUTOYO - MTI CORP. (M)  
18 ESSEX RD.  
PARAMUS, NJ 07652  
1-201-368-0525

Manufacturers of high precision tools. Most notably  
for framebuilding are V-blocks, dial indicators,  
vernier calipers, height gages, micrometers, precision  
ground flat stock, and bevel protractors.

NEW ENGLAND CYCLING ACADEMY (M, F)  
MERIDEN ROAD  
LEBANON, NH 03230  
1-603-448-5423

The New England Cycling Academy was originally founded  
as a summer training camp offering serious and  
responsible instruction to aspiring racing cyclists of  
all ages. Working with its students, the Academy  
developed THE FIT KIT . This system determines optimum  
frame dimensions as well as properly sized component  
selection. The ROTATIONAL ADJUSTMENT DEVICES included  
in THE FIT KIT are used to precisely align the cleats  
on cycling shoes so that no medial or lateral stresses  
are induced on the knee.

The Academy also produces THE FRAME ALIGNMENT SYSTEM.  
This is a portable system to check and cold set a frame  
into alignment.

Other services offered by the Academy are Professional  
video productions, clinics and consulting.

OSELL, TERRY (W, F)  
1003 27th AVE. S.E.  
MINNEAPOLIS, MN 55414  
1-612-331-2723

Custom framebuilder - will ship small orders of tube sets, braze-ons, lugs and bottom bracket shells on a prepaid basis.

PARK TOOL (M)  
2250 WHITE BEAR AVE.  
ST. PAUL, MN 55109  
1-612-777-9768

Manufacturer of a complete line of bicycle tools. For framebuilders they amke an excellent floor mounted frame alignment jig.

PINTO IMPORTS, MEL (I, W)  
P.O. BOX 2198  
FALLS CHURCH, VA 22042  
1-703-237-4686

We sell professional quality tools, and the supporting componentry to build bicycles, including tandems. A few examples follow: Viner, Alan, Romani, T.A., Stronglight, Campy, CLB, Regina, Cinelli, Ideale, Brooks, Avocet, Cortina, Huret, Simplex, Bluemels, LaPrealpina, Silca, Hite, Zefal, Park, Var, BRC, Mavic, Ambrosio, Fiamme, Super Champion, Weinmann, Vittoria, Wolber, Mel Pinto Special Tandems and tandem components.

QUALITY BICYCLE PRODUCTS (W, F)  
2550 WABASH  
ST. PAUL, MN 55114  
1-800-346-0004

Bicycle parts wholesaler. Good selection of braze-ons, tube sets, lugs, bottom brackets, and fork crowns.

R & E CYCLES (R, M, W, F)  
5627 UNIVERSITY WAY N.E.  
SEATTLE, WA 98105

Manufacturers of Rodriguez tandems and wholesalers of tandem framebuilding supplies.

SANTANA CYCLES INC. (W, M, F)  
BOX 1205  
CLAREMONT, CA 91711  
1-714-621-6943

Major importer of Ishiwata tubing. Will also sell braze-ons and Santana/Ishiwata tandem tube sets to independent framebuilders. Also sells Columbus tandem tube sets.

SEROTTA CYCLES (M, F, R)  
GRANGE ROAD  
GREENFIELD CENTER, NY 12833  
1-518-587-9085

Manufacturers and sellers of the Serotta size cycle -  
an adjustable "mock-up" bicycle frame which is useful  
for sizing a rider on a frame that is yet to be built.

SHERWIN WILLIAMS CO. (M)  
P.O. BOX 60277  
CLEVELAND, OH 44115  
1-800-223-0431

Manufacturers of polyurethane enamels, acrylic enamels,  
acrylic lacquers and other paint products.

SHIMANO SALES CORP. (I, M, F)  
P.O. BOX 2775, 9530 COZY CROFT AVE.  
CHATSWORTH, CA 91311  
1-213-767-7777

Importers of the Tange brand frame tube sets. Also  
American branch of the Japanese Shimano Company -  
manufacturers of dropouts, bottom bracket shells, fork  
crowns, lugs and braze-ons. Catalogues available on  
request.

SNAP-ON TOOLS CORP. (M)  
KENOSHA, WI 53141-2801  
1-800-242-4391

Manufacturers of basic shop tools useful to the bicycle  
trade.

SPEED RESEARCH (M, W, F)  
P.O. BOX 6776  
BEND, OR 97708  
1-503-389-4313

Manufacturers of the circumference sizing tool for  
checking inside diameters of seat tubes.

STARRETT (M)  
ATHOL, MA 01331  
1-617-249-3551

Manufacturers of high precision tools. Most notably  
for framebuilding are V-blocks, dial indicators,  
vernier calipers, height gages, micrometers, precision  
ground flat stock, and bevel protractors.

STRAWBERRY RACING CYCLES (I, W, F)  
530 N.W. 9th AVE.  
PORTLAND, OR 97209  
1-800-321-5532

We build a small number of frames. Please find below an alphabetical listing of suppliers whose products we distribute, of the Italian company Marchetti & Lange for whom we are the USA agent, and the few tools, parts and service Strawberry Cyclesport Inc. sells.

BOCAMA: Lugs, fork crowns, bottom brackets  
COLUMBUS: Tubing  
GIPIEMME: Braze-on's, fork/stay ends, tools  
EPS: Front derailleur braze-on fixture, fork brazing fixture.  
MARCHETTI & LANGE: Bicycle fabrication tooling  
STRAWBERRY CYCLESPORE INC.: Carbide insert and H.S.S. tube mitre cutters, brazing rod, brazing flux, cutter sharpening service.  
VAR: Frame milling and bicycle assembly tools.

SUNTOUR USA (I, M)  
10 MADISON ROAD  
FAIRFIELD, NJ 07006  
1-201-575-1128

The American branch of the Japanese Suntour Company. They offer a complete selection of dropouts and a few brazed-on shift lever sets and brazed-on front derailleurs.

SUTHERLAND'S BICYCLE SHOP AIDS (M, W)  
BOX 9061  
BERKELEY, CA 94709

Publisher of the Sutherland's Manual. This manual gives complete specs that any framebuilder would need to know with concern to bearings, threads, and other critical sizes. Also in the manual are detailed descriptions of how to use cutting tools.

T. I. STURMEY-ARCHER OF AMERICA (I, W, M, F)  
1014 CAROLINA DRIVE  
WEST CHICAGO, IL 60185  
1-800-323-9194

The American branch of SturmeY-Archery of England and related to T.I. Reynolds and T.I. Raleigh. They are the American Importers for Reynolds frame tubing and Haden lugs, crowns, bottom brackets, and braze-ons.

Carrying tubing sets and lugs for professional framebuilders. Some films and video for general consumption and use with bicycle clubs.

Also full line of STURMEY-ARCHER and Brooks saddles, featuring the new ELITE alloy brake hubs and Colt Aero-design saddles.

Also complete line of professional wheelbuilding machinery and robotics.

TEN SPEED DRIVE (I, W)  
131 TOMAHAWK DRIVE UNIT 6  
INDIANA RIVER BEACH, FL 32937  
1-305-777-5777

Ten Speed Drive Imports, Inc. an authorized distributor and importer for Columbus tubing, Cinelli lugs and frame building equipment and Ten Speed Drive braze-on components, distributes to retail bicycle stores and framebuilders throughout the U.S. For more information contact the above address.

TORELLI IMPORTS (I, W, F)  
P.O. BOX 3163  
2388 E. LAS POSAS ROAD  
CAMARILLO, CA 93010  
1-805-484-8705

Importers and wholesalers of the Cobra line of tools.

TRUE TEMPER CYCLE ( M )  
871 RIDGEWAY LOOP, SUITE 201  
MEMPHIS, TN 38119  
1-901-767-9411

Manufacturers of American-made butted bicycle tubing sets.

UNION CARBIDE CORP. - LINDE DIVISION (M)  
270 PARK AVE.  
NEW YORK, NY 10017  
1-800-325-8501

Manufacturers of welding products and producers of bottled gasses.

UNITED BICYCLE TOOL SUPPLY (W) or: THE THIRD HAND (R)  
12225 HWY 66  
ASHLAND, OR 97520  
1-503-482-1750

Importers and sellers of the most complete selection of bicycle tools in the U.S. RETAIL SHOPS address all inquiries to United Bicycle Tool Supply. People without a business phone listing or state tax permit address all inquiries to The Third Hand.

VAR (M, W)  
6, RUE PASTEUR  
75011 - PARIS  
FRANCE  
TEL: 700.03.88  
355.26.64 or 700.01.16

Manufacturers of very specialized bicycle tools.

WILSON, G.P. (M, F)  
1668 CHALCEDONY STREET  
SAN DIEGO, CA 92109  
1-619-272-2434

Manufacturers of high quality investment cast stainless steel dropouts. Will fill small orders on a prepaid basis only.

WOOD, PHIL (M, W)  
153 W. JULIAN STREET  
SAN JOSE, CA 95110  
1-408-298-1540

Manufacturer of high quality bicycle components.

Goods: 1) 1 1/4 Round chrome-moly tubing - .035 or .049 wall.  
2) .800 x 1.600 Oval tubing - same wall thicknesses.  
3) Crankshafts for special frames (straight diameter for pressed on bearings)  
4) Bicycle Research Products Frame machining tools.

## LUGLESS BUILDING

Most of this manual is devoted to silver brazed lugged framebuilding. However, this is not the only option in framebuilding. Many builders choose to build without the use of lugs. There are three main reasons for choosing to build lugless:

1. Use of oversized tubes sometimes makes it impossible to use lugs. Most lug sets are made for bikes with standard British or French tube diameters. Thus, when building tandems with large chainstays, 1-3/8" down tube, 1-1/8" top tubes, and an oval bottom tube or when building mountain bikes with 1-1/4" down tubes and 1-1/8" top tubes, very few if any suitable lugsets are available.
2. Non-standard designs often eliminate the possibility of using lugs. Building a frame with a radically sloping top tube, a frame that allows the rear wheel to come between twin seat tubes, a frame that is highly experimental in design, or building a recumbent are all situations which could require lugless construction.
3. Lugless building is definitely a faster process. Labor can be cut by anywhere from 15 to 30 percent, depending on which type of lugless construction is used.

As might be expected, there are also disadvantages to lugless building. One main disadvantage is temperature. All forms of lugless building are hotter than silver brazed construction. Some forms of lugless building are only a couple hundred degrees hotter, but other forms are over a thousand degrees hotter. Heat causes distortion and annealing from slow cooling. It causes embrittlement from fast cooling. A builder wants to deal with these three problems as little as possible.

This section of THE PATEREK MANUAL covers lugless building as a supplement to the building a framebuilder is already doing. Please keep in mind that the author is not saying to build only lugless frames. Nor is he saying don't build lugless. There are applications for both types of construction and a truly talented builder can swing back and forth between both. The following pages cover the main types of lugless building used in the bicycle industry. The section then finishes up with a checklist for lugless building which can be used in conjunction with the checklist appearing earlier in the book.

### EXTERNAL FILLET BRAZING (LARGE FILLETS)

This is the type of joint seen on many lugless tandems and high quality mountain bikes. The tubes are mitered the same way as lugged joints. The mitered joint is then tacked and checked to see if the angle is correct. The builder then slowly builds up the joint till a large fillet is formed all the way around the joint. Excess brazing material is filed and ground away, taking great care not to remove any steel adjacent to the jointy. Sanding is done with strips of emery cloth for a fine finish.

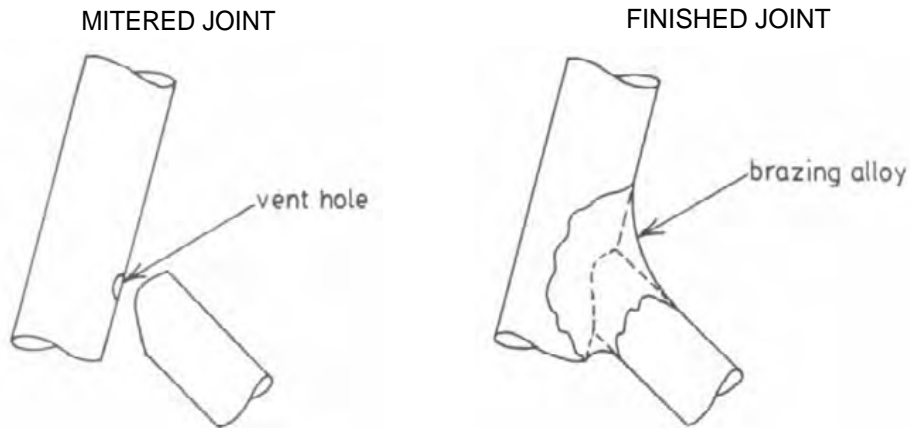

ill.115: External fillet brazing (large fillets)

### EXTERNAL FILLET BRAZING (SMALL FILLET)

This is a type of joint found on less expensive framesets. Making a smaller fillet is a way to cut costs while at the same time sacrificing some in the way of quality. Since the fillets are smaller, they can not be smoothed out as easily and are just as well left untouched after brazing. Smaller fillets have one distinct advantage over larger ones; there is less heat distortion with the smaller fillet.

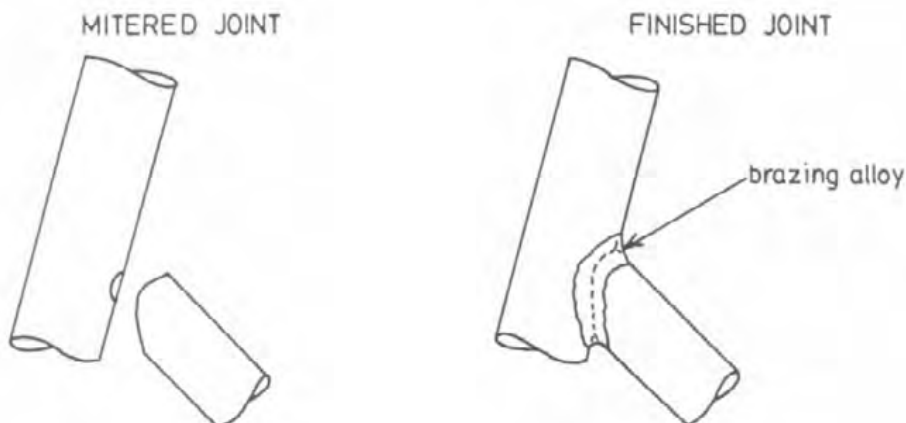

ill.116: External fillet brazing (small fillet)



### INTERNAL FILLET BRAZING

Very few bikes are built with internal fillet brazing. It is a process that takes a lot more skill on the part of the builder. With internal fillet brazing, the tubes are mitered as usual, but a brass contoured ring is inserted before the tubes are clamped in the fixture. The builder then heats up the whole joint till the brass can be seen seeping from the joint. Gravity is of the utmost importance in this process. The joint must be held so as to allow the brass to flow down and out. The intriguing thing about this type of joint is that it appears that there is nothing holding the joint together. Of course, since the fillet is smaller in diameter and since there is less brazing material, this joint is the weakest of the lugless joints.

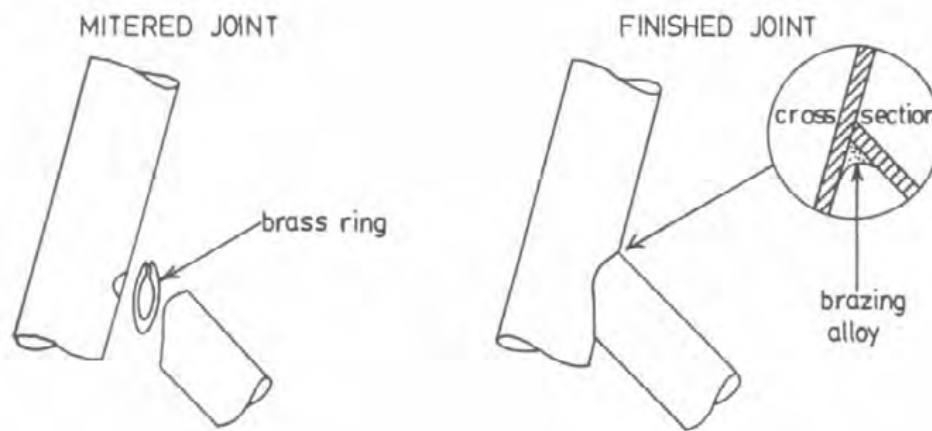

ill.117: Internal fillet brazing

### INTERNAL-EXTERNAL FILLET BRAZING

This is an expensive way to do a joint and very few builders will go to the trouble of using this method. The first step is to do an internal fillet as above. Then a large fillet is built up and finished as described at the top of page 8-2.

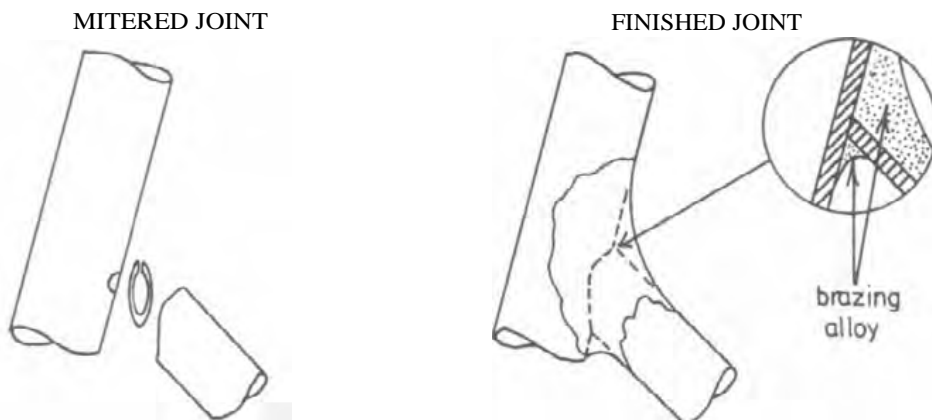

ill.118: Internal-external fillet brazing

#### RECOMMENDATIONS AND HINTS FOR DOING LUGLESS BRAZED JOINTS:

1. For easy clean up of flux, use Welco #17 water soluble brass brazing flux. Most brass brazing fluxes are not water soluble and must be chipped off or sandblasted away. Welco #17 takes at least a half hour of soaking in hot water to dissolve sufficiently.
2. Several types of brazing alloy can be used. The old standard low temperature brass rod that sells for \$3.00 a pound is acceptable. Eutectic makes a rather expensive Nickel-Bronze alloy which works well. Allstate makes a mid-priced Nickel-silver alloy which works well (ask for Allstate #11). Allstate #11 is the author's favorite; because of its machining properties, it will not gum up tools as much as the brass rod. It work-hardens up to 200 on the Brinell scale.
3. If Welco #17 is not available, use a standard powdered brazing flux. Any of the above brazing rods can also be purchased with a flux coating. Remember, standard brazing flux will have to be chipped away after brazing. The steel adjacent to the brazing alloy has been annealed and will dent if chipping is done too vigorously.
4. Chrome-Moly tubing is the best for fillet brazing. It holds up well under the higher temperatures involved. All of the bicycle frame tubing companies offer sets of tubing made of Chrome-Moly. Chrome-Moly aircraft tubing can be purchased at many small municipal airports. If using aircraft tubing, different wall thicknesses can be specified. For general purpose work, ask for .035" wall. For heavy duty work, ask for .049" wall. For tandem bottom tubes, ask for .065" wall. For light work using tubes smaller than 1/2" in diameter, ask for .028" wall. A .020" wall can not be recommended for lugless building.
5. If using a standard bicycle frame tubing kit to build a lugless frame, discard the stock head tube and obtain an Ishiwata tandem head tube or a piece of 1-5/16" diameter aircraft tubing with a wall thickness of .072". A standard head tube is much too thin for lugless building and will distort drastically.
6. Lugless bottom bracket shells are cheap and can be purchased from most wholesalers who sell frame supplies. If not available, have a local machine shop make one 1.625" O.D. X 1.325" I.D. X 2.717" long (tolerances - plus or minus .002") Then tap it out after it has been attached to the seat tube.

## TIG WELDED LUGLESS JOINTS

Chrome-Moly does not always have to be brazed together. Another option is Gas Tungsten Arc Welding or GTAW (also referred to as Tungsten and Inert Gas or TIG.). TIG welding is similar to arc welding in that an electrical current is used to create the heat. It is also similar to Oxy-Acetylene in that the Tungsten stylus is manipulated in much the same way as a gas flame. The added benefits are being able to control the strength of the arc with the foot and achieving the necessary heat instantaneously. Because of the foot control, the arc can be kicked up far beyond the necessary heat for a short period of time. When the necessary temperature is achieved in a few seconds, the foot can be backed off to the working temperature. Since the arc is so hot, long preheats are not necessary. The joint can be completely finished in only a minute or two. Because of the great speed involved, metal only centimeters away from the joint is not even hot. Consequently, since the nearby metal hasn't even become red hot, it does not reach the "critical temperature." (Depending on the alloy, the critical temperature occurs at approximately 1800 degrees F. At this temperature, the steel's crystalline structure is beginning to change, which alters its strength characteristics drastically.) After TIG welding, the frame can be cold set. When the frame is in proper alignment, a full heat treatment can be done on the frame. This relieves any stresses built up in the frame. Cold setting and heat treating can be done several times. (Heat treating can not be done on a brazed frame; the temperature necessary for the process would melt all of the joints apart.) After heat treating, the TIG welded frame can be thoroughly shotpeened. Shotpeening not only relieves stresses which may still exist in the frame, it also literally puts back strength which was lost from hitting the critical temperature. (Shotpeening can't be done as effectively on a lugless brazed frame; the shotpeening ruins the smooth finish of the joint.) If done properly, the TIG welded frame is far stronger than any of the other methods described thus far. The main drawbacks to TIG welding are: 1) The equipment necessary is far more expensive than oxy-acetylene. 2) The joints do not have a finished look at all. 3) Few customers realize the benefits of a properly done TIG welded joint.

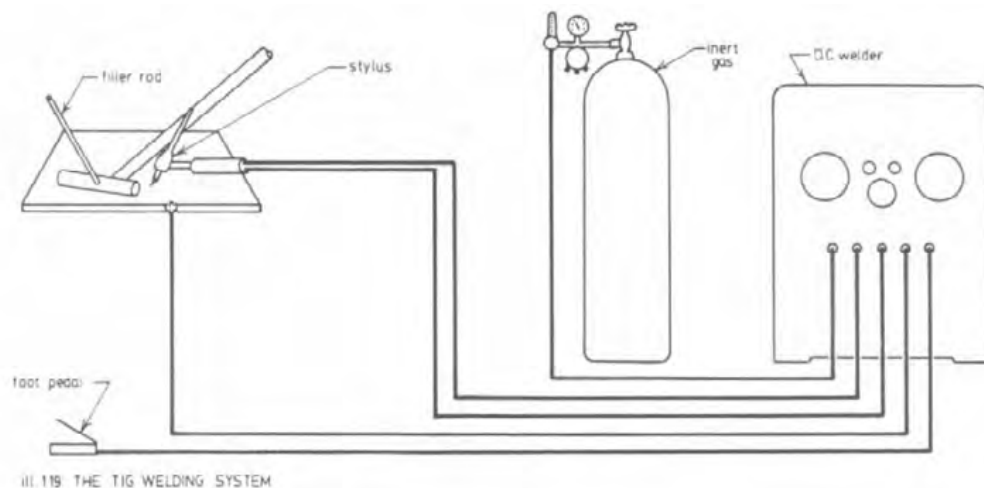

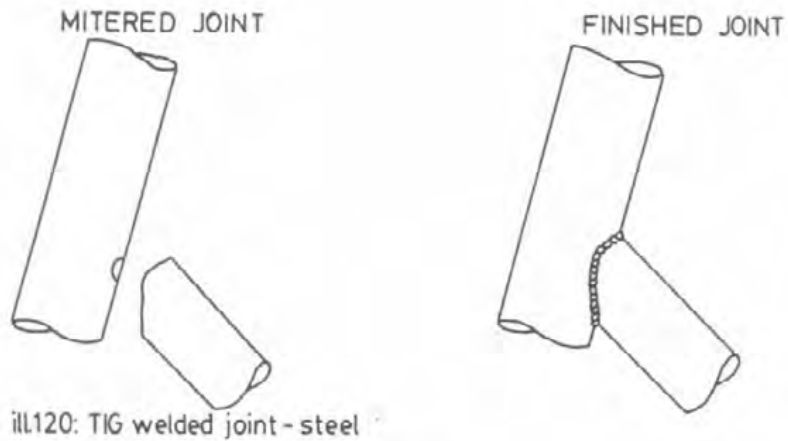

#### RECOMMENDATIONS AND HINTS FOR THE TIG WELDED JOINT

1. A standard Chrome-Moly bicycle frame tubing set can be used. An exception is the head tube, which must be replaced with a thicker tandem head tube or 1-5/16" O.D. X .072" wall Chro-Mo aircraft tubing.
2. Do not mix alloys of steel in the frameset. If 4130 Chro-Mo is used for the tubes, the bottom bracket shell must always be made of 4130 Chro-Mo. Such a bottom bracket shell may have to be made if not readily available. (See specs on page 8-4.)
3. Dropouts, bridges, and braze-ons can be brazed in place if heat treating will not be done. If heat treating will be done, everything must be TIG welded.
4. Any heat treating should be done by qualified aircraft personnel and may be quite expensive.
5. Shotpeening should also be done by qualified aircraft personnel.
6. Use only Chro-Mo steel filler rod in TIG welding Chro-Mo steel.
7. TIG welded joints need virtually no clean-up because they are done in an envelope of inert gas.
8. If brazing is to be done in the vicinity of a TIG welded joint, TIG first and braze later.
9. Practice extensively on pieces of scrap before attempting to weld thin-walled tubing.

## ALUMINUM LUGLESS JOINTS

Let's be honest. I have dedicated 3 years of my life to writing this book about bicycle framebuilding with steel components. I enjoy working with steel and hope it outlives the aluminum craze. A massive chunk of the world's bicycle industry relies on steel frames and a major move away from that direction could be quite upsetting to the industry. For that reason the following advantages and disadvantages of aluminum may show some bias.

### ADVANTAGES OF USING ALUMINUM FRAMES

1. Aluminum does not corrode the way steel does. When steel starts to rust, it can eventually rust away into thin air, as is quite evident on many Wisconsin automobiles. Aluminum develops a thin layer of corrosion (aluminum oxide) on its surface and that is as far as it goes. The only way the corrosion can go deeper on aluminum is if the aluminum oxide is polished and a new layer is allowed to develop.
2. Aluminum frames are generally lighter than steel frames.

### DISADVANTAGES OF USING ALUMINUM FRAMES

steel frame. To be repaired properly, an aluminum frame must be sent back to the factory where it can be TIG welded and re-heat-treated properly. In emergency situations steel frames can be brazed by a small welding shop.

2. Aluminum frames need an additional acid treatment before painting can be done.
3. Once the set of "braze-ons" are in place on an aluminum frame, it becomes quite difficult to customize or modify the frame. A steel frame can be sent to a local builder for a complete new set of braze-ons.
4. Aluminum frames often use oversized tubes. Since the industry is set up for frames with 1" and 1-1/8" diameter tubes; front derailleurs, pump clips, chainstay stops, bottle cage clips, and many other accessories won't fit. Nothing standard will fit these "Blimps," AND, since they are made of aluminum, they must go back to the factory for modifications.
5. Steel has a threshold below which fatigue is no problem. Aluminum has no "safety valve" like that. Why do you think most aluminum bikes have steel forks?

## TIG WELDING OF ALUMINUM PARTS

Welding aluminum creates problems for the welder. As mentioned earlier, aluminum will form an oxide on the surface. The interesting thing about aluminum-oxide is that it melts at 3500 degrees F, while aluminum melts at only 1215 degrees F. When the aluminum is heated up to what is expected to be a comfortable welding temperature, nothing seems to be happening. The joint gets hotter and hotter and still nothing happens. Then suddenly the whole joint plops in a big puddle on the floor and the piece is ruined. Here is what happened: By the time 1215 degrees had been reached, a hard crust of aluminum-oxide had formed and encased the whole joint area. As the temperature increased, the aluminum didn't seem to melt when, in fact, it was already molten and only held its shape because of the aluminum-oxide crust. When 3500 degrees was finally achieved and the crust finally melted, the molten Aluminum could no longer keep its form and plopped on the floor.

The discrepancy between the melting temperatures of aluminum and aluminum-oxide is only part of the problem. Aluminum is an incredibly efficient conductor of heat. Because of this, an oxy-acetylene torch often lacks the output to heat the joint for welding. Consequently, when the joint plops on the floor, it's a rather large section of the joint that is affected.

To overcome these problems in welding aluminum joints, the pieces must be TIG welded. TIG welding does two things simultaneously: 1) Since the TIG system envelops the weld bead in a bubble of inert gas, aluminum-oxide can't form. 2) Since the TIG system has far more heating capabilities than oxy-acetylene, the area being welded can be heated to welding temperature almost instantaneously, before the aluminum can conduct the heat away. (The proper method is initially to kick the amps up very high with the foot pedal and then to drop quickly back to the necessary temperature. This delivers nearly 7000 degrees F for a few seconds.)

### TIG WELDED LUGLESS ALUMINUM JOINT (SIMPLE)

The aluminum joint is mitered just like any other joint. A bead is then laid all around the circumference of the joint. An experienced technician can do this in 45 to 90 seconds. The joint is done. There is no clean-up. The joint is now ready for heat treating.

MITERED JOINT

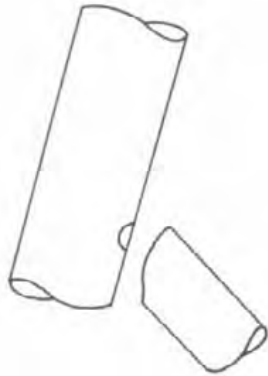

FINISHED JOINT



ill,121: TIG welded joint- aluminum (simple)

#### TIG WELDED LUGLESS ALUMINUM JOINT (BUILT UP)

The built-up aluminum joint is a more attractive joint. It has successive layers of weld beads built up to form a large fillet. When the fillet is completed, it is cleaned and smoothed out. The result is a joint similar to the brass brazed fillet in appearance. The main problem with the built-up joint is greater distortion due to more heat for a longer period of time. Additional distortion is caused each time a successive bead of aluminum is added.

MITERED JOINT

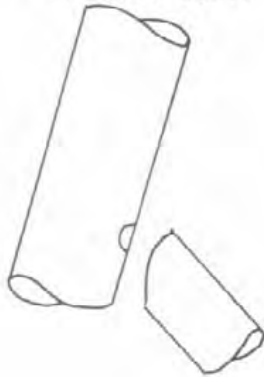

BEAD BUILD-UP



FINISHED JOINT



ill,122: TIG welded lugless aluminum joint

I hope this information on aluminum lugless construction gives you plenty of ammunition when customers approach you on the merits of aluminum bicycle frames.

## MIG WELDED LUGLESS STEEL JOINTS

Another method of welding steel quickly and efficiently is to use Gas Metal Arc Welding (GMAW) also known as Metal and Inert Gas (MIG). MIG welding also uses a bubble of inert gas to prevent oxidation. It is as fast as TIG, but, due to the size of the gun and the lack of a foot control, it does not produce as delicate a bead as TIG.

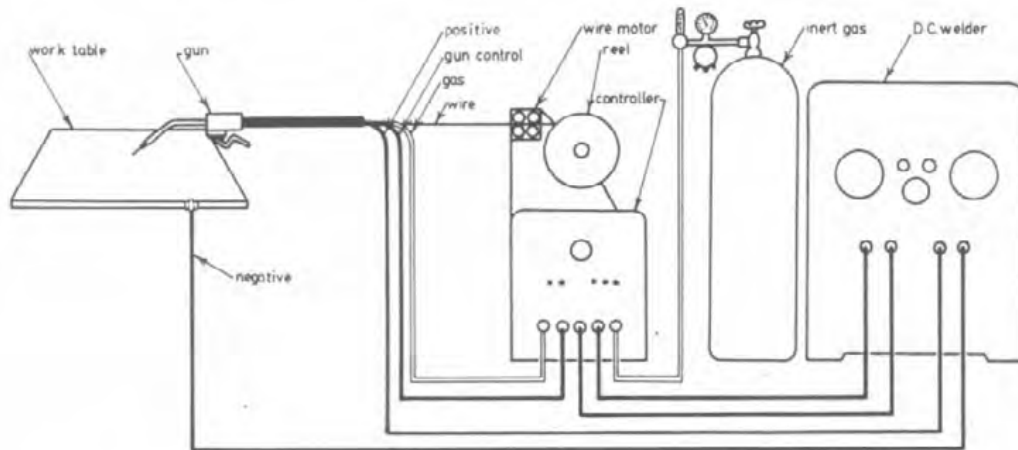

ill.123: THE MIG WELDING SYSTEM

Anywhere a MIG bead is produced, it looks rather unsightly and bulky. For this reason, it is desirable either to smooth the bead out with a grinder or place the bead in an inconspicuous place. Below are diagrams of a popular, low cost, commercially produced, MIG welded frame

MATCHED STAMPINGS



FINISHED JOINT



ill.124: MIG welded joint



## FRAMEBUILDER'S CHECKLIST FOR LUGLESS CONSTRUCTION

The following is a detailed step-by-step checklist to be used by the framebuilder who is familiar with the checklist in Section 3 of this book and is ready to attempt a lugless frame.

Since there are many similarities between lugged construction and lugless construction, this list is to be used in conjunction with the checklist in Section 3. This new checklist will have the builder go to the earlier checklist and execute designated steps there. When those steps are completed, the builder will then return to this checklist and execute the steps in lugless construction which are different from lugged construction. The builder will be constantly referred back and forth through the two checklists while building a lugless frame.

### I. THE DRAWING (The crown must be purchased by this time.)

1. Go to the drawing section on page 3-3 and do steps 1 through 10. After completing those steps, return here.
2. Since the lugless head tube is 1-5/16" in diameter, draw a pair of lines parallel to the head tube centerline with one line 21/64" on one side of the centerline and the other 21/64" on the other side of the centerline. The head tube has just been drawn
3. Go back to page 3-4 and do steps 12 through 16. After completing those steps, return here.
4. Since there are no lugs, the HT/DT TUBE INTERCEPT POINT can be determined arbitrarily by the builder. In lugless building, 1cm is a good HT/DT INTERCEPT POINT. This will allow enough area to build a fillet. Now move to the back edge of the head tube and measure up from the previous line a distance of 1cm. to the HT/DT INTERCEPT POINT. Make a mark at that point.
5. Make a decision:
  - A. If the frame will have a 1-1/8" diameter down tube, go to page 3-5 and do steps 18 through 22. After completing those steps, return here.
  - B. If the frame will have a down tube with a non-standard diameter, make a new framebuilder's straightedge to match the diameter of the down tube to be used. Now go to page 3-5 and do steps 18 through 22. After completing those steps, return here.

1. GENERAL PREPARATION (The tube set, bottom bracket shell, and 'cork crown should have been purchased by now.)

..Go to page 3-7 and execute step 3. After completing that step, return here.

to page 3-7 and execute steps 5 through 10. After completing those steps, return here.

bottom bracket shell. If the seat tube is butted, the butted end goes against the bottom bracket shell. The best way to find the butted end is to find out which end a 27.2mm seat post will easily fit into. The other end is the butted end. To avoid confusion, wrap the non-butted end with a ring of masking tape. The miter can be roughed in with the grinding wheel and cleaned up with a file. The miter must be checked for squareness with a machinist's square (fig. 190). It must also be checked for gaps by holding it against the bottom bracket shell and looking for light between the two pieces (fig. 191). During this procedure, the tube should be held in a Park clamp or a pair of framebuilder's tube clamps. (See Fixtures.) (See figs. 14 & 15)

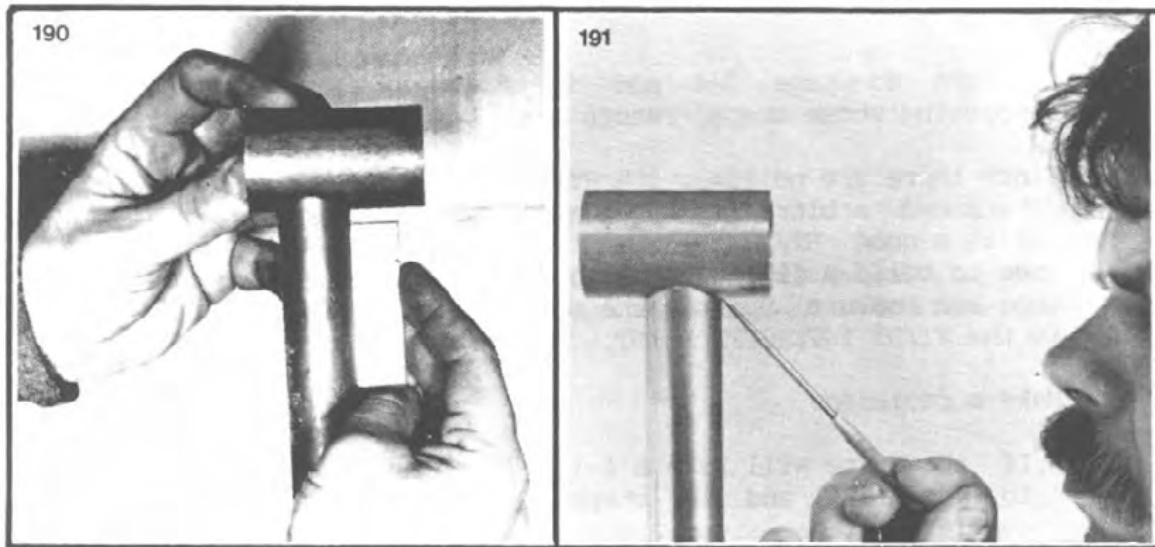

4. Miter the end of the down tube where it hits the backside of the head tube. (It will be mitered to an angle of 56 to 63 degrees.) For Reynolds, miter the short butt now. For Columbus, make sure to have the correct A, B, or C set. The miter can be roughed in with the grinding wheel and finished off with an 8" half round file. Again, the tube should be held in a Park clamp or tubing blocks. The miter can be checked with the three devices that follow:

A. The angle of the miter must be checked with a bevel protractor frequently during the mitering process. The correct angle may be taken from the drawing with the bevel protractor.

B. The proper fit must be checked with a piece of head tube. The head tube must nestle into the miter with an absolute minimum of light showing through between the two pieces.

C. To see if the miter falls directly along the centerline of the down tube, a machinist's square can be laid across the two peaks of the miter. Both should be at the same height. (figs. 13 to 20.)

5. Miter the short butted end of the top tube where it meets the backside of the head tube. If using non-butteted tubing, either end can be mitered. Again, the angle can be taken directly from the drawing. Aside from the angle necessary, the procedure is identical to that used for mitering the down tube. To avoid confusion later, it is very important to wrap a ring of masking tape around this first end.

III. THE FRONT TRIANGLE - At this point, no brazing has been done and only one end of each tube has been worked with. Materials on hand at this time should include the prepped tube set, 1 pound of brazing rod as described on page 8-3, Welco #17 or other brass brazing flux, medium emery cloth and sanding belts for the dynabrade sander.

1. Drill a 1/2" air expansion hole in the bottom bracket shell. It should be located midway between the two faces of the shell. (fig. 192)

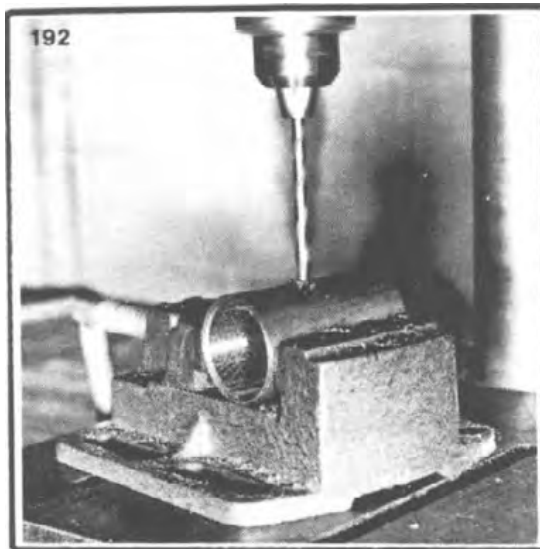

2. Clean the bottom bracket shell and mitered end of the seat tube for brazing. Cleanliness is not as critical as it is in silver brazing so clean up can be done with a strip of emery cloth.
3. Very little fixturing is necessary for lugless joints. Clamp the seat tube in the Park clamp with the miter pointing straight up in the air.
4. Spread a generous amount of flux around the mitered end of the tube.
5. Spread a generous amount of brass brazing flux on the bottom bracket shell around the air expansion hole.
6. Carefully set the lugless bottom bracket shell into the miter of the seat tube so that the air expansion hole vents into the seat tube.
7. With a ruler that measures in increments of .5mm, see that the bottom bracket shell overhangs the same amount on each side of the seat tube. Measure on the left (fig. 193). Then measure on the right (fig. 194).

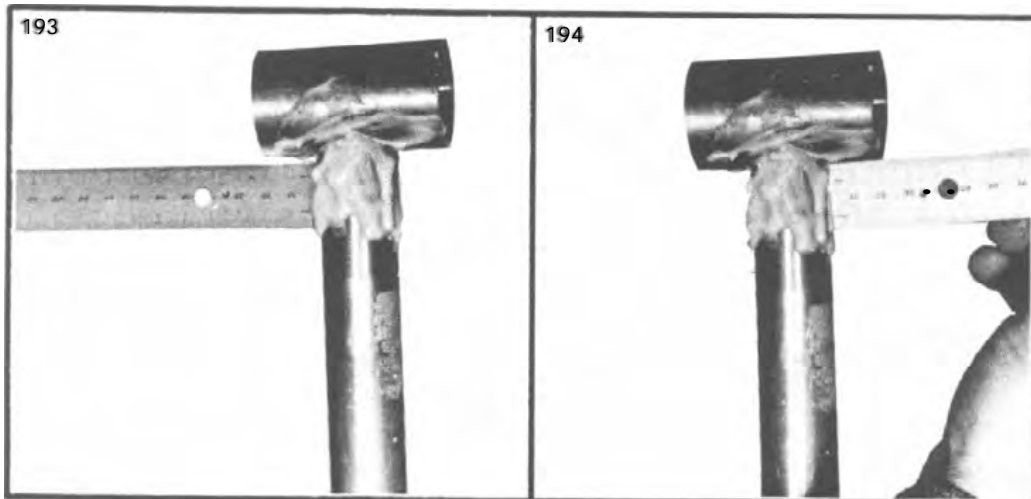

8. While the seat tube/bottom bracket shell is sitting upside down, tack the joint with the brazing alloy. (fig. 195)
9. After the joint is tacked, flip the seat tube right side up and continue brazing. It's a good idea to have the tube mounted only lightly in the clamp and have the clamp fastened only lightly in the stand. That way, the joint can be easily twisted to any working angle with only one hand. (Careful

where you grab, things are going to be hot!) As brazing continues, "tinning" should be done first. Tinning is where a small amount of brazing alloy is applied all of the way around the joint. This assures that the brazing alloy will be present all of the way to the crotch of the joint. After tinning, build fillets only on the sides of the joint. It is important not to build fillets on the front or back of the joint because the chainstays and down tube must be able to bottom out against the bottom bracket shell when they are mitered. A fillet at the front or back of the joint will only have to be ground away later. (fig. 196)

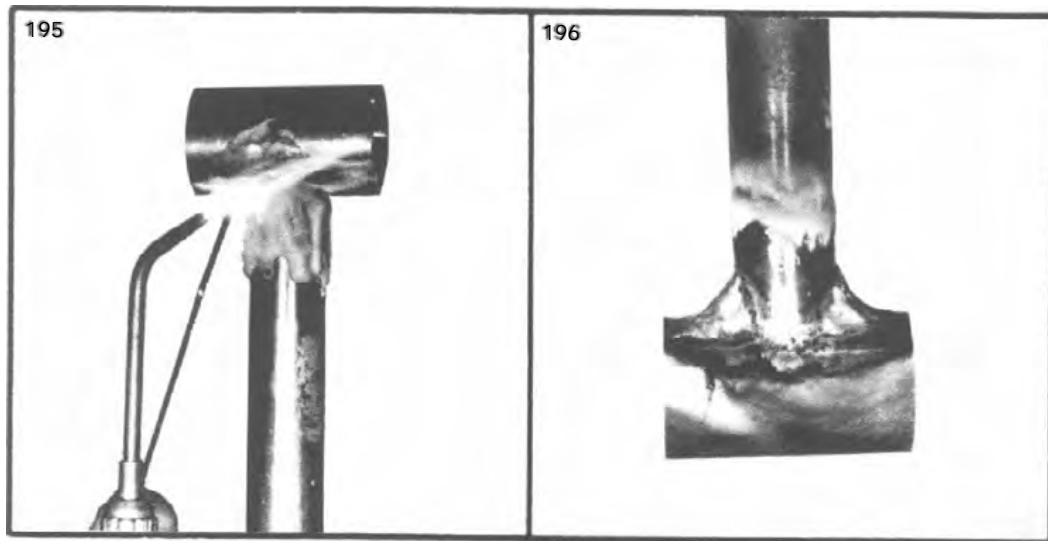

cleaned off. If using Welco #17 water soluble brass brazing flux, soak the joint in extremely hot water for at least a half hour. Although Welco #17 is water soluble, it does not work as well as silver solder flux and may have to be scraped some as well. Do not scrape flux with the fingernails! It is as sharp as glass and will cut skin readily. If using a standard brass brazing flux, soaking in water will be of no use. In this case, the flux must be removed by filing and chipping. (Use a file that is in bad shape already as filing on flux will ruin a good file.) It is very important not to chip the flux too hard as the steel close to the joint has been softened by the heat of brazing. Vigorous chipping could put many unsightly peen marks in the steel tubing which would make the frame unsound. When filing flux away, it is important not to remove steel. Removing any steel could cause undercutting which would also cause the frame to be unsound. Undercutting will become intensely visible after painting. Illustration 125 shows severe undercutting.

PROPERLY DONE JOINT



BADLY UNDERCUT JOINT



11. After all of the flux has been cleaned, the bottom bracket shell must be tapped and faced. If the shell has been pre-tapped, determine which side is tapped with a British left hand thread and stamp an L on that side of the shell so as not to become confused as to which side is right or left later on. If the shell has not been pre-tapped, simply choose a side and stamp the L in the side of the shell. Before stamping letters or numbers in the bottom bracket shell, always screw in a bearing cup so the shell does not deform from the force of the blow (fig. 197). When the shell has been properly marked to show left from right, go to page 3-15 and do steps 7 through 9. After completing those steps, return here.



12. Work can now begin on the bottom head joint. With a jeweler's file mark the HT/DT INTERCEPT POINT on one side of the head tube. (1cm is recommended) As soon as this point is marked, this locates the backside and the bottom of the head tube.
13. With V-blocks and a machinist's square, place the headtube directly over its correct place on the drawing. Transfer the centerpoints of the down and top tubes up to the head tube and mark those points. There should now be three marks in a line, the HT/DT POINT, the location of the down tube air expansion hole, and the location of the top tube air expansion hole.
14. Drill both air expansion holes to a diameter of 1/2". (Remember - huge air expansion holes!) Figure 198 shows the air expansion holes and the HT/DT INTERCEPT.

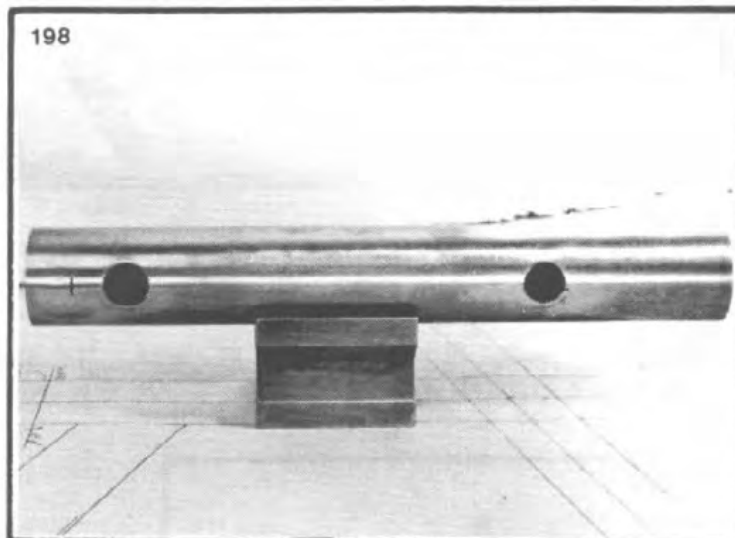

5. Clean the mitered end of the down tube for brazing. Remember, cleanliness is not as critical as with silver solder. Emery cloth will be sufficient.
16. Apply flux
17. Mount the down tube in the Park clamp so that it points up in the air at about a 60 degree angle. (Again, jiggling in lugless building is simple and in some cases non-existent.)
18. Clean and flux the proper end of the head tube. (Remember, it is the end with the file mark.)
19. Slide a 1" diameter bar into the head tube to be used as a counterbalance while the joint is being tacked (fig. 199). By positioning this bar correctly, the headtube will balance very neatly in the crotch of the miter.

20. Place the head tube into the miter so the air expansion hole vents into the down tube and the mark for the HT/DT POINT is flush with the bottom side of the down tube (Fig. 200)  
(IMPORTANT: DON'T DO THE ANGLE BACKWARDS!)

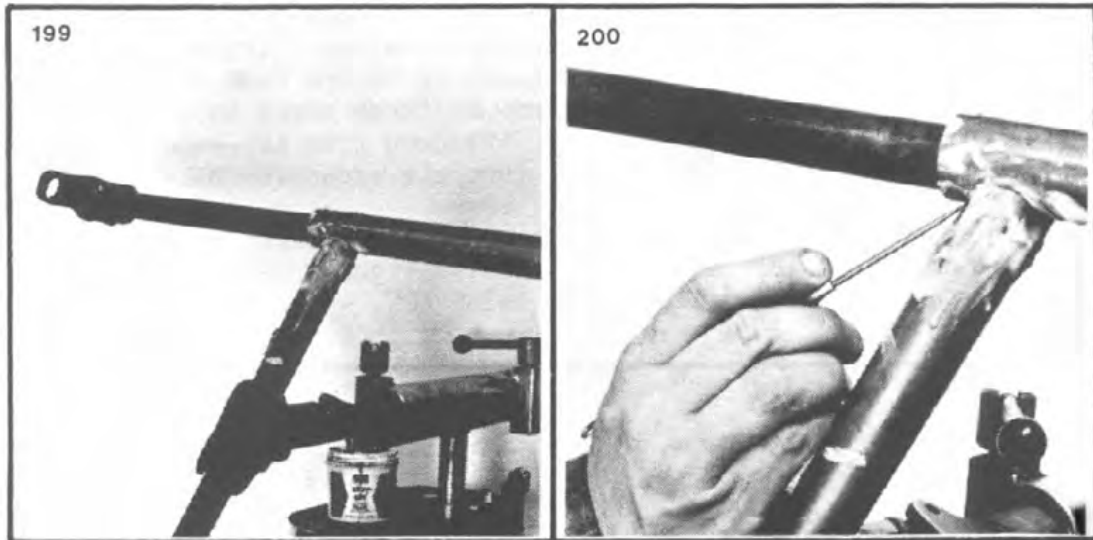

21. Tack the sides of the joint and remove the 1" steel bar.

2. After the joint has cooled some, elevate it over the drawing with V-blocks and a machinist's square to see how the angle of the joint compares to the drawing (fig. 201).





23. At this point, the joint has only been tacked. If the joint is off it can be corrected by strategically applying heat while brazing the rest of the fillet. Put the piece back in the stand and build the fillet as per the hints in illustration 126.

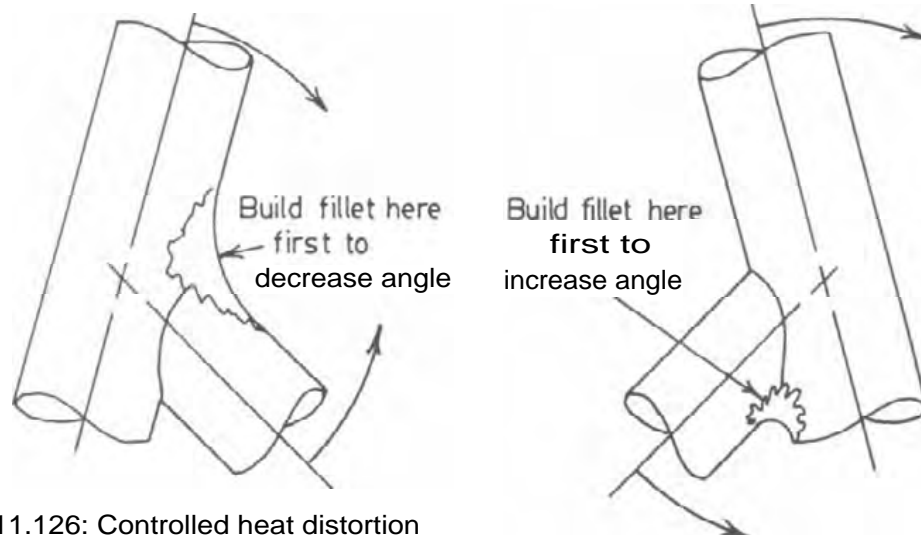

111.126: Controlled heat distortion

Don't forget, this joint is the most important one in the whole frame. If this one is incorrect, the whole front end geometry will be off. For that reason, this joint should be done carefully and should be checked against the drawing 2 or 3 times during brazing to see that the angle is preserved while the fillet is being built. With practice, it should be possible to braze a bottom head joint with a minimum of cold setting.

24. When a fillet of the desired size has been attained (a smaller radius fillet will cause less heat distortion but a larger one is stronger and easier to clean up cosmetically), check the angle against the drawing again. If cold setting is necessary, slide the 1" bar into the head tube, lay the head tube on the floor. Put a foot on the 1" bar, and either lift on the down tube to lessen the angle of the joint or push down on the down tube to increase the angle of the joint (fig. 202). Always finish a cold setting session by checking the angle of the joint against the drawing on the surface table. (The use of a down tube protector sheath would be a good idea during this procedure.)



25. Elevate the down tube/head tube assembly over the drawing with V-blocks and machinist's square.

26. After making sure the tubes are directly above their counterparts on the drawing, put the machinist's square against the non-butteted end of the down tube and mark the overall length of the down tube on the drawing with a pencil (fig. 203). This may be accurately done by using the machinist's square to transfer the down tube length down to the drawing. Measure the distance from the mark just made on the drawing to the point on the drawing where the crotch of the down tube miter will hit the bottom bracket shell (fig. 204). Take the measurement just made and lay it out along the left and right sides of the down tube coming up from the non-butteted end (fig. 205). The down tube should now be marked where the crotch of the miter will lie (fig. 206).

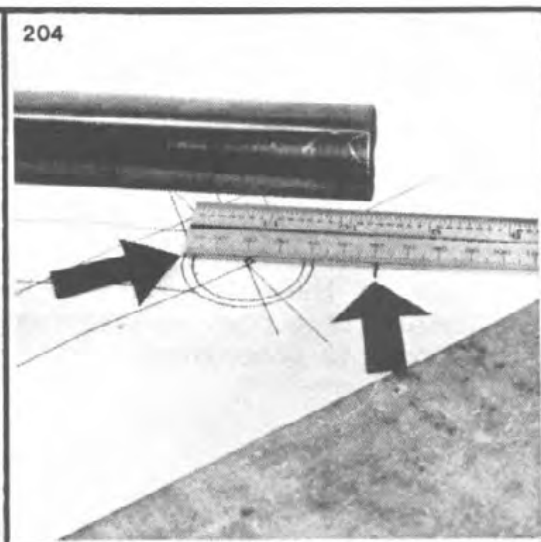
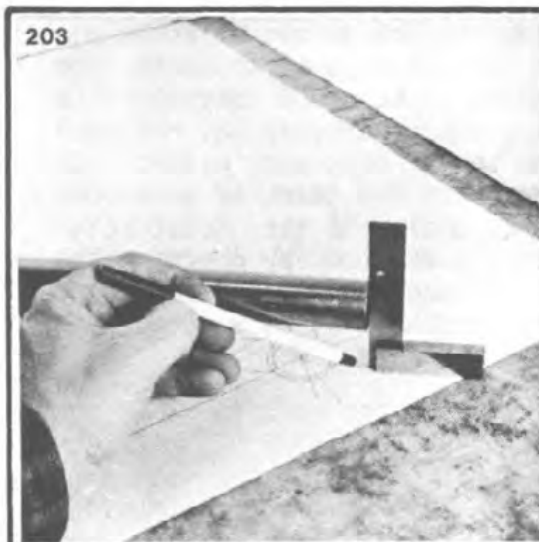

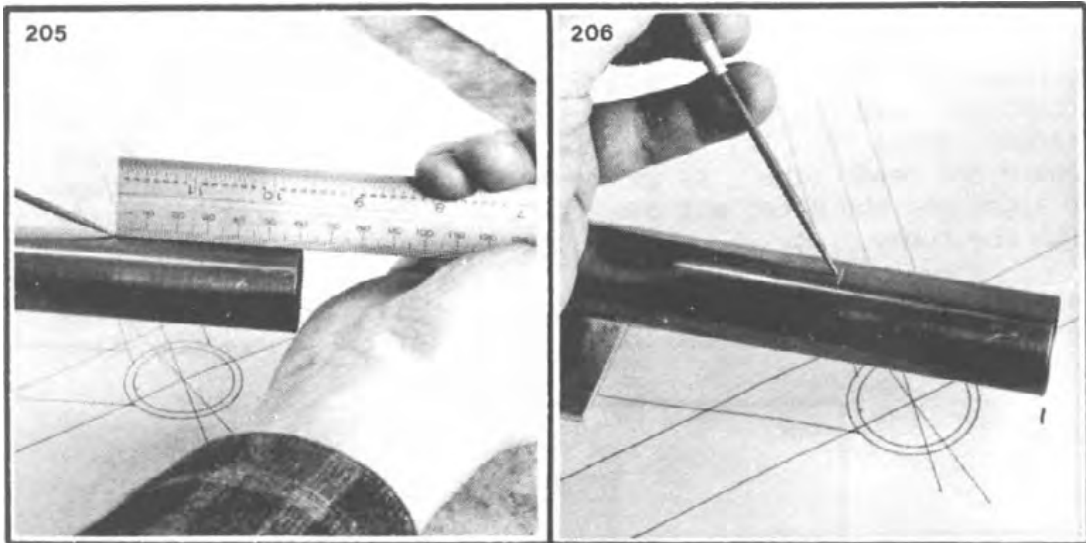

27. Cut the down tube off 15mm longer than the marks just made indicate.

28. Rough the miter in on the grinder (fig. 207). Do not go beyond the two marks. In fact, it's a good idea to leave the down tube 1 or 2mm too long at this point (fig. 208).

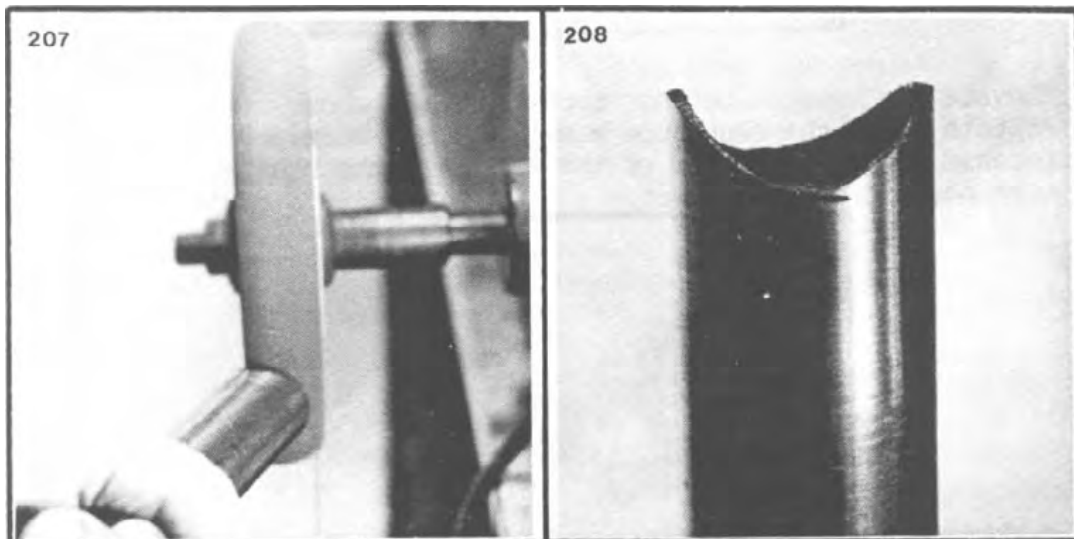

29. Finish mitering can be done with a 10" half round file. A 10" will most closely match the radius of the bottom bracket shell. Great care must be taken to have the miter lie perpendicular to the plane of the head tube. In most small workshops, this can only be done by eyeball. Use an extra bottom bracket shell to lay into the crotch of the miter and sight toward the head tube. As in the earlier miters, check for gaps of light in the miter and check to see that the miter is square with the tube.

30. Elevate the DT/HT above the drawing again. The length of the down tube can be checked with the machinist's square now (fig. 209).

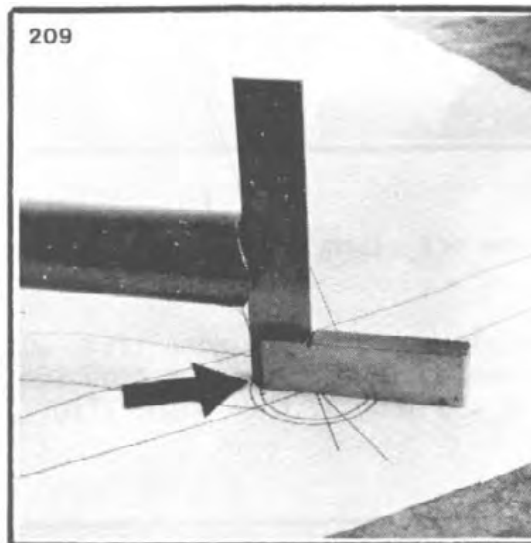

31. Elevate the seat tube and bottom bracket above the drawing. At this point the seat tube must be canted backward (fig. 210) because the second part of the miter at the base of the down tube has not been made yet.

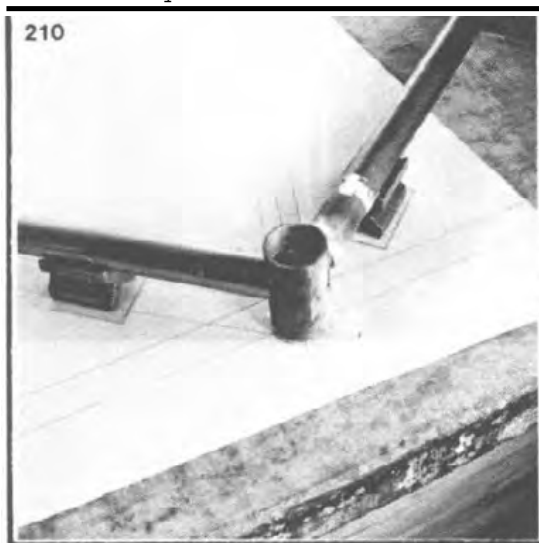

Since the frameset probably has three different sized tubes (1-1/8" seat tube, 1-1/4" down tube, 1-5/16" head tube), it is extremely important to have the correct build-up under the V-blocks that are under each tube. This way, all the tubes will have the same level centerpoints (CP). (If there is confusion as to how to find the CP of tubes, see pages 9-19 through 9-22 of the precision measuring section.) Figure 211 shows three diameters of tubing built up to have the same CP.

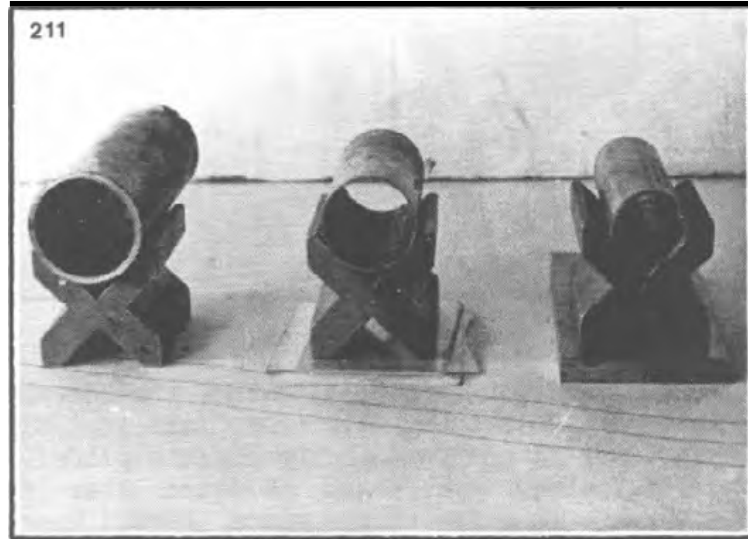

To obtain the same CP for all tubes, take a height measurement for the largest diameter tube as it lies in the V-blocks. Subtract the radius of that tube from that measurement. This will be the CP of that tube. The other of the smaller tubes should have the same CP as the largest tube. Take the height measurement of one of the smaller tubes and subtract the radius; that will give the height of that tube's CP. Of course, that smaller tube will have a lower CP than the largest tube. To get the same CP for both tubes, build up shims under the smaller tube till the height reading minus the radius has the same value as that of the largest tube. Do this for all tubes while working on the surface table. A CP of 50mm for all tubes is a comfortable working height.

32. The second part of the miter at the bottom bracket end of the down tube must be made now. This is a trial-and-error procedure. Slowly start removing metal for this miter until the head tube, down tube, seat tube, and bottom bracket shell can all be placed above the drawing without having gaps between the down tube and the bottom bracket shell. This is probably the most difficult joint to do in framebuilding. Don't be upset if the first try doesn't come out right; The frame will just have to be a couple of millimeters shorter than the drawing. Figures 212 & 213 show the finished miter.

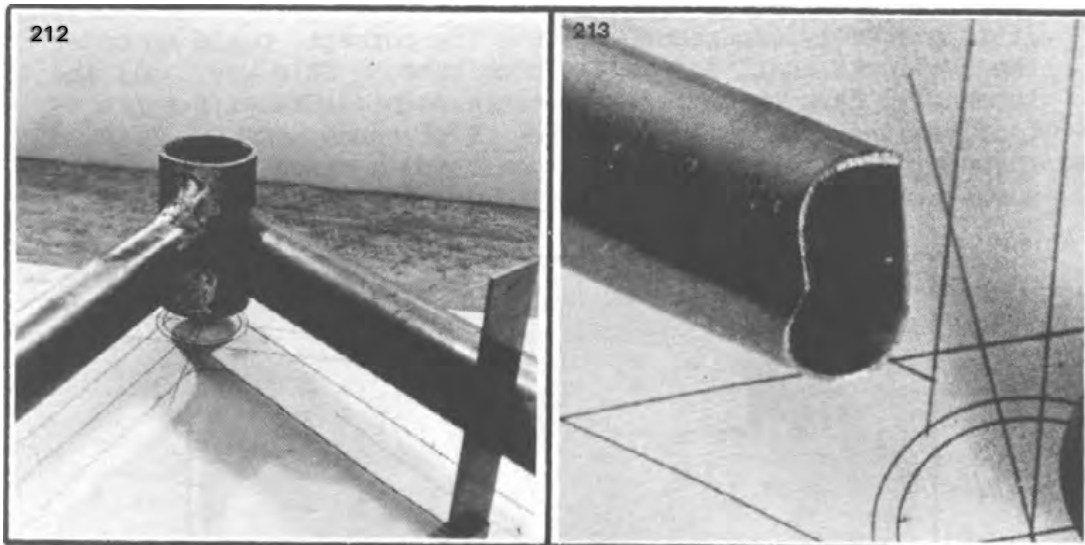

33. An air expansion hole must be drilled into the bottom bracket shell so that the down tube will vent into it. Great care must be taken to drill the hole in the correct place. At this point, the untrained eye would perceive that the down tube/bottom bracket is a reversible piece. WRONG! Remember the L stamped into the bottom bracket shell? Put your right hand on the face of the shell where the L is stamped. Put your left hand on the face of the shell that has not been marked. Now put your nose in the hole at the top end of the seat tube. You are now looking directly at the location where the air expansion hole should be drilled. If you miscalculate after those directions, you deserve to have a 1/2" hole in the back side of your bottom bracket shell!

34. Drill hole.

35. Clean up bottom bracket shell and end of down tube for brazing.

36. Apply flux to both surfaces.

37. Lay the tubes into the V-blocks again and re-align all tubes with the drawing using the machinist's square.

38. Lay a heavy weight across the head tube and seat tube. This heavy weight will hold the seat and head tubes tight against the surface table and keep them in the same plane while the joint is being tacked. Note heavy bar stock of aluminum in fig. 214.

39. Carefully slide a piece of sheet metal between the bottom bracket and the surface table (fig. 214). This will protect the surface table from any flux or brazing material that drops off the joint during tacking. If the frame tubes have a CP of about 50mm or more, the piece of sheet metal will slide in easily. If the bottom bracket is too close to the surface table, go back and shim up the V-blocks to gain more height.

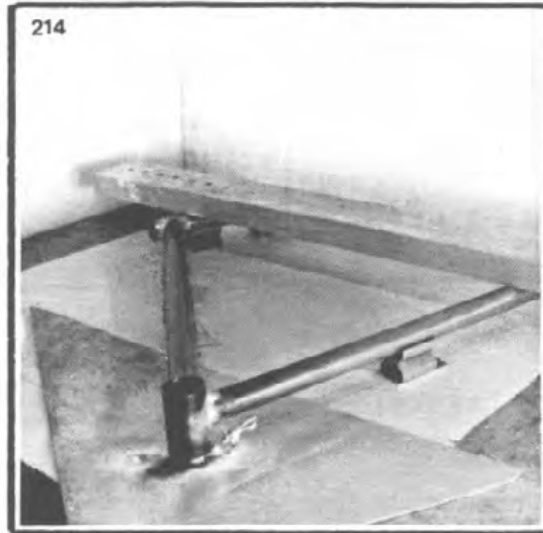

40. Double check to see that the tubes are true with the lines on the drawing.
41. Double check to see that the down tube is bottoming out against the bottom bracket shell.
42. Tack the joint in three places (fig. 215).
43. After tacking has been done, the tubes can be lifted from the drawing and the rest of the fillet can be built up in the Park stand (fig. 216). As before, careful application of heat can be used to control heat distortion. Remember, the tubes pull toward the fillet being built up.

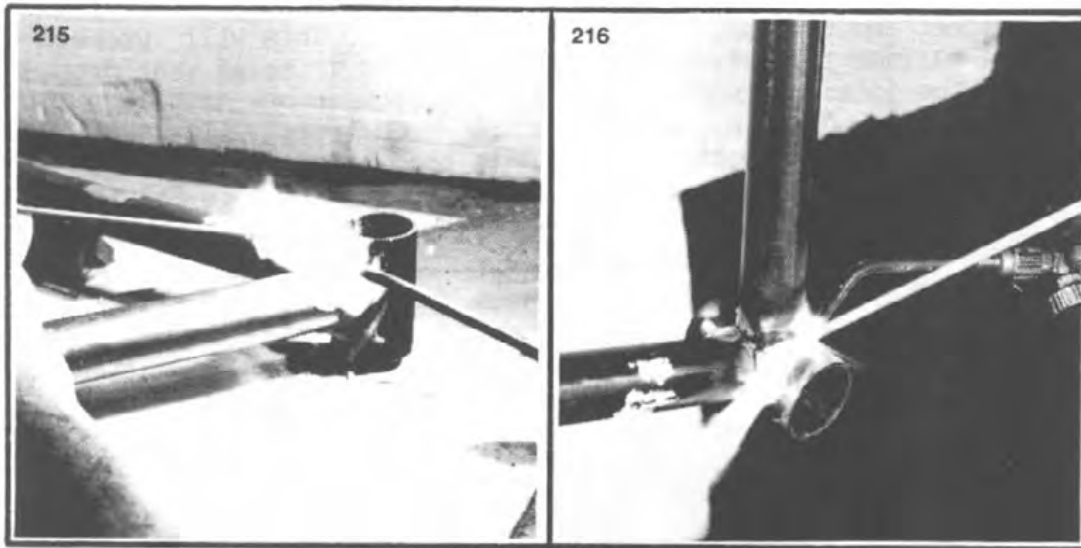

44. After the joint has cooled sufficiently, all flux should be cleaned off.
45. Tap and face the bottom bracket shell again. Yes - Again! Down tube deflection must be checked with the bottom bracket mike. Due to the increased temperature of lugless work, the bottom bracket faces are completely out of parallel by now. Earlier in this section a 69mm bottom bracket shell was recommended. The extra millimeter allows the shell to be faced several times without going undersized. Leave Campagnolo guides 724/1 and 724/2 inside the bottom bracket shell during cold setting. This will help eliminate distortion to the shell.
46. Check the down tube for deflection to the left or the right (figs. 46 & 47).
48. If the down tube has deflected in either direction, clamp the faces of the bottom bracket shell in the soft jaws of the vise and pull in the direction necessary to eliminate the deflection. Check for deflection again and coldset more if necessary. Try not to overshoot the mark; each time cold setting is done, work hardening of the metal occurs. Too much work hardening means brittleness.
49. Lay the frame in the V-blocks again and check to see if the angles of the frame match the drawing. The angle where the down tube and seat tube meet the bottom bracket shell may have to be coldset to match the drawing. If cold setting is necessary, slide a 1" steel bar down the seat tube and lay the seat tube on the floor. Step on the seat tube and grasp the



head tube with both hands (fig. 217). Push downward to make the angle smaller. Pull upwards to make the angle larger. Check this several times against the drawing while cold-setting so as to be assured of achieving the correct angle. The bottom head joint should have been properly coldset earlier and should not be tampered with at this time.

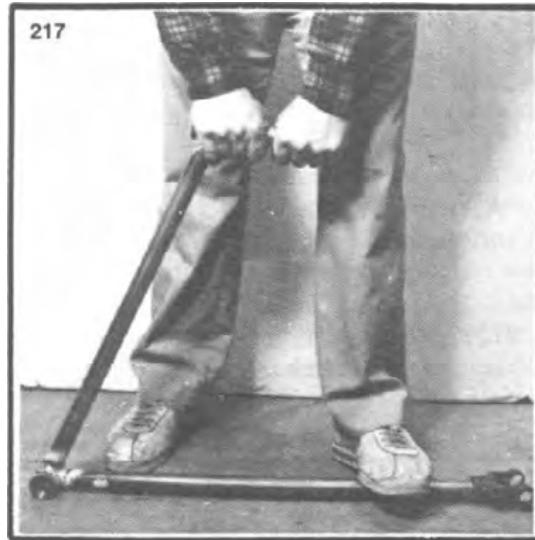

50. Lay the frame in the V-blocks and situate it directly above the drawing using the machinist's square.
51. Using the machinist's square, locate the points where the top tube hits the backside of the head tube. Make a mark there with a triangular jeweler's file. (See Fig. 64)
52. Using a machinist's square, locate the points where the top tube hits the front of the seat tube. Make a mark there with a file (fig. 66).
52. Using the machinist's square, locate the position for the air expansion hole where it vents into the top tube. Make a mark there and drill the air expansion hole at that point (fig. 66). (The air expansion hole in the head tube should have been drilled earlier; if it hasn't been drilled, do so now.)
53. Use emery cloth to clean the head tube and seat tube for brazing.
54. Clamp the frame in the Park clamp until it is needed again.
55. Double check to see that a ring of masking tape has been put around the top tube near the first end that was mitered.

56. Go to the drawing and measure the distance from the point where the top of the top tube hits the back side of the head tube to the point where the top of the top tube hits the front of the seat tube.
57. Go to page 3-23 and execute steps 57 through 62. (There will be some minor discrepancies with the numbering of certain steps, but the crazy sentence above should make it less confusing.) After completing those steps, return here.
58. When the joint is mitered to the proper fit, sand the ends of the top tube with emery cloth to prepare it for brazing.
59. Set the top tube in place between the head tube and the seat tube. The top tube will not want to stay in place. To make it stay in place install a modified C-clamp #1 around the head tube right above the top tube. Install another modified C-clamp #1 around the seat tube right below the top tube. These two clamps will prevent the top tube from creeping down in front and creeping up in back. The modified C-clamps can be seen in figure 218.

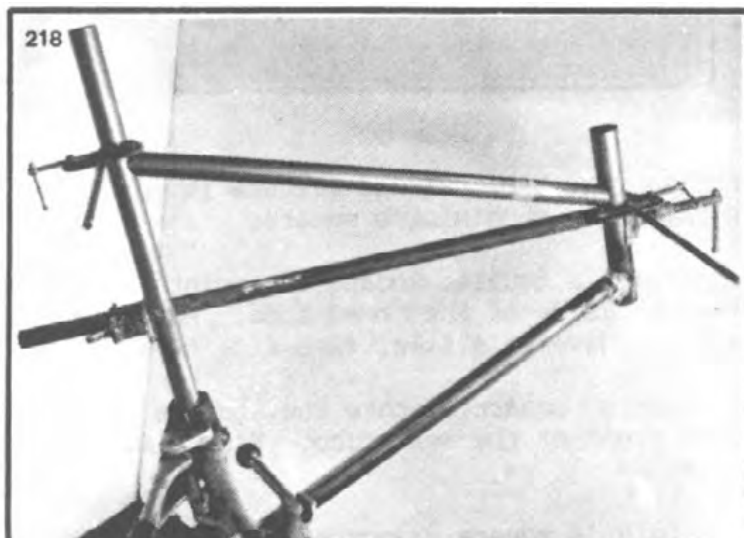

60. Install a modified bar clamp to push the head tube and seat tube together (fig. 218).
61. Apply a generous amount of flux to the joints at each end of the top tube.
62. Tack the top tube to the head tube in two places.
63. Tack the top tube to the seat tube in two places.
64. Remove the modified bar clamp and both modified C-clamps.

65. Tinning should be done to the head tube/top tube joint before building the rest of the fillet.
66. Finish building the brazed fillet where the head tube and top tube meet.
67. Tinning should be done to the seat tube/top tube joint before building the rest of the fillet.
68. Finish building the brazed fillet where the seat tube and top tube meet.
69. After the joints have cooled sufficiently, all flux must be removed as described earlier.
70. Now clean-up must be done on the bottom head joint, top head joint, and seat cluster joint. The first step is to take the die grinder with an abrasive cut-off wheel mounted in it and gently sweep over the brass fillets (fig. 219). This will take down the more noticeable high spots. GRIND AWAY AT THE FILLET MATERIAL ONLY!! Any grinding into the steel will cause very unsightly undercutting. It is easy to tell when the grinder hits steel; the steel throws sparks - the brass won't.
71. Now the three joints can be smoothed out with a Dynabrade sander (fig. 220). (If you don't have a Dynabrade sander, see if you can borrow or rent one.) When sanding with the Dynabrade, use a 60 grit belt and expect to wear out two belts for each joint. Do 95% of the sanding on the brass fillet. The remaining 5% of the sanding can be used to smooth out the brass surface as it meets the steel. Here again, undercutting is a definite problem and must be avoided. Undercutting is frustrating because it won't show up until the frame is painted.

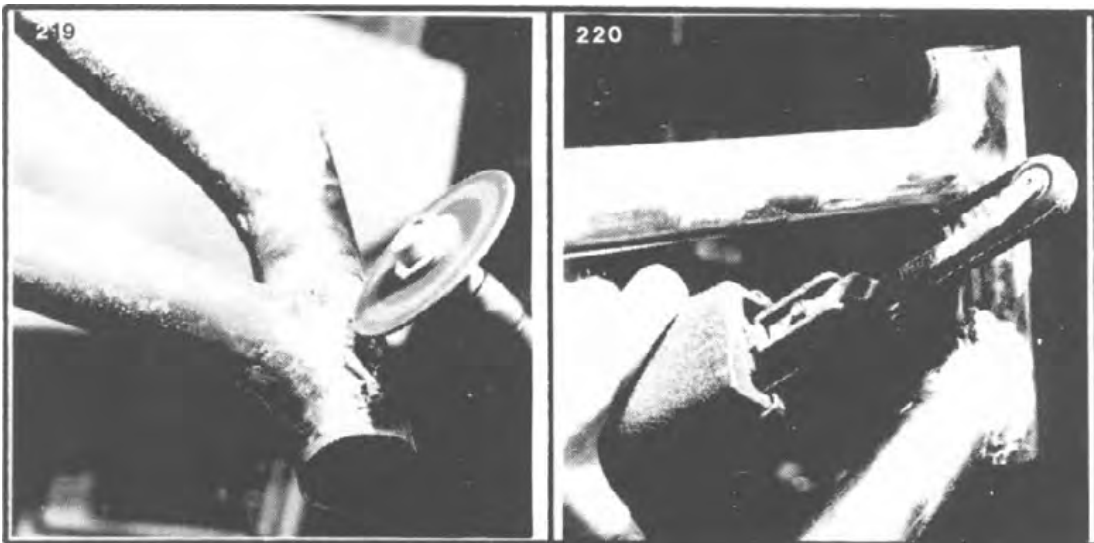

72. Final sanding can be done with strips of emery cloth. Emery cloth can be purchased in 100 foot rolls with a width of 1". Use 100 grit emery cloth strips torn to lengths of about 15". Pull the strip with one hand while holding it down tightly with the thumb of the other hand (fig. 221). This is when you cut the web of skin between the thumb and forefinger and it really hurts! Some sanding can be done shoe shine style (fig. 222), but won't have the cutting power the other way does.

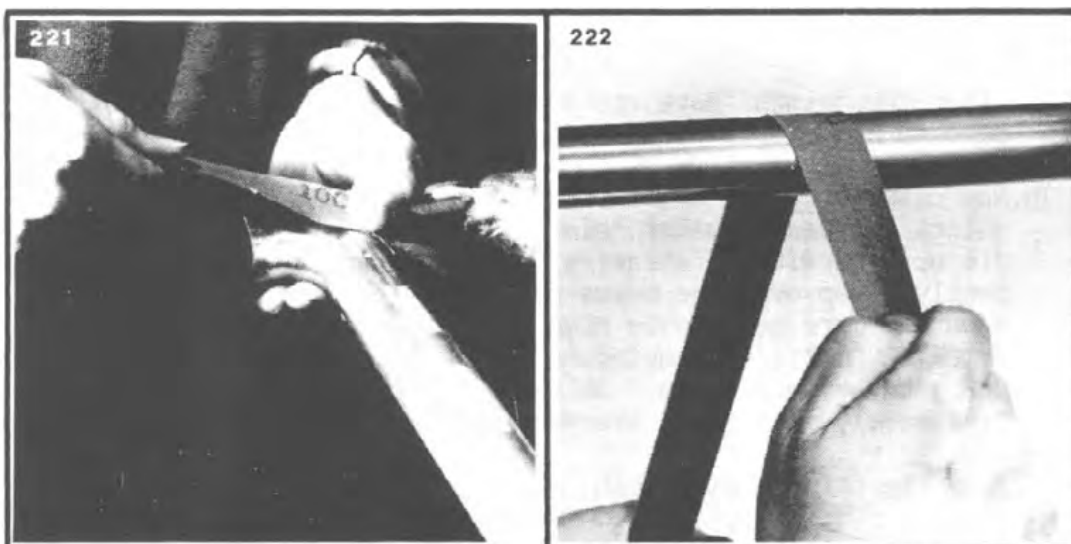

3. Face mill and ream the top of the head tube with Campagnolo tool #733 or equivalent (fig. 78).

<sup>7</sup>4. Face mill and ream the bottom of the head tube with Campagnolo tool #733 or equivalent (fig. 79).

IV. THE FORK - All materials needed for the fork have already been listed. Building the fork is the same as it is for lugged construction. Go to page 3-26 and execute all of the steps for building a fork. (#1 through #42) Return here when finished with the fork.

#### V. THE REAR TRIANGLE

1. If the frame has a 1-1/4" diameter down tube, put 1/16" thick washers in the seat clamp of the rear end jig as shown in fig. 223 to the right.

2. Go to page 3-35 and execute steps 1 through 10. After completing those steps, return here.

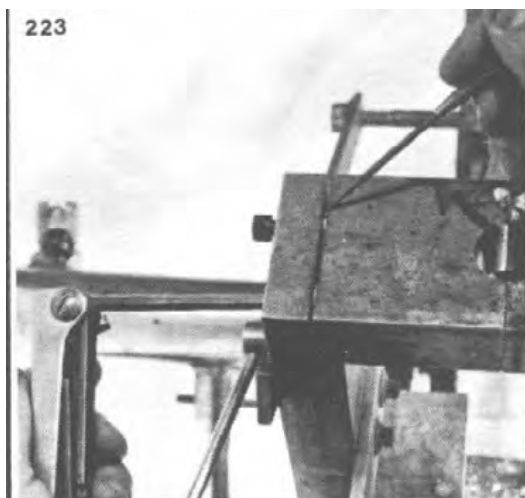

3. Make a choice.

A. Often, tandems and mountain bikes have extra beefy chainstays. If this is true of the frame being built, the rear dropouts can not be silver brazed into place because the gap will be too big to fill. So, clean and prep the ends of the chainstays and the dropouts for brass brazing (Same procedure as used to prep the fillet joints). Apply flux and brass braze the dropouts into the ends of the chainstays. Now, go to page 3-37 and execute steps 14 through 16. After completing those steps, return here.

B. If the chainstays are not too hefty, they can be silver brazed in place. Go to page 3-37 and execute steps 11 through 16. After completing those steps, return here.

4. Miter the chainstays so they will span the distance from the back side of the bottom bracket shell (fig. 224). This is not a very difficult miter to do. It's just tedious. It is important to have both chainstays exactly the same length if using vertical dropouts.

5. Remove the chainstays from the jig and drill two 5/16" air expansion holes into the bottom bracket shell so the chainstays can vent into the bottom bracket (fig. 225).

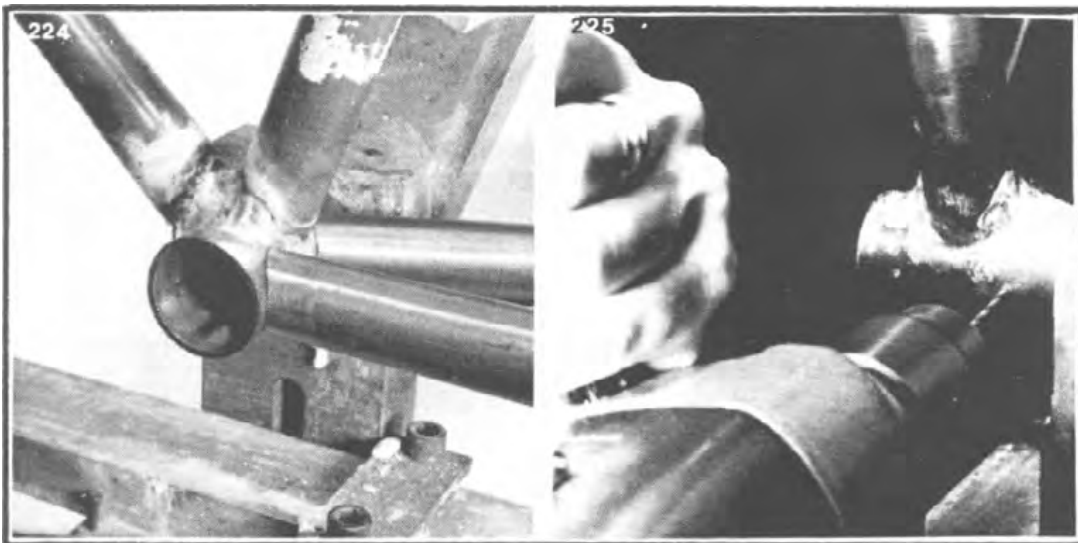

6. Sand the ends of the chainstays clean for fillet brazing.

7. Sand the bottom bracket shell clean for fillet brazing.

Reinstall the chainstays into the jig, apply brass brazing flux, and forget about them for a while.

9. Go to page 3-38 and execute steps 26 through 47. After completing those steps, return here.

10. Tack the chainstays to the bottom bracket shell with the same brazing alloy that is being used to build fillets (fig. 226).



11. Silver braze the seat stays onto the dropouts. (See fig. 37.)

12. Silver braze the slugs onto the sides of the seat tube where it meets the top tube. (This may require some fillet building with silver.) (See fig. 138.)

13. Remove the frame from the rear end jig.

14. Finish building the fillets around the

bottom bracket shell.

15. Clean up the joints around the bottom bracket area with a die grinder, Dynabrade and emery cloth as described earlier.

16. Cosmetically clean up the joint where the dropouts fit into the seat stays.

17. Braze an alien type seat post binder fitting onto the back upper part of the seat tube.

18. Go to page 3-42 and execute steps 54 through 56. After completing those steps, return here.

**VI. BRIDGES AND BRAZE-ONS** - The rest of the frame can be finished the same way a lugged frame is finished. Go to page 3-42 and finish the frame as per the instructions in the bridges and braze-ons section.

PRECISION MEASURING

Inspection is of utmost importance in all aspects of our high tech world. From space shots which send men to the moon, to microprocessors, to nuclear reactors, to plastic chess pieces, we always need to know what quality we are turning out. Proper inspection techniques will tell us this. Two hundred years ago craftsmen made flintlock rifles by hand. Parts were not interchangeable, and when something had to be replaced, a new piece had to be made by hand. There was no guarantee from one rifle to the next of what size parts would be or even the quality of each part. Then, in 1798, Eli Whitney was given a government contract to produce 10,000 muskets. Whitney felt that parts should be interchangeable from one gun to the next, and consequently introduced "the uniformity system". By the time of the bicycle boom in the 1800's interchangeable parts were a part of everyday life. And at that time, inspection of manufactured parts had become quite sophisticated. On the right is an excerpt from an 1891 edition of the Eagle Bicycles catalogue that bears this out: Not very tight tolerances back then, were there? Of course, our Numerex machines, Cordax machines, and Laser beams of today have left our grandfathers in the dust. The important question is whether bicycle framebuilders have left their grandfathers in the dust as well. There are still bicycle framebuilders today who are building bikes like the flintlock makers of bygone days. They have no idea what head tube angle a bike has when it rolls out the door. They have no way of predicting what head tube angle the next frame will have. They have no way of producing a fork with a

THE EAGLE BICYCLE MFG. COMPANY.

bearings are not so noticeable as in a machine depending solely upon the muscles of the human body for motion. In a bicycle the least additional friction is as quickly noticed by the experienced rider as a stiff leg would be by a pedestrian. Experience has shown that steel balls are the best medium to be placed between the metal surfaces of a bearing, and that by allowing them to roll in a circle between hardened surfaces the wear and friction is reduced to a minimum. It can easily be seen that the balls and bearing have to be very accurate in size and surface, for they must be adjusted until there is no side play, and yet run freely. The balls used in the bearings of the Eagle are of tool steel, drop-forged, rolled and ground. The size in the large and small wheels is  $\frac{3}{32}$  12 thousandths of an inch diameter, and in the pedals 187 thousandths of an inch diameter. Before being used each ball is separately tested in a micrometer gauge, and if it vary half

a thousandth part of an inch in diameter, or from a perfect round, it is discarded. The sectional illustrations will show the balls, cones and method of adjusting as used in the Eagle. As the balls and bearing cones are tempered PS hard as glass, and are adjusted until there is not a thousandth of an inch in play, it is very evident that if one ball were a  $\frac{1}{1000}$  of an inch larger than the rest in a bearing, it would prevent the bearing from being properly adjusted, leaving all the other balls loose, and probably result in the breaking of the large ball, or the injury of the cones. These bearings are all made by us with the greatest care; the cones, after being hardened, are

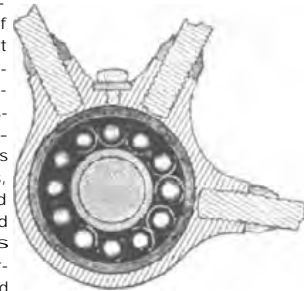

ground with an emery wheel to insure their being perfectly true, and every bearing is carefully tested before the machine is allowed to leave the factory.

The Eagle Pedal, while it is in general form and appearance similar to the usual popular form of ball-bearing pedal, has advantages in shape and method of supporting the grip rubbers

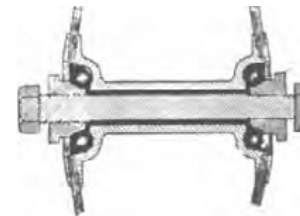

specified amount of rake. They don't even know if a brake bridge will be the correct height for a short reach brake and keep the dropouts 126mm apart at the same time. Some builders simply dismiss the importance of whether their bikes meet specs or not. People who build frames like this are in the same league with the flintlock makers of yesteryear.

One part of inspection is precision measuring which can and should be done by the framebuilder. In the earlier exerpt, it was plain to see that their tolerances were not very close back then. After all, bearings today come in tolerances of plus or minus .000003"! (That's right - three millionths.) The next question is, "Why would anyone want to measure a frame down to millionths of an inch?" No one would, and anyone who tries is crazy. The idea is to attain a happy medium somewhere between the flintlock maker and the aerospace engineer. By doing inspection of bicycle frames in the form of precision measuring, the builder can more confidently ensure the quality control of the frame. By choosing a range of tolerances that are not too hard to achieve but tight enough to ensure uniformity from one frame to the next, the builder knows exactly where he stands and can improve accordingly.

#### WHAT IS PRECISION MEASURING?

It's easy to measure the width of a piece of writing paper with a ruler. It's 8-1/2". Any second-grader can do that. How about measuring its thickness? That's not so easy. The ruler won't work any more. We need something more accurate, something that is calibrated in smaller units. This is the first aspect of precision measuring--MINUTE CALIBRATION. In order for it to be a precision measurement, it must be tiny. Measurements in calibrations smaller than 1/64" can be considered precision in nature.

Measure the head of a pin with a ruler and write down the answer. Then hand the pin and ruler to another person and have him do the same. Pass it on to the next person and so on. Compare answers. Chances are, they are not the same. With a micrometer, the answers would be all the same or so close that there would be little argument. This brings us to the second concept of precision measuring--REPEATABILITY. No matter how many times the object is measured or who measures it, the answer is the same.

Ask a jockey how tall a horse is. He may tell you it is 14 hands high. Ask an Englishman how heavy he is. He may tell you he weighs 12 stones. Ask a yachtsman how fast he is traveling. He may tell you 12 knots. Ask an acupuncturist how far it is from your nose to your ear lobe. He may say it is 4 puces. Inches, hogsheads, leagues, decisters, cubits, feet, barrels, drums, acres, hectares, barns, sheds, and AU's are all measurements of one sort or another. Each is based on a different



unit and many have no relation to one another. Precision measuring, in this country, bases everything on the inch and decimal divisions thereof. More advanced countries base their precision measurement on millimeters and divisions thereof. This is the last aspect of precision measuring--STANDARDIZATION. The I.S.O. dictates to us which units we will use in precision measurement.

#### DIVIDING UP THE INCH AND CENTIMETER

There are three different popular methods of reading the measurements taken in an inspection room:

- A. THE LED READOUT- With the coming of microchips and computers, we now have those red square shaped numbers on everything from children's toys to space shuttle control panels. A variety of precision tools comes with LED readouts, certain models of micrometers, calipers, and height gages come with this luxury. A tool with an LED readout can be read with no practice and no knowledge of how the tool works. If you can afford tools such as this, go ahead and buy them.
- B. THE DIAL INDICATOR- Many precision tools come equipped with a round dial with a needle that gives readings in increments of thousandths or ten-thousandths. (From now on ten-thousandths will be simply referred to as tenths.) These too are relatively easy to read and can be figured out in a fairly short amount of time.
- C. THE VERNIER SCALE- Most tools will have a scale along the side of the main scale of the tool. This auxiliary or vernier scale takes time to learn and requires practice to use it well. Since most of the tools you buy will be equipped with a vernier, that is the scale that will be discussed in this book.

Perhaps the best tool to start with is the vernier caliper. First of all, it is relatively inexpensive. Secondly, it is a tool that no framebuilder or bike mechanic should be without. Thirdly, it has a vernier and is read much the same way as any other of the precision tools having a vernier scale.

Look at the main scale first. It consists of a shaft that is usually 6" long. One edge of the main scale will have inches broken down into ten equal parts; each tenth of an inch should be considered  $100/1000$ " (written .100" - see fig. 228). Now, look a little closer. Each division of .100" is broken up again into 4 equal parts. These smaller divisions are  $25/1000$ " (written .025" - see fig. 229). When we take a measurement, we have to add these values up in our heads.

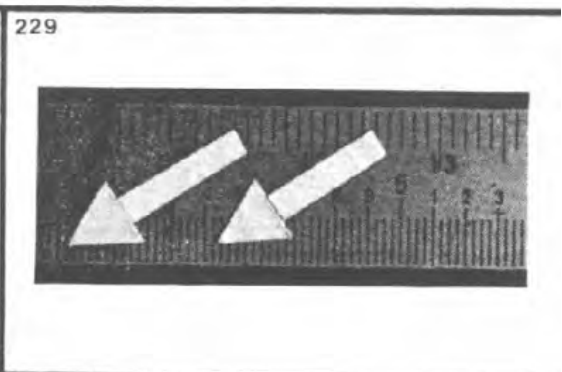
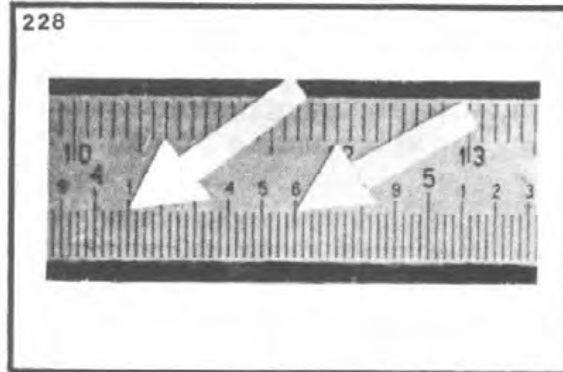

There is a stationary jaw and a sliding jaw on the caliper. Notice that along one edge of the sliding jaw is a series of numbers from 0 to 25. This set of numbers is the vernier scale. A very close inspection of the vernier scale shows that only one mark on the vernier lines up with one mark on the main scale. If the 7 mark on the vernier lines up with a mark on the main scale no other marks line up. Therefore the 7 should be made note of. Fig. 230 below shows a caliper on which the 7 mark lines up.

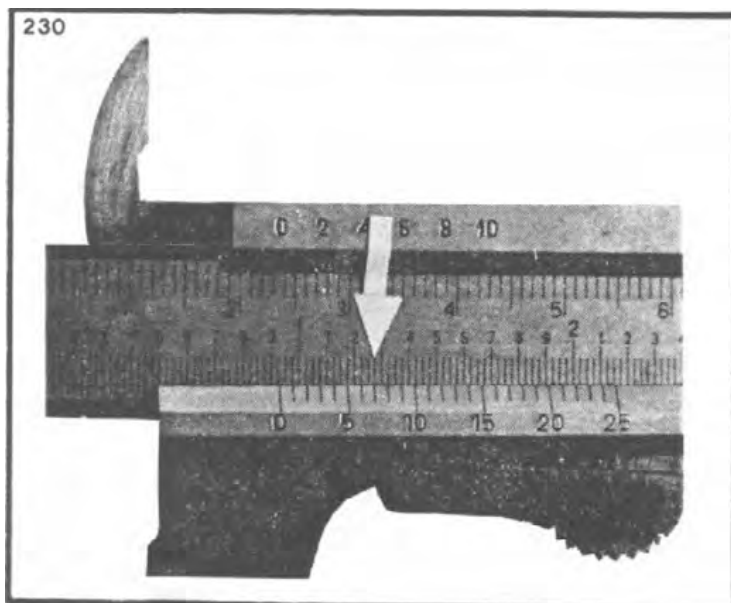

Now let's try a measurement. Slide the jaws together on the down tube of a bicycle frame. We must watch the location of the zero on the vernier scale. Let's add up the divisions we have

gone past with that zero. We have passed the large number 1 on the main scale but haven't come to the large number 2 yet. In other words, we have gone one inch but not yet two inches. Write down 1.000" on a piece of paper. Now let's look at the smaller set of numbers between the large 1 and the large 2. Note that we have passed the small number 1 with our vernier zero but have not yet come to the small number 2. In other words, we have gone .100" but not yet .200". Write 0.100" below the other number on that piece of paper. Now let's look at the four tiny divisions after the small number 1 on the main scale. If you squint, you can see we have just barely gone past the first mark after the small number 1 (For those of you who are more experienced, don't forget the coat of paint adds .002" to the radius of the tube.). This means we have gone .025" but have not yet come to .050". Write down 0.025" under the two other numbers on that piece of paper. Let's look at the vernier now. Which mark on the vernier scale lines up with a mark on the main scale? Hopefully, it will be the 4, which means .004". Write 0.004" on the piece of paper. The next step is to add the four numbers up to get the answer for the measurement. The vernier in fig. 231 below shows the reading we just took.

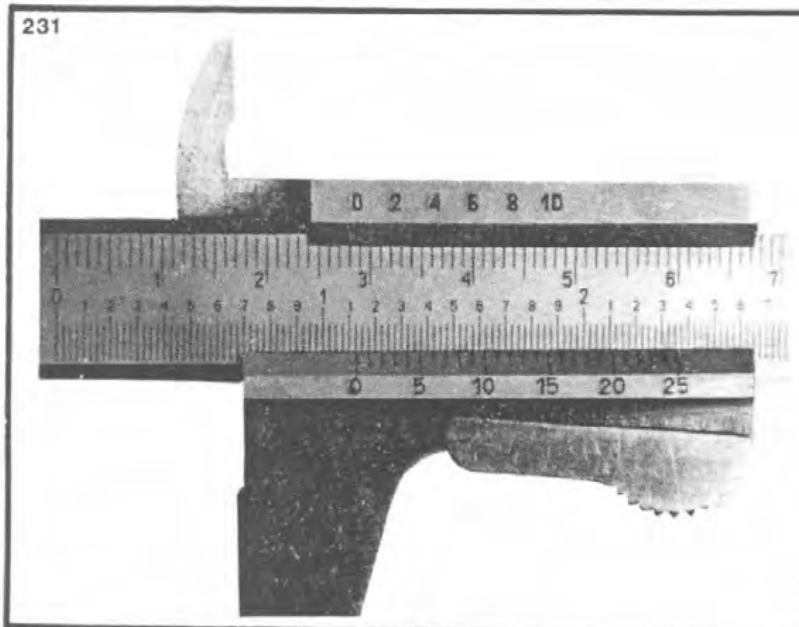

$$\begin{array}{r}
 1.000'' \\
 0.100'' \\
 0.025'' \\
 + 0.004'' \\
 \hline
 1.129''
 \end{array}$$

The metric version is done in exactly the same way. The photo above shows 2 whole centimeters plus 9 whole millimeters plus .7 millimeters on the vernier scale. Think of 9 millimeters as .9 centimeters and .7 millimeters as .07 centimeters. Now add the three values up as done on the right. A good caliper will have both Metric and English calibrations on it.

$$\begin{array}{r}
 2.00\text{cm} \quad 2.00\text{cm} \\
 9.00\text{mm OR} \quad .9\text{ cm} \\
 \underline{.7\text{mm}} \quad + \underline{.07\text{cm}} \\
 7 \quad 2.97\text{cm}
 \end{array}$$

$$\begin{array}{r}
 20.0\text{mm} \\
 9.0\text{mm} \\
 \text{OR} \quad \underline{+ .7\text{mm}} \\
 29.7\text{mm}
 \end{array}$$

That is measuring with a vernier caliper. By following those steps of recording and adding the successive increments on the main scale and vernier scale, any measurement from 0" to 6" can be taken. The vernier height gage (fig. 232) has a similar scale and can be adapted to almost instantly after learning the vernier caliper. The bevel protractor (fig. 233) is also quite easy to use after mastering the vernier caliper. The only differences with the vernier on the bevel protractor are that it is on a curved surface and it measures degrees and minutes instead of inches or centimeters.

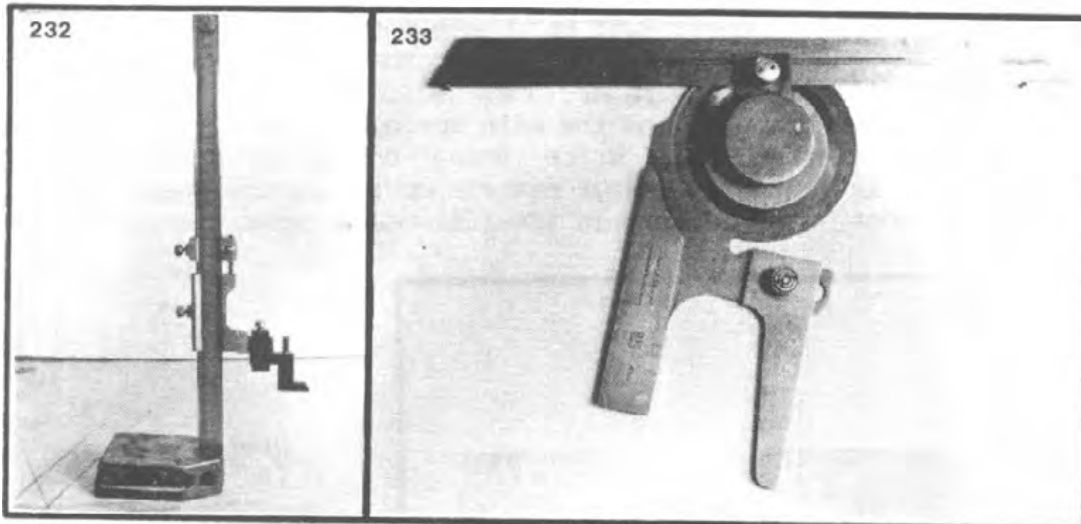

Another tool that all framebuilders should be familiar with is the micrometer. The micrometer is also available with LED readouts or with a vernier scale. However, most builders will have no need to go to such small increments with a micrometer. (A micrometer with a vernier scale measures down to "tenths".) Therefore, a standard "mike" with no auxiliary scale is sufficient.

Mikes come in different sizes too. Each mike only measures a span of an inch (25mm for metric models). In other words, the smallest size mike will measure anything from 0" to 1". the next size will measure from 1" to 2", and so on. A 1" mike is a good item to own. A 2" mike is optional - most builders could get along without it. A 3" mike is questionable - about the only thing that can be measured with it is bottom bracket width. A 4" mike is getting too extravagant for the average framebuilder. It has no use in framebuilding. A 5" mike could be used to measure hub widths but is not really necessary. With bicycles, Metric mikes work well since specs are usually in metric.

Measuring with a mike is similar to measuring with a vernier caliper but due to some basic differences, it will be explained here briefly. The micrometer is made up of eight main parts as shown in fig. 234 below:

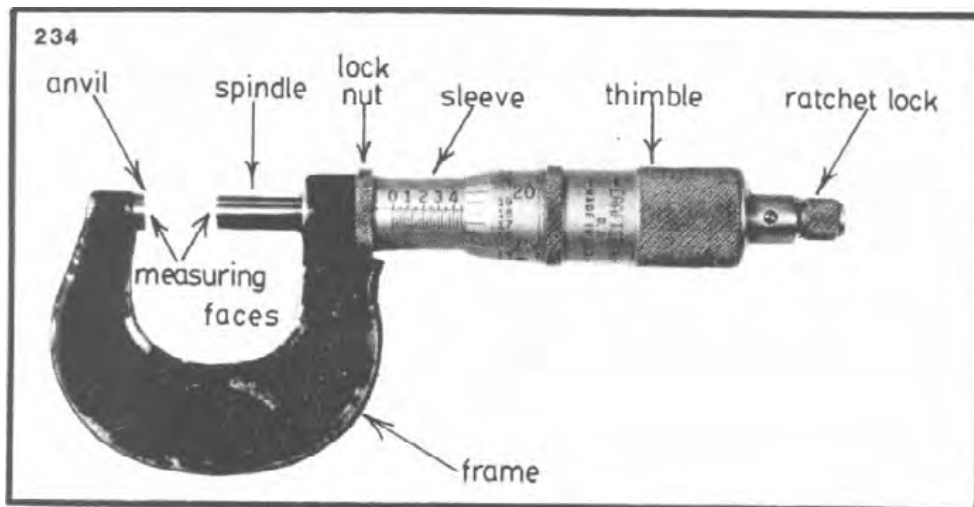

When measuring with the mike, put the piece to be measured between the anvil and the spindle. Tighten the thimble by turning the ratchet stop with the thumb and forefinger. When the ratchet clicks 2 or 3 times, the mike is tight enough for a reading. The mike is read first in inches, then in sets of hundredths, then in sets of twenty-five thousandths, then in individual thousandths. This is similar to the vernier caliper but the whole set-up is read sideways while it is wrapped around a cylinder (the sleeve).

To get the number of whole inches, take the first of the two numbers that designate the size of the mike and write that down on a piece of paper. For example; if it is a 0" to 1" mike, write down 0.000". If it is a 1" to 2" mike, write down 1.000". If it is a 2" to 3" mike, write down 2.000" - and so on.

To get hundredths, note how the thimble will cover up the numbers on the sleeve as it is screwed down toward the piece to be measured. Find the largest number on the sleeve that is still visible and write that down on the paper as follows; If 3 is the largest number showing, write down .300". If 7 is the largest number showing, write down .700", etc.

Groups of twenty-five thousandths can be read in the same way as with the caliper. Write down how many groups of twenty-five thousandths appear after the highest visible number on the sleeve but before the thimble. If only one group appears, write down .025". If two groups appear, write down .050". If three groups appear, write down .075".

To get individual thousandths, look at the set of numbers that encircle the thimble. These numbers range from 0 to 25 and only one of them will line up with the main line on the sleeve. If the 7 lines up, write down ".007". If the 12 lines up, write down ".012", etc.

Here is a practical example. The mike pictured in fig. 235 below, is a 0" to 1" mike, so write down 0.000". Note that the highest number still visible on the sleeve is 4. Write down ".400". Two groups of twenty-five thousandths are showing, so write down ".050". The number 13 lines up with the line on the sleeve, so write down ".013". Now, add up the column of figures. Your answer should be 0.463". With practice, all of this can be done mentally without writing figures down.

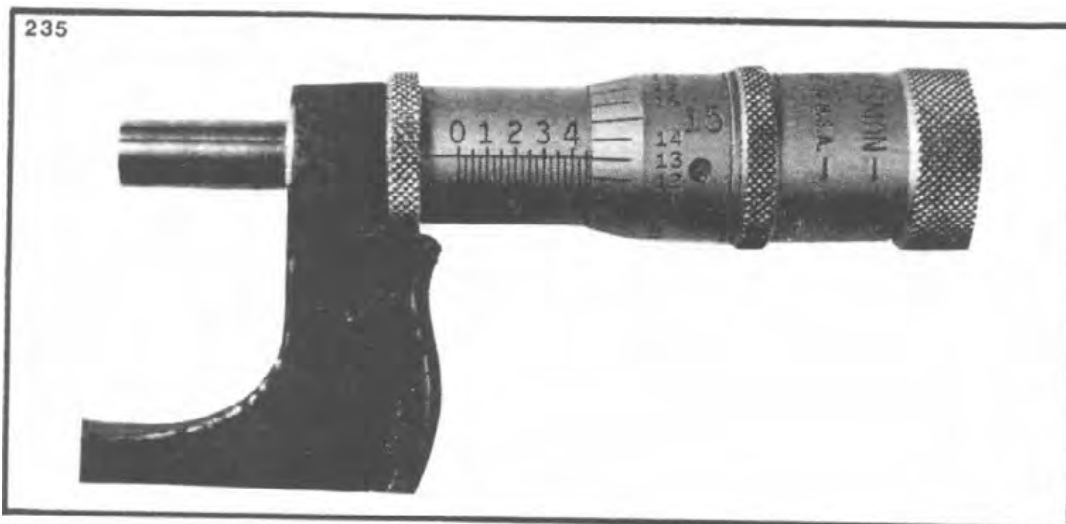
$$\begin{array}{r}
 0.000'' \\
 .400'' \\
 .050'' \\
 + .013'' \\
 \hline
 0.463''
 \end{array}$$

After familiarity is established with vernier calipers and micrometers, many other precision tools will be easy to read and interpret. The vernier scale is an integral part of many precision tools and the micrometer head can be found mounted to precision tools as well as fixtures. Armed with this knowledge of reading the scales of precision tools, you're ready to go on to find out more about their applications in bicycle framebuilding.

## WORKING ON THE SURFACE PLATE

A surface plate can be made of granite, marble, or a piece of blanchard ground steel. Stone surface plates are commercially made and are definitely far superior to metal plates which are usually ordered to specs from a blanchard grinding company. The main items to consider in choosing a surface table are; STABILITY, TOLERANCES, SIZE, MATERIAL, and FINISH.

### STABILITY

How well does the table hold its shape and flatness over the years? Stone is by far the most stable. Cast iron and cold rolled steel come in a close second. Stone is affected very little by heat, cold, humidity, or pressure. Variations in flatness can be observed with metal tops. If the plate will be kept inside a heated shop and supported underneath substantially, there should be no problems with the stability of a metal table.

### TOLERANCES

How accurately is the table ground? Stone plates are ground to plus or minus .0002" or less. A blanchard ground steel plate will probably be ground to tolerances of plus or minus .005". For most applications in framebuilding, a blanchard ground plate will be adequate. Tighter tolerances always cost more. If the budget can handle it, by all means get the more precise stone plate.

### SIZE

Surface plates come in a variety of sizes. Some may be as small as 6" square and others may be as big as 10 or 20 feet across. In choosing the size of a surface table, only one consideration must be weighed. How long is the longest span that will ever be measured on this plate? Ideally, since frames seldom get longer than 40" from the rear dropouts to the head tube, a 40" long plate would be nice. In the other direction, bicycles seldom get taller than a 27" seat tube so, a 27" wide plate would be nice. A steel, blanchard ground plate of these dimensions should be at least 1" thick. Stone plates have thickness predetermined by the manufacturer. That's a pretty big plate and a lot of steel or stone to own. To cut corners, a framebuilder could cut the length by a third and flip-flop the frame if necessary. That should get it down to a workable size and an affordable price.

## MATERIAL

Stone plates are commonly available in pink or black granite. Either is more than adequate for framebuilding applications. Metal plates could be made of almost anything, but should only be made of cast iron or cold-rolled steel. Of all the metals available, these two will prove to be the most stable. Avoid aluminum or stainless steel surface plates. They will both do a hula dance during a 20 degree temperature change!

## FINISH

Of course a fine finish is of the utmost importance in selecting a surface plate. Blanchard grinding will leave a pattern of radiating arcs in the surface of the steel. These grooves are extremely fine but, nevertheless, can be felt while lightly rubbing a hand over the surface. Tool bases will sit nicely on top of these marks with no problem. The only way to get the steel surface smoother is to have it precision ground. (This would add so much to the cost of the plate that it would be just as cheap to buy a stone plate.) Stone plates may have a glossy or satin finish. The theory is that the satin finish does not allow a cushion of air to develop under the tool base. Any of these finishes are more than adequate for framebuilding applications.

## ALTERNATE SOURCES FOR SURFACE PLATES

It is not always necessary to lay out a large amount of cash for a surface plate. Surface plates are in abundance around us every day. The top of a large table saw makes a beautiful surface plate after the blade is dropped and the fence removed. Surface planer beds, drill press tables, jointer tables, marble table tops and even gravestones can be used as surface plates. One good source of fine surface plates is old printer's typesetting tables. They are made of marble and are ground to fine tolerances. They are also readily available because of the massive technological changes in the printing industry. (I was lucky enough to find 2 of them for less than \$100.00 apiece!) Hunt around.

I

There are two drawbacks to using steel surface plates. First of all, they rust. Keep them lightly oiled and away from humidity or dripping water sources. Second, they dent. If something hard and heavy is dropped on a steel plate, it will leave a dent and an adjacent high spot. Be careful.



## BILATERAL SYMMETRY

Like human beings, bicycle frames have bilateral symmetry. In other words, if we slice a bicycle frame down the center to split it evenly into right and left halves, each half will be a mirror image of the other in every sense. If the frame is damaged or built misaligned, the halves will be slightly different from each other. When we mount a frame on a surface plate, we will be looking for these variations in bilateral symmetry. If the seat tube has deflection as it leaves the bottom bracket, if the dropouts are both to one side, or if the head tube has twist, this bilateral symmetry is altered. In which case, the problem must be remedied, tolerated, or the frame disposed of.

## MOUNTING THE FRAME TO THE SURFACE PLATE

Before doing any inspection of the frame set whatsoever, the bottom bracket faces must be faced with a Campagnolo tool #725 or an equivalent that uses inserted guides. After they are faced, the faces of the bottom bracket shell provide one of the most accurate surfaces to locate against.

The frame must be mounted above the surface plate so that the bottom bracket faces are parallel to the surface of the plate. If there are no mounting holes in the surface plate, a heavy counterbalance can be machined to secure the frame in the proper position (See fig. 236). If threaded holes are provided in the surface plate a more simple mounting device can be machined (See illustration #127 below.)

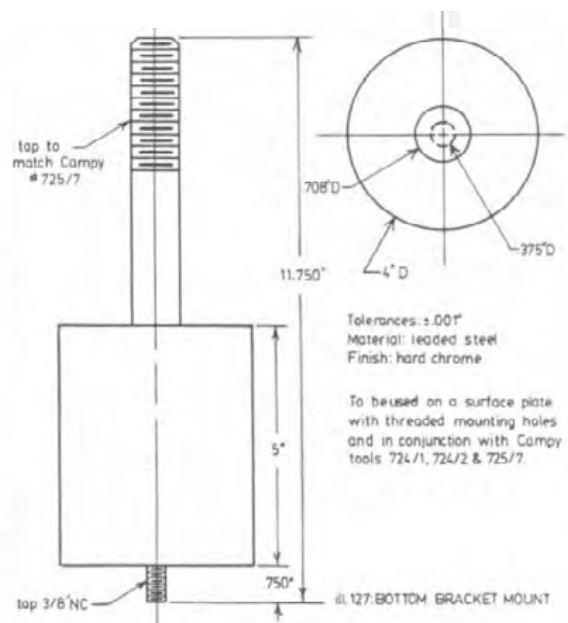
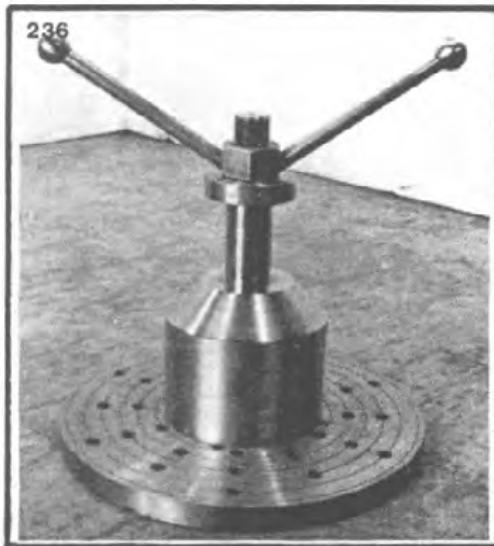

When the frame is mounted horizontally on the plate, the front and rear triangles may be checked to see if any of the tubes deviate from the central plane of the frame. If there is any deviation, straightening should not be done while the frame is mounted in the inspection fixtures. Forcing and torquing on inspection fixtures will only serve to take them out of tolerance. If that happens, they become useless. Ideally, the crooked frame should be removed from the inspection fixtures, placed in a Park FRS-1 stand and straightened there. (Use of the FRS-1 stand will be covered in the frame repair section available in August of 1986.)

#### CHECKING FOR SEAT TUBE DEFLECTION

Perhaps the first item to check is whether the seat tube is deflected to the left or right as it leaves the bottom bracket shell. (Just as a human being, a bicycle frame has a left and a right side. Even when a person lies in bed on their side, their left hand is still left and the right hand is still right. The same goes for a frame.) To determine whether a seat tube has deflection, place the scribe of the vernier height gage on the seat tube close to the bottom bracket shell and take a reading (fig. 237). Now slide the vernier height gage up close to the seat lug and take another reading (fig. 238). The difference of the two readings is the amount of deflection. (Remember when we did a similar check with the bottom bracket mike? The amount of deflection was 1/2 of the difference between the two readings. Not so on the surface plate. The readings are only taken on one side of the frame, so the difference between the two readings is the actual deflection.)

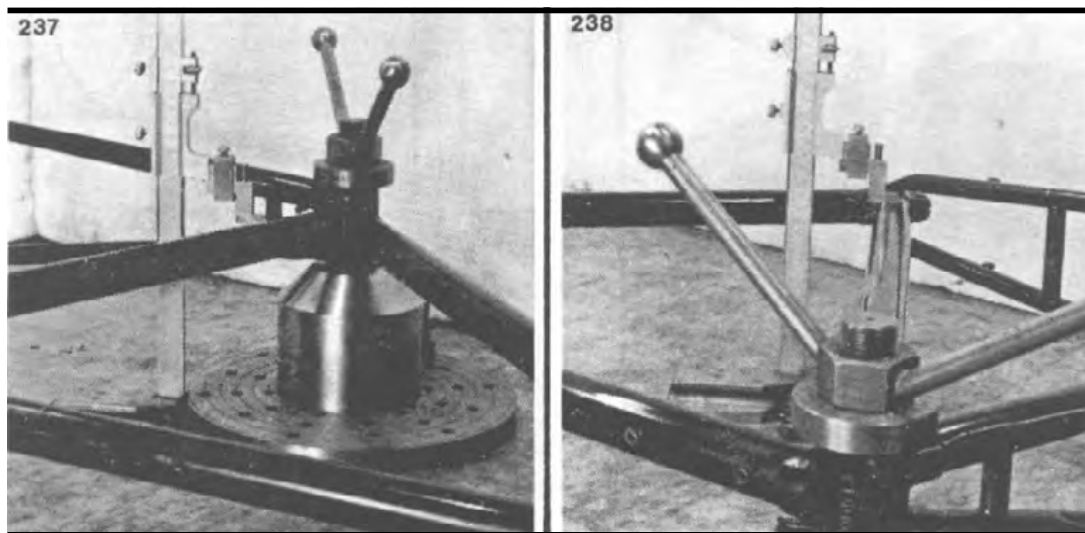

How much deflection is acceptable? In the case of mass produced frames, deflection of as much as .250" over a span of 18" is fairly common! That is not to say it is acceptable. However, consider the price range of the bike. Did the customer even pay for tight tolerances? On more expensive framesets, deflection of .125" may be quite common. On a high quality limited production frameset, deflection of more than .050" should be considered unacceptable. In the case of a custom frame, an experienced builder should easily be able to keep that figure under .050" and with practice approach readings as small as .025" deflection.

#### CHECKING FOR DOWN TUBE DEFLECTION

Checking for down tube deflection is done the same way as checking for seat tube deflection. Take the first reading close to the bottom bracket shell (fig. 239). Take the second reading just below the point where the down tube meets the head tube (fig. 240) The same tolerances apply.

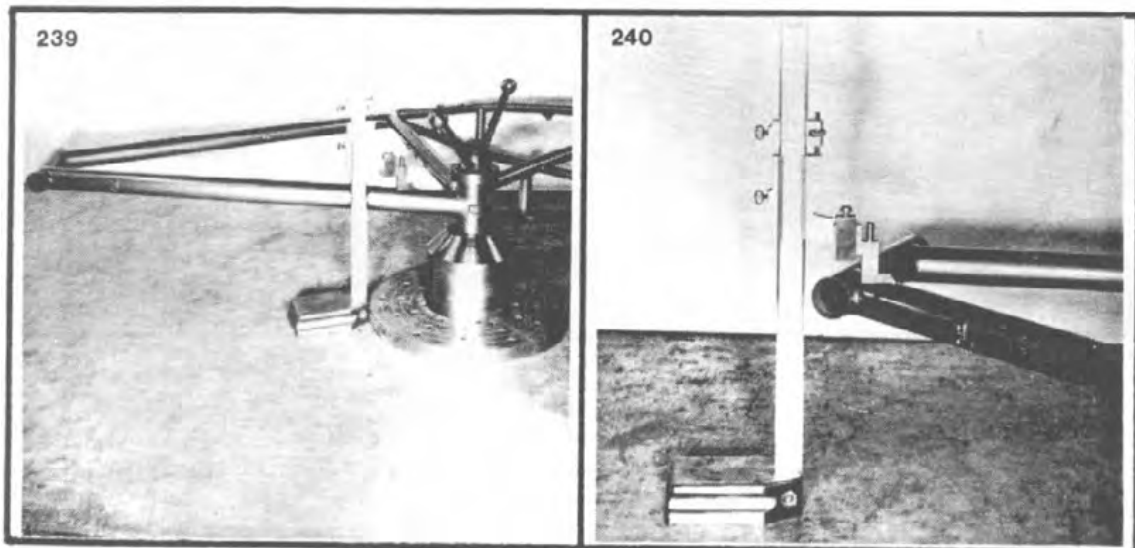

"Aha," some of the more experienced readers may be saying, "These tubes are not always perfectly round!" This is true. If a more accurate reading is desired, mount a dial indicator to the vernier height gage and take a constant reading along the entire length of the tube. This is what is commonly called splitting hairs. Average runout on even the highest quality tubing can be as much as .005" out of round on the radius. This should be taken into consideration in inspection techniques. If runout is .005", a person is crazy to try to hold tolerances of less than .005". A frame holding tolerances of less than .010" might occur on an average of 1 out of 100 frames. Tolerances of .015" would be quite difficult to achieve. Tolerances of .025" over a span of 18" are more reasonable.

## MEASURING HEAD TUBE TWIST

Head tube twist refers to the problem of having a head tube that lies in a plane that is askew with the plane of the seat tube. This would cause the bike's wheels to run in different tracks, which could result in severe handling problems. Readings can be taken by mounting a dial indicator to the height gage and finding the low spot on the press fit dimension that accepts the lower head cup (fig. 241). Set the dial at zero and then take the same measurement on the press fit dimension that accepts the upper head cup (fig. 242).

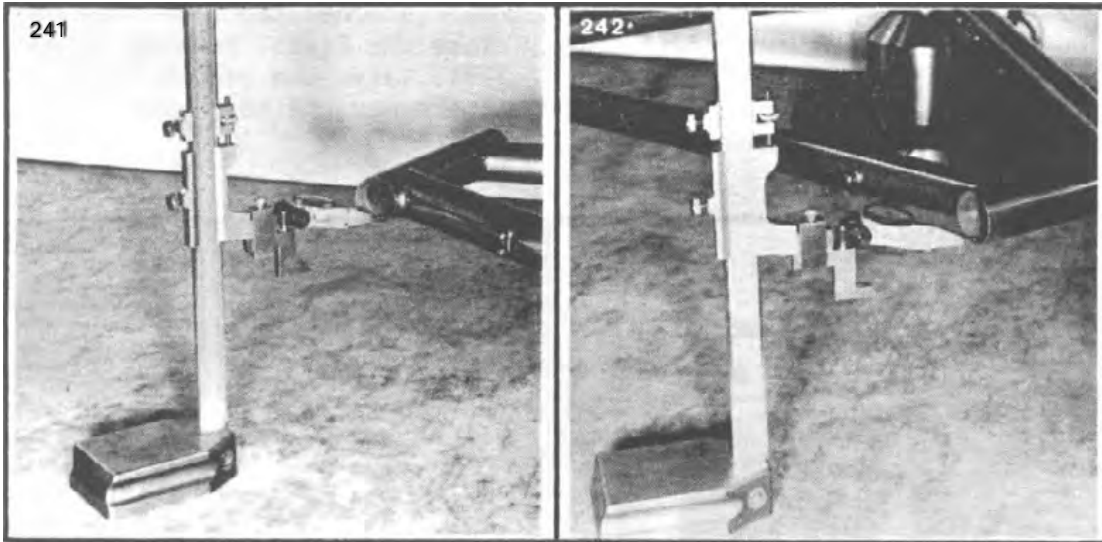

Let's say that the first measurement is 8.763" up from the surface plate and the second measurement is 8.863" up from the surface plate. Now measure the length of the head tube. Let's say it's 6.000" long. This means that the head tube rises away from the surface plate .010" over a span of 6.000". This doesn't mean much until we compare it with a 6.000" length of the seat tube. Take a height measurement anywhere along the seat tube. Now, take another one 6.000" away from the first one. Record how much the seat tube rises or falls over a span of 6.000". Compare this with how much the head tube rises or falls in that amount of distance. If they both rise the same amount, that's OK. If they both fall the same amount, that's OK. If there is a difference between the two, there may be a problem. Tolerances should be tight on head tube twist. If the head tube rises or falls over .010" more than the seat tube, the wheels will be running in different tracks at least .060" apart where they meet the ground. Strive for a difference of rise or fall between the head tube and seat tube of no more than .010" over a span of 6.000".

## CHECKING THE REAR TRIANGLE PLANE

In checking the plane of the rear triangle, the first thing that must be done is to establish the theoretical center of the bottom bracket shell. The easiest way to do this is to take a height reading of the surface on the fixture where the bottom bracket shell rests (fig. 243). Then get a height reading of the surface that comes in contact with the other bottom bracket face (fig. 244). The half-way point between these two measurements is the theoretical center of the bottom bracket shell. A good way to obtain these measurements is to use the universal gage as shown below.

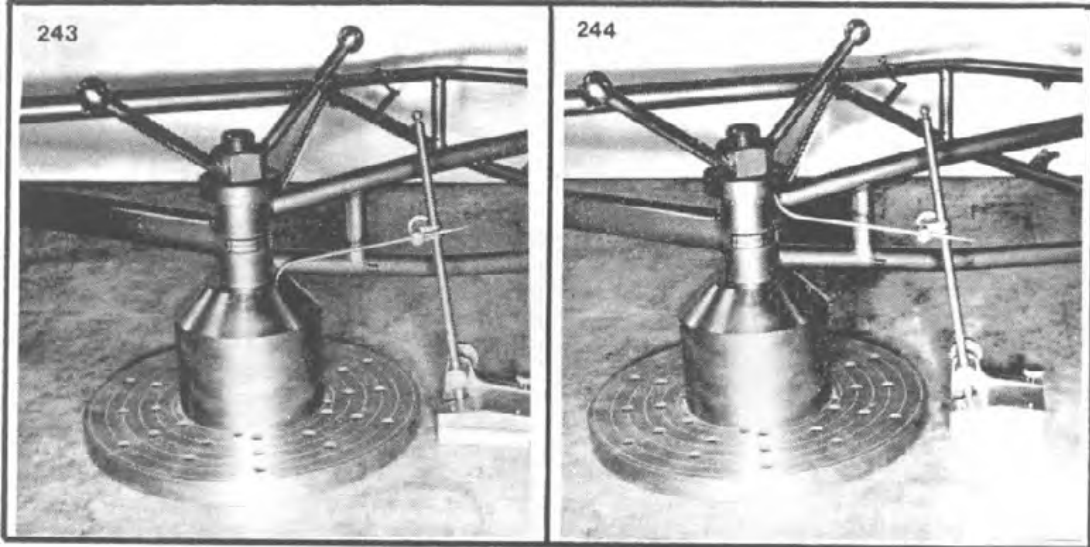

After the heights are found with the universal gage, they can be quantified into inches or centimeters by one of two methods as shown in figures 245 and 246 below.

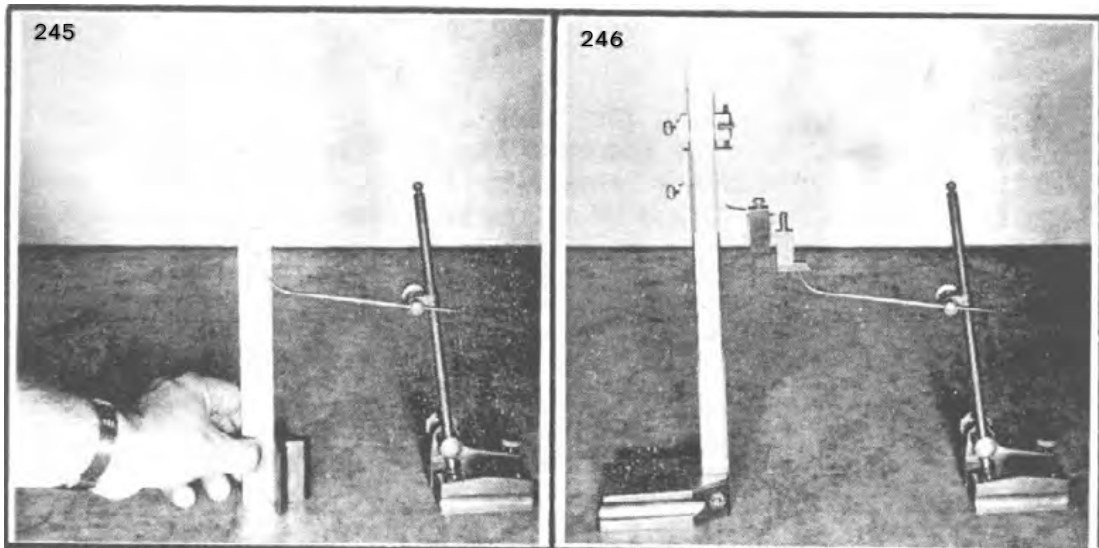

When the theoretical center (TC) has been established, measurements can be taken on the rear dropouts. First, take a height measurement to the inside face of the dropout closest to the surface plate (fig. 247). Call this measurement H1. Then take a height measurement on the outside face of the dropout furthest from the surface plate (fig. 248). Call this measurement H2. Take a reading of the thickness of a dropout (fig. 249). Call this measurement T.

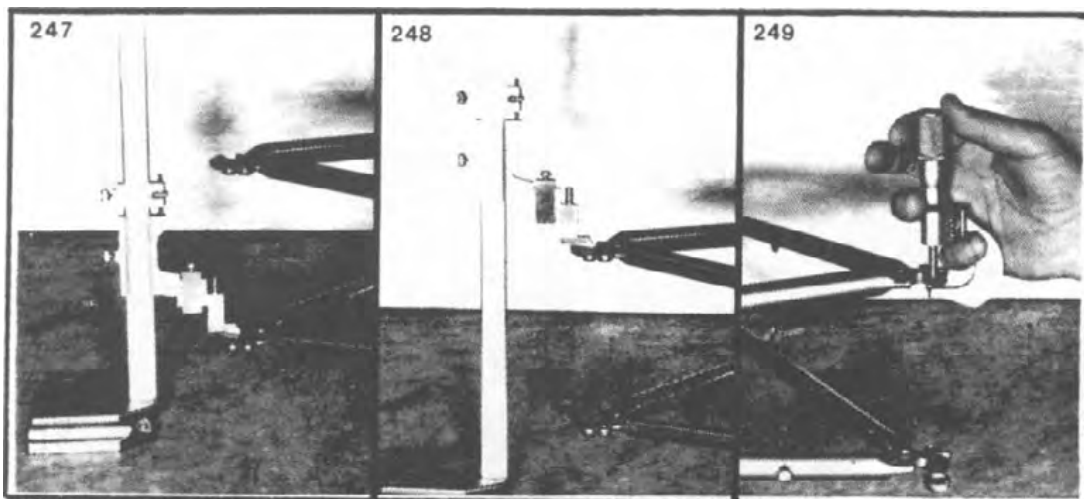

With these values, the exact orientation of the rear triangle can be determined.

$$\text{Dropout Spacing (for hub width)} = H2 - H1 - T$$

With the Dropout Spacing (DS) and the TC a theoretical rear triangle can be set up. The theoretical rear triangle diagram can be filled in with numbers that would simulate a perfect rear triangle with the given TC and DS. Here are formulas to fill out the diagram.

$$\text{Theoretical H1} = \text{TC} - (.5 \times \text{DS})$$

$$\text{Theoretical H2} = \text{TC} + (.5 \times \text{DS}) + T$$

Here is the diagram to fill in with the TC, DS, Theoretical H1, and Theoretical H2.

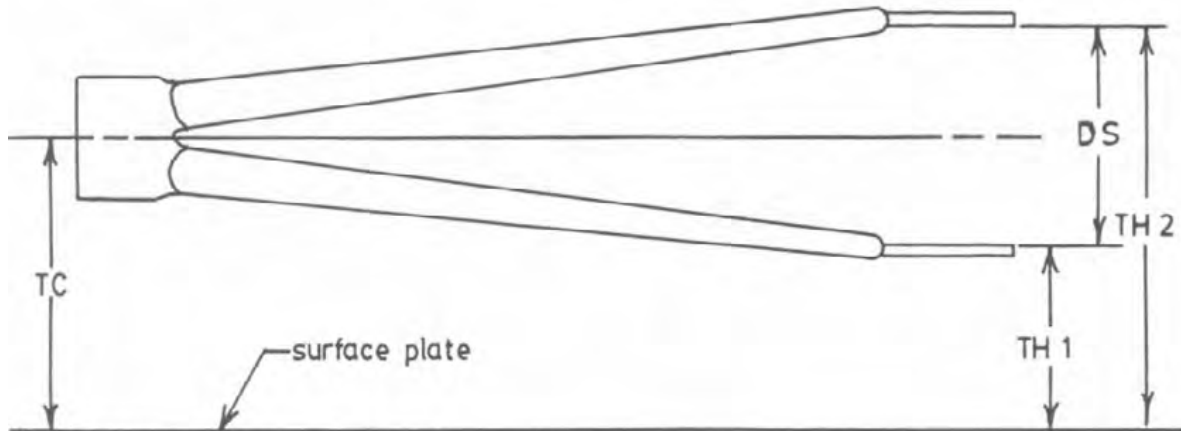

ill. 128: Theoretical rear triangle

Now, take the actual H1 and H2 found on the surface plate and compare them with the theoretical H1 and H2 figures. This is where the alignment of the rear triangle is determined. Ideally, H1 should match Theoretical H1 and H2 should match Theoretical H2. If there is not a match, cold setting must be done to correct this. Tolerances that might be expected on a top notch custom frame would be plus or minus .025". If there is a bad match between the theoretical measurements and the actual measurements, this will show up as bad chain line which could cause such problems as excessive chatter in certain gears, excessive rubbing on the inside face of the outer chainring or even unwanted "automatic" shifting in certain gears.

#### MOUNTING THE FRAME VERTICALLY ON THE SURFACE PLATE

Vertical mounting requires two items: 1-the fork that was built to match the frame and 2-either a real or dummy headset. A set of dummy hubs are mounted in a pair of V-blocks (fig. 250). The dropouts are then set in place on the dummy hubs (figs. 251 & 252). The V-blocks are then set on top of parallels or some other type of precision pedestal (figs. 251, 252, & 253). With the frame in this position (fig. 253), bottom bracket drop, seat tube angle, and head tube angle can be measured.

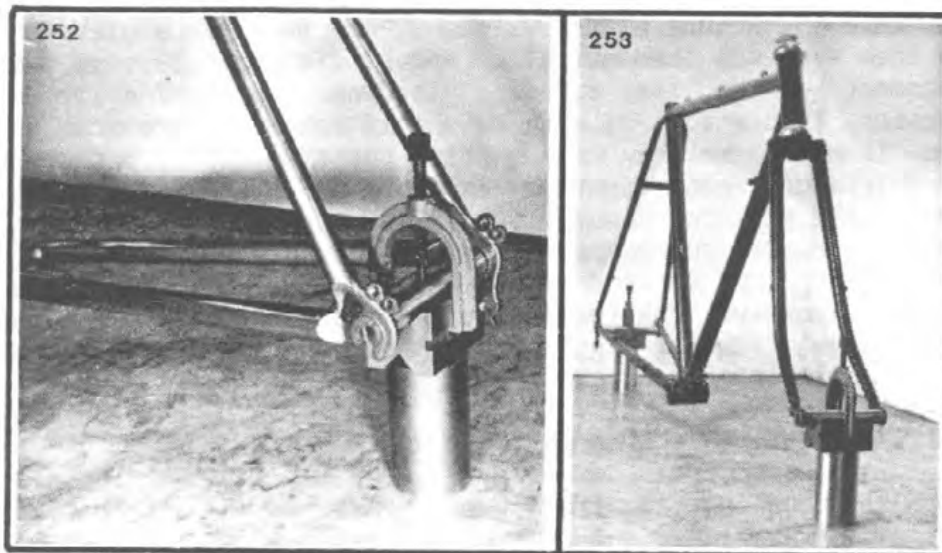
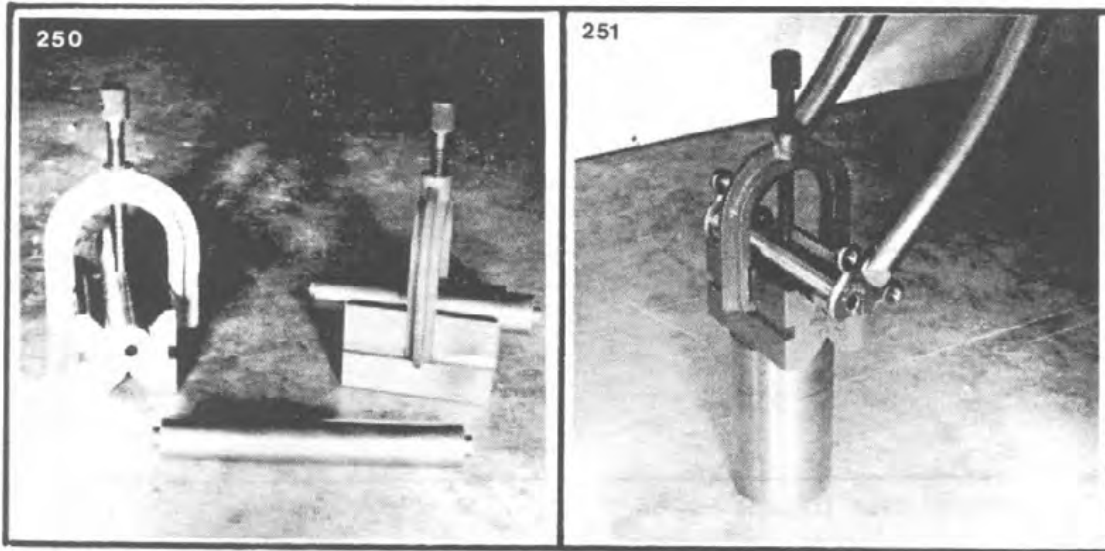

Seat tube angle can be measured by mounting a bevel protractor on a vernier height gage and resting the blade against the tube (fig. 254). Head tube angle is taken by installing a headset with the same O.D. on both cups and resting a straightedge against those two diameters to drop the angle down to the bevel protractor (fig. 255). Readings can then be taken directly off the scale on the bevel protractor.



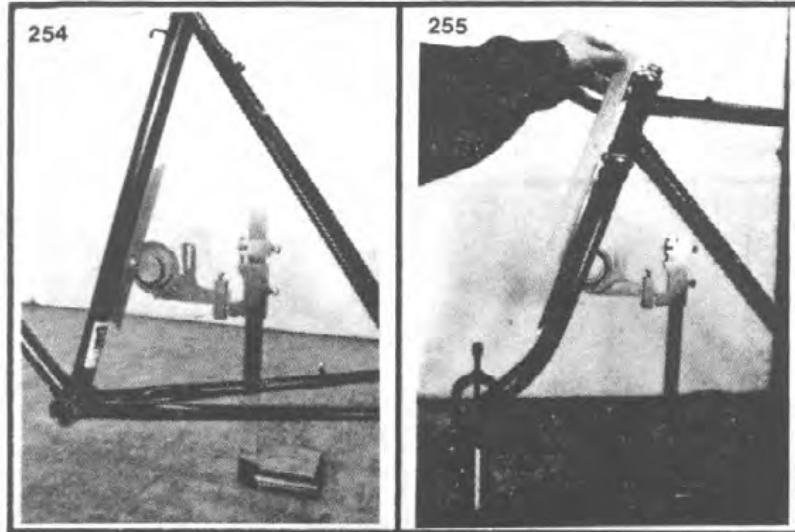

#### MEASURING BOTTOM BRACKET DROP

This is a more complicated procedure. Measure the diameter of the dummy hubs (fig. 256) and divide by 2 to get the Dummy Hub Radius (DHR). Measure the outer diameter of the bottom bracket shell (fig. 257) and divide by 2 to get the Bottom Bracket Radius (BBR).

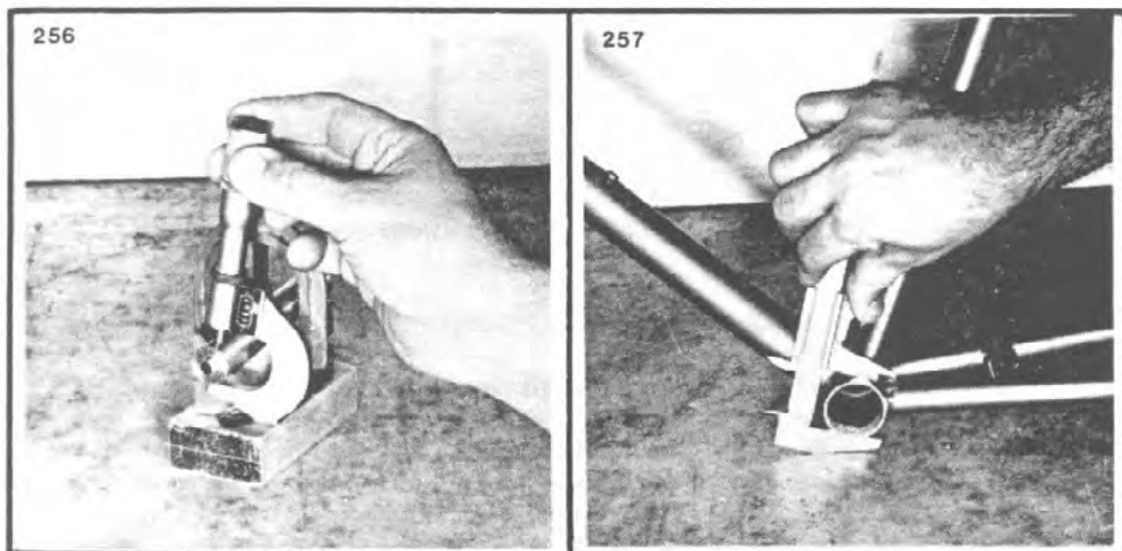

Measure to the top of the dummy hub as it is mounted in the V-block with the proper build-up or pedestal under it (fig. 258). Call this height measurement DHH. Measure to the top surface of the bottom bracket shell (fig. 259). Call this measurement BBH.

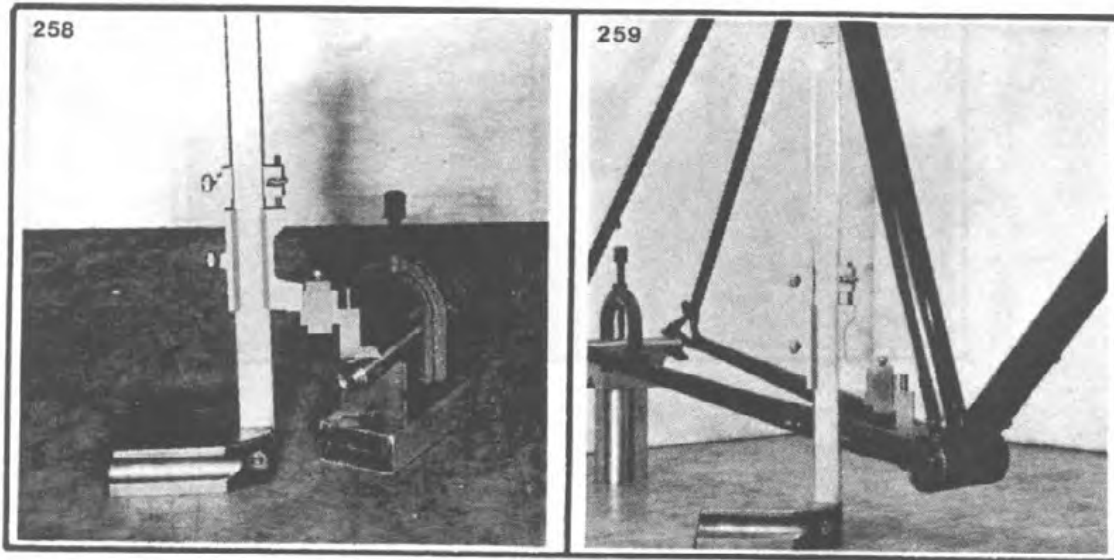

With DHR, BBR, DHH and BBH the exact bottom bracket drop can be found with the following formula.

$$\text{Bottom Bracket Drop} = (\text{DHH} - \text{DHR}) - (\text{BBH} - \text{BBR})$$

Tolerances for bottom bracket drop can be plus or minus .025" for top notch custom built frames.

#### DOWN TUBE AND TOP TUBE ANGLE

The angles of the top and down tubes can be easily measured while the frame is mounted vertically. These measurements are of little importance.

#### MOUNTING THE FORK ABOVE THE SURFACE PLATE

A Starrett #567 V-block is a convenient way to mount a fork for inspection. The #567 has 3/8" NC threaded holes in the bottom which allow the V-block to be fastened to a more massive plate that can serve as a counterbalance for the fork. The following pictures show a #567 Starrett V-block being used.

## MEASURING FORK RAKE

Clamp the steering column in the V-block and use the universal surface gage to level both sides of the crown. Take a reading on the left side of the crown (fig. 260). Take a reading on the right side of the crown (fig. 261). If the readings don't match, twist the column in the V-block and take the readings again. Repeat this until the two readings on the crown are the same. (The readings can also be taken with the vernier height gage.)

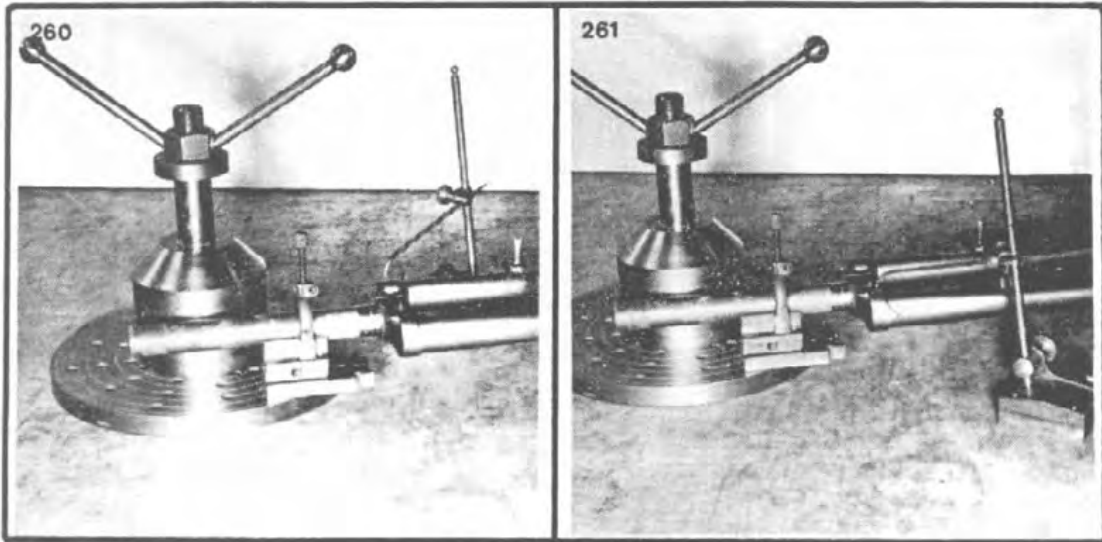

## MEASURING RAKE ON THE FORK

This is a procedure almost identical to the measuring of bottom bracket drop on a previous page. Start out by measuring the steering column diameter and dividing by 2 to get the radius (fig. 262). Call this measurement SCR. Measure the diameter of the front dummy hub and divide to get the radius (fig. 263.) Call this measurement DHR (again).

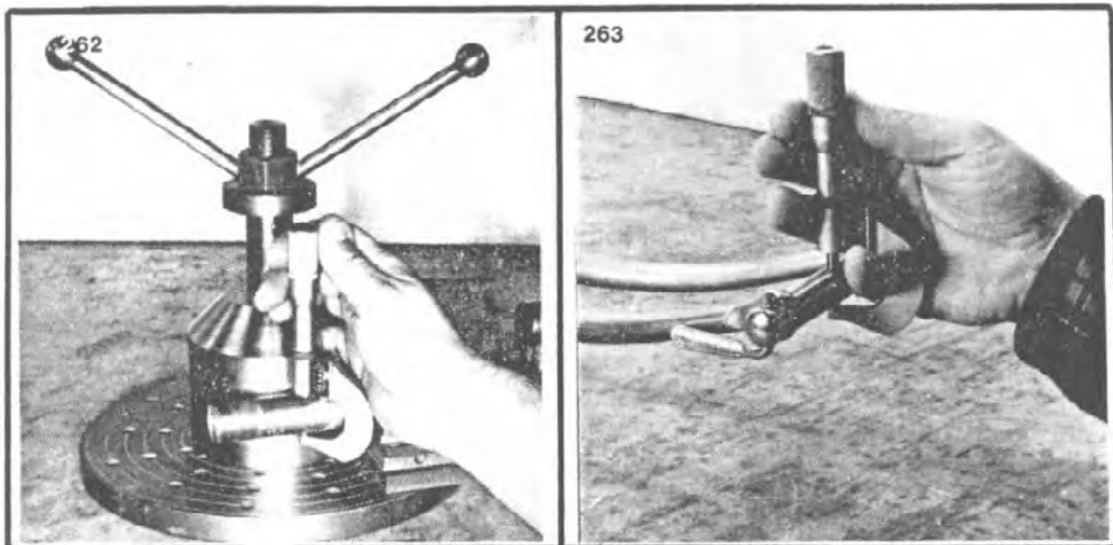

Measure the height of the steering column from the top of the surface plate (fig. 264). Call this measurement SCH. Measure the height of the top of the dummy hub from the surface plate (fig. 265). Call this measurement DHH (again).

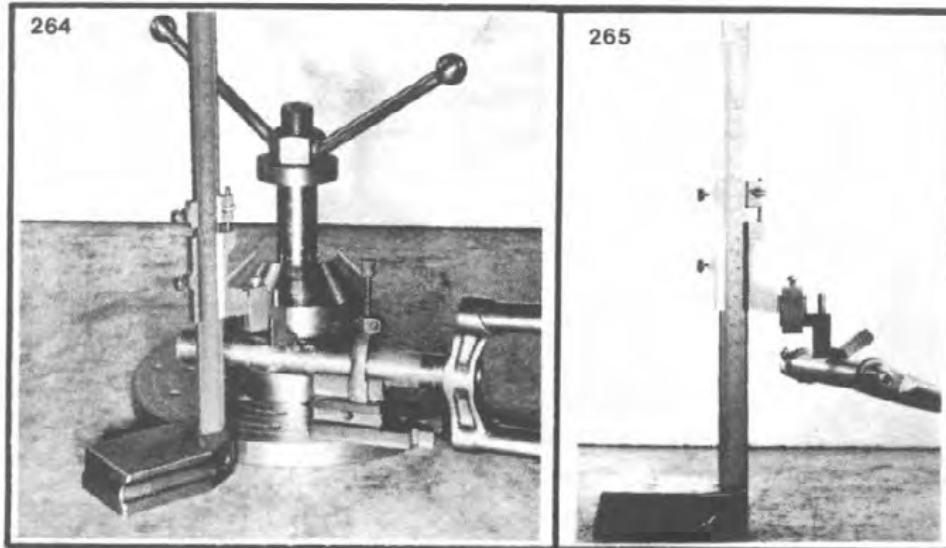

With SCR, DHR, DHH, and SCH the exact amount of rake can be determined with the following formula.

$$\text{RAKE} = (\text{DHH} - \text{DHR}) - (\text{SCH} - \text{SCR})$$

Cold setting to change the rake can be done with the Park FFS-1 and FT-4 tools. Although rake could be checked on the FT-4, for the sake of accuracy the fork should be remounted on the surface plate for another check for rake. Tolerances for fork rake can be plus or minus .025". (For any questions regarding what fork rake should be, see pages 1-7 to 1-10 of THE PATEREK MANUAL.)

#### CHECKING FORK TWIST WHILE FORK IS MOUNTED HORIZONTALLY

Take a height reading on the left side of the crown and call that measurement LCH (fig. 260). Take a height reading on the right side of the crown and call that measurement RCH (fig. 261). This is an identical procedure to the one at the top of page 9-20.

Take a height reading on a point of the left dropout where the axle would rest and call this measurement LDH (fig. 266). Take a height reading on the corresponding point of the right dropout and call it RDH (fig. 267).

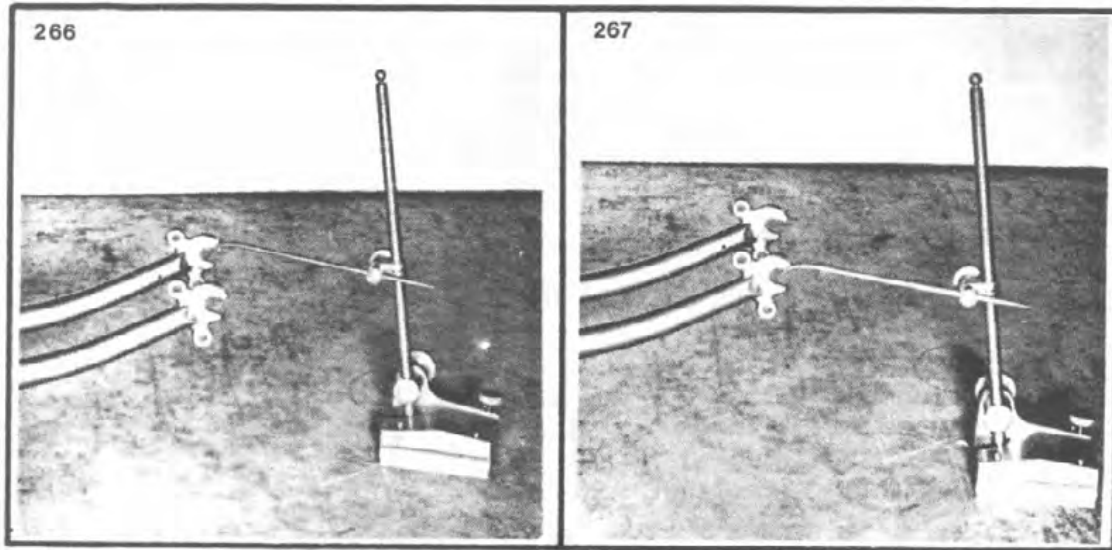

The following formula will tell how much twist there is in the fork.

If  $LCH = RCH$  then  $LDH - RDH = TWIST$   
 Twist may be expressed as a positive or negative number.

Acceptable tolerances for twist would be a difference of .015" between LDH and RDH. Correcting fork twist can be done by old setting with Park FT-4 and FFS-1. For more accuracy in inspecting for fork twist, return to the surface plate.

#### MOUNTING THE FORK PERPENDICULARLY TO THE SURFACE PLATE

For other operations the fork will have to be rotated 90 degrees in the V-block. To be sure that the fork is exactly perpendicular to the table, keep a machinist's square tight against the crown as the clamp of the V-block is being tightened. In the picture to the right (fig. 268), the vernier height gage is being used instead of a machinist's square.

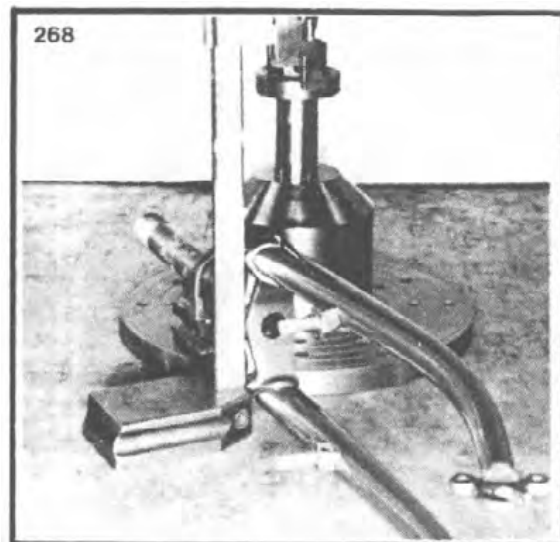

#### CHECKING FOR TWIST WHILE FORK IS MOUNTED PERPENDICULARLY TO PLATE

The fork can be tested for twist very easily at this point. Simply slide the machinist's square along the length of the blades and observe any gaps between the blades of the fork and the blade of the square. This is a much quicker check than the earlier one. It tells not only when there is twist, but also tells when there are any differences in camber between the two fork blades. However, when the fork is held perpendicular to the plate it is difficult to quantify twist.

#### CHECKING DROPOUTS IN RELATION TO THE CENTERLINE OF THE FORK

This procedure is nearly identical to checking the rear triangle plane. The first step is to find the fork centerline (FCL). Subtract SCR from SCH (figs. 262 & 264) to get FCL. As with the rear triangle, take a height reading to the inside face of the lower dropout and call that HI (fig. 269). Take a measurement to the outside face of the upper dropout and call that H2 (fig. 270). Measure the thickness of a dropout (fig. 271) and call that T.

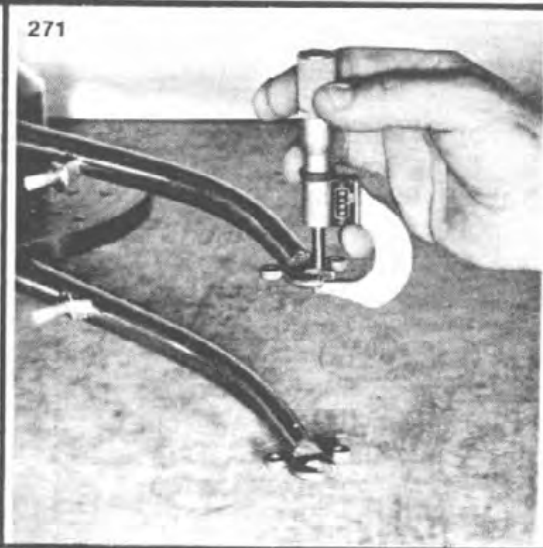
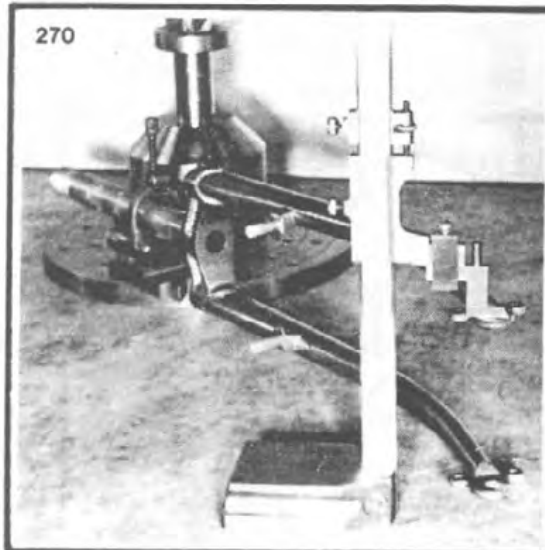
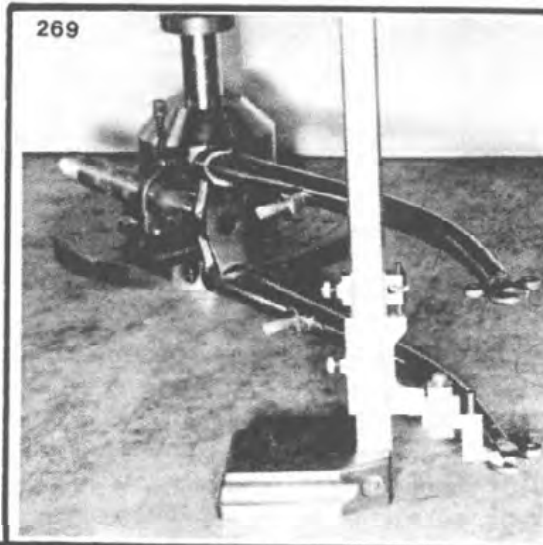

An alternate way to get the measurements for the centerline of the fork is to use a universal surface gage and measure to the inside faces of both dropouts (figs. 272 & 273). The results can be transferred to a steel rule held vertically in a V-block (fig. 245).

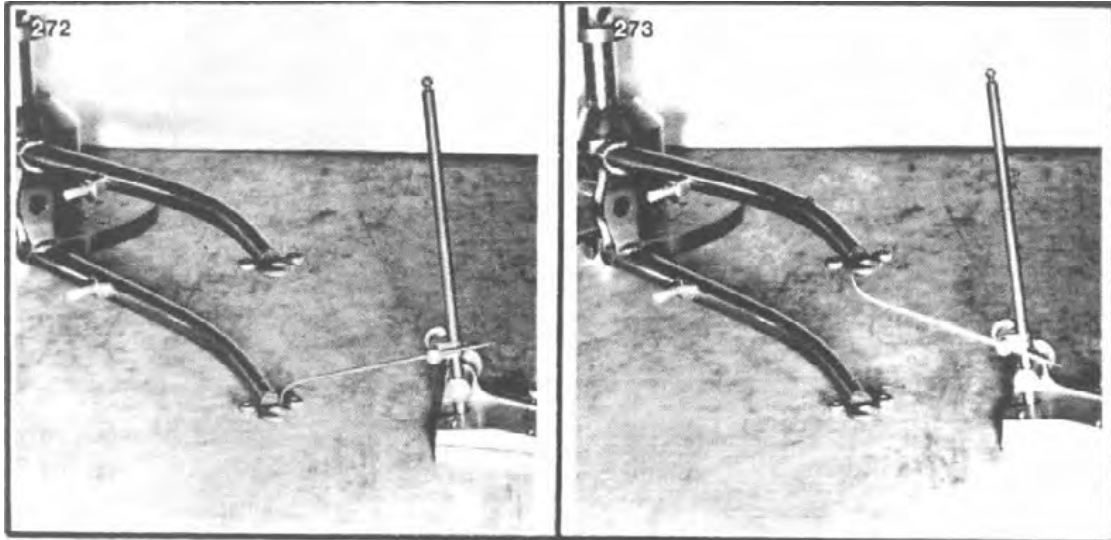

With these values, the exact orientation of the fork can be determined.

$$\text{Dropout Spacing (for hub width)} = H2 - H1 - T$$

With the dropout spacing (DS) and the FCL a theoretical fork can be set up. The theoretical fork diagram can be filled in with numbers that would simulate a perfect fork with the given DS and FCL. Here are the formulas to fill out the diagram.

$$\text{Theoretical } H1 = \text{FCL} - (.5 \times \text{DS})$$

$$\text{Theoretical } H2 = \text{FCL} + (.5 \times \text{DS}) + T$$

Here is the diagram to fill out with the FCL, DS, Theoretical H1, and Theoretical H2.

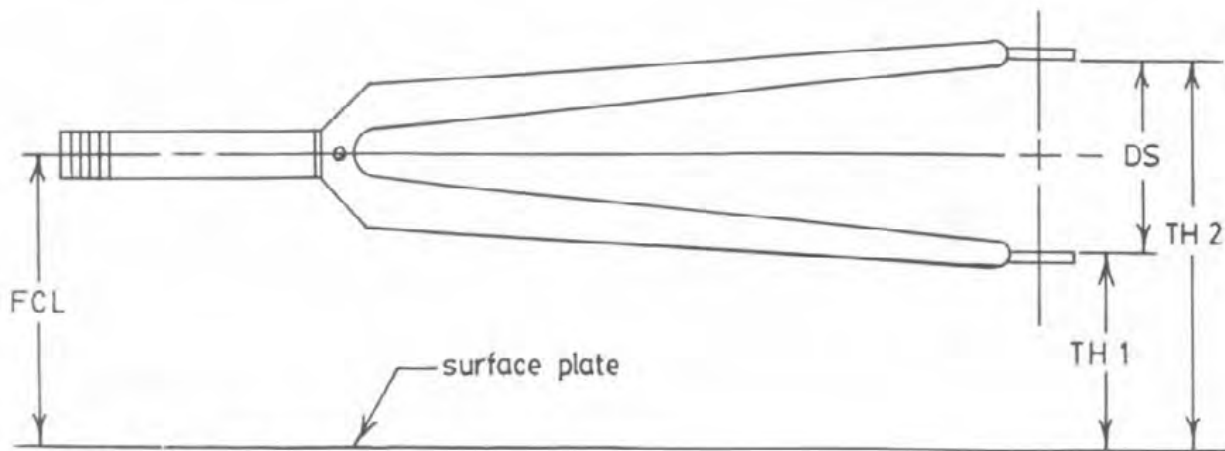

ill.129: Theoretical fork

Now take the actual H1 and H2 found on the surface plate and compare them to the theoretical H1 and H2 figures. This is where the left/right alignment of the fork is determined. Ideally, H1 should match theoretical H1 and H2 should match theoretical H2. If there is not a match, coldsetting must be done to correct this. Tolerances that might be expected on a top-notch custom frame would be plus or minus .015". IMPORTANT: If fork twist and fork centerline are within tolerances and both blades have matching camber, but the rim sits to one side in the fork, one of the dropouts is further from the crown than the other. If this is the case, one of the dropouts must be heated up and pulled out of the slot until the problem is eliminated.

A surface plate is by far the most versatile method, for the inspection of bicycle frames. The technician is not locked in to inspecting only bicycle frames. There are many inspection devices manufactured for the surface plate which would allow it to be used for a multitude of other uses. Sine bars, gage blocks, jack screws, and indicators can open up other horizons the builder probably never thought of before. Furthermore, for the equipment freaks out there, Brown & Sharp, Mitutoyo, and Starrett make tools and equipment that have a nicer look and feel than anything in the bicycle industry.

Three reference books to check out would be; 1-The Machinist's Handbook, a thick green book available in most book stores for about \$40.00, 2-The Machinist's Ready Reference, a small ringbound book available for under \$5.00, 3-The Starrett Catalogue.



## THE CORBETT METHOD

When covering the subject of precision measuring of bicycle frames, one can not stop blindly with one method. The outstanding characteristic of the PATEREK method is to locate on the bottom bracket faces, which has been a standard procedure for many years. The CORBETT method locates on two points on the seat tube and one point on the head tube. This method is quite simple and the holding fixture is much less expensive than the one used in the PATEREK method. (Please don't think that the author is being presumptuous in naming these two methods after himself and his buddy. It is simply being done here to differentiate between the two methods.) Note how the build-up under the seat tube is shimmed up  $1/16$ " more than the build-up under the head tube. This allows for the difference in tubing diameters (fig. 274).

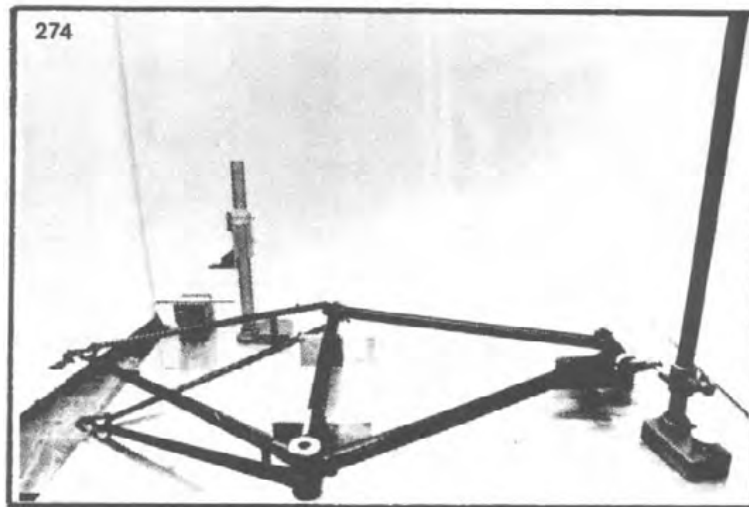

With the frame resting on the three parallels, all the same measurements can be taken that were taken in the earlier method. Seat and down tube deflection translate into bottom bracket twist by this method. Note how the indicator can be swept over the bottom bracket faces to show if there are high or low sides.

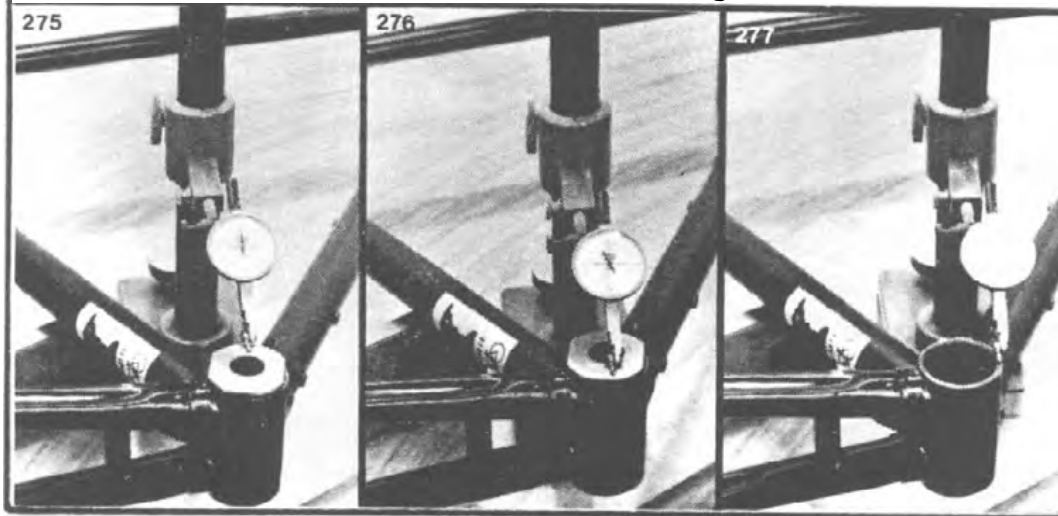

Measuring head tube twist is easy too. As in the PATEREK method, simply use the indicator to find the low spot of the bore in the top (fig. 278) and bottom (fig. 279) of the head tube. Since the seat tube is unquestionably parallel to the plate, any variation immediately translates into head tube twist. Head cups offer a nice precision bore to locate on.

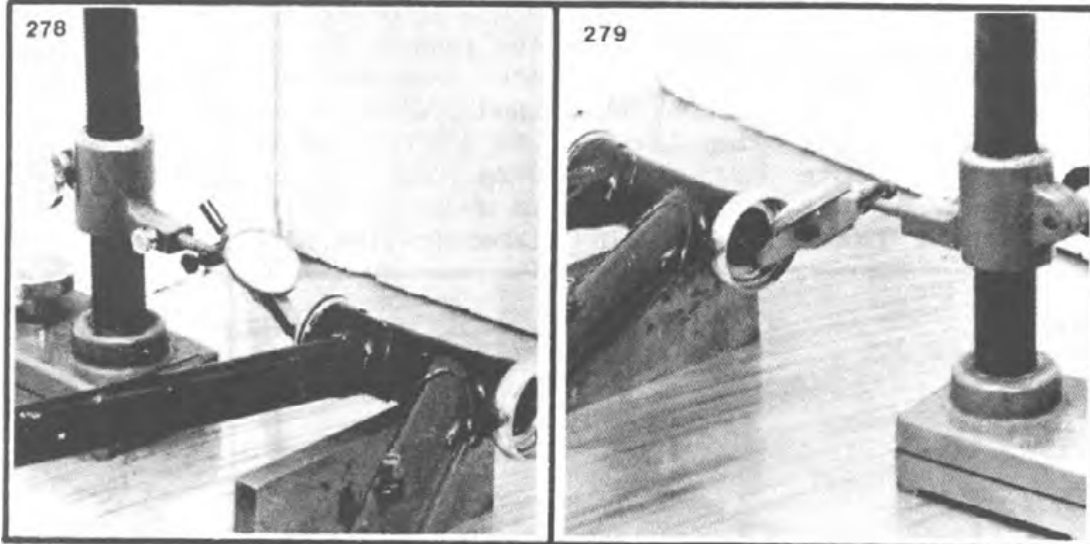

In finding the relationship between the planes of the front and rear triangles, the flip-flop method is used. First the inside face of the right dropout is checked with the height gage (fig. 280). Then the frame is flipped over and the inside face of the left dropout is checked (fig. 281). This gives a very exact measurement because when the frame is flipped like this, the error is doubled and easier to spot. Ideally, both inside faces should give the same reading.

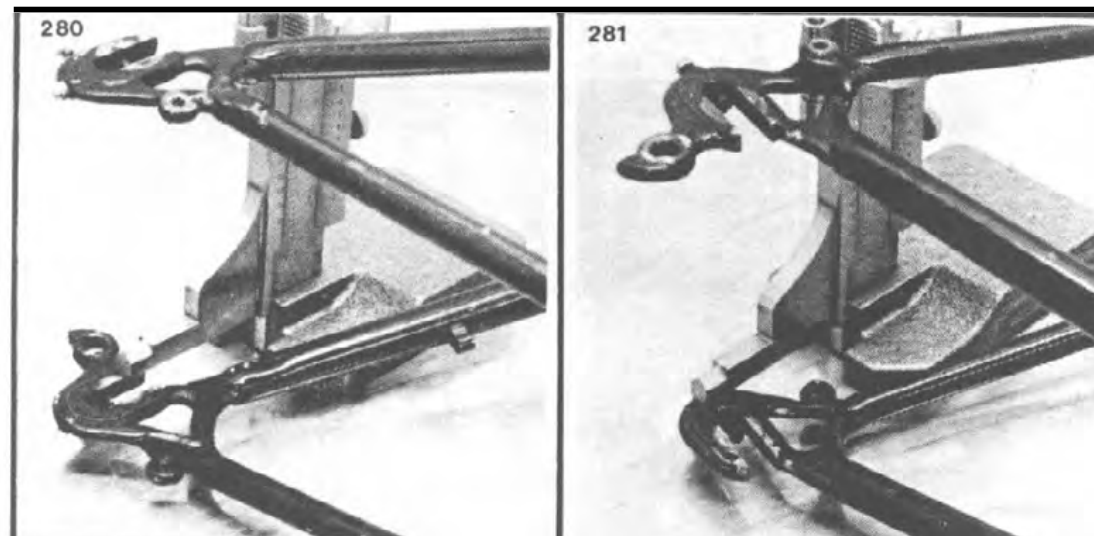

Fork rake can be checked by mounting the fork in a V-block and resting it on another V-block to gain height from the surface plate. First the left side of the dummy hub is indicated. Then the right side is indicated (fig. 282). Twist the steering column till both readings are the same. A reading is then taken to get the dummy hub height (DHH). Another reading is taken to get the steering column height (SCH). Subtracting the two heights and radii will give rake. (Note the use of the VAR fork crown race slide hammer as a counterbalance.)

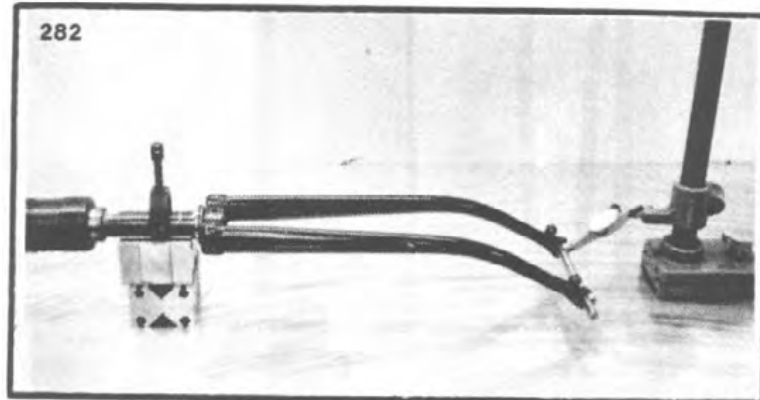

The nice feature of THE CORBETT METHOD is that the fork never leaves the V-block after it is indicated in. Flip the V-block 90 degrees and check for twist with a machinist's square (fig. 283). The tips can now be checked in relation to the centerline. Take a height reading on the inside face of the left dropout (fig. 284). Don't remove the fork from the V-block. Flip the whole assembly and take a reading on the inside face of the right dropout (fig. 285)

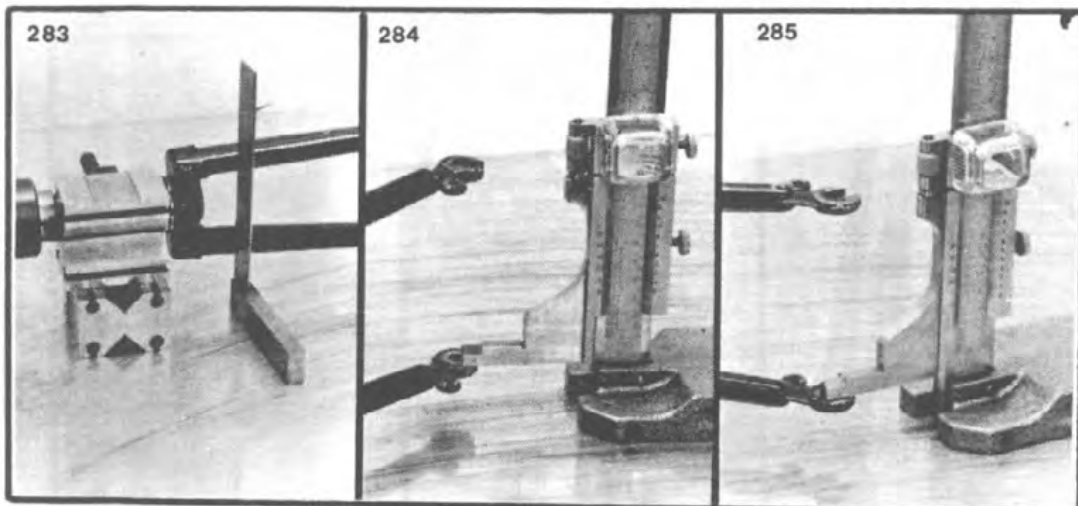

The option of measuring fork blade length was not offered in the PATEREK method. In the CORBETT method, while the fork is still mounted in the V-block, it is turned vertically and the tips are measured in relation to their distance from the surface plate. This requires a way to mount an indicator about 15" up from the surface plate. (figs. 286 & 287)

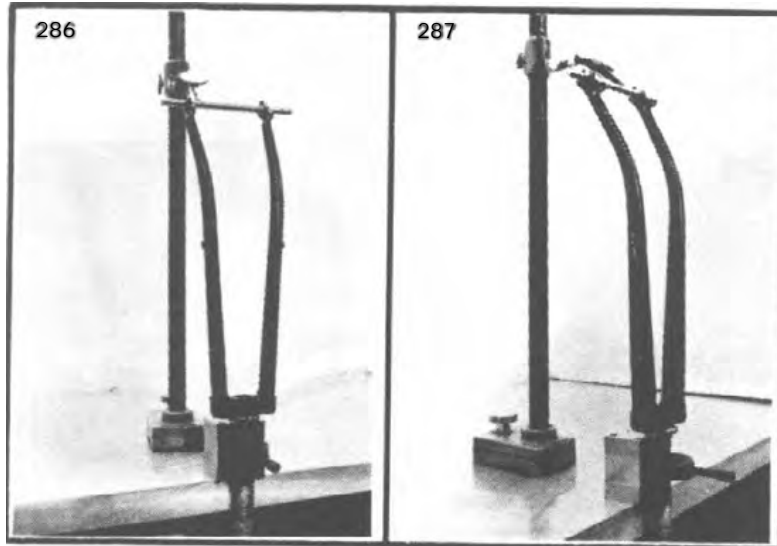

Mounting the frame vertically above the surface plate is done almost identically in both methods. In figure 288, head tube angle is being measured. Note how the measurement is being located on the outer diameter of a high quality headset. Also, note how the angle is being dropped down to meet the protractor. In figure 289 The height of the dummy axles is being measured in the same way as the PATEREK method. In figure 290, a Campagnolo fixed cup is used to find bottom bracket height. (Since the Campy cup is exactly 36mm across the flats, 18mm is subtracted from the height measurement.)

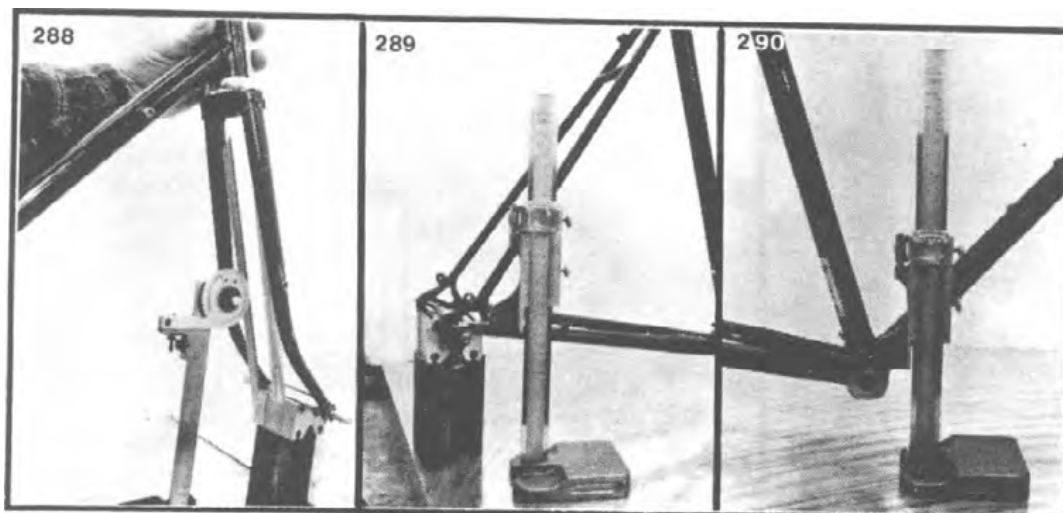

THE FRAME ALIGNMENT SYSTEM - THE NEW ENGLAND CYCLING ACADEMY

There are not many precision measuring systems put out strictly for the purpose of bicycle frame inspection. The Frame Alignment System is one definitely worth mentioning. Its fixtures are of the highest quality, yet simple and easy to use. The system consists of a bed with a swing arm and bottom bracket clamp attached, a dummy hub gage, a jack and a cheater bar. A universal surface gage, Campagnolo H tools, Campagnolo 724/1 & 724/2 tools, and Marchetti and Lange head tube extensions are also used with this system. (fig. 291)

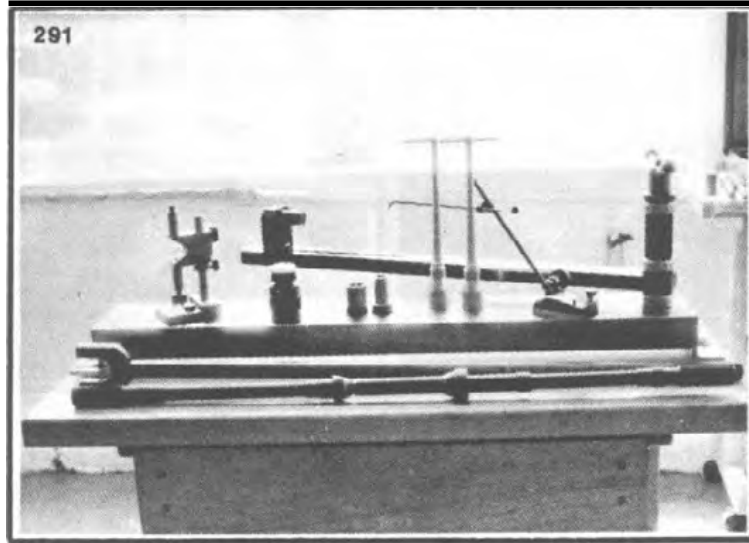

N.E.C.A. recommends spraying an all purpose lubricant (fig. 292) on the precision ground surface and lightly honing it (fig. 293) to remove any burrs which may develop from any rough use.

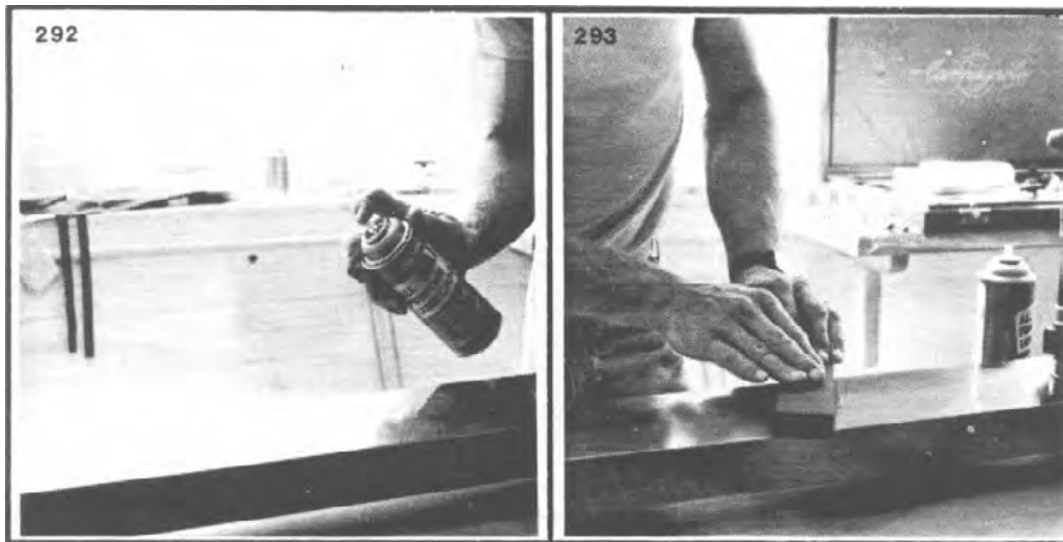

As required with any precision measuring of bicycle frames, the bottom bracket shell must be faced. Since the Frame Alignment system has been designed to accommodate Campagnolo #724/1 & 724/2 inserts (fig. 294), the bottom bracket should be faced with Campagnolo tool #725. After facing, the bottom bracket shell (with inserts still in place) can be lowered right onto the bottom bracket clamp (fig. 295).

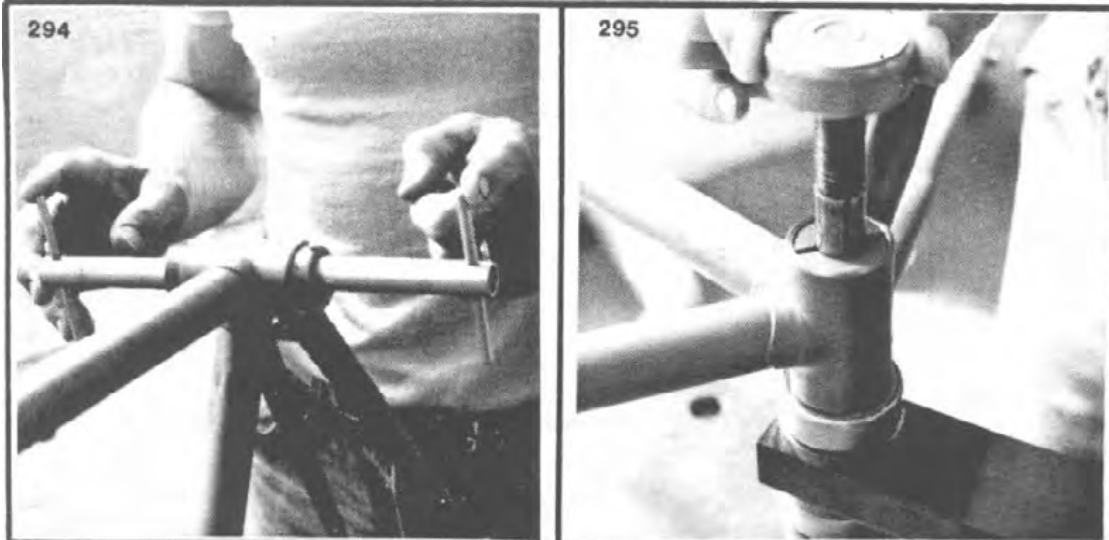

Since the bottom bracket clamp rotates on precision bearings, the frame can be easily rotated so that any frame member can be directly above the precision ground bed (fig. 296). Note how the jack can be put under a tube that lies above the bed. This is done for two reasons: 1. The jack can be used as a **gage** by passing it under different locations along the tube and checking for clearance; 2. The jack can provide support for certain cold setting operations. (Note how tapping the finger in figure 297 determines if the jack is touching the head tube.)

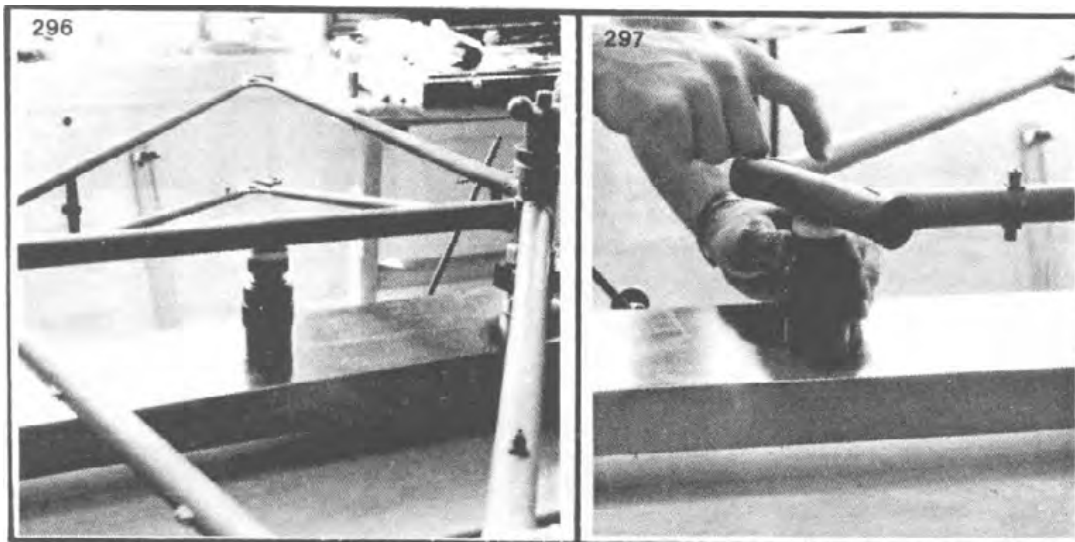

To provide additional support and stability, the swing arm can be aligned with the seat tube and a fitting inserted into the top of the seat tube (fig. 298). In figure 299 the swing arm as well as the jack are in place while the head tube is being measured for twist.

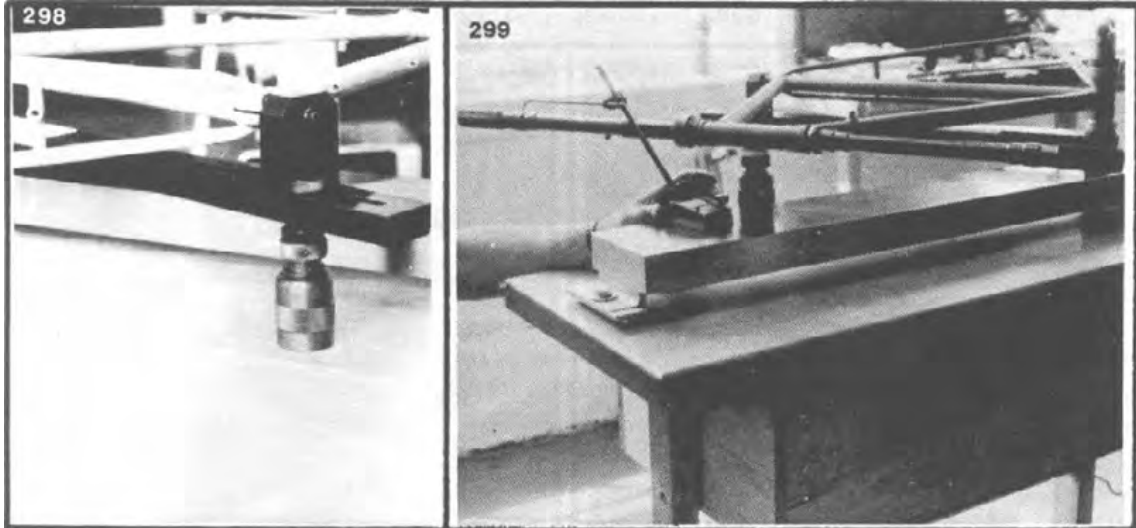

N.E.C.A. fully recommends cold setting while the frame is mounted in the Frame Alignment System. In figure 300, the cheater bar is being used to raise the head tube to put it in the same plane as the seat tube. In figure 301, the head tube is being pushed downward to accomplish the same thing but in the opposite direction.

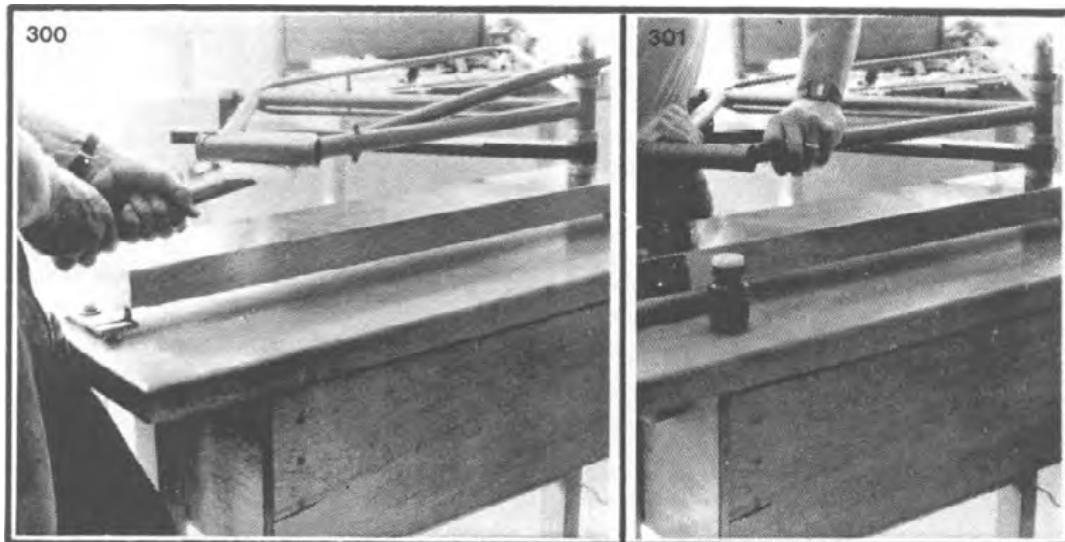

A unique and very necessary part of the Frame Alignment System is the Dummy Hub Gage. This device simultaneously finds the theoretical central plane of the frame and the theoretical location of the inside faces of the dropouts. N.E.C.A.'s Bill Farrell locates the central plane of the frame close to the bottom bracket (fig. 302). In figure 303 he shows the interchangeable studs that simulate 100mm, 120mm, and 126mm hub widths.

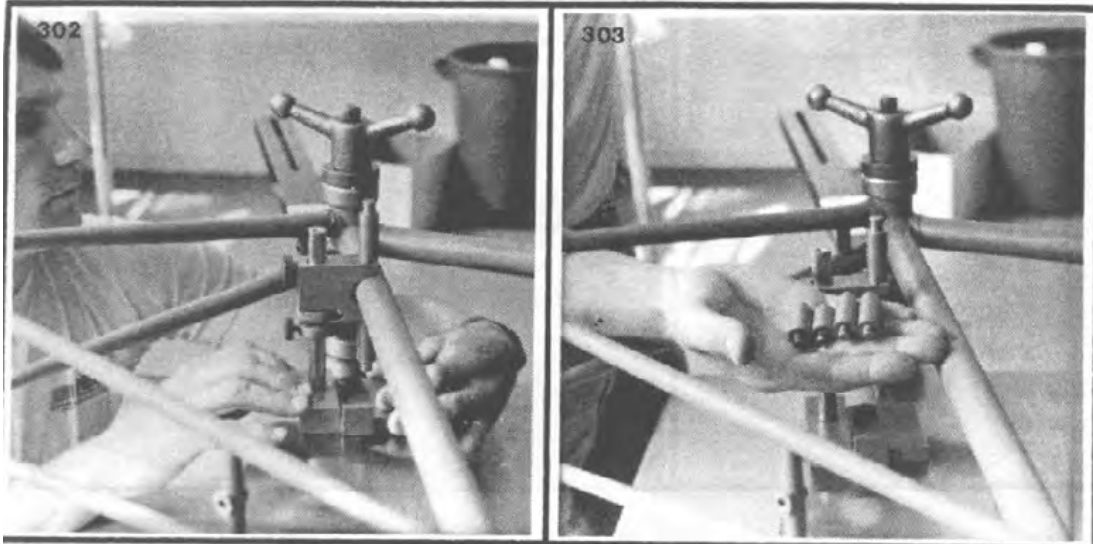

The Dummy Hub Gage can be used to determine whether the rear dropouts are equidistant from the centerline of the frame (fig. 304). If they are out of line, they can be cold set into place. Note how this can be done by hand (fig. 305). A great deal of force is not always necessary for cold setting procedures.

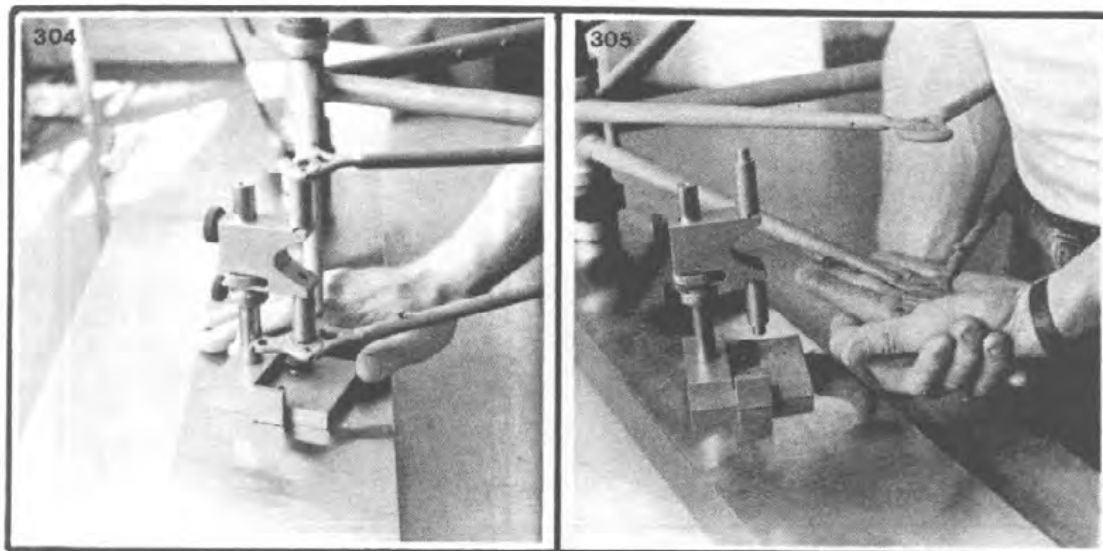



To check tracking between the fork and the rest of the frame, a fork can be installed with a high quality headset. The frame and fork can then be put in place on the bottom bracket clamp. The dummy hub gage can then be set to the seat tube close to the bottom bracket. A reading can then be taken at the front dropouts (fig. 306).

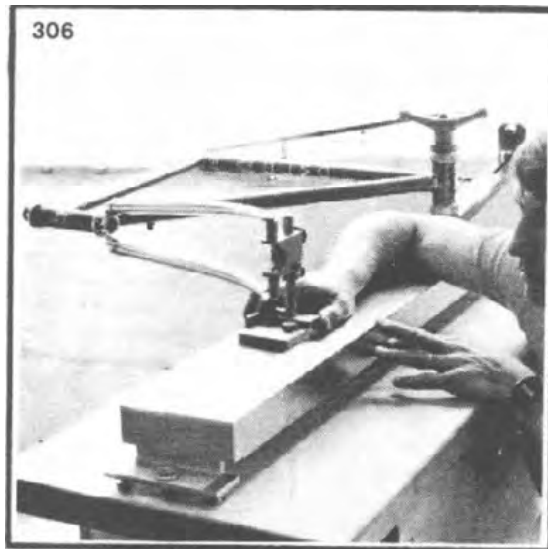

Another component of The Frame Alignment System is the fork inspection fixture. This fixture is not available to framebuilders and is only used at N.E.C.A. It clamps to the bed and holds a fork so that it can be checked in reference to the precision ground surface. The first step is to determine the centerline of the fork by setting the Dummy Hub Gage to the steering column (fig. 307)

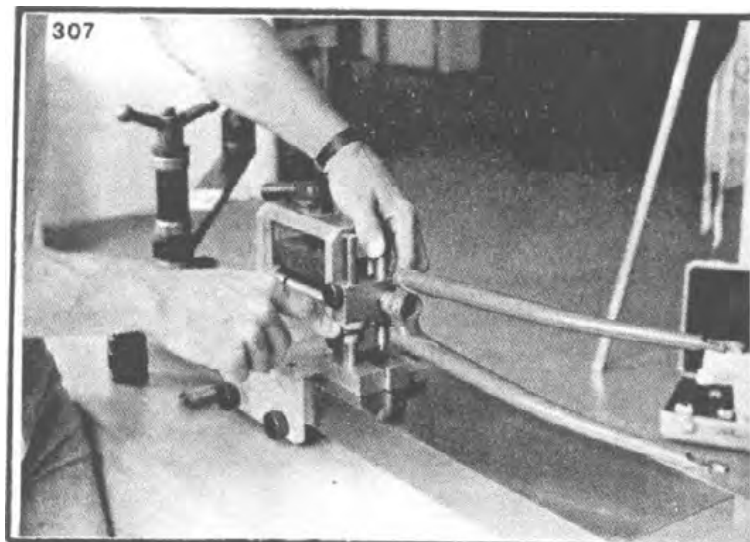

Step two in inspecting the fork is to square the blades with the precision ground surface. This is done by holding the studs of the Dummy Hub Gage tightly against the top backside surfaces of the fork blades while tightening the clamp (fig. 308). Step three is to move the Dummy Hub Gage to the dropouts and see how easily it slides into place (fig. 309). Cold setting is then done accordingly.

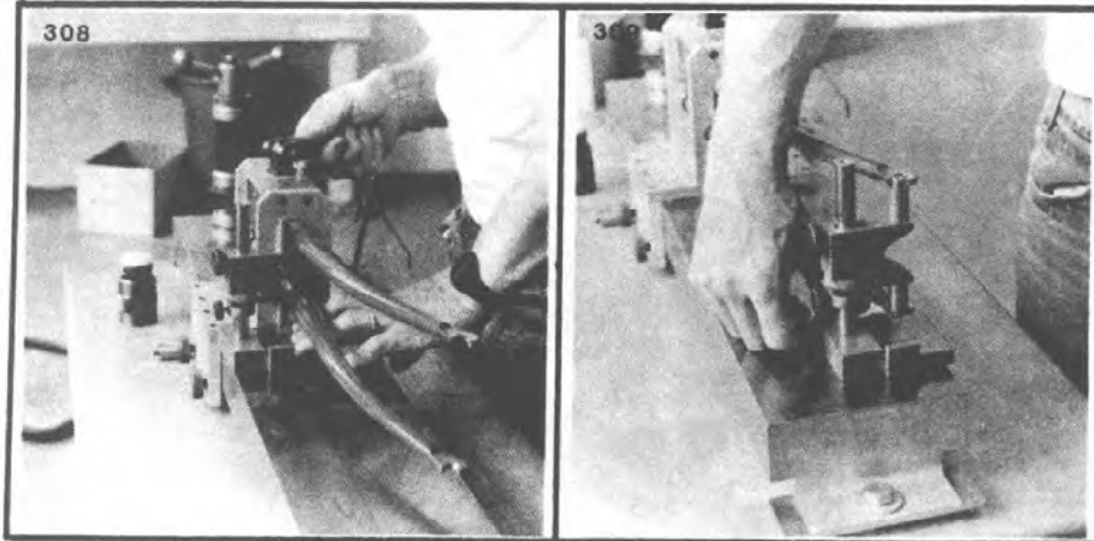

For more information on The Frame Alignment System, write to the New England Cycling Academy. Mailing information can be found in the resource section of this book.

In the area of precision measuring, we have some really accurate devices nowadays. Tolerances in thousandths of an inch are nothing compared to what is on the market now. Some bicycle manufacturers are now advertising that they use inspection devices that are accurate to  $+.00001"$ . This is misleading to the consumer and the independent framebuilder should be aware of the tactics used by some of the larger companies. It is totally unrealistic and assinine to try to build bicycle frames to tolerances in the range of  $.00001"$ . To stress a point, a fork could be mounted in the horizontal plane and indicated to the nearest hundred thousandth of an inch. A ball point pen could then be gently rested on the dropouts and they will more than likely drop at least  $.00001"$  and take the fork out of tolerance momentarily. When reading these ads, the reader should ask himself if the ad says that the inspection device is accurate to  $+.00001"$  or is the frame falling within those tolerances. Those are two totally different ideas. A person can measure the fish he caught at Lake Minnetonka last summer with a machine accurate to  $.00001"$  but that does not necessarily mean that fish tastes better because it was measured on incredibly accurate equipment.

A NUMEREX machine is shown in figures 310 & 311. This particular unit is accurate to  $+.00001"$ . It is excellent for inspecting B-1 Bomber parts or Space Shuttle parts. It operates with a probe that measures coordinates on X, Y, & Z axes. (Wouldn't it be tempting to put this in my next catalogue and make some sort of outlandish claim?)

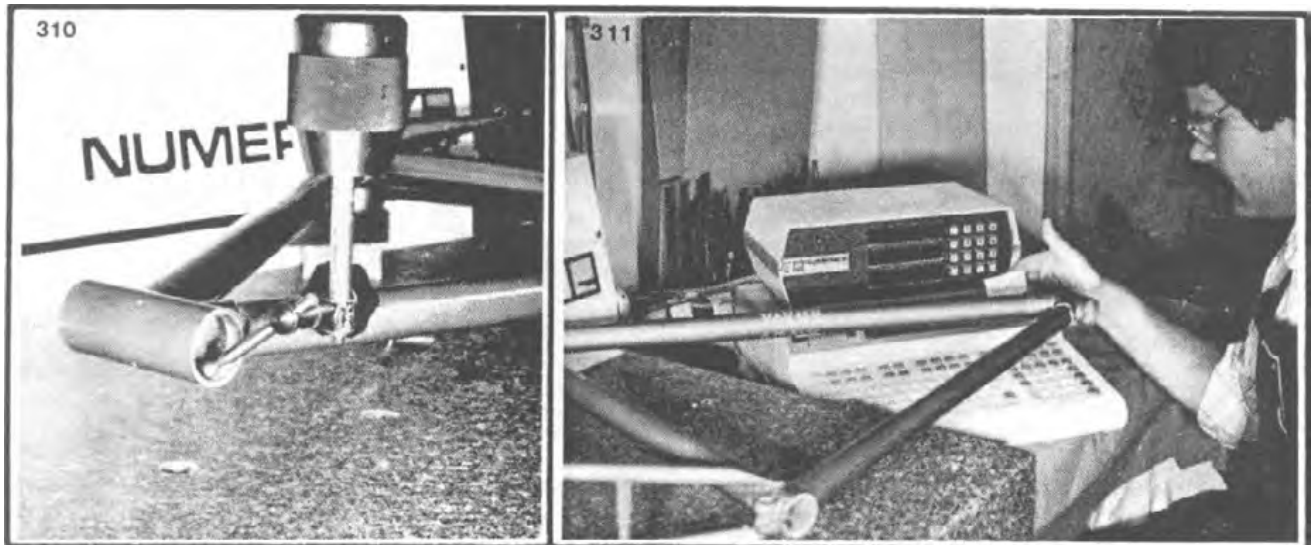

The CORDAX IV (fig. 312) is also a coordinate measuring machine that measures along X, Y, & Z axes. It too, has accuracy to  $.00001"$ . Look at the low quality fork that is mounted in the CORDAX. Just because this low quality fork was measured with a CORDAX doesn't make it any better.

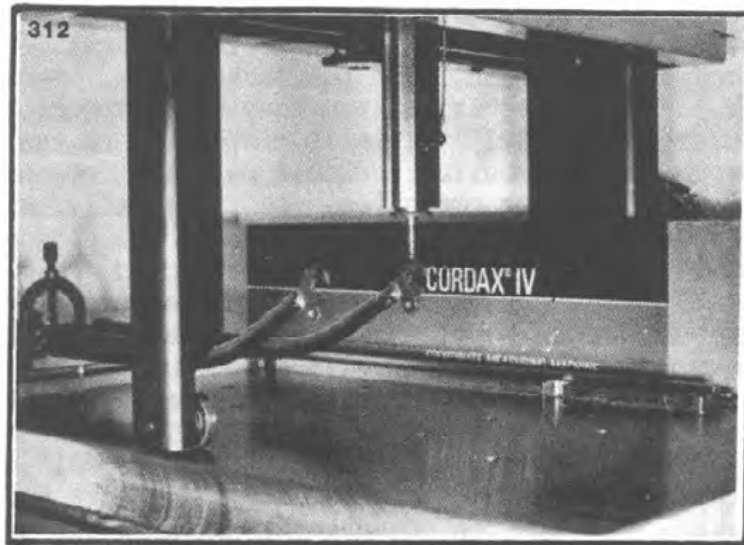

The Mitutoyo Height Master (fig. 313) is one of the most sensitive height gages available today. It is also accurate to .00001". Anyone working on communications satellite parts should definitely have one.

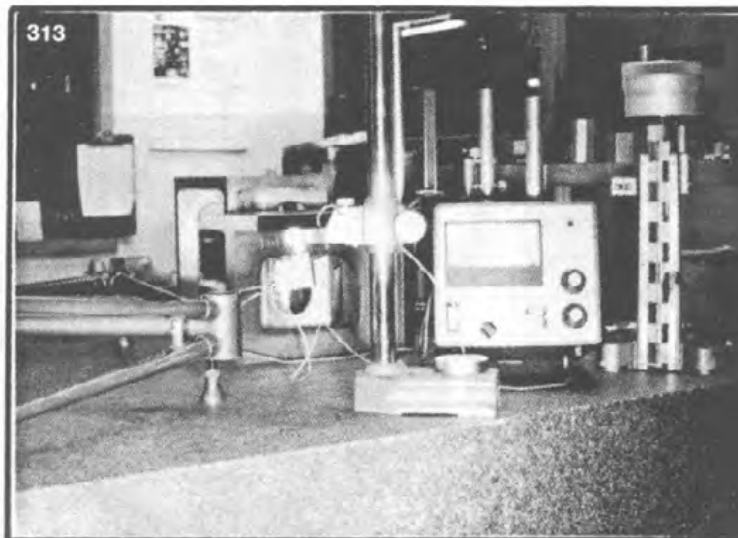

One of the silliest pictures I've seen in a national bicycle magazine was of a framebuilder who was working on one of the Olympic funny bikes. He had incredibly sensitive inspection equipment and was wearing a pair of white gloves! In our efforts to turn out better products, let's not lose touch with reality. As we leave those framebuilders and flintlock makers of yesteryear in the dust, let's not give the framebuilders of tomorrow something to laugh about. Choose a realistic set of tolerances and try to maintain them.

## PAINTING

This section of THE PATEREK MANUAL will deal with painting preparation- masking- priming- color coats- plating- touch-up, paint supplies- and painting equipment. Due to the fact that the author is highly familiar with the DuPont- 3M- and Binks product lines. there will be some obvious leanings in those directions.

There are some highly technical areas that will not be covered in this section because the DuPont Refinish Shop Manual does such a good job. It would be advisable to purchase a copy of this publication from a local DuPont dealer, drill four extra holes in the left margin. and clip it in this section of the book. It answers such questions as how problems are caused in painting and how they are remedied. (DuPont is listed in the resource section of this book.)

It is important to add at this time that painting is probably the process in the manufacturing of bicycle frames that is most hazardous. Not only does it pose the threat of respiratory damage. kidney failure, and even neurological disorders if continual exposure to the fumes is experienced, but the risk of fire is also extremely high. These factors must be considered before starting a painting business and all possible precautions must be taken to lessen these hazards.

Before continuing there are some basic rules to remember before attempting to paint:

- 1--Don't mix different brands of paint products.
- 2-Don't wear wool, flannel- or any other fuzzy clothing that might create a problem with lint.
- 3-Don't paint when you're tired or frustrated.
- 4-Spare no expense in obtaining and installing proper fire extinguishing and ventilation equipment.
- 5-Always use a respirator of adequate design.
- 6-When in doubt, follow the directions on the back of the cans.

DO NOT SMOKE WHILE PAINTING, DO NOT ALLOW OTHERS 'It) SMOKE WHILE YOU ARE PAINTING AND DO NOT ALLOW AN OPEN FLAME IN THE ROOM AT ANY TIME!!!!!!

## PAINTING AND THE LAW

Before setting up a painting system, there are a few items that must be checked out. Due to the fact that spray painting is a definite health and fire hazard, there may be some major stumbling blocks before starting out.

First of all, check the zoning requirements the city may have regarding spray painting. Since a spray painting operation would emit polluting and even poisonous fumes, it may be classified as an industrial business rather than a simple commercial business. Such a classification may require that the operation be located in an industrial park or industrially zoned area of the city. Failure to follow city zoning such as this would be an invitation for a shutdown by the city.

If there are other employees working in the shop where the painting is to take place, The National Institute of Occupational Safety Health (N.I.O.S.H., formerly known as O.S.H.A.) regulations must be checked out. N.I.O.S.H. has very strict requirements whenever there is a threat to the safety or health of any employee in any business. Spray painting is one activity that is under tight control.

A call to the local fire department would be a good idea. They will know all of the ordinances regarding fire safety and prevention. Many cities may require a paint shop to be located on a concrete floor or in a cinder block room. Many municipalities forbid or at least discourage spray painting in a wood frame structure without the proper modifications.

The insurance company should be notified. Many insurance companies will not pay for damages from fires if they are not notified ahead of time of any change of status of the insured. They must be informed of any fire or health hazards that may be posing a threat. Looking through the insurance policy papers may yield the necessary information being sought. A word of warning - commercial spray painting may increase insurance premiums substantially!

People who own businesses in rural settings are usually under much less regulation.

If all of the above items have been thoroughly investigated, it's time to start setting up.

## THE PAINTING SYSTEM

The painting system is made up of four major parts; 1-the booth, 2-the gun, 3-the compressor, 4-the breathing system. Below is an illustration of an ideal bicycle framepainting system.

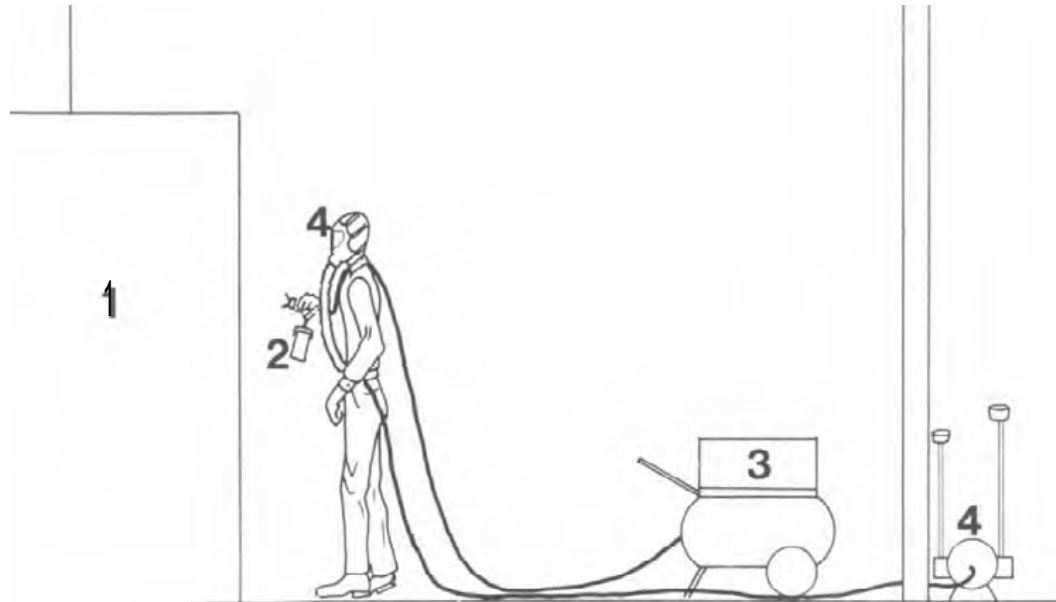

41130 THE PAINTING SYSTEM

### THE BOOTH

When building a booth, three main considerations must be made in its design- 1)the shell, 2)lighting, 3)ventilation.

### THE SHELL

The shell of the booth should be made of a relatively heavy gage of sheet metal. Never construct a shell out of wood or cardboard! A safe painting booth must be able to contain a flash fire long enough to allow the painter to grab a fire extinguisher. This would be difficult with a wooden booth and impossible with a cardboard booth. A shell made of combustible material would start to burn almost immediately and need to be extinguished itself. A commercially made booth with an industrial strength shell can be purchased for several thousand dollars (fig. 314). A less substantial booth can be made by a local plumbing and heating outfit for less than \$200,00.

Another important requirement for a booth shell is to be big enough to completely surround any item that will be painted in it. A booth 46" X 48" X 48" is large enough to paint even a 27" frame. The 46" dimension will allow the sheet metal worker to utilize the full 4 feet of a sheet of steel in two directions and allow for seams on the 46" side.

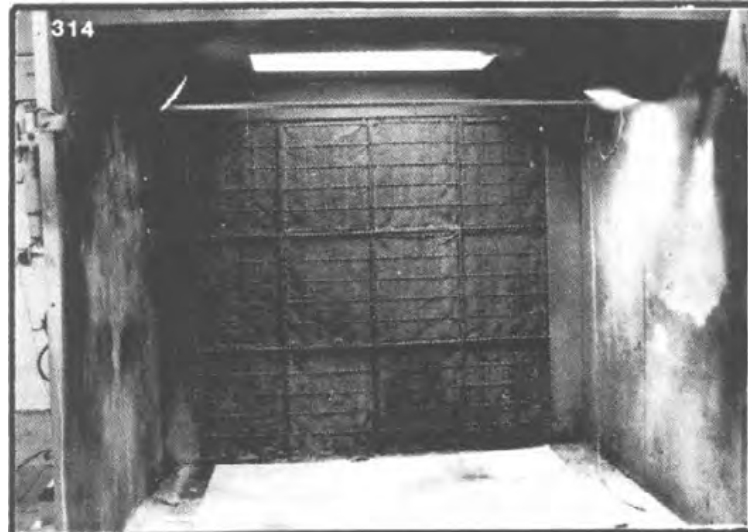

#### LIGHTING

Good lighting is of the utmost importance in producing good paint jobs. It is necessary to be able to see the finest detail while painting and good lighting will make this possible. It is difficult to detect a run forming or the presence of orange peel in a poorly lit booth. Incandescent bulbs are preferred, as they do not tend to produce sparks the way fluorescent bulbs can. If fluorescent bulbs are used, they must be mounted outside the booth with glass or plastic sheets or windows keeping them from being in contact with the paint fumes. Incandescent bulbs may be put in immediate contact with paint fumes without the fear of causing fires. Use 3 or more 200 watt bulbs in a booth big enough to paint a bicycle frame.

#### VENTILATION

The booth should be ventilated from the rear, and preferably from the upper half of the booth. By ventilating from the rear, the fan will push the harmful fumes out the back while at the same time pulling fresh air past the operator and into the booth. This air flow is very important.



A fan must be mounted in the back of the booth to provide the necessary air flow. Choosing the correct type of fan is important to lessen fire hazards. Electric motors produce sparks and most electric motors are open at the ends. By looking in the ends while the motor is running, the sparks can be plainly seen. These sparks are the fire hazards. Paint fumes that come in contact with these sparks can easily ignite and cause a flash fire. Some motors are sealed so that the sparks they produce can not come in contact with any paint fumes. This is the type of motor to choose for a paint booth. With luck a fan with a sealed motor can be found. Such a fan can be mounted directly in the opening at the back of the booth. This would be the simplest way to mount a fan. A safer way to mount a fan would be to mount a squirrel cage fan (fig. 315) within the duct work coming off the back of the booth. The squirrel cage fan can then be run by a motor outside the duct work which doesn't come in contact with paint fumes.

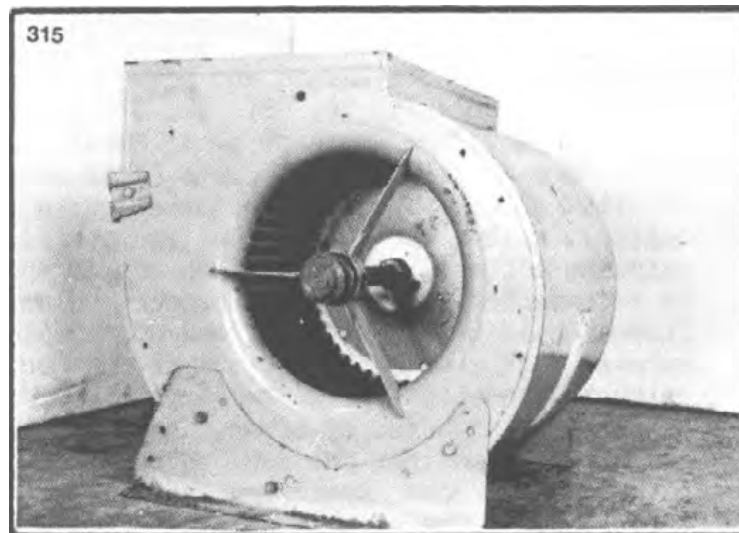

Most municipalities will require a filtration system to remove the particulates from the fumes before they are released into the atmosphere. On the previous page, the filters can be plainly seen in the back of the commercial booth. A furnace filter can be installed in the small custom-made booth. Make sure the fan is powerful enough to pull a steady air flow right through the furnace filter!

A final important item for any paint booth is to have ductwork or a hood that will direct fumes to a safe area. Do not blow paint fumes where passersby may inhale them.

## THE GUN

The gun is one of the most important pieces of equipment in painting. Most people who wish to start painting bicycle frames find it hard to choose the correct painting gun and cup. Here are a few criteria to go by to make the decision easier.

airbrush (fig. 316), is a scaled down version of a paint gun. Some people may have a tendency to buy an airbrush because it is small and so are bike frames. An airbrush is for very fine detail work and should only be used as an extension of what can already be done with the existing paint gun. A skilled technician can do something as fine as pinstriping with an airbrush. If an airbrush were used to paint a whole frame, It would have to be refilled about 4 times because the cup capacity is so small. An airbrush should not be purchased until skill and technique are developed with a regular gun and cup.

2. Make sure the gun is small enough to handle the job. Many guns are quite large and heavy. A large gun such as Binks models 7, 26, 18, 62, 370, or 69 are quite large and would be unwieldy in a small paint booth such as the one described earlier. (A Binks model 7 is shown in fig. 318.) These guns have quite a large cup (1 quart), which is more than is ever necessary for painting a frame. The only time any of these guns would be recommended would be for production work where many frames would be painted the same color. In this way the excess left over at the bottom of the cup is not wasted as much. Another time a larger gun could be used would be for priming a run of bikes. Another disadvantage of a large gun is that the fan pattern may not be able to be adjusted down small enough to do a bike frame efficiently. The primary consideration with a large gun then turns out to be "waste."
3. Settle only for stainless steel needle valves and orifices with teflon seals. Gaskets should be made of leather or rubber. Some cheaper guns will use aluminum in place of some stainless parts and plastic in place of other metal parts. A cheaper gun with aluminum castings and plastic parts will wear out quickly and deliver a poorly formed fan pattern after only a short period of time; aluminum cups are quite acceptable however.

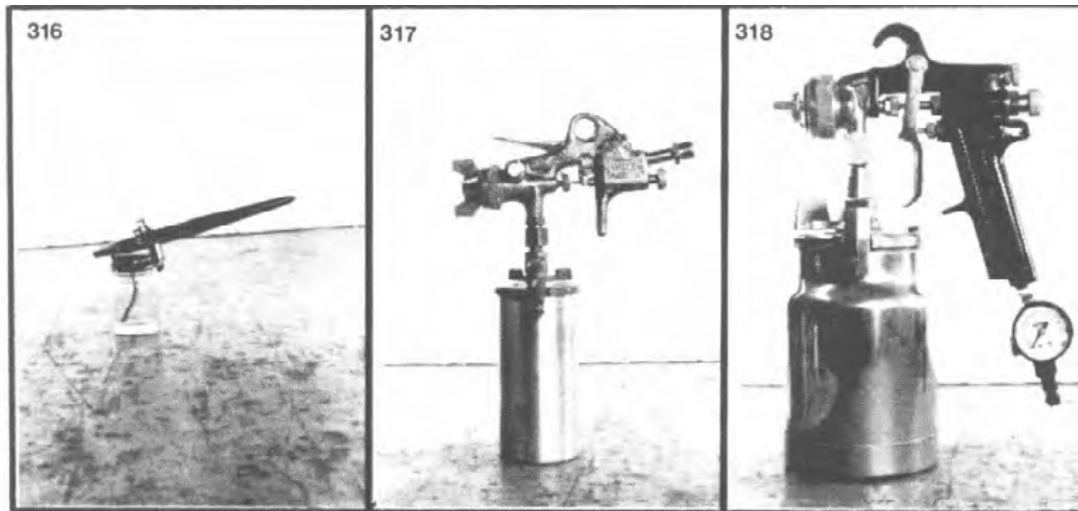

The gun and cup (the cup is often purchased separately) that best fit these criteria are usually referred to as a "touch-up gun." Binks, DeVilbus, and Sharpe all make a touch-up gun. They all fit easily into the palm of the hand, have the necessary stainless and teflon parts and hold approximately 8 oz. of paint, which is about enough to paint one frameset.

The author's choice was a Binks #115 touch-up gun (shown in fig. 317). It was easy to obtain locally and was highly recommended by another painter.

The principles which make the paint gun operate are simple and easy to understand. Air rushes through a horizontal tube and passes over the top of a vertical tube which is submerged in the paint. This airflow causes a reduction of pressure at the top of the vertical tube. At this point, the only thing that can happen is for the paint to rise in the vertical tube. When the paint reaches the top of the vertical tube, it is caught in the airflow at the front of the horizontal tube. The airflow then forces the paint forward. There is a very simple device that art students once used, consisting only of these two pieces of tubing--a mouth-operated spray gun (ill. 131) Perfume spray bottles are another variation of the same principle; they have a supply of compressed air (the bulb) and a nozzle to spread out the mist. From this point, further embellishments can be added: air pressure control, fan size control, and fan rotation control. Add the correct size of cup, necessary stainless steel and teflon parts, and a compressed air supply and "Voila!," you have a gun suitable for painting a bicycle frame.

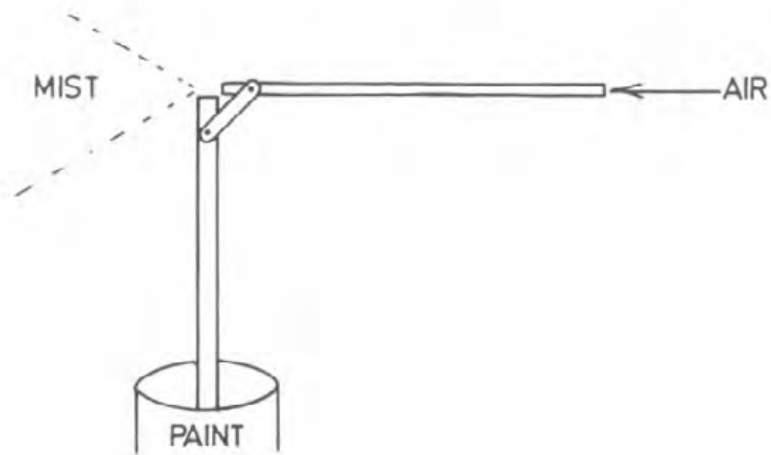

L1.131: Mouth operated spray gun (not for use with automotive paints)

#### MAKING THE NECESSARY TEMPORARY ADJUSTMENTS

The #115 gun, as well as most other touch-up guns, has four temporary adjustments. They are temporary in that they can be made without tools and can be made in only seconds during the middle of a painting session. These four adjustments are: 1) fan control, 2) fan rotation, 3) fluid control, and 4) air pressure control at the compressor.

1. FAN CONTROL- Adjusting the fan is quite simple. On the front left hand side of the gun is a knurled knob (arrow in fig. 319). Turning this knob clockwise gives a smaller fan. Turning it counter-clockwise gives a larger, flatter fan. A very small fan is preferable in bicycle frame painting because tube diameters are relatively small areas to paint and a smaller fan reduces waste due to overspray.

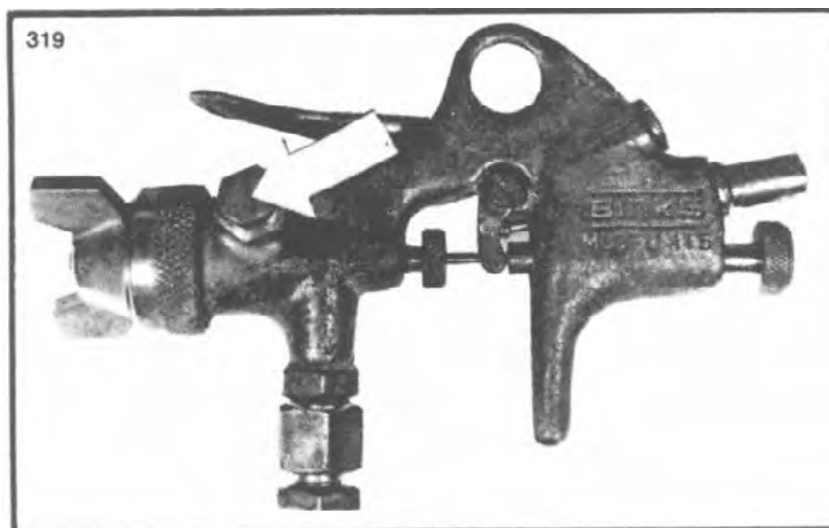

2.FAN ROTATION- Adjusting fan rotation is also quite simple and is done on a personal preference basis. The nozzle on the front can be rotated by loosening the large knurled ring on the front of the gun (white arrow in fig. 320), and twisting the two stubs that protrude from the nozzle (black arrow in fig. 320). After the nozzle is rotated to the correct position, the ring can be tightened again. (Do not overtighten!) Rotating the nozzle is done for one main reason--by doing so, the gun may be held so that the flattened fan is aligned with the object being painted. In other words, the painter does not have to tilt the gun so much to get good coverage while painting.

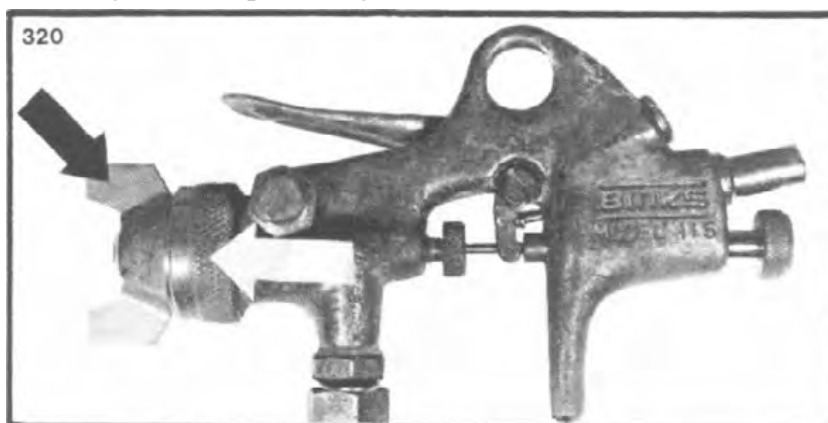

3.FLUID CONTROL- The amount of paint being supplied to the nozzle of the gun must be balanced with the pressure going to the nozzle. This adjustment can be made with the knurled knob at the back of the Binks #115 gun (arrow in fig. 321). Turn it clockwise for more fluid, counter-clockwise for less fluid. It is best to start at low fluid setting and work up to the correct setting. Not enough fluid can result in not being able to cover large areas well and can produce an "orange peel" effect. Too much fluid will cause runs to occur much more easily. Try to get a comfortable setting in the mid-range. Expect to adjust fluid settings as often as two or three times in one painting session.

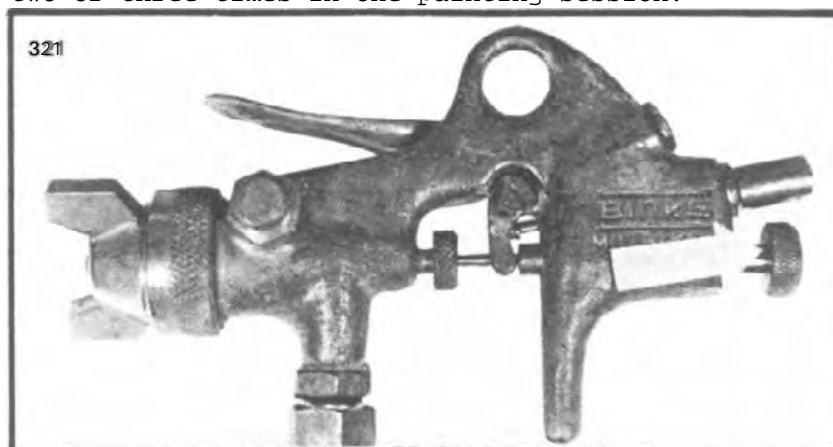

4. PRESSURE CONTROL AT THE COMPRESSOR- Directions for different paint products will call for varying delivery pressures. Metallics often call for more pressure than solids. Primers might call for even less pressure than solids. Look at the directions on the can to see what pressure is recommended for that particular paint. Even so, these are only estimates, and variations in temperature and humidity may necessitate altering these specs. The pressure can be set quite easily by turning in the screw at the diaphragm for more pressure and turning out the diaphragm screw for less pressure. The diaphragm will have a pressure gage mounted by it to indicate line pressure (fig. 323). If the compressor does not have a diaphragm with a gage, an in-line add-on kit can be purchased for about \$25.00 (fig. 322).

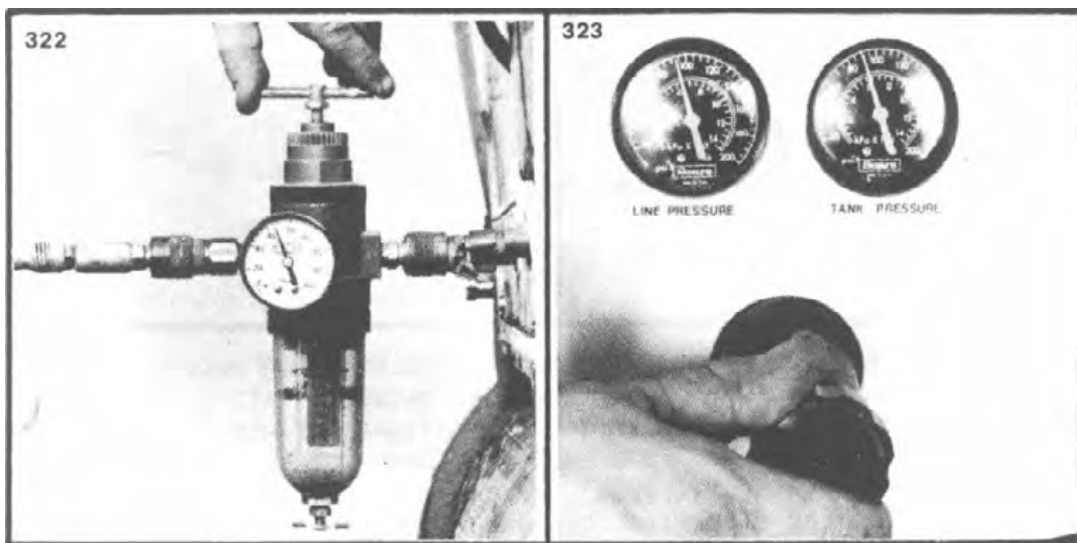

#### GUN MAINTENANCE

Four things must be done to the gun on a regular basis: 1) flushing the gun at the end of a painting session or when changing colors, 2) replacing worn needle valves, 3) total breakdown and clean-up, 4) replacement of seals and seats.

1. When a painting session is finished or when changing colors, the gun and cup must be flushed with clean solvent. Lacquer thinner is suitable for most gun cleaning procedures. Dump the excess paint in a proper waste container. Scrub the gun and cup with solvent and a toothbrush. (Pepsodent Toothbrushes will not melt in lacquer thinner.) Now, just as if painting, shoot solvent through the gun for about 30 seconds. Dump the solvent, which is now quite discolored, into a proper waste container. Repeat this with clean solvent. This may have to be repeated two or three times until only clean mist comes out of the front of the nozzle.

**WARNING:** The cleaning solvent can stay trapped in some of the cavities of the gun for several days. When next shooting a color or clear coat, spray the paint for about 15 seconds to clean out any solvent residue before shooting paint onto the work surface.

2. There are some strong abrasives in automotive paints. These abrasives will wear out needle valves in short order. As a general rule, the life expectancy of a needle valve is about 25 bicycle frame painting jobs. Wear on the needle valve can be identified as a shiny ring appearing around the taper at the front end of the needle valve. Figure 325a shows a new needle valve and figure 325b shows a worn needle valve. Pulling the valve out and putting it back in is quite simple. Just unscrew the fluid control (fig. 321) all the way and the needle valve can be pulled straight back and out. Reverse the procedure to replace the valve. Sometimes a difficulty arises when the three-piece needle valve is completely disassembled or a different model needle valve must be purchased. In either of these cases, the two locknuts must be reinstalled on the needle at the right adjustment. It is important that the air passageway opens up before the paint passageway opens. This can be done by screwing the locknuts backward or forward on the back end of the needle (fig. 324). The proper setting will have the trigger hitting the stud that opens the airflow (white arrow in fig. 326), about 1/32" before it opens up the fluid flow (black arrow in fig. 326).

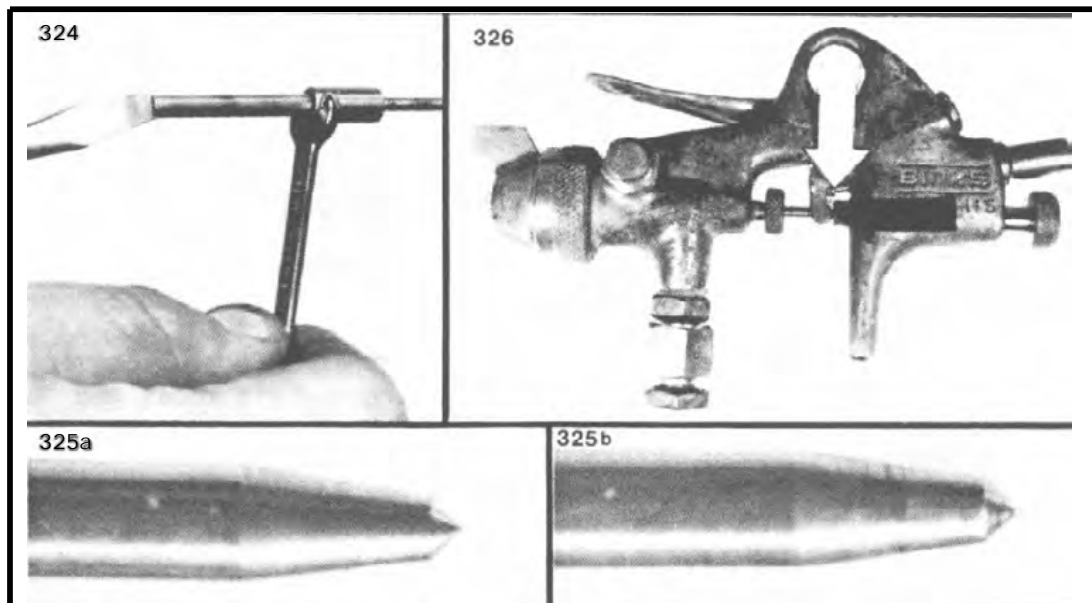

3. After painting 12 to 15 framesets, the gun and cup should be completely broken down and soaked for several hours in paint remover. Ditzler Aircraft Remover works well. All orifices and passageways should be cleaned out with a fine brush. (Pet stores sell fish aquarium brushes that are like miniature bottle brushes.) Never clean orifices or passageways with metal objects! Smaller holes that are clogged may be cleaned with an individual bristle of a bottle brush. While reassembling the gun, be sure all paint remover is completely removed. When the gun is fully assembled, flush it thoroughly with solvent. Paint remover left in the gun could ruin the next paint job! Don't forget to shoot paint through the gun for 15 or 20 seconds at the beginning of the next painting session. Solvent left in the gun could also ruin the next paint job.

4. The set of tiny rubber gaskets and the teflon seal should be replaced on the Binks #115 after painting about 50 framesets. This is quite simple and inexpensive to do and could be done during about every third breakdown of the gun.

By following these maintenance steps, a gun will give many years of top-notch service. The benefits are obvious immediately. The result--improved paint finishes.

#### THE COMPRESSOR

The compressor is a valuable piece of equipment in any shop. It has applications in machine, welding, woodworking, repair, and other types of shops. In selecting a compressor for a paint shop there are two considerations to be made: 1) There should be a way of setting the line pressure for different paint products; if a diaphragm for adjusting pressure is not available, an in-line kit can be purchased., 2) The compressor should be able to deliver about 5 cubic feet of air per minute at 60 psi. Here are a few hints and suggestions for compressor set-up and maintenance:

1. Install a water extractor in the line running to the paint gun. This will ensure that no water vapor gets into the paint spray mist.
2. It is not a good idea to run air tools off the same line as the paint gun. Oil used for lubricating air tools can back up in the line and eventually go through the paint gun. Some water extractors extract oil as well.
3. The tank of the compressor should be bled on a regular basis. Humidity in the air will build up inside the tank till it becomes water again. A compressor kept in a basement in a humid climate can build up over a quart of water per month!



- 4.If the compressor is the piston type, check the oil level in the crankcase at least four times a year.
- 5.Check the voltage being delivered to the motor. A low power supply could burn out the motor.
- 6.If using extension cords, use heavy duty ones that can handle the power supply. Light duty extension cords can reduce the power supply and can eventually damage the motor.
- 7.Check the belt frequently to make sure it is not slipping on the pulleys.
  - 8.Check the pulley set screws to make sure the pulleys are not slipping on the shafts.
- 9.If there is an air filter for incoming air, see that it is kept clean. See owner's manual for proper cleaning procedures.

#### THE BREATHING SYSTEM

It can not be stressed enough that painting with automotive paints is extremely hazardous to a person's health. The active ingredients in polyurethane enamels are poly-iso-cyanates. Some of the chemical disasters in this decade have been with the closely-related methyl-iso-cyanates. These cyanide-based chemicals are killers, as has been demonstrated in the news lately. In other words, polyurethane enamels can be killers under the wrong circumstances. The lung, nerve, kidney, and liver damage caused by repeated exposure to these products is cumulative and permanent! If the correct precautions are taken while painting, the risk is substantially lowered. If the maximum precautions possible are taken, there is little or no health risk. Proper ventilation has already been discussed, but that is only half of it. The other half is a proper breathing system. Painting with a booth is not enough. Not only do the vapors have to be exhausted away, the painter has to be getting a good supply of fresh air to breath.

There are four types of breathing systems discussed here: 1) the disposable fiber mask, 2) the face mask with charcoal filters in the front of the cheeks, 3) the face mask with the back-mounted charcoal filter, and 4) full coverage face masks with an independent air supply.

Before beginning a discussion of these respirators, the subject of facial hair should be mentioned. A painter with a beard is at a greater health risk than one who is clean-shaven. A beard breaks the air seal around the sides of the mask. When this seal is broken, paint fumes can easily leak in the sides of the mask. This makes the respirator a useless piece of equipment. A mustache is usually no problem since the mask creates an air seal over the bridge of the nose and has no contact with the upper lip. There is only one mask suitable for a painter who insists on having a beard. This is a full coverage mask with an independent air supply and with an air seal around the neck.

## THE DISPOSABLE FIBER MASK

Several companies manufacture a disposable mask (fig. 327). These usually come in a box of 10 for less than \$10.00. These masks are absolutely not suitable for painting with automotive paints! They should only be used for the following reasons:

- 1.Sanding operations with a lot of airborne dust
- 2.Protection when breathing cold air

A disposable mask removes a fairly large percentage of particulates but it does not remove chemical vapors associated with painting.



## THE FACE MASK WITH CHARCOAL FILTERS IN FRONT OF THE CHEEKS

The next type of respirator is the one with filters in front of the face (figs. 328 & 329). This mask removes some chemical vapors, as well as a high percentage of particulates. The activated charcoal in the filters is what helps this unit remove some of the chemical vapors. However, this mask is not suitable for automotive painting either. The main reason is that it takes its air supply from the area directly in front of the face. The area in front of the painter's face has a very high concentration of paint fumes; this is true no matter how good the ventilation system is. Drawing an air supply from in front of the painter's face is extremely hazardous. This type of mask should only be used for the following operations:

- 1.Sanding operations with a lot of airborne dust
- 2.Protection while breathing cold air
- 3.Welding and brazing operations where cadmium fumes or a lot of soot is being produced.

Again, this mask is not adequate for automotive painting.



FACE MASK WITH THE BACK MOUNTED CHARCOAL FILTER

A few companies manufacture a respirator that has a hose going to a charcoal filter mounted on the painter's back (fig. 330 & 331). This type of unit is the minimum requirement for safely painting with automotive paints. The air supply behind the painter is relatively free from contaminants when working in front of a well designed booth. Since this respirator has a hose between the mask and the charcoal pack, it has an added advantage. If the unit comes with a mask that only covers the nose and mouth, a full face mask can be purchased and easily screwed into place. Full face coverage will protect the eyes which act as a fairly direct pathway to the inside of the body.



## FULL COVERAGE FACE MASKS WITH INDEPENDENT AIR SUPPLY

Several companies manufacture total breathing systems for painting with automotive paints. These have a face mask (usually full coverage) with a hose that attaches to a waste belt. A long hose connects the mask at the waste belt to a diaphragm compressor which is a distance away or in another room. This system draws an air supply from an uncontaminated area and brings it to the painter. This type of system provides maximum protection, and brings health risks to an absolute minimum. When this system is set up properly, it can be used to handle a multitude of dangerous substances. Figure 332 shows the Binks breathing system. A partial coverage mask can be seen in figure 334 and a full coverage mask by MSA is in figure 333. Here are some suggestions for setting up an independent air supply system:

2. Use only diaphragm or oilless compressors! A piston type compressor will deliver oil fumes from the crankcase to the face mask. This poses an even more severe health risk than the paint would. An overheated shop compressor will actually produce carbon monoxide fumes! The result of using the regular shop compressor for a breathing system could actually be fatal. In which case the painter need not worry about long term effects.
3. Do not use a holding tank of any sort for the compressor! Storing air for breathing in a tank should only be done by hospitals, emergency crews and SCUBA shops. To be done properly, the air must be filtered several times and have the correct moisture content. This cannot be effectively done in a paint shop. The net result would be breathing a "foul" air supply.
4. If there are no simple dust filters on the compressor's intake port, fashion some simple ones out of clean foam rubber.
5. Set up the system so that the compressor will deliver an air supply from another room that can be sealed (by a door) from the work area. An added precaution would be to run a hose from the compressor's intake to an outdoor air supply. Do not set the diaphragm compressor in a "dead air" area. Good ventilation and air circulation in the room is very important.

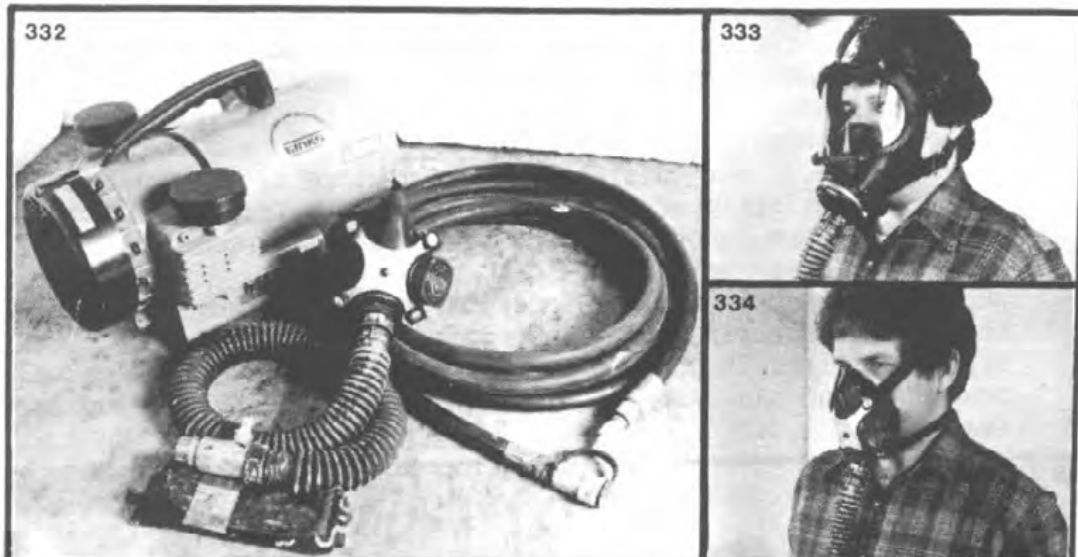

#### PREPARATION FOR PAINTING

A paint job can only be as good as the initial preparation of the underlying metal. In preparing the frame for painting, the surface must be totally cleaned of dust, oil, rust and any old paint that would be present when repainting an older frame. Failure to remove any of these substances can result in a poor paint job.

#### REMOVING OLD PAINT

Removing old paint can be done in a variety of ways: 1) with a chemical stripper, 2) sandblasting and 3) wetsanding.

#### CHEMICAL STRIPPING

One method of chemically removing paint is done by brushing on a commercially prepared paint stripping solution (fig. 335). As the paint starts to soften and wrinkle, it can be gently scraped off. This process may have to be repeated several times before the paint is fully removed. In the case of more stubborn patches of paint or hard-to-get-at places, a wire wheel works well.

Paint strippers have some powerful chemicals in them. For this reason, adequate ventilation is an absolute must, and rubber gloves are also required. Do not use latex gloves, as the paint remover will dissolve them after a period of time. Safety glasses should also be worn, especially when working on the wire wheel. The wire wheel will throw up pieces of wire occasionally, as well as small globs of paint remover. If either of these gets into the eyes, it is very painful and could even result in a visit to the doctor.

If the solution is chemically compatible with the existing paint job, the old paint will immediately start to wrinkle and separate from the frame. If the stripper is not the correct match for the old paint, it will be a real chore to remove it. For this reason, it is important to buy the correct paint stripper. Do not buy a paint stripper from the local hardware store. Most of those strippers are for varnish, latex paint and oil base enamels. Go to an automotive supply store and buy some automotive paint stripper or aircraft paint stripper. (The author's favorite brand is Aircraft Remover by Ditzler (fig. 335). It is quite powerful and is water soluble (fig. 336), so clean-up is easy.)

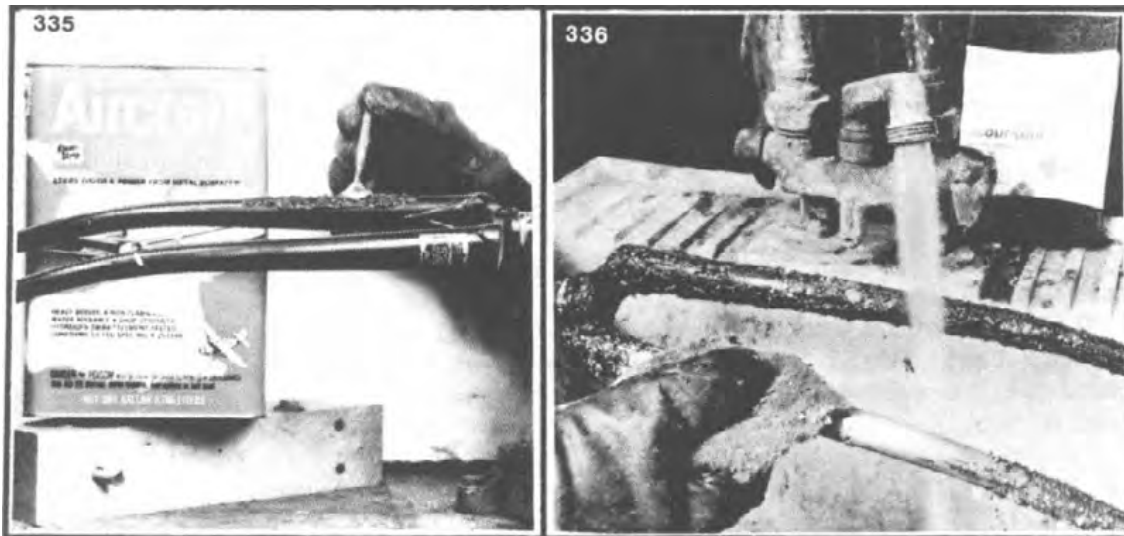

Another method of chemically stripping paint is to set up a dip tank of methyl-chloride. Methyl-chloride is the active ingredient in many brands of paint strippers. When paint strippers are prepared, the methyl-chloride must be combined with a carrier that gives the final product a jelly-like consistency. This allows the stripper to be applied without immediately falling off the item being stripped. Unfortunately, the jelly-like carrier diminishes the potency of the stripper. If pure methyl-chloride is put into a strip tank, it is much more powerful than any commercially prepared solution. It is also far more hazardous than any commercially made product! With a dip tank of this sort, a frame can be dipped and the paint should fall off in only a few minutes. One major drawback of this method is the expense. The solution must be replaced when it becomes highly contaminated with sluffed-off paint. Methyl-chloride in 30-gallon drums is quite expensive. Here are some safety hints for setting up a dip tank:

1. Use only heavy-gage stainless or soapstone in constructing the tank. Old chemistry lab sinks are ideal.

2. The dip tank must have a lid with overlapping sides.
3. Set up the tank in a well ventilated area.
4. Float 5cm of water on top of the methyl-chloride. This cuts evaporation markedly. It is the evaporation that is the real hazard.
5. Have a way of locking the tank and keep it locked up at all times when not in use!

Below is a diagram of the correct way to set up a dip tank.

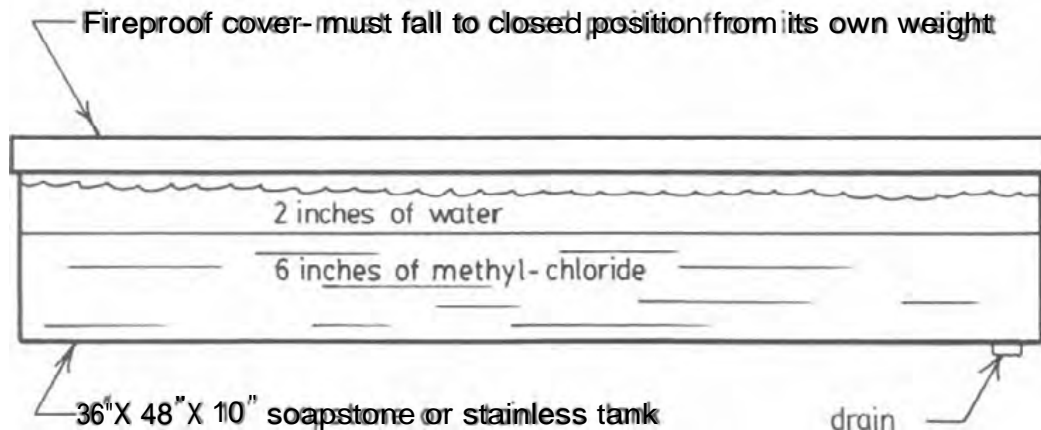

### ill.132: Dip tank

#### SANDBLASTING

Another way of removing paint is by sandblasting. This is an acceptable method for removing paint from heavier and cheaper frames. Sandblasting is quite harsh on the surface of the frame. In the case of lightweight tubing, it is possible actually to blow a hole through the tubing wall if the worker is not careful. Sandblasting can also remove brazing material from joints leaving unsightly gaps in some instances. Sandblasting does have one redeeming grace: It can actually put strength back into an overheated brass brazed frame. (In ways, sandblasting is very similar to shot peening. Shot peening is done to metal objects to relieve stresses built up during high temperature processes.) If the decision is made to sandblast frames, choose a reliable firm to do it and make sure they are aware of the problems of working with bicycles.

#### WETSANDING

Wetsanding should not be done with the intention of removing all of the paint. It should be done to a frame that is receiving touch-up work. In the case of a frame that has been dinged up with a few chips and scratches, these

imperfections can be "feathered out" with a piece of Wetordry sandpaper and water. (Wetordry is a 3M brand name that designates a type of sandpaper that can be used wet or dry.) When used with water, Wetordry paper will not clog up as easily. This allows the paper to be used much longer before discarding it. To feather out nicks and scratches in a paint job, use a 320 grit paper. After all of the wetsanding is done, the frame may be shot with a new coat of paint right over the old coat. Below, figure 337 shows a poor job of wetsanding where sanded edges are too abrupt. Figure 338 shows a good job of feathering.

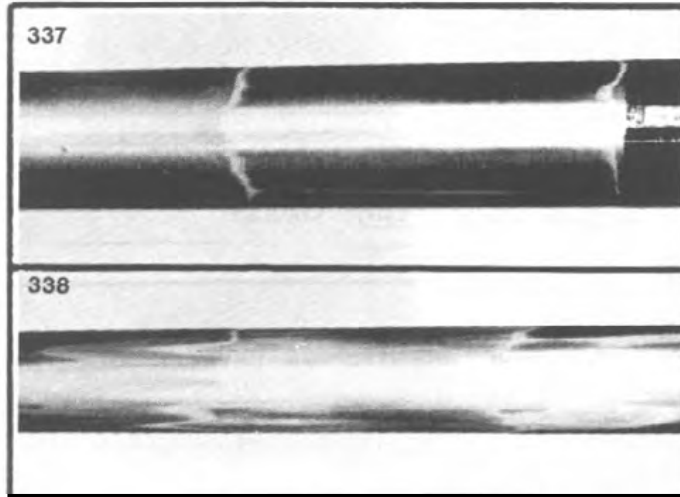

NOTE: It is the personal preference of the author not to wetsand any frame other than one of his own. Wetsanding and repainting a strange frame can be a real headache. If an inferior paint job was done by someone else, the wetsanded-repainted paint job will be only as good as the original paint job. If problems develop in the future, the customer will expect a free repaint by the last person to paint the frame.

#### METALPREP

After the frame has been completed (step VI-42 on page 3-51) or when the paint has been entirely stripped from an older frame, a phosphoric acid scrub-down must be done. Doing this will clean and "etch" the surface of the metal to be painted (etching refers to the action of the acid on the metal). By applying phosphoric acid to the surface of the metal, rusting can be greatly inhibited or even arrested. This will allow the paint to be sprayed onto a surface that has no rust on it. Here some safety hints for doing a phosphoric acid scrub down:



1. Wear rubber gloves when handling phosphoric acid. If the acid comes in contact with open sores, scabs, or mucous membranes it will eat away body tissues for days until the body can neutralize the acid.
2. Wear a respirator mask. A simple one with charcoal filters will do.
3. Do the scrub down outside. Indoors, the acid fumes will ruin latex paint jobs on interior walls.
4. Wear long sleeves and long pants in case of splashing.
5. Safety glasses would not be a bad idea.

Following are the actual steps to use in performing the phosphoric acid scrub-down:

1. Obtain the following: DuPont 5717S metal prep (phosphoric acid), A Brillo or 3M green scouring pad with no soap (other brands will decompose in the acid), a small hypodermic syringe with the needle removed, a disposable plastic bowl with about a pint capacity, and a terry cloth rag.
2. Fill the bowl about half full of acid. The directions say to dilute the acid, but full strength gives quicker results.
3. With the green pad, scrub the entire surface of the frame and fork with the acid. Don't be afraid to scrub hard. Do not scrub chromed areas.
4. Fill the syringe with acid and shoot it inside of all of the tubes. Remember, it was said large air expansion holes were important (fig. 66). It was also recommended to drill two air expansion holes for each tube (figs. 97 & 135). All of these earlier suggestions were given to make the phosphoric acid flush more effective.
5. Allow the frame and fork to stand for 10 to 15 minutes so the acid will have time to etch the metal. This will take less time in warmer surroundings.
6. Thoroughly rinse the outsides and flush the insides of the tubes with cold water. Using cold water will allow more time to work before the frame starts drying off.
7. Towel the frame and fork dry with the terry cloth rag.
8. With the airblower from the compressor, blow any remaining residue from any of the crevices of the frame and fork. Also blow into each air expansion hole so any residue from inside the tubes will come out the opposing air expansion hole. (Time for safety glasses)

#### MASKING AND INSTALLING PAINTING HANDLES

Now that the metal prep has been finished, painting handles can be installed and masking can be done. Note the different painting handles that can be fashioned (figs. 339 through 344). These allow the frame to be handled easily without the fear of smearing the paint.

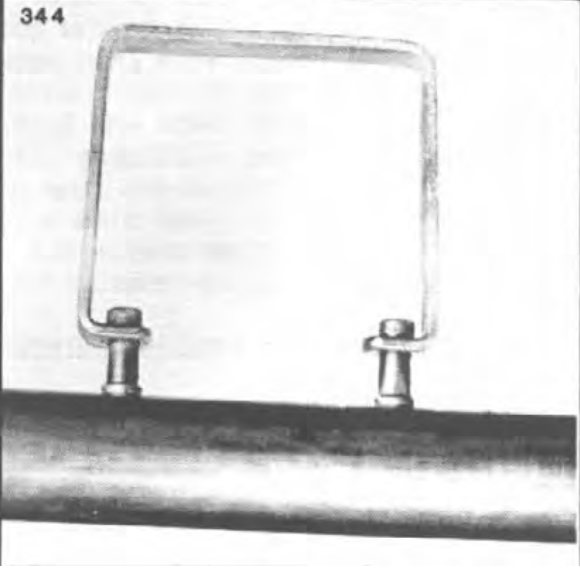
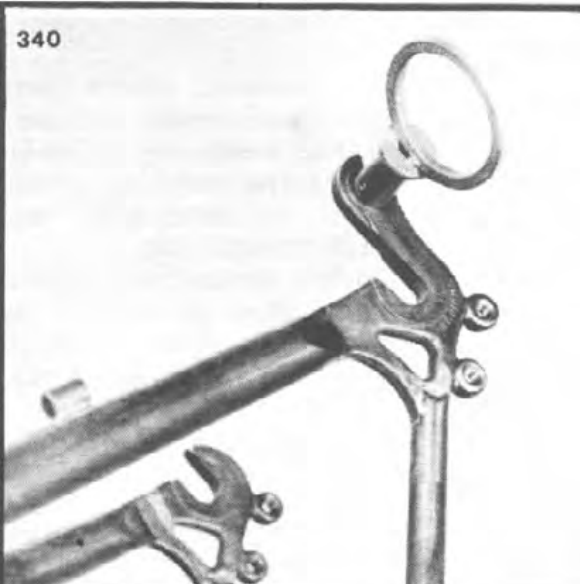
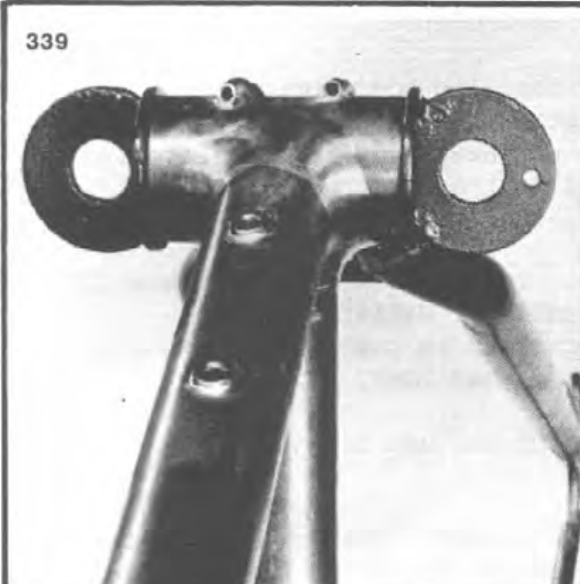

Masking can be broken down two ways: 1) necessary and 2) cosmetic.

Necessary masking consists of the fork crown race seat (fig. 345), the small cylinder of cantilever studs, the cylindrical portion of shift lever studs, the bottom bracket faces (unless a sealed bottom bracket set will be used), and the head tube ends which are optional (fig. 346). All frames should have these items masked to make assembly of the completed bike easier. By masking these items, bearing seats

out. All of these may be masked with a high grade of masking tape except the bottom bracket faces which are covered by the painting handles.



Cosmetic masking consists of masking chrome and masking for a two tone paint job. Masking chrome may be done in two ways. One way is to cover the whole area with a high grade of masking tape and carefully cutting the excess away with a razor knife (fig. 347). The other way is to carefully paint the area to be masked with rubber cement, which can be rubbed off after the paint job is finished (fig. 348). (The author has had very little experience with the latter method and prefers masking tape.) Some lunatics have suggested applying grease to the chromed areas and rubbing it off after the paint job is finished. There could be no better way to create the worst rash of "fisheyes" ever seen on a bicycle frame! All painters should be doing everything possible to keep oil and grease away from all painting equipment and supplies. Masking panels in a two tone job can be done with a combination of freezer or waxed paper and masking tape. The freezer paper can be cut to nearly the size needed and wrapped around the tube with the slick side toward the frame. Masking tape can then be used to finish it off around the edges (fig. 349). Do not use a fibrous paper like newspaper to mask with.

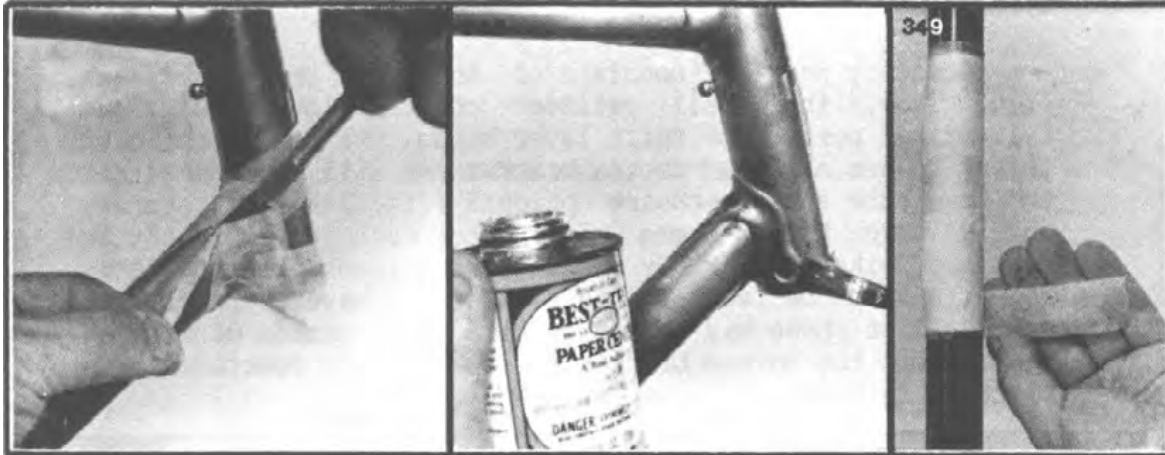

A word about masking tape - Do not buy rolls of masking tape at the dime store or hardware store and expect good performance from it. Such tape is thicker and stiffer and harder to work with. For not much more money, the right tape can be purchased at automotive supply stores. Using the right type of masking tape allows the painter to "form" it around curves. The thinner tape will also leave less of a ridge between the colors. Always remove masking tape as soon as possible! If left for too long a period of time, masking tape can even ruin a chrome finish.

#### DEGREASING AND USE OF TACK RAG

After masking and installing of painting handles, the frame should be degreased and gone over with a tack rag. This is a simple process but very important. The frame has been handled extensively up to this point and has a variety of contaminants on its surface, the worst of which would be oil or grease that could have come from bench tops, or even the painter's hair or perspiration. To remove these substances, soak a paper towel in lacquer thinner and wipe down the frame and fork. (Don't forget good ventilation!) Try to use a paper towel that does not leave much lint. After degreasing, wipe the frame and fork thoroughly with a tack rag. A tack rag is a piece of cheese cloth impregnated with a sticky, waxy substance that will remove all particles of lint from the surface of the frame and fork. Tack rags can be purchased from an automotive paint supply store. They are relatively inexpensive. Purchase 2 or 3 brands and see which works best. (Some brands aren't very good.) Do not worry about leaving some of the waxy substance on the metal surface - it is compatible with the paints that will be used.

## A HEALTH WARNING

Here again, it is of importance to warn about the health risks involved in painting with automotive paints. They are killers! If there are any second thoughts about using them, talk to a toxicologist (a medical doctor specializing in poisonous substances and their effects on the human body). If there are children around the shop, they are at a health risk. Pregnant women should by all means avoid any exposure to the fumes. Men who are considering fathering a family in the near future may be risking birth defects. People with respiratory ailments such as asthma or emphysema can die in a matter of minutes due to over exposure to these paint fumes. Long-term cumulative and permanent damage to the nervous system, liver, and lungs can result from careless use of these products.

On the other side of the coin, the performance of polyurethane enamels outperforms any other paint on the market. Many painters wouldn't even think of using anything other than polyurethane enamels.

If, after considering the implications involved, the framebuilder decides not to go into painting frames, there are alternatives. One alternative is the "rattle can" method. This is a bad choice at best. Rattle cans are manufactured for the general public and by law can not contain any of the chemicals that make a high quality paint job so much better. Furthermore, the pressure used in rattle cans is so low that atomization of paint particles is poor. Last of all, the can is not adjustable and the orifices are made of plastic. Any self-respecting builder would not paint a fine custom frame with a rattle can. The other alternative is probably the best. Find an experienced painter who is willing to do the work on a regular basis. Many framebuilders who are experienced painters are more than happy to take on the extra work. If an auto body painter is willing to do the work, try him out on a garbage frame first. Bicycle frames are totally different from cars when it comes to painting. Many auto body painters won't touch a second frame after wrestling with the first one.

## PAINT PRODUCTS

There are several paint products that can be used effectively for painting bicycle frames. Acrylic lacquer, acrylic enamel, epoxy primers, and polyurethane enamels are the more popular ones these days. Since the author's experience is mostly with epoxy primers and polyurethane enamels, those are the ones that will be covered. The three most well known names in polyurethane enamels are Ditzler (Deltron), Sherwin Williams (Sunfire), and DuPont (Imron). Here again, the author's experience lies mostly with DuPont products so that is what will be covered. Much of the information will transfer over to the other brands.

## TWO PART EPDXY PRIMER

DuPont Corlar is a primer that comes in two parts. Number 8245 is the light gray paint and 826S is the activator. Corlar also comes in a red oxide color, but the author doesn't recommend it highly for painting bicycles due to the problems in adequately lighting cylindrical objects. A new can of Corlar must be stirred; significant settling occurs on the shelf and 3 cm of sludge on the bottom is normal. The activator does not have to be stirred. After stirring out all lumps, the two parts can be mixed. Mixing should be done in a clean metal container or a plastic container from a chemistry lab. There should be calibrations visible on the inside of the container. The mixing cup can be calibrated for easy mixing with a light tap from a hammer and center punch (fig. 350). Use two parts of 824S to 1 part of 826S. Mixing should be done at room temperature an hour before the paint will be used. A good time to mix the paint is just before the phosphoric acid metal prep. This will allow an hour or so for masking and degreasing of one or more frames. After the paint has been standing for an hour or more, it is time to add reducer to get the right viscosity. Paint that is too thick will send spatter out of the front of the gun. Paint that is too thin will run too easily. To achieve the correct viscosity, buy a DuPont viscosimeter (fig. 351). It only costs about \$5.00 and is worth its weight in gold. For priming bicycle frames, DuPont Corlar should run through the viscosimeter in 20 seconds. (Point of interest: If too much Corlar is mixed up, it can be refrigerated for up to 2 weeks. If it is refrigerated, it can not be put in the same refrigerator with food. Since Corlar looks like milk, use only its original can to store it in this manner. Put a hasp on the refrigerator door and padlock it!)

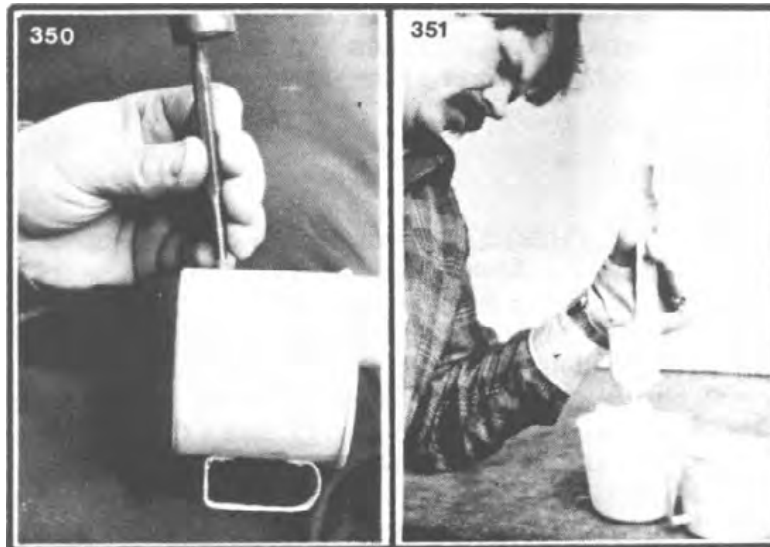

## REDUCER

Reducer is another word for thinner. Reducers are "specific." In other words, the correct reducer must be used with the paint that is being used. If in doubt, look at the directions on the back of the paint can to find out which reducer is recommended. It is not a good idea to mix and match brands of paint products. Because of minor variations in formulas, always use DuPont reducers to add to DuPont paint products. Corlar may be thinned or reduced with #3602S DuPont acrylic lacquer reducer. DuPont makes several acrylic lacquer reducers that will work. However, #3602S is a "fast" reducer that will flash over faster than the others. This will allow the color coat to be applied sooner and will also lessen the probability of runs.

Paints should be reduced in the paint booth with all respiration equipment in place and the ventilation system turned on. A pair of rubber gloves should be worn from now until the frame is fully painted. Latex kitchen gloves are less cumbersome and will not break down in painting chemicals.

Clean-up of paint equipment after working with Corlar can be done with acrylic lacquer thinner. See gun maintenance.

## LINT CHECK

This is also a good time for the painter to check out the clothing he has on. Flannel, wool, or any other fuzzy material should not be worn while painting. The airborne lint particles will be drawn through the booth due to the air flow. These lint particles can land on the frame and cause unsightly blemishes. Another good way to cut down the problem of airborne lint particles is to spray a light mist of water in the air with a plant mister. The water droplets will cling to dust and lint particles and drop to the floor.

## POLYURETHANE ENAMEL

DuPont Imron is also a two part paint. However, don't confuse it with an epoxy paint, like Corlar, which is also a two-part paint. Imron is a polyurethane enamel. Imron does not sit on a shelf and settle for months at a time like premixed paints. The color requested is mixed when it is ordered. This does not mean that stirring or shaking is not necessary. After the Imron is mixed and taken back to the paint shop, pigments and particulates in the paint start to settle and go to the bottom almost immediately. Imron must be shaken vigorously within one or two minutes of pouring it into the gun. If the Imron is allowed to sit for any length

of time without being shaken, a slightly different color will result. After that, the original color from that particular can will not be possible again due to an upset in ratios of the paint mix.

Imron can be reduced with DuPont #8485S but, reducing Imron for bicycle frame painting is not highly recommended. Since there is a problem with runs occurring on bike frames already, reducing would only make the problem worse.

Imron is mixed 3 parts paint to 1 part activator (DuPont #192S - If Imron activator is not available, DuPont Centari activator is the same thing.) The easiest way to mix the two part paint is to carefully make four punch marks up the side of the cup (fig. 352). The marks can then be used to measure the paint. First, fill the cup to the first mark with the activator (fig. 353). (If the activator is put in first, the mixed paint will not have to be shaken as much.) Then, pour the Imron paint in to the fourth mark (fig. 354). The gun should now be put in place in the following manner. Before the vertical tube from the gun touches the freshly activated paint, depress the trigger. While air is rushing through the gun, submerge the tube. Continue to spray fresh paint through the gun for about 15 seconds. By doing this, any lacquer thinner from the last flush will have been expelled before it has a chance to mix with the Imron. This is important to do. That initial shot of lacquer thinner can wrinkle the back side of a fork blade or one side of a chain stay. Now, fasten the cup in place, pick up the gun, and gently swish it in a circular motion to further mix up the activated Imron. Don't shake the gun or paint will come out the bleeder hole of the cup. The Imron is now ready to shoot.

Clean-up of DuPont Imron can be done with acrylic lacquer reducer. See Gun Maintenance.

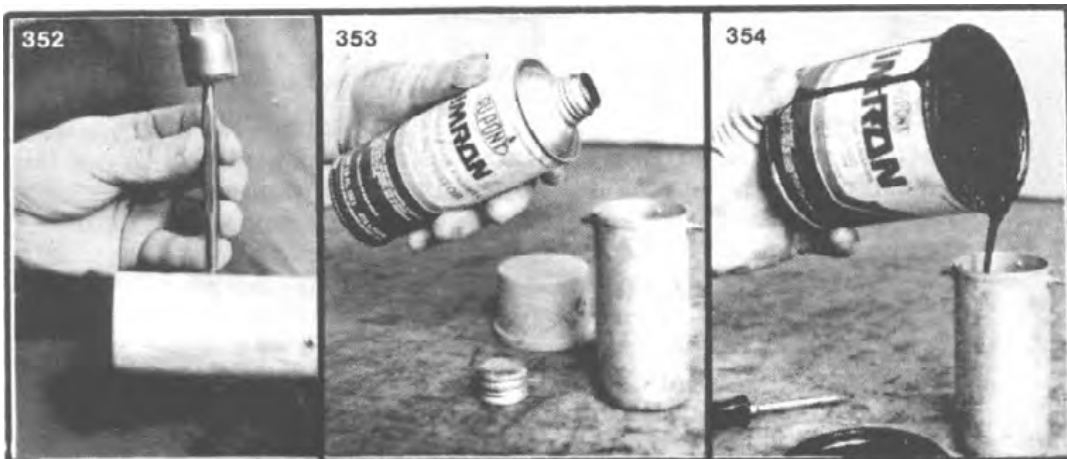



## ACCELERATOR

To hasten drying time, DuPont #189S polyurethane accelerator can be added. 189S should be added to an 8 oz. cup with an eyedropper a few drops at a time. Adding accelerator will allow masking to be done sooner. It may also be a good thing to do with some of the light greens or light blues which tend to run more easily. Occasionally, the very dark colors will leave unsightly highlights around sharp edges. Accelerator may help soften those highlights. The main drawback of using accelerator is that orange peel occurs much more readily. Ratios for 1895 are given on the side of the bottle. However, for bicycle frames, a little experimentation may be required.

## CLEAR COATS

Clear coats may be applied at any time - even months after the color coat. Clear coats (DuPont 500S) are mixed and applied exactly the same way as DuPont color coats. Here are some suggestions for applying clear coats:

- 1.If applying a clear coat immediately after the color coat has been applied, no special preparation needs to be done. Just shoot the clear right over the top of the color. This might be done to smooth out airbrush work or color blending work.
- 2.If applying a clear coat within 72 hours of normal air drying, no special preparation needs to be done. Shoot the clear right over the color coat. This would be done in the case of painting a two-tone where the panel color is painted on Day 1, the base color is painted on Day 2, and the clear coat is painted on Day 3.
- 3.After longer periods of drying or force drying (baking), the surface must be gone over lightly with a fine steel wool before applying a clear coat. This would be done to rejuvenate a dulled or scratched paint job. After using the steel wool, rub the frame down extensively with a tack rag to remove the massive particles of steel wool lint.
- 4.If decals are applied on top of the paint job before the clear is applied, problems arise. To have less problems affixing decals, the frame should be baked at about 125 degrees F for four to six hours. Working with dry transfer decals can be a disaster if the frame has only air dried over night. A whole line of letters could peel off the sheet and not come off again under such

paint, bake, affix decals, clear coat, and bake again. This does not allow the clear coat to adhere as well to the color coat, but the process works well. Another procedure would be to paint, bake, steel wool, affix decals, clearcoat, and bake again.

## FORCE DRYING OR BAKING

To speed up the process, paint jobs can be force dried. Some paints, such as baking enamels, will never dry unless they are baked at 350 degrees for several hours. This is not the case with acrylic lacquers, acrylic enamels, and polyurethane enamels. They will fully dry and harden (cure) at room temperature in about 30 days. This is where a problem arises. These paint jobs are fragile and highly susceptible to chips and scratches during this drying time. It is risky business to turn over an uncured paint job to a novice bike mechanic. Frame clips or a bicycle repair stand clamp can ruin a new paint job.\* This is where force drying comes in handy. A new paint job can be baked overnight at about 125 degrees F. This is about equivalent to two weeks of air drying. An easy and inexpensive way to do force drying is to close up the paint booth with heating lamps inside it.

Contrary to popular belief, baking does not make a paint job any stronger than normal air drying. It only speeds things up.

\* NOTE: Never clamp a repair stand directly onto any high quality paint job whether it is cured or not. If possible, always clamp onto the seat post. If it is too difficult to clamp onto the seat post, put some freezer paper, waxed paper or 10 mil poly in the jaws of the clamp each time a frame is put in the stand.

## DECALS

There are two major types of decals; 1) decals that are covered with a clear coat and 2) decals that go on top of the paint job.

1. Dry transfers which are affixed by rubbing them onto the surface (fig. 358), water transfers which are affixed by soaking them in water and sliding them off onto the surface (fig. 357), and alcohol transfers are examples of decals that can be covered with a clear coat. Applying these decals takes a lot of practice. The biggest problem with the water and alcohol transfers is in being able to handle them delicately enough. Water and alcohol transfers should be allowed to dry for 8 hours before applying a clear coat.
2. Mylar decals and foil decals are examples of decals that go over the top of the paint job (figs. 355 & 356). Do not try to put a clear coat over them as it will not look good at all. The decals are too thick and too smooth to clear coat adequately. Application is so easy a five year old can do it. Just peel the backing and put in place.

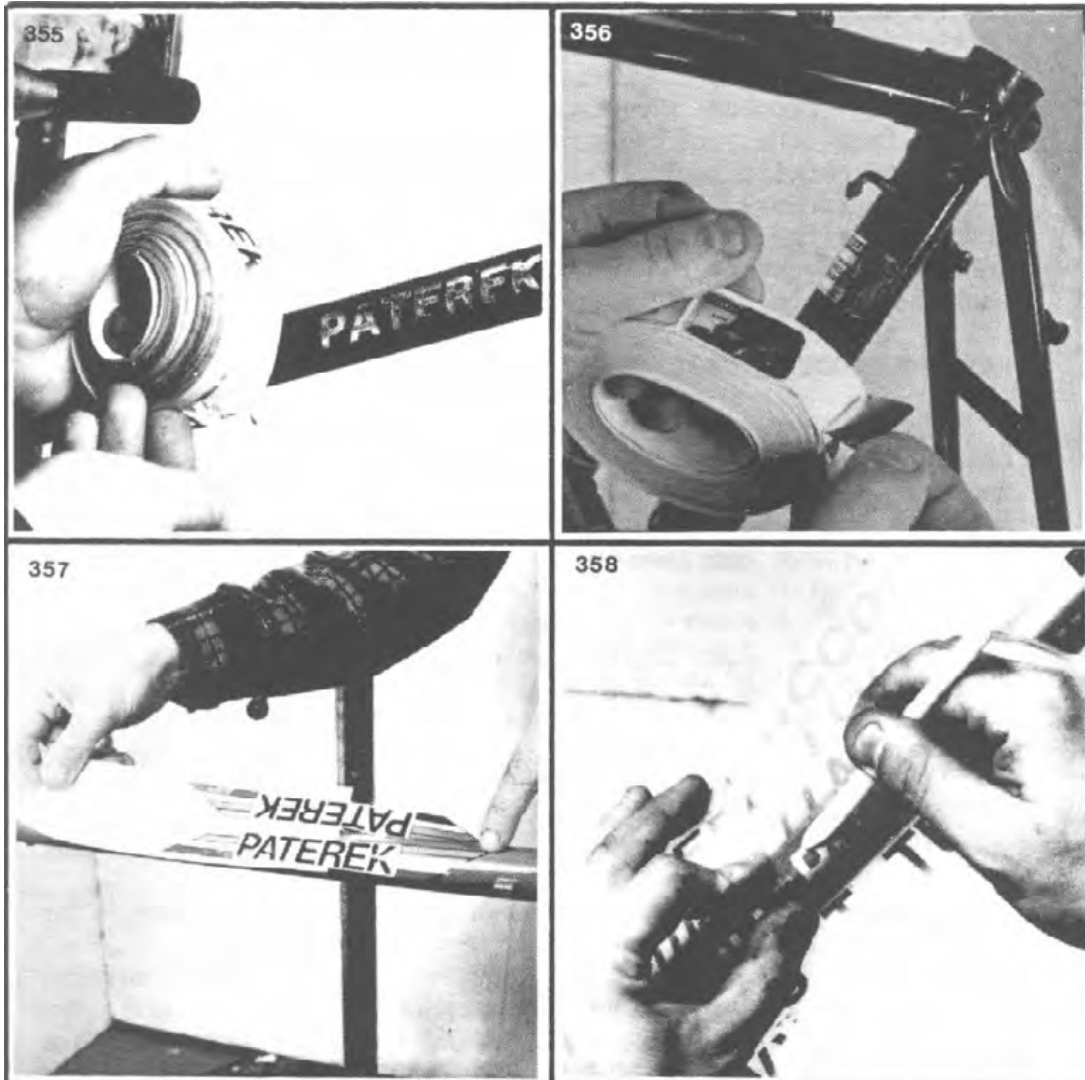

In the four pictures above can be seen the different ways in which decals can be applied. They each have their advantages and disadvantages. The most versatile is probably the dry transfer method, which can be done in over 100 type styles. However it is time consuming. Water slide decals are by far the most attractive, but they are the most expensive. Foil and Mylar decals are relatively inexpensive and can be used for other applications as well but, cheapen the look of a custom frame.

## PLATING

There should be some mention of the plating of bicycle frames. Bicycle frames can be plated with a variety of metals such as chrome, brass, silver, gold, platinum, nickel, and many others. The presence of the metal applied to the surface of the bicycle frame has no detrimental effect on the strength of the steel. However, certain acid baths are required in the plating process. During this preliminary "pickling" process the steel takes on available hydrogen atoms from the acid baths. This causes what is called "hydrogen embrittlement." Hydrogen embrittlement causes the steel to fracture along shear planes more easily. Thus, the strength of the steel frame is greatly diminished. A builder who wants the utmost in strength characteristics in a frame should not have plating done.

## PAINTING TECHNIQUES

This is a rather difficult subject. Painting takes a lot of practice and there really isn't any way to gain the steady hand and necessary smooth movements to paint a frame from a book. About all that can be done is to list a few final hints and leave the rest up to the reader.

1. Paint with the gun about 20 to 25 cm away from the work.
  2. Inspect the work frequently for runs and orange peel. Remove it from the booth and hold it up to a bright light and look carefully. If a run develops, don't touch it! Carefully rotate the frame and try to get gravity to remove the run. If that fails, don't touch it. Let it dry over night and wetsand it out the next day. Then reshoot the color again. If orange peel is developing, check the fluid control and slow down your sweeping movement of your arm.
  3. Be careful about going over a spot too many times. The fork crown is a problem in this respect.
  4. Check the backside of braze-ons for paint coverage. Some problem areas are: the top of the binder bolt, the top of the brake bridge, behind the left bottom bracket guide and the fronts and backs of top tube cable guides.
  5. When the frame is finished clamp the seat tube painting handle in the Park stand and rotate the frame every five or ten minutes.
  6. Do not paint when you are tired or upset!
- i
- people asking too many questions, or a telephone can be difficult to contend with.
8. Don't try to cover everything in one coat. First, do a light tack coat. Then finish up about half an hour later with the final glossy coat.

FRAMEBUILDERS' VARIATIONS:

Pg. 2-3

Brazed-on front derailleur; The new Shimano Dura-ace EX front derailleur for 1985 will be interchangeable with Campagnolo.

Pg. 2-5 to 2-6

Cantilever brake sets; The new Suntour XC power brakes are not interchangeable with any other brand of cantilever. Separate mounting bosses provided by Suntour must be brazed-on instead of the cantilever studs shown at the bottom of page 2-5. Below is a drawing showing the different style boss and the approximate locations for off-road bikes.

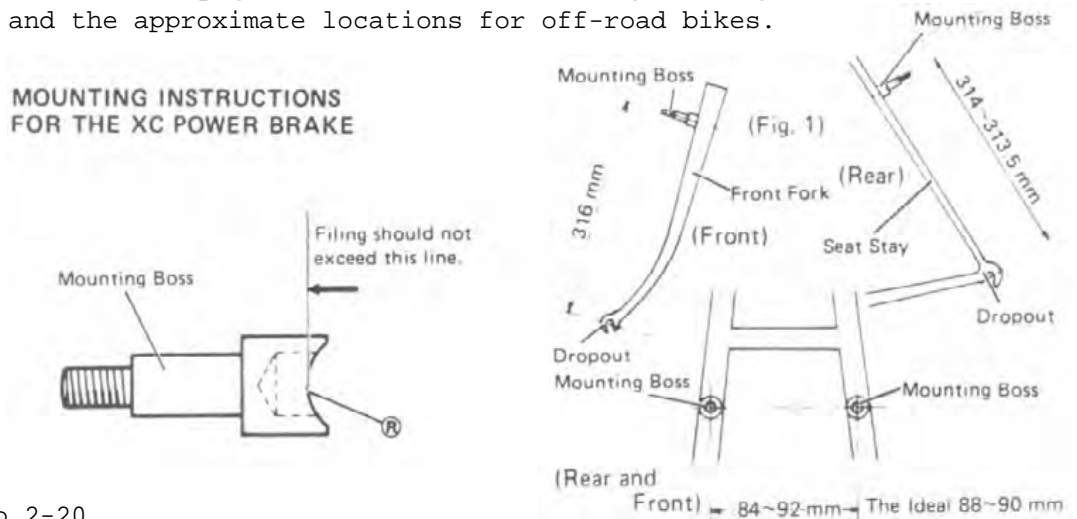

Pg. 2-17 to 2-20

Chainstay bridges; A small number of bottom bracket shell manufacturers have integrated the chainstay bridge right into the casting. These have only appeared at national bike shows as of January of 1985.

Pg. 2-24 to 2-30

Seat clusters; Strawberry now sells a yoke shaped fitting that acts as a combination brake bridge and seat cluster. Below is a sketch. Note the location of the binder for the seatpost.

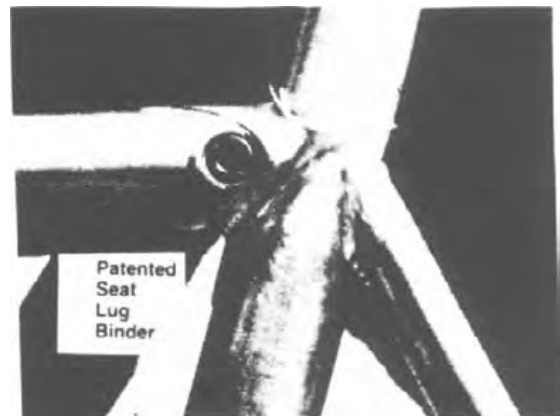

pg. 2-34 to 2-35

Lug sets; Tange is now marketing an investment cast lug set. Little or no reaming is required. Little or no clean-up is required. Short points and no cut-outs.

Pg. 2-34 to 2-35

Lug sets; Ohtsuya Medalist lugsets are available from Quality Bicycle Products. These are investment cast with short points and no cut-outs. They can be best described in one word; "petite." They require little or no reaming and very little cleab-up. The seat lug has an internal rim for the top edge of the seat tube to butt up against.

Pg. 2-34 to 2-35

Lug sets; Lug sets are now available from Bill Davidson. They are investment cast. Minimum order ..... 10 sets.

Pg. 2-35 to 2-37

Bottom bracket shells; Tange is now marketing an investment cast bottom bracket shell. It requires little or no reaming. It's available in BSA specs and the machining on the threads and faces is excellent. The brand name is cast rather deeply into the under side.

Pg. 2-35 to 2-37

Bottom bracket shells; Ohtsuya Medalist bottom bracket shells are available from Quality Bicycle Products. It is investment cast with excellent machining on threads and faces. Available in BSA specs. It requires only moderate reaming. It displays 2 cutouts; one below the downtube and the other behind the seat tube.

Pg. 2-35 to 2-37

Bottom Bracket Shells; Bottom bracket shells are now available from Bill Davidson. They are investment cast. Minimum order ..... 10.

Pg. 2-44 to 2-45

Dropouts; A new set of Shimano verticals are available. They are listed as FE-SF-22. They have raised faces, cutouts, and derailleur hanger. They are made of forged steel and have 8 eyelets. (Same as FE-SF-21 except with double eyelets)

Pg. 2-49

A special top tube is available from Columbus. It has a crease running along its side. This allows for neat storage of the rear brake cable without the use of clips or braze-ons. It can be purchased seperately and used with any tube set.

Pg. 2-64

Tube sets; Tange has recently introduced the 1000 series. Send to Shimano for more information.

Pg. 2-64

Tube sets; Tange has recently introduced the 900 series. Send to Shimano for more information.

Pg. 2-64

Tube sets; Tange **has recently introduced the Infinity series of tubing.** This is a seamed tubing that has tapered walls rather than butted walls. During coldworking, the seams nearly disappear **from sight and the** tube takes on almost the same strength properties as seamless tubing. Send to Shimano for more information. The Infinity name comes from the concept that the tubes do not have a starting or stopping point for the butt. In effect, they are infinitely **butted.**

## TOOLS

Pg 6-12

A Chadwick 28 adjustable reamer can be purchased to ream the fork crown for the general prep ( See fig 29 on pg3-61). A chadwick # 30 reamer can be purchased to ream damaged British or French bottom bracket shells to the minor diameter of Italian bottom bracket threads. Equivalent reamers are available from HKC and VAR.



Pg. 6-12

An adjustable sizing stand can be purchased from Benotto to simulate the actual fit that a proposed frame will have for a customer. These are available only on a special order basis from Italy and delivery time is long. They should be used only as a selling aid and not for frame design. Recommended procedure is to use them in conjunction with the Fit Kit and the completed working drawing.

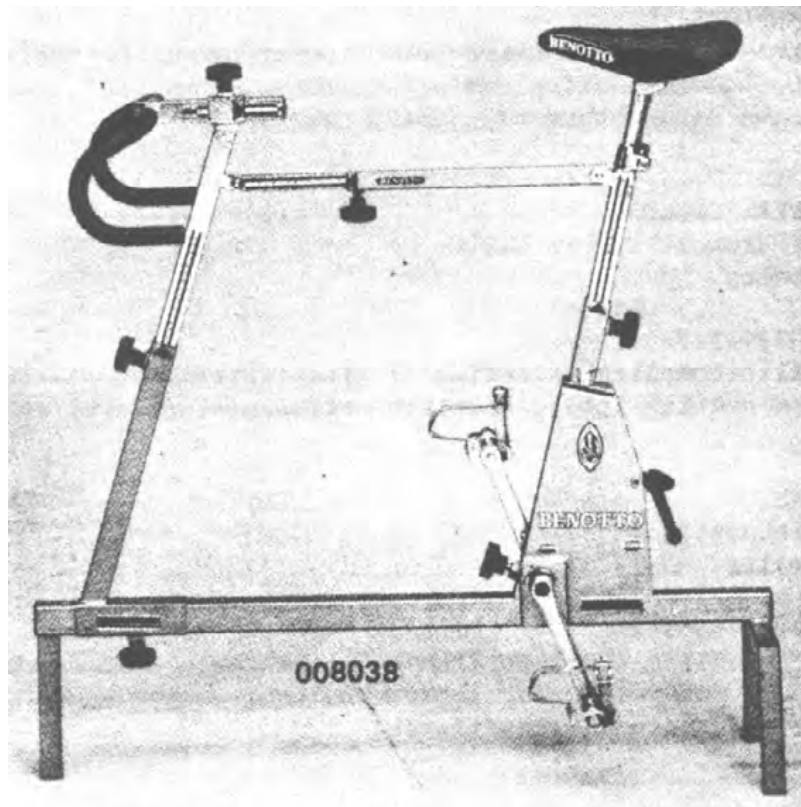

Pg. 6-12

The SAPO frame alignment kit can be purchased from Lee Katz. This kit allows the builder to check the alignment of the fork, headtube, front triangle, and rear triangle precisely. (See Katz in the resource section.)

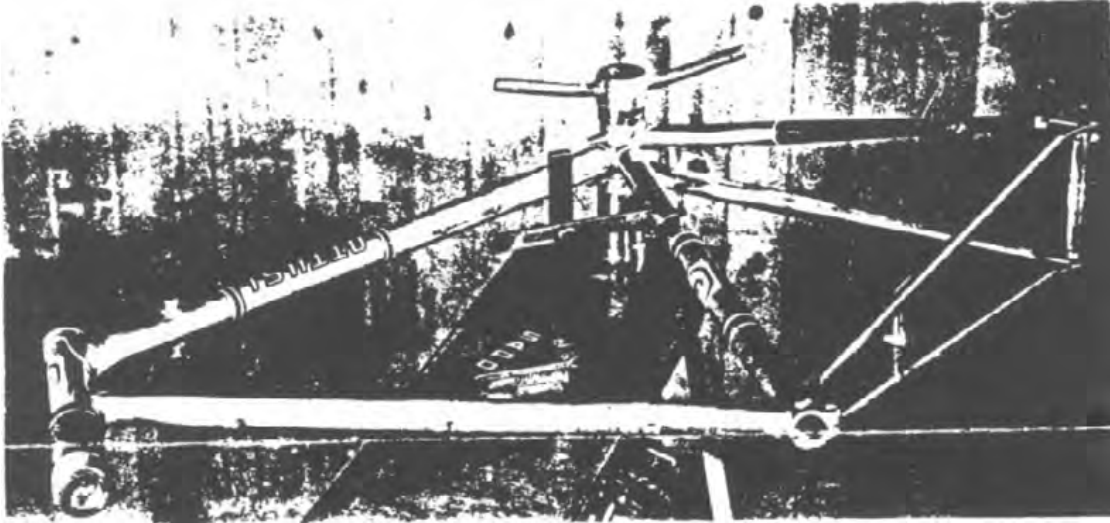

RESOURCES:

Pg. 7-7

SATTERLEE'S (R)  
2200 East Franklin Avenue  
Minneapolis, MN  
55404  
ph. 612-370-2511

Satterlee's has an extensive selection of precision tools. They carry the Starrett, Chadwick, Union and other brands. They will ship orders UPS -COD if you have manufacturers' numbers ready.

Pg. 7-8

THE SILVER TOOLBOX (R)  
717-721 Marshall Street N.E.  
Minneapolis, AN  
55413  
ph 612-379-2217

They sell a complete selection of fine finishing tools such as rifflers, abrasives, and cutting tools. Complete catalogues are available for \$2.00.

Pg. 7-5

GRANGER'S (R)  
2616 27th Ave. So.  
Minneapolis, AN  
55406  
ph. 612-721-5531

Granger's sells a complete line of power tools such as drill presses, pneumatic tools, die grinders, electric motors, compressors, welding outfits, etc. A complete catalogue is available.



Pg. 7-4

CYCLE IMPORTS (I, W)  
P.O. Box 287  
Cornish, Maine  
04020  
ph. 207-625-8781

Cycle Imports sells a complete line of framebuilding supplies including Reynolds and Columbus tube sets, Cinelli materials, and Shimano & Campagnolo dropouts. They also sell individual Reynolds and Columbus tubes. Send for catalogue and price list.

Pg. 7-2

BIKE MACHINERY (H)  
PRODUZIONE MACCHINE SPECIALI  
Via Sottoripa, 14/A  
Seriate (BG) Italy

ph. 035/299.093-24068

Bike Machinery manufactures a complete line of framebuilding fixtures and precision measuring fixtures which are set up with hydraulics and pneumatics for increased speed and efficiency. The products are marketed in the U.S.A. through Primo Consorzio under the Cinelli name.

Pg. 7-6

NIKKO SANGYO CO., LTD. (M)  
14-23, 4-Chome,  
Shiratori, Katsushika-ku  
Tokyo, Japan

ph. (03)601-7616

Nikko Sangyo manufactures a complete line of lugs, I-pc. forks, bottom bracket shells, and single piece headtube/headlug units.

Pg. 7-4

CYCLO GEAR COMPANY LTD. (H)  
Crown Works, Baltimore Road, Perry Barr  
Birmingham B42 1DP  
England

ph. 021-356-7411

Cyclo offers a line of reasonably priced framebuilding tools including bottom bracket taps, crown cutters, fork dies, and dropout aligning tools. Send for list of American Distributors.

Pg. 7-5

ISHIWATA SEISAKUSHO CO., LTD. (M)  
Head Office: 2-19-19 Shiohama  
Kawasaki-ku  
Kawasaki, Japan

ph. 044-266-3934

Ishiwata manufactures a complete line of cycle frame tubing and distributes through a small number American distributors. Send for a list of those distributors.

# Andrew Hague

Manufacturers of quality pedal cycle components



## TOP EYES

We offer two types, flat and fluted in three diameters of 13mm, 14mm and 16mm. The flat top eyes are available in three lengths in each of the three diameters. The long ones are for wrap over seat stays.

We can engrave both the flat and the fluted top eyes.

All the top eyes are hollowed for lightness.

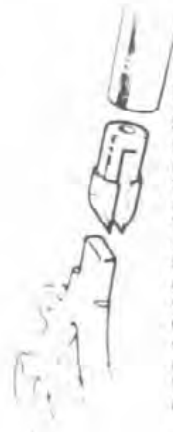

## BOTTOM EYES

Shifts in fashion have now determined that a concave end to the fork blade is preferable to a domed end. To facilitate making this shape we offer bottom eyes which eliminate tiresome filing and avoid the weakness of filling with brass. They are available to fit front forks as well as the rear.

## CENTRE PULL BRAKE HANGER

Tandems and cyclo cross cycles prefer the power of centre pull brakes and to maximise efficiency they need a rigid brazed-on hanger with a cable adjuster. We have carefully bent the 5/16" diameter tubing and brazed on the central boss, tapped it and fitted an aluminium screw.



## BOTTOM BRACKET SHELL

This is simply a 68mm long seamless steel tube tapped to take English size bottom bracket fittings. It is used for the rear of tandems or other lugless frames.



**SEAT PIN BOLTS.** With a 5mm allen key socket at both ends. Available either plated or in stainless steel.



**SEAT LUG LINER.** This fits inside the ears of the seat lug to reinforce against the compression of the seat pin bolt.



**SEAT PIN BOLT BUSH.** Use this instead of the ears of a seat lug. Gives a neater appearance when the removable bolt is preferred.



**CURVED BRAZE-ON.** Fits against the 1 1/8" diameter seat tube. The M8 stainless steel socket screw recesses inside and accepts a 6mm allen key.



**BRAZE-ON M6.** Made from 1/4" bar with the head of the stainless steel M6 screw fitting inside.



## CHAIN HOOK

Braze on to the lower end of seat stay to accommodate the chain with the wheel removed.

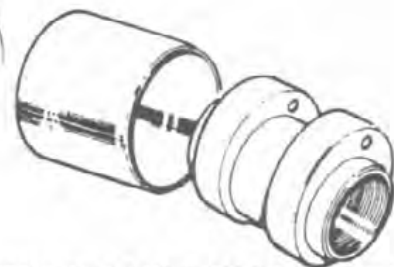

## TANDEM ECCENTRIC FRONT BOTTOM BRACKET

A steel shell is supplied with two bushes with M8 screws to braze-on as clamps. If required we will supply this already brazed and cut by machine.

The bottom bracket is made from 2 1/8" diameter aluminium bar, 68mm long and threaded 1.37" BSC for the English size solo bottom bracket fittings.

To facilitate brazing the frame tubes to the shell we offer a steel keeper to fit in the shell. It is designed to prevent the shell distorting out of round whilst not acting as a heat sink.

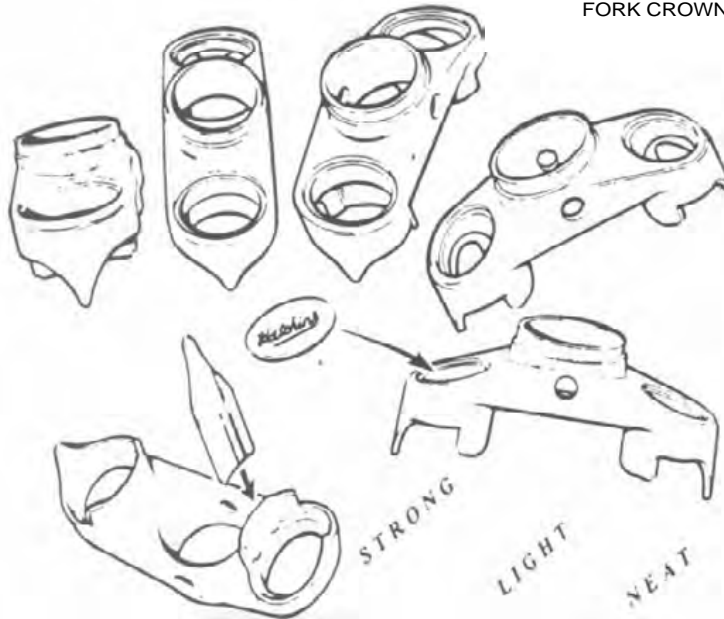

**FORK CROWN** This crown has been designed by Andrew Hague for the modern lightweight bicycle. It is made for us by Midland Investment Casting Ltd. in Kidderminster using our own tooling. It is very strong, being made in EN8 steel and annealed and heat treated,

There is no superfluous metal which means that it is one of the lightest crowns in the world. **During brazing the lack of unnecessary mass makes it easy to avoid overheating the fork blades and steering column, thus ensuring a stronger pair of forks.**

The open shoulder allows expansion gases to escape from inside the fork blades. Brass can be fed through the aperture as well as into the bottom of the crown ensuring that there is proper brass penetration and a good joint. Please note that we recommend Reynolds tubing and have followed their advice on leaving a gap of four thousandths of an inch between the blades and crown in order to allow the brass to penetrate. Blades that have to be hammered into a crown run the risk of being dry jointed and pre-stressed. The crown is made to fit the continental 'oval style of blades. It is ideal for use with 753 tubing.

The investment casting has a smooth surface finish needing no cleaning up which is of considerable benefit to the frame builder.

Small illegible text, possibly a reference or copyright notice.

easiest method of fastening them in 4 with a small amount of adhesive. The unique feature of the aluminium disc creates endless opportunities to individualize the appearance of your bicycle.

The crown is supplied with fork blade liners which can be used as they are or filed into fancy shapes.

#### MACHINED FRAME COMPONENTS

Our wide range of frame components is made with fully automatic equipment so that production costs are as low as possible and the precision repeated consistently. Whether you want ten parts or a million we can meet your needs.

We are also able to undertake sub-contract engineering work which other companies are unable to handle because of the precision, intricacy and quantity required. If you think that we can help please contact us. Visitors are always welcome to inspect our factory,

#### CABLE GUIDES AND STOPS



Bottom Bracket Tunnel



Bottom Bracket Groove



Sloping Sides Guide, with flat on the bottom.



Slotted Guide, with flat on the bottom.



Cutaway Guide, with flat on the bottom.



Cutaway Stop, with flat on the bottom.



Divers Helmet Guide without slot, mitred to fit 1" tube.



Divers Helmet Guide with slot, mitred to fit 1" tube.



Hexagonal Guide



Hexagonal Stop



Round Guide



Round Stop



Grooved Guide, with flat on the bottom



**FORK END EYELET**

3/8" diameter with a flat on the bottom. This serves as another fork end eyelet for mudguards or a pannier carrier. Tapped M5 and supplied with a stainless steel screw.

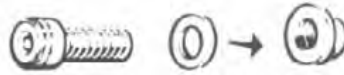

**BOTTLE CAGE BOSS — Recessed**

Fits into a 7mm hole in the frame tube so that the top hardly protrudes. Tapped M5. Supplied with stainless steel screw.

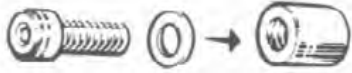

**BOTTLE CAGE BOSS — Straight**

Tapped M5. Mounts on the frame tube. 3/8" diameter. Supplied with stainless steel screw.

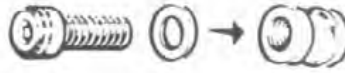

**BOTTLE CAGE BOSS — With Waist**

This is a light version of the straight boss. The waist makes it suitable for brazing to the upper seat stays as a pannier carrier mounting. Tapped M5 and supplied with a stainless steel screw.

**BRAKE BRIDGES**

We have a special machine which was made to our own design to mitre brake and chain stay bridges to any exact length, at any angle to fit any diameter. If you are making more than a hundred frames of any one size it will be cheaper to let us make them on the bridge machine than to do it yourself. We can also make bridges for mixed frames.

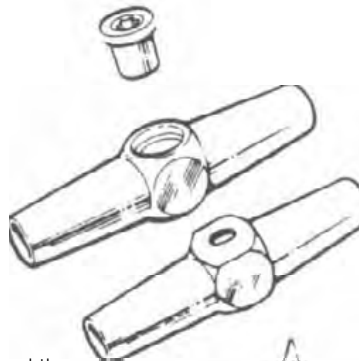

One piece bridge, made from square bar, hollow and supplied with two recessed M6 nuts, one for the brake bridge and the other for the fork crown.



Reinforcing piece to fit around the brake bridge. Available in three sizes to fit 1/2", 7/16" or 3/8" tubing. These have a neat Welled shape.



Insert type reinforcing piece.

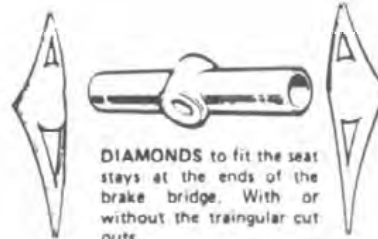

**DIAMONDS** to fit the seat stays at the ends of the brake bridge. With or without the triangular cut outs.

Pg. 7-5

ANDREW HAGUE CYCLES LTD.

(M, W, F)

Cwm Draw Industrial Estate

Ebbw Vale, Gwent. NP3 5AE

Wales

British Isles

ph. 0495 305915

Andrew Hague manufactures a complete line of fork crowns, slugs, braze-ons, bridges, and framebuilding fixtures. Any of the Hague product line can be ordered from England or through Phil Wood (See Wood, Phil in the resource section of this book.).

i  
generate gear charts, calculate spoke lengths, and geometrically design custom bicycle frames. Because of the nature of the problems these programs attempt to tackle there is a certain amount of error involved in the spoke length and frame geometry programs. The error that exists is associated with how effectively the user can make the necessary measurements the program calls for. There are three measurements that can make or break the frame geometry program:

Inseam measurement--- Incorrect measurement of the rider's inseam will result in the wrong seat tube length for the rider the frame is being designed for. Check THE PATEREK MANUAL or THE FIT KIT DIRECTION MANUAL for the proper method in making this measurement.

Torso Measurement & arm measurement-- Incorrect measurement of these two variables will result in the top tube being of an incorrect length. Check THE PATEREK MANUAL or THE FIT KIT MANUAL for the proper method in making these measurements.

The spoke length program depends on the user making several accurate measurements. However, one of these measurements is far more critical than the others:

Rim diameter-- This measurement is critical to the operation of this program. A device must be made to accurately find the rim diameter each and every time. Do not use the Wheelsmith device! It works for their program but will not give readings that are accurate for this program.

The gear chart program will present no such problems and should generate accurate results every time.

Due to the fact that these programs rely heavily on the user's abilities to measure properly, The Framebuilders' Guild, Robert Wi ek, John Corbett, Tim Paterek, and Joe Hesse do not accept any legal liabilities due to faulty frame design resulting from inaccuracies in body measurements.

Make a few trial runs of the programs before fully implementing them in your business. Make sure you are happy with the results before you introduce your customers to "HI-TECH" bike design.

For your convenience these programs are not protected against copying so that you can make back-up copies. Please don't pirate our programs. Send the business our way. We will appreciate it.

For updated versions of the program, send your disk and \$5.00 to:

The Framebuilders' Guild  
Rt. 2, Box 234  
River Falls, WI 54022

We will send you an updated version of the program. The next updated version will be available in December of 1986.

TO OBTAIN THE IBM  
COMPATIBLE DISK FOR THIS  
PROGRAM SEND \$29.95 TO:

KERMESSE DISTRIBUTORS

464 CENTRAL AVE. UNIT #2

HORSHAM, PA. 19044

**215-672-0230**

## INSTRUCTIONS FOR SPOKE CALCULATION PROGRAM

This computer program is designed to work on Apple Iie, Iic, or IBM compatible computers. Check the label on the diskette to see that you have the correct program for your computer.

### STEP 1:

Boot up your computer as you usually do. THE PATEREK PROGRAMS are not boot-up disks.

### STEP 2:

Insert THE PATEREK PROGRAM disk into drive 1.

### STEP 3:

Type the following command:

PATEREK (return)

### STEP 4:

You should now see the opening menu which displays the name PATEREK in flashing letters. On the menu are three choices;

S)poke length  
G}ear charts  
E)xit to DOS

Choose S to get into the spoke length program.

### STEP 5:

The program will ask whether you want to enter data in Metric units or English units. Choose M or E.

### STEP 6:

When entering data, always use the same units. In Metric it is best to use Millimeters. In English use thousandths of an inch. Entering a measurement in centimeters after using millimeters will cause all answers to be incorrect. Entering a measurement in feet after using inches will cause all answers to be incorrect.

HUB WIDTH is measured across the outsides of the flanges. (See the diagram at the right.)

HUB DIAMETER is measured from the center of a hole on one side of the flange to a hole center directly on the other side of the same flange. (See page 12-2 of Sutherland's Handbook.)

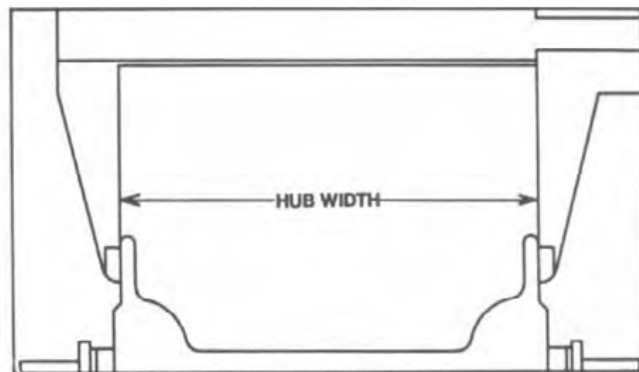

RIM DIAMETER is measured from the theoretical point where the end of the spoke pokes through a hole in one side of the rim to the same theoretical point on the other side of the rim. (See page 12-17 of Sutherland's Handbook.)

NUMBER OF SPOKES is simply how many spokes there will be in the wheel. e.g. 24, 28, 32, 36, 48 etc.

CROSSES IN PATTERN is how many crosses there are in the spoke pattern. e.g. 3 cross, 4 cross, etc. Be careful, this program will give results for patterns that are not possible. Keep in mind that wheels with less spokes can't be built with large numbers of crosses.

STEP 7:

This program will give immediate results. It will display spoke lengths for an undished front wheel, a five speed rear wheel, and a six speed rear wheel. It will then ask if you want to compute another. Enter Y to go through the program again. Enter N to exit to the main MENU.

IMPORTANT:

the results this program will deliver are only as good as the measuring that is done to obtain HUB WIDTH, HUB DIAMETER, and RIM DIAMETER. As you get more accustomed to measuring these items, the results will become more accurate.

#### INSTRUCTIONS FOR GEAR CHART PROGRAM

STEP 1:

Boot up your machine as you usually do. THE PATEREK PROGRAMS are not boot-up disks.

STEP 2:

Insert THE PATEREK PROGRAM into drive 1.

STEP 3:

Type the following command:

PATEREK (return)

STEP 4:

you should see the opening menu which displays the name PATEREK in flashing letters. On the menu are three choices;

{G} ear charts

Choose G to get into the gear chart program.

STEP 5:

The program will ask whether you want to enter data in Metric units or English Units. Choose M or E.



STEP 6:

You will be asked to enter the wheel diameter. Enter it in inches if you chose English. Enter it in Centimeters if you chose Metric. Press return.

STEP 7:

You will be asked how many sprockets there are on the rear hub. You can choose as many as 7 sprockets for the rear. Press return.

STEP 8:

You will be asked how many chainwheels there are on the front. You can choose as many as 3 chainwheels. Press return.

STEP 9:

You will now see a grid on the left hand side of the screen with the cursor blinking in the first location on the left. Type in the number of teeth on the smallest sprocket desired and then press return. The cursor moves to the next slot. Enter the number of teeth desired for the next to the smallest sprocket and press return. The program will automatically advance through the grid till all of the sprockets are entered. It will then proceed to the chainwheel portion of the grid. Enter chainwheels the same way as you entered sprockets. When the last chainwheel size is entered, the program is executed.

STEP 10:

This is what you will see on the screen:

THE FRAME BUILDERS" GUILD  
Gear Charts

		SPROCKET					LW Sp ###.#	
		18	22	26	8			
C	: 13	15				54 13 112.2		
H	+ - - - - V.	%				49 13 101.8 14		
A						54 15 97.2		
I	54 : 112.2	97.2	81.0	66.3	56.1	49 18 01.0 10		
N						39 13 81.0 0		
						49 18 73.5 10		
						%39 15 70.2 4		
w						54 22 66.3 4		
H	49 : 101.8	88.2	73.5	60.1	50.9	49 22 60.1 8		
E						39 18 58.5 1		
E						%54 26 56.1 3		
L								
S	79 : 81.0	70.2	58.5	47.9	40.5	39 22 47.9 4		
						79 26 40.5 10		

ENTER ACTION DESIRED  
(%) Grid Percentages  
{C}hange Gears  
{E}nd Process

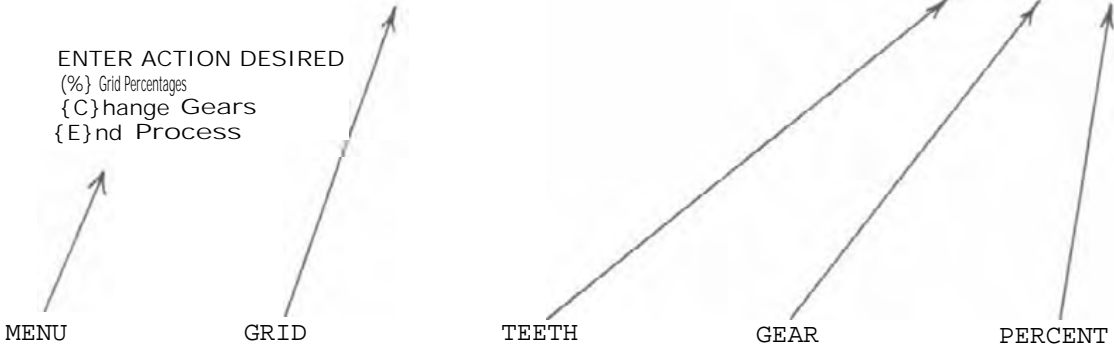

MENU - The menu will allow you to return to the main menu by choosing E. It will allow you to alter sprocket and chainwheel sizes by choosing C. It will allow you to see an overview of the percentage differences on the grid by choosing %. It will allow you to get a printout of the gears you have chosen by pressing P.

GRID - The grid displays the gears chosen in an array that is easy to read.

On the right of the screen, you will see another array of numbers. The numbers appearing in the three columns are all of the gears you have chosen in descending order. The three columns can be broken down as follows:

TEETH - This column tells which tooth combinations make up that particular gear. First is chainwheel size, then sprocket size.

GEAR - This column tells the value of each gear. (Multiplying this value by Pi will give the distance traveled in that gear in one pedal revolution.)

PERCENT - This column gives the percent of change from one gear to the next as you descend through the gears. This is probably the most important column. You will want to look for large percentage jumps or small percentage jumps and alter the numbers of teeth to eliminate these irregularities.

STEP 11:

Check out the sprockets and chainwheels you have chosen and see how they appear in the program. If you like the set-up, press P to get a print out. If you don't like the set-up, choose C from the menu and make the changes you want. Keep doing this till you arrive at the combination you want. What used to take hours with a hand calculator can now be done in about 15 minutes.

STEP 12:

To end the process, choose E.

SPECIAL FEATURES:

CROSS OVER GEARS are highlighted so that you can take them into consideration when setting up your gears. A low percentage figure immediately before or after a crossover gear should not be worried about. A large percentage change before or after a cross over gear should be worked with.

CHAINWHEEL ORDER is put in descending order on the grid. The program does this automatically even if you enter the chainwheel sizes in reverse order. In this way, the array is more easily read after the program is executed.

## INSTRUCTIONS FOR FRAME GEOMETRY PROGRAM

The PATEREK frame geometry program is only available for the IBM PC and PC compatibles. Be sure your machine is compatible with IBM before attempting to use this program.

### STEP 1:

Boot up your machine as you usually do. THE PATEREK PROGRAMS are not boot-up disks.

### STEP 2:

Insert THE PATEREK PROGRAM disk into drive 1.

### STEP 3:

Type the following command:

```
PATEREK (return)
```

### STEP 4:

You should see the opening menu which displays the name PATEREK in flashing letters. On the menu are four choices;

```
S poke length
G ear charts
F rame geometry
E xit to DOS
```

Choose F to get the frame geometry program.

### STEP 5:

The program will ask you if you want to use Riders body measurements or Bike's known measurements.

Choose R if you are actually measuring the rider for whom the frame is being built. Go to STEP 6.

Choose B if you know the dimensions of the frame to be built or if you are obtaining the dimensions from THE FIT KIT. If you choose B, the program will ask you to choose R to design a racing frame, S for sport/touring, T for touring, or M for mountain. (The program will automatically design a mountain frame with a 1-1/4" diameter down tube and a 1-1/8" diameter top tube.) After choosing the frame style a new display will come on the screen asking you to make the following entries:

```
Seat tube length
Top tube length
Wheel radius
*Fork crown thickness
**Lower stack height
***HT/DT intercept point
```

**Make all entries to the nearest tenth of a centimeter.**

Now that the known dimensions have been entered,  
the program will compute the unknown dimensions on  
the right side of the screen.

Go to STEP 10.

STEP 6:

The program will ask you which style of frame you want to design. Choose R for a racing frame, S for sport/touring, T for touring, or M for mountain (The program will automatically compute mountain bikes with 1-1/4" down tubes and 1-1/8" top tubes.) Do not press return.

STEP 7:

The program will ask whether you want to enter data in Metric or English. (This option is for rider's body measurements only. After entering those measurements, the program will automatically revert to Metric for the rest of the session.) If you choose Metric, enter all body measurements in centimeters and kilograms. If you choose English, enter all body measurements in inches and pounds. The measurements are as follows:

Height -- in stocking feet  
Weight -- Within 3% accuracy is sufficient.  
Inseam -- Up tight in the crotch in stocking feet  
Torso -- See page 1-6 of THE PATEREK MANUAL.  
Arm -- See page 1-6 of THE PATEREK MANUAL.

Press return after each entry.

STEP 8:

The program will now ask the wheel radius you intend to use on this frame. (This includes the tire radius.) There are two prompts at the bottom of the screen. You may choose one of those or enter one of your own. It must be entered in centimeters. Press return. You will now see a screen display showing all of the known measurements for the proposed frame.

STEP 9:

You are now required to enter the following to the nearest tenth centimeter:

\*Fork crown thickness  
\*\*Lower stack height  
\*\*\*HT/DT intercept point

Press return after each entry. After the last entry, the computer will compute the unknowns on the right side of the screen.

\*To find fork crown thickness, see page 1-17 of THE PATEREK MANUAL.  
\*\*To find lower stack height, see letter C on page 14-7 of Sutherland's Handbook.  
\*\*\*To find HT/DT intercept point, see page 1-17 of THE PATEREK MANUAL.

STEP 10:

Before going on with the program, examine the screen display. All of the known dimensions are on the left side and all of the computer generated unknowns are on the right side. Note how the knowns are numbered in fields from 1 to 13. Fields 1 and 2 were generated by entering the rider's body measurements. Fields 3 through 8 and 10 are values assigned to the style of frame you chose. Field 9 was chosen directly by you. Field 11 is due to the fork crown you have chosen to use on this frame. Field 12 is due to the headset you intend to use on this frameset. Field 13 is due to the lug set you chose to use for this frameset. In about the middle of the screen you are told how much clearance you will have between the front tire and the down tube and the clearance between the rear tire and the seat tube. If you do not like the idea that many of the variables were predetermined for this frame, you can change any field except #5 and the program will recompute a new set of unknowns. (The only way to alter field #5 is to alter your initial method of measuring the rider's inseam.)

At the bottom of the screen you will see this prompt:

```
Enter input field ## to change or 99 to end process
```

If you want to change any of the 13 fields (except #5), type the number of that field and then press the return key. There is now a prompt at that line. Enter the desired dimension in degrees to the nearest tenth or centimeters to the nearest tenth. Then press return. You may do this any number of times with any field except #5 and the computer will begin to generate new data. When you are satisfied with your results, enter 99 and press return. You will now see a new menu that looks like this:

```
M = Return to menu
T = Compute toe clip overlap
G = Print Geometrical specs.
C = Print component list
```

STEP 11:

By choosing M, you will return to the main menu. Doing this will wipe out all data on this frameset and you will have to start all over. Going back to the main menu will allow you to run one of the other PATEREK PROGRAMS.

STEP 12:

By choosing T, you can compute toe clip overlap for this particular frameset. You will be asked for the following input:

```
Lateral offset -- this is the distance from the
centerline of the frameset to the centerline of
the toe clip. (Campagnolo cranks and pedals are
approximately 12cm on the left side.)
```

Toe clip and pedal -- this is the measurement from the centerline of the pedal spindle to the inside face of the front of the toe clip. Examples: Campagnolo pedal with a short toeclip is 7.5cm, with a medium toe clip is 9cm, with a long toe clip is 10.5 cm.

Crank length -- this is the length of the crank arm you are using IN CENTIMETERS. For instance, if you are using 165mm cranks, enter 16.5.

Press the return key after each entry.

After the crank length entry the toe clip information will be expressed as a clearance or interference. If you want to change the design of the frameset to correct toe clip overlap, press the # key and goe back to STEP 10.

STEP 13:

By choosing G, you can get a geometrical spec sheet printout.

The program will first ask for a hub width. (This is for your convenience on the printout.) Common hub widths are 12cm for a five speed, 12.6cm for a six speed, and 13cm for a mountain bike or drum brake. Press return.

The program will then ask you to enter the customer's name, address, and phone number. (an additional line is allowed for a long address or a business address.) Press return after each entry.

The computer will now print out a custom work order with all of the necessary geometrical specs, name, address, etc. Note at the bottom of the printout is a recommendation for the lightest tubing to use for this rider. This is based on the rider's weight that was entered earlier.

If you want to go back and make changes again to do a different printout, press the # key and go back to STEP 10.

STEP 14:

By choosing C, you can print up a component list for this frameset.

At this point the computer will prompt you through all of the frame components such as;lugs, tubing, bottom bracket, etc. Simply use the keyboard like a typewriter and press return after each entry. When you get to the bottom of the list, you will be asked if there are any changes to be made. If YES, type Y followed by return. This will allow you to go through the list again. If you want to change an item, do so and press return. If you don't want to

change an item, just press return. If there are no further changes to be made when you reach the end of the list type N followed by return.

Now, in exactly the same way, you will be prompted through the braze-on list. If you do not wish to use a particular braze-on, press return for that item. When you come to the end of the list and there are no further changes to be made, type N followed by return.

You may now list additional braze-ons and special requests. If there are none, just type return a few times till the printout starts.

An additional feature of the component printout is a worksheet for bicycle components such as cranks, tires, toe clips etc. So, when the computer finishes up with page 2, let it continue on to print out page 3.

STEP 15:

To properly log off from the frame geometry program, choose M from the menu. This takes you back to the main menu. Then choose E. This will allow you to exit to DOS.

HELP LIST FOR FORK CROWN THICKNESSES AND HT/DT INTERCEPT POINTS

COMMON FORK CROWN THICKNESSES

Henry James	1.9cm
Davidson	1.6cm
QBP	1.7cm
Cinelli	
CCA & CC	1.5cm
SCA	1.45cm

COMMON HT/DT INTERCEPT POINTS

Henry James	1.0cm
Davidson	.75cm
QBP	.65cm
Cinelli	.6cm

## PLANS FOR FIXTURES

The following 21 plates are a set of technical line drawings giving all dimensions and specifications and dimensions of the framebuilding fixtures shown throughout THE PATEREK MANUAL. They are done with the person in mind who has dabbled in framebuilding and wants to make a substantial financial commitment. If built properly, these fixtures will produce frames that are aligned well. Many corners can be cut in producing these fixtures. However, in doing so, the final quality of the frames is in jeopardy.

If any confusion arises as to what these fixtures do or look like, isometrics and photos appear in numerous locations of THE PATEREK MANUAL.

Considering that a majority of the bicycle industry is in metric, one may wonder why these plans are in English specifications. The explanation is easy. These are plans for a local job shop to use. Try walking into a small machine shop with a set of metric plans and see what happens.

There are numerous nuts and bolts used in the make-up of these fixtures. Little or no specs are given on these items. Specs should be able to be derived from a combination of isometric drawings and corresponding thread specs on the drawings.

Before attempting to produce anything else, the dummy hubs should be constructed first. Parts 9 & 10 and parts 3 & 4 should be made in conjunction with each other.

Certain materials are recommended for each piece. Careful consideration was given to these recommendations and in most cases departure from these recommendations is not advised.

In THE PATEREK MANUAL the rear end jig, head tube stabilizer bar and bottom bracket jig are shown separately. These plans have incorporated all three items into one unit.

It is plain to see that unlike THE PATEREK MANUAL, these sheets are printed only on one side. This has been done so that the plates can be more easily kept track of during production.

Last of all, it is the author's contention that many of these fixtures are in the public domain. The remainder of them are original work of the author and no one should be able to claim a patent on them. However, the drawings themselves are copyrighted and the PATEREK name is a trademark. Anyone is welcome to build and market as many of these fixtures as they like with no need to pay any royalties to Tim Paterék. Reproduction and distribution of the plans themselves is expressly prohibited. Use of the PATEREK name in any manner in the marketing of these fixtures is expressly prohibited.



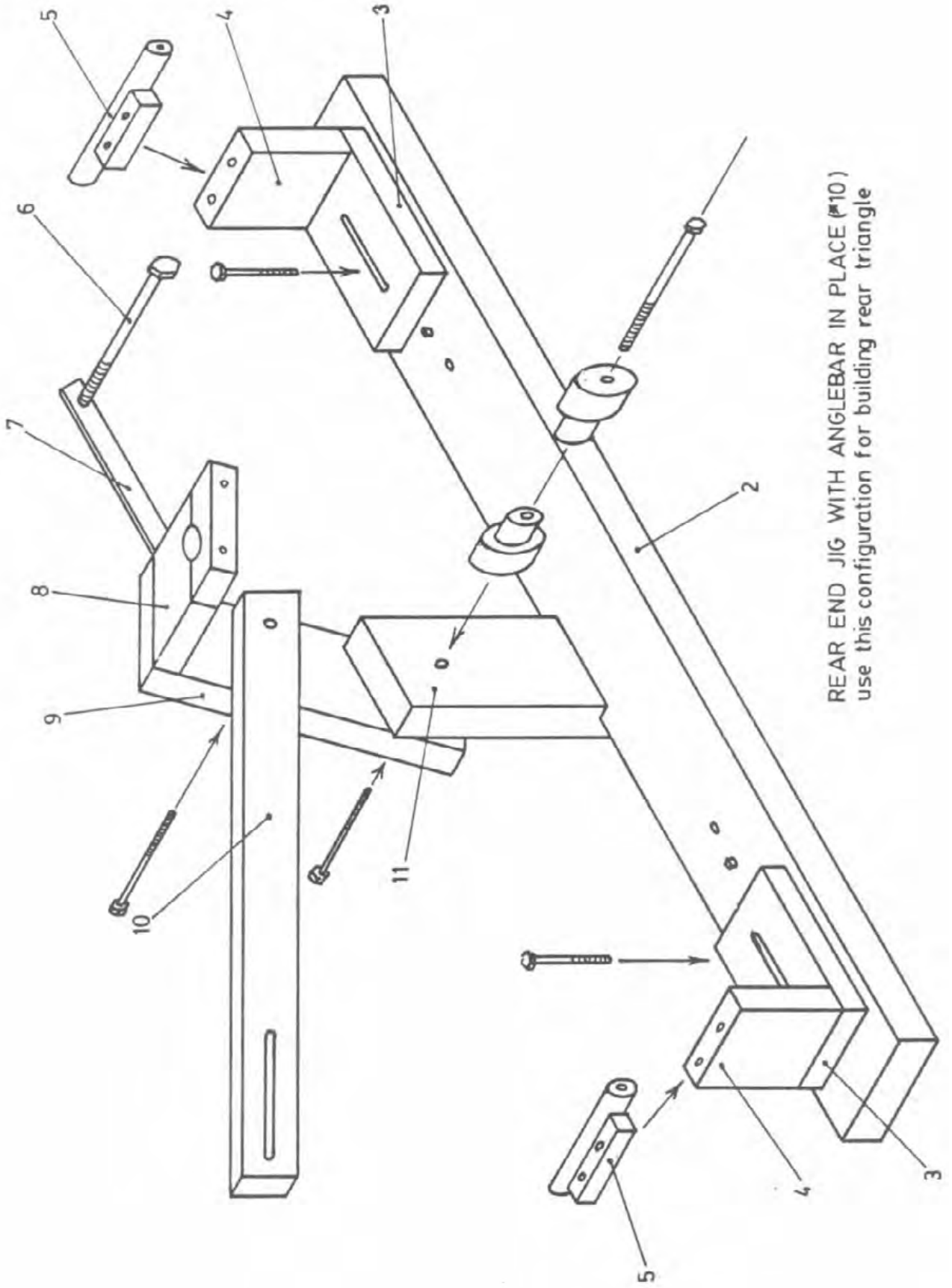

REAR END JIG WITH ANGLEBAR IN PLACE (#10)  
use this configuration for building rear triangle

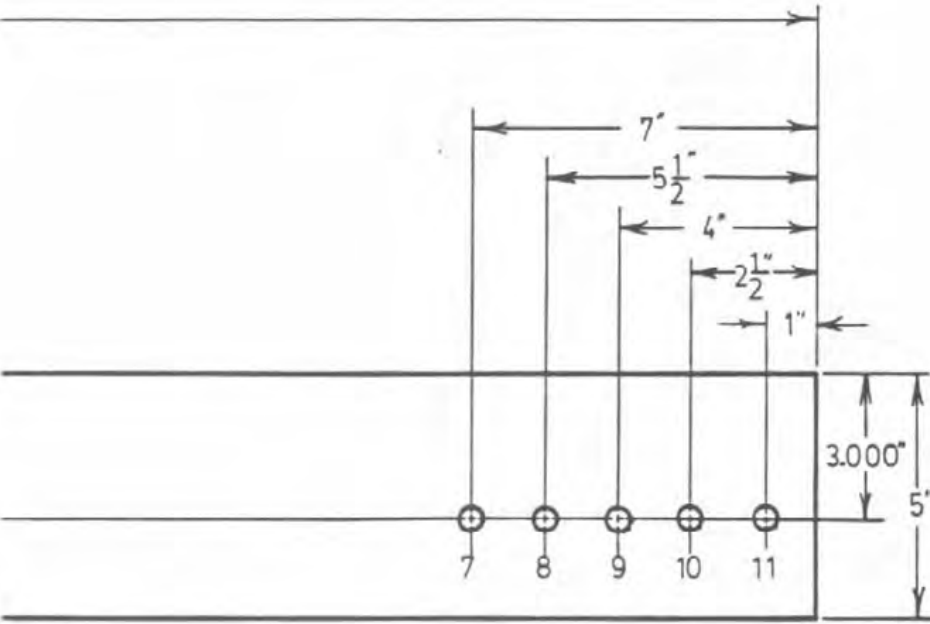

Make all odd numbered holes for press fit with .500" pegs.

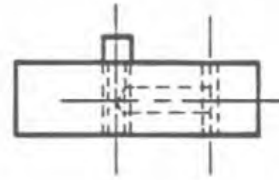
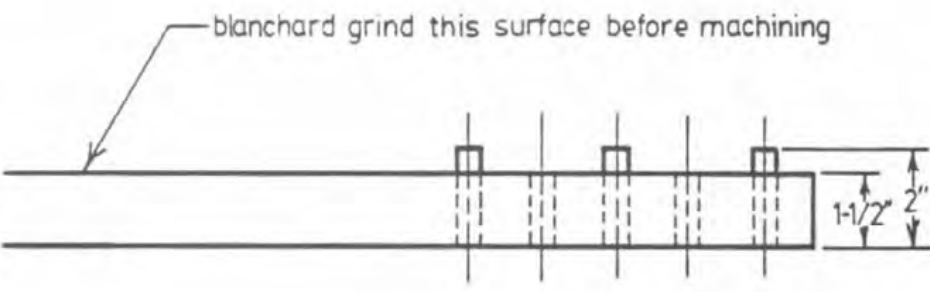

G

Material: T-6 aluminum or 1020 steel

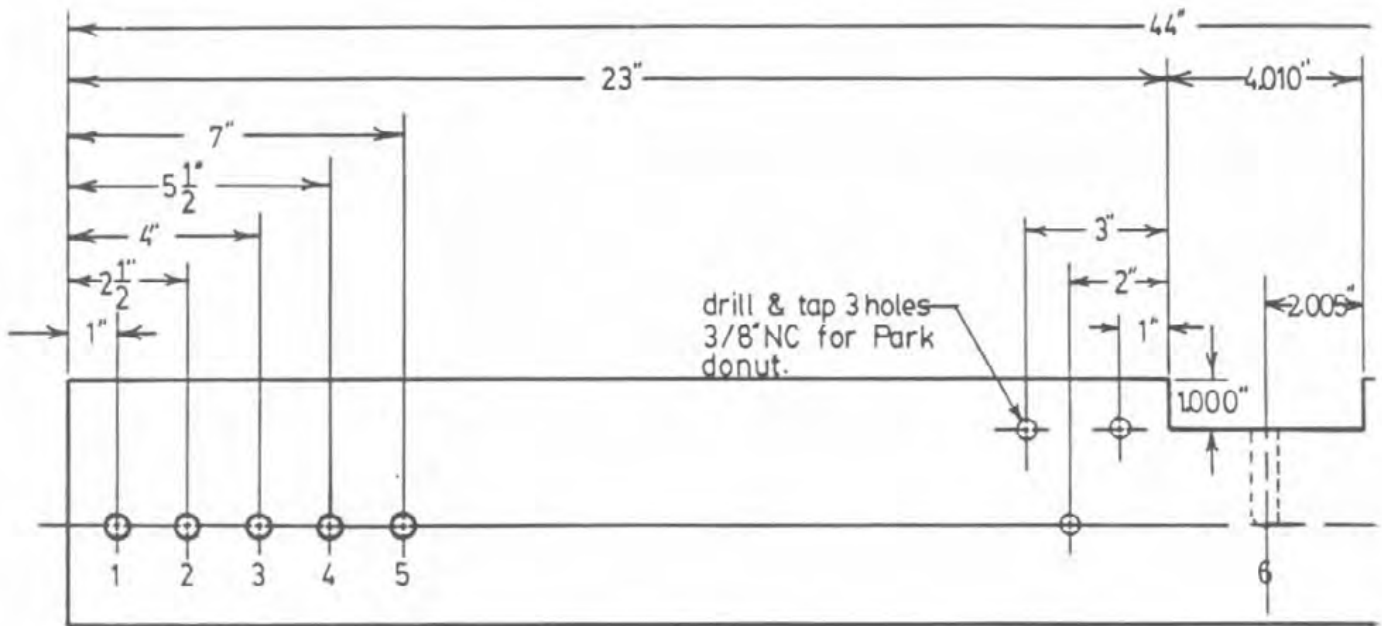

drill & tap all even numbered holes 1/2" NC.

8 1

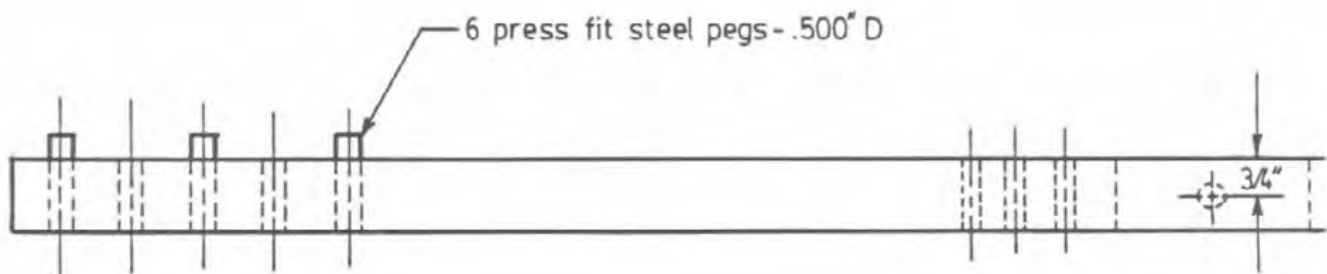

BASE FOR REAR END

Drawn by: Tim Paterek

Scale: 1/4 size

Tolerances;  $\pm 1/64"$  - fractional, t.002 - deci

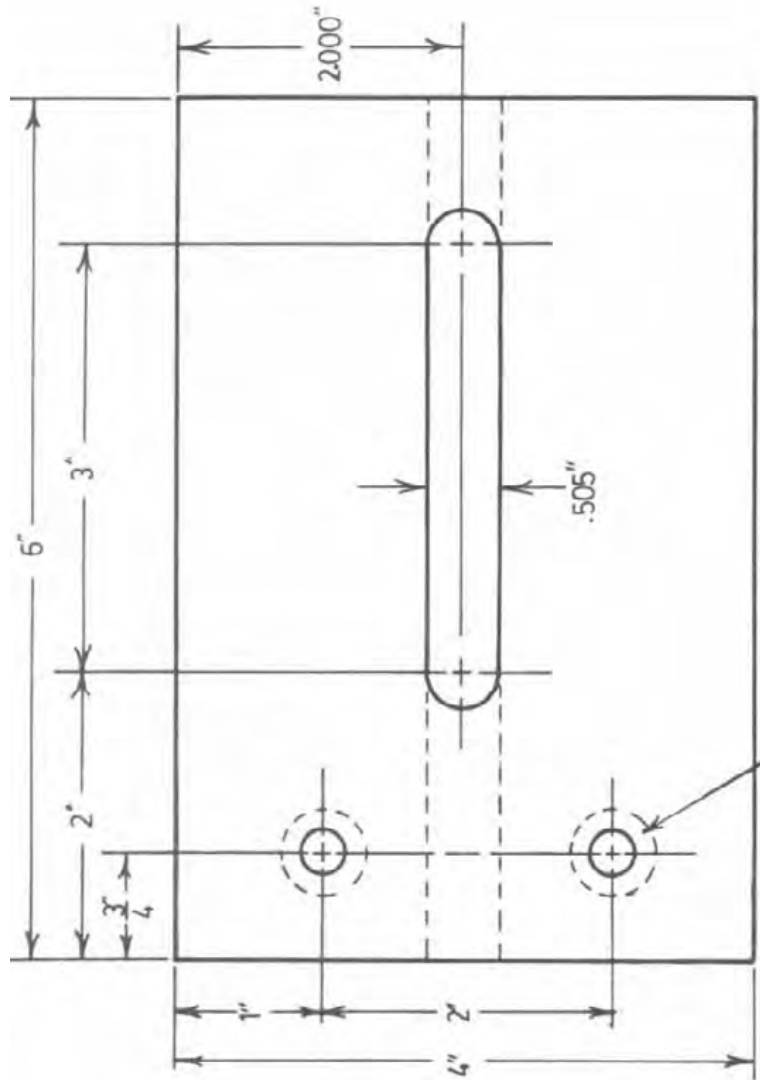

drill & countersink for 5/16" (countersinking is acceptable if desired)

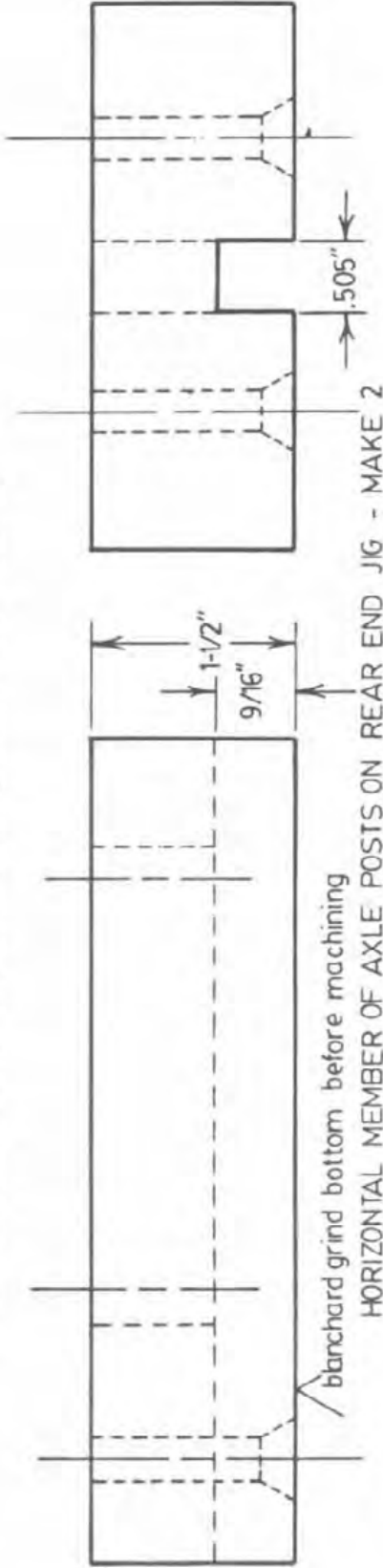

blanchard grind bottom before machining

HORIZONTAL MEMBER OF AXLE POSTS ON REAR END JIG - MAKE 2

Drawn by: Tim Paterek

Scale: 3/4 size

Tolerances: ± 1/64" - fract., ± .002" - dec.

Material: T-6 or 1020

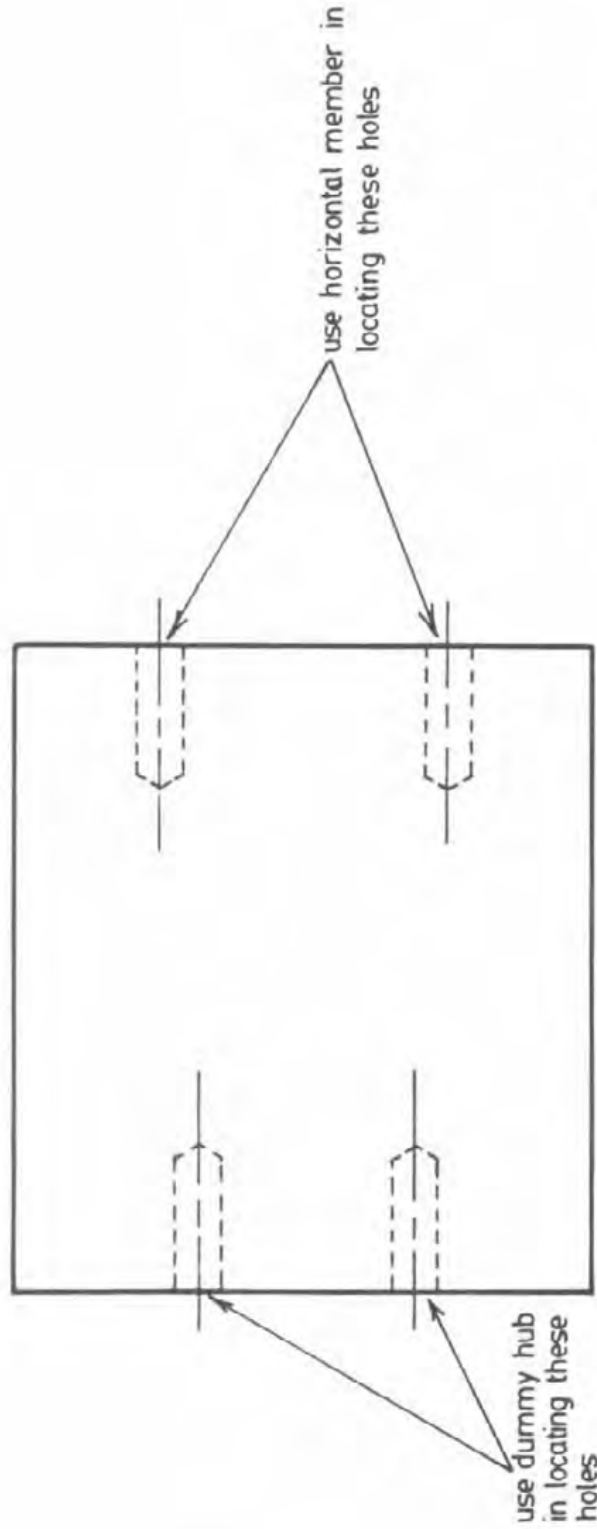

drill 4 holes - 1" deep  
tap 5/16" NC

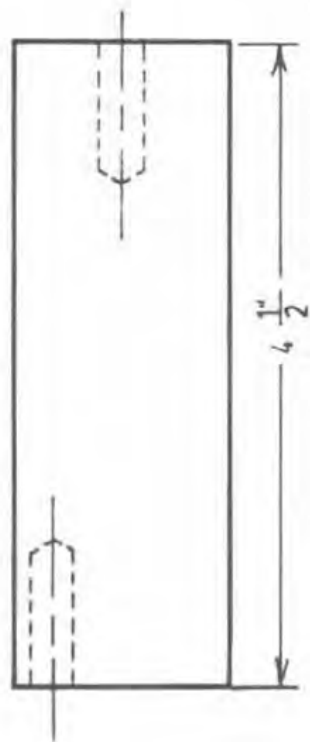

VERTICAL MEMBER OF AXLE POSTS ON REAR END JIG - MAKE 2

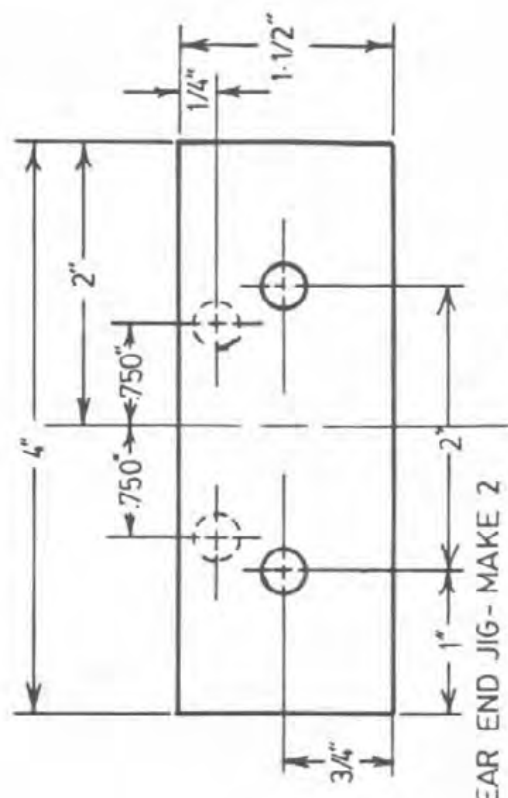

Drawn by: Tim Paterek    Scale: full size    Tolerances:  $\pm 1/64''$  - fract.,  $\pm .002''$  - dec.    Material: T-6 or 1020



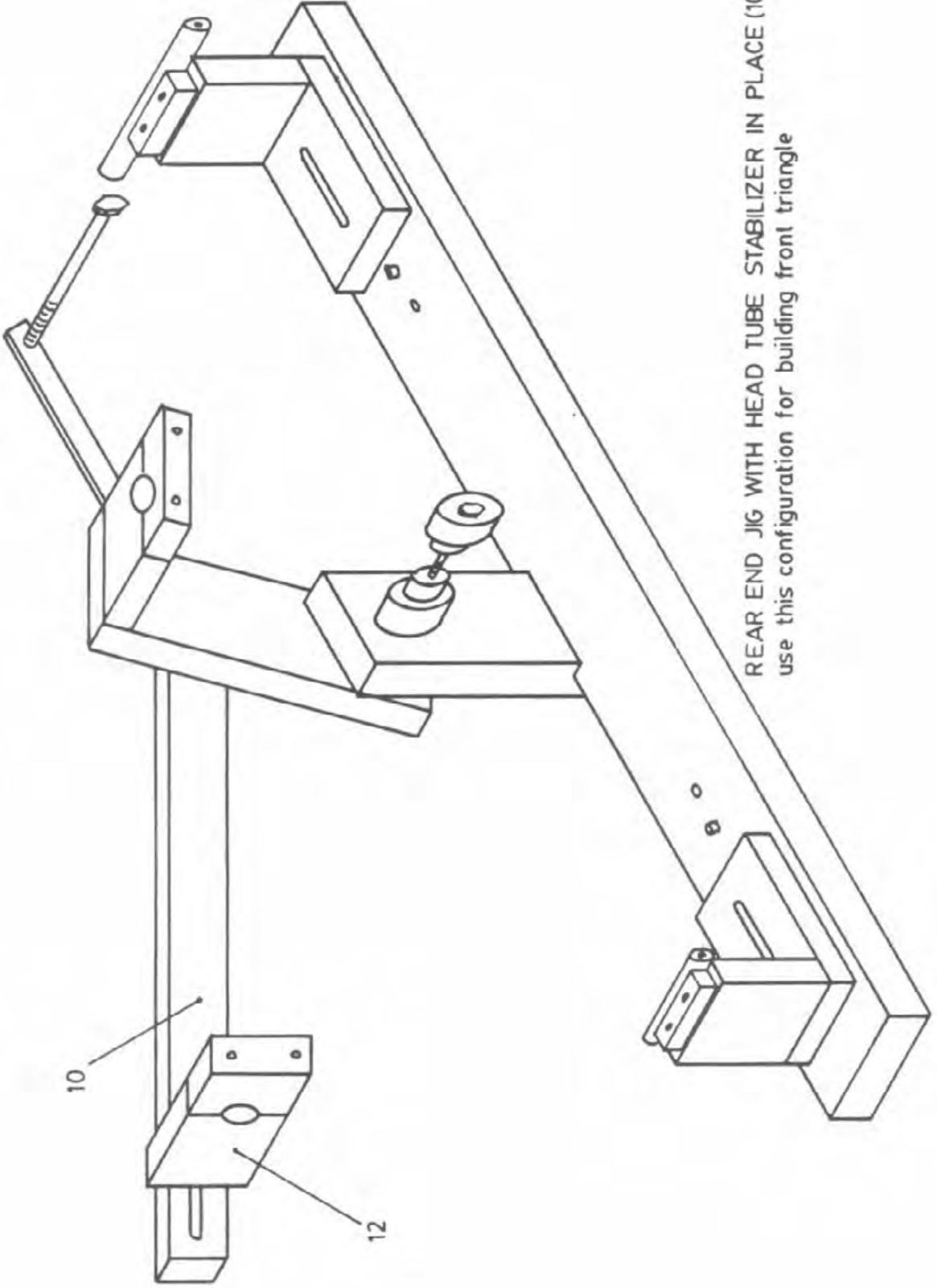

REAR END JIG WITH HEAD TUBE STABILIZER IN PLACE (10&12)  
use this configuration for building front triangle

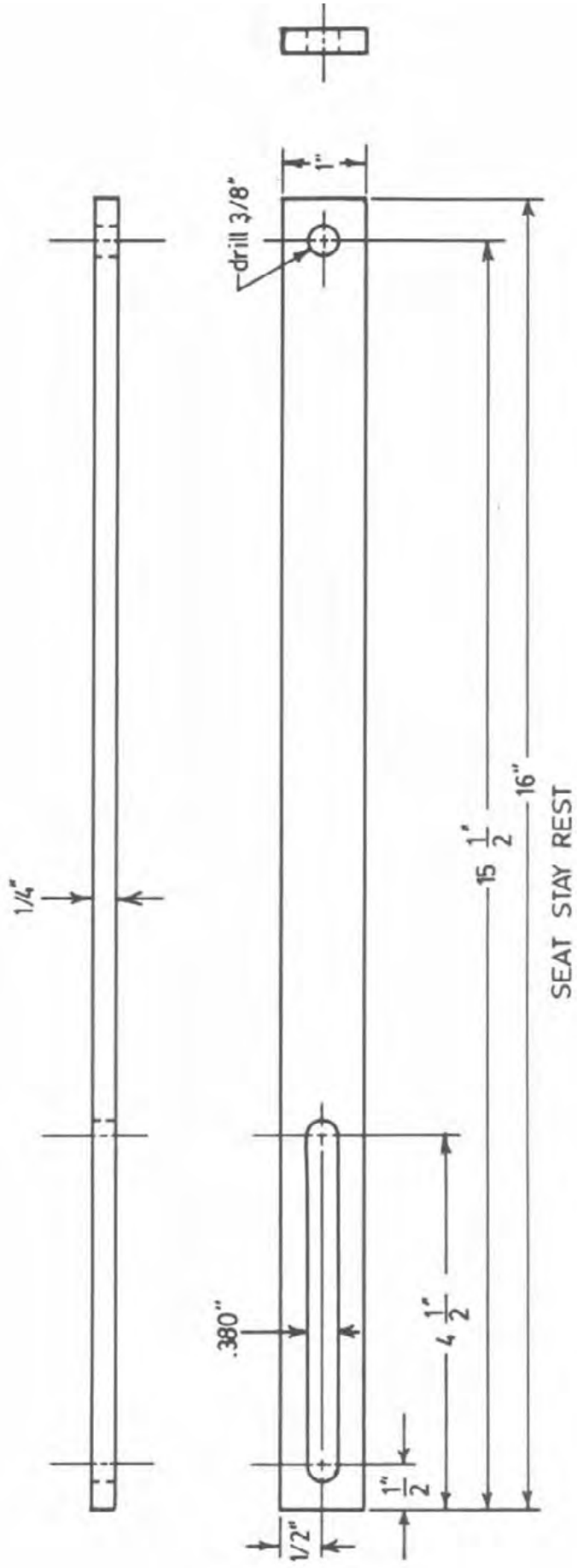

Drawn by: Tim Paterek      Scale: 1/2 size      Tolerances:  $\pm \frac{1}{64}$ " - fract.,  $\pm .002$ " - dec.      Material: 1020



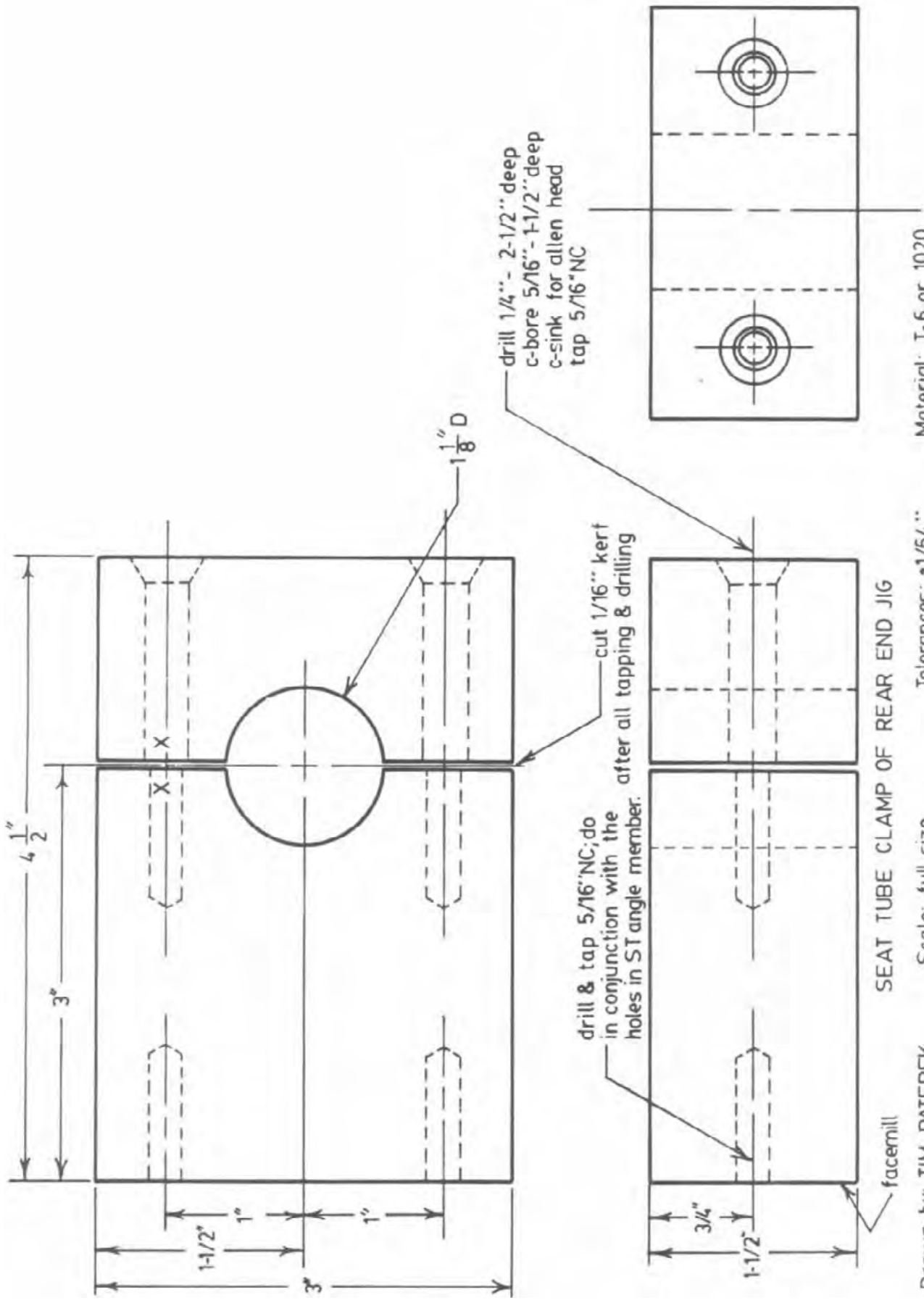

Material: T-6 or 1020

Tolerances: ±1/64"

Scale: full size

Drawn by: TIM PATEREK

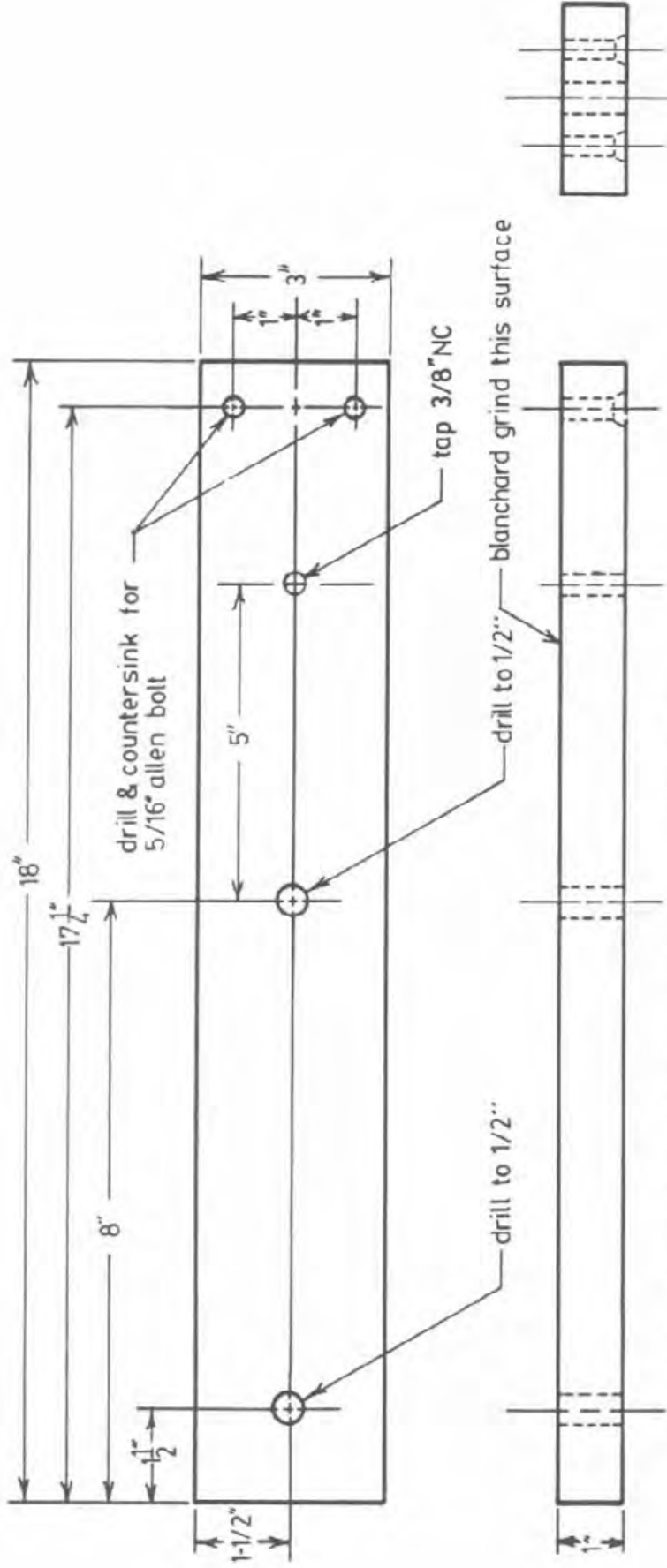

SEAT TUBE ANGLE ADJUSTING MEMBER OF REAR END JIG

Drawn by: Tim Paterek      Scale: 3/8 size      Tolerances:  $\pm 1/64$ "      Material: T-6 or 1020

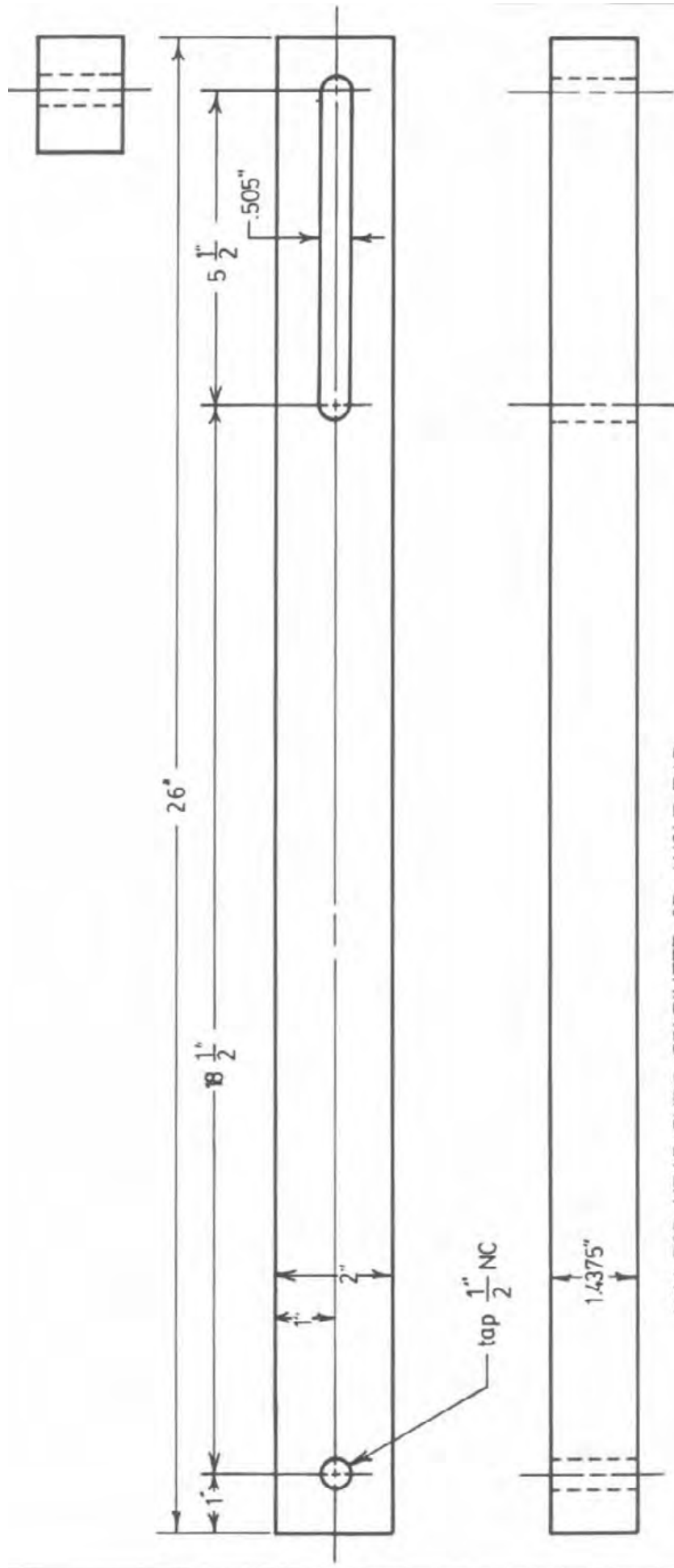

ARM FOR HEAD TUBE STABILIZER OR ANGLE BAR

Drawn by: Tim Paterek      Scale: 3/8 size      Tolerances:  $\pm 1/64$ " - fract. ,  $\pm .002$ " - dec.      Material: T-6 Aluminum

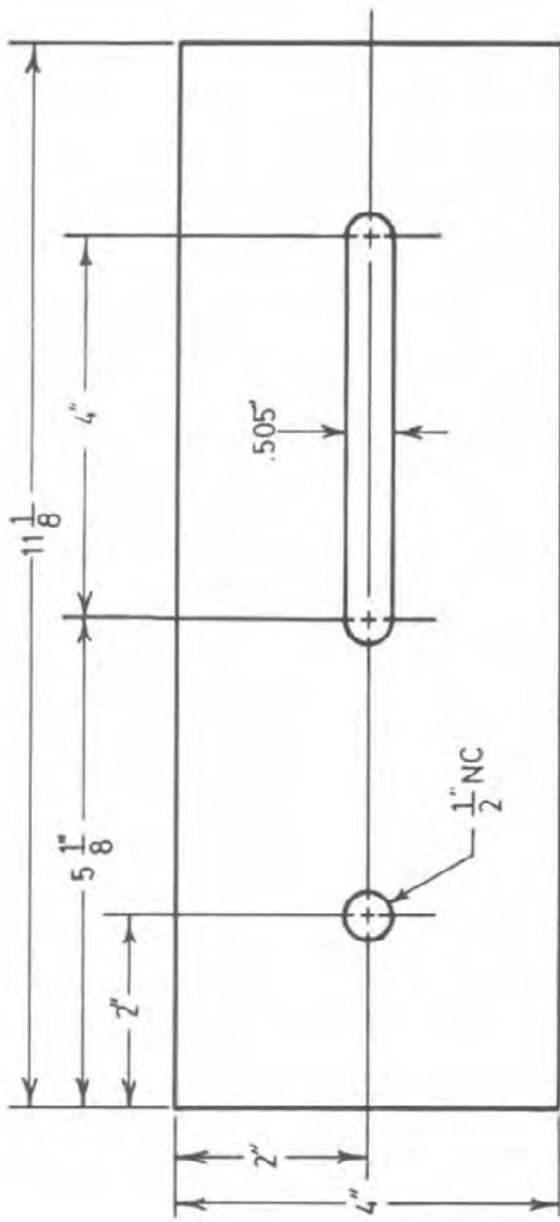

blanchard grind to thickness - both sides

BOTTOM BRACKET DROP ADJUSTMENT MEMBER OF REAR END JIG

Drawn by: Tim Paterek

Scale: 1/2 size

Tolerances:  $\pm 1/64$ " - fract.,  $\pm .002$ " - dec.

Material: 1020

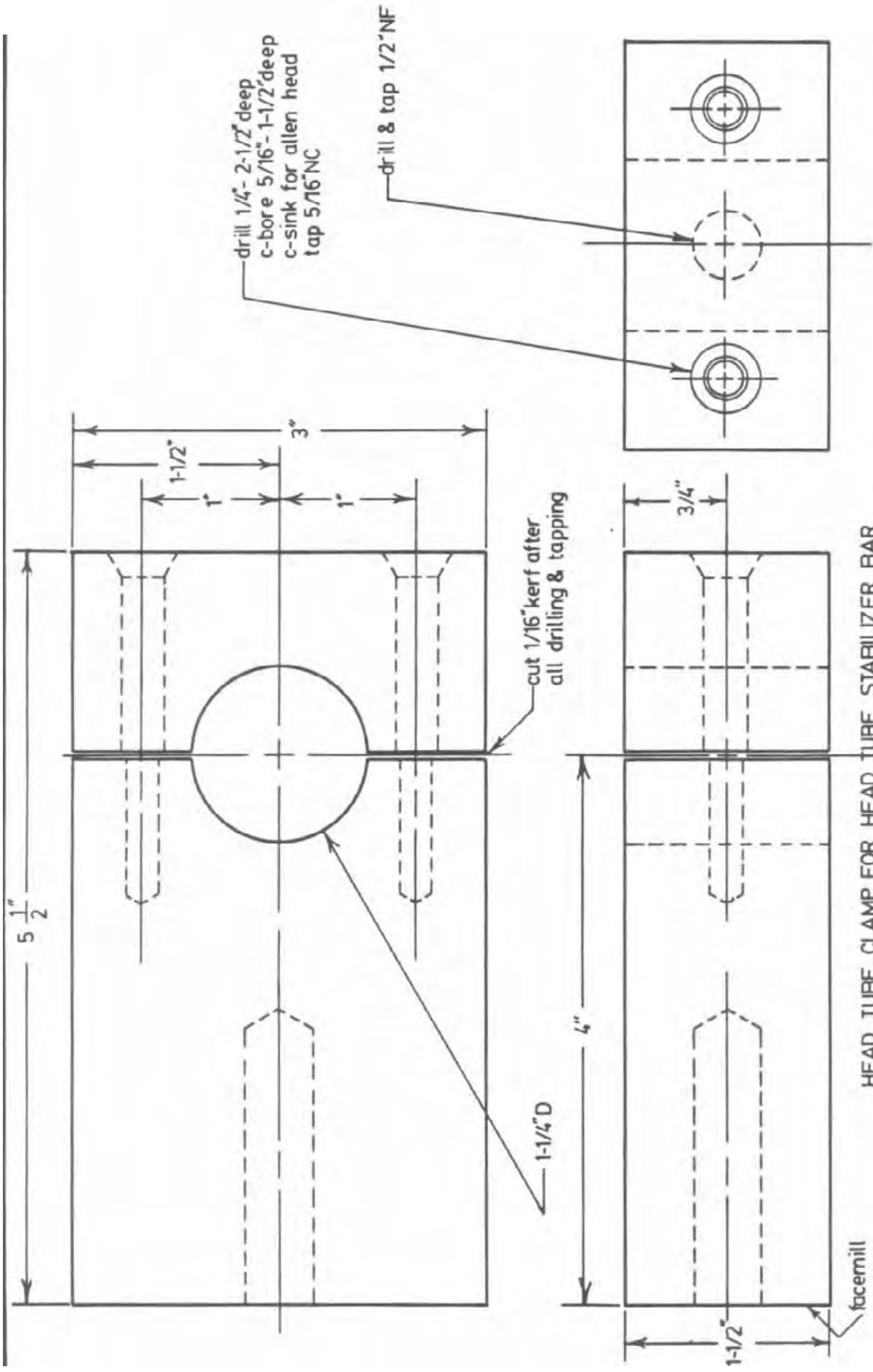

HEAD TUBE CLAMP FOR HEAD TUBE STABILIZER BAR

Drawn by: Tim Paterek      Scale: full size      Tolerances:  $\pm 1 \frac{1}{64}$ "      Material: T-6 or 1020

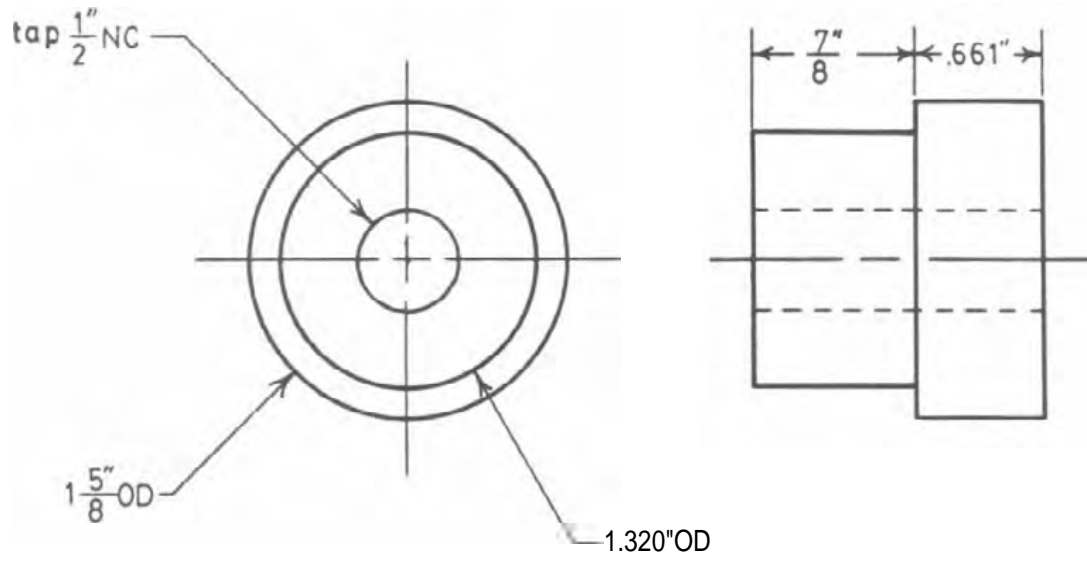

RIGHT HAND BOTTOM BRACKET PLUG

Drawn by: Tim Paterek

Tolerance:  $11/64''$ - fract. ,  $\pm .002''$ - dec.

Scale: full size

Material: 1020 steel or 306 stainless

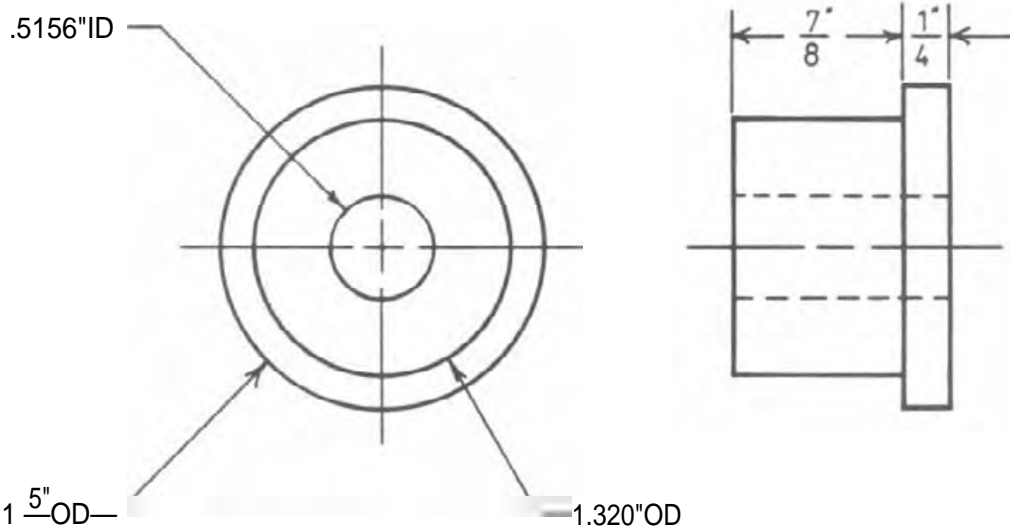

LEFT HAND BOTTOM BRACKET PLUG

Drawn by: Tim Paterek

Tolerances:  $t1/64''$ -fract.,  $\pm .002''$ -dec.

Scale: full size

Material: 1020 steel or 306 stainless

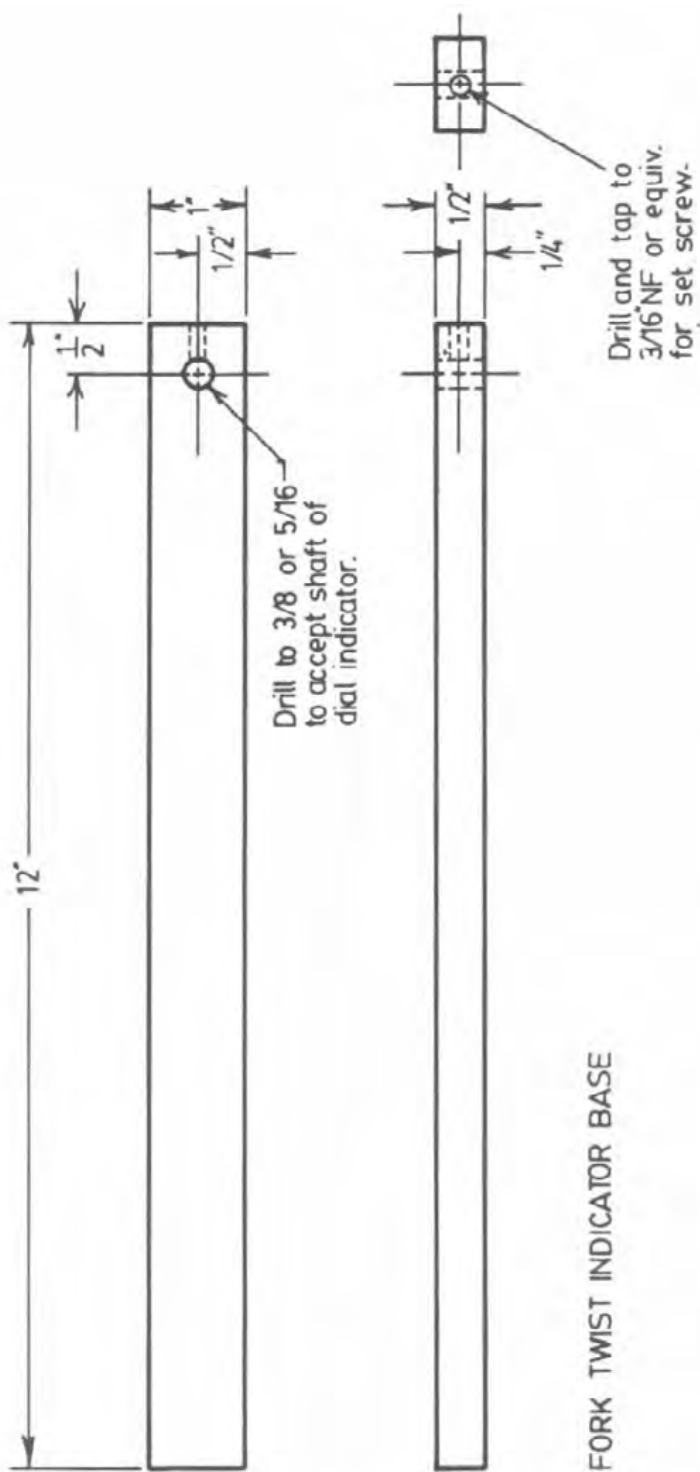

Drill to 3/8 or 5/16 to accept shaft of dial indicator.

FORK TWIST INDICATOR BASE

Drawn by: Tim Paterek      Scale: 1/2 size      Tolerances:  $\pm 1/64$ "      Materials: 1020 steel or 304 stainless

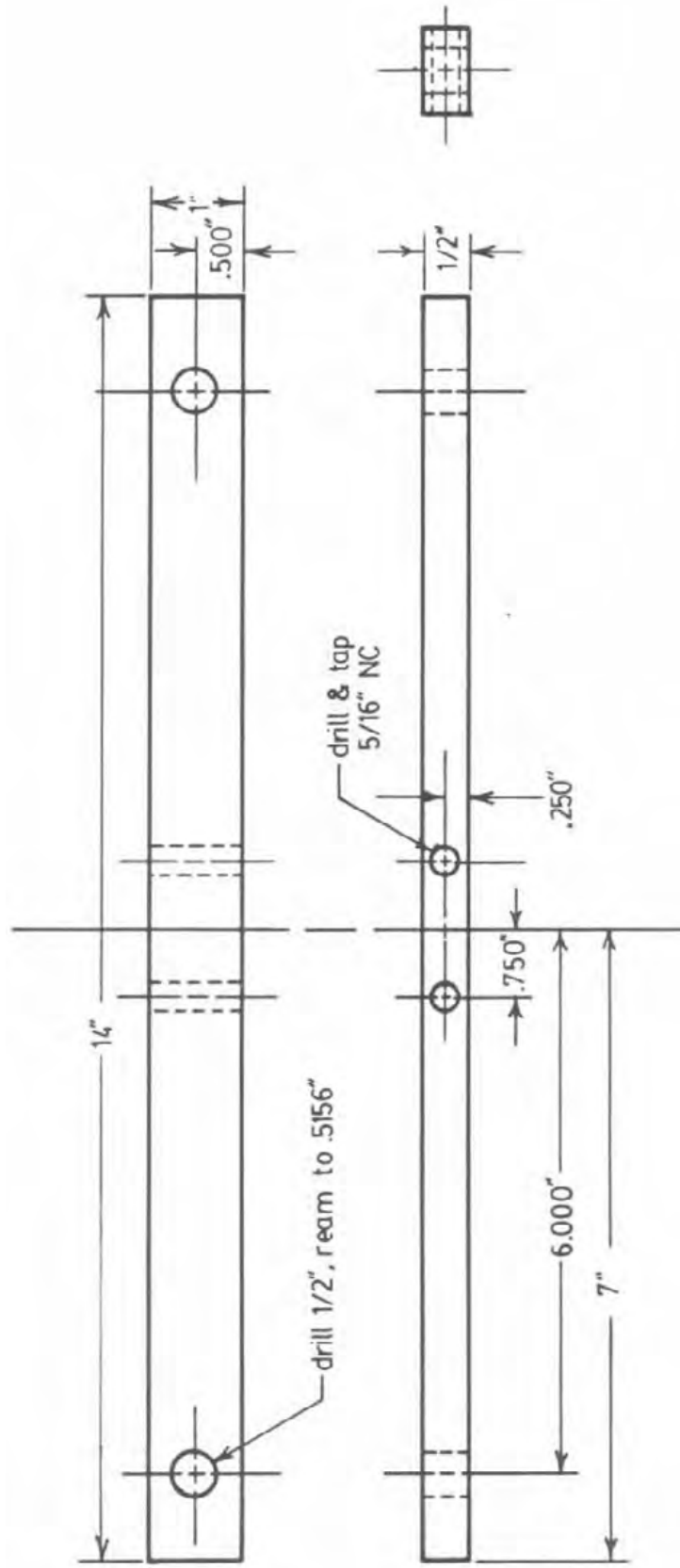

FORK JIG CROSS BAR

Drawn by: Tim Paterek      Scale: 1/2 size      Tolerances: ±1/64" - fractional, ±.001" - decimal      Material: 1020 steel



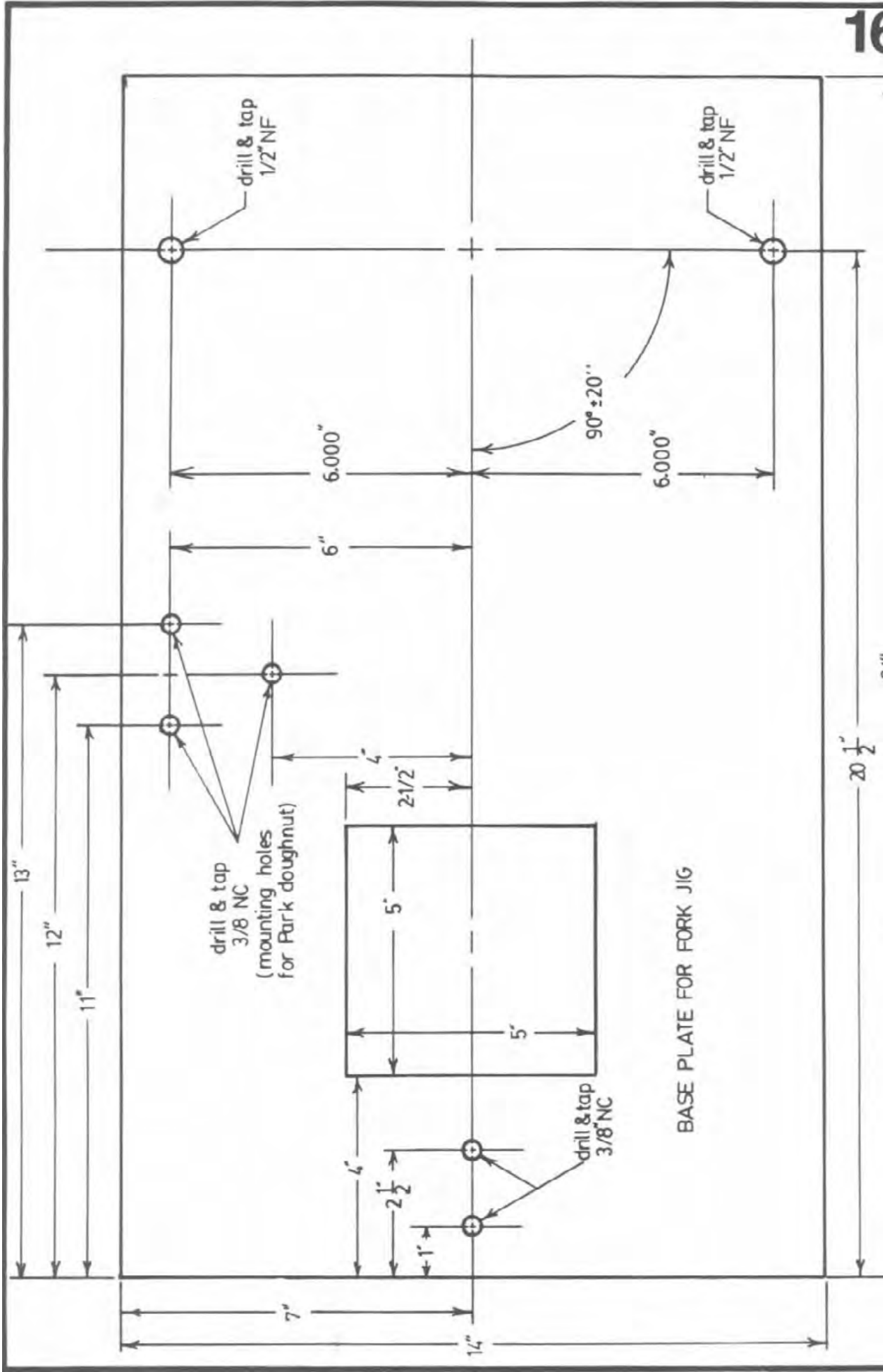

BASE PLATE FOR FORK JIG

Drawn by: Tim Paterek    Scale: 3/8 size    Tolerances: ± 1/64" - fractional, ± .0005" - decimal    Material: 1/2" F-6 Alum. plate or 3/8" cold rolled steel blanchard grind before machining

\* drill & tap 5/16" NC for rake setting

\* drill & tap 10 -32 for tip stop

\* drill & tap 3/8 NC for hold down plate

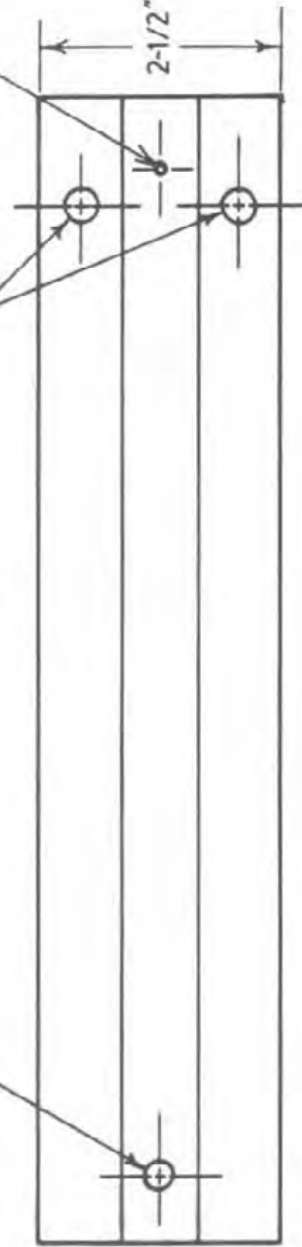

mill slot: 3/8" R,  
1/4" deep

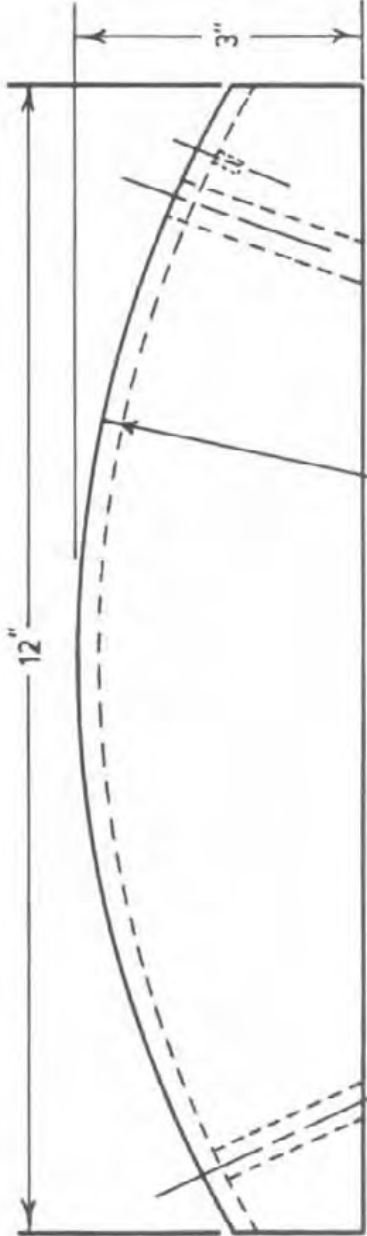

FORK BLADE BENDER

Drawn by: Tim Paterek    Scale: 1/2 size    Tolerances: ± 1/32"    Material: T-6 Aluminum or Hard Maple

\*hole locations not critical

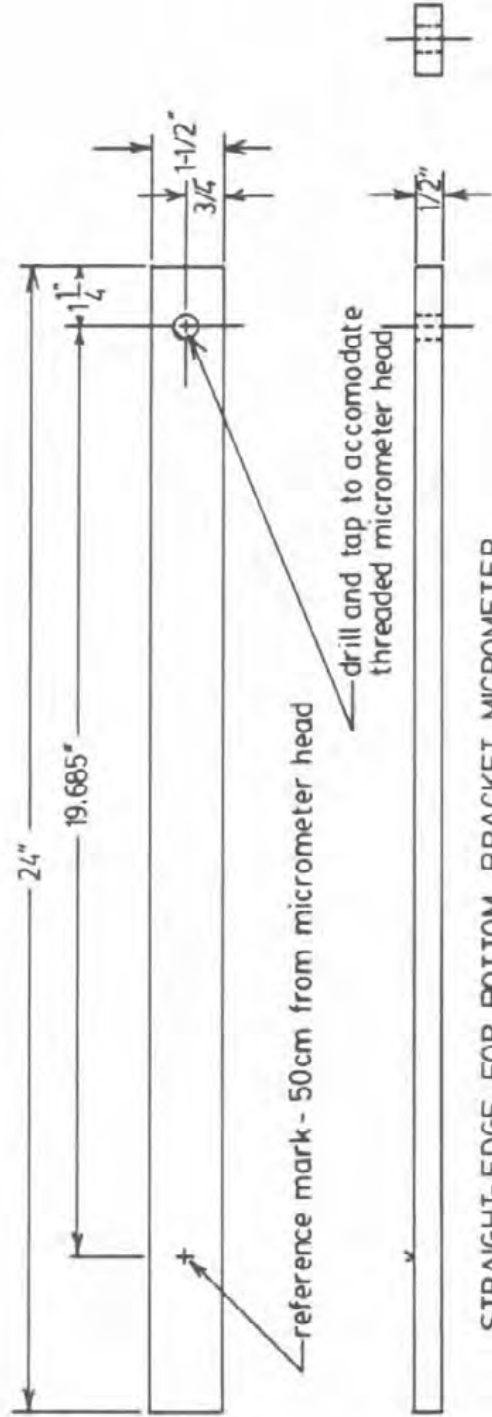

Drawn by: Tim Paterek

Scale: 1/4 size

Tolerances: ±1/64" fractional, ±.005" decimal

Material 1020 steel or 304 stainless



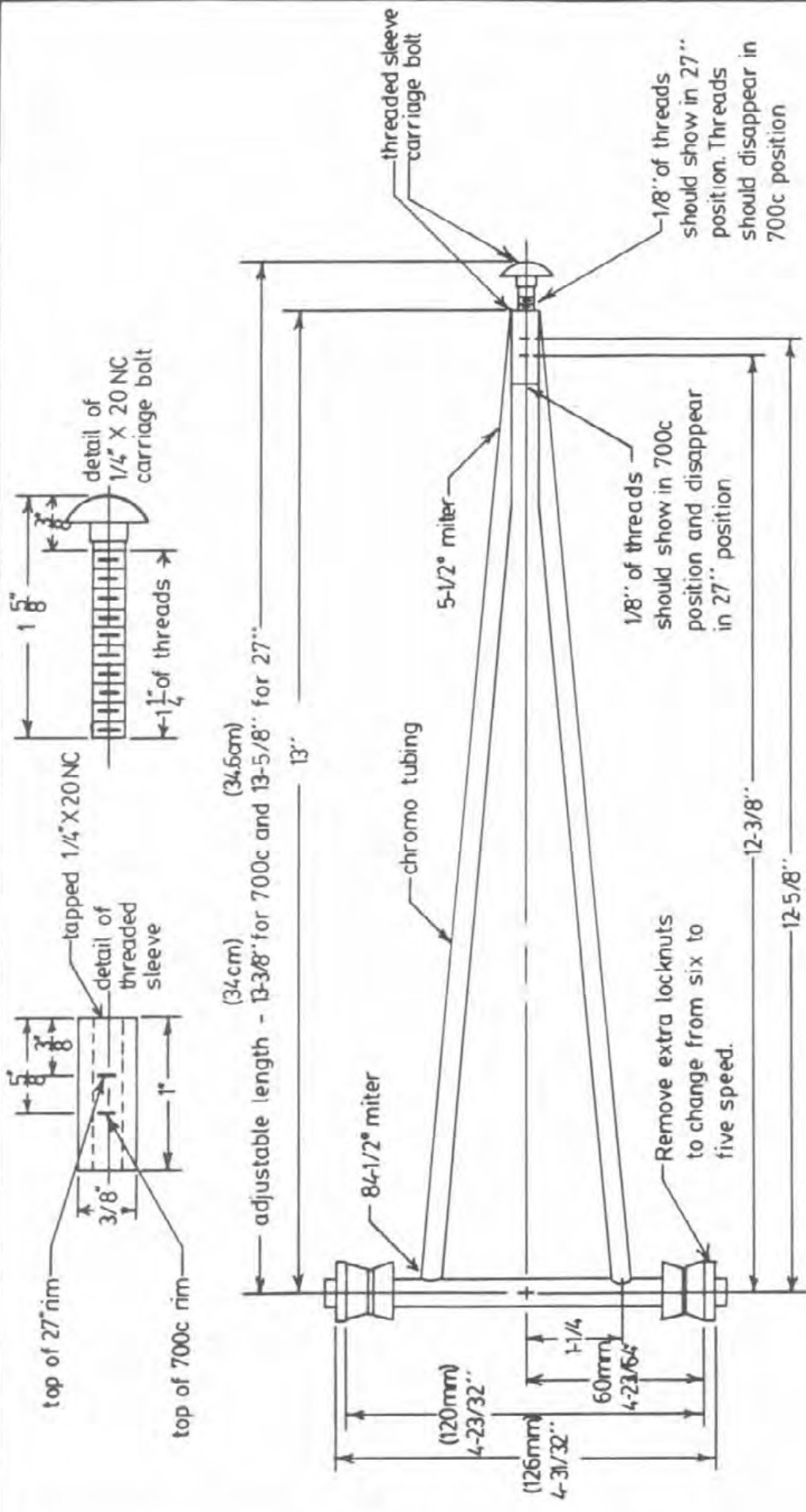

DUMMY WHEEL

Drawn by: Tim Paterek  
 tubing, Campagnolo 6spd axle, 4 Campy NR locknuts, 1/4" carriage bolt, 1/4" carriage bolt, 2 lockwashers, threaded sleeve, 2-3mm thick locknuts.  
 Scale: 1/2 size  
 Tolerances: ± 1/64"  
 Materials: 1/4" OD, X.028" Wall chromo

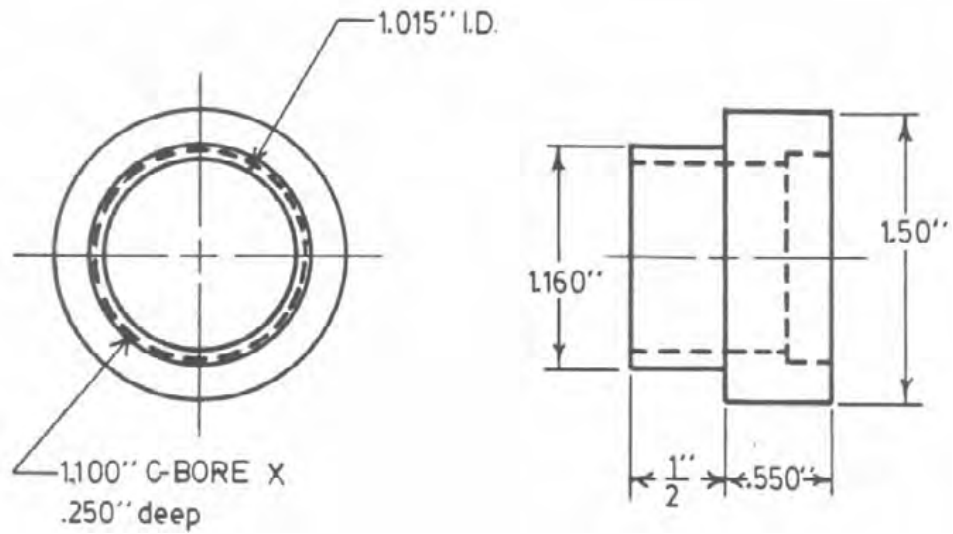

DUMMY HEADSET - LOWER PORTION

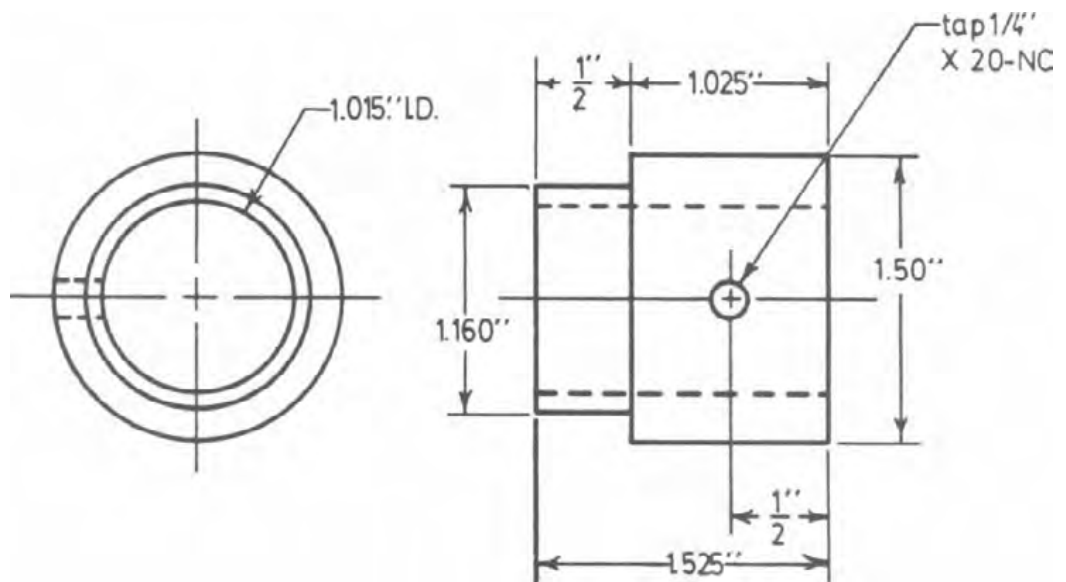

DUMMY HEADSET - UPPER PORTION

Drawn by: Tim Paterek  
Material: T-6 Aluminum or 1020 Steel

Scale: full size  
Tolerances:  $\pm 1/64$ " - fractional, .t.003" - decimal

## DIRECTIONS FOR IMPLEMENTING THE GENERIC PATEREK CATALOG

1. Anyone who purchases this catalog at full wholesale price is given permission to make the necessary alterations within and reproduce their own personalized version in any quantity they deem necessary.
2. After each repair, braze-on, or painting procedure there is a number in parentheses. This number is an estimation of roughly how long the item should take a builder in hours. For example: a (.8) would mean eight tenths of an hour to do that particular job. That number in parentheses can be multiplied by the hourly rate the builder charges. For example: if the builder charges \$20.00 per hour (not an unrealistic figure), multiply the (.8) above by \$20.00. The answer is \$16.00. That would be the labor charge for an item taking eight tenths of an hour at \$20.00 per hour. Go through the whole catalogue and figure out the correct amounts to write in the blanks. HINT: Try to type in the numbers or use transfer lettering to create a professional look.
3. Some items will have a second blank after the labor price. This second blank is for cost of materials. For example: installing a brazed-on front derailleur would have a labor charge as well as a cost of materials charge for the derailleur itself. Only some items will have this second blank. Go through the whole catalog and figure out a retail price to write in the cost of materials blanks.
4. All line drawings throughout the catalog have had the geometrical specs deleted. Write in the preferred specs for each model bike. For example: write in a head tube angle of 73 degrees for a touring bike if that is the angle that you put on that model of bike.
5. At the bottom of the page of contents is a space for your business card. Glue one of your business cards in that space. HINT: A black and white business card will look the most professional.
6. With transfer lettering, letter your name on the front cover.
7. At the top of page six are specs for several taps reamers and dies. Take a bottle of "white-out" and blank out the sizes you do not own.
8. After all of the necessary data has been entered into the generic catalogue, take it to your printer and have as many copies as necessary run off.
9. Dispose of this page.

# THE FRAMEBUILDER'S CATALOG





TABLE OF CONTENTS

Braze-on price list .....  
Painting price list .....  
Frame repair prices and descriptions .....  
Touring framesets.....  
Sport/touring framesets .....  
Racing framesets .....  
Builder's guarantee .....  
Ordering information .....  
Frameset order form.....  
Component order form

\*\*\*\*\*  
\* \*  
\* \*  
\* \*  
\* \*  
\* glue your business card here \*  
\* \*  
\* \*  
\* \*  
\* \*  
\*\*\*\*\*

**THE FRAMEBUILDER'S CATALOG**



BRAZE-ON PRICE LIST

		labor	mater
1. Water Bottle Mounts			
A. Plain . . . . .	(.25)	S	S
Scalloped Diamond Stiffeners . . . . .	(.30)	5	.....
C. Plain Diamond Stiffeners . . . . .	(.30)	\$	..... \$
2. Brazed on Front Derailleur (includes Derailleur)			
A. Campagnolo . . . . .	(.80)	\$	.....
Shimano Dura Ace . . . . .	(.70)	\$	.....
3. Shift Lever Bosses			
A. Campagnolo			
(also fits; Simplex S.L.J.. Rino Suntour)	(.40)	\$	S
R. Modified Campagnolo (for use of Parcons)	(.50)	C	\$
C. Shimano . . . . .	(.40)	.....	\$ ==
4. Cantilever Brake sets (specify regular. tandem or mountain use)			
Levers and cables not included			
A. Mafac . . . . .	(.60)	5	.....
Dia Compe . . . . .	(.60)	\$	..... S
C. Shimano . . . . .	(.60)	5	..... 5
5. Rear Rack Fittings			
A. Internal (using water bottle boss). . .	(.30)	\$	
R. External . . . . .	(.25)	S	..... 5
6. Low Rider Mounts (old style) . . . "	(.40)	5	5
Low Rider Mounts (new style) . . . . .	(.75)	5	5
7. Top Tube Cable Guides			
A. 2 Close Loops . . . . .	(.50)	5	
B. 2 Distant Loops . . . . .	(.50)		
C. 1 Loop . . . . .	(.50)	5	..... 5
8. Cable Stop			
A. Shimano . . . . .	(.20)	5	.....
B. Campagnolo . . . . .	(.20)	5	..... 5
C. Split Style . . . . .	(.20)	S	..... 5
D. Heavy Duty . . . . .	(.20)	5	
9. Pudic peg - Specify brand length, and tube to be installed on			
A. Standard . . . . .	(.25)	\$	_____
1/4' hall to mount Silca under top tube .	(.25)	\$	\$
10. Clamp stop . . . . .	(.20)	r	5
11. Chain Hanger . . . . .	(.20)		\$ \$
12. Bottom Bracket Guides			
A. Campagnolo (ton side) . . . . .	(.50)	S	..... 5
B. Shimano (top side) . . . . .	(.50)	\$	..... 5
C. Cinelli (top side) . . . . .	(.58)	\$	
D. Under Side . . . . .	(.60)	\$	
13. Barcon stops •• S <sup>P</sup> ecify style (see # _____)	(.50)		5
14. Extra Eyelets for fenders (pair) . . . . .	(.40)		
15. Brake bridge reinforcing sleeve			
A. Standard . . . . .	(.60)	5	..... 5
Allen Type . . . . .	(.60)		
15. Spoke Carrier/Chainstay Guard . . . . .	(.90)	_____	5
17. Center Full Hanger			
A. Simple Loop . . . . .	(.75)	\$	
9. Triangular . . . . .	(1.2)	\$	.\$ _____

# **PAINTING**

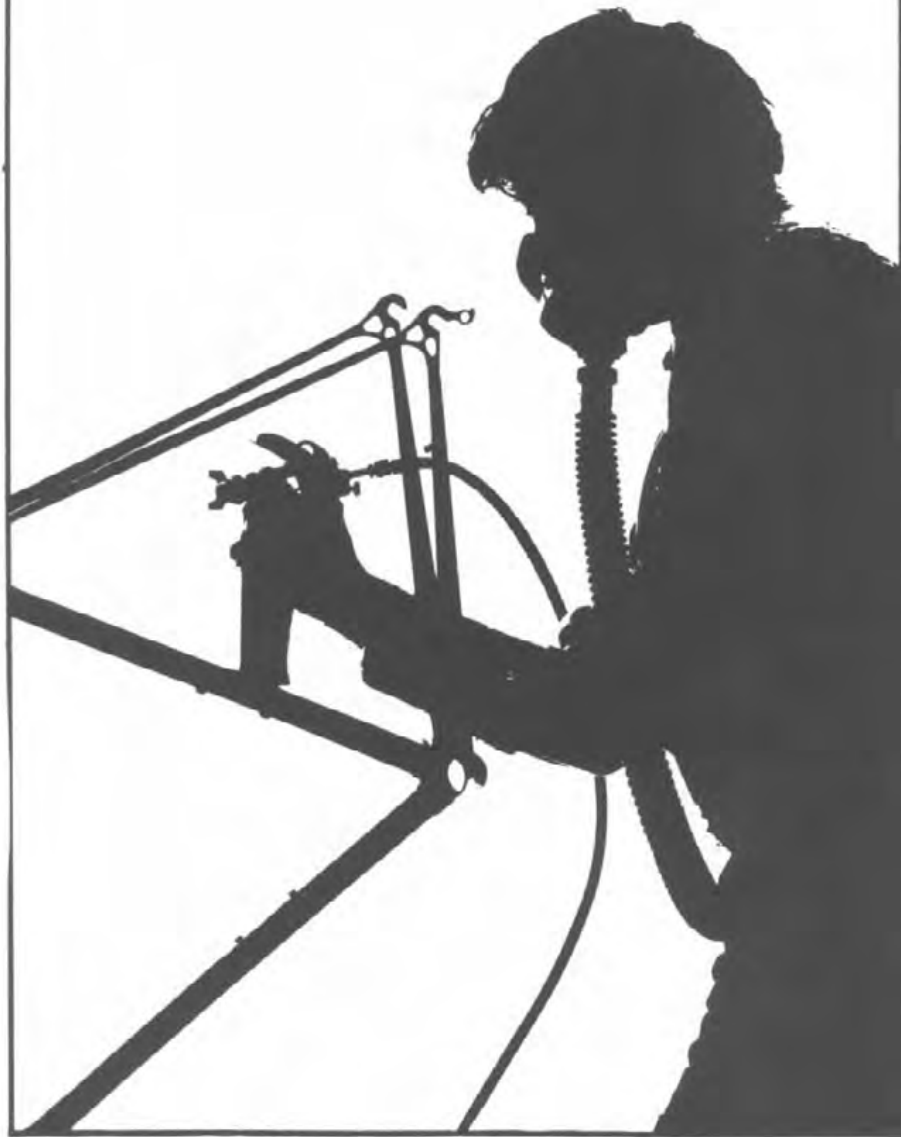

PAINING PRICE LIST

labor mater

OVERHAUL FOR PAINTING: This includes repacking the bottom bracket & head and removing & replacing all components. (3) \$ \_\_\_\_\_ ?  
Overhaul hubs and drive train (additional charge). . . (1.5) \$ \_\_\_\_\_

STRIPPING OLD PAINT: Paint is removed with an industrial aircraft stripper. Sandblasting is harsh and can damage thinwall tubing ..... (1 to 2) \$.....

REMOVING EXTENSIVE SURFACE RUST: If there is a lot of surface rust where there are bare spots in the existing paint job, this must be removed with a wire wheel. (.5 to 1) \$ \_\_\_\_\_

MASKING CHROME:

- Stays and rear dropouts ( 1) \$
- Fork blades. ( 1) \$
- Head lugs ( 1) \$
- Fork crown ( 1) \$

CLEAR COAT: The only time a clear coat is applied is to protect decals or when it is specifically asked for. . . (1) \$ \_\_\_\_\_ \$ \_\_\_\_\_

SINGLE COLOR PAINT JOB: All paint jobs will be done with automotive quality paints. Make sure a card or piece of masking tape is firmly attached to the frame which has the frame serial number, new color name, and color number on it. Also includes metal prep ..... (3) \$..... \$ \_\_\_\_\_

TWO TONE PAINT JOB: With magic marker, mark exactly where the contrasting color bands will be. Write serial number, color names, -and color numbers on a card or piece of masking tape and attach it to the frame. BE VERY CLEAR AS TO WHICH IS THE BASE COLOR AND WHICH IS THE CONTRASTING COLOR!! Also includes necessary masking and clear coat (4-5) \$ \_\_\_\_\_

DECAL WORK: Decal work is done on an individual basis. All requests for decals will be given an estimate at \$ \_\_\_\_\_ per hour before beginning .....

# FRAME REPAIR



FRAME REPAIR PRICES

THESE PRICES ARE FOR A FULLY STRIPPED FRAMESET.

Bottom bracket taps on hand: British Italian French Swiss  
 Steering column dies on hand: British Italian French  
 Head tube reamers on hand: 30.2mm 30.0mm  
 Crown race cutters on hand: 26.4mm 27.2mm

labor mater

BOTTOM BRACKET

Clean out or straighten out threads ..... (.25)\$ \_\_\_\_\_  
 Face milling (light cut) ..... (.25)\$ \_\_\_\_\_  
 Face milling from 70mm to 68mm (heavy cut) ..... (.50)\$ \_\_\_\_\_  
 Fill damaged threads with brass and cut new  
     threads to the original thread specs ..... (1 0)\$ \_\_\_\_\_  
 Ream and retap to Italian specs ..... (.50)\$ \_\_\_\_\_  
 Repair stripped Italian bottom bracket  
     shell to accept British or French cups ..... (2 0)\$ \_\_\_\_\_ \$ \_\_\_\_\_  
 Reinsert and rebraze an existing frame tube which  
     has pulled out of the bottom bracket shell ..... (.75)\$ \_\_\_\_\_

HEAD

Jack out frame which is bent from a head-on collision  
     (There may be ripples left after this.) ..... ( 40)\$ \_\_\_\_\_  
 Mill and ream top and bottom of head tube  
     (Specify press fit dimensions desired.) ..... ( 25)\$ \_\_\_\_\_  
 Remove head tube twist--to put head tube  
     and seat tube in the same plane ..... (.50 to 1.5)\$ \_\_\_\_\_

FORK

Ream 22mm French steering column to 22.2mm British size. .. (.25)\$ \_\_\_\_\_  
 Straighten blades to desired rake ..... ( 25)\$ \_\_\_\_\_  
 Straighten steering column which is bent  
     at the site of the crown race or above ..... ( 20)\$ \_\_\_\_\_  
 Align tips ..... ( 20)\$ \_\_\_\_\_  
 Reattach dropout (send old dropout with fork) ..... ( 80)\$ \_\_\_\_\_  
 Replace dropouts ..... 20.00 ..... (2.0)\$ \_\_\_\_\_  
 Replace blades: (specify british or continental) ..... (2-5)\$ \_\_\_\_\_  
 Mill fork crown race seat. (Specify 26.4mm or 27.2mm). . . (.25)\$ \_\_\_\_\_  
 Tap steering column to fit smaller frame  
     First centimeter ..... ( .25)\$ \_\_\_\_\_  
     Each additional cm ..... ( 10)\$ \_\_\_\_\_  
 Fill damaged threads with brass  
     and retap to old thread specs ..... ( 75)\$ \_\_\_\_\_

FRAME REPAIR PRICES cont.

REAR TRIANGLE	labor mater
Replace dropouts (Specify brand)	
Each	(2 0)\$
Pair	(3 0)\$
Replace chainstays (Specify brand)	
Includes bridge and cable stop	
Each	(2 5)\$
Pair	(4 0)\$
Replace seatstays (Specify brand)	
Includes brake bridge & chainhanger	
Each	(2 5)\$
Pair	(4 0)\$
Replace or relocate brake bridge	
Standard bridge .....	(1.25)\$ <del>---</del>
Bridge with stiffeners and reinforcer .....	(1.50)\$ <del>---</del>
Straighten seat stay with no kink .....	(.25)\$ ....
Straighten seat stay and fill & smooth out kink .....	(1.00)\$
Fill derailleur hanger threads with brass and retap. . .	(.50)\$-----
Modify Simplex dropout to accommodate Campy derailleur .	(.50)\$
Clean out chain adjuster threads .....	(.25)\$-----
Align tips .....	(.20)\$
Align derailleur hanger .....	(.20)\$ ---
Realign rear triangle to be in the same plane as the front triangle .....	(.50 to 1.50)\$
Open rear triangle to accomodate 6 speed	
Cold bend (not highly recommended) .....	(.25)\$
Install longer brake bridge--see above.	

FRONT TRIANGLE

Ream seat tube for an easy slide fit with seat post. (Send seat post that will be used ).....	(.25)\$	
Replace ruined seat post binder bolt	(1 0)\$	
Splice a cracked frame tube back together	(1 0)\$	\$
Replace head tube	(3	\$-----
Replace down tube	(3	\$-----
Replace top tube	(3 5)\$	\$-----
Replace seat tube	(3 5)\$	
Replace bottom bracket shell .....	(4.0 to 6.0)\$	
Replace top tube, head tube, and down tube . . .	(8.0 or more)\$	

\*\*\*\*\*  
\* \* \* \* \*  
\* WARNING: SOME OF THE REPAIRS LISTED \*  
\* IN THIS CATALOG MAY NULLIFY THE \*  
\* FACTORY WARRANTY. DISCUSS THIS WITH \*  
\* A DEALER OR DISTRIBUTOR IF THERE \*  
\* ARE ANY QUESTIONS IN THIS MATTER. \*  
\* \* \* \* \*  
\*\*\*\*\*



FRAME REPAIR PRICES cont.

labor mater

DRESSING A FRAME

Since many new factory frames are not cleaned up very well at the factory, the dealer must see to it that the bottom bracket is tapped and faced, the head tube is milled and reamed, the fork crown is milled, the seat tube is reamed for a proper fit, the tips are aligned, and all small threaded holes are cleaned out. (This should also be done after painting) ..... (1.5)\$ \$

COSMETIC REPAIRS

Any "body work" to be done on frames will be given a written estimate and sent to the customer for approval before starting.

All burned paint on frame repairs will be feathered out and covered with primer. A complete repaint is advised.

Heated chrome will discolor and will not be rechromed unless requested. Estimate on price and time will also be given.

---

# CUSTOM FRAMES

These frames are each individually designed and hand built one at a time. No two frames are the same unless ordered that way by a customer. They are built totally to the buyer's specifications and requests. Every lug, dropout, and bottom bracket shell is filed and sanded to remove unsightly blemishes. Each joint is brazed and inspected for alignment and workmanship before continuing. A superior automotive quality finish is applied to further enhance the fine workmanship already inherent in the frame. As a further service to the customer, the frameset is carefully "dressed" to allow the components to be installed without problems.



Level-1 (TOURING) These are built for the beginning or light duty tourist. Double butted tubing, stamped bottom bracket shell, stamped dropouts, stamped lugs, and cast crown come stock on this model. For touring these frames have a low bottom bracket, long chainstays. shallow head tube angle with matching rake and clearance for fenders. Braze-ons include one water bottle. bottom bracket guides top tube guides. chainstay cable stop, chainhanger, rear rack mounts. and extra eyelets for mounting fenders. The finish is an automotive quality finish with mylar decals.

Price \$ \_\_\_\_\_

-11-

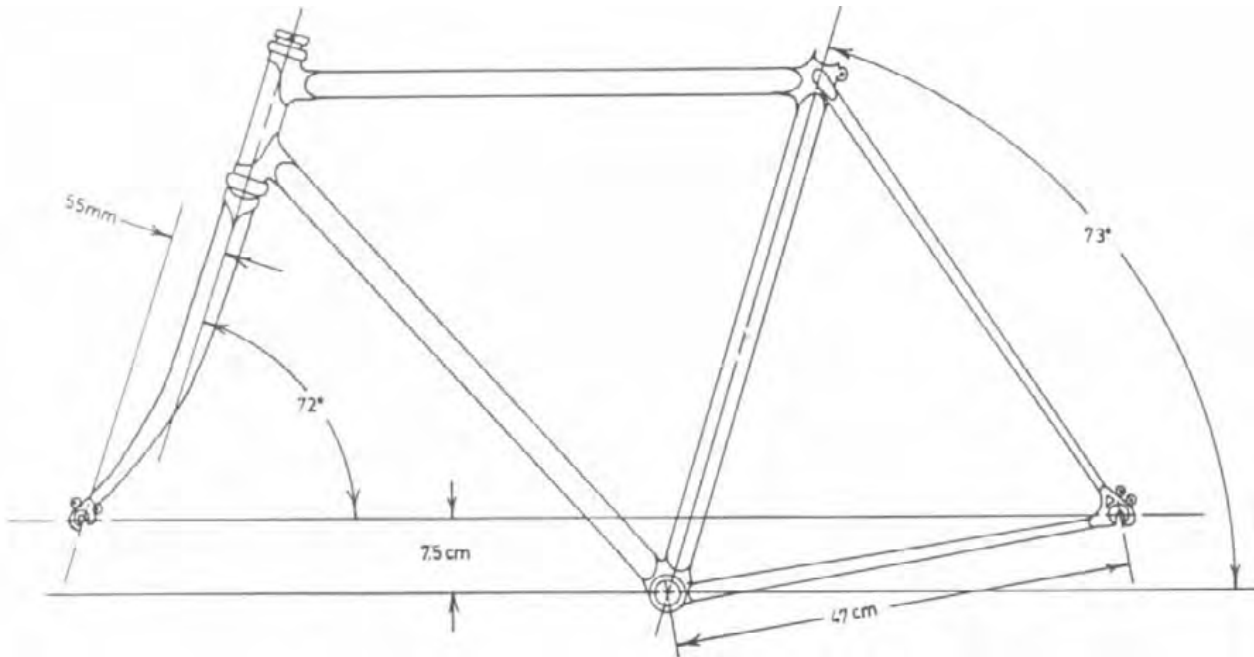

LEVEL-1 (SPORT/TOURING) These are built for the beginning sport rider who likes to tour at a fast pace with a light load as well as dabble in a little amateur racing. Double huttet tubing, stamped bottom bracket shell, stamped dropouts, stamped lugs, and cast crown come stock on this model. For sport/touring these frames maintain a happy medium in head tube angle, rake, bottom bracket drop, and chainstay len<sup>g</sup>th. Braze-ons include one water bottle: bottom bracket guides, top tube guides, chainstay cable stop and chainhanger. The finish is an automotive finish with mylar decals. price \$ \_\_\_\_\_

-12-

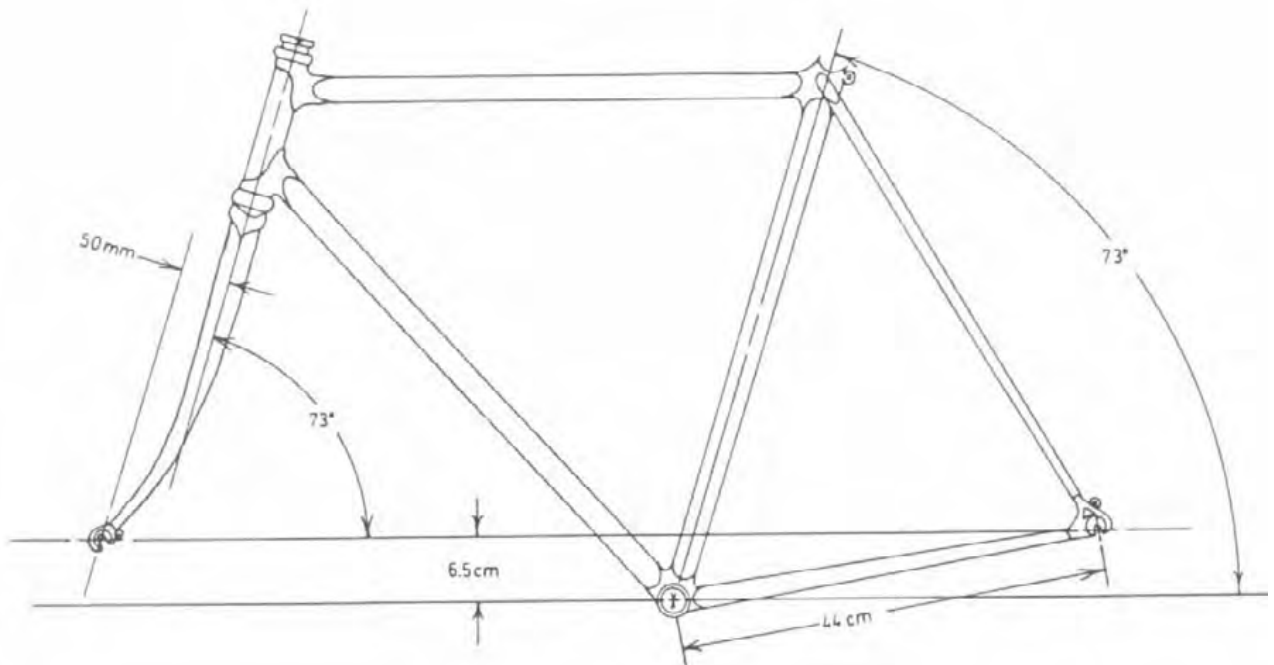

LEVEL-1 (RACING) These are built for the beginning racer who is entering citizen races or racing category 4. Double butted tubing, stamped bottom bracket shell, stamped dropouts, stamped lugs and cast crown come stock on this model. For racing these frames have a high bottom bracket, short chainstays, steep head tube angle with matching rake and minimum clearances. Braze-ons include one water bottle, bottom bracket guides, top tube guides, chainstay cable stop, and chainhanger. Eyelets are removed. The finish is an automotive finish with mylar decals.

price \_\_\_\_\_

-13--

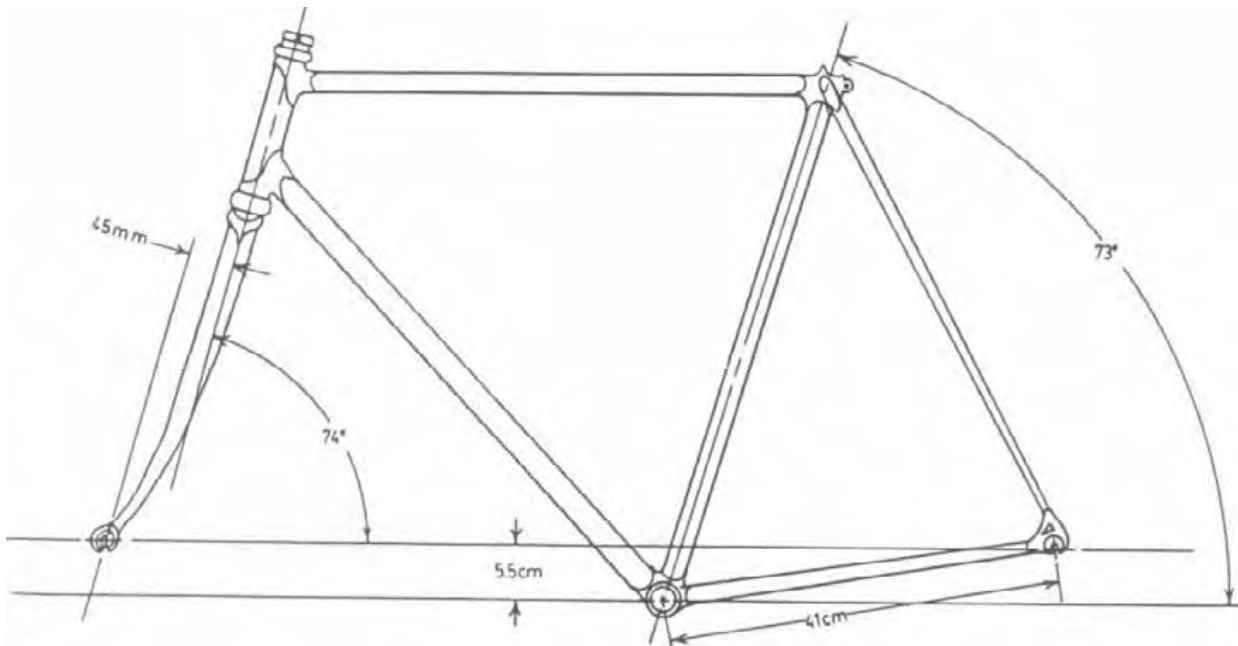

LEVEL-2 (TOURING) These are built for the more experienced tourist who takes extended trips with a lot of gear. Double butted tubing, cast bottom bracket shell, cast crown, cast lugs, and forged dropouts come stock on this model. For touring these frames have a low bottom bracket, long chainstays, shallow head tube with matching rake, and clearance for fenders. Braze-ons include two water bottles, bottom bracket guides, top tube guides, chainstay cable stop, chainhanger, rear rack mounts, extra eyelets for fenders, spoke carrier, lowrider braze-ons, pump peg, modified lever bosses, cantilevers, and center-pull hanger. The finish is a polyurethane enamel with dry transfer decals and a final coat of clear on top.

price \$ \_\_\_\_\_

--14--

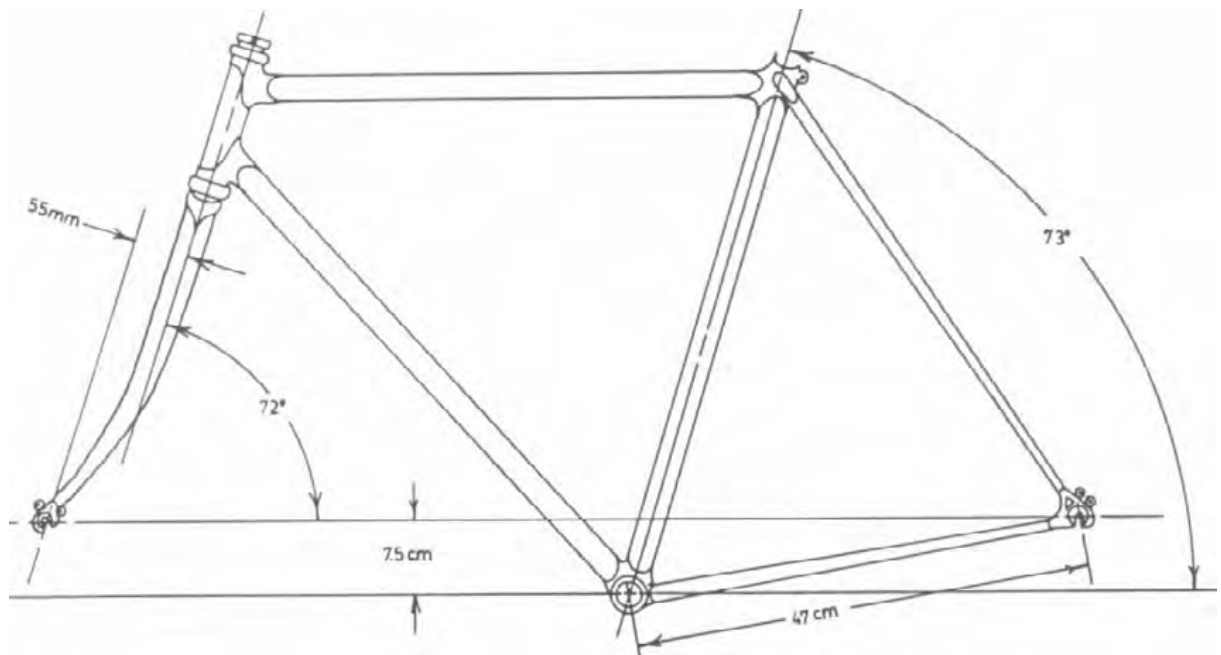

LEVEL-2 (SPORT/TOURING) These are built for the sport rider that likes to tour fast with a charge card and traveler's checks yet dabble in amateur racing. Double butted tubing (SL available on request), cast bottom bracket shell, cast crown, cast lugs, and forged dropouts come stock on this model. For sport/touring these frames maintain a happy medium in head tube angle, rake, bottom bracket drop, and chainstay length. Braze-ons include two water bottles, bottom bracket guides, top tube guides, chainstay cable stop, lever bosses, pump Peg and alien style brake bridge (Brazed-on front derailleur is optional). The finish is a polyurethane enamel with dry transfer decals and a clear coat on to<sup>P</sup>. price \$ \_\_\_\_\_

--15--

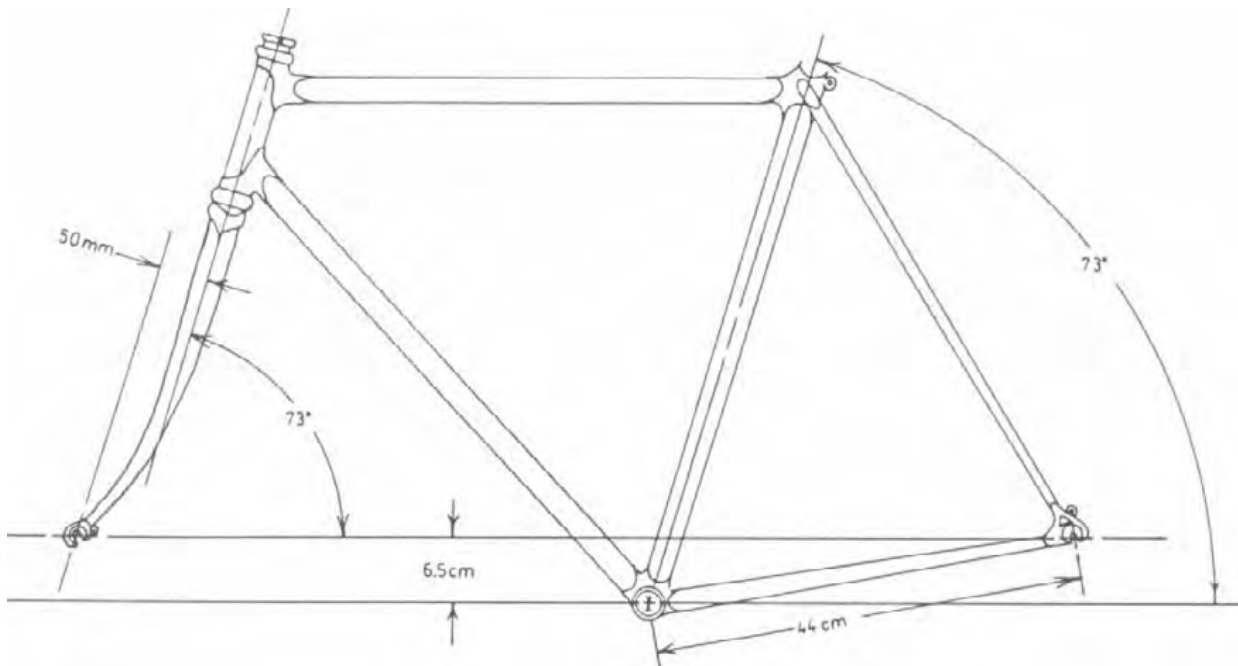

LEVEL-2 (RACING) These are built for the serious racer who trains on a regular basis and attends a number of races throughout the season. Double butted tubing (SL available on request), cast bottom bracket shell, cast crown, cast lugs, and forged dropouts come stock on this model. For racing these frames have a high bottom bracket, short chainstays, steep head angle with matching rake, and minimum clearances. Braze-ons include two water bottles, bottom bracket guides, top tube guides, chainstay cable stop, lever bosses, pump peg, and alien style brake bridge (brazed-on front derailleur is optional). The finish is a polyurethane enamel with dry transfer decals and a clear coat on top.

price \$           

-16-

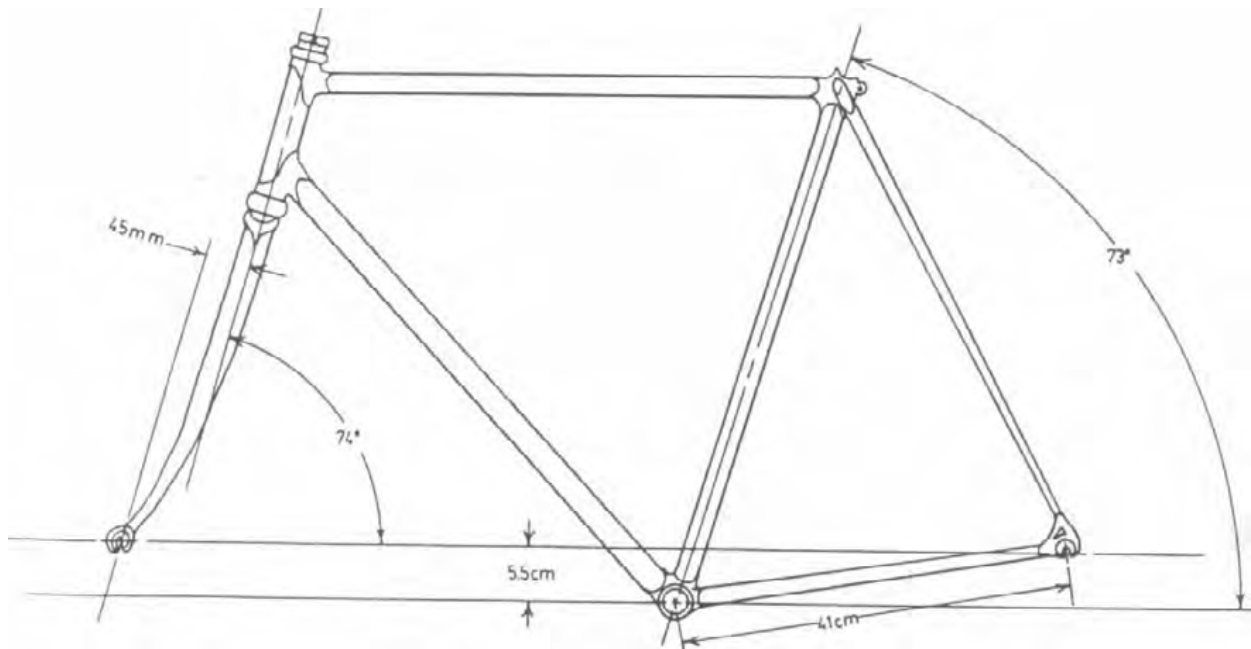



ADDITIONAL BRAZE-ONS Braze-ons can be added or subtracted from any frameset ordered. See the braze--on price list in the front of the catalogue.

For very tall riders. the Reynolds Tall set" can be built as big as 76cm. This adds \$50.00 to the cost of the frame.

For riders between 160 and 195 pounds who want to ride SL, the downtube and chainstays can be replaced with standard 531 material. This adds \$35.00 to the cost of the frame.

#### FRAMEBUILDER'S GUARANTEE

All frames listed herein are guaranteed against any defects in materials and workmanship. In case of a warranty problem, the frame will be repaired or replaced at no charge. In the event any other framebuilder alters or repairs the frame in any way. the warranty will be voided. Due to the fact that rider weight and size is considered in the <sup>P</sup>roduction of all these frames, the warranty ends upon sale of the frame to a second owner. In the event any non-standard frame style is requested by a customer, a conditional warranty will be written on the sales receipt.

## ORDERING INFORMATION

If ordering a custom frameset please fill out the frameset order form paying particular attention to the following items:

HEIGHT: In metric if Possible. Barefoot only.

WEIGHT: This information is needed to tell which tube set may be best for you.

INSEAM: Crotch to floor barefooted.

ARM LENGTH: Shoulder to wrist.

CUBIT LENGTH: This measurement is taken by bending your elbow and measuring from the tip of the elbow to the tip of your middle finger.

FRAME TYPE: Racing, Touring Sport/Touring,

(If you order a racing frame, you may want to specify if it's to be used for criteriums, time trials, or general road racing.)

GEOMETRY SPECS: Seat tube length is the only one

that feedback is really needed from you.

BRAZE-ONS: Check any additional brazed on equipment that you want if it's not included on the model of bike you want.

MATERIALS SPECS: You should not have to write anything here unless you are ordering something that is out of the ordinary.

NOTES: Write down the model frame you are ordering. e.g. LEVEL 1 LEVEL 2 etc.

SHIPPING: Include \$20.00 for shipping and handling.

PAYMENT: Half down and half on delivery.

COLORS AND SPECIAL VARIATIONS: An automotive paint color chart can be ordered to assist in choosing the right color.

If interested in

any variations in seat cluster, bridges, lugs dropouts, etc. Check THE PATEREK MANUAL for ideas.

FRAMESET ORDER FORM/SPEC SHEET

Today's Date \_\_\_\_\_  
 Target Date \_\_\_\_\_

Name \_\_\_\_\_  
 Address \_\_\_\_\_  
  
 Phone \_\_\_\_\_  
 Height \_\_\_\_\_ Weight \_\_\_\_\_  
 Inseam \_\_\_\_\_ Arm Length \_\_\_\_\_  
 Cubit Length \_\_\_\_\_  
 Frame Type \_\_\_\_\_

-NOTES-

GEOMETRIC SPECS:

Seat tube length \_\_\_\_\_  
 Top tube length \_\_\_\_\_  
 Front center \_\_\_\_\_  
 Chainstay length \_\_\_\_\_  
 Seat tube angle \_\_\_\_\_  
 Head tube angle \_\_\_\_\_  
 Bottom bracket drop \_\_\_\_\_  
 Fork rake \_\_\_\_\_  
 Estimated trail \_\_\_\_\_  
 Bridge clearance \_\_\_\_\_  
 Crown/tire clearance \_\_\_\_\_  
 Rear hub width \_\_\_\_\_  
 Tire size \_\_\_\_\_

BRAZE-ONS:

add \$

MATERIALS SPECS:

L. H. BB guide \_\_\_\_\_ Tubing \_\_\_\_\_  
 R. H. BB guide \_\_\_\_\_ Lugs \_\_\_\_\_  
 Chainstay stop \_\_\_\_\_ Bottom bracket \_\_\_\_\_  
 W. B. #1 \_\_\_\_\_ Fork crown \_\_\_\_\_  
 W. B. #2 \_\_\_\_\_ Drop outs \_\_\_\_\_  
 W. B. #3 \_\_\_\_\_ Paint \_\_\_\_\_  
 W. B. #4 \_\_\_\_\_ Brazing Material \_\_\_\_\_

Top tube stops \_\_\_\_\_

Top tube guides \_\_\_\_\_ COST OF FRAMESET:

Lever bosses \_\_\_\_\_

Barcon stops \_\_\_\_\_ Base price of frame \$ \_\_\_\_\_

Pump peg \_\_\_\_\_

Rear rack mounts \_\_\_\_\_ Extra braze-ons \_\_\_\_\_

Low rider mounts \_\_\_\_\_

Spoke carrier \_\_\_\_\_ Special requests \_\_\_\_\_

Cantilevers \_\_\_\_\_

Cut-outs \_\_\_\_\_ Subtotal \_\_\_\_\_

Headcrest \_\_\_\_\_

Other \_\_\_\_\_ Tax \_\_\_\_\_

Total \_\_\_\_\_

Downpayment \_\_\_\_\_

Braze-on total \_\_\_\_\_

**Balance Due**

Est. Delivery Date

<u>DESCRIPTION</u>	<u>ESTIMATED PRICE</u>	<u>ACTUAL PRICE</u>
Drive Train:		
Cranks _____		
BB _____		
Chainrings _____		
Pedals _____		
Toe clips _____		
Toe straps _____		
Chain _____		
Freewheel _____		
Wheels:		
Hubs _____		
Spokes _____		
Rims _____		
Rimstrips _____		
Tubes _____		
Tires _____		
Shifting system:		
Fr. derailleur _____		
R. derailleur _____		
Levers _____		
Cables _____		
Clamps _____		
Brake system:		
Running gear:		
Headset _____		
Seatpost _____		
Saddle _____		
Bars _____		
Stem _____		
Bar Wrap _____		
Plugs _____		
Pinch bolt _____		
Accessories:		
	Pump _____	
Carrier _____		
Lights _____		
Bottle rack _____		
Bottle _____		
Speedo _____		
Lock _____		
Other:		

Name _____	Component Group Total _____
Address _____	Tax _____
	Total _____
Phone _____ Zip _____	Down Payment _____
<b>Bike Type _____</b>	<b>Balance Due _____</b>

## GLOSSARY

This glossary is composed mainly of terms associated with bicycle framebuilding. There are many other terms within this list that come from the areas of metallurgy and machine shop. Together, these areas will provide a large vocabulary of terms for the bicycle framebuilder.

ACME THREAD, A thread form characterized by being blunt and thick with the faces of the thread being at only a slight angle. This thread form is particularly useful in handling a load which exerts itself along the length of the threaded rod. An ACME thread may be found on some hand operated framebuilder's cutting tools.

AMERICAN NATIONAL THREAD, The threads commonly found on stove bolts in hardware store bins. The thread form is a uniform one with 60 degree angles on the faces of the threads and the peaks of the threads slightly rounded. This thread is particularly useful where high precision is not required and high volume production is necessary.

ANNEAL, To heat a metal, such as steel, and cool it slowly. By doing this steel can be softened for easier machining. Annealing also makes the metal less brittle.

ANODIZE, An electrolytic process in which the surface of a piece of metal forms a protective coating for the metal. In practice, it amounts to a type of "controlled corrosion" which is usually used on aluminum components in the bicycle industry. With slight modifications to the process, almost any color that is desired can be produced.

BEVEL PROTRACTOR, A precision measuring device used to measure angles in small increments. Some are equipped with a vernier scale which allows measurements down to 5 minutes in accuracy.

- BORE, A process used in machine shops to enlarge a hole in a precise manner. In a lathe a stable boring bar holding a tool bit goes down the inside of the hole while the piece turns. In a mill a spinning tool bit goes down into the hole of a rigidly held piece of metal. Boring guarantees the diameter, location, and depth of a hole to specified tolerances.
- BOSS, Any protrusion which comes up beyond the surface of an object. In bicycle frames this would refer to many types of braze-ons, (e.g., lever bosses, water bottle bosses, chainhanger boss, etc.)
- BOTTOM BRACKET DROP, The distance below the centers of the axles the center of the crank spindle lies.
- BOTTOM BRACKET SET, The set of parts consisting of spindle, cups, bearings, lockring, and protecting sleeve which are inserted into the bottom bracket shell.
- BOTTOM BRACKET SHELL, A fitting that can be stamped, cast, or in the case of lugless building, machined. It forms the union between the seat tube, down tube, and chain stays, and provides a transversely threaded hole for installation of the bottom bracket set.
- BRAKE BRIDGE, The cross member spanning the seat stays just above the rear wheel. It is usually brazed in place and provides a stable mounting place for rear caliper brakes, fenders, or carriers.
- BRAZE, A metal joining process in which parent metals are joined by melting between them an alloy that melts at a lower temperature than the parent metals. The alloy cements the parent metals together without drastically altering their physical characteristics. Common brazing alloys utilize elements such as silver, brass, and nickel. Brazing refers only to performing the above process at 800 degrees F or higher. Synonym: HARD SOLDERING.
- BRAZE-ONS, Any clip, peg, or boss which is attached to the surface of the frame by means of the brazing process.

BURR, See wire edge.

outside diameter dimension but has abrupt changes in the inside diameter thus giving the tube thicker walls at the ends.

which one thread face comes out from the shaft at a right angle to the shaft. The opposing thread face has a very gradual slope. These threads are particularly useful when there is a load in one direction but not in the other direction.

CADMIUM, An element somewhat resembling tin in appearance. When melted, it gives off a yellowish gas which can cause severe respiratory disorders. Cadmium should be considered dangerous and proper ventilation and breathing apparatus should be used when working with it. Cadmium is the element that gives silver solder its excellent flow characteristics.

CAMBER, To arch slightly. See fork rake.

CARBIDE, A compound of carbon with a metal. Used in making cutting tool bits because of its extreme hardness. Carbide bits are produced by compressing powdered carbide. Often mixed with tungsten.

CARBURIZING FLAME, A flame used in Oxy-Acetylene in which there is more acetylene than oxygen. Characterized by a longer soft blue flame. Good for doing work where oxidation is a problem.

CASE HARDENING, To harden steel or an alloy of steel on the outer surface only. Done by a combination of heat treatment and addition of carbon.

CAST, To form a piece of metal in a mold while it is in a liquid state.

CASTER, The state of being out of parallel as in wheels or, more notably, dropouts.

CENTER PUNCH, A hardened metal rod which has a 90 degree point ground on the end. It is used for making a mark more visible than one left by a prick punch. A center punch is usually hit with substantial force.

CHAIN STAYS, The frame members that span the distance between the bottom bracket shell and the dropouts. Chain stays usually have an external taper, causing a gradual decrease in outer diameter from one end to the other.

CHAIN STAY BRIDGE, The member spanning the distance between the chain stays just in front of the rear tire.

CHROMIUM-MOLYBDENUM ALLOY, A steel alloy with traces of the elements chromium and

is harder and stiffer in physical properties. Synonyms: Chrome-Moly, CHRO-MO.

COLD SET, A process of forcefully bringing frame members into tolerance without the use of heat. Can either be done by hand or with specifically designed fixtures.

COSMOLINE, A grease used to protect metal items from rusting. Often applied to tube sets to arrest rusting while in storage.

COUNTER BORE, 1) To bore out a cylindrical hole for a certain distance so as to form a flat bottom of the hole for receiving the head of a screw. 2) The tool that will do the counterboring process.

cylindrical hole so that the top of that hole has a cone-shaped configuration. This allows a flathead screw to be driven in so that the top of that screw is flush. 2) A tool that will do countersinking.

CUBIT, The distance from one's elbow to the fingertips. Can be used as a rough indicator in determining the length of the handlebar stem.

DIE, 1) A cutting tool used to cut a thread on the outside of a cylinder. 2) The forming or cutting piece held in a press.

DRILL, To make a hole in a piece of stock by use of a rotating, helical cutting tool.

DROPOUTS, The frame member to which the wheels are attached. OR, The location from which the wheels "drop out" of.

FACE, To clean up the end of a cylindrical piece of stock on a lathe or milling machine. As in facing a bottom bracket shell.

FILE, 1) A hardened steel tool with teeth formed in its flattened surface for the purpose of metal removal. 2) To use a file.



FIXTURE, Any specifically designed piece of equipment which is meant to hold, bend, or measure an item during a manufacturing process. Fixtures are usually custom built or built in very limited numbers.

FLUORIDES, A chemical compound made by the union of Fluorine and another element. Fluorides are present in water soluble silver solder flux. Fluorides are skin irritants and particularly annoying to the mucous membranes. Great care should be taken so that fluorides are not inhaled.

FLUTE, A furrow or groove as in ornamentation on a column. Seat posts are often fluted. Some chain stays are fluted to make clearance for the tire.

FLUX, A substance that is applied to a braze joint before brazing begins to keep the area clean and free of oxidation. Flux can come in paste form, powder form or even applied to the outer surface of brazing rods in hard form. In the case of silver soldering, flux is also a temperature indicator. See fluorides.

FORK BLADES, The slightly curved frame members that span the distance between the fork crown and the front dropouts. Fork blades can come in round, British oval (narrow), or Continental oval (fat) cross sections.

FORK CROWN, The frame member that forms a union between the fork blades and the steering column. Fork crowns can come to fit Continental blades, round blades, or British blades. They can be inserted or overlapping. See the section on fork crowns in the variations section.

FORK CROWN RACE, The piece of the headset that sets directly on the fork crown. Commonly available in press-fit dimensions of 26.4mm and 27.2mm.

FORK CROWN RACE SEAT, The location on the fork crown that the fork crown race sets on. It should be a press-fit with the fork crown race.

FORK RAKE, The amount of offset in the fork or a perpendicular distance from the head tube centerline to the front axle centerline.

FORK SWOOP, A misalignment resulting from the curvature of the fork blade not being in the same plane as the oval of the fork blade.

FRONT CENTER, The distance from the center of the bottom bracket to the center of the front axle.

FRONT TRIANGLE, That part of the frame which is made up of the head tube, down tube, seat tube, and top tube. In actuality, the front triangle is a trapezoid.

HEAD TUBE, The frame member that spans the distance from the top tube to the down tube. The head tube usually falls in a narrow angle range of 71 to 75 degrees off horizontal.

HEIGHT GAUGE, A precision instrument used for finding, transferring, and marking heights while working with objects on the surface table. A height gauge has no calibrated markings such as a vernier height gauge would have.

HIGH CARBON STEEL, A type of steel alloy in which the amount of carbon added makes the steel extremely hard and ideal for making cutters to cut other metals.

HIGH SPEED STEEL, A type of steel alloy with traces of Chromium, Tungsten, or Molybdenum. High speed steel makes excellent cutting tools and is sometimes preferred by machinists over high carbon steel.

HONE, Honing dresses the inside surface of a cylindrical hole through the use of spring loaded spinning stones. Honing does not guarantee location, diameter, and depth of a hole as boring does. Only small amounts of metal should be removed by honing.

HYDROCHLORIC ACID, An aqueous solution of Hydrogen Chloride. (HCl) A very strong acid which can be used in rust removal and some clean-up operations. However, if used as such, a rust retarding treatment must immediately follow or the HCl will continue to attack the metal for some time. USE ONLY WITH ADEQUATE VENTILATION! THE FUMES ARE ABSOLUTELY DEADLY IF INHALED! Synonym: Muriatic Acid.

HYDROGEN EMBRITTLEMENT, A condition in which available hydrogen acts upon steel making it lose strength and tend to shear more easily along shear planes. The most common cause of this condition is due to pickling and plating baths. Thus, chrome plating can be a significant contributing factor to hydrogen embrittlement.

I.S.O. International Standards Organization. An organization dedicated to establishing standards and norms in the industrial world.

JIG, See fixtures.

J.I.S. Japanese Industrial Society. An organization of Japanese industries dedicated to establishing standards and norms in the Japanese industrial community.

LUGS, Stamped or investment-cast fittings that form a reinforcing sleeve at the joints of bicycle frames. Can also be thought of as miniature fixtures that hold the frame members in place during brazing. See variations section for more information.

MACHINE, (verb) To remove metal from a piece of stock. The stock can be held rigid while the cutter moves over it, as in the case of a milling machine or the stock can move while the cutter remains stationary, as in a lathe.

MANGANESE-MOLYBDENUM, A steel alloy with minute traces of the elements manganese and molybdenum mixed in. the result is a stiffer and stronger alloy more suitable for framebuilding.

METRIC, A measurement system invented during the French Revolution that is based on a unit called a meter. It is an entirely decimal system that is extremely easy to use. Unlike other measuring systems, it has total continuity between volume, weight, and distance scales. The metric system is the preferred measurement system of scientific communities and technologically advanced societies.

MILL, To remove metal from a piece of stock by holding the stock rigid while the cutter head glides over the surface. Milling machines can be large and complex like a vertical or horizontal milling machine or they can be very simple such as a hand operated milling tool. One form of milling often used in framebuilding is face milling. This is done to the bottom bracket faces and the head tube faces to make them parallel with each other.

MITERING, A special type of cutting that is done to allow pieces to come together at an angle as in the corners of a picture frame. In framebuilding these mitered joints will be more saddle shaped, allowing the pieces to come together at an angle and have one wrap partially around the other. Simple miters involve cutting only one radius into the miter. Compound miters can involve 2 or more radii in the miter.

MODULUS OF ELASTICITY, Elasticity refers to a metal's ability to snap back to its original dimensions after being subjected to stresses. The modulus of elasticity simply quantifies this ability for different metals.

NEUTRAL FLAME, In Oxy-Acetylene work a neutral flame is one in which equal amounts of oxygen and Acetylene are allowed to come to the torch tip for combustion. This type of flame is characterized by having a short inner cone to the flame. Neutral flames are the specified flame for many applications.

OXIDIZING FLAME, In Oxy-Acetylene work an oxidizing flame is one that has more Oxygen than Acetylene going to the torch tip for combustion. This flame type is characterized by a very small and bright cone, as well as a hissing noise. The major use for this type of flame is for cutting purposes while using a special cutting tip.

PAINTING, The process of applying a protective surface of lacquer, enamel or latex to an otherwise unprotected surface. Application can be done by brushing, dipping, spraying, or electrostatics. Spraying of lacquers and enamels is most often used by the custom framebuilder.

PHOSPHORIC ACID, Any one of the three oxygen acids of phosphorous. Used to remove and arrest iron oxide (rust). Also useful in preparing steel surfaces to accept paint. Use only in well ventilated areas. DO NOT LET PHOSPHORIC ACID COME IN CONTACT WITH ANY BODY TISSUES; PARTICULARLY OPEN SORES, SCABS, OR MUCOUS MEMBRANES!

PLAIN GAUGE, A type of tubing that has a constant wall thickness throughout.

PILOT HOLE, A small diameter hole that is drilled before the desired diameter hole is drilled. When going to a large hole diameter, several pilot holes should be drilled in the same location and each a few steps larger than the last. This lessens the work load that each successive drill bit must handle.

PLATING, Putting a thin layer of metal over the surface of another metal or even non-metal piece through the process of electrolysis. Plating can be done with a variety of metals such as gold, silver, nickel, chrome, and brass. It can be done for a variety of reasons, most notably for rust protection and decoration on bicycle frames.

PREHEAT, The period of time that it takes to heat up a braze joint to the correct temperature for brazing to begin.

PRESS FIT, A precision fit between two machined pieces that is so tight that extreme pressure is necessary to put the two pieces together.

PRICK PUNCH, A hardened metal rod that has a 60 degree point ground on one end. It is used for making a mark more visible than scribe marks. A prick punch is only hit lightly with a hammer.

REAM, To enlarge a hole by using a fluted cutter called a reamer. Reaming guarantees the size of a hole but not its location or depth. Reaming can be done under power on a lathe or a mill. It can also be done by hand as in reaming a head tube with the correct tool from the mechanics toolcase.

REAR TRIANGLE, That part of the bicycle frame consisting of the seat stays, chain stays, dropouts, and bridges.

SAND, To remove metal in minute amounts from a piece of stock by rubbing with a silicon-carbide or aluminum-oxide impregnated piece of paper or cloth.

SCRIBE, 1) To lay out marks or lines that show what final dimensions will be or where holes or other modifications will be. To make scribe marks more visible, layout dye is brushed on the surface before the marks are made. 2) The name of the tool used to scribe lines.

SEAT CLUSTER, That part of the frame where the top tube, seat tube, and seat stays meet.

SEAT STAYS, The frame members that span the distance from the seat cluster to the rear dropouts.

SEAT TUBE, The frame member that spans the distance from the seat cluster to the bottom bracket. Also, the tube in the frame that most people will equate its length with the actual size of the bike.

SHARP V THREAD, A theoretical thread form. All National, Whitworth, and Metric threads are flattened or rounded at the top and bottom of the threads. The sharp V thread is not in theory. However, such a thread would have quite ragged edges after being cut and would need to have them rounded.

SHEAR STRENGTH, The amount of resistance encountered when trying to shave off a piece of metal such as a rod. The proper set-up for testing shear strength is to bolt or rivet two plates together very tightly and then slide the plates apart which will shear off the bolt or rivet. A properly done, silver brazed, lugged joint has tremendous shear strength. If done with too much clearance, such a joint has greatly diminished shear strength.

SINGLE POINT, A term used to describe the method in which threads are cut on a lathe or a mill using a special single pointing head. Unlike a hand-held die and die-stock which uses a cutter with several flutes, the single point set up cuts threads with only one tool bit that has only one point cutting the thread. In effect, it's almost like a needle moving along the groove on a phonograph record. Single pointing by a skilled technician produces the most precision threads of any method.

SLUGS, See Topeye.

SOLDER, A metal joining process in which parent metals are joined by melting between them an alloy that melts at a lower temperature than the parent metals. The alloy cements the parent metals together without drastically altering their physical characteristics. The most common soldering alloys are made of tin and lead. Soldering refers only to performing the process below 800 degrees F. Synonym: soft soldering.

SPLINE, 1) A flat, rectangular piece of metal fitting into a groove or slot between parts as in a hub and axle. Synonym: axle key. 2) One of the lengthwise grooves on a spindle that has such a set of grooves on the end so that another piece with a matching set of grooves will not turn on that spindle. Similar to flutes.

SQUARE, 1) A four-sided polygon with all equal sides and equal angles. 2) A condition in which two lines or planes meet each other at 90-degree angles. 3) A tool used for measuring to see if two lines or planes meet at 90-degrees to each other.

SQUARE THREAD, This is a thread form characterized by having the faces of the thread at right angles to the length of the threaded shaft. This thread is particularly useful when there is a load along the length of the threaded shaft in either or both directions.

STAMP, 1) To punch a specifically contoured piece of metal out of a larger sheet of that metal with a cutting die and a press. 2) To Form a flat piece of metal into a three dimensional form with a forming die and a press.

STEERING COLUMN, The threaded portion of the fork that rises nearly vertically out of the fork crown.

STEM, The unit that attaches the handlebars to the steering column. Colloq: gooseneck.

STRESS RELIEF, The easing of tension built up in metal parts usually due to heat distortion and forces involved in brazing or welding. Stress can be relieved in welded parts by certain heat treatments. Stress can be relieved in brazed parts through cold working or shot peening.

STRESS RELIEF HOLE, A hole drilled at the end of a slot such as the seat post binder slot. Such a hole spreads the stresses out over a larger area and lessens the chance of a crack from developing from the base of that slot.

STIFFENERS, Pieces brazed to a bicycle frame to increase the wall thickness in a particular location. Common places for stiffeners are on the inside faces of the fork blades, around water bottle holes, or at the ends of the bridges. Synonym: tangs

SURFACE PLATE, Any bench top or table top that is made of steel, marble, or granite and ground to a precision flatness. Surface plates can be almost any size from 12" square to several feet across. Uses of surface plates include; securing fixtures, precision measuring and locating points, lines and planes on objects. Synonyms: surface table, true table, true plate

SWAGED, 1) To form or to fashion especially as in iron or steel. 2) A tool used by blacksmiths for stamping or molding heated metal into a desired shape. 3) To shape by means of a swage. Fork blades, chain stays, and seat stays are "swaged" to their desired shape.

TANGS, See stiffeners.

TAP, 1) To cut a helical groove around the outside of a round cylinder or the inside of a hole with the intension of being able to screw a matching piece together with it. 2) The tool used to cut the helical groove in the inside of a hole.

TAPERED, Any object that gets uniformly smaller from in size from one end to the other. Seat stays, chainstays, and fork blades taper from one end to the other. Some frame tubes taper in wall thickness. This is different from butting, as butting is an abrupt change in wall thickness. Tapering is a gradual and uniform change.

TENSILE STRENGTH, The capacity of a material to withstand longitudinal strain or rupture. Example: The tensile strength of the rope is put to the test when playing Tug-o-war. In The U.S. tensile strength is measured in pounds per square inch. In some countries, it is measured in Kilograms per square millimeter. In the scientific community, it is felt that the proper way to measure it is in Newtons per square millimeter.



TOOL STEEL, Any of a variety of extremely hard alloys of steel used primarily for cutting metals which are softer than these tool steels. Tool steels can be made by altering the amounts, presence, or absence of any of the following trace elements; Carbon, Chromium, Tungsten, and Molybdenum. Tool steels are divided into 6 major categories: 1. Water hardening, 2. Shock resisting, 3. Cold work, 4. Hot work, 5. High speed, and 6. Special purpose. Most of the cutters on hand operated framebuilding tools are high speed tool steel.

brazed into the top of the seat stays.  
Synonym: slug.

TOP TUBE, The horizontal (or near horizontal) frame member that spans the distance between the seat cluster and the head tube.

TRAIL, The result of mathematically correlating the the variables of head tube angle, fork rake, and wheel diameter. See the section on frame geometry for greater detail.

TUNGSTEN, This metal has the highest known melting point (6200 deg F or 3427 deg C). It is often combined with carbide in making extremely hard cutting tools with a high resistance to wear. Other uses are; light filaments, scribes, and GTAW (TIG welding) styluses.

TURN, To fashion a piece of metal, wood or plastic into a desired form by mounting it while mounted in the chuck of a lathe and removing material by rotating the stock against a rigidly mounted cutting tool.

V-BLOCK, A square piece of metal with a V shaped groove cut into one or more sides. It can be used to hold and/or secure cylindrical objects in relation to a surface plate.

VENT HOLE, Any hole drilled into a bicycle frame to allow expanding gases to escape safely during the brazing process. Synonym: Air expansion hole.

VERNIER, A scale often found on precision tools to gain a finer degree of accuracy. Verniers can be found on calipers, micrometers, protractors, and height gauges.

WELD, To join two parent metals into one piece by melting them together. Unlike brazing, another metal is not used to bond the parent metals. In welding, a filler rod of the same material as the parent metals is used to fill gaps and depressions along the weld seam. Welding can be done in a variety of ways, such as; oxy-acetylene gas, propane gas, Arc (sometimes called stick welding), GTAW (sometimes called TIG welding), GMAW (sometimes called MIG welding), and Resistance welding (sometimes called spot welding). Most welding processes are some variation of the preceding methods.

WHEEL BASE, The distance from the center point of the front axle to the center point of the rear axle.

WHITWORTH THREAD, A thread form used quite extensively in Great Britain prior to the Second World War. It is characterized by having thread faces that slope at an angle of 55 degrees. The tops of the threads are rounded. Use of Whitworth threads has greatly diminished over the last few decades.

WIRE EDGE, A ragged edge along a freshly ground or machined piece of stock. A wire edge should be removed by honing. Synonym: burr.

WORK HARDEN, To increase the hardness of a metal by filing, machining, bending, or pounding the metal. Many metals are specially alloyed for their property of being able to be work hardened. Shot peening is a controlled form of work hardening which adds a significant amount of strength to the original metal. This can even restore strength lost through the brass brazing process. Synonym: cold working

WORM THREAD, A thread form that is very similar to the Acme thread. The only real difference is that the worm thread has higher peaks on the threads. See: Acme Thread.

YIELD STRENGTH, The point at which a metal actually gives in and begins to deform. In tensile tests, yield strength is the point at which the metal starts to stretch but before it breaks.

INDEX

This index has been written to pull all the PATEREK material together. After the PATEREK SUPPLEMENT is clipped into the PATEREK MANUAL- this index will give locations of subjects in both books. When the letters YP appear after an entry, the information will be found in the yellow pages at the end of THE PATEREK MANUAL. When the word general is used in an entry, it indicates general information is given on the subject.

AIR COMPRESSOR		
general	6--9 through 6-10	
in painting	11-12 through 11-13	
AIR EXPANSION HOLES		
bottom head lug		3-17
for top tube	3-25, 3-73,	8-27
in brake bridge		3-47
in fork blades	3-33,	3-84
in seatstays		3-41
down tube and seat tube into bottom bracket	3-13,	8-24
ALUMINUM		
oxide formation		8-7, 8-8
ALUMINUM LUGLESS JOINTS		
advantages and disadvantages		8-7
ANDREW HAGUE		
fork jig		5-12
frame components		YP
frame jig		5-12
ARM MEASUREMENT		
in formula	1-5 through 1--6	
BELT SANDER		
general		6-10
BENOTTO		
sizing machine		YP
BEVEL PROTRACTOR		
general	6-6 through 6-7,	9-6
BILATERAL SYMMETRY		
general		9-11
BOTTOM BRACKET		
68 and 70mm		2-37
Cinelli		2-35
Davidson		YP

BOTTOM BRACKET cont.	
different nationalities	2-36 through 2-37
drop	1-13, 3-3
face milling	3-15, 3-50, 3-66, 3-105, 8-26
guides	2-11 through 2-12
Haden	2-36
height	1-2
Henry James	2-36
jig	3-13, 3-65
jig (illustration)	5-9
measuring drop	9-19 through 9-20
micrometer	3-16, 3-67, 5-3
Otsuya-Medalist	YP
RGF	2-36
stamped and cast	2-35
Tange	YP
tapping	3-15, 3-50, 3-66, 3-105, 8-26
BOTTOM BRACKET SHELL - LUGLESS	
dimensions	8-4
BOTTOM HEAD LUG	
air expansion hole	3-17
angle	3-17 through 3-18
BRAKE BRIDGE	
fitting and cutting	3-45 through 3-46
installation of	3-100
reinforcing sleeve	2-13 through 2-14
styles	2-20 through 2-24
BRAZE-ONS	
installation of	3-101 through 3-104
price list	4-2
BRAZING	
alloy	3-12
applying flux	3-13
blades into crown	3-34, 3-90
bottom head lug onto head tube	3-16 through 3-17
clean and prep	3-11 through 3-13
clean up	3-15
down tube into bottom bracket	3-71 through 3-72
down tube into bottom head lug	3-18, 3-69
dropouts into chainstays	3-37
dropouts into fork blades	3-26 through 3-27, 3-83
external fillets	8-2
external-internal fillets	8-3
internal fillets	8-3
lower head lug	3-68
nickel-bronze alloy	8-4
nickel-silver alloy	8-4

BRAZING cont.	
procedure	3-13 through 3-15
rear triangle	3-41, 3-97 through 3-98
seat tube into bottom bracket	3-65
steering column into crown	3-29, 3-79 through 3-80
tinning	8-15, 8-29
top tube in place	3-76 through 3-77
Welco #17 flux	8-4, 8-15
BRIDGE MATERIAL	
detailed description	2-55 through 2-56
CABLE STOPS	
general	2-9 through 2-10
CANTILEVER	
brakes	2-5 through 2-7
location of studs	2-6
Suntour XC brakes	YP
CENTER PULL HANGERS	
general	2-15
CENTERING	
rear wheel	3-44 through 3-45
CHAIN HANGER	
general	2-11
CHAINSTAY	
bridges	2-17 through 2-20
cross section	2-54 through 2-55
cutting notch for dropout	3-8, 3-63 through 3-64
detailed description	2-54 through 2-55
ends	2-56
length	1-14 through 1-15
CHAINSTAY BRIDGE	
installation of	3-48, 3-101
CHAINSTAYS	
fitting and cutting	3-37 through 3-38, 3-95
heavy duty in lugless work	8-31
CLAMP STOP	
general	2-11
COLDSETTING	
down tube out of bottom bracket	3-21
rear triangle	3-42 through 3-44
seat tube out of bottom bracket	3-16, 3-67

COMBINATION SQUARE		
general		6-7
COMPONENT SHEET		
order form		4-7
COORDINATE MEASURING MACHINE		
Cordax	9-37 through	9-38
Numerex		9-37
CORBETT METHOD, THE		
dropouts related to centerline	9-28,	9-29
introduction		9-27
measuring fork blade length		9-30
measuring head tube twist		9-28
measuring rake		9-29
mounting fork vertically		9-30
mounting frame vertically		9-30
relationship of front and rear triangles		9-28
resting frame on build-ups		9-27
sweeping bottom bracket faces		9-27
COUNTERBALANCE		
for head tube during brazing	8-17 through	8-18
CRESTS		
illustrations	2-15 through	2-16
CRITICAL TEMPERATURE		
of steel		8-5
CROTCH CLEARANCE		
in seat tube length formula		1-2
CUBIT		
related to stem length		1-5
CUSTOM FRAME		
price list	4-4 through	4-5
CUTOUTS		
illustrations	2-15 through	2-16
DAVIDSON		
bottom bracket shells		YP
lug sets		YP
DAVISON FORMULA		
error of		1-10

DEFLECTION		
of down tube	3-16, 3-67, 8-26, 9-13	
of seat tube	3-16, 3-67, 9-12	
DIAL INDICATOR		
general		9-3
DIE GRINDER		
general		6-8
use of in lugless building		8-29
DOWN TUBE		
deflection of	3-16, 3-67, 8-26, 9-13	
detailed description		2-48
mitering short butted end		3-9
mitering long butted end	3-19 through 3-20, 3-70 through 3-71	
protector sheath		5-9 through 5-10
DRILL BITS		
general		6-5
DRILL PRESS		
general		6-9
DROPOUT		
attaching		2-46 through 2-47
brazing in front set	3-26 through 3-27, 3-83	
brazing in rear set		3-37
chain adjusters		2-41
chart	2-44 through 2-45	
front		2-43
standard road		2-41
track or rear loading		2-43
vertical		2-42
DROPOUTS		
fitting of	3-63 through 3-64	
use of H tools		3-49
DUMMY BRAKE		
use of		3-85
illustration		5-3
DUMMY HEADSET		
use of	3-29, 3-35	
illustration	5-1 through 5-2	
DUMMY REAR WHEEL		
use of	3-45, 3-48, 3-100 through 3-101	
illustration		5-2

DYNABRADE		
general		6-11
use of	3-60 through	3-61
use of in lugless building		8-29
EMBELLISHMENTS		
illustration	2-15 through	2-16
EYELETS		
extras for fenders	2-12 through	2-13
FACE MILLING		
of bottom bracket	3-15, 3-50, 3-66, 3-105,	8-26
of head tube	3-26, 3-77 through	3-78
FILES		
general	6-3 through	6-4
FILLET BUILDING		
description of process	8-14 through	8-15
FIRE EXTINGUISHER		
general		6-12
FIRST AID KIT		
general		6-12
FIT KIT, THE		
general	1-6, 6-11	
FIXTURES		
bending	5-9 through	5-11
holding	5-4 through	5-9
measuring	5-1 through	5-4
FLUX		
clean up of brass flux		8-15
clean up of silver flux		3-15
health warning		3-13
FORK		
bending blades	3-7, 3-62	
blade bender	5-11, 3-62	
cutting notches in blades	3-8, 3-63 through	3-64
dropouts related to centerline	9-24 through 9-25, 9-29,	9-36
measuring of rake	9-29, 9-20 through	9-22
measuring of twist	9-22 through 9-23,	9-29
mounting on surface plate	9-20, 9-29,	9-30
rake	1-8, 3-4	
theoretical (diagram)		9-26



FORK BLADES		
cutting recommendations		2-53, 3-31
detailed description		2-52 through 2-53
fitting and cutting		3-84 through 3-88
FORK CROWN		
Andrew Hague		YP
Cinelli		2-40
counterboring		3-30, 3-81
cross sections		2-38
Henry James		2-40
inserted		2-39
overlapping		2-39
reaming of		3-61
slope		2-39
stiffeners		2-39, 2-40
thickness		1-17, 3-5, 3-52
Zeus		2-41
FORK CROWN RACE SEAT		
milling of		3-31, 3-82
FORK JIG		
illustration		5-7, 5-12
set up		3-33 through 3-34, 3-88 through 3-90
FORK TWIST INDICATOR		
illustration		5-4
use of		3-34, 3-89 through 3-90
FRAME ALIGNMENT SYSTEM, THE		
general		6-12
care of the bed		9-31
checking tracking		9-35
coldsetting front triangle		9-33
dummy hub gage		9-34, 9-36
facing bottom bracket		9-32
list of components		9-31
measuring head tube twist		9-33
mounting frame		9-32
relationship of front and rear triangles		9-34
swing arm		9-33
use of jack		9-32 through 9-33
working with fork		9-35 through 9-36
FRAME DESIGNER'S STRAIGHT EDGE		
general		5-4
use of		3-5
FRAME REPAIR		
price list		4-3 through 4-4

FRAMESET		
order form		4-6
FRONT CENTER		
general		1-12
FRONT DERAILLEUR		
brazed on		2-3, YP
GRINDING WHEELS		
general		6-4
H TOOLS		
checking front dropouts		3-35, 3-91
checking rear dropouts		3-49, 3-101
HAND OPERATED ELECTRIC DRILL		
general		6-4
HEAD TUBE		
angle		1-7
detailed description of	2-50 through	2-51
face milling of	3-26, 3-77 through	3-78
rising and falling of		1-10
stabilizer bar	3-20, 3-72, 5-9	
tandem gage		8-4, 8-6
twist	9-14, 9-28, 9-33	
HEADSET		
lower stack height		1-16, 3-52
HEAT DISTORTION		
controlled during brazing		8-19
related to fillet size		8-19
HEIGHT GAGE		
Mitutoyo Height Master		9-38
photos	9-14 through 9-16, 9-19 through	9-20
HYDROGEN EMBRITTLEMENT		
and plating		11-32
INSEAM LENGTH		
as used in formula		1-2
INTERCEPT POINT HT/DT		
in front end geometry		1-17
in lugless construction		8-11
related to drawing		3-5, 3-53

INTERCHANGEABLE PARTS		
The Uniformity System		9-1
INTERCLAVIC NOTCH		
related to frame geometry		1-6
ISHIWATA		
comparison chart		2-62
discontinuation of 025 sets		YP
EX and EXO sets		YP
LED READOUT		
on precision tools		9-3
general		2-8
LUG SETS		
Cinelli		2-34
Davidson		YP
Haden		2-35
Henry James		2-34
Otsuya		YP
Prugnat		2-34
Tange		2-35, YP
LUGS		
comparison of cast and stamped	2-33 through	2-34
investment cast	2-32 through	2-33
stamped	2-31 through	2-32
MACHINIST'S SQUARE		
general		6-6
in building front triangle	3-11 through	3-26, 3-70, 3-73
in building lugless	8-20, 8-24,	8-27
MECHANIC'S TOOL CASE		
general		6-1
MICROMETER		
bottom bracket		3-16, 3-67
explanation of its use		9-6 through 9-8
MIG WELDING		
lugless joints-steel		8-10
MINUTE CALIBRATION		
of measurement		9-2

MITERING	
general	3-56 through 3-58
bottom end of down tube	3-19, 3-71
buted end of seat tube	3-9
short buted end of down tube	3-9
short buted end of top tube	3-10 through 3-11
MITERING-LUGLESS	
bottom end of down tube	8-20 through 8-24
buted end of seat tube	8-12
short buted end of down tube	8-12
short buted end of top tube	8-13
MODIFIED BAR CLAMP	
illustration	5-6
in lugged construction	3-25, 3-76
in lugless construction	8-28
MODIFIED C-CLAMP #1	
illustration	5-7 through 5-8
in lugged construction	3-77
in lugless construction	8-28
MODIFIED C-CLAMP #2	
illustration	5-8
use of	3-77
N.I.O.S.H. (O.S.H.A.)	
and painting regulation	11-2
O.S.H.A.	
see N.I.O.S.H.	
ORDINANCES	
and painting	11-2
OTSUYA-MEDALIST	
bottom bracket shell	YP
lug sets	YP
PAINTING	
accelerator	11-29
adjusting air pressure	11-10
and plating	11-32
breathing systems	11-13 through 11-17
calibration of mixing cup	11-26
clear coats	11-29
compressor	11-12 through 11-13
decals	11-30 through 11-31
degreasing	11-24
force drying or baking	11-30
handles	11-21 through 11-22

PAINTING cont.		
health warning		11-25
lint		11-27
masking	11-23 through	11-24
metal prep	11-20 through	11-21
poly-urethane enamel (Imron)	11-27 through	11-29
preparation for	11-17 through	11-24
price list		4-3
reducer		11-27
sandblasting		11-19
stripping old paint	11-17 through	11-19
tack rag		11-24
techniques	11-32 through	11-33
thinner		11-27
two part epoxy primer (Corlar)		11-26
viscosimeter		11-26
wetsanding	11-19 through	11-20
PAINTING BOOTH		
lighting		11-4
the shell	11-3 through	11-4
ventilation	11-4 through	11-5
PAINTING GUN		
adjusting needle valve	11-11 through	11-12
choosing of	11-6 through	11-7
fan control		11-8
fan rotation		11-9
fluid control		11-9
maintenance of		11-10
principles of		11-7
PAINTING SYSTEM, THE		
illustration		11-3
PARK STAND		
general		6-5
PHOSPHORIC ACID		
metal prep	3-51, 3-106, 11-20 through	11-21
PLATING		
and hydrogen embrittlement		11-32
and painting		11-32
PUBIC ARCH		
and sizing of frame		1-6
PUMP PEGS		
general		2-10

REAMERS		
	Chadwick	YP
REAMING		
	chainstay holes in bottom bracket	3-95
	inside diameter of fork crown	3-7, 3-61
	inside diameters of bottom bracket shell	3-6, 3-59
	inside diameters of lugs	3-6, 3-59
	of seat tube	3-42, 3-98
REAR END JIG		
	illustration	5-5
	set up	3-35 through 3-37, 3-91 through 3-95
REAR RACK		
	braze-on fittings	2-7
REAR TRIANGLE		
	alignment by string method	3-48
	brazing of	3-97 through 3-98
	coldsetting	3-42 through 3-44
	in relation to front triangle	9-15 through 9-17
	persuader	5-10
REPEATABILITY		
	of measurement	9-2
RESPIRATOR		
	disposable	11-14
	full coverage with air supply	11-16 through 11-17
	use of	3-26
	with two filters in front of cheeks	11-14 through 11-15
	with back mounted filters	11-15
SAPO		
	frame alignment fixtures	YP
SEAT CLUSTER		
	Strawberry with seatstay yoke	YP
SEAT CLUSTERS		
	styles of	2-24 through 2-30
SEAT POST		
	binder slot	3-42, 3-99
SEAT TUBE		
	angle	1-2, 1-11, 3-3
	deflection of	3-67, 3-16, 9-12
	detailed description of	2-49 through 2-50
	length	1-2, 1-3, 3-3
	mitering	3-9
	reaming of	3-42, 3-98

SEATSTAYS		
	detailed description of	2-55
	ends of	2-56
	fitting and cutting	3-38 through 3-40, 3-96
	taper of	2-55
	use of slugs or topeyes	2-31, 3-96
SERIAL NUMBER		
	stamping in bottom bracket and fork	3-50 through 3-51, 3-105 through 3-106
SHIFT LEVER BOSSES		
	general	2-4
SHOTPEENING		
	of TIG welded frames	8-5, 8-6
SIZE AND WEIGHT		
	recommendations	4-5
SOFT JAWS		
	general	5-6
SPOKE CARRIER		
	general	2-14
STANDARDIZATION		
	of measurement	9-2 through 9-3
STEEL BAR		
	1" diameter	5-10
	1-1/8" diameter	5-10
STEERING		
	geometry	1-7
	posetive-neutral-negetive	1-10
STEERING COLUMN		
	detailed description of	2-51 through 2-52
	fitting and cutting	3-28, 3-29, 3-78 through 3-79
STEM		
	length	1-4 through 1-5
STRAWBERRY		
	seat cluster with seatstay yoke	YP
STRESS RELIEF		
	by means of shotpeening	8-5, 8-6
	hole	2-30, 3-42, 3-99

## SURFACE PLATE

alternate sources	9-10
finish	9-10
material	9-10
measuring fork rake	9-20 through 9-22, 9-29
mounting fork horizontally	9-20, 9-29
mounting fork perpendicularly	9-23, 9-29
mounting frame to	9-11 through 9-12
mounting frame vertically	9-17 through 9-18
size	9-9
stability	9-9
tolerances	9-9

## TANGE

1000 series tube sets	YP
900 series tube sets	YP
bottom bracket shells	YP
Infinity series tube sets	YP
investment cast lug sets	YP
stamped lug sets	2-35

## TAPPING

bottom bracket	3-15, 3-50, 3-66, 3-105, 8-26
----------------	-------------------------------

## TIG WELDING

lugless joints-aluminum	8-8
lugless joints-steel	8-5

## TINNING

during brazing	8-15, 8-29
----------------	------------

## TIRE

clearance	1-15 through 1-16
-----------	-------------------

## TOP TUBE

angle	1-16
brazing into place	3-76 through 3-77
cable guides	2-9
Columbus-creased	YP
detailed description of	2-49
fitting & mitering	3-21 through 3-24, 3-74 through 3-76
length	1-4, 3-4
mitering short butted end	3-10 through 3-11

## TORSO MEASUREMENT

and sizing of frame	1-5 through 1-6
---------------------	-----------------

## TRAIL

description	1-8 through 1-9
formula	1-9



TUBING		
	clamps	3-56, 5-5
	Columbus chart	2-61
	composition chart	2-66
	intro to comparison charts	2-57 through 2-60
	Ishiwata chart	2-62
	oversized	8-1
	oversized for aluminum	8-7
	Reynolds chart	2-63
	substitutions	2-56 through 2-57
	Tange chart	2-64
	tensile strength chart	2-66
	True Temper chart	2-65
	variations	2-47 through 2-66
UNDERCUTTING		
	description of	8-15, 8-29
	diagram	8-16
UNIFORMITY SYSTEM, THE		
	interchangeable parts	9-1
V-BLOCKS		
	general	6-7, 6-8
VERNIER CALIPERS		
	general	6-6
VERNIER SCALE		
	explanation of	9-3 through 9-6
WISE		
	general	6-2 through 6-3
WATER BOTTLE		
	braze-on fittings	2-2 through 2-3
WELDING TANKS AND APPARATUS		
	general	6-2
WHITNEY, ELI		
	and the uniformity system	9-1
WORK HARDENING		
	general	8-26
WORKING DRAWING		
	diagram	3-2
ZONING		
	and painting	11-2

# Please Register Me With The Frame Builders' Guild.

## I Understand That Registered Builders:

- Can participate in any Guild sponsored activities.
- Will receive two newsletters a year.
- Are allowed two free Hotsheet ads per year.
- May start the certification process at any time.
- Will be registered in the Guild's computer directory.

Enclosed is \$15.00 in check or money order for a yearly membership for.

NAME \_\_\_\_\_

ADDRESS \_\_\_\_\_ PHONE \_\_\_\_\_

CITY \_\_\_\_\_ STATE \_\_\_\_\_ ZIP \_\_\_\_\_

**Dear Mr. Paterek,**

**I have an idea that could improve the Paterek Manual. It is as follows:**

---

---

---

---

NAME \_\_\_\_\_

ADDRESS \_\_\_\_\_ PHONE \_\_\_\_\_

CITY \_\_\_\_\_ STATE \_\_\_\_\_ ZIP \_\_\_\_\_

**SEND TO:**

The Frame Builders' Guild  
Rt 2 - Box 234  
River Falls, W1 54022