



D-DAY FOR DPI

First sight of IMSA's bid to make US sportscars great again

Driving Technology Into Pole Position

INTERNATIONAL

RACE TECH

Motorsport Engineering

JANUARY 2017 No. 194 UK £5.95 USA \$11.99

www.racetechmag.com

Bernoulli

How Merc burned off rivals by pushing F1 tech to the max – and beyond! – in the V6 hybrid era

F1 2016

Season Review

+ How did they do?
We rate the opposition



It really does give you wings!

Jenson Button's 2017 racecar? Honda's Global Rallycross Supercar

www.racetechmag.com
9 771356 297055
01 >

ACCELERATE INNOVATION



www.avl.com/racing



SIMULATE



ENGINEER



MAKE



TEST



RACE



RACE TECH

Motorsport Engineering

Volume 24 Issue 2

Published December 2016

The next issue will be published

in early January 2017

ISSN 1356-2975

SUBSCRIPTIONS

Subscriptions from Kimberley Media Group Ltd
841 High Road, Finchley, London N12 8PT
Tel +44 (0)20 8446 2100
Fax +44 (0)20 8446 2191

Overseas copies are sent via air mail
Special offer 12 issues for the price of 10
12 issue subscription UK: £45.00
Europe: €97.50, US/Canada: US\$127.40
Rest of World: £75.00

All major credit cards accepted. Cheques and money orders only in Pounds Sterling payable to Kimberley Media Group Ltd.

BACK ISSUES AVAILABLE:

8, 9, 10, 11, 13, 14, 15, 16, 17, 18, 19, 20, 21, 22, 23, 24, 25, 26, 27, 28, 29, 30, 31, 32, 33, 35, 36, 37, 38, 39, 40, 41, 42, 43, 44, 45, 46, 47, 48, 49, 50, 52, 53, 54, 55, 56, 57, 58, 59, 60, 61, 62, 66, 67, 68, 69, 70, 71, 72, 73, 74, 75, 76, 77, 78, 79, 80, 81, 82, 83, 84, 85, 86, 87, 88, 89, 90, 91, 92, 93, 94, 95, 96, 97, 98, 99, 100, 101, 102, 103, 104, 105, 106, 107, 108, 109, 110, 111, 112, 113, 114, 115, 116, 117, 118, 119, 120, 121, 122, 123, 124, 125, 126, 127, 128, 129, 130, 131, 132, 133, 134, 135, 136, 137, 138, 139, 140, 141, 142, 143, 144, 145, 146, 148, 149, 150, 151, 152, 153, 154, 155, 156, 157, 158, 159, 160, 161, 162, 163, 164, 165, 166, 167, 168, 169, 170, 171, 172, 173, 174, 175, 176, 177, 178, 179, 180, 181, 182, 183, 184, 185, 186, 187, 188, 189, 190, 191, 192, 193

Price including post & packing:

UK: £5.50, Europe: £6.50, Rest of World: £7.55

You can pay by cheque or credit card but please note the minimum on Switch & Delta is £14

Race Tech (ISSN: 1356-2975) is published monthly by Kimberley Media Group Ltd.

Cover image: Bloxham/LAT

Design & Production:

Maluma Design Associates,

Printed by Warners Midlands plc
© Kimberley Media Group Ltd.

All rights reserved. Reproduction (in whole or in part) of any article or illustration without the written permission of the publisher is strictly prohibited. While care is taken to ensure the accuracy of information, the publisher can accept no liability for errors or omissions. Nor can responsibility be accepted for the content of any advertisement.

F1 2016

Season Review

How Merc burned off rivals by pushing F1 tech to the max - and beyond! - in the V6 hybrid era

✚ How did they do? We rate the opposition

COVER STORY PAGE 24

ON THE COVER

24 F1 2016 season review

The Abu Dhabi GP brought down the curtain not just on a season, but on an era. Craig Scarborough analyses Merc's magic

52 Making U.S. sportscar racing great again

IMSA has opened a new chapter of sportscar racing with a DPI category that mates manufacturer-specific bodywork and engines to the global LMP2 platform. Seb Scott meets Mark Raffauf, director of racing platforms at IMSA

58 It really DOES give you wings!

Jenson Button's next car? The F1 star has a Honda deal, loves rallycross and admits that it's on his to-do list in 2017. Hal Ridge reports on an innovative GRC Honda that might just suit him...

INDUSTRY NEWS

- 6 Competition debut for first electric rallycross car; new Dakar MINI released; Formula E an option for Ferrari; PERRINN reveals 2017 Formula 1 prototype design; IndyCar looking back to improve its looks; WEC hybrid regs frozen for three years; Kia launches TCR challenger; first IMSA DPI breaks cover; Indy to become NASCAR's third 'plate track'?

COMMENT

- 20 Anthony Peacock says the end of VW's WRC glory days is about a public display of atonement rather than making a practical difference
- 90 Sergio Rinland has always been fascinated by simulation, but not everybody shared his enthusiasm!

FACE TO FACE

- 22 It is not often that one meets the person whose name is actually the same as the badge that adorns a car, but Soheila Kimberley did when she talked to Henry Ford III
- 70 Steve Eriksen, vice president and chief operating officer for Honda Performance Development, tells William Kimberley that the GRC is helping reach a younger generation

WORLD ENDURANCE CHAMPIONSHIP

- 38 Touted as a pretender to F1's throne just months ago, the World Endurance Championship is now reeling after Audi's withdrawal. Or is it? Gary Watkins asks the uncomfortable questions

ENGINE TECHNOLOGY

- 46 Honda won a thrilling BTCC title shootout but, as Chris Pickering discovers, its campaign shows road car innovation can pose challenges for the racetrack

NEW PRODUCTS FOR 2017

- 72 With more than 1000 exhibiting companies set to unveil their newest racing products at the 2016 Performance Racing Industry (PRI) trade show in Indianapolis from 8-10 December, William Kimberley has a look at just some that have caught his eye before the doors open

BRAKE LATER



FERODO Racing brake pads give you race winning bite, deceleration and control all the way to the Apex.

FERODO[®]
RACING

WWW.FERODORACING.COM

The Ferodo brand is a registered trademark of  FEDERAL-MOGUL MOTORPARTS

EDITOR

William Kimberley

CONSULTANT EDITOR

Mark Skewis

DEPUTY EDITOR

Sophie Williamson-Stothert

CONTRIBUTING EDITORS

Andrew Charman

EDITORIAL ASSISTANT

Sebastian Scott

Thiam Loong Ser

PHOTOGRAPHY

LAT

ART EDITOR

Paul Bullock

ADMINISTRATION/**SUBSCRIPTIONS**

Adam Atamturk

ACCOUNTS MANAGER

Vikki Amour

SALES EXECUTIVE

Mike Norman

COMMERCIAL DIRECTOR

Maryam Lamond

MANAGING DIRECTOR

Adrian Goodsell

PUBLISHING DIRECTOR

Soheila Kimberley



841 High Road, Finchley
London N12 8PT
Tel: +44 (0) 208 446 2100
Fax: +44 (0) 208 446 2191

www.kimberleymediagroup.com

KIMBERLEY
MEDIA GROUP LTD



@racetechmag



facebook.com/
RaceTechmagazine

FAREWELL AUDI AND THE ATTENTION TIME OF A GNAT

AS I write this the final World Endurance Championship race of the season has finished, with Audi taking a 1-2 in Bahrain – a fitting end to what has been an incredible journey for the team. For me personally it is a very sad time to think that next year the cars bearing the four rings will not be competing at Le Mans or any other circuit in the series. When the news came out, as I wrote in the last issue, it was a bombshell. I had heard rumours that it was withdrawing at the end of 2017, but rather dismissed it hoping that it was just speculative rumours, but no, the plug had been pulled.

I know that Formula E is a worthy championship and probably represents the future in many ways, and I can quite understand why Audi has made the move, especially with the recent news that Volkswagen is to cease selling diesel models in the US, so why promote the technology? I also understand that this is quite a political decision, and one that probably needed to be taken, especially with the probability that it is going to close the plant that makes the Phaeton in Dresden. When I say this is a token measure it sounds heartless – bearing in mind that 500 workers will either lose their jobs or be relocated – but for the car company it's a major blow as this plant in former East Germany was a flagship one. I remember going on the-then new Phaeton launch and visiting the plant which was all shiny and new and stood in complete contrast to its surroundings. However, it represented an investment in the future of this part of Germany, so if this plant has to close, and it has not necessarily been decided at the time of writing, then it's virtually impossible to spend a few hundred million euro racing two cars around the planet – even if the cost in overall terms is miniscule.

One irony is that the proposed change in the power unit regulations in 2018, which would have required extensive investment, has now been postponed until the end of the 2019, a decision now too late for Audi.

It was always very keen to exploit the knowledge it gained through its motor racing

programme was transferred to the production car side of the business and from that every Audi driver benefited, as did the rest of the planet incidentally, with the lessons learnt in engine technology that led to cleaner and more frugal engines, both diesel and petrol.

Regulation changes are something that Bernie Ecclestone is keen to see in Formula 1. He told *The Sunday Times* that the races are too long and should be cut into two 40-minute segments, and that in the break between them the drivers should be interviewed about how they're doing. He also took the opportunity of questioning the motives of some drivers, putting forward the notion that they were just content to compete in the top series and not particularly race. That's quite a statement and I imagine would cause a few to get a bit hot under the collar. I'm not sure I can imagine any other sport where the person running the sport would make such a public observation.

I can see where he is coming from with the call for shorter races, although I personally would hate to see such a thing happen. But he is right when he says that if the sport is to engage the young – which he says has such a short attention rate – then things must change.

Engaging the young is something that is close to this magazine's heart, but in trying to reach them, we have to make sure that we do not discard elements that over the years have proved successful. A short attention span is a modern phenomenon and is a worry, but I am not sure that we should be changing everything around us so that those with a gnat's attention span should dictate what we do and how we do it. There must be other ways. **RT**



William Kimberley
EDITOR



ABOVE The Peugeot 207-based electric rallycross car made its competition debut in the torrentially wet conditions in Austria in early November

Competition debut for first electric rallycross car

Hal Ridge

THE world's first electric rallycross car, featured in-depth in RT193, made its competition debut in Austria on 6 November driven by former World Rally Championship podium finisher, Manfred Stohl.

Competing at the Race of Austrian Champions, held at former FIA European Rallycross Championship venue, Greinbach, STARD's Peugeot 207-based two-motor machine was up against a range of rallycross Supercar and World Rally opposition. In torrentially wet conditions, an incorrect tyre choice early in the day didn't provide a true representation of the car's potential, but with a switch to different rubber after the qualifying races, Stohl delivered the third overall laptime in the four-wheel drive car which currently has the equivalent of 544 horsepower, against the more conventionally powered competition.

"We were a bit too optimistic with the tyre choice," said Stohl. "It was particularly tough with a brand new car in such difficult conditions, but on the other hand we collected a lot of important new data and experience for the development of the car, so we're very happy with the day. We have clearly seen that our torque distribution on

the front axle needs some more optimisation for such tricky conditions in order to avoid too much understeer."

Talk of electric rallycross has been rife since STARD announced its creation in October. In withdrawal announcements by Audi from the World Endurance Championship and Volkswagen from the World Rally Championship, both marques issued statements that included interest in future involvement in the electrification of rallycross.

Just days after STARD launched its car, the US-based Global Rallycross Championship revealed plans to include a new all-electric category in 2018, as a joint venture with the United States Auto Club (USAC).

"The 2018 season will be a landmark year for us as we welcome electric vehicles to the grid for the first time," said GRC CEO, Colin Dyne. "The electric car is one of the hottest topics in the automotive industry and manufacturers across the globe have recognised its immense potential. We want to embrace this technology."

GRC organisers say the new category will be run in addition to the existing Supercar and Lites classes. "This electric series will add a new dynamic that will never replace the current formula, but will be an important part of our expansion," said Dyne. While no further

announcement has been made about the US series' plans, *Race Tech* understands that it will be a single-make formula.

Part of the draw of live rallycross events is the anti-lag fuelled noise and aggression of the top-level Supercars, in short, quick-fire races, and there have been concerns raised about the lack of noise from electric cars in the rallycross environment. However, there has been support for such a concept too. Recently crowned 2016 World Rallycross champion Mattias Ekstrom is backing electrification in rallycross.

"I think rallycross is going to be one of the best places to showcase high-performance electric cars," said the Swede. "In Formula E the cars are not so fast and are supposed to last for quite a long time. I think rallycross could be the complete opposite and show the maximum performance of an electric car and in an extreme way."

The EKS team owner thinks the sport is a few years from including a high-level electric category. "I believe in five to 10 years there will be a very good electric rallycross championship, because the technology is coming. I would definitely like to develop an electric rallycross Supercar. Imagine if you had a 1000 horsepower car – it would be insanely cool." **RT**



Porsche recommends Mobil 1 and MICHELIN

www.porsche.com/futuresportscar

**The battle for every hundredth of a second
is won through partnerships spanning years.**

Porsche wins the FIA World Endurance Championship for the second year in a row.

We would like to thank all our partners for their exceptional support: DMG MORI, Chopard, Vodafone, Schaeffler, Michelin, Mobil 1, TRILUX, adidas, VELTINS, Scania, A123 Systems, Red Bull, Alpinestars, HAZET, Osram, uvex, Walter Knoll and Hauser Catering.

DMG MORI CHOPARD



SCHAEFFLER



PORSCHE



ABOVE The Tesla Model S was put through its paces while tyre testing in both Spain and France

TESLA TESTING

BARCELONA, Spain: Electric GT Championship, the world's first 100% zero-emissions GT championship, recently enjoyed a successful three days of testing. The Tesla Model S, which has been chosen as the spec car for the inaugural season in 2017, completed 520 km of running with 93 laps completed at the Circuit de Barcelona-Catalunya and Circuit Paul Ricard. The tests focused on how the Pirelli P Zero tyres behaved on the race-prepared Tesla with different pressures and how they reacted to the impressive amount

of torque that the car produces. They also gave a chance to run the car with numerous mandatory components, including OMP safety equipment, a roll cage, a new cooling system, a carbon-fibre adjustable spoiler and panels, and full carbon splitter added.

During the first day in Spain, 70 km were completed on just a single battery allowing Pirelli to collect crucial data to aid tyre development. Pirelli test driver Guillaume Meura and EGT's Agustín Payá shared duties behind the wheel. Grand prix winner Heinz-

Harald Frentzen joined them 10 days later at Paul Ricard and was impressed with the performance and reliability of the car and tyres. Meura and Payá also drove as 87 km were completed on a single battery.

"I am very pleased with the behaviour of the P Zero tyres in these early stages of development," said Mark Gemmill, Electric GT Championship CEO. "After analysing the data, it supported the race simulations that we had predicted prior to these tests. We also were able to run some regulation parts that have been fitted and we are happy with the performance this has brought."

The EGT Championship will consist of 20 international drivers, both male and female, racing for 10 professional teams in identical Tesla Model S machines equipped with the latest OMP safety equipment and running on bespoke Pirelli tyres. EGT will visit seven classic European circuits in its inaugural season, including Paul Ricard, Barcelona, Zandvoort, Estoril and the Nürburgring, before staging three non-championship races in the Americas. **IT**

New Dakar MINI revealed

Hal Ridge

MUNICH, Germany: Multiple Dakar winning team X-Raid has launched its new MINI John Cooper Works Rally, replacing the MINI ALL4 Racing with which it has won the gruelling endurance event on four occasions.

The new car, based on a Mini Countryman, is a completely new design and has been upgraded in a range of areas over its predecessor. BMW Group's wind tunnel has been used to improve the aerodynamics of the four-wheel drive machine, which is significantly more aggressive in its body styling.

The Trebur-based German team redesigned its previous car in 2014 to relocate two spare wheels from the rear to underneath the crew, and in the newly designed tubular spaceframe chassis the new MINI can accommodate the third spare wheel in the lower section. The improvement in the centre of gravity has also been aided by lowering the cooling package in the rear of the car.

CP Autosport has constructed the tubular spaceframe, while X-Raid has devised the removable front subframe that means the front-mounted engine can be removed in just over an hour. Two Reiger suspension units are housed at each corner, providing

the maximum four-wheel drive wheel travel of 250 mm.

The 3.0-litre twin-turbo 6-cylinder diesel engine produces 340 horsepower, with the new-for-2017 38 mm turbo restrictor in place. Engine mapping has been one of the key areas of development, with improvements to driveability and fuel consumption.

The interior of the new car has also been revised with three separate areas on the dashboard, the driver and co-driver each having their own information, with a shared display in the centre.

"The new car is just great," said Sven Quandt, X-raid CEO. "It's a vehicle that is

based on a thorough wind tunnel design. This made for better aerodynamics and in combination with further new functions we succeeded in clearly increasing the car's performance. One of the advantages achieved in the wind tunnel is a higher top speed combined with a better acceleration at beyond 140 km/h – important areas for improvements. The vehicle's COG was lowered significantly too. We placed 50 kg in the centre of the car about 50 centimetres lower, improving the vehicle's handling, agility and drivability on any kind of terrain."

The 2017 event will be the fifth time the Dakar has been run in South America. Starting on 2 January in Paraguay, the route will take crews into Bolivia and end in Argentina 12 days later. **IT**



ABOVE A new version of the Dakar Mini, based on the Countryman, will be competing in the 2017 event

AT
TOP SPEED

APPROACHING THE FINAL TURN

**SHOCK ABSORBERS
& CLUTCHES** FROM ZF

torsport



zf.com/motorsport



zf.com/motorsport



COMMANDING VICTORY

ON THE TRACK & RALLY COURSE – ZF POWERS THE CHAMPIONS
ZF.COM/MOTORSPORTS



MOTION AND MOBILITY



ABOVE If Ferrari should ever go to Formula E, the team would not need the same level of support as it currently enjoys

Formula E an option for Ferrari in the future

William Kimberley

MARANELLO, Italy: Ferrari has discussed plans about entering the Formula E series in the future, according to its CEO Sergio Marchionne. He was speaking in a teleconference that came after the announcement of the Italian company's Q3 earnings on the New York Stock Exchange, when he was asked whether the company had considered entering Formula E. Other

manufacturers involved in the series include Audi, which recently announced that it was withdrawing from the World Endurance Championship to concentrate on the all-electric series, Citroën, Jaguar and Renault whilst Mercedes has an option to join and others, including Honda, have expressed an interest

However, Marchionne qualified Ferrari's future involvement by saying that there would have to be fundamental changes to

the way the series is currently run. He cited the changeover of cars midway through the race as a barrier and also running spec cars.

"I'm going to give you two answers to the problem," he replied in the teleconference. "If Formula E requires people to change cars during a race because we exhaust the power available within a given car, that is not something that Ferrari would naturally gravitate to.

"Secondly, the standardisation associated with the electric car is something which runs against the grain of Ferrari because otherwise it will prevent [Ferrari] from playing whatever it is that it does technically on a vehicle."

As things stand, the series is unlikely to welcome another arrangement for chassis setups as it wants the development to focus upon furthering electric powertrain technology. However, if the series does bow to pressure and makes the changes needed to attract Ferrari, Marchionne said it would still be a few years away from joining. **RT**

Refocusing on the US and Formula E

William Kimberley

PATRICK ORTH has been appointed as general manager of ZF Race Engineering North America who has taken up the position having worked for the parent company in Schweinfurt in driveline technology.

"He now has the task to set up a strategy for the North American market, especially in the IMSA WeatherTech Sportscar Championship with new cars coming in,

IndyCar and NASCAR in the near future," said Norbert Odendahl, managing director of ZF Race Engineering. "If you want to be aggressive in this market you need to cover all the high-end motorsport activities including touring cars and GT3. There's a great deal of potential for us here, especially with our newly expanded product range following the integration of the TRW braking and steering systems into our product portfolio. It means that we are

actively looking to hire a few more people as well."

Global Rallycross is also in Odendahl's crosshairs, its association with Volkswagen proving dividends, the Volkswagen Andretti Rallycross team drivers Scott Speed and Tanner Foust becoming first and second respectively in the championship in 2016.

However, he underlines the point that the North American business is there to make money and is not there just to create an image for the group. "Having said that, we still need some halo projects to highlight our capabilities in having state-of-the-art products in the car which can't be measured in the profit and loss account."

Back in Europe, ZF Race Engineering opened e-Mobility, a new division in January 2016 which is responsible for the group's involvement in Formula E. Within the e-Mobility division, the company is combining all of its activities in car and commercial vehicle electrification at its Schweinfurt location.

"We are now working closely with the Venturi team with the aim of developing a competitive electric drivetrain, not just the shock absorbers but the inverter, gearbox and the engine, for season 5 in 2018." **RT**



ABOVE ZF has entered Formula E to develop a competitive electric drivetrain

progressive braking

Leading the way in braking innovation

Come see us at
PRI stand 5023
Autosport Engineering
stand E1250



At Alcon, we push brake technology as hard as you push on the track. For over 30 years, Alcon have been supplying winning solutions to competitors in series ranging from F1 to grassroots motorsport and everything in between.

Alcon constantly push the boundaries on caliper, disc and actuation technology and new materials. So whether you compete off-road or on the track, you can rely on Alcon's expertise to help you win.

Contact us today to see how Alcon can help with your brake or clutch requirements.

HEAD OFFICE UK +44 (0)1827 723 700



www.alcon.co.uk



Shorter F1 races and demotivated drivers

William Kimberley

LONDON, UK: Formula 1 boss Bernie Ecclestone has said that the sport needs to consider introducing two shorter races in place of one long one as part of a radical overhaul to help appeal to modern audiences. He believes F1 needs to follow the lead of other sports that are looking at ways to bring in shorter formats, and feels that having two 40-minute races with a break in the middle where drivers could be interviewed would be a hit with television viewers, sponsors and advertisers. However,

the 86-year-old has questioned if there would be the "courage" to make such a significant change to the sport's traditional weekend schedule.

In the interview with *The Sunday Times* he proposed that qualification would take place on the Saturday as currently happens for the first race with the grid for the second race being set by the results of the first race. "It would shake things up with lighter, faster cars," he said, "but I don't know if we have the courage to change. Times change though and it is something we must look at.

"All American sports have time-outs built

in, mainly because American audiences can't concentrate. They grow up with everything in 15-minute segments on TV. People are the same everywhere now."

In the same interview he lashed out at some Formula 1 drivers, questioning their racing instincts. "Too many drivers hit the radio at the first sign of pressure or contact. We need to make it easier for drivers to race fairly. I don't think they should deliberately bang wheels but if they are racing each other and they go close and touch, so what?

"I often wonder if some of these guys want to race or just be out there in an F1 car." **RT**

PERRINN reveals 2017 Formula prototype design

Seb Scott

SKIPTON, UK: Formula 1 is gearing up for a radical technical change in 2017 which will mark a new chapter for both vehicle aesthetics and performance.

While no teams have revealed renders or details of their 2017 challengers, a glimpse of the future has been offered by former Williams F1 designer Nicolas Perrin, owner of PERRINN – a cloud based engineering company.

Perrin and his team of designers have produced a full CAD model of a prototype car designed around the 2017 Formula 1 technical regulations. Unlike most design projects, this example is unique in the fact that PERRINN has provided full public access to the model and its constituent parts.

"Our organisation is open to everyone," said Perrin. "Followers are awarded a free share by registering on our website and more shares can be earned by investing time with us."

With the 2017 Formula 1 project released, Perrin confirmed the company's future plans. "Our next project is the development of the Perrinn app, a collaboration platform that will improve the way we work together. It's what we hope are the beginnings of a global, digital workforce for the 21st century." **RT**

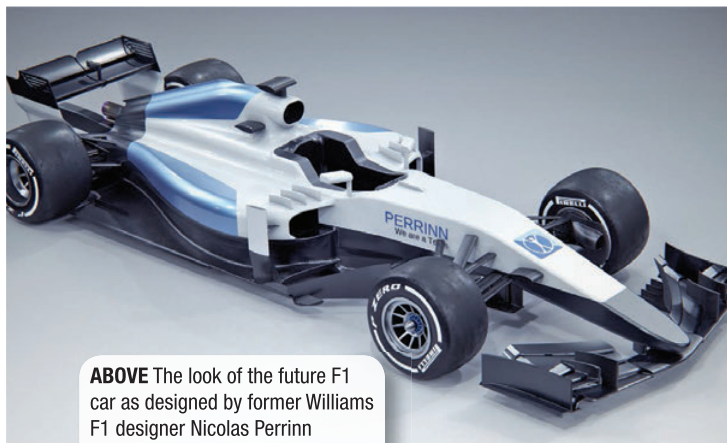

ABOVE The look of the future F1 car as designed by former Williams F1 designer Nicolas Perrin

IndyCar looking back to improve its looks

Andrew Charman



ABOVE Smoothing out: The high airboxes and aero appendages of the current IndyCar could be on the way out

INDIANAPOLIS, IN: The look of the Dallara DW12 used in the Verizon IndyCar Series is set to greatly improve in 2018 with the introduction of new universal bodywork. IndyCar's single-kit future, reported in *Race Tech* 192, is likely to see the car adopt a visual profile more akin to the days of the former ChampCar rival series, wearing smooth bodywork without many of the extra aerodynamic devices used on the current cars, while also removing the large air scoop behind the driver.

This will be achieved by incorporating the air scoops into the sidepods to feed the new twin-turbocharged engines, and improving the performance of the car's underbody aerodynamics to negate the need for add-on wings.

To enable the underside aero to be updated, the sidepods will be extended to fill much of the space between the cars' wheels, in the process negating the need for the floor-mounted guards that are currently designed to prevent wheels interlocking.

The Verizon IndyCar Series has also confirmed that the current Dallara DW12 chassis, introduced in 2012, will be retained until the end of the 2020 season, after which it could be potentially replaced by an all-new chassis. Indy officials are believed to want to maintain stability in the chassis while the series moves into a new single-kit aerodynamic package through 2018. **RT**

History Made!

Ford GT wins Le Mans again and ARP was there holding the engines together with off-the-shelf and custom-made fasteners.

4,700 catalog items and special orders by request

ARP fasteners provide strength and reliability for every type of racing.

All ARP fasteners are manufactured entirely in our own ISO 9001:2008 and AS9100 registered facilities in Southern California.

Manufactured in the U.S.A.
Raced All Over the World

#1

Le Mans 2016

ARP

automotive *Racing* products

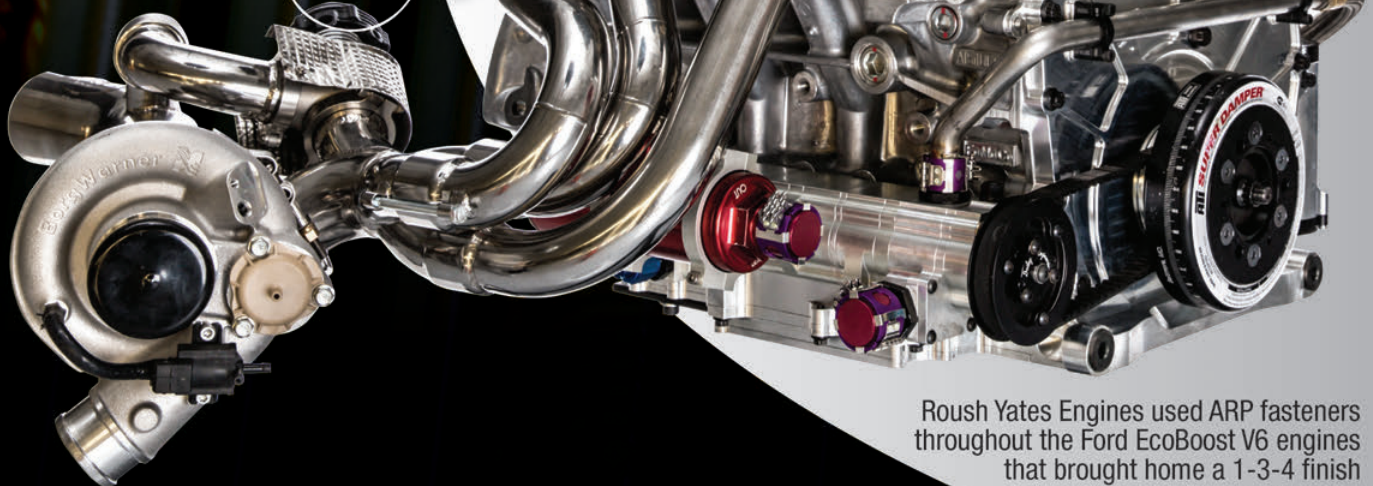

Roush Yates Engines used ARP fasteners throughout the Ford EcoBoost V6 engines that brought home a 1-3-4 finish in the LMGTE Pro Class at Le Mans 2016.

www.arp-bolts.com

request a free catalog

1863 Eastman Ave • Ventura, CA 93003

Toll-free in the U.S.A 1.800.826.3045

Outside the U.S.A. +1.805.339.2200

Special Orders +1.805.525.1497





DPI Mazda revealed

ABOVE Mazda's new Daytona Prototype international will be upholding the Japanese manufacturer's colours in the IMSA WeatherTech SportsCar Championship in 2017

William Kimberley

LOS ANGELES, CA: The new Daytona Prototype international Mazda RT24-P race car was unveiled at the Los Angeles Auto Show in November. After significant on-track testing, it will make its racing debut at the 2017 Rolex 24 at Daytona in late January. It will be powered by the Mazda MZ-2.0T engine which raced during the 2016 IMSA season. The approximately 600 bhp engine, developed and raced with Advanced Engine Research (AER), is a 2.0-litre, inline 4-cylinder turbocharged engine.

Mazda makes great note that the bodywork was developed by Mazda designers utilising the so-called KODO—Soul of Motion design philosophy. KODO represents the instant that energy becomes motion, such as the muscular beauty as an animal pounces or a human leaps into action. The KODO design cues on the

Mazda RT24-P include the sleek body contours and the five-point Mazda grille.

"KODO design is at the heart of any vehicle that carries a Mazda badge, and that is very evident in the design of the 2017 Prototype," said Ken Saward, senior manager of design at Mazda Design Americas, which falls under the Mazda North American Operations umbrella. "We considered the two main parameters of designing a successful race car for this series: aerodynamic performance and the new-for-2017 technical regulations. Working with Multimatic's aerodynamicist and engineers, we discovered that applying the KODO design philosophy to the surfaces and the silhouette of the car enabled us to create a dynamic, purposeful-looking design and a very aerodynamically efficient one."

Managing the two-car Mazda Prototype factory race team is Florida-based SpeedSource Race Engineering. The team will race the

new Riley Mk 30 chassis, developed by Riley Technologies in relationship with Multimatic.

"This is a huge moment for Mazda Motorsports and the entire Mazda family," said John Doonan, director of Mazda Motorsports North America. "To have a car which features Mazda design language at the top level of our motorsports programme is meaningful for us as a brand. We believe we have the right team, the right drivers and the right chassis to win races and championships.

"Mazda has good, long-standing relationships with Riley and Multimatic, and is happy to be the first to test their new chassis. We look forward to seeing it make its racing debut at Daytona with Mazda bodywork and the Mazda MZ-2.0T engine. The strategic vision of IMSA to give auto manufacturers this opportunity to integrate our branding — to better engage our passionate fans — is unique and we're proud to be the first to unveil what is possible." **RT**

WEC hybrid regs frozen for 3 years

William Kimberley

THE current LMP1 hybrid technical regulations will be frozen until the end of 2019. The decision, which follows Audi's withdrawal from the World Endurance Championship, was taken by a Strategy Committee meeting between representatives of the two LMP1 Hybrid manufacturers, Porsche and Toyota, Pierre Fillon, president of the Automobile Club de l'Ouest, and Sir Lindsay Owen-Jones, president of the FIA Endurance Commission. It means that it has put on hold the planned changes that would have allowed for an additional or third energy-retrieval system while introducing a new 10 megajoule hybrid sub-class above the existing 8MJ top division.

This proposal will complement the other decisions already taken on the same subject such as limiting the number of team members, the number of aero packages permitted, and the amount of wind tunnel sessions and testing days allowed thus promoting strong technological competition and innovation in the coming years without an unlimited escalation of expenditure.

The commitments made by the LMP1 Hybrid manufacturers will be put before the FIA World Council meeting for approval. **RT**

Kia reveals TCR challenger

Andrew Charman



THE TCR International Series specification Kia cee'd developed and built by Dutch team STARD – Stohl Advanced Research and Development – was unveiled during the final meeting of the TCR Benelux Series at the Circuit Jules Tacheny, Mettet on 29 October. The car is based on the five-door version of the roadgoing cee'd and uses the new 2.0-litre Theta II turbocharged direct injection engine developed by the Hyundai/Kia R&D centre in Namyang, South Korea. **RT**



Life Racing



Professional engine, chassis and gearbox control electronics

Providing control solutions for Le Mans LMP1, WRC, WTCC, Indy Lights plus many production formulas.

Direct injection, stand-alone or integrated paddle shift systems, drive-by-wire, intelligent power distribution, electronic fusing and high reliability wiring systems are all manufactured for the most demanding applications. Life Racing has extensive experience developing turbocharged and normally aspirated engines and supporting diverse racing series including F1, WRC, WEC and Le Mans, WTCC and more...

Contact us to find out more about our products...

Life Racing Ltd

6 Repton Close , Basildon, Essex, SS13 1LE, UK
Tel: +44 (0) 1268 904124 Email: info@liferacing.com
www.liferacing.com

Indy to become NASCAR's third plate track?

Andrew Charman

INDIANAPOLIS, IN: Reports from the US suggest NASCAR attempts to boost the quality of the racing in its headline series could result in the Indianapolis Motor Speedway being declared a 'plate track', teams being required to use horsepower cutting restrictor plates. The plates were introduced to NASCAR in 1988 in a bid to cut increasing speeds at the 2.5-mile long Daytona and 2.6-mile Talladega super speedways. Originally designed to reduce the amount of air entering the carburetors in the days before fuel injection arrived in the series in 2012, they are now bolted under the throttle body and perform a similar function. The horsepower cut is significant, from around 725 to 445 hp.

Currently only Daytona and Talladega are designated plate tracks, and the power cut results in the cars being equalised and generally circulating in one large pack, inches apart at around 190 mph. While this produces exciting action for spectators, it also often

results in highly dramatic accidents involving several cars, known in NASCAR parlance as 'the big one'.

The annual Brickyard 400, held at the home of the Indianapolis 500 and regarded as the second most prestigious race in NASCAR after the Daytona 500, has suffered the opposite problem of too few passes for the lead. There were only four in the 2016 race, and the governing body is now thought to be considering the plate option as a potential answer. Reports suggest that the 2017 Indianapolis race for the second-division

Xfinity Series could run with the plates, and if successful could result in the plates being used in the Sprint Cup Series race from 2018.

NASCAR has already announced a further reduction in the size of the restrictor plate as part of its 2017 rules package, again in an attempt to cut speeds at Daytona and Talladega. The initial restrictor plate hole size will decrease from 57/64ths of an inch (22.622 mm) to 7/8ths (22.225 mm). However, the plates could be subject to further changes following the 'Happy Hour' practice session at the two meetings. **RT**



ABOVE Follow my leader: NASCAR apparently believes that restrictor plates could be the key to changing Indianapolis races from single-line processions to packs of the like seen at Talladega (inset)

NASCAR sides with regulation

Andrew Charman

DAYTONA BEACH, FL: Attempts by NASCAR teams to improve the aerodynamic sideforce of their cars and as a result the ability of the car to turn into corners have been curbed by the governing body.

In an unusual move, NASCAR issued a technical bulletin on 9 November, five days before the penultimate meeting of the season at Phoenix, clarifying with immediate effect the location of the slots used for mounting the truck trailing arms to their brackets. The truck arm suspension, which dates back to the 1960s, is today bespoke to NASCAR, consisting of an I-beam and trailing arms with the beam firmly mounted to the rear axle and effectively turning the axle into a large anti-roll bar.

The bulletin, which applies to teams in both the headline Sprint Cup and supporting Xfinity Series, states: 'Truck trailing arm mounting slugs may be used to locate the truck trailing arms on the truck trailing arm mounting brackets. If used, truck trailing arm mounting slug slots must be perpendicular to the slots on the truck trailing arm mounting brackets.'

According to a NASCAR spokesman, teams had been working in this area to create rear yaw or sideforce. The changes will be incorporated into the 2017 rules package. **RT**

Fewer tyres, but not crew – in NASCAR

Andrew Charman

DAYTONA BEACH, FL: NASCAR has indicated that for the 2017 season it intends to reduce the number of tyres used by teams in its headline Sprint Cup Series. How many tyre sets are used by a team varies depending on the type of track and the length of the race, but can be between nine and 14 sets. While NASCAR has given no further details of any proposed reduction, it is thought that it could be applied to allocations at intermediate tracks – which form the majority of Sprint Cup venues – and according to some reports could be as much as three sets.

However, plans to reduce the number of crew in the pitlane during a stop will not be progressed in 2017. *Race Tech* reported last month that a reduction from six to five persons 'over the wall' was under consideration, on both cost and safety grounds, but following discussions with team owners, the idea has been dropped, at least for 2017. **RT**



LEFT Tyred out: Less space in the NASCAR pit lane will likely be necessary to accommodate Goodyear's products in 2017

A GLOBAL PERFORMANCE

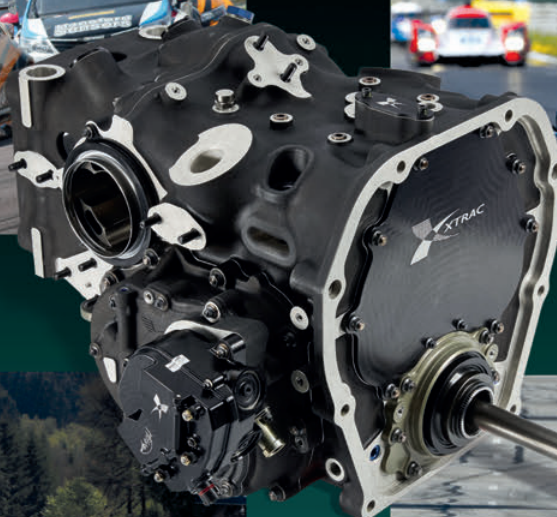

P1159F
transverse
LMP2
gearbox

With a reputation for producing lightweight and reliable transmissions for championship-winning teams around the world, it's no surprise that our engineers have been working round the clock to stay ahead of the competition. New products, new innovations and new technologies are giving our customers the edge to maintain their own positions at the front of the field.

Quality - Performance - Reliability



UNITED KINGDOM • INDIANAPOLIS • MOORESVILLE
+44 (0) 1635 293 800 +1 (317) 472 2454 +1 (704) 799 4489

www.xtrac.com

FIA's Laurent Mekies to give lecture at Autosport International

BIRMINGHAM, UK: FIA safety director Laurent Mekies will deliver the Motorsport Safety Fund's prestigious Watkins Lecture on Friday 13 January at Autosport International. Named after former long-standing Formula 1 Medical and Safety Delegate, Prof Sid Watkins, the 20th annual lecture will cover a number of topical issues relating to motorsport safety.

Mekies began his motorsport career with the Asiotech Formula 3 team before joining the Arrows Formula 1 team in 2001. In 2002, he joined the Minardi Formula 1 team as a race engineer, graduating to chief engineer in 2006 when Scuderia Toro Rosso acquired Minardi, and to head of vehicle performance in 2012. In 2014, he left Scuderia Toro Rosso to join the FIA as safety director and replaced Herbie Blash as

F1 deputy race director in early 2016.

Free admission but by ticket only which can be requested via the Motorsport Safety Fund's website, the lecture takes place at the Gallery Suites at the NEC, Birmingham, during Autosport International.

"The Watkins Lecture is a core part of Autosport International," said Kate Woodley, Autosport International show manager, "and with 15 years of experience at the pinnacle of motorsport, Laurent's lecture promises to give unique insight into the world of racing and how the FIA continues to champion safety in our industry."

The Watkins Lecture is just one of the many highlights planned at Autosport International in January. Europe's largest pre-season event will mark four decades of the Williams Martini Racing F1 team.

Furthermore, the Trade and Technical area plus the engineering hall will once again act as Europe's premier forum for suppliers and buyers of cutting edge motorsport technology to network and forge long-lasting business contacts ahead of the forthcoming season. **RTI**



ABOVE FIA safety director Laurent Mekies will deliver the Motorsport Safety Fund's prestigious Watkins Lecture at the Autosport Show

IndyCar slows its brake switch

INDIANAPOLIS, IN: The switch by the Verizon IndyCar Series from Brembo to Performance Friction Corporation brakes, reported in *Race Tech* 192, is to be a staged process. IndyCar has announced that in the 2017 season teams will continue to use the current Brembo calliper, but the discs, pads and supporting hardware will be supplied by PFC.

The new PFC calliper is currently under development – its Monobloc design has been completed and teams are expected to be able to inspect it early in the 2017 season and to begin testing with it following the Indianapolis 500 in May. It will then be mandated for the 2018 season.

The switch to PFC was confirmed after

teams reacted highly positively to the systems after testing them – braking issues having long been a prime cause of complaint amongst drivers. PFC has already been able to reduce the weight and number of components in the system by introducing a peg-based mounting for the discs, eliminating the bolts and washers of the previous system. **RTI**

PERSONNEL



It has been confirmed that **Zak Brown** will join the McLaren Group as executive director following the departure of **Ron Dennis** who remains a board member due to his 25% shareholding in the business. By accepting the job, Brown turned down

the opportunity of joining Formula 1's owner Liberty Media in a senior position. Reporting directly to McLaren Technology Group's executive committee, he will jointly lead the businesses with chief operating officer **Jonathan Neale** as part of the first step in the Group's transition to a new and strengthened organisational structure. The process of identifying and recruiting a new Group chief executive officer will continue.

"As founder of Just Marketing International (JMI) – now the world's largest motorsport marketing agency – I've often worked closely with McLaren as I say, and I've developed some excellent relationships across the company. Together we've delivered some great sponsorship deals, including Johnnie Walker, GSK, Hilton, Lenovo, Chandon and NTT."

Highly-regarded Formula One engineer **Sam Michael** has joined Australian V8 Supercar team Triple Eight Race Engineering. Michael, who enjoyed a 21-year career in F1 overseeing engineering programmes at Williams and McLaren, before moving home to Australia at the end of 2014, will replace technical director **Ludo Lacroix** who is leaving the team at the end of the 2016 season.

Matt Borland is moving from Stewart-Haas Racing, where he was vice president of technology overseeing both NASCAR and Formula 1 teams, to become 2017 crew chief for the Menards No 27 Sprint Cup Series entry at Richard Childress Racing. Interim crew chief **Danny Stockman** will return to RCR's Xfinity Series programme.

BBS

Technik aus dem Motorsport



Our Forged Magnesium wheel just won "SEMA 2017 Best New Wheel"



The Lightest Approved Road Wheel for the GT3-RS in the world

BBS of America, Inc. | 800-422-7972 | BBS-USA.com

#raceproven



THE HOLE IN VW'S POLO ARGUMENT

Anthony Peacock says the end of VW's WRC glory days is about a public display of atonement rather than making a practical difference

In the end, something had to give. With the Volkswagen Group facing a potential total settlement of up to 19 billion Euros for the infamous 'dieselgate' scandal (considerably more than the Group's entire yearly profit) the axe has fallen on VW's rally programme, shortly after Audi terminated its Le Mans campaign.

With Audi, the reason was maybe more understandable – the group wanted nothing more to do with the word 'diesel' – but the Volkswagen situation is more nuanced. Officially, this has nothing to do with the monstrous legal bill, although Volkswagen board member Frank Welsch alluded to the "challenging conditions" currently faced by the Volkswagen brand.

Instead, the manufacturer euphemistically speaks of "realignment" – with a focus on new (in other words, demonstrably green) technologies such as electric vehicles.

While Audi has an involvement in Formula E, there are no plans for Volkswagen to go down a similar route. Instead the focus will be on customer racing: in other words, making money out of motorsport rather than spending it.

But it's all very relative: Volkswagen spends up to 60 million Euros on rallying (actually less than that, considering the contributions from Red Bull and other sponsors). In other words, not even one per cent of what it might have to pay out for dieselgate. In practical terms, it will make little difference: instead, these cuts are all about public atonement.

Another justification for pulling the programme is that it's a case of mission accomplished. Volkswagen has dominated rallying in a way that no other manufacturer has ever done. Since making its debut on

the 2013 Rallye Monte-Carlo up to the point where the team's withdrawal was announced, the Polo R WRC had racked up 42 wins from the 51 rallies it had contested. There had also been 85 podiums and 622 stage wins (out of a possible 980): that's a 63% strike rate on stage wins and an 82% strike rate on rally wins.

Technical chief Francois-Xavier Demaison says that there's no single thing that makes the car faster than the others; instead it's a combination of small advantages – especially when it comes to aerodynamics and power output – that leads to an overall margin of superiority. That, as well as the biggest budget in the WRC and the services of some of the best drivers in the world.

Volkswagen will probably want to retain at least one of its three factory drivers, as it's not turned its back on rallying entirely. The company is going to be developing a Polo R5, using many of the lessons learned from

the all-new 2017 Polo R WRC, which was due to have competed on next year's World Rally Championship under the latest, more aggressive rules that hark back to the glory days of Group B.

Perhaps the biggest loss from a sporting and technical point of view is the fact that we'll never see the 2017 Polo R WRC – which is complete, ready to go, and probably the best rally car in the world – compete. According to one leading engineer: "The car could be re-engineered to fit another car with a similar platform – but that's not the sort of technology you just want to give away."

Realistically, the only option for the Polo WRC to live again would be within the guise of a Skoda Fabia – already well-established as a top R5 manufacturer – but that will all depend on company politics and the future direction of the sport.

With the environmental agenda driving motorsport forwards – F1 has hybrids, Volkswagen is talking about 'future technologies' and there will even be an electric class in global rallycross – how long can the World Rally Championship remain relevant from a technical point of view? **RT**



BELOW The best rally car we never had: the next Polo R WRC was already developed when the axe fell

RACE CAR

ROAD CAR

PERFORMANCE

HISTORIC

SPECIAL VEHICLES

CUTTING **EDGE** TECHNOLOGY

PRECISION PERFORMANCE

Come see us in 2016 at
PRI stand 4815

and in 2017 at
Autosport Engineering
stand E380



The PRO 5000 R offers you Radi-CAL™ brake caliper technology in an entry level range.

Forged designs, developed using our vast experience in motorsport, incorporate the latest innovations from our pioneering asymmetric design concept.

The new 2016 range will comprise four 4-piston and three 6-piston options.

Fit AP Racing brakes and clutch systems for race success.

The science of friction

T: +44 (0) 24 7663 9595 E: racetech@apracings.co.uk W: www.apracings.com

AP
RACING

THE GENERATION GAME

It is not often that one meets the person whose name is actually the same as the badge that adorns a car, but **Soheila Kimberley** did when she met Henry Ford III

THE United States of America may not have a royal family, but it does have a number of families that can be identified as the ruling aristocracy. Generation after generation is born into a business which he or she is expected to continue until the next generation arrives to take over the reins. One such is Henry Ford III, the 34-year-old great grandson of Henry Ford the founder.

However, he does not take his heritage for granted, and is currently working his way through the business to learn the ropes. His position as the marketing director at Ford Performance at a time when Ford was coming up to its 50th anniversary of its historic win at Le Mans was a stroke of genius in its timing. If it's one thing that has brought Ford the headlines this year, it is its class win at the famous race in France with the Ford GT and Ford himself was in the thick of it.

He firmly rejects the premise that its participation in the race this year was just a marketing exercise, good though the publicity was. "We really firmly believe that it ultimately benefits the customer for us to test and prove out technology in the harshest of conditions, which is really on the race track," he says. "The learning from that is then cascaded down through our product line and actually benefits the customer, so when we were looking at a GT programme, we knew that for this car to be successful as a road car it had to be successful as a race car.

"We also knew that we had a 50th anniversary to celebrate and so from a marketing standpoint it was a great opportunity for us to retell a story that we think is of interest to both race enthusiasts and non-race enthusiasts. The story of our rivalry with Ferrari 50 years ago really is a great one but we can retell it through the lens of technology and innovation.

"At Ford we are trying to do a lot of different innovative things, many of which have nothing to do with motorsport but different ways of thinking about mobility, ride sharing and all that. However, we also want to talk about innovation through

performance and the GT is the absolute showcase of technology for the Ford Motor Company right now. It gives us a great way to talk to everyone about innovation and technology."

He is quick to acknowledge the support his company has had from its principal

“We have looked at Formula E and it hasn't been the right fit and the right time for us”

suppliers, namely RoushYates for the powertrain and Multimatic for the chassis. "RoushYates has been a partner to Ford for quite some time and we had been testing and proving out that engine in the Daytona Prototype car that we had been racing for a couple of years," says Ford. "So we knew that it had a good foundation to be competitive in endurance racing.

"Multimatic has also been a great partner for quite some time. It is an expert in carbon fibre manufacturing, which is a key

component of this car, and so was a logical choice. It also had experience in motorsport and so was a good fit for us."

Ford says that Audi's announcement of its withdrawal from the World Endurance Championship caught him off guard when it came but he concluded that the Volkswagen Audi Group Board had to make the best decision for its business. Asked whether he could foresee Ford entering Formula E, he is less reticent.

"We have looked at Formula E and it hasn't been the right fit and the right time for us, but we are always continuing to look at opportunities and to better understand how each series is evolving. Formula E has had some great growth over the past couple of years so we will continue to look at it and investigate any opportunities and if it makes sense at some point in the future, then maybe consider it."

For now, though, Ford is sticking with the GT in endurance racing. The publicity it has generated in addition to the knowledge transfer to the production car side of the business has already paid dividends, something that Ford hopes will continue for the next few years. **RT**

BELOW Henry Ford III with *Race Tech* publishing director Soheila Kimberley

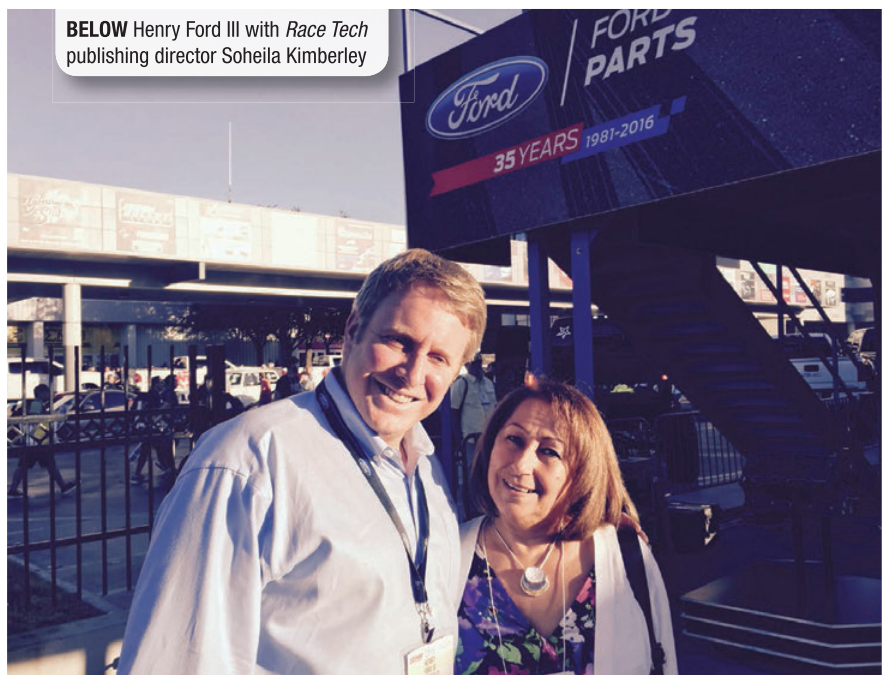

There's always room for improvement

STOPTECH

HIGH PERFORMANCE BRAKE SYSTEMS®

Brake late, finish first



STREET



STREET / TRACK



TRACK ONLY



FULL RACE

StopTech Big Brake Kits for the iconic 1969-1989 Porsche 911

The program covers the most common stock wheel sizes and model year variations

StopTech brake components require little-to-no vehicle modifications

Significantly improved braking performance, feel and modulation

Reduced brake fade



**advanced
performance
parts**

European Distributor: Advanced Performance Parts BV • 3851 SM Ermelo • The Netherlands

+31 341 759110

info@advancedperformanceparts.eu

www.stoptech.com



BELOW Ferrari and Red Bull arguably had an edge on tyre management but Merc's 'whole weekend' approach kept them at bay

THE ULTIMATE GAME OF CHASE

The Abu Dhabi GP brought down the curtain not just on a season, but on an era. **Craig Scarborough** analyses Merc's magic



As the 2016 FIA F1 season drew to a close in Abu Dhabi, Mercedes AMG had made a clean sweep of six world championships in three years. With the end of the season also there came an end of an era, whereby the chassis regulations will change dramatically for 2017.

It can be argued the current regulations have elements dating back to 2006 with the narrow track chassis, or the 2009 simplification of aero. But the post-2014 rules have been a distinct era, in both chassis and power unit regulations, and it's been under these rules that Mercedes AMG has dominated the sport.



PERFECT PREPARATION

F1's regulations do not move in nicely segregated circles: the aforementioned narrow (1800 mm) track chassis and narrow tyre formula dates to the mid-nineties, where cornering speed was being targeted for safety reasons. Not much of those regulations are still current on either chassis or powertrain. Instead, the current era is partly defined by the 2009 rules that severely limited aero surfaces from the extravagances of the 2008 cars, this being a move targeted to improve overtaking. This basic aero package was redefined to cut even more scope for downforce in 2014, the changes being allied to the new downsized hybridized turbo engine.

Curiously, since the 2009 changes only two 'teams' have dominated the sport, Red Bull and Mercedes, albeit the latter was named Brawn GP back in 2009 and now races as Mercedes AMG. Thus, the Brackley chassis nicely topped and tailed the era, both times powered by a Mercedes power unit.

Implied in this book-ending of the era, what became Mercedes AMG clearly declined between 2010 and 2013. Indeed, the resource constraints on the eponymous Brawn GP team, reborn from the Honda operation, had already seen a slowing of development through the championship-winning 2009 season.

Ross Brawn had saved the operation from closure at the end of 2008. Its acquisition by Mercedes at the end of 2009 saw the team reborn once more, initially with Brawn himself at the helm. But changes in personnel, funding and design stunted the rise of the team during the last years of the V8 era.

SECRETS OF SUCCESS

Upon Brawn's departure, Toto Wolff became team principal and Niki Lauda the link between the team and the Mercedes board. There was the coup in recruiting Paddy Lowe from McLaren, and the technical team also grew with Bob Bell, Geoff Willis and Aldo Costa all being given top level roles. At first this seemed a top-heavy management structure, with such heavy hitters from other top teams all in the same place. But this structure starts to explain the subsequent success of Mercedes AMG in the post-2014 F1 era.

Each of the triumvirate was given specific non-overlapping responsibilities and the cooperation between them made this a successful structure. But just as important were their objectives: none of these managers

were there to bring immediate success to the V8-engined car programme; rather, to focus on what was required for 2014, with its new chassis and powertrain rules.

Indeed, the Mercedes V8 car programme was a disaster: several questionable car concepts with short wheelbase and high CoG were run; there were huge issues with tyre degradation; and generally the aerodynamics lacked in detail compared to rivals. Some of these problems were overcome with a slick race engineering operation, development team and, not least, the V8 engine with its KERS being class of the field.

In the run-up to 2014, the Mercedes AMG operation signalled its intent with early publicity of its power unit. This showed how far Mercedes was ahead with its development. In contrast, Renault was late to promote its PU

The sprinkling of defeats inflicted upon it have stemmed from its own misfortunes or weather-related factors. In seasons of 20 or more races, this is dominance statistically far exceeding any other team in a season. So how has Mercedes achieved this? How has it continued to out-develop its rivals?

Many point to the Power Unit as an overriding reason for the team's performance. This is clearly a factor, but its customer-engined teams have yet to win a race, only Ferrari and Renault PUs having beaten the Mercedes AMG. Intrinsic to the regulations is parity on the homologated hardware of the PU, while the same fuel and lubricants from Petronas are also supplied to the customer outfits. This leaves installation and software as the sole variables. But it's clear its customers greatly benefit from the near-parity

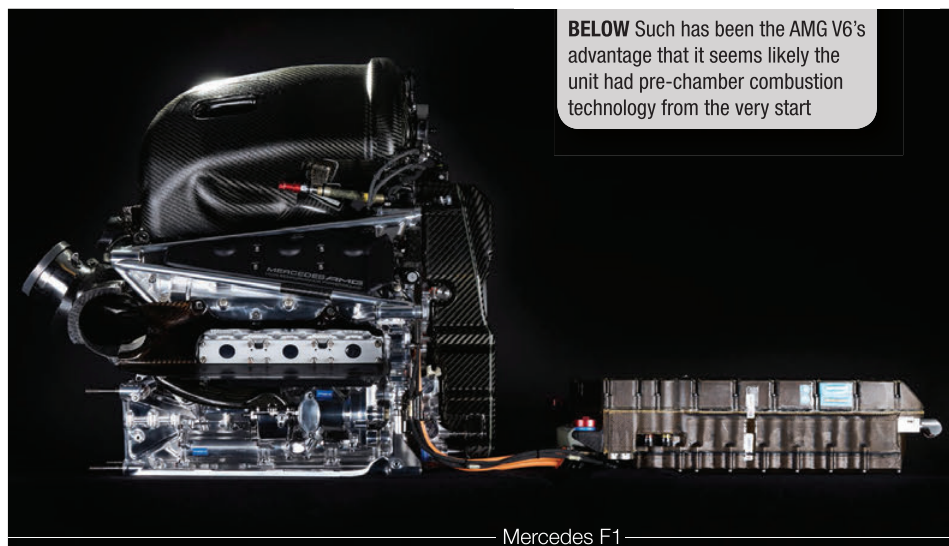

BELOW Such has been the AMG V6's advantage that it seems likely the unit had pre-chamber combustion technology from the very start

Mercedes F1

programme and Ferrari has yet to publish a single image of its power unit, some three years into the V6 hybrid programme.

As testing of the new chassis and hugely complex power unit commenced in Barcelona in the spring of 2014, it was the Mercedes straight out of the garage and completing huge mileages reliably. Renault and, to a lesser extent, Ferrari struggled to get the car even to run. Moreover, the W05 chassis was quick and didn't wreck its tyres. It was as if the four years before had never happened and Brawn GP re-liveried as a Silver Arrow had come out to continue its success.

THE V6 TURBO HYBRID ERA

As Brawn GP had demonstrated, a quick start to a season does not imply continued success, yet this is exactly what Mercedes AMG has achieved in the past three years.

in PU supply: for the most part they have a powertrain that outperforms the other three manufacturers supplying the grid.

Looking closer at the Mercedes PU, it was clear from race one in 2014 that the Mercedes was a far more considered design. In both its layout and hybrid strategies, the package was a generation ahead of Renault and Ferrari.

Its layout was much acclaimed in season one, the single turbocharger being split with the compressor at the front of the engine and the turbine at the rear, joined by a long shaft that also passes through the MGU-H in the centre of the engine's vee. Many claims in the media of the advantages of this layout were far-fetched, but there are packaging benefits: shorter tracts for exhaust and inlet, and a separation of the turbo stages improved thermal management inside the engine bay.

It could be argued that the compressor hanging off the front of the engine also ►

has packaging drawbacks. Recessing the unit with its air feed ducting inside the rear bulkhead of the monocoque makes the fuel tank section of the monocoque longer. Along with the turbo, Mercedes also packages the water-to-air intercooler in the same area along with the hybrid battery and control electronics. This forces the engine to be placed further rearward along the wheelbase. With Mercedes favouring a shorter wheelbase, this was aerodynamically inefficient, but the compromises in packaging have clearly been overcome as chassis performance is not a weak point.

While a big talking point, perhaps the split turbo was not the silver bullet for the PU. In 2014 Mercedes was immediately able to recover more energy from the turbo and pass it back to the ERS-K to extend the endurance of the 160 hp hybrid boost around the lap. In the race this meant the Mercedes drivers had far more than the mere 33 seconds of ERS-K boost around the lap. To the point, in fact, where diminishing returns meant that more energy recovery could not be exploited, as the car is traction-limited and full hybrid power is already available for all the throttle time around a lap. It took Renault and Ferrari an extra year to get to the same level of hybrid efficiency.



ABOVE Mercedes remains the sole team able to move to a different setting in order to extract more power during qualifying

Craig Scarborough

The other key advantage for Mercedes was highlighted in 2014, when ERS failure in the Canadian GP led Rosberg to run for much of the race with no hybrid power – that meant he was missing some 160 hp! Although the race was lost to the Red Bull Renault in the final laps, the Mercedes demonstrated it was competitive in the race with IC engine power alone.

It was already well known that the Mercedes AMG was a powerful package, but the IC engine was pushed hard in that race. Even

with the 100 kg/hr fuel flow limit and 100 kg race fuel limit, somehow Mercedes AMG could push the IC engine for nearly the whole GP with an impressive power output. Other teams were running the engine with leaner fuel maps to eke out the fuel for the whole race.

This feat showed how the combustion efficiency of the Mercedes IC engine was far above its rivals. Although Mercedes has never admitted it, pre-chamber combustion technology has most likely been on the power ▶

“While a big talking point, perhaps the split turbo was not the silver bullet for the PU”

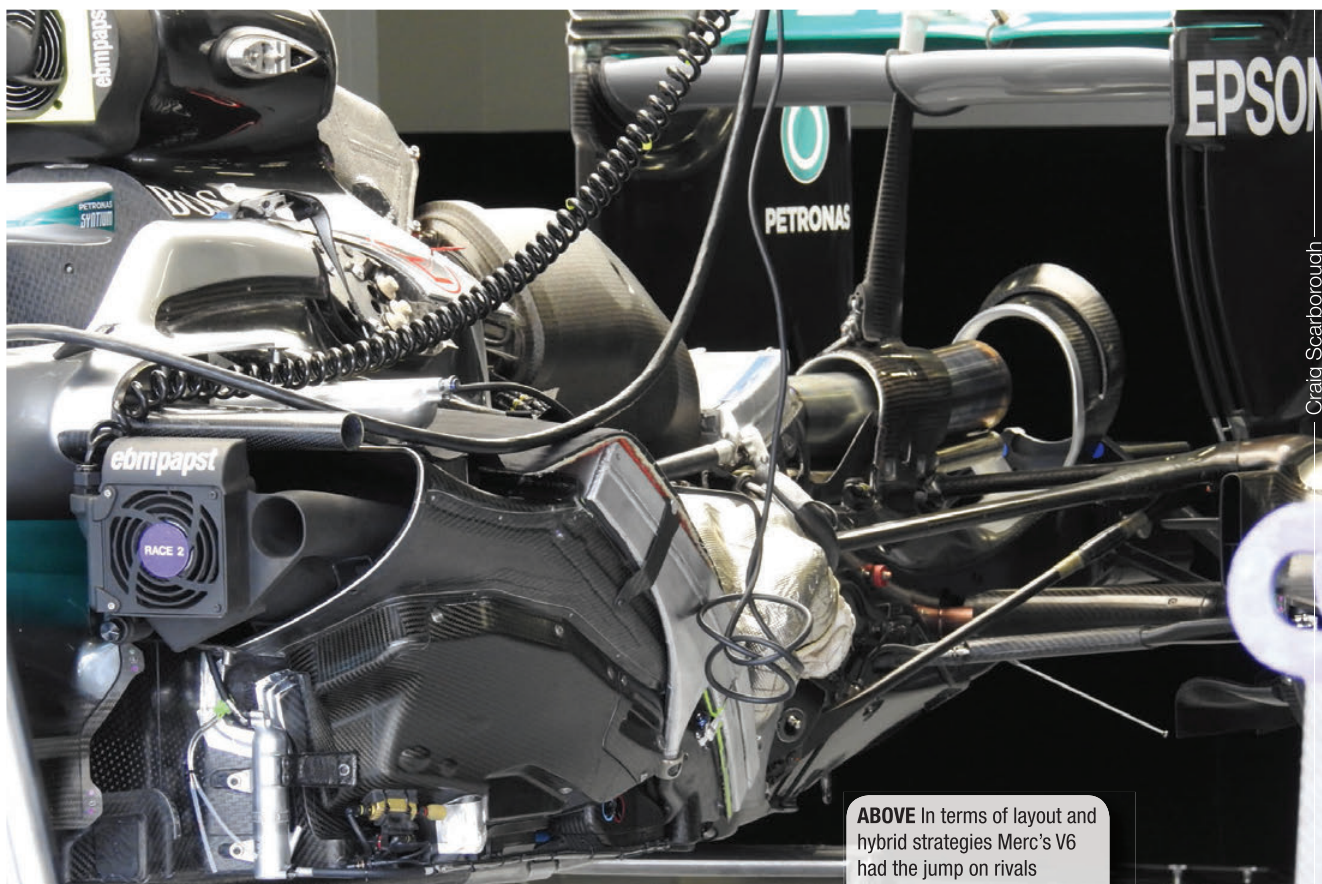

ABOVE In terms of layout and hybrid strategies Merc's V6 had the jump on rivals

Craig Scarborough

Let Precision Technologies help
put you at the front of the grid

SUPPLIERS TO: F1 GT HISTORIC INDY MOTO GP WEC WRC

LOOKING FOR A WINNING FORMULA?

- ▶ Providing super surface finishes
- ▶ Mastering complex metallurgy
- ▶ Measuring critical dimensions
- ▶ Heat treatment conditions
- ▶ Compensating for complex heat gradients

We manufacture extremely high precision components to win in the most demanding environments. Using the latest technologies and best skills, we deliver cutting edge engineering solutions for F1 and other leading motorsport teams.

Specialists in metrology compliance, we can manufacture to tolerances of +/- 2-microns. Whether you need low volume series production or bespoke engineered components, we can fulfil your exacting requirements.

Get race fit!

Call Colin Palin,
Technical Sales Director, in confidence

T: +44 (0) 1827 315 050

E: colinp@ptilttd.co.uk



PRECISION

TECHNOLOGIES

ENGINEERED PRECISION



www.precisiontechnologies.co.uk

BELOW Intensive development of its power unit saw Mercedes push the technology to the max – and sometimes beyond. It was markedly less aggressive with race settings in the second half of the 2016 campaign, reducing the PU duty cycle



Bloxham/LAT

unit from day one.

Ferrari's Mahle-developed TJI (Turbulent Jet Ignition) system didn't arrive until mid-2015. With this technology, the power available from the minimal fuel flow is far greater.

Indeed, Mercedes is still the sole F1 team to be able to turn up the power in qualifying. Even on weekends where its rivals are pushing the team on pace through the build up to final qualifying, Mercedes simply adds several tenths from engine power in the final session to achieve pole position. It remains unknown how this is possible, but Mercedes' early focus on development before 2014 and its holistic approach to what's required from a power unit integrated into a chassis has paid off handsomely.

WHOLE CAR - WHOLE WEEKEND APPROACH LEAVES REST BEHIND

This integrated approach typifies how Mercedes tackles each GP. Just as Red Bull learned during its dominance in the V8 era, if you have an inherent advantage on pace, you can then manipulate the car and the race weekend to maximize the results. In Red Bull's case, it found with a fundamental edge on speed it could run more wing for more downforce. Already quick enough to annex pole position, this provided quicker race laps, but compromised top speed. In a race this means being less able to overtake or defend, but of course if you have pole and can hare away from the pack in the opening laps, then this overtake/defending wasn't going to be necessary.

Mercedes soon found itself in this position: with a strong likelihood of pole, then the

weekend strategy can be to maximize race performance. In the current era that means Pirelli tyre management, being careful not to let the tyre slide, which will soon overheat it. Therefore, the high downforce approach could work well, as this keeps the car inline through the turns and looks after the tyre better.

But Mercedes went further still with this thinking: with high downforce, fast turn performance is improved, leading to quicker lap times, but this means the tyres are being worked hard with all the energy from the quicker corners. So, it caps fast turn performance and focuses on other areas of the lap, such as slower corners and straight line speed.

In 2014, other team engineers were saddened to see from the GPS traces that the Mercedes were quicker on every part of the

lap: acceleration, deceleration, top speed and in fast or slow corners. This later preference to save the tyres in fast turns meant that we saw many teams citing their faster corner speeds as a sign that they were getting on terms with Mercedes, but this was just an illusion created by Mercedes' whole weekend approach.

Towards the middle of this season Mercedes was coming under pressure on lap time away from final qualifying. The lead in the race was not a huge gap, but instead capped by Red Bull or Ferrari. Again, this goes back to the 'quick in qualifying and look after the tyres in the race' approach, but this also served to underline how the cars have become tyre-limited in the race.

With greater inherent pace, Mercedes, like Red Bull before it, found that it could go quicker but had to manage the high ▶

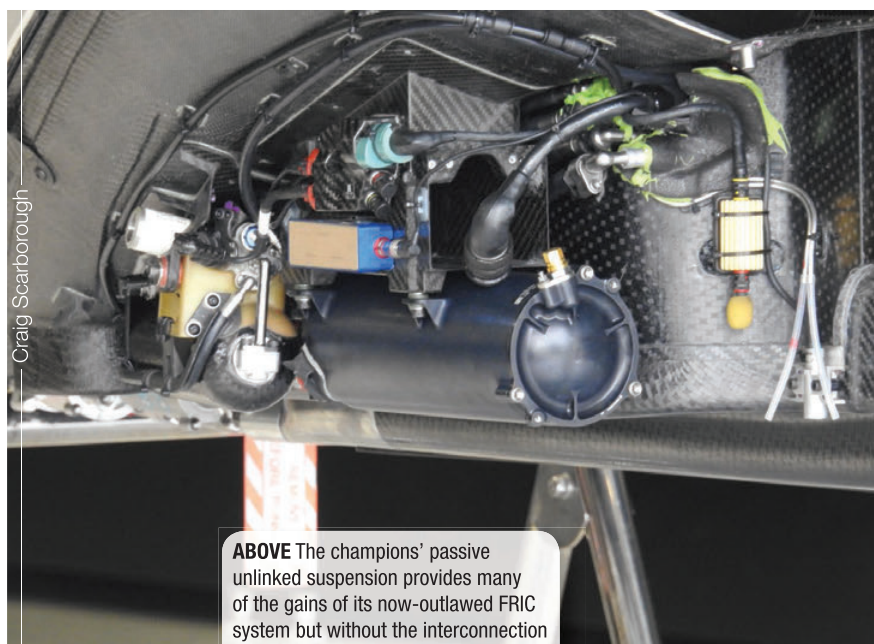

Craig Scarborough

ABOVE The champions' passive unlinked suspension provides many of the gains of its now-outlawed FRIC system but without the interconnection

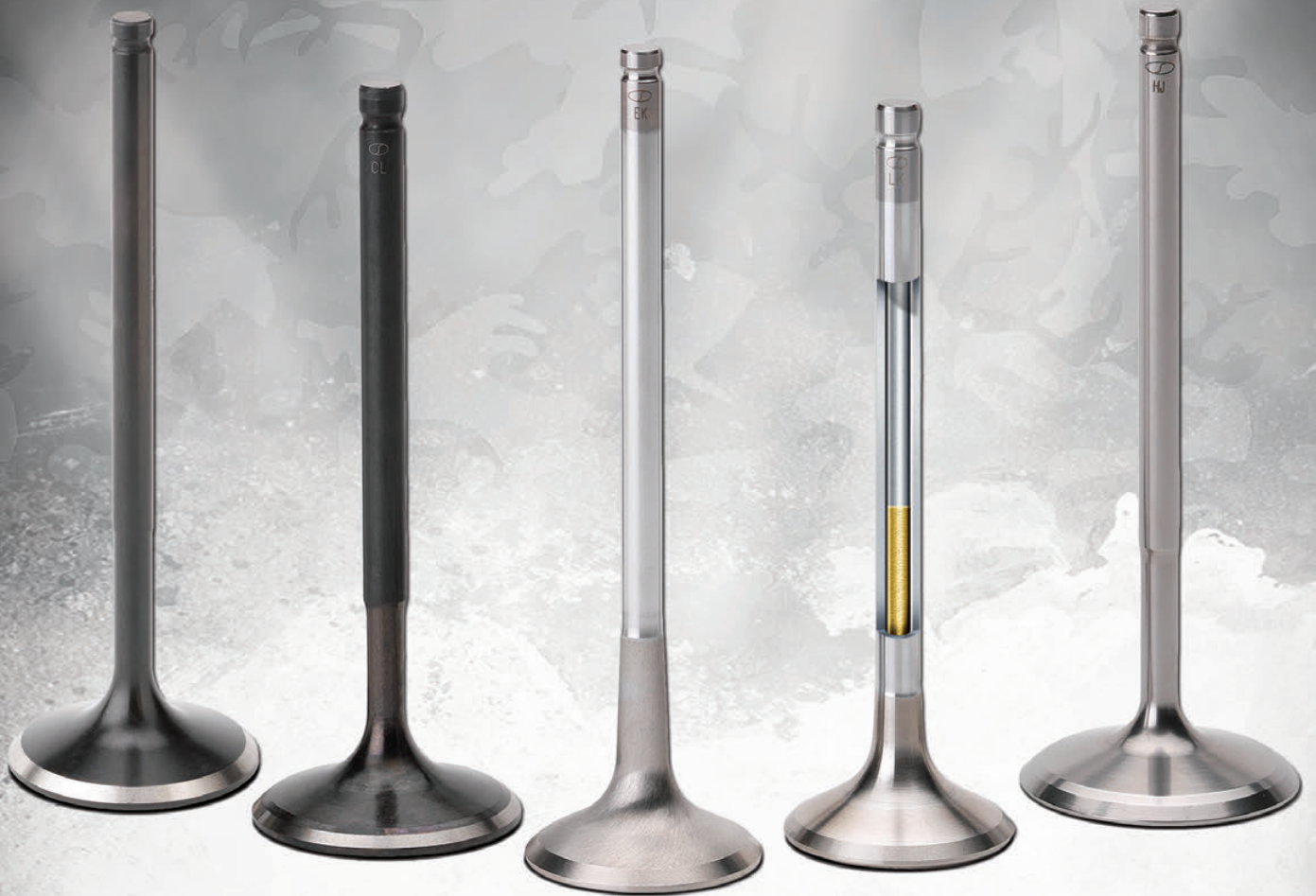

CHOOSE YOUR

WEAPON

STREET PERFORMANCE / HIGH PERFORMANCE / INCONEL / SODIUM FILLED / TITANIUM VALVE

FUSING PERFORMANCE, DURABILITY, AND SUPERIOR CRAFTSMANSHIP THERE ISN'T A BETTER CHOICE FOR PERFORMANCE VALVE TRAIN COMPONENTS. CHOOSE YOUR WEAPON AND DESTROY THE COMPETITION.

WWW.SUPERTECHPERFORMANCE.COM



degradation Pirelli tyres in the races. With the Red Bull and Ferrari marginally better on tyre management – partly as their pace is slightly off that of the leading Mercs – the champions have become wary of rivals in the race.

Mercedes AMG has not been perfect throughout these three seasons. In a more competitive environment its failures – while no disgrace with such complex PUs – could have cost the championship. In the latter part of the 2016 campaign Mercedes AMG has notably reduced the duty cycle on the PU by being less aggressive with settings during the race.

Nevertheless, no team has been able to carry a prolonged fight to Mercedes AMG in any of these seasons. Its failings can therefore be excused as a part of an aggressive push on the power unit.

CHASSIS

As proven through the late V8 era, a good power unit is not a guarantee of success: the chassis needs to contribute just as much to the whole car performance. Although the Mercedes AMG chassis was not a success in the V8 era, by late 2013 the

corner had been turned. Thereafter it has demonstrated that it could run innovative ideas and not follow the herd.

When the W05 rolled out in 2014, this was clearly a different approach to the new rules than the other teams. Shorter in wheelbase and shorter in the gearbox, due to the hardware packaged ahead of the engine, Mercedes challenged the typical thinking that long wheelbase gives better aero. Equally, the phallic and ugly approach to the new nosecone rules adopted by other teams was countered with the elegant 'U'-shaped nose of the new car.

Cooling the turbo's charge air with a water-to-air intercooler saved sidepod volume, to partly offset the shorter rear end. While the intercooler added weight, this goes to show how far ahead of the game on weight saving the team was, when other teams had to initially run above the minimum weight limit. Further sidepod volume was reduced with the ERS cooler being fed from ducts around the roll hoop.

These philosophies continued into the 2015 and 2016 seasons. During this time other teams were exploiting far greater rear ride heights as a mechanism to increase

downforce from the underbody. Red Bull, for instance, went to the most extreme rake with some 150 mm of rear ride height to increase the air flow expansion under the car. However, Mercedes AMG has never run to this extreme, despite being amongst the best with the secret weapon in raked set ups: the interlinked suspension.

Continuing from a system fitted in the V8 era, Mercedes could control pitch under braking with a suspension linked front to rear with passive hydraulics. This hydraulic pitch control, known as FRIC, prevented the front ride height eroding under braking and aero load, allowing the team to run lower front ride height and higher rear height without grinding the underbody legality plank away in the process. Somehow Mercedes was able to get the underbody downforce without such extremes of rake, but no doubt the FRIC set up helped.

When these systems were banned mid-2015, a key advantage was lost – not that the relative competitiveness of the team dropped. Mercedes AMG continued to develop a passive unlinked suspension system, providing much of the gains without ▶

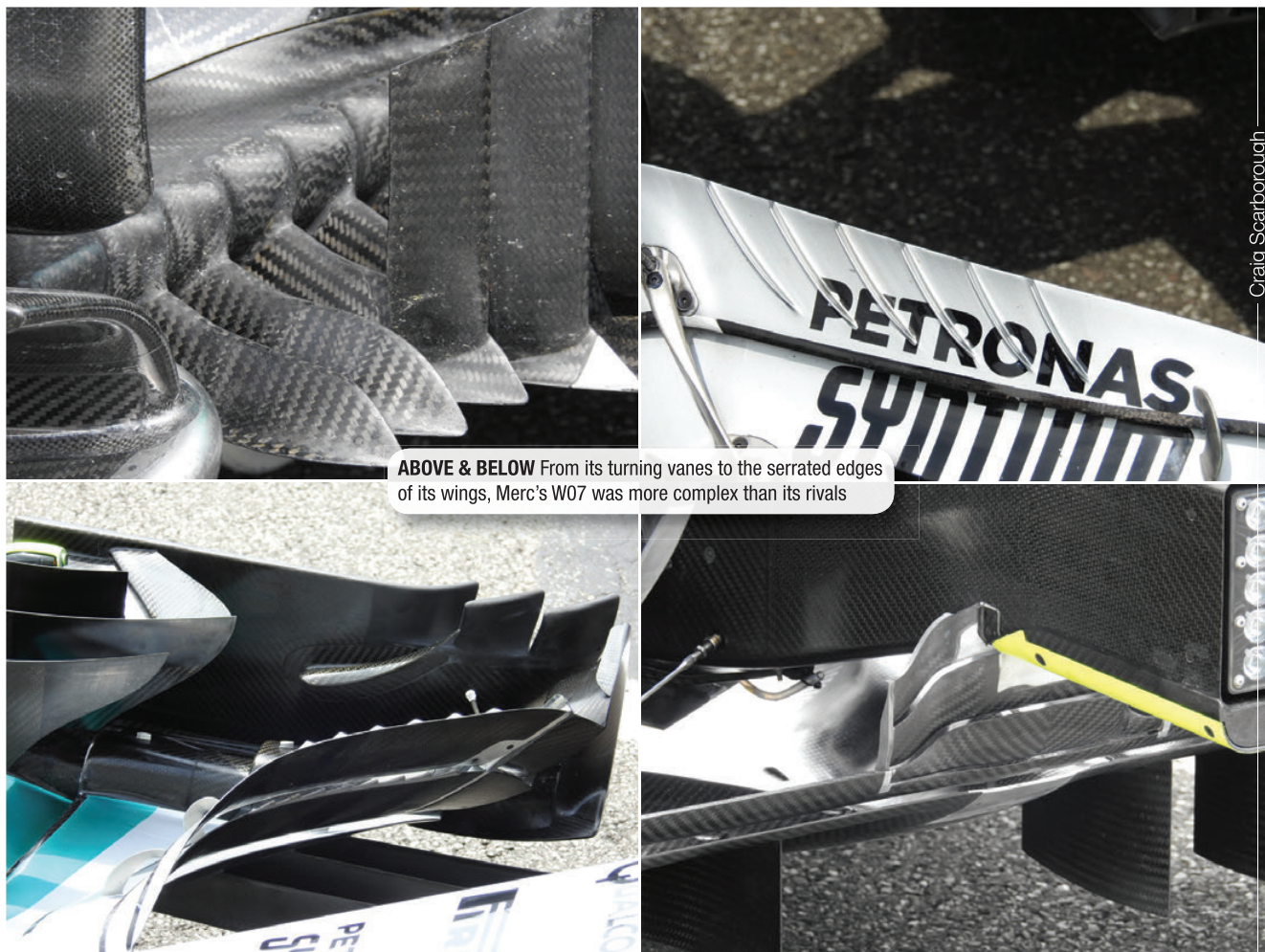

ABOVE & BELOW From its turning vanes to the serrated edges of its wings, Merc's W07 was more complex than its rivals

Craig Scarborough

Motorsport. Redefined.



Highly Evolved.

The STACK LCD Motorsport Display is the next evolution of driver communication and data acquisition. Designed specifically for the harshest of environments, the carbon composite housing is IP67 sealed against water and dust intrusion and will easily withstand 20 g of continuous vibration and 50 g of shock. Our 7" LCD panel ensures easy visibility under all circumstances with a retina level pixel density, unmatched brightness and an optically bonded lens for extreme glare suppression. The display layout is fully configurable to your individual specifications. The system will accommodate four programmable data bus channels (2 CAN and 2 serial) in conjunction with a nearly limitless amount of discrete analog sensors and its integrated 3 Axis Accelerometer. Data collection can occur at up to 1 kHz and the internal memory allows for practically infinite recording time. User definable warnings take advantage of super bright, multi-coloured LEDs placed around the perimeter of the chassis to alert the driver to critical onscreen information. Quite simply, everything else suddenly seems a bit dated.

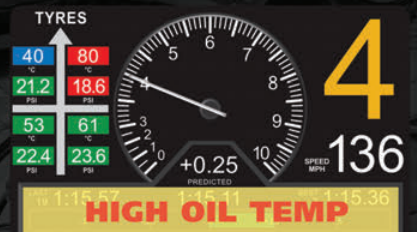

Actual Screen Images



World Class Instrumentation



stackltd.com





ABOVE & BELOW Ferrari and Red Bull, with its fast-developing Renault power unit (below), are best placed to pounce with the regulatory shake up

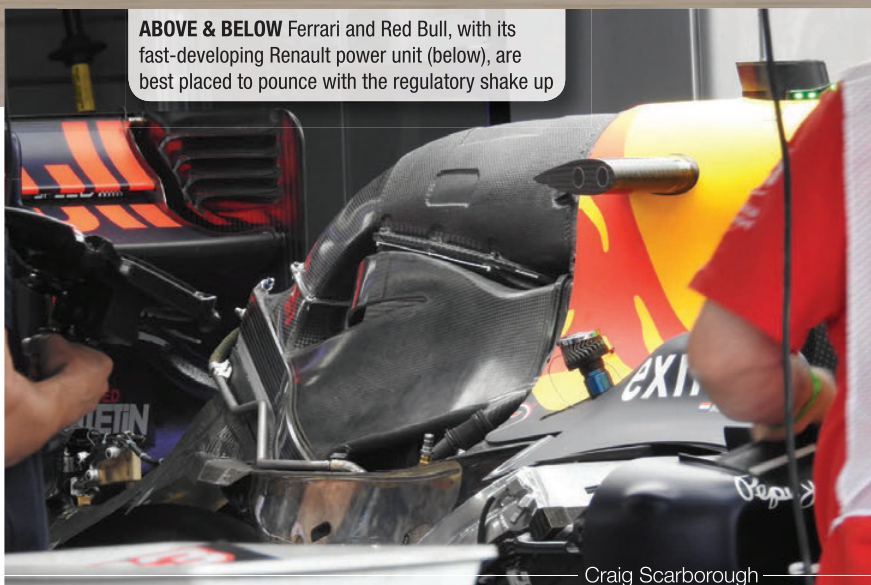

— Craig Scarborough —

the interconnection.

With this setup the Mercedes adopts a unique ride in F1: very soft in slow speed roll and very stiff in pitch. Onboard shots show the Mercedes AMG front suspension pushrod hardly moving under braking, while similar shots show they move considerably in roll through chicanes. This is a function of heave and roll being decoupled by the rocker spring/damper arrangement and the hydraulic heave control tuned for braking.

This was captured graphically at the Japanese GP at Suzuka, where the car is heavily loaded laterally in a turn with a huge amount of roll evident from the chassis. This gives mechanical grip and some say an element of passive rear wheel steering from toe change in the turns.

Aerodynamically the 2014 and 2015 cars started to lead the pack in complexity, adding to the chassis performance, to the point where Red Bull was eclipsed as having the best chassis early in the new V6 formula. However Red Bull came back on form in the later part of this era and the Ferrari chassis threatened in 2015, only to stagnate in 2016.

As with the power unit, Mercedes AMG pushed aggressively with development

throughout these three years and in 2016 perhaps reached the zenith of what's possible with these chassis rules. Soon after its launch and continuously throughout the season, the Brackley aero team broke up aero surfaces to provide more sharp edges to control airflow with tip vortices, from the front wing, turning vanes, bargeboards and floor edges. More and more slots were added to the car, making it far more complex than any of its rivals.

Being complicated isn't an obvious recipe for performance, but while Red Bull found pace with a more organically smoothed bodywork philosophy, Mercedes' contrasting complex approach worked equally well. Every update tested on the car was adopted for race use and showed the correlation between design, simulation and reality worked. This left Mercedes in a sweet spot of doing no wrong.

By the end of the season, with new rules for 2017, team principal Toto Wolff rightly pointed out that Mercedes AMG may have "maxxed out" what was possible with the current rules. Certainly, the development curve was giving fewer rewards for the effort put in. This was highlighted by the closing of the performance gap by Red Bull and Ferrari in the latter races.

NEW RULES, NEW ORDER?

The process to agree the rules for 2017 and beyond has been a fraught one, with many vested interests of those involved to catch up or retain pace relative to rivals. Perhaps uniquely in F1's history, the aim of the rules has been solely to make the cars faster around the track. So with wider tyres, wider cars and greater underbody aero potential, will these rules truly draw to a close the Mercedes AMG era?

Perhaps not. While the cars will look very different, the changes retain a lot of the same demands on the chassis. The power unit is unchanged and is even freed from the shackles of the token development system. So there is no immediate reason to think the regulations are going against Mercedes AMG's strong points. Indeed, its engineers proposed bigger changes to the rules, even though it might have disadvantaged them.

If we consider that Mercedes took advantage of a lull in performance in the V8 to gear up for the new V6 era, one questions how it could have performed this conjuring act again during such an intensive and successful spell. But without strong season-long opposition, could it not only have diverted resources to focus on chassis changes but been holding back PU developments for 2017?

If the probability is that Mercedes AMG will keep it prime position as top team in 2017, harnessing the lessons and experience gained since 2009, the changes nevertheless fuel the hope of a two-way title fight. Not two-way in terms of the one team's driver pairing, but two teams equal on performance over the course of a season. Red Bull, Ferrari, maybe even McLaren will all be desperate to end the Mercedes AMG V6 era and make the new one their own. **RT**

The evolution in **FLUID HORSEPOWER™** continues...

XRP ProPLUS Race Hose™

ANTI-STATIC PTFE IS COMPATIBLE WITH ALL AUTOMOTIVE FLUIDS AND FUELS

A highly compressed, non-porous matrix resists fuel permeation and diffusion.

SMOOTH INTERNAL TUBE

Superior flow rates, minimum pressure drop AND ease of clean-out, not possible in convoluted hoses.

EXTERNAL CONVOLUTIONS

Promote hoop strength for vacuum resistance and supports tight bend flexibility.

PATENTED MANUFACTURING PROCESS

Creates a full PTFE smooth-bore hose for optimal flow with external convolutions for flexibility.

RACE CRIMP HOSE ENDS

Hundreds of styles. Choice of full hex or lightweight turned down swivel nuts. Black is standard, also available in Blue or Super Nickel.

A CHOICE OF OUTER BRAIDS

XS: Stainless Steel,
XM: Lightweight XtraTemp Monofilament
XK: Aramid Fiber, XT: Tube only for inside fuel cells
and New XKS: Silicone over Aramid.



SUPERIOR VACUUM SUPPORT

An engineered design with an externally wound stainless steel wire that provides great vacuum support and tight bend capability.

ANTI-STATIC PTFE TUBE
A high flowing, smooth bore, PTFE tube with external convolutions for flexibility. No internal convolutions to restrict flow.

A CHOICE OF LIGHTWEIGHT BRAIDS:

XM - XtraTemp Monofilament, XK - Aramid and
NEW XKS: Gloss black Silicone over Aramid braid.

Go to www.xrp.com to learn more about the ProPLUS Race Hose™ product line.

An exceptional achievement in race hose technology...

NEW... XKS SILICONE OUTER COVER
Gloss black Silicone covering over XK Aramid braid reinforcement. Excellent protection for BOTH ProPLUS & ProPLUS Xtreme.

PROPLUS RACE REUSABLE HOSE ENDS ARE AVAILABLE NOW!

ProPLUS Xtreme Race Hose™

Highly Kink-Resistant,
Quite Possibly The Perfect
Dry Sump Vacuum Race Hose

 Follow us on Instagram @XRPracing

 Like us on Facebook /XRPinc

UNITED STATES XRP, Inc.
5630 Imperial Hwy., South Gate, CA 90280
sales@xrp.com tel +1 562 861 4765 fax +1 562 861 5503

EUROPE & UK Protec Fuel Systems Ltd.
info@protecfuelpumps.com tel +44 (0) 121 572 6533

XRP®

THE XTREME IN RACECAR PLUMBING

TEAM BY TEAM

Merc was number one but, given the resources available to them, how did its rivals rank?

Craig Scarborough delivers his verdict

2 RED BULL

When you consider that this time last year Red Bull and Renault were close to separation, with desperate attempts being made to find an alternative engine supply, the result of its 2016 season is incredible.

Red Bull elected – perhaps was given no choice – to stay with Renault. By the end of 2015 the Red Bull chassis had regained the shine it lost with the switch to non-exhaust-blown aerodynamics in 2014. Renault's failure to get on terms with the new power unit regulations left it short on power and reliability, but its winter development programme saw the 2016 PU a far more competitive package. It kicked-out more power than expected even from the first races and over the whole season proved to be a very reliable package too.

Red Bull's chassis, meanwhile, continued to make the best of putting Renault's bulky cooling package into a small set of sidepods. In contrast to Mercedes AMG it was the far more simplistic bodywork that made the RB12 unique. Taking simpler shapes with less sharp edges, the car looked much cleaner than its rival. Although the RB12 sported probably the

steepest rake angle of any car, the chassis was kept composed by a hydraulic pitch control system, with a roll damper also evident slung between the front rockers.

As the season progressed the power from the Renault PU kept on coming, despite a minimal development token spend. This, allied to the diligent chassis development from Red Bull, saw the package start to pressure Mercedes on like-for-like pace.

With Renault free to totally redevelop its power unit over the winter and the main regulation changes playing to Red Bull's trump card, the chassis, it looks like Red Bull should be even more competitive next year.

3 FORCE INDIA

When Force India launched its VJM09 pre-season, the year-on-year change appeared minimal. But, the team was out of phase on development having delivered a major car update mid-2015, leaving it less resources to play with over the winter. When it once more introduced a mid-season update, it transformed the car's middling early season pace.

With a better chassis, plus the Mercedes

power unit and gearbox, the team put in a series of strong results, assisted in no small part by canny race tyre strategies. By the season's end, Force India had Williams beaten and had worked up to a deserved fourth place in the constructors' championship.

4 TORO ROSSO

After a promising 2015, Toro Rosso was left without a powertrain for 2016 until Ferrari stepped in with a supply of 2015 power units, which Toro Rosso then mated to a Red Bull Technologies gear cluster housed in its own carbon case. The doubt and delay over the PU should have distracted the work on the rest of the project, but the STR11 proved to be a capable and influential racecar.

It was always going to be a season of two halves as the year-old Ferrari PU would not receive any development and thus lost out on power to its rivals as the campaign progressed. True enough the power deficit showed itself, but far earlier than expected due to the progress made by both Renault and Honda.

This left the team with less early season opportunities to shine, especially as star driver Max Verstappen switched to Red Bull after the first four races. So, the car soon struggled on top speed and aero development switched to drag reduction to keep it competitive, but this was a losing battle.

5 WILLIAMS

Having made a leap in relative pace back in 2014 with the new regulations, Williams appeared only to have pegged the gap to



ABOVE Red Bull's RB12 featured probably the steepest rake of any car



BELOW The ever more complex front wings, showcased here by Force India, were modular to simplify things where possible



ABOVE Williams switched focus to the new rules package



ABOVE McLaren's front wing mounts like turning vanes. Gains with the PU and aero enabled more progress than results alone suggested



ABOVE Managing heat transfer from brakes to tyres was a 2016 battleground. Toro Rosso, like rivals, even used asymmetric brake blanking to get different levels of heat into left and right tyres

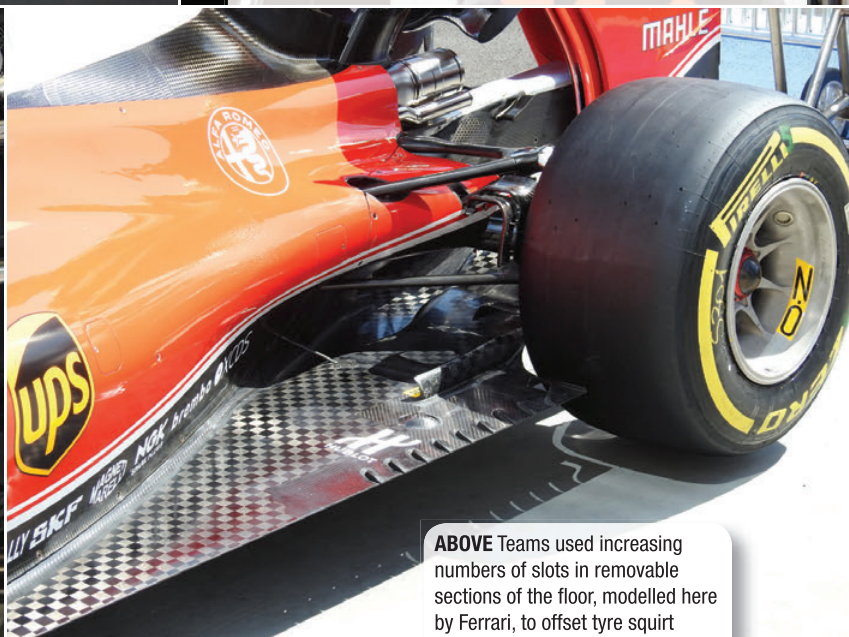

ABOVE Teams used increasing numbers of slots in removable sections of the floor, modelled here by Ferrari, to offset tyre squirt

Mercedes in the subsequent two seasons. Unfortunately, Ferrari, Red Bull and now Force India have stepped into that gap.

Its FW38 was a major redesign of the outgoing car, with different aerodynamic and suspension philosophy. The car, however, was tricky to handle and tyre use was one of its weaker points. Without a perceived threat from the midfield, focus soon shifted to 2017. As development of the current car waned, the impact was greater tyre management troubles and poor race finishes.

6 FERRARI

Ferrari's SF16-H looked the part and the stage seemed set for the squad to carry the fight to Mercedes AMG this season.

The team had corrected the old car's understeer tendencies, updated the power unit layout and had the driver/engineer pairings to meet CEO Sergio Marchionne's targets. Testing saw them well prepared, clearly sitting behind Mercedes and ahead of the rest of the pack. Melbourne even

gave hope for a win, when Mercedes was struggling. So where did it all go wrong?

Technical director James Allison, a pivotal figure, took time away after a family bereavement. On his return, he did not see eye to eye with Marchionne's idea for a technical structure. With this, Dirk de Beer left the aero department and suddenly the team was all at sea.

The summer came and went without any obvious chassis development. Nor was any new technical director recruited. Matteo Binotto, previously head of the engine department, took the reins and Marchionne was adamant that was all that was needed. By the season's end, though, Ferrari had fallen behind Red Bull on pace and in the championship.

It might be that Ferrari had already switched its focus to the new season, with an all-new chassis and power unit. Instead, though, it seemed that the direction given to the team after its catastrophic 2014 form had again been lost and 2017 doesn't bode well for the Scuderia.

7 McLAREN

There was huge progress with McLaren and its power unit partner Honda, even if sometimes the pace and results didn't show it. By the season's end the McLaren chassis was starting to match those towards the front of the grid, increased rake and complex but more conventional front end aero having brought the car the pace it needs.

However, outright pace is still capped by engine power and this in turn restricts the downforce and thus drag the team can afford to run on the chassis. Honda's progress has been clear: its ERS efficiency issues were resolved over the winter, then the in-season development focused on upscaling the turbo compressor and the MGU tied to it. By the season's end it had gained more power, but was handicapped in the race by fuel consumption issues, as it lacked the lean burn technology of Mercedes and Ferrari.

If the partnership continues on this trajectory, both parties should enjoy a far more competitive 2017. ▶

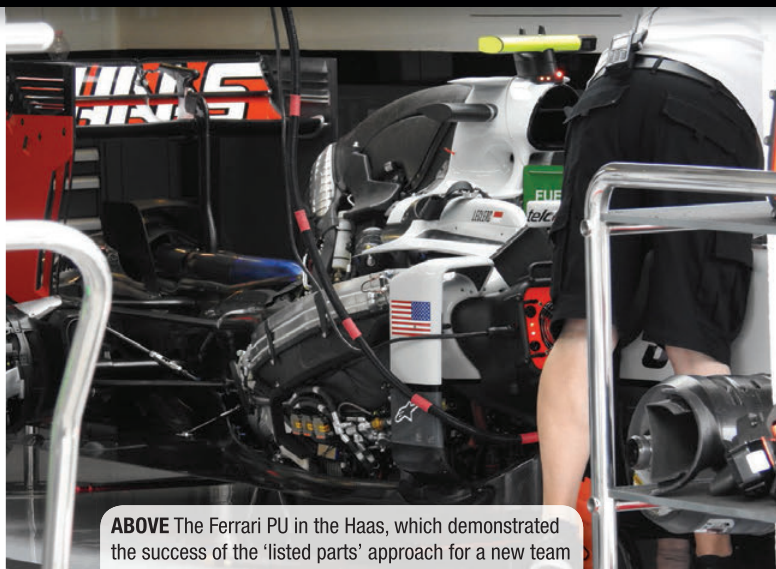

ABOVE The Ferrari PU in the Haas, which demonstrated the success of the 'listed parts' approach for a new team



ABOVE Manor: big improvement



ABOVE Sauber was one of the teams to converge on Toro Rosso-style rear wing slots

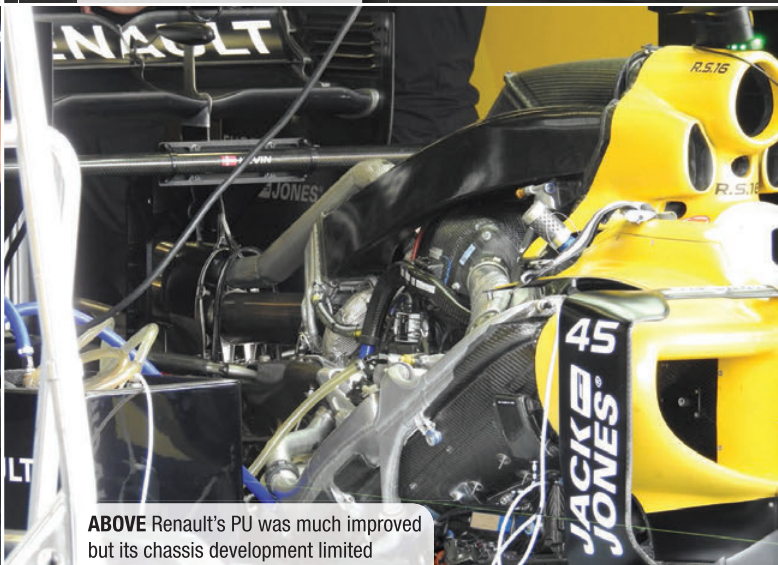

ABOVE Renault's PU was much improved but its chassis development limited

8 HAAS

It was an upside-down season for Haas. Paddock wisdom suggested it would start slowly and improve; it was, in fact, the opposite.

Taking Ferrari's powertrain and any non-listed chassis items, the team was left to design its own tub, crash structures and aero package. There were also the facilities, people, processes and equipment to be put in place.

The car was quick and reliable out of the box, when inspired tyre strategy won points in the opening races. But warning signs were there amongst the good news, as second driver Gutierrez was having all the problems.

As the season progressed, brake issues – firstly brake-by-wire, then brake material consistency – increasingly occupied the team. With its early targets already met, the focus soon switched to the big redesign for the 2017 rules, so the current car's development faltered. Thus, the season proved the listed-parts approach to entering F1 was a valid one, but there remain the growing pains of a new team maturing.

9 MANOR

Having gone bust in 2014, then scraped through to start 2015 a race late, only to lose its two founding members at the end of the season, you might think it would have been enough just to survive the 2016 campaign. Yet the team bucked expectations and put in a strong performance throughout the year.

Now equipped with a Mercedes power unit mated to a Williams gearbox, the car's underpinnings were solid. The Banbury-based team then put together a new chassis, having run modified 2014 cars last year. With a group of ex-McLaren senior staff, the result was an improving package that was capable of beating other midfield teams in qualifying by season's end.

10 SAUBER

Sauber's season was given a second wind when new owners came on board with investment. With the Ferrari powertrain, the team's competitiveness should have

been secure, but the chassis was merely a development of the 2015 car and only mid-season updates aided its cause.

The new investment and a series of key technical signings make 2017 look more promising, but the 2016 season – Brazil's upset aside – was one to forget.

11 RENAULT

Reincarnated as Renault once again, the Enstone design team, like Toro Rosso, was hampered by the late decision over which powertrain it would run. So, the car switched from the excellent Mercedes PU to the lesser but improving Renault unit.

Starved of resources through 2015 and into the early design phase of the RS16, progress on the new car was stunted. It bore much of the design work of the Lotus E23 and even used the old gearbox casing left over from the previous Renault-engined Lotus.

Renault's reinvigorated effort was always going to focus on the 2017 car, so development of the RS16 was limited. It was hindered further by too many tub-breaking incidents. **RT**

Race winning Harnesses World class Sensors

Design & manufacture since 1986



PRI 2016
Indianapolis
EXHIBITOR AT BOOTH :
4627

Renvale Harnessing

- Leaders in electrical harness design & manufacture since 1986
- 17 F1 World championships won using our systems
- Specialists in system design, manufacture & support
- Vast experience in all kinds of design, from WRC, WEC, WTCC, F1 and Moto GP all the way through to Americas Cup
- Benchmark manufacturing and quality control systems
- 3D modelling capability



Texense Sensors

- Leading sensor supplier to motorsport since 1999
- Precision engineered, high accuracy embedded solutions for extreme environments
- NEW - Wireless infrared tyre temperature & aero pressure sensors
- Thermocouple amplifiers (patented), accelerometers & gyroscopes
- Strain gauge bonding + amplifiers
- YAW pitot sensors & multi-channel aero sensors

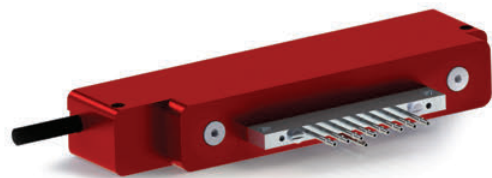

CRISIS? WHAT CRISIS?

Touted as a pretender to F1's throne just months ago, the World Endurance Championship is now reeling after Audi's withdrawal. Or is it? **Gary Watkins** asks the uncomfortable questions



ABOVE With Audi heading for the exit door, the front of the WEC field suddenly looks sparse

NOTHING catastrophic." That is how World Endurance Championship boss Gerard Neveu has summed up the news that Audi would withdraw from the series at the end of the 2016 season. Was he putting on a brave face after news that came on what, he concedes, wasn't the "best day for the championship", or is the WEC really still in rude health as it heads into its sixth season since its rebirth in 2012?

Neveu and Pierre Fillon, president of WEC promoter the Automobile Club de l'Ouest, have been at pains to stress that the series is about much more than the manufacturers fighting it out at the front with their increasingly high-tech LMP1 prototypes. They are right, but only up to a point. Factory

participation by manufacturers showcasing their technical excellence – and there are now only two left in Porsche and Toyota – is the calling card of the WEC.

The factories and their big-name drivers reach out to the public in a way that even the major car makers competing in GTE Pro do not. There's a financial angle, too. The P1 manufacturers make the big marketing spend that is so important to the economic health of the championship and its centrepiece round at Le Mans.

A HOLE TO FILL

Audi's departure has left a gaping hole in so many respects, not least because it had an

unbroken 18-year involvement in the premier prototype class at the Le Mans 24 Hours and beyond. The German manufacturer and its four-ring emblem had come to symbolise prototype racing. Le Mans without Audi just won't seem right for many.

Yet Audi's history at Le Mans proves that a two-manufacturer set-up is sustainable. Who was complaining at the end of the last decade and the beginning of this that there were only two manufacturers in Audi and Peugeot battling it out at the front at Le Mans? Not least in the years of the great contests of 2008 and '11.

FIA Endurance Commission president Lindsay Owen-Jones, who presides over the body that is best described as the cabinet in



AdrenalMedia.com

of the grid will hang around. Manufacturers traditionally don't stay in the highest echelons of sportscar racing forever.

Toyota historically has come and gone. The current programme, launched ahead of the restart of the WEC, is its first since its Le Mans assaults with the GT-One of 1998-99. Porsche competed for outright honours at Le Mans almost continuously for the 30 years up to 1998, and was then absent for the 15 years leading up to its return with the original 919 Hybrid in 2014.

The arrival of a third manufacturer in LMP1 would provide the WEC with the security – the safety net, if you like – that was suddenly withdrawn upon Audi's announcement that it was pulling out of the arena after 13 Le Mans victories and two WEC drivers' titles, not to mention its successes over the Pond in the

head of Audi Sport Dr Wolfgang Ullrich as an "additional programme".

Moreover, he explained that putting its backing behind Abt for Formula E season three – having previously loaned its name and technology – was "on a completely different level" to its involvement in the WEC and "completely separated" from any decisions about its continuation therein.

Audi's statement did hint at the truth behind its WEC withdrawal. It talked of a drive to reduce the company's motorsport budget and said that the decision needed to be understood "in the context of the current burdens of the brand", which is a reference to the financial liabilities likely to follow "dieselgate".

If there was any doubt about the real reason for ending its LMP1 involvement

“ Keeping the regulations frozen until the end of 2019 doesn't mean that the technology will stand still”

American Le Mans Series.

Neveu and Fillon insist there is interest from new manufacturers: Neveu says there are "many discussions". What they can't say, understandably, is who might be coming, nor can they offer any kind of timeline for the arrival of a newcomer.

THE QUESTION OF COSTS

The cost of competing in the technological playground that is LMP1 is immense and remains an obstacle to potential entrants, and, as it turned out, the continuing participation of its longest-serving player.

The idea that Audi's withdrawal – and in particular its timing – is not directly related to the "dieselgate" emissions row that engulfed parent company Volkswagen Group last year is plainly wrong. The wording of Audi's official announcement suggesting that it had made a decision to end its WEC involvement in order to focus on Formula E, even at a time when it is gearing up to roll out a range of electric cars into the marketplace, was nothing more than PR spin.

Factory backing of the Audi Sport Team Abt Formula E team, to be followed up by a full works participation in season four of the FIA's electric-vehicle championship in 2017/18, had been announced in early September and was described shortly afterwards by

right now, it was confirmed just seven days later when VW axed its World Rally Championship programme.

Ullrich's words about Formula E being on an entirely different level are, of course, a reference to the costs involved. The exact expenditure on either programme can't truly be known, but there is an extra nought involved with a WEC campaign compared with a Formula E assault.

Renault was reputed to have spent not much more than €10 million to win the title in the second season of the EV series, whereas Audi and Porsche have been spending more than €100 million annually in the WEC. Perhaps much, much more.

The question is whether the level of expenditure required for a winning campaign in the WEC is sustainable? One potential entrant thinks not.

Peugeot has an interest in returning to an arena in which it was successful over the course of a five-year stint prior to the relaunch of the WEC. It only won the Le Mans 24 Hours on one occasion in 2009, but it had the measure of Audi in the forerunner to the WEC, the Intercontinental Le Mans Challenge, winning all three pilot races in 2010 and then seven of the eight rounds the following season. Then, against the backdrop of mounting losses and factory closures, it pulled the plug on the programme three months ▶

the structure of government of the WEC, has put just that view.

"Some of the best pages of the history of endurance racing have been written by two brands fighting – Peugeot versus Audi, Audi versus Toyota," he says. "There is nothing wrong with two manufacturers fighting it out in a championship and at Le Mans."

The former chairman of cosmetics giant L'Oreal and a three-time competitor at Le Mans does add a caveat, however. "From a regulator's point of view it is better to have more people at the table and more guarantees," he stresses.

His use of the word guarantees is significant. Because there are no guarantees how long the two remaining participants at the sharp end

BELOW The spend on windtunnel resources had already been capped and a working group devoted to cutting costs, but more needed to be done. The rules freeze was vital to steady the ship

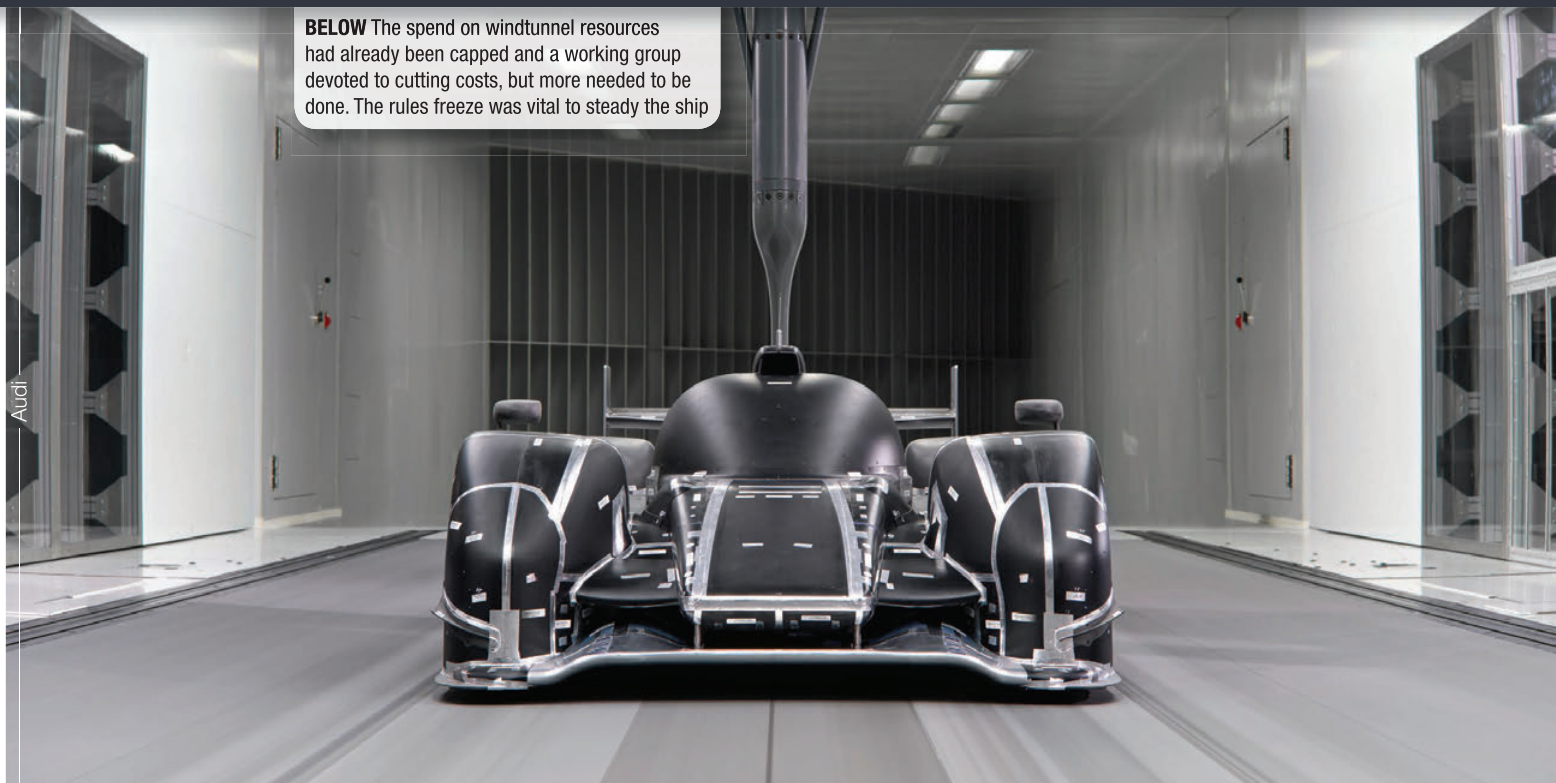

ahead of the start of the first season of the new-look WEC.

But its competitions boss, Bruno Famin, maintains that a comeback is not possible while costs remain at present levels. "Our boss has said that we will come back when the conditions are right," he says. "The first concerns the financial health of PSA [Peugeot's parent company] and the second the cost of competing in the WEC. PSA is a little bit better [than at the time of its withdrawal], but the costs are still too high.

"There's no doubt that the WEC offers a good technological platform for manufacturers, but the championship is not sustainable at the present cost level. Manufacturers will more and more think about the return they are getting on their investment."

RULES FREEZE

The ACO and the FIA, together with Porsche and Toyota, took a bold – but perhaps inevitable – decision to freeze its rule book over the course of the weekend of the series finale in Bahrain. There arguably wasn't any other option as the WEC attempts to attract a new manufacturer in LMP1.

The decision delays the new regulations that were due to come into force at the start of 2018 until the end of the following season. An increase in the scope of the hybrid regulations, which would have allowed an additional or third retrieval system and created a new upper 10 megajoule sub-class, would undoubtedly have resulted in an increase in development budgets. New survival cell rules would also

have come with a cost implication.

Vincent Beaumesnil, sporting director of WEC promoter the Automobile Club de l'Ouest, describes the move that keeps the present regulations in force until the end of the 2019 season as "a tough decision, but a sensible one". He insists that the freeze "makes complete sense in the context of the current situation".

Porsche LMP1 team principal Andreas Seidl perhaps sums it up best with his comment. "We had to freeze the level of complexity in order to stabilise the costs and make it attractive to newcomers."

A constant evolution of technology was part of the philosophy of the efficiency-based LMP1 rulebook introduced at the start of the 2014 season. But putting a hold on that

evolution will not remove the ability of the manufacturers to showcase their high-tech credentials, according to Seidl.

"It was important not to take a backwards step; we need to maintain the technology and the scope to develop it further," he explains. "Keeping the regulations frozen until the end of 2019 doesn't mean that the technology will stand still. We will continue to drive for greater efficiency within the regulations as they stand."

Where the rules go beyond 2019 has yet to be determined. That is likely to depend on who comes to the rule-making table with a desire to join Porsche and Toyota in the top class of the WEC.

"As always we will be listening to the manufacturers already involved," says ▶



ABOVE The LMP1 manufacturers' marketing spend is important to the economic health of the series



Audi Sport
Official Supplier



IMPERIAL RANGE



METRIC RANGE



TENDER | HELPER



OFF ROAD



COIL SLEEVE



BUMP STOPS

DOMINATE THE TRACK. RULE THE STREET.

ERS | Eibach Race Spring System

- Over 1,300 single components - main and tender springs - metric and imperial, various auxiliary race suspension accessories, ready and in stock on 5 continents
- Comprehensive Program of single components
- Single Main Springs with highest rate-linearity and lowest rate tolerance
- Progressive Characteristics via set-up of different springs serially - double or even triple spring combinations
- Extreme Low Weights achieved through Super Hi-Ten materials and manufacturing technology
- Smallest Solid heights, maximized spring travels and higher maximum loads
- Spring Surface Stabilization through specialized shot peening
- Every ERS Spring preset to block
- Block and Sag Resistant
- Smallest Tolerances and precise plane parallelism of spring ends
- High Dynamic Durability - under Motorsports conditions
- High quality corrosion protection by phosphating and epoxy coating
- Springs Printed with part-number (speaking code = rate and dimensions)
- Individual protective single box packaging

Beaumesnil, "and those that are looking for the opportunity to join."

The WEC is trying to buy itself time and the good news is that it appears to have the time to tempt in another manufacturer. Porsche's participation is confirmed until the end of 2018 and senior bosses have suggested that they envisage a long-term presence in the traditional motorsport stomping ground of the brand. Toyota Motorsport GmbH has stated that there is no end-date for the P1 programme, even with the marque's return to the World Rally Championship in 2017.

On the other hand, the ACO needs two manufacturers under the terms of its contract with the FIA to run the WEC. Think back to 2012, and Peugeot's sudden withdrawal in the build-up. Toyota had to be persuaded to enter the full championship in what had been planned as a development year in which it would pick and choose its races. Plan B involved Honda, which was represented by two privateers running the ARX-03a developed by its Honda Performance Development motorsport arm.

Neveu stresses that the WEC will fulfil the conditions to award full world championships in LMP1 next year. Speculation that the ACO's latest contract, signed in 2014 and covering the 2015-17 seasons, stipulates three manufacturers is "absolutely wrong", he says.

If there is no real shortfall in manufacturers competing in LMP1, there is in the privateer ranks. The decision of the Anglo-Swiss Rebellion Racing squad, the top independent

Photos: AdrenalMedia.com

BELOW Jewel in the crown: the struggle to assemble a top class field in the WEC is magnified at the Le Mans 24 Hours



in P1 this decade, to step down to LMP2 next year is hardly as seismic as Audi's withdrawal, but it is significant for a class that has dwindled through the short history of the current WEC.

The disappearance of Audi from the grid means that there is likely to be just five P1 cars at the 2017 WEC opener at Silverstone in April. That's four factory cars and a lone privateer entry from the German-based ByKolles squad, which is the only indie with anything approaching confirmed plans for next season.

Nowhere will this dearth of P1 cars be more apparent than at the front of the 60-strong Le Mans grid, whether or not Toyota and Porsche run three cars. Toyota insists that it has yet to make a decision on fielding an additional car at the 24 Hours for the first time since its

return to the top flight of sportscar racing, though sources at TMG are suggesting that it is more likely than in previous seasons. Porsche maintains that its decision to downgrade from three to two cars in the name of cost saving – and made in conjunction with Audi in the immediate aftermath of "dieselgate" – has yet to be altered.

The WEC and the ACO need to bring back the privateers that have deserted the P1 class in the current era. The pace of development of the hybrid factory cars has left the independents, without the benefit of energy retrieval, further and further behind. They are no longer in the same race.

Think back to 2012 and the inaugural year of the WEC in its latest incarnation. There were five P1 privateers who raced regularly in the ▶



ABOVE Rebellion's defection from the LMP1 privateer ranks was another blow



RACE FOR INNOVATION

WINDFORM ADDITIVE MANUFACTURING
& HIGH PRECISION CNC MACHINING



RACING HAS CREATED OUR MANUFACTURING EXCELLENCE

CRP USA leads excellence in **Advanced 3D Printing Service** with **Windform material** to high-performance sectors like space, aviation, automotive and entertainment from its facility in Mooresville, North Carolina. Offering you the same craftsmanship, quality, reliability, and innovative solutions that have made CRP Group a preferred partner to racing teams for over 45 years.



www.crp-usa.net

LONG-STANDING EXPERIENCE

info@crp-usa.net

WE ARE AT PRI SHOW WITH PRO-SYSTEM - BOOTH 413, GREEN HALL

series, and two more at Le Mans.

The ACO and the FIA, which jointly draft the WEC's regulations, have put in place a series of rule breaks for the private entrants over the next two seasons with the aim of encouraging them back. Changes or not, Rebellion's decision was motivated partly by a realisation that the new breed of LMP2 that comes on stream next year will be snapping at their heels. It believes that the rule changes for next year, which include a deeper and more efficient rear wing, bigger dive-planes at the front and a weight break, will barely keep them clear of the latest P2s.

The ACO isn't so sure. It believes that the tweaks have the potential to enable a privateer P1 car to move much closer to the factory cars, which will be robbed of downforce under another wave of rules changes in place for next season.

Beaumesnil suggests that a privateer could be "very competitive" in 2017. "Get someone to do the simulations, and you will see," he explains. "If you design a car to these rules, you would be much, much closer to the factories."

He admits that getting the privateers back on the grid is "the top priority" handed to him by Fillon. He believes that the helping hand given to the privateers, which is set to include the introduction of a rear Drag Reduction System in 2018, could yield results for that season.

The first team to jump has been Russian entrant SMP Racing, a long-standing WEC participant. Its BR Engineering offshoot, which produced the BR01 LMP2 racecar in 2015-16, will be developing a non-hybrid P1 car for 2018 in conjunction with Dallara.

Beaumesnil hints that there are more announcements to come from newcomers to the P1 privateer ranks: "There is a lot of interest. We could very quickly have five or six private cars."

GOOD NEWS ELSEWHERE

Neveu is right when he says that good news abounds the WEC right now. That is very much the case in GTE Pro. Ford joined the party for this season, of course, while BMW announced in September that it will enter the series in 2018 with a WEC-eligible replacement for the GT3-based M6 LM with which it competes in the IMSA SportsCar Championship in North America.

In between times, Porsche will be back with a pair of factory 911 RSRs in 2017. The German manufacturer took a sabbatical in



2016, while it developed a car specifically to the new rules that came into force this season, and has confirmed that its planned return will not be affected by the budget cuts across the VW Group.

The growth in manufacturer participation in GTE Pro could also be matched by an increase in the prestige of the class. The GT drivers' and manufacturers' titles, which are currently "World Endurance Cups", could become full world championships like the end-of-season prizes awarded in LMP1.

The idea, first raised by Aston Martin three years ago, is due to go before the FIA's World Motor Sport Council for the first time at the start of December. However, Owen-Jones warns that the FIA remains "extremely parsimonious with the concept of a world title".

THE GRID SHOULD HOLD UP

The target remains to have a full grid of 32 cars next year, according to Neveu.

That figure is determined by the capacity

of the smallest pit complexes on the WEC schedule and freight constraints.

That appears to be achievable for 2017. The LMP2 grid looks likely to hold up, even in the first year of a new formula. Some teams are departing like Strakka Racing, which is forging an alliance with McLaren to race a fleet of 650S GT3s in the Blancpain GT Series, and there are question marks over others.

But Rebellion Racing is likely to remain in the WEC. It has yet to confirm its programme, except to say that it will run ORECA, but has intimated that its preference is for another campaign at world level. There are also other teams with WEC aspirations that didn't receive entries this season.

"There are good prospects in front of us," says Neveu. "In the coming months we will have good news about new LMP2 teams, maybe privateer LMP1 teams, and we already have had an announcement about a new manufacturer in GTE [BMW's entry in 2018]," he says. "The WEC is not only about LMP1 hybrids." **RT**



PRI2016 Indianapolis
EXHIBITOR
BOOTH # 4145

VBOX VIDEO

VBOX VIDEO captures stunning video in full 1080p HD with real-time graphical overlay.

Supplied in a rugged, water resistant case, with two cameras, internal GPS logger, backup battery supply, up to 30s video pre-buffer and real-time graphical overlay, **VBOX VIDEO** represents the ultimate in tough, reliable motorsport video loggers.

VBOX VIDEO when used with **CIRCUIT TOOLS** - intuitive, simple to use data analysis software developed by racing drivers for racing drivers - can quickly help any level of driver go faster.

- Dual Camera HD – 1080p
- Real-time graphical overlay
- Ultra-smooth video
- Class leading driver training software (Windows, macOS & iOS versions)
- 10Hz GPS data logging
- Video record pre-buffer
- Camera preview over WiFi
- CAN interface



VBOX VIDEO HD2 available to order online now

Professional racing drivers share their experience on advanced circuit driving techniques in our **FREE eBook**:
www.vboxmotorsport.co.uk/ebook

www.vboxmotorsport.co.uk

YOU could hardly have written a better script. Just two points separated Team Dynamics' Gordon Shedden from the British Touring Car Championship (BTCC) crown as the lights went out on the final round at Brands Hatch. After a tense few laps clawing his way up the field, Shedden speared past championship rival Sam Tordoff and went on to take his second consecutive BTCC drivers' crown. Powering him to victory was a 2-litre Next Generation Touring Car (NGTC) engine developed by Neil Brown Engineering (NBE), which had made its competition debut just six months beforehand at the same circuit.

Under the skin, it's basically the same turbocharged K20C powerplant as you'll find in the production Honda Civic Type R. This marked something of a departure from the

team's previous engine (also developed by NBE) which was essentially a turbocharged derivative of the K20A, the Type R's naturally aspirated predecessor.

In many respects the K20C is a leap forward, with turbocharging and direct injection already designed into the production unit. It's an engine that suits the role of a high performance road car very well, but some of its design features proved to be more of a challenge when adapting it to be a race engine. Chief among these is the integrated exhaust manifold, which is designed primarily to reduce emissions on the road car. In essence it eliminates the traditional exhaust manifold, instead integrating the exhaust primaries into one outlet before they leave the cylinder head.

For a road car, this minimises the distance

the exhaust gasses have to travel before they reach the catalytic converter and hence reduces heat loss. This means the catalyst takes less time to get up to operating temperature, reducing cold start emissions. It also generally has the effect of simplifying the exhaust design, saving weight and reducing costs; all of which are win-win for a production engine.

For a race engine things aren't quite so straightforward. Keeping the exhaust energy up is good news for the turbocharger, but it puts more heat into the water jacket, which then needs to be dissipated. It also creates issues for the exhaust tuning, because the length and diameter of each pipe is effectively set in stone (or at least cast in aluminium). Plus, almost by definition, packaging four exhaust tracts into one across a short space leads to very uneven primary lengths.

Under the Next Generation Touring Car (NGTC) rules, conventional exhaust manifolds can be discarded and replaced with bespoke items to a more or less free design. The standard cylinder head must be retained, however, which means that engines with integrated manifolds are effectively stuck with them. Some teams have exploited a clause in the rules that allows them to use an engine from elsewhere in the manufacturer's portfolio to avoid this problem. One is rumoured to have done so after the integral exhaust manifold was found to cost them around 40 hp compared to an older version of the same engine with an external manifold!

As a factory-backed outfit, Team Dynamics was understandably keen to use the same engine as the Civic Type R production car, which meant finding a solution.

"An awful lot of the work on this engine stems from the fixed geometry of that exhaust," explains NBE managing director, Neil Brown. "We carried out a lot of 1D simulation using GT Power to get the breathing right. Some of the parameters we didn't have at the time, but we used as much as we could from the previous engine and experience. In the end it turned out we were very close."

This is the first time the company has used simulation so extensively on a project and it's really come into its own, comments Brown: "We were able to reach solutions a lot quicker than we would have done traditionally. Afterwards I asked our chief designer how we would have got on without

HOW THE BTCC WAS WON

Honda won a thrilling BTCC title shootout but, as **Chris Pickering** discovers, its campaign shows road car innovation can pose challenges for the racetrack



ABOVE Both on and off the track, a lot of hard work underpinned Shedden's third BTCC crown

Honda



ABOVE With turbocharging and direct injection, the K20C's features are ideal for the road but its integrated exhaust manifold posed challenges for the racetrack

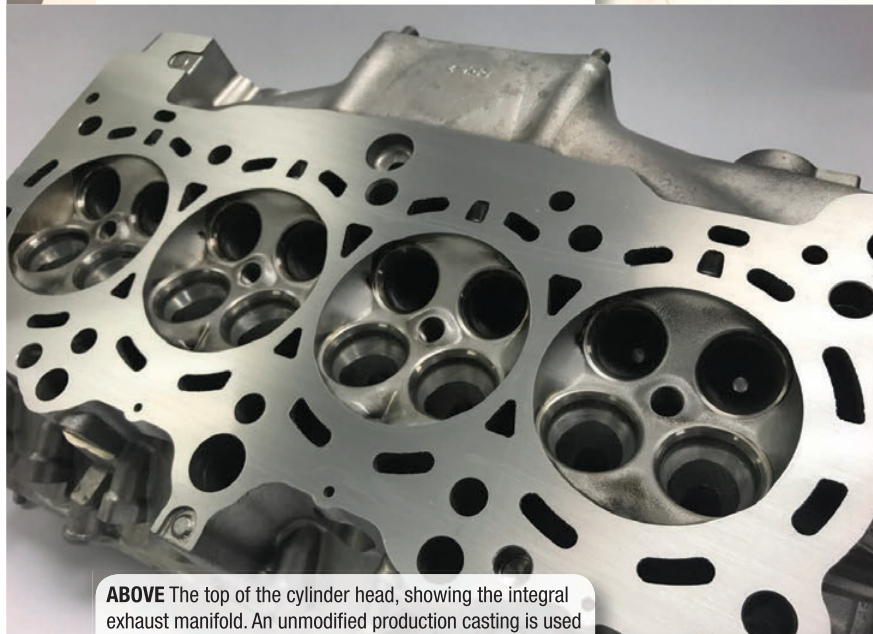

ABOVE The top of the cylinder head, showing the integral exhaust manifold. An unmodified production casting is used

that and his reply was that, 'We'd have been a long time getting where we are'. For us as a small company, the software and someone to operate it was quite a big investment, but it's paid off."

The integrated exhaust also brings extra challenges from a development perspective. During dyno testing, it's common practice to put individual lambda sensors and temperature probes on the primary pipes of an exhaust manifold to gauge the cylinder-to-cylinder variation. That's virtually impossible to do with integrated ports hidden behind the water jacket.

OPEN FOR BUSINESS

Another area that added complications was the K20C's open deck cylinder block. Here, the liners are surrounded by the water jacket rather than solid metal. This reduces weight, improves cooling and simplifies the casting process somewhat, so it's good news for a road car. However with the higher stresses of race applications it means the liners have less support than they would in a closed deck design, so they're more prone to so-called panting, where they move around within the block.

"Initially we found that the cylinders were panting, which could lead to cracking in the bores, so we braced those with a deck plate," comments Brown. "That gives some additional strength to the top of the cylinder. We also switched to a different steel liner design."

In the production engine, the liner finishes below the top of the block. NBE found that this could cause the block to crack an aluminium section between the cylinders, so it now uses a full length liner from top to bottom. "It's not the first time we've come across this on a racing engine," notes Brown. "On a previous project we found fitting a deck plate was the only way to keep the headgasket on."

On the intake side things were a little more straightforward. NBE invoked an oft-used clause in the TOCA rules which states that the production intake manifold may be substituted for a bespoke item if it's 'unsuitable for race use' or doesn't allow sufficient clearance to the mandatory NGTC front subframe. The new design is relatively conventional in principle, with four equal-length runners leading into a plenum ▶

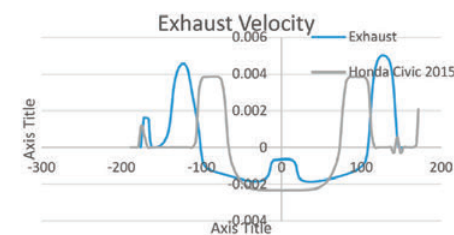
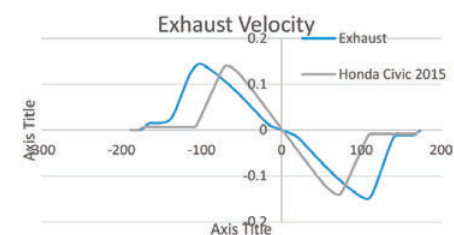
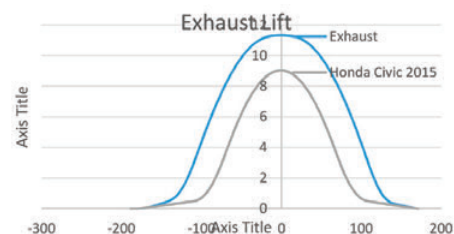

ABOVE Exhaust valve lift and velocity for the 2016 engine versus its 2015 predecessor



ABOVE Exhaust manifold showing unequal lengths of the primaries

B A B A
2-3 1-4

chamber. What's slightly unusual is its size.

"We've ended up with very long intake pipes and quite a sizeable plenum chamber," explains Brown. "Initially we planned to run a much smaller plenum. This performed very well when we ran it on the dyno, but it was inducing pressure spikes that took us over the maximum manifold pressure."

DIFFERENT CHALLENGES

The NGTC regulations were designed to bring touring car engines closer to their production equivalents, at a time when most categories still used naturally aspirated Super 2000 screamers. Overall, Brown says it works well, but it does pose a different set of challenges to a traditional race engine. "It is sometimes harder to get the performance out of an engine when you're starting with features that are already there rather than designing and manufacturing them," he notes.

All NGTC engines must use certain mandatory parts, including the same Owen Developments turbocharger, a spec intercooler from PWR and a Cosworth SQ6 ECU. Aside from the 2-litre capacity, the rules stipulate that the block and cylinder head castings must remain unmodified, including the ports and the combustion chambers. There's also a 7,000 rpm rev limit (coincidentally, identical to the K20C in the production Civic Type R) and an 11 mm cap on valve lift.

The production car's variable valve timing (VVT) system is carried over to the race unit. This features a chamber with a series of vanes on the end of the camshaft. It uses a solenoid-controlled valve to change the balance of oil pressure between the two sides of each vane; so any imbalance causes the camshaft phaser to rotate, advancing or retarding the cam timing.

In production form, the K20C also features Honda's famous VTEC system, which basically switches between two different sets of lobes on the same camshaft to alter lift and duration. For race application a

simpler arrangement with a single set of lobes and rockers has been employed. The valves themselves are bespoke items from US company Supertech, with Scherdel springs, while the followers and retainers are produced in-house.

Lower down the engine, it's a similar mixture of production parts and bespoke additions. The stock crankshaft is used, but the rest of the reciprocating assembly is new. The pistons have been produced to NBE's design by Omega, while the connecting rods come from Arrow Precision.

Under the NGTC rules, the engine has to run a wet sump, so NBE modified the stock item with additional baffling. Virtually all of the sensors and actuators are carried over from the production engine too, including the fly-by-wire throttle unit. Most of the bearings and gaskets are taken from the production engine, while specialist fixings are provided by the MJ Wilson Group.

Interestingly, the fuel injection system is also carried over from the road car. The K20C is the first BTCC engine that Brown and his colleagues have produced with direct injection. A lot of CFD time went into spray targeting for the injectors and piston bowl shape, he explains, with some quite surprising results.

"In the end we found it very hard to better

the production engine's spray pattern and targeting," he confesses. "In fact, we thought we'd found a better solution from another engine we'd designed, but when we analysed it that turned out not to be the case, so we're now looking forward to trying the Honda injector in that engine!"

POWER POTENTIAL

TOCA uses a carefully developed calculation to determine the baseline boost settings of each engine. This is based on steady state flow through the intake ports and the intake valve lift profile. It's not intended to equalise power as such, but rather to ensure that each engine has the same potential to make power; the rest is left up to the engine builder.

While this baseline boost setting theoretically equalises the maximum power that could be extracted from each engine there are still a number of different ways to approach it. An intake system that flows too well can result in a very low boost pressure that makes it harder to get the mandatory NGTC turbo to work effectively. There's also little point in developing a high-flow intake if you don't have the means to extract the gasses on the other side. With that in mind, the NBE intake system was designed to offer a relatively modest flow figure. ▶

Intake Forward

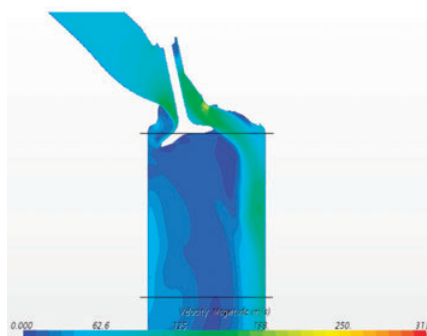

Intake Reverse

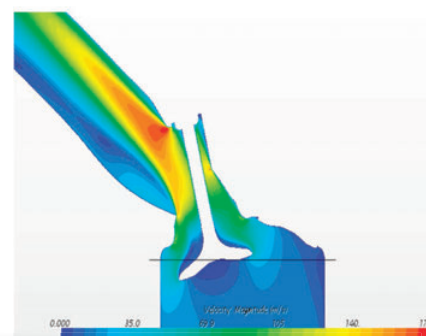

ABOVE & BELOW This is the first time the company has used simulation so extensively on a project

Exhaust 1-4 Forward

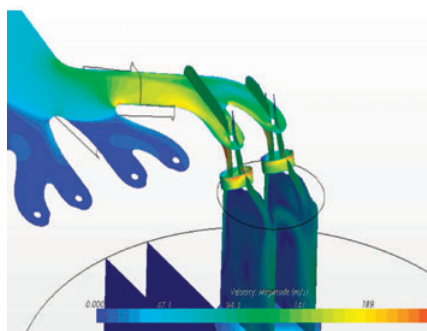

Exhaust 2-3 Forward

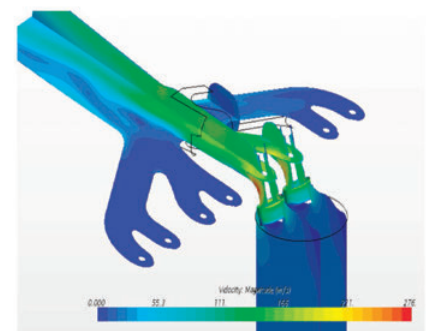

pankl
RACING SYSTEMS



High Tech | High Speed | High Quality

Pankl Engine Systems GmbH & Co KG

A member of Pankl Racing Systems

A-8600 Bruck/Mur, Kaltschmidstrasse 2-6

Phone: +43(0)3862 51 250-0

FAX: +43(0)3862 51 250-290

e-mail: engine@pankl.com

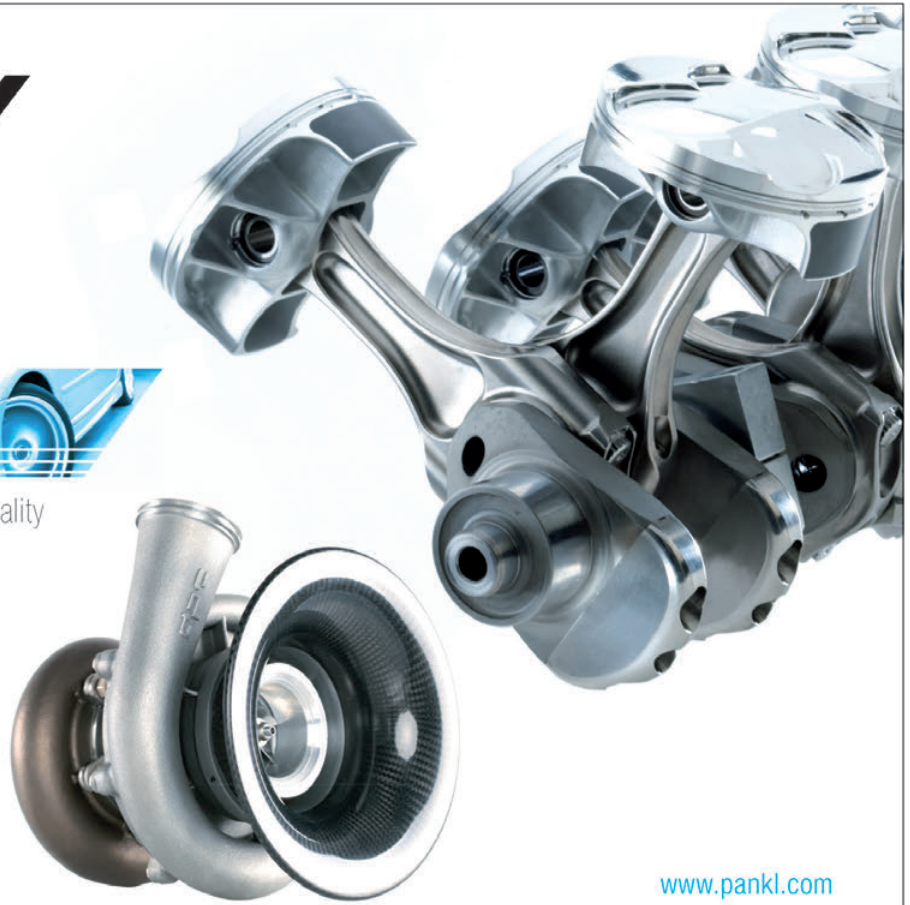

www.pankl.com

NBE
NEILBROWNINGENGINEERING
COMPETITION ENGINES

2016 Championship wins in:-
BTCC Driver Championship: Honda
BTCC Manufacture Championship: BMW
BTCC Team Championship: BMW
DTM Manufacture Championship
DTM Team Championship

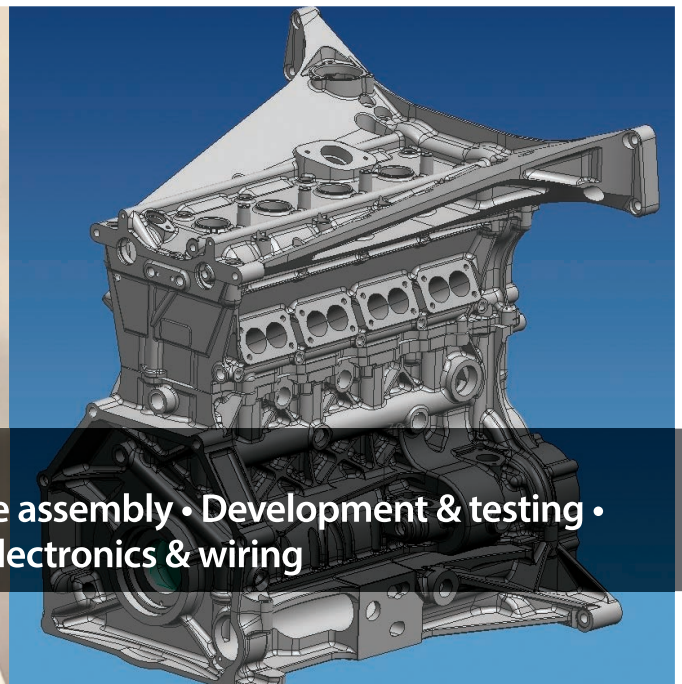

Services & capabilities that we offer:-

• Design • Analysis • Manufacture • Engine assembly • Development & testing •
Test Bed & Calibration • Track Support • Electronics & wiring

Neil Brown Engineering Ltd

Benner Road, Wardentree Lane Ind Estate, Spalding, Lincs, PE11 3TZ

Tel: +44 (0) 1775 723052

Fax: +44 (0) 1775 710570

www.nbe.co.uk

FIND
MORE
FREE
MAGAZINES

FREEMAGS.CC



ABOVE A deck plate (dark grey) was fitted to overcome cylinders 'panting'

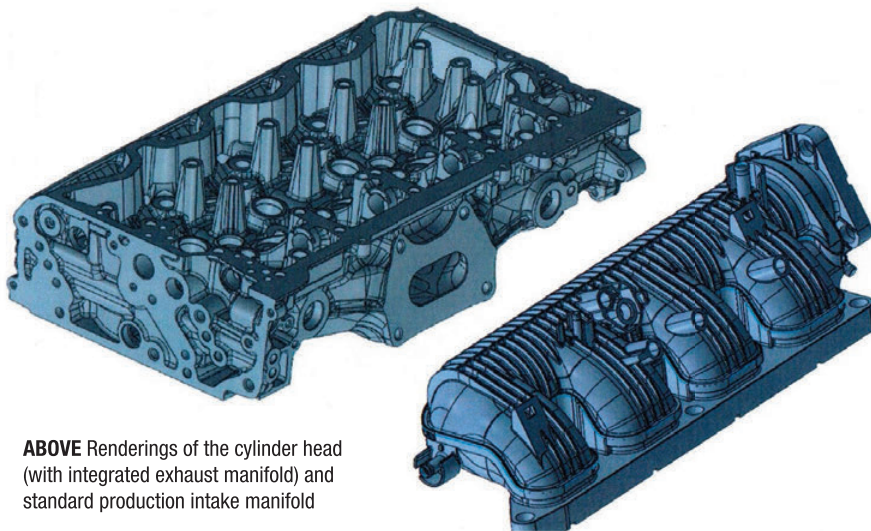

ABOVE Renderings of the cylinder head (with integrated exhaust manifold) and standard production intake manifold

"Within reason, we wanted to get the highest boost pressure we could," comments Brown. "Ultimately, the power potential of the engine is still capped, but it places the turbo in a more advantageous area of its compressor map."

To improve scavenging the engine runs a very short exhaust cam duration (184 degrees where previously it was over 230). The idea behind this is to trap as much of the intake charge as possible, Brown explains.

TOCA does also consider additional parameters such as an Integrated Exhaust Manifold which gave the engine an allowance over the calculated boost limit. Without any means to analyse or simulate the effect of the integrated exhaust manifold, engine dynamometer testing was used to gauge how it compared to a traditional external design. The end result was a 0.16 bar increase from the calculated figure.

The boost pressure limit that was allocated by TOCA is more boost than you'd find on most high performance

road cars, but it's still a relatively modest figure in motorsport circles. Nonetheless, there's a lot of work involved in managing the boost control. Conventional anti-lag systems are banned in the BTCC, but one of the benefits of using direct injection is

that fuel can be injected during the valve overlap period to maintain exhaust energy. Brown says that turbo lag has essentially been eliminated by using strategies like this within the ECU.

FORCE TO BE RECKONED WITH

Perhaps the biggest achievement of this project is that every last shred of development work and a substantial portion of the manufacturing has been carried out in-house by NBE. Although it's a force to be reckoned with in BTCC circles it's still a relatively small company overall with less than 25 people. Nonetheless it has comprehensive manufacturing facilities spread between its two sites in York and Spalding, even including specialist capabilities like cam grinding.

The company has been part of the driving force behind numerous Honda BTCC cars stretching back to the Super Touring era. That looks set to continue into 2017 and beyond, with the engineers planning various refinements to the K20C. There are no plans to change the fundamental specification, but the cam profiles can be tweaked as part of the annual engine balancing process without the need to fully re-homologate.

"The engine has a huge amount of torque low down at present, but we're looking to raise that up the rev range a little bit further," says Brown. "There's also some on-going work to optimise the boost control and improve the cooling."

With four months or so to go before the start of the new season, Team Dynamics will be looking to come back stronger than ever. **RT**



ABOVE NBE's work on the Honda earned it a nomination for *Race Tech's* Race Engine Designer of the Year award

The future of fire suppression ...now extended

zero[®] 3620

FIREMARSHAL

lifeline

To satisfy the demands of a growing number of categories, we have adapted our ground breaking, patented* Zero 3620 fire suppression technology to our new Firemarshal range.

Tested to comply with the FIA 8865 standard, this intelligent series also offers a significant cost benefit over other approved systems.

- Single cylinder dual discharge technology
- Protects cockpit and engine bay
- Meets the FIA 8865 fire suppression standard
- Suitable for unleaded, diesel and E85
- Versatile installation options

*UK Patent No GB2523902



Onboard Fire Safety Systems

zero[®] 3620

zero[®] 360

zero[®] 2000

zero[®] 0



Lifeline safety knows no bounds

In tune with our expertise in fire safety, we have developed a range of ancillary products that include rain lights, quick release steering wheel bosses, race mirrors and rollcage padding.



Champions of Safety

www.lifeline-fire.co.uk

Lifeline Fire and Safety Systems Ltd, United Kingdom Head Office Tel: +44 (0)24 7671 2999, USA Tel: +1 (540) 251 2724, Email: sales@lifeline-fire.co.uk

lifeline

Fire & Safety Systems Ltd.

MAKING AMERICAN PROTOTYPES GREAT AGAIN

IMSA has opened a new chapter of sportscar racing with a DPi category that mates manufacturer-specific bodywork and engines to the global LMP2 platform. **Seb Scott** quizzes Mark Raffauf, director of racing platforms at IMSA

What does the DPi class mean to IMSA?

"The Daytona Prototype international (DPi) class is, in terms of philosophy, a continuation of the existing Daytona Prototype (DP) programme. The finest example of it branding-wise would be the Corvettes. Everybody said that the DP cars were ugly but they weren't designed to be pretty, they were designed to race. If you look back, people begin to realise that this is

the closest sportscar racing in history.

"We had DP cars, which were just steel spaceframe cars with a lot of power and no downforce, against smaller more aero-efficient LMP2s. Trying to get them to go around a track the same way is just not possible. You can match the time but the way they make the time up is completely different, which is where you run into issues. So the future for us is substantially easier than the past because now we're dealing

with the same car underneath.

"We chose this as a development of our existing DP concept using a more modern car and feel that the DP association is a plus. It was a bigger-picture move to base it on a standardised car platform that the rest of the world was using, which is why we're using the new-generation LMP2 cars. We learned that seven constructors cannot build enough cars to stay in business; from our experiences you needed to limit how many people [constructors] participate because they can't all succeed."

Why do the DPis have to be different to the LMP2 cars?

"For the ones who want to profess that the world of sportscar racing is the same, it's not. It has never been the same and it probably never will be. IMSA has always taken a slightly deviant route from the ACO and the FIA because our motorsport here is different.

"I go back to the days of GTP (FIA Group C) and GTX (FIA Group 5) too. IMSA always created something that complements our marketing strategy, which is different compared to Europe. The whole evolution of IMSA, in one way or another, over time has had some connection back to Le Mans – we ▶

RIGHT The intent of DPi is to give manufacturers a platform to demonstrate their roadcar DNA. Mazda's RT24-P, launched at the L.A. Auto Show, conforms to the brand's "KODO Design" ethos, most notably with the grille and badge styling



Photos: Mazda

READY FOR THE TRACK? NOT 'TIL YOU'VE CHECKED WITH VP!

DON'T LEAVE POWER ON THE TABLE.

For 40 years, VP's fuels have earned a reputation for superior power and performance. If you're using or selling race fuel, you owe it to yourself to see how VP Racing Fuels can optimize your performance.



NEED QUALITY PERFORMANCE OFF THE TRACK?



VP Madditives®



VP Small Engine Fuel



VP PowerWash™



VP Sportsman's Containers®

VP's expanded product line incorporates the same leading edge technology for best-in-class performance in a variety of applications.

Contact VP today for more information!
Dealer and Distributor Inquiries Welcome

Marc Wesler
Marc.Wesler@VPRacingFuels.com



MAKIN' POWER!™
www.VPRacingFuels.com

BELOW The DPis feature a pronounced splitter and heavy reliance on flowing air beneath the nose, below the car, and out through the exits behind the front wheels



have Daytona and Sebring which are 'the other two'. IMSA has always recognised and said Le Mans is the Indy 500 of Europe. In those days where we had everybody playing in Group C and GTP, any boardroom in the world with a car company who was involved in this kind of racing would say that the number one prize is Le Mans, number two is Daytona and number three is Sebring.

"They [the FIA and ACO] have the king and we have the queen and the dukes, so to speak. These races have the most credibility to manufacturers. Winning the world championship, winning the Camel GT championship in North America or the JSPC in Japan were always fourth on the list. These individual events have always superseded the championship as a whole; it's because they're the big events.

"We always create a product that fits our marketing situation, which is somewhat unique within the automotive industry. We wanted to give manufacturers the opportunity to create something that captures the DNA of their brand. In doing that, each manufacturer has looked at it differently and taken a slightly different approach: some are mimicking certain elements of cars that exist; others are creating a whole brand style, not modelled on any car in particular but if you looked at it, you would know what brand it represents.

"This is our premium class. These will be the cars that win at Daytona, Sebring and Petit Le Mans. In our marketplace this is the overall winning car."

Mazda, Nissan and Cadillac are well underway with their respective DPi programmes with their chassis constructors. What does the future hold for the new class in both the short and long-term?

"We already have a fourth car coming [for 2017], but it won't be ready for the beginning of the year and there are another two manufacturers now well into the design process – making the decision to invest and to do it is still yet to come from those two though.

“IMSA has always taken a slightly deviant route from the ACO and FIA because our motorsport is different”

"We have four manufacturers already, each with a minimum of two cars; some will have four cars. That's not a bad start and we will have seven of them on the grid at Daytona representing three different chassis constructors. It means that there are seven chassis that have been sold that the [chassis] constructors wouldn't have been able to sell otherwise. The impression from the constructors is that this isn't a bad deal and it is encouraging more relationships. Our job isn't to stop now but is to continue through to 2017, '18, '19 and '20 to fine-tune the process, make it easier and propagate them [the cars]."

How do the new cars look?

"The cars look different, they look very cool. They are aerodynamically disadvantaged a little bit because they look cooler: it's not all function, there's some aesthetic to it. The diversity of the look is also one of the goals and they are attractive – they don't all look the same.

"The overall dimensions of the length, width and height of the DPi cars are the same; manufacturers can play around with the shape of the nose by inserting panelling. The height of the sidepod can be modified

by filling out the sidepod and making it a little bit higher which makes

it appear to be more full but it does create more drag. Finally there is the lighting treatment with the use of LEDs to create the overall image of the car. All of that is combined together to create a unique look and that's what we're looking for."

The 2017 LMP2 car manufacturers have made a step up in performance compared to their previous cars. The gap between LMP1-L and LMP2 cars this year has been incredibly close – sometimes separated by just a second per lap. Are the DPi cars on the same level as LMP1-L?

"From our perspective the entire process technically is to make sure the Gibson- ▶

Open architecture simulators and software that put you in control



With our open architecture hardware and software, a Cruden DIL simulator is a ready-to-run tool that's easily customizable to your needs.

- Works with existing vehicle modelling packages (VI-grade, IPG, CarSim, VeDyna, SIMPACK, dSPACE ASM, AVL VSM, Dymola etc.) or our fully open Simulink Vehicle model (CVSM)
- Apply your own motion-cueing algorithms
- Incorporate your own hardware
- Panthera simulator software suite works with any desktop, static or motion simulator

Cruden supplies flexible, durable, high performing simulators and their modular components: hardware, software (Panthera), vehicle models, content and screens and projectors. We can have you up and running quickly, starting from a desktop application to a full simulator package, backed up with support, maintenance and consultancy.

Find out more - www.cruden.com

Race Car and component development
Driver training
Race preparation and strategy
Race Car set-up

powered LMP2 car is the baseline to which we will tune the engines and aerodynamics of the DPi variants.

"You could take these cars and there are only two things that would need to be adjusted: one is you'd need another 100 horsepower, which some of the engines do have available to them; the second is that they'd need to be a little bit lighter because they are built to the 930 kg weight whereas the ACO is proceeding with 830 kg for the LMP1 privateers. I'm not sure we could remove 100 kg from one of these cars though without taking out the engine!

"The Gibson is a racing engine, though. We're using essentially stock blocks – GT3 production motors which are inherently bigger and heavier. From the bulkhead rearward, the back of our cars are quite different. You have to cool these things differently and they are physically larger and heavier, so there's going to be a little bit of a difference in that dynamic with the Gibson cars which are pretty much the exact same layout."



ABOVE The RT24-P (Road To 24-Prototype) is built by Multimatic/Riley

For some years now the ACO and FIA have struggled to produce a healthy-sized LMP1-L grid because interested parties are often put off by the cost of the class. Would it be wrong to assume that the new DPi platform is a good template for LMP-L?

"The interests of what Le Mans needs and what Asia needs should be decided and managed by the people whose responsibility it is. It wouldn't be proper or fair for me to tell another series what to do and we don't have any export interests at all. DPis are for IMSA as we have a 12-race championship with four big endurance races, a six, 10, 12 and 24-hour race.

"Having something that helps the industry

business model be successful is a plus, so we really saw no negatives other than in some instances there were certain variables that we were going to establish and control ourselves for our events. It has never been 'you need to do what we are doing' from either party; we are doing what we are doing for us and our business. We have to do this because that is the nature of the beast.

"If it does become something that is attractive, it will probably have to be something where those who are involved go to the other players and suggest to adopt this model. It's not for us to tell anybody how to run their events and vice versa. We do try and cooperate in a good way every way that we can." **TI**

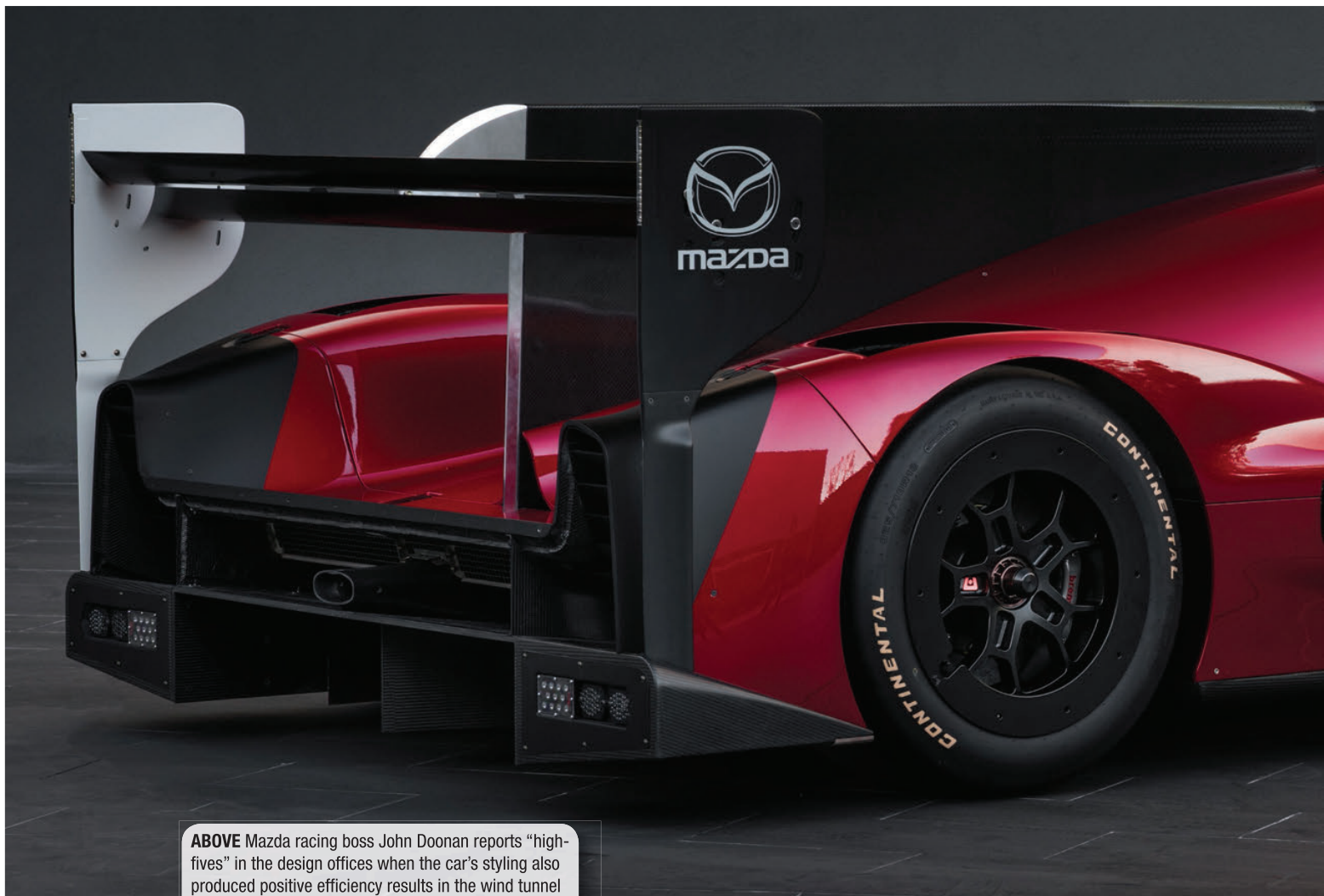

ABOVE Mazda racing boss John Doonan reports "high-fives" in the design offices when the car's styling also produced positive efficiency results in the wind tunnel



APPLY ONLINE
CHOOSE YOUR OWN START DATE

The WORLD'S FIRST ONLINE Motorsport Engineering Degrees

FdSc Motorsport Engineering | BSc (Hons) Motorsport Engineering



CONGRATULATIONS!

Team NMA - Lotus Evora GTE
2nd Place in GTO - GT Cup 2016

Accelerate YOUR Career In Motorsport!

AFFORDABLE - FLEXIBLE - ONLINE

Why Study with NMA?

- 40% lower fees than other universities
- Access to student loans for UK students
- Choose your own start date, no term times or semesters, work at your own pace & study from anywhere in the world
- Mature students welcome - No upper age limit
- Earn while you learn
- No travel or accommodation costs
- Study Online & On-track
- Free industry standard CAD software

* Degrees are awarded by our academic partner Staffordshire University.



Who should do this course?

- Want to improve your career prospects by becoming a highly qualified Motorsport Engineer?
- Work or volunteer in motorsport without a degree?
- Work in the automotive sector and would like a career change into motorsport?
- Want a motorsport degree but can't justify the time/travel & accommodation costs at university?
- Have work or family commitments & need to earn while you learn & study flexibly for your motorsport qualification?

If you answered YES to any of the above, then...

The NMA Online FdSc or BSc (Hons) in Motorsport Engineering are THE courses for YOU!

NMA now has students from SEVEN F1 teams!

+44 (0)1159 123456

<http://motorsport.nda.ac.uk>

A LEAP INTO THE FUTURE

Jenson Button's next car? The F1 star has a Honda deal, loves rallycross and admits that it's on his to-do list in 2017. **Hal Ridge** reports on an innovative GRC Honda that might just suit him...

RALLYCROSS technology has progressed in leaps and bounds in recent seasons but, while gains have been found in almost every area of chassis development, the fundamentals of the suspension design have remained the same. There is a huge debate in the sport as to whether a double wishbone or MacPherson strut system is better, with some teams even using different approaches on the front and rear of cars, notably Munnich Motorsport's Seat Ibizas in the FIA World Rallycross Championship.

One of the great allures of rallycross is a

rulebook that is more open than in other disciplines, allowing for innovation and creation, and the Civic Coupe that Honda campaigned in the American-based Global Rallycross Championship this season, built by Swedish outfit OlsbergsMSE, embraces innovation. Not only is the Civic different from the hatchbacks more commonly used in rallycross, but it features a radical

suspension design.

Having previously run Ford Performance's rallycross programme until a parting of ways in 2015, Andreas Eriksson's OMSE squad – one of the most successful teams in the sport – formed a partnership with Honda USA and HPD (Honda Performance Development). The Civic Coupe was launched in March 2016, aligning itself with the release of the road-going version.

"Everyone thought I'd built a 'Fonda', but now they can see we've built something completely different. In my eyes this is the future of a rallycross car – it's a completely different concept," says OlsbergsMSE CEO Andreas Eriksson, alluding to the fact that onlookers suspected his firm had used its existing platform under the Civic. "I was discussing the future with several manufacturers. Honda asked for a quote and we came to an agreement. I didn't know what car they wanted to use until October (2015), but it wasn't totally finalised until the end of November. We started all the major planning in December and we needed to be ▶

“We were really brave with this car. I took a lot of risks”

BELOW "A good car is not the same as a winning car!" The next iteration of the Civic is being designed to leap to the top of the field



Motorsport Sensors

NEW

Quantum 360

Non-contact position sensor capable of measuring through non-ferrous material



EcoSense

Low-cost liquid level sensor designed for all common fuels and oils



Reventec Ltd
Downton Business Centre, Salisbury, SP5 3HU UK
+44 (0)1725 557203 info@reventec.com
www.reventec.com



THE PERFECT MATCH UP

IQ3S STREET DASH

Performance instrumentation for street vehicles. More than a digital dash, the IQ3s is a complete replacement for your factory dash cluster, providing visuals for standard road functions such as speed, turn signals, fuel level, high beam, parking brake, time, odometer, trip and much more. In addition, the IQ3s can connect to Racepak's optional GPS module, where mechanical speed input is not available and is compatible with over 20 aftermarket stand-alone EFI products.



VIRTUAL DASH APP

Turn your iPhone or iPad into a high tech, on the fly display by wirelessly streaming data direct from any Bluetooth enable Racepak data recorder or digital dash. Our Virtual Dash App is easily paired to your data recorder or digital dash utilizing the Racepak Bluetooth module.

SALES@RACEPAK.COM / 949.709.5555 / WWW.RACEPAK.COM



VISIT US AT PRI-BOOTH #425

ready for April, so it was tight."

Like Prodrive had originally planned with its Mini WRC concept, OMSE had already begun working on its unique rallycross Supercar platform that it could implement into any chassis, so it was ahead of the game when the agreement was reached with Honda.

"We were really brave with this car, I took a lot of risks but at the same time I felt comfortable because we have a lot of knowledge and experience," says Eriksson, who for the first time has had the whole car designed in CAD before work began in the shell-shop at the team's Nynashamn base. "This is the first car that OMSE has built completely on the computer – we can simulate everything. We have a lot of people working on electronic technology, which has moved forward a lot. Five years ago we broke an engine; now the management system just adjusts a little and it's fine. But mechanical development has been lacking for the last 20 years. That's my passion."



ABOVE Compared to its road-going cousin, the Civic Coupe GRC features more of everything – except weight

The Civic uses inboard suspension, more akin to that of a circuit racing car than in their rally or rallycross cousins, but while radical, OMSE has prior experience of the concept, having used it on the single-make GRC and RX Lites support-category cars.

"This idea has advantages and disadvantages. It's the biggest difference on this car (to the others in the field), but we are working hard on it and making it work

well," says Eriksson. "With the Lites car, we had a clean sheet of paper so we could do whatever we wanted, and now we've incorporated that into a Supercar. Everyone needs to remember that this is the first version; I already learned a lot of things that we can improve going forward."

INBOARD SUSPENSION

Like any conventional inboard suspension design, OMSE's Civic has a wheel carrier mounted to a lower A-arm, mounted to bolt-on subframes as per the regulations, and a pushrod, which is connected to a damper mounted 'inboard', inside the chassis at a near horizontal angle. "This way we can get more weight off the wheel, and put the ▶



ABOVE & BELOW Unlike conventional rivals, the Civic uses inboard suspension with the damper mounted inside the chassis at a near horizontal angle (below right)

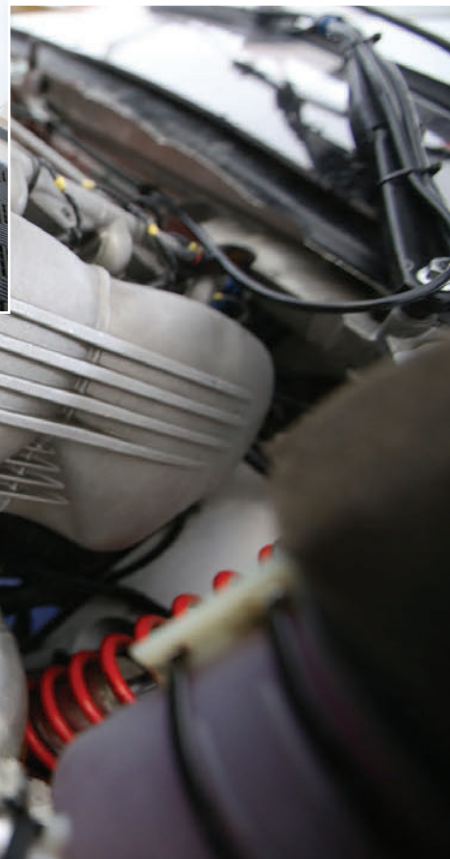

The Lightest, Most Flexible Hose and Fitting Combination Available!

USA North Carolina

704.793.4319

sales@bmrsusa.com

California NEW!

714.415.0080

socialsales@bmrsusa.com

UK Slough

01753.545554

sales@bmrsuk.com

www.bmrs.net



Powerful. Reliable. Lean. PowerBox PBX 90



BOSCH

Invented for life



Visit us at
**ASI in
Birmingham**
January 12 - 13,
2017, Hall 9,
Booth E475



ABOVE The 2-litre turbocharged powerplant was created under the 'custom engine' regulations

dampers in a different place in the car," he says. "It's the same thing as everything else really, but it means the forces through the wheel act a little differently."

Rallycross cars rely on having considerable suspension travel, to deal with big jumps and large kerbs. Eriksson won't be drawn on the amount of travel the Civic has, but says it isn't compromised with the inboard design. "We can do whatever we want; it's the driveshaft that actually makes the restriction. When the car flies, you don't see anything, the dampers are hidden away. I love doing something different, at least people are wondering what is happening!"

MAJOR CHALLENGE

The Swede explains that one of the major challenges of the build was fitting the suspension design into the chassis, around the existing regulations about what can and can't be removed from the standard bodyshell. "It's really difficult to make it fit into the car, that was the biggest challenge, to get it to fit into the FIA box," he says, stipulating that the car has been built to suit both American and World Championship rules. "I wanted the car to be legal everywhere and it is. I worked with the GRC to have the same rules as the FIA. I want the cars to be competitive in both, and it's pretty

close. The differences between the series now are small and if we can keep it that way, it's great to have one car for one sport."

With the car capable of competing in America and world-wide, the team had intended to run a Civic for Swedish driver Sebastian Eriksson (no relation to Andreas) at the Canadian round of the World Rallycross Championship this year, but with the decision made late, ran out of time in applying to have it added to the list of 'cars not homologated with the FIA but eligible in Supercar'. While the focus remains on returning to the GRC, Eriksson

hasn't ruled out the possibility of running the same car or similar in the World Championship in the future.

In 2016, the team ran its Ford Fiestas as a private outfit in World RX. "We couldn't get the paperwork on our side ready [to race in Canada]," he says. "That would have been a great event to test and compare. Honda North America are really keen that I need to get a good result for them in America. The car is competitive, and I know it is good, but I need it to be a winner. A good car is not the same as a winning car so we need to get that sorted and then we will see what happens." ▶



ABOVE This is the first car that OMSE has built completely on the computer

Full Engine Builds/Rebuilds
Machining Services
Full Workshop Facilities



Full Race Car Preparation
Dynamometer Testing
Race Day Support



CADILLAC REBUILT ENGINE



LAMBORGHINI LM002



PONTIAC 461 V8 REBUILD

Cross Street, Burton Upon Trent, Staffordshire. DE14 1EF
Telephone & Fax: +44 (0) 1283 566783 Email: info@competitionengineservices.co.uk

www.competitionengineservices.co.uk

JSW Group



obp
PRO-RACE V3
UNIVERSAL FIT PEDAL SOLUTIONS

available
in 1, 2 or 3
pedal
versions



Put your foot down!

Demand Top Quality

Our most exciting product development to date, the Universal Fit Pro-Race Series has just been taken to the next level.

Pro-Race V3 Upgrades and Benefits:

- Aircraft grade aluminium billet pedals, pads and box
- Hard anodized protected finish
- Left and right and up and down pad adjustment
- Adjustable pedal ratio and accelerator throw
- Super responsive accelerator return
- Adjustable accelerator stop
- DBW and Alcon spec upgrade compatible
- Adjustable clutch overthrow stop
- Upgraded strength and rigidity design
- Incredible Strength Pedals & Box Tested up to 700 Kgs

Telephone:
+44 (0)1487 812 301
www.obpltd.com

obp
MOTORSPORT™



Designed and
manufactured in
the UK



ABOVE HPD's tie up with OMSE saw the collaboration produce a racecar before the road-going version had even been launched

The rules in overall width between the GRC and World RX differ slightly. While in World RX a car can be widened by 70 mm per side, in GRC there is a maximum width to adhere to (1905 mm). "We could make the Civic even wider than it is in the World Championship if we liked," comments Eriksson. "We've made the car so we can adapt it easily." The Civic's panels are of carbon fibre and Kevlar composite, aside from the driver's door and roof, which remain steel as per the regulations.

The Civic's shape lends itself to being aerodynamically efficient, with a large adjustable rear spoiler to aid stability. "Time was too short before this year, but we are planning wind tunnel tests at different scales before next season," says Eriksson. "There

is more that can be done so there will be updates, and it will look more aggressive going forward. We've kept the weight as low as possible in the chassis. Compared to the Fiesta, the Civic's total height is lower. We are trying to keep the driver low as well, but one of the challenges is that because the car is wide, the drivers need to be a little higher so they can see the corners."

Sebastien Eriksson, one of the team's regular drivers, says it feels like a 'proper' racing car. "It felt very good when we got to the first race. Of course testing is one thing and racing is totally different, and we struggled a bit in the beginning because there wasn't much time before the season, but every time we have gone on the track this year we find something new," explains the

GRC race-winner. "The Civic feels like a proper purpose-built race car: it's not like a converted standard car – it's really built for rallycross.

Inside, the drivers have an uncluttered cabin, as one would expect, which is fitted with the mandatory safety features. A Pectel LCD dash is linked to the Pectel SQ12 ECU, and separate Sadev gear-position indicator, as per the regulations. The floor-mounted pedal box is designed by Swedish firm Tibuc, more commonly associated with making specialist engine inlets.

BRAKES MADE FOR RALLYCROSS

While the Civic's suspension configuration is unique, OMSE has used a known quantity for the dampers, which are multi-way adjustable, made by Öhlins. Staying with the same philosophy, the car uses a longitudinally-mounted six-speed Sadev transmission. "The gearbox, diffs (plate and ramp mechanical types) and driveshafts are from Sadev, but we make the propshaft in-house now," notes Eriksson. "We are a big partner to Sadev. We demand a lot from them, but they are very reactive and have done very well for us." Alcon brakes (featured in RT189) are used to stop the Civic and the company is another long-term-partner of OMSE.

"They are really the only company that develops specific brakes for rallycross," says Eriksson. "Rallycross is not rallying and rallycross is not racing; they understand that."

The car uses six-pot front callipers and four- ▶

BELOW Alcon's bespoke rallycross brakes are used

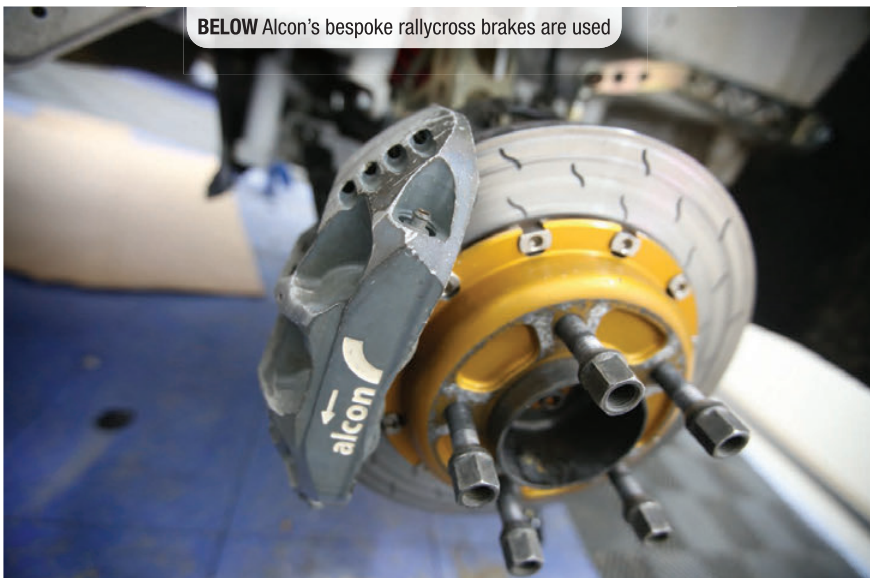

AUTOSPORT'S NEW DOUBLE STANDARD



Andretti Technologies TE Connectivity Test Car

With almost double the number of contacts of standard equivalent shell sizes, the DEUTSCH ASDD Series connectors from TE Connectivity (TE) are a revolution in autosport connector design. The ASDD connectors were developed to bring high density and high performance into the smaller wire sizes racing teams prefer. Featuring conductive black zinc nickel coating, interfacial wire sealing and a sealed insert to prevent moisture ingress, ASDD Series connectors are setting the pace for reliable connectivity in harsh autosport environments.

Connect with TE to learn how our high-speed connectivity solutions for autosport applications can give your team the winning edge at te.com/autosport



©2016 TE Connectivity Ltd. All Rights Reserved. DEUTSCH, EVERY CONNECTION COUNTS, TE, TE Connectivity and the TE connectivity (logo) are trademarks of the TE Connectivity Ltd. family of companies.

EVERY CONNECTION COUNTS



Surface Engineering



Coatings



Decorative Finishing



Engineering Consultancy



Specialist surface engineering solutions

Sandwell are world leaders in surface engineering, offering a wide range of innovative solutions to help you meet your engineering challenges. Whether it involves specialist shot peening, bead blasting, specialised coatings or even decorative finishing, our team of experts can provide the right solution for you.

Contact us today to see how we can help improve performance and durability of your components.

Sandwell UK Ltd, 2 Foundry Place, Towcester, Northamptonshire NN12 6FP
Telephone: +44 (0) 1327 350205 Email: sales@sandwell-uk.com

Sandwell 
shot peening & specialist coatings

www.sandwell-uk.com



pot rear, with vented discs, inside 17x8 KMC wheels. "We try to make everything as light as possible but it also needs to work. If you make it too light you can get too much heat and lose the brakes. It's all a combination."

Eriksson says that while the weight of the brakes is key to getting the rotational mass moving in a crucial phase of a rallycross race, there are more factors involved: "It's about gear ratios, power, where the power band is, the weight of the wheels, but really the limitation of all rallycross cars is the tyres, because that's what we have. It doesn't matter what we do around it, if you don't get the grip out of the tyre – you're done." The GRC uses a control BF Goodrich radial tyre, as opposed to World RX, which uses Cooper crossply rubber.

Like the more conventional suspension orientation options, another well-trodden debate in rallycross is over engine

orientation: transverse or longitudinal.

Eriksson's OMSE cars have been long-serving longitudinal machines, and the Civic continues that trend. "We are in-line with our engine, and it's a good question why we have done this way," he says. "I've tried both, there are advantages and disadvantages to both, but we have our own concept that I like and believe in."

While a longitudinal layout gives a more even weight distribution over a transverse car, making it potentially more stable and predictable, Eriksson also sees benefits of a transverse layout: "You can lower the engine a lot and get the weight really low down that way, so there's two different ways of looking at it."

The Civic's 2-litre turbocharged engine is created under the 'custom engine' regulations, an amalgamation of OMSE technical expertise allied with long-term ▶

Civic Coupe GRC Spec List

Bodyshell	OMSE
Engine	OMSE/Mountune
Radiator	OMSE
Intercooler	OMSE
Management	Cosworth
Dash	Cosworth
Seat	Sparco
Harnesses	Sparco
Pedal box	Tibuc
Gear indicator	Sadev
Fuel cell	Merin
Transmission	Sadev
Brakes	Alcon
Dampers	Öhlins
Wheels	KMC
Air filters	K&N

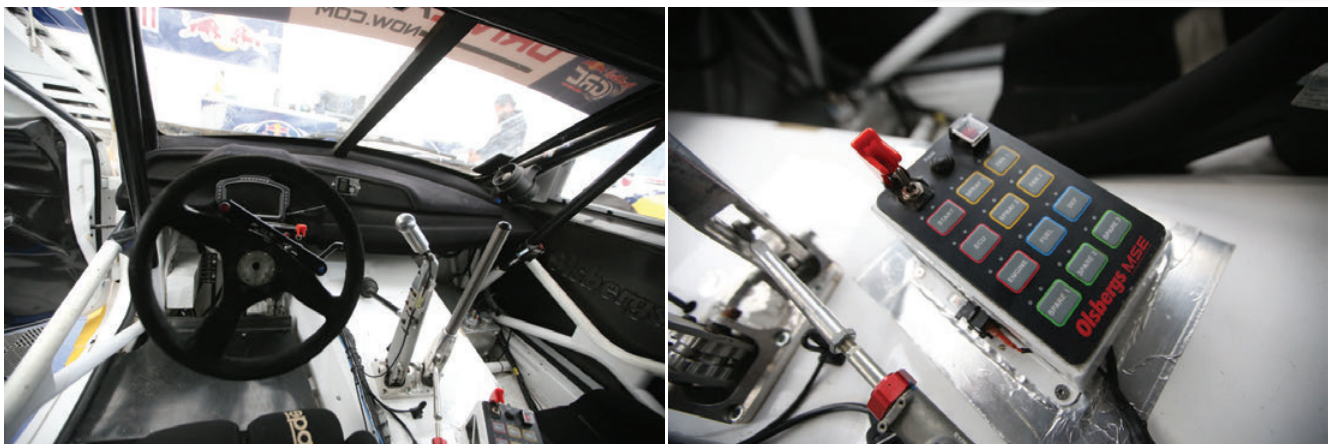

ABOVE & BELOW Inside the Civic's uncluttered cabin



International Endurance Series • FIA World Endurance Championship • Continental Tire SportsCar Challenge • Pirelli World Challenge • Trans Am Series • British Touring Car Championship • FIA Formula One World Championship
 FIA European Drag Championship • V de V • F1 Powerboats • Rallycross Lites • FIA World Rally Championship
 NHRA • NASCAR • IndyCar • IMSA SportsCar Championship • Global Rallycross • FIA World Rallycross

Please see us at
 PRI Booth: 4128



Specialists in Wiring Harnesses and Electric Power Assisted Steering for Motorsport.

DCE can also provide hardware for:

- Bosch M4 ABS
- Sensors
- Pneumatic Paddle Shift
- Data Acquisition
- Engine Management
- Lithium Batteries



USA Mooresville, USA
T +1 (704) 230 4649
E salesusa@wiringlooms.com

UK & Europe Maldon, UK
T +44 (0)1621 856451
E sales@wiringlooms.com



World Leading Performance



MANLEY Valve Train Upgrades

- » VAC High Performance Valves & Springs
- » Essential for High HP cars
- » For BMW N54, S65, S54 and more



ATI Harmonic Dampers

- » VAC Exclusive for BMW M50, S54 and MORE!
- » Unbridles Horsepower and unleashes torque
- » Reduces engine wear from reduced vibration



Billet Dry Sump Kits

- » Increases HP and Reliability
- » 4-cyl, 6 cyl, V8 & V10 applications
- » Full Kits with Pumps also available



tilton Clutch & Flywheel Kits

- » Rally, Race, & Carbon Clutches
- » Lightweight Flywheel included!
- » Twin & Triple Disc Clutches in 5.5" & 7.25"



SCHRICK



+1.215.462.4666

www.vacmotorsports.com

2501 Snyder Ave, Philadelphia, PA 19145, USA

sales@vacmotorsports.com



ABOVE & BELOW The radiator is relocated to the rear of the car, fed by ducts in the rear quarter panels, with warm air evacuated through the tailgate



engine partner, Mountune. "The engine is completely new," says Eriksson. "Mountune put it together but it's an OMSE engine that I'm really proud of. I was worried about the engine because one of the biggest problems was that we couldn't run an engine of the make with such short development time, but the custom engine regulations [where any 2-litre engine can now be used in a rallycross Supercar as long as the components fit within strict dimension and weight regulations] have made it possible. There are a lot of restrictions. You could actually make an engine of the same make even more powerful, but a custom engine you can make stronger."

Bolted to the engine is a custom-made inlet and exhaust manifold, specifically designed for the installation, while the Garrett turbocharger houses a regulation 45 mm restrictor. Eriksson won't commit to any further details about the motor in the Civic, but in ballpark figures for a rallycross Supercar, power will be in the region of 600 bhp with approximately 800 Nm torque.

As with every professionally-built rallycross

Supercar, the radiator is relocated to the rear of the car, behind a bulkhead fed by ducts in the rear quarter panels, with warm air evacuated through the tailgate. The repositioning gets the radiator out of harm's way, be that through contact or dirt and dust, while it also frees up room for the largest intercooler possible up front. Both items are made especially for OMSE. Asked about the challenges of moving the water from the front to the rear of the car, Eriksson simply replies: "When you know how to do it, it's easy."

The fuel tank, located in the floor behind the driver, is made by Merin and complies with 2017 GRC regulations, having a 30-litre capacity.

The minimum weight limit in the GRC (1330 kg) is 30 kg higher than in World RX, and the Civic started the year 80 kg too heavy. That is an area on which the team has worked hard during 2016, and gives reason for Eriksson to be confident ahead of next season, on top of a raft of other upgrades: "Running a C model car

means it's really hard and expensive to get the weight down, and the project came together so quickly. We have a lot planned and next year we will be ready."

The face of rallycross is changing. Honda elected to team up with OMSE to promote and market a new road-going version of the car, similar to Ford's approach with the Focus RS RX in the World Championship. A few years ago, manufacturers wouldn't have considered rallycross an option for aiding the launch of a new vehicle onto the consumer market.

YOUTH MARKET

"The Civic is one of Honda's most important products. It's a product that's aimed at the youthful market and that aligned really nicely with a programme in rallycross," says Marc Sours, HPD's chief engineer and technical advisor to the rallycross programme. The marque explored a number of options of who to work with before settling on OMSE: "We did due diligence, but in the end, OMSE has been very successful on this particular form of racing and we've been pleased with the partnership. The collaboration of Honda working with their experience has been a good mix, and we're very pleased with the podium finishes we've had this season."

A number of M-Sport-built Ford Fiestas and the works-backed Volkswagen Andretti Autosport Beetle team (that has escaped Volkswagen's 'realigning' of motorsport activity and will remain in 2017) compete at the front in the GRC, but in the hands of regular drivers Sebastian Eriksson and Finn Joni Wiman, the Civic scored five podiums in 2016. It was a solid starting point on which to develop for the new concept.

"This car wasn't sold before we launched the race version, so I'm privileged to have built a car that wasn't even on the road, and now we see the sales numbers of the Civic in America, it's fantastic. I'm lucky to be part of something like this," says [Andreas] Eriksson. "The timeline was really tight before the start of the season, but HPD have helped a lot with the project – they have a lot of knowledge. It's a new world to work with them, and I think we can really improve moving forward. The technology we have today compared to what we had 20 years ago is amazing, but I don't think it's even close to where it could be and we will keep pushing. Hopefully in 10 years' time we can look back and see that we really did something with this." 

HOLINGER AMERICA

GEARED TO WIN

GEARBOXES
DIFFERENTIALS
PADDLESHIFT
DRIVELINE COMPONENTS

ENGINEERING
SERVICE
MAINTENANCE



FORD Mustang GT4

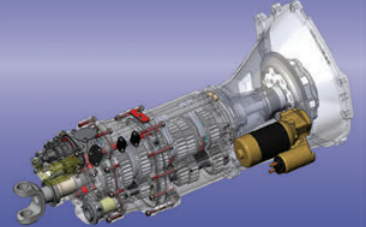

HOLINGER: Proven performance as an OEM.
Large enough to go global, yet extremely flexible, efficient, and close to our customers.
With three key locations, we are accessible nearly around the clock:

PRI #740
Autosport #E680

HOLINGER
AMERICA

Aliso Viejo, CA USA
T +1 949 362 8750
www.holingeramerica.com
info@holingeramerica.com

HOLINGER
ENGINEERING

Kilsyth, VIC Australia
T +61 3 9761 7964
www.holinger.com.au
info@holinger.com.au

HOLINGER
EUROPE

Petting, Germany
T +49 8686 984426
www.holinger.de
info@holinger.de

Paoli UK is coming!

In 2017 Paoli will get you **Paoli UK** to be closer to the UK customers!

Please download our new catalogue 2017
from our official website www.paoli.net



paoli[®]

Dino Paoli S.r.l.
Via G. Dorso, 5 - 42124 Reggio Emilia - Italy
Tel. +39 0522 364511 - Fax +39 0522 304864
www.paoli.net - sales@paoli.net



ABOVE & LEFT HPD buys bodies-in-white from the factory, so can offer chassis, engines and a host of components to potential racers

the chassis components to them but when Andreas Eriksson, the team's CEO and team principal, pointed out that the car was still a little heavy, it ended up going back to the factory where special parts that didn't apply to the chassis were made to reduce weight. It was an amazing co-operative agreement. It's a great way to get involved because you go with someone who is experienced, who knows what to do and you can learn about the environment and how it operates at fairly low risk.

"Technically the series has some very interesting things that we are looking at for the future," continues Eriksen, "as we are currently in the managing stage and not diving into the technical details, but having gone to the Los Angeles race for the season finale and talked to the organisers about the rules and regulations, I think there are some very interesting things we can do there."

Eriksen and his marketing colleague George Harmon are excited by prospects that the series offers, especially as it is reaching a younger generation, one that has taken

“ *The latest versions of the Civic have become wildly popular* **”**

in large numbers to the Civic. "The latest versions of the Civic have become wildly popular, selling even better than the Accord," he says. "We're trying to capitalise on that with the GRC programme while also raising the level of support to those folks who want to race the car. As we showed on our stand at SEMA, we buy bodies-in-white from the factory that racers can purchase as well as engines, clutches, brakes, suspension and a whole list of components. It means that our customer can build up a racecar properly rather than buying something from the junkyard that has a lot of the things you don't want on it."

Looking ahead, Eriksen is encouraged by what he calls noises coming from both IMSA and the World Challenge: "There's some new direction coming from both IMSA and World Challenge with hints that they may be bringing TCR to the US. I think that's a perfect match for the Civic as TCR by definition is purely front-wheel drive cars and that matches our production direction very well." **IT**

CIVIC DUTIES

Steve Eriksen, vice president and COO of Honda Performance Development, tells **William Kimberley** that the GRC campaign is paying dividends by helping reach a younger generation

As the vice president and chief operating officer for Honda Performance Development, Steve Eriksen and the management team there are responsible for all the racing activities of American Honda, its parent organisation. As with the motorsport arm of many car manufacturers, its job is to win races but at the same time it has to stand on its own two feet financially.

The parent company may dictate "pinnacle" series in which it wants to be involved, such as being an engine supplier to IndyCar and the forthcoming Acura NSX GT3 programme as reported in the November (192) issue of *Race Tech*, but in other areas it is down to HPD to evaluate the return on investment. Its racing activities are wide-ranging and include the Ridgeline Baja Race Truck, the US Formula 4 championship, karting, Midgets and Quarter

Midgets and a whole slew of grassroots motorsport series. However, the most high profile series in which it is currently involved is Global Rallycross.

Rather than develop the car itself, it handed that responsibility to Olsbergs MSE, the specialist engineering company that has so successfully carved out a niche for itself in this branch of the sport.

"We've never been in GRC before and American Honda was looking for a turnkey solution to get started and Olsbergs MSE represented exactly that as it has so much experience," says Eriksen. "We provided the bits of the Civic that they needed and they went ahead and produced the car which has been pretty competitive out of the box with a number of podiums in its first season."

He comments that the relationship with Olsbergs MSE has been successful from the outset. "We were supplying a lot of



Deliver On Track with D.O.T

It's on the track where it matters. Everything else is merely a distraction. When it comes to logistics, this distraction can become expensive and time-consuming.

Delivered On Time have over 80 years of collective experience in global motorsport logistics including Formula One, WRC, Superleague Formula, Macau GP and A1 GP World Cup of Motorsport as well as global events like the Olympic Summer and Winter Games and the FIFA Football World Cup.

D.O.T are therefore ideally placed to support your efforts in the ALMS, as well as the WEC and the 24hrs of Le Mans.

Our services include:

- Express service within the USA and Europe for all motorsport events
- Dedicated project team for total event logistics
- Air and sea charters to meet your event requirements
- In house ATA Carnet service – easing movement of your operations
- Network of approved international agents
- Round the clock operations, 365 days a year
- Ability to move cargo via air, land and sea
- Customs clearance anywhere around the world

Contact us today to find out how D.O.T. can help you make the most of your logistics so you can focus on what really matters.

T: +44 (0)20 8890 5511

W: www.deliveredontime.com

E: sales@deliveredontime.com



ALL EYES ON INDY

With more than 1000 exhibiting companies set to unveil their newest racing products at the 2016 Performance Racing Industry (PRI) trade show in Indianapolis from 8-10 December, **William Kimberley** has a look at just some that have caught his eye before the doors open

THE PRI Show in Indianapolis has long been the Mecca of the motorsport world where buyers from around the globe gather to do business in every segment of the racing industry. From engine parts, suspension components, data acquisition and safety gear to new metal alloys and coatings, machine equipment and race electronics, every race product and accessory imaginable will be on display at the Indiana Convention Center in Indianapolis.

ARP, for example, will be displaying several new kits and applications for 2017 adding a total of 22 pages to its catalogue. "Our R&D department has been working pretty well flat out," says Chris Brown, ARP's specialty products director, "as we believe it's important to keep coming out with new applications. We have revisited some of our earlier kits and also increased our diesel offerings."

Brown highlights the Ford EcoBoost engine, ARP developing a wide range of kits for the different variants: "The turbocharged 2.3 EcoBoost is available in the Mustang in Europe and there's a great opportunity to get more power out of it, usually involving increased boost pressure. This means more load on the cylinder head, so more load on the bottom end so it was a no-brainer to develop kits for it, as it was with the 2.0. However, the 3.5-litre V6 EcoBoost also presents opportunities. The great thing about the globalisation of the automotive industry is that what used to be unique to just one market is now worldwide."

Piper Cams has been designing and manufacturing performance camshafts and exhausts since the late 1960s and is returning to the PRI for the sixth time where its latest range of products can be viewed. These include a VVT delete kit for the Subaru FA20 engine which is half the weight of the

normal pulleys, so reducing a great deal of mass. "The VVT mechanism is made out of steel and very heavy," says Piper Cams' technical director John Crabb, "but ours is all alloy and so saves around four kilos."

For the track day and high-performance market **Ferrea Racing Components** has developed its range of Competition Plus valves that are manufactured using special aerospace quality alloys, including the EV8-Z18, which provides high tensile strength. An exclusive two-step slow forging process ensures proper grain flow and virtually eliminates any damage to the material structure. The valves are then heat-treated and stress-relieved over a 48-hour period, which is the crucial base of the molecular integrity. These valves feature avionics-quality hard chrome along with a specially applied hard tip.

A recent addition to the range is the Gens 4 and 5 Dodge Viper, Ferrea working with New Jersey company **Headgames Motorworks** on cylinder head development. When turbocharged, the notor delivers in excess of 2000 bhp. ▶

BELOW Ferrea has developed many applications for the Honda K-series

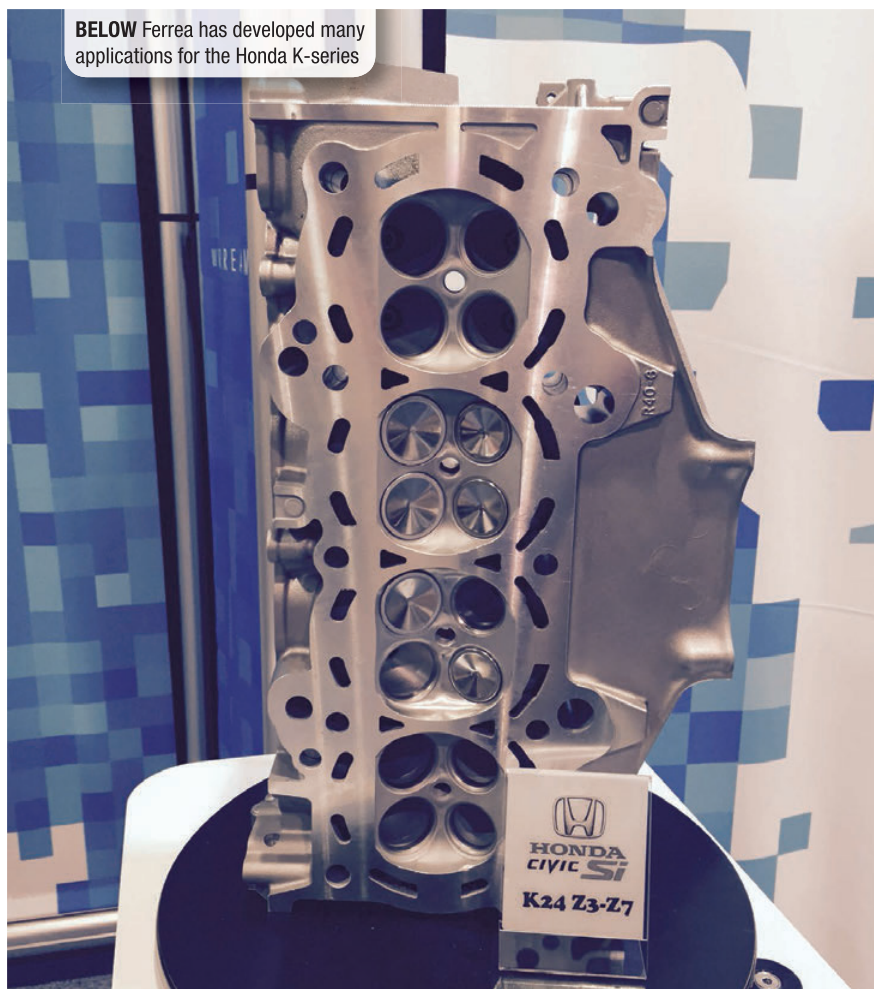

CHAMPIONSHIP WINNING ELECTRONIC & ELECTRICAL SOLUTIONS

FOR THE MOTORSPORT INDUSTRY

With experience in F1™, Moto GP, LMP1, LMP2, GTE & GT3, WRC, WTCC, IMSA, IndyCar, NASCAR and Rally Raid, we have a comprehensive understanding of what it takes to design and produce championship winning motorsport equipment

TYRE PRESSURE &
TEMPERATURE MONITORING

FORCE MEASUREMENT

WIRING HARNESSES

COMPOSITES



Professional
MotorSport
WORLD EXPO 2016

COME AND SEE US ON STAND 5038

+44 (0) 1379 646200

bf1systems.com



Booth 1840
Visit us at PRI

WOSP



www.wosperformance.co.uk



Alternators

Starter Motors

Dynators

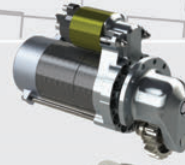

BESPOKE STARTING AND CHARGING SYSTEMS

Supplying OE based units to the classic, vintage, race and bespoke car market for over 25 years catering for vehicles from 1908-2017 and race series including WRC, WEC, WTCC and Le Mans.



Who's starting & charging you?

O.E. QUALITY.
NO COMPROMISE.



BELOW PRI remains the Mecca of motorsport

"Most of the OE-type valve springs and retainers are not very reliable, especially when the motor is turbocharged, while for the normally aspirated with larger cams, compression, the reliability doesn't always hold up as well, which is why we have developed this range," comments Zeke Urrutia, director of marketing at Ferrea. "We see this as being an important growing market for us."

The Honda K-series is proving to be very popular with engine builders. As such Ferrea has developed many applications for it. "While the Honda B-series remains a decent market, a lot of the guys have graduated to the K-series as it's so much more available and for the price, and especially the dynamics of the cylinder heads powerwise," says Urrutia. "We already have a full set of valves, springs, retainers and locks for that application which is more geared for street performance. We're really expecting 600 bhp but not any further with this engine. Turbocharging it may be the priority in a lot of these builds and so we're upgrading most of the materials into the Competition Plus series, and especially the valve springs and the retainers."

The refuelling bottle has been the same for a very long time but the European side of **Aero Tech Laboratories (ATL)** has come up with a bit of a redesign, primarily to make the bottles a little bit easier to use and handle while also making them even

more accessible pricewise. "Where the previous design had some machined items on to achieve a twin filler or a neck of 135 degrees as needed on some cars, we've now incorporated the option to go 135 degrees into the bottle design through the clever use of moulded hose that has allowed us take out a large piece of expense," says James Gornall, ATL's sales manager in Europe. "It now means that the twin ones or the 135 degree neck options are quite a bit cheaper, approximately around £200.

"The twin red head is a very quick valve if you are looking for some good endurance racing equipment, and is spec'ed on the new GT3 Corvette and the Mercedes AMG GT. It's also on both sides of the Aston Martin and we have a particular bottle variant that enables this."

There will be the usual array of hoses on display at the **SamcoSport** stand, including its Samco ProFuel, the world's first performance silicone hose for permanent fuel use.

All its hoses are designed, tested, hand-crafted and "Made in Britain" from the finest quality European-sourced silicone and reinforcing fabrics, specifically designed for automotive use. The company claims that its high-grade silicone offers much better stability at the high operating temperatures and pressures encountered during racing. Additionally, flow rate and heat transfer to the radiator can be

improved whilst expansion and deformity under load is reduced.

Its hoses meet or exceed the requirements of SAE J20 and are manufactured under an ISO 9001:2008 quality system. Its hoses are also available in a wide range of original and premium solid colours as well as SamcoSport's unique designs.

A new series of pedal assembly will be seen on the **Tilton** stand at the PRI, that slots in between the clubman level 600 Series and the 900 Series for the high-end professional teams which have pivot mount masters and a fixed "gimbal-type" balance bar that virtually eliminates brake migration through the braking zone.

"We've taken the 600 Series pedal assembly and adapted the pivot-mount master cylinders to it as well as a high efficiency version of the standard balance bar that keeps it in the horizontal plane," says Kirk Skaufel, Tilton's director of sales and marketing. "It improves efficiency and allows the use of the pivot mount master cylinder, so you're getting 95% of the performance on the 900 Series pedal assembly at a price point that's a lot closer to the 600 Series. The 600 Series is about a \$200 assembly and the 900 Series around a \$1500 pedal assembly and this new range will be about \$560.

"At the same time we've redesigned the pivot mount master cylinders that used to be referred to as the 77 Series rear pivoting ▶



**STAND WITH US
OR RACE AGAINST US**



Tech Line: 954-733-2505 • Toll Free: 888-733-2505 • www.ferrea.com

FOLLOW US ON:   

CELEBRATING



epr: technology group
ENGINEERING MOMENTUM

composite motorsport components

F1, IndyCar, LMP, WRC

single components to complete assemblies and tooling
from chassis to bodywork to suspension, to high-temperature applications

100% confidentiality

t: 01332 680420
e: sales@epmtechnology.com
www.epmtechnology.com



aerospace | automotive | bespoke | defence | motorsport

master cylinder – designed to be used with the 900 Series pedal assemblies – but are now the 78 Series. The two are directly interchangeable.”

78-Series master cylinders offer the latest in racing master cylinder technology in a very lightweight and compact design. The rear spherical bearing mount and one-piece piston/pushrod eliminate side thrust into the master cylinder bore, providing consistent and repeatable braking.

“When we developed the 78 Series we also found ways of reducing the cost of manufacturing so we’ve dropped the price by 40%,” says Skaufel. “We also made improvements to the master and have incorporated a dust boot that we’ve never had on them before. We’ve also put an external return spring within that boot, so it’s a lot more positive. We’re trying to provide the Pro-Am level guy with the benefits of a pivot mount master cylinder system at a price that meets their budget.”

The **ZF Race Engineering** engineers have developed a new damper generation in keeping with the STTV principle – the Single Tube Twin Valve design – a modern solution with a double pressure valve. The spring platform height is adjustable and it is offered with either a 36 or 45 mm piston diameter.

When compared to dampers with external gas reservoirs, the internal gas reservoir has significant advantages regarding installation space and weight. Depending on the design and component size, these benefits can be as much as 15 per cent. Additionally, the interior base valve also permits higher damper rates in the bump direction. Furthermore, greater scope arises for the damper curve configuration. Instead of a bump rate increase, customers

can also decide to reduce the gas pressure. Noticeable handling dynamic advantages arise as a result.

ZF Race Engineering has defined a particularly wide range of applications for its new design. The damper and suspension strut were conceived specifically for touring cars and GT models in motorsport. At the same time, owners of sporting, high calibre tuning cars can also rely on the advantages of the new solution.

Also to be found on the ZF Race Engineering booth are the Sachs Performance coil over dampers. The mono-tube struts follow the upside-down principle, which ensures greater stiffness and a reduction in unsprung mass and permit the vehicle ride-height and damping characteristics to be changed. The valve system allows flexible damping characteristics, with damping force adjustment made via a bypass on the piston. A big advantage for users is that the adjustment is user-friendly because the bump and rebound is adjusted simultaneously by a click.

The company will also be displaying the innovative Sachs Anti Stall Clutch that prevents the engine being stalled at the start of a race. The system combines the advantages of a centrifugal clutch with the proven friction package of a multi-plate clutch and, at the same time, retains the option of manual clutch activation.

The Anti Stall Clutch’s friction package is no longer activated by the familiar diaphragm spring but a new mechanism. The forces used in a centrifugal clutch are diverted by a special rocker arm in the axial direction. Despite a net weight in the low two-digit gram range, these centrifugal weights can generate a contact pressure of up to four tons. The reason for these high values is that the forces increase to the square of the actual rotational speed.

The engineers constructed a new clutch housing to guarantee the rigid redirection of these centrifugal forces. In contrast, the clutch plates and drive plates of the two- or three-plate clutch modules available originate from well proven product ranges. Each of the 140 mm diameter plates transmits up to 250 Nm of torque – in other words, the two-plate version transmits up to 500 Nm and the three-plate version as much as 750 Nm.

Thanks to this system the starting procedure can be made with lower engine revs in the future because the clutch prevents system-related rev drops or even the engine stalling. These low revolutions significantly ease the load acting on the friction linings. For this reason, ZF Race Engineering relies on sinter linings for the Anti Stall Clutch. They have a higher static coefficient of friction than carbon clutches. Furthermore, the wear behaviour of sintered metal in the case of so-called ▶



ABOVE The new Sachs Performance coil over damper was originally conceived for touring cars



Pro Alloy Motorsport, 15 Rookwood Way, Haverhill, Suffolk, CB9 8PB

SPECIALIST **MOTORSPORT** ENGINEERING



Pro Alloy Motorsport are one of the leading manufacturers of alloy radiators, intercoolers, fuel systems and specialist alloy motorsport products. Our products are built to exacting specifications by craftsmen and technicians who have honed their skills from many years of intensive research, development and fabrication. From race cars to fast-road, through to thoroughbred classics, Pro Alloy has the solution to ensure your car stays ahead of the competition....

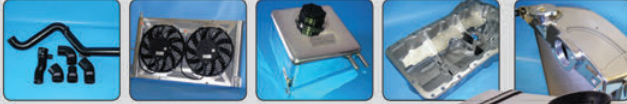

BESPOKE MANUFACTURING

Pro Alloy Motorsport specialise in one-off and small batch runs, working from drawings, photographs or physically on the car itself. We are happy to produce bespoke items such as radiators, fuel tanks, intercoolers, custom pipe work + more.

☎ 01440 710266

🌐 www.proalloy.co.uk

@ sales@proalloy.co.uk

🐦 Tweet Us @ProAlloy 📘 facebook.com/proalloy.motorsport

www.proalloy.co.uk



FLURO-Gelenklager GmbH



Call us first...



Unit 23 Silverstone Circuit Towcester Northants NN12 8TN
T: 01327 857822 F: 01327 858096 www.tridentracing.co.uk



www.bredaracing.com

tyres trolleys stands telai engine-gearbox trolleys sollevatori wishbones pit gantries wheel nut sockets toe bars machine rifornimento benzina leve sospensioni cavalletti customized equipment ruote set up quick release jacks set up scales pit stop equipment dal 1988 nel motorsport frames uprights zimmers roll bars set up wheels motorsport passion barre assetto air jacks bussole dado ruota attrezzature pit stop portamozzii pit wall stands refuelling systems quick jacks weighing systems



BREDA RACING

Tel. +39 049 9070456 Fax +39 049 9070472 Info@bredaracing.com
Padova - Italy

BREDA RACING NORTH & SOUTH AMERICA
EXCLUSIVE REPRESENTATIVE & DISTRIBUTOR

CASELINER
MOTORSPORT PIT EQUIPMENT
AMERICA

CaseLiner® America, LLC
Lafayette, NJ 07848 USA
Info@caseliner.us



ABOVE StopTech's Circle Track Kit

micro-slip is more favourable than that of carbon fibre. This increases the service life of the design. Customers benefit from this decision in terms of price as well. Despite the greater design complexity of the centrifugal mechanism, the price of the Anti Stall Clutch is comparable to that of a depression-operated carbon clutch.

Californian brake company **StopTech** is releasing a new circle track programme for Late Model Dirt and Late Model Asphalt. It includes adapter rings for discs (rotors) so they can be converted to floating ones, and calliper brackets – the callipers will all be radial mount – that will allow the calliper to be spaced depending on disc selection.

"If you run different disc thicknesses or ones with different diameters, the bracket allows the calliper to be moved to where it needs to be centred on the disc," says Mark Cornwell, StopTech's vice president of sales and marketing. "This way the team has flexibility on what it puts onto the car without reinvesting in the whole system over and over again.

"The other complement to the whole system is that we've re-engineered our small callipers to be as light as possible, especially for the Dirt market because the brakes aren't being used in the same way as in an Asphalt car with typically lower line pressures, so we've really tried to scale the callipers to lower the weight. We've also made the rotor selection where there's very lightweight options and that way the Dirt track racer can potentially lose around six to 14 pounds in the system with a lot of that weight being rotating and unsprung.

"As you go to the Asphalt market, we've built a new front calliper because it needs to be much larger while the lightweight

Dirt callipers can be used on the rear axle because the rear on an Asphalt car does very little work. That system being the callipers, the rotors, the adapters for the rotors, plus direct bolt-on replacement rotors and a line of racing brake pads for Dirt or Asphalt is offered where it's configured into Dirt Lightweight or Standard and also Asphalt road racing and circle track."

There will be a great deal to see on the **Essex Parts Services** stand which is the US distributor for **AP Racing** which is showing six new entry level brake callipers. Featuring innovative Radi-CAL technology, the callipers represent the next generation of the popular Pro 5000 range and set the benchmark for value and efficiency.

The CP9446 is a four-piston calliper suitable for general competition use. It has a forged two-piece alloy body and benefits from a radical asymmetric design concept, offering superior dynamic performance. Featuring a radial mount with 180 x 35 mm centres, the calliper suits discs up to Ø380 x 32/28 mm thickness. The smaller bore version, CP9447, is of the same design but is suited for rear applications.

The four-piston calliper CP9448 is of comparable design, including a forged, two-piece alloy body featuring a radial mount with 152 x 44 mm centres, being suitable for brake discs measuring Ø380 mm x 32/28 mm thickness. It is suitable for front applications and benefits from a four-pound anti-knockback spring fitted as standard.

The CP9449 is a four-piston calliper suitable for rear brake applications. It features a radial mount of 152 x 44 mm centres, suiting discs up to Ø380 x 32/28 mm thickness. The CP9450 and CP9451 are comparable but utilise different sized pistons.

These latest additions to AP Racing's Radi-CAL range feature an integral pad retainer that is designed to enhance calliper stiffness as well as stainless steel pistons and wear plates. A bolted pad retainer with a quick-release spring clip is also supplied.

Alcon's product range continues to grow, one of its latest being the RC6 aftermarket calliper that won the prestigious Global Media Award at SEMA in November. Manufactured from forged alloy, it's suitable for fitment with a wide variety of discs with a diameter of between 380 mm and 410 mm and with a width of between 34 mm and 36 mm.

On a smaller scale is the RC4 calliper that can accommodate discs with a diameter of between 330 mm and 360 mm, and with thicknesses of between 28 mm and 32 mm.

With so many amateur rally cars running around on **Bilstein** shock absorbers, the company has introduced a new range to cater for this market, especially as some of the cars onto which they're fitted are now quite long in the tooth. However, it has taken the opportunity to improve their efficiency and precision with the use of new material and technology. While they are physically a little larger than the originals, although they are direct replacements, Bilstein has ensured that they remain relatively inexpensive compared to some of the more sophisticated products in its range.

Reventec, the company that has been behind some cutting-edge technologies in its short life, has now come up with the EcoSense liquid level sensor series, developed to address the need for a ▶



ABOVE Reventec's new EcoSense liquid level sensor



WORLD CLASS TECHNOLOGY

Producing quality technical valvetrain components for all forms of motorsports.



TUV Rheinland
AS9100C
Certified Custom
Manufacturing Facility

FEATURES

QUALITY
KNOWLEDGEABLE STAFF
EXCEPTIONAL DELIVERY TIME
CUSTOM SOLUTIONS



EXCEPTIONAL VALUE

X2 Valves and Valvetrain are born from Xcelodyne, the leader in world class racing valvetrain components. Built with the quality and engineering you've come to expect from Xcelodyne's successful racing heritage **SUPERIOR PERFORMANCE, EXCEPTIONAL VALUE!**



EXCEPTIONAL FEATURES

TIGHTEST TOLERANCES
FINEST MATERIALS
BEST FINISHES

TITANIUM & STEEL VALVES

www.xcelodyne.com

800-448-1223

42 High Tech Boulevard
Thomasville, NC 27360

PRI SHOW

Booth #1325
Indianapolis, IN USA

Tel: +33 2 43 60 10 81

ZA du Bray, 72320
Vibraye - France



PRI 2016
FIND US AT
BOOTH 4524

CONNECTED TO THE TRACK

When you invest in a set of the worlds finest high performance silicone hoses, you are not only upgrading your car. You are connecting to a feeling, an attitude and a driving thrill only SAMCO sport can give you. Are YOU connected?



#GETCONNECTED



CONNECT
TO VICTORY

Silicone Hoses handcrafted in Britain. Victorious around the world. For the full range and to check availability for your car visit samcosport.com

low-cost alternative to custom designed capacitive sensors. Available in an almost infinite variety of length and mounting configurations, the sensors can fit almost any fluid tank/sender application requiring accurate level measurement.

Integrated electronics in the flange provide a standard 0-5 VDC output, which interfaces with almost all standard industry liquid level gauge and data-loggers. The EcoSense electronics can withstand temperatures up to 125°C, ideal for oil monitoring applications while delivering continuous precision level sensor measurements.

"We identified that there's a gap in the market for a good quality, reliable, robust, lower cost product," says Reventec director Neville Meech, "and the EcoSense is a result of that after a year's development perfecting it. We think we're the first to produce a genuine low cost product of this nature. It directly addresses a widespread requirement for a reliable, solid-state alternative to less reliable mechanical float

devices, while keeping the unit cost well below that of typical capacitive devices of equal quality. We've had a lot of interest from people who would otherwise have passed us by."

To be found on the **Performance Trends** booth is a shock dyno which offers a very affordable alternative to motorised shock dynos costing two to three times as much, but which produces the same results. Features include a 1.5 hp VAC motor, which is ideal for most trailers and generators. The stroke is adjustable for one, two and three-inch strokes and with standard 36-inch masts and three-inch stroke, the eye to eye of the shock will cycle between 22.5 inches to 25.5 inches. Mast extensions are available to accommodate longer shocks.

There is an optional shock temperature sensor and an Optional Plus version of the shock dyno and it is software compatible with Windows XP through Windows 10. Performance Trends also offers retro-fit

kits for updating existing motorised shock dynos and can work with existing sensors while current sensors can be updated.

Fidanza Performance will be showing its lightweight steel flywheel, something that its customers have been requesting for quite some time. "Compared to the aluminium ones we make, the lightweight steel is a single piece and won't be serviceable like the aluminium ones although they may be resurfaced once or twice, but after that it has reached the end of its life," says Fidanza Performance's Matt Polena. "To begin with we are targeting the Subaru WRXs and the Mitsubishi Evo guys for track racing and drag racing."

Wavetrac Differentials claims to have the only torque sensing differential on the market with patented technology that maintains drive when an unloaded wheel condition arises.

"The technology in the differential can ▶

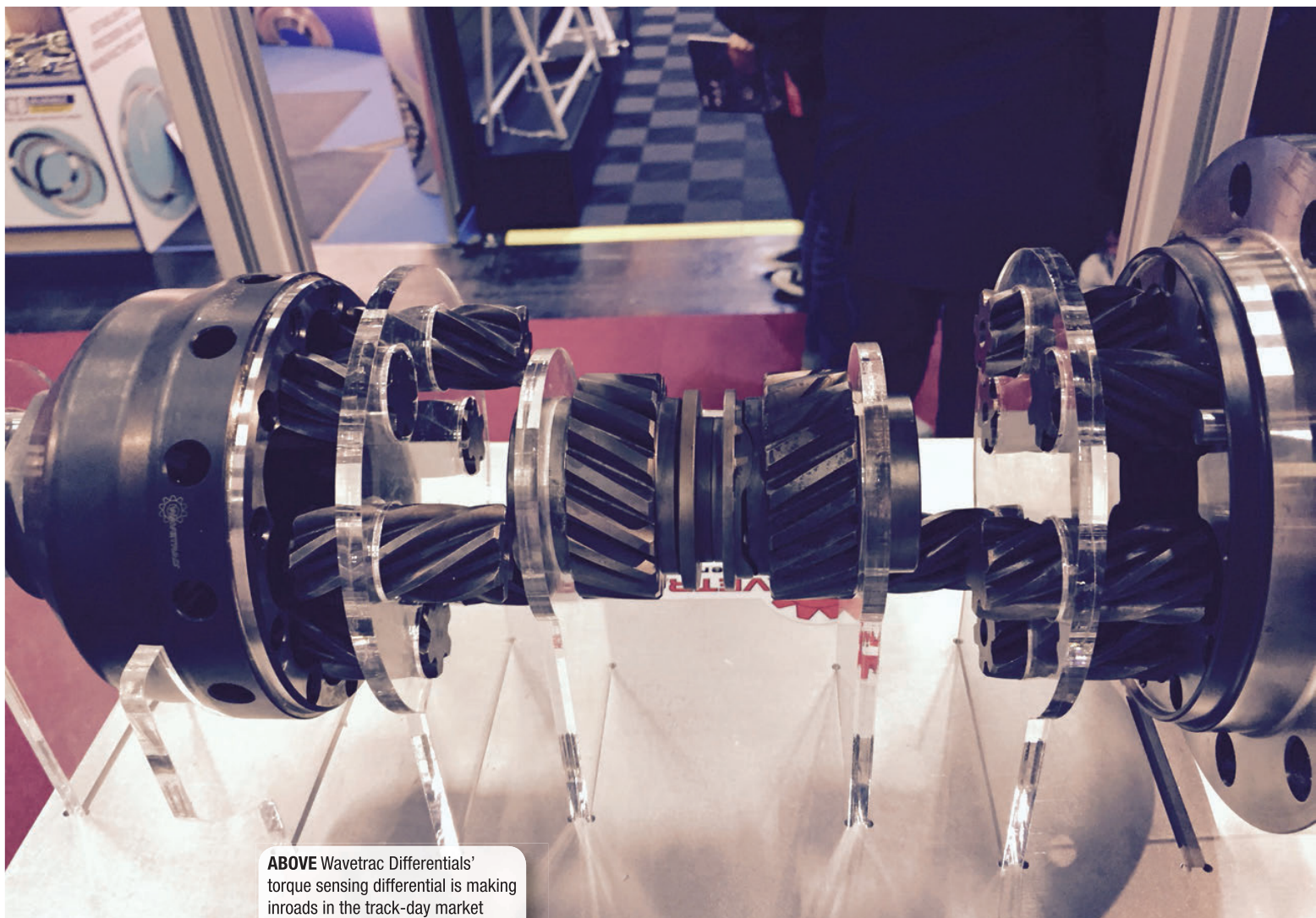

ABOVE Wavetrac Differentials' torque sensing differential is making inroads in the track-day market

PUSHING CARS TO THE LIMIT

Pushing cars to the limit

INTERNATIONAL

TrackCar

Performance



Sub prices:

One year/4 issues

UK - £18

Europe - £34

USA & ROW - £44

Two years/ 8 issues

UK - £33

Europe - £62

USA & ROW - £79

Written and edited by RACE TECH's Editor-in-Chief William Kimberley along with former Track Driver Editors Mark Hales and Carl Owen, Track Car Performance magazine focuses on how to make your cars more competitive and what to look for when kitting them out. The magazine will appeal to everyone from the person who just wants to take their car to the track for a bit of fun to the high-end track car owner who all have the same mission in mind – and that is to go as fast as possible along a given piece of track. • Track Day Drivers • Club Racers • Professional Drivers • Online Racing Enthusiasts • Engineers • Motorsport Enthusiasts.

www.trackcarperformance.com

be used on an everyday car but it also has the distinct advantage on a track day-type application over other Torsen-style differentials as it offers improved traction, so better application of power for more time around a given lap," says Dana Clark, Wavetrac's manager, technical operations.

The product portfolio ranges from US domestic such as the Jeep Cherokee SRT8, the Ford SVT Raptor, Viper SRT10 and the Pontiac GTO/Z to US imports such as the Mk 2 Ford Focus ST, the BMW 135i and the Mini Cooper S.

There will be plenty to see on the **Holley Performance Products** stand such as the all-new billet remote oil filter mounts from Earl's. These remote mounts make it simple to relocate the oil filter to any easy-to-reach location under the bonnet. Constructed of billet 6061-T6 aluminium and anodised black, they feature dual -10 AN O-ring port inlet and outlets – two on each side – for endless routing options. One of the extra ports can be used to attach a mechanical oil temperature gauge.

WOSPerformance has been manufacturing and supplying its OE-based starter motors and alternators to a dealer network since the 1980s. It boasts large stocks, short lead times and customers that include Aston Martin, Cosworth, Dallara, Jaguar, McLaren, Renault Sport, and race series such as F3, GP3, Supercar Lites RallyX and Indy Lights.

Working closely with its sister company in California, **HiTorque - IMI Performance Products**, it claims to be a world leader with over 1500 starter applications designed and manufactured using only OE platforms and parts catering for hostile and



ABOVE The all-new billet remote oil filter mounts from Earl's will be found on the Holley Performance Products stand

bespoke environments.

The WOSP 300 series alternators are race proven, compact units offering the best size and power/weight ratio available and at far lower rpm than alternatives due to their patented design which enables them to offer up to 80% of their maximum output at average idle speeds and peak output of up to 390 amps. As well as its new generation 300 series units, WOSP also continues to build and supply its conventional 200 series alternators.

WOSP also produces a range of Dynators. As awareness of these alternators in disguise grows, so does the range of applications. Built to be the most authentic and reliable on the market, they are available to directly replace over 120 different models of dynamo/generator.

One of the key new products worth looking out for on the **Bosch Motorsport** stand is its pre-ignition spark plug. "The object is to combine the classic spark plug with the new concept," says Bosch Motorsports engineer Konstantin Schramm. "With Formula 1 and World Endurance Championship regulations

focusing more and more on fuel efficiency, the target is to achieve the burning under very lean conditions.

"When it comes to gasoline engines, the fuel is directed at high pressure into a pre-chamber in the spark plug where the ignition process begins so that the burning within the chamber is decreased along the lines of the Mahle jet ignition, which is working with a second injector. The result is a far leaner process."

Another Bosch Motorsport product worth checking out is its new Premium-PowerBox, the PBX 190, a new version based on the PowerBox 90 model with an increased range of functionality. It is targeted at the high-end professional motorsport market such as the WEC and the World Rally Championship.

The PowerBox is an intelligent control and security unit for modern racing cars. It manages the electricity distribution in the vehicle and replaces common relays, fuses and circuit breakers. By reducing the number of commonly used electronic distribution components, weight can be pared effectively and reliability of the entire system increased. Furthermore, PowerBox offers advanced diagnostic capabilities to make troubleshooting electrical issues in the vehicle a more simple and efficient task than was possible with common relays, fuses and circuit breakers.

Stack is a very well known name when it comes to dashboard instruments, data logging, tyre pressure monitoring systems and video systems and while it became part of the US **AutoMeter** group in 2007, it was still seen as a separate entity. However, recent changes have meant that it is being relocated into the parent group in Sycamore, Illinois although the intention is that it will still retain its identity.

Andrew English has now left the company ▶



ABOVE WOSPerformance's 2.2 kW universal drop gear starter

SAVE THE DATE

12-15TH JANUARY 2017*

 **AUTOSPORT**
INTERNATIONAL

**THE RACING
CAR SHOW**

TRADE & TECHNICAL AREA
IN ASSOCIATION WITH

Driving Technology Into Pole Position
RACE TECH
INTERNATIONAL
Motorsport Engineering

"YOU CAN ENJOY EVERYTHING TO DO WITH
MOTORSPORT AT AUTOSPORT INTERNATIONAL
AND WHET YOUR APPETITE FOR THE COMING
SEASON." **DAMON HILL, OBE**

AUTOSPORTINTERNATIONAL.COM

*12TH AND 13TH TRADE DAYS ONLY



ABOVE Racepak's V-net heart rate sensor module hooks up to a data logger

to set up 213 Performance, although he still intends to work with AutoMeter. His place as European co-ordinator is taken by Kris Carlson, who is extremely familiar with the Stack brand having been its North American sales manager.

"We view Stack as AutoMeter's technology brand, a position it will retain and as such it will continue to develop the higher technology," says Carlson. "AutoMeter's business is instrumentation, primarily focused on the street performance business and mostly road car based, but we do a fair amount on the racing side with instrumentation. Things like datalogging, video and electronics integration, though, we view as part of the Stack brand going forward."

Carlson confirms that with its foot in the street performance business there will be opportunities to exploit the Stack brand there as well: "We are exploring several opportunities currently on the AutoMeter side of the business with regard to diagnostic performance information based off the OBD2 port. We currently have an app in development that will interact with that wirelessly that allows for the display and viewing of the information on a tablet or mobile device. We are exploring opportunities of how that might fit into the Stack business and the European market as well.

"Our product is currently designed as a parent system, so we provide both the app and the hardware solution. Our investigations were that available third party products didn't necessarily integrate well with certain apps."

New software is the name of the game for **Ole Buhl Racing**, says sales engineer Michael Longman: "In the past, you had the analogue position signals from the throttle but it's now like a serial-type communication, something that is incorporated in virtually all the engines in new production cars. We were a bit worried that our hardware couldn't do it without a mod but the software means that we can now do that. For example, on a TCR engine it's been a question of exchanging the throttle body for an older one but the manufacturers didn't like it as the standard OEM part wasn't being used but we can now control the next generation of throttles."

Longman also confirms that OBR is working on the next-generation lower cost Powerbox. Featuring plastic connectors, power stud and a composite lid and aluminium base, it should be available to be seen on the OBR stand at the PRI.

OBR has also developed a CAN steering wheel that replaces the cable with just four wires, or five with the radio, not only enhancing the wheels' features but also lowering the cost.

Life Racing will be showing the SD4, a brand new fully configurable 4-inch dash display system that was originally developed for A1GP cars that have been purchased by AFRIX in South Africa, but which can be used on any platform. It can show any graphics, the shift lights can be customised, as can the strategies and even the buttons that come with it. There are 10 normal push buttons plus a dedicated radio

switch and there are a configurable number of rotaries and paddle levers, all of which can be specified at the time of build.

"The wheel has also been ergonomically shaped," says Life Racing's Jason English, "so you can see the way the hands have been moulded and the buttons moulded around the shape of the hands so they're easy for the driver to press. It's also been sculpted so the driver has a good line of sight and has been designed with the driver in mind as a priority. Even the padding area is changeable. We understand from our motorsport experience how difficult it is to see all the warnings while keeping the car on the track at the same time.

"The technology in it has evolved from our current D5 and D4 dash display systems and has improved CAN configurability so all the data systems can be used as well as the internal memories. It's also very flexible in terms of its electrical connection to the car. It means that it's possible to have a through-the-column connection and also a curly lead connection for lower cost formulae. The idea is that this same product can be used for different series or different applications."

Life Racing's new D8 8-inch display system will be of particular interest to the US market. It uses the technology from the SD4 system as well as that from the D5 and D4 in a central hub not only for a larger display system as favoured by the US market, but also used as a data and analysis system. It also includes the Life Racing GPS system built-in for increased accuracy.

"We foresee the D8 dash as the central hub where all the data analysis can be connected to the system and also displayed to the driver, again keeping that flexibility," says English. "It's a very high resolution screen in which the user can install their own graphics and the LEDs are all fully colour configurable; complicated maths can be added as there are very powerful processors with floating point architecture so we can give the user full configurability. However, at the same time it's very easy to set up, which suits the US market."

Racepak will be showing its new V-net heart rate sensor module that hooks up to a Racepak data logger. "Lots of times a driver's heart rate has a huge effect on reaction time so we've developed this module that also consists of an armband that fits onto the driver's forearm and/or bicep that can ►

PEGASUS

your **IN-STOCK** source for...

Goodridge 811 and 910
Super-flex PTFE hose



fully resistant to fuel
vapor penetration!



Davies Craig electric
coolant pumps



Silicone coolant hoses



... and much more!

Pegasus Auto Racing Supplies • New Berlin, WI USA
800-688-6946 • 262-317-1234

PegasusAutoRacing.com

Racers serving racers around the world since 1980

TOP QUALIFIER

Around the world or around the track, you won't find a higher quality line of bearings and rod ends with Aurora's proven 40 year track record.



Aurora Bearing Company
901 Aucutt Road
Montgomery IL. 60538



Complete library of cad drawings and 3D models available at:
www.aurorabearing.com

Ph: 630-859-2030



**Sense
Measure
Control**



UK +44 (0) 1476 568057

USA +1 (203) 792 8686

sales@kasensors.com

kasensors.com

KAlibrated solutions for motorsport

Performance Trends

www.performancetrends.com

Visit our website for more info, to
download **FREE** demos, or call... **248-473-9230**

Software and electronics for all types of
racing and engine building, including:

- Engine Performance Simulation
- Cam Testing
- Cam Measurement & Analysis
- Manual & Automatic Spring Testers
- Flow Bench Electronics & Software
- Flow Bench Accessories
- Swirl & Tumble Meters
- Dyno Software, Data Acquisition & Control

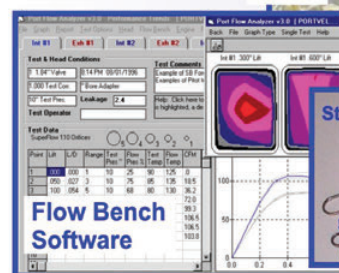
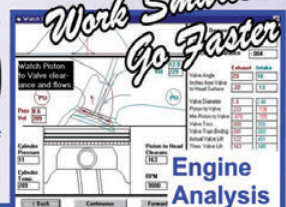

Standard Intake Pitot Tube
Velocity Probes
Less than .600" total width
Mini Pitot Tube

stream all the information via Bluetooth to the Racepak data logger," says Tim Anderson, Racepak Data president.

"It doesn't sound like a big deal but in something like drag racing, the heart rate goes up at the end of the burn out when they're backing up. It's just another piece of the puzzle because the reality is that we are already recording pretty well everything on the car, so let's look at the driver. We are starting with the heart rate but have plans to measure other elements of the driver in the future."

BBS of America is riding high at the moment, given a big boost by winning its second consecutive new product award at the recent SEMA Show in Las Vegas, this time for its forged magnesium Porsche GT3-RS wheel. "We are very fortunate to have some very high spec products coming out of our motorsport department in Germany," says Craig Donnelly, president of BBS America. "The unique thing about this is that over a factory set of wheels you are able to drop 27 lb (12 kg) of unsprung weight, a rather big feat on a car that's already highly optimised. Forged magnesium is something that we've done since 1991 in Formula 1 and then we brought it to the OE market in 2005 with the Carrera GT and also on the 918 and now we have an aftermarket wheel, so all areas of business."

BF1 Systems has released details of its new sensor that gives five cones of infrared

BELOW BBS's award-winning forged magnesium Porsche GT3-RS wheel



measurement across the tyre. Many teams will be familiar with the standard TPMS, which is air pressure and air temperature, and some more with the infrared sensor, which is air pressure, air temperature and one infrared measurement of the inner carcass temperature. However, the new

system is altogether more sophisticated, allowing a far more comprehensive range of internal measurements.

In total, there is an array of 16 points across the inside of the tyre that can be covered, of which any five can be turned on. Once the customer decides which of the five options they need to measure, whether it be across the tread pattern, either or both shoulders, or a mixture of the two, this is then fixed and remains in place for the rest of the sensor's life.

"How it works is that the sensor has an aperture that zones in on a particular spot on the tyre which measures the blackness of the tyre and from that the infrared radiation can be measured," says Ben Gale, technical sales engineer, BF1 Systems. "It can't be seen from the eye, but it's something that's picked up by the cameras."

The data is live streamed, the sensors measuring and transmitting every second. "It's a one Hertz transmission, the ECU or antennae on the cars picking up the signal which is processed by the BF1 System's ECU," says Gale. "All the data is transmitted across from the high-speed CANbus."

The sensors are currently only being built for Formula 1 and are designed to last the ▶



ABOVE BF1 Systems is pushing the boundaries of infrared tyre measurement

OBR

Control Systems

WHY FOLLOW WHEN YOU CAN..... **LEAD**

SEE US PRI SHOW
STAND #4031

OBR
Control Systems



OBR ENDURANCE MSP

Backlit, UV florescent inks for extra visibility. Up to 20 switches, 3 analogue inputs exported via CAN.

PCM2 UNRIVALLED CAPABILITIES

The highest current handling, over 48 output channels. Open CAN protocol across 4 individual CAN ports, 16 analogue & 14 digital inputs.

OBR CAN STEERING WHEEL

Custom shape, colour, labels & logo. Backlit as standard, paddles & rotary switches available.

Specialising in engine / power management systems and a complete range of data logging, displays, sensors, actuators and wiring

WWW.OBR.UK.COM



Thermal systems testing for pumps & heat exchangers

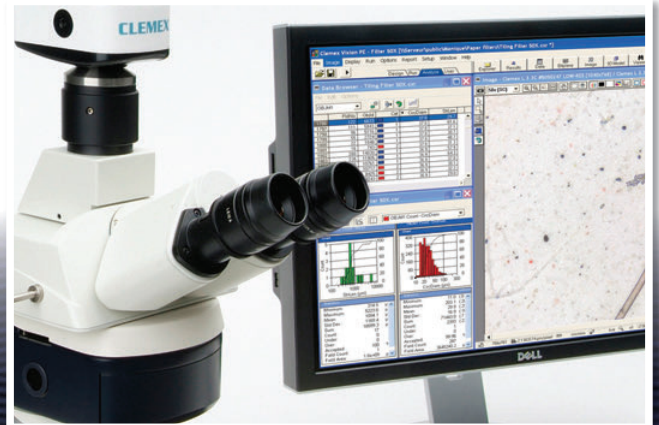
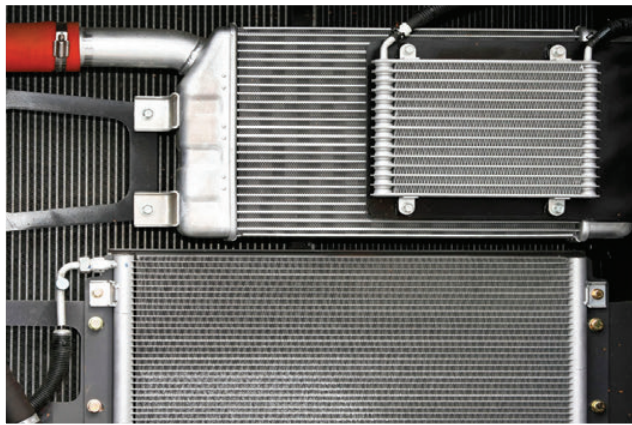

- Calorimetric Wind Tunnel Heat Exchanger Testing
- Durability Testing
- Component Cleanliness Assessment

WWW.youngcalibration.CO.UK

Unit 4, Ham Business Centre, Brighton Road, Shoreham by Sea, West Sussex, BN43 6RE, UK

• Tel: 01273 455 572 • Email: enquiries@youngcalibration.co.uk

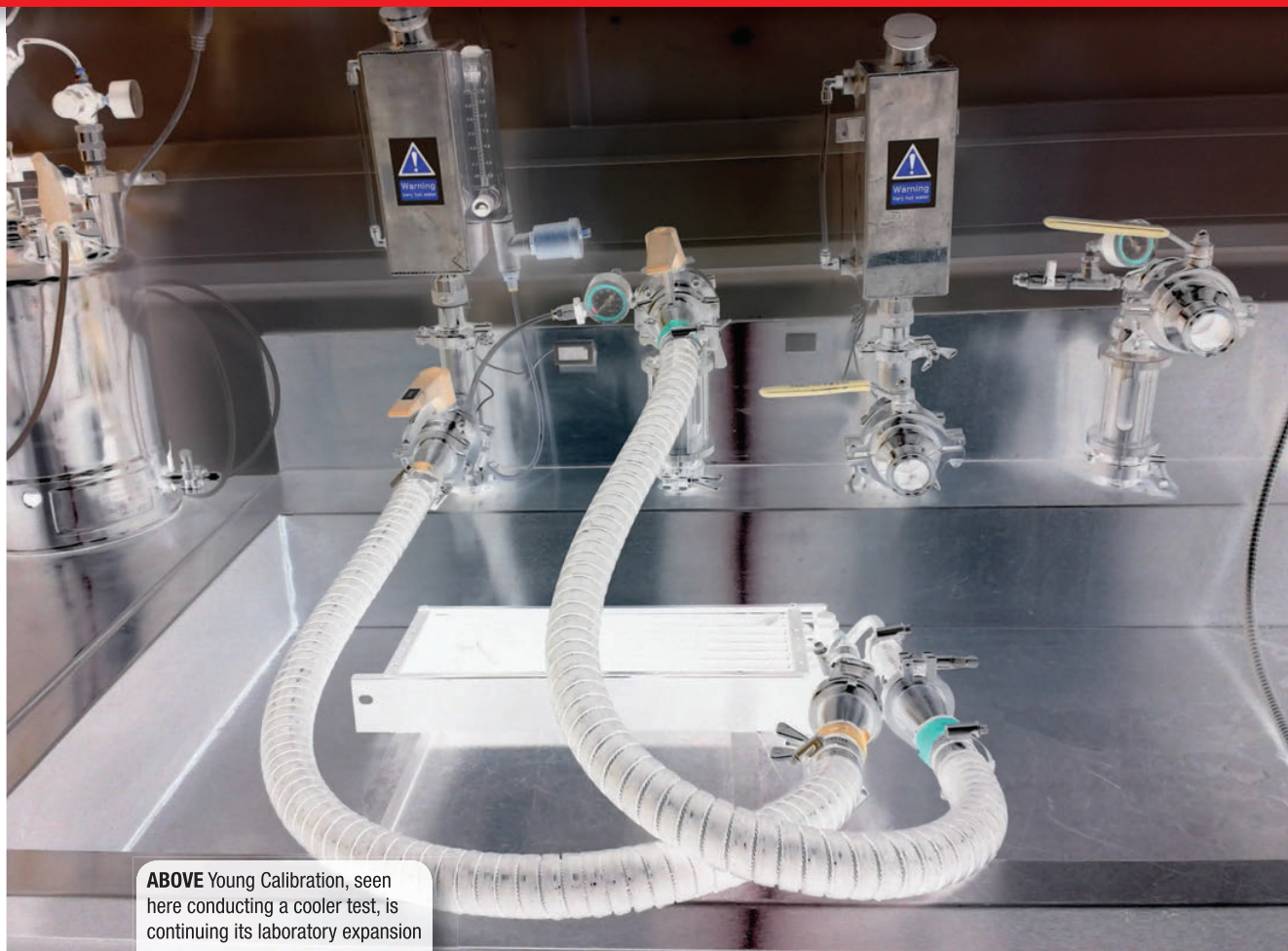

ABOVE Young Calibration, seen here conducting a cooler test, is continuing its laboratory expansion

full season plus some leeway just in case the batteries die in mid season. "The teams are currently using our standard infrared sensor for the entire season, but are now moving over to this five-pixel sensor," says Gale.

Asked whether he could see the number of active sensors increased from five, he says that this will be possible in the future, the current limiting factor being the sensor battery life: "There were two limiting factors with the infrared sensor, specifically in Formula 1. Over the years, tyres have become increasingly hotter and consequently have got closer to the thermal limits of our sensor, which have now been increased with the five-pixel one so that it can now go up to 140°C compared to the 125°C of the older sensor, which gives us a lot of scope for a few more years in F1.

"The second point is the battery life. If we were to run 16 points it means that many more measurements would be taken, so running the electronics harder which would have a knock-on effect on the battery life. However, as battery technology progresses, and at the rate it is progressing, and as electronics take less current in use, it's going to progress. The future is very exciting."

In other areas, including normal tyre development, the sensor having to last a full season is not a factor, and Gale confirms

that the level of interest in the new five-pixel sensor is enormous. "Tyre development is also much more complicated than it ever was before, so the need to understand its composition, the way that the sidewalls are manufactured and their stiffness, the five pixel sensor is going to make everything far more quantifiable and what we have developed is proving to be of huge interest to the tyre companies."

One company that is offering services rather than products is **Young Calibration** which is continuing its laboratory expansion with the opening of the new Durability Test Laboratory. The facility provides pre-production validation, prototype development and type approval testing for electromechanical and thermal fluid components utilised within the internal combustion engine.

Significant investment has allowed expansion of its calorimetric wind tunnels to include extended capabilities for component durability and reliability testing. Predominantly covering pre-production and prototype systems for lubrication, coolant and charge air ancillary components, the laboratories can now also provide high volume test capabilities for production line stoppages with modular and automated test rigging utilised throughout.

Having a 24-hour emergency call-out facility enables high priority production line problems to be addressed with immediate attention and with minimal disruption to the ongoing production.

The company has presently completed projects and rectification solutions for the identification of leaks, component performance issues, casting porosity, assembly misalignment and component cleanliness issues.

Koni has recently launched the TrackDay kit to its range of dampers. It is based on Formula 1 damper technology that Koni launched in the early 2000s and is currently still being used in GP2, GP3, Formula 3 and GT.

The wide range of 64 pre-defined damping curves allows the use of several spring rates for multiple track and road conditions. Eight adjustment positions are available for the TrackDay kit in both rebound as well as bump, all easily adjustable and felt by distinct stops, or clicks, to assure that each port can only be either open or closed. Each of these positions will give a noticeable and repeatable damper curve change.

A central element in the TrackDay kit is a valve preloaded port system that has been recognised over the years as a very solid basis for optimum handling and tuning. **ti**

DOCKING

Advanced Cooling Systems

Water Radiators
Intercoolers
Oil Coolers
Heat Exchangers
System Design
Ancillary Products

Manufactured to your requirements by the UK's leading supplier.

E info@dockingengineering.com
Tel 00 44 (0) 1327 857164
Fax 00 44 (0) 1327 858011
Website www.dockingengineering.com
Unit 15 Silverstone Circuit • Silverstone Northants • NN12 8TL • United Kingdom

CARTEK
MOTORSPORT ELECTRONICS

NEW PRODUCT RANGE
FOR 2017

WIRELESS STEERING WHEEL CONTROLS

Newly revised 8 Channel Wireless Control System now with multi coloured and UV fluorescent sticker sheets.

BATTERY ISOLATOR XR

The new XR is our most powerful Solid State Battery Isolator yet.

CAN-BUS SIGNAL CONVERTER

Now designed for OBD ports making it even easier to install.

VISIT US AT:

AUTOSPORT
INTERNATIONAL

STAND 8244

www.CARTEKMOTORSPORT.com

EARL'S

PERFORMANCE PRODUCTS

CUSTOM BRAKE LINES | OIL COOLERS | HOSE | FITTINGS
ADAPTERS | FILTERS | NOS | FUEL PUMPS & REGULATORS

FUEL LAB NOS Holley pump EARL'S ACEL WIGGINS STÄUBLI

Visit www.earls.co.uk for the full range
Online Shop now Available

Earl's Performance Products UK Ltd
Units 15-16 Silverstone Circuit, Northants, United Kingdom NN12 8TL

+44(0) 1327 858221 | sales@earls.co.uk

QUOTE "RTech2013"
WHEN ORDERING TO
RECEIVE DISCOUNT

Whether you need one or a hundred,

WOODWARD

can build it to fit your needs.

Power steering racks in custom length and travel, 7 ratios, 3 pinion angles, 2 piston diameters, and 30 valve profiles!

Pre-engineered solutions, short lead times, and reasonable cost... just download a Type CF design worksheet and e-mail your requirements to:

tech@woodwardsteering.com

THE IMITATION GAME



Sergio Rinland has always been fascinated by simulation, but not everybody shared his enthusiasm!



ABOVE The Williams FW11 in full flight. 'So, who's going to be brave enough to tell Patrick he's not doing things right?'

SOME innovators 'ride the wave' of a technology; others get washed away by it!

In the early 2000s a colleague and I designed and developed a Driver-in-Loop simulator but we did not get any takers, even though at the time McLaren was showing the way. Instead, we found many 'unbelievers' and could not commercialize it.

Only a few years later, every F1 team started to develop their own, once they saw how Lewis Hamilton hit the ground running after spending endless hours in the McLaren simulator. I was reminded of this by the last issue of Race Tech [RT193], in which Mark Catherall gave an excellent account of how McLaren and Lewis got the jump on their rivals through simulation.

On a personal level, I had started by simulating suspensions and vehicle dynamics in the mid/late '70s. In fact, my thesis was a vehicle dynamics simulator

using a cumbersome perforated tape computer at the university. I was always interested in vehicle dynamics and suspension systems, so it was a natural development to go from sliding rule and drawing board to wanting to have mathematical models to actually have more and more accurate results.

I would not have been able to develop that program without the help of a university professor, who was a bit of a loose cannon, a genius, lecturing on Mathematics, Physics and Chemistry. In the process he designed many rockets, which actually flew. I used to go to his house and spend hours developing the maths equations to later write them as computer code – a lot of work!

When I defended my thesis, my tutor, who was the Fluid Dynamics teacher, another genius, was asked by my mates – who had camped outside to see how I was doing, because they were all racing fans – "What

grade did you give Sergio, sir?" I will always remember his reply: "One hundred per cent. I did not understand a word of what he was saying, but it looked as if he knew what he was talking about!"

Once in F1, I used a simplified version of that program to calculate suspension systems. Then in the late '80s, when I was at Brabham, we commissioned a programmer to write a code to combine my primitive vehicle dynamics simulator with an aeromap developed by the aerodynamicists. Our aim was to study in more detail the behaviour of suspension and aerodynamics around a lap.

The reception I used to get whenever I mentioned the prospect of simulation would vary. When I worked at RAM, for instance, Olivetti gave us their first portable computer. I duly installed it at my desk and started to translate the code of my program to the language of that computer, so I could calculate the suspensions and performance of the car.

One day, coming back from a race mid-season, I saw that the computer was no longer at my desk. When I asked, "Where is it?" the answer came from inside John Macdonald's office. "Sorry Sergio, I gave it to the son of our sponsor. The little bugger wanted it to play some computer games." Imagine my reaction, if you will; not easy because people know me as a person who is normally quiet and collected!

Later, when I was at Williams with Enrique Scalabrini, we were designing the front and rear suspension. We calculated the FW11 with my program and went to tell Patrick Head that the geometry was not very good because the roll centres were moving too much – in cars where the suspension hardly moved! Just imagine Patrick's answer...

I think the bottom line is that if you look up the word 'simulation' in a dictionary (or Google) it says: "Simulation is the imitation of the operation of a real-world process or system over time." And therein lies the rub: it is *imitation*, not the real thing, so modelling of the different aspects of a racecar has to be very accurate and has to be constantly validated with the real car. Otherwise, there is the risk of getting into the 'rubbish in-rubbish out' situation.

Above all, a simulator is a tool and not a magic wand. There are many stories of teams following 'simulation data' which did not take into consideration some important aspects. The end result was inevitably a car that ended up being a disaster. **RT**

The Original

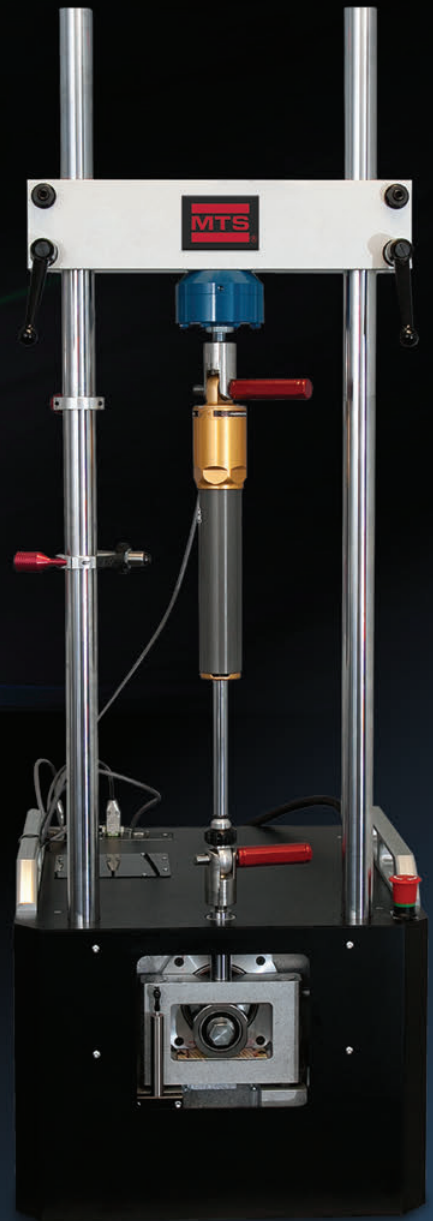

MTS ROEHRIG CRANK DYNO

Kurt Roehrig's original electric crank dyno remains the trackside tool-of-choice for testing and tuning racing vehicle dampers.

Deployed by racing teams worldwide, MTS Roehrig Crank Dynos provide the basic sinusoidal testing capabilities needed to quickly and accurately optimize vehicle performance for specific track and race day conditions.

All-electric MTS Roehrig Crank Dynos feature:

- » Accurate and repeatable performance
- » Compact, portable designs
- » Easy-to-use software
- » Clean, energy-efficient operation
- » Minimal facility and maintenance requirements

Learn how MTS Roehrig Crank Dynos can help you meet critical damper performance testing needs with speed, efficiency and confidence. Contact MTS today.

Telephone: 1-952-937-4000
Toll Free: 1-800-328-2255
E-mail: info@mts.com
www.mts.com

© 2016 MTS Systems Corporation. MTS is a registered trademark of MTS Systems Corporation in the United States. This trademark may be protected in other countries. RTM No. 211177.

Products or company names other than trademarks of MTS Systems Corporation are used for identification purposes only and may be trademarks of their respective owners.

MTS GROUND VEHICLE TESTING SOLUTIONS

be certain.

Congratulations on continuing the legacy!

Thank you for choosing



Ryan Briscoe Richard Westbrook
Mike Hull Mike O'Gara Mel Harder Brad Goldberg
Ryan VanKlombenburg John Hennek Ken Brooks Brett Knostman Phil Binks
Jessica Mace Chris Snyder Tyler Montgomery Kevin Edgley Reid Esquivel
Shelby Tracey Robbie Fast Bob Terrando Spence Hall Tyler Rees Damon Elff
Steve Namisnak Kris Badger Brian Beck Ashley Parlett Lee Blackwell
Jason Richardson Lee Orebaugh Grant Weaver

1st
Continental Tire Monterey
Grand Prix Mazda Raceway Laguna Seca

1st
Sahlen's Six Hours Of
The Glen Watkins Glen International

1st
Mobil 1 SportsCar Grand Prix
Canadian Tire Motorsport Park



www.pfcbrakes.com

800.521.8874

