



© Ame9001
Dreamstime.com

“FOR AN EVEN LARGER PRODUCT SELECTION, VISIT EDARLEY.COM”



tools including hundreds of product videos. Hyperlinks are located at the bottom of each catalog page to give you quick access to the web format. We've upgraded eDarley with a mobile friendly design so ordering on your phone or tablet is a snap. You rely on your life saving equipment to perform under extreme conditions. We rely on your satisfaction as a customer.

TURNOUT GEAR	1 - 29
WILDLAND	30 - 39
NOZZLES	40 - 51
MONITORS	52 - 58
FOAM	59 - 72
HOSE	73 - 87
WATER SUPPLIES	88 - 99
ADAPTERS & FITTINGS	100 - 109
RESCUE TOOLS	110 - 167
HAND-HELD LIGHTS	168 - 179
TRAFFIC CONTROL	180 - 187
EMERGENCY LIGHTS & SIRENS	188 - 201
EMERGENCY MEDICAL SUPPLIES	202 - 209
HAZMAT	210 - 230
APPARATUS EQUIPMENT	231 - 259
VENTILATION	260 - 263
AIR SYSTEMS	264 - 273
FIRE PROTECTION	274 - 279
OUTDOOR WARNING SIRENS	280 - 281
BADGES	282 - 283
STATION SUPPLIES	284 - 294
PUMPS	295 - 313
WATER PURIFICATION	314 - 317
APPARATUS	318 - 328
TERMS & INDEX	330 - 335

ORDER ONLINE OR BY PHONE TODAY

edarley.com™ 1.800.4.DARLEY



DARLEY CHAMPION™ GEAR

HEAD-TO-TOE GEAR PACKAGE

Inside every firefighter beats the heart of a Champion. Those with the passion to rise to the occasion.

Darley now offers a head-to-toe solution for your turnout gear needs at a special package price. Package includes Nomex® turnout gear coat and pants, Fire-Dex® 911™ helmet, Darley gold gauntlet gloves, Nomex® hood, Hellfire™ structural firefighting boots, and Fire Fighter gear bag with carrying strap.

Our Champion™ gear is built to hold up in the toughest of conditions and is loaded with all the features you expect including plenty of large pockets and clips for your tools and communication equipment, reinforced knees, double-stitched seams and comfortable overlapping collar. Your safety is most important so we've included bright, reflective 3M™ Scotchlite™ triple trim, a fire resistant Nomex® IIIA outer shell and Drag Rescue Device per the latest NFPA safety standard.



DARLEY GOLD
GAUNTLET GLOVES



JUMBO GEAR BAG



NOMEX® HOOD



HELLFIRE™ STRUCTURAL
FIREFIGHTING BOOTS



FIRE-DEX® 911™
HELMET

PACKAGE SAVINGS OF \$155

DARLEY CHAMPION™ GEAR PACKAGE INCLUDES:

CAT#	DESCRIPTION	SIZE	COLOR	PRICE
BK407	Darley Champion™ Gear Coat - Nomex®	See Size Chart	Yellow, Black, Tan, Red or Navy	\$714.95
BK408	Darley Champion™ Gear Pants - Nomex®	See Size Chart	Yellow, Black, Tan, Red or Navy	\$392.95
BB009	Hellfire™ Structural Felt-Lined Firefighting Boots	Size: 7-14, 15 Width: M, W, XW	Black	\$122.95
BH127	Darley Gold Gauntlet Gloves	S-XL, Jumbo	Gold	\$52.95
AM003	Fire-Dex® 911™ Helmet	N/A	Red, Black, Yellow or White	\$172.95
AK020	Nomex® Hood	One Size Fits All	White	\$27.95
AS037	Jumbo Gear Bag	N/A	Red with Black Trim	\$64.95
	GEAR PURCHASED SEPARATELY			\$1,549.65
	HEAD-TO-TOE GEAR PACKAGE SPECIAL PRICE			\$1,394.95

PACKED WITH FEATURES

FIT FOR A CHAMPION

- 1** OVERLAPPING COLLAR
Throat protector with Velcro® closure
- 2** MIC CLIPS
Left and right chest Nomex® mic clips
- 3** RADIO POCKET
9" x 3" x 2" with double notch flap
- 4** EMBROIDERED PATCH
Durable stitching
- 5** COAT CLOSURE
Velcro® and easy-slide zipper
- 6** COAT CUFFS
Polymer coated Kevlar® cuff and shoulder reinforcement
- 7** PATCH POCKETS
Two 10" x 10" pockets with drainage holes
- 8** REFLECTIVE TRIM
3" 3M™ Scotchlite™ lime/silver triple trim on coat and pants
- 9** REMOVABLE DRD
Drag Rescue Device
- 10** COAT LINER
Nomex® Q8 with Stedair® 3000 viral barrier
- 11** SUSPENDERS
Adjustable, black
- 12** 32" COAT
Nomex® IIIA outer shell
- 13** REINFORCED KNEES
Polymer coated knee and cuff reinforcements
- 14** PANTS
Nomex® IIIA outer shell
- 15** PANT LINER
Nomex® Q8 with Stedair® 3000 viral barrier
- 16** PANT CLOSURE
Inner hook and loop outer hook and dee
- 17** BELLOWS POCKETS
Two 10" x 10" full bellows pockets
- 18** TAKE-UP STRAPS
Fabric with postman slides



Champion™ Gear Turnout Sizing

Coat		
Size	Chest	Sleeve
Small	36"-38"	32"
Medium	40"-42"	34"
Large	44"-46"	35"
XLarge	48"-50"	35"
2XLarge	52"-54"	36"

Pants		
Size	Waist	Inseam
Small	30"-32"	29"
Medium	34"-36"	29"
Large	38"-40"	29"
XLarge	42"-44"	29"
2XLarge	46"-48"	29"

* For detailed measuring instructions go to www.edarley.com/turnoutmeasuring



DARLEY CHAMPION™ GEAR NOMEX®/KEVLAR®

STEP UP TO A HIGHER LEVEL OF PROTECTION,
DURABILITY AND COMFORT

new

**Coat Features:**

- ▶ 32" length
- ▶ Tough Nomex®/Kevlar® outer shell for increased durability and heat tolerance
- ▶ Stedair® 3000 on E89 moisture barrier
- ▶ Athletic cut back and elbow
- ▶ Zipper with Velcro® outer closure
- ▶ 3" NYC triple trim
- ▶ Combination handwarmer/bellows pockets
- ▶ Black arashield cuffs for added wear resistance
- ▶ Radio pocket with flap
- ▶ Flashlight holder
- ▶ Mic clip

Pant Features:

- ▶ Rear bib for added protection
- ▶ Zipper with Velcro® outer closure
- ▶ Two take up straps
- ▶ Reinforced cuffs
- ▶ Arashield reinforced cuffs
- ▶ Padded reinforced arashield knees
- ▶ Athletic knee design
- ▶ Two bellows pockets
- ▶ Free H back suspenders

OVERLAPPING
COLLARZIPPER W/VELCRO®
OUTER CLOSUREACTION BACK,
KNEES & ELBOWSHIGH BACK PANTS
W/SUSPENDERSDRAG RESCUE
DEVICEARASHIELD PANT
CUFFS & KNEES**Custom Name Panel**

Customize your gear with your choice of 2" (up to 12) or 3" (up to 8) letters.

**SPECIFY MATERIAL**

AS51901	Custom Name Panel	\$15.95
AS51902	Letters	\$3.95/per letter

SPECIFY COAT AND PANT SIZE (SEE PAGE 3 FOR SIZING CHART)

SPECIFY COLOR: Black, Tan or Yellow

BL458	Darley Champion™ Gear Kevlar®/Nomex® Coat	\$889.95
BL459	Darley Champion™ Gear Kevlar®/Nomex® Pants	\$635.95

Fast 2 Week Shipping

*** For detailed measuring instructions go to www.edarley.com/turnoutmeasuring**

Assault Gear

Coat Features:

- ▶ 32" length
- ▶ Two semi-bellows and hand warmer pockets
- ▶ Radio pocket and mic clip
- ▶ 3M™ Scotchlite™ trim
- ▶ Zipper with Velcro® outer closure
- ▶ Drag Rescue Device (DRD)

Pant Features:

- ▶ Rear bib design for added protection
- ▶ Zipper with hook and loop closure
- ▶ Reinforced cuffs and knees
- ▶ Two bellows pockets
- ▶ FREE H Back Suspenders

Turnout Sizing

Coat		
Size	Chest	Sleeve
Small	36"-38"	32"
Medium	40"-42"	34"
Large	44"-46"	35"
XLarge	48"-50"	35"
2XLarge	52"-54"	36"

Pants		
Size	Waist	Inseam
Small	30"-32"	29"
Medium	34"-36"	29"
Large	38"-40"	29"
XLarge	42"-44"	29"
2XLarge	46"-48"	29"

*** For detailed measuring instructions go to www.edarley.com/turnoutmeasuring**



Nomex®/Kevlar® Assault Gear Shown



TURNOUT GEAR

SPECIFY COAT AND PANT SIZE

SPECIFY COLOR: Yellow with Red/Orange Solid Trim or Black with Yellow Solid Trim

AR010	Nomex IIIA® Assault Gear Coat	\$923.95
AR011	Nomex IIIA® Assault Gear Pants	\$750.95

SPECIFY COAT AND PANT SIZE

SPECIFY COLOR: Khaki with Lime/Yellow Silver Triple Trim Fast 5 Day Shipping

BB004	Nomex®/Kevlar® Assault Gear Coat	\$1,082.95
BB005	Nomex®/Kevlar® Assault Gear Pants	\$766.95

SPECIFY COAT AND PANT SIZE

SPECIFY COLOR: Gold with Lime/Yellow Solid Trim or Black with Red/Orange Solid Trim Fast 5 Day Shipping

AR014	PBI® Matrix® Assault Gear Coat	\$1,369.95
AR015	PBI® Matrix® Assault Gear Pants	\$1,124.95

Ranger Combat Ready Gear

Fire Fighting is stressful enough without having to fight your gear too. That's why we used our experience making Morning Pride brand turnouts that allow the gear to move with the firefighter's body, not against it. Mobility, comfort, toughness. Ranger Combat Ready Bunker Gear has it all.

Tails™ Features:

- ▶ Kevlar®/Nomex® outer shell
- ▶ Aralite®/Nomex® thermal liner facecloth
- ▶ Stedair® moisture barrier
- ▶ Comfort chinstrap
- ▶ Coat cuffs
- ▶ Velcro® zipper closure
- ▶ Nomex® tabbed long wristlets
- ▶ Articulating rapid rescue strap with new coat
- ▶ Lime 2-tone Scotchlite™ reflective triple trim
- ▶ Radio chest pocket
- ▶ Half high bellow pockets
- ▶ Mic Tab

Pant Features:

- ▶ Kevlar®/Nomex® outer shell
- ▶ Aralite®/Nomex® thermal liner facecloth
- ▶ Stedair® moisture barrier
- ▶ 1" narrow Velcro® fly
- ▶ Lime 2-tone Scotchlite™ 3" cuff trim
- ▶ Kevlar®/Nomex® bellows pockets
- ▶ Reinforced knees - Arashield gold
- ▶ Dyna-Fit Suspenders

Accessories not included



Honeywell

Turnout Sizing

Coat		
Size	Chest	Sleeve
Small	36"-38"	33"
Medium	40"-42"	33½"
Large	44"-46"	34"
XLarge	48"-50"	34"
2XLarge	52"-54"	34"

Pants		
Size	Waist	Inseam
Small	30"-32"	30"
Medium	34"-36"	30"
Large	38"-40"	30"
XLarge	42"-44"	30"
2XLarge	46"-48"	30"

SPECIFY COAT and PANT SIZE

BK207	Ranger Tails™ Coat (Kevlar®/Nomex® OS Gold)	\$1,000.95
BK208	Ranger Pants (Kevlar®/Nomex® OS Gold)	\$692.95

*** For detailed measuring instructions go to www.edarley.com/turnoutmeasuring**



Aluminized Cover Helmet

The Aluminized Cover Helmet provides all of the improved fit, ride, components and tough "FYR-Glass" shell to meet the NFPA 1976, 2000 edition performance requirements for proximity / ARFF operation. "Lite Force Plus Proximity" is certified to meet these new requirements. *Ship. wt. 5 lbs.*

- ▶ Standard "Prox" configuration with adjustable throat protector
- ▶ Shroud/earflaps have breathable W.L. Gore moisture barrier and are lined with a "Protective Comfort" quilted FR cotton facecloth thermal liner
- ▶ Includes gold-coated, 6" faceshield & helmet cover

AS306	Aluminized Cover Helmet	\$510.95
-------	-------------------------	----------

Aluminized Attack Gear

With occupational hazards becoming more complex, you can be confident that the Aluminized Attack Gear offers superior protection. When you have to face high temperatures or high risk situations, this gear provides the ultimate protection.

Coat Features:

- ▶ Zipper/Velcro® closure
- ▶ Leather cuff reinforcements
- ▶ Neoprene sleeve wells
- ▶ 4" Nomex® wrists
- ▶ 9x9 patch pockets
- ▶ "Easy Grip" DRD
- ▶ Hanger loop
- ▶ Liner inspection port
- ▶ Thermal enhanced liner shoulders
- ▶ Nomex® liner pocket die-cut leather backed hardware

Pant Features:

- ▶ Velcro®/hook & dee fly closure
- ▶ Leather cuff reinforcements
- ▶ Boot cut
- ▶ Self material take-up straps
- ▶ Liner inspection port
- ▶ Self material knee reinforcements
- ▶ Double layer padded knees
- ▶ Die-cut leather backed hardware
- ▶ 8-point suspenders



SPECIFY SIZE: S-XL

BK262	35" 7oz. Aluminized PBI Attack Coat	\$799.95
BK263	Optional 8"x3.5"x2" Radio Pocket	\$29.95
BK264	7oz. Aluminized PBI Attack Pants	\$569.95



Aluminized Complete Approach Suit

Designed for personnel engaged in maintenance, repair and operational tasks in areas of low ambient temperature up to 200°, or high radiant heat up to 2000°. The aluminized glass suit comes with 32" coat, hood with gold reflective faceshield, pants, gloves and boots. Will accommodate SCBA. Not for fire entry. *Ship. wt. 25 lbs.*



Cat#	Description	S, M, L	XL
L540	Complete Approach Suit	\$1,059.95	\$1,099.95

Super Gloves

A New Era in Fire Fighting Hand Protection

- ▶ True 3-D hand-shaped styling with staggered layer seaming
- ▶ Bubble-Flex and Flex-Tuck construction
- ▶ Eversoft black cowhide cuffs
- ▶ Digiroo™ digital kangaroo grip on palm and fingers
- ▶ 3-D Air Assist™ thermal lining
- ▶ Top grain kangaroo leather on back
- ▶ Durable Crosstech® moisture barrier
- ▶ Wool 3-D heat guard on the back of hand delivers extra insulation
- ▶ NFPA 1971, 2007 ed. certified



SPECIFY SIZE: S-XXL

BG123	Gauntlet Super Gloves	\$116.95/pr.
BG124	Wristlet Super Gloves	\$119.95/pr.



Eclipse Elk Skin Gloves

- ▶ Superior overall fit
- ▶ Swing Thumb™ style and innovative wrap around index finger for excellent dexterity
- ▶ Unique convertible cuff can be worn as knitwrist or gauntlet style
- ▶ Leather retaining band acts as 360° pull tab
- ▶ 1" longer than others
- ▶ Reduced hand fatigue and improved grip
- ▶ SEF® Modacrylic® lining and moisture barrier
- ▶ Meets NFPA, OSHA and CAL-OSHA standards
- ▶ Ship. wt. 2 lbs.

SPECIFY SIZE: S-XXL

AM060	Eclipse Elk Skin Gloves	\$69.95/pr.
-------	-------------------------	-------------



Fire Mate™ Leather Gloves

- ▶ **Q.** Why is Dual Certification important to me?
- ▶ **A.** It's your only guarantee of 13% better puncture resistance, 50% better dexterity, 11% better grip
- ▶ Palm absorbs up to 1/2 lb. less water weight and stays lightweight and soft
- ▶ Crosstech® glove insert or polyurethane moisture barrier
- ▶ Certified to meet both NFPA 1971 & high-dexterity NFPA 1951 standards
- ▶ Ship. wt. 1 lb.



SPECIFY SIZE: S-XXL

AS692	Fire Mate™ Leather Gloves	\$94.95/pr.
-------	---------------------------	-------------



Crosstech® Direct Grip Gloves

These Shelby Firewall® gloves are designed for better fit and performance. Durable wash and wear Koala® tanned leather palm for soft, flexible abrasion resistance. Highly engineered Insular textile construction for the back of the hand, thermal and flame resistance with increased pliability for added range of hand and finger motion. With Crosstech® Products you know you've got the best in liquid penetration resistance against blood, body fluids, and NFPA common chemicals. Ship. wt. 1 lb.



SPECIFY SIZE: S-XXL

AS034	Crosstech® Direct Grip Wristlet Gloves	\$110.95/pr.
BD208	Crosstech® Direct Grip Gauntlet Gloves	\$109.95/pr.





Eversoft Gloves

Our new Eversoft glove is made for fire departments seeking strong, durable hand protection at an unbeatable price. Gloves exceed all requirements of NFPA 1971.

- ▶ Cowhide, black Eversoft split leather – ensures long wearing toughness, but with a softer, more comfortable feel
- ▶ SEF liner – Self-Extinguishing Fleece provides a durable yet soft thermal layer
- ▶ PRO-TECT™ moisture barrier glove insert is waterproof and wind resistant
- ▶ Kevlar® thread for high-strength, high-temp security
- ▶ Proudly Manufactured in the USA

SPECIFY SIZE: S-XXL

BL433	Wristlet Eversoft Gloves	\$49.95
BL434	Gauntlet Eversoft Gloves	\$42.95

FDX G1 Structural Gloves

The FDX G1 is the only high-dexterity glove in its class to have a 60+ TPP. Made of all high quality materials, using only full-grain leathers and Kovenex-R® as the thermal liner, the G1 provides immeasurable protection and exceptional mobility.

- ▶ Full grain goat and pigskins used across palm for extra padding and protection
- ▶ Innovative Kovenex-R® thermal protection, is thin and lightweight while providing exceptional durability and protection from heat and flame
- ▶ Pre-curved, ergonomically designed fingers
- ▶ Abrasion resistant, doesn't stiffen after getting wet, offers excellent breathability, and becomes softer with use
- ▶ Exceeds NFPA 1971, 2007
- ▶ Imported



SPECIFY SIZE: S-XL

BL111	FDX G1 Structural Gloves	\$79.95/pr.
-------	--------------------------	-------------

Darley Gold Gloves

Now with Gore Protection

- ▶ Offers unmatched comfort, protection and performance in an NFPA fire glove
- ▶ Gore RT7100 waterproof, breathable barrier system is the same proven technology used by many of the leading turnout gear manufacturers
- ▶ Every liner is sewn, seam sealed and 100% dunk tested
- ▶ Best in class technology means better dexterity, no liner pull-outs and performance even after exposures in hot structural environments
- ▶ Heavy weight Koala tanned outershell will remain soft after repeated soakings
- ▶ Made in USA

SPECIFY SIZE: S-XL, Jumbo

BH127	Darley Gold Gauntlet Gloves	\$52.95/pr.
-------	-----------------------------	-------------

Fire-Dex® Direct Grip Fire Gloves

OSHA Compliant Gloves

- ▶ Two-ply Nomex® knitwrist
- ▶ Fully lined

NFPA Compliant Gloves

- ▶ Two-ply Nomex® knitwrist or gauntlet
- ▶ Crosstech® Direct Grip® liquid barrier
- ▶ Lining, liquid barrier and leather sewn at fingertips

- ▶ Made with double-chromed, tanned, heat-resistant leather
- ▶ Fully lock-stitched w/Kevlar® thread
- ▶ Elastic backside hugger for comfort
- ▶ Leather hanger loop for drying
- ▶ Full size leather pull tab
- ▶ Available in OSHA and NFPA compliant styles
- ▶ Ship. wt. 1 lb.

SPECIFY SIZE: S-XL

X920	Fire-Dex® Direct Grip Gloves, OSHA Knitwrist	\$57.95/pr.
BK203	Fire-Dex® Direct Grip Gloves, NFPA Knitwrist	\$83.95/pr.
BK204	Fire-Dex® Direct Grip Gloves, NFPA Gauntlet	\$83.95/pr.



edarley.com

Shop online for more gloves 24/7 at edarley.com/gloves

Elk/Pig NFPA Gloves

- ▶ Split elk hide and Shelby abrasion-resistant brushed pigskin
- ▶ Gore™ RT7100 glove barrier fabric
- ▶ NFPA & CE compliant
- ▶ Heavy-weight
- ▶ Fire retardant
- ▶ Shelby "Black Line" Nomex® wristlet



SPECIFY SIZE: S-XL, Jumbo

BD144	Elk/Pig NFPA Wristlet Gloves	\$84.95/pr.
BD145	Elk/Pig NFPA Gauntlet Gloves	\$77.95/pr.

Pigskin Firewall® Gloves

Wash & Wear Pigskin Firewall® Gloves last 4x longer than others. Outer shell stays soft and supple even after repeated soakings. Gloves come with a sewn-in, breathable, liquid-proof barrier for bacteria and chemicals. Meets the highest requirements in terms of durability and abrasion resistance. AC542 and BA003 meet NFPA 1971, 2001 Edition. Made in USA. Ship. wt. 1 lb.

- ▶ Nomex® knitwrist
- ▶ Vapor barrier (NFPA only)
- ▶ Gunn cut seamless palm
- ▶ Thermal lining
- ▶ OSHA and NFPA styles available



SPECIFY SIZE: S-XL

AC542	Pigskin Firewall® Gloves, NFPA Wristlet	\$79.95/pr.
BA003	Pigskin Firewall® Gloves, NFPA Gauntlet	\$77.95/pr.
AC543	Pigskin Firewall® Gloves, OSHA Wristlet	\$49.95/pr.

Koala Gloves

- ▶ Shelby® Koala tanned, split cowhide
- ▶ Gore™ glove barrier fabric
- ▶ Fire retardant
- ▶ Wing thumb
- ▶ Nomex® wristlet
- ▶ Breathable barrier
- ▶ Sewn in liner/barrier systems
- ▶ NFPA/CE compliant
- ▶ Ship. wt. 1 lb.



SPECIFY SIZE: S-XL

AW122	Koala Gloves Knitwrist	\$73.95/pr.
BA002	Koala Gloves Gauntlet	\$72.95/pr.

FIREWALL® ARFF Gloves

- ▶ Crosstech® Direct Grip® glove liner
- ▶ Aluminized PBI®/Kevlar® knit
- ▶ Breathable
- ▶ NFPA 1976-2000 compliant
- ▶ 2-Ply Nomex® wristlet



SPECIFY SIZE: M-XL

AW114	Firewall® ARFF Gloves	\$146.95/pr.
-------	-----------------------	--------------



Fire-Dex® Footwear

Protection for the Heat of the Battle

- ▶ Pull-on loops are reinforced with extra layer of leather and Kevlar® thread to guarantee them for the life of the boot under normal wearing conditions
- ▶ 3M silver industrial wash flame resistant fabric reflective trim (8935) - enhances visibility
- ▶ Vibram® FIRE&ICE™ heel guard - Promotes longevity, creates and maintains shape of ergonomically designed heel cup
- ▶ Vibram® FIRE&ICE™ toe guard - Provides additional grip where you need it and promotes longevity of toe cap
- ▶ 2.2 mm silicone tanned FR full grain, heavy weight leather
- ▶ Rugged diamond plated ladder shank area increases traction
- ▶ Molded cement outsole with articulating louvers provides additional traction to the medial side of the foot
- ▶ Red no skid pattern helps reduce slippage in wet conditions and releases water from being trapped beneath the outsole

SPECIFY SIZE: 8-11, 12, 13, 14

SPECIFY WIDTH: M, W or XW

BK159 Fire-Dex® Footwear

FireDex
Protection for the Heat of the Battle®

\$292.95



Proximity/Bunker Boots

- ▶ Athletically designed for unencumbered performance and agility
- ▶ Specially designed profiled boot to accommodate the largest legs fitting comfortably under proximity pants
- ▶ High performance fire resistant and waterproof leather has been independently tested to withstand the harsh environment of JP8 commonly found in ARFF environments
- ▶ Proven for more than 20 years in the fire service, the Goodyear welt is made to withstand the harsh proximity environment
- ▶ Improved heel pocket and comfortable molded insert defend against heel slippage while stabilizing and minimizing back and leg strain
- ▶ Vibram® lug soles with Fire & Ice compound are cemented and security stitched for the greatest protection possible in extreme radiant heat conditions
- ▶ Steel bottom plate and shank for complete protection
- ▶ Double radiant layers and aluminized shield keep heat transfer away from your feet in high heat conditions
- ▶ Full height bootie with 7.5 oz of Virgin Kevlar® felt quilted to Cambrelle® and laminated to Crosstech®

SPECIFY SIZE: 7-13, 14, 15, 16

SPECIFY WIDTH: D, E, EEE

BK254 Proximity/Bunker Boots

\$499.95



Waterproof Side Zip Composite Safety Toe Boots

- ▶ 8" convenient side zip
- ▶ Dual density rubber outsole with integrated EVA impact pads
- ▶ Non-marking rubber, mini-lug outsole
- ▶ Safety toe, blood borne pathogen resistant, waterproof and slip resistant

SPECIFY WIDTH and SIZE: (Uni-Sex)

MENS: Medium and Wide 7-12, 13, 14

WOMENS: Medium and Wide 7-10, 11, 12

BB134 Waterproof Side Zip Boots

Theraguard
SHOES

\$99.95

DON'T MISS
More boots in
Wildland (p30-39)
Rescue Tools (p110-167)

Hellfire™ Insulated Boots

Hellfire™ series provides superior protection for structural fire fighting. *Ship. wt. 6 lbs.*

- ▶ Construction - Lug outsole, removable polyurethane insole, polyester needled felt lining, meets NFPA, UL certified
- ▶ Oversized steel toe cap - Allows generous layers of insulating materials to fit inside the toe cap to reduce conductive heat
- ▶ Strategic placement of steel midsole blocks heat as well as punctures - Separation from the foot via midsole insulation reduces temperature penetration
- ▶ Cushion shin guard with rung-gripping texture - Dual-purpose design is textured for stability and cushioned for comfort
- ▶ High-temperature resisting reflective patches - Vulcanized patches retain full brightness and reflectivity over time, even at high temperatures
- ▶ Polyurethane removable insole - Provides athletic shoe comfort and additional thermal protection



SPECIFY WIDTH: M, W, XW SPECIFY SIZE: 7-14, 15

BB009	Felt Lined Hellfire™ White Lug Sole	\$122.95
AZ248	Light Insulated Hellfire™ Calendared Sole	\$158.95
AZ250	Insulated Hellfire™ Lug Sole	\$158.95



AZ248 sole



AZ250 sole



BB009

Pull-Up Structural Leather Fire Boots

You can depend on the quality and comfort of Thorogood boots - since 1892. All Thorogood structural firefighting boots meet the requirements of NFPA 1971-2000 and are constructed with the features you demand, like long-lasting Vibram® soles and Sympatex® waterproof barriers for blood borne pathogen protection. Other safety features include waterproof, flame and cut resistant leather, electric shock resisting stainless steel plate and thermal barrier. *Meets NFPA & ANSI; UL Certified. Ship. wt. 6 lbs.*

- ▶ Made in the USA
- ▶ Safety toe
- ▶ Blood borne pathogen resistant
- ▶ NFPA - structural firefighting
- ▶ Waterproof
- ▶ Vibram® fire sole
- ▶ Medium, Wide and Extra Wide
- ▶ Whole and Half Sizes: 5-13, 14, 15



SPECIFY WIDTH and SIZE

AM147	14" Pull-Up Structural Leather Fire Boots	\$279.95
-------	---	----------



Wide Toe Bunker Boots

- ▶ Black boulder, waterproof, full-grain, fire-resistant leather upper
- ▶ Goodyear welt construction
- ▶ Vibram® heat, abrasion, cut resisting Kevlar®
- ▶ Rubber outsole
- ▶ Polyurethane insole with removable insert
- ▶ Superknit lining
- ▶ Rubber midsole
- ▶ Fiberglass shank
- ▶ Built-in shin guard
- ▶ Sympatex® Waterproof
- ▶ Blood borne pathogen resisting membrane
- ▶ ANSI 175/C75 steel toe EH
- ▶ Roomier wide toe design
- ▶ Steel triple ladder shank



SPECIFY WIDTH: M,W and XW SPECIFY SIZE: 5-13, 14, 15

AW019	Wide Toe Bunker Boots	\$286.95
-------	-----------------------	----------



DryGuy™ Drying Systems

Sweet 16™ Boot and Glove Dryer

Have you ever faced the daunting prospect of putting warm feet into cold, wet footwear? DryGuy™ is the country's leading supplier of footwear and accessory dryers to the outdoor and ski markets. These proven products are now available for the fire service professional. Both models feature a whisper-quiet rotary blower that provides a blast of heated or unheated air for fast drying. Approximate dry time for gloves or boots is 1-2 hours. 120 V AC, On/Off, three hour timer. You can count on DryGuy™ products to keep you warm and dry. What are you waiting for? Get out there!

- ▶ Dries both gloves and boots up to 16"

BD142 DryGuy™ Sweet 16™ Boot Dryer \$81.95



PRO 5007 Structural Firefighting Boots

- ▶ **Exclusive Bootie Package:** Cambrelle lining, a full-height Crosstech® moisture barrier and 7.5 oz. Kevlar® thermal barrier
- ▶ **Breathable Advance™ Ripstop Fabric:** Significantly reduces the weight of the boot while maintaining durability and flexibility
- ▶ **Supportive Goodyear Welt Construction:** Allows airflow in the sole, keeping it ventilated, durable, and strong
- ▶ **Premium Quality Military AB Leather:** Full grain, flexible, durable, and water resistant
- ▶ **Reflective Welt:** Visible below the pant line
- ▶ **Secure Heel System:** Strategically placed to substantially reduce heel slippage
- ▶ **Corrosion-resistant Triple Rung Shank:** Superb arch and ladder support
- ▶ **Patented Visible PowerHeel™**
- ▶ **Texon board shinguard**
- ▶ **Heavy-duty round handle straps**
- ▶ **Heavy-duty waterproof leather reinforced side and back stays**
- ▶ **Broad oblique steel toe**
- ▶ **Patented PowerToe™** improves life cycle of toe area by 5x
- ▶ **Vibram® lug broad-base sole** provides maximum wear, traction, and durability, and improved structural balance
- ▶ **Removable molded insert**
- ▶ **Puncture resist stainless steel bottom plate** exceeds NFPA standard for incidental punctures on the fire ground

SPECIFY SIZE: 7-12, 13, 14, 15, 16
SPECIFY WIDTH: D, E, EEE

BL362 PRO 5007 Leather 14" Structural Firefighting Boots \$392.95



30" Hip Boots

- ▶ Insulated
- ▶ Natural rubber compound
- ▶ Molded lug sole
- ▶ Steel, toe, bottom plate and shank
- ▶ Wool felt lining
- ▶ **Height: 30"**
- ▶ Not certified to any NFPA Standard

SPECIFY SIZE: 7-16 Whole Sizes Only
WIDTH: Wide Only

BL109 30" Hip Boot Model 2700 Boots \$292.95



Premium Ranger™ Air Boots

Premium, top of the line model, offers complete protection and lightweight comfort. Only rubber boot on the market utilizing athletic spacer mesh material laminated to buoyant, waterproof neoprene. A combination of natural rubber and butyl rubber ensures complete chemical protection to certified standards.

- ▶ Lightweight and rugged with one layer of natural rubber and one layer of butyl rubber
- ▶ Self insulating Neoprene liner combined to spacer mesh material is buoyant, waterproof and comfortable
- ▶ Removable Breath-o-Prene® insert for topnotch arch support
- ▶ Steel bottom plate, toe and shank
- ▶ Rounded leather straps and top line protects against leg rub and pant abrasion
- ▶ Height: 15"
- ▶ Weight: 6.3 lbs
- ▶ Chemical agent protection to Mustard HD (Protocol TOP-8-2-501 Swatch Test) - 24hrs.

SPECIFY SIZE: 7-15½, 16

SPECIFY WIDTH: N, M, or W

BL104	Premium Ranger™ Air Model 1000 Boots	\$232.95
-------	--------------------------------------	----------

Kevlar®/Nomex® Lined Boots

Insulated and non-insulated light weight models feature Kevlar®/Nomex® lining and are equipped with a shinguard for additional ladder-rung shin protection. Roomy steel toe provides extra comfort, and steel bottom plates and shanks offer unmatched impact/compression and puncture protection.

SPECIFY SIZE: 7-15½, 16

SPECIFY WIDTH: N, M, or W

BL105	Insulated Kevlar®/Nomex® Lined Model 1500 Boots	\$175.95
BL106	Non-Insulated Kevlar®/Nomex® Lined Model 2500 Boots	\$170.95

Insulated, Lightweight Boots

Insulated lightweight boot with wool felt lining. Roomy steel toe provides extra comfort, and steel bottom plates and shanks offer unmatched impact/compression and puncture protection.

SPECIFY SIZE: 7-15½, 16

SPECIFY WIDTH: N, M, or W

BL107	Insulated, Lightweight Model 1600 Boots	\$165.95
-------	---	----------

NFPA Foot Protection Boots

Non-insulated model featuring a wool felt lining. Roomy steel toe for extra comfort and impact/compression protection, and steel bottom plates and shanks offer unmatched puncture protection.

SPECIFY SIZE: 7-15½, 16

SPECIFY WIDTH: N, M, or W

BL108	NFPA Foot Protection Model 2600 Boots	\$142.95
-------	---------------------------------------	----------





A



B



C

Gear not included



D

A. Fire Fighter Gear Bag

- ▶ One of the biggest gear bags in the industry
- ▶ Now available with wheels
- ▶ Overall bag size: 29"x17"x16"
- ▶ Main compartment: 18"x17"x16"
- ▶ 4 additional pockets including an extra large helmet pocket
- ▶ Reflective trim along straps and on bottom
- ▶ Vented main compartment with Velcro® front closure



BK201

BK200	Fire Fighter Gear Bag with Carrying Strap	\$59.95
BK201	Fire Fighter Gear Bag with Wheels	\$78.95

B. Jumbo Gear Bag

There is plenty of room in this one. It has four pockets along with the main storage area. The end pocket on the left is 8"Wx15"D x17"H, the right pocket is 3"Wx15"Dx17"H, along with two slot pockets. The overall measurements are 33"Lx15"Dx17"H. ID window, handle wrap, and Maltese Cross. Nylon. Red with Maltese Cross. Ship. wt. 3 lbs.

AS037	Jumbo Gear Bag	\$64.95
-------	----------------	---------

C. Wide Mouth Darley® Gear Bag

Features a zipper top, making it the fastest opening bag on the market. Loading and unloading your gear has never been easier. Made of Cordura® nylon with 1½" straps held together with Velcro® closures. Gear bag measures 24"Lx17"Hx14"W. Red with Maltese Cross. Ship. wt. 2 lbs.



BK186	Wide Mouth Darley® Gear Bag	\$59.95
-------	-----------------------------	---------

D. X-Large Turnout Bag

- ▶ Multiple pockets and compartments
- ▶ Padded shoulder strap
- ▶ Reflective stitching
- ▶ Heavy-duty zippers
- ▶ 600 denier polyester outer shell fabric
- ▶ Grab-n-go pull strap with grabber
- ▶ Overall Dimensions: 16"x25"x15"
- ▶ Side Pockets: 16"x2"x15"
- ▶ Total Capacity: 7,280 cu. in.

SPECIFY COLOR: Black or Red

BL429	X-Large Turnout Bag	\$42.95
-------	---------------------	---------

A. Alpha Gear Bag

Designed to hold turn out coat, pants, helmet, boots, and miscellaneous equipment. A 1½" web handle supports the weight of the bag's contents. This bag is 25% larger than the average gear bag on the market. The extra large size measures 13½"x16"x24". Made of heavy Cordura® nylon with a urethane coated back. Has a #10 YKK® self-repairing nylon coil zipper. Logo: Fire Fighter wording only, in gold print. 5,200 cu. in. *Ship. wt. 1 lb.*

new lower price



A

COLOR: Red with Black Trim

BK188 Alpha Gear Bag \$44.95

B. Darley Turnout Gear Bag

Available in two sizes, this bag is designed to hold your turnout coat, helmet, boots and other miscellaneous equipment. Bag features a front outside zippered pocket to carry smaller items. Standard bag measures 13½"Lx 13"Hx24"W. The extra-large gear bag has 25% more room measuring 13½"Lx16"Hx24"W. Available in choice of plain red, red with Maltese Cross or Royal Blue with Star of Life. *Ship. wt. 3 lbs.*

Red Blue



SPECIFY COLOR: Plain Red, Red with Maltese Cross or Royal Blue with Star of Life

AJ093 Standard Turnout Gear Bag \$60.95

AJ027 Extra-Large Turnout Gear Bag \$74.95



B

C. Boot Style Turnout Gear Bag

- ▶ 2" wide nylon webbing
- ▶ 550 cubic feet larger
- ▶ Maltese Cross
- ▶ Lime triple trim
- ▶ Reinforced bottom
- ▶ Nylon strap grabber
- ▶ ID window
- ▶ Bag size: 17"x18"x20.5"

new



C

BL414 Boot Style Turnout Gear Bag \$32.95

D. Walk-Away Gear Bag

Oversized and loaded with features. Reflective trim, Maltese Cross, handle wrap, optional shoulder strap, vinyl bottom, ID window, zippered side pocket for gloves and personal items. Mesh vents on each side under the storm flaps allow the bag to vent while the flap protects the contents from extreme weather. The three-sided heavy-duty zipper allows you to open the bag and step into your bunker gear and walk away. *Measures 16"Wx19"Dx18"H. Nylon. Red with Maltese Cross. Ship. wt. 3 lbs.*



D

AS035 Walk-Away Gear Bag \$45.95



A

A. SCBA Carrying Bag

Easy to transport and store, this durable, rectangular SCBA carrying bag features reinforced handles, a shoulder strap, and dual zipper entry. Internal padding protects SCBA and mask. Also features an accessory zipper pouch and internal straps with side release buckle. *Dimensions: 30"Lx12"Wx13"H. Ship. wt. 3 lbs.*

BG532 SCBA Carrying Bag \$59.95



B

B. Darley Nylon Mesh Turnout Bag

The Darley Nylon Mesh Bag's large size allows you to stuff all your gear into one bag. The heavy-duty, heavyweight, nylon weave poly webbing allows for air circulation. *Black mesh with lime yellow straps. Measures 24"x15"x15". Ship. wt. 2 lbs.*

AC537 Mesh Turnout Bag \$31.95



C

C. Hazmat Equipment Bag

It can be used to hold your hazardous materials clothing or other related items. Has an outside pocket for extra gloves and small items. A 2" web handle helps support the weight. Made of Cordura® nylon. Haz-mat Equipment in yellow Lettering. *Ship. wt. 2 lbs.*

COLOR: Royal Blue
AW362 Hazmat Equipment Bag \$64.95



D

D. PPE Duffle Bag

Designed to carry personal protective equipment such as gas mask or SCBA face-piece, protective suits, gloves, and other personal items.

- ▶ Lightweight and durable
- ▶ Constructed with 400 denier nylon pack cloth
- ▶ Measures: 12"Wx13"Hx24"L , 3750 cu. in.
- ▶ Weight: 1.5 lbs.

COLOR: Black
BL390 PPE Duffle Bag \$30.95
BL391 PPE Duffle Bag (Plain, No Logo) \$28.95

Fire-Dex® 911™ Helmet

The 911® helmet provides solid, dependable, comfortable protection in a multitude of environments and still allows for a wide range of vision and long-use. Helmet shell is made of the lightest fiberglass composite offering superior protection against high temperature and chemical hazards. Its unique foam impact insert assembly provides even more top and side protection. Long lasting, easy-to-clean, high-gloss, flame-retardant finish resists scratches and UV rays. Replaceable 4" PPC wrap around face shield features an easy-to-operate tension adjustment and plastic bracket to provide maximum dielectric protection. Meets NFPA 1971, 2000 Edition. *Ship. wt. 5 lbs.*

- ▶ Colored throughout fiberglass compression molded shell
- ▶ Fiberglass shell has superior flame and heat resistance
- ▶ Thermal impact cap is a low density injection mold
- ▶ 2 pieces that are inseparable
- ▶ 6 way overhead suspension straps allowing for a more customized helmet "ride"
- ▶ 3 piece headband with ratchet assembly for easy adjustments (6.5" - 9")



SPECIFY COLOR

AM003	Fire-Dex® 911™ Helmet	\$172.95
-------	-----------------------	----------

Fire-Dex® 1910 Traditional Style Helmet

The 1910 features a fiberglass compression molded shell with superior flame and heat resistance, thermal impact cap, ratchet adjustment, and an adjustable headband that fits all SCBA's. SEI Certified to meet or exceed NFPA 1971, 2007 edition. *Ship. wt. 5 lbs.*

- ▶ Ear/neck cover of black Nomex® lined with FR cotton
- ▶ 3M Scotchlite solid lime yellow tetrahedrons trim
- ▶ Knit sweatband and nape
- ▶ 4" visor or Innerzone 3™ goggles
- ▶ Compression molded fiberglass shell



SPECIFY COLOR

BL363	Fire-Dex® 1910 Helmet with 4" Visor	\$240.95
BL364	Fire-Dex® 1910 Helmet with Innerzone 3™ Goggles	\$248.95

Cairns 660C Fiberglass Helmet

Helmet shell is reinforced, high-temperature resistant molded fiberglass. Cairns' patented shell release helps reduce the chance of neck injury by allowing the shell to release, leaving the impact cap behind for protection under severe upward impact. Beneath the shell is a high-temperature foam cap for increased thermal and impact protection. Headband features adjustable front for perfect fit between helmet and SCBA mask and 3-position rear ratchet adjustment. Other features include full brim, high-temperature edge trim, faceshield wing protectors, Nomex® chinstrap with quick-release and postman slide, Nomex® neck/ear protector and 4" Tuffshield faceshield. Helmet fronts sold separately. Meets NFPA 1971, 2000 Edition. *Ship. wt. 5 lbs.*



SPECIFY COLOR

AA843	Cairns 660C Fiberglass Helmet	\$258.95
AF093	Cairns 660C Replacement Faceshield	\$56.95





Structural Fire Helmet with Faceshield and TrakLite™ Helmet Lighting System

Bullard TrakLite™ integrated helmet lighting system blends engineering, functionality and safety to help firefighters see forward in dark or smoky conditions without bulky or cumbersome additions. Meets NFPA 1971-2013 Standard.

- ▶ **Performance:** Features 8 bright white LEDs protected behind heat-resistant glass, TrakLite™ provides a readily-available source of light in most any situation. TrakLite™ also features a bright blue “buddy indicator” light on the rear of the helmet.
- ▶ **Safety First:** The weight of TrakLite™ is distributed between the front and rear of the helmet to offer a more balanced lighting solution.
- ▶ **Easy Operation:** Single rotary switch powers both the front LEDs and the rear buddy indicator light. Powered by four AAA batteries. Runtime of at least 6 continuous hours at a minimum brightness level of 50%.



SPECIFY COLOR

BK091	Structural Fire Helmet w/Faceshield and TrakLite™ Helmet Lighting System	\$281.95
-------	--	----------



Traditional Firefighting Helmets

Phenix Technology's Traditional Helmets boast a low center of gravity and is center balanced, thus, promoting a very low degree of neck fatigue. Our traditional models interface with any SCBA mask. Our standard suspension liners are fully adjustable from 6½" to 8½". *Ship. wt. 4 lbs.*

- ▶ American made brass eagle finial
- ▶ High temperature thermoplastic dome
- ▶ Eight™ lime-yellow reflective tetrahedrons
- ▶ Closed cell energy impact cap
- ▶ Exclusive Phenix suspension liner (nape strap or ratchet)
- ▶ Custom comfort pad integrated into suspension liner.
- ▶ Black Nomex® and fire retardant cotton 8" earlaps (sewn-in or detachable)
- ▶ Nomex® webbing chinstrap (postman's slide, quick release, or combination)
- ▶ NFPA compliant goggles with long strap (ATAC or ESS)
- ▶ D-ring on rear brim

BL241

- ▶ Top grade veg-tanned leather shell with commemorative 9-11 filigree design
- ▶ Compliant to current NFPA, CAL and US OSHA standards

BL242

- ▶ High temperature compression molded composite shell with commemorative 9-11 filigree design



SPECIFY COLOR

BL241	TL2 Traditional Leather Firefighting Helmet w/Goggles	\$453.95
BL242	TC1 Traditional Composite Firefighting Helmet w/Goggles	\$259.95

Cairns 1010 Traditional Style Helmet

Features new tough, through color, reinforced, high-temperature resistant, molded fiberglass composite shell that resists cracking and chipping. Cairns' patented shell release helps reduce the chance of neck injury by allowing the shell to release, leaving the impact cap behind for protection under severe upward impact. Beneath the shell is a high-temperature foam cap for increased thermal and impact protection. Headband features adjustable front for perfect fit between helmet and SCBA mask and 3-position rear ratchet adjustment. Other features include high-temperature edge trim, faceshield wing protectors, Nomex® chinstrap with quick-release and postman slide, Nomex® neck/ear protector and 4" Tuffshield faceshield. *Helmet fronts sold separately. Meets NFPA 1971, 2000 Edition. Ship. wt. 5 lbs.*



SPECIFY COLOR

AF781	Cairns 1010 Helmet	\$325.95
AF094	Cairns 1010 Replacement Faceshield	\$60.95



BL242



The FireDome® LT™ Helmet

The FireDome® LT structural fire helmet is the result of 20 years of Bullard engineering, polymer technology and expertise. The Bullard Tough LT comes standard with the all-new and innovative, patented Quick-Attach Blade System, that permits the firefighter to simply press on or off either a blade-mounted faceshield or blade-mounted goggles in seconds. This helmet can also be enhanced with a variety of optically correct visors, goggles, and neck protectors to equip your fire department with complete head, face and neck protection to meet your specific applications. With the new compact design and lower center of gravity, the LT keeps weight evenly distributed and holds the helmet stable on the head. *Meets NFPA 1971-2013 Standard. Ship. wt. 5 lbs.*

- ▶ Compact
- ▶ Innovative
- ▶ Change from goggles to facemask in seconds
- ▶ Lightweight
- ▶ Low center of gravity

SPECIFY COLOR		Red	Blue	Yellow	Orange	Lime	Black	White
AW498	FireDome® LT™ Helmet with Faceshield							\$174.95
AW499	FireDome® LT™ Helmet with Goggles							\$174.95



TURNOUT GEAR

FireDome® Helmets

- ▶ Fiberglass or Thermoplastic outer shell
- ▶ Urethane foam impact liner provides insulation from heat, impact and penetration
- ▶ Chin strap with combination adjustment
- ▶ Sure-Lock® Ratchet for easy adjustment
- ▶ Nylon or Nomex® energy-absorbing crown strap
- ▶ Optically correct faceshield
- ▶ Nomex Ear/Neck Protector
- ▶ Inner Shell

Red	Blue	Yellow	Orange	Lime	Black	White
-----	------	--------	--------	------	-------	-------

2-year warranty

FireDome® FX Helmet - Fiberglass

Firefighters frequently exposed to chemicals and hydrocarbons appreciate the FireDome® FX with a resin-bonded fiberglass outer shell. Fiberglass helmets are more resistant to chemical attack and more stable at extreme temperatures than those made of thermoplastic. *Meets NFPA 1971-2013 Standard. Ship. wt. 5 lbs.*

SPECIFY COLOR (see colors listed above)		
AF086	FireDome® FX Helmet with Faceshield	\$200.95
AS354	FireDome® FX Helmet with Goggles	\$207.95

FireDome® PX Helmet - Thermoplastic

Firefighters who need a more durable helmet choose the FireDome® helmet with injection-molded thermoplastic outer shell. Constructed with a high-heat thermoplastic providing greater impact and penetration resistance than fiberglass; plus it's more reliable with repeated heat exposures. *Meets NFPA 1971-2013 Standard. Ship. wt. 5 lbs.*

SPECIFY COLOR (see colors listed above)		
AF088	FireDome® PX Helmet with Faceshield	\$200.95
AS027	FireDome® PX Helmet with Goggles	\$208.95

FireDome® UST Traditional Helmet

Comfort and protection is now better than ever. The UST's outer shell is made with Thermoglas® offering a new standard of toughness and durability without sacrificing comfort. Chipping and cracking found in conventional fiberglass helmets is virtually eliminated while still providing chemical resistance and stability at extreme temperatures. The UST features impact liner, high-heat thermoplastic inner shell, Sure-Lock® adjustable headband, replaceable and washable brow pad, Nomex® chin strap with quick-release buckle and postman's slide fastener, Nomex® ear/neck protector, brass eagle, reflective tetrahedrons, and your choice of 4" faceshield or goggles. *Meets NFPA 1971-2013 Standard. Helmet fronts sold separately. Ship. wt. 5 lbs.*

SPECIFY COLOR		Red	Black	Yellow	White
AW373	FireDome® UST Helmet with Faceshield				
AW374	FireDome® UST Helmet with Goggles				



5-year warranty



BL249

Ben Franklin 2 Plus Traditional Helmets

You can't beat the combinations of a traditional styled helmet with the strongest outer shell on the market by Morning Pride. *Ship. wt. 4 lbs.*

- ▶ **Strongest Shell on the Market** - Test show that FYR-Glass is 42% more resistant to impact penetration than helmets made of fiberglass
- ▶ **FYR-Glass Technology** - Provides a helmet that is lighter, lower ride, more comfortable and better fitting
- ▶ **High Heat Performance** - No other shell finish stands up to high heat like FYR-Glass
- ▶ **Low Ride, Better Fit, Low Center of Gravity** - 8-point suspension and wider interior gives wearer superior comfort and fit
- ▶ **More Sizes, More Adjustability** - Our headband/ratchet will fit the largest range of hat sizes of any NFPA helmet on the market - plus for position depth adjustments
- ▶ **Accessories** - Screaming eagle, padded adjustable ratchet system, protective Nomex® earflaps, combo adjustable chin strap, Reflexite® patches. Leather shield not included
- ▶ *Meets and exceeds NFPA 1971, 2000*

Red Black Yellow White

SPECIFY COLOR

AR319	Ben Franklin 2 Plus Helmet with Goggles	\$269.95
AR318	Ben Franklin 2 Plus Helmet with Faceshield	\$267.95
BL249	Ben Franklin 2 Plus Low Rider Helmet w/Goggles	\$234.95
BL250	Ben Franklin 2 Plus Low Rider Helmet w/Faceshield	\$230.95



BL252

Lite Force Plus Modern Helmets

Morning Pride's very best modern helmet is the perfect choice for comfort, safe head protection. *Ship. wt. 4 lbs.*

- ▶ **Strongest Shell on the Market** - Test show that FYR-Glass is 42% more resistant to impact penetration than helmets made of fiberglass
- ▶ **FYR-Glass Technology** - Provides a helmet that is lighter, lower ride, more comfortable and better fitting
- ▶ **High Heat Performance** - No other shell finish stands up to high heat like FYR-Glass
- ▶ **Low Ride, Better Fit, Low Center of Gravity** - 8-point suspension and wider interior gives wearer superior comfort and fit
- ▶ **More Sizes, More Adjustability** - Our headband/ratchet will fit the largest range of hat sizes of any NFPA helmet on the market - plus for position depth adjustments
- ▶ **Accessories** - Padded adjustable ratchet system, protective Nomex® earflaps, combo adjustable chin strap, Reflexite® trim
- ▶ *Meets and exceeds NFPA 1971, 2000*

Red Black Yellow White

SPECIFY COLOR

AR321	Lite Force Plus Helmet with Goggles	\$209.95
AR320	Lite Force Plus Helmet with Faceshield	\$209.95
BL251	Lite Force Plus Low Rider Helmet with Goggles	\$181.95
BL252	Lite Force Plus Low Rider Helmet with Faceshield	\$175.95

Double Down Helmet Clips

Designed by Firemen. For Firemen™.

- ▶ **LIGHTWEIGHT** - Set of four clips weigh less than 1 oz.
- ▶ **TOUGH** - Made from high temp thermoplastic, with 3M™ VHB adhesive
- ▶ **NECESSARY**- Works on any helmet, works with all major head lamp straps, and goggle straps
- ▶ **ADAPTABLE** - Designed to hold BOTH the headlamp strap, and goggle strap securely on any helmet
- ▶ **Designed in the USA**

BK390 Double Down (Set of 4 Clips) \$7.95



Holds strap securely on any helmet



EV1 Traditional Helmets

The progressive interface and cutting-edge features of EV1 helmets offer unmatched performance with a sturdy, sleek, lightweight design that customizes fit for unparalleled comfort and superior functionality. Low-profile design combined with lighter-weight materials provides superior comfort, optimal fit, and improved balance. Proprietary EZ Touch feature allows for one-touch deployment of your face and eye protection. No fuss. No hassle. Stows internally and provides adjustment to fit your face perfectly. Features a safety lock and a cushioned nose guard. EZ Touch face and eye protection is released at the touch of a finger and is the only solution for quick one-hand deployment. Unlike the competition's helmets, our standard models include leather headband and ratchet covers and an easy-to-adjust hook and loop headband system.

Features:

- ▶ EZ Touch internal face and eye protection with safety lock
- ▶ Black Nomex® 2-layer FR cotton ear covers
- ▶ EZ Clip replaceable and reversible chinstrap with quick-release and postman slide
- ▶ Composite fiberglass shell
- ▶ Large hang-up loop
- ▶ Bulldog edge beading

BL247:

- ▶ Golden alloy-plated eagle front holder
- ▶ Anti-catch safety bracket for leather fronts
- ▶ 8 Reflexite® lime trapezoids
- ▶ Certified to NFPA 1971

BL248:

- ▶ 5 – 1" x 4" Reflexite® lime bars
- ▶ Large hang-up loop



SPECIFY COLOR

BL247	EV1 Traditional Helmet	\$273.95
BL248	Evolution Modern Helmet	\$254.95

FoxFire® Illuminating Products

- ▶ Increases visibility and positional orientation
- ▶ Can be charged by any light source (sun, artificial light, low light)
- ▶ Illuminates up to 17 hours when fully charged
- ▶ Glow/illumination serves as a "light emitter"
- ▶ May be recharged repeatedly by any light condition
- ▶ Energy efficient, eco-friendly and no batteries required
- ▶ Made of industrial grade high temperature resistant silicone
- ▶ Can withstand high temperatures



Helmet Bands

Made with industrial grade silicone that is not only durable but also resistant to high temperatures. Will fit most helmets and is flexible enough to add wedges, lights, nails and more.

- ▶ Track firefighters and increase safety in smoky or dark environments
- ▶ Flat measurements: 11.5" x 1.5"

Helmet not included



BL224	Helmet Bands	\$22.95
-------	--------------	---------

Helmet Sticker

Identify your crew in total darkness with these illuminating tetrahedrons. Patented combination of high-output photoluminescent and extreme reflectivity. High temperature resistance with a strong bonding adhesive backing.



Helmet not included

BL227	Helmet Sticker TET (Single)	\$4.95
BL228	Helmet Sticker TET (Set of 8)	\$37.95

Authentic Leather Helmet Shields

Made the old-fashioned way, these shields combine tightly sewn layers of first rate, 100% genuine leather throughout with meticulous detailing. No other leather shield is finer. Shields are custom-made and non-returnable. Available in both 4" or 6" sizes and your choice of color for shield, panel, lettering and center piece, as well as different configurations. Ask your Darley representative for a Shield Ordering Form. Ship. wt. 1 lb.

Shield Centers

A variety of shield centers are available at an additional cost. Please ask your Darley representative.



AR031	Authentic Leather Shield	\$48.95
AR03401	Center Ornament for 4" Shield	\$17.95
AR035	Center Ornament for 6" Shield	\$19.95
AR036	Center Decal for 4" and 6" Shield	\$7.95



Scotchlite® Helmet Shapes



SPECIFY COLOR: Lime/Yellow, Red/Orange

AR038	Helmet Bar	\$18.95/pk. of 16
AR039	Helmet Tetrahedron	\$18.95/pk. of 20
AR040	Helmet Diamond	\$18.95/pk. of 12
AR041	Helmet Tetra Bar	\$18.95/pk. of 12

Self-Adhesive Helmet Decals



Rescue, Fire, and Flag Decals

R715	Rescue Decal	\$3.95
R717	Fire Helmet Decal	\$3.95
AF096	Flag Helmet Decal	\$3.95

Personalized Crescents

Try our personalized crescents! Each personalized crescent comes with white background and your choice of color letters (minimum order 25).



SPECIFY PERSONALIZED TITLE

AF095	Personalized Crescents	\$5.95/ea.
-------	------------------------	------------

Leather Shields with Passport

The shield and passport allow fire departments to know the whereabouts of their firefighters at all times. Each Passport shield comes with a removable, Velcro® center piece Passport bearing the firefighter's name. When he takes a position, he removes the passport and places it on the engine. Shields are custom-made and non-returnable. Ship. wt. 1 lb.



Removable Passport



SPECIFY SIZE: 4" or 6". SPECIFY COLOR OF SHIELD, PANEL AND LETTERING. Ask your Darley representative for a Shield Ordering form.

AR032	Leather Shields with Passport	\$51.95
AR03402	Passport Only	\$21.95

Crescents

▶ White background with black letters



Crescent Titles

FIREFIGHTER	FIRST RESPONDER
CAPTAIN	FIREFIGHTER/EMT
CHIEF	FIRE RESCUE
DEPUTY CHIEF	ENGINEER
LIEUTENANT	EMT
RESCUE	FIRE POLICE
ASST. CHIEF	RESERVE
BATTALION CHIEF	FIRE MARSHALL
COMMISSIONER	SAFETY OFFICER
PARAMEDIC	VOLUNTEER
HAZMAT TEAM	

SPECIFY TITLE

R714	Crescents	\$3.95/ea.
------	-----------	------------

A-Tac® Firefighter's Goggles

Protective goggles designed to specifically protect the firefighter in structural, wildland and other emergency situations. A-Tac® firefighter's goggles pass the NFPA 5000 5-minute heat exposure test. Features a silicone strap and body with hard coated/anti-fog inner and outer lens. Fits over prescription, safety and sunglasses. Can be removed from the helmet, without tools and worn directly on head. Includes goggle clips for both traditional and contemporary helmets. *Meets NFPA and ANSI. Ship. wt 1 lb.*

AM058 A-Tac® Firefighter's Goggles \$49.95



Goggle Clips Included

ESS Innerzone 2™ Goggles

The ESS Innerzone 2™ is designed to withstand the rigors of structural collapses and other hazardous situations that demand primary eye protection, the Innerzone 2™ is fully NFPA compliant, including the 500° 5-minute NFPA oven test. *NFPA 1971-2013 compliant.*

- ▶ Functions well with all major structural firefighting helmet designs
- ▶ High heat-resistant mounting brackets carry a lifetime warranty and securely attach to helmet brim, no drilling required
- ▶ Patented Snap-on/Snap-off™ mounting system allows goggles to be stowed on the front or rear of a helmet
- ▶ Use on helmet alone or together with face shield or flip-downs
- ▶ 2-piece strap system made of 26mm-wide, high-memory woven Nomex®
- ▶ Frame made from high heat-resistant materials
- ▶ Full-perimeter ventilation and filtration system
- ▶ Lenses feature ESS ClearZone™ anti-fog and anti-scratch lens coating
- ▶ Lenses provide 100 UVA/UVB protection and precise optical clarity for distortion-free vision
- ▶ Lenses are highly impact resistant and exceed the impact requirements of ANSI Z87.1-2010+



AR306 Innerzone 2™ with Snap On/Off Mounts \$51.95



Snap-On/Off™ Mounts



Innerzone 3™ Wraparound Straps

The ESS Innerzone 3™ features a wrap-around strap system that secures to structural helmets with two Velcro® tabs. Designed to protect eyes during extrications, USAR, and other hazardous situations that demand primary eye protections. The Innerzone 3™ is fully NFPA compliant, including the 500° 5-minute NFPA oven test. *NFPA 1971-2013 compliant.*

- ▶ Functions well with all major structural firefighting helmet designs
- ▶ Patented Speed Clip™ strap system makes adjustment quick and easy
- ▶ 2-piece strap system made of 26mm-wide, high-memory woven Nomex®
- ▶ Frame made from high heat-resistant materials
- ▶ Full-perimeter ventilation and filtration system
- ▶ Lenses feature ESS ClearZone™ anti-fog and anti-scratch lens coating
- ▶ Lenses provide 100 UVA/UVB protection and precise optical clarity for distortion-free vision
- ▶ Lenses are highly impact resistant and exceed the impact requirements of ANSI Z87.1-2010+



BC014 Innerzone 3™ with Wraparound Straps \$46.95

BL467 FirePro1971 FS Goggles \$49.95



Wraparound Strap



BL467



BC014

Nomex® HeatSleeve™

The ESS Nomex® HeatSleeve™ helps protect the goggles from the elements when not being worn, keeping them clean, scratch free, and buffered from heat. ESS recommends this accessory for its Innerzone™ structural goggles.



BL011 Nomex® HeatSleeve™ \$13.95



Goggles not included

Add-A-Clip

The fast and easy method for attaching turnout gear. *Ship. wt. 1 lb.*

► **Convenience**

Attach your gear right where you need it. Mounts almost anywhere.

► **Simplicity**

Do it yourself. Threaded stud mounts easily, penetrates webbing or fabric, screws tight.

► **Flexibility**

Three different clip-options to meet your most demanding applications.



AS044	Add-A-Clip/Split Ring	\$8.95
AS045	Add-A-Clip/Swivel Snap Clip	\$16.95
AS046	Add-A-Clip/Side Release with Ring	\$10.95
AZ242	Add-A-Clip/Snap Clip	\$11.95

Shield Saver

- Protects both sides of faceshield to prevent scratches
- Reduces eye injuries
- Durable marine-grade vinyl reduces frequency of faceshield replacement
- Velcro® closure
- Available for 4" or 6" faceshields
- *Ship. wt. 2 lbs.*



SPECIFY SIZE: 4" or 6"

AW142	Shield Saver	\$14.95/ea.
-------	--------------	-------------

PX/FX Replacement Faceshields

4" Faceshield

- Hard-coated PPC
- Enhanced optics
- Mounting hardware not included

6" Faceshield

- Hard-coated polycarbonate
- Mounting hardware not included



AF091	Replacement Faceshield 6"	\$57.95
AF092	Replacement Faceshield 4"	\$66.95

Glove Strap

Never Lose Your Gloves

- Keeps gloves ready to use and easy to locate
- Strap clips easily onto your turnout gear or bag with nickel plated clip
- Secure with heavy-duty Velcro® closure
- *Ship. wt. 1 lb.*



SPECIFY COLOR: Red, Yellow, or Black

AJ109	Glove Strap	\$4.95
-------	-------------	--------

Gear Keeper Mic Retractor



The Gear Keeper is a rugged, retractable gear attachment system, designed to utilize and protect gear in severe environments with maximum break strength and durability. Fully extends to 20" and retracts safely back into place. It's that easy; no more fumbling, dropping, dangling or damage. *Ship. wt. 1 lb.*

- Threaded stud mount
- High-impact case
- Patented flushing system salt water proof
- Multi-force options



AR303	Gear Keeper Mic Retractor	\$21.95
-------	---------------------------	---------

Bourke Eye Shield

Made of extremely tough polycarbonate plastic. Offers excellent eye and upper face protection, yet won't trap smoke. Mounts easily and snugly on helmet brim. Lens holders are aluminum, other parts stainless steel. Hinged feature allows instant protection. Uses two brass screws to hold shield to brim. *Ship. wt. 1 lb.*



best seller

SPECIFY COLOR: Clear, Smoke, Amber, or High Temp Yellow

R726	Bourke Eye Shield	\$53.95
------	-------------------	---------



A. EZ Adjust Padded Suspenders

Designed with 8-point attachment. EZ release - just push up with finger or thumb. EZ tighten - just pull down on the EZ to find round rings. Pads are made with FR rated closed cell foam and sewn to allow for adjustment by end user. 47" length. *Ship. wt. 1 lb.*

BG243 EZ Adjust Padded Suspenders \$35.95

B. Turnout Suspenders

- ▶ 2" H-Style suspenders
- ▶ Heavy-duty cotton webbing
- ▶ Heavy-duty elastic ends
- ▶ Eight-point metal clips

DON'T MISS
More suspenders in
Wildland (p34)

AZ244 Non-Reflective Suspenders \$9.95

C. Traditional Suspenders

Materials

- ▶ Straps: Polypropylene red, heavy-duty elastic,
- ▶ 2" wide, .055" thickness, 400 minimum tensile strength
- ▶ Attachment point elastic: 1/2" wide, double layer, 5 1/2" long for each of 8 button tabs
- ▶ Leather tabs: eight leather tabs for button attachment
- ▶ Leather back patch

Construction

- ▶ Crossover style, heavy-duty elastic
- ▶ Crossed in rear with leather back patch
- ▶ 8-point leather tabs, 42" long
- ▶ All seams double stitched for added strength

BD015 Traditional Suspenders \$32.95

D. Leather Fireman's Suspenders

Leather suspenders are handcrafted in the U.S.A. with the finest quality 10-12 ounce, full grain, drum dyed English bridle leather.

BH103 Leather Fireman's Suspenders 39 1/2"-45 1/2" \$45.95

BH104 Leather Fireman's Suspenders 39 1/2"-48 1/2" \$47.95

E. H-Style Suspenders

Features your choice of 2" elastic or non-elastic webbing with leather ends. An excellent choice for high back pants. *Ship. wt. 1 lb.*

AW116 Elastic Suspenders \$25.95

AW117 Non-Elastic Suspenders \$24.95

F. Padded Suspenders

- ▶ 8-pt. heavy-duty button attachment
- ▶ Extra large "quick adjust" rings to accommodate gloved fingers
- ▶ "H" back design
- ▶ Heavy-duty cotton webbing
- ▶ Foam padded straps

SPECIFY SIZE: S (36"), M (42"), L (48")

BG568 Padded Suspenders \$17.95



Our Best Hood Deal

Nomex® Blend Hood

- ▶ UL/NFPA Compliant
- ▶ One-piece construction with shoulder insert
- ▶ 19" overall length
- ▶ One size fits all
- ▶ Nomex®/Lenzing blend



AZ152 Nomex® Hood \$20.95

SureFit™ COBRA™ Hood

SureFit™ COBRA™ hoods incorporate a 3" wide center panel rather than the traditional center seam, which allows the hood to contour to the shape of the head for improved fit and comfort. PARA-TEK FR™ TRI-BLEND. Lightweight yet excellent Thermal Protection Performance. Vertical char length is the lowest we've ever seen averaging less than half an inch in both directions after five washings. Highest arc rating for a lightweight hood.



COLOR: Heather Green

BL290 SureFit™ COBRA™ Hood \$32.95

Protective Hoods That Go On Easy & Seal Tight

Meets NFPA Standards 1971 (Current Edition)

Features easy-sealing face opening that fits snugly for maximum protection and keeps its shape even after repeated usage; elastic face opening stretches to 15" for easier donning. Flat seams won't dig and seamless chin area provides for added comfort. Full 13" double layer head for better face and neck protection. Double 8" back and front bib keeps hood from coming untucked. *One size fits all. Ship. wt. 1 lb.*



AK020

NOTCHED SHOULDER

AK020 Nomex® Hood \$27.95

AK022 PBI Hood \$33.95



Add A Little Color

Meets NFPA Standards 1971 (Current Edition)

Features easy-sealing face opening that fits snugly for maximum protection and keeps its shape even after repeated usage. Elastic face opening stretches to 15" for easier donning. Flat seams won't dig and seamless chin area provides for added comfort. Hood is 2-piece construction, notched shoulder with insert. *One size fits all. Ship. wt. 1 lb.*



Black



Navy

Black Grey Navy Red Yellow

SPECIFY COLOR

AK021 P84 Hood

\$34.95

CarbonKnight Hood

With a TPP rating of ~37.4, Carbon Knight hoods have the highest TPP rating on the market - that is 87% higher than the NFPA requirement of 20! Manufactured with a double layer of black thermal knit material, CarbonKnight hoods are wider than the competition, which allows for superior air circulation. CarbonKnight is a tri-blend composition with added Kevlar® for superior strength and durability. *Ship. wt. 1 lb.*



- ▶ TPP rating of 37.4
- ▶ Meets 18" NFPA minimum requirement

COLOR: Black

AZ246 CarbonKnight Hood

\$33.95

Ultra C6 Hood

Protection...Comfort...Function

The new carbon tri-blend Ultra C6 has been engineered to address the concerns and needs in the safety world. Its unique mix of fibers maximizes the inherent performance properties of each fiber to provide optimal protection and comfort. Enhanced comfort adds to functionality and improves performance and efficiency in the workplace. *Ship. wt. 1 lb.*

- ▶ One piece 100% Nomex® thread with notched shoulder
- ▶ Length: 18", face opening: 5"
- ▶ Meets or exceeds NFPA 1971-2007 Edition & is UL certified

COLOR: Black

BH029 Ultra C6 Hood

\$31.95



What's Hot In Hoods

- ▶ NFPA 1971 (current edition) UL Certified
- ▶ Two-piece construction, notched shoulder long bib design
- ▶ 21" overall length which is 3" longer than NFPA requires
- ▶ Longer length will ensure hoods to stay tucked into other PPE - overall smoother fit
- ▶ Universal Size



BK361	Green Camo Hood	\$40.95
BK362	Fight Like a Girl Hood	\$40.95
BK363	Support a Cure Hood	\$40.95
BK364	Fighting Irish Hood	\$40.95
BK365	Shamrock Hood	\$40.95
BK366	U.S. Flag Hood	\$40.95

Pac II Hoods



Old Glory
Red, White & Blue
100% Nomex®

Convict
Black & White
100% Nomex®

Tie Dyed
Multi-colored
Nomex® blend

Flame
Multi-colored
Nomex® blend

All Pac II hoods meet NFPA and CAL/OSHA standards.
Ship. wt. 1 lb.

AS717	Pac II Hood, Old Glory	\$34.95
AS718	Pac II Hood, Convict	\$34.95
AS719	Pac II Hood, Tie Dyed	\$34.95
AZ161	Pac II Hood, Flame	\$34.95



Carbon X Hood

Highest Flame Resistance

- ▶ 50% Higher than Nomex®
- ▶ 30% Higher than PBI

Lightweight Yet Excellent TPP

- ▶ 20% Lighter than most NFPA compliant hoods
- ▶ TPP rating of 28

Non-flammable

- ▶ If exposed to extreme heat or flame, fabric glows but won't burn
- ▶ Retains a certain tenacity at temperatures exceeding 2300°F for over 90 sec.

ONE SIZE FITS ALL

AW017	Ultimate™ Carbon X Hood	\$42.95
AW115	Classic™ Carbon X Hood	\$33.95

Ladder Hook Extension

Ladder Hook Extension allows the rescuer to attach themselves to a ladder rung or tower platform. Overall length of 18" provides the perfect length to give the rescuer both comfort and safety. NFPA requirements mandate a maximum overall length of 18". Easy-to-operate double locking snap hooks are located at each end of the strap. The XL hook on one end will open to 2.5" to accommodate any ladder rung. The small end of the Ladder Hook Extension attaches to the D-ring constructed of Kevlar® webbing. Available with steel or aluminum alloy hooks. Strength: 5000 lbs. Ship wt. 2 lbs.



AZ103	Ladder Hook Extension (Kevlar®) w/Steel Hooks	\$69.95
AZ104	Ladder Hook Extension (Kevlar®) w/Alum. Hooks	\$97.95

Bunker Belt®

Transporting PPE Gear Made Easy!

The Bunker Belt® System is your bag without a bag. The Bunker Belt® enables fire fighters to easily assemble all their gear on the Bunker Belt®, including boots, bunker pants, coat, helmet, tool bag, face mask bag, gloves and any other items you want to attach. Assemble all your gear in less than 60 seconds and deploy your equipment for calls in less time. Made in the U.S.A.



BG507

- ▶ 2" heavy & super heavy weight webbing
- ▶ Red or black attachment strap with 4 carabiners
- ▶ Shoulder strap with rubber comfort pad
- ▶ Quick-release buckles for fast deployment
- ▶ Boot strap with custom slide and keeper for easy adjustment

BG504 - Sold separately.
Tools not included.



BG507



BG507	Bunker Belt® (Specify Attachment Strap Color: Black or Red)	\$42.95
BG504	Pocket Tool Fold with Flap	\$21.95

Personalized Accountability I.D. Tags



Firefighters' personalized durable plastic I.D. tags. Various colors available for customizing your emergency system. Heavy-duty trigger snap attaches to turnout gear. A simple system for satisfying accountability requirements of the fire service. Comes inscribed with Fire Department Name, Firefighter Company Number and Firefighter Name all in white letters. Yellow & white tags come with black lettering. Ship. wt. 1 lb.

SPECIFY COLOR
and INSCRIPTION

AF084	Accountability Tags	\$9.95/ea.
-------	---------------------	------------

Universal Radio Holder

Three-part system (sold separately) mates comfortably with scissor snaps and D-Rings. The radio holder is universal to fit most radios and the anti-sway strap was designed to keep your radio on a tether and reach at all times.

- ▶ 1 1/4" wide and made of heavy duty leather
- ▶ Speaker mic attaches to a leather loop for easy access
- ▶ Strap can be used on either shoulder
- ▶ Scissor snaps on both ends of the Anti-Sway strap allow for easy placement on your rig keeping your radio in reach at all times
- ▶ Designed to securely fits most radios
- ▶ 2 elastic cords help secure the radio while 2D-Rings allow it to mate with the Radio Strap



AW286

BH101

AW285

AW285	Universal Radio Holder	\$24.95
AW286	Leather Radio Strap	\$24.95
BH101	Anti-Sway Strap	\$7.95

Nylon Life Belts

Made For Maximum Safety, Durability, Versatility and Comfort

Made with nylon especially woven to meet rigorous strength, texture and durability requirements. Webbing has a minimum breaking strength of 9,000 pounds. Assembled belt will withstand 2,000 pounds. The 3" wide buckle strap, sewn with high-tenacity nylon thread and riveted with copper rivets to the 5" wide body strap, is fitted with a double tongue buckle, which enables fast engagement and release of belt. *Ship. wt. 5 lbs.*



SPECIFY BELT SIZE

J922	Life Belt with Pompier Hook only	\$168.95
J923	Life Belt with Pompier Hook, Crash Axe Sheath	\$190.95

Escape Belts

First Kevlar® fire Escape Belt certified to NFPA Class I personal escape harness standards. Waist belt of harness utilizes quick connect "Double Locking" snap hook and D- ring adjuster system. Forged D-ring used for main attachment point has a minimum breaking strength of 5000 lbs., epoxy coated red. Truck/escape belt is constructed of 9000 lbs. Dupont Kevlar® webbing. Kevlar® webbing is coated with a special process to reduce wear and abrasion. Belt is constructed with two layers of webbing to increase stiffness while carrying tools. Contrasting color Kevlar® thread is used to aid in visual inspection. Pad under waist buckle made of black Nomex® material. Belt comes with two additional light weight D-rings that can be adjusted on the rear of the belt to affix a Personal Escape Rope Pack. *NFPA (1983/2001 Edition) Certified. Ship wt. 2 lbs.*

AZ102 Escape belt nylon holster can be used for carrying fire axe or halligan tool.



SPECIFY SIZE: L - 34-54, XL - 44-68

AZ100	NFPA Kevlar® Escape Belt	\$136.95
AZ101	Nylon Escape Belt	\$94.95
AZ102	Fire Tool Holster for Escape Belt	\$32.95

Pac Mule Ultra Ladder Belt

The Ultimate Hands-Free Truckman's Belt Designed by Firefighters

These lightweight belts provide 4" of Coolmax back padding for wraparound support and keep SCBA from hitting your spine. Carry tools and equipment in any situation without slipping or tangling. D-rings Velcro® up and out of the way when not being used. Belt is made from 3M Scotchlite, flame-resistant, highly reflective material. Adjusts easily to fit over your turnout gear. Features rear carabiner slots, a carabiner and an 18" lanyard. BK122 has the same features as AZ241 with added capabilities of making a ladder belt into a Class II harness by attaching the leg straps. *Exceeds NFPA for escape belts. Color coded by size for quick identification. Ship. wt. 2 lbs.*



X-Large Shown



BK122

Specify Waist Size

Medium, Black: 28"-33"	X-Large, Yellow: 42"-50"
Large, Blue: 34"-40"	XX-Large, Red: 52" & up

AZ241	Ultra Ladder Belt	\$181.95
BK122	Ultra Ladder Belt with Harness	\$231.95

Leather Truckman's Belt

The traditional firefighter's Truckman's belt now has an improved design; use it for just about anything. Constructed of top-grain leather, measures 1 1/2" wide and is fully adjustable. Includes heavy-duty snap hook and 2 heavy-duty rings. Folds are riveted as well as stitched for durability. All hardware is chrome plated brass. Optional equipment hook and ring are easily added with secure screw rivets. *Ship. wt. 3 lbs.*



Ring Hook

H992	Leather Truckman's Belt	\$45.95
AR308	Equipment Hook	\$9.95
AR309	Equipment Ring	\$9.95



Fireball™ Pack

Designed for those who feel that less really is more. This pack is built to meet NFPA 1977 specifications.

- ▶ SCS™ patented load-trapping suspension
- ▶ 100oz (3L) Hydration pocket (reservoir not included)
- ▶ Removable New Generation Fire Shelter case (attach to pack or belt)
- ▶ Side pockets each hold one 1L bottles
- ▶ 12 fusee carrying capacity
- ▶ No swing fire shelter case, flaps covering all zippers
- ▶ ¾" dual density foam padding in hip belt and harness
- ▶ Dimensions: 13.5"Lx11"Wx5"D
- ▶ Capacity: 1200 cu in
- ▶ Weight: 2.75 lbs.
- ▶ Materials: 1000D Cordura®, Nylon Webbing, #10 & #8 YKK® Zipper, 3M™ Reflective Tape, Nylon Hardware

SPECIFY COLOR: Red or Black

BL009 Fireball™ Pack

\$119.95

FUSION Daypack

True North's FUSION daypack is constructed of rugged rip-stop fabric. The FUSION has multiple pockets inside and out so whether it's computer cables and iPods; or first-aid gear and walkie-talkies you'll be able to find it fast. Padded laptop sleeve in main pocket fits a 15" laptop, and doubles as a 3 liter hydration carrier when you travel off the beaten path.

- ▶ Padded spacer mesh shoulder straps and back panel to increase airflow and keep you cooler
- ▶ Main Compartment is 18"Lx13"Wx5.5"D with padded laptop sleeve or a 3 liter hydration reservoir pocket; two mesh organizer pockets, and plenty of room for books, files and your large must-have items
- ▶ Middle compartment is 16"Hx9W"x2"D and includes 3 stash pockets, 2 pen pockets, an electronics pocket, and a zippered pocket
- ▶ Outside stash pocket is 9"L x9"Wx1.5"D and includes quick-release buckle closure and blinker light attachment
- ▶ Mesh water bottle pocket on right side and zippered side electronics pocket on the left
- ▶ Constructed of abrasion, moisture and tear-resistant rip-stop for exceptional durability
- ▶ Dimensions: 18"Lx13"Wx9"D
- ▶ Capacity: 1800 cu in
- ▶ Weight: 1.85 lbs.
- ▶ Materials: Rip-stop fabric, nylon webbing, #10 & #8 zipper, nylon hardware, nylon, mesh

COLOR: Red

BL010 FUSION Daypack

\$58.95



Wildland Packs

BA089 Includes:

- ▶ Main: 16"x 10"x7", front pocket: 10"x 10"x3"
- ▶ SCS™ patented suspension
- ▶ Professional grade SCS™ harness and waist belt
- ▶ Removable gearbag
- ▶ Detachable SAR pouch
- ▶ Backdraft ventilation panel
- ▶ 100 oz. hydration pocket
- ▶ Side pockets each hold two 1-liter bottles

BA090 Includes:

- ▶ Main: 17"x11"x8", front pocket: 9"x10"x3"
- ▶ Professional grade SCS™ harness and waist belt
- ▶ SCS™ patented load-trapping suspension
- ▶ Removable gearbag
- ▶ Detachable SAR pouch
- ▶ 100 oz. hydration pocket
- ▶ Each side pocket holds 1 liter bottle
- ▶ Daisy chain on top of gear bag for attaching additional gear

SPECIFY COLOR: Red or Black

BA089 FIREFLY Wildland Pack
BA090 Spit Fire Wildland Pack

Ship wt.

5 lbs.
4 lbs.

Price

\$190.95
\$149.95

FireLine™ Shirt

Designed in accordance to the U.S. Forest Service Specifications. Generously patterned to allow unrestricted range of motion and comfort. Can be worn by itself as a shirt or layered over your favorite tee as a lightweight jacket.

- ▶ 3" high shirt style collar
- ▶ 3" hanger loop at neck
- ▶ Two large patch style breast pockets with hook and loop flap closures
- ▶ Left pocket includes pen/pencil slot
- ▶ Set-in style sleeves with adjustable hook and loop tab closure at cuffs
- ▶ Extra large melamine button front closure
- ▶ Shirt tails are extra-long and squared off to be worn either tucked in or outside pants
- ▶ Meets or exceeds NFPA 1977 Standard on Protective Clothing and Equipment for Wildland Fire Fighting (Current Edition)
- ▶ Meets CAL-OSHA Requirements – Passes Fed. Test 191, Method 5903.2; CAL-OSHA Sections 3406(d). Complies with OSHA Rule 29 CFR Part 1910, 269



SPECIFY SIZE: S-XL

BL001	Yellow Indura® Ultra Soft Fireline™ Shirt	\$78.95
BL002	Yellow Nomex® 111A Plain Weave Fireline™ Shirt	\$112.95

Double Duty™ BDU Pants

PGI's Double-Duty™ pants are dual classified to NFPA 1975 and 1977 Standards by Underwriters Laboratories for use as both station wear and wildland firefighting PPE. Now you can get the best of both worlds – a good looking and comfortable station wear pant which is great for working around the station or being worn in public yet rugged and protective enough to be worn on the fireline. PGI's signature relaxed fit and functional design is sure to make the Double-Duty™ BDU pant a station wear favorite.

- ▶ Signature relaxed fit for maximum mobility and comfort
- ▶ Rear of waistband is elasticized for maximum freedom of movement and comfort
- ▶ Oversized double needle top stitched bellowed cargo pockets on thighs expand to give you plenty of storage capacity for firefighting accessories and secure with hook and loop flap closures
- ▶ Front slash pockets have extra deep bags and are contoured to keep contents from falling out
- ▶ Two large rear double needle top stitched patch pockets with hook and loop flap closures
- ▶ Corrosion-resistant brass snap at waist
- ▶ Double reinforced crotch panel extends wear life
- ▶ Hook and loop ankle straps backed with self-fabric adjust close through metal box ring take up
- ▶ Leg outseams are sewn with five-thread safety stitch, then top stitched with a double-needle lockstitch
- ▶ All points of stress are bartacked
- ▶ Meets or exceeds NFPA 1977 Standard on Protective Clothing and Equipment for Wildland Fire Fighting (Current Edition)
- ▶ Compliant with NFPA 70E (Current Edition) – Meeting the performance specifications of ASTM – F-1506 for wearing apparel used by electrical workers exposed to arc and related thermal exposures
- ▶ Meets CAL-OSHA Requirements – Passes Fed. Test 191, Method 5903.2; CAL-OSHA Sections 3406(d)
- ▶ Complies with OSHA Rule 29 CFR Part 1910, 269



Pants		
Size	Waist	Inseam
Small	27"-30"	28" S
Medium	31"-34"	30" R
Large	35"-38"	32" L
XLarge	39"-42"	34" XL
2XLarge	43"-46"	36" XXL
3XLarge	47"-50"	38" XXXL

SPECIFY COLOR: Yellow or Green
SPECIFY SIZE: S-XXXL

		S-XL	XXL	XXXL
BL003	Yellow Indura® Ultra Soft® Double Duty™ Fireline™ Pants	\$147.95	\$162.95	\$179.95
BL004	Green Indura® Ultra Soft® Double Duty™ Fireline™ Pants	\$162.95	\$179.95	\$195.95
BL005	Yellow Nomex® Double Duty™ Fireline™ Pants	\$188.95	\$189.95	\$206.95
BL006	Green Nomex® Double Duty™ Fireline™ Pants	\$200.95	\$220.95	\$240.95

Fireline™ DELUXE™ Jumpsuit

The DELUXE™ Jumpsuit has the best features of our DELUXE™ Coat and Pant combined into one. Meticulously engineered to provide unrestricted freedom of movement and unsurpassed comfort and protection. Complete protection in a convenient one-piece jumpsuit.

- ▶ Full length two-way self-locking zipper front closure extends to the top of the collar and is covered by a self-fabric storm flap which secures shut with five
- ▶ Elasticized waistband with adjustable side take-up straps allow 4" waist adjustments
- ▶ Radio pocket on left chest with hook and loop flap closure and mic holder loop set above flap
- ▶ Cell phone/pager pocket on right breast with hook and loop flap closure and
- ▶ D-Ring loop at pocket bottom for hanging gear or gloves
- ▶ Extra deep front slash pockets with hook and loop flap closures to keep contents secure
- ▶ Two large rear pockets with hook and loop flap closures
- ▶ Gusseted leg cuffs are elasticized and have adjustable hook and loop closures
- ▶ Extra-long leg zippers allow easy donning and doffing with boots on
- ▶ 2" wide 3M Scotchlite™ Reflective Material -9587 Fluorescent Lime/Yellow Fire
- ▶ Meets or exceeds NFPA 1977 Standard on Protective Clothing and Equipment for Wildland Fire Fighting (Current Edition)
- ▶ Meets CAL-OSHA Requirements – Passes Fed. Test 191, Method 5903.2; CAL-OSHA Sections 3406(d)



Jumpsuits	
Size	Chest
Small	34"-36"
Medium	38"-40"
Large	42"-44"
XLarge	46"-48"
2XLarge	50"-52"
3XLarge	54"-56"
Size	Inseam
Short	5'4"-5'7 1/2"
Regular	5'8"-6'1 1/2"
Tall	6'1"-6'4"

SPECIFY SIZE: S-XXXX

		S-XL	XXL	XXXL
BL007	Yellow Indura® Ultra Soft® 9 oz. Fireline™ DELUXE™ Jumpsuit	\$299.95	\$329.95	\$359.95
BL008	Yellow Nomex® III Fireline™ DELUXE™ Jumpsuit	\$350.95	\$385.95	\$420.95

FIRESAFE™ Wildland Jacket and Pants

Chieftain's FireSafe™ Wildland jacket and pants are designed to be trustworthy protective gear that is highly comfortable and functional. It has maximum thermal protection while minimizing the potential dangers of heat stress. This coverall is available in either Nomex IIIA® or INDURA®, both known in the protective clothing industry for their exceptional flame resistance characteristics. All FireSafe™ Wildland suits are certified by UL to meet NFPA 1977 (2005 edition) for Wildland Protective Apparel.

Jacket Features:

- ▶ Zipper and Velcro® double front closure
- ▶ Bellowed underarms for increased flexibility
- ▶ Extra wide collar with Velcro® adjustable throat tab keeps out water
- ▶ Ample sleeve pattern allow for freedom of movement
- ▶ Universal radio pocket fits all modern radios
- ▶ Velcro® adjustable utility loop keeps gloves handy
- ▶ Velcro® adjustments on cuffs permit tight seal
- ▶ Large 10"x10" pockets with drainage eyelets feature flaps with Velcro® closures
- ▶ NFPA Approved Scotchlite™ Triple Trim in lime-yellow/silver

Pant Features:

- ▶ Roomy gusseted crotch
- ▶ 9"x10" leather knee reinforcements
- ▶ Belt loops
- ▶ Adjustable waist straps
- ▶ Velcro® adjustments on cuffs
- ▶ Nomex® cuff reinforcements
- ▶ Zipper/snap pant fly closure
- ▶ Lime/silver triple trim
- ▶ Elastic on each side of waistband

Meets or exceeds NFPA 1977, 1998 and CAL-OSHA specifications

SPECIFY SIZE: S-XXL

BB051	FIRESAFE™ Wildland Yellow Nomex® Jacket	\$231.95
BB052	FIRESAFE™ Wildland Yellow Nomex® Pants	\$206.95
BB053	FIRESAFE™ Wildland Yellow Indura® Jacket	\$170.95
BB054	FIRESAFE™ Wildland Yellow Indura® Pants	\$160.95



FIRESAFE™ Wildland Coveralls

- ▶ Zipper and Velcro® double front closure system prevents water and debris intrusion
- ▶ Ample sleeve patterns allow for freedom of movement while wearing under clothing
- ▶ Fire retardant leather knee reinforcements improves safety and durability
- ▶ Double slider zippers permit top or bottom unzipping
- ▶ Extra wide collar with Velcro® adjustable throat tab keeps out water
- ▶ Universal radio pocket fits all modern radios & includes drainage eyelet
- ▶ Hand pocket/pass through allows for extra comfort, storage, & access

- ▶ Velcro® adjustable utility loop keeps gloves handy
- ▶ Elastic enhanced waistband for better fit and improved comfort
- ▶ Rear pockets with drain holes allot extra storage
- ▶ High-visibility NFPA Approved Scotchlite™ Triple Trim in Lime/Silver
- ▶ Adjustable Velcro® closures on cuffs and pant legs permit tight sealing properties

SPECIFY SIZE: S-XXL

BB055	FIRESAFE™ Wildland Nomex® Coveralls	\$328.95
BB086	FIRESAFE™ Wildland Indura® Coveralls	\$254.95

PGI Wildland Gear

The Most Comfortable Fabric For Wildland Garments On The Market!

Coat Features:

- ▶ 3M™ Scotchlite™ Flame-Resistant Retro Reflective lime/yellow 2" wide triple trim
- ▶ Large cargo hip pockets with hook/loop flap closures expand for extra storage capacity
- ▶ 4" high collar, no bulky throat strap, hange loop at neck
- ▶ 2-way brass zipper
- ▶ Articulated elbows
- ▶ Gusset at cuff has secondary hook/loop strip
- ▶ Adjustable cuffs incorporate hook/loop tab
- ▶ Radial sleeve design allows full arm movement
- ▶ Radio pocket with hook/loop closure
- ▶ Seamless shoulders eliminates bulky seams

Pant Features:

- ▶ Self-locking brass zipper front closure
- ▶ Corrosion-resistant anodized brass snap at waist and anodized carbon steel ladder buckle with cotton take-up straps
- ▶ Self material waistband with elasticized back and seven 2" wide belt loops
- ▶ Optional knee pad made from super soft 100% flame-resistant closed cell Neoprene

PGI Wildland Gear Sizing

Coat	
Size	Chest
Small	34"-36"
Medium	38"-40"
Large	42"-44"
XLarge	46"-48"
2XLarge	50"-52"
3XLarge	54"-56"

Pants	
Size	Waist
Small	27"-31"
Medium	31"-35"
Large	35"-39"
XLarge	39"-43"
2XLarge	43"-47"
3XLarge	47"-51"
Inseam	
Size	Length
Regular	28"-32"
Long	32"-35"

How to Order

- ▶ Specify coat size and length
- ▶ Specify pant size and inseam

- ▶ Welt-style rear pockets have spade-style flaps
- ▶ Front slash-style pockets have extra deep contoured pocket bags
- ▶ Knee-high brass leg zippers mounted to Nomex® tape
- ▶ 3M™ Scotchlite™ Flame-Resistant Retro reflective lime/yellow
- ▶ Articulated knees with inside knee pocket
- ▶ Expandable over-sized mid thigh cargo pockets
- ▶ 2" wide triple trim sewn around legs, between knees and cuffs
- ▶ Partially elasticized cuffs allow it to be tightly secured without impeding circulation or movement



BD026



WILDLAND

Cat#	Description	S-XL	XXL	XXXL
BD026	Yellow 9oz. Indura® Ultra Soft FireLine™ Coat	\$177.95	\$195.95	\$213.95
BD027	Yellow 9oz. Indura® Ultra Soft FireLine™ Pants	\$184.95	\$203.95	\$221.95
BD028	Yellow 6oz. Nomex® IIIA FireLine™ Coat	\$230.95	\$253.95	\$276.95
BD029	Yellow 6oz. Nomex® IIIA FireLine™ Pants	\$228.95	\$251.95	\$274.95

OPTION FOR COATS

- BD030 Reflective 3" High Silver Scotchlite™ Iron-On Letters \$4.95/ea.

OPTION FOR PGI PANTS

- BD031 Knee Pads - FR Neoprene \$8.95/pr.

FirePro™ Wildland Goggles

Evolutionary Eye Protection

The compact, low-profile FirePro™ frame optimizes fit and function with all helmets, while the full-perimeter ventilation and filtration system minimizes lens fogging and filters airborne particles, dust, and debris. The ESS FirePro-EX™ model features a two-piece strap system and Snap-on/Snap-off™ helmet mounting brackets which attach to a helmet brim (no drilling required). The extra-thick, 2.8mm high-impact lenses provide wide peripheral vision and distortion-free optics. All ESS FirePro™ goggles exceed ANSI Z87.1+, US Federal OSHA, and are compliant with wildland fire equipment performance requirements including the 350°F for 5-minute oven test. FirePro-FS™ and FirePro-EX™ goggles are certified as complaint to NFPA 1977 Standard on Protective Clothing and Equipment for Wildland Fire Fighting, 2011 Edition.

BK003:

- ▶ 1-Piece wraparound strap with Velcro® tabs

BK004:

- ▶ Snap-on/Snap-off™ Brackets
- ▶ 2-Piece Strap System

BK004	FirePro-EX™ Wildland Goggles	\$47.95
BK003	FirePro-FS™ Wildland Goggles	\$40.95



BK003

Features:

- ▶ Interchangeable lenses
- ▶ Durable face padding
- ▶ Speed-clip straps
- ▶ Extra-wide field of view
- ▶ 2.8mm lenses
- ▶ ClearZone FlowCoat anti-fog and anti-scratch lens coatings
- ▶ Anti-microbial face padding
- ▶ Rx available



Brush Pro Mask and The Xcaper®

The Whiffs® Brush Pro mask is made of Advance Nomex®. The breathing port is made of Nomex® knitted hood material. Both carry a 1050° heat rating. The Brush Pro mask is lined with blue Indura® Ultra Soft® cloth with a hydro lone finish which helps to wick moisture from the firefighters face and prevents the transfer of radiant heat to the skin. The Brush Pro mask is versatile and excellent for wildland firefighting and structural overhaul/ mop-up. Its sleek design makes it comfortable to wear, even in hot climates. Features black Velcro® attachments on outside of mask for goggles and optional neck shroud. (*Xcaper® filters, Whiffs® Shroud, and Goggles are sold separately.*) *Ship. wt. 1 lb.*

AW368	Brush Pro Mask*	\$51.95
AW369	Brush Pro Shroud	\$23.95
AW370	Xcaper® Filters	\$6.95
AW371	Nomex® Carry Bag	\$15.95

*Filter Not Included



AW369



AW370



AW371

Hot Shield Wildland Firefighter Face Mask

The Hot Shield Wildland Firefighter Face Mask is a patented highly flame resistant face protector designed by firefighters for use in all wildland firefighting operations. BK088 offers the extreme protection against burns to the face/neck with the added benefit of blocking and reducing the inhalation of smoke and ash particulate. Multiple layers of patented CarbonX help maintain the crucial airspace firefighters want and human skin needs to survive extreme temperatures. The soft comfortable inside liners (also CarbonX) absorb perspiration, adding to user comfort.

- ▶ One size fits all (hook & loop fasteners behind neck)
- ▶ Extreme thermal protection (radiant heat or direct flame) of major portions of the face and neck
- ▶ Reduction of inhalation of airborne particulate by means of a screening mesh and use of a disposable filter w/exhalation valve
- ▶ One year materials and workmanship warranty
- ▶ **Main Users:** Firefighters and other workers that are subject to direct flame, radiant heat, smoke and airborne particulate hazards in an outdoor environment and where use of a self-contained breathing apparatus is either impractical or impossible



BK088	Hot Shield Wildland Firefighter Face Mask	\$74.95
BK089	Filters for Face Mask	\$34.95/Case of 10



BK088

BK089

Radio Chest Harnesses

Single Radio Harness

- ▶ Made of tough yellow Cordura®, black nylon webbing and hard plastic sliders and buckles
- ▶ Features double pencil pockets, spare battery pocket and full mesh map pocket with side entry
- ▶ Unique elastic slip cord system will secure any size radio with full access to the radio controls

Double Radio Harness

- ▶ Same features as AW180, but carries two radios tuned to different frequencies



AW180	Single Radio Harness	\$45.95
AW181	Double Radio Harness	\$62.95

Wildland Suspenders

- ▶ Dark green straps with "Wildland Fire Fighter" woven into the heavy-duty non-stretch shoulder straps
- ▶ "H" back style
- ▶ Elastic at ends for freedom of movement
- ▶ 4-point metal alligator clips to fit all wildland gear



DON'T MISS

More suspenders in Turnout Gear (p25)

BD017	Wildland Fire Fighter Suspenders	\$43.95
-------	----------------------------------	---------

WildFire Protective Headgear

Designed specifically to meet the requirements of wildland firefighters. They offer fire fighters protection, versatility, comfort, and value. Made of high-heat thermoplastic which offers superior impact protection and penetration resistance in non-structural, high-heat environments. In addition, they deliver added electrical insulation required for ANSI Z891-1986 Class A & B helmet specifications. Features include glare-reducing texture, shell-bonded goggle retainer clips for secure storage of eye protection and reflective strips for increased wearer visibility through smoke at night. Accepts a full range of mounting brackets for face shield visors or face shield screens. Meets NFPA 1971, 2005. *Ship. wt. 1 lb.*

- ▶ More secure suspension attachments
- ▶ Simple headband adjustments for a custom fit
- ▶ Larger replaceable pillowed brow pad
- ▶ Seamless suspension straps



SPECIFY COLOR

AC511	WildFire Front Bill Cap Helmet	\$50.95
AC512	WildFire Full Brim Hat Helmet	\$50.95
AC513	Nomex® Ear/Neck/Face Protector	\$34.95
AC516	6" Clear Polycarbonate Visor	\$25.95
BD016	Nomex® Shroud	\$33.95



WILDLAND

Wildland Firefighting Gloves

Constructed of heavy-weight, abrasion resistant pigskin with wristlet for wildland and rescue applications. Keystone design allows for natural thumb movement and better dexterity. Seams are lock stitched and sewn with Kevlar® thread. CE Compliant. Meets NFPA 1977 Standard on Protective Clothing and Equipment for Wildland Fire Fighting, 2005 Edition.

SPECIFY SIZE: XS-XL, J

BK209	Wildland Firefighting Gloves	\$37.95
-------	------------------------------	---------



Power EMS/Wildland 8" Boots

- ▶ Flexible L-Protection® puncture-resisting insole material
- ▶ Two row padded leather top
- ▶ Shaft vapor exhaust vents
- ▶ Meets the requirements of NFPA 1999, standard on protective clothing for emergency medical operations, 2008 edition
- ▶ Meets the requirements of NFPA 1977, standard on protective clothing and equipment for wildland firefighting, 2005 edition

SPECIFY SIZE: 7-14, 15

SPECIFY WIDTH: M, W, XW

BK125	Power EMS/Wildland 8" Boots	\$202.95
-------	-----------------------------	----------



Wildland Fire Kevlar® Boot

- ▶ 10" black boulder waterproof leather
- ▶ Oil, heat and slip-resisting Vibram® logger
- ▶ Drill vamp lining
- ▶ Polypropylene removable insole
- ▶ Leather board and rubber midsole
- ▶ NFPA wildland requirements
- ▶ Kevlar® thread and lace
- ▶ Solid brass stud hooks

SPECIFY WIDTH: M, W, and XW, & SIZE: 5-13, 14, 15

AZ377	10" Wildland Fire Kevlar® Boot	\$245.95
-------	--------------------------------	----------



A



A. Long Handle Firefighting Shovel

- ▶ Forged steel head
- ▶ Solid shank blade
- ▶ Rear turned steps
- ▶ 44" wood handle
- ▶ Ship. wt. 7 lbs.

AJ462 Long Handle Firefighting Shovel \$61.95

B



B. Fire Swatter

The flexible swatter beats the air away from the flames, smothering the fire instantly. Made of rubber treated belting 12"x15". Riveted to a shank cleated on the underside. Shank is driven into the ferruled end of a 60" ash handle, with rivet through ferrule and shank. *Ship. wt. 2 lbs.*

E252 Fire Swatter \$49.95

C



C. Forestry "McLeod" Fire Tool

- ▶ Combination hoe/rake
- ▶ Bolted blade
- ▶ 3 1/2" teeth
- ▶ 48" wood handle
- ▶ Ship. wt. 6 lbs.

AJ463 Forestry "McLeod" Fire Tool \$83.95

D



D. Steel Fire Rake

In forest fire and prairie fire fighting this tool is valuable for raking fire lines, cutting underbrush and weeds, cleaning ditch-banks, etc. Soft steel eye and back with TEMPERED steel blades or teeth. Price includes 60" fitted ash handle. *Ship. wt. 5 lbs.*

D114 Steel Fire Rake \$43.95

E



E. Double Edge Bush Axe

Both edges sharpened. Blades reinforced, carefully forged and tempered. A well-balanced tool for fast work and a favorite wherever used. 36" handles included. *Ship. wt. 5 lbs.*

D115 Double Edge Bush Axe \$57.95

F



F. Pulaski Axe

The Pulaski Axe is a special forest fighting tool. Along with the standard single bit edge, there is also a special Mattock blade for dirt grubbing and trenching. Comes with polished red finish and 36" hickory handle. *Ship. wt. 5 lbs.*

X586 Pulaski Axe \$56.95

Ranger Rigid-Pak Brush Pump

Thick walled polyethylene plastic tank will take rough handling and harsh environments. Non-slosh rounded design keeps the unit comfortable, balanced and steady. The full padded pillow comforts that impinging feel of other tanks. The unit is completely corrosion resistant. It will not rust like galvanized steel models and is less expensive than stainless steel tanks. Adjustable padded shoulder straps are rugged yet fit comfortably and distribute the weight evenly down your back. Tank holds 5 gallons. *Ship. wt. 2 lbs.*



AS242



Back View

AS241	Ranger Rigid-Pak Brush Pump	\$164.95
AS242	Ranger Carrying Bracket	\$65.95

5-Gallon Poly Indian Pump

The 5-gallon Smith Indian pump is a full service unit. Designed with many features to help diminish operator fatigue. This unit is sure to be a workhorse for any department.

- ▶ 5-gallon UV resistant polyethylene tank will not dent & is completely corrosion resistant
- ▶ Pump is fabricated from 2 seamless brass cylinders, a guide bushing on the inner cylinder allows for bind free operation
- ▶ Combination nozzle allows operator to change from straight stream to cone spray
- ▶ Pump can be serviced by hand for complete in field maintenance
- ▶ 52" oil resistant hose for greater pump mobility
- ▶ Molded base and handle keep unit comfortable and balanced
- ▶ Large 4" filler opening with drop-in filter screen
- ▶ Removable padded shoulder straps are fully adjustable, includes sliding clip
- ▶ Lumbar support and waist belt added for comfort and stability



BE038	5-Gallon Poly Indian Pump	\$171.95
-------	---------------------------	----------

Indian Fire Pump

A 5-gallon portable hand-operated pump and tank. Brass pump is durable and easy to clean. Nozzle easily changes from straight stream to cone spray quickly. Tank cap has cam lock with watertight gasket and ventilation hole to prevent collapse. Heavy-duty, 1³/₄" removable polypropylene shoulder straps and carrying handle. *Ship. wt. 18 lbs.*

- ▶ All-brass pump
- ▶ Nozzle chain
- ▶ Carrying straps
- ▶ 5 gallon tank



B690	Indian Fire Pump, Galvanized	\$191.95
L574	Indian Fire Pump, Stainless Steel	\$285.95

ACCESSORIES

E743	Running Board Rack, Red Enamel with Straps	\$48.95
S896	Polypropylene Carrying Strap	\$11.95
S897	Pump 18" Long Less Adjustable Nozzle	\$128.95
S899	Strap for Running Board Rack	\$23.95

Darley Drip Torch

Easy-to-use and requires no pumping or preheating. Simply soak and light the igniter; as you angle the drip torch at a downward angle it drips a trail of flaming fuel. Check valve in cover and fuel trap on spout provides double protection against flashback. Other features include interchangeable parts, breather valve, oil-proof gaskets and sealed outlets to guard from slopping fuel. Holds 1¹/₄ gallons of diesel or kerosene fuel. *Ship. wt. 3 lbs.*



W439	Darley Drip Torch	\$147.95
W440	Truck Mounting Bracket	\$63.95

Back Pack System

- ▶ 18 lt. (4 gal.) flexible back pack water extinguisher
- ▶ Thermo-welded flexible water tank
- ▶ Made with canvas, reinforced with synthetic yarns
- ▶ Double action pump and large fill port
- ▶ Very efficient and easy-to-use
- ▶ Foam attachment available
- ▶ Easy-to-store and transport
- ▶ Excellent to control, mop up and extinguish forest fires
- ▶ Comfortable to wear
- ▶ Ship wt. 5 lbs.



AW226 Genfo Back Pack System \$185.95

Collapsible Back Pump

Corrosion-resistant Neoprene coated Nylon bag and single-stroke brass pump make the U235 one of the best values on the market. Lightweight, collapsible bag holds 5 gallons of water, conforming to the shape of your back. Watertight and reinforced construction means you stay dry. Straps won't rip, mildew or twist while in service. Oil-proof, 44" hose with stainless steel, monel and brass connections, connects 18" pump. Hose has rustproof quick connectors. The new 4" ABS polymer cap makes it much easier to fill with less time; replaces the old 2.5" metal cap. The seams have doubled in strength with a new ultrasonic welding process. *Ship. wt. 5 lbs.*

best seller



U235 Collapsible Back Pump \$172.95

Fire Shelter with Case

No wildland firefighter should be without a personal fire shelter. In an emergency situation, the fire shelter could save a life. The shelter meets Forest Service specs. Changes from the prior standard include the addition of a shelter floor and quick-grab handles for faster deployment 10"x6"x4 1/2". *Ship. wt. 5 lbs.*



AB397 Fire Shelter with Case (Standard Size) \$376.95

Indian Chief Dual Bag Fire Pump

The "Indian Chief" is a 5 gallon inner bag liner inside a protective, nylon fabric, collapsible outer bag. It forms to your back for greater comfort.

- ▶ Rugged outer bag offers more protection from punctures
- ▶ Harness straps with chest cinch strap help balance the load and prevent straps from pulling outward
- ▶ 2 liners come with fire pump – extra liner is stored in the outer pouch of the nylon bag
- ▶ Indian "Fedco" all brass pump, quick connect and dual nozzle



BL243 Indian Chief Dual Bag Fire Pump \$194.95

Forestry Pump & Backpack

BK210:

The Scotty pump is a single action pump with a foam eduction attachment and air aspirating nozzle. It eliminates the need to batch mix when Class A foam is required. Each time the pump is charged, 1% of foam concentrate is educted into the pump chamber. The air aspirating nozzle generates foam when the pump is discharged.

BK211:

The Scotty pump is a single action pump. The pump has a brass pump chamber protected by an engineering-grade polymer sleeve. No tools are required to disassemble the unit. It can be completely disassembled by hand for in-the-field maintenance.



BK210

BK210 Forestry Foam Pump and Backpack \$258.95
 BK211 Forestry Water Pump and Backpack \$189.95

Gated Wye Valves

Rugged lightweight wye valves divide one line into two; female inlet with two male outlets. Constructed of high-quality aluminum and plastic with hard-coated threads. Valves are quarter turn. Meet or exceed GSA requirements for use by the US Forest Service. *Ship. wt. 4 lbs.*

SPECIFY ANY THREAD COMBINATION: NST or NPSH

AM076	Gated Wye, 1" Inlet x 2-1" Outlets	\$213.95
AM077	Gated Wye, 1 1/2" Inlet x 2-1" Outlets	\$263.95
AM075	Gated Wye, 1 1/2" Inlet x 2-1 1/2" Outlets	\$260.95
AM078	Gated Wye, 2 1/2" x 2-1 1/2" Outlets	\$256.95

Hose Clamp

Made from high-quality cast aluminum and brass. Off-set handle allows the user to more easily operate while wearing gloves. Designed to be used with today's light weight single jacket wildland 1" and 1 1/2" fire hose. When clamped on the hose, it locks securely and safely in the closed position. *Ship. wt. 2 lbs.*

AM096	Hose Clamp	\$66.95
-------	------------	---------

Water Thief In-Line Tee Valve

Designed to be installed at intervals in long lines to provide independently controlled outlets for 1" branch lines with full 1/2" waterway. When used in fire-line sprinkler systems, these valves provide the ability to adjust water flow to each sprinkler in the line. Valuable for mop-up work and for filling canteens and backpacks. Meets U.S. Forest Service specifications. 1 1/2" NH x 1" NH. *Ship. wt. 2 lbs.*

AJ478	Water Thief In-Line Tee Valve	\$148.95
-------	-------------------------------	----------

Forestry Nozzle

Akron Brass has introduced their new 1" forestry nozzle. The nozzle is a dual flow, adjustable pattern nozzle designed with the lower flow rates and rugged simplicity needed for wildland/forestry applications. Its simple twist operation takes you through the following settings: off, low flow straight stream, low flow narrow fog, high flow straight stream and high flow fog. *Ship. wt. 1 lb.*

- ▶ Dual flow - 10 and 30 gpm
- ▶ 1" rigid female inlet
- ▶ Durable, lightweight Pyrolite
- ▶ Small, compact design - 4" length



BB097	Forestry Nozzle	\$114.95
-------	-----------------	----------

Specialty Nozzles

This Adjustable Fan Stream Nozzle is another "one of a kind" from Kochek, allowing the user to apply the widest fan or adjust to a smooth-bore stream reaching distances of up to 80 feet. A unique shutoff feature makes it the most versatile nozzle of its type. BL280 offers 4 different spray volumes. It is a simple rotation of the knurled red band.



BL280	1.5" NH Straight Bore Nozzle w/4 Settings	\$53.95
BL281	Jet and Fan Nozzle GHT & 1" NPSH	\$52.95





TurboJet® Nozzles

The Akron® adjustable gallonage TurboJet® nozzle is unmatched in today's fire service for its flexibility and flow control. The TurboJet® is an adjustable gallonage nozzle, where flow remains the same in all patterns at each GPM (LPM) setting. Use the TurboJet® one time and it is easy to see why it's the "nozzle of choice" by fire fighters worldwide.

- ▶ Larger, more legible labels
- ▶ Simple to operate (1/4 turn from straight stream to fog, raised lug marks straight stream for limited visibility operations)
- ▶ Easy to service & repair
- ▶ Meets new European Standard
- ▶ 1 1/2" mid-range, wide range and 2 1/2" TurboJets meet Insurance Services Office (ISO) Requirements
- ▶ 100 psi (7 bar) Rated Pressure Standard - 75 psi (5 bar) Optional with Quality Flow Performance as Low as 50 psi (3.45 bar)



Cat#	Description	GPM	Ship. Wt.	Price
T363	1" TurboJet® Nozzle with Pistol Grip	13-25-40-60	3 lbs.	\$824.95
T364	1" TurboJet® Nozzle	13-25-40-60	3 lbs.	\$728.95
T365	1 1/2" TurboJet® Nozzle	30-60-90-125	4 lbs.	\$754.95
AS154	1 1/2" TurboJet® Breakapart Nozzle	30-60-90-125	3 lbs.	\$853.95
T366	1 1/2" TurboJet® Nozzle with Pistol Grip	30-60-90-125	4 lbs.	\$932.95
W146	1 1/2" Mid-Range Nozzle	95-125-150-200	6 lbs.	\$996.95
T367	2 1/2" TurboJet® Nozzle Direct Connect	125-150-200-250	6 lbs.	\$1,013.95
AS155	1 1/2" Wide Range Nozzle	30-95-125-150-200	6 lbs.	\$846.95



SaberJet™ Nozzles

The First Truly Multi-Purpose Nozzle

The SaberJet™ Nozzles are the newest in firefighting nozzle technology. With a choice of the new Single Shutoff SaberJet™ or the original Dual Shutoff SaberJet™, they are both the first truly multi-purpose nozzle with the penetration of a solid bore tip and the advantages of a fog pattern. The new Single Shutoff SaberJet™ has a unique three position handle and ball to give you solid bore, fog, or close positions. The nozzle is capable of operating efficiently at pressures as low as 50 psi for reduced firefighter fatigue, or up to 100 psi for maximum flow. This versatile nozzle is well-suited for multiple applications. If you are looking for a truly multi-purpose nozzle, look no further...SaberJet™ is your answer. 10-year warranty. More sizes available, call for details.

Ship. wt. 3 lbs.



SaberJet™ Single Shutoff Nozzle

- ▶ 3/4", 7/8", 15/16", or 1" tips
- ▶ 135 gpm @ 100 psi fog flow
- ▶ Durable, lightweight Pyrolite® construction
- ▶ Multiple applications: interior, exterior, low pressure, CAFS, foam, cooling, etc.
- ▶ NFPA 1964 compliant
- ▶ 10-year warranty

SaberJet™ Dual Shutoff Nozzle

- ▶ The first truly multi-purpose nozzle
- ▶ Sizes available:
 - 3/8", 1/2" and 5/8" orifices with 1" inlet
Fog Flow 60 or 95 gpm @ 100 psi
 - 3/4", 7/8" and 1" orifices with 1 1/2" or 2 1/2" inlet
Fog Flow 135 at 100 psi

SPECIFY TIP SIZE

AW095	1" SaberJet™ (DSO) Nozzle with Pistol Grip	\$961.95
AW096	1" SaberJet™ (DSO) Nozzle	\$857.95
AS246	1 1/2" SaberJet™ (DSO) Nozzle with Pistol Grip	\$1,004.95
AS247	1 1/2" SaberJet™ (DSO) Nozzle	\$961.95
AS248	2 1/2" SaberJet™ (DSO) Nozzle with Pistol Grip	\$1,091.95
AS249	2 1/2" SaberJet™ (DSO) Nozzle	\$1,044.95
BA143	1 1/2" SaberJet™ (SSO) Nozzle	\$857.95
BA144	1 1/2" SaberJet™ (SSO) Nozzle with Pistol Grip	\$888.95
BA145	2 1/2" SaberJet™ (SSO) Nozzle	\$956.95
BA163	2 1/2" SaberJet™ (SSO) Nozzle with Pistol Grip	\$976.95

*Combination streams apply only to SaberJet™ Dual Shutoff Nozzles

Assault™ Nozzles

A Revolutionary Alternative to Automatic Nozzles

Akron® Assault™ Nozzles combine the quality stream performance at a variety of pressures with the simplicity of a fixed orifice. Durable and simple design make the Assault™ an unbeatable value. Meets NFPA 1964. *Ship. wt. 5 lbs.*

- ▶ Enhanced flow characteristics on 2½" Assaults (deeper throat design)
- ▶ Larger, more legible labels
- ▶ Easy to operate (¼ turn from straight stream to fog, raised lug marks straight stream for limited visibility operations)
- ▶ Better stream performance at pressures as low as 50 psi
- ▶ Low maintenance due to simple, durable design
- ▶ Meets new European Standard
- ▶ Affordably priced
- ▶ Simplified nozzle training
- ▶ No recalibration required
- ▶ Easy to service & repair

Available GPM/PSI	
95 @ 75	95 @ 100
125 @ 75	125 @ 100
150 @ 75	150 @ 100
175 @ 75	175 @ 100
	200 @ 100



Nozzle Comparison	Assault™ Automatics	
Control of flow by pump operator	YES	YES
Quality stream performance over a wide range of flows	YES	YES
Simple nozzle operation	YES	YES
No recalibration necessary	YES	NO
Low Maintenance	YES	NO
NFPA Compliance	YES	NO

SPECIFY GPM/PSI

AJ500	Assault™ Nozzle, 1½"	\$528.95
AJ503	Assault™ Nozzle, 1½" with Pistol Grip	\$599.95
AJ501	Assault™ Breakapart, 1½" with Pistol Grip and Twist Shut-Off	\$755.95
AJ502	Assault™ Breakapart, 1½" with Twist Shut-Off	\$755.95

Saber™ Shutoffs

Lightweight Pyrolite® finished ball shutoff with an integral straight bore tip. Shutoff and tip locked with ball bearings. Full 1⅜" waterway. *Ship. wt. 5 lbs.*



AZ344	1½" Saber™ Shutoff	\$355.95
AZ345	1½" Saber™ Shutoff with Pistol Grip	\$409.95
AZ346	2½" Saber™ Shutoff	\$470.95
AZ347	2½" Saber™ Shutoff with Pistol Grip	\$509.95



Pyrolite Shutoffs

Tough, lightweight ball shutoffs with a full-time restricted swivel base ensures the handle can be positioned for easier operation. *Ship. wt. 5 lbs.*



AW125	Shutoff 1" Swivel Inlet x 1" Male, 1" Waterway	\$383.95
AW126	Shutoff w/Pistol Grip 1" Swivel Inlet x 1" Male, 1" Waterway	\$417.95
AW127	Shutoff 2½" Swivel Inlet x 1½" Male, 1⅜" Waterway	\$497.95
AW128	Shutoff w/Pistol Grip 2½" Swivel Inlet x 1½" Male, 1⅜" Waterway	\$547.95
AW129	Shutoff 1½" Swivel Inlet x 1½" Male, 1⅜" Waterway w/Pistol Grip	\$447.95
AW130	Shutoff 1½" Swivel Inlet x 1½" Male, 1⅜" Waterway	\$399.95
AW131	Shutoff 2½" Swivel Inlet x 2½" Male, 2" Waterway	\$814.95

Color Code Your Nozzles Colored Handles

Add color to your nozzles. A rainbow of colors are available for handles and pistol grips on most Akron nozzles. Specify color when ordering, or order separately for easy retrofitting.



SPECIFY COLOR: Black, Gray, White, Yellow, Red, Green, Orange, Blue	
SPECIFY MAKE and MODEL NUMBER OF NOZZLE	
BH198	Colored Handle \$27.95

Pistol Grips



SPECIFY COLOR: Black, Gray, White, Yellow, Red, Green, Orange, Blue	
AZ579	Pistol Grip \$20.95



Chief™ Constant Flow Nozzles

Fixed-flow Chief™ nozzles efficiently deliver a constant gallonage from straight stream to full fog. The simple, rugged design makes the Chief™ easy to use, train with, and reliable in tough situations. Superior hydraulics, due to a fully machined waterway, result in excellent stream quality and reach.

- ▶ Accurate, flow-efficient, constant gallonage operation
- ▶ Industry leading stream quality

		Hose	Thread	GPM	
W137	Chief™ Nozzle	1"	1"	15, 30, 45, 60	\$599.95
W138	Chief™ w/Pistol Grip	1"	1"	15, 30, 45, 60	\$651.95
U382	Chief™ Nozzle	1½"	1½"	60, 95, 125, 150	\$611.95
U383	Chief™ w/Pistol Grip	1½"	1½"	60, 95, 125, 150	\$690.95
W139	Chief™ Nozzle	1¾"-2½"	1½"	175, 250, 325	\$741.95
W140	Chief™ w/Pistol Grip	1¾"-2½"	1½"	175, 250, 325	\$754.95
W141	Chief™ Nozzle	2½"	2½"	175, 250, 325	\$809.95
W142	Chief™ w/Playpipe*	2½"	2½"	175, 250, 325	\$1,399.95
AW099	Chief™ Nozzle Tip	1½"	1½"	60, 95, 125, 150	\$478.95
AW100	Chief™ Nozzle Tip	1¾"-2½"	1½"	175, 250, 325	\$532.95
AW101	Chief™ Nozzle Tip	1¾"-2½"	2½"	175, 250, 325	\$629.95

*Playpipe with shut-off

Select-O-Matic® Automatic Nozzles

Pressure-regulating Select-O-Matic® nozzles automatically adjust to fluctuating water flow to maintain effective pressure and a consistent fire stream in all flow ranges. Our patented, completely unobstructed waterway allows more gpm at lower pressures than any competitive brand. All models flush easily without shutting down and provide constant flow on either fog or straight stream, making them ideal for the application of AFFF foam. *Ship. wt. 4 lbs.*

- ▶ Completely unobstructed waterway
- ▶ Patented pressure-regulating system
- ▶ Corrosion resistant; no lubrication required



		Hose	Thread	GPM	
R847	Booster Nozzle	1"	1"	10-75	\$797.95
R848	Nozzle	1½"	1½"	60-125	\$807.95
U406	Nozzle w/Pistol Grip	1½"-1¾"	1½"	60-200	\$1,006.95
AZ348	Low Pressure 75 psi	1½"-1¾"	1½"	60-200	\$952.95
R850	Nozzle, Direct Connect	2½"	2½"	75-325	\$1,119.95
R851	Nozzle w/Pistol Grip	1½"	1½"	60-125	\$851.95
R852	Nozzle w/Pistol Grip	1"	1"	10-75	\$849.95
R853	Nozzle w/Playpipe	2½"	2½"	75-325	\$1,573.95
R854	Nozzle w/Playpipe*	2½"	2½"	75-325	\$1,745.95

*Break-apart design

Phantom Selectable Gallonage Nozzles

The selectable gallonage Phantom® nozzle lets the firefighter select the appropriate flow. The wide selection range standard with the Phantom® makes it one nozzle for every use, from brush to interior attack. The Phantom® is designed for reliable performance with rugged metal selector ring and dual drive metal ball shut-off.

- ▶ True 75 psi pressure rating
- ▶ Five flow settings: 30 – 95 – 125 – 150 – 200
- ▶ Dual drive metal dhutoff

BB027	Phantom Selectable Gallonage Nozzle	\$682.95
BB028	Phantom Selectable Gallonage Nozzle w/Pistol Grip	\$725.95
BB029	Phantom Selectable Gallonage Tip	\$508.95
BB030	Phantom Selectable Gallonage Tip w/Twist Shutoff	\$508.95

Chief Constant Flow Nozzles with Glow Bumper

In situations where light and visibility is critical, our phosphorescent TPE (thermo-plastic elastomer) bumpers help improve awareness and location tracking. Charged by any light source, even firelight, the Glow Bumper aids firefighters during dark, dim, and poor visibility interior attacks.

- ▶ Phosphorescent TPE bumper – glows brightly for hours
- ▶ Charged by any light source, including firelight
- ▶ Aids firefighters during poor visibility interior attacks



		Hose	Thread	GPM	
BD148	Chief Nozzle	1"	1"	15, 30, 45, 60	\$671.95
BD149	Chief w/Pistol Grip	1"	1"	15, 30, 45, 60	\$722.95
BD150	Chief Nozzle	1½"	1½"	60, 95, 125, 150	\$681.95
BD151	Chief w/Pistol Grip	1½"	1½"	60, 95, 125, 150	\$764.95
BD152	Chief Nozzle	1¾-2½"	1½"	175, 250, 325	\$813.95
BD153	Chief w/Pistol Grip	1¾-2½"	1½"	175, 250, 325	\$826.95
BD154	Chief Nozzle	2½"	2½"	175, 250, 325	\$881.95

FlipTip™ Nozzles



BL387:

The Tip-Only Model is an ideal choice for an addition to any ball valve shut off. The FlipTip™ quickly and positively allows the initial attack team a choice stream performance.

- ▶ 1½" NH Female Inlet, tip only style, 15/16" rear tip, 1/2" front tip
- ▶ Lightweight and compact design
- ▶ Tips easily removed for line extension

BL387



BL388:

Integrated with a high volume ball shutoff, the combination FlipTip™ provides a single nozzle that offers a choice of hard hitting streams. The detent style ball shutoff allows positive operator control and the rugged durability of polymer handles and pistol grip.

- ▶ 1½" NH Female Inlet, valve and pistol grip style, 15/16" rear tip, 5/8" front tip
- ▶ High volume detent valve for maximum performance
- ▶ Compact integrated design

BL388



BL389:

Integrated with a high volume ball shutoff and a G-Force combination nozzle, the FlipTip™ provides a single nozzle that offers both a hard hitting smoothbore and high performance combination nozzle. The detent style ball shutoff allows for positive operator control.

- ▶ 1½" NH Female Inlet, valve and pistol grip style, 5/16" rear tip, automatic 150 gpm @ 75 psi pressure control, fixed tactile indicator shaper control, spinning stainless steel fog teeth

BL389



BL387	FlipTip™ 1½" NHF Tip	\$435.95
BL388	FlipTip™ 1½" NHF Tip w/Integrated Ball Valve and Grip	\$655.95
BL389	FlipTip™ 1½" NHF Tip w/G-Force w/Integrated Ball Valve and Grip	\$855.95





BL089

Automatic



BL090

Selectable



BL091

Fixed Gallonage

G-Force Nozzles

The G-Force Series of Task Force Tips handline nozzles are designed to provide high performance fire streams in a highly affordable package. Offering your choice of regular or low pressure in fixed, selectable and automatic configurations, the G-Force nozzles integrate an exclusive slide style valve for turbulence free performance even when gated. Other high quality features include an inlet debris screen to prevent stream pattern disruption and easily identified color coded pistol grips and handle covers. Each nozzle incorporates G-Force's unique stainless steel spinning teeth for a wide protective fog pattern, bonded front rubber bumper, reflective labeling, and a standard five year warranty.

- ▶ Durable polymer handle developed for the harshest fire ground operations while offering reduced maintenance costs
- ▶ Color-coded shut-off handle, grips, and Scotchlite™ labels
- ▶ Unique inlet debris screen - unparalleled protection from debris that can affect stream quality
- ▶ Flush without shutdown, integrated tactile pattern indicator, and bonded long lasting rubber bumper
- ▶ Unique slide valve design - total firefighter flow control and outstanding stream quality, even with the nozzle valve gated and the flow reduced
- ▶ Stainless steel spinning teeth for wide fog pattern - tactile indicator provides easy pattern selection
- ▶ NFPA #1964 compliant (2008) edition
- ▶ Ship. wt. 5 lbs.



Cat#	Type	Inlet	Flow Rates GPM	Price
BL089	Automatic	1½" Female	60-150 gpm @ 100 psi	\$495.95
BL090	Selectable	1½" Female	30 - 60 - 95 - 125 - 150	\$495.95
BL091	Fixed Gallonage	1½" Female	150 gpm @ 100 psi	\$495.95



1.5" NH Metro 1 Nozzles

Fixed gallonage nozzle with 14 flow and pressure choices. Includes flush without shutting down, patented slide type valve for turbulence-free flow control, six detent flow positions, and "Gasket Grabber" inlet screen. Lightweight hardcoat anodized aluminum for maximum resistance to corrosion and wear. 1.5" NH (38mm) full-time swivel rocker lug coupling is standard.

BL026 - Pistol Grip is mounted below the valve



BL025

BL025	1.5" Metro 1 Nozzle	\$660.95
BL026	1.5" Metro 1 Nozzle with Pistol Grip	\$660.95

ULTIMATIC 125 Nozzles

Compact Size and Reduced Weight

- ▶ Fully automatic 100 psi nozzle
- ▶ Flow range of 10-125 gpm
- ▶ Includes built-in pistol grip
- ▶ Six-position detent flow control
- ▶ Exclusive TFT slide valve
- ▶ "Gasket Grabber" inlet screen
- ▶ Molded rubber bumper with power fog teeth
- ▶ Hard-coated for resistance to corrosion and wear
- ▶ Flush without shutting down

		Hose	Thread	GPM	
Z315	Nozzle with Pistol Grip	1 1/2"	1 1/2"	10-125	\$873.95
Z313	Nozzle without Grip	1 1/2"	1 1/2"	10-125	\$873.95

TFT Handline Automatic Nozzles

The Handline series of automatic (100 psi) nozzles is ideal for 1 3/4", 2", 2 1/2" and 3" hose lines. Features flush without shut down, molded rubber bumper, and stainless steel slide valve. *Ship. wt. 5 lbs.*

		Hose	Thread	GPM	
Z318	Nozzle with Grip	1 1/2"-2 1/2"	1 1/2"	95-300	\$1,125.95
AC704	Nozzle without Grip	1 1/2"-2 1/2"	1 1/2"	95-300	\$1,125.95

ThunderFog Selectable Gallonage Nozzles

ThunderFogs are ideal for any 1 1/2", 1 3/4", 2", or 2 1/2" hose line. AC705 and AC706 have twist type shutoff, AC707 and AC708 have ball type shutoff. *Ship. wt. 3 lbs.*

- ▶ Available in tip-only configuration for break-and-extend operations or with stainless steel ball shutoff
- ▶ Available with stainless steel spinning teeth standard or optional fixed teeth
- ▶ Exclusive TFT stainless steel ball shutoff and "quick change" rear valve seat
- ▶ Accepts both low and multi-expansion foam attachments

		Hose	Thread	GPM	
AC705	Nozzle, Twist without Grip	1 1/2"-2 1/2"	1 1/2"	30-200	\$589.95
AC706	Nozzle, Twist without Grip	1 1/2"-2 1/2"	1 1/2"	95-250	\$589.95
AC707	Nozzle with Pistol Grip	1 1/2"-2 1/2"	1 1/2"	95-250	\$895.95
AC708	Nozzle with No Pistol Grip	1 1/2"-2 1/2"	1 1/2"	95-250	\$895.95
AS518	Nozzle with Playpipe	2 1/2"	2 1/2"	95-250	\$1,183.95

Mid-Force Automatic Nozzles

- ▶ 70 - 200 gpm
- ▶ Utilized pressure control for easy maintenance or upgrades
- ▶ Unique gasket grabber - unparalleled protection from debris that can affect stream quality
- ▶ Famous slide valve design - total firefighter flow control and outstanding stream quality, even with the nozzle valve gated and the flow reduced
- ▶ Unique "full-filled" fog pattern - quick straight stream to fog pattern for immediate response & maximum protection
- ▶ NFPA #1964 compliant (2003) edition
- ▶ *Ship. wt. 12 lbs.*

AS156	Mid Force Automatic Nozzle 1 1/2"	\$1,134.95
AS157	Mid Force Automatic Nozzle 1 1/2" w/Pistol Grip	\$1,134.95



NOZZLES



Use on any size hose



Automatic dual pressure

Viper Fire Fighting Nozzle



The Viper Industrial Heavy-Duty Nozzle with ergonomic rubber-coated pistol grip is an exceptional value for in-plant fire protection or wildland firefighting. It can break apart to help extend hose lines with both the tip and the pistol grip capable of shutting off. The spinning teeth add to the full fog pattern and the protective rubber bumper keeps the tip from sparking. A 95 gpm tip is standard and various tips are available making it the best value in its class.

SPECIFY THREADS: NST or NPSH		Ship. Wt.	Price
AM141	Viper Fire Fighting Nozzle	6 lbs.	\$288.95

Darley 1.5" Breakapart Nozzles



- ▶ Ball valve shut-off
- ▶ Pistol grip design
- ▶ Ideal for wildland or industrial fire protection
- ▶ Tip also shuts off

AW227	Darley 1.5" Breakapart Nozzle (100 gpm Constant Flow)	\$288.95
AW228	Darley 1.5" Breakapart Nozzle (20-60 gpm Dual Range)	\$288.95

Adjustable Fog Nozzles

Adjustable Fog Nozzles are constructed of hard coated aluminum with brass and stainless steel internal components.

They come with a heavy duty rubber bumper for added protection. These nozzles flow from 10 gpm or less and are ideal for wildland fire fighting, industrial fire protection and wash down applications.



AW102	1" 10-23 gpm Nozzle	\$93.95
AW103	1" 10-23 gpm Nozzle (Bumperless)	\$79.95
AW104	1 1/2" 20-60 gpm Nozzle	\$115.95
AW105	1 1/2" 20-90 gpm Nozzle	\$115.95

Viper Automatic Nozzles



Rugged and durable nozzles that offer quality and at an affordable price in an automatic nozzle. You'll have the versatility of variable pattern control from straight stream to wide angle fog and capability of flushing without pattern changes or shutting down. Spinning teeth give superior fog protection and reach. Carbon-composite shutoff ball valve and control are highly resistant to wear and corrosion and give greater impact resistance. Other features include full time swivel inlet, hi-impact absorbing rubber bumper and pistol grip. Made of anodized aluminum. *Ship. wt. 6 lbs.*

- ▶ Compact and lightweight
- ▶ Easy maintenance
- ▶ Ergonomic design
- ▶ Pistol grip and ball shutoff

SPECIFY 1" AND 1 1/2" THREADS:
NST or NPSH; 2 1/2" is NST only

Cat#	Inlet	Flow Rates GPM	Price
AM132	1"	15 - 50	\$479.95
AM133	1 1/2"	25 - 100	\$479.95
AM134	1 1/2"	50 - 160	\$479.95
AM13501	1 1/2"	80 - 200	\$585.95
AM13502	2 1/2"	80 - 200	\$595.95

Viper Select Gallonage Nozzles



- ▶ Compact and lightweight
- ▶ Easy maintenance
- ▶ Ergonomic design
- ▶ Pistol grip and ball shutoff

Specify 1" and 1 1/2" threads:
NST or NPSH; 2 1/2" is NST only

Cat#	Inlet	Flow Rates GPM	Price
AM142	1"	15 - 30 - 50 - 60	\$477.95
AM143	1 1/2"	30 - 60 - 95 - 125	\$477.95
AM144	1 1/2"	75 - 100 - 125 - 150	\$477.95
AM145	1 1/2" or 2 1/2"	95 - 125 - 150 - 200	\$559.95
	Specify inlet size		
AM146	2 1/2"	125 - 150 - 200 - 250	\$578.95

Firefighting Handline Nozzles



This nozzle is a multi-gallage device which gives the nozzle man a greater degree of flexibility. The flow rate can be manually adjusted during operation without having to shut the nozzle down. It has been designed to give a constant flow, whether the stream pattern selected is on straight stream, power cone or wide angle fog. Constructed of anodized black aluminum or plain brass. Main features include: spinning turbine teeth which give excellent breakup of the water stream, flush mechanism, large ribbed rubber bumper, large rubber handle, dual Trunion drive on ball shut-off which provides smoother shut-off and less maintenance, ball shut-off is of the full flow type with chrome brass ball and nylon seats. *Nozzle comes standard with 1/2" female NST. Ship. wt. 2-9 lbs.*

CHEM GUARD

▶ Adjustable to 30-60-95-125 gpm

Cat#	Description	Length	Wt.	Price	Ship.
AF258	Aluminum Nozzle w/Out Grip	7 ⁵ / ₈ "	2 lbs.	\$601.95	
AF259	Aluminum Nozzle w/Grip	8 ¹ / ₈ "	3 lbs.	\$652.95	
AF260	Brass Nozzle w/Out Grip	7 ⁵ / ₈ "	7 lbs.	\$856.95	
AF261	Brass Nozzle w/Grip	8 ¹ / ₈ "	9 lbs.	\$936.95	

Blue Devil Nozzle



The Blue Devil Nozzle offers heavy-duty construction for operating in the most difficult conditions of fire fighting.

- ▶ Designed to work up to 570 psi
- ▶ Highly durable and shock-resistant
- ▶ Professional results from lower gallage settings
- ▶ Deeper ribs in selector ring for better grip, even with gloves
- ▶ Permanent laser engraved flow information and position data
- ▶ Spinning teeth easier to replace
- ▶ Metal ball to work under high pressure

SPECIFY THREAD: NST or NPSH

Cat#	Description	Performance	Weight	Price
BE268	1" Nozzle	5-15-25-50 gpm @ 100 psi	5 lbs.	\$599.95

Darley Ball Shutoff Valves

Feature female swivel base, horseshoe shutoff, hard, anodized aluminum construction, polymer ball and seats, neoprene seals and stainless steel swivel bearings. *Ship. wt. 2 lbs.*



AM071	1" Ball Shutoff	\$147.95
AM072	1 1/2" Ball Shutoff	\$164.95
AM073	1" Ball Shutoff with Pistol Grip	\$158.95
AM074	1 1/2" Ball Shutoff with Pistol Grip	\$158.95

Constant Flow Nozzles

These nozzles provide a continuously adjustable stream, from a full fog to a straight stream and twist shutoff. Constructed of anodized aluminum and brass with stainless fasteners. Heavy-duty neoprene bumpers. *Ship. wt. 1 lb.*



SPECIFY THREAD: NST or NPSH

AM080	1" Constant Flow Nozzle, 30 gpm	\$90.95
AM081	1 1/2" Constant Flow Nozzle, 60 gpm	\$114.95
AM082	1 1/2" Constant Flow Nozzle, 100 gpm	\$114.95

Playpipe Nozzles

Axial Playpipe with stacked tip smooth bore nozzle with 1 1/4", 1 1/8" & 1" outlets. Equipped with removable debris screen, durable metal ball and a smooth waterway. Available with fulltime 2 1/2" Swivel, NST only.

- ▶ Weight: 7.2 lbs.
- ▶ NFPA 1901 requires pumper equipment to include one playpipe with shut off and tips



BL238	2 1/2" x 1 1/2" Playpipe with Triple Stack Tip, 1 1/4, 1 1/8" & 1" Outlets	\$674.95
-------	--	----------

Stop It! Right Now! With FlameFighter Piercing Nozzles

The FlameFighter provides quick and efficient access through roofs, doors, walls, floors and even foundation blocks to extinguish fires from attic to basement. It gets you to the source of a fire quickly. In just seconds one or two firefighters can insert the FlameFighter into virtually any desired entry point and generate a high pressure water spray covering up to 2,400 square feet at 150 psi delivering 212 gpm. For vehicle fires, it easily pierces the hood, door or trunk to make for quick extinguishing. What's more, whether you're using water or foam, the precisely placed openings in the nozzle send out a pressuring spray that extinguishes or cools most any fire. *Piercing Nozzle Tip Spraying Unit covers over 2,400 sq. ft. at 150 psi. Can also adapt to foam applications. 5-yr. warranty. Ship. wt. 10 lbs.*

The Original FlameFighter - Made of chrome-plated high-quality steel. Measures 60" long. Comes equipped with a 1 1/2" NST hose connection (other threads available). Protruding handles allow for easy control by one or two persons. Rear is weighted so it can be used as a battering ram.

Lightweight FlameFighter - A lighter weight 3 foot applicator made of high-quality steel and aluminum. Comes with 1 1/2" pistol grip ball shutoff.

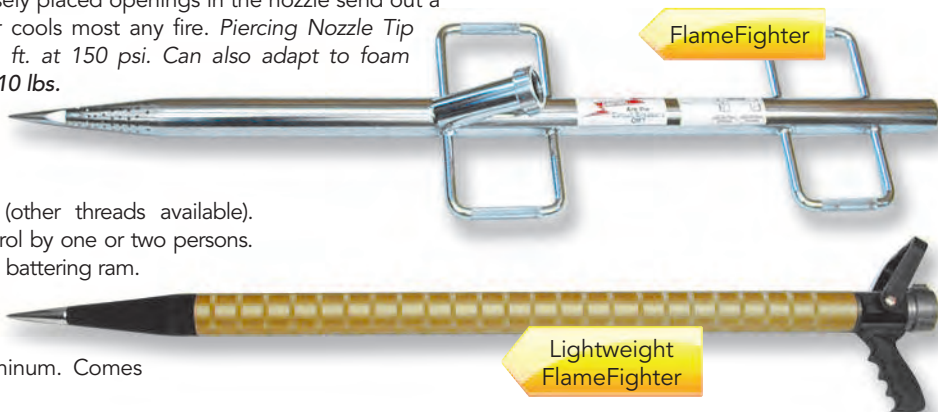

Uses:

- ▶ Houses
- ▶ Car & trucks
- ▶ Garages
- ▶ Barns
- ▶ Mobile homes

AJ550	FlameFighter Piercing Nozzle	\$1,670.95
AJ549	Lightweight FlameFighter Piercing Nozzle	\$1,136.95

900 Series Piercing Nozzles

These nozzles combine the best of durability, flexibility and are light in weight. They can accommodate extensions for extra reach (2' per extension). They can also be driven in with a mallet if needed. This unique nozzle design needs to be driven in only 3.75" to have full penetration of the sprayer unit. Ideal for walls with coverage of up to 25 feet in all directions. It's powerful enough for fires in attics, basements, mobile homes, garages, vehicles or any confined space. These piercing nozzles feature a unique safety handle. That allows a firefighter to safely hold the unit when a mallet is being used to drive the nozzle in. The handle is removable if needed. They come with 1.5 NST threads as standard; other threads are available. Designed for the rugged demands of the Fire Service worldwide. *Ship. wt. 9-24 lbs.*



Cat#	Description	Ship. Wt.	Price
AS160	Nozzle 2' with (1) 2' Extension	9 lbs.	\$765.95
AS161	Nozzle 2' with (1) 2' Extension and Shutoff Valve	9 lbs.	\$1,142.95
AS162	Nozzle 4' with (1) 2' Extension	12 lbs.	\$914.95
AS163	Nozzle 4' with (1) 2' Extension and Shutoff Valve	12 lbs.	\$1,310.95
AS166	Battering Ram Nozzle Plus (1) 2' Extension	24 lbs.	\$1,002.95
AS167	Battering Ram Nozzle Plus (1) 2' Extension with Shutoff Valve	24 lbs.	\$1,245.95

900 Series 90° Piercing Nozzles

- ▶ Ideal for use on car fires or confined space
- ▶ All FlameFighter nozzles qualify for ISO points
- ▶ Delivers up to 139 GPM
- ▶ Storage brackets included
- ▶ 1 1/2" NST F
- ▶ 38" long
- ▶ 5-year warranty
- ▶ **Ship wt. 9-12 lbs.**



AS164	Nozzle 90° (Car Fires)	\$693.95
AS165	Nozzle 90° (Car Fires) w/Shut Off Valve	\$933.95

Fyrestick Piercing Nozzle

The Perfect Fire Fighting Tool For:

- ▶ Attic and roof fires: Shingle, slate, metal, wood
- ▶ Underwood vehicle fires: Car hoods and doors
- ▶ Mobile home fires: Walls and doors
- ▶ Warehouse fires: Garage doors and roofs
- ▶ Many more applications

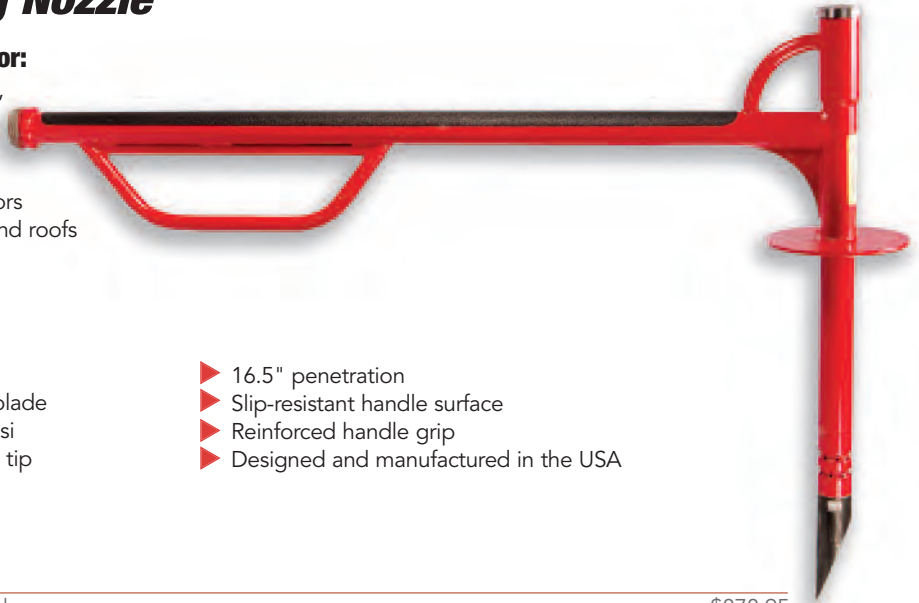

Features:

- ▶ Sledge-head replaceable anvil
- ▶ Patented spray head & piercing blade
- ▶ Spray jets flow 100 gpm @ 100 psi
- ▶ 20° angled replaceable hardened tip
- ▶ 1.5" NST hose fitting
- ▶ 16.5" penetration
- ▶ Slip-resistant handle surface
- ▶ Reinforced handle grip
- ▶ Designed and manufactured in the USA

BK008

Fyrestick Piercing Nozzle

\$878.95

Piercing Applicator Nozzle

Use a sledge hammer to drive the Piercing Applicator Nozzle through concrete blocks, mobile homes, etc.

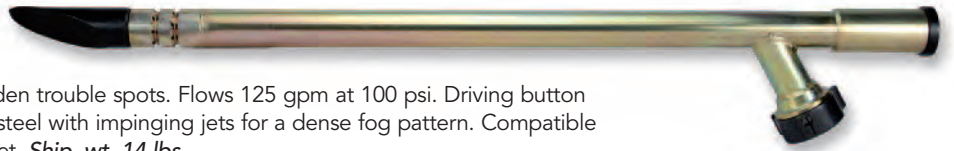

Designed to get water or foam to hidden trouble spots. Flows 125 gpm at 100 psi. Driving button and point are made of hardened tool steel with impinging jets for a dense fog pattern. Compatible with AFFF and Class A foams. 1½" inlet. *Ship. wt. 14 lbs.*

AF239

Piercing Applicator Nozzle, 3'

\$845.95

AF240

Piercing Applicator Nozzle, 6'

\$899.95

Augustus Fire Tool®

Augustus Fire Tool for Portable Extinguishers - The Augustus Tool can operate in conjunction with CO₂, Pressurized Water or Dry Chemical extinguishers. The tool is supplied with a six foot hose to replace the existing hose on the extinguisher and is fitted with a quick-connect male coupling to connect to the tool's inlet handle female brass safety-lock coupling. *Ship. wt. 14 lbs.*

Augustus Fire Tool for Hose Lines - This model is designed to be used with a booster tank operation. The tool can be supplied from a booster tank using either a 1" booster line, 1½" or 1¾" pre-connect hose line with a flow in excess of 55 gpm. Comes with a female swivel connection for either 1" or 1½" hose equipped with National Standard Hose Thread or any thread your department uses. *Ship. wt. 15 lbs.*

- ▶ Use on vehicles and confined spaces
- ▶ Portable or hose line



Hardened stainless steel tip



Female National Standard hose thread/female brass safety-lock coupling



PORTABLE MODELS - SPECIFY EXTINGUISHER MAKE/MODEL

AG065	Fire Tool with CO ₂ Hose	\$962.95
AG066	Fire Tool with Dry Chemical Hose	\$962.95
AG067	Fire Tool with Water Foam Hose	\$962.95
AK174	Portable Complete Package	\$1,025.95

HOSELINE MODELS

AG069	Fire Tool with 1" Female Swivel	\$945.95
AG070	Fire Tool with 1" Flat Hose Whip and Swivels	\$1,015.95
AK175	Complete Hoseline Package	\$1,223.95

Deluge Tips, Smooth-Bore Tips and Devices



A. Deluge Tip

- ▶ 9" long
- ▶ 1 1/2" orifice
- ▶ 2 1/2" base thread
- ▶ Hardcoat aluminum

Ship wt. 1 lb.

AJ524	Deluge Tip	\$141.95
-------	------------	----------

B. Discharge Pipe

Two sets of stream straightener fins ensure maximum reach and solid streams. For use on all monitors. Max. flow rate 1,750 GPM.

Ship wt. 1 lb.

- ▶ 11" or 16" long
- ▶ 2 1/2" inlet and discharge
- ▶ Hardcoat aluminum

AJ525	Discharge Pipe, 11"	\$195.95
AJ526	Discharge Pipe, 16"	\$216.95

C. Deluge Tip with Stream Straightener

- ▶ 11" long
- ▶ 2 1/2" base thread
- ▶ 1 1/2" orifice
- ▶ Built-in stream straightener
- ▶ Hardcoat aluminum

Ship wt. 1 lb.

AJ527	Deluge Tip with Straightener	\$203.95
-------	------------------------------	----------

D. Stream Straightener

Use with all large-volume discharge devices for increased range and effective reach. Ship wt. 1 lb.

- ▶ 3" long
- ▶ 2 1/2" inlet and outlet threads
- ▶ Hardcoat aluminum

AJ528	Stream Straightener	\$69.95
-------	---------------------	---------

E. 6" Smooth Bore Tip

- ▶ 6" long
- ▶ 1 1/2" base thread
- ▶ 1 1/8" orifice
- ▶ Hardcoat aluminum

Ship wt. 1 lb.

AJ530	6" Smooth Bore Tip	\$99.95
-------	--------------------	---------

F. Double Stack Tip

- ▶ 6 3/4" long
- ▶ 1 1/2" base thread
- ▶ 1" female base thread
- ▶ Hardcoat aluminum
- ▶ 1 5/16" x 1/2" orifice

Ship wt. 1 lb.

AJ533	Double Stack Tip	\$152.95
-------	------------------	----------

G. Deluge Stack Tip

- ▶ 12" and 17" long
- ▶ 2 1/2" base thread
- ▶ Two middle threads, underwriters P.P.S. 2" NH
- ▶ 1 1/2" top thread
- ▶ 1 3/8", 1 1/2", 1 3/4" orifices
- ▶ Hardcoat aluminum

Ship wt. 3 lbs.

AJ534	12" Triple Deluge Stack Tip	\$251.95
AJ537	17" Quad Deluge Stack Tip	\$301.95

H. Triple Handline Stack Tip

- ▶ 8 1/2" long
- ▶ 1 1/2" base thread
- ▶ 1 1/2" middle thread
- ▶ 1 1/4" top thread
- ▶ 1", 1 1/8", 1 1/4" orifices
- ▶ Hardcoat aluminum

Ship wt. 1 lb.

AJ536	Triple Handline Stack Tip	\$226.95
-------	---------------------------	----------

1 1/2" Straight Bore Nozzles

The New Standard in Smooth Bore Nozzles

- ▶ 4" in length
- ▶ Constructed of anodized aluminum
- ▶ Outlets available in: 1/2", 3/4", 15/16", 1, 1 1/16", 1 1/8", and 1 1/4"
- ▶ 1 1/2" Rigid Base NST



BB032	1/2" Outlet	\$92.95
BB033	3/4" Outlet	\$92.95
BB034	15/16" Outlet	\$92.95

1" Straight Bore Nozzle

- ▶ 5" in length
- ▶ Constructed of anodized aluminum
- ▶ Outlet: 15/16"
- ▶ 1" Rigid Base NST



BB035	15/16" Outlet	\$92.95
-------	---------------	---------

Stacked Tips

- ▶ Sold as a set, taper from 1 1/4" to 1 1/8" to 1"
- ▶ Constructed of anodized aluminum
- ▶ 1 1/2" rigid base NST



BB036	Stacked Tips, Outlet 1 1/4" to 1 1/8" to 1" (Set of 3)	\$241.95
-------	--	----------

Cellar Nozzle

The Cellar Nozzle has a ball bearing revolving action for attacking fires in hard-to-reach places. The AF242 has a 1½" rigid base with 6 variable angle orifices. It flows 95 gpm at 50 psi; measures 3½"L. The AF241 has a 2½" base with 9 variable angle orifices. It flows 250 gpm at 100 psi; measures 5⅞"L. *Ship. wt. 2 lbs.*



AF242	Cellar Nozzle, 1½"	\$462.95
AF241	Cellar Nozzle, 2½"	\$594.95

Viper Black Knight Nozzle

The Black Knight is constructed in 1½" size and adjustable from wide fog to shut off position, with flows up to 95 gpm. The Black Knight is much more durable and dependable compared to conventional polymer nozzles as it is highly reinforced with fiberglass which allows the nozzle to hold its shape under heat and pressure. It includes brass internal stems for corrosion resistance, and has a rubber bumper. Great for brush, wildland fires and industrial applications. *Ship. wt. 2 lbs.*



AW106	Viper Black Knight Nozzle 1½" 95 gpm	\$25.95
-------	---	---------

Chimney Snuffer Kit

The Chimney Snuffer quickly and safely suppresses chimney fires using an ultra-fine spray, greatly reducing potential water damage. The durable 5 lb. nozzle head is simply operated by a single firefighter and easily breaks through potential blockages within the chimney. Eight strategically placed nozzles provide 40 gallons per hour at 60 psi, allowing the Chimney Snuffer to be supplied by an attack line, 1" line, or even a garden hose. The entire package weighs less than 15 lbs. and is easily stored in apparatus compartment. *Ship. wt. 19 lbs.*

- ▶ Includes: nozzle head, burn resistant rubber hose, 1" ball style shut off, 1.5 x 1" adapter and ¾" garden hose adapter
- ▶ Compact, lightweight and simple to deploy
- ▶ Ideal for use in all types of chimney liners
- ▶ Head easily breaks through creosote buildup, nests or other debris



AR159	Chimney Snuffer Kit	\$655.95
-------	---------------------	----------



A. Underwriters & Factory Mutual Playpipes

Made with 2½" base and 30" long. Screw nozzle, swivel handle, Marlin wound and painted red. Standard discharge tip 1⅞". *Ship. wt. 10 lbs.*

288	Underwriters Playpipe, 30" NH	\$269.95
R661	Factory Mutual Playpipe, 15" NH	\$265.95
B45801	Underwriters Playpipe Tip with 1⅞" Discharge (Brass Tip Only)	\$56.95

B. Hose Pipes

Cast Brass, for 1½" and 2½" fire hose. *Ship. wt. 5 lbs.*

E137	1½" Pipe, Discharge ½", 10"L	\$27.95
E138	2½" Pipe, Discharge 1", 12"L	\$54.95

EZ PUP Allows You To Fight Fire . . . Not Fatigue

The EZ PUP contoured shape fits against your body like a rifle stock; this makes it possible to transfer the reactionary forces of a charged line away from the arms and to an area of the body that has larger muscle and bone mass such as the shoulder, hip or thigh. These positions allow you stand erect, thus taking the twist and strain off the back. What's more, the EZ PUP allows for one hand operation, leaving the other hand free to adjust the nozzle. Comes standard with high visibility, photo-luminescent stripes. *Ship. wt. 5 lbs.*



SPECIFY THREAD TYPE

AK012	EZ PUP, 1½"	\$457.95
-------	-------------	----------



Use The Ozzie™ Oscillating Portable Nozzle

...And Use Personnel Somewhere Else

Ozzie™ Oscillating Monitors have powerful sweeping water streams for high performance attack and protection. Its unique water driven monitor sweeps the outlet back and forth in a smooth, wave-like motion to provide cooling and protection while unmanned. Ozzie™ Oscillating Monitors operate by themselves to provide greater flexibility by protecting exposures while personnel work elsewhere. They are suited for hazmat situations, protecting exposures and attacking fires. *Ship. wt. 31 lbs.*

- ▶ Adjustable sweeping range
- ▶ Sweeping range 30° either side of center
- ▶ Vertical travel from 35° to 90° above horizontal
- ▶ Built-in pressure gauge
- ▶ On/Off knob can stop oscillation at any point



AC934	Ozzie™ without Nozzle	\$3,136.95
AC934A	Ozzie™ with Nozzle	\$3,621.95

MercuryMaster1000™ Monitor

The MercuryMaster1000™ is the newest innovation to the portable monitor line. This monitor is the smallest and lightest of all 1000 gpm monitors in the firefighting industry. The MercuryMaster1000™ will free up valuable time at the fire scene with its quick deployment and free up precious space on the fire truck with its compact size.

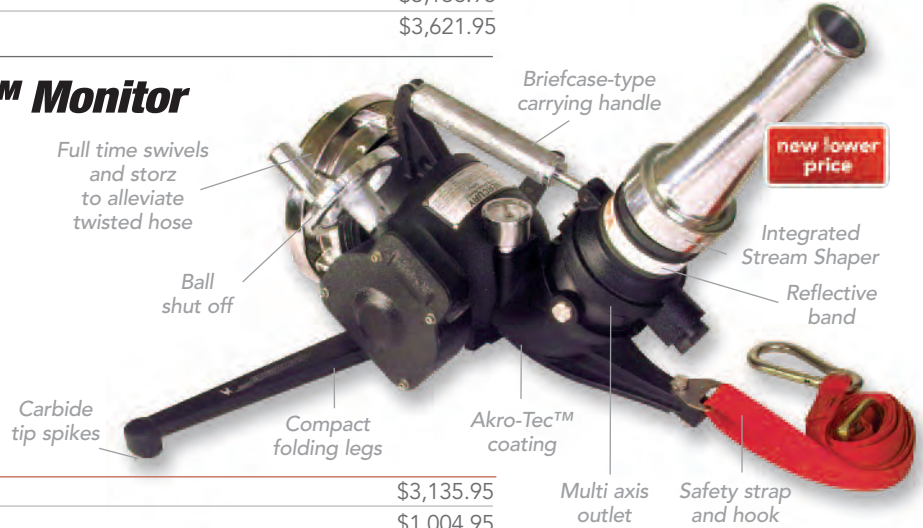

BD163	MercuryMaster1000™	\$3,135.95
BD164	Adjustable Flow Nozzle	\$1,004.95
BD165	Automatic Nozzle	\$980.95
BD166	Chrome Triple Stacked Tips	\$499.95
BD167	Chrome Deluge Tip	\$331.95
BD168	Storage Bracket	\$188.95

Mercury Quick Attack Monitor

The Mercury Quick Attack Monitor is the newest innovation in fire fighting equipment. This monitor is smaller than any other portable ground monitor so it can be set up quickly and left unmanned at the fire scene to free up valuable personnel. Mercury Monitor comes with an integrated stream shaper.

Features:

- ▶ Compact size and weight
- ▶ Rated flows up to 500 gpm
- ▶ Quick deployment
- ▶ Better ground stability
- ▶ Unmanned use



AW467	Mercury Quick Attack Monitor	\$3,393.95
AW470	Mounting Bracket	\$178.95
AW468	Stacked Tips	\$357.95
AW469	Mercury Nozzle 500 gpm	\$532.95

GP Manual Monitor

1000 GPM (3800 LPM)

The GP Manual Monitor is one of the most cost effective, highest performing firefighting monitors found worldwide. The rugged, lightweight design was engineered using some of the world's most advanced computer aided design and testing technology, resulting in performance seen by no other 1000 gpm monitor today. Once you grab the dual handled controls, you will know you are using the most highly maneuverable, easiest operating, most versatile fire service monitor in the world. No other monitor in it's class even comes close! **Ship. wt. 17 lbs.**

- ▶ Rated flow up to 1000 gpm
- ▶ Rotation continuous 360°
- ▶ Elevation +90° to -45°
- ▶ Cast-in turning vanes & integrated removable stream shaper for maximum reach and stream performance
- ▶ Built-in pressure gauge
- ▶ "T" handle manual control provides precise, easy positioning and control
- ▶ Compact, efficient design requires minimum mounting space
- ▶ **Dimensions:** 13¹/₄"Hx11"Wx9¹³/₁₆"D
- ▶ **Inlet:** 3"
- ▶ **Outlet:** 2¹/₅" NH



MONITORS

BK396	GP Manual Monitor	\$1,086.95
BK397	GP Deluge Tip (<i>Specify Tip: 1¹/₄"</i> , <i>1³/₈"</i> , <i>1¹/₂"</i>)	\$132.95
BK398	Plain Deluge Tip (<i>Specify Tip: 1³/₄"</i> , <i>2"</i>)	\$256.95

Forestry Monitor

300 GPM (1140 LPM)

The Forestry Monitor is the latest addition to the Akron Brass electric monitor family. It provides an extremely rugged durable design ideal for brush and wildland firefighting. This compact monitor features a fully sealed integrated electrical control system with waterproof locking connectors for pinpoint stream positioning and accuracy. **Ship. wt. 25 lbs. (Not including nozzle)**

- ▶ Low flow adjustable electric fog nozzle with flush 30-60-95-125 gpm
- ▶ CAN proportional speed joystick control
- ▶ Lightweight Pyrolite construction
- ▶ Integrated and sealed electronics
- ▶ Waterproof (IP 67 rated) locking connectors
- ▶ Simple "plug and play" installation
- ▶ 320° maximum rotation range with stops at +/-90°
- ▶ 135° maximum elevation range with stops at -45° and -20°
- ▶ 12v or 24v option
- ▶ **Dimensions:** 13³/₁₆"Hx11⁹/₁₆"Wx8²⁹/₃₂"D
- ▶ **Inlet:** 2"
- ▶ **Outlet:** 1¹/₂"



SPECIFY: 12v or 24v Monitor

BK395	Forestry Monitor (Complete Package)	\$5,118.95
-------	-------------------------------------	------------

TurboMaster™ Master Stream Nozzle

The TurboMaster™ is a multi-flow Master Stream Nozzle designed to meet the changing needs for applications where manual control is preferred. Features include: combination fog/straight stream (no shutoff), 2¹/₂" swivel inlet, four constant-gallage settings of 500/750/1000/1250 gpm and spinning turbine teeth for full fog pattern. **Ship. wt. 3 lbs.**



AC714	TurboMaster™ Master Stream Nozzle	\$1,280.95
-------	-----------------------------------	------------

Excel 1000™ Nozzle

Precise settings let you control the amount of water being used for applications where manual control is desired. Flow patterns range from wide angle fog to straight stream. Rugged, lightweight Pyrolite® for easy handling. Specifications: Combination fog and straight stream constant gallonage nozzle with four settings - 300, 500, 800 and 1000 gpm @100 psi. Flow setting may be changed by rotation of the unique, spring-loaded baffle head. Nozzle has a 2½" rocker lug swivel inlet, spinning turbine teeth and lightweight Pyrolite® construction. *Ship. wt. 3 lbs.*

AC715

Excel 1000™ Nozzle

\$959.95



The Apollo™ Hi-Riser Elevates Your Fire Fighting Power

The Apollo™ Hi-Riser eliminates the need for extra deck mount extension devices or telescoping pipes. It elevates 24" above the base of the flange in seconds for operation over light bars and other obstructions while in the deck mount mode. It also easily rotates down to a low-profile position for dual inlet ground operation. Provides a powerful straight stream through a full flow 3" waterway and reduces water turbulence with built-in turning vanes. In the deck mode, elevate from 90° above to 45° below horizontal with a 360° rotation; in portable mode, it elevates from 90° above to 150° below horizontal with 180° rotation. Sturdy, portable dual-inlet ground base has foldaway cast T legs, ground spikes and safety chain to help maintain stability. Monitor has Pyrolite construction. *Ship. wt. 70 lbs.*

- ▶ Easy one-step disconnect
- ▶ Pressure gauge
- ▶ Handwheel control
- ▶ Nozzle included
- ▶ Dual-inlet ground base

Ground Mode

Inlets: 2½" or 3" clappered swivel
 Flow: 800 gpm-Dual Inlet
 1,000 gpm-Single Inlet
 Outlet: 2½"

Deck Mode

Inlet: 3" flange
 Flow: 1250 gpm
 Outlet: 2½"



SPECIFY 2½" OR 3" GROUND BASE INLETS

AK068 Apollo™ Hi-Riser without Nozzle

\$4,992.95

AK069 Apollo™ Hi-Riser with Nozzle

\$6,334.95



Apollo™ 2-Inlet Monitor

This lightweight, portable monitor (36 lbs. without tube and tip) can be either truck mounted as a deck mount or quickly removed and used remotely from the truck. Rugged Pyrolite® construction with 3" waterway and (2) 2½" clappered, swivel inlets (3" available upon request). Rated at 1250 gpm (deck flow), it allows less than 10 psi pressure loss @ 800 gpm. Comes with 3" flange for deck mount units. Available with or without tube and tips or with a master stream nozzle. *Ship. wt. 36 lbs.*

- ▶ 360° rotation when mounted in the deck mode, 180° in the portable mode
- ▶ Vertical travel from 80° above to 15° below horizontal with built-in 35° safety stop
- ▶ 3" waterway with cast-in turning vanes for efficient flow
- ▶ Direct mount - A combination 3" NPT female and 3" flange
- ▶ Carbide spikes for extended wear



Deck mount & portable models



Y310 Apollo™ Deck/Portable Monitor with Tube and Tips

\$3,889.95

AC980 Apollo™ Portable Monitor with Tube and Tips

\$3,669.95

AC984 Apollo™ Portable Monitor without Tube and Tips

\$2,822.95

AC982 Apollo™ Portable Monitor, with 1000 gpm Automatic Nozzle

\$4,803.95



Carbide spike

Deck mount & portable models

Stinger® 2.0 Lightweight Monitors

This portable, lightweight, double-duty monitor can be mounted on fire apparatus or moved on its portable base to another location. It releases easily from either mode of operation with a quick twist of the lock-release handle that also doubles as a carrying handle. It's designed for flows up to 1250 gpm in the deck mount, and 1000 gpm or 800 gpm with the portable base. The 3" waterway provides less turbulence and friction loss making it 25% more efficient than many other 2-inlet monitors. Inlet fittings: (2) 2½", (1) 3½" swivel, (1) 4" Storz or (1) 5" Storz. Deck unit comes with 3" flange. Foldable adjustable legs. *Ship. wt. 34 lbs.*

SPECIFY INLET SIZE WHEN APPLICABLE

Y245	Stinger® Portable with Tube & Quad Tips	\$3,540.95
Y245A	Stinger® Portable with 300-1000 gpm Automatic Nozzle	\$4,395.95
Y245B	Stinger® Portable/Deck Mount with Tube & Quad Tips	\$3,558.95
Y245C	Stinger® Portable/Deck Mount with 300-1000 gpm Automatic Nozzle	\$4,673.95
Y245D	Stinger® Deck Mount with Tube & Quad Tips	\$2,596.95
Y245E	Stinger® Deck Mount with 300-1000 gpm Nozzle	\$3,374.95
Y245F	Stinger® Storage Mounting Bracket	\$294.95



Sidewinder® Electric Remote Controlled Wildland Monitor

The Sidewinder® is an electric remote controlled wildland monitor that mounts on the front bumper of off-road or wildland firefighting apparatus. Sidewinder's 180° spray covers a large area, making it ideal for fighting forest, grass, range and brush fires. Made of rugged, lightweight Elk-O-Lite® with fully enclosed and sealed stainless steel gears and motors. *Ship. wt. 20 lbs.*

- ▶ 135° vertical travel; 180° or 334° horizontal travel
- ▶ Constant flow across 3 nozzle options: 45 gpm, 150 gpm, or 475 gpm
- ▶ Flow efficient 2.0" vaned waterway
- ▶ Dual ball races with stainless steel bearings

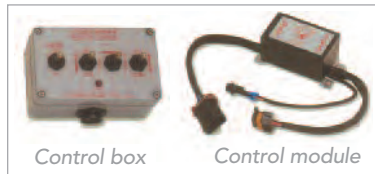

SPECIFY DEGREE OF ROTATION: 334 or 180
 SPECIFY VOLTAGE: 12 or 24
 SPECIFY GPM: 15 - 30 - 45, 60 - 95 - 125 - 150, 175 - 200 - 250 - 350 - 400 - 475
 SPECIFY MOTOR SPEED: 2 motors, SPECIFY: fast, slow, or combo of both

AJ510 Sidewinder® Remote Controlled Monitor \$4,992.95



X-Stream® Master Stream Nozzle

The X-Stream® series of master stream nozzles are the most efficient and effective master stream combination nozzle available to the fire service today. It is designed to flow from 350-1250 gpm @ 75 psi and maintain sufficient pressure to apply that flow as an effective fire stream. No manual gallonage setting is necessary; the spring mechanism within the nozzle adjusts automatically to provide the desired flow. This 2.5" nozzle is ideal for any master stream application. *Ship. wt. 8 lbs.*

- ▶ Patented, permanently lubricated seals
- ▶ Lightweight Elk-O-Lite® aluminum construction
- ▶ 75 psi low-pressure operation



AZ360 X-Stream® Master Stream Nozzle \$1,267.95



TFT Master Stream

The TFT Master Stream fully-automatic nozzle has a flow range of 150-1250 gpm. Constant nozzle pressure is regulated to 100 psi. Continuously variable from straight stream to wide fog. Includes halo ring for manual pattern control. Rubber bumper incorporates TFT "Power Fog" teeth for full-filled, finger-free fog pattern. 2½" NST coupling is standard. 3", 3½", and 4" couplings are optional at extra cost. *Ship. wt. 10 lbs.*



AC716 TFT Master Stream Nozzle \$1,138.95



new

Cobra™ EXM Monitor

The Cobra™ EXM is a complete monitor with an integrated control box, ready for 2-wire connection to any other EXM enabled component. Its compact, elliptical waterway delivers up to 1250 gpm with an industry leading swing radius of 6". As standard, enabled for either wired or wireless EXM network connection. Motors NEMA 4 rated, 11-27 VDC power. Inlet: 3"-150# F, 4"-150# F, DN80-PN16 F, 3" NPT, 3" BSPT. Outlet: 2.5" NHT & BSPP.

- ▶ Compact – Just 16" tall with a 6" swing radius
- ▶ 165° vertical travel; 350° horizontal travel
- ▶ EXM Technology – Plug and Play J1939 CAN Bus network

ELKHART BRASS
Fire Fighting Equipment

BL468	Cobra™ EXM 1250 gpm Monitor & Controls	\$6,806.95
BL469	Cobra™ EXM 1250 gpm Monitor & Controls w/Nozzle	\$8,908.95
BL470	Cobra™ EXM 1500 gpm Monitor & Controls	\$6,853.95
BL471	Cobra™ EXM 1500 gpm Monitor & Controls w/Nozzle	\$9,055.95

Vulcan Monitor

The Vulcan delivers the compact size and lightweight you want, without sacrificing the power and performance you need. At 17 pounds and only 16" high, Vulcan is your best choice for the restricted space of aerial platforms and pumpers. Vulcan is not only the smallest device of its kind on the market, it's the mightiest with a unique configuration for efficient flows up to 1250 gpm. *Ship. wt. 20 lbs.*

- ▶ Lightweight - only 17 pounds
- ▶ Compact - just 16" high
- ▶ 3" NPT or flange inlet
- ▶ Pressure gauge with bumper guard
- ▶ Lightweight, cast Elk-O-Lite® aluminum

ELKHART BRASS
Fire Fighting Equipment

AW342	Vulcan Monitor (Deck Pipe Only)	\$908.95
AW343	Vulcan Monitor with 282A Stream Shaper	\$1,538.95
AW344	Vulcan Monitor with Stream Shaper and SM-1250 (2.5") Nozzle	\$2,380.95
AZ364	Vulcan Copperhead (Brass, Monitor Only)	\$1,168.95



R.A.M. Monitor

The R.A.M. rapid attack monitor features the largest deployed footprint of any portable monitor yet. The ultra-efficient double pivot waterway features only 9 psi friction loss and allows an effective stream throughout horizontal and vertical travel. The standard hydraulic safety system automatically increases down force under conditions that normally limit stability. The R.A.M. is rated 500 gpm @ 75 psi. The R.A.M. package includes monitor with 2.5" swivel inlet, mounting bracket and R.A.N. fog/straight stream nozzle with integral stream shaper. *Measures only 16.2" stowed.*

- ▶ Industry leading stability & safety
- ▶ Designed for unmanned operation
- ▶ Active safety system



ELKHART BRASS
Fire Fighting Equipment



BB102	R.A.M. Package (Monitor, R.A.N. and Mounting Bracket)	\$2,415.95
BB103	R.A.M. Monitor	\$2,052.95
BB104	R.A.N. (Rapid Attack Nozzle)	\$441.95
BB105	Mounting Bracket (Not Shown)	\$119.95
BB106	Triple Stacked Tips	\$287.95
BB107	Deluge Tip	\$180.95
BB108	Stream Shaper (For Stacked and Deluge Tips Only)	\$151.95

BlitzForce Portable Monitor



The BlitzForce is Task Force Tips' innovative, lightweight, and highly versatile portable attack monitor. Rated up to 500 gpm with either a combination nozzle or stacked tips, BlitzForce integrates a low loss waterway with positive locking valve control, and a corrosion preventing anodized and powder coat finish. An exclusive high strength tie-down strap and carbide tipped folding legs offer extreme stability in varying fire environments. With an integral stream shaper for superior reach and penetration performance, the BlitzForce delivers a 20° side to side and a 20° to 60° up and down range of stream motion. A five year warranty and Apparatus Storage bracket are standard.

- ▶ Manufactured from lightweight, high strength aluminum alloy and has been hard coat anodized and powder coated for ultimate corrosion protection
- ▶ Offers a 20° low attack angle when manned and 30°-60° when unmanned with 20° side-to-side horizontal movement from center
- ▶ Features a ball valve with locking pin to prevent unwanted opening and integrated stream shaper
- ▶ Includes a 100-500 GPM combination adjustable fog/straight stream nozzle, or Quad Triple Tips, an integrated safety tie down strap, storage bracket, and unique folding legs with carbide tips



BL087	BlitzForce Portable Monitor ZN Combination	\$1,495.95
BL088	BlitzForce Portable Monitor Stacked Tips	\$1,495.95

Blitzfire Monitor

Flow range up to 500 gpm. The monitor features low-friction inlet and outlet pivots. Elevation is manually adjustable between 10 and 50 degrees either side of center. The safety shut-off valve will shut off flow if monitor slides or lifts. It has six detent flow positions with a patented turbulence-free slide valve for operator flow control. When the legs are folded, the carbide tip points up for carrying safety. Folded size is 25.5" Lx8.1" W x10" H. Standard inlet is 2.5" NH rocker lug swivel. Standard outlet is 2.5" rigid male threads. *Ship. wt. 29-46 lbs.*

AZ366 Includes:

- ▶ Blitzfire monitor (specify inlet and outlet)
- ▶ Storage bracket
- ▶ Max-Series tips (specify inlet)
- ▶ 3 stacked tips
- ▶ 5" stream straightener (specify inlet and outlet)

AZ365	Blitzfire Monitor	\$2,698.95
AZ366	Blitzfire Monitor (Package)	\$3,750.95



Crossfire® Master Stream Appliance

Crossfire® utilizes the Safe-Tak valve to help ensure firefighter safety. It's a lever-operated butterfly valve connected to a foot on the base of the monitor. In normal operation, the valve is open allowing maximum flow of 1,250 gpm. However, should the monitor start to tip for any reason, the valve closes, cutting the flow area by 90% and reducing the reaction force. By not closing completely, it allows a continued flow, minimizing water hammer. Take a look at all the great features of the Crossfire®. Features include safety plunger, high-visibility gauge, multiple inlets (double 2½" or single 3", 3½", 4", 4½" NST, 4" or 5" Storz), rotational lock lever, quick connect base, stainless steel legs with carbide-tipped spikes, automatic drain and safety strap. *Ship. wt. 50 lbs.*



5-year warranty

SPECIFY INLET SIZE

AF249	Crossfire® Monitor with Stack Tips	\$3,847.95
AF250	Crossfire® Monitor with M-R Nozzle	\$4,032.95

2 1/2", 3" or 4" inlet



Permanent Mount Station Monitors

Station monitors were specifically designed to meet all the needs of municipal and industrial applications. The balanced, full flow, seamless, 2 1/2" single waterway configuration reduces friction loss, improving streams and distance. Operates easily at all pressure ranges. 1,40° vertical, 360° horizontal (750 gpm); 140° vertical, 360° horizontal (1200 gpm). Carbon steel construction with stainless steel discharge and Zerk fittings for lubrication. Your choice of permanent mount tiller bar or steering wheel handle. Red epoxy finish inside and out for effective corrosion resistance. 3" flange base. **Ship. wt. 50 lbs.**

- ▶ Less friction loss
- ▶ Carbon steel construction
- ▶ Balanced flow design
- ▶ Single waterway
- ▶ Stainless steel discharge
- ▶ 2 1/2", 3" or 4" waterways

SPECIFY INLET SIZE

AB079	Station Monitor, 750 gpm, with Tiller Bar	\$1,052.95
AB080	Station Monitor, 750 gpm with Steering Wheel	\$1,107.95
AJ092	Station Monitor, 750 gpm with Tiller-Short Radius	\$874.95
AB081	Station Monitor, 1200 gpm with Tiller Bar	\$985.95
AB082	Station Monitor, 1200 gpm with Steering Wheel	\$1,333.95

1 1/2" Truck Mount & Portable Monitors

Designed for lower flow requirements with a 1 1/2" waterway and swivel inlet for easy hookup with soft discharge line. Rated at 125 gpm at 100 psi with flows up to 350 gpm. Carbon steel construction with stainless steel discharge, Zerk fittings for lubrication and tiller bar handle. 140° vertical and 360° horizontal movements. Red epoxy finish inside and out for effective corrosion resistance. Available in three different styles. Truck Mount style (AJ091) allows removal of the monitor from the permanent base when not in use. Portable style (AC935) comes with two 22" stabilizing legs for use anywhere you need it with 20° vertical and 80° horizontal travel. Permanent Mount (AF245) comes with 1 1/2" flange base for deck mounting. **Ship. wt. 30 lbs.**

Portable

Ideal for Class A foam and forestry

22" stabilizing legs

- ▶ Available styles: truck mount, portable, permanent

AC935	1 1/2" Portable Monitor	\$1,052.95
AF245	1 1/2" Permanent Monitor	\$723.95
AJ091	1 1/2" Truck Mount Monitor	\$1,052.95

JACKRABBIT Monitor

The JACKRABBIT is a low-profile, durable, lightweight aluminum monitor with a full 3" waterway. This unit is ideal for fire department and fire appliance applications. The portable base allows the unit to be dropped in place and left unattended when appropriate. Capable of flows up to 1250 gpm, it is easily adjustable in the horizontal plane and then locked in position by a locking mechanism. There is a safety stop at 30° above the horizontal plane. The vertical travel is controlled by adjustable hand wheel with worm gear drive fitted with grease Zerk for easy lubrication. **Ship. wt. Approx. 40 lbs.**

- ▶ Full 360° rotation - with truck mount
- ▶ Red epoxy paint finish
- ▶ Inlet - (2) 2 1/2" NH (female) standard
- ▶ Liquid-filled pressure gauge
- ▶ Stainless steel ball bearings at all rotation joints
- ▶ Grease fittings for lubrication
- ▶ Discharge 2 1/2" MNST
- ▶ Legs lock in folded and deployed positions

Flow up to 1250 GPM

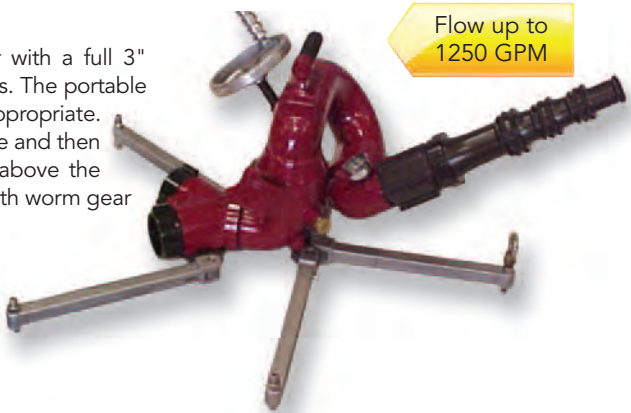

INCLUDES MONITOR, FOLDING BASE, 3" FLANGE ADAPTER, STREAM SHAPER, STACKED TIP SET, AND RESTRAINING STRAP

AZ362	JACKRABBIT Monitor	\$3,442.95
-------	--------------------	------------

The Low Profile Rattler Monitor

The Rattler Monitor is a low profile style monitor with a full 3" waterway manufactured in corrosion-resistant brass. It is the ideal monitor for marine, offshore or potentially corrosive atmospheres. Capable of flows up to 1250 gpm, it is easily adjustable in the horizontal plane and then locked in position by a locking mechanism. The vertical travel is controlled by an adjustable hand wheel with worm gear drive. Other features includes red epoxy finish, vertical travel from 90° above to 60° below the horizontal and stainless steel ball bearings at all rotation joints. 2 1/2" discharge male NST. **Ship. wt. 52 lbs.**

SPECIFY FLOW: 350, 500, 700 gpm

AF251	Rattler Monitor (Monitor Only)	\$2,089.95
AZ361	Rattler Monitor w/Nozzle	\$2,772.95



CHEM GUARD

Chemguard Foam

CHEMGUARD

First Class Foam Concentrate

The U.S.D.A. Forest Service has approved Chemguard First Class as meeting all of the requirements of U.S.D.A Forest Service specification 5100-307. It has passed NFPA 18 wetting agent standard 2006 Edition. This standard tests the agent at dilution rates of 0.1% to 1.0% for use on Class A fuels. First Class combines excellent wetting characteristics with great foam formation for superior effectiveness on Class "A" Fires. For use in ground trucks, CAF Systems, helicopter and fixed wing aircraft with buckets, water scooper or tanks. Contains no hazardous material, safe for the environment. First Class works very well with CAFS at ratios of 0.4% or greater. **Ship. wt. 45 lbs.**

- ▶ Wildland fires
- ▶ Ground applications
- ▶ Aircraft applications

PRICED PER GALLON, SOLD IN 5-GALLON CONTAINERS

BB135	First Class Foam Concentrate	\$22.95/gal.
-------	------------------------------	--------------

Class A & Wetting Agents

Class A Foams/Wetting Agents - Chemguard's Class A foam concentrate is a mixture of foaming and wetting agents. When proportioned with water it changes the properties of the water, reducing the surface tension and allowing for greater penetration in all Class A fuel and wildland fires. It also gives the water a foaming ability, allowing it to remain and cling to the surfaces without run off. Class A is effective in fighting forest fires and many deep-seated fires such as tires, paper, and wooden structures. Class A Plus works very well with CAFS at ratios 0.5% or greater.

PRICED PER GALLON, SOLD IN 5-GALLON CONTAINERS

Cat#	Description	Benefits	Price
AC721	Class A Plus	Non-corrosive, Non-Toxic Biodegradable For rates of 0.1% - 1.0%. Meets NFPA 298	\$20.95/gal.
AC724	Chemwet	Highly Concentrated Wetting and Penetrating Agent (Allows for Quicker Extinguishment and Stretches Water Supply)	\$31.95/gal.

High Expansion Foams

High Expansion Foam Concentrates - These agents are synthetic based and are suitable for use with low, medium or high expansion foam generating equipment. Normally used at a proportioning rate between 1 and 3%, they are used in contained areas such as mining operations, ship hold areas, etc. where volume fire control is required. A high expansion generator can be used to fill the entire area with a large amount of very light, expanded foam bubbles, and depending upon the type of generator, ratios of up to 1,000 to 1 can be achieved. Fires involving solid materials as well as flammable liquids can be controlled and extinguished. High expansion foam also has special advantages in dealing with spills of Liquefied Natural Gas (LNG).

PRICED PER GALLON, SOLD IN 5-GALLON CONTAINERS

Cat#	Description	Benefits	Price
AC722	X-TRA High	High Expansion Foam Provides Superior Fire Suppression Expansion and Vapor Barrier Against a Broad Range of Materials	\$24.95/gal.

Training Foam

Training Foam Products - Supertrain is specially designed synthetic foam formulations which are biodegradable and environmentally friendly for use in live fire-training sessions. This formulation is suitable for use with both fresh and salt water and can be used with all siliconized dry chemical agents and can be proportioned at either 3% or 6%.

Priced per gallon, sold in 5-gallon containers

Cat#	Description	Benefits	Price
AC723	Supertrain Training Foam	Cost Effective Training	\$13.95/gal.

Contact Your Darley Representative With Your Protein or Fluoroprotein Foam Needs



FOAM

Chemguard Foam

CHEMGUARD

FOAM



Aqueous Film Forming Foam (AFFF)

Aqueous Film Forming Foam (AFFF) - is a specially formulated synthetic concentrate. A vapor suppressing aqueous film is formed by foam solution draining from the expanded foam blanket. These products are intended for use at proportioning rates of 1%, 3% and 6% on Class B hydrocarbon type fuels such as; crude oils, gasoline, kerosene, diesel fuel and aviation fuels. AFFF's also exhibit excellent wetting characteristics when used on Class A fires. Both aspirating and water fog type nozzles are suitable when using these foams. Either fresh or sea water may be mixed with these foams to achieve excellent results.

PRICED PER GALLON, SOLD IN 5-GALLON CONTAINERS

Cat#	Description	Benefits	Price
AC719	3% AFFF	An Industry Standard, the Most Commonly Used AFFF	\$25.95/gal.
AS290	3% AFFF Mil. Spec	Highest Quality AFFF Available on QPL MIL-F-24385F Listed	\$32.95/gal.
AC720	6% AFFF	Lowest Cost AFFF	\$20.95/gal.
AS292	1% AFFF	Requires Less Concentrate Than 3% or 6% Products	\$55.95/gal.

Alcohol Resistant Aqueous Film Forming Foam (AR-AFFF)

new lower price

Alcohol Resistant Aqueous Film Forming Foam (AR-AFFF) - is specially formulated with a physical polymer membrane/barrier between the fuel surface and the foam blanket. They are intended to be used at proportioning ratios of 1% and 3% for hydrocarbon fuels and 3% or 6% for polar fuels such as alcohol, ketones, methanol and MTBE products. AR-AFFF's may also be used on Class A fires. AR-AFFF's suppress the hazardous vapors emitted from these polar and hydrocarbon fuels. Chemguard's AR-AFFF's are suitable for use with foam chambers, standard water fog nozzles, air-aspirating nozzles and foam makers.

PRICED PER GALLON, SOLD IN 5-GALLON CONTAINERS

Cat#	Description	Benefits	Price
AC717	3%-6% AR-AFFF	Concentrate for Use on Both Hydrocarbon and Polar Solvent Fuel Fires	\$25.95/gal.
AS291	3%-3% AR-AFFF	AR-AFFF Keep Mixture Ratio the Same for all Fires, Eliminate Costly Mistakes	\$32.95/gal.
BD197	1%-3% AR-AFFF	Highest Quality AR-AFFF Cost Effective 1% Hydrocarbon and 3% Polar Solvents	\$44.95/gal.

Low Temperature Foam

BD018 and BD019 - Freeze protected 3%-3% proportions 3 parts concentrate to 97 parts water for hydrocarbon and polar fuels. Intended for top side use on type II and type III applications. *UL listed. Ship. wt. 45 lbs.*

BD020 - Freeze protected AFFF Solution, good to minus 40°F. This product is not intended to be proportioned. Works well on Class B fires. Designed for use in Trimax units and flight line extinguishers.

PRICED PER GALLON, SOLD IN 5-GALLON CONTAINERS

Cat#	Description	Benefits	Price
BD018	3% AFFF	Low Temperature Foam, UL Listed to Minimum Use Temperature of -20°F	\$32.95/gal.
BD019	3% AR-AFFF	Ultraguard Low Temperature Foam	\$39.95/gal.
BD020	Foam Solution	Blizzard Freeze Protected Solution Foam Temperature Range of -40°F	\$29.95/gal.

**Contact Your Darley Representative
With Your Protein or Fluoroprotein Foam Needs**

Practice Foam Train for Pennies!

Practice Foam is an answer to the requests "give us an inexpensive product to train with!" Practice Foam is a variable percentage Class A type product. Safe and inexpensive to use, Practice Foam may be educted at low to high percentages to achieve the desired results of your training session. Although not intended for a "working fire", Practice Foam is entirely suitable for extinguishing training ground fires.

- ▶ Non-toxic, biodegradable and self-dissipating
- ▶ Plenty of suds - no clean up required
- ▶ For training only; NOT for fire fighting

BG113 Practice Foam \$38.95/5-gal. pail

X-pando Foam Concentrate

A detergent type variable percentage/variable expansion blend of foaming and wetting agents intended for Class A and B fires. Use through a CAFS or eductor to produce volumes of high-expansion foam or with regular foaming equipment consistent with the type of foam required. X-pando may be used with most foam making equipment. X-pando extinguishes with volumes of wet, moist foam, cutting the oxygen supply while creating cooling steam as the area is blanketed or completely filled. Used at 3% or less, X-pando offers low percentage use rates combined with reasonable per-gallon cost and infinite shelf life to give you a "general purpose foam value".

BG115 X-pando Foam Concentrate \$51.95/5-gal. pail

Phos-Chek Class A Foam

Provides superior foam generation at 0.1-1% use concentration. Phos-Chek has been tested by the U.S. Forest Service and is approved for use from ground engines, helicopter buckets, and helicopters equipped with fixed tanks. It is a U.L. listed wetting agent at 0.25% use rate effective on both Class A & B combustibles. Meets the requirements of NFPA 1150. Contains no EPA listed hazardous materials. Phos-Chek Class A works very well with CAFS at ratios of 0.2 to 0.3% and can produce the good dry foam associated with CAFS. *Ship. wt. 45 lbs.*

PRICED PER GALLON, SOLD IN 5-GALLON CONTAINERS

AS285	Phos-Chek 5-gal. Container	\$18.95/gal.
AS289	Phos-Chek 55-gal. Drum	\$16.95/gal.
AS286	Phos-Chek 4 oz./Case of 36	\$92.95

Silv-ex Foam Concentrate

A multiple expansion Class A foam concentrate formulated from specialty hydrocarbon surfactants, stabilizers, inhibitors and solvents. Its combination of surfactants and solvents provides extremely good cold weather performance. The original forest fire control concentrate. Proven effective on many deep seated Class A fires. Can be proportioned from 0.1% to 1.0% in fresh, brackish or sea water. Silv-ex works very well with CAFS at ratios of 0.2 to 0.3% and can produce very good dry foam associated with CAFS. *Ship. wt. 45 lbs.*

PRICED PER GALLON, SOLD IN 5-GALLON CONTAINERS

AB410	Silv-ex Foam Concentrate	\$25.95/gal.
-------	--------------------------	--------------

Foam Cap Wrench

Made from aluminum alloy the wrench loosens and tightens 70mm foam container caps with ease. Wrench is 9½" long with an outside diameter of 3¼". *Ship. wt. 1 lb.*

AF640	Foam Cap Wrench	\$13.95
-------	-----------------	---------

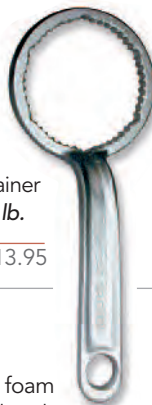

X-Stream Premium Class A Foam

Chemguard has introduced X-Stream, the first and only premium Class A foam concentrate designed specifically for compressed air foam (CAFS). When mixed with water at concentrations of 0.1 - 1.0%. X-Stream produces a super-thick foam with a significantly longer throw distance that clings to horizontal and vertical surfaces with minimal runoff drastically reducing burnback.

PRICED PER GALLON, SOLD IN 5-GALLON CONTAINERS

BH124	X-Stream Premium A Foam	\$21.95/gal.
-------	-------------------------	--------------



PRO/pak Foam System

Everything You Need in One Portable Unit to Apply Foam Quickly

Making great foam is easy with the PRO/pak. Everything you need is contained in one lightweight package that attaches to the end of your 1" fire hose. It can work on pressures as low as 50 psi. With its small size and versatile nozzles you can have foam capability without the expense of built-in systems costing thousands of dollars. Features a high-impact 2 1/2 gallon foam reservoir with built-in eductor that can be set to the ratio of your choice. Large, easy-open fill port has an indicator to show the type of liquid in the tank. The flow is controlled by a twist grip valve/carrying handle. With each quarter turn you select the discharge velocity for inlet pressures between 40 and 500 psi. System comes complete with a straight stream nozzle, low expansion nozzle and medium expansion nozzle. Nozzles can be directly attached to the eductor for one-handed operation, or a short section of hose can be added for maneuverability. Designed for Class A 3% or 6% AFFF & AR Foams. Ship. wt. 15 lbs.

new lower price



Includes:

- ▶ PRO/pak Unit
- ▶ 3' Extension Hose
- ▶ Shoulder Strap
- ▶ 3 - Quick-Connect Nozzles

SPECIFY INLET THREADS; 1" NH OR NPSH

AJ255	PRO/pak Foam System	\$1,022.95
AJ256	Piercing Nozzle	\$225.95
AJ257	Mounting Bracket	\$112.95
AJ258	25' Discharge Hose	\$122.95
AJ259	Waist Strap	\$22.95



Macaw™ Backpack

Miniaturized CAF Power

Originally designed for rapid attack in fire suppression, this miniature 5-gallon (18.9L) CAF powerhouse expands foams up to 70:1 depending on nozzle and foam solution used. The Macaw™ can effectively deploy liquid formulas, air aspirated foam and CAF with simple control adjustments. Ship wt. 30 lbs.

Proven effectiveness for:

- ▶ Mop up and overhaul operations
- ▶ Decontamination operations
- ▶ Hazardous material clean up
- ▶ Wet line construction
- ▶ Class A and B fire suppression
- ▶ CAF training
- ▶ Vapor suppression
- ▶ Nuisance fires and spills

PURCHASE INCLUDES NOZZLE SHOWN

AM234	Macaw™ Backpack with Cylinder, 4500 psi	Call for Pricing
AM235	Macaw™ Backpack without Cylinder	Call for Pricing
AM236	Fan Tip Nozzle	Call for Pricing
AM237	Piercing Applicator Tip	Call for Pricing



Precision Foam Testing Kit

The Precision Foam Testing Kit is designed to simplify the process of testing foam systems for proportioning accuracy. This kit utilizes liquid conductivity and a precision digital scale to accurately prepare standards and test discharge samples; the same method used by nationally recognized testing laboratories when testing systems for listing and approval. Ship. wt. 6 lbs.

Includes:

- ▶ 1 - Protective carrying case with foam protective padding
- ▶ 2 - 10ml sample pipettes (12" L)
- ▶ 1 - Precision digital electronic 250 gram scale with 0.1 gram accuracy
- ▶ 5 - 3ml sample pipettes (6" L)
- ▶ 6 - 150ml graduated sample beakers
- ▶ 1 - 500ml water sample bottle
- ▶ 1 - 100ml graduated cylinder
- ▶ 2 - 10ml sample syringes
- ▶ 1 - 250ml wash bottle
- ▶ 10 - Test charts (reproducible)
- ▶ 1 - Instruction manual

AZ292	Precision Foam Testing Kit	\$762.95
-------	----------------------------	----------



FoamPro® 1600 Series Proportioning System

No other system delivers foam as easily and accurately as the FoamPro®. All it takes is a flip of the switch to start the system. FoamPro® adjusts automatically to any changes in flow rate or pressures. Plus, the patented, high-tech, electronic controller does all of the work for you. To make the foam wetter or drier simply adjust the dial to change the foam concentrate level. When you use the FoamPro®, you don't have to worry if the foam solution is correct-the system does the proportioning all automatically. Simply set the percentage you want on the control module. Because the precise proportioning is done by measuring flow instead of pressure, you do not have to shut down to add lines, change pressure or refill the foam tank. What's more, the FoamPro® conveniently interfaces with Compressed Air Foam Systems. Meets NFPA Standards. Ship. wt. 68 lbs.



Exclusive Features

- ▶ Automatic proportioning
- ▶ Adjustable dial control
- ▶ Proportions continuously
- ▶ No foam goes through the fire pump
- ▶ No in-line restrictions
- ▶ Installs in new or existing apparatus
- ▶ Delivers 0.1 to 1.7 gpm of concentrate

TANK SENSOR REQUIRED

AJ247	FoamPro® with 1½" Flowmeter	\$3,471.95
AJ248	FoamPro® with 2" Flowmeter	\$3,471.95
AJ249	Tank Sensor, Vertical Mount	\$75.95

AVAILABLE OPTIONS

AJ251	8 gal. Polypropylene Foam Tank	\$220.95
-------	--------------------------------	----------

36 Gallon Mobile Foam Cart

- ▶ Features a fiberglass tank
- ▶ Nozzle features a ball type shut-off valve for better stream control and is designed to give a constant flow rate with either a straight stream or "Fog" pattern
- ▶ Includes 50' of 1½" rubber lined, single jacket fire hose with lightweight 1½" NST couplings
- ▶ Includes 3"x16" pneumatic tires
- ▶ Pick-up tube on the in-line eductor is manufactured in stainless steel
- ▶ Eductor has variable metering valve settings for 1%, 3%, and 6%
- ▶ Available in either a 60 gpm or 95 gpm flow rate



Cat#	Description	Includes	Ship. wt.	Price
BG161	36 gal. Foam Cart	1½"x50' Hose/95 gpm Eductor/Handline Nozzle	150 lbs.	\$3,711.95
BG162	36 gal. Foam Cart	95 gpm Eductor	145 lbs.	\$3,072.95

High Expansion Foam Generators

The Super Vac HXG High Expansion Foam Generator is the perfect solution for your foam needs. The HXG can be ordered to fit any Super Vac fan including all PPV fan styles. No need to buy and store an entire foam generator when the Super Vac HXG takes up a fraction of the space and cost. Used in conjunction with high expansion foam concentrates, it can produce foam up to 1000:1 expansion for tough extinguishments including confined space, mining operations, and ship hold areas. Fire involving solid materials or flammable liquids can also be controlled and extinguished. The Super Vac HXG also has advantages for handling the tough spills of Liquefied Natural Gas (LNG).



- ▶ Water Flow: 100 - 300 lpm (27 - 79 gpm)
- ▶ Inlet Pressure: 4 - 14 bar (58 - 203 psi)
- ▶ Water Flow: 80 - 180 lpm (21 - 48 gpm)
- ▶ Foam Eductor: Matched to fan type, included
- ▶ Expansion: 500:1 to 1000:1



BE041	High Expansion Foam Generator for <16" Fan	\$3,429.95
BE042	High Expansion Foam Generator for >18" Fan	\$3,689.95

Foam Proportioning Systems and CAFS

Fast Foam 50 or 250

FOAM

APPLICATIONS

- ▶ Mini pumper – 50, 250
- ▶ Pumper tanker – 250
- ▶ Pumper – 250
- ▶ Wildland – 50, 250

STANDARD EQUIPMENT

- ▶ Stainless steel check valve
- ▶ Venturi
- ▶ Panel mounted controller
- ▶ Installation kit

Features: The Fast Foam systems offers a reliable, accurate, compact foam proportioning system at an economical price. The systems are optional and for use on single and dual line systems.

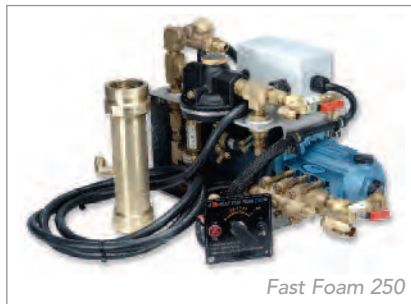

Fast Foam 250



Fast Foam 50

Model	Performance	Dimensions	Weight	Price
Fast Foam 50	Up to 50 gpm @ 1% at pressures up to 175 psi	19"Lx10"Wx14"H	64 lbs. (29 kg)	\$3,375.00
Fast Foam 250	Up to 250 gpm @ 1% at pressures up to 250 psi	21"Lx10"Wx12"H	75 lbs. (34 kg)	\$4,920.00

Odin AutoValve™ Kits

The AutoValve™ features nine light valve positions for fast reference. The pressure display also functions as a valve position indicator in increments of 1 - 100. This allows for ultra fine adjustments by punching the decrease/ increase "Dry and Wet" CAFS buttons for small changes of foam consistency. Fully waterproof design with all sealed switches, protected by overlay membrane.

Kit Includes:

- ▶ Controller with wiring harness
- ▶ Solution valve and actuator, stainless steel
- ▶ Instruction manual
- ▶ Air valve and actuator, stainless steel

Expanded AutoValve™ Kits also available. Please call Odin at 319-987-2226 for more information.



Model	Description	Price
SAV001.5	Standard 1½" AutoValve™ Kit	\$1,903.00
SAV002.0	Standard 2" AutoValve™ Kit	\$1,936.00
SAV002.5	Standard 2½" AutoValve™ Kit	\$2,650.00
SAV003.0	Standard 3" AutoValve™ Kit	\$2,852.00

PTO Driven Compressor Kit

APPLICATIONS

- ▶ Mini pumper
- ▶ Rescue pumper
- ▶ Tactical tender
- ▶ Wildland/Interface

STANDARD EQUIPMENT

- ▶ Horizontal mount air/oil receiver
- ▶ Control panel with high temperature shut down
- ▶ Odin AutoBalance™ valve system
- ▶ American made
- ▶ Master air check valve
- ▶ Remote air intake filter kit
- ▶ Stainless steel, plate type heat exchange with thermo valve
- ▶ Available in 150 and 200 cfm with inlet valve and mounting bracket
- ▶ 150 cfm: 5 year warranty, 200 cfm: Lifetime warranty

Features: The compressor receives its power from the apparatus transmission PTO. Please consult Odin for the correct engineering application. Pump is supplied by customer. 2½" and 3" standard and expanded kits are available. Please call Odin at 319-987-2226 for more information.



Model	Performance (Air)	Dimensions	Ship. Wt.	Price
PTO Driven Compressor Kit	200 cfm @ 125 psi	Contact Odin Foam for Schematic and CAD Drawings of Components	585 lbs. (265 kg)	\$13,060.00
	150 cfm @ 125 psi		535 lbs. (243 kg)	\$11,975.00

Darley Around-The-Pump Proportioning Kit

The Darley Around-The-Pump Proportioning Kit is a simple and inexpensive way to add foam capability to all discharges of a truck. It allows for different flow requirements separately or in any combination. A portion of the truck output goes through an eductor and back to the inlet side of the pump. A metering valve is adjusted for the correct foam percentages based on the total discharge.

This system offers several advantages when compared to an inline eductor:
Variable Flow Rate - Discharge rate can be adjusted for the specific application. The rate is infinitely variable up to the max. flow of the unit.
Variable Pressure - System operates at any pressure above 120 psi. The pump operation is the same with foam or water.
No Back Pressure Restrictions - Unit is not affected by hose length or elevation loss.
No Nozzle Restrictions - Unit operates with any size or type of nozzle.
Note: Maximum 5 psi Hydrant Pressure.

- ▶ Inexpensive & simple to use
- ▶ Foam at all outlets
- ▶ Max. 3% flow - 400 gpm - 1515 lpm
- ▶ Max. 6% flow - 200 gpm - 757 lpm
- ▶ Drive flow - 25 gpm - 95 lpm
- ▶ Variable flow rates
- ▶ No friction loss or elevation restrictions

G365	Darley Around-The-Pump Proportioner Kit, (Down to 1% @ 60-400 gpm)	\$1,012.95
AM152	Darley Around-The-Pump Proportioner Kit, (Down to 0.5% @ 100-1400 gpm)	\$1,829.95

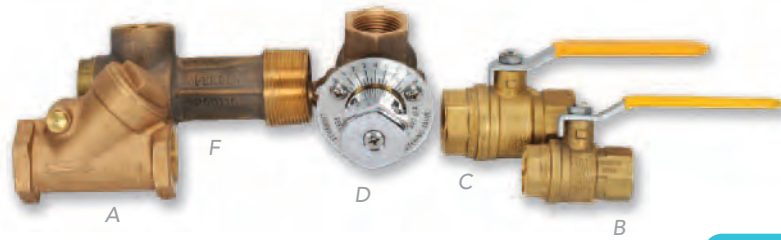

Kit Includes:

- A. Swing Check Valve (shown above)
- B. Foam Concentrate Shut-Off Valve (shown above)
- C. Eductor Supply Valve (shown above)
- D. Foam Metering Valve (shown above)
- E. Instruction Panel Plate (shown below)
- F. Eductor (shown above)

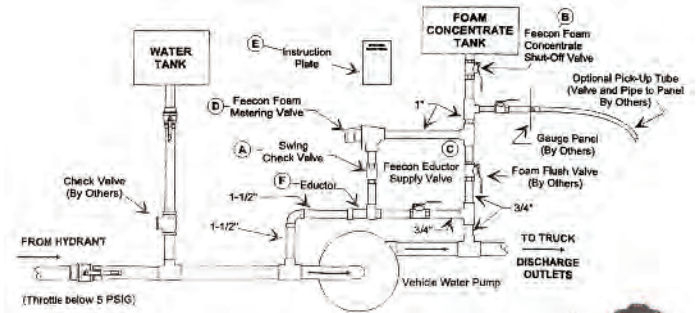

Class A Foam Mixer System for Portable Pumps

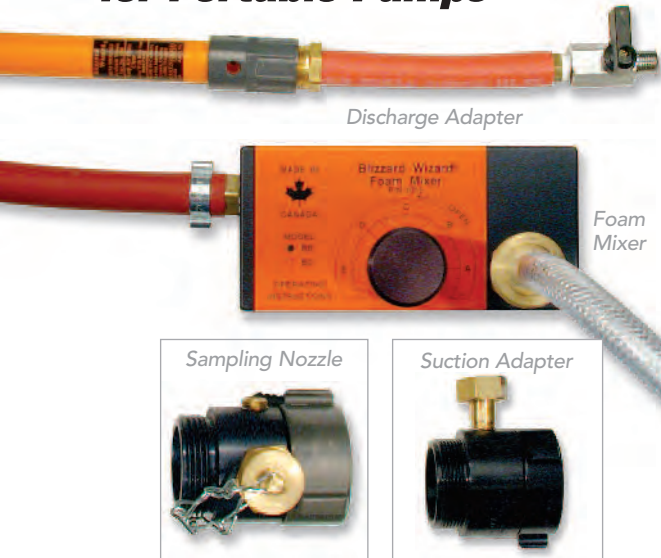

This foam-making kit can be attached to a forestry fire-fighting pump. The kit consists of a 2" suction hose adapter, a 1 1/2" discharge hose adapter which is equipped with a shut-off valve and foam sampling nozzle and a variable around-the-pump foam liquid concentrate mixer with a pick-up tube. The inductor can be adjusted to pickup liquid concentrate in quantities small enough for the smallest nozzle, all the way up to an amount large enough to treat over 150 gallons of water per minute. The quality of water/foam solution being produced can easily be determined by the foam sampling nozzle located on the discharge hose adapter. The mixer can be fitted to most pumping units.

AC993	Class A Foam Mixer System	\$611.95
-------	---------------------------	----------

By-Pass Eductors with Metering Dial

VIPER By-Pass Foam Eductors can now be equipped with Dial knob for use with Class A or B foam. There is an off setting for extra long 48" pickup hose and stainless steel wand. All the moving parts are easy to use with gloved hands. Made of hardcoat anodized aluminum for corrosion protection.

WITH METERING DIAL (OFF, .5%, 1%, 3%, 6%)

Cat#	Description	NST Inlet	GPM	Price
BLO27	By-Pass Eductor	1"	30	\$452.95
BLO28	By-Pass Eductor	1 1/2"	60	\$452.95
BLO29	By-Pass Eductor	1 1/2"	95	\$452.95
BLO30	By-Pass Eductor	1 1/2"	125	\$452.95

Portable In-Line Foam Eductors

These "Venturi" eductors are constructed of rugged brass alloys. Their efficient and simple design assures the lowest possible friction loss. Metering devices on all these eductors are easily removed for cleaning and are designed with a stainless steel ball check to prevent foam contamination when the line is shut down. Eductors are suitable for all types of foams. **Ship. wt. 10 lbs. Specify inlet size.**

- ▶ Eductor with female swivel inlet and male outlet
- ▶ Removable metering/check valve and pick-up tube
- ▶ Clear PVC pick-up hose

Cat#	GPM	Inlet	Outlet	Max. Hose	Trim	Price
H581	60	2 1/2" or 1 1/2"	1 1/2"	300'	Brass	\$675.95
W202	95	2 1/2" or 1 1/2"	1 1/2"	150'	Brass	\$674.95
H583	125	2 1/2" or 1 1/2"	1 1/2"	300'	Brass	\$675.95
W204	250	2 1/2"	2 1/2"	200'	Brass	\$1,089.95

AkroFoam Master Stream Nozzle with Pickup Tube

The AkroFoam foam nozzles are self-educing master stream nozzles designed for educating foam at flow rates up to 1000 gpm (4800 lpm).



- ▶ Manual pattern control spring loaded baffle that allows flow setting selection of 350, 500, 750, or 1000 gpm (1325, 1900, 2900, or 3800 lpm) with a simple push and turn of the baffle head
- ▶ Quick connect, adjustable metering head with pick up rates 1% & 3%, plus 6% for 350 & 500 gpm (1325 & 1900 lpm) and 1% & 3% for 750 & 1000gpm (2900 & 3800 lpm)
- ▶ Integrated foam shutoff

BL486	AkroFoam Master Stream Nozzle with Pick Up Tube	\$1,502.95
BL487	AkroFoam Master Stream Nozzle with Pick Up Tube & Shutoff	\$1,606.95
BL488	Optional Drum Kit	\$88.95

Round The Pump Foam Inductor/Mixer

An economical and easy-to-use method for foam induction. Inducts foam concentrate into the hose lines of portable pumps. Perfect for use in wildland fires. Designed with a control knob calibrated to induct foam concentrate ratios of .1%, .5% and 1% into hose lines flowing 8, 15, 30 and 50 gpm. *Ship. wt. 1 lb.*

- ▶ 1.5"x1.5"x75" tee connector
- ▶ 2"x2"x75" tee connector



AJ253 Round The Pump Foam Inductor/Mixer \$577.95

Pyrolite® In-Line Educators



Akron Municipal Educators feature a large, easy to read, and removable metering dial with infinite settings between 0 and 6%. Detents at 1/4, 1/2, 1, 3, and 6%. The Educators are rated to flow at 200 psi (14 bar) inlet pressure and works well with nozzles rated at 75 and 100 psi (5 and 7 bar). *Ship. wt. 8 lbs.*

- ▶ 1 1/2" or 2 1/2" swivel inlet x 1 1/2" male, except where noted
- ▶ 30" pickup hose standard on 60, 95, and 125 gpm (230, 360, and 475 lpm) educators, 48" optional
- ▶ 48" pickup hose standard on 250 gpm (950 lpm)

AZ340	Pyrolite® In-Line Educator 60 gpm	\$688.95
AZ341	Pyrolite® In-Line Educator 95 gpm	\$688.95
AZ342	Pyrolite® In-Line Educator 125 gpm	\$688.95
AZ343	Pyrolite® In-Line Educator 250 gpm	\$962.95

Portable By-Pass Educator

The Portable By-Pass Educator has a built-in by-pass chamber, allowing the operator to change from water to foam without shutting down.



- ▶ Brass with chrome trim
- ▶ Changes easily to water line use
- ▶ 8 quick-change handle positions with a Swing-Out™ valve handle

Cat#	GPM	Inlet	Outlet	Price
BL031	60	1 1/2"	1 1/2"	\$1,429.95
BL032	95	1 1/2"	1 1/2"	\$1,429.95
BL033	125	1 1/2"	1 1/2"	\$1,429.95

ATP FOAM FLURRY™

The ATP FOAM FLURRY™ is our most economical proportioner. It is simple-to-install and operate, and works without 12v power—no amperage issues for small pumps. For your next Darley portable pump purchase, or for retrofitting your current pump, the ATP FOAM FLURRY™ will deliver foam cost effectively.

- ▶ 12 volt. All brass construction—no plastic
- ▶ Fast adjusting variable control ball valve
- ▶ Capable of .5% injection rate up to 100 gpm
- ▶ Remote mount operation placard
- ▶ Includes installation kit



BL125 ATP FOAM FLURRY™ \$525.95

FoamCheck PRO

Foam Concentrate Meter

The Scotty FoamCheck Pro obtains real-time measurement of the percentage of foam concentrate in fire fighting hose lines. The user simply runs fresh water through the included Sensor Tee (after mounting it on the discharge side of the pump) while pressing the "Zero" button on the Display Console for five seconds. Then set the pump's foam proportioner to 1% and flow foam/water solution while holding the "Cal" button for five seconds. The Console is now ready to display the real-time measurement of foam concentration flowing through the Sensor Tee. The Scotty FoamCheck Pro consists of the Display Console (5.7" x 3.8" x 2.3"), a 1 1/2" Sensor Tee with either NHT or NPSH threads and a 5' long cable for connection to the Display Console. The FoamCheck Pro is self-powered by 2 AA batteries, which are included. The maximum recommended operating pressure for the FoamCheck Pro is 200 psi.



- ▶ Automatic power down after 6 hours saves battery life
- ▶ Polycarbonate, weatherproof enclosure
- ▶ Senses foam concentration 60 times a second
- ▶ Display console is IP65 rated for outdoor use
- ▶ Automatic display backlight shuts off after 15 seconds



BL244	FoamCheck Pro Foam Concentrate Meter	\$359.95
-------	--------------------------------------	----------

Mid-X Medium Expansion Foam Tube



- ▶ Capable of foam expansion to 50:1
- ▶ Maximum flow 250 gpm
- ▶ Maximum pressure 100 psi
- ▶ Ship. wt. 5 lbs.

AZ294	For Use On Akron 1 1/2" Turbojet Nozzles	\$499.95
AZ295	For Use On Akron Mid-Range Turbojets, Mid-Range Saberjets and 2 1/2" Saberjet Nozzles	\$499.95
AZ296	For Use On Akron 1 1/2" Assaults, Wide Range Turbojets, 1" & 1 1/2" Saberjet Nozzles	\$499.95

Quick-Attack™ Foam Aeration Tubes

Pyrolite® foam tubes are designed to easily and quickly clamp on to various Akron® nozzles. Use the chart below to determine the proper Quick-Attack™ foam tube. *Ship. wt. 3 lbs.*

- ▶ Reach up to 75'
- ▶ Provides air-aspirated foam capability - up to 12:1 expansion ratio with AFFF
- ▶ Flow: AF26401 - 30 gpm, AF26409 - up to 250 gpm, all others up to 125 gpm
- ▶ Length: AF26401 - 11 1/2", all others 16 3/4"



Cat#	Bumper Nozzle	Years	Diameter	Price
AF26401	1" TurboJet	2000 - Current	3"	\$203.95
	1" Assault Force & Defender	2000 - Current	3"	
		All	3"	
AF26402	1 1/2" TurboJet	Pre 1993	3 3/8"	\$287.95
	1 1/2" Industrial TurboJet	All	3 3/8"	
AF26403	1" TurboJet	1993 - 2000	3 5/8"	\$287.95
	1 1/2" TurboJet	1993 - Current	3 5/8"	
AF26404	Mid-Range TurboJet	1993 - Current	4 1/2"	\$287.95
	Mid-Range & 2 1/2" SaberJet	All	4 1/2"	
AF26405	1 1/2" Marauder w/Molded Teeth	All	3 5/8"	\$287.95
	1 1/2" 3015-3021	All	3 5/8"	
AF26406	1 1/2" Marauder w/Spinning Teeth	All	3 3/4"	\$287.95
AF26407	1 1/2" & Mid-Range Assault	All	3 7/8"	\$287.95
	Wide-Range TurboJet	All	3 7/8"	
	1" & 1 1/2" SaberJet	All	3 7/8"	
AF26408	Mid-Range Akromatic	All	4 1/4"	\$307.95
	2 1/2" Industrial TurboJet	All	4 1/4"	
AF26409	2 1/2" TurboJet	1993 - Current	4 1/2"	\$483.95

Solid Foam Technology

No Eductors, No Foam Pails



The Quick STIK system uses solid foam/wetting agent that is inserted into the specially perforated foam sleeve. Matched up with a 30-60-95-125 gpm adjustable nozzle, this Quick STIK system can deliver up to 600 gallons of foam/water mixture per stik.

BC141	Foam Proportioner with Quick STIK Technology	\$1,193.95
BC054	TS TURBO AFFF/AR 12/cs	\$367.95
BC056	TS CLEAN STIK Degreaser 12/cs	\$178.95
BL501	BUCKEYE Standard Class A 12/cs	\$299.95



Bubble Cup Nozzles

The dual or single-gallonage Bubble Cup nozzle is a uniquely designed aspirating fog/foam nozzle created to be used with AFFF and Protein type foams for fire brigades and hazardous materials incidents or for structural and wildfire applications of Class A foaming agents. Capable of producing a conventional straight stream, wide protective fog pattern and aspirating foam, the Bubble Cup is a nozzle that provides an extra measure of protection. Nozzles are backed by a full 5-yr factory warranty and 24-hr certified repair. *Ship. wt. 4 lbs.*

SPECIFY GPM: 20/60 or 20/95

AC990	Bubble Cup Nozzle Tip, 1 1/2"	\$354.95
AC991	Bubble Cup Nozzle with Shut-Off, 1 1/2"	\$445.95
AC992	Bubble Cup Nozzle w/Shut-Off & Pistol Grip, 1 1/2"	\$445.95

Viper Foam Nozzle

- ▶ Durable Viper Ball Valve
- ▶ Construction: Lightweight aluminum
- ▶ Up to 12:1 expansion ratio
- ▶ Available in your choice of 60 or 90 gpm
- ▶ Weight: 3.5 lbs
- ▶ Length: 19"



Cat#	GPM	Inlet	Price
BL034	60	1 1/2"	\$399.95
BL035	95	1 1/2"	\$399.95

Nothing Foams Like A "Madd Dog" Expansion Aspirating Foam Attachment



The Madd Dog Attachment makes better foam than any other multiple expansion aspirating nozzle. Designed by a fire captain with firefighter safety, quality, versatility, performance and cost in mind. Produces low-expansion foam with excellent stream projection or medium expansion foam with incredible production. The aspirating attachment is constructed of pressure-injected polymer resins which make it economical, lightweight and incredibly rugged and will fit a variety of combination nozzles. *Ship. wt. 2 lbs.*



ISO Points

AK244	Madd Dog Foam Attachment	\$146.95
L685	1 1/2" Lexan Nozzle	\$13.95

Foam Nozzle w/Pick-Up Tube

These 1 1/2" and 2 1/2" aerating type foam nozzles are lightweight, cord wrapped and include a clear PVC hose and strainer and pick-up tube which means each tube requires no eductor and can draw foam directly from a container. The AG129 and AG174 foam nozzles are the most inexpensive way to deliver foam in the 60 to 95 gpm range and are very light and easily handled. Maintenance and cleaning are very simple. The AG175 foam nozzle delivers 120 gpm of foam and can be used with 2 1/2" lines. It will supply foam in an expansion ratio of approximately 14 to 1 and would be suitable for most small spills and foam application requirements. *Ship. wt. 7 lbs.*



No eductor required

Cat#	Description	Swivel	GPM	Length	Price
AG174	Foam Nozzle w/Pick-Up Tube	1 1/2"	60	36 1/4"	\$689.95
AG129	Foam Nozzle w/Pick-Up Tube	1 1/2"	95	38"	\$857.95
AG175	Foam Nozzle w/Pick-Up Tube	2 1/2"	120	41"	\$1,171.95

Blizzard Wizard® Class A Foam Nozzles

Blizzard Wizard® foam nozzles are rated at 11, 23, 34, 50 and 60 gpm at 100 psi nozzle pressure. The unusual long reach-of-stream (up to 75') is possible because of the patented "turbulence induction plates" that use such a small amount of available water pressure to make foam. Nozzle body is made of ABS plastic. AC994 made of hard anodized aluminum. *Ship. wt. 2 lbs.*



Cat#	Size	Flow (GPM)	Stream	Price
AF850	1 1/2" NST	50	75'	\$60.95
AF851	1 1/2" NST	34	70'	\$54.95
AF852	1 1/2" NST	23	50'	\$50.95
AF853	3/4" GHT	11	45'	\$31.95
AC994	1 1/2" NST	60	75'	\$112.95

Fire Hose Caps

Allows Discharge Hoses to be Used as Air Lines

Put the power of your CAFS (Compressed Air Foam System) to even more use by using your firefighting hoses as air lines for operating pneumatic tools. All Darley CAFS capable discharge hoses can be used as air lines by simply not flowing water and foam into the hose prior to the injection of compressed air. This adapter can either be installed on the end of your 1 1/2" or 1 3/4" firefighting hose or onto the threads of your discharge nozzle. Fill air bags, lifting mats, operate chisels, cutting tools, or even blow debris off the road at an accident scene. You could even use your CAF system as a positive pressure fresh air system to evacuate smoke from a building. Your capabilities are limited only by your imagination.



Cat#	Description	Finish	Price
OFG00091	1.5" Hose Cap with Air Chuck	Chrome	\$69.95
OFG00092	1.5" Hose Cap with Air Chuck	Brass	\$69.95

CAFS Nozzles

BL036 - Combination of the ball shutoff with full 1" inlet waterway and the 1 5/16" outlet smooth bore tip . Both parts are constructed of hard coated aluminum.

BL037 - Combination of the ball shutoff with full 1 1/2" inlet waterway and 1 1/8" outlet smooth bore tip . Both parts are constructed of hard coated aluminum.



BL036 & BL037 - SPECIFY NST OR NPSH FOR INLET

Cat#	Description	Inlet	Length	Weight	Price
BL036	1" CAFS Nozzle	1"	10"	2 lbs.	\$199.95
BL037	1.5" CAFS Nozzle	1 1/2"	10 1/2"	4 lbs.	\$308.95



2 1/2" CAFS Pistol Grip Nozzle

Do you want to pack the most CAFS punch possible in a 2 1/2" hand line? Most 2 1/2" nozzles are nothing more than a 1 3/8" waterway shutoff with a 2 1/2" swivel inlet. Not this nozzle... this pistol grip ball shutoff features a 2 1/2" swivel inlet and a 2 1/2" threaded outlet with a full 2" internal ball

opening. This allows more CAFS to be propelled unobstructed through this lightweight pistol grip ball shut-off. We also finish off this Brutus of a shut off with a set of dual stacked tips so you can choose between the 2 1/4" and a 2" tip opening. Easily flows 120 gallons per minute of foam solution and 120 cfm of compressed air at the NFPA recommended 125 psi. *Ship. wt. 7 lbs.*

CAFS-Force Nozzles

Pressure for foam and water



BD156



new lower price

- ▶ CAFS - Force nozzle delivers both foam AND water
- ▶ The ONLY automatic nozzle combination specifically designed for CAFS and water applications
- ▶ Engineered specifically for optimal foam stream performance, as well as low pressure nozzle operations for water use alone



BH190	2 1/2" CAFS Nozzle Combo	\$729.95
-------	--------------------------	----------

BD155	CAFS-Force Nozzle Combination	\$1,238.95
BD156	CAFS-Force Tip	\$832.95

SabreJet Dual Shutoff Nozzle

new



FOAM

This very versatile pistol-grip ball shut-off features the large 1 3/8" ball opening and a 1 1/8" smooth bore tip for making very good CAFS stream from wet to medium foam types. It also has a secondary control for spraying plain water, foam solution, or wet CAFS stream through the fog spray nozzle. This nozzle therefore is a great tool for your CAFS attack lines to be able to provide a wide variety of real world spray stream and also to be able to spray plain water if desired.



SPECIFY HANDLE COLOR: Red, Black, Blue or White

BL386 1 1/2" SabreJet Dual Shutoff Nozzle \$1,091.95

CAFS Smooth Bore Nozzle

This very durable, pistol-grip, ball shut-off features a full unobstructed 1 3/8" ball opening. With the tip removed, this shut-off does not "strip" any bubbles from the CAFS stream. It therefore can produce the "shaving cream" type foam product. The 1 1/4" smooth bore tip when installed slightly shapes the stream and holds back a bit of CAFS pressure to keep the hoseline stiffer and avoid kinking. This combo is a staple on any CAFS truck.

new



BL397 CAFS Smooth Bore Nozzle \$452.95

In Line Foam Eductors

new



BL378



In line Foam Eductors have a metering head with easy-read knob for use with Class A foam at .25% and .5% and with ARC-AFFF foam at 1%, 3% and 6%. Extra large 36" pickup hose and stainless steel wand are ideal for use with high viscosity foams. The meter head is equipped with a unique backflush push-button for fast cleaning, and is secured to the eductor body with a rugged disconnect. All controls are easy to use with gloves. Made of hardcoat anodized aluminum for corrosion protection. The required inlet pressure is 200 psi. The maximum allowable back pressure is 130 psi.

Cat#	Description	Inlet	GPM	Price
BL376	In Line Foam Eductor	1 1/2" NH	60	\$706.95
BL377	In Line Foam Eductor	2 1/2" NH	60	\$706.95
BL378	In Line Foam Eductor	1 1/2" NH	95	\$706.95
BL379	In Line Foam Eductor	2 1/2" NH	95	\$706.95
BL380	In Line Foam Eductor	1 1/2" NH	125	\$706.95
BL381	In Line Foam Eductor	2 1/2" NH	125	\$706.95

Quadracup Tips

The QuadraCup Series is a rugged and dependable selectable gallonage nozzle with a retractable foam aspiration sleeve. When the outer sleeve is in the retracted position, the nozzle operates the same as the TFT QuadraFog. Flow can be set to any one of four flow settings, or to a flush mode. The front end can be rotated from straight stream through wide fog patterns. Uniquely cut fixed metal fog teeth produce a wide range of fog patterns.

new



BL384



BL382



BL382	1 1/2" NH Quadracup Tip	\$495.95
BL383	1 1/2" NH Quadracup Tip Nozzle	\$729.95
BL384	1 1/2" NH Quadracup Tip Nozzle w/Pistol Grip	\$729.95

Compressed Air Foam Systems

Mongoose

Features: Kawasaki: 28 HP @ 3600 rpm, air cooled, V twin, 2 cylinder gasoline powered, 12 vdc electric start, Darley Model 2BE: Fully adjustable 1 1/2" CAF discharge mix point, 2 1/2" water discharge, 2 1/2" direct tank fill, 2 1/2" NPT suction inlet, air jet primer, 2 1/2" water and air pressure gauges, pump drain valve, stainless steel plumbing, illuminated, laser cut, brushed stainless steel panel with infused powder coat painted labels, foam injection system controls installed, air compressor, rotary screw encapsulated, lightweight aluminum frame, Darley Fast Foam 50 Class "A" Foam proportioner.

Options: Custom Water/Foam tank, custom full aluminum skid/tank, CAF discharge valve, suction valve, laser cut aluminum sides, hose reels – steel economy or all alloy CAF rated, fuel tank ,control panel. **Available in Kubota diesel. Call for details.**

Simultaneous Flow (NFPA)
56 gpm & 23 cfm @ 125 psi
Simultaneous Flow
80 gpm & 40 cfm @ 100 psi

Mongoose Gas



FOAM

Model	Performance		Inlet	Outlet	Dimensions	Dry Weight	Price
	Water	Air Compressor					
Mongoose Gas	120 gpm @ 100 psi 250 gpm @ 40 psi	50 cfm @ 125 psi	2 1/2" NH	2 1/2" NH	Length: 36" +6" air flow Width: 47 1/4" Height: 33"	850 lbs.	Call for Pricing 877-634-6223

Derringer

- ▶ Mini Pumper
- ▶ Rescues
- ▶ Wildland/Interface

Features: 33.5 HP Kubota diesel engine, liquid cooled-4 cylinder, indirect injection, naturally aspirated diesel engine, pressure-lubricated, 12vdc 40-amp alternator, glow plugs, remote oil drain, Darley 1.5 AGE water pump, 2 independent CAF discharge mix points, rotary screw air compressor, Foam Pro 1601 Injection system, all aluminum tube structure, laser cut SS panel, 1 1/2" panel discharge CAFS, 2 1/2" direct tank fill, 2 1/2" NPT suction inlet, Darley 12 V primer, Odin Electric door - full engine / compressor instrumentation, 3 1/2" gauges - discharge, inlet and air pressure.

Simultaneous Flow (NFPA)
100 gpm & 50 cfm @ 125 psi
Simultaneous Flow
130 gpm & 60 cfm @ 100 psi



Model	Performance		Dimensions	Weight	Price
	Water	Air Compressor			
Derringer	125 gpm @ 125 psi	60 cfm @ 125 psi	Length: 48" Width: 48" Height: 37"	1,350 lbs. Ship. wt. for base unit only	Call for Pricing 877-634-6223

Weapon

This NFPA 1901 rated rear mount module is time tested with a history of over 20 years. This module maintains a short front to back to fit a quick attack truck. Patented Odin drive system.

Features: 73 HP Deutz, air cooled, 4 cylinder, turbo-charged, diesel fueled, 12 volt electric start with oil pressure gauge, temperature gauge, voltmeter, tachometer/hourmeter, vernier throttle, Darley 2 1/2 AGE pump, 2-independent 1 1/2" CAF discharge mix points, 1-2 1/2" water discharge, 1-2 1/2" tank to pump suction inlet, 1-direct tank fill with 2 1/2" NH female swivel, inlet, master drain valve, 12 volt electric primer system and stainless steel plumbing.

Simultaneous Flow (NFPA)
200 gpm & 100 cfm @ 125 psi



Other additional units available. Call for details.

Model	Performance		Inlet	Outlet	Dimensions	Weight	Price
	Water	Air Compressor					
Weapon	250 gpm @ 150 psi 175 gpm @ 200 psi 125 gpm @ 250 psi	125 cfm @ 125 psi	2 1/2"	2 1/2"	Length: 56" Width: 48" Height: 38"	1,800 lbs.	Call for Pricing 877-634-6223

LDMBC Pump

FOAM

AutoCAFS™ -
Air Pressure
Balancing Valve

Air Distribution
Manifold

Available as a
complete module

Electric "Hot Shift" Clutch

Air Compressor Intake Valve
▶ Vertical Mounted (Shown)
▶ Horizontal Mounted (Optional)

Belt Driven
Compressor

APPLICATIONS

- ▶ Aerial
- ▶ Pumper
- ▶ Rescue pumper
- ▶ Pumper tanker

STANDARD EQUIPMENT

- ▶ 4 - 2½" NH, ¼ turn, ball valves
- ▶ 2 - 5" or 6" NH suction adapters and caps
- ▶ Discharge and suction companion flanges as needed
- ▶ Air shift
- ▶ 1610 or 1710 full round yokes standard
- ▶ Output shaft for AZ02900 220 cfm compressor package
- ▶ AutoCAFS™ Commander

Features: 1000-1750 gpm, single stage, centrifugal, midship mounted pump forward.

Optional Equipment: Foam manifold, air distribution manifolds, CAFS valve packages, FoamPro system can be pre-installed and tested.

Compact oil reservoir with
built-in oil separator

LDMBC
Front View

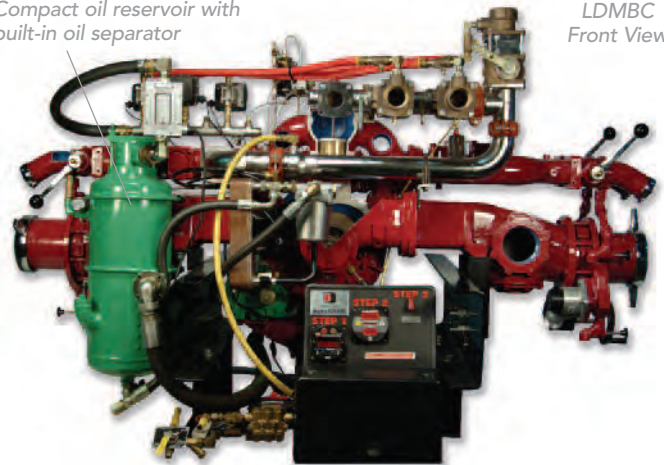

AutoCAFS™



AutoCAFS™ Commander control system. Indicates and operates all CAFS functions and system information.

AutoCAFS™

Model	Performance		Dimensions	Weight
	Simultaneous Water	Simultaneous Compressed Air		
LDMBC	1250 gpm @ 125 psi	220 cfm @ 125 psi	Length: 40" Width: 76" Height: 46"	2,200 lbs. (997 kg)

Lightweight Double Jacket Attack Hose

Backed By a 10 Year Warranty

- ▶ 100% synthetic all polyester double jacket
- ▶ 100% mildew resistant
- ▶ Thin wall high tensile EPDM rubber liner
- ▶ UL listed
- ▶ Packs tighter
- ▶ 25% lighter
- ▶ 10 year warranty
- ▶ Made in the USA

new



SPECIFY COLOR: Yellow, Blue, Red or Orange		White	Colored
BL283	Eco-10 1 1/2" x 50' Hose	\$87.95	\$102.95
BL284	Eco-10 1 3/4" x 50' Hose	\$99.95	\$117.95
BL286	Eco-10 2 1/2" x 50' Hose	\$139.95	\$160.95
BL287	Eco-10 3" x 50' Hose	\$197.95	\$219.95

DARLEY 800 Hose

Polyester Double Jacket 800 psi Hose

- ▶ Designed specifically for the toughest fire fighting jobs
- ▶ Long-lasting synthetic rubber lining and rugged double jacket construction
- ▶ Jackets are woven from the finest high-tensile 100% polyester yarn
- ▶ Tight weave in both jackets mean no drying is required
- ▶ Mildew resistant
- ▶ First choice of many fire departments and industrial users
- ▶ Color: White

10-year warranty



Cat#	Hose Size	Test Pressure	Annual Service Test	Weight per 50' Coupled	Price per 50' Coupled
R755	1 1/2"	800 psi	400 psi	18 lbs.	\$88.95
T410	1 3/4"	800 psi	400 psi	19 lbs.	\$110.95
BB154	2"	800 psi	400 psi	26 lbs.	\$162.95
R757	2 1/2"	800 psi	400 psi	32 lbs.	\$156.95
R758	3"	800 psi	400 psi	40 lbs.	\$234.95
2" Standard, 2" x 1 1/2" NH			3" Standard, 3" x 2 1/2" NH		

How To Order Darley 800 or Cord Hose

Length: All hose will be shipped in 50 ft. lengths. 75 ft. or 100 ft. lengths are available (pricing available upon request).

Couplings: All hose will be shipped with hard-coated, lightweight, rocker lug couplings, unless otherwise specified (brass couplings available for an additional charge).

Threads: NST (NH) threads are standard. IPT (NPSH) available at no additional charge (other threads available for \$5.00 per set).

DARLEY Cord Hose

All-Polyester Double Jacket 800 psi Hi-Tech Polymer Impregnation Hose
Darley - Cord 800 is a unique attack-grade fire hose, developed specifically for the rigorous environment of fire department use.

- ▶ All-polyester double jacket construction
- ▶ Ozone-resistant, high-tensile synthetic rubber liner
- ▶ Most advanced fire hose in the industry
- ▶ Lightweight and extremely durable
- ▶ Outside jacket is thoroughly impregnated with a heat-set High-Tech Polymer, providing durability and ease of maintenance (superior to Hypalon)
- ▶ Completely immune to any effects of mildew

10-year warranty



SPECIFY COLOR: Yellow, Red, Tan, Blue, Black, or Orange

Cat#	Hose Size	Test Pressure	Annual Service Test	Weight per 50' Coupled	Price per 50' Coupled
U273	1 1/2"	800 psi	400 psi	18 lbs.	\$101.95
U275	1 3/4"	800 psi	400 psi	19 lbs.	\$120.95
BB155	2"	800 psi	400 psi	26 lbs.	\$177.95
U276	2 1/2"	800 psi	400 psi	32 lbs.	\$171.95
W109	3"	800 psi	400 psi	40 lbs.	\$246.95
2" Standard, 2" x 1 1/2" NH			3" Standard, 3" x 2 1/2" NH		

Requires less storage space, allowing more room for hose or equipment

HOSE



A



B



C



D

NFPA 1961

A. DarQuest Lightweight Hose

Synthetic All Polyester Double Jacket Hose

- ▶ 100% synthetic all polyester double jacket
- ▶ 100% mildew resistant
- ▶ Single-ply synthetic polyurethane liner resists ozone
- ▶ Attack hose designed for Hi-Rise applications
- ▶ Special construction to reduce friction loss by 21%
- ▶ Reduced weight, increased flexibility
- ▶ 5 year warranty against delamination and manufacturer's defects
- ▶ Lining meets and exceed all potable water MIL-H-24606B and NSF-61 (National Sanitation Foundation) standards for the manufacturing of potable use hose
- ▶ Tested and stenciled in accordance with NFPA Standard 1961
- ▶ Color: Orange

Cat#	Hose Size	Test Pressure	Annual Service Test	Weight per 50' Coupled	Price per 50' Coupled
AB083	1 1/2"	800 psi	400 psi	17 lbs.	\$128.95
AB084	1 3/4"	800 psi	400 psi	18 lbs.	\$153.95
AB085	2 1/2"	800 psi	400 psi	27 lbs.	\$198.95
AB086	3"	600 psi	300 psi	33 lbs.	\$261.95

B. Magnum 800 - Nylon Hose

This double jacket attack hose is manufactured using tightly woven entangled filament nylon 6.6 yarns in both the inner and outer jackets to promote abrasion resistance and kink-resistance. With higher tensile strength than that of polyester, the Magnum 800 is designed for aggressive fire department use. Magnum 800 meets and exceeds all current NFPA 1961 and 1962 specifications for attack hose. Construction: 100% all synthetic entangled NYLON 6.6 Tube: EPDM rubber lined for the best ozone resistance.

Hose Size	Weight 50' Coupled	Annual Service Test Press.	Hose Size Test Press.
1 3/4"	18 lbs.	400 PSI	800 PSI
2 1/2"	28 lbs.	400 PSI	800 PSI

SPECIFY COLOR:
Yellow or Orange

BH092	1 3/4" x 50' Magnum 800 Hose	\$155.95
BH093	2 1/2" x 50' Magnum 800 Hose	\$210.95

C. Darley Hi-Rise Hose

Lightweight hose ideal for high-rise packs. At about half the weight of standard double jacketed hose, it is easier and less stressful to carry up stairs. Made of 100% synthetic nylon and completely protected by an abrasion and chemical-resistant orange colored nitrile rubber cover. 1 3/4" size is coupled with 1 1/2" NST lightweight anodized couplings standard. Tensile strength of 2000 psi. 50' of Darley Hi-Rise Hose coils to only 10". 5-year warranty. Color: hi-visibility orange.

Cat#	Hose Size	50'	75'	100'
AM104	1 3/4"	\$127.95	\$180.95	\$231.95
BH087	2 1/2"	\$176.95	\$246.95	\$315.95

D. Combat Ready Hose

This hose is designed specifically for aggressive interior fire attack operations. The outer jacket is woven from staple polyester yarns over an inner liner consisting of a one-piece extruded through-the-weave tube. Combat Ready is manufactured in a high-visibility white with one red and one blue stripe running the length of the hose. This heat-resistant, drag-resistant and kink-resistant hose has superior friction loss characteristics. Ship. wt. 18-26 lbs.

- ▶ Abrasion-resistant
- ▶ High visibility
- ▶ 10-year warranty
- ▶ Low friction loss

Ozone resistance

Cat#	Hose Diameter	Service Pressure	Acceptance Pressure	Weight Per 50' Coupled	Price Per 50' Coupled	Price Per 100' Coupled
AS322	1 3/4"	500 psi	1000 psi	18 lbs.	\$244.95	\$463.95
AS323	2 1/2"	500 psi	1000 psi	26 lbs.	\$327.95	\$617.95

Darley Fire Hose

Features:

- ▶ **Ease of Handling** - Uniquely constructed inner liner with resilient reinforcement helps ensure maximum flow with minimum friction loss
- ▶ **Tough and Durable** - Specially formulated rubber compound provides a tough cover that resists tear and abrasion, snags, hot embers, cuts and most chemicals
- ▶ **Construction** - Extruded Interlocking Matrix
- ▶ **Cover** - 100% Synthetic Nitrile Ribbed Rubber
- ▶ **Reinforcement** - 100% Synthetic Fiber, Circular Woven

- ▶ **Inner Liner** - 100% Smooth, Synthetic Nitrile Rubber
- ▶ **Rating** - 1" - 3" - 600 PSI Test, 4" - 5" - 400 PSI Test

Applications:

- ▶ Relay and Tandem pumping
- ▶ Crash fire rescue
- ▶ Industrial fire fighting
- ▶ Rural water supply
- ▶ Aerial equipment supply
- ▶ Military

Darley Extruded Rubber Attack Hose

SPECIFY COLOR WHEN ORDERING.

Cat#	Size	Colors Available	Price 100' Coupled	Price 50' Coupled	Price 25' Coupled
AC659	1"	Yellow Only	\$228.95	\$127.95	\$75.95
AC665	1½"	Blue, Black, Red, Yellow	\$274.95	\$153.95	\$89.95
AC666	1¾"	Blue, Green, Orange, Red, Yellow	\$329.95	\$186.95	\$101.95
AC667	2"	Blue, Red, Yellow	\$375.95	\$197.95	\$148.95
AC668	2½"	Blue, Orange, Red, Yellow	\$414.95	\$224.95	\$131.95
AC669	3"	Blue, Green, Red, Yellow	\$508.95	\$281.95	\$176.95



Darley L.D.H.

UNCOUPLED HOSE AVAILABLE - PRICING UPON REQUEST.

SPECIFY NST with ROCKER LUG or STORZ COUPLING

SPECIFY COLOR: Red, Yellow, Blue or Orange

Cat#	Size	Price 100' Coupled	Price 50' Coupled	Price 25' Coupled
AC670	4"	\$529.95	\$324.95	\$230.95
AC671	5"	\$653.95	\$400.95	\$282.95
BH005	6"	\$1,096.95	\$750.95	\$577.95



SUPPLYLINE™ Hose

Double jacket all-polyester hose intended to transfer large volumes of water with minimal friction loss. Lightweight and compact, occupies less space than conventional rubber-covered LDH. Flexible to -60°F. Construction: circular woven, double jacket, 100% virgin spun polyester. Tube: Extruded T.P.U. elastomer - ozone and age resistant.

Hose Size	Threaded Bowl Size	Weight 100' Uncpld.	Proof Press.	Service Test Press.	Burst Press.
4"	4¾"	68 lbs.	600 PSIG	300 PSIG	900 PSIG
5"	5¾"	84 lbs.	600 PSIG	300 PSIG	900 PSIG

Hose comes with Storz coupling		25'	50'	100'
BB109	4" SUPPLYLINE™ Hose w/ Encap Treatment	\$374.95	\$469.95	\$725.95
BB110	5" SUPPLYLINE™ Hose w/ Encap Treatment	\$485.95	\$567.95	\$889.95



Darley Soft Suction Hose

Light, flexible and strong. All 100% Polyester jacket or nitrile rubber. Will not mildew or rot. Coils smaller and handles easier. Choose from 5" double jacket or rubber covered hose. Priced per 10 foot sections. *Other sizes available, call for pricing.*

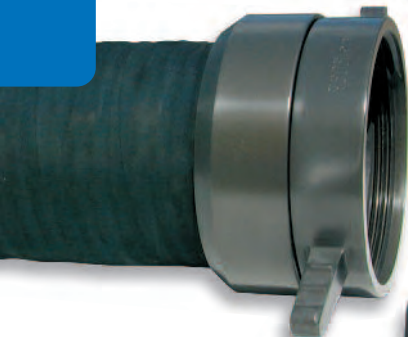

5"x10' Double Jacket Soft Suction Hose

HOSE WITH NH LONG HANDLE DOUBLE FEMALE				
BD001	4"	4.5"	5"	6"
4"	\$374.95			
4.5"	\$374.95	\$374.95		
5"	\$374.95	\$437.95	\$437.95	
6"	\$374.95	\$437.95	\$437.95	\$451.95
HOSE WITH NH LONG HANDLE FEMALE X STORZ				
BD002	4"	4.5"	5"	6"
4" Stz	\$374.95	\$374.95	\$391.95	\$395.95
5" Stz	\$374.95	\$374.95	\$391.95	\$406.95

5"x10' Rubber Covered Soft Suction Hose

HOSE WITH NH LONG HANDLE DOUBLE FEMALE					
BD003	4"	4.5"	5"	6"	
4"	\$359.95				
4.5"	\$359.95	\$359.95			
5"	\$359.95	\$430.95	\$430.95		
6"	\$432.95	\$430.95	\$430.95	\$448.95	
HOSE WITH NH LONG HANDLE FEMALE X STORZ					
Cat#	Description	4"	4.5"	5"	6"
BD004	4" Storz	\$359.95	\$335.95	\$359.95	\$381.95
BD005	5" Storz	\$359.95	\$342.95	\$378.95	\$391.95

Darley Hard Suction Hose

Smooth bore, hard suction hose for heavy-duty service. Meets NFPA 1961 and 1901. Comes with lightweight anodized couplings installed; long handle female x rocker lug male. *Price on request for other lengths.*

PRICE PER 10-FOOT SECTION COUPLED

Cat#	Size	Ship. Wt.	Price
T165	2 1/2"	26 lbs.	\$172.95
T166	3"	32 lbs.	\$252.95
T167	4"	46 lbs.	\$365.95
T168	4 1/2"	49 lbs.	\$429.95
T169	5"	59 lbs.	\$599.95
T170	6"	70 lbs.	\$642.95

Darley Clear PVC Suction Hose

Lightweight - Tight Bend Radius

This lightweight suction hose can be easily handled by one firefighter. Black ridged helix and smooth bore give this hose unrestricted flow. Clear flexible connector web allows for visual monitoring of incoming water. Sold standard in 10-foot lengths, coupled. NST threads standard. *Pricing available for longer lengths. Ship. wt. 45 lbs.*

- ▶ Operates in extreme temperatures
- ▶ Sold complete with end couplings
- ▶ For drafting only

AW135 SPECIFY SIZE:

4" x 10' Storz LH	\$488.95
5" x 10' Storz LH	\$576.95
6" x 10' Storz LH	\$738.95

AA841 SPECIFY SIZE:

1 1/2" x 10' RLF x RLM	\$68.95
2 1/2" x 10' RLF x RLM	\$140.95
3" x 10' RLF x RLM	\$205.95
4" x 10' LHF x RLM	\$255.95
4 1/2" x 10' LHF x RLM	\$350.95
5" x 10' LHF x RLM	\$366.95
6" x 10' LHF x RLM	\$464.95

Barrel Strainers

Cylindrical holes provide a greater area of entrance for the water and allow full capacity pumping. *Made of coated aluminum. NST threads standard. Ship. wt. 7 lbs.*

	2 1/2"	3"	4"	4 1/2"	5"	6"
AM107	\$73.95	\$75.95	\$90.95	\$107.95	\$117.95	\$128.95

Foot Valve Barrel Strainers

Opens and closes automatically when you start and stop drafting water. Allows full flow for capacity but when you stop pumping it closes instantly and keeps the pump primed by preventing water from flowing out. Complete with eyebolt for rope. *NST threads. Prices on request for other threads. Ship. wt. 28 lbs.*

	2 1/2"	3"	4"	4 1/2"	5"	6"
AM106	\$96.95	\$102.95	\$143.95	\$157.95	\$165.95	\$176.95

See page 95
for more strainers

A. Spec 187 Forestry Hose

Extremely lightweight all synthetic forestry hose which meets or exceeds all USDA Spec 187 TYPE 2 specifications. This all polyester polyurethane lined fire hose is super light weight, however designed for everyday fire department use. Available in either yellow (according to TYPE 2 spec) or white. Construction: Circular bias woven, single jacket, 100% all polyester. Tube: Extruded TPU—ozone and age resistant. 300 psi service test.



		50'	100'
BH088	1" White SPEC 187 Type 2 Hose	\$82.95	\$140.95
BH089	1½" White SPEC 187 Type 2 Hose	\$86.95	\$147.95
BH090	1" Yellow SPEC 187 Type 2 Hose	\$96.95	\$168.95
BH091	1½" Yellow SPEC 187 Type 2 Hose	\$101.95	\$177.95

B. RACK HOSE™

All-polyester single jacket interior protection hose for buildings and plants. Lightweight and compact, replaces unlined linen foot for foot. Approximately half the weight of standard rubber lined single jacket hose. Construction: Single jacket, all-virgin filament polyester, circular plain weave. Tube: Extruded T.P.U. elastomer - ozone and age resistant. 250 psi service test.

		50'	75'	100'
AS176	1½" Rack Hose™ with Brass NST Couplings	\$81.95	\$116.95	\$148.95
AS177	2½" Rack Hose™ with Alum. NST Couplings	\$164.95	\$227.95	\$277.95

C. Darley Booster Hose

For service pumpers we recommend our BG280 and BG281 Booster Hose. It assures all around dependable service and years of trouble-free use. Couplings come in aluminum pin hole. NST.

Cat#	Inside Diameter	PSI	50'	100'
BG280	¾"	800	\$237.95	\$422.95
BG281	1"	800	\$270.95	\$433.95
BK222	1½"	200	\$208.95	\$399.95

OTHER THREADS AVAILABLE. CALL FOR PRICING.

D. Lightweight Booster Hose

new

- ▶ Lightweight, kink resistant, non collapsible
- ▶ Equipped with full flow expansion ring and 1" lightweight aluminum rocker lug coupling
- ▶ Single jacket, 1005 high tensile strength virgin polyester yarns; smooth TPU lining ensures the minimum friction for maximum flow
- ▶ Highly resistant to ozone abrasion, offering outstanding low temperature performance, excellent mechanical properties, and as good resistance to oil and grease
- ▶ 300 psi service pressure

		50'	100'
BL385	1" Booster Hose w/ Repairable Couplings	\$174.95	\$317.95

E. Lightweight Booster Hose

- ▶ 400 psi service test pressure
- ▶ Half the weight of other brands of booster hose
- ▶ Fits standard reels without kinking (4½" radius)
- ▶ Non-collapsible rigid booster reel hose
- ▶ Single jacket with yellow Yermatex® treatment
- ▶ Polyurethane lined yielding low friction loss and easy handling

Couplings

- ▶ BD113 Coupling - Aluminum 1"x1¼" NH forestry pin hole set
- ▶ BD114 Coupling - Aluminum 1"x1½" NH R/L

Cat#	Description	50'	100'
BD113	¾" Yellow Hose with Coupling	\$184.95	\$324.95
BD114	1" Yellow Hose with Coupling	\$189.95	\$359.95

See pages 238 & 239 for reels





A. Hose Hoist

- ▶ For raising/lowering hose, ladders, etc. to and from the roof or through windows
- ▶ Akrolite™ construction

J735 Hose Hoist

\$383.95

B. Hose & Ladder Strap

Use the hose and ladder strap to advance hose, drag pre-connected hose from the truck or carry non-charged hose up a ladder. Tough nylon webbing with lightweight aluminum alloy drag handle on one end and adjustable hook end on other. Fits up to 2½" hose. **Ship. wt. 1 lb.**

M684 Hose & Ladder Strap

\$32.95

C. Darley Rope Hose Tool

Made of lightweight and extremely strong nylon. The steel hook is attached around the hand spliced area of the tool. Rope length 9 feet. **Ship. wt. 3 lbs.**

T401 Darley Rope Hose Tool

\$62.95

Hose Handler with Dewatering Bar

- ▶ Prevent some back injuries related to handling large diameter hose
- ▶ Lift and move rolled large diameter hose: 5" hose = 110 lbs. per 100' lengths; 6" hose = 130 lbs. per 100' lengths
- ▶ Move any large diameter hose that is charged: take the kinks out of LDH or move LDH out of the roadway to prevent it from being run over by vehicles
- ▶ Remove water and air from LDH to facilitate easier repacking
- ▶ Lift large beams used in trench rescue or any other large item that may fit in the "jaws" of the Hose Handler
- ▶ Built-in spanner wrench to connect and disconnect LDH butts: Storz or standard thread
- ▶ Gives firefighters a more ergonomically correct grip on heavy, awkward and difficult-to-handle objects
- ▶ Made of stainless steel and tenzaloïd, an aluminum alloy, to ensure long life and no rusting
- ▶ 1 year warranty

Remove water & air from hose



Lift heavy rolled LDH



Non-marking hose, heavy-duty wand and handle



BE298 Hose Handler with Dewatering Bar

\$264.95

BE299 Truck Mount

\$41.95

Fire Hose Tester with Pressure Washer and Tool Tray

The Fire Hose Tester is easy-to-use and comes standard with four outlets, stainless steel balls valves, 1½ NST male discharges and a 1½ NST male inlet, 3 gallons a minute at 600 psi. It is capable of testing up to 6" diameter hose, and 300' per discharge. The Fire Hose Tester comes standard with an easy-to-use wheeled cart that fits through standard 36" doorways. Also included is a built-in pressure washer with 25' of ¾" non-marking hose, a quick-release, heavy-duty wand and handle, a stainless steel nozzle with stream straightener and a quick-connect injector and metering valve for adding cleaning agents to the water supply.



BG535 Fire Hose Tester with Pressure Washer and Tool Tray

\$2,246.95



Bowring Personal Firefighter Tool

This tool is proudly made in the U.S.A., designed by firefighters for firefighters. The Bowring is a compact, light weight, multi-purpose tool that will be used at some point on every fire alarm. The Bowring is 8.3" tall, 5.9" wide, .375" thick and only weighs 22 ounces, so it easily fits into your bunker pants.

- ▶ Hose advancement - fits six different size hoses
- ▶ Emergency bailout descender - two different options
- ▶ RIT firefighter drag - hook and drag
- ▶ Gas shut off - two different options
- ▶ Auto extrication - windshield removal, glass ripper
- ▶ O2 wrench
- ▶ Door wedge - just hang it on the hinge
- ▶ Water shut off
- ▶ Mattress hook - hook the wire frame and pull it out
- ▶ Forcible entry tool
- ▶ Spanner wrench - fits pin lugs, rockerlugs, storz lugs
- ▶ Sheet rock ripper - cleanly rips through while looking for hot spots
- ▶ Nance drill - absolutely the fastest most efficient technique ever
- ▶ Denver drill - great for that second story rescue

BL240 Bowring Personal Firefighter Tool \$124.95

Super Spanner Wrench

Fits any standard 4" and 5" Storz or locking type Storz coupling on one end; the other end fits 1 1/2" to 3" rocker lug type fire hose couplings. Use the center slot as a gas shutoff. Wrench set includes 4 Super Spanner Wrenches and Mounting Plate. *Ship. wt. 1-7 lbs.*



AR228 Super Spanner Wrench \$22.95
 AR229 Super Spanner Wrench Set \$107.95
 AR230 Super Spanner Mounting Plate \$37.95

Darley Storz Spanner Wrench Set

Wrench set includes your choice of 2 or 4 Storz Spanner Wrenches mounted on a cast aluminum holder base plate. Holder is powered for corrosion resistance and surface-mountable. Wrenches are made of a lightweight aluminum casting with comfortable grip for 4"-5" Storz connections. *Ship. wt. 2 lbs. (4 wrench set).*



Cat#	Description	Includes	Price
BK374	Spanner Wrench 4" - 5"	1 Wrench	\$17.95
BK375	Double Storz Wrench Set	2 Wrenches & Holder	\$79.95
BK376	Quad Storz Spanner Wrench Set	4 Wrenches & Holder	\$96.95

Wrench Holder Set

Mounts on apparatus for easy accessibility. Convenient, snap action aluminum holder complete with two spanners for any style or size coupling from 1 1/4" to 4". Also includes an adjustable hydrant wrench for pentagon nuts up to 1 3/4" or square nuts to 1 1/4". Hydrant wrench fits 2 1/2" couplings. Ductile iron zinc plated head. Handle is steel zinc plated. *Ship. wt. 9 lbs.*

H711 Holder with Two Wrenches \$66.95
 L780 Holder w/Two Spanner Wrenches and Hydrant Wrench \$87.95

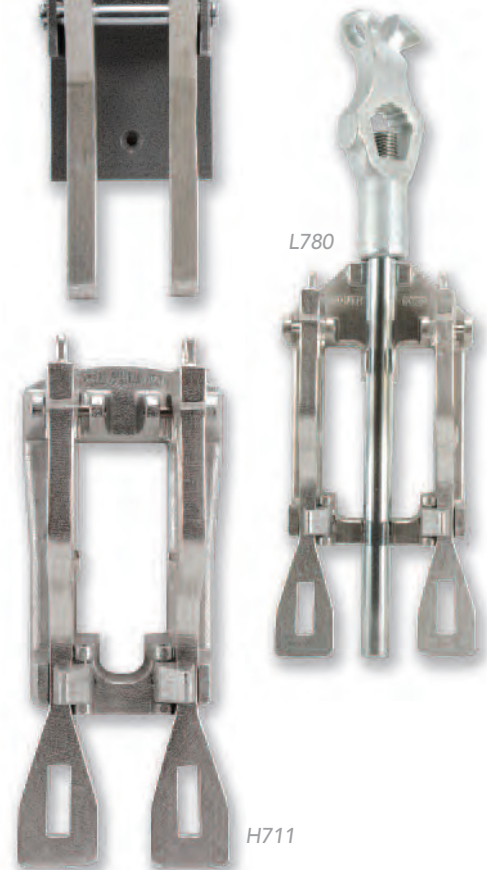

best seller



A



B



C

A. Darley Spanner Wrench

Lightweight aluminum spanner. Includes belt hook eye, hammer head and gas cock shut-off. Fits couplings from 3/4" to 4". *Ship. wt 1 lb.*

B397 Darley Spanner Wrench \$15.95

B. Double End Spanner Wrench

Double end hole type spanner, fits 3/4" and 1" booster hose couplings and 2 1/2" hole type fittings. *Ship. wt 1 lb.*

L800 Double End Spanner Wrench \$17.95

C. Folding Spanner Wrench/Belt Ring

Ultra-light non-sparking folding spanner with extra wide pry end, and gas shut-off. Fits couplings from 3/4" to 6" *Ship. wt 1 lb.*

AZ357 Folding Spanner Wrench/Belt Ring \$33.95

Hydrant Wrenches

T240 - Adjusts to pentagon nuts from 1 1/4" to 1 3/4" or square nuts to 1 1/4". Replaceable brass insert protects hydrant nut. Also fits 2 1/2" to 4 1/2" couplings.

E119 - Malleable iron, cadmium plated hydrant wrench adjusts to pentagon nuts from 1 1/4" to 1 3/4" or square nuts to 1 1/4". Fits couplings from 1 1/2" to 6".

C285 - Zinc plated ductile iron head and 7/8" steel handle. Opening accepts any pentagon nut up to 1 3/4" or 1 1/4" square nut. Fits 2 1/2" pin or rocker lug. *Ship. wt. 5 lbs.*



T240



E119



C285

T240	Hydrant Wrench	\$74.95
E119	Hydrant Wrench	\$27.95
C285	Hydrant Wrench	\$21.95

Premium Quality Spanner Wrench

It's made from aerospace alloy aluminum. This means it's ultra-light and super strong. Plus, because it is non-sparking, it's safe to use in hazardous situations. You'll never go wrong with the best. Compatible with most brackets. Fits up to 3 1/2" couplings, has gas cock shutoff. *Ship. wt. 1 lb.*

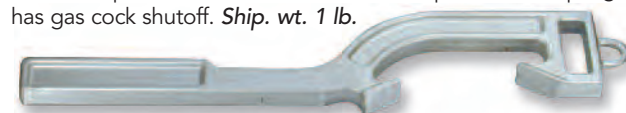

AJ281 Premium Quality Spanner Wrench \$20.95

Hydrant Wrench

new

- ▶ Fits hydrant stems both 1" (square and pentagon) and 1.5" (pentagon)
- ▶ Will work on worn stems
- ▶ No more adjusting, just put the open end over the hydrant stem and pull the handle, the harder you pull, the tighter the grip
- ▶ To release, just relax and lift it off the stem
- ▶ Will actually stay on the stem and not in the mud while you work
- ▶ The spanner end of the wrench is designed for use on 2 1/2" and larger fittings
- ▶ Weight: 5 lbs.
- ▶ Length: 18"



BL425 Hydrant Wrench \$68.95



Pentagon

Res-Q-Rench

- ▶ Spanner wrench works with 1 1/2" and 2 1/2" rocker lug couplings
- ▶ Only folding spanner that works w/4" & 5" storz locking couplings
- ▶ Made from glass-reinforced nylon
- ▶ Folds compactly into your pocket
- ▶ Integrated carbide tip
- ▶ Heavy-duty seat belt cutter
- ▶ Prying tool
- ▶ 12" open; 8" close
- ▶ *Ship. wt. 1 lb.*



Rocker Lug & Storz Wrench



Window Punch



Pry Tool



Seatbelt Cutter



Gas Shutoff

AM292 Res-Q-Rench \$22.95

Milwaukee Strap Hose Pack

BE024 - This highly durable hose pack constructed of heavy 22 oz. reinforced vinyl with double thickness side, bottom and ends keeps your hose in an attack-ready condition. This pack has a center handle for a one person carry and two end handles for a two person carry. Three Velcro® straps secure the contents and the pack holds up to 150' of 1½" or 1¾" hose. There are three brass grommet drain holes to allow for wet hose to be packed. One end opens so hose may be pulled out for an easy hose lay. **Dimensions:** 50"Lx8"Wx9"H. **Ship. wt. 4 lbs.**



Products not included with bags

BK187 - 36" long bag holds up to 150' of 1½" or 1¾" hose. Completely unfolds for access and storage. **Dimensions:** 36"Lx8"Wx12"H. **Ship. wt. 5 lbs.**

BE024	Milwaukee Strap Hose Pack (One End Opens)	\$151.95
BK187	Milwaukee Strap Hose Pack (Completely Unfolds)	\$185.95

Milwaukee Strap Hose and Accessory Bag

Constructed with firefighters in mind. Made of durable 22 oz. reinforced vinyl. Double thickness in side, bottom and ends. Easily carried by a 2" nylon webbing handle. For on scene visibility there is 2" reflective side trim. This bag can hold 75' of 1½" or 1¾" hose and accessories which makes it ideal for standpipe connections and hose operations as a tool bag. A brass grommet allows water drainage and a Velcro® strap secures the contents. Loops on each end for optional shoulder strap. **Dimensions:** 17"Lx10"Wx 12"H. **Ship. wt. 2 lbs.**



BE025	Milwaukee Strap Hose & Accessory Bag	\$91.95
-------	--------------------------------------	---------

Jackstrap Hose Strap

Be Safer and Secure

Safety is your number one responsibility. How secure is your equipment when the apparatus is in motion? A loose length of hose on a busy street or highway has the potential to cause serious damage. The Jackstrap will give you the peace of mind that the hose end is properly fastened. A must for every fire truck.

- ▶ Heavy-duty 2" polypropylene strap
- ▶ Adjustable hose loop helps secure hose to apparatus
- ▶ Adjustable hydrant loop helps with hose stretch
- ▶ Handy carry pocket holds hydrant tool
- ▶ Adjustable shoulder loop helps control nozzle



JACKSTRAP
BY FIRE RESEARCH CORP.

FRC
FIRE RESEARCH CORP.
choose the best.



Jackstrap shown with carabiner securing hose on back of truck. Carabiner not included.

BC136	Jackstrap Hose Strap	\$64.95
-------	----------------------	---------

Wildland Hose Pack

Designed with the rugged demands of wildland firefighting in mind. This ergonomically designed hose pack allows the firefighter to transport up to 300 ft. of forestry hose and appliances comfortably while allowing the firefighter to have their hands free to carry tools or navigate difficult terrain. Made of ballistic nylon.



new

Tools and hose not included



BL438	Wildland Hose Pack 2-100' Rolls	\$124.95
BL439	Wildland Hose Pack 3-100' Rolls	\$134.95

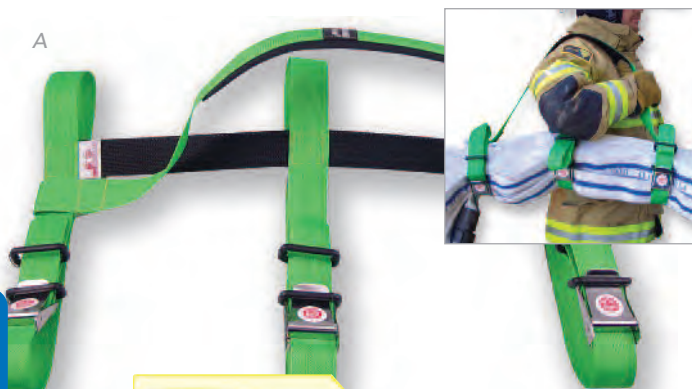

Large carrying capacity

A. Gripper Hose System

An Effective Way Of Transporting Hose

The Gripper Hose System consists of three heavy duty nylon straps, with a padded shoulder sling, all sewn together to create a hose harness. The gripper has a padded high visibility shoulder sling, with three 2" wide, 42" long, 3000-pound strength webbing to secure the hose. Utilizes cam buckles and torque rings and is easily opened with a gloved hand. The 42" long straps have the capacity to hold more hose than the average firefighter can carry. *Ship. wt. 4 lbs.*

AF151

Gripper Hose System

\$127.95



B. Hose Vice

Carry More Hose Easier

The Hose Vice is the latest in the evolution of our hose carrying systems. This product incorporates many ideas given to us by our customers. Features include: an updated shoulder strap, which is adjustable and removable. The shoulder strap is long enough that a firefighter can carry the bundle across the body for better balance. Two fire-fighters can also carry The Hose Vice. Handles have been incorporated into the ends of the four straps, along with 2 molded rubber grips on top. Two firefighters simply utilize these handles. The overall length is 35" and each strap has an adjustable circumference range of 20" - 38". Capacity is 150 OR 200' of 1 1/4" hose as shown. 3M reflective has been added to increase visibility. Made in the USA. *Ship. wt. 3 lbs.*

AK187

Hose Vice

\$206.95



C. Double Donut Strap

The Double Donut Strap holds two 50-foot sections of 1 3/4" hose. Consists of two heavy-duty nylon webbing straps with a Velcro® closure attached to a 3-inch center ring and shoulder strap. *Ship. wt. 3 lbs.*

- ▶ Easy storage - hose stacks and compactly fits into compartments
- ▶ Shoulder strap aids firefighters in carrying and deploying hose
- ▶ Pre-coiled hose gives you the option to add on to an existing hose lay, or reduce a larger line

AJ283

Double Donut Strap

\$80.95



D. High-Rise Hose Strap

- ▶ Carry up to 100' of hose
- ▶ Color-coded reflective trim, silver marks the nozzle or hose end
- ▶ U-Shaped design, keeps hose center of gravity close to your own
- ▶ Four heavy-duty nylon straps cinch the hose tight
- ▶ Allows fast movement in narrow spaces
- ▶ Carry over SCBA or shoulder for hands-free movement

BB065

High-Rise Hose Strap

\$66.95

Large Diameter Hose Strap

The Large Diameter Hose Strap (LDHS) assists in getting large diameter hose off the hose bed for attachment to a water source safely and allows the engine to proceed for fire operations. Constructed of 3" nylon webbing, with a tensile strength of 22,550 lbs. Strong stitching with heavy brass rivets give you long life. This device allows the firefighter to pull the hose off the rig and place it over a hydrant with additional hose secured with the hook & loop strap, with plenty of spare hose for attachment. Also works great for tanker operations to secure the hose with a heavy hook & loop closure with a zinc-plated adjuster, allowing for additional hose for hydrant operations. Tab allows for operations with heavy firefighting gloves. When used in conjunction with the Oversized Hydrant Tool Kit or the Tool Bag, the firefighter has everything needed to complete efficient and safe hydrant operations. **Color: yellow, length: 60", weight: 32 oz. Ship. wt. 5 lbs.**

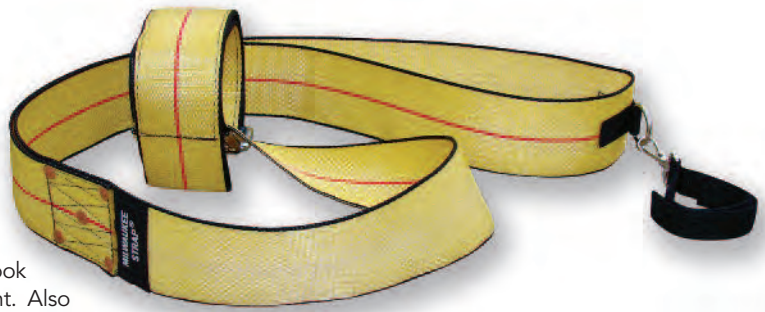

BG151 Large Diameter Hose Strap \$61.95

Single Hose Wrapper

The Hose Wrapper is designed to accommodate your need for that special hose pack. A heavy-duty nylon strap with four leverage points, this strap adjusts from an 18" circumference out to 32". It has a hook & loop closure with 12" of reflective material. The amount of hose the wrapper will secure depends upon the size, type, style and length of layers. Sold as a single strap. **Color: green, weight: 8 oz. Ship. wt. 1 lb.**



BG152 Single Hose Wrapper \$23.95

Hydrant Tool Bag

BK185

Holds your hydrant tool and related items. Attaches to hydrant end of hose and need not be removed when charging the line. Straps are made of 2" webbing and velcro and will attach to 2 1/2" through LDH hose. Constructed of 14oz vinyl to take the abuse. *Hose not included. Ship. wt. 1 lb.*



Cat#	Description	Dimensions	Price
AR327	Hydrant Tool Bag	22" Lx16" Circumference	\$30.95
BK184	Hydrant Tool Bag	22" Lx20" Circumference	\$37.95
BK185	Hydrant Tool Bag	27" x9" x6"	\$66.95

AR327

Darley Hydrant Strap

Never Lose Your Tools

The Hydrant Strap increases the speed and safety of your hydrant hook-ups. The complete Hydrant Strap includes a six-foot loop of heavy-duty nylon webbing fastened to the end of your supply or suction line by a three-foot hose strap. The hose strap is made from seat belt material with a seat belt type buckle. Attached to the hose strap is a tool pouch containing the tools needed for hydrant hook-up. The firefighter stands on the ground and pulls the Hydrant Strap fastened to the end of the supply line in the hose bed and loops the strap over the hydrant. The engine can then lay the hose line. After the hose lay is finished, it is simply unbuckled. **Ship. wt. 1 lb. without tools.**



Carrying strap

Cat#	Description	Price
AC961	Hydrant Strap without Tools	\$49.95
AC961	Hydrant Strap with Tools	\$97.95
AC962	Hydrant Strap with Tools	\$97.95

Hose Washer

Cleans your dirty and caked hoses. Simply connect the hose washer to a fire hydrant or pumper (40 to 60 psi recommended) and watch the action of the water automatically feed the hose through the washer. Washer produces a conical multi-jet water stream that cleans effectively and economically. AJ515 - automatic feed washer, AJ453 - manual feed washer.
Ship. wt. 15 lbs.

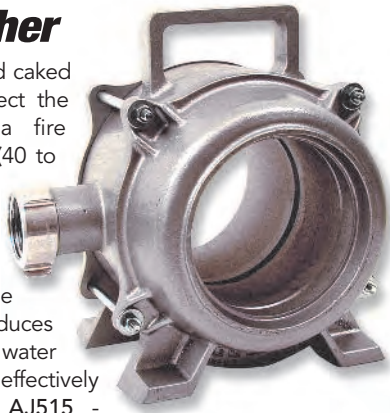

AJ515	Hose Washer for Hose Up to 3" Diameter	\$629.95
AJ453	Hose Washer for Hose Up to 5" Diameter	\$918.95

Brute X-Pander

Weighing 45 pounds, 32% less than the Brute I, the X-Pander is perfect for in-house or mounted in a service van for field repairs. Requires 50% fewer strokes to expand and 75% fewer strokes to release than the Brute I. The X-Pander can couple from 1" through 3" couplings.
Ship. wt. 50 lbs.

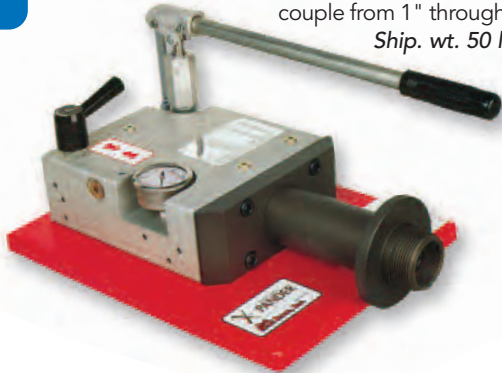

AZ356	Brute X-Pander	\$2,682.95
-------	----------------	------------

Stainless Steel Hose Washer

A powerful automatic feed washer for up to 5" hose. Dual conical water jet float the hose while removing soluble contaminants. The hose washer can be simply mounted with a length of hose to a pumper, or hydrant. Maintain water pressure at 60 to 80 psi to obtain best results. Sturdy construction in stainless steel ensures very long reliable service even under the most adverse conditions. **Ship. wt. 10 lbs.**



AW136	Hose Washer for Hose Up to 3 1/2" Diameter	\$530.95
AW137	Hose Washer for Hose Up to 5" Diameter	\$785.95

Hose Cutter

- ▶ Heavy duty aluminum construction
- ▶ Powder coated for a tough, hard finish
- ▶ Easy and safe to use
- ▶ Ratchet handle raises & lowers steel blade
- ▶ Handgrips for easy transporting
- ▶ Makes clean, straight cuts
- ▶ Cuts hose up to 6"

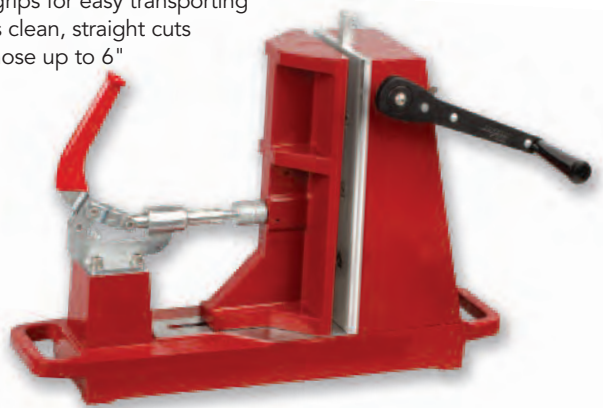

BH170	Hose Cutter	\$1,345.95
-------	-------------	------------

Expansion Units

Complete expansion unit assembly for attaching 1" through 6" couplings. Note: Red Head expansion units are compatible with some other manufacturers' expanders. Please specify the manufacturer and model.
Ship. wt. 1 lb.



AF202	1" w/Drawbar (Pull Type)	\$376.95
AF204	1 1/2" w/Drawbar	\$354.95
AF209	1 3/4" w/Drawbar	\$380.95
AF214	2 1/2" w/Drawbar	\$379.95
AF217	3" x 2 1/2" w/Drawbar	\$403.95
AF218	3" w/o Drawbar	\$452.95

Expansion Rings

The metal used is a scientifically correct mixture which is best adapted for the purpose of giving the maximum coefficient of expansion without fracture. **Ship. wt. 1 lb.**



Cat#	O.D.	Length	Price
41602	1"	1"	\$2.95
41603	1 1/2"	1"	\$2.95
41604	2 1/2"	1 1/2"	\$3.95
41605	3"	2"	\$6.95
41607	4"	2"	\$14.95
41608	4 1/2"	2"	\$18.95
41609	5"	2"	\$24.95
41610	6"	2"	\$28.95

Heavy-Duty Expansion Ring Couplings

Tough extruded lightweight, high strength aluminum alloy. For heavy municipal and industrial use. **Ship. wt. 3 lbs.**



Cat#	Hose	Thread	Min. Max.		Price
			Bowl	Bowl	
AJ284	1 1/2"	1 1/2"	1 11/16"	2"	\$36.95
AJ285	2 1/2"	2 1/2"	2 11/16"	3 1/16"	\$39.95
AJ286	3"	2 1/2"	3 3/16"	3 13/16"	\$74.95

Quic-Bridge® Hose Guards

One of the most economically priced hose bridges available and requires little storage space. Made of extruded aluminum to accommodate 16" or 24" widths (5" hose). Each bridge consists of one center hose guard and two ramps; neoprene feet hold the bridge firmly in place and vehicle tires do not come into contact with the hose line. Remove one ramp and bridge can be used to jump a curb. *Ship. wt. 192 lbs.*

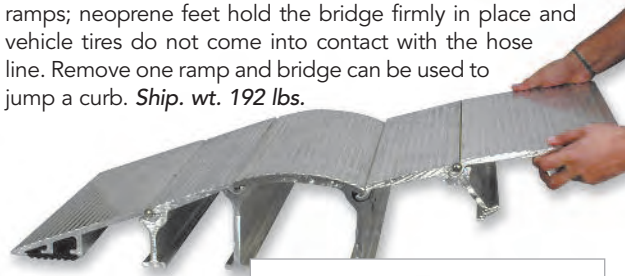

Quick and Easy Ramp Assembly



SOLD IN SETS OF TWO BRIDGES

AM098	Hose Ramp, 16"	\$846.95/set
AM099	Hose Ramp, 24"	\$1,184.95/set

Rubber Hose Bridges

Bridges give you economical hose line protection for up to 5" LDH hose lines. They are 12" wide and can be interlocked to any width. Equipped with reflective safety strips for added visibility. Made of Fiber Reinforced Rubber. *Ship. wt. 38 lbs.*



SOLD IN SETS OF TWO BRIDGES

AW133	Up to 4" Hose	\$501.95
AW134	Up to 5" Hose	\$575.95

Hose Ramps

No rust aluminum supports up to 50,000 loads. Ramp are traction ribbed and stiffened for extra strength. Other features include non-skid bottom, one piece construction and won't bend or sag. Easily stack sets for convenient transport. *Ship. wt. 90 lbs.*



SOLD IN SETS OF SIX 2-FOOT SECTIONS

J545	Aluminum Hose Ramp for up to 3" Hose	\$729.95
------	--------------------------------------	----------

Hose Shutoff Clamp

A lightweight shutoff clamp for double jacket hose up to 3". Press down on handle and the rubber jaws lock in place. Comes complete with mounting bracket. *Ship. wt. 18 lbs.*

Includes Mounting Bracket



H875	Hose Shutoff Clamp	\$726.95
------	--------------------	----------

Hose Rollers

Remove Air & Water Easily From Your Hose

Hose Rollers are designed to remove air and water from your 1½" to 5" single or double jacket hose. Heavy duty nylon rollers are durable for years of dependable service. Simply feed the hose through and walk the length of the hose. Two-person model AF155 is hinged at one end to clamp around the hose. One-person model AF154 slips over the end of the hose and the handles compress the rollers against the hose. *Ship. wt. 10 lbs.*



AF154

Hose not included



AF155

AF154	One-Person Hose Roller	\$197.95
AF155	Two-Person Hose Roller	\$169.95

Hose Jacket Sleeve Stops A Leaky Hose

For 2½" hose

Use for emergency repair of burst/leaky hose or even as an emergency adapter for the connection of two hose lines with different threads in situations where pressures do not exceed 150 psi. Made of reinforced cast Akrolite® body with molded neoprene inner liner. Fits all 2½" hose (from 2¾" to 3⅝" O.D.) Measures 13" long. Red only. *Ship. wt. 20 lbs.*

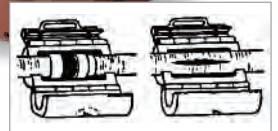

B683	Hose Jacket Sleeve	\$855.95
------	--------------------	----------

Hebert Hose Clamp

Saves time and labor when removing burst hose, relieving pressure on a line or changing fittings without damaging hose. Simple to operate and releases quickly. *Dimensions: 12.5"Hx15"Wx5.5"D, 6" Opening. Ship. wt. 24 lbs.*

G301	Hebert Hose Clamp for up to 3" Hose	\$246.95
G30102	Hebert Hose Clamp for up to 6" Hose	\$416.95
G30101	Running Board Bracket	\$49.95



iso points

Leather Hose Jacket

Made of top-grain, heavy-duty leather and fits 2½" hose. So handy, simple and inexpensive that every apparatus should have a couple. Great for ISO rating points. *Ship. wt. 1 lb.*

B82301	Leather Hose Jacket	\$46.95
--------	---------------------	---------



iso points



3-Tier Rack

Freestanding & Mobile Hose Cart

Save time and eliminate back strain from carrying hose with the Hose Cart. Mobile unit has heavy-duty brake casters that allow for ease of rolling and hold the cart in place when loading or unloaded. Heavy-duty steel rails with a durable red powder coat finish easily support 100' coils. Ships knocked down for freight savings. Easy to assemble. Available in 2 or 3 tier units mobile or freestanding. Freestanding model may be bolted to floor for additional stability. An optional cover plate (AR117) provides a flat surface for holding bottle carriers or other items. *Ship. wt. 315-560 lbs.*



2-Tier Cart

AR117



AS213

Cat#	# of Tiers	Hose Storage	Dimensions	Ship. wt.	Mobile	Freestanding
BH032	2-Tier	Up To 1,300' of 2 1/2" Hose	72" L x 79" H x 34" W	250 lbs.	\$1,575.95	\$1,475.95
BH033	2-Tier	Up To 2,000' of 2 1/2" Hose	104" L x 79" H x 34" W	425 lbs.	\$1,993.95	\$1,893.95
AS214	3-Tier	Up To 2,000' of 2 1/2" Hose	72" L x 87" H x 34" W	315 lbs.	\$1,837.95	\$1,737.95
AS215	3-Tier	Up To 3,000' of 2 1/2" Hose	104" L x 87" H x 34" W	560 lbs.	\$2,413.95	\$2,313.95

OPTIONAL ACCESSORIES

AR117	20" x 31" Cover Plate	\$74.95
AS213	Hose Winder	\$499.95



Dual Purpose Dryer

Dries Hose or Clothing in Just a Few Hours

The Dual Purpose Dryer allows hose and turnout gear to be dried quickly and safely, minimizing shrinkage while ensuring a rapid return to service. When emergencies arise, you want your equipment ready to go, so it's essential to get hose and turnout gear back into service as quickly as possible. Our high capacity drying cabinet handles up to 500' of 5" hose. Ten removable galvanized steel shelves permit other items to be dried in the cabinet, and a 12-hr. timer shuts down the dryer automatically. You'll use less energy and never overheat and damage the hose. *Call for detailed specifications. Ship. wt. 1,100 lbs.*



Hose not included

SPECIFY VOLTAGE REQUIREMENTS

AJ457	Dual Purpose Dryer	\$13,499.95
-------	--------------------	-------------



H686

One-person operation

The Automatic Fire Hose Washer

"It All Comes Out in the Wash"

You'll be amazed at how thoroughly, easily and quickly this remarkable cleaner does its job. Ashes, dirt, silt, mud and sludge are all scrubbed and flushed away, restoring hose to its original color. Quiet, chain-drive operation eliminates need for service and repairs. Built to last a lifetime and equipped with long wearing, genuine nylon brushes. Check out all the great features of the Automatic Fire Hose Washer. *Ship. wt. 680 lbs.*

- ▶ **Hose is Self-Propelled** - Convenient foot pedal applies pressure on pivoted wringer roll, pulling hose through the washer under its own power.
- ▶ **Uniform Washing** - Wringers propel hose through washer, ensuring an even, uniform cleaning at a rate of about 30 ft. per minute.
- ▶ **Cleaning Action** - Hose is soaked in immersion tank filled with lukewarm or cold water. Add detergent as you see fit.
- ▶ **Drains Hose Linings** - Squeegee action of neoprene wringer rolls eliminates necessity of hanging hose in tower to dry.
- ▶ **Washes Edges** - Hose imbeds itself in the soft-staggered nylon brushes, scrubbing edges as well as flat surfaces.



Shown With Optional Table

H887	Automatic Fire Hose Washer	\$13,499.95
H686	Hose Loading Table	\$1,624.95

A. Dry and Store Hose Rack

With the Dry and Store Hose Rack, you can dry hose and store it on the same unit. Unit consists of the top mounted drying rack where hose and other equipment dries naturally and quickly, and one lower level storage rack. Dry up to 900' of 1½" to 1¾" hose or up to 600' of 2½" to 3½" hose and simultaneously store up to 650' of 2½" hose. Heavy-duty steel construction with durable red powder coat finish. Ideal for use in smaller stations. *Ship. wt. 250 lbs.*

Hose not included

BB039 Dry and Store Hose Rack \$1,993.95

B. Mobile Hose Dryer

With the Mobile Dryer, equipment dries naturally and quickly with fresh air, prolonging the life of your equipment. Used to dry immersion entry suits, wet or dry dive gear, and decontaminated hazmat entry suits. The Mobile Hose Dryer holds up to 1200' of 1½" or 1¾" or up to 800' of 2½" - 3" hose. *Ship. wt. 220 lbs.*

- ▶ **SAFE** - no more climbing to hang or retrieve hose
- ▶ Costs thousands less than conventionally built towers
- ▶ Stores and dries in small area
- ▶ Durable red powder coat finish
- ▶ Dimensions: 80" Lx33" Wx 88" H



AS703 Mobile Hose Dryer \$1,615.95

C. Hose Rack Brackets

Build Your Own Hose Rack

Protect your hose with ample ventilation and allow quick and easy access for inspection. Build your own rack with pipe and lumber using these handy brackets designed for easy adjustable installation. Brackets are lightweight, high-strength aluminum. *Ship. wt. 4 lbs.*

- ▶ Bracket easily adjusts up or down pipe for desired height

AR346 Small Bracket for 1½" Pipe \$43.95

AR347 Large Bracket for 2" Pipe \$45.95

D. The Hose Coiler

Roll Hose Quicker and Easier Than Ever

Designed by a firefighter to make it quicker and easier to coil 1" to 3" double jacket hose in lengths up to 50 feet (single jacket forestry hose in lengths of 100 feet). Simply attach the mounting bracket to the rear of your apparatus, pickup truck or any emergency vehicle waist-high, insert the coiler crank and roll away. The coiler itself is made of two parts which nest together for compact storage. Once the hose is coiled simply remove the tight coil from the inside section and you're done; no more bending over to pick up heavy coils. Use this system anywhere you choose to install the mounting bracket (included). Also available are trailer hitch mounts. *Call for pricing. Fits in hitch receiver and Wildland Mounts pound in the ground.*

Cat#	Description	Ship. wt.	Price
AM100	Hose Coiler, for 1" to 1½" Hose	8 lbs.	\$206.95
AM101	Hose Coiler, for 1½" to 3" Hose	8 lbs.	\$206.95
BE026	Hose Coiler, for 5" to 7" Hose	12 lbs.	\$243.95

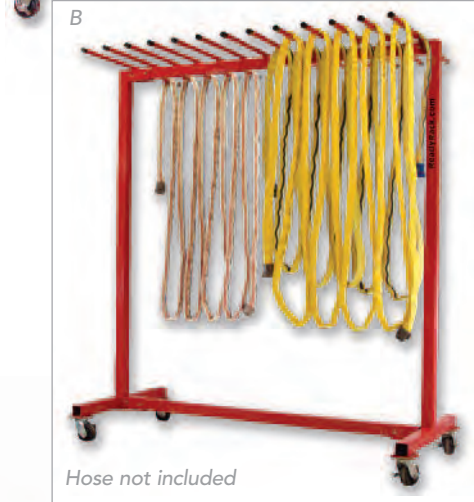

Darley Flow Test Kit

Accurately Measure Flow in Hydrant Systems & Fire Pumps

Darley offers its own Flow Test Kit with several outstanding design features that make it easier to use than kits offered by others. Precise Flow Measurement—Accurately measures flows from 160 to 1500 gpm within 30 psi to 200 psi pitot gauge range. Reliable Conversion Table—Flow results based on standard flow charts and proven with extensive water volume tests. Type of Gauge—Liquid-filled dial gauge: 3 1/2" diameter, Grade A-1% accuracy, 0 psi to 200 psi range; vibration-free readings. Tester Body—Nozzles and swivel inlet are made of heat-treated aluminum alloy. Parts are hard-coated anodized to provide an extremely durable, protective surface. Automatic Coupling Design for instant and positive nozzle bore change. Renewable Brass Pitot Blade allows easy, inexpensive pitot blade replacement. Order the complete Darley Test Flow Kit or the Darley Economy Kit. *Ship. wt. 18 lbs.*

best seller



Complete Flow Test Kit

- ▶ Set of six nozzle tips: 1", 1 1/4", 1 1/2", 1 3/4" 2" & 2 1/4"
- ▶ One - 2 1/2" NST Female swivel inlet
- ▶ Complete instructions and flow chart
- ▶ Molded plastic foam padded case

Y899	Darley Flow Test Kit with Carrying Case	\$1,033.95
Y899L	Darley Flow Test Kit with Metric Conversion Kit	\$913.95
AF328	Darley Economy Flow Test Kit, Specify Four Nozzle Tips Sizes	\$848.95
PA663	Replacement Pitot Blade	\$62.95
D232-7	Optional 2 1/2" Nozzle	\$79.95

Economy Flow Test Kit

- ▶ Choice of four nozzle tip sizes
- ▶ One - 2 1/2" NST Female swivel inlet
- ▶ Plastic Tool Box with tool tray

Portable Test Kit

The Darley Portable Test Gauge Kits are to be used in conjunction with annual apparatus pump testing or for checking the accuracy of pump panel gauges. The gauges are 3 1/2" diameter, easy-to-read, and liquid filled. A 0-30" vacuum and 0-300 psi pressure gauge are standard. The Test Gauges are connected directly to the apparatus through the Underwriter's test fittings. All pressure gauges are in large, easy-to-read 5 psi increments. The vacuum gauge is in .5 Hg increments. All gauges have a +/- 1% full scale accuracy certified by the gauge manufacturer. The Flexible high-pressure hose have 1/4" male swivels for fast and easy connection to apparatus test fittings. Standard hose length is 36". The mounting plate is made from 1/4" black PVC foam board. An air/water bleed-off valve is conveniently located so that with a touch of a finger all air is bled from the pressure gauge hose and fittings to ensure accurate pressure gauge readings. *Ship wt. 9 lbs.*

- ▶ Gauge - Dial
- ▶ Dial - 3 1/2"
- ▶ Accuracy - 1% of full scale ANSI B40.1 Grade 1A
- ▶ Case Fill Fluid - Interlube
- ▶ Hose - Two 36" with pressure bleeder valve on hose for pressure gauge
- ▶ Hose Connections - 1/4" NPT swivel male x 1/4" NPT rigid female
- ▶ Mounting Plate - Plastic, double broke for hanging test kit from rails or valve handles
- ▶ Warranty - 3-year manufacturer's warranty on gauges



AW144 Portable Test Kit \$481.95

Dual Function Digital Tachometer

For Contact and Non-Contact Measuring

This handheld Digital Tachometer is a dual function instrument providing contact and non-contact measurement of rotational and linear motions. It features eight character display with floating decimal point, a four function-last memory, and sixteen units of measure always displayed and maximum/minimum & average. With an accuracy of + or - .025% of indicated reading + or - LSD, this Tachometer is ideal for production, engineering, inspection, quality control and maintenance. This model comes complete with a convex tip, concave tip, 10 cm linear measuring wheel and carrying case. The power supply is a NEDA type 1604, 9-volt transistor battery, and the most significant display character flashes to indicate need for replacement. The compact size and the light weight of this model makes for easy, one-hand operation while the rugged, high-impact housing provides for years of dependable service. *Ship. wt. 1 lb.*



Accessories

- ▶ Measuring Wheel
- ▶ Concave Tip
- ▶ Convex Tip

AC800 Dual Function Digital Tachometer \$304.95

Piezometer for Testing Pumps & Hydrants

With a Piezometer you can take pressure readings and determine the amount of water flowing from any size opening up to 8" in diameter. You need a Piezometer for taking flowing pressures to get an accurate check on the fire fighting efficiency of your pumpers and hydrants. You may have gauges that give you the static pressure (the pressure when no water is flowing) but without checking the flowing or velocity pressure you can't know positively how much water can be delivered through the outlet. All brass tube with bleeder valve. *Made to Underwriters specifications; Discharge table included. Ship. wt. 2 lbs.*

R558	Piezometer with Gauge and Case	\$175.95
F626	Piezometer with Gauge	\$144.95
R560	Piezometer Only	\$120.95
U359	Piezometer with Liquid-Filled Gauge and Vibration-Free Performance	\$204.95



Hydrant Test Outfit

Flowing and Static Testing

This is the kit you need for finding the flowing and/or static pressure of water coming from any 2 1/2" opening. We include, as shown here, both the gauge itself and all the hardware you need for clamping it to a 2 1/2" threaded opening. The standard gauge reads to 60 psi but if specified, we can supply a 160 psi gauge at the same price. The other gauge, complete with long handle brass NST cap, will show the static pressure in hydrants and mains. *Standard gauge is 100 psi (200 psi same price). Ship. wt. 7 lbs.*

J137	Hydrant Test Gauge Outfit	\$515.95
------	---------------------------	----------



Hydrant Gauges Tests Flowing Pressure

Our velocity gauge shows what pressure and how much water will flow from a hydrant. It is universally adapted to any 2 1/2" thread or any 2 1/2" opening. We made the gauge to suit your pressure. If your greatest main flowing pressure is 60 psi or less, this is ideal. *Price includes case and printed discharge table. Ship. wt. 3 lbs.*

R599	Hydrant Gauge	\$249.95
------	---------------	----------

Fire Hydrant Pressure Gauge Tests Static Pressure

Shows pressure in the main or hydrant. Complete with 2 1/2" gauge, bleed-off valve and chrome-plated brass cap. Easily installed by removing the hydrant cap and screwing on the pressure gauge assembly. Rocker lugs afford an easy grip with a spanner wrench. Gauge instantly shows the static pressure in the hydrant when it is turned on. Dial pressure is 100 psi unless 200 psi is specified. Made only for 2 1/2" NST. *Ship. wt. 5 lbs.*

R530	Fire Hydrant Pressure Gauge	\$105.95
------	-----------------------------	----------



Insight Portable Flow and Pressure Meter

Use the new Insight Portable Flow Tester to determine the flow and pressure capabilities of your suppression systems or flow test your automatic nozzles, pumpers or hydrants. Test your department's effectiveness, calibrate your automatic nozzles, pumpers or hydrants. All Insight Portable Flow Tester series meters incorporate a new processor that allows for new features including multiple flow point calibration and multiple tube size. The Insight Portable Flow Tester series is an easy-to-use meter which displays gpm directly without doing any calculations. Cap the tube for static pressure.

- ▶ Based on the DFA400 series flow meter
- ▶ Displays both flow rate and total flow
- ▶ Flow readout in 4-digit LED display & accurate to within 1% or reading
- ▶ Paddle wheel flow sensor
- ▶ Hard shell case with handle for display (10 3/4" H x 9 3/4" W x 7" H)
- ▶ Cut-out in case provides space for coiled cord storage

AS538	Portable Flow and Pressure Meter	\$2,283.95
AS539	Portable Flow and Pitot Pressure	\$2,462.95
AW310	4" Tube (No Sensors) NPTM/ Flow Port	\$436.95
AW311	Paddle Wheel Flow Sensor	\$139.95



Flow Tube



Portable Flow & Pressure Meter



The Hose Monster®

The Safest, Most Accurate Way to Test Fire Pumps Flush & Evaluate Water Supplies Through Hydrants

A built-in reversible pitot and precisely machined orifice permit simultaneous testing and flushing, or flushing and sediment discharge alone, along with UL Certified Accuracy of flow rate measurements. The patented design minimizes damage to landscaping and passing autos by controlling and dramatically reducing the force of flowing water. Zero thrust - it just lies there no matter how much water is flowing. And the pitot is reversible to prevent damage while flushing. The Hose Monster® should be used with hose; attachment directly to the hydrant is not recommended. Ask us about accessories. NST threads standard; other threads available. UL Certified. *Ship. wt. 2 1/2"-27 lbs., 4" & 4 1/2"-45 lbs.*

- ▶ 2 1/2" Hose Monster® - use for pump testing and hydrant flow testing; includes built-in pitot system
- ▶ 4 1/2" Hose Monster® - use for hydrant flow testing; includes internal orifice plate for flow rate readings

AK246	2 1/2" Hose Monster®	\$968.95
AK248	4 1/2" Hose Monster®	\$991.95



HydrantPro Diffuser

- ▶ New design - Lightweight with quality aluminum swivel adapter
- ▶ Estimates gallons flushed - Available in 100psi/1680gpm or 160psi/2120gpm high quality liquid filled gauge
- ▶ Diffuses flow to reduce damage while flushing hydrant
- ▶ Swivels to Aim Flow - Point the flow where you want to flush
- ▶ Ruggedly constructed to provide years of dependable service
- ▶ Replaceable pressure tube assembly and ball-bearing swivel hydrant adapter



HydrantPro

BK126	2 1/2" NST HydrantPro Diffuser (100psi/1680gpm)	\$479.95
BK127	2 1/2" NST HydrantPro Diffuser (160psi/2120gpm)	\$479.95
AM163	Inner Tube for 2 1/2" Diffuser	\$32.95
BK128	Carrying Case for 2 1/2" Diffuser (BK126 & BK127)	\$78.95
AF331	4 1/2" NST Swivel Piezo Diffuser	\$612.95

Hydrant Diffuser

Protect Property and Vehicles From Possible Water Force Damage

best seller

Created to overcome the constant problem of traffic disruption and water force damage to property and vegetation in the testing area. Discharge stream velocity is slowed and redirected while flowing through a series of steel grids. The pattern diverter, on outer edge of discharge cone, directs diffused stream to side or down, depending on adjustable settings. Slots in the case inlet adapter permit a firm hold of pitot gauge against the full water force before diffusion, assuring a more accurate pitot reading. The pipe-like projection at the right serves as a handle for easy threading during hydrant attachment. Even high pressure hydrants delivering 1125 gpm are now limited to a discharge distance of 5'. Fully in accord with "Special Interest Bulletins" of the American Insurance Association. 2 1/2" NST threads. 17"Hx17"Wx29"L. *Ship. wt. 22 lbs.*



S672	Hydrant Diffuser	\$549.95
------	------------------	----------

All-Weather Line Gauge

The Line Gauge is used for testing static pressure or flowing pressure in nozzles or hoses. Comes equipped with a 300 lb. glycerine-filled gauge. Body is made of hard-coated aluminum alloy. *Ship. wt. 4 lbs.*

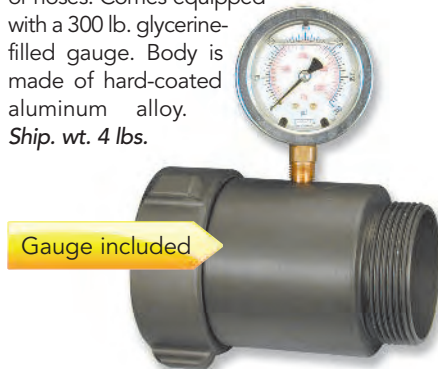

AK059	Line Gauge, 1 1/2"	\$109.95
AK060	Line Gauge, 2 1/2"	\$118.95

Other Apparatus Flow Test Gauges & Equipment



Gauges With 1/2" Bottom Connection

Z277	Vacuum Gauge, 4 1/2"D, 30" in Increments of 1/5 of 1"	\$124.95
Z278	Pressure Gauge, 4 1/2"D, 0-400 psi in Increments of 5, 1/4" Bottom Connection	\$136.95
Z279	Hand-Held Tachometer for Pump Panel RPM Checks	\$105.95

RICE Portable Hose Tester Series



The RICE Hydro line of portable fire hose testers is the culmination of a design effort incorporating 33 years of experience. Featuring safety and speed to quickly fill and bleed hoses during testing. RICE offers LARGE VOLUME at LOW PRESSURE and LOW VOLUME at HIGH PRESSURE to safely eliminate wild lines. Independently controlled stainless steel ball valves eliminate the expense of purchasing extra caps when all outlets are not being used. All RICE hose testers meet or exceed NFPA standards and are available in gas, electric, or diesel power sources, offering various gpm and psi ratings. All RICE fire hose testers come with a 5-year full product warranty.

Four-Outlet Tester

Offers 3 gpm at 500 psi, powered by a 1 HP 50/60 hertz TEFC motor. Capable of testing to 6" diameter coupled hose, up to 300 feet. Features 4 independently controlled stainless steel ball valves, with 1 1/2" NST male discharges and 2 1/2" NST female inlet swivel. *Ship. wt. 175 lbs.*

AA930 Four-Outlet Hose Tester \$2,071.95

Two-Outlet Tester

Offering the same features as the model AA930, in a portable Two-Outlet unit. With a footprint of 28"x23"x19", this lightweight, compact design is perfect for tight and confined spaces, such as on board ships and vessels. *Ship. wt. 127 lbs.*

AF416 Two-Outlet Hose Tester \$1,975.95

Fire Hose Tester

A full line of hose testers offering various gpm and pressure ratings. Featuring four independently controlled stainless steel ball valves, 1 1/2" NST outlets, 2 1/2" NST swivel inlet, enclosed in a rugged, heavy-duty, welded steel chassis. *Ship. wt. 194 lbs.*

Cat#	Description	GPM	PSI	Price
AW146	5.5 HP Gas B&S	5	1000	\$3,863.95
AW147	5.5 HP Gas Honda	5	1000	\$3,863.95
AZ517	3 HP Electric	5	800	\$4,215.95
AZ518	3 HP Electric	4	1000	\$4,215.95
AZ519	5.5 HP Gas Honda	3.5	1000	\$3,194.95
AZ520	5.5 HP Gas B&S	3.5	1000	\$3,242.95
AZ521	5.5 HP Gas Honda	10	450	\$3,094.95
AZ522	5.5 HP Gas B&S	10	450	\$2,881.95

Line Cage

- ▶ Heavy gauge welded steel frame, powder coated
- ▶ Locking hitchpins enclose and secure hose to Line Cage
- ▶ Safely limits the mobility of line when rupture occurs
- ▶ Multiple locking holes to accommodate various hose sizes
- ▶ Stops a burst or ruptured line from retracting beyond the location of the tool
- ▶ Meets NFPA 1962.7.6.26 requirements: "Securing and Anchoring" fire hose while being tested

BE079 Line Cage \$124.95

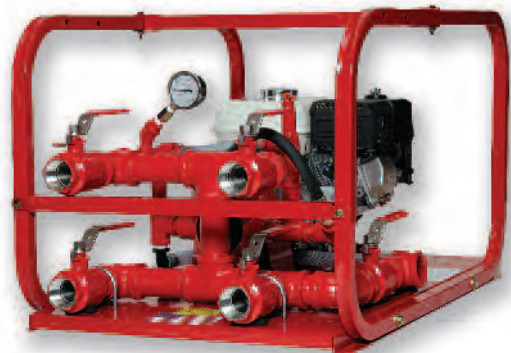
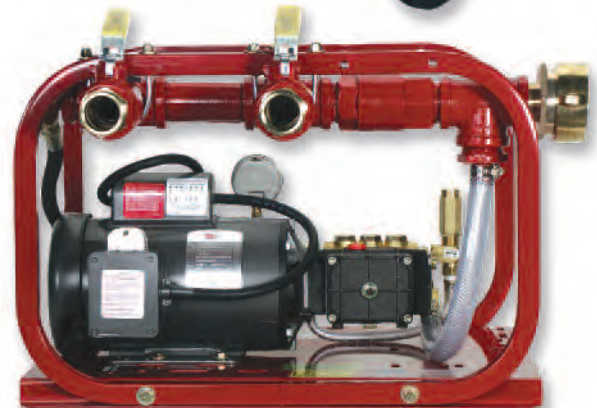



Hydrostatic Test Pump

The DPH-3B is the most preferred hydrostatic test pump on the market today. A large-volume, medium-pressure test pump, recommended for testing up to 36" lines. The 11gpm 550 psi diaphragm pump allows the handling of up to 10% chlorine solution and has the ability to be run dry without damage to the pump.

Ship. wt. 114 lbs.

- ▶ Automatic Pressure Regulator
- ▶ Heavy-duty welded steel frame and base
- ▶ Liquid-filled gauge, ensures accurate readings
- ▶ Inlet 9' suction hose with strainer
- ▶ High pressure outlet hose with quick couplers



AS364 Hydrostatic Test Pump \$2,729.95



Fire Hose Wand Accessory

A Year-Round Contributor

Unlike other pressure washers, the AA931 Pressure Wand accessory offers a maximum of 500 psi to give cleaning power with less risk of damage to decals or paint. The dual tipped wand allows users to select soap, water, or both. Maximum cleaning range allowed with 50 foot quick coupled high pressure hose. Ship. wt. 20 lbs.



AA931 Fire Hose Wand Accessory \$418.95



Hose Tester Accessories

AC7281525	1 1/2" Rigid RL F x 2 1/2" M	\$18.95
AG7355025	5" S x 2 1/2" Rigid F	\$128.95
BK072	1 1/2" Cap with Chain and Petcock	\$33.95
BK073	2 1/2" Cap with Chain and Petcock	\$39.95
BK074	5" Storz Cap with Chain and Petcock	\$79.95



Watertight Products Protector™ Cases

BD129

- ▶ Fold down overmolded handle
- ▶ Weight with foam: 5 lbs.

BD130

- ▶ Fold down overmolded handle
- ▶ Transport wheels
- ▶ Weight with foam: 20 lbs.

BD131

- ▶ Fold down and retractable handle
- ▶ 2" transport wheels
- ▶ Weight with foam: 26 lbs.

BD132

- ▶ Fold down main handle
- ▶ Retractable handle
- ▶ Seven large latches
- ▶ New super heavy-duty quad wheels
- ▶ 2" transport wheels
- ▶ Weight with foam: 33 lbs.

BD133

- ▶ Two-person lift handles
- ▶ Retractable handle
- ▶ New super heavy-duty quad wheels
- ▶ 2" transport wheels
- ▶ Weight with foam: 42 lbs.



ALL CASES: Black only

Cat#	Exterior Dimension	Interior Dimensions	Price
BD129	13.4"Lx11.6"Wx6"D	11.8"Lx18.9"Wx5.2"D	\$102.95
BD130	22.1"Lx17.9"Wx10.4"D	20.4"Lx15.4"Wx9"D	\$232.95
BD131	24.8"Lx19.4"Wx13.9"D	21.4"Lx16.3"Wx12.6"D	\$313.95
BD132	30.7"Lx20.5"Wx11.6"D	28.5"Lx17.4"Wx10.5"D	\$325.95
BD133	31.5"Lx22.9"Wx19"D	28.2"Lx19.7"Wx17.6"D	\$430.95



Lightweight Pump

Powered by Honda's easy-starting, 31cc mini 4-stroke engine, this lightweight pump weighs only 15 lbs. and can pump up to 40 gpm. *Ship. wt. 17 lbs.*

- ▶ Engine - Honda 4-stroke, single-cylinder, air-cooled engine, GX31, 1.5 hp, OHV
- ▶ Displacement - 31cc
- ▶ Bore and Stroke - 1.5 x1.0"
- ▶ Compression Ratio - 8:0:1
- ▶ Pump Type - General purpose, centrifugal, self-priming
- ▶ Priming Time - 120 sec @ 16.4"
- ▶ Drive System - Direct
- ▶ Discharge Capacity - 40 gal/min
- ▶ Suction Port Diameter - 1.0" NPT
- ▶ Discharge Port Diameter - 1.0" NPT
- ▶ Total Head Lift - 100'
- ▶ Suction Head Lift - 23'
- ▶ Maximum Pressure - 43 psi
- ▶ Dimensions - 13.0"x9.8"x12.8"
- ▶ Dry Weight - 15 lbs.

BB040 Lightweight Pump \$448.95

General Purpose Pump

- ▶ Performance - Delivers a maximum discharge capacity of 275 gpm, maximum head of 85'
- ▶ Engine - Honda 4-stroke, single-cylinder, air-cooled engine, GX160, 5.5 hp, OHV
- ▶ Displacement - 163cc
- ▶ Bore and Stroke - 2.7"x1.8"
- ▶ Compression Ratio - 8:5:1
- ▶ Oil Alert® - Standard
- ▶ Pump Type - Centrifugal, self-priming
- ▶ Volute - Rigid-mounted cast iron
- ▶ Impeller - Cast iron
- ▶ Mechanical Seal - Silicon carbide
- ▶ Priming Time - 150 sec @ 16.4"
- ▶ Drive System - Direct
- ▶ Discharge Capacity - 275 gal/min
- ▶ Suction Port Diameter - 3" NPT
- ▶ Discharge Port Diameter - 3" NPT
- ▶ Total Head Lift - 85'
- ▶ Suction Head Lift - 26'
- ▶ Maximum Pressure - 37 psi
- ▶ Solids Handling - ⁵/₁₆"
- ▶ Dimensions - 20.1"x15.2"x17.9"
- ▶ Dry Weight - 60 lbs.

BB041 General Purpose Pump \$635.95
BH008 Hose Kit * \$284.95

*Hose Kit Includes: 20 ft. suction hose, soft discharge hose, strainer

"Mop-up" Dewatering Pump

If You Need to Move 1,000 Gallons of Water Fast, We've Got the Pump for You!

The "Mop-up" Pump is perfect for flat roofs, flooded garages and basements. Features a unique non-return valve built-in just below the impeller. Liquid will stay in the pump and pump-line after shutdown and not release out on the floor. The pump bottom is rubber clad to protect against damage to the floor surface. It will pump down to 1/2 of an inch, and start up in only a small puddle of liquid. Water cleanup after a fire is made easy with the "Mop-up" Pump. All pumps are equipped with thermal overload protection against overheating and delivered standard with 2" NPT connection. A Superior motor, with protection for longer life, less maintenance and less downtime! *Note: If the pump is to be used as a portable unit, it is strongly advised to add a "Ground Fault Interrupter" to the power supply line.* *Ship. wt. 27 lbs.*



AF412 "Mop-up" Dewatering Pump \$568.95

DON'T MISS

More pumps on pages (p295-313)



WATER SUPPLIES

Honda Trash Pump

- ▶ Heavy-duty 3" construction trash pump
- ▶ Easy-starting Honda 8hp OHV commercial engine
- ▶ Full frame protection
- ▶ 319 gal./min. capacity
- ▶ Solid handling capability up to 1 1/16"
- ▶ Easy-to-use quick clean out port
- ▶ Easy-to-service impeller wear plate
- ▶ Protected by Honda Oil Alert®



BG155 Honda Trash Pump \$1,728.95
BH008 Hose Kit * \$284.95

*Hose Kit Includes: 20 ft. suction hose, soft discharge hose, strainer



Darley Dry Hydrant Water System

With more and more people living and working in areas beyond the protection of domestic fire hydrants, local fire departments must be prepared to deliver large volumes of water with tankers and use portable tanks at the fire scene which rely on ponds, lakes, or streams. Consider this economical Dry Hydrant System that any department can afford. The Darley system offers everything you need: adapters, strainers, caps and fittings all made of tough extruded aluminum.

All adapters in the Darley system are fitted and secured, assuring vacuum-tight joints. You can count on this system for years of trouble-free service. **Ship wt. 10 lbs. All items are sold separately. Purchase the straight sections of PVC pipe/elbows locally which will save you both money and freight charges.**

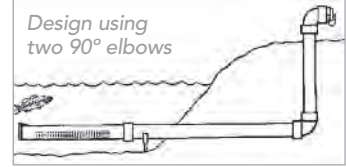
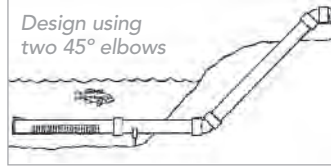

		4.5" NST	5" NST	6" NST
AS235	6" PVC Dry Hydrant Male Adapter with Cap (Aluminum)	\$174.95	\$174.95	\$190.95
AS236	6" PVC Dry Hydrant Male Adapter with Cap & Elbow 90° (Aluminum)	\$198.95	\$204.95	\$206.95
AS237	6" PVC Dry Hydrant Male Adapter with Cap & Elbow 45° (Aluminum)	\$198.95	\$204.95	\$220.95
AS365	6" PVC Dry Hydrant Female Adapter with Cap (Aluminum)	\$236.95	\$246.95	\$259.95
AS366	6" PVC Dry Hydrant Female Adapter with Cap & Elbow 90° (Aluminum)	\$270.95	\$280.95	\$290.95
AS367	6" PVC Dry Hydrant Female Adapter with Cap & Elbow 45° (Aluminum)	\$270.95	\$280.95	\$290.95
AS238	Horizontal PVC Strainer with Back Flushing Cover 6"			\$138.95
AS239	Shallow Water Strainer (Tear Drop Style) 6"			\$383.95
AS240	Full Time In-Line Swivel 360° Swivel 6"			\$199.95
W409J	Underwater PVC Bracket			\$22.95



Float-Dock Strainer

Pump Pond Water Free of Debris

The Float-Dock strainer is a valuable piece of equipment that can save the day in many fire fighting situations. Float-Dock lets you use the water in ponds or streams, both shallow and deep. Because it operates below scum and debris and above sand and muck, it screens out the materials that wear out impellers, packing and bearings. Since Float-Dock strainers are self-leveling, there are no whirlpools or suction loss. It will draft in as little as 5" of pond water at pump's rated capacity. In deep water, Float Dock drafts clean water below the surface. Each unit is fully guaranteed.

Cat#	Strainer	Float	Coupling	Price
H224	4"x6"x14"	5"x15"x18 1/2"	2 1/2"	\$331.95
H22401	4"x6"x14"	5"x15"x18 1/2"	3"	\$375.95
H225	7"x10"x18 1/2"	7"x21"x26 1/2"	4"	\$486.95
H22502	6"x8"x18 1/2"	7"x21 1/2"x26 1/2"	4 1/2"	\$502.95
H22603	6"x8"x18 1/2"	7"x21 1/2"x26 1/2"	5"	\$534.95
T134	7"x16"x18 1/2"	7"x21 1/2"x26 1/2"	6"	\$720.95

Carrying Rack

Float-Dock strainers fit snugly in this lightweight carrying rack with rubber bumpers and live rubber strap to hold the unit securely in place. Mounts either on running board or inside a compartment.

T135	Carrying Rack, for 2 1/2" & 3"	\$97.95
T136	Carrying Rack, for 4", 4 1/2" & 5"	\$131.95



Low-Flow Strainer

Strainer will perform at maximum pumping capacity down to a water level of just 1 1/2" with no suction loss. Surface turbulence will not affect this strainer. Can be easily stored in truck compartment. Sizes 4" thru 6" come with 1 1/2" cast aluminum jet siphon. **Ship. wt. 24 lbs.**

X892	Low-Flow Strainer, 2 1/2"	\$330.95
X893	Low-Flow Strainer, 3"	\$334.95
X894	Low-Flow Strainer, 4"	\$382.95
X895	Low-Flow Strainer, 4 1/2"	\$396.95
X896	Low-Flow Strainer, 5"	\$442.95
X897	Low-Flow Strainer, 6"	\$495.95

Self Leveling Floating Strainers

- ▶ Increased flow rates due to high intake ratio
- ▶ Maximum pump flows
- ▶ Light weight design
- ▶ New compact design for easy storage
- ▶ Handle for ease of carrying
- ▶ Vortex Shield protects against whirlpooling
- ▶ Full time swiveling strainer
- ▶ Most efficient strainers on the market



BK012

BK012	1 1/2" Self Leveling Floating Strainer	\$174.95
BK013	2 1/2" Self Leveling Floating Strainer	\$239.95
BK014	3" Self Leveling Floating Strainer	\$292.95
BK015	4" Self Leveling Floating Strainer	\$486.95
BK016	4 1/2" Self Leveling Floating Strainer	\$607.95
BK017	5" Self Leveling Floating Strainer	\$619.95
BK018	6" Self Leveling Floating Strainer *	\$657.95

* Recommended for pumps 1250 to 1500 gpm.

Low Level Strainer with Jet Siphon

This compact unit can be used as both a water transfer device as well as a low level strainer. Features lightweight 6061-T6 aluminum construction with red powder coat finish for long life. Will draft in as little as 3" of water without whirlpooling. Pivoting neck enables base to stay flat on the tank bottom. Comes standard with internal screen (all sizes) and jet siphon (4"-6"). Call for pricing on optional Cam Lock or Storz fittings. **Ship. wt. 25 lbs.**

2 1/2" AND 3" ARE NOT MANUFACTURED WITH A JET SIPHON
CALL FOR PRICING ON STORZ AND CAM LOCK FITTINGS.

	2 1/2"	3"	4"	4 1/2"	5"	6"
AS227	\$303.95	\$324.95	\$350.95	\$357.95	\$391.95	\$463.95

Power Jet Siphon

Ideal for departments that rely on portable tanks for water supply. Maximizes the flow of water through the suction hose using a venturi action. Made of lightweight, long-lasting aluminum construction. 1 1/2" female assist x 2 1/2" thru 6" discharge. **Ship. wt. 25 lbs.**

	2 1/2"	4"	4 1/2"	5"	6"
AS228	\$97.95	\$137.95	\$149.95	\$151.95	\$154.95

Bottom Guard Barrel Strainer

The new innovative "Bottom Guard Strainer" was designed to work with gravity. As the strainer moves toward the water's bottom, the *guard* swivels to the underside of the barrel strainer providing a clean, stable platform from which to draft.

- ▶ Rugged, lightweight and compact
- ▶ Continual swivel "bottom guard" prevents the collection of debris from bottom
- ▶ Ideal for use in silt, rocky or weeded conditions
- ▶ Aluminum construction with wrinkle black powder coated finish on bottom guard



Back View

BK235	2.5" NH Bottom Guard Barrel Strainer	\$185.95
BK236	3" NH Bottom Guard Barrel Strainer	\$219.95
BK237	4" NH Bottom Guard Barrel Strainer	\$247.95
BK238	4.5" NH Bottom Guard Barrel Strainer	\$249.95
BK239	5" NH Bottom Guard Barrel Strainer	\$269.95
BK240	6" NH Bottom Guard Barrel Strainer	\$329.95

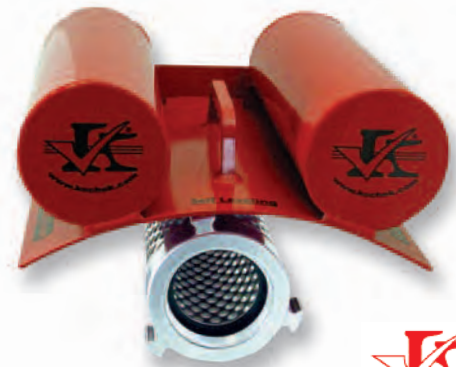

DON'T MISS
More products like this
in Hose (p73-87)



WATER SUPPLIES

Portable Collapsible Fol-Da-Tank

The First and Still the Best

It was more than 50 years ago that the first Fol-Da-Tank was introduced to firefighters, who recognized its value and quality immediately. Fol-Da-Tank Co. has been continually improving frame and fabric designs to help provide the most reliable portable water tank in the industry. Fol-Da-Tank has proved to be the practical answer as an extra water supply for rural areas, where water pressure is low or as a back-up facility for municipal fire departments. It's available in nine standard sizes. Fol-Da-Tank doubles the fire fighting ability of a tanker truck at an affordable price. Two firefighters can unload from the truck and set up in 30 seconds. While pumper empties the Fol-Da-Tank, a tanker can be supplying more water. With the fire out, Fol-Da-Tank can be emptied quickly with the exclusive 10" diameter drain sleeve. You can store the drain sleeve inside or outside of the tank.



Construction Features:

- ▶ Liners - Hypalon, FDA
- ▶ Frames - Steel, resistance welded 14-gauge 7/8" round steel tubing with snag-free finish
- ▶ Hinges - Die-cut
- ▶ Grommets - Solid brass
- ▶ Bolts - Heavy-duty

SPECIFY COLOR: Hypalon - Red or Yellow

Fol-Da-Tank Steel Frame		Gallons						
Cat#	Description	600	1000	1500	2100	2500	3000	4000
BL234	17oz. HPR	\$838.95	\$1,003.95	\$1,223.95	\$1,447.95	\$1,592.95	\$1,799.95	\$2,141.95
BL235	22oz. HPR	\$930.95	\$1,186.95	\$1,432.95	\$1,599.95	\$1,745.95	\$2,010.95	\$2,402.95
Liners								
BL236	17oz. HPR	\$653.95	\$814.95	\$965.95	\$1,084.95	\$1,237.95	\$1,447.95	\$1,831.95
BL237	22oz. HPR	\$780.95	\$914.95	\$1,102.95	\$1,220.95	\$1,451.95	\$1,677.95	\$1,831.95



Easy 1-person setup

Self-Supporting Frameless Portable Water Tank

These self-supporting frameless water tanks have been designed to meet the most stringent requirements of rural/urban fire fighting. Problems with inadequate or unusable supplies of water are eliminated by the use of open top self-supporting portable water tanks. In remote areas, the self-supporting tanks are designed for standby water containment, water shuttling situations and to provide a continuous portable water supply. In remote areas, the SST may be filled by pumping water from a natural water source, such as a stream or creek, with a small gas-operated pump. As the self-supporting tank begins to fill with water, its unique design allows it to become self supporting

automatically. The SST can be used as a mixing tank as well as a temporary holding in hazardous waste situations. It may be quickly drained through a threaded flange fitting on the side. The tank is totally collapsible and easily stored in its own compact storage bag. Made of heavy-duty industrial PVC.

- ▶ No frame, assembly, foot pump, auxiliary air or need to inflate
- ▶ Use as mixing tank, water relay, water storage
- ▶ Use for fire fighting, hazardous waste, etc

SPECIFY NST or IPT, male or female threaded flange coupling, installed. SPECIFY SIZE CHOICE of threaded drain flange coupling, 1 1/2"-5" available. 6" additional cost.

SPECIFY COLOR: Yellow, Red or Orange.

Cat#	Gal.	Size Open	Ship.wt.	Price
AJ182	500	2'8"x5'0"x6'6"	50 lbs.	\$657.95
AJ183	1000	2'8"x7'3"x8'10"	55 lbs.	\$964.95
AJ184	1500	2'8"x9'2"x11'10"	60 lbs.	\$1,062.95
AJ185	2000	2'8"x10'x12'5"	65 lbs.	\$1,543.95
AJ186	2500	2'8"x12'x13'6"	70 lbs.	\$1,687.95
AJ187	3000	2'8"x13'x14'9"	75 lbs.	\$2,072.95
AJ188	4000	2'8"x14'x16'	90 lbs.	\$1,700.95
AJ189	5000	2'8"x17'x19'	100 lbs.	\$3,314.95
BC001	6" Flange Coupling			\$269.95

Supply Line Holder



Secures hose quickly and minimizes turbulence. 2 1/2" and 3" hose sizes. Frees up personnel for other duties. **Ship. wt. 18 lbs.**

Y211	Supply Line Holder, 2 1/2"	\$200.95
Y212	Supply Line Holder, 3"	\$225.95

Threaded Low-Level Strainer

High volume low-level strainer is made of hard anodized and powder-coated aluminum. Clog-resistant stainless steel filter has over twice as much flow area as a 6" hose. This keeps friction down to .5 psi (1" Hg) at 1500 gpm and reduces the potential for air vortices to form as water sinks towards the 2.5" minimum usable depth. Oversized sealed ball pivot allows 45° range of hose angle without constricting the flow path.



BL038	4.5" Threaded Low-Level Strainer	\$935.95
BL039	5" Threaded Low-Level Strainer	\$935.95
BL040	6" Threaded Low-Level Strainer	\$935.95
BL041	5" Storz Low-Level Strainer	\$935.95
BL042	6" Storz Low-Level Strainer	\$935.95

Universal Storz Coupling

Works with Storz & Threaded Connections

Features:

- ▶ Machined aluminum
- ▶ Includes plastic dust cover and chain
- ▶ Custom colors available (standard red)
- ▶ Available with reducer and cap

Shown w/ optional cap and reducer



Applications:

- ▶ Tank fill
- ▶ Pump panel conversions
- ▶ Hydrant applications

AS694	2.5" F RIGID NST x 4" S x 2.5" M NST	\$287.95
AS696	2.5" F SW NST Elbow x 4" S x 2.5" M NST	\$351.95
AS698	2.5" F RIGID NST x 5" S x 2.5" M NST	\$319.95
AS700	2.5" F SW NST Elbow x 5" S x 2.5" M NST	\$455.95
AS713	1.5" NST Cap	\$14.95
AS714	2.5" NST Cap	\$22.95
AS715	2.5" NST Rigid RL F x 1.5" NST M Reducer	\$22.95

Turbo Draft™ Fire Eductor

The Portable Fire Hydrant

- ▶ Gain access to remote water supplies up to 250' away
- ▶ Generate usable fire flows up to 670 gpm
- ▶ No need for cumbersome hard sleeve
- ▶ Recognized by insurance agencies as an alternate water supply source
- ▶ Lightweight design sets up in minutes with standard fire hose

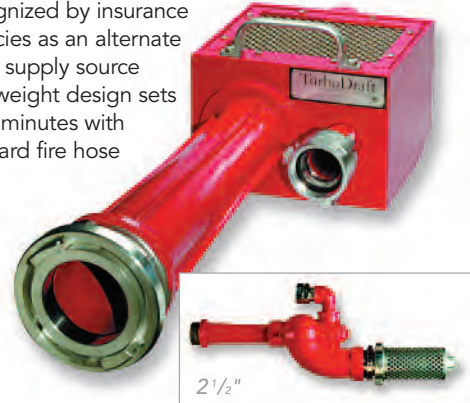

Cat#	Description	Ship. wt.	Price
AZ137	5" Turbo Draft™	55 lbs.	\$3,525.95
AZ138	2 1/2" Turbo Draft™	20 lbs.	\$2,195.95

Snaptank™

Snaptank™ is the space saving, easy-to-deploy alternative to traditional rigid framed relay tanks. Realize all the advantages of a rigid framed relay/dump tank with the mobility and compact packaging of an unsupported freestanding tank. No spill over, no rolling. Nothing in the industry offers more structural integrity on flat or uneven ground than the Snaptank™. Constructed of the finest aircraft quality aluminum components, Snaptank™ is light yet durable and can be fully functional in minutes. Five models offer capacities from 1000-3000 gallon, each plumbed with a standard 3" threaded flange with plug and packaged in a compact field bag.



	1000 gal.	1500 gal.	2000 gal.	2500 gal.	3000 gal.	
AZ372	Snaptank™ with 22 oz. Liner	\$1,650.95	\$1,797.95	\$2,030.95	\$2,265.95	\$2,550.95
AZ373	Ground Covers	\$90.95	\$145.95	\$170.95	\$195.95	\$219.95
AZ374	Replacement Field Bags	\$96.95	\$96.95	\$106.95	\$106.95	\$111.95
AZ375	Replacement Liner 22 oz. Vinyl with Flange and Cap	\$772.95	\$833.95	\$1,025.95	\$1,111.95	\$1,167.95

Diaphragm Pumps

Self-priming, non-clogging and extremely versatile. Perfect in dozens of applications. Empty meter boxes, electrical connection boxes, dewater pits, trenches and any other area where unwanted liquids are present. 12' Suction lift and 12' delivery head. Capacity ranges from 12-30 gpm depending on model. Mounts with four screws to a board or other surface and can be placed in any position without losing its suction. *Ship. wt. 2-10 lbs.*

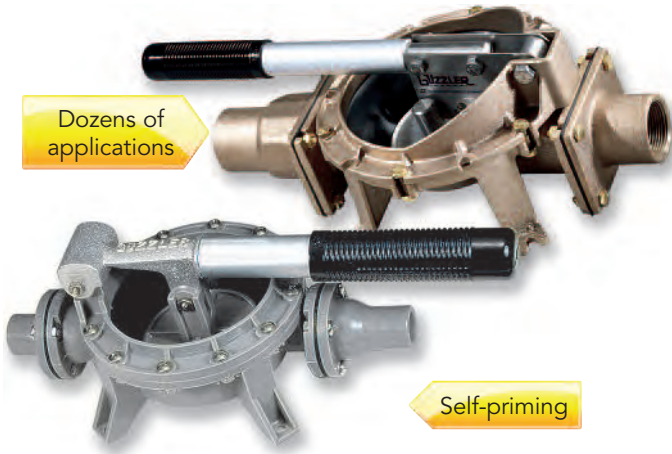

P360	Diaphragm Pump, 12 gpm 10"x5"x4", 1" O.D. Ports	\$52.95
P361	Diaphragm Pump, 15 gpm 10"x5"x4", 1 1/2" O.D. Ports	\$67.95
P362	Diaphragm Pump, 30 gpm 14"x8"x7", 2" O.D. Ports	\$401.95

Darley Hydrant Flags

Darley flags improve fire hydrant's visibility when covered by snow or weeds. Simply remove the 2 1/2" cap, slip on and position the flag in an upright position, then tighten cap. It's that easy. 3/8"x52" steel rod and 3"x5" flag have a powder-coated red finish. *Ship. wt. 3 lbs.*



SOLD IN LOTS OF 25 OR MORE

S840	Hydrant Flags	\$9.95/ea.
	Order lots of 50 for	\$8.95/ea.

Connect Fire Hose to Hydrant in Seconds

- ▶ Permanent hydrant adapter
- ▶ No more time-consuming threading and tightening
- ▶ Only 1/4 turn connects hose to hydrant
- ▶ A must where multiple steamer thread sizes are used in your area
- ▶ Special threads also available
- ▶ *Ship wt. 5 lbs.*



AS225	Permanent Hydrant Adapter 4" STORZ x 4 1/2" NST	\$150.95
AS226	Permanent Hydrant Adapter 5" STORZ x 4 1/2" NST	\$150.95

Darley Fire Hydrant Hand Pump

Pump Your Hydrants Dry, Frozen Hydrants Are Serious Hazards

The hydrant pump will pump a hydrant empty in a few strokes. Made with quality materials to last for years. The cylinder is seamless drawn brass. The plunger rod is steel with a 3/8" diameter, the cylinder has a 1 1/2" diameter. Top and bottom castings are extra-heavy solid brass castings. The pumping handle is solid hardwood. Can't rust, always ready-to-use. Only one hose is needed to drop down the body of the fire hydrant. Hose is 8 feet long with coupling included. *Ship. wt. 9 lbs.*

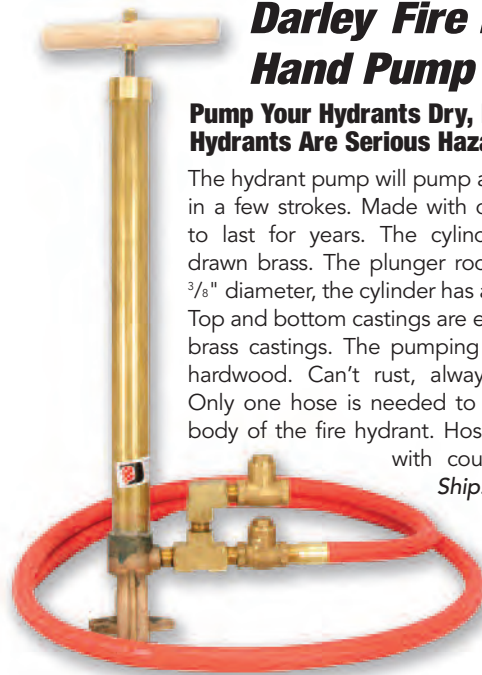

539	Fire Hydrant Hand Pump	\$255.95
-----	------------------------	----------

Hydrfinder

The 6" wide, reflective red striping tape on the white fiberglass shaft affords instant day and night visual location of the fire hydrant. The 3/8" diameter fiberglass shaft is attached to a heavy-duty MIL SPEC chrome-plated carbon-spring mount that allows for 360° flexibility. The Hydrfinder is adaptable to most standard fire hydrants with an easy-to-install 5/8" diameter bolt-on steel mounting bracket. *Ship. wt. 3 lbs.*

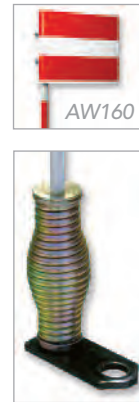

AW159	Hydrfinder	\$22.95
	Order lots of 60 or more for	\$18.95
AW160	Flag (Option for Hydrfinder)	\$7.95

"Out-of-Service" Hydrant Markers

Designed as an effective method of identifying Out-of-Service Hydrants. Just remove the hydrant cap, slide on the marker and replace the cap. It's highly visible and easy to read with white letters on red. Durable Lexan® construction withstands abuse and temperature changes. *Ship. wt. 1 lb.*



MINIMUM ORDER OF 10		
BC108	Hydrant Marker, 2 1/2"	\$7.95/ea.
BC109	Hydrant Marker, 4 1/2"	\$12.95/ea.

Automatic Suction Valve

This suction inlet valve is designed to operate as an automatic flow control valve eliminating the need for manual adjustments in relation to water flow. During hydrant operation, it automatically opens in proportion to flow demand while the automatic check valve action helps prevent water hammer. It will also automatically balance the flow between multiple sources. During drafting operation, the check valve action holds prime water when flow is stopped, plus allows switching to booster tank and back to draft without flow interruption. Its compact design will not interfere with pump controls or running boards. Valve can be greased without removal from pumper. Overall length 9 1/2". Any thread size, male or female combination from 4" to 6." Ship. wt. 20 lbs.

- ▶ Compact design
- ▶ Versatile application



SPECIFY SIZE AND THREADS OF FEMALE AND MALE

T280	Automatic Suction Valve	\$1,788.95
------	-------------------------	------------

Tanker Dump Valve

Install your own dump valve. Simply screw in the male NPT threaded flange that comes with the package. To this you bolt the valve itself and another NPT threaded flange (gaskets included). It's quick-opening, full-flow, compact, bubble-tight, is easily maintained and mounts in any position. The valve body is rust-proof epoxy coated aluminum. Ship wt. 19 lbs.

SPECIFY THREADS AND SIZES; Allow 4-6 weeks for delivery

M718	3" Dump Valve Package, Disc Diameter 3 3/8"	\$145.95
M719	4" Dump Valve Package, Disc Diameter 4 3/8"	\$209.95
M720	5" Dump Valve Package, Disc Diameter 5 7/16"	\$560.95
R689	6" Dump Valve Package, Disc Diameter 6 1/8"	\$680.95



Newton Kwik Dump Valve

...Because Every Second Counts

The Newton Kwik-Dump Water Valve, with its quality construction and trusted performance for over twenty-five years, gets the job done fast. It is 29% faster than any other conventional gravity flow valve tested. It can dump 3000 gallons of water per minute, under ideal conditions. As an average, an 1800 gallon tanker can be emptied in less than one minute. All Newton Valves are constructed so that all parts constantly in contact with water are made of stainless steel, brass, or rubber, to give many years of trouble-free service. The remainder of the valve is made of hot-rolled, prime painted mild steel. The standard valve comes with top-mounted controls and handle, and a 3° angle on the flange. Can be readily adapted to tanker trucks already in use. Call Darley today to get a Newton Kwik-Dump Water Valve in your truck. Outlets are 10" x 10" square. Standard 24" valves can be shortened and remote handle configuration is also available for additional costs. Includes instructions and templates.

AJ173	Kwik Dump, Angle Flange	\$574.95			
AR281	Kwik Dump, Handle and Controls on Left	\$629.95	X601	24" Slip on Extension for 10" Valve	\$164.95
AR282	Kwik Dump, Handle and Controls on Right	\$629.95	X602	36" Slip on Extension Chute for 10" Valve	\$184.95
AR288	Kwik Dump, Controlled by Air Cylinder	\$1,444.95	X603	48" Slip on Extension Chute for 10" Valve	\$209.95
AR297	Additional Charge for Stainless Steel Flange on Mild Steel Valve	\$63.95	AR293	90° Elbow Chute for 10" Valve	\$358.95
			X605	36" Telescoping Chute for 10" Valve	\$484.95



Drop Down Folding Tank Rack

Easy-to-install on either elliptical or side step body tankers. Manually pulls down to deploy folding tanks of all sizes. Made of all stainless steel. Ship. wt. 100 lbs.

- ▶ Quickly deploy your folding tank



Optional Diamond Plate Wind Deflector

For Tank Sizes

AF700	Drop Down Folding Tank Rack	1,000 to 3,000 gal.	\$1,228.95
AF701	Drop Down Folding Tank Rack	3,000 to 4,000 gal.	\$1,420.95
AF702	Wind Deflector		\$175.95

Angle and Suction Elbows

Suction Elbows Allow Carrying Pre-Connected Suction Hose

Angle elbows are used on the discharge gate of a pumper to relieve strain and prevent kinking of hose. Suction elbows allow the speed and convenience of pre-connected suction hose. Rocker lug swivel. *Ship. wt. 3 lbs.*

- ▶ Prevent kinking
- ▶ Relieve hose strain



R477	Angle Elbow, 2 1/2" 45°, Chrome	\$89.95
R479	Suction Elbow, 2 1/2", 90°, Chrome	\$465.95

British Instantaneous Fittings

Darley offers a complete line of British Instantaneous fittings. These models are available in lightweight alloy. Fittings have hard-coat anodized finish. All 2 1/2" connections are made to conform to the BS336 standard. *Ship. wt. 3 lbs.*



BITF (British Instantaneous Fittings)		
AJ089	2 1/2" BITF x 2 1/2" MNST Fitting	\$156.95
AJ088	2 1/2" BITM x 2 1/2" MNST Fitting	\$47.95
AJ087	2 1/2" BITM x 2 1/2" FNST Fitting	\$50.95
BD006	2 1/2" BITF x 2 1/2" FNST Fitting	\$104.95
BD007	2 1/2" BIT Cap	\$99.95
BD008	2 1/2" BIT Plug	\$35.95

Swivel Bushing

Chrome-plated brass, double female bushing, internal lug, rocker lug swivel. *Ship. wt. 4 lbs.*

AK061 - Double Female Swivel Bushing		
1 1/2" NPT x 1 1/2" NST Swivel	\$97.95	
1 1/2" NPT x 2 1/2" NST Swivel	\$119.95	
2 1/2" NPT x 2 1/2" NST Swivel	\$85.95	
3" NPT x 2 1/2" NST Swivel	\$131.95	
AK062 - Double Female Swivel Bushing with Screen Insert		
1 1/2" NPT x 2 1/2" NST Swivel	\$121.95	
2 1/2" NPT x 2 1/2" NST Swivel	\$135.95	
3" NPT x 2 1/2" NST Swivel	\$136.95	

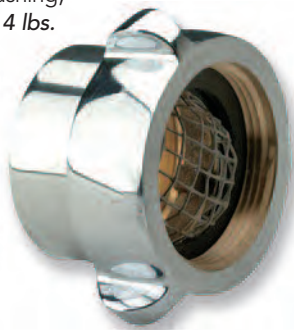

Suction Elbow Swivel Female to Male

Ideal for fire apparatus with front suction connections. Aluminum elbows from 2 1/2" through 6". Long handle female swivel x male rigid standard. Specify NST, NPSH or NPT threads. Call for pricing on special threads, Storz fittings and/or rocker lug design. *Ship. wt. 4-7 lbs.*



(AS125 - SPECIFY 45° or 90°) **Male**

Female	2 1/2"	4"	4 1/2"	5"	6"
2 1/2"	\$165.95	\$214.95	\$207.95	\$213.95	—
4"	\$217.95	\$232.95	\$232.95	\$263.95	\$263.95
4 1/2"	\$232.95	\$238.95	\$232.95	\$269.95	\$272.95
5"	\$238.95	\$274.95	\$282.95	\$287.95	\$293.95
6"	—	\$283.95	\$288.95	\$296.95	\$311.95

Suction Swivel Adapter

Chrome-plated brass with screen; 2 1/2" NST swivel female x 2 1/2" NPT male. *Ship. wt. 3 lbs.*

W505	Adapter	\$122.95
------	---------	----------



Chrome-Plated Brass Bushings

Female NPT by male hose thread bushing with internal lugs. Available with or without screen. *Ship. wt. 4 lbs.*

W504 - Chrome Plated Bushing

1 1/2" NPT F x 1 1/2" NST M	\$78.95
2 1/2" NPT F x 2 1/2" NST M	\$58.95
4" NPT F x 4" NST M	\$152.95
4 1/2" NPT F x 4 1/2" NST M	\$214.95
5" NPT F x 5" NST M	\$264.95
6" NPT F x 6" NST M	\$339.95
AK014 - Chrome Plated Lug Bushing with Screen	
2 1/2" NPT F x 2 1/2" NST M	\$56.95
4" NPT F x 4" NST M	\$152.95
4 1/2" NPT F x 4 1/2" NST M	\$231.95
5" NPT F x 5" NST M	\$257.95
6" NPT F x 6" NST M	\$293.95



Neoprene Gaskets

F850 Neoprene Face Gaskets, for cap and female swivels, remain fresh and resilient for years and will not swell or distort out of shape. R664 Tail Gaskets for the coupling bowl are made of a "livelier" Neoprene to prevent "bulge out" under the expansion ring. *Ship. wt. 1 lb.*



Cat#	Priced per dozen	1 1/2"DJ	1 1/2"SJ	2 1/2"DJ	2 1/2"SJ	3"DJ	3"SJ		
R664	Recoupling Gaskets for Hose	\$9.95	\$9.95	\$13.95	\$13.95	\$19.95	\$19.95		
Cat#	Priced per dozen	3/4"	1"	1 1/2"	2 1/2"	3"	4"	4 1/2"	5"
F850	Female Swivel Gaskets	\$5.95	\$9.95	\$8.95	\$15.95	\$16.95	\$37.95	\$36.95	\$33.95

Darley Brass Hex Hose Adapters

CAT# AM137 - NPT MALE X NST MALE

NPT MALE	NST MALE				
	1"	1½"	2"	2½"	3"
1"	\$26.95	—	—	—	—
1½"	\$23.95	\$12.95	—	—	—
2"	—	\$60.95	—	\$25.95	—
2½"	—	\$56.95	—	\$24.95	—
3"	—	—	—	\$36.95	\$132.95



CAT# AM138 - NPT FEMALE X NST MALE

NPT FEMALE	NST MALE				
	1"	1½"	2"	2½"	3"
1"	\$32.95	—	—	—	—
1½"	—	\$10.95	—	—	—
2"	—	\$46.95	—	—	—
2½"	—	—	—	\$26.95	—
3"	—	—	—	\$52.95	\$92.95



Note: NPT has a tapered thread and is used for plumbing applications. Requires tape or pipe sealant.

Hydrant and Suction Hose Connections

B268 has a double swivel with long handles on both ends (pin lugs on one end or both ends same price). B269 is a solid fitting with long handles (pin lugs same price). Chrome plated brass. Ship. wt. 21 lbs.

CAT# B268 - NST FEMALE X NST FEMALE

NST FEMALE	NST FEMALE			
	4"	4½"	5"	6"
2½"	\$404.95	\$444.95	\$493.95	\$530.95
4"	\$463.95	\$486.95	\$540.95	\$645.95
4½"	—	\$524.95	\$580.95	\$607.95
5"	—	—	\$758.95	\$714.95



CAT# B269 - NST MALE X NST FEMALE

NST MALE	NST FEMALE			
	4"	4½"	5"	6"
2½"	\$241.95	\$253.95	\$303.95	\$341.95
4"	\$255.95	\$316.95	\$379.95	\$398.95
4½"	—	\$329.95	\$398.95	\$418.95
5"	—	—	\$441.95	\$415.95
6"	—	—	—	\$511.95



Long Handle Chrome Suction Caps

AW060	Chrome 4" NH Cap	\$159.95
AW061	Chrome 4½" NH Cap	\$220.95
AW062	Chrome 5" NH Cap	\$237.95
AW063	Chrome 6" NH Cap	\$248.95



Aluminum Chrome Caps

Chrome-plated aluminum hose caps include chain. NST thread standard. Ship. wt. 1 lb.

AW089	1" Chrome Cap	\$29.95
AW090	1½" Chrome Cap	\$30.95
AW091	2" Chrome Cap	\$37.95
AW092	2½" Chrome Cap	\$45.95



Double Male and Double Female Connections

Ship. wt. 2 lbs.

CHROME PLATED/BRASS DOUBLE MALE

B24301	2½", Chrome, NST	\$62.95
B24302	1½", Chrome, NST	\$51.95
B24303	2½", Chrome, Other Thread	\$90.95
B24304	1½", Chrome, Other Thread	\$32.95
B24305	2½", Brass, Any Thread	\$75.95
B24306	1½", Brass, Any Thread	\$59.95

CHROME PLATED/BRASS DOUBLE FEMALE

B24401	2½", Chrome, NST	\$114.95
B24402	1½", Chrome, NST	\$91.95
B24403	2½", Chrome, Other Thread	\$180.95
B24404	1½", Chrome, Other Thread	\$149.95
B24405	2½", Brass, Any Thread	\$149.95
B24406	1½", Brass, Any Thread	\$120.95



Hose Plug for Female Thread

Specify finish, thread and with or without chain. NST thread standard. Prices for other threads are available on request. Ship. wt. 3 lbs.

Cat#	Size	Rough Brass	Chrome Plate
L877	1½"	\$17.95	\$41.95
L877	2½"	\$27.95	\$40.95

With chain add \$1.40



Hose Reducers

CHROME PLATED BRASS

42B04	1½" NST x ¾" GHT	\$43.95
42B	2½" NST x 1½" NST	\$37.95

POLISHED BRASS

42B01	1½" NST x ¾" GHT	\$33.95
42B02	2½" NST x 1" NST	\$54.95
42B03	2½" NST x 1½" NST	\$31.95

Chrome-Plated Hose Caps

Chrome-plated brass hose caps include chain. NST thread standard. Ship. wt. 1 lb.

B52600	Hose Cap, 1"	\$42.95
B52601	Hose Cap, 1½"	\$24.95
B52602	Hose Cap, 2½"	\$35.95
B52603	Hose Cap, 3"	\$61.95



Lexan Threaded Caps

Cut the cost of theft, while providing maximum protection. Includes sturdy, plated attaching chain and inside gasket. NST, SIPT(NPSH). Red only.

U81401	1½" Threaded Cap	\$5.95
U81402	2½" Threaded Cap	\$5.95



Lightweight Aluminum Alloy Adapters

Double Swivel Female...

...for adapting from male to female. Made from extruded lightweight aluminum alloy, then hardcoated to resist corrosion and abrasion. *Ship. wt. 1-6 lbs.*



AC725 / Double Female

F	1"	1 1/2"	2"	2 1/2"	3"	4"	4 1/2"	5"	6"
1"	\$17.95	\$25.95							
1 1/2"	\$25.95	\$23.95	\$36.95	\$39.95					
2"		\$33.95	\$36.95	\$39.95					
2 1/2"		\$39.95	\$39.95	\$34.95	\$72.95	\$102.95	\$112.95	\$149.95	\$264.95
3"				\$72.95	\$57.95	\$122.95	\$134.95	\$158.95	\$245.95
4"				\$102.95	\$122.95	\$95.95	\$121.95	\$179.95	\$237.95
4 1/2"				\$109.95	\$134.95	\$121.95	\$117.95	\$179.95	\$263.95
5"				\$149.95	\$157.95	\$179.95	\$179.95	\$170.95	\$243.95
6"				\$264.95	\$245.95	\$237.95	\$253.95	\$171.95	\$211.95

Double Male...

...for adapting from female to male. Made from extruded lightweight aluminum alloy, hardcoated to resist corrosion and abrasion. *Ship. wt. 1-6 lbs.*



AC726 / Double Male

M	1"	1 1/2"	2"	2 1/2"	3"	4"	4 1/2"	5"	6"
1"	\$15.95	\$27.95	\$30.95	\$30.95					
1 1/2"	\$27.95	\$15.95	\$25.95	\$26.95					
2"		\$25.95	\$25.95	\$27.95	\$70.95				
2 1/2"	\$30.95	\$27.95	\$27.95	\$19.95	\$50.95	\$77.95	\$87.95	\$171.95	
3"			\$72.95	\$50.95	\$48.95	\$108.95	\$106.95	\$241.95	
4"				\$77.95	\$108.95	\$88.95	\$117.95	\$125.95	\$154.95
4 1/2"				\$88.95	\$106.95	\$119.95	\$100.95	\$125.95	\$147.95
5"				\$185.95	\$241.95	\$125.95	\$125.95	\$104.95	\$122.95
6"						\$154.95	\$147.95	\$122.95	\$138.95

Long Handle Double Swivel Female...

...for adapting male hydrant or suction thread to female hose thread. Made from extruded lightweight aluminum alloy, hardcoated to resist corrosion and abrasion. *Ship. wt. 1-6 lbs.*



AC727 / Long Handle Double Female

F	2 1/2"	3"	4"	4 1/2"	5"	6"
2 1/2"	\$52.95	\$93.95	\$121.95	\$134.95	\$199.95	\$283.95
3"	\$93.95	\$87.95	\$171.95	\$180.95	\$193.95	\$255.95
4"	\$121.95	\$171.95	\$152.95	\$152.95	\$191.95	\$249.95
4 1/2"	\$134.95	\$208.95	\$160.95	\$211.95	\$231.95	\$274.95
5"	\$205.95	\$193.95	\$191.95	\$222.95	\$274.95	\$305.95
6"	\$284.95	\$266.95	\$249.95	\$274.95	\$305.95	\$311.95

Rigid Rocker Lug Female...

...to male adapter. If an adapter is ordered with the same size/thread on both ends it will only serve as an extension. Made from extruded aluminum alloy, hardcoated to resist corrosion and abrasion. *Ship. wt. 1-6 lbs.*



AC728 / Male

F	1"	1 1/2"	2"	2 1/2"	3"	4"	4 1/2"	5"	6"
1"	\$12.95	\$22.95	\$35.95	\$35.95					
1 1/2"	\$18.95	\$18.95	\$18.95	\$18.95	\$71.95				
2"		\$18.95	\$30.95	\$31.95	\$72.95				
2 1/2"	\$35.95	\$18.95	\$21.95	\$22.95	\$44.95	\$95.95	\$106.95	\$138.95	\$176.95
3"	\$82.95	\$71.95	\$71.95	\$52.95	\$51.95	\$118.95	\$142.95	\$158.95	\$171.95
4"				\$97.95	\$120.95	\$110.95	\$143.95	\$157.95	\$205.95
4 1/2"				\$111.95	\$142.95	\$130.95	\$144.95	\$180.95	\$223.95
5"				\$145.95	\$147.95	\$141.95	\$171.95	\$157.95	\$249.95
6"				\$305.95	\$290.95	\$196.95	\$211.95	\$243.95	\$276.95

Long Handle Swivel Female...

...to rocker lug rigid female. For adapting male to female. Made from extruded lightweight aluminum alloy, hardcoated to resist corrosion and abrasion. *Ship. wt. 1-6 lbs.*



AC729 / Rigid Female

SF	1 1/2"	2"	2 1/2"	3"	4"	4 1/2"	5"	6"
2 1/2"	\$76.95	\$84.95	\$89.95	\$113.95	\$123.95	\$166.95	\$258.95	\$316.95
3"			\$115.95	\$117.95	\$199.95	\$215.95	\$260.95	\$295.95
4"			\$136.95	\$178.95	\$216.95	\$271.95	\$322.95	\$319.95
4 1/2"			\$168.95	\$215.95	\$253.95	\$240.95	\$332.95	\$332.95
5"			\$232.95	\$236.95	\$288.95	\$299.95	\$369.95	\$344.95
6"			\$373.95	\$394.95	\$334.95	\$389.95	\$241.95	\$380.95

Rocker Lug Swivel Female...

...to rocker lug rigid female. For adapting male to female. Made from extruded lightweight aluminum alloy, hardcoated to resist corrosion and abrasion. *Ship. wt. 1-6 lbs.*



AC730 / Rocker Lug Female Adapter

SF	1 1/2"	2"	2 1/2"	3"	4"	4 1/2"	5"	6"
1 1/2"	\$29.95	\$35.95	\$41.95					
2"	\$36.95	\$36.95	\$57.95					
2 1/2"	\$51.95	\$60.95	\$65.95	\$89.95	\$99.95	\$143.95	\$255.95	\$293.95
3"			\$91.95	\$83.95	\$175.95	\$191.95	\$237.95	\$272.95
4"			\$110.95	\$155.95	\$191.95	\$237.95	\$307.95	\$296.95
4 1/2"			\$165.95	\$191.95	\$208.95	\$216.95	\$308.95	\$310.95
5"			\$209.95	\$213.95	\$271.95	\$307.95	\$345.95	\$321.95
6"			\$346.95	\$371.95	\$310.95	\$364.95	\$337.95	\$355.95

Rigid Long Handle Female...

...to male adapter. For changing hydrant or suction hose threads or sizes. Made from lightweight aluminum alloy, hardcoated to resist corrosion and abrasion. *Ship. wt. 1-6 lbs.*



AC731 / Male

F	2 1/2"	3"	4"	4 1/2"	5"	6"
2 1/2"		\$75.95	\$126.95	\$138.95	\$209.95	\$255.95
3"	\$83.95	\$81.95	\$150.95	\$171.95	\$191.95	\$250.95
4"	\$126.95	\$152.95	\$143.95	\$175.95	\$189.95	\$238.95
4 1/2"	\$138.95	\$174.95	\$161.95	\$176.95	\$212.95	\$253.95
5"	\$180.95	\$180.95	\$174.95	\$202.95	\$242.95	\$285.95
6"	\$337.95	\$318.95	\$227.95	\$242.95	\$267.95	\$308.95

Long Handle Swivel Female...

...to male adapter. Made from extruded lightweight aluminum alloy, hardcoated to resist corrosion and abrasion. *Ship. wt. 1-6 lbs.*



AC732 / Male

F	2 1/2"	3"	4"	4 1/2"	5"	6"
2 1/2"	\$75.95	\$99.95	\$120.95	\$153.95	\$266.95	\$319.95
3"	\$101.95	\$93.95	\$187.95	\$202.95	\$250.95	\$297.95
4"	\$122.95	\$165.95	\$202.95	\$239.95	\$317.95	\$322.95
4 1/2"	\$176.95	\$202.95	\$281.95	\$227.95	\$318.95	\$375.95
5"	\$266.95	\$224.95	\$285.95	\$317.95	\$354.95	\$360.95
6"	\$355.95	\$385.95	\$320.95	\$373.95	\$358.95	\$386.95

NST shipped unless otherwise specified. Prices other than National Standard (NH or NST) or Iron Pipe (NPSH, IPT or SIPT) available on request.

Akron Brass – Product Innovator and Worldwide Leader

Black Max™ Piston Intake Valve



The Black Max™ Piston Intake Valve has been designed for harsh environments of today's fire service. It's superior materials and enlarged waterway allows you to maximize flows and efficiency. *Ship. wt. 32 lbs.*

10-year warranty



- ▶ **Improved Corrosion Resistance:** The combination of the stainless steel piston housing, poly-impregnated body and polymer piston maximizes product life
- ▶ **Field Serviceable:** A unique 2-piece design allows the piston intake valve to be field serviceable
- ▶ **Extended Durability:** Full 10-year warranty against manufacturing defects and corrosion
- ▶ **Full Flow:** 2000 gpm (7600 lpm) - Enlarged waterway for maximum flow efficiency
- ▶ **Low Friction Loss:** Only 7 psi @ 2000 gpm (.5 bar @ 7600 lpm)

AS126	4" Storz x 5" NSTFSW	\$1,642.95
AS127	4" Storz x 6" NSTFSW	\$1,642.95
AS128	5" Storz x 5" NSTFSW	\$1,642.95
AS129	5" Storz x 6" NSTFSW	\$1,642.95
AS130	6" Storz x 5" NSTFSW	\$2,025.95
AS131	6" Storz x 6" NSTFSW	\$2,025.95

Lightweight Leader Line Wye

Lightweight Leader Line Wye has a 2½" NST swivel female inlet x (2) 1½" NST male outlets. Used to divide (1) 2½" hose into (2) 1½" hose lines. Each 1½" outlet is independently controlled by high strength polymer handles. *Ship. wt. 5 lbs.*



Two 1½" independently controlled outlets



AF787 Lightweight Leader Line Wye \$411.95

Water Thief

The Water Thief is made of lightweight aluminum alloy. It is designed for laying, extending or adding 1½" or 2½" lines without interfering with the operation of other lines. Has self-locking valves for positive handle positioning. Available in 2½" NST swivel female inlet x (1) 2½" NST valved outlet and (2) 1½" NST male valved outlets. *Ship. wt. 14 lbs.*

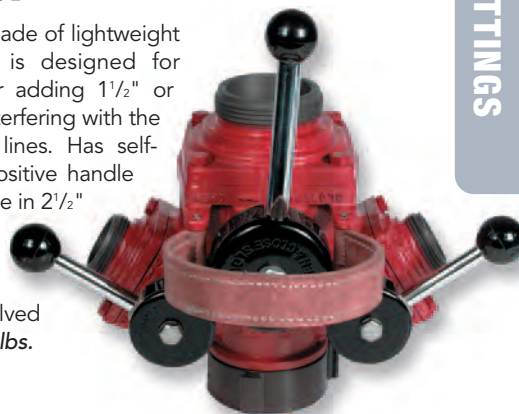

AF811 Water Thief \$1,378.95

Hydrant Wye

The Hydrant Wye is made of lightweight aluminum alloy and is used for laying two lines from a hydrant to a pumper or for branching a 2½" or larger supply line to two 2½" lines. Has self-locking valves for positive handle positioning. Available in sizes 2½" to 6" female inlet x (2) 2½" NST male swivel valves outlets. *Ship. wt. 17 lbs.*



AF78801	2½" F x (2) 2½" Male	\$1,366.95
AF78802	3" F x (2) 2½" Male	\$1,470.95
AF78804	4" F x (2) 2½" Male	\$1,649.95
AF78805	4½" F x (2) 2½" Male	\$1,652.95
AF78806	5" F x (2) 2½" Male	\$1,698.95
AF78807	6" F x (2) 2½" Male	\$1,820.95

Suction Siamese

Suction Siamese is made of lightweight aluminum alloy. Used to feed pumper suction or aerial platforms with one or two, 2½" or 3" hose lines. Has self-locking valves for positive handle positioning. Available in sizes 2½" to 6" female swivel x (2) 2½" NST swivel female valved inlets. *Ship. wt. 19 lbs.*



AF78901	(2) 2½" F x 2½" F	\$1,312.95
AF78902	(2) 2½" F x 3" F	\$1,428.95
AF78903	(2) 2½" F x 4" F	\$1,551.95
AF78904	(2) 2½" F x 4½" F	\$1,604.95
AF78905	(2) 2½" F x 5" F	\$1,904.95
AF78906	(2) 2½" F x 6" F	\$1,832.95

ADAPTERS & FITTINGS

Gated Brass Ball Valve



Female 2 1/2" rocker lug swivel inlet with (2) 1 1/2" male outlets. Operates easily under high pressure. Red body with chrome trim or polished brass. Rugged die-cast handles. NST threads. *Ship. wt. 10 lbs.*

- ▶ Two way
- ▶ Quarter turn
- ▶ Full flow



AR119 Gated Ball Valve, Polished Brass \$317.95

Lightweight Gated Valve

No more heavy brass valves to carry around. Our lightweight line wyes with aluminum construction cut the overall weight by more than 30% when compared to traditional brass valves. *Ship. wt. 8 lbs.*



BE257 2 1/2" NSTF Inlet x (2) 1 1/2" NSTM Outlet Valve \$214.95
 BE315 2 1/2" NSTF Inlet x (2) 2 1/2" NSTM Outlet Valve \$329.95

Forestry Wye

Male adapters are easily removed for adjustments of seats.

- ▶ 1 1/2" female inlet x two 1 1/2" male outlets
- ▶ *Ship. wt. 3 lbs.*



BK218 1" NSTF x (2) 1" NSTM Forestry Wye \$176.95
 BK219 1 1/2" NSTF x (2) 1 1/2" NSTM Forestry Wye \$176.95
 BK220 1 1/2" NSTF x (2) 1" NSTM Forestry Wye \$176.95

2 1/2" Gated Wye

TFT's 2 1/2" Gated Wye is designed for the rugged fire ground environment, yet is the lightest most flow efficient ever created.

- ▶ Lightweight, only 10 lbs.
- ▶ Less than 10 psi loss at 1000 gpm
- ▶ Exclusive color-coded folding handles store out of the way even in the tightest compartments
- ▶ The ONLY valve to offer an automatic valve lock even up to 250 psi operating pressure



BG525 2 1/2" F Inlet x (2) 2 1/2" M Outlet Gated Wye \$1,068.95

Gated Wye



2 1/2" female swivel inlet x (2) 1 1/2" male outlets. Quarter-turn aluminum ball valves provide a positive shutoff. Full flow 1 1/2" ball waterway. *Ship. wt. 5 lbs.*



BL399 Gated Wye 2 1/2" NH x 1 1/2" NH Outlets \$418.95

Hi Rise Wye

2 1/2" female swivel inlet x (2) 1 1/2" male outlets. This wye is intended for use in high rise packs. One branch of the wye connects to the hose in the pack. The other branch has a quarter-turn aluminum ball valve for positive shutoff. Super tough folding nylon handles. 2 1/2" NH female rocker lug swivel inlet coupling is standard. *Ship. wt. 5 lbs.*



BL400 Hi Rise Wye 2 1/2" NH Inlet \$418.95

Water Thief



TFT's 2 1/2" x 1 1/2" Water Thief is a lightweight valve with full 2 1/2" and 1 1/2" waterways. 300 psi (20 bar) operating pressure from either side of the valves. Field replaceable valve seats. Quarter turn valve handles with low force to move even under pressure. Automatic valve lock on 2 1/2" valve keep it's position while flowing at partial openings. *Ship. wt. 10 lbs.*

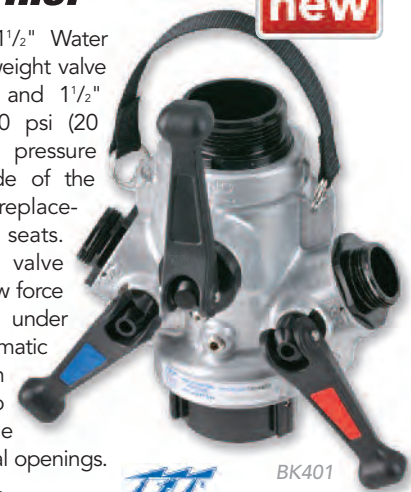

BK401

BL401 Water Thief 2 1/2" x 2 1/2" \$1,318.95
 BL402 Water Thief 2 1/2" x 2 1/2" Long Handle \$1,318.95

Gate Valve

Our new gate valve is constructed of lightweight Pyrolite® with a heavy-duty wedge gate design, a non-rising stem and a handwheel for easy operation at standard pressures. The handwheel can also be utilized as a carrying handle for easy transport of the valve. The unique design of the Gate Valve provides minimal friction loss and meets the NFPA slow close requirements. *Ship. wt. 9 lbs.*



AW161	3" NHF x 3 1/2" NHM	\$956.95
AW163	4" NHF x 4" NHM	\$956.95
AW164	4 1/2" NHF x 5" Storz	\$1,045.95
AW165	4 1/2" NHF x 4" Storz	\$1,045.95

2.5" Hydrant Gate Valve

- ▶ High-strength, heat-treated, hard-anodized aluminum body
- ▶ Inlet swivel machined from 6061-T6 seamless aluminum extrusion hardcoat anodized to MIL-A-8625 Type III, Class 1
- ▶ Features a non-rising bronze stem with bronze gland, gate, nipple and seat
- ▶ Heavy-duty wedge w/crank handle
- ▶ Excellent shutoff to control water hammer
- ▶ Less than 9 turns required to open or close



Red Head
Brass, LLC



Open Pressurized Gates Slowly

BG264	2.5" Hydrant Gate Valve	\$296.95
-------	-------------------------	----------

Hydrant Flushing Elbow

Diverts the water force away from traffic or landscaping during periodic hydrant flushing. Available in 2 1/2", 4" or 4 1/2" female swivel connection. Brass connection with aluminum elbow. *Ship wt. 5 lbs.*



Y807	Hydrant Flushing Elbow, 2 1/2" Thread	\$117.95
Y808	Hydrant Flushing Elbow, 4" Thread	\$249.95
U827	Hydrant Flushing Elbow, 4 1/2" NST	\$254.95

Hydrant Gate Valve

new

Lightweight non-rising stem gate valve 2 1/2" NH female swivel x 2 1/2" NH male is excellent for hydrant and other hose line/water control. There is a spinning knob on hand wheel for easy open/close, with a built in slow close safety operation. The gate, spindle, female swivel, male threads, and the body inside and out are all anodized for maximum corrosion resistance. This valve has low friction loss and is maintenance free. The gate valve has a working pressure of 250 psi.



- ▶ Weight: 4.5 lbs.
- ▶ 6" L x 5" W x H

BL337	2 1/2" Hydrant Gate Valve	\$192.95
-------	---------------------------	----------

Hydrant Diffuser

Lightweight and easy to handle. 2" PVC body with ABS nut. 45° discharge will swivel 360°. *Thousands sold, 100% factory guarantee. Ship wt. 1 lb.*



45° DISCHARGE / 360° SWIVEL		
AW157	Hydrant Diffuser	\$43.95

Hydrant Valve

- ▶ Lightweight alloy
- ▶ 2 1/2" full flow waterway
- ▶ Adapter easily removed for seat adjustment
- ▶ 2 1/2" female inlet x 2 1/2" male outlet
- ▶ Self-locking handle for positive positioning
- ▶ *Ship. wt. 8 lbs.*



BK221	2 1/2" Hydrant Valve	\$279.95
-------	----------------------	----------

Multi-Use Adapter

The latest multi-use adapter. Perfect for hazmat decontamination. Other uses include forestry units, portable water, a portable drinking water. You will also find it useful for vehicle wash down. *Available in 1 1/2" or 2 1/2" NST. Ship. wt. 3 lbs.*



AJ09901	Hazmat Adapter 1 1/2" F x (2) GHT M	\$27.95
AJ09902	Hazmat Adapter 2 1/2" F x (2) GHT M	\$45.95

Storz Adapters 2 1/2" through 6"

Locking Storz On All Adapters To Meet NFPA

Storz to Long Handle Swivel Female

Storz to long handle swivel female adapter. Made of 6061-T6 aluminum alloy, then hardcoated to reduce corrosion and abrasion. *Ship. wt. 3 lbs.*



AG733 / Female

S	2 1/2"	3"	3 1/2"	4"	4 1/2"	5"	6"
4"	\$167.95	\$196.95	\$196.95	\$187.95	\$200.95	\$213.95	\$231.95
5"	\$205.95	\$216.95	\$216.95	\$226.95	\$231.95	\$239.95	\$258.95

Storz to Rigid Male

Storz to rigid male adapter. 6061-T6 lightweight aluminum alloy, hardcoated for protection against corrosion and abrasion. *Ship. wt. 3 lbs.*



AG737 / Male

S	2 1/2"	3"	3 1/2"	4"	4 1/2"	5"	6"
4"	\$113.95	\$108.95	\$116.95	\$133.95	\$124.95	\$146.95	\$150.95
5"	\$138.95	\$132.95	\$158.95	\$158.95	\$144.95	\$172.95	\$179.95

Storz to Rigid Female

Storz to rigid female adapter. 6061-T6 aluminum alloy, hardcoated to reduce corrosion and abrasion. *Ship. wt. 3 lbs.*



AG735 / Female

S	2 1/2"	3"	3 1/2"	4"	4 1/2"	5"	6"
4"	\$114.95	\$114.95	\$120.95	\$129.95	\$129.95	\$133.95	\$171.95
5"	\$128.95	\$132.95	\$149.95	\$149.95	\$159.95	\$180.95	\$203.95

Storz to Swivel Female

Storz to rocker lug swivel female adapter. 6061-T6 aluminum alloy, hardcoated for protection against corrosion and abrasion. *Ship. wt. 3 lbs.*



AG734 / Female

S	2 1/2"	3"	3 1/2"	4"	4 1/2"	5"	6"
4"	\$129.95	\$165.95	\$165.95	\$186.95	\$186.95	\$187.95	\$236.95
5"	\$158.95	\$178.95	\$178.95	\$194.95	\$199.95	\$204.95	\$252.95

Storz to Swivel Female Elbow

Storz to female swivel 30° elbow, long handles. Storz head made of 6061-T6 aluminum alloy, elbow made from tough, lightweight AL-MAG 35. Hardcoat anodized to resist abrasion and corrosion. *Ship. wt. 3 lbs.*



AG732 / Female

S	2 1/2"	3"	3 1/2"	4"	4 1/2"	5"	6"
4"	\$169.95	\$229.95	\$237.95	\$228.95	\$245.95	\$309.95	\$313.95
5"	\$186.95	\$254.95	\$254.95	\$298.95	\$266.95	\$310.95	\$332.95

Storz to Swivel Female 30° Elbow

Storz to female swivel 30° elbow, rocker lug. Storz heads made of 6061-T6 aluminum alloy, elbow made from tough, lightweight AL-MAG 35. Hardcoat anodized to resist abrasion and corrosion. *Ship. wt. 3 lbs.*



AG731 / Female

S	2 1/2"	3"	3 1/2"	4"	4 1/2"	5"	6"
4"	\$169.95	\$229.95	\$236.95	\$229.95	\$236.95	\$283.95	\$309.95
5"	\$186.95	\$256.95	\$256.95	\$285.95	\$234.95	\$265.95	\$359.95

Storz to Storz Adapters

Storz to Storz adapters allow you to connect Storz couplings of different sizes. They are particularly useful in mutual aid evolutions. This adapter can be used in combinations from 1-inch Storz to 6-inch Storz. For use on 4" or 5" hose. *Ship. wt. 3 lbs.*



AJ100	5" Storz x 4" Rigid Storz	\$215.95
AJ101	5" Storz x 4" Swivel Storz	\$328.95
AW068	6" Storz x 4" Storz	\$186.95
AW069	6" Storz x 5" Storz	\$196.95

Storz Blind Caps

Storz blind cap is made of aluminum alloy, hard-coated for resistance to abrasion and corrosion. Comes with standard 18" stainless steel cable. Suction gasket comes standard. *Ship. wt. 3 lbs.*



AG73625	Storz 2 1/2" Blind Cap	\$20.95
AG73630	Storz 3" Blind Cap	\$41.95
AG73640	Storz 4" Blind Cap	\$44.95
AG73650	Storz 5" Blind Cap	\$65.95
AG73660	Storz 6" Blind Cap	\$118.95

Gate Valve With 25° Elbow

Lightweight aluminum alloy design includes non-rising stem, elbow, relief valve, air bleeder and 4" through 6" female swivel. For use on pumper intake. *Ship. wt. 29 lbs.*



Locking Storz

AR122	4" Storz to 4" NST Female Swivel	\$713.95
AR123	4" Storz to 4½" NST Female Swivel	\$713.95
AR124	4" Storz to 5" NST Female Swivel	\$713.95
AR125	4" Storz to 6" NST Female Swivel	\$731.95
AR126	4" Storz to 4" Storz Female Swivel	\$731.95
AR127	5" Storz to 4" NST Female Swivel	\$731.95
AR128	5" Storz to 4½" NST Female Swivel	\$731.95
AR129	5" Storz to 5" NST Female Swivel	\$731.95
AR130	5" Storz to 6" NST Female Swivel	\$731.95
AR131	5" Storz to 5" Storz Female Swivel	\$731.95

Gate Valve

A lightweight, compact, non-rising stem gate valve with air bleed off and 4" through 6". For use on the hydrant steamer connection. *Ship. wt. 24 lbs.*



Locking Storz

AR132	4" Storz to 4" NST Female Swivel	\$573.95
AR133	4" Storz to 4½" NST Female Swivel	\$573.95
AR134	4" Storz to 5" NST Female Swivel	\$573.95
AR135	4" Storz to 6" NST Female Swivel	\$573.95
AR136	4" Storz to 4" Storz Swivel	\$573.95
AR137	5" Storz to 4" NST Female Swivel	\$589.95
AR138	5" Storz to 4½" NST Female Swivel	\$589.95
AR139	5" Storz to 5" NST Female Swivel	\$589.95
AR140	5" Storz to 6" NST Female Swivel	\$589.95
AR141	5" Storz to 5" Storz Swivel	\$666.95

Ball Intake Relief Valve

The Ball Intake Relief Valve has straight waterways for less friction loss. A shorter, more compact body for better running board clearance. The intake relief valve is anodized for corrosion resistance, and has a time tested relief valve with field adjustable pressure ratings. *Ship. wt. 32 lbs.*



AW085	4" Storz x 5" NH Ball Intake Relief Valve	\$1,113.95
AW086	4" Storz x 6" NH Ball Intake Relief Valve	\$1,113.95
AW087	5" Storz x 5" NH Ball Intake Relief Valve	\$1,184.95
AW088	5" Storz x 6" NH Ball Intake Relief Valve	\$1,184.95

Aluminum Piston Intake Relief Valve

new lower price

We designed this truck inlet valve to incorporate quick-connection, fast but controlled opening, with air bleeder and relief valve. 45° inlet provides smooth water flow for reduced friction loss. A special aluminum alloy results in greater corrosion resistance. *Ship. wt. 25 lbs.*



AS132	4" Storz x 4½" NST F SW	\$879.95
AS133	4" Storz x 5" NST F SW	\$879.95
AS134	4" Storz x 6" NST F SW	\$879.95
AS135	5" Storz x 4½" NST F SW	\$839.95
AS136	5" Storz x 5" NST F SW	\$839.95
AS137	5" Storz x 6" NST F SW	\$839.95

Stainless Steel Piston Intake Relief Valve

Stainless Steel Piston Intake Relief Valve was designed to incorporate quick-connection, fast but controlled opening, with air bleeder and relief valve. 45° inlet provides smooth water flow for reduced friction loss. This valve is covered by a 10-year warranty against failure due to corrosion. *Ship. wt. 27 lbs.*



AW070	4" Inlet Storz x 4½" NH F Outlet	\$1,177.95
AW071	4" Inlet Storz x 5" NH F Outlet	\$1,177.95
AW072	4" Inlet Storz x 6" NH F Outlet	\$1,177.95
AW073	5" Inlet Storz x 4½" NH F Outlet	\$995.95
AW074	5" Inlet Storz x 5" NH F Outlet	\$995.95
AW075	5" Inlet Storz x 6" NH F Outlet	\$995.95

Maximize Your Water Flow with LDH Appliances



3-Way Ball Valve

Designed to distribute water to three small diameter lines from a large diameter line, or supply a large diameter line from smaller supply lines. 3-way ball valve features an adjustable pressure relief valve to reduce water hammer. Ball valve body is made of lightweight, high-strength aluminum with powder coat finish. Ball assembly is hard-coat anodized aluminum. Large waterways help minimize pressure loss. *Ship. wt. 21 lbs.*

- ▶ Locking storz
- ▶ 3-way ball valve
- ▶ 12¹/₄"Lx16"Wx11"H

AS142	4" S x (3) 2 ¹ / ₂ " NSTM	\$963.95
AS143	4" S x (3) 2 ¹ / ₂ " NSTF	\$847.95
AS144	5" S x (3) 2 ¹ / ₂ " NSTM	\$973.95
AS145	5" S x (3) 2 ¹ / ₂ " NSTF	\$973.95



2-Way Ball Valve

Designed to distribute water to two small diameter lines from a large diameter line, or supply a large diameter line from smaller supply lines. Ball valve body is made of lightweight, high-strength aluminum with red powder coat finish. Ball assembly is hard-coat anodized aluminum. Large waterways help minimize pressure loss. *Ship. wt. 12 lbs.*

- ▶ Locking storz
- ▶ 2-way ball valve
- ▶ 10"Lx9"Wx8"H

AS146	4" S x (2) 2 ¹ / ₂ " NSTM	\$384.95
AS147	4" S x (2) 2 ¹ / ₂ " NSTF	\$425.95
AS148	5" S x (2) 2 ¹ / ₂ " NSTM	\$417.95
AS149	5" S x (2) 2 ¹ / ₂ " NSTF	\$425.95



3-Way Manifold

This lightweight, compact unit is a simple, economical way to feed multiple small lines with one large line, and continue with a large line. All outlets are valved. Relief valve and pressure gauge are standard. *Ship. wt. 42 lbs.*

- ▶ 17¹/₂"Lx21¹/₂"Wx13"H

BC006	4" Storz Inlet x 4" Storz Outlet x (2) 2 ¹ / ₂ " NH M	\$1,289.95
BC007	5" Storz Inlet x 5" Storz Outlet x (2) 2 ¹ / ₂ " NH M	\$1,305.95



Supply Multiple Attack Lines Manifold

Sizes come with 4" or 5" Storz connection on both. Large gated intake and discharge plus (4) 2¹/₂" gated discharges. Portable manifold is designed to take advantage of the increased flow capabilities of large diameter hose. Can supply multiple attack lines without a pumper. Brings your hydrant to the fire scene. Fabricated from lightweight, high-strength aluminum alloy and is hard coat anodized. Provided with large full flow waterways, relief valve and a glycerine filled pressure gauge to indicate residual pressure. *Ship. wt. 51 lbs.*

- ▶ Locking storz
- ▶ 5-Way manifold
- ▶ 16"Lx21"Wx13"H

AR142	4" Storz Intake to (4) 2 ¹ / ₂ " NST Male Outlets and (1) 4" Storz Gated Outlet	\$1,351.95
AR143	5" Storz Intake to (4) 2 ¹ / ₂ " NST Male Outlets and (1) 5" Storz Gated Outlet	\$1,351.95

3-Way Siamese

Aluminum construction with large waterways. 2½" NST female swivel inlets. Convenient carrying handle. *Ship. wt. 18 lbs.*



AW078	3-Way Siamese 4" S x (3) 2½" NH Inlet	\$593.95
AW079	3-Way Siamese 5" S x (3) 2½" NH Inlet	\$593.95

LDH Hydrant Valve

This unique valve permits the first-in pumper to lay the large diameter line directly from hydrant to fire and start pumping water. If more pressure is required to boost the pressure at the hydrant to take full advantage of available water, another pumper can connect to the hydrant valve and start pumping with no interruption in flow. A third position provides emergency shut-down capability. Extension 13", 17¾"Wx13"H. *Ship. wt. 27 lbs.*



AS150	LDH Hydrant Valve 4" S x 4" NST	\$1,297.95
AS151	LDH Hydrant Valve 4" S x 4½" NST	\$1,314.95
AS152	LDH Hydrant Valve 5" S x 4" NST	\$1,312.95
AS153	LDH Hydrant Valve 5" S x 4½" NST	\$1,312.95

Jumbo Short Ball Intake Valve

- ▶ Suited for high performance water flow with large waterways and limited loss at flows up to 3,000 gpm
- ▶ Unique polymer ring coupling design, stainless half ball design and other internal stainless components, hard anodized and powder coated finish prevent unwanted corrosion
- ▶ Multiple control configurations
- ▶ Swiveling inlet to prevent kinking of supply line
- ▶ Remains dry when in the shut position



BL043	4" Rigid Storz Jumbo Short Ball Intake Valve	\$1,926.95
BL044	5" Rigid Storz Jumbo Short Ball Intake Valve	\$2,019.95
BL045	6" Rigid Storz Jumbo Short Ball Intake Valve	\$2,019.95

Super Flow Large Ball Valve

Designed specifically for feeding to or from large diameter hoses. This valve has full flow 4½" waterways. Each outlet is provided with a ball gate valve to permit easy shutoff of the water flow. The valve has an adjustable relief valve to reduce effects of water hammer. The large gated wye eliminates the need to lay multiple lines. Particularly useful in supplying multiple apparatus with large diameter hose. *Ship. wt. 56 lbs.*

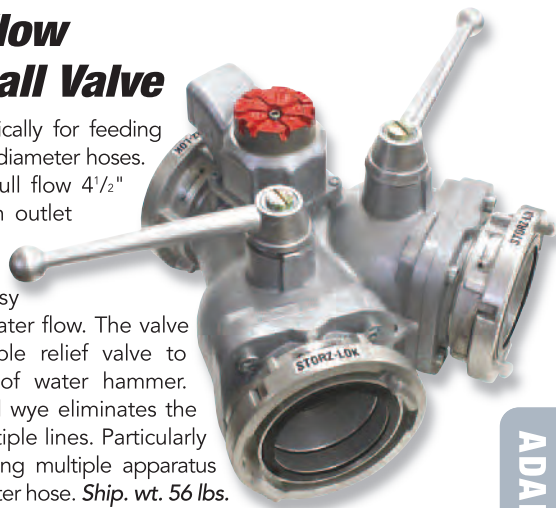

▶ Locking storz

AR120	Super Flow Ball Valve, 4" Storz to (2) 4" Storz	\$2,033.95
AR121	Super Flow Ball Valve, 5" Storz to (2) 5" Storz	\$1,932.95

Siamese 2-Way Clappered

The Siamese 2-way clappered is made primarily of aluminum alloy that has been heat treated. The Siamese's other major components are made of stainless steel and galvanized brass. This lightweight and smaller design minimizes the friction loss by up to three times. *Ship. wt. 8 lbs.*



AW080	(2) 2½" F Inlet x 2½" M Outlet	\$300.95
AW081	(2) 2½" F Inlet x 4" M Outlet	\$406.95
AW083	(2) 2½" F Inlet x 4" Storz Outlet	\$349.95
AW084	(2) 4" Storz x 4" Storz Outlet	\$937.95

2-Way Siamese

These reliable clappered Siamese valves are used for feeding one large line with multiple smaller lines. Clapper valve allows for single line usage as well. Powder-coat aluminum finish with carrying handle. Other sizes also available. Length 10½"Lx10"Wx 5"H. *Ship. wt. 8 lbs.*

▶ Single clapper

AS138	2-Way Siamese 4" Storz x (2) 2½" NST F SW	\$240.95
AS139	2-Way Siamese 4" Storz x (2) 2½" NST M	\$240.95
AS140	2-Way Siamese 5" Storz x (2) 2½" NST F SW	\$264.95
AS141	2-Way Siamese 5" Storz x (2) 2½" NST M	\$264.95

Be Prepared For Any Situation With The Right Tool From Darley

RESCUE TOOLS



Metal Cutting Claw

PARATECH

best seller



A

PARATECH



B



Metal Cutting Claw

PARATECH



C

PARATECH



D

A. Hooligan Tool

These heavy-duty tools were designed to pound, puncture, pry, twist, and cut most obstacles you may encounter. Features your choice of standard or metal cutting claw, machine-grooved non-slip grips. Duckbill has long, smooth incline to force windows and interiors doors. Pike is long, sharp, tapered and gently curved to fit a lock or latch. Electroless Nickel finish. **Ship. wt. 13 lbs.**

STANDARD CLAW

R631	30" Hooligan Tool	\$181.95
T982	36" Hooligan Tool	\$190.95
T983	42" Hooligan Tool	\$200.95
AF350	Mounting Bracket	\$56.95

METAL CUTTING CLAW

AK176	30" Hooligan Tool	\$181.95
AK177	36" Hooligan Tool	\$190.95
AK178	42" Hooligan Tool	\$215.95
AF350	Mounting Bracket	\$56.95

B. Lightweight Aluminum Hooligan Tool

Standard Claw with Electroless Nickel Finish

The Paratech Hooligan Tool has set the standard of excellence for Halligan Tools. Now available with a machined alloy shaft for lighter weight, these heavy-duty tools were designed to pry, pound, puncture, twist, and cut open or remove all types of barriers between emergency service and saving lives. **Ship. wt. 8 lbs.**

- ▶ Doubles as a nail puller and gas shut off tool
- ▶ Parallel claw opening fits over hooks, hasps and many door bars
- ▶ Gently curved claw maximizes prying leverage

AZ391	24" Lightweight Aluminum Hooligan Tool	\$186.95
AZ392	30" Lightweight Aluminum Hooligan Tool	\$196.95

C. Multi-Purpose Pry Axe®

The Pry Axe® has been the best-selling tool for over 30 years and is used by departments worldwide. It's a lightweight, multi-purpose, slam and ram tool designed to pry, twist, chop, cut metal, twist off locks or latches and much more. This efficient tool allows forcible entry by a single person when time is critical. Pry Axe® head and claw assemblies are separate sections forged from high-alloy steel and heat treated for maximum strength. Solid steel shaft extends the axe to 28" and rubber sleeve provides a sure grip. **Ship. wt. 8 lbs.**

- ▶ Pike
- ▶ Recessed blade
- ▶ Axe blade
- ▶ Molded grip
- ▶ Spanner wrench
- ▶ Extended shaft
- ▶ Claw shaft
- ▶ Shaft release
- ▶ Standard claw with gas shutoff
- ▶ Metal cutting claw

Z117	Pry Axe® with Metal Cutting Claw (15" Closed, 28" Open)	\$266.95
Z118	Pry Axe® with Standard Claw (15" Closed, 19" Open)	\$266.95
Z119	Pry Axe® with Both Claws	\$355.95
Z123	Sheath for Pry Axe®	\$39.95
AF350	Mounting Bracket	\$56.95

D. The Biel Tool

The new Biel Tool is now one piece made out of heat treated, electro-polished stainless steel with an extremely durable ergonomically rubber molded handle. The new Biel Tool incorporates many of the features found in the world famous Pry Axe®, but is much smaller and light enough to wear on a belt or carry in the pocket of a bunker coat. This is a perfect personal size multi-purpose forcible entry and rescue tool; designed for forcing door and windows, prying and twisting hasps and locks, light overhauling, nail removal, gas shutoff, metal cutting and chopping. **Ship. wt. 4 lbs.**

W509	Biel Tool	\$165.95
W509A	Sheath	\$34.95

A. Quic-Bar® Forcible Entry Tool

The one-piece forged construction gives you maximum strength and power when you need it. The tapered pike is ideal for forcing padlocks or driving into material to facilitate prying. Greater width and curvature on the wedge and draw ends provide powerful leverage for prying operations. Pry and wedge ends are narrower than other tools on the market for faster, easier penetration. *Ship. wt. 10 lbs.*

M742	30" Single-Piece Forged Quic-Bar® with rings	\$183.95
BD082	24" 3-Piece Forged Quic-Bar	\$185.95

Mounting Brackets

M743	Mounting Bracket for Tools 30" or Larger	\$45.95
AJ458	Mounting Bracket for Tools 12" to 20"	\$48.95

B. Zak Entry Tool

Exceeds the capabilities of similar tools with a federally approved hammerhead design. Made of lightweight, heat-treated aircraft stainless steel. The tubular steel handle reduces the overall weight while enhancing leverage, control and balance. *Full lifetime guarantee. Ship. wt. 3 lbs.*

SPECIFY COLOR: Red, Yellow or Black

AR330	30" Entry Tool Kit	\$214.95
AR331	36" Entry Tool Kit	\$221.95
AR332	42" Entry Tool Kit	\$238.95

C. 30" Pro Bar

A Halligan-type forcible entry tool. One-piece construction of aircraft alloy steel, drop forged. The fork, adz and point are designed with the correct lengths, widths and tapers to enable easy penetration and maximum leverage. Length: 30". *Ship. wt. 10 lbs.*

SPECIFY FINISH: Black or Silver

Z150	30" Pro-Bar	\$228.95
------	-------------	----------

D. Roof Hook

The Akron Roof Hook is designed to perform reliably through the toughest use and abuse seen in today's firefighting industry. It is designed with the highest grade materials for a long lasting, durable, and maintenance-free tool. Hollow steel shaft & powder-coated finish for unparalleled corrosion resistance. *5-year warranty.*



BG537	17" Roof Hook with Ram Knob Foot For Gas Shutoff	\$56.95
BG539	36" Roof Hook	\$80.95
BG540	48" Roof Hook	\$89.95
BK037	60" Roof Hook	\$95.95
BG541	72" Roof Hook	\$109.95
BG542	96" Roof Hook	\$119.95

E. Griff Hook

A unique tool for officers, nozzles and roof men. The chisel end is used as a prying tool for cuttle hatches and roof doors. Features all-purpose head, aircraft steel shaft, Celtex grip, 2 welded rings and heavy-duty carrying sling.

AR174	36" Griff Hook	\$95.95
-------	----------------	---------

F. 6' All Purpose Hook

The most versatile hook used in the fire service today. Multitude of uses, such as opening ceilings, walls, floors, moldings and casings to the rapid removal of wood, lath and plaster, tin and sheet metal, plasterboard, fiberboard and sheetrock. Features specially tapered hook-head point, two workable ends, super strength fiberglass pole, stainless steel wear sleeve, choice of knob end, electrically non-conductive, and Celtex grips.

BL019	6' All Purpose Hook	\$84.95
-------	---------------------	---------



M743



A



B



C



D



E



F

new lower price

RESCUE TOOLS

new



Illuminating Grip Wrap

Provides at-a-glance identification with day-glow colors that illuminate in the darkness. Each roll is approximate 55" which is enough for the center of a large halligan, 6' New York hook or two axe handles. Unique surface clings to itself and allows grip on wet or dry tools with or without gloves.

- ▶ Heavy duty, made of industrial grade reinforced silicone
- ▶ May be secured in place by wrapping duct tape, electrical tape, zip tie etc on end to keep it from unraveling
- ▶ Does not have adhesive so it can be re-used
- ▶ Illuminates up to 17 hours when fully charged
- ▶ Can be charged by any light source (sun, artificial light, low light)

SPECIFY COLOR: Orange, Neutral/Blue, Neutral/Green, Yellow/Green

BL225 Illuminating Grip Wrap \$44.95



Hi-Viz Lime Flat Axe

Hi-Viz 36" Flat Axe

- ▶ Made in the USA
- ▶ Rugged and perfect for ventilation, forcible entry or overhaul
- ▶ Handle construction is solid Hi-Viz pultruded fiberglass with non-slip grip
- ▶ Yellow handle construction is a strong pultruded fiberglass core with an injection molded jacket for added strength
- ▶ Axe heads are bonded to the fiberglass handle with strong two part epoxy
- ▶ Axe heads are drop forged with high carbon steel

SPECIFY HANDLE COLOR: Hi-Viz Orange with Reflective Tape, Hi-Viz Lime with Reflective Tape, or Yellow

BK382	6 lb. 36" Flat Axe	\$45.95
BK383	8 lb. 36" Flat Axe	\$105.95
BK384	6 lb. 36" Pick Axe	\$51.95
BK385	8 lb. 36" Pick Axe	\$105.95



Yellow Pick Axe

FireAxe

Finally. A FireAxe That Says "Goodbye" to the Old Wood Cutter's Blade.

- ▶ Designed for work on the fire ground
- ▶ More efficient, less weight
- ▶ Fiberglass handle features solid core construction
- ▶ Shaped to cut from the top half of the axe blade
- ▶ Heat-treated for strength and durability
- ▶ Contoured for weight distribution and halligan tool (*halligan tool not included*)
- ▶ Does more work than an 8 lb. axe head
- ▶ 36" contoured axe handle
- ▶ Patent pending



Contoured axe head holds claw of halligan tool

PARATECH

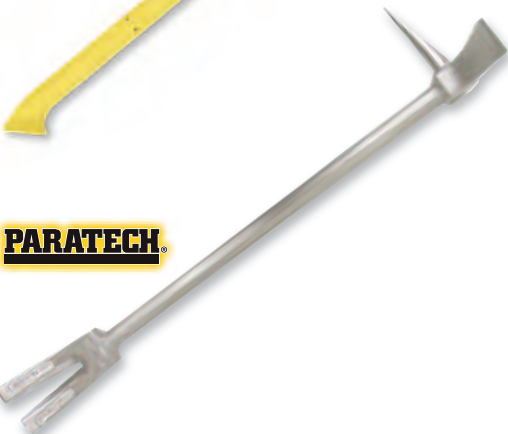

BG300 36" FireAxe \$174.95

PARATECH

Hooligan SPF Tool

The Hooligan SPF is a single piece forged (SPF) tool intended to exceed FDNY specifications for primary hand held forcible entry tools. It is made from a single piece, closed die forging for absolute consistent lengths. *Ship. wt. 10 lbs.*

- ▶ Recessed nail puller type claw, a thin curved profile
- ▶ Cable groove at rear end of tool head
- ▶ Electroless nickel plating

AZ393 30" Hooligan SPF Tool \$220.95

A. Truckman® Battle Axe

This truly unique, innovative hand tool can be used for ventilation, forcible entry, confined space, extractions and much more. Axe head is made of drop forged, hi-carbon, heat-treated, polished steel. It's lightweight (less than 3 lbs.) with a center balance that gives you a solid feel with less stress. Carrying pocket is made of F.R. Cotton scabbard with 1½" Kevlar® belting. Quick-release buckle opens the carrying pocket for instant access. *Ship. wt. 7 lbs.*

AJ508	Truckman® Battle Axe, Fiberglass Handle	\$95.95
AJ509	Truckman® Battle Axe, Hickory Handle	\$112.95

B. Iron Sling

- ▶ Designed to carry an axe and halligan tool
- ▶ Adjustable shoulder strap to fit all firefighters
- ▶ Quick-release buckle allows easy removal with gloves on
- ▶ Color-coded reflective strap for low visibility conditions
- ▶ Perfectly balanced so you can carry both tools hands-free

BB064	Iron Sling	\$30.95
-------	------------	---------

C. Personal Fire Axe

The personal safety tool for every firefighter. The fire axe is easy-to-carry and easily accessible. A fast-working fire tool in tight spots, where the precision-balanced 1.5 lb. pick-head axe, and 14" curved hickory-handle permits easy swinging. Pick-head axe features two heads; standard for cutting and a heavy-duty pick for forcible entry. *Ship wt. 2 lbs.*

BB162	Personal Fire Axe	\$47.95
-------	-------------------	---------

D. Darley Standard & Serrated Crash Axes

Insulated steel handle to 20,000v. 15" long. *Ship. wt. 3 lbs.*

J728	Serrated Crash Axe	\$100.95
J729	Standard Crash Axe	\$95.95
J72801	Leather Sheath	\$26.95

E. Leather Axe Sheath

Made from top-grain, tanned cowhide, sewn and riveted for strength. Features heavy-duty double belt clips. Fits 6 lb. pick head axe. *Ship. wt. 1 lb.*

AF425	Leather Axe Sheath	\$31.95
-------	--------------------	---------

Bronze Axes

AF531:

- ▶ Ribbons personalized with 1 line of type per ribbon
- ▶ Max 12 characters per ribbon

AS688 and AS683:

- ▶ Inlaid brass plate included with 3 lines of personalized type
- ▶ Max 21 characters per line

Ship. wt. 9 lbs.

AF531	36" Maltese Cross with Ribbons	\$325.95
AS688	36" Maltese Cross	\$325.95
AS683	36" Chief Axe	\$325.95



Fiberglass handle

Hickory handle



B

C

D

E



A. Pick and Flat Head Fire Axes

Twice As Hard As Regular Axes

The pick head axe is far superior to any other axe on the market. The axe head is made from high-grade tool steel, then heat-treated, making the entire head twice as hard as a regular axe. This axe will cut through 16 penny nails and stay razor sharp. The head of the axe has a mirror polish (not chrome) allowing for quick, easy cleaning. It has a 5" pick (twice as long as all others) and built-in guard to protect the handle. Handles come in 28", 32", and 36" in either wood (hickory) or fiberglass. All fiberglass handles are made by NUPLA Corp. and are designed to be shaped as close to wood as possible. Handles are rated at 1,200 lbs. *Made in the U.S.A.*

SPECIFY HANDLE: Fiberglass or hickory. SPECIFY HANDLE SIZE: 28", 32", or 36"		
BG138	6 lb. Pick Head Axe	\$179.95
BG139	8 lb. Flat Head Axe	\$189.95

B. Buster Tool



- ▶ Designed for rugged use day after day
- ▶ Features an axe blade for cutting and busting
- ▶ Specially designed "H" section pike for penetration
- ▶ Ergonomically shaped, molded neoprene rubber handle w/grip-enhancing surface
- ▶ Positive grip prying claw with nail pulling feature and claw locking lever for 2-position claw placement
- ▶ "Slam & Ram" capability for quick and decisive entry
- ▶ Alloy 17-4 PH hardened stainless steel

Cat#	Description	Length	Weight	Price
BD038	Buster Tool with Compact Claw	21 1/2"	5.3 lbs.	\$299.95
BD039	Buster Tool with Standard Claw	23 1/4"	5.7 lbs.	\$299.95
BH173	Buster Tool with Metal Cutting Claw	23 1/4"	5.7 lbs.	\$299.95

C. Shoring Hammer



More Than Just A Hammer

Here is an essential tool for your rescue operations. The new Shoring hammer from Paratech is simple, unique and multi-functional. The shoring Hammer head is square for easier corner access and has a spanner wrench designed in. With three options for nail pulling and two open slots for gas shut-off valves, for 3/16" open-ended wrench on the claw end, the Shoring Hammer is perfect for a variety of rescue situations. Positive grip ridges are on both sides of the handle. The Paratech Shoring Hammer is cast from high-alloy steel with an electroless nickel plate finish and weighs 3 lbs.

BD042	Shoring Hammer	\$101.95
-------	----------------	----------

D. Firemaxx Tool

14 Tools in One

- | | | |
|------------------|----------------------|----------------------------|
| ▶ Axe | ▶ Battery disconnect | ▶ Hinge remover |
| ▶ Hammer | ▶ Windshield cutter | ▶ Pry bar |
| ▶ Spanner wrench | ▶ Rappelling ring | ▶ Storz latch opener |
| ▶ Gas shut-off | ▶ Dry wall cutter | ▶ Hood remover |
| ▶ Water shut-off | ▶ Forcible entry | ▶ Ship. wt. 10 lbs. |

BB099	Firemaxx Tool	\$139.95
-------	---------------	----------

E. 16" Officer's Tool Kits

All-steel construction, welded and forged. The two 16" Officer's Tool Kits below include a Kerry key, Shove knife, Holder and Non-Slip Celtex grip. *Ship. wt. 6 lbs.*

- | | | | |
|-------------|---------------|----------|------------------------|
| ▶ Kerry key | ▶ Shove knife | ▶ Holder | ▶ Non-slip Celtex grip |
|-------------|---------------|----------|------------------------|

AC597	Officer's Tool Kit	\$75.95
AC598	Officer's Tool Kit with Mini-Type Halligan Personal Tool	\$95.95

Forcible Entry Fire Rescue Tools From Darley

A. Darley Fire Axes

Your choice of handles. Fiberglass handle fire axes are stronger than steel, lighter than aluminum and as flexible as hickory. Fiberglass handles won't splinter and will not conduct electricity. The Pick-Point Crucible Steel Axe Head is epoxy-bonded to a cushion grip fiberglass handle.

new lower price Pick-Point Axe

DARLEY AXES, 6 LBS.

L957	36" Pick-Point Axe, Fiberglass Handle	\$65.95
370	36" Pick-Point Axe, Hickory Handle	\$51.95
T225	36" Flat Head Axe, Fiberglass Handle	\$57.95
J745	36" Flat Head Axe, Hickory Handle	\$48.95
L958	Replacement Fiberglass Handle	\$19.95

OTHER WEIGHTS

AW187	36" Pick-Point Axe, 8 lb., Fiberglass Handle	\$143.95
AW188	36" Flat-Head Axe, 8 lb., Fiberglass Handle	\$143.95
BK273	28" Pick-Point Axe, 2 ³ / ₄ lb., Hickory Handle	\$45.95

B. T-N-T Multi-Purpose Fire Tool

Every firefighter has found himself at a scene with the wrong tool or the need for multiple tools. The T-N-T Tool is an axe, bar, double jacket and a pike pole all in one. Head and pike ends are made from high-carbon, heat-treated steel and the handle is solid fiberglass. *Ship. wt. 14 lbs.*

- ▶ Ventilate
- ▶ Pull ceilings
- ▶ Force entry
- ▶ Breach walls
- ▶ Cut holes

AJ237	8.5 lb. Head, 40" Handle	\$234.95
AJ238	6.5 lb. Head, 40" Handle	\$218.95
AJ239	6.5 lb. Head, 35" Handle	\$218.95
AJ240	6.5 lb. Head, 30" Handle	\$218.95

C. T-N-T Iron

- ▶ Patented T-N-T head with the T-N-T CLAW stored in handle
- ▶ Compact heavy duty tool
- ▶ Used to open doors in or out
- ▶ Light enough to do many doors
- ▶ Use as a break and rake
- ▶ *Ship. wt. 20 lbs.*



BL413	T-N-T Iron	\$279.95
-------	------------	----------

D. Emergency Fire Tool Set

Includes:

- ▶ 6 lb. or 8 lb. flathead axe
- ▶ Marrying strap
- ▶ 30" halligan bar

AJ115	Emergency Fire Tool Set with 8 lb. Axe	\$317.95
BL534	Emergency Fire Tool Set with 6 lb. Axe	\$246.95
AJ114	Velcro® Marrying Strap Only	\$15.95

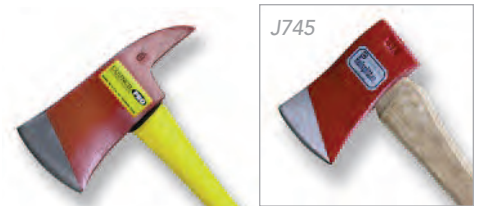

4 tools in 1



new



RESCUE TOOLS

Pike Pole Mounting Bracket

- ▶ Cast aluminum dual pike pole holder assembly kit (with rubber trim-lock)
- ▶ Finish: ball-burnished



BK087 Pike Pole Mounting Bracket \$49.95

Spring Loaded Crow Bar Bracket



Ship. wt. 2 lbs.

U327 Crow Bar Bracket, Chrome \$41.95/set

Pike Pole, Axe & Tool Brackets



P807	Tool Bracket, Bottom Mount, Vinyl Covered, 3/4" to 1" OD	\$56.95
P808	Tool Bracket, Bottom Mount, Vinyl Covered, 1 1/2" to 2 1/2" OD	\$56.95
P809	Tool Bracket, Side Mount, Vinyl Covered, 3/4" to 1" OD	\$56.95
P810	Tool Bracket, Side Mount, Vinyl Covered, 1 1/2" to 2 1/2" OD	\$56.95
U330P	Pike Pole Handle Bracket, Side Mount, 1 1/2" OD	\$26.95
M754	Pike Pole Ring, Aluminum OD, 2 1/8"	\$18.95
M755	Pike Pole Ring, Cast Brass OD, 2 1/8"	\$48.95
AW202	Axe Blade Bracket, Zinc CP	\$31.95
BK215	Axe Handle Side Mount Bracket, Zinc CP	\$21.95

Pike Poles - I-Beam



Ship. wt. 5-22 lbs.		Standard Hook	Dry Wall Hook	Rubbish Hook
AS251	3' I-Beam Pike Pole with D-Ring Handle	\$79.95	\$121.95	\$119.95
AS252	4' I-Beam Pike Pole with D-Ring Handle	\$92.95	\$128.95	\$126.95
AS254	6' I-Beam Pike Pole	\$82.95	\$116.95	\$113.95
AS255	8' I-Beam Pike Pole	\$90.95	\$152.95	\$122.95
AS256	9' I-Beam Pike Pole	\$81.95	\$110.95	\$104.95
AS257	10' I-Beam Pike Pole	\$105.95	\$126.95	\$122.95
AS258	12' I-Beam Pike Pole	\$116.95	\$146.95	\$144.95

Pike Poles - Elliptical



Ship. wt. 5-11 lbs.		Standard Hook	Dry Wall Hook	Rubbish Hook
AS259	3' Elliptical Pike Pole with D-Ring Handle	\$70.95	\$102.95	\$100.95
AS260	4' Elliptical Pike Pole with D-Ring Handle	\$75.95	\$111.95	\$106.95
AS261	6' Elliptical Pike Pole Two Grips	\$70.95	\$104.95	\$99.95
AS262	8' Elliptical Pike Pole Two Grips	\$87.95	\$115.95	\$121.95
AS263	9' Elliptical Pike Pole Two Grips	\$87.95	\$112.95	\$114.95
AS264	10' Elliptical Pike Pole The Double Gripper	\$114.95	\$154.95	\$148.95
AS265	12' Elliptical Pike Pole The Double Gripper	\$125.95	\$169.95	\$148.95



Darley Pike Poles

White Ash Handle

Cat#	Length	Weight	Price
M722	6'	5 lbs.	\$54.95
M723	8'	6 lbs.	\$65.95
M724	10'	7 lbs.	\$95.95

Fiberglass-Hollow or Wood Core

Length	T979 - Wood Core	T980 - Hollow Core
6'	\$108.95	\$68.95
8'	\$116.95	\$75.95
10'	\$169.95	\$110.95
12'	\$195.95	\$125.95
14'	\$236.95	\$155.95

Fiberglass I-Beam

Cat#	Length	Weight	Price
L952	6'	7 lbs.	\$75.95
L953	8'	9 lbs.	\$85.95
L954	10'	11 lbs.	\$111.95
L955	12'	13 lbs.	\$106.95
L956	14'	15 lbs.	\$114.95
L985	16'	17 lbs.	\$124.95

Any Pike Pole 10' and longer sent via Motor FRT.

Closet Hook

Ideal for opening halls, closets, crawl spaces or upholstery. Plastic core handle will not crack, splinter, warp, rot or absorb moisture. Malleable iron pike and "D" handle are bonded in epoxy.



P819	32" Closet Hook	\$102.95
T981	"D" Handle for Pike Pole	\$34.95

Kwik Access Tool

KATools (Kwik Access Tool) are ideal when searching for hidden fires, making smoke inspection cuts, opening interior finishes, cutting cables and wires, removing doors and clearing windows. This patented, multi-purpose tool is designed for push-pull motions required in cutting and probing, and the KATool will open sheetrock walls and ceilings. Additionally, it will work well on plaster/lathe, wire/plaster, lathe and tongue and groove. Sold with protective leather sheath.

- ▶ Searching for hidden fires
- ▶ Smoke inspection cuts
- ▶ Opening interior finishes
- ▶ Cutting cables and wires
- ▶ Removing doors
- ▶ Clearing windows



Cat#	Pole Length	Handle	Price
BB059	16" Blade/41" Fiberglass	"D"	\$213.95
BB060	16" Blade/72" Fiberglass	Butt Grip	\$247.95
BB061	16" Blade/72" Fiberglass	"D"	\$247.95

Dry-Wall Hook with "D" Handle

Can be used on dry wall and other materials such as wood, plaster, sheet metal, etc. Large 4" contact and honed point makes penetration and removal easier. At the back of the blade is a flexible hook to be used in areas of limited space. Large tooth area and head size makes prying easier plus the combination rake/hose design makes this an exceptional overhauling tool. *Ship. wt. 10 lbs.*



BG227	3' Dry Wall Hook with "D" Handle	\$76.95
BG228	4' Dry Wall Hook with "D" Handle	\$85.95
BG229	6' Dry Wall Hook with "D" Handle	\$93.95
BG230	8' Dry Wall Hook with "D" Handle	\$101.95
BG231	10' Dry Wall Hook with "D" Handle	\$115.95
BG232	12' Dry Wall Hook with "D" Handle	\$119.95

Trash Hook with "D" Handle

Developed to find hidden fire in deep-seated smoldering fires normally found in dumps or dumpsters. Our trash hook, with two large six-inch pointed prongs, will grasp debris in huge chunks. *Ship. wt. 10 lbs.*



BG233	4' Trash Hook with "D" Handle	\$73.95
BG234	6' Trash Hook with "D" Handle	\$81.95
BG235	8' Trash Hook with "D" Handle	\$88.95
BG236	10' Trash Hook with "D" Handle	\$95.95
BG237	12' Trash Hook with "D" Handle	\$102.95

NUPOLE™ Quick Disconnect

The Nupole™ Fire Pole System is simple to use. It lets you carry a lot of tools with less investment of equipment space. Just connect the head you need to the handle, add one or more extensions and you now have the tool of your choice to do the job. The heart of this system is an extremely tough and rigid, yet easy-to-use connection, capable of carrying great loads. Features overlapping aluminum aircraft connectors with quick-release button.



Part	Description	Price
AJ590 - AJ592	3' Pike Head	\$55.95
AJ583	3' Trash Hook Head	\$74.95
AJ584	3' Wall Hook Head	\$115.95
AJ587	3' Butt Grip End	\$37.95
AJ588	3' Steel "D" Grip End	\$45.95
AJ589	3' Aluminum "D" Grip End	\$74.95
AJ590	3' Extension	\$46.95
AJ591	4' Extension	\$49.95
AJ592	8' Extension	\$67.95

NUPOLE™ ROOF KIT

Includes Pike Head, Ventilation Hook Head, Steel "D" Grip and 4' Extension.



AJ595	Nupole™ Roof Kit	\$227.95
-------	------------------	----------

RESCUE TOOLS



A. Sledge Hammers

- ▶ Durable, compact tool
- ▶ Hi-Viz lime or yellow handles
- ▶ Reflective striping to aid in low light
- ▶ Fiberglass handle
- ▶ Head is drop forged w/high carbon steel
- ▶ Made in USA

BH044	6 lb. Sledge Hammer 24"	\$49.95
BH045	8 lb. Sledge Hammer 36"	\$49.95
BK216	10 lb. Sledge Hammer 36"	\$49.95

B. Barracuda Rescue Saw

Get a handle on this multi-purpose rescue saw to cut through most anything such as windshields, mobile homes, aircraft, ice, wood, sheet metal, etc. Features 10 two-sided, cross-cutting teeth that cut on pull as well as push strokes. You'll get positive control from the rear "D" handle and celtex fireproof, covered upright front handle. Comes with protective plastic point cover. *Ship. wt. 5 lbs.*

AK091	Barracuda Rescue Saw	\$149.95
-------	----------------------	----------

C. All-Purpose Tool

One of our best sellers. Used by thousands of departments because it makes the job easy and safe. Made of hexagon steel, painted blue. Overall Size 5/8"x18". *Ship. wt. 3 lbs.*

D178	All-Purpose Tool	\$17.95
------	------------------	---------

D. Pinch Bars

Made of 1" hexagon steel, one end forged with a square point, the other end straight and with the shape of a chisel. Great for prying and other entry applications. The 4 ft. Pinch Bar is just like R597 but the chisel shape end is offset instead of straight. *Ship. wt. 9 lbs.*

R596	36" Pinch Bar	\$39.95
R597	48" Pinch Bar	\$48.95
R598	54" Pinch Bar	\$52.95
R600	48" Offset Pinch Bar	\$54.95

E. Fire Department Crowbar

Ship. wt. 9 lbs.

B439	52" Painted Tool Steel	\$41.95
AA936	36" Painted Tool Steel	\$30.95

F. Compound Lever Bar

Hexagon Steel 7/8" x 36" long. A handy tool to break open doors, jimmy windows, pry off hinges and locks, pull up flooring and much more. *Ship. wt. 9 lbs.*

C757	Compound Lever Bar	\$21.95
------	--------------------	---------

G. 48" Demolition Bar

The new Demolition Bar is a truly multi-purpose tool that can be used for anything from roof ventilation and forcible entry to any kind of recovery work. The forks can slide beneath shingles or flooring to be pried up using the leverage of its handle. The Demolition Bar's sharp edges puncture cleanly through drywall allowing you to locate the studs to remove wall panels.

- ▶ Bent handle for maximum leverage
- ▶ Ideal height for ripping up flooring reducing firefighter fatigue
- ▶ High visibility orange powder paint finish
- ▶ Non-slip grips
- ▶ Weight: 9 lbs.

BL020	48" Demolition Bar	\$109.95
-------	--------------------	----------



Mini Crash Kit

- ▶ Magnetic Case - Perfect to slap on the side of a crashed vehicle
- ▶ Heavy duty seat belt cutter
- ▶ Heavy duty spring window punch - the SAFE way to pop glass
- ▶ Heavy duty cable cutter
- ▶ Heavy duty tongue & groove pliers
- ▶ EMS scissors
- ▶ Mini pry bar
- ▶ Water-resistant auto markers - perfect for the triage of multiple vehicles



BH012 The Mini Crash Kit \$214.95

Stanley® FuBar® Forcible Entry Tools

Introducing Stanley® FuBar® Forcible Entry Tools. At up to 30" in length and 9 lbs. in weight, these extreme tools provide outstanding leverage and excellent grips for more destructive demolition work.

- ▶ 8-in-1 tool
- ▶ Demolition head
- ▶ Gas shut-off feature
- ▶ Spanner wrench
- ▶ Pry bar for ripping
- ▶ Board jaw sized for grabbing lumber
- ▶ 2nd tier board jaw fits square hydrant nuts
- ▶ Hydrant wrench
- ▶ Beveled nail slot
- ▶ One-piece forged steel
- ▶ Flame-resistant grips
- ▶ Carabiner holes
- ▶ Heat-treated & tempered striking face
- ▶ Hi-visibility 3M™ Scotchlite™



BG519 18" Stanley® FuBar® Forcible Entry Tool \$84.95

BG520 30" Stanley® FuBar® Forcible Entry Tool \$154.95

ChannelLock 6 'N 1 Rescue Tool

26 ounces of valve-twisting, wire-cutting, life-saving power in your pocket.

- ▶ Hardened tool steel punch shatters safety glass
- ▶ Aggressive cross-hatch teeth twist & pull anything that gets in your way
- ▶ Laser heat-treated cutting edges cut wires and cables easily
- ▶ Pry-bar quickly pries open windows and doors
- ▶ Slot for shutting off standard gas safety valves
- ▶ Spanner wrench tightens and loosens up to 6" hose couplings
- ▶ Made in USA



BH098



BH148

BH098 Linesman Cutter Rescue Tool \$49.95

BH148 Cable Cutter Rescue Tool \$49.95

BH102 Closed Top Holster \$24.95

S.O.S.™ 3-In-1 Tool

Revolutionary Tool That Breaks Through Concrete Block

It's the tool that can save your life. The Special Operations Survival Tool (S.O.S.) combines a pry bar, a sledge hammer and a super-hard hook into one dynamic tool. The hook end actually breaks through solid concrete block. Constructed of forged alloy steel, it's been heat-treated for extra strength and durability. Use it as a battering ram to get into a room for rescue or when you have to get out of a dangerous situation fast. The S.O.S.™ Tool is the first of its kind - a multi-use tool that's as efficient as it is convenient. It gives you peace of mind in dangerous situations by letting you get out of trouble fast. 100% Made in the U.S.A.

- ▶ Sledge hammer features machined striking face
- ▶ Solid, one-piece construction
- ▶ Handle won't break in an overstrike
- ▶ Lifetime warranty



BK005 S.O.S.™ 3-In-1 Tool \$168.95

RESCUE TOOLS



- ▶ Heavy-duty
- ▶ Extended nose straps
- ▶ Extra heavy jaw bolts

A



B



C

- ▶ Soft Metal: 7/16"
- ▶ Medium Metal: 7/16"
- ▶ Hard Metal: 5/16"



D

- ▶ Jaw Opening 3/8"
- ▶ Non-Conductive
- ▶ Handle to 100,00 volts



- ▶ 10" or 28" Cutter Capacity
- ▶ Cut cable or wire

AW189



AW190



F



G



A. H.K. Porter Heavy-Duty Industrial

Extra-heavy jaw bolts and straps make these the most rugged around. Center cut, round edge cutters up to Brinell 455, Rockwell C48 hardness. Have nose straps for longer jaw life. *Ship wt. 18 lbs.*

T988	36" Heavy Duty Bolt Cutter	\$239.95
T987	36" Industrial Grade Bolt Cutter	\$174.95
J874	36" Industrial Grade Bolt Cutter with Fiberglass Handles	\$246.95
H962	42" Chain & Padlock Cutters	\$313.95

B. Fire Service Bolt Cutters

- ▶ High-carbon machined steel jaws cut rods, bolts, bars & chains, etc.
- ▶ Tubular steel handles with angled grips allow maximum leverage
- ▶ Turn 50 lbs. of hand pressure into 4,000 lbs. of cutting pressure
- ▶ Drop-forged jaws with center-cut blades
- ▶ Lifetime warranty



BK241	14" Fire Service Bolt Cutters	\$33.95
BK242	18" Fire Service Bolt Cutters	\$39.95
BK243	24" Fire Service Bolt Cutters	\$49.95
BK244	36" Fire Service Bolt Cutters	\$78.95
BK245	42" Fire Service Bolt Cutters	\$127.95

C. General Purpose Center Cut Cutters

All-purpose jaws with center-cut blades. Toggle joints turn 50 lbs. of hand pressure into 4,000 lbs. cutting pressure to cut soft, medium and hard metals. Lockplate keeps jaws from loosening and screw-type adjustment realign edges. Strong, durable, lightweight fiberglass handles. *Ship. wt. 5 lbs.*

AL234	24" General Purpose Center Cut Cutter	\$170.95
-------	---------------------------------------	----------

D. ElectraShield BoltMaster

A premium, hardened steel bolt-cutter. Features an advanced polymer handle that is non-conductive to 100,000 volts. Lightweight with advanced camming action for tremendous cutting force. Replaceable cutting teeth. *Ship. wt. 6 lbs.*

AM293	24" ElectraShield BoltMaster	\$199.95
-------	------------------------------	----------

E. Cable Cutters

Can be used as either cable or wire rope cutters and is available in two sizes. The 28" model has Celtex grips for added comfort. The smaller size can be used for battery terminals.

AW189	28" Cable Cutter (1 1/4" Jaw Capacity)	\$45.95
AW190	10" Cable Cutter (7/8" Jaw Capacity)	\$12.95

F. Connection Mallet

Unbreakable rubber mallet with a solid Celtex no-slip grip fiberglass handle, epoxy glued and pinned. Mallet will not break on overstrike and will give a lifetime of use. *Ship. wt. 2 lbs.*

AJ311	Connection Mallet, 2 lbs.	\$17.95
-------	---------------------------	---------

G. Dead Blow Hammer

Features patented Power Drive® deadblow technology which produces 40% more driving force. Dead blow assembly is completely encased within a tough polypropylene outer jacket for lifetime durability. Non-marring and surface-protective striking face with ergonomic grip design. *Ship. wt. 2 lbs.*

AM180	Strike-Pro Dead Blow Hammer	\$23.95
-------	-----------------------------	---------



A. Salvage Kit

Featuring the Adapt-a-Pole™

The Salvage Kit featuring the Adapt-a-Pole™ is designed to deliver a multi-purpose tool for use in every situation. This tool allows for flexibility and versatility from the same handle. To change tools or hooks, simply disengage the Adapt-a-Pole™ locking mechanism, select and attach the desired tool or hook for the job. Then it's back to work. There is no longer a need to carry several different tools to accomplish the many tasks around the fire ground. The Adapt-a-Pole™ provides the tool and hooks for all those tasks in one simple yet effective tool. The Salvage Kit Adapt-a-Pole™, a must have for every fire apparatus.

Includes:

- ▶ 1 - 3' dry wall hook
- ▶ 1 - Squeegee
- ▶ 1 - Square nose shovel
- ▶ 1 - Push broom
- ▶ 2 - 4' handles
- ▶ 1 - 4' extension

BC029 Salvage Kit \$487.95

B. Collapsible Rescue Shovel

The Collapsible Rescue Shovel has been the tool of choice for many first responders. Its compact, lightweight design makes it easily transportable, yet rugged enough to get the job done under extreme conditions. The blade is engineered to be used as a shovel, axe, saw, hoe or piercing tool. *Ship. wt. 3 lbs.*

- ▶ Axe
- ▶ Piercing tool
- ▶ Shovel
- ▶ Hoe
- ▶ Saw

AK010 Collapsible Rescue Shovel \$22.95

C. Firefighting Shovels

Round point shovels are hollow back with 8½"x12" blade. Square point shovels are also hollow back with 9½"x11½" blades and rolled step. The fiberglass handles provide unsurpassed life, comfort and safety. Heat treated and tempered blades resist wear and breakage. *Ship. wt. 5 lbs.*



AZ378	Round Point 48" Handle Shovel	\$43.95
AZ379	Round Point 27" D-Handle Shovel	\$39.95
AZ380	Square Point 48" Handle Shovel	\$43.95
AZ381	Square Point 27" D-Handle Shovel	\$41.95

D. Aluminum Scoop Shovel

The large, heavy-duty square blade is heat treated and tempered to resist wear and breakage. Ideal for getting rid of fire debris, scooping gravel and other course materials. *Shovel blade measures 15¼"x19¾" with 27" handle. Ship. wt. 5 lbs.*



AB045 Aluminum Scoop Shovel \$64.95

DON'T MISS
Mounting brackets in
App. Equip. (p231-259)

RESCUE TOOLS

Hand Tool Rescue Kit

The Hand Tool Rescue Kit you have always wanted to put together but never did. Now you can pound, cut, pry, saw, seal, loosen, tighten and dig with an assortment of top-quality industrial-grade hand tools built to deliver years of dependable service. Kit features Sandvik "ergonomic" tools specially designed to reduce or end work-related injuries. The kit also includes a heavy-duty seat belt cutter, cable cutter with insulated handles for working on live voltages up to 1,000 volts, military spec tri-fold shovel and more. All tools carried in a black plastic case. *Ship. wt. 40 lbs.*

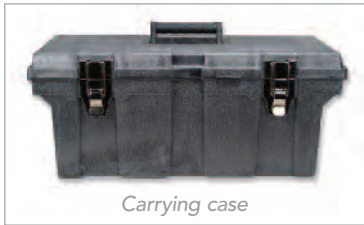

Carrying case

AR178 Hand Tool Rescue Kit \$1,114.95

MV Fire/Rescue Crash Kit

- ▶ Hood release tool
- ▶ Quik-Kut glass removal tool
- ▶ Pyroshield rescue blanket
- ▶ Glass hammer
- ▶ MV plug pattie
- ▶ Battery cable cutter
- ▶ Pro hacksaw
- ▶ Spring window punch
- ▶ Valve stem tool
- ▶ 9 1/2" tongue & groove pliers
- ▶ MX 4-in-1 screwdriver
- ▶ 8" adjustable wrench



BA125 MV Fire/Rescue Crash Kit (Red) \$684.95

Complete Crash and Rescue Tool Kit

All-purpose set of tools for use in crash and fire emergencies. Contains everything needed to quickly and efficiently cut through metal, webbing, wood, rope, and other obstructions. *Ship. wt. 15 lbs.*

- ▶ Metal Cutting Saw - 16" blade
- ▶ Aircraft Cable Cutter - cuts 1/8" to 1/4" capacity and 14" long
- ▶ Lineman's Pliers - 8" long/extra strong
- ▶ Hack Saw Frame - adjusts from 8" to 12", faces 4 ways, and adjusts 90° for vertical or horizontal cuts
- ▶ 3 Hack Saw Blades - hard toothed, silver steel for fast cutting
- ▶ Grappling Hook & Rope - 52" sling
- ▶ 2 Phillips Head Screwdrivers - 6" and 8"
- ▶ 2 Slotted Head Screwdrivers - 6" and 8"
- ▶ 3 Wooden Plugs - plug fuel and control lines
- ▶ Vise Grip Wrench - 10" long
- ▶ Serrated Edge Hand Axe - 15" long with handle insulated for 20,000v
- ▶ Safety V Blade Rescue Knife
- ▶ Weather-resistant, mildew-resistant, rubber-coated nylon hi-vis yellow carrying case



Complete kit folds into an easy-to-carry case



L471 Complete Crash and Rescue Tool Kit \$425.95

Mechanics 170 Piece Tool Set

- ▶ **Crescent® Quick-Release Ratchets**
 - 1/4", 3/8", 1/2" drive
 - Chrome Vanadium
 - Release button must be engaged to remove socket
- ▶ **Extensions & Adapters**
 - 1/2" drive 5" extension bar
 - 3/8" drive 3" and 6" extension bar
 - 3/8" female to 1/4" male adapter
 - Chrome Vanadium
- ▶ **Sockets**
 - 6 point SAE and Metric sockets - 1/2" and 1/4" drive
 - 12 point SAE and Metric sockets - 3/8" drive
 - 5/8" and 13/16" spark plug sockets
 - Chrome Vanadium
- ▶ **Crescent® 8" Long Nose Pliers**
 - Chrome Vanadium steel
 - Non-slip cushioned handle grips
- ▶ **Crescent® Mechanic's Combination Wrenches**
 - Heat-treated
 - Mirror polish finish in SAE and Metric
- ▶ **Crescent® 10" Tongue & Groove Pliers**
 - New rivet construction with joint interlock
- ▶ **8" Adjustable Wrench**
 - Chrome alloy steel
 - 1" jaw capacity
- ▶ **Crescent® Magnetic Bit Driver**
 - Chrome Vanadium steel
 - Ergonomic cushion grip
- ▶ **Crescent® Driver Bits & Holder**
 - S2 tool steel for durability
 - 40 bits and 4 holders
- ▶ **Crescent® Hex Keys**
 - SAE and Metric

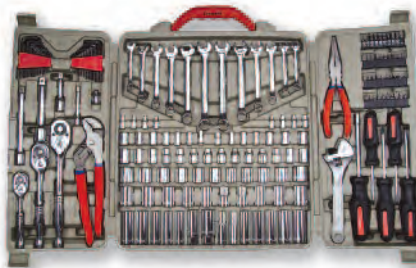

Carrying case

BG118 Mechanics 170 Piece Tool Set \$127.95

FF Wedge™

Designed and Patented by a Firefighter

In the past, wedges were usually placed under the door with limited results. The FF Wedge™ with its interlocking notch design can be placed in a variety of positions giving personnel more options. The FF Wedge™ is light in weight and able to hold open a variety of door types. The wedges can be hung from a door knob, lever or handle to be used as a room search indicator. The unique interlocking design allows wedges to be placed in tandem vertically or horizontally. Available in black or yellow. *Measures: 5 1/4" L x 2" H x 1" W.*

Includes:

- ▶ 1 - 3" aluminum carabiner - not intended for climbing
- ▶ 4 - retention clips - stainless steel with a 6-8 pound pull release
- ▶ 4 - wedges with lanyards and decals

new

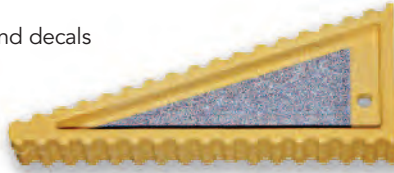

BL354	4 Wedge™ Black System	\$24.95
BL355	4 Wedge™ Yellow System	\$24.95

IMPORTANT SALES NOTE

ALL LOCK TOOLS **SOLD ONLY TO DEPARTMENTS**

Order Must Be Verified by Department Letterhead
(Not for emergency use, or for use on all locks)

Lock Pulling Tool Kits

The K-Tool is driven over the protruding edge of the lock cylinder and then pried off with a Hooligan Tool or similar tool. The lock cylinder is pulled out of the door and the key tools are then used to operate the mechanism. Includes leather pouch, set of key tools, K-Tool and instructions. *Ship. wt. 4 lbs.*



The R-Tool is designed to pull all types of lock cylinders too large for the K-Tool unit such as locks that extend out from the door and 1" round are easily pulled with the R-Tool. The R-Tool consists of: R-Tool, Nylon carrying case, set of lock tool keys and a shove knife.

T986	K-Tool Kit	\$139.95
BB062	R-Tool Kit	\$184.95

Elevator Key Set

Manufactured to conform with the majority of elevator manufacturer's access keys. This convenient set of quality keys consists of: volt-resistant key with 5,000-volt resistance of spring steel; swing door access key; rib key "T" style; vandal-proof access key; half-moon key (large); half-moon key (small); drop key, adjustable; side exit key; "Z" key round stock; knife key with "T" handle; shove knife; kerry key. Set comes on a large jailers ring for easy storage and use. Split ring for easy removal. *Ship. wt. 1 lb.*



AC820	Elevator Key Set	\$199.95
-------	------------------	----------

Deluxe Master Emergency Entry Tool Kit

Master Emergency Entry Tool Kit is the #1 selling door opening kit in the towing industry! The kit is constructed of heat-treated, chrome-plated, spring steel. *Ship. wt. 1 lb.*

- ▶ Wide bar
- ▶ Thin bar
- ▶ Slide lock button tool
- ▶ Gas cap key
- ▶ Instruction book
- ▶ Dual tool
- ▶ Strap it
- ▶ Split wedge
- ▶ Narrow wedge
- ▶ Carrying bag



best seller

AJ581	Emergency Tool Kit	\$98.95
-------	--------------------	---------

Shove Knife - Does the Job of Three

The fastest, damage-free means of opening residential, office interior doors with key in the knob locks. Works from either side of the door. If the door opens inward, you shove the knife in back of the molding stop and retract the latch. For doors that open towards you, the knife is slipped in from above or below the latch point, jiggled and pulled to retract the latch. *Ship. wt. 1 lb.*



AH164	Shove Knife	\$6.95
-------	-------------	--------

Wedge It™

Nearly indestructible plastic sprinkler wedges are superior to traditional wood. Gripper edges keep wedge in place, and recycled plastic construction means they won't soak up water or break. High-visibility yellow makes retrieval easier, and can be used again and again. A pre-drilled hole has been added for your choice of "lasso" for fast, easy retrieval. *Use as a sprinkler or door wedge. Dimensions: 5 1/4" L, 1.7" at wide end. Color: Yellow. Ship. wt. 1 lb.*



BD190	Wedge It™ (Minimum Order 6)	\$1.95
-------	-----------------------------	--------

The Glas-Master

Removes Glass in Less Than a Minute

The Glas-Master is truly an extraordinary tool that is manually operated; no electricity or hydraulics needed. No other tool cuts glass windshields faster and more effectively, helping reduce rescue time significantly. Cuts on pull stroke thereby pulling glass to the outside, away from the victim. It can also be used on fiberglass, wood, plaster or even underwater rescue. What's more, the Glas-Master has its own storage of the spring-loaded center punch so it won't get lost or misplaced when it is needed most. *Ship. wt. 4 lbs.*



- ▶ Window punch
- ▶ "T" handle
- ▶ Spike
- ▶ Blade with cover
- ▶ Front guard

AB885	Glas-Master	\$174.95
AB885A	Glas-Master Replacement Blade	\$26.95

RAM Entry Tool Gets The Job Done



Two different models of RAM tool allow for one or two-person operation. It is easy-to-carry, easy-to-use and easy-to-stow. Durable and long-lasting construction of epoxy/ steel striking head reinforced with fiberglass rods, safety grips of non-slip, electrically nonconductive Celtex with vinyl clad, high-tensile strength and aircraft steel cable cores. RAM I (shown) is designed for one-person emergency entry. 30" long and weighs 35 lbs. The kinetic energy is greatly increased to 20,000 lbs. RAM II is designed as a two-person ram which may be used by one strong person. This two-person Ram is 30" long. *Ship wt. 45 lbs.*

One or two-person operation

AA680	Ram I Entry Tool	\$249.95
AE096	Ram II Entry Tool	\$299.95

Hinge Hook - Keep Almost Any Door Open



As any firefighter knows, closed doors can trap you in a room. Traditional wedges have been used to keep doors open but these can come loose and dislodge if the door is bumped. The Hinge Hook is a simple, reusable, reliable device that can be inserted over the hinge of almost any door to aide in preventing door closure. It's made of zinc-coated steel and is welded and bent to keep the door open at a 75° angle or less. Light enough to carry on your turnout gear, high rise packs and belts. A handy multipurpose accessory ring can hold a handlight, flashing strobe, cyalume stick, etc. *Ship. wt. 1 lb.*

AM184	Hinge Hook	\$10.95
-------	------------	---------

Fat Ivan® - The World's Only Fold-Up Door Chock



- ▶ Corrosion resistant, engineered plastic and zinc plated steel
- ▶ Made in the USA
- ▶ Safe, secure design, never slips off hinge or comes out accidentally
- ▶ Compact (4"x2"x1") and light-weight, weighing only 5 oz.
- ▶ One-handed operation
- ▶ Also great for high rise emergency packs
- ▶ Will not tear fire gear



BK360	Fat Ivan® Door Chock	\$15.95
-------	----------------------	---------

"V" Blade Rescue Knife

Cuts through seat belts. Precision made of high-strength aluminum alloy. Tip fitted with Dzus Key for opening aircraft panels. Will cut 10,000 lb. strength webbing with one stroke. *Ship. wt. 3 lbs.*

L470	"V" Blade Rescue Knife	\$56.95
L470X	Replacement Blade	\$16.95

Duck Bill Lock Breaker

All steel tapered head. Designed to be placed in the shackle of a padlock and when hit with a mallet or the back of an axe, it easily spreads the shackle open. Celtex insulated steel doweled handle. *Ship. wt. 10 lbs.*

W515	Duck Bill Lock Breaker	\$109.95
------	------------------------	----------

Res-Q-Me



What would you do if you were trapped in a rolled over vehicle, or in a car submerged in water? This ingenious device is intended to be placed with your car keys. It contains a spring-loaded stainless steel pin that will break any tempered glass window and a stainless steel blade for cutting seatbelts. The break-apart design allows the RES-Q-ME to be quickly removed from its storage location without removing the keys from the ignition. *Ship. wt. 1 lb.*

AS656	Res-Q-Me	\$8.95
-------	----------	--------

USAR Mission Back Pack

- ▶ Designed as a 72 hour deployment pack
- ▶ Detachable (back-up) suspender straps allow the bag to be used as a stand-alone back pack
- ▶ Sized to easily carry and compartmentalize the essentials
- ▶ Foul weather storm flap completely covers the pack and cleanly stows away
- ▶ 2100 cu. in of space
- ▶ Bright yellow interior to increase visibility
- ▶ Rugged handle allows carrying like a duffel bag
- ▶ Adjustable helmet or rain gear pocket



BL392

USAR Mission Back Pack

\$114.95



new

USAR Load Bearing Harness

- ▶ 102 oz. CamelBak reservoir with bite valve cover included
- ▶ Waterproof zipper
- ▶ Fog Manual pocket and covered pockets
- ▶ MOLLE® attachment system
- ▶ Breathable spacer mesh back panels
- ▶ Bright yellow interior pockets
- ▶ 3 Dimensional reflective trim
- ▶ Radio Pocket
- ▶ Strap management system
- ▶ Spring clips to hang glow sticks
- ▶ Velcro patches to attach ID-Panels (not included)
- ▶ Drag Handle
- ▶ Compatible with detachable back pack



BL393

USAR Load Bearing Harness

\$224.95

Lights not included



new

USAR Load Bearing Harness Belt

Ergonomically designed for maximum comfort and strength; the wide padded lumbar supporting belt is field tested and proven. Incorporating our exclusive modified MOLLE® attachment system; quickly attach accessory bags that use MOLLE® or Alice Clips. Our innovative Drop Leg straps easily mount and adjust in any position on the belt to facilitate mounting additional bags against the thigh.

- ▶ Breathable spacer mesh back panels
- ▶ Dual adjusting buckle
- ▶ Modular design
- ▶ Wide padded lumbar support
- ▶ Waist max: 66"
- ▶ Waist min: 38"



BL394

USAR Load Bearing Harness Belt

\$44.95



new

Alpha-10 Fire Line Pack

- ▶ Top loader: uses a dry bag closure mechanism
- ▶ Oversized, open side pockets fit multiple water / SIG bottles
- ▶ Heavily padded, softer belt, suspenders, yoke and back
- ▶ Tapered suspenders reduce rubbing while working
- ▶ Dynamic Load Management System compresses entire pack without blocking access
- ▶ CamelBak 102 oz Omega reservoir included
- ▶ Fire Shelter Case is detachable, right or left hand pull, and can be mounted to the belt
- ▶ 2200 cu. in. (main body alone)
- ▶ NFPA certified
- ▶ Weight: 6.6 lbs.



COLOR: Black

BL395

Alpha-10 Fire Line Pack

\$304.95



new



True North L-2 Lightspeed RIT Bag

Light, Fast and Durable. Made with exclusive Fire Shield Resistant Iron-Cloth™, the L-2 is the same size, and has many of the same features as the L-1, but with one BIG difference - pull the side zipper and the bag expands to allow the addition of a rope bag (sold separately). Innovative access-hatch design allows quick and easy access to spare face piece and valve set.

- ▶ Extremely wear resistant Heat Shield™ skid plate
- ▶ Designed to hold all makes of masks and bottles
- ▶ Quick-Draw transfill hose pocket
- ▶ Top flashlight holder makes bag easy to find in low visibility conditions
- ▶ 60" shoulder strap can be re-positioned for carrying, dragging, or lowering the air bottle
- ▶ 2 tool pockets provide fast access to small hand tools, light sticks

BH113	True North L-2 Lightspeed RIT Bag	\$226.95
BH114	Rope Bag	\$51.95



All Hands High Rise Pack

This sturdy vinyl High Rise Pack will hold up to 150 ft. of 1³/₄" double jacket hose. Front storage pocket with Velcro® closure is great for carrying valves, adapters or tools. Rubber grip carrying handles and shoulder harness included. Reflective trim on two sides for easy visibility. Bag measures 33"Lx12"Wx12H". Available with soft or rigid bottom. Ship wt. 10 lbs.

SPECIFY COLOR: Red or Black

AZ484	High Rise Bag with Rigid Bottom	\$219.95
AZ485	High Rise Bag with Soft Bottom	\$195.95



RIT Multi Tool Transport Bag

The RIT TEAM Multi Tool Transport is 33"x12"x12" featuring a rigid bottom with rails. There are three mini pockets on the inside with a large zippered pocket on the outside. This bag has grab handles in the center, two grab handles on the ends for two men, and a shoulder strap. It features an open top with two safety straps that have attachment points for strobes or other items. Bag can hold up to 100 lbs. Ship. wt. 12 lbs.

BB063	RIT TEAM Multi Tool Transport Bag	\$206.95
-------	-----------------------------------	----------

Can Harness

The latest in Extinguisher (Can) Harnesses, held in place by two 3" Velcro® straps, has a holding power of 2,700 lbs. A safety strap with a "D" ring goes through the hanging bracket on all cans. If for some reason the holding straps are torn, the safety straps will keep the can from falling out. The Can Harness can be carried over the shoulder or horizontally with your hand. This harness is also great for carrying large, spare SCBA cylinders when entering high rises or on your F.A.S.T. team assignments. Ship wt. 1 lb.



AZ113	Can Harness	\$41.95
-------	-------------	---------

True North T-1 RIT Bag

Updated with new ultra tough Fire Resistant Iron-Cloth™. The T-1's ruggedness combined with features such as the separated hose pockets, and rigid plastic shield to protect the valve set and face piece.

- ▶ Designed to hold all makes of masks and bottles
- ▶ Two air hose pockets allow you to have trans-fill and face piece pre-connected to air bottle
- ▶ Four tool pockets provide fast access to small hand tools, 18" bolt cutters, light sticks, etc.
- ▶ Daisy chain provides secure place to attach infrared imagers and other gear
- ▶ 48" shoulder strap can be re-positioned for carrying, dragging, or lowering the air bottle



BH112	True North T-1 RIT Bag	\$209.95
-------	------------------------	----------

Rapid Response Blanket

All-Purpose Tactical Rescue Tool

The Kovenex® Rapid Response Blanket is a high-performance, flame and tear-resistant blanket used by extrication professionals and fire rescue teams. Tested to NFPA standards, Kovenex® far surpasses the performance of treated wool blankets, refusing to burn or tear. It will provide you and your rescue victims the needed protection against fire, intense heat and burn, shattered glass particles and sharp metal edges. *Dimensions: 58"x73"*.

- ▶ **Safer** - Patented, high-performance fabric resists fire and tear, protecting you and your rescue victims against open flames, shattered glass and sharp objects
- ▶ **Easier** - Kovenex® blankets are lightweight, yet durable, engineered to smother fire or wrap around a rescue victim for protection against burn and flying debris
- ▶ **More effective** - Tested to NFPA standards, Kovenex's heat blocking capabilities prevent contact burns

BA137	Kovenex® Rapid Response Blanket	\$99.95
BG505	Kovenex® Rapid Response Blanket w/Heavy-Duty Bag	\$139.95



DON'T MISS

More blankets on page 209



Special Operations Recovery Drag

This life saving device is the most efficient means of removing a downed firefighter or victim from the "Hot Zone". The S.O.R.D (Special Operations Recovery Drag) is lightweight, compact, and easily deployed. The S.O.R.D rides in its own bag inverted next to a firefighter's air pack, on a bandolier system, staying out of the way, enabling firefighters to continue their work. When needed, the firefighter simply brings the S.O.R.D. forward, opens the top flap and deploys. It has no buckles, snaps, or straps. It can be easily managed by one person, saving the lives of many. The Cotton Duck S.O.R.D. does not exceed any rating but is manufactured to 2,000 lbs. - 2,200 lbs. as a Nylon Border. The center consists of a single ply Cotton Duck with a good abrasive factor for dragging and gives the center 800 lbs. - 1,000 lbs. of carrying capacity.



COLOR: Fire Red

BB148	S.O.R.D. Cotton Duck	\$138.95
-------	----------------------	----------



RESCUE TOOLS

SAR Utility Vinyl Bucket

The SAR Bucket is made of 22 oz. rip stop vinyl and heavy-duty cotton. The SAR Bucket can tackle almost any job. Whether it be lowering equipment into confined spaces, collecting debris to be removed, or carrying tools and specialty equipment. Every fire truck should have a SAR Bucket.

Bucket has storage pockets, four holsters, and a padded handle for hauling heavy loads with less fatigue on your hands.



AZ139	SAR Utility Vinyl Bucket	\$77.95
-------	--------------------------	---------

The Tool Bag

Developed for easy access to commonly used tools. No flaps, zippers or closures to get in the way when specific tools are needed quickly. Constructed with R&B Fabrication's "TUFF BOTTOM" this bag has superior durability, yet it is extremely lightweight. The outside side walls of the bag are constructed of heavy reinforced vinyl and the inside walls have rigid plastic for support and durability. Outer pocket has ample room even for large diameter hose wrenches. Reinforced webbed straps make the handles strong and easy to use even when wearing thick firefighting gloves. *Measures: 21"x9"x9 1/2". Ship. wt. 1 lb.*



Tools not included



COLOR: Red		
BB042	The Tool Bag	\$84.95

Turtle Plastics Chocks, Wedges and Cribbing

- ▶ Made from 100% recycled plastic (HOPE-high density polyethylene)
- ▶ Oil, chemical, and bloodborne pathogen resistant

- ▶ Non-absorbent
- ▶ Virtually indestructible
- ▶ High-visibility yellow lanyards for easy carrying and gripping

- ▶ Lighter than wood
- ▶ Splinter free
- ▶ Available in black and yellow

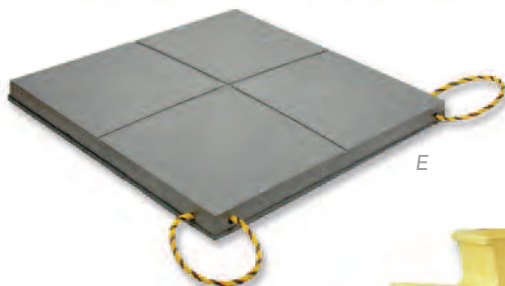
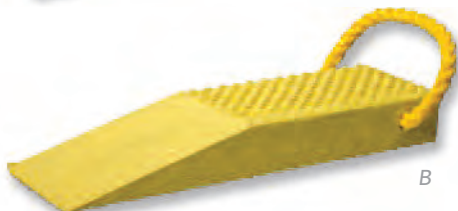

G

A. Standard Cribs

- ▶ Features & benefits: Cleaner and safer than oil-soaked wood. Non-splitting and lighter than wood. Aggressive patterned, slip-resistant pyramid-locking surface. Use to build super stable box crib. Each crib has rope handle.

Cat#	Dimensions	Black	Yellow
AS525	2"x4"x18"	\$17.95	\$20.95
AJ320	4"x4"x18"	\$31.95	\$40.95

B. Standard Wedges

- ▶ Features & benefits: Patterned surface with NEW 11° angle. Rope handle attached.

Cat#	Dimensions	Black	Yellow
AS526	2"x4"x12"	\$13.95	\$15.95
AJ322	4"x4"x20"	\$17.95	\$21.95

C. Stepped Wedges

- ▶ Features & benefits: Stepped top surface that slopes downward for extra gripping power.

Cat#	Dimensions	Black	Yellow
AJ323	3"x8.5"L	\$23.95	\$30.95
AJ324	6"x8.5"L	\$61.95	\$76.95

D. Lincoln Logs

- ▶ Features & benefits: Stable Lincoln Log cribs interlock as they stack. Three notches top and bottom allow for use as either 2-box or 3-box crib. Built-in handle design.

Cat#	Dimensions	Black	Yellow
AS270	4"x4"x18"	\$30.95	\$38.95
AZ513	6"x8"x24"	\$107.95	\$127.95

E. Bag Pad

- ▶ Features & benefits: Thick pad centers air bag and prevents air bag punctures from road debris.

Cat#	Description	Dimensions	
AS272	Bag Pads	1½"x24" Square	\$94.95

F. Standard Step Chocks

- ▶ Features & benefits: For use on passenger cars. Built-in hand hold. Lightweight, yet has very stable base dimensions.
- ▶ Dimensions: 24¾"x5¾"(base)x3¾"(top)x10¾"H, step is 3¾"W

Cat#	Weight	Black	Yellow
AJ328	16 lbs.	\$112.95	\$140.95

G. Giant Step Chocks

- ▶ Features & benefits: Saves critical set-up time, super stability on large trucks, buses and SUVs.
- ▶ Dimensions: 31½"x11"(base)x5"(top)x22"H, step is 5"Wx6"D

Cat#	Weight	Black	Yellow
AS271	64 lbs.	\$314.95	\$393.95

Turtle Plastics Cribbing Kits

Quick Response Starter Crib Kit

Ideal for rural police, chief's vehicles, and small rescues.

Includes:

- ▶ 2 - Step chocks
- ▶ 2 - 3" wedges
- ▶ 1 - 1"x9" square lock block
- ▶ 1 - 2"x9" square lock block
- ▶ 1 - 25"x15"x6" carrying bag
- ▶ Weight: 42 lbs.



Cat#	Description	Black	Yellow
BE295	Quick Response Starter Crib Kit	\$467.95	\$575.95

Urban Search & Rescue Cribbing / Wedge Kit



AM187

Features:

- ▶ Will never dry out
- ▶ Non-absorbent (all petro chemical and bodily fluids)
- ▶ Fast stabilization

AM187 Includes:

- ▶ 24 - 4"x4"x18" Cribs
- ▶ 24 - 2"x4"x18" Cribs
- ▶ 12 - 2"x4"x12" Wedges
- ▶ 12 - 4"x4"x20" Wedges
- ▶ 1 - Carrying Bag/
- ▶ 4 - Toters
- ▶ Ship. wt. 400 lbs.

AZ512 Includes:

- ▶ 24 - 4"x4"x18" Cribs
- ▶ 24 - 2"x4"x18" Cribs
- ▶ 12 - 2"x4"x12" Wedges
- ▶ 12 - 4"x4"x20" Wedges
- ▶ 4 - Step Chocks
- ▶ 2 - Medium Step Chocks
- ▶ 2 - Giant Step Chocks
- ▶ 24 - Lincoln Logs
- ▶ 2 - Bag Pads
- ▶ 2 - Shoring Cribs
- ▶ 8 - Super Cribs
- ▶ 1 - Hose Bridge Set
- ▶ 2 - Super Wedges
- ▶ 2 - Carrying Bags/
- ▶ 6 - Toters
- ▶ Ship. wt. 1,490 lbs.



Cat#	Description	Black	Yellow
AM187	USAR Kit	\$1,818.95	\$2,263.95
AZ512	USAR Super Kit	\$8,983.95	\$10,560.95

Crib Kits

Crib Kit A Includes:

- ▶ 1 - Set of Lock Blocks

Crib Kit B Includes:

- ▶ 1 - Set of Lock Blocks
- ▶ 1 - 3W Wedge
- ▶ 1 - 6W Wedge
- ▶ 2 - 18" Lincoln Logs

Crib Kit C Includes:

- ▶ 1 - Set of Lock Blocks
- ▶ 1 - 3W Wedge
- ▶ 1 - 6W Wedge
- ▶ 2 - Shoring Crib
- ▶ 4 - 18" Lincoln Logs

Crib Kit D Includes:

- ▶ 1 - Set of Lock Blocks
- ▶ 1 - 3W Wedge
- ▶ 1 - 6W Wedge
- ▶ 2 - Shoring Crib
- ▶ 1 - Giant Step Chock
- ▶ 8 - 18" Lincoln Logs

Free Bonus Package with Purchase of a Crib Kit. Valued at over \$300



Description	Kit A	Kit B	Kit C	Kit D
2"x4"x18" Crib	6	12	24	48
2"x4"x12" Wedge	2	4	8	16
4"x4"x18" Crib	6	12	24	48
4"x4"x18" Lincoln Log	4	8	16	32
4"x4"x20" Wedge	2	4	8	16
3"Wx8.5"L Wedge	2	4	6	8
6"Wx8.5"L Wedge	2	4	6	8
1" Thick x 9" Sq. Lock Block	1	2	3	4
2" Thick x 9" Sq. Lock Block	1	2	3	4
3" Thick x 9" Sq. Lock Block	1	2	3	4
Step Chock	2	4	8	16
Medium Step Chock		2	4	8
Giant Step Chock			2	4
24"x24" Bag Pad Gray		2	4	8
Top Bag Pad		2	4	8

Cat#	Description	Ship. wt.	Black	Yellow
AS273	Crib Kit A	175 lbs.	\$989.95	\$1,286.95
AS274	Crib Kit B	525 lbs.	\$2,767.95	\$3,458.95
AS275	Crib Kit C	1,195 lbs.	\$6,252.95	\$7,799.95
AS276	Crib Kit D	2,225 lbs.	\$11,256.95	\$12,779.95

Champion™ Rescue Tools

Available as a complete system, or individual components can be ordered to be compatible with any existing rescue tools

All Champion Power Tools:

▶ **Fluid Type:** Phosphate Ester, Mineral Oil or Ethylene Glycol

▶ **Fluid Pressures:** 5,000 or 10,500 compatible with any system.

▶ **Safety Factor:** 4 to 1 burst on all hydraulic components

Guillotine Cutter



- ▶ Max Cutting Force: 248,000 lbs. at 1/2" back from blade tip
- ▶ Type of Cutter: Guillotine
- ▶ Cutter Opening: 4.5"
- ▶ Cutter Weight: 30.5 lbs.
- ▶ Dimensions: 27.5"x6.3"x6.8"
- ▶ Limited lifetime warranty

SPECIFY: 5,000 or 10,500 psi

AW273 Guillotine Cutter \$3,695.95



Monster Mini Spreader



- ▶ Spreading Force:
5,000 psi - 14,000 lbs.
10,500 psi - 25,000 lbs.
- ▶ Opening Distances: 11"
- ▶ Gripping Arm Surface: 10"
- ▶ Weight: 28 lbs.
- ▶ Dimensions: 27.5"x6.75"x7.75"
- ▶ Your choice of fluid type
- ▶ Limited lifetime warranty



SPECIFY: 5,000 or 10,500 psi

AW272 Monster Mini Spreader \$4,195.95



Rescue Ram

Champion Rescue Tools Rams are the most unique style on the market. They can be run as an interlocking set or independently. When interlocked they provide up to 52" of spreading distance. The stainless steel heads have an aggressive multi-tooth design that digs into the surface being pushed and greatly reduces slippage commonly seen in other rams. Uses attached control valve or remote controller for increased safety and visibility for the operator.

▶ Limited lifetime warranty

21"-33" Rescue Ram with Attached Valve

- ▶ Force: 13,000 lbs.
- ▶ Weight: 24 lbs.
- ▶ Closed Length: 21.0"
- ▶ Open Length: 33.0"

21"-33" Rescue Ram

- ▶ Force: 13,000 lbs.
- ▶ Weight: 19.3 lbs.
- ▶ Closed Length: 21.0"
- ▶ Open Length: 33.0"

13"-19" Rescue Ram

- ▶ Force: 13,000 lbs.
- ▶ Weight: 13.4 lbs.
- ▶ Closed Length: 13.0"
- ▶ Open Length: 19.0"



AW274	Rescue Ram 13"-19" for 5,000 psi	\$1,195.95
BL223	Rescue Ram 13"-19" for 10,500 psi	\$1,195.95
AW275	Rescue Ram 21"-33" for 5,000 psi	\$1,795.95
BL218	Rescue Ram 21"-33" for 10,500 psi	\$1,795.95
BL216	Rescue Ram 21"-33" with Attached Valve for 5,000 psi	\$2,495.95
BL217	Rescue Ram-21"-33" with Attached Valve for 10,500 psi	\$2,495.95
AW276	Dual Remote Control Unit	\$955.95
AW277	Coupler (Connects Rams/Up to 52" Length)	\$210.95

Power Units

The Honda engines are dependable and hardworking and can operate the power unit at 5,000 psi or 10,500 psi all day long and year after year. The 6.5 HP Honda SIMO Power Unit Four Cycle is able to operate two tools simultaneously with an air cooled engine, spark arresting muffler and recoil rope starter. 3.0 Honda Ultra Light Power Unit allows two-tool hook-up but only single tool operation at a time.

3.0 Honda Ultra Light

- ▶ Weight: 44 lbs.
- ▶ 19"Lx12"Wx18"H

6.5 Honda SIMO Power Unit

- ▶ Weight: 69 lbs.
- ▶ 23.5"Lx17"Wx17.5"H



AW278

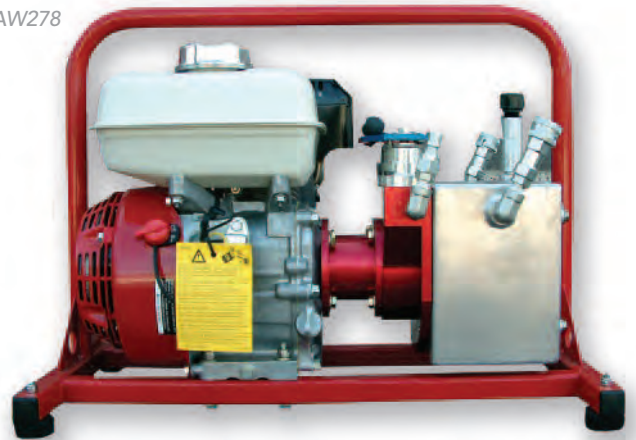

AW278	6.5 Honda SIMO Power Unit	\$5,495.95
BG400	3.0 Honda Ultra Light Power Unit	\$4,695.95
AW280	30' Thermal Plastic Twin Line Hose	\$684.95

Custom Hose Length Available

The BEAST™

The BEAST™ is tested and proven to handle the most demanding 5 star crash rated vehicles. Made in the USA.

Features:

- ▶ Weight: 51.9 lbs
- ▶ Dimensions: 28.0"x12.5"x8.0"
- ▶ Operating Pressure: 5,000 psi
- ▶ Compatible with any low pressure system
- ▶ Limited Lifetime Warranty

BD170:

- ▶ Cutter and Spreader in one tool, you can change from full size cutter to a powerful spreader in seconds by pulling three pins
- ▶ Generates 35% more cutting force than any other 5,000 psi tool in the market
- ▶ Outfitted with Champion's patented laminated cutting blades with internal safety restraints
- ▶ Opening: 10.75" Cutter with 3.5" Power Notch; 28.0" spreader with 16.0" of parallel travel
- ▶ Accessories Include: 1 full size USAR cutting head and 1 full size spreading head for one low price

BL201:

- ▶ Type of Tool: Scissor
- ▶ Opening: 10.75" Cutter with 3.5" Power Notch
- ▶ Outfitted with Champion's patented laminated cutting blades with internal safety restraints
- ▶ Generates 35% more cutting force than any other 5000 psi tool in the market
- ▶ Accessories Include: 1 full size USAR cutting head



Cutter

Spreader



BL202:

Dash displacements, door removals or just skinning a vehicle quickly to expose cutting points, THE BEAST™ Spreader is the tool for the job.

- ▶ Type of Tool: Spreader
- ▶ Opening: 28.0" Spreader with 16.0" of parallel travel
- ▶ Accessories Include: 1 full size spreading head



	Multi-Tool	Cutter	Spreader
Type of Tool	Scissor Cutter & Spreader	Scissor Cutter	Spreader
Cutting Force	294,000 lbs.	294,000 lbs.	
Spreading Force	65,000 lbs.	-	65,000 lbs.

BD170	The BEAST™ Multi-Tool	\$5,695.95
BL201	The BEAST™ Cutter	\$5,395.95
BL202	The BEAST™ Spreader	\$5,395.95

The SUPER BEAST

As the world's auto makers continue designing safer and stronger vehicles each year, the 10,500 psi SUPER BEAST generates unmatched force to handle these ever changing materials for years to come. With power like this, there's no need to learn the technique of "the work around". THE SUPER BEAST is tested and proven to handle the most demanding 5 star crash rated vehicles.

Features:

- ▶ Weight: 51.9 lbs
- ▶ Dimensions: 28.0"x12.5"x8.0"
- ▶ Operating Pressure: 10,500 psi
- ▶ Compatible with most high pressure systems
- ▶ Limited Lifetime Warranty

BL203:

- ▶ Type of Tool: Scissor
- ▶ Opening: 10.75" Cutter with 3.5" Power Notch
- ▶ Outfitted with Champion's patented laminated cutting blades with internal safety restraints
- ▶ Accessories Include: 1 full size USAR cutting head



BL203	The SUPER BEAST Cutter	\$5,395.95
BL204	The SUPER BEAST Spreader	\$5,395.95
BL205	The SUPER BEAST Multi-Tool	\$5,695.95



Spreader



Cutter

BL204:

- ▶ Type of Tool: Spreader
- ▶ Opening: 28.0" Spreader with 16.0" of parallel travel
- ▶ Accessories Include: 1 full size spreading head

BL205:

- ▶ Type of Tool: Scissor Cutter and Spreader
- ▶ Opening: 10.75" Cutter with 3.5" Power Notch; 28.0" spreader with 16.0" of parallel travel
- ▶ Accessories Include: 1 full size USAR cutting head and 1 full size spreading head for one low price

	Multi-Tool	Cutter	Spreader
Type of Tool	Scissor Cutter & Spreader	Scissor Cutter	Spreader
Cutting Force	500,000 lbs.	500,000 lbs	
Spreading Force	140,000 lbs.	-	140,000 lbs.

Hand Operated Combi Tool

The manual combi tool is a highly flexible and easy-to-use tool. The pump body with the lever are able to rotate through 360° in order to ensure a flexible and comfortable working position. Furthermore, it weights only 41 lbs., which makes the tool easy to carry and to operate.

- ▶ Powerful combination tool for cutting, spreading and squeezing operations
- ▶ Can be used in any position, horizontal or vertical
- ▶ Build-in safety valve



BL403 Hand Operated Combi Tool \$4,453.95

Darley Chain Kit

- ▶ 6' "J" hook
- ▶ 3' "C" hook
- ▶ 2' "T" hook
- ▶ 7' Pull chain assembly
- ▶ 12' Extension chain
- ▶ 2 - Cheater chains
- ▶ Carrying container
- ▶ Ship. wt. 50 lbs.



AZ525 Darley Chain Kit \$565.95

Emergency Equipment Staging Platform

The Emergency Equipment Staging Platform is 6'x10', color coded and marked. This MAT-1 features a ribbed storage area for air cylinders. There are also storage areas for power tools, ropes, and EMS equipment. MAT-1 is expandable to meet the size of any incident. Each MAT-1 panel is also sold separately and comes standard with green and red which has "Full and Empty". The two yellow panels have "Power Tools and Hand Tools". The two blue sections have "EMS and Ropes" and the long middle section has "Hooks" embroidered for long lasting markings. The sections are easily expanded or retracted as needed. *Carrying strap included.*



AZ486 MAT-1 Emergency Equipment Staging Platform \$255.95

Rescue Chain Package

The Rescue Chain Kit can help save time and lives in any crash rescue situation involving pulling or moving of steering columns, seats, doors, dash boards, etc. This package can be used separately or as a companion to your hydraulic equipment. Chains and hooks are gold chrome-plated. *Ship. wt. 80 lbs.*

- ▶ Carrying container
- ▶ 1 - Chain Come-A-Long with 1½-ton capacity and 5' pull
- ▶ 1 - 6 anchor chain, 6' long with "J" hook at one end and "T" hook at other
- ▶ 1 - Loading hook, 5' long with 5/8"x3" ID round ring for connecting chain
- ▶ 1 - "Cheater" chain, 20" long with grab hooks
- ▶ 1 - Pulling chain, 20' long, with slip hook at one end and grab hook at other end



AB886 Rescue Chain Package \$951.95

“Strip and Peek” Trim and Molding Removal Tool

The Trim and Molding Removal Tool is designed to expose the following hazards while preparing to extricate a victim from an automobile accident.

Reveal These Hazards:

- ▶ Air bag canisters that have 3000 psi - 10,000 psi
- ▶ Seat belt pre-tensioners, positioned in the lower portion of the “B” post
- ▶ Wire looms that are connected to the air bags and pre-tensioner systems
- ▶ Expose the super structure of the vehicle prior to cutting brain box for the air bags

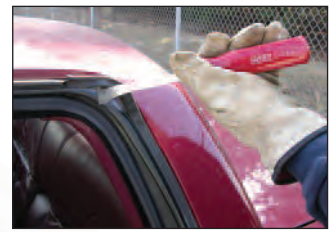

BH137 “Strip and Peek” Tool

\$19.95

AUTO CRIB-IT™ Step Chock

Spring Activated for Stabilizing Vehicles in Seconds

- ▶ Spring activated for stabilizing vehicles in seconds
- ▶ Automatically re-adjusts and locks during operations
- ▶ Taller than most step-chocks. Up to 13" in height
- ▶ Super compact! Leaves storage space for other vital equipment
- ▶ Can be positioned completely under and parallel to rocker panels to avoid trip hazards
- ▶ Lightweight high-strength aluminum
- ▶ Only weighs 14.5 lbs.
- ▶ Quick and easy 1/4 turn lock
- ▶ Easily decontaminated
- ▶ Rated for 2000 lbs. max. load



BH117 AUTO CRIB-IT™ Step Chock

\$947.95/set of 2

Lifting Bag Kit

Extremely powerful and uniquely versatile, the Power Hawk Rescue System is unlike any other rescue tool in the world. This All-Electric (no hydraulics) “jaws” type rescue tool utilizes Curtiss-Wright aerospace gear technology developed for demanding military fighter-jet flight control applications. By eliminating hydraulics completely and utilizing 12 volts DC power, the VERSATILITY of the Power Hawk makes it the perfect choice for many applications.



Includes:

- ▶ Portable air compressor, 12 V DC up to 100 psi
- ▶ 22"x22" heavy lift air bag, 20.3 tons
- ▶ 18"x18" heavy lift air bag, 12.6 tons
- ▶ 12"x12" heavy lift air bag, 5.5 tons
- ▶ Hand-held double fitting controller
- ▶ 20' yellow inflation hose
- ▶ 20' red Inflation hose
- ▶ 20' blue inflation hose
- ▶ Adapter for standard air hose connection w/pressure regulator and gage

Applications:

- ▶ Vehicle extrication
- ▶ Crash & salvage
- ▶ Damage control
- ▶ Rapid-intervention teams
- ▶ Collapse rescues
- ▶ Remote rescues
- ▶ Indoor and confined space operation
- ▶ Forcible entry
- ▶ Special operations & more

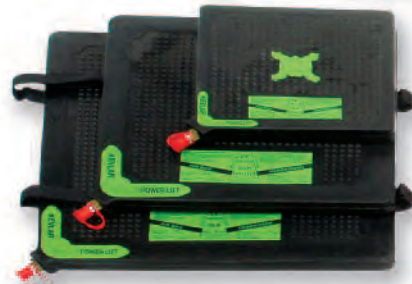

BH171 Lifting Bag Kit with 12vdc Compressor

\$5,119.95

Airgun Kit

700-750 high impact blows per minute, 7 pound, pneumatic impact tool. Combining ease of handling, very low air consumption and high power output. It is an ideal tool for rescue work. Vehicle crash sites, metal clad buildings, aircraft penetration, exhaust ducts and composite structural material are typical barriers often faced by rescue personnel. The Airgun, using one of several specially designed tool bits, should be your tool of choice when faced by these situations. Ideal confined space tool. *Ship. wt. 31 lbs.*



PARATECH.

- ▶ Airgun, with inline oiler
- ▶ Pressure regulator, 6,000 - 300 psi
- ▶ 3/8" diameter, 32' hose
- ▶ 10" curved metal cutter bit
- ▶ 11" bullpoint bit
- ▶ 11" chisel, 3/4" wide bit
- ▶ Lubricating oil, 4 oz.
- ▶ Retainer service tool
- ▶ Hex key 7/32"
- ▶ Hex key 3/16"
- ▶ Operating and instruction manual
- ▶ Plastic safety goggles
- ▶ Ballistic nylon carrying case 23"x10 1/4"x13"

BB136 Airgun Kit \$3,036.95

Rapid Toolguard

With the price of rescue tools so high, can you afford to let them rust? Rapid Toolguard will prevent rust and protect tools without leaving a sticky surface to attract dirt like most lubricants do.

- ▶ Prevents rust to improve performance and extend tool life
- ▶ Use to protect tools
- ▶ Penetrates deep to seal out harmful moisture & prevent corrosion



BE047 Rapid Toolguard \$7.95

Sure Cut System

The Sure Cut System will cut virtually any metal, both ferrous and non-ferrous, and is faster than conventional oxy-acetylene cutting. Our system does not require preheating or cleaning the material before cutting. It is easy-to-use and is cost effective for most applications.

Features:

- ▶ No Carbon Residue - Clean cuts with no carbon to grind away
- ▶ Portable - It can be used in remote areas with the use of a 12v battery
- ▶ Faster - Sure Cut is as much as five times faster than oxy-acetylene cutting and up to ten times faster than Carbon Arch Gouging, depending on the thickness of material to be cut
- ▶ Easy-to-Use - With Sure Cut equipment, all you need is an ignition source (welder, 12 or 24v battery or torch) and oxygen to operate



BH017 Tool Box Kit with Standard Holder and 24 Rods* \$726.95
 * 12 each 1/4" and 12 each 3/8"x24" QC rods

Heavy Rescue Outfit

The PETROGEN® Heavy Rescue Outfit is designed for extensive steel cutting in a heavy rescue situation. The components were assembled with the input of firefighters and USAR members. Hundreds of fire departments and USAR teams are using the PETROGEN® system. *Ship. wt. 45 lbs.*



BA126 Heavy Rescue Outfit \$2,025.95

Professional Extricator Hydraulic Rescue Kits

Extricator Forcible Entry Kit

Use it to open damaged doors in plants and factories, or raise clutch and brake pedals in auto rescue extraction by using the Spreader and Wedge combination. Come-a-longs and chains are used to pull seats, doors, steering columns, and to roll quarter panels out of the way. The straight Ram and attachments are used to lift heavy objects and push metal within the vehicle to free trapped victims. This kit will allow you to move in multiple directions at the same time. **Ship. wt. 150 lbs.**

T861 Extricator Forcible Entry Kit \$5,346.95



10-Ton Deluxe Rescue Kit

The capability for providing big power in compact spaces. Spreader toes lift heavy machinery, elevators, etc. "Wedgie" and "Spreader" rams open car doors, move steering columns, bumpers and obstructing metal. Two powerful rams are included. Includes 16 gauge metal box. **Ship. wt. 122 lbs.**

L871 10-Ton Deluxe Rescue Kit \$4,041.95

5-Ton Deluxe Rescue Kit

This compact set provides professional capability at a low cost. Includes large "Spreader" ram for lifting fallen objects, prying doors, bars, damaged sections, etc. Contains "Wedgie" and a powerful 5-ton ram with a 5" stroke. 16 gauge lockable/sealable metal box included. **Ship. wt. 64 lbs.**

L870 5-Ton Deluxe Rescue Kit \$3,039.95

5-Ton Rescue Kit

A lightweight set, stores easily and provides basic tools for emergency extrication work. Ideal for patrol cars and emergency vehicles. Includes 2-rams, "Wedgie" and 5 1/4" stroke ram with 5-ton capacity. **Ship. wt 28 lbs.**

L869 5-Ton Rescue Kit \$1,836.95



RESCUE TOOLS

Air Hammer Rescue Kits

Easy Operating Kits Featuring Non-Turn Chisels

High-quality Air Hammer Rescue Kits have been designed specifically for extrication and are field-proven not only for emergency extrications but for all types of emergency cutting such as: factory doors, casement windows, fire doors and many other jobs. Release the trigger and the tool stops instantly. Completely portable and compact enough to be easily carried in fire trucks and rescue vehicles. Operated off fresh air tanks, compressors, nitrogen bottles, cascade systems or air brake outlets. *Use with either 2216 or 4500 psi air tanks.*



Steel box included in all kits

Standard Duty Kits

Complete Kit with everything necessary to hook up to an air tank and begin extrication work.

- ▶ Hammer for .401-in. shank tools
- ▶ Retainer
- ▶ Regulator
- ▶ Moil point (turn type)
- ▶ 15 ft. 1/4" Hose
- ▶ 2-double blade panel
- ▶ 2-Kwik Cutter (non-turn)
- ▶ 2-Kwik Cutter, 18" (non-turn)
- ▶ 2-1/4" male connector
- ▶ 1/4" male coupler
- ▶ 1/4" female coupler
- ▶ Gauge guard
- ▶ Steel kit box
- ▶ 4 oz. oil

S878 Standard Duty Air Hammer Kit \$872.95



S878

Heavy-Duty Kits

Features Heavy-Duty Hammer with longer piston stroke for more powerful cutting action. Includes non-turn and turn-type chisels.

- ▶ Hammer for .401-in. shank tools
- ▶ Retainer
- ▶ Regulator
- ▶ Moil Point (turn type)
- ▶ 2-Double blade panel cutter (non-turn)
- ▶ 2-Kwik Cutter (non-turn)
- ▶ 2-Kwik Cutter, 18" (turn type)
- ▶ Ripper chisel (turn type)
- ▶ 15 ft. 1/4" Hose
- ▶ 2-Kwik Cutter, 18" (non-turn)
- ▶ 2-Panel Cutter (turn type)
- ▶ 2-Kwik Cutter (turn type)
- ▶ Male connector (2)
- ▶ Male coupler
- ▶ Female coupler
- ▶ Gauge guard
- ▶ Steel kit Box
- ▶ 4 oz. Oil

AJ318 Heavy-Duty Air Hammer Kit \$1,469.95



AJ318

Super-Duty Kits

Features Super-Duty Hammer, our most powerful and hardest hitting hammer. Includes non-turn and turn-type chisels.

- ▶ Hammer for .498-in. shank tools
- ▶ Retainer
- ▶ Regulator
- ▶ 2-Ergo chisel grip (non-turn)
- ▶ 12-in. moil point (non-turn)
- ▶ 2-Double blade panel cutter (non-turn)
- ▶ 2-Kwik Cutter (non-turn)
- ▶ 2-Kwik Cutter, 18" (non-turn)
- ▶ 2-Double Panel Cutter (turn type)
- ▶ 2-Kwik Cutter (turn type)
- ▶ 2-Kwik Cutter, 18" (turn type)
- ▶ 3/8" male connector (2)
- ▶ 3/8" male coupler
- ▶ 3/8" female coupler
- ▶ Gauge guard
- ▶ 20" Steel kit box
- ▶ 4 oz. oil
- ▶ 15 ft. 3/8" hose

AJ472 Super-Duty Air Hammer Kit \$2,294.95



AJ472

HYDRA-RAM Hydraulic Emergency Entry Tool

10,000 pounds of force is presented by 138 lbs. of pumping to acquire $\frac{3}{4}$ " stroke to a maximum thrust opening of 4 inches. The Hydra-Ram can be placed in any position, even upside down, without any effect on its operation; this is a first in hydraulics. Because of its unique size, 13" and only 12 lbs., it can be slung or carried on your belt. The entire unit can be controlled by one user alone, making it truly a one-person operation tool. No hoses, tanks or pumps so there is no maintenance or leaking fluid. Jaws are made of stainless steel with 220,000 psi tensile strength. Special finger grips give a non-slip holding surface. *Ship. wt. 15 lbs.*

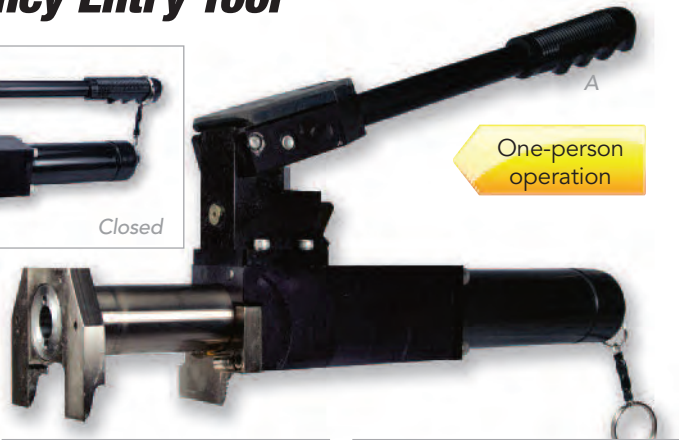

One-person operation

Includes:

- ▶ A. HYDRA-RAM tool
- ▶ B. Cordura® carrying bag
- ▶ C. Mallet
- ▶ D. Carrying sling



AE097 HYDRA-RAM Hydraulic Emergency Entry Tool

\$1,624.95



Use the right tool for the right job and let the tool do the work

Percussive Rescue Kit

You'll feel the difference as soon as you hold it. This slam and ram tool exerts a striking force as you've never seen. You'll hear the solid "thud" as the slam bar strikes one of the six assorted tool bits. The ram travels up to 13.6" for maximum impact. Whether you're breaking a brick/block wall or pounding through locks and latches, this tool makes you more efficient. With the slam and ram feature, there is no deflection of pounding force. All of the energy is used to strike effective, penetrating blows by a single person. When hydraulic, electric and pneumatic power is gone or unavailable, you'll still be punching and pounding with this rescue tool.

Complete Kit Includes:

- ▶ Percussive tool bar
- ▶ Lockbreaker claw
- ▶ Metal cutting claw
- ▶ Bull point
- ▶ Chisel
- ▶ Wide chisel
- ▶ Carrying bag



Cat#	Description	Weight	Price
AC614	Complete Rescue Tool Kit	29 lbs.	\$984.95
AC621	Percussive Rescue Tool Only	14.2 lbs.	\$554.95

Darley Ram Jammers

For Vehicle Extrication

When doing a dash roll-up, place the Ram Jammers against the B-posts on each side of the vehicle. Then, instead of only getting one push with the medium hydraulic rams, Ram Jammers give you a secure base to make a second and then a third push for the "Maximum Dash Roll-Up." This will give you a large amount of room in the front of the patient, making it easier to apply spinal immobilization devices. They also absorb the force of the rams to prevent fractures at the B-post. *Ship. wt. 45 lbs.*

Provides secure base

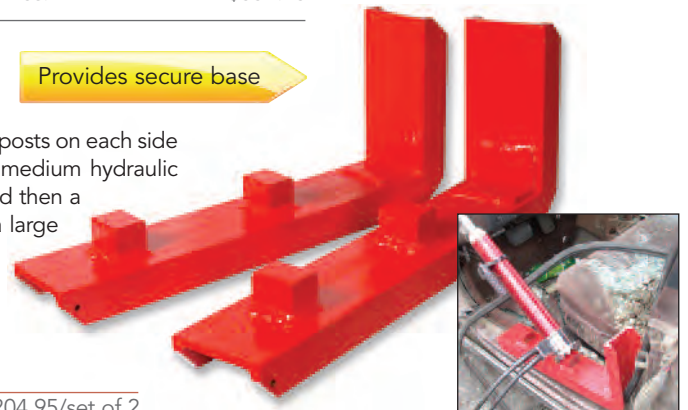

AF349 Darley Ram Jammers

\$204.95/set of 2

Paratech Stabilization & Support Systems

Vehicle Stabilization Kits

Paratech's Vehicle Stabilization Kits have the strength and flexibility to handle any size vehicle, any time, anywhere! This includes sub compact cars, buses, cement trucks, and even train locomotives! Additionally, these components provide added value of being interchangeable with your other Paratech Strut kits for building collapse and trench rescue. They are sturdy, reliable, easy-to-use and the strongest on the market! The Vehicle Stabilization Kit has a maximum load capacity up to 40,000 lbs. GVWR with a 4:1 safety factor and can stabilize most single vehicle applications.

Ship. wt. 114 lbs.

Features:

- ▶ Strongest VSK on the market
- ▶ Can develop into a complete system as components are added
- ▶ Easy-to-maintain
- ▶ 5-year guarantee
- ▶ Compatible w/other Rescue Strut kits

AZ462 Includes:

- ▶ A. 2 - 24" Acme strut
- ▶ B. 2 - 12" Strut extension
- ▶ C. 2 - 24" Strut extension
- ▶ D. 4 - Multi-Base
- ▶ E. 2 - Hinged ground plate
- ▶ F. 2 - 27' Ratchet belt w/finger hooks
- ▶ G. 2 - Tie down keys with/J hooks (not pictured)

BH172 Includes:

- ▶ C. 1 - 24" Strut extension
- ▶ D. 2 - Multi-Base
- ▶ F. 2 - 27" Ratchet belt
- ▶ H. 1 - 25"-36" Acme thread strut
- ▶ I. 1 - 37"-58" Acme thread strut
- ▶ J. 1 - 36" Strut extension (not pictured)
- ▶ K. 2 - 6" Hinged base w/anchor



Cat#	Description	Maximum Load Capacity	Price
BH172	Compact Vehicle Stabilization Kit	40,000 lbs.	\$2,645.95
AZ462	Vehicle Stabilization Kit	40,000 lbs.	\$3,368.95
BG157	Highway Vehicle Stabilization Kit (Call for Details)	80,000 lbs.	\$6,016.95
BG158	Interstate/Motorway Vehicle Stabilization Kit (Call for Details)	120,000 lbs.	\$15,616.95

PARATECH

RESCUE TOOLS

Multi-Base

Paratech introduces the new Multi-Base for use in a wide array of vehicle stabilization and structural collapse scenarios. Arrive on scene knowing you will always have the right tool. The Multi-Base is four bases in one: use either of its two top points as a "Cone Base", angled center area as a "V-Base", engineered deep cut center slot as a "Chain Wedge" and its angled top shape as a "Corner Base".

PARATECH



V Base



Cone Base



Chain Wedge



Corner Base



BG529 Multi-Base

\$184.95

Telescoping Aluminum Support System

Prospan Manufacturing's vehicle stabilization product is called TASS. TASS is a 3-tiered, telescoping aluminum support system. Designed primarily for the stabilization of motor vehicles involved in roadway crashes, the TASS can be used for light structural support applications as well. The TASS is made almost entirely of anodized aluminum and stainless steel. Like all of the Prospan products, it has been designed to be incredibly strong, simple-to-use and virtually maintenance-free.

- ▶ Telescoping aluminum supports 26"-48" span
- ▶ Baseplate - 10" w/detent pins
- ▶ Baseplate shoring adapters
- ▶ Vehicle adapters
- ▶ V-Grip attachments
- ▶ Conical-shaped attachments
- ▶ Ratchet straps - 20" w/hook cluster



BC028

Telescoping Aluminum Support System

\$1,729.95

new

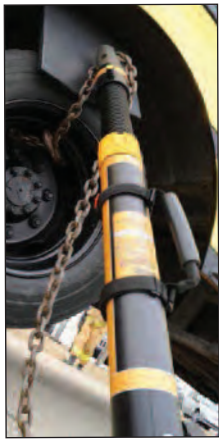

HydraFusion Strut Kits

Paratech HydraFusion Struts offer users the ability to lift up to 10 U.S. tons with a safety factor of 2:1 and to stabilize up to 20,000 lbs. with a safety factor of 4:1. The innovative built in Dual Shaft End Adaptor allows users to safely use existing cache of Paratech Longshore, Lockstroke, or AcmeThread Struts and Extensions in conjunction with the incredible lifting ability of the HydraFusion Strut.

- ▶ Available in three sizes: 4", 10" and 16"
- ▶ No-spill, flat face hydraulic couplings
- ▶ Non-conductive 10' kink-resistant hose
- ▶ Two speed, single acting, 10,000 psi, metal hydraulic pump

Kit Includes:

- ▶ HydraFusion Strut and pump with hose
- ▶ **Ship Weight:**
4" Kit 34 lbs.
10" Kit 44 lbs.
16" Kit 53 lbs.

PARATECH

HYDRAFUSION STRUT

BL490	HydraFusion Strut 4" Kit	\$2,299.95
BL491	HydraFusion Strut 10" Kit	\$2,599.95
BL492	HydraFusion Strut 16" Kit	\$2,899.95



TVS Kit

Paratech introduces the 'All in One' Vehicle Stabilizer with its Twistlock Vehicle Stabilizer (TVS) system. The TVS is the answer for a no assembly required system that responders can easily stabilize a vehicle accident scene quickly and effectively. With the Twistlock Collar just simply twist, extend, lock and the TVS can stabilize 10,000 lb. with a 2:1 safety factor at any height. No load charts needed.

- ▶ Multipurpose head
- ▶ Adjustable handle
- ▶ Integrated ratchet belt
- ▶ 90° base folds flat for storage
- ▶ Carrying bags included with kit
- ▶ **Ship. wt. 90 lbs**

new

PARATECH

BL493	TVS Kit	\$3,181.95
-------	---------	------------

Vehicle Maintenance Kit G2

Made of the highest quality neoprene and 3 layers of Aramid reinforcement, Paratech's Maxiforce Air Lifting Bags have the strength, durability and flexibility to tackle your lifting needs. The Paratech Vehicle Maintenance Kit is perfect for use to lift vehicles, or other heavy objects to perform scheduled or emergency maintenance and repairs. Not only are these bags versatile but operation is simple too. Just position the bag under the load and inflate; within seconds your load is lifted. This bag system can lift, move, or shift weights of up to 83 tons with ease!

- ▶ 2 - W168
- ▶ 2 - Inline relief valve
- ▶ 1 - 16' black hose with couplings
- ▶ 1 - 16' yellow hose with couplings
- ▶ 1 - 16' red with couplings
- ▶ 1 - Dual deadman bag controller

PARATECH

BL494	Vehicle Maintenance Kit G2	\$4,784.95
-------	----------------------------	------------



new

Maxiforce Air Lifting Bags

Maximum Force Where You Need It Most!

The Maxiforce Air Lifting bag is a thin, strong, molded envelope. It is made from a neoprene-covered Aramid reinforcement and has the power to lift, move or shift weights up to 70 tons. Of course there is more to a lifting bag system than the bag itself. The control equipment and components play a critical role in successful lifting bag use. Unlike other lifting bag systems, Paratech manufactures all of its major control components. This assures the quality of the lifting bag system from inflation to deflation.

- ▶ Made of the highest quality neoprene and embedded with 3 layers of Aramid fiber reinforcement on each side
- ▶ Each bag has been subjected to a stringent factory pressure test
- ▶ The thinner the bag, the better! Maxiforce Air Lifting bags range in thickness from 5/8" to 1"
- ▶ Small, molded, raised dimples provide an interlocking surface for stacking 2 lifting bags (no more than 2 bags may be stacked)
- ▶ Air inlet is threaded to receive a brass nipple. No corrosion and easy-to-repair!
- ▶ Inflate from any air source
- ▶ Technical data molded into the bag and the famous "X" marks the center of the load
- ▶ Operating pressure 118 psi

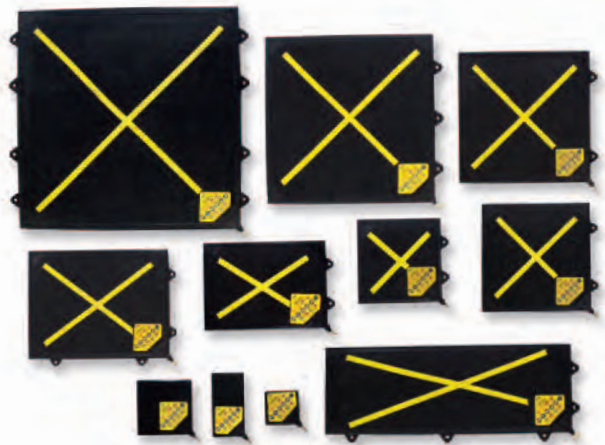

PARATECH

RESCUE TOOLS

Individually Priced Air Bags						
Cat#	Description	Dimensions	Capacity	Height	Weight	Price
BG131	KPI-1	6" x 6" x 5/8"	1.2 tons	3" Lift	2 lbs.	\$331.95
BG132	KPI-3	6" x 12" x 5/8"	2.8 tons	3.5" Lift	3 lbs.	\$438.95
BG133	KPI-5	10" x 10" x 5/8"	4.3 tons	5.4" Lift	4 lbs.	\$590.95
W163	KPI-12	15" x 15" x 3/4"	10.8 tons	8" Lift	10 lbs.	\$770.95
W164	KPI-17	21" x 15" x 3/4"	15 tons	9" Lift	13 lbs.	\$820.95
W165	KPI-22	20" x 20" x 3/4"	20.2 tons	11" Lift	16 lbs.	\$1,028.95
BH153	KPI-28	20" x 26" x 3/4"	26.8 tons	11.7" Lift	19.6 lbs.	\$1,096.95
W166	KPI-32	24" x 24" x 3/4"	29.9 tons	13" Lift	22 lbs.	\$1,152.95
W167	KPI-35L	42" x 15" x 3/4"	31.1 tons	9.3" Lift	23 lbs.	\$1,326.95
W168	KPI-44	28" x 28" x 3/4"	41.5 tons	15" Lift	30 lbs.	\$1,827.95
W169	KPI-74	37" x 37" x 1"	70.2 tons	20" Lift	60 lbs.	\$2,615.95

Lifting Air Bag Sets - Prices Do Not Include Control Packages				
Cat#	Description	Bag Quantity	Contents	Price
AF387	Model 234	7 Air Bag Set	1 Each of Bags W163 - W169	\$9,541.95
AF388	Model 117	7 Air Bag Set	1 Each of Bags W163, 2 Each of W164 - W166	\$8,101.95
BK412	Model 48	3 Air Bag Set	1 Each of Bags W164, BH153 and W166	\$3,069.95
BG135	Model 92	9 Air Bag Set	1 Each of Bags BG131 - BG133, W163, W165, 2 Each of W164 and W166	\$6,983.95
BG136	Model 245	10 Air Bag Set	1 Each of Bags BG131 - BG133 and W163 - W169	\$10,901.95

Air Cushion Lift Kits

Paratech's Rescue Air Cushions are designed as an advanced rescue tool. They are an ideal tool for high lift requirements of non-reinforced, broad surfaces found on trucks, vans, and light aircraft. Especially effective in the rescue or recovery of downed animals. The cushions are also used by collapse rescue teams to fill collapse voids and regain support for rescue struts, wall braces, and shoring.

- ▶ Repair kit, storage and carrying case
- ▶ 2 - Rescue Air Cushions with pressure reliefs
- ▶ Dual safety controller with quick connect coupling
- ▶ 1 - 16' of 3/8" diameter high pressure hose with quick connect coupling
- ▶ 2 - 20' of 1" diameter low pressure hose with quick connect coupling



PARATECH

Cat#	Description	Rating	Color	Price
AZ424	6 Ton Air Cushion Lift Kit Kevlar Reinforced	14.5 psi	Black Nylon	\$5,245.95
AZ425	10 Ton Air Cushion Lift Kit Kevlar Reinforced	14.5 psi	Black Nylon	\$5,862.95
AZ426	14 Ton Air Cushion Lift Kit Kevlar Reinforced	14.5 psi	Black Nylon	\$6,515.95

Control Packages

The Paratech Control packages are essential to your Maxiforce Air lifting bag needs! Included in these packages is everything that you need to operate your Maxiforce Air lifting bags. Whatever the job, these control packages will meet your needs!

AF391 Includes:

- ▶ 1 - Dual deadman safety relief & control valve
- ▶ 1 - Pressure regulator-piston type 6,000-135 psi (414-9 bar) CGA 347/346 inlet
- ▶ 1 - Black air hose (3/8" D x 16' L)
- ▶ 1 - Yellow air hose (3/8" D x 16' L)
- ▶ 1 - Red air hose (3/8" D x 16' L)



AF391

BG134 Includes:

- ▶ 1 - Dual deadman safety relief & control valve
- ▶ 1 - Pressure regulator-diaphragm type 6,000-135 psi (414-9 bar) CGA 347/346 inlet
- ▶ 4 - Inline relief valves

- ▶ 1 - Black air hose 3/8" D x 16' L
- ▶ 1 - Blue air hose (3/8" D x 16' L)
- ▶ 1 - Yellow air hose (3/8" D x 16' L)
- ▶ 1 - Red air hose (3/8" D x 16' L)
- ▶ 1 - Green air hose (3/8" D x 16' L)
- ▶ 2 - Paratech nipple with 1/4" NPTM
- ▶ 2 - Paratech nipple with 1/4" NPTF

- ▶ 2 - Paratech nipple with 1/8" NPTM
- ▶ 1 - Paratech nipple with tire chuck
- ▶ 1 - Shutoff adapter nipple with industrial
- ▶ 2 - "Y" with 2 couplings and 1 nipple
- ▶ 1 - Shutoff adapter nipple with twist lock
- ▶ 1 - Custom carrying case

AF391	Control Package, 6,000-135 psi	\$1,388.95
BG134	Control Package, 6,000-135 psi	\$3,004.95

Working Air® Cart

- ▶ Continuous regulated air supply for airbags, rescue support systems & portable impact tools
- ▶ Lightweight and portable
- ▶ One - 150 psi and one - 300 psi low pressure regulators
- ▶ 3-way diverter valve allows for switching between cylinders
- ▶ Shut-off valve and high pressure manifold permit access to alternative air sources
- ▶ Low pressure alarm sounds between 400-500 psi

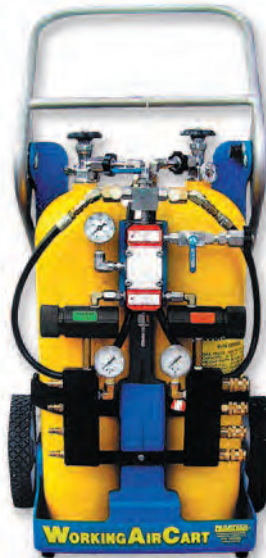

Cat#	Description	Weight	Price
BD040	Working Air® Cart	110 lbs.	\$5,729.95

Working Air® Cylinder

These are lightweight, sturdy cylinders, ready to use. Have an economical air supply on hand. Made of strong, high density aluminum; stand-up design allows more convenient vertical storage. They take the rough handling at an emergency scene without the concern for costly fiber damage to your SCBA cylinder. Best of all, they cost much less than new high-pressure breathing air cylinders. This means that your department can economically maintain a high-capacity air system without tapping SCBA resources. *Note: not for breathing air. Ship. wt. 10 lbs.*



AC630	Working Air® Cylinder / 13 cu. ft.	\$393.95
-------	------------------------------------	----------

SCBA / Rescue Bag - One Bag, Two Uses!

This bag can be used as an SCBA cylinder bag or as a rescue bag. It has two handles and an over the shoulder strap, a silver reflective stripe for low visibility situations.

Rescue Bag Features:

- ▶ One bag makes up one complete, easily accessible rescue kit
- ▶ Holds up to 3 mini rescue bags & 1-2 small bags
- ▶ Holds three 50' coils of air supply hose
- ▶ 1 - 9" dia. insert holds Controller & Regulator
- ▶ 1 - 9" dia. insert holds 45 or 60 min. air bottle

SCBA Cylinder Bag Features:

- ▶ Safe storage and transport of SCBA cylinders
- ▶ Holds 2 cylinder inserts per bag
- ▶ Insert have 9" diameter tube w/hard plastic bottom and rigid side walls to keep cylinders protected & upright

BH034	SCBA/Rescue Velcro Closure w/Two 30min. LP Bottle Inserts	\$188.95
BH035	SCBA/Rescue Velcro Closure w/Two 45-60min. LP Bottle Inserts	\$188.95
BH036	SCBA/Rescue Zipper Closure w/Two 30 min. LP Bottle Inserts	\$188.95
BH037	SCBA/Rescue Zipper Closure w/Two 45-60min. LP Bottle Inserts	\$188.95



Fire Tiger Tooth Blades

Fire Tiger Tooth and Safety Diamond Blades outlast abrasive cutting discs 100 to 1, saving valuable time replacing abrasive blades as they wear down. Fits on 4", 4½" hand-held grinders, 7" circular saws, 12"-14" gas saws, and chop saws. Includes 22mm bushing.



Uses:

- ▶ Masonry
- ▶ Concrete
- ▶ Roof tile
- ▶ Dry wall
- ▶ Stainless steel
- ▶ Copper pipe
- ▶ Steel
- ▶ Plastic
- ▶ Stucco
- ▶ PVC
- ▶ Rebar
- ▶ Wood
- ▶ Tile backer board
- ▶ Corrugated roofing
- ▶ Polyethylene pipes



Cat#	Description	Diameter	Arbor	Width	Price
BE273	Fire Tiger Tooth Blade	12"	1"	.125	\$194.95
BE274	Fire Tiger Tooth Blade	14"	1"	.125	\$244.95



Maxiblade

Carbide Tip Rescue Blade For Rescue Saws

Rescue Blades for Rescue Saws: A deep gullet, 14", 30 tooth carbide tip blade for rescue saws emergency use with excellent cutting characteristics. The deep gullet clears chips and other debris from the cut faster, increasing cutting performance from less powerful rescue saws (70 - 80cc). Ship. wt. 5 lbs.

*Note: Certain saw manufacturers do not allow use of carbide blades under any circumstances. Check manufacturers' position regarding use of carbide blades prior to purchase.

Cat#	Description	Diameter	Arbor	Blade Thickness	Price
BL460	Maxiblade	14"	1"	.095	\$139.95



Warthog™ Ventilation Blade

The Last Roof Ventilation Blade You'll Ever Buy

The aggressive tooth design of the Warthog™ blade easily and quickly cuts through roofing materials, wood flooring and siding. Heavy-duty construction helps prevent tip loss, which is the major problem with standard carbide tipped blades. The tip is mounted to the blade by a special process. This process cushions the tip mounting and makes this blade the most durable, and probably the last, ventilation saw blade you will ever buy. Ship. wt. 7 lbs.

- ▶ It doesn't bind. Due to the aggressive tip angle, all you have to do is feed the blade into the surface to be cut and it does the rest.
- ▶ It doesn't clog. Even when going through multiple layers of roofing paper and tar. The deep tooth design deposits cut materials outside the blade guard, keeping cutting performance high.
- ▶ It lasts like no other blade; the heavy-duty tips are a full 3/8" wide and 5/8" tall.
- ▶ Tip loss is a problem of the past. It is proven by fire departments all over the USA to be a dependable, high-performance blade like no other

Blade comes standard with 1" arbor (center) hole.
 AS269 - 20mm to 1" spacer (Stihl and other saws with 20mm arbors)
 AS268 - 7/8" to 1" spacer (saws with 7/8" arbors)



AJ572	Warthog™ Blade	\$274.95
AS268	Warthog™ Blade 7/8" to 1" Spacer	\$9.95
AS269	Warthog™ Blade 20mm to 1" Spacer	\$9.95

Piraya Diamond Blades

For years the fire service has requested "one blade that cuts all materials" for rescue saws. The Piraya Diamond Blade is as close to meeting this requirement as is technically possible in today's Diamond Blade industry. The Piraya Diamond Blade is vacuum-braided using high-quality grade diamonds for fast, smooth cutting and long blade life. Fits all rescue saws using 12" and 14" diameter blades.



Uses:

- ▶ Concrete
- ▶ Masonry
- ▶ Metal
- ▶ Plastic
- ▶ Wood
- ▶ Copper
- ▶ Glass block
- ▶ Windshields
- ▶ Auto parts
- ▶ Aluminum
- ▶ Stainless steel
- ▶ Corrugated roofing



BG238	12" Piraya Diamond Blade	\$199.95
BG239	14" Piraya Diamond Blade	\$239.95



Blade sold separately



14" saw

Rescue Saws, Kits, Blades & Accessories

AM083 Contains: Partner/Husqvarna K-12 FD 94cc 14" fire rescue saw, full size steel case or aluminum space saver case, fire-department carbide tipped blade, two combination steel/concrete rescue abrasive wheels, safety gas can, hearing protector, goggles, spare belt and air filter, air filter oil, 2-cycle engine oil, can of gasoline stabilizer, combination screwdriver/ wrench and instruction manual.

AR179 Contains: Modified 94cc Partner/Husqvarna K970 94cc active 2 cycle gas engine. Fire Department modifications include: constant on "READY START" ignition switch, large "D" Handle starter grip, chrome plated blade guard with welded "D" ring for attaching saw sling and saw carrying sling.

AW198 Contains: Partner/Husqvarna K-12 FD 94cc 14" saw, diamond plate aluminum case, Maxi blade, four rescue abrasive wheels for cutting both steel and concrete, safety gas can, hearing protector, goggles, spare belt and air filter, air filter oil, 2-cycle engine oil, can of gasoline stabilizer, combination screwdriver/ wrench and instruction manual.

Kit Includes:

- ▶ Partner/Husqvarna K-12 FD 94cc 14" saw
- ▶ Steel case
- ▶ Carbide tipped blade
- ▶ 2-Rescue abrasive wheels
- ▶ Safety gas can
- ▶ Hearing protector
- ▶ Goggles
- ▶ Spare belt & air filter
- ▶ Air filter oil & engine oil
- ▶ Gasoline stabilizer
- ▶ Combo screwdriver/wrench
- ▶ Instruction manual

- ▶ 95cc 2-cycle gas engine
- ▶ Lightweight - 22.7 lbs.
- ▶ Chrome blade guard
- ▶ Large "D" handle starter
- ▶ Carrying sling
- ▶ Reflective lettering



AM083	K-12 FD Standard 14" Rescue Saw Kit with Full Size Steel Case	\$2,298.95
AR179	K-12 FD Fire Department Rescue Saw 14" Guard 95cc Gas Engine	\$1,697.95
AW198	K-12 FD Mega 14" Rescue Saw Kit with Full Size Aluminum Case	\$2,613.95
BE278	14" Lightning Diamond Blade - Use/Metal and Masonry	\$249.95

Pro-Saw/Cut Off Saw

Cut Through Virtually Any Material

The Pro-Saw/Cut Off Saw can cut virtually any material - brick, steel, concrete. You name it, we can cut it. The perfect fire service saw. Ergonomically designed to work in confined spaces. Light weight and powerful for easy and safer operation. Built tough to meet your rugged demands.

- ▶ Highest power-to-weight ratio
- ▶ Ergonomically designed half wrap handle
- ▶ Large "D"-ring for easy starting
- ▶ Superior torque and lower emissions
- ▶ Advanced 5-stage air filtration system



Blade sold separately

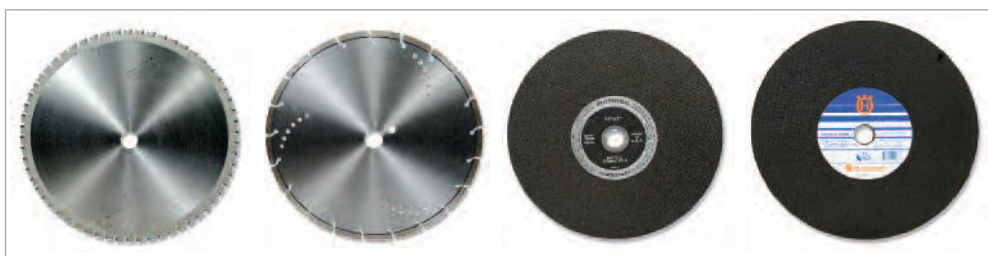

Multi-Purpose Blade

USAR Diamond Metal Cutting Blade

Metal Cutting Blade

Masonry Blade

AZ412	Pro-Saw 12" Cutoff Saw	\$1,586.95
AZ413	12" Multi-Purpose Blade	\$227.95
AZ414	12" USAR Diamond Metal Cutting Blade	\$545.95
AZ415	12" Metal Cutting Blade	\$21.95
AZ416	12" Masonry Blade	\$21.95

T-Rex Metal Cutting Saw

The Next Generation of Forcible Entry, Extrication and Collapsible Rescue Saws

- ▶ Cuts steel as easily as cutting plywood
- ▶ Cuts most building materials effortlessly
- ▶ Specially designed cover collects chips & sparks
- ▶ Five times faster and cleaner than other saws
- ▶ Spindle lock for fast, easy blade changes
- ▶ 2" depth of cut with adjustable angles up to 45°
- ▶ Retractable blade guard
- ▶ Overload switch



AZ417	Metal Cutting Rescue Saw with AZ418 Blade and Case	\$907.95
AZ418	7" Mild Steel Blade	\$113.95
AZ419	7" Variety Aluminum Blade	\$140.95
AZ420	7" Stainless Steel Blade	\$151.95

High Speed Rescue Saw Blades

P834	14" Metal Cutting Blade	\$16.95
P835	14" Concrete/Masonry Blade	\$16.95
P836	14" 48 Tooth Wood Cutting Blade	\$148.95



Super VC3 Power Pro Cutoff Saw

Rescue operations demand fast and reliable cutting equipment. Super Vac's response is the SVC3 Power Pro Cutoff Saw, a high-performance saw designed for the fire and rescue service. The SVC3's rugged, lightweight engine turns an industrial diamond blade that's voracious enough to cut through a variety of materials including residential roofing, concrete and rebar, and sheet metal - all without the use of water. Fire and rescue features include a multi-position cutting arm, blade safety shield that adjusts without having to fumble with hard-to-grasp knobs, D-ring pull handle, and a manual compression release for quick starts. A water tube dust suppression system is standard.

- ▶ Fast and easy starting
- ▶ Blade cuts through anything
- ▶ 2 cutting arm positions



Cat#	Dimensions	HP	Bar	Diam.	Weight
BG206	12.5"Hx13"Wx33.5"D	5.7	14"	14"	21.8

BG206	14" Cutoff Saw with Tiger Tooth Blade	\$1,944.95
BG207	14" Cutoff Saw, Full Kit, Tread Plate Box	\$3,193.95

Super Power Pro V3 Ventilation Saw

With a powerful Dolmar 6.3 HP engine that turns at 13,500 RPM, your department can rely on the Super Vac SV3 Power Pro Saw for venting and rescue operations. With a full-wrap handle designed for maximum versatility, this saw tackles a variety of operations with ease, including cutting through residential roofing, removing downed trees, and ripping through various building materials. With a quick-start compression release and an "always on" ignition, the SV3 is ready-to-go when you are.

- ▶ Chisel chain/depth gauge
- ▶ Airmaster filtration
- ▶ D-ring handle



Cat#	Dimensions	HP	Bar	Weight
BG208	11.25"Hx13"Wx34.5"D	6.3	16"	20.8
BG211	11.25"Hx13"Wx38.5"D	6.3	20"	21.6

BG208	16" Saw with Guard/Depth Gauge	\$2,485.95
BG209	Chisel Chain Loop for 16" Bar	\$253.95
BG210	16" Vent Saw, Full Kit, Tread Plate Box	\$3,024.95
BG211	20" Saw with Guard/Depth Gauge	\$2,531.95
BG212	Chisel Chain Loop for 20" Bar	\$297.95
BG213	20" Vent Saw, Full Kit, Tread Plate Box	\$3,116.95

Quick Silver Saw & Accessories

BK097 & BK099 Include:

- ▶ 1 saw with D-Ring handle
- ▶ 1 pair safety glasses
- ▶ 1 pair ear plugs
- ▶ 1 container 2 cycle oil
- ▶ 1 gallon metal safety gas can
- ▶ 1 set manuals
- ▶ 1 carbide chisel chain
- ▶ 1 Dolmar filter set consisting of:
 - ▶ 1 air filter cartridge
 - ▶ 5 pre filters

edarley.com

For additional information and product features, go to www.edarley.com/rescue



BL096	16" Saw with Q/S Depth Gauge (Installed)	\$2,484.95
BL097	16" Saw Kit with Q/S Depth Gauge (Installed)	\$3,033.95
BL098	20" Saw with Q/S Depth Gauge (Installed)	\$2,539.95
BL099	20" Saw Kit with Q/S Depth Gauge (Installed)	\$3,116.95
BL094	Billet Aluminum Pull Handle	\$47.95
BL095	Billet Aluminum LED Flashlight Holder (Includes Light)	\$129.95

Team/HUSQVARNA K-12 FD 74cc Rescue Saw

Contains: K-12 FD 74cc 12" fire rescue saw. Modified 74CC Partner/Husqvarna K760 Active 2 cycle gas engine. Fire Department modifications include: constant on "READY START" ignition switch, large D Handle starter grip, chrome plated blade guard with welded "D" ring for attaching saw sling and saw carrying sling.

DON'T MISS
More blades
on page 142

Features:

- ▶ Air-cooled 2-stroke engine
- ▶ Active Air Filtration™
- ▶ X-Torq®
- ▶ SmartCarb™
- ▶ DuraStarter™
- ▶ EasyStart™
- ▶ Reversible cutting arm
- ▶ Easy-adjust blade guard
- ▶ Wet Kit
- ▶ Replaceable arbor bushing



Blade and sling sold separately



BL100	Team/HUSQVARNA K-12 FD 74 Rescue Saw	\$1,219.95
BL101	Optional Sling Assembly	\$86.95
BG238	12" Piraya Blade	\$199.95

Concrete Chain Saw Kit

The newly designed chain saw uses a diamond segment chain to cut concrete, brick and masonry. This unique saw offers several cutting features not found on conventional circular blade rescue saws. It is an invaluable tool for use in emergencies such as earthquakes, building collapse and terrorist incidents.

Features:

- ▶ Large "D" handle starter grip - Replaces standard rubber grip, easier to use especially with heavy gloved hands
- ▶ Heavy-duty brass couplings - Replaces standard plastic water hose couplings for added durability
- ▶ Water hose restraint strap - Use of water with this saw is essential, the installed water hose restraint strap is permanently mounted to the rear handle of the saw, simply slip the hose through the nylon strap and the water hose is kept out of the way during saw operation
- ▶ Saw carrying sling - Easy-to-use and store, handy when use of both hands for balance and climbing are required

Includes:

- ▶ K950 chain saw
- ▶ Diamond segment chain
- ▶ Diamond plate aluminum case
- ▶ Brass water connectors
- ▶ Water hose restraint strap
- ▶ Wrench/screwdriver
- ▶ Safety gas can
- ▶ Operating instructions
- ▶ Bar & chain guard
- ▶ Carrying sling
- ▶ Hearing protectors
- ▶ Goggles
- ▶ Air filter oil
- ▶ 2-cycle oil
- ▶ Spare air filter



BD107	Concrete Chain Saw Kit with 14" Bar and Diamond Segment Chain	\$3,243.95
BD108	Concrete 14" Chain Saw with 14" Bar and Diamond Chain	\$2,633.95

RESCUE TOOLS

VentMaster™ Heavy-Duty Fire Rescue Saws

The new VentMaster™ Fire Rescue Saws are the TOUGHEST fire rescue chain saws on the market today.

- ▶ **NEW VentMaster COBALT Guide Bar** - Features COBALT alloy inserts at wear points. This alloy is extremely hard with excellent wear, galling, and impact resistance. It will retain these properties at very high operating temps.
- ▶ **IMPROVED KIS-40 Depth Gauge** - The simplest and most durable depth gauge design. Adjusts cutting depth from 1/4" to 6". Can be removed in seconds without tools for full-length cutting.
- ▶ **Raptor Carbide Chain** - Features an "open dual raker" design to protect the carbide cutters and control the depth of cut. Will quickly cut through lightweight building materials.
- ▶ **IMPROVED Plated Steel Splash Guard** - Strong and durable to protect the saw during extreme cutting operations. Mounted with aviation-style star washers to prevent loosening due to vibration.
- ▶ **Other Features** - Professional-grade Husqvarna engine, glove-grip starter handle, ergonomic full-wrap handle, air-injection filtration system, scrench tool mounted on handle, one-step choke/start/stop switch



Shown with BK202



BC064	VentMaster™ 576HD w/16" Guide Bar & Depth Gauge, .404 Pitch	\$1,994.95
BC065	VentMaster™ 576HD w/20" Guide Bar & Depth Gauge, .404 Pitch	\$2,111.95
AM115	Raptor Carbide Chain, 16" with .404 Pitch	\$208.95
AM116	Raptor Carbide Chain, 20" with .404 Pitch	\$254.95
BK202	Optional LED Light	\$119.95

Ventmaster™ Upgrade Kits



Give Stihl, Echo, Cutters Edge (Jonsered) or many other saws the performance advantage of a VentMaster™ Fire Rescue Saw! Each kit includes guide bar, chain, sprocket and depth gauge.

Adjustable Depth Gauge - The KIS-40 depth gauge provides maximum safety for roof ventilation, allowing smoother, faster cuts without "rolling rafters" - rest the weight of the saw on the gauge, not the firefighter! It can be installed, adjusted from 0" to 6" depth or removed in just seconds, and won't trap debris or heat.

High Alloy Guide Bar - Designed for "plunge cuts" and maximum carbide chain performance. The bar has a precision-milled guide groove, hardened rails and totally integrated sealed nose bearings. Available in 16" and 20" lengths, slotted to accommodate KIS-40 Depth Gauge.



Cat#	Description	Available for These Saws	Price
AS116	16" Guide Bar, .404/.063 Chain	Stihl .046 and Larger	\$610.95
AS114	16" Guide Bar, .404/.063 Chain	Husqvarna, Poulan, Jonsered, Echo QV8000	\$610.95
AW173	20" Guide Bar, .404/.063 Chain	Husqvarna, Poulan, Jonsered, Echo QV8000	\$662.95

Univent Pro-Saw

The Univent Pro-Saw is ideal when your compartment space is limited. It has the best power to weight ratio compared to any other saw in its class. This is virtually the safest saw ever built with our exclusive spring loaded depth gauge. It also gives the operator more reach and comfort while using the saw, and eliminates cutting rafters out from under you. The Pro-Saw was designed and engineered just for the rugged demands of the fire service with features no other saw can offer.

- ▶ Large D-ring handle
- ▶ Smart start
- ▶ Full wrap handle is standard
- ▶ 71 cc (4.5 cubic inch)
- ▶ 6.5 hp
- ▶ 13,500 rpm
- ▶ 13 lbs. (without bar or chain)



BD043	Univent Pro-Saw 16" with Depth Gauge/Sabretooth FD Chain	\$1,971.95
BD044	Univent Pro-Saw 16" with Depth Gauge/Cobra Chain	\$2,085.95
BD045	Univent Pro-Saw 20" with Depth Gauge/Sabretooth FD Chain	\$2,106.95
BD046	Univent Pro-Saw 20" with Depth Gauge/Cobra Chain	\$2,242.95

Extrication Rescue Glove with Barrier

- ▶ Pre-curved glove with two-way stretch
- ▶ Air flow Cordura and accordion style back
- ▶ Interior fleece lining and "Snuggler" with taslon debris blocker wrist area
- ▶ Hipora waterproof barrier and breathable insulation
- ▶ Kevlar® reinforced palm, finger tips and knuckles
- ▶ Armor-Dillo knuckle protection
- ▶ Cotton terry brow wipe
- ▶ Reinforced rubber pull with hidden cord carabineer loop
- ▶ Reflective finger tips and trim

SPECIFY SIZE: S-XL, Jumbo

BK092 Extrication Rescue Glove w/Barrier \$65.95/pr.



911 Barrier Extrication Gloves

- ▶ Waterproof and breathable Hipora® barrier to protect hands from micro-organisms such as TB, Hepatitis, Staph and HIV
- ▶ O.S.H.A. Bloodborne Pathogens Standards (29CFR 1910.1310)
- ▶ Molded TPR (Thermal Plastic Rubber) knuckles reduce impact and increase dexterity
- ▶ Boxed finger tip design for better fit and comfort
- ▶ Cut resistant Kevlar® palm, thumb, finger and side panels



SPECIFY SIZE: S-XXL

BD141 911 Barrier Extrication Gloves \$58.95/pr.



Rescue Gloves

Featuring Patented SuperCuff Technology with Protection and Dexterity Like Never Before!

- ▶ Kevlar® palm panels with anatomic cutouts create maximum cut resistance without restricting grip
- ▶ 6mm segmented padding across the knuckles creates padding that moves with you
- ▶ 3M Reflective markings for increased visibility and increased safety
- ▶ Gel padding reduces vibration and decreases injury



SPECIFY SIZE: S-XXL

BE280 Rescue Gloves \$41.95/pr.



Hybrid Extrication Hi-Vis Gloves

Built with the best materials and product construction and the highest degree of safety in mind. Thermal Plastic Rubber (TPR) is strategically placed through sonic welding and durable stitching on the top of hi-vis green outer shell in the finger, knuckle and dorsal regions for extra protection. The Ringers' patented Supercuff™ technology tops off the glove for a non-binding, non-restrictive easy-open cuff for quick entry.

- ▶ Supercuff Technology for full range of motion
- ▶ CE Certified puncture and cut protection



SPECIFY SIZE: S-XXL

BK277 Hybrid Extrication Hi-Vis Gloves \$49.95/pr.





Impact-X™ Gloves

Abrasion resistant materials have been strategically placed to maximize hand protection and supply superior grip and dexterity. Our quality craftsmanship and ergonomic design provide for unprecedented comfort during extended wear. Mechflex gloves are highly functional, comfortable and fashionable. *Ship. wt. 1 lb.*

- ▶ Durable synthetic leather palm and fingers
- ▶ Shock-absorbing gel padded palm
- ▶ Anti-slip palm and fingertip patches
- ▶ Neoprene knuckle protector
- ▶ Not for fire fighting

SPECIFY SIZE: S-XXL

BK217 Impact-X™ Gloves \$18.95/pr.



Padded Palms

Rope Rescue Gloves

RINGERS rappelling gloves are the most technically advanced rappelling gloves available. These gloves were developed in harmony with local and government agencies to satisfy the requirements of today's rescue and tactical needs. These gloves are also excellent for any kind of rope handling work. *Ship wt. 1 lb.*

- ▶ Unique gel padded rope control channel
- ▶ Clarino® palm and fingertip patches do not get slippery when wet
- ▶ Pittards Amortan palm for improved wear
- ▶ Incredible fingertip dexterity



SPECIFY SIZE: S-XXL

AW124 Rope Rescue Gloves \$39.95/pr.



AW123

BG508

Elastic closure keeps out cut glass and debris

Extrication Gloves

Are you still using firefighting gloves for extrication? This superior glove is made specifically to protect you from the hazards of extrication without compromising flexibility and design. This anatomic design features Genuine Nash Clarino®, a state-of-the-art material that's abrasion resistant with great grip, sensitivity and dexterity. Totally machine washable to remove blood-borne pathogens, hydraulic fluids etc. and will not harden after it gets wet. *Ship. wt. 1 lb.*

- ▶ Tough Armortex® reinforced index finger and thumb joint
- ▶ Tough Armortex® puncture resistant palm pads
- ▶ Double Kevlar® Stitched palm pads
- ▶ Anatomically designed palm pads for unparalleled freedom of movement



SPECIFY SIZE: S-XXL

AW123 Extrication Gloves Long Cuff \$49.95/pr.

BG508 Extrication Gloves Short Cuff \$53.95/pr.



Xtrication Gloves

A pre-curved, form-fitting extrication glove designed by auto extrication specialists. Anatomically-designed glove body is entirely made of "air-textured", high tenacity, genuine DuPont Cordura®. This exceptionally durable, lightweight material is reinforced with Schoeller-Keptec at all the high wear areas. Additionally, glove has vented, form-fitting protective rubber guards welded to the backs of all fingers, reflective trim, a brow wipe and elastic "snuggler" at wrist to repel debris.

- ▶ Welded rubber finger guards
- ▶ Reflective trim
- ▶ Terry brow wipe
- ▶ Shelby Velcro® light attachment

SPECIFY SIZE: S-XXL

AW121 Xtrication Gloves \$55.95/pr.

Armorcore™ Extrication Gloves

Complies with ANSI and CE Safety Standards

For use by fire, safety and rescue professionals, this super-duty glove represents the ultimate combination of advanced protective technology and highest quality materials. Our proprietary cut and puncture resistant fabric lines the palm side of the glove and is reinforced with genuine goatskin leather in high wear and gripping areas. The top of the hand is protected by a Kevlar® outer shell as well as TPR knuckle and full-length finger protection. Combined with reflective materials throughout the top of hand and fingertips, this glove has it all.

new



Molded hard knuckle TPR and finger guards protect against impacts.



ArmorCore™ fabric meets or exceeds ASTM/CE Level 5 for cut and puncture resistance.

SPECIFY SIZE: S-XXL

BL431 Armorcore™ Extrication Gloves \$89.95

Extrication Leather Gloves

Fire, safety and rescue professionals all can use the hand protection offered by the Leather Extrication glove. Premium Cowhide Leather protects the palm and between fingers while reinforced Kevlar® panels add grip and puncture resistance. The top of the hand is protected by a Kevlar® outer shell as well as TPR knuckle and finger protection. An elastic gaiter cuff keeps debris out, making this glove versatile enough for everything from extrication to overhaul.

new



TPR knuckle and flexible finger TPR's guard against impacts.



Premium Cow Hide leather with Armortex® reinforcement panels.

SPECIFY SIZE: S-XXL

BL432 Extrication Leather Gloves \$59.95

Darley Multi-Purpose Utility Gloves

Great for extrication, mop-up, as a general work glove around the fire scene, the firehouse and at home. New design includes comfortable Spandex fabric that keeps elasticity even after multiple washings. Tough deerskin palm and fingers remains soft and pliable even after drying. A great Darley value!

new



Darley value

SPECIFY SIZE: S-XL

BL292 Darley Multi-Purpose Utility Gloves \$17.95

RESCUE TOOLS

FR Cotton Extrication Suit

- ▶ Stand up collar with hook & loop closure: Bi-swing back, hook and loop
- ▶ Adjustable straps at wrist, 12" leg zipper with hook and loop
- ▶ Adjustable straps at ankle: brass zipper front with hook and loop storm flap, lined sleeves, padded elbows, forearms, knees and shins
- ▶ 2 rear patch pockets with flaps
- ▶ Side-entry pockets with pass through hook & loop closures, semi-bellows pockets with flap on each thigh
- ▶ Radio pocket with flap & utility strap
- ▶ Mic clip above radio pocket
- ▶ Hook and loop take-up straps at wrist
- ▶ Large pocket on right chest with utility loop, pencil pocket on left sleeve, scissor pocket with strap on right semi-bellows pockets
- ▶ Glove strap with clip in waist band on right side
- ▶ Reflective trim around upper sleeve, lower legs and across upper back



Sizing				
Size	Waist	Inseam	Chest	Sleeve
Small	32"	29"	36"-38"	33"
Medium	36"	29"	40"-42"	34"
Large	41"	29"	44"-46"	35"
XL	45"	29"	48"-50"	36"
2XL	50"	29"	52"-54"	37"
3XL	54"	29"	56"-58"	38"
4XL	58"	29"	60"-62"	39"
5XL	62"	29"	64"-66"	40"

SPECIFY SIZE: S-5XL

SPECIFY COLOR: Navy, Royal Blue, Red, Khaki

BK123 9 oz. FR Cotton Extrication Suit \$186.95

FR Indura® Cotton Coveralls



- ▶ 9.0 oz. per square yard Indura®
- ▶ Heavy-duty, two-way brass zipper
- ▶ Nickel plated brass snaps
- ▶ Two patch breast pockets, pencil slot in left pocket
- ▶ Two hip pockets with a snap closure on the left
- ▶ 2-in-1 utility/tool pocket on right leg
- ▶ Side access to pants with snap closure
- ▶ Adjustable cuffs with snap closures
- ▶ Sewn throughout with Nomex® thread



Tan Navy

- ▶ Short: 5'4" - 5'7"
- ▶ Regular: 5'7½" - 5'11"
- ▶ Tall: 5'11½" - 6'3"

Chest	36	38	40	42	44	46	48	50	52	54	56
Short:	•	•	•	•	•	•	•	•	•	•	•
Regular:	•	•	•	•	•	•	•	•	•	•	•
Tall:	•	•	•	•	•	•	•	•	•	•	•

SPECIFY SIZE

SPECIFY COLOR: Navy or Tan

BL461 FR Indura® Cotton Coveralls \$129.95

Technical Rescue Boots

Some of the finest leather fire boots made. When your job gets tough, these boots perform for you, giving you lightweight comfort and protection. Made of waterproof, flame and cut-resistant leather with tempered steel safety toe and scuff-resistant "sharkskin" leather toe covering. Heavy-duty, non-marking lug sole is oil, heat, and slip-resistant and features a stainless steel puncture-resistant bottom plate. Other features include Kevlar® laces, heat and corrosion-resistant eyelets, lace-in duty zipper, comfort weave lining, removable cushion footbed, total boot membrane by Sympatex® and double rubber insole. *Ship. wt. 6 lbs.*



Lace-in zippers

- ▶ Metatarsal Protection
- ▶ Medium, Wide and Extra Wide
- ▶ Sizes: 5-14, 15, 16, 17, 18
- ▶ Meets NFPA for Structural, T.R.I. and Wildland

SPECIFY WIDTH AND SIZE

BH086 Technical Rescue Leather Boots



\$279.95

Vertex® Vented Helmet

Ventilated Helmet for Work at Height and Rescue

- ▶ Six-point mesh liner conforms to the shape of the head for improved comfort
- ▶ Shock absorption achieved through deformation of the outer shell
- ▶ CenterFit adjustment system ensures centering and optimal stability of the helmet on the head
- ▶ Adjustable ventilation holes with sliding shutters
- ▶ Side slots for mounting hearing protection
- ▶ Inserts for accepting a VIZIR face shield
- ▶ Slot for mounting a PIXA headlamp
- ▶ Four clips for mounting a headlamp with an elastic headband
- ▶ Chin strap designed to limit risk of losing helmet during a fall (strength greater than 50 daN)



PETZL

Red White Yellow Black

SPECIFY COLOR: Red, White, Yellow or Black

BK351 Vertex® Vented Helmet \$114.95

SAR All Risk Helmets

- ▶ Search and rescue / confined space / CBRN environments
- ▶ Water rescue / swift water / marine / ribs / hovercraft
- ▶ Forestry fire fighting
- ▶ Ambulance / E.M.S.
- ▶ Wildland fire fighting / general search area
- ▶ Maritime rescue / coastal border security
- ▶ Working at height / urban climbing
- ▶ Meets the requirements of:

NFPA 1951:2001,
NFPA 1952:2010
& ANSI Z89.1
Type 2 Class C



Red White Yellow Black

SPECIFY COLOR: Red, White, Yellow or Black

BL410 SAR All Risk Helmet \$173.95

BL411 Helmet Vent Covers-Photo Illuminescent \$14.95/pr.

BL412 Clear Full Marine Visor \$93.95

Advent® Search and Rescue Helmet

Made to help protect against the hazards encountered by paramedics, emergency medical technicians and search and rescue personnel. Offers top, front, side and rear impact and penetration protection with polycarbonate outer shell and ABS inner shell. It's easy to size to your head with the Sure-Lock® ratchet headband and 8-point suspension. Chin strap with quick-release buckle is permanently attached. Decals not included. 6" Poly-carbonate faceshield sold separately. Meets ANSI, CSA and OSHA standards. Ship. wt. 3 lbs.



DON'T MISS

More helmets in
Turnout (p1-29)
Wildland (p30-39)

Yellow Blue Orange Red White

SPECIFY COLOR: Yellow, Blue, Orange, Red, or White

AC380 EMS Helmet \$98.95

AC381 Search & Rescue Helmet \$111.95

AC390 6" Faceshield \$57.95

BB175 Hardware for AC390 \$23.95

USRX Urban Search & Rescue Helmet

The USRX, a dual purpose urban search and rescue and structural firefighting helmet, is the result of 50 years of Bullard thermoplastic technology, engineering expertise and market responsiveness. The USRX is designed to protect first responders in every USAR application, from high angle to confined space rescue. The outer shell of the USRX is made of high-heat Ultem® thermoplastic. The Bullard Sure-Lock® ratchet headband offers both a quick-turn of the knob head size adjustment and a new, unique 3-position height adjuster for balance and comfort. The USRX comes standard with a new, unique 3-point chin strap, ESS goggles and Bullard's Quick-Attach Blade mounting system. The USRX is designed for comfort, safety, and cost-effective maintenance. NFPA 1951-2001 and NFPA 1971, 2007 compliant. Ship wt. 5 lbs.

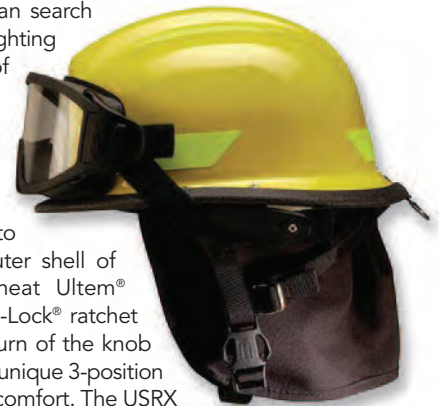

- ▶ Urethane impact liner
- ▶ M-Pact shell
- ▶ Sure-Lock® ratchet suspension
- ▶ Black rip-stop Nomex® ear/neck protector
- ▶ Quick-Attach™ faceshield
- ▶ Quick release 3-point chinstrap
- ▶ Edge beading
- ▶ Leather ratchet cover

Bullard

SPECIFY COLOR: White, Red, Yellow, Black, Blue, Lime-Yellow

BC075 USRX Urban Search & Rescue Helmet \$193.95

SuperStatic2™ and HTP™ Static Rope



Sterling Rope revolutionized the production of static rope with the creation of its SuperStatic2™ Rope, the original 48 carrier static rope (1/2" and 7/16"). The smoother sheath finish reduces vibration, allowing for more control during lowering and extrication procedures. HTP™ (High Tenacity Polyester) has a very low elongation of less than 1% stretch per 300 lb. load. It provides greater resistance from UV and certain chemicals, and has the highest tensile strengths for their size. SuperStatic2™ and HTP™ Static certified to NFPA 1983, 2006 edition by UL. Available in Blue w/Tracer, Yellow w/Tracer, White w/Tracer, and Red w/Tracer. 5/8" SuperStatic2™ is only available in solid colors: Red, Blue, and Black.

3/8" (9.5-10mm) SuperStatic2™/HTP™ Static

Single person rescue/rappel rope. Ideal for anchors, low stretch rescue, rappelling and confined space operations. Great for SAR teams, fire and police departments, and rescue squads. *Specify length and color combination.*



Cat#	Description	Tensile	Price
AW404	SuperStatic2™ Nylon 150'	5,396 lbs.	\$137.95
AW405	SuperStatic2™ Nylon 200'	5,396 lbs.	\$157.95
AW406	SuperStatic2™ Nylon 300'	5,396 lbs.	\$235.95
AW407	HTP™ Static 150'	5,981 lbs.	\$124.95
AW408	HTP™ Static 200'	5,981 lbs.	\$164.95
AW409	HTP™ Static 300'	5,981 lbs.	\$247.95

1/2" (13mm) SuperStatic2™/HTP™ Static

General use rescue rope. Used in mainline rescue and belay line systems. Suitable for low stretch/high strength rescue, low and steep slope rescue, high angle safety work, window washing, industrial safety and confined space operations. *Specify length and color combination.*



Cat#	Description	Tensile	Price
AW392	SuperStatic2™ Nylon 150'	9,241 lbs.	\$159.95
AW393	SuperStatic2™ Nylon 200'	9,241 lbs.	\$209.95
AW394	SuperStatic2™ Nylon 300'	9,241 lbs.	\$318.95
AW395	HTP™ Static 150'	9,084 lbs.	\$154.95
AW396	HTP™ Static 200'	9,084 lbs.	\$199.95
AW397	HTP™ Static 300'	9,084 lbs.	\$307.95

7/16" (11-11.5mm) SuperStatic2™/HTP™ Static

Single-person rescue/rappel rope. Ideal as a one-man assault line. Great for police and security tactical teams, military operations, wilderness rescue, window washing and rappelling. *Specify length and color combination.*

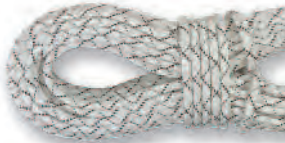

Cat#	Description	Tensile	Price
AW398	SuperStatic2™ Nylon 150'	6,744 lbs.	\$133.95
AW399	SuperStatic2™ Nylon 200'	6,744 lbs.	\$177.95
AW400	SuperStatic2™ Nylon 300'	6,744 lbs.	\$262.95
AW401	HTP™ Static 150'	7,667 lbs.	\$132.95
AW402	HTP™ Static 200'	7,667 lbs.	\$175.95
AW403	HTP™ Static 300'	7,667 lbs.	\$268.95

5/8" (15.5-16mm) SuperStatic2™/HTP™ Static

Single-person rescue/rappel rope. Ideal as a one-man assault line. Great for police and security tactical teams, military operations, wilderness rescue, window washing and rappelling. *Specify length and color combination.*



Cat#	Description	Tensile	Price
BE001	SuperStatic2™ Nylon 150'	10,701 lbs.	\$181.95
BE002	SuperStatic2™ Nylon 200'	10,701 lbs.	\$239.95
BE003	SuperStatic2™ Nylon 300'	10,701 lbs.	\$332.95
BE004	HTP™ Static 150'	11,962 lbs.	\$181.95
BE005	HTP™ Static 200'	11,962 lbs.	\$262.95
BE006	HTP™ Static 300'	11,962 lbs.	\$396.95



F4 FireTech Escape System

The F4 FireTech Escape System offers a reliable, easy to use system for personal escape. This system includes the FireTech 32, the proven rope of FDNY. This kit also includes:

- ▶ 50' FireTech
- ▶ F4 Escape Device
- ▶ SAFE-D three-stage carabiner
- ▶ Crosby FireFighter anchor hook

\$1 from each system goes to the National Fallen Firefighters Foundation.



BL291	F4 FireTech Escape System	\$309.95
BL426	Lightning™ GT Hook	\$86.95
BL427	Lightning™ Hook	\$74.95
BL428	F4™ Fire Tech Escape System with Lightning™ GT Hook	\$323.95

Marathon™ Dynamic Ropes



The Marathon™ Dynamic Ropes are the most technically advanced ropes in the world. The trademark of the Marathon™ ropes is its high denier sheath construction and incredible durability. Marathon ropes are perfect for professional and high abuse applications like training and mountain warfare operations. Engineered for performance in the field and featuring Sterling Rope's exclusive DryCore™. DryCore™ helps maintain the core fibers properties in wet and icy conditions. UIAA and CE EN 892 certified.



8.8 mm Half Dynamic Rope

Perfect for ice, ski mountaineering, and glacier travel.

SPECIFY COLOR: Olive Drab Green, Yellow, Purple or Orange

Cat#	Description	Price
ML482	8.8mm x 165' Half Dynamic Rope	\$114.95
ML483	8.8mm x 200' Half Dynamic Rope	\$148.95
ML484	8.8mm x 230' Half Dynamic Rope	\$229.95

10.1 mm Pro Dynamic Rope

Durable marathon sheath and lightweight at 63 g/M.

SPECIFY COLOR: Olive Drab Green, Red, Yellow, Green or Orange

Cat#	Description	Price
ML479	10.1mm x 165' Pro Dynamic Rope	\$132.95
ML480	10.1mm x 200' Pro Dynamic Rope	\$172.95
ML481	10.1mm x 230' Pro Dynamic Rope	\$264.95



11 mm Mega Dynamic Rope

The most durable dynamic rope available.

SPECIFY COLOR: Olive Drab Green, Purple, Burnt Orange or Black

Cat#	Description	Price
ML476	11mm x 165' Mega Dynamic Rope	\$143.95
ML477	11mm x 200' Mega Dynamic Rope	\$187.95
ML478	11mm x 230' Mega Dynamic Rope	\$287.95

Utility Rope

Sterling's economy utility rope is perfect for many non-life-safety applications such as hauling tools and equipment, lashing gear, etc. It is easy to tie knots with and is not too stretchy. White with tracers. Not for rappelling or life safety use.



Cat#	Description	Tensile	300'	600'
BE007	3/8" (10mm) Utility Rope	2,200 lbs.	\$171.95	\$358.95
BE008	1/2" (13mm) Utility Rope	5,000 lbs.	\$240.95	\$460.95

1/2" (12.7mm) Safety Glow Rope

Two-person rescue rope with reflective yarns makes it highly visible in low light to dark situations. Suitable for confined space rescue, caving, night rescues, and industrial safety applications.



Cat#	Description	Tensile	150'	200'	300'
BE010	1/2" 12.7mm Rope	9,500 lbs.	\$163.95	\$217.95	\$329.95

Prusik Cords

Prusik cords serve many functional purposes in the field and are a must have for technical rescue teams. They are extremely versatile in tandem prusik belays, load release devices, as ratchets in pulley systems, and anchor systems. Sterling Rope's prusik cords are made of 100% nylon and have a construction that gives great durability, suppleness and handling.

SPECIFY COLOR: Blue w/Tracer, Red w/Tracer, Orange w/Tracer, or Tan w/Tracer

Cat#	Description	Tensile	165'	330'
AW412	7mm Cord	2,878 lbs.	\$69.95	\$131.95
AW413	8mm Cord	3,754 lbs.	\$80.95	\$160.95

Tubular Webbing

1" Mil-Spec webbing is a must have for rescue personnel. It can be used for building anchors, making improvised harnesses, lashing litters, and many other uses. Mil-Spec webbing is rated to 4,000 lbs.



Cat#	Description	Price
AW411	1"x300' Tubular Webbing	\$98.95

RESCUE TOOLS

CMC Fire-Rescue Harness

UL Classified to NFPA 1983 - Class III and ANSI Z359.1

Enhanced with a new Fall Arrest Indicator and work-positioning side D-rings, the Fire-Rescue Harness remains the most versatile, multiple-use harness in fire rescue. Used by fire department rescue teams, USAR teams, helicopter crews, and wilderness SAR teams, this extremely popular harness features multiple D-ring attachment points, and our JackBack™ removable padding with breathable D3 cloth, which keeps shoulder straps separated, and makes donning and doffing a breeze. The dorsal D-ring allows adjustment for different size rescuers, but stays in place when loaded, greatly increasing comfort. The front waist D-ring allows a comfortable, stable sitting position for rappels and the sternum D-ring works well for helicopter hoists. Gear loops have been improved for easier access, and quick-connect shoulder straps and leg loops make donning the harness simple and fast. Pads on the leg loops can be adjusted to the most comfortable position. The front lift assembly accepts screw links for adding a chest ascender or safety lanyards. Attachment points: front waist, sternal, dorsal, sides. Available in two sizes. *Ship wt. 4 lbs.*



Size	Waist
Small/Medium	28" - 34"
Large/X-Large	34" - 46"

SPECIFY SIZE: Small/Medium, Large/X-Large

BA082	CMC Fire-Rescue Harness (28"-34")	\$350.95
BA083	CMC Fire-Rescue Harness (34"-46")	\$350.95



CMC Rescue Harness

UL Classified to NFPA 1983 - Class II

Designed for rope rescue and rappelling. Back in 1983 CMC Rescue designed the Rescue Harness to meet the needs of search and rescue better than a recreational climbing harness. The D-ring attachment point made connecting carabiners easy even when hanging in the harness. Extra wide waist and leg loops created more of a "work platform" than the slim profile of a climbing harness. Today's harness has waist and leg pads with breathable D3 cloth for greater comfort, a rear waist D-ring for travel restraint, and gear loops on each side. With more than a quarter-century of use-inspired evolution, the Rescue Harness continues to set the standard for superb comfort and performance. *Ship wt. 3 lbs.*



SPECIFY SIZE: Regular or X-Large

AJ338	Padded Rescue Harness	\$173.95
-------	-----------------------	----------



CMC ProSeries Harness Combo

UL Classified to NFPA 1983 - Class III

Designed for rope rescue, rappelling, and confined space rescue, the CMC ProSeries Harness Combo consists of the ProSeries Rescue Harness and ProSeries Chest Harness, which together make a Class III full-body harness. The chest harness can be removed to allow the seat harness to be used alone. If your primary need is a Class III harness, but you want the flexibility of also having a seat harness, the Combo is the perfect fit. *Ship wt. 8 lbs.*

- ▶ Rear attachment point
- ▶ Front chest D-ring transfers load to the sit harness, increasing comfort in a vertical lift
- ▶ Chest harness attaches to front and back
- ▶ D-rings on sit harness
- ▶ Built-in lumbar support
- ▶ Web-Keepers™ secure loose ends of the web coming out of the buckles
- ▶ Molded padding with breathable D3 cloth provides a better fit with greater comfort and lighter weight
- ▶ Larger front D-ring easily accepts three rescue carabiners
- ▶ 1 3/4" web adjusting strap wraps completely around for stronger harness
- ▶ Quick-fit buckles on the legs make donning the harness easy and quick

Size	Waist
Small	26" - 30"
Regular	30" - 44"
X-Large	42" - 46"



SPECIFY SIZE: Small, Regular, X-Large

AZ587	Harness Combo (Chest and Rescue Harness)	\$449.95
-------	--	----------



SMC Locking Rescue Carabiners

SMC Rescue Carabiners are state-of-the-art in steel rescue carabiners. The D shape increases strength necessary for rescue situations. The locking mechanism used on these carabiners locks on the gate, not on the body of the carabiner. This allows you to tighten the knob, load the carabiner and not have to retighten the knob. The large size has a gate opening of 1.12", adequate to fit over the rail of a stokes litter. The X-Large size has an opening of 1.40" and will fit standard 1.25" diameter ladder rung. The parts of these carabiners are meticulously finished and plated prior to assembly, insuring smooth free gate action. Meets NFPA 1983(2001)-General use where listed.

- ▶ Aluminum Locking D
- ▶ High strength
- ▶ Lightweight
- ▶ 6,000 lb. Rating
- ▶ NFPA 1983(2001)-Light Use



Cat#	Description	Finish	MBS	Price
AW215	SMC NFPA Locking D	Brite Anodized	6,069 lbs.	\$20.95
AW216	SMC NFPA Locking D	Black Anodized	6,069 lbs.	\$20.95

SMC Locking Carabiners

- ▶ Stainless steel
- ▶ Large and X-Large Locking D
- ▶ High strength
- ▶ Smooth operation
- ▶ Better resistance to corrosion
- ▶ Sleeves lock on gate to prevent jamming or vibrating loose



Cat#	Description	Finish	MBS	Price
AJ329	Large Locking D	Brite	10,566 lbs.	\$32.95
AW217	NFPA Large Locking D	Brite	10,566 lbs.	\$33.95
AJ330	NFPA Large Locking D	Black	10,566 lbs.	\$37.95
AJ332	NFPA Large Stainless Steel D	Brite	10,341 lbs.	\$56.95
AJ333	Large Aluminum Locking D	Brite	7,643 lbs.	\$31.95
AW218	NFPA XL Steel Locking D	Brite	12,814 lbs.	\$39.95

SMC Locking Lite D Steel Carabiners

- ▶ Lite D steel
- ▶ Compact size
- ▶ High strength



Cat#	Description	Finish	MBS	Price
AW219	SMC NFPA Lite Locking D	Brite Alloy Steel	9,667 lbs.	\$32.95
AW220	SMC NFPA Lite Locking D	Black Alloy Steel	9,667 lbs.	\$35.95

CMC ProSeries Pulleys

UL Classified to NFPA 1983 - General Use

Basic Building Blocks of Most Rescue Systems. No detail has been overlooked in these high-efficiency pulleys. These compound or complex system workhorses feature precision sealed ball bearings to minimize loss of mechanical advantage. The large carabiner hole supports multiple carabiners, and the smooth, rounded edges on the high-strength aluminum side plates minimize rope fraying. The bottom is shaped for maximum efficiency with Prusik hitches but also works well with Gibbs-type ascenders. Large anodized aluminum sheaves provide efficiency, and low-profile axle fasteners reduce snags when the pulley is moving.



Cat#	Description	Ship. wt.	Price
BA162	Blue ProSeries Single Pulley	1 lb.	\$94.95
BA076	Gold ProSeries Double Pulley	2 lbs.	\$129.95

KOOTENAY Pulley

The large space between the top of the side plates and sheave allow for passage of knots and the large diameter (76 mm) sheave creates excellent efficiency. The locking pins on the sheave allow the pulley to be used as an anchor. For use with ropes from 8-19 mm. Safe working load: 10kN. CE certified EN12278. Ship. wt. 1 lb.



BH057	KOOTENAY Pulley	\$172.95
-------	-----------------	----------

Gibbs Ascenders

Gibbs ascenders provide excellent performance under the most adverse conditions, even with muddy or iced ropes. They are widely used by rescue teams as mechanical Prusiks in systems and rappels. The spring-loaded model will support its own weight when there is no load on the cam. Gibbs ascenders feature a high-quality forged cam, which provides a product with no cast parts.

The 1/2" ascenders have undergone several rescue performance improving changes. The shell bottom has been modified creating a curved interface, which improves the holding power. Also, the shell thickness has been increased by 50%. Ship. wt. 2 lbs.



BA077	Aluminum Gibbs Ascenders	\$71.95
BA078	Stainless Gibbs Ascenders	\$71.95

CMC Anchor Plate

UL Classified to NFPA 1983 - General Use

A Classic CMC Rescue Innovation. An original design that has withstood the test of time, the CMC Rescue Anchor Plates keep the carabiners holding the different parts of your rescue system from jamming together. The hardware becomes easier to see, making safety checks more accurate. It can also keep you from clipping a carabiner into the wrong loop of the anchor web. For anchor systems, it makes an excellent collection point. These Anchor Plates are used in CMC Rope Rescue classes, which allows students to set up systems faster with fewer mistakes. Hole diameters: small – 7/8" (22 cm), large – 2" (51 cm). *Ship. wt. 1 lb.*



AW214 CMC Anchor Plate \$52.95

CMC Rescue 8 Descenders

UL Classified to NFPA 1983 - General Use

Machined from 1/2" (12.5-mm) plate, the CMC Rescue classic Rescue 8 design has been refined for even better performance with today's selection of rescue rope. Descenders no longer routinely use 16-mm (5/8") rope, so the smaller dimensions of the Rescue 8 provide greater control. The proprietary finish on the aluminum model provides outstanding wear resistance, while the nickel-chrome-plated steel model excels in high-wear situations, such as sandy, gritty environments. The extended carabiner hole accommodates multiple carabiners. *Ship. wt. 1 lb.*



AW222 CMC Steel Rescue 8 \$87.95

BA079 CMC Aluminum Rescue 8 \$54.95

SMC NFPA Brake Bar Rack

With the large diameter brake bars and the addition of the SMC Tie-Off Bar, the SMC Brake Bar Rack passes the test for general use rating without the use of a connector bar. This improvement maintains the rack's performance while greatly increasing the ability to adjust the friction. Assembly required, instructions included. NFPA 1983 (2001) - General Use. NFPA 3 sigma MBS: 4,946 lbs. *Ship. wt. 2 lbs.*

- ▶ Tie-off bar
- ▶ 5 aluminum bars
- ▶ 6 bar rack frame
- ▶ 6,000 lb. rating

AW223 NFPA Brake Bar Rack \$116.95

BH029 NFPA Rack 90° Eye \$116.95



SMC 2" Prusik Minding Pulleys

This mid-sized minding pulley is the perfect choice for rigging with 7/16" (11 mm) rope or when you don't have room for a 3" pulley. *Ship. wt. 1 lb.*

- ▶ Precisions machined aluminum side plates and sheaves
- ▶ Sealed bearings
- ▶ Double pulleys include a becket



SPECIFY COLOR: Green or Black

Cat#	Description	Tread	Price
BH050	Single SMC 2" Prusik Minding Pulley	1.5"	\$58.95
BH051	Double SMC 2" Prusik Minding Pulley	1.5"	\$94.95

Grappling Hook

Made of 1/2" forged steel eyebolt welded with 5-chrome alloy steel tines, which are heat treated and coated with tough epoxy for long lasting protection. *Ship. wt. 10 lbs.*

AA932 Grappling Hook \$113.95



SMC/RA Pulleys

These pulleys were designed for rescue operation by Russ Anderson. The sideplates are made of stainless steel. They rotate freely allowing the pulley to be installed on the rope at any point. Pulley models accept 3/4". Double pulleys have one becket with a 3/4" diameter hole for ease in rigging block and tackle systems. Available with oilite bronze bushing or with sealed ball bearing. *Ship. wt. 1 lb.*



AW211 2" x 1/2" Oilite Pulley \$43.95

AW212 2" x 1/2" Double Oilite Pulley \$76.95

AW213 4" x 5/8" Double Oilite Pulley \$180.95

Petzl I'D Self-Braking Descenders

Its auto-locking feature combined with a locking position for the handle make the Petzl I'D an excellent descender for working on rope. Additional safety features include an anti-panic function that stops the descent if the handle is pushed too far and an anti-error safety catch that reduces the risk of an accident from the incorrect installation on the rope. Maximum descent distance: 660' (200m). The small model has a safety clip on the swinging side plate that reduces the risk of dropping the device when removed from the rope, such as when passing intermediate anchors. *UL classified to NFPA 198 EN 341 Class A.*



Cat#	Description	Finish	NFPA Rating	Price
BG121	Self-Breaking Descender	Gold	Light Use	\$209.95
BG122	Self-Breaking Descender	Red	General Use	\$209.95

CMC Rescue Steel Locking D Carabiners

UL Classified to NFPA 1983 – General Use

This proven workhorse of General Use carabiners is available in both Screw-Lock and Auto-Lock gates. On the Screw-Lock models the nut locks against the gate to prevent jamming. Auto-locking carabiners decrease the possibility that the user will forget to lock the gate or that the gate will vibrate unlocked while in use. With the safety of a three-stage auto-locking gate that can be easily opened with one hand, these compact models maximize strength yet allow a gate opening wide enough to fit over most litter rails. Every carabiner is proof loaded.



Cat#	Gate Type	Finish	MBS	Price
BG271	Auto-Lock	Gold	8,992 lbs.	\$47.95
BG272	Screw-Lock	Gold	8,992 lbs.	\$35.95
BG273	Screw-Lock	Black	8,992 lbs.	\$36.95

Traverse 540° Rescue Belays

UL Classified to NFPA - General Use

Developed specifically to meet the needs of rescue system belays, the 540° Rescue Belay is a self-locking device that meets demanding drop-test criteria - able to hold falling loads quickly while limiting the peak force. This well-engineered device is easy to rig and the symmetrical design reduces the risk of improper loading. A built-in release lever releases the tension on the belay rope, eliminating the need for a release hitch. *Designed for use with kernmantle rescue ropes from 11.5 to 13mm. 3 MBS: 8,093 lbs. Passes the BCCTR Rescue Belay Competence Drop Test Criteria. Ship. wt. 3 lbs.*



Cat#	Description	Rope Size	Price
BG267	Small 540° Rescue Belay	10.6-11.5mm (7/16")	\$378.95
BG268	Large 540° Rescue Belay	11.5-13mm (1/2")	\$378.95

Lightweight Rappel Gloves

Often copied, never equaled! Leave it to the rope experts to come up with the best gloves for rope work. Lightweight, pliable goatskin provides excellent finger dexterity while two extra layers of cowhide across the palm maximize protection where you need it most. *Ship. wt. 1 lb.*



SPECIFY SIZE: S-XXL	
BH023	Lightweight Rappel Gloves \$32.95

SMC Edge Roller



Reduce friction when going over the edge with the versatile RA/SMC Edge Roller. Two edge rollers connected by quick links will lay over a right angle such as a rack wall or edge of a building. This efficient 4" wide single edge roller ships with screw links for connecting two or more rollers together. *Ship. wt. 5 lbs.*

- ▶ 5/8" steel axle
- ▶ Rubber on bottom
- ▶ Two 3/16" quick links included
- ▶ 4" wide aluminum roller

AZ586	SMC Edge Roller	\$176.95
-------	-----------------	----------

ProSeries Anchor Straps

UL Classified to NFPA 1983 - General Use



Our popular ProSeries Anchor Straps are used by all types of rescue agencies to quickly set strong, secure anchors. Our straps are sewn with all the care and quality we put into our CMC harnesses. The D-Ring allows the use of high-strength web without compromising carabiner strength. One end is larger so the other end can pass through allowing the strap to be rigged in a Girth Hitch. Remember to avoid triaxial loading on any carabiner to maintain system strength. *End-to-end configuration: 6,000 lbs.*

BG270	5' Blue Anchor Strap (Medium)	\$40.95
AZ580	7' Blue Anchor Strap (Large)	\$42.95

Personal Escape Rope

Sterling's Personal Escape Ropes are manufactured to yield a perfect balance of strength, abrasion resistance, and handling so they perform flawlessly the moment they are needed. The escape ropes are designed with tough sheaths and the proper elongation to help absorb impact force during a "bail out." The 8mm diameter has a high tensile strength and a great hand for packing into turnout gear or drop bags. Available in neon yellow or orange. Certified to NFPA 1983, 2006 edition for Escape Rope. Ship. wt. 2 lbs.

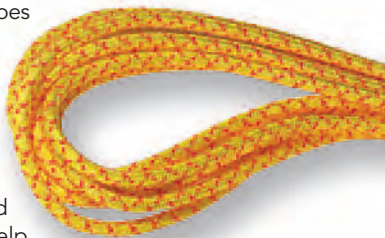

Cat#	Description	Tensile	50'	75'
BE009	Nylon Escape Rope	3,754 lbs.	\$31.95	\$46.95

CMC Rescue Rope Bags

Solid performers for years, the popular CMC Rescue Rope Bags feature a variety of innovative elements. Contoured backpack-style shoulder straps offer greater comfort when carrying a heavy bag. Bag tops are made of rugged pack cloth for easier closing. Handles, just inside the top, can be used to hold the bag open for quicker stuffing or to carry the bag from the top, haul-bag style. A soft rubber side-carrying handle is comfortable on the hand. The bottom of the bag has a large grommet to pass the rope through, plus sewn web loops to tie the rope end off inside or outside of the bag. The #1 Rope Bag is all CORDURA® nylon and features an external web handle.

Color: Orange.



Cat#	Description	Rope Capacity	Price
AZ590	CMC Rescue Rope Bag	200'	\$58.95
BB056	CMC Rescue Rope Bag	250'-300'	\$68.95

F4 Descender Escape Device

The F4 descender is a new innovative escape device that gives firefighters an advanced, yet simple tool for emergency egress. The F4's sleek, light-weight design (6 oz.) is certified with Sterling's escape ropes. It is engineered to allow for easy horizontal movement. The auto-locking feature adds security and confidence for a hands-free exit of a structure. The F4 can be used by all sizes of firefighters. The low profile shape packs easily in many bags and styles UL certified to NFPA, 1983, 2006 Edition for Escape. Ship. wt. 1 lb.

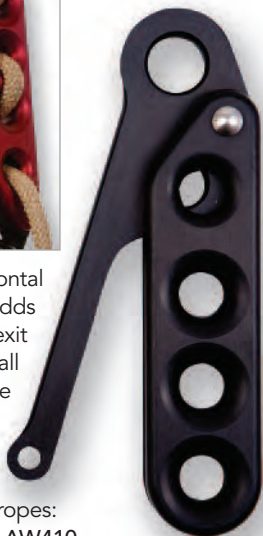

- ▶ Weight - 6 oz.
- ▶ Length - 6", width - 2"
- ▶ MBS - 3,035 lbs.
- ▶ Approved ropes:
 - RIT 500 - AW410
 - Personal Escape Rope - BE009

SPECIFY COLOR: Red or Black

BH186	F4 Descender Escape Device	\$74.95
-------	----------------------------	---------

RIT Heat Resistant Search Line and Escape Rope

Rapid Intervention Teams (RIT) face the most demanding and extreme conditions during search operations. Overcoming extreme heat, ground obstacles, and poor visibility are just some of the hurdles faced when searching for and rescuing trapped firefighters or civilians. Firefighter safety and survival has become an important focus and Sterling RIT Lines are an integral rescue tool in search and bailout operations.



RIT 900 6.8mm - 100% aramid fiber search line. Designed with a supple hand to enable long lengths of cord to be stuffed in a pocket or bag, deployed efficiently, and easily tied with directional knots. Heat resistant to 932F.

RIT 500 8mm - Heat resistant escape rope or search line. Aramid sheath provides heat and cut resistance and nylon core gives flexibility for packing and handling with gloved hands. Sheath is heat resistant to 932F. 5436lbs Tensile. Certified to NFPA 1983, 2006 edition for Escape Rope.

Cat#	Desc.	Tensile	150'	200'	300'
AS277	RIT 900	4,200 lbs.	\$132.95	\$176.95	\$263.95
AW410	RIT 500	5,486 lbs.	\$149.95	\$198.95	\$298.95

CMC Rescue RIT Kits

UL Classified to NFPA 1983 – General Use

Improved! Often the solution to navigation in an unknown structure with poor visibility is a small cord attached at the entrance and deployed as a firefighter moves through the building, so he can retrace his steps to the entry point or be located by a Rapid Intervention Team. With a carabiner on each end, a partner's line can be attached to yours to extend the distance. The 50 ft. length works well for residences and small structures. The 150 ft. length is a good choice for larger commercial buildings. These kits include CMC Rescue's new reflective RIT Line and two bright orange ProTech™ Manual-Lock Carabiners with keeper pins.



Cat#	Length	Weight	Price
AZ582	50'	1 lb. 11 oz.	\$168.95
AZ583	150'	2 lbs. 10 oz.	\$294.95

CMC MPD Rope Rescue Truck Cache™ Kit

When setting up systems, this well-organized kit provides efficient access to all the rigging hardware needed to set up a main line and belay. The case can be laid on the ground or suspended from the side of a vehicle with integrated gutter hooks, yet when closed, fits easily into a vehicle cabinet or behind the seat.

Kit Includes:

- ▶ Truck cache
- ▶ UltraPro 4 edge protector
- ▶ 2- FastLink anchor strap
- ▶ 1" Web - 40' (2x20')
- ▶ XL Edge pad
- ▶ 2 - Short prusik loop
- ▶ 2 - Anchor strap sleeve
- ▶ 2 - MPD 13mm
- ▶ 2 - Double swivel pulley
- ▶ 5 - ProSeries manual lock
- ▶ 3 - Single swivel pulley



BL023 CMC MPD Rope Rescue Truck Cache™ Kit \$2,799.95

CMC MPD Rope Rescue System

UL Classified to NFPA 1983 – General Use

More than nine years of research and development went into CMC Rescue's patent-pending Multi-Purpose Device (MPD), which features major innovations in advanced technical hardware for rope rescue professionals. The MPD's high-efficiency pulley, with an integral rope-grab mechanism, means it can be used as a lowering device on the main line and belay line systems and be quickly changed over to a raising system without switching out or replacing hardware. The combination of essential features into a single device simplifies on-scene rigging, expediting the rescue. The revolutionary MPD increases user safety with:

- ▶ Reduced weight
- ▶ Fewer components
- ▶ Faster rigging
- ▶ Quicker changeovers
- ▶ Simplified training
- ▶ Lower risk

Features:

- ▶ Variable-friction descent control device for rescue systems and rappels
- ▶ High-efficiency pulley with integral rope-locking mechanism (ratchet) for a haul system
- ▶ Built-in becket allows cleaner rigging and more efficient pulley systems
- ▶ MPD allows main line and belay line rigging to be mirror images of one another
- ▶ One device functions as both a lowering brake and ratcheting pulley for raising
- ▶ Converts rapidly to a retrieval line for confined space operations to a retrieval line
- ▶ Meets BCCTR Rescue Belay Competency Criteria



SPECIFY COLOR: Red or Slate (Blue)

BL022 CMC MPD Rope Rescue System \$694.95

CMC Escape Artist System

UL Classified to NFPA 1983 – General Use

This compact system is small enough to be worn in the pocket of bunker pants. Instead of rope it contains CMC Rescue's new FR Escape Web, developed at the request of firefighters looking for a more compact, lightweight escape solution. Its proprietary web features 100% Technora® fiber for superior strength and durability when exposed to heat and flame. This compact, lower profile system can be worn closer to the body. The web-based system also includes the CMC Rescue Flash Hook escape anchor (the lightest certified escape anchor on the market today), which delivers outstanding strength with minimal weight. The unique design of the FR Escape Bag holds the anchor and web securely, but allows quick access to the Flash Hook, which is housed in its own special pocket. The bag attaches to your belt or harness with hook and loop, or you can thread your belt through the tunnel loop. Use the included tether to connect the system to your escape belt or harness for rapid deployment.



BL024 CMC Escape Artist System \$438.95

CMC USAR Task Force Kit

A good package for a truck or engine company that responds to over-the-side rescues or needs a vertical lift capability for trench or confined space rescues, this kit contains the primary rope rescue equipment on most of the FEMA and USAR requirements lists.

- ▶ 2 - #2 Rope Bags
- ▶ 2 - Fire-Rescue Harness
- ▶ Rectangular Litter
- ▶ One-Piece Patient Tie-In Sys
- ▶ 2 - Rescue 8
- ▶ 4 - Adjustable Litter Strap
- ▶ 4 - ProSeries Manual-Lock
- ▶ Etrier with Tie-In
- ▶ ProSeries Litter Harness
- ▶ 2 - Edge Pad - XL
- ▶ 2 - FastLink Anchor Strap
- ▶ Truck Cache
- ▶ 1" Web - 72' (6x12')
- ▶ 1" Web - 90' (6x15')
- ▶ 5 - ProSeries Pulley
- ▶ Anchor Plate
- ▶ 11 - ProSeries Screw-Lock
- ▶ Long Prusik Loop
- ▶ Shasta Gear Bag
- ▶ Litter Pack
- ▶ Rectangular Litter Insert
- ▶ Pelvic Harness
- ▶ 2 - Gibbs Ascender
- ▶ FastLink Pick-Off Strap
- ▶ ProTech Auto-Lock
- ▶ 5 - Short Prusik Loop
- ▶ ProSeries Litter Harness Bag
- ▶ UltraPro 4 Edge Protector
- ▶ 2 - Anchor Strap Sleeve
- ▶ 2 - 1/2" Rescue Lifeline - 200'
- ▶ 1" Web - 30' (6x5')
- ▶ 1" Web - 120' (6x20')



- ▶ 2 - ProSeries Load Release Strap
- ▶ Rescue Rack
- ▶ ProTech Oval
- ▶ 2 - Short Prusik Loop

BD050 CMC USAR Task Force Kit

\$6,114.95

CMC Rope Rescue Team Kit - Rigging

Containing the minimum equipment required to handle most high or low-angle rope rescue responses, this kit includes a main line with mechanical advantage for raising and a descent control device for lowering, a belay line, a litter with a patient-packaging system, and gear for setting up anchors.

- ▶ Rectangular Litter
- ▶ One-Piece Patient Tie-In Sys
- ▶ Litter Pack
- ▶ ProSeries Litter Harness Bag
- ▶ ProTech Auto-Lock Carabiner
- ▶ 4 - ProSeries Manual-Lock Carabiners
- ▶ 5 - Short Prusik Loop
- ▶ 2 - FastLink Anchor Strap
- ▶ 4 - Adjustable Litter Strap
- ▶ 1" Web - 40' (2x20')
- ▶ 1/2" Rescue Lifeline - 200'
- ▶ UltraPro 4 Edge Protector
- ▶ Shasta Gear Bag
- ▶ 2 - #2 Rope Bag
- ▶ 2 - Load Release Strap
- ▶ 5 - ProSeries Pulley
- ▶ Long Prusik Loop
- ▶ Rectangular Litter Insert
- ▶ Pelvic Harness
- ▶ Lifesaver Victim Harness
- ▶ ProSeries Litter Harness
- ▶ 2 - Gibbs Ascender
- ▶ 11 - ProSeries Screw-Lock
- ▶ ProTech Manual-Lock Carabiner
- ▶ FastLink Pick-Off Strap
- ▶ 2 - Anchor Strap Sleeve
- ▶ Etrier with Tie In
- ▶ 1" Web - 24' (2x12')
- ▶ 1/2" Rescue Lifeline - 200'
- ▶ 2 - Edge Pad - XL
- ▶ Truck Cache
- ▶ Rope Rescue Manual
- ▶ Anchor Plate
- ▶ Rescue Rack
- ▶ ProTech Oval
- ▶ 3 - Short Prusik Loop



BD051 Rope Rescue Team Kit

\$5,240.95

CMC CSR Pulley Kit

The patented locking mechanism in our CSR Pulley is easy to release under load, creating much greater efficiency with the lowering and raising necessary to a confined space rescue. The machined aluminum swivels at both ends of the system eliminate any potential twisting of the lines. This system is also an excellent choice for confined space entry or rope access work where a heavy-duty pulley system is desired.

- ▶ 1 - 200' - 1/2" Static-Pro Lifeline
- ▶ 1 - CSR Pulley
- ▶ 1 - CSR Double Pulley
- ▶ 2 - ProSeries Aluminum Manual-Lock Carabiner
- ▶ #3 Rope Bag

BG274 CSR Pulley Kit

\$1,053.95



SKED-EVAC™ CSR Kit

Confined Space Rescue System

- ▶ Sked-Evac™ tripod
- ▶ Sked-Evac™ tripod bag
- ▶ Sked basic rescue system
- ▶ Oregon Spine Splint II
- ▶ Stifneck cervical collar kit
- ▶ Skedco 4:1 rescue kit
- ▶ 2 - Full body adjustable rescue harnesses
- ▶ Tag line
- ▶ Belay line
- ▶ Skedco 12'x3" anchor sling
- ▶ Continuous loop sling
- ▶ Handled ascender
- ▶ Skedco rescue stirrup with screw link
- ▶ Rope pad
- ▶ 24" RAVEN rope guard
- ▶ 6 large locking "D" steel carabiners
- ▶ 2 PETZL industrial helmets



Cat#	Description	Ship. wt.	Price
AS448	Skedco Sked-Evac™ CSR Kit 25' Depth	158	\$4,114.95
AS449	Skedco Sked-Evac™ CSR Kit 50' Depth	168	\$4,269.95
AS450	Skedco Sked-Evac™ CSR Kit 75' Depth	178	\$4,578.95
AS451	Skedco Sked-Evac™ CSR Kit 100' Depth	188	\$4,578.95

SKED-EVAC™ Tripod

The Sked-Evac™ Tripod extends to ten feet high at the three anchors which are available to clip into. Each of the anchors is anodized red for easy identification, and all are equally well centered to handle a load. The anchors, header, and legs are interconnected with 1/2" stainless steel bolts to provide maximum strength. The header limits the distance the legs can spread. When at full extension, this tripod allows you to bring the patient in a stretcher completely out of the hole. It is rated to handle an NFPA rescue load. Included with the tripod is a chain which passes through the feet to provide greater strength and stability. The legs are adjustable in 5" increments, and Skedco provides safe working load data for each tripod height on each tripod. Brackets are available for mounting most popular winches. **Ship. wt. 74 lbs.**



AS441	Sked-Evac™ Rescue/Entry Tripod	\$1,372.95
AS442	Sked-Evac™ Tripod Carrying Case	\$98.95

Rescue Hauler 4:1 Pulley Device

This ingenious device combines a 3" double pulley with a cam. The rope can move in only one direction when the cam is engaged. It allows you to raise a load by pulling on the tail end of the rope, releasing it, and getting another grip. The cam can be released manually by pulling on the attached cord. The cam is guaranteed for life. There are no hidden parts to this device, facilitating minimal maintenance and easy inspection in the field. The pulley sheaves and body of the Rescue Hauler and matching pulley are anodized. The Rescue Hauler accommodates rope sizes from 3/8" to 1/2". Maximum recommended load at the cam is 2,300 lbs. Minimum break strength when in use is 12,000 lbs. When used with a separate double pulley, it gives you a 4:1 mechanical advantage.

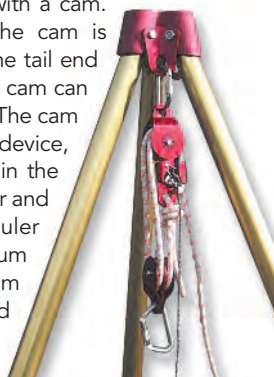

AS443	Skedco Rescue Hauler	\$251.95
-------	----------------------	----------

Skedco Rescue System

This litter is designed for use in mass casualty incidents. These incidents could be airline crashes, terrorist incidents, Haz-Mat or any other incident where large numbers of people must be evacuated. The HMD Sked® is extremely versatile. It can be dragged over virtually any terrain including stairways. It requires less effort from rescuers wearing level A protection. The two inch side release buckles on all straps are easy to handle with the thick gloves on level A or B suits. The straps are polypropylene for resistance to chemicals. They have sewn loops on the ends for quick attachment and removal.

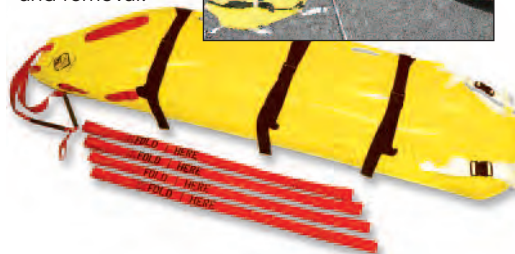

BA091	HMD Sked® Rescue System	\$349.95
BA092	HMD Sked® Body Only	\$284.95
BA093	HMD Sked® Strap Kit	\$58.95
BA094	HMD Sked® Rapid Deployment Case	\$116.95

SKED® Basic Rescue System

The original and still the best solution for confined space, high angle or technical rescue, and traditional land based applications. The Sked® stretcher is a revolutionary design which provides outstanding patient protection and security. The Sked® comes equipped for hoisting by helicopter in horizontal position spaces. When the patient is packaged, the stretcher becomes rigid. The durable plastic provides protection for the patient while allowing extrication through the most demanding confined spaces. The stretcher is rolled for storage in a tough Cordura® backpack which is included with the system. The system ships at 19 lbs. and comes complete for most applications. *Available in International Orange.* **Ship. wt. 19 lbs.**



AS452	Sked® Basic Rescue System	\$607.95
-------	---------------------------	----------

Patriot Rite Rescue Device



- ▶ Rapid deployment in less than 1 minute
- ▶ Easy to use and resets quickly in cases of multiple victims
- ▶ Integrated full body harness, tested by Underwriters Laboratories and exceeds the 1983 NFPA 2012 testing
- ▶ Harness has a unique "quick connect" fastening system
- ▶ Flame retardant covering protects harness
- ▶ Short length of the rap makes it easy for one person to maneuver in tight quarters
- ▶ Interchangeable bases allows for customized rescue operation
- ▶ Multiple rate handles at top and both sides allow easy for carrying and hoisting operations

BL420	Patriot Rite I Rescue Device	\$1,499.95
BL421	Patriot Rite II Rescue Device	\$1,499.95
BL422	Patriot Rite III Rescue Device	\$1,624.95
BL423	Patriot Rite IV Rescue Device	\$1,524.95

Safer Search System

This system aides in conducting team searches when conditions such as building construction, layout, and/or inherent hazards are beyond the scope of the ordinary search techniques. It includes a search rope with direction and distance markers every 25', a stuff bag, and a Safer Search Device (SSD) that slides along the rope and automatically locks in place. The SSD has attachment loops for tag lines, to provide connection points for multiple rope operations, or to secure a tie-off point.

- ▶ Lock/direction markers and distance markers help firefighters know their position along the search rope
- ▶ Markers are designed to allow for quick and easy rope deployment from the bag
- ▶ All are anodized, machined 6061-T6 aluminum
- ▶ Shapes are easy to feel with a gloved hand
- ▶ Markers are locked in place with a stainless steel set screw



FRC
FIRE RESEARCH CORP.
choose the best.

Cat#	Description	200'	300'	400'
BG543	Safer Search System w/Rope, 2 Taglines (15' ea.), and Bag	\$940.95	\$1,244.95	\$1,539.95
BG544	Safer Search System w/Rope, 2 Retractable Taglines (9' 8" ea.), and Bag	\$1,043.95	\$1,347.95	\$1,688.95

Sling-Link MAST™

Multiple Application Service Tool (MAST)

The MAST™ is a tool that should be carried in the bunker pant pocket or the specially designed pouch...and absolute must while on the fire floor. The Sling-Link MAST™ has the versatility of a rope with the convenience and speed of a sling.



AW503 - The "Personal Pocket Tool" is a must for every firefighter. This tool has a minimum break strength of 4,500 lbs. and is excellent for the firefighter's bunker pant pocket. The MAST™ is an OSHA approved lifting sling and meets NFPA 1983 as Personal Use or General Use Auxiliary Harness. *Dimensions: 1" wide, five 2' loops for a total of ten feet long. Ship. wt. 1 lb.*

AZ398 - This tool has a minimum break strength of 7,500-9,000 lbs. and is the tool most often found in the RIT Pak or carried by heavy rescue personnel. This MAST™ is a rated commercial grade lifting sling. *Ship wt. 1 lb.*



AW503	Sling-Link MAST™ (Personal Pocket Tool)	\$48.95
AZ398	Sling-Link MAST™	\$82.95
AZ399	MAST™ Bag for AZ398	\$29.95

Manhole Entry System

Combines the advantages of the Quick-Couple™ canister and the Manhole Entry System.

- ▶ Quick-Couple™ Canister with 5' and 15' duct plus duct coupler
- ▶ Manhole entry device
- ▶ Universal mount
- ▶ 90° elbow
- ▶ Blower



CONFINED SPACE MANHOLE ENTRY SYSTEM, COLOR: Black

BD059	Manhole Entry System (Hazardous Locations) 115VAC Powered Blower	\$2,784.95
BA001	8" 1/3 HP Blower-Exhauster (Hazardous Locations) 115V	\$1,495.95
BD060	Quick-Couple™ Long Canister, 2 pcs, (8) Conductive Duct	\$783.95
BD061	Conductive Manhole Entry Device	\$549.95
BD056	Saddle Vent Universal Mount	\$80.95

SADDLE VENT™ SYSTEM, COLOR: Yellow

BD052	Manhole Entry System	\$969.95
AS281	8" 1/2 HP Blower-Exhauster 115V	\$382.95
BD053	Quick-Couple™ Canister, 2 pcs, 8" duct (5' & 15') & Duct Coupler	\$388.95
BD054	Manhole Entry Device	\$443.95
BD055	90° Elbow	\$108.95
BD056	Universal Mount	\$80.95

In-Line Heater System

Hot - Because it's designed and built by RAMFAN specifically to work inline with the Turbo Blower to generate warm, clean air for portable tents and confined space. Indirect-fired. No CO!

Hotter - Because it produces 70,000 BTU's (5,000 more than the others) and it's available in 2 kit types: For confined spaces - Turbo Blower, the Heater and our Quick-Couple™ Canister with a choice of 15' or 25' of duct. For tents: Turbo Blower, the heater, 15' duct and duct storage bag

Hottest - In portability, durability and heat-ability because it's a Total RAMFAN In-Line Heating System that offers fast and easy set-up, outstanding performance and new, value pricing, too.

- ▶ 70,000 BTU's output up to 10 hours of heat from standard (20 lb.) propane tank
- ▶ Systems include regulator assembly for propane tank connection
- ▶ Heater weight: 32 lbs.



BD063	In-Line Heater System	\$3,023.95
AS282	8" 1/3 HP Blower-Exhauster 115V Included Quick-Coupler Canister with 25' Duct	\$643.95
BD065	70,000 BTU Propane Heater-No Tank-Use with BD066 (Includes Regulator)	\$2,483.95
BD066	Propane Regulator and 12' Hose Assembly for use with BD065	\$175.95

8" BLOWER/EXHAUSTER

RAMFAN has combined high performance turbo fan design with high strength polymers to create a line of rugged, portable turbo blowers that are ideal for rescue, confined space and hazardous ventilation and deliver the highest airflow in their class. The double-wall, polyethylene casing is lightweight, corrosion and chemical-resistant and handles the bumps and falls of rescue operations. When conditions become dangerous, the tough, conductive housing adds static dissipation to its properties.

Quick-Couple™ Reversible Canister

Detachable in seconds, the Quick-Couple™ Canister with attached duct conveniently reverses from discharge to suction, making use and storage easier while protecting duct from rips and tears. Available with 15ft/4.6m or 25ft/7.6m of duct. Quick-Couple™ Canister is compatible with UB20 Manhole Entry System, high or low pressure misting system.

AS281 - AS282

- ▶ High impact polyethylene shell
- ▶ Polypropylene turbo fan blade
- ▶ Compact design, ultra quiet - 74dB
- ▶ IP65 rain tested
- ▶ 12V DC model available

BA001 - AS284

- ▶ Anti-Static housing
- ▶ Lightest Blower in its class
- ▶ Tough dual wall construction
- ▶ Quick-Couple™ Canister with Anti-Static duct for hazardous locations

AS281	8" Blower/Exhauster 1/3 HP 115V	\$382.95
AS282	8" Blower/Exhauster with Quick-Couple™ Canister, 25' Duct	\$643.95
BA001	8" Blower/Exhauster 1/3 HP 115V	\$1,414.95
AS284	8" Blower/Exhauster w/Quick-Couple™ Canister, 25' Anti-Static Duct	\$2,042.95



RESCUE TOOLS

WindMate™ 350 Wind Meter

The WindMate™ 350 is a prize-winning, comprehensive weather monitor, which gives full environmental data specific to your location and includes a 48-hr history for every function, hour-by-hour and in a bar graph. The USA fluxgate compass reads when held vertically, gives wind direction in degrees and compass points; it calculates crosswind & head/tail wind. The compass can be calibrated for variation/declination and deviation. In addition to wind speed/direction, temperature, barometric pressure, altitude, and humidity, the unit includes wind chill, Wet Bulb, Dew Point, Delta T & Density Altitude. WM-350 gives an accurate weather forecast and an audio storm alarm alerts you to weather changes, even if the unit is off.



BK246 WindMate™ 350 Wind Meter \$259.95

Get The Full View With Wide-Angle Binoculars



AW093



Whether you use your binoculars for fun or professionally, you know that good binoculars make a difference. While several binoculars may be optically equal, some are better than others. No matter what the need may be, these wide-angle binoculars offer the advantage of a wider field of view perfect for forestry firefighting. Binoculars backed by a lifetime warranty. Available in two powers. *Ship. wt 2 lbs.*

AW093	Wide-Angle Binoculars, 7x35	\$35.95
AW094	Wide-Angle Binoculars, 10x50	\$46.95

Fireground Compass®

Quickly and Easily Navigate Your Way to Safety

The Fireground Compass® is a lightweight, easy-to-use tool that combines a compass with rotating bezels. It has a "building bezel" with four points labeled A-B-C-D, corresponding to firefighters' current labeling system for each side of a building. First, the compass is oriented to north. Then, the bezel rotates to reference the A-B-C-D sides of the building. Together, the compass and rotating bezel combine to give users a common reference point. A separate, "command bezel" helps indicate where the command post or point of entry is located relative to the building. The durable and heat-resistant compass is illuminated by LED lights and sized specifically to be used with gloved hands. *Ship. wt. 2 lbs.*

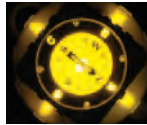

Compact size:
4 3/4" diameter

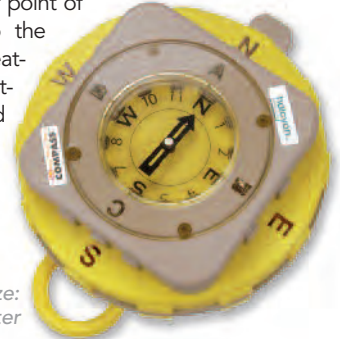

BH004 Fireground Compass® \$98.95

Water Rescue Throwline Bag Set

An inexpensive alternative to the high-performance throwline bags. The Redi-Line Throwline Bag is ideal for the shore based rescuer arriving first on scene. If your response area has water hazards, there should be a throwline in every patrol car, municipal truck, and fire apparatus. The Redi-Line Bag Set makes preparedness affordable. Available in 50' and 75' lengths. The pack cloth bags have our quick-release strap and top handle for easy throwing. An Ethafoam disc provides flotation.



AZ591	50' Rescue Redi-Line Throwline Bag Set	\$59.95
AZ592	75' Rescue Redi-Line Throwline Bag Set	\$73.95

Water Line Rescue Rope

Sterling produces a full line of float ropes for swiftwater, flood, ice, and ocean rescue operations. We use the highest quality fibers available for significantly more durability and strength than typical float ropes. Our innovative ropes, like the Grabline Glo, provide rescuers with tools they need to complete the mission. *NFPA 1983, 2006 edition for Throwline. Berry Amendment Compliant. Made in the USA.*

Waterline - High tenacity polypropylene with high strength nylon core



Cat#	Description	Diameter	Weight	Min. Break Strength	75'	200'	300'
BH197	Water Rope 3/8" Yellow w/Red Tracer	3/8" / 9.5 mm	3.3lbs.	3440 lbs.	\$29.95	\$77.95	\$117.95

Ice Commander™ Rescue Suit

Floatation and Thermal Protection in a Quick Don Suit

The Mustang Ice Commander™ is the suit of choice for search and rescue teams, fire departments, and ice rescue professionals. The floatation and insulation performance of a snap in buoyancy liner allows users to immerse themselves for long periods of time in icy cold water and maintain mental and physical capabilities.

- ▶ Water-tight hood and face seal
- ▶ Integrated gloves and attached boots
- ▶ SOLAS™ reflective tape and Velcro® patch for light attachment
- ▶ Heavy duty, full-length, water-tight zipper
- ▶ Waterproof & durable welded nylon outer shell
- ▶ High performance urethane-coated nylon exterior
- ▶ Integral self-adjusting safety harness
- ▶ Ergonomic ice awl pockets - secured with Velcro® (ice awls not included)
- ▶ Removable inner buoyancy liner - constructed of closed-cell AirSoft™
- ▶ Reinforced knees padded with 2.5 mm neoprene
- ▶ Reinforced seat and elbows
- ▶ Measurements: Adult universal sizing, fits height: 4'11" - 6'6", and weight: 110 lbs. - 330 lbs.

new



BL315 Ice Commander™ Suit (Universal Adult) \$945.95

Universal Swift Water Rescue Vest

Industry Leading Universal PFD for Swift Water Rescue

- ▶ 25 lbs. (111 N) buoyancy
- ▶ Drag handle and D ring
- ▶ Quick donning with 7 adjustment tabs to create a customized fit for chest sizes from 30" - 52"
- ▶ Layered floatation
- ▶ MOLLE® webbing on both shoulders & back
- ▶ Velcro® panel on back for ID patches
- ▶ 2 large self draining pockets provide ample storage options
- ▶ Durable harness with 2" webbing
- ▶ Quick release belt
- ▶ 500 denier, Cordura® outer shell
- ▶ Over 62 sq. in. of SOLAS™ tape

new



COLOR: Fluorescent Yellow-Green/Black
BL462 Universal Swift Water Rescue Vest \$219.95

Survival Rescue Stick

Throwable Emergency Rescue Inflatable

- ▶ Compact and weighs less than 1 lb.
- ▶ Can be thrown distances almost 3x that of a typical rope bag or life ring (between 110'-150')
- ▶ Automatically inflates in seconds after contact is made with water, providing rapid emergency floatation
- ▶ Offers 35 lbs. of buoyancy - more than the 7 lbs. required to keep a conscious person afloat
- ▶ Easy to repack and reuse

new



BL317 Survival Rescue Stick \$195.95

Water Cascade Helmet

The Cascade is a superior quality swiftwater helmet which provides a high level of protection. Extra foam padding provides an ergonomic fit and makes the Cascade a multiple impact helmet. Includes three crown pads for a custom fit to your head. Patent pending neck-strap system holds the helmet firmly in place. Unique "rain-gutter" front drains water away from your face. Special side slots make wearing sunglasses more comfortable. Guaranteed for life. Ship. wt 1.5 lbs.

new



DON'T MISS
More helmets on page 151



SPECIFY SIZE: M-XL
SPECIFY COLOR: White, Red or Yellow
BL398 Water Cascade Helmet \$54.95

Stearns SAR Mesh PFD Vest

The "Mesh" PFD provides added comfort in warm weather conditions. The soft, lightweight mesh provides a high level of ventilation. Soft Aquafloam™ and durable Crosstech® foam provide comfort as well as the floatation. Two large pockets close with hook and loop fastener. Zippered front is backed by three 1-1/2" belts. USCG Approved Type III. Color: International Orange.

Vest Sizing

Size	Waist
Small	36"-38"
Medium	40"-42"
Large	44"-46"
XLarge	48"-50"
3XLarge	50"-52"



SPECIFY SIZE
BA086 Stearns SAR Mesh PFD Chest Vest \$89.95

RESCUE TOOLS

Rescue Kit 1 with Power Talk Box

The CON-SPACE Rescue Kit 1 with Power Talk Box is configured for a team of five rescuers consisting of two primary rescuers, two standby rescuers and a hole watch/team leader, for entries of 100' (maximum distance 1500'). They system can be configured for up to fourteen people using available modules and accessories. The command module is battery-powered, compact and lightweight making it completely portable. Three 1.5v alkaline "C" cells provide 400 hr. life on standby and all electronics are fuse protected. A low battery LED indicator gives 12 hr. warning battery replacement. System and accessories are waterproof. Molded fiberglass enclosures, knobs, and cables are impervious to a wide range of chemicals.

Includes:

- ▶ 1 - CSI-2100 command module
- ▶ 1 - CSI-2131 power talk box
- ▶ 1 - Cable splitter - Double w/mic mute switch
- ▶ 1 - Operator headset single-side, 32"
- ▶ 4 - Rescue facemask com set with universal speaker
- ▶ 4 - Speaker harnesses
- ▶ 1 - 1' operator cable w/mic mute switch
- ▶ 1 - 20' operator cable w/mic mute switch
- ▶ 1 - 50' cable with connectors
- ▶ 4 - 100' cable with connectors with strain relief/snap hook
- ▶ 1 - Cable coiler
- ▶ 1 - Cable bag for 100'-300' of cable
- ▶ 1 - 2000 carrying case



AZ400 Rescue Kit 1 with Power Talk Box \$7,743.95

FireCraft® trACer™ Non-Contact AC Voltage Detector

new

- ▶ Detects AC voltage at a safe distance
- ▶ Pinpoints direction of downed lines
- ▶ Detects power in unused outlets
- ▶ Fits in pocket for hands-free use
- ▶ Audio and visual signals
- ▶ Storage case and DieHard® battery included
- ▶ MADE IN THE U.S.A.
- ▶ Patent Pending



Case included



BL253 FireCraft® trACer™ \$324.95

Victim Locator Kit

The Victim Locator Kit is lightweight, portable, battery-powered and can be operated by a single rescuer. Multiple kits can be deployed simultaneously on the same site without interfering with each other. Completely stand alone system that gives a single rescuer the ability to search a collapse. On location of a victim, 2-way voice communication is established immediately. Attaching a metal or PVC pipe to the back of the probe allows rescuers to push it deeply into a collapse through holes and cracks.

Includes:

- ▶ 1 - CSI-1100 mini module
- ▶ 1 - Rescue probe
- ▶ 1 - Probe behind-head headset-double w/mute
- ▶ 1 - 25' probe interface cable
- ▶ 1 - Rope coupler for probe
- ▶ 1 - Pipe coupler for probe
- ▶ 1 - 50' probe cord/snap hook
- ▶ 1 - Carrying case



AR314 Victim Locator Kit \$2,807.95

HotStick Voltage Detector

High Sensitivity Detector For
Emergency Responders

new

The HotStick provides warning of exposed high voltage AC from a safe distance without the need to contact the surface carrying the current. It gives early audible ("beeping") and visual (flashing LED) warnings, and beeps and flashes more rapidly the closer it comes to the voltage. Comes with a built-in self test so there is no doubt about it functioning properly.

- ▶ CONFIRM power shutdown, lockout, tag out, disconnects
- ▶ FIND hidden sources of dangerous AC from a safe distance
- ▶ DETECT power line back feeds from motor generators and energized pools of water
- ▶ ENSURE a safe environment for your vehicular rescue
- ▶ PROTECT the life of your first responders
- ▶ CHECK IT trust is good – checking is better



Case included

BL318 HotStick Voltage Detector \$358.95

Eclipse™ Thermal Imager

The Bullard Eclipse is the fire service industry's first low-cost, lightweight, personal-issue thermal imager designed for every firefighter. This ultra-small imager, weighing 1.5 pounds, is ergonomically shaped to fit in the palm of a firefighter's hand and easily attaches to a firefighter's gear. Designed to equip each firefighter with a thermal imager in a fire, the Eclipse features a super lightweight design, easy one-button operation, quality images, and 1000 degree dynamic range.

- ▶ **Power Source:** NiMH rechargeable battery – 3 hour operating time
- ▶ **Display:** Digital, Liquid Crystal Display (LCD)
- ▶ 2.4" Diagonal TFT active Matrix display
- ▶ Desktop battery charger with one battery
- ▶ Eclipse control panel software
- ▶ **Weight:** 24 oz.
- ▶ **Dimensions:** 3.4"Hx6.5"Lx 4"W



COLOR: Red

BK249	Eclipse™ Thermal Imager	\$4,494.95
BK250	Eclipse™ Thermal Imager and Powerhouse™ Bundle	\$4,794.95

Argus® Mi-TIC Mini Thermal Imager

World's Smallest High Resolution Firefighting Thermal Imager



- ▶ Multiple wear options
- ▶ Picatinny rail at the top of camera
- ▶ Includes dual use vehicle/desktop charger
- ▶ Direct Temperature Measurement (DTM)
- ▶ Tri-mode sensitivity for clear scene imagery and temperatures in excess of 1832° F (1000° C)
- ▶ Customizable start-up screen
- ▶ On-screen time and date (user configurable)
- ▶ Field removable germanium lens
- ▶ Super-fast start up time, less than 5 seconds
- ▶ 2 hr. lithium phosphate rechargeable batteries
- ▶ No software required, plugs into PC via docking station
- ▶ Extremely lightweight at just over 1.5 lbs.
- ▶ 2.7" LCD screen, 160 x 120 resolution
- ▶ Easy to use
- ▶ **Ship. wt. 3 lbs.**



BL307	Argus® 160Mi-TIC 1 Button 30 hz Thermal Imager	\$4,995.95
BL308	Argus® 160Mi-TIC 3 Button 30 hz Thermal Imager	\$5,375.95
BL309	Argus® 320Mi-TIC 1 Button 30 hz Thermal Imager	\$6,235.95
BL310	Argus® 320Mi-TIC 3 Button 30 hz Thermal Imager	\$6,615.95
BL311	Argus® Mi-TIC Lithium Phosphate Battery (Small)	\$275.95
BL312	Argus® Mi-TIC Lithium Phosphate Battery (Large)	\$325.95

Argus® 4 Thermal Imager

The Argus® 4 is the next generation of highly successful Argus® Thermal Imaging Camera (TIC) from e2v. It uses an uncooled high-resolution 320x240 pixel, Amorphous Silicon (ASI) Microbolometer Detector. The camera has been specifically designed to help fire fighters to see through smoke, identify and rescue casualties and locate hot spots or the seat and spread of the fire.

- ▶ Scene colorization - user selectable choice of color palettes
- ▶ Direct Temperature Measurement (DTM)
- ▶ SceneSave™ digital image capture - 100 image capacity
- ▶ Tri-Made sensitivity
- ▶ Customizable start-up screen
- ▶ Ambient temperature measurement
- ▶ Digital double zoom
- ▶ On-Screen time and date



BK189	Argus® 4 Thermal Imager	\$8,994.95
BK190	Truck Battery Charger	\$339.95

RESCUE TOOLS

ProPolymer® Flashlights

The professional's choice for high-performance alkaline powered flashlights. The ProPolymers® are completely waterproof (submersible to 200'), extremely tough and incredibly bright. Their powerful Xenon or LED beams produce a brilliant pre-focused beam that can be activated by a tail switch. Made of nonconductive polymer case with thermoplastic elastomer grip, making it perfect for wet grip handling or gloved hands. Features rubber face cap for impact and shock resistance. Yellow only. UL Class I, Division I listed for use in hazardous locations. *Ship. wt. 2 lbs.*



Cat#	Description	Length	Output	Price
AM276	2 "AA" Xenon	6.06"	3,500 cp	\$17.95
AM277	4 "AA" Xenon	6.38"	11,000 cp	\$28.95
AM278	3 "C" Xenon	8.77"	12,000 cp	\$36.95
AW354	4 "AA" LED	6.5"	67 lumens	\$31.95
BC016	3 "C" LUX	9.3"	3,500 cp	\$51.95



4AA ProPolymer® Lux Flashlight

1 watt, 10,000 hour, super high-flux LED provides a longer reaching, brighter beam that's 10 times brighter than a high-intensity LED. Ergonomically shaped for maximum hand comfort. *Length: 7". Ship. wt. 1 lb.*

- ▶ Powered by 4 "AA" alkaline batteries
- ▶ Up to 3,500 peak beam cp, 40 lumens
- ▶ Wrist lanyard connection
- ▶ Waterproof
- ▶ Runs up to 4 hrs. at full intensity with 2 additional hrs. of declining usable light

Compatible with BG534
Helmet Lighting Kit

SPECIFY COLOR: Yellow or Black

BC015	4AA ProPolymer® Lux Flashlight	\$45.95
BC017	4AA Helmet Clip	\$23.95



4AA Helmet Lighting Kit

Hands-Free Lighting

The firefighter's helmet flashlight clamp can be attached to the brim of both traditional (up-brim) and modern (down-brim) firefighter's helmets and is adjustable. The components of the flashlight clamp are made of stainless steel. *Ship. wt. 1 lb.*

Includes:

- ▶ ProPolymer® 4AA Lux Div 2 LED flashlight
- ▶ Blackjack helmet clamp
- ▶ Rubber helmet strap
- ▶ Adjustable wrist lanyard

Features:

- ▶ Powered by 4 "AA" alkaline batteries
- ▶ Super high-flux LED provides up to 3,500 peak cp (42 lumens)
- ▶ Waterproof, non-conductive, corrosion-proof
- ▶ Deep Parabolic Beam Generator produces smooth, long range brilliance
- ▶ Solid State Power Regulation provides max light output
- ▶ Runs up to 4 hrs. at full intensity w/2 additional hrs. of declining usable light
- ▶ Length: 7"



Helmet not included



BG534	4AA Helmet Lighting Kit	\$57.95
-------	-------------------------	---------

3315 Compact LED Flashlight

The new 3315 LED flashlight is a lightweight, compact design housing only 3AA batteries powers a single LED for 113 lumens of super bright LED light. Safety approved for the most volatile work environments, the 3315 LED flashlight is safe, and one of the most efficient flashlights on the market today.

- ▶ Compact, using 3AA batteries
- ▶ Safety Approved - CI II III Div 1, ATEX Zone 0, IECEx
- ▶ Economical
- ▶ Includes security lanyard
- ▶ Lumens: 113
- ▶ Run Time: 9.75 hours
- ▶ Peak Beam Intensity: nearly 6,000

SPECIFY COLOR: Black or Yellow

BL464 3315 Compact LED Flashlight \$34.95

SabreLite™ 2010 Recoil LED™

- ▶ Tested lumen value 65
- ▶ 1 watt luxeon LED using Recoil LED Technology™
- ▶ 3 C alkaline batteries (not included)
- ▶ 50 hrs. battery burn time
- ▶ O-ring sealed w/twist-on shroud
- ▶ Rugged ABS body
- ▶ Submersible to 500'
- ▶ Polarity battery guard tray included
- ▶ Approvals: Class I, II, III, Div. 1 Gp. DFG T4, Class I, Div. 2, Gp. ABDCD T4 CE II 3 GD T135°C EEx nL IIC T4

SPECIFY COLOR: Black or Yellow

BE045 SabreLite™ 2010 Recoil LED™ \$59.95

Super SabreLite®

The SabreLite®'s Laser Spot™ Xenon lamp produces a tightly focused 12,000 CP white beam. Submersible to 500 feet with an unbreakable ABS body and high-impact polycarbonate lens. Comes complete with convenient carrying package: belt spring clip, stainless steel split ring and lanyard. Requires 3 C-cell batteries (not included). *FM, CSA, MSHA and AUS approved nonincendive; UL approved, Class I Division I approved. Ship. wt. 1 lb.*

SPECIFY COLOR: Black or Yellow

AK112 Super SabreLite® \$34.95

StealthLite™ - One-Hand Operation

- ▶ Tested lumen value 25.0
- ▶ Precision aluminum, Xenon fired lamp module
- ▶ 4AA alkaline batteries (included on select packaging)
- ▶ Unbreakable Lexan body with a hi-impact nylon lens
- ▶ One-handed safety switch
- ▶ 4.0 hrs. battery burn time
- ▶ Submersible to 500'
- ▶ Double shock mounted battery compartment
- ▶ Adjustable wrist lanyard

SPECIFY COLOR: Black or Yellow

AK113 StealthLite™ \$33.95

Universal Helmet Light Holder

- ▶ Allows for dozens of configurations
- ▶ Tough Polymer construction w/brass inserts and stainless steel hardware
- ▶ Fits all models of fire helmets
- ▶ Fits 17 Pelican flashlight models
- ▶ Ship. wt. 1 lb.



BE046 Universal Helmet Light Holder \$13.95



new



BL464



BE045



AK112



AK113

HAND-HELD LIGHTS



BK114



BK224

POLYTAC® LED Flashlight

With its virtually indestructible nylon polymer housing, and piercing brightness of its unbreakable C4®, this tactical light will be by your side for a long, time.

Features:

- ▶ Powered by two 3v CR123A lithium batteries
- ▶ Up to 5,200 candela and 130 lumens measured system output
- ▶ 3 hours continuous run time
- ▶ Length: 5.22"
- ▶ Waterproof to 1 meter for 30 minutes
- ▶ Tail cap push button switch

BK224 Includes:

- ▶ POLYTAC® LED (yellow) flashlight
- ▶ Lithium batteries
- ▶ BlackJack mount
- ▶ Helmet band

SPECIFY COLOR: Black or Yellow

BK114	POLYTAC® LED Flashlight	\$45.95
BK224	POLYTAC® LED Flashlight (Yellow) with Mounting Kit	\$66.95



Mag-Lite Rechargeable Flashlight System



The ultimate lighting tool. The rechargeable Mag-Lite is the most powerful and durable handheld flashlight of its size. The unit comes complete and ready to be mounted anywhere. Features a battery stick that is rechargeable up to 1,000 times, charging base, high-intensity halogen lamp, solid-state electronics throughout and adapters for both work (110V AC converter) and car (12V DC adapter) so your Mag Flashlight can go with you. Beam can be focused from spot-to-flood with a twist of the head and includes a spare bulb in the tail cap. Made of anodized aircraft aluminum for many years of reliable use. *Ship. wt. 2 lbs.*



Stinger®/PolyStinger®
10-hour charger

AB714	Mag Charger 40,000 CP	\$120.95
AG093	Spare Battery Stick	\$30.95
AG094	Replacement Bulb	\$5.95



AE597

Stinger® LED Rechargeable

- ▶ Case Material: Machined aircraft aluminum with non-slip rubberized comfort grip and anti-roll rubber ring
- ▶ Length: 8.85" L, 12.8 oz.
- ▶ Light Source: C4 LED technology, impervious to shock with 50,000 hr lifetime
- ▶ Light Output: Up to 17,000 candela (peak beam intensity); up to 180 lumens
- ▶ On/Off: Dual switch technology: Independent working push button tailcap switch or head switch
- ▶ Charging: 10 hours to fully charge
- ▶ High, medium and low brightness modes

BK020	Stinger® DS LED Flashlight	\$159.95
AE597	Stinger® Xenon Flashlight	\$117.95
AF230	Replacement Battery	\$28.95
AF231	Replacement Bulb	\$9.95



Rechargeable Batteries

AZ221	Responder Battery	\$25.95
AZ222	Vulcan Battery	\$15.95
AZ223	Survivor Battery	\$51.95
AZ224	Superstinger Battery	\$16.95
AZ225	Stinger Battery	\$13.95
AZ226	SL35/35X Battery	\$47.95
AZ227	SL20XP Battery	\$20.95
AZ228	SL15X Battery	\$20.95
AZ229	Scorpion Battery	\$10.95
AZ230	Lite Box Battery	\$23.95
AZ231	SL20/20X Maglite Battery	\$22.95



FoxFury Command 20

Ultra-Slim 20 LED Fire Helmet Light

Fits ALL fire helmets with goggles, Bourke eyeshields, EZ-Flips, and Defender visors, and external faceshields. Meets NFPA fire resistant requirements (500°F for 30 minutes). *Ship. wt. 1 lb.*



LED / Light Output:

- ▶ 60 lumens
- ▶ 20 LEDs: 18 white, 2 green

Durability:

- ▶ Polycarbonate housing
- ▶ Fire and impact resistant
- ▶ Waterproof to 20'

Battery:

- ▶ 4 AA batteries
- ▶ Life: 7 to 12 hrs.

Features:

- ▶ 3 modes
- ▶ Optimized blend of focused, distance, and panoramic light
- ▶ Rear safety LED (Red)
- ▶ Tap on/off switch
- ▶ Dimensions: 4.8"Wx0.7"Dx1"H

BK367 Command 20 Fire Helmet Light \$88.95

Petzl DUO® LED Headlamp

- ▶ Durable construction
- ▶ Waterproof down to -5 meters
- ▶ Halogen light for long-range, focused lighting
- ▶ 5 LEDs for flood beam lighting with a long burn time
- ▶ Adjustable and comfortable elastic headband
- ▶ Lockable on/off switch
- ▶ Light body can be tilted
- ▶ Spare halogen bulb in the light body of the headlamp
- ▶ Operates on 4 AA/ LR6 batteries (included)



BA084 Petzl DUO® LED Headlamp \$108.95
 BA085 DUO® Halogen Bulb \$8.95

FoxFury Discover Tasker

Powerful Ultra-Slim LED Fire Helmet Light

Fits ALL fire helmets with goggles, Bourke eyeshields, EZ-Flips, and Defender visors, and external faceshields. Meets NFPA fire resistant requirements (500°F for 30 minutes). *Ship. wt. 1 lb.*



LED / Light Output:

- ▶ 100 lumens
- ▶ 3 white LEDs

Durability:

- ▶ 6061 aluminum housing with stainless steel sidepods
- ▶ Fire and impact resistant
- ▶ Waterproof to 10'

Battery:

- ▶ 4 AA batteries
- ▶ Life: 7 to 12 hrs.

Features:

- ▶ 2 modes: Low (45%), high (100%)
- ▶ Removable lens - can be replaced if damaged
- ▶ Uniform horizontal beam
- ▶ Rear safety LED (Red)
- ▶ Tap on/off switch
- ▶ Dimensions: 2.8"Wx0.7"Dx0.6"H

BK368 Discover Tasker Fire Helmet Light \$114.95

2690 HeadsUp Lite™

The 2690 HeadsUp Lite™ won't leave you in the dark. With 60 lumens of LED light, 10 hours of battery burn time and weighing in at 4.1 ounces, it's brighter, more efficient, compact and lighter than other headlamps in its class. The no-nonsense rotary bezel switch is easy to operate, even when wearing bulky gloves. The 2690 is made of impact and chemical resistant ABS and it's water resistant for all-weather use. It comes with an adjustable and comfortable cloth strap, as well as a heavy duty rubber strap that will not slip off your climbing helmet.



BH123 2690 HeadsUp Lite™ \$29.95



Vantage® Helmet-Mounted Light

Compact, Powerful, Shock-proof, & Virtually Indestructible



- ▶ Lightweight, compact, low profile design easily attaches above or below full brim on fire helmets
- ▶ Anodized aircraft aluminum, high impact, chemically resistant engineering polymer LED housing
- ▶ Fits both traditional and modern style helmets & hard hats
- ▶ Solid-state current regulation for consistent illumination
- ▶ IPX7 rated, waterproof up to 1 meter for 30 minutes
- ▶ Up to 5,800 candela peak central intensity; 100 lumens measured system output
- ▶ 6 hrs. of continuous runtime to the 10% output level
- ▶ Meets NFPA 1971-8.6 (2007) requirements
- ▶ Length: 3.26"
- ▶ Ship. wt. 1 lb.



BG518 Vantage® Helmet-Mounted Tactical Light \$148.95

UK Helmet Lights

- ▶ ABS body won't crack, dent, corrode or conduct electricity
- ▶ Bright, narrow beam with a Xenon halogen or LED bulb
- ▶ Helmet clips offer hands-free illumination with a swivel head
- ▶ FM approved (Class I, Division for use in hazardous locations)
- ▶ Batteries included
- ▶ Ship. wt. 1 lb.



AZ111



BH048



BE088

COLOR: Yellow

AZ110	4AA Xenon - 38 Lumen	\$24.95
BE088	4AA eLED Zoom Light - 77 Lumen	\$47.95
AZ111	Stainless Steel Helmet Clip	\$15.95
BH048	Low Profile Rylee Clip	\$12.95

BlackJack Helmet Flashlight Mount

- ▶ Tough: Built from aircraft grade 6061 aluminum
- ▶ Necessary - Superior under brim patented design securely holds light on the helmet where you put it, where you need it
- ▶ Adaptable: Fits most firefighting helmets, both traditional and modern styles from SureFire, Pelican, UK, Streamlight & Bright Star 4AA Lights
- ▶ Ship. wt. 1 lb.



SPECIFY LIGHT: SureFire, Pelican, UK, Streamlight, or Bright Star 4AA Lights

BD077 BlackJack Helmet Flashlight Mount \$21.95

Vizion™ 3AAA eLED Headlamp

- ▶ Waterproof design for all weather use
- ▶ 3 selectable beam patterns: spot, diffuse, and red diffuse
- ▶ Large push button control switch works with heavy gloves
- ▶ Powered by 3 alkaline or lithium AAA cells
- ▶ Rotating beam angle adjustment knob, no hinge to break
- ▶ Great for Clearing brush in wildland firefighting operations
- ▶ Made in the USA
- ▶ Ship. wt. 1 lb.



BG506 Vizion™ 3AAA eLED Headlamp - 65 Lumen \$32.95

Trident® LED Headlamp

For the ultimate in convenience, safety, and dependability, use the hands-free Trident® headlamp. The Trident® is truly unique because it combines a super-bright bulb with 3 LEDs giving you high power and longevity. This lightweight headlamp features 3-way lighting for short, medium and long distance. Plus, with a durable design and a battery life of more than 150 hours, the Trident® gives you the peace of mind you need in challenging situations.
Ship. wt 1 lb.



AW283 Trident® LED Headlamp \$28.95

Survivor® C4 LED Flashlight

One of the Brightest, Right-Angle LED Flashlights in the World!

- ▶ 4 modes of operation: High, Low, Moonlight and Flash
 - Flash mode runs 8 hours continuous
 - Moonlight mode runs 20 days continuous
- ▶ High beam: Up to 36,000 candela peak beam intensity; 140 lumens
- ▶ Low beam: Up to 12,000 candela peak beam intensity; 47 lumens
- ▶ Runtimes:
 - Ni-Cad: High - 3.5 hrs., Low - 13+ hrs., Flash - 7+ hrs.
 - Alkaline: High - 4 hrs., Low - 15+ hrs., Flash - 7+ hrs.
- ▶ Rechargeable model includes back-up alkaline battery pack
- ▶ Charger meets NFPA 1901-14.1.11.2 (2003) mounted in any position
- ▶ Limited lifetime warranty
- ▶ UL listed



FLASHLIGHT COLOR: Orange

BD203	Survivor® LED Rechargeable with AC/DC	\$154.95
BD204	Survivor® LED Rechargeable with AC	\$179.95
BD205	Survivor® LED Rechargeable with DC	\$179.95
BD206	Survivor® LED (Alkaline Model)	\$69.95

Weatherproof push button actuator provides easy operation even when wearing gloves

Shock-proof, 50,000 hr. life C4 LED

Deep-dish parabolic reflector produces narrow beam

Change batteries quickly & easily, no tools necessary

Spring loaded clip easily attaches

Dual power source: 4 "AA" alkaline batteries or rechargeable Ni-Cad battery

Rugged nylon polymer body



HAND-HELD LIGHTS

The Responder Right Angle Flashlight Lets You Choose the Power Rechargeable Ni-Cad or Alkaline Battery-Powered Responder

A unique and revolutionary design that features interchangeable power supply, a must-have option for professionals on the job. With the 4.8-volt Ni-Cad rechargeable pack, the Responder provides more than 2 hours of continuous light and a quick charge time of 2 hours. Should you not have time to recharge, simply replace the rechargeable battery pack with four C-cell Alkaline batteries and you immediately have five more hours of light. Light easily snaps into charger/storage unit and features one-handed release. Rugged, impact-resistant polycarbonate housing is lightweight (entire light weighs less than one pound), water-resistant and can be worn on the optional shoulder strap or clipped to your belt or pocket. Pre-focused beam comes from the super-bright halogen bulb producing 45,000 CP with Ni-Cad battery and 60,000 CP with Alkaline batteries. Oversized push button switch allows easy, one-handed operation with gloves. Comes with a two spare bulb holder (spare bulbs sold separately). Survives 30 ft. drop test, UL/CUL/CSA certified for hazardous locations. Responder (Division 1) Orange, Responder (Division 2) Yellow. Ship. wt. 3 lbs.

- ▶ Rechargeable Ni-Cad or Alkaline operation
- ▶ Quick change bulb
- ▶ Oversized On/Off glow labels
- ▶ Charges in 2 hours

AS052	Orange Responder Div. 1 Flashlight	\$180.95
AS053	Yellow Responder Div. 2 Flashlight	\$162.95



Non-Rechargeable Alkaline Battery-Powered Responder Components:

- ▶ Lens ring: Flame-retardant Santoprene
- ▶ Lens: Polycarbonate
- ▶ Bottom cap: Super-tough nylon
- ▶ Switch: Super-tough nylon
- ▶ Tube: Super-tough nylon
- ▶ Reflector: Ultem 1000
- ▶ Contact: Foam mesh bag (for alkaline batteries)
- ▶ Dimensions: 2 1/2" L x 3" W x 7" H
- ▶ Survives 30 foot drop test
- ▶ Push-button switch
- ▶ Waterproof
- ▶ 2 hour charge time
- ▶ Lightweight (1 pound)
- ▶ 60,000 cp and 5 hr. burn time with Alkaline batteries (6.0v)
- ▶ Spare bulb compartments
- ▶ Halogen bulb

BG107	Orange Responder Class 1, Div. 1 Flashlight	\$67.95
BG108	Yellow Responder Class 1, Div. 2 Flashlight	\$67.95



BG108



LED Responder Right Angle Flashlight

BL404:

- ▶ Interchangeable power supply
- ▶ Easily switch from rechargeable to alkaline
- ▶ Wide-eye lens
- ▶ Oversized push button switch
- ▶ Stainless steel clip
- ▶ 30' drop

BL405:

- ▶ First right angle with Lithium Ion battery technology
- ▶ Extremely lightweight
- ▶ Battery charge indicator
- ▶ Slim and compact to keep it close to your body
- ▶ LED charge status indicator

BL404	Alkaline LED Responder Right Angle Flashlight	\$68.95
BL405	Rechargeable LED Responder Alkaline Right Angle Flashlight	\$159.95



LED Right Angle Flashlight

Pelican leads the way yet again with its new right angle light. Featuring downcast LEDs for illuminating your path, this new LED light also features 174 lumens (high) and 95 lumens (low), and a signaling mode. Another first is a built in battery life indicator so you will know your light's battery level before you go in. Compact, rugged, and light-weight, this new LED light contains the latest technology, Pelican's legendary build quality and lifetime guarantee of excellence.

- ▶ Runtime: High: 4h 45m Low: 8h 30m
- ▶ Light output: High: 174 lumens
Low: 95 lumens
- ▶ Beam Distance: High: 278 meters
Low: 175 meters
- ▶ Length: 5.36"



COLOR: Yellow

BL200	LED Right Angle Flashlight	\$109.95
BL295	LED Right Angle Rechargeable Flashlight	\$148.95



Big Ed™ Flashlight

Pelican packs the brightness of up to 65,000 CP and long run times into its Big Ed™ flashlights. Their chemical-resistant, unbreakable Xenoy® bodies and heavy-duty stainless steel clothing clips provide unbeatable durability. Included back-up lamps ensure the flashlights' long life. A quick-change battery ejection button makes battery removal simple. *Color: Yellow.*

Big Ed™ Rechargeable

Provides 65,000 CP for two hours and 15 minutes, along with the back-up option of four hours at 45,000 CP. The double charger can handle both the primary light and spare battery pack simultaneously. Offers 150-hour lamp life. *Ship. wt. 9 lbs.*



AS005	Big Ed™ Rechargeable with 110V Fast Charger	\$212.95
-------	---	----------

Big Ed™ Alkaline 4C

Big ED Alkaline 4C – Offers choice of two hours at 55,000 CP (primary) or four and three-quarters hours at 45,000 CP (back-up). Offers 100-hour lamp life. Requires 4 C-cell batteries. *Ship. wt. 5 lbs.*

AS004	Big Ed™ Alkaline 4C	\$110.95
-------	---------------------	----------

Little Ed™ Recoil™ LED with Photoluminescent Shroud

Don't be fooled by the name. This right angle light packs a punch. The Little Ed™ is made of ABS resin that's extremely strong, light weight, corrosion-proof, resistant to extreme temperatures, and is outfitted with our Recoil LED™ module. The Little Ed™ uses a 1 watt LED that's aimed backwards into the reflector. 100% of the light is captured and aimed forward as a tight collimated beam that's as bright as an incandescent. The Little Ed™ with photoluminescent shroud is outfitted with a lens ring that emits a bright glow in the dark. The new generation photoluminescent material in the plastic absorbs the energy from any light source - fluorescent lights, the sun, or even the flashlight's own beam. No more fumbling in the dark for your flashlight. For hands-free use, a stainless steel clip is built-in. Attach the Little Ed™ to your turnout coat or work shirt. It is powered by 4 AA alkaline cells (included). *Approvals: Class I, Div. 2 Gp. ABCD T4A; Class II, Div. 2 Gp. FG.*

- ▶ Light source: Recoil LED™
- ▶ Tested Lumen value: 84.0
- ▶ Tested Lux value: 4,300
- ▶ Batteries: 4 AA alkaline (included)
- ▶ Battery burn time: 32 hrs.
- ▶ Watts: 1, Voltage: 6
- ▶ Length: 7.51"
- ▶ Ship. wt. 1 lb.



BE308

BE308	Little Ed™ Recoil™ LED	\$71.95
BE309	Little Ed™ Recoil™ LED with Photoluminescent Shroud	\$74.95
BC049	Little Ed™ Recoil™ LED Rechargeable	\$136.95

UK Unilite Right Angle Light

- ▶ Universal right angle head rotates 360° to allow firefighters to point the light beam in any direction
- ▶ Includes a removable heavy-duty polycarbonate belt clip/pocket clip and split ring with clip for attachment to turnout gear
- ▶ Waterproof to ten feet in wet conditions
- ▶ Tough, non-corroding ABS and polycarbonate plastic construction
- ▶ O-Ring seal to prevent dust and dirt invasion
- ▶ Safety rating Class 1 Division 2 for hazardous locations
- ▶ Ergonomic shape
- ▶ As bright as the C-cell competition
- ▶ Withstands 6-foot drop to concrete
- ▶ Brightness: 37.7 Lumen
- ▶ Lamp: 2.1 watt, high brightness Xenon filled
- ▶ Burn time: 4-5 hours
- ▶ Batteries: 4/AA



Swivel Head

BB002	UK Unilite Right Angle Light - 38 Lumens	\$29.95
BL046	4AA LED Right Angle Light - 77 Lumens	\$57.95

PolyTac® 90 Compact Flashlight

Strobe Runs for 6 Hours

This new fixed right-angle back-up light with D clip is now available with or without a Gear Keeper accessory. This versatile right angle compact tactical flashlight can clip onto turn-out gear, ACH or onto our new elastic head strap for a headlamp. It's super bright, can be operated easily with gloves and is encased in a virtually indestructible nylon polymer housing.

- ▶ 90° head
- ▶ 1 meter impact resistance tested
- ▶ O-ring sealed; IPX7 rated design; waterproof to 1 meter for 30 minutes
- ▶ Integrated carabiner style D-ring for a variety of attachment methods
- ▶ Fully rotatable/reversible/removable clip to allow a variety of mounting positions
- ▶ LED Solid State Power Regulation provides maximum light output throughout battery life
- ▶ Individually serialized for positive identification
- ▶ BK380: Gear Keeper option with tether features spectra nylon line with 36" extension; 6 oz. retraction force



Integrated carabiner style D-ring

Head mounted push button switch

C4® LED technology, shock-proof w/50,000 hr. lifetime

High-impact, super tough nylon polymer

COLOR: Orange

BK379	PolyTac® 90 Flashlight with Lithium Batteries	\$62.95
BK380	PolyTac® 90 Flashlight with Gear Keeper and Lithium Batteries	\$77.95

HAND-HELD LIGHTS

E-FLOOD™ and E-Spot™ LED Lanterns

The E-Flood™ and E-Spot™ models are industrial-duty, rechargeable, portable lanterns featuring power LED technology for high brightness, long run-time and high reliability. The E-Flood™ models use 6 LEDs and wide pattern reflectors to produce a uniform flood pattern.

- ▶ C4® LEDs, impervious to shock with a 50,000 hr lifetime
- ▶ Optimized electronics provide regulated intensity
- ▶ 2 levels of lighting:
 - High: 4,000 candela, 615 lumens, up to 8 hrs.
 - Low: 2,150 candela, 330 lumens, up to 18 hrs.
- ▶ Zero-maintenance, 6V, 12 amp-hr sealed lead acid battery is rechargeable up to 500 times
- ▶ High impact ABS thermoplastic housing
- ▶ Rubberized impact bumper, lens ring and cushioned-grip handle
- ▶ Fits existing LiteBox® chargers
- ▶ IPX4 Rated for weather resistant operation



BK047

E-Spot™ Features:

- ▶ 2 user programmable ultra-bright blue tail-light LED's
- ▶ Includes shoulder strap
- ▶ C4® LED technology for high brightness
- ▶ 2 levels of lighting:
 - High: 55,000 candela peak beam intensity, 540 lumens, up to 7 hrs.
 - Low: 32,000 candela peak beam intensity, 330 lumens, up to 15 hrs.



BK226

COLOR: Orange

BK047	E-Flood™ LiteBox® Standard System with AC/DC, Shoulder Strap & Mounting Rack	\$235.95
BK048	E-Flood™ LiteBox® Firebox Vehicle Mount System with DC, Shoulder Strap	\$227.95
BK049	E-Flood™ FireBox® Standard System with Dual Rear LED's, AC/DC, Shoulder Strap & Mounting Rack	\$250.95
BK050	E-Flood™ FireBox® Vehicle System with Dual Rear LED's, DC, Shoulder Strap	\$241.95
BK226	E-Spot™ FireBox® with 120V AC/12V DC	\$227.95
BK227	E-Spot™ FireBox® with Vehicle Mount System	\$218.95
BK228	E-Spot™ LiteBox® with 120V AC/12V DC	\$214.95
BK229	E-Spot™ LiteBox® with Vehicle Mount System	\$205.95
BK370	E-Spot™ Upgrade Kit	\$56.95
BK371	E-Flood™ Upgrade Kit	\$75.95

Knucklehead® Spot Light

Designed to Put Light Where You Need it, the Knucklehead® is the Most Versatile Light You Will Ever Own.

- ▶ Shockproof C4® premium LED technology combined with a deep dish parabolic reflector produces a focused beam for longer distances – 210 meters on high beam
- ▶ Durable spring-loaded clip for easy attachment to turnout gear and uneven surfaces
- ▶ Features a 210° articulating head that rotates a full 360°
- ▶ 4 modes: High, Low, Moonlight and Flash
- ▶ Dual power source: Accepts rechargeable NiCd battery pack or 4 "AA" alkaline batteries
- ▶ Rubber dome push-button actuator
- ▶ Removable magnet with 135 lb. pull strength features a replaceable rubber boot
- ▶ Optimized electronics provide regulated intensity
- ▶ High-impact, super-tough nylon polymer construction for exceptional durability
- ▶ 2 meter impact-resistance tested
- ▶ IPX4 rated for water-resistance
- ▶ Serialized for positive identification
- ▶ 9.2" (23.4 cm); NiCd 23.1 oz. (655 grams); Alkaline 18.3 oz. (519 grams)
- ▶ Assembled in USA

new



COLOR: Orange

BL496	Knucklehead® Spot 120V AC/12V DC Light	\$159.95
BL497	Knucklehead® Spot Alkaline Light	\$89.95

Vulcan®

Industrial-Duty, Lightweight, Rechargeable, Waterproof Lantern; It's Virtually Indestructible.

Vulcan® Standard Features:

- ▶ High-intensity halogen bi-pin bulb
- ▶ 8 watt spot provides up to 80,000 candela (peak beam intensity), 150 lumens typical
- ▶ Up to 3.25 hrs. continuous run time per charge
- ▶ Zero-maintenance 4.5 amp-hour sealed lead acid battery is rechargeable up to 500 times
- ▶ Red and green LEDs give charge status
- ▶ Serialized for positive identification
- ▶ High-impact ABS thermoplastic housing with rubberized cushioned grip handle
- ▶ Waterproof
- ▶ Dimensions: 7.5"x5"x6.5"
- ▶ Assembled in USA
- ▶ Ship. wt. 4 lbs.



NFPA



STREAMLIGHT
HERE'S THE STRAIGHT

VULCAN™

AK277	Vulcan® AC/DC System	\$123.95
AK278	Vulcan® Vehicle Mount System	\$104.95

Vulcan® AC/DC System

120-volt AC & 12-volt DC charger, shoulder strap & charging rack

Vulcan® Vehicle Mount System

Truck mountable 12-volt DC direct wire charging rack & shoulder strap

Fire Vulcan® Lanterns

Available in Halogen or LED Rechargeable

The Fire Vulcan® is the brightest, lightest and smartest lantern in its class. The life-saving taillights are just part of what makes the Fire Vulcan® such a critical firefighting tool. In fact, this versatile lantern is ideal for the many roles of a firefighter. It provides all the benefits of the original Vulcan® (powerful, lightweight, and waterproof), but now offers even more. The LED rechargeable features new C4 LED technology and our special reflector makes it 5x brighter than competing lights. Meets NFPA requirements.

AZ116 Features:

- ▶ Ultra-bright blue taillight LEDs offer 2 modes: "steady" and "blinking"
- ▶ Easy-to-operate toggle switch
- ▶ High-visibility orange
- ▶ Compact and lightweight
- ▶ Extremely powerful: 80,000 cp
- ▶ Rugged, high-impact thermoplastic housing
- ▶ Waterproof
- ▶ Fits existing Vulcan® chargers
- ▶ Ship. wt. 4 lbs.

BG522 Features:

- ▶ Up to 80,000 candela peak central intensity; 150 lumens
- ▶ 2 lightweight lithium ion nanotechnology cells: recharges in 5 hrs.
- ▶ Charger base meets requirements of NFPA 1901
- ▶ IPX7 rated design - waterproof to 1 meter for 30 minutes
- ▶ Deep-dish parabolic reflector produces a tight beam with optimum peripheral illumination
- ▶ Rated product, Class I Division 2 Groups A, B, C, D, Temperature T4A; Class II Division 2 Groups F, G, Class III, Temperature T-54°C (T6)
- ▶ Run times: Steady high LED & taillights: up to 3 hrs to the 10% output level; low: up to 6 hrs
- ▶ C4 LED, impervious to shock with a 50,000 hr lifetime
- ▶ 8 programmable functions
- ▶ About 45% lighter than the halogen Fire Vulcan®
- ▶ Ship. wt. 3 lbs.



BG522

Fits existing Vulcan® chargers



AZ116	Fire Vulcan® Halogen Standard System	\$147.95
AZ117	Fire Vulcan® Halogen Vehicle Mount System	\$138.95

BG522	Fire Vulcan® LED Standard System with AC/DC	\$193.95
BG523	Fire Vulcan® LED Vehicle Mount with 12v DC	\$200.95
BG524	Fire Vulcan® LED without Charger	\$176.95



VULCAN™

HAND-HELD LIGHTS

best seller

The All-Purpose LiteBox®

One of the most popular, rechargeable portable lanterns on the market. The LiteBox® is a world class rechargeable lantern that sets the standard for power, longevity and strength. Features an innovative swivel neck that pivots up to 90° and a 360° rotating head for hands-free use. Made of non-conductive, tough high-impact ABS thermoplastic housing with black rubberized impact bumper, lens ring and cushioned grip handle. Battery is guaranteed for up to 500 recharges. The LiteBox® standard system includes the light, shoulder strap, rechargeable battery, 120v AC and 12v DC chargers and mounting rack that is truck-mountable. *Mounting rack meets NFPA requirements mounted in any position. Comes in orange only. Ship. wt. 9 lbs.*

X481A	Standard System, 8w Spot	\$165.95
X481	Standard System, 20w Flood	\$165.95
AG626	Vehicle Mount, 8w Spot	\$154.95
AG627	Vehicle Mount, 20w Spot	\$154.95
AF22802	Lite Box® Spare Battery, 6v	\$45.95
AK207	Bi-Pin Spot Bulb	\$9.95
AK208	Bi-Pin Flood Bulb	\$9.95
AF22901	Sealed Beam Spot Bulb	\$20.95
AK209	Sealed Beam Flood Bulb	\$19.95

Note: Sealed Beam replacement bulbs are only for LiteBoxes® purchased before August 1997.

NFPA



FIREBOX® Rechargeable Lantern

Industrial-duty, rechargeable, portable lantern featuring a halogen bi-pin bulb and 2 programmable ultra bright blue tail-light LEDs.

- ▶ High intensity 8 watt halogen
- ▶ Two ultra bright blue LED taillights
- ▶ Taillight LEDs and main lamp function in selectable "steady" or "blink" modes
- ▶ Fits existing LiteBox® chargers
- ▶ Toggle switch and reinforced D-rings
- ▶ Meets NFPA 1901 for mounting on fire apparatus
- ▶ Run time of up to 9 hours
- ▶ Bi-pin bulb
- ▶ Ship. wt. 8 lbs.



BC115	Orange FIREBOX® Lantern (Light Only)	\$149.95
BC116	Orange FIREBOX® Lantern 120v AC/12v DC	\$175.95
BC117	Orange FIREBOX® Lantern Vehicle Mount 12v DC	\$168.95



E-Flood® LiteBox® HL™

The E-Flood® LiteBox® HL™ is an Industrial-duty, rechargeable, completely portable high lumen flood light. The E-Flood® LiteBox® HL™ uses six LEDs and wide pattern reflectors to produce a uniform flood pattern with two selectable beam widths and three light output intensities. Integral D-rings allow attachment of the included shoulder strap.

- ▶ Runtime: 8 hrs. at 1,200 lumens
4 hrs. at 2,400 lumens
2 hrs. at 3,600 lumens
- ▶ Fits existing LiteBox® chargers
- ▶ Runs indefinitely from 12v source
- ▶ Weight with battery: 10.4 lbs.
- ▶ Streamlight's Limited Lifetime Warranty



COLOR: Orange

BL498	E-Flood® LiteBox® HL™ Standard System 120v AC/12v DC, Shoulder Strap & Mounting Rack	\$376.95
BL499	E-Flood® LiteBox® HL™ Vehicle Mount System 12v DC Direct Wire Rack, Shoulder Strap	\$376.95
BL500	E-Flood® LiteBox® HL™ without Charger	\$345.95



Lighthawk Lanterns

Available in Xenon or Super-Bright LED

The Lighthawk LED is super-bright, lightweight, durable and is constructed of chemical and heat-resistant nylon. The Lighthawk MAX (BC130) is powered by lithium ion technology and features a long life Xenon bulb. The Lighthawk LED (BG146) uses state-of-the-art LED technology, producing a piercing beam of usable lights to make it the brightest lantern on the market. *Ship wt. 4 lbs.*

- ▶ 4-cell
- ▶ Lightweight
- ▶ Burn to charge ratio: BC130-1:1, BG146-2:1
- ▶ BC130 - long life Xenon bulb
- ▶ BG146 - Bright lantern at 100 lumens; 4,000 + Lux at 7 feet
- ▶ Low battery indicator lets you know there are 30 min. of power remaining



BC130



BG146
Green

	Battery Pack	Burn time	Bulb Type	Bulb Life	Weight
BC130	4-Cell	Up to 3hrs.	12 watt (Xenon)	50 hrs.	1.9 lbs
BG146	4-Cell	Up to 7 hrs.	LED	30,000 + hrs.	1.9 lbs.

BC130 Lighthawk MAX (Color: Orange) \$229.95

BG146 Lighthawk LED (Specify Color: Red or Green) \$249.95

NightBlaster® Cordless Rechargeable Spotlight

Many Times More Powerful Than Your Car's Headlamps!

- ▶ 2,000,000 cp rechargeable spotlight
- ▶ 100-watt quartz halogen bulb
- ▶ Cordless operation
- ▶ Easy access battery
- ▶ Charge or operate with 12-volt cord
- ▶ Operates with internal battery removed; less weight



Easy access battery



AW267 NightBlaster® Cordless Rechargeable Spotlight \$39.95

Pelican LED Lantern

At just 3 pounds and 710 lumens, the new Pelican LED Lantern packs the power without the weight. Four LEDs, powered by the latest generation NiMH batteries illuminate a distance of 450 yards (411.5 meters). Whether you're on a USAR team or the 3rd shift at a refinery, you'll appreciate the compact size and high output of the new Pelican LED Lantern. It's loaded with innovative technology and features.

- ▶ 120° rotating head
- ▶ Burn time: 4.75 hrs. (low) / 1.75 hrs. (high)
- ▶ Battery status indicator
- ▶ 3 mode switch (high, low, flashing)
- ▶ Approved to NFPA 1901



SPECIFY COLOR: Yellow or Black
BK181 Pelican LED Lantern

\$318.95

HAND-HELD LIGHTS

BG516



BK230



Public Safety Vests

Public Safety Vests meet the new ANSI/ ISEA 207-2006: American National Standard for high-visibility public safety vests. Their breakaway design prevents entanglement. Easy on/off with hook and loop front closure and fully adjustable sides. Added features include mic tab, clear badge chest pocket with closure and radio chest pocket with flap closure. Made with ANSI tricot fabric and 3M™ Scotchlite® reflective tape.

BG515

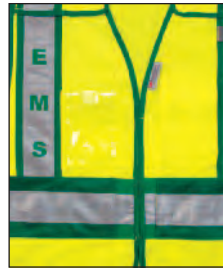

BG517



SPECIFY SIZE: M/L, XL/2X, 3X/4X

BG515	Public Safety Vest EMS	\$30.95
BG516	Public Safety Vest FIRE	\$30.95
BG517	Public Safety Vest POLICE	\$30.95

Dual Certified Safety Vest

Our BK230 has everything you want in a public safety vest at an unbeatable price. Vest meets both the ANSI-ISEA 207-2006 FR NFPA 701 and 107-2004 Class II Level II FR NFPA-701 standards. Polyester mesh construction with FR treatment, 5 point breakaway, 3M reflective tape with contrasting trim. The vest is loaded with pockets for your radio/mic loop, pens, plus two on the inside. One size fits L – 5XL (48" -66") with adjustable waist. Imported.

BL047 - Same as BK230 with direct printing on the back and the front of the vest. Direct printing is in black.

BK230	Dual Certified Safety Vest	\$21.95
BL047	Dual Certified Safety Vest with Legend	\$34.95

Public Safety ANSI Vest

Conforms to ANSI-ISEA 207-2006 FR NFPA 701

This flame retardant Public Safety Vest has high cut sides allowing you access to your duty belt and pockets. Velcro® closure on sides, shoulders and front provide a five-point breakaway safety design. The tear-away style can help you if you are snagged by a moving object or involved in a struggle. 100% lime, polyester micromesh fabric with contrasting 2" 3M™ Scotchlite® reflective trim. Direct print also available on front and back. Machine washable. Made in the USA. Ship wt. 2 lbs.

Legends:

- ▶ EMS
▶ Fire
- ▶ Fire Rescue
▶ Incident Commander
- ▶ Security Police
▶ Police

SPECIFY LEGEND. Other stock legends available, call your sales representative for a complete listing.

Cat#	Description	L/50"	XL/54"	2XL/62"	3XL/68"	4XL/74"	5XL/80"
BH084	Public Safety Vest (No Legend)	\$46.95	\$46.95	\$46.95	\$56.95	\$56.95	\$56.95
BH085	Public Safety Vest (Legend in Front & Back)	\$51.95	\$51.95	\$51.95	\$62.95	\$62.95	\$62.95

LED Flashing Safety Vests

Feel Safer Now That You Can Be Seen

The new LED flashing safety vest is a 20 light (9 on the front and 11 on the back) LED flashing vest that can be seen from approximately 600 yards, weather permitting. The LED flashing safety vest can be custom printed front and back or left blank. These LEDs are powered by 3 AA batteries that can easily be turned off by a push button on the front when not in use. The LEDs will remain lit for approximately 200+ hours. *The LED flashing safety vest meets ANSI Class 2 requirements. One size fits all with adjustable straps on the side.*



BE285	Orange LED Flashing Safety Vest with Adjustable Straps	\$25.95
BE286	Yellow LED Flashing Safety Vest with Velcro® Straps	\$25.95

Fire Resistant Vest

- ▶ Velcro® front closure
- ▶ ANSI-certified polyester mesh (6 oz.)
- ▶ 2" Scotchlite® striping
- ▶ Inside pocket
- ▶ Meets ANSI 107 Class 2, NFPA 701 & ASTM F1506 vertical flammability
- ▶ Ship wt. 1 lb.

SPECIFY SIZE: S/M, L/XL, XXL/XXXL

BC107	Lime Fire Resistant Vest	\$28.95
-------	--------------------------	---------



Fire Command Vest Set

This prepackaged kit consists of a carrying case and 10 large size vests that are better for fitting over turnout gear. The carrying case is designed to carry ten vests, including large sizes, in the elastic loops. Vests can be mixed and matched. Interior slot pocket allows for a command board up to 18"x24" made of 1000 denier Cordura® nylon with a 4"x18" reflective panel on the side. *Carrying case is red and 19"x25"x5". Ship wt. 8 lbs.*

Titles
INCIDENT COMMANDER
SAFETY OFFICER
OPERATIONS
INFORMATION OFFICER
ACCOUNTABILITY
REHAB
STAGING
AIR SUPPLY
WATER SUPPLY



BC037	Fire Command Vest Set	\$456.95
-------	-----------------------	----------

Quick Deploy™ Spring Cone™ Tote and Bag System



- ▶ Compact for easy storage on any truck, or in vehicle trunk
- ▶ Meets MUTCD requirements for 28" highway traffic cone
- ▶ Flexible Spring Cone™ splits wind for increased stability
- ▶ Quickly deployed Spring Cone™ delineates traffic at any scene
- ▶ Cone is made of a durable, bright orange, flexible mesh material
- ▶ Rubber base holds cone in place and grips the road for stability
- ▶ Flexible spring allows cone to automatically self deploy
- ▶ Lightweight - cones are half the weight and pack in one-third the space of traditional highway cones

SPRING CONES WITH PLASTIC TOTE STORAGE SYSTEM

BB071	(2) 28" Reflective (6" & 4"), 3 lb. Spring Cones	\$95.95
BG142	(2) 28" Reflective (6" & 4"), 5 lb. Spring Cones	\$97.95

SPRING CONES WITH WIRE/MESH TOTE STORAGE SYSTEM

BB073	(4) 28" Reflective (6" & 4"), 3 lb. Spring Cones and 1 Tote	\$174.95
BG143	(4) 28" Reflective (6" & 4"), 5 lb. Spring Cones and 1 Tote	\$175.95
BB075	(6) 28" Reflective (6" & 4"), 3 lb. Spring Cones and 1 Tote	\$223.95
BG144	(6) 28" Reflective (6" & 4"), 5 lb. Spring Cones and 1 Tote	\$249.95

SPRING CONES

BB077	28" Reflective (6" and 4"), 3 lb. Spring Cone	\$34.95
BG145	28" Reflective (6" and 4"), 5 lb. Spring Cone	\$39.95



TRAFFIC CONTROL



Fold & Roll™ Sign System

Emergency personnel face not only the hazard at the situation they are attempting to suppress, but they are also facing hazards from motorists driving through or near an emergency scene. Advanced warning signs alert motorists of hazardous conditions ahead and create a higher level of awareness. Proper training in the use and deployment of signage is essential as are general safety guidelines to be used in hazardous situations. *Ship. wt. for sign 8 lbs., sign and stand 27 lbs.*

Legends

- | | |
|--|---------------------------|
| ▶ Accident Ahead | ▶ Command Post |
| ▶ Detour. Extra charge for arrows, call your Darley representative for pricing | ▶ Incident Ahead |
| ▶ Emergency Scene Ahead | ▶ Fire Area Keep Out |
| ▶ Collapse Zone | ▶ Traffic Emergency Ahead |
| | ▶ Fire Training Ahead |

SPECIFY LEGEND: See Above SPECIFY COLOR: Orange or Pink

BA107	36" Sign/Stand Fold & Roll™ Sign System	\$246.95
BA108	48" Sign/Stand Fold & Roll™ Sign System	\$293.95
BA109	36" Sign Only	\$134.95
BA110	48" Sign Only	\$197.95

Pop-Up Flashing Cones

- ▶ Safe, compact, highly visible and collapses flat for easy storage
- ▶ Meets MUTCD Standards
- ▶ Constructed of orange waterproof nylon
- ▶ Internal light has two settings: steady burn & flashing
- ▶ Cone light endures 100,000 flashes or 36 hrs. of steady burn
- ▶ Replaceable lithium battery
- ▶ Sold in packs of 4 or 5 cones with one carrying bag included
- ▶ Meets the new 2009 NFPA 1901 apparatus standard for fire apparatus
- ▶ *Ship. wt. 17 lbs.*



BH143

BH144

BG503	28" Pop-Up Flashing Cones w/Orange Plastic Base (Set of 4)	\$129.95
BH143	28" Pop-Up Flashing Cones w/Orange Plastic Base (Set of 5)	\$149.95
BH144	30" Pop-Up Flashing Cones with Black Plastic Base (Set of 5)	\$189.95

Darley Traffic Cones

Feature brilliant Day-Glo fluorescent orange color with ultraviolet additives to protect against color fading and wide base for maximum stability. Available with or without reflective collars. *Color: Orange*

All Cones		
Size	Case	Weight
12"	30	45 lbs.
18"	20	68 lbs.
28"	10	58 lbs.
36"	10	110 lbs.

WITHOUT REFLECTIVE COLLARS

		Price Ea.
T444	12" Traffic Cone	\$5.95
T445	18" Traffic Cone	\$8.95
T446	28" Traffic Cone	\$12.95
T447	36" Traffic Cone	\$21.95

WITH REFLECTIVE COLLARS

		Price Ea.
AK263	12" Traffic Cone with 4" Collar	\$9.95
AK264	18" Traffic Cone with 6" Collar	\$13.95
AK265	28" Traffic Cone with 4" and 6" Collars	\$21.95
AK266	36" Traffic Cone with 4" and 6" Collars	\$26.95

Fluorescent Lime Cones

- ▶ Wide body design
- ▶ Flow molded, dayglow fluorescent lime with white inner liner
- ▶ Differentiates work zone for added measure of safety
- ▶ Fluorescent color increases pedestrian and driver awareness
- ▶ Comes with a 4" and 6" collar
- ▶ Color: Fluorescent lime

BE019	28" Fluorescent Lime Cone	\$28.95
BE020	36" Fluorescent Lime Cone	\$34.95

Stacker Cones

The full 42" length of the Stackers are eye level to drivers. Because of their molded-in handle they are easier to use and they are stackable, requiring less storage and transport space. Its octagonal base makes it virtually impossible to tip over in ordinary circumstances. Stacker Cones are available with your choice of base as well as optional striping. *Ship. wt. 2 lbs.*

- ▶ Tallest cones available
- ▶ Convenient storage

STACKER CONE - SPECIFY COLOR: Yellow or Orange

Cat#	Description	Colors	Price
AL239	Stacker Cone	Yellow or Orange	\$14.95

CONE COLLARS - SPECIFY COLOR

Cat#	Description	Colors	Price
AL243	4" Cone Collar	Silver or Blue	\$14.95
AL244	6" Cone Collar	Silver or Green	\$14.95

CONE BASES

Cat#	Description	Weight	Price
AL240	Plastic Cone Base, Sand Fillable	16 lbs.	\$9.95
AL241	Rubber Cone Base	16 lbs.	\$22.95

Clip-On Safety Warning Signs

Fits Traffic Cones & Delineators

By using the Clip-On Safety Signs with your present cones and delineators, you can now give fast and simple directions at a quick glance. This makes for a safer work area and more effective flow of traffic. They're easy to install with a firm grip that locks onto any standard traffic cone barrel or delineator. Sign is made of super strong durable ABS plastic and is available with or without reflective lettering. *Call for pricing on other sizes. Ship. wt. 1 lb.*

SPECIFY LEGEND - Minimum Order is 5

AG170	Safety Sign, Non-Reflective	\$10.95/ea.
AG171	Safety Sign, Reflective	\$19.95/ea.

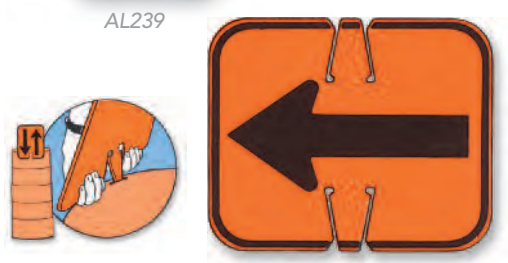

TRAFFIC CONTROL

Day/Night Barricade Tape

The brand new technology of Day/Night visibility barricade tape is formulated with an exclusive night time visibility silver ink that is combined with our superior co-extruded polyethylene to provide a cost-effective and disposable solution to your night time needs. Length: 3"x1000', thickness: 3 mil. Ship. wt. 4 lbs.



SPECIFY LEGEND: Caution, Danger, Fire Line Do Not Cross

BA101 Day/Night Barricade Tape \$15.95/roll

Barricade Banner Tape

It's so inexpensive that you can carry a spool in every emergency vehicle. Each spool is 3"x1000' and made of tough 2 mil. polyethylene. Available in various colors and legends. Ship. wt. 4 lbs.

1000-foot rolls!

Choose From A Variety Of Different Titles

- Fire Line Do Not Cross
- Caution Do Not Enter
- Caution Radiation Area
- Danger Do Not Enter
- Caution Biohazard



SPECIFY LEGEND

AJ351 Barricade Banner Tape \$11.95/roll

Lightweight Megaphone



- ▶ Patented Piezo Dynamic technology allows efficient operation
- ▶ Lasts 40 hrs. continuously on 8 "C" cells
- ▶ Weighs 50% less than a conventional model
- ▶ Adjustable volume
- ▶ Can also use rechargeable batteries
- ▶ Charge with 12V DC car cable or plug-in DC transformer

BH058 Lightweight Megaphone \$73.95

Homeland Security I.D. Kit

Be prepared for any Homeland Security Emergency and give your customers options. Our specialty tape and tags will carry appropriate legends that will help organize departments or areas, in case of an emergency, as well as assist in newly adopted security measures. Tapes are available in our standard specifications for barricade tape and adhesive tapes.

Kit Includes:

- ▶ 1 - Command Post
- ▶ 1 - Public Info Area
- ▶ 2 - Staging Area
- ▶ 1 - Decon Area
- ▶ 1 - Hot Zone
- ▶ 2 - Warm Zone
- ▶ 2 - Cold Zone



ROLLS INCLUDED MEASURE 3" X 500'

AZ619 Homeland Security Hazmat I.D. Kit \$86.95

Always Be Prepared with Instant A-Frame Plastic Barricades

Heavy, rugged and very visible; excellent for crowd control and crime scene protection. I-Beam construction, available in 6' or 10' lengths, assures additional rigidity and protects the high-intensity reflective sheeting. A-frame legs come with upper and lower panels slots and can be internally ballasted with sand. Beams have precise fit into matching slots on A-frame pieces. The white color never needs painting and the entire unit won't rust or give splinters. Complete unit includes two A-frame pieces and your choice of one or two I-beams. Ship. wt. 19 lbs.

- ▶ High-intensity sheeting



AG647 A-Frame Barricade with 6' I-Beam \$115.95

AH323 A-Frame Barricade with 8' I-Beam \$136.95

AG648 A-Frame Barricade with 10' I-Beam \$183.95

AH324 A-Frame Barricade with (2) 6' I-Beams \$184.95

AH325 A-Frame Barricade with (2) 8' I-Beams \$228.95

AH326 A-Frame Barricade with (2) 10' I-Beams \$330.95

Handheld Paddle Signs

For use at accidents, road blocks, by school patrols and others. Perfect for traffic control. Large 18" diameter with bold 6" high letters. Made of tough, durable material that's lightweight, corrosion-resistant and without sharp edges. STOP is white against red, SLOW is orange/ black with wood handle. Ship. wt. 1 lb.



P120	18" STOP/SLOW	\$14.95
P121	18" STOP Both Sides	\$14.95

Turbo Flare Day/Night Emergency Flares

Toughest, Safest, Brightest, and Smartest 24-hr. Electronic Road Flare



- ▶ State-of-the-art electronic flare
- ▶ "C" batteries not included
- ▶ Made from Surlyn - one of the toughest synthetics known to man
- ▶ Weatherproof "O" ring seal
- ▶ Light source: 20 high-output LEDs
- ▶ Spring-loaded moisture-resistant ON/OFF switch
- ▶ Low battery indicator light
- ▶ 100,000 hr. life LEDs



SPECIFY COLOR: Red, Orange, or Amber

BG164	8 SOS Deployment Case with Pennant Flags	\$593.95
BG165	Single Unit SOS	\$62.95

FlareAlert™

The FlareAlert™ is a battery-operated electronic safety flare visible for miles from both the ground and air. The FlareAlert™ has a battery life of approximately 20 hours in flash mode and approximately 6 hours in steady on mode. The bulb life is approximately 10 years.



- ▶ Weather resistant
- ▶ Compact and lightweight design
- ▶ Dual lighting options
- ▶ Magnetic base
- ▶ Environmentally friendly
- ▶ Easy-to-use
- ▶ No fumes
- ▶ Crush resistant: 20,000 lbs. vehicle
- ▶ Safe for indoor use
- ▶ No dangerous hot flames
- ▶ Affordable
- ▶ LED Technology

BC038	FlareAlert™ Electronic Flare	\$18.95
-------	------------------------------	---------

Three-Triangle Vehicle Warning Kit



No flares or electric flashers are necessary with the Vehicle Warning Kit. The kit includes three fold-out reflective triangles that snap into position in seconds. Each triangle is attached to a heavy four pound weighted base. Made of tough plastic with reflective red and fluorescent orange on both faces. Comes complete with handy carrying case for easy storage. Ship. wt. 15 lbs.

P639	Three-Triangle Vehicle Warning Kit	\$21.95
------	------------------------------------	---------

Flare Container

Conveniently Store Your Flares and Keep Them From Damage

Keep your flares together, easily accessible and safe from damage. Flare Container can hold up to twelve 30-minute flares. Easy to open cap and large handle make it user-friendly. It's so inexpensive, one can be kept in every vehicle. Ship. wt. 1 lb.



AH002	Flare Container	\$13.95
-------	-----------------	---------

Darley Safety Flares



15 and 20-minute flares sold in cases of 72. 30-minute flares sold in case of 36.

Cat#	Type	Case Price
AF409	15 Minute, No Spike	\$98.95
W947	20 Minute, No Spike	\$113.95
W948	30 Minute, No Spike	\$80.95
AF410	15 Minute, With Spike	\$112.95
W949	20 Minute, With Spike	\$132.95
W950	30 Minute, With Spike	\$91.95
W951	20 Minute, With Stand	\$134.95
AF411	30 Minute, With Stand	\$92.95

Flashback Five™ Light Baton

"The Brilliance of a Lightbar - The Size of a Flashlight"

The Flashback Five's advanced LED light and reflector technology makes it the brightest and most powerful signal light available. Its five stage switch provides red, blue, red/blue alternating, red/blue blend and a flashlight selection. The 20 brilliant LED bulbs can be seen for up to 1 mile and provides 300 hours of continuous flashing! The Flashback Five™ can be used as a signal light, a vehicle warning light (with its built in magnetic mount tailcap - placement can be anywhere on vehicle) or as an "on-the-scene" dash or deck light. Its weather-resistant body is made of high-impact ABS plastic and operates up to 7 hours on 4 AA batteries. Flashback Five™ also has a non-slip textured grip with a built-in belt clip and wrist strap. Measures 13 1/2" long. *Ship. wt. 3 lbs.*

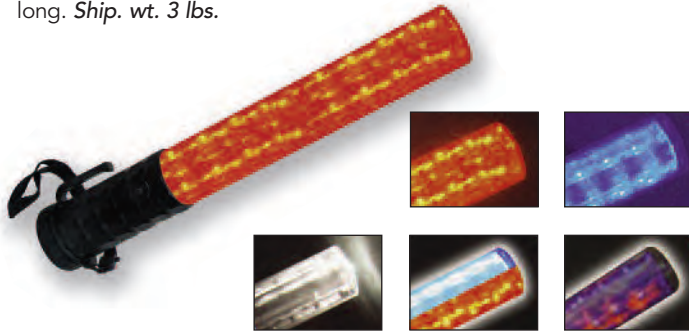

BG125 Flashback Five™ Light Baton \$46.95

Gyalume Light Sticks

Gyalume light sticks will not cause an explosion or be a fire hazard in areas which contain combustible mixtures of gases or liquids. 12-hour light emission is provided by a chemical reaction which takes place when two solutions are allowed to mix. *Ship. wt. 1 lb.*



SPECIFY COLOR: Yellow, Red, or Green

BD037 6" 12 hr. Light Stick \$1.95/ea.
Minimum order of 10

Multi-Purpose Glow Baton™

A high-quality versatile signaling device that has hundreds of uses. Switches colors with a push of the button. Features a non-incendiary design that eliminates the hazard caused by standard road flares and will not burn or damage clothing or other items. Built to perform under the most hazardous conditions in day, night or other low-visibility situations. Made of water-proof, high-strength industrial grade plastic. Takes 2 "AA" batteries not included. Measures 13 1/2" long. Available in one, two or three color. *Ship. wt. 1 lb.*



Push Button Color Change

AM202 Glow Baton™, Red \$37.95
AM203 Glow Baton™, Red/Green \$42.95
AM204 Glow Baton™, Red/Green/Blue \$53.95

2-in-1 Traffic Baton

- ▶ 2 separate functions (baton-flashlight)
- ▶ 4 operating modes:
 - Baton steady (18 LEDs): 8 hrs of battery life
 - Baton flash (18 LEDs): 11 hrs of battery life
 - Flashlight (12 white LEDs): 10 hrs of battery life
 - Flashlight w/baton steady (30 total LEDs): 6 hrs of battery life
- ▶ Durable ABS casing with polycarbonate lens
- ▶ Magnetic base, will stick to vehicle
- ▶ Dimensions: 10³/₈" x 1¹¹/₁₆" x 1¹¹/₁₆"
- ▶ Weight: 8.4 oz with batteries
- ▶ Battery operated (requires 3 AA alkaline batteries, not included)



BH097 2-in-1 Traffic Baton \$31.95
BE023 Tripod \$12.95

Lite Tracker™

Be seen in low visibility situations. Super bright LEDs provide an attention-getting strobe that can be seen from a mile or more away. This small, lightweight device is housed in a virtually indestructible polycarbonate case and easily attaches to clothing or belts with its grip clip or D-ring. Takes 2 "AAA" batteries (included) for 50 continuous hours of use. Its waterproof design makes it ideal for marine applications. Diver's model is tested to 100 feet. **AR300 comes in amber only.** *Ship. wt. 1 lb.*



Push Button Activation

Amber Blue Green Red

SPECIFY COLOR FOR AR299

AR299 Lite Tracker™ \$41.95
AR300 Diver's Model (Amber) \$44.95

FLASHBACK™ LED Light Baton

The FLASHBACK™ LED Light Baton is the most visible flashing signal light available. The 6 highly-luminous LED bulbs can be seen for up to 3/4 of a mile and flash approximately 150 times per minute. FLASHBACK™ provides a minimum of 300 hours of continuous flashing operation. The three stage switch provides off, flashing or steady light. The weather resistant body is made of ABS high impact plastic, while the tube is PC transparent material. *Ship. wt. 1 lb.*

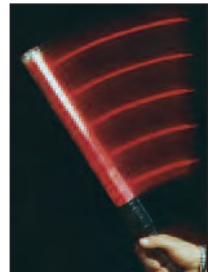

BB069 FLASHBACK™ LED Light Baton \$28.95

Lightman Strobe

Be Seen Up To 3 Miles In Dense Smoke and Fire

Intensely bright xenon strobe will help you be seen in any low visibility situation, giving 83 FPM (800,000 CP) and can be seen up to 3 miles. Easily attaches to turnout gear, belts and clothing or traffic cones, reflective triangles or even vehicles. With the four different mounting adapters included, you can use the Lightman just about anywhere. Rugged construction is reliable in extreme weather conditions with no danger of fire or spark. Takes 2 "AA" batteries (not included).
Ship. wt. 1 lb.

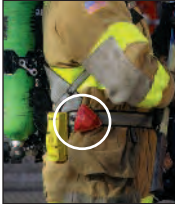

Amber Blue Green Clear Red

SPECIFY COLOR

AH024 Lightman Strobe \$25.95

LED Light Kits

The Lightman ultra-bright, wide-angle LED models give you extraordinary visibility, durability, and battery life. They are palm-sized and weigh less than four ounces with battery installed. Accessories in the kit include a suction cup, belt clip, magnet, and all-purpose eyelet.

	Amber	Blue	Red	White
AZ434 Lightman LED Kit	\$28.95	\$26.95	\$27.95	\$33.95

Flight Site Landing Zone Kit

The Flight Site 5-strobe system, with its 12,800' ceiling, identifies the landing zone to the pilots from great distances. It's easy-to-use and quickly deployed. Patented Weightwashers™ will not allow the strobes to move even under the heaviest rotorwash conditions. Enhance your medicavac landing zones as well as emergency scenes. Ship. wt. 5 lbs.

Includes:

- ▶ 5 Xenon Strobe
- ▶ 5 clear lenses
- ▶ 5 amber lenses
- ▶ 5 red lenses
- ▶ 5 Weightwashers™ for stabilizing strobes
- ▶ 10 AA batteries
- ▶ Carrying bag



AK281 Flight Site Landing Zone Kit \$239.95

TRAFFIC CONTROL

360° High Visibility Flashing Beacons and Kits

Features:

- ▶ 360° high-visibility flashing LED beacons
- ▶ Portable, safe, easy-to-use, and cost effective (2 cents/hr.)
- ▶ Bright, clear colors
- ▶ Up to 80 hr. battery life with low battery indicator
- ▶ Tough and dependable with one year limited warranty

Specifications:

- ▶ Beam brightness: 15,000 - 25,000 millicandela
- ▶ Max beam conspicuity: between horizontal and 10° above horizontal
- ▶ Flash rate: 120 flashes per minute
- ▶ Batteries: 2 Alkaline D cells (not included)
- ▶ Battery life: Up to 80 hrs. at full brightness
- ▶ Height: 8" (including optional base)
- ▶ Weight: 1 lb. (including batteries)

360° HIGH-VISIBILITY RED BEACON WITH 8 LED

BE275	Red Beacon with Low Battery Indicator	\$62.95
BE276	Rubber Base	\$3.95

BE277 Includes:

- ▶ 4 amber units with 1 blue unit
- ▶ 5 rubber bases
- ▶ or 4 red units with 1 blue unit
- ▶ Laminated instruction card
- ▶ Storage bag

HELICOPTER LANDING ZONE KIT WITH BEACONS SPECIFY COLOR

BE277	4 Amber Beacons and 1 Blue Beacon	\$319.95
-------	-----------------------------------	----------



Shown with optional base (BE276)

Detachable optional base (BE276)



- Shatterproof 360° polycarbonate lens
- Patented Fresnel lens
- Reflective strip and fluoro body
- High-strength clips
- Impact-resistant ABS cap
- Low battery indicator
- Failsafe positive activation Microswitch
- Advanced Battery Protection System
- Impact-resistant ABS body
- Precision o-rings

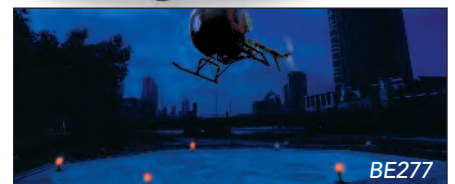

BE277

Strobe Beacons



Firebolt Plus

For dependable warning at an affordable price, count on the Firebolt line of strobe beacons. All models feature modular construction for easy installation and maintenance. Power supplies are moisture and vibration resistant, and will automatically adjust to function at multi-voltages. Firebolt Plus is available in a 2-joule (single flash) version and features a replaceable flash tube. The modular construction allows the flash tube to be easily replaced without the use of tools.

- ▶ Polycarbonate base available in permanent and magnetic models

FIREBOLT STROBE

Flash Rate: 60 ± 5
Voltage: 12-72VDC
AMP Draw: 0.24 @ 12V
Ship. Weight: 1 lb



SPECIFY COLOR: Amber, Blue or Red

AW491	Firebolt Plus Strobe Beacon/Permanent Mount	\$73.95
AW492	Firebolt Plus Strobe Beacon/Magnetic Mount	\$73.95

LED Pulsator®

The industry's most popular strobe platform is now LED. Federal Signal's LED Pulsator® features zero maintenance lighting with our innovative LEDNode™ technology. The high-profile LED beacon combines a powerful, solid-state light source and encapsulated digital circuitry with advanced dome optics to produce a bold, high intensity flash. The impact resistant, polycarbonate base and potted construction provide superior performance in extreme shock and vibration. LED Pulsator® beacons are backed by a 5-year warranty.

- ▶ Ten selectable "strobing" flash patterns
- ▶ Multi-voltage, 12-24 VDC; maximum of 0.80-amps, 0.35-amps average.



SPECIFY LED COLOR: Amber or Red

BL049	Pulsator® LED Color Dome Beacon	\$159.95
-------	---------------------------------	----------

360° LED Beacon with a Twist

- ▶ 18 watt LEDs, 10 selectable flash patterns
- ▶ Synchronizing capabilities with same series LED light
- ▶ Extremely low current draw
- ▶ Durable polycarbonate, twist-off lens
- ▶ Universal flange base
- ▶ Completely encapsulated circuit for increased weather and shock resistance
- ▶ Amber Lens with Amber LED array
- ▶ Voltage: 10v-30v DC
- ▶ Amp Draw: 0.6 amps @ 12v DC, 0.3 amps @ 24V DC
- ▶ Dimensions: BH179: 4³/₄" Hx6¹³/₃₂" D
BH180: 6¹¹/₁₆" Hx6¹³/₃₂" D



BH179	360° LED Beacon with Twist-Off Short Lens	\$125.95
BH180	360° LED Beacon with Twist-Off Tall Lens	\$125.95

Sentry® Warning Beacon

Federal Signal's Sentry® beacon is a reliable, effective warning light in an attractive, compact package. The large parabolic reflector and brilliant 55-watt halogen bulb combine to produce an intense 80,000 candelas per flash. This beacon is available in 12 or 24 volts and offers excellent 360° warning coverage with 95 flashes per minute rotators. Made of non-corrosive, high-impact polycarbonate, which provide extended service life. It has a twist-off dome, and all major components are field replaceable without the use of tools. Meets NFPA 1901. Ship. wt. 2 lbs.



SPECIFY COLOR: Red or Amber

AW229	Sentry® Warning Beacon, Magnetic Mount	\$118.95
AW230	Sentry® Warning Beacon, Permanent Mount	\$87.95

Rotating Beacon

- ▶ Open parabolic design reflector
- ▶ Standard or fast speed
- ▶ 24 volt option
- ▶ 50 watt
- ▶ Permanent mount
- ▶ Meets NFPA specifications when properly configured
- ▶ Ship. wt. 2 lbs.



SPECIFY DOME COLOR

AK158	Rotating Beacon	\$96.95
-------	-----------------	---------

The Darley® Tear Drop

This aerodynamic light is the ideal choice for unmarked cars or the volunteer. Excellent workmanship and the quiet, dependable operation of the unit make it a very special value. The gear drive rotates the highly polished reflector to produce approximately 90 flashes per minute from the 50 CP bulb (available in standard or halogen bulb). Magnetic base has 51 lbs. pull. Exclusive on this light is a slotted bracket for semi-permanent mounting. Comes complete with 10' cigarette lighter plug-in cord. Measures 4⁵/₈"Hx5³/₈"Wx6³/₄"L. *Ship. wt. 3 lbs.*



SPECIFY DOME COLOR

T625	Darley® Tear Drop	\$44.95
U191	Darley® Tear Drop with Halogen Bulb	\$47.95

Hotshot II Emergency Light

- ▶ Most compact portable emergency dash light
- ▶ Optional highly polished reflector gives intense flash
- ▶ Gear drive rotates the reflector at 90 flashes per minute
- ▶ Comes with vinyl shield and 60 lb. magnet mounting plate
- ▶ 4.13" Diameter, 4" Height
- ▶ Amp draw: 4 amps
- ▶ 50-watt halogen bulb combined with a highly polished reflector gives this light a high intensity flash
- ▶ Made in the USA
- ▶ *Ship. wt. 3 lbs.*



SPECIFY DOME COLOR

BA004	Hotshot II Emergency Light	\$58.95
AJ120	Reflector	\$24.95

Darley® Low Profile Dash Light

Its low profile design allows it to fit under sloping windshields with minimum obstruction and maximum visibility for those that need to see it. Features a wide-angle reflector for longer flash duration and brighter impulse from its 50-watt halogen light. 90 flashes per minute. Measures 7¹/₈"Dx3¹/₂"H. *Ship. wt. 3 lbs.*



SPECIFY DOME COLOR

U949	Darley® Low Profile Dash Light	\$58.95
AJ121	Suction Mount Dash Bracket	\$14.95
Y832	Universal Tri-Flector	\$22.95

SLR Beacon

The new SLR beacon combines traditional rotating technology and LEDs in one package to bring a one-of-a-kind solution to the market. Built to meet the demands of the tough work environments you face - the SLR beacon is the driving force of rotating LED technology.

- ▶ Federal Signal's patented SOLARIS® reflector optic technology
- ▶ Superior light output from 12 LEDs for maximum work zone visibility
- ▶ About half the amp draw of a traditional 12 VDC halogen rotating beacon
- ▶ Fully-potted for extended product durability



SPECIFY COLOR: Red or Amber

BL152	SLR Beacon	\$369.95
-------	------------	----------



Arch™ LED Beacon

- ▶ Brightest LED beacon on the market
- ▶ Provides 360° coverage (except in Half Beacon Model)
- ▶ 36 LED (full) or 18 LED (half) versions
- ▶ Full versions come in solid, multicolor (dual color) or steady burn white LEDs
- ▶ Economical Half Beacon Model is designed for half solid flashing and half with no light protecting driver's from flashback
- ▶ Multiple flash patterns include NFPA approved patterns w/synchronous capability
- ▶ 13 multi-color flash patterns
- ▶ Permanent mount standard

SPECIFY COLOR: Red, Blue or Amber

BL480	Arch™ 36-LED Beacon	\$482.95
BL481	Arch™ 18-LED Beacon Colored Lens & LEDs (1/2 LEDs & 1/2 Empty)	\$337.95



new



- ▶ 12 volt, reverse polarity protected
- ▶ 6 amps max with 3 amps average
- ▶ 5-year warranty on LEDs
- ▶ Dimming mode feature
- ▶ Failure mode detection feature

Star Mini-Phantom™

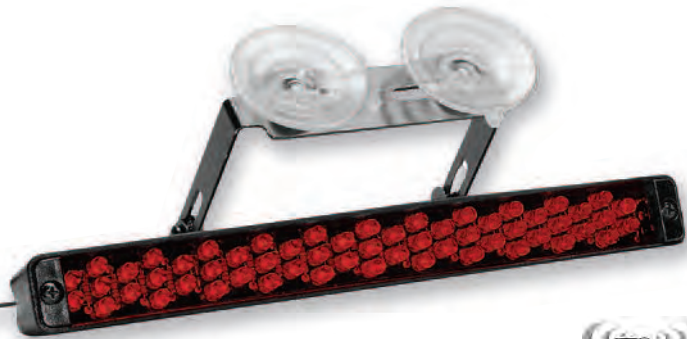

- ▶ Perfect for undercover or unmarked vehicle applications
- ▶ Low profile - less than 1" high and lightweight
- ▶ Dash, deck, mirror, or suction cup mount
- ▶ 57 long-life LEDs
- ▶ 3 custom selectable flash patterns via push button switch
- ▶ For interior applications only
- ▶ ULB9: Cigarette plug adapter with lighted on/off switch
- ▶ Includes mounting hardware and instructions
- ▶ Dimensions: 9" L x 1 3/8" W
- ▶ Ship. wt. 1 lb.

		Amber	Blue	White	Red
BC106	Star Mini-Phantom™	\$99.95	\$162.95	\$179.95	\$99.95

LED X™ Dual Stack Exterior Light



- ▶ Sealed and waterproof
- ▶ Housing available in black or silver finish
- ▶ Rust-proof, diecast aluminum housing
- ▶ 7 flash patterns including Steady-Burn
- ▶ No color until illuminated
- ▶ 1/2 amp per module
- ▶ Multiple mounting capabilities
- ▶ Excellent perimeter light for vehicles
- ▶ 5" L x 3 1/4" W x 1" H
- ▶ Stacked Dual Head LED X™
- ▶ Exterior light - flashing
- ▶ 5-year warranty



SPECIFY DIRECTIONAL, Wide, or Vertical Optics
 SPECIFY COLOR: Red/Red, Red/Blue, Red/Amber or Red/White

BA138	LED X™ Dual Stack Exterior Light	\$430.95
-------	----------------------------------	----------

Slimlighter™ Lights

The Latest in Ultra Bright LED Dash, Deck, and Windshield Lighting

- ▶ Long life. LED's are rated for 100,000 hrs. of operation because they have no glass or filaments to break
- ▶ Low current consumption
- ▶ Highly effective wide angle and straight on light output
- ▶ Perfect size for windshield, dash, deck, or headliner
- ▶ Clear outer lens, optional color lenses
- ▶ 21 selectable ScanLock™ flash patterns
- ▶ Super-LED™ features built-in On/Off switch, 21 selection pattern switch and 8' cord with cigar plug
- ▶ Swivel bracket for permanent or suction cup mounting
- ▶ Optional bail bracket
- ▶ 5-year Heavy Duty Professional warranty
- ▶ Dimensions: 1 5/8" H x 16 3/8" W x 1 13/16" D
- ▶ Lightweight polycarbonate housing with rounded corners is safer for use inside of the vehicle in the event of an accident or airbag activation



WHELEN

SPECIFY COLOR: Red/Red, Red/Blue, or Blue/Blue

AZ178	Slimlighter™ Super-LED Series	\$331.95
AZ179	Bail Mounting Bracket	\$27.95

WARRIOR™ Torus™ Windshield Mounted Deck Lights

- ▶ Torus™ LED technology supercedes Optix providing superior light output
- ▶ Compact size takes less space on the dash or deck
- ▶ Unique design prevents light signal from flashing into driver's eyes
- ▶ Reverse polarity protection feature
- ▶ 9' lighter plug power cord
- ▶ 5 user selectable flash patterns on 3-up models
- ▶ Flash pattern memory
- ▶ Less than 0.2 amp draw
- ▶ Suction cup or L-Bracket Mounting
- ▶ 5-year warranty on LEDs



Amber Blue Red White



SPECIFY COLOR: Amber, Blue, Red, White

BE055	Warrior™ Torus™ Windshield Mounted Deck Lights	\$139.95
-------	--	----------

Visor LED Flip Light

- ▶ 26 flash patterns
- ▶ Less than 0.5 amp per module
- ▶ Colored or clear outer lenses
- ▶ 9' lighter plug with on/off switch
- ▶ Mounts with two Velcro® Straps
- ▶ Dimensions: 5³/₈" Hx11" Wx1"D
- ▶ Weight: 1.4 lbs.
- ▶ 5 year warranty
- ▶ Meets all applicable SAE and California title 13 specifications when properly configured

High functioning,
low cost undercover
emergency visor light



SPECIFY COLOR: Red/Blue or Blue/Blue

BK111	Visor LED Flip Light Clear Lens with Colored LEDs	\$120.95
BK112	Visor LED Flip Light Colored Lens with Colored LEDs	\$120.95

STARBURST™ DLX3 Series LED Auxiliary Light

- ▶ Small and weather-resistant
- ▶ Intense STAR generation-3 LEDs have current limit protection over entire operating voltage and reverse polarity protection
- ▶ Can be synchronized with other STARBURST™ DLX3s
- ▶ High/low power select and 11 different selectable flash patterns
- ▶ Ships complete with five 3' attached wires, gasket and instructions
- ▶ Dimensions: 1⁷/₁₆" Hx4" Wx1⁷/₈" D, Voltage: 10v - 16v DC
- ▶ Ship. wt. 1 lb.



Amber Blue Red White

SPECIFY COLOR: Amber, Red, Blue, or White

BE048	STARBURST™ DLX3 Series LED Auxiliary Light	\$95.95
-------	--	---------

MOUNTING BRACKETS

BE049	Deck Mounting Bracket	\$7.95
BE050	Truck Mounting Bracket	\$7.95
BE051	Universal Mounting Bracket	\$12.95
BE052	Rear License Plate Mounting Bracket	\$14.95

Viper™ S2 with SOLARIS® Reflector Technology

- ▶ Bright/advanced SOLARIS® reflector technology with outstanding off-axis light output
- ▶ Cigarette plug or 2-phase (unique) synchronization
- ▶ Functional push button pattern and synchronization control
- ▶ 23 new and innovative warning flash patterns
- ▶ Versatile mounting bracket with Snap-On flash guard included



Amber Blue Red



SPECIFY COLOR FOR SINGLE AND COMBO FOR DUAL: Amber, Red, or Blue

BD200	Single Head Viper™ S2 w/Cigarette Plug	\$186.95
BD201	Single Head Viper™ S2 w/Phase/Synchronized Wire	\$200.95
BH073	Dual Head Viper™ S2 w/Cigarette Plug	\$351.95
BH074	Dual Head Viper™ S2 w/Phase/Synchronized Wire	\$359.95

Compact LED Dash Light

LED technology produces an ultra-bright light using less energy and creating less heat than halogen and strobe dash lights. Features 80 high-intensity LEDs to produce a far-reaching light that won't wash out in bright sunlight. Flashes in seven different patterns including variable speed and random flash. On/off and pattern selection switches are conveniently mounted on the housing. Measures only 1¹/₂" Hx 6¹/₂" L x 1¹³/₁₆" D. Comes with a fused cigarette light plug, 10' power cord and mounting bracket. *Ship. wt. 5 lbs.*



AR211	Compact LED Dash Light, Red	\$153.95
AR212	Compact LED Dash Light, Amber	\$158.95
AR213	Compact LED Dash Light, Blue	\$332.95
AR214	Compact LED Dash Light, Blue/Red	\$237.95

EMERGENCY LIGHTS & SIRENS

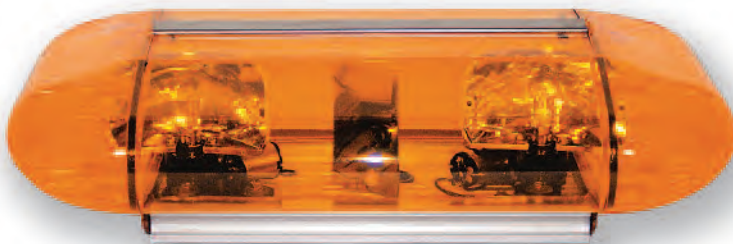

Impulse Mini-Bar

An aerodynamic, low profile mini-lightbar available in 20" and 24" lengths. Features polycarbonate Lexan lenses and a fully RF suppressed motor that rotates halogen bulbs at 160 rotations per minute. 24" mini-lightbar offers two inserts to the front and two inserts to the rear for multiple lens coloration. Available in your choice of configuration and comes complete with permanent mount. *Ship. wt. 7 lbs.*



SPECIFY LENS COLOR



Cat#	Description	Size	Configuration	Price
AF488	Impulse Mini-Bar	20"	2 Rotators, 1 Mirror	\$159.95
AF489	Impluse Mini-Bar	20"	3 Rotators	\$181.95
AC883	Impluse Mini-Bar	24"	2 Rotators, 1 Mirror	\$245.95
AC884	Impluse Mini-Bar	24"	3 Rotators	\$299.95



new

Quadrant™ Mini Bar

- ▶ 4 Torus™ style optic LED lightheads which provide outstanding signal strength and light spread
- ▶ 4 LEDs per light module
- ▶ Polycarbonate lenses and base
- ▶ Magnetic/suction cup mount and permanent mount standard
- ▶ Magnets spring loaded to allow mini bar to conform to uneven mounting surfaces
- ▶ Includes 9' straight cord and plug-in lighter cord with flash pattern selection switch built in
- ▶ 19 selectable flash patterns to choose from
- ▶ Dimensions: 11" Lx2.4"H (without mounting feet)
7.3"Dx3.1"H (with mounting feet)

SPECIFY LENS COLOR: Red, Blue, Amber or Clear with Amber LEDs



BL477	Quadrant™ Mini Bar	\$166.95
-------	--------------------	----------



HighLighter™ LED Mini-Lightbar

The HighLighter™ LED mini-lightbar is a low profile, modular design of the industry leading HighLighter™ mini-lightbar. The HighLighter™ LED combines the high-performance ROC (Reliable Onboard Circuitry™) with the high-efficiency Solaris® reflector design. This innovative concept offers uniform 360° light distribution, which means no dark spots or shadows.



Split LED

- ▶ Incorporates ROC™ LED technology
- ▶ Magna Select™ allows the user to easily switch flash patterns using a magnet (patent pending)
- ▶ More than twenty user-selectable flash patterns
- ▶ Synchronize or alternately flash with multiple HighLighter™ LED units or a variety of other LED light heads
- ▶ Perfect in areas with "No Idle" policies



SPECIFY LED COLOR: Red, Blue, or Amber

BG282	HighLighter™ LED with Cigarette Plug & Suction Cup Mount (Colored Lens)	\$418.95
BG283	HighLighter™ LED with Cigarette Plug & Suction Cup Mount (Clear Lens)	\$418.95
BG284	HighLighter™ LED with Sync Wire and Permanent Mount (Colored Lens)	\$418.95
BG285	HighLighter™ LED with Sync Wire and Permanent Mount (Clear Lens)	\$418.95

SPLIT LED, SPECIFY COLOR COMBINATION: Red, Blue, or Amber

BG566	HighLighter™ LED with Cigarette Plug & Suction Cup Mount (Clear Lens)	\$494.95
BG567	HighLighter™ LED with Sync Wire and Permanent Mount (Clear Lens)	\$467.95



Magna Select™

LED Mini Light Bar

- ▶ High profile warning signal provides 360° visibility
- ▶ 2 levels of unique LED reflectors in each beacon provide a focused signal for superior brightness
- ▶ Low amp draw and bright output provide the ideal beacon for everyday use
- ▶ Lighter plug and mounting options provide versatility for different applications
- ▶ 2 synchronous LSS222 LED beacons under one lens
- ▶ 2 levels of 8 LEDs in each beacon
- ▶ 39 built-in user selectable flash patterns, including 4 simulated rotating patterns
- ▶ Dimensions: 16.5"Lx5.25"Hx8"W
- ▶ 5 year warranty
- ▶ Meets SAE J845, Class 1



Provides two rows of LEDs in a compact package!

SPECIFY COLOR: Blue, Red, Red/Blue or Amber LEDs for BK105 & BK107 & BK109

SPECIFY COLOR: Blue, Red or Amber Lens/LEDs for BK106 & BK108 & BK110



Cat #	Description	Mount	Price
BK105	LED Mini Light Bar Clear Lens with Colored LEDs	Permanent Mount	\$349.95
BK106	LED Mini Light Bar Colored Lens with Colored LEDs	Permanent Mount	\$349.95
BK107	LED Mini Light Bar Clear Lens with Colored LEDs	Magnetic Mount	\$357.95
BK108	LED Mini Light Bar Colored Lens with Colored LEDs	Magnetic Mount	\$357.95
BK109	LED Mini Light Bar Clear Lens with Colored LEDs	Suction/Magnetic Mount	\$369.95
BK110	LED Mini Light Bar Colored Lens with Colored LEDs	Suction/Magnetic Mount	\$369.95

Frontier Light Bar

- ▶ Includes both permanent and magnetic mounting hardware
- ▶ Change flash patterns with the "Capacitive Touch" feature (just the touch of a finger)
- ▶ 21 flash pattern selections provide plenty of options for alerting oncoming traffic
- ▶ 4 high quality Torus™ 6-LED lightheads in front and rear, 4 high quality Torus™ 9-LED lightheads in corners
- ▶ 9' straight cord with lighter plug and switch
- ▶ Rated 100,000 hour life
- ▶ Dimensions: 17.2"Lx3.8"Hx10.8"D
- ▶ 5 year LED warranty



Change patterns by touch!

SPECIFY COLOR: Blue, Red, Red/Blue or Amber LEDs for BK103

SPECIFY COLOR: Blue, Red or Amber Lens/LEDs for BK104



BK103	Frontier Light Bar Clear Lens with Colored LEDs	\$349.95
BK104	Frontier Light Bar Colored Lens with Colored LEDs (Lens and LEDs Same Color)	\$349.95

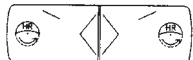

AR240 - 2 Rotators,
2 V-Shaped Mirrors,
2 Wall Style Mirrors



AR241 - 5 Rotators,
2 Diamond Mirrors



AR242 - 4 Rotators,
4 Alley Lights, 2 Rear Amber,
2 Diamond Mirrors, Flashers,
2 Takedown Lights

Star Warning Light Bars

Made with impact-resistant polycarbonate lenses and heavy-duty aluminum base, this bar is built to last. Features include fully RF suppressed motor, aerodynamic low profile, 90 RPM, all halogen bulbs and your choice of 12 or 24v. Permanent mount included. *Ship. wt. 35 lbs.*



SPECIFY 12 or 24 VOLT AND LENS COLOR
SPECIFY COLOR: Red, Blue, Amber or Clear

AR240	Star Warning Bar, 36"	\$307.95
AR241	Star Warning Bar, 48"	\$448.95
AR242	Star Warning Bar, 48"	\$521.95
AR243	Gutter/Gutterless Mount Kit, Specify Vehicle	\$39.95

JetSOLARIS Lightbars with ROC™ and SOLARIS™ Technology



- ▶ All models feature SOLARIS® LED reflector technology
- ▶ Innovative ROC™ (Reliable Onboard Circuitry™)
- ▶ Can be configured to meet NFPA requirements
- ▶ Available in 48" and 54" lengths
- ▶ 5 year LED product warranty
- ▶ 360° of warning coverage
- ▶ Color: Red with clear center



Cat#	Description	Color	Price
BA139	48" JetSOLARIS Lightbar with ROC™ and SOLARIS® Technology	Red	\$1,618.95
BG178	54" JetSOLARIS Lightbar with ROC™ and SOLARIS® Technology	Red	\$1,613.95

Star Interceptor

- ▶ Wider design for better light distribution
- ▶ Sloped end domes for better vehicle contour image
- ▶ Adjustable lower level lights allow optimal positioning of light output
- ▶ Patented shock-mounted rotator system for long-lasting, quiet, rotator operation
- ▶ Dual ball-bearing rotator spindle for smooth, quiet, rotator operation
- ▶ Low profile
- ▶ Ship wt. 35 lbs.



SPECIFY COLOR: Red, Blue, Amber or Clear

AW248	46" Halogen 4 Rotator Warning Package	\$482.95
AW249	46" 4 Strobe Warning Package	\$729.95
AW250	46" 6 Halogen Rotator Police Package with Arrow Director	\$1,008.95

EMERGENCY LIGHTS & SIRENS

NFPA Justice® Super-LED® Series

The performance you want in a cost-competitive, Super LED® lightbar. Justice® is loaded with options and designed for easy operation, upgrade and serviceability. The sleek 2 1/4" profile not only provides today's popular stealth appearance but reduces air drag for better fuel economy.

- ▶ 12" wide and only 2 1/4" high (without mounting feet)
- ▶ Black polycarbonate base on an extruded aluminum platform for added strength
- ▶ Solar Panel compensates for parasitic draw from the vehicle's computer, improves battery efficiency and extends battery life
- ▶ Standard passenger side cable



- ▶ Clear outer lens standard with a moisture resistant compression fit gasket
- ▶ Service oriented. Change colors, upgrade or service lightbar in the field
- ▶ Simply remove 4 or 6 screws to access any section of the lightbar
- ▶ Replace any lighthouse by removing one screw and single connector

COLOR: Red and White

BL293	56" NFPA Justice® Super-LED® Series	\$1,564.95
BL294	62" NFPA Justice® Super-LED® Series	\$1,636.95

WHELEN

21IF™ LED Lightbar

- ▶ Using the latest LED Torus™ technology, the 21IF™ lightbar series provides more superior light output and better off-angle lighting than our current 2100 models using Optix lighthoods
- ▶ Independent flashing lighthoods (no central controller board required)
- ▶ Economical, yet advanced, this lightbar offers a host of standard features delivering the best low profile LED lightbar on the market
- ▶ Flasher (both Halogen and LED)



- ▶ User selectable flash patterns changeable on each lighthouse
- ▶ LIT3 mounting kit with adapter included
- ▶ Non-central controller
- ▶ Clear lens standard
- ▶ Dimming mode

SPECIFY LENS COLOR: Clear, Red or Amber SPECIFY LED COLOR: Blue, Red or Amber

BL478	4 Torus™ 4 LED Heads, 4 Torus™ 6 LED Heads in the Corners & Halogen Alley & Take Down Lights	\$1,035.95
BL479	9 Torus™ 4 LED Heads, 4 Torus™ 6 LED Heads in the Corners & Halogen Alley & Take Down Lights	\$1,587.95



LED Perimeter Lights

Compact Lights That Make a Big Impact on Your Vehicle

MicroPulse™ 6-LED Lighthead

Stealth and power are united in the MicroPulse™ 6-LED lighthead. Nineteen multiple flash patterns create versatility that allows the lighthead to flash as a solid or split-color and operate from a 12-24 VDC power source. Plus multiple MicroPulse™ lightheads can synchronize for optimum enhancement of any lighting application.

- ▶ Multiple mounting options for various applications
- ▶ Superior warning with six high power LEDs
- ▶ Super slim design offers a wider range of mounting areas
- ▶ 3 year LED warranty

SPECIFY MOUNT: Surface or Hood

SPECIFY COLOR: Red-Red, Red-Blue, Blue-White, White-White, Amber-Amber

BL110	MicroPulse™ 6-LED Lighthead	\$124.95
-------	-----------------------------	----------



IPX6 LED Warning Light

The "IPX6" LED warning light models feature Federal Signal's SOLARIS® LED reflector technology and our SpectraLux™ multi-color LED capability. These compact LED warning lights are ideal for use as grille lights or use in other auxiliary warning light applications. Each IPX6 model includes a black polycarbonate mounting bezel, gasket, and mounting hardware. Horizontal mount.



SPECIFY COLOR: Amber, Blue, Red, White or Green

BL151	IPX6 LED Warning Light	\$129.95
-------	------------------------	----------



QuadraFlare™ 9"x7" LED Perimeter Warning Light

- ▶ NFPA 1901 and GSA KKK-E compliant models
- ▶ Outstanding off-axis warning
- ▶ 26 built-in flash patterns, including "Quad-X" and "Steady"
- ▶ Flash patterns are push-button programmable
- ▶ Independent side control on split LED models
- ▶ Clear or color lens options
- ▶ 5 year warranty on LED components

SPECIFY LED COLOR: Red, Blue, or Amber

BH077	9"x7" QuadraFlare™ LED Warning Light Colored Lens	\$249.95
BH078	9"x7" QuadraFlare™ LED Warning Light Clear Lens	\$249.95
BH095	Chrome Trim Bezel	\$19.95
BH096	Black Trim Bezel	\$19.95



EMERGENCY LIGHTS & SIRENS

QuadraFlare™ 6"x4" Perimeter Light

- ▶ Advanced SOLARIS® Technology in a 6"x4" package
- ▶ 5 year warranty on LED components
- ▶ Available with built-in flasher featuring 16 selectable patterns
- ▶ Meets NFPA and GSA K-spec compliant upper and lower level requirements

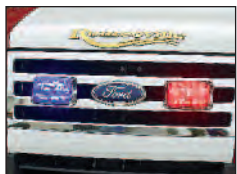

Amber Blue Red

Shown w/BG201

SPECIFY LED COLOR: Red, Blue, or Amber

BG199	QuadraFlare™ Color Lens LED Warning Light*	\$138.95
BG200	QuadraFlare™ Clear Lens LED Warning Light	\$138.95
BG201	Chrome Trim Bezel with Gasket	\$13.95
BG202	Black Trim Bezel with Gasket	\$13.95

* Color lens are the same color as LEDs

IMPAXX Light Head

- ▶ High-output LEDs and SOLARIS® Reflective Technology
- ▶ Compact size allows for a variety of mount locations
- ▶ Advanced off-axis and center focused lens available
- ▶ Fully encapsulated waterproof housing
- ▶ Wide variety of synchronized patterns
- ▶ 5 year warranty



Amber Blue Red White

SPECIFY LED COLOR: Amber, Blue, White or Red

BG187	IMPAXX 3 LED Clear Lens Warning Light	\$89.95
BG188	IMPAXX 3 LED Color Lens Warning Light*	\$89.95
BG189	Chrome Surface Mount	\$6.95
BH071	External Mount	\$24.95

* Color lens are the same color as LEDs



FRC
FIRE RESEARCH CORP.
choose the best.



FRC
FIRE RESEARCH CORP.
choose the best.

Spectra 900 Surface Mounted LED Light

The surface mounted Spectra 900 LED light is designed specifically for ambulance and emergency response vehicles. This low profile surface mount fixture is easy to install with no panel cutout required and it provides an incredible 5000 lumens with no generator required. A unique lens set was designed to project all the LED light down onto the scene where EMTs need it most.

- ▶ 24 white LEDs
- ▶ 5000 lumens at 12 or 24 volts DC
- ▶ All aluminum light housing with chrome colored bezel
- ▶ Extremely low profile extends less than 1³/₄" from panel
- ▶ Mounts to a flat surface with 4 screws
- ▶ 9" wide, 6³/₄" high
- ▶ Wiring extends from weatherproof strain relief at rear of light

SPECTRA 900

BK075 Spectra 900 Surface Mounted LED Light \$498.95

Firefly Compartment Mounted LED Light

The Firefly brings ultra bright white LED light to all compartments that exceeds other fixtures. The LEDs are housed in a waterproof anodized case, built tough for all environments. Firefly is easy to install because it can be mounted in any orientation and on any flat surface.

- ▶ 4 white, long life LEDs
- ▶ UltraBright 650 lumens light output
- ▶ Can be used for ground or surface lighting
- ▶ Completely water proof sealed electronics
- ▶ Small and compact; 2⁵/₈" diameter and 3³/₄" thick
- ▶ 5 year LED lighting warranty

BK095 Firefly Compartment Mounted LED Light
(12 VDC 0.8 amps) \$138.95



BH042

WELDON
A DIVISION OF AMIRON BRASS

Diamondback™ LED Perimeter Warning Light

These LED lights provide incredible brightness, unmatched directional visibility, customized pattern and styling flexibility, and unique serviceability. Each light incorporates patented V-LED™ technology, allowing for the LEDs to be field serviceable and upgradeable. The light flash patterns can be completely re-configured via wireless downloads without removing the lens or lamp from the vehicle. Loaded with powerful innovations, the Diamondback™ delivers unprecedented performance to the emergency response community.

- ▶ Patented V-LED™ technology, for superior thermal efficiency and excellent brightness
- ▶ 4 independently controlled LED segments allow for unmatched flash pattern options: left/right, up/down, x-pattern, chasing and many more
- ▶ Flush mount design utilizes only four screw holes and a wire exit hole

Cat#	Description	Red LED	Amber LED	Blue LED	White LED
BG203	4"x6" LED with Color Lens Warning Light	\$164.95	\$164.95	\$185.95	N/A
BG204	4"x6" LED with Clear Lens Warning Light	\$164.95	\$164.95	\$185.95	\$185.95
BH041	2"x6" LED with Color Lens Warning Light	\$120.95	\$120.95	\$129.95	N/A
BH042	2"x6" LED with Clear Lens Warning Light	\$120.95	\$120.95	\$129.95	\$129.95
BG205	Chrome Bezel for 4"x6" Light				\$22.95
BH043	Chrome Bezel for 2"x6" Light				\$19.95

SUNSTRIP Ultrabright LED Light

SUNSTRIP is the brightest LED strip light available. This high quality ultra bright white LED light is ideal for compartments, panels, under body applications, and stairwells. It is designed tough to withstand any vehicle vibration.

- ▶ Ultra bright 300 lumens light output per 18" length
- ▶ Completely waterproof and submersible
- ▶ LEDs housed in a strong 5/8" diameter Lexan tube
- ▶ Easy to install
- ▶ Long operating LEDs - rated at 50,000 hours
- ▶ 5 year LED lighting warranty



Cat#	Description	Length	Lumens	Current@12v	Price
BK352	LED 12vdc SUNSTRIP Light	9"	150	0.17 amps	\$62.95
BK353	LED 12vdc SUNSTRIP Light	18"	300	0.35 amps	\$81.95
BK354	LED 12vdc SUNSTRIP Light	27"	450	0.52 amps	\$119.95
BK355	LED 12vdc SUNSTRIP Light	36"	600	0.70 amps	\$137.95
BK356	LED 12vdc SUNSTRIP Light	45"	750	0.87 amps	\$173.95
BK357	LED 12vdc SUNSTRIP Light	54"	900	1.05 amps	\$200.95
BK358	LED 12vdc SUNSTRIP Light	63"	1050	1.22 amps	\$233.95

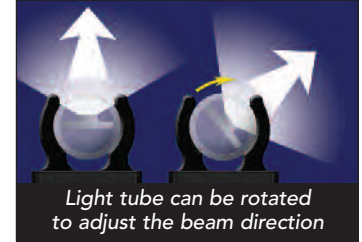

Light tube can be rotated to adjust the beam direction

Roof Mount Halogen Spotlight

Features interior control handle with finger-tip switch for safety and convenience. Gives full 360° continuous vertical rotation and 180° horizontal adjustment. 6" round light head with lead-proof design and clear halogen lamp with your choice of 160,000 CP (50-watt) or 245,000 CP (100 watt). Standard 2 3/4" roof clearance. Includes universal mounting bracket, template and instructions for easy installation. Ship. wt. 7 lbs.

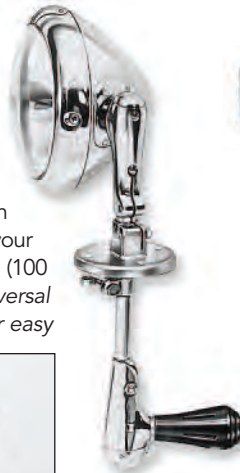

Interior control



J510	Roof Mount Spotlight, 245,000 CP	\$146.95
T608	Roof Mount Spotlight, 160,000 CP	\$122.95

Vehicle Tail Lights

The AF496, AF497, AF498 and AF499 are 7"x8" surface mount lights, to be used as warning or scene light. AF500 measures 2 1/2"x5 1/2" and can be used as a step light or ground light. Ship. wt. 2 lbs.



AF497 - Turn Light with Arrow



AF496

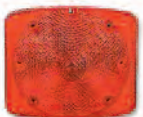

AF499

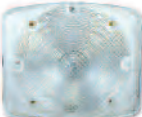

AF498



AF500

AF496	Tail Light/Stop Light, Red	\$36.95
AF497	Turn Light w/Arrow (Specify Red or Amber)	\$38.95
AF498	Back-Up Light	\$36.95
AF499	Red Light	\$36.95
AF500	Intersection Light (Specify Red or Clear)	\$13.95

Panel Light/Shield



Lights up your pump panel for easy visibility and helps protect it from the weather at the same time. Comes with weather proof sealed lights. Polished anodized aluminum. Custom sizes available. Ship. wt. 3 lbs.

AJ551	Panel Light/Shield, 18"	\$96.95
AJ552	Panel Light/Shield, 30"	\$116.95
AJ553	Panel Light/Shield, 52"	\$143.95

Oscilaser

The Oscilaser offers a simple and reliable rotating motion or a model with an up and down movement while oscillating side to side, with a parabolic reflector for maximum light output. The Oscilaser also has an optional Bezel, and can be mounted on the front, rear, grille, bumper. Dimensions: 6 3/4" L x 3 3/4" W. Ship wt. 1 lb.



Amber Blue Red Clear



SPECIFY LENS COLOR: Amber, Blue, Clear or Red		
AW255	Oscilaser with Flush-Mountable Bezel	\$179.95
AW256	Oscilaser Flush-Mountable	\$117.95

EMERGENCY LIGHTS & SIRENS

Wig-Wag Headlight Flasher Kit



Produces the popular Wig-Wag flash for headlights at 90 flashes per minute. Features double-pole, double-throw rocker switch, indicator light with an electromechanical alternating Tridon flasher. The complete kit comes with 12-foot wire and mounting bracket. Black metal housing with "On" indicator light. *Ship. wt. 1 lb.*

REPLACEMENT FLASHERS AVAILABLE

AD924 Wig-Wag Flasher with Tridon Flasher \$46.95

Stealth Switch Control Panels

The industry standard in compact, reliable switch control panels. Used on thousands of emergency vehicles all over the United States and Canada. Features mini-Euro style rocker switches with LED effect indicator lights and vinyl coated steel housing. Interchangeable backlit legend inserts are white with black letters. *Ship. wt. 2 lbs.*

Stealth 2 Panel

Features 4 rocker switches. A 40 AMP relay/40 AMP circuit breaker is included. (3) 20 Amp fused switch output, and ATO fuses. Mounting bracket included.



AR238 Stealth 2 Panel \$139.95

Stealth 3 Panel

Features 6 rocker switches. A 40 AMP relay/40 AMP circuit breaker is included. (5) ATO fused switch outputs. 18" pigtail included. Mounting bracket included.



AR239 Stealth 3 Panel \$150.95

Siren/Speaker Package

- ▶ LED speaker diagnostics
- ▶ Wail, Yelp, Air horn, Phaser, Manual, and Two Tone
- ▶ Self-resetting circuit protection against speaker shorts
- ▶ Integrated public address microphone
- ▶ 7 light functions
- ▶ Dual color backlighting on keypad (Amber and Red)
- ▶ 4 position progressive slide switch w/LED indicators
- ▶ Drives one or two 100 watt speakers
- ▶ Patent pending cyclonic expansion chambers
- ▶ Ultra compact - only 3" deep
- ▶ Rugged glass filled nylon housing - will not rust



BH178



INCLUDES: D-44 Cyclone™ speakers (BH178) and SPBRK-16 Universal "L" Bracket

BH177 Siren/Speaker Package

\$625.95

Power Supply

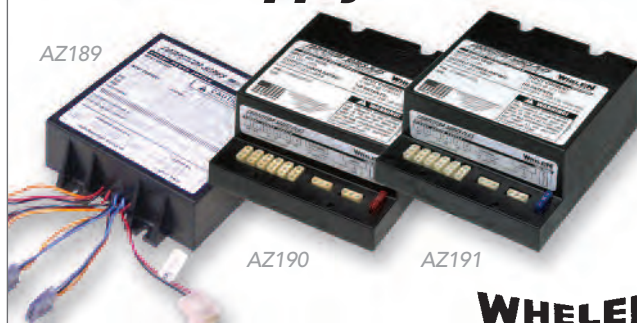

WHELEN

50 Watt Strobe Power Supply

4-outlet, 50-watt output, 67-watt input. *Ship. wt. 4 lbs.*

AZ189 Strobe Power Supply \$137.95

60 Watt Strobe Power Supply

6-outlet, 60-watt output, 80-watt input 12/24 VDC. *Ship. wt. 4 lbs.*

AZ190 Strobe Power Supply \$184.95

90 Watt Strobe Power Supply

6-outlet, 90-watt output, 1200-watt input. *Ship. wt. 4 lbs.*

AZ191 Strobe Power Supply \$215.95

STAR-PAK® Remote Strobe Kit

The STAR-PAK® remote strobe kit incorporates six outlets with 24 customer-selectable flash patterns all in a 90 watt system. Multiple strobe head combinations can be enabled. Customer-selectable Day/Night mode. Features power reduction to operating heads in case of head failure, RFI protection, cooling fan, and Visual System Diagnostics (VSD™). Ships complete with power and control leads and instructions.

BG180

- ▶ 90w remote power supply
- ▶ Clear strobe tube assemblies
- ▶ 15' cables w/attached connectors
- ▶ Lighted toggle switch

BG181

- ▶ 15' cables w/attached connectors
- ▶ 20' cables w/attached connectors
- ▶ 90w remote power supply
- ▶ Clear strobe tube assemblies
- ▶ Lighted toggle switch



BG180 STAR-PAK® 90w Kit w/6-Phantom Strobe Heads \$369.95

BG181 STAR-PAK® 90w Kit w/4-Phantom Strobe Heads \$325.95

Compact and Reliable Mini-Siren

Efficient, economical and reliable performance with effective traffic clearing capability. 100-watt output and can operate from any 12-volt vehicle system. Features wail, yelp, priority, manual (peak and hold) and airhorn siren tones controlled by two rocker switches. A new built-in intersection clearing feature adds both an eight-second yelp or eight-second priority tone for effective traffic management. Includes mounting bracket. Measures 1 1/2"H x 5 1/2"L x 6 1/2"W. Ship. wt. 3 lbs.



FEDERAL SIGNAL CORPORATION
Emergency Products

AR234 Mini-Siren \$181.95

PA 300 Electronic Siren Plug In PC Board - Includes Airhorn Sound

The W691 provides all basic siren tones; TAP II, PA, radio rebroadcast, as well as a built-in airhorn sound with siren override. It is protected against all failure modes by a fuse that is replaceable without tools and can operate from any 12-volt positive or negative ground vehicle electrical system. Taps are included for 100 or 200-watt speakers. Comes complete with a swinging bracket which enables mounting in a variety of positions. Ship. wt. 6 lbs.



Illuminated
face plate

FEDERAL SIGNAL CORPORATION
Emergency Products

W691 PA 300 Electronic Siren \$341.95

V-Con® Siren

CODE 3
PUBLIC SAFETY EQUIPMENT, INC.

Compact, Easy-to-Use, and Reliable

- ▶ All models have PA, radio-rebroadcast, air horn, backlighting, "Hit-N-Go" function, and 3 siren tones: Wail, Yelp, & Hi-Lo or HyperYelp™
- ▶ BA14201 - HyperYelp™
- ▶ BA14202 - Hi-Lo
- ▶ BA14203 - Includes light controls - 3 level slide switch and 4 on/off push buttons for 7 levels of control
- ▶ 6 1/2"L x 2 1/2"H x 5 1/2"W
- ▶ Ship. wt. 5 lbs.



BA14201

BA14201	V-Con® Siren with HyperYelp™	\$309.95
BA14202	V-Con® Siren with Hi-Lo	\$309.95
BA14203	V-Con® Siren with Hi-Lo with Light Control	\$474.95

5-Function Siren With Phaser Mode

With the ability to run at 200 watts for extended periods, the AR264 sets the standard for emergency vehicle sirens. The primary operating modes are Phaser, Yelp, Wail, Hands-Free, Manual, Alert and Radio. It features separate volume controls for the radio repeat and public address functions, public address override, and speaker diagnostics. The siren is backlit for easy nighttime readability. Ship. wt. 9 lbs.



AR264 5-Function Siren \$173.95

PA650 Series Remote Siren

- ▶ Full featured 100w remote siren with light control
- ▶ Microphone/switch controls combined
- ▶ Progressive push button control mimics slide switch action
- ▶ Eight 10 amp light and auxiliary relay positions
- ▶ Perfect for undercover and slick top applications



BG182 PA650 Series 100w Remote Siren \$411.95

EMERGENCY LIGHTS & SIRENS

Remote Siren System with Handheld Controller

- ▶ PA with built-in noise cancelling mic
- ▶ Radio rebroadcast
- ▶ Stand-by
- ▶ Siren Scroll
- ▶ Park kill with Level 3 drop-out option
- ▶ Horn ring transfer
- ▶ Vehicle light control buttons (3 progressive, 4 Auxiliary)
- ▶ All buttons are backlight with on/off color change
- ▶ Level 3 auto siren tone on
- ▶ Keypad, backlight off option
- ▶ Push button programmable airhorn pitch tones
- ▶ 2 programmable airhorn pitch tones
- ▶ Volume control thumbwheel on hand-held controller
- ▶ Siren Lock
- ▶ Timed output
- ▶ Momentary switch available
- ▶ Optional jumpers via special order
- ▶ EU lock to any level
- ▶ 5 year warranty



CODE 3
PUBLIC SAFETY EQUIPMENT INC.

BK113 Remote Siren System with Handheld Controller \$334.95

Federal Q Electromechanical Siren

Beautiful, Streamlined, Chrome Plated, Commands Respect

This siren includes grille, brake, and chrome finish. It is designed to be pedestal mounted but is also offered less the rear housing for flush mounting. Heavy-duty coaster clutch is subject to very little wear. The unique clutch design delivers a longer coast-down sound once power is removed, thereby reducing battery drain. For quick silencing, an electric brake is also a standard feature. 12-volt, operating current 100 amps. The AC895 model comes complete with stainless steel finish, grille, brake, pedestal and rear housing. Model AC896 is for flush mounting and does not include pedestal or rear housing. *Ship. wt. 49 lbs.*

- ▶ 123 dB at 10 feet

FEDERAL SIGNAL CORPORATION
Emergency Products



Chrome
Plated

AC895 Electromechanical Siren \$2,092.95
AC896 Electromechanical Siren, for Flush Mounting \$1,662.95

Darley Special Siren

This siren is compact, lightweight and corrosion-resistant. Features a 4½" rotor, pedestal mount and outputs 101 dB at 10'. Draws 12.5 amps at 12vDC. Measures 7"Lx5"Hx 4½"D. *Ship. wt. 4 lbs.*



AF453 Darley Special Siren \$81.95

e-Q2B Electronic Siren

The e-Q2B has been completely designed to incorporate 200W Class D audio amplifier for increased reliability. In addition, external diagnostics have been added to monitor power, output voltage and current monitoring. New features include park kill input, which immediately shuts off the siren when vehicle is in park and horn ring input which allows the user to cycle through siren tones. Finally, an audio output has been added to allow the e-Q2B to work with the Federal Signal Rumbler Intersection Clearing System.



FEDERAL SIGNAL CORPORATION
Emergency Products

AR235 e-Q2B Electronic Siren \$2,308.95

Truck Mount Speaker

Rectangular speaker is perfect for truck mounting. Made to take the heavy and extended use of today's vehicle applications. Has black baked enamel finish on the driver and rectangular bell is black plastic.

Ship. wt. 10 lbs.

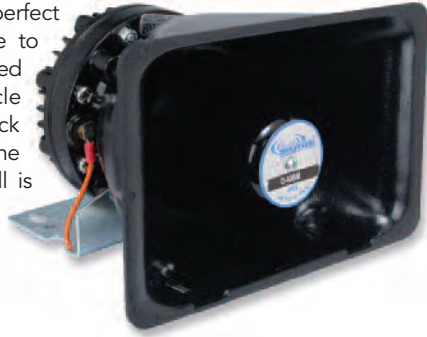

AB343 100-watt Truck Mount Speaker \$118.95

D-44 Cyclone 100 Watt Speaker

The new Cyclonic 100 watt speaker is an industry first using the advantages of cyclonic technology. This proven technology provides clear and crisp sound and have now been utilized for sirens. 100 watts of power produces a noticeable difference in sound output as the sound waves are pushed out in a cyclonic action created by the unique housing design.

- ▶ Cyclonic Expansion Chamber for clear and crisp sound
- ▶ Glass filled nylon housing
- ▶ Replaceable drive
- ▶ Universal two-piece adjustable bracket
- ▶ Only 3" deep fits into all applications
- ▶ Ship. wt. 7 lbs.



BH178 D-44 Cyclone 100 Watt Speaker \$175.95

Federal Signal 100-Watt Speaker

The 100-watt speaker uses advanced housing material and field replaceable neodymium drivers to provide effective, high-quality sound at an affordable price. The speaker only weighs 6 lbs. and measures 7.7"Wx5.7"Hx4.7"D. The speaker is easily rotated allowing for either vertical, or horizontal mount orientation, and the P.E.T. (polyethylene terephthalate) housing material is exceptionally strong, while resistant to heat, moisture and will not corrode as most metallic materials do.

Ship. wt. 6 lbs.



AW243 Federal Signal 100-Watt Speaker \$169.95

Neodymium Speaker



The Neodymium Speaker's advantage revolves around it's newly designed drier component. The element neodymium, and magnetic materials are combined to create a speaker package that is powerful, compact and affordable. This low-cost, compact design provides for added mounting location flexibility, and is compatible with all Federal Signal electronic siren amplifiers. Ship. wt. 4 lbs.

AW242 Neodymium Speaker \$178.95

Grille or Bumper Mounted Speaker

A high-visibility speaker. Has high-gloss electropolished bell housing made from drawn aluminum for strength and durability. Can be grille or bumper mounted. Ship. wt. 10 lbs.



AR236 100-watt Grille or Bumper Mounted Speaker \$198.95

DynaMax™ Compact Speaker

The slimmest 100-watt speaker on the market today, measuring just 5.5"H x 5.9"W x 2.7"D. The DynaMax™'s ultra-slim, lightweight (5 lbs.) design allows it to easily install in many locations on your emergency vehicle. This exceptionally durable speaker is fully encapsulated; no terminals are exposed. Solid aluminum construction incorporates the driver and projector into the housing allowing the unit to operate cooler and run more efficiently than conventional speakers. Black finish. Ship. wt. 5 lbs.

Just 2⁵/₈" wide



BG183 DynaMax™ Compact Speaker \$236.95

BG184 Universal Bail Bracket \$22.95

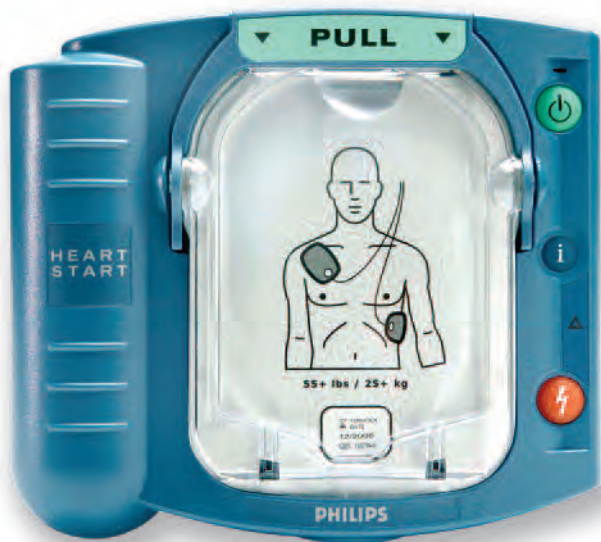

Ready When Needed

The OnSite has a long-life battery:

- ▶ 5-year shelf life plus 4-year installed life
- ▶ Same battery technology used with confidence in millions of cameras

Automatic self-test helps ensure continued readiness:

- ▶ Daily self-tests check electrical components, subsystems and battery
- ▶ Self-test also verifies that the pads cartridge is installed and in working order
- ▶ Blinking green "Ready" light means the OnSite has passed its last self-test, so you can be confident the defibrillator is ready for use

HeartStart OnSite Defibrillator

The First Defibrillator Available Without a Prescription to Commercial Users

Philips, the leader in portable defibrillation innovation, designed the HeartStart OnSite Defibrillator for the ordinary person in the extraordinary moment. The first commercial defibrillator without a prescription, the OnSite is designed to be the easiest to use and most reliable defibrillator available. The innovative technology, based on extensive research and user feedback, has produced a defibrillator so easy-to-use that you can potentially save the life of a coworker, friend, or anyone else stricken with sudden cardiac arrest. Weighing just 3.3 pounds, this small and lightweight defibrillator can be easily carried to the victim's side. Using clear, calm voice instructions, the OnSite Defibrillator guides you through each step of defibrillation, including CPR coaching. Integrated SMART pads placed on the victim's bare skin transmit information to the defibrillator, which senses and adapts to your actions every step of the way. HeartStart OnSite includes proven Philips technologies for heart rhythm assessment (SMART Analysis) and defibrillation energy delivery (SMART Biphasic). And like all HeartStart defibrillators, it can be used to treat infants and children as well as adults.

Easy-to-Use:

- ▶ Using the HeartStart Defibrillator is simple. Pulling the green handle activates the defibrillator and voice instructions. These instructions are paced to your actions, to help guide you through the entire process from placing each pad on the patient to delivering a defibrillation shock.

BG129 HeartStart OnSite Defibrillator

\$1,313.95

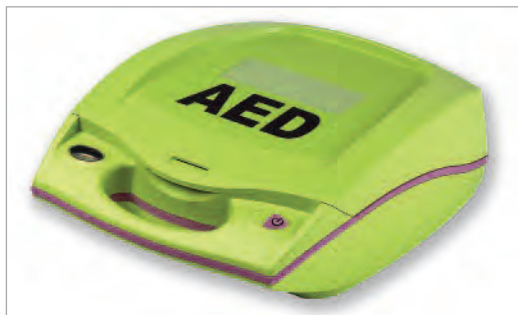

ZOLL® AED Plus® Defibrillator

The First and Only Full-Rescue AED

When a cardiac arrest occurs, the fact is that only half of the victims will need a shock. The other half require high-quality cardiopulmonary resuscitation (CPR). You deserve an automated defibrillator (AED) that helps you all the time, one that can actually see when you are doing CPR and provide help. You need more than just commands without assistance. That's not smart, and it's certainly not help. Only ZOLL's AED Plus® features Real CPR Help™, a tool that is able to actually see what you are doing and provide feedback to help you do it well. Audio and visual prompts help you rescue with confidence and clarity unmatched by any other AED. *Soft carrying case included.*

- ▶ **Not pushing hard enough?** It will tell you to push harder.
- ▶ **Pushing hard enough?** It will say, "Good compressions."
- ▶ **Not pushing fast enough?** A metronome will lead you to the right rate. It will even show you the depth of each compression. In real time.
- ▶ **Not yet started?** The AED Plus® will tell you again to get started.
- ▶ **Compressions stopped?** It will tell you to continue.



BH199

ZOLL® AED Plus® Defibrillator

\$1,649.95

Large EMS Duffle

Easily-accessible main compartment, ten inside pockets, four outside pockets and numerous elastic hold-downs. Removable padded insert to hold "D" sized oxygen tank.

- ▶ 1 - Oxygen cylinder "D" tank
- ▶ 1 - Regulator (left handed, 0-25LPM)
- ▶ 1 - Bag valve resuscitator (adult)
- ▶ 1 - Sodium chloride irrigation 500ml
- ▶ 1 - Airway kit
- ▶ 1 - Sphygmomanometer/stethoscope set (adult)
- ▶ 1 - Sphygmomanometer (pediatric)
- ▶ 1 - Utility scissors 5 1/2"
- ▶ 1 - Penlight flashlight
- ▶ 4 - Gloves
- ▶ 1 - Pair goggles
- ▶ 1 - Face mask - Earloop
- ▶ 3 - Non-rebreather O2 masks (adult)
- ▶ 2 - Non-rebreather O2 masks (pediatric)
- ▶ 3 - Nasal cannula (adult)
- ▶ 1 - Oxygen tubing
- ▶ 1 - Oral glucose tube
- ▶ 2 - Multi-trauma dressing
- ▶ 1 - Sterile burn sheet
- ▶ 6 - Combine dressing 5"x9"
- ▶ 15 - Gauze pads 4"x4"
- ▶ 10 - Gauze pads 2"x2"
- ▶ 2 - Vaseline dressing 4"x4"
- ▶ 60 - Bandages assorted (3/4"x3", 1" 3 5/8"x2 1/4")
- ▶ 6 - Roll gauze 3"
- ▶ 6 - Roll gauze 4"
- ▶ 1 - Tape 1"x10"yds. uncovered
- ▶ 1 - Tape 2"x10"yds. uncovered
- ▶ 1 - Tape 3"x10"yds. uncovered
- ▶ 3 - Triangle bandages
- ▶ 2 - Biohazard bags 10 gal.
- ▶ 3 - Instant cold packs 4"x5"
- ▶ 1 - Obstetrical kit
- ▶ 1 - Foil baby bunting
- ▶ 2 - Bulb syringe
- ▶ 1 - Rescue "Space Blanket"
- ▶ 3 - Disposable cuffed masks (adult)
- ▶ 2 - Disposable cuffed masks (child/sm. adult)
- ▶ 1 - Flashlight
- ▶ 1 - Elastic bandage 3"
- ▶ 1 - Elastic bandage 4"
- ▶ 1 - Pressure bandage super thick
- ▶ 1 - Pressure bandage 4"x4"



BH039	Large EMS Duffel with Supplies, Cylinder and Regulator	\$454.95
BH040	Large EMS Duffel with Supplies	\$296.95

Personal Trauma Bag

Padded carrying handle, sewn-in three compartment liner with padded bottom, Star of Life with space for you to personalize, bag bottom made of nylon reinforced waterproof vinyl, two end pockets with zipper closure, 22 elastic loops for small items, lime-yellow reflective trim, removable shoulder strap made of 2" webbing with shoulder pad. Dimensions: 8"Dx7"Hx18"L. 800 Denier water repellent polyester. *Weight 28 oz. Ship. wt. 2 lbs.*

COLOR: Navy

BE014	Personal Trauma Bag	\$37.95
-------	---------------------	---------



Large Urban Rescue Pack

A true rescue back pack with a wide variety of uses from the mountains, to air service, or a squad. Main compartment is fully padded with closed cell foam for protection. All internal pockets are held in a place by Velcro® and are removable. The back pack has a web carrying handle and padded contoured shoulder straps, chest strap and waist strap. A false back allows for storage of shoulder straps when not needed. The front outside has a zippered storage compartment 10"Wx15"Hx3"D. On each side is a removable pocket 5"Wx11"Hx2"D. 3M™ Scotchlite™ Reflective Material strips are sewn on three sides. Silk-screened with a white "Star of Life". Made of 1,000 denier Cordura® nylon with a #10 YKK heavy duty self repairing nylon zipper. The Black does not have a Star of Life or reflective trim. The main compartment flap has an 18" slot pocket and six attached clear vinyl compartments. Will hold a "C" or "D" size oxygen sleeve or may be rearranged without an oxygen tank.

BL054 Includes:

- ▶ BD069 - Initial Stock for Trauma Bag
- ▶ BL112 - Oxygen Bag Initial Stock
- ▶ Measures: 11"Wx20"Hx6" D
- ▶ Weight: 2.75 lbs. (bag only)

SPECIFY BAG COLOR: Navy, Orange, or Black

BL053	Large Urban Rescue Pack	\$343.95
BL054	Large Urban Rescue Pack with Supplies	\$668.95



Initial Stock for Trauma Bag

Prepackaged poly bag with all the supplies needed to initially stock trauma bags.

- ▶ 1 - Rescue shears
- ▶ 1 - Bandage shears
- ▶ 1 - Penlight with pupil gauge
- ▶ 1 - B/P cuff
- ▶ 1 - Stethoscope dual head
- ▶ 1 - Oral airway set
- ▶ 1 - 15 gram glucose
- ▶ 2 - Cold packs
- ▶ 2 - 1" tape (adhesive)
- ▶ 3 - 5"x9" combi pads
- ▶ 3 - 2" comforting gauge (sterile)
- ▶ 3 - 4" comforting gauge (sterile)
- ▶ 10 - 2"x2" gauze pads
- ▶ 1 - 4"x4" gauze pads
- ▶ 10 - 1" bandaids or assorted
- ▶ 5 - Pairs of gloves
- ▶ 1 - CPR mask
- ▶ 10 - Antiseptic towelettes
- ▶ 10 - Triple antibiotic wipes
- ▶ 10 - Alcohol preps
- ▶ 1 - Multi-trauma dressing
- ▶ 1 - Foil rescue blanket
- ▶ 4 - Triangular bandage
- ▶ 1 - Burn sheet
- ▶ 1 - Bite stick



BD069 Initial Stock for Trauma Bag \$136.95

Trauma Pac™

Trauma Pac™ offers the essential basic life support components for the first responder. The adjustable nylon webbing can fit 20" to 54" waists. Reflective trimmed pac measures 10"Lx6"Hx5"W.

- ▶ 1 - Triangular bandage
- ▶ 1 - 1" Adhesive tape
- ▶ 3 - 3" Sterile conforming bandages
- ▶ 8 - 4"x4" Sterile pads
- ▶ 2 - 5"x9" Abdominal pads
- ▶ 25 - 1"x3" Adhesive bandages
- ▶ 1 - 3" Elastic bandage
- ▶ 1 - Burn/blood stopper bandage
- ▶ 1 - CPR Lifeshield™
- ▶ 1 - Plastic bite stick
- ▶ 2 - 5"x9" instant ice packs
- ▶ 8 - Antimicrobial hand wipes
- ▶ 10 - Triple antibiotic ointments
- ▶ 4 - Ammonia inhalants
- ▶ 1 - Thermal rescue blanket
- ▶ 4 - Latex gloves
- ▶ 1 - Instrumental pack (4 1/2" splinter forcep, 5 1/2" bandage scissor, 5 1/2" St. Kelly forcep, deluxe shears, penlight, lifesaver belt cutter)



BG244 Trauma Pac™ (Specify Color: Orange or Navy) \$46.95

BG245 Trauma Pac™ Refill Kit \$28.95

Darley First Aid Kit

Keep It Anywhere - 25 Person

- ▶ 30 - Antiseptic wipes
- ▶ 6 - First Aid/burn cream packets, .9 gm
- ▶ 6 - Triple antibiotic ointment packets, .5 gm
- ▶ 1 - Bottle 4 oz. eye flush
- ▶ 2 - Eye pads w. strips
- ▶ 12 - Pain relief tablets
- ▶ 1 - Instant cold pack
- ▶ 1 - ea. 40" triangular bandage
- ▶ 1 - ea. 4" gauze bandage
- ▶ 4 - Fabric knuckle bandages
- ▶ 5 - Fabric fingertip bandages
- ▶ 60 - Plastic adhesive strips, 1"x3"
- ▶ 1 - First Aid Guide (ANSI 2009 version)
- ▶ 1 - Scissors
- ▶ 1 - Forceps
- ▶ 5 - Sterile gauze pads, 4"x4"
- ▶ 1 - Large wound pad
- ▶ 4 - Nitrile exam gloves
- ▶ 1 - Roll 1/2" x 5 yd. adhesive tape



AG100 Darley First Aid Kit \$20.95

Emergency Burn Kit

A complete burn kit, easily portable, for risk environments where burn injuries are possible. Dimensions: 12"L x 10"H x 3"D.

- ▶ 2 - Burn dressings 4"x4"
- ▶ 1 - Burn dressings 8"x8"
- ▶ 6 - Burn gel packs 1/8 oz.
- ▶ 3 - Roll gauze pads 4"x4 yds.
- ▶ 4 - Cold packs 4"x5"
- ▶ 4 - Gloves
- ▶ 1 - Cohesive bandage 3"x5 yds.
- ▶ 8 - Gauze pads 3"x3"
- ▶ 2 - Adhesive tapes 1"x5 yds.
- ▶ 1 - Paramedic Scissors



BK233 Emergency Burn Kit \$52.95

Oxygen Bag Initial Stock

Prepackaged poly bag with all the supplies needed to initially stock the oxygen bag.

- ▶ 1 - Oxygen regular (Brass) 0-15L constant flow
- ▶ 1 - Aluminum "D" oxygen tank with toggle handle
- ▶ 1 - Bag-valve-mask (adult)
- ▶ 2 - Adult-non-rebreather mask
- ▶ 3 - Pediatric non-rebreather mask
- ▶ 2 - Adult nasal cannula



BL112 Oxygen Bag Initial Stock \$315.95

BLS Case

Outfitted with everything required for basic life support. Main compartment has four clear color-coded zippered pouches and flat storage area to hold paperwork and/or flat supplies. Five outside zippered pockets. *Dimensions: 13 1/2"L x 15"H x 11"D.*

- ▶ 2 - Combine pads 5"x9"
- ▶ 10 - Gauze pads 4"x4"
- ▶ 8 - Gauze pads 3"x3"
- ▶ 15 - Gauze pads 2"x2"
- ▶ 4 - Roll gauze pads 4"x4" yds.
- ▶ 4 - Roll gauze pads 2"x2" yds.
- ▶ 20 - Alcohol prep pads
- ▶ 1 - Sodium chloride irrigation solution 500 ml.
- ▶ 1 - Pocket CPR mask non-rebreather
- ▶ 1 - Facemask w/shield
- ▶ 1 - N95 particulate mask
- ▶ 1 - Tweezers
- ▶ 2 - Bio-Waste bags
- ▶ 1 - Paramedic shears
- ▶ 1 - Utility scissors 5"x5"
- ▶ 1 - Safety glasses
- ▶ 2 - Vaseline dressings 4"x4"
- ▶ 2 - Burn dressings 4"x4"
- ▶ 1 - Sterile burn sheet
- ▶ 2 - Multi-Trauma dressings
- ▶ 1 - Redi-spilt
- ▶ 1 - Sam® Splint Junior
- ▶ 1 - Foil Baby Bunting
- ▶ 1 - Bulb syringe
- ▶ 1 - Triple antibiotic ointment 1oz.
- ▶ 1 - Providone iodine ointment 1oz.
- ▶ 1 - Hydrogen Peroxide 16oz.
- ▶ 1 - Oral glucose
- ▶ 4 - Gloves
- ▶ 2 - Cold packs
- ▶ 1 - BP Cuff/Scope combo
- ▶ 4 - Eye wash 1 oz.
- ▶ 1 - Transparent Surgical tape - 1"x10 yds.
- ▶ 1 - Transparent Surgical tape - 2"x10 yds.
- ▶ 10 - Adhesive bandages - 1"x3"
- ▶ 5 - Adhesive bandages - 3/4"x3"
- ▶ 5 - Adhesive bandages - 2"x4 1/2"
- ▶ 5 - Adhesive bandages knuckle
- ▶ 5 - Adhesive bandages fingertip
- ▶ 5 - Adhesive bandages butterfly
- ▶ 2 - Triangular bandages
- ▶ 2 - Elastic bandages 3"
- ▶ 1 - Flashlight LED
- ▶ 1 - Penlight flashlight



BK231	BLS Case	\$92.95
BK232	BLS Case with Supplies	\$279.95

Completely Stocked Trauma Bag

Cordura® Trauma Bag features all the first aid supplies you'll need. Large main compartment divided into three sections along with a roomy front pocket plus two zippered side pockets. *Dimensions: 20 1/4"L x 7"H x 11 1/2"D.*

- ▶ **Topicals:**
- ▶ 10 - Alcohol wipes
- ▶ 10 - Benzalkonium chloride Towelettes
- ▶ 1 - 4 oz. eyewash
- ▶ 10 - Iodine swab sticks
- ▶ 10 - Triple-Antibiotic ointment
- ▶ 10 - Vionex® wipes & dry towelettes
- ▶ 5 - Water-Jel® Burn Jel®
- ▶ **Gauze & Tapes:**
- ▶ 6 - Eye pads
- ▶ 4 - Combine pads-5"x9"
- ▶ 10 - Gauze pads-2"x2"
- ▶ 10 - Gauze pads-3"x3"
- ▶ 10 - Gauze pads-4"x4"
- ▶ 2 - Tapes 1"-2"x5yds.
- ▶ 1 - Trauma dressing-10"x30"
- ▶ **Bandages:**
- ▶ 4 - Conforming bandages - 2"x4yds.
- ▶ 2 - Conforming bandages-3"x4yds.
- ▶ 4 - Conforming bandages-4"x4yds.
- ▶ 1 - Elastic bandage-3"x5yds.
- ▶ 100 - Plastic bandages -3/4"x3"
- ▶ 2 - Triangular bandages - 40"x40"
- ▶ **Tools & Misc:**
- ▶ 2 - Bio-Waste bags (1 gallon, 11"x14")
- ▶ 1 - Rescue Space® blanket 56"x84"
- ▶ 10 - Cotton applicator 6" 2pk.
- ▶ 2 - Disposable cold packs
- ▶ 1 - Blood pressure cuff
- ▶ 1 - Water-Jel® Burn dressing 4"x4"
- ▶ 1 - Airway (6 sizes)
- ▶ 10 - Ammonia inhalants
- ▶ 1 - CPR Microshield®
- ▶ 1 - Bulb syringe
- ▶ 8 - Gloves
- ▶ 1 - Penlight
- ▶ 1 - Bite stick
- ▶ 1 - Sam® splint
- ▶ 1 - Paramedic scissors
- ▶ 1 - Splinter forceps
- ▶ 1 - Stethoscope,
- ▶ 3 - Thermometers
- ▶ 1 - Glucose (15gm)
- ▶ 1 - Poison antidote kit



AM253	Trauma Bag Only	\$69.95
AM254	Stocked Trauma Bag	\$209.95

Medic Kit

Case is rust-proof, dent-proof, and chemical resistant. *Dimensions: 16 1/2"L x 8 3/4"H x 7 1/2"D.*

- ▶ 1 - Bandages assorted, 60/bx
- ▶ 2 - Burn dressings 4"x4"
- ▶ 1 - Cohesive bandage 3"x5 yds.
- ▶ 4 - Cold packs 5"x6", disposable
- ▶ 10 - Gauze pads, sterile 2"x2"
- ▶ 10 - Gauze pads, sterile 4"x4"
- ▶ 2 - Rescue blankets 56"x84"
- ▶ 3 - Triangular bandages 40"x40"
- ▶ 4 - Eye pads, medium
- ▶ 1 - Eyewash 4oz.
- ▶ 10 - Gloves, vinyl
- ▶ 1 - Hydrogen peroxide
- ▶ 1 - Scissors, paramedic
- ▶ 1 - CPR Microshield®
- ▶ 1 - Tape 1"x10 yds.
- ▶ 1 - Tape 1/2"x10 yds. Uncovered
- ▶ 25 - BZK towelettes
- ▶ 2 - Pressure bandages
- ▶ 1 - Splinter forceps (Tweezers)
- ▶ 4 - Roll Gauze 4"x4 yds.
- ▶ 1 - Triple antibiotic ointment 1oz.



AZ430	Medic Kit	\$138.95
-------	-----------	----------

Derma-Lite™ Nitrile Gloves

Durability & Puncture Resistance

The smart choice to protect today's EMS professionals from bloodborne pathogens. Three times as puncture/tear resistant as natural rubber latex gloves of the same thickness. The great feel and contour shape hug your hand for maximum comfort yet they're thin enough to let you get an accurate pulse; plus micro texture gives you a better grip. Other features include ambidextrous fit, non-sterile and your choice of lightly powdered or powder free. *Sold in box of 100.*

Ship. wt. 2 lbs.

- ▶ 5 mil.
- ▶ Powder or powder-free
- ▶ Rolled cuff
- ▶ Latex-free

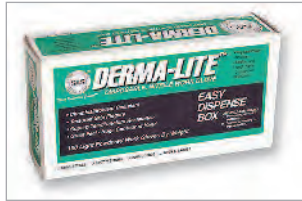

SPECIFY SIZE: Large or XLarge

AR195	Derma-Lite™ Gloves, Lightly Powdered	\$11.95/box
AR196	Derma-Lite™ Gloves, Powder Free	\$12.95/box

Oxygen Case

Designed for an ambulance company to provide extra protection for regulator. 1/2" foam padding, four inside pockets for tubing and supplies. Holds a D-sized tank. Imported. 1000D nylon in green. *Dimensions: 21 1/2" L x 8" D.*

- ▶ 1 - Oxygen cylinder D-sized tank w/toggle
- ▶ 1 - Oxygen brass regulator 0-25 LPM left handed
- ▶ 2 - Non-rebreather masks - adult
- ▶ 1 - Non-rebreather mask - pediatric
- ▶ 2 - Nasal cannula - adult
- ▶ 2 - Oxygen tubing supply
- ▶ 4 - Gloves (latex/vinyl)



BB080	Oxygen Case	\$27.95
BB081	Oxygen Case with Supplies	\$239.95

Emergency Oxygen

A durable emergency oxygen system packaged in an attractive and molded attach-type case. The system comes filled and ready-to-use. When full, the unit will deliver over 1 hour of emergency oxygen for use between the time of an incident that involves respiratory difficulty and the arrival of professionally trained personnel. Includes 0-15 liters per minute adjustable flow regulator. Unit is refillable for maximum economy. *Ship. wt. 10 lbs.*



U268	Emergency Oxygen	\$294.95
------	------------------	----------

LIFE® OxygenPac Emergency Oxygen Unit

- ▶ **Simple and easy to use:** External 2-step instructions and clear cover
- ▶ **Inhalator:** Administer supplemental oxygen for a breathing victim
- ▶ **Resuscitator:** Oxygen enriched mouth-to-mask CPR for a non-breathing victim
- ▶ Easily portable with convenient handle
- ▶ 20"x6"x9" - 16 lbs. - aluminum cylinder
- ▶ Wall mount for recognition and accessibility, always available on display for easy access
- ▶ Simple "On-Off" control lever
- ▶ Constant reading supply gauge
- ▶ 90 min. supply @ 6 lpm - 566 liters Oxygen
- ▶ Resuscitation LIFE® CPR Mask with one-way valve fits both adult and child
- ▶ Cylinder is easily disposable/replaceable
- ▶ Tight seal protects unit from dust and moisture
- ▶ Units come ready-to-use full of Oxygen with wall brackets and screws
- ▶ 5 year warranty



BL368	LIFE® OxygenPac Emergency Oxygen Unit	\$424.95
BL370	LIFE® OxygenPac Spare Cylinder	\$184.95

CPR Micromask™

Includes one pair of Nitrile gloves and single use, disposable Micromask™ featuring one-way, replaceable filtered valve and adjustable cushion for proper seal on adults, children or infants. Packaged in blue nylon, zippered pouch convenient to carry on your belt. *Ship. wt. 1 lb.*



AK238	CPR Micromask™	\$14.95
-------	----------------	---------

Mini-Pouch CPR Kit Take It Anywhere You Go

Ensures that emergency personnel always have CPR shield within reach. *Color: Orange. Ship. wt. 1 lb.*

Includes:

- ▶ CPRotector
- ▶ 2 - Latex gloves
- ▶ 1 - Antiseptic towelette
- ▶ Convenient carrying pouch complete with key ring, belt loops and front pocket



AF286	Mini-Pouch CPR Kit	\$7.95
-------	--------------------	--------

A. Plastic Backboard

Rugged, one-piece, lightweight polyethylene spineboard with twelve large handholds for easy handling, built-in runners, low profile and X-ray translucent. *Bright yellow. Dimensions: 72" L x 16" W. Load capacity: 400 lbs. Ship. wt. 20 lbs.*

AR226 Plastic Backboard

\$161.95

One-piece polyethylene

B. X-Ray Translucent Backboards

Pro-Tech Gel Pads can be easily added for additional support and patient comfort at an additional charge. *Dimensions: 72" L x 16" W at head and 14" at foot, 1 3/4" thick.*

- ▶ Improved patient immobilization
- ▶ 1/4" raised head-end maintains cervical spinal canal
- ▶ Pediatric and adult compatible
- ▶ 100% X-Ray translucent
- ▶ 650 lb. capacity
- ▶ Weighs only 14 lbs.

SPECIFY COLOR: Orange, Red, Green, Blue, Lime, or Yellow

BK275	Backboard 650 lbs. without Pins	\$129.95
BK276	Backboard 650 lbs. with Pins	\$139.95
BH134	Full Body Pro-Tech Gel Pad	\$106.95
BH136	Torso Pro-Tech Gel Pad	\$72.95

C. Scoop Stretcher

- ▶ Thermally-treated polymer construction does not get too hot or cold
- ▶ Ergonomic ease of use
- ▶ X-ray translucent
- ▶ Twin safety lock for smooth and non-binding locking and unlocking
- ▶ Narrow foot-end frame
- ▶ Head section recessed to maintain proper cervical alignment
- ▶ Four length options accommodate patients of different heights: 65", 70", 74", and 79"
- ▶ Easy-to-clean surface is impervious to fluids
- ▶ Folds to 47" for compact storage
- ▶ Includes three burgundy restraints

BD171	Scoop Stretcher	\$804.95
BD172	Storage Case	\$61.95

D. Traverse Titan Rescue Stretcher

The top rail of the Titan Rescue Stretcher is a full 1" diameter making the stretcher easier to handle when carried for extended periods. Durathene netting eliminates cuts and scrapes caused by broken wire. Back support is molded High Density Polyethylene for greater durability. Steep-sided design allows a narrower stretcher with the same width at the bed which will accept standard sized back boards. Narrow width and rounded ends provide greater maneuverability in tight locations. *Comes with four stretcher straps. Material: Stainless steel. Dimensions: 83" L x 23" W. Load rating: 2,500 lbs. Ship. wt. 31 lbs.*

BC039	Rescue Stretcher (Tapered Shape)	\$632.95
BC040	Rescue Stretcher (Rectangular Shape)	\$632.95

E. Plastic Stretcher - Ideal For Rugged Rescue Situations

Yellow high-density polyethylene shell, supported by a stainless steel outer rail, permanently attached with stainless steel semi-tubular rivets. Features molded runners, fully exposed outer rail, non-absorbent foam pad secured to stretcher and four patient restraint straps. Measures 84 1/2" x 24" x 7 1/2" and has a load capacity of 1200 lbs. *Ship. wt. 31 lbs.*

AF742 Plastic Stretcher

\$614.95

F. Evacuation Chair

Designed for use in confined areas. 2" standard automotive-style patient restraint straps included. Green vinyl covers are made of 18 oz. antibacterial material and are fungus and rot-resistant for long-lasting durability and also easy cleanup. *Dimensions: 35 1/4" H x 18 1/8" W x 22 3/8" D; 8" folded. Ship. wt. 20 lbs.*

BB082	Evacuation Chair	\$712.95
BB083	Evacuation Chair with Extended Handles	\$824.95
BB084	Evacuation Chair with Four Wheels	\$783.95



Splint Stretchers

Standard Splint Stretcher

Nylon web straps at chest, abdomen, thigh, and calf. Adjustable foot rests for vertical lifting. Frame is $\frac{5}{8}$ " steel tubing; cross braces and runners $\frac{3}{16}$ "x $\frac{3}{4}$ " flat steel. Basket is 18 gauge. 1" hexagon steel mesh netting.

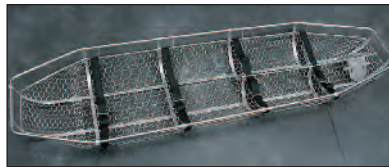

Break-Away Splint Stretcher

The stretcher breaks into two halves which can be back-packed to the point of rescue and assembled in seconds. It can be secured to a standard back-pack for carrying. Three positive lock clasps secure two halves together. Four 60" web straps are standard. Stores in space 44"x12"x24".



Stretcher Bridle Sling

The Stretcher Bridle Sling provides vertical or horizontal lifting capacity of up to 2,000 lbs. Made of 1" nylon webbing resistant to moisture and fungus rot with forged snap hooks and 3" ID forged steel suspension ring. *Ship. wt. 5 lbs.*

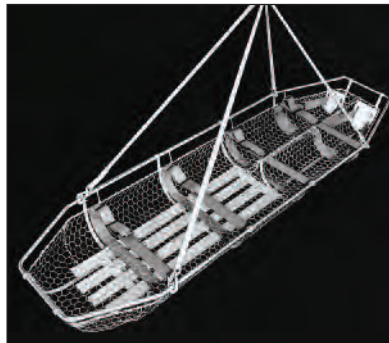

AW207	Standard Splint Stretcher	\$271.95
AW208	Break-Away Splint Stretcher	\$598.95
AF743	Stretcher Bridle Sling	\$113.95
AW209	Disposable Pillow	\$10.95

Easy-Fold Aluminum Stretcher

This Medical Corps type litter/stretcher is made with light-weight aluminum poles, and shaped hardwood handles. The cover is durable 18 oz. vinyl coated nylon. Patient restraint straps and replacement cover is available *Dimensions: Open: 87"Lx22" W 4 $\frac{1}{2}$ "H, Folded: 43 $\frac{1}{2}$ "Lx22"Wx3 $\frac{1}{2}$ "H. Ship. wt. 14 lbs.*

AR225	Easy-Fold Stretcher	\$213.95
-------	---------------------	----------



Immobile-Vac Extremity Splint Set

The Immobile-Vac system provides a rigid splint by removing the air from the splint, allowing it to conform to the exact position of the limb. Vinyl-coated polyester material easily deflates with a hand-held vacuum pump (included) and one valve evacuates the entire unit.

Leg Splint offers adjustable, removable and quick-buckle straps cutting splinting time down. **Arm Splint** forms around the arm without exerting external pressure. Includes hand pump, leg splint, arm splint, adapter and carrying case. *Ship. wt. 10 lbs.*



AK240	Immobile-Vac Extremity Splint Set	\$415.95
-------	-----------------------------------	----------

Nylon Safety Belts

For controlling movement of a person in a bed, wheelchair or stretcher. Your choice of one or two-piece safety belt. Easy to clean. *Ship. wt. 1 lb.*



COLOR: Black

J279	One-Piece Safety Belt, 72"	\$15.95
AJ029	Two-Piece Rail Safety Belt, 60"	\$15.95

Universal™ Head Immobilizer



Simple to use, lightweight and easy to clean. Composed of two plastic-coated, closed cell foam head supports, a universal attachment base and two durable head straps. Base plate fits all Ferno wooden, aluminum and plastic backboards. Head supports can be used on standard backboards, or turned around for use on the Scoop Stretcher.

BE015	Universal™ Head Immobilizer	\$139.95
-------	-----------------------------	----------

KED™ Kendrick Extrication Device

For extricating patients from auto accidents and confined spaces. Immobilizes head, neck and torso while minimizing further injury. New color-coded straps for visibility. Wraparound design provides horizontal flexibility for application and vertical rigidity for support. Three handles sewn in. Can be inverted as hip splint; adapts for children and pregnant women. Includes wraparound vest, Adjusta-Pad™, neck roll, two head straps and carrying case. Case is vinyl-coated nylon, large enough to carry extrication collars. Stores rolled for immediate use. Size (flat) 32 $\frac{5}{8}$ " long, 31 $\frac{1}{2}$ " wide, 1" thick. *Capacity 500 lbs. Ship. wt. 8 lbs.*



X638	KED™ Kendrick Extrication Device	\$148.95
------	----------------------------------	----------

Nomex® Safety Blanket

Use in an emergency to help protect against flames, treat shock or to smother flames on clothing. The flame-resistant fiber is acid resistant and also high temperature resistant. Measures 60"x80". *Ship. wt. 10 lbs.*

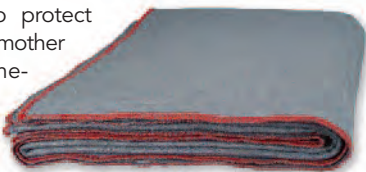

AJ075 Nomex® Safety Blanket \$61.95

Flame Resistant Wool Blanket

An ideal emergency blanket for every rescue vehicle. Made of 80% wool and can be cleaned. Measures 66"x84". Color: maroon. *Ship. wt. 4 lbs.*



BK006 Flame Resistant Wool Blanket \$34.95

Disposable Emergency Blanket

Used by emergency services nationwide to help keep patients warm and dry. Provides insulation to retain body heat while protecting from cold or wet weather. Individually wrapped in a poly bag, keeping it clean and ready to use at any time. Made of laminated urethane foam. Measures 54"x80". *Ship. wt. 1 lb.*



AK242 Disposable Blanket \$5.95/ea.

Water-Jel Fire Blanket

A one-step system for Emergency First Aid on a burn victim. It puts out the fire, stops burn progression and cools the skin, eases pain, and protects against airborne contamination. Water-Jel Fire Blankets consist of a scientifically formulated cooling gel and a special carrier. The 100% worsted wool blanket is soaked in a water-based/water-soluble, bacteriostatic and biodegradable gel. The full size blanket adequately covers a patient or can be used to douse a fire or dangerous white phosphorous. *Dimensions: 5'x6'. Shelf life: 5 years. Ship. wt. 21 lbs.*



AA714 Water-Jel Fire Blanket \$169.95

Water-Jel Burn Wrap

Smallest and most versatile of the blankets, it is ideal for covering torso, leg, or entire back injuries. *Dimensions: 3'x2½'. Shelf life: 5 years. Ship. wt. 10 lbs.*



X856 Water-Jel Burn Wrap \$75.95

Water Rescue Manikins

These adult and adolescent models are made of durable vinyl plastic with rust-resistant skeletons, articulated joints, and optional CPR capabilities. When filled with water, the manikin will submerge to the neck. Add an additional 5-10 pound weight to sink.



BA114 Adult Water Rescue Training Manikin \$674.95

BA115 Adult Water Rescue Training Manikin and CPR \$884.95

Rescue Randy™



Randy's fully articulated body duplicates the weight and resiliency of a human body and can be positioned for realistic patient handling or extrication in situations too hazardous or uncomfortable for volunteer victims. His rugged construction means years of use in any rescue training environment from poletop retrieval to tunnel or confined space rescue, automobile extrication, firefighter's carry practice, smoke-filled buildings etc. Available in several weight sizes. *Clothing not included. Ship. wt. 125 - 185 lbs.*

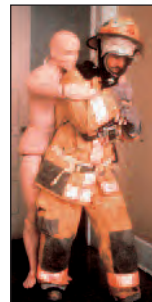

AC057 Rescue Randy™, 105 lbs. \$903.95

AL246 Rescue Rudy™, African American, 105 lbs. \$859.95

AC058 Rescue Randy™, 145 lbs. \$1,071.95

AL247 Rescue Rudy™, African American, 145 lbs. \$1,071.95

AC059 Rescue Randy™, 165 lbs. \$1,222.95

AL248 Rescue Rudy™, African American, 165 lbs. \$1,213.95

AS369 Rescue Randy™ Combat Challenge, 165 lbs. \$1,222.95

AS370 I.A.F.F. Rescue Randy™ with Additional Reinforcement, 165 lbs. \$1,282.95

8" x 18" Burn Dressing

The largest burn dressing - excellent to cover sizeable areas such as the thigh, shoulder, or back area. Large enough to wrap around the bottom portion of the leg or the thorax area. *Gel-soaked, sterile, and foil-packed. Shelf life: 5 years. Ship. wt. 3 lbs.*



X857 8"x18" Burn Dressing \$14.95



Boots not included



Interceptor® Level A Deluxe Suit

Interceptor® is the apex of Lakeland Industries' chemical protective clothing line. There is an Interceptor® suit for your needs; gas, vapor, aerosol, liquid or particulate protection. Interceptor® offers dependable protection, superior performance and patented garment features that have been proven over a broad range of chemical challenges in a wide range of environments. Available in encapsulating and non-encapsulating configurations.

- ▶ Patented ShurSeal Teflon® visor process permanently seals the visor into the suit with no sewing involved so that liquids can't penetrate the visor edge
- ▶ Teflon® outer layer on visor prevents impairment of vision due to chemical contact
- ▶ Seams sealed inside and out for maximum protection



SPECIFY SIZE: S-XXL

		S-XL	XXL
BL067	Interceptor® Level A Deluxe Wide-View Suit	\$952.95	\$999.95
BL068	Interceptor® Level A Deluxe Suit	\$889.95	\$933.95

ChemMAX® 3 Coverall

Ideal for the industrial environment as well as emergency responders and law enforcement, ChemMAX® 3 uses the latest technology to produce a superior product. Durable and lightweight, ChemMAX® 3 provides a barrier against a broad spectrum of toxic industrial chemicals, dual use chemicals, chemical warfare agents and other harmful contaminants. The multi-layer film is applied to a heavy polypropylene non-woven for increased strength and durability. The barrier film is significantly softer than other products on the market, resulting in a quiet, more comfortable garment. Put your trust in a ChemMAX® 3 garment and you will feel confident that you are doing your best to protect your team from the dangers lurking around them.



SPECIFY SIZE: S-XXL

		S-XL	XXL
BL069	ChemMAX® 3 Coverall	\$54.95	\$56.95

ChemMAX® 4

Heavy Duty Chemical Splash Protection that is High in Performance and Comfort!

This line of high performance chemical protection can be used in work environments where hazardous or non-hazardous contaminants may be present. ChemMAX® 4 is at the top of the ChemMAX® line of clothing. ChemMAX® 4 features a 6 layer protective barrier that will stand up to the toughest of hazardous chemical environments.



SPECIFY COLOR: Yellow, Tan or Dark Green

SPECIFY SIZE: S-XXL

		S-XL	XXL
BL070	ChemMAX® 4 Coverall	\$80.95	\$84.95
BL071	ChemMAX® 4 Encapsulated Suit	\$195.95	\$205.95

Zytron® 500 Totally Encapsulating Suit

Zytron® 500 is top of the class - and the classic responder choice for hazmat and other demanding situations. It's tough, built for mobility, and based on patented technology that created the first material to survive eight full hours against the ASTM F1001 Test Battery with no breakthrough. With that kind of Kappler heritage built into the fabric, it's no wonder that responders around the world trust Z500 garments for ultra-demanding applications.

Features:

- Double-taped seams
- Large, expanded-view face shield of 40 mil PVC
- Easy-to-reach 48" (122 cm) gas-tight PVC zipper, with double storm flap and hook-and-loop closure
- Two covered one-way exhaust valves
- Attached sock boots with boot flaps for added protection
- BL103 - Glove system includes field replaceable Butyl gloves
- Roomy tapered sleeves and ergonomic garment design

SPECIFY COLOR: Orange or Charcoal
SPECIFY SIZE: S-XXXL

		S-XL	2XL-3XL
BL102	Zytron® 500 Totally Encapsulating Level B Suit Rear Entry	\$316.95	\$347.95
BL103	Zytron® 500 NFPA 1994/2007 Edition Class 2 Certified Totally Encapsulating Suit Front Entry	\$1,161.95	\$1,278.95

Tychem® Encapsulated Suit

Inner Suit:

- ▶ Double taped seams
- ▶ Three layer EX faceshield (PVC 40 mil/Teflon® 5 mil/PVC 20 mil)
- ▶ Gas-tight zipper closure
- ▶ Double storm flaps
- ▶ Four exhaust valves
- ▶ Expanded back
- ▶ Attached three layer gloves (Neoprene/EVOH film/KEVLAR® knit)
- ▶ Attached sock boots
- ▶ Outer boot flaps

Outer Suit:

- ▶ Aluminized fiberglass
- ▶ Sewn NOMEX® seams
- ▶ EX faceshield (Lexan® 20 mil)
- ▶ Hemmed wrists
- ▶ Velcro® closure
- ▶ Storm flap
- ▶ Four exhaust vents
- ▶ Expanded back

Flashover protection

DuPont®
Tychem®

SPECIFY SIZE: M-XL

BK011	Tychem® TK Front Entry Encapsulated Suit	\$2,234.95
BK030	Tychem® TK Rear Entry Encapsulated Suit	\$2,234.95

ONESuit® Flash Hazmat Suit

The Only Single-Skin Ensemble Certified to NFPA 1991 Including Flash Fire Protection

ONESuit® Flash is designed to meet the real-world needs of those who work in the most dangerous environments. Our decades of experience in advanced fabric technology, combined with input from people who actually wear hazmat suits, enabled us to create this lightweight, single-skin protective garment that protects the wearer from chemical/vapor form. ONESuit® Flash provides an additional level of protection against chemical fires.

- ▶ NFPA 1991 (2005 ed.) certified - highest level of protection: flash fire, liquefied gas
- ▶ Maximum protection against C/B agents
- ▶ No overcover
- ▶ Lightweight design for remarkable user comfort
- ▶ Life cycle twice that of other suits, no shelf life
- ▶ Reusable and decontaminable
- ▶ Detachable secondary visor
- ▶ Internal belting system
- ▶ Knee reinforcements and integral booties
- ▶ Includes ONEGlove® Hazmat Glove (BG531 - see pg. 213)



SPECIFY SIZE: S-XXXL

BG530	ONESuit® Flash Hazmat Suit	\$2,779.95
-------	----------------------------	------------

Boots not included



Boots not included



HAZMAT

Universal Pressure Test Kit

The Universal Pressure Test Kit is designed for periodic air pressure testing on all Level A fully encapsulated suits. This compact, lightweight kit is completely self-contained, requiring no external air supply. *Ship. wt. 10 lbs.*



BL073 Universal Pressure Test Kit \$1,788.95

ChemMAX® 2 Encapsulated Suit

Introducing ChemMAX® 2! Offering quality, value, durability and the proven protection of Dow Saranex® 23P barrier film.

ChemMAX® 2 is the second level of barrier protection in the new ChemMAX® line of products from Lakeland Industries. ChemMax® 2 is a superior and economical chemical protective suit developed using the knowledge and expertise that you have come to expect from Lakeland. The unparalleled strength and softness of ChemMAX® 2 features Dow Saranex® 23P film on two layers of a unique bi-component spunbond nonwoven substrate and provides protection for chemical mixing and handling, environmental clean up, hazardous materials remediation and response, pharmaceutical manufacturing, spray painting and general industry.



SPECIFY SIZE: S-XXL
 BL072 ChemMAX® 2 Encapsulated Suit \$98.95/Case of 3 \$103.95/Case of 3

Personal Protective Equipment Drying Stand

Designed for Chemical Suits or Wet and Dry Dive Gear

- ▶ Tough epoxy powder coat finish
- ▶ Naturally air dries suits and gear
- ▶ Durable steel construction
- ▶ Accepts all suit styles and sizes
- ▶ Corrosion-resistant
- ▶ Economically priced



BC097 Personal Protective Equipment Drying Stand \$154.95

HAZMAT



Pyrolon® CRFR Coveralls

Pyrolon® CRFR protective wear...they're unique, disposable, chemical resistant and flame retardant, meeting NFPA 2113 requirements. Pyrolon® CRFR garments bar contaminating flammable substances like paint, oil, grease, hazardous liquids, and dry particulates from penetrating inner clothing. *Designed to be worn over woven thermally protective coveralls, such as woven Nomex®, for environments where flash fire is a concern.*

- ▶ Light chemical splash protection
- ▶ Meets NFPA 2113 requirements
- ▶ Self extinguishing
- ▶ Won't melt or drip



Cat#	Description	S-XL	XXL
BH150	Pyrolon® Coverall w/Attached Elastic Face, Wrists & Ankles	\$37.95	\$39.95
BH151	Pyrolon® Coverall w/Attached Hood, Elastic Face, Wrists and Attached Boots	\$47.95	\$49.95

Silver Shield/4H Gloves

North uses a five-layer technology compacted into 2.7 millimeters in its Silver Shield/4H glove. Each layer acts as a barrier against various epoxies and industrial chemicals, together safeguarding against over 280 chemicals. This superior protection makes the gloves ideal for emergency response and hazmat clean up. Additionally, for applications where cuts, punctures, or abrasions can occur, the Silver Shield/ 4H can be used as a permeation-resistant liner under a protective glove. *Ship. wt. 1 lb.*



SPECIFY SIZE: S-L

AS088 Silver Shield/4H Gloves

\$6.95

Nitrile Rubber Gloves

Gloves are 15 mil. thick Nitrile Rubber (unsupported). Gloves offer excellent resistance to most solvents, acids, animal fats and alcohols. Measures 13" long, unlined. Comes in Green color. Sold per dozen. *Ship. wt. 1 lb.*

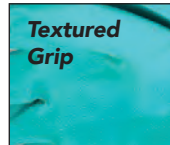

SPECIFY SIZE: S-XXL

AM033 Nitrile Gloves

\$18.95/dz.

Guardian Neoprene Gloves

When you work with dangerous chemicals, you want your glove to protect exactly as promised, with uncompromising consistency. You want a glove to be comfortable and rugged with total performance features. The Guardian is all of this plus it's fire retardant. It's made with painstaking precision and each glove is "solution dipped" for maximum chemical impermeability. Manufactured to the NFPA 1992 Splash Garment Specifications Level "B". When worn over the Silver Shield gloves, they meet the NFPA 1991 Standard on Vapor Protective Suit for Hazardous Chemicals Level "A". *Ship. wt. 1 lb.*

▶ 14" long

▶ Extra long gauntlet



SPECIFY SIZE: S-L

AC970 Guardian Neoprene Gloves

\$39.95/pr.

ONEGlove® Hazmat Gloves

OneGlove® is the revolutionary protective glove that combines incredible dexterity with superior protection against cuts and punctures, chemical/biological agents, industrial solvents and chemicals, and flash fires. Our decades of experience on the leading edge of fabric technology enabled us to create a lightweight, one-piece hazmat glove that's easy to put on and take off, works with virtually all protective suits, and is so flexible that carrying out manual tasks is much easier than with standard multi-glove systems.

- ▶ Certified to NFPA 1991, 2005 edition; NFPA 1992, 2005 edition; and NFPA 1994, 2007 edition
- ▶ Universal cuff
- ▶ Outstanding dexterity compared to multi-glove systems
- ▶ Integrated construction for comfort and safety
- ▶ Superior protection from hazardous materials
- ▶ Universal suit compatibility
- ▶ Water resistant cut and puncture resistant
- ▶ CHALLENGE® Chemical Protective Barrier
- ▶ Moisture Management made from Nomex®



SPECIFY SIZE: S-XXL

BG531 ONEGlove® Hazmat Gloves

\$155.95

HAZMAT



HazProof® Boots

With the growing reality that chemical warfare agents are now a threat to the civilian population, domestic preparedness programs are developing rapidly. The HazProof® boot, made of special polymer material, has also been tested to Military Standard 282 and will provide protection against certain chemical warfare blister and nerve agents! Certified to NFPA 1991, 2005 Edition for chemical and hazmat cleanup, emergency response, and domestic preparedness.

- ▶ Injection molded seamless construction for 100% liquid proof protection
- ▶ Larger foot area is engineered to accommodate the extra bulk of an encapsulated suit, for comfortable fit
- ▶ Smooth exterior surface for easy decontamination
- ▶ Stretch fastener closure system allows for easy on/off while wearing gloves
- ▶ Meets ANSI spec. Z41 PT99 M I/75 C/75 EH, for steel toe impact and compression, and electrical protection
- ▶ Steel mid-sole meets and exceed ANSI Z41 PT 99 PR
- ▶ Steel shank provides firm arch support
- ▶ Blown closed cell EVA mid-sole for all day cushion comfort
- ▶ Sure grip cleated outsole has excellent abrasion and slip resistance
- ▶ Bright orange color for high visibility

TINGLEY
A TRADITION SINCE 1888

SPECIFY SIZE: 7-13

BH108 HazProof® Boots

\$85.95



HAZMAX® Boots

The Finest Boot Made for Hazardous Materials Handling

AW038:

- ▶ Steel toe, steel shank, & steel midsole for complete protection
- ▶ One-piece injection molded construction, eliminates seams

BD023:

- ▶ One-piece injection molded
- ▶ Excellent slip resistance
- ▶ Steel toe, shank, and midsole



SPECIFY SIZE: Mens 6-15

AW038 16" Over The Sock Boots

\$96.95

BD023 11" EZ Fit Boots

\$95.95



Isotherm® Cool Vest

Bullard's revolutionary Isotherm® technology offers unparalleled cooling power, helping to reduce the chance of heat-related illnesses that sometimes occur in today's difficult work environments. Specially engineered to maintain a constant 55°F, the vest will provide cooling for approximately two and a half hours. Uses an interchangeable front/back cool pack system and is fully adjustable. Comes in dark blue in a large size only. *Ship. wt. 2 lbs.*

Bullard

AS089 Isotherm® Cool Vest

\$205.95



Chem-Tape®

An innovative solution for added protection in liquid chemical situations. It has been tested and proven against warfare agents and many other chemicals. *Ship. wt. 1 lb.*

AK036 Chem-Tape®

\$31.95/roll

T.ex Single Gas Monitor

The T.ex is a high quality single gas monitor that offers monitoring for O₂, CO or H₂S gas levels and provides a direct readout of any gas responses. If preset alarms are exceeded, audible, visual, and vibrating alarms are activated, and data is stored on the internal data logging memory. Completely programmable, it is easy to operate and has facilities to calibrate and print out data if needed.

- ▶ Refurbishable battery and sensors
- ▶ Rugged design with robust alligator clip
- ▶ 360° highly visible alarm with audible, and vibration alarms standard
- ▶ Programmable alarm levels, user options
- ▶ IR data transfer to computer
- ▶ UL Approved - Class 1, Div 1, Groups A, B, C, D - Certified Intrinsically Safe
- ▶ 2 year warranty



BK027	T.ex Single Gas Monitor (O ₂ -25%)	\$184.95
BK028	T.ex Single Gas Monitor (H ₂ S-0-100ppm)	\$184.95
BK029	T.ex Single Gas Monitor (CO-0-100ppm)	\$184.95

Draeger Tubes

		Range	Price
AS456	Acetone 100/B Short Term Draeger Tubes	100-12,000 ppm	\$73.95
AS457	Acid Test	Qualitative	\$73.95
AS459	Ammonia 0.25/a	0.25-3 ppm	\$85.95
AS460	Carbon Dioxide 0.1%/a	0.1-6 Vol.%	\$65.95
AS461	Carbon Monoxide 10/b	10-3,000 ppm	\$65.95
AS462	Chlorine 0.2/a	0.2-30 ppm	\$67.95
AS465	Hydrocyanic acid 2/a	2-150 ppm	\$68.95
AS468	Oxygen 5%B	5-23 Vol.%	\$165.95
AS454	Accuro® Pump		\$418.95
AS455	Deluxe Kit Accuro®		\$629.95

All Draeger Tubes are available. Call Darley for prices.

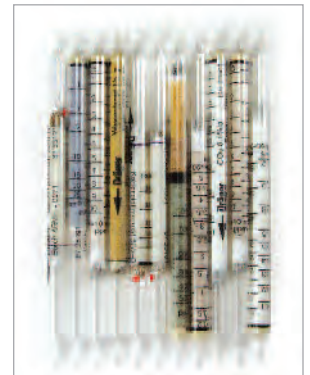

CMS Emergency Response Kit

The CMS Emergency Response Kit is designed to have all the equipment on-hand that is necessary to assess various hazardous gases and vapors in ambient air. The test results are evaluated on-site providing response personnel a clear course of action. The CMS System is a unique combination of reagent chemistry and electronics providing a gas spot check system of unequalled accuracy. The LCD display prompts the user throughout the simple sampling procedure that is identical for any test. The CMS analyzer never requires warmup or calibration and features an integrated data-recorder that stores measurement values with time/date. *Ship. wt. 17 lbs.*

BA018	CMS Emergency Response Kit	\$4,329.95
-------	----------------------------	------------



Draeger X-am 2000 Detector

This detector reliably measures combustible gases and vapors, as well as O₂, CO, and H₂S. Its ergonomic design, mobile phone dimensions and low weight make it the perfect companion in your daily work. Reliable measurement technology, long sensor life and easy operation guarantee maximum safety at extremely low cost of ownership.

- ▶ Lightweight and small in size
- ▶ Vapor-sensitive EX measurement
- ▶ Long-life electrochemical sensors
- ▶ Robust and water-tight
- ▶ Gas inlets on two surfaces
- ▶ Range of alarm functions
- ▶ Flexible power supply
- ▶ Intelligent data management
- ▶ User registration in seconds
- ▶ 3 year warranty on LEL sensors
- ▶ 2 year warranty on CO, H₂S and O₂ sensors



BG240	X-am 2000 4-Gas Detector: EX, O ₂ , CO, H ₂ S	\$756.95
-------	---	----------

Darley Service Center

Throughout our catalog, our NEW Authorized Service Center logo will appear by products that can be sent to our facility for repair and calibration. Darley is an Authorized Service Center for gas detection equipment manufactured by BW Technologies (Honeywell), Draeger, and Sensit Technologies.

Our Service Center Provides:

- ▶ Repairs
- ▶ Calibrations
- ▶ Replacement parts and components
- ▶ Calibration gas and equipment



Our goal is to provide customers with a facility where they can confidently send their equipment for expedient and quality factory authorized repair and calibration, by a factory trained technician, at a reasonable price.

Call 800-323-0244 x 367 or email dsc@darley.com for more information and pricing.



GasAlert Extreme CO Gas Detector

Designed with durability and comfort in mind, the GasAlert Extreme reliably monitors for any single gas hazard within its wide range of available toxic gas models. With easy on/off operation, this single gas detector offers extended longevity with a two year field-replaceable battery. A wide range of user options, multi-language display and data-logging functionality make the GasAlert Extreme an ideal for many applications.

- ▶ Direct, real-time readings on large LCD
- ▶ Operates through consecutive shifts -exceptional battery run-time
- ▶ Secure and accurate history with data-logging



BK051	GasAlert Extreme CO Gas Detector	\$264.95
-------	----------------------------------	----------



GasAlertClip Extreme Gas Detector

As the world's most popular and widely used zero-maintenance gas detector, the GasAlertClip Extreme offers continuous, reliable protection. This single gas detector requires no calibration, sensor replacement, or battery charging. The simplicity of the GasAlertClip Extreme combined with minimal training requirements and negligible maintenance costs, make the GasAlertClip Extreme one of the most cost-effective PPE solutions for facility workers and on-site contractors.

- ▶ Durable, reliable and easy to use with no downtime
- ▶ Record keeping is accurate and easy with automatic event logging
- ▶ Exceptionally low cost of ownership



BK052	GasAlertClip Extreme H2S Gas Detector	\$188.95
BK053	GasAlertClip Extreme CO Gas Detector	\$188.95
BK054	GasAlertClip Extreme SO2 Gas Detector	\$309.95
BK055	GasAlertClip Extreme O2 Gas Detector	\$188.95



GasAlertQuattro

With the GasAlertQuattro's easy to identify bump test and calibration icons, power options to outlast your shift, one-button simplicity and IntelliFlash that provides continuous visual confirmation of detector operation and compliance, seeing is believing.

- ▶ Alkaline pack with three AA batteries
- ▶ Charger wall plug with rechargeable battery
- ▶ Calibration cap and tubing
- ▶ Reversible screwdriver



BK056	GasAlertQuattro 4-Gas Detector (%LEL, O2, H2S, CO)	\$744.95
BK057	GasAlertQuattro 3-Gas Detector (%LEL, O2, CO)	\$694.95



GasAlertMicro 5 PID Detector with Pump H2S, CO, O2, Combustibles & VOCs

- ▶ Integral concussion-proof boot
- ▶ Powered by rechargeable lithium batteries
- ▶ Triple alarms (audible, visual and vibrating)
- ▶ Multi-language support in English, French, German, Spanish and Portuguese
- ▶ Large, user selectable backlit LCD
- ▶ 4 alarm levels: Low, High, TWA and STEL
- ▶ Wide range of user selectable field options including password protection, safe and stealth modes
- ▶ Self-Tests: Full function self-test confirms sensor, battery and circuitry integrity and audible/visual alarms on activation



BL320	GasAlertMicro 5 PID Detector with Pump	\$1,894.95
-------	--	------------

A. SENSIT® GOLD G2 Series

Whether you need an investigation tool or a confined space monitor - you can depend on the SENSIT® GOLD G2 to provide the safety and accuracy you need. *Ship. wt. 2 lbs.*

- ▶ Internal pump
- ▶ Push button operation
- ▶ Field calibration
- ▶ Operation memory
- ▶ Infrared download
- ▶ Made in the USA

- ▶ AS076 - SENSIT® EX-CO - detects combustibles and carbon monoxide
- ▶ AS078 - SENSIT® EX-CO Plus - detects combustibles, carbon monoxide, and oxygen
- ▶ AS080 - SENSIT® 4 Gas - detects combustibles, carbon monoxide, oxygen, and hydrogen sulfide



AS076	SENSIT® GOLD G2 Series 2 Gas with Pump	\$1,224.95
AS077	Calibration Kit for AS076	\$184.95
AS078	SENSIT® GOLD G2 Series	\$1,524.95
AS079	Calibration Kit for AS078	\$299.95
AS080	SENSIT® GOLD G2 Series 4 Gas with Pump	\$1,874.95
AS081	Calibration Kit for AS080	\$581.95

B. SENSIT® HXG-2d Combustible Gas Detector

The First Affordable Gas Detector With True Digital Display

The SENSIT® HXG-2d gas detector pinpoints leaks quickly with its true digital display that reads in PPM & LEL and the electronic tick control. Ideal for natural, butane and propane gas leaks. The SENSIT® HXG-2d is safe, durable and reliable. Made in the USA.



BL076	SENSIT® HXG-2d Combustible Gas Detector	\$394.95
-------	---	----------

C. SENSIT® TKX Combustible Gas Leak Detector

SENSIT® TKX is the perfect choice when locating hard to find natural gas or propane gas leaks. Low maintenance and low initial cost makes this product the ideal choice for the budget conscious.

- ▶ Long battery life
- ▶ Low-cost sensor
- ▶ Adjustable tick rate system
- ▶ Red leak indicator
- ▶ Made in USA
- ▶ *Ship. wt. 2 lbs.*



BD070	SENSIT® TKX Combustible Gas Leak Detector	\$194.95
-------	---	----------

D. Sensit® P100 Gas Monitor

Detects hazardous levels of Carbon Monoxide, Hydrogen Sulfide or Oxygen

The SENSIT® P100 has high and low alarm levels through audio, visual and vibratory warnings. TWA and STEL alarms are also included, as well as alarm-event data logging. Durable rubber-coated housing withstands incredible abuse and is nearly waterproof.

- ▶ Easy-to-use one button operation
- ▶ Operates 2 years before service is required
- ▶ Serviceable sensors
- ▶ Easy calibration
- ▶ Made in USA
- ▶ Limited 2 year warranty (including sensors)

BH003	SENSIT® P100 CO (Carbon Monoxide) Gas Detector	\$259.95
BL065	SENSIT® P100 H2S (Hydrogen Sulfide) Gas Detector	\$219.95
BL075	SENSIT® P100 O2 (Oxygen) Gas Detector	\$219.95



HAZMAT

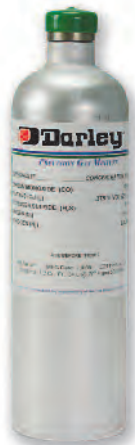

Calibration Gas

Darley offers a complete line of calibration gas for all gas detector manufacturers. Darley makes it easy to keep your gas monitors working and up to manufacturers specifications. Order your Darley Test Gas Today and stay compliant and safe.



SPECIFY: DETECTOR MODEL & MANUFACTURER

BL321	34 Liter Alum. Cyl. (CO, H2S, Comb. & O2)	\$160.95
BL322	58 Liter Alum. Cyl. (CO, H2S, Comb. & O2)	\$220.95
BL323	34 Liter Steel Cyl. 100 ppm Isobutylene	\$65.95
BL324	34 Liter Steel Cyl. Sensit® Gas Mix (Methane)	\$46.95

Bump It Confidence Cylinders



- ▶ 30+ Bump Checks per cylinder
- ▶ 3-month shelf life on reactive mixtures
- ▶ Available in single and multi gas concentrations
- ▶ Use for weekly test or verification of monitor readings
- ▶ No hazardous materials shipping charge



BL325	Bump It Quick Check 4 Gas or Single Gas Mixture (Non-Hazardous Cyl.)	\$35.95
-------	--	---------

PS200 Series 4 Gas Detector

BL407:

- ▶ Robust, rugged and compact
- ▶ Simple 1-button operation
- ▶ 15 combinations of (LEL/O2/CO/H2S)
- ▶ Audible, LED and vibrating alarms
- ▶ Fully certified
- ▶ Sensor integrity checking
- ▶ Low cost of ownership
- ▶ Bumper to bumper 2 year warranty (5 years for electronic parts)
- ▶ Standard USB charging

BL409:

- ▶ Simple user interface
- ▶ Full bump, calibration and charging features
- ▶ Easy recording of bump/calibration results
- ▶ Stand-alone, PC or ethernet versions
- ▶ Robust construction
- ▶ User friendly software

new



BL408



BL409



BL407	PS200 4 Gas Detector	\$744.95
BL408	Rubber Boot	\$40.95
BL409	Auto Bump/Calibration Station	\$809.95

HAZMAT

VISA™ Gas Monitor

The VISA™ is a well proven, highly reliable 1-5 gas monitor with 12 user selectable smart plug and play sensors to choose from. Unique ability to operate the instrument in pump or diffusion mode add flexibility of use. The unit has built in pump, sample hose, audible and visual alarms, and a 2 year warranty. Various probes and harnesses are available for specific applications and the high impact case ensures the instrument won't be affected by heavy use in the field.

- ▶ Fully programmable alarm and operation functions password protected
- ▶ World's only one button, no tools required switch from pump to diffusion mode saves on battery life
- ▶ O2, LEL, CO, H2S, C12, NH3, NO, NO2, CO2, SO2 Dual Tox, PID
- ▶ IP 67 rated
- ▶ Audible, visual, TWA, STEL alarms are standard and user settable
- ▶ Perfect hazmat tool that allows over 75 field configurations in just minutes
- ▶ Low 5 year cost of ownership
- ▶ UL Approved-Class 1, Div. 1, Groups ABCD



BK023	4 Gas Monitor, O2, LEL, CO, H2S with 3AAA Batteries	\$624.95
BK024	4 Gas Monitor, O2, LEL, CO, H2S with Rechargeable with Pump	\$794.95
BK025	5 Gas Monitor, O2, LEL, CO, H2S, NH3 with Rechargeable with Pump	\$1,106.95
BK026	Calibration Kit for 4 Gas Monitor	\$334.95

MAXIWEDGE Kit

This kit offers greater versatility by increasing leak sealing solutions to problems resulting from punctures, gashes, slits and slashes in tanks, cylinders and containers both mobile and stationary. Gas, liquid and bulk material leaks can now be controlled until more permanent solutions are available. When soaked in liquid, softwood will slightly swell forming a tighter seal.

Wedges Included:

- ▶ 7 - 5/8" x1" x8"
- ▶ 5 - 1 1/2" x10" x10"
- ▶ 7 - 5/8" x2" x8"
- ▶ 3 - 4" x4" x18"
- ▶ 7 - 5/8" x3" x8"
- ▶ 7 - 2 1/2" x3" x12"
- ▶ 7 - 2 1/2" x1" x12"
- ▶ 7 - 2 1/2" x2" x12"
- ▶ 7 - 1 1/2" x2" x10"
- ▶ 7 - 1 1/2" x1" x10"
- ▶ 7 - 1 1/2" x 3" x10"

Plugs Included:

- ▶ 10 - 0" x1" x3"
- ▶ 10 - 0" x2" x4"
- ▶ 10 - 0" x3" x8"
- ▶ 1 - 1" x5" x10"

Also Includes:

- ▶ 1 - Non-spark mallet
- ▶ 1 - Carrying crate
- ▶ Kit (case) dimensions: 24"x15.5"x15.5"
- ▶ Kit Weight: 39 lbs.



BK124 MAXIWEDGE Kit \$355.95

Offset T Patch Kit "A-1"

This new universal leak control kit has components to repair punctures, cracks, gashes or surface rotting of all containers, just as our universal kits you may already have. Additionally, this new kit will allow you to patch some holes that previously were more difficult, such as cracks close to the edge of tanks or supports, and cracks that toggle wings will not fit into. All necessary tools and hardware are included.

Includes:

- ▶ Large twin T patch with offset T-bolts
- ▶ Taper surface with offset T-bolts
- ▶ Ladder patch with 3/4" foam backing instead of 1/4" hard rubber
- ▶ Offset T patches for holes and cracks near edge of tank



BH016 Offset T Patch Kit "A-1" \$599.95

Wedges, Putty & Stop-It (WPS) Spill Control Kit

Includes:

- ▶ Plug-N-Dike Plug rug
- ▶ Plug-N-Dike premixed putty
- ▶ Wooden wedges
- ▶ Fix Styx
- ▶ Lead wool
- ▶ Stop-it-pipe repair system
- ▶ Toolbox



BH015 WPS Spill Control Kit \$369.95



Plug & Wedge Kit

With this kit, gashes and punctures in tanks, cylinders, gas lines, etc. can easily be plugged to stop or control liquid, gas, or bulk material leaks. Made from softwoods, these plugs and wedges will swell when saturated and slightly conform to the area being sealed.

Includes:

- ▶ 15 - 1"x3" Tapered Plugs
- ▶ 10 - 2"x4" Tapered Plugs
- ▶ 10 - 3"x8" Tapered Plugs
- ▶ 3 - 5"x10" Tapered Plugs
- ▶ 5 - 1/4"x3/4" Threaded Plugs
- ▶ 5 - 1"x12" Wedges
- ▶ 5 - 2"x12" Wedges
- ▶ 5 - 3"x12" Wedges
- ▶ Hardwood Mallet
- ▶ Drawstring Sack
- ▶ **Ship. wt. 20 lbs.**

Y935 Plug & Wedge Kit

\$261.95

Drum Repair Kit

Contains the items you need to repair punctures, cracks, gashes or surface rotting of containers. From installation tools to OSHA approved barricade tape to mark off the area of a hazardous leak, you'll find a variety of items included in Drum Repair Kit series "D".

Includes:

- ▶ Hose tape
- ▶ Sheet metal screws with neoprene compression seals for pinhole size punctures
- ▶ Rubber patches
- ▶ Lead wool and epoxy putty for cracks
- ▶ "T" bolt patches with neoprene pads
- ▶ Barricade tape
- ▶ Plugs
- ▶ Ball plugs and felt-covered wooden plugs for gashes
- ▶ **Ship. wt. 17 lbs.**

AB184 Drum Repair Kit

\$303.95

AF133 Drum Repair Kit with Non-Sparking Tools

\$454.95

Hazardous Materials Patch & Plug Response Kits

The Series "AE" is a collection of over 40 common components for emergency and temporary leak stoppage due to punctures, gashes, cracks and surface rotting. Series "C-1" Pipe Plugger with Valve Kit - Allows hazardous materials to be temporarily contained, piped off to alternate location or flared. Series "C-2" External Pipe Leak kit - Has unlimited uses in municipalities, chemical plants, manufacturing facilities or anywhere a pipe line is used. Contains pipe bandages covering nominal pipe sizes from 1/2" to 4".

Series "AE" Kit Contains:

- ▶ Sheet metal screws with neoprene compression seals
- ▶ Tubeless tire repair kit
- ▶ OSHA-approved 200" roll of barricade tape
- ▶ 8"x12" piece of solid neoprene
- ▶ 22" piece of foam material
- ▶ Lead wool epoxy putty that hardens like steel, hot or cold hose repair tape, basic tool set for patching
- ▶ Twin "T" stainless plate with foam
- ▶ 8x2" stainless backed neoprene patch-hardwood cribbing
- ▶ 2 - 22' nylon straps and buckles
- ▶ 2 - "T" bolt crack patches for awkward-shaped breaks
- ▶ 6 - Surface plugs for curved surfaces, wedged wooden plugs covered with felt
- ▶ 2 - ball plugs
- ▶ Carrying case
- ▶ **Ship. wt. 33 lbs.**

Series "C-1" Kit Contains:

- ▶ 20' vinyl tube, tool kit
- ▶ 10 - Standard pipe plugs
- ▶ 3/4" regulating valve
- ▶ Carrying case
- ▶ **Ship. wt. 35 lbs.**

Series "C-2" Kit Contains:

- ▶ 10 - Pipe bandages for covering pipe sizes from 1/2" to 4"
- ▶ Soft and hard neoprene liner material and comes complete with your choice of standard or non-sparking tools
- ▶ Carrying case
- ▶ **Ship. wt. 33 lbs.**

AB975 Series "AE" Kit

\$541.95

AF132 Series "AE" with Non-Sparking Tools

\$753.95

AB976 Series "C-1"

\$577.95

AF032 Series "C-2" with Standard Tools

\$398.95

AF105 Series "C-2" with Non-Sparking Tools

\$546.95

Chlorine Institute Emergency Kits

Emergency Kit "A"

For 100-150 lb. Chlorine Cylinders

The emergency kit "A" contains devices to stop leaks at the valve, fusible plug, and in the side walls of chlorine 100 and 150 lb. cylinders which conforms to specification DOT 3A480. Two instruction booklets explaining application of each device are included. Includes accessory equipment and tools which are labeled and color coded. Kit is packaged within a heavy-duty plastic box measuring 35"x13 1/4"x14". *Ship. wt. 115 lbs.*

AF033 Emergency Kit "A" \$2,743.95



Emergency Kit "B"

For One-Ton Containers

The emergency kit "B" contains devices to stop leaks at the valves, fusible plugs, and side walls of chlorine one-ton containers which conform to specifications DOT 106A500X. Two instruction booklets explaining application of each device are included. Will contain leaks in container valves, will seal leaks in container side wall and will contain leaks in container fusible plugs. Includes accessory equipment and tools which are labeled and color coded. Packaged in a heavy-duty plastic box measuring 35"x13 1/4"x14". *Ship. wt. 113 lbs.*

AF034 Emergency Kit "B" \$2,705.95



Emergency Kit "C"

For Tank Cars & Tank Trucks

The emergency kit "C" contains devices to stop leaks at the safety valve or angle valves of chlorine tank cars and trucks. Conforms to DOT 105A500W and MC331 specifications, for chlorine service. Two instruction booklets explaining application of devices are included. Will contain leaks in tank car angle valves and safety relief valve. Includes accessory equipment and tools which are labeled and color coded. Kit is packaged within a heavy-duty plastic tool box measuring 36"x18 1/2"x20". *Ship. wt. 168 lbs.*

AF035 Emergency Kit "C" \$3,141.95



Gasket Kits (Not Shown)

All gaskets are molded from EPDM elastomer. The AF767 kit is for application with kit "A" to stop leaks in SO₂ containers. The AF768 kit will stop leaks in one-ton containers when using kit "B" and the AF769 kit will stop leaks in tank cars when using kit "C". *Ship. wt. 6 lbs.*

AF767 Sulfur Dioxide Cylinder Gasket Kit with 4 Gaskets \$396.95

AF768 Sulfur Dioxide One-Ton Container Gasket Kit with 6 Gaskets \$480.95

AF769 Sulfur Dioxide Tank Car & Tank Truck Gasket Kit with 4 Gaskets \$417.95

Tank, Pipe, Drum Sealing Kit

Paratech's Leak Sealing Bags shut down leaks on pipes, tankers, railroad tank cars quickly, simply, and safely. Just strap a Paratech chemical resistant reinforced neoprene air bag over the leak, then adjust and tighten the ratchet belts and inflate. *Ship. wt. 70 lbs.*

- ▶ Special harness design allows the bag to slide into position easily
- ▶ Applies up to 22 psi over the damaged area to stem the flow, seal the leak, and reduce contamination fast
- ▶ Crews can work away from the hazard zone with the provided 16' hose
- ▶ Works effectively on both smooth and rough surfaces

Contains:

- ▶ 1 - Leak sealing bag 24"x24"
- ▶ 1 - 30' orange ratchet belt
- ▶ 1 - 30' yellow ratchet belt
- ▶ 1 - Extension belt 20' orange
- ▶ 1 - Extension belt 20' yellow
- ▶ 2 - 16' orange hose
- ▶ 1 - 6"x6" leak sealing bag
- ▶ 1 - Single controller 22 bypass with 2 couplings
- ▶ 1 - 6"x12" leak sealing bag
- ▶ 1 - 10"x10" leak sealing bag
- ▶ 1 - 15"x21" leak sealing bag
- ▶ 3 - 8' wrap around Velcro® strap
- ▶ 2 - 4' wrap around Velcro® strap

BD024 Tank, Pipe, Drum Sealing Kit \$4,519.95



HAZMAT

17-Piece Tool Kit

- ▶ Shoe handle brush
- ▶ 9" crate opener
- ▶ 16 oz. claw hammer w/fiberglass handle
- ▶ Common knife 5³/₄" blade, 7³/₄" OAL
- ▶ Deck scraper, 1¹/₂" blade x 15" long
- ▶ Spray booth scraper, 3" blade x 9¹/₄" long
- ▶ Standard screwdriver - 5¹/₁₆" tip, 6" blade
- ▶ 12" groove joint pliers
- ▶ #3 phillips screwdriver
- ▶ 12" tin snips
- ▶ 8" adjustable wrench
- ▶ 12" adjustable wrench
- ▶ 14" pipe wrench (aluminum)
- ▶ 12" bung wrench (fits 3³/₄" x 2")
- ▶ 7" long nose pliers with cutters
- ▶ 8" combination pliers
- ▶ **Ship. wt. 20 lbs.**

AF040

17-Piece Tool Kit

\$1,134.95



11-Piece Tool Kit

- ▶ 8" combination pliers
- ▶ Shoe handle brush
- ▶ Putty knife (stiff) 1¹/₄" x 3⁹/₁₆", blade 7³/₄" OAL
- ▶ Common knife 3¹/₈" blade, 6³/₄" OAL
- ▶ 10" groove joint pliers
- ▶ #2 phillips screwdriver
- ▶ Standard screwdriver - 5¹/₁₆" tip, 6" blade
- ▶ 16 oz. claw hammer w/fiberglass handle
- ▶ 6" adjustable end wrench
- ▶ 10" adjustable end wrench
- ▶ 10" adjustable pipe wrench
- ▶ **Ship. wt. 11 lbs.**

W174

11-Piece Tool Kit

\$637.95

6-Piece Tool Kit

- ▶ Standard screwdriver - 5¹/₁₆" tip
- ▶ 6¹/₂" combination pliers
- ▶ 8" adjustable end wrench
- ▶ 9" crate opener
- ▶ #2 phillips screwdriver
- ▶ #10 groove joint pliers
- ▶ **Ship. wt. 4 lbs.**

AR088

6-Piece Tool Kit

\$306.95



Yes-Tool

Does The Job of Six Tools

For hazmat, vehicle rescue and fire fighting, we offer one tool that does it all! The non-sparking Yes-Tool offers the combination of six tools in one. This tool is made of high strength beryllium copper. **Ship. wt. 7 lbs.**

- ▶ Crash axe
- ▶ Hydrant wrench
- ▶ Spanner wrench
- ▶ Pry bar
- ▶ Hand pick
- ▶ Gas shut-off

AA808

Yes-Tool

\$324.95



Hazmat Hooligan Tool

This heavy-duty forcible entry tool was designed for emergency service personnel operating in the presence of hazardous vapors. Combining the design of one of the world's most popular forcible entry tools and manufactured from spark-resistant material makes this an important addition to your hazmat team. Features duckbill and your choice of standard or metal cutting claw. Standard Claw is gently curved for maximum prying leverage and machine sharpened with recessed nail puller. Claw will fit over locks, hasps and many gas shut-offs. Metal Cutting Claw combines the capability of prying and cutting heavy-gauge metal and composites. **Ship. wt. 13 lbs.**

- ▶ Heavy-duty
- ▶ Spark-resistant material
- ▶ Standard or metal cutting claw

AC623

AC622

AC622	Hazmat Hooligan Tool, Standard Claw	\$450.95
AC623	Hazmat Hooligan Tool, Metal Cutting Claw	\$450.95

Syntho-Plug Football

Syntho-Plug is a football shaped, polyurethane impregnated, water activated foam plug used to temporarily stop the flow from a leak in anything. It is initially pliable to insert into a void and quickly expands and hardens to fill the void. It can even be applied below the water line.

- ▶ Ready to use
- ▶ Simple application
- ▶ Effective, time saving
- ▶ No mixing, no mess
- ▶ Sets rock hard in minutes
- ▶ Dimensions: 3.25"x6"
- ▶ Applications: Spill containment, marine thru-hull damage



COLOR: Yellow

BL406 Syntho-Plug Football \$59.95

Plug N' Dike Pre-Mix

Plug N' Dike Pre-Mix is a non-toxic material which forms an immediate seal to control flammable and/or hazardous leaks and spills. It is a combination of a polymer in a bentonite base that produces a seal against penetration of fuels and chemicals. No surface preparation needed. Plug N' Dike Pre-Mix is a plugging material; it does not absorb. *Ship. wt. 10 lbs.*



X878 Pre-Mix - 10 lbs./1 gal. \$49.95
X877 Pre-Mix - 1 lb. Container \$20.95

Plug N' Dike Granules

Plug N' Dike Granules - available in 5 gal. or 10 lb. container. It works! Just knead with water to form a sticky paste. An excellent first response method to control many spills and solve maintenance problems. Use it to plug fuels and most chemicals, to dike pressurized or large spills, and to seal off drains. Can be used to keep leaking equipment operating without complete shutdown. *Ship. wt. 10 lbs.*



AC644 Granules-10 lb. \$16.95
X879 Granules-5 gal. \$59.95
AC64401 Granules Carton \$59.95
4-10 lb. containers per carton

First Step: Identify the Spill

With these classifier kits, chemicals or elements of waste water can be classified quickly. Each kit uses classifier strips which change color when in contact with the unknown liquid. Just match that color on the classifier color chart to classify the type of chemical present. Each kit contains six classifier strips, polypropylene thread, one pair of nitrile gloves, and a reusable classifier chart, all in a convenient carrying tube. *Ship. wt. 1 lb.*



SPILLY WATER

AA803 Chemical Classifier \$57.95
AB912 Wastewater Classifier \$57.95

Darley Code Red Emulsifier

Darley Code Red Emulsifier is a non-flammable emulsifier that works to emulsify petroleum spills to reduce the hazard of combustion. By emulsifying the petroleum products the spill is rendered into a non-flammable biodegradable solution.

- ▶ Multi-purpose
- ▶ Environmentally friendly
- ▶ Non-hazardous
- ▶ All natural
- ▶ Excellent detergency
- ▶ Non-flammable

PRICED PER GALLON,
SOLD IN 5-GALLON CONTAINER

BL437 Darley Code Red Emulsifier \$18.95/gal.



DrainProtector™

DrainProtector™ prevents spills from entering grates, manholes and large drains. Flexible, chemical-resistant polyurethane products can be cleaned easily with warm, soapy water and used over and over again. *Ship. wt. 8-51 lbs.*

NOTE: 2-PIECE MINIMUM ON 18" AND 24"

AS096 18"x18"x1/2" DrainProtector™ \$119.95
AS097 24"x24"x1/2" DrainProtector™ \$183.95
AS098 36"x36"x1/2" DrainProtector™ \$383.95
AS100 48"x48"x1/2" DrainProtector™ \$621.95



Safety Sorbent

The Fast Economical Response

Natural ingredients that absorb liquids quickly and effectively by chemical hydration, which retains and eliminates secondary spills caused by leaking. *Non-biodegradable, inert and insoluble in common liquids; contains no "free-silica" or other hazardous material in accordance with EPA guidelines. Ship. wt. 51 lbs.*

- ▶ Acids
- ▶ Caustics
- ▶ Oils
- ▶ Solvents
- ▶ Toxic liquids

AK190 Safety Sorbent, Case of 12/40 oz. cartons \$21.95
AK191 Safety Sorbent, 25 lb. Bag \$13.95
AK193 Safety Sorbent, 40 lb. Box \$23.95



HAZMAT

FAST & CONVENIENT WAYS TO CONTAIN SPILLS

Emergency Spill Kit

Includes:

- ▶ 1 - 1¾ lb. Super sorbent shaker carton
- ▶ 15 - 3x4' Haz socks
- ▶ 2 - Pairs of P.V.C. gloves
- ▶ 2 - Disposable suits w/hoods and boots
- ▶ 100 - Univ. green sorbent pads
- ▶ 2 - Pairs of goggles
- ▶ 8 - Disposable bags w/ties
- ▶ 1 - Roll of caution tape
- ▶ 1 - 20 lbs. Cob fractions
- ▶ 1 - Respirator
- ▶ 1 - Emergency Response Guide Book
- ▶ 1 - 30 gal. blue poly drum



BH063 Emergency Spill Kit \$309.95

Grab & Go Portable Spill Kit

Includes:

- ▶ 1 - Pair of goggles
- ▶ 3 - 16"x18" pads
- ▶ 4 - 3"x46" poly socks (oil only)
- ▶ 1 - Pair of Nitrile gloves
- ▶ 1 - 5 gal. pail, hammer on lid
- ▶ Socks and pads are oil and petroleum specific



BH062 Grab & Go Portable Spill Kit \$49.95

Poly Drum Spill Kits

Includes:

- ▶ 40 - 3"x46" General purpose socks
- ▶ 200 - Green universal sorbent pads
- ▶ 10 - Hazardous pillows
- ▶ 12 - 3"x10' haz socks
- ▶ 5 - Disposal bags with ties
- ▶ 2 pr. - Nitrile gloves
- ▶ 1 pr. - Goggles
- ▶ 1 - Emergency Response Guidebook
- ▶ 1 - 95 gal. yellow poly over pack with screw lid



BH061 Poly Drum Spill Kit \$499.95

Dufflebag Spill Kit

Includes:

- ▶ 2 - Poly socks 3"x46"
- ▶ 10 - White (oil only) sorbent pads
- ▶ 1 - Pair nitrile gloves
- ▶ 1 - Plug patty
- ▶ 1 - Emergency response guide
- ▶ 1 - 55 gal. drum liner
- ▶ 1 - Water-resistant bag



BH031 Dufflebag Spill Kit \$77.95

HAZMAT

Universal Spill Pillows, Socks & Pads

Immediate Containment of Hazardous & Toxic Spills

- ▶ Small micron diameter fibers provide greater retention and strength
- ▶ Absorbs 16x its own weight
- ▶ Use in, under and around machinery for a clean workspace
- ▶ Absorb spills such as oils, coolants, solvents, and water
- ▶ Ship wt. 13 lbs.



Cat#	Description	Size	Price
AS516	Universal Pillow	18"x18"	\$78.95/case of 10
AS517	Universal Socks	3"x4'	\$48.95/case of 15
AS234	Single Weight Pad	16"x18"	\$107.95/case of 200

Keep A Set Of Clean-Up Tools With Your Spill Kits

Hazmat Clean-Up Brush & Handle

AB961-Clean-Up Brush is made with tough, resilient polyester brush bristles that are chemical resistant and non-sparking brush block. Lightweight, rust and corrosion-resistant and withstands a wide temperature range with low moisture absorption. Totally sterilizable. Measures 2½"x19".

AB964-One piece, 51" long fiberglass handle. *Ship wt. 3 lbs.*

DON'T MISS
Mounting brackets in
App. Equip. (p231-259)

AB961	Clean-Up Brush Only	\$51.95
AB964	Fiberglass Handle Only	\$32.95

Chemical Resistant Squeegees

Use spill squeegees for quick and easy cleanup of chemical spills. They are made of corrosion-resistant high-density polyethylene and will not rust. These lightweight, nonsparking squeegees are available in bench and floor models. Bench model: 8" with blade; 12" handle. Floor model: 18" with blade; 53" handle. *Ship. wt. 3 lbs.*

AB905	Bench Spill Squeegee	\$29.95
AB906	Floor Spill Squeegee	\$43.95

Polypropylene Non-Sparking Shovels

An excellent shovel to be used in chemical spill situations. The green scoops of these shovels are protected with an anti-static agent which minimizes surface charges. They are designed in two pieces for easy storage in spill kits. Lightweight, non-rusting and virtually unbreakable. Both shovels feature two-piece construction, D-grip and anti-static. *Ship. wt. 4 lbs.*

AA810	Non-Sparking Shovel (38½"L x 10½"W x 14"H)	\$39.95
AA811	Non-Sparking Shovel (40½"L x 14"W x 18"H)	\$53.95



Overpac® Salvage Drum

High density polyethylene drum provides a safe, economical means for transport and temporary storage of damaged or leaking hazardous liquids containers, including PCBs. With a capacity of 95 gallons, it will accept all steel drums up to 55-gallon size. The twist-on lid incorporates a closed cell polyethylene gasket and is easily secured without tools. Polyethylene drum is nestable for convenient storage. *Ship. wt. 50 lbs.*

AB188	Overpac® Salvage Drum	\$278.95
-------	-----------------------	----------

All-Steel Salvage Drums

Designed to fully enclose damaged or leaking containers. All units have a removable cover with rubber gasket, 12-gauge bolt ring closure and exclusive multilingual salvage drum logo. Interior is coated with mild corrosive inhibitor; epoxy-ph nolic lining is optional (except 8 and 10 gallon sizes). Try our **Quad-Pak** that includes a selection of four drums that conveniently fit inside each other for storage. *UN & DOT Certified for Hazardous Materials.*

Salvage Drums		Ship. wt.	Unlined	Lined
AM045	85-Gallon Drum	80 lbs.	\$119.95	\$134.95
AM046	55-Gallon Drum	60 lbs.	\$105.95	\$114.95
AM047	30-Gallon Drum	35 lbs.	\$75.95	\$83.95
AF290	10-Gallon Drum	15 lbs.	\$48.95	N/A
Quad-Pak Salvage Drums		Ship. wt.	Unlined	Lined
AM040	Quad-Pak: 8, 20, 55 & 85 gal. Drums	181 lbs.	\$338.95	\$383.95
AM043	Quad-Pak: 10, 30, 55 & 85 gal. Drums	189 lbs.	\$367.95	\$397.95



HAZMAT

Decon Shower Elevation Grid

Elevation grid prevents the build up of washed away contaminants by elevating the responder's feet 5½" above ground during decontamination. Features no sharp edges or slivers to harm people, sturdy molded sockets that permit levels to be positively locked at any height, lightweight construction and flow through grid design to let liquids and small scrap drain away. Made from rugged HDPE chemical-resistant resins. *Dimensions: 24"x36", 5½" grid. Ship. wt. 23 lbs.*

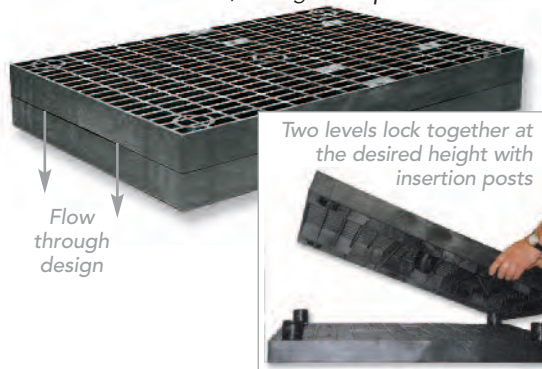

AF039 Decon Shower Elevation Grid \$197.95

Decontamination Manifold

The Warthog Decontamination Manifold reduces the flow of water from a 1½" fire hose to a series of three spigots. Garden hoses can be attached directly to the manifold and run to a decon shower or used separately as needed.



BG102 Decontamination Manifold \$164.95

Hazmat Fluid Transfer Pump

A chemically-resistant hand operated, self-priming pump that is designed to transfer hazardous materials from a Hazmat Decon Pool into a recovery drum. Constructed of polypropylene body and nitrile diaphragm, the 10 gpm pump is mounted on a 6"x18" polyethylene pump plate and comes complete with 12' of chemically-resistant wire-reinforced hose. *Ship. wt. 8 lbs.*



AJ059 Hazmat Fluid Transfer Pump \$292.95

Portable Decon Shower & Disposable Pool

The **Hazmat Decon Shower** is a portable, collapsible, 1½" PVC shower that is designed for decontaminating emergency response personnel. The unit is color-coded for ease of assembly and sets up in only five minutes. A crisscross water flow pattern is provided from the upper support bars. Shower comes in a canvas carrying duffel bag measuring approximately 42"x26"x12". *Ship. wt. 65 lbs.* The **Hazmat Decon Pool** (sold 2 per case) is disposable and compact. It is easily stored in a space of only 60"x21"x3". The pool has a 12 mil. polyethylene liner, is durable and weighs only 15 lbs. The pool sets up in 30 seconds. *Ship. wt. 30 lbs.*



- ▶ Crisscross water pattern
- ▶ Color-coded assembly
- ▶ 60"x60"x12"

AC164 Decon Shower \$757.95
AC165 Decon Pool - 2 pools per case \$296.95/case

EMS Disposable Decon System

Decon system is portable, disposable, lightweight (10 lbs.) and fits standard EMS stretcher. Decon frame is made of cardboard and lined with yellow, chemical resistant PVC laminated nylon. Comes complete with PVC drain, hose and 5 gallon collapsible, polyethylene container. Can be set up in 60 seconds. Measures 84"Lx24"Wx 8"H fully assembled. Comes in case of three decon systems. *Ship. wt. 34 lbs.*



Folds for easy storage

AC451 EMS Disposable Decon System \$712.95/case of 3

Multi Manifold

Quickly connecting standard ¾" hose to hydrants, fire hoses or fire apparatus. Constructed of corrosion-free aluminum pipe, fittings and 500 PSI certified brass ¼" turn ball valves. Ideal for multiple hose connections. *Ship. wt. 5-8 lbs.*



AW042 1-1½" NH Inlet/ 6-¼-Turn One-Way Ball Valves \$596.95
AW043 1-2½" NH Inlet/ 6-¼-Turn One-Way Ball Valves \$608.95

Standard Decontamination Shower System



Specifications:

- ▶ Total output: 15 gpm (2.5 gpm per shower head)
- ▶ Dimensions: assembled 42"x36"x84"; unassembled 74"x27"x27"
- ▶ Single water inlet: standard garden hose
- ▶ Approximate set-up time: 3-4 minutes
- ▶ Ship. wt. 192 lbs.

Features:

- ▶ Unique quick-connects for fast assembly
- ▶ Fully collapsible design
- ▶ Six shower heads plus an independent hand-held sprayer
- ▶ Heavy-duty, chemical-resistant privacy enclosure
- ▶ Translucent roof panel to allow light into shower
- ▶ Stores and transports in two easy-to-carry vinyl bags

SYSTEM INCLUDES SHOWER, POOL, ELEVATION GRIDS AND CARRYING BAGS

BA061

Standard Decontamination Shower System

\$2,850.95

Quick Response™ Shower System



Designed for field response, the Quick Response™ Shower is durably constructed to withstand frequent training, and compact enough to fit in a portable carry bag. System includes Quick Response™ Shower, compact pool, elevation grid and vinyl carrying bag. *Ship. wt. 96 lbs.*

Shower Features:

- ▶ Unique quick-connects for fast assembly
- ▶ 3 shower heads plus an independent hand-held sprayer
- ▶ Tough construction for frequent training and use
- ▶ Vinyl bag for storage and transport

Shower Specifications:

- ▶ Total output: 7.5 gpm
- ▶ Dimensions: assembled 43.2"x46.8"x88.8"; unassembled 49"x15.5"x9.5"
- ▶ Single water inlet: standard garden hose
- ▶ Approximate set-up time: 2-3 minutes

BA062

Quick Response™ Shower System

\$1,455.95

Econoflo Multipurpose Fire Hose

Perfect for decon and clean up



A versatile, multipurpose high-pressure fire hose made with 100% virgin polyester and lightweight, high strength Thermo Plastic lining. Coupled with brass ferrule type couplings, garden hose thread. Applications include decon, filling pump cans, protecting pump operating areas, supplying sprinklers, low volume handlines, remote fireline protection and mop up use. Easily carried and stored. 300 psi working pressure; 5/8" hose size. Purchase includes 50' of hose, nozzle and pouch. Yellow only. *Ship. wt. 2 lbs.*

AJ512

Econoflo Multipurpose Fire Hose

\$70.95

Electric Water Pump

Pumps water from collection pool to waste water container. Uses standard garden hose. 110V, 19 GPM. *Ship. wt. 10 lbs.*



BA065

Electric Water Pump \$179.95

Decon Shower Brush



Features:

- ▶ Disposable, soft brush
- ▶ Features handle with hook hole
- ▶ *Ship. wt. 2 lbs.*

BA064

Decon Shower Brush \$8.95

Decon Wand

The perfect accessory to easily expand your existing system, or use alone for small-scale decon procedures. Simply connect this hand-held device to a standard garden hose and you're ready to begin. Decon wand disassembles into two pieces for compact storage, and assembles with quick-connect coupling. Valve allows for shutoff and water flow adjustment. *Ship. wt. 3 lbs.*

Specifications:

- ▶ Total output: 2.5 gpm
- ▶ Dimensions: assembled 44 1/2"x6"x2 1/2"
- ▶ Approximate set-up time: 30 sec.

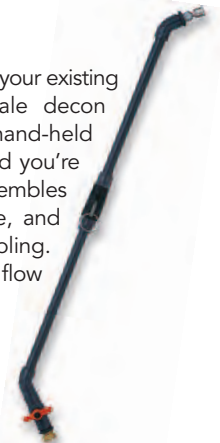

BA066

Decon Wand

\$79.95

Decon Showers and Accessories

The BA068 is a three-line wide (4', 5', 4'), 3 or 4-station mass casualty Decon Shower System which handles two or three parallel lines of casualties at the same time in three or four sequential stations - (1) undress, (2) detergent shower #1 - (3) rinse shower #2 OR handle 2 personnel in separate showers simultaneously in each lane, (4) redress. This unit deploys in under two minutes, and when configured as a three-line system, it processes up to six ambulatory persons at a time or 3 non-ambulatory persons on stretchers simultaneously - or any combination. When configured as a 2-line system (this is accomplished by removing the two center divider curtains that make the unit a 3-line unit and hanging the middle divider curtain) this unit processes two non-ambulatory patients on stretchers or up to 4 ambulatory personnel in a two-line wide (6.5', 6.5') configuration.

The BA069 is a four-line (43.5"x4 Lines W), 3 or 4-station mass casualty decon shower system which handles four parallel lines of casualties at the same time in three or four sequential stations - (1) undress, (2) detergent shower #1 - (3) rinse shower #2 OR handle 2 personnel in separate showers simultaneously in each lane, (4) redress. This unit deploys in under three minutes, processes four non-ambulatory patients on stretchers or up to 8 ambulatory personnel at a time and/or any combination of the above.



BA069

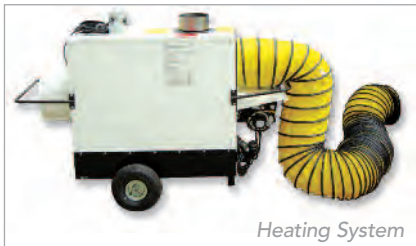

Heating System



Conveyor Roller System

DECON SHOWERS

		Ship. wt.	Price
BA068	10'Wx10'Lx9'H Hazmat Decon Shower System	95 lbs.	\$11,950.95
BA069	13'Wx23'Lx9'H Hazmat Decon Shower System	350 lbs.	\$22,162.95
BA070	Hazmat Decon Elevation Grid 3'Wx2'Lx2' ⁷ / ₈ " H	15 lbs.	\$145.95
BA071	1/4 HP Electric Submersible Pump	20 lbs.	\$538.95

ACCESSORIES

BA072	Conveyer Roller System Adj. 2' - 8' Length	165 lbs.	\$1,208.95
BA073	Conveyer Roller System Adj. 3' - 12' Length2	10 lbs.	\$2,127.95
BA074	"CLIMAT 40 A" Heating System w/10 gal. Fuel Tank	275 lbs.	\$7,075.95
BA075	13,200 BTU 110-volt Air Conditioner	165 lbs.	\$7,647.95

Portable Decon Spray Hoop

Fast, Convenient, Cost-Efficient Decon System

The Portable Decon Hoop has dozens of decontamination applications. The hoop design concentrates water at the area being decontaminated, minimizing the amount of water required and offers better control. It's constructed of durable, lightweight, corrosion-free aluminum pipe and tube. The two-piece (optional 4-piece) design means quick on-site setup and breakdown and is easily stored. On/Off control on hoop and uses standard ³/₄" hose connection. Comes with two 43" handles extendible to 66". **Ship. wt. 4 lbs.**

- ▶ Quick on-site setup & breakdown
- ▶ Uses standard hose connection
- ▶ Minimizes overspray

Uses:

- ▶ Self wash-off
- ▶ Two-person
- ▶ Three-person
- ▶ Equipment
- ▶ 55-Gal. barrels
- ▶ Overpacks
- ▶ Backboard patients
- ▶ Bunker gear

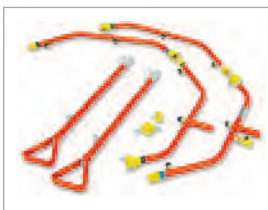
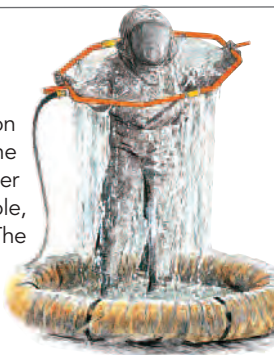

AB958	Decon Hoop, 2-piece with Outside Handles	\$715.95
AJ427	Decon Hoop, 4-piece Design Includes Inside & Outside Handles	\$1,067.95
AJ428	Decon Hoop Storage Bag (For AJ427 Only)	\$279.95

Hi-Vis Dike Tubing

This rapidly deployed containment tubing can be used for containing hazardous materials. The Dike Tubing can also be used to stop or divert flowing water or fast moving spills from a liquid chemical release of product. Just fill with water and deploy to desired shape or length. Compact and stores easily.

- ▶ Dimensions: 11"Dx100'L
- ▶ 9 mil poly tubing
- ▶ Ship. wt. 8.5 lbs.

new

COLOR: Orange

BL361	Hi-Vis Dike Tubing	\$41.95
-------	--------------------	---------

Portable DeCon Waste Pools

- ▶ Quick setup for on-site use
- ▶ Reusable pool and disposable liner
- ▶ Compresses for stowage and requires no air or water to inflate
- ▶ Removable, durable protective ground pad with permanently attached belts and quick couplers quickly attach the pool's waste water retention ring
- ▶ Ship. wt. 18 lbs.



AW040	6' Portable DeCon Waste Pools	\$724.95
AW041	6' Pool Liner, 10mil, 10/pkg.	\$307.95

FSI Decontamination Shelters/Showers

Frame: Heavy Duty 1100 Dtex Polyester Coated with plastomer on both sides, UV/Chemical resistant.

Cover: Heavy Duty 420 Denier nylon (or Polyester) coated with Polyurethane (PVC) on both sides. UV/Chemical resistant.
Standard Colors: Blue, Green, and White.

Standard Equipment: Integral ground floor, 2/4/6 roll up windows are size dependent, roll-up, full zip, dirty entry/clean exit doors, air inflation valve, pressure relief valve, hand pump, jack, Pegs/Rods, Repair kit, manual, carry bag, and hammer. Multiple colors available. Units can attach to a second shelter. Other options available (below the pricing table).

Optional Equipment: Decon pool, cross divider curtain, shower curtain stall, shower head, waste pump.



AW051	10'Wx15'Lx8'H Shelter	\$8,219.95
AW052	13'Wx23'Lx9'H Shelter	\$11,076.95
AW053	20'Wx40'Lx10'H Shelter	\$26,087.95
AW055	Cross Divider Curtain for AW052	\$205.95
AW056	Cross Divider Curtain for AW053	\$420.95
AW057	Shower Curtain Stall	\$484.95
AW058	Shower Head	\$188.95

Hazmat/Decon Shower

Compact packaging for ease of storage, transport and handling. Imagine portable, one-piece packaging weighing only 102 lbs. and measuring just 64"x14"x21". Superbly designed for storage in a standard vehicle compartment and easy handling by one or two people. Simplicity that becomes a "solution"! Incredible "ingenuity" is demonstrated with only six components needed for complete assembly in less than two minutes with no tools required. *Ship. wt. 102 lbs.*

- ▶ Shower frame with roof trusses
- ▶ Free standing 5'x5'x6' primary berm with 3/4" GHT drain fittings
- ▶ Complete fabric frame cover with zippered entrance and exit doors
- ▶ Quick connect plumbing harness complete with five adjustable nozzles
- ▶ Supply side pigtail with master shutoff
- ▶ Equipment carrying bag



AZ406	Hazmat Decon Shower	\$2,623.95
AZ407	3'x4' Elevated Flexible Matting	\$144.95
AZ408	5'x5'x6' Staging Pool with 3/4" GHT Drain or Sump Pump Attachment	\$344.95
AZ409	110v Electric Sump Pump Kit with Protective Case	\$433.95
AZ410	500 Gallon Gray Water Bladder Kit with Gray Water Adapter	\$652.95

Totally Enclosed DeCon Waste Tank

Ideal for light storage situations and First Response Applications. Constructed of 28 oz. PVC coated Rip-Stop woven fabric. Provides for superior durability and long service. Large filler opening with 4" cap. Floating filler ring collar keeps filler opening above fluid level at all times during filling. Outlet is configured with a 3" NPT FM thread with cap plug provided. *Ship. wt. 90 lbs.*

Note: Tanks are ideal for portable or non-portable water storage situations such as disaster, flood, fires, etc. These tanks can be stowed in a tight space/compartment and take the place of bulky hard-walled tanks. They are designed to be transported by trucks or trailers.

AZ289	110 Gallon DeCon Waste Tank	3'Lx5'Wx12'H	\$903.95
AZ290	150 Gallon DeCon Waste Tank	4'Lx5'Wx12'H	\$1,093.95
AZ291	300 Gallon DeCon Waste Tank	4'Lx6'Wx24'H	\$1,351.95



HAZMAT

Confined Space Duct

The Confined Space Duct is constructed of a high quality, fire resistant, chemically stable material. It allows workers and equipment to pass by easily in tight spaces by simply collapsing the duct. Once something has passed through, the duct expands back to full air capacity. The Confined Space Duct has been engineered to be used on the discharge side of the fan.



- Dimensions:
3' Horizontal Length
8' Vertical Length
8" Diameter



BL074 Confined Space Duct \$499.95

Pro Vent 70 Hot Tent Heater

Pro 70 Hot Vent is your safest choice for High-Volume SAFE heat! System includes stainless steel 70,000 BTU sealed heat exchanger with redundant electronic ignition (requires 2 AA batteries) and rugged transport cart. (Propane tank not included.)



BK404

BK404 Pro Vent 70 Heater w/Pro Combo \$2,599.95
AW049 Pro 70 Hot Vent Tent Heater \$2,017.95
AZ628 Pro Combo (Blower, 2 Air Ducts, & Storage Bag) \$598.95

HeatPac 25

HeatPac 25 will provide over 55,000 BTU's of heat for over ten hours when connected to a standard propane tank. This can heat air at a temperature rise of 80° over ambient and a flow of 500 cfm. When not being used to warm trapped patients or freezing firefighters, the fan and duct can be used for confined space ventilation without the heater. Perfect for the department that wants to provide their customers with the utmost in comfort during difficult situations.

Ship. wt. 42 lbs.



AW048 HeatPac 25 \$4,374.95

Confined Space Nano Ventilators

Super Vac's Nano is the perfect, cost effective solution to confined space ventilation challenges. The rugged Nano can be used for either supply air or exhaust ventilation, or delivering the highest airflow in its class. It comes in your choice of standard or static dissipating hazardous location options.



BG215



BG214

Cat#	Motor	Dimensions	CFM	Wt.
BG214	1/3 hp, Standard	11.5"x10.75"x16"	1037	20
BG215	1/3 hp, Hazardous Location	11.5"x10.75"x16"	1037	22

BG214 8" Fan w/25' Duct for Standard Ventilation \$879.95

BG215 8" Fan w/25' Duct for Hazardous Ventilation \$1,992.95

Pro 70 "T" Water Heater

The Pro 70 "T" is the best high-volume instant, portable hot shower system available. This system is the number one choice for high-volume hot water demands for hazmat and militaries world wide. Expect instant 100° water up to 3 gallons per minute. Simple-to-use, just attach to any garden hose and push the electronic ignition button (operates on AA battery). Includes rugged dolly with large air-filled tires for easy transport. Stainless steel industrial quality for 24/7 operation. Ship. wt. 64 lbs.

AW050 Pro 70 "T" Water Heater \$1,899.95



Rapid Tent



The Rapid Tent provides a spacious 100 square feet of unobstructed floor space with over 7 feet of headroom, yet can be deployed in under one minute. These units can be combined with one another to double the floor space. The ground flaps provide stability, while the open floor design makes them perfect to set over a wrecked car or for easy clean up after hazmat situations. Perfect for hazmat or Dive Teams in northern latitudes, and to provide quick shelter for Command Staff during an extended incident. Ship. wt. 67 lbs.

AW047 10'x10' Rapid Tent with Rear Door \$2,655.95

FOCUS Lamphead

Versatile Low Profile Lamphead. Compact. Durable.

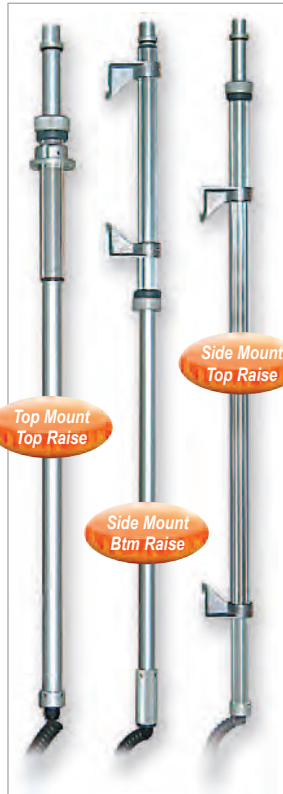

Don't Waste Precious Light

The high intensity FOCUS lamphead does not waste precious light. It is designed to focus 100% of the light produced into the area where it is needed. The FOCUS is built tough and has a compact design that allows it to be mounted in places that traditional lighting fixtures do not fit.

Breakthrough in Scene Lighting

The FOCUS lamphead was designed to light up the emergency scene evenly, putting 100% of the light on the scene. A high percentage of the light produced by a conventional light fixture is wasted away from the emergency scene and gets dim at a distance. The FOCUS lamphead uses a uniquely designed patented reflector to eliminate wasted light. The curved reflector has over 50 parabolic surfaces that redirect all of the light produced and focus it evenly into the action areas. This allows the FOCUS to put all of the light onto the scene, providing more light close to the vehicle as well as being brighter at a distance.

- AM262 - Top mount, top raise pole with FOCUS lamphead
- AM263 - Side mount, bottom raise pole with FOCUS lamphead
- AM266 - FOCUS lamphead only

SPECIFY WATTAGE

Watts	Volts	Amps	AM262	AM263	AM266
300	12	25	\$780.95	\$780.95	\$391.95
500	120	4.2	\$690.95	\$684.95	\$304.95
1000	120	8.3	\$780.95	\$780.95	\$365.95
1000	240	4.2	\$780.95	\$780.95	\$365.95

Standard T3 Quartz bulb is located at top of reflector to maximize light emission

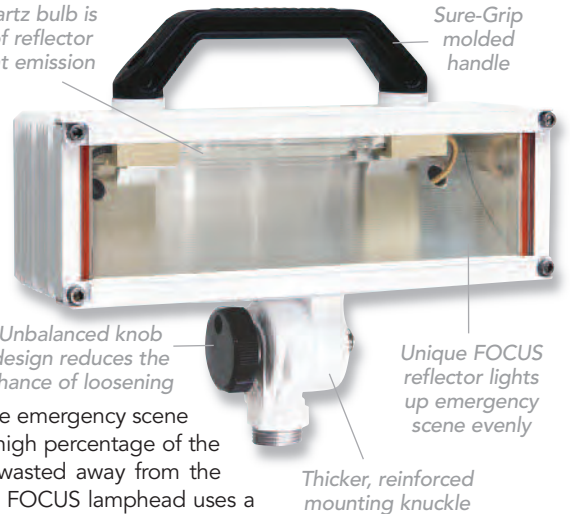

Thicker, reinforced mounting knuckle

FOCUS
 HIGH INTENSITY LIGHTING

FRC Tripods

The Industry's Finest Tripods With the Best Features

- ▶ **Twist Lock:** FRC's unique locking ring operates from either direction
- ▶ **Air Cushioned Pole Release:** Allows the pole to lower slowly, when released, on a cushion of air helping to prevent pinched fingers and damage to the bulb
- ▶ **Ease of Set-Up:** Designed to deploy all three legs at the same time, allowing the unit to be set up quickly and easily at an incident
- ▶ **Lightweight Anodized Aluminum Poles:** The standard tripod weighs just 16 pounds
- ▶ **Extends up to 12':** Designed to permit "overextension" of its legs so the tripod's lamphead can reach this incredible height
- ▶ **Cammed Knobs:** The pole tightening knob will not unscrew or come off due to vibration



- ▶ **Anti-Chatter Legs:** Rubber covers at the bottom of the legs ensure a quiet ride
- ▶ **Small Footprint:** When closed the unit sets into an incredibly small lower bracket allowing ease of mounting just about anywhere
- ▶ **Truck Mountable:** All tripods are truck mountable, allowing them to be used as telescoping lights on the vehicle and off
- ▶ **Wire Guard:** As shown is standard
- ▶ **Ship. wt. 17 lbs.**

AM259	Tripod with FOCUS Lamp, 500w (120v)	\$879.95
AM260	Tripod with FOCUS Lamp, 1000w (120v)	\$967.95
AB335	Tripod Holder for Truck	\$162.95



OPTIMUM Lamphead

Advanced Technology. Unique Reflector.

Revolutionary Design

The OPTIMUM is a revolutionary lamphead that puts more light on the scene without the need for an increase in power. The OPTIMUM lamphead provides the maximum transfer of light from the bulb to the scene.

Setting the Trend

The OPTIMUM uses a uniquely designed, vacuum deposit, polished reflector to maximize light emission. OPTIMUM's large curved front lens and exclusive "head down" shape produces a uniform beam that lights up an area 100° vertically by 150° horizontally. The OPTIMUM lamphead has been designed to take advantage of the HID (High Intensity Discharge) bulbs and produce light up to 11,250 lumens without the need of a generator.

HID Lighting: High Energy Efficiency

More Lumens: Metal Halide bulbs generate 75 lumens per watt. A 150 watt Metal Halide bulb provides 4 to 5 times the lumen output when compared to a 150 watt quartz halogen bulb.

Longer Life: Metal Halide bulbs last 7x longer than quartz halogen bulbs and even though the initial cost is higher, Metal Halides have a lower total operating cost over the life of the bulb.

Excellent Light Color: The output light from a Metal Halide bulb is closer to natural sunlight than most other light sources. This white light is preferred because it provides better visual acuity and it provides 4 to 5 times more light than quartz halogen bulbs.

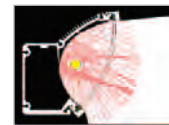
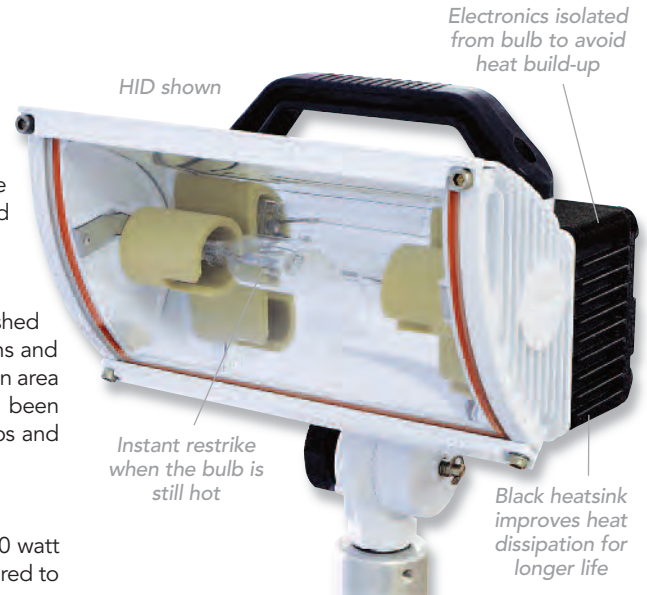

Advanced Technology - A cross section of an OPTIMUM lamphead showing it's unique reflector that directs 100% of the light onto the work and action areas.



SPECIFY MAKE AND MODEL OF CAB FOR CONTOUR MOUNT

AZ502	OPTIMUM Side Mount Push Up Telescopic Light 500W 120V QTZ	\$724.95
AZ503	OPTIMUM Side Mount Push Up Telescopic Light 750W 120V QTZ	\$724.95
AZ504	OPTIMUM Top Mount Fixed Pedestal Light 70W 12V HID	\$987.95
AZ505	OPTIMUM Top Mount Fixed Pedestal Light 150W 12V HID	\$1,131.95
AZ506	OPTIMUM Tripod Telescopic Light 500W 120V QTZ	\$904.95
AZ507	OPTIMUM Tripod Telescopic Light 750W 120V QTZ	\$904.95

EVOLUTION LED Lamphead

The Cost Effective, Affordable LED Solution.
Ideal for Upgrading Your Existing Fleet.

EVOLUTION low profile LED lampheads generate more than 15,000 lumens of ultra bright white light. The unique LED arrays, parabolic reflector, and lens produce more usable light in a compact lamphead. EVOLUTION lampheads are available with all FRC telescopic poles, fixed, and brow mounts.

- ▶ **Brighter Light:** More than 15,000 lumens of ultra bright LED light
- ▶ **Whiter Light:** Closest thing to natural sunlight
- ▶ **Uniform High Quality White Light:** The widest light pattern
- ▶ **Long Operating Hours:** Rated at 50,000 hours
- ▶ **Full Brightness at Power On:** Instant restarts
- ▶ **Parabolic reflector and lens** directs all the light onto scene
- ▶ Lamphead can be used with 12 or 24 volt DC systems (13/6.5 amps)
- ▶ Five year LED lighting warranty



BK093	EVOLUTION LED Lamphead DC with Standard Tripod	\$1,723.95
BK094	EVOLUTION LED Lamphead DC Portable	\$1,333.95

Handheld Remote Area Lighting System

- ▶ Polycarbonate lens is lightweight and impact-resistant
- ▶ Maintenance-free LED array w/life expectancy of 50,000 hrs
- ▶ Fully extendable mast with 360° rotating head
- ▶ Waterproof rubber activation switch
- ▶ Mast extension lock
- ▶ Variable tension angle lets light shine at any angle
- ▶ Metal battery chassis distributes load to handle
- ▶ Durable base soaks up impact
- ▶ Up to 2,000 lumens of tested LED light output
- ▶ Silent, energy efficient, rechargeable battery
- ▶ Retractable handle and rugged wheels for easy mobility
- ▶ Low heat
- ▶ Meets Class 1, Div 2
- ▶ Ship. wt. 25 lbs.



BH018 Handheld Remote Area Lighting System \$724.95

9440 Remote Area Lighting System

The most innovative RALS unit to date, the 9440 moves fast to light up ravines, confined spaces, riverbanks...any place generator lights can't go. Deployed, the mast extends 7' high, shining light over low obstructions encountered by traditional lantern style lights. With a 120 degree beam spread and up to 2400 lumens, the entire emergency area will have the light you need for a safe and swift operation. The 9440 is maintenance free, using super tough LED lamp modules and NiMH batteries for up to 6 hours of continuous light.



Folded View



SPECIFY COLOR: Yellow or Black
BK225 9440 Remote Area Lighting System \$1,135.95

Remote Area Lighting System

Using solid-state mounted LEDs coupled with a thermally efficient light engine and the Pelican Protector™ Case. The Remote Area Lighting Systems (RALS) gives the user the ultimate maintenance free portable floodlight station to get the job done efficiently, safely and on time. The RALS houses two of it's light heads and it's multi-stage charger for that total self-contained convenience. It is also equipped with a telescopic handle and rugged wheels for ease of transport. Includes a convenient low battery warning system and waterproof activation switch.

- ▶ High Flux LED, 50,000 hr. life
- ▶ Lumen Value: 2000 (low) and 4000 (high)
- ▶ 2 lamp heads, 24 LEDs per head
- ▶ 90° beam spread
- ▶ 2 brightness settings
- ▶ 12v rechargeable battery, 9 hr. charge time
- ▶ Battery burn time: 14 hrs. (low), 7 hrs. (high) from full discharge
- ▶ 500 cycle battery life
- ▶ Low battery warning
- ▶ Head Dimensions: 6.5" Lx7.87" Wx2.56" D
- ▶ Cord Length: 13.78"
- ▶ Weight: 51 lbs.



BK403 Remote Area Lighting System \$1,750.95



APPARATUS EQUIPMENT

Nomad Prime Portable Rechargeable Area-Spot Light

2 Years to Develop. 20 Seconds to Deploy.

We took our time to save you yours. The rechargeable LED Nomad quickly deploys even in the worst terrains imaginable. Folds up to the size of a poster-tube for easy carry and storage.

Features:

- ▶ 3 intensities (Low, Medium, High)
- ▶ Can be used as spotlight or area light
- ▶ Telescoping and rotating head (340°)
- ▶ On/Mode switch at base of unit
- ▶ Hold-down clamp
- ▶ Yellow leg tape (included)
- ▶ Dimensions: 33"Lx4.6"Dx95" max height
- ▶ Ship. wt. 20 lbs.

LED / Light Output:

- ▶ Up to 4,000 lumens
- ▶ 75 watt power consumption
- ▶ Spotlight (8°) or area light with diffuser Lens
- ▶ See up to 1.1 mi. (2.0 km)



BK369	Nomad Prime Area-Spot Light	\$1,242.95
-------	-----------------------------	------------

Extenda-Lite

Quartz Flood Lighting

Extenda-Lite® Lights are designed to withstand the rigors demanded by the fire service, providing superior lighting in every situation. Akron's lights are manufactured using the highest quality materials and workmanship.

- ▶ Heavy-duty anodized construction for extreme strength and durability
- ▶ 1 1/4" tripod base spreads from 22" to 54" to provide ultimate stability
- ▶ 72" extends to 132" high
- ▶ Twist lock for quick and easy height adjustment
- ▶ Offered in a variety of lighting options
- ▶ Ship. wt. 12 lbs.



AS333	500w Extenda-Pod	\$659.95
AS335	1000w Extenda-Pod, 120v	\$706.95
AS336	1000w Extenda-Pod, 240v	\$706.95
AS337	1500w Extenda-Pod, 120v	\$706.95
AS338	1500w Extenda-Pod, 240v	\$706.95
AS339	Three-Piece POD Bracket	\$109.95



AS335

Durable powder coated and anodized aluminum & stainless steel hardware

SceneStar™ LED Scene Light

The new LED High Power Scene Light has been engineered to provide industry leading levels of light output with consistency and reliability. The SceneStar™ will continue to provide overall illumination even at elevated operating temperatures through optimized thermal management. Solid-state electronics ensure a lifetime of peak performance.

- ▶ Light Head Dimensions: 14"W x 4 1/4"H x 5.6"D
- ▶ No ultraviolet light to attract insects during nighttime operation
- ▶ Designed for long LED life: 50,000+ hrs.
- ▶ High impact, UV resistant handles & heat sink cover
- ▶ Serviceable construction (Sustainable LED technology)
- ▶ Low heat
- ▶ CE and UL ratings pending
- ▶ Mounting options: Tripod, pole, portable, recessed, brow, fixed, under aerial
- ▶ 5-year warranty
- ▶ 12 Volt DC (AC units available. Call for details.)

Engineered reflector for optimum light output

Instant On/Off



BK391	SceneStar™ LED 14000 Lumen Portable Scene Light	\$1,057.95
BK392	SceneStar™ LED 19000 Lumen Portable Scene Light	\$1,212.95
BK393	SceneStar™ LED 14000 Lumen POD Light	\$1,481.95
BK394	SceneStar™ LED 19000 Lumen POD Light	\$1,667.95



Shatterproof, hard-coated polycarbonate lens

Shadow-RT

The Shadow-RT is designed to provide light quickly over any situation, and made to fit a variety of vehicles that would benefit from quick, quality lighting such as fire engines, chief's vehicles, trailers, and police vans. The Shadow-RT has been designed to be highly-adaptable, with two arm lengths and the ability to customize number and wattage of lamp heads and to rotate 355°.

- ▶ Full deployment in under 15 seconds
- ▶ All-weather (not affected by ice buildup, high winds, blowing dust)
- ▶ Ability to overhang edge of vehicle
- ▶ Umbilical remote controller with 15' cord
- ▶ All-electric (no air or hydraulics required)
- ▶ Shadow-RT rotates 355°
- ▶ Maintenance-free
- ▶ Five-year warranty
- ▶ NFPA 1901 Compliant



COMMAND LIGHT

Cat#	Description	Power Requirements	Price
BE058	Shadow-RT 4x100watt	45 amps, 12 vdc	\$4,401.95
BL017	Shadow-RT 2x 150 LED	Varies depending on fixture 30-45 amps, 12 vdc	\$8,063.95
BE060	Shadow-RT 4x350watt	1.5 kw, 110 or 220 vac	\$4,401.95
BE061	Shadow-RT 4x500watt	2.0 kw, 110 or 220 vac	\$4,401.95
BE062	Shadow-RT 2x1500watt	3.0 kw, 220 vac	\$4,401.95
BL018	Shadow-RT 4x150 LED	60-100 amps, 12 vdc	\$9,399.95

SHADOW-RT OPTIONS

AS421	Strobe Light (<i>Specify Color: Amber, Blue, Clear, Green, Red</i>)		\$319.95
AS422	Panel Mounted Controls		\$853.95
AS423	Spare Handheld Controller		\$479.95
AS424	80" Arm		\$679.95
BL016	Back Light		\$1,249.95

“Shadow” by Command Light

Now you can get quick, low-cost lighting that electrically tilts into place, greatly increasing the efficiency of rescue personnel and enhancing public safety. One unit on each side of a pumper provides more light, faster and safer, than four pole lights. The “Shadow” is designed to be highly adaptable, with the ability to customize the arm, length, and the number and wattage of lamp heads. Fit a “Shadow” to your department’s lighting needs. *Ship. wt. 80 lbs.*

- ▶ Full deployment in under 15 seconds
- ▶ Umbilical 6' cord remote controller
- ▶ All-electric, no hydraulics
- ▶ No scheduled maintenance
- ▶ 5 year warranty



COMMAND LIGHT

AS419 Shadow Light, 3x500 watt

\$2,095.95

APPARATUS EQUIPMENT

The Junction Box

The Junction Box gives you the opportunity of having four receptacles located in one incredibly durable drop box. Large integral handle and made of heavy-duty cast aluminum designed to give maximum protection to internal electrical parts. Each side is fitted with a 1/4" thick polypropylene faceplate that is brightly backlit. Cover plates are spring loaded, snap type and imprinted with the voltage and amperage rating of receptacle. Measures 9 1/4" W x 5 1/2" D x 8 1/2" H. Receptacles are UL Listed and grounded. Call about custom configurations. Ship. wt. 11 lbs.

Cat#	Power	Amps	Volts	Price
AM164	Direct Wire	20	125	\$321.95
AM165	Plug	20	125	\$321.95
AM166	Direct Wire	15	125	\$321.95

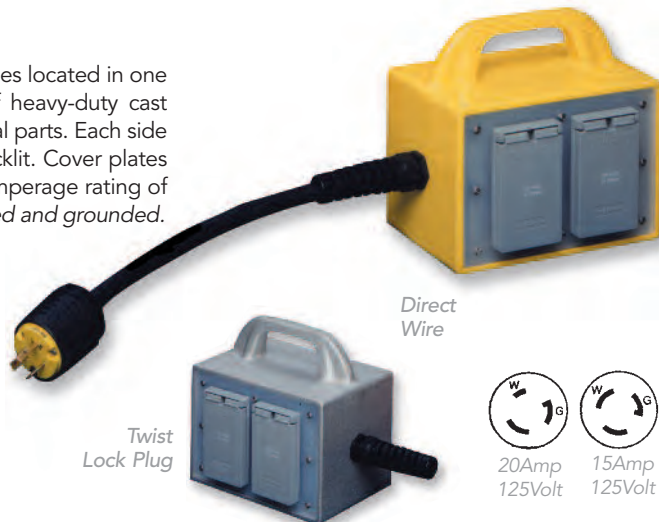

Optimum Portable Light

Brightest Lampheads Available

- ▶ **Efficiency** - The brightest and best designed lights in the industry. A unique reflector design transfers more light from the bulb to the scene.
- ▶ **Reliable & Tested** - Manufactured from heavy-duty, thick aluminum for long life and many hours of dependable performance. Tested under actual emergency situations.



AZ509	Portable Light 500W 120V QTZ w/15 Amp 3-Prong Twist-Lock	\$500.95
-------	--	----------

Portable Hand Light

A powerful 500w (120v) light head features a highly-polished specular hammertone reflector which almost doubles its light output. Sturdy aluminum housing with high-temperature carrying handle and tilt control knob. Heavy-duty ground tripod base with rubber footings. Optional mounting bracket allows you to mount it in any position. Meets NFPA; UL Listed. Ship. wt. 3 lbs.

AR301	Portable Hand Light	\$319.95
AR302	Mounting Bracket	\$46.95

Darley Portable Floodlight

Spring mounted base protects against vibration, dirt and moisture; also adds to life of lamp. Hubbell twist lock male connector and rubber boot seal out dirt and water and insure tight connection. Sure-grip handle is cool at all times and elevation knob is designed with special friction lock. Mounted on a large tip-proof base. 110-volt lamp. Cords sold separately. Chrome quick-release hold-down clamps for mounting floodlight on fire apparatus are also available. Meets OSHA requirements. Ship. wt. 9 lbs.

G547	Portable Floodlight, 110-volt	\$379.95
AA725	Quick Release Hold Down Clamps (Complete Set)	\$177.95
REPLACEMENT LAMPS FOR G547		
R650	Hi-Flood, 500 watt, 120-volt	\$31.95



Diesel Generators

- ▶ Individual circuit breakers
- ▶ Kohler® engine
- ▶ Electric start/recoil start
- ▶ Automatic low-oil shutdown
- ▶ Voltmeter
- ▶ Hour meter
- ▶ Heavy-duty frame
- ▶ Steel fuel tank
- ▶ Extended run time
- ▶ Easy maintenance
- ▶ 2 year warranty
- ▶ Weight: 266 lbs.
- ▶ Run time: 14 hrs @ 50% load

new



Cat#	Watts	HP	Weight	Size	Price
BL417	5000	7.5	182 lbs.	35 1/2"x23"x24 1/2"	\$3,981.95
BL418	6000	10	187 lbs.	35 1/2"x23"x24 1/2"	\$4,121.95
BL419	13000	19	380 lbs.	44"x23"x27"	\$7,742.95

NOVA-LITE

A near perfect combination of power and portability, the NOVA-LITE features a dependable Honda EB-3000 generator with GFCI and a run time of 6 to 9 hours, all with power to spare. This super-quiet power plant is rack mounted on a custom built handcart for easy and fast portability. Two 500W Quartz Halogen Tele-Lites® are mounted on rugged telescoping supports making them instantly ready for use. Raise them up to 82" from the ground, rotate and angle them to get light exactly where you need it. Two more 500W Quartz Halogen Tele-Lites® are rack mounted on the back side of the cart. That makes a total of 2000 watts of brilliant quartz halogen lighting right where you need it. At only 140 lbs., the NOVA-LITE is easy to maneuver with its rugged off-set stainless steel handle. The NOVA-LITE. Put it on your team and win against the darkness.

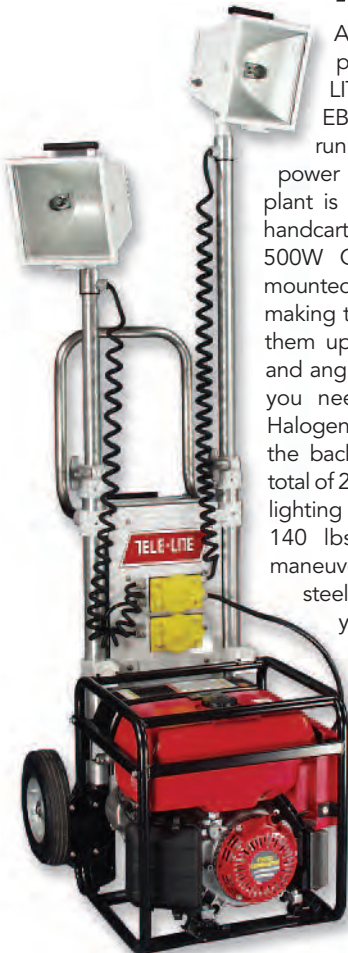

BB087 NOVA-LITE \$5,175.95

Honda Generators



- ▶ Heavy-duty frame protects generator from damage
- ▶ Larger 6.6 gallon fuel tank for longer run times
- ▶ Multiple front panel outlets for easy power connections
- ▶ Wide handles for easy transport
- ▶ Honda GX Industrial Commercial engine for easy starting, reliability, and Oil Alert®
- ▶ Oversized muffler for quieter operation
- ▶ Four step fuel filtering provides consistent fuel to prevent carburetor plugging
- ▶ AVR provides consistent, stable power output, superior to brushless generators
- ▶ Auto Choke for easier starting in varying conditions

Cat#	Watts	HP	Weight	Size	Price
BB088	5000	11	223 lbs.	41.9"x27.2"x29.2"	\$3,232.95
BB089	6500	13	227 lbs.	41.9"x27.2"x29.2"	\$3,862.95

Honda Generator Lights

- ▶ **More Power** - 1000w and 2000w maximum output with 900w and 1600w continuous output
- ▶ **More Versatility** - Either generator will accept any of Extenda-Lite's light heads-up to their rated power capacity
- ▶ **More Mobility** - These generators go where power cords can't
- ▶ **More Efficient** - Simultaneous AC/ DC use is great for fire or accident scene investigations
- ▶ **More Running Time** - With Honda's Eco throttle on, the generator automatically throttles down when the light is turned off
- ▶ **More Safety** - AC/DC circuit breakers and USDA qualified spart arrester for mufflers are standard



Cat#	Generator	Light Watts	AC Output	Wt.	Price
AR198	Honda EU1000i	500	1000	39	\$1,812.95
AZ449	Honda EU2000i	500	2000	57	\$2,295.95
BE056	Honda 1000w Inverter Generator				\$1,378.95
BE057	Honda 2000w Inverter Generator				\$1,873.95

Heavy-Duty Extension Cord

The heavy-duty 100' power cord is ideal for use with all portable electrical requirements. Use on fire grounds, rescue scenes, or any place that requires durable, high quality, power cords.

- ▶ Cord length: 100'
- ▶ Superior durability
- ▶ Water and oil-resistant
- ▶ UL listed
- ▶ CSA approved STW or SJTW
- ▶ MSHA approved for flame resistance
- ▶ Meets Federal Spec. JC-5808



Cat#	Plug	Amp	Wire		Voltage	Weight	Black	Yellow
			Gauge					
BC060	Straight Blade	15	14/3	300	300	8 lbs.	\$157.95	\$256.95
BC061	Straight Blade	15	12/3	300	300	12 lbs.	\$231.95	\$262.95
BC062	Twist Lock	20	14/3	300	300	8 lbs.	\$155.95	\$267.95
BC063	Twist Lock	20	12/3	300	300	12 lbs.	\$232.95	\$260.95

Cord Reel Light

Cord Reel Lights are reverse-wired live cord reels, which allows a plug on the cord to be plugged into a power source while the Cord Reel Light is carried to the fire ground or work site. The Cord Reel Light allows the scene to be illuminated while providing a receptacle for additional tools or lights. Akron Brass' Cord Reel Lights come in 10" cord reels with either 500 or 750 watt low profile Beta Light heads.



Cord not included



BB090	Cord Reel Light 500 watt	\$590.95
BB092	Cord Reel Light 750 watt	\$618.95

Live Cord Reels

Allows fast, easy, manual deployment and retraction of extension cords without twisting or knotting, thus prolonging cord life. They are made of heavy-duty steel tubing powder-coated red for a long lasting durable finish. An enclosed electrical hub and heavy-duty brass slip rings (per NFPA) will carry up to 300 amps continuously. Reels come standard with a six-foot cord and L5-20, 125 volt-20 amp twist lock plug - other configurations available. Cord lengths listed below are based on 300 volt rating. *Ship. wt. 27 lbs.*

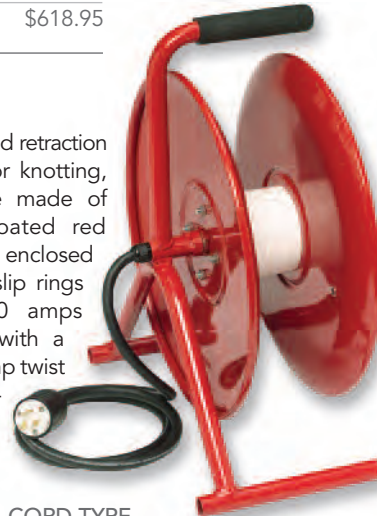

Cat#	Reel Size	CORD TYPE				Price
		16/3	14/3	12/3	10/3	
AZ539	10"	150'	125'	100'	-	\$184.95
AZ540	15"	-	300'	200'	100'	\$184.95
AZ541	18"	-	450'	300'	175'	\$196.95

Electric Rewind Cord Reel

In an effort to continue to supply the equipment to meet the firefighter's every need, Akron Brass is proud to introduce the updated Electric Rewind Cord Reel to the Power Distribution line. It has a more durable enclosed hub and improved flow performance through the reel with an enhanced waterway. This cord reel contains many of the great features of our portable cord reels along with many new innovative features for the electric rewind market. *Will fit up to 250' of 12/3 600 volt wire.*

- ▶ Heavy-duty construction
- ▶ Powder-coated parts and stainless steel hardware
- ▶ Motor can mount on all for sides including the rear for a slim design that maximizes compartment space
- ▶ Removable hub for ease of installation
- ▶ Includes gang box attached to the commutator (not pictured)
- ▶ Live slip ring design
- ▶ Includes relays
- ▶ 1500 psi rating
- ▶ 5 year warranty



See Optional Junction Box AM164



BD159	Electric Rewind Reel	\$1,058.95
BD160	Guide Rollers	\$97.95
BD161	Cord Ball Stop for 10-Gauge Wire	\$22.95

Bowtie Coil Keepers

Keeps Your Cords Neatly Coiled & Convenient to Store

The Bowtie Coil Keepers are a must for any vehicle carrying extension cords. These strong, nylon-woven straps wrap tightly around extension cords to keep them neatly coiled until you need them, held firmly together with a Velcro® closure. *Ship. wt. 1 lb.*

- ▶ Keeps cords neatly coiled
- ▶ Velcro® closure
- ▶ Hanging double D-ring



AM062	Bowtie Coil Keepers, 1 1/2"Wx15"L	\$9.95/2 pack
AM063	Bowtie Coil Keepers, 2"Wx21"L	\$11.95/2 pack

Booster Hose Reels

Include all the information below.
Specify left/right based on facing outlet.

► **For Manual:** Specify crank side (left or right)
Specify inlet side (left or right)
Note: must be same side as motor/crank
Specify Color: Red, Silver, White or Primer Coat
Specify Size No. (see chart)
Specify 90° or Straight Inlet swivel
Specify size (3/4" or 1") and outlet thread type

► **For Electric:** Specify motor side (left or right)
and motor position (front or back)
Note: must be same side as motor/crank

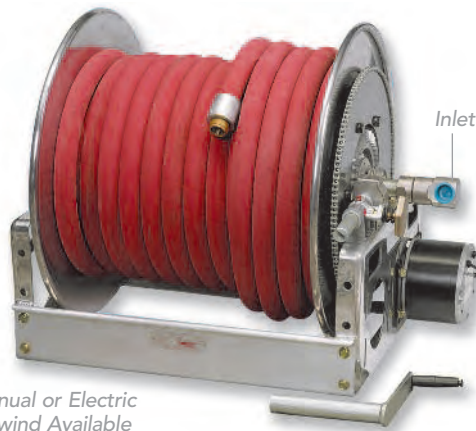

Manual or Electric
Rewind Available



Rugged, long lasting booster hose reel in choice of steel or aluminum to handle your 3/4" or 1" I.D. booster hose.

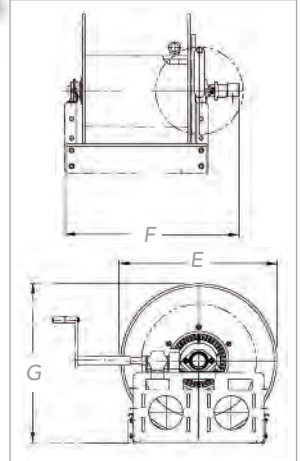

Size No.	HOSE REEL CAPACITY IN FEET		OVERALL REEL DIMENSIONS IN INCHES			APPROX. STEEL WT. LBS. (CRANK)		APPROX. ALUMINUM WT. LBS. (CRANK)	
	I.D. 3/4" O.D. 1 1/32"	I.D. 1" O.D. 1 1/16"	E	F	G	Net.	Ship.	Net.	Ship.
01	150	100	21 5/8	34 1/4	21 1/2	102	144	80	122
02	150	100	23	25 3/4	23 1/2	92	134	75	117
03	250	150	23	32 1/4	23 1/2	105	147	82	124
04	200	100	28 3/4	18 1/4	29 7/8	100	150	80	130
05	250	150	28 3/4	21 3/4	29 7/8	107	157	83	133

"F" dimension is the same for both electric & manual models. Add 40 lbs. to weights shown for electric models.

Electric Rewind Booster Hose Reels

AM167	Aluminum Booster Hose Reel	\$1,464.95
AM168	Steel Booster Hose Reel	\$1,064.95

Manual Booster Hose Reels

AM169	Aluminum Booster Hose Reel	\$1,049.95
AM170	Steel Booster Hose Reel	\$649.95
OPTION		
AZ633	Roller and Spool Installed	\$174.95

Drop-In Style Booster Reel

These reels are an excellent choice for drop-in units or smaller apparatus compartments where space is a premium. They're built to the same design standards as our larger reels, just lighter in weight and more compact. Available in either electric or crank rewind. Reels will hold up to 100' of 1" or 200' of 3/4" booster hose. Dimensions: (E) Crank/16.5", (E) Elec/19", (F) Crank/46.62", (F) Elec/39.75", (G) 18.12".

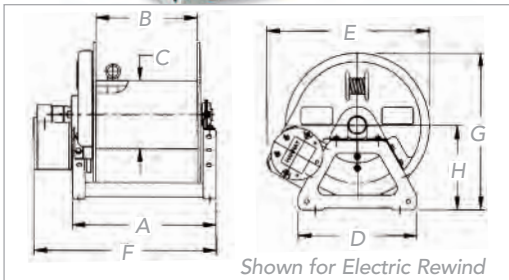

Shown for Electric Rewind

AJ513	Drop-In Style Booster Reel/Electric	\$734.95
AJ514	Drop-In Style Booster Reel/Crank	\$359.95

Booster Tools

Get Darley's complete set of booster tools for attaching 3/4" and 1" couplings. Try our lubricant to help ease coupling when installing.
Ship. wt. 2 lbs.

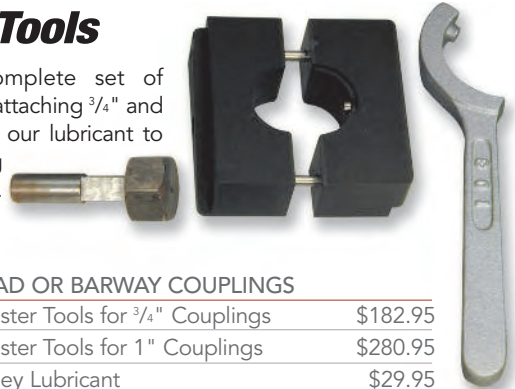

SPECIFY REDHEAD OR BARWAY COUPLINGS

P915	Booster Tools for 3/4" Couplings	\$182.95
P916	Booster Tools for 1" Couplings	\$280.95
P917	Darley Lubricant	\$29.95

Roller and Spool Assembly



Speed your hose handling and reduce wear on hose. Buffed stainless steel rollers. Assembly includes roller, 2 blocks, 2 spools, bearings and all fastenings. Length of roller should be the same as the reel drum length. (Larger sizes are available for an extra charge). **Ship. wt. 13 lbs.**

SPECIFY LENGTH: Up to 38"

R698	Roller and Spool Assembly	\$139.95
------	---------------------------	----------

Swivel Joints

Pressure balanced design for low rotation torque. Hardened carbon steel barrel for strength and long wear. NPT threads. **Ship. wt. 3 lbs.**



T961	1" Swivel Joint	\$76.95
T963	1" Seal Kit for Above	\$39.95
AF774	1 1/2" Swivel Joint	\$227.95

APPARATUS EQUIPMENT

Compact Reels (ELF and ESF Series)

For Utility or Breathing Air Hose

The slow, even rewind speed provided by the specially engineered gear motor will be appreciated by users, and eliminates any need for installing a speed control device. These reels are the most compact available (without sacrificing hose or cable life by using an undersized drum diameter).

- ▶ Available for all 3 rescue reel types: air, twin hydraulic or cord
- ▶ New gear motor rewind (12 or 24V available) for slow, powerful rewind in small footprint
- ▶ Takes up only 70% of the space of a traditional reel for same capacity hose or cable
- ▶ Universal 6" drum diameter, extending hose or cable life by meeting manufacturer's minimum bend radius
- ▶ Highly durable 2-coat finish (alkyd-modified topcoat over e-coat primer)
- ▶ Switch and circuit breaker provided with all ELF reels
- ▶ **ELF Series:** 14.5" maximum height (20% lower profile than standard reel)
- ▶ **ESF Series:** 14" maximum height (27% lower profile than standard reel)



ELF Series

Choose an ELF model when height of reel must be minimized

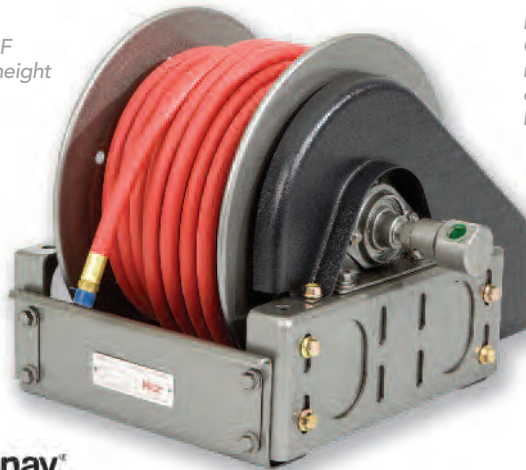

ESF Series

Choose an ESF model when depth of reel must be minimized

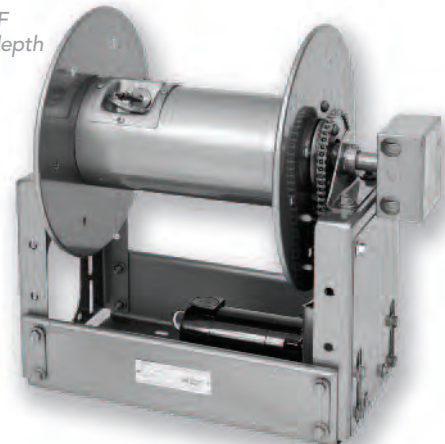

Compact Low Height Rescue Reels (ELF Series)

Utility Air Starting at \$926.95

Compact Narrow Depth Rescue Reels (ESF Series)

Utility Air Starting at \$897.95

Low Profile Booster Reel

By being shorter and not requiring as much compartment depth, the Low Profile Booster Reel was designed to take up less space than similar reels in the industry. It easily fits in low profile compartments, or when overhead height is a concern. It was designed to be extremely durable, by utilizing powder coated finishes and stainless steel hardware. In the Akron Brass tradition, it includes standard features such as chain guards, hand crank and tensioner. Solenoid, push button switch, and circuit breaker are also included at no additional charge for added ease of installation. The Low Profile Booster Reel is perfect for brush trucks, skid units, rear compartments of apparatus, or even off road utility vehicles. Most importantly, the Booster Hose Reel carries the standard 5 year warranty!

- ▶ Handles 3/4" and 1" ID booster hose
- ▶ **Dimension:** 17 1/4" H x 39" W x 15 1/2" D
- ▶ **Capacity:** up to 250' of 3/4" or 150' of 1" redline
- ▶ Powder coated finish available in red or silver
- ▶ **Standard inlet:** 90° super swivel with the 1" female NPT threads
- ▶ **Standard outlet:** 1" male NST threads (1 3/8" x 8 TPI)
- ▶ 1000 psi pressure rating



Shown with optional guide rollers assembly and nozzle

BH079 Low Profile Booster Reel

\$1,326.95



Apparatus Master Switches

It's recommended equipment of the NFPA for protection from short circuits. All switches disconnect the battery from the electric system at the turn of the switch. Use on apparatus with single or dual battery systems. Switch positions include: OFF, BATT. #1, BATT. #2, and BOTH. 5 1/2" diameter, for use on 6-36 volt systems. U654 meets KKK-A-1822A ambulance specifications, includes terminals for battery pilot lights. All metal T227 is a 2-position switch for single battery system, 6 or 12 volt only. 2 1/2" diameter. Continuous duty rating of 175 amps. *Ship. wt. 1 lb.*



T228	Battery Selector Switch	\$37.95
U654	Battery Selector (Meets KKK-A-1822A)	\$89.95
T227	Battery Selector Switch	\$24.95

Automatic Battery Charging Systems

Auto Charge 11 - For Dual Batteries



Auto Charge 11 is a fully automatic battery charger for vehicles with dual battery systems. The new and improved unit contains two completely independent chargers to sense and control the current to the batteries. Thus parasitic loads on one battery have no effect on the second battery. Total output current is limited to protect the charger but may be supplied to either battery if the adjacent battery does not require it. Normally the current output is proportioned between batteries as required. Comes complete with charging indicator panel. *Three-year warranty. 120v input. Ship. wt. 12 lbs.*

SPECIFY VOLTAGE: 6, 12, or 24

Y644	Auto Charge 11	\$463.95
------	----------------	----------

Auto Charge 12 - For Single Batteries



The Auto Charge 12 is a fully automatic battery charger for vehicles with a single battery system. Unique electronic sensing circuits sense the true battery voltage, while eliminating the need for external sense wires. The maximum output of the charger is 12 amperes. When the battery is fully charged, all charging stops. There is no overcharging, and no water boil off. It is ruggedly constructed for mounting in the vehicle. *Ship. wt. 12 lbs.*

SPECIFY VOLTAGE: 6, 12, or 24

Y645	Auto Charge 12	\$411.95
------	----------------	----------

Pump Plus

Air Compressor/Battery Charger Package

The Pump Plus is a small air compressor and a completely automatic battery charger packaged together. Air compressor is designed to be mounted on vehicles with air brakes to maintain the air pressure in the air brake system while the vehicle is not in use. A pressure switch senses the system pressure and operates the compressor whenever the pressure drops below a predetermined level. Battery charger is completely automatic and is for vehicles with dual battery systems. The batteries are automatically charged and maintain full charge while still being isolated from each other. This unit contains two independent chargers to sense and control the current to the batteries. Designed to mount directly on the vehicle. 12v compressor has 1-yr. warranty; Battery Charger comes with 3-yr. warranty. *Ship. wt. 20 lbs.*

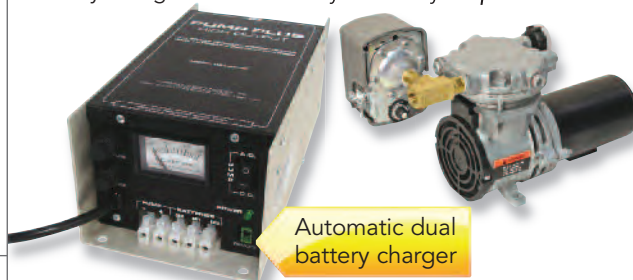

Z112A	Pump Plus HO Package	\$885.95
Z111	12v DC Auto Pump Compressor	\$496.95
Z112	120v AC Auto Pump Compressor	\$522.95

Auto Charge 2000 Kit

Complete Charging System at An Affordable Price

Auto Charge 2000 is a high-output, dual battery charger that independently charges two batteries. Includes the Auto Charge 2000 automatic battery charger and Auto Eject (20 amp) automatic power line disconnect, providing a complete vehicle charging system that saves you money. Unique electronic sensing circuits sense the true battery voltage while eliminating the need for external sense wires. There is no overcharging and no water boil off. What's more, a built-in battery saver handles the problem of battery loading from rechargeable hand lights, portable radios and other loads. Comes complete with weatherproof, bar graph display that shows the charging condition of each battery; may be remotely mounted. 120v input, 15 amp output. *Three-year warranty. Ship. wt. 17 lbs.*

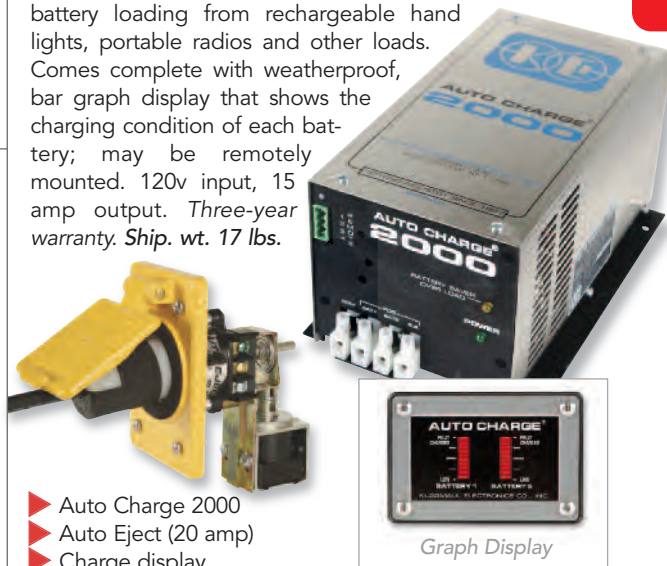

- ▶ Auto Charge 2000
- ▶ Auto Eject (20 amp)
- ▶ Charge display

AC905	Auto Charge 2000 Kit	\$757.95
-------	----------------------	----------

Super Auto Eject & Auto Eject

Super Auto Eject is a completely sealed automatic power line disconnect. This prevents contamination of the mechanism by road dirt and insures long, reliable life. Comes with a weatherproof cover that is spring loaded to close, preventing water from entering. A solenoid wired to the vehicle's starter is energized when the engine is started. This instantaneously drives the plug from the receptacle. This simple, reliable device eliminates the broken cables which result when drivers forget to remove the shore line when driving away. The Auto Eject comes without sealed housing. *All units come with 120v AC connector. Both models are weatherproof. Ship. wt. 2 lbs.*



Auto Eject

Comes without rear housing

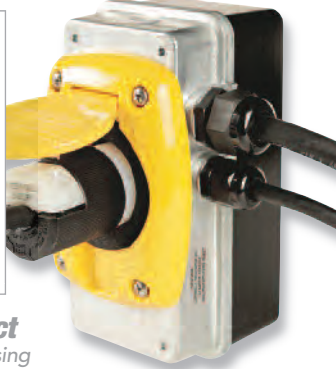

Super Auto Eject
Comes with rear housing

SPECIFY COLOR: Red, White, Yellow or Gray

AG130	Super Auto Eject, 15 Amp	\$249.95
AG131	Super Auto Eject, 20 Amp	\$278.95
Y885	Auto Eject, 15 Amp	\$193.95
AF527	Auto Eject, 20 Amp	\$223.95

Rear View Backup Cameras

LCD Systems Feature:

Color LCD system with 1 day-night camera, remote control, camera audio, 65'/20m cable, mounting hardware and instructions.

BH080 Also Includes:

- ▶ 5" LCD flat panel monitor
- ▶ Supports up to 3 cameras



BH080

BH081 Also Includes:

- ▶ 7" color LCD flat panel monitor with remote control
- ▶ Wide screen
- ▶ Supports up to 4 cameras
- ▶ 3 camera input with 1 RCA A/V in for GPS



BH081

BH082 Features:

Color camera with massive infrared LED cluster to light up your view in darkness or bad weather. Color model features automatic switch mode-goes to high resolution black-and-white in low light, switches back to brilliant color in daylight.

BH080	5" LCD System	\$495.95
BH081	7" LCD System	\$583.95
BH082	Color Day-Night Camera	\$182.95
BH083	15 meter 4-pin Camera Cable	\$19.95

Auto Charge Dual Status Center

The Auto Charge Status Center is a universal indicator that works with all Kussmaul Electronics battery chargers, as well as indicating voltage on vehicles without a charger. The indicator reads battery voltage and indicates the condition of the battery via LED's: Hi voltage, fully charged, charging and low voltage. In addition to the LED status indicators, a 3-digit indicator displays the battery voltage with an accuracy of 100 millivolts. The display toggles between battery #1 and battery #2. The indicator fits Kussmaul standard indicator panel cut outs.



- ▶ Weatherproof enclosure
- ▶ Mounted on the outside of a vehicle
- ▶ 3 year warranty

BK214	Auto Charge Dual Status Center	\$158.95
-------	--------------------------------	----------

Electronic Back-Up Alarm

A heavy-duty back-up alarm using an electric output circuit. Requires less than 9 sq. inches of mounting surface. Designed to meet or exceed SAE specifications. 12-volt DC connects to back-up light circuit. Other voltages on request. Weighs only 5 oz. Available in 97 db, 107 db or Multi-Function Dual models. *Ship. wt. 2 lbs.*



AW257

U673	Electronic Back-Up Alarm 97 db	\$27.95
U674	Electronic Back-Up Alarm 107 db	\$42.95
AW257	Electronic Back-Up Alarm Multi-Function Dual	\$42.95

Automatic Air Eject

This simple, reliable, solid brass device permits pressurizing the vehicle's air pressure system from an external source. Automatically, when the engine is started, the air line is disconnected. Comes with the mating connector, check valve and simple installation instructions. *Full 2-year warranty. Ship. wt. 3 lbs.*

- ▶ Automatically disconnects air line when vehicle is started
- ▶ Eliminates broken air lines



AG133

AB034	Automatic Air Eject	\$232.95
AG133	Weatherproof Adapter Kit	\$51.95

Insight Digital Flowmeter Kit

The Insight flowmeters are specifically designed for use on fire apparatus where flowing water is often turbulent and unsteady. This hi-tech indicating device is compact to take up minimal panel space and built rugged to withstand the conditions found at fire scenes. *Includes: display, sensor mount, and 10' sensor cable.*

- ▶ Displays gpm directly
- ▶ Push button totalizer (displays the total number of gallons flowed since pumping began)
- ▶ All-aluminum casing
- ▶ Paddlewheel style flow sensor
- ▶ Datalink interface
- ▶ Internal micro-processor
- ▶ Supply voltage: 9-30 VDC
- ▶ Supply current: 0.5 amp
- ▶ Simple installation
- ▶ Display dimensions: 3.26" W x 3.25" H, 2.72" panel cutout required
- ▶ Linearizer feature - allows for multiple flow point calibrations
- ▶ Safeflow feature - preset excessive and inadequate flow warning settings
- ▶ Datalink allows for unlimited readouts and summation of accumulated flow from all discharges



FRC
FIRE RESEARCH CORP.
choose the best.

SPECIFY PIPE DIAMETER

AS313	Insight Digital Flow Meter Kit, 1" - 6" Pipe	\$700.95
BG550	Insight Plus Digital Flow & Pressure Meter Kit, 1" - 6" Pipe	\$885.95

Engine Throttles

- ▶ Throttle always starts from idle regardless of dial position for safer operation
- ▶ Complete solid state, no potentiometer or electro-mechanical switch
- ▶ Smart dial senses dial speed for fast and fine RPM setting
- ▶ Throttle engages only when safety interlock signal is received
- ▶ FRC data link allows for multiple throttle installation

FRC
FIRE RESEARCH CORP.
choose the best.



AW288	Infinity-S for Cummins IS	\$329.95	AW294	Infinity-PRO for Caterpillar	\$525.95
AW289	Infinity-S for Detroit Series 50 & 60	\$329.95	AW295	Infinity-PRO for Ford Engines	\$727.95
AW290	Infinity-S Throttle for Navistar & Detroit Series 40	\$329.95	AW296	Infinity-PRO for Mack Engines	\$525.95
AW291	Infinity-PRO for Cummins IS	\$525.95	AW297	Infinity-PRO for Scania Engine	\$525.95
AW292	Infinity-PRO for Detroit Series 50 & 60	\$525.95	AW299	Infinity-PRO for Mercedes Engines	\$525.95
AW293	Infinity-PRO for Navistar and Detroit Series 40	\$525.95			

PumpBoss Pressure Governors

The FRC PumpBoss has long been admired by the fire industry for its ability to effectively control pump pressure and its capability to clearly display critical information related to safe pump operation. Building on these capabilities FRC has designed the next generation of PumpBoss pressure governors.

- ▶ The use of two 600 psi pressure sensors; one for pump discharge and one for pump intake to provide improved defense against pump cavitations
- ▶ Separate buttons for Pressure and RPM for the ease of selecting either mode of operation
- ▶ 2-line digital message display to clearly show the pressure and RPM settings during normal operations, as well as warning alarms and fault codes
- ▶ An additional 4" bi-color LED bar graph specifically for transmission temperature
- ▶ Built-in day/night sensor that adjusts the brightness of the display LED's to ensure clear viewing

FRC
FIRE RESEARCH CORP.
choose the best.



BH195	PumpBoss Governor for Detroit Diesel, Cat. and Cummins IS	\$1,963.95
-------	---	------------

OTHER GOVERNORS AVAILABLE

AW301	PRO-S Pressure Governor PSI/Cummins iS Series Engines	\$1,964.95
AW302	PRO-S Pressure Governor PSI/Detroit Diesel Engines	\$1,964.95
AW303	PRO-S Pressure Governor PSI/Non-Electric Engines	\$3,023.95
AW305	PRO-S Pressure Governor PSI/Caterpillar Engines	\$1,964.95

APPARATUS EQUIPMENT



TankVision

Water/Foam Volume Indicators

The TankVision is your solution to tank volume monitoring. Available for both water and foam, each with distinctive color and styling. Mini-displays for remote in-cab mount are similarly color coded. A single TankVision primary display can drive an unlimited number of remote displays as well as in cab mini-displays. For remote warning, an optional Large Light Driver is available with current draw capability up to 5 amp per light. The TankVision uses a pressure transducer to provide a highly accurate liquid volume. *Ship. wt. 3 lbs.*

- ▶ Ultra Brite LEDs display exact water/foam remaining
- ▶ Flashing warning when actual volume is below 25%
- ▶ Rugged waterproof cast aluminum housing
- ▶ Unit self-calibrates to any size/shape tank regardless of dimensions
- ▶ Easy-to-operate and install

AR317	TankVision Gauge Kit, with Master Display Sensor and 10' Cable	\$429.95
AS309	TankVision In-Cab Mini Display for Water	\$152.95
AS312	TankVision Remote Driver for "Large Lite" Display	\$255.95

Quint Water Level Monitor

Five-light readout that uses green, amber and red lenses with red flashing refill light. Complete unit consists of readout, bezel plate and stainless steel sensor. Additional readout available without sensor. *Ship. wt. 5 lbs.*

SPECIFY: 12 or 24-volt, positive or negative ground and tank dimensions

X940	Quint Water Level Monitor	\$233.95
X942	Additional Readout	\$129.95

SERVICE KIT FOR X940 INCLUDES: 5-domed lenses, 4-replacement bulbs, 1-flasher replacement bulb, 2-plate screws and 1-bulb extracting tool

AB017	Service Kit for Quint Level Monitor	\$24.95
-------	-------------------------------------	---------

Water Level Monitor

R157

Easy-to-read indicator. Water Level Monitor uses four red lights to show water level in sequence as water drains away. Complete unit includes control box, bezel plate, and stainless steel sensor. *Ship. wt. 1 lb.*

SPECIFY: 12 or 24-volt, positive or negative ground & tank dimensions

R157	Water Level Monitor	\$189.95
------	---------------------	----------

SERVICE KIT FOR R157 INCLUDES: 4-domed lenses, 4-replacement bulbs, 2-plate screws & 1-bulb extracting tool

AB016	Service Kit for Water Level Monitor	\$19.95
-------	-------------------------------------	---------

Tachometer Gauge

Modernize your present apparatus with these precision gauges. Accurate within 2% of full scale on conventional and transistorized 12-volt positive or negative ground ignition. Chrome-plated brass with double-strength, curved glass window. The pointer is painted fluorescent red for easy visibility. Will not produce radio interference. Easily installed and comes complete. Measures 3³/₁₆" in diameter. *Ship. wt. 1 lb.*

- ▶ Highest quality components
- ▶ Meets rigid specifications
- ▶ Shock and vibration-proof
- ▶ Guaranteed waterproof

L918	Tachometer, RPM Range 0-6000, for 4-6-8 Cylinder Vehicles	\$38.95
------	---	---------

W483	Tachometer, RPM Range 0-4000, for Diesel Engines, with Sender	\$79.95
------	---	---------

Liquid-Filled Gauges

Eliminates Needle Pulsation for Accurate and Easy Readings

Crystal-clear Interlube keeps needle fluctuation to a minimum. The SUBZ II freeze-proof isolator keeps gauge working down to -40°F. It's also weathertight so there is no condensation; stops corrosion. Lubricates internal parts, stops wear, maintains accuracy under temperature fluctuations. Zytel (nylon) case with bright stainless steel trim ring has plexiglass lens. 6" gauge has cast aluminum case. Gauges measure 0-600 psi and up to 30" vacuum. *Ship. wt. 5 lbs.*

BLACK AND WHITE FACE GAUGES WITHOUT LOGO ARE AVAILABLE

T179	2 ¹ / ₂ " Liquid-Filled Compound Gauge	\$45.95
AK075	2 ¹ / ₂ " Liquid-Filled Compound Gauge with Bottom Connection	\$43.95
T180	3 ¹ / ₂ " Liquid-Filled Compound Gauge	\$71.95
AK076	3 ¹ / ₂ " Liquid-Filled Compound Gauge with Bottom Connection	\$71.95
T181	4 ¹ / ₂ " Liquid-Filled Compound Gauge	\$96.95
U966	Similar to T181 but with 1000 psi	\$96.95
U967	6" Liquid-Filled Compound Gauge	\$284.95

Panel Hole Size Needed for Gauge Installation:

2.5"	3.5"
2.69"(68.33mm)	3.78"(96.01mm)
4.5"	Tolerance
4.85"(123.19mm)	-.020"(0.51mm)

APPARATUS EQUIPMENT

Butterfly Valves

- ▶ Rotating the handle to open disc 1/4 turn allows an almost unrestricted water flow
- ▶ The 10 position lever handle with positive detents allows the valve to be opened or closed incrementally for a controlled water flow
- ▶ Comes standard with a bleeder valve
- ▶ Available with 4", 4 1/2", 5" or 6" male or female hose
- ▶ Ship. wt. 45 lbs.



LEVER HANDLE

BL272	6" NHSWFLH x 6" NHM	\$999.95
BL273	5" NHSWFLH x 5" NHM	\$999.95
BL274	4.5" NHSWFLH x 4.5" NHM	\$999.95
BL275	4" NHSWFLH x 4" NHM	\$999.95

HANDWHEEL

BL276	6" NHSWFLH x 6" NHM	\$1,083.95
BL277	5" NHSWFLH x 5" NHM	\$1,083.95
BL278	4.5" NHSWFLH x 4.5" NHM	\$1,083.95
BL279	4" NHSWFLH x 4" NHM	\$1,083.95

Heavy Duty Swing-Out™ Valves

Designed for the harsh realities of today's fire service when water contaminants challenge a valve's sealing capabilities. Swing-Out™ design for quicker and easier servicing. No need to remove valves from plumbing when servicing. Operating pressures to 250 psi (17 bar).



Cat#	Description	Size	Weight	Price
P880	Heavy Duty Swing-Out™ Valve	1"	6 lbs.	\$194.95
P881	Heavy Duty Swing-Out™ Valve	1 1/2"	8 lbs.	\$267.95
P882	Heavy Duty Swing-Out™ Valve	2"	12 lbs.	\$312.95
P883	Heavy Duty Swing-Out™ Valve	2 1/2"	24 lbs.	\$383.95
P884	Heavy Duty Swing-Out™ Valve	3"	28 lbs.	\$585.95

- ▶ 90° handle travel
- ▶ Stainless steel ball with Hydromax provides longer valve life and improved sealing abilities
- ▶ Simple two seated design
- ▶ Meets NFPA requirements



Drain Valve

Don't risk frozen lines and corrosion. Easy-to-install push-pull design allows fast draining where you want it. Stainless steel shaft. Outlet and inlet 3/4" NPT female. Ship. wt. 3 lbs.



R742	Drain Valve, East Brass Body	\$45.95
AF773	Drain Valve with Panel Mount Flange	\$52.95

Push/Pull Primer Valve

Panel mounted priming valve is easy to install in a 1 1/4" diameter panel hole. New, lightweight anodized aluminum construction with improved porting assures long life and trouble free service. Large, chrome plated T-handle for easy grip and activation. Connection ports are 1/2" NPT female. Assembly includes valve, cast panel plate, primer activation switch, and wiring pigtail. Ship. wt. 2 lbs.

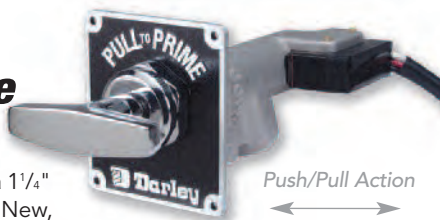

VM00310	Push/Pull Primer Valve	\$277.95
---------	------------------------	----------

Valve Repair Kits



Valve repair kits are convenient, economical and easy-to-use. Each kit contains the most frequently replaced parts to help cut down on maintenance time and costs. Kits come sealed to ensure a clean and adequate supply of parts for each job. Kits now are with new Fusion CF™ Composite ball. Ship. wt. 1 lb. * Valve and nozzle repair kits are available for most Akron, Elkhart and some other products in use today. Please call us with nozzle or valve make and model for price quote.

Kits for Akron 7800 & 7600 Swing-Out™ Series Valves w/Tork-Lok

AK103	Valve Repair Kit, 1"	\$63.95
AK104	Valve Repair Kit, 1 1/2"	\$81.95
AK105	Valve Repair Kit, 2"	\$103.95
AK106	Valve Repair Kit, 2 1/2"	\$104.95
AK107	Valve Repair Kit, 3" & 3 1/2"	\$151.95

Kits for Darley Standard and Full-Flow Valves (excludes ball)

G239A1	Valve Repair Kit, 2 1/2" for Standard Valves	\$50.95
G240A1	Valve Repair Kit, 2 1/2" for Full Flow Valves	\$100.95

Darley Heat Exchanger

Can be installed in the engine cooling system of any pumper. Instead of going directly into the engine cooling system, mixing with the anti-freeze solution, diluting it and then going out through the radiator overflow pipe, the flow of cool water from the pump bypasses through the condenser coils in the Heat Exchanger. The liquid in the cooling system circulates around the condenser coils and is completely cooled. Prevents loss of anti-freeze solution. 24" long. *Ship. wt. 10 lbs.*



F618 Darley Heat Exchanger \$239.95

Radiator Heat Exchanger Fits Between Radiator Hoses

Does the same job as our F618 Heat Exchanger but fits between the radiator hoses to make installation easier. Only additional connections required are tube lines from pump discharge to return line to suction side of pump. Measures 9 1/2" long. *Ship. wt. 9 lbs.*

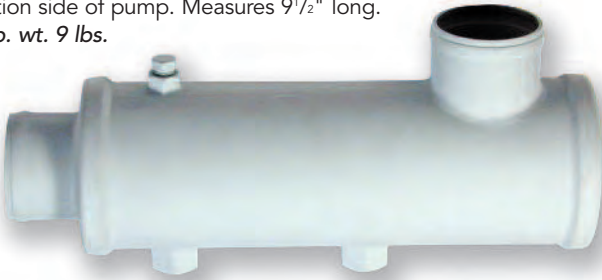

SPECIFY 1 3/4", 2" or 2 1/4"
R592A Radiator Heat Exchanger \$265.95

Vernier Throttle Control

Easily installed throttle designed for apparatus. Provides both instant and micro meter fine adjustment together with a locking action which is not affected by vibration while pumping. The instant adjustment is conveniently made by a push-pull movement of the knob after a slight pressure is applied on the thumb button. The fine or Vernier adjustment is made by simply turning the same knob. Throttles are shipped complete, ready-to-install in 15' or 20' lengths. *Ship. wt. 5 lbs.*

F62101 15' Vernier Throttle Control \$34.95
F62103 20' Vernier Throttle Control \$38.95

Mattydale Swivel

Rugged cast brass elbow for use with mattydale hose beds. 1 1/2" NPT female free swivel inlet with 1 1/2" NST male outlet. Rough brass finish. *Ship. wt. 4 lbs.*



U307A 1 1/2" NPT x 1 1/2" NST \$88.95
U307B 2" NPT x 1 1/2" NST \$84.95
U307C 2 1/2" NPT x 2 1/2" NST \$265.95

Magnesium Anode Pole Attracts Rust & Corrosion

Sacrificial catalytic action of these magnesium anodes can help to prevent rust or corrosion from attacking your booster tank. Threaded mounting plate suspends the 3/4"x32" solid anode in the tank water. Bar is easily cut to fit tanks less than 32" deep. Comes with flange and gasket. *Ship. wt. 3 lbs.*

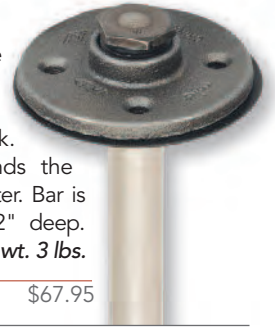

U971 Magnesium Anode Pole \$67.95

Brass Swing Check Valves

Swing check valves are a vital component in units that must prevent water or foam from the pump from reaching the water tank. All-brass heavy-duty construction. *Ship. wt. 8 lbs.*



U917 1 1/2" Brass Swing Check Valve \$18.95
U918 2 1/2" Brass Swing Check Valve \$64.95
U919 3" Brass Swing Check Valve \$100.95

Ground Sweep Nozzle

Constant-flow fixed nozzles so we must know the gpm you want at 100 psi. Choose from 5 to 40 gpm (3/4") or from 40-100 gpm (1"). Pre-set at factory, easily field re-settable. Fog capability to 120°. *Ship. wt. 1 lb.*



SPECIFY MALE OR FEMALE
NPT (TAPERED)
Z321 Fixed Nozzle, 3/4" \$153.95
Z322 Fixed Nozzle, 1" \$163.95

Air Primer

- ▶ Super quiet
- ▶ Lightweight and small mounting space
- ▶ Power: Air operated (No electrical power required)
- ▶ Corrosion resistant brass construction
- ▶ Oil-less Design: Environmentally safe
- ▶ Self draining
- ▶ No moving parts
- ▶ Air requirements:
 - (2) Barrel = 7 cfm
 - (3) Barrel = 10 cfm
- ▶ BL012 & BL013: For Darley/Waterous pumps
- ▶ BL014 & BL015: For Hale pumps



BL012 Air Primer (2) Barrel .75" F NPT-Remote Mtd. \$884.95
BL013 Air Primer (3) Barrel .75" F NPT-Remote Mtd. \$884.95
BL014 Air Primer (2) Barrel H-Midship Direct Mtd. \$884.95
BL015 Air Primer (3) Barrel H-Midship Direct Mtd. \$884.95

Sledge Hammer Bracket

Designed for use with 2 to 16-pound Double Face Sledges and 1 to 3-pound Dead Blow Hammers. Bracket is 2³/₄"Hx3"D - expandable from 5¹/₄" to 8³/₄"W to fit various-sized tools. Made of stainless steel for years of lasting service. *Ship. wt. 3 lbs.*

AS325 Sledge Hammer Bracket \$82.95

Axe Holder Bracket

Designed for use with 6-pound flat or pick head axe. Bracket is 5"Hx2¹/₈"D. Expands from 7¹/₄" to 8¹/₄" W to fit most axe heads. 2¹/₂"Hx1¹/₄"W slot in end for pick to protrude. Axe blade protected by a replaceable plastic sleeve. Pinned handle holder accepts up to 2⁵/₁₆"W handle. Stainless steel for trouble-free service. *Ship. wt. 4 lbs.*



AS331 Axe Holder Bracket \$154.95

AS332 Axe Wall Mounting Bracket \$118.95

Quic-Mount® Bolt Cutter Bracket

Designed for use with 18" to 36" bolt cutters with adjustable stop and pin. Utility straps hold the bolt cutter handles firmly in place. Comes with one fixed strap and one variable strap. *Ship. wt. 3 lbs.*

AR158 Quic-Mount® Bolt Cutter Bracket \$88.95

Cup Mount Cylinder Holder

Neoprene mounts are ideal for storage of cylindrical items such as SCBA and oxygen cylinders, fire extinguishers, rescue tools, etc. *Ship. wt. 5-9 lbs.*

AW334 5.4" to 5.8" Cylinder \$108.95

AW335 6.75" Cylinder \$135.95

AW336 7.25" Cylinder \$148.95

Mounting Brackets

Variable Mounting Brackets are designed to accommodate various diameter tools and equipment. Brackets are powder-coated aluminum. *Ship. wt. 1 lb.*

AW330 Horizontal 1"-1.3" \$23.95

AW331 Horizontal 1.3"-1.6" \$23.95

AW332 Vertical 1"-1.3" \$23.95

AW333 Vertical 1.3"-1.6" \$25.95

Quic-Bar®/Axe Mounting Bracket Set

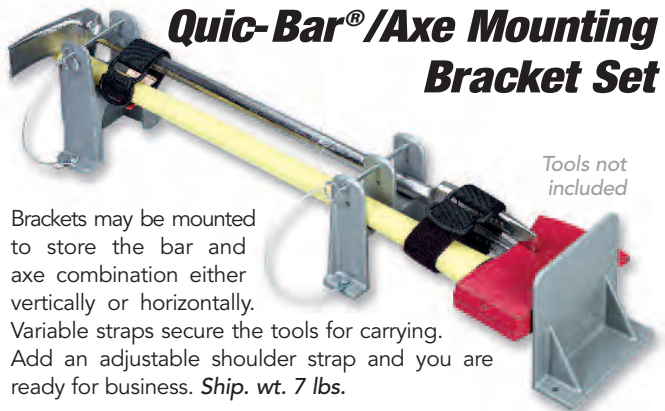

Tools not included

Brackets may be mounted to store the bar and axe combination either vertically or horizontally. Variable straps secure the tools for carrying. Add an adjustable shoulder strap and you are ready for business. *Ship. wt. 7 lbs.*

AS329 Quic-Bar/Axe Mounting Bracket Set w/Stop \$141.95

AS330 Straps for Quic-Bar® & Axe Mounting Bracket \$69.95

Round Gas Can Mount

Round gas can mount was designed for safety cans with 9" and 13" diameter bases. The safety can is held in place by a 1" nylon safety strap with a quick-release buckle. *Ship. wt. 7 lbs.*



AS328 Gas Can Mount Up to 2 Gal. 9³/₄"IDx2¹/₈"D \$92.95

BD079 Gas Can Mount Up to 5 Gal. 13¹/₂"IDx2¹/₈"D \$102.95

Quic-Mount Holder

Rectangular Holder
7¹/₂"Wx14³/₄"L

Oval Holder
6³/₄"Wx9¹/₄"L



AW328 Rectangular Holder for 5-Gallon Jerry Can \$107.95

AW329 Oval Holder for 1-Gallon Oval Safety Can \$76.95

Chain Saw Mount

Mount chain saws, abrasive cut-off saws and other gasoline engine tools on these specially designed brackets. Absorbent pad collects fluids and may be changed as required. Safety strap secures the saw on the bracket. *Ship. wt. 10-12 lbs.*



Saw not included

AS326 Large Mount - 11¹/₂"x17¹/₂" \$146.95

AS327 Small Mount - 10"x15" \$143.95

Horizontal Mounting Posts

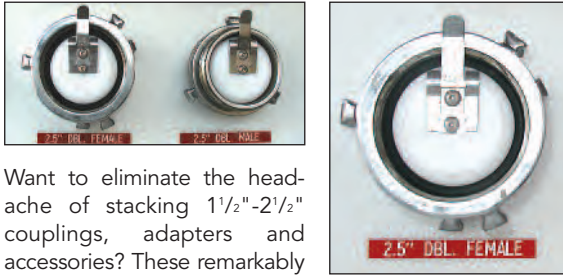

Want to eliminate the headache of stacking 1½"-2½" couplings, adapters and accessories? These remarkably simple and unique Horizontal Mounting Posts for double male or female configurations are designed to save cabinet storage space and improve overall truck neatness and efficiency. With no stacking, you can instantly spot the size adapter or coupling you need. Special stainless steel spring clip provides secure holding yet quick-action release. Durable construction materials will not corrode, swell or crack. Single screw mounting takes only minutes.

BE304	1.5" Double Female	\$24.95
BE305	1.5" Double Male	\$24.95
BE306	2.5" Double Female	\$31.95
BE307	2.5" Double Male	\$31.95

Storz Lok

- ▶ Corrosion-free
- ▶ Mounts in any position
- ▶ **Strong:** resistant to heat and cold
- ▶ **Fast acting:** mount or dismount
- ▶ **Easy-to-use:** no moving parts
- ▶ **Self-locking:** the automatic lock on the coupling locks it in place
- ▶ **Rattle resistant:** the "quiet mount" no metal-to-metal contact



BC019	Storz Lok 4" Mount	\$44.95
BC020	Storz Lok 5" Mount	\$51.95
BL265	Storz Lok 6" Mount	\$63.95

Storz Hardcoat Mounting Plates

High-tensile aluminum construction with anodized finish to resist abrasion and corrosion. **Ship wt. 1 lb.**

AF63801	4" Plate	\$30.95
AF63802	5" Plate	\$36.95



Quick Action Nozzle Holder

Running board holder for nozzles and fittings. Positive grip, triple-lock lugs. Designed for NST threads, but will fit similar threads. The spring and lever handle permits proper tension with a quick, easy release. **Ship. wt. 2 lbs.**

G321	2½" Chrome Plated	\$39.95
G421	1½" Chrome Plated	\$40.95

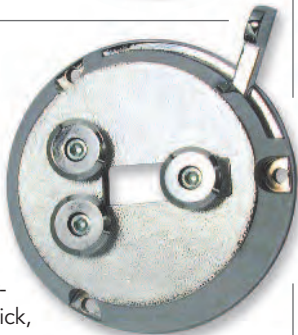

Storz Fitting Holders

For 4" and 5" Storz

Simplicity and practicality highlight the new line of ¼ turn fitting holders. The unique self-locking feature easily mounts 4" and 5" Storz couplings and adapters. Simply drop the fitting in the slots, pull down and it's locked in place. To release, just lift up - nothing to turn, spin or unscrew. The non-corroding, powder-coated aluminum base needs no maintenance. Two flat-head screws are all that is required for mounting.



Cat#	Description	Dimensions	Price
BE302	Single Storz Fitting Holder	8"x8"x1"	\$50.95
BE303	Double Storz Fitting Holder	8"x17"x1"	\$78.95

Booster Nozzle Holder

Two-Position Mounting Bracket For Versatility

This neoprene rubber cup mount is the ideal way to mount pre-connected nozzles on fire and emergency vehicles. Bracket sold separately. **Ship. wt. 3 lbs.**



U400	Nozzle Cup Mount 3½" I.D.	\$69.95
U401	Nozzle Cup Mount 5½" I.D.	\$92.95
U402	Nylon Coated Bracket (Black)	\$29.95

Mounting Plate

Male mounting plate is made of aluminum. **Ship. wt. 1 lb.**

new



BL365	1½"	2½"	3"	4"	4½"	5"	6"
	\$13.95	\$17.95	\$20.95	\$34.95	\$40.95	\$48.95	\$49.95



Holds Any Threaded Fitting Securely

Self-draining with three center mounting holes. Aluminum NST Threads.

new



BL366	1½"	2½"	3"	4"	4½"	5"	6"
	\$16.95	\$24.95	\$31.95	\$45.95	\$50.95	\$58.95	\$63.95



Threaded Fitting Holders

Adjusts from 4" to 6"



Unique spring-loaded, capturing-knob design eliminates specialized thread requirements. Fittings snap on and off, so no extra mounting space is required. Holders feature selectable positioning of the capturing knobs to accommodate any size fittings in the 4" to 6" diameter range. Multiple-Size Fitting Holders mount quickly to either vertical or horizontal surfaces, interior or exterior. Two flathead screws are all that is required. The non-corroding, powder-coated aluminum base needs no maintenance, and the capturing knobs are made of a special durable plastic that will not swell or crack. 30-pound spring tensioning holds fittings securely while allowing fast on/off action. Features stainless steel hardware.

Cat#	Description	Dimensions	Price
BE300	Single Threaded Fitting Holder	8"x8"x1 ⁷ / ₈ "	\$93.95
BE301	Double Threaded Fitting Holder	8"x17"x1 ⁷ / ₈ "	\$146.95

Heavy Duty Mounting Brackets

Constructed out of 1/8" powder-coated aluminum, these Heavy Duty Mounting Brackets can be used to mount a variety of tools and equipment. The heavy duty construction suits tools such as Haligan, Kelly or Claw tools.

The brackets are lined with an aluminum vinyl strip which helps tools 1" in diameter securely in place.



BH130	Heavy Duty Mounting Bracket	\$32.95
-------	-----------------------------	---------

D-Handle Mounting Bracket

D-Handle Mounting Brackets are designed to hang "D"-style handle tools simply and practically.



BH131	D-Handle Mounting Bracket	\$22.95
-------	---------------------------	---------

Horizontal Extrication Tool Holder for Wrap Around Handles

Designed for the horizontal mounting of cutters, spreaders, and combis with grip handles that wrap completely around the tool body. Consists of four heavy-duty aluminum components-one cradle, one strap bracket and two tip brackets. Mounts to virtually any flat surface. Great for use in bumper, "Coffin" compartments and other spaces where storage height is restricted. Gravity keeps the tool resting firmly in the cradle while the adjustable tip brackets and nylon retention strap prohibit shifting while the apparatus is in motion.

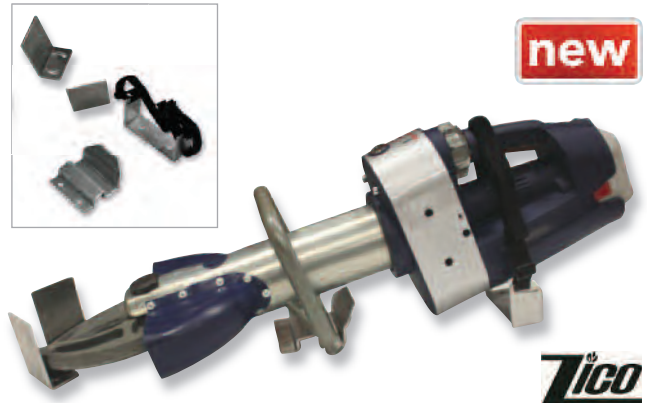

BL465	Horizontal Extrication Tool Holder For Wrap Around Handles	\$102.95
-------	--	----------

Multiversal Extrication Tool Holder

- ▶ Secures many popular models of cutter, spreader and combination tool upright in the compartment
- ▶ Features more than 10 individually adjustable components, including tilt angel, for a most secure fit
- ▶ Reusable. Accommodate a new/replacement tool with only a few minor adjustments
- ▶ Eliminates need for expensive custom box fabrication when purchasing a new apparatus or replacing tools on an existing one
- ▶ Heavy duty, lightweight aluminum construction



BL466	Multiversal Extrication Tool Holder	\$398.95
-------	-------------------------------------	----------

Ring Handle Bracket

Capture the end of the tool or handle with the Ring Handle Bracket. 2" opening.



BH129	Ring Handle Bracket	\$22.95
-------	---------------------	---------

P.A.C. Mounting Systems



Tool Hanger Kit

Bracket is designed to permit simple mounting for shovels, brooms, and other "T" head equipment. The tool hanger provides a simple, cost-effective method to hold a wide range of tools. Made of rugged, molded urethane. Resistant to weather, impact, UV and corrosion. Includes Tool Hanger and Handlelok. Hardware/fasteners included. Color: black. Ship. wt. 1 lb.



BE071 Tool Hanger Kit \$78.95

Pickhead Axe Hanger/Pocket Kit

Provides the flexibility of mounting the axe head on top (hanger) or bottom (pocket). Made of rugged, molded urethane. Resistant to weather, impact, UV and corrosion. Includes Pickhead Axe Hanger, Handlelok and 2 Fastener Packets. Color: black. Hardware/fasteners included. Ship. wt. 2 lbs.

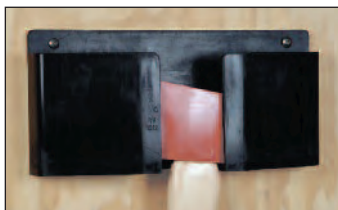

BE072 Pickhead Axe Hanger/Pocket Kit \$148.95

Halligan Tool Mount Kit

Safe, secure, and dependable storage in any position. Made of rugged, molded urethane. Resistant to weather, impact, UV and corrosion. Includes Dual Point Holder, Claw End Holder, Toolok and 2 Fastener Packets. Hardware/fasteners included. Ship. wt. 3 lbs.



BE075 Halligan Tool Mount Kit \$124.95

Handlelok Stretchlok System

An innovative, adjustable mounting bracket that provides secure mounting for tools, axe handles, poles and other equipment up to 1 3/4" in diameter. The stretchlok system allows quick release for easy retrieval. Made of elastomer. Hardware/fasteners included. Ship. wt. 1 lb.

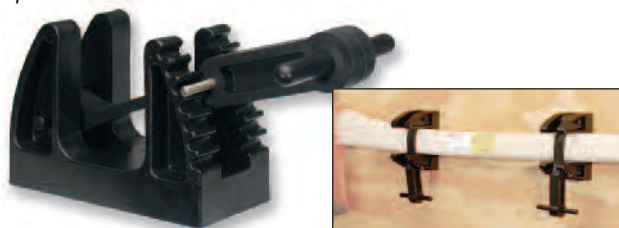

AF659 Handlelok Stretchlok System \$33.95

Soft Mount

Provides a load-bearing base that conforms to the shape of the tool and returns to its normal shape when the load is released. The high-tech flexible elastomer is resistant to most hydraulic fluids, water, fuel and oils. It provides a unique way to cushion-mount power tools when used in conjunction with the Adjustamount, Super Adjustamount or Jumbo Lok. Made of rugged, molded urethane. Resistant to weather, impact, UV and corrosion. Includes Soft Mount and 2 Fastener Packets. Hardware/fasteners included. Color: black. Ship. wt. 2 lbs.



BE073 Soft Mount \$108.95

Spreader Base Mount Kit

Kit can be mounted vertically or horizontally. Spreader Base together with the easily adjusted Adjustamount Kit provides secure, quick-acting mounting. Made of rugged, molded urethane. Resistant to weather, impact, UV and corrosion. Includes Spreader Base, Adjustamount Kit and Fastener Packet. Hardware/fasteners included. Color: black. Ship. wt. 3 lbs.



BE074 Spreader Base Mount Kit \$107.95

Jumbo Lok

- ▶ 3 pivot positions
- ▶ Adjustable mounting bracket w/grip range of .375" to 3.250"
- ▶ 3" square Hurst rams
- ▶ 3" D Holmatro rams
- ▶ Ship. wt. 1 lb.

Use to Mount:

- ▶ Folding ladders
- ▶ Electric drills
- ▶ Heavy-duty jacks
- ▶ Ropes
- ▶ Nozzles
- ▶ Chains
- ▶ Dual poles
- ▶ Playpipes



BC018 Jumbo Lok \$64.95

Keep Your Tools Organized with P.A.C. Mounts



Toolok

Features easy, fast locking and instant release. Black body, yellow elastomer locking strap tool mount, grip range 1/8" to 1/2". *Hardware/fasteners included. Ship. wt. 1 lb.*



AW338 Toolok \$20.95

Stow-N-Lok

Ideal for Exterior Mounting

FAST tool storage with clamp-action brackets. **PLUS** simple positive locking strap when ready.

- ▶ Grip range 1" to 1 1/2" diameter
- ▶ Adjustable, high-strength, fast-action locking strap
- ▶ 2 Heights:
Tall: for long hooks
Short: for close mounting

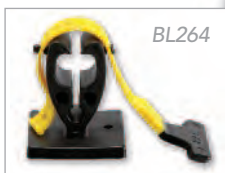

BL263 Stow-N-Lok \$38.95
BL264 Stow-N-Lok Short \$38.95

Super Adjustamount

The Super Adjustamount is the big brother to the original Adjustamount. Rugged modules designed to mount on unistrut or Pac Dual Trac provide unlimited positioning with countless uses, i.e.: hydraulic power tools, shoring, etc. Lockstrap usable length 15". *Hardware/fasteners included. Ship. wt. 2 lbs.*

AW341 Super Adjustamount \$55.95
AW416 Super Adjustamount Kit (Includes Unistrut) \$71.95

Ironslok

The industry's best. Safe, secure and dependable storage for 30" Halligan, 36" Flathead, 6 or 8 lb. Force Axe. Can be mounted in horizontal or vertical position. *Hardware/fasteners included. Ship. wt. 7 lbs.*



AW391 Ironslok \$230.95

Flexmount Brackets

Flexible Y-shaped mounting brackets designed to provide a secure grip-type mount that wraps around poles, nozzles, tools and other items with a grip range from 1 3/4" to 2 1/2". Made from a unique state-of-the-art elastomer that is exceptionally tough, non-sparking and resistant to impact. There's no springs to corrode or break. *Hardware/fasteners included. Ship. wt. 1 lb.*



AF658 Flexmount Bracket \$34.95
AW337 Short Flexmount Bracket \$31.95

Hookloks

Clamp-action/mounting brackets that depend on automatic clamping force and hook action to restrain tools. Grip range 1" to 1 1/4". *Hardware/fasteners included. Ship. wt. 1 lb.*

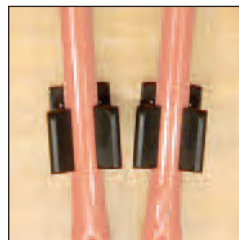

AW340 Hookloks \$32.95/pr.

Universal Hanger

Rugged, molded urethane bracket (black) can be used in pairs for simple mounting of shovels, brooms, fire swatter, and other "T" head equipment. *Hardware/fasteners included. Ship. wt. 1 lb.*

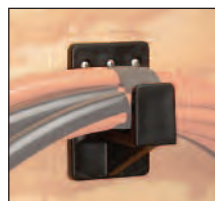

AW339 Universal Hanger \$18.95

APPARATUS EQUIPMENT

Nylon Strap Kit

Nylon Strap Kits include two bolt down footman loops brackets and a 1.00" nylon strap with a pinch and release buckle. Ideal for strapping down tools and or large equipment such as vent fans, cribbing, rescue jacks and other hard to secure items. Sizes listed are listed are the maximum lengths and may be adjusted to secure smaller items.



BH118	1" x 30" Nylon Strap Kit	\$22.95
BH119	1" x 48" Nylon Strap Kit	\$24.95
BH120	1" x 64" Nylon Strap Kit	\$26.95

Helmet Holder

Zico's helmet holder has been tested to 9 G's and complies with the 2009 edition of NFPA 1901 for use inside of crew cabs. It holds both traditional and contemporary style helmets without any adjustment needed. To secure the helmet, simply slip the helmet's hook onto the mount and pull the strap over the crown. Removing the helmet is as simple as pulling the strap down and lifting the helmet up.



BH014 Helmet Holder \$54.95

2 1/2" Adapter Mount

- ▶ Provide safe, secure mounting and easy access
- ▶ 2 1/2" adapter
- ▶ One hand operation
- ▶ Corrosion-free and resistant to heat and cold
- ▶ Can be mounted in any position, even upside-down



BH026 2 1/2" Adapter Mount (For Double Male & Double Female Mounts) \$41.95

Shovel Mounting Bracket

New shovel mounting system holds one or two shovels securely in place. Bracket adjusts to hold one or two handles with no rattle or movement. Hanger projections secure the shovel heads with a 7 1/4" W x 4" H base and four mounting holes.

DON'T MISS

More brackets in Rescue (p110-167)

BE076



BE076 Shovel Hanger w/7 1/4" W x 4" H Base \$55.95
BE077 Shovel Bracket for 1 or 2 Tools \$39.95

Adapter Hanger

Adapter hanger is ideal for mounting couplings, adapters, electrical cords, hoses, etc. Mounting plate is 4" square, post is 6" long and mounted on a 60° angle. Ship. wt. 1 lb.



AS324 Adapter Hanger \$43.95

Igloo Mount for 10 Gallon Cooler

- ▶ Holds coolers firmly in place
- ▶ Made of steel with PVC coating
- ▶ Includes mounting straps
- ▶ Ship. wt. 15 lbs.



Cooler not included



BA165 Igloo Mount \$212.95

Quic Choc® Wheel Chock

Holds On Ice, Mud, Sand, Concrete or Asphalt

Made of tough, high-tensile strength aluminum alloy and will withstand years of hard usage. Can be easily positioned and removed.

Cat#	R537	AF671	AF674	AF677
Price	\$50.95	\$90.95	\$92.95	\$202.95
Height	6 1/2"	8 1/4"	8 1/2"	12"
Width	6"	8 5/8"	8"	11 1/4"
Length	11 3/4"	15"	14 13/16"	21"
Weight	3.7 lbs.	7.6 lbs.	7.5 lbs.	17.6 lbs.
MEETS SAEJ348 FOR TIRE DIAMETER UP TO			32"	44"
	Cat#/Price	Cat#/Price	Cat#/Price	Cat#/Price
Horizontal Holder	R538/\$68.95	AF672/\$82.95	AF675/\$81.95	N/A
Vertical Holder	R539/\$54.95	AF673/\$52.95	AF676/\$45.95	AF679/\$66.95



Available in different sizes

Quic-Choc® Folding Wheel Chock

This new folding aluminum wheel chock requires only a 6"Hx10 1/2"W x 20 3/8"D area for storage. Can be stored under fire or rescue vehicles. The collapsible design allows the chock to lock in the open position simply by pulling out the back casting and pushing down. Just release the safety latch to close back into the folding position. Convenient carrying handle makes transport and placement of chock a snap. Made of high-tensile strength aluminum with rear opening, hand grip and a double row of rugged teeth to grip almost any surface. Meets applicable NFPA standards.



BA159 Choc not included

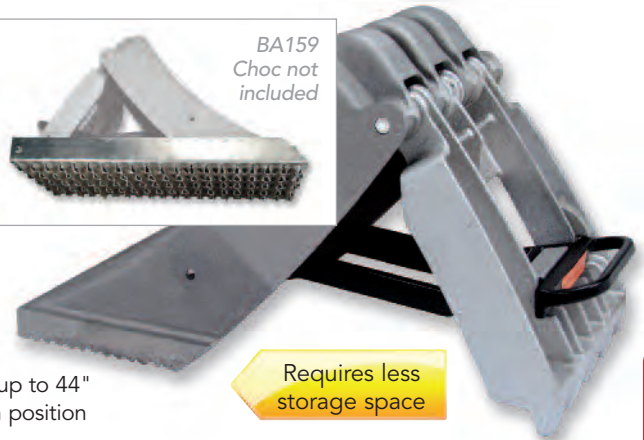

Requires less storage space

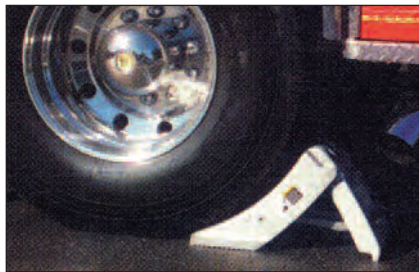

▶ Can be used with tires up to 44" in diameter in the open position

AG083	Folding Wheel Chock	\$288.95
AG084	Horizontal Holder (for AG083)	\$73.95
CONVERT YOUR WHEEL CHOCK FOR WILDLAND FIRE FIGHTING		
BA159	Wildlands Adapter (for AG083)	\$59.95
BA160	Horizontal Holder (for BA159)	\$165.95

Wildland Wheel Chock

Complete assembly with the aluminum base plate.

BA161	Wildland Wheel Chock with Plate for 32" Wheel	\$135.95
-------	---	----------



ManSaver Apparatus Bars

Simple safety bars will help prevent or reduce injuries due to falling off the apparatus in the excitement of operations, in darkness or operating in wet conditions. It is designed to be mounted across the open walk throughs of pumpers. It's spring loaded so that it will always return to the horizontal position. To enter, simply push the ManSaver in or up; to exit swing it up. Made of aluminum extrusion and aluminum bronze castings, making it rust-proof. Covered with layer of foam and tough rip-stop red or yellow vinyl outer covering. *Ship. wt. 8 lbs.*

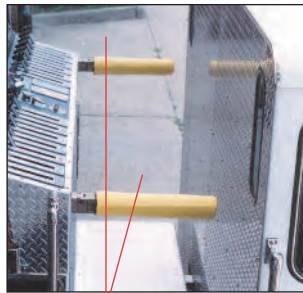

Bars push in or swing up

SPECIFY LENGTH: 14"-36" even sizes		
W423	ManSaver Safety Bar	\$299.95/ea.



Wheel Chocks

- ▶ Single comes with heavy-duty eye bolt
- ▶ Doubles are connected together with a lanyard so both wheels can always be chocked
- ▶ Color: "Easy-to-see at night" yellow
- ▶ Material: Recycled polyethylene which is resistant to petrol chemicals
- ▶ 5 year product guarantee
- ▶ Dimensions: 6"Wx4"Hx9.5"L



BE287	Single Wheel Chock	\$29.95
BE288	Double Wheel Chock	\$62.95



Emergency Stutter Tone Airhorn

Emergency vehicles can travel with more safety when equipped with Emergency Airhorns emitting directional, machine gun series of blasts. Operates on pressure up to 125 lbs. controlled by an electric valve. Connects directly to air brake junction box. Chrome plated; measures 24½" with 6" flare. *Ship. wt. 7 lbs.*

AA957 Emergency Stutter Tone Airhorn \$222.95

Equipment Glides to Fit Your Truck Stow Generators & Other Essential Special Equipment



Heavy-duty slide mounting glides for handling large equipment inside compartments. One pair of 20" glides are rated at 231 lbs., the 12" are 250 lbs. Zinc plated steel tracks have predrilled mounting holes, 3" high and ¾" wide. Bumper stops, steel ball bearings. Call Darley today for more information. *Ship. wt. 12 lbs.*



Closed

U308 12" Heavy Duty Glide \$67.95/pr.
U309 20" Heavy Duty Glide \$81.95/pr.

Truck Made™ Storage Solutions "Organizing America's Fire Trucks"

Now you can get tough, rugged and dependable boxes, trays, and storage handling systems with the proven performance of PolyBilt® quality! Made from the same dependable material as the rugged PolyBilt® bodies and Polyprene™ water and foam tanks, these new storage systems make organizing your equipment easy!

- ▶ Won't rust, crack or dent
- ▶ Easily cleaned
- ▶ Mounts directly into compartments with the U308 equipment glides
- ▶ FDA-approved non-porous material
- ▶ Lightweight and stackable
- ▶ Perfect for any hazardous or bio-terrorist compliance issue
- ▶ Cost-effective storage
- ▶ Custom sizes and engravable front plates are available. Call for details.



SPECIFY COLOR: Matte Black, Gloss Black, Gloss White, Matte Blue, Matte Red or Matte Yellow

AZ526 3"x22"x30" Polyprene Tray \$159.95
AZ527 3"x22"x40" Polyprene Tray \$159.95
AZ528 10"x10"x22" Polyprene Box \$144.95
AZ529 10"x10"x40" Polyprene Box \$199.95

Decorative Chrome-Plated Fire Bell

Beautiful, large 12" Fire Bell, cast in bronze with polished chrome finish. Comes with stand and clapper. Available with your choice of decorative ornamental top eagle or acorn nut. *Ship. wt. 40 lbs.*



R181 12" Bell with Eagle, Chrome-Plated \$1,225.95
R182 12" Bell with Acorn, Chrome-Plated \$1,292.95
AS418 12" Bell with Eagle, Gold \$1,345.95

Compartment Matting



Save 10% on box of 36

- ▶ Heaviest tile on the market
- ▶ Fast and easy-to-install
- ▶ Made from 100% recycled PVC
- ▶ 50% more height than others, providing faster evaporation while protecting the surface below
- ▶ Brackets and clips can mount directly to tile
- ▶ Resistant to most common chemicals, greases and solvents
- ▶ ¾" thickness prevents "scrunching" that occurs when using thinner, less rigid tiles



AF681

Each Box of 36
AF680 Turtle Tiles – 12"x12" \$6.95 \$192.95
AF681 Male Edge \$2.95
AF682 Female Edge \$2.95



SCENEdots™ "Patent Pending"

Reflective Apparatus Stickers

As founder of this new method of striping tread plate, we have proven that a "dot" is the easiest configuration to install between the treads of diamond plate and no straight edges to keep aligned during the installation process. With our continued product development, we now have our NEW SCENEdots™ available in the 3M Diamond Grade on a MULTI-dot application sheet that works on all tread plate. 2 1/2 sheets per square foot.

- ▶ SCENEdots™ come in a sheet consisting of 56 dots
- ▶ NFPA recommends that all fire apparatus have red & yellow inverted "V" (Chevron) reflective striping covering a minimum of 50% of the rear of the vehicle
- ▶ Easily retro-fit your current apparatus to comply to the new NFPA standard
- ▶ Convert your apparatus to a barricade instead of a target
- ▶ Uses only 3M™ Scotchlite® retro-reflective material which has a 7-yr. warranty
- ▶ Create any striping configuration in any length or width without measuring or cutting the material
- ▶ No striping experience required, anyone can do it
- ▶ Most trucks can be completed within 4 hours
- ▶ Distinctive LED appearance when reflecting light

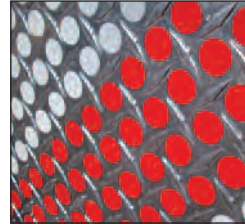
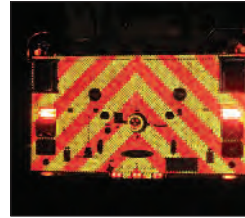

BH094

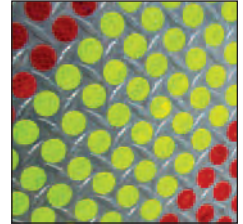

BK079

SCENEdots™

BK079

- ▶ Made of 3M Diamond Grade (4x brighter)
- ▶ MULTI-dot application sheet
- ▶ Sealed edges

SPECIFY COLOR BH094: Red, White, Blue, Yellow/Green, Orange, or Black

SPECIFY COLOR BK079: Red, White or Yellow/Green

BH094	SCENEdots™ Reflective Apparatus Stickers	\$11.95/per sheet
BK079	SCENEdots™ (Diamond Grade) Reflective Apparatus Stickers	\$18.95/per sheet

Apparatus Accessories



AF695



AF694



AF685

AF685	Air Bottle Compartment Door, 8.06"D	\$75.95/ea.
AF694	Ladder Bracket with Lock	\$99.95/ea.
AF695	Surface Mounting Step, 7"x 5.25"	\$30.95/ea.

Emergency Vehicle Reflective Striping

For improved visibility and a more professional look to all your emergency vehicles. Reflective striping with pressure-sensitive adhesive backing. Comes in 150' rolls so you can cut to size depending on the area of coverage. Easy-to-install. Comes standard in white. *Ship. wt. 5 lbs.*

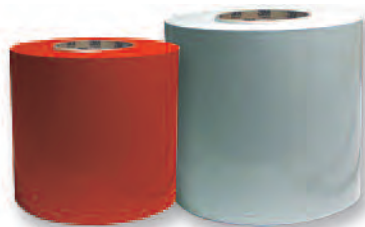

Cat#		1"	2"	3"	4"	6"
AZ467	Red Striping	\$61.95	\$122.95	\$183.95	N/A	N/A
AZ469	White Striping	\$61.95	\$122.95	\$183.95	\$245.95	\$367.95

Fireman's Friend Drying Cloth

This large 17"x27" drying cloth soaks up large volumes of water and other liquids quickly. The soft, absorbent material will not scratch or leave lint. It dries quicker and easier than chamois or any other towel you can find. *Ship. wt. 1 lb.*



T235	Fireman's Friend Case of 6	\$12.95 \$9.95/ea.
------	----------------------------	--------------------

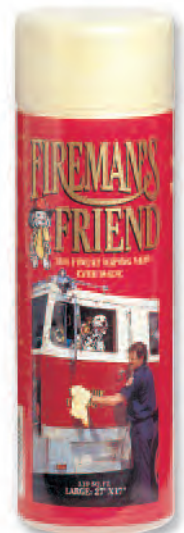

APPARATUS EQUIPMENT

Oversized Folding Steps

Easily installed on apparatus wherever a convenient assist step is needed. Folds up flush against mounting surface. Made of high-strength die cast, zinc/ aluminum alloy with corrugated safety step to prevent slipping. *Ship. wt. 1 lb.*

new lower price

Meets NFPA



AB990	Oversize Folding Step	\$58.95
AB043	Stainless Steel Folding Handhold	\$21.95

Folding Step

- ▶ Designed to fold-up when not in use
- ▶ Exceeds the 1901 & 1904-91 requirement specs
- ▶ Finish: Ball-burnished
- ▶ Raised tread
- ▶ Chrome plated
- ▶ BK086: Meets NFPA Standard

Folds up



BK085	Folding Step	\$37.95
BK086	Folding Step w/Lights	\$48.95

Automatic Door Holder

Recognized for its simplicity and utility, this "spring in column" device offers easy installation and automatic support for a compartment door that opens up or out. Releases when moderate side pressure bends the spring out of column, allowing the door to be closed. *Ship. wt. 1 lb.*



W501	Automatic Door Holder	\$31.95
------	-----------------------	---------

Counter Balance Spring

The Safe and Easy Way to Keep Compartment Doors Up

This product ends the bother of holding up compartment doors while reaching for equipment. Entire assembly for one door consists of two of the springs and arms shown. The handle shown (which is the lock) is only on one of the two units. Locks in place when door is open and you must release latch to lower. Rated at 30 lbs. Cadmium plated. Case-hardened arms for extra-long wear. Width $\frac{3}{4}$ ". From center of hole to center of hole as shown in open position $12\frac{5}{8}$ ". Unit comes complete. *Ship. wt. 5 lbs.*



Release Lever

W499	Counter Balance Spring Assembly	\$105.95
------	---------------------------------	----------

Brackets, Tubing & Grab Rails

Surface Mount Brackets

The F615 Surface Mount End Bracket bolts to any horizontal or vertical flat surface. The F616 bolts to any inside surfaces. The F617 Center Mount Bracket is used in the center of long railings for support. *Ship. wt. 1 lb.*

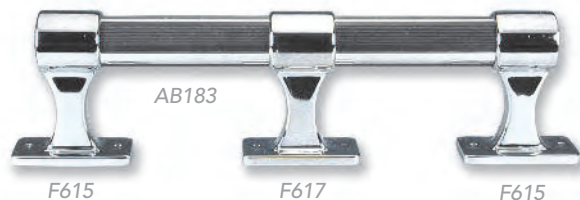
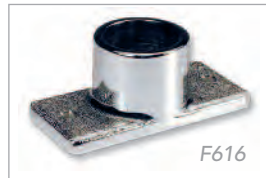

F615	Surface Mount End Bracket	\$19.95/ea.
F616	Flush Mount End Bracket	\$19.95/ea.
F617	Center Mount Bracket	\$19.95/ea.

Stainless Steel Tubing

Tubing is a strong 16-gauge, $1\frac{1}{4}$ " stainless steel tube that is polished and buffed. Fittings are chrome-plated brass. *Ship. wt. 1 lb./ft.*



SPECIFY LENGTH NEEDED

AB183	Stainless Steel Tubing	\$12.95/ft.
-------	------------------------	-------------

Slip-Resistant Grab Rail

Slip-Resistant Grab Rail is extruded aluminum tubing with black rubber inserts. *Ship. wt. 1 lb./ft.*



SPECIFY LENGTH NEEDED

AB044	Slip-Resistant Grab Rail	\$11.95/ft.
-------	--------------------------	-------------



AW345

Use Skull Savers

Don't Risk Ladder Injuries

Walking into the heel of a ladders always painful and extremely dangerous. Skull Saver is easily visible and cushions any contact. Slight tug opens the Velcro® fastener, closes with finger pressure. Stays on in high winds, rain, or ice. Includes extra strap for permanent attachment to apparatus. *Contact us for pricing on custom sizes. Ship. wt. 6 lbs.*



R891	Single Leg 4"Hx9"Wx5"D	\$54.95
R891XA	Super (A)* 23"Hx9"Wx8"D	\$93.95
R891XB	Super (B)** 22"Hx5"Wx8"D	\$93.95
U697	Super Duper 27"Hx12"Wx8"D	\$108.95
AW345	USA Flag 23"Hx9"Wx8"D	\$93.95
AW346	USA Flag 27"Hx12"Wx8"D	\$108.95

*Super (A) model is for two-section ladders made after June 1984.

**Super (B) model is for two-section ladders made prior to June 1984.



"Little Giant" Ladder Mount Set

- ▶ Mount your "Little Giant" ladder vertically or horizontally
- ▶ Made of powder-coated steel
- ▶ Chrome-plated handle
- ▶ Ship. wt. 8 lbs.

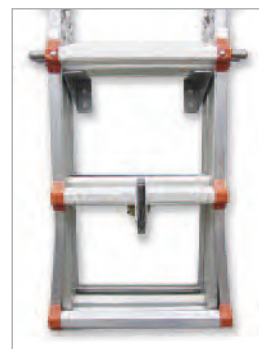

BA166	"Little Giant" Ladder Mount Set	\$139.95
-------	---------------------------------	----------

Little Giant Ladder System

One Ladder Does It All

The Little Giant Ladder System will perform all the functions listed below. You will replace many of the ladders you now carry with this one compact product. Its expense is justified when you consider its convenience and the fact that you will always have the right ladder on the job when you need it.

- ▶ Ladder folds for convenient transportation and storage
- ▶ Unlock ladder and unfold partially to set up step ladder mode
- ▶ Step ladder telescopes on 1' increments to form many heights
- ▶ Telescoping design allows ladder to be used on stairways
- ▶ Separate the sections and combine to form two step ladders
- ▶ Unfold ladder and snap in straight ladder configuration
- ▶ Telescopic design allows for many heights in extension mode
- ▶ Non-NFPA, rated up to 375 lbs.

BB127	7' - 11' Type IAA Little Giant Ladder System	\$449.95
BB128	9' - 15' Type IAA Little Giant Ladder System	\$545.95
BB129	11' - 19' Type IAA Little Giant Ladder System	\$595.95
BB130	Work Platform	\$43.95

Duo Safety Ladders

Aluminum Fire Ladders

Solid beam aluminum construction. Duo-Safety exclusive tongue and groove construction that holds sections firmly and rigidly, without brackets, hooks, or obstructions.

Two-Section (900-A Series)

Cat#	Length	Closed	Width	Weight	Price
S965A	20'	12' 2 ³ / ₄ "	21 ³ / ₄ "	60 lbs.	\$546.95
S965	24'	14' 2 ³ / ₄ "	21 ³ / ₄ "	71 lbs.	\$611.95

Banking thickness = 5³/₈"

Three-Section (1225-A Series)

Cat#	Length	Closed	Width	Weight	Price
S970A	30'	13' 3"	24"	108 lbs.	\$933.95
S970	35'	15' 3"	24"	130 lbs.	\$1,022.95

Banking thickness = 9¹/₈"

Folding Ladders

Lightweight, these ladders fold into a compact bundle for storing or carrying. In the open position, special locking devices keep the ladders absolutely rigid. Equipped with Duo-Safety Ladder shoes as an extra precaution. 300 lb. duty rated.

Aluminum (585-A Series)

Cat#	Length	Closed	Width	Weight	Price
S956	8' 3 ¹ / ₄ "	9' 3 ¹ / ₂ "	12 ¹ / ₈ "	14 lbs.	\$171.95
S956A	9' 3 ¹ / ₄ "	10' 3 ¹ / ₂ "	12 ¹ / ₈ "	16 lbs.	\$193.95
S957	10' 3 ¹ / ₄ "	11' 3 ¹ / ₂ "	12 ¹ / ₈ "	19 lbs.	\$207.95
S958	12' 3 ¹ / ₄ "	13' 3 ¹ / ₂ "	12 ¹ / ₈ "	21 lbs.	\$225.95
S959	14' 3 ¹ / ₄ "	15' 3 ¹ / ₂ "	12 ¹ / ₈ "	24 lbs.	\$239.95

Banking thickness = 1³/₄" x 3³/₄"

Fiberglass Fire Ladders

Fire ladders using extruded fiberglass channel rail construction and aluminum rungs welded to aluminum bocks and riveted to the fiberglass side rails. Safety yellow color for better visibility.

Two-Section Ladders (YGE-2 Series)

Cat#	Extended	Closed	Width	Nested	Weight	Price
R639	16'	10'	23"	7"	80 lbs.	\$658.95
R640	20'	12' 3 ¹ / ₂ "	23"	7"	94 lbs.	\$942.95
R641	24'	14' 3 ¹ / ₂ "	23"	7"	105 lbs.	\$979.95

Wall Ladders (YGW Series)

Cat#	Length	Width	Height	Weight	Price
R642	12'	19 ¹ / ₄ "	3 ³ / ₈ "	28 lbs.	\$304.95
R643	14'	19 ¹ / ₄ "	3 ³ / ₈ "	32 lbs.	\$327.95
R644	16'	19 ¹ / ₄ "	3 ³ / ₈ "	37 lbs.	\$381.95

Roof Ladders (YGR Series)

Cat#	Length	Closed	Width	Weight	Price
R645	12'	19 ¹ / ₄ "	3 ³ / ₈ "	33 lbs.	\$348.95
R646	14'	19 ¹ / ₄ "	3 ³ / ₈ "	38 lbs.	\$377.95
R647	16'	19 ¹ / ₄ "	3 ³ / ₈ "	42 lbs.	\$425.95

Aluminum Roof Ladders

Channel Rail construction gives extra strength without cumbersome weight.

(775-A Series)

Cat#	Length	Width	Weight	Price
S976	10' 2 ¹ / ₂ "	19"	24 lbs.	\$239.95
S977	12' 2 ¹ / ₂ "	19"	28 lbs.	\$261.95
S978	14' 2 ¹ / ₂ "	19"	31 lbs.	\$285.95

Banking thickness = 2³/₄"



S965

S956

R639

S976

All ladders over 8' are shipped via motor freight. All orders **MUST BE** inspected before acceptance upon delivery.

Alco-Lite Aluminum Ladder Company

Combination Ladders

Functionally engineered for ease of operation as a step or extension ladder with dozens of uses. Compact design converts easily to extension ladder or "A" ladder. Accessible from both sides. Special heavy duty "A" bracket allows for quick, easy set-up. Meets NFPA.

Cat#	L	A-Ht	A-W	W	Wt.	Price
P704	6'2"	5'10"	4'3"	20 1/2"	27 lbs.	\$392.95
P705	7'4"	7'0"	4'11"	20 1/2"	29 lbs.	\$440.95
P706	8'6"	8'2"	5'4"	20 1/2"	33 lbs.	\$453.95
P707	9'8"	9'1"	6'5"	20 1/2"	38 lbs.	\$530.95

Banking thickness = 6 3/8"

Truss Type Ladders

Two-Section Ladders (TEL Series)

Oversized 2 1/4" pulley for easy operation. 45' and larger ladders equipped with staypoles.



Cat#	Ext. Closed		Banking		Wt.	Price
	L	L	W	Thickness		
Z354	20'	13'0"	22 1/4"	6 7/16"	93 lbs.	\$813.95
Z355	24'	15'4"	22 1/4"	6 7/16"	110 lbs.	\$900.95
Z356	28'	16'6"	22 1/4"	6 7/16"	118 lbs.	\$1,060.95
Z357	30'	17'8"	22 1/4"	6 7/16"	126 lbs.	\$1,144.95
Z358	35'	20'0"	22 1/4"	6 7/16"	141 lbs.	\$1,265.95
Z359	40'	22'4"	23 1/2"	8 1/8"	214 lbs.	\$1,689.95
Z360	45'	25'10"	23 1/2"	8 1/8"	232 lbs.	\$1,807.95

Three-Section Ladders (TEL3 Series)

3-fly section activated by cable and operates automatically with center section. Oversized 2 1/4" pulley for easy operation. 45' and larger ladders equipped with staypoles.

Cat#	Ext. Closed		Banking		Wt.	Price
	L	L	W	Thickness		
Z347	24'	12'0"	25 3/8"	9 1/16"	142 lbs.	\$1,493.95
Z348	28'	13'2"	25 3/8"	9 1/16"	154 lbs.	\$1,580.95
Z349	30'	14'4"	25 3/8"	9 1/16"	163 lbs.	\$1,520.95
Z350	35'	15'6"	25 3/8"	9 1/16"	175 lbs.	\$1,649.95
Z351	40'	16'8"	27"	9 1/16"	223 lbs.	\$1,996.95
Z352	45'	19'0"	27"	10 3/4"	242 lbs.	\$2,130.95
Z353	50'	20'2"	27"	10 3/4"	273 lbs.	\$2,373.95

Roof Ladders (TRL Series)

Designed for scaling roofs. High-strength steel, 3/4" rotating roof hooks with reinforcing brace.

	L	W	Wt.	Price
Z362	12'5"	19 1/16"	43 lbs.	\$431.95
Z363	14'9"	19 1/16"	50 lbs.	\$455.95
Z364	16'11"	19 1/16"	56 lbs.	\$512.95
Z365	18'2"	19 1/16"	60 lbs.	\$536.95

Z362-Z367 Banking thickness = 3 3/4"

	L	W	Wt.	Price
Z366	20'6"	19 1/16"	65 lbs.	\$586.95
Z367	24'0"	19 1/16"	76 lbs.	\$689.95
AR162	26'4"	19 1/16"	92 lbs.	\$945.95
AR163	28'8"	19 1/16"	100 lbs.	\$1,020.95

AR162 and AR163 Banking thickness = 5 7/16"

Folding Attic Ladders

The ultimate in lightweight portability for low to medium height access. Folds laterally into 5 1/4" wide. Hinge locks ladder into position. Large, heavy cast aluminum swivel safety shoes assure the best traction. Handles allow for easier and safer carrying. Designed for maximum one-man load. Meets NFPA.



Cat#	Open		Folded		Wt.	Price
	L	L	W	W		
Z390	8'3"	9'3"	5 1/4"	15 1/2"	12 lbs.	\$176.95
Z391	10'6"	11'5"	5 1/4"	15 1/2"	14 lbs.	\$213.95
Z392	12'8"	13'8"	5 1/4"	15 1/2"	17 lbs.	\$231.95
Z393	14'11"	15'11"	5 1/4"	15 1/2"	21 lbs.	\$252.95

Banking thickness = 2"

Aluminum Pumper Type Ladders

Two-Section Ladder (PEL Series)

Oversized 2 1/4" pulley for easy operation.

Cat#	Ext. Closed		Banking		Wt.	Price
	L	L	W	Thickness		
Z373	12'	8'5"	21"	5 1/16"	48 lbs.	\$401.95
Z374	14'	9'7"	21"	5 1/16"	53 lbs.	\$442.95
Z375	16'	10'9"	21"	5 1/16"	59 lbs.	\$483.95
Z376	20'	12'0"	21"	5 1/16"	66 lbs.	\$539.95
Z377	24'	14'3"	21"	5 1/16"	75 lbs.	\$604.95
Z378	28'	16'7"	22"	5 13/16"	114 lbs.	\$787.95
Z379	30'	17'9"	22"	5 13/16"	122 lbs.	\$850.95
Z380	35'	20'1"	22"	5 13/16"	139 lbs.	\$958.95

Three-Section Ladders (PEL3 Series)

3-fly section activated by cable and operates automatically with center section. Oversized 2 1/4" pulley for easy operation.

Cat#	Extd. Closed		Banking		Wt.	Price
	L	L	W	Thickness		
Z368	24'	12'2"	23 1/2"	7 1/4"	105 lbs.	\$844.95
Z369	28'	13'4"	25"	8 1/4"	145 lbs.	\$913.95
Z370	30'	14'6"	25"	8 1/4"	158 lbs.	\$1,012.95
Z371	35'	15'8"	25"	8 1/4"	170 lbs.	\$1,080.95
Z372	40'	17'0"	26"	8 1/4"	220 lbs.	\$1,559.95

Roof Ladders (PRL Series)

High-strength steel, 3/4" rotating roof hooks with reinforcing brace for durability.

	L	W	Wt.	Price
Z381	8'5"	18 1/2"	27 lbs.	\$237.95
Z382	10'9"	18 1/2"	33 lbs.	\$258.95
Z383	12'0"	18 1/2"	36 lbs.	\$275.95
Z384	14'3"	18 1/2"	42 lbs.	\$294.95

Banking thickness = 2 7/8"

	L	W	Wt.	Price
Z385	16'7"	18 1/2"	48 lbs.	\$331.95
AR160	18'10"	18 1/2"	54 lbs.	\$421.95
AR161	20'0"	18 1/2"	60 lbs.	\$469.95

Banking thickness = 2 7/8"



APPARATUS EQUIPMENT



▶ Adjustable & portable



▶ Adjustable & portable



Gas Positive Pressure Ventilators

Super Vac's gasoline-powered PPV's offer a variety of features to meet the needs of fire departments all across the world. The Super Vac 18" leads the way for more powerful positive pressure ventilation. These powerful ventilators are designed to go places with two no-flat tires and handle, making them easy to move from scene to scene. Lever action tilt allows the firefighter to adjust quickly to 20°, 10°, 0° or -10° angles to ventilate stairwells and basements. It's the only smoke ventilator in the fire industry that has this feature. Other features include Honda engine, 7-blade fan system, zinc-plated fasteners, and electrostatically applied powder-coated paint, baked to a hard coat for a more scratch-resistant finish. **18" units ship. wt. 59 lbs., 20" & 24" units ship. wt. 115 lbs.**



Cat#	Size	HP	CFM	Price
BD033	16"	4.0	11,740	\$2,269.95
AC952	18"	6.5	15,590	\$2,839.95
AC953	20"	6.5	18,580	\$2,959.95
AC954	24"	9.0	20,920	\$3,659.95

Direct Drive Gas Smoke Ejector

Super Vac superior quality and design make it easier to store and stronger than other round fans. Housing totally encloses all moving parts and enables you to stack one unit on top of the other for more forced ventilation. It features 9250 CFM from 4-blade cast aluminum propeller and direct drive system that eliminates belts, pulleys and ball bearings, for years of trouble-free operation. Powder-coated, hard-coated paint finish for scratch resistance, housing has four handles for easy carrying, can be used with duct on inlet or outlet side. **Dimensions: 15.5"Dx19"Wx19.5"H.** Made in USA. **Ship. wt. 49 lbs.**



J670	Gas Smoke Ejector	\$1,919.95
------	-------------------	------------

Positive/Negative Pressure Ventilators

This is the most powerful 16" fan in the industry. It can easily be used for both negative and positive pressure ventilation. Running at 3500 RPM, it has the power to force or pull air deep into a structure or underground vault. Perfect for the department that wants a powerful fan for negative, positive pressure, or large confined space ventilation. **Requires a 20 amp circuit to start and run.**



Cat#	HP	RPM	Voltage	Housing	C.F.M.	Wt.	Price
AC947	1½	3450	115/230	Alum.	9622	71 lbs.	\$2,689.95
AC948	1½	3450	115/230	Alum.	9622	71 lbs.	\$3,279.95

*AC948 has explosion-proof motor

Flexible Duct & Adapters

These hose sections are tough, lightweight, extremely flexible and crush-resistant. They attach easily to the Smoke Ejector with the quick-release attachment on the adapter ring. They're ideal for moving large quantities of air for ventilation, air conditioning, and for fume and smoke control in hard-to-reach places. **Hoses are priced with fan to hose adapter. Call for prices on longer hose extensions.** **Ship. wt. 1 lb./per foot.**



AC937A	12"x10'	\$560.95
AC937B	12"x20'	\$669.95
AC937C	16"x10'	\$644.95
AC937D	16"x20'	\$881.95
AC937E	20"x10'	\$828.95
AC937F	20"x20'	\$1,137.95
AC937G	24"x10'	\$798.95
AC937H	24"x20'	\$1,413.95

Accessories



BL081	Exhaust Extension for Gas Fan (Specify Model#)	\$269.95
BL082	Exhaust Extension Glove Heat Shield	\$450.95
BL083	Tilt Frame for 12" Fan	\$624.95
BL084	Tilt Frame for 16" Fan	\$649.95
BL085	Universal LED Light Kit for Electric/Gas PPV	\$129.95



Manhole Adapter



BL077	Manhole Adapter, 12" Fan to 24" Manhole	\$264.95
BL078	Manhole Adapter, 12" Fan to 30" Manhole	\$274.95
BL079	Manhole Adapter, 16" Fan to 24" Manhole	\$264.95
BL080	Manhole Adapter, 16" Fan to 30" Manhole	\$274.95



Electric Smoke Ejectors

The most popular smoke ejectors in the fire service. They all have the features that have made Super Vac the most respected name in the business. Square housing design which gives it added strength and stability; handles on every corner, which makes them easy to hang on windows, doorways, ladders, or to stack. And Super Vac's patented propeller, cast in one piece of special aluminum alloy, produces a much greater intake of air into the vacuum side, eliminating turbulence at the tips. All Super Vac's are designed to easily accept spiral duct, with adapters on the output side for positive ventilation, or the input side for negative ventilation, allowing you to clear the toughest confined space ventilation problem.



20" Blade Smoke Ejector

- ▶ Explosion Proof Motor: M912 & M912A
- ▶ Overall Dimensions: 25¹/₄"Hx24³/₄"Wx16¹/₄"D

Cat#	HP	RPM	Voltage	Housing	C.F.M.	Wt.	Price
M910	1	1725	115/230	Steel	9500	85 lbs.	\$1,889.95
M910A	1	1725	115/230	Alum.	9500	70 lbs.	\$2,049.95
M912	1	1725	115/230	Steel	9500	93 lbs.	\$2,709.95
M912A	1	1725	115/230	Alum.	9500	71 lbs.	\$2,869.95

24" Blade Smoke Ejector

- ▶ Explosion Proof Motor: J598
- ▶ Overall Dimensions: 28¹/₂"Hx28"Wx18³/₄"D

Minimum 6kw generator w/20amp circuit is recommended to power these blowers

Cat#	HP	RPM	Voltage	Housing	C.F.M.	Wt.	Price
J597	1 ¹ / ₂	1725	115/230	Steel	10,800	110 lbs.	\$2,399.95
J598	1 ¹ / ₂	1725	115/230	Steel	10,800	115 lbs.	\$3,359.95

16" Blade Smoke Ejector

- ▶ Explosion Proof Motor: J594 & J594A
- ▶ Overall Dimensions: 19¹/₄"Hx18³/₄"Wx13"D

Cat#	HP	RPM	Voltage	Housing	C.F.M.	Wt.	Price
J593	1/3	1725	115	Steel	5200	44 lbs.	\$1,029.95
J593A	1/3	1725	115	Alum.	5200	39 lbs.	\$1,189.95
J594	1/3	1725	115/230	Steel	5200	49 lbs.	\$1,639.95
J594A	1/3	1725	115/230	Alum.	5200	44 lbs.	\$1,799.95

Electric PPV VR2

Super Vac electric variable speed models VR2 run on GFCI with no problems. They are designed with variable speed, 0-2500 rpm, 1hp and 1.5hp electric motors. All are GFCI compatible, able to operate on 15 amp circuit. These VR2 ventilators provide precise control of the air movement and up to 30% more airflow than other single speed electric PPV. The tilt control has four positions for air flow control in sizes 16", 18" 20" and 24". Super Vac VR2 models have a five-year manufacturer's warranty and a two-year motor warranty.



Cat#	HP	Dimensions	Motor	C.F.M.	Wt.	Price
BH191	1	16"Dx20"Wx20"H	Variable Speed	9,500	66 lbs.	\$2,331.95
BH192	1.5	18.75"Dx22"Wx20.75"H	Variable Speed	12,355	77 lbs.	\$2,592.95
BH193	1.5	18.75"Dx24.5"Wx25.20"H	Variable Speed	14,625	86 lbs.	\$2,682.95
BH194	1.5	20.5"Dx28.5"Wx27.75"H	Variable Speed	15,875	109 lbs.	\$2,899.95

Smoke Ejector Holder

Made from high-tensile aluminum alloy for maximum strength. Locking action permits adequate pressure to secure the smoke ejector against door jams or window frames. Rubber cushion and pads remain pliable down to -40° F. Includes set of hanger hooks, extras available. Adjusts from 28" to 40". *Ship. wt. 8 lbs.*



P780	Smoke Ejector Holder	\$85.95
R720	Hanger Hooks (2)	\$10.95

Mountain Mister

- ▶ Converts existing PPV or smoke ejector into a cooling rehab fan
- ▶ Non-corrosive components
- ▶ Rugged powder-coated finish
- ▶ Precision machined aluminum
- ▶ Maximum cooling range available
- ▶ 1/4" turn shutoff valve
- ▶ Easily attached to outlet guard of fan to produce a cooling mist, 3/4" garden hose connection
- ▶ Reduces effects of heat stress, increases comfort



AZ251	Super Vac Mountain Mister	\$342.95
-------	---------------------------	----------

VENTILATION

Gas Power Blowers

Tempest Gas Power Blowers are designed to provide the best value for fire and industrial applications. The direct-drive design allows for a smaller package and a lighter weight unit. Vibration problems that are common to most Gas Power Blowers have been virtually eliminated due to the use of higher quality, four-cycle gas engines, more precisely balanced and engineered impellers and vibration absorbing, spring-loaded rear "feet".

- ▶ **AirFlex Composite Impeller** - for superior performance without the engine blockage common to other blowers. This aerodynamic impeller delivers higher pressure with less distortion of the air cone - critical for effective PPV.
- ▶ **Turbo 2000 Shroud** - increases air velocity by up to 30% and keeps the Tempest signature air cone intact for superior performance and efficiency.
- ▶ **Roll-Cage Frame** - all Tempest blowers are manufactured with a lightweight, welded roll-cage frame which protects the fans shroud, blades and engines. The frames ergonomic design also allows for easy lifting and carrying.

DON'T MISS
More products like this
Hazmat (p210-230)
Station Supp. (p284-294)



Cat#	Size	HP	Engine	Dimensions	CFM	Wt.	Price
AM118	16"	5.5	Honda	19"Wx19 ³ / ₄ "Dx21 ¹ / ₄ "H	12,008	67 lbs.	\$2,027.95
AM120	18"	5.5	Honda	22 ¹ / ₂ "Wx21"Dx24"H	14,773	77 lbs.	\$2,296.95
AM122	21"	6.5	Honda	25"Wx21"Dx26"H	20,152	79 lbs.	\$2,385.95
BK038	16"	6.5	Briggs	21"Wx20"Dx22 ¹ / ₂ "H	11,541	77 lbs.	\$1,665.95
BK039	18"	6.5	Briggs	24 ¹ / ₄ "Wx21 ¹ / ₂ "Dx24 ¹ / ₄ "H	14,341	82 lbs.	\$1,935.95
BK040	21"	6.5	Briggs	25"Wx21"Dx26 ¹ / ₄ "H	18,025	87 lbs.	\$2,249.95
BK041	24"	6.5	Briggs	29"Wx21 ¹ / ₂ "Dx30 ¹ / ₄ "H	19,232	98 lbs.	\$2,115.95

Special Operations Blower

The Tempest Special Operations Power Blower is the latest addition to the positive pressure ventilation and attack arsenal. The fan's unique grille and shroud design create a Laminar Air Flow (LAF) which requires increased setback (8'-10') and is highly effective in unique fireground scenarios such as multi-story stairwells, highrise structures, complex structures and commercial structures > 5,000 ft. The SO blower also showcases a number of new features like wheels now located in the back and a wider footprint for increased stability.

new



Cat#	Description	Size	CFM	Dimensions	Weight	Price
BL415	Special Operations Blower	18"	15,792	20 ¹ / ₂ "x22 ³ / ₄ "x21"	86 lbs.	\$2,475.95
BL416	Special Operations Blower	21"	19,396	24 ¹ / ₂ "x25 ³ / ₄ "x24"	116 lbs.	\$2,655.95

Exhaust Extension

Make the Best Blower Even Better.

The exhaust extension is the ideal solution for reducing the amount of exhaust and CO introduced during PPV operations. The hose is 2"x10' and made of durable polyethylene that can withstand temperatures from -20°C to +375°C. Two hoses can be combined for up to 20' of extension.



AS112	Exhaust Extension	\$257.95
-------	-------------------	----------

Misting Ring

Attached to any 16" or larger blower, this misting ring instantly creates a cool mist envelope, lowering the overall temperature of the surrounding air. Ideal for firefighter rehab. Can also be used to knock down dust and other suspected particles. Three nozzle sizes available with flow rates from 0.5 to 5.8 gph (1.1 gph standard).

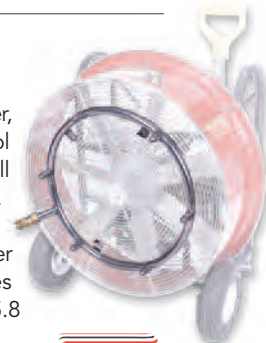

AR280	Misting Ring	\$272.95
-------	--------------	----------

GFCI Compatible Variable Speed Blowers

The VSG Variable Speed drive and motor provide enhanced ventilation capabilities. Use low speeds for quiet operation during removal of fumes and odors. Use high speeds for aggressive ventilation and fire attack.

- ▶ **GFCI Compatibility:** The Tempest VSG Variable Speed PPV blower is compatible with all GFCI protected circuits
- ▶ **Powerful 1.5hp Motor:** Enough power for all blade sizes (16", 18", 21", 24") while operating on a 20amp circuit
- ▶ **NEMA-4 Rated Motor & Drive:** Water and weather resistance to withstand extreme operating conditions
- ▶ **Excellent Blower Visibility:** Shroud and motor are painted Safety Yellow to enhance job site visibility



Easy-to-read controller with large rheostat knob and start/stop switch



Cat#	Description	Wt.	Estimated CFM	Max Amp Draw	Price
BK096	16" GFCI Compatible Variable Speed Blower	83 lbs.	11,125	17	\$2,376.95
BK097	18" GFCI Compatible Variable Speed Blower	88 lbs.	11,861	17	\$2,568.95
BK098	21" GFCI Compatible Variable Speed Blower	94 lbs.	13,414	17	\$2,664.95
BK099	24" GFCI Compatible Variable Speed Blower	100 lbs.	12,901	17	\$2,661.95

* Air performance data is estimated pending AMCA 240-96 certification. AMCA is an independent air movement testing organization.

Visit www.amca.org for more information.

Electric Blowers

The most comprehensive line of Electric Powered Blowers for PPV and NPV available today. Built on the same chassis that has been so successful for our Tempest Gasoline Powered Blowers, our Electric Powered Blowers are powerful, durable and versatile while maintaining the ability to operate on a standard household current.

- ▶ No exhaust emissions, which can collect Carbon Monoxide inside the structure that you are trying to ventilate
- ▶ Never requires "oil change" or has gas go bad while sitting in storage
- ▶ Designed to start and run off a standard residential 120v 20amp receptacle without tripping the circuit breaker
- ▶ Power supply is readily available at most work sites



Explosion proof motor



VENTILATION

Cat#	Diameter	HP	CFM	RPM	Width	Depth	Height	Lbs.	Price
AS106	16"	1.5 TEFC	11,804	3,450	18.5"	20"	20.5"	66	\$1,751.95
AS107	18"	1 TEFC	8,748	1,750	22.25"	21"	24"	71	\$2,024.95
AS108	21"	1 TEFC	11,698	1,731	25"	21"	26"	72	\$2,116.95
BG288	24"	1 TEFC	12,867	1,736	28.25"	22.5"	30"	75	\$2,127.95

Full line of Honda Portable Power Generators (domestic and international) available.

Smoke Ejector

Used by fire departments around the globe for more than fifty years, traditional smoke ejectors have proven to be the most versatile tool for smoke ventilation. Tempest smoke ejectors have all the standard features including the AirFlex Composite Impeller and other designs to provide years of dependable service, with a durable steel housing, rigid frame and optional duct adapter that easily attaches to a blower's inlet or outlet. 18.75"Wx14.25"D x19.5"H.

3,200 CFM



1/3 HP, 16" blade

Cat#	Description	HP	CFM	RPM	Lbs.	Price
AW179	Smoke Ejector	1.5 TEFC	3,200	1,736	47	\$994.95
AZ571	Ducting Adapter with 16"x15' Ducting					\$824.95

Super Pass® II

With Accountability Storage Key

An invaluable tool for recognizing downed firefighters. Features "Auto On" that provides you with the assurance that your PASS device is turned on automatically when accountability key is removed, activating device into the "Sensing" mode. When there is a lack of motion for approximately 18-23 seconds, the Super Pass® II activates into "Pre-Alarm" mode accompanied by sweeping audio signal and pulsing LED display. After approximately 30-35 seconds of lack of motion the unit will go into "Full Alarm" mode with a loud alarm signal varying in pitch and constant rapid pulsing LED display. Other Features: When in the "Sensing" mode the Super Pass® II can be put into "Alarm" mode any time by pressing the "Alarm" button. To turn the unit off simply replace the accountability key or press the reset buttons simultaneously. The unique Accountability Storage Key snaps onto the Super Pass® II and features a clear identification window which can be used to personalize the keys with photos, names, numbers, bar codes, etc. Case is made of rugged, high-temperature, impact-resistant and translucent polycarbonate plastic that glows when LEDs are activated. Uses 9v alkaline battery. *Ship. wt. 1 lb.*

best seller



- ▶ Auto on
- ▶ Alarm Button
- ▶ Reset Buttons
- ▶ Grip Clip
- ▶ LEDs
- ▶ Sound Ports
- ▶ Accountability Key
- ▶ Translucent Case
- ▶ Lack of motion & temp. sensing

AM051	Super Pass® II, Lack of Motion	\$258.95
AM052	Super Pass® II, Lack of Motion Plus Temperature Sensing	\$277.95

SuperPass™ 3

NFPA 1982, 2007 Edition Compliant

SuperPASS™ 3 was designed and tested to meet the life safety needs of firefighters. It is third party certified compliant to NFPA 1982, Standard on Personal Alert Safety Systems (PASS), 2007 Edition. *Meets or exceeds the 2007 Edition Standard Requirements for PASS.*

- ▶ **Motion Sensor:** 3-axis, solid-state, accelerometer enhanced durability
- ▶ **Activation:** Auto-on with proprietary accountability key
- ▶ **Attachments:** Two methods - wire clip and universal "SA-clip"
- ▶ **Status Display:** Large 6-character, alphanumeric, LED read-out of PASS status and external temperature (RTD Model Only)
- ▶ **Alarm Audio Output:** Dual resonating sound cavities produce 95+ dBA @ 10ft w/sound discernability of 6 dBA against given background noise
- ▶ **Real Time Clock:** Records accurate date and time information
- ▶ **Data Logging:** Records over 8,000 PASS status changes in a non-volatile memory with date and time log. Data is downloadable to any PC
- ▶ **Switching:** Solid-state magnetic activation
- ▶ **Batteries:** 4 Duracell MN1500, AA, 1.5 volt Alkaline
- ▶ **Battery Life:** Over 200 hrs in Sensing Mode and 10 to 12 hrs in Alarm
- ▶ **Dimensions:** 3"Wx4⁹/₁₆"Hx2⁵/₁₆"D

Reset button

LEDs illuminate the case during sensing, pre-alarm, and full-alarm modes



Protective silicone cover protects PASS from severe impact, vibration and high temp.



Resonating sound ports

BG569	NFPA SuperPass™ 3, Lack of Motion	\$469.95
BG570	NFPA SuperPass™ 3, Lack of Motion w/Temp. Sensing	\$489.95

MAYDAY Air Breathing Tubes

The MAYDAY Air breathing tubes are an inexpensive emergency replacement for the mask-mounted regulator for a firefighter who is lost and out of air. Each MAYDAY Air connects directly to the SCBA face piece enabling the facepiece to remain in position. The 30" heat resistant breathing tube enables the wearer to go mask-to-mask, out a window, under or through a wall.

- ▶ Simple
- ▶ Push & twist connection
- ▶ Low-profile
- ▶ Inexpensive
- ▶ Easily stored
- ▶ Heat resistant breathing tube

Cat#	SCBA Type	Style	Price
BH182	Scott	All	\$34.95
BH183	MSA	Fire Hawk	\$29.95
BH184	MSA	1/4 Turn	\$29.95
BH185	Draeger	All	\$29.95

Mask not included, Shown with BH182



Rol-Loc SCBA Holder

The Rol-Loc has been tested to well over 9 G's and complies with the 2009 edition of NFPA 1901 for use inside of crew cabs. It can be adjusted to fit any size bottle or brand SCBA currently on the market. Releasing the SCBA is as simple as pulling on the release and standing up. To put the SCBA back in the Rol-Loc, just place the valve in the footplate and push back. Now it is locked and ready for the next call. The Rol-Loc fits most seats and the release can be mounted anywhere on the seat.



- ▶ Simple as pulling the release and standing up
- ▶ No straps to deal with
- ▶ Repositionable release cord
- ▶ Easy to retrofit into existing apparatus



BH013

Rol-Loc SCBA Holder

\$399.95

Darley Air Mask Pak

Air Mask Paks protect expensive SCBA masks from damage due to casual storage, and meet OSHA guidelines for personalized equipment. Darley Mask Paks are mildew-resistant, which is a big plus when storing a wet mask. And all Air Mask Paks are made from 1000 Denier Cordura® nylon, to withstand heavy use. Comes with a side-release metal snap hook and reflective tape. *Ship wt. 1 lb.*



AZ106

Darley Air Mask Pak

\$24.95

SCBA Mask Bag

Built for rugged use and maximum protection, these red SCBA bags are constructed of heavy-duty vinyl with Velcro® closures and overlapping side panels. Large pull tabs allow for fast removal of masks.



COLOR: Red

BK196 SCBA Mask Bag - 9"x9"x6"

\$23.95

Air Mask Bag

This 400 denier nylon SCBA mask bag is lined with soft flannel fabric to prevent scratches to the face piece. Velcro® closure, D-ring for hanging and an ID window. It fits all current SCBA masks. Measures 14"Hx6"D. *Ship. wt. 1 lb.*

COLOR: Red

AW107 Air Mask Bag

\$12.95



DON'T MISS

More bags in
Turnout (p1-29)

SCBA Air Mask Bag

Made from heavy Cordura® nylon. Bottom opening style holds your air mask while leaving it attached to the regulator. Hangs by a spring snap. Top opening style has a hook/loop closure flap with four brass grommets for mounting. *Ship. wt. 1 lb.*



Top opening

AF108

Bottom opening

SPECIFY COLOR: Red or Yellow

AF108 Air Mask Bag Top Opening - 14"Hx9"Wx6"D

\$29.95

AF763 Air Mask Bag Bottom Opening - 14"Hx10"Wx4"D

\$25.95

AIR SYSTEMS

EZ-LOC SCBA Bracket

- ▶ Locks into place quickly and easily by lightly pressing down on top clamp
- ▶ No need to risk damage to fingers and SCBAs by slamming, jamming or shoving bottle back into place
- ▶ Patented ratchet design locks SCBA over a range of engagement - even in a partially closed position
- ▶ Fits most SCBAs with only minor adjustments
- ▶ NFPA 1901-09 compliant and third party tested to exceed NFPA 9G standard

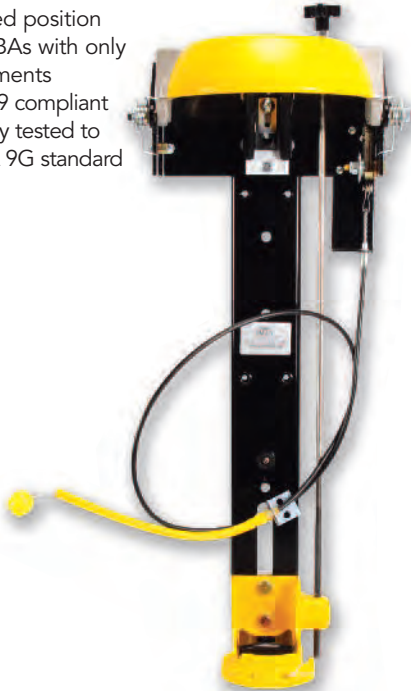

BK252 EZ-LOC Mechanical Bracket \$372.95

Load & Lock™ Air Pack Bracket

- ▶ NFPA required ejector spring insures that the SCBA cannot rest in the bracket unsecured
- ▶ Preventing accidental damage to firefighters and equipment
- ▶ Easily secure SCBA with one hand
- ▶ Quick and easy to adjust
- ▶ Snug fit
- ▶ NFPA 1901-03 compliant
- ▶ Ship. wt. 1 lb.



AZ451	Load & Lock™ Bracket	\$110.95
AZ452	Load & Lock™ Strap	\$43.95
AZ453	Conversion Kit - Includes 2 Seats, 1 Load & Lock™ Strap	\$65.95
AZ454	Ejector Spring	\$16.95

Walkaway® Brackets

When every second counts, you can rely on Walkaway® Brackets to provide instant access to your vital breathing apparatus. All brackets are constructed of steel and are thermoplastic coated. High cycle clips have a multi-layer coating and have been tested to over 50,000 cycles. High cycles are non-abrasive, making them an excellent choice for use with carbon fiber air cylinders. *Meets NFPA Requirements (For installation in cab when equipped with AS075 Collision Restraint Strap).* Ship. wt. 1 lb.



AS070

AS071

AS072



	5.4" - 5.8" (15 - 30 min. cylinder)	6.75" (30 - 45 min. cylinder)	7.25" (60 min. cylinder)
AS070	●	●	●
AS071	●	●	●
AS072	●	●	●
AS073	●	●	●

AS070, AS071, AS072, AS073 - SPECIFY SIZE (see chart above)

AS070	Knockdown Walkaway® Bracket (Standard)	\$47.95
AS071	Knockdown Walkaway® Bracket (High Cycle)	\$54.95
AS072	Scott Knockdown Walkaway® Bracket (High Cycle)	\$84.95
AS073	Scott Knockdown Walkaway® Bracket (High Cycle) with PHS Strap Assembled	\$128.95
AS074	Positive Holding Strap	\$13.95
AS075	Collision Restraint Strap	\$40.95

Plastic Air Cylinder Storage Rack

Keep your SCBA bottles protected and organized with the PACSR. BG527 units are stackable to allow for maximum usage of space. The one size fits any bottle. Units can be mounted horizontal or vertical.



Two units shown together, sold individually. Straps sold separately.

BG527	Plastic Air Cylinder Storage Rack	\$73.95
BG528	Straps	\$18.95

Cylinder Mate Mobile Unit

- ▶ 300-lb capacity wheels
- ▶ All units bolted together for added stability
- ▶ Two 11" commercial grade urethane handles
- ▶ Front wheel locks
- ▶ Also available in 16 & 25 unit carts, Call for pricing



BH027	Cylinder Mate Mobile Unit (12-Pack)	\$1,805.95
-------	-------------------------------------	------------

Quic-Seat® Cushioned Back Rest

Mounts above and behind existing seat cushions providing the ultimate in firefighter comfort. Frame is made of cushion-molded foam covered with heavy-duty vinyl. The short side supports easily accommodate your SCBA hip harness. Mounting brackets included plus pre-drilled holes for mounting Walkaway® bracket (sold separately). Color: Black. Dimensions: 8"W x 22"H overall. Headrest: 6" high; Side Support: 4" wide. Ship. wt. 10 lbs.



Walkaway® Bracket Sold Separately (see page 266)

AA909	Quic-Seat® Cushioned Back Rest	\$248.95
-------	--------------------------------	----------

Cylinder Mate

The Best Companion your SCBA Cylinder Ever Had



Self-adjusting support slides do not cause damage to the cylinder



- ▶ Restrains cylinder under impact of 10-G's in any direction
- ▶ Meets NFPA 1901 impact requirements
- ▶ Self-supporting units that can be stacked and mounted together horizontally or vertically
- ▶ Automatically adjusts to hold cylinders
- ▶ Matching bolt holes allow for bolting to a base and/or to each other
- ▶ Release elastomer locking strap
- ▶ Dimensions: 24 1/8" L x 8" W x 8" H
- ▶ Non-corrosive



BA167	Cylinder Mate 30-40 Minutes	\$182.95
BL271	Cylinder Mate 60 Minutes	\$249.95

SCBA Seats

The Flamefighter SCBA seat is built for the rugged demands of firefighting. Tough 46 oz. vinyl with high-density foam and quality stitching throughout ensure durability. Additionally, the split in the headrest holds the shoulder straps securely in place for easy donning of the SCBA. Large lower openings give the waist belt a place to be out of the way. Easily fits most brands of SCBAs and apparatus. Ship wt. 38 lbs.



AS069	SCBA Seat	\$905.95
-------	-----------	----------

12 Cylinder Storage Unit

Polished diamond plate and PVC cylinder tubes. Tidy up your station and protect your SCBA cylinders at the same time with this convenient storage unit. Ship. wt. 330 lbs.



Shown with AW113

AW112	12 Cylinder Storage Unit	\$1,895.95
AW113	Optional Mobile Platform w/Casters	\$435.95

SCBA Brackets

SCBA brackets assure instant access to vital breathing apparatus. Install on walls, fire trucks or other stable surfaces.

Bracket uses high-quality nylon coating protects cylinder from damage. Quality, removable spring clips are non-mar with rounded edges to protect cylinders and come with a lifetime warranty. Includes backplate, two clips, footplate and necessary nuts and bolts. *Extra clips available, comes assembled.* **Ship. wt. 5 lbs.**



5.25" Bracket: 30-minute tanks
6.38" to 6.75" Bracket: 30 min./
low 45 min. tanks
7.25" Bracket: 60-minute tanks

AR043	SCBA Bracket, 5.25"	\$48.95
AR044	SCBA Bracket, 6.38" to 6.75"	\$48.95
AR045	SCBA Bracket, 7.25"	\$48.95
AR046	Bracket Clip, 5.25"	\$15.95
AR047	Bracket Clip, 6.38" to 6.75"	\$15.95
AR048	Bracket Clip, 7.25"	\$15.95



"Ready-Set-Go" (RSG) SCBA Bracket

The new "RSG" NFPA compliant restraint uses a completely redesigned system to hold the SCBA in place in the event, the vehicle is in a collision. It uses a positive locking "Halo" to hold the top of the tank in place. And a "Receiver" to secure the valve end of the tank. The Halo is released when the firefighter simply pushes down on the release button mounted conveniently in the seat. The release button can be mounted on the left, right, or front edge of any seat. *NFPA 1901-03 compliant.*



BD193	NFPA SCBA Bracket (30 min. High Pressure)	\$401.95
BD194	NFPA SCBA Bracket (30 min. Low/45 min. High Press.)	\$401.95
BD195	NFPA SCBA Bracket (60 min. Low Press./High Press.)	\$401.95

Heavy-Duty Safety Strap

Storage compartment safety strap keeps SCBA secure in non-crew areas. Features thumb push adjustment buckle for quick-release. Made of yellow nylon. **Ship. wt. 1 lb.**



BD080	Heavy-Duty Safety Strap	\$20.95
-------	-------------------------	---------



3-Point Release Safety Strap

Keep SCBAs securely locked yet easily donned in crew areas where SCBAs are stored. With just one pull on the lanyard the SCBA is released and you're ready to go. **Ship. wt. 1 lb.**



AR050	3-Point Release Safety Strap	\$86.95
-------	------------------------------	---------



SCBA Bracket with Safety Strap

In crew areas where SCBA's are stored, keep them locked securely in place with this system. You can don th SCBA while enroute and keep it safely secured. When you reach your destination, pull the lanyard from between your legs, or along side the seat and you are ready to go! The 14,000 fits all brands and tanks sizes. **Ship. wt. 5 lbs.**

► Flamefighter 3-Point Release



AZ618	Uni-Bracket (Assembled)	\$103.95
AZ533	Uni-Bracket (Unassembled)	\$99.95
AZ534	Cradle Only (Retrofit)	\$12.95

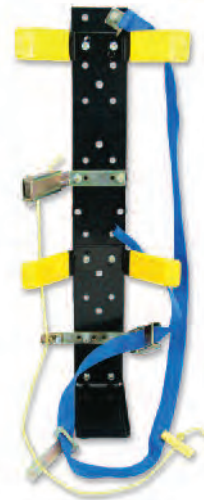

SCBA Storage Bag

Protect your breathing apparatus from dust and tampering. Each cover is made of vinyl and features a built-in pocket for mask storage and standard zipper closure. Purchase includes masonite backboard for bracket mounting. SCBA bracket sold separately. **Ship. wt. 2 lbs.**

SPECIFY COLOR: Red or Yellow		
AR051	SCBA Storage Bag	\$153.95



Ultrasonic SCBA Cleaning System

Specially Designed to Clean Your SCBA Masks Better

Our systems and solutions are easy-to-use, environmentally friendly, and cost efficient. Fire departments and industrial safety facilities throughout the country depend on us to get their equipment flawlessly clean without damaging the integrity of the apparatus. Major mask manufacturers recognize Ultrasonic Cleaning technology as an accepted SCBA cleaning method. Ultrasonic Cleaning offers the most thorough cleaning and disinfecting process with minimal disassembly; it reaches both interior and exterior surface areas, where most manual cleaning processes will miss. Ultrasonic Cleaning gives you the best overall cleaning at an affordable price.

Note: number of masks cleaned at one time will vary depending on mask size

ALL SYSTEMS INCLUDE: Ultrasonic Cleaning Unit, SCBA Rack and Cleaning Solution

AK194	AG-360 Cleaning System	\$2,072.95
AK195	AG-650 Cleaning System	\$2,536.95
AK196	AG-1000 Cleaning System	\$3,626.95

# of Masks	
AK194	1-2
AK195	2-4
AK196	4-6

Easy-to-operate



Collapsible Bottle Carrier

Solves all of your spare cylinder needs. In the expanded position it will hold up to 8 bottles with carrier handles. When not in use it collapses to fit most apparatus compartments for easy storage. Heavy-duty construction with nylon coating.

Ship. wt. 17 lbs.



Cat#	Description	Fits Bottles	Price
AR067	Small Bottle Carrier	Up To 5 1/2"	\$188.95
AR066	Large Bottle Carrier	Up To 6 3/4" - 7 1/4"	\$188.95

SecureALL™ SCBA Locking System Retrofit Kit

- ▶ Secure Fit - Patented auto-lock system holds SCBA in place for a secure fit in all directions
- ▶ Quick, Easy Exit - Patented one-touch release handle is located in the seat cushion
- ▶ Strapless - No straps or clamps to snag on auxiliary equipment
- ▶ Easy Adjust - Locking System is easily adjustable; all adjustment points use similar hardware
- ▶ Universal Fit - Fits all H.O. Bostrom Tanker and other manufacturers' seats including ABTS and non-ABTS seats
- ▶ Stores all U.S. and international SCBA brands and sizes while in transit or while stored in fire trucks
- ▶ Meets NFPA 1901 standards and EN 1846-2 requirements



BL060	SecureALL™ SCBA Locking System Retrofit Kit	\$537.95
-------	---	----------

Multi-Pak™ and Technical Rescue Cart

The MULTI-PAK™ series of small bottle air carts has been designed with the user in mind. Choose from any basic designs to fit the simplest or most complex job application. All of the small MULTI-PAK™ carts feature fold-down handles, recessed control panels, rounded cart corners, quick-release hose racks, and many other features. For complex air distribution applications, choose the Technical Rescue Cart which has been designed to provide air for all the various respirators and unique rescue tools used by Technical Rescue Teams. Stainless steel cart and color designated control panel allow one side of panel for respirator breathing air and one side for any tool requirements. Either cylinder air or mobile truck air can operate this cart.



BA020	Multi-Pak™ 2 Cylinder Air Cart 2400 psi with 2-outlet Manifold	\$1,084.95
BA021	Multi-Pak™ 2 Cylinder Air Cart 4500 psi with 2-outlet Manifold	\$1,284.95
BA022	Multi-Pak™ 2 Cylinder Air Cart 4500 psi with 4-outlet Manifold High Flow Regulator, No Cylinders	\$1,385.95
BA023	Multi-Pak™ 2 Cylinder Air Cart 4500 psi with 4-outlet Manifold, Powder Coat Steel Frame, High Flow Regulator, Cylinder Selector Valve, Additional 0-125 psi Regulator with 1 Outlet Manifold for LP Tools or Lift Bags, No Cylinders	\$2,085.95
BA024	Technical Rescue Cart, No Cylinders	\$3,484.95
BA025	60 cf DOT Aluminum Cylinder 2216 psi 30 min.	\$494.95
BA026	87 cf DOT Carbon Fiber Cylinder 4500 psi 1 hr.	\$1,174.95
BA027	Nylon Cart Cover	\$234.95



BA022 - Cylinders sold separately

AIR SYSTEMS

Draeger PSS™ 5000 NFPA SCBA

The PSS™ 5000 is one of the most ergonomically advanced self-contained breathing apparatus carrying systems designed to date, giving firefighters increased comfort, safety and performance. This new generation of breathing apparatus combines established technology and state-of-the-art materials for a system that is built to withstand harsh firefighting conditions.

- ▶ Unimpeded, 360 °audio and visual availability
- ▶ Vulcanized chloroprene rubber is designed for simple cleaning and decontamination
- ▶ Ergonomic design minimizes fatigue
- ▶ Outstanding thermal, impact and chemical resistance
- ▶ Easy maintenance and service

This system includes Backplate, FPS 7000 Face Mask (medium) and installed PSS 7000 Heads-Up Display receiver. Bottles (listed below) are purchased separately. Approvals NFPA 1981-2007. *Ship. wt. 17 lbs.*

Mask included



PSS™ 5000



Dräger

BL061	PSS™ 5000 HP CGA SCBA w/ FPS 7000 Face Mask Installed PSS 7000 Receiver for Face Mask	\$5,525.95
BL062	Multilink Buddy Breather	\$451.95

Draeger PSS 3000 OSHA SCBA

Our new PSS 3000 is ideal for plant maintenance, operational safety, and other industrial applications. Easy assembly and disassembly, as well as non-absorbent, chemical-resistant materials makes cleaning and maintaining the SCBA quick and easy. Contoured carrying harness provides maximum comfort at both the shoulders and the waist and optimizes load distribution.

Includes PSS 3000 high or low pressure with Panorama Nova P EPDM mask. Bottles (listed below) are purchased separately. NIOSH Approval. *Ship. wt. 10 lbs.*



Panorama Nova



Dräger

BL063	PSS 3000 HP SCBA w/ Panorama Nova P EPDM Mask	\$1,492.95
BL064	PSS 3000 LP SCBA w/ Panorama Nova P EPDM Mask	\$1,609.95

Bottles



Dräger

AS085	30-Minute 2216 psi Aluminum Bottle	\$471.95
AZ493	30-Minute 2216 psi Carbon Bottle	\$858.95
AS086	30-Minute 4500 psi Carbon Bottle	\$940.95
AS087	45-Minute 4500 psi Carbon Bottle	\$1,148.95
AZ494	60-Minute 4500 psi Carbon Bottle	\$1,293.95

SCBA/Bottle Bands

Ideal for SCBA bottles and water cans, these illuminating equipment bands are made of high grade temperature resistant silicone.

- ▶ May be recharged repeatedly by any light condition
- ▶ Flat measurements: 8" x 3"

Bottle not included



BL226	SCBA/Bottle Bands	\$32.95
-------	-------------------	---------

SCBA Replacement Cylinders

SCI has been manufacturing composite cylinders for over 35 years. With over two million cylinders sold, SCI cylinders have never had a field service failure or major recall. The standard cylinder is durable, lightweight and performance based - no other cylinder compares in price.

- ▶ D.O.T. and TC approved
- ▶ **Industry leader:** SCI has over 2 million units in service without a field service failure
- ▶ **Superior quality:** 15-year life expectancy
- ▶ **Bottles only: Valves sold separately**

4 CYLINDER ORDER MINIMUM

Cat#	Approx. Duration	Description	For Use With	Price
BG217	30 min. LP	Low Press., 2216 psi	All Brands of Packs (Except MSA)	\$464.95
BG218	30 min. LP	Low Press., 2216 psi	For MSA Packs	\$464.95
BG219	30 min. HP	High Press., 4500 psi	All Brands of Packs (Except ISI & Survivair)	\$474.95
BG220	30 min. HP	High Press., 4500 psi	For ISI & Survivair Air Packs	\$474.95
BG221	45 min. HP	Stubby Sized, 4500 psi	All Brands of Packs (Except ISI)	\$519.95
BG222	45 min. HP	Stubby Sized, 4500 psi	For ISI Air Packs	\$509.95
BG223	45 min. HP	High Press., 4500 psi	All Brands of Packs (Except ISI & Survivair)	\$519.95
BG224	45 min. HP	High Press., 4500 psi	For ISI & Survivair Air Packs	\$519.95
BG225	60 min. HP	High Press., 4500 psi	All Brands of Packs (Except ISI & Survivair)	\$649.95
BG226	60 min. HP	High Press., 4500 psi Std.	For ISI & Survivair Air Packs	\$649.95



Mobile Bottle Rack

Holds Up To:

- ▶ 12 - Low Profile Bottles
- ▶ 9 - 30-Minute Bottles
- ▶ 6 - 60-Minute Bottles

BASED ON ESTIMATED DIAMETER OF MANUFACTURES CYLINDER

AZ455 Mobile Bottle Rack \$225.95

Protect SCBA Cylinders with Quic-Access Cabinets

Protect your SCBA cylinders and keep them easily accessible. Cabinets are made of ABS materials with highly-visible safety yellow doors. A bulb seal gasket locks out moisture and dirt, while thermoplastic hinges and latches are highly-resistant to corrosive chemicals and ultraviolet exposure. Each cabinet features two or four windows to allow external inspection of contents and air cylinder pressure readings. Labels are provided to identify the size of the SCBA unit(s) mounted inside. Simply mount a Walkaway® bracket, sold separately, to the inside of the cabinet to secure SCBA. Cabinets can also accommodate protective clothing, emergency equipment, or emergency respirators. Available in single or double cylinder styles. *Ship. wt. 21-29 lbs.*



SCBA BRACKETS SOLD SEPARATELY	Cylinder Type	Dimensions	Price
AK007 SCBA Quic-Access Cabinet	Single Cylinder	32"Wx32 ¹ / ₂ "Hx14 ¹ / ₄ "D	\$486.95
AK008 SCBA Quic-Access Cabinet	Double Cylinder	21 ¹ / ₂ "Wx32 ¹ / ₂ "Hx14 ¹ / ₄ "D	\$651.95

Industrial Storage Cabinets

These strong, durable cabinets are made of injection-molded plastic, with UV protection for years of use. They come with stainless steel parts and rubber gaskets to keep out moisture, dirt, corrosive, chemicals and ultraviolet light even in the harshest environments. SCBA/ General Storage cabinets come with Velcro® strap, face piece hook, and yellow box with black door.



SCBA/GENERAL STORAGE – WALL MOUNT	Dimensions	Price
AS436 2 SCBA Escapes	29"Hx13 ¹ / ₂ "Wx9"D	\$176.95
AS437 1 SCBA 1 Spare	29"Hx22"Wx10"D	\$415.95
AS438 1 SCBA 1 Spare	33"Hx21"Wx11"D Window	\$392.95

Breathing Air Cascade System

4500 PSI & 6000 PSI Pigtailed Systems

With a pigtailed system, each cylinder is connected together with a tee connection and a 24" flexible pigtail. To cascade this system when filling SCBA cylinders, the operator must open and close each storage cylinder valve individually as needed. Cylinders are DOT Approved. Fill hoses not included.

System Includes:

- ▶ Your choice of 4500 or 6000 psi cylinders
- ▶ Cylinders with valve and cap
- ▶ Tee connections
- ▶ Seal-tight inlet cap
- ▶ 24" flexible pigtail between each cylinder
- ▶ Steel storage rack (also available without rack)



4500 PSI SYSTEM	System	Price w/	Price w/out
		Rack	Rack
AJ362	2 Cylinder	\$2,159.95	\$1,529.95
AJ363	3 Cylinder	\$2,889.95	\$2,239.95
AJ364	4 Cylinder	\$3,639.95	\$2,939.95
AJ365	5 Cylinder	\$4,119.95	\$3,419.95

6000 PSI SYSTEM	System	Price w/	Price w/out
		Rack	Rack
AJ368	2 Cylinder	\$3,559.95	\$2,929.95
AJ369	3 Cylinder	\$4,999.95	\$4,349.95
AJ370	4 Cylinder	\$6,459.95	\$5,779.95
AJ371	5 Cylinder	\$7,919.95	\$7,769.95

Enclosed Fill Station



AM026

These heavy-duty steel NFPA compliant fill stations protect the operator and bystanders in the event of an SCBA cylinder rupture while filling. These each have an inlet gauge, Fill Pressure Regulator, regulated pressure

gauge, 1 fill valve and gauge per fill position. Each fill line is equipped with hand tight universal fill connector to fit all standard SCBA cylinders 2216, 3000, and 4500 psi. The SCBA cylinder holders are lined to prevent scuffing of the cylinders. Painted with a durable powder coat finish. **Ship. wt. 800 lbs.**

Cat#	Cylinder	Cascade Controls	Price
AZ456	One	None	\$5,839.95
AM025	Two	None	\$6,900.95
AM026	Two	Four	\$9,812.95
AM027	Three	None	\$7,855.95
AM028	Three	Four	\$10,767.95

SCBA Manifolds



SCBA manifolds are rated up to 6000 psi. Can be installed in a station or in an apparatus if cylinders are difficult to access. Includes 6000 psi metering control valve for each bank, an inlet valve for filling the system, and a #4 male JIC on each bank inlet. **Ship. wt. 8 lbs.**

AJ378	2-Bank Manifold	\$389.95
AJ379	3-Bank Manifold	\$499.95
AJ380	4-Bank Manifold	\$609.95
AJ381	5-Bank Manifold	\$713.95
AJ382	6-Bank Manifold	\$823.95
AJ383	8-Bank Manifold	\$1,043.95

Pressure Reducing Regulators

AJ376 - For use on systems over 3000 psi and below 5500 psi. 0-6000 psi inlet, 0-5000 outlet. CGA-347 nut and nipple on the inlet side and male thread on outlet side. 0-6000 psi gauge on both inlet and outlet of regulator. AJ377 - For use on 6000 psi systems. 0-6000 psi inlet, 0-5000 outlet. #4 JIC male inlet, CGA-347 male outlet. 0-7500 psi inlet gauge, 0-6000 psi outlet gauge. **Ship. wt. 5 lbs.**



AJ376	Pressure Reducing Regulator	\$399.95
AJ377	Pressure Reducing Regulator	\$449.95

Fill Hoses

Deluxe fill hose is 6' long with shut-off valve. Features 6000 psi gauge with a rubber boot, bleeder valve and hand-tight nut and nipple that will fill either 2216 psi or 4500 psi. Connects directly to a CGA-347 male thread. **Ship. wt. 5 lbs.**



AJ374	Fill Hose	\$274.95
-------	-----------	----------

Flexible Pigtail

24" Pigtail with CGA-347 nut and nipple on both ends. For use with systems over 3000 psi and below 5500 psi. **Ship. wt. 2 lbs.**



AJ375	Flexible Pigtail	\$109.95
-------	------------------	----------

Thread Saver® Prevent Valve Damage

Damaged valve threads can disable your SCBA. The Thread Saver® is the most inexpensive way to help prevent damage. This simple plastic device slips easily onto the valve orifice to keep elements such as ice, dust or dirt away; plus they glow in the dark for easy identification. **Ship. wt. 1 lb.**



AR068	Thread Saver®	\$4.95
-------	---------------	--------

Bauer SCBA Filling Compressors

Use these compressors to fill either individual SCBA or a cascade system. These compressors have the longest life and lowest maintenance cost of any compressor on the market. We have features like pressure lubrication, stainless steel cooling tubes and a full-flow oil filter that the competitors wish they had. All compressors include: automatic pressure switch, automatic condensate drain, high-temperature shutdown, hourmeter, gauge panel, UL approved electrical system and a Bauer P series purifier. System meets OSHA, NIOSHA, and CGA standards, requires a containment fill station to meet NFPA requirements. *Call us today for more detailed specifications.*
Ship. wt. 800 lbs.

Available Voltages

- ▶ Single Phase: 208, 230 or 460
- ▶ Three Phase: 208 or 240
- ▶ 6.0 CFM - fills 30 min. bottle in 8 minutes
- ▶ 13.3 CFM - fills 30 min. bottle in 4 minutes

SPECIFY VOLTAGE 50 OR 60 HERTZ

AR054	Compressor System, 6.0 cfm/Single Phase	\$13,123.95
AR055	Compressor System, 6.0 cfm/Three Phase	\$13,056.95
AW108	Compressor System 1-6K Single Phase 5.0 cfm	\$18,461.95
AW109	Compressor System 1-6K Three Phase 5.0 cfm	\$18,396.95
AW110	Compressor System 3-6K Single Phase 13.0 cfm	\$22,493.95
AW111	Compressor System 3-6K Three Phase 13.0 cfm	\$22,026.95

Purchase includes delivery technician services with full 1-year on-site warranty. (Mileage surcharge may apply)



AR054

Bauer Oceanus Compressor System

A Portable, Economical, Compact, High Pressure Compressor

This pressure-lubricated 5000 psi compressor is ideal for the emergency response team that requires a highly portable compressor for filling SCBA or SCUBA cylinders. Standard equipment includes the compressor, 4.9 SCFM Charging Rate, the Bauer Triplex Purifier, a snorkel for the intake, and your choice of one-phase electric, three-phase electric or gasoline engine all mounted on a stainless steel base. The gasoline powered model features a Subaru engine, a pressure shutdown switch, and hour meter. Suitable for use with a maximum of a 2 cylinder, 4500 psi cascade system. Automation package includes magnetic starter, pressure switch, auto drains and 10' of power cord. **Ship. wt. 200 lbs.**

AZ457	Gasoline-Powered Bauer Oceanus Compressor System	\$5,536.95
AZ458	One-Phase 220-240 Volt Bauer Oceanus Compressor System	\$5,077.95
AZ459	Three-Phase Bauer Oceanus Compressor System (Specify Volts Needed)	\$5,017.95
BH068	Automation Package for AZ458 & AZ459 (Highly Recommended. Call for Details)	\$3,599.95

new lower price



AZ457

Carbon Monoxide Monitor

Easily Retrofitted to Existing Compressor Systems

Includes:

- ▶ Digital display
- ▶ 110 vac or 12 vdc
- ▶ Regulators for air pressure reduction
- ▶ Alarm light
- ▶ Audible option switch service shut off valve
- ▶ Solid state electronics
- ▶ Compressor shutdown option
- ▶ Easy field calibration kit
- ▶ NEMA 4 enclosure
- ▶ All airline connections
- ▶ Power cord

Features:

- ▶ Wall mounted
- ▶ Digital readout
- ▶ Accepts up to 6000 psi
- ▶ Constantly reading
- ▶ Audio and visual alarms
- ▶ Adjustable alarm level
- ▶ Plug and Play with most modern Bauer compressors

* Carbon Monoxide Monitor is required by NFPA 1989

BH067	Carbon Monoxide Monitor	\$2,574.95
-------	-------------------------	------------



Aerotest Breathing Apparatus Tester

The purity of air from high and low pressure cylinders and compressor filling stations may be tested. The Aerotest measuring device is provided with a quick disconnect for connection to either a pressure reducer or an air supply socket. Adapters are provided for connection to U.S. standard equipment. All components of the Aerotest Breathing Air Testers are arranged in a transport case and ready-to-use. **Ship. wt. 9 lbs.**

- ▶ Supply Pressure: Maximum 4500 psi
- ▶ Flow: 0.2 L/min and 4.0 L/min
- ▶ Detects: Oil, CO₂, CO, H₂O Vapor

AW197	Aerotest Breathing Apparatus Tester	\$3,994.95
-------	-------------------------------------	------------



AIR SYSTEMS



Halotron I Clean Agent For A, B & C Fires

The most broadly tested and approved 1211 replacement product available that's safe, environmentally friendly, effective and easy-to-use! Halotron is a clean fire extinguishing agent that is discharged as a precisely dispersed rapid evaporation liquid. It performs in a manner similar to Halon 1211 but leaves no residue and is effective against Class A, B and C fires. The primary extinguishing mechanism is the absorption and removal of heat from the combustion zone. Halotron utilizes an HCFC (HydroChloro-Fluorocarbon), non-conductive based agent pressurized with argon. What's more, the Ozone Depletion Potential (ODP) is nearly zero; that's twelve times lower than the EPA maximum. Each extinguisher has a bar coded label for documenting location, inspection, repair, etc. Ideal for use on electrical equipment, computers, vehicles, laboratories and aircraft rescue firefighting. EPA, FAA, U.S. Coast Guard, NFPA approved. Bracket included.

Cat#	Size	UL Rating	Valve	Application	Bracket	Price
AR089	1.4 lbs.	1B:C	Alum.	Nozzle	Wall/Vehicle	\$100.95
AR090	2.5 lbs.	2B:C	Alum.	Nozzle	Wall/Vehicle	\$110.95
AR091	5 lbs.	5B:C	Alum.	Nozzle	Wall/Vehicle	\$178.95
AR092	11 lbs.	1A:10B:C	Brass	Hose & Nozzle	Wall	\$374.95
AR093	15.5 lbs.	2A10B:C	Brass	Hose & Nozzle	Wall	\$539.95

Regular B:C Fire Extinguishers

Siliconized sodium bicarbonate based dry chemical, with free-flowing and non-caking additives. Smothers fires in flammable liquids and pressurized gases and is electrically non-conductive. Bar coded labels. Bracket included.

Cat#	Size	UL Rating	Valve	Application	Bracket	Price
S255	2½ lbs.	10B:C	Alum.	Nozzle	Wall/Vehicle	\$37.95
S256	5 lbs.	10B:C	Alum.	Nozzle	Wall/Vehicle	\$49.95
AF568	6 lbs.	40B:C	Brass	Hose & Nozzle	Wall	\$74.95
AF566	10 lbs.	60B:C	Alum.	Hose & Nozzle	Wall	\$77.95
H782	10 lbs.	60B:C	Brass	Hose & Nozzle	Wall	\$91.95
AF567	20 lbs.	120B:C	Alum.	Hose & Nozzle	Wall	\$125.95
H783	20 lbs.	120B:C	Brass	Hose & Nozzle	Wall	\$139.95



FIRE PROTECTION



Purple K B:C Potassium Bicarbonate Extinguishers

Specially fluidized and siliconized potassium bicarbonate dry chemical, effective on flammable liquids and pressurized gases and is electrically non-conductive. Bar coded labels. Bracket included.

Cat#	Size	UL Rating	Valve	Application	Bracket	Price
AF569	2½ lbs.	10B:C	Alum.	Nozzle	Wall/Vehicle	\$47.95
AF570	5 lbs.	30B:C	Alum.	Hose & Nozzle	Wall/Vehicle	\$63.95
AF572	10 lbs.	80B:C	Brass	Hose & Nozzle	Wall	\$108.95
AF571	20 lbs.	120B:C	Alum.	Hose & Nozzle	Wall	\$146.95
AF573	20 lbs.	120B:C	Brass	Hose & Nozzle	Wall	\$182.95

Extinguisher Chemical Refill

90% or more active firefighting agents

Made to recharge your fire extinguisher. Manufactured to rigid quality specifications to assure high-performance and superior flow characteristics. Ship wt. 50 lbs.

Cat#	Type	Chemical	Price
AF561	ABC	Monoammonium Phosphate	\$142.95
AF562	BC Reg.	Sodium Bicarbonate	\$69.95
AF563	BC Purple K	Potassium Bicarbonate	\$149.95



Extinguisher Vinyl Covers

- ▶ Discourage tampering
- ▶ Vinyl coated cover
- ▶ Bright red color
- ▶ Velcro® closure
- ▶ Fits 5 to 10 lb. D.C. extinguisher
- ▶ Dimensions: 12½" x20"



P854	Extinguisher Cover	\$9.95
------	--------------------	--------

ABC Fire Extinguishers

Easy-to-use and maintain. Specially fluidized and siliconized mono ammonium phosphate dry chemical. Insulates Class A fires and coats the surface to which it is applied. Smothers and breaks the chain reaction of Class B fires. Bar coded labels. Electrically non-conductive. *Bracket included.*



Cat#	Size	UL Rating	Valve	Application	Bracket	Price
P614	2½ lbs.	1A:10B:C	Alum.	Nozzle	Wall/Vehicle	\$41.95
P615	5 lbs.	2A:10B:C	Alum.	Hose & Nozzle	Wall/Vehicle	\$58.95
AF557	5 lbs.	2A:10B:C	Brass	Hose & Nozzle	Wall	\$72.95
AF553	5 lbs.	3A:40B:C	Alum.	Hose & Nozzle	Wall/Vehicle	\$55.95
AF554	10 lbs.	4A:80B:C	Alum.	Hose & Nozzle	Wall	\$89.95
AF558	10 lbs.	4A:80B:C	Brass	Hose & Nozzle	Wall	\$103.95
AF555	20 lbs.	20A:120B:C	Alum.	Hose & Nozzle	Wall	\$150.95
J559	20 lbs.	20A:120B:C	Brass	Hose & Nozzle	Wall	\$172.95

Carbon Dioxide Extinguishers

Discharges a white cloud of "snow" which smothers a fire by eliminating its oxygen. Effective for Class B flammable liquid fires and is electrically non-conductive. Aluminum cylinder. *Bracket included.*



Cat#	Size	UL Rating	Valve	Application	Bracket	Price
H790	5 lbs.	5B:C	Brass	Horn	Wall	\$155.95
H791	10 lbs.	10B:C	Brass	Hose and Horn	Wall	\$236.95
H792	15 lbs.	10B:C	Brass	Hose and Horn	Wall	\$267.95
H793	20 lbs.	10B:C	Brass	Hose and Horn	Wall	\$331.95

Peerless Pump Type Water Extinguishers

Rated 2A, the Peerless Pump Type Water Extinguishers can be filled while in use and are simple-to-operate. You can test it without loss of water by directing the stream back into the tank. The operator controls the discharge. Moving parts made of corrosion-resistant brass and copper. Immediate operation; no priming needed.



2½ Gallon Size

AF577	Polished Copper	\$492.95
R588	Chrome Plated Copper	\$483.95
R587	Red Enamel Copper	\$399.95
H897	Red Enamel Steel	\$363.95
R589	Vehicle Bracket	\$198.95

5 Gallon Size

AF578	Polished Copper	\$515.95
R591	Chrome Plated Copper	\$504.95
R590	Red Enamel Copper	\$458.95
H798	Red Enamel Steel	\$395.95
R592	Vehicle Bracket	\$202.95

Class D Fire Extinguishers

Safest unit on the market, with long hose and wand reach for operating safely. OSHA requires this type of extinguisher in manufacturing areas. **Sodium Chloride** based is specially designed to be used on burning metals, such as magnesium, sodium, potassium, sodium-potassium alloys, uranium and powdered aluminum. **Copper Agent** based is specially designed for use on lithium and lithium alloy fires. 30 lbs., hose & applicator. *Wall bracket included.*

AF559	Sodium Chloride	\$438.95
AF560	Copper Agent	\$720.95



Water & Foam Stored Pressure Extinguishers

Easy-to-use, maintain and service. Stainless steel cylinders, chrome-plated brass valve, and bar coded labels.

Water Extinguisher: utilizes the cooling, soaking and penetrating effect of 45-55 ft. stream of water for Class A fires. Optional loaded stream/anti-freeze charge protects from freezing.

Foam Extinguisher: uses FFFP foam for Class B fire fighting capability. *Bracket included.*

Ship. wt. 9 lbs.

Options

AF579	Water Conditioner, 1½ oz. bottle	\$5.95
BA180	Loaded Stream/Anti-Freeeze Charge	\$56.95
AF581	FFFP Foam Refill	\$36.95

Cat#	Type	Size	UL Rating	Application	Bracket	Price
H795	Water	2½ gal.	2A	Hose & Nozzle	Wall	\$111.95
				Hose & Air		
AF580	FFFP	2½ gal.	3A:20B	Aspirating Nozzle	Wall	\$180.95



FIRE PROTECTION

Heavy-Duty Extinguisher Brackets

Brackets listed below are for Amerex extinguishers, but will fit any other extinguisher with same size cylinder. If you are unsure or are in need of a bracket not listed, please call your Darley representative.



AF868 \$10.95 AF863 \$40.95 AF864 \$46.95

Type	Size	Rating	AF868	AF863	AF864
Halotron	5 lbs.	5B:C	•		
CO2	5 lbs.	5B:C		•	
CO2	10 lbs.	10B:C			•
CO2	15 lbs.	10B:C			•
ABC	5 lbs.	2A:10B:C	•		
ABC	5 lbs.	3A:40B:C	•		
ABC	10 lbs.	4A:60B:C		•	
ABC	20 lbs.	20A:120B:C			•
BC	5 lbs.	10B:C	•		
BC	6 lbs.	40B:C		•	
BC	10 lbs.	60B:C		•	
BC	20 lbs.	120B:C			•
Purple K	5 lbs.	30B:C	•		
Purple K	10 lbs.	80B:C		•	
Purple K	20 lbs.	120B:C			•
Water	2.5 gal.	2A			•
Foam	2.5 gal.	3A:20B			•

Extinguisher Cabinets



BB021

BB020

BB022

Cat#	Description	Size	Price
BB020	Red/Black Extinguisher Cabinets	26"Hx9"Wx9"D	\$123.95
BB021	Red/Black Extinguisher Cabinets	27 1/2"Hx10"Wx8 1/2"D	\$168.95
BB022	Red/Black Extinguisher Cabinets	27 1/2"Hx22 1/2"Wx9"D	\$303.95
BB023	Extinguisher Cabinets	32 1/2"Hx12 1/2"Wx10 1/2"D	\$204.95
BB024	Extinguisher Cabinets	23"Hx7 1/2"Wx7 1/2"D	\$104.95

Universal Vehicle Extinguisher Bracket



Universal brackets have heavy-duty steel back with weather & scratch resistant polyurethane enamel paint finish. Large rubber grommets on bracket back cushion cylinder while strong securing cords keep the cylinder in place. Securing cords easily attach for either left or right hand closings and are impervious to extreme temperatures. There are no moving metal parts to break, loosen or wear out and the bracket is adjustable to several cylinder sizes. *Ship. wt. 3 lbs.*

AF869	Bracket for 2 1/2 & 5 lb. Dry Chemical Extinguishers	\$26.95
AF870	Bracket for 6 and 10 lb. Dry Chemical Extinguishers, 5 lb. CO ₂ Extinguishers, 11 & 15.5 lb. Halotron 1 Extinguishers	\$27.95
AF871	Bracket for 20 lb. Dry Chemical Extinguisher, 2 1/2 gal. water extinguisher, 15 & 20 lb. and CO ₂ Extinguishers	\$33.95

Dry Chemical Wheeled Fire Extinguisher



- ▶ Brass, chrome-plated operating valve
- ▶ 240 PSI operating pressure
- ▶ Heavy-duty steel cylinder, carriage and hose hanger assembly
- ▶ Quick-release 25 ft. discharge hose with brass/chrome-plated ball type shut-off nozzle
- ▶ Large color coded Mylar instruction labels
- ▶ "Ultra" corrosion-resistant red polyurethane paint finish
- ▶ Smooth rolling 12 1/2" semi-pneumatic rubber-tired wheels
- ▶ DOT 4BW240 agent cylinder
- ▶ Operating temp; -40°F to +120°F
- ▶ U.S. Coast Guard Approved



Cat#	Agent	UL Rating	Capacity	Hose Length	Hose Dia.	Price
AF582	ABC	30A:160B:C	50 lbs.	25 ft.	1/2"	\$1,226.95
AF583	Regular	160B:C	50 lbs.	25 ft.	1/2"	\$1,178.95
AF584	Purple K	160B:C	50 lbs.	25 ft.	1/2"	\$1,230.95
AF585	ABC	40A:240B:C	125 lbs.	50 ft.	3/4"	\$2,178.95
AF586	Regular	240B:C	150 lbs.	50 ft.	3/4"	\$2,199.95
AF587	Purple K	320B:C	125 lbs.	50 ft.	3/4"	\$2,238.95
AF598	Carbon Dioxide	20B:C	100 lbs.	40 ft.	1/4"	\$3,220.95

Other styles available. Call your Darley representative for information and pricing.

Type I Safety Cans

Easy-to-Fill and Easy-to-Use, and the Economical Choice for Flammables

Compliant Type I Safety Cans are designed with a single spout to filling and pouring. The self-closing, leakproof lid controls vapors and provides security from spills and leaks.

- ▶ Fully compliant - meets OSHA and NFPA Code 30
- ▶ Self-closing lid controls vapors and spills
- ▶ Premium 24-gauge coated steel body and handle durability and chemical resistance
- ▶ Quality backed by exclusive Ten-Year warranty



D89802	One-Gallon Type I Safety Can	\$33.95
D89803	Two-Gallon Type I Safety Can	\$36.95
D89804	Five-Gallon Type I Safety Can	\$39.95

Type II AccuFlow™ Transfer Cans

Combine Safety with Maximum Convenience When Handling Flammables

Compliant Type II AccuFlow™ Safety Cans offer additional convenience with two openings: top opening with ergonomically designed life lever for easy filling, and a second opening equipped with a flexible metal hose for targeted pouring into small apertures. The 5/8"x9" nose also provides a safe bonding path to the receiving vessel. Patented, innovative manifold automatically vents to provide fast, precision, plug-free pouring. *Ship. wt. 9 lbs.*



AK045	One-Gallon Transfer Safety Can	\$74.95
AK046	Two-Gallon Transfer Safety Can	\$75.95
AK047	Five-Gallon Transfer Safety Can	\$76.95

Safety Can Cabinets

Central Storage for Your Flammable Liquids

Now you can have on-site storage for your flammables or combustibles. These cabinets offer hands-on easy access with minimal exposure plus provide central storage for your corrosive liquids. They save traveling time, minimize employee exposure and seal off your flammables when temperatures get too high. As high-quality safety storage cabinets, they're designed to meet safety requirements in a variety of applications such as laboratories, production areas, schools, hospitals etc., wherever space for flammable and hazardous liquids is needed and at a premium. For even more space-saving storage try the Undercounter Storage Cabinets. They mount flush with other cabinetry and feature vent openings in back wall. *Ship. wt. 190 lbs.-387 lbs.*

Check Out These Outstanding Features

- ▶ Double-Wall Thermal Barrier: Cabinet puts an 18-gauge, double-wall insulated air between you and your flammable liquids
- ▶ Maximum Storage/Efficiency: Reinforced shelves have built-in troughs, and leakproof wells to contain spills
- ▶ Locking Mechanism: 3-point lock with fail-safe closing mechanism
- ▶ Tri-Lingual Label: English, Spanish, and French
- ▶ Dual Vents: Vents are strategically placed with built-in flash arresters
- ▶ Leakproof Sill: Base of cabinet is a full 2" deep to contain spills
- ▶ Superior Powder Finish: Powder coat, high-gloss, paint finish resists solvents, acids and alkalis
- ▶ Adjustable Leveling Feet: Adjustable at all four cabinet corners to ensure proper alignment for tight door closure

CABINETS COME IN HI-GLOSS YELLOW ONLY

Cat#	Description	Size	Shelves	Doors	Dimensions	Price
AK048	Safety Can Storage Cabinet	60 gal.	2	2	65"x34"x34"	\$1,090.95
AK049	Safety Can Storage Cabinet	45 gal.	2	2	65"x43"x18"	\$905.95
AK050	Safety Can Storage Cabinet	30 gal.	1	2	44"x43"x18"	\$730.95
AK051	Undercounter Storage Cabinet, 22-gal. with Manual Closing Doors	22 gal.	1	2	35"x35"x22"	\$710.95
AK052	Undercounter Storage Cabinet, 22-gal. with Self-Closing Doors	22 gal.	1	2	35"x35"x22"	\$798.95

Cabinets comply with OSHA regulations and are designed to meet NFPA.

new lower price



AK048



AK050



AK052

FIRE PROTECTION

Lexan Combination Nozzles

A. 1 1/2" Straight Stream/Fog Nozzle

Constructed of polycarbonate and precision molded from the latest developments in the industry. Ideal for industrial and commercial installations, as well as small fire companies. Available Threads: 1 1/2" NST, SIPT(NPSH); Height: 4 5/8"; Gallonage: 75 GPM. Ship. wt. 1 lb.

L685	1 1/2" Straight Stream/Fog Nozzle	\$13.95
------	-----------------------------------	---------

B. 3/4" and 1" Combination Fog Nozzle

Molded from polycarbonate material. Designed for booster lines, and small diameter hose. Ideal for fighting grass fires. Available Threads: 1" NST, SIPT(NPSH) & 3/4" GHT; Height: 4 3/4"; Gallonage: 1"-22 GPM, 3/4"-8 GPM. Ship. wt. 1 lb.

M767	3/4" and 1" Combination Fog Nozzle	\$14.95
------	------------------------------------	---------



Outside Hose House

Storage house is a safe and convenient hose and equipment storage house. Designed to accommodate up to 300' of 2 1/2" hose as well as nozzles, fire axes and other fire fighting equipment. Available in your choice of 16 gauge cold-rolled steel, galvanized steel or aluminum housing (red finish). Weather-proof sloping top and side louvers for ventilation. Double reinforced doors have continuous hinges with two-point locking chrome handle. Features adjustable center shelf and "Fire Hose" decal. Ship. wt. 195 lbs.

SPECIFY LEG SIZE: 12", 18" or 24"

U817	Outside Hose House, Steel	\$849.95
AJ292	Outside Hose House, Galvanized Steel	\$1,027.95
AJ293	Outside Hose House, Aluminum	\$1,309.95



FIRE PROTECTION

Quikfit Sprinkler Shut Off

Simple, quick, positive shutoff for many types of sprinkler heads with openings of approximately 7/8" wide by 1" high or 3/4" wide by 1 1/16" high. Allows sprinkler heads out of fire area to be shut off. Ship. wt. 1 lb.



G423	Quikfit Sprinkler Shut Off	\$49.95
------	----------------------------	---------

Angle Valves

Cast brass body. NPT Female by any standard male hose thread outlet. Ship. wt. 12 lbs.

300 PSI

SPECIFY MALE OUTLET

H88801	1 1/2" Angle Valve	\$53.95
H88802	2 1/2" Angle Valve	\$109.95



Hose Pin Rack Units

Darley® Pin Rack Units are designed for standpipe use and are assembled and packaged before shipment. Furnished with a rough brass valve, red enamel rack and machined brass nipple, couplings and nozzle. They consist of U.L. listed and F.M. approved valve, rack hose and nozzle as follows:

1 1/2" Assembly - Includes 1 1/2" angle valve, hose rack, 1 1/2" rack nipple, 1 1/2" rack light hose, 1 1/2" couplings, pin or rocker lugs and 1 1/2" fog nozzle.

2 1/2" Assembly - Includes 2 1/2" angle valve, hose rack, 2 1/2" rack nipple, 2 1/2" x 1 1/2" reducer, 1 1/2" rack light hose, 1 1/2" couplings, pin or rocker lugs and 1 1/2" fog nozzle.

1 1/2" ASSEMBLY - SPECIFY THREAD TYPE	Ship. wt.	Price
T32301 1 1/2" Assembly with 50' of Hose	14 lbs.	\$232.95
T32302 1 1/2" Assembly with 75' of Hose	17 lbs.	\$259.95
T32303 1 1/2" Assembly with 100' of Hose	19 lbs.	\$289.95
2 1/2" ASSEMBLY - SPECIFY THREAD TYPE	Ship. wt.	Price
T32304 2 1/2" Assembly with 50' of Hose	22 lbs.	\$381.95
T32305 2 1/2" Assembly with 75' of Hose	24 lbs.	\$381.95
T32306 2 1/2" Assembly with 100' of Hose	25 lbs.	\$391.95



Infrared Thermometers

The world's most popular, professional, handheld, non-contact thermometer using infrared technology to measure the temperature of materials up close or from a distance in less than a second. Lightweight, compact and easy to use. You simply aim, pull the trigger and read the temperature on a large, backlit LCD display. Safely measure hot, hazardous or hard-to-reach materials without contaminating or damaging material's surface. Check all the great features. *Ship. wt. 2 lbs.*

BL086:

- ▶ Dual laser sighting
- ▶ **Temperature range:**
-76° to 932° F
(-60° to 500° C)
- ▶ **Distance/Spot:** 12:1
- ▶ Accuracy +/- 2%
- ▶ Captures maximum temperature during scan
- ▶ Back-lit LCD display
- ▶ Batteries provide 180 hours of continuous operation

BK247:

- ▶ Dual laser sighting
- ▶ **Temperature range:**
-76° to 1157°
(-60° to 625°C)
- ▶ **Distance/Spot:** 16:1
- ▶ Accuracy +/- 2%
- ▶ Amber backlit LCD Display
- ▶ Uses 2 AAA batteries



BL086	Laser Thermometer 932°F 12:1	\$88.95
BK247	IR Thermometer with Dual Lasers	\$173.95

Professional IR Thermometers

The Professional IR Thermometers are a heavy-duty IR dual-laser thermometer with advanced temperature processing, high resolution optics and built-in LED Flashlight. Advanced system-on-chip engineering is the key ingredient of the series of long range infrared thermometers.

BD191:

- ▶ Dual laser sighting
- ▶ **Temperature range:**
-76° to 1600° F
(-60° to 871° C)
- ▶ **Distance/Spot:** 30:1
- ▶ Bright, built-in laser
- ▶ Accuracy +/- 2%
- ▶ Back-lit LCD display
- ▶ Auto Off
- ▶ Batteries provide 180 hours of use
- ▶ Programmable High and Low audible temperature alarms

BK248:

- ▶ Dual laser sighting
- ▶ Hi/low alarm
- ▶ MAX, MIN, DIF and AVG temp. settings
- ▶ **Distance/Spot:**
50:1
- ▶ Accuracy +/- 2%
- ▶ **Temperature range:**
-76° to 1832°
(-60° to 1000°C)
- ▶ High intensity white LED flashlight
- ▶ High and Low audible temperature alarms

BD191	Therma Twin Long Range IR Thermometer	\$199.95
BK248	Extra Long Range IR Thermometer	\$359.95

Thermal Scanner System

The RedHawk™ thermal scanner is the latest and most advanced addition to the time-proven line of thermal scanners. Designed specifically for detecting hotspots, SmartSight™ Technology provides superior hot spot detection a higher contrast ratio than other thermal sensors - up to 1000x greater than TICs and IR thermometers. The RedHawk™ includes Class II red aiming laser for pin point location of hot spots inside structures, walls, ceiling, etc. The RedHawk™ also uses a loud, audible alarm to alert the presence of a hot spot.

- ▶ SmartSight™ Technology
- ▶ Lightweight - less than 1 lb.
- ▶ Operates through glass
- ▶ 3 year unconditional warranty
- ▶ AA batteries (included)
- ▶ Rugged waterproof storage case, carrying pouch, retractable lanyard
- ▶ Help needed alarm



DYN-OPTICS

BK043	RedHawk™ Thermal Scanner System	\$998.95
-------	---------------------------------	----------



What Makes Darley Sirens the Industry's Finest?

A potent combination of the latest technology applied to time-tested siren designs. Darley outdoor warning sirens are Omni-directional and distribute the siren's full decibel output 360° around the siren at all times. Another hallmark of Darley's superior product is the use of continuous duty motors. Our siren motors are rated for approximately 10,000 hrs. of continuous, uninterrupted service. This means that there is no cooling period, no shut-down time. The siren works when you need it to work, period. All of Darley sirens are backed by the industry's longest warranty and best customer service.

* Sentry rating based on field tests using FEMA Guidelines; assumes perfect conditions, actual coverages may vary based on multiple factors. No guarantee is expressed or implied concerning dB or SPL of sirens.

Skirted Warning Siren in Single-Phase or Three-Phase

A power packed, entry level siren, this siren is our first step into large scale, warning sirens. With its low power demands, this compact siren is meant for spot signaling or industrial warning. This 5 HP performer is rated at 107 dB(c) @ 100 ft. continuous*. Plus, its projection skirt is meant for projecting sound down and flooding the immediate vicinity with intense warning signals.

Available in single or three phase power. Ship wt. 250 lbs.

SEE ACCESSORIES BELOW

AC46701	5 HP, Three-Phase Siren with Skirt	\$2,857.95
AC46801	5 HP, Single-Phase Siren with Skirt	\$3,101.95
AB331	Pole Mounting Bracket	\$463.95
AB934	Siren Heating System	\$786.95

Single-Phase or Three-Phase Siren with Projection Horns

With over 3,000 units in service world-wide, this rock solid model has seen it all. It features a 5 HP, continuous duty motor pushing its aluminum rotor and is rated at 109 dB(c) @ 100 ft. continuously*. The majority will find their way to the tops of utility poles where they will warn of approaching tornadoes or burning fires. Available in single or three phase power. Ship wt. 250 lbs.

SEE ACCESSORIES BELOW

AC46702	5 HP, Three-Phase Siren with Horns	\$3,198.95
AC46802	5 HP, Single-Phase Siren with Horns	\$3,444.95
AB331	Pole Mounting Bracket	\$463.95
AB934	Siren Heating System	\$786.95

THREE-PHASE SIREN ACCESSORIES

AC455	Motor Starter/General Enclosure	\$471.95
AC456	Motor Starter for 5HP, Three Phase Siren	\$607.95

SINGLE-PHASE SIREN ACCESSORIES

AC457	Motor Starter/General Enclosure	\$472.95
AC458	Motor Starter for 5HP, Single Phase Siren	\$592.95



Our Most Popular Single-Tone Siren

This siren from Darley is fast, efficient, and worry-free. This siren is our go-to model for those applications demanding durability, performance, and reliability. With a 7.5 HP, continuous duty motor pushing its aluminum rotor, this siren produces 112 dB(c) @ 100 ft. continuously*. Yet another state of the art system from Darley, created with tried and true technology for a winning combination. Available in single or three phase power. Also available with a battery backup option. Call for details. Ship wt. 325 lbs.

AR245	7.5 HP Three-Phase Siren with Horns	\$4,416.95
AC459	Motor Starter for Three-Phase Siren/Standard Enclosure	\$497.95
AC460	Motor Starter for Three-Phase Siren/Weatherproof Enclosure	\$621.95
AR246	7.5 HP Single-Phase Siren with Horns	\$5,285.95
AC461	Motor Starter for Single-Phase Siren/Standard Enclosure	\$673.95
AC462	Motor Starter for Single-Phase Siren/Weatherproof Enclosure	\$848.95
AB331	Pole Mounting Bracket	\$463.95
AB934	Siren Heating System	\$786.95

Our Loudest Single-Tone Warning Siren

Dependability, we all want it, in our cars, dishwashers, lawnmowers, even in ourselves. This siren was introduced in 1981, was designed to be just that. With over 5,000 units in service world-wide, this rock solid siren is our cornerstone. With a 10 HP, continuous duty motor pushing its aluminum rotor, this siren produces 115 dB(c) @ 100 ft. continuously*. A mainstay in emergency warning across the globe, it is ready to protect. Available in single or three phase power. Ship wt. 350 lbs.

Y772	10 HP, Three-Phase Siren with Horns	\$4,596.95
AC463	Motor Starter for Three-Phase Siren/Standard Enclosure	\$687.95
AC464	Motor Starter for 10HP, Three Phase Siren	\$848.95
Y774	10HP, Single Phase Siren with Horns	\$5,690.95
AC465	Motor Starter for Single-Phase Siren/Standard Enclosure	\$848.95
AC466	Motor Starter for 10HP, Single Phase Siren	\$1,021.95
AB331	Pole Mounting Bracket	\$463.95
AB934	Siren Heating System	\$786.95

OUTDOOR WARNING SIRENS



Dual-Rotor/Two-Tone Warning Siren for the Bigger Jobs

Our most affordable dual-tone siren, this giant is designed to excel in almost any application. It's staged horn projectors provide a large, even coverage area with two distinct sound pitches. Rated at 122 dB at 100', the AG610 and AG613 are OMNI-DIRECTIONAL sirens which produce continuous 360° coverage, a clear advantage over rotating sirens. No fiberglass or plastic materials here! All exposed siren components are made of zinc-plated, steel construction, which are powder coated for the most durable finish available. Available in any color. Ship wt. 600 lbs.

AG610	10 HP Three-Phase, Dual Tone Siren	\$8,247.95
AG611	Motor Starter for Three-Phase Siren Standard Enclosure	\$666.95
AG612	Motor Starter for Three-Phase Siren/Weatherproof Enclosure	\$823.95
AG613	10 HP Single-Phase, Dual Tone Siren	\$7,707.95
AG614	Motor Starter for Single-Phase Siren/Standard Enclosure	\$823.95
AG615	Motor Starter for Single-Phase Siren/Weatherproof Enclosure	\$991.95
AB331	Pole Mounting Bracket	\$463.95
AB934	Siren Heating System	\$786.95

The Darley "Decibel-Busting" 15 HP Siren

First installed in 1978, the original was intended to be the "go to" siren for larger communities. With over 3,000 units in service world-wide, it has no problem inspiring confidence. With a 15 HP, continuous duty motor pushing two aluminum rotors, this siren produces 122 dBc @ 100 ft. continuously*. Confidence? Look no further than for the ultimate in service and reliability. Available in single or three phase power. Also available with a battery backup option. Call for details. Ship wt. 750 lbs.

AC433	15HP, Three Phase Siren with Horns	\$8,497.95
AC453	Motor Starter for Three-Phase Siren/Standard Enclosure	\$856.95
BD126	Motor Starter for 15HP, Three Phase Siren	\$1,020.95
AB330	Start/Stop Switch	\$84.95
AC431	15HP, Single Phase Siren with Horns	\$9,870.95
BD127	Motor Starter for Single-Phase Siren/Standard Enclosure	\$1,163.95
BD128	Motor Starter for 15HP, Single Phase Siren	\$1,153.95
AB331	Utility Pole Mounting Bracket	\$463.95
AB934	Siren Heating System	\$786.95

110v Electro-Mechanical Indoor/Outdoor Alarm Siren

Tens of thousands of satisfied customers have used this siren in a wide range of industrial, municipal, and emergency signaling applications. This siren employs a carefully machined and balanced aluminum fan and housing, and aluminum, powder coated projectors. The air intake is screened to protect against foreign matter. Corrosion protected, it is suitable for permanent outdoor installation. The model F-2 tested @ 117 dB. @ 10 ft. outdoor, 113 dB. @ 10 ft. in an anechoic chamber, and at 103 dB(A) in a reverberant room to U.L. Standard 464. This model runs on 120 volt AC/DC power, with running amperage of 2.5 amps. It can also be ordered in 240/250 AC/DC. Ship. wt. 13 lbs.

R828	Darley 110-Volt Alarm Siren	\$499.95
------	-----------------------------	----------

G3 Siren Controller - Wireless Siren Activation & Control

- ▶ Auto Test Function: Standard, Automatic, Daily, Weekly activation replaces clock networks
- ▶ PLC based environment (Programmable Logic Controller)
- ▶ Whip antenna standard
- ▶ User-programmable siren timing controls
- ▶ Can receive up to 16 different frequencies in one unit. Low band/UHF/VHF/900 MHz
- ▶ Up to 4 DTMF codes per group and up to 4 groups mean 16 different codes/functions
- ▶ DTMF and Two-Tone Sequential can be combined in the same unit
- ▶ Battery backup capability is standard
- ▶ Two-way communication via SCADA ("Talk Back Enabled") (GEN 5 Series)
- ▶ Windows-based programming environment

G1 Siren Controller - Hand Wired Activation and Control

- ▶ Auto Test Function: Standard, Automatic, Daily, Weekly activation replaces clock networks
- ▶ PLC based environment (Programmable Logic Controller)
- ▶ User-programmable siren timing controls
- ▶ Battery backup capability is standard
- ▶ Overload protection is standard
- ▶ Windows-based programming environment

SPECIFY FREQUENCY, TONE CODES, AND SIGNAL TIMING

BG167	G3 Siren Controller	\$1,993.95
BG168	G1 Siren Controller	\$1,044.95



OUTDOOR WARNING SIRENS

Six Great Blackinton Finishes To Choose From

- Nickel Plate** - Nickel Plating over polished badge base
- Rhodium Plate** - Platinum over nickel-brilliant white finish
- Gold Electroplate** - Gold tone w/rich, bright appearance
- Hi-Glo** - Gold tone with brilliant luster and clear coating
- Karatclad** - Gold tone with heavy coating of karat gold
- Two Tone** - Combination of gold and silver colors



Badges Shown Actual Size

B1009 B899 B427 B1496



B544 B539 B523 B30

Badge Ordering Form Can Be Found Online at www.edarley.com/orderforms
(No Badge Phone Orders Accepted)

Cat#	Nickel	Rhodium	Gold Plate	Hi-Glo	T.T.	Karatclad®
B484	\$39.95	\$41.95	\$48.95	\$69.95	\$78.95	\$90.95
B544	\$43.95	\$48.95	\$55.95	\$78.95	\$84.95	\$96.95
B652	\$64.95	\$76.95	\$83.95	\$107.95	\$107.95	\$136.95
B899	\$76.95	\$82.95	\$91.95	\$113.95	\$113.95	\$140.95
B1496	\$43.95	\$48.95	\$55.95	\$78.95	\$84.95	\$96.95
B30	\$43.95	\$48.95	\$55.95	\$78.95	\$84.95	\$96.95
B427	\$48.95	\$51.95	\$57.95	\$80.95	\$87.95	\$100.95
B523	\$43.95	\$48.95	\$55.95	\$78.95	\$84.95	\$96.95
B539	\$52.95	\$53.95	\$62.95	\$84.95	\$91.95	\$105.95
B736	\$76.95	\$82.95	\$91.95	\$113.95	\$113.95	\$140.95
B1009	\$52.95	\$56.95	\$64.95	\$55.95	\$93.95	\$108.95

Ask About Darley's Special Quantity Discounts



B652 B484

BADGES

Badges Shown
Actual Size



B38



B957



B538



B296



B96



B537



B519



B297



B39

Badge Ordering Form Can Be Found Online at www.edarley.com/orderforms

(No Badge Phone Orders Accepted)

Cat#	Nickel	Rhodium	Gold Plate	Hi-Glo	T.T.	Karatclad®
B38	\$43.95	\$48.95	\$55.95	\$78.95	\$84.95	\$96.95
B39	\$43.95	\$48.95	\$55.95	\$78.95	\$84.95	\$96.95
B96	\$52.95	\$56.95	\$64.95	\$85.95	\$93.95	\$108.95
B296	\$48.95	\$51.95	\$57.95	\$80.95	\$87.95	\$100.95
B297	\$41.95	\$46.95	\$52.95	\$74.95	\$78.95	\$91.95
B519	\$41.95	\$46.95	\$52.95	\$74.95	\$78.95	\$91.95
B537	\$52.95	\$53.95	\$62.95	\$84.95	\$91.95	\$105.95
B538	\$52.95	\$53.95	\$62.95	\$84.95	\$91.95	\$105.95
B957	\$43.95	\$48.95	\$55.95	\$78.95	\$85.95	\$96.95

Ask About Darley's Special Quantity Discounts

Badge Centers

State Centers

All 50 States Available



Plain

FREE with any badge purchase



Rim Color

FREE with Hi-Glo, Two-Tone or Karatclad® Badge (\$3.00 additional on other)



Full Color

FREE with Hi-Glo, Two-Tone or Karatclad® Badge (\$5.00 additional on other)

Firefighter Centers

All Levels of Command Available

Plain

FREE with any badge purchase

One Color

FREE with Hi-Glo, Two-Tone or Karatclad® Badge (\$3.00 additional on other)
SPECIFY STYLE & COMMAND ON ORDERING FORM



EMS Centers

Plain

FREE with any badge purchase

One Color

FREE with Hi-Glo, Two-Tone or Karatclad® Badge (\$3.00 additional on other)

Two Color

FREE with Hi-Glo, Two-Tone or Karatclad® Badge (\$5.00 additional on other)

SPECIFY CENTER NUMBER & STYLE ON ORDERING FORM



A6193



A4247



A4256



A3948



A4013

BADGES

Ready Rack™ Storage Systems

The open air design of Red Rack™, along with our Dry Kwik accessories, provides for free air circulation and helps dry PPE much faster. As a result, mold and mildew will not prematurely destroy the fibers of your gear and it will last longer. Red Rack™ components are coated with a durable red powder coat finish.

Standard Features:

- ▶ 20" and 24" wide sections
- ▶ 20"Dx72"H compartments
- ▶ Adjustable helmet shelf
- ▶ Adjustable boot shelf
- ▶ Adjustable apparel hooks
- ▶ 2 - Utility hooks
- ▶ Heavy-duty powder coat finish
- ▶ Label holder for nameplate
- ▶ Dry Kwik coat hanger
- ▶ Horizontal hanger rod



A. Wall Mounted Red Rack™ Turnout Gear Storage System

Cat#	Openings	20"Wx20"Dx72"H (Per Opening)	24"Wx20"Dx72"H (Per Opening)
BD085	1	\$337.95	\$376.95
BD086	2	\$537.95	\$561.95
BD087	3	\$751.95	\$783.95
BD088	4	\$966.95	\$1,007.95
BD089	5	\$1,181.95	\$2,251.95
BD090	6	\$1,397.95	\$1,460.95
BD091	7	\$1,612.95	\$1,683.95
BD092	8	\$1,826.95	\$1,945.95
BD093	9	\$1,902.95	\$2,039.95
BD094	10	\$2,258.95	\$2,278.95

Call your Darley representative for pricing on more openings.

B. Single-Sided Mobile Red Rack™

Cat#	Three 20" Sections 64"Lx20"Dx79"H	Three 24" Sections 76"Lx20"Dx79"H
BD095	\$845.95	\$953.95

Units are supplied with four swivel caster - two with foot-operated brakes.

C. Double-Sided Mobile Red Rack™

Cat#	Six 20" Sections 64"Lx20"Dx79"H	Six 24" Sections 76"Lx20"Dx79"H
BD096	\$1,412.95	\$1,480.95

Units are supplied with four swivel casters - two with foot-operated brakes.

USA Ready Rack™ Storage Systems

The open-air design of Red Rack™, along with our Dry Kwik accessories, provides for free air circulation and helps PPE dry much faster. As a result, mold and mildew will not prematurely destroy the fibers of your gear and it will last longer. Dry gear helps reduce steam burns. Red Rack™ components are coated with a durable red powder coat finish. All Red Rack™ storage systems include the following:

- ▶ Made in the USA!
- ▶ Mobile units are supplied with four swivel casters, two with foot operated brakes
- ▶ Structurally superior design does not require rear grid
- ▶ Red Rack™ is designed to stand up to the rugged demands of the Fire Service
- ▶ Tubular steel design is the strongest configuration on the market and does not require a rear grid
- ▶ SAFER! Open back design allows easy access to your station's building code approved electrical outlets
- ▶ Easier to assemble!

Standard Components:

- ▶ Adjustable boot and helmet shelves
- ▶ Adjustable apparel hooks
- ▶ Label holder
- ▶ Hanging pole



Wall Mounted USA Red Rack™ Turnout Gear Storage System

Cat#	Openings	20"Wx20"Dx72"H	24"Wx20"Dx72"H
		(Per Opening)	(Per Opening)
BL113	1	\$432.95	\$438.95
BL114	2	\$701.95	\$715.95
BL115	3	\$843.95	\$988.95
BL116	4	\$1,264.95	\$1,288.95
BL117	5	\$1,531.95	\$1,561.95
BL118	6	\$1,805.95	\$1,841.95
BL119	7	\$2,072.95	\$2,134.95
BL120	8	\$2,366.95	\$2,414.95
BL121	9	\$2,633.95	\$2,687.95
BL122	10	\$2,907.95	\$2,987.95

USA Single-Sided Mobile Red Rack™

BL124 - Security option single sided

- ▶ Includes: Top Security shelf, rear security panel and lockable door

Cat#	Three 20" Sections	Three 24" Sections
	64"Lx20"Dx79"H	76"Lx20"Dx79"H
BL123	\$1,267.95	\$1,303.95
BL124	\$2,074.95	\$2,161.95

Units are supplied with four swivel casters - two with foot-operated brakes.



Mobile Turnout Ready Rack™

Keep Your Gear Ready To Go



Each Compartment Has

- ▶ 2-Utility Hooks
- ▶ Member Name Plate



Single-sided



Double-sided

Turnout Ready Rack™ Wall Mounted & Free Standing



Double-sided



Single-sided

Mobile Turnout Ready Rack™ gets your department's turnout where you need it, when you need it and provides air circulation for drying. All of this requires very little space. Each 18" wide compartment on the rack holds a complete set of turnout gear plus utility items. The exclusive full-length dividers separate each compartment providing free air flow. The Mobile Ready Rack is available in both single and double-sided configurations. Side and back ledges keep turnout gear secure and casters can be locked in place. Hooks and hangers are included and assembles in just minutes with no tools needed. Racks are chrome plated and coated with clear epoxy finish.

Ship. wt. 184 lbs.

Maximizes storage capacity and provides air circulation for drying your department's turnout. Choose from fixed units to fit your station's wall or freestanding to maximize floor space. Each 18" wide compartment on the rack holds a complete set of turnout gear including helmet, coat, pants, boots, SCBA mask and utility items. The exclusive full-length dividers separate each compartment, providing free air flow. Hooks and hangers are included. Racks are chrome plated and coated with clear epoxy finish. Ship. wt. 184 lbs.

- ▶ Dry Kwik Coat Hanger
- ▶ 2 Utility Hooks
- ▶ Member Name Plate

Sections	Length	Price
4	72"	\$748.95
6	108"	\$1,138.95
8	144"	\$1,404.95
12	216"	\$2,040.95
20	360"	\$4,034.95

Section	Length	Price
8	72"	\$1,140.95
12	108"	\$1,758.95
16	144"	\$2,149.95
24	216"	\$3,059.95
40	360"	\$5,111.95

Section	Length	Price
4	72"	\$704.95
6	108"	\$1,068.95
8	144"	\$1,263.95
10	180"	\$1,626.95
12	216"	\$1,836.95
15	270"	\$2,295.95
16	288"	\$2,384.95
18	324"	\$2,622.95
20	360"	\$2,809.95
25	450"	\$4,134.95

Cat#	Description	Dimensions	Price
AB444	Single-Sided Mobile Rack	21"Dx72"Lx78"H	\$818.95
AB445	Double-Sided Mobile Rack	36"Dx72"Lx78"H	\$1,203.95

Ready Rack Worktable

- ▶ Available in two or three compartment models
- ▶ Quick-change shelves can accommodate SCBA bottles, tools and storage bins
- ▶ BK154 includes four shelves
- ▶ BK155 includes six shelves
- ▶ Industrial stainless steel top
- ▶ Heavy duty casters provide easy mobility
- ▶ Shelving can customize to fit your workspace needs
- ▶ Powder coat finish for lasting durability

BK154	Ready Rack Two Section Worktable	\$873.95
BK155	Ready Rack Three Section Worktable	\$1,163.95
BK156	Optional Bins	\$49.95
BK157	V-Shelves	\$46.95
BK158	Flat Shelves	\$46.95

S.O.S. Rack

Design accommodates SCUBA cylinders, Oxygen bottles, & SCBA cylinders. The modular design allows you to configure each compartment with any combination of specialized shelves and/or flat shelving for gear bags, turnout gear & dive gear storage/drying. The S.O.S. Rack features four 1,050 lb. capacity casters and is constructed of heavy duty steel tubing with high strength wire. A durable powder coat finish protects the rack and will provide years of service.

- ▶ Dimensions: 32"Dx81"Hx76"L
- ▶ Store up to 18 low profile SCBA cylinders per vertical section
- ▶ Flat shelves available for gear bags & other equipment
- ▶ Specialized bottle shelves hold SCUBA, Oxygen, and SCBA cylinders securely
- ▶ Legendary Ready Rack quality
- ▶ Ships knocked down to save you money

BH145	S.O.S. Rack	\$1,799.95
BH146	S.O.S. Rack Bag Storage w/12 HBS Shelves	\$1,721.95
BH147	S.O.S. Rack Cylinder Storage w/12 V Shelves	\$1,721.95

PPE/Turnout Gear Cleaner

Preserves the quality of gear with Citrosqueeze®, the turnout gear cleaner used by some of the largest US fire departments and by authorized turnout gear cleaning and repair centers nationwide. Citrosqueeze® is formulated to remove the harmful and stubborn hydrocarbons and soils resulting from fires and chemical spills while maintaining the integrity of turnout gear. Solutions® D™ is a concentrated disinfectant detergent with a pH that is NFPA compliant for PPE and turnout gear. It is an effective detergent/cleaner, deodorizer, disinfectant, virucide, mildewstat and fungicide. *Citrosqueeze® PPE cleaner is tested and proven safe by Dupont, Southern Mills, W.L. Gore & Asscos. (Germany), 3M Products, Safety Comments International, Inc., and CIBA Specialty Chemicals.*

BK064	Citrosqueeze® (4) 1-Gal. per Bottle per Case	\$112.95
BK065	Citrosqueeze® (1) 5-Gal. Pail	\$140.95
BK067	Solutions® D™ (1) 5-Gal. Pail	\$252.95



Picture shown with optional additional shelving. Supplies not included.



BH145



BH147



BH146



BK065

Continental Washer-Extractors



Clean Gear The Right Way with a Continental Washer

Fire contaminants can expose firefighters to cancer-causing carcinogens and eventually weaken the gear meant to protect them. Blood and body fluids can further expose them to deadly diseases. That's why the NFPA recommends washing soiled turnout gear immediately after exposure to fire or body fluids. The NFPA also warns against cleaning gear in homes or public laundries to avoid cross-contamination. Continental washer-extractors properly clean turnout gear – removing contaminants and biohazards while preserving fabric integrity. They offer a compact design, so machines fit into unconventional locations like truck bays and utility rooms. The programmable control ensures water temperature, extract speed, cleaning chemicals, fill levels and cycle times are perfectly suited to properly clean and decontaminate turnout gear according to manufacturer recommendations. Continental washer-extractors are designed with the future in mind, and are programmable to handle future changes in protective fabrics. So, fire departments can feel secure knowing their investment will handle their laundry needs today and tomorrow.



Single Phase Washers

BH159	M-Series Hard Mount Washer-Extractors (1-Set)	\$4,039.95
BH160	M-Series Hard Mount Washer-Extractors (3-4 Sets)	\$8,276.95
BH161	M-Series Hard Mount Washer-Extractors (5-6 Sets)	\$10,055.95

DRYGEAR Drying Systems

Dries coats, bunker pants, boots, helmets and gloves quickly. Better than a tumble drier for use on your expensive bunker gear. Dries gear from the inside out by forcing gentle warm air through hollow hangers. Available in three to eight stations. *Ship wt. 376-464 lbs.*

Features:

- ▶ NFPA Compliance 1851
- ▶ No mechanical action to damage gear
- ▶ Runs with or without heat
- ▶ Built-in overheat protection
- ▶ More power and increased air for faster drying
- ▶ Fully dry washed gear in 4-5 hrs.
- ▶ Easy access transparent roll-up flap
- ▶ Wheeled casters option for easy movement



DryGear PLUS Features:

- ▶ Removable hanger assemblies allow the DryGear PLUS to dry fire hose and other loose equipment
- ▶ Loosely coiled hose or equipment is placed on the rack
- ▶ Roll the rack into the DryGear PLUS and close the roll-up flap
- ▶ Select air and heat or air only and set the timer

DON'T MISS
More drying systems in
Turnout (p1-29)



STATION SUPPLIES



DryGear Professional

AW348	DryGear Professional - 3 Station	\$5,162.95
AW349	DryGear Professional - 4 Station	\$5,379.95
AW350	DryGear Professional - 8 Station	\$6,817.95

DryGear PLUS

BD185	DryGear PLUS - 3 Station with Removable Hangers	\$5,326.95
BD186	DryGear PLUS - 4 Station with Removable Hangers	\$5,597.95
BD187	DryGear PLUS - 8 Station with Removable Hangers	\$7,253.95

BD188	3" Wheeled Casters for Portable Station	\$233.95
BD189	Dryer Cart for Hose and Loose Equipment	\$629.95

Versitol Solution For All Washing Machines

A highly-effective yet gentle multi-purpose cleaner. Safe for all automatic washing machines. Removes smoke residue from all washable fabrics and surfaces, especially from expensive turnout gear containing Kevlar®, Nomex®, Duck, Nylon, PBI, Hypalon, Nitrile Rubber and Fiberglass.

Ship. wt. 37 lbs.



AC258	Versitol Solution	\$126.95
-------	-------------------	----------

Case includes four 1-gallon bottles

Cyclone Drying Systems

For all firefighters who need fast effective drying of their gloves, boots and turnout gear. Heated air blows through vented drying arms to quickly dry wet gear from the inside out - providing comfort, eliminating mildew and ensuring safety in high heat situations. Boots and gloves are dry in an hour. With drying arm extensions to reach further down the arms of coats or the legs of pants the BK402 can dry 1 set of wet turnout gear in about 2 hours, a fraction of the normal time. Cyclone Dryers can be plugged into an existing 120v wall outlet and once anchored to standard 16" wall stud centers extend less than 14" from the wall. Fit with an efficient, custom motor, these dryers boast very low operating costs and unbelievably low noise levels. A digital 120-minute timer allows you to set the time needed for drying and forget about it.

- ▶ Weight: 65 lbs.
- ▶ Dimensions: 17 1/4" W x 66" H x 13 1/2" D



Side Temp. Controls



BK059	Cyclone Boot/Glove Drying System	\$849.95
BK402	Cyclone w/Drying Arm Extensions for Turnout Gear	\$899.95

Fast Dry Coat Hanger

Keeps expensive coats organized and dry! Gear dries quicker because air circulates better inside the garment, allowing fabric-fibers to dry faster. Specify open or closed hook style. Ship wt. 1 lb.

Dry gear faster!



AF072	Coat Hangers	\$9.95/ea.
-------	--------------	------------

Fast Dry Glove Hanger

Keeps expensive gloves organized and dry! Gear dries quicker because air circulates better inside the garment, allowing fabric-fibers to dry faster. Specify open or closed hook style. Ship wt. 1 lb.



AF10602	Glove Hangers	\$9.95/ea.
---------	---------------	------------

HangAir Gear Dryer

The HangAir dries turnout gear in hours. This gives you the opportunity of several uses of a dry suit throughout the day. The secret is a high-powered waterproof fan which pushes 120 cubic feet of dry air per minute through your suit as it hangs on a wide shoulder hanger. An added benefit is that the quick drying process retards the development of bad odors. The HangAir is molded from an incredibly tough plastic resin. When not in use, the cord can be stowed underneath the wing.

- ▶ 15' power cord attached to a universal power 100-240 vac wall adapter
- ▶ Safe, low-voltage 12v fan for safety
- ▶ Steel hook supports up to 100 lbs.
- ▶ 120 cfm high-power fan
- ▶ Tough, non-corroding resin and steel construction



BG216	HangAir Gear Dryer	\$45.95
-------	--------------------	---------

VersaMist® Misting Fan

The VersaMist® portable misting fan combines low pressure mist and high speed air movement to create cool comfort indoors or out for athletes, rescue squads, firemen, construction workers, assembly line workers, tents, patios, pool decks and other hot spots.

- ▶ 18" UL507 rated, imported 3-speed fan; up to 6600 cfm
- ▶ 1.4 Tons (16,000 BTU/hour) of cooling capacity
- ▶ Cools the air up to 30°F
- ▶ Large 10 gallon reservoir allows 5 hours of continuous use
- ▶ Low pressure mist pump enclosed in rugged enclosure with tip switch
- ▶ Runs on 115V; 12V and 220V models available
- ▶ Includes 25' outdoor-rated power cord with integrated GFCI
- ▶ Also available with wheels for greater flexibility and convenience (BH028)
- ▶ Two-year limited warranty
- ▶ Made in the USA



BH028



AS431

DON'T MISS

More products like this
Hazmat (p210-230)
Ventilation (p260-263)

AS431	VersaMist® Misting Fan	\$738.95
BH028	VersaMist® Misting Fan with Wheels	\$844.95

STATION SUPPLIES

Salvage-Master Wet Vacuum

Highly Efficient Wet Vacuum Unit

Salvage-Master's ability to remove water from deep floor cracks, carpets, tile, concrete, asphalt and wood floors greatly reduces overall fire or spill damages and subsequent insurance loses. In addition, Salvage-Master's fast action performance (the 5.9 gallon tank fills in 18 seconds and empties in 14 seconds) helps prevent warpage, curling floors and seepage through ceilings. As an extra convenience, Salvage-Master features a special float device that automatically activates a high-pitched sound to indicate when the tank is full. Comes complete with a rubber squeegee, GFCI plug, and 1-year warranty.



BH142



- ▶ Shoulder On/Off switch
- ▶ 5.9 gallon tank capacity
- ▶ Drain hose
- ▶ Two piece wand
- ▶ Ground fault circuit plug
- ▶ 50' electrical cord
- ▶ Ship. wt. 35 lbs.

BH141	Salvage-Master Wet Vacuum	\$1,616.95
BH142	Optional Carpet Adapter	\$98.95

Salvage Covers and Runners

Canvas Covers: Treated with a fire and water resistant finish. Meets requirements for California State Fire Marshall, NFPA-701 (large scale), and CPAI Section 6. Water-resistant finish and mildew inhibitors added.

Vinyl Covers: Excellent wear and tear resistance, waterproof. Meets California State Fire Marshall requirements, UL-214 Classified, ASTM-E-84, Class A Flame standard. Easily wipes clean.



Salvage Covers

Cat#	Material	Size	Ship. wt.	Price
J860	Canvas	12'x14'	15 lbs.	\$102.95
J861	Canvas	12'x18'	19 lbs.	\$131.95
J862	Canvas	14'x18'	22 lbs.	\$153.95
J857	Vinyl	12'x14'	20 lbs.	\$93.95
J858	Vinyl	12'x18'	26 lbs.	\$121.95
J859	Vinyl	14'x18'	30 lbs.	\$141.95

Runners

Cat#	Material	Size	Ship. wt.	Price
AR103	Canvas	24"x20"	6 lbs.	\$36.95
AR104	Canvas	30"x20"	6 lbs.	\$42.95
AR101	Vinyl	24"x20"	6 lbs.	\$33.95
AR102	Vinyl	30"x20"	6 lbs.	\$39.95

Darley Chimney Scraper



Simply lower in the closed position and withdraw in the open position. This scrapes the fire-causing soot from the chimney walls. All you need is the chain. One end attaches to the "closed position" ring and the other to the "open position" ring. **Ship. wt. 9 lbs.**

G113	Chimney Scraper	\$76.95
------	-----------------	---------

TUFF•GUARD

Kink-Free Professional Grade Hose

TUFF•GUARD truly is the perfect hose for cleanup around the fire station. The unique polypropylene double helix construction makes this the most flexible and highly unkinkable hose. The double helix construction also allows the TUFF•GUARD hose to be 35%-50% lighter than garden hose, flexible and weather resistant from -20°F - 158°F, abrasion and chemical resistant, and crush proof all while retaining its superior durability. Unlike garden hose, the heavy duty brass ferrules thread onto the outer helix to anchor the couplings making end pull-offs and leaks virtually impossible.



- ▶ Kink-free
- ▶ Professional grade
- ▶ Maximum flow fittings
- ▶ Easy handling



COLOR: Red

BLO92	5/8" GHT x 50' TUFF•GUARD Hose	\$59.95
-------	--------------------------------	---------

Fire Broom

The hardwood handle, stiff textured Palmyra fiber and metal cap are locked under tons of pressure to prevent loose handles and fiber fallout. Bonded red finish, inside and out, to resist chipping, flaking and rusting. This broom has been designed to exceed the rigorous demands of fire suppression work while being light enough to be easily carried to remote areas; it's used by fire fighters under the harshest of conditions. **Overall length: 53 3/4". Ship. wt. 3 lbs.**



H755	Palmyra Fire Broom	\$20.95
------	--------------------	---------

Battle Fogger



The Battle Fogger's simple design is an extremely effective fog machine incorporating a large heating block, a strong whisper-quiet pump, and our cutting-edge Rapid Change Technology (RCT) capillary tube replacement system. The large one-gallon integrated fluid tank prevents leaks and drips, a special hammer-tone finish resists scratches and wear, and a built-in handle balances off the sleek, rugged chassis. The Pro Fogger comes standard with a 25' deluxe remote, and onboard microprocessor, a built-in hose adapter, and a replacement RCT capillary tube kit. *Ship. wt. 25 lbs.*

AW352	Battle Fogger	\$1,148.95
AW415	Smoke Fluid, 4-Liter	\$55.95

Superior Smoke Machine



With a powerful 1300-watt heating core and reliable high-pressure piston pump, this machine delivers an impressive output of 4800cfm. It will quickly fill your training area with dense, persistent, non-irritating smoke with excellent obscuring power. Comes standard with 32-foot wired remote control featuring a selection for manual or self-timed operation. Simply set the control flow rate, duration of smoke blasts and interval between blasts. The Superior Smoke Machine will continuously refill an area with smoke at a steady, constant rate. Other features include thermal cutoff to prevent "wet smoke" and LED status lights. Unit holds one gallon of smoke fluid. UL listed. *Ship. wt. 32 lbs.*

AM240	Superior Smoke Machine	\$921.95
AM241	Smoke Fluid, 1-Gallon	\$54.95

Smoke Canister

Strictly for use during your department mask drills. The Smoke Canister generates 500,000 cubic feet of dense white smoke for five to six minutes burning time. Smells and looks like fire smoke but will not leave odors or residue to damage clothing or walls. Irritating to discourage laxity in training exercise. Could be hazardous when used indoors without self-contained breathing apparatus. *Ship. wt. 4 lbs.*



R429	Smoke Canister	\$348.95/case of 6
------	----------------	--------------------

Passfire™ Burn Pan Training Unit

The Halcyon Product's Passfire™ is a cost-effective, portable solution to contained, controlled burns for training purposes. It is used by fire departments, training firms, or by the person responsible for the fire extinguisher training.

- ▶ Conduct safe fire extinguisher training, while maintaining a clean environment with the most inexpensive training unit on the market
- ▶ Firefighter designed and approved
- ▶ Helps businesses and organizations comply with OSHA 1910.157
- ▶ Uses clean burning propane and is environmentally-friendly
- ▶ Fire is contained within the pan and does affect the surround training areas, eliminating mess and damage
- ▶ Deep stainless steel pan contains the controlled fire while providing long product life
- ▶ Sturdy supports for set up on any flat surface
- ▶ Contains quick disconnects for easy set up and tear down and provides additional security, controlling the supply of propane to the copper burn element
- ▶ Drain in bottom of pan for easy clean up and water disposal
- ▶ 25' propane hose
- ▶ Dimensions: 25"Lx25"Wx16"H
- ▶ *Ship. wt. 57 lbs.*



BK069	Passfire™ Burn Pan Training Unit	\$2,944.95
-------	----------------------------------	------------

Smoke Candles

For Fire Training and Testing Sewer/Water Mains

Eliminates costly equipment and time wasted when attempting to pinpoint leaks. This highly-visible smoke blends readily with air. They can also be used to trigger fire alarms, observe air flow or used as a signal. Other uses are to test fire masks, and use in Fire Service Training and exercises. No residue to stain clothing or building interiors; no explosives. H166A has a double wick. *Ship. wt. 4 lbs.*



Cat#	Burn Time	Size	Volume	Price Per Dozen
L409	60 sec.	1 1/2" x 2 1/2"	8,000 cu. ft.	\$49.95/dz.
H165	2-3 min.	1 1/2" x 5"	40,000 cu. ft.	\$90.95/dz.
H166A	2-3 min.	1 1/2" x 5"	40,000 cu. ft.	\$96.95/dz.

FireCalc Pocket Calculator

The FireCalc Pocket Calculator is back. The FireCalc is the only calculator on the market to offer solutions for engine pressure, friction loss, application rate, flow rate, reaction force, etc. A training tool every firefighter needs when determining fire ground hydraulics. *Ship. wt. 1 lb.*

- ▶ Metric capability
- ▶ Review features
- ▶ Auto power off
- ▶ CE approved
- ▶ Mathematical functions



BH030 FireCalc Pocket Calculator \$43.95

Portable Seat Organizer

Holds & Secures All Your Daily Items

- ▶ Most popular seat organizer on the market
- ▶ Form-fitting pockets secure clipboards, flashlights, maps, files, pens, etc.
- ▶ Seat brackets allow mounting over the front side passenger seat
- ▶ Built-in carrying handle
- ▶ Black, impact-resistant ABS
- ▶ Dimensions: 21"x14"x3³/₄"
- ▶ *Ship. wt. 5 lbs.*



AE151 Portable Seat Organizer \$64.95

Clipboard Organizers

Provides Convenience and Organization

- ▶ Neatly organize your papers
- ▶ Two compartments
- ▶ Removable top compartment
- ▶ 8¹/₂"x12"
- ▶ Pencil tray
- ▶ *Ship. wt. 3 lbs.*

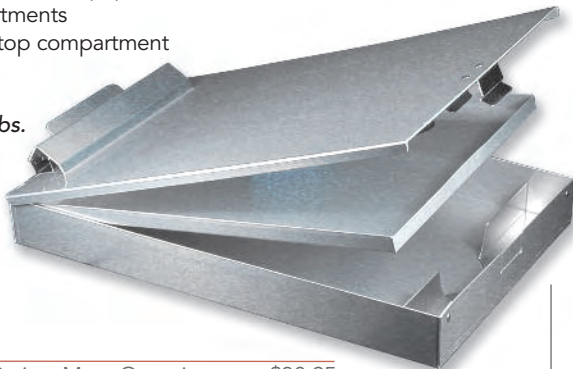

AE311 Cruiser Mate Organizer \$30.95

Custom Accountability Tags

Be sure all firefighters are accounted for! Custom tags are 3¹/₂"x2¹/₈" and are guaranteed against breakage for 10 years. White lettering and allows 13-22 characters per line. Deluxe clip can be easily opened while wearing gloves.



BA104 - SPECIFY COLOR: Red, Blue, Orange, Yellow, Brown, Green, Gray, Black, Light Blue, Bright Green

BA104	Tags with Deluxe Clip	\$18.95/ea.
BA105	Truck Ring with Tag	\$23.95
BB058	Large Ring	\$8.95

Status Boards

Status Boards provide true accountability because you record the team assignments and entry times. This way, if someone does not come out on time you know where to send the F.A.S.T or R.I.T. team to begin their search. The Status Boards help maintain order and provide key information in the event of a problem. *Comes with eight rings and sections for collecting.*

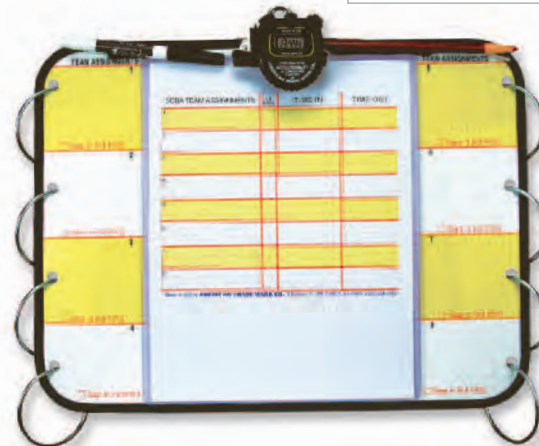

BA102	Deluxe Status Board	\$140.95
BA103	Sector Status Board	\$80.95

Sliding Pole Landing Mat

No fire station equipped with a sliding pole should be without a landing mat. It's 2" thick foam pad with unicell construction which helps cushion landings. Measures approximately 32" in diameter with a 3 1/2" center hole. The materials are similar to those used in marine applications and as such are impervious to oils and will resist dry rot. Installs by sliding over top of station pole. Also available for larger or smaller diameter poles. **Ship. wt. 10 lbs.**



AL233	Sliding Pole Landing Mat	\$280.95
S888A	Brass Sliding Pole	Call your Darley representative for pricing

Nylon Flags

Offers the combination of beauty and long-life for every purpose. The 100% nylon material provides a rich, lustrous appearance. Because of the superior strength-to-weight ratio, Dura-Lite flags have superb wearing strength, yet are so light, they fly in even the slightest breeze. These quality flags have individually embroidered or sewed stars. Stripes are carefully sewn together with a special thread, using a lock stitch for long life. All flags are finished with a strong, polyester canvas heading and spur-type brass grommets. Larger sizes have roped headings with galvanized metal thimbles.



How to Choose the Right Flag Size

To determine the most effective size flag for your flagpole: the length of the flag should be approximately equal to one-fourth of the height of the pole above the ground. For example, the recommended size flag for a 40' pole is a 6'x10' flag.

L897	3'x5' Nylon U.S. Flag	\$23.95
L898	4'x6' Nylon U.S. Flag	\$31.95
L899	5'x8' Nylon U.S. Flag	\$47.95
L899A	6'x10' Nylon U.S. Flag	\$68.95
L900	8'x12' Nylon U.S. Flag	\$127.95

Emergency Escape Ladder

Here's economical fire protection for every home. Makes almost any window an instant fire escape. Just hang brackets over window sill, toss out ladder and climb down. Sturdy hooks slip over most window sills. All-steel, tangle-free construction with rungs, which means the Life Ladder is always ready; nothing to rot or warp. Bottom rung is painted red for faster locating. Adjustable 6 1/8" standoffs keep the ladder away from walls to allow plenty of room and reduce chances of slipping. **Ship. wt. 23 lbs.**



13' or 25'

AR336	13' Life Ladder	\$58.95
P844	25' Life Ladder	\$88.95

Smoke Escape Hood

The Smoke Hood is a lightweight, portable, easy-to-don hood designed for self-rescue in the event of a fire. It protects the wearer for a minimum of 15 minutes from smoke, carbon monoxide and toxic gases normally present during a fire. It is an ideal personal escape device which can be used in emergency situations occurring in homes, office or apartment buildings, schools, hospitals, plant facilities and hotels. **Ship. wt. 2 lbs.**



AS651	Smoke Escape Hood	\$193.95
-------	-------------------	----------

Chimfex®

Protect Your Home From Dangerous Chimney Fires

new lower price



- ▶ Suppresses a chimney fire in an average of 22 sec.
- ▶ Indispensable as the first line of defense for controlling chimney fires
- ▶ Chimfex® smoke emissions rise up the flue to replace the oxygen
- ▶ In a few seconds Chimfex® will effectively smother the chimney fire
- ▶ Fast, toss-in convenience
- ▶ Allows a homeowner to react effectively to control flames and heat build-up during a chimney fire until professional firefighters arrive
- ▶ Works safely with no water damage
- ▶ Use in wood stoves or fireplaces

BK042	Chimfex®	\$17.95
-------	----------	---------

STATION SUPPLIES

Darley Station Signs

Darley's top-quality, durable, and long-lasting station signs are made of two materials. Engineer Grade Reflective Sheeting on .080 Aluminum.

No Parking

12"x18" red letters and border on white background.

	Legend	RA
R5302	NO PARKING FIRE LANE	\$20.95
R54L02	NO PARKING FIRE LANE	\$19.95
R54R02	NO PARKING FIRE LANE	\$19.95
R5402	NO PARKING FIRE LANE	\$19.95
R7802	RESERVED PARKING	\$21.95
R7702	NO PARKING FIRE ZONE	\$19.95
R7602	NO PARKING FIRE STATION	\$20.95

Warning Signs

Black on yellow background.

	Legend	RA
W118S02	Fire Truck Symbol - 30"x30"	\$69.95
W118P02	"Fire Station" - 18"x24"	\$36.95



RA = Engineer Grade Reflective Sheeting on .080 Aluminum

Darley Vehicle Signs

"Keep Back 500 Feet" Scotchlite Sign

Letters and border come in white against red background. Measures 36"x4". Available in self-adhesive or aluminum plate. *Ship. wt. 1 lb.*

J880	"Keep Back 500 Feet", Self-Adhesive	\$9.95
J881	"Keep Back 500 Feet", Aluminum Plate	\$16.95
G451	"Fire Department", Aluminum Plate	\$7.95

Passenger Warning Signs

Every fire truck as well as department vehicle should carry one of these signs. Highly visible and guaranteed durability to keep passengers safe from harm. *Complies with NFPA 1901. Ship. wt. 1 lb.*

Z326	Passenger Warning Sign	\$6.95
Z327	Passenger Rear Step Warning Sign	\$6.95



Darley Equipment Markers

These are pressure-sensitive reflective decals to help your department identify valuable equipment and label for appropriate use. Available in your choice of colors provided and name of department. *Ship. wt. 1 lb.*

Strip of 10 → **AF832**
Equipment Markers
5/8" x 2 1/2"
Sold in strips of 10

Available Color Combinations

- ▶ White on Red
- ▶ Blue on White
- ▶ Black on Yellow
- ▶ Green on White

Strip of 5 → **AF833**
Equipment Markers
1 1/16" x 2 1/16"
Sold in strips of 5

SPECIFY COLORS AND COPY - MINIMUM ORDER 10 STRIPS

AF832	Equipment Markers, 5/8" x 2 1/2"	\$6.95/Strip
AF833	Equipment Markers, 1 1/16" x 2 1/16"	\$6.95/Strip

Davey Portable Pumps

The Affordable, Portable, Engine-Driven Self-Priming Pumps

The Darley® Davey pumps, also known as the "affordable portables" are the most economical choice in portable, high-efficiency pumps. Their compact design makes them ideal for a variety of applications such as firefighting, tank filling and water transfers.

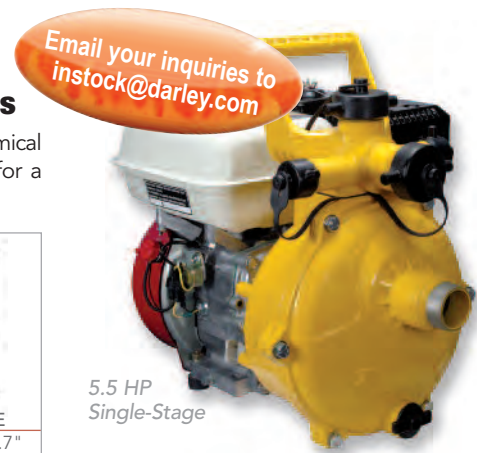

5.5 HP
Single-Stage

6.5 HP
Two-Stage



10 HP
Two-Stage



13 HP
Two-Stage



Email your inquiries to instock@darley.com

PUMP DESIGN FEATURES

- ▶ Marine-grade aluminum casing
- ▶ 3-Way discharge port with 1 - 1.5" NPTM, 2 - 1" NPTM
- ▶ 1.5" NPTM suction
- ▶ Zinc-plated casing bolts
- ▶ Mechanical shaft seal
- ▶ Nitrile rubber seal and casing "O" rings
- ▶ Self-priming up to 19 feet
- ▶ Easy installation
- ▶ Compact & lightweight
- ▶ High pumping efficiency
- ▶ Low oil protection
- ▶ Spark arrestor/exhauster diverter

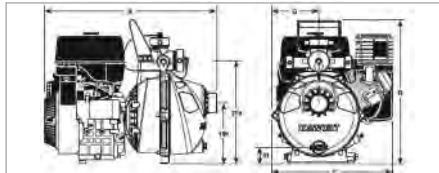

Cat#	A	B	C	D	E
AK302	17.5"	15.3"	15.3"	6.7"	11.7"
AK312	20.1"	15.3"	14.8"	6.7"	11.7"
AK304	20.3"	15.3"	15.3"	6.7"	11.7"
AK300	23.8"	15.3"	15.6"	6.7"	11.7"
AK308	21.4"	17.7"	17.1"	7.5"	12.6"
AK301	22"	17.7"	16.8"	7.5"	12.6"
AK313	25"	19.5"	18.5"	7.9"	13"
AK305	22.9"	18.7"	18.0"	7.5"	12.6"
AK306	22.4"	17.5"	17.9"	7.5"	12.6"

5.5 HP AND 6.5 HP SINGLE-STAGE

- ▶ 5.5 HP Honda and 6.5 HP Briggs & Stratton OHV Vanguard with recoil backup
- ▶ Weighs approx. 49 lbs.

PERFORMANCE

95 gpm (378 L/M) @ 39 psi (2.7 bar)
60 gpm (227 L/M) @ 70 psi (4.8 bar)
20 gpm (76 L/M) @ 90 psi (6.2 bar)

AK302	5.5 HP Honda OHV with Recoil Start	\$1,250.00
AK312	6.5 HP Briggs & Stratton OHV Vanguard with Recoil Start	\$1,260.00

5.5 HP AND 6.5 HP TWO-STAGE

- ▶ 5.5 HP Honda and 6.5 HP Briggs & Stratton OHV Vanguard with recoil backup
- ▶ Weighs approx. 60 lbs.

PERFORMANCE

65 gpm (246 L/M) @ 48 psi (3.3 bar)
50 gpm (189 L/M) @ 81 psi (5.6 bar)
20 gpm (76 L/M) @ 120 psi (9.0 bar)

AK304	5.5 HP Honda OHV with Recoil Start	\$1,460.00
AK300	6.5 HP Briggs & Stratton OHV Vanguard	\$1,540.00

9 HP AND 10 HP TWO-STAGE

- ▶ 9.0 HP Honda and 10.0 HP Briggs & Stratton OHV Vanguard or Yanmar Diesel all with electric start & recoil backup
- ▶ Weighs approx. 80 lbs.

PERFORMANCE

120 gpm (454 L/M) @ 36 psi (2.5 bar)
95 gpm (378 L/M) @ 83 psi (5.7 bar)
60 gpm (227 L/M) @ 118 psi (8.1 bar)
20 gpm (76 L/M) @ 144 psi (9.9 bar)

AK308	9.0 HP Honda Two-Stage	\$2,840.00
AK301	10.0 HP Briggs & Stratton OHV Vanguard	\$2,490.00
AK313	10.0 HP Yanmar Diesel Two-Stage	\$4,910.00

13 HP TWO-STAGE

- ▶ 13.0 HP Honda and Briggs & Stratton with electric start & recoil backup
- ▶ Weighs approx. 92 lbs.

PERFORMANCE

120 gpm (454 L/M) @ 40 psi (2.8 bar)
95 gpm (378 L/M) @ 108 psi (7.4 bar)
60 gpm (227 L/M) @ 133 psi (9.2 bar)
20 gpm (76 L/M) @ 146 psi (10.0 bar)

AK305	13.0 HP Briggs & Stratton	\$2,860.00
AK306	13.0 HP Honda Two-Stage	\$3,150.00
BE078	Automatic Pressure Relief Valve kit	\$140.00

OPTIONAL ROLL CAGE

Pre-drilled powder-coated roll cage with battery tray fits 6.5-13 HP gasoline-driven Davey Firefighter pumps. Measures 30"x19"x21".

AK310	Optional Pump Roll Cage with Battery Tray	\$456.00
-------	---	----------

PUMPS

Darley Marine Portable Pumps

6.5 HP

2BE 6.5H

- ▶ Dependable Honda engine
- ▶ Dewatering
- ▶ Light-duty brush truck
- ▶ Transfer and supply

Features: Honda Model GX200, air cooled 4-stroke OHV, single-cylinder, horizontal shaft, 6.5 HP (4.8kW 3600 rpm) max, torque 1.35kg-m/2,500 rpm, transistorized pointless ignition system, recoil starting system, fuel tank capacity 6 qt., dual silent air cleaner, 2011 Carb and EPA Compliant.

Contact Darley for Coast Guard Model Specifications.

Coast Guard Model Includes: 15' suction hose with strainer, 20' of discharge hose with camlock, fuel tank, spare starter rope, flashlight (no batteries) instruction card. *Below performance is from a 5' lift using 15' of 3" suction hose.*



Model	Uses	Performance	Inlet	Outlet	Dimensions	Weight	Price
2BE 6.5H	Volume	275 gpm @ 12 psi 175 gpm @ 28 psi 100 gpm @ 45 psi	3" Cam Lock	3" Cam Lock	Length: 18" Width: 16" Height: 19"	49 lbs. (22 kg)	\$5,170.00
2BE 6.5HCG (Coast Guard Model P6) NSN 4320-01-470-5515							\$6,220.00

10 HP Diesel

2BE 10YDN

- ▶ Dependable Yanmar Diesel engine
- ▶ Booster tank fill
- ▶ Dewatering
- ▶ Multiple hand lines
- ▶ Transfer and supply



Features: 10 HP Yanmar diesel engine, 4-cycle air cooled, direct injection, single cylinder, 406cc displacement, recoil rope start, dry replaceable air cleaner, aluminum alloy engine block, 1.45-gallon fuel tank, exhaust primer.

Options: Powder coated roll cage, battery kit, adapters and caps, and hand primer.



Model	Uses	Performance	Inlet	Outlet	Dimensions	Weight	Price
2BE 10YD	Volume	250 gpm @ 15 psi 180 gpm @ 50 psi 95 gpm @ 90 psi	3" NPT	1-2 1/2" NPT or 2-1 1/2" NPT	Length: 24" Width: 24" Height: 23"	163 lbs. (74 kg)	\$8,080.00
2BE 10YDN (Navy P100) NSN 3H 4320-01-387-2869							\$13,100.00

21 HP Marine

2BE

Features: Honda GX 630 4-cycle, V-twin, OHV, replaceable oil filter, 37.7 cu. in. displacement, 12-volt starter, 17 amp regulated alternator, recoil rope start back-up. Ships complete with aluminum 6061 T6 frame, mounted panel, jet coated exhaust, painted engine, 316 stainless shaft, and hard anodized pump casing.

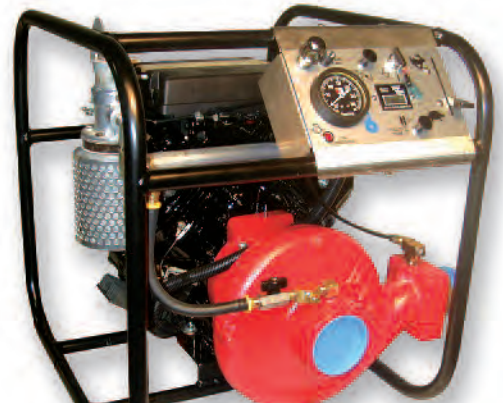

Model	Uses	Performance	Inlet	Outlet	Dimensions	Weight	Price
2BE 21H Marine	Volume	380 gpm @ 25 psi 150 gpm @ 115 psi 100 gpm @ 135 psi	3" NPTF	1-2 1/2" NPT or 2-1 1/2" NPT	Length: 25.25" Width: 21" Height: 23.75"	190 lbs. (86 kg)	\$8,045.00

Portable Pumps

Ohler Pumps

- ▶ Fuel transfer with electric start
- ▶ Potable water transfer
- ▶ Water transfer
- ▶ Pump case, inlet flange, volute, impeller, and wear plate are sand cast aluminum and heat-treated
- ▶ Anodized aluminum quick couplings
- ▶ Shaft extension and metal seal components constructed of stainless steel
- ▶ Air-cooled, single cylinder, 4-stroke diesel engine
- ▶ Self lubricating mechanical shaft seal
- ▶ 6.1 horsepower (continuous) at 3,600 rpm
- ▶ Fuel capacity of 2.5 hours of operation at rated load

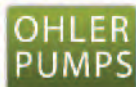

150AAMCFP-1B30CS

Model	NSN	Description	Price
150AAMCFP-1B30CS	4320-01-547-8729	150 gpm Fuel Transfer Pump w/Electric Start Option (Portable)	\$7,502.00
150AAMCWP-1B30	4320-01-547-8734	150 gpm Potable Water Transfer Pump (Portable)	\$6,230.00
RA1029	4320-01-259-4407	125 gpm Water Transfer Pump (Portable)	\$7,096.00
RA1013	4320-01-390-8214	125 gpm Fuel Transfer Pump (Portable)	\$7,129.00
AFPS-6315-24VDC	4320-01-247-2633	DC Motor-Driven Fuel Transfer Pump w/Accessories Package	\$5,635.00

10.5 HP or 11 HP Dolphin™ Floating Pump

- ▶ Dependable Briggs & Stratton or Honda engine
- ▶ New float design for easier carrying and greater stability
- ▶ Take advantage of swimming pools, reservoirs, ponds, etc.

Features: 11 Honda or 10.5 HP power built Briggs & Stratton, single-cylinder, 4-cycle, recoil rope start, 2-quart fuel tank, hard anodized aluminum alloy pump casing, bronze impeller.

Float: High-density polyethylene filled with closed-cell polyurethane foam. Four built-in carrying handles.



10.5 Briggs and Stratton

Model	Uses	Performance	Inlet	Outlet	Dimensions	Weight	Price
10.5 HP BS Floating Pump	Volume	390 gpm @ 20 psi 250 gpm @ 40 psi 200 gpm @ 45 psi 100 gpm @ 60 psi	4" Screened	2 1/2" NH	Length: 33" Width: 30" Height: 20"	110 lbs. (50 kg)	\$2,960.00
11 HP Honda	Volume		4" Screened	2 1/2" NH		120 lbs. (54 kg)	\$3,100.00

13 HP Vanguard

Features: 13 HP Briggs & Stratton Vanguard Engine with 8.35 qt. gas tank, 12-volt starter, 16 amp regulated alternator, recoil rope start back-up, electric start with recoil rope back up, exhaust primer, bronze impeller and wear rings, stainless steel shaft, discharge head with check valve, base with fold away carrying handles, aluminum alloy gear case and engine adapter, heat treated alloy steel helical gears, adjustable throttle.

Options: Gauge, caps, adapters and batteries. Other options available.



2BE 13V-Twin

Model	Uses	Performance	Inlet	Outlet	Dimensions	Weight	Price
1-1/4AGE 13V-Twin	High Press. Low Vol.	60 gpm @ 170 psi 40 gpm @ 230 psi 20 gpm @ 275 psi	1 1/2" NPT	2-1 1/2" NPT	Length: 27" Width: 21" Height: 23"	145 lbs. (66 kg)	\$5,020.00
1-1/2AGE 13V-Twin	Med. Press. Med. Vol.	120 gpm @ 80 psi 100 gpm @ 110 psi 20 gpm @ 185 psi	2" NPT	2-1 1/2" NPT or 1-2 1/2" NPT	Length: 27" Width: 21" Height: 23"	145 lbs. (66 kg)	\$5,190.00
2BE 13V-Twin	Med. Press. High Vol.	300 gpm @ 15 psi 150 gpm @ 75 psi 80 gpm @ 100 psi	3" NPT	2 1/2" NPT	Length: 27" Width: 21" Height: 23"	145 lbs. (66 kg)	\$4,540.00

PUMPS

Darley Portable Pumps

18 HP Vanguard

- ▶ Booster Reel
- ▶ Multiple Hand Lines
- ▶ Wildland/Attack Fire Suppression
- ▶ Hard anodized aluminum alloy casing and discharge valve
- ▶ Sulfuric anodized aluminum alloy gear case and engine adapter

Features: 4 cycle, 18 HP, V-twin, OHV, 8.35 qt. fuel tank, replaceable oil filter, 34.75 cu. in. displacement, 12-volt starter, recoil rope start back-up, 16 amp regulated alternator, bronze impeller and wear rings, stainless steel impeller shaft, Ceramic coating through packing box, heat treated alloy steel helical gears.

Options: Gauge, adapters and caps, Other options available

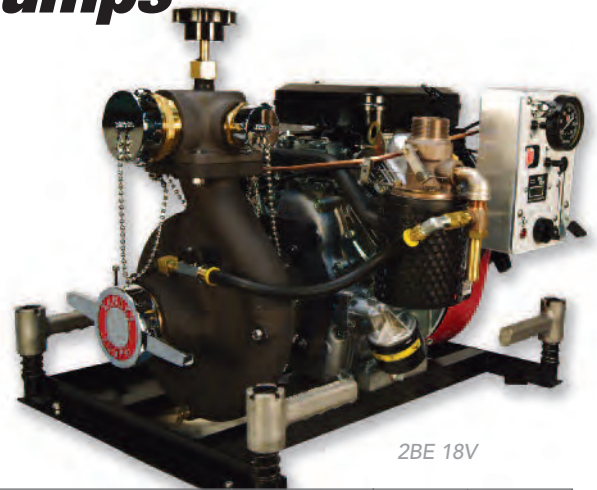

2BE 18V

Model	Uses	Performance	Inlet	Outlet	Dimensions	Weight	Price
1-1/4AGE 18V	Pressure	60 gpm @ 230 psi 40 gpm @ 315 psi 20 gpm @ 360 psi	1 1/2" NPT	2-1 1/2" NPT and 1-2 1/2" NPT	Length: 27" Width: 21" Height: 25"	145 lbs. (66 kg)	\$5,880.00
1-1/2AGE 18V	Pressure	120 gpm @ 130 psi 100 gpm @ 170 psi 50 gpm @ 250 psi	2" NPT	2-1 1/2" NPT or 1-2 1/2" NPT	Length: 27" Width: 21" Height: 25"	145 lbs. (66 kg)	\$5,870.00
2BE 18V	Volume	375 gpm @ 25 psi 300 gpm @ 45 psi 100 gpm @ 140 psi	3" NPT	2-1 1/2" NPT and 1-2 1/2" NPT	Length: 27" Width: 21" Height: 25"	145 lbs. (66 kg)	\$5,550.00
HE 18V	Volume	520 gpm @ 15 psi 300 gpm @ 55 psi 100 gpm @ 70 psi	Assem. #1 - 4" NPT Assem. #2 - 4" NH Assem. #3 - 4" NH	3" NPT 1-2 1/2" NPT & 2-1 1/2" NPT 2-2 1/2" NH Valves	Length: 27" Width: 21" Height: 25"	215 lbs. (98 kg)	\$6,390.00 \$6,590.00 \$7,390.00

21 HP Honda

- ▶ Dependable Honda engine
- ▶ Booster tank fill
- ▶ Multiple hand lines
- ▶ Wildland/Attack fire suppression

ALSO SEE MARINE VERSION FOR FIRE BOATS ON PAGE 296!

Features: Honda GX 630, 4 cycle, V-twin, OHV, replaceable oil filter, 38.5 cu. in. displacement, 12-volt starter, 20 amp regulated alternator, 6gal. fuel tank, hose and adapter, alloy casing, adjustable throttle, fold-away carrying handles, mechanical seal

Options: Adapters, caps, control panel, etc.

Also available in 10 or 13 hp & in 18 hp with Briggs Vanguard



HE 21H

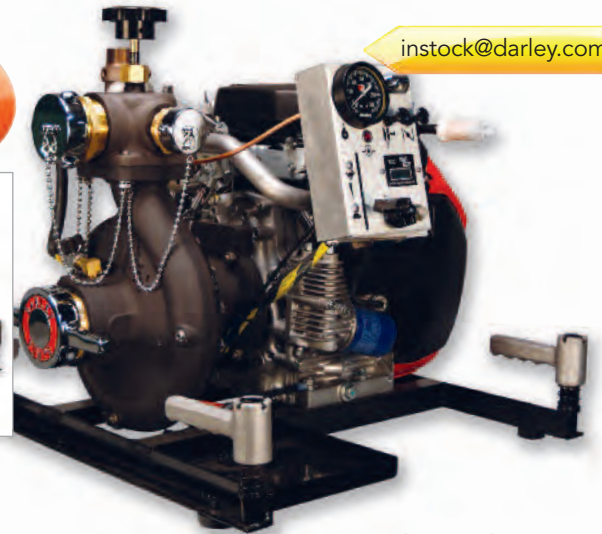

instock@darley.com

2BE 21H shown with options

Model	Uses	Performance	Inlet	Outlet	Dimensions	Weight	Price
1-1/4AGE 21H	Pressure	60 gpm @ 250 psi 40 gpm @ 320 psi 20 gpm @ 360 psi	2" NPT	2-1 1/2" or 1-2 1/2" NPT	Length: 24" Width: 24" Height: 23"	145 lbs. (66 kg)	\$6,180.00
1-1/2AGE 21H	Pressure	120 gpm @ 155 psi 75 gpm @ 230 psi 35 gpm @ 300 psi	2" NPT	2-1 1/2" or 1-2 1/2" NPT	Length: 24" Width: 24" Height: 23"	145 lbs. (66 kg)	\$6,020.00
2BE 21H	Volume	380 gpm @ 25 psi 150 gpm @ 115 psi 100 gpm @ 135 psi	3" NPT	2-1 1/2" & 1-2 1/2" NPT or 1-2 1/2" NPT	Length: 24" Width: 27" Height: 22"	190 lbs. (86 kg)	\$6,180.00
HE 21H	Volume	535 gpm @ 20 psi 320 gpm @ 60 psi 100 gpm @ 70 psi	Assem. #1 - 4" NPT Assem. #2 - 4" NH Assem. #3 - 4" NH	3" NPT 1-2 1/2" & 2-1 1/2" NPT 2-2 1/2" NH Valves	Length: 24" Width: 24" Height: 23"	215 lbs. (98 kg)	Assem. #1 - \$7,120.00 Assem. #2 - \$7,520.00 Assem. #3 - \$8,290.00

Darley Portable Pumps

23 HP Vanguard

- ▶ Dependable Briggs & Stratton Vanguard engine
- ▶ Booster tank fill
- ▶ Multiple Hand Lines
- ▶ Wildland/Attack fire suppression
- ▶ 2-year engine, lifetime ignition warranty

Features: Briggs & Stratton Vanguard 23 HP, 4 cycle, 23 HP, V-twin, OHV, replaceable oil filter, 12-volt starter, recoil rope start back-up, 16 amp regulated alternator, 6 gal. fuel tank, hose and adapter, hard anodized aluminum alloy casing and discharge valve, sulfuric anodized aluminum alloy gear case and engine adapter, bronze impeller and wear ring, mechanical seal, heat treated alloy steel helical gears, ball bearing construction pump and engine, built-in discharge check valve, adjustable discharge valve, fold-away carrying handles

Options: Illuminated gauge panel, adapters & caps, spark arrest muffler, battery kit, and wrap around frame.

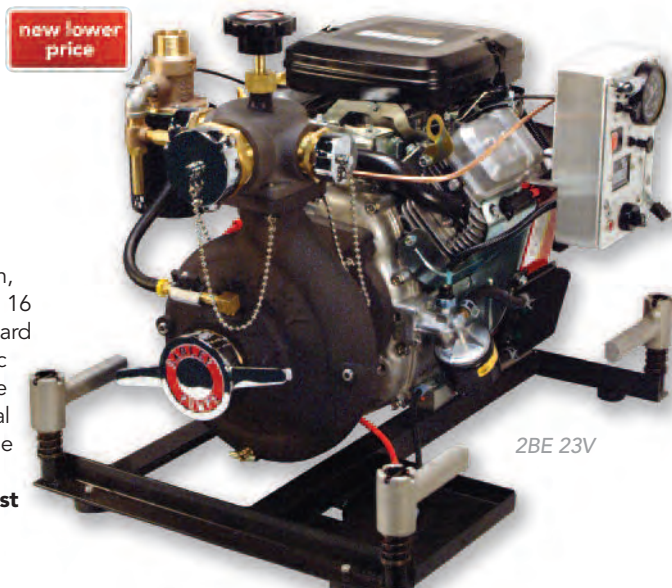

2BE 23V

Model	Uses	Performance	Inlet	Outlet	Dimensions	Weight	Price
1-1/2AGE 23V	Pressure	120 gpm @ 145 psi 50 gpm @ 255 psi 20 gpm @ 265 psi	2" NPT	2-1/2" NPT	Length: 24" Width: 21" Height: 24"	180 lbs. (82 kg)	\$6,110.00
2-1/2AGE 23V	Pressure	290 gpm @ 45 psi 100 gpm @ 135 psi 50 gpm @ 175 psi	2 1/2" NPT	2-1 1/2" NPT and 1-2 1/2" NPT	Length: 24" Width: 21" Height: 24"	190 lbs. (86 kg)	\$6,230.00
2BE 23V	Volume	390 gpm @ 30 psi 200 gpm @ 110 psi 100 gpm @ 140 psi	3" NPT	2-1 1/2" NPT and 1-2 1/2" NPT	Length: 24" Width: 21" Height: 24"	195 lbs. (89 kg)	\$6,050.00
HE 23V	Volume	535 gpm @ 20 psi 300 gpm @ 60 psi 100 gpm @ 70 psi	Assem. #1 - 4" NPT Assem. #2 - 4" NH Assem. #3 - 4" NH	3" NPT 1-2 1/2" NPT & 2-1 1/2" NPT 2-2 1/2" NH Valves	Length: 24" Width: 21" Height: 24"	220 lbs. (100 kg)	\$6,640.00 \$7,110.00 \$7,660.00

35 HP Vanguard

2-1/2 AGE

- ▶ Booster Reel
- ▶ Booster Tank Fill
- ▶ Multiple Hand Lines
- ▶ Wildland/Attack Fire Suppression

Features: 4 cycle, 31 HP, 2 cylinder, air-cooled gas engine, electric start, cast iron cylinder sleeve, 20 amp alternator, hard anodized aluminum alloy casing, sulfuric anodized aluminum gear case and engine adapter, bronze impeller and wear rings, stainless steel impeller shaft, mechanical seal, ball bearing construction, a adjustable discharge valve.

Options: Control panel, adapters and caps.

Other options available.

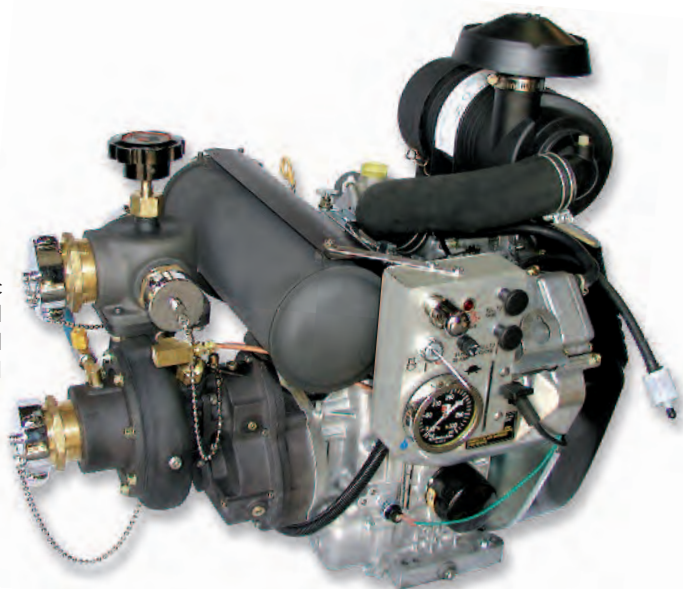

PUMPS

Model	Uses	Performance	Inlet	Outlet	Dimensions	Weight	Price
2-1/2AGE 35V	High Volume & High Pressure	300 gpm @ 100 psi 200 gpm @ 150 psi 50 gpm @ 265 psi	2 1/2" NPT	2-1 1/2" NPT & 1-2 1/2" NPT	Length: 28" Width: 27" Height: 31"	205 lbs. (93 kg)	\$8,030.00

Darley Portable Pumps

35 HP

HGE 35V

- ▶ 4 Stroke gasoline Engine
- ▶ Booster Reel
- ▶ Multiple Hand Lines
- ▶ Wildland/Attack Fire Suppression
- ▶ Control Panel: Mounted with engine controls and pressure gauge

Features: Aluminum alloy casing and discharge valve, aluminum alloy gear case & engine adapter, stainless steel shaft, skid base, helicle gears, discharge check valve, throttle, exhaust primer, 6 gallon plastic fuel tank, bronze impeller and seal ring, mechanical seal, electric start, flywheel alternator, fuel and oil pump filters, engine is a 35 HP Briggs air cooled, V-Twin, OHV, 4 cycle.

Options: Anodized pump casing is available to reduce the weight of the pump.

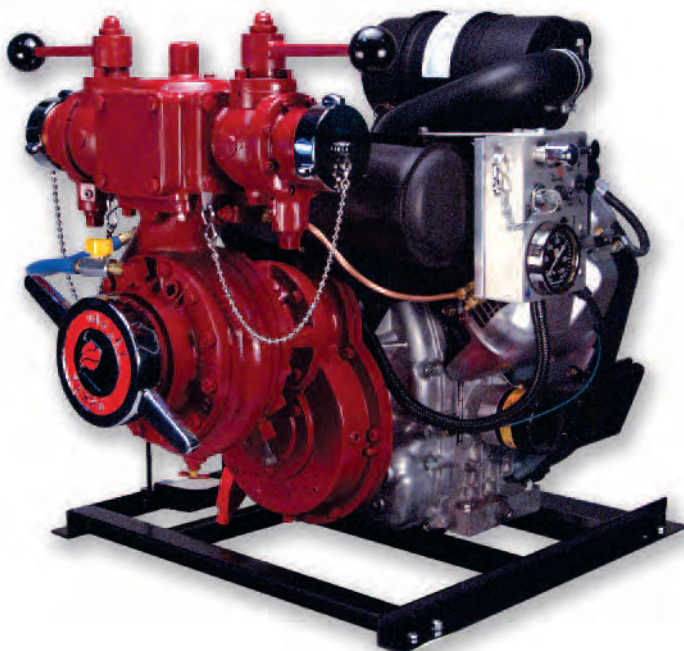

Model	Uses	Performance	Inlet	Outlet	Dimensions	Weight	Price
HGE 35V (Air-Cooled)	High Vol. Med. Press.	500 gpm @ 50 psi 300 gpm @ 105 psi 100 gpm @ 170 psi	Assem. #1 - 4" NPT Assem. #2 - 4" NH Assem. #3 - 4" NH	3" NPT 1-2 1/2" & 2-1 1/2" NPT 2-2 1/2" NH Valves	Length: 29.5" Width: 27" Height: 31"	330 lbs. (149.7 kg)	Assem. #1 - \$8,610.00 Assem. #2 - \$9,210.00 Assem. #3 - \$9,790.00

64 HP

HE 64RP "Hercules" & HE 64RS "Hercules"

- ▶ Dependable Rotax engine
- ▶ Booster tank fill
- ▶ Transfer and supply
- ▶ Multiple hand lines
- ▶ Wildland/Attack fire suppression

Ask about our marine version!

Powerful 64 hp engine

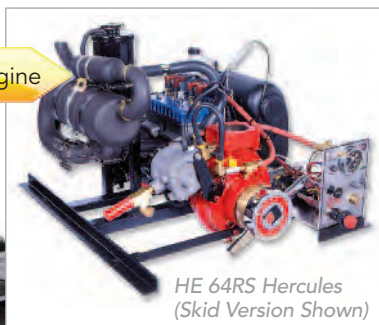

Features: 64 HP Rotax 582, 2 cylinder, 2-cycle, liquid-cooled, 12-volt electric start and recoil rope start back-up, 6 gal. fuel tank, hose and adapter, 170W lighting and recharging coil, aluminum alloy casing, bronze impeller and seal ring, stainless steel impeller shaft, mechanical seal, belt driven rotary primer, heat exchanger with thermal protection circuit, skid mounted, control panel with governor, ignition switch and compound pressure gauge, loss of prime shutdown.

Options: Electric governor required for performance above 200 psi. Call for additional options.



Model	Uses	Performance	Inlet	Outlet	Dimensions	Weight	Price
HE 64RP Hercules (Portable)	Performance	575 gpm @ 100 psi 320 gpm @ 200 psi 165 gpm @ 250 psi	4" NH	2-1/4" Turn Self-Locking 2-2 1/2" NH Valves	Length: 34" Width: 30" Height: 26"	225 lbs. (102 kg)	\$18,600.00
HE 64RS Skid Mounted - Call for details							\$17,100.00

Darley Portable Pumps

24 HP Diesel Kubota

1-1/2 AGE & 2BE

- ▶ Booster reel
- ▶ Multiple hand lines
- ▶ Transfer and supply
- ▶ Wildland/Attack fire suppression

Features: Kubota D902 - 24 HP, 3600 rpm, liquid cooled diesel, replaceable oil filter, replaceable fuel filter, 12-volt starter, hard anodized aluminum alloy casing, bronze impeller and seal ring, stainless steel impeller shaft, silicon carbide mechanical seal, ball bearing construction, adjustable throttle.

Options: Dual panels and throttles, rotary vane primer, injection style packing gland.



2BE 24K

Model	Uses	Performance	Inlet	Outlet	Dimensions	Weight	Price
1-1/2AGE 24K	Low Vol. High Press.	25 gpm @ 335 psi 75 gpm @ 220 psi 120 gpm @ 130 psi Max pressure 400 psi	2" NPT	2-1/2" NPT or 1-2/2" NPT	Length: 36" Width: 22.3" Height: 26.3"	371 lbs. (168 kg)	\$13,600.00
2BE 24K	High Vol. Med. Press.	200 gpm @ 115 psi 300 gpm @ 80 psi 390 gpm @ 20 psi	3" NPT	2-1/2" NPT and 1-2/2" NPT	Length: 35" Width: 22.3" Height: 26.3" (40" w/exhaust)	371 lbs. (168 kg)	\$13,120.00

26 HP Diesel LD

1-1/2 AGE & 2-1/2 AGE

- ▶ Booster Reel
- ▶ Multiple hand lines
- ▶ Wildland/Attack fire suppression

1-1/2 AGE
also available
with a high
volume impeller

Features: Kohler - 26 HP, air cooled, 12-volt starter, 11.5 amp, alternator, remote fuel shutoff, hard anodized aluminum alloy casing and discharge valve, aluminum alloy gear case and engine adapter, bronze impeller and wear rings, stainless steel impeller shaft, mechanical seal, heat treated alloy steel helical gears, ball bearing construction, built in discharge check valve, adjustable discharge valve, adjustable throttle.

Options: Dual remote control panels, adapters and caps.



2-1/2 AGE 26 L/D

2-1/2AGE 26L/D OFTEN IN STOCK!

High Volume 1-1/2 AGE	High Pressure Impeller 1-1/2 AGE	Performance 2-1/2 AGE
180 gpm @ 115 psi 100 gpm @ 230 psi 50 gpm @ 250 psi	120 gpm @ 200 psi 100 gpm @ 240 psi 50 gpm @ 315 psi	300 gpm @ 80 psi 100 gpm @ 180 psi 50 gpm @ 190 psi

Model	Performance	Inlet	Outlet	Dimensions	Weight	Price
1-1/2AGE 26L/D	See Charts Above	2" NPT	2-1/2" NPT or 1-2/2" NPT	Length: 35" Width: 24" Height: 24"	330 lbs. (150 kg)	\$11,100.00
2-1/2AGE 26L/D	See Charts Above	2 1/2" NPT	2-1/2" NPT and 1-2/2" NPT	Length: 35" Width: 24" Height: 24"	330 lbs. (150 kg)	\$11,300.00

PUMPS

39 HP Diesel Kubota

1-1/2 AGE & 2-1/2 AGE

new

- ▶ Booster Reel/Booster Tank Fill
- ▶ Multiple Hand Lines
- ▶ Wildland/Attack Fire Suppression

Features: Kubota V1505 Diesel - 39 HP naturally aspirated, 4 cylinders, liquid-cooled, 12-volt, electric start, 40 amp alternator, pressure lubed, oil and fuel pump filters, hard anodized aluminum alloy casing and discharge valve, sulfuric anodized aluminum alloy gear case, bronze impeller and wear rings, stainless steel impeller shaft, mechanical seal, ball bearing construction, built in discharge check valve, adjustable discharge valve, engine control panel.

Options: Dual panels, electric and manual throttles, rotary vane primer, adapters and caps.

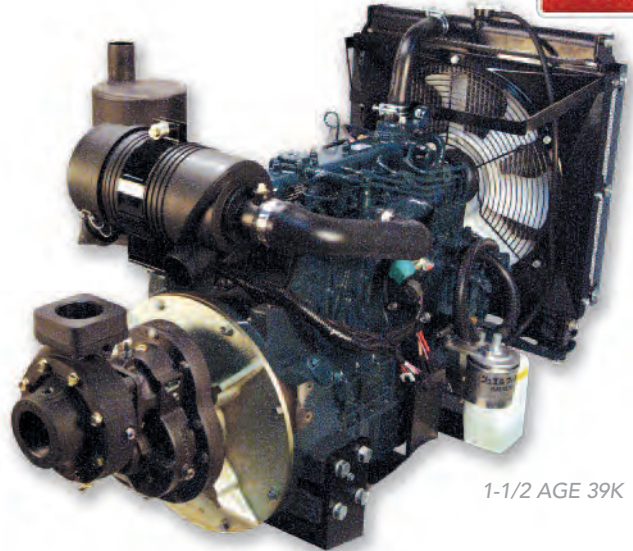

1-1/2 AGE 39K

Model	Uses	Performance	Inlet	Outlet	Dimensions	Weight	Price
1-1/2AGE 39K (Liquid-Cooled)	High Press. Med. Vol.	25 gpm @ 300 psi 80 gpm @ 310 psi 160 gpm @ 245 psi	2" NPT	2-1/2" NPT or 1-2/2" NPT	Length: 41" Width: 24" Height: 42 1/2"	523 lbs. (237 kg)	\$14,210.00
2-1/2AGE 39K (Liquid-Cooled)	High Press. Med. Vol.	50 gpm @ 180 psi 150 gpm @ 170 psi 320 gpm @ 100 psi	2 1/2" NPT	2-1/2" NPT or 1-2/2" NPT	Length: 41" Width: 24" Height: 42 1/2"	528 lbs. (240 kg)	\$14,330.00

59 HP Diesel Kubota

HSE 250K

- ▶ Meets 250 gpm @ 150 psi for Type 2 structure engines
- ▶ Meets 150 gpm @ 250 psi for Type 3 wildland engines

Features: Kubota V2403M Diesel - 59 HP turbo diesel engine, 4 cycle, liquid cooled, mounted engine control panel, mechanical seal, stainless steel shaft, aluminum alloy gear case & engine adapter, heat treated alloy steel helical gears.

Options: Dual panels with electronic throttles, relief valve with pilot light, both 12V and 24V fluidless primers are available.



PUMPS

Model	Performance	Inlet	Outlet	Dimensions	Weight	Price
HSE 250 Kubota	360 gpm @ 150 psi 250 gpm @ 200 psi 175 gpm @ 255 psi 125 gpm @ 294 psi	4" NH	3" NPT	Length: 50" Width: 22" Height: 40"	886 lbs. (402 kg)	\$18,100.00

Darley Skid/Trailer Mounted Pumps

Darley skid-mounted and trailer-mounted pumps offer versatile pumping protection ranging from a basic pump end through a fully engineered turn-key system. A wide variety of pump and engine combinations are available. Though all units come standard with an engine control panel with throttle making the unit operable, Darley® can provide units with custom pump control panels including traditional master gauges and relief valve or with Darley® ergonomic Auto Control Governor.

Pump Performance: Ratings from 250 gpm through 1500 gpm UL
Pump Models: HE 500, KSE 750, LSE 1000, PSE 1000-1500
Engines: Cummins, John Deere, Deutz, Isuzu, GMC
Trailers: Single or double axle, tongue jack, rear stabilizers, 2" ball
Mountings: Cross-mount, skid or trailer mounted styles are available

Optional Accessories Include:

- ▶ Custom control panels
- ▶ 12v primers
- ▶ Relief valves
- ▶ Trailers
- ▶ Gas and diesel models
- ▶ Storage containers
- ▶ Suction hose troughs with straps and foot loops
- ▶ Fuel tanks
- ▶ Suction and discharge hose with nozzles

Applications:

- ▶ Industrial
- ▶ Rural

Ask about our
variety of marine
drives for fire boats!

Engineering Requirements:

Contact the Darley Engineering Department at 800-634-7812 for quotes, proper engine horsepower and RPM requirements.

Trailer-mounted
engine driven pump



HE500/Isuzu 4BD1

PUMPS

Contact Darley For a Copy of Our Full Pump Catalog

PTO Pumps

HM 250, 350, 500 PTO Pumps

The compact design of the HM, along with its capacity and durability makes it an ideal pump for a mini-pumper, wildland vehicle or tanker and will take up only a minimum amount of the payload space on your chassis. The space and weight saved enables you to carry a larger booster tank with better weight distribution. While intended as a booster pump, the HM also serves equally well when pumping from a hydrant or drafting. You can depend on it for discharging effective pressure streams through 1½" and 2½" hose. If you are considering replacing an old, worn-out pump on an apparatus, the HM is ideal for retrofitting; in fact we recommend the HM pump wherever there might be a tight and difficult installation. The HM Assembly #3 pump comes as a complete assembly (with or without relief valve) for immediate midship installation. The three basic models let you add only the performance features you need. All HM configurations offer the convenience of pump-and-roll operation.

Standard Equipment:

- ▶ Vertically split, cast-iron bronze fitted pump casing
- ▶ Impellers opposed design to eliminate end thrust
- ▶ Broached impeller (not keyed) for longer life
- ▶ Oversized, deep groove radial-type bearings for longer life
- ▶ 10-tooth splined shaft for durability

Assembly #1:

Single stage, centrifugal pump, gearbox assembly, 2½" NPT discharge, 3" NPT suction (HM250/350) 4" NPT suction (HM500)

Dimensions:

- ▶ 15"Lx11"Wx18"H, 127 lbs. (58 kg) HM250/HM350
- ▶ 16"Lx11"Wx18"H, 140 lbs. (64 kg) HM500

Assembly #2:

Single stage, centrifugal pump, gearbox assembly, suction elbow, discharge head with check valve, 2 - 2½" NPT discharge, 3 - 3" suction (HM250 /350), 3 - 4" Victaulic suction (HM500)

Dimensions:

- ▶ 25"Lx14"Wx31"H, 150 lbs. (68 kg) HM250/HM350
- ▶ 27"Lx16"Wx34"H, 200 lbs. (91 kg) HM500

Assembly #3:

Single stage, centrifugal pump, gearbox assembly, suction elbow, discharge head with check valve, complete manifolds, discharge valves, adapters and caps, 2 - 2½" NH ¼ turn ball valves, 2 - 3" NH suction adapters and caps (HM250/350), 2 - 4" NH suction adapters and caps (HM500)

Dimensions:

- ▶ 25"LxBody Widthx31"H, 325 lbs. (148 kg) HM250/HM350
- ▶ 27"LxBody Widthx34"H, 425 lbs. (193 kg) HM500



Assembly #1

HM 250 Performance

250 gpm @ 150 psi
175 gpm @ 200 psi
125 gpm @ 250 psi

HM 350 Performance

350 gpm @ 150 psi
245 gpm @ 200 psi
175 gpm @ 250 psi

HM 500 Performance

500 gpm @ 150 psi
350 gpm @ 200 psi
250 gpm @ 250 psi



Assembly #2



Assembly #3

PUMPS

1-1/2 & 2-1/2 AG PTO Pumps

Pump Casing: Vertically split type. Aluminum alloy, bronze fitted is standard; all-bronze optional.

Pump Shaft: Precision-ground stainless steel with long-wearing ceramic hard-coating under packing glands. Shaft is splined for broached impeller hubs for greater resistance to wear, torsional vibration and torque imposed by engine.

Impeller: High-strength bronze alloy accurately balanced and splined to pump shaft for precision fit and durability. Seal ring design eliminates end thrust.

Bearings: Deep-groove radial-type ball bearings, oversized for long life. Bearings are protected at openings from road dirt and water splash with oil seals.

Shaft Seal: Easy maintenance of the exclusive Darley Injection Packing System which allows pump to be repacked in minutes. Optional mechanical seal is also available.

Call for complete specifications, suction, discharge, dimensions and weights.

Pump	Inlet	Outlet
1-1/2 AG	2" NPT	2" NPT
2-1/2 AG	2½" NPT	2½" NPT

1-1/2 AG Performance

150 gpm @ 80 psi
100 gpm @ 200 psi
35 gpm @ 300 psi

2-1/2 AG Performance

325 gpm @ 150 psi
260 gpm @ 200 psi
140 gpm @ 300 psi



1-1/2AG

Now available in either rotation

PTO Pumps

JMP 500

Two stage, series/parallel, centrifugal pump, PTO driven

Standard Equipment:

- ▶ 3 - 2½" NPT discharge flanges
- ▶ 3 - 4" NPT suction flanges
- ▶ Rotation: engine or opposite engine
- ▶ Gear ratio to fit PTO
- ▶ Mounting angles

Dimensions:

- ▶ 24½" Lx12"Wx26"H, 250 lbs. (114 kg)

JMP 500 NH(Normal Pressure, High Pressure)

- ▶ Simultaneous for normal pressure, high pressure
- 200 gpm @ 110 psi
- 100 gpm @ 290 psi

Optional Equipment:

- ▶ Air powered staging valve with 1¾" air cylinder
- ▶ 3-gear gearcase



JMP 500
3-Gear

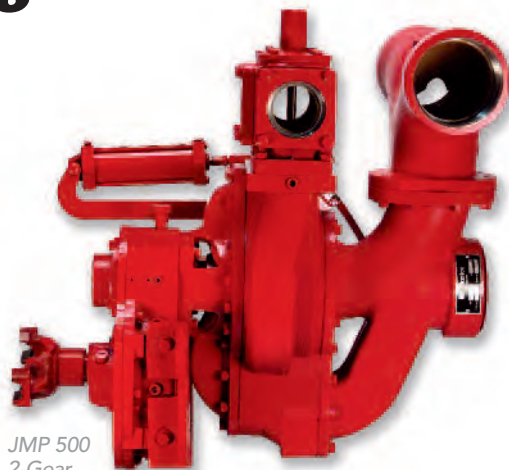

JMP 500
2-Gear

JMP 500 Performance

- 500 gpm @ 150 psi
- 375 gpm @ 200 psi
- 250 gpm @ 250 psi
- 100 gpm @ 500 psi

Choice of the U.S. Forest Service and California Department of Forestry

LSP 500, 750, 1000

Assembly #1:

Single stage, centrifugal pump, PTO driven, 2 gear case

- ▶ 18"Lx17"Wx26"H, 325 lbs. (148 kg)

Assembly #2:

Single stage, centrifugal pump, PTO driven, suction elbow, discharge head with check valve

Dimensions:

- ▶ 29"Lx17"Wx39"H, 435 lbs. (197 kg)

Assembly #3:

Single stage, centrifugal pump, PTO driven, suction elbow and suction manifold with nipple, discharge head with check valve, discharge manifold and discharge valves

Dimensions:

- ▶ 29"Lx84"Wx39"H, 670 lbs. (304 kg)



Assembly #3

Standard Equipment:

- ▶ 3" or 4" NPT discharge flanges
- ▶ 5" or 6" suction flanges
- ▶ Rotation: engine or opposite engine
- ▶ 1410 lock on yoke
- ▶ Mounting angles



Assembly #1

LSP 500 Performance
500 gpm @ 150 psi
350 gpm @ 200 psi
250 gpm @ 250 psi

LSP 750 Performance
750 gpm @ 150 psi
525 gpm @ 200 psi
375 gpm @ 250 psi

LSP 1000 Performance
1000 gpm @ 150 psi
700 gpm @ 200 psi
500 gpm @ 250 psi

PSP 1000, 1250, 1500

Standard Equipment:

- ▶ 5" NPT discharge flanges
- ▶ 6" NPT or weld suction flanges
- ▶ Rotation: engine or opposite engine

Single stage, centrifugal pump, PTO driven

- ▶ 19"Lx18"Wx23"H, 345 lbs. (157 kg)

Options: Discharge manifold, available as 2 gear (pictured) or 3 gear transmission

PSP 1000 Performance
1000 gpm @ 150 psi
700 gpm @ 200 psi
500 gpm @ 250 psi

PSP 1250 Performance
1250 gpm @ 150 psi
875 gpm @ 200 psi
625 gpm @ 250 psi

PSP 1500 Performance
1500 gpm @ 150 psi
1050 gpm @ 200 psi
750 gpm @ 250 psi



PUMPS

Pumps

PSD 1000, 1250, 1500 "Silent Pak"

Single Stage, Centrifugal, Single Suction Impeller, Direct (Gearless) Drive to Impeller, PTO Driven

Standard Equipment:

- ▶ 5" NPT discharge flanges
- ▶ 6" NPT or weld suction flange
- ▶ 1410 companion drive flange
- ▶ Rotation: engine or opposite engine

Features:

- ▶ Quiet – No transmission to generate pump noise
- ▶ Compact – Pump weighs only 225 pounds
- ▶ Economical – Priced at a fraction of the cost of conventional splitshaft midship pumps
- ▶ Maintenance Free – No maintenance required for the pump when ordered with a Darley mechanical seal

1500 gpm rating from Chelsea when using their Model 870XAFJP-B5XV series PTO with a 200% ratio and an Allison EVS 3000 Series transmission. The engine speed needed is only 2049 rpm, so it can be matched with most engines on the market capable of producing at least 225 net horsepower. The Allison transmission must be ordered with the 1:00 PTO provision, but the pump can run off the 8:00 or 1:00 position.



PSD 1500

PSD 1000 Performance

1000 gpm @ 150 psi
700 gpm @ 200 psi
500 gpm @ 250 psi

PSD 1250 Performance

1250 gpm @ 150 psi
875 gpm @ 200 psi
625 gpm @ 250 psi

PSD 1500 Performance

1500 gpm @ 150 psi
1050 gpm @ 200 psi
750 gpm @ 250 psi

1500 GPM rating using the Chelsea 870/877 PTO on the EVS transmission

PSRH 1000 - 1500

Single Stage, Centrifugal, PTO Driven
3 Gear Gearcase

Assembly #1:

- ▶ 4" or 5" NPT or weld discharge flange
- ▶ 2nd stage pump
- ▶ 5" or 6" NPT or weld flange suction
- ▶ Rotation: Engine or Opposite Engine
- ▶ 1410 lock on yoke

Assembly #3:

- ▶ Discharge manifold with 4-2 1/2" NH, 1/4 turn, ball, discharge valves and caps, mounted
- ▶ 3" NPT discharge tap
- ▶ 5" or 6" NPT or weld flange suction

2nd Stage H 100 Booster

Single Stage, Centrifugal, High Pressure Booster. Can Be Added To Any Midship Or PTO Pump For Simultaneous High Flow, High Pressure - Pressure up to 600 psi.

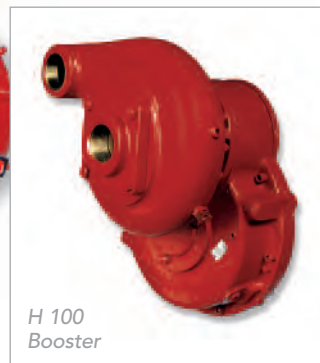

H 100 Booster

PSRH 1000 Performance

1000 gpm @ 150 psi
700 gpm @ 200 psi
500 gpm @ 250 psi

PSRH 1250 Performance

1250 gpm @ 150 psi
875 gpm @ 200 psi
625 gpm @ 250 psi

PSRH 1500 Performance

1500 gpm @ 150 psi
1050 gpm @ 200 psi
750 gpm @ 250 psi

High Pressure 2nd Stage Simultaneous Flows

200 gpm @ 400 psi
100 gpm @ 580 psi

Pumps

Split-Shaft LDM-XHD-PTO

Transmission Casing: Alloy cast-iron with adequate oil reserve capacity helps ensure low operating temperature.

Drive Shafts: Precision-ground heat-treated alloy steel STD on XHD.

Gears: 2 $\frac{5}{8}$ " XHD face helical. Precision-cut from heat-treated alloy steel for quiet operation and long life.

Gear Shift: A heat treated alloy steel splined spur gear engages either pump drive gear or truck drive shaft gear. A two position positive-lock manual selection lever in cab is standard. Air powered shift control is optional.

Bearings: Deep groove radial type ball bearings, oversized for long life. Bearings are protected at openings from road dirt and water splash with oil seals and water slinger.

Pump Gear Ratios: For optimum matching of engine to pump, the following step up ratios are available: 1.34, 1.49, 1.66, 1.86, 2.12, 2.44, 2.66 also 1 to 1. Available with engine or opposite engine rotation.

LDM-XHD-PTO-O:

Opposite engine rotation, Gear ratio: 0.93 to 1 thru 1.27 to 1

LDM-XHD-PTO-E:

Engine rotation, Gear ratio: 1:34 to 1 thru 2.67 to 1

Hydraulically Driven Pumps

The pumps have been adapted to the following standard hydraulic motor mounts:

1 $\frac{1}{2}$ AGH - SAE "B" flange,
13T 16/32 involute spline shaft

HH100 - SAE "B" flange,
14T 12/24 involute spline shaft

HH250/350/500 - SAE "C" flange,
14T 12/24 involute spline shaft

JMH500 - SAE "C" flange,
14T 12/24 involute spline shaft

LSH1000 - SAE "C" flange,
14T 12/24 involute spline shaft

Now available
up to 1000 GPM

Shown with Optional
Hydraulic Motor

Great for pumping
independent of
road speed

KSRH 500, 750, 1000

500-1000 gpm, Single Stage, Centrifugal, Rear Mount Pump with Independent Second Stage

Standard Equipment:

- ▶ Discharge manifold with 2 $\frac{1}{2}$ " NH, $\frac{1}{4}$ turn, ball, discharge valves and caps, (2 - 500 gpm, 3 - 750 gpm, 4 - 1000 gpm) mounted
- ▶ 3" NPT discharge flange
- ▶ 5" NH suction and cap
- ▶ 4" NPT suction tap
- ▶ Complete mounting kit
- ▶ Independent 2nd stage, high pressure booster, mounted direct to main pump transmission

Dimensions:

- ▶ 33"Lx31"Wx33"H, 510 lbs. (232 kg)

KSRH 500 Performance

500 gpm @ 150 psi
350 gpm @ 200 psi
250 gpm @ 250 psi

KSRH 750 Performance

1250 gpm @ 150 psi
875 gpm @ 200 psi
625 gpm @ 250 psi

KSRH 1000 Performance

1000 gpm @ 150 psi
700 gpm @ 200 psi
500 gpm @ 250 psi

High Pressure

200 gpm @ 400 psi
100 gpm @ 500 psi

PUMPS

LDM Midship Pump

Single-Stage or Multi-Stage

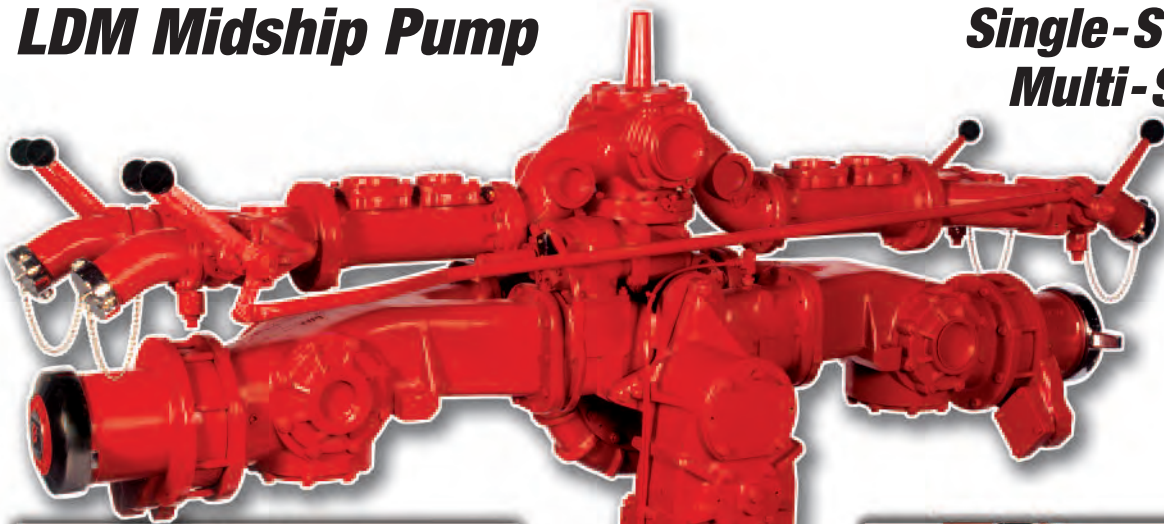

Patented AutoCool™

► Eliminates the possibility of oil contamination because it cools oil from outside the transmission.

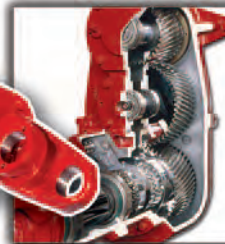

Magna Trans Performance

- Driveline Rating of - 19,230 ft. lbs.
- Extra Oil Capacity - 64 oz.
- Bullet Nose Sliding Clutch Gear
- Easy Access Dipstick

LDM PUMP FEATURES THAT SET US APART

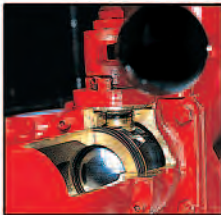

Self-Locking Discharge Valves

Bronze valves with stainless steel ball valves stay secure in the position. 1/4 turn valves won't creep, even under maximum pressure, and there are no clumsy twist handles to lock.



LDMH High Pressure Option

Optional high-pressure booster pump can be added to most Darley models for pressure up to 600 psi.



AutoControl™ Governor

Regulates pump pressure and monitors all engine vital signs. This aut. pressure governor constantly monitors and adjusts the throttle to safely maintain the desired pressure.



Pressure Relief Valve

Automatically activates valve at pre-set pressures up to 800 psi. Remote panel control unit provides on/off selector valve, hand wheel pressure setting control and flush valve to clean the strainer. Equipped with emergency override.



Oil-Less Primer

Positive displacement rotary vane vacuum pump with self-lubricating vanes requires no lubricant for thousands of primes. No need to mount and fill a reservoir. Fluid primers are still available. Available in 12 or 24 volt.



Overheat Protection System

Stainless steel and brass temperature relief system has a preset temp of 120°F which then dumps up to 55 gpm into atmosphere after which the system resets automatically. Available in 12 or 24 volt.



Injection Packing

Time saving and reliable, this Darley exclusive feature allows the pump to be repacked in minutes, rather than hours, and eliminates the chance of an on-scene mechanical seal failure.

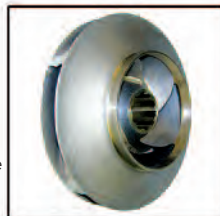

Vacuum Cast Impeller

Accurately balanced to fit a 10-splined stainless steel pump shaft for exceptional durability and efficiency. Twisted vane design allows for higher lift.

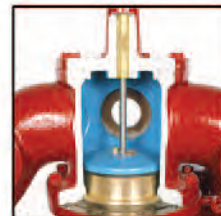

Discharge Check Valve

This automatic discharge check valve permits Darley pumps to be primed with discharge gates open and caps removed when drafting to get water on the fire rapidly. Pump holds prime during intermittent drafting operations.



Mechanical Seal Option

Optional mechanical seal is made with a silicon carbide stationary face which is extremely hard and heat dissipative, resisting wear and dry running damage.



Impeller Shafts

Impeller shafts incorporate SAE 10-tooth spline rather than keyed press fits for exceptional durability with our broached impeller. A splined fit is stronger than a single key, so it never shears.

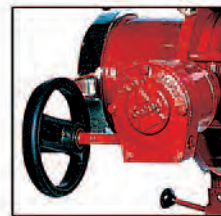

Butterfly Valves

Behind-the-panel butterfly valves are available in either manual or electric, meeting the latest NFPA slow close and relief valve requirement.

HM 500 Solution Series™ Module

The HM 500 Solution Series™ features the Darley HM 500 PTO-driven pump with a control panel that has all the bells and whistles.

Save valuable space and weight!

Features:

- ▶ 500 - 700 lbs. (dependent on options)
- ▶ 4 bolt frame attachment, turnkey package
- ▶ PTO Driven HM 500
- ▶ 4" suction
- ▶ 2½" auxiliary suction
- ▶ 2" pump to tank, push pull controlled
- ▶ Darley AutoControl™ governor
- ▶ Darley oil-less primer
- ▶ Water level gauge
- ▶ Electrically actuated tank to pump
- ▶ 2 - 2½" panel mounted discharges, Lever controlled
- ▶ 2 - 1½" crosslays, push-pull controlled

Options:

- ▶ Hand wheel controlled tank to pump
- ▶ Air actuated tank to pump
- ▶ Front/rear discharge
- ▶ Deck gun
- ▶ Foam level gauge

new



PSP 1250 Solution Series™ Module

Features:

- ▶ 900 lbs. - 1,100 lbs. (Approximate weight range)
- ▶ 6 bolt attachment to frame rail, turnkey package
- ▶ PTO driven
- ▶ Single side 6" suction intake
- ▶ Fully engineering side slung module
- ▶ Darley AutoControl™ governor
- ▶ Darley rotary vane primer
- ▶ 2" Akron push-pull controlled tank fill
- ▶ 4" Darley tank to pump swing check valve assembly
- ▶ Water level gauge

Options:

- ▶ Transmission mounting angle for improved driveline angles
- ▶ 6" Butterfly valve, manual hand wheel controlled
- ▶ 3 – Panel mounted 2½" discharges (Optionally lever or push-pull controlled)
- ▶ Up to 3 - 3" Akron electrically actuated water only discharges (LDH passenger, LDH rear, LDH monitor/deck gun, LDH front bumper, etc.)
- ▶ 1 - 3" Akron electrically actuated water/foam discharge
- ▶ 3 - 2" Akron push-pull controlled water/foam discharges for cross-lay, speed-lay, or front discharge
- ▶ Foam level gauge
- ▶ Foam Pro 2001/2002 system

The PSP 1250 Solution Series™ is ideal for tankers and economical pumpers.



1500 gpm rating Available without Intake Valve

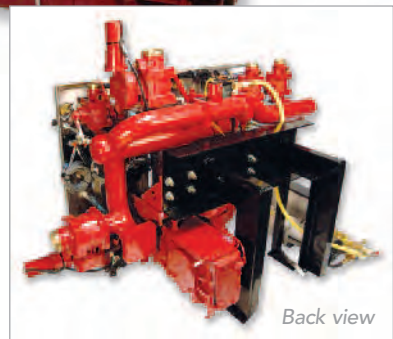

Back view

PUMPS

Optional Pump Accessories

Darley AutoControl™ Governor

The pump AutoControl™ Governor not only regulates pump pressure, but monitors all essential engine vital signs. This automatic pressure governor constantly monitors and adjusts the pump throttle to safely maintain the desired pressures.



- ▶ Pump intake and discharge pressures in both psi and Kpa
- ▶ Pump cavitation alarm & adjustment back to idle
- ▶ Engine monitoring of oil pressure, water temperature, battery voltage, and engine rpm
- ▶ Preset function for instant and reliable operation
- ▶ Save money, a pressure relief valve or individual gauge controls are no longer required

2603145	Darley AutoControl™ Governor, All Engines	\$4,040.00
4216300	Darley AutoControl™ Governor, Ford 6.0	\$4,040.00

Discharge Relief Valve

Darley relief valves are made of high-strength bronze alloy for corrosion resistance and long service life. For pressure relief, these valves will automatically activate at a preset pressure up to 800 psi. Remote panel control provides ON/OFF selector valve, large handwheel pressure setting control, flush valve and strainer. A switch attachment actuates a pilot light to indicate when the valve is either open or closed. A mechanical override allows the valve to be closed manually. *Ship. wt. 35 lbs.*



VR00700	3" Thru 1500 GPM	\$1,840.00
VR00500	Suction Relief Valve	\$1,390.00

Smart Panel

- ▶ Control engine speed
- ▶ Acts as pressure regulator
- ▶ Waterproof
- ▶ Displays discharge pressures
- ▶ Forces back to your preset
- ▶ Rotary knob for setting pressure/rpm
- ▶ 7" high contrast color LCD screen
- ▶ Acts as CAFS Commander (opt)
- ▶ Used on LE600 pumps for USMC



4227800	Smart Panel	\$6,795.00
---------	-------------	------------

Darley Fuel Tanks

Darley's fuel tanks are another great accessory for your portable pump. The plastic fuel tanks are EPA compliant. *Ship. wt. 4 lbs.*

KE00128	6 Gallon Fuel Tank	\$260.00
KE00129	3 Gallon Fuel Tank	\$247.00



Rotary Vane Primer

Positive displacement rotary-vane vacuum pump for 20' to 28' suction lifts with any make, capacity, or style fire pump. Constructed of aluminum alloy, heat-treated and hard-coat anodized to take the punishment of fire service. Solenoid-operated motor runs from vehicle's electrical system. Priming system includes bronze push/pull valve with electric switch, and complete mounting and operating instructions. Rotary-vane priming pump with valve, solenoid and motor. 12 volt or 24 volt. *Ship. wt. 42 lbs.*



AP00950	Rotary Vane Primer	\$1,410.00
AP00960	Fluid-less Vane Primer	\$1,410.00

Control Panel

Control panels are available on many of Darley's portable pumps. Standard panel includes a RUN/STOP ignition switch, a starter button, throttle, and liquid-filled gauges. It will also work with recoil rope start engines. *Ship. wt. 1 lb.*



AC01104	Control Panel	\$541.00
---------	---------------	----------

Multi-Port Isolated Valve

This 6-port drain is designed with independent ports which virtually eliminate inaccurate gauge readings. *Ship. wt. 4 lbs.*



VD00600	Multi-Port Isolated Valve	\$390.00
---------	---------------------------	----------

Master Drain

Heavy brass tubing and plunger, stainless steel rod. Eight holes tapped for iron pipe fittings to hold copper tubing from up to eight locations.



VD00102	Master Drain	\$230.00
---------	--------------	----------

Injection Packing

Packing adjustments are made simple with Darley Injection Packing. *One tube contains eight pellets. Ship. wt. 1 lb.*



3817104	Injection Packing	\$31.00
---------	-------------------	---------

FAST ATTACK SKIDS

ATTACK 1

Standard Equipment:

- ▶ 13 HP twin impeller Darley Davey pump with Honda engine
- ▶ 200 gallon Pro Poly tank
- ▶ F4000 Hannay electric rewind reel
- ▶ 100' of 1" booster hose
- ▶ Self-priming up to 19'
- ▶ 1.5" or 2.5" NST suction adapter
- ▶ 1" tank recirculation
- ▶ 1.5" tank to pump and discharge

Features:

- ▶ Ergonomically designed
- ▶ Forkliftable to standard pick-up bed
- ▶ Solid pump performance for grass firefighting

Theoretical Friction Loss in 100' of 1" Booster @ 100 psi

12 gpm = 2 psi
 20 gpm = 6 psi
 30 gpm = 14 psi



Attack 1

Model	Performance	Dimensions	Weight	Price
Attack 1	120 gpm @ 40 psi 95 gpm @ 108 psi 20 gpm @ 146 psi	Length: 94" Width: 48" Height: 42"	700 lbs. (318 kg)	\$8,600.00

ATTACK 1

with Options

Email your inquiries to skids@darley.com

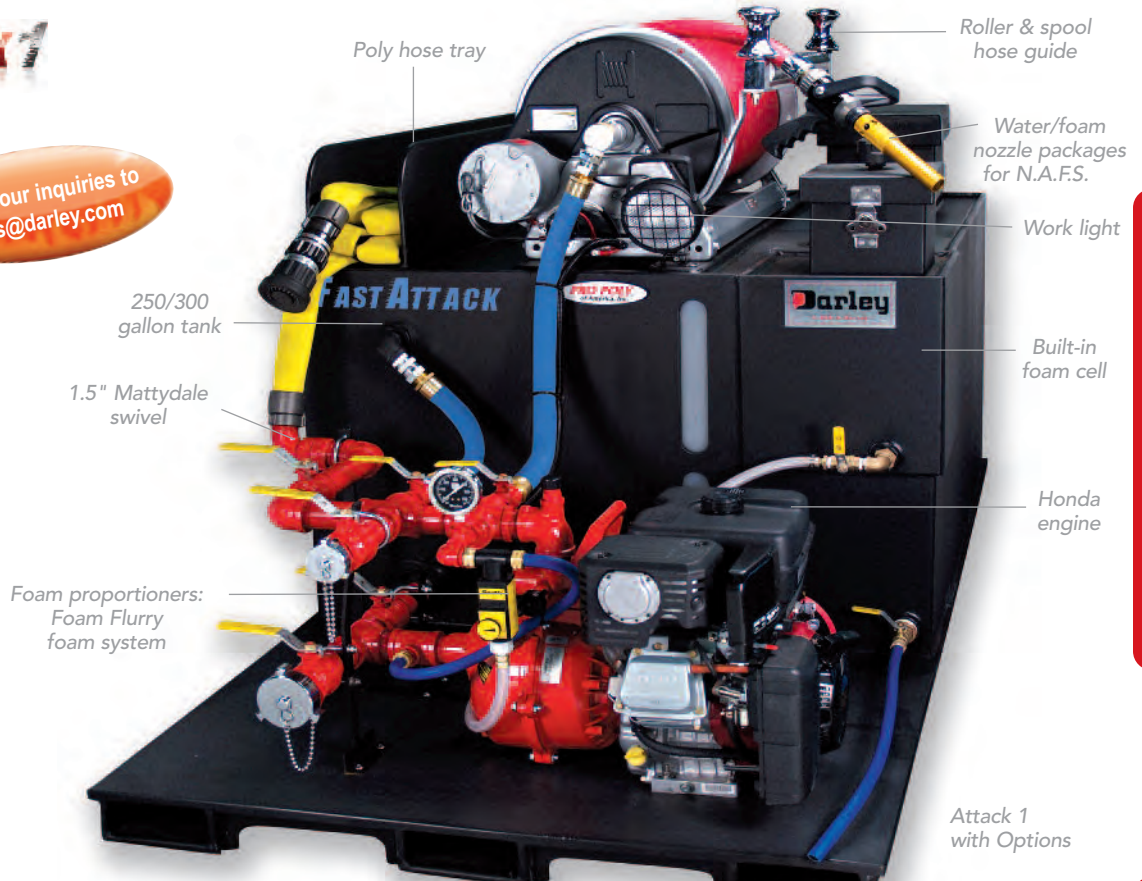

Attack 1 with Options

PUMPS

FAST ATTACK SKID ATTACK 2

The Attack 2 has the same tank and reel as the Attack 1 but standardizes on our gear-driven or direct-drive Darley pump coupled to an 18 hp engine with control panel.

Standard Equipment:

- ▶ Darley 18 hp pump
- ▶ Exhaust primer
- ▶ 200 gallon Pro Poly tank
- ▶ Hannay electric rewind reel
- ▶ 100' of 1" Booster hose

Options:

- ▶ Briggs Vanguard, Honda and diesel engines
- ▶ N.A.F.S. Nozzle Aspirated Foam Systems
- ▶ JakPak drop-ins bodies
- ▶ See the Attack 1 with options



Model	Performance		Dimensions	Weight	Price
	1.5AGE18V	2BE18V			
Attack 2	120 gpm @ 130 psi 100 gpm @ 170 psi 25 gpm @ 270 psi	375 gpm @ 25 psi 300 gpm @ 45 psi 100 gpm @ 140 psi	Length: 94" Width: 48" Height: 42"	900 lbs. (409 kg)	\$11,200.00

UHP-HV®

Ultra High Pressure - High Volume

The UHP-HV® (Ultra High Pressure-High Volume) module offers the best of both worlds for the wildland-urban interface. Darley has combined our versatile direct-drive 2BE pump and the CAT 7CP high pressure piston pump to meet all your firefighting needs in one compact package. Main pump can be used for water transfer or for 1½" hose for structural attacks while the belt driven CAT can produce low flow high pressure flows in excess of 1300 psi with optional foam through the ½" HP hose.

Features:

- ▶ CAT 7CP high pressure piston pump with foam injection
- ▶ High pressure pump belt drive system
- ▶ High volume Darley 2BE pump
- ▶ Bronze impeller and seal rings
- ▶ Broached impeller for longer life
- ▶ Oversized bearing for longer life
- ▶ 10-tooth splined shaft for durability
- ▶ Exhaust primer
- ▶ Powder coated aluminum frame
- ▶ All stainless plumbing
- ▶ Electric rewind Hannay Reel with 200' of ½" hose, full capture leads
- ▶ Dual Strike Gun with holster (20' effective discharge)
- ▶ Reel Height: 42.5"

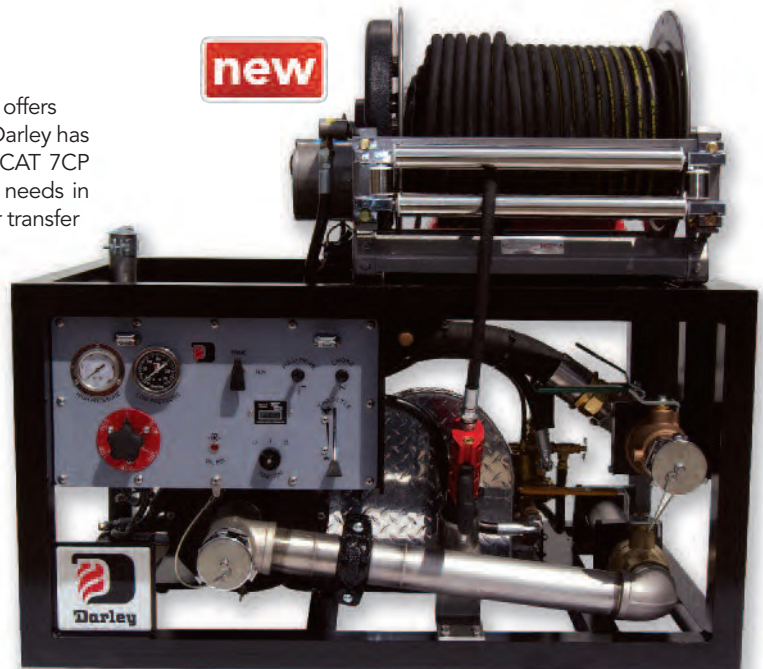

The UHP-HV® utilizes our patented Odin drive system driving our 2BE high volume pump and a high pressure CAT piston pump.

Model	Individual Flows		Simultaneous Flows		Dimensions	Weight
	UHP	2BE23V	UHP	2BE23V		
UHP-HV®	8 gpm @ 1200 psi	275 gpm @ 55 psi 175 gpm @ 100 psi 45 gpm @ 140 psi	3 gpm @ 600 psi 3.5 gpm @ 780 psi 4 gpm @ 1050 psi	250 gpm @ 45 psi 160 gpm @ 80 psi 30 gpm @ 125 psi	Width: 46" Height: 24½" Width: 32"	569 lbs. (258 kg)

NFPA 13D Fire Sprinkler Pumps

Standard

Features:

- ▶ Industrial duty stainless steel vertical inline pump
- ▶ Cartridge type mechanical seal
- ▶ High efficiency TEFC industrial/commercial duty motor
- ▶ Suction manifold with suction gauge and locking ball valve
- ▶ Discharge manifold with check valve, pressure gauge, and locking ball valve
- ▶ Wall mounted enclosure with pressure switch, relay, and restart time delay
- ▶ Optional flow switch

Standard Plus

With Pumperciser™

Features:

- Same pump and manifold features as Standard System as well as:
- ▶ Standard Plus control panel

Control Panel Features:

- ▶ The residential markets only automatic pump exerciser called the "Pumperciser™" which will provide a weekly automatic start/stop of the pump
- ▶ NEMA 2 red enclosure
- ▶ Motor HP rated disconnect switch
- ▶ Integrated minimum run timer and restart time delay
- ▶ Integrated mechanical pressure switch with single adjusting dial and 10 psi fixed differential reset
- ▶ Weekly exercise timer
- ▶ Remote start input
- ▶ Power on indication light
- ▶ Third party monitoring contacts for pump running and power failure
- ▶ Brass bulkhead connection for discharge pressure sensing line

Self Testing System

Features:

- Same pump and manifold features as Standard System as well as:
- ▶ Suction manifold with pressure sensing line and locking ball valve
 - ▶ Discharge manifold with check valve, pressure sensing line, and locking ball valve
 - ▶ Market's only control panel featuring push button calibration
 - ▶ Market's only control panel with web browser and email capability
 - ▶ Market's only Self Testing control panel
 - ▶ Self Testing panel includes

Control Panel Features:

- ▶ The market's only automatic drop in pressure pump start test – A true test of the pump functionality
- ▶ Web browser and email capability with a user defined IP address. Status of Pump Running, Test Mode Active, Test Successful, and system Fault Light can be monitored and emailed
- ▶ The market's only dual transducer based system with brass bulkhead fittings
- ▶ The market's only panel with a "green check mark" notification on panel face to indicating system is charged and ready
- ▶ NEMA 2 red enclosure
- ▶ Motor HP rated disconnect switch
- ▶ Motor contactor



FIRE SPRINKLER PUMPS
by Darley

Water Purification



Darley PuriFire® Systems is our complete line of water purification systems that can be used by first responders, military personnel, residential home owner preppers or campers. Our wide selection of systems can be quickly deployed to establish and maintain a drinkable water supply in the event of an emergency situation.



WP009



Pouch sold separately

WP012



new



Pure Sip Personal Water Filter

The Pure Sip is a personal water filter designed to be a light-weight, simple and highly reliable device that provides safe, "good tasting" drinking water from questionable sources for emergency conditions, disaster, military use, and remote recreational situations. Proven effective by laboratory testing for over 20 years, Pure Sip kills 99.99% of bacteria and 99.7% of viruses instantly on contact and also filters out cysts such as Cryptosporidium and Giardia. Made in USA.

WP00101	Pure Sip Personal Water Filter	\$19.95/each
WP00102	Pure Sip Personal Water Filter	\$220.95/12pk.
WP00103	Pure Sip Personal Water Filter	\$440.95/24pk.

Aquapure Traveler Personal Water Purifier

The Aquapure Traveler is a high performance personal water purification system that is designed for those who may find themselves in places where water quality is dubious or even dangerous. The unique filter incorporates M.A.D. (Mechanically Advanced Disinfection) technology that eliminates bacteria, viruses, larger pathogens, chemicals, heavy metals, dirt and odor.

- ▶ **Bottle capacity:** 750ml
- ▶ **Filter capacity:** Up to approximately 350L, depending on the water quality



WP011

WP009	Aquapure Traveler Personal Water Purifier Drinking Bottle	\$79.95
WP010	Insulated Pouch	\$13.95
WP011	Replacement Filter Cap	\$69.95

Inline Filter Assembly

Turn your hydration system into a water purification system. Just add a Survivor Inline (IWP). It installs easily and quickly into the hydration system's drinking tube with the Pure Hydration Purelink Quick Connectors used in the Armoured Reservoir. Using the same innovative technology as the world renowned Aquapure Traveller, this unique filter incorporates M.A.D. (Mechanically Advanced Disinfection) technology that eliminates bacteria, viruses, larger pathogens, chemicals, heavy metals, dirt and odor. Tested and approved for use by the London School of Hygiene and Tropical Medicine.

- ▶ **Filter capacity:** Up to approximately 350L, depending on the water quality



WP012	Inline Filter Assembly	\$89.95
-------	------------------------	---------

Armoured Reservoir

The Armoured Reservoir is an ultra-resistant reservoir made using Pure Hydration's unique Armour Weave material. Due to the extreme hard-wearing nature of this material the Armoured Reservoir gives you all the benefits of a hydration pack without having to carry a whole separate system. The reservoir is incredibly durable as it resists tears and punctures no matter how heavy handed the user is and can be placed directly into any backpack. This gives you the freedom to keep fully hydrated while on the move. This works with the Pure Hydration Survivor Inline Filter. Works with WP012.

- ▶ **Capacity:** 3L



WP013	Armoured Reservoir (3L)	\$79.95
-------	-------------------------	---------

Forward Osmosis Drinking Bags

Create drinkable water from any water source using forward osmosis technology. Osmosis is a natural process that involves the passage of water through a membrane due to osmotic pressure generated by a high concentration of dissolved solids on one side.

A. Hydro Pack

A one-time-use emergency hydration pouch that provides potable drinking water from fresh water. Each pouch is pre-filled with a flavored osmotic agent which, when fully hydrated, becomes 12 fl. oz. (355 ml.) of an electrolyte enriched drink. Just place the bag in fresh water and within a few hours, you have a reliable drinking source.

WP002	Hydro Pack	\$25.95/6pk.
WP003	Hydro Pack Bucket	\$69.95/30pk.

B. Sea Pack Crew

A one-time-use emergency hydration pouch that provides fresh drinking water any water source, including seawater. This offers the easiest desalination technology available on the market, requiring no power. Open the bag and place in the water to allow the osmotic agent to react with the water. This will induce the forward osmosis process and within a few hours you have a reliable bag of hydration. Just place the bag in the fresh or salt water and within a few hours, you have a reliable drinking source.

WP006	Sea Pack Crew 17oz. Desalination Pouches	\$49.95/3pk.
WP007	Sea Pack Crew 17oz. Desalination Pouches	\$299.95/18pk.

C. X-Pack and Sea Pack

WP004 Features:

A multi-use emergency water filtration pack that makes 54.5 fl. oz. (1.6 L) of a clean electrolyte enhanced drink from brackish and fresh water. Each X-Pack contains 10 syrup cartridges to create a reliable source of hydration in a disaster scenario. Can be used 20 times continuously after first use. Comes with bag and 10 refills. Just place the bag in the fresh water and within a few hours, you have a reliable drinking source.

WP008 Features:

A multi-use emergency water filtration pack that makes 17 fl oz (500ml) of a clean electrolyte enhanced drink from any water source, including sea water. Each Sea Pack contains 8 syrup cartridges to create a reliable source of hydration in an emergency situation. Comes with bag and 8 refills. Just place the bag in the fresh or salt water and within a few hours, you have a reliable drinking source.

WP004	X-Pack Includes 10 packs of Syrup	\$57.95
WP005	X-Pack 2oz. Refill Syrup and Dye Tabs	\$22.95/10pk.
WP008	1 Sea Pack Includes 10 packs of Syrup Refills	\$79.95



Model 3S2P



Model 3S3P

PuriFire® Systems Model 3S2P

- ▶ Power source: Solar panel with rechargeable battery
- ▶ 3 stage purification process
- ▶ Capacity: 2,400 gallons per day of safe drinking water
- ▶ Specialty filters address:
 - Bad taste/Odor
 - Heavy metals/Nitrate removal
 - VOC reduction
- ▶ High intensity UV system
- ▶ Operating pressure: Maximum 60 psi
- ▶ Chemical free disinfection
- ▶ 1 year warranty
- ▶ Dimensions: 20.6" Lx16.9"Wx8.1"H
- ▶ Weight: 35 lbs.

PuriFire® Systems Model 3S3P

- ▶ Power source: Vehicle, 12 VDC and cigarette lighter adapter
- ▶ 3 stage purification process
- ▶ Capacity: 3,600 gallons per day of safe drinking water
- ▶ High intensity UV system
- ▶ Specialty filters address:
 - Bad taste/Odor
 - Heavy metals/Nitrate removal
 - VOC reduction
- ▶ Operating pressure: Maximum 60 psi
- ▶ Chemical free disinfection
- ▶ 1 year warranty
- ▶ Dimensions: 25" Lx20"Wx9"H
- ▶ Weight: 49 lbs.

Model
Versa Pak
Advanced
Oxidation



Model Versa Pak
Reverse Osmosis



PuriFire® Systems Model Versa Pak

- ▶ Power source: 12 VDC battery with 64 W solar panel option
- ▶ 4-part water treatment series for First Responder or Military use
- ▶ Capacity: 1,440 gallons per day
- ▶ Reverse Osmosis Module: Converts sea, brackish and fresh water into high quality drinking water
- ▶ Advanced Oxidation Module: Utilizes a 5 step purification process with dual filtration, ion-exchange, UV and Ozone
- ▶ Decontamination Module: Recirculates ozone to aid in emergency wound management
- ▶ Service Module: Holds all replacement materials and test kits for long term sustainable deployment
- ▶ Maximum feed water TDS level:
Fresh Water RO-2000ppm / Sea Water RO: 35,000 ppm
- ▶ Chemical free disinfection
- ▶ 1 year warranty
- ▶ All system dimensions: 24"Wx19"Lx8"H

new



Versa Pak Sea 200

Versa Pak Sea 200

- ▶ Power source: 12 or 24 VDC
- ▶ Energy Recovery Desalination System
- ▶ 99.4% rejection rate of salt and impurities
- ▶ Capacity: 8.5 gallons per hour/ 200 gallons per day
- ▶ Ruggedized for the most difficult and austere situations
- ▶ Optional Service Pak for long term sustainable deployment
- ▶ Scalable technology
- ▶ Weight: 60 lbs.
- ▶ Larger quantities of water output available

Desalination



Model 5S3P

PuriFire® Systems Model 5S3P

- ▶ Power source: Rechargeable 12 VDC battery
- ▶ 5 stage purification process
- ▶ Capacity: 3,600 gallons per day of safe drinking water
- ▶ Operating pressure: 90 psi
- ▶ High intensity UV system
- ▶ Multimedia carbon filters
- ▶ Maximum feed water TDS level: 1000 ppm
- ▶ Feed water pressure: 90 psi
- ▶ Stainless steel spigot and inline strainer
- ▶ Chemical free disinfection
- ▶ 1 year warranty
- ▶ Dimensions: 28"Lx21"Wx18"H
- ▶ Weight: 150 lbs.
- ▶ Technology is scalable to 12,000 gallons with our 7S10P

Mobile Purification Wagon

Mobile Water purification Wagons are self-contained, light weight and easy to move, water purification systems capable of producing a continuous supply of safe, good tasting drinking water.

- ▶ Power source: Solar Panel with battery storage or generator/direct power
- ▶ 3 stage purification process, plus absolute 1 micron cyst filter for giardia and cryptosporidium
- ▶ Capacity: 2520 gallons per day of safe drinking water @ less than 4 cents per gallon
- ▶ Tested and proven, proprietary mixed media filter will kill bacteria and viruses instantly on contact
- ▶ Precise capacity metering
- ▶ Exceeds US EPA and WHO water purity standards
- ▶ Chemical free disinfection
- ▶ 1 year warranty
- ▶ Dimensions: 52" Lx24"Wx33"H
- ▶ Weight: Solar power: 236 lbs.
Generator/direct power: 151 lbs.



Mobile Purification Trailer

Self Contained Mobile Water purification trailer system to purify surface and brackish water with simple to use turnkey operation. Custom units available for specific requirements.

- ▶ Power source: Self contained 3500 or 8250 watt generator/direct power or solar power
- ▶ 4 Stage purification process with cyst filtration for giardia and cryptosporidium.
- ▶ Capacity: 20,000 gallons per day
- ▶ Proprietary mixed media filter will kill bacteria and viruses instantly on contact
- ▶ Exceeds US EPA and WHO water purity standards
- ▶ Chemical free disinfection
- ▶ Air lift design
- ▶ Precise Capacity Metering
- ▶ 1 year warranty
- ▶ Dimensions: Surface Water Unit: 11.10'Lx 7'Wx6.5'H
Surface/Brackish Water Unit: 13.10'Lx7'Wx6.5'H



Mobile Purification Trailer

PuriFire® Systems Model 4S10F

Mobile Fire Truck Integrated Purification Systems

- ▶ Power source: 12 VDC from fire truck
- ▶ 4 stage purification process
- ▶ Capacity: 12,000 gallons a day of drinking water
- ▶ High intensity UV system
- ▶ Ozone disinfection
- ▶ Operating pressure: 90 psi
- ▶ Chemical free disinfection
- ▶ 1 year warranty
- ▶ Dimensions: Varies per model



Model 4S10F

VISION SERIES APPARATUS

"The Simple Truth is Adequate Recommendation"
W.S. Darley circa 1920



THE FIRETRUCK - In a class of its own. To appreciate its real beauty, you have to see it work at a fire. The ultimate in fire suppression performance, durability and overall design.

CHOICE OF CHASSIS - THE FIRETRUCK is available on a variety of suitable chassis.

STANDARD FEATURES - Hydraulic 6 KW generator, Night Scan light tower and many more.

SUPPORT - THE FIRETRUCK is backed by training experts, manuals, schools, authorized service and repairmen.



VISION PANEL - You will want to touch it, but its real beauty is that it will almost run itself. New embedded colored graphic design. So ergonomically friendly, that we had to patent it.

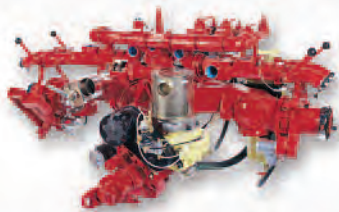

PUMP SYSTEM - Darley® LDMBC 1500 GPM single stage pump. Fully engineered and integrated - It is our flagship pump system.

COMPRESSED AIR FOAM SYSTEM - AutoCAFS™ with 225 CFM hot shift controlled compressor. "One touch" air engagement and foam proportioner controls makes it EZ.

CONTROL PANEL - Unique Total Vision panel with "Wrap-Around" design.



BODY - PolyBilt model 164 Integral Series Pumper-Rescue body with 1000 gallon integral tank. Limited lifetime body warranty is standard.

MATERIALS - Rugged polymer construction. Impact resistant and corrosion free. Easy to repair & hard to damage.

SAFETY FIRST - Low mounted speedlay and low mounted ladder storage for quick and easy access are examples of an emphasis on safety.



AutoCAFS™



CHAMPION

Use Darley's simple "EZ Spec. Program" to help determine which truck will work best for you. (See pages 324-327)

DARLEY CUSTOM DESIGNED VISION SERIES



W.A.S.P. PUMPER

Wildland Attack/Structural Protection



- ▶ Darley up to 1250 gpm midship pump with AutoCAFS™
- ▶ All wheel or 4x2 drive available
- ▶ Designed to meet NFPA pumper standards
- ▶ Maneuverable and user friendly for EZ access
- ▶ Cost effective design saves you money



*Darley AutoCAFS™ - Compromise Nothing
"When better CAFS are built, Darley will build them."*

Darley Vision Series feature LIFETIME WARRANTIES on the pump, tank and body!

BADGER

Toughest Flatbed Truck Body Available

new

- ▶ Diamond plate trim
- ▶ Ready to bolt to your chassis
- ▶ Integrated water & foam tank - up to 400 gallons
- ▶ Front transverse compartment for long-handled tool storage
- ▶ R.O.M. roll-up shutters with track lighting
- ▶ LED DOT lighting
- ▶ 82" and 98" widths available
- ▶ Optional additional rear side compartments
- ▶ Optional paint and striping package



Shown with optional Darley pump, ATP Foam Flurry Proportioner and reel installed

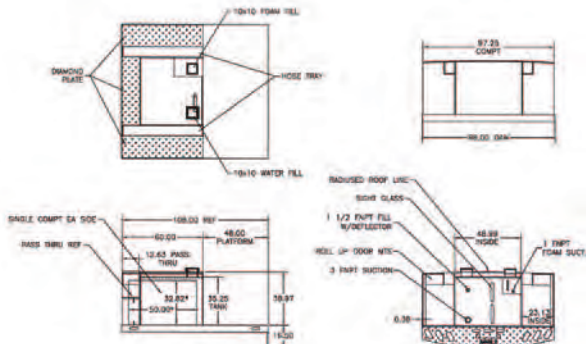

www.darley.com • www.edarley.com • www.polybilt.com

www.edarley.com/apparatus | 1.800.323.0244

APPARATUS

DARLEY FIRE APPARATUS



“THE FIRETRUCK” Custom Pumper

- ▶ LDMBC 1500 midship pump with AutoCAFS™ II
- ▶ Copolymer body construction



Conquest Commercial Pumper

- ▶ LDMBC 1500 midship pump with AutoCAFS™ II
- ▶ Stainless steel body construction



Vision Commercial Pumper

- ▶ Midship pump with AutoCAFS™ II
- ▶ Copolymer body construction



Vision Custom Pumper

- ▶ LDMBC 1500 midship pump with AutoCAFS™ II
- ▶ Copolymer body construction



Challenger Custom Pumper

- ▶ LDMBC 1500 midship pump with AutoCAFS™ II
- ▶ Aluminum body construction

APPARATUS

www.darley.com • www.edarley.com • www.polybilt.com

DARLEY FIRE APPARATUS



Challenger Pumper Tanker

- ▶ LDM 1250 midship pump
- ▶ Aluminum body construction



Vision Wetside Tanker

- ▶ HM 500 midship pump
- ▶ Copolymer wetside body construction



Vision Pumper/Tanker

- ▶ LDMBC 1500 midship pump with AutoCAFST™ II
- ▶ Copolymer body construction



Vision Tanker/Pumper

- ▶ PSM 1000 midship pump
- ▶ Copolymer wetside body construction



Vision Tanker/Pumper

- ▶ PSM 1250 midship pump
- ▶ Copolymer wetside body construction

www.darley.com • www.edarley.com • www.polybilt.com

DARLEY FIRE APPARATUS



Vision Initial Attack Pumper

- ▶ LSMC midship pump with AutoCAFS™ II
- ▶ Copolymer body construction



Vision StakPak Wildland

- ▶ HE 500 BSD Diesel Pump with WildCAFS
- ▶ Copolymer flatbed body construction



Challenger Initial Attack Pumper

- ▶ HM 500 midship pump
- ▶ Aluminum body construction



Vision PolyPak Wildland

- ▶ Rear mount pump system with AutoCAFS™ II
- ▶ Copolymer body construction



Vision Initial Attack Pumper

- ▶ LSMC midship pump with AutoCAFS™ II
- ▶ Copolymer body construction

APPARATUS

www.darley.com • www.edarley.com • www.polybilt.com

DARLEY FIRE APPARATUS



Vision Series 75' Aerial

- ▶ Copolymer body construction
- ▶ 75' steel rear mount aerial



Challenger 65' Industrial Aerial

- ▶ Aluminum body construction
- ▶ 65' 2-section steel rear mount aerial



Challenger 104' Aerial Platform

- ▶ Aluminum body construction
- ▶ 104' 4-section steel rear mount platform



Vision Light Duty Rescue

- ▶ 2-door or 4-door chassis
- ▶ Copolymer body construction



Challenger Heavy-Duty Rescue

- ▶ Custom or commercial chassis
- ▶ Aluminum or stainless steel body construction

www.darley.com • www.edarley.com • www.polybilt.com

www.edarley.com/apparatus | 1.800.323.0244

APPARATUS

323

DARLEY EZ SPECS

VISION • CONQUEST • CHALLENGER • RESCUE/AERIALS • INITIAL ATTACK • WILDLAND

VISION SERIES



Darley Vision Rear Mount Pumper

VS008
Rear 1250 Pump - 1000 gal. Tank
CoPoly Pumper Rescue Body
Hi Sides Both Sides



Darley Vision CAFS Pumper

VS005
Top 1500 Pump (CAFS) - 1000 gal. Tank
CoPoly Pumper Rescue Body
Hi Sides Both Sides



Darley Vision CAFS Pumper

VS002
1500 Pump (CAFS) - 1000 gal. Tank
CoPoly Pumper Rescue Body
Hi Sides Both Sides



Darley Vision CAFS Pumper (THE FIRETRUCK)

VS006
Top 1500 Pump (CAFS) - 1000 gal. Tank
CoPoly Pumper Rescue Body
Hi Sides Both Sides



Darley Vision CAFS Pumper (THE FIRETRUCK)

VS003
1500 Pump (CAFS) - 750 gal. Tank
CoPoly Pumper Rescue Body
Hi Sides Both Sides



Darley Vision Pumper Tanker

VS009
Front 1250 Pump - 1250 gal. Tank
CoPoly Pumper Body
Low Right Side with Ladder



Darley Vision CAFS Pumper

VS007
Enclosed 1500 Pump (CAFS) - 1000 gal. Tank
CoPoly Pumper Rescue Body
Hi Sides Both Sides



Darley Vision Pumper Tanker

VS011
1250 Pump - 2000 gal. Tank
CoPoly Pumper Rescue Body
Hi Sides Both Sides

See www.darley.com for full EZ Spec library • Models shown are also available in aluminum
www.darley.com • www.edarley.com • www.polybilt.com

DARLEY EZ SPECS

VISION • CONQUEST • CHALLENGER • RESCUE/AERIALS • INITIAL ATTACK • WILDLAND

VISION SERIES PUMPER AND TANKERS



Darley Vision Tanker

VT001
2000 gal. Tank
CoPoly Tanker Body
One Compartment Each Side



Darley Conquest Tanker

CQ001
1250 Pump - 1000 gal. Tank
Stainless Pumper Body
Low Right Side with Ladder



Darley Vision Tanker

VT003
500 Pump - 2000 gal. Tank
CoPoly Tanker Body
One Compartment Each Side



Darley Challenger CAFS Pumper

CH003
1500 Pump (CAFS) - 750 gal. Tank
Aluminum Pumper Rescue Body
High Sides Both Sides



Darley Vision Pumper Tanker

VS010
1250 Pump - 1500 gal. Tank
CoPoly Pumper Rescue Body
Hi Sides Both Sides



Darley Challenger Pumper

CH002
1500 Pump - 1000 gal. Tank
Aluminum Pumper Rescue Body
High Sides Both Sides



Darley Vision Tanker

VT002
2500 gal. Tank
CoPoly Tanker Body
One Compartment Each Side



Darley Challenger CAFS Pumper

CH006
1500 Pump (CAFS) - 1000 gal. Tank
Aluminum Pumper Rescue Body
High Sides Both Sides

DARLEY EZ SPECS

VISION • CONQUEST • CHALLENGER • RESCUE/AERIALS • INITIAL ATTACK • WILDLAND

RESCUE / AERIALS



Darley Vision Rescue

RS001
CoPoly Rescue Body



Darley Vision Rescue

RS002
CoPoly Rescue Body

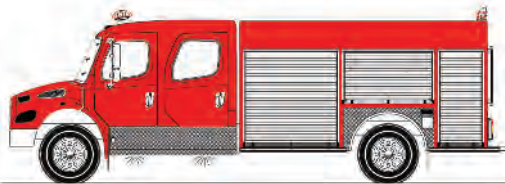

Darley Challenger Rescue

RS003
Aluminum Rescue Body



Darley Challenger Rescue

RS004
Aluminum Rescue Body



Darley Challenger 75 Aerial

AR001
1500 Pump - 300 gal. Tank
Aluminum Aerial Body



Darley Vision 75 Aerial CAFS

AR002
1500 Pump (CAFS) - 300 gal. Tank
CoPoly Aerial Body



Darley Challenger 109 Aerial

AR003
1500 Pump - 300 gal. Tank
Aluminum Aerial Body



Darley Challenger 104 Platform

AR004
1500 Pump - 300 gal. Tank
Aluminum Aerial Body

DARLEY EZ SPECS

VISION • CONQUEST • CHALLENGER • RESCUE/AERIALS • INITIAL ATTACK • WILDLAND

INITIAL ATTACK & WILDLAND

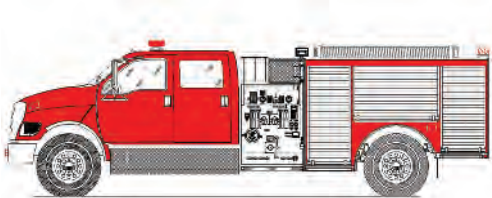

Darley Initial Attack CAFS Pumper

IA004
LSMC 1000 Pump - 725 gal. of Water, 50 gal. of Foam
CoPoly Attack Body
Ford F650 4x2 4-Door Cab



Darley Initial Attack CAFS

IA005
PSMC 1000 Pump (CAFS) - 300 gal. Tank
CoPoly Attack Body



Darley Initial Attack CAFS

IA007
Odin Lethal Weapon (CAFS) - 300 gal. Tank
CoPoly Attack Body



Darley Initial Attack

IA009
PSM 1250 pump - 300 gallon tank
CoPoly Attack Body

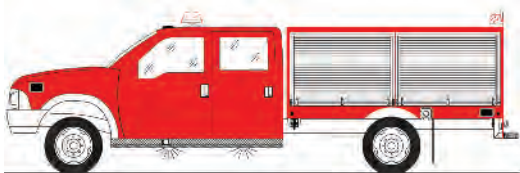

Darley Wildland CAFS

WL004
HE500 BS 34 Pump (CAFS) - 450 gal. Tank
CoPoly StakPak Body



Darley Wildland

WL005
1½ AGE 18V Pump - 300 gal. Tank
CoPoly PolyPak Body
Front Transverse Compartments



Darley Wildland CAFS

WL006
HE500 49 Pump (CAFS) - 500 gal. Tank
CoPoly PolyPak Body



Darley Wildland

WL008
JMH 500 Rear Pump - 300 gal. Tank
CoPoly PolyPak Body

POLYBILT POLYMER TRUCK BODIES

POLYBILT

INNOVATIVE TECHNOLOGY BUILT FOR LIFE



TankRPak™ Series



PolyPak™ Series



JakPak™ Series



StakPak™ Series



RescuePak™ Series



Custom Pumper Bodies

Built and backed by the best – 100 plus years of combined Fire Industry Support.
Contact us today at 1-800-864-3817.

PolyBilt® builds truck bodies with patented, integrated compartmentation. Bodies that are so tough, they are virtually “bullet-proof”. From Initial Attack to Heavy Duty Customs – we have complete body solutions to meet your needs.



SELECTIONS:

- ▶ Custom or Standard (Pak Series) Designs
- ▶ Built for OEM's, Distributors, Service Centers and FDs
- ▶ Un-finished and finished construction - the choice is yours
- ▶ Designed to fit any style emergency and/or fire vehicle

BENEFITS:

- ▶ Corrosion Free “Limited Lifetime Warranty”
- ▶ Safety – Low center of gravity for improved stability
- ▶ Impact Resistant – Resists dents and dings, yet easy to repair
- ▶ Strong – Integrated tank/body design for maximum strength or integrity



Rescue/Utility



Tankers/Quick Attack



Aerials/Pumpers



Paul Darley
President & CEO
Ext. 330
pauldarley@darley.com



Bill Darley
Chairman of the Board
Ext. 308
billdarley@darley.com



Peter Darley
Exec. VP/COO
Ext. 331
peterdarley@darley.com



Jeff Darley
Exec. VP/COO
800-527-0068
jeffdarley@darley.com



James Long
Executive VP, Equip. Div.
Ext. 332
jameslong@darley.com



Nick D'Asta
CFO
Ext. 311
nickdasta@darley.com



Tom Darley
Equipment Sales Mgr.
Ext. 323
tomdarley@darley.com



Jim Darley
Pump Sales Mgr.
Ext. 306
jimdarley@darley.com



Jason Darley
Reg. Pump Sales Mgr.
800-634-7812
jasondarley@darley.com



Ryan Darley
Pump Sales
800-634-7812
ryandarley@darley.com



Matt Darley
Product Manager
Ext. 354
mattdarley@darley.com



Steve Darley
Customer Service
Ext. 347
stephendarley@darley.com

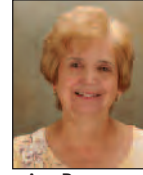

Ann Praxmarer
HR & Export/Import
Doc. Mgr. Ext. 312
annpraxmarer@darley.com



George McCullough
Dir. of Sales & Business Dev.
Defense Div. Ext. 361
georgemccullough@darley.com



Brandie Windham
Asst. Defense Div. Mgr.
Ext. 351
brandiewindham@darley.com



Neal Brooks
National Apparatus
Sales Mgr.
nealbrooks@darley.com



Tony Rodriguez
Dir. of Purchasing
Ext. 334
tonyrodriguez@darley.com



P.O. Philip
Shipping Mgr.
Ext. 326
panakalphilip@darley.com



Kevin Sofen
Business Development
Water Purification Ext. 328
kevinsofen@darley.com



Robert Bond
General Mgr.
319-987-2121
robertbond@darley.com



Amanda Dombrowski
Marketing Director
Ext. 349
amandadombrowski@darley.com



Joe Catania
Web Department Mgr.
Ext. 352
joecatania@darley.com



Peter Capulli
Supply Chain Mgr.
Ext. 310
petercapulli@darley.com



John Heaton
Vendor Relations Mgr.
Ext. 366
johnheaton@darley.com



Karen Catanese
Equipment Sales
Ext. 346
karencatanese@darley.com



Debbie Tharp
Equipment Sales
Ext. 317
debbietharp@darley.com



Mary Ann Paderski
Equipment Sales
Ext. 318
maryannpaderski@darley.com



Yolanda Crawford
Equipment Sales
Ext. 304
yolandacrawford@darley.com



Glenn Costa
Equipment Sales
Ext. 319
glenncosta@darley.com



Scott Nichols
Equipment Sales
Ext. 309
scottnichols@darley.com



Michael Whitlaw
Equipment Sales
Ext. 333
michaelwhitlaw@darley.com



Jack Moore
Pump Sales
Ext. 345
jackmoore@darley.com



Ron Voisard
Export Sales
Ext. 305
ronvoisard@darley.com



Jeff Schlitter
Export Sales
Ext. 325
jeffschlitter@darley.com



Troy Carothers
CAFS Product Mgr.
800-527-0068
troycarothers@darley.com



Lairy Normand
Customer Service
Representative
lairynormand@darley.com



Mike Ruthy
Chief Engineer
800-634-7812
mikerruthy@darley.com



Mike Daley
Apparatus Sales Mgr.
800-634-7812
mikedaley@darley.com



Gene Normand
Plant Manager
800-634-7812
genenormand@darley.com



Mark Baker
General Mgr.
800-634-7812
markbaker@darley.com



Dave Maier
Odin Product Mgr.
541-336-5067
davemaier@odinfoam.com



Norm Falch
Pump Cust. Serv. Mgr.
800-634-7812
normfalch@darley.com



Terry Hughes
Apparatus Sales
800-634-7812
terryhughes@darley.com



Fred Reiter
Customer Service
800-634-7812
fredreiter@darley.com



Mike Hayes
Customer Service
800-634-7812
mikehayes@darley.com



Dennis Harp
Purchasing Agent
dennis@darley.com



Steve D'Agostino
Liaison Mgr. Govt. Div.
stevedagostino@darley.com



Tim Debs
Sr. Account Mgr.
Ext. 322
timdebs@darley.com



Jeff Mehal
Outside Sales
jeffmehal@darley.com



Guy D'Amico
Outside Sales
guydamico@darley.com



Ed Orolin
Outside Sales
edorolin@sbcglobal.net



Frank Rodgers
Outside Sales
frankrogers@darley.com



Tony Bonanno
Outside Sales
tonybonanno@darley.com



James Phillips
Outside Sales
jamesphillips@darley.com



Ron Lueschow
Outside Sales
ronlueschow@darley.com



Eric Blom
Outside Sales
ericblom@darley.com



John Hanson
Gas Detection
Service Center Mgr.
johnhanson@darley.com



Joe Kasper
Defense Sales
Ext. 512
joekasper@darley.com



Robert Turk
Defense Sales
Ext. 365
robertturk@darley.com



Jennifer Pinares
Defense Sales
Ext. 353
jenniferpinares@darley.com



Kristin Emery
Defense Sales
Ext. 358
kristinemery@darley.com



Angie Garcia
Defense Sales
Ext. 359
angiegarcia@darley.com



Dale Jeon
Defense Sales
Ext. 335
dalejeon@darley.com



Vergie Rouse
Receptionist
vergie@darley.com

EMPLOYEE PHOTOS



325 Spring Lake Drive
Itasca, IL 60143-2072
1-800-4-DARLEY
Monday - Friday
7:00 a.m. - 5:30 p.m. CT

TERMS AND CONDITIONS

*100% Satisfaction Guaranteed
or Your Money Back*

Pricing

Prices listed in this catalog are current as of September 1, 2013. Due to the wide selection of products being offered, prices may change without notice. We also reserve the right to make corrections in the event of a misprint. Please confirm pricing with a Darley® representative at time of order. Volume discounts are available. Darley will match pricing on any lower offer from another supplier.

Open Account Terms

Terms of Net 15 Days shall be extended to city and other governmental agencies in good standing. These terms are also granted to businesses rated "good" or "high" and have a rating from CC to 5A by Dun & Bradstreet. Those companies that do not have a D&B rating in this range should contact our Credit Department at 1-630-735-3500 for a complete credit application. We encourage new customers placing their first order to make their initial payment by check or credit card. This will help avoid any shipping delays that may occur during the credit review process.

Orders Placed By Individual

All individual orders must be accompanied by full payment (cashiers check, money order or credit card) plus shipping charges and applicable state tax. We accept Visa, MasterCard, and American Express.

Sales Tax

We are required by law to add sales tax to goods shipping into the following states: IA, IL, AZ, CA, WI, GA, NC, PA, TN, CO, VA, & OH. State laws require us to have your signed exempt/resale certificate on file at our offices. We will be forced to charge you sales tax, if we do not have this documentation. All sales to individuals in these listed states are always taxable.

Order Forms / Turnout Measurement Guide

Now available online at: www.edarley.com/orderforms and www.edarley.com/turnoutmeasuring

Damaged Goods / Shortages

In the event that you receive a damaged or short shipment, you must immediately file a claim with the carrier. Under ICC regulations this claim is the consignee's (your) responsibility. Please contact our Customer Service Department 1-800-4-DARLEY for assistance.

No Hassle Returns

Please contact our Customer Service Department at 1-800-4-DARLEY. For return instructions. A return authorization number (RMA) will be required.

Restricted Sales Items

Darley® carries a wide range of products intended for sale to public safety professionals. Orders for goods including, but not limited to, badges, personal identification, emblems and nameplates must be placed on department letterhead with official identification.

Change of Address / Duplicate Mailings

It's important for Darley® to keep our mailing lists as current as possible. Please advise us of any change of address or personnel. In the event you've received duplicate mailings, simply photocopy the addresses listed on the back of the catalog and send them to Darley®. As a token of our appreciation, we'll take \$5 off your next purchase.

Government Orders GSA schedule GS-07F-0387Y

Darley offers many products throughout our catalog which can be ordered at substantially reduced government pricing through the GSA schedule:

- ▶ Call: 630-735-3500 for a GSA quote
- ▶ Email: GSA@darley.com for a GSA quote
- ▶ Order online: www.GSAadvantage.com

For more detailed information, and to register for this program please visit <http://www.troopssupport.dla.mil>.



TERMS AND CONDITIONS

Shipping & Handling Charges

Pre-Paid Domestic Orders

- ▶ Order will ship most economical way unless otherwise requested.
- ▶ Rates apply to prepaid orders shipped via UPS Ground.
- ▶ All other orders will be invoiced at the actual freight charge plus \$2.50 for handling & insurance.
- ▶ Maximum weight allowed per package is 70 lbs.
- ▶ Maximum size per package is 108" (length & girth).
- ▶ Rates apply to U.S. Continental 48 States.
- ▶ Hazardous Material charges are additional.

Value of Merchandise

Charge

0 - \$25.00	\$7.95
\$25.01 - \$50.00.....	\$9.95
\$50.01 - \$100.00.....	\$11.95
\$100.01 - \$200.00.....	\$15.95
\$200.01 - \$300.00.....	\$19.95
\$300.01 - \$400.00.....	\$24.95
\$400.01 - \$500.00.....	\$26.95
\$500.01 and up	3% of Order

Please Add Shipping and Handling

A

AC Voltage Detector	166
Accountability Tags	24, 292
Adapters	100-102, 106
Add-A-Clip	24
AEDs	202
Aerotest Breathing Apparatus Tester	273
Air Bag Kit	133
Air Bottle Door	255
Air Cart	140
Air Cylinder Storage Rack	267
Air Cylinders	140
Air Horn	254
Air Lifting Bags	138-139
Air Mask Bags	265
Air Packs	269
Air Primer	246
Airgun 40 Kit	134
Ajax Tool Kits	135
Alarm, Back Up	242
All Purpose Hook	111
All-Purpose Tool	118
Anchor Plate	156
Anchor Straps	157
Anodes	246
Apparatus	318-328
Apparatus Flow Test Gauges	90
Apparatus Test Kits	88
Approach Suit	6
Area Lighting	Inside Back Cover
Around the Pump Proportioner	65
ARRF Gear	6
Ascenders	155
ATP Foam Flurry	66
Augustus Fire Tool	49
Auto Chargers	241
Auto Crib	133
Auto Eject	242
AutoCAFS	72
Automatic Suction Valve	99
AutoValve	64
Axe Sheath	113
Axe, Bush	36
Axe, Pulaski	36
Axes	110, 112-115

B

Back Pack, Urban Rescue	203
Back Packs USAR	125
Back Up Alarms	242
Back Up Cameras	242
Backboards	207
Backpacks	30
Backpack Pumps	37-38
Badges	282-283
Bags	
Air Mask	265
EMS	203-205
Firefighting Gear	2, 14-16, Inside Back Cover

High Rise	126
RIT	126
Rope	158
SCBA Rescue	140
SCBA Storage	268
Water Throwline	164
Bags, Air Lift	139
Bail Out Kits	152, 158-159
Ball Valves, Jumbo	109
Bands, Air Bottle	270
Barracuda Saw	118
Barrel Strainers	76
Barricade Tape	184
Barricades	184
Batons, Flashing	186
Batteries	170
Battery Chargers	241
Battle Axe	113
BDU Pants	31
Beacons	188-189
Belays	157
Bell, Chrome	254
Belts, Stretcher	208
Belts, Tool	28
Biel Tool	110
Binoculars	164
Blades, Saw	141-143
Blanket, Rescue	127
Blankets	209
Blind Caps	106
Blowers, PPV	260-263
Bolt Cutters	120
Booster Hose	77
Booster Reels	239-240
Booster Tools	239
Boots	
Firefighting	2, 10-13, Back Cover
Hazmat	214
Rescue	150
Station	10
Wildland/EMS	35
Bottle Carrier	267
Bottles, SCBA	270-271
Bourke Eye Shields	24
Bowring Tool	79
Bowtie Coil Keepers	238
Boxes, Storage	254
Brackets	
Extinguisher	276
Helmet Light	168-169, 172
Brackets, Hose Rack	87
Brackets, Mounting	116-117, 247-252
Brake Bar Rack	156
Breathing Apparatus	270
British Instantaneous Fittings	100
Broom, Fire	290
Brooms, Hazmat	225
Brush, Decon Shower	227
Brute X-Pander	84
Bunker Belt	28
Burn Dressing	209
Burn Pan Training Unit	291
Burn Trauma Kit	204

C

Calculator, Fire	292
Calibration Gas	218
Camera, Thermal Imaging	167, Inside Back Cover
Cameras, Back Up	242
Can Harness	126
Cans, Safety	277
Caps with Petcock	92
Caps, Hose	101
Caps, Storz	106
Carabiners	155
Carbon Monoxide Monitor	273
Carrying Rack, Float Strainer	94
Cart, Technical Rescue	269
Cascade Systems	272
Cases, Pelican	92
Cellar Nozzle	51
Chain Kits	132
Chain Saws	144-146
Champion Rescue Tools	130-131
Channel Locks	119
Chargers, Battery	241
Check Valves	246
Chemical Classifier	223
Chemical Resistant Squeegees	225
Chem-Tape	214
Chest Harnesses	34
Chimfex	293
Chimney Scraper	290
Chimney Snuffer	51
Chlorine Institute Emergency Kits	221
Chocks	128
Chocks, Vehicle	253
Chrome Caps	101
Citrosqueeze	287
Clamp, Hose	39
Class A Foam Mixer	65
Clipboard Organizer	292
Closet Hook	117
CMS Kit	215
Collapsible Bottle Carrier	269
Collision Restraint Straps	268
Combi Tool	132
Command Lights	235
Compartment Lights	196
Compartment Matting	254
Compass, Fireground	164
Compound Lever Bar	118
Compressed Air Foam Systems	71-72
Compressor Kits	64
Compressors	273
Con Space Kits	166
Cones, Traffic	183
Confined Space Blower	160
Control Packages	140
Controller, Siren	281

Cooling Vest	214
Cord Reel Light	238
Cord, Electrical Extension	238
Counter Balance Spring	256
Couplings, B.I.	100
Coveralls	32
Coveralls, Rescue	150
CPR Masks	206
Crash Axe	113
Crash Rescue Tool Kits	122
Crash Suit	6
Crescents	22
Crib Kits	129
Crow Bar Bracket	117
Crowbars	118
CSR Pulley Kits	160
Cushions, Air	139
Cutters, Hand	120
Cutting Torches	134
Cyalume Light Sticks	186
Cylinder Mate	267
Cylinders, SCBA	270-271

D

Day Pack	30
Dead Blow Hammer	120
Decals, Helmet	22
Decon Hoop	228
Decon Shower Brush	227
Decon Shower Elevation Grid	226
Decon Spray Hoop	228
Decon Wand	227
Decon Waste Pools	228
Decon Waste Tank	229
Decontamination Manifold	226
Defibrillators	202
Demolition Bar	118
Descenders	157-158
Dewatering Pumps	93
Dike Tubing	228
Disposable Decon System	226
Door Markers	124
Door Springs	256
Double Donut Strap	82
Double Down Helmet Clips	20
Draeger Tubes	215
DrainProtector	223
Drip Torch	37
Drop In Units	311
Drum Repair Kit	220
Drums, Salvage	225
Dry Chemical Wheeled Fire Extinguisher	276
Dry Guy	12
Dry Hydrant Water System	94
Dry Wall Hooks	116-117
Dryer, Boot	12
Dryer, Hose	336
Dryers	288
Drying Stand	212
Duck Bill Lock Breaker	124
Ducting, PPV	260

E

Edge Roller	157
Eductors	65-66, 70
Elbows	100
Elevation Grid	226
Elevator Key Set	123
Emergency Lights	188-197
Emergency Oxygen	206
EMS Duffle Bag	203
EMS Helmet	151
Emulsifier	223
Engine Throttles	243
Equipment Markers	294
Escape Belt	29
Escape Hood	293
Escape Kits	152, 158-159
Escape Ladders	293
Evacuation Chair	207
Expansion Rings	84
Expansion Units	84
Extension Cords	238
Extinguisher Brackets	276
Extinguisher Cabinets	276
Extinguisher Chemical Refill	274
Extinguisher Vinyl Covers	274
Extinguishers	274-276
Extrication Device	208
Extrication Gloves	147-149
EZ Pup	51

F - G

Face Masks	34
Faceshields	24
Fan, Misting	289
Fans, Confined Space	160
Fans, PPV	260-263
Fast Attack Units	311
Fast Foam	64
Fat Ivan Door Chock	124
FF Wedge	123
Fill Hoses	272
Fill Station	272
Fire Apparatus	318-328
Fire Broom	290
Fire Extinguishers	274-276
Fire Hose Washer	86
Fire Shelter	38
Fire Swatter	36
Fire Trucks	318-328
Fireground Compass	164
Fireman's Friend	255
Firemaxx Tool	114
First Aid Kit	204
Flags	293
Flags, Hydrant	98
Flare Container	185
FlareAlert	185
Flares	185
Flashing Beacons and Kits	186
Flashlights	168-179

Flexible Pigtail	272
Float Dock Strainer	94
Floating Pumps	297
Floodlights	236
Flooring Tiles	254
Flow & Pressure Meter	88
Flow Test Kits	88
Flowmeter Kit	243
Foam	59-61
Foam Cart	63
Foam Generator	63
Foam Mixers	65
Foam Nozzles	67-70
Foam Proportioners	63-65
Foam Testing Equip	62
Foam Tubes	67-68
Foam Wrench	61
FoamCheck	67
Fold & Roll Sign System	182
Fol-Da-Tanks	96
Folding Tank Rack	99
Footwear	10-13
Forestry Clothing	31-35
FuBar	119
Gas Detection	215-218
Gas, Calibration	218
Gate Valves	105, 107
Gated Wyes	39
Gauges, Hydrant	89
Gauges, Liquid Filled	244
Gauges, Testing	90
Gear Bags	14-16
Gear Dryers	288
Gear Keepers	24
Generator Light	237
Generators	237
Gibbs Ascenders	155
Glas-Master	124
Glides	254
Glove Strap	24
Gloves	
ARFF	9
Extrication	147-149
Firefighting	2, 7-9
Hazmat	213
Nitrile	213
Rescue	147-149
Rope	148
Wildland	35
Goggles	23, 33
Governors	243
Grab Rails	256
Grappling Hook	156
Griff Hook	111
Grip Wrap	112
Grips, Nozzle	41
Ground Sweep Nozzles	246

H

Halligan Bars	110-112
Hammer, Shoring	114
Hammers, Dead Blow	120

Handheld Paddle Signs	185
Handles	256
Handles, Nozzle	41
Hangers	289
Harness, Rescue	154
Hazmat Boots	214
Hazmat Clean-Up Brush & Handle	225
Hazmat Gloves	213
Hazmat Hooligan Tool	222
Hazmat Showers	226-229
Hazmat Suits	210-212
Head Immobilizer	208
Headlamps	171-172
Headlight Flasher Kit	198
Heat Exchangers	246
Heat Sleeve	23
Heater, Confined Space	160
Heaters, Tent	230
Hebert Hose Clamp	85
Helmet Accessories	20-22
Helmet Decals	22
Helmets	
Firefighting	2, 17-21
Rescue/USAR	151
Swift Water	165
Wildland	35
Hi Rise Wye	105
High Rise Hose Straps	82
Hinge Hook	124
Hoods	2, 26-27
Hooligan Tool, Hazmat	222
Hooligan Tools	110, 112
Hose	73-77
Hose & Ladder Strap	78
Hose Bridges	85
Hose Caps	69
Hose Cart	87
Hose Clamps	39
Hose Coiler	87
Hose Connections	101
Hose Cutter	84
Hose Dryer	336
Hose Guard	85
Hose Handler w/Dewatering Bar	78
Hose Hoist	78
Hose House	278
Hose Jacket	85
Hose Monster	90
Hose Pin Rack Units	278
Hose Pipes	47, 51
Hose Plugs	101
Hose Rack Brackets	87
Hose Racks	87
Hose Ramps	85
Hose Reducer	101
Hose Reels	239-240
Hose Rollers	85
Hose Rope Tool	78
Hose Testers	78, 91-92
Hose Turn Table	86
Hose Vice	82
Hose Washers	84, 336
Hose Wrapper	83

Hose, Econoflo Multipurpose	227
Hot Shield Masks	34
Hot Stick	166
Hydrafinder	98
HydraFusion Struts	139
Hydrant Adapter	98
Hydrant Diffuser	90
Hydrant Elbow	105
Hydrant Flags	98
Hydrant Gauges	89
Hydrant Markers	98
Hydrant Pump	98
Hydrant Strap	83
Hydrant Test Outfit	89
Hydrant Tool Bag	83
Hydrant Valves	105
Hydrant Wrenches	80
Hydrant Wye	103
Hydra-Ram	136
Hydraulic Cutters	130
Hydraulic Rescue Tools	135

I

Ice Rescue Suit	165
ID Tags	24
Indian Pumps	37
Infrared Thermometer	279
Intake Relief Valves	103, 107
Iron Sling	113
Isotherm Cool Vest	214

J - K

Jackstrap	81
Jet Siphon	95
Jump Suits, Rescue	150
Jumpsuits	32
Junction Boxes	236
K12 Saw	142
KED Extrication Device	208
Kwick Access Tool	117

L

Ladder Bracket	255
Ladder Hook	29
Ladder Pads	257
Ladders	257-259, 293
Landing Mat	293
Landing Zone Kit	187
LDH Hose	75
LDH Hydrant Valve	109
Leather Fronts	22
Level A & B Suits	210-212
Lever Bar	118
Lexan Caps	101
Lexan Combination Nozzles	278
Lifting Bag Kit	133
Lifting Bag Pads	128
Light Baton	186
Light, RAL	Inside Back Cover
Lightbars	192-194

Lighting, Telescoping	231-232
Lightman Strobe	187
Lights, Portable Flood	233, 236
Lincoln Logs	128
Line Cage	91
Line Gauge	90
Liquid Filled Gauges	244
Lite Tracker	186
Lock Breaker	124
Lock Pulling Tools	123
Lockaid Tool	123
Low Level Strainer	95, 97

M

Macaw CAFS	62
Mallets	120
Man Saver Bars	253
Manhole Entry System	160
Manifold, Hazmat	226
Manifolds, SCBA	272
Manifolds, Water Supply	108
Markers, Hydrant	98
Mask, Hot Shield	34
Masks, Wildland	34
Master Switches	241
Mat, Landing	293
Mats, Staging	132
Matting	254
Mattydale Swivels	246
Maxiforce Bags	139
Maxiwedge Kits	219
Mayday Air Breathing Tubes	264
McLeod Tool	36
Medic Kit	205
Megaphone	184
Milwaukee Strap	81
Misting Fan	289
Misting Ring	262
Mobile Bottle Rack	271
Monitors, Water	52-58
Monitors, Gas	215-218
Mountain Mister	261
Mounting Brackets	116, 247-252
Multi-Base	137
Multi-Pak & Technical Rescue Cart	269
Multi-Purpose Rescue Device	159
Multi-Use Adapter	105

N

Neoprene Gaskets	100
Newton Kwik Dump Valve	99
Non-Sparking Shovels	225
Nova-Lite	237
Nozzle Handles	41
Nozzle Holders	
.40-51, 248-249, 336, Back Cover	
Nozzles	
Foam	67-70
Ground Sweep	246
Handline	40-51
Lexan	278

Monitor	52-56
Smooth Bore	336
Wildland	39
Nylon Safety Belts	208

O

Odin CAFS	71
Officer's Tool	114
Offset T Patch Kit	219
ONEGlove	213
Outdoor Warning Sirens	280-281
Overpacs	225
Oxygen Case	206
Oxygen Supply Kit	204

P

Pac Mule Belt	29
Packing, Pump	310
Packs USAR	125
Packs, Hose	81-82
Packs, Wildland	30
Pads, Hazmat	224
Panel Lights	197
Pant, Wildland	31, 33
Pass Devices	264
Passports, Helmet	22
Patch & Plug Response Kits	220
Percussive Rescue Kits	136
Perimeter Lights	195-196
PFD Vest	165
Pick Guard	113
Piercing Nozzles	48-49
Piezometer	89
Pike Pole Brackets	117
Pike Poles	116-117
Pillows, Hazmat	224
Pinch Bars	118
Piston Intake Relief Valves	103, 107
Playpipes	47, 51
Pliers, Channel Locks	119
Plug & Wedge Kit	220
Plug N' Dike Products	223
Plugs, Hose	101
Pocket Organizer	28
Poles, Sliding	293
Poly Boxes and Trays	254
PolyBilt	328
Pop Up Cones	182
Portable Pumps	295-299
Portable Water Tank	96
Power Supply	198
Power Units	131
PPE/Turnout Gear Cleaner	287-288
PPV Fans	260-263
Pressure Governors	243
Pressure Reducing Regulators	272
Primer Valve	245
Primer, Pump	310
Primers	246
Pro Bar	111
ProPak	62

Proportioners	63-65
Prusik Cord	153
Pry Axe	110
PTO Compressor Kit	64
Pulaski Axe	36
Pulley Device	161
Pulley Kits	161
Pulleys	155-156
Pump	
Accessories	310
Back Pack	37-38
Darley	295-313
Davey	295
Dewatering	93
Diaphragm	98
Electric Water	227
Floating	297
Hazmat Transfer	226
Hydrant	98
Hydraulic	307
Midship	308
Modules	309
Packing	310
Portable	295-299
PTO	304-307
Pump Relief	310
Rear Mount	307
Relief Valves	310
Skid Mounted	301-303
Split Shaft	307
Systems	309
Trailer Mounted	303
Trash	93
Pump Plus	242
Purifier	309-313
PVC Suction Hose	76

Q - R

Rack, Drying	336
Rack, SCBA	271
Racks, Gear	284-287
Racks, Folding Tank	99
Racks, Hose	87
Radio Harness	34
Radio Holder	28
Rakes	36
RAL Light	Inside Back Cover
Ram Entry Tool	124
Ram Jammers	136
Ramps, Hose	85
Rapid Tent	230
Ready Racks	284-287
Reels, Electrical	238
Reflective Striping and Stickers	255
Relief Valves, Piston Intake	103, 107
Relief Valves, Pump	310
Remote Lighting	231-238
Remote Strobe Kit	198
Repair Kits, Valves	245
Rescue Harnesses	154
Rescue Helmets	151
Rescue Manikins	209

Rescue Randy	209
Rescue Saw	118
Rescue Tools, Hydraulic	130-131
Res-Q-Me	124
Res-Q-Rench	80
RIT Kits	158
Rite Rescue Device	162
Roller and Spool Assembly	239
Roof Hook	111
Rope	152-153, 158, 164
Rope Bags	158
Rope Hose Tool	78
Rope Rescue Gloves	148
Runners	290

S

S.A.R. Bucket	127
S.O.R.D. Drag Device	127
S.O.S. Tool	119
Saddle Vent	160
Safer Search System	162
Safety Bars	253
Safety Can Cabinets	277
Safety Warning Signs	183
Salvage Covers & Runners	290
Salvage Drums	225
Salvage Kit	121
Salvage-Master Wet Vacuum	290
Saw Blades	141-143
Saws	142-146
SCBA	270
SCBA Mask Bags	265
SCBA Brackets	266, 268
SCBA Cleaning System	269
SCBA Cushions	267
SCBA Manifolds	272
SCBA Quic-Access Cabinets	271
SCBA Seat	267
SCBA Storage Bag	268
Scene Dots	255
Scene Lighting	231-238
Seat Organizer	292
Seats, SCBA	267
Sheath, Axe	113
Shelter, Fire	38
Shelters	228-229
Shield Saver	24
Shields, Leather	22
Shirts, Wildland	31, 33
Shoring	137-138
Shoring Hammer	114
Shove Knife	123
Shovel, Long Handle	36
Shovels	121, 225
Shower Systems	226-229
Showers, Decon	226-229
Siamese Valves	109
Siamese, Suction	109
Sign, Fold and Roll	182
Signs	294
Signs, Cone	183
Signs, Paddle	185

Silver Shield Gloves	213
Siphon Jet	95
Siren/Speaker Package	198
Sirens	198-200
SKED Rescue System	161
Skid Units	311
Skull Savers	257
Sledge Hammer	121
Slide In Units	311
Sliding Pole Mat	293
Sliding Poles	293
Sling Link Mast	162
Smoke Candles	291
Smoke Canister	291
Smoke Ejector Holder	263
Smoke Machines	291
Smooth Bore Nozzles	50, 336
Snaptank	97
Socks, Universal Hazmat	224
Sorbents	223
Spanner Wrenches	80
Speakers	201
Spill Kits	224
Splints	208
Spreader	130
Spring Loaded Cones	182
Sprinkler Shut Off	278
Squeegees	225
Stacked Tips	50
Stacker Cones	183
Staging Platforms	132
Station Racks	284-287
Station Signs	294
Status Boards	292
Steps, Folding	256
Storage Cabinets	271
Storage SCBA Bottle	267
Storz Adapters	106
Storz Hydrant Coupling	98
Storz Wrenches	79
Strainers	76, 94-95, 97
Straps	
Anchor	157
Glove	24
Hose	82
Mounting	252
Radio	28
Stretcher	208
Stream Straightener	50
Stretchers	207-208
Strip and Peek Tool	133
Striping, Reflective	256
Suction Hose	76
Suction Siamese	109
Suction Valve	99
Super Pass Devices	264
Super Spanner Set	79
Supply Line Holder	96
Survival Rescue Stick	165
Suspenders	25, 34
Swatters	36
Swing Out Valves	245
Swivels	100, 239, 246

Syntho-Plug Football	223
----------------------	-----

T

T.I.C.	167, Inside Back Cover
Tachometer	88
Tags, Accountability	24, 292
Tail Lights	197
Tank Anodes	246
Tank Level Gauge	244
Tank Ranks	99
Tank, Pipe, Drum Sealing Kit	221
Tanker Dump Valve	99
Tape, Barricade	184
Tee Valve	39
Telescoping Flood Lights	231-232
Tent Heater	230
Tents	228-230
Test Kits, Apparatus	88
Thermal Imager	167, Inside Back Cover
Thermal Scanners	279
Thread Saver	272
Throttle, Vernier	246
Tiles, Apparatus	254
Tips, Nozzle	50
Tool Bag	127
Tool Brackets	116, 247-252
Tool Guard	134
Tool Kit, Mini Crash	119
Tool Kits	222
Tool Sets	122
Torch, Drip	37
Torches, Cutting	134
Tower Lights	235
Tracer Voltage Detector	167
Traffic Baton	186
Traffic Cones	183
Transfer Cans	277
Trash Pumps	93
Trauma Pac	204
Trays, Storage	254
T-Rex Saw	143
Tripod Lighting	231, 233-234
Tripods	161
Truck Cache	159
Truckman Battle Axe	113
Truckman's Belt	29
Tubes, Draeger	215
Turbo Draft	97
Turbo Flares	185
Turnout Gear	2-6
Turtle Tiles	254
TVS Kit	139

U - V

Ultrasonic SCBA Cleaner	269
Universal Pressure Test Kit	212
Universal Storz Coupling	97
USAR Crib Kits	129
USAR Rescue Kits	160
Vacuum, Salvage Master	290
Valves	

Angle	278
Ball Intake Relief	107
Butterfly	245
Check	246
Repair Kits	245
Swing Out	245
Tanker	99
Vehicle Chocks	253
Vehicle Entry Tools	123
Vehicle Maintenance Kit	139
Vehicle Stabilization Kits	137-138
Vehicle Warning Kit	185
Vernier Throttle Control	246
Versitol Solution	288
Vests, Floatation	165
Vests, Safety	180-181
Victim Locater Kit	166

W - X

Walkaway Brackets	266
Wand Accessory	92
Warning Sirens	280-281
Warthog Blade	141
Washer-Extractors	288
Water Heater	230
Water Level Gauge	244
Water Purification	314-317
Water Rescue Rope	164
Water Thief	39, 103-104
Water-Jel Burn Wrap	209
Webbing	153
Wedges	123, 129
Wheel Chocks	253
Wheeled Extinguishers	276
Wildland Gear	31
Wildland Packs	30
Wind Meter	164
Work Area Lighting	231-238
Working Air Cylinders	140
Worktable	287
Wrap, Hand Tool	112
Wrench Sets	79
Wrench, Foam	61
Wrench, Res-Q-Rench	80
Wrenches, Spanner	80
Wyes	39, 104, 108-109

Y - Z

Yes-Tool	222
Zak Entry Tool	111



Darley
Shop Online
24/7 at
edarley.com

1" Viper Nozzle

Low flow, high quality, high performance MOP UP nozzle that flows from 5 gpm to 40 gpm. 1" select gallonage nozzle with ball shutoff, bail handle, and pistol grip.

new

- ▶ Extruded from E-LITE alloy
- ▶ Hard-coated for corrosion protection and durability
- ▶ Spinning teeth offer a wide, complete fog pattern
- ▶ Selector ring has 4 flow positions
- ▶ Constant gallonage in all positions
- ▶ MOP 5-10-25-40 gpm @ 100 psi



BL424 1" Viper Nozzle \$459.95

Darley Smooth Bore Nozzle

Rugged smooth bore nozzle with the largest waterway available for outstanding flow. All aluminum construction (shutoff valve, tip, ball, handle) with stainless steel fasteners. ¹⁵/₁₆" smooth bore tip with rubber bumper is 5 1/2" long. High-Rise shutoff, 1 1/2" NH connection with full 1 1/2" waterway. Anodized aluminum finish. Ship wt. 1 lb.

new



BL495 Darley Smooth Bore Nozzle \$174.95
BL506 1 1/2" NH Mini Stream Shaper \$37.95



Ready Rack Hose Washer

new

- ▶ Heavy gauge stainless steel construction
- ▶ Easy one person operation - no pedals to hold down
- ▶ Automatic feed - drive motor powers the washer brushes and exit squeegees
- ▶ Water boost pump - Pressurizes standard garden hose to 3,000 psi for powerful cleaning
- ▶ Faster cleaning time - Speed of 25 ft/min; wash and rinse in one process
- ▶ Mobile - Heavy duty 4" casters
- ▶ Cleans hoses up to 4" in diameter
- ▶ Shut off water valve at machine
- ▶ Water drain - 6' flexible drain line from bottom of cabinet
- ▶ Removable rear panel for easy access to components for service or maintenance
- ▶ 2 - 10" Nylon scrub brushes - provide a deep and thorough scrubbing
- ▶ Compact Design - Only 46" L x 40" H x 24" W
- ▶ Power: 220v - 20amp
- ▶ Made in USA

BL472 Ready Rack Hose Washer \$13,494.95

Ready Rack PPE/Hose Dryer

new

- ▶ Custom built for firefighter turnout gear (PPE) and hoses
- ▶ Simple controls with factory preset temperatures ensure proper drying temperature for each unique clothing or turnout item
- ▶ Made from heavy-duty steel construction with a white powder coat finish



BL473 shown with optional BL474

BL473 Ready Rack PPE/Hose Dryer \$7,994.95
BL474 Hose Drying Rack \$649.95
BL475 Air Flow Coat Hanger \$318.95
BL476 Air Flow Boot Hanger \$390.95

FIRE FIGHTING EQUIPMENT



Premium Turnout Bag

- ▶ Fully molded top, bottom and sides
- ▶ Largest zippers available
- ▶ Retractable luggage-style handle can be zipped away
- ▶ Larger and wider wheels than similar bags
- ▶ Rear and bottom are reinforced with diamond-embossed waterproof neoprene
- ▶ All corners and high-stress areas are rubber reinforced
- ▶ Large top flap opens the full length of the bag
- ▶ Hi-Vis lime-yellow/silver triple reflective trim
- ▶ Reflective tape stitched into all Firefighter webbing and handle
- ▶ Embroidered Maltese Cross logo, not screen printed
- ▶ Larger bag than ANY competitors
- ▶ Dimensions: 32"Hx18"Wx18"D"



new



SPECIFY COLOR: Black or Red

BL430 Premium Turnout Bag with Wheels \$122.95

9420 LED Work Light

A Deal You Can't Resist

Now you can start your day before sunrise with the new portable Pelican ProGear 9420 LED Work Light. Equipped with two LEDs (1000 lumens of light and 4 hours of burn time), plus a 5' high mast deploys in seconds and illuminates your entire work area. With the 9420, you will get the job done without the hassle of power cords. The new Pelican ProGear 9420 LED Work Light: Keeps you moving at the speed of light.

new



BL463 9420 LED Work Light \$298.95

FLIR Thermal Camera Kits

The new FLIR K40 and K50 Fire Service TICs are simpler to use and make it easier to see under the most challenging conditions. A larger 4" LCD display shows FLIR's renowned thermal image quality with extra clarity. Five imaging modes help speed tactical decisions and the search for survivors. Oversized buttons allow effortless gloved-handed operation. The K-Series also provides capture for up to 200 jpeg IR snapshots. You can review them later from the onboard archive or export to your computer via USB to generate reports. The K-Series has been rugged designed, with IP67 rating, to withstand a 2 meter drop onto concrete as well as water submersion. And FLIR's innovation and manufacturing economies of scale make the K40 and K50 the most affordable thermal imaging cameras (TICs) in their class, putting more thermal imaging power into the hands of more first responders.

Kits Include:

- ▶ Thermal imaging camera (TIC)
- ▶ Tabletop charger with power supply
- ▶ Tripod adapter (UNC 1/4"-20)
- ▶ Hard case
- ▶ 2 - Li-Ion batteries
- ▶ USB cable
- ▶ Retractable lanyard
- ▶ Neck strap
- ▶ FLIR tools software (scratch cards)

new

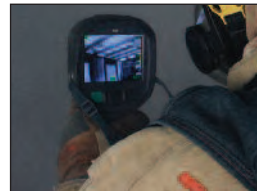

BL504



BL503	FLIR K40 Thermal Camera Kit 240x180	\$3,944.95
BL504	FLIR K50 Thermal Camera Kit 320x240	\$4,944.95
BL505	Truck Charger	\$794.95



325 Spring Lake Drive
Itasca, IL 60143-2072

PRSRT. STD.
U.S. POSTAGE
PAID
W.S.Darley
& Company

Code:

Acct:

Fire-Dex® Leather Boots

- ▶ Lightest boot in its class
- ▶ Vibram® Fire & Ice sole provides superior slip resistance and flexibility in extreme cold or heat
- ▶ Steel protective package includes spacious steel toe and ribbed steel shank for support and comfort on ladders and uneven surfaces
- ▶ PS5 ES puncture resistant fabric protects foot from nails and other puncture hazards
- ▶ Dual density SMART™ foam insert absorbs and disperses impact energy
- ▶ Padded shin guard for protection and comfort on ladders and while crawling
- ▶ Integrated pull on loops are reinforced for superior durability
- ▶ Antibacterial inner liner
- ▶ Waterproof moisture barrier provides blood borne pathogen protection
- ▶ NFPA 1971, 2013 and CSA compliant



COLOR: Gray
SPECIFY SIZE: 7-12, 13, 14, 15, 16 SPECIFY WIDTH: M, W or XW
BL502 Fire-Dex® Leather Boots

\$234.95

HydroFX Nozzle

The HydroFX flow indicator is the latest innovation in hand-line nozzle accessories. HydroFX can be used in frontline firefighting to help indicate if there is a problem with the flow from your fixed gallonage nozzle. You can trust the leader for innovative products with unmatched performance and reliability.

- ▶ Turns ON automatically when water pressure is sensed in the nozzle
- ▶ Goes into sleep mode when not in use
- ▶ Bright LED lights indicate good, marginal or low flow
- ▶ Battery check function uses the LEDs to notify of low battery
- ▶ Sleek low profile design doesn't add bulk to the nozzle
- ▶ Includes: "AAA" lithium batteries, 40+ hours of continuous operation
- ▶ Simple customizable programming of the light indicators
- ▶ No recalibration needed



Available GPM/PSI			
95 @ 75	95 @ 100		
125 @ 75	125 @ 100		
150 @ 75	150 @ 100		
175 @ 75	175 @ 100		
	200 @ 100		



BL482	Assault Nozzle 1 1/2" with HydroFX	\$784.95
BL483	Assault Nozzle 1 1/2" with Pistol Grip and HydroFX	\$859.95
BL484	Assault Breakapart Nozzle 1 1/2" with Pistol Grip, Twist Shut-Off and HydroFX	\$994.95
BL485	Assault Breakapart Nozzle 1 1/2" with Twist Shut-Off and HydroFX	\$994.95