

PERCUSSIVE TOOLS

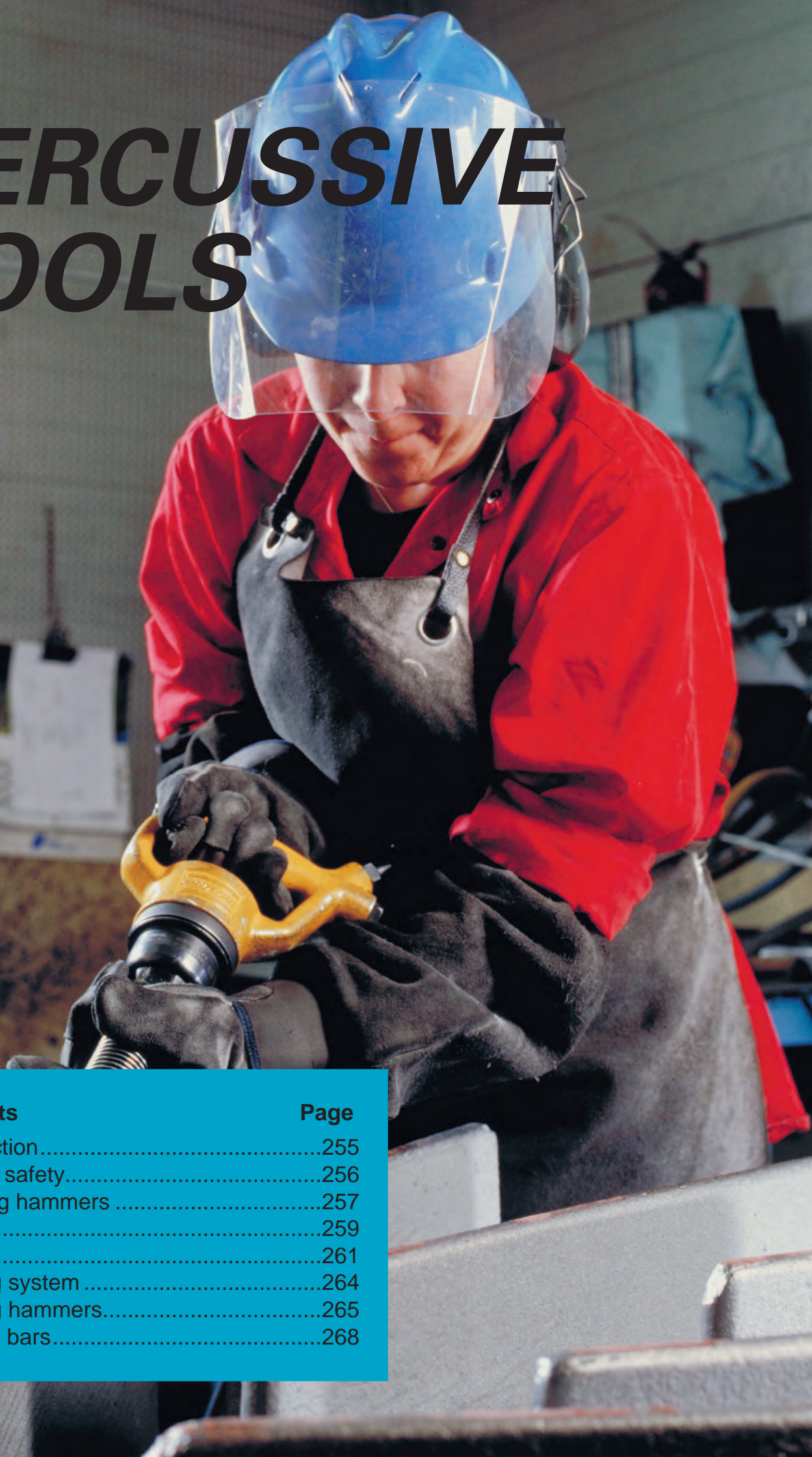

Contents

Page

Introduction.....	255
Product safety.....	256
Chipping hammers	257
Scalers.....	259
Chisels.....	261
Riveting system	264
Riveting hammers.....	265
Bucking bars.....	268

These tools make light of the toughest jobs

Atlas Copco percussive tools are ideal for all material removal tasks in foundries, engineering workshops and shipyards. Built-in-ergonomic features such as vibration damping reduce the human load, delay fatigue and help protect the operator against the ill effects of long-term exposure to vibration and noise.

Our tools are made out of lightweight alloys to keep weight down while maintaining performance. This makes our tools extremely effective in the hands of your skilled operators.

WELD FLUX REMOVAL

Our tools are used when fettling welds from flux and spatter and in general scaling operations.

The conventional scaler RRC 13 and RRC 13B with a blowing function are the preferred models for these types of application. These tools have the right power and a sturdy reliable design. They also have a low vibration level for conventional models.

RUST AND PAINT REMOVAL

Rust and paint removal is a common application found in various types of industries such as shipbuilding, large transport sector and on offshore rigs.

Our RVM07B has low noise and is vibration damped. The standard chisel delivered with the tool is carbide tipped for a long service life. The tool is also equipped with a clean blowing device.

For lighter jobs the needle scaler RRC 13N is the ideal tool. Needle sets of different shapes and material are available to suit most operations.

CHIPPING AND SCALING

Percussive tools for chipping and scaling are widely used in all kinds of metalworking, construction and other industrial areas. Applications could be slag chipping, concrete trimming and sheet-metal cutting.

We offer high power-to-weight tools for these kind of applications. RRF 21/31 and RRD 37/57 models are vibration damped for operator comfort.

Our RRC22-RRC75 models are robust and highly dependable conventional chipping hammers suitable for heavy roughening.



Product Safety

IMPORTANT: All local safety regulations with respect to installation, operation and overhaul must always be followed.

AVOID ACCIDENTS

- 1** The chisel, die or punch may fall out or may be shot out of the tool accidentally causing serious injury.



To prevent injury from a flying chisel:

- Always use a retainer.
- Inspect the retainer for wear or damage regularly.



- Be aware that the chisel may break during operation.
- Never trigger a hammer unless held against a work piece.
- Remove chisel, die or punch from tool when work is over.
- When finishing a job, disconnect the tool from its air supply.
- Before changing accessories, chisel or die – disconnect the tool from the air supply.

- 2** Chips and sparks should be prevented from striking an eye or another worker.



To prevent vision loss:

- Always wear eye protection.
- Isolate work of this kind by using barriers between work stations.
- Do not use the tool for other purposes than it is intended for.

- 3** Gloves protect fingers from pinching, scuffing and scraping.

- Protectives shoes may prevent your feet from being injured.

- 4** Explosive atmosphere must not be ignited.



To prevent injury and property loss from fires:

- Use other technique.
- Use accessories of non sparking material (e.g. needle attachment of Beryllium copper for a needle scaler).

- 5** Electric shock may be fatal.

- Avoid chiseling into electric wiring hidden inside walls etc.

LONG TERM RISKS

- 6** Always use ear protection.



To prevent gradual loss of hearing due to exposure to high noise level – wear ear protection.

- 7** Vibration may be harmful to hands and arms.



- Use vibration dampened tools if available.
- Reduce the total time of exposure to vibrations, particularly if the operator has to guide the chisel by hand.

- 8** Dust generated during operation may be harmful.

- Use spot suction or a breathing apparatus.

PROPER USE AND MAINTENANCE

- 9** Do not perform idle blows with a hammer.



- They will cause high internal stresses and shorten the life of the tool.
- Note the risk of shooting out the chisel, die or punch if the retainer is not in order or damaged.

- 10** Quick coupling.

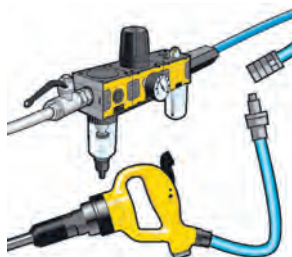

- If a coupling is used on a percussive tool, it should be separated from the tool by a whip hose (length 0.5 m).

- 11** Follow the tool manual and the lubrication instructions.

- 12** Perform overhauls at regular intervals.

- **RRF21/31** have a sturdy D-handle in light metal alloy for a high power-to-weight ratio and steady grip. The compact, vibration-controlled design offers good accessibility and ease of use.
- **RRD37/57** are light, quiet and have a long service life. They have light alloy tool casings, low vibration and noise levels, vibration damping in both hand grips, and piped away exhaust.



Model	Blows Hz	Piston dia		Stroke		Energy per blow		Length mm	Weight		Bushing		Air consumption		Hose size		Air inlet BSP	Ordering No.
		mm	in	mm	in	J	ft lb		kg	lb	mm	in	l/s	cfm	mm	in		
RRF21-01	57	18	0.7	33	1.3	2.0	1.5	245	1.75	3.3	12.7 ^c	0.50	6.5	13.8	10.0	3/8	3/8	8425 1104 05
RRF31-01	38	22	0.9	43	1.7	4.4	3.2	265	2.5	5.3	12.7 ^c	0.50	7.5	15.9	10.0	3/8	3/8	8425 1104 15
RRF31-02	38	22	0.9	43	1.7	4.4	3.2	265	2.5	5.3	12.7 ^c	0.50	7.5	15.9	10.0	3/8	3/8	8425 1104 16
RRD37-11	35	27/19 ^a	1.1/0.8	70	2.8	6.8	5.0	418	3.0	6.6	17.3 ^d	0.68	7.2	15.3	12.5	1/2	special ^e	8425 1101 22
RRD57-11	31	28/18 ^b	1.1/0.8	92	3.6	9.3	6.9	458	3.4	7.5	17.3 ^d	0.68	9.5	20.1	12.5	1/2	special ^e	8425 1103 20
RRD57-12	31	28/18 ^b	1.1/0.8	92	3.6	9.3	6.9	458	3.4	7.5	17.3 ^d	0.68	9.5	20.1	12.5	1/2	special ^e	8425 1103 38

^a Effective piston dia 19 mm, 0.75 in.

^b Effective piston dia 21.5 mm, 0.85 in.

^c ISO.

^d Spline.

^e Integrated hose barb.

-01 and -11: Guided models.

-02 and -12: Non guided models.

Chipping Hammers

- **Dependable** – Their robust construction makes them highly dependable.
- **Efficient** – RRC65 and RRC75 have a blow rate which makes them particularly suitable for roughening.
- **Chisel retainer** – for safer jobs – RRC22-RRC75 are delivered with a chisel retainer as standard. For the same reason choose a tool that can be guided via the machine itself and not by holding the chisel.

Atlas Copco chipping hammers of series RRC are delivered with a standard, guided ISO hexagon nozzle (-01) or a round, non guided shank nozzle (-02).



Model	Blows Hz	Piston dia		Stroke		Energy per blow		Length mm	Weight		Bushing		Air consumption		Hose size		Air inlet BSP	Ordering No.
		mm	in	mm	in	J	ft lb		kg	lb	mm	in	l/s	cfm	mm	in		
RRC22F-01	62	15	0.6	52	2.0	2.7	2.0	260	2.2	4.9	12.7 ^a	0.50	6.2	13.1	10	3/8	3/8	8425 0202 22
RRC22F-02	62	15	0.6	52	2.0	2.7	2.0	260	2.2	4.9	12.7 ^a	0.50	6.2	13.1	10	3/8	3/8	8425 0202 30
RRC34B-01	45	24	0.9	67	2.6	5.5	4.1	330	4.5	9.9	17.3 ^a	0.68	8.0	14.0	12.5	1/2	special ^b	8425 0212 53
RRC65B-01	40	29	1.1	50	2.0	10.0	7.3	335	5.9	13.0	17.3 ^a	0.68	10.8	22.9	12.5	1/2	special ^b	8425 0225 33
RRC75B-01	30	29	1.1	75	3.0	16.0	11.8	390	6.5	14.3	17.3 ^a	0.68	14.0	29.6	12.5	1/2	special ^b	8425 0225 58

^a ISO. ^b Integrated hose barb.

Dimensions

Model	L mm	H mm	D mm
RRF21	245	160	33
RRF31	265	170	36
RRD37	418	175	—
RRD57	458	190	—

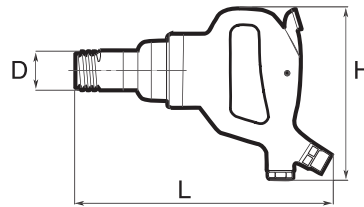

RRF21/31

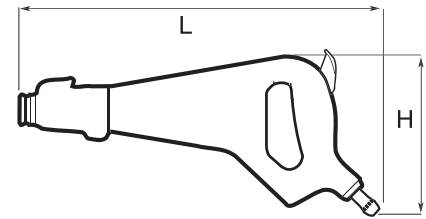

RRD37/57

Model	L mm	H mm	D mm
RRC22	260	155	34
RRC34	330	160	43
RRC65	335	170	54
RRC75	390	170	54

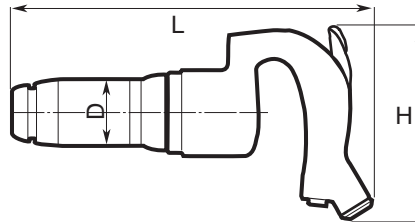

RRC

Accessories Included

RRF MODELS

Chisel retainer and a hose fitting

RRD MODELS

Flat chisel
Silencer complete
Hand grip
Key

RRC MODELS

Chisel retainer and hose fitting

Optional Accessories

Model	Ordering No.
Power regulator	
RRF21 and -31	3512 0273 80
Retainer, open type	
RRF21	3512 0290 90
RRF31	3512 0305 90
Protective handle kit	
RRF21	3512 0349 81
RRF31	3512 0349 82

CHISELS

For a wide choice of chisels, see separate page.

Productivity Kits

Model	Max air flow	Hose, 5 m	Coupling	Lubrication	Ordering No.
For percussive tools with 3/8" BSP air inlet incl. whip hose					
MIDI Optimizer F/RD EQ10-R13-W	23 l/s	Rubair 13 mm	ErgoQIC 10	Yes	8202 0850 14
For percussive tools incl whip hose, no tool nipple included					
MIDI Optimizer F/RD EQ10-R13-W	23 l/s	Rubair 13 mm	ErgoQIC 10	Yes	8202 0850 15

RVM07B is the obvious choice for task such as weld dressing light concrete trimming and for removal of paint and rust.

- **Vibration-damped with low-noise level.**
- **Two-job capacity** – RVM07B features a clean-blowing device which is very useful in order to keep the work piece clean from slag and other particles from the process.



RVM07B

Model	Blows Hz	Length mm	Weight incl. standard chisel		Air consumption		Hose size		Air inlet BSP	Ordering No.
			kg	lb	l/s	cfm	mm	in		
RVM07B	100	273	1.7	3.8	3.8	8.1	6.3	1/4	1/4	8425 0105 25

Dimensions

Model	L mm	D mm
RVM07B	273	38

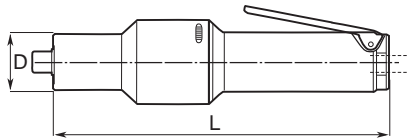

Scalers

Choose between two different models for heavy slag chipping and for instant trimming of concrete.

- **High removal rate** – RRC13 is very effective and has a high removal rate in relation to its low weight.
- **Well proven** percussive mechanism and retainer.
- **Two-job capacity** – RRC13B with extra clean-blowing device.
- **Improved back head** – Throttle valve and lever with really Heavy Duty performance for long service life. Clean blowing system with twice the previous blow



RRC13B

capacity. Big blow button for easy operation and sturdy valve stem to resist rough handling.

Model	Blows Hz	Piston dia		Stroke		Energy per blow		Length mm	Weight		Air consumption		Hose size		Air inlet BSP	Ordering No.
		mm	in	mm	in	J	ft lb		kg	lb	l/s	cfm	mm	in		
RRC13	73	15	0.6	35	1.4	1.4	1.0	221	1.4	3.1	4.0	8.0	10	3/8	3/8	8425 0101 30
RRC13B	73	15	0.6	35	1.4	1.4	1.0	231	1.6	3.5	4.0	8.0	10	3/8	3/8	8425 0101 33

Dimensions

Model	L mm	H mm	D ₁ mm	D ₂ mm
RRC13	221	65	45	41.5
RRC13B	231	65	45	41.5

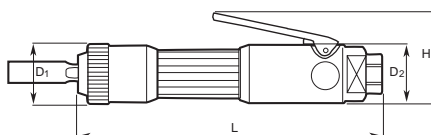

Needle Scaler

The effective needle scaler, RRC13N, is based on the same fundamental design as the straight chipping hammers of type RRC13.

- **Sturdy design** – Easy to maintain.
- **Versatile** – The needle scaler is used to remove welding slag, rust and paint from steel structures.



RRC13N

Model	Blows Hz	Piston dia		Stroke		Energy per blow		Length mm	Weight		Air consumption		Hose size		Air inlet BSP	Ordering No.
		mm	in	mm	in	J	ft lb		kg	lb	l/s	cfm	mm	in		
RRC13N	73	15	0.6	35	1.4	1.4	1.0	352	1.9	4.2	4.0	8.0	10	3/8	3/8	8425 0101 36

Dimensions

Model	L ₁ mm	L ₂ mm	D m
RRC13N	282	352	38

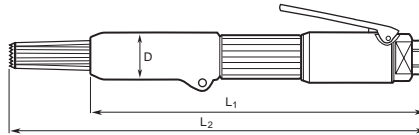

Accessories Included

FOR RRC13

Hose fitting
Scaling chisel

FOR RMV07B

Hose fitting
Flat carbide tipped chisel 10x120 mm

Optional Accessories

FOR RRC13, 13B

RRC13 / RRC13B	Ordering No.
Hand guard	3510 0246 90
Silencer	3510 0366 80

Chisels for RRC13 and -13B:
Square shank 13.0 mm

FOR RRC13N

NEEDLE-SET OF 19 NEEDLES, LENGTH 100 MM

Material	Ordering No.
Steel, standard	3510 0221 90
Steel flat ends	3510 0227 90
Stainless steel flat ends	3510 0228 90
Beryllium copper flat ends (spark resistant)	3510 0229 90

FOR RMV07B

Carbide tipped chisels and through hardened chisels with other length and width, see separate page for chisels.



Productivity Kits

Model	Max air flow	Hose	Coupling	Lubrication	Ordering No.
For percussive tools with 3/8" BSP air inlet incl. whip hose					
MIDI Optimizer F/RD EQ10-R13-W	23 l/s	Rubair 13 mm	ErgoQIC 10	Yes	8202 0850 14
For percussive tools incl whip hose, no tool nipple included					
MIDI Optimizer F/RD EQ10-R13-W	23 l/s	Rubair 13 mm	ErgoQIC 10	Yes	8202 0850 15

Chisels for chipping hammers and scalers

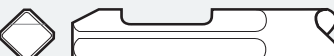
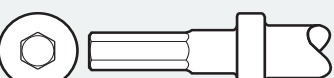
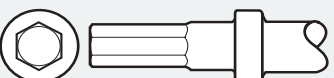
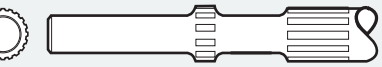
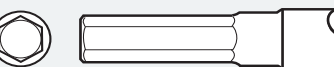

CHISELS FOR CHIPPING HAMMERS. All chisels are normally through hardened. Otherwise, see tables.

Figure	Shank type	Tools	Table
	Square shank 13.0 mm	RRC13 RRC13B	1
	Extended square shank ISO, 12.7 mm		1
	Hexagon and round shank ISO, round collar 12.7 mm	RRC22F-01, RRC22F-02 RRF21, RRF31	2
	Hexagon shank ISO round collar 17.3 mm	RRC34B-01 RRC65B-01 RRC75B-01	3
	Round shank ISO, with splines 17.3 mm	RRD37 RRD57	3
	Hexagon shank ISO without round collar 17.3 mm	RRC34-01 RRC65-01 RRC75-01	4
	Round shank ISO, without collar 17.3 mm	RRC34-02 RRC65-02 RRC75-02	4
	Special shank	RVM07B	5

Chisels for chipping hammers and scalers

1 A. Chisels with square shank 13.0 mm B. Chisels with square shank ISO 12.7 mm



Chisel type	Designation	Width		Length		Square 13 mm (1/2") Ordering No.	ISO Extended square 12.7 mm (1/2") Ordering No.
		mm	in	mm	in		
	Chisel blank	15	0.59	155	6.1	3085 0020 00	
		15	0.59	200	7.9	3085 0020 01	
		15	0.59	300	11.8	3085 0020 02	
	Flat chisel	15	0.59	165	6.1	3085 0227 00	3085 0230 01
		15	0.59	200	7.9	3085 0227 01	
	Wide flat chisel	35	1.38	165	6.5	3085 0032 00	3085 0232 01
		35	1.38	200	7.9	3085 0032 01	
		35	1.38	300	11.8	3085 0032 02	
		55	2.17	165	6.5	3085 0332 00	
	Angle scraper chisel	35	1.38	165	6.5	3085 0176 00	3085 0362 00
		35	1.38	200	7.9	3085 0176 01	
		55	2.17	165	6.5	3085 0333 00	
	Scaling chisel	15	0.59	155	6.1	3085 0018 00	3085 0229 01
		15	0.59	200	7.9	3085 0018 02	
		15	0.59	300	11.8	3085 0018 01	

2 A. Chisels with hexagon shank ISO, round collar 12.7 mm B. Chisels with round shank ISO, round collar 12.7 mm



Chisel type	Designation	Width		Length		Hex ISO 12.7 mm (1/2") Ordering No.	Round ISO 12.7 mm (1/2") Ordering No.
		mm	in	mm	in		
	Chisel blank	13	0.51	200	7.9	3085 0182 00	
		13	0.51	350	13.8	3085 0182 01	
		13	0.51	400	15.7	3085 0182 04	
		13	0.51	500	19.7	3085 0182 05	
	Flat chisel	13	0.51	200	7.9	3085 0183 00	3085 0184 00
		35	1.38	300	11.8	3085 0376 00	
	Sharp chisel	15	0.59	200	7.9	3085 0170 00	
		15	0.59	300	11.8	3085 0170 01	
	Spot weld chisel	17	0.69	200	7.9	3085 0301 00	
	Angle scraper chisel	30	1.18	200	7.9	3085 0262 00	
	Pipe cutting chisel	20	0.78	200	7.9	3085 0302 00	
		35	1.38	200	7.9	3085 0303 00	
	Plate cutting chisel	14.5	0.57	200	7.9	3085 0263 00	
	Plate cutting chisel	16	0.62	200	7.9	3085 0173 00	
	Moil point chisel	13	0.51	200	7.9	3085 0297 00	
		13	0.51	305	12.0	3085 0297 01	

Chisels for chipping hammers and scalers

3 A. Chisels with hexagon shank ISO, round collar 17.3 mm B. Chisels with round ISO shank with splines 17.3 mm

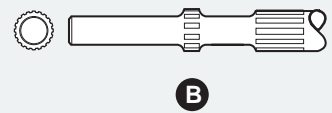
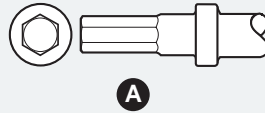

Chisel type	Designation	Width		Length		Hex ISO 17.3 mm (0.68") Ordering No.	Width		Length		Round ISO with splines 17.3 mm (0.68") Ordering No.
		mm	in	mm	in		mm	in	mm	in	
	Chisel blank	22	0.86	335	13.1	3085 0220 00	22	0.86	250	9.8	3085 0242 00
		22	0.86	560	22.0	3085 0220 01	22	0.86	340	13.4	3085 0242 01
		22	0.86	1060	41.7	3085 0220 02	22	0.86	550	21.7	3085 0242 02
	Flat chisel	22	0.86	260	10.2	3085 0221 00	22	0.86	215	8.5	3085 0236 00
		22	0.86	335	13.1	3085 0221 01	22	0.86	250	9.8	3085 0236 01
		22	0.86	560	41.9	3085 0221 02	22	0.86	340	13.4	3085 0236 02
		22	0.86				22	0.86	800	31.5	3085 0242 03
		22	0.86				22	0.86	1200	47.2	3085 0242 04
	Flat chisel	32	1.26	335	13.1	3085 0989 00	32	1.26	340	13.4	3085 0252 00
		50	1.97	335	13.1	3085 0235 00	50	1.97	340	13.4	3085 0250 00
		130	5.12	400	15.7	3085 0342 00	130	5.12	400	15.7	3085 0998 00
	Wide flat chisel Extra wide flat chisel	50	1.97	335	13.1	3085 0235 00	50	1.97	340	13.4	3085 0250 00
		130	5.12	400	15.7	3085 0342 00	130	5.12	400	15.7	3085 0998 00
	Angle scraper chisel	50	1.97	335	13.1	3085 0349 00	50	1.97	335	13.2	3085 0350 00
		50	1.97	335	13.1	3085 0349 00	50	1.97	335	13.2	3085 0350 00
	Moil point chisel	22	0.86	335	13.1	3085 0223 00	22	0.86	340	13.4	3085 0249 00
		22	0.86	560	15.7	3085 0223 01	22	0.86	560	15.7	3085 0223 01

4 A. Chisels with ISO shank without collar, round B. Chisels with ISO shank without collar, hexagon

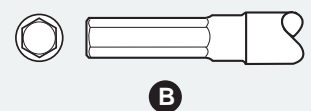

Chisel type	Designation	Width		Length		Round 17.3 mm (0.68") ISO Ordering No.	Hexagon 17.3 mm (0.68") ISO Ordering No.
		mm	in	mm	in		
	Chisel blank	23	0.91	200	7.9	3085 0150 00	
		23	0.91	560	22.0		3085 0140 01
	Flat chisel	23	0.91	225	8.9	3085 0225 00	3085 0224 00

5. Chisels with special shank



Chisel type	Designation	Material	Width		Length		Ordering No.
			mm	in	mm	in	
	Flat chisel	Tungsten carbide	10	0.39	120	4.7	3085 0321 00
		Through hardened steel	10	0.39	120	4.7	3085 0325 00
		Tungsten carbide	10	0.39	200	7.9	3085 0321 01
		Tungsten carbide	10	0.39	300	11.8	3085 0321 02
		Tungsten carbide	20	0.79	120	4.7	3085 0345 00
		Through hardened steel	20	0.79	120	4.9	3085 0346 00
	Wide chisel	Tungsten carbide	35	1.38	120	4.7	3085 0322 00
		Through hardened steel	35	1.38	120	4.7	3085 0327 00

Minimum vibration, maximum productivity

Atlas Copco's top-of-the-line riveting systems are designed to minimize the riveter's exposure to vibration, while maintaining high tool performance. The RRH recoilless riveting hammer has an air cushion behind the hammer piston which efficiently kills vibrations. The same air dampening technique is used in RBB bucking bars. It raises individual productivity and boosts output in your plant.

The Atlas Copco riveting system includes vibration-damped hammers RRH and bucking bars RBB – as well as conventional riveting hammers RRN.

The vibration-damped riveting hammers – RRH – are available in different sizes.

Each size is available in "Trigger start" and "Push to start" models.

The conventional riveting hammer – RRN – is available in one size: RRN11P.

CRITICAL FACTORS

The number of blows and the power are critical factors which determine the strength of a riveted joint. A few powerful blows are needed to fill out the hole and form a head when upsetting the rivet. The impact force is critical to some extent when working with aluminum alloys, as too many blows can embrittle the metal.

In terms of capacity, the tools overlap. The selection guide below helps you to find the right tool for your particular application of riveting.

The vibration-damped bucking bars RBB are available in two versions – the simple spring damped – SP type and the air servo assisted SA type.



Selection Guide

Hammer model ^a	Nominal Max. Rivet Diameter Capacity						Bucking bar model required ^b	
	Dural		Steel		Titanium			
	mm	in	mm	in	mm	in		
RRN11	2-5	3/32 - 3/16	1-4	3/32 - 5/32				
RRH04	2-5	3/32 - 3/16	1-4	3/21 - 5/32			RBB04	RBB10
RRH06	4-7	5/32 - 1/4	3-6	1/8 - 1/4	2-4	3/32 - 5/32	RBB10	RBB16
RRH08	5-8	3/16 - 5/16	4-7	5/32 - 1/4	3-6	1/8 - 1/4	RBB10	RBB16
RRH10	5-9	3/16 - 3/8	6-8	1/4 - 5/16	4-7	5/32 - 1/4	RBB16	
RRH12	8-11	5/16 - 7/16	7-10	1/4 - 3/8	6-9	1/4 - 3/8	RBB16	
RRH14	11-13	7/16 - 1/2	9-12	3/8 - 15/32	8-11	5/16 - 7/16	RBB16	

^a Hammer capacity depends on direct/indirect riveting as well as Panel density and stiffness.

^b Bucking bar capacity is dependent on dolly weight.

Vibration-damped

Riveting Hammers

RRH is a unique series of riveting hammers incorporating completely revolutionary ergonomic advantages.

- **Versatile** – RRH can easily cope with rivets in diameters up to 13 mm.
- **Vibration-damped system** – The RRH vibration-damped riveting hammer, combined with the RBB vibration-damped bucking bar, offer an unbeatable system for riveting.
- **Adjustable power.**
- **Adjustable hand guard** – Support hand grip is vibration-damped.
- Now new models with trigger start for excellent handling. Pistol grip with rubber coating.



Model	Airframe ref	Blows per minute	Rivet set shank		Piston dia		Stroke		Energy per blow		Weight		Air consumption		Hose size		Air inlet	Ordering No.
			mm	in	mm	in	mm	in	J	ft lb	kg	lb	l/s	cfm	mm	in	BSP	
With push start																		
RRH04P-01	2X	3960	10.0	0.4	15	0.6	40	1.6	2.0	1.5	1.0	2.2	3.7	6	6.3	1/4	1/4	8426 1111 07
RRH04P-02	2X	3960	10.2	0.4	15	0.6	40	1.6	2.0	1.5	1.0	2.2	3.7	6	6.3	1/4	1/4	8426 1111 15
RRH04P-12	2X	3960	10.2	0.4	15	0.6	40	1.6	2.0	1.5	1.0	2.2	3.7	6	6.3	1/4	1/4	8426 1111 25
RRH06P	3X	2160	10.2	0.4	15	0.6	102	4.0	6.0	4.4	1.3	2.9	9.0	19	10.0	3/8	1/4	8426 1111 04
RRH08P	4X	1440	10.2	0.4	15	0.6	137	5.4	8.0	5.9	1.4	3.0	10.0	21	10.0	3/8	1/4	8426 1111 09
RRH10P	5XB	1500	12.7	0.5	19	0.7	118	4.6	13.0	9.6	2.0	4.4	12.0	24	10.0	3/8	1/4	8426 1110 20
RRH12P	7XB	1200	12.7	0.5	19	0.7	153	6.0	16.0	11.8	2.1	4.6	13.0	28	10.0	3/8	1/4	8426 1110 47
RRH14P	9XB	1080	12.7	0.5	19	0.7	188	7.4	19.5	14.4	2.2	4.8	13.0	28	10.0	3/8	1/4	8426 1110 80
With trigger start																		
RRH04P TS-12	2X	3960	10.2	0.4	15	0.6	40	1.6	2.0	1.5	1.0	2.2	3.7	6	6.3	1/4	1/4	8426 1111 27
RRH06P TS	3X	2160	10.2	0.4	15	0.6	102	4.0	6.0	4.4	1.3	2.9	9.0	19	10.0	3/8	1/4	8426 1111 66
RRH08P TS	4X	1440	10.2	0.4	15	0.6	137	5.4	8.0	5.9	1.4	3.0	10.0	21	10.0	3/8	1/4	8426 1111 68
RRH10P TS	5XB	1500	12.7	0.5	19	0.7	118	4.6	13.0	9.6	2.0	4.4	12.0	24	10.0	3/8	1/4	8426 1110 70
RRH12P TS	7XB	1200	12.7	0.5	19	0.7	153	6.0	16.0	11.8	2.1	4.6	13.0	28	10.0	3/8	1/4	8426 1110 72
RRH14P TS	9XB	1080	12.7	0.5	19	0.7	188	7.4	19.5	14.4	2.2	4.8	13.0	28	10.0	3/8	1/4	8426 1110 81

-01 means 10 mm short shank rivet set.

-02 means 10.2 mm short shank rivet set.

-12 means 10.2 mm stand shank rivet set.

Conventional Type

Riveting Hammers

For riveting in confined spaces we recommend our RRN11 riveting hammer.

- **RRN11** – is the smallest riveting hammer available on the market, with unique accessibility.
- **Adjustable** – The RRN11 has a built-in adjustment knob with which you can set the power for different rivet materials and sizes.
- **Controllable** – The trigger is easily operated and provides excellent control.



Model	Airframe ref	Blows per minute	Rivet set shank		Piston dia		Stroke		Energy per blow		Weight		Air consumption		Hose size		Air inlet	Ordering No.
			mm	in	mm	in	mm	in	J	ft lb	kg	lb	l/s	cfm	mm	in	BSP	
RRN11P-01	2X	3960	10.0	0.4	15	0.6	40	1.6	2.0	1.5	1.2	2.6	3.4	7.2	6.3	1/4	1/8	8426 1101 05
RRN11P-02	2X	3960	10.2	0.4	15	0.6	40	1.6	2.0	1.5	1.2	2.6	3.4	7.2	6.3	1/4	1/8	8426 1101 13

-01 means 10 mm short shank rivet set.

-02 means 10.2 mm short shank rivet set.

Dimensions

Model	L mm	H mm	C mm
RRH			
RRH04-01	160	147	23
RRH04-02	160	147	23
RRH04-12	175	147	23
RRH06	225	147	24
RRH08P	244	147	24
RRH10P	264	150	27
RRH12P	299	150	27
RRH14P	334	150	27
RRN			
RRN11P	100	170	23

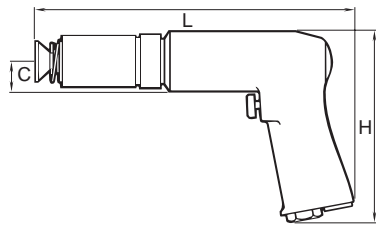

RRH

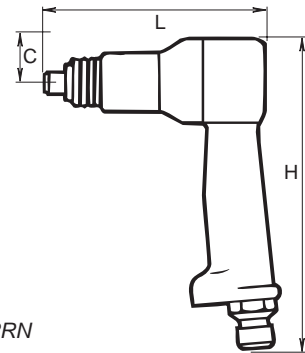

RRN

Accessories Included

FOR RRH MODELS

Hose fitting
Flush set
Open spring retainer

FOR RRN11P

Hose fitting and retainer
Blank rivet set
Retainers for blank and flush rivet set

Optional Accessories

RIVET SETS. RRH AND RRN

Hammer type	Model	Shank mm	Flush set	Ordering No.	Blank rivet set	Ordering No.
RRH04P-01 RRN11P-01	(-01)	10.0 spec		3085 0347 00		3006 0983 00
RRH04P-02 RRN11P-02	(-02)	10.2 spec		3085 0352 00		3085 0353 00
RRH04P-12 RRH06P RRH08P	(-12)	10.2 std		3085 0324 00		3085 0022 00
RRH10P RRH12P RRH14P		12.7 std		3085 0323 00		3085 0021 00
RRH04P-12 RRH06P RRH08P		10.2 std				3085 0212 00 Mandrel blank
RRH04P-12 RRH06P RRH08P		10.2 std				3085 0212 02

An efficient riveting system consists of vibration-damped bucking bars together with vibration-damped riveting hammers.

- **Self-adjustable** – RBB10SA and RBB16SA feature a self-adjusting damping system which requires a compressed air supply. RBB04SP, RBB10SP and RBB16SP use a spring as damping element and consequently do not require an air supply.
- **Flexible** – The bucking bars can be fitted with several different interchangeable dolly configurations via a quick change retainer for maximum flexibility.
- **Cramped spaces** – Mini bucking bars RBB04SP are ideal for work in confined spaces. The large mass types -04, -05 will in most applications set the rivet faster than the smaller models.

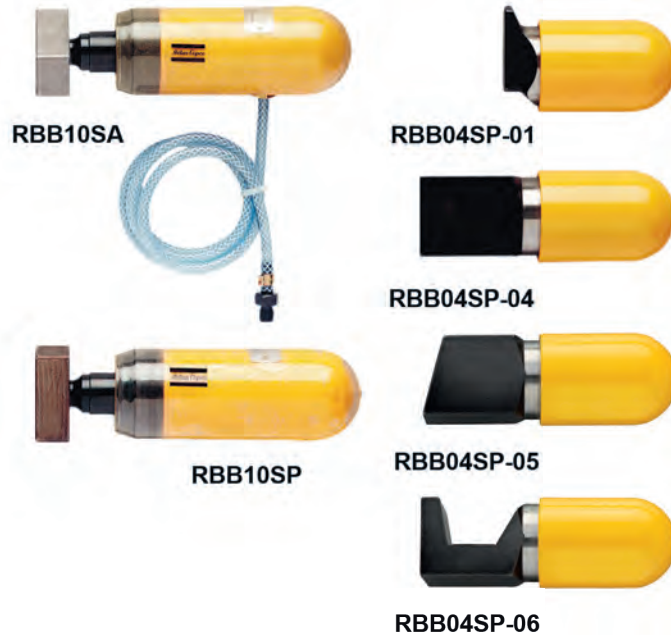

Model	Weight		Diameter		Air consumption		Ordering No.
	kg	lb	mm	in	l/s	cfm	
With standard dolly^a							
RBB10SA	1.3	2.9	48	2.0	0.5	1.1	8426 9101 77
RBB10SP	1.1	2.4	48	2.0	–	–	8426 9101 74
RBB16SA	1.9	4.2	48	2.0	0.5	1.1	8426 9101 78
RBB16SP	1.7	3.7	48	2.0	–	–	8426 9101 76
Mini bucking bars							
RBB04SP-01	0.8	1.8	46	1.8	–	–	8426 9101 10
RBB04SP-04	1.3	2.9	46	1.8	–	–	8426 9101 13
RBB04SP-05	1.4	3.1	46	1.8	–	–	8426 9101 14
RBB04SP-06	1.1	2.5	46	1.8	–	–	8426 9101 15

^a Standard dolly assy (3085 0335 93).

Accessories Included

ALL SA-MODELS

Hose and hose fitting
Plastic cover

ALL 10/16 MODELS

Plastic cover

Optional Accessories

Designation	Ordering No.
Rod 5 mm	3085 0365 03
Rod 50 mm	3085 0365 04
Rod 100 mm	3085 0365 05

Dimensions

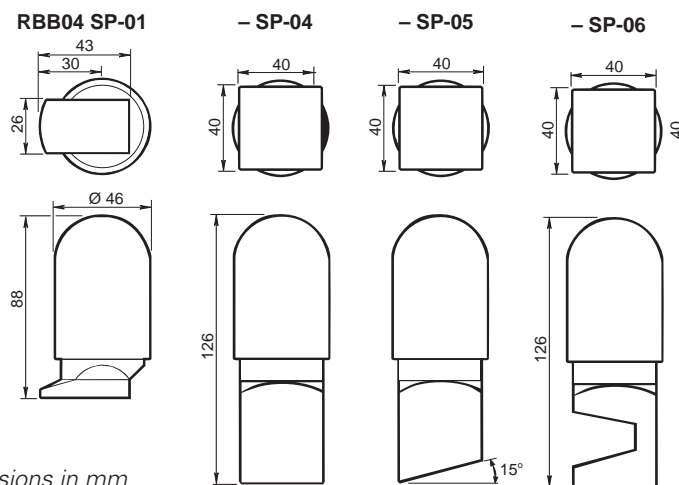

Dimensions in mm

DIMENSIONS RBB10/16

Model	L mm	H mm	C mm
RBB10SA/SP	165	49	140
RBB16SA/SP	200	49	198

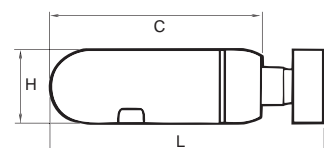

Optional Accessories

DOLLIES FOR RBB10 AND RBB16, ALL MODELS

Dolly type	Weight		Ordering No. With rod 5 mm	Weight		Ordering No. With rod 50 mm	Weight		Ordering No. With rod 100 mm
	kg	lb		kg	lb		kg	lb	
A	0.37	0.8	3085 0335 93 ^a	0.47	1.0	3085 0335 94	0.67	1.5	3085 0335 95
B	0.25	0.55	3085 0363 93	0.35	0.8	3085 0363 94	0.55	1.3	3085 0363 95
C	0.36	0.8	3085 0364 93	0.46	1.0	3085 0364 94	0.66	1.5	3085 0364 95
D	0.43	0.9	3085 0337 93	0.53	1.2	3085 0337 94	0.73	1.6	3085 0337 95
E	0.35	0.8	3085 0339 93	0.45	1.0	3085 0339 94	0.65	1.5	3085 0339 95
F	0.57	1.3	3085 0336 93	0.67	1.5	3085 0336 94	0.87	1.9	3085 0336 95
G	1.00	2.2	3085 0338 93	1.10	2.4	3085 0338 94	1.30	2.9	3085 0338 95
H	0.62	1.4	3085 0340 93	0.72	1.6	3085 0340 94	0.92	2.0	3085 0340 95
J	0.62	1.4	3085 0341 93	0.72	1.6	3085 0341 94	0.92	2.0	3085 0341 95

^a Standard dolly assy.

Other dollies can also be used, apart from Atlas Copco's, and press fitted onto a rod. Please see rod (i.e. hole) specification in the below drawing. Custom design dollies are recommended to be manufactured locally and fitted on to Atlas Copco rods.

DIMENSIONAL DRAWING OF DOLLIES AVAILABLE

