

# FIREARMS NEWS

GUN SALES, REVIEWS, & INFORMATION

MARCH 2021  
ISSUE 5

## SPRINGFIELD ARMORY'S 2020 WAYPOINT 6.5MM PRC RIFLE DOUBLE FEATURE!

**RIKK RAMBO**  
TAKES THE WAYPOINT  
ON AN ALASKAN  
ADVENTURE!

**DAVID FORTIER**  
STRETCHES  
THE LEGS ON  
WAYPOINT  
2020 OUT TO  
800 YARDS!

**JAMES TARR**  
EVALUATES  
ATAC DEFENSE'S  
BASIC PLUS  
AR-TYPE RIFLE

SMALL ARMS OF THE  
RUSSO-FINNISH  
WINTER WAR,  
PART I BY PAUL SCARLATA



# ELMS



## EXPERT LASER MARKSMAN SYSTEM



### Available Calibers

9MM .45ACP .40S&W  
380ACP \*10MM \*.38SUPER  
\*9MM MAKAROV \*.223  
\*.45 LONG COLT

\* Available in Gen 2 - ELMS Gen3 available Winter 2020

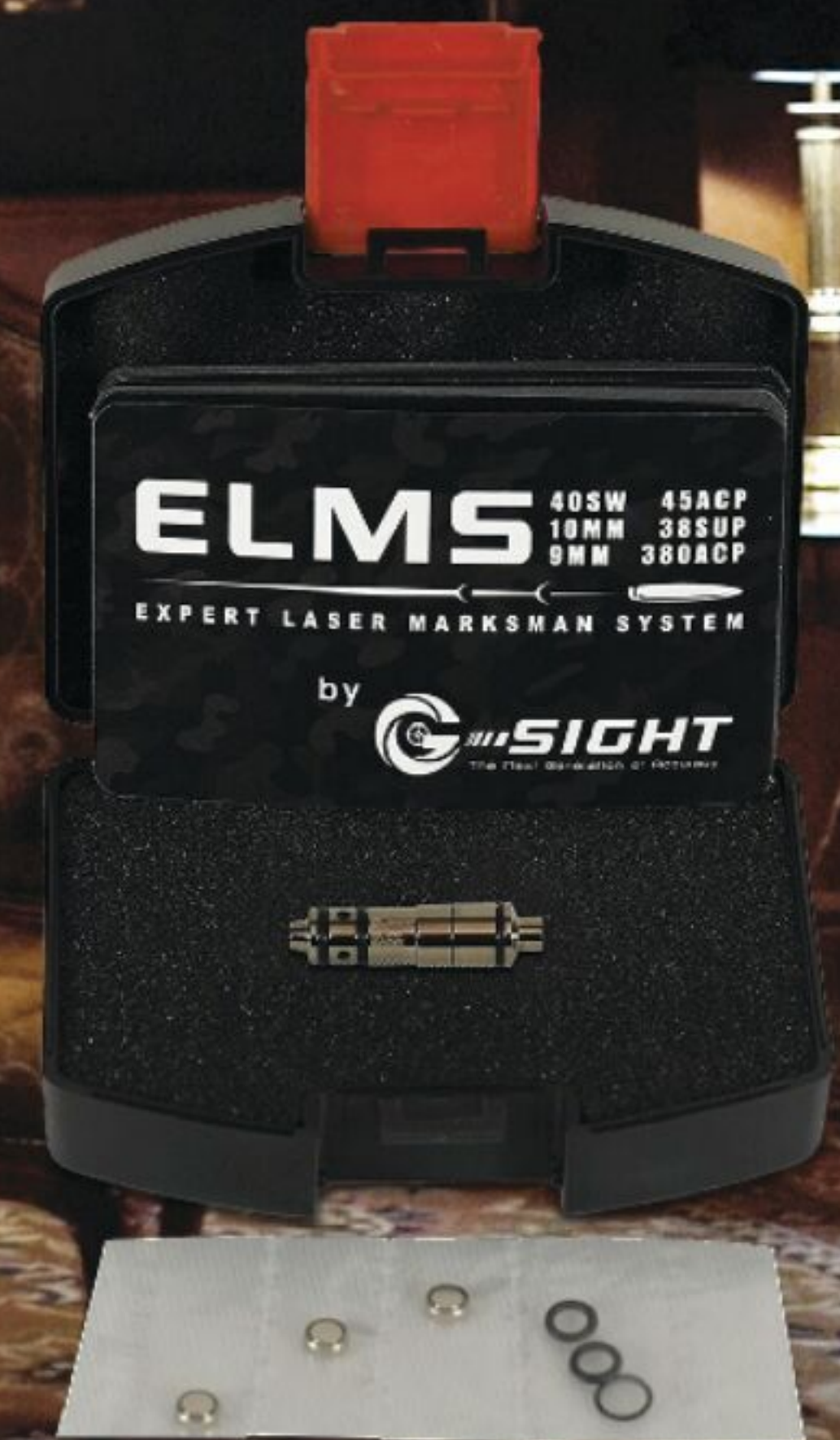

[g-sight.com](http://g-sight.com)

TRAIN AT HOME WITH YOUR OWN GUN



# THE NEW **RRAGE** IN ENTRY CARBINES

**LAR-15 RRAGE RIFLE DS1850**  
with RRA Six-Position Tactical CAR

**16" LIGHTWEIGHT CHROME MOLY**  
1:9 Twist Barrel

## INTRODUCING THE **LAR-15 RRAGE RIFLE**

**Punching above its weight class**, this new entry carbine features a sleek monolithic upper receiver/handguard with side and bottom MLOK® ports. **This NEW RRAGE sets a higher benchmark for all entry carbines to follow.**



**LAR-15 RRAGE RIFLE QUICK SPECS:** CALIBER: .223/5.56MM NATO CHAMBER  
WEIGHT: 5.7 POUNDS LENGTH: 36"

**ONLY AVAILABLE THROUGH  
YOUR LOCAL DEALER.**

**ROCKRIVERARMS.COM**



**PERFORMANCE TUNED.**

\* Optics and scope mount not included.

All inquiries for  
**Advertising, Editorial:**  
**1-800-521-2885, ext. 5064**  
**2 News Plaza, 3<sup>rd</sup> Floor**  
**Peoria, IL 61614**

### PLACING AN AD

Advertisers will furnish **FIREARMS NEWS** with copy legibly printed or typewritten on one side of the paper only. Please leave a margin of at least 1" on all sides. Classified ad copy can be submitted on disk, e-mailed to [firearmsnews@outdoorsg.com](mailto:firearmsnews@outdoorsg.com), through [www.firearmsnews.com](http://www.firearmsnews.com), or picked up from your web site.

Contact the Art Director before submitting electronic display advertising.

Due care and diligence is used in checking advertising copy for accuracy, but the Publisher makes no warranty, express or implied. Advertisers and **FIREARMS NEWS** are not responsible for typographical errors, mistakes or misprints.

All ads received too late for the current issue will be inserted in the following issue, unless you qualify the submission of the ad. Existing ad copy may be substituted if new copy fails to arrive by the specified date.

Advertising is credit card, check or money order in advance. If uncertain as to the cost of your ad, submit it and we will advise the amount to be remitted, and we will refund any overage.

Artwork is kept in our files for 13 months and then destroyed. Reproduction quality is not guaranteed.

**FIREARMS NEWS** reserves the right to omit any ads that in its opinion are objectionable.

In addition, **FIREARMS NEWS** will no longer accept ads offering the following items for sale: Plans, videos or books for converting semi-automatic firearms into full-automatic firearms.

Sound suppressor plans, and videos. Plans or formulas for making explosives, booby traps, etc.

Lock picks, Slim-Jims, etc. and lock picking instructions.

Also, items related to the above.

**If in doubt about your ad, call us.**

### AD DEADLINE DATES

ISSUE	DEADLINE	ISSUE	DEADLINE
Vol. 75 - Issue 8	Mar. 8	Vol. 75 - Issue 11	Apr. 26
Vol. 75 - Issue 9	Mar. 29	Vol. 75 - Issue 12	May 10
Vol. 75 - Issue 10	Apr. 12	Vol. 75 - Issue 13	May 21

**NOTE: ALL ad space MUST be reserved and art materials MUST be received BEFORE the above DEADLINE DATES!**

### COMPLAINTS AGAINST ADVERTISERS

We want **FIREARMS NEWS** readers to receive prompt, friendly service from our advertisers. If you have experienced bad service from a **FIREARMS NEWS** advertiser, you may submit a complaint in writing to **FIREARMS NEWS**, Dept. CL, 2 News Plaza, 3rd Floor, Peoria, IL 61614. You can e-mail to [firearmsnews@outdoorsg.com](mailto:firearmsnews@outdoorsg.com) or fax to (309) 679-5476. We do not accept complaints by telephone. Note that **FIREARMS NEWS** is not a law enforcement agency and cannot investigate complaints. We will contact the advertiser on your behalf, and a continuing pattern of complaints can cost an advertiser its advertising privileges.

### SUBSCRIPTION INQUIRIES

**BE AWARE THAT FIREARMS NEWS ONLY ACCEPTS SUBSCRIPTION REQUESTS FROM AUTHORIZED AGENTS! WE MAY NOT HONOR REQUESTS FROM UNAUTHORIZED AGENTS, AND YOU THEREFORE MAY LOSE YOUR MONEY IF YOU BUY FROM AN UNAUTHORIZED AGENT.** If you are offered a subscription to **FIREARMS NEWS**, please call 1-800-345-6923 to determine if the agent is authorized. For more information on subscription scams, please visit [www.ftc.gov](http://www.ftc.gov).

**To change your address:** Call our toll-free customer service number or E-mail us with your new address **6 to 8 weeks before** your move. **If you receive a bill after you've paid:** Our letters probably crossed in the mail. Please disregard any bill or renewal notice you receive soon after mailing your payment or order. (If you continue to receive notices, please let us know.)

**If your issue is damaged or missing:** Call our toll-free number or E-mail us. We'll replace the issue or extend your subscription, whichever you prefer. Remember, **FIREARMS NEWS** is published 24 times a year.

**Toll-Free Subscription Number**  
**1-800-345-6923**  
 Outside U.S.; call 386-447-6318  
**E-mail: [sgncustserv@cdfsfulfillment.com](mailto:sgncustserv@cdfsfulfillment.com)**

# FIREARMS NEWS®

An Outdoor Sportsman Group® Publication

#### PUBLISHER

Mike Schoby

#### EDITORIAL EDITOR

Vincent L. DeNiro

#### FIELD EDITORS:

Senior Field Editor

David Fortier

Gunsmithing

Gus Norcross

Historic Military Arms

Paul Scarlata

Hunting

Rikk Rambo

Machine Guns & Tactics

Leroy Thompson

Movie Guns

Dr. Will Dabbs

NFA & Airguns

Patrick Sweeney

Pistols

James Tarr

Columnists

Mark Chestnut, David Codrea, Jim Grant,

Jeff Knox, Vin Suprynowicz

#### DESIGN

SENIOR ART DIRECTOR

Bill Smalley

ASSISTANT ART DIRECTOR

Ashley N. Honea

ASSISTANT ART DIRECTOR

Mark Kee

#### PRODUCTION

PRODUCTION MANAGER

Terry Boyer

#### ADVERTISING

ADVERTISING DIRECTOR

Pat Bentzel (East Region) (717) 695-8095

[patrick.bentzel@outdoorsg.com](mailto:patrick.bentzel@outdoorsg.com)

ADVERTISING SALES MANAGER

Mark Thiffault (720) 630-9863

[mark.thiffault@outdoorsg.com](mailto:mark.thiffault@outdoorsg.com)

ACCOUNT EXECUTIVE, AD SALES

Brendan Vorobiev (734) 800-6666

CLASSIFIED ADVERTISING REPRESENTATIVE

Sue Fitch (309) 679-5064

#### Western Region

Hutch Looney & Associates

email: [hutch@hlooney.com](mailto:hutch@hlooney.com)

#### NATIONAL AD SALES

Account Director – Detroit Office

Kevin Donley (248) 798-4458

National Account Executive – Chicago Office

Carl Benson (312) 955-0496

Direct Response Advertising/Non-Endemic

Anthony Smyth (914) 409-4202



PRESIDENT & CHIEF EXECUTIVE OFFICER

Jim Liberatore

CHIEF OPERATING OFFICER,

PUBLISHING & BRANDED MEDIA

Mike Carney

EVP, GROUP PUBLISHER & OPERATIONS

Derek Sevcik

VP, CONSUMER MARKETING

Peter Watt

VP, MANUFACTURING

Deb Daniels

SENIOR DIRECTOR, PRODUCTION

Connie Mendoza

DIRECTOR, PUBLISHING TECHNOLOGY

Kyle Morgan

SENIOR CREATIVE DIRECTOR

Tim Neher

DIRECTOR, DIGITAL EDITORIAL

Jeff Phillips

For questions regarding digital editions, please contact [digitalsupport@outdoorsg.com](mailto:digitalsupport@outdoorsg.com)

#### MEDIA

[outdoorsg.com](http://outdoorsg.com)

#### TELEVISION

[outdoorchannel.com](http://outdoorchannel.com)

[thesportsmanchannel.com](http://thesportsmanchannel.com)

[worldfishingnetwork.com](http://worldfishingnetwork.com)

#### HUNTING

[bowhunter.com](http://bowhunter.com)

[bowhuntingmag.com](http://bowhuntingmag.com)

[gundogmag.com](http://gundogmag.com)

[petersenshunting.com](http://petersenshunting.com)

[northamericanwhitetail.com](http://northamericanwhitetail.com)

[wildfowlmag.com](http://wildfowlmag.com)

#### FISHING

[bassfan.com](http://bassfan.com)

[floridasportsman.com](http://floridasportsman.com)

[flyfisherman.com](http://flyfisherman.com)

[gameandfishmag.com](http://gameandfishmag.com)

[in-fisherman.com](http://in-fisherman.com)

#### SHOOTING

[gunsandammo.com](http://gunsandammo.com)

[handguns.com](http://handguns.com)

[rifleshooter.com](http://rifleshooter.com)

[shootingtimes.com](http://shootingtimes.com)

[firearmsnews.com](http://firearmsnews.com)

*Firearms News* (USPS Periodicals Permit 23130) is published 24 times a year. Semimonthly January through December by OUTDOOR SPORTSMAN GROUP, 1040 6<sup>th</sup> Ave., 17<sup>th</sup> Floor, New York, NY 10018. Periodical postage paid at New York, NY and at additional mailing offices. **POSTMASTER:** Send address change (Form 3579) to *Firearms News*, P.O. Box 37539, Boone, IA 50037-0539. Return undeliverable Canadian addresses to: 500 Rt. 46 East Clifton, NJ 07011. Canada Post Publications Mail-Agreement No. 41405030.

**To know when your subscription expires:** Check the printed address label on the magazine cover. The date your subscription expires appears to the right of your name and address. Allow 6-8 weeks after renewing for the label to reflect your new expiration date.

**Occasionally, our subscriber list is made available to reputable firms offering goods and services that we believe would be of interest to our readers. If you prefer to be excluded, please send your current address label and a note requesting to be excluded from these promotions to: Outdoor Sportsman Group – 1040 6th Ave, 17th Floor, New York, NY 10018 Attn: Privacy Coordinator, or email your label information and note to [privacy@outdoorsg.com](mailto:privacy@outdoorsg.com)**



PRINTED IN THE U.S.A.



Copyright 2021 by Outdoor Sportsman Group®  
 All Rights Reserved. No part of this book may be reproduced without written permission.

**FIREARMS NEWS®** is a registered trademark of Outdoor Sportsman Group® in the United States.

The Publisher and authors make no representations or warranties regarding the accuracy, completeness or timeliness of the information

contained in this publication. Any reliance or use of the information is solely at your own risk, and the authors and Publisher disclaim any and all liability relating thereto. Any prices given in this issue were suggested prices at the press time and are subject to change. Some advertisements in this magazine may concern products that are not legally for sale to California residents or residents in other jurisdictions.

# STOP DIGGING FOR YOUR GUNS

## THE XL SPINS!

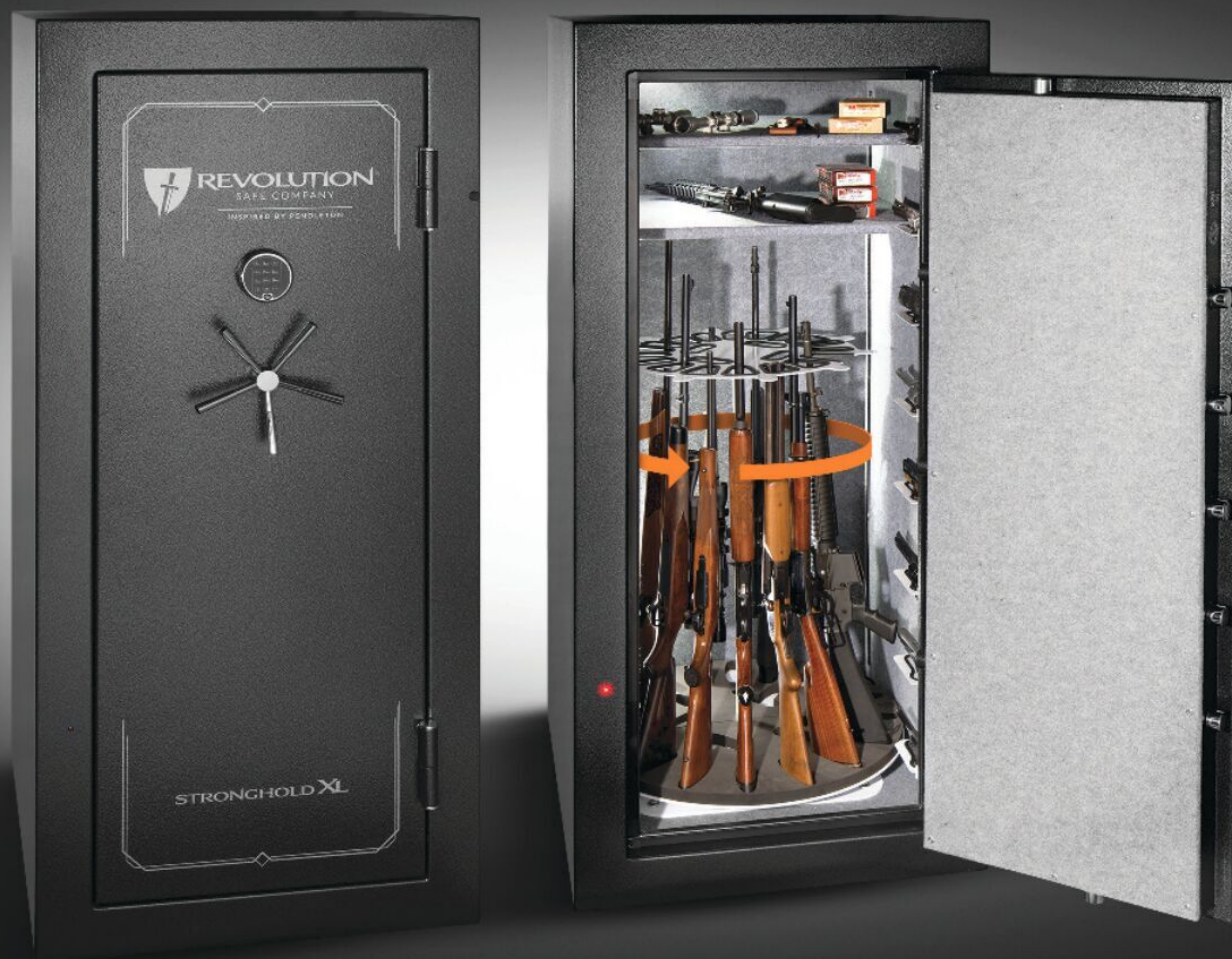

## STRONGHOLD XL

Lights | Moisture Control | Security | High Capacity Revolving Gun Storage

**GET IN LINE NOW! PLACE YOUR DEPOSIT AT 770-466-6181.**



**REVOLUTION**<sup>®</sup>  
SAFE COMPANY

INSPIRED BY PENDLETON

**Visit [RevolutionSafes.com](http://RevolutionSafes.com) for more information.**

# CONTENTS

## 8 PRODUCT SHOWCASE



### 10 A YEAR AND RIFLE TO REMEMBER: THE SPRINGFIELD 2020 WAYPOINT AND AN ALASKAN HUNT!

Rikk Rambo

### 36 400 TO 800 YARDS

We Stretch the Legs on Springfield Armory's New 6.5mm PRC Model 2020 Waypoint

David M. Fortier

### 46 ATAC DEFENSE'S BASIC PLUS RIFLE

More Than You Know

James Tarr

### 56 SMALL ARMS OF THE RUSSO-FINNISH WINTER WAR, PART 1

"Hakkaa päälle!"

Paul Scarlata

### 82 THE FIGHTING BUNCH GIVES LESSON FROM PAST ON COMMITMENT IT TAKES TO OVERCOME ELECTORAL FRAUD

David Codrea

### 84 NEWSSTAND

Recent News For the Firearms Community



facebook.com/  
FirearmsNewsMag



twitter.com/  
FirearmsNewsMag



instagram.com/  
firearmsnews

# DISPLAY ADS

1791 Gunleather..... 29

## A

Altor Corporation..... 35

American Gunsmithing Institute  
..... 69

American Tactical, Inc. .... 112

AMG International Armory ..... 104

AR15Mold.com .....102, 106

## B

Black Hills Ammunition, Inc ..... 43

Bob's Gun Shop ..... 106

Bravo Company USA  
..... 12, 13, 16, 17, 33

Buffalo Arms Company ..... 107

## C

CBRPS, LLC ..... 107

Centerfire Systems, Inc..... 107

Crosscut Saw Co. .... 103

## D

D.B. Stewart Enterprises, LLC ... 105

## G

G-Sight Solutions..... 2

Grizzly Industrial ..... 41

## H

Handi Racker ..... 103

Hornady Mfg Co Natl..... 7, 65, 103

Hunter's Lodge Corp. .... 77

## K

Kahr Arms ..... 9, 55

## L

L&S Supply..... 103

## M

M&A Parts ..... 73

McCutchen Firearms..... 33

## N

Nextten Stauer, LLC..... 31

Nighthawk Custom ..... 111

## O

Outdoor Sportsman Group 63, 66, 83

## P

Pendleton Safes..... 5

## R

Rapidfire Triggers, Inc.  
..... 102, 104, 105, 106, 108

Rock River Arms, Inc..... 3

Ruben Mendiola, Jr..... 105, 109

## S

S & K Scope Mounts ..... 105

Sabot Designs LLC..... 102

Sarco, Inc. .... 79, 87-101

SCCY Industries ..... 23

Smith Wesson, Inc. .... 51

Starline..... 25

Stocky's LLC..... 35

## T

Tippmann Products, Inc. .... 25

## U

Uintah Precision..... 29

UltiMAK ..... 35

## V

Visir, Inc. .... 33

## W

Walther Arms, Inc. .... 21



# SECURITY IN STEALTH MODE

## RAPID® SAFE NIGHT GUARD™

The new RAPiD® Safe Night Guard™ hides in plain sight. Its size, shape and clock display make it look at home in any room. And its rugged construction and patented RFID technology keep your handgun secure and always close at hand.

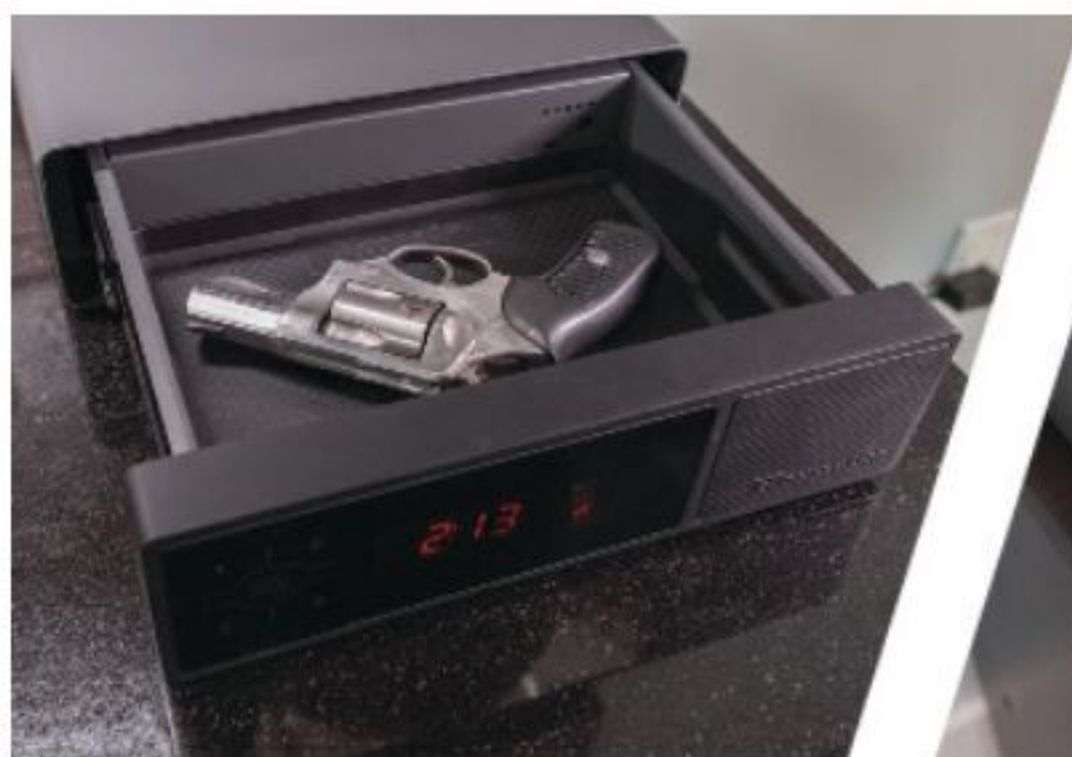

Discreet display panel and spring-assist drawer.



Touch-free RFID access using wristband, key fob or decal.



Alternate entry method includes programmable keypad.



USB ports, key backup and 1,500-lb. rated security cable.

800-338-3220 | [HORNADYSECURITY.COM](http://HORNADYSECURITY.COM)

Control all your RAPiD® Safes  
with the same RFID tag.



# PRODUCT SHOWCASE

## THE NEW DESPERADO 12-GAUGE DOUBLE-BARRELED SHOTGUN PISTOL!

The Desperado gives you an extra two inches of barrel over the six-inch Diablo model for extended range and tighter shot patterns! Check out these features:



- Barrel Length:** 8" Length hand polished Blued Barrel
- Type:** Break open-break action Double Barrel Side-by-side, smooth-bore
- Overall Length:** 12"
- Caliber:** 12 Gauge – Conventional 209 Primer Breech Plug Design BP muzzleloader, suggested load 40gr ffg, 1/2 oz shot (also available in 20 gauge)
- Finish:** Polished Blued
- Weight:** 4 Lbs.
- Type:** Single Hammer, Double Barrel, Single Trigger, 209 Primer Ignition ML
- Stock:** Black finish rubber hand guard and large 3 finger rubber Grip
- Sight Bead:** Sight bead installed
- Price:** \$639.00

No license or FFL required, order direct.

For more information please visit: [AmericanGunCraft.com](http://AmericanGunCraft.com) or call (612) 716-2597

## AMERICAN TACTICAL, INC. OFFERS UPDATED SCHMEISSER S60 MAGAZINE WITH WINDOW



AMERICAN TACTICAL

American Tactical, Inc. in partnership with German arms manufacturer, Schmeisser GmbH, has been exclusively importing and distributing the Schmeisser S60 60-round AR-15 magazines. Made from glass reinforced polymer, this patented stick magazine features a unique follower system that allows for double capacity from a normal AR magazine without being bulky or cumbersome. New for 2021, the updated Schmeisser S60 features a side window and a last round bolt hold open integrated in the follower. Designed to shoot both .223 REM & 5.56x45MM, the Schmeisser S60 will give you an instant capacity upgrade over the standard AR mag at an affordable price for your AR carbine or pistol.



View full product details for the Schmeisser S60 magazine with window at [AmericanTactical.us](http://AmericanTactical.us)

## NEW FOR 2021 – HOWA CARBON STALKER MINI ACTION!

Legacy Sports International is excited to announce the arrival of the HOWA CARBON STALKER Mini Action Series of rifles that will be SHIPPING to select HOWA distributors and dealers across the USA for 2021. The HOWA CARBON STALKER Mini Actions will be available in .223, 7.62x39 and 6.5 Grendel with a 22-inch standard Howa barrel that is fitted into an excellent Custom Carbon Fiber wrapped stock that brings the weight of this functional mighty lightweight beauty in at 4.11 pounds! This rifle is a perfect companion for numerous hunting applications from deer hunting to varmint hunting while providing exceptional accuracy and price! (Look for the Howa Carbon Stalker short action and long action series coming soon as well!)

- Howa Mini Action Standard 22-inch Barrel
- .223, 7.62x39, 6.5 Grendel
- Custom Carbon Fiber Super-Lightweight Stock
- 2-Stage Match Trigger
- 3-Position Safety
- Detachable Magazine
- 4.11 lbs. – Rifle Only
- Sub-MOA Assurance
- Lifetime Warranty
- MSRP \$999



**Howa**  
Precision Rifles & Barreled Actions

For more information on all of the LSI product line or to request a FREE 2021 catalog please call (775) 828-0555 or visit: [LegacySports.com](http://LegacySports.com)



# **DESERT EAGLE<sup>®</sup>**

MADE IN THE USA



**MAGNUM  
RESEARCH<sup>®</sup>**

[WWW.MAGNUMRESEARCH.COM](http://WWW.MAGNUMRESEARCH.COM) | [WWW.MAGNUMRESEARCHCUSTOMS.COM](http://WWW.MAGNUMRESEARCHCUSTOMS.COM)

# THE





**A YEAR AND RIFLE TO REMEMBER:**

# **SPRINGFIELD**

# **2020 WAYPOINT**

**AND AN ALASKAN HUNT!**

By Rikk Rambo Cover and lead photo by Mike Anschuetz

**D**id you ever have a one or two week run of bad luck that reminded you of an extremely cliché and played-out country song? You know the ballad I'm talking about...the one where you get laid off from your job, your spouse leaves you for your best friend, your dog dies, and you run your pickup truck right off the ding-dong-danged interstate? Short or tall, rich or poor, 9mm aficionado or .45 ACP fan (or for the purpose of this article, 6.5 Creedmoor or 6.5 PRC) we have all been there at some time in our lives.

Now take the above laundry list of misery, stretch it out to a year-long debacle, and augment it with a contentious, uncivil presidential/congressional election and the endless deluge of "nails on a chalkboard" political ads that accompanied it. But wait! That's not all, folks! Act now and you'll get a global pandemic complete with industrial scale, region-wide lockdowns and surgical mask requirements!

*[Cont. to page 14]*

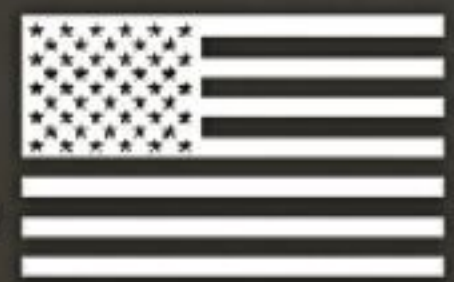

- Trijicon AccuPoint TR24G 1-4x24 Riflescope \$1,099.00
- BCM® Diamondhead Folding Rear Sight \$119.00
- BCM® KMR-A15 KeyMod Rail Handguard 15 Inch \$199.95
- BCMGUNFIGHTER™ QD End Plate \$16.95
- BCMGUNFIGHTER™ Stock \$55.95
- GEARWARD Ranger Band 20-Pak \$10.00
- BCMGUNFIGHTER™ Grip Mod 0 \$25.95
- American Defense RECON X Scope Mount \$189.95
- BCM® Diamondhead Folding Front Sight \$99.00
- BCMGUNFIGHTER™ KMSM KeyMod QD Sling Mount \$17.95
- BCMGUNFIGHTER™ Vertical Grip Mod 3 \$18.95
- BCM® Low Profile Gas Block \$44.95
- BCMGUNFIGHTER™ Compensator Mod 0 \$89.95
- BCM® A2X Flash Suppressor \$34.95

**B5 Systems SOPMOD Bravo Stock \$58.00**

**Blue Force Gear VCAS Sling \$59.95**

**BCM® PNT™ Trigger Assembly**  
Polished - Nickel - Teflon  
**\$65.95**

**Wilson Combat Tactical Trigger \$269.95**

**Inforce WML-HSP \$129.00**

**Trijicon TA31RCO-M4 ACOG 4x32 \$1,422.05**

**Aimpoint PRO Patrol Rifle Optic \$441.00**

**BCM® KMR-A KeyMod Free Float Rail Handguards**

Same as the fantastic original KMR Handguards but machined from aircraft aluminum!

BCM 9 Inch KMR-A9 ..... **\$176.95**  
 BCM 10 Inch KMR-A10 ..... **\$179.95**  
 BCM 13 Inch KMR-A13 ..... **\$189.95**  
 BCM 15 Inch KMR-A15 ..... **\$199.95**

**PWS DI KeyMod Rail Handguard**

Free float KeyMod rail for AR15/M4 pattern rifles.

PWS DI 12 Inch Rail ..... **\$249.95**  
 PWS DI 15 Inch Rail ..... **\$249.95**

**PWS KeyMod Polymer Bipod Adapter \$23.95**

**Daniel Defense SLiM Rail Handguard**

Slim, Light, Modular KeyMod free float handguard.

DD SLiM Rail 12.0 ..... **\$265.00**  
 DD SLiM Rail 15.0 ..... **\$265.00**

**Daniel Defense KeyMod Bipod Adapter \$48.00**

**Daniel Defense KeyMod 1 O'Clock Offset Rail Assembly \$40.00**

**BCM GUNFIGHTER™ KeyMod 1-Inch Ring Light Mount**

For 1" diameter lights **\$39.95**

**BCM GUNFIGHTER™ KeyMod Modular Scout Light Mount**

For SureFire Scout Light **\$39.95**

**BCM GUNFIGHTER™ KeyMod Modular Light Mount**

For 1913 mounted lights **\$39.95**

**Arisaka Inline KeyMod Scout Mount \$37.00**

**Arisaka Ring KeyMod 1" Light Mount \$45.00**

**Thorntail KeyMod Offset Adaptive Light Mounts**

Thorntail 1.030 Mount **\$70.00**  
 Thorntail M3M6 1913 Mount **\$50.00**

**Arson Machine Company KeyMod Light Mounts**

Scout M600 Mount **\$48.00**  
 1" Ring Mount **\$44.00**

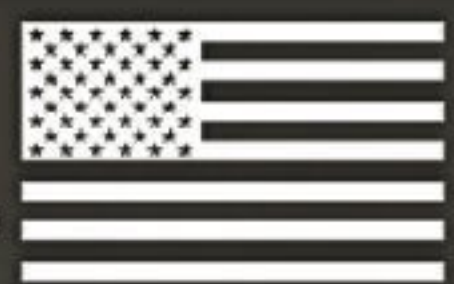



- Midwest Industries Folding Front Sight \$79.95
- Midwest Industries ERS BUIS \$93.95
- GEARWARD Ranger Band 20-Pak \$10.00
- BattleComp 1.5 \$155.00
- BCMGUNFIGHTER™ 1913 Modular Light Mount, KeyMod \$39.95
- BCMGUNFIGHTER™ KAG Kinesthetic Angled Grip, KeyMod \$18.95
- BCMGUNFIGHTER™ KMSM KeyMod QD Sling Mount \$17.95
- BCM® KMR-A13 KeyMod Rail Handguard 13 Inch \$189.95
- BCMGUNFIGHTER™ QD End Plate \$16.95
- BCM® PNT™ Trigger \$65.95
- BCMGUNFIGHTER™ Stock \$55.95
- BCMGUNFIGHTER™ Grip Mod 3 \$17.95
- TangoDown ARC MK2 30 Round Mag \$19.48
- BCM® Polymer Trigger Guard \$6.95
- PWS FSC556 Tactical Compensator \$94.95



**BCMGUNFIGHTER™**  
**Comp Mod 0 - 556**  
Threaded 1/2x28 for 5.56 AR15 platform  
**\$89.95**

**Comp Mod 1 - 556**  
Threaded 1/2x28 for 5.56 AR15 platform  
**\$94.95**



**IWC KeyMod QD RL Sling Mount**  
Accepts heavy duty or standard QD swivels  
**\$17.00**

**IWC KeyMod Hand Stop**  
Mount-N-Slot design . . . . . **\$34.95**



**BCM® KeyMod Picatinny Rail Sections**  
Mil-Std 1913 rails, Nylon Rails available in Black, Flat Dark Earth and Foliage Green.

- Nylon Rail, 3 Inch . . . . . **\$8.95**
- Nylon Rail, 4 Inch . . . . . **\$11.95**
- Nylon Rail, 5.5 Inch . . . . . **\$14.95**
- Aluminum Rail, 3 Inch, Black . . . . . **\$19.95**
- Aluminum Rail, 4 Inch, Black . . . . . **\$24.95**
- Aluminum Rail, 5.5 Inch, Black . . . . . **\$29.95**



**PWS KeyMod Picatinny Rail**  
Polymer Rail, 5 Slot . . . . . **\$11.95**  
Aluminum Rail, 5 Slot . . . . . **\$28.95**



**BCMGUNFIGHTER™ Enhanced Lower Parts Kit**  
BCM® PNT™ Trigger Assembly, BCM® Mod 3 Grip, BCM® Trigger Guard, and Mil-Spec hardware kit.  
BCMGUNFIGHTER™ ELPK, semi-auto. . . . . **\$119.95**



**BCMGUNFIGHTER™ KAG Kinesthetic Angled Grip**  
Uses a biomechanically efficient forward rake, small profile, textured front and back for positive engagement. Impact resistant polymers, available in Black, Flat Dark Earth, Foliage Green and Wolf Gray.

- KAG-KM, KeyMod Version . . . . . **\$18.95**
- KAG-1913, Picatinny Rail Version . . . . . **\$19.95**



**BCM® KeyMod Rail Panel Kits**  
In Black, Flat Dark Earth, Foliage Green and Wolf Gray.  
5.5 Inch Rail Panels, 5-Pack . . . . . **\$9.95**



**Vltor Carbine EMOD Stock \$119.65**

**VTAC MK2 Wide Sling \$44.95**



**BCMGUNFIGHTER™ VG MOD 3**  
Low-profile length for increased mobility and decreased "snag". Made in the U.S.A. from impact resistant polymers, available in Black, Flat Dark Earth, Foliage Green and Wolf Gray.

- VG-KM-MOD-3, KeyMod Version . . . . . **\$18.95**
- VG-1913-MOD-3, Picatinny Version . . . . . **\$19.95**



**Aimpoint Comp M4S**  
Red dot sight, fully NVD compatible, with QRP2 Picatinny Rail Mount  
**\$889.00**



**EOTech HOLOgraphic Weapon Sights**  
Model 512 **\$429.00**  
Model 552 **\$529.00**



**Rikk Rambo and the Springfield Waypoint 2020 in 6.5 PRC getting some pack-time.**

[Cont. from page 11]

Thankfully, where there is darkness, there is also light, and since nature truly abhors a vacuum, something stunningly good actually did happen in 2020. The 'something' in question was a factory-customized and highly accurate rifle from the glorious folks at Springfield Armory. The Geneseo, Illinois crew were even brave enough to include the dreaded number previously under discussion into the weapon's name-sake: The 2020 Waypoint!

#### **Cloak, Dagger... and a Non-Disclosure Agreement?**

When I was asked by *Firearms News* editor Vincent DeNiro to test and evaluate a new rifle from Spring-

field Armory, I immediately said yes...or to be more factually accurate "Yes, please." Springfield Armory held a special place in my heart thanks to a handgun I was magically authorized to carry by my parent federal law enforcement agency as a primary duty pistol. In the eleven years prior to this dispensation, I happily lugged a Glock 21 (.45 ACP) along with me on many adventures (as well as weddings, bar-mitzvahs, funerals, and trail runs). Tragedy struck only two weeks after my qualification with the new handgun, however, when some Glock fanboy took over the firearms section back at Quantico and nixed me and my fellow investigators/tactical operators' authorization to carry our Springfield Armory masterpieces with a

swipe of his imperious, plastic-loving (and most likely soft, feminine, and well-manicured) hands. I was once again crushed under the bootheel of oppression (and Glock-only culture), but for that luxurious fourteen days in September 2009, I carried a customized, agency serialized Springfield Operator 1911 in .45 ACP.

But look at me, getting all misty-eyed...let's get back to the rifle.

The next course of action was to speak with my contact at Springfield Armory. By the end of the conversation, I had a really upbeat feeling about the weapon en route to my position. Our dialogue included descriptors and industry jargon like "carbon ensconced barrel," "fully adjustable stock," "multiple



**The 6.5 Creedmoor and 6.5 PRC...Two similarly great cartridges just begging for controversy!**



**The 2020 Waypoint in its natural setting...THE BACKCOUNTRY.**



**A duty pistol that demonstrates Springfield Armory's mettle: The "Operator" in .45 ACP.**

integrated QD points," and "fluted bolt." Before I could completely wrap my head around the Waypoint 2020's 'Golden Corral' buffet of high-speed specs and enjoy the appropriate wave of euphoria that comes with the prospect of carrying a new rifle into Alaska's testing grounds, something unexpected happened... something that instantly received my full attention: the request for my signature on a counter espionage-esque legal document that is sure to perk up even the most worldly and crusty of ears: a Non-Disclosure Agreement. Whether you operate in a sensitive position within the military, federal law enforcement, foreign intelligence gathering entities, or aerospace industry, when you hear the words "*We're going to need you to sign an NDA,*" your senses heighten, your pupils dilate, and you may even rotate your head sideways with a look on your face reminiscent of a dog hearing a funny noise.

Ultimately, the reason for the NDA wasn't nearly as 'cloak and dagger' mysterious as I thought. The agreement was simply because Springfield Armory's press release for the rifle was still forthcoming and I needed to keep my yap shut until the cat was officially out of the bag. I signed the agreement, hit the send button, told my Geneseo, Illinois counterpart I enthusiastically looked forward to the receipt of his company's "still warm off the production line" Alaska test victim, and ended the call. I felt like all the bases had been covered, and as a battle-hardened veteran of nearly 28 years in the trenches of local, state, and federal law enforcement, I like to think of myself as ruthlessly and unerringly thorough and prepared.

That's why no one was more surprised than me when ten seconds after the line went dead, I realized I didn't have even the slightest idea of what type of rifle action/platform was headed north. Was it a Modern Sporting Rifle/AR-10 based platform? Maybe a more traditional, tried and true bolt-action? Mayhaps even a phase plasma rifle in the twenty-watt range or particle beam accelerator carbine? No clue. In order to feel better about not asking for an answer to this complex question, I told myself it was likely Springfield Armory didn't even want me to know the secret to this riddle due to the air of secrecy surrounding the rifle and timing of the press release. With my self-esteem salvaged over, I waited for the weapon's arrival confident in the knowledge of at least one important rifle factoid. The caliber of the new Springfield Armory



**A two-decade younger author after a highly sensitive (and successful) 'snatch and grab' somewhere in the Caribbean: NDA needed? Meh...fuhgedaboutit!**

offering headed northward to the 'Last Frontier' was the flat shooting, hard hitting 6.5 PRC.

The 2020 Waypoint arrived in the 49th state and my good friend "Yog" and the management at Great Northern Guns (GreatNorthernGuns.com) were suitably impressed. If only the good folks at Springfield Armory could have figured out a way to pipe the 20th Century Fox movie intro music out of a small speaker in the shipping container during the unboxing, our experience would have been complete! We paused to

gaze upon Springfield Armory's new showpiece: a bolt action rifle that exhibited the traits and sported the components of a well thought out, rugged, highly accurate longarm. The plot twist and primary theme of our "unboxing ceremony" dialogue focused on one key issue: The Waypoint didn't look or feel like a factory rifle. Its appearance was more in line with a rifle customized to a degree that would make its price-point a bit spooky for a Non-Fortune-500 rifleman's budget.

[Cont. to page 18]



**The Springfield Armory 2020 Waypoint in 6.5 PRC: Just sign that silly NDA kid...it's good for ya!**



# RESOLUTE

**PROFESSIONAL GRADE WEAPONRY®**

[BRAVOCOMPANYMFG.COM](http://BRAVOCOMPANYMFG.COM)



# BCM GUNFIGHTER™



## BCMGUNFIGHTER™ Pistol Grip

- Reduced grip angle keeps wrist in line for improved trigger control
- Hinged Trap Door interior storage with water resistant rubber gasket
- Mod 0 similar to A1/A2 backstrap, Mod 1 with high rise backstrap
- Mod 2 up to 1/4 inch wider with interchangeable backstraps/inserts
- Mod 3 up to 1/4 inch wider with high rise backstrap/extended insert
- All Mods available in Black, Flat Dark Earth, Foliage Green, Wolf Gray

**BCMGUNFIGHTER Pistol Grips** . . . . . Prices start at **\$17.95**



## BCMGUNFIGHTER™ Stock

- Over a year in design, specifically engineered geometry, with no weak links. New patent pending latch reinvents the interface with the receiver extension, providing superior strength.
- Simple modular, snag free design utilizes only 5 parts and 1 screw
- 2 ambidextrous sling mounting options including QD swivel socket
- Color matched rubber buttpad for secure shoulder placement
- Available in Black, Flat Dark Earth, Foliage Green and Wolf Gray

**BCMGUNFIGHTER Stock** . . . . . **\$55.95**



## BCMGUNFIGHTER™ Vertical Grip

- Forward angle increases rigidity of the forearm, provides more natural wrist angle
- Featuring an aggressive texture, and generous storage volume
- Cross bolt designed to work with improvised tools
- Reversible clamp for fastener setup on either side
- Made in the U.S.A. from high quality, impact resistant polymers
- Available in Black, Flat Dark Earth, Foliage Green and Wolf Gray

**BCMGUNFIGHTER VG - Screw Mount** . . . **\$20.00**



## BCMGUNFIGHTER™ Vertical Grip - Short

- Low-profile length for increased mobility and decreased "snag" factor
- Forward angle increases rigidity of the forearm, provides more natural wrist angle
- Aggressive texture, generous storage volume
- Made in the U.S.A. from high quality, impact resistant polymers
- Available in Black, Flat Dark Earth, Foliage Green and Wolf Gray

**BCMGUNFIGHTER VG-S - Short, Screw Mount Version** . . . **\$35.95**

**BCMGUNFIGHTER VG-S-KM - Short, KeyMod Version** . . . . **\$39.95**



## BCMGUNFIGHTER™ VG

- Low-profile length for increased mobility and decreased "snag" factor
- The forward angle increases the rigidity of the forearm, while providing a more natural wrist angle
- Can be mounted in reverse angle to increase control when grabbing handguard and grip
- Flat sides with aggressive texture give better control to the shooter
- Anchor and bolt system offers a simple and robust design, while maintaining a light-weight 1.9 ounces
- Made in the U.S.A. from high quality, impact resistant polymers
- Available in Black, Flat Dark Earth, Foliage Green and Wolf Gray

**BCMGUNFIGHTER VG-KM-MOD-3 - KeyMod Version** . . . . . **\$18.95**

**BCMGUNFIGHTER VG-1913-MOD-3 - Picatinny Rail Version** . . **\$19.95**



## BCMGUNFIGHTER™ KAG Kinesthetic Angled Grip

- Forward rake gives positive retention when using "C-clamp" method of handguard support, works as a rest for supported firing positions
- Slight angle without bulk adds just the right amount of strain relief to the wrist without substantially increasing the girth of the handguard
- Small profile, textured front and back for positive engagement
- Innovative patent pending attachment method allows for robust clamping and alignment with minimal hardware and accessory size
- Made in the U.S.A. from high quality, impact resistant polymers
- Available in Black, Flat Dark Earth, Foliage Green and Wolf Gray

**BCMGUNFIGHTER KAG-KM - KeyMod Version** . . . . . **\$18.95**

**BCMGUNFIGHTER KAG-1913 - Picatinny Rail Version** . . . . . **\$19.95**



All pricing is subject to change without notice. Please see our website for current pricing.

Hartland, WI U.S.A. / Toll Free: 1-877-BRAVO CO (1-877-272-8626) / Fax: 262-367-0989 / [BravoCompanyMFG.com](http://BravoCompanyMFG.com)



**Business end of the 2020 Waypoint...topped off with a Springfield Armory Radial Muzzle Brake.**



**The ominous name of the Springfield Bolt-Gun is offset by its rock solid, factory installed picatinny optic-mounting rail and enlarged ejection port!**

*[Cont. from page 15]*

The dialogue that ensued with my Great Northern Guns cohorts in the safe, comfortable environment of their old-school Alaska store would play itself out later, but in a much different and real-world venue: on board a saltwater vessel venturing onto the treacherous and storm-swept seas of the Gulf of Alaska and across the rugged, wintery terrain of Kodiak and Afognak Islands in search of Sitka black tail deer.

### **The Rifle**

Springfield Armory's new bolt-gun didn't travel all the way to Alaska for a mere range session and specifications review. It made the journey to be a part of a real-world testing evolution in one of the harshest environments on the planet.

Before we get to the pain, let's cozy up with the rifle and accessories that would accompany my hunting party and me across the Gulf of Alaska and onto two rugged islands in the Kodiak Archipelago.

The Waypoint 2020 is a rifle that exhibits all of the traits of a custom rifle but for one...a credit score wrecking price tag. To preclude skipping any of the rifle's components, as well as the optic and other accessories that became the Waypoint's traveling companions, we'll start from the rifle's buttstock and move forward.

The stock of the rifle is manufactured by AG Composites, a veteran-founded and owned (not to dime out their 'parent' organizations, but "Rangers Lead the Way!" and Semper Fi!) stock making firm hailing from the great state of Alabama. This ergonomic and sturdy stock is comprised of 100% hand-laid carbon fiber, is pillar bedded, and exhibits a unique, hand-painted camouflage scheme available in custom "Evergreen" or "Ridgeline" patterns. Both patterns break up the profile of the weapon quite well. The Waypoint variant I acquired was fitted with a three-axis adjustable cheek comb and a Pachmayr Decelerator recoil pad. The rear of the stock also has three QD (quick detach) points for patrol carry (QD points on both sides of stock for right handers and southpaws) and sling/shoulder carry. The Waypoint's foreend also houses three QD points to accommodate your favorite sling-carry method.

**Profile of a Weapons System: The Waypoint, Nightforce NX8, Magpul MS1-QDM, and Alaska-made Diamond D Leather buttstock cartridge carrier.**



A whole lot of awesome going on...the Magpul MS1 QDM, BSF carbon barrel, and NX8 optic.

The core of the weapon is its precision manufactured action. The Waypoint's bolt is heat treated and fluted. It is bolstered with dual locking lugs and cock-

ing cams. The bolt's residence is equally equipped for reliable, rapid reload evolutions and features an enlarged ejection port, sliding extractor, and dual-plane feed ramp. All of these technical aspects are interesting, but the most important point I took away from the Waypoint's 'power plant' occurred when I cycled the action. The rifle's bolt slid into locked-forward and locked-to-the-rear positions as if it were riding on rails made of butter.

Above the Waypoint's enlarged ejection port resides a Picatinny rail for attachment of your favorite optic. It is always a small but satisfying victory when a rifle or handgun's rail system is factory installed and a trip to the gun store or online vendor in a quest for the correct scope mounting rail system is avoided.

The trigger is the brainchild of Triggertech, a company based 'north of the border' in Mississauga, Ontario. This trigger system is adjustable from 2.5-5 pounds, but its real claim to fame is "trigger-break to primer strike/ignition" time. The engineer/cerebral-minded folks at Springfield Armory and Triggertech estimate the total time for this evolution to be a mere 1.9 milliseconds. The importance of this number comes to play in relation to the deviation in point of aim that can occur under field conditions (or just a plain old-fashioned case of buck fever or a nervous disposition). The less "lock time," the less chance the shooter has of fudging up a potential shot of a lifetime.

Last, but definitely not least on our rundown of the Waypoint is the barrel. Springfield Armory utilized the engineering and carbon fabrication know-how of BSF Barrels, a Wisconsin based firm with a reputation for manufacturing sturdy, accurate, and heat-dissipating carbon fiber-wrapped rifle barrels. The Waypoint's barrel is designed for all three of the aforementioned traits important in a reliable and accurate firearm that may be destined for use in harsh conditions. The roll-wrapped carbon sleeve is purposefully married to the barrel sparingly. In fact, 95% of the carbon sleeve is not in direct contact with the barrel. This bit of tradecraft, in addition to additional fluting

and other heat-dissipating countermeasures, promotes enhanced cooling benefits for the barrel. Accordingly, cooler barrel temps promote increased accuracy when repeated rounds are being sent down range.

**The Finishers:**

**An Alaska-Tough Optic and Rifle Sling**

Whether you are a Beverly Hills fashionista or a United States Marine Corps Raider, who doesn't like to accessorize? Here's a rundown on the 2020 Waypoint's traveling companions: The Nightforce NX8 2.5-20X 50mm F2 rifle scope and the Magpul MS1 QDM sling.

I expected the acquisition of an Alaska-tough rifle scope for the Waypoint would be no picnic, given production demands that coincided with 2020's uptick in firearms, ammunition, and accessory sales. I was dead wrong. A simple phone call to one of my SHOT Show compatriots from Nightforce (NightForceOptics.com) and the Waypoint was in business. Several days after speaking with my Orofino, Idaho-based Nightforce partner-in-crime, their NX8 2.5-20X 50mm F2

2.5-20x50 F1/F2		
	2.5-20x50F1	2.5-20x50F2
Magnification Range	2.5-20x	2.5-20x
Focal Plane	First	Second
Body Tube Diameter	30 mm	30 mm
Overall Length	12.0 in/305 mm	12.1 in/308mm
Mounting Length	5.4 in/138 mm	5.4 in/138 mm
Weight	28.3 oz/802 g	28.6 oz/811 g
Click Value	.250 MOA or .1 MRAD	.250 MOA or .1MRAD
Internal Adjustment Range	E: 110 MOA/32 MRAD W: 80 MOA/23 MRAD	E: 110 MOA/32 MRAD W: 80 MOA/23 MRAD
Parallax Adjustment	11 yd-∞	11 yd-∞
Eye Relief	3.5 in/88 mm	3.5 in/88 mm
Field of View @ 100 yd/m	2.5x: 41.8 ft/13.9 m 20x: 7.0 ft/2.3 m	2.5x: 36.7 ft/12.2 m 20x: 6.1 ft/2.0 m
Exit Pupil	2.5x: 7.1 mm 20x: 2.5 mm	2.5x: 5.9 mm 20x: 2.5 mm
Illumination	Digillum™	Digillum™
Elevation Feature	ZeroStop®	ZeroStop®
Power Throw Lever	Standard	Standard
Reticles Available	MOAR™ MIL-C™ MIL-XT™ TReMoR 3™	MOAR-CF2™ MIL-CF2™



**Nightforce NX8  
2.5-20x50mm F2  
spec sheet.**

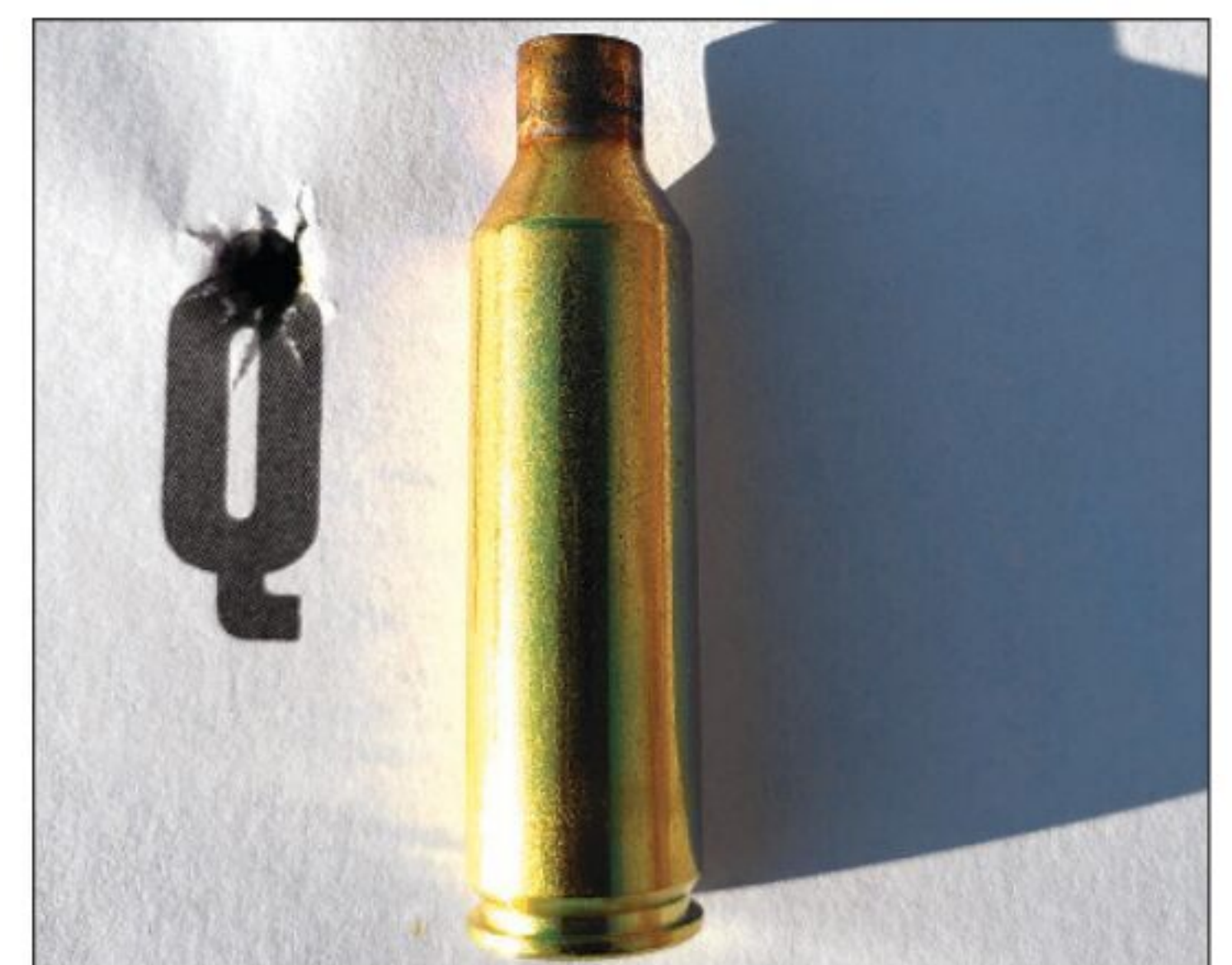

Well...that saved a couple of bucks! First shot down-range from the Waypoint at 100 yards.



The Hornady 143-grain ELD-X Hunter keeping it close at 100 yards (1/2-inch, five-shot group).



It's a tie! The Hornady 143-grain ELD-X Hunter and 147-grain ELD Match scored twin 1 1/2 inch groups at 200 yards.

was riding handsomely and solidly on the waypoint. This model of NX8 has a magnification range that is perfect for Alaska. While the vast majority of Alaskan big game I have harvested were stalked (or as is the case with moose, called) to within approximately fifty yards or less of their demise and did not require a rifle scope with heavy-duty magnification, it's advantageous to have that extra bit of long-range juice in the event you are hunting big country for sheep and the like. My initial impression of the NX8 was that it was solid...as in, if you were a 1920's beat-cop in Chicago and had to pick between an old-school hickory cudgel, lead-filled blackjack, or an NX8 as an impact weapon, tough decisions would have to be made. This scope provides the shooter with five brightness settings for both red and green digital illumination of the primary center reticle, as well as windage and elevation pattern. The optic also features Nightforce's "Zero-Stop" function for an immediate and simple return to zero, as well as a power throw lever for easy and swift magnification adjustments. As a bonus, the illumination component will turn off after an hour of non-use to extend your battery life.

The sling I chose for the Waypoint was Magpul's MS1 QDM. I have carried this sling, as well as its predecessors, on hunting rifles as well as duty long arms. It is extremely versatile, virtually unbreakable, and can be transitioned at light speed from a shoulder/back carry configuration to patrol carry. The MS1's adjustment slide is the key to its ability to lengthen or



It's good to have a lot of carbon in your diet! Great view of the Waypoint's Carbon fiber stock and barrel on range day.

shorten swiftly, even while on the move across tricky terrain. The MS1 QDM's suitability for both hunting and tactical carry is bolstered by factory-installed quick-disconnect swivels and a corrosion-fighting Melonite finish.

**The Range**

Before any Alaskan adventure begins, the rifles and/or handguns that will be active participants require serious vetting. This meant spending an entire day at the range with the Waypoint 2020. During early winter in the 49th State, that means all 6.5 hours of it!

You know those competition television shows like *Forged in Fire* and *The Great British Baking Show* where the judges don't reveal who won at the end of the episode immediately, but rather wait for approximately 20 seconds whilst playing dramatic music and panning in on the anxious, sometimes apoplectic faces of the contestants? Well, the Waypoint 2020 was having none of that drama and the first shot down range at 100 yards nearly punched the bullseye out of the target.

The ammunition I acquired to run the 2020 Waypoint through its paces during these trying (and ammo-sparse) times were two flat-shooting cartridges from Hornady: 143-grain ELD-X Precision Hunter (2,960 fps), and the 147-grain ELD Match (2,910 fps).

I was surprised to find that Hornady's 143-grain ELD-X Hunter performed slightly better out of my Waypoint than its match grade sibling. The difference was nearly unnoticeable at the 100-yard line. The ELD-X Hunter was laser-beam accurate, knocking an amazing half-inch group through paper, followed closely by the ELD-Match, which five-hole punched a 3/4-inch group. At 200 yards, the ELD-X Hunter's narrow margin of victory ended, with the Hornady siblings scoring twin 1 1/2-inch groups. Equally impressive was the mere 1 1/2 to 2-inch bullet-drop from the 100-yard groups to the 200-yard evolution.

Although I wasn't planning on shooting a blacktail deer at any distance beyond 200 yards on Kodiak or Afognak Islands, I knocked out two five-shot groups at 300 yards for curiosity's sake with the Hornady Hunter and Match ammunition from the bench. I would classify the results as "close enough for government work," or for our purposes, close enough to insure a clean harvest on a Sitka black tail deer. Both the ELD-X Hunter and ELD-Match again shot nearly twin three-inch groups. Did I have the Nightforce NX8 cranked up to 20 power? Yes...but as I heard more than once during my military service: "If you ain't cheatin', you ain't tryin'!"

With the sighting in/accuracy testing segment off the range session complete, I launched a rapid-fire barrage of three magazines (nine rounds) at two metal gongs at the three-hundred-yard line to test functionality. This string of fire was flawless. The bolt glided effortlessly throughout every cycling of the action and

[Cont. to page 22]

SPRINGFIELD ARMORY 2020 WAYPOINT ACCURACY CHART	
<b>Hornady 143 Grain ELD-X Precision Hunter (Muzzle Velocity: 2960 FPS)</b>	
100 Yards:	1/2 inch
200 Yards:	1 1/2 inches
300 Yards:	3 inches
<b>Hornady 147 Grain ELD-Match (Muzzle Velocity: 2910 FPS)</b>	
100 Yards:	3/4 inch
200 Yards:	1 1/2 inches
300 Yards:	3 inches
All groups shot consisted of five rounds from a bench rest; Weather conditions were clear and calm; temperature approximately 25 degrees Fahrenheit.	



NEW

# PDP

It's our duty to build the best performing firearm...

# IT'S YOUR DUTY TO BE READY



Red Dot Ergonomics



Performance Duty Grip Texture



Red Dot Ready

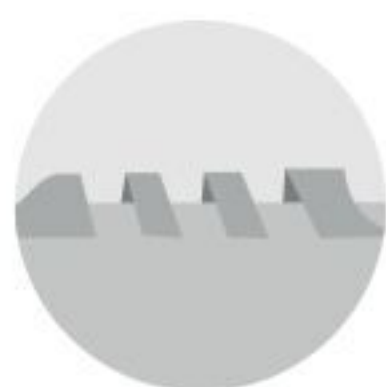

SuperTerrain Serrations



Modularity



Performance Duty Trigger

PDP Full Size



PDP Compact

What does it mean to be ready?  
[waltherarms.com](http://waltherarms.com)



© 2020 Walther Arms Inc. | All Rights Reserved



**AHOY! Afognak Island to starboard! Enjoy the sunlight while ye can, ya scurvy dogs!**

[Cont. from page 20]

with the low recoil of the 6.5 PRC cartridge, target reacquisition and engagement was blazingly fast.

The range-testing phase was over. The 2020 Waypoint exhibited the accuracy, design characteristics, and accuracy to back up the claim it staked as a hunting rifle to be reckoned with. The next segment of testing and evaluation would not take place in the relatively sedate and clinical environment of a rifle range. The rifle and Nightforce optic were about to graduate to the 'big leagues': Alaska's punishing and oftentimes treacherous wilderness.

The Waypoint/Nightforce duo seemed to be rugged, sturdy, and real-world capable...but like the many weapon systems that made their way north before them, the harsh, unforgiving backcountry of the 'Last Frontier' would be the final arbiter.

### Surf's Up: Kodiak and Afognak Islands

The saltwater vessels "Kingpin" and "Casino" sliced neatly through the calm waters of the Kodiak small-boat harbor and onto the open expanse of sea separating Kodiak from Afognak Island. The seas on the Gulf of Alaska were a bit rowdy, but still relatively tame when compared to the wrath they were capable of dishing out.

The Kingpin would be my hunting party's home for the next six days while pursuing black tail deer (and hopefully avoiding Kodiak brown bears still active and on pre-hibernation food-finding patrol) on Afognak Island. The Casino was, for lack of a better designation, our assault craft. It was a dual-hulled landing craft capable of inserting hunters onto remote beaches and segments of rocky shoreline and would provide us with a means of ingress/egress from our hunting areas on Afognak. Both boats were operated by Alaska Ocean Pros, and the owner, Gabe Linegar, would be our outfitter and boat captain on this trip. We were also in the capable hands of Gabe's deckhands, Jimmy and Simon. It should be noted that I offered to give Jimmy and Simon really cool call-signs/stage names in this article for dramatic purposes, but just like James Bond, they were way to suave for a cheap parlor trick like that.

**"Lehigh" Mike Cyrus scouting some island property with his SSK improved Contender stoked with 152-grain Lehigh Defense .309 JDJ perfection.**



**Our home away from home (M/V Kingpin) and 'assault craft' (M/V Casino).**

On board the Casino with me were my tried-and-true hunting partner "Handsome Jay," and two of his life-long friends from Minnesota, Chad and Steve. The fifth and final member of our merry band (and winner of the "furthest distance traveled" award) was Mike Cyrus. I met Mike, a driving force at Lehigh Defense (and recently SSK Firearms, SSKFirearms. LehighDefense.com) and his wonderful wife, Kellie, at the 2019 SHOT Show. Mike is a forward-thinking, engineering genius in the field of innovative bullet design, ballistics, and the manufacturing processes necessary to generate modern, highly effective projectiles.

[Cont. to page 24]

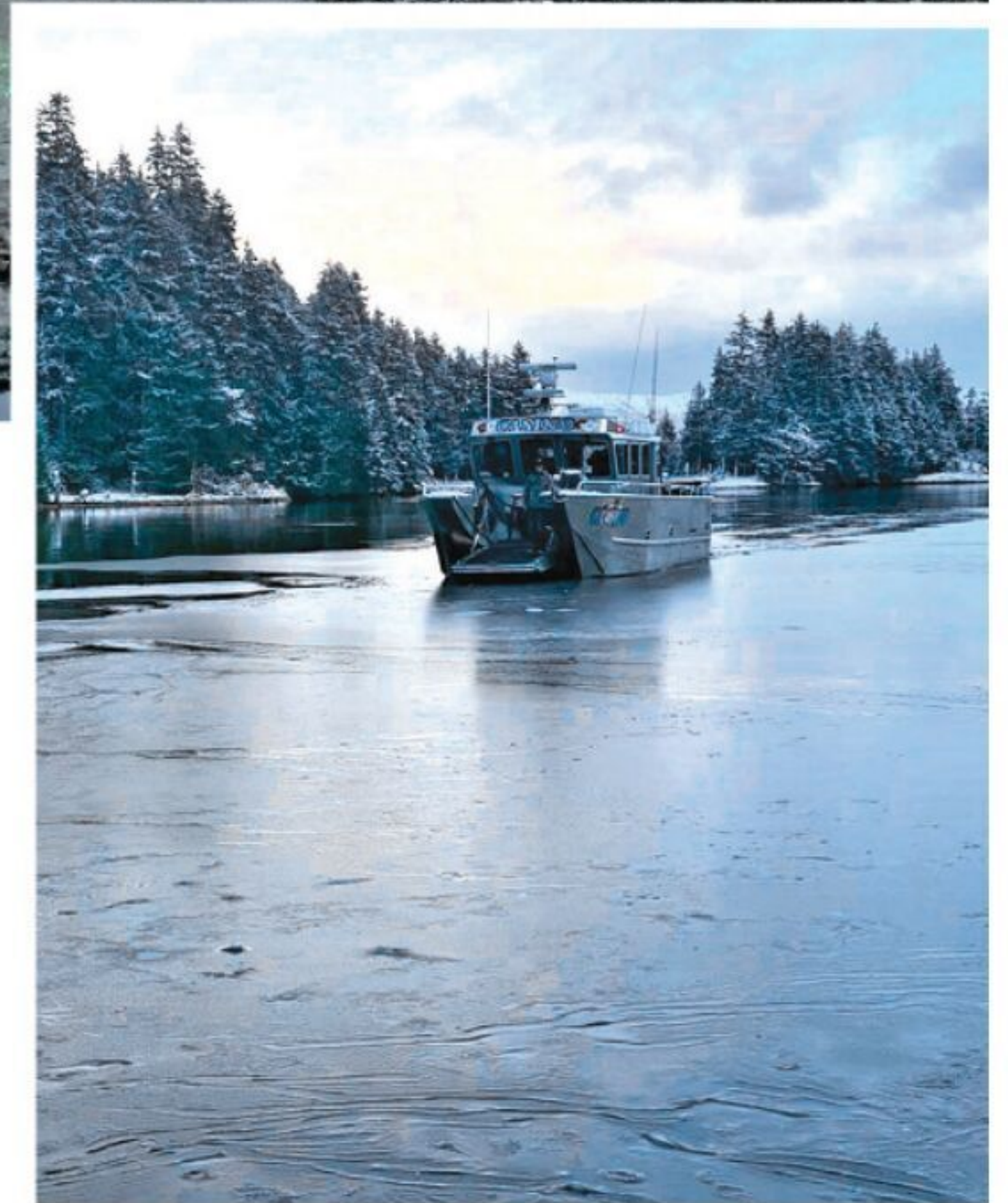



# THINK FAST



STRIKER-FIRED

5.5LB TRIGGER

10+1 CAPACITY

RED-DOT OPTIC

\$399.99

# DVG-1<sup>®</sup>

RD

**Think Fast:** Everything moves fast these days, but we know a few things about staying a step ahead of the competition. That's why we created the DVG-1RD; a striker-fired subcompact 9mm. The factory-equipped red-dot optic means faster target acquisition and our proprietary manufacturing process means big savings on a performance firearm.

Learn more at [sccy.com/dvg](https://sccy.com/dvg)



©2021 SCCY Firearms, All Rights Reserved



**The Waypoint's 'wingman': My tried and true S&W Performance Center Model 629 in .44 Magnum...loaded with homemade Barnes 'Buster' 300 grain tank-killers.**

[Cont. from page 22]

More importantly, he represents everything I have come to appreciate about the firearms/sporting goods industry during my last several years as a gun writer. Allow me to get sappy for just a moment. I've only been a gun-writer for three years, but in that time, I've come to appreciate how special the overwhelming majority of people involved at all levels of the shooting/hunting/outdoor manufacturing industry truly are. From the men and women behind the counter in your small-town gun store to the CEO's, media reps, and design engineers you meet at SHOT Show and other events, the one thing that will never be lost on me are how they seem like...family. Mike had been chomping

at the bit to get an Alaska trip under his belt and the Kodiak/Afognak deer hunting expedition fit the bill. He braved the 14 hour "Covid-19 Express" plane trip from Columbus, Ohio to Anchorage, recuperated for two days at the 'Rambo Mountain Bed & Breakfast,' and flew with Jay and I to Kodiak for our high-seas, swashbuckling island adventure.

#### **The Alaska Code of Predator and Prey: More of a Guideline Than a Rule**

Our quarry, the diminutive (but delicious) Sitka black tail deer, was the primary game animal on our to-do list. Conversely, the super-sized critter we

hoped to avoid on this hunt came in the form of Kodiak bears. These coastal giants were still patrolling the islands' hills and dales in a never-ending quest for things to put in their cavernous bellies. Their quest for hot eats (unlucky mammals) and cool treats (fish and carrion) would continue until the dead of winter hit the islands in late December, at which time deep snow and rapidly deteriorating weather would send them packing into their dens. Until then, however, they could become troublesome at best, and predatorily deadly at worst.

In the spirit of transparency, I would not choose the 6.5 PRC as a brown bear hunting cartridge. The 6.5 PRC was not intended for dedicated use against large bodied, ice-age era apex predators that can weigh up to 1,200 pounds or more. However, in a clinch, and with good shot placement and a spot of luck, this round is capable of permanently sending a large bruin to the penalty box (ie: making him/her take a dirt nap). I was comfortable in carrying the Waypoint 2020 on this hunt as it would not be going it alone. The Waypoint would be partnered up with my tried and true .44 magnum Model 629 from Smith and Wesson's performance center stoked with an extremely stout handload featuring 300 grain Barnes "Buster" dangerous game bullets.

I also had a secret weapon accompanying me on this hunt, and his name was Mike Cyrus. How tough is Mike? Well, after our first day of hunting (with little time for him to acclimate from his native Midwest "sub-tropical" environment to the frozen hinterlands of Alaska), all was revealed. The Last Frontier can humble a person...from harsh climatic and surf conditions, to daunting terrain, to unpredictable, dangerous game animals. I've seen softer men and women's brows furrow, pupils dilate, and lips quiver during their first hours in the 49th state's backcountry...but by gar, not Mike Cyrus, armed with his single-shot,

[Cont. to page 26]



**My hunting partner, Mike Cyrus...a man so tough, they say his smile can cure Covid-19, Ebola Zaire, and Herpes Simplex 1 thru 43½. Too bad he's never smiled.**

**Mike and I getting ready to hoof it from our beach-head into the Afognak high-country on our last day of 'fair-weather' hunting!**





# 9MM GATLING GUN



## MAN CAVE MUST HAVE

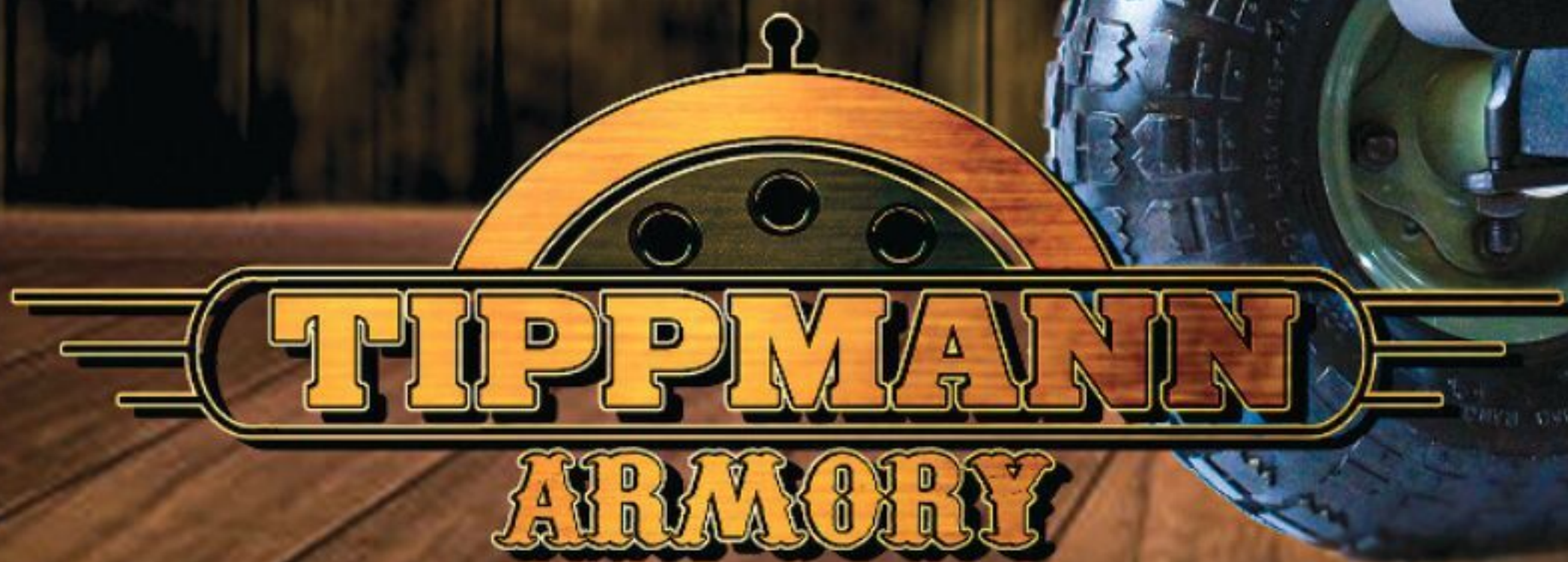

800-671-1498  
TIPPMANNARMORY.COM

# VALUE THAT HOLDS TRUE

Starline's new line of high quality rifle brass hits the mark, every time, so you can too. Superior quality brass at the best possible price — Starline's rifle brass is a Value that Holds True.

**PURCHASE FROM YOUR FAVORITE RELOADING SUPPLIER OR ORDER FACTORY DIRECT.**

100% AMERICAN MADE & OWNED

STARLINEBRASS.COM | 1(800) 280-6660



**I would have rather it been Sasquatch...**

*[Cont. from page 24]*

break-open action SSK Industries-improved Contender in .309 JDJ and Glock 21 backup pistol. Mike strolled into the back country with a spring in his step and a smile on his face.

They say that when the Boogie Man wakes up in the middle of the night suffering from night-terrors brought on by an anxiety attack, he checks under his bed for Chuck Norris...but did anyone ever stop and ask who Chuck Norris looks for when he nervously peeks into the inky blackness under HIS rack? That's right.

Mike Cyrus.

The first two days of the hunt were marked by blue skies, temperatures in the 40's, and calm wind conditions. In light of my previous hunting experience on



**Hunting day #2 and our last hint of sunlight before things got...Alaska-y!**

Kodiak, and its surrounds (multi-week, unguided, two-man expedition-style Kodiak bear hunts in 2008 and 2012), I considered this wonderful weather an anomaly. The kind of anomaly you don't kick out of bed for eating crackers!

Each morning, the Casino would drop Chad and Steve, then Handsome Jay, then Mike and I off at separate locations to hike up into Afognak's highlands. Mike and I hunted as a team for the bulk of the first day and well into the second, however, terrain and potential harvest opportunities dictated that we split up and hunt a short distance from each other on the second afternoon. I wasn't worried...Mike was a tough guy with grit in his teeth and nails in his knuckles, we



**Remember when I said Mike Cyrus never smiled? I was in error. Here we see him pondering what it would be like to harvest a Kodiak bear with his 3¾- inch long Buck Hunter lock-blade.**



**A moist but fully-functional Waypoint halfway through a seven-mile hike.**

**Rikk Rambo happily using his Magpul MS1-QDM sling on foot-patrol during another stormy day in the islands.**



**Handsome Jay and the Waypoint score!**



**Alaska made gear that works (and saves your back): The deer gets a ride on a Northern Sledworks 4' Signal Pulk ([AirFramesAlaska.com/Northern-Sled-Works/s/1877.htm](http://AirFramesAlaska.com/Northern-Sled-Works/s/1877.htm)).**

both had hand-held radios for emergency situations, and not a single bear track was to be seen during our previous two days of steady climbing and hiking. Mike whispered his plans, went solo, and disappeared down the logging road. It was at that moment when Mother Nature decided to showcase her sense of humor.

Mike made it around the corner and a grand total of 100 yards out of my sight before coming across extremely fresh tracks of a sizeable Kodiak bear. The bear had cut up onto the logging road from a wooded area and continued on, going the same direction as Mike. Remember what I said about Mike's fortitude? Well, if I had to guess, Mike probably gazed upon those huge tracks for a second or two, said to himself "*Well...it's a free country and there's enough logging road for both*

*of us*" and continued on. I gave up on my area after an hour and found Mike's tracks intermingled with the bruin's. Thankfully, Mike's tracks were fresher than the bears, so I didn't have to sprint after my hunting partner to make sure he wasn't about to have an unwanted "wing-man" on his six! When I did catch up with Mike, he spotted two bucks chasing does into a wooded area across a respectable beaver pond. No shots presented themselves, so we headed back to our beach rendezvous with the Casino as darkness fell.

#### **The Waypoint 2020 vs. Everything Maritime Alaska Had to Throw at It!**

Remember those first two days of bluebird skies, luau-worthy temperatures, and wind conditions that

would make a 1,000-yard shooter at Camp Perry want to weep tears of joy? Two days of disgustingly good weather that wouldn't even put a Nerf-Gun at risk of getting scratched or even lightly moistened? That was about to change. A hurricane-like weather pattern was building and rolling our way from Siberia. The Waypoint was about to meet "real Alaska" in the form of five full days of exposure to rain, snow, sleet, and violent winds carrying all three of the previously mentioned forms of precipitation into every crack and crevice Springfield Armory's new bolt gun and its Nightforce optic had to offer.

For the rest of the hunt, the 2020 Waypoint and Nightforce NX8 took a hammering. Handsome Jay and I swapped rifles each day (I also brought along

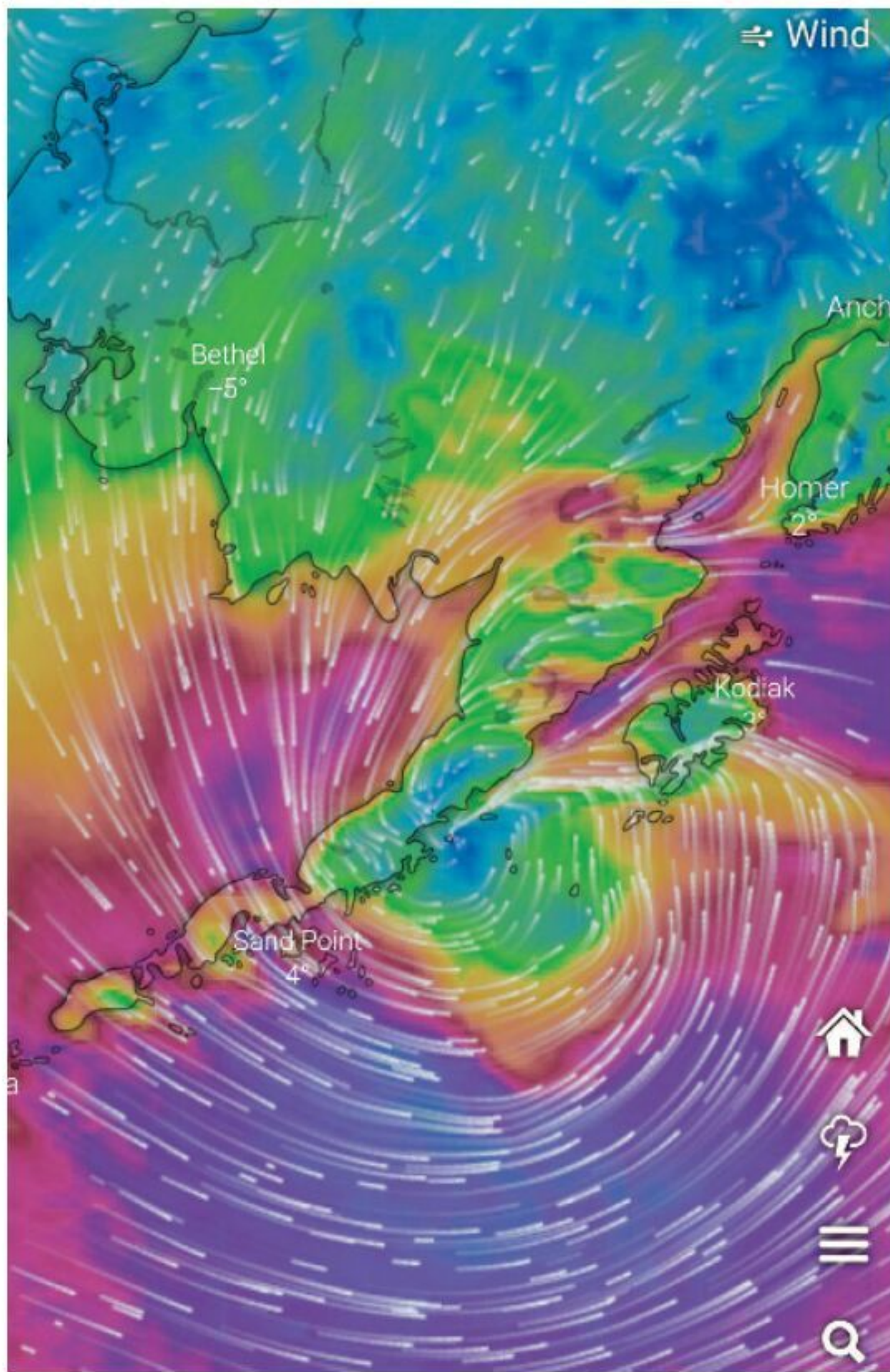

**This is what profanity looks like when digitally enhanced (the coming storm)!**

a Wilson Combat rifle in .358 Winchester that needed a good beating or three for testing purposes), but it mattered not who hunted with it...the Waypoint would not have another easy day on this trip.

With two days left to hunt, the Waypoint, in the capable hands of 'Handsome Jay,' was at the right place at the right time and scored on a respectable 7-point... or 4x3 if you live west of the Mississippi! Mike, Jay, and I were hunting in gale force winds and driving sleet when the blacktail stepped onto a logging road approximately 60 yards from Jay. The Hornady 6.5 PRC round dropped the deer in its tracks and the pack-out back to our beachhead was a simple walk down a logging road.

When everyone was back safe and sound on the Kingpin that evening, Captain Gabe briefed us on the rapidly approaching "polar low" (local science lingo for an arctic hurricane) and the prognosis was bad. If we didn't get the 'h-e-double-toothpicks' back across open ocean to Kodiak by the following evening, we may be spending the week of Thanksgiving hunkered down in an Afognak island cove in some alternate reality universe version of *Gilligan's Island*.

Since none of us were willing to draw straws on who would play Mary-Ann or Ginger, common sense ruled the day and we decided to pull up stakes early and hightail it back to Kodiak the following afternoon before the storm turned three to five-foot seas into 25-35 plus-foot monsters.

#### **Worst ...D-Day Reenactment...Ever.**

The next morning, Handsome Jay, Chad, and Steve opted to stay on the Casino and engage in some duck-



**What you call hell, the author calls...a wheelhouse... and also the spot where he bunked while aboard the Kingpin! (There was a large forward berth, but also a lot of snoring and other...unsavory bodily functions!)**

hunting. The seas were building, but Captain Gabe offered to drop Mike and me off for one more go at the blacktail before returning to Kodiak in late afternoon. We geared up and Gabe expertly navigated the landing craft to a steep, rocky bank. The surf was building, and the conditions weren't ideal for a non-comedic beach deployment, but I was game, and Captain Gabe lowered the ramp and approached the drop-off point.

I'm not a proud man, so let's just tell like it is. Lehigh Mike was the prudent one in our two-man party. As we made our final approach to shore, two things were abundantly clear. The steep, rocky beach was getting hammered by a respectable surf and the landing craft's extended, bobbing and lurching ramp would not have exactly made good material for an artist who prefers to paint still life scenes. Mike, who was behind me as I prepared to storm the beach, took note of these aggravating factors and politely whispered in my ear: "*Good luck, nincompoop...it's your funeral. Peace out...and if you need me, I'll be in the wheelhouse with Captain Gabe...hopefully he keeps the Cardi B rap music to a minimum.*" or something like that...anyway, the point is, I was going solo onto that rocky beach and up that mountain.

Timing was everything. I stood on the edge of the ramp as the bow heaved up and down with the surf. In order to successfully egress from the landing craft correctly, I would have to step off the ramp as the bow came down and that surf evolution's wave receded. My cat-like reflexes, honed from decades of military



**The weapon system that took a lickin' and kept on hittin'! The Waypoint/Nightforce duo scores a 1/2 inch group at 100 yards...even after their Edmund Fitzgerald/Gordon Lightfoot experience!**

and high-risk law enforcement operations, were in full play as I waited to spring, ninja-like, onto the beach. The bow of the 40-foot landing craft dipped, the ramp plunged to a mere foot above the slippery black rocks, and a large wave rushed backward under the Casino, clearing my landing zone. It was go-time.

What happened next was the subject of much debate in the coming days. Depending on the observer's angle of view, individual depictions varied, but one fact remained indisputable: The D-Day landings on those infamous Normandy beaches may have gone differently for the U.S. and its allies had the brave soldiers who fought there utilized my ham-handed beach-storming technique.

[Cont. to page 30]



The Holster of the Year,  
NOW IN OWB

# ULTRA CUSTOM™

This Holster Changed  
**EVERYTHING!**



**1791 GUNLEATHER**  
1791gunleather.com

The Ultra Custom holster with Memory-Lok® Technology allows you to mold & re-mold your holster with the included molding tools for the ultimate in customization.



**UP UINTAH PRECISION**

UINTAHPRECISION.COM   

**TRUE BOLT ACTION  
AR10 / AR15  
RIFLES & UPPERS**



**Did you have a nice 'trip' this 'fall?' The Waypoint and Nightforce got off light with only a scuff and abrasion to the NX8's windage turret cap!**

### Alaska Tough: Aftermath of the Great Alaskan One-Man Beach Party!

When I took the plunge into the rocks, the Waypoint was in the worst position imaginable: slung over my right shoulder. I landed on the rifle and scope with the full weight of my body and backpack. The ornery surf got a couple additional licks in on me and rolled me partway onto my back. I did a reasonably good impression of an upended turtle before managing to regain my footing and do a totally rad combat roll (soaking wet) back onto the Casino's ramp.

Normally, I would use one of my catch-phrases like "No one was more surprised than me" to describe how I felt about not suffering even the slightest injury, but the truth of the matter was this: Everyone on the boat who witnessed my graceful, ballet-worthy plunge into the drink couldn't believe I'd survived it unscathed, with nary a broken pelvis or femur, not even a shattered left testicle!

The Waypoint, Nightforce, and I received the full salty benefits of my nosedive onto the rocky beach and complimentary dousing in the frigid waters of the Pacific. The only thing I would suffer from in the aftermath was some good-natured ribbing (I believe it was one of the Minnesota boys who bent down, grabbed my arm, helped me to my feet, and informed me that the U.S. Judges had given me a 10, but their jerk-wad Russian and French counterparts chastised the size of my splash-signature and gave me a 7.5).

The fallout for the Waypoint and Nightforce, however, remained to be seen. I swabbed the action and barrel with Rem-Oil, made the jaunt back to Kodiak, and returned to the mainland in time for Thanksgiving. Call me crazy, but I had high hopes the rifle and optic could take a licking from Mother Nature better than Evander Holyfield's ear did from Mike Tyson.

Several weeks later, I had my answer. I visited a local range and shot two tight groups at 100 and 200 yards...and they were smack-dab in the same grid coordinate on that target as they had been during the initial sight-in. Viva!

### The Takeaway

Alaska always sets a high bar for weapons, accessories, clothing, and other gear necessary for a safe, successful expedition/hunt. Maritime hunting along the 49th State's incredible 33,904 miles of coastline, especially in winter, ramps up the need for tested and true equipment to an even greater degree. The Waypoint 2020 and rugged, beautifully illuminated Nightforce NX-8 not only survived, but thrived in that environment. The Waypoint 2020 and its Nightforce NX-8 partner in crime had endured nearly a week-long pummeling by Afognak Island's rugged terrain and abominable weather conditions. More importantly, however, was that it survived something far more dangerous than anything the elements or landscape could dish out: My lack of grace and good judgement!

My criticism of this rifle is short...just like me... which is a perfect segue for a quick discussion about

[Cont. to page 32]



**There's no place like home...or Kodiak, Alaska!**

[Cont. from page 28]

The second I stepped off the ramp, a rogue, out-of-sync wave, significantly larger than its predecessors, caused the ramp to buck upwards. My already committed foot was suddenly an additional foot above the rocks as I plunged forward with no chance for a graceful recovery. My boot slammed into the rock and pebble covered beach and somehow, even though I pitched forward at a less than graceful angle, I man-

aged to stay on my feet. My 40-pound backpack didn't do me any favors as I lurched slightly to the right on my other leg, but the deal breaker came in the form of widow-maker wave number two. It was thigh-high and knocked me sideways...I was going down...hard...into rocks...and the Waypoint and Nightforce optic were about to get an abject lesson in how Alaska is "the state that breaks things."

# Now, THIS is a Knife!

This 16" full tang stainless steel blade is not for the faint of heart —now **ONLY \$99!**

In the blockbuster film, when a strapping Australian crocodile hunter and a lovely American journalist were getting robbed at knife point by a couple of young thugs in New York, the tough Aussie pulls out his dagger and says "That's not a knife, THIS is a knife!" Of course, the thugs scattered and he continued on to win the reporter's heart.

Our Aussie friend would approve of our rendition of his "knife." Forged of high grade 420 surgical stainless steel, this knife is an impressive 16" from pommel to point. And, the blade is full tang, meaning it runs the entirety of the knife, even though part of it is under wraps in the natural bone and wood handle.

Secured in a tooled leather sheath, this is one impressive knife, with an equally impressive price.

This fusion of substance and style can garner a high price tag out in the marketplace. In fact, we found full tang, stainless steel blades with bone handles in excess of \$2,000. Well, that won't cut it around here. We have mastered the hunt for the best deal, and in turn pass the spoils on to our customers.

**But we don't stop there.** While supplies last, we'll include a pair of \$99, 8x21 power compact binoculars, *and* a genuine leather sheath **FREE** when you purchase the *Down Under Bowie Knife*.

**Your satisfaction is 100% guaranteed.** Feel the knife in your hands, wear it on your hip, inspect the impeccable craftsmanship. If you don't feel like we cut you a fair deal, send it back within 30 days for a complete refund of the item price.

**Limited Reserves.** A deal like this won't last long. We have only 1120 *Down Under Bowie Knives* for this ad only. Don't let this beauty slip through your fingers at a price that won't drag you under. Call today!



**BONUS!** Call today and you'll also receive this genuine leather sheath!



**EXCLUSIVE FREE**

Stauer® 8x21  
Compact  
Binoculars  
-a \$99 value-  
with purchase of  
Down Under Knife

## What Stauer Clients Are Saying About Our Knives



"This knife is beautiful!"

— J., La Crescent, MN



"The feel of this knife is unbelievable...this is an incredibly fine instrument."

— H., Arvada, CO

**Down Under Bowie Knife \$249\***

**Offer Code Price Only \$99 + S&P Save \$150**

**1-800-333-2045**

**Your Insider Offer Code: DUK127-01**

You must use the insider offer code to get our special price.



**Rating of A+**



**Stauer®** 14101 Southcross Drive W., Ste 155, Dept. DUK127-01  
Burnsville, Minnesota 55337 [www.stauer.com](http://www.stauer.com)

\*Discount is only for customers who use the offer code versus the listed original Stauer.com price.

**California residents please call 1-800-333-2045 regarding Proposition 65 regulations before purchasing this product.**

- Etched stainless steel full tang blade ; 16" overall
- Painted natural bone and wood handle
- Brass hand guards, spacers & end cap
- Includes genuine tooled leather sheath

Stauer... *Afford the Extraordinary.*®





[Cont. from page 30]

barrel length. While the 24-inch barrel length of the Waypoint in 6.5 PRC is a non-issue for open country and most mountain hunting, a shorter barrel would improve its ability to be carried and/or employed in the thick spruce, alder, and other flora found in forested terrain. Don't wrinkle your brow quite yet, though, because the good men and women at Springfield Armory already have a solution for those of you who spend the majority of your time hunting this type of country. The .308 Winchester version of the Waypoint sports a 20-inch barrel and retains all of the other fine attributes of the version of the rifle I dragged through the snow, rain, sleet, and surf of Afognak Island. My second and final gripe involves the factory supplied three round AICS short-action magazine. I found the magazine a bit skimpy in capacity. My 'Karen-esque Complaint' number two is also nothing to get anyone's thongs, pantaloons, or skivvies in a bind over, because the simple workaround comes in the form of an additional seven-round magazine available for purchase from Modular Driven Technologies (MDTTac.com).



**To the victor goes the...most excellent steak tips! Black tail deer at its finest!**

Accolades are the easy part of this review. The Waypoint 2020 and Nightforce NX-8 optic that accompanied it are Alaska-tough. Even after constant exposure to snow, sleet, and rain over a six-day period, as well as their complete immersion in saltwater (with only a rudimentary cleaning), there was no

[Cont. to page 34]

**The Waypoint and Nightforce doing what they do best... operating magnificently in less-than-ideal conditions!**



**On a scale of "One to Predator," the Waypoint blends very well into its Alaska environment with its "evergreen" camouflage pattern.**





xinfrared.com

www.infrayusa.com  
info@infrayusa.com

Mini Series

Smallest spotter, but with incredible performance, Either handheld or head-mounted, this unit can revolutionize how you see the world around you.



Toll Free: 800-769-7125

Phone: 682-499-0047



# BCMGUNFIGHTER™



Carbine Length

Mid-Length

## BCMGUNFIGHTER™ PKMR Polymer KeyMod Rail Handguards

- Direct "drop-in" design replacement handguard for AR15's with mil-spec front sight base
- Natural ergonomics, slim, comfortable and lightweight, with an aggressively textured area for enhanced traction
- Featuring a reinforced KeyMod interface for durable accessory support with three, six-hole KeyMod mounting surfaces
- Aluminum heat shield reduces heat transfer to the handguard and shooters' hand
- Patent Pending design, made in the U.S.A.
- Will only fit round carbine-type handguard retaining cap
- Available in Black and Flat Dark Earth

### BCMGUNFIGHTER™ PKMR

**Carbine Length** .....\$24.95  
**Mid-Length** .....\$26.95



BravoCompanyMFG.com • Hartland, Wisconsin U.S.A.

Toll Free: 1-877-BRAVO CO (1-877-272-8626) • Fax: 262-367-0989

Pricing subject to change without notice. Please see website for current pricing.

# .50 BMG

ENGINEERED PRECISION



PRECISION BIG-BORE  
BOLT-ACTION  
RIFLES AND UPPER  
RECEIVERS

Offering complete upper receiver assemblies for the AR-15 style lower as well as complete rifles. Meticulously designed and manufactured by our team of engineers for durable, reliable, and accurate performance. Proudly made in the USA and protected by a limited lifetime warranty.

**ONE-PIECE  
BILLET RECEIVER**  
Induction hardened with integrated picatinny rail and lugs for extreme strength



**MAPS SAFETY**  
Mechanically assisted pin safety blocks firing pin until the bolt system is in battery



**MF-50M**  
Mag-Fed model utilizes the acclaimed Accuracy International 5-round box mag



**CALIBER OPTIONS**  
Available in .50 BMG and .416 Barrett



**6-PORT HIGH-VOLUME  
GAS BRAKE**  
(Armalite tank brake available)



**FREE-FLOATING  
BULL BARREL**  
(30" and 22" available)



**CUSTOM COLORS**  
(Optional)



(844) 635-0669

mccutchenfirearms.com

cs@mccutchenfirearms.com

\*FFL transfer required for upper receivers and rifles

## GEAR THAT WILL GET YOU THROUGH!

The 2020 Waypoint project would not be complete without a brief rundown on the clothing and gear that protected us and our equipment in the harsh, early-winter climate of Afognak Island. The Alaska-tough gear that worked during this and other previous hunts included:

- Outer Rain Shell: Sitka Gear 'Stormfront' Jacket
- Insulation/Mid Layer: Sitka Gear 'Kelvin Lite Down' Jacket
- Hunting Pants: Fjallraven 'Keb' Gaiter Trousers (also great for mountain hunting)
- Boots: Rocky Arctic Bear Claw (Gore-Tex/1400 grams Thinsulate)
- Back Pack: The Eberlestock 'J34 Just One'

The Sitka Gear jackets my hunting partners and I have utilized on multiple expeditions in Alaska and elsewhere have made the difference between comfortable, dry hunts or miserable, potentially dangerous ones. Fjallraven, in my experience, makes some of the best hunting pants in the world, whether for use during Dall Sheep or

Mountain Goat hunts, or lowland Moose hunts. They are fast drying and tough as nails...titanium nails dipped in whatever that crap was they injected into Wolverine's bone marrow (Adamantium?). Rocky Arctic Bear Claws are warm, dry, and nearly indestructible. I've only gone through one other pair of Rocky Arctic Bear Claws since my 17-year hunting career began in Alaska, and when they finally gave up the ghost, my family and friends had a Viking funeral for them. I won't lie...I may have cried...and also started a forest fire. Finally, the 'play of the day' on this hunt was carrying my gear and rifle in an Eberlestock 'J34 Just One' backpack. I've used Eberlestock gun-packs for years, and the J34 is the best so far. It has a built-in rifle carrier that provides immediate access to your weapon in a clinch, and is expandable for carrying a moderate amount of gear, as well as game. The J34's ergonomics and fit make it extremely comfortable, even when your load is heavy, and when combined with a light-weight, water-resistant pack cover, it is bomb-proof. **FN**

[Cont. from page 32]

noticeable corrosion evident anywhere on the weapons system. The rifle and accompanying optic took a crushing blow when my heavy pack and I landed directly on top of them on that rocky Afognak beach, yet remained 'x-ring accurate' and maintained zero when range tested in the aftermath. The Nightforce scope performed perfectly, through thick and thin, without even a hint of condensation on its brilliantly clear glass. The Waypoint's trigger is smooth, almost as if it is in direct competition with the bolt, and the accuracy speaks for itself. In relation to functional aesthetics, the 'Evergreen' camo pattern of the rifle's stock matched Alaska's early-winter spruce/snow background nearly perfectly.

The Springfield Waypoint 2020, in 6.5 PRC, is a flat-shooting, game harvesting machine. For once, Alaska and I were on the same page of music when it came to trying to break something, yet we both failed. It survived one of the toughest environments in the world and is fully capable of giving you everything you could want from a customized rifle in a convenient, well made longarm straight from the good folks at Springfield Armory's factory floor in Geneseo, Illinois.

2020 may have had its moments, but at least Springfield Armory Waypoint gave us one of the bright ones! **FN**



Just like fine wine, pairing is important: The Nightforce NX8 equipped 2020 Waypoint riding smartly in an Eberlestock J-34 Rifle Pack.

### SPRINGFIELD ARMORY 2020 WAYPOINT RIFLE

<b>Caliber:</b>	6.5 PRC (also available in .308 Winchester, 6mm Creedmoor, and 6.5 Creedmoor)
<b>Model #:</b>	BAW92465PRCCFGA
<b>Stock:</b>	Adjustable with Carbon Fiber/ Custom Evergreen Camo Pattern; Hybrid Profile; M-Lok®
<b>Barrel:</b>	Free-floated BSF 24" Carbon Fiber, 1:8, Mil-Spec Green Cerakote; H-264
<b>Receiver:</b>	Model 2020 Stainless Steel, Mil-Spec Green Cerakote® H-264
<b>Optics Mount:</b>	Picatinny Mount, Rem 700 SA Pattern
<b>Bolt:</b>	Fluted 4140 Tool Steel/Nitride
<b>Trigger:</b>	TriggerTech Adjustable, 2.5 – 5 lbs.
<b>Muzzle Device:</b>	SA Radial Brake, 5/8-24 threading
<b>Magazine:</b>	3-round detachable
<b>Weight:</b>	7 lbs. 3 oz.
<b>Length:</b>	43.5"
<b>MSRP:</b>	\$2,399 (as tested), \$1,699 (with fluted 416 stainless steel barrel)
<b>Contact:</b>	Springfield Armory, Springfield-Armory.com, (800) 680-6866

## Advanced Mounting Solutions

Ultra-low, Forward Optic Mounts  
for M-14, M1A, Mini-14, M1 Carbine,  
AK, and M1 Garand

Patented, combat proven rail systems, optics,  
stock kits & grips.

*"Because Good People Need Better Weapons"*



**UltiMAK**<sup>TM</sup>

Enhanced Performance

2216 S. Main, Suite B2  
Moscow, ID 83843  
208-883-4734

[www.ultimak.com](http://www.ultimak.com)

## You Will Be Amazed At The Accuracy Inherent In Our Accublock® Stocks!



LRC™ Thumbhole



M50™ Adjustable



LRC™ Vertical Grip



LRC™ Sporter

True Drop-in  
Models To Fit  
Most 700's

Long Range Composite  
Accublock® Stocks

Your Choice **\$219**

Compare at \$329  
★★★★★  
Customer  
FIVE STAR  
Rated

## Accublock® Aluminum Bedding System



**Instant Precision**

Do It Yourself  
Installs In  
10 Minutes  
Screws  
Included

**Stocky's**

ph (561) 584-8500  
America's Gunstock Specialists!

**INSTANT  
SHIPPING**

[www.NewRifleStocks.com](http://www.NewRifleStocks.com)

**EXPERT  
SUPPORT**

## STAY ON TARGET



SUBSCRIBE TODAY

FIREARMS NEWS is available on updated iPad/iPhone,  
most Android devices, and the Microsoft Store for Windows.

For More Information Visit

**FIREARMSNEWS.COM**

## Lowest Price Pistol Ever!

The Altor® Pistol is Virtually Indestructible  
Perfectly Simple and Simply Perfect®  
Survival, Backup or Stash Gun



Contact your local firearms  
dealer to get one

MSRP .380 \$125.00

MSRP 9 MM \$135.00

MADE IN THE USA

©2021 ALTOR CORPORATION All Rights Reserved

Visit [www.altorcorp.com](http://www.altorcorp.com) for more info and videos

# 400 TO 800

We Stretch the Legs on Springfield Armory's New 6.5mm PRC Model 2020 Waypoint

By David M. Fortier  
Photography by Rachel R. Fortier



How well does Springfield Armory's new Model 2020 Waypoint shoot? To find out we stretched its legs from 400 to 800 yards.

# YARDS



**The Model 2020 Waypoint is a good-looking bolt-action hunting rifle boasting some great features for the long-range hunter.**



**W**hen *Firearms News* first learned of Springfield Armory's entrance into the bolt-gun hunting rifle market we carefully considered how we should cover it. Rather than a traditional review, our editor Vince DeNiro decided on an exciting two-prong approach. One Springfield Armory Model 2020 Waypoint rifle would go to Rikk Rambo in Alaska and another to me here in Kansas. Rikk would take his Waypoint and head off into the Alaskan wilds after Sitka black-tailed deer and spin his version of *War and Peace* about the adventure. His rifle would have to endure everything the "Last Frontier" could throw at it. The Waypoint rifle I received would be put to work on the range to check its practical accuracy, and I'd supply a concise look at the rifle, its 6.5mm PRC cartridge and their performance.

While Kansas lacks the incredibly harsh environmental conditions Alaska is famous for, it brings one thing to the table, wind. The Kansas winter wind blowing across the empty landscape is something which must be experienced. Like the lyrics in a James

Taylor song, "Lord knows when the cold wind blows it'll turn your head around." So, I put the Waypoint to work in blistering conditions engaging steel targets at practical long-range hunting distances. In this fashion we hoped readers would get a good feel for what Springfield Armory's new Model 2020 Waypoint was capable of.

Before we head off to the range though, let's examine this interesting new design. Springfield Armory's Model 2020 Waypoint is a blend of "old-school cool" and modern features you would expect from a custom rifle. Springfield Armory currently chambers the Waypoint for four short-action cartridges, the hugely popular 6mm and 6.5mm Creedmoor, the new 6.5mm PRC (Precision Rifle Series) seen here and the venerable .308 Winchester. Currently it is only offered as a short-action, and the Waypoint is a conventional dual-lug design with 90-degree rotation and an enlarged ejection port.

The receiver is CNC-machined from billet and hardened afterwards to prevent warping or distortion.

Bolt lug recesses are EDM (Electrical Discharge Machining) cut and the recoil lug is machined integral to the receiver. The design also features an optimized extraction cam surface and a hybrid dual-plane feed-ramp to aid reliability. Riding inside the action is a fluted bolt with square-bottom flutes, sliding 0.20-inch wide extractor and dual cocking cams for an easy and smooth bolt-throw. The bolt handle is long, provides good leverage and has a removable knob. The bolt design requires no tools for stripping, allowing easy maintenance, even in the field. A Nitride finish is standard on the bolt of all models.

A robust M700 pattern one-piece M1913 "Picatinny" rail is both pinned and bolted to the top of the receiver for added durability and peace of mind. This comes in handy if, say a rogue wave flattens you while disembarking from a landing craft in a heavy Alaskan



**Springfield Armory has introduced their first bolt-action hunting rifle, the Model 2020 Waypoint.**



**The Waypoint is available in (R to L) 6mm Creedmoor, 6.5mm Creedmoor and the 6.5mm PRC along with the .308 Winchester (not shown).**



inside a carbon fiber jacket. As the barrel is fluted, the carbon fiber only comes in contact with a small portion of the surface area of the barrel, approximately 5%. This leaves air gaps between the carbon fiber and the barrel flutes, to aid cooling. In addition, to further enhance accuracy the roll-wrapped carbon fiber sleeve is under tension. The goal of all this is to provide an accurate but very light barrel which does not experience a shifting Point of Impact as it heats/cools. The muzzle is threaded and fitted with a radial muzzle brake to reduce recoil. My 6.5mm PRC test rifle featured a 24-inch barrel while 6mm Creedmoor and .308 Win rifles come with a 20-inch tube and 6.5mm Creedmoor a 22 incher.

Keeping with the lightweight theme, the barreled action is pillar bedded into an AG Composites' carbon-fiber stock. Each stock is hand-laid and intended to be very rigid and robust, yet very light. If you wish to upgrade, you can add an adjustable comb, but this does add about 12 ounces. The stock features two aluminum pillars, five QD sling attachment points and a Decelerator recoil pad. At six o'clock, the fore-end features three M-LOK slots for easy mounting of a bipod or other accessories.

With the standard stock the 6.5mm PRC Waypoint with carbon fiber barrel weighs in at just six pounds 14 ounces. With the adjustable comb it weighs in at seven pounds and 10 ounces. A stainless steel barrel adds eight ounces to either model. Overall length is 43.5 inches. Finish options are either H-264 green or H-256P Desert Verde Cerakote on the action, barrel shank and brake with either hand-painted Ridgeline or Evergreen camo on the stock.

The end result is not only light and very capable at long range, but also blessed with handsome looks. Here is a rifle which can go long, without that erector set look currently in vogue. Plus, Springfield Armory's Model 2020 Waypoint is fairly reasonably priced for what they offer. So, this should give you some useful insights into the rifle itself, but what about the 6.5mm PRC cartridge our review rifle was chambered for?

storm ("cough, cough" Rikk). A low-profile bolt stop is fitted along with a Triggertech trigger. The trigger mechanism sports a low-profile safety lever, their Frictionless Release Technology and is user adjustable from 2.5 to 5 pounds. Feed is from detachable AICS pattern box magazines. These are both fairly well-designed and readily available on the aftermarket. The magazine release is located inside the trigger guard and ambidextrous.

Up to this point, the 2020 Waypoint sounds fairly conventional, and it is. The plot to our story though is about to take a twist. While a conventional deep-fluted stainless steel barrel is available, the premium upgrade is a BSF jacketed carbon fiber barrel. This has distinctive looks and noticeably reduces weight. It features a deep-fluted stainless steel barrel of smaller diameter



Currently, Springfield Armory is only offering the Waypoint as a short-action. It features a conventional dual-lug design with 90-degree rotation and an enlarged ejection port.



An extended bolt handle and nicely sculpted bolt knob provide plenty of leverage.



While a conventional deep-fluted stainless steel barrel is available, you can upgrade to a lightweight BSF jacketed carbon fiber barrel.



**Feed is from detachable AICS pattern box magazines. These are both fairly well-designed and readily available on the aftermarket.**

I can remember when many in the industry said the 6.5mm bore-size would never catch on with American shooters and sportsmen. My how times change, in recent years both the 6.5mm Grendel and 6.5mm Creedmoor have become hugely popular. American riflemen have finally recognized the potential of efficient .264-inch projectiles with their high Ballistic Coefficients and impressive Sectional Density. When the 6.5mm Creedmoor finally gained mainstream popularity it led to American riflemen reexamining old classics, such as the 6.5x55mm Swedish Mauser. Perhaps more importantly, it led to industry introducing new 6.5mm cartridges, such as the 6.5mm PRC.

For all intents and purposes, the 6.5mm PRC is a short magnum which provides 250 to 300 fps or so of velocity over the 6.5mm Creedmoor with equal

weight projectiles. Due to this the exterior ballistics are further improved. More importantly, the increase in velocity improves terminal performance making the PRC a better hunting cartridge at distance and on larger game than the Creedmoor. Keep in mind, the 6.5mm Creedmoor was originally developed for punching paper in NRA High Power. The Creedmoor is a good, but not great hunting cartridge on larger/tougher animals. The PRC ups the ante without a

large increase in recoil or completely axing barrel life. Plus, it fits into a compact short-action.

As this is *Firearms News* and not a straight hunting publication, let's take a quick look at a few 6.5mm military cartridges which laid the groundwork for the success of both the 6.5mm Creedmoor and PRC. If you think 6.5mm cartridges are a recent innovation, think again. This bore-size first became popular in the late 19th Century during the great arms race

[Cont. to page 42]



**An adjustable cheek-riser is an option, but it does add 10 ounces to the weight of the rifle.**



**Underneath the fore-end you'll find three MLOK slots for mounting a bipod or other accessory.**





# Grizzly Industrial®

PURVEYORS OF  
FINE MACHINERY®  
SINCE 1983

QUALITY MACHINES, GREAT PRICES!

## 8" X 30" 1½ HP VARIABLE-SPEED KNEE MILL WITH RAM HEAD

- Motor: 1½ HP, 220V, 3-phase, 4.8A
- Power Required: 220V, Single-phase
- Table Size: 8" x 30"
- Spindle Speeds: variable, 220-2250 RPM
- Spindle Taper: R-8
- Spindle Travel: 3½"
- Head Tilt: Left/Right – 45°
- Approx. shipping weight: 1006 lbs.



**WARNING! †¹**  
**G0695 Only \$4995<sup>00</sup>**

**\$369<sup>00</sup>**  
SHIPPING

## 9" X 39" 2 HP HORIZONTAL/VERTICAL MILL WITH POWER FEED

- Vertical spindle motor: 3 HP, 220V, Single-phase, 13A
- Horizontal spindle motor: 2 HP, 220V, Single-phase, 8.6A
- Table size: 9½" x 39½"
- Vertical Spindle Speeds: 285-2300 RPM
- Horizontal Spindle Speeds: 72-1300 RPM
- Spindle Travel: 5"
- Head Tilt: Left/Right – 90°
- Approx. shipping weight: 2050 lbs.

MADE IN  
AN ISO  
9001  
FACTORY



**WARNING! †¹**  
**G0757 Only \$5795<sup>00</sup>**

**\$469<sup>00</sup>**  
SHIPPING

## SOUTH BEND 9" X 48" 3 HP TURRET MILL WITH DRO

- Motor: 3 HP, 220V, 3-phase, 8.5A
- Power Required: 220V, Single-phase
- Spindle Taper: R-8
- Table size: 9" x 48"
- Spindle Speeds: 60 – 5000 RPM
- Spindle Travel: 5"
- Head Tilt F/B / L/R: 45° / 90°
- Approx. shipping weight: 2365 lbs.



**WARNING! †¹**  
**SB1027F Only \$13,995<sup>00</sup>**

**\$475<sup>00</sup>**  
SHIPPING

## SOUTH BEND 10" X 54" 5 HP 3-PHASE MILL WITH DRO

- Motor: 5 HP, 220V, 3-phase, 14A
- Power Required: 220V, Single-phase
- Spindle Taper: R-8
- Table size: 10" x 54"
- Spindle speeds: 60 - 5000 RPM (electronic variable)
- Spindle Travel: 5"
- Head Tilt F/B / L/R: 45° / 90°
- Approx. shipping weight: 3350 lbs.



**WARNING! †¹**  
**SB1028F Only \$16,995<sup>00</sup>**

**\$655<sup>00</sup>**  
SHIPPING

## 12" X 36" GUNSMITHING LATHE WITH ENCLOSED GEARBOX

- Motor: 2 HP, 220V, Single-phase, 8.5A
- Spindle Bore: 1.57"
- Spindle Taper: MT#5
- Spindle Speeds: 70 – 1400 RPM
- Spindle Type: D1-5 Camlock
- Approx. shipping weight: 1236 lbs.

MADE IN  
AN ISO  
9001  
FACTORY



**WARNING! †¹**  
**G0750G Only \$4750<sup>00</sup>**

**\$369<sup>00</sup>**  
SHIPPING

## 14" X 40" GUNSMITHING GEARHEAD LATHE

- Motor: 2 HP, 220V, Single-phase, 10A
- Spindle Bore: 1.57"
- Spindle Taper: MT#5
- Spindle Speeds: 70 – 2000 RPM
- Spindle Type: D1-5 Camlock
- Approx. shipping weight: 1550 lbs.



**WARNING! †¹**  
**G0709 Only \$5795<sup>00</sup>**

**\$369<sup>00</sup>**  
SHIPPING

## 16" X 40" 3-PHASE GUNSMITHING LATHE

- Motor: 4 HP/3 HP, 3-phase, 220V, 17A/8.5A
- Spindle Bore: 2.0625"
- Spindle Taper: MT#6
- Spindle Speeds: 45 – 1800 RPM
- Spindle Type: D1-6 Camlock
- Approx. shipping weight: 3300 lbs.



**WARNING! †¹**  
**G0509G Only \$9995<sup>00</sup>**

**\$655<sup>00</sup>**  
SHIPPING

## SOUTH BEND 14" X 40" ELECTRONIC VARIABLE-SPEED 440V TOOLROOM LATHE WITH FAGOR DRO

- Motor: 5 HP, 440V, 3-phase, 7.8A
- Spindle Bore: 2.0625"
- Spindle Taper: MT#6
- Spindle Speeds: 20 – 2500 RPM
- Spindle Type: D1-6 Camlock
- Approx. shipping weight: 3212 lbs.



**WARNING! †¹**  
**SB1013F Only \$21,250<sup>00</sup>**

**\$655<sup>00</sup>**  
SHIPPING

## SOUTH BEND 14" X 40" LATHE WITH DRO

- Motor: 5 HP, 220V, 3-phase, 15.5A
- Spindle Bore: 2.0625"
- Spindle Taper: MT#6
- Spindle Speeds: 20 – 2500 RPM
- Spindle Type: D1-6 Camlock
- Approx. shipping weight: 2984 lbs.



**WARNING! †¹**  
**SB1012F Only \$21,500<sup>00</sup>**

**\$655<sup>00</sup>**  
SHIPPING

\*To maintain machine warranty, 440V operation requires additional conversion time and a \$250 fee. Please contact technical service for complete information before ordering.

**grizzly.com** 1-800-523-4777  
TECHNICAL SERVICE: 570-546-9663

Due to rapidly changing market conditions, our advertised prices may be increased at any time without prior notice.



**WARNING! †¹: Cancer & Reproductive Harm**  
Some products we sell can expose you to chemicals known to the State of California to cause cancer and/or birth defects or other reproductive harm. For more information go to [www.P65Warnings.ca.gov/product](http://www.P65Warnings.ca.gov/product)



**To further enhance accuracy, the roll-wrapped carbon fiber sleeve is under tension. The goal of all this is to provide an accurate but very light barrel.**

[Cont. from page 40]

instigated by the French fielding of the smokeless powder 8x50mmR "Lebel" cartridge in 1886.

Dating from 1890 is the Italian 6.5x52mm "Carcano." The Italian Army never really evolved this load which consisted of a 162-grain jacketed round nose projectile 0.267 inch in diameter with a velocity of approximately 2,300 fps. My favorite early 6.5mm is the 1891 vintage 6.5x55mm "Swedish Mauser." It was originally developed for service with the United Kingdoms of Sweden and Norway and its updated load consisted of a 139-grain Spitzer FMJ with a velocity of 2,601 fps from an m/96. In 1897, Imperial Japan adopted the 6.5x50mm Semi-Rimmed (SR), which is commonly referred to as the 6.5mm Arisaka. The updated load adopted with the Type 38 Arisaka rifle featured a 139-grain Spitzer FMJ with a muzzle velocity of approximately 2,500 fps. In the post-war years, all



**The muzzle is threaded and fitted with a radial muzzle brake to reduce recoil. Recoil is very mild and it's a comfortable rifle to shoot.**

three of these cartridges saw use in the hunting field where they performed well.

The 6.5mm PRC offers quite a step up in performance over these 19th Century classics, as well as more modern designs like the .260 Rem, 6.5x47mm Lapua and 6.5mm Creedmoor. Developed by the engineers at Hornady, they based it on the .300 Ruger Compact Magnum cartridge case. So, it features a .532-inch case head with some body taper before the 30-degree shoulder. Overall length is 2.96-inch, which is optimized for use with 140-grain and slightly heavier bullets. Its ability to propel very efficient 140- to 147-grain projectiles at around 3,000 fps makes it flat shooting and very well-suited for long-range hunting, especially in high winds.

Unfortunately, due to the current ammo panic, I only had one load available for testing. This was Hornady's 147-grain ELD Match. The 147-grain ELD

Match bullet has an excellent reputation and possesses a very high Ballistic Coefficient (BC) of .697 G1. While perhaps a trifle heavy in a 6.5mm Creedmoor, it does very well in the 6.5mm PRC. The efficient bullet design provides a flatter trajectory, less wind deflection, higher retained velocity and energy at the target and reduced time of flight. All very good things to have on your side in the hunting field.

Conditions during testing varied from 25 to 35 degrees F, overcast and windy. A Leupold 3-18x44mm VX-6HD scope with 1/4 MOA adjustments was used during testing. This is a good looking optic well-suited for this rifle's intended purpose. Color rendition is accurate, resolution is good and the turrets had fairly distinct clicks with 20 MOA of adjustment per full turret rotation. Magnification range is very wide and the reticle is located in the Front Focal Plane. The rifle arrived with the Leupold already mounted and was ready for testing out of the box.

Settling in at my range, I fired one shot at 100 yards to confirm zero. With that out of the way I carried all my gear to the top of my shooting tower,

[Cont. to page 44]



**As the LabRadar shows the 6.5mm PRC is a step up from a 6.5mm Creedmoor or .260 Remington.**



**The rifle arrived with the Leupold mounted so a quick confirmation of zero was done from the bench at 100 yards. All further testing was conducted from the supported prone.**



We never rest on our laurels. That would mean resting.

And we can't rest. Because there's always this thought: that somehow, some way, our high-performance ammunition could be...just a little closer to perfect. So we shift this. Tweak that. Sometimes, nothing. But sometimes, *whoa, like that.* And that just lights a fresh fire under our ass.

TO LOCATE A DEALER NEAR YOU, PLEASE CALL 800.568.6625



WWW.BLACK-HILLS.COM

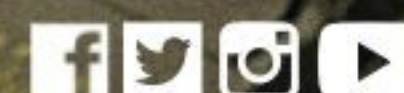

# ANYTIME ANYWHERE

DIGITAL ACCESS NOW INCLUDED WITH YOUR PAID SUBSCRIPTION!

ENJOY DIGITAL ACCESS ON YOUR PHONE, TABLET & MORE\*

# SUBSCRIBE TODAY AT

WWW.FIREARMSNEWS.COM

CURRENT SUBSCRIBERS GO TO MYMAGNOW.COM AND SELECT "CREATE DIGITAL ACCOUNT"

\*Digital Edition is available on updated iPad/iPhone, most Android devices, and the Microsoft Store for Windows

[Cont. from page 42]

set-up my rest, rear bags, ammo and went to work prone. I knew Rikk would do testing at the shorter distances, so I went straight to 400 yards. Keeping in mind I was shooting without a spotter in a gusting 15+ mph wind, my goal was to see how well the Waypoint grouped at distance. I was interested to see the group size, group shape, vertical dispersion and if the rifle did anything funny as the barrel heated. A bit of horizontal dispersion was expected simply due to the windy conditions.

The four-round magazine loads easily for the first three rounds and then the last cartridge requires a good bit of effort. Load four rounds into and it doesn't want to seat on a closed bolt. With the bolt open it clicks into place nicely. Rounds chamber easily with little effort. The safety is easy to reach, the fore-end is just wide and flat enough to sit well on a rest or pack and I found the stock comfortable. While the pistol grip area is a bit more vertical than I might prefer, I had no issues and this is a rifle you will likely be shooting prone or off a support. Out of the box I found the trigger good and it breaks cleanly. If it were

mine, I'd adjust it a bit to take some of the weight out as received.

Recoil, thanks to the brake is mild. It's a very comfortable rifle to shoot and I had no problem spotting my own shots. The bolt is a traditional 90-degree rotation design, and the long bolt handle provides plenty of leverage. Fired cases extracted smoothly and ejected cleanly without issues. The empty magazine ejected with the push of the button and the mag release was easy to manipulate even with cold fingers.

I had made a simple data card using Hornady's 4DOF Ballistic Calculator, so I checked this and got to work at 400 yards. Laying prone I fired two three-shot groups to get a feel for the rifle. Out of the box the trigger is a bit heavier than I'd prefer, but the rifle felt comfortable as I became accustomed to it. These groups averaged 2.5 inches so I moved on. My first shot at 500 yards went over the top of the eight-inch plate I was aiming at, and was slightly to the right.

I dialed out some elevation, dialed in a bit more wind and my second shot impacted the top of the plate. I maintained my hold and followed this up



Here is a 3.8 inch 5-shot group fired at 500 yards in windy conditions.

with another four hits. Extreme spread of these five shots was 3.8 inches, with the group spread horizontally. Vertical spread came in at only 1.5 inches. So, I was getting some horizontal spread due to the windy conditions, but the Waypoint was still shooting into .72 MOA ( $3.8 / [1.047 \times 5]$ ) at 500 yards. I repainted the plate and fired another five rounds. These looked

## REVOLUTION TARGETS' RESETTING STEEL TARGETS

Revolution Targets is a relatively new name in the target world, but they are not new to the firearms industry. They are a subsidiary of Pendleton Safes and Revolution Safes. Revolution Targets has an economical line of resetting steel targets specifically designed with the precision rifleman in mind. Their Compact Precision Rifle Targets consist of 2-, 3-, and 4-inch steel plates on a simple drive-in metal stake. Light and easy to carry and store, you simply drive it into the ground and shoot. Due to their design, they automatically reset. They are available in a single and dual plate design with either a vertical or horizontal configuration. Place them at 100 yards and you can practice your precision shooting and never have to walk down-range to reset a target. They are very well made, durable, easy to use and a lot of fun.

Revolution Targets also offers a host of different designs, including plate racks and torso targets. My favorite though is their Portable Long Range Target. One of the challenges when shooting at long range,

especially if you do not have a spotter, is not-knowing if you connected. This is especially true with certain smaller calibers. Revolution Targets' Portable Long Range Target solves this problem. Hit the center plate and it flashes a red plate so you know you hit.

The design is very well thought out and made from quality materials. It features high quality welds for a long service life and even features grease fittings. The design is portable, easy to move, quick to set-up and easy to take down. Use of an economical 2x4 wood upright allows you to easily change the target height per your particular range needs. If the 2x4 gets shot up, simply swap it for a new one.

The target consists of a stand, 2x4 wood upright, steel torso with a 10-inch diameter round reactive hit zone and a 10-inch diameter round hit indicator. The target is manufactured from AR500 steel in both 3/8 and 1/2 inch thicknesses depending upon your needs. When you hit the center reactive hit zone it will pivot back and the top red plate will pivot down

into view. So it flashes an easy to see red indicator when you hit the center plate. Plus, it automatically resets for the next shot. This design works very well, even with .223 Remington at 700 yards. Build quality is excellent, it's very well designed and rotation is smooth. You can shoot the center once, and see the hit indicator flash, or you can shoot it multiple times with the right timing and get it to spin. It always returns properly to its rest position due to gravity. Downside? Just it's price, which is \$680 for the 3/8-inch model. For more information on these and their entire line of targets visit [RevolutionTargets.com](http://RevolutionTargets.com) **FN**



Revolution Targets economical Compact Precision Rifle Targets consist of resetting 2, 3 and 4-inch steel plates on a simple drive-in metal stake.

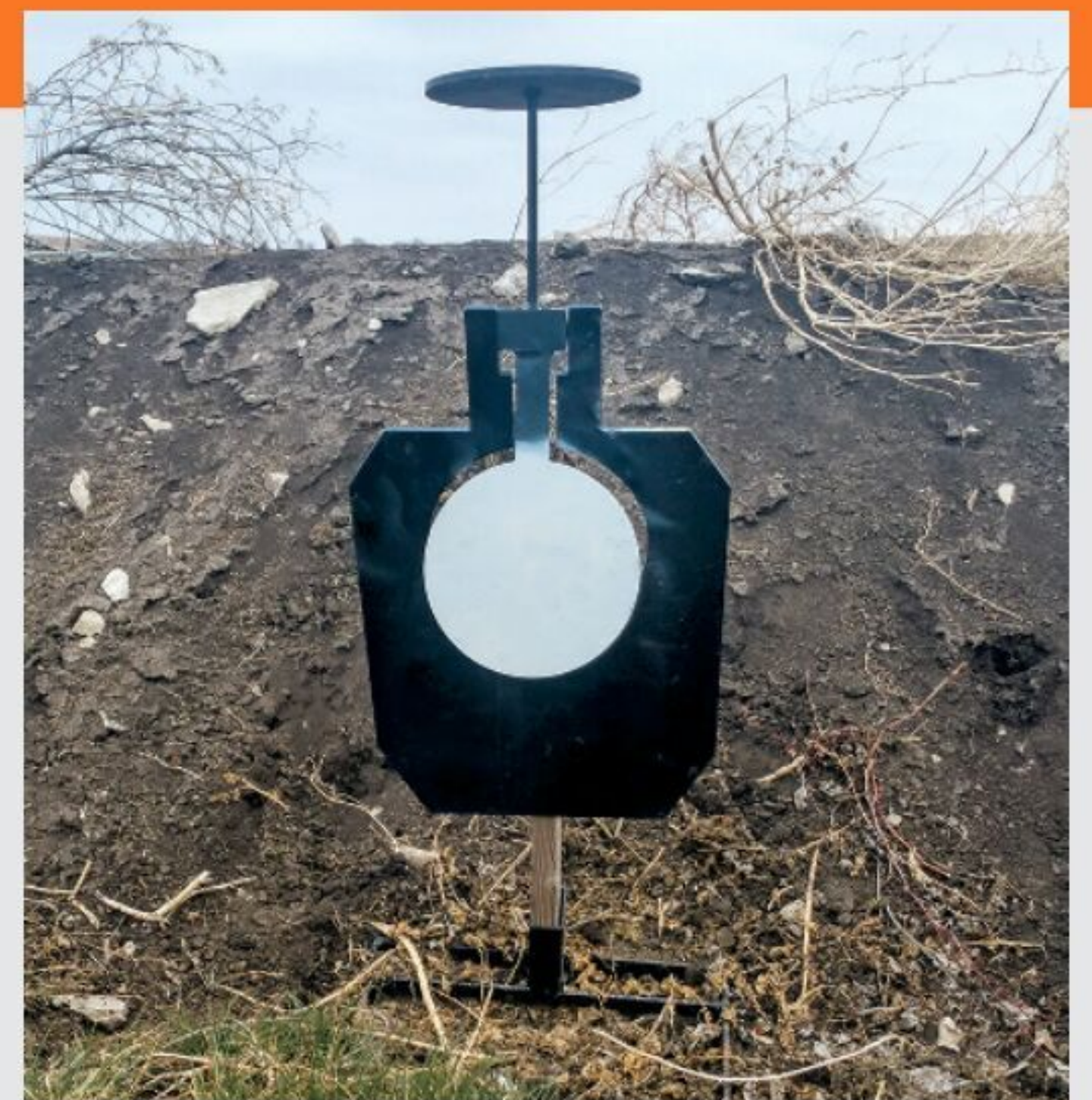

Revolution Targets Portable Long Range Target is a silhouette with a 10-inch center plate. Hit the center plate and the top plate pivots down, flashes red and indicates a hit.



The Portable Long-Range Target is very well designed, nicely made and built for hard use. It is easy to set-up and provides instant feedback on a center hit.



The wind at 700 yards was a bit tricky but I was quickly on the center swinging plate of the Revolution Targets Portable Long Range Target.



At 700 yards three rounds went into 2.5 inches with all five into 6.8 inches. This was the largest group of the day.

**500 YARD ACCURACY CHART  
SPRINGFIELD ARMORY MODEL 2020 WAYPOINT 6.5mm PRC**

Load	Bullet Weight (gr.)	Muzzle Velocity (fps)	Standard Deviation	Average Group (in.)
Hornady ELD Match	147	2,978	36.6	3.8

Accuracy results are an average of two five-shot groups fired supported prone at 500 yards. Velocity figures are 10-shot averages recorded with a LabRadar Doppler chronograph at the muzzle at an ambient temperature of 35 degrees F at 1,030 feet above Sea Level.

basically identical to the first five. I reloaded the magazine and fired four as fast as I could work the bolt and get back on target. Here the leverage provided by the bolt handle was appreciated, feeding was smooth, and the brake did its job well. All four rounds smacked the plate.

I dialed in a bit more elevation and windage into the Leupold and moved to 700 yards. The wind was being a bit tricky, and my first three rounds went high into the black silhouette rather onto the white swinging plate. These measured five inches. So, I dropped some elevation out and my next shot was on the swinging plate. Three rounds went into 2.5 inches with all five

into 6.8 inches (.92 MOA). Again the dispersion was mainly horizontal with one flier really opening things up on me. After finishing my group at 700 yards, I immediately moved to 800 yards. The 6.5mm PRC cartridge will generate some heat, so I was interested to see if this would noticeably affect group size. I guessed on the elevation and windage and came up just a bit low on the silhouette, but I had a first round hit on steel at 800 yards. I maintained my hold and fired another four. Three rounds went into 3.5 inches and I kept all five in six inches (.71 MOA).

On a calm windless day this rifle and load would likely turn in some very impressive groups. But that's not typically what you see in the field. My results demonstrate what the rifle/load/optic is capable of under less than ideal conditions firing prone. For a first try I think Springfield Armory did a very good job with their new Model 2020 Waypoint. It carries well, the fore-end is nicely contoured and sits in bags well without being uncomfortable or blocky. The pistol grip works well prone and the rubber recoil pad keeps the butt from sliding around.

The stock texture feels good in the hand and the rifle balances very well. It hangs nicely offhand and is easy to shoot from traditional positions. While 90-degree rotating dual-lug front-locking bolt designs are as American as mom and apple pie, they have never been noted for their speed. However, the length and angle of the Waypoint's bolt handle provides plenty of leverage to get your hustle on. Fast follow-up shots

**SPECIFICATIONS — SPRINGFIELD ARMORY MODEL 2020 WAYPOINT**

<b>Action Type:</b>	Manual rotating bolt
<b>Caliber:</b>	6.5mm PRC
<b>Capacity:</b>	3-round detachable box magazine
<b>Barrel:</b>	24 inches, Carbon Fiber sleeved, 1 turn in 8" RH twist
<b>Overall Length:</b>	43.5 inches
<b>Weight:</b>	7 pounds 10 ounces
<b>Stock:</b>	Hybrid Profile, Carbon Fiber w/Adjustable cheek riser
<b>Length of Pull:</b>	13.5 inches
<b>Finish:</b>	Cerakote
<b>Trigger:</b>	Single-stage adjustable from 2 to 5 pounds
<b>Sights:</b>	None, Mil Std 1913 rail
<b>Safety:</b>	Two-position
<b>Price:</b>	\$2,399 MSRP
<b>Manufacturer:</b>	Springfield Armory Springfield-Armory.com

**SOURCES**

**Springfield Armory**  
Springfield-Armory.com

**Leupold**  
Leupold.com

**Hornady Manufacturing**  
Hornady.com



At 800 yards I was a bit low and to the right, but on steel.



This 800-yard group has three rounds in 3.5 inches and all five in 6 inches or .71 MOA.

are not an issue. The jacketed carbon fiber barrel system is visually attractive, reduces weight and shoots well. Balance point is directly ahead of the mag well (with the Leupold mounted). The muzzle feels a bit light, making it quick to the shoulder and fast on moving targets. Yet, the rifle has just enough forward weight to be stable offhand while still being light and easy to carry.

Springfield Armory guarantees their Waypoint will keep three rounds in .75 MOA. This one had no issue doing that, even at 800 yards. Price for the stainless steel barrel model is \$1,699 while the MSRP for the carbon fiber barreled model, as seen here is \$2,399. It will be interesting to see how Springfield Armory expands this line in the future. **FN**



**The Basic Plus Rifle from ATAC Defense offers you everything you need in an AR and nothing you don't, plus a Cerakote finish. This rifle is in Burnt Bronze. ATAC Defense might be a new name to you, but they've been making OEM parts for other companies for years.**

ATAC DEFENSE'S

By James Tarr

# BASIC PLUS

# RIFLE

More Than You Know



In 2021, the fact that there are many quality companies making AR-15s, companies many people might not have heard of, is a good thing — it means those smaller companies are not likely to be sold out of product due to the panic buying that's been going on for most of a year as I write this, and to which there is no end in sight.

One of those companies you probably haven't heard of is ATAC Defense. ATAC Defense has been in manufacturing for twenty years, and started out making automotive components. For the last seven years they've been making OEM firearm parts — more

than 300 — for various companies. In the past year they've decided to start making complete rifles and pistols under their own name.

ATAC makes rifles in 5.56 NATO and 300 Blackout, and pistols in 5.56 NATO and 9mm. ATAC Defense offers their rifles in various "trim packages," using an automotive term, and I asked them to send me one of their Basic Plus rifles to review. The Basic Plus seemed to be the best balance of price versus features.

While trends and what's "hot" in ARs tends to change almost on a yearly basis, the Basic Plus rifle follows the template of what is the most popular

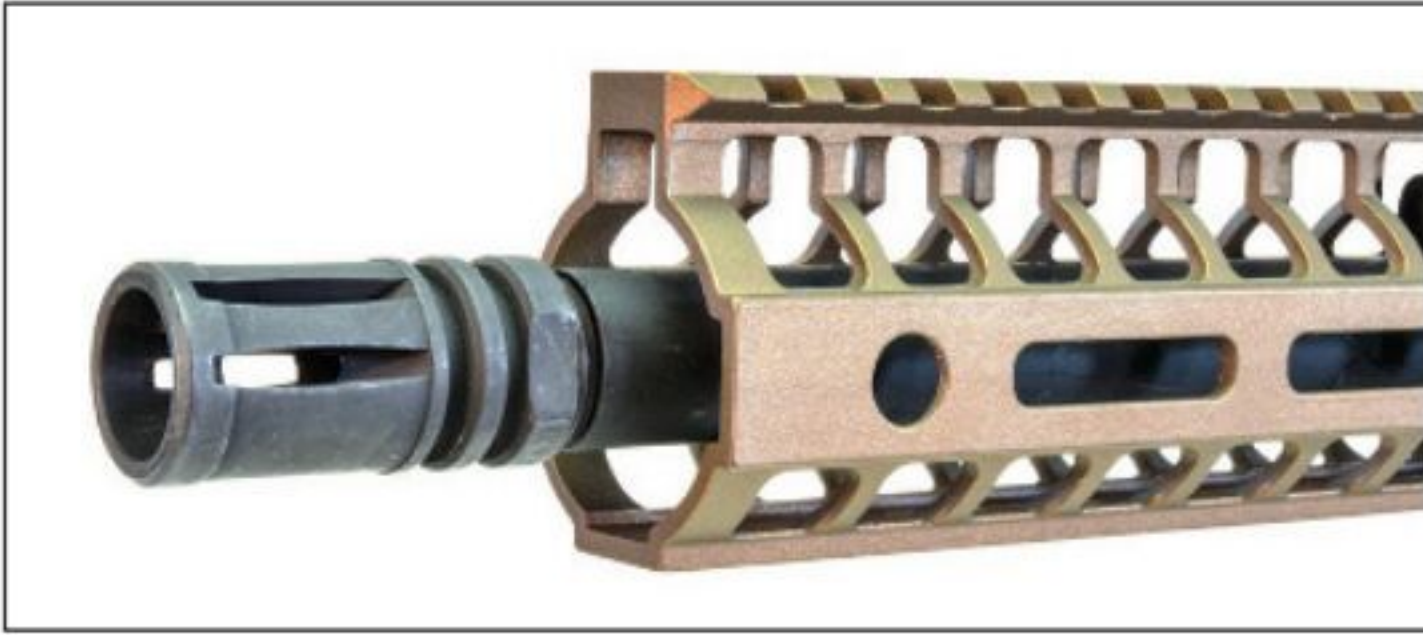

The handguard is one of ATAC's own design, and features QD sling sockets at the muzzle end to either side. The barrel is tipped with a standard A2 flash hider.



The ambi charging handle is one of the two upgrades from the Basic Rifle, the other being a coated bolt carrier group.



Chances are if you own an AR, it has some parts in it made by ATAC Defense, even if you've never heard of them. They supply OEM components to many manufacturers, including some who have defense contracts.

AR-15 design on the market right now — a collapsible stock paired with a 16-inch barrel freefloating inside an aluminum handguard.

For those of you paying attention, you'll have noted that the rifle in the photos is not black. The listed price of the Basic Plus rifle includes a Cerakote color treatment of your choice on the receivers and handguard — black, Tungsten (silver), FDE, OD Green, or Burnt Bronze, like my sample. The Burnt Bronze has a bit of metallic glitter to it, but as you can see from the photos the glitter is very subtle, more “stylish” than “strip club.”

Aluminum does not rust, so it doesn't really need a protective coating for that reason. And most of you aren't camo'd up and stalking through the Hindu Kush, looking for tangos to slot, so you don't need a colored rifle to help you blend into the background. What color finishes do for the average Joe (apart from looking cool, of course, which is always



ATAC Defense's Basic Plus Rifle adds a nickel-born bolt carrier group and oversize charging handle to their standard AR. It comes standard with a mid-length gas system and a 15-inch handguard.

very important) is keep your gun from turning into a branding iron when it is out in the sun. A black gun sitting in the sun, even in the mild Midwest, will soon get too hot to touch. Anything you can do to keep your gun cool, especially if you're doing a lot of shooting, is a good thing.

The sixteen-inch barrel is made of 4150 ChromeMoly Vanadium steel. It starts out as a barrel blank and ATAC turns it into a barrel in-house. The barrel is button rifled and given a 1:7 twist and a 5.56 NATO chamber. ATAC only recently started offering mid-length gas systems as seen on this rifle, and you should still be able to get one with a carbine-length gas system as well if you're more of a traditionalist.

Most people now believe a mid-length gas system to be the best for this length barrel. Compared to a carbine-length gas system, a mid-length gas system reduces operating pressures somewhat, which result in a slightly (we're talking fractions of a second)

slower bolt speed. This makes for less wear on the parts as well as slightly reduced recoil. While the US military as a whole hasn't caught on, the URG-I (Upper Receiver Group — Improved) now being fielded by U.S. Special Forces features a 14.5-inch M4 barrel with a mid-length gas system to improve barrel/bolt life.

The barrel is given an M4 profile, which means it is slender behind the gas block and .750" at the gas block and beyond. Interestingly, ATAC goes out of their way to state that their barrels start out as steel barrel blanks per Mil-B-1159SE. This is the military specification for barrels of small arms weapons, which I had to look up — it covers alloys, steel bars, and blanks under two inches in diameter.

1:7-inch twist, 5.56 NATO chamber, and the manufacturer known for their OEM work going out of their way to point out the barrel was made from Mil-Spec barrel blanks? I'm no Einstein Holmes, but being a





Offering everything that's currently popular in ARs — collapsible stock, mid-length gas system, long free-float handguard — ATAC Defense's Basic Plus rifle also comes standard with a Cerakote finish.



The nickel boron coating on the bolt/carrier keeps it slick, which helps to keep it running longer when its dirty. It is far easier to clean than a standard bolt carrier.

“picatinny” rail runs atop the entire length of the handguard.

Longer handguards are in fashion, but they actually serve a purpose. Two purposes: first, they provide the maximum amount of area possible for mounting accessories — lights, lasers, vertical foregrips, angled front sight, angled foregrips, slings, bipod, hand stop, grilled cheese sandwich, whatever.

Secondly, the current accepted “tactical” technique for employment of an AR is to get your support hand off that darn magwell and move it as far

forward as possible. That way you are better able to manage recoil and drive the muzzle between targets faster.

Total unloaded weight of this rifle is six pounds five ounces, which is somewhat light for a rifle with such a long handguard. That reasonable weight is mostly due to the slender profile of the barrel, but the skel-eonized nature of the handguard helps. Unloaded the rifle balances over the barrel nut. Total length with the stock extended is 35.75-inches. Collapsing the stock fully brings the overall length down to 32.25-inches.

The upper and lower receiver are both 7075 T-6 aluminum forgings and machined in-house. ATAC states that they leave the upper receiver lugs slightly oversized, and they hand fit each upper and lower to reduce slack and/or rattle. While the fit between receivers on my sample wasn't as bank vault-tight as I've seen on some CNC/billet guns, it was even, with minimal gap and no rattle. There are pictogram markings on both sides of the lower receiver for the selector.

As for the lower receiver, ATAC broaches the magazine well in-house. The Basic and Basic Plus rifles offer a threaded bolt catch pin and a threaded (captured) rear detent pin. And while you might be suspicious about claim that the upper and lower receivers being hand-fit, check out the right side of the magazine well, below the ATAC logo. Instead of the standard generic caliber and model designations you see

trained detective (no, seriously, I spent most of 20 years as a private investigator before quitting to do this “job”) it's easy to guess that means ATAC makes M4 barrels for a company which has a contract with the U.S. military to supply M4s. A gun company you probably thought made all their own barrels.

At the end of the barrel you'll see the standard A2 birdcage flash hider, and the barrel is given a standard phosphate coating. The gas block is a low profile model held in place by two set screws.

The 15-inch handguard is an ATAC design. It is constructed of 6061 aluminum and features M-LOK attachment slots at 3, 6, and 9 o'clock. There are QD sockets on either side of the handguard, front and rear, for mounting a sling. The MIL STD 1913



**The basic G.I.-style pistol grip, stock, and trigger are the only parts of this rifle people might want to swap out. However, you can't get two people to agree on which are the best aftermarket replacements, so not paying the factory for a BCM pistol grip when you want a Magpul (or vice versa) ultimately saves you money.**

with many manufacturers (half the AR receivers in my house read CALIBER: MULTI) you'll see that this lower receiver is etched with a model and caliber, indicating that didn't happen until it was already matched with a top end and they knew whether it was going to be a rifle or a pistol, and what caliber.

In fact, every part is inspected. After hand assembly, the complete rifle is inspected, test fired, then inspected again before being shipped out. Each rifle and pistol ships with a lockable hard case and one magazine, in my case a black Magpul Gen M3.

As for the bolt carrier group, ATAC is once again happy to point out that all of their parts meet or surpass Mil-Spec — and as anyone who has been in the military can tell you, there is a specification for EVERYTHING.

The bolt is machined from Carpenter 158 steel, which is both the Mil-Spec for AR bolts and the industry standard. If you're a gun geek and get off on specs, let me throw this info at you, straight from the ATAC website: "Carpenter No. 158® alloy is a

chrome-nickel alloy steel .... Fully treated, Carpenter No. 158 alloy attains a core strength of approximately 160 ksi (1103 MPa) tensile strength with a yield point of approximately 135 ksi (931 MPa). These high mechanical properties will be developed in sections up to 5" (127 mm) thick. In addition, case hardened articles possess a higher wear resistant case because of the special alloy content of the steel. Specifications: AMS 6265, ASTM A646, QQ-S-624C, SAE J1249"

Again, if you haven't caught on that ATAC likely does OEM work for companies which have military contracts, I advise you not to get into detective work. However, just to make sure my assumptions trained professional investigative deductions weren't all wrong I reached out to my contact at ATAC. He told me this:

"James, you are correct. JMS Manufacturing (ATAC Defense's) parent company has a Commercial and Government Entity (CAGE) Code issued by the Defense Logistics Information Service (DLIS) as a contractor identifier for companies bidding, or doing

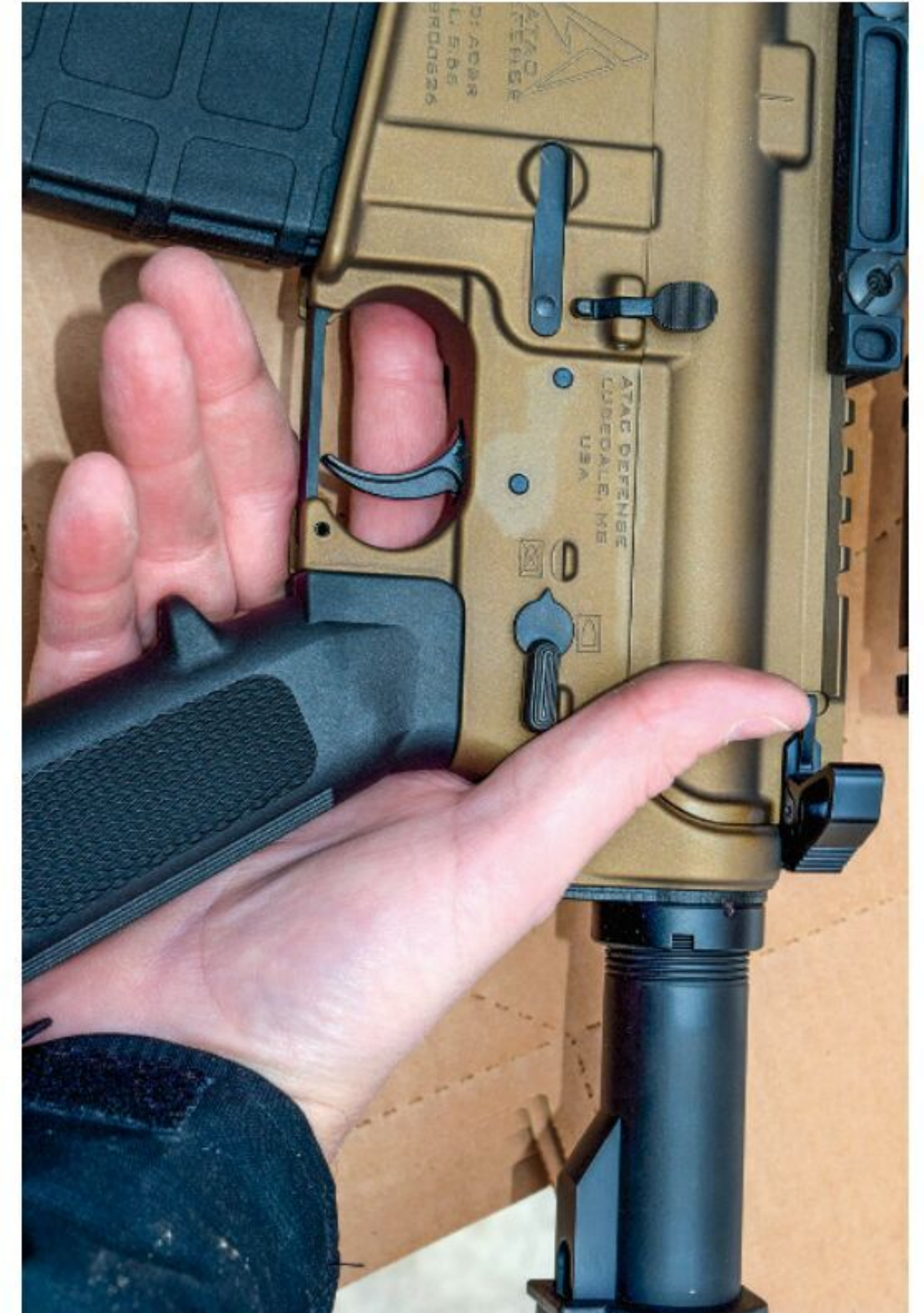

**Tarr doesn't care for the A2 pistol grip as the finger groove is in the exact wrong spot for his fingers, and he prefers more material under the web of his hand. But everyone has different tastes, and as pistol grips swap out in just a minute using just a screwdriver, so keeping the G.I. pistol grip is a smart move and keeps cost down.**

*business with the U.S. Department of Defense (DOD). We machine parts for over 300 companies in the firearms industry. Due to NDAs being in place, we can't go into detail about who or what we are manufacturing for these companies. The ATAC Defense line of firearms was released in February of 2020, and was spawned from a desire to provide a quality firearm at an affordable cost."*

After machining, their bolts are HP/MPI (high-pressure, magnetic-particle inspection) tested. I can throw another couple of paragraphs of steel-tech

[Cont. to page 52]



**Most people now believe a mid-length gas system to be the best for this length barrel. Compared to a carbine-length gas system, a mid-length gas system reduces operating pressures somewhat, which result in a slightly (we're talking fractions of a second) slower bolt speed. This makes for less wear on the parts as well as slightly reduced recoil.**



**The Burnt Bronze cerakote has a tiny bit of metallic glitter in it, but it is subdued — more stylish than strip club.**

*We the People*  
insure domestic Tranquillity provide for the common Defence promote the general Welfare and secure the Blessings of Liberty to our selves and our Posterity We ordain and establish this Constitution for the United States of America

**A FOUNDATION SO STRONG, WE BUILT A NATION ON IT.**



Behind each gun we build is an empowered American, writing their individual story joining the thousands of stories that weave the living fabric of the American experience. Start your story at [smith-wesson.com](http://smith-wesson.com).





**While Cerakoted rifles look cool, the main functional advantage to a non-black rifle is that they don't get too hot to touch in the sun.**

[Cont. from page 50]

geekspeak at you, but basically that means the bolts have undergone testing designed to reveal potential flaws (“*surface and shallow subsurface discontinuities*”) in the steel.

The M16-profile carrier is constructed of AISI8620, which is a chomemoly nickel low alloy steel. The gas key is also made to spec, installed with the proper bolts which are then staked in place.

What's the difference between ATAC's Basic and this Basic Plus rifle, other than the \$80 extra for the latter? The Plus substitutes an oversize ambi charging handle for the standard GI piece, and gives you a bolt carrier group (BCG) with an NiB (nickel-boron) coating. Considering most ambi charging handles are \$80, they're basically throwing in the BCG coating for free.

The NiB carrier is deliciously smooth in the hand. If you've never run an NiB bolt carrier group, the coating means they are very lubricious (or slickery, if you prefer, which is an actual real word that I swear I didn't make up). Not only does that coating mean the gun runs smoother, it means the BCG is much easier to clean. Generally, when cleaning, you barely have to scrub an NiB BCG at all, just wipe it down with a rag and most of the gunk comes right off with almost no effort.

The bolt carrier is paired with a standard carbine buffer and the aforementioned ambidextrous (more properly described as bilateral) charging handle that is unmarked but is the spitting image of the well-regarded Radian Raptor.



**Tarr finished his last case of Winchester 5.56 ammo testing this rifle, which made him both happy (because he was shooting) and sad (because ammo currently is worth its weight in gold).**



**The castle nut is properly staked. A small detail, but important.**

In the lower receiver you'll get the standard GI-style controls, and that includes the trigger group. The trigger pull on my sample provided a gritty eight-pound trigger pull, which is a bit heavier than average for a GI-type trigger pull. It works fine for a “general use” AR, but which I'd swap out if I intended to use the rifle for any precision work.

ATAC's top-of-their-line ADER features their 3.5-pound tuned trigger, available in either single- or two-stage models, but I understand why they didn't upgrade the trigger in this rifle. First, it would cost more money, and a better trigger would be wasted on a lot of consumers. Secondly, you'd be hard-pressed to find two AR fans to agree on which type or improved pull-weight trigger (aftermarket or otherwise) should be put into the rifle. Everyone has their favorite “match” trigger, and none of them are cheap.

I would like to point out that ATAC's trigger group is not “Mil-Spec” for one very good reason — there is no Mil-Spec for a semi-auto trigger group whether made by ATAC or anyone else. The only trigger groups fielded in AR-pattern rifles by our military



**The lines on both the upper and lower receiver were clean and perfect, and the rifle came from the factory nicely lubed.**

(M16, M4, etc.) are select fire, either Safe/Semi/Full or Safe/Semi/3-Round-Burst.

At the back end of the rifle you'll see a polymer GI-style stock riding on a six-position buffer tube. The castle nut holding the tube to the receiver is properly staked. The pistol grip is a standard A2 style. If, at some point, you decide you want to change or upgrade your stock or pistol grip, that is easily done. Personally I always swap out the A2 pistol grip for two reasons. First, I want more material under the web of my hand, for a proper reach to the trigger. Secondly, I've got skinny fingers, and the finger groove on the A2 pistol grip is in exactly the wrong place for me. Your experience, as they say, may differ.

Their top of the line rifle is the ADER (ATAC Defense Enhanced Rifle), and sports upgraded furniture and fully bilateral controls. Ambi controls are what all the cool kids are getting on their rifles, but to be honest most people don't use them, and they cost money. I like the Basic Plus rifle because it gives you everything you need and nothing you don't, leaving you cash in your pocket to upgrade the pistol grip, stock, and/or trigger in the future.

Honestly, the basic G.I.-style pistol grip, stock, and trigger are the only parts of this rifle people might want to swap out. However, you can't get two people to agree on which are the best aftermarket replacements, so not paying the factory for a BCM pistol grip when you want a Magpul (or vice versa) ultimately saves you money. I also think every rifle which might possibly be used for defensive work should be equipped with iron sights, but I'm a bit old-school in that regard.

Personally, while I know the more vertical pistol grips like the BCM Gunfighter are more ergonomic, I prefer a more angled pistol grip. I also don't like rubberized grip textures, and want my pistol grip to have a compartment in which to store spare batteries for my optic. If you have any time behind the AR platform you'll soon develop your own preferences.

As this rifle is somewhat light I mounted a Trijicon 1-8X AccuPower for all of my testing, both close-up fun and accuracy work at distance. The scope was in a Midwest Industries QD mount. I really like the scope but I always end up shying away from permanently planting it on one of my personal rifles as it weighs two pounds two ounces with the mount. That's a lot of weight for a guy who likes to run either light rifles or short and light pistols.

With the scope and a loaded magazine in place this rifle weighs nearly nine and a half pounds. That means recoil was very soft even with just a standard flash hider, but no .223/5.56 AR is a bruiser. Honestly, unless you're running your AR in competition you don't want or need a muzzle brake as they're so abusively loud. If you think the AR has too much recoil, go spend a weekend shooting an M1 Garand.

When it came time to head to the range, my Texas friends were all in shock due to the snowfall in their state, but here in Michigan we were enjoying spring-like 40-degree days, which in January are about as common as a cat who obeys commands.

During accuracy testing, the Trijicon scope helped, and the eight-pound trigger hindered. Ultimately the Basic Plus Rifle demonstrated average accuracy for a modern commercial AR, which means most loads ran between 1-2 MOA. Which, honestly, is excellent. Most people struggle to shoot up to the accuracy potential of their rifles, and forty years ago finding a factory rifle (of any type) which could do close to one inch groups was rare. Now it's the rule, rather than the exception.

FYI: while there are amazing and awesome muzzle devices on the market, the basic standard G.I. A2 birdcage flash hider found on the end of this barrel works pretty darn well in killing flash. That's what is found on the muzzles of the rifles our troops use, after all, the guys most likely to be shot at by other people if they can see their muzzle flashes, so you'd hope A2 would be pretty efficient. It is.

When it comes to topping rifles like the Basic Plus with optics, if you intend the rifle to be used for defensive purposes, there are two schools of thought — the red dot school and the LPVO (low power variable optic) school. The red dot guys will argue that you don't need magnification — in the unlikely event you ever do need to address bad guys with your rifle,



**Low power variable optics (LPVOs) have their advantages. Firing from the standing, supported position (left forearm pressed against a vertical post), with the Trijicon AccuPower 1-8X cranked all the way up, Tarr put an entire 30-round magazine into the head of an IDPA target at 75 yards.**

**ATAC DEFENSE BASIC PLUS RIFLE**

Load	Bullet Weight (gr.)	Velocity (fps)	SD	Avg Group (in.)
<b>.223 REMINGTON</b>				
Hornady V-Max	55	2,940	35	2.26
Federal Fusion SP	62	2,801	24	1.66
Black Hills OTM	77	2,614	25	1.79
<b>5.56 NATO</b>				
Winchester FMJ	55	2,950	37	2.08
Black Hills TSX	62	2,893	28	1.22

Accuracy results are the averages of four five-shot groups at 100 yards from a sandbag rest. Velocities are averages of ten shots measured with an Oehler Model 35P 12 feet from the muzzle.

they'll be close enough to be an immediate threat to you, which means inside fifty yards, and perhaps inside your house.

Proponents of LPVOs follow the "better to have it and not need it" school of thought on optics. A 1-4X, 1-6X, or 1-8X like the Trijicon AccuPower will have all the magnification you'll need to engage targets out to the limits of the gun, optic, and cartridge.

I've set guns up both ways, and you have to decide what's best for you and your situation. I live in the

suburbs, which means even if I climbed up onto my roof with my rifle (I don't generally recommend this, BTW, it tends to excite your neighbors and irritate local law enforcement) the longest shot I would have is under three hundred yards. At that distance you barely need to worry about drop with the 5.56, and I've made shots at that distance using just a red dot. However ...

Magnified optics do not, technically, help you shoot better. They help you see better, which in turn



**Tarr worked the rifle off a barricade as well. With the scope at 1X the rifle worked very well at speed. The only hindrance was the heavy trigger pull.**

usually helps you be more precise with your shots. In a hunting situation or at distance, they allow you to better identify your target. At 300 yards with a non-magnified red dot you're just aiming roughly at the center of the target and hoping for the best. With a scope, you can see the target, pick your aiming point, and sometimes even spot your hit.

For an example of this, check out the accompanying target photo. Firing from the standing, supported position (left forearm pressed against a vertical post), with the Trijicon cranked all the way up to 8X, I put an entire thirty round magazine into the head of an IDPA target at 75 yards.

At 8X I could see my hits, and the scope allowed me to aim at the precise center of the head. Considering I've got an astigmatism, and most red dot reticles aren't round to me but instead the uneven shape of squashed grapes, that's far better accuracy than I (or most people) could do running just a red dot. Especially when saddled with a gritty eight-pound trigger. And the beauty of LPVOs is that you can crank them back down to 1X and use them at close range, which is what I did later, running speed drills with the rifle, both offhand and using a barricade.

During that range trip I had the ATAC, a top-secret Springfield AR rifle soon to be reviewed in these pages (also with a mid-length gas system), and a Rise

Armament 11.5" AR pistol with a carbine-length gas system. Shooting them all together it was easy to see how much softer recoiling a mid-length gas system is, and you can even discern the slightly slower recoil speed of the bolt group.

These days nobody has the ammo for a full-on torture test using cases of ammo, but I can say that I didn't experience even a single hiccup in the testing I did of this rifle. I did finish my last case of Winchester 5.56 NATO FMJ in testing this rifle, which made me both happy (because I was at the range, shooting) and sad (because I finished the case, of course, try to keep up).

While you might not have previously heard of ATAC Defense, as far as I'm concerned that's a good thing. Because it means you get a quality MilSpec-or-better product for a price less than what you might pay from other, more well-known companies. Who probably most likely have ATAC parts in their guns. Just sayin ....

*James Tarr is a longtime contributor to Firearms News and other firearms publications. He is also the author of several books, including CARNIVORE, which was featured on The O'Reilly Factor. Check out his latest novels at his website, OfficialJamesTarr.com* **FN**

#### SPECIFICATIONS: ATAC DEFENSE BASIC PLUS RIFLE

<b>Caliber:</b>	5.56 NATO
<b>Weight:</b>	6 lbs., 5 oz
<b>Overall Length:</b>	32.25" (stock collapsed) 35.75" (stock extended)
<b>Receiver:</b>	Forged aluminum
<b>Barrel:</b>	16.0", CMV, mid-length gas system, 1/7" twist
<b>Gas Block:</b>	Compact
<b>BCG:</b>	Nickel-boron coating
<b>Muzzle Device:</b>	A2
<b>Stock:</b>	G.I. style, six-position adjustable
<b>Pistol Grip:</b>	A2
<b>Handguard:</b>	15" ATAC M-LOK compatible
<b>Charging Handle:</b>	Ambidextrous oversize
<b>Trigger:</b>	Single stage, 8 pounds (as tested)
<b>Sights:</b>	None
<b>Accessories:</b>	One 30-round magazine, lockable hard case
<b>MSRP:</b>	\$1,109
<b>Manufacturer:</b>	ATAC Defense AtacDefense.com



DONT TREAD ON ME



**Auto  Ordnance**

EST. 1916

MADE IN THE USA

[WWW.AUTO-ORDNANCE.COM](http://WWW.AUTO-ORDNANCE.COM)



**A Finnish ski trooper armed with an Sk.Y. kivääri M/28.**



# SMALL ARMS OF THE RUSSO-FINNISH WINTER WAR PART I

## “Hakkaa päälle!”

By Paul Scarlata

Photos by: Paul Budde, James Walters, Ted Derryberry, Nathan Reynolds or as indicated

The Scandinavian nation of Finland differs from its Nordic neighbors in a number of ways. First of all, unlike the Swedes, Danes and Norwegians who are of Germanic ethnicity, the Finns are Finno-Ugric and more closely related to the Baltic peoples such as the Estonians and Latvians. Their language (Sámi) is a variation of Uralic and is distantly related to Hungarian.

Before the 13th century, what we know today as Finland (Suomi) consisted of mostly tribal territories. Around 1150 Swedish crusaders, using the excuse of converting the pagan Finns to Christianity, began conquering the region and by the 14th century much of coastal and southern Finland was under the control of Sweden. Until the early 1520s, control of the region fluctuated between Denmark and Sweden.

The warlike nature of the Finn people was acknowledged from early on. During the Thirty Years War (1618–1648), the Finnish light cavalry of the Swedish king Gustavus Adolphus were considered some of the most effective — and fearsome — members of the Protestant armed forces. Their battle cry “hakkaa päälle” (“hack them down!”) struck fear in their opponents and earned them the name Hakkapeliitat.<sup>1</sup>

As a result of their loss in the Finnish War (1808–1809), Sweden ceded most of Finland to Tsarist Russia where it became the semiautonomous Grand Duchy of Finland. Under Russian rule the economy grew slowly but after 1855 significant cultural, social, intellectual progress and industrialization occurred. Tensions increased after the Russification policies were enacted in 1889 resulting in increasing discontent and the growth of anti-Russian organizations. Several of latter attempted to stockpile arms in hopes of rebelling but the Tsar’s secret police, the Okhrana, managed to prevent any open rebellion.

Recognizing the Finns military abilities, and as they did with many of their subject peoples, the Tsarist government raised several Finnish regiments,

*“Sergeant Vaino Raatikainen quietly turned the safety of his Sk. Y. kivääri M/28-30 off as he watched the column of Red Army soldiers floundering through the deep snow into the ambush site. His company of ski troopers had shadowed the Soviet column for the better part of a day before circling around them and laying their ambush in this shallow valley. His men, invisible in the winter landscape in their white snow suits, calmly awaited his signal to open fire. Several of them were armed with Konepistooli L-31 submachine guns, that would provide a withering volume of*

*fire to pin the Reds down, and then his sharpshooters with their M/28-30s would settle matters.*

*Vaino had been fighting Stalin’s Red Army since 1939 and had nothing but contempt for their clumsy incompetence and the profligate way in which they wasted their soldiers’ lives. He had heard many of the frightened, half-frozen Red Army conscripts they captured refer to his invisible, swift moving ski troopers as “Belaya Smert” (the White Death). The hundred or so exhausted Russian soldiers now blundering into the valley below were about to find out why.”*

— Fictional story by Paul Scarlata based upon his broad study of books and articles on Finnish war history.

several of which became elite units such as the Finnish Guards Battalion and as members of the Russian Imperial Guard.

With the outbreak of WWI in 1914, the Russians were afraid that the Finns might revolt or that the Swedes would attempt to retake Finland, but none of these scenarios materialized. The outbreak of the conflict was a total surprise for the Finns and panic quickly gripped the populace. There were rumors that the Germans were preparing to invade Finland, and that the city of Helsinki was going to be bombed.

The Great Duchy of Finland did not have an army and it was not required to send soldiers to the front. However, many Finns volunteered for the Russian army, some of them reaching high rank, such as Baron Carl Gustaf Mannerheim, the future Marshal of Finland and president of the county (see below).

Due to its close proximity to Saint Petersburg the Russians placed high importance on Finnish territory, fearing a possible landing by German forces near the capital. By the end of 1914, about 35,000 Russian soldiers were deployed in Finland to protect it from

German attack and suppress anti-Russian feeling among the populace.

Because of the oppressive measures taken by the Russians, increasing number of Finns felt they would be better off to side with Germany. In May 1915, several thousand volunteers fled to Germany where they were formed into a military unit, the 27th Jäger Battalion (Jääkäriiliike), who were sent to fight on the Eastern Front. As consequence the Russians lost what little confidence they had in the Finns.

When the Russian Revolution erupted in 1917, Finland took advantage of the turmoil and declared its independence. They soon found themselves under attack by local communists (Red Guards), supported by the thousands of Russian troops still in Finland. The Finns formed volunteer Home Guard units, the Suojeluskunta (“White Guards”), while the Jääkäriiliike and several thousand German troops were transported to Finland to support them in the bloody civil war that followed.

By Spring 1918, under the command of Baron Mannerheim, the White Guards had defeated the Finnish



**Soldiers of the Jääkäriiliike pose for a unit photo in their training camp in Germany.**



**1918. Youthful members of the Suojeluskunta armed with obr. 1891g and Mauser Kar. 98AZ rifles.**

communists and drove the remaining Russian troops back across the border. While a regular army, the Suomen Armeija, was established, the Suojeluskunta remained in existence.<sup>2</sup>

The Suojeluskunta maintained its own command structure, ordnance department, weapons repair and manufacturing facility Suojeluskuntien Ase-Ja Konepaja Osakeyhtio, known by its initials SAKO, and its members kept their weapons at home.

The period after the Finnish Civil War until the early 1930s was a politically unstable time in Finland due to the continued rivalry between the conservative and socialist parties. The Suomen Kommunistinen Puolue (Finnish Communist Party) was declared illegal in 1931 and the following year the anti-communist



**1917. Finnish Red Guards armed with a mixture of obr. 1891g and Type 30 rifles.**

Lapuan like (Lapua Movement) attempted a failed coup and was also banned.

Finland pursued a foreign policy of strict neutrality even though the Soviets, unsuccessfully, attempted to cajole them into an alliance against a resurgent Nazi Germany.

In 1939, the USSR demanded that Finland cede the port city of Hanko, portions of the Karelian Isthmus and several islands in the Gulf of Finland to Soviet control and demilitarize the fortifications (the "Mannerheim Line") that Finland had constructed near the Russian border. Having no doubts whatsoever as to the Soviets' real intentions, the Finns refused.

It was apparent that Stalin's real intention was to conquer all of Finland and went so far as to establish the Suomen kansantasavalta (Finnish Democratic Republic) headed of Finnish communists and who called upon Finnish "workers and peasants" to overthrow the democratic government in Helsinki.

After faking a series of border "incidents" on November 30, 1939, the Red Army invaded Finland.

The aptly named "Winter War" would show the world the determination, bravery and military abilities of the Finnish people. Although vastly outnumbered in men and material, the Finns — with the aid of the severe winter weather — showed what free riflemen fighting for their homes were capable of and inflicted a series of humiliating defeats upon the Red



**A member of the Jääkäriiliike armed with a obr. 1891g rifle.**



**From 1918 to 1946, Baron Carl Gustaf Mannerheim was the commander in chief and president of Finland.**



Members of the Soujeluskunta on maneuvers in the late 1920s.



A Soviet propaganda photo showing the glorious Red Army marching into Finland to “liberate” it.



1939. Soviet cavalry crossing the border into Finland.

**SPECIFICATIONS:  
JALKAVAENKIVÄÄRI M/91**

<b>Caliber:</b>	Patruunaa Kal. 7,62mm
<b>Overall Length:</b>	51.25 in.
<b>Barrel Length:</b>	31.6 in.
<b>Weight:</b>	9 lbs.
<b>Magazine:</b>	5 rd. charger-loaded
<b>Sights:</b>	Front: Inverted V blade Rear: V notch adj. from 200 to 800 meters
<b>Bayonet:</b>	Socket style with 16 in. cruciform blade



This close up of the M/91 receiver shows charger loaded, single column magazine and its distinctive short bolt handle.

Army, stopping their early advances (literally) cold. [EDITOR’S NOTE: An incredibly well-done movie, with English subtitles, about this historical event was produced in 1989 and is available via Amazon.com. Look up *The Winter War* directed by Pekka Parikka.]

**Finnish Rifles**

When Finland gained its independence, they obtained tens of thousands of former Tri lineinaya Vintovka obr. 1891g (Mosin-Nagants) from surrendering Russian troops and Russian army depots. Originally both the Suomen Armeija and Suojeluskunta were issued these as the Jalkavaenkivääri M/91 (Infantry Rifle model 91).<sup>3</sup>

Finnish soldiers disliked the M/1891’s long bayonet and preferred to use their traditional puukko hunting knives for hand to hand combat.

The Patruuna Kal. 7,62mm was identical to the Russian Tri lineinaya patron obr. 1908g and consisted of a rimmed, bottle necked case 54mm long whose 147 gr. Spitzer bullet was propelled to 2,650 fps.

In addition, the Finns “inherited” numbers of Russian Kazachya vintovka obr. 1891g (Cossack) and Dragunskaya vintovka obr. 1891g (Dragoon) rifles Known in Finnish service as Rakuuna-Ja



The Jalkavaenkivääri M/91 was one of the primary rifles of the Finnish armed forces from 1917 through 1945.



Soldiers of the Suomen Armeija armed with the Jalkavaenkivääri M/91.



The puukko hunting knife was the preferred bladed weapon of Finnish soldiers.



Kasakkakiväärit M/1891, these differed from the standard obr. 1891g in having shorter barrels and thinner forearms. The Finns modified their sights, stocks, installed front sight guards and issued most of them to mounted units.

As many Finns were avid hunters, marksmen, and target shooters the rather crude M/91, many of which had seen years of rough service with corrosive ammunition, came in for criticism.

To update their rifles, in the early 1920s the Suojeluskunta rebuilt many of them with heavy weight barrels purchased from Schweizerische Industriegesellschaft (SIG) and several German companies, improved triggers, sights regulated in meters, and redesignated them the Jalkavaenkivääri M/91-24.<sup>4</sup> So as to be able to mount the Mosin socket bayonet on the rifles, the first few inches of the barrel was turned down to the original diameter.

### SELECTION OF FINNISH MOSINS

#### WANT TO BUY ONE?

**Rock Island Auction Co.**

[www.rockislandauction.com/detail/1032/956/six-mosin-nagant-bolt-action-rifles](http://www.rockislandauction.com/detail/1032/956/six-mosin-nagant-bolt-action-rifles)

**Morphy Auctions**

<https://auctions.morphyauctions.com/lot-289984.aspx>

#### PARTS:

**Sarco**

[www.sarcoinc.com/rifle-parts-accessories/mosin-nagant/](http://www.sarcoinc.com/rifle-parts-accessories/mosin-nagant/)

**Numrich Arms**

[www.gunpartscorp.com/gun-manufacturer/mosin-nagant](http://www.gunpartscorp.com/gun-manufacturer/mosin-nagant)

**Liberty Tree Collectors**

[www.libertytreecollectors.com/productcart/pc/viewCategories.asp?idCategory=17](http://www.libertytreecollectors.com/productcart/pc/viewCategories.asp?idCategory=17)

#### SPECIFICATIONS:

### RAKUUNA-JA KASAKKAKIVÄÄRIT M/1891

<b>Caliber:</b>	Patruunaa Kal. 7,62mm
<b>Overall Length:</b>	48.75 in.
<b>Barrel Length:</b>	29.9 in.
<b>Weight:</b>	8.6 lbs.
<b>Magazine:</b>	5 rd., charger-loaded
<b>Sights:</b>	Front: Inverted V blade Rear: V notch adj. from 400 to 2,700 arshini
<b>Bayonet:</b>	Socket style with a 16 in. cruciform blade

The Finns issued ex-Russian obr. 1891g Dragoon rifles as the Rakuuna-Ja Kasakkakiväärit M/1891. (Courtesy Ted Derryberry)



The Jalkavaenkiväär M/91-24 was commonly referred as Lotta-kivääri (Lotta Rifle). (Courtesy Ted Derryberry)

In Finland, the M/91-24 was commonly referred as Lotta-kivääri (Lotta Rifle). The Lotta-Svärd was an auxiliary organization of the Suojeluskunta composed mostly of women. In 1923, they had collected sufficient funds to purchase new barrels and so the M/91-24 was nicknamed the “Lotta Rifle.”<sup>5</sup>

But attempts to make the overly long, unwieldy M/91 into a more practical rifle continued and in 1927 and 1928 both the Armeija and Soujeluskunta developed more radical modifications of it.

The Armeija’s Jalkavaenkivääri M/27 featured a shorter, heavier barrel, standard type sling swivels, a front sight with protective ears, a modified rear sight and a knife style bayonet. Finnish troops referred to the M/27 as the “Pystykorva” (“Spitz ears”) because the front sight protectors reminded them of that dog’s upright ears.

The Suojeluskunta’s Sk.Y. kivääri M/28 differed from the M/27 in that the barrel utilized a different rifling pitch, an improved trigger mechanism and the original style sling mounting slots in the stock were retained. SAKO assembled all M/28s, some with barrels supplied by SIG and the Finnish firm of Tikkakoski.

The Ratsuväenkivääri M/27 (Cavalry Rifle) differed in having a 20.5-inch barrel and a turned down bolt handle.



Jalkavaenkivääri M/91-24’s muzzle was reduced to allow mounting the obr. 1891g socket bayonet. (Courtesy Ted Derryberry)



A member of the Suojeluskunta armed with a M/91-24 rifle.



A warmly dressed member of the Lotta-Svärd serving as an air raid warden.

To address continuing complaints about the M/28, years later the Suojeluskunta’s Capt. Harald Mansner designed yet another rifle — the Sk. Y. kivääri M/28-30. It featured a heavy, free-floating barrel that was fitted with an aluminum sleeve under the muzzle band

so that a hot, expanding barrel, or a warped stock, would not affect accuracy. A heavy duty tangent rear sight was fitted, and the protected front sight was screw adjustable for windage.



Finnish soldiers firing Jalkavaenkiväärit M/27.



Two white clad Finnish soldiers armed with Jalkavaenkiväärit M/91 and M/27.

SPECIFICATIONS: JALKAVAENKIVÄÄRI M/27	
Caliber:	Patrunna Kal. 7,62mm
Overall length:	46.6 in.
Barrel length:	27 in.
Weight:	9.7 lbs.
Magazine:	5 rd. charger-loaded
Sights:	Front: Protected blade Rear: U notch, adj. from 200 to 800 meters
Bayonet:	Knife style with an 11.8 in. blade



The army’s Jalkavaenkivääri M/27 featured a shorter, heavier barrel, standard type sling swivels and front sight ears. (Courtesy Ted Derryberry)

Late production M/27s had a reinforced barrel/bayonet band. (Courtesy Ted Derryberry)



The Suojeluskunta's Sk.Y. kivääri M/28 was similar to the army's M/27 but used an improved trigger and rifling pitch. (Courtesy Ted Derryberry)

#### SPECIFICATIONS: Sk.Y. KIVÄÄRI M/28

Caliber:	Patrunna Kal. 7,62mm
Overall Length:	46.5 in.
Barrel Length:	27 in.
Weight:	9 lbs.
Magazine:	5 rd. charger-loaded
Sights:	Front: Protected blade Rear: U notch, adj. from 200 to 800 meters
Bayonet:	Knife style with an 11.8 in. blade



A Suojeluskunta dog handler armed with a Ratsuväenkivääri M/27. Note the shorter barrel and turned down bolt handle.

#### SPECIFICATIONS: Sk. Y. KIVÄÄRI M/28-30

Caliber:	Patrunna Kal. 7,62mm
Overall Length:	46.6 in.
Barrel Length:	27 in.
Weight:	9.7 lbs.
Magazine:	5 rd. charger-loaded
Sights:	Front: Protected blade Rear: U notch, adj. from 150 to 2,000 meters
Bayonet:	Knife style with an 11.8 in. blade



The Sk. Y. kivääri M/28-30 is considered the most accurate of all the Mosin-Nagant series of rifles. Note the heavy duty, tangent rear sight. (Courtesy Ted Derryberry)



Members of the the Suojeluskunta armed with Sk.Y. kiväärit M/28.



The M/28-30 is considered to be the most accurate of all the Mosins and was used by Finnish marksmen to garner a number of international shooting awards.

During the war years the Armeija and Suojeluskunta decided to simplify production and training by adopting a common rifle, the Sotilaskivääri M/39,

which many consider the epitome of the Mosin-Nagant series. The M/39 used the same sights as the M/28 but utilized a thinner, free floating barrel, the trigger was modified to provide a light let off and most had pistol grip stocks. Dual sets of sling swivels on the bottom and left side of the stock allowed

[Cont. to page 64]



Two Suojeluskunta dog handlers armed with Sk. Y. kiväärit M/28-30.



A Suojeluskunta sharpshooter firing an Sk. Y. kiväärit M/28-30.



**AMERICAN AIRGUNNER**



**QUICK HUNTS**

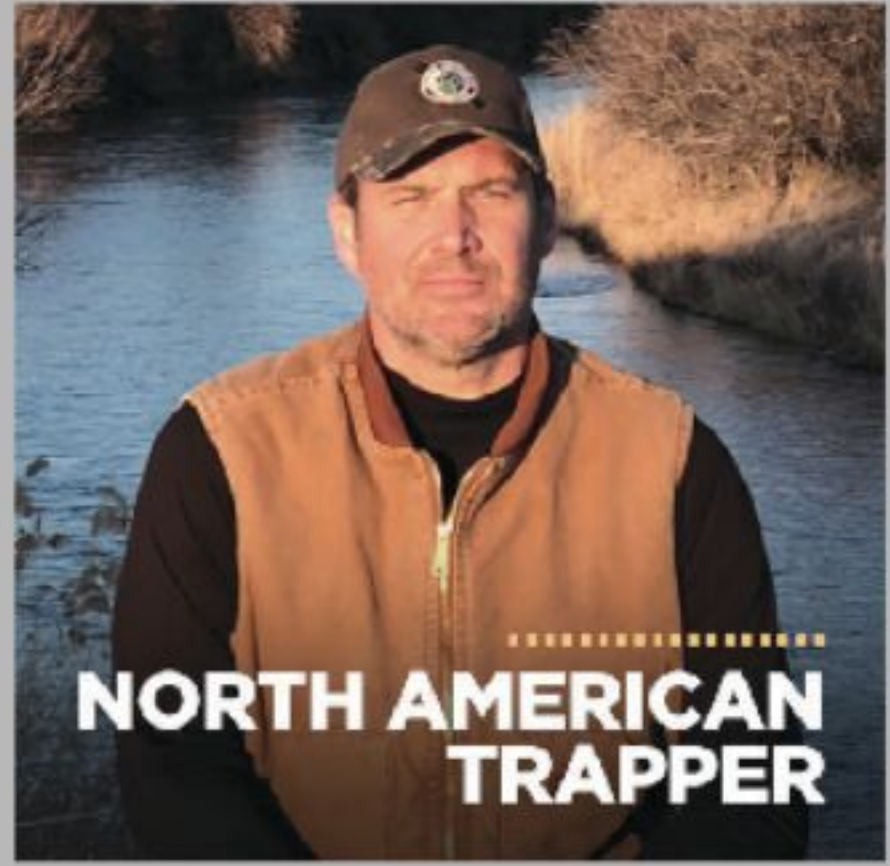

**NORTH AMERICAN TRAPPER**

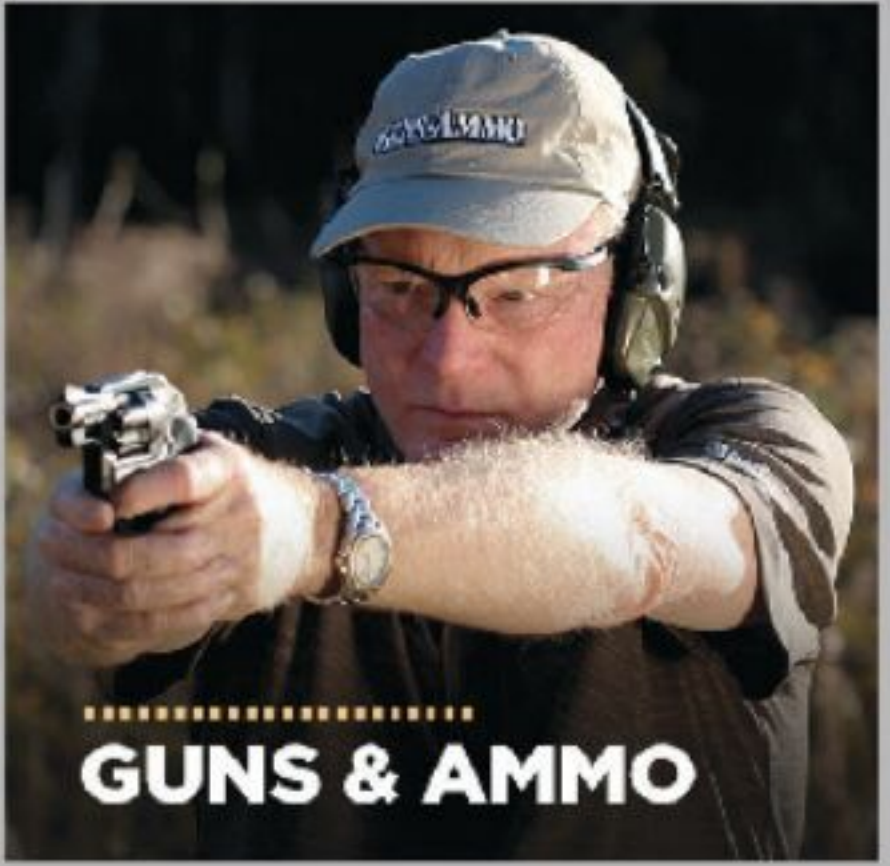

**GUNS & AMMO**



**MADE FOR THE OUTDOORS**



**HANDGUNS & DEFENSIVE WEAPONS**

**WELCOME, FIREARMS FANS**

You can feel the power every Thursday night. That's when firearms aficionados all across America tune in for the best in ballistic action, valuable tips from the pros, eye-opening range tests and expert product reviews.

**BEGINS**  
**LOCK & LOAD THURSDAYS** **8** P ET



**SPORTSMAN**



In 1939, all branches of the Finnish armed forces adopted the Sotilaskivääri M/39. Note its distinctive pistol grip stock. (Courtesy Ted Derryberry)

### SPECIFICATIONS: SOTILASKIVÄÄRI M/39

Caliber:	Patruunaa Kal. 7,62mm D166
Overall Length:	46.75 in
Barrel Length:	27 in.
Weight:	9.5 lbs.
Magazine:	5 rd. charger-loaded
Sights:	Front: Blade Rear: U notch adjustable from 150 to 2,000 meters
Bayonet:	Puukko-style with a 9-inch blade



Finnish soldiers armed with Sotilaskiväärit M/39.



Boxes of Patruunaa Kal. 7,62mm D166.



To make up for shortages and battlefield attrition, the Finns assembled rifles from parts of damaged arms. This rifle, with a M/27 barreled action in a M/28/30 stock, is typical.

[Cont. from page 62]

it to be carried comfortably by infantry or mounted troops.

With the Sotilaskivääri M/39, the Finnish army standardized on the Patruunaa Kal. 7,62mm D166. Originally developed for use in machine guns this cartridge was loaded with a 200gr., 7,65mm (.311"), boat-tail, Spitzer bullet moving at 2,600 fps which improved the range and accuracy of rifles. Being most Finn Mosin barrels made before 1940 had 0.308"–0.309" bores, many had their throats of the barrels relieved to accommodate the larger diameter D166 bullet and rifles thus modified had a "D" stamped on the receiver.

### Foreign Rifles Used by Finland

Because of the rapid expansion of their armed forces, the Finns were forced to use a number of obsolete and non-standard rifles. The most useful were the Swedish Karabin m/94-17 and Gevär m/96 Mausers (Ruotsalainen Karabiini M/94 & Jalkavaenkivääri M/96).

When the USSR invaded Finland, the Swedish government and civilians provided their neighbor with large amounts of aid including 77,000 Mauser rifles and carbines. They also allowed volunteers to travel to Finland to help her resist the Soviet aggression and nine thousand Swedes — the Svenska frivilligkåren (Swedish Volunteer Corps) — arrived completely

equipped with their own weapons and equipment.<sup>6</sup> Of the many foreign volunteers who came to Finland that winter, the Swedish contingent, mostly army veterans and reservists, was the largest, best trained, equipped, acclimatized and saw the most combat.

When the Swedes left in 1940, they conveniently "forgot" to take their weapons with them leaving the hard-pressed Finns with over 8,000 rifles and carbines.

The Finns also utilized a wide variety of rifles left by, or captured from, the retreating Russians in 1918. Among these were Type 30 and Type 38 Arisakas (Japanilainen Jalkavaenkivääri M/97 & M/05; Russian Vintovka Vinchestya obr. 1915g (Kivääri M/1895

[Cont. to page 67]



Sweden sold the desperate Finns 77,000 Gevär 96 Mausers which were used until 1945.



# NOTHING GETS BEYOND THIS VAULT DOOR



## Available in:

- 32-inch out-swing or in-swing
- 36-inch in-swing

Create your own safe room or enhance the security of any closet, room, or storm shelter with the SnapSafe® Vault Door. Its thick steel construction and easy installation allow an effective and affordable way to protect an existing area from theft and unintended intrusion.

- 12-gauge door and door frame, available with in-swing or out-swing configurations.
- Features nine 1-inch live locking bolts.
- Comes standard with a SecuRam™ digital lock with key backup.
- Integrated steel trim finishes the exterior doorway.
- Premium slip clutch handle protects lock mechanism against forced entry.



**SnapSafe**®  
A Hornady® Company

1-877-214-4470 | [snapsafe.com](http://snapsafe.com)



THE WEST WAS MADE FOR HEROES

# LONGMIRE

MONDAYS 9P ET

Outdoor



Members of the Svenska frivilligkåren armed with Gevär 96 Mausers.



Members of the Svenska frivilligkåren armed with Gevär 96 Mausers. Note one of them has a captured Soviet Avtomaticheskaya Vintovka Simonova 1936g.



Members of the Svenska frivilligkåren serving in Finland.



A Finnish soldier armed with a Gevär 96 guarding Russian prisoners.

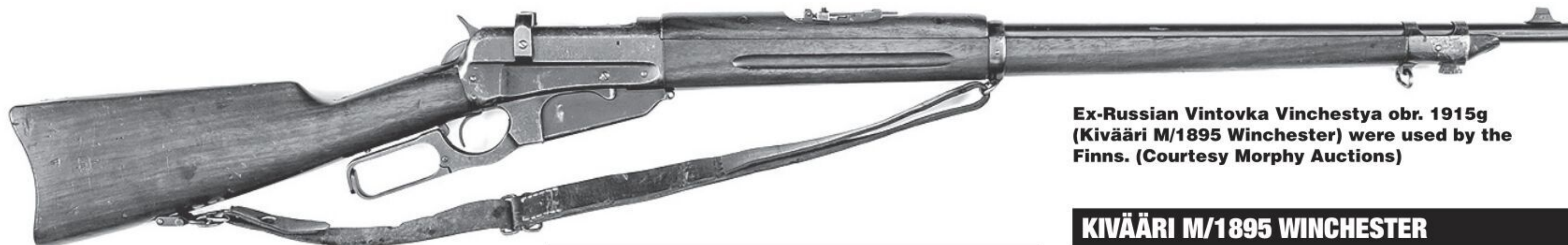

Ex-Russian Vintovka Vinchestya obr. 1915g (Kivääri M/1895 Winchester) were used by the Finns. (Courtesy Morphy Auctions)

[Cont. from page 64]

Winchester) and Russian obr. 1870g Berdans (Jalkavaenkivääri M/1870).

In 1940, the Finns purchased 100,000 Moschetto Modello 38 Carcanos (Italialainen Kiväri M/38 Terni) from their erstwhile Italian allies. The marksmanship savvy Finns had a low opinion of the Italian rifles and replaced them with Mosin-Nagants whenever they became available or captured.

Because of their non-standard ammunition and parts, except for the Swedish Mausers which were used by front line troops, the Finns issued most of these rifles to Home Guards, rear echelon and support troops, artillery units and civilian guards.

On November 30, 1939, Soviet forces invaded Finland with 21 divisions, totaling 450,000 men, and bombed Helsinki inflicting substantial damage and casualties. In response to international criticism, Soviet Foreign Minister Vyacheslav Molotov stated

**SPECIFICATIONS:  
KIVÄÄRI M/1895 WINCHESTER**

<b>Caliber:</b>	Patrunna Kal. 7,62mm
<b>Overall Length:</b>	46 in.
<b>Barrel Length:</b>	28 in.
<b>Weight:</b>	9 lbs.
<b>Magazine:</b>	5 rd. charger-loaded
<b>Sights:</b>	Front: Blade Rear: U notch adj. from 400 to 3,200 arshini
<b>Bayonet:</b>	Sword style with 16 in. blade

that the Soviet Air Force was not bombing Finnish cities, but rather dropping humanitarian aid to the starving Finnish population, sarcastically dubbed "Molotov bread baskets" by Finns.

**KIVÄÄRI M/1895 WINCHESTER**

**WANT TO BUY ONE?**

Rock Island Auction Co.  
www.rockislandauction.com/  
detail/57/3025/fine-winchester-model-1895-russian-contract-musket

Morphy Auctions  
www.morphyauctions.com/  
jamesdjulia/item/2117-369/

**PARTS:**

Joe Salter/Down East Antiques  
www.joesalter.com/category/Winchester-Parts

Numrich Arms  
www.gunpartscorp.com/gun-manufacturer/  
winchester/rifles-win/1895-win

Classic Firearms & Parts  
http://cfnparts.com/  
index.php?route=product/category&path=256

The initial Soviet invasion force consisted of 21 infantry divisions, four tank brigades, massive amounts of artillery and overwhelming numbers aircraft stretching from Murmansk in the north to Leningrad in the south.

To oppose them, the Finns fielded eight infantry divisions most stationed behind the Mannerheim Line on the Karelian Isthmus and around Lake Ladoga while the northern front was defended by units of the

[Cont. to page 70]

### SPECIFICATIONS: RUOTSALAINEN JALKAVAENKIVÄÄRI M/96

**Caliber:** 6,5 skarpa patroner m/94

**Overall Length:** 49.5 in.

**Barrel Length:** 29 in.

**Weight:** 9 lbs.

**Magazine:** 5 rd. charger-loaded

**Sights:** Front: Inverted V-blade.  
Rear: V-notch adj. from 300 to 2,000 meters

**Bayonet:** Knife style with 8 in. blade

### GEVÄR M/96 MAUSER

#### WANT TO BUY ONE?

##### J&G Sales

[www.jgsales.com/swedish-1896-mauser-bolt-action-rifle,-6.5x55-swede,-29-barrel,-1903-mfg,-c-r,-good,-used.-p-103628.html?osCsid=fca5fbc2c7c26f16f6a6f7d414c96656](http://www.jgsales.com/swedish-1896-mauser-bolt-action-rifle,-6.5x55-swede,-29-barrel,-1903-mfg,-c-r,-good,-used.-p-103628.html?osCsid=fca5fbc2c7c26f16f6a6f7d414c96656)

##### Classic Firearms

[www.classicfirearms.com/m96swedishmauser/](http://www.classicfirearms.com/m96swedishmauser/)

#### PARTS:

##### Sarco

[www.sarcoinc.com/rifle-parts/mauser/swedish-mauser/](http://www.sarcoinc.com/rifle-parts/mauser/swedish-mauser/)

##### Numrich Arms

[www.gunpartscorp.com/gun-manufacturer/mauser/rifles-mauser/96-swedish/accessories-swed96](http://www.gunpartscorp.com/gun-manufacturer/mauser/rifles-mauser/96-swedish/accessories-swed96)

##### Apex Gun Parts

[www.apexgunparts.com/rifles/bolt-action/mauser/swedish-mauser.html](http://www.apexgunparts.com/rifles/bolt-action/mauser/swedish-mauser.html)



Home guard rifles stacked in the snow include two Jalkavaenkiväärit M/1870.

### SPECIFICATIONS: JAPANILAINEN JALKAVAENKIVÄÄRI M/05

**Caliber:** 6,5mm Type 38

**Overall Length:** 50.2 in.

**Barrel Length:** 31.4 in.

**Weight:** 9.2 lbs.

**Magazine:** 5 rd. charger-loaded

**Sights:** Front: Inverted V blade  
Rear: V notch adj. from 300 to 2,000 meters

**Bayonet:** Sword style with 15.5 in. blade



1939. Home guards, armed with Kiväärit M/1895 Winchester, patrolling Helsinki.



A Finnish machine gun squad. The soldier on the far right is carrying a Kivääri M/1895 Winchester.

### VINTOVKA BERDANA OBR. 1870g

#### WANT TO BUY ONE?

##### IMA

[www.ima-usa.com/products/original-imperial-russian-model-1870-berdan-ii-infantry-long-rifle-dated-1884?variant=26170224197](http://www.ima-usa.com/products/original-imperial-russian-model-1870-berdan-ii-infantry-long-rifle-dated-1884?variant=26170224197)

#### PARTS:

##### Numrich Arms

[www.gunpartscorp.com/gun-manufacturer/berdan](http://www.gunpartscorp.com/gun-manufacturer/berdan)

### SPECIFICATIONS: VINTOVKA BERDANA obr. 1870g

**Caliber:** Patron 4.2 linii obr. 1868g

**Overall Length:** 53.4 in.

**Barrel Length:** 32.8 in.

**Weight:** 9.8 lbs

**Magazine:** Single shot

**Sights:** Front: Inverted V blade  
Rear: V notch adj. from 200 to 1,500 arshini

**Bayonet:** Socket style with 23 in. blade

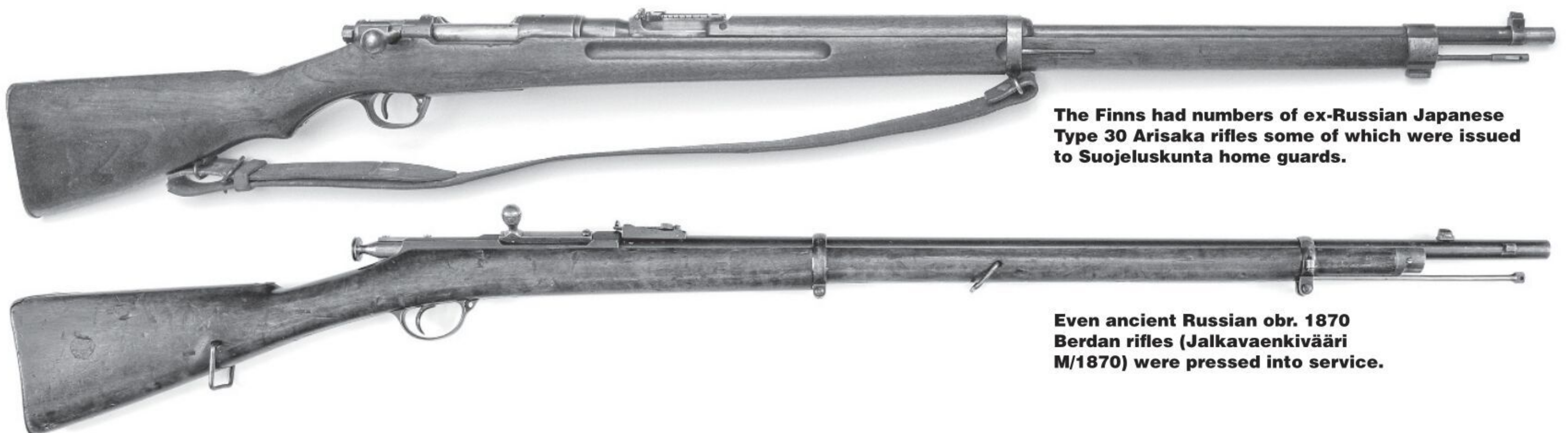

The Finns had numbers of ex-Russian Japanese Type 30 Arisaka rifles some of which were issued to Suojeluskunta home guards.

Even ancient Russian obr. 1870 Berdan rifles (Jalkavaenkivääri M/1870) were pressed into service.

# BE PREPARED FOR WHATEVER IS COMING!

## AGI Armorer's Courses on DVD How-to Maintenance Videos for Your Guns!



- You will learn **detailed step-by-step** Design, Function, and Operation of your specific model.
- AGI Armorer's Courses use **cut-away guns to provide close-up views inside the firearms.**
- Learn how to completely disassemble and reassemble ALL your guns with confidence.
- **Advanced Training** on DVD by Master Gunsmiths. *This is NOT just basic field stripping.*
- **Training on DVD so they can't block you!** Have this information available when you need it.

Become an Expert on every gun you own! Each AGI Armorer's Course DVD runs 90 minutes to 2 hours in length, covers the entire "family" of that particular model of firearm, and includes a free printable schematic. **66 different courses available! Here are just a few . . .**

AKS47 Semi-Autos • Beretta 92 Pistols • Glock Pistols • Colt 1911 .45 Auto Pistols • SKS Rifles • AR15 Rifles  
M1 Garands • Remington 870 & 1100 Shotguns • S&W Revolvers • Mossberg Shotguns • Ruger® Revolvers  
Ruger® 10/22® Rifles • Ruger® LCP®/LC9® • Ruger® Mini-14® • S&W M&P Pistols  
Ruger® MKI, MKII & MKIII, .22 Pistols • Springfield Armory XD Pistols • **NEW! SIG P320**

48 other titles available - go find your guns at: \$39.95 each plus s/h



# AmericanGunsmith.com

AGI has trained more professional and hobby gunsmiths than any other school!  
Call a Student Advisor today at **1-800-797-0867** to learn more and order.

Mention/enter offer code FN21RR when ordering

*LAST CHANCE!*

# WAREHOUSE CLEARANCE SALE!

*ACT NOW!*

We are closing out these items:

### Kommando Parts Kit - Grade 1

\$99 \$10 shipping  
95% of parts, rough cut  
unfinished bolt and barrel.  
No sales to CA, WA or where prohibited.



### Grade 2

\$59 \$10 shipping. 70% of parts. Will make great  
dummies, includes almost all parts except bolt and barrel.  
No sales to CA, WA or where prohibited.

*Limited to stock on hand*

### OTHER PARTS AVAILABLE:

- AKS** - Pistons, Hammer & Triggers, Misc. Parts
- BREN Parts** - .308 Bolts, firing pins, and much more!
- STEN MKIII Ejectors, Military Magazines**

# MORE PRODUCTS BEING ADDED DAILY!

### STERLING SMG PARTS SETS!



Imported several years before the barrel ban.

### LAST ONES AVAILABLE!



The most reliable submachine gun ever made.

The receiver has been destroyed by torch cutting in several places with a section of the tube missing and saw cutting in front of the magazine well and behind the rear sight, carefully preserving all the parts. (except the receiver which has been destroyed) Includes: **Original Barrels** with the best bores we've seen, Sterling Manual. \$397 ship \$15. **SAVE! Buy 3 - get free shipping.** No sales to CA, WA or Washington DC. Magazines are not included but used magazines are available at \$25 each - limited quantities and limit two mags per parts set purchased. \*No mags will be shipped to CA, CO, HI, CT, MD, MA, NJ, NY, VT, WA, Chicago, Aurora, Highland Park, Cook County IL, Washington DC or where otherwise prohibited by law.

Go to: **CATCoArms.com** to purchase or call **707-253-8338**





The Finns purchased Moschetto Modello 38 Carcanos (Itälialainen Kiväri M/38 Terni) from Italy.



Finnish home guards being issued Itälialainen Kivärit M/38.



Finnish horse artillery troops armed with Itälialainen Kivärit M/38. Note the folding bayonets on the rifles.



The Soviets bombing of Helsinki caused considerable damage.

### SPECIFICATIONS: ITÄLIALAINEN KIVÄRI M/38 TERNI

<b>Caliber:</b>	Cartucce a Pallottola cal. 7,35
<b>Overall Length:</b>	40.2 in.
<b>Barrel Length:</b>	21 in.
<b>Weight:</b>	7.5 pounds
<b>Magazine:</b>	6 rd. clip loaded
<b>Sight:</b>	Front: Inverted V blade Rear: V notch fixed for 300 meters <sup>7</sup>
<b>Bayonet:</b>	Knife style with folding 8 in. blade



A Finnish soldier armed with an Itälialainen Kiväri M/38 Terni.

### ITÄLIALAINEN KIVÄRI M/38 TERNI

#### WANT TO BUY ONE?

Rock Island Auction Co.

[www.rockislandauction.com/detail/51/289/two-italian-bolt-action-carbines](http://www.rockislandauction.com/detail/51/289/two-italian-bolt-action-carbines)

#### Guns International

[www.gunsinternational.com/guns-for-sale-online/rifles/military-rifles---non-us/finnish-winter-war-wwii-terni-m38-carcano-carbine-w-bayonet---sling-sa-7.35.cfm?gun\\_id=101388524](http://www.gunsinternational.com/guns-for-sale-online/rifles/military-rifles---non-us/finnish-winter-war-wwii-terni-m38-carcano-carbine-w-bayonet---sling-sa-7.35.cfm?gun_id=101388524)

#### PARTS:

##### IMA

[www.ima-usa.com/products/original-italian-wwii-m1938-mannlicher-carcano-rifle-folding-bayonet?variant=26171937093](http://www.ima-usa.com/products/original-italian-wwii-m1938-mannlicher-carcano-rifle-folding-bayonet?variant=26171937093)

##### Sarco

[www.sarcoinc.com/search.php?search\\_query=carcano%20m38&section=product](http://www.sarcoinc.com/search.php?search_query=carcano%20m38&section=product)

##### Numrich Arms

[www.gunpartscorp.com/gun-manufacturer/carcano](http://www.gunpartscorp.com/gun-manufacturer/carcano)

[Cont. from page 68]

Suojeluskunta and border guards. Finnish armored forces were virtually nonexistent, and they possessed few anti-tank weapons. Stockpiles of ammunition, fuel and other materials were estimated to only last for a few weeks.

But the Finns had two great advantages: weather and terrain.

The winter of 1939–40 was exceptionally cold with the Karelian Isthmus experiencing temperatures as low as  $-45^{\circ}\text{F}$ . Finnish soldiers were skilled in cross country skiing and acclimatized to the cold, snow, forest, and long hours of darkness were factors that the Finns could use to their advantage. The Finns dressed in proper winter clothing while the elite ski troopers wore a lightweight white snow cape which made them invisible as they attacked Soviet columns.

Conversely, Red Army soldiers, many of them conscripts from Central Asia and peasants from the treeless steppes of Russia, found operating in heavily-forested Finnish terrain confusing and demoralizing. They were unaccustomed to the severe Arctic weather and lacked proper clothing resulting in thousands dying from frostbite.

There were few paved roads connecting Finland to the USSR forcing the Reds to move along frozen muddy tracks and through impenetrable forest. Soviet troops had no skill in skiing thus were restricted to movement by road and were forced to move in long columns. The Red Army lacked proper winter tents, and troops had to sleep in improvised shelters. The cold weather did confer one advantage to the Soviets as their tanks could move over frozen terrain and bodies of water, rather than being immobilized in swamps and mud.



A "former" Soviet tank destroyed by the Finns.



A captured Soviet tank taken into Finnish service.



The Finns used sledges pulled by reindeer to move equipment through the snow-covered forests.



Fast moving, invisible Finnish ski troopers were the bane of the Red Army.



A group of Finnish soldiers take a break to brew coffee and dry their socks around a camp fire.



A group of starving, freezing Soviet soldiers captured by the Finns.

While the Red Army was superior in numbers and materiel, Finns used the advantages of speed and maneuver. On the Ladoga Karelia front Finnish ski troopers attacked and isolated portions of numerically superior Soviet columns and dealt with them individually. During these operations the Finns captured vast quantities of Soviet weapons most of which, due to their commonality of small arms and ammunition, could be taken into service immediately.

For many of the encircled Soviet troops, staying alive was an ordeal comparable to combat. The men were freezing and starving and endured poor sanitary conditions. Historian William R. Trotter described these conditions as follows: "The Soviet soldier had no choice. If he refused to fight, he would be shot. If he tried to sneak through the forest, he would freeze to death. And surrender was no option for him; Soviet propaganda had told him how the Finns would torture prisoners to death."<sup>8</sup>

To deal with Soviet armor the Finns utilized "Molotov cocktails." A glass bottle containing a slightly sticky mixture of gasoline, kerosene, tar and potassium chlorate. Further refinements included the attachment of wind-proof matches or a phial (vial) of chemicals that would ignite on breakage, thereby removing the need to pre-ignite the bottle.

A British War Office report dated June 1940 noted that: "The Finns' policy was to allow the Russian tanks to penetrate their defenses, even inducing them



**The Finns repeatedly ambushed and destroyed Soviet columns.**



**Finnish ski troopers moving through a winter forest.**



**The Red Army lost more men to the frigid Finnish winter than to bullets.**



**The Red Army lost more men to the frigid Finnish winter than to bullets.**



**The Finns used gasoline bombs called "Molotov cocktails" to destroy Soviet tanks.**



**A Finnish soldier armed with a Swedish Gevär m/96 guarding a box car full of Molotov cocktails.**

to do so by 'canalizing' them through gaps and concentrating their small arms fire on the infantry following them. The tanks that penetrated were taken on by gun fire in the open and by small parties of men armed with explosive charges and petrol bombs in the forests and villages .... The essence of the policy was the separation of the armoured vehicles from the infantry, as once on their own the tank has many blind spots and once brought to a stop can be disposed of at leisure."<sup>9</sup>

#### **Soviet Rifles**

In the 1930s, the Red Army was undergoing a small arms modernization program. While many of their units were still armed with the Tri lineinaya Vintovka

obr. 1891g, they had adopted an updated version of the Dragunskaya vintovka obr. 1891g as the Vintovka obr. 1891/30g.

The Vintovka obr. 1891/30g replaced the earlier rifle's octagonal receiver with a round one, utilized a simplified magazine interrupter, a tangent rear sight while the bayonet's locking system was simplified. The USSR adopted the metric system around this time which resulted in the cartridge being renamed the 7,62mm patron obr. 1930D.

In the late 1930s, so as to provide cavalry, artillery, communications and transport troops with a lighter, handier weapon the Karabin obr. 1938g was adopted. It featured all of the obr. 1891/30g improvements but did not take a bayonet.

[Cont. to page 74]





# M&A PARTS INC. / WWW.MAPARTSINC.COM



964 Donata Ct. / Lake Zurich, IL 60047 / Tel: 847-550-8246 / Fax: 847-550-0654



Hours: 9:00 AM to 5:00 PM CST. Most orders shipped within 24 hours. Send certified check or money order, add approximate shipping. All federal, state and local laws must be adhered to. Illinois residents add 7.75% sales tax. All prices and specifications are subject to change without notice.



**CHECK OUR WEBSITE FOR WEEKLY SALES AND NEW PRODUCTS !!!**

## COMPLETE UPPERS

WITH COMPLETE BARREL ASSEMBLY, EJECTION PORT COVER AND FORWARD ASSIST, FULLY ASSEMBLED, HEAD-SPACED AND TEST FIRED. INCLUDES BOLT CARRIER GROUP AND CHARGING HANDLE ASSEMBLY! NO FFL REQUIRED!

### CAR Uppers

### CAR Lightweight Uppers

### Mid-Length Uppers

### M4 Style Uppers



**Mil-Spec Forged Flattop T-Marked Upper Receiver**  
Barrel with M4 Feed Ramps / A2 Flash Hider  
Mil-Spec Forged F-Marked FSB / A2 Sight Post  
CAR Handguards w/Heatshield

- 5.56mm / 16 Inch Chrome-Moly 1:9 .....\$400.00
- 5.56mm / 16 Inch Chrome Lined 1:9 or S.S. 1:8 ..\$450.00
- 300BLK 16 Inch Chrome-Moly 1:8 .....\$400.00
- 9mm / 16 Inch Chrome-Moly Nitride 1:10.....\$435.00
- 7.62x39 16 Inch Chrome-Moly Nitride .....\$445.00



**Mil-Spec Forged Flattop T-Marked Upper Receiver**  
LtWt Barrel with M4 Feed Ramps / A2 Flash Hider  
Mil-Spec Forged F-Marked FSB / A2 Sight Post  
CAR Handguards w/Heatshield

- 5.56mm / 16 Inch Chrome-Moly 1:9 .....\$400.00
- 5.56mm / 16 Inch Chrome Lined 1:9 .....\$450.00
- 5.56mm / 16 Inch Chrome-Moly 1:7 .....\$400.00
- 5.56mm / 16 Inch Chrome Lined 1:7 .....\$450.00



**Mil-Spec Forged Flattop T-Marked Upper Receiver**  
Barrel with M4 Feed Ramps / A2 Flash Hider  
Mil-Spec Forged F-Marked FSB / A2 Sight Post  
Mid-Length Handguards with Heatshield

- 5.56mm / 16 Inch Chrome-Moly 1:9 .....\$400.00
- 5.56mm / 16 Inch Chrome Lined 1:9 or S.S. 1:8 .....\$450.00
- 5.56mm / 16 Inch Chrome-Moly 1:9 or 1:7 LTWT.....\$400.00
- 9mm / 16 Inch Chrome-Moly Nitride 1:10.....\$435.00
- 458 SOCOM / 16 Inch Chrome-Moly 1:14 .....\$550.00



**Mil-Spec Forged Flattop T-Marked Upper Receiver**  
M4 Barrel with M4 Feed Ramps / A2 Flash Hider  
Mil-Spec Forged F-Marked FSB / A2 Sight Post  
M4 Handguards w/Heatshield

- 5.56mm / 14.5 or 16 Inch Chrome-Moly 1:9 .....\$400.00
- 5.56mm / 14.5 or 16 Inch Chrome Lined 1:9 .....\$450.00
- 5.56mm / 14.5 or 16 Inch Chrome Lined 1:7 .....\$450.00
- 5.56mm / 16 Inch Stainless steel 1:8.....\$450.00
- 5.56mm / 16 inch Chrome-Moly 1:8 .....\$400.00

### Varmint Uppers

### 20 Inch Rifle Uppers

### Commando Uppers

### Pistol Uppers



**Mil-Spec Forged Flattop T-Marked Upper Receiver**  
Varmint Barrel with M4 Feed Ramps  
Picatinny Rail Gas Block Front Sight Base  
Aluminum Free Float Tube

- 5.56mm / 16 Inch Stainless Steel 1:8 .....\$445.00
- 5.56mm / 20 Inch Stainless Steel 1:8 .....\$465.00
- 5.56mm / 24 Inch Stainless Steel 1:8 .....\$465.00
- with optional Versa-Pod Bipod..... add \$55.00



**Mil-Spec Forged Flattop T-Marked Upper Receiver**  
Barrel with M4 Feed Ramps / A2 Flash Hider  
Mil-Spec Forged F-Marked FSB / A2 Sight Post  
E2 Handguards with Heatshield

- 5.56mm / 20 Inch Chrome-Moly 1:9 .....\$415.00
- 5.56mm / 20 Inch Chrome-Moly 1:9 LTWT.....\$425.00
- 5.56mm / 20 Inch Chrome Lined 1:9 .....\$465.00
- 5.56mm / 20 Inch Stainless Steel 1:8 .....\$465.00



**Mil-Spec Forged Flattop T-Marked Upper Receiver**  
Barrel with M4 Feed Ramps / A2 Flash Hider  
Mil-Spec Forged F-Marked FSB / A2 Sight Post  
CAR Handguards with Heatshield

- 5.56mm / 11.5 Inch Chrome-Moly 1:9 .....\$400.00
- 5.56mm / 11.5 Inch Chrome Lined 1:9 or 1:7 .....\$450.00
- 300 BLK 10.5 Inch Chrome-Moly 1:8 .....\$400.00
- 7.62x39 / 11.5 Inch Chrome Lined 1:10.....\$465.00



**Mil-Spec Forged Flattop T-Marked Upper Receiver**  
Barrel with M4 Feed Ramps / A2 Flash Hider Picatinny  
Rail Gas Block Aluminum Free Float Tube

- 5.56mm / 7 1/7 or 11.5 Inch Chrome-Moly 1:9 .....\$425.00
- 5.56mm / 11.5 Inch Chrome Lined 1:9 .....\$475.00
- 300 BLK 8 or 10.5 Inch Chrome-Moly 1:8 .....\$425.00
- 9mm / 4 or 10.5 Inch Chrome-Moly 1:10.....\$445.00

### CHARGING HANDLES / CARRIERS / HANDGUARDS

### UPPERS - OPTIONS & UPGRADES

### GAS BLOCKS / FRONT & REAR SIGHTS

- Tactical Charging Handle Latch.....add \$15.00
- PR Big Latch.....add \$20.00
- BCM Gunfighter Ambi Charging Handle.....add \$75.00
- Troy Industries Ambi Charging Handles.....add \$75.00
- Chrome Carrier Group Assembly.....add \$25.00
- Nickel Boron Carrier Group Assembly.....add \$55.00
- CAR Quad Rail (Imported).....add \$25.00

- Diamondhead VRST or X..... 10" \$160, 13.5" \$185, 15" \$195
- M&A M-Lok or Keymod..... 7" \$40, 9" \$50.00, 12" or 15" \$65
- Magpul MOE CAR/Mid.....add \$25.00, Std add \$30.00
- MI #17 or DoubleStar CAR 2 Piece Quad..... add \$120.00
- Rock River Arms Half Quad Free Float..... add \$110.00
- Troy Alpha or M-Lok..... 7" \$135, 9" or 11" \$150, 15" \$170
- YHM CAR or Mid Diamond Quad Rail..... add \$130.00

- Low Profile .750 Alum..... add \$0.00 / Steel \$25.00
- Single Rail GB .750 Alum..... add \$0.00 / Steel \$45.00
- Gas Block Flip-Up Front Sight .750.....\$80.00
- Quad Rail Gas Block .750 or .936 Steel.....\$65.00
- AIM Flip-Up M.A.D. Rear .....\$35.00
- Diamond Flip-Up Rear Sight.....\$110.00
- Magpul Polymer Front Sight, Rail Height.....\$40.00

- Magpul Polymer Flip-Up Rear Sight..... \$55.00 PRO \$95.00
- Mil-Spec Detachable Carry Handle.....\$90.00
- MI Flip-Up Front Sight, Gas or Rail Height.....\$75.00
- Troy Flip-Up Rear Sight, Gas or Rail Height.....\$90.00
- Troy Flip-Up Rear Sight.....\$110.00
- YHM Flip-Up Front Sight, Gas or Rail Height .....\$70.00
- YHM Flip-Up Rear Sight .....9680 \$100.00, 5010 \$115.00

### Pistol Grips

### Lower Receiver Parts

### Vertical Foregrips

### Front / Rear Sights



- Hogue \$20.00 Sniper Grip \$35.00 Ergo w/ storage \$25.00
- GI A2.....\$5.00
- DPMS PSGI.....\$35.00
- Ergo Sure Grip.....\$25.00
- Ergo Sure Grip Deluxe Palm Swell.....\$55.00
- Ergo Grip with storage.....\$25.00
- Magpul MOE.....\$20.00, Magpul MOE+.....\$24.00
- Magpul K / K2 or Slimline.....\$20.00, K2+.....\$24.00
- Sniper Grip.....\$39.00
- UTG STD Grip.....\$15.00
- UTG Combat Grip.....\$20.00



- RRA NM 2 Stage \$115.00
- GEISSELE SSA \$220.00
- ACC-U-Wedge.....\$3.00
- AR15 LPK w/ Grip.....\$65.00
- AR15 LPK (LESS FCG & GRIP).....\$35.00
- AR15 LPK w/ RRA 2 Stage.....\$140.00
- AR15 Ambi Selector.....\$25.00
- Magpul BAD Lever.....\$29.00
- Magpul Enhanced Triggerguard.....\$20.00
- Magpul Enhanced Mag Release.....\$20.00
- Magpul Moe Triggerguard.....\$9.00
- RRA Winter Trigger Guard.....\$15.00



- Promag Vert Grip \$15.00
- CAA \$69.00
- CAA FVG (Folding).....\$35.00
- CAA MVG.....\$25.00
- Daniel Defense.....\$45.00
- GPS O2 Grip Bipod.....\$105.00
- Magpul AFG 1 or 2.....\$35.00
- Magpul MVG (MOE).....\$20.00
- Magpul RVG (Rail).....\$25.00
- SOG Graphite.....\$35.00
- UTG Alum w/ 150 Lumen Light.....\$65.00
- UTG Alum.....\$35.00
- UTG Foldable.....\$25.00
- UTG STD.....\$20.00



- Troy Battle Sight Rear \$100.00
- Troy M4 or HK Style Front \$90.00
- AIM Fixed Rear.....\$35.00
- GI Deatchable Carry Handle.....\$95.00
- Diamond Head Flip-Up Rear.....\$110.00
- M&A Fixed Front.....\$35.00
- M&A Flip Front.....\$40.00
- Magpul MBUS Front.....\$40.00
- Magpul MBUS Rear.....\$55.00
- RRA N. M. Carry Handle.....\$160.00
- Troy Front SOCC.....\$95.00
- Troy Rear SOCC.....\$110.00
- YHM 9584 GB Front Sight.....\$105.00

Please call for other options and upgrades

### DPMS 308 UPPER ASSEMBLY

Includes BCG and Charging Handle



- 308 16" Upper Assembly Post w. 15" Mlok.....\$555.00
- 308 16" Upper Assembly w/ 12" KEYMOD.....\$555.00



- 308 20" Std W / DPMS FF.....\$545.00



- 308 20" Std W / DPMS FF & Rail Gas Block.....\$545.00

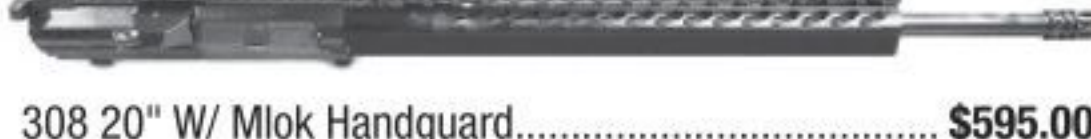

- 308 20" W/ Mlok Handguard.....\$595.00



- 243 DPMS 20" Std Upper Assembly.....\$725.00



- DPMS Upper.....\$185.00



- DPMS BCG.....\$195.00
- 16" DPMS Barrel.....\$195.00

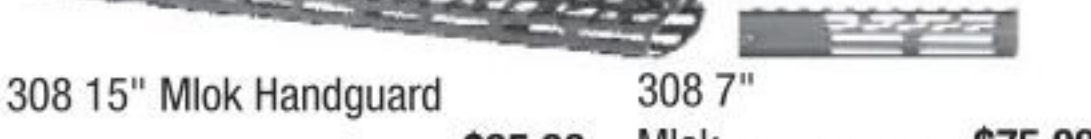

- 308 15" Mlok Handguard \$95.00
- 308 7" Mlok.....\$75.00



- 338 Federal DPMS 20" Std Upper Assembly.....\$695.00



- 308 Buffer Assembly.....\$60.00



- 308 LPK.....\$75.00
- W / RRA 2 Stage.....\$155.00



- Less FCG & Grip.....\$55.00

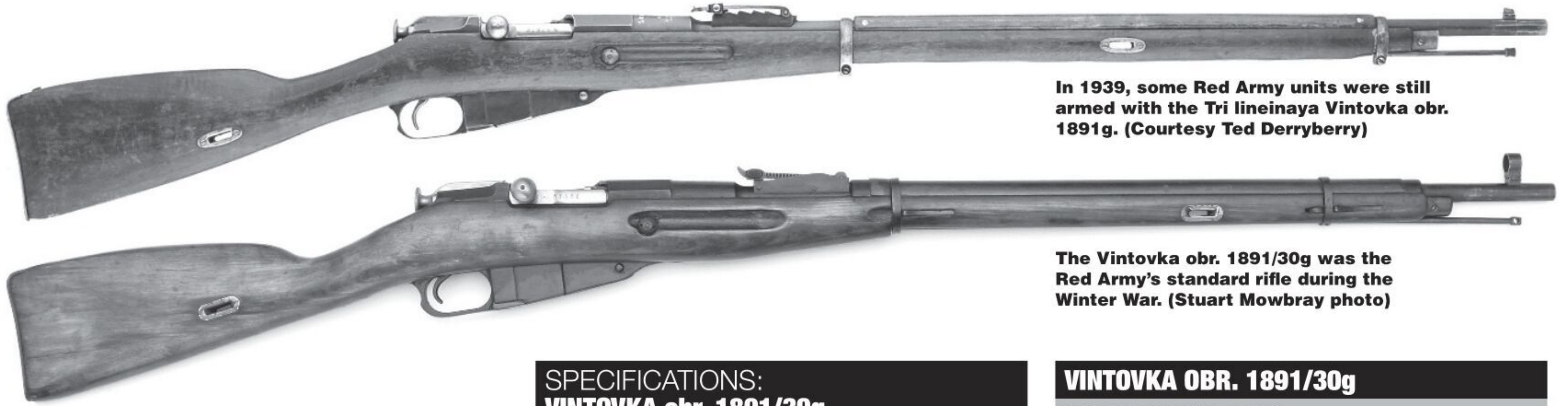

In 1939, some Red Army units were still armed with the Tri lineinaya Vintovka obr. 1891g. (Courtesy Ted Derryberry)

The Vintovka obr. 1891/30g was the Red Army's standard rifle during the Winter War. (Stuart Mowbray photo)

[Cont. from page 72]

It is a little-known fact that the Imperial Russian army was the first military organization to issue a selective fire assault rifle. In 1906, Capt. Vladimir Grigoryevich Fyodorov, an engineer at the Sestroretsk arsenal, began work on a semiautomatic rifle which used a short recoil system and was chambered for a proprietary 6.5mm cartridge. Trials in 1913 proved the feasibility of Fyodorov's rifle but the outbreak of WWI put the skids on further development.

In 1915, production of a modified rifle capable of selective fire and chambered for the readily available Japanese 6.5mm Type 30 cartridge was approved for issue. Production at the Kovrov Arms Factory was slow and as result of turmoil of the Revolution and the subsequent civil war, only 3,200 rifles were manufactured by 1924. They saw very limited use during WWI, the Revolution and ensuing Civil War.

To provide their troops with additional automatic weapons, in 1939 numbers of Fyodorovs were taken out of storage and issued to Red Army units fighting



Soviet soldiers armed with the Vintovka obr.1891/30g.

#### SPECIFICATIONS: VINTOVKA obr. 1891/30g

<b>Caliber:</b>	7,62mm patron obr. 1930D
<b>Overall Length:</b>	45.8 in.
<b>Barrel Length:</b>	27.75 in.
<b>Weight:</b>	8.8 lbs. (unloaded)
<b>Magazine:</b>	5 rd. charger-loaded
<b>Sights:</b>	Front: Hooded post Rear: U notch adj. from 100 to 2,000 meters
<b>Bayonet:</b>	Socket style with 16 in. cruciform blade

the Finns. Reportedly they did not stand up to the harsh winter conditions and the use of non-standard ammunition limited their usefulness.

In the 1930s, the Red Army embarked upon a program to develop a semiautomatic rifle. After a series of trials in 1936 a design by Sergei Gavrilovich Simonov was adopted as the Avtomaticheskaya Vintovka Simonova 1936g (AVS-36). A gas operated, selective

[Cont. to page 76]



#### VINTOVKA OBR. 1891/30g

##### WANT TO BUY ONE?

Rock Island Auction Co.

[www.rockislandauction.com/detail/2012/301/mosin-nagant-model-9130-rifle](http://www.rockislandauction.com/detail/2012/301/mosin-nagant-model-9130-rifle)

##### Snajperskaja Vintovka obr. 1891/30g

Rock Island Auction Co.

[www.rockislandauction.com/detail/52/3649/mosin-nagant-9130-rifle-762x54-r](http://www.rockislandauction.com/detail/52/3649/mosin-nagant-9130-rifle-762x54-r)

Morphy Auctions

<https://auctions.morphyauctions.com/lot-285391.aspx>

##### PARTS:

Sarco

[www.sarcoinc.com/search.php?search\\_query=91%2F30&section=product](http://www.sarcoinc.com/search.php?search_query=91%2F30&section=product)

Numrich Arms

[www.gunpartscorp.com/gun-manufacturer/mosin-nagant/1891-mn](http://www.gunpartscorp.com/gun-manufacturer/mosin-nagant/1891-mn)

Liberty Tree Collectors

[www.libertytreecollectors.com/productcart/pc/viewCategories.asp?idCategory=17](http://www.libertytreecollectors.com/productcart/pc/viewCategories.asp?idCategory=17)



The Finns captured untold numbers of weapons from the Red Army.

**GUNS&AMMO**

# AR-15

**Don't miss an issue of the most popular AR-only publication available!**

You'll find detailed photography, the most in-depth reporting and exclusive field tests of what's trending. Every issue includes the greatest ensemble of contributors with proven experience using these rifles while serving in the military, in law enforcement or on the competitive playing field.



On newsstands  
**NOW.**

Available online at [osgnewsstand.com](http://osgnewsstand.com)

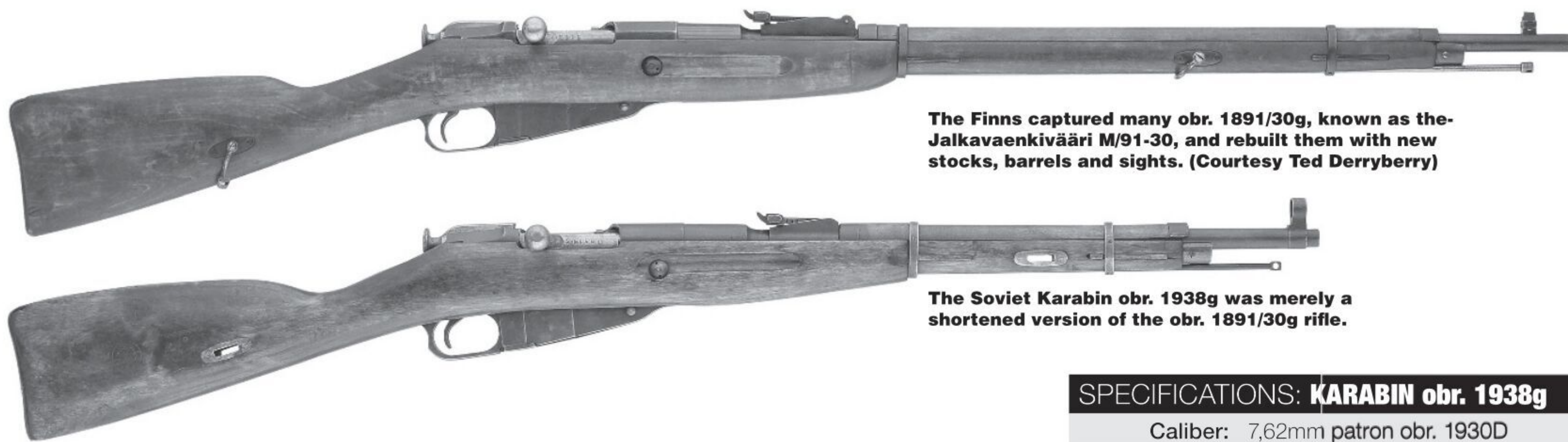

The Finns captured many obr. 1891/30g, known as the Jalkavaenkivääri M/91-30, and rebuilt them with new stocks, barrels and sights. (Courtesy Ted Derryberry)

The Soviet Karabin obr. 1938g was merely a shortened version of the obr. 1891/30g rifle.

[Cont. from page 74]

rifle it was fed from a fifteen round magazine and was chambered for the 7,62mm patron obr. 1930D.

The AVS-36 used a rather complicated locking system which proved unreliable when subjected to field service and was overly ammunition sensitive. They saw wide service in the opening days of the Winter War and some were still in use during WWII. Reportedly about 60,000 were built before production ceased in 1938.

The AVS-36 was replaced by the Samozaryadnaya Vintovka Tokareva obr. 1938g. (SVT-38) A semiauto rifle designed by Fedor Vasilievich Tokarev, it used a gas operated, short-stroke piston with tilting bolt and the gas system was adjustable to compensate for fouling, ammunition quality and environmental extremes. It was chambered for the standard 7,62mm patron obr. 1930D and was fed from a ten round box magazine. They are recognizable by their two-piece stocks with a cleaning rod held in a groove in the right side.

Numbers were issued early in the Winter War, but field service showed them to be overly long and cumbersome, difficult to maintain, the magazine tended to fall out while internal parts proved fragile and broke easily especially in sub-zero temperatures. Production of the SVT-38 was terminated in April 1940 after some 150,000 examples had been manufactured. While some remained in Red Army service until early in WWII most were withdrawn by late 1940.

Tokarev was instructed, reportedly by Stalin himself, to "correct" the SVT-38's faults and by July 1940

[Cont. to page 78]



A Finnish soldier armed with a Jalkavaenkivääri M/91-30, and his reindeer, pose on a frozen lake.



A trio of stern looking Soviet commissars. The man on the right is holding a Karabin obr. 1938g.



A young Finnish dog handler armed with a Soviet Karabin obr. 1938g.

**SPECIFICATIONS: KARABIN obr. 1938g**

Caliber:	7,62mm patron obr. 1930D
Overall Length:	40 in.
Barrel Length:	20 in.
Weight:	7.6 lbs.
Magazine:	5 rd. charger-loaded
Sights:	Front: Hooded post Rear: U notch adj. from 100 to 1,000 meters
Bayonet:	None

**KARABIN OBR. 1938g**

**WANT TO BUY ONE?**

Classic Firearms  
[www.classicfirearms.com/m38rifle/](http://www.classicfirearms.com/m38rifle/)  
 Rock Island Auction Co.  
[www.rockislandauction.com/detail/1027/613/four-bolt-action-military-rifles](http://www.rockislandauction.com/detail/1027/613/four-bolt-action-military-rifles)



A Finnish officer with a captured Soviet Karabin obr. 1938g.

SEE OUR WEB SITE  
www.hunterslodge.com

# Hunters Lodge Corporation

## Historical Firearms and Accoutrements

NO CREDIT CARDS.  
CHECK OR MONEY  
ORDER ONLY.

**SPECIAL!!!**

### SPANISH "OVIEDO" SHORT RIFLE



FFL or C&R required

### MODEL 1916 SPANISH MAUSER INFANTRY SHORT RIFLES

A great deal on these wonderful, handy short style rifles in the commonly available 7x57 Mauser known as the Spanish Hornet by their enemies. Featuring side mounted slings for back carry in rough terrain and manufactured with excellent Spanish steel. Spain is also known for proof testing their arms, something even the Germans did not always do. During Spain's long history of conflict these guns had the chance to be proven in battle and certainly did. Highly sought after by guerrilla fighters and may feature such marking of communist, Fascist or royal factions. The condition is battle worn but standing tall, bluing may have turned brown and stocks may be arsenal repaired. Overall good and at only \$149.88 your wife or girlfriend should have one too, in fact Ole' Zeke encourages it! Hand select is available and will be cosmetically better cond. Add \$20.00. Cleaning rod add \$9.00, sling add 14.00.

PREMIUM GUNS ARE ALSO AVAILABLE AS WELL AS SOME 7.62X51 AND RARE EXPERIMENTAL 8MM VERSIONS. PRICE ON REQUEST.

### BRITISH NO1 MKIII SMLE 303 CAL RIFLE



FFL or C&R required

Early example of one of the finest main battle weapons ever put into service. In use with the British Empire for decades and still as good as it ever was. Very good, battle ready condition. Yours only \$378.00. Hand select add \$25.00, Original dated sling \$19.95.

### 1888 GERMAN COMMISSION RIFLE

NO FFL REQUIRED. ANTIQUE. Broken, may be missing parts, bolt is included. Find beautiful metal and bores under a century of grease.

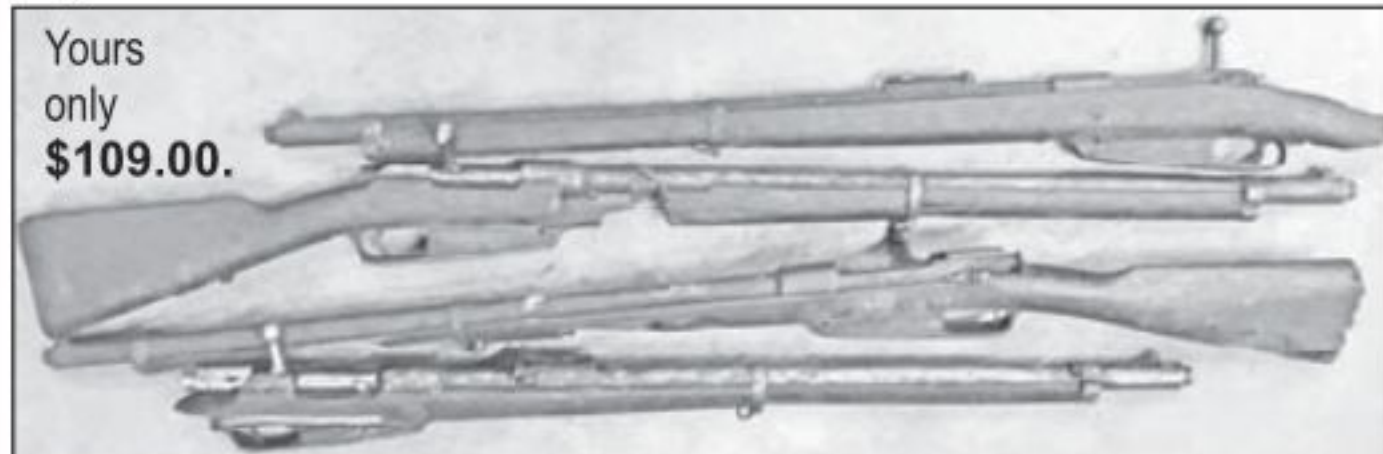

Yours only \$109.00.

### MODEL 1904/39 8MM PORTUGUESE MAUSER / VERGUEIRO RIFLE

C&R or FFL required. Designed in 1904 by Officer Jose Vergueiro to include all of the best features from Mauser and Styer. Bolt action, all milled parts with walnut heart wood stocks and hand assembled in Germany at D.W.M. In use from 1904 till 1974. The end of an era, the last of an empire.



Fantastic rifle to obtain for your collection. Yours only \$384.88. Hand Select \$25.00, sling \$19.95.

### BRITISH No 4 MK 1 RIFLES

FFL or C&R required.

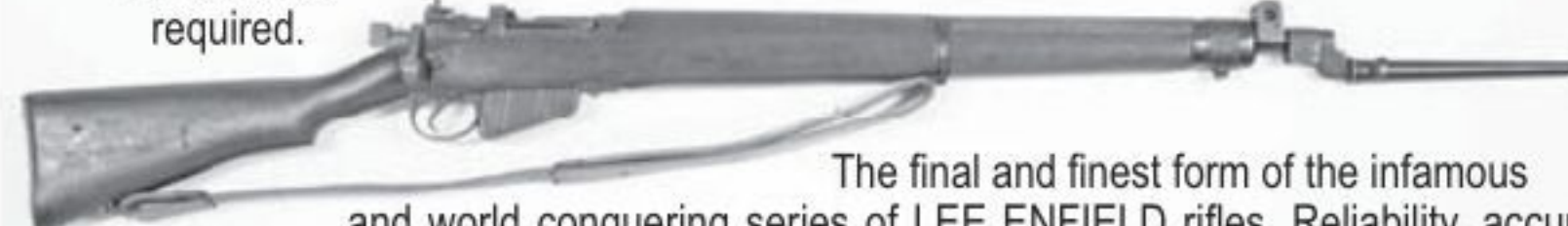

The final and finest form of the infamous and world conquering series of LEE ENFIELD rifles. Reliability, accuracy and handling were all improved in this final iteration. Own the last but the best of the British Empire. Some of the nicest examples we have seen in a while. Only \$419.88. Hand select add \$25.00. Sling \$19.95, bayonet \$48.88, frog \$6.45, pull thru \$4.99, action cover \$19.88. BUY THE WHOLE SHEBANG INCLUDING HAND SELECT FOR \$515.50.

### RARE C96 BROOMHANDLE REPLICA PISTOLS



\$105.00

NO LICENSE REQUIRED

Each one manufactured by skilled craftsmen in Europe. All moving parts. Real wood grips, none fireable. Handsome collector's item. You will love it! Only

### "OLE ZEKE'S TREASURES"

- YUGO M48 8MM RIFLES very good \$258.88. Hand select available
- BRITISH .303 MK III WWII ISSUE RIFLES good to very good \$298.88, hand select available \$20.00

- VZ 24 WWII COMPLETE STOCKS good to very good \$37.88, hand guard \$12.88, hand select \$10.00
- FRENCH MAB "D" .32ACP PISTOLS good cond. missing parts, only \$47.88. FFL required.
- AUSTRIAN STEYR MANLICHER 8x57r straight pull carbines, good to very good, only \$232.88, ammo on clips, some nazi marked. \$9.00 per full clip.

### M1943 SPANISH MAIN BATTLE RIFLES

Good condition. Only \$169.50



FFL or C&R required

A finely crafted Spanish 8mm short rifle following the pattern of the original k98 German short rifle. The last rifle for Spain to be made in the old ways. Although, giving way to a new era these hardy and accurate rifles did their job superbly. Manufactured from famously superior Spanish steel and certainly able to take a lickin' and keep on a tickin'. As-is rifles available, might have crack in stock or handguard, will be dirty, but complete, one off top \$94.88.

### 1942 EXPERIMENTAL ITALIAN CARCANO CARBINES 6,5X52 MM WITH AN ORIGINAL LEATHER SLING

**Sale**



FFL or C&R required

These guns were an effort to make a well handling and accurate carbine that did not utilize a folding bayonet. Improvements were made for accuracy with the bayonet and reset for zero. The result is a lighter more accurate and less clumsy version.

A success with variable twist rifling. Now that 6,5 X 52 mm is easily obtainable, these will make rugged little bush guns that will one up more expensive hardware. Only \$192.88. Hand select add \$25.00.

Custom made tan leather carbine scabbard available. Only \$29.95.

### U.S. MARINE CORPS SWORDS

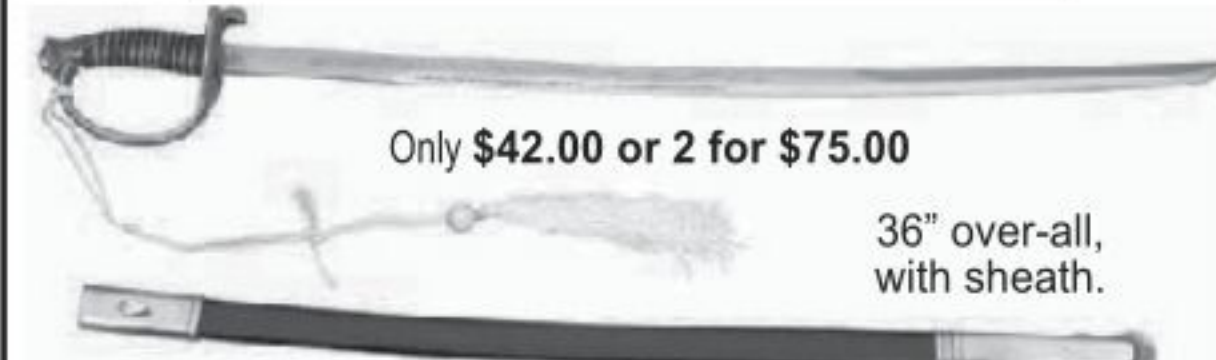

Only \$42.00 or 2 for \$75.00

36" over-all, with sheath.

A dazzling reproduction available in simulated gold or simulated silver.

### RARE ARGENTINE MODEL 1891 BRASS HANDLE BAYONETS

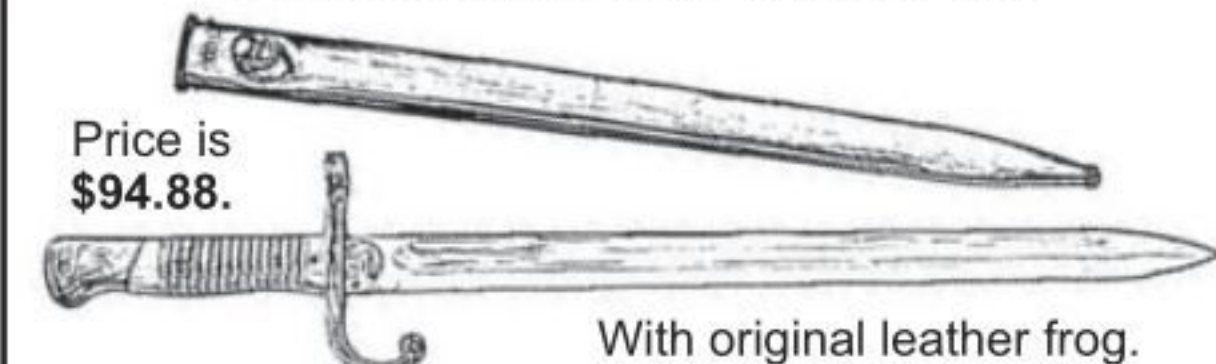

Price is \$94.88.

With original leather frog.

### 1940'S U.S. MILITARY AXE



\$35.50

MFG from RAZOR quality Swedish steel. Supply limited.

### USMC KNIFE WITH A LEATHER SCABBARD



12" overall. Only few available \$39.95.

### GAHENDRA MARTINI BEAUTIFUL HANDSOME WOOD STOCK SET



Cond NEW Original.

Supply limited.

Yours only \$179.50.

### SADDLE BAGS



All leather, flap close with straps. Ideal for horseback, 3 or 4-wheeler. Hard to come by. Available in Tan and Black. At our special price Only \$29.95

### HAND WOVEN EXTRA LARGE VAQUERO SADDLE BLANKETS



56"X74" Approx. 4 lbs., the highest quality Falsa blanket, proudly made in America by Texan artisans. \$32.88.

### USMC MP ORIGINAL 38 SNUB NOSE BLACK LEATHER SHOULDER HOLSTER RIG



Yours only \$49.88. Beautiful cond. Unissued. Supply limited.

### RUSSIAN FLARE PISTOL HOLSTER

Brown Leather. w/ shoulder straps. Fits most flare pistols \$9.50 each.

### ITALIAN BERETTA M-92 MILITARY POLICE BLACK LEATHER HOLSTER



Only \$19.45

### POWDER HORNS



Made from real horn Only \$17.88

### BULLWHIP

HAND MADE in Texas, 8 foot leather bullwhip. Only \$29.88.

### LEATHER RIFLE SCABBARDS

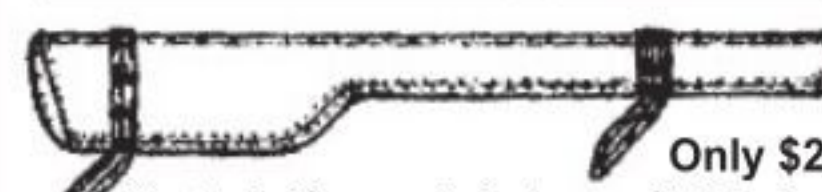

Only \$29.95

Most all rifles and shotguns fit. Designed for horseback, but works great on ATVs or Jeep side mount.

### NORTH VIETNAM REGULAR ARMY HELMET UNISSUED.



SPECIAL COLLECTOR'S FIND! Exc. to new condition. Limited supply. Only \$39.95 - WHILE SUPPLY LASTS.

Ordering Information: Please remit via check or money order. All firearms except those noted NO FFL REQ. - REQUIRE a signed in ink Dealer FFL. Please add sufficient shipping on all orders. There is no min. order. All orders shipped as quickly as possible without delays. Returns require a Customer Service RA number prior to return. Return shipping at customer's expense. No shipping charges refunded; in-house credit only. All prices subject to change. 20% Restock/Handling on Returns. Inspection period 3 days.

Some pictures for illustration only.

P.O. BOX 203 • ETHRIDGE TN 38456-0203.

Telephone # 931-766-0755 • e-mail: info@hunterslodge.com • Check out our website at www.hunterslodge.com



The Avtomat Fyodorov obr. 1916g was the first selective fire, assault rifle to be used in combat.

**SPECIFICATIONS: AVTOMAT FYODOROV obr. 1916g**

Caliber:	6.5mm Type 30
Overall Length:	40.9 in.
Barrel Length:	20.5 in.
Weight:	9.6 lbs.
Magazine:	25 rd. detachable box
Rate of Fire:	600 rpm (full auto)
Sights:	Front: Blade Rear: V notch adj. from 300 to 1,500 arshini
Bayonet:	Sword style with 15.5 in. blade

[Cont. from page 76]

the Samozaryadnaya Vintovka Tokareva obr. 1940g (SVT-40) was in production. A number of internal parts were made lighter, the magazine release redesigned, the stock was of one-piece construction and the cleaning rod was housed under the barrel. Apparently, most SVT-40s were issued to non-commissioned

officers and elite units like the naval infantry and to snipers.

A selective fire version, the Avtomaticheskaya Vintovka Tokareva obr. 1940g (AVT-40) was issued in limited numbers but proved uncontrollable when fired in automatic mode and experienced high levels of

[Cont. to page 80]

**SPECIFICATIONS: AVTOMATICHESKAYA VINTOVKA SIMONOVA 1936g**

Caliber:	7,62mm patron obr. 1930D
Overall Length:	48 in.
Barrel Length:	24 in.
Weight:	9.5 lbs.
Magazine:	15 rd. detachable box
Rate of Fire:	800 rpm (full auto)
Sights:	Front: Blade Rear: U notch adj. from 100 to 1,500 meters
Bayonet:	Knife style with 13 in. blade



1940. Three Soviet soldiers armed with the Avtomat Fyodorov obr. 1916g, take a break for a smoke.



A Red Army soldier with an AVS 36 guarding a Soviet sniper.



A dispirited looking group of Red Army soldiers marching off to Finland. Note several are armed with the AVS 36.



A trio of Finnish soldiers armed with (L to R) an AVS-36, a Lahti-Soloranta M/26 light machine guns and a Tokareva obr. 1940g.

**AVTOMATICHESKAYA VINTOVKA SIMONOVA 1936g (AVS-36)**

**WANT TO BUY ONE?**

Morphy Auctions  
[www.morphyauctions.com/jamesdjulia/item/1064-369/](http://www.morphyauctions.com/jamesdjulia/item/1064-369/)

**PARTS:**

IMA  
[www.ima-usa.com/products/original-soviet-pre-wwii-1936-avs-36-rifle-first-model-bayonet-rare?variant=26156933445](http://www.ima-usa.com/products/original-soviet-pre-wwii-1936-avs-36-rifle-first-model-bayonet-rare?variant=26156933445)



The Avtomaticheskaya Vintovka Simonova 1936g a selective fire rifle chambered for the full powered 7,62mm patron obr. 1930D. (Courtesy Morphy Auctions)

# SARCO, INC.

CALL  
Us!

**LET'S MAKE A DEAL**

CALL  
Us!

**610.250.3960**

AND ASK FOR CHOLLY, DAVE OR MARK

**DAVE MICHELS**

*mgdave@sarcoinc.com*

*ext. 223*

**CHOLLY STEEN**

PRESIDENT & CEO

*csteen@sarcoinc.com*

**MARK DOTTEN**

*mdotten@sarcoinc.com*

*ext.224*

**www.SARCOINC.com**

**50 Hilton Street, Easton, PA 18042**



**EXTRA SURPLUS TO SELL??**

**MATERIAL SITTING AROUND ACCUMULATING ANOTHER YEAR OF DUST??**

SARCO, one of the top 2 gun parts and general surplus dealers & importers in the U.S., is interested in your surplus material! Our primary interest is in gun parts, ammunition, ammo components, guns, cannon, aircraft, military vehicles, uniforms, field gear, etc. We are also interested in commercial firearms or parts, and surplus commercial inventory.

**NO DEAL IS TOO BIG OR TOO SMALL !!**

We will consider all offers and we assure you of our prompt and discreet attention to your offering. Mutually beneficial business is just a call away!

**WE CAN SELL YOU SURPLUS AS WELL ! INQUIRE !!**



Weapons captured from the Red Army including several AVS-36 rifles.



A Finnish soldier firing a captured Soviet Tokareva obr. 1938g.



Soviet soldiers armed with Tokareva obr. 1940g rifles.



Finnish soldiers armed with captured Tokareva obr. 1940g rifles

[Cont. from page 78]

breakage and malfunctions. Few were issued before manufacture ceased in 1943.

The Finns captured large quantities of all of the above-mentioned Soviet weapons and issued them to their own troops. The SVT-40 was especially popular as, with quality Finnish-made ammunition and maintenance by educated and motivated troops, it provided reliable and provided the outnumbered Finns with much needed firepower.

**Sniper Rifles of the Russo-Finnish War:**

Both sides fielded snipers during the conflict although the Finns, with their traditions of marksmanship and hunting, were used in larger numbers and were more effective than the Soviets.

The most common rifle used by both sides were various models of the Mosin-Nagant equipped with

**SAMOZARYADNAYA VINTOVKA TOKAREVA OBR. 1938g & 1940g**

**WANT TO BUY ONE?**

Rock Island Auction Co.  
[www.rockislandauction.com/detail/75/3487/russian-svt-1938-tokarev-rifle-wbayonet](http://www.rockislandauction.com/detail/75/3487/russian-svt-1938-tokarev-rifle-wbayonet)

Rock Island Auction Co.  
[www.rockislandauction.com/detail/1031/4398/two-soviet-svt40-tokarev-semiautomatic-rifles](http://www.rockislandauction.com/detail/1031/4398/two-soviet-svt40-tokarev-semiautomatic-rifles)

Morphy Auctions (SVT38)  
<https://auctions.morphyauctions.com/LotDetail.aspx?inventoryid=203340>

Morphy Auctions (SVT40)  
<https://auctions.morphyauctions.com/lot-283538.aspx>

**PARTS:**

Sarco  
[www.sarcoinc.com/svt-40-tokarev-rifle-spares-pack/](http://www.sarcoinc.com/svt-40-tokarev-rifle-spares-pack/)

Numrich Arms  
[www.gunpartscorp.com/gun-manufacturer/tokarev/rifles-tok/40-tok](http://www.gunpartscorp.com/gun-manufacturer/tokarev/rifles-tok/40-tok)

IMA  
[www.ima-usa.com/products/original-rare-soviet-russian-long-bayonet-for-the-svt-38-self-loading-rifle-with-scabbard-and-belt-loop](http://www.ima-usa.com/products/original-rare-soviet-russian-long-bayonet-for-the-svt-38-self-loading-rifle-with-scabbard-and-belt-loop)

**SPECIFICATIONS: SAMOZARYADNAYA VINTOVKA TOKAREVA obr. 1938g**

Caliber:	7,62mm patron obr. 1930D
Overall Length:	48 in.
Barrel Length:	24 in.
Weight:	8.7 lbs.
Magazine:	10 rd. detachable box
Sights:	Front: Blade Rear: U notch adj. from 100 to 1,500 meters
Bayonet:	Knife style with 13 in. blade

**SPECIFICATIONS: SAMOZARYADNAYA VINTOVKA TOKAREVA obr. 1940g**

Caliber:	7,62mm patron obr. 1930D
Overall Length:	48.3 in.
Barrel Length:	24.6 in.
Weight:	8.5 lbs.
Magazine:	10 rd. detachable box
Sights:	Front: Blade Rear: U notch adj. from 100 to 1,500 meters
Bayonet:	Knife style with 13 in. blade

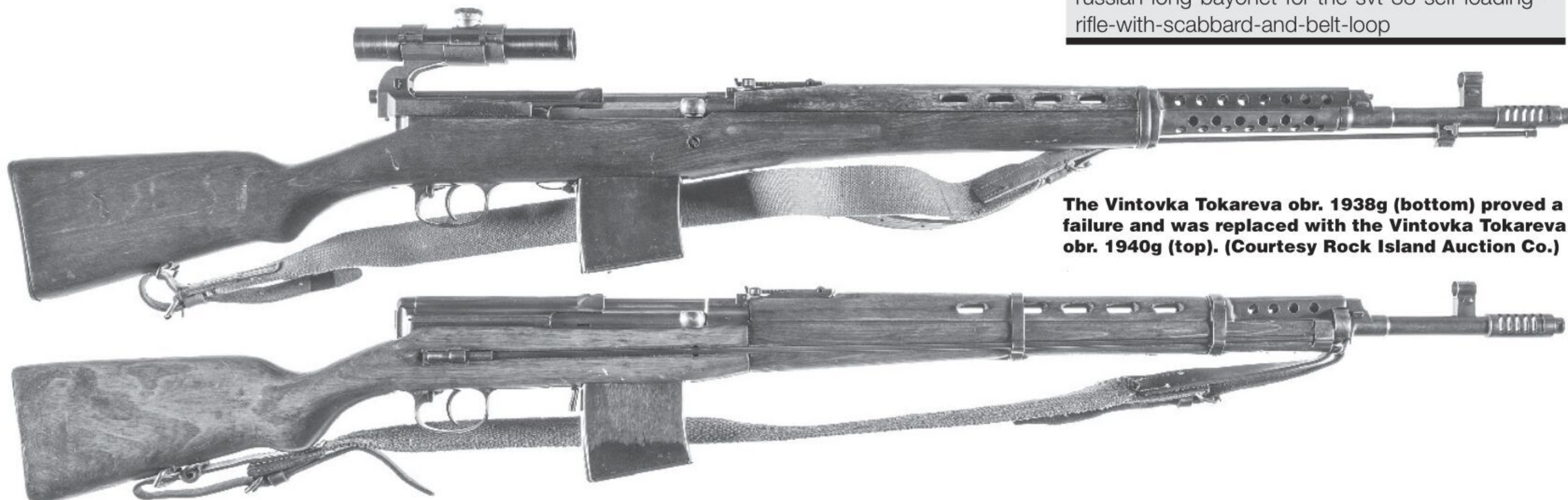

The Vintovka Tokareva obr. 1938g (bottom) proved a failure and was replaced with the Vintovka Tokareva obr. 1940g (top). (Courtesy Rock Island Auction Co.)



**WEAPON DESIGNATIONS**

Soviet	Finnish
Vintovka obr. 1891/30g	Jalkavaenkivääri M/91-30
Karabin obr. 1938g & Karabin obr. 1944g	Karabiini M/38 & M/44
Avtomaticeskaya Vintovka Simonova 1936g	Automaattikivri M/36 Simonov
Samozaryadnaya Vintovka Tokareva obr. 1938g	Kerta-Automaattikivri M/38 Tokarev
Samozaryadnaya Vintovka Tokareva obr. 1940g	Kerta-Automaattikivri M/40 Tokarev



**Finnish snipers used a variety of Tarkka-Ampujakiväärit.**



**Both the Soviets and Finns used Tokarev rifles with telescopic sights for sniping.**



**The Finns and Swedish volunteers used numbers of Gevär m/41 sniper rifles.**

**GEVÄR M/41 MAUSER**

**WANT TO BUY ONE?**

**Rock Island Auction co.**

[www.rockislandauction.com/detail/74/1477/swedish-mauser-model-41b-bolt-action-sniper-rifle](http://www.rockislandauction.com/detail/74/1477/swedish-mauser-model-41b-bolt-action-sniper-rifle)

telescopic sights. In 1933, the Suojeluskunta had Sako assemble a number of M/28 and M/28-30 rifles with Zeiss telescopic sights. Known as the Tarkka-Ampujakivääri M/28 and Tarkka-Ampujakivääri M/33, they remained in service until 1944. The Suomen Armeija's first sniper rifle, the Tarkka-Ampujakivääri M/37 was assembled on M/27 rifles with scopes provided by Oy Physica of Helsinki.

Among the Mausers obtained from Sweden were small numbers of the Gevär m/41, which were selected m/96 rifles that were equipped with the Swedish AGA 3x65 scopes. They were used by members of the Svenska frivilligkåren and Finnish marksmen.

As was their practice, the Finns made use of captured Soviet sniper rifles, the Snajperskaja vintovka obr. 1891/30g, which were fitted with PE and PEM telescopic sights.

In Part II of this report, we will examine the automatic weapons used by both the Finns and Soviets during the Winter War.

For those interested in a concise history of Finnish military small arms, I recommend Markku Palokangas' three volume set of books: Sotilaskäsiaseet Suomessa 1918-1988 (ISBN 951-25-0508-8)

*I would like to thank the following for providing materials used to prepare this report: Markku Palokangas, Tim Hawkins, Ted Derryberry (<http://l7.62x54r.net>), Joel Kolander, Sarah Stoltzfus, Doss White, Peter Kokalis (dec.), John Rasalov, Rock Island Auction Company ([RockIslandAuction.com](http://RockIslandAuction.com)), Morphy Auctions ([MorphyAuctions.com](http://MorphyAuctions.com)) and Century International Arms. **FN***

**ENDNOTES:**

- <https://en.wikipedia.org/wiki/Hakkapeliitta>
- Even members of the Suojeluskunta were required to serve a three year hitch in the Suomen Armeija.
- Translation: Kivääri = Rifle; Kiväärit = Rifles
- The M/91's rear sights were originally regulated in arshini (paces) or about 0.72 meters.
- [www.jaegerplatoon.net/RIFLES2.htm](http://www.jaegerplatoon.net/RIFLES2.htm)
- The Corps' motto was "Finlands sak är vår!" (Finland's cause is ours!).
- Beginning in 1943 the Finns mounted adjustable rear sights on some of their M/38s.
- Trotter, William, R. The Winter War: The Russo-Finnish War of 1939-40 (5th ed.). Aurum Press.2002.
- [https://en.wikipedia.org/wiki/Molotov\\_cocktail](https://en.wikipedia.org/wiki/Molotov_cocktail)

# THE FIGHTING BUNCH

## GIVES LESSON FROM PAST ON COMMITMENT IT TAKES TO OVERCOME ELECTORAL FRAUD

By David Codrea

**F**or ten long years, the citizens of McMinn County, Tennessee, lived under a regime as dictatorial as Nazi Germany and Imperial Japan because wealthy industrialist Paul Cantrell stole every election that decade through ballot box seizures and secret vote counts to ensure his victory,” a book review solicitation from St. Martin’s Press notes. “To free their friends and family from authoritarian rule, approximately 3,500 WWII soldiers who fought fascist tyranny abroad returned home and formed the nonpartisan GI ticket to oppose Cantrell’s machine in the next election.”

The book is *The Fighting Bunch: The Battle of Athens and How World War II Veterans Won the Only Successful Armed Rebellion Since the Revolution*, by *New York Times* bestselling author Chris DeRose.

“It really could not be coming at a better time as our country discusses possible electoral fraud in the ... presidential election,” the publicist writes. “It’s highly relevant to today’s conversation surrounding the importance of protecting the Second Amendment.”

That stirring intro is professionally crafted to whet your interest and convince you to buy the book. Here is what I think of it, as an impartial reviewer not particularly impressed by *NYT* popularity, one who has written about the Battle of Athens and how it might play out today with the militarization of law enforcement, and who, before I read it, was completely unfamiliar with DeRose and his work:

This is the best book I have read in years.

Like many Second Amendment advocates, I have been familiar with the basics of the story. DeRose, through exhaustive digging has managed to give us what late radio commentator Paul Harvey called “the rest of the story.” He did that by interviewing remaining witnesses, through painstaking historical research and through evident hard work and persistence. He tells the story through a narrative that appeals because it flushes out the characters and shows the scope and pervasiveness of brutal corruption that could only be overcome through heroic acts by men who dared to risk all.

We see that corruption through an established Democrat political machine with reach far beyond local politics, one that had grown increasingly brazen in its confidence that it could get away with anything. That included stuffing ballot boxes with fraudulent votes, altering counts, intimidating, threatening, and assaulting opposition candidates and voters, and doing the same to poll watchers who tried to do their

job. It was all enforced by armed, badged, and brutal thugs, quick with a fist, a blackjack, or a gun to use against anyone who did not show “proper” submission to their “authority.” And they had the judges in their back pockets, ready to ignore charges or issue in-your-face rulings that only encouraged more misdeeds.

Bullied and cowed for years, the citizens had been conditioned to accept that state of things as their lot until a monumental event happened: The GIs returned home from the war after having been battle-forged in hell and emerging victorious.

DeRose profiles the horrors the prominent figures behind “The Battle of Ballets and Bullets” endured and survived. These were not men who would allow themselves to be tyrannized by badged sadists and authoritarian punks. They had fought beyond most human limits to free the world from tyranny and were not about to submit to it at home.

In many ways, *The Fighting Bunch* reminds me of a real-life actualization of my favorite chapter, “The Scouring of the Shire,” from *The Return of the King*, the third book of J.R.R. Tolkien’s *The Lord of the Rings* trilogy. It is a story element bafflingly left out of the movie version. The hobbits, having prevailed though the horrors, sacrifices and losses to defeat the most powerful evil force on Middle Earth, returned home to find it ruled by arrogant and brutal scoundrels backed by corrupt “Shiriff” enforcers. As with Athens, the ruffians tried to tyrannize battle-hardened warriors at their peril and to their downfall.

The free and fair election that was the reason behind forming the nonpartisan “GI ticket” was won only through armed resistance and capturing the ballots that had been impounded at the jail. One of the reasons much of the story DeRose uncovered has heretofore been unknown is that in the aftermath, many of the principal GIs involved clammed up about it.

That was partly due to legal considerations and, because once they had secured their victory and defeated the machine, the patriotic victors, unlike those who steal elections, made real “unity and healing” a top priority. That is the way of those who value freedom. And it is the way of those who do not value freedom to paint men who do as “rightwing extremists” and worse.

I cannot come up with enough superlatives to tell you why I believe all gun owners striving for a govern-

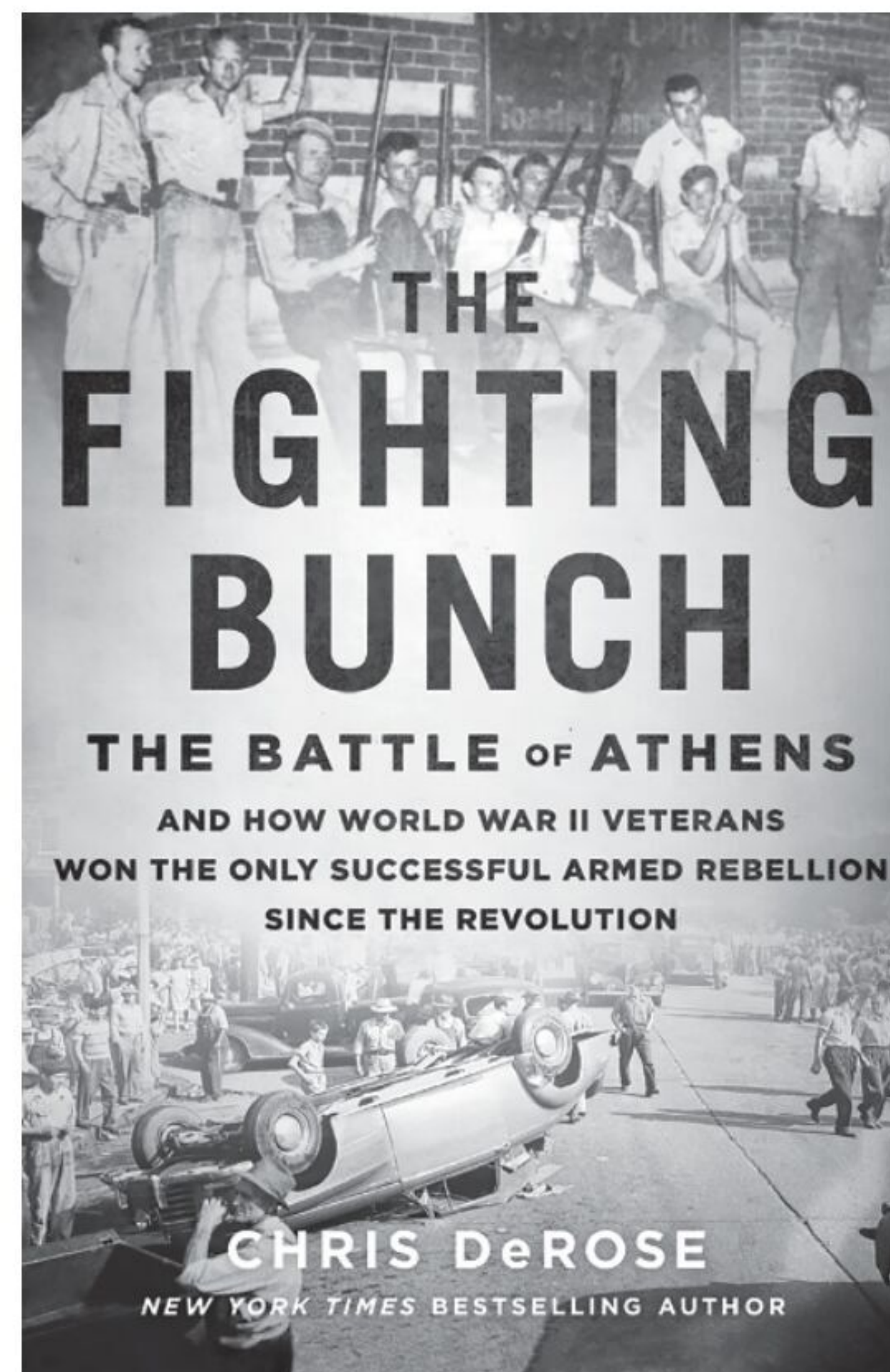

ment that “secures the Blessings of Liberty” should read this insightful, informative and gripping book. You can get a copy for yourself at Amazon (Hardcover or Kindle), Barnes & Noble (Hardcover or Nook), Books-a-Million and the like, and find out more at St. Martin’s parent company’s website, MacMillan Publishers ([us.macmillan.com](http://us.macmillan.com)).

### About David Codrea:

David Codrea is the winner of multiple journalist awards for investigating / defending the RKBA and a long-time gun owner rights advocate who defiantly challenges the folly of citizen disarmament. In addition to being a regular featured contributor for *Firearms News* and *AmmoLand Shooting Sports News*, he blogs at “The War on Guns: Notes from the Resistance,” and posts on Twitter: @dcodrea and Facebook. **FN**

GUN STORIES

# LET FREEDOM RING

*Wednesday Night At The Range* is a loud and proud celebration of our freedoms. In one explosive night, we bring you the latest firearms and gear, competitive shooting action, personal defense strategies, historic weaponry and much more.

## WEDNESDAY NIGHT AT THE RANGE



BEGINS

7 P ET



SHOOTING GALLERY



SHOOTING USA



AMERICAN RIFLEMAN

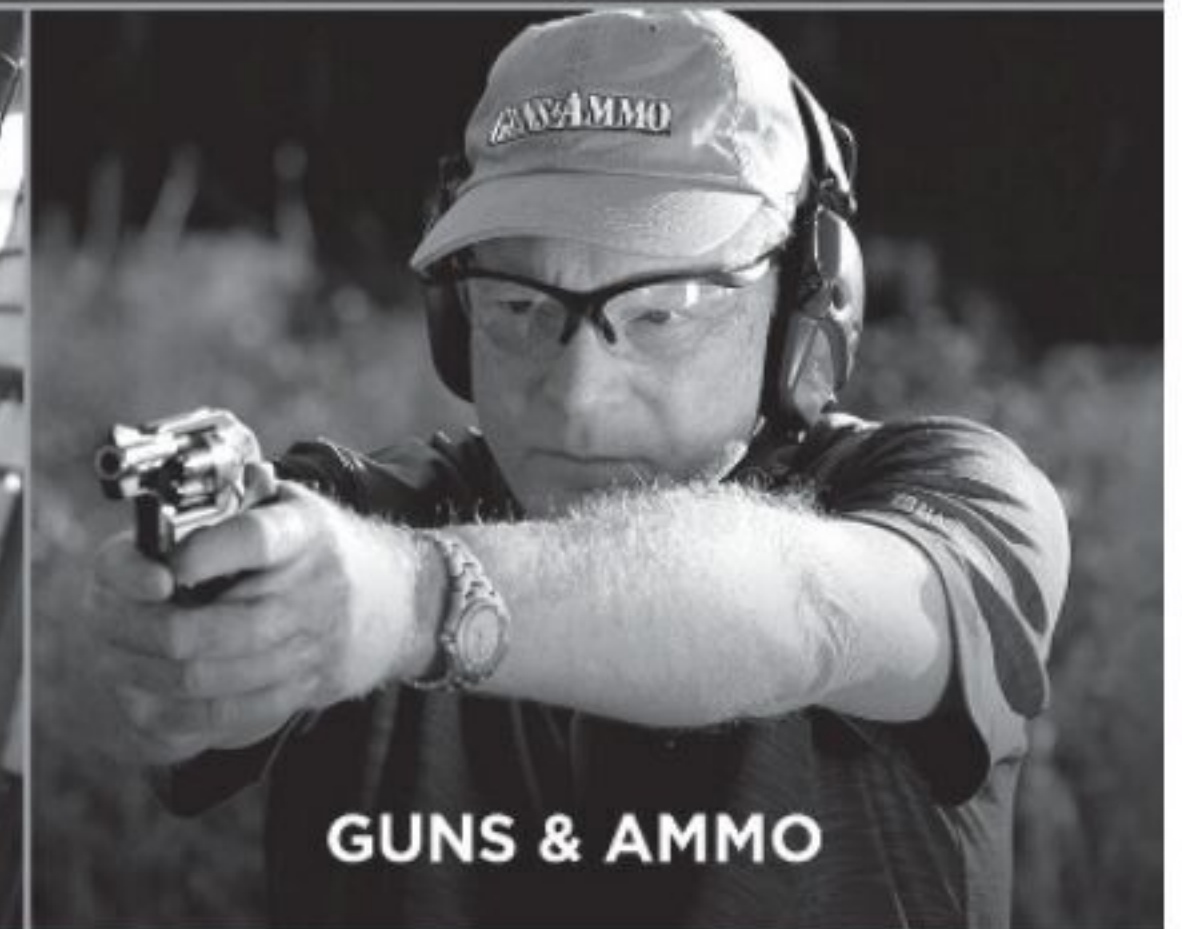

GUNS & AMMO

# NEWSSTAND

RECENT NEWS FOR THE FIREARMS COMMUNITY

## D.C. MAYOR BANS LEGAL CARRY BEFORE TRUMP RALLY

GUN FREE ZONE

By Mark Chesnut

Is a constitutionally protected right really even a right if a low-level politician can suspend that right at his or her own whim and convenience?

That's the question many Washington, D.C., gun owners are likely asking after signs appeared around the capital outlawing carry of firearms, even by those with carry permits, just ahead of Wednesday's scheduled rally in support of President Donald Trump.

At the direction of Mayor Muriel Bowser, Metropolitan police have been posting signs that read:

"First Amendment Activities

All firearms prohibited within 1,000 feet of this sign

DC Code: 7-2509.07

Metropolitan Police Department

Effective: Monday, January 4, 2021,

through Thursday, January 7, 2021."

So, what's the deal with this DC Code 7-2509.07? Surely, there can't actually be a city law that allows the Second Amendment to be trampled just because citizens are practicing their First Amendment rights to peacefully gather, can there?

Actually, there is. And while I'm not a lawyer, I don't see any way this statute could be considered constitutional.

It states:

"No person holding a license shall carry a pistol in the following locations or under the following circumstances:

A gathering or special event open to the public; provided, that no licensee shall be criminally prosecuted unless:

(A) The organizer or the District has provided notice prohibiting the carrying of pistols in advance of the gathering or special event and by posted signage at the gathering or special event; or

(B) The licensee has been ordered by a law enforcement officer to leave the area of the gathering or special event and the licensee has not complied with the order."



Certainly such a city ordinance runs counter to the intent of the Founders, who specifically mentioned the right to "keep" and "bear" arms when penning the Second Amendment. And even though the First Amendment right of free speech is enumerated before the right to bear arms in the Bill of Rights, even the uneducated understand that these liberties aren't listed in descending order of importance, so a First Amendment-protected rally doesn't outweigh the Second Amendment-protected carry of a firearm.

While many might ask what difference it makes given D.C.'s long history of denying Second Amendment rights, things have changed somewhat in the District of late. This move by the mayor comes at a time when more people are acquiring concealed carry permits in D.C. than ever before.

A *Washington Post* story from last spring reported that since a court struck down the city's "good reason" provision for issuing carry permits, the number of licensed carriers had jumped to more than 4,000. And interestingly, more than half of those are held by people residing outside the District.

Does a mayor have the power to unilaterally strike down the constitutional rights of more than 4,000 people because she doesn't think they need to be carrying a firearm in her city on a particular week? While the answer seems to be yes, it certainly doesn't pass the smell test.

*Freelance writer and editor Mark Chesnut is the owner/editorial director at Red Setter Communications LLC. An avid hunter, shooter and political observer, he has been covering Second Amendment issues and politics on a near-daily basis for the past 20 years. FN*

# YET ANOTHER REASON GUN OWNERS ARE CYNICAL ABOUT POLITICIANS

By Mark Chesnut

**A**fter an all-hands-on-deck push of gun control measures last year that resulted in numerous new restrictions on Virginia residents, Democrat lawmakers in the Commonwealth seem to be backing away from reintroducing or pursuing such legislation in 2021?

“Why?” you might ask.

Simple: Because it’s an election year.

In fact, anti-gun Gov. Ralph Northam, who has never seen a gun restriction he didn’t like, isn’t continuing to push his long anti-gun wish list in order to protect Democrat politicians from having to remind their constituents about their support for sweeping restrictions.

“It was a campaign promise that a lot of us ran on,” Northam told 8News when asked if he would push the failed assault weapons ban that Democrats strongly favored last year. “That one bill on assault weapons didn’t move forward, but six other pieces of legislation did and I think because of that Virginia is a safer state. But I’ll leave that up to the discretion of the legislation and whatever they do I’ll be supportive of.”

Of course, Virginia is not a safer state because of those new anti-gun laws. And the fact that pro-gun advocates were able to stop the assault weapons ban — at least temporarily — was one positive occurrence in the Commonwealth in 2020.

Still, hearing legislatures pretend to not really support such a bill in 2021 is an insult to law-abiding citizens whose rights are at stake. While Democrat Delegate Mark Levine says he won’t push the bill forward this year because it’s a shortened and largely virtual session, it’s easy to see he’s protecting his anti-gun cronies from voters.

“Most of the session will be devoted to things that are less controversial,” Levine told WRIC-TV. “That doesn’t mean I’ve given up fighting for this cause. The goal is to stop making it really easy to commit mass murder.”

While politicians who change their priorities every other year just to stay in office are an excellent reason why so many gun owners have become cynical about their supposed “life-saving” proposals, the fact that they continue to be reelected doesn’t speak highly for voters’ memories.

Virginia gun owners should learn where their representatives stand on the issues and how they have voted on critical legislation in the past, then support them or work to replace them with someone who respects their rights. Hoping things will somehow get better with an anti-gun majority in the General Assembly is a sure strategy for continued loss of essential liberties.

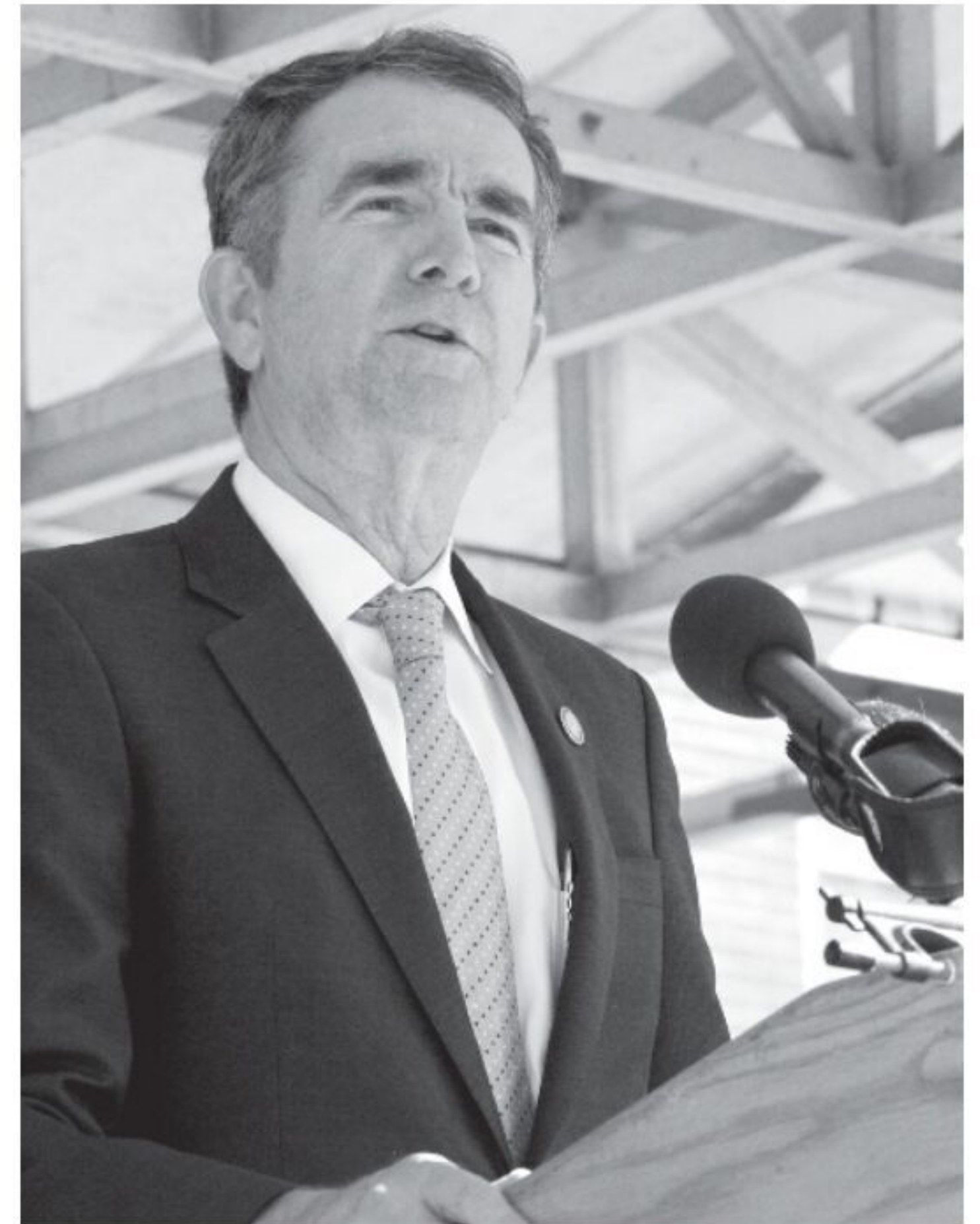

*Freelance writer and editor Mark Chesnut is the owner/editorial director at Red Setter Communications LLC. An avid hunter, shooter and political observer, he has been covering Second Amendment issues and politics on a near-daily basis for the past 20 years. **FN***

# FROM MAGA TO MAYHEM – PROTESTER SHOT DEAD AND SEN. LINDSEY GRAHAM INCORRECTLY CALLS THE USA A “DEMOCRACY”

By Clay Bell

**A** large rally of President Donald Trump supporters in Washington, D.C., on the same day as Congress was set to vote on certifying electoral college results for the presidential election turned to chaos when some of the participants stormed the capitol grounds.

According to widespread media reports, hundreds of protesters pushed through barriers surrounding the Capitol’s perimeter, some even clashing with officers in riot gear. Some demonstrators apparently gained access to the Capitol building, and armed guards were sent to secure the front door of the House of Representatives. Authorities used smoke grenades to clear the Senate side of the Capitol.

The DC National Guard was quickly activated by the Department of Defense. “Acting Secretary Miller has been in contact with Congressional leadership,



and Secretary McCarthy has been working with the D.C. government. The law enforcement response will be led by the Department of Justice," a Pentagon spokesman said.

After rallying the troops, Trump backed off quickly when some took matters into their own hands and tried to storm the Capitol building. According to reports, some Trump supporters were disenchanted with the president for telling them to go home after spending weeks encouraging them to come to D.C. and support him.

For his part, the president's son, Donald Trump Jr., said that those who stormed the Capitol were wrong and "not who we are." He tweeted, "Be peaceful and use your 1st Amendment rights, but don't start acting like the other side. We have a country to save and this doesn't help anyone."

Speculation among some Trump supporters was that many of those storming the Capitol weren't Trump supporters at all, rather radical leftists trying to make those on the political right appear criminal. A photo accompanying an interesting thread at AR15.com showed one of the demonstrators with a hammer and sickle tattoo, a Communist Russia symbol.

Interestingly, the so-called "mainstream" media, which consistently referred to leftwing rioting, looting and vandalism by Black Lives Matter and Antifa as "peaceful protests," have completely changed their tune. CNN and others referred to those on the right side of the political spectrum as a "mob," "rioters," "disgraceful violence" and a "coup attempt."

During the chaos on the Capitol grounds, one female protester was shot in the neck and later died. Another report said that multiple officers had been injured, with at least one taken to a hospital for treatment.

Interestingly, in calling for an end to the unrest, U.S. Sen. Lindsey Graham, R-South Carolina, chose to add to the confusion by incorrectly referring to the United States as a "democracy" when, in fact, most know it is a constitutional federal republic.

"Those who made this attack on our government need to be identified and prosecuted to the fullest extent of the law," Graham said on social media. "Their actions are repugnant to democracy."

Congress has not yet set a time to reconvene and consider certifying the electoral college ballots. **FN**

# ANTI-GUN PROVISIONS PASSED IN 2021 CONSOLIDATED APPROPRIATIONS ACT

By Mark Chesnut

**W**ith nearly all news-watching Americans concentrating on how many millions of dollars Congress would send Pakistan for gender studies in the so-called COVID Stimulus Bill, an even bigger measure was passed that has far more longstanding repercussions.

Just before passage of the so-called "stimulus," Congress also passed the FY 2021 government spending deal. And true to its longtime pork-fraught nature, as well as special favors for many different interest groups.

Unfortunately for American gun owners, some of these favors were granted to gun-ban groups via provisions deep within the measure.

How can you tell how truly bad the spending deal really is for gun owners? Simple: See what gun-ban proponents think about it.



is due to the longtime anti-gun lie that Congress earlier forbid the Centers for Disease Control and Prevention (CDC) from doing research on gun violence. In truth, all that law does is prevents the CDC from

Shannon Watts, head of the gun-ban group Moms Demand Action, was equally pleased Congress included so many anti-gun Christmas presents for her organization in the measure.

"Federal action to combat gun violence is more crucial than ever as we face a pandemic that has made the gun violence crisis worse," Watts said "This package is a great start, and we'll keep pushing for more funding and legislation that will save lives."

Any readers who are surprised Congress would hide such provisions in an important spending measure haven't been paying much attention of late. Michael Bloomberg's millions regularly buy favors among his anti-gun cronies in Congress. Then, it's always left to America's gun owners to try to fight such laws in an effort to retain what limited bit of freedom we still maintain.

*Freelance writer and editor Mark Chesnut is the owner/editorial director at Red Setter Communications LLC. An avid hunter, shooter and political observer, he has been covering Second Amendment issues and politics on a near-daily basis for the past 20 years. **FN***

## UNFORTUNATELY FOR AMERICAN GUN OWNERS, SOME OF THESE FAVORS WERE GRANTED TO GUN-BAN GROUPS VIA PROVISIONS DEEP WITHIN THE MEASURE.

In this case, John Feinblatt, president of Everytown for Gun Safety, said, "This package is a critical step forward in answering the call to address our nation's gun violence crisis. As we head into the new year, we look forward to working with Congress and the new administration to make sure the federal government has the resources it needs to comprehensively address gun violence in all its forms."

One thing Feinblatt was so excited about is the \$25 million earmarked for "gun violence research." This

doing expressly anti-gun research that advocates for more restrictive gun laws.

Another provision cheered by Everytown is one that would encourage the Veteran's Administration to trample the rights of veterans by confiscating guns from them without due process. While trying to prevent runaway veteran suicides is a very important endeavor, utilizing "red-flag" type laws that allow those who have fought for our freedom to not be able to enjoy that same freedom is a disgrace.

50 Hilton Street, Easton PA 18042  
 Showroom Open: Mon - Sat,  
 10am to 5pm, Friday til 7pm  
 Tel: 610.250.3960  
 Fax: 610.438.2548  
 info@sarcoinc.com  
 Phones Open: Mon - Fri,  
 8:30am to 5pm



# SARCO, INC.

EST. 1962

THE LEADING SUPPLIER IN FIREARMS. PARTS. ACCESSORIES.

www.SARCOINC.com



Use your Smart Phone to Scan the QR Code and go straight to our website!



**JUST IN!!** 'Like new' guns that have been properly demilled into kit form. The kit includes all cut parts of the receiver and cut barrel, serviceable internals, sights, and folding stock assy. Comes with 1 magazine. A venerable historic SMG that has travelled the world in combat from the 'Reichstag' to the jungles of Indochina, and plains of Ethiopia.....

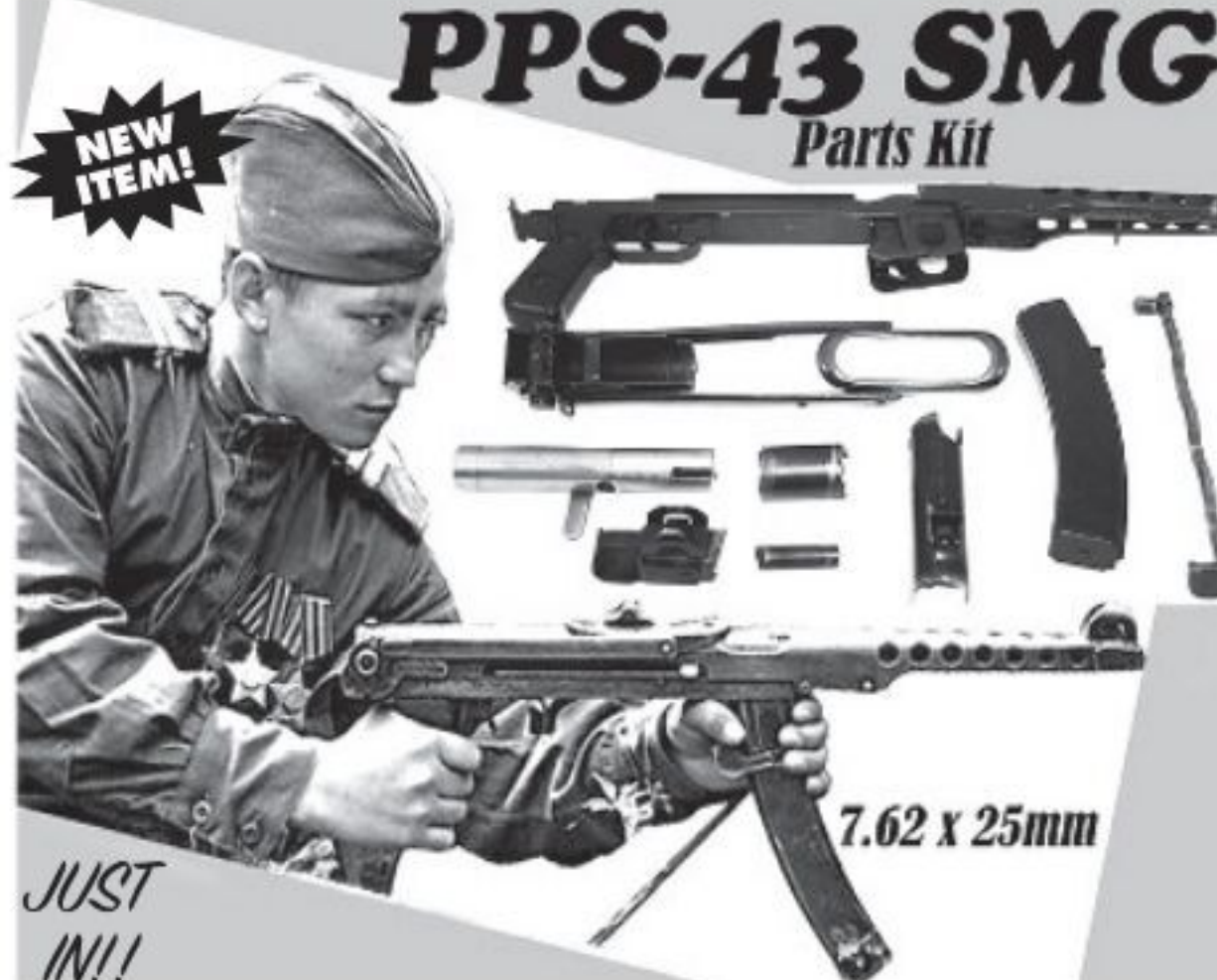

**\$129.00 MMP030**



Manufactured by Israel, these parts sets were stripped down from Israeli Military Service rifles and are in very good shape and contain all parts for the gun except for the barrel and receiver. The set comes with a Sling and Metric 20 rd. magazine

where permitted by law. Perfect kit for building your shooting FAL with one of the semi auto receivers and barrels offered elsewhere. Kit is sold without flash hider.

..... **\$425.00 FAL320**  
 Add a flash hider for an extra..... **\$25.00**

**Please Note:** These kits are in nice condition. Others have sold for cheaper but we are told they were a low quality seller with sometimes missing or broken parts. BUY QUALITY!!

**NOW'S THE TIME!! BE THE FIRST TO KNOW ABOUT OUR DEALS !!!**

Join Our EMAIL BLAST List Today By Texting SARCO to 22828 And Receive A SPECIAL DISCOUNT ! By doing so, you'll get our latest email blast offers, sale items and notifications of new goodies coming in! AND... after you sign up, receive a FREE deck of authentic Cold War, Unissued & Illustrated AIRCRAFT CARDS! Just add them to your cart using part number MISC168 and enter source code EMAIL-BLAST at check out to receive them for FREE. What are you waiting for?? Get On The List!!

**USGI ORIGINAL M79 GRENADE LAUNCHER STOCKS & HANDGUARDS**

1. Composite Stock with Rubber Pad, Swivel, & Screw ..... **\$25.00 M79002**
2. Wood Stock Stripped ..... **\$45.00 M79001**
3. Wood Stock Stripped with Wood Handguard .... **\$75.00 M79006**

See our website for details!!



**DOUBLE STACK PISTOL MAG LOADER FOR 9MM & 40 S&W**

Rugged synthetic loader with an ergonomic feel is comfortable to use and saves your finger tips and patience! The Loader is perfect for the double stack magazines that load with 9mm & 40 S&W ammo. Black color. New List price is \$12.95



**SARCO SPECIAL..... \$7.95 each**  
 or 3/..... **\$19.95 MISC897**

**BACK IN STOCK! U.S. M31 RIFLE GRENADE (INERT)**

Full size steel & aluminum rifle grenade initially brought forth in the late 1950s and served till about 1972 with the Army & Marine Corps., eventually being replaced by the LAW Rocket. Inert, new. Very Limited. .... **\$59.95 MISC875**



**CHECK OUT OUR NEW SELECTION OF REMINGTON AND BROWNING FURNITURE!**

**REMINGTON 870 12 GAUGE EXPRESS BIRCH STOCK CUT CHECKERING**  
**\$74.95 STK440**



**REMINGTON 1100 20 GAUGE PARTIAL BUTTPLATE STOCK**  
**\$74.95 STK435**



**REMINGTON 40X STOCK SHORT CHANNEL**  
**\$95.00 STK348**



**A NEW DELIVERY OF BROWNING A5 BUTTSTOCKS, JUST IN THE DOOR! VERY LIMITED ON SOME MODELS**

**BROWNING AUTO 5 16 20 GAUGE FACTORY BUTTSTOCK W/ CHEEK PIECE** **\$195.00 STK431**  
**BROWNING AUTO 5 16/20 GAUGE FACTORY BUTTSTOCK** **\$195.00 STK429**



**JUST IN!!** Born out of the need for a multiple use Rifle Grenade that would fit numerous Rifles found in Africa during the 60s, 70s, 80s. Mauser 98, FN-49, Enfield #4, Garands, Carbines, M14, M16 and various other Rifles, all had 'clip on' style Grenade Launchers that shared the same style launching shaft. Sold 'Inert' and strictly as a 'display piece'. Shaft & fins are steel and head is of a two-piece machined aluminum construction. Overall length @12.25 inches / weight 29.3 oz. While they last!!!  
 ..... **\$49.95 AM196**

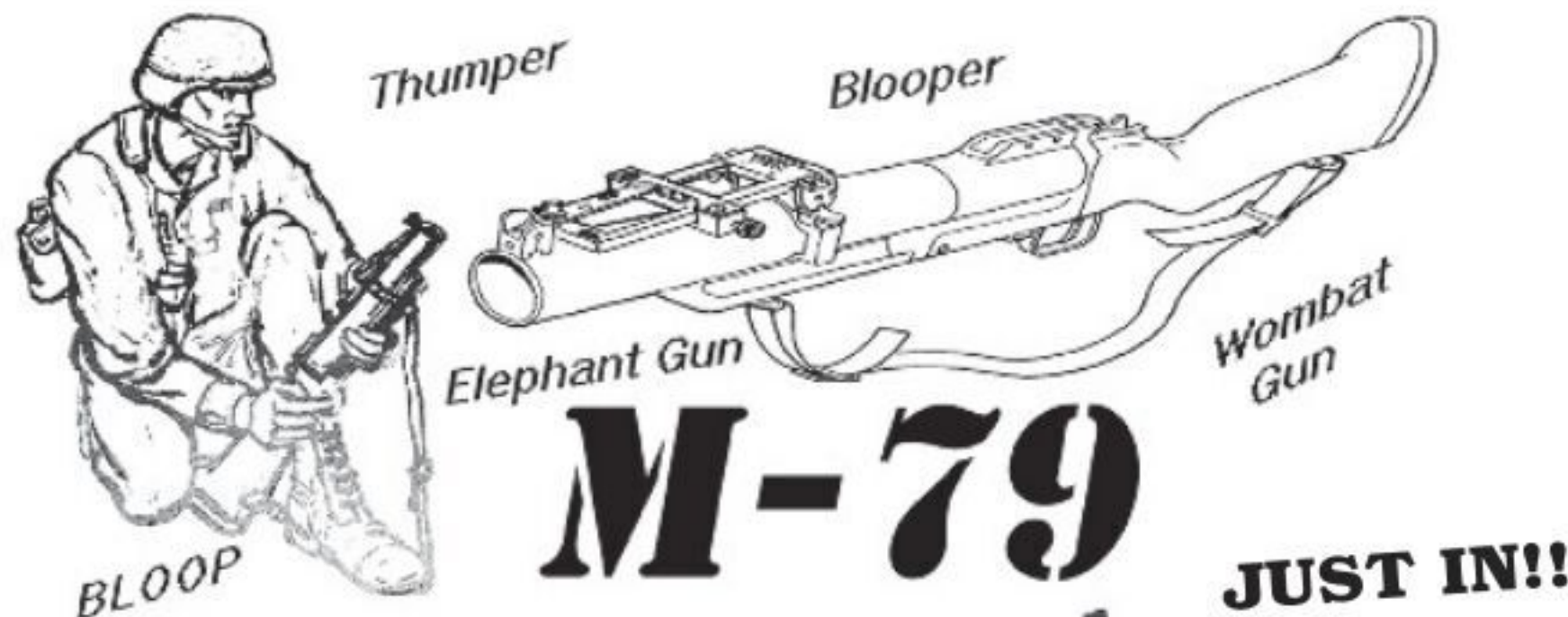

**GRENADE LAUNCHER**

Sarco has created a full size replica of the venerable M79 Grenade Launcher made famous in Vietnam and beyond. Combining newly made metal parts coupled with original USGI Stock furniture and accessories, this non firing display piece is like having the real thing! The Rear Sight flips up and locks, safety locks the trigger, and the Barrel Latch swings to allow the barrel to open. The M79 comes with Sling (color may vary), small arms M79 Pouch, and Combo Tool. Wood Stocks have been taken from original Vietnam era M79s that we had to deactivate in earlier decades and fortunately the rubber butt pads are in excellent condition. To comply with regulations, the front muzzle tip has a colored ring on the outside. Very Limited Production. Only about 3 dozen remain!  
 ..... **\$385.00 REP42**

**M14E2 STOCK FRONT GRIP ASSEMBLY AND RAIL**

Nearly impossible to find, we have had the M14E2 Vietnam era Front Grip Assembly, newly manufactured with the internal stock rail. Now you are able to add this USGI wartime grip to your incomplete M14E2 stock, convert your m14 or M1A1 stock to accept it, or add it to your 'tricked out M21' sniper system. Very limited run. Swiveling front grip with sling swivel, 2 screws, and stock internal rail..... **\$95.00 M14371**



**ITALIAN GOTHIC SUIT OF ARMOR WITH STAND**

6½ feet tall!  
 See our website!  
**\$1200.00 ARM11**

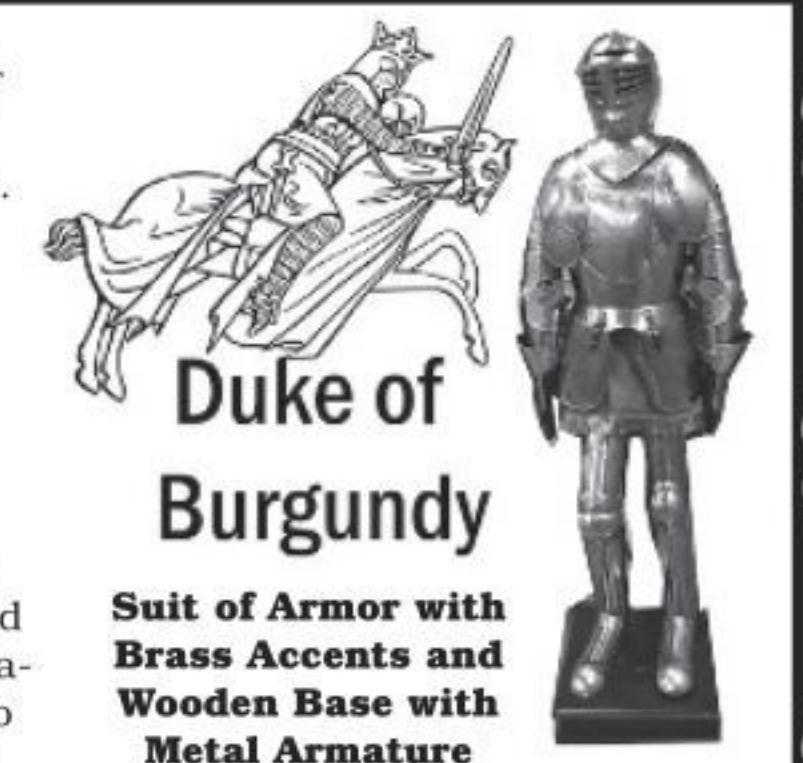

Duke Of Burgundy Armor Suit Full sized, steel set of Medieval Armor standing over 80" tall on wood base. Nicely crafted for authenticity with brass plates with etchings on the chest, inner arm joints, gauntlet cuffs, and knees. Helmet has articulated moving visor and waist has a red inner skirt. Beautifully made and a terrific value! Metal armature is simple and quick to assemble. Perfect for your 'Man Cave'! This Duke even comes with a SWORD !!  
 ..... **\$750.00 MISC137**

!! ATTENTION !!

SEE OUR WEBSITE FOR THE CURRENT AVAILABILITY OF OUR AR KITS

EVERYTHING IS REALLY TIGHT ON AR15 KITS - SOME PARTS ARE REALLY HARD TO GET! PLEASE CHECK OUR WEBSITE ON THE AVAILABILITY ON ALL VARIOUS AR KITS!

Super Sale on AR15 Rail Covers

4 pcs of rubberized 6-7/8" rail covers in Black for the best price of \$4.80 a set! (What a deal! Previous price was \$3.95 each!) 4 Black Rail Covers \$4.80 LA017



M16/AR15 COMBINATION TOOL

Save time with this wrench assy. that will speed up your maintenance of the M16 / AR15 and CAR15 platforms. Built with 4140 powder coated steel, this will outlast your Rifle!

\$17.95 AR440 ON SALE!



AR15/M16 LEATHERWOOD SCOPE MOUNT \$15.00 AR417



AR15/M16 CLEANING KIT & ACCESSORY KIT

- Bore brush, Cleaning rod, Tooth brush, Oiler, Muzzle cap, Dual front sight tool, Chamber brush, Broken shell extractor, Stripper clip guide, Grenade launcher Tension band

\$17.50, 3 for \$49.95 AR240

M16 ACCESSORY KIT - HEAVY DUTY

Cleaning tooth-brush (GI) Silent sling, Front sight tool, Muzzle cover, Magazine dust covers (6), Plastic mag carriers (4) (Israeli G.I.), Broken shell extractor, Cleaning rod, Stripper guide, 2 Grenade launcher tension band (rare). Value \$83.50

Sarco Special Price \$19.95 AR238



AR15/M16 SPRING KIT

A set of all of the coil & torsion springs in the AR15 or M16. Ideal item for your spare parts box. Price if bought separately \$18.30 Kit Price only. Includes recoil springs for Shortie M4 Kit \$12.95 AR134 3 for \$32.95 Standard Stock Kit \$12.95 AR397 3 for \$32.95

AR15/M16 RIFLE PARTS

Table listing various rifle parts like Dummy Rounds, AR Safety, Disconnector, Hammer, etc. with prices.

JUST IN THE DOOR - ALL NEW REMINGTON® PARTS!!

Table listing Remington parts like .308 STD A2 Buffer Assembly, .308 Firing Pin, etc. with prices.

AR15 UPPER RECEIVER PARTS KIT, REMINGTON®

Charging handle, Ejection port cover, Ejection port pin, Ejection port spring, Forward assist, Forward assist pin, Forward assist spring \$29.95 F620987



PICATINNY PROJECT RAIL

These have a Picatinny Rail on top and a dovetail underneath. They are about 7 inches overall. There is a lock screw recess on top. Use your imagination and skill to make use of these rails. Great for custom projects. So if you have an old upper that has a broken top handle you can repurposed them into a flat top. See our website for more details \$1.95 each or 3 / \$4.95 F1004157



Just Bought 10,000 M16 GI MUZZLE COVERS!

Plastic, colors may vary. \$1.50 each, 3 for \$2.95, or Buy 100 for \$25.00! AR192



REMINGTON 16" BARREL, 5.56MM, LOW GAS BLOCK VERSION / OPTICS READY

Original new Remington AR15 M4 Barrel with 1 in 9 twist in 5.56mm, low gas block profile w/bayonet lug & phosphate coated \$159.95 F1003536



See our website for M16 RETRO VIETNAM ERA TYPE PARTS

AR15 ACCESSORIES

Table listing AR15 accessories like Cleaning rod, Muzzle Cap, Stripper clip guide, Magazine dust covers, etc. with prices.

M16 4 PIECE CLEANING ROD

29 1/2" long. Threaded \$6.95 CLN030

M16A2 HANDGUARD SET COMPLETE WITH METAL LINER

CURRENT PRODUCTION \$16.10 AR184



NEW M16A2 ROUND HANDGUARD SETS MILITARY PRODUCTION

Shortie length w/liner \$14.95 AR185



AR SHORTY BUTTSTOCK INSTALLATION WRENCH

Free Bonus - other end of wrench fits the 1911 barrel bushing \$2.95 TOOL031



EARLY VIETNAM OIL SPOON FOR M14/M16 RIFLES

Just over 4 inches long, this was used to pour oil into the weapon's tight spaces and the cup portion is angled at about a 30 degree's. Very limited \$5.00 OIL043

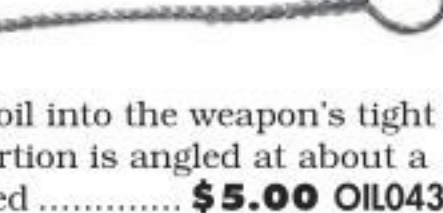

AR15/M16 UPPER RECEIVER VICE BLOCKS

To securely hold your upper firmly without damage to the upper or the barrel on barrel installation. Will work on any AR upper (receiver not included) \$29.95 AR467

AR15 LONG VENTILLATED FLASH SUPPRESSOR

Steel flash suppressor with standard threading for Govt./Commercial 5.56/.223 barrels. 5.5 inches long \$19.95 AR212



AR15 LONG SLOTTED FLASH HIDER

Steel flash hider similar to the Vietnam CAR-15 with standard threading for Govt./Commercial 5.56/.223 barrels 5.5 inches long \$19.95 AR213



AR15 AND M16

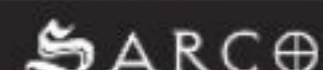

www.sarcoinc.com

AR15 LOWER RECEIVER PARTS SET

Super price! Includes all parts shown except for the receiver. Comes with late model pistol grip and our hammer & trigger pin diameter is the industry standard at .154. Some Colt made guns use a .170 diameter which is not compatible with our parts \$45.00 ea. AR001



SARCO'S M16 MULTIPLE MAGAZINE CARRIER

Secure metal clip holds two magazines for quick change firing and tactical applications. We've made thousands for the U.S. Govt.! See our web site for details \$14.95, or 4 for \$45.80 AR203 (metal clip holder only)



AR/M16 ARMORER'S KIT

Be ready when the time comes! Quality tool set for removal & installation of parts. Easily worth the cost just for the quality vise block set! INCLUDES - VISE BLOCK, DELTA WRENCH, TOOL BRUSH, BROKEN SHELL EXTRACTOR, BORE & CHAMBER BRUSHES, 1 SIGHT TOOL, CLEANING ROD SET \$91.50 value for just \$49.95 \$59.95 AR373



AR-15 DUAL FRONT SIGHT TOOL

Two-in-One tool with dual functions to adjust both 4-prong and 5-prong front sights. Makes adjusting the front sight on your A1 and A2 a snap. \$5.95, 3 for \$14.95 AR175



See our bayonet page 8 for M16 (M7) bayonets

M16 AUTO SEAR

Few only \$19.95 AR095 Buy a replacement(s) for your legal M16. All NFA rules apply. Note: These go out of time with use.

AR15/M16 CHAMBER BRUSH

Original style \$3.95 AR205

AR-15 TAPCO INTRAFUSE HANDGUARD SET

New sporting design makes these 6.5" handguards with 3 accessory rail covers, a convenient change of variety for your M4 style rifle. Color: black \$29.95 AR420 CLOSE OUT! \$9.95 3 for \$27.00



M16/AR15 EARLY 'DUCKBILL' FLASH HIDER

Early U.S. Advisors & Air Force 'Model 01' flash hidiers originally issued with the guns starting in 1963. These were succeeded by the standard GI 'prong' flash hider & later in 1969 by the 'birdcage' model. New mfg. \$9.95 AR423

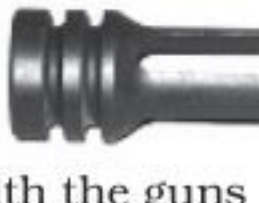

FLASH HIDERS

M16A2 \$8.95 AR007



SIGHT ADJUSTING TOOL

BACK IN STOCK!! AR15/M16A2 SIGHT ADJUSTING TOOL 4 PRONG \$4.90 AR158



Large table listing various parts like AR15/M16 Front and Rear Takedown Detent, AR15/M16 Magazine Catch Spring, etc. with prices.



**M14 PARTS**

**M1A1/ M14 SIDE SCOPE MOUNT**

Black anodized. Steel hardware included, lightweight, 4.3" length  
 ..... **\$39.95** M14012



**M14 7.62 NATO CHAMBER BRUSHES**

G.I. ratchet chamber brush originally made for use with the M14 rifle, but will work just as well in most 7.62mm NATO rifles, new ..... **\$2.95** or 3 for ..... **\$6.95** M14016

**M14 FLASH HIDER PLIERS**

Available once again. New condition. A necessity for your M14 ensemble ..... **\$16.50 ea.** TOOL039



See our website for **ITALIAN GARAND BARRELS**

**NEW!!! M14 BARRELS IN STOCK**

Brand new .308 cal M14 Barrels made by one of the best U.S. barrel manufacturers..... **\$175.00 ea.** M14124

Turn back to the front page of our ad for the **M14 E2 Stock Front Grip Assembly w/Stock Rail !**  
 - ALSO -  
 We're having these **M4 E2 STOCKS** made - Check back periodically as they should be in soon!

**M14 WALNUT STOCK**

Nice Military rework... **\$45.00** M14363

**M14/M1A SIGHT PROTECTORS**

Military style plastic snap-on covers to protect the front and rear sights and the flash hider muzzle of the M14/M1A rifle.  
 New ..... **\$6.50**  
 3 for ..... **\$17.95** M14022



**M14 RIFLE CLEANING KIT**

Kit consists of following items:  
 G.I. sectional cleaning rod, Rod handle/combination tool, Ratchet chamber brush, .30 cal. bore brush  
 G.I. carrying pouch..... **\$12.50** CLN070



**M14 STRIPPER CLIPS**

12 original clips for... **\$9.95** STC016

**M14 SPECIAL ITEMS**

- M14 Bolt stop G.I. .... **\$22.95** M14091
- M14 Buttplate assy hinged, G.I. .... **\$29.95** M14047
- M14 Connector rod G.I. .... **\$19.95** M14049
- M14 Firing Pin, original G.I. .... **\$21.00** M14058
- M14 Front stock swivel set, new G.I. .... **\$8.95** M14117
- M14 Handguard w/retaining clip, Fiberglass G.I. .... **\$12.50** M14005
- M14 Handguard w/o retaining clip, Fiberglass G.I. .... **\$9.95** HNGD13
- M14 Handguard, Walnut ..... **\$24.95** M14120
- M14 Op rod spring guide ..... **\$19.95** M14051
- M14 Recoil Spring, TRW Orig G.I. .... **\$7.45**
- M14 Recoil Spring, TRW Orig G.I. .... **\$29.95**
- M14 Rear Sight Aperture, .052 NM ..... **\$41.50** M14127
- M14 Rear Sight Aperture, .059 NM ..... **\$41.50** M14364

**M14 20RND MAGAZINE**

Newly Manufactured..... **\$16.94** RM024

**SARCO** (610) 250-3960 WWW.SARCOINC.COM

**M1 GARAND BARREL, .30.06 CALIBER, BRAND NEW**

Brand New.... M1 GARAND BARRELS... Newly manufactured barrels ready to install on your M1 Garand Receiver. Made by one of the premier barrel manufacturers in the U.S.A., these .30-06 caliber barrels and .308 barrels are manufactured from 4140 steel with 4 groove rifling and a 1 in 10 twist. Beautiful high quality parkerized replacement barrels. Because they are made here in the U.S., they do not have the ungainly import barrel markings. A great chance to get rid of that 'Blue Sky' or other import marked barrel and also restore accuracy! ..... **\$149.95** GRD157 *US Made by old school barrel maker*  
**\*Barrels should always be installed by a qualified gunsmith.**



**M1 GARAND RIFLE 'LINED' LEATHER JEEP SCABBARD**

Marked improvement over the WW2 issue scabbard! Has the same outward appearance with brass guard for the charging handle and rich brown color with two leather straps and has been improved with a soft lining on the inside to protect your valuable investment from scratches and undue wear. Great for all sorts of similar sized rifles and works beautifully on horseback too!

**SALE! ..... \$44.95 \$59.95** GRD382



**LATE T-37 M1 GARAND SNIPER FLASH HIDER**

**\$34.50** GRD111



**We still have a few ORIGINAL WW2 ERA GARAND STOCKS W/ MARKINGS. See our website!**

**M1 GARAND ACCESSORY PACK**

Terrific set of accessories for the Shooter or Reenactor! Made up of both original and reproduction items, the Pack includes the following items:  
 GARAND GUN CASE, GARAND CARTRIDGE BELT, MILITARY MANUAL, M10 CLEANING SET w/brush, CHAMBER BRUSH, GI BORE CLEANER, CLEANING ROD STOP, 3 EN-BLOC STRIPPER CLIPS, M15 G.L. SGT.CASE, PULL THRU ROD & CORD  
 ALSO: Your choice of 1907 Leather Sling or Canvas WW2 style sling. Specify when ordering. A Retail Value of over \$145.00 For Just. **SALE! ..... \$59.95 \$79.95** GRD329  
**\*\*\*A great gift for a Garand owner!\*\*\***



**WWII PATTERN WEB GARAND SLING**

Just reproduced for U.S. complete with markings. OD with all proper metal fittings Beautiful. Proper for Springfield and Garand .... **\$9.95** SLNG057



**FOUND A FEW MORE M1C SNIPER RIFLE GRIFFIN & HOWE PATTERN MOUNT BASES**

Parkerized - Complete with the 3 screws & 2 pins ..... **\$24.95** GRD285  
 We also have the pin & screw set for ..... **\$12.95** GRD327



**M1 GARAND OP ROD**

.308 length - 1/2 inch shorter than standard..... **\$125.00** GRD175  
**Finally Back In Stock!** We dug out a pile of Garand standard GI Op Rods ..... **\$175.00** GRD052



**M1 GARAND RIFLE (More on page 4!) 3**

**M1 GARAND CLEANING KIT SALE!!**

Kit contains M10 cleaning rod, bore brush and a G.I. carrying pouch. CLN064  
 ..... **\$14.95 \$17.49**  
 3 for .. **\$39.95 \$49.50**  
 Handle for M10 cleaning Rod for Garand Rifle - hard to find ..... **\$4.95 \$7.95**  
 3 for ..... **\$14.00 \$22.50** CLN047  
 Orig G.I. M10 handles ..... **\$6.95 \$9.95** GRD281



**NEW GI GARAND BUTTPLATES**

We bought 'em 30-40 years ago. Found another small batch in the warehouse sort. Believe this is the end.  
 ..... **\$40.00 \$44.95** GRD326  
 Conetta Mfr. While they last!



**BRAND NEW M1 GARAND BARRELS**

**Currently produced in USA by a 30 Year Top Line Barrel MFG .30-06 barrels in stock!**

Newly manufactured barrels ready to install on your M1 Garand Receiver. Made by one of the premier barrel manufacturers in the USA, these .30-06 caliber barrels are manufactured from 4140 steel with 4 groove rifling and a 1 in 10 twist. Beautiful high quality parkerized replacement barrels. Because they are made here in the US, they do not have the ungainly import barrel markings. A great chance to get rid of that 'Blue Sky' or other import marked barrel and also restore accuracy! Barrels should always be installed by a qualified gunsmith.

.30-06..... **\$149.95** GRD157



**M1D SCOPE MOUNT**

Scope mounts for the M1D Garand Sniper rifle. These are for the 7/8" diameter M81 - M82 - M84 Scope. New condition ..... **\$42.50** GRD112



**BACK IN STOCK!!**

**M1D GARAND BARREL BLOCK**  
 ..... **\$42.50** GRD113



**GARAND BROKEN SHELL EXTRACTORS**

.30-06..... **\$7.95** BSE006



**M1 GARAND WWII LEATHER SCABBARD**

These leather scabbards were used by horse cavalymen and truck and jeep drivers. These heavy leather unlined scabbards have the tunnel to cover the operating rod handle and two leather carrying straps with brass hardware. Perfect reproduction.  
 ..... **\$49.95** GRD137



**OUR LATEST FABULOUS BUY ON BARREL BLANKS!**

All previous buys have been a sellout - most of these have been profiled so they are ready for your project. **NOTE:** These are all first class production. LIMITED SUPPLY **NOTE:** We even have .20cal blanks **NOTE:** We are told that these blanks sell for up to \$200. These are ALL 1st class blanks. NO rejects, blemis or GD2.

Part #	Caliber	Length	Diameter	Profile	Twist	Material	Description	Price
BB060	270 Cal	24 inches	N/A	#1 1/2	1-10.	4140	Unfinished Profile Blank	<b>\$59.95</b>
BB062	243 Cal	24 inches	N/A	#1 1/2	1-10.	4140	Unfinished Profile Blank	<b>\$59.95</b>
BB063	22Cal	24 inches	N/A	#1 1/2	1-14.	4140	Unfinished Profile Blank	<b>\$59.95</b>
BB070	5.56 Cal	16 inches	1 Dia	N/A	1-10.	Stainless	Threaded & Chambered AR15	<b>\$39.95</b>
BB073	270 Cal	26 inches	N/A	#3	N/A	4140	Unfinished Profile Blank	<b>\$59.95</b>
BB083	458 Socom	18 inches	1.032 Dia	N/A	1-14.	stainless	Milled Finish Barrel Blank	<b>\$59.95</b>
BB084	10/22 Ruger	18.5 inches	.920 Turned	N/A	4140	4140	Uncrowned	<b>\$45.00</b>
BB086	260 Rem AR15	22 inches	N/A	N/A	stainless	Extension, pins & gas holes	<b>\$125.00</b>	
BB087	22RF	17 inches	.750 Dia	N/A	1-16.	4140	Turned Blank	<b>\$49.95</b>

**NEW ADDITIONS!!!**

- BB095 Barrel Blank 24.5" .17 Cal 1-9, 4140 1.032 dia ..... **\$49.95**
- BB096 Barrel Blank 26.75" .17 cal, 1-9, 4140 1.250 dia. .... **\$49.95**
- BB097 Barrel Blank 26.75" .17 cal, 1-9, SS 1.250 dia. .... **\$49.95**
- BB098 10/22 Barrel Blank 18" 17 1-9 SS .920 dia needs finishing ..... **\$49.95**
- BB099 Barrel Blank 25.5" .22 RF 1-16 4140, 1. dia ..... **\$49.95**
- BB100 Barrel Blank 24.5" .243, 1-10, 4140, 1.20 dia. 1 left ! ..... **\$49.95**
- BB103 Barrel Blank 16.5" .264 cal 1-8 4140, 1.032 dia. 1 left ! ..... **\$49.95**
- BB107 Barrel Blank 21.75" .270, 1-10, 4140 1.2 dia ..... **\$49.95**
- BB108 Barrel Blank 26.75" .270, 1-10, 4140, 1.312 dia ..... **\$49.95**
- BB109 Barrel Blank 11" .30 cal 1-7 SS 1.032 ..... **\$49.95**
- BB110 Barrel Blank 9.5" .30 Cal 1-7, 4140 1.2 dia ..... **\$49.95**
- BB111 Barrel Blank 11" .30 cal 1-8 SS 1.032 ..... **\$49.95**
- BB114 10/22 Barrel 18" 22Mag 1-16, SS .920 dia. 1 left ! ..... **\$49.95**
- BB116 10/22 Barrel 22RF 1-16 18" 4140 .920 dia..... **\$49.95**
- BB118 Barrel Blank 9" 12 GA, Smooth bore, SS, 1.312 dia. .... **\$49.95**
- BB120 Barrel Blank 26.5" 22 Cal 1-14, 4140 #3 contoured blank ..... **\$49.95**
- BB121 Barrel Blank 24.5" 22 RF 1-16 4140, 1. dia ..... **\$49.95**
- BB122 Barrel Blank 16.625" 22LR, 4140, 1-16, 1 dia ..... **\$49.95**
- BB123 Barrel Blank 19" 45-70, 1-22 SS 1.312 dia..... **\$49.95**
- BB125 Barrel Blank 13" 5.56, 4140, 1-7, .98 dia ..... **\$49.95**
- BB126 AR10 Barrel 18" 6.5 Creedmoor 1-8 SS, 1.190 dia hub, thread, chamber..... **\$49.95**
- BB132 AR10 Barrel Blank 20.5 .243, 1-10 SS, 1.190 dia hub, thread, chamber..... **\$49.95**
- BB133 AR10 Barrel Blank 13.5" 308, SS 1-10 1.190 dia hub, thread, chamber..... **\$49.95**
- BB136 AR15 Barre Blank 22" .224 Valkyrie 1-7 4140 TM, Contoured hub, thread, chamber ..... **\$49.95**
- BB139 AR15 Barrel Blank 8.5" 5.7x28 1-7 SS..... **\$49.95**
- BB140 AR15 Barrel Blank 12" OTD, SS, Legend 1-12 .. **\$49.95**

**Just In !!**

**.30 CALIBER BRAND NEW RIFLE BARREL BLANKS**

These are U.S. GI 1903A3 Springfield barrels that have had the front & backend cutoff. Perfect for your special project! ..... **\$19.95**  
 3 for ..... **\$49.95** BB141  
**Overall length:** approximately 18.3 inches,  
**Breech O.D:** 1.04 inches, **Muzzle O.D:** 0.67 inches

**AVAILABLE AGAIN M14 FULL AUTO PARTS KITS**

M14 Selector, Pin & Spring  
 M14 Selector Shaft  
 M14 Sear Release  
 M14 Connector Rod Full Auto  
 M14 Selector Lock ..... **\$75.00** M14014



**Almost Sold Out!**

**M1 GARAND PART SETS**

We can piece together a few M1 Garand parts sets - All but the receiver - The stock and hand-guard set will be our new stock set GRD278. Condition of all parts is from good to new. Most are G.I. Sorry, but these have to be \$730 as some Garand parts are getting tough to acquire and cost is high. .30-06 ..... **\$730.00** GRD380

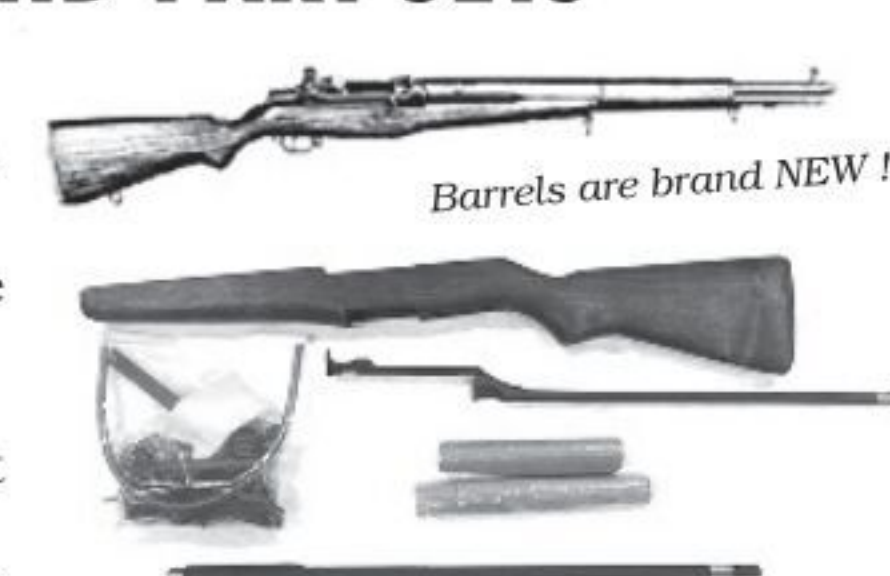

**Just In!! NEW VARIATION OF THE .308 M1 GARAND KIT**

Again, all parts but the receiver with an original Italian .308 barrel. This unit is 1/2 inch shorter than a standard Garand ..... **\$495.00** GRD387

**SARCO**

50 Hilton Street, Easton PA 18042  
610.250.3960 Fax: 610.438.2548  
[www.sarcoinc.com](http://www.sarcoinc.com)  
**We have 30 Different Variations of Handguards - See our website!**

**VICTORIAN HANDCUFFS AND LEG IRONS!**

Based on original Hiatt / Derby handcuffs, these are steel and quite functional. You could still find yourself getting fastened to one or both of these if you get too rowdy drinking gin & tonics in Mombassa .... Used throughout the British Commonwealth and beyond. Gently antiqued in rust patina, they are heavy, rugged, and interesting curios of a bygone era. New.

**Victorian handcuffs with key ... \$19.95 MISC719**  
**Victorian leg irons with key ... \$24.95 MISC824**  
**Set of handcuffs with leg irons \$35.00 MISC849**  
*See Our Website For Pictures & Details!*



**ORIGINAL G.I. M1 GARAND BOLTS** USGI Original Stripped Bolts - VG cond ..... **\$69.95 GRD070**  
Complete **\$89.95 GRD071**

Go to our website for a complete selection of Garand collector bolts by maker and dash variation. We have sorted out 13 variations - we even offer heat treat lots for serious collectors.

A perfect reproduction of the **GRENAD LAUNCHING RUBBER BOOT** (slip on) for the Springfield and M1 Garand. Absolutely meticulously beautiful!! **\$34.50 MISC088**

**M1 GARAND OPERATING ROD TIPS (pistons)** Brand new, made to Government specs. Replace your worn piston - diameter .5265" (high end + .0005") Made of the proper 174PH steel. **SALE \$7.95 \$9.95**, 3 for **\$21.95 \$22.95 GRD211**

**WW2 ORIGINAL M1 GARAND BARRELS** These are decorator condition w/ poor bores. Few only..... **\$49.95 GRD330**

**SPECIAL M1D SNIPER COMBO SET** T-37 Flash hider, New G.I. Handguard Barrel Block, Scope Mount. Value \$200.00. **GRD145 SPECIAL \$149.50**

**BRAND NEW GARAND STOCK & HANDGUARD SETS IN WALNUT**

The stocks are new walnut G.I. stocks that were .308 cal & we retrofitted them to .30-06. Fit is perfect for .30-06. There is a tiny hairline from the conversion that is visible. Handguards are new production walnut.

Complete stock set (wood only) ..... **\$79.95**  
3 for ..... **\$219.95 GRD278**  
We can also offer the stock alone which makes a great replacement for your CMP worn out drill rifle or regular Garand stock ..... **\$59.95**, 3 for ..... **\$169.95**  
20 for..... **\$995.00 GRD279**

*Quantity purchases, please call Cholly. Will trade on quantities*

**GARAND PARTS**

GRD330 Barrel G.I. Orig WWII Dated, poor bore & some rust ..... **\$49.95**  
GRD002 Barrel "Clunker Grade" ..... **\$20.00**  
GRD071 Bolt (Complete) ..... **\$89.95**  
GRD070 Bolt (Stripped Used) ..... **\$69.95**  
**See our website for a complete offering of Collector Garand bolts**

CLN172 Bronze bore brush 30 cal  
10/ ..... **\$9.95**  
100/ ..... **\$69.95**  
GRD198 Bullet Guide, milled, New ..... **\$15.00**  
GRD065 Bullet Guide, stamped, New ..... **\$12.00**  
GRD046 Butt Swivel ..... **\$8.00**  
GRD220 Buttplate Assy, brand new ..... **\$24.95**  
GRD043 Buttplate Screw Bottom (Long) ..... **\$2.95**  
GRD044 Buttplate Screw Upper (Small) ..... **\$2.00**  
GRD115 Carrying Case ..... **\$14.95**  
GRD021 Clip Ejector ..... **\$4.95**  
GRD081 Clip Latch ..... **\$24.50**

**U.S. WW2 M7 GRENADE LAUNCHER**

M7 Grenade Launchers now available! Connects quickly to the M1 Garand Rifle and locks in place with an attached clip. Great compliment to your collection and allows the Rifle Grenades to be mounted. We can offer the launcher on its own, and also with an original inert M11 Rifle Grenade at a savings from buying each item separately. Launcher new mfr.

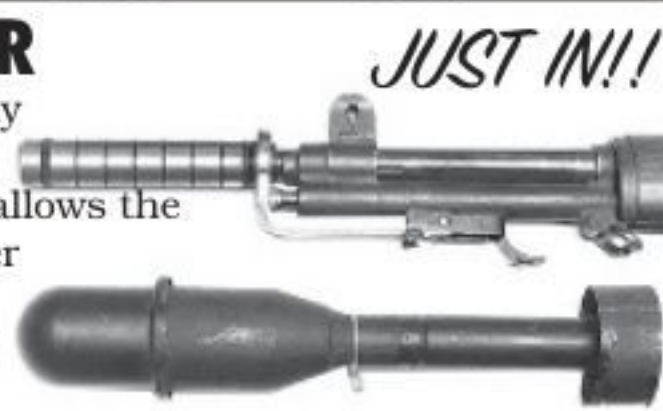

M7 Grenade Launcher ..... **\$69.95 RLO20**  
M7 Grenade Launcher with M11 inert Rifle Grenade ..... **\$99.95 RLO21**

**WINCHESTER 97 TRENCH GUN BAYONET LUG & HEAT SHIELD W/ SCREWS**

**PLEASE NOTE:** These will only fit original Winchester 97s with the correct grooves cut - If your barrel does not have the grooves cut for the screws, they will have to be machined. These will not fit reproduction Winchester 97s currently on the market. Will ONLY fit P14 & P17 bayonets



..... **\$129.00 W97058**

**M1 GARAND M82 SNIPER SCOPE**

New precision 2.5x scope marked with Govt. part numbers, complete with sun shade and rubber eye cup. Perfect quality scope for making an M1D, M1C or 03A4 sniper rifle. Beautifully constructed and clinically accurate!



..... **\$260.00 SCP040**

**SPARE PIN & SPRING KIT FOR M1 GARAND**

Clip latch spring Hammer pin  
Extractor spring Trigger pin  
& plunger Lower band pin  
Hammer spring Op rod catch pin  
Op rod spring  
Clip latch pin **Value over \$25 - \$12.95 GRD219**

**GARAND SNIPER LEATHER CHEEKPAD**

Special new low price. **GRD124**  
Exact repro with proper markings **\$18.95** 3 for **\$49.95**



**COMBO. New Style M3A1 TOOLS WITH CHAMBER BRUSH**

The Latest and best.  
A. Used G.I. **\$25.00 GRD134**  
B. Like new tool w/new brush **\$30.00 GRD138**  
C. Absolutely New G.I. WWII original tool in orig G.I. grease & G.I. package (no brush) ..... **\$40.00 GRD165**

Available Again - Ratchet chamber brushes for the M1 Garand ..... **\$4.95**, 3 for ..... **\$9.95 TOOL044**

Orig. Brass oil & throng set, exc. condition. **OIL015** ..... **\$35.00**  
Orig plastic oil & throng set, used exc. condition **OIL016** ..... **\$8.50**

**M1C/M1D SNIPER PARTS**

1. M1D rear handguard New G.I. original HNGD031 ..... **\$24.95**  
2. T37 flash hider GRD111 ..... **\$34.50**  
3. M1D barrel block GRD113 ..... **\$59.95**  
4. M1D scope mount GRD112 ..... **\$47.50**

**M1 GARAND STYLE REAR SIGHT BASE...**

**For Your Next Project!** Originally designed for the M1 Garand rifle, this great little sight base is perfect for your next project. It allows you to actually add the superb and precise M1 Garand Rear Sight assy. components onto the weapon of your choice. Imagine having the ability to dial elevation and traverse measurements on a commercial or project rifle the same way you can on the Garand! With the same ease and precision that you don't find on most rifles. The base has a concave bottom with 2 mounting holes. Accepts the superior M1 Garand windage pinion & elevation aperture sold separately. Fits well on the Ruger 10-22 as well, but can be used on almost any project you come up with **SALE!** ..... **\$15.95 \$19.95 MISC727**



**M1 GARAND LINED GUN COVERS**

Olive drab & U.S. marked ... **\$28.95 GRD345**



**WW2 M1C GARAND RIFLE FLASH HIDER**

M1C Garand Sniper Rifle flash hider as used in WW2, simply and quickly, attaches on the muzzle end & bayonet lug of the rifle. Hard to find item is finally available after more than a decade! Get one before they disappear again! Late mfr. .... **\$125.00 GRD388**



**.30 CAL ONE PIECE USGI CLEANING ROD** ..... **\$9.95**, 3 for **\$27.50 CLN113**

M84 repro scope buyers from other sources - we have original G.I. unnumbered **M84 SCOPE DATA PLATES** from Libbey Owen Ford (the manufacturer) NOS. You can number your scope to your gun on an original date plate. M84 repro scope buyers from other sources - we have unnumbered M84 scope data plates. You can number your scope to your gun on this data plate ..... **\$29.95 M84014**

**M1 STAINLESS STEEL GARAND OP ROD SPRINGS**

The Best On The Market! Just got a new fresh shipment made from G.I. blueprints. Replace your tired spring or put away a spare now! **Stainless Steel 17-7** ..... **\$7.95**  
3 for ..... **\$22.95 GRD171**  
Standard op rod Spring ..... **\$5.95**  
3 for ..... **\$13.95 GRD059**



**M1 GARAND REAR SIGHT PARTS - STANDARD & MATCH**

GRD094 Complete Rear Sight Assy, late model ..... **\$64.95**  
GRD084 Rear Sight Base ..... **\$27.00**  
GRD088 Rear Sight Aperture ..... **\$10.00**  
GRD348 Rear Sight Aperture, Match peep hole .059 ..... **\$13.50**  
GRD093 Rear Sight Aperture Cover ..... **\$5.95**  
GRD090 Windage Knob Assy ..... **\$14.00**  
GRD086 Elevating Pinion Assy, Yard graduations ..... **\$24.95**  
GRD363 Elevating Pinion Assy, Meter graduations ..... **\$29.95**

**NATIONAL MATCH REAR SIGHT ITEMS**  
GRD095 Complete National Match Rear Sight w/Hooded Cover. (Elevation pinion assy not included as it is the same as a standard Garand elevation pinion) ..... **\$90.00**

(When ordering, please specify which size aperture hole you would like - two Options shown several items down in this list.)  
GRD085 National Match Rear Sight Base ..... **\$46.50**  
GRD091 National Match Windage Knob ..... **\$25.00**  
GRD089 National Match Hooded Aperture (.052 hole) ..... **\$41.50**  
GRD154 National Match Hooded Aperture (.059 hole) ..... **\$41.50**

• Please Note - all sight parts above also work with the M14 too!

• Buyers Note - the aperture is made slightly 'oversized' to fit to your Sight Base. The fitting procedure is simple and instructions are included. See our web site for the instructions as an option.

**'EARLY' M1 GARAND SIGHT PARTS**  
GRD182 Pinion, early stripped original ..... **\$55.00**  
GRD092 Windage Knob, G.I. original ..... **\$25.00**  
GRD189 Lock Bar, early rear sight ..... **\$35.00**

Once again available!  
**M1 GARAND OPERATING ROD CATCH ASSEMBLIES**  
at a reasonable price!  
**\$30.00 GRD063**

**WORLD WAR II PATTERN M1 GARAND CARRYING CASE**

WWII military style canvas carrying case for the M1 rifle. These "U.S." marked cases are made of heavy, olive drab canvas and equipped with a zipper, leather tabs and a shoulder carrying strap.  
GRD115 ..... **\$14.95 ea.**, 3 for ..... **\$42.95**



**FRONT HALF G.I. M1 GARAND RECEIVER**

**\$9.95**, 3 for **\$24.95 GRD143**  
Neat paper weight!



**M1 GARAND FRONT & REAR SIGHT COVERS**

Perfect for protecting your prized Match Sights installed on the rifle. Plastic covers slip on & off easily. Set of Front & Back covers ..... **\$6.00 GRD114**

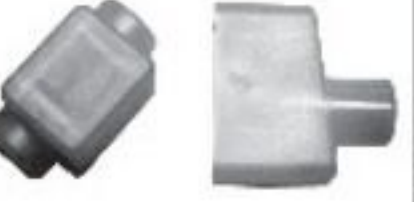

**M1 GARAND CLIPS**

**New current production by G.I. contractor** ..... **\$2.50 each GRD275**  
Nice fresh spring tension in your clip **SPECIAL GARAND CLIPS**  
1.2 round clip for match shooters ..... **\$8.00 ea.**  
5 for ..... **\$24.95 GRD131**  
2.5 round hunting clips ..... **\$8.00 ea.**  
5 for ..... **\$24.95 GRD130**

**M1 GARAND STOCK HARWARE SET**

Complete set of M1 Garand Stock Hardware. Either new or excellent parts..... **\$39.95 GRD136**

**DON'T TREAD ON ME FLAG**

Cotton 3'x 5' flag with loop on top and cord on the bottom. Vibrant message gets the point across! ..... **\$18.00 FLAG14**



**'DON'T TREAD ON ME' TRICOLOR PATCH**

Show your 'Moxie' by standing up for the Bill of Rights amongst other principles with this machine sewn patch! Good for attachment to shorts, shirts, vests, jackets etc. In this age of bureaucratic overreach, it's a necessity! Size 3-7/8" x 2-3/4" ..... **\$5.95 MISC911BC**



**FRENCH FOREIGN LEGION BERET OF THE FAMED 2E REP PARATROOPER**

Sarco has a very limited 'run' of wool Green Berets with the famed French Foreign Legion 2e REP badge. A unit famed for fierce fighting, especially in Indochina and Algeria, but also a familiar sight on the frontiers where Mercenaries are operating. Three sizes available. Beret with Badge ..... **\$29.95 HAT10** (U.S. sizes 7-1/4, 7-1/2, 7-3/4)



GRD100 Gas Cylinder Lock (Used) ..... **\$20.00**  
GRD286 Gage GI barrel diameter-gas cylinder .5991. .... **\$75.00**  
GRD016 Hammer ..... **\$24.95**  
GRD015 Hammer Pin ..... **\$2.00**  
GRD013 Hammer Spring ..... **\$2.00**  
GRD014 Hammer Spring Plunger ..... **\$4.00**  
GRD041 Handguard Band Rear ..... **\$5.00**  
GRD039 Handguard Ferrule Front ..... **\$6.00**  
GRD032 Handguard, Rear walnut w/o metal, good ..... **\$20.00**  
GRD033 Handguard, Front walnut w/ metal, good ..... **\$25.00**  
GRD040 Handguard Spacer Front ..... **\$5.00**  
GRD089 Hooded Rear Sight Aperture National Match ..... **\$39.95**  
GRD037 Lower Band ..... **\$15.00**  
GRD038 Lower Band Pin ..... **\$1.00**  
OIL002 Lubriplate pot, G.I. 3 for ..... **\$3.95**  
CLN116 M10 cleaning rod handle. .... **\$7.45**, 3 for ..... **\$22.35**  
M84017 M84 Sniper Scope Cover, Orig. Oiler, late plastic WWII, new ..... **\$13.95**  
OIL015 Oiler, brass & throng set, exc ..... **\$35.00**

OIL016 Oiler, plastic & throng set, used, exc. .... **\$8.50**  
GRD052 Operating rod G.I. .... **\$175.00**  
GRD063 Op rod catch assy ..... **\$30.00**  
GRD088 Rear Sight Aperture ..... **\$10.00**  
GRD094 Rear Sight Assembly Late ..... **\$64.95**  
GRD084 Rear Sight Base ..... **\$25.00**  
GRD085 Rear Sight Base National Match ..... **\$46.50**  
GRD093 Rear Sight Cover ..... **\$5.95**  
GRD017 Safety ..... **\$17.50**  
GRD112 Scope Mount M1D ..... **\$47.50**  
GRD101 Sear ..... **\$6.00**  
GRD114 Front & Rear Sight protective cover with muzzle can ..... **\$6.00**  
SLNG024 Sling Repro WWII Leather, brass hook ..... **\$16.95**  
SLNG025 Sling Repro WWII Leather, steel hook ..... **\$16.95**  
GRD107 Stacking Swivel ..... **\$8.00**  
GRD108 Stacking Swivel Screw, new ..... **\$2.95**  
5/ ..... **\$11.95**  
GRD028 Garand stock for .308 NATO cal gun, new ..... **\$49.95**  
GRD048 Stock Ferrule, new GI In the grease ..... **\$15.00**

GRD375 Stock Ferrule Assembly, New ..... **\$20.00**  
GRD047 Stock Ferrule Stripped ..... **\$10.00**  
GRD049 Stock Ferrule Swivel ..... **\$6.00**  
GRD050 Stock Ferrule Swivel Screw ..... **\$2.95**  
GRD027 Stock U.S. / G.I. Average, Used Condition, No Cracks ..... **\$49.95**  
GRD024 Stock U.S. / G.I. Select, Used Cond ..... **\$75.00**  
GRD323 Trigger forging, orig G.I. new ..... **\$4.95**  
GRD009 Trigger & Sear Assembly ..... **\$12.00**  
GRD019 Trigger Guard Milled ..... **\$25.00**  
GRD020 Trigger Guard Stamped ..... **\$16.50**  
GRD023 Trigger Housing Assembly ..... **\$99.00**  
GRD022 Trigger Housing Stripped ..... **\$39.95**  
GRD152 Trigger Housing, Win. Reparked Stripped ..... **\$74.95**  
GRD008 Trigger Pin ..... **\$2.00**  
GRD092 Windage Knob early original ..... **\$55.00**  
GRD090 Windage Knob (Late Style) ..... **\$12.00**  
GRD212 G.I. winter trigger in orig. pkg ..... **\$19.95**

### G-3 ZF SCOPES & MOUNTS

Haven't had these in years! Original German military service ZF-1 Sniper Scopes with original claw mounts for the G-3 Rifle. Manufactured by Hensoldt/Wetzlar, these scopes are premium quality and although used, are in excellent condition and come complete with green case, claw mount, filter eyepiece. Some optics may have a few black specs, but otherwise in great shape. **NOTE: We can now offer a SECOND Version of the ZF-1 that has a see-through reticle that can be illuminated.**

You can check our website for more info. & pictures.

**ZF-1 Hensoldt/Wetzlar Sniper Scope package** - Please specify if you prefer version 1 (w/reticle light block) or version 2 (w/reticle light block) when ordering..... **\$395.00**  
~~\$495.00~~ SCPO58

These will also fit the PTR91



### STOCKS AND FORENDS

**Super Commercial Stock Deal....all brand new original stocks and forends!**

Seriously the best deal we have offered in a long time on wood for firearms under the mfg names such as Mossberg, Marlin, H&R, Savage, Ithaca, S&W, and Winchester. 15 different stock and forends at a fraction of the cost and with no duplicates.

Total Value \$587.00, but Sarco's Special Price is 1 LOT (all 15 pieces) for .... **\$150.00**  
or buy 2 LOTS for ..... **\$265.00! STK363**

This is a great opportunity for Gun Show sale items and if you sell 3 of the 15 items, you're out of it!

**PLEASE NOTE:** There is a \$20 Handling Fee on this item



### A NICE ASSORTMENT OF FACTORY CASTINGS

Others may call these 80% receivers

- C45284** P12/P13 type, wide body 1911 type double action frame casting. No parts interchange with 1911
- C45288** P12/P13 type double stack single action. Uses most 1911 type parts (see other ad) Alloy light weight frame.
- C45289** P14 type double stack double action steel frame. No parts interchange with 1911.
- C45294** P14 type, wide body 1911 type steel double action frame casting. These also have the enhancement of a lower accessory rail in front of the trigger guard. No parts interchange with 1911.

Special price for all above frame castings ..... **\$24.95**. Big Buyers call MG Dave or Cholly. We also have other wide body configurations available. No returns on frame castings.

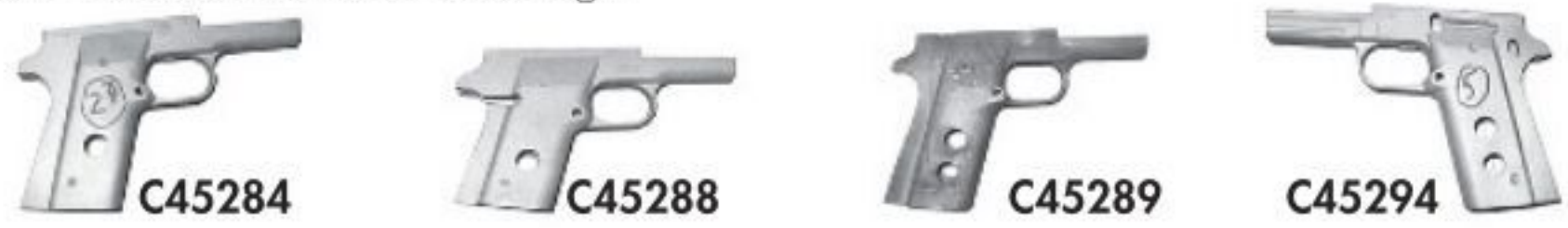

### 1911 SERIES 80 SINGLE STACK, DOUBLE ACTION, FULL SIZE PISTOL FRAMES IN ORDNANCE GRADE STEEL!

These are finished frames except for several features that are unfinished to comply with BATF directives classifying these as Non-Firearms in their present condition. Slide rails, hammer & sear pin holes, mainspring housing retaining pin, and ejector leg holes remain to be applied. Grip screw holes are drilled and tapped.

1911 Frame Casting #500649 Extra Small Para, 80% Frame - for 3" slide. Series 80, aluminum, Double stack, Single action ..... **\$62.50 C45331**

1911 Frame Casting #500675 Para LDA Officers Length, 80% Frame - in steel with checkered front grip strap. Accepts 4.25" or smaller slide. Single stack and Double action ..... **\$49.98 C45332**

1911 Frame Casting #500678 Agent Extra Small Steel, 80% Frame - with checkered front strap. Single stack, double action, and fits 3" slide and ramped barrel ..... **\$49.95 C45333**

NOT FOR SALE IN NJ - See new change in law. Not for sale in PA until further notice.



### BAVARIAN POLICE SHOULDER HOLSTER

Leather shoulder holster with synthetic expansion shoulder straps and alligator clips was a standard service holster for many detectives in Bavaria who carried smaller handguns than the predominant P1/P38 pistol. These holsters will hold small frame pistols like the PPK, PP, and Makarov. May have some blemishes or writing from their service. In excellent condition. These rest on the left chest for Right Hand Draw. .... **\$15.95 HOL204 (very limited)**



### WEST GERMAN POLICE SHOULDER HOLSTER

Original leather shoulder holster designed for law enforcement inspectors. Holds compact pistols like the Walther PPK, PP, and as large as a Russian Makarov pistol. These are used in very good condition. May have some blemishes or discoloration from service use ..... **\$19.95 HOL203 (very limited)**



### CONVERTIBLE DIGITAL SNOW JUMP SUIT

Sarco has a really effective snow camouflage jump suit that has removable arm & leg segments and can be worn over existing clothing. Capacious pockets and a double zip front make this a great 'wilderness', 'hunting', or 'garage work' suit. Remarkably effective camouflage pattern as used by current military contractors. Sizes LG, XL, 2XL. Specify size when ordering ..... **\$115.00 MISC796**



### - ATTENTION - REGARDING OUR .45 1911 BUILDERS KITS

Our famous 1911 .45 kits are **VERY TIGHT. They could even be gone by the time this ad hits. At the moment, we have a few commercial kits... Check our website for the availability of all our 1911 kits!**

**CHECK OUR WEBSITE FOR:**  
PARA LDA Spring Kits #PARA312  
PARA Put Away Kits #PARA311

Have 50 to 100 Special 1911 Slides on our website. Just came in! Have specially marked Para slides and also unmarked special and hard to get standard 1911 slides.

### .45 SLIDE CASTINGS

Sizes 3" to 4"  
**Colt 1911/1911A1 .45 ACP. See Our Website!!**

### MILITARY RIFLE SLINGS ORIGINAL & REPRO

- SUNG024** 1907 WW I Sling (Brass Hardware) Repro ..... **\$16.95**
- SUNG025** 1907 WW II Sling (Steel Hardware) Repro ..... **\$16.95**
- SUNG001** AR15/M16 Black Silent Sling... **\$5.95**
- SUNG002** AR15/M16 Padded Assault Sling ..... **\$19.95**
- SUNG075** Chilean Mauser M1895 Carbine, fair, few only ..... **\$14.95**
- BAR008** BAR Sling Repro ..... **\$25.00**
- SUNG023** Egyptian Maadi AK sling ..... **\$9.95**
- SUNG028** Egyptian Rashid Sling, Carbine ..... **\$9.95**
- SUNG096** Enfield canvas, Black canvas ... **\$6.95**
- SUNG094** Enfield canvas, Olive Drab canvas ..... **\$6.95**
- SUNG095** Enfield canvas, RAF Blue canvas ..... **\$6.95**
- SUNG027** Japanese Arisaka Sling Type 38 Repro ..... **\$17.50**
- SUNG008** Japanese Arisaka Sling Type 99, Leather w/steel hardware, brown, 1.5" wide ..... **\$14.50**
- SUNG098** Japanese Naval, leather ..... **\$13.00**
- SUNG093** Japanese Pacific WW2 Rubberized Canvas ..... **\$19.00**
- SUNG012** La Coruna 98/43 Sling (Spanish style) La Corona (Fair-Good)... **\$14.95**
- SUNG042** Lee Enfield #3 or #4 Sling WWI w/ Brass Stamp late production... **\$7.95**
- SUNG079** Lee Enfield Pattern 14 leather sling ..... **\$12.95**
- SUNG006** M1/M2 Carbine Sling Khaki (Repro) ..... **\$9.95**
- SUNG005** M1/M2 Carbine Sling O.D. (Repro) ..... **\$7.95**
- M36032** Mas 36 & 36/51 Original, VG Cond, Rifle Sling ..... **\$15.95**
- SUNG011** Mauser 98K Sling (WW II style) Repro ..... **\$14.50**
- SUNG018** Mosin Dog Collar 91/30 Sling, New Mfr ..... **\$12.95**
- SUNG103** Mosin Dog Collar 91/30 Sling, Original Russian ..... **\$19.95**
- SUNG119** Mosin Nagant Leather Sling, new w/ brass buckle & loop ..... **\$19.95**
- SUNG007** Russian SMG Sling PPSH41 ..... **\$9.95**
- SUNG017** SKS Sling Tab, new leather ..... **\$2.00**
- SUNG041** SKS Sling w/Leather Tabs New ..... **\$6.95**
- STN021** Sten Web Sling. Good cond. Needs cleaning. Few Only ..... **\$9.95**
- SUNG038** Thompson WWII Khaki Sling ..... **\$18.95**
- SUNG061** Tokarev rifle, Original - Super Rare! 3 for ..... **\$34.95**
- SUNG020** UZI Original Sling w/leather loops ..... **\$9.95**
- SUNG126** Yugoslavian K98, M48, M24 Rifle Sling ..... **\$12.95**



www.sarcoinc.com

5

### 1911 SLIDE CASTINGS

- 1911 Slide Casting Compact for 4" Barrel ..... **\$14.95 C45291**
- 1911 Slide Casting Sub Sub Compact for 3" Barrel ..... **\$14.95 C45293**

### ROCK ISLAND ARMORY 5" THREADED

**RAMPED BARREL W/THREAD CAP**  
1911 threaded barrel with thread cap included. Full size Government model 5" 45acp ,ramped (Clark /Para) with link and pin, diameter & thread pattern .578x28tpi ..... **\$89.95 AC26**

**We just received a shipment of our famous G.I. pattern 1911 .45**

**caliber 5 inch barrels!** The rifling is absolutely beautiful and the bore surface is very smooth. Made from ordnance steel. Grab 'em while they last! ..... **\$59.95 C45202**

### ROTO HAMMER FORGED 1911, 5" BARREL

Precise and consistent specs make these the barrel of choice for the 1911 pistol. These .45 cal. barrels are made in the USA and available at a Super price! ..... **\$64.95 C45011**

### RAMPED 5" STANDARD BUSHING 1911 9MM BARRELS

Found a few in the back from our parts paradise! These are the Clark / Para Ord pattern. Each barrel comes with a free link & pin. Sold elsewhere from \$80-\$200, Our Special Price ..... **\$69.95**  
3 for ..... **\$199.95 C45429**

### THREADED 1911 BARRELS

- 5-1/2 Inch. Brand new black oxide finished barrels in 3 calibers. Thread is standard .578x28 TPI.
- 9mm Model 1911 5-1/2" barrel ..... **\$60.00 C45360**
- .38 Super Model 1911 5-1/2" barrel ..... **\$60.00 C45361**
- .400 Corbon Model 1911 5-1/2" barrel ..... **\$60.00 C45362**
- .45 ACP model 1911, 5.5" barrel ..... **\$65.00 C45321**

### THREADED PROTECTION CAP FOR THREADED BARRELS

Barrels with .578x28 threads per inch ..... **\$13.00 C45363**

### OUTSTANDING ASSORTMENT OF QUALITY 1911 BARRELS

### ROTO 4M HAMMER FORGED .45 ACP, 9MM & .38 SUPER

Built to precise tolerance by a special hammer forging process, these barrels are the best you can buy! The hammer forging forms the barrel around a precision mandrel and holds the tolerance to .0001". This is much better than the typical broached barrels found elsewhere Note: 5" & 6" .45 barrels are L.H. twist - all others are R.H. twisted

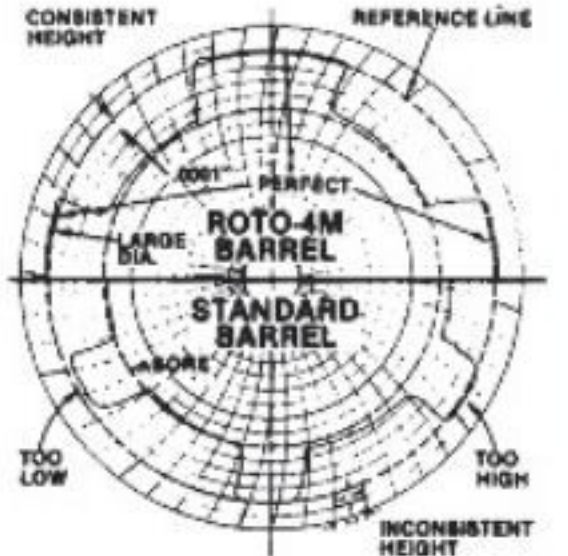

**COMPARE THE ROTO-4M BARREL FOR ROUNDNESS AGAINST A STANDARD BROACHED BARREL FROM A WELL KNOWN MANUFACTURER. ALL ROTO-4M BARRELS ARE MADE IN THE USA.**

Brand new extra length barrels for all Colt/1911/Government Model type automatic pistols. These barrels are made by the Special Roto-4M Hammer forge process which produces the most precise and consistent barrels for the best accuracy. Minor hand fitting may be necessary for some guns.

**Barrels do not include link & pin. Link & pin available w/barrel purchase for additional \$5.00 C45281** Available in:

- .400 Corbon Barrels**
- 4 1/4" Commander ..... **\$56.70 C45105**
- 6" ..... **\$61.70 C45104**
- 7" ..... **\$65.70 C45018**
- STD 5" ..... **\$56.70 C45025**
- .45 ACP**
- 4 1/4" Comm ..... **\$54.70 C45010**
- 5" ..... **\$54.70 C45011**
- 6" ..... **\$62.70 C45013**
- 7" ..... **\$63.70 C45014**
- 16" ..... **\$82.50 C45016**
- 9MM LUGER**
- 4 1/4" Comm ..... **\$56.70 C45163**
- 5" ..... **\$56.70 C45019**
- 6" ..... **\$61.70 C45020**
- 7" ..... **\$65.70 C45021**

**.40 S&W 1911 5" BARREL** ..... **\$56.70 C45277**

**.38 SUPER**  
4 1/4" Comm ..... **\$54.70 C45164** Note: 9mm & .38's will not fit the .45 slide

### SERIOUS ABOUT COMBAT SHOOTING? ROTO 4M COMPENSATED BARREL

DOD contractors have been buying up our Roto 4M barrels because they work! MODEL 1911 COMPENSATED BARRELS in 3 calibers will reduce recoil and speed your target acquisition especially during multiple shots. Takes a minute to install our barrel that comes with Barrel Bushing and permanently attached and ported Compensator. Also there is less weight on the muzzle end than with conventional screw on muzzle compensators. Most people comment on the change of performance, but also that it looks great too! Sold elsewhere for \$175-\$200, Sarco's price is ..... **\$89.95 \$99.95**  
Specify caliber when ordering: New, made in USA. **.38 cal C45024, .45 cal C45015, .400 corbon C45194**



### USGI COMBAT BELT FOR INDIVIDUAL EQUIPMENT

Recently released from U.S. Govt. service, these military combat belts are built to last under extreme conditions. 2-1/4" wide, this belt is size 'Large' for waists over 30 inches. Grommets allow for attachment of load bearing equipment/suspenders. Excellent condition ..... **\$12.95 MISC917**



**SARCO**  
www.sarcoinc.com

**1911 GENERIC PISTOL LANYARD**  
Dark green braided cord with metal lanyard hook clasp.  
**\$5.95 MISC821**



See our website for **STAINLESS STEEL 1911 PARTS**

**BRONZE .45 CAL. CLEANING BRUSHES**  
5 for **\$4.85 C45098**

**SPECIAL .45 COLT AUTO REPAIR PARTS KIT**  
Containing the following parts: 4 grip screws, 2 grip screw escutcheons, 2 mainsprings, plunger tube spring, sear spring, 2 ejector pins, 2 mag. catch springs, 1 firing pin stop, 2 firing pin springs, 4 hammer strut pins, 2 firing pins, 2 mainspring housing pins, 1 recoil spring. Regular \$37.00 **SPECIAL \$22.50 C45091**

**.45 1911 DIAMOND GRIPS ROSE WOOD**  
These brand new rosewood grips are made in the original WWI style with the "Diamond" pattern checkering. Give your .45 Auto the classic look and feel of the original Colt 1911 design!  
..... **\$14.95 GRP162RW**



**1911 .45 SPARE PARTS TIN, USED**  
'USGI' 1911 Squad Cleaning Kit Can used for storing parts during cleaning. Very difficult to find. Steel. VG condition ..... **\$24.95 C45088**



**U.S. WW2 PISTOL LANYARD**  
Woven cotton OD green lanyard with leather cinch and reinforced leather end with steel attaching hook at 41 inches long. Very difficult to find originals! New made and used with Model 1911, S&W Model 10 etc ..... **\$7.95 MISC385**



**.45 AUTO FRAME KIT**  
All parts to build a 1911A1 frame (except the frame itself). Includes trigger, hammer, grips, sear, mainspring, safety, etc., (no slide stop) **\$89.95 ea. C45099**

**.45 BARREL BUSHING WRENCH**  
Free Bonus - Other end is an M16 shorty buttstock installation wrench ..... **\$2.95 TOOL031**

Sarco has the goods to 'trick out' your 1911 pistol with a wood stock and accessories! Buy a complete set of parts to create a pistol with 16" - .45 barrel, stock, holster and connecting parts or buy individual parts to help you create your own custom stock. We have two full sets to select from ( Pictured items F & G above ), which provide you everything needed for the conversion. Items A thru E can be purchased individually to help you with your own custom project.

A. Lightweight 1911 Stock .....	<b>\$49.95</b> C45402
B. Standard 1911 Stock Assy .....	<b>\$35.00</b> C45390
C. 16 inch .45 ACP Barrel.....	<b>\$82.50</b> C45016
D. Mainspring for Wood Stock Connection .....	<b>\$18.95</b> C45391
E. 1911 Stock Building Hardware Kit - contains metal parts that will allow you to build your own custom stock and install the pistol to the stock. Contains slotted mainspring housing, 2 brackets with pair of screws and escutcheons, and knurled tightening screw .....	<b>\$34.95</b> C45394
F. Complete Lightweight 1911 Stock Rig - holster, 16" barrel, slotted mainspring housing, wood stock with metal hardware .....	<b>\$164.95</b> C45428
G. Complete Standard 1911 Stock Rig - holster, 16" barrel, slotted mainspring housing, wood stock with metal hardware .....	<b>\$149.95</b> C45392
H. Holster for Stock Rig (Pictured in the sets above) .....	<b>\$45.00</b> C45393

**M1911 "DIAMOND" GRIPS**  
These brand new walnut grips are made in the original World War I style with the "Diamond" pattern checkering. Give your 45 Auto the classic look and feel of the original Colt 1911 design  
..... **\$13.95/pr. 3/..... \$36.50 GRP162**



**FULL PIN SET** for Colt .45 Auto. All seven pins for the M1911. New ..... **\$4.85/ set. 10 sets for .... \$38.50 100 sets for ..... \$285.00 C45195**

**FOUND IN WAREHOUSE!! ORIGINAL G.I. COLT .45 AUTO COMPOSITION GRIPS**  
These were long ago taken off G.I. 1911A1's - when the guns were demilled. V.G. excellent condition  
..... **\$24.95 GRP131**  
**Just a solution to your bad/broken CMP grips!**



**WIDE BEAUTIFUL GRIP SAFETY FOR 1911 .45 AUTO**  
Stop the pinch in the web of your hand (I used to get bloody) **\$16.50, 3 for \$49.95 C45079** (Note: These are for short rear tang frame. You can fit them to Std. frame)



**.45 AUTO SPRING KIT** One each of all 6 springs in a Colt .45. A \$13.25 value for only. Includes sear spring **\$7.75 ea. C45002, 10 sets for \$65.00. 100 sets for \$450.00**

**NEW, ARMSCOR...45 Recoil Springs** for the 1911 pistol rated at 16lbs ..... **\$4.95 C45326**  
Mag Catch for wide body 1911 frames. Comes with release and spring..... **\$16.95 C45327**

**SARCO SPECIAL**  
Four of our famous 1911 .45 mags with 2 pouches (below) for only **\$34.95, C45310**  
Two of our famous 1911 .45 mags plus a web mag pouch (below) for only **\$18.95 C45213**

**DOUBLE MAG POUCHES FOR COLT 1911 .45**  
Exact repro with WWII markings. We had these 2 years ago but got lost in the warehouse **C45280**  
3 for ..... **\$4.95**  
11 for ..... **\$11.95**  
**1911 AUTO MAGAZINE, 7RD**  
5 for ..... **\$8.95**  
10 for ..... **\$39.95**  
20 for ..... **\$75.00 C45298**

**WIDE SPUR HAMMER**  
Desirable M1911 type checkered wide spur hammers for the Colt .45 auto pistol. These are new, ready to install and upgrade your pistol. Heavily checkered (not grooved) wide spur provides a sure grip when thumb cocking or decocking. **\$12.50 C45054** (Comparable price \$23.00) **Note:** These are due in a month. Send order and get on the list



**(all NFA rules apply)**



**1911 Stock Rig Conversions**  
Funnest Way to Extend your 1911 Shooting to the Limit!

A. B. C. D. E. F. G.

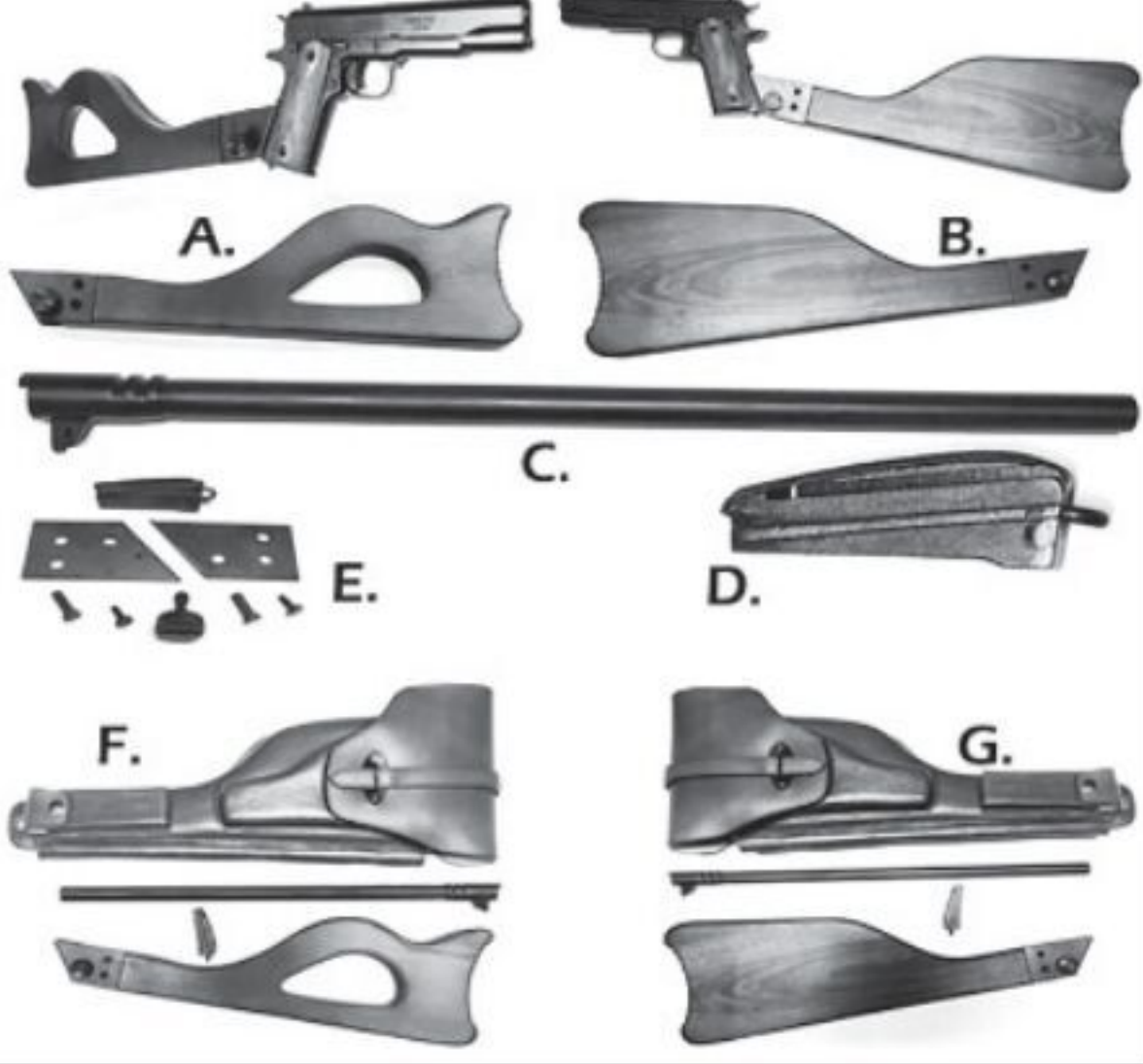

For Colt mfg revolver barrels, see our website.

**JUST FOUND FROM 45 YEARS AGO!!!**  
**BRAND NEW ORIGINAL COLT 1911 NICKEL PLATED 1911 THUMB SAFETY**  
A few only!! **\$65.00 each** **C45432** We be DIGGIN'!!



**COLT 1911 STEEL MAINSPRING HOUSING**  
Housing is grooved for a sure grip 1911A1 style - nicely blued. With Lanyard Loop..... **\$16.50**  
3 for ..... **\$47.50 C45081**  
Without Lanyard Loop ..... **\$16.50**  
3 for ..... **\$47.50 C45171**



**.45 1911 FLAT MAINSPRING HOUSING, NEW**  
Brand new, flat (M1911 Style) steel housings, checkered nicely for a sure grip. Matt gray/black finish. These are nice! ..... **\$13.50, 3 for ..... \$37.50 C45082**



**SARCO SPECIAL**  
**WORLD WAR I PATTERN .45 1911 MAGS WITH LANYARD LOOP**  
C45295 - 1911 mag with lanyard loop ..... **\$11.95**

Buy 3 mags for **\$34.95** and get a free pistol lanyard for the mags. These are rarely seen now a days. Best way to participate in fast combat shooting where you must drop and load mags quickly. Avoids damage to your dropped magazines. WWI Cavalry and vehicle crews would keep 2 or 3 mags on a lanyard for combat purposes! Original mags came with hemp twine so you could tie them to the lanyards individually. These magazines are made on the same automated machinery as our famous magazines shown above. This is the mag to have if you want to be serious about CQB firing and reloading quickly. Very popular for modern combat pistol tournaments.  
**SPECIAL OFFER!** 2 lanyard loop mags w/lanyard and U.S. military double mag pouch ..... **\$23.50 C45318**

..... **\$23.50 C45318**



**JUST IN !! USGI WHITE 1911 DOUBLE MAGAZINE POUCH**  
Original white canvas GI double magazine pouch for standard Model 1911 pistol magazines. Will have some blemishes or minor stains, but will clean up and is in excellent physical condition. Great for your Snow Camouflage outfit or for Provost Marshall / Military Police outfits. Belt loop on back and internal snap for use with military pistol belt. Very Limited! Pouch only..... **\$14.95 C45440**



**1911 ORIGINAL SCREWDRIIVER & TAKE-DOWN TOOL**  
Just In! 1911 new G.I. surplus screwdriver/takedown tool - Limited supply! Wont last long!  
..... **\$14.95 C45320**

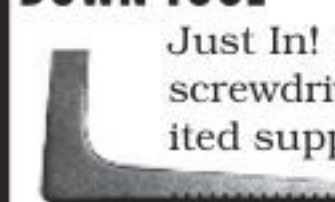

Grade 1 Ballester Molina Barrel - 95%+ finish ..... **\$59.95 BAL013**  
See our website for more Ballester Molina barrels and other parts!

**1911 7RD .45 MAGAZINE, US GI ORIGINAL 1911 MAGAZINES**  
In very good condition released from the military decades ago. We purchased these long ago and lost track of them. Steel magazines are standard 7 rd. .45 caliber ..... **\$14.95 C45369**



**JUST IN... FOR YOUR MODEL 1911 PISTOL!**  
Model 1911, 8 round .45 ACP stainless steel magazine ..... **\$15.95 RPM306**  
Model 1911, 15 round .45 ACP stainless steel magazine ..... **\$17.95 RPM307**  
Model 1911, 15 round .45 ACP standard blued finish magazine **\$17.95 RPM308**



**1911 9MM 10RD MAGAZINE**  
For your 1911 chambered in 9mm Luger. Perfect for your 9mm Rock Island 1911 or other 1911 style pistol as replacement or additional magazines!..... **\$24.95 RPM269**



**A NEW WORLD OF 1911 .45 AUTO MAGS**  
SARCO HAS GONE TO EXTENSIVE LENGTHS TO DEVELOP A SUPERIOR 1911 .45 MAGAZINE. We have sold probably 150,000 of our price busters, but we decided we need a new & better 1911 mag & we are very pleased with our new program. This is the results of over a year of product development.  
**Plus with all of the above a killer price \$8.95 ea., 5 for \$39.95 C45298**  
This is half the price of most reasonable .45 mags! OEM or Large Quantity Buyers Contact Cholly or Dave at (610) 250-3960 ext. 223. Check our website for additional info & pictures of our fabulous tooling.



**NOTE! AT LEAST \$1 UNDER ANY COMPETITOR**

**NEW VARIATIONS OF OUR 1911 .45 ACP MAGS - JUST IN THE DOOR**  
Stainless steel magazines ..... **\$14.95, 3 for ..... \$40.00 RPM121**



**1911 .45 ACP 7rd MILITARY MARKED MAGAZINES**  
.45 ACP #1005-00-8694 MFR8R320 ..... **\$10.95, 3 for ..... \$29.95 RPM155**



**8 ROUND .45 MAGAZINE**  
New, blued steel magazine for all .45 ACP Government Model/M1911 type pistols. Base plate also acts as finger rest to improve your grip on the gun ..... **\$16.95 ea. RPM319**



**1911 .45 AUTO PISTOL PARTS**

C45095 Auto Builders Kit (Less Frame & Slide)	<b>\$149.95</b>
C45097 Auto Builders Kit (Less Frame)	<b>\$279.95</b>
C45096 Auto Builders Kit (Less Frame, Slide & Barrel)	<b>\$119.95</b>
C45099 Frame Kit	<b>\$89.95</b>
C45091 Auto Repair Parts Kit	<b>\$22.50</b>
C45374 Barrel, 5" 1911 Colt .38 Super, new in the wrap	<b>\$135.00</b>
C45010 Barrel, 4 1/4" Commander, Roto, .45	<b>\$54.70</b>
C45017 Barrel, 5" Roto, .38	<b>\$54.70</b>
C45024 Barrel, 5" Roto, .38, w/Compensator	<b>\$101.95</b>
C45011 Barrel, 5", Roto, .45	<b>\$54.70</b>
C45015 Barrel, 5" Roto .45 w/Compensator	<b>\$101.95</b>
C45025 Barrel, 5" Roto, 400 Cor-Bon	<b>\$56.70</b>
C45019 Barrel, 5" Roto, 9mm	<b>\$56.70</b>
C45009 Barrel, 6" Roto, .38	<b>\$61.70</b>
C45013 Barrel, 6", Roto, .45	<b>\$62.70</b>
C45020 Barrel, 6" Roto, 9mm	<b>\$61.70</b>
C45018 Barrel, 7" Roto, .38	<b>\$65.70</b>
C45014 Barrel, 7" Roto, .45	<b>\$63.70</b>
C45021 Barrel, 7" Roto, 9mm	<b>\$65.70</b>
C45016 Barrel, 16" Roto	<b>\$82.50</b>
C45040 Barrel Bushing	<b>\$6.50</b>
C45087 Barrel Bushing Wear Gauge	<b>\$19.95</b>
C45085 Barrel Bushing Wrench	<b>\$2.95</b>
C45026 Barrel Link Pin	<b>\$1.00</b>
C45028 Barrel Link, #13, NM	<b>\$8.95</b>
C45027 Barrel Link, Std	<b>\$4.95</b>
C45098 .45 Cal. Bore Brush	<b>\$1.25</b>
C45251 Colt 1911 Cleaning Rod M4	<b>\$6.95</b>
C45045 Disconnecter	<b>\$7.50</b>
C45068 Ejector	<b>\$4.75</b>
C45067 Ejector Pin	<b>\$1.00</b>

C45030 Extractor	<b>\$12.00</b>
C45044 Firing Pin	<b>\$4.95</b>
C45301 Just in the door! Series 80, 9mm & .38 Super firing pins- Now available for 1911 pistols	<b>\$5.95, 3 for ..... 14.95</b>
C45029 Firing Pin Spring	<b>\$1.75</b>
C45043 Firing Pin Stop	<b>\$4.25</b>
C45032 Front Sight A1	<b>\$5.00</b>
C45079 Grip Safety, Wide Extended Parked (Note: These are for short rear tang frame. You can fit them to Std. frame)	<b>\$16.50</b>
C45078 Grip Safety, Long Tang	<b>\$12.00</b>
C45073 Grip Screw Bushing	<b>\$1.00</b>
GRP131 Grip Set, Plastic, GI, exc	<b>\$24.95</b>
GRP162 Grip Walnut, Diamond Style, new	<b>\$13.95</b>
C45052 Hammer Pin	<b>\$1.00</b>
C45312 Hammer pin, Stainless Steel	<b>\$2.00</b>
C45056 Hammer Strut	<b>\$3.50</b>
C45055 Hammer Strut Pin	<b>\$1.00</b>
C45053 Hammer, Regular Spur	<b>\$9.95</b>
C45054 Hammer, Wide Spur	<b>\$12.50</b>
RPM155 Magazine, 1911 .45 ACP GI marked #1005-00-8694 MFR8R320	<b>\$10.95, 3 for \$29.95</b>
RPM319 Magazine, 1911 .45 8rd, Blued	<b>\$16.95</b>
RPM158 Magazine, 1911 .45 Compact	<b>\$24.95</b>
C45060 Mag Catch	<b>\$6.95</b>
C45061 Mag Catch Extended	<b>\$9.95</b>
C45327 Mag Catch Wide Body, Armscor	<b>\$16.95</b>
C45062 Mag Catch Lock	<b>\$2.00</b>
C45313 Mag catch lock, Stainless Steel	<b>\$3.00</b>
C45063 Mag Catch Spring	<b>\$1.00</b>
C45094 Magazine Pouch	<b>\$7.95</b>
C45047 Main Spring	<b>\$2.00</b>
C45084 Main Spring Cap	<b>\$1.25</b>
C45083 Main Spring Cap Pin	<b>\$1.00</b>
C45314 Mainspring housing pin, Stainless Steel	<b>\$6.95</b>
C45059 Main Spring Housing Retainer Pin	<b>\$1.40</b>

C45082 Main Spring Housing, Flat (Checkered)	<b>\$13.50</b>
C45145 Main Spring Housing Flat & Grooved, Composite	<b>\$8.75</b>
C45081 Main Spring Housing, Steel w/loop	<b>\$16.50</b>
C45171 Main Spring Housing, Steel w/o loop	<b>\$16.50</b>
C45050 Main Spring Retainer	<b>\$1.00</b>
C45049 Main Spring, for Alum.Frame	<b>\$1.25</b>
C45001 Rear Sight	<b>\$4.75</b>
C45326 Recoil Spring, Armscor	<b>\$4.95</b>
C45036 Recoil Spring, Standard	<b>\$2.75</b>
C45037 Recoil Spring Guide	<b>\$4.65</b>
C45034 Recoil Spring Plug	<b>\$4.00</b>
C45039 Recoil Spring Plug, Commander length - FRESH OFF THE BOAT!	<b>\$5.00</b>
C45232 Recoil Spring Plug G.I. New	<b>\$14.95</b>
C45126 Recoil Spring, High Speed	<b>\$3.95</b>
C45138 Reverse Recoil Spring Plug	<b>\$7.50</b>
C45150 Reverse Recoil Spring Plug, Stainless Steel	<b>\$6.95</b>
C45074 Safety Plunger	<b>\$1.45</b>
C45075 Safety Plunger Spring	<b>\$1.75</b>
C45086 Screw Driver & Take Down Tool	<b>\$4.95</b>
C45058 Sear	<b>\$8.50</b>
C45057 Sear Pin	<b>\$1.00</b>
C45051 Sear Spring	<b>\$3.95</b>
C45160 Slide, Military	<b>\$124.95</b>
C45092 Slide Kit, Military	<b>\$174.95</b>
C45076 Slide Stop Plunger	<b>\$1.45</b>
C45003 Slide Stop, Standard	<b>\$12.00</b>
C45002 Spring Kit	<b>\$7.75</b>
C45046 Thumb Safety	<b>\$10.00</b>
C45365 Trigger Steel, 3 Hole	<b>\$12.95, 3 for ..... \$36.50</b>
C45148 Trigger, medium steel non-adjustable	<b>\$11.95</b>
C45077 Tube Slide Stop & Safety Plunger	<b>\$4.95</b>

**JUST IN !!**  
**BRITISH ENFIELD #4 MARK 1 CRUCIFORM SPIKE BAYONET**

This is the original designed spike bayonet that was more expensive to manufacture because of its unique 'Cruciform' blade similar to the French style cruciform. Very difficult to find originals and they were only produced for a brief time during the war. These fit the No.4 MK1 Enfield Rifle. Comes with scabbard. New / Very Limited ..... **\$59.95 BAY325**



**NO.4 ENFIELD SPIKE BAYONET W/ SCABBARD**

Excellent condition original WWII, fits all # 4 Enfield Rifles. Standard MKII bayonet with MKI scabbard ..... **\$17.95 BAY106**

**#1 MK3 & #4 MK1 ENFIELD SPECIAL ITEMS**

- LE3076 #1 MK3 Bolt, .22 LR cal, complete, super rare ..... **\$150.00**
- LE3064 #1 MK3 Bolt, complete ..... **\$99.95**
- LE3078 #1 MK3 Buttplate, brass, original ..... **\$20.00**
- LE3074 #1 MK3 Buttstock, original G.I. brand new ..... **\$39.95**
- LE3059 #1 MK3 Extractor spring ..... **\$10.00**
- LE3075 #1 MK3 Safety Assy, complete ..... **\$19.95**
- LE3095 #1 MK3 Sliding dust cover, Long Lee and Lee Medford, RARE - few only ..... **\$100.00**
- SING079 #1 MK3 Sling, MLE-SMLE Pattern 14... Reproduction of the "Pattern 14" leather sling used for the SMLE (Short, Magazine Lee Enfield) starting in 1914 ..... **\$9.95**
- LE3049 #1 MK3 Striker (firing pin) new original factory ..... **\$20.00**
- LE3084 Rifle ID Disc - 1" disc w/4 proof and/or mfg markings ..... **\$6.95**
- LE4077 #4 MK1 Buttplate, brass, original, VG ..... **\$22.00**
- LE4005 #4 MK1 Bolt head, original standard, ..... **\$22.00**
- LE4117 #4 MK1 Barrel, orig GOOD ..... **\$60.00**
- LE4125 #4 Buttstock, used good cond ..... **\$35.00**
- LE4062 #4 MK1 Cleaning rod pull thru, original, new, ..... **\$2.95**
- LE4013 #4 MK4 Extractor spring ..... **\$12.00**
- LE4063 #4 MK1 Safety Assy, complete ..... **\$20.00**
- LE4096 #4 MK1 Scope Rings for the brass Israeli #32 scope, for the Israeli #4 Enfield sniper rifle (few only), original ..... **\$59.95/set**
- LE4059 #4 MK1 Stock Set, new (stock & forend & 2 handguards) Original ..... **\$149.50**
- LE4079 #4 MK1 Stock & Handguards Set, used ..... **\$135.00**
- LE4111 #4 MK1 Swivel, Early ..... **\$9.00**
- LE5001 #5 MK1 Buttstock Assembly for British Jungle Carbine-late production, includes buttplate assembly ..... **\$39.95**

**Now we have delightful #1 MKIII Complete Stock Sets**

- Original refurbished buttstock
- New production new rear handguard
- New production forend
- New production front handguard

Bring your Enfield up to the delightful! **\$149.95 LE3091**



Note: Wood will need staining in order to match

**ENFIELD #1 MK3 FORENDS !**

Finally available.... Brand new unstained Beech Forends to replace all of those ugly worn out Forends on the #1 MK3 Enfield Rifles. These forends are properly inletted on the inside and contoured evenly on the outside to provide your military Enfield #1 Mk3 Rifle the perfect profile & enhancement. Stain it to match your handguards. Best way to improve the silhouette and value of your Enfield ! ..... **\$85.00 LE3110**

SEE OUR WEBSITE... FOR 1000s OF ENFIELD PARTS & ACCESSORIES!!

**#4 MK3 ENFIELD CAST SPIKE BAYONET WITH MK3 PLASTIC SCABBARD**

Almost gone! These scabbards are very hard to find! ..... **\$19.95 BAY300**

**Just dug out - A few original British brass oilers for British Enfield Rifles ..... \$21.75 OIL008**

**BRITISH ENFIELD CANVAS SLING**

We are now able to offer you 2 of the Wartime canvas slings used on the Lee Enfield Rifles as well as 1 post war issue sling. These are new made and all feature brass hardware and an accurate cotton weave. Colors available: KAHKI W/ WWII INK STAMP..... **\$6.95 each**

**LEE ENFIELD #1 MK3 AND #4 MK1 FIRING PIN REMOVAL TOOL**

Vital tool necessary to strip a Lee Enfield bolt or replace a firing pin. Fits the .303 MKIII, No. 4 and No. 5 Enfields. Made of 1144 stress proof steel - we couldn't break one ..... **\$8.95 LE3067**

**BRAND NEW !!!! ORIGINAL #1 MK3 ENFIELD BARRELS!** Been sleeping for over 30 years in the warehouse! They have GI blue finish and are original! Like new! While they last..... **\$124.95 each** or 3 for ..... **\$299.95 LE3103**

**COMPLETE SET OF #4 ENFIELD STOCK HARDWARE** Buttplate, bands, swivels, handguard ring, stock bolt and all related screws and washers. 17 parts ..... **\$39.95 LE4103** See our website for complete list of parts in kit

**ENFIELD #4 MAG FOLLOWER AND SPRING!** Put one or more away for the future to protect against mag failures! ..... **\$7.50 LE4119 Limited Supply**

**PARKER HALE NO. 4 ENFIELD TARGET/MATCH SIGHTS** w/o adjustable aperture **\$49.95 PH007** See our website for details

**ENFIELD #1 MK3 CANVAS RIFLE COVER (CASE) W/KHAKI SLING CARRY STRAP, WWII PATTERN** Made from heavy canvas material, this gun case's overall length is 46" and fits the Enfield #1 MKIII, #1 MKIV rifles & many other rifles. Beside the main compartment it has a smaller pouch originally used for a cleaning kit case. Has two sling hoops on the back for attaching a strap so you can carry it over the shoulder. We even include a khaki sling carry strap..... **\$16.95 LE3092**

**BRITISH 9 POCKET CAVALRY BANDOLIER** New made 1903 era British/Australian Cavalry heavy duty leather bandolier held 90 rds. of Enfield ammunition. 40 more rounds of ammunition than the standard infantry bandolier, and frequently was also worn around the neck of the trooper's horse ..... **\$45.00 MISC634**

**BAYONETS See More On The Next Page!**

**M1 GARAND BAYONETS**

Sarco has a limited quantity of M1 Garand Bayonets in both original, and new/ late production versions with blade lengths from 6.5 to @ 16 inches, sold with, and without scabbards.

- A. **Original 10" Model 1943, Unmodified Bayonet w/ late production US scabbard ..... \$74.95 BAY193**
- B. **Original M5A1 bayonet w/ M5A1 scabbard ..... \$36.50 BAY189**
- C. **ALSO... We have RARE M5A1 Garand bayonets marked KM5A1 ..... \$59.95 BAY020**
- D. **Original Korean Army version of the 1943/ 1905 blade shortened to their requirement of between 6.5-7" length. These were imported from the military by Arlington Ordnance years ago, and we have found a handful remaining in the warehouse. Complete with original Korean short scabbard.. \$49.95 BAY240**
- E. **Also have a few original Korean scabbards by themselves Used..... \$14.95 ea BAY135**

Go to our website for a full listing!

**SPECIAL RARE COLLECTOR M1 GARAND BAYONETS. FEW ONLY AVAILABLE. SEE OUR WEBSITE.**

**BAYONET FROGS**

- A. **SWEDISH MAUSER - original, fair condition ..... \$5.95 MSR258**
- B. **JAPANESE ARISAKA - late mfg, new, for Type 38 & Type 99 bayonets..... \$9.95 BAY115**
- C. **GERMAN K98 MAUSER - late mfg, new, fits WWII K98 bayonets ..... \$9.95 MSR111**
- D. **SWISS BAYONET FROG - Swiss military frog as issued for the STGW-57 rifle bayonet. Also works with the K31 bayonets and many other similar style bayonets and scabbards..... \$8.95 BAY272**

- E. **ROMANIAN AK47 BAYONET FROG - Original leather military frog in used/very good condition ..... \$7.95 AK060**
- F. **GERMAN 1898/05 WW1 FROG - Excellent new made version of the German WW1 frog for bayonets. Perfect for our 'Butcher' and 'Pioneer' bayonets and with WW1 German markings ..... \$14.95 BAY290**
- G. **WW2 Enfield Canvas Frog For Spike Bayonets, new Mfr ..... \$7.95 BAY334**

We have 4 leather historical bayonet Frogs for wearing on waist belts.



www.sarcoinc.com



**SUPER FIND! ORIGINAL BRITISH ENFIELD BRASS OILERS!**

Enfield collectors...we have been so fortunate to find about 100 original Enfield brass oilers in the mountain. Earl has been nice enough to sort out all of these into the original sources. Some we only have one of, while others we have a few. I can't believe he found 22 different variations! Take a look and satisfy your desires while they last - They were covered in 80 years of grease & grunge. He cleaned 'em up so he could read the markings. See our website (#OIL008) for the various markings.



**Project Lovers Special #4 ENFIELD GDII BARRELED RECEIVERS**

Lets call 'em "Battlefield Relics" Will have flaws - these are the ones we didn't want to build. As-Is, no returns. 10 for **\$150.00**, 25 for **\$295.00**, 50 for **\$500.00 GUN717 - FFL Required**

**HARD TO FIND ORIGINAL BRITISH MILITARY #4 ENFIELD MKII FORENDS \$110.00 LE4124**

**ORIGINAL EARLY ENFIELD SLOTTED REAR HANDGUARDS Excellent - new \$35.00 LE4065**

**LEE ENFIELD #1 MK3 HANDGUARD FRONT**

New production ..... **\$35.95 LE3073**

JUST IN THE DOOR !!

**#4 MK1 RIFLE MAGAZINE**

.303, 10 rd. capacity and broad arrow marked. We've worked on having these made accurately for over 2 years of development & testing. Exactly like the WW2 issue magazine! Extremely difficult to find on the market and we've been very challenged to keep originals in stock. Now all of our hard work to bring these to you can pay off and at an unbeatable price! ..... **\$29.95 each.** 3 for ..... **\$84.95** 10 for ..... **\$229.95 RM61** PLEASE NOTE: There are many variations in manufacture of #4 Enfield Rifles - Although we don't get any returns (like zero) we want to make you aware of this and we found at times some minor fitting may be needed.



**ENFIELD #4 MKII SNIPER RIFLE CHEEK PIECES** Just in the door! Complete with proper brass screws. Use to build your sniper rifle or also to create a high comb buttstock **\$34.95 LE4106**



**NO.4 MK1 WW2 ACTION COVER**

Canvas cover as issued during both World Wars. This action cover is newly manufactured in the correct weave, snaps, grommets, and leather tie down. Also comes with period markings. Perfect for completing your Enfield Rifle ensemble... **\$14.95 LE4115**



**BRITISH ENFIELD ACCESSORY KIT**

Sling, firing pin tool, oiler, and field cleaning rod. (pull-thru) Value \$22, Special ..... **\$16.95 LE4061**



**NO.4 MK2 STOCK SET**

Hard to find! #4 MKII Stock Set, used w/o cross bolt. Excellent condition. Color does not match. ALMOST SOLD OUT! Only 20 sets left! Never available again!! ..... **\$149.95 LE4074**



**ENFIELD SMLE MKIII REAR HANDGUARD**

New **\$39.95 LE3090**



**ENFIELD STRIPPER CLIPS**

We just bought the last small quantity we know of. They are now dinosaurs. All new original. While they last! **\$3.00 ea.** 5 for **\$12.95 STC010**

**ENFIELD STRIPPER CLIPS WITH POUCH / 10 PACK**

Convenient military pouch with 10- .303 Enfield Stripper Clips, unissued. .... **\$28.95 STC039**



See our website for ORIGINAL ENFIELD #5 JUNGLE CARBINE FOREND & HANDGUARDS !

**BRITISH 1903 ENFIELD 5 POCKET MODEL AMMUNITION BANDOLIER**

Used just prior to WW1 through WW2 and beyond in British Commonwealth forces. Rugged leather combined with brass hardware to provide the soldier and easy method of lugging around ammo. Convenient to take to the range too! ..... **\$38.00 MISC501**



See our website for **CMP GARAND M1 M1943 & M1 10" BLADE BAYONET REPAIR KITS**

See our website for **BLACK PLASTIC BAYONET GRIPS FOR U.S. 1943 10" & U.S. 1942 16" BAYONETS**

**SPRINGFIELD WOOD BAYONET GRIPS**

New production, new condition wood grips for the M 1905 pattern bayonet as used on the M1903 Springfield rifle. Fix up or up-grade your old bayonets with these beautiful new grips. Heavily grooved for better holding, just like some originals we found and sent to the wood workers to copy. Nut included. Ready to fit on to your blade ..... **\$9.95** per set or 3 sets for ..... **\$24.95 GRP143** Screw is available if needed. Special price if bought with grips ..... **\$2.00 BAY163**

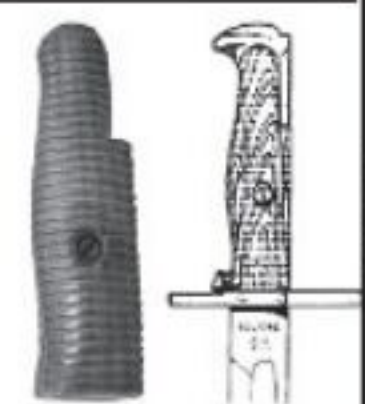

**SARCO**

www.sarcoinc.com

BAYONETS CONTINUED FROM PAGE 7

**K98 BAYONET WITH BAKELITE GRIPS, WWII JUST IN !!**

Finally we have them back in stock! Beautiful late manufacturer K98 Bayonet & Scabbard with bakelite/plastic grips w/markings. New condition.  
..... **\$39.95 BAY254**



**TURKISH M5 BAYONET W/ ALUMINUM HANDLE**

Fed up with plastic grips that would chip or crack in combat, the Turkish Army changed over to an aluminum grip for the M5 Bayonet as used with the Garand Rifle that they used since the Korean War. The end result is a really solid bayonet with a weathered profile that is unique and provides an 'almost soldier proof' damage free grip. Used for Turkish Honor Guards too. Feels solid, looks rugged.  
..... **\$24.95 BAY357**



**1918 U.S. TRENCH KNIFE MODEL**

Developed by the American Expeditionary Force, this combat fighting knife was contracted to U.S. and French manufacturers. With over 1.2 million ordered, only about 119,000 were produced before the war ended. Handle of solid brass with a 6.5 inch blade. Our Mark 1 knife is the rarer version and is engraved with the 'Au Lion' cartouche on the ricasso. New..... **\$39.00 BAY333**  
\*Sold as a curio collector item and without scabbard.

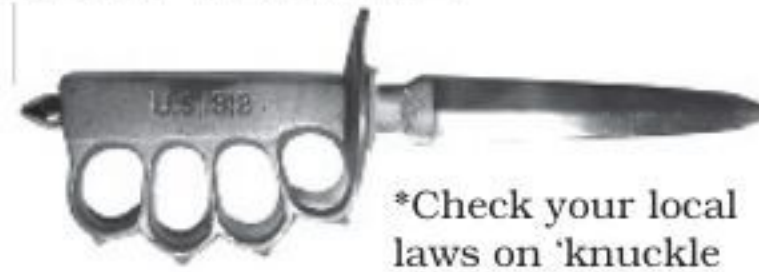

**1918 TRENCH KNIFE SCABBARD**

Steel Scabbard 'LFC' marked and dated 1918 with Black finish on the scabbard. Goes perfectly with our 1918 Trench Knife or use as an accurate replacement for your original damaged scabbard. Scabbard ONLY. New..... **\$24.95 BAY352**



**BRITISH SYKES FAIRBAIRN FIGHTING KNIFE W/ SCABBARD**

British & Allied soldiers loved this knife which was specifically made for sentry removal and still to this day, serves with the SAS. Steel 7.5" long blade. Sykes Brass Handle Knife w/ Scabbard..... **\$24.95 BAY274**  
**Back in stock! Steel handle..... \$24.95 BAY275**



**BEAUTIFUL LATE PRODUCTION SCABBARDS FOR YOUR CMP AND COLLECTOR BAYONETS**

M3 scabbard for 16" M1942 bayonet ..... **\$18.95**, 3 for **\$45.00 BAY176**  
10" Garand scabbard..... **\$12.95**, 3 for **\$34.95 BAY175**



**GERMAN BUTCHER SCABBARD, WWI**

Steel replacement scabbard for the First World War German bayonet M1898 /05. This scabbard has been reproduced from an original and fits both the plain and 'sawtooth' variety blades. Scabbard only..... **\$18.95 BAY273**



**WWI GERMAN 'PIONEER' BAYONET SCABBARD**

@23" Long. Scabbard only **\$19.95 BAY276**

**M8A1 BAYONET SCABBARDS**

**M8A1 Scabbards to fit the following bayonets!**  
M5 & M5A1 Garand, M3 Trench Knife, M4 for M1 Carbine, M6 for M14 Rifle, M7 for M16  
New Military Contract..... **\$19.95 ea BAY083**  
Excellent used military contract..... **\$17.95 BAY191**  
We have a small quantity of U.S. G.I. M8A1 scabbards.  
VG condition..... **\$19.95 BAY040**  
(Call Cholly for bulk purchases on M8A1 scabbard BAY083)  
Original G.I. new M8A1 scabbard. Just found a few in the warehouse from the old days.  
Has original USGI scabbard body..... **\$24.95 BAY041**



**BRITISH ENFIELD # 5 JUNGLE CARBINE BAYONET & SCABBARD**

Our new manufacture #5 bayonet is well made and checked for fit on an original military Lug/Flash hider. Fits both the Enfield Jungle Carbine and the Sterling sub machine gun.  
..... **\$44.95 BAY145**



**M1905 (1943) O.L. REPRODUCTION BAYONET WITH M3 SCABBARD 16" BLADE**

This awesome reproduction of the M1905 bayonet with M3 scabbard is a must have, correct bayonet for the 1903 Springfield, 1903A3 Springfield and the M1 Garand. It has the 16" blade with all correct markings on scabbard and blade, at this price you can finally own a faithful reproduction of a WWII US Bayonet. Use it on your rifle or simply as a display of our Proud Military History!!!..... **\$47.50 BAY182**  
**Marked: OL 1942 with bursting bomb**



**1905 SPRINGFIELD BAYONET PROJECT**

Set of original and new made parts for assembling a 1905 bayonet. Years ago we had 2,000 blades manufactured and rewelded onto handles with great success, allowing us to sell 1905 bayonets again. Now we have a very limited group of these complete sets of parts remaining. The handles and hilts are from original U.S. bayonets that were demilled by the U.S. govt. Plastic grips and internal handle parts and blade are new mfg. GI marking on blade. Set of parts: ..... **\$29.95 ea.**  
or 8 for ..... **\$199.99 BAY232**  
\*Add a scabbard for..... **\$12.95 ea.**  
or 10 for ..... **\$99.95 BAY233**



**1905 BAYONET BLADE**

We have some extra new manufactured blades that can be used in a bayonet project. Length 16", U.S. 1905 style, in the white..... **\$9.95 BAY253**

**RARE FAL TUBULAR BAYONET**

Bayonet w/ scabbard w/o belt connection ..... **\$18.95 BAY171**  
Bayonet w/o scabbard..... **\$9.95 BAY156**



South African R1 Fal bayonets coming soon - Inquire!

**A. U.S. 1910 Springfield Leather Bound Scabbard with belt clip**

..... **\$27.95 BAY347**



**B. U.S. Springfield Canvas Bound Scabbard WW1 with belt hooks**

..... **\$29.95 BAY266**



**FRENCH FOREIGN LEGION PARATROOP KNIFE**

Version modified from the British Sykes model and carried by Legion Paras throughout campaigns in Indochina, Algeria, Kolwezi, etc. Very light and a superior grip to the standard Sykes Fairbairn knife. High Carbon sharpened steel blade is blackened and adorned with low luster French Legion Para emblems. Blade @7" long. Overall length @12". Comes with Sykes style leather scabbard as used by the French..... **\$59.95 BAY322**



**BAYONET GRIPS & SCREWS**

BAY164 Original Yugo '98 Mauser bayonet grip sets..... **\$8.95**,  
LE3083 Original grips for Enfield #1MKIII (1907) bayonet ..... **\$9.95**  
BAY163 Original new G.I. grip screws for 1903 Springfield & WWII Garand bayonet..... **\$3.95 ea.**,  
4 for ..... **\$10.00**  
BAY179 Original new grip set for the British #7 bayonet for the #4 Enfield..... **\$12.95**

**M16 BAYONETS**

Sarco is pleased to offer an original USGI, foreign military contract, and new mfg bayonets. New G.I. M16 bayonet in original, G.I. packaging. Only A Few Left!..... **\$39.50 BAY172**



(Fits Galil, too)

**JOHNSON M1941 BAYONET & SCABBARD**

8

Finally back in stock after a long wait!!! Very rare steel Johnson Rifle bayonet and leather scabbard as issued to the U.S. Marines in WW2. Always been difficult to find, these are newly manufactured and identical to the original with a blade length of about 7.5". Used by select Marine units in WW2 and by 'Mercs' invading Cuba at the Bay of Pigs. Very Limited  
..... **\$99.00 \$125.00 BAY024**



**M1941 Johnson Scabbard**

For collectors who have a Johnson bayonet without its scabbard, we have had some extra scabbards made up. New leather scabbard - Johnson M1941..... **\$25.00 \$29.95 BAY043**



**METAL BAYONET SCABBARD GRAB BAG**

Some dings, some dents, some rust may appear as well as perhaps a missing or damage throat, but on the whole, an interesting group of metal scabbards that range anywhere from 8.5 inches to 19.5 inches long. Set of 10 scabbards, sold as is..... **\$49.95 BAY355**



**M1 (1943) O.L. REPRODUCTION BAYONET WITH M7 SCABBARD 10" BLADE**

This awesome reproduction of the M1 bayonet with M7 scabbard is a must have, correct bayonet for the 1903 Springfield, 1903A3 Springfield and the M1 Garand. At this price you can finally own a faithful reproduction of a WWII US Bayonet. Use it on your rifle or simply as a display of our Proud Military History!!  
..... **\$34.95 BAY183**  
**Marked: OL 1943 with bursting bomb**



**MOSIN 91/30 BAYONET**

Exc condition ..... **\$16.95 BAY019**  
**MOSIN NAGANT 91/30 BAYO** Exc w/New Scabbard, excellent condition ..... **\$32.00 BAY084**  
**MOSIN NAGANT M91/30 & EARLY CARBINE BAYONET** - Mosin short 11.5 inch ..... **\$44.95 BAY261**  
**MOSIN NAGANT MODEL /44 / CARBINE BAYONET** - 2 variations available in limited supplies:  
A. Mosin 44 Bayonet w/Single Ear connection. 1945 & earlier..... **\$44.50 BAY262**  
B. Mosin 44 Bayonet w/Double Ear connection ..... **\$44.50 BAY263**



**U.S. 1917 BOLO KNIFE & SCABBARD**

Made in substantial numbers during WW1 and in several variations from 1897 to 1917, we can offer this full tang, tempered version of the 1917 model complete with period markings on knife & cloth and leather bound scabbard. This is a real 'Chopper', meant to use both blade and heft to hack things apart from fire wood to the 'Hun' in the Trench. With a little care, it will last a lifetime!..... **\$99.95 BAY321**



**INDIA PATTERN SCABBARD #1 MARK 3**

**\$19.95 BAY131**



**ALLIED D-DAY FIGHTING KNIFE**

Cruciform 7" blade was a sleek low profile sentry removal tool using the French Cruciform style blade. One of many specialized fighting knives used by allied troops during the D-Day invasion..... **\$24.95 BAY256**



**FINALLY AVAILABLE**

1917 Scabbard, U.S. .... **\$22.95 BAY278**



**SKS SPIKE BAYONET STRIPPED**

..... **\$12.95 BAY031**



**DANISH M8 SCABBARD BODIES**

Original Danish military wood Scabbard bodies as used on M8 series scabbards for the M1, M14, Danish G3, & M16 bayonets. Nice wood grain with a hardening coat makes this the perfect replacement scabbard body for upgrading your M8 scabbard from a plastic fiberglass body. Scabbard body is 7 inches long and unissued..... **\$10.00 Each**  
or 3 pcs. for ..... **\$24.95 BAY356**



**VARIOUS COLLECTORS BAYONETS & ACCESSORIES**

BAY304 1891/M1938 Carcano Cavalry Carbine bayonet, original, steel ..... **\$49.95**  
BAY251 1891/M1938 Carcano Cavalry Carbine bayonet, new production ..... **\$30.00**



50 Hilton Street, Easton PA 18042  
610.250.3960 Fax: 610.438.2548

www.sarcoinc.com

### M1 CARBINE PARTS

- CRB090 Banana Clip Pouch..... **\$9.95**
- CRB023 Barrel Band 1st Model..... **\$14.95**
- CRB036 Barrel Band Retaining Spring..... **\$3.85**
- CRB026 Barrel Band w/ Bayonet Lug, Commercial, not parkerized..... **\$19.95**
- CRB025 Barrel Band w/Bayo Lug New, G.I. Parkerized..... **\$26.50**
- CRB093 Blank Adapter..... **\$9.95**
- CRB002 Bolt Assembly & Disassembly Tool..... **\$22.50**
- CRB070 Bolt, stripped, new flat (WW2 style)..... **\$84.50**
- CRB096 Brass Deflector..... **\$8.95**
- CLN172 Bronze bore brush 30 cal..... 10/**\$9.95**
- CRB032 Buttplate (Used)..... **\$8.00**
- CRB031 Buttplate Screw..... **\$1.50**

### M1 CARBINE SLINGS AND OILERS

SLING AND OILER SET **\$10.95** ea.  
 50 sets for..... **\$349.50** (\$7.00/set)  
 100 sets for **\$599.00** (\$6.00/set) CRB088  
 OILER ONLY..... **\$4.95** ea.

- 50 for..... **\$149.50**
- 100 for..... **\$275.00** OIL019
- SLING ONLY..... **\$7.95** ea.
- 50 for..... **\$300.00**
- 100 for..... **\$350.00** SLNG005
- Early WWII pattern Khaki color M1 Carbine sling..... **\$9.95** SLNG006

- CRB094 Carrying Case..... **\$14.95**
- CRB028 Demilled Front Receiver M1/M2..... **\$12.50**
- CRB067 Ejector..... **\$5.00**
- CRB066 Ejector and Spring..... **\$6.75**
- CRB068 Ejector Spring..... **\$1.50**
- CRB063 Extractor..... **\$17.00**
- CRB065 Extractor Spring..... **\$1.25**
- CRB064 Extractor Spring and Plunger..... **\$3.50**
- CRB069 Firing Pin..... **\$17.50**
- CRB097 Flash Hider..... **\$29.95**
- CRB080 Front sight..... **\$12.50**
- CRB079 Front Sight Pin..... **\$1.25**
- CRB175 Front Sight Removal Tool..... **\$29.95**
- CRB082 Gas Piston..... **\$13.00**
- CRB083 Gas Piston Nut..... **\$6.00**
- HNGD06 Handguard, M3 carbine w/hole for M3 sniper scope..... **\$35.00**
- CRB184 Handguard rivets..... **20 for \$5.00**

- CRB044 Hammer..... **\$17.00**
- CRB046 Hammer Pin..... **\$1.50**
- CRB041 Hammer Spring..... **\$2.50**
- CRB042 Hammer Spring Plunger..... **\$5.95**
- CRB100 M1A1 Pistol Grip Current Production..... **\$19.95**
- CRB014 M2 Potbelly stock, used G.I. walnut..... **\$49.50**
- CRB113 M3 Sniper Scope Battery Charging Rack. Charges 8-10 batteries. Orig new G.I. in crate can ship UPS (136#)..... **\$295.00**
- CRB056 Mag Catch..... **\$13.00**
- CRB058 Mag Catch Spring and Plunger..... **\$3.25**
- CRB057 Mag Catch, late w/mag support..... **\$13.00**
- CRB135 Mag Spring Put-Away New G.I. 15 rd 3 for..... **\$2.95**  
**\$5.95**

- CRB010 Magazine, 15 shot, new..... **\$11.95**
- OIL019 Oiler..... **\$4.95**
- CRB003 Piston Nut Wrench..... **\$12.95**
- 3/**\$34.95**
- CRB177 Rear Sight Installation Adjustment Tool..... **\$79.95**
- CRB154 Rear Sight, milled..... **\$29.95**
- CRB155 Rear Sight, late stamped..... **\$17.50**
- CRB102 Recoil Check/Muzzle Brake..... **\$29.95**
- CRB001 Recoil Plate..... **\$9.95**
- CRB030 Recoil Plate Nut..... **\$2.75**
- CRB029 Recoil Plate Screw..... **\$2.25**
- CRB020 Recoil Spring (Hi-Speed)..... **\$4.50**
- CRB021 Recoil Spring Guide..... **\$6.00**
- CRB022 Recoil Spring Housing (Early)..... **\$22.50**
- CRB019 Recoil Spring Std..... **\$3.75**
- CRB055 Safety (Flip Type)..... **\$10.00**
- CRB059 Safety Spring and Plunger..... **\$2.95**
- CRB104 Scope Mount w/Rings..... **\$24.95**

- CRB049 Sear..... **\$13.00**
- CRB050 Sear with hump..... **\$12.00**
- CRB051 Sear Spring..... **\$1.50**
- CRB038 Selector Spring..... **\$4.00**
- CRB015 Slide M1..... **\$75.00**
- CRB016 Slide, G.I., late M2..... **\$75.00**
- CRB017 Slide Stop..... **\$2.95**
- CRB018 Slide Stop Spring..... **\$1.50**
- CRB088 Sling and Oiler Set..... **\$10.95**
- SLNG006 Sling Khaki (New Reproduction)..... **\$9.95**
- SLNG005 Sling O.D. (New Reproduction)..... **\$9.95**
- CRB052 Trigger..... **\$7.95**
- CRB061 Trigger Housing M1..... **\$14.95**
- CRB062 Trigger Housing M2..... **\$75.00**
- CRB043 Trigger Housing Pin..... **\$85.00**
- CRB048 Trigger Pin..... **\$2.00**
- CRB053 Trigger Spring..... **\$1.25**
- CRB004 Trigger Spring Removal Tool..... **\$3.95**

### M1 CARBINE PARTS & ACCESSORIES

#### OUR FAMOUS M1A1 PARATROOPER CARBINE STOCKS

THIS LOT ALMOST SOLD OUT BUT WE HOPE TO HAVE OUR NEXT SHIPMENT OF M1A1 STOCKS IN SHORTLY!!! This is a perfect and exact reproduction of the WWII M1A1 Paratrooper Stock. Each stock has a matching handguard, so your treasured carbine will look beautiful.  
 (See website for other M1A1 Stock Parts)



**\$149.95**  
CRB098

This is absolutely the best quality available

**Other Accessories Available:** Carbine Stock Pouch **\$9.45** CRB134  
 Sling and Oiler **\$10.95** CRB088  
 Bulk buyers of this great stock, call Dave or Cholly.

### COMBO SPECIAL!

M1/M2 CARBINE FLASH HIDER AND M1/M2 CARBINE MUZZLE BRAKE/ RECOIL CHECK... Together for **\$49.95** CRB132



M1/M2 CARBINE MUZZLE BRAKE/ RECOIL CHECK **\$29.95** CRB102



M1/M2 CARBINE FLASH HIDER **\$29.95** CRB097



### M1 TRIGGER HOUSING

**\$75.00** CRB061

### M2 TRIGGER HOUSING, G.I.

**\$85.00** CRB062



### M1 CARBINE BOLT, STRIPPED

New flat (WWII style) M1 forged Carbine bolt..... **\$84.50** CRB070



### WWII PATTERN M1 CARBINE CARRYING CASE - UNLINED

These are a very close copy of the World War II M1 carbine case. O.D. canvas with proper brass zipper and leather tabs. "US" marked. Carrying strap included. Will hold all M1 and M2 carbines. New condition.



Unlined Cover..... **\$14.95** ea,  
**\$42.95** CRB094

### USMC WW2 FROG CAMO CARBINE STOCK POUCH

First time available, this is the '2 magazine pouch' that fits over the M1 Carbine Stock. Available in the USMC 'Frog' camo pattern of WW2, in both Jungle green pattern and the Beach khaki pattern - your choice. This has been reproduced from an original used by the French in Indochina.



Jungle Green camo. Carbine Mag Pouch CRB213-GR..... **\$11.95**  
 Beach Pattern camo. Carbine Mag Pouch CRB213-KH..... **\$11.95**

**M1 CARBINE DUAL CLIP HOLDER**  
**\$5.95** CRB101



### M1 CARBINE SPRING KIT

A put-away special: slide stop, recoil, extractor, ejector, sear, hammer trigger, & mag catch spring \$14.00 value. Only..... **\$6.95**.  
 3 for..... **\$18.95** CRB137

**M1 CARBINE SPRING & PIN KIT**  
 All the pins & springs in a M1 Carbine **\$9.95**,  
**3 for \$27.95** CRB173

We have M3 sniper scopes and one super rare M2 sniper scope in stock. Also new original G.I. parts - Check our website or call MG Dave

### RARE G-41 HAMMER SPRING

Few only - these break. For G-41 rifle only. **\$9.95**, 3 for **\$17.95** G43069

### ORIGINAL G-43 EAST GERMAN POLICE SLINGS

From late 40's/early 50's, VG condition, Original..... **\$24.95** SLNG110

### G-43 RECOIL SPRING SET, THE LONG AND SHORT

Put one or more sets away for the future! Only..... **\$8.95** a set, or 3 sets for..... **\$23.95** G43073

**We Wish All Of Our Customers Good Health and Safety During These Times of Uncertainty**

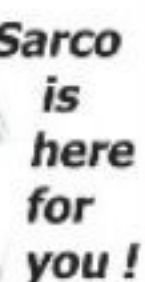

### G-43 RIFLE PARTS

#### G-43 SPRING SET

We finally completed this project all brand new live springs. Tune up your G-43 or keep a set as a "put away". These kits will run out. Old weak springs not only affect function but also take a toll on the hard parts in your gun. Springs are copied exactly from the originals. This kit is sold elsewhere for \$80.00 and are sold out there! Buy one for your gun & one to put away for when they're gone or go in business at..... **\$14.95/set**.  
 2 sets for..... **\$28.95**  
 10 sets for..... **\$140.00** G43067

- 1 front recoil spring
- 1 hammer torsion spring
- 1 rear recoil spring
- 1 trigger torsion spring
- 1 gas piston spring
- 1 safety plunger spring
- 1 mag catch Torsion spring

**G-43 Canvas Mag Pouch (repro) w/2 new Mags**  
**\$103.95** G43056



**G-43 Canvas Pouch by itself**..... **\$12.95** G43002

**G-43 Leather Mag Pouch with 2 new 10rd mags**  
**\$103.95** G43061

**G-43 10rd Magazine**, New MFG - Well-made and tested, steel. Meticulously made identical to the original..... **\$54.95** G43001



### G-43 RIFLE PARTS

- G43040 Sight Hood..... **\$14.95**
- G43073 Recoil Spring Set..... **\$8.95**
- G43072 Wehrmacht Belt with Buckle & Two Double Leather Pouches..... **\$42.95**
- CLN015 G43/K43 Cleaning Rod, 12 1/2", threaded..... **\$12.95**
- G43068 Safety Plunger spring..... **\$4.00**
- G43061 Double Pouch w/2 Mags, Leather Repro Limited Quantity!  
**\$103.95**
- G43060 Double Leather Mag Pouch, Repro Limited Quantity!  
**\$16.50**
- G43056 Mag Pouch with 2 mags..... **\$103.95**
- G43029 Sear (trigger) Spring..... **\$9.95**
- G43023 Hammer Spring..... **\$9.95**
- G43021 Magazine Catch Spring..... **\$8.00**
- G43016 Actuator Rod Spring (gas piston Spring)..... **\$6.00**
- G43012 Safety Retainer..... **\$9.50**
- G43011 Sliding Dust Cover..... **\$14.95**
- G43010 Recoil Spring, Rear..... **\$5.95**
- G43007 Recoil Spring, Front..... **\$5.95**
- G43003 Extractor..... **\$24.95**
- G43002 German Mag Pouch, WW2 reproduction..... **\$12.95**
- G43001 Magazine, New MFG..... **\$54.95**
- CLN014 Mauser 98K 12 1/2" Cleaning Rod..... **\$12.95**



### Now In Stock After 5 Months!

### M1 CARBINE BARRELS

#### New & Made to the G.I. Print!

Sarco has obtained brand new U.S. made barrels in 4140 steel that are completely machined, bored, properly cut with inlets for the front sight, machined & swedged gas block/ piston, breech with proper hood not found on commercial barrels, and bore with a 1 in 20 twist! Barrels are in the 'white', without finish. Finally you can be assured of the perfect replacement barrel for your M1 Carbine. **NOTE:** features of this barrel also include: **Short chambered** .015, **Heat treated** 4140 (28-30 RC) **Gas Cylinder/Block** made from 4140 steel, rolled and swedged onto the barrel. These are NOT castings nor are they soldered or welded onto the barrel, but made from forged bar, pressed, swedged, and rolled into place as the original GI barrels were prepared!  
**Sarco's special introductory price: \$159.95** CRB183

USA MADE BY OLD SCHOOL BARREL MAKER

**M1 CARBINE SLIDE \$75.00**  
 CRB015



**M2 CARBINE SLIDE G.I.**  
**\$75.00** CRB016



We have a M1 Carbine straight stocks and M2 Carbine potbelly stocks available... Check our website!

**M1/M2 CARBINE BARREL BAND W/BAYONET LUG (3RD MODEL)**  
 G.I. Parkerized.  
 Original, G.I.  
**\$26.50** ea., CRB025



### WWII M1 CARBINE LEATHER SCABBARD

These are truly Scarce as Hens Teeth! For whatever reason there are very few of these remaining on the collectors market so we have thoughtfully had them made from an original utilizing strong leather, brass cover and correct fasteners, and markings. This was used by Cavalry, on motorcycles, jeeps, half-tracks etc. Originally made for the full stock M-1 Carbine, it also fits similar sized firearms like the Ruger® 10/22® with the Sarco stock. Originals can fetch \$400-\$700. Sarco brings this quality leather item to you at the fabulous price of **\$57.95** CRB189



Gun not included

### M1 CARBINE MILLED REAR COMBAT SIGHT

Back in stock. Sorry, but the stamped M1 Carbine sight will not be produced anymore - The tooling was destroyed.  
**\$29.95** CRB154

### Check our website for new 15 & 30 ROUND CARBINE MAGAZINES - In stock - GI pattern

15rd magazine..... **\$11.95** CRB010  
 30rd magazine..... **\$16.95** CRB008  
 Ordering instructions are in the ad and on our website.



### M1 CARBINE MAGAZINE DUST COVER

Original rubber dust covers back in stock after many years! These are G.I. and in excellent condition. They fit easily over the top feed area of the magazine. 5 pcs. for..... **\$3.95**, 10 pcs. for..... **\$5.95**, 25 pcs. for..... **\$12.50** CRB095

**Check our website for G.I. M1 sorted Collector Parts!**

### ORIGINAL BOX OF 100 DUST COVERS

M1 Carbine fans will love this deal! Original G.I. cardboard box containing 100 pcs. of the rubber carbine dust cover..... **\$19.95**, 2 for..... **\$34.95** CRB188

### CAMOUFLAGE GREEN BURLAP ROLLS U.S. G.I.

Roll size: 300 feet, 2 inches wide..... **\$9.95** MISC306



### M1 CARBINE BANDS

First model barrel band assembly with swivel and screw. Perfect for restoration of an early WWII pattern carbine. New. Just bought a good deal on 1st model M1 Carbine barrel bands and will pass it on to you. Previously \$20-\$25 ea, now!!... **\$14.95**, 3 for **\$39.95** CRB023



**USGI MOLLE CANTEN POUCH / UTILITY POUCH**  
**MOLLE GEAR - PERFECT FOR HOLDING AMMO, TOO!!**

Recently released from Govt. Service, these woodland camouflage Canteen pouches are in excellent shape with good draw cords, latches, and straps. Two side pouches are intended for water purification tabs and other items, but if a canteen is not used, the main pouch can handle a 'hundred round' belt of 7.62mm or 5.56 ammo perfectly. MOLLE fasteners on back allow it to be mounted on belts, backpacks, etc... Woodland Canteen Pouch only ..... **\$9.95 MISC919**



**FINALLY BACK IN STOCK !!**

**G3 BARREL**

New, U.S. production  
**\$149.95 G3108**

Check sarcoinc.com for parts list for the Mitchell AR, AK & Galil .22!



**VIKING & CELT NECK RINGS**

Worn around the base of the neck by both men and women Celts and Norsemen, the 'Viking Torque' (or Torc) has been recorded back as far as 1200 BC to 600 AD and is considered imbued with powers of independence for the free born, warrior status, and an earthly connection with deities. We have three of the common types. One of brass, one of copper antiqued and one of silver. Your choice..... **\$29.95**

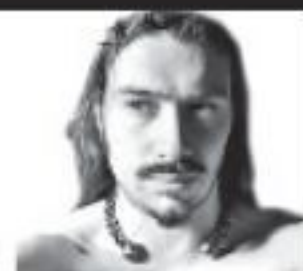

Brass Neck Ring MISC847  
 Copper Neck Ring MISC846  
 Silver Neck Ring MISC863



**NEW 1903A3 WALNUT HANDGUARDS**

New, unstained..... **\$29.95 SPF377W**  
 A3 handguards clips..... **Pack of 2 for \$3.85 SPF084**

**U.S. M1903 & 03A3 RIFLE PARTS**

SPF001 Band Front Sight 1903.....	<b>\$13.50</b>
SPF002 Band Front Sight 1903A3.....	<b>\$12.00</b>
SPF253 Band Lower, new GI blue 1903.....	<b>\$25.00</b>
SPF011 Band Lower (milled) 1903.....	<b>\$20.00</b>
SPF012 Band Lower w/Swivel (milled) 1903.....	<b>\$23.95</b>
SPF014 Band Lower w/Swivel (stamped) 1903A3.....	<b>\$17.50</b>
SPF018 Band Screw Upper Band 1903.....	<b>\$3.00</b>
SPF019 Band Screw Upper Band 1903A3.....	<b>\$3.00</b>
SPF263 Band & Hardware Set, milled 1903.....	<b>\$54.95</b>
SPF265 Band & Hardware Set, 1903A3.....	<b>\$49.95</b>
SPF003 Base rear sight (not sleeve).....	<b>\$12.00</b>
SPF306 Bolt, smooth body, bent handle.....	<b>\$125.00</b>
SPF004 Bolt Late (complete).....	<b>\$42.00</b>
SPF005 Bolt Late (stripped).....	<b>\$20.00</b>
SPF008 Bolt Sleeve (stripped).....	<b>\$15.00</b>
SPF009 Bolt Sleeve Lock.....	<b>\$4.75</b>
SPF010 Bolt Sleeve Lock Spring.....	<b>\$1.75</b>
SPF384 Bolt sleeve w/lock & spring.....	<b>\$19.95</b>
SPF308 Bolt smooth body, early straight handle, good cond.....	<b>\$140.00</b>

SPF352 Bolt stripped & welded in firing pin hole 1903(A3).....	<b>\$3.95</b> , 5 for <b>\$14.95</b>
SPF351 1901 era, Springfield bolt body, smooth, not heat treated.....	<b>\$300.00</b>
SPF357 Bolt R marked for early Remington 1941-42, stripped.....	<b>\$65.00</b>
SPF358 Bolt BF (Bonnie Forge) Springfield 1941 & 42, stripped, like new.....	<b>\$45.00</b>
CLN172 Bronze bore brush 30 cal.....	10/ <b>\$9.95</b>
SPF091 Butt Swivel (milled) 1903.....	<b>\$6.50</b>
SPF061 Butt Swivel (stamped) 1903A3.....	<b>\$5.00</b>
SPF016 Buttplate (milled) 1903(used).....	<b>\$20.00</b>
SPF015 Buttplate (stamped) 1903A3 used.....	<b>\$18.95</b>
SPF121 Buttplate Milled fine checkered.....	<b>\$35.00</b>
SPF402 Buttplate milled, heavy (wide) checkering - unchecked trap.....	<b>\$99.95</b>
SPF020 Cutoff.....	<b>\$8.50</b>
SPF021 Cutoff Plunger.....	<b>\$2.00</b>
SPF023 Cutoff Screw.....	<b>\$2.00</b>
SPF024 Cutoff Spindle.....	<b>\$3.50</b>
SPF022 Cutoff Spring.....	<b>\$1.50</b>

**1903 SPRINGFIELD HEAVY CHECKER NM BUTTPLATE**

These are original National Match Butt plates for Springfield Rifles These are the heavy checkered type. In excellent condition..... **\$250.00 SPF407**



**SPRINGFIELD 1903 & 1903A3 'C' STOCKS**

**BEECH STOCK OPTIONS**  
 Beech C Stock w/ stain ..... **VIRTUALLY SOLD OUT!** **\$139.95 SPF2765**  
 Beech C Stock w/o stain(natural)..... **\$129.95 SPF276**  
 To either Stock, add a New Handguard for..... **\$23.00**  
**Available in Walnut and in Beech.**

**WALNUT STOCK OPTIONS**  
 Walnut C Stock w/ stain..... **\$159.95 SPF276WS**  
 Walnut C Stock w/o stain (natural)..... **\$149.95 SPF276W**  
 To either Stock, add a New Handguard for..... **\$25.00**

**BRAND NEW!! SPRINGFIELD 1903A3 BARRELS**  
 High quality 4140, 4-groove barrels with shallow chamber (.044") to accommodate for receiver variations, extractor cut, front sight cut out for base, with a 1 in 10 twist. In the white and unmarked! **\$110.00 SPF387** (Very Limited Availability) Can be converted to an '03 barrel by adding an '03 rear sight sleeve!

**SPRINGFIELD RIFLE**

SPF342 Die cast buttplate assemblies for 1903 Springfield - looks like a milled buttplate (new orig). Super rare! Collector's dream.....	<b>\$39.95</b>
SPF309 Early '03 bolt stop, new orig. G.I.....	<b>\$16.00</b>
SPF028 Ejector.....	<b>\$5.00</b>
SPF029 Ejector Pin.....	<b>\$2.00</b>
SPF025 Extractor.....	<b>\$14.95</b>
SPF027 Extractor Collar.....	<b>\$10.00</b>
SPF026 Extractor w/ Hole.....	<b>\$16.50</b>
SPF033 Floorplate (milled) 1903.....	<b>\$19.95</b>
SPF034 Floorplate Catch Assembly.....	<b>\$8.75</b>
SPF031 Follower (milled) 1903.....	<b>\$7.00</b>
SPF030 Follower (stamped) 1903A3.....	<b>\$10.00</b>
SPF032 Follower Spring.....	<b>\$4.00</b>
SPF036 Front Sight Base Pin.....	<b>\$1.50</b>
SPF035 Front Sight Blade 1903.....	<b>\$6.00</b>
SPF333 Front sight blade 1903A3.....	<b>\$5.00</b>
SPF044 Front Sight Cover.....	<b>\$12.95</b>
SPF093 Front Sight Key 1903A3.....	<b>\$2.25</b>
SPF037 Front Sight Pin.....	<b>\$1.50</b>
SPF039 Front Sight Screw 1903.....	<b>\$2.75</b>
SPF038 Front Sight w/Stud 1903.....	<b>\$9.95</b>
HNGD01 Handguard 1903 (new G.I.).....	<b>\$13.00</b>
HNGD37 Handguard 1903 used cracked repairable.....	10/ <b>\$39.95</b>
HNGD02 Handguard, U.S. 1903A3 (new G.I.).....	<b>\$65.00</b>
SPF084 Handguard Clips (Two Packs).....	<b>\$3.85</b>
SPF043 Handguard Plastic (New) 1903A3.....	<b>\$15.00</b>
SPF049 Handguard Ring to Receiver 1903A3.....	<b>\$6.00</b>
SPF347 Lower band assy w/swivel, used orig Remington 1903.....	<b>\$47.50</b>
SPF349 Lower band screw, new 1903A3.....	<b>\$1.95</b>
SPF046 Mainspring.....	<b>\$4.00</b>
SPF053 Safety Lock.....	<b>\$8.00</b>
SPF054 Safety Low Scope Type.....	<b>\$16.50</b>
SPF086 Screw Buttplate Large.....	<b>\$2.95</b>
SPF085 Screw Buttplate Small.....	<b>\$2.45</b>
SPF092 Screw Stacking Swivel 1903.....	<b>\$2.00</b>
SPF056 Screw Trigger Guard Front.....	<b>\$3.00</b>
SPF057 Screw Trigger Guard Rear.....	<b>\$3.00</b>
SPF074 Screwdriver Three Blade.....	<b>\$9.95</b>
SPF055 Sear.....	<b>\$7.50</b>
SPF087 Sear, Pederson Device.....	<b>\$65.00</b>
SPF072 Sear Pin.....	<b>\$2.00</b>
SPF062 Sear Spring.....	<b>\$2.00</b>
SLNG067 Sling keeper, 1/4" for 1907 sling, orig. new GI.....	<b>\$5.95 ea.</b>
2 for.....	<b>\$9.95</b>
SPF013 Sling Swivel for Band (milled) 1903.....	<b>\$7.50</b>
SPF067 Spring Band Retainer (milled).....	<b>\$14.50</b>
SPF066 Spring Band Retainer (stamped).....	<b>\$4.00</b>
SPF058 Stacking Swivel and Band (exact reproduction) 1903A3.....	<b>\$15.00</b>
SPF068 Stacking Swivel Used G.I. (milled)1903.....	<b>\$9.50</b>
SPF366 Stacking swivel and band assembly, 1903A3 G.I. used.....	<b>\$18.00</b>
SPF367 Stacking swivel 1903A3 G.I. new.....	<b>\$6.00</b>
SPF335 1903A3 stamped replacement rear sight. Perfect for drill rifles.....	<b>\$5.95</b>
3 for.....	<b>\$14.95</b>
SPF113 Stock cross bolt & nut.....	<b>\$9.65</b>
SPF090 Striker.....	<b>\$7.40</b>
SPF052 Striker Rod.....	<b>\$6.00</b>
SPF051 Striker Sleeve.....	<b>\$3.00</b>
SPF076 Striker Grooved.....	<b>\$13.95</b>
SPF077 Trigger Pin.....	<b>\$1.50</b>
SPF075 Trigger Plain.....	<b>\$9.95</b>
SPF368 Trigger guard, 1903A3 used G.I.....	<b>\$32.00</b>
SPF382 Trigger guard, 1903A3-Reparked.....	<b>\$36.00</b>
SPF117 Trigger Guard 1903 type, Milled.....	<b>\$49.95</b>
SPF078 Trigger Guard 1903, Orig GI.....	<b>\$95.00</b>
SPF079 Trigger Guard (stamped) 1903A3.....	<b>\$31.50</b>
SPF083 Upper Band (stamped) 1903A3.....	<b>\$16.00</b>
SPF081 Upper Band Used (milled) 1903.....	<b>\$26.00</b>

**SARCOINC** www.sarcoinc.com **10**

**US KRAG & SPRINGFIELD KERR RIFLE SLING**

Original complete with the 'NobuckL' sling hardware, correct weave, and khaki color. This was also originally used on the 1921 & 1928 Thompson SMG before they shortened it during the war. Long length of sling is @45", and short length is @14.5". New. .... **\$22.00 SLNG104**



**SPRINGFIELD RIFLE LEATHER KERR SLING**

Expensive to make, this leather sling sported the brass Kerr 'NOBUCKL' system for their canvas slings from WW1 thru WW2. Fits loads of rifles and will last a lifetime of use. High quality and a classic! New..... **\$24.00 SLNG115**



**Note: Almost all of our Springfield parts are original, new G.I. bought 30-40 years ago**

**COMPLETE HARDWARE SET FOR 1903A3 SPRINGFIELD**

Same list as parts to the left only 1903A3 late pattern. Value \$55.00. **Special \$49.95 SPF265**

**1903 SPRINGFIELD LOW SCOPE SAFETY ASSY**  
**\$16.50 SPF054**



**BORE CLEANING BRUSHES**  
 .30 caliber brass bore brushes, new.  
**\$9.95/10 • \$39.95/50 •**  
**\$69.95/100**  
 CLN172

**SPRINGFIELD STRIPPER CLIPS**  
 Early brass WWI..... **\$4.00 ea.**, 5 for..... **\$15.00 STC025**

**1903 SPRINGFIELD GRENADE LAUNCHING BOOTS**  
 A perfect reproduction of the grenade launching rubber boot (slip on) for the Springfield and M1 Garand. Absolutely meticulously beautiful!!..... **\$34.50 MISC088**



**SPRINGFIELD PUT AWAY KIT 1/2 PRICE!**  
 Trigger, 2 sears, 1 milled follower, 2 ejector, 2 strikers, 1 mainspring, 2 trigger pins, 1/2 price special..... **\$15.80 SPF095**

**EXTRA LONG REAR GUARD SCREWS FOR 1903A3 RECEIVERS**  
 The standard guard screw only goes up part way in an A3 receiver. This screw fills the hole to make your rifle more attractive. Haven't had these for 20 years. The G.I. screws only engages a few threads. **\$3.95 ea.**, 3 for **\$9.95 SPF360**

**1903 & A3 SPRINGFIELD SPRING KIT**  
 A put-away for the future all springs in the gun - bolt sleeve lock, main, cut-off, sear, floor plate catch, & magazine follow \$15.00 value - Only..... **\$4.45**, 3 for..... **\$11.45 SPF248**

**M1903 & 03-A3 "SPRINGFIELD" RIFLE KITS**

These kits consist of every part of the "Springfield" rifle except the stock, receiver, and barrel assy. (w/ sight bases). Kits will have bolts, bands, stamped trigger guard, swivels, trigger, etc. Use these kits to build up to a rifle on your receiver or to rebuild an old '03. All parts are in new or like new condition. **Note:** Rear sight parts may be used G.I.  
 A. M1903 Parts Kit includes new handguard..... **\$159.95 ea.** SPF127  
 B. M1903A3 Parts Kit..... **\$149.95 ea.** SPF126  
 C. For a new G.I. 2 groove 03A3 barrel add..... **\$190.00** SPF080  
 D. Special on new '03A3 barrels if bought with an '03 or 'A3 kit (can also be converted to an '03 barrel with '03 kit by adding '03 rear sight sleeve)..... **\$100.00** SPF387  
 (price valid only if purchased with kit)  
 If you want an unfinished receiver casting in either kit, add \$19.95 SPF405 Not for sale in NJ

**SPRINGFIELD 80% RECEIVER CASTINGS**  
**\$39.95 SPF405**  
 Not for sale in NJ  
 in PA until further notice

**1903 SPRINGFIELD RIFLE 10 RD. MAGAZINE**  
 Steel 10 rd., .30-06 magazine for the 1903 series of Springfield military rifles. Makes a day at the range more fun and looks great on the rifle too! Fits the 1903 trigger guard..... **\$69.95 RM84**

**See our website for all M1 & M2 .22 Springfield parts.**

**COMPLETE NEW SCREW SET FOR 1903 & 1903A3 SPRINGFIELD**  
 Includes:  
 Upper band screw..... Rear guard screw  
 Front guard screw..... 3 Small buttplate and swivel screws  
 Large buttplate screw..... Cut off screw  
 Stacking swivel screw.....  
 Lower band screw.....  
**Note:** the 1903 kit also includes the front sight screw (value \$23.00) SPF378 - screw set for 1903A3 **\$9.95** (value \$26.00) SPF379 - screw set for 1903 **\$9.95**

**BRAND NEW 1903A3 SPRINGFIELD REAR SIGHTS ASSEMBLIES**  
 Forgot we had 'em..... **\$29.95**, 3 for..... **\$84.95** SPF370  
 Original G.I. A3 rear sight used VG..... **\$40.00** SPF294  
 Check our website for A3 Sight Parts

**SPRINGFIELD RIFLE ACCESSORY SET**  
 Canvas roll up pouch with original spare maintenance items to keep your Springfield Rifle running well. See our website for details!.... **\$34.95 SPF389**

**Chrome Springfield Parts - We have 30 different chromed Springfield parts. Very small quantities. Check our website for list. All parts are used off of drill rifle.**

**1903A3 PIN & SPRING KITS**  
 All the pins & springs in a Springfield rifle - 03 & A3 included..... **\$9.95**, 3 for..... **\$24.95** SPF341

**1903 & A3 SPRINGFIELD BUTTPLATE COLLECTION**  
 See our website!

**M1903 TRIGGER GUARDS MILLED (NOT STAMPED 03A3 TYPE)**  
 Absolutely beautiful repro of 1903 Springfield milled trigger guard. Can't really tell from original. Replace the stamped 'A3 guard in your rifle with one of these beauties. Finished in matte black, stripped (no floorplate) **\$49.95 ea.** SPF117. Complete assy - trigger guard with floorplate & catch assy **\$69.50** SPF343

**1903A3 TRIGGER GUARD ASSEMBLIES**  
 A brand new complete assembly - trigger guard + follower + spring + 2 screws - \$51 value..... **\$39.50** SPF375  
 Complete assembly, used surplus - \$51.50 value..... **\$39.50** SPF376  
 Trigger guard only, brand new..... **\$31.50** SPF079

**SPRINGFIELD 1907 SLINGS, LEATHER - AS USED IN WWI & WWII**  
 1. SLNG024 WWI Model 1907 Sling (w/ brass hardware and WWI date)..... **\$16.95 ea.**, 3 for..... **\$47.95**  
 2. SLNG025 WWII Model 1907 Sling (w/ steel hardware and WWII date)..... **\$16.95 ea.**, 3 for..... **\$47.95**

**SPRINGFIELD HANDGUARDS**  
 Original G.I. walnut handguards.  
 M1903, New, unissued..... **\$13.00** HNGD01  
 1903A3 used cracked repairable..... **\$59.95** SPF261  
 10 for.....  
 1903A3 plastic for drill rifle..... **\$15.00** SPF043  
 1903 handguard Type 2 (1910 to 1916)..... **\$150.00**  
 1903 handguard NM..... **\$100.00**



BRITISH PARKER HALE GLOBE TYPE FRONT SIGHTS

Top of the line Parker Hale target sights from their finest target rifle! ..... \$14.95 PH005



- Large mounting lock screw.
Marked with Parker Hale logo
Anshutz size tube 13/16"
Comes with one reticle insert - reticle insert styles will vary, sorry no choice.
Originally used on Parker Hale MKII & International Target Rifles.
Fits on dovetail base (not included).

U.S.M1917 & BRITISH P-14 ENFIELD PARTS

Almost all parts are new G.I.

Table listing various parts for M1917 and P-14 rifles with prices. Includes items like Bolt Stripped, Bolt, Extractor, Floorplate, Magazine Box, Speed Lock, Striker, Triggerguard, etc.

P14 & P17 Handguards are interchangeable. Order under P17 part #s. See our website for all other P17 & P14 parts

BRAND NEW ORIGINAL 98 MAUSER STRAIGHT BODY STRIPPED BOLTS

Bought from the FN warehouse in Belgium. The original FN production. These came out of the FN Factory in a buy of left over parts in the warehouse. Unnumbered. Never in a gun..... \$49.95 MSR517

Extra Special - Our new '98 bolt with new firing pin \$64.95 MSR518

MAUSER RIFLE BARRELS VARIOUS MODELS

- 1. Kar 88, 8x57, original used, with good bores, 17 1/2" ..... \$75.00 MSR096 with hand pick bores . \$95.00 MSR097
2. Rare Argentine M1909 Engineers Carbine barrel - bores vary ..... \$100.00 MSR512
3. 1908 Brazilian Barreled: Fair ..... \$40.00 MSR659

MISC. 98 MAUSER ITEMS

- 1. Original Argentine SOM sniper scope w/base & leather case ..... \$3495.00
2. Rare M98/43 La Corona Spanish muzzle cover ..... \$9.95 MSR217
3. VZ24 Mauser new original stock disc ..... \$4.95
3 for ..... \$12.50 MSR523
4. Original Israeli K98 grenade launcher, like new ..... \$49.95 MSR575
5. Orig Yugoslav, 98 & M48 etc Mauser oller ..... \$4.95 MSR576
6. Rare original 1904 Portuguese Verguiero front sight cover, new ..... \$9.95 MSR591

TOKAREV RIFLE & PISTOL PARTS

SVT-40 TOKAREV RIFLE SPARES PACK

Sarco has a new spares pack for the venerable SVT-40 Tokarev Rifle. These parts just came in and we can offer you an unbeatable deal on this parts package. Pack consists of Bolt with Extractor, Front End-gas housing & flash hider, Rear Sight-complete, Trigger Housing complete, and Piston Rod. Normally these parts would fetch \$350.00, but Sarco's special price is ..... \$64.95, 3 for \$179.95 TOK089



TOKAREV TU-90 GRIPS

Like new \$14.95, 3/ \$29.95 GRP194 See our website for more Tokarev parts!



PROPER 8x57mm BORE BRUSHES

Bronze brush - 5 for ..... \$5.50 CLN124
Stainless steel brush for cleaning those tough military bores 5 for ..... \$8.95 CLN121



'98 MAUSER SPORTER RIFLE PARTS

Steel hinged trigger guard assembly ..... \$69.95 MSR326
Single stage trigger (uses original sear) ..... \$14.95, 3 for \$39.95 MSR205
Note: Delightful single stage trigger assembly—this takes the historic 'creep' out of your trigger pull. It is interchangeable with your standard trigger. A must for all shooters looking to improve the performance of their Mauser 98.
Low scope safety - for scope mounting on 98 Mauser scoped Sporter. Fits & works on standard military bolt sleeve ..... \$17.75 MSR162



'98K MAUSER ACCESSORY KIT

Cleaning rod. Our famous K98 Repro sling, front sight hood. Value \$55.00
Sarco Special ..... \$24.95 MSR365



K98 RIFLE STOCK DISC

Usually inserted in the right side of Mauser stocks in the 1930s and in Garrison rifles of the Home Guard through the early war years. Would ID mfg., date, serial # ..... \$4.95 MSR596



K98 MAUSER HANDGUARD

Beautiful new hardwood hand-guard ready to replace that old worn out handguard! ..... \$19.95 HNGD42

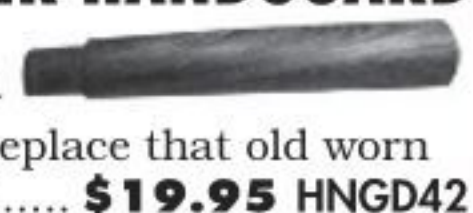

'BALKANS' MP40 SUBMACHINE GUN POUCH



A staple of SMG gunners in the bitter Yugoslavian campaigns against the Germans, Italians, Axis Croats etc. . . and a common piece of gear for Chetniks & Tito's Partisans. This pouch found use with magazines for German MP40, Beretta SMG, Sten, Orta M41 SMGs etc. Used, leather in VG condition with shoulder strap. Holds 4 mags. Original!..... \$19.95 MISC960

ORIGINAL MAUSER '98 AND OTHER MAUSER HANDGUARDS

Table listing Mauser handguards with prices. Includes MSR216, HNGD55, HNGD17, HNGD34, HNGD36.

GERMAN MADE H&K DESIGN ADAPTABLE FLASH HIDER

Proven design! 7.62mm (30cal) metric 15 x 1 right hand thread ..... \$7.95, 3 for \$19.95 MISC795



EXTRA LONG LOCKING LUG MAUSER K98 BOLT

To Solve 98 Mauser Headspace Problems - New Mauser '98 bolts FN made from years ago. These are new original bolts with extra length locking lugs to repair excess headspace guns. Been hiding for years. Stripped, brand new original FN..... \$79.95 MSR517L



MAUSER '20" ROUND 'TRENCH' MAGAZINE

Check your local laws and/or our website for mag restrictions \$49.95 MSR167



Check our website for a fabulous assortment of '98 Mauser trigger guards over 35 variations - we had a big sort! Have over 30 varieties of Bolts, too!!

GERMAN WW2 MAUSER G33 /40 FRONT SIGHT HOOD \$24.95 MSR633



'98 MAUSER FRONT SIGHT COVERS Back Again! New condition ..... \$6.50, 3 for ..... \$17.95 MSR153



MAUSER K98 SNIPER RIFLE SPECIAL EXTENDED SAFETY

We have them for the first time! To go with your Mauser sniper rifle project. Others sell for \$69.95 ..... \$24.95 MSR574



MAUSER RIFLE CLEANING RODS

- 1. 98K 12.5 inch rod, for most 98K and G-43 rifles ..... \$12.95 ea. CLN014
2. 98 K 10 inch, for early 98K ..... \$12.00 CLN013
3. G33/40 Rod, Special length rod used only on the Czech Mountain carbines made by the Germans as the G33/40 ..... \$14.95 CLN016
4. VZ24 Rod, Correct length and diameter rod for the Czech VZ24 rifles. Also correct for G24 (T) rifle ..... \$13.50 CLN018
5. Chamber cleaning tool, wood ..... \$3.95 CLN062
6. 12 1/2" rod for M98/43 Spanish ..... \$12.50 CLN019
7. Cleaning rod M93 17 1/4" ..... \$10.00 CLN049
8. Cleaning rod - Turkish model 38 Mauser & M98 ..... \$11.95 CLN127
9. M95 Mauser Chilean rifle ..... \$13.50 CLN129
10. Argentine M91 & M1909 Mauser ..... \$15.00 CLN024
11. 1916 Spanish short rifle ..... \$12.50 CLN136
12. Chilean M1935 short rifle ..... \$25.00 CLN131
13. Swedish M1938 carbine ..... \$12.50 CLN021
14. Brazilian M1908 Mauser ..... \$12.50 CLN026
15. GEW 98 Mauser WWI ..... \$12.50 CLN025

HOODED BOLT SLEEVE ORIGINAL NEW COMMERCIAL FN MADE (FROM THE 60'S)

Note: These are original FN milled from BAR stock - current offerings are castings. Finally available again, hooded bolt sleeve for use with trigger mounted safety mechanism. These are the type used on all of the high quality Mauser sporters. Our sleeves are original F.N./Belgium manufacture, left over from their production of Mauser Sporters several decades ago. We found a small cache of these desirable hooded bolt sleeves at the FN plant and bought them all. All are beautiful polished steel, new condition ..... \$54.95 each MSR119



BACK AGAIN!! NEW PRODUCTION '98 MAUSER FIRING PINS

We just produced these out of the best 4140 steel - The good news is that we redesigned the cocking piece knoches to fit multiple manufacturing variations of the cocking piece. For years we have suffered pins and cocking pieces that won't fit together and hours and hours of sorting for fit. Problem solved + a new 4140 pin ..... \$22.50 MSR431



Go to our website for the last of our true re-creation of the Mauser 98 WW2 Turret Scope mounts - almost sold out and we are not running them again because they are too expensive to manufacture!



Mitchell Arms parts for .22cal rifles are available on our website!

98 MAUSER GUARD SCREW SET

Table listing Mauser guard screw sets with prices. Includes MSR372, MSR373.

98 MAUSER COMMERCIAL GUARD SCREW SETS

Commercial set, new ..... \$6.95 MSR158

SEE OUR WEBSITE FOR THE FULL SELECTION OF '98 MAUSER PARTS

Table listing various Mauser parts with prices. Includes MSR105, MSR106, MSR096, MSR304, MSR097, MSR114, MSR115, MSR117, MSR118, MSR120, MSR121, MSR359, MSR434, MSR122.

Table listing various Mauser parts with prices. Includes MSR404, MSR123, MSR125, MSR126, MSR127, CLN014, CLN025, CLN018, CLN013, CLN049, CLN074, MSR135, MSR136, MSR138, MSR139, MSR141, MSR143.

Table listing various Mauser parts with prices. Includes MSR142, MSR146, MSR147, MSR148, MSR151, MSR153, MSR155, MSR157, MSR150, MSR158, MSR158(A), MSR373, MSR372, MSR159.

Table listing various Mauser parts with prices. Includes MSR161, HNGD34, MSR162, MSR129, MSR193, MSR415, MSR175, MSR180, MSR185, MSR149, SLNG010, STC013, MSR208, MSR206.

SARCO 11

www.sarcoinc.com 610.250.3960

GERMAN MAUSER RIFLE

MAUSER STOCK MILITARY ISSUE

1908 Brazilian Mauser long rifle stock, good cond. .... \$75.00 MSR366
1908 Brazilian Mauser long rifle stock w/handguard, good cond. .... \$85.00 MSR375
VZ24 Stock original, used condition Good ..... \$99.00 VZ24004
VZ24 handguard, used Good - VG ..... \$35.00 HNGD36
VZ24 Stock & handguard set, Good ..... \$130.00 MSR668
12. Yugoslav M48 Mauser Rifle Stock, good condition ..... \$95.00 MSR669

Use above 1908 Mauser stocks to rework the 1908's with cracked stocks currently on the market.

NEW ARRIVALS! RARE '98 CONTRACT MAUSER SLINGS

Brazilian M1908 detachable Sling Swivel, For GEW 98 as well ..... \$8.50 MSR324
Proper parade sling loop for Brazilian 1908 to go with the butt swivel above ..... \$4.00 MSR193
Set of above MSR324 & MSR193, only ..... \$9.95 MSR415
Orig used Spanish Mauser Model 1893 & M1916 rifle sling ..... \$12.95 SLNG058

98 MAUSER 8x57MM STRIPPER CLIPS

Steel 5rd ..... \$2.70 STC013

MAUSER 98K WWII STYLE SLING

New MFR ..... \$14.95, 3 for ..... \$39.95, 10 for ..... \$120.00 SLNG011

K98 MAUSER RIFLE COMPLETE HINGED TRIGGER GUARD SET (CASTINGS)

We got 'em! \$19.95 MSR626 See our website!

M98 MAUSER BOLTS

Complete bolt assembly with firing pin, extraction, bolts sleeve, etc. Standard length '98 bolt, fits German 98K, Czech VZ24, Argentine '09, etc. Gew 98 style bolts. Good, original condition \$98.95 ea. MSR123



**PISTOL & RIFLE STRIPPER CLIPS**

STC005	EA. 3 for 10 for		
	AR15/M16 Guide	\$1.50	\$3.50 \$9.95
STC003	Carcano (may have light pitting)	\$6.95	N/A N/A
STC034	Carcano, brass 6.5mm/7.35, 6rd	\$9.95	N/A N/A
STC010	Enfield .303	\$3.00	\$8.25 5/\$12.95
STC039	Pack of 10 Enfield .303 stripper clips w/ pouch	\$28.95	
STC011	Steyr Hahn 9mm Auto for the 1911/1912	\$8.95	\$24.95 N/A
STC014	Mosin Nagant	N/A	\$2.35 \$7.50
STC016	M14	12 for \$9.95	
STC025	1903 Springfield, Brass, Original	\$4.00	\$10.00 \$30.00
STC029	1891 & 1909 Argentine	\$1.50	\$3.25 \$9.00
STC031	Mannlicher 7.65 pistol	\$6.50	\$18.00 \$49.95
STC013	'98 Mauser steel stripper clip	\$2.70	\$7.50 \$22.50
STC018	'93 Mauser brass	\$3.00	\$8.00 \$20.00
STC028	Orig. '98 Mauser brass, never seen before. Few only	\$3.00 ea.	
STC033	Replacement Mauser C-96 Broomhandle 8rd original military	N/A	N/A \$10.00
STC012	C96 Broomhandle, 10rd	\$7.50	N/A N/A
STC006	Rare 1896 Mannlicher	\$24.95	\$59.95

Note: all above stripper clips are original except 91/30

**UNIVERSAL 9MM STRIPPER CLIPS**

1/2" wide 3-1/4" long holds 10 rds. Got a pile of 'em so cheap cheap! STC036

10 for.....\$9.95  
50 for.....\$40.00  
100 for.....\$60.00

**T.V. WATCH'IN PROJECT**

Same 9mm clips as above but some rust - easily cleanable: STC038

10 for \$5.95 500 for \$125.00  
50 for \$20.00 1000 for \$200.00  
100 for \$30.00

**GERMAN HELMET 1889 PRUSSIAN KURASSIER, PICKELHAUBE**

Beautiful Pre-WWI model military helmet made from steel with leather liner, brass scalloped chinstrap, cockades, steel spike and brass emblem. Inscription embossed on brass emblem translates from German as, 'With God for King and Country'. (Mit Gott Fur Koenig und Vaterland)

**\$84.95 HLM012**

**ABOUT HIGH CAPACITY MAGAZINES:**

Although we try to stay abreast of current State gun laws, it is a herculean task with over 20,000 laws on the books. By ordering, you are stating that you are complying with your Local & State laws. Most States allow large capacity magazines. Some do not. If you are unsure on this issue, contact your Local or State law enforcement to confirm what is allowed. This is a partial list of States with some hi-capacity restrictions: NJ, NY, MA, MD, HI, KS, CO, CT, IL and various county laws therein including Chicago, D.C. CA residents - check your laws as they are changing.

**ONLINE ORDERS**

Go to [www.sarcoinc.com](http://www.sarcoinc.com)  
Its fast, secure & convenient!

**PHONE ORDERS**

Call (610) 250-3960  
Hours opened M-F 8:30am-5pm EST. If possible, please have the part #'s of each item ready for our order takers. If you have any technical questions, they will connect you to the most appropriate department.

**EMAIL ORDERS** - [info@sarcoinc.com](mailto:info@sarcoinc.com)

Include your name, full address (indicate if its commercial or residential) and contact info. Include part #'s of items and what ad you saw them in.

**FAX ORDERS**

610-438-2548 (order department)  
610-250-3961 (showroom)  
610-250-3962 (gunroom - fax all FFLs here)

**MAIL ORDERS** - SARCO, INC.

50 Hilton St, Easton PA 18042  
When writing your check, please include \$9.50 for shipping, (\$12.50 for rifle stocks & barrels). Actual shipping cost is determined by the weight of the package. You will be contacted if amount included is insufficient or a refund is due. There is a \$25.00 fee for all returned checks.  
**See our page 29 in the 2nd issue of the month for FIREARMS Ordering Info.**

**SWEDISH MAUSER PARTS**

Go to our website for a complete list of Swedish Mauser rifle parts

**C96 BROOMHANDLE MAUSER 712 (SCHNELLEFEUER) WOOD STOCK & HARNESS SET**

The wood stocks specifically designed to hold the selective fire version of the C96 Mauser. Very difficult to find, and this is for the real pistol, not the air soft version. Late production/walnut. Get one while you can. Won't last long! Comes with leather harness.

**\$184.95 MSR654-SET**



**STYER HAHN 9MM AUTO STRIPPER CLIPS**

For the 1911/1912.....\$8.95  
3 for.....\$24.95 STC011

**FINALLY BACK IN STOCK AFTER 2 YEARS! C96 BROOMHANDLE 10RD STRIPPER CLIPS, NEW MFG**

Works with both .30 Mauser and 9mm Luger ammunition. The traditional 10rd clip is new made like the original and has German markings.....\$7.50 STC012



**C-96 BROOMHANDLE STRIPPER CLIPS**

Works with both .30 Mauser and 9mm Luger ammunition. The 8 round is an original military strip-per clip. 8rd. C96 Clip. 10 for.....\$10.00  
25 for.....\$20.00  
50 for.....\$35.00  
100 for.....\$50.00 STC033

**MAUSER C96 BROOMHANDLE CLEANING ROD**

\$7.95 CLN164

**AVAILABLE AGAIN!! SWEDISH MAUSER HIGH FRONT SIGHTS**

Specially made tall front sights so you can zero your rifle at 100 yards. Most of these rifles shoot very high at short range as their minimum sight setting is 300 meters. Use of our high sight blade will allow you to get accurate sightings at 100 yards. Made to look like the original sights. These sights install in the existing dovetail. Made in U.S.A., Blued steel, Milspec quality, Swedish M96 and M38 Tall Front Sight. Now back in stock.....\$13.95 MSR283



**Note About Shipping:**

Sarco deals with a lot of material that is very difficult to find and much of the original wartime material undergoes refinishing, manipulation, and repair as needed. With this in mind, we are not Amazon... While our aspiration is to ship your order quickly, some items may take a little more time to prepare so please be patient! Most orders go out quickly.

**SHIPPING**

**ALL ORDERS WILL BE RECEIVED, PROCESSED AND SHIPPED OUT OF OUR PENNSYLVANIA LOCATION.**  
MINIMUM SHIPPING AND HANDLING CHARGES START AT: \$9.50. Rifle Stocks and Barrels...\$12.50  
Call for larger items on prepaid orders  
\* NJ residents please add 6.625% sales tax. Not all items available to NJ residents.  
\* PA residence please add 6% sales tax  
All orders to Alaska and Hawaii shipped via US Mail, unless customer specifically requests Blue or Red Label UPS (not available for online orders). Employees not authorized to modify prices or conditions stated in this advertisement. \*\*Most orders ship within 7-14 days\*\*

**CUSTOMER SERVICE:**

[info@sarcoinc.com](mailto:info@sarcoinc.com)  
**PARTS QUESTIONS:**  
[parts@sarcoinc.com](mailto:parts@sarcoinc.com)  
**MACHINE GUN QUESTIONS:**  
[mgdave@sarcoinc.com](mailto:mgdave@sarcoinc.com)  
Sarco only sells products to persons 18 years or older

We are forever adding pictures to our website, but we have a lot of stuff and it takes time. If you dont see a picture of something you need, email us. We'll add it to the website and reply back with the link!

**MAUSER 712 (SCHNELLEFEUER) WOOD STOCK**

SARCO has a half dozen of the wood stocks specifically designed to hold the selective fire version of the C96 Mauser. Very difficult to find, and this is for the real pistol, not the air soft version. Late production/walnut. Get one while you can. Won't last long! Mauser 712 Wood Stock.  
..... \$150.00 MSR654



**C96 MAUSER BROOMHANDLE STOCK & HARNESS**

Well-made, beautifully crafted hardwood stock and leather holster. Pistol fitting connects quickly and the pistol can be stored in the wood stock and then inserted in the leather holster. Includes cleaning rod. Made famous during WWI. Stock & harness only. Comes with two 8rd stripper clips for a limited time.  
.....\$149.95 MSR340

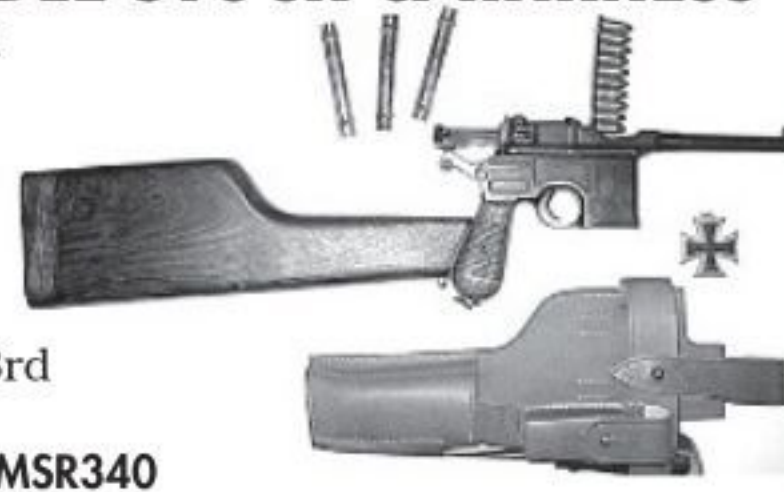

**MAUSER BROOMHANDLE (C96) PISTOL GRIPS**

Available Again! Just got in 600 pair. Custom made WOOD grips to match the originals. Complete with escutcheons & grip screws. Immaculate copies in the many variations.  
GRP125 C96 Mauser standard fine line early grips - 20 lines  
GRP126 C96 Mauser standard fine line early grips with Red 9 - 20 lines  
GRP121 C96 Mauser model 1930 grips - 11 lines  
GRP122 C96 Mauser model 1930 grips with Red 9 - 11 lines  
GRP123 Bolo (small grips) Mauser pistol with standard lines - 20 lines  
GRP124 Bolo (small grips) Mauser pistol with standard lines and Red 9 - 20 lines \$19.95 a pair, 3 for \$54.95



These grips are superb reproductions. Others may sell cheaper but I guess they know what their stuff is worth.

**SWEDISH MAUSER RIFLE PARTS**

- MILITARY RIFLE OILER**  
Swedish design double oilers, issued with all variants of Swedish Mauser rifles.  
.....\$1.95 each MSR289
- CLEANING ROD EXTENSION**  
3 for.....\$2.95 ea. MSR269  
.....\$6.95
- CLEANING ROD GUIDE** new original  
3 for.....\$4.95 ea. MSR369  
.....\$11.95
- M1896 CLEANING ROD**.....\$10.00 CLN020
- M1938 CLEANING ROD**  
.....\$12.50 CLN021
- M1896 REAR SIGHT ASSY w/sleeve**  
.....\$25.00 MSR291
- SWEDISH MODEL CG63 MATCH RIFLE.**  
new original buttplate with crown over "C" crest - 5 1/2 x 1 3/4".....\$14.95  
3 for.....\$34.95 MSR263
- Swede Mauser **FIRING PIN**  
.....\$19.95 MSR494
- SWEDISH LONG RIFLE MAUSER BOLTS** M1896, M38.....\$49.95 MSR260
- SWEDISH MAUSER ACCESSORY KIT**  
For the Swedish Mauser M1896 Rifles. Kit includes one each of the following items:

- Cleaning Rod (M96 only)
- Cleaning Brush
- 5 Stripper Clips
- Double Metal Oiler
- Cleaning Rod Guide
- Cleaning Rod Extension

Reg. \$60.00 SARCO  
**PRICE SALE!**  
**\$19.95 MSR253**



**MAUSER SCHNELLEFEUER WOOD STOCK FOR 20 ROUND MAGAZINE AND HARNESS SET**

A tremendous rarity, we have been able to have the 'wide body' Mauser Schnellfeuer stock made to carry and attach the Automatic pistol. This stock allows you to insert the gun in with the 20 rd. magazine attached which is different from the Mauser 712 standard stock. We have a very limited number in stock so act quickly because we may not be able to offer them again. Set includes wood holster stock and leather harness.....\$275.00 MSR667B



See our website for Collector Grade M96, CG63 & CG80 Mauser Bolts

See our website for Swedish Mauser Cleaning Rod Extensions #MSR644

**LJUNGMAN AG-42 RIFLE OILER**  
\$14.95 OIL038

**SWEDISH LJUNGMAN RIFLE BARREL**  
Original, New \$125.00 AG42010

~ Swedish Mauser Flash Hiders Are Coming! Inquire ~

**NEW SWEDISH MAUSER FIRING PINS**

\$19.95 MSR494



**COMPLETE SWEDISH BOLTS**  
Bolt is straight handle and in excellent condition.  
**\$79.95 MSR493**

**SWEDISH M96 AMMUNITION BANDOLIER**

One of the nicest and best quality bandoliers on the market with pockets that are expanding and capacious! Heavy duty water buffalo leather with brass hardware and can be used on the waist as well as across the chest with a working fastened length of @ 62 inches and adjustable downward. NEW.  
.....\$49.95 MSR632



~ FOR PARTS & ACCESSORIES ~  
Visa and MasterCard accepted. Sorry no COD's.

**ORDERING INSTRUCTIONS**

Our ads in the Firearms News are catalogue prices and may not reflect any sales or higher pricing found on our website.

Prices are subject to change without notice. We are not responsible for typographical errors or misprints.

Over 95% of our inventory is listed in the Firearms News. We have to move items to our website to make room for new stuff. So if you don't see something, check [www.sarcoinc.com](http://www.sarcoinc.com) or call us.

**DISCLAIMER**

Parts sold by Sarco should be installed only by a competent gunsmith. These products are sold as is and without a warranty. No liability is expressed or implied for damage or injury which may result from the improper installation or use of these products.

**OUR GUARANTEE**

Our guarantee is simple and easy to understand. If you are not satisfied with any item received from us you have 5 days to return it for a replacement or a refund of the advertised price. All returns must be accompanied by a letter WITH YOUR INVOICE NUMBER and explanation of the problem. Before returning anything, please see our guarantee on our website.

**EASTON SHOWROOM VISIT**  
Showroom opened Mon-Sat 10am-5pm / Friday Opened til 8pm. For directions to the showroom, see website. In Stock Inventory - If you are planning on visiting the showroom, feel free to call ahead to make sure that we stock the item(s) that you need. Please give us a least a few days' notice before your visit in case we need to retrieve goods in from our other warehouses. Note that the prices in Firearms News are dealer prices and may not be the same prices as in our showroom.

**ORDER PROBLEMS, Damaged or Missing Packages**

Call (610) 250-3960 and ask for Liz ext 208 or email [lhesler@sarcoinc.com](mailto:lhesler@sarcoinc.com) **BACKORDERS**  
Check the status of an existing Backorder, Call (610) 250-3960 or email: [backorder@sarcoinc.com](mailto:backorder@sarcoinc.com) SARCO deals in modern as well as obsolete and hard to find merchandise and offers full & prompt refund on any cancelled backorders prior to ship. **WEBSITE Questions or Issues** Call (610) 250-3960 and ask to be transferred to the e-Commerce Department or email [ecom@sarcoinc.com](mailto:ecom@sarcoinc.com) **INTERNATIONAL** Call (610)250-3960 and ask for Mike ext 210 or email [international@sarcoinc.com](mailto:international@sarcoinc.com)

**SARCO 12**

**SPLIT TAIL CAP IN RHODESIAN STYLE GRASS PATTERN CAMO**

Pattern French "Bigard" Style split tail caps. See our website for available sizes. Very Limited / New.  
.....\$22.00 HAT16



**BROOMHANDLE C-96 MAUSER PISTOL PARTS & ACCESSORIES**

20rd detachable Magazine for Schnellfeuer & Broomhandle detachable magazine handgun.....\$65.00 RPM270  
Bolt stop, new.....\$30.00 MSR638  
Extractor, late model current production.....\$29.95 MSR329  
Firing pin & spring.....\$35.00 MSR331  
Firing pin spring.....\$8.00 MSR332  
Floorplate.....\$60.00 MSR396  
Trigger spring.....\$25.00 MSR343  
Hammer (Schnellfeuer) 1 only.....\$150.00 MSR619  
Locking block, Original.....\$65.00 MSR345  
Locking block, repro.....\$35.00 MSR515  
Main spring.....\$4.50 MSR337  
Main spring plunger.....\$14.00 MSR338  
Recoil spring.....\$6.00 MSR341

**REGARDING LOCAL, CITY & STATE REGULATIONS**

You warrant by ordering from Sarco Inc., that you are in compliance with the laws of your local, city and State regulations and that you are a legal adult without any legal restrictions in regards to your purchase. With 20,000 plus laws on the books it is difficult for us to know what laws may affect your purchase where you reside. Please check your local and State laws before ordering.

**RETURNS**

We offer a 5-day inspection period on all of our merchandise, except for special order items which are not refundable. Items that state they are sold "as-is" are not returnable.  
• **PHONE ORDERS, EMAILED, FAXED OR MAILED-IN ORDERS:** You will need a Return Authorization Number to return something. Please email [returns@sarcoinc.com](mailto:returns@sarcoinc.com) or call (610) 250-3960 for a RT #. Feel free to check on the status of your return, credit or refund.  
• **ONLINE ORDERS:** Please visit our website [www.sarcoinc.com](http://www.sarcoinc.com) and click the Return Policy link. Fill out the printable form and mail it back with your package. Feel free to email our e-Comm department at [ecom@sarcoinc.com](mailto:ecom@sarcoinc.com) to check on the status of your return or call (610) 250-3960 and ask to be transferred to the e-Commerce Department.  
We do not refund any shipping cost unless the error/problem causing the return is our fault. Returns may be subject to a 10% restocking charge.

**SARCO**  
www.sarcoinc.com  
610-250-3960

**HEAVILY TESTED AK-47 MAGAZINE** NEW!

Sarco has just received what may be the best, most durable, and high performance AK magazine on the market. Critically tested for reliable feed, locking, and ease of use, this magazine is synthetic and has survived the grueling 'Serb' method of mag testing. 7.62x39 with 30 rd. capacity. New ..... \$19.95  
3 for ..... \$49.95 RM102



**STEEL TYPE 99 PROTECTIVE SHIELD**

As used by Japanese forces during WW2. Complete with handle and monopod. New SALE! ..... \$80.00  
~~\$99.95~~ MISC443



**ALMOST GONE!!**



**JAPANESE ARISAKA RIFLE PARTS FOR TYPE 38 & 99 - PLEASE SPECIFY WHEN ORDERING**

BAKELITE MUZZLE COVER..... \$11.00 JAP9915  
TYPE 99 DUST COVER..... \$19.95 JAP9903 **BACK IN!!**  
TYPE 38 DUST COVER - Steel \$19.95 JAP3811 *We've got these too!*  
EXTRACTOR..... \$40.00 JAP3801  
**JAPANESE ARISAKA SLINGS**  
WWII JAPANESE NAVAL SLING FOR ARISAKA & VZ-24 RIFLES ..... \$14.95 SLNG098 **BACK IN!!**

TYPE 99 'PACIFIC' RUBBERIZED CANVAS SLING - Developed to resist mildew and create a lighter sling. Laminated just like the original w/ brass hardware and markings. Wartime use of 1942-45. Unlike our competitors, we have included the leather sling keeper which the others omit! ..... \$19.00 SLNG093  
TYPE 38 Leather Sling - brass hardware, brown. 1-1/8" wide..... \$17.50 SLNG027  
TYPE 99 Leather Sling - w/steel hardware, brown, 1.5" wide..... \$17.50 SLNG008  
**JAPANESE ARISAKA CLEANING RODS**  
TYPE 99  
LONG ROD @29-3/16"..... \$17.95 CLN044  
SHORT ROD 23-3/4"..... \$14.95 CLN045  
LAST DITCH' TRANSITIONAL ROD @4-7/8"..... \$12.00 CLN147  
ARISAKA TYPE 1 & 2 PARATROOPER ROD 21-1/2"..... \$17.50 CLN046  
TYPE 38  
LONG ROD @29-1/4"..... \$17.95 JAP3803  
SHORT ROD @23-1/4"..... \$17.50 CLN148  
CARBINE @17"..... \$19.95 CLN008  
**TYPE 100 & ARISAKA PARATROOPER BAYONET**  
..... \$75.00 BAY279  
**BAYONET FROG** - Late mfg., new for Type 99 and Type 38 bayonets. Excellent reproduction..... \$9.95 BAY115

**Japanese Arisaka Type 30 Bolt**, Complete, No Head Assembly ..... \$135.00 JAP3006  
**Japanese Arisaka Type 30 Bolt**, Stripped..... \$65.00 JAP3007  
  
**TYPE 99 MONOPOD** - Nice reproduction of the rifle monopod made in steel just like the original. Great way to complete your rifle since most monopods are missing from guns on the market..... \$29.95 JAP9902  
**WW2 ARISAKA RIFLE 'PAPERWEIGHTS'**  
1 set of Cut Arisaka Receivers..... \$9.95 each  
or 5 sets for ..... \$38.95 JAP9918

**JAPANESE NATIONAL FLAG**  
3 x 5 foot cotton flag with cord, with a slight antique faded salmon white back ground similar to aged WW2 Japanese flags ..... \$14.95 FLAG18



**JAPANESE TYPE 99 PACIFIC RUBBERIZED CANVAS SLING** SLNG093 \$19.00  
**JAPANESE NAMBU TYPE 14 HOLSTER**  
Clam shell holster as used by Japanese forces in WWII. Very well made hard shell flap and tab with brass hardware..... \$40.00 HOL001



**SKS RIFLE PARTS & ACCESSORIES**

**SKS PHENOLIC STOCK W/ FOREND**  
China's military machine under Mao, ramped up production of Phenolic or synthetic stocks during the late 60s when it became clear that the tensions along the Sino Soviet border were intensifying toward 'all-out war'. Wood was too precious to strip for the manufacture of millions of Chinese SKS rifles so synthetics were applied to AKs and SKSs alike. Good stocks are getting hard to find. We have a few dozen original SKS stocks w/forend. Some minor color blemishes, but overall very good..... \$99.95 SKS100

**SKS CHINESE STOCK & HANDGUARD**  
used with metal handguard. Good condition \$99.95 SKS090  
Stock is cut for the Chinese spike bayonet.

**SKS/ AK 'C' TYPE SIGHT TOOL**  
The original un-breakable carbon steel "C" tool. The "C" tool enables elevation and windage adjustments to the front sights of AKM, SKS, Galil, and similar semi-automatic rifles ..... \$9.95.  
3 for ..... \$24.95 SKS041

**SKS Chinese bayonet blade stock** ..... \$98.00 SKS092  
**SKS Chinese Stock** with handguard - with bayonet slot filled ..... \$99.95 SKS094

- SKS043 Accessory kit..... \$9.95
- SKS011 Bolt new..... \$45.00
- SKS093 Buttplate..... \$10.00
- SKS072 Buttplate/rear swivel screw..... \$2.00
- SKS038 Buttplate trapdoor assembly, new..... \$5.00
- SKS056 Buttstock anti rattle spring..... \$3.00
- CLN095 Cleaning jag..... \$2.50
- CLN092 Cleaning rod..... \$12.00
- SKS013 Firing pin, new..... \$15.00
- SKS042 Front sight tool, "T" type..... \$3.95
- SKS048 Gas port cleaning tool..... \$2.95
- SKS007 Hold open latch..... \$8.00
- OIL032 Oil bottle..... \$3.00
- SKS002 Piston extension..... \$20.00
- SKS003 Piston return spring, new..... \$5.00
- SKS035 Rear sight button, new..... \$4.00

**JAPANESE ARISAKA**

**JAPANESE RISING SUN FLAG**  
Cotton 3'x5' flag with loop on top and cord on bottom like the original WW2 flags. Originally adopted by the Army, but later dominated for use by the Japanese Navy..... \$18.00 FLAG12



**JAPANESE TYPE 100 & ARISAKA PARATROOPER BAYONET**  
BAYONET & SCABBARD for the WW2 Japanese Paratroop rifles, Type 100 SMG, and Type 99/38 rifles \$75.00 BAY279

**JAPANESE WW2 TROPICAL ARMY HAT**  
Available in 4 sizes:  
7-1/4",  
7-1/2",  
7-5/8",  
7-3/4"  
\$19.95 HAT07 **NEW!**



**JAPANESE INFANTRYMAN'S OIL BOTTLE**  
Steel oil bottle with brass top as issued to infantry in order to keep their rifle operational. New ..... \$16.95 JAP9916

**WW2 JAPANESE ARMY HELMET W/ NET**  
Steel helmet complete with suspension, chin strap, and helmet net as used by Japanese forces during WW2. Excellent quality and perhaps even better than the original. New made..... \$54.95 HLM038

**JAPANESE WW2 PARATROOPER BANDOLIER** NEW!  
Japanese Khaki bandolier (only) \$27.95 MISC676  
Japanese Khaki bandolier with 17 Brass stripper clips \$39.95 MISC685

**U.S. GUANTANAMO BAY MINE FIELD SIGN**  
These metal signs are imprinted with both Spanish and English warnings. See our website for details! ..... \$8.00 MISC338

- SKS036 Rear sight leaf spring, new..... \$4.00
- SKS055 Rear sight leaf w/slide..... \$25.00
- SKS033 Rear sight leaf, new..... \$15.00
- SKS034 Rear sight slide, new..... \$6.00
- SKS071 Rear swivel..... \$8.00
- SKS041 Sight tool, "C" type..... \$9.95
- SLNG041 Sling, exc..... \$6.95
- STC024 Stripper clips ..... 3/\$4.50

**AK RIFLE PARTS & ACCESSORIES** 13

**JUST IN!! LEATHER AK47 / VZ58 MAGAZINE POUCH**  
Original Military leather magazine pouch holds 4 AK47 or VZ58 magazines. Belt loops on back. Good for similar sized magazines like Galil, 40rd. AR15 etc. Used, exc..... \$12.95 VZ5802



**JUST FOUND!**  
**ORIGINAL MILITARY AK FIRE CONTROL PARTS SETS**  
Consists of hammer, trigger, disconnecter..... **SALE!! \$14.95**  
3 for ..... \$39.95 AK067  
Also found - Just a few...  
**ORIGINAL AK AUTO SEARS** ..... \$14.95 AK068

5 & 10rd WASR Magazines in 5.45 x 39 cal.  
**AVAILABLE NOW!**  
See Our Website!

**REDDISH/BROWN AK-47 GRIP WITH LONG SCREW**  
Used in excellent shape. Reddish Brown Grip alone ..... \$22.95 GRP219  
Reddish Brown Grip with Screw ... \$25.00 GRP223  
Long grip Screw alone ..... \$3.00 AK080

**BLACK AK-47 GRIP W/ COMPONENTS**  
Used excellent condition original AK parts: Black Grip alone ..... \$7.00 GRP220  
Black Grip w/ screw, washer, bottom cap ..... \$16.95 GRP224  
Screw & Washer for black grip ..... \$7.00 AK081  
Bottom Cap for black AK grip ..... \$3.00 AK082

**AK47 SLINGS**  
Khaki..... \$6.95 SLNG033-TAN  
Black..... \$6.95 SLNG033-BLK

**AK 47 (AMD65 HUNGARIAN HANDGUARD)**  
Stamped steel handguard in excellent condition actually can work nicely for all sorts of AK and specialty gun projects. Strong and only 4.4 ounces! Original GI..... \$12.50 HNGD54

**STANDARD RPK M72 BIPODS**  
Just in the door, we have excellent condition Yugoslavian M72 series bipods. Perfect replacements and terrific for gun projects where a solid versatile bipod is required. M72 Bipod..... \$27.00 AK078

**RHODESIAN SELOUS SCOUT RIFLE / SHOTGUN CASE**

Heavy cotton gun bag very similar to the British rifle bag, but slightly shorter and in a mustard color. About 41" long. Large Rhodesian Selous Scout emblem stenciled on one side. These gun bags will hold some rifles, but were primarily used to hold Greener and Belgian Browning Shotguns barracks, watchtowers, Eland Armored Cars etc ..... \$15.95 MISC394

**More Parts Just in the Door...**

- AK47 Disconnecter, GI used exc..... \$7.00 AK069
- AK47 Hammer, full auto, GI used exc .... \$8.95 AK070
- AK47 Muzzle bearing, round, GI used exc ..... \$4.50 AK071
- AK47 Rate reducer assy, GI used exc .... \$5.00 AK072
- AK47 Sear spring, GI used exc..... \$4.00 AK073
- AK47 Trigger single hook, GI used exc \$9.95 AK074
- AK47 Trigger double hook, GI used exc ..... \$9.95 AK075
- AK47 Trigger Guard Assy, with catch GI used exc. .... \$20.50 AK076
- Dust Cover ..... \$10.00 AK042
- Extractor gage (orig.)..... \$19.95 AK036
- Blank Adapter ..... \$3.95 AK013
- Broken Shell Extractor for 7.62 x 39 Good for SKS & AK \$2.99 ea. 4 for ... \$10.00 BSE020
- AK 3 PRONG FLASH HIDER - M16 pattern. Looks neat on gun ..... \$8.95, 3 for..... \$25.95 AK033
- AK47 MAGAZINE LOADER FOR LOADING & UNLOADING - Double thumb depressing levers. Makes the process easier ..... \$17.99 AK048
- JUST IN! AK RIVET SETS**  
Complete set of the PROPER rivets needed to build an AK..... \$9.95 AK051
- Back In Stock! AK SEMI PARTS PACK**  
Correct parts for building an AK Semi Auto. Counts as 3 compliant parts under US Sec.922r. Made in the USA by High Standard..... \$25.95 AK052
- AK63 / AMD-65 COMPENSATOR**  
Steel flash hider/compensator for AK47 Rifles such as the AK-63, AMD-65, and similar AK47 variants with the same threaded muzzles. 2-7/8" long, 3.95 oz. weight, 14 x 1 left hand thread. Helps make the AK more controllable in automatic or fast semi firing. **SALE!** ..... \$8.95 \$19.95 MISC562

**AK STRAIGHT MAGAZINE POUCH**  
Excellent condition \$4.00 AK064

**HUNGARIAN AMD65 FOLDING BUTTSTOCK ASSEMBLY**  
Excellent condition AMD65 right side folding wire stock is exceptionally strong, low weight, and stable making it perfect for Hungarian AKs, and any project that you might have. Complete w/ trunnion assy. Very limited ..... \$57.00 AK077



# SARCO LUGER PARTS

www.sarcoinc.com

See our website for OUR Original Luger Cleaning Kit (#CLN171)

### LUGER SIDE PLATE ASSEMBLY... BACK IN STOCK!

Complete side plate with trigger lever and trigger lever pin installed! Minor fitting required  
..... **\$59.95** LGR067

**LUGER SPRING KIT** All the coil springs in a Luger - mainspring, trigger spring, firing pin spring & extractor spring.  
..... **\$9.95**, 3 for **\$26.75** LGR138

### LUGER DRESS-UP SET

Get one of our Luger holsters, a pair of new checkered wood grips, and a new magazine loading tool. All 3 pieces, a \$58.00 value. Only **\$49.95**/set LGR082

### LUGER ARTILLERY STOCK HOLSTER RIG

Exact reproduction of the Luger Artillery model leather holster rig used by German troops. Our Artillery holster rig includes the holster itself, cleaning rod, carrying strap, leather pieces to connect to a stock board, and 2 pocket magazine pouch which goes on the carry strap. We offer this set with a wood stock and without a wood stock:

1. Wood Stock with Brown Leather Artillery Holster Rig ..... **\$129.95** LGR088
2. Brown Leather Artillery Holster Rig (without stock) - includes carry strap & magazine pouch ..... **\$34.95** LGR086
3. Wood Stock with Black leather Artillery Holster Rig ..... **\$129.95** LGR175
4. Black Leather Artillery Holster Rig (without stock) - includes carry strap & magazine pouch ..... **\$44.95** LGR176

LGR170 1908 Trigger bar ..... **\$45.00**  
LGR044 ARMY LUGER WOOD BOTTOM..... **\$9.95 ea** or 5 for **\$45.00**  
LGR043 NAVY LUGER WOOD BOTTOM ..... **\$9.95 ea** or 3 for **\$27.95**  
LGR153 Breech bolt new, perfect current production ..... **\$99.50**  
May require minor fitting of rails due to variation in receivers  
LGR048 Double mag pouch, Leather ..... **\$9.95**  
LGR087 Double mag pouch w/2 wood base mags (current production)..... **\$56.50**  
LGR146 Ejector, M1900 beautiful new production ..... **\$79.50**  
LGR016 Ejector, late model, new production ..... **\$29.95**  
LGR145 Extractor, M1900 beautiful new production ..... **\$79.50**  
LGR084 Extractor, new production ..... **\$26.95**  
LGR142 Extractor, new production - a wee bit narrow but works fine. Need clean-up of the casting - dirt cheap ..... **\$10.00**  
LGR019 Extractor spring..... **\$2.00**  
LGR160 Extractor & Firing pin combo ..... **\$44.50**

LGR020 Firing Pin, beautiful & new ..... **\$19.95 ea**, 3 for **\$49.95**  
LGR022 Firing pin spring ..... **\$3.00**  
LGR023 Firing Pin Spring Guide..... **\$19.95**  
LGR159 Full Spring Kit (new) - springs for: hold open latch, extractor, locking bolt recoil, sear bar, trigger mag catch, firing..... **\$44.50**  
LGR030 Grip screw ..... **\$5.00**  
LGR040 Hold open latch spring, new May require minor fitting due to variations in frame slot length ..... **\$8.00**  
LGR156 Locking bolt spring ..... **\$12.00**  
LGR041 Locking bolt take down lever..... **\$24.95**  
LGR061 Mag catch spring ..... **\$8.00**  
LGR050 Mainspring (recoil) ..... **\$4.50**  
LGR072 Sear bar (trigger bar) spring, repro ..... **\$8.00**  
LGR149 Side Plate, Original, milled, in the white ..... **\$49.00**  
Check our websites for more Original Luger parts  
LGR066 Side plate, stripped ..... **\$36.50**  
LGR062 Thumb safety, Late Orig ..... **\$50.00**  
LGR074 Trigger lever..... **\$19.95**  
LGR073 Trigger lever pin repro..... **\$7.75**

### LUGER PUT AWAY OR SHOP KIT

Extractor, Ejector, Firing pin, Mainspring, Extractor spring, Firing pin spring, Locking bolt spring \$104.50 value - Sarco's Price **\$49.95** ~~\$69.95~~ LGR161 Stash It Now!

### ORIGINAL SWISS LUGER 9RD MAGAZINE

Fits all original Lugers ..... **\$125.00** ~~\$150.00~~ LGR538

### LUGER TOOL W/ EARLY MARKING

Just in, some Luger tools with the pre WW2 Eagle with drooping wings common on 1930s Lugers ..... **\$8.45** LGR180

### LUGER GRIPS SPECIAL!!

Just made a large purchase of beautiful checkered wood grips for the ever-popular Luger pistol. These are the nicest looking reproduction grips we've seen. Sharp checkering, nice color, and properly finished edges make this a sure-fire winner. Due to variations in frames some minor fitting may be necessary. Dress up that old import Luger today GRP118 *Special of the month* **\$19.95**, 3 for **\$49.95**

See our website for our LUGER SNAIL DRUM HOLSTER !!

### LUGER ATTACHING STOCK IRON

Sarco sells the metal part that allows you to attach a stock onto the Navy or Artillery Luger. This is newly machined and has all of the contours of the original military part. We have sold these on our own wooden stocks for years. Great for fixing a bad stock or for making your own custom fit Luger stock. Limited SALE ..... **\$44.95** ~~\$49.95~~ LGR148

### LUGER LOADING & DISASSEMBLY TOOL WITH WW2 MARKINGS

..... **\$8.45** LGR068

### NAVY LUGER STOCK

We are selling this hardwood Luger Navy Stock originally manufactured 50 years ago, sold without the attaching iron for the pistol, but with the metal data disc installed. These are the last of what we brought into Sarco in the late 1980s. Good for making your own custom luger stock with some ingenuity. May be blemishes .... **\$39.95** LGR187

### LUGER ARTILLERY SIGHT

Finally back in stock, but only a handful! Graduated leaf assy out to 800 yards. New mnfr. .... **\$150.00** LGR077

WE HAVE LUGER 'ARMY' & 'NAVY' WOOD MAGAZINE BOTTOMS - SEE OUR WEBSITE !

### BACK IN STOCK!

### FRENCH 1877 WWI CANTEN

French 2 Liter canteen was the mainstay implement for carting potable water and even wine for the French Army, from the disastrous Franco Prussian War through WWI. Unique design with air vent and carry strap and a green blue felt covering. New ..... **\$49.95** MISC889



### WANTED TO BUY!!!! STRIPPERS!

Do you have a bunch of old strippers just hanging around? Well if so, sell them to us and we will put them to good use. We will make a cash or trade offer for stripper clips in good used condition. Offers only made on quantities of 100pcs and above. Contact Dave at Ext.130 or email - mgdave@sarcoinc.com



### ORIGINAL WW2 TRAINING AIDS AND SPARE PARTS FOR THEM

Weapon Training Aids for 1919A4, BAR, Garand & M1 Carbine. Large Scale for Classroom Use.



Check our website! Contact Dave for details at Ext.223.

### Manufacturers...

Sarco has contracted thousands of reproduction line items in metal, wood, leather & canvas products from different vendors. We would be pleased to hear from new Manufacturing vendors who can offer their services. Contact Mark or Dave. Email at mdotten@sarcoinc.com or mgdave@sarcoinc.com

### U.S. WWII PARATROOPER SIGNAL CRICKET

Brass metal clapper. Puts out a distinctive clicking sound so that allied troops could communicate to "friendlies". U.S. embossed ..... **\$7.50** MISC284

### MOSIN NAGANT RIFLE

#### MOSIN NAGANT PARTS

See our website for full listing!

N91003 Firing pin spring..... **\$6.00**  
N91004 Firing pin ..... **\$19.95**  
N91080 Extractor, reproduction ..... **\$25.00**  
N91006 Bolt head..... **\$19.95**

#### ORIGINAL MOSIN M91/30 BAYONET

**\$16.95** BAY019  
MOSIN NAGANT 91/30 BAYO Exc w/ New Scabbard, excellent condition  
**\$32.00** BAY084

#### MOSIN NAGANT M91/30 & EARLY CARBINE BAYONET

Mosin short 11.5 inch  
**\$44.95** BAY261

#### MOSIN NAGANT 91 CLEANING KIT, ORIGINAL

**\$9.95** N91051

1. Takedown tool
2. Cleaning Jag
3. Cleaning Rod Handle Set
4. Muzzle Cleaning Rod Guide
5. Hold All Pouch
6. Oiling Kit, Original

#### MOSIN NAGANT SUPER CLEANING KIT

Takedown tool, Cleaning Jag, Cleaning Rod Handle Set, Muzzle Cleaning Rod Guide, Hold All Pouch, Oiler, 2 ammo pouches and 10 stripper clips..... **\$26.50** N91056

#### MOSIN DOG COLLAR 91/30 SLINGS

Original Russian **\$19.95** SLNG103



#### MOSIN NAGANT LEATHER SLING

The leather Mosin Nagant sling was used early on in the issuance of the Model 91/30 rifles **\$19.95** SLNG119



#### MOSIN DOG COLLAR 91/30 SLINGS

We have been out for six months just found a new batch. New mfr **\$12.95** SLNG018



#### JUST IN THE DOOR ORIGINAL SLINGS FOR MOSIN MODEL 38 & MODEL 44 CARBINE

We've been out for a year ..... **\$14.95** ea. 3 for ..... **\$34.95** SLNG060

#### Mosin rifle stripper clips in stock again - 3 for \$2.35, 10 for \$7.50

STC014

### MOSIN NAGANT RIFLE ACCESSORIES

1. PAIR OF RUSSIAN AMMO POUCHES, original Mosin Nagant... **\$9.95** N91045
2. CLEANING ROD HANDLE Handle for cleaning rod issued on every rifle ..... **\$4.95** CLN086
3. FINNISH M28/30 new original handguard..... **\$24.95** N91041
4. Original Dual Compartment Mosin oiler ..... **\$6.95** N91069
5. FIRING PIN PROTRUSION GAGE & Screwdriver Tool ..... **\$15.00** TOOL050

## BROWNING HI POWER

SEE OUR WEB PAGE FOR EXTENSIVE HI POWER PARTS LISTING

#### FABULOUS CURRENT PRODUCTION

FN pattern wood Hi-power Checkered grips. Just like previous FN production. Need minor fitting inside mag well ..... **\$17.50**  
3 for ..... **\$44.50** GRP174

### BROWNING HI-POWER HOLSTER

Well-made copy of the holster as used by German forces after occupation of the Browning factories. Marked with German code and Waffen marks. .... **\$24.95** HOL021

### 1936 BROWNING HI POWER HOLSTER / STOCK RIG

Leather combination of 'Sam Brown model belt' and holster to hold the 1935 Hi Power pistol and wood stock. Assembly includes leather belt (adjust between @39-46 inches), a mag pouch (hold 2 mags), cross strap, and leather holster which will hold the 1935 Hi Power pistol and the original style board stock in separate pouches. Wood stock or pistol not included. .... **\$115.00** BHP077



### FINALLY BACK IN STOCK!!!! GET YOURS NOW BEFORE THEY'RE GONE AGAIN!!!



**BROWNING HI-POWER WOOD STOCK**  
WE HAVE A FEW DOZEN COMING IN NOW! PUT YOUR ORDER IN NOW 'CAUSE THEY WON'T LAST LONG!!  
**\$145.00** BHP055  
Brand New!  
NFA Rules Apply

#### F.N. HIGH POWER 9MM MAGAZINES

Brand new magazines. New commercial quality. 13 rd., blue Ea. .... **\$17.95**, 3 for ..... **\$49.50**, RPM105 Browning Hi Power Magazine Loader..... **\$4.95** BHP072

#### HI POWER STOCK FROG

As used with the Inglis wood stock. Allows you to attach the wood stock to your belt. Canvas with metal clip just like the original ..... **\$12.95** BHP076

#### BETSY ROSS FLAG

Well made, heavy duty cotton layered with 13 embroidered Stars ..... **\$34.95** FLAG56  
(High quality.....Not cheap nylon or poly!)

#### BROWNING HI-POWER LANYARD RING & SCREW

& STUD ASSEMBLY New **\$19.95** BHP069

#### REMINGTON 760 FOREND HIGH GLOSS CHECKERED

*JUST IN!!*  
Note: Varnish is peeling on tip, otherwise it's in new condition .. **\$69.95** STK442

### FRENCH FOREIGN LEGION PARA BADGE

Metal badge, the symbol of the 2eREP French Foreign Legion Foreign Parachute Regiment. Worn by countless soldiers and adventurers in history and a familiar sight throughout Africa where Mercenaries and contract soldiers find post service opportunities. The circled winged armed 'Dextrochere' is a symbol of 'earned' fortitude in the ranks of soldiers worldwide. 1-3/4 inch diameter with retaining pin ..... **\$7.95** MISC826

### MOSIN NAGANT 91 ACCESSORY KIT \$24.95 N91052



- Contains:**
- 2 ammo pouches
  - 1 soft pouch
  - 1 sling
  - 1 oiler
  - 1 combo tool
  - 2 jags and a few assorted parts

**SARCO**  
**PISTOL AND RIFLE MAGAZINES**

**Our latest rare find!**  
**ORIGINAL SWISS LUGER MAGS!**  
 These have not existed. VG condition. Only a small lot - already half gone. Note, this is the going price for a regular original Luger magazine  
 ..... **\$125.00** LGRS38

**PPSH41/22 50 ROUND DRUM**  
 ..... **\$149.95** RM78

**LAST CHANCE TO GET .22 CALIBLER RIFLE MAGAZINES FOR YOUR PPSH !**  
**Only A Small Quantity Left !!**

**PPS-41/22 & PPS-50 30RD BANANA MAGAZINE**  
 ..... **\$39.95** RM80  
 \*\*\*PLEASE NOTE: These items are restricted in certain states and/or localities. Any order with a billing or shipping address to a state or locality with restrictions on this item will have the item removed automatically.

**BEST PRICE ANYWHERE !!!**

**GLOCK 17 - 17RD, 9MM MAGAZINE**  
 Composite magazine holding 17 rds.  
 ..... **\$11.99** RPM292

**MAS 49 & 49/56 MAGAZINE**  
 Original 10 rd. 7.5mm French issue magazine. Sold out months ago, but a got a few more back in. Get 'em while you can!  
 ..... **\$49.95** RM018

See e-sarcoinc.com for extensive magazine listings

**STAR 9MM SUPER MAGS**  
 ORIGINAL MAGS FOR STAR MODELO SUPER 9MM LARGO.  
 ..... **\$29.95** RPM132

**LORCIN .380 AUTO**  
 Had no stock for years.  
 ..... **\$22.50** RPM276

**TOKAREV 7.62x54 RIFLE MAGAZINES**  
 New Condition  
 ..... **\$49.00** MISC053

**RASHEED RIFLE MAG - ORIGINAL!**  
 Very Limited  
 ..... **\$100.00** RM40

**HUNGARIAN FEG P9R/P9RK PISTOL MAGAZINES**  
 Made for the Hungarian High Power clone P9R/P9RK pistol. New 10 rd. original replacement mags. **These magazines DO NOT fit the FEG P9M or FEG P9. These do not fit FN or Canadian Hi Powers. Check your gun—No Returns.** Sold elsewhere for \$25.00! SARCO price. **\$19.95** ea. RPM106

**G43 RIFLE MAGAZINES**  
 BACK IN STOCK!! **\$54.95** G43001

**HUNGARIAN FEG AP-MBP PISTOL MAGAZINE**  
 Original 8 rd. steel magazine in very good condition. 7.65mm. Hard to find so stock up now!  
 ..... **\$29.95** RPM315

**MAGAZINES FOR M16/AR15 USGI M261 CONVERSION KIT**  
 We've got both the U.S. Army M261 magazine in steel (right), and the rare U.S. Air Force version 'Teflon' magazine (left). Army M261 .22 Magazine ..... **\$24.95** M26120  
 Air Force .22 Magazine ..... **\$75.00** RM44

**CZ-52 PISTOL MAGAZINE**  
 Steel CZ-52, 8rd magazine for 7.62x25mm Ammunition. Original CZ mag body! Get one now before they're gone again!  
 ..... **\$22.00** CZ5202

**HAKIM RIFLE MAG - ORIGINAL !!**  
 VG condition  
 ..... **\$95.00** RM87  
 Coming in 4-6 weeks

**DESTROYER CARBINE MAGS**  
 ..... **\$7.95** ea, 10 for **\$50.00**, 25 for **\$79.50** RM004

**ASTRA 400 MAGS**  
 9mm Largo - original  
**\$24.95** 3 for **\$64.95** RPM159

**MAGAZINES FOR WINCHESTER .22 RIFLES**  
 (Current production) for model 75, 52, etc.  
**\$19.95** RM002 - found a few more

**RIFLE MAGAZINES**

ITEM NUMBER	DESCRIPTION	PRICE
RM61	#4 MK1 .202 10rd.....	\$29.95
	3/.....	\$84.95
	10/.....	\$229.95
BRNO03	BRNO .22 LR bolt action 10 shot mag. Original.....	\$39.95
RM004	Carbine Destroyer.....	\$6.95
RM64	CZ-452 Rifle 10rd Original, steel. Fits CZ-452 rifle and holds 10rds of 22LR. Also good for the Norinco JW-15 rifle. Excellent Condition.....	\$70.00
RM101	Franchi SPAS-15 mag.....	\$163.75
RM39	Joloar, Orig.....	\$60.00
RM43	KKW Mauser & MAS 45 .22 training rifle mag, Original.....	\$24.95
RM011	Lee Enfield MKIII 10 Round, Refurbished.....	\$29.95
RM012	Lee Enfield MKIII 10 Round, Early version w/follower retainer tab.....	\$42.95
RM001	.22 Hornet M4 survival rifle magazine, original.....	\$49.95
RM40	Rasheed, original.....	\$100.00
RM85	Swiss KE 7 Neuhausen LMG.....	\$9.95
RM58	VZ52 Rifle 7.62x45.....	\$64.95
RM72	VZ52 Rifle 7.62x39, 10rd Orig. Exc.....	\$75.00
VZ5801	VZ58 Rifle 7.62x39, 30rd.....	\$17.95, 4/\$70.00
RM002	Winchester M52.....	\$19.95

RPM035	CZ-Model 1936.....	\$26.00
RPM038	Mauser Model 1910.....	\$35.00
RPM037	Mauser WTP, New.....	\$28.00
RPM039	Ortgies.....	\$34.00
RPM040	Raven.....	\$21.95
RPM041	Sterling Model 300.....	\$26.00
RPM042	Unique.....	\$26.00
RPM043	Walther Model # 8.....	\$36.00
RPM044	Walther Model # 9.....	\$42.00
RPM045	Walther Model 2&5.....	\$28.00
RPM046	Webley Model 1906/1909 w/o Ejector.....	\$28.00

**.32 CALIBER**

RPM047	Astra Model 300/3000, Side Magazine Catch.....	\$26.00
RPM048	Bayard Model 1908.....	\$34.00
RPM049	Beretta Model 1919.....	\$34.00
RPM050	Beretta Model 1934.....	\$38.00
RPM051	Beretta Model 70 Puma.....	\$36.00
RPM053	Browning Model 1900.....	\$35.00
RPM054	Browning Model 1910.....	\$35.00
RPM055	Browning Model 1922.....	\$35.00
RPM263	1922 Browning German Marked.....	\$50.00
RPM056	Colt Model 1903.....	\$34.00
RPM057	CZ Model 1927.....	\$43.00
RPM058	Dreyse Model 1907.....	\$34.00
RPM059	Femaru Model 37.....	\$40.00
RPM193	French Mod 1935 A Long, 8rd. Orig.....	\$65.00
RPM170	French Mod 1935 S, 7rd, Orig.....	\$65.00
RPM060	Frommer Stop.....	\$36.00
RPM064	MAB Model D .32 ACP orig.....	\$22.95
RPM065	Mauser 1914, repro.....	\$47.00
RPM066	Mauser Model HSC.....	\$42.00
RPM067	Ortgies.....	\$36.00
RPM070	Sauer Model 38-H.....	\$46.00
RPM072	Steyr.....	\$28.00
RPM073	Walther Model #4.....	\$35.00
RPM075	Walther PP/PPKS, early flat side repro w/ finger rest.....	\$38.00
RPM076	Walther PPK.....	\$34.00
RPM078	Webley.....	\$30.00

**.38 & .357 CALIBER**

RPM079	Colt Model 1900 .38 Auto.....	\$38.00
RPM151	Colt .38 Super.....	\$29.00
RPM080	Llama .38 Super, Narrow Floorplate.....	\$30.00
RPM081	Llama Model 6 .38 Super.....	\$30.00
RPM082	Llama Model 8 .38 Super.....	\$30.00
RPM083	Star Model A .38 Super 9mm.....	\$38.00

**.380 CALIBER**

RPM084	Browning Model 1910.....	\$35.00
RPM085	Browning Model 1922.....	\$35.00
RPM088	Colt Pony (Star-Model D).....	\$38.00
RPM153	Colt Mustang.....	\$28.00
RPM089	CZ DA Model 1938.....	\$36.00
RPM090	CZ Model 1924.....	\$30.00
RPM091	Femaru P-37.....	\$40.00
RPM092	Frommer Stop.....	\$28.00
RPM093	H&K Model # 4.....	\$35.00
RPM094	Mauser HSC Reproduction.....	\$40.00

**PISTOL MAGAZINES .22 CALIBER**

RPM001	Astra Constable.....	\$44.00
RPM002	Beretta Minx S.R.....	\$38.00
RPM003	Beretta Model 948 L.R.....	\$43.00
RPM004	Bernardelli Model 60.....	\$34.00
RPM005	Bernardelli V.P. (Vest Pocket).....	\$34.00
RPM006	Browning Challenger/Nomad.....	\$45.00
RPM008	Colt Woodsman Late (Magazine Catch on Side).....	\$38.00
RPM010	Galesi.....	\$30.00
RPM011	Galesi (Vest Pocket).....	\$28.00
RPM012	Hi-Standard Duramatic L.R.....	\$38.00
RPM013	Hi-Standard H.D.....	\$36.00
RPM015	Hi-Standard H.D.M.....	\$43.00
RPM014	Hi-Standard Model B.....	\$45.00
RPM016	Hi-Standard Supermatic.....	\$38.00
RPM274	Jennings .22.....	\$22.95
RPM019	Star Model F.....	\$38.00

**.25 CALIBER**

RPM126	Astra Cub.....	\$34.00
RPM021	Astra Fire Cat, Orig.....	\$28.00
RPM023	Bauer.....	\$35.00
RPM024	Bayard.....	\$30.00
RPM025	Bayard Model 1908.....	\$30.00
RPM028	Beretta Jet Fire.....	\$32.00
RPM026	Beretta Model 1915.....	\$28.00
RPM029	Beretta Model 418.....	\$35.00
RPM030	Beretta Model 950B.....	\$34.00
RPM027	Bernardelli Flat Bottom.....	\$28.00
RPM031	Browning Baby.....	\$32.00
RPM032	Browning Model 1906.....	\$25.00
RPM291	Colt Junior .25 mag. original.....	\$34.95
RPM033	Colt Repro/Hammerless.....	\$32.00
RPM034	CZ-DUO.....	\$32.00

ITEM NUMBER	DESCRIPTION	PRICE
RPM095	Ortgies.....	\$36.00
RPM096	Remington Model 51.....	\$35.00
RPM097	Savage Model 1910/1917.....	\$36.00
RPM098	Walther PPK.....	\$32.00
RPM099	Walther PPK/S.....	\$27.00

**8MM CALIBER**  
 G43001 German G43 New MFG..... **\$54.95**

**9MM CALIBER**

RPM290	.22 TCM/9mm 17 round.....	\$32.99
RPM159	Astra Model 400.....	\$24.95
RPM101	Astra Model 600.....	\$36.00
RPM316	Beretta 92 FS, 10rd.....	\$19.95
RPM150	Beretta Brigadeer & Helwan.....	\$30.00
RPM105	Browning Hi-Power 13 Round, Blued (9mm Caliber).....	\$17.95
RPM106	Hungarian Hi-Power P9R.....	\$19.95
RPM107	Lahti Original.....	\$9.95
RPM109	Radom.....	\$45.00
RPM110	S&W Model 39.....	\$26.00
RPM111	Star BM, BKM, BKS Starfire, Starlite.....	\$36.00
RPM152	Star Firestar.....	\$30.00
RPM114	Star Model B.....	\$35.00
RPM132	Star Super 9mm Largo (9x23).....	\$29.95
RPM112	Taurus Model 92.....	\$14.95
RPM102	Glisenti repro.....	\$60.00
P38079	Walther P38 1960 'banner marked' Military mag w/Nato stock #.....	\$39.95

**40 S&W**  
 RPM317 S&W Model 4053, 8rd..... **\$24.95**

**.41 & .45 CALIBER**

C45376	1911 Black Nickel Finish (.45cal).....	\$12.50
RPM307	1911 Stainless Steel 15 rd, (.45 ACP).....	\$17.95
RPM308	1911 Blued Steel 15 rd, (.45 ACP).....	\$17.95
RPM289	1911 Double Stack 13 round (.45 caliber).....	\$24.99
RPM309	1911 Drum (.45 caliber).....	\$64.95
RPM319	1911 .45 Cal 8rd, Blued Magazine.....	\$12.99
RPM158	.45 1911 Compact Magazine.....	\$24.95
RPM269	1911 9mm 10 Round Magazine.....	\$24.95
RPM119	Ballister Molina (.45 Caliber).....	\$5.95
RPM121	Colt Model 1911 Stainless Steel 7 round (.45 Caliber).....	\$14.95
	3/.....	\$40.00
RPM303	Desert Eagle 8rds.....	\$35.00
RPM266	Norwegian Model 1914 Original (.45 caliber) Rare, w/loop.....	\$65.00
RPM118	Star Model S.S. (.45 Caliber).....	\$38.00
RPM117	Star Model PD (.45 Caliber).....	\$42.00

**RARE RIFLE STOCKS**

MSR366	1908 Brazilian Mauser long rifle stock, good cond.....	\$75.00
MSR375	1908 Brazilian Mauser long rifle stock with handguard, good cond.....	\$85.00
FN49001	FN 1949 .30-06 cal stock, good condition - will rework well (we did one) - Complete with handguard set.....	\$99.95
FN49068	FN49 .30-06 stock.....	\$135.00
FN49078	FN49 .30-06 stock & handguards reworked in our shop (this is a reworked #4).....	\$159.95
M36058A	MAS 36/51 stock set w/all metal.....	\$145.00
STK345	Mossberg144 stock, used exc.....	\$45.00
STK385	Mossberg 42B military stock.....	\$36.50
STK339	Norinco JW15 .22 bolt action clip fed rifle stock, new original.....	\$34.95
P14012	P14 Enfield stock with handguard set, original.....	\$230.00
P17044	P17, Front handguard new walnut. Also fits P14.....	\$35.00
P17045	P17, Front handguard used walnut. Also fits P14.....	\$25.00
P17061	P17, Front handguard new hardwood. Also fits P14.....	\$34.95
P17060	P17, Front handguard used hardwood. Also fits P14.....	\$20.00
P17046	P17, Rear handguard new walnut. Also fits P14.....	\$40.00
P17062	P17, Rear handguard new hardwood. Also fits P14.....	\$30.00
STK004	Remington 1934 military rifle stock, good.....	\$200.00
STK343	Remington 513T target rifle stock, used VG - low comb.....	\$34.95
STK341	Stevens 416 .22 TGT stock, VG used, orig.....	\$65.00
STK342	Stevens 416 .22 TGT stock w/buttplate, new orig.....	\$100.00
STK401	Winchester 75 TGT stock without mag release/hardware, original, used, Good - VG good, stripped.....	\$89.95
STK344	Winchester 75 TGT stock complete with mag catch, trigger guard mag guide, front swivel base, buttplate and buttplate swivel. Original - Good/VG.....	\$99.95
MSR669	Yugoslav M48 Mauser Rifle Stock, good condition.....	\$95.00

**WE OFFER A SPECIAL SELECTION OPTION FOR MOST OF OUR STOCKS FOR AN EXTRA \$10.**

**RARE SPAS-15 MAGAZINE** ONLY 5 LEFT!!  
 12 GA, 6 rounds, parkerized steel, new. Best price going.  
 ..... **\$163.75** RM101

**BRAND NEW ORIGINAL TOKAREV MILITARY PISTOL MAGAZINES**  
 Just in! SALE..... **\$9.95 \$18.00**, 3 for ..... **\$26.95 \$49.95** RPM160

**AK .22CAL LR (ORIGINAL EAST GERMAN) 15-20 ROUND MAGAZINE**  
 AK .22 cal mag extends from 15 to 20 rounds  
 SALE **\$9.95 \$15.00** AK006

**TAURUS M92 & M99 9MM MAGAZINE**  
 Super price **\$14.95 ea**, 3 for **\$42.95** RPM112

**AR15/M16 50RD DRUM**  
 New **\$79.95** AR422

**AR15/M16 100RD DRUM**  
 Front of drum is colored while the rear is clear to see remaining rounds. The package comes with a dust cover, a mag loader and a carrying case..... **\$115.00** AR383  
 Specify drum color when ordering:  
 Tan, w/black pouch  
 Green w/green pouch  
 Call for availability on Black drum w/black pouch (\$125.00) See our page 12 or our website for Hi Cap Mag restrictions

**M14 20RND MAGAZINE**  
 Newly Manufactured  
 ..... **\$16.95** RM024

**LAHTI PISTOL MAGAZINES**  
 Genuine Swedish surplus magazines for the 9mm Model 1940 Lahti Pistol. Excellent condition.  
 ..... **\$9.95 ea**. RPM107

There are many variations of the SPANISH RUBY — See our website to get the correct magazine

See our website for **PARA ORDNANCE MAGS!!**

**MAGAZINES FOR REMINGTON .22 RIFLES**  
 New, blued steel replacement magazine for the 513T series of Rem. .22 rifles and all Rem series 500 rifles 5rd..... **\$24.95** RM058

**Airguns For Sale S3000**

**AIRGUN REPAIR & SERVICE**  
Factory authorized Crosman, Benjamin and Sheridan warranty service. We also repair Daisy, Beeman and many other makes of pellet and bb guns. No firearms. Most repairs \$65-\$100. We buy used airguns and parts. In business since 2005.  
**ACCURATE AIRGUNS LLC**  
Ph: 360-656-5123  
Email: airguns@comcast.net  
Website: accurateairguns.com

**A Miscellaneous For Sale S3100**

**AMF M1 Navy Trophy Rifle. .308** Caliber. Approximately 5,000 survived. Looks unfired with box and some documents. \$13,500. Doug Oefinger 863-444-1849. No pictures.

**Colt Named Model For Sale S3280**

**Colt 1918 B.A.R.** serial number 1. Excellent condition. Original wood. No Bipod. Used as a display gun at Colt.

\$325,000. Serious inquiries only. Doug Oefinger 863-444-1849. No pictures.

**Heckler & Koch (H&K) S3780 For Sale**

**California D.O.J. HK Model 94.** Ex D.O.J. gun, refinished. \$6,500. Doug Oefinger 863-444-1849. No pictures.

**Luger Handguns For Sale S4080**

**LUGERS, P-38'S. Broom Handles,**

**Nambus, Accessories, German, Japanese, War Relics. List \$2.**  
**Hoffman, 4105 Stephanie, Branch, MI 49402. 231-462-3594, 863-291-3594.**

**Military Arms For Sale S4200**

**1903 A4 Sniper,** Overall condition excellent. "W" stamped behind the trigger, came from the National Guard in the 1960's. \$7,500. Doug Oefinger 863-444-1849. No pictures.

**www.StormWerkz.com**  
**Small Arms Upgrades**  
**Made in USA**

**GOVERNMENT 1911 A-1 .45 cal.** surplus Kraft boxes: Colt, Remington, ITHACA, US&S with wrapping paper. \$27.75 plus postage. Ray 847-854-6608.

**1903 COLT U.S.** property marked 32 and 380 cal. boxes with proper instruction sheet, paper and cleaning rod. \$39.95 plus postage. Ray 847-854-6608.

**BLUEPRINTS**  
American 180, AN-M2, Austen, Berretta, Bar, BMG 30, 50, Czech25, 383, FN-FAL, Hotchkiss, Kommando, Lanchester, Mac-10, Madsen, Mat-49 28-A1, M1A1, M3A1, M-16, M-37, M-203, MG-34, MP- 34, 38, 40, 41, Owen, PAF, PPSH-41, PPS-43, Reising, Sola, Star,

**LUGERS- HUNDREDS IN STOCK!**  
**SIMPSON LTD IS THE LARGEST LUGER DEALER**  
Find holsters, stocks, tools, magazines, books, manuals, appraisals, and more at **WWW.SIMPSONLTD.COM**  
Watch our Speaking Luger series on YouTube!

**FLECHETTE SHOTGUN AMMO**  
LONG RANGE - BORE SAFE - HIGH PERFORMANCE  
STEEL DARTS  
12 GA PATENTED SABOT HOLDS 19 NEW HEAT TREATED 8 GR FLECHETTES MV 1925 FPS 2 3/4" SHELL - CALL OR ORDER ONLINE  
12GA 10RDS 12GA 25 RDS 12GA 100RDS  
PRICE INCLUDES GROUND SHIPPING  
**SABOT DESIGNS LLC**  
541-770-6047 10AM-5PM PST  
**WWW.SABOTDESIGNS.COM**

**THE ALL NEW "HELLFIRE RANCH™" RAPID FIRE TRIGGER SYSTEM FOR "NON-ASSAULT RIFLES". (PAT PEND.)**

**INTRODUCING THE "MAGNABRACE™" ADJUSTABLE INSTANT ON/OFF OR PERMANENT PISTOL ARM BRACE. (PAT. PENDING.)**



**\$39.95** (plus S&H)

Snaps in place easily!

- Perfect for MINI-14, MINI-30, 10/22, and most Ranch Style Rifles with or without pistol grips.
- Goes ON and OFF in seconds.
- All Metal Construction.
- Allows for accurate aimed single shots, bursts, or emptying of magazines.
- Perfect for Varmints, Hog Shooting or Protection from any intrusion.
- Rapid Fire availability when you need it.
- ATF legal



**\$69.95** (plus S&H)

- Installs instantly via a super strong directional magnetic system with a 70 lb. pull strength.
- Can be permanently installed with 3m adhesive disc included that is as strong as a metal rivet.
- 3 position snap detent system for quick and positive adjustment.
- Mounts on AK pistols, Dracos, Macs, Uzi and a host of others.
- Adds accuracy and rapid fire controllability.
- Looks fabulous on the guns.
- Tough polymer metal construction with velcro arm strap.
- NFA legality card included.

**CALL (770) 249-2991 or go to ROCKINLOCK.COM or FIREQUEST.COM and watch the videos and get yours today!**

**AAO WWW.AAOMFG.COM**  
FOR MORE INFORMATION CALL US AT: (601) 514-0660

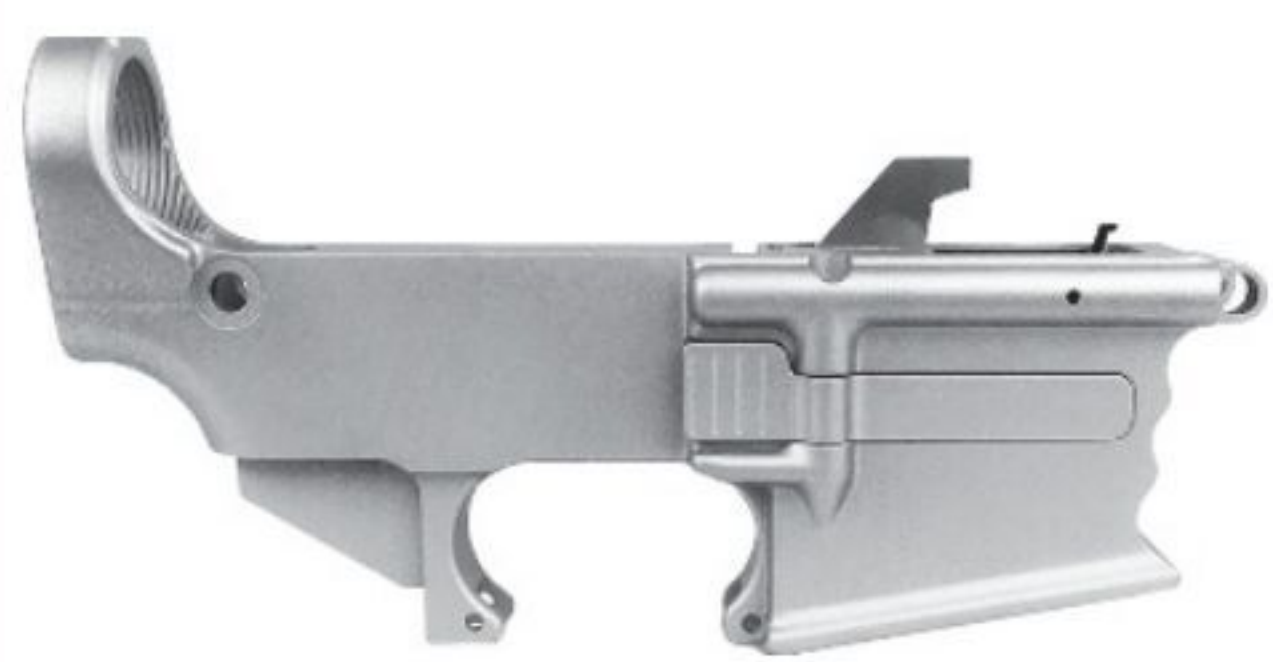

**AR9 Dedicated Glock Magazine 80% lower with Last Round Bold Hold Open \$109.99**



**80% AR15 Lowers - .223/5.56 - Mil-Spec \$40.50**



**AR9 Dedicated S&W M&P Magazine 80% lower with Last Round Bold Hold Open \$109.99**



**Mil-Spec Lower Parts Kits \$46.50**

*We are a family owned and operated business that specializes in manufacturing innovative products for the 2A lifestyle.*

Like, comment and share all the latest news!

[www.facebook.com/FirearmsNewsMag](http://www.facebook.com/FirearmsNewsMag)

Find us on



Sten II & V, Sterling, Suomi, Swedish K, UD-42, Vickers, Vigneron, Yugo 49, 56. \$15 each or 2/\$25, Complete package \$125. SIG-57, MG-42 and M-14 are \$25 each. Make payment to: C. Shilling PO Box 25932, Colo. Springs, CO 80936 wmem1a1@zandsindprecmach.com

\$11,000. Doug Oefinger 863-444-1849. No pictures.

CLASS II FULL AUTO DRILLING FIXTURES For MAK-90/AK-47 (w/ pins & bushing)--\$48.50 shipped or AR-15/M-16, M-11/9 & HK--\$33.50 shipped. All NFA Rules Apply. Order online at [www.ftfindustries.com](http://www.ftfindustries.com) or mail to:

FTF Industries, Box 68, Hildebran, NC 28637 (cert. funds, M/C or Visa).

**STEN MARK II & III BARRELS,**  
New Manufacture,  
Original Length \$45.00;  
AMD-65 extended  
muzzlebrakes AK74 style  
\$27.00, Shipping \$5.50  
each.  
**KELLER ENTERPRISES,**  
PO Box 563,

**M1 CARBINE PARTS**

Download Our FREE Catalog!!  
[www.bestcarbineparts.com](http://www.bestcarbineparts.com)

Carbine Barrels  
Stock Pouches  
Slings & Early Oilers  
Stocks & Handguards  
Type I Early Flip Sights

- \*Type I, II Dog Leg Hammers
- \*Flat & Round Bolts: \$95.00 & Up
- \*Front Bands Type I, II & III
- \*Front & Rear Sights
- \*Swivels (All Mfgs.): \$18.00 & Up
- \*Mag. Rel. Type I, II & III: \$32.00 & Up
- \*MIAI Recoil Plate Covers: \$65.00
- \*MIAI Butt Plate Springs: \$10.00
- \*MIAI Coil Springs (Pistol Grip): \$10.00
- \*Type I Band Screws: \$7.50

\*\*\* Celebrating 30+ Years\*\*\*

**L&S SUPPLY, INC.**

22211 Lofton Ave. N  
Scandia, MN 55073  
E-Mail: [lsupply@spacestar.net](mailto:lsupply@spacestar.net)  
Or call: (651)773-9972  
15 DAY 100% Satisfaction Guaranteed

**Military/Automatic Arms For Sale S4220**

**T161/M60** .308 caliber, excellent condition, C&R eligible. \$65,000. Doug Oefinger 863-444-1849. No pictures.

**MP40** Good numbers matching with matching magazine painted black and appears to have never been blued. \$18,000. Doug Oefinger 863-444-1849. No pictures.

**AKM Underfolder Conversion Gun.** \$25,000. Serious inquiries only. Doug Oefinger 863-444-1849. No pictures.

**Aircraft Lewis Gun** Reg. Live but welded together, blued, no magazine.

*CROSSCUT SAW COMPANY*



THE FINEST IN PEOPLE POWERED GOODS  
P.O. Box 7872, Seneca Falls, N.Y. 13148  
315-568-5755

[www.crosscutsaw.com](http://www.crosscutsaw.com)  
Quality Saws, Knives, and  
Hard-to-Find Tools.  
Catalog \$1 U.S. (\$3 Foreign)

**Handi-Racker.com**  
The Safest Way to Rack Your Pistols



Load and unload  
Clear Jams  
Aids in disassembly  
Aids in assembly

patent #9,194,636

Dealer Inquiries Welcome  
(515) 480-4905

MSRP was \$29.99  
NOW only \$24.99



**IRON PRESS™**

Representing the next evolution in single stage press technology, the Lock-N-Load® Iron Press™ is built to be the heaviest, most rigid press in its class. Tight tolerances in manufacture and assembly combine to provide consistency and precision that will deliver match accurate ammunition, round-after-round, year-after-year.

**AUTOMATIC PRIMING SYSTEM**

The gravity fed Automatic Priming System (sold separately or with the Kit) helps increase reloading efficiency by allowing more processes to happen simultaneously.



**ACCESSORY DECK**

Provides quick access to trays for bullets or cases, and storage for chamfer and deburr tools, case neck brushes, primer pocket cleaners and more.



**PATENTED SHELL HOLDER PLATFORM**

Allows users to deprime, pause and remove the case to chamfer and deburr, then easily replace the case to prime.



**LOCK-N-LOAD® BUSHING SYSTEM**

Incorporating our patented Lock-N-Load® bushing system, change overs are lightning fast.



**SUPERIOR STRENGTH**

Industry leading strength and further ease of use comes from the spring assist 1-1/8" solid steel ram and ambidextrous handle.



*Pictured with accessories from the Iron Press Kit. Dies and cartridge components sold separately.*



**Hornady®**

800.338.3220 | HORNADY.COM

Military/Automatic Arms For Sale S4220

Safety Harbor, FL 34695. 727-726-2500. www.stenparts.com

.50 BMG UPPERS,

.50 BMG RIFLES www.SHTF50.com

STEN MARK II, III, & V spring kits \$20, \$5 shipping KELLER ENTERPRISE

PO BOX 563 Safety Harbor, FL 34695. 727-726-2500 www.stenparts.com

STEN MkII \$30, STEN MkIII \$35, Sterling \$35, Yugo 56 \$45; Receiver Tubes w/bonded templates made from

4130 Tubing. Correct OD/ID Shipping extra. Keller Enterprises, PO Box 563, Safety Harbor, FL 34695. 727-726-2500. www.stenparts.com

Keller Enterprises, PO Box 563, Safety Harbor, FL 34695. 727-726-2500 www.stenparts.com

WWII Sten MKIII parts set, demilled, ORIGINAL barrel, \$250 shipped. leetoolandmachine.com

DEPOT LEVEL Maintenance on your U.S. Military Machine Guns. Most M16, M60 and .50 cal. parts in stock. We can put your M18 or M20 recoilless rifle back together. Sub-cal units available. M60 Mil Spec Channels Parked \$150. Gunsmith 203-605-4578.

Remington Rifles Wanted S4441

Buying Remington No. 1 Rolling Blocks & Hepburns in Long Range Creedmoors, Mid-Range, Short-Range and Schuetzen Target Models. 509-826-5512, randyman@ncidata.com

R Miscellaneous For Sale S4560

M55 Reising. Came from H&R in the 1980's. No metal on the wood stock. \$12,000. Doug Oefinger 863-444-1849. No pictures.

Accessories For Sale S5200

AMMO, Antique/Obsolete, in original boxes. Most American sporting calibers including obsolete rimfires. NO lists, reloads, military/foreign. Ray Giles, RTG Sporting Collectibles LLC, 214-361-6577 www.rtgammo.com

GUNS FOR MOVIES OR FUN! PISTOLS • RIFLES • MACHINE GUNS DERRINGERS • ROCKET LAUNCHERS

Advertisement for movie guns featuring a clapperboard and a grid of firearms with prices: M1 CARBINE \$79.95, M92 \$39.95, M4 CARBINE \$49.95, MAC11 \$39.95, SIG 552 MACHINE GUN \$49.95, DESERT EAGLE \$39.95, MP5 SD3 W/ SILENCER \$49.95, SIG 226 \$39.95, GERMAN MP40 SUBMACHINEGUN \$49.95, UZI PISTOL \$39.95, US .45 AUTOMATIC \$39.95. Includes text: 'We have been selling guns to the movie industry for 25 years and have just about anything...' and 'No FFL required.'

INTRODUCING SECRET SERVICE DARK WEB PHONE!

- No monthly fees. Free Calls and Texts
• Untraceable and can't be tracked.
• Automatically deletes searches and clears footprints.
• Dark Web access where anything is possible.
• Changeable email and phone numbers.
• Built in Secret Camera/Microphone
• Complete with charger

Image of a smartphone with a starburst graphic saying '85% more internet!' and text 'Only \$89.95 plus S&H'.

ONLY AVAILABLE FROM HYPERGAT.NET

CZ24 REPLACEMENT Receiver Tube Section w/template. 4130 tubing with correct OD & ID \$45.00 Shipping \$5.50

AMG INTERNATIONAL ARMORY (All Military Gunsmithing) Military Gunsmith 35 yrs. Experience Former NATO Defense Contractor Kit Building / Rebuild / Repair / Refinish • FN-FAL • FN-49 • M-1 • Garand • M-1 Carbine • British Enfields • M-1A • AR-15 • 98's • O3's • All U.S. and Foreign Rifles & Pistols Repaired and much more! Full Mil-Spec Finishes Including: Parkerizing, Manganese Phosphate, Polymer, Teflon, Porcelainized Enamel and Bluing. Premium AK Builds and Other Custom Builds Available! GUY SNELEN • email: guyamg@centurytel.net Phone: 417.754.1097 • M-F 9AM-4PM CST

FIREARMS NEWS JANUARY 2021 | ISSUE 1. SMITH & WESSON'S NEW OPTICS READY M&P9 COMPACT PISTOL. AERO PRECISION'S M4E1 ATLAS S-ONE AR-15 PISTOL UPPER. THE DIABLO DOUBLE-BARRELED 12-GAUGE BLACK POWDER PISTOL. WEBLEY AND SCOTT SELF-LOADING PISTOLS. 'MAD MIKE' HOARE - MERCENARY EXTRAORDINAIRE, PART I. SMALL ARMS OF THE CONGO CRISIS (1960-1965).

Save money with the #1 source of firearms! FIREARMS NEWS Firearms & Accessories SUPERSTORE!

FIREARMS NEWS is loaded with exciting bargains on rifles, shotguns, revolvers, and pistols. Save on all kinds, makes, models, manufacturers, and vintages. Plus discover your best buys on ammo, optics, gun parts, and many more accessories, supplies, & services.

Three magazine covers: 'BACK IN THE 'NAM SPECIAL ISSUE' featuring the Brownells BRN-601; 'FIREARMS NEWS RONIN' featuring the Royal Tiger Imports G-91 Carbine; 'RETRO GUNS SPECIAL ISSUE!' featuring the Ruger Mini-14 Folder.

SUBSCRIBE TODAY (Digital access now included with your paid subscription) www.mymagnow.com/p or call 1-800-345-6923 VISA/MASTERCARD/AMEX/DISCOVER



**Antiques S5270**

**SARCO, INC. -MIG 21 jet fighter cockpit section from the DDR (East German) Air Force.** We have only one single-seater. ATF will not allow the import of military aircraft, so this is the end. Ours was saved from the smelter at the last possible minute. The single-seater will be missing the stick and maybe some instruments. The cockpit was cut out of existing planes that were phased out of service. **Single cockpit MIG - \$9000.00 MMP011.**

Please call us at (610) 250-3960 to order this item. These are oversized items. Cockpit shipped via truck at our 55% discount. See pictures of the actual unit

and read more by visiting our website [www.E-Sarcoinc.com](http://www.E-Sarcoinc.com).

**Barrels For Sale S5280**

**CORSON'S BARRELS** 1000 New, Used, and Obsolete Shotgun Barrels. Buy, Sell, Trade. 928-718-4282 Arizona. [dccorson@citilink.net](mailto:dccorson@citilink.net), [www.corsonsbarels.com](http://www.corsonsbarels.com)

**Granpa's Gun Parts**  
US Springfield Parts  
Krag, 1903, Trapdoors,  
Muskets & More!  
[www.granpasgunparts.com](http://www.granpasgunparts.com)



**Browning X-Bolt**

**S&K SCOPE MOUNTS LLC**

Offering a *HUGE* line of Skulptured bases for Remingtons, Winchester, Brownings, Kimbers, and more!

Don't forget our ex-military mounts!!

Ph: 800-578-9862

Email: [comments@scopemounts.com](mailto:comments@scopemounts.com)

[www.scopemounts.com](http://www.scopemounts.com)



**1917 ENFIELD P14 or P17**



**NOW IMPROVED FOR 2021**

**HYPERGAT TRIGGER SYSTEM**

Fits most all Rifles and Pistols .22 to .50cal

**WWW.HYPERGAT.NET**

Mounts easily- Does not obstruct trigger-600 to 1000 rpm  
"Fully auto type Fire" - ATF Legal

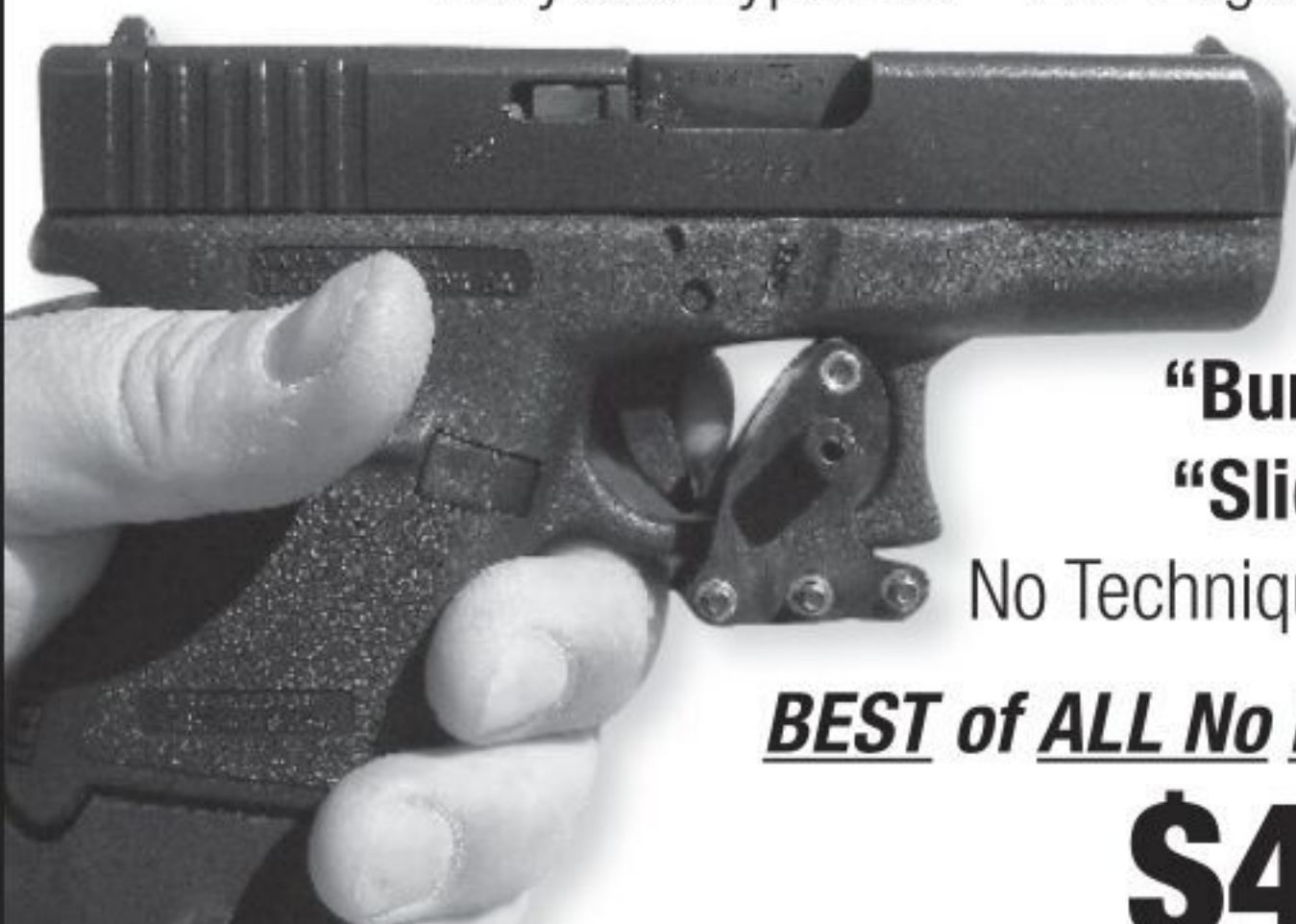

**NO**  
"Bump-Firing"  
"Slide-Firing"  
No Technique required!

**BEST of ALL No High Price!!**

**\$49.95**

"FORCE MULTIPLYER" Complete with the "Hypergat" Trigger System.

See our AMAZING videos on our website!

**THIS IS THE EASIEST BEST RAPID FIRE TRIGGER SYSTEM IN THE WORLD!**

Go to our website or Call 970-417-4860 and get yours today!!

**HYPERGAT.NET or FIREQUEST.COM**

**RUBEN MENDIOLA**  
**DEALERNFA, INC. SINCE 1985**

PO Box 566300, Miami, FL 33256-6300, 305-271-3436

**TOLL FREE: 866-NFA-WANT (866-632-9268), FAX: 866-415-7066,**  
**CELL: 786-256-6746 for pics or text, EMAIL: [Ruben@dealernfa.com](mailto:Ruben@dealernfa.com),**  
**HOURS: 8am-9pm Eastern, 7 days a week**

**100s OF MACHINE GUNS ON SALE!!**

Colt M16, M16A1, M16A2, 614, AR15 conversions, DIAS, Auto Links, all types and configurations. HK MP5, MP5K-PDW, HK33, G3, HK51, HK21, Sear, Double Push Pin & Registered Receiver Guns. HK Registered Machine Guns Sear.

Thompsons, Colt 21 & 28, WWII Savage & Bridgeport M1 & M1928 & Commercial Guns, Reising, M2 Carbines, M3 Grease Guns, FNC, Ruger 556, AK47, MP40, MP44, Stens MKII, S&W 76, MK760, M10 45ACP & 9mm, M11 9mm & .380.

Maremont and Rock Island M60 & M60E6. Belt Fed 1919A4, 1917A1, Browning M2HB .50 Cal, FightLite MCR060 Belt Fed Uppers for AR15 or M16 Platforms.

**Extremely Rare Museum Quality Very Early Presentation Colt 1918 BAR**

Pre-May Sales Samples Available only to Dealers.

HK MP5, MP5K, HK33, HK53, Steyr AUGs, FN FAL, BAR, UZI Full Size & Mini, M3 Grease Guns, Thompson, Walther MPK & MPL, Beretta 93R LNIB & SC70, Restricted Post Sample: Glock 18

We are Always in the Market to Purchase Quality Machine Guns. We will never sell guns until they have been received and inspected. My staff and I welcome prospective clients to come and inspect the firearms they are interested in purchasing in our state of the art, high security facility. We are dedicated, full time dealers with a full-time staff. Every item we offer for sale is in stock and owned by us. We are not brokers, or a consignment store. We send every HK conversion to Terry Dyer for inspection and upgrade.

*Please visit our website for the full list of inventory specials.*



**WE PROVIDE THE BEST QUALITY GUNS ON THE MARKET.**

**A Dealer You Can Trust!**



**www.dealernfa.com**  
**ALWAYS PAYING TOP DOLLAR!**

**Clips & Magazines For Sale S5380**

**VEPR & SAIGA**  
METAL MAGAZINES U.S. Made.  
Also, AK floor plates. See us at:  
CSSPECS.COM  
or Call 386-490-1102

forty years experience with CDM shotguns. We have 10,000 parts plus 12 other firearms manufacturers. B&C Gunsmithing, Call Monday-Thursday, 12 noon - 4pm, 928-733-8350.

**ORIGINAL PRECISION**  
MANUFACTURER OF  
**LOCK DELETE**  
FOR S&W REVOLVERS  
**UNIVERSAL MOONCLIP**  
**TOOL**

MOONS DEMOONS RIM OR NON RIM BRASS  
MULTI-CAL 32 THRU 460 ALL BRANDS  
**J.D. @ 480-305-3236**  
**ORIGINALPRECISION.COM**

COLT Lightning Springs. One each of the following: Trigger spring, Hand Spring, Strut Spring, Cyl stop spring, Ejector spring, \$24.50 per set plus \$5 shipping.  
Poppert's, Box 413, Glenside, PA

19038. www.PoppertsGunParts.com

GUNSMITH'S Assortment: Screws, springs, pins, 100 pieces, \$14.50 plus \$5 shipping: Poppert's, Box 413, Glenside, PA 19038.  
www.PoppertsGunParts.com

**GUN PARTS:** You name it. Professional service since 1965. General Parts List, \$5. Traders Den, 1655 Olson Dr., Cook, MN 55723. Mail order or by appointment only. 218-666-5083.

**firearmfinishinginc.com**

Firearms Refinishing. No More Rust! Parkerizing, Moly, Ceramic. Call 337-230-4815, alomar.resources@cox.net

**PMD Gunsmithing**  
**Specializing in Firearm Restoration**

Rebluing, Stock Refinishing, and Repair. Better than New!  
**www.pmdgunsmithing.com**  
Call 330-240-5960 to receive **FREE SHIPPING** both ways with your restoration project.

**Gun Parts For Sale S5500**

**B&C Gunsmithing 928-733-8350**  
Charles Daly Miroku Shotgun Repairs.  
Original Parts. Gunsmith with over

**Gun Parts Wanted S5501**

**Wanted:** 1903 A3 Smith Corona upper barrel band with screw hole & has bayonet log on it. Call Jeff 412-421-3777 or write Jeff at 6582 Beacon St, Pittsburgh, PA 15217-1843.

**Gunsmith & Dealer Services S5540**

**GUN BLUING**  
**and RESTORATION**

**MILLIONS OF GUN PARTS!!**

**WE NOW HAVE 300 MODELS ON THE WEB**

VISA-MASTER-DISCOVER  
Company Check or MO.

**BOB'S GUN SHOP**  
P.O. Box 200  
Royal, AR 71968

**FAX 501-767-2750**  
**www.gun-parts.com**  
**gunparts@hsnp.com**

**BROOMHANDLE BARREL RELINING**  
Broomhandles to 30 Mauser using the finest liners. Rust bluing available. Guaranteeing the finest job around. Established shop of 41 years. Redman's Rifling & Reboring, 189 Nichols, Omak, WA 98841. 509-826-5512. Prices & Info: [www.redmansrifling.com](http://www.redmansrifling.com)

**BARREL RELINING** in .22 RF, 25-20, 32-20, 38-40, 44-40. Installing the finest liners, manufactured by

**UNLEASH INCREDIBLE FIREPOWER**  
**WITH THE NEW HELL-FIRE GEN2™**

- Installs quickly and easily
- Looks built in and part of your rifle
- Non Bumpfire Technology
- Can be shot firmly against shoulder
- Select fire Micro Adjust knob
- Can be fired with one hand for pistols
- Adjustable rate of fire-Up to 900 rpm
- ATF legal certificate
- Can be retrofit to most anything
- Made in USA-All Metal-Patent Pending



**INSTALLS IN SECONDS !!**

**CUSTOM FIT FOR AR15'S AND AK'S. RETROFIT PKG FOR OTHERS.**

**\$59.95**  
(plus S&H)

**ALL NEW SNAP-ON VERSION ONLY \$34.95**

**ROCKINLOCK.COM ♦ FIREQUEST.COM ♦ (770) 249-2991**

**ATAC DEFENSE**

**ATACDEFENSE.COM**  
**(601) 963-0300**

**ADER 5.56 - ATAC DEFENSE ENHANCED RIFLE**

**AMBI SAFETY & AMBI MAG RELEASE WITH OVERSIZED MAG BUTTON, LARGE AMBI CHARGING HANDLE AND BOLT RELEASE, MUZZLE BRAKE, NICKEL BORON COATED C158 BOLT CARRIER GROUP, ENGAGE HAND GRIP AND MINIMALIST STOCK**

**ADER - \$1399**

**ADBR 5.56 - ATAC DEFENSE BASIC RIFLE**

**ADBR - \$1069**

**EACH ADBR IS A SUPERIOR ENTRY LEVEL RIFLE HAND FIT BY MARKSMEN THAT DEMAND ACCURACY AND RELIABILITY**

**FANATICAL BUILD QUALITY SLICK GERAKOTE FINISH**

**WE WELCOME DEALER INQUIRIES**

CONVERT YOUR

**GUNS TO CASH**

Advertise in *Firearms News* to reach customers anywhere in the country.  
Call today! 1-800-521-2885, ext. 5064

**FIREARMS NEWS**

Check us out on the internet!



**www.firearmsnews.com**

Redman's. Professional Craftsmanship  
Guaranteed. Established shop of 41  
Years.  
Redman's Rifling & Reboring,  
189 Nichols, Omak, WA 98841.  
509-826-5512.  
Prices & info www.redmansrifling.com

**\$59.95**

Remington 870-1100-1187  
Magazine Tube Detent  
Swage Kit 12 or 20 gauge

**\$32.95**

Bad@\$\$ Gunsmith Tools  
Rick's Place Gunsmith  
Made in the USA . 501-658-7347  
www.ricksplace.biz

Pratt & Whitney Sine Bar Rifling  
Machine. Call 509-429-6856.

**Gun Barrel Reboring Machine**  
(hydraulically operated), tooling &  
training. This equipment is for reboring  
an existing barrel up to a bigger size.

REAMERRENTALS.COM  
ONLINE CATALOG  
400+ Calibers Available.  
Call (800) 996-0426.

**Gunsmith & Dealer S5560  
Supplies**

Remington 742 - 7400  
Barrel Nut Wrench

**CBRPS LLC.**  
AK  
SKS  
Saiga  
Ruger  
Remington  
Mosin Nagant  
Bullpup stock kits  
www.cbrps.com

**We Have a Huge Selection  
of Old and Hard to Find  
Shooting Supplies and  
Accessories!**  
Holsters | Gun Cases  
Ammo | Reloading | Sights  
Free Digital Catalog!  
**Buffalo ARMS CO.**  
208 263-6953  
8am - 4:30pm M - F PST  
660 Vermeer Court, Ponderay, ID 83852  
www.BUFFALOARMS.COM

STACKIN' EM DEEP AND SELLIN' EM CHEAP

# CENTERFIRE SYSTEMS

 since 1992

**GIVE US A CALL! IN-HOUSE CUSTOMER SERVICE REPS 6 DAYS A WEEK!**

**Original 7.62x25MM Polish PPS43 Parts Kit**  
w (3) 35rd Mags, Mag Pouch, Sling  
**\$129.99** w Folding Stock  
**\$149.99** w Wood Stock  
KIT\_PPS43.2 KIT\_PPS43.52.2

**Original 5.56x45 NATO Austrian Steyr AUG Bullpup Rifle Parts Kit**  
KIT\_STEYRAUG  
**\$299.99**

**Cetme C Factory Parts Kit**  
.308/7.62x51 w/Mag Loader and 2 Slings  
KIT\_CETME002  
**\$199.99**

**Visit centerfiresystems.com for more kits, magazines, and firearms!**

**Compatible with GLOCK Steel-lined Polymer**  
Your Choice  
**\$15.99** EACH  
26rd 45ACP for Glock 21, 21C, 28  
MAGGLO45  
33rd 9mm for Glock 17, 18, 19, 26  
MAGGLO9  
31rd 40S&W for Glock 22, 23, 27, 31, 32, 33  
MAGGLO40

**15 OR 17rd 9mm**  
MAGGLO9\_01 or 02  
Your Choice  
**\$9.99** EACH  
13rd 45ACP  
MAGGLO45\_01  
**\$9.99** EACH  
13 OR 15rd 40S&W  
MAGGLO40\_02 or 01  
Your Choice  
**\$12.99** EACH

**Aftermarket & OEM AK-47 Mags & Drums**  
Starting as low as **\$9.99**  
20rd MAG0251  
30rd MAGAKA-KR30

**Aftermarket & OEM AR-15 Mags & Drums**  
Starting as low as **\$9.99**  
30rd MAG0301

**U.S. PALM AK30 TangoDown AK-47 7.62X39MM DuPont Polymer 30rd Magazine**  
Date Stamped May 2015  
**\$29.99**  
FACTORY NEW

**pro mag MKA1 Akdal 12GA MKA 1919 20rd Polymer Drum**  
**\$99.99**

**10rd AR-15 .410GA Polymer Magazines**  
MAG0515  
**\$17.99**  
15rd Polymer Magazines  
MAG0516  
**\$20.99**

**12GA MKA 1919 10rd Magazine**  
MAG0709  
**\$27.99**

**IMG .410 Complete Upper Receiver**  
For AR-15 with 10 RD Magazine  
ACCI317  
**\$319.99** Flip Up Sights, & Buffer

**GEAR HUNTING TARGETS HOLSTERS FIREARMS MAGAZINES AMMUNITION OPTICS PARTS ACCESSORIES EAR&EYE PRO SURPLUS**  
M-F 9-6 Sat 9-2  
800-950-1231 & **CENTERFIRESYSTEMS.COM**  
and SO. MUCH. MORE...  
PRICES & AVAILABILITY SUBJECT TO CHANGE WITHOUT NOTICE

**Gunsmith & Dealer Supplies** **\$5560**

Not cheap but a rare opportunity. 509-429-6856.

**BARREL LINERS:** 17 Mach II, 22RF, 25-20, 32-20, 38-40, 44-40. Satisfaction Guaranteed. Prices & info on website at [www.redmansrifling.com](http://www.redmansrifling.com)

**SARCO, INC. - COMMERCIAL GUN STOCK LOTS FOR SHOW SALES!** Fabulous opportunity to buy new commercial stocks & forends for brand names like Mossberg, S&W, Ithaca, Marlin, H&R, Winchester, Savage, etc. **One lot of 15 Stocks & forends with no duplicates for \$150.+Sh. (STK363).** Sell 3 pcs and your out of it! Rest is profit. Multiple lots get better price! Great for gun show and store sales. Sarco Inc. **610.250.3960** or visit [www.E-Sarcoinc.com](http://www.E-Sarcoinc.com) for a vast wealth of goodies !!

**Militaria For Sale** **\$5700**

**LUFTSCHUTZ HELMET VG \$400. POLICE BLACK HELMET DD \$1000. ARMY DD HELMET \$675. ALL HAVE GOOD LINERS. PARTY FLAG 4X8 W/TIES \$350. CALL DENNIS 732-364-5361.**

**SOVIET MILITARIA!**

Trade & Buy. Send \$3 for Catalog. **RUSSIAN STORE** 7657 Winnetka Ave, Suite #203, Winnetka, CA 91306 818-999-1257 [russianstoreinla@yahoo.com](mailto:russianstoreinla@yahoo.com)

**Indian Relics - B.C.**

\$1.00 for Color Catalog. Indian, P.O. Box 246 Independence, KY 41051

**Militaria Wanted** **\$5701**

**1917 A1 TRIPOD, COMPLETE, GOOD CONDITION. CALL DON 941-755-9308.**

**Miscellaneous For Sale** **\$5720**

**Ugly But Cheap!** Prehistoric Authentic Indian Arrow Heads. Complete Undamaged. Found Lake Ozark Missouri. 21 For \$27.50. Makes Nice Display Frame. Indian Head Cent \$3.00; Silver Eagle, \$25.00. Satisfaction Guaranteed. Richard's 126-FN Honeysuckle, Eldon, MO 65026.

**Reloading Components For Sale** **\$5800**

**BRASS**  
Once Fired Range Cleaned.  
9mm. \$50/1000  
40 S&W \$50/1000  
223/556 \$80/1000  
For Other Calibers Call Chuck. 623-341-9122. [www.bremersbrass.com](http://www.bremersbrass.com)

**RELOADERS**

All Pistol & Rifle Calibers, Inspected & Polished. 817-834-5716 [thbrassman@aol.com](mailto:thbrassman@aol.com)

**SABOTS!**

4,000 FPS out of your .30 caliber rifle? It's possible with our sabots! You can load and shoot .22 caliber bullets in any .30 caliber cartridge. Our six fluted design enables instantaneous separation of sabot from the bullet at the muzzle. Add \$5 for each order. Utah residents add 6.25% sales tax. No COD's or credit cards.

**J&D Components**  
75 East 350 North, Orem Utah 84057 [www.jdcomponents.com](http://www.jdcomponents.com)

**POWDER, BRASS-BULLETS:**

Powder: WC844 (223) Virgin surplus 159.00, 4+156.99, WC860-

69.00, 4+64.00, SALE WC872-WC867 48.00 Surplus, Unfired Primed LC 223 from ammo 500-79.99, 1000-149.99; 223 LC military 60m , 45 Auto, Tumbled 1000-89.99, 308 LC Primed Unfired Brass, from ammo, 500-140.00; See web for other Military-Commercial Brass: New and Fired **BULLETS:** 308 IMI M-80 147gr. FMJ-500-89.00, Sierra 224-77gr. Special match 500-118.00, WOLF 224 55 FMJ 1000-79.99, Hornady 224 55gr. PSP-FMJ 94.99m, Federal 223 55 FMJ m193 - 94.99m; 223 M855 62 FMJ -124.99; 223-M856 tracer, Military Surplus-99.00m; 50 API Silver Unsize 289m, Sized 339m, 50 Tracer 279.00, sized 329.00 See web for complete 50 Bullet List, plus WW-Remington-Hornady Commercial Bullets:

see web for current Prices: Brian McDonald 74880 Johnson Run Rd. Kimbolton, OH 43749 9AM-5PM, 330-833-4360 Fax No. 740-492-0063 Web: [PatsReloading.com](http://PatsReloading.com)

**SARCO, INC. - FLECHETTE DARTS:** 1 inch long military flechettes in stock. Sold in 2 oz. (#MISC288) and 1 lb. (#MISC307) packs. Original USGI. Sarco Inc., **610.250.3960.** Visit [www.E-Sarcoinc.com](http://www.E-Sarcoinc.com) for a vast wealth of goodies !!

**Reloading Equipment Wanted** **\$5821**

**RELOADING EQUIPMENT & Gun related stuff WANTED!** Attention Estates, Gun Shops, Collectors! Sell me your no longer used reloading equipment, casting, gunsmithing equipment & tools. Presses, dies, molds, Stocks, grips and Misc. parts too. I buy the items left over after others buy the guns. Gladly travel for large collections. Call Rick (330)806-4169 or email [ricketts711@sbcglobal.net](mailto:ricketts711@sbcglobal.net)

# ADVERTISE WITH US

Published for more than 65 years, *Firearms News* (formerly *Shotgun News*) is the world's largest gun sales publication.

## FIREARMS NEWS



SMALL ARMS OF THE CUBAN REVOLUTIONS, PART I

For dealers, auctioneers and private sellers, *Firearms News* —both in print and online — provides the best and most active consumers of guns and gun products anywhere.

**CONTACT US TO PLACE YOUR AD TODAY!**

**1.800.521.2885 Ext. 5064**

INTRODUCING THE ALL NEW...

# HELLFIRE STEALTH

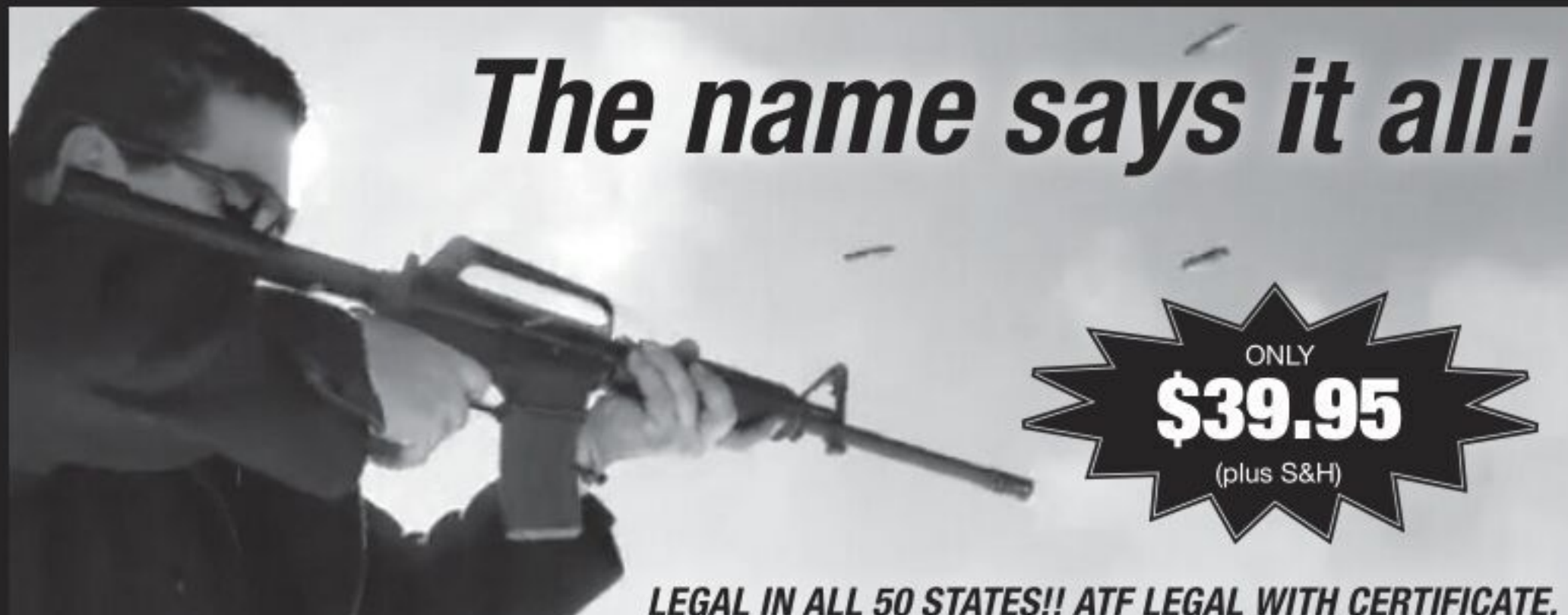

*The name says it all!*

**ONLY \$39.95** (plus S&H)

LEGAL IN ALL 50 STATES!! ATF LEGAL WITH CERTIFICATE.



You simply just squeeze the trigger.

Activate/Deactivate/Adjust with the hidden Micro knob.

This incredible new system installs invisibly within your grip on any AR15 style rifle invisibly. It can be activated or deactivated in seconds. It legally allows you to pull your guns trigger at it's highest rate legally. It installs in minutes and nobody but you will know it's there. It features a micro-adjust for activation and deactivation. It looks absolutely built in. It is revolutionarily the best rapid fire system for these new volatile times. Get them now before new laws outlawing "Fast Shooting" arrive. This may very well be the best system ever devised for AR15 platforms. It is constructed of all Steel for a lifetime of reliability. The shooter always maintains control and single function of the trigger so you can fire single, double, bursts or empty mags and it is the only system that is 100% legal for now in all 50 states!

**ONLY AT ROCKINLOCK.COM AND FIREQUEST.COM**

**Scopes, Rings & Bases For Sale** S5840

**RIFLESCOPES**  
Browse Online Catalog at  
**4scopes.com**  
Get Free Shipping!

**Surplus Gear For Sale** S5880

**SARCO, INC. - WW2 VEHICLE RADIO SETS:** SCR528 (#RAD04), SCR506 (#RAD02), & SCR508 (#RAD03) radio sets with mounting bases. Perfect for completing your military vehicle. Supplies are dwindling. Sarco Inc., Call Dave or Mark: **610.250.3960** or visit **www.E-Sarco.com** for a vast wealth of goodies !!

**SARCO, INC. - RPG-2 ROCKETS (INERT) (#RL005):** Original Vietnam era rockets with the warhead removed and replacement inert head installed. Great for completing your RPG launchers!  
Sarco Inc. **610.250.3960**  
Visit **www.E-Sarcoinc.com** for a vast wealth of goodies !!

**SARCO, INC. - FRENCH 73MM BAZOOKA:** LRAC-50 bazooka as used by the post war French in Vietnam & Algeria. Never on the market before. Comes with shield and optics, deactivated to ATF specs. Very limited!  
Sarco Inc., **610.250.3960**  
Visit **www.E-Sarcoinc.com** for a vast wealth of goodies !!

**"Government being instituted for the common benefit, protection, and security of the whole community, and not for the private interest or emolument of any one man, family or class of men; therefore, whenever the ends of government are perverted, and public liberty manifestly endangered, and all other means of redress are ineffectual, the people may, and of right ought, to reform the old, or establish a new government. The doctrine of non-resistance against arbitrary power, and oppression, is absurd, slavish, and destructive of the good and happiness of mankind."** New Hampshire Constitution of 1784.

**"A well regulated militia, being necessary to the security of a free state, the right of the people to keep and bear Arms, shall not be infringed."** The Second Amendment of the United States Constitution.

"An instance within the memory of some of this house will show us how our militia may be destroyed. Forty years ago, when the resolution of enslaving America was formed in Great Britain, the British Parliament was advised by an artful man, who was governor of Pennsylvania, to disarm the people; that it was the best and most effectual way to enslave them; but that they should not do it openly, but weaken them, and let them sink gradually, by totally disusing and neglecting the militia." George Mason at the Virginia Ratification Convention, June 14, 1788.

**"But it ought always to be held prominently in view that the safety of these States and of everything dear to a free people must depend in an eminent degree on the militia. Invasions may be made too formidable to be resisted by any land and naval force which would comport either with the principles of our Government or the circumstances of the United States to maintain. In such cases recourse must be made to the great body of the people, and in a manner to produce the best effect. It is of the highest importance, therefore, that they be so organized and trained as to be prepared for any emergency."** President James Monroe's First Inaugural Address, 1817.

No clause in the Constitution could by any rule of construction be conceived to give to congress a power to disarm the people. William Rawle, *A View of the Constitution* (1829).

**DON'T MISS OUT**

Go to **FIREARMSNEWS.COM** and click on subscribe for your print and/or digital issues.



# RUBEN MENDIOLA DEALERNFA, INC.

PO Box 566300, Miami, FL 33256-6300, 305-271-3436  
**TOLL FREE: 866-NFA-WANT (866-632-9268), FAX: 866-415-7066,**  
**CELL: 786-256-6746 for pics or text, EMAIL: Ruben@dealernfa.com**  
**HOURS: 8am-9pm Eastern, 7 days a week**

## !WANTED!

ALL TYPES OF QUALITY LEGAL MACHINE GUNS!



### NO COLLECTION TOO LARGE! GENEROUS FINDER'S FEES GLADLY PAID!

Estate and Machine Gun Appraisals!  
Before Selling Your Guns, Please Call Me To Make Sure You Are Getting The Most For Them!  
**CONSISTENTLY PROVIDING EXCELLENT AND DISCREET SERVICE & FAIRLY PRICED HIGH QUALITY MACHINE GUNS SINCE 1985!**  
Attorney Available for Trust or Estate Matters.

**\*\*WE PAY UP FRONT\*\***

100% of the Agreed Price Before You Ship Your Guns!  
You Will Never Have To Wait Until I Sell Your Guns in Order to Be Paid!  
100% Risk, Worry & Hassle Free Transactions!  
Avoid the Uncertainty of Consignment or Brokering!  
Specializing in Investment Grade Transferable Machineguns  
Specialist in Law Enforcement Purchases and Cashless Trades



**www.dealernfa.com**  
**ALWAYS PAYING TOP DOLLAR!**

# INDEX CLASSIFIEDS

## CLASSIFIED CATEGORIES

FIREARMS NEWS offers classified ads in more than 440 categories, from airguns to Winchesters. Both For Sale and Wanted categories are available. Please call (800) 521-2885, ext. 5064 for a complete list of categories if you don't see your class listed here.

FIREARMS NEWS is published by Outdoor Sportsman Group®.

Some of the common classifications are:

- Colt M1911 Semiauto Variants For Sale ..... \$3300
- Fabrique Nationale (FN) For Sale ..... \$3620
- Heckler & Koch (H&K) For Sale ..... \$3780
- Military Arms For Sale..... \$4200
- Military Arms Wanted..... \$4201
- Military/Automatic Arms For Sale..... \$4220
- Military/Automatic Arms Wanted..... \$4221
- Remington Rifles For Sale..... \$4440
- SIG Handguns For Sale..... \$4640
- Taurus Handguns For Sale..... \$4840
- Winchester Rifles For Sale ..... \$5080

### Accessories, Knives, & Gunsmithing Services

- Accessories For Sale..... \$5200
- Accessories Wanted..... \$5201
- Ammunition For Sale..... \$5220

- Ammunition Wanted..... \$5221
- Appraisal Services..... \$5260
- Archery For Sale..... \$5240
- Archery Wanted..... \$5241
- Aviation For Sale..... \$5250
- Antiques..... \$5270

#### b

- Barrels For Sale..... \$5280
- Barrels Wanted..... \$5281
- Binoculars & Spotting Scopes For Sale..... \$5300
- Binoculars & Spotting Scopes Wanted ..... \$5301
- Books & Magazines For Sale..... \$5320
- Books & Magazines Wanted..... \$5321

#### c

- Cartridge Collections For Sale ..... \$5340
- Cartridge Collections Wanted ..... \$5341
- Clips & Magazines For Sale..... \$5380
- Clips & Magazines Wanted..... \$5381
- Cowboy Action Accessories For Sale..... \$5390
- Cowboy Action Accessories Wanted..... \$5391
- Clubs & Organizations ..... \$5420

#### e

- Education & Home Study..... \$5440
- Engravers..... \$5460

#### g

- Gun Cleaning Supplies..... \$5475
- Lists, Consignments & Collections For Sale ..... \$5480
- Lists, Consignments & Collections Wanted ..... \$5481
- Gun Parts For Sale..... \$5500
- Gun Parts Wanted..... \$5501
- Gun Safes For Sale..... \$5520

- Gun Safes Wanted ..... \$5521
- Gun Shows ..... \$6150
- Gunsmith & Dealer Services ..... \$5540
- Gunsmith & Dealer Supplies ..... \$5560

#### h

- Holsters For Sale ..... \$5580
- Holsters Wanted ..... \$5581
- Hunting Guides ..... \$5600
- Hunting Supplies ..... \$5620

#### k

- Knives & Bayonets For Sale ..... \$5640
- Knives & Bayonets Wanted ..... \$5641

#### l

- Lost & Stolen..... \$5660

#### m

- Metallic Sights For Sale ..... \$5680
- Metallic Sights Wanted ..... \$5681
- Militaria For Sale ..... \$5700
- Militaria Wanted ..... \$5701
- Miscellaneous For Sale..... \$5720
- Miscellaneous Wanted ..... \$5721
- Muzzleloader Accessories For Sale..... \$5730
- Muzzleloader Accessories Wanted..... \$5731

#### p

- POR, Firearms & Miscellaneous..... \$5750
- Print, Stamps & Collectibles For Sale..... \$5760
- Print, Stamps & Collectibles Wanted..... \$5761

#### r

- Real Estate ..... \$5770
- Reloading Components For Sale ..... \$5800
- Reloading Components Wanted ..... \$5801

- Reloading Equipment For Sale ..... \$5820
- Reloading Equipment Wanted ..... \$5821

#### s

- Sales & Auctions..... \$6120
- Scopes, Rings & Bases For Sale..... \$5840
- Scopes, Rings & Bases Wanted..... \$5841
- Scopes, Laser Sights For Sale..... \$5850
- Scopes, Laser Sights Wanted ..... \$5851
- Services ..... \$5852
- Shooting Events..... \$6140
- Stocks & Grips For Sale ..... \$5860
- Stocks & Grips Wanted ..... \$5861
- Surplus Gear For Sale..... \$5880
- Surplus Gear Wanted..... \$5881
- Swords For Sale..... \$5920
- Swords Wanted ..... \$5921

#### t

- Taxidermy Services..... \$5940
- Taxidermy Supplies..... \$5960
- Targets For Sale..... \$5980
- Triggers For Sale ..... \$5990
- Triggers Wanted ..... \$5991

#### v

- Videos For Sale ..... \$6000
- Videos Wanted ..... \$6001

**There are more than 400 other categories available. Please call (800) 521-2885, ext. 5064 for a complete list.**

Category \_\_\_\_\_ PRINT ONE WORD PER SPACE - TWO WORDS FREE

1	2	3	4	5	6
7	8	9	10	11	12
13	14	15	16	17	18
19	20	21	22	23	24
25	26	27	28	FREE	FREE

Please use additional sheet of paper for larger ads.

**MAIL** completed form to: Firearms News, Dept. CL, 2 News Plaza, 3rd Floor, Peoria, IL 61614  
or **EMAIL** ad and all information below to: FirearmsNews@outdoorsg.com

### PLEASE INCLUDE FULL ADDRESS & PHONE NUMBER FOR OUR RECORDS

NAME \_\_\_\_\_

ADDRESS \_\_\_\_\_

CITY \_\_\_\_\_ STATE \_\_\_\_\_ ZIP \_\_\_\_\_

DAYTIME PHONE \_\_\_\_\_

METHOD OF PAYMENT:  Check/Money Order Enclosed  MC  VISA  AMEX  DISCOVER

CARD # \_\_\_\_\_ Exp. Date \_\_\_\_\_

SIGNATURE \_\_\_\_\_

START DATE: \_\_\_\_\_

___ X 8pt plain @ 40¢	=	_____
___ X 8pt bold @ 80¢	=	_____
___ X 10pt bold @ \$1.00	=	_____
___ X 10pt bold caps @ \$1.60	=	_____
___ X 12pt bold @ \$1.80	=	_____
___ X 12pt bold caps @ \$2.20	=	_____
	X	_____ # of issue(s)
<b>MINIMUM: \$4.00</b>	\$	_____ Total Due

Continue running until notified & charge credit card monthly

GERMAN ENGINEERING  
MEETS **HIGH CAPACITY**



Additional 9mm  
cylinder upgrade  
available

KORTH NXS/NXA  
**8SHOT**



The World's Finest  
1911 Pistols



**NIGHTHAWK**  
CUSTOM

877-268-4867  
[www.nighthawkcustom.com](http://www.nighthawkcustom.com)

# FXH-45 MOXIE

BY AMERICAN TACTICAL

**SOLD SEPARATELY: RUKX GEAR  
DOUBLE PISTOL CASE | \$29.95**  
TAN ITEM# ATICTDPCT  
BLACK ITEM# ATICTDPCB

**RUKX  
GEAR**

**SOLD SEPARATELY: DUOSIGHT | \$39.95**  
ITEM# ATIDUOSIGHT

**SOLD SEPARATELY  
PICATINNY RAIL INSERT | \$24.95**  
ITEM# ATIFXHPICRAIL



- Full Size Patented Hybrid 1911
- Single Action
- Semi Automatic
- Caliber: .45 ACP
- Black Polymer Grips
- One 8RD Magazine Included
- Removeable Top Plate Allows the Addition of Optics Mount
- Accepts Glock front and rear sights, including aftermarket night sights
- Height: 5.4"
- Length: 8.7"
- Weight: 1.95 lbs Empty w/ no Magazine



ITEM# ATIGFXH45M

**MSRP \$399.95**



AMERICAN TACTICAL

Quantities limited. Not responsible for printing errors. Sale subject to stock on hand. Prices subject to change without notice. ATI will ONLY transfer ownership of a firearm to individuals or agencies in possession of a valid Federal Firearms License (FFL). This means we cannot ship directly to you unless you are an FFL holder.

**LOCATE A DEALER  
BY GOING TO:**

**WWW.AMERICANTACTICAL.US**  
AND CLICK "FIND A DEALER NEAR YOU"  
(LOCATED AT TOP AND BOTTOM OF THE WEB PAGE)

**DEALER INQUIRIES OR  
BECOME A STOCKING DEALER**  
CALL 1.800.290.0065  
EMAIL SALES@AMERICANTACTICAL.US

**CAN'T FIND A DEALER IN YOUR AREA?  
PURCHASE THESE PRODUCTS DIRECTLY  
FROM AMERICAN TACTICAL**

**FREE SHIPPING**

WHEN YOU USE SHIPMOXIEFREE DIRECTLY AT  
AMERICANTACTICAL.US DURING CHECKOUT.  
EXPIRES 05/01/2021 (OFFER VALID IN ONLY  
THE 48 CONTIGUOUS UNITED STATES)