

BF 109 F-2 / G Model



I suggest that you print this in black and white and skip the last pages that have images instead of stencils to save your printer ink. Note that the hole for the motor mount are measured for a flight test C-Pack motor, the GT2215/09. Also, be aware that your skin stencils may vary due to build imperfections so always cut bigger than your need and trim down after gluing.

Materials:

2 Foam board sheets, 2 poster board sheets, 2 coffee stir straws, 4 bbq skewers.

BF109 F-2

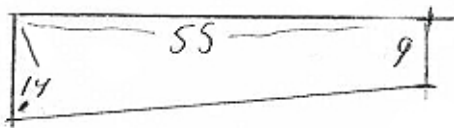
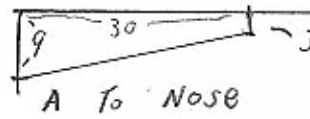
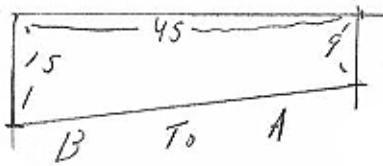
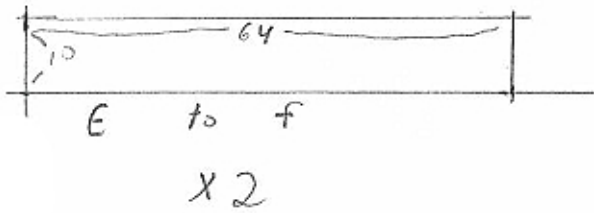
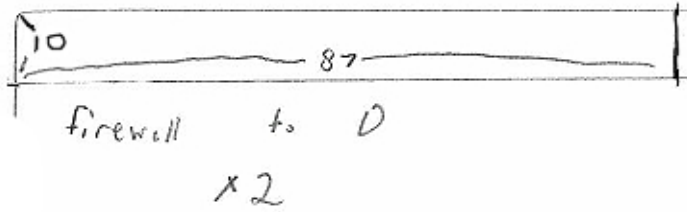

C to B

wing
angle
Tool

SPor x 2

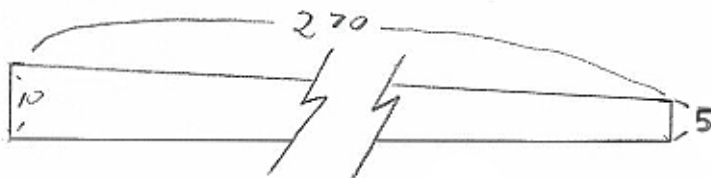

wing Tip
Stencil

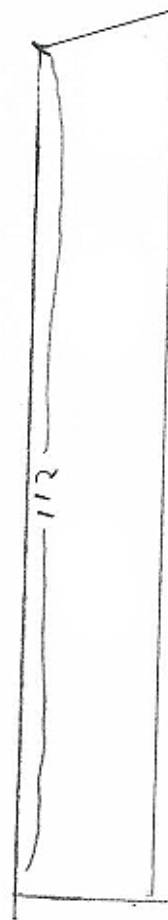

Bf 109 f-2

nose

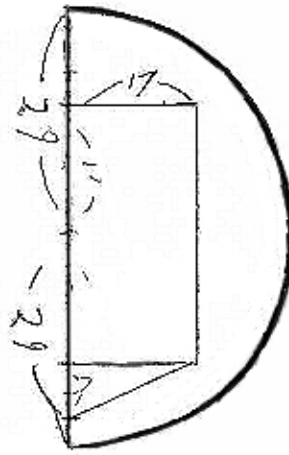

A

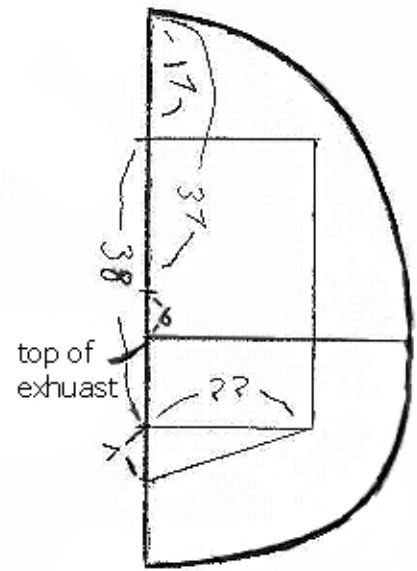

top of exhaust

f109 f-2

C ↑

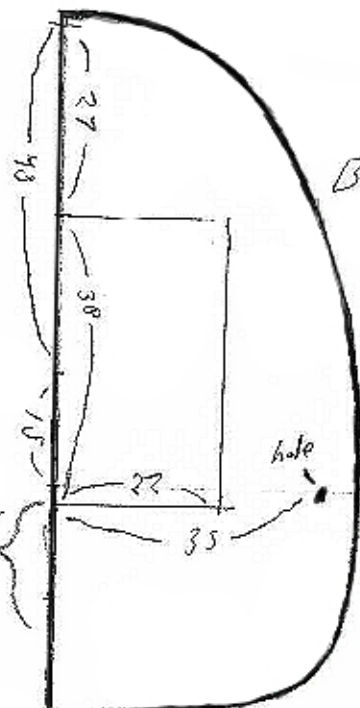

Cut here for preferred Battery

hole

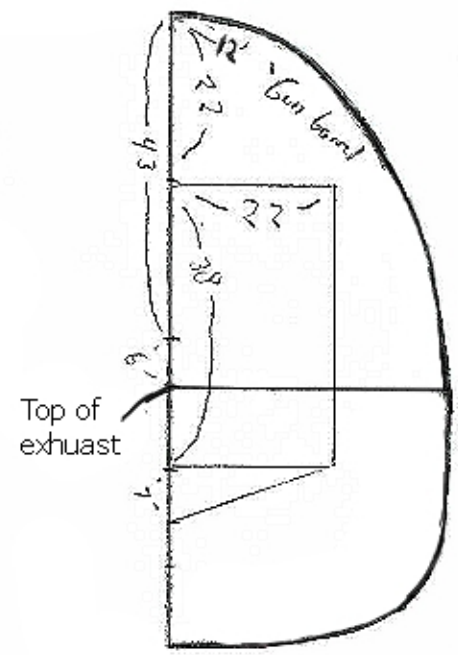

Top of exhaust

Gun barrel

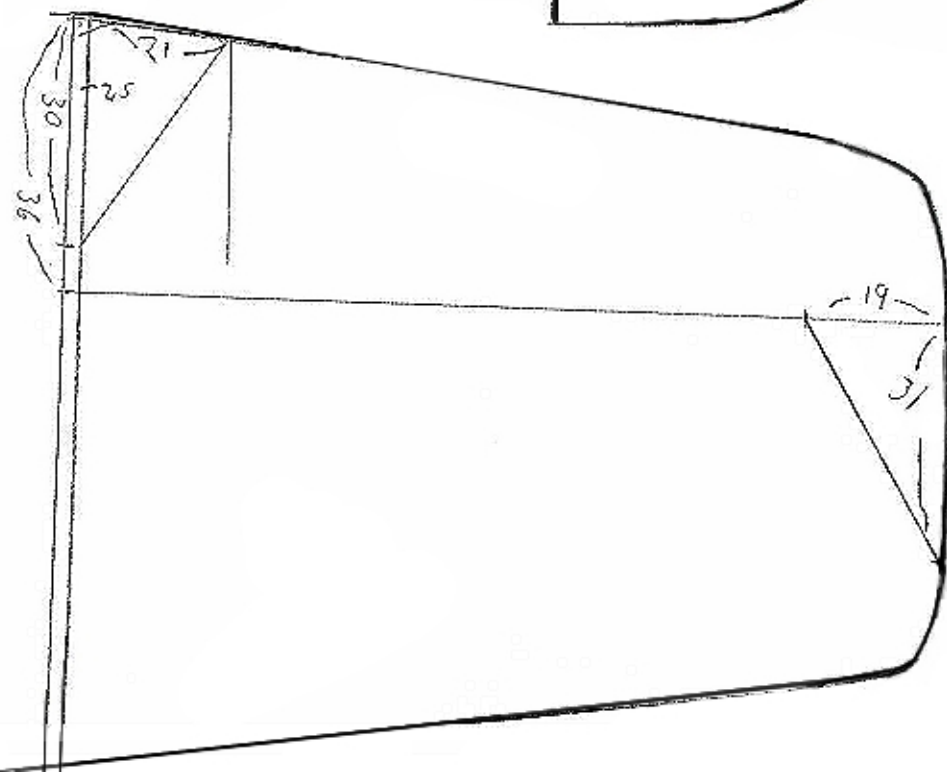

BF 109 F-2

H ↑

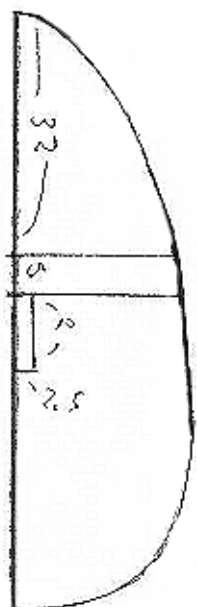

I ↑

↑

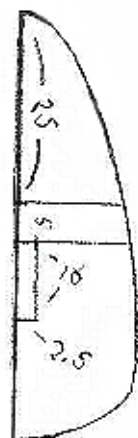

BF 109 F

BF 109 F-2

D ↑

↑

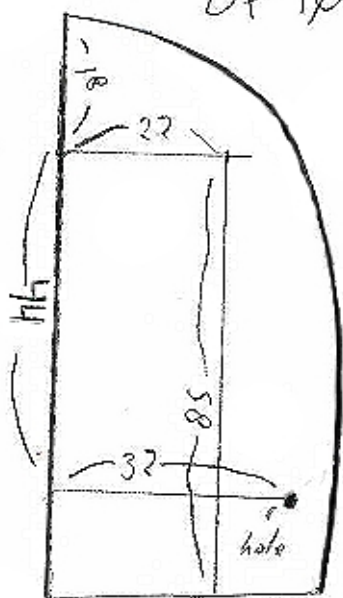

E ↑

↑

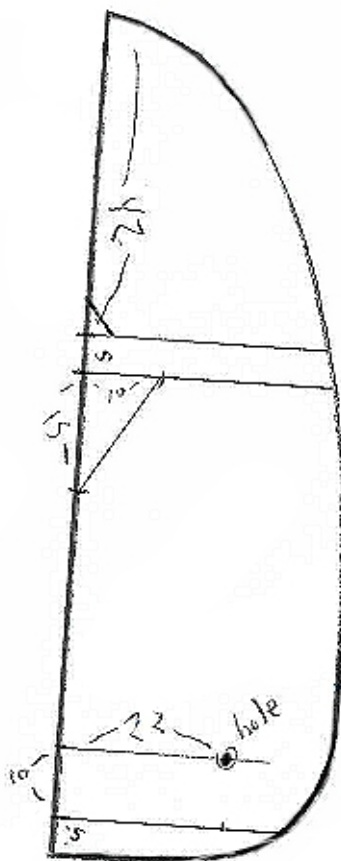

BF 109 F-2

↑

fire wall

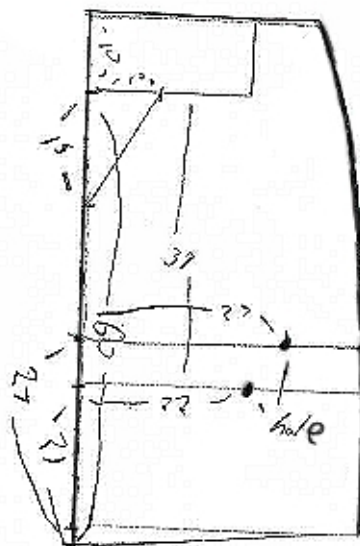

BF 109 F-2

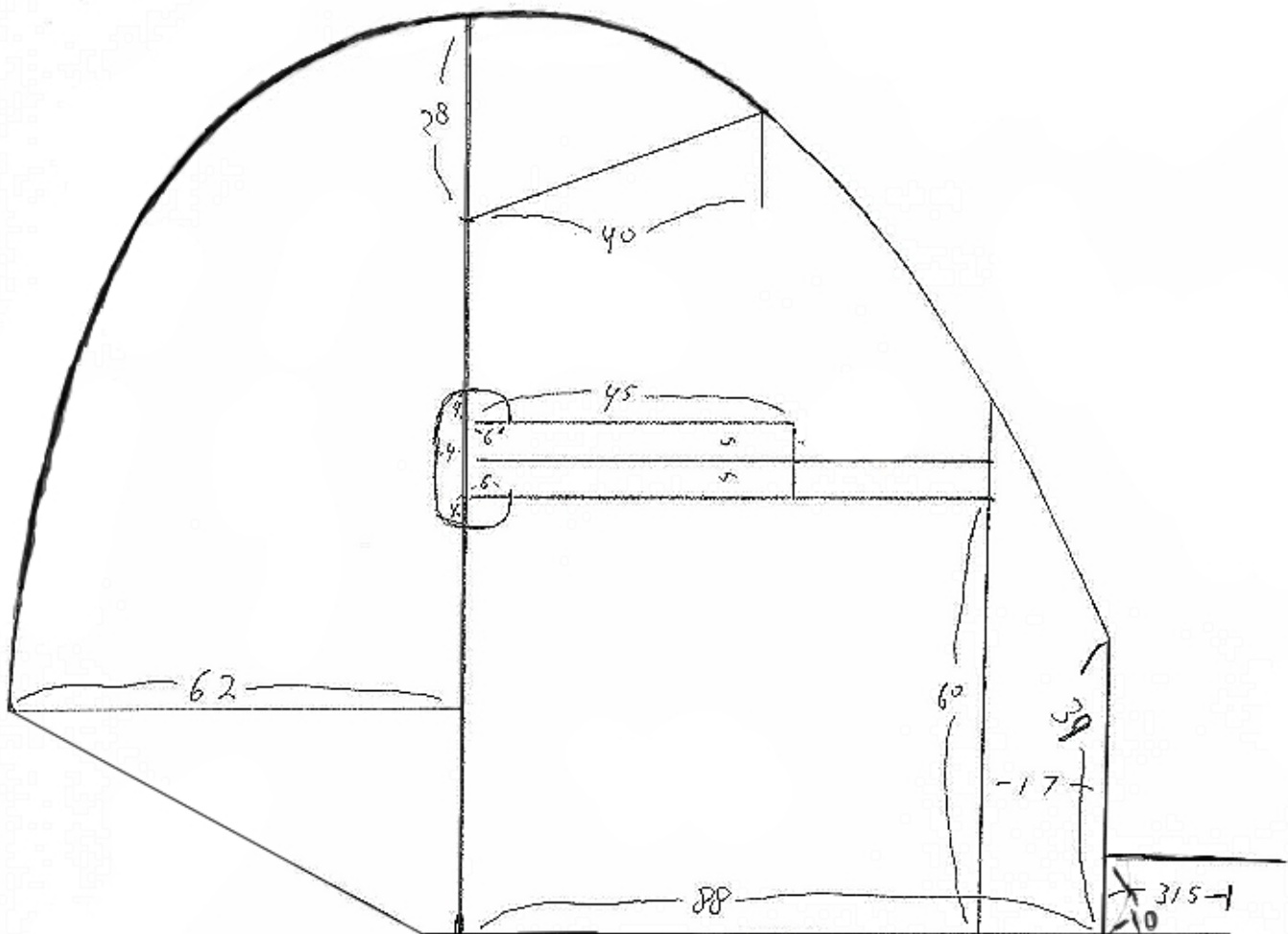
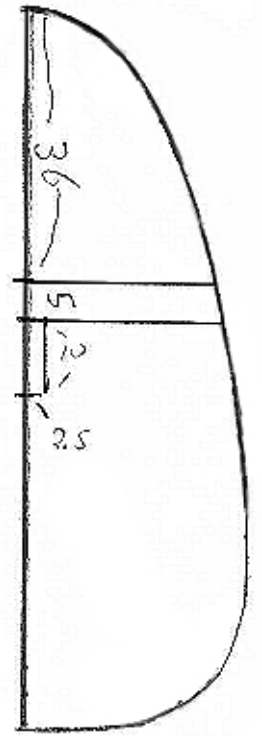
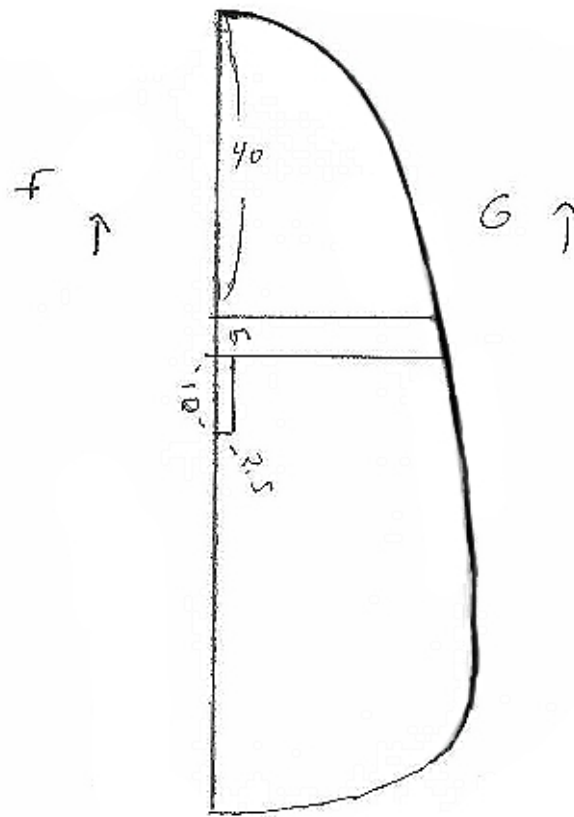

Bf 109 F-2

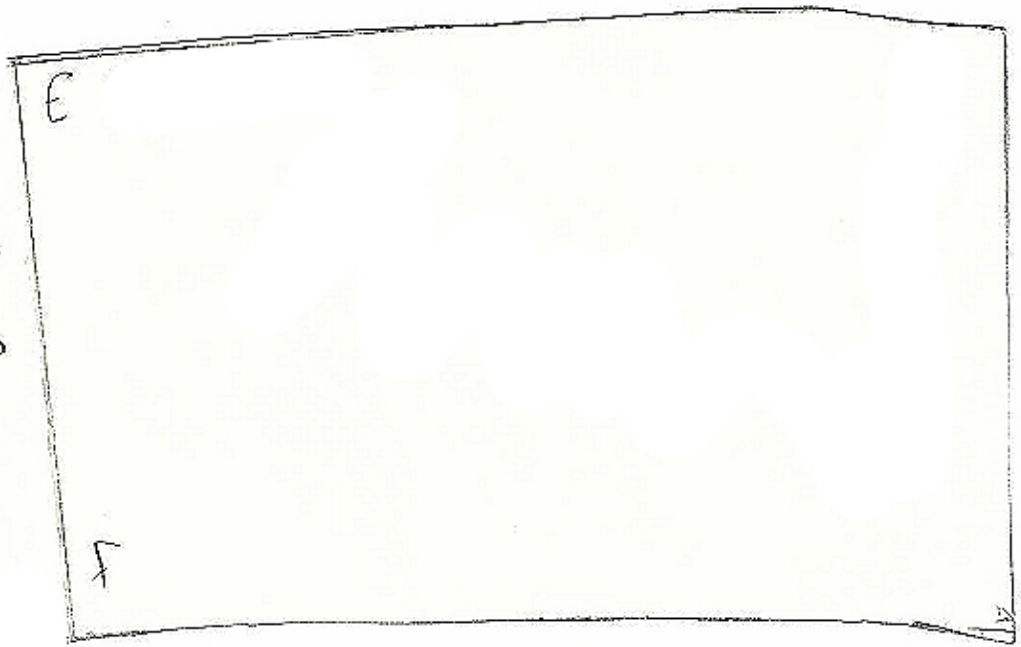

Bf 109 F-2

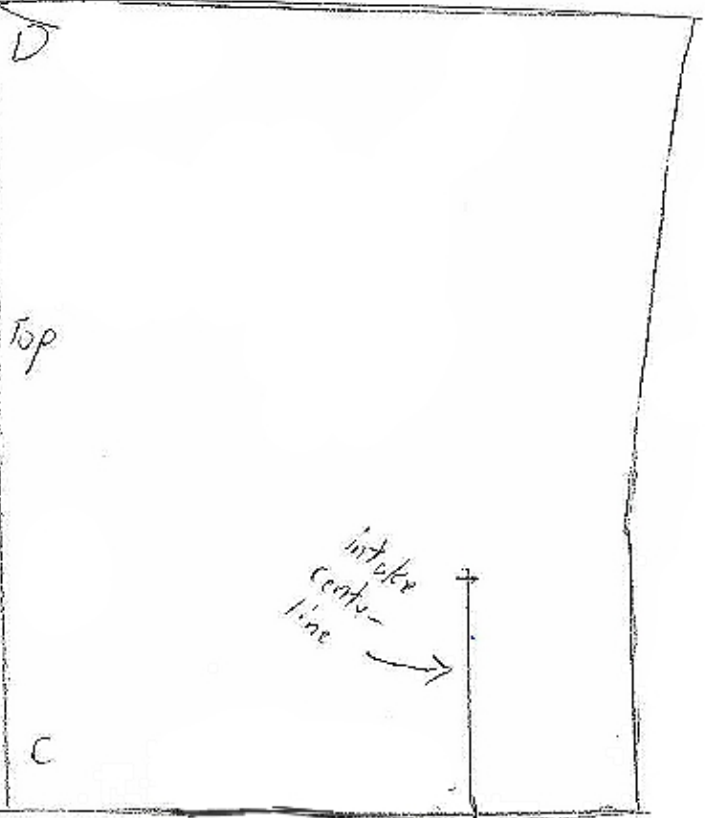

Bf 109 F-2

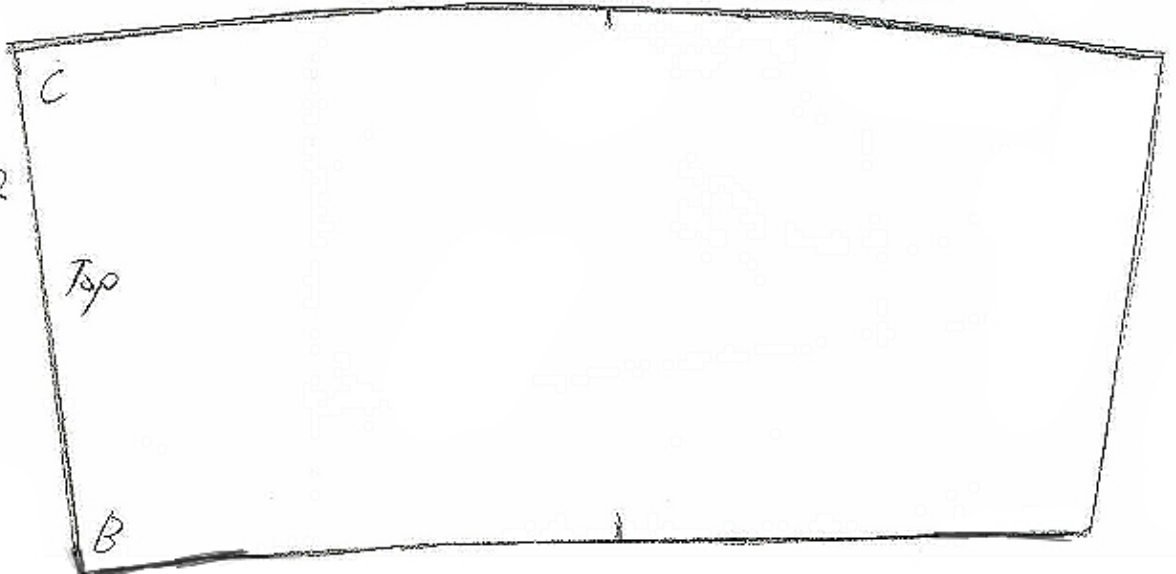

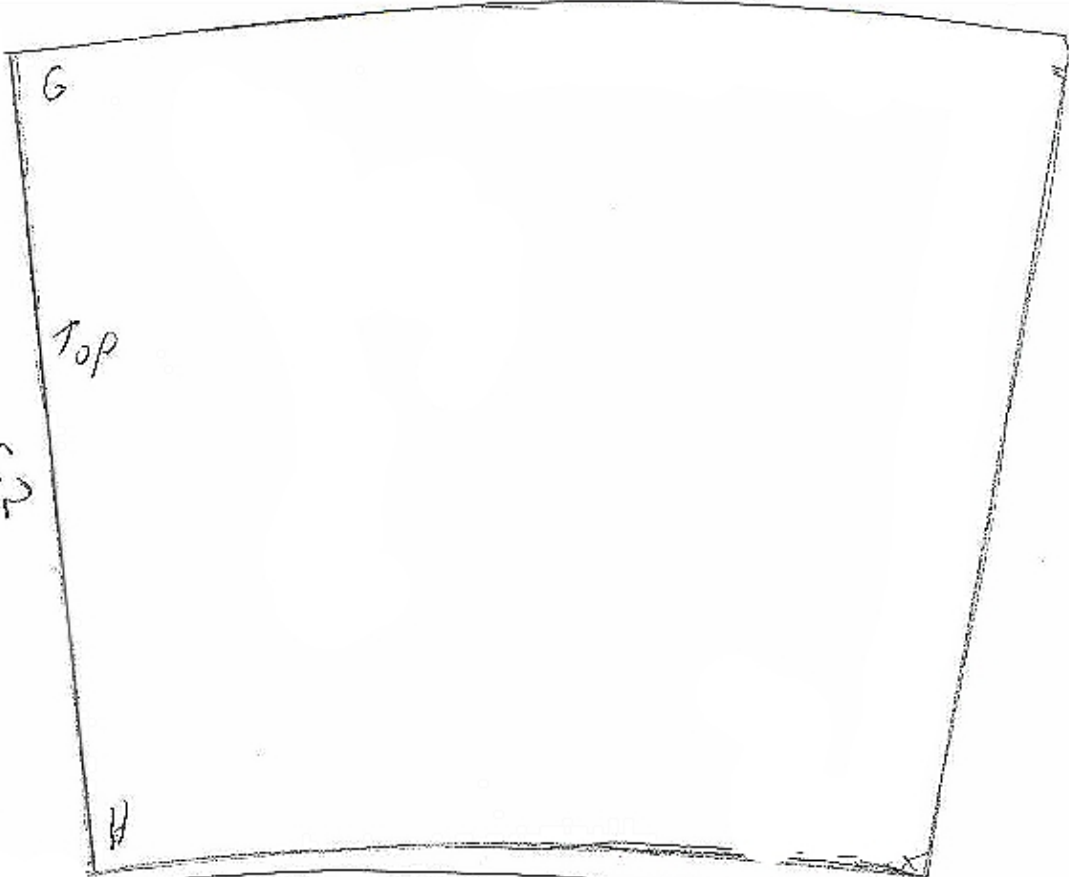

BF 109 F-2

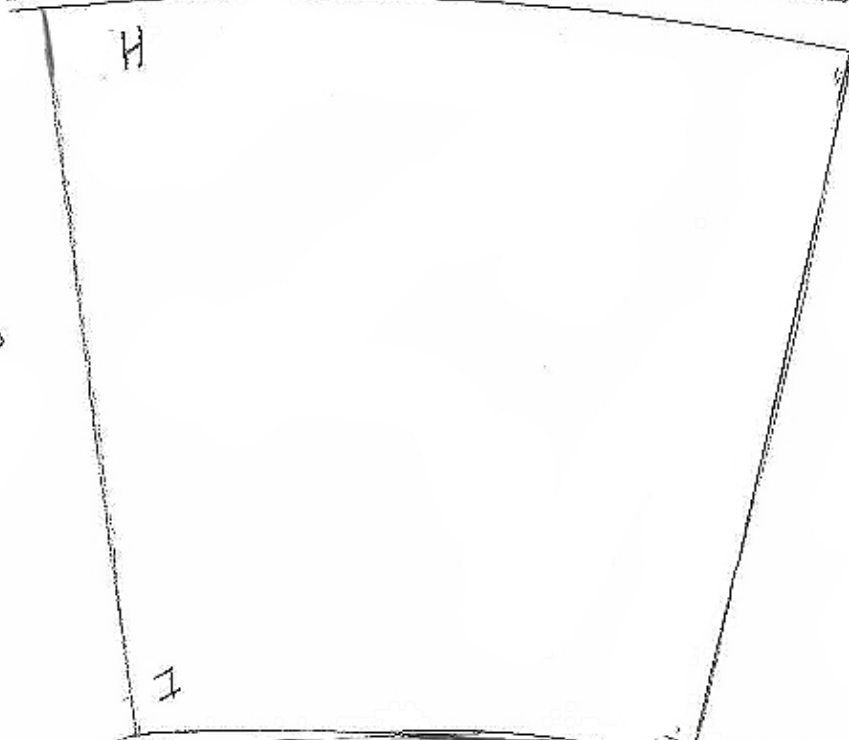

BF 109 F-2

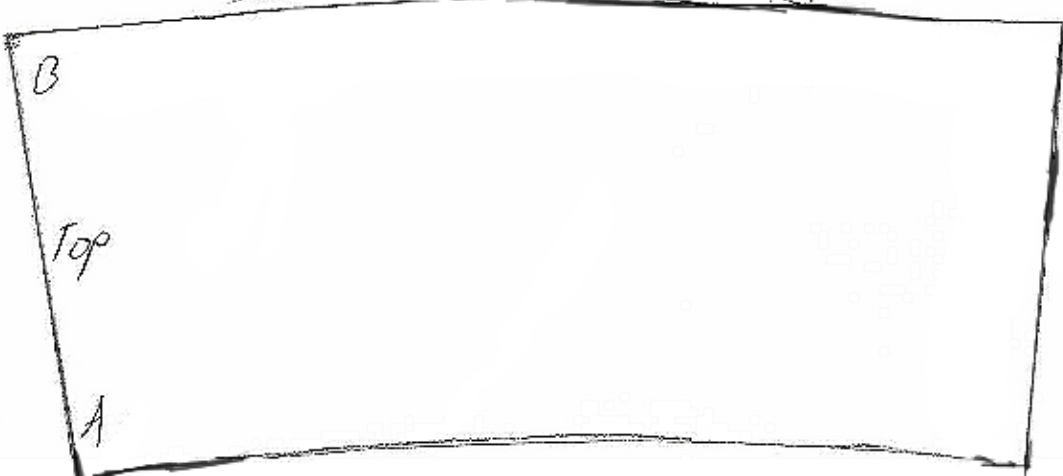

BF 109 F-2

DS 109 f-2

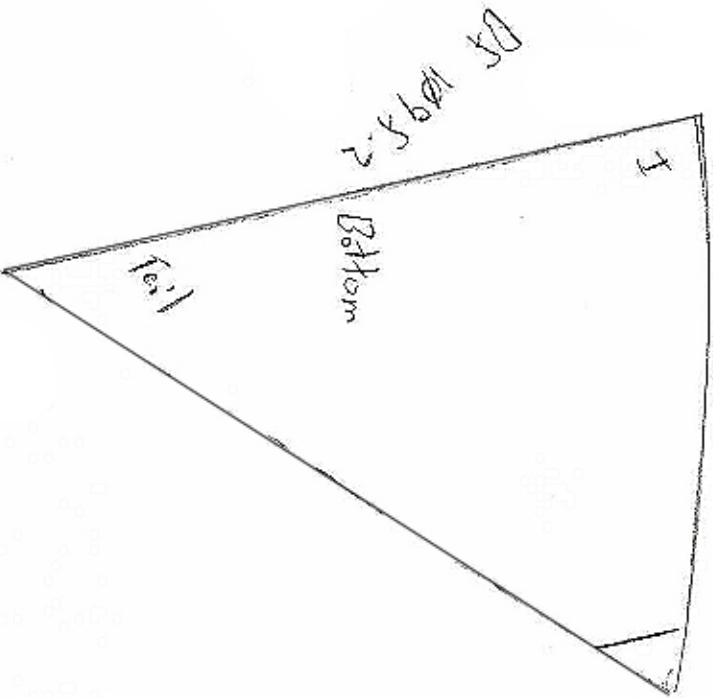
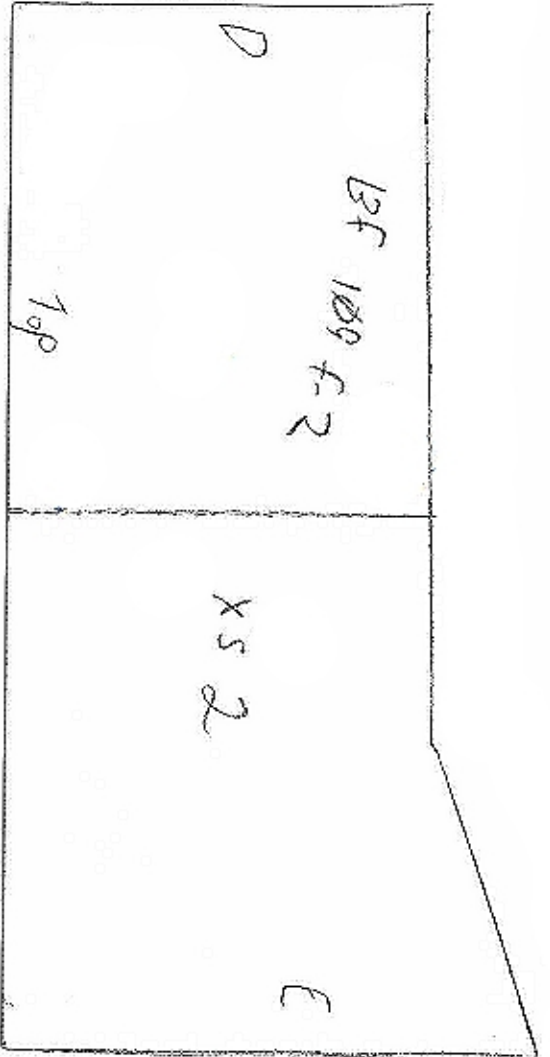
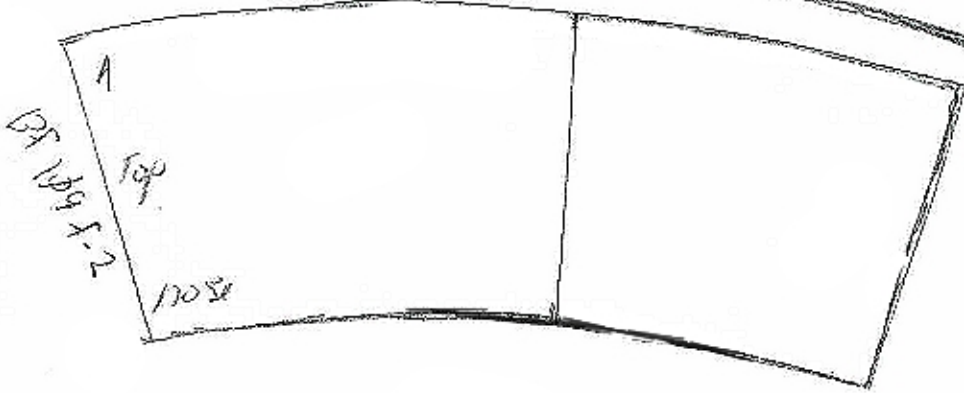

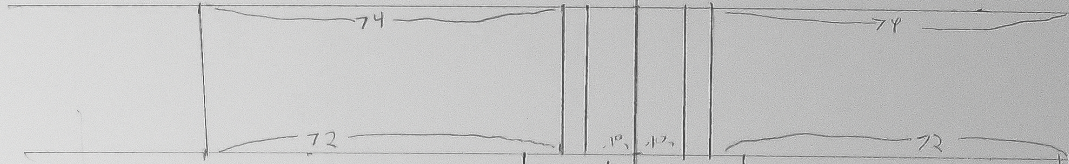

BF 109 F.2

T-347-

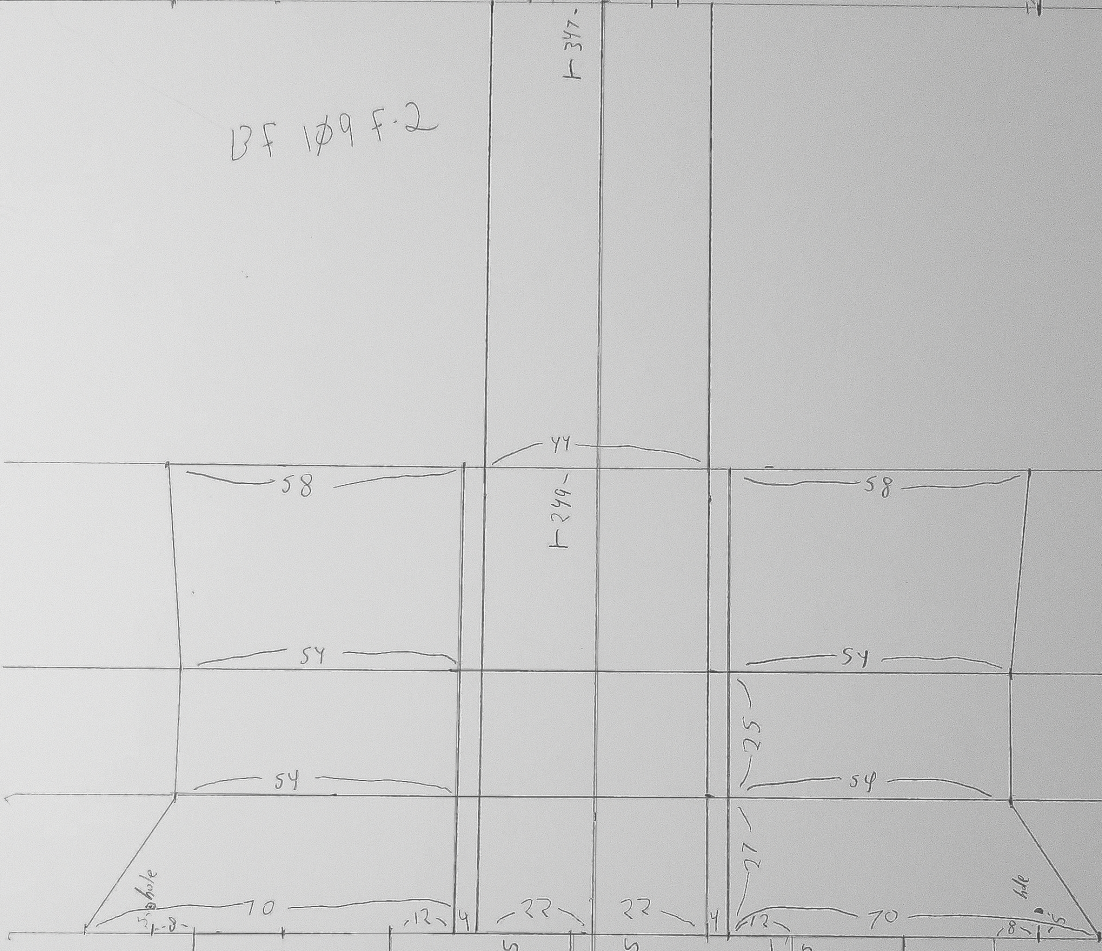

T-249-

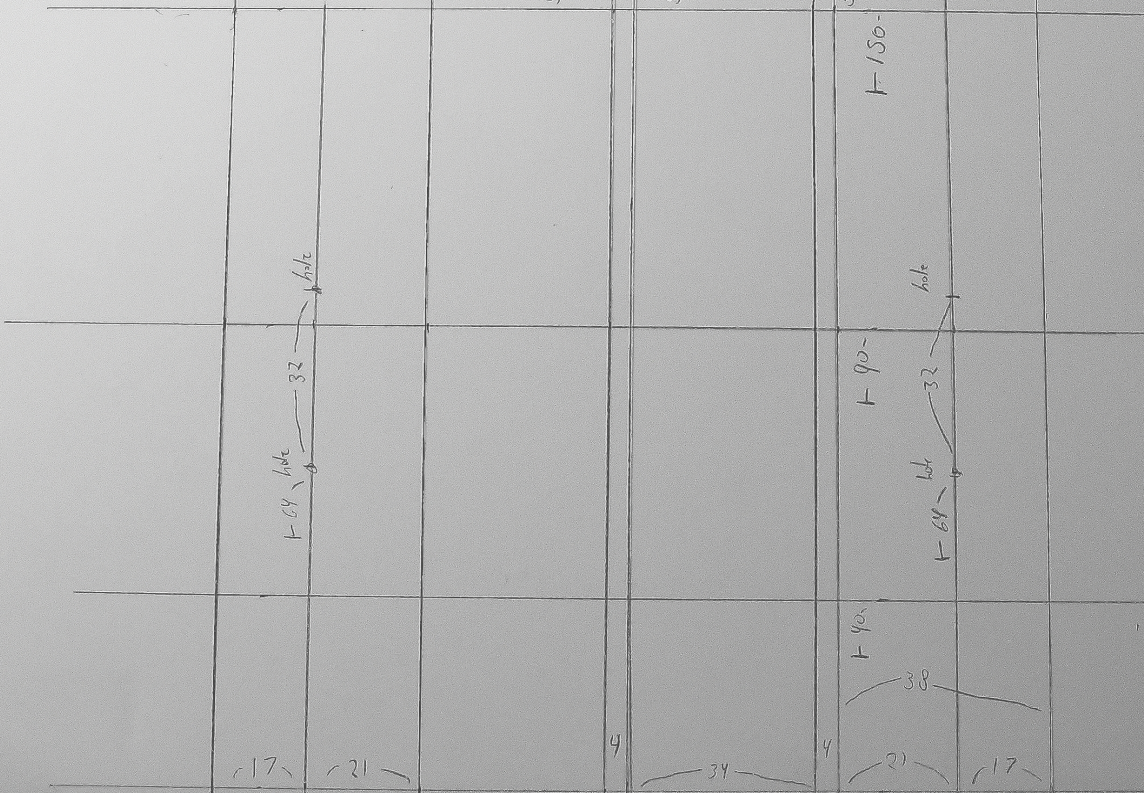

T-150-

T-64 hole

T-68 hole

T-90-

