

Firefighter Fatalities and Injuries

The Role of Heat Stress and PPE



UNIVERSITY OF ILLINOIS
FIRE SERVICE INSTITUTE
FIREFIGHTER LIFE SAFETY
RESEARCH CENTER



Firefighter Fatalities and Injuries: The Role of Heat Stress and PPE

**Firefighter Life Safety Research Center
Illinois Fire Service Institute
University of Illinois at Urbana-Champaign**

July 2008

Foreword

More firefighters die in the line of duty from heart attacks than from any other cause. And slips, trips and falls cause a large number of firefighter injuries. While the origins of heart attack and slip, trip and fall may appear unrelated, previous research suggests that heat stress may be a common causal factor in both heart attacks and slips, trips and falls. Research further suggests that one common, critical factor can potentially mitigate both of these injuries and fatalities: modified personal protective equipment (PPE).

This report of the “Cardiovascular and Biomechanical Responses to Fire Fighting and PPE” research project provides a review of the known research and new and important findings concerning the interrelationship of cardiovascular function, biomechanics and the design of personal protective equipment. This research will only be of value to the fire service if it is read and the science it documents is translated into department and firefighter action.

The Illinois Fire Service Institute at the University of Illinois at Urbana-Champaign assembled an interdisciplinary research team from the Departments of Kinesiology and Community Health, Psychology and Mechanical Science and Engineering, along with the College of Medicine and Skidmore College, plus two industrial partners, Total Fire Group and International Personnel Protection. Together, this group created a research team that has now formed the basis for a national Firefighter Life Safety Research Center to investigate technologies and human response that will help researchers and responders work together to identify the core factors related to firefighter injury and death. I want to recognize the 15 year commitment of Professor Denise Smith to this field of research and the leadership of Dr. Gavin Horn the IFSI Research Director.

This research effort was only possible through the willingness of firefighters and firefighter leaders to participate in the human subject tests and medical evaluations. More than 122 firefighters actually participated in the project representing fire departments across the spectrum from fulltime career to volunteer. Funding, which made the project possible, was funded through the Department of Homeland Security’s Assistance to Firefighters Fire Prevention and Safety via the Assistance to Firefighters Grant (AFG) program.

The research will continue and so must the effort to implement the findings through the implementation of firefighter health and safety recommendations on the fireground and off. We at IFSI look forward to continuing our work to bring researchers and firefighters together for the health and safety of firefighters everywhere.

Respectfully,



Richard L. Jaehne
Director
Illinois Fire Service Institute



Firefighter Fatalities and Injuries: The Role of Heat Stress and PPE

This study was supported by a Federal Emergency Management Agency (FEMA) Assistance to Firefighters Grant (AFG) under the Fire Safety and Prevention Program (EWM-2006-FP-02459). The grant was awarded to the University of Illinois at Urbana-Champaign (Gavin Horn and Denise Smith, Principal Investigators). The Fire Prevention and Safety Grants (FP&S) are part of the Assistance to Firefighters Grants (AFG) and are under the purview of the Grant Programs Directorate in FEMA. FP&S grants support projects that enhance the safety of the public and firefighters from fire and related hazards. In fiscal year 2005, Congress reauthorized funding for FP&S and expanded the eligible uses of funds to include Firefighter Safety Research and Development (R&D). Research and Development activities emphasize reducing injuries to firefighters. Priorities include studies in areas of clinical, behavioral, and social sciences research; technology and product development; and health database systems.



Acknowledgements

Primary Authors

Denise L. Smith, Ph.D., Professor of Exercise Science, Skidmore College; Research Scientist, Illinois Fire Service Institute, University of Illinois at Urbana-Champaign

Gavin Horn, Ph.D., Research Scientist, Illinois Fire Service Institute; Research Scientist, Department of Mechanical Science & Engineering; Interim Director, Illinois Homeland Security Research Center, University of Illinois at Urbana-Champaign

Eric Goldstein, B.A., Assistant Fire Service Education Specialist, Illinois Fire Service Institute, University of Illinois at Urbana-Champaign

Steven J. Petruzzello, Ph.D., Associate Professor, Director of Exercise Psychophysiology Laboratory, Department of Kinesiology & Community Health, University of Illinois at Urbana-Champaign

Contributing Authors

Brian Brauer, Ed.M., Assistant Director, Illinois Fire Service Institute, University of Illinois at Urbana-Champaign

Bo Fernhall, Ph.D., Professor, Department of Kinesiology & Community Health, University of Illinois at Urbana-Champaign

Greg Freund, M.D., Professor and Head of Pathology, Integrative Immunology and Behavior Program, University of Illinois at Urbana-Champaign, and Director of Cytopathology, Carle Clinic Laboratory, Medical Director of Carle Clinic School of Cytotechnology

Elizabeth T. Hsiao-Weckler, Ph.D., Assistant Professor, Department of Mechanical Science & Engineering, University of Illinois at Urbana-Champaign

Karl Rosengren, Ph.D., Professor, Department of Kinesiology & Community Health, University of Illinois at Urbana-Champaign

Krishna Tangella, M.D., Vice President, Board of Directors, Christie Clinic, Champaign, IL

Jeffrey Woods, Ph.D., Associate Professor, Director of Exercise Immunology Laboratory, Department of Kinesiology & Community Health, University of Illinois at Urbana-Champaign

Reviewers

Bradley Bone, Director of Firefighting Programs, Illinois Fire Service Institute, University of Illinois at Urbana-Champaign

David Clark, Ed.M., Deputy Director, Illinois Fire Service Institute, University of Illinois at Urbana-Champaign

Michael Dailey, M.D., FACEP, Regional EMS Medical Director, Assistant Professor Department of Emergency Medicine, Albany Medical College, Albany, NY

Steven T. Edwards, M.G.A., Director, Maryland Fire and Rescue Institute, University of Maryland, College Park, MD

Craig Haigh, B.S., CFO, NREMT-P, Chief, Hanover Park Fire Department, Hanover Park, IL

Stephanos N. Kales, M.D., MPH, FACP, FACO-EM, Assistant Professor, Harvard Medical School, Occupational Medicine Residency Director, School of Public Health, Boston, MA

Kevin Roche, M.P.A., Assistant Fire Marshall at Phoenix Fire Department, Phoenix, AZ

Kenneth S. Wojtecki, Chief of Fire Safety, Division of Safety, City of Chicago Fire Department, Chicago, IL

Firefighter Fatalities and Injuries: The Role of Heat Stress and PPE

We wish to express our appreciation to the following Fire Departments from across Illinois who participated in the study:

Bloomington Fire Department
Bondville Fire Department
Buckley Fire Protection District
Carbondale Township Fire Department
Carroll Fire Protection District
Champaign Fire Department
Chicago Fire Department
Clinton Fire Department
Cornbelt Fire Protection District
Crystal Lake Fire Rescue Department
DeKalb Fire Department
East St. Louis Fire Department
Eastern Prairie Fire Protection District
Edge-Scott Fire Protection District
Frankfort Fire Protection District
Galesburg Fire Department
Hoffman Estates Fire Department
Homer Fire Protection District
Lake Zurich Fire Rescue Department
Lansing Fire Department
Lincolnwood Fire Department
City of Litchfield Fire Department
Mattoon Fire Department

Moline Fire Department
Naperville Fire Department
Nokomis Area Fire Protection District
Oswego Fire Protection District
Ottawa Fire Department
Paxton Fire Department
Pekin Fire Department
Quincy Fire Department
River Grove Fire Department
Robinson Fire Department
Rock Island Fire Department
Romeoville Fire Department
Salem Fire Protection District
Savoy Fire Department
Schaumburg Fire Department
Spring Grove Fire Protection District
Springfield Fire Department
Streator Fire Department
Taylorville Fire Department
Tolono Fire Protection District
Urbana Fire Rescue Services
Watseka Fire Department
Wheaton Fire Department

Acknowledgements

We gratefully acknowledge the substantial support we received from staff members in the following University of Illinois departments and units:

Illinois Fire Service Institute

Administration and administrative staff

Instructional staff

Stokers

Information Technology staff

Library

Department of Kinesiology and Community Health

Balance and Gait Laboratory

Exercise and Cardiovascular Research Laboratory (Graduate Student: Chris Fahs)

Exercise Immunology Research Laboratory (Graduate Student: Cesar Vasquez)

Psychophysiology Laboratory

Department of Mechanical Science and Engineering

Advanced Materials Testing and Evaluation Laboratory

Human Dynamics and Control Laboratory (Graduate Students: Kiwon Park and Pilwon Hur)

College of Medicine

Department of Internal Medicine

Department of Pathology (Graduate Student: Uzma Ahmad)

We want to acknowledge and thank several partners and individuals, who contributed significantly to the success of this project, including:

Bill Farnum, Tad Schroeder and Jason Lindsey, who provided the majority of photos used in this report.

Bill Grilliot (Total Fire Group) and Jeff Stull (International Personnel Protection, Inc.), who led the PPE design and production portion of the study.

Christie Clinic (Urbana, IL) which provided phlebotomists and analyzed blood samples.

Georgetown Hematology Research Lab (C. Kessler, MD and H. Jacobs), who analyzed blood samples for specific fibrinolytic and coagulatory markers.

Illini Emergency Medical Service, that provided on-scene rehabilitation to participants.

Steven B. Gutzmer, who provided assistance throughout the study in rehab, data collection, and manuscript review.

Sue Blevins, who assisted in every aspect of this study.

We wish to express our thanks to the following individuals and organizations who demonstrated their commitment to this project throughout all phases of the study:

Chicago Fire Department

Champaign Fire Department

Champaign County Fire Chiefs Association

Edge-Scott Fire Protection District

Hanover Park Fire Department

Illinois Fire Chiefs Association

National Fallen Firefighters Foundation

Savoy Fire Department

Urbana Fire Department

Senator Richard J. Durbin

United States Senate

Representative Timothy V. Johnson

U.S. House of Representatives

Representative Melissa L. Bean

U.S. House of Representatives

Executive Summary

Firefighting is a potentially dangerous occupation. In a typical year more than 100 firefighters die in the line of duty, while tens of thousands are injured. By far, the leading cause of line-of-duty deaths is sudden cardiac events. While injuries result from a myriad of factors, slips, trips and falls consistently account for a large portion of fireground injuries.

Part 1 of this report is divided into three primary sections, addressing cardiovascular disease in the fire service, gait and balance issues as they relate to slips, trips and falls, and finally, how heat stress may be related to both cardiac events and slips, trips and falls. The cardiovascular section details the medical progression of cardiovascular disease, cardiovascular risk factor prevalence in the fire service, and the potential role of firefighting as a trigger for a sudden cardiac event. The section on biomechanics details how personal protection equipment (PPE) influences gait and balance parameters and provides a theoretical link to slips, trips and falls on the fireground. The final section of Part 1 explores the role of heat stress and specifically proposes a model where heat stress influences cardiovascular events and the development of fatigue that may be related to slips, trips and falls on the fireground.

Part 2 describes an integrated research study designed to investigate the effects of firefighting on cardiovascular parameters and biomechanical variables. This study documented laboratory-based cardiovascular risk factors among a large cohort of firefighters and investigated the effects of different PPE configurations on physiological and biomechanical responses to live fire firefighting activities. Study participants included 122

male firefighters from across the state of Illinois with a wide range of firefighting experience. The group was nearly equally divided between career and volunteer firefighters. The participants were relatively young (mean age = 29.5 years), were free of known cardiovascular disease or balance/gait impairment and were not taking medications for hypertension or high cholesterol. Participants engaged in 18 minutes of firefighting activity in a burn tower that contained live fire. Temperatures were maintained at approx 100°F and 170°F at the floor and waist level, respectively. Firefighting activities included repeated work-rest cycles, with firefighters doing stair climbing, forcible entry, search and rescue, and a simulated hose pull.

Major findings include:

- A large percentage of the firefighters who participated were overweight or obese based on BMI measures.
- A large percentage of these firefighters were pre-hypertensive or hypertensive.
- Eighteen minutes of simulated firefighting activity causes significant physiological disruption including an increase of heart rate (75 bpm) and an increase of core temperature (1.2°F).
- The simulated firefighting activities caused a significant increase in platelet numbers and a significant increase of platelet activation (resulting in faster clot formation).
- Firefighting activity resulted in an increased level of coagulation (increased factor VIII activity and PF1.2) and significant changes in clot breakdown (fibrinolysis).
- PPE configuration had no significant effect on physiological, perceptual, blood chemistry, or coagulatory responses to firefighting activity.

Executive Summary (continued)

- Donning of firefighting personal protective equipment caused significant detriments in gait and balance parameters regardless of which configuration of PPE was worn.
- Enhanced PPE had a smaller detrimental effect on some gait parameters than the Standard PPE.
- Eighteen minutes of simulated firefighting activity had negligible further effects on gait and balance parameters compared with the effect of donning firefighting PPE.

Part 3 of this document provides recommendations to the fire service based specifically on the theoretical foundations from Part 1 and the results of the research project detailed in Part 2. Where appropriate, we have provided recommendations to national organizations, fire departments and individual firefighters.

It is our earnest hope that this document and the recommendations contained herein stimulate additional conversations in the fire service and help to improve health and safety for this nation's firefighters.

Table of Contents

PART 1 – THEORETICAL FOUNDATION: UNDERSTANDING FATALITIES AND INJURIES IN THE FIRE SERVICE

Introduction	1
Firefighter Fatality Statistics	2
Firefighter Injury Statistics	3
Challenge to the U.S. Fire Service	4
Cardiac-Related Events in the Fire Service	5
Cardiovascular Disease	5
The Progression of Cardiovascular Disease	6
Risk Factors for Developing Cardiovascular Disease	8
Risk Factors among Firefighters	9
Decreasing Cardiovascular Disease Risk Factors	12
Cardiovascular Stress of Firefighting	12
Restropective Study of Cardiac Events in the Line of Duty	13
Research Findings Regarding the Physiological Effects of Firefighting	14
Factors Affecting Cardiovascular and Thermal Strain	16
Slips, Trips and Falls in the Fire Service	20
Slip, Trip and Fall Injuries on the Fireground	20
Importance of Biomechanical Factors	22
The Central Role of Heat Stress	24

PART 2 - RESEARCH PROJECT: CARDIOVASCULAR AND BIOMECHANICAL RESPONSES TO FIREFIGHTING AND PPE

Background and Significance	27
Purpose	29
Methodology	30
Study Design	30
Subjects	30
Cardiovascular and Exercise Research Laboratory Test Period	31
Testing Protocol	31
Measures	31

Table of Contents (continued)

Illinois Fire Service Institute Live Fire Test Period	33
Testing Protocol	33
Burn Structures and Temperatures	34
Simulated Firefighting Activities	36
Personal Protective Equipment (PPE) Ensembles	38
Measures	39
Results and Discussion	45
Cardiovascular and Exercise Research Laboratory Testing	45
Descriptive Data	45
Measures of Cardiovascular Health	45
Illinois Fire Service Institute Live Fire Test Period – Physiological and	
Perceptual Results	47
Descriptive Data	48
Physiological Results	48
Blood Chemistry Results	49
Hematological Results	49
Platelet Function Results	52
Coagulatory Function Results	52
Perceptual and Psychological Results	53
Illinois Fire Service Institute Live Fire Test Period – Biomechanical Results	55
Gait Study Results	55
Balance Study Results	58

PART 3 - RECOMMENDATIONS FOR THE FIRE SERVICE

Medical Readiness for Duty	63
Physical Fitness Requirements	65
On-scene Rehabilitation and Hydration Strategies	67
Personal Protective Equipment	68

REFERENCES



Part One: Theoretical Foundation

Introduction

The American fire service has historically maintained a very different role in the collective psyche of the American people than that of its counterparts in other industrialized nations. An element of this difference is derived from the history of the American fire service: Decentralized and local, American fire departments are often considered a part of their community, indeed, as an embodiment of service and self-sacrifice that are imbued in classic Jeffersonian values. Whereas the fire departments in most other developed nations are either regionally or federally organized and deployed, American departments generally represent a single municipality and have deep connections with the citizens they serve. The American fire service is also unique due to the comparatively high number of structure fires, and commensurate fire damage, fatalities and injuries that occur annually. Fire departments in the United States respond to 1.8 million fires each year – or about four fires every minute. Annually, more than 5,000 Americans are killed and 100,000 are injured as a result of fires, and annual property loss due to fires has been estimated to be as high as \$10 billion. In international rankings, the United States has a higher death rate due

to fires than any European country and has the fourth highest rate among all developed nations (USFA, 2005).

However, the respect that Americans hold for the fire service cannot be solely explained by the localization of the American fire department or the unusually high number of structure fires. Instead, it is the conceptualization of the firefighting as a truly selfless calling, the subsumption of the individual for the preservation of the life and property of an anonymous citizen that has captured the imagination of generations of Americans. It is therefore understandable that the occasion of a firefighter fatality or serious injury is a cause of great concern and consternation in the community, as well as a time of grief for the family and fire department.

Firefighting is considered to be an extremely hazardous occupation, with a myriad of potential casualties for job-related mortality or morbidity. In fact, more than 100 firefighters die in the line of duty every year, a disproportionately high number compared with other industrialized nations. Various characteristics of the American

fire service, such as a tactical focus on aggressive interior fire attack and a preponderance of light-weight building construction, can explain a portion of the higher fatality levels. However, the majority of firefighter fatalities do not occur as a direct result of products of combustion (burns, smoke inhalation), but rather as a result of sudden cardiac death. The leading cause of firefighter injury is likewise not a direct result of products of combustion, but attributed to slips, trips and falls. These facts indicate that the fire service must focus a great deal of attention on understanding the etiology of these events and initiating proactive mitigation strategies.

Firefighter Fatality Statistics

There were a total of 1,006 fire service Line-of-Duty Deaths (LODD) reported for the 11-year period from 1995-2005. In 2006, the Bureau of Labor Statistics published statistics that revealed

there were 16.6 firefighter fatalities per 100,000 employed (career-only) firefighters, which is lower than the observed fatality rates of many other hazardous occupations (for example, 49.5 for miners, 33 for agricultural workers); however, this statistic can be misleading as it does not account for the relative infrequency of an individual firefighter operating at the fireground. In 2002, the National Fire Protection Agency reported 5.7 fatalities per 100,000 structure fires (Fahy, 2002). As seen in Figure 1.1, the number of firefighter fatalities has not changed significantly over the past two decades. The rate of firefighter fatalities at structure fires has remained relatively constant despite a consistent decrease in fires since the 1970s, from approximately 1.1 million in 1975 to under 600,000 in 2000, a decrease largely explained by improved municipal building codes, a greater emphasis on fire prevention, and changing socioeconomic demographics in urban cen-

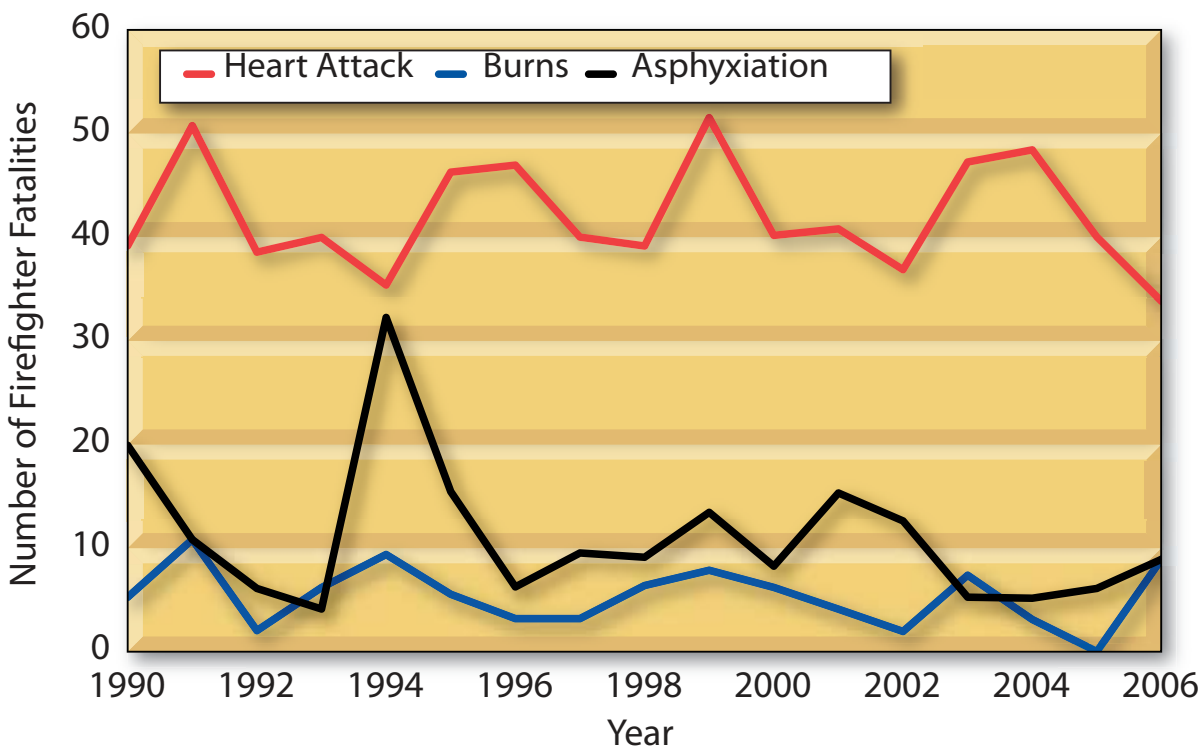

Figure 1.1. Fireground fatalities by cause (Washburn, LeBlanc and Fahy, 1991-1999; Fahy and LeBlanc, 2000-2004, 2006; LeBlanc and Fahy, 2005; Fahy, LeBlanc and Molis, 2007)



Part One: Theoretical Foundation

ters. The overall number of firefighter fatalities has declined by 38% since 1977 but increased slightly (7%) since 1990.

The common misconception that the products of combustion – heat and smoke – are responsible for the majority of firefighter LODD is perennially disproved by the fatality statistics. As seen in Figure 1.1, sudden cardiac death accounts for a far greater proportion (approximately 40% to 50%) of fatalities than either smoke inhalation or burn injury. Based on United States Fire Administration (USFA) data, 43.9% of all firefighter fatalities from 1990-2000 were due to cardiac events, nearly doubling the second leading cause (trauma) (USFA, 2002). Statistically, firefighting presents a far higher risk of cardiac events (~45%) than other professions represented on the

Bureau of Labor Statistics occupational hazard listing. The Bureau of Labor Statistics reports 15% of all fatalities incurred in the occupational trades are due to heart attack, including 22% for law enforcement, 13% for construction trades and 17% for mining (Bureau of Labor Statistics, 2006).

Firefighter Injury Statistics

In 2006, 83,400 firefighter injuries were reported, with 53% of the injuries occurring on the fireground (Karter and Molis, 2007). Figure 1.2 shows, that from 1990 to 2004, the total number of fireground injuries has declined from 57,100 to 36,880 (but increased to 44,210 in 2006); yet the number of cases related to the two leading causes of injury – slips, trips and falls (24.5% of all fireground injuries) and overexer-

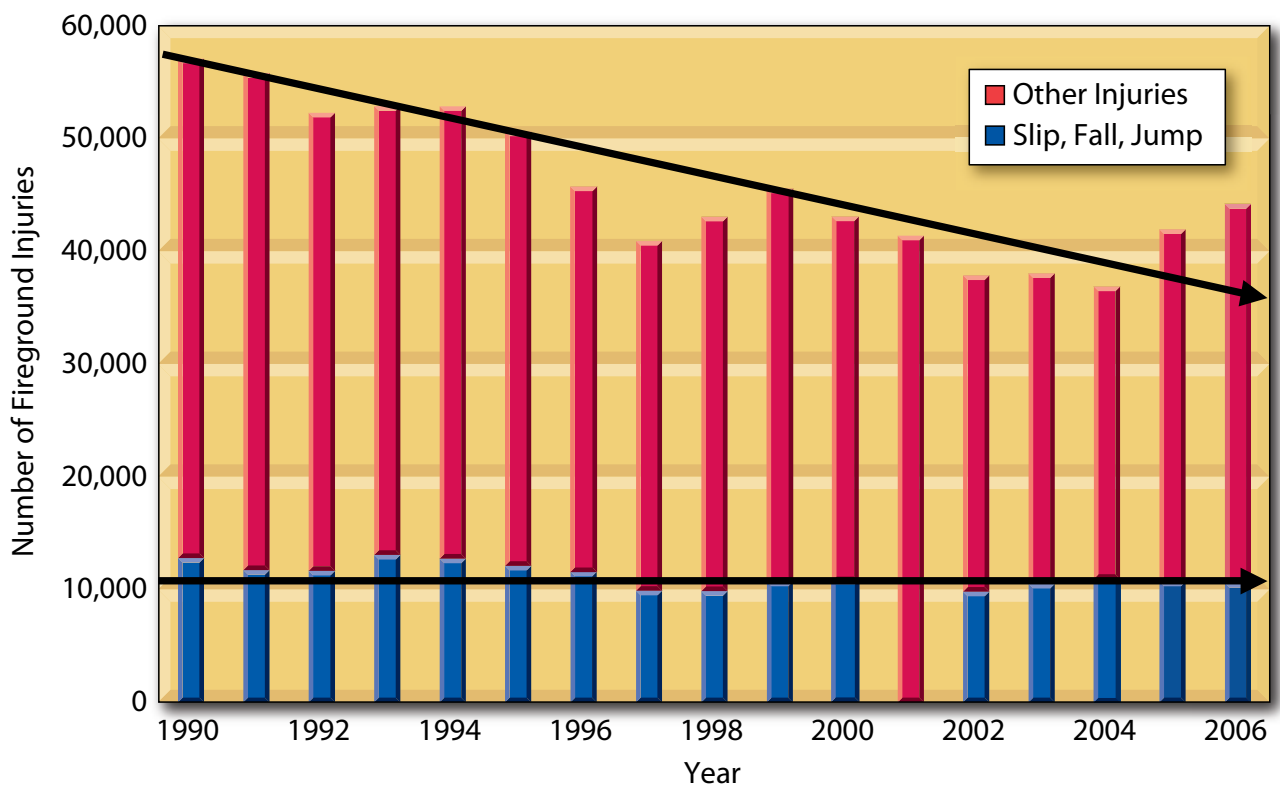

Figure 1.2. Fireground injury trends from 1990-2006 (Karter and Molis, 2003-2007; Karter and LeBlanc, 1991-1999; Karter and Badger, 2000-2001).

tion/strain (25.8% of all fireground injuries) – have remained relatively constant (approximately 23,000) (Karter and Molis, 2007). Increased rate of fatigue, reduction in flexibility and mobility, and changes in a firefighter’s center of gravity due to wearing firefighting personal protective equipment (PPE) and carrying firefighter tools can be linked to slip, trip and fall injuries as well as overexertion/strain injuries. There have been few systematic studies to address the effects of firefighting personal protective equipment ensembles on the biomechanics of firefighter motion, let alone the interactions between heat stress, PPE, and slips, trips and falls.

Challenge to the U.S. Fire Service

The high occupational rate of injuries and cardiac-related fatalities among firefighters compared with other professions provides a clarion call to the fire service to:

- Better understand the individual factors that predispose firefighters to such a high risk for injury and cardiac death,
- Better understand the physiological effects of firefighting activity and how firefighting may serve as a trigger for cardiac events, and
- Develop and test strategies to mitigate the cardiovascular and physical stress associated with firefighting activity.





Part One: Theoretical Foundation

Cardiac-Related Events in the Fire Service

Cardiovascular Disease

Cardiovascular disease is the leading cause of death in the United States, accounting for approximately 650,000 deaths per year, approximately 25% of all deaths in the United States (Kung et al., 2008). Cardiovascular disease also exacts a considerable toll on the fire service. As noted earlier, approximately 45% of all line-of-duty deaths among firefighters are due to sudden cardiac death, whereas less than 10% are due to burn injuries (USFA, 2002). Cardiovascular fatalities occur in individuals with underlying cardiovascular disease (diagnosed or undiagnosed), and they are more likely to occur following fire suppression activities (Kales, 2007). Thus, effective strategies to lessen cardiovascular fatalities in the fire service must address:

- Individual Risk Factors that place firefighters at increased risk for sudden cardiac events, and

- Factors Associated with Firefighting that may trigger a cardiac event in susceptible individuals.

Reducing cardiac-related fatalities requires proactive steps to reduce cardiovascular disease (CVD) progression (including medical exams and physical fitness/wellness programs) and better understanding of how the stress of firefighting may serve as a trigger for a sudden cardiac event. Figure 1.3 provides a simple model to understand how sudden cardiac events are likely to occur on the fireground. Cardiovascular disease develops over a prolonged period of time, starting in childhood. The plaque accumulation and disease may progress silently, as hypertension or hypercholesterolemia, or with clinical manifestations, such as angina or chest pain. As the disease progresses, the plaque accumulation in the artery increases, and the damage to the arterial wall can

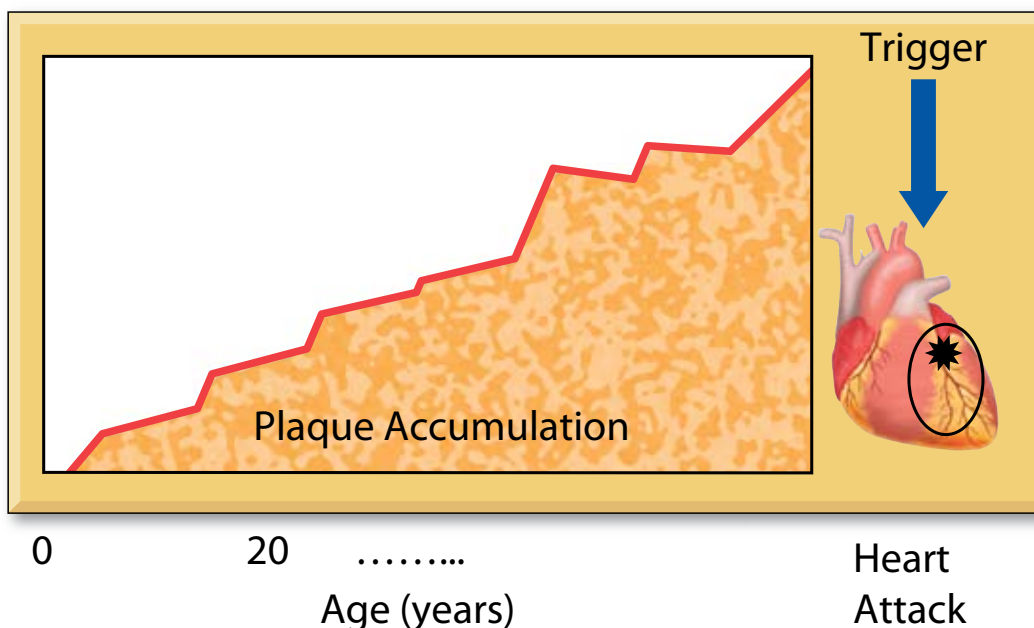

Figure 1.3. Simplified model of cardiovascular disease in the fire service.

affect vascular function and the delivery of blood flow; however, this slow progression that develops over years, and even decades, can immediately change to an acute life-threatening event in seconds or minutes. A sudden cardiac event usually occurs when a trigger causes plaque to rupture and a clot to form, blocking a coronary artery.

Decreasing the number of fatalities in the fire service requires an understanding of how cardiovascular disease progresses, as well as how firefighting may serve as a trigger for sudden cardiac events. Building upon this understanding, research efforts must be focused on designing and testing the effectiveness of interventions to address the chronic and acute physiological processes involved in sudden cardiac events.

The Progression of Cardiovascular Disease

Cardiovascular disease refers collectively to a state of disease in the blood vessels. If blood vessels become narrowed by the buildup of plaque or obstructed by a blood clot, then blood, and the oxygen and nutrients it carries, cannot be delivered to the vital organs of the body. If blood supply to the brain is impeded, a stroke occurs. If blood flow to the heart muscle is impeded, a heart attack occurs. The National Fire Protection Association (NFPA) now uses the term Sudden Cardiac Death to refer to quick-onset deaths due to heart attacks and other heart-related fatalities (Fahy, 2005). The terms *coronary heart disease* (CHD) and *coronary artery disease* (CAD) describe specific forms of cardiovascular disease in which the blood vessels supplying the heart muscle are narrowed or obstructed.

When there is an obstruction in a coronary vessel (or any blood vessel), the tissue below the blockage does not get adequate oxygen. If the lack of oxygen, *ischemia*, to the heart is too severe, the heart tissue dies: a *myocardial infarction* means

death of heart muscle tissue. If the area supplied by the blood vessel is very small, the person may recover from the heart attack or may not even know that he or she has suffered a heart attack; however, if the area below the occlusion is too great, the heart cannot continue to function as an effective pump, and death results. Ischemia of heart cells can also cause cardiac electrical abnormalities, or arrhythmias. These arrhythmias are often the cause of death in myocardial infarction.

The cause of a *heart attack* is a lack of blood flow to an area of the heart. The cause of *sudden cardiac arrest* is an arrhythmia, a bad electrical rhythm in the heart muscle. A heart attack can cause a fatal arrhythmia, or the arrhythmia may arise due to an inherent problem with the electrical cells of the heart without any vessel being occluded (a primary arrhythmia). Most frequently, these problems happen together and decreased blood flow (ischemia) to heart cells causes an arrhythmia. These arrhythmias, usually ventricular fibrillation or ventricular tachycardia, are often the immediate cause of death in heart attack victims. In non-fatal cardiac events, there is adequate oxygen and the cells do not cause independent beats. However, when oxygen levels are inadequate the heart cells will try to beat independently (an arrhythmia). As a result, the heart can not act as an efficient pump and the person will die unless the condition is rapidly identified and corrected. A small area of the heart muscle generating a false rhythm can cause a sudden cardiac arrest even in cases where there is only a small area of ischemia.

Atherosclerosis. Atherosclerosis refers to the disease condition in which plaque builds up in the arterial wall, narrowing the vessel opening. Far from being a simple vessel through which blood flows, an artery is a complicated structure that plays an important role in managing blood



Part One: Theoretical Foundation

clotting and that constantly changes size to meet the demands of the tissue it supplies. Figure 1.4a is a schematic of a healthy artery. The innermost layer, the endothelium, is composed primarily of a single layer of cells that, under normal conditions, play a critical role in preventing blood clots. When this layer is disrupted or damaged, it can cause blood to clot.

Development of Atherosclerotic Plaque. Figure 1.4 presents a schematic of how plaque develops in a coronary artery. Figure 1.4 (a) represents a healthy artery with no plaque and an intact endothelium. The endothelium possesses anti-clotting properties. The initiation of atherosclerotic plaque buildup may begin quite early in life; there is strong evidence that it begins during childhood for many people in Western developed countries. Therefore, it is important to consider cardiovascular disease as a long-term, chronic disease that begins early in life, although symptoms are often delayed until middle age or thereafter. Also, it must be stressed that asymptomatic cardiovascular disease may become very advanced. In approximately 20% to 25% of individuals, the first sign of cardiovascular disease is a fatal heart attack (Myerburg et al., 2005). This reinforces the need for young firefighters to take steps to avoid or delay atherosclerosis. It also suggests that firefighters in their 30s, 40s, and 50s should seriously address the health issues of cardiovascular disease, even if they are symptom free.

Figure 1.4 (b) presents an artery that contains atherosclerotic plaque. The plaque contains a lipid-rich core, composed largely of fat, and is covered by a fibrous cap. The events in the development of atherosclerotic plaque are very complex and are described only briefly here.

The first step in the initiation of atherosclerosis is damage to the endothelium, the smooth layer of cells that line the blood vessel and is in contact

with the blood. Damage may occur due to high blood pressure, chemicals from inhaled cigarette smoke or products of combustion at a fire, or infection. Damage to the endothelium causes or allows cholesterol, specifically low-density lipoproteins (LDLs), to move into the wall of the blood vessel. The presence of LDLs allows white blood cells to move into the arterial wall. The white blood cells ingest the LDLs and become known as foam cells. Foam cells release chemicals that stimulate smooth muscle to grow and divide in the arterial wall. The additional smooth

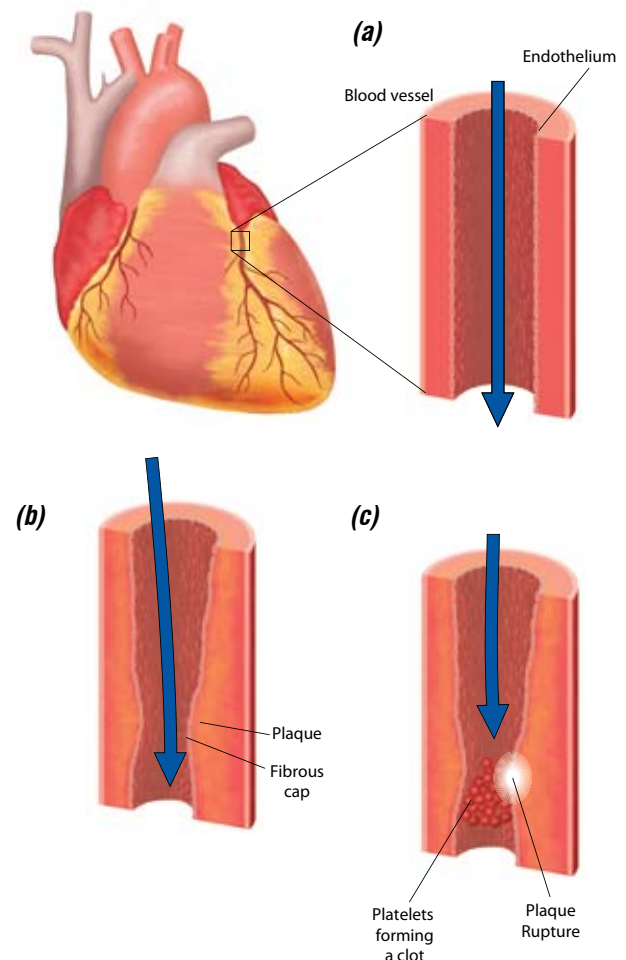

Figure 1.4. (a) Normal healthy artery; (b) plaque accumulation in an artery; (c) plaque rupture and clot formation.

muscle in the arterial wall causes other material to accumulate in the vessel wall, thus causing the atherosclerotic plaque to grow. In later stages, the plaque may become calcified. The end result is a fatty plaque that contains a core that is rich in lipids (LDLs) and dead or dying cells covered by a fibrous cap.

Plaque Rupture and Clot Formation. The body has a highly complicated mechanism that balances the need to keep blood in the liquid state under normal conditions with the need to produce blood clots quickly when faced with a damaged blood vessel. It appears that most cases of acute heart attack are “triggered” when an atherosclerotic plaque ruptures, causing the development of a clot (thrombus). As depicted in Figure 1.4 (c), the clot occurs because the disruption of the plaque exposes platelets and blood coagulatory factors to underlying tissue, such as the smooth muscle and connective tissue in the vessel walls, that do not possess the anticlotting factors that intact endothelium does. The plaque itself contains factors that cause platelets to stick together and a clot to begin to form. Also, exposure of the blood to underlying tissue causes the platelets to adhere to one another and form a platelet plug. The platelet plug is then reinforced by strands of fibrin to form a clot. A clot may be small enough that it does not occlude an artery, in which case

the person may not exhibit symptoms. Conversely, the clot may be large enough to block an artery, causing a heart attack.

Risk Factors for Developing Cardiovascular Disease

A risk factor is a characteristic that is present early in life and is associated with an increased risk of developing future disease. A *modifiable risk factor* is a risk factor that can be minimized, for example through diet, exercise, or modified personal habits. Table 1.1 presents several non-modifiable and modifiable risk factors for cardiovascular disease. Men are more likely to suffer cardiovascular disease at a younger age than females; thus, being over 45 years is considered a risk factor for males and being over 55 years is a risk factor for females. Family history is defined as the premature death of a parent or sibling from cardiovascular disease (before 55 years for males or before 65 years for females).

Modifiable risk factors deserve a great deal of attention because it is through altering these risk factors that a person can influence his or her likelihood of developing cardiovascular disease. There are six major modifiable risk factors: smoking, hypertension (high blood pressure), hypercholesterolemia (high cholesterol levels), obesity, diabetes or impaired glucose tolerance,

Table 1.1. Risk factors for developing cardiovascular disease.

Non-Modifiable Risk Factors	Major Modifiable Risk Factors
Age	Cigarette smoking
Heredity	Hypertension
Race	Hypercholesterolemia
Gender	Obesity
	Diabetes mellitus
	Physical inactivity



Part One: Theoretical Foundation

and physical inactivity. The more risk factors that an individual has, the greater the likelihood that he or she will suffer from cardiovascular disease. The good news is that armed with information, supported by departmental policies and programs, and encouraged by co-workers and family, most firefighters can reduce their risk for cardiovascular disease by following reasonable guidelines for healthy living.

Risk Factors among Firefighters

Given the strenuous nature of firefighting and the responsibilities of the job, all attempts should be made to reduce modifiable cardiovascular risk factors. Unfortunately, there is mounting evidence that a large number of firefighters have one or more risk factors known to increase the risk of cardiac death. This section will briefly review what is known about the prevalence of risk factors among firefighters.

Smoking. Approximately 21% of the adult population in the United States smokes cigarettes, and approximately 4,000 young people (12-17 years) begin smoking each day (AHA, 2008). Cigarette smoking is a causal factor in an estimated 430,000 deaths per year in the United States, more than 40 percent of them due to cardiovascular disease (Gaziano, 2001). In fact, as early as 1983, the United States Surgeon General established smoking as the leading avoidable cause of cardiovascular disease. Thus, the cessation of cigarette smoking is one of the most important interventions that can be undertaken to decrease the risk of premature death due to cardiovascular disease. On average, smokers die 13 to 14 years earlier than non-smokers (AHA, 2008).

Smoking has several detrimental effects on the cardiovascular system, including damaging the endothelium and increasing clotting potential. Smoking is also associated with increased LDL

levels, increased LDL oxidation and elevated blood glucose levels.

The prevalence of smoking in the fire service is difficult to describe precisely because of differences across age spans, regional variation in smoking rate across the country, and possible differences between career and volunteer firefighters. A study published in 2006 found that approximately 30% of firefighters who retired due to cardiovascular disease were smokers and 22% of those who retired for non-cardiac reasons were smokers. In contrast, among active firefighters, only 10% were smokers (Holder et al., 2006). It appears that the prevalence of smoking among firefighters is decreasing; however, given the significant cardiovascular damage caused by smoking, it is important to continue programs aimed at smoking cessation within the fire service.

Hypertension. The relationship between elevated blood pressure and cardiovascular disease is direct, continuous and independent of other risk factors (Kaplan and Zipes, 2005). Elevated blood pressure causes damage to the cardiovascular system: It damages blood vessels and increases the work the heart must do, often leading to structural changes in the heart wall (left ventricular hypertrophy). Due to the asymptomatic nature of hypertension, it often goes unnoticed and untreated for many years. Furthermore, because high blood pressure is frequently present without symptoms, patients are often not diligent about taking anti-hypertensive medications.

A prospective study among 334 firefighters found that 20% had high blood pressure (140/90 mmHg) at baseline and another 20% had high-normal blood pressure (>135/85 mmHg) (Sorterriades et al., 2003). Four years after the baseline measurements were taken, the percentage of hypertensive firefighters increased to 23%. Perhaps

the most notable finding from this study was that 80% of firefighters with high blood pressure were not receiving treatment despite receiving annual examinations and encouragement to follow up with their personal physicians. These findings reinforce the need to have regular medical exams that include an assessment of cardiovascular risk factors, and the need for appropriate treatment when risk factors are identified.



Cholesterol. One of the hallmarks of atherosclerotic cardiovascular disease is deposition of cholesterol (specifically low-density lipoproteins, LDL) into the walls of the artery, causing the fatty plaque to accumulate. Blood cholesterol levels and levels of LDLs increase with aging (Davis et al., 2002). A prospective study that investigated the lipid profiles of career firefighters at baseline and after four years found that total cholesterol levels decreased from 224 to 214 mg/dL, but the percentage of firefighters being treated for high cholesterol increased from 3% to 12%. The percentage of firefighters with borderline-high cholesterol (200-239 mg/dL) increased from 36.1% to 42.8%. It is also worth noting that the firefighters with high cholesterol (>240 mg/dL) also had a greater incidence of obesity than firefighters with cholesterol levels below 240 mg/dL (46.4% vs 28.9 %).

Obesity. The high prevalence of obesity is a major concern in the fire service. A body mass index (BMI) over 25 is considered overweight and a BMI greater than 30 is considered obese. The risk of cardiac death increases with elevated BMI. Clark et al. (2002) found that 80.7% of a cohort of career firefighters had a body mass index of greater than 25. Soteriades et al. (2005) conducted a study in which more than 300 career firefighters underwent a baseline physical and were retested after five years. The BMI of the group increased from 29 to 30, and the prevalence of obesity increased from 35% to 40%. Furthermore, the prevalence of extreme obesity (defined as $BMI \geq 40$) increased fourfold. Both studies found that increased BMI is directly correlated with elevated blood pressure and cholesterol. Additionally, a follow-up study performed by Soteriades et al. (2008) also found that obese firefighters are more likely to suffer a disability requiring time off work over a 6-year follow-up period.

Diabetes. Diabetes is a metabolic disorder characterized by the inability to use sugar (glucose) effectively. In nondiabetic individuals, blood glucose levels increase following the ingestion of carbohydrates, complex or simple sugars. Increased levels of glucose cause the pancreas to release insulin, which helps transport glucose from the blood stream into the cells of the body where the glucose is used to make energy or is stored as fuel for later use. There are two primary types of diabetes, Type I and Type II. In both types, untreated people have high circulating levels of glucose. Type I diabetics do not produce the insulin that their bodies need to get circulating glucose into cells for use by the body. Individuals with Type II diabetes tend to have high insulin levels because their cells are resistant to the effects of insulin, a condition known as insulin re-



Part One: Theoretical Foundation

sistance. Prior to the diagnosis of Type II diabetes, many people may have an element of insulin resistance and may be considered “pre-diabetic.” Thus, the pancreas continues to produce insulin in an attempt to move glucose into the cell. Since insulin is not effective, however, diabetics often cannot effectively transport glucose from the blood stream into the cells of the body. Thus, all diabetics have high glucose levels in the blood (hyperglycemia).

People with diabetes have a 300% to 500% increased risk of cardiac events. Furthermore, 75% of all deaths among diabetic patients are from cardiovascular disease. Additionally, individuals who have diabetes along with other risk factors are at a much higher risk than non-diabetic individuals with the same number of risk factors. High blood glucose levels (hyperglycemia) are associated with damage to the smallest blood vessels (such as those in the retina of the eye) and increased atherosclerosis. High insulin levels are also associated with enhanced blood clotting (Ridker, 2001).

Diabetes often coexists with other risk factors for cardiovascular disease. In fact, the cluster of risk factors has been termed *metabolic syndrome* or *metabolic syndrome X*, and it includes abdominal obesity, hypertension, dyslipidemia (elevation of lipids in the blood) and diabetes. Therefore, it is important that a person with diabetes very aggressively control other risk factors for cardiovascular disease. A diabetic should lose excess body weight, exercise regularly and eat a diet low in simple sugars and carbohydrates. Because of the complexity of the disease, its relationship to heart disease, and the difficulty controlling blood glucose levels, a person with diabetes should consult regularly with his or her physician regarding an appropriate diet and exercise program and the need for medication.

Physical Inactivity. Physical inactivity is another risk factor for cardiovascular disease: The less exercise a person gets on a regular basis, the greater the incidence of cardiovascular disease. Physical inactivity is also related to several of the modifiable risk factors. A lack of exercise increases an individual’s risk of obesity, hypertension, dyslipidemia and diabetes. The risk of cardiovascular disease in inactive people is about twice that of physically active individuals – approximately the same as for hypertension and dyslipidemia (Plowman and Smith, 2003). In fact, physical inactivity is responsible for approximately 200,000 deaths per year in the United States (Ridker, 2001).

Increased physical activity improves work capacity, increases strength, decreases injury rates and improves heat tolerance. Exercise training also has a positive impact on several other cardiovascular risk factors: It decreases blood pressure, increases good cholesterol levels (HDL), improves glucose tolerance and causes loss of fat. In addition to these substantial benefits, exercise also strengthens the heart muscle, enhances the dissolving capacity of the blood (making unwanted clots less likely) and stabilizes the electrical activity of the heart.

The physical fitness profile of firefighters is likely to vary greatly both between and within individual fire departments. Roberts and colleagues have demonstrated the effectiveness of a 16-week physical training program in enhancing aerobic capacity ($VO_2\text{max}$) among recruit firefighters (Roberts et al., 2002). After 16 weeks of training, this group of just more than 100 recruits improved their estimated $VO_2\text{max}$ by 28% (35 to 45 ml/kg/min). Whereas the initial fitness values were below those generally considered necessary for firefighting activities, the values obtained after the training program compare favorably to estimates of aerobic capacity needed to perform firefighting activities (Sothmann et al., 1992).

Given the importance of physical fitness for performing the physical work of firefighting and its role in decreasing cardiovascular risk factors and improving health, it is imperative that firefighters and fire departments embrace the current fitness initiatives being advanced by the major fire service organizations, including NFPA 1583.

Decreasing Cardiovascular Disease Risk Factors

Cardiovascular disease is a major threat to the health and safety of firefighters. In order to stay healthy, and address the risk factors for developing cardiovascular disease, firefighters should adopt healthy lifestyle habits. In short, to reduce the risk of suffering a heart attack or stroke, it is imperative that firefighters:

- Do not smoke or stop smoking.
- Follow a regimen of moderate aerobic exercise.
- Eat a balanced diet, avoiding excess saturated fats and excess simple sugars, and maintain normal body weight.

Table 1.2 highlights the risk factors that are influenced by each of the above recommendations. Of particular note is the benefit of moderate exercise in eliminating or favorably affecting five of the six modifiable risk factors.

Cardiovascular Stress of Firefighting

While operating at a structure fire, firefighters perform strenuous physical work while wearing heavy, highly insulating personal protective equipment. At many incidents, work must be performed in a hot environment and under psychologically stressful conditions. As a result of the combination of heavy work, encapsulating gear, and hostile environmental conditions, firefighting results in significant physiological strain – affecting nearly every system of the body. The resultant cardiovascular and thermal strain, however, poses the greatest risk to the firefighter.

There are two primary approaches that scientists have employed to understand the cardiovascular stress associated with firefighting. One approach

Table 1.2. Recommendations for decreasing cardiovascular risk factors.

Recommendations	Risk Factor Influenced
Exercise Moderately	Decreased Blood Pressure Improved Lipid (Cholesterol) Profile Decreased Body Fat Improved Glucose Tolerance Eliminates Physical Inactivity
Eat a Balanced Diet	Improved Lipid (Cholesterol) Profile Decreased Body Weight Improved Glucose Tolerance May Decrease Blood Pressure
Don't Smoke	Smoking



Part One: Theoretical Foundation

is to retroactively review the information on firefighters who have suffered cardiac events in the line of duty and to determine what the firefighter was doing at or prior to the time of the event. This approach has shown clearly that fire attack and suppression activities do serve as a trigger for cardiac events. A second approach measures physiological responses to firefighting or simulated firefighting activity to better understand the mechanics by which the stress of firefighting may precipitate a sudden cardiac event. Studies of this type have clearly documented the fact that firefighting is very stressful on the body and leads to several physiological changes that could cause sudden cardiac events in vulnerable individuals. The final section will address the specific factors of firefighting that directly affect cardiovascular and thermal strain on firefighters.



Retrospective Study of Cardiac Events in the Line of Duty

A recent study documented the relative risk of sudden cardiac death associated with different firefighting activities (Kales et al., 2007). The authors reviewed firefighter fatalities for an 11-year period from 1994 to 2004 (excepting the deaths associated with September 11, 2001). Estimates of the proportion of time spent performing various activities were obtained from a municipal fire department, from a group of 17 large metropolitan fire departments, and from a national database. These groups reported spending 2%, 5% and 1%, respectively of their time in fire suppression activity. In contrast to the small percentage of time that was spent in fire suppression, 32% of firefighter fatalities occurred during these activities. Odds ratios for death from coronary heart disease during fire suppression were then calculated compared with nonemergency duties (reference category). The resultant odds ratios were 53, 12 and 136 for the municipal department, the metropolitan departments and the national data set, respectively. This means that firefighters are approximately 12 to 136 times more likely to die of coronary heart disease during fire suppression activities than during nonemergency duties.

Additionally, there is compelling evidence that cardiac events are most likely to occur in individuals with a history of cardiac disease or with known risk factors for cardiovascular disease. A recent study that compared fatal and non-fatal cardiac events in firefighters found that a previous diagnosis of coronary heart disease, current smoking, and hypertension were highly significant and independent predictors of fatal cardiac events. Each of these predictors were associated with an approximately 4-fold increase in risk of death (Geibe et al., 2008). Other studies that have compared professionally active firefighters to firefighters experiencing on-duty cardiac events, have found that a previous diag-

nosis of coronary heart disease is associated with a 15-fold and 9-fold increase in the risk of on-duty cardiac death or disability retirement due to heart disease, respectively (Kales et al., 2003; Holder et al., 2006). A study that reviewed on-duty firefighter fatalities over the 10-year period of 1995-2004 found that 43.7% of the fatalities were attributable to sudden cardiac death. Post mortem information was available on 308 of the 440 victims of sudden cardiac death. Of these, 43.5% had prior known heart-related conditions and another 31.5% had arteriosclerosis heart disease identified by autopsy (Fahy, 2005). Taken together, these studies show definitively that a history of heart disease is a strong predictor of future fatal cardiac events, and strongly suggest that aggressive screening and risk factor management is essential for firefighters.

Research Findings Regarding Physiological Effects of Firefighting

It is well accepted that firefighting requires strenuous work; however, it is difficult to fully describe the physiological effects of firefighting. The majority of the research describing the physiological effects of firefighting has investigated relatively short bouts of firefighting activity in a training structure that contains live fires or in response to work while wearing personal protective equipment in a hot laboratory (climate chamber). While these studies provide valuable information about the effect of work and heat on the human body, it is likely that the results obtained in these controlled conditions underestimate the physiological stresses encountered during an actual working fire when firefighters are facing all the challenges of a real emergency. Studies conducted in a live fire situation have limitations in terms of the standardization that can be achieved and the variables that can be measured. Additionally, the studies that have been conducted often have used relatively small numbers of subjects and have often relied on relatively healthy young sub-

jects that do not reflect the overall demographic of the American fire service. Nonetheless, these studies contain valuable information about the physiological stress of firefighting.

Numerous studies have documented that strenuous firefighting activities can lead to near maximal heart rates that are attained quickly and remain elevated for prolonged periods of time. A classic study conducted in the mid-1970s recorded heart rate and ECG data of firefighters while they were on duty (Barnard and Duncan, 1975). This study was one of the first to document that heart rates are elevated (mean increase 47 beats per minute) in response to an alarm and remain elevated en route. While this initial study provided limited data, it did document high heart rates during fire suppression (including one subject with a heart rate greater than 188 beats per minute for a 15-minute period) and noted subtle changes in the electrocardiogram (ECG) of firefighters en route to the fire (ECG data could not be gathered during firefighting activities due to excessive movement artifact).

Since the 1970s, considerable research has sought to quantify the physiological stress of firefighting. Of course, the first obstacle encountered by researchers who undertake this task is to replicate “firefighting activities” because the conditions that firefighters encounter vary so greatly. The different approaches that are taken to simulate “firefighting” activity account for much of the variability that is found in the literature.

As depicted in Figure 1.5, researchers at the University of Illinois conducted a study in a structure that contained live fires and found that three repeated bouts (approximately 7 minutes) of simulated firefighting activity (with a 10-minute rest between the second and third trial) caused the participant’s average heart rates to reach approximately 189 beats per minute (Smith et al., 2001).



Part One: Theoretical Foundation

The subjects in this trial were recruit firefighters with a mean age of 29 years. In other words, in this short bout of firefighting activities, participants reached age-predicted maximum heart rate (estimated maximal HR = 220 – age). These findings are consistent with other published studies that investigated heart rates during strenuous firefighting activities in a training setting (Manning and Griggs, 1983) and during actual emergencies (Duncan and Barnard, 1979; Sothmann et al., 1992). Other studies have reported lower heart rates during firefighting training (Romet and Frim, 1987). The study conducted at the University of Illinois also measured cardiac stroke volume changes as a result of the repeated bouts of firefighting activity (Figure 1.5b). Stroke volume increases along with heart rate during dynamic exercise in order to provide the blood flow necessary to supply the working muscles and other vital organs. During firefighting activity, however, stroke volume was significantly decreased by the end of the third bout of activity. These results were found despite a 10-minute rest between the second and third trial in which the participants consumed water. It is likely that the decrease in stroke volume can be attributed to venous pooling from increased vascular compliance due to raised core temperature along with a reduction in plasma volume (see below).

Due to a combination of high environmental temperatures and physical exertion, firefighting causes core body temperature to increase. Rossi et al. (2003) reported that approximately 15 minutes of firefighting activities in a training facility resulted in an average increase of 1.0°F in recruit firefighters. Smith et al. (1998) reported greater increases in core temperature, with an average increase of 2.5°F, in a group of career firefighters who completed three repeated bouts (~6 minutes) of firefighting activity (with a 10-minute break between the second and third trial) in a structure that contained live fires. Eglin et al. (2004) per-

formed a study to investigate physiological responses of instructors at a fire academy as they often are exposed to heat for a longer duration than recruits. On average, the core temperature of the instructors rose approximately 1.8°F over the 40 minutes of data collection; indeed, 8 of the 13 instructors had core temperatures over 102°F.

Concomitant with elevated temperatures, performing strenuous work in a hot environment causes profuse sweating. The body sweats in an attempt to lower its temperature through evaporative cooling. However, the encapsulating properties of firefighting bunker gear creates a warm, moist, stagnant microclimate around the skin,

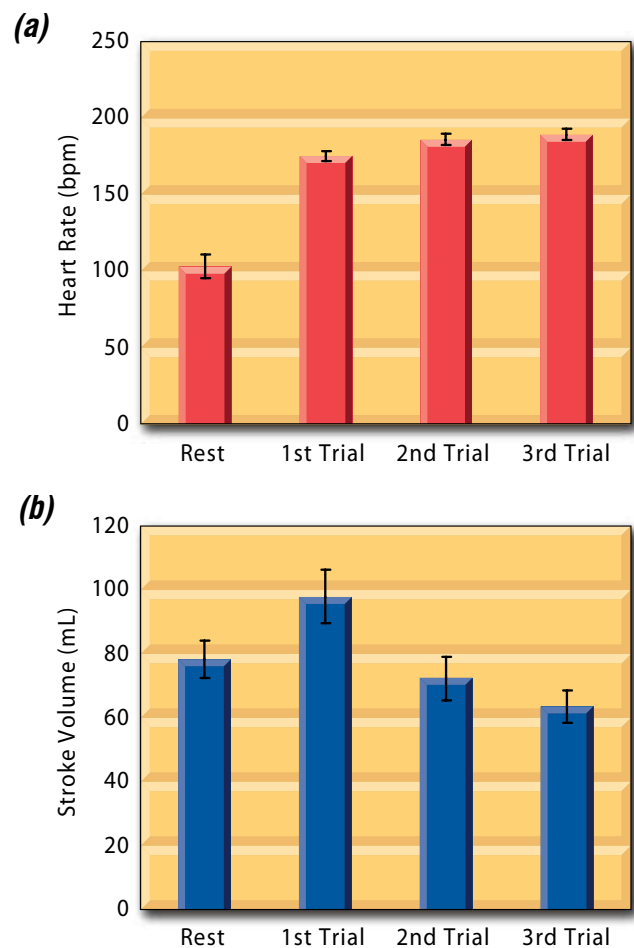

Figure 1.5. (a) Heart rate and (b) stroke volume responses to training exercises. (Smith)

severely limiting the evaporation of sweat, and hence, the effect of evaporative cooling. Profuse sweating can decrease plasma volume, placing additional strain on the cardiovascular system and further impairing thermoregulation. Smith et al. (2001b) have reported a 15% reduction in plasma volume following approximately 17 minutes of strenuous simulated firefighting activity. Sweat rates resulting in body weight loss of 2.8 pounds per hour have been reported during exercise in a hot environment while wearing PPE (Selkirk et al., 2004). Studies that have investigated sweat loss during firefighting activities have generally reported modest sweat loss (1.1-2.2 pounds) due to the limited time (<30 minutes) that the activities were continued (Smith et al., 1998; Eglin et al., 2004; Wilkerson et al., 2004). Perhaps more important than the actual sweat rate reported following brief bouts of simulated firefighting activity, is the high sweat rate that firefighters experience while wearing their gear. In practical terms,

firefighters often work in their PPE for periods that extend far beyond the time tested in most studies. A firefighter dons his or her gear at the station, travels in the gear, and then wears that gear through firefighting activity and clean-up activity. Under real-life conditions the firefighter is likely to be sweating much of the time.

Factors Affecting Cardiovascular and Thermal Strain

The magnitude of the thermal and cardiovascular strain experienced by a firefighter depends on a number of environmental and personal factors (Figure 1.6). Environmental factors that affect the physiological response to firefighting include: the work that is performed, the environmental conditions in which the work is performed, and the personal protective equipment that is worn. Personal factors of importance include: individual characteristics, medical conditions, fitness status and hydration status.

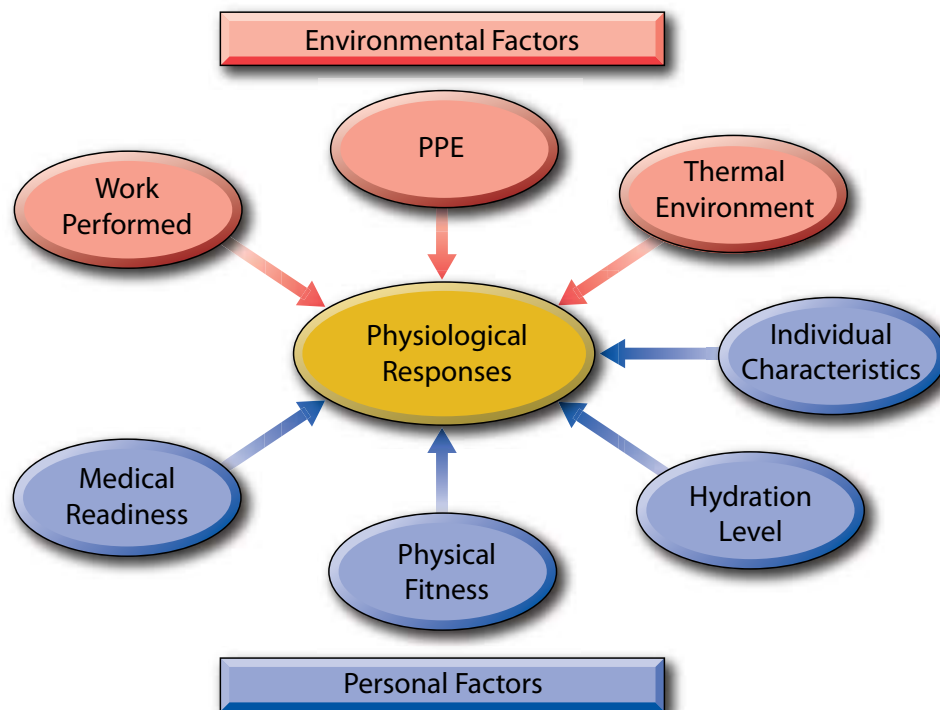

Figure 1.6 Summary of factors influencing physiological response to firefighting.



Part One: Theoretical Foundation

Work. Although it is common to speak of a generalized physiological response to firefighting, a multitude of different tasks may be performed on the fireground at various intensity levels. These include: throwing ladders, climbing stairs with heavy loads, performing a search, advancing a line, application of water, venting a roof, forcing a door and overhauling a room. Clearly the work that is being performed has a major influence on the physiological response: the more strenuous the work, the greater the cardiovascular response. Furthermore, the more muscular work that is done and the longer it is performed, the more core temperature rises if sweat is not able to evaporate and cool the body (Romet and Frim, 1987; Holmer and Gavhed, 2007).

Environmental Conditions. It is well known that working in a hot environment creates greater physiological and psychological strain than performing the same work in a thermoneutral environment (Rowell et al., 1969; Sawka and Wenger, 1993; Smith et al., 1997). In an attempt to better understand the relative contributions of heavy physical work and environmental heat on the physiological responses to firefighting, Smith et al. (1997) conducted a study that compared physiological responses to an overhaul task in ambient conditions with no fire (~59°F) to the same task performed with live fires in the structure (~195°F at chest level). Heart rate increased to an average of 139 beats per minute in the ambient conditions and to 175 beats per minute in the live-fire condition. Tympanic temperatures increased by slightly more than 5.4°F in the live-fire condition and less than 1.0°F in the ambient conditions. These results confirm that live-fire conditions add considerably to the cardiovascular and thermal strain of firefighting.

Personal Protective Equipment. Personal protective equipment (PPE) is necessary to protect firefighters from burn and inhalation injuries;

however, because of its weight and its restrictive properties, PPE also adds to the metabolic work that must be performed, and interferes with heat dissipation because of encapsulation. Thus, PPE adds to the cardiovascular and thermal strain associated with firefighting. In a laboratory study that compared 15 minutes of treadmill walking in a firefighter's station uniform to 15 minutes of walking in fully encapsulated PPE with SCBA, Smith et al. (1995) found that heart rate was 50 beats per minute higher while wearing the fully encapsulating gear. Rectal temperature was also higher in the gear, rising 1.3°F in the PPE trial and only 0.4°F when the station uniform was worn. Importantly, this study also included a PPE configuration that was not fully encapsulating (similar to the gear worn before the updated NFPA in 1971) in which firefighters wore three-quarter-length coats, rubber pull-up boots and no hood. At the end of the trial in the three-quarter coat, heart rate was 16 beats per minute less than in the fully encapsulating trial, and rectal temperature was 1.0°F less. This result clearly indicates that the type of PPE and the extent to which it reduces heat dissipation (through sweat evaporation) can affect physiological response to work in the gear.

Individual Characteristics. A firefighter's age, gender and body size all affect physiological responses to firefighting activities. In general, the risk of heart attack while fighting a fire increases as the age of the firefighter increases (Figure 1.7). Excess body fat creates additional cardiovascular strain on a firefighter by adding to the metabolic work that must be done to move the firefighter's mass and to move blood through additional tissue. Excess body fat also increases the thermal strain associated with strenuous activity by providing additional insulation, impeding range of motion and mobility, and interfering with heat dissipation.

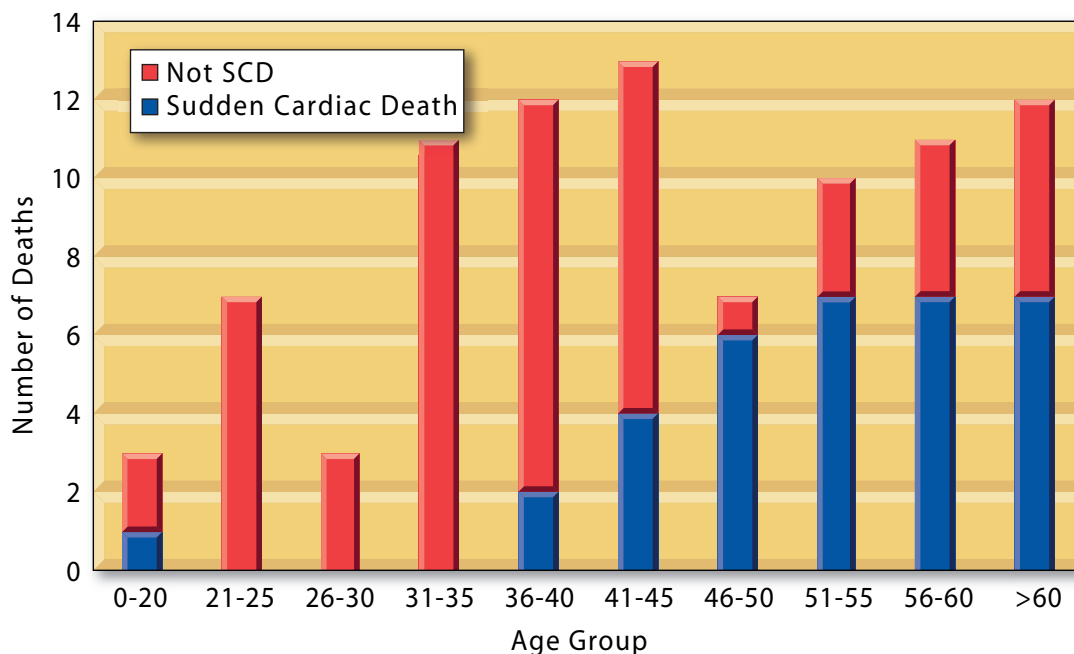

Figure 1.7. Cardiac deaths by age group. (Fahy et al., 2007).

Medical Condition. The combination of heavy work, severe heat, and mental stress present during firefighting activities necessitates that firefighters be in good health to operate safely on the fireground. A firefighter with cardiovascular disease is more susceptible to cardiac events on the fireground. In fact, a retrospective analysis of sudden cardiac events over a 10-year period found that 75% of firefighters who suffered fatal events had pre-existing cardiovascular disease (Fahy, 2005). High blood pressure, high cholesterol, and obesity must be taken very seriously because they greatly increase the risk of cardiovascular mortality. Diabetes, or pre-diabetes (impaired glucose tolerance), is especially dangerous because it is associated with several cardiovascular risk factors. Because of the importance of cardiovascular risk factors and underlying cardiovascular disease as it relates to cardiac-related fatalities, a major portion of this review is directed to cardiovascular risk factors.

Fitness Level. High levels of fitness are necessary to successfully and safely perform physically demanding firefighting activities. A fit firefighter can perform the same amount of work with less cardiovascular and thermal strain than a less fit firefighter. A fit firefighter also has a greater reserve to perform more work. Firefighters need to possess a high degree of muscular fitness (muscle strength and endurance) and cardiovascular fitness (aerobic fitness). Aerobic fitness is especially important because it:

- Increases the efficiency of the heart
- Improves work capacity
- Increases plasma volume
- Improves thermal tolerance
- Provides cardioprotection by enhancing anti-clotting activity of the blood
- Enhances the ability of blood vessels to dilate to allow more blood to be supplied to muscles



Part One: Theoretical Foundation

Hydration Level. Firefighting can induce large volumes of sweat loss due to the heavy work, hot conditions, and impermeable nature of the PPE. During strenuous work in hot conditions or in impermeable clothing, humans can lose more than two quarts of sweat an hour. As noted above, it is common for firefighters to lose more than a quart of sweat per hour while working in hot ambient temperatures wearing PPE (Selkirk et al., 2006). This sweat loss contributes to a decrease in plasma volume, adds additional strain on the cardiovascular system and decreases thermal tolerance.

Importantly, previous research has shown that firefighters are often dehydrated before beginning firefighting activity (DiMarzo et al., 2006), a situation that poses an additional risk for severe dehydration and heat illness during firefighting.

Summary

These findings demonstrate that the increased risk of cardiac death among firefighters is based upon a combination of factors: an increase in cardiac strain due to the exertion of firefighting activity, as well as inherent and acquired risk factors that are endemic to the population as a whole.



Slips, Trips and Falls in the Fire Service

Slip, Trip and Fall Injuries on the Fireground

The National Fire Protection Association conducts yearly surveys of firefighter injuries to provide a national estimate of their frequency and characteristics. In 2006, the NFPA estimated that, on average, 26.9 injuries occurred on the fireground per 1,000 fires (Karter and Molis, 2007). Nearly 25% of these fireground injuries in 2006 were attributed to falls, slips or missed jumps, ranking second to injuries caused by overexertion and strain (Figure 1.8).

Since 1990, injuries due to slips, trips and falls have consistently ranked as either the first or second most common cause of injury, averaging over 11,200 injuries per year (Karter and Mo-

lis, 2003-2007; Karter and LeBlanc, 1990-1999; Karter and Badger, 2000, 2001). Total fireground injuries have declined from 57,100 in 1990 to a low of 36,880 in 2004, followed by a slight increase in the past two years, a trend that fairly closely follows the change in total fire incidence over the same time period. Alarming, injuries due to slips, trips and falls have remained relatively constant over this same time period. In fact, 2004 saw the highest number of slip, trip and fall injuries since 1996. Table 1.3 outlines some of the most common origins of slip, trip, and fall injuries on the fireground that typically occur while at ground level, such as crossing or moving over objects, icy surfaces, or wet surfaces (Karter, 2003).

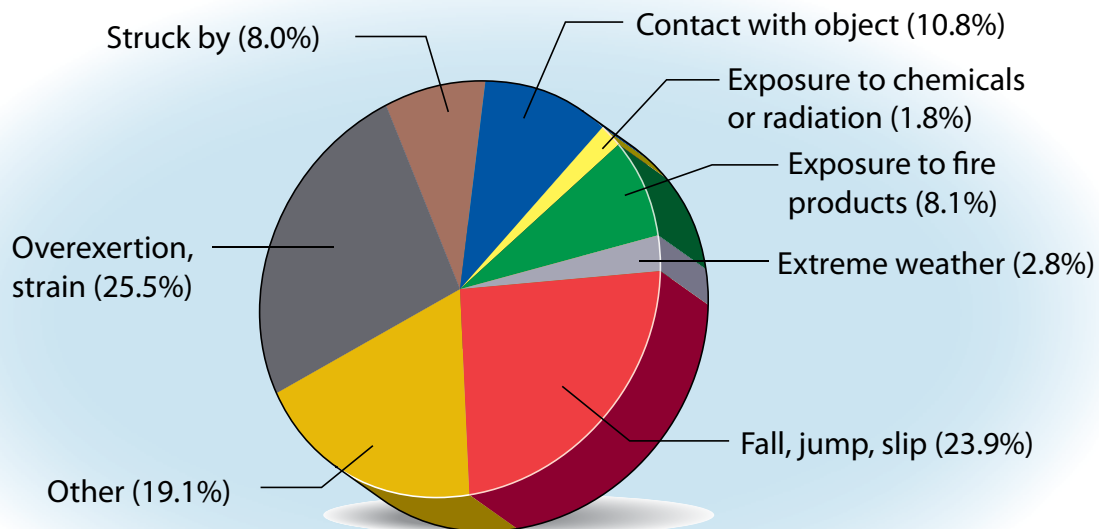

Figure 1.8. Fireground injuries by cause in 2006 (Karter and Molis, 2007).



Part One: Theoretical Foundation

Not only are slips, trips and falls one of the most common source of injuries, but falls and loss of balance can result in significant injury and loss of productivity. The most common types of moderate and severe injuries that resulted from a fall or jump were sprains and strains, accounting for 65% of injuries. Fracture and dislocations were responsible for 14% (Houser et al., 2004). Cloutier and Champoux (2000) found that, among firefighters in Quebec, Canada, accidents due to falls resulted in the longest work absences. In another study of firefighters in Alberta, Canada, while 16% of all firefighter injuries were due to slips, trips, and falls, these accidents accounted for 25% of the total time lost due to injury (Ault, 2002). These data highlight the impact of these injuries on worker health and productivity.

Despite the large quantity of data indicating that falls and loss of balance result in high injury rates and high rates of lost work time, efforts to un-

derstand the underlying mechanisms and develop possible interventions to reduce these events have been relatively limited. This lack of recognition is highlighted by the annual number of injuries due to falls, slips or missed jumps since 1990, which has remained relatively constant, even as the total number of firefighting injuries has substantially decreased over the same period of time.

Only a few individuals within the firefighting profession have attempted to address this issue in published literature, but rarely from a research-based approach. In 1994, Chief Vincent Dunn, a deputy chief with the Fire Department of New York (FDNY), wrote a piece in his “Safety and Survival” column of *Firehouse* titled “Falls, Slips and Missed Jumps” (Dunn, 1994). In this article, Chief Dunn emphasizes to fellow firefighters that it is important to be conscientious while moving around the fireground and not to

Table 1.3. Causes of firefighter injuries due to slipping and falling on the fireground, 1994-98 average (Karter, 2003).

Cause of slip or fall	Minor or moderate injuries	Severe injuries
Over object	1,490	10
On icy surface	1,510	25
On steps or stairs	1,305	14
On wet surface	885	15
In hole or outside structure	710	11
From ladder	385	5
In unguarded opening in floor	270	18
On flat surface	310	7
From structure	145	9
In or onto emergency apparatus	120	-
Other	1,455	19
<i>Total</i>	8,585	133



trip over fire hoses or slip and fall on wet or icy steps and pavement. He provides practical advice such as lighting up the fire scene, designating the engine chauffer to spread salt or sand on steps and surrounding streets, and “tucking” the body to protect the head in the event of a fall. He notes that firefighters tend to have “tunnel vision” when fighting the fire, such that they only concentrate on their given assignment and are not cognizant of their surroundings.

Similarly, D.R. Adams conducted a study as part of the National Fire Academy (NFA) Executive Officer Program (Adams, 2000). Adams had observed that a number of the members in his volunteer fire department, with no apparent sensory deficits, experienced slips and falls at emergency and non-emergency incidents while wearing turn-out gear. In response, Adams assessed the effect of wearing personal protective equipment on the balance and stability of firefighters. He compared differences in balance performance when wearing a station uniform or PPE using a computerized balance assessment device. He found that turn-out gear impairs balance; however, the subject population in this project was too small ($n = 3$) to enable generalization.

While some of the factors likely related to slips and falls are determined by the nature and environment of the fire scenes and cannot be easily prevented, others are likely due to both individual and equipment characteristics whose modification may prevent injury. Thus, there are a number of individual and equipment factors that might be altered in order to reduce the risk for particular injuries.

Yearly statistics show that slips, trips and falls are some of the most common and costly injuries to firefighters, yet little systematic research has been dedicated to helping firefighters reduce this

type of injury. Substantial resources have been dedicated to understanding and preventing slips, trips, and falls in other at-risk occupations, such as coal miners (Bell et al., 2000) and postal workers (Bentley and Haslam, 2001). The fireground is an inherently dangerous location with certain risks that cannot be avoided; however, through properly designed gear modifications and slip and fall interventions, we believe that this type of injury can be significantly mitigated.

Importance of Biomechanical Factors

Despite epidemiological data indicating that injuries due to slips, trips and falls are a serious problem among firefighters, limited rigorous academic research examining biomechanical changes due to firefighting have been conducted. The most detailed effort to date was carried out by Punakallio and coworkers, who conducted a series of studies focused on balance abilities of Finnish firefighters in the late 1990s and early 2000s (Punakallio, 2005). Some interesting results were obtained from these studies that can be extended to the American fire service:

- The balance ability of firefighters older than 50 was significantly worse than younger firefighters. Comparing this result to other occupations (construction workers, nurses) indicated that the decline in the fire service is more pronounced (Punakallio, 2003). In a separate study, the balance abilities of older Finnish firefighters (43-56 years) were more negatively impacted than younger firefighters (33-38 years) while wearing firefighting PPE when visual input is reduced (Punakallio et al., 2003).
- A functional balance test (where firefighters walk across a wooden plank without falling off) had a higher correlation coefficient and repeatability than a dynamic stability measurement (firefighters stand on a force plate and move their center of gravity following



Part One: Theoretical Foundation

visual input) (Punakallio, 2004). These tests were determined to provide reliable balance tests for screening in occupational health care for the fire service as well as other occupations.

- Regardless of age, wearing firefighting PPE was found to significantly impair balance in both postural (standing still) and functional (while moving) measures (Punakallio et al., 2003). The SCBA (with steel air cylinders) was determined to have the most significant effect on functional balance.
- In a slipping test, firefighters who experienced a slip long enough to significantly increase the risk of an unavoidable fall (5 cm) performed significantly worse on the dynamic stability test (Punakallio et al., 2005). Thus, a dynamic stability test may be used to evaluate balance abilities in firefighters and determine those who may be at a higher risk for slipping on the fireground. They recommend instituting training exercises that enhance balance abilities to firefighters training protocols.
- A firefighter's perceived work ability was quantified through a work ability index (WAI) questionnaire at baseline in 1996 and repeated again 1999 (Punakallio et al., 2004). A poor performance on the balance test in 1996 was found to be a reliable predictor of a reduced WAI in the 3-year follow-up.

In a separate set of studies in the United States, Kincl et al. (2002) have shown that changes in balance due to wearing PPE can be determined by measuring postural sway during standing balance tests. Their initial study indicated that higher levels of USEPA PPE altered postural stability significantly; however, a recent study focusing on balance changes in firefighters indicates that wearing PPE – both with and without SCBA –

actually improved postural stability (Sobeih et al., 2006). These results contradict the functional and dynamic balance results from Punakallio et al. (2003) and Adams' pilot study. Another interesting result from this study was that stability was found to decrease with prolonged shift work, indicating a possible increase in the propensity for slips and falls later in a firefighters' shift.

Analyses of the effect of firefighting PPE on the ability to walk with a normal gait cycle are much scarcer than balance studies. Biomechanical performance has been found to decrease with PPE use, as maximum walking speed and endurance time have been found to be reduced significantly with the addition of PPE (Louhevaara et al., 1995). The authors correlated this result with the extra mass of firefighting PPE and SCBA. They conclude that all means to decrease the weight of firefighting PPE should be considered in order to maintain sufficient power output in physically demanding firefighting activities.

Preliminary results from a current study conducted at the University of Illinois focusing on the effect of SCBA cylinder weight suggests that gait stability while negotiating obstacles is impaired by a heavier SCBA cylinder (Park et al., 2008). Reductions in all gait parameters (e.g., gait speed, step length, obstacle clearance) were found, suggesting reduced obstacle crossing safety. Furthermore, these changes appear to be accentuated by increasing walking speeds and obstacle height. These studies indicate modifications in firefighting PPE can affect gait; however, it is not known how strenuous firefighting activities with the combined effect of heat stress and PPE use affects the biomechanics of balance and gait stability.

Central Role of Heat Stress

Firefighting involves performing strenuous muscular activity in a hot and hostile environment while wearing heavy and restrictive PPE. As a result of this combination of stressors, firefighters experience heat stress. Heat stress, and the resulting elevation in body temperature, has a myriad of effects on the human body, most notably: hastening the onset of muscular fatigue, promoting dehydration, increasing cardiovascular strain, and interfering with cognitive function. Firefighters are vaguely aware of all these effects – that is, every firefighter knows that firefighting leads to muscular fatigue, profuse sweating, high heart rates, and, at times, trouble concentrating on multiple tasks simultaneously.

The USFA noted that in 2005 there were 3,550 reported injuries due to thermal stress, which is a low estimate given the under-representation of injuries reported to the federal database (USFA, 2006). Among these injuries, 2,480 occurred while operating on a fireground, demonstrating the additive effect of PPE and firefighting activity. Tens of thousands of firefighters are also injured each year due to slips, trips and falls on the fireground.

We hypothesize that heat stress also plays a central role in firefighter fatalities and injuries. Sudden cardiac death is the leading cause of line-of-duty fatalities, and it is well established that heat stress increases cardiovascular strain. It is well accepted that heat stress adds to the work of the heart due to the need to supply blood to working muscles and the skin, because of the sweating which decreases plasma volume, and a decrease in venous return due to vasodilation in the veins. There is also recent evidence that heat stress may activate platelets and lead to greater coagulation. Figure 1.9 presents an integrated model of the role of heat stress in contributing to the leading cause of line-of-duty death (sudden cardiac events) and the leading cause of line-of-duty injury (slips, trips and falls). This model provides the theoretical framework for the research project presented in Part 2.

Tens of thousands of firefighters are injured each year due to slips, trips and falls on the fireground. Heat stress leads to the early onset of muscular fatigue and hence may be a contributing factor to these injuries through changes in the firefighters' biomechanics associated with walking and balancing.



Part One: Theoretical Foundation

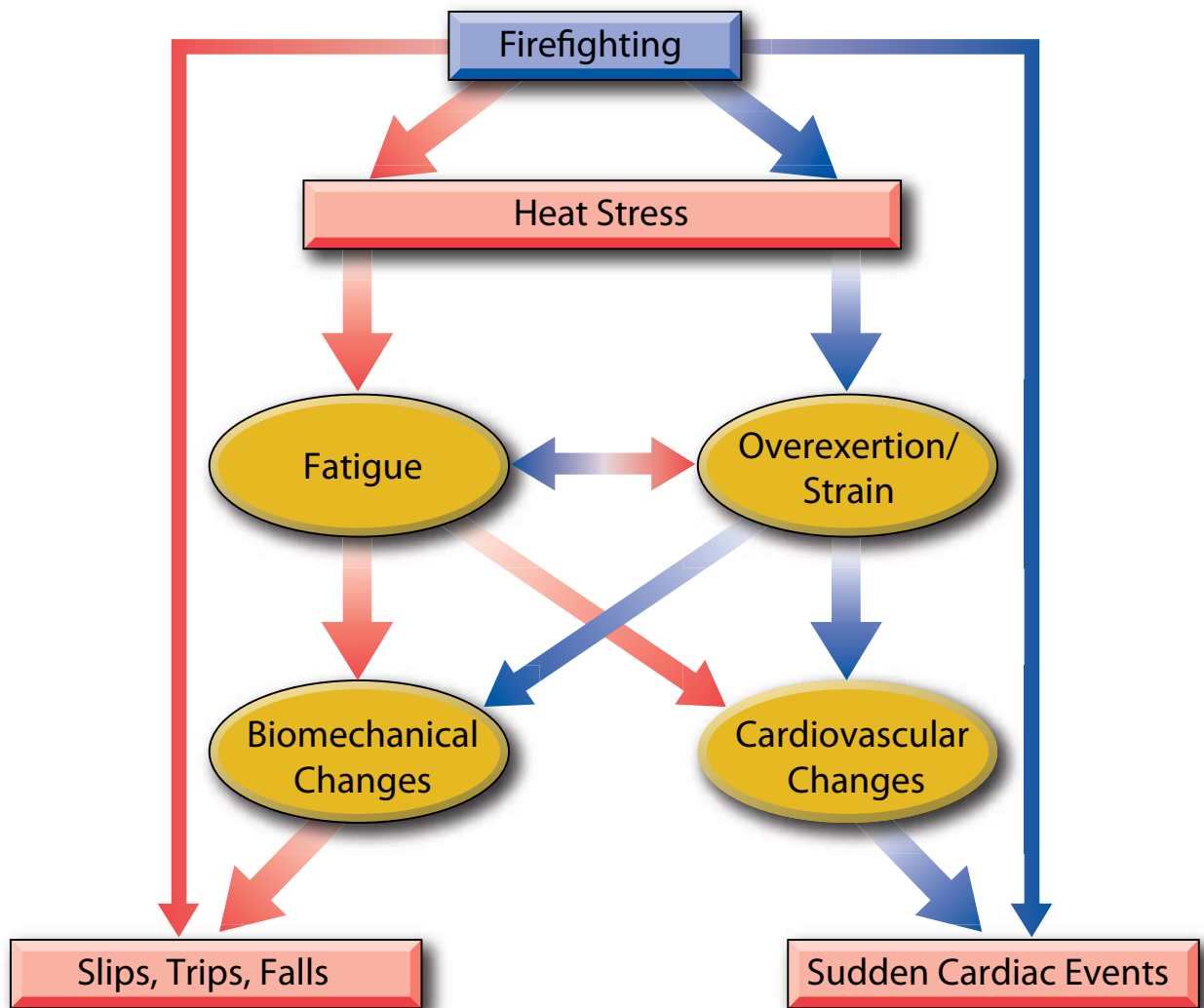

Figure 1.9. Model of the role of heat stress in contributing to firefighter injuries and fatalities.



Part Two: Research Project

Study Background/Significance

As outlined in Part 1, firefighting is a dangerous profession with a significant incidence of occupational fatalities and injuries. Over the past 15 years, 40% to 50% of line-of-duty deaths in the fire service were caused by overexertion or stress and associated cardiovascular disruptions that resulted in heart attacks (LeBlanc and Fahy, 2006). This percentage of heart-related occupational fatalities is nearly double that of the next highest profession (USFA, 2002). In addition to the tragedy of lives cut short and the emotional impact of a firefighter fatality on the family, the department and the community, there is a significant financial cost to federal and state government. As of October 2005, the federal government death benefit paid to the survivors of each fallen firefighter is approximately \$283,000. If current trends continue, more than \$14 million will be paid in death benefits in 2008 due to heart attacks alone. The financial and emotional burden of fatalities will continue every year until heart-related fatalities are significantly reduced. These staggering costs do not even include the medical and additional expenses from the 600-1,000 additional on-duty firefighters who suffer non-fatal heart attacks each year (Karter and Molis, 2006).

Additionally, tens of thousands of firefighters are injured in the line of duty each year. Encouragingly, total fireground injuries have declined since 1990, following the national trend in total fire incidence; however, injuries due to slips, trips and falls – the leading cause of fireground injury – have not decreased nearly as rapidly. Many of these injuries can be traced to changes in biomechanics – especially in balance and gait – that



result from the heat stress and fatigue of firefighting. While slips, trips and falls are the most common source of firefighter injury, they are also among the most devastating in lost work time, increasing staffing costs and potentially reducing personnel available for emergency response.

While fighting a fire, the human body is stressed by a combination of factors including strenuous muscular work, intense heat, and heavy, restrictive, and highly insulative personal protective equipment. These combined factors lead to heat stress and cardiovascular disruptions that may contribute to heart attack fatalities, as well as changes in biomechanics resulting in slip, trip and fall injuries. Therefore, it is necessary to systematically investigate the magnitude of the cardiovascular disruptions and biomechanical changes associated with strenuous firefighting activities and scientifically test interventions designed to lessen the detrimental changes that increase the risk of heart attack or slips, trips and falls.

Few interventions can be designed to reduce the muscular work or intense heat encountered during firefighting activities; however, every structural firefighter in the country wears similar personal protective equipment, making it an attractive option for intervention. Furthermore, our previous research has documented that PPE configuration can affect physiological and performance variables (Smith et al., 1998; Smith et



al., 1995). Thus, redesigning PPE to reduce heat stress and mitigate cardiovascular disruptions and biomechanical changes may positively affect both the leading cause of firefighter fatalities and injuries.

The urgent need for this type of research is clearly highlighted in the National Fallen Firefighters Foundation's National Fire Service Research Agenda (NFFF, 2005). This project addresses three issues that the agenda identifies as highest priority for reducing firefighter line-of-duty deaths and injuries:

- Risk factors relating to cardiovascular disease in the fire service
- Physiological and psychological effects of heat stress
- Identifying fireground factors that contribute to fire service injuries and fatalities



Part Two: Research Project

Purpose

There were three primary purposes of this study:

- To determine the prevalence of specific cardiovascular risk factors or early indications of cardiovascular disease in a cohort of volunteer and career firefighters.
- To investigate the effects of simulated firefighting activity on:
 - Physiological and perceptual variables,
 - Blood parameters (especially related to clotting), and
 - Gait and balance variables.
- To determine if the gear ensemble worn during firefighting activity affected the responses listed above.



Methodology

Study Design

Participants who were enrolled in the study were asked to complete two test periods:

- Live fire test period at the **Illinois Fire Service Institute (IFSI)**, which included performing simulated firefighting activities in a training structure that contained live fires.
- Lab test period that included visiting the **Cardiovascular and Exercise Research Laboratory** at the University of Illinois, where resting measures of cardiovascular health were obtained.

A total of 122 firefighters completed the firefighting activities at IFSI, and 110 firefighters completed a cardiovascular assessment at the Cardiovascular and Exercise Research Laboratory.

Subjects

Participants were male firefighters from fire departments across the state of Illinois; affiliation with career or volunteer fire departments was divided nearly evenly. Firefighters were recruited for participation in the study primarily through word of mouth but also using informational brochures, courses at IFSI, and principal investigator visits to firehouses and fire association meetings. All participants were fully informed of the purpose of the study, were told that their participation was voluntary, were provided an opportunity to ask questions of the investigators, and were informed of the requirements of participation. Participants were then asked to read and sign an informed consent document indicating that they



understood the risk and benefits of participation, the procedures involved, and that their participation was voluntary.

Prior to participation in the testing, participants were also required to complete a health history questionnaire. Firefighters who indicated that they had a diagnosed history of atherosclerotic cardiovascular disease or who were taking medications for high blood pressure or cholesterol were excluded from participating in the study. Participants who had taken medication that affects blood platelets or blood clotting (such as aspirin, other pain relievers or cold medications) were not allowed to participate until at least 7 days had elapsed since their last ingestion of such medication. Firefighters who reported a history of balance and gait impairments, neurological disease, reduced visual function or who wore PPE outside the size range available were not able to participate in the study.



Part Two: Research Project

Cardiovascular and Exercise Research Laboratory Test Period

Testing Protocol

During the lab test period (either prior to the fire-fighting activities or more than 48 hours after fire-fighting), firefighters underwent a test session in the Cardiovascular and Exercise Research Laboratory. Each of the 110 participants arrived at the lab having not eaten, smoked or consumed alcohol or caffeine for at least 4 hours. While at the laboratory, participants underwent a non-invasive assessment for a number of early indicators of cardiovascular disease, including measurement of carotid artery stiffness, augmentation index (wave reflection), carotid intima-media thickness, flow mediated dilation, pulse wave velocity and forearm blood flow.

Measures

Carotid Stiffness. Carotid pressure was first obtained using a pen-shaped transducer (Atcor SphygmoCor). Following this, stiffness of the carotid artery was measured using ultrasound technology (Aloka ProSound 5500). A linear probe was used to record changes in artery diameter during the cardiac cycle in the carotid artery. Stiffer arteries are associated with an increased risk of cardiovascular disease.



Augmentation Index (AIx). Radial artery pressure waveforms were attained using the same pen-shaped transducer at the wrist. Waves are reflected at arterial bifurcations (where the artery splits) and based on the reflection of these waves relative to the initial blood pressure wave, augmentation index (the increase in blood pressure due to reflected pressure waves) and wave reflection time were determined. Stiffer arteries are associated with higher augmentation index, lower reflection time, and increased risk of cardiovascular disease.

Intima-Media Thickness (IMT). Using ultrasound technology, an image of the carotid artery was obtained and recorded. The image was then analyzed to determine the thickness of the inner lining of the artery, called the intima-media. Increased thickness of this layer is indicative of atherosclerotic plaque deposition in the arterial wall.

Flow-Mediated Dilation (FMD). Blood flow was measured at rest and after 5 minutes of occlusion (to cause a maximal blood flow response). With the participant lying on his back, an ultrasound probe was placed on the brachial artery (inside of the upper arm). Blood flow velocity and artery diameter were recorded over a 10-second period at rest to determine baseline blood flow. To determine the ability of the artery to dilate and increase blood flow, a standard blood pressure cuff was placed over the forearm and inflated to 250 mmHg to occlude the forearm and hand blood flow for 5 minutes. After 5 minutes of occlusion, the cuff was released and blood flow and artery diameter was again measured over a 3-minute period to assess the blood flow response to occlusion. A higher blood flow and dilation following occlusion indicates the ability of the blood vessels to increase blood supply to tissue. Con-

versely, a low maximal blood flow and dilation following occlusion suggests the vessels are not able to respond appropriately to the need for increased blood flow.

Pulse Wave Velocity (PWV). Regional arterial stiffness was measured using pulse wave velocity. To assess heart rate, three electrodes were placed on the subject's torso, one on each collar bone and a third on the lower rib. Using the pen-shaped transducer, arterial waveforms were recorded at two sites: the carotid artery in the neck and the femoral artery at the top of the leg. The distance between these sites was measured using a tape-measure. After the pulse waveforms were obtained by the transducer, the velocity was calculated by dividing the distance between sites by the time it took waveforms to traverse the various pulse sites. A higher velocity is indicative of a stiffer vessel in that region.

Forearm Blood Flow. A pressure-sensitive strain gauge was placed around the widest portion of the forearm while a standard blood pressure cuff was placed over the upper arm. The cuff on the upper arm was inflated to a low pressure (50



mmHg) and then deflated every 15 seconds while the strain gauge measured forearm blood flow via changes in forearm circumference.

Peak Forearm Blood Flow (reactive hyperemia). A standard blood pressure cuff was placed over the upper arm and inflated to a pressure of 250 mmHg for 5 minutes. Following release of this cuff, a second cuff over the upper arm was inflated to a low pressure (50 mmHg) and then deflated every 15 seconds while a strain gauge placed around the widest portion of the forearm measured forearm blood flow via changes in forearm circumference for 3 minutes.



Part Two: Research Project

Illinois Fire Service Institute Live Fire Test Period

Testing Protocol

Figure 2.1 provides a timeline of the live fire testing protocol conducted at the Illinois Fire Service Institute for each of the 122 firefighters that completed this portion of the study.

The day prior to testing, a research staff member met with each participant and provided them with a gastrointestinal (GI) temperature pill (Mini Mitter VitalSense Core Temp Capsule). Each participant was given instructions to ingest the pill about 8-12 hours prior to the live fire testing. On the day of testing, participants reported to the 6-story Burn Tower on the IFSI Champaign campus. Firefighters began their check-in procedure

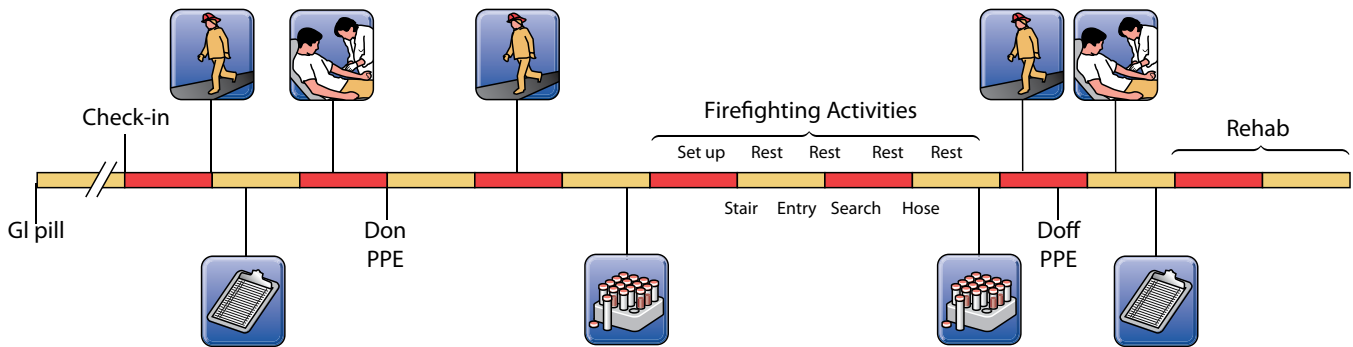

Each colored bar indicates 5 minutes

Symbol	Description
	Balance or Gait analysis: Baseline - station blues, Pre-firefighting, Post-firefighting - in PPE
	Blood collection: Pre-firefighting, Post-firefighting
	Psychological Questionnaires: Pre-firefighting, Post-firefighting
	Physiological data collection: Pre-firefighting, Post-firefighting

Figure 2.1. Timeline for the live fire testing protocol.

in the North Bay. During check-in, a research staff member verified the completion of all pre-requisite forms. The participant was then given a clipboard with their participant ID number and a data sheet.



Upon completion of the check-in process, the participant was sized for the specially designed PPE. PPE type (Standard or Enhanced) was assigned based upon the order of the participants entering the testing course, so that PPE type alternated as much as possible. Participants were then instrumented with a heart rate monitor (Polar Electro, Inc., Vantage XL) and skin patches on the forearm and neck to record temperature (Mini Mitter VitalSense Dermal Patch).

Once sized for PPE, the participants proceeded to the South Bay where several biometric baseline measurements were collected (height, leg length). The participants then performed either a Balance or a Gait Test in their station uniform and proceeded to the Blood Draw Room, located just adjacent to the South Bay, where several tubes of blood were drawn for subsequent analysis.



After their blood draw, participants donned their PPE (except for their mask and hood), and repeated the Balance or Gait Test in full gear. Baseline physiological data (heart rate, temperatures, blood oxygenation, blood carboxylation) were then recorded, and the participants were asked to provide answers to several perceptual measures (thermal sensations, respiratory difficulty, how good/bad they felt). The participants then met with a principal investigator and reviewed the tasks that would be performed on the live fire testing course. Upon notification by an investigator, the participants then donned their mask and hood, turned on their SCBA, locked their regulator into their mask, and entered the live-fire training course.

Burn Structure and Temperatures

Live-fire testing was conducted on the second floor of the Illinois Fire Service Institute Burn Tower. The reusable Burn Tower is concrete block and steel construction with steel doors and windows to provide ventilation. The second floor is laid out as shown in Figure 2.2, with a lower level measuring 14.5 by 19.5 feet where



Part Two: Research Project

all firefighting activities took place and an upper level measuring 20 x 20 feet raised 2 feet from the lower floor. Two firesets, loaded with wood pallets and straw (for ignition purposes only) were located on the upper level, 5 feet back from the lower level. The structure provided multiple means of egress – stairs to the first floor, stairs to the third floor, and a door to the upper level of the second floor, where a ladder to the ground was available.

In order to maintain room temperatures, three thermocouples were installed in the building near the search station: located 6 inches above the floor, 4 feet above the floor and 8 feet above the floor (~1 foot below the ceiling). Type K (chromel-alumel) thermocouples with factory-welded beads were utilized in conjunction with a digital data acquisition system (Omega Engineering, OM-DAQPRO-4300). Data was sampled from each thermocouple every 10 seconds

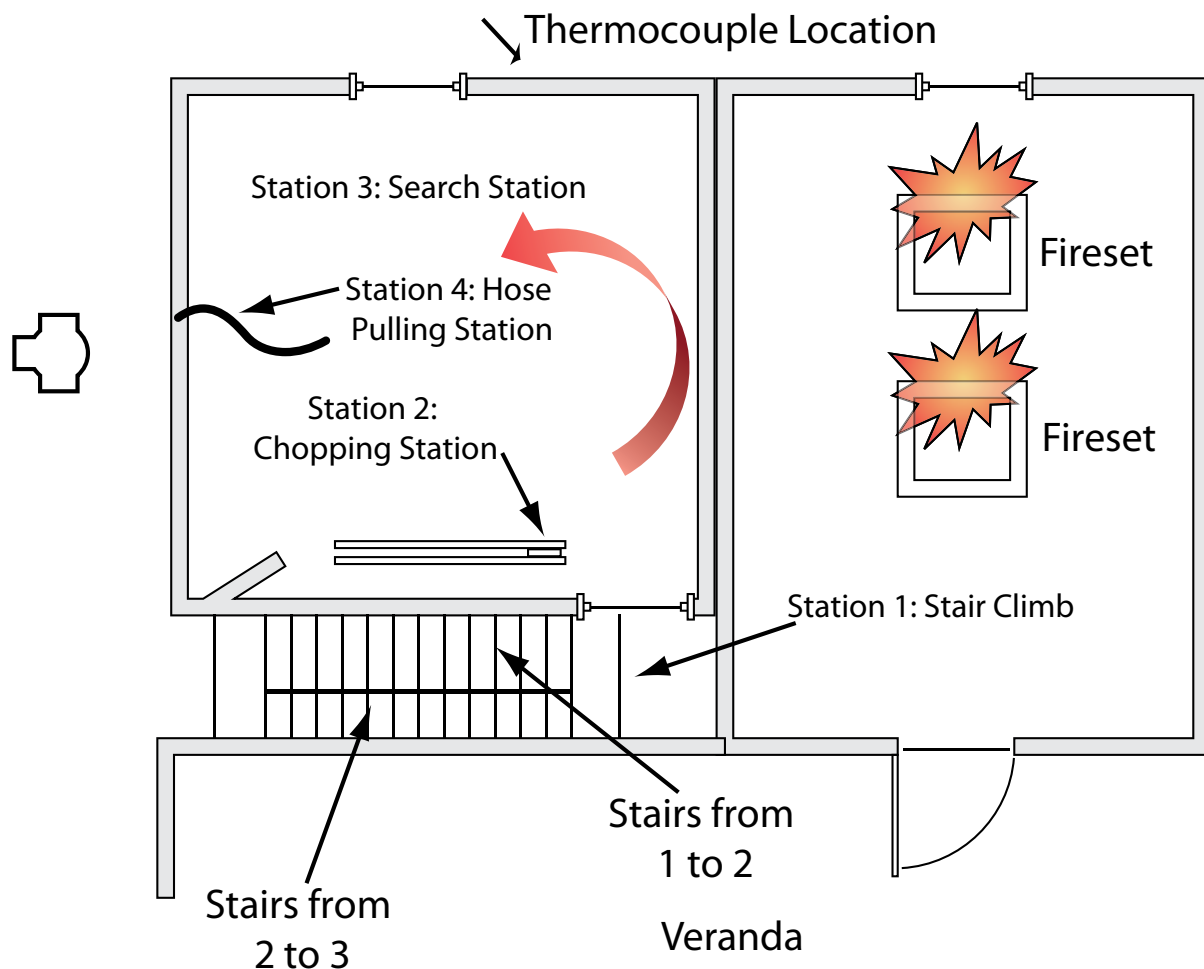

Figure 2.2. Schematic of 2nd floor of IFSI Burn Tower set up for research protocol.

and was continuously monitored to maintain the room conditions as consistent as possible (Figure 2.3).

Firesets were lit anywhere from 30 minutes to one hour prior to subjects beginning their live-fire testing. By preheating the building, relatively stable conditions could be maintained during testing. Throughout the burn, trained stokers controlled the temperature monitored by the thermocouples by adding small fuel packages to the firesets sequentially and controlling the ventilation conditions in the room. The temperatures at the mid-level point were maintained at roughly 160-180°F and the floor temperatures were maintained at 95-105°F. The prescribed firefighting activities required subjects to work almost exclusively in the vertical location between the middle and floor thermocouple.

Simulated Firefighting Activities

The participants completed 18 minutes of simulated firefighting activities consisting of nine 2-minute periods of alternating work-rest cycles. The work cycles included stair climbing, simulated forcible entry, a simulated search and simulated hose advance (Figure 2.4 a-d).

Each participant was paired up with a member of the research staff, trained in firefighting, and wearing full PPE to safely escort them throughout the protocol. Initially, the participant climbed a single flight of stairs to the second floor of the tower, walked to a corner of the room and knelt down for a 2-minute acclimatization period. After acclimatization, the participant proceeded to walk up and down three stairs for 2 minutes. The lower three stairs were used to maintain a consistent thermal loading on the firefighter. These

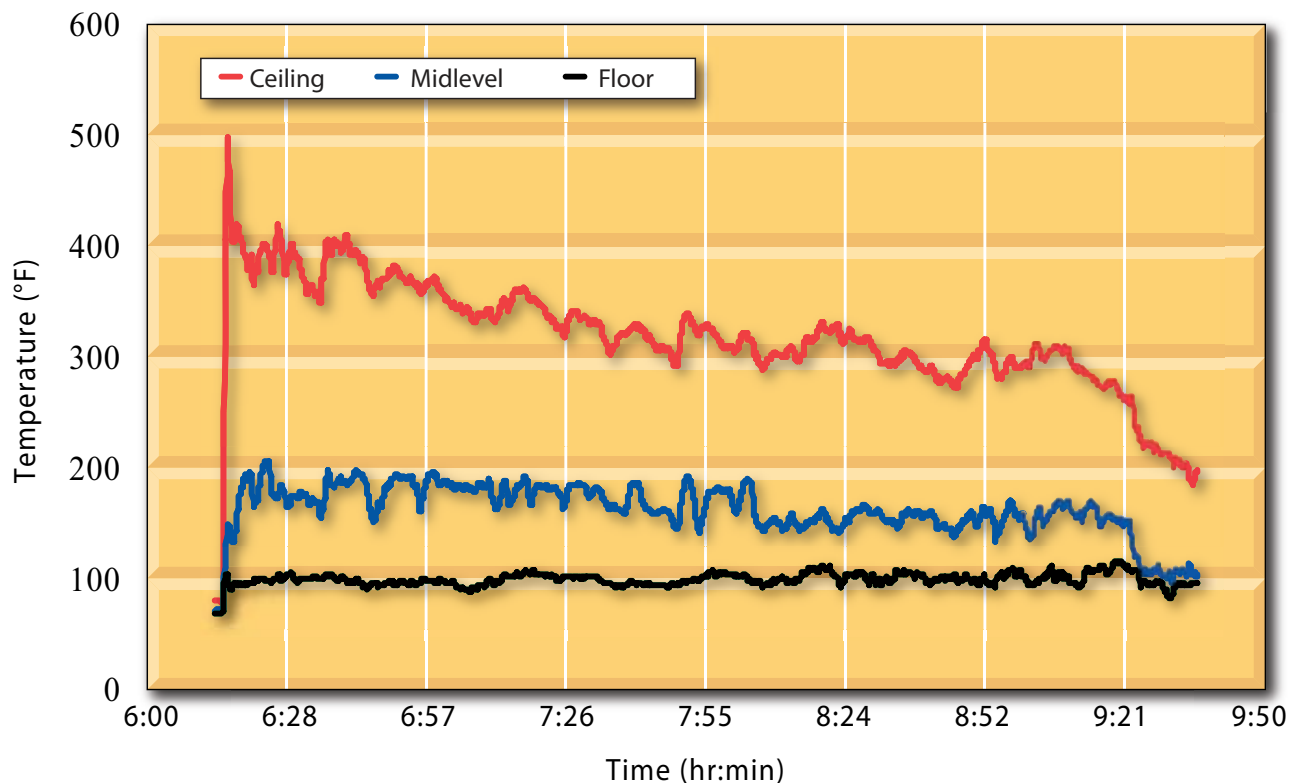

Figure 2.3. Temperature on the 2nd floor of the Burn Tower during testing.



Part Two: Research Project

stairs were 7.5 inches high, 11 inches deep, and 30 inches wide. During each test, the escort monitored the participant's heart rate and radioed the highest rate during each station to the investigator downstairs. At the conclusion of each station, the participant rested for 2 minutes as the safety escort demonstrated the next task. Next, the participant straddled a force machine (Keiser Force Machine), and used a 9-pound sledgehammer to drive a sled 5 feet down and back on a metal track for 2 minutes. After another 2-minute

rest period, the participant performed a secondary (slow and thorough) search from side to side along the back 14.5-foot wall for 2 minutes. This was again followed by a 2-minute rest period. In the final 2-minute station, the participant repetitively completed a motion similar to advancing a charged hoseline on a 3.8-foot hose segment (1.5 inch diameter) attached to a cable that ran over a pulley and was suspended vertically outside the building with a 10-pound weight on the end. Upon completion of the final test, partici-

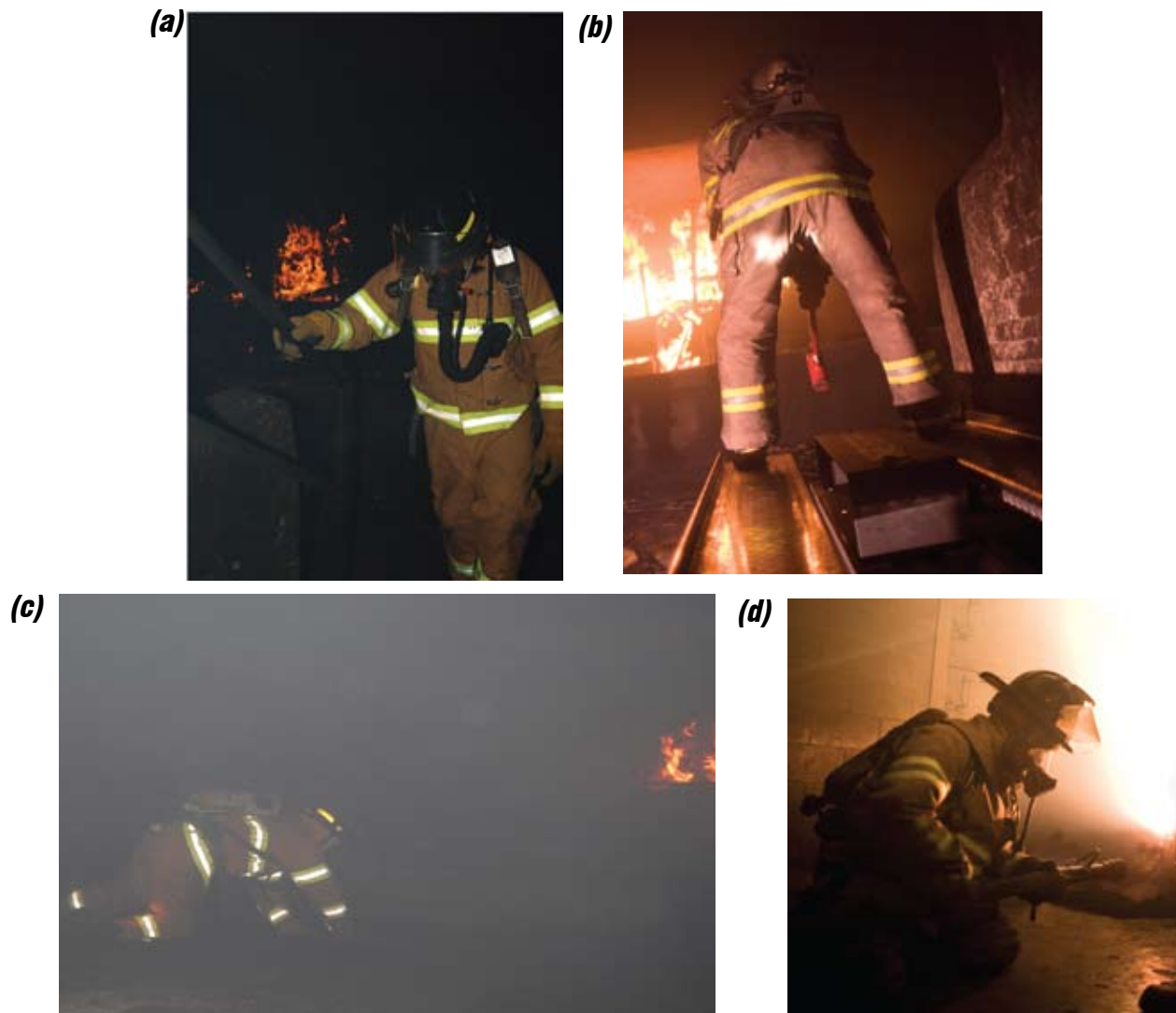

Figure 2.4 Simulated firefighting activities: (a) stair climb, (b) forcible entry, (c) search and (d) hose advance.

pants knelt quietly for 2 minutes and proceeded downstairs.

As soon as the participants descended the stairs, they were asked to remove their regulator, their hood, and one glove. They were then asked the same perceptual questions concerning how they felt, how hot they were, how hard they were working, and their respiratory difficulty. Physiological measures of body temperature, heart rate, blood oxygenation and blood carboxylation, readings were also obtained.



As soon as the perceptual data were gathered, participants repeated the Balance or Gait Test for a third time, followed by a post-exertion blood sample collection. Once the blood draw was completed, firefighters were taken to the Rehabilitation area, where they were given water and/or Gatorade and passively cooled. In Rehab, the participants' core and skin temperatures, blood pressure, and heart rate were monitored. After 10 minutes, if the participant's heart rate was under 100 beats per minute and they were not complaining of any symptoms of heat exhaustion (such as dizziness, lightheadedness, nausea), they were released from the study.

Personal Protective Equipment (PPE) Ensembles

Participants were assigned to one of two PPE ensembles prior to testing – either Standard or



Enhanced PPE. Table 2.1 provides a comparison of the two ensembles. The Standard PPE was relatively heavy, provided a high degree of thermal insulation and relatively low breathability. It was designed to reflect the PPE that is worn by a “typical” fire department without a large budget for PPE. The Standard PPE included bunker gear with a spun Nomex[®] lining, a Kevlar[®] fully-encapsulating hood, leather gloves with a Kevlar[®] wrist gauntlet, rubber boots and a traditional-style helmet. The full ensemble weighed 24.5 pounds without the SCBA. Both ensembles utilized the same SCBA, which weighed approximately 21 pounds.

The Enhanced PPE was relatively light and provided less thermal insulation than the Standard PPE. It was designed to reflect some of the lightest PPE available that meets current NFPA standards, along with some novel design elements that may be brought to market in the near future. Enhanced PPE included bunker gear with an Indura FR cotton lining, a Nomex[®] hood, a low-profile helmet, leather gloves, and lightweight leather boots. The Enhanced PPE also included a novel design element that circulated exhaled air from the firefighter face piece to the coat's inner lining in an attempt to assist with heat dissipation by providing a means for evaporative



Part Two: Research Project

cooling within fully encapsulating PPE. The full ensemble weighed 21 pounds on average without the SCBA.



Both ensembles were provided by Total Fire Group, with design input from International Personnel Protection specifically for this study. Utilizing two sets of new PPE ensured that all participants were wearing PPE that was similarly

“broken in.” The materials used in both ensembles meet NFPA 1971 standards, including for total thermal protection (TTP) and breathability (or total heat loss – THL).

Measures

Physiological Measurements. Core and skin (neck, forearm) temperature, heart rate, and carbon monoxide and oxygen saturation of the

Table 2.1. Comparison of the PPE ensembles.

Enhanced Configuration	Standard Configuration
<p>Bunker gear with an Indura FR cotton lining, which circulated exhaled air from the firefighter to the coat's inner lining.</p> <p>Nomex[®] hood</p> <p>Leather gloves</p> <p>Lightweight leather boots</p> <p>Lightweight, low-profile helmet</p>	<p>Bunker gear with a spun Nomex[®] lining</p> <p>Kevlar[®] fully-encapsulating hood</p> <p>Leather gloves - Kevlar[®] wrist gauntlet</p> <p>Rubber boots</p> <p>Traditional-style helmet</p>
	

blood data were collected while the firefighters were in station uniform prior to testing, after the participant donned his PPE (pre-firefighting) and after firefighting activities were completed (post-firefighting). Additionally, heart rate was recorded while the participants were engaged in the simulated firefighting tasks in order to provide an index of the cardiovascular strain associated with each task. The participants' core and skin temperatures were monitored using a Mini Mitter VitalSense Monitor. Heart rate was recorded via a Vantage XL wireless heart rate monitor (Polar Electro, Inc.). Carbon monoxide and oxygen saturation were measured immediately prior to and immediately after participants exited the course using a RAD-57 pulse oximeter/carboxyhemoglobinometer (Masimo, Inc.).



Perceptual Measures. Table 2.2 provides an overview of each of the perceptual measure scales used in this study. Ratings of perceived

Table 2.2. Perceptual measures scales.

Feeling Scale		Breathing Scale		Thermal Sensations		Borg's Rating Scale of Perceived Exertion	
+5	Very Good	1	My Breathing is OK Right Now	0.0	Unbearably Cold	6	No Exertion at All
+4				0.5		7	
+3	Good	2		1.0	Very Cold	8	Extremely Light
+2				1.5		9	Very Light
+1	Very Good	3	I am Starting to Breathe Hard	2.0	Cold	10	
0				2.5		11	Light
-1	Fairly Bad	4		3.0	Cool	12	
-2				3.5		13	Somewhat Hard
-3	Bad	5	I am Not Getting Enough Air	4.0	Comfortable	14	
-4				4.5		15	Hard (Heavy)
-5	Very Bad	6		5.0	Warm	16	
				5.5		17	Very Hard
		7	I Can't Breathe	6.0	Hot	18	
				6.5		19	Extremely Hard
				7.0	Very Hot	20	Maximal Exertion
				7.5			
				8.0	Unbearably Hot		



Part Two: Research Project

exertion (RPE) were recorded using the 15-point Borg scale (Borg, 1998). Subjects were asked to rate how hard they were working on the tasks during the period immediately preceding the data collection. Numbers on the scale were anchored with descriptions that ranged from “no exertion at all” (RPE=6) to “maximal exertion” (RPE=20). Perceptions of respiratory distress were assessed using the 7-point psychophysical scale category scale developed by Morgan and Raven (1985). Odd numbers on the scale were anchored with descriptions (e.g. “My breathing is okay right now,” “I can’t breathe,” etc). Perceptions of thermal sensations were assessed using the rating scale developed by Young et al. (1987), with verbal anchors ranging from unbearably cold to unbearably hot. These measures were administered immediately before and after subjects had completed their 18 minutes on the testing course. Subjects made verbal responses that were verified and recorded by an investigator. Finally, state anxiety, which reflects feelings of nervousness and apprehension (Spielberger et al., 1983), was measured using a modified 10-item version of the State Anxiety Inventory (Form Y-1; Spielberger et al. 1983) before testing began and again after testing was completed.



Blood sampling. Venous blood was drawn from the antecubital vein immediately before and af-

ter firefighting activity using a 21-gauge needle. Blood samples were obtained by a trained phlebotomist with little or no stasis.

Complete Blood Cell Count. Venous blood samples were collected in vacutainer tubes containing K3-EDTA, maintained at room temperature, and analyzed within 2.5 hours of collection. CBC analysis was performed using a Cell-Dyn 3200 automated analysis system (Abbott Diagnostics) using flow cytometry technology.

Blood Chemistry. Venous blood samples were collected in Serum Separator tubes, inverted several times, allowed to clot at room temperature, and then centrifuged at 3,700 rpm for 9 minutes. Samples were stored refrigerated at 4°C if samples were not tested immediately. Testing for the following analytes was performed on the Vitros 950 (Johnson & Johnson, Ortho Clinical): Albumin, Total Protein, Total Bilirubin, Calcium, Alkaline Phosphatase, AST, Sodium, Potassium, Chloride, Glucose, Creatinine, BUN, Carbon dioxide, ALT.



Platelet Function. Venous blood samples were collected in a vacutainer containing 3.2% sodium citrate. Samples were maintained at room temperature and analyzed within 2 hours of collection. Before analysis, the blood was properly mixed by gently inverting the tube three times by hand to ensure anticoagulation by 3.2% sodium

citrate. Epinephrine-induced and ADP-induced platelet aggregability was analyzed using a Platelet Function Analyzer (PFA-100, Dade Behring). The PFA-100 aspirates whole blood under high shear rates (5,000-6,000 seconds⁻¹) through an aperture cut into the membrane coated with collagen and adenosine 5'-diphosphate (collagen/ADP) or epinephrine (collagen/Epi). Blood was pipetted (800µl) into the disposable cartridges containing collagen-epinephrine and collagen-ADP within one hour and analyzed for time to occlusion. Results were represented in seconds to occlusion.

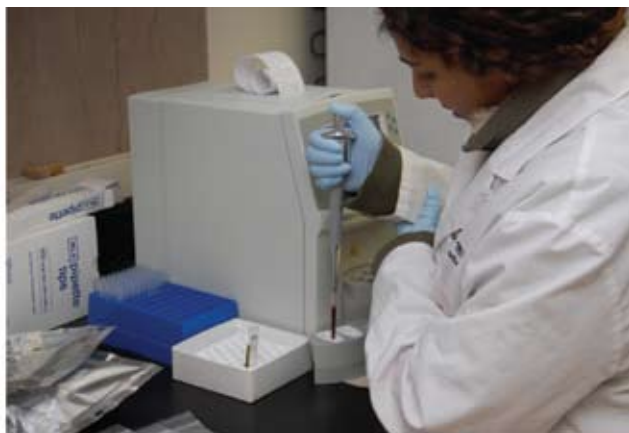

C-Reactive Protein (CRP). Venous blood samples were drawn into vacutainers with no additives and then centrifuged at 1,200 times the force of gravity for 15 minutes at 39°F. Serum was stored at -112°F until analysis. High sensitivity ELISA kits were used to determine CRP levels in serum samples according to the manufacturer's protocol (Diagnostic Automation Inc.). The functional sensitivity of the assay was determined to be 0.1 milligrams/liter (determined with inter-assay coefficient of variation < 20%) and the intra- and inter-assay coefficient of variation 4.4% and 3.3%, respectively.

Coagulatory and Fibrinolytic Variables. Blood samples were drawn into tubes containing 3.2%

sodium citrate for measurements of all coagulation and fibrinolytic factors, except for the assessment of t-PA activity, in which those samples were drawn into Stabilyte tubes (Biopool, Wicklow, Ireland). All of these samples were centrifuged at 2,300 rpm for 25 minutes at 39°F with the plasma removed and placed into 12 aliquots, and stored at -70 degrees centigrade for later analysis.

PAI-1 antigen and t-PA antigen were analyzed in duplicate using an enzyme-linked immunosorbent assay kit (American Diagnostica, Stamford, CT). Human prothrombin fragment 1+2 (PF1.2) was measured in duplicate using an enzyme-linked immunosorbent assay kit (Dade Behring / Siemens, New Castle, DE). Factor VIII activity was analyzed in duplicate using a chromogenic assay kit (Chromogenix/DiaPharma Group Inc., West Chester, OH).

Balance and Gait. The goal of this portion of the study was to assess changes in gait and balance parameters due to the use of PPE, different PPE configurations and 18 minutes of strenuous firefighting activities. Half of the study participants were tested using the gait protocol, while the remaining participants were tested on a new functional balance test designed for this study. Participants were evaluated at three testing periods: initially in station uniform (baseline), after the participant donned his PPE (pre-firefighting) and after firefighting activities were completed while still in PPE (post-firefighting). Post-firefighting testing occurred within 1 to 2 minutes after completing the simulated firefighting activities (immediately after collection of post-firefighting perceptual measures).

Gait Protocol. For the gait protocol, participants were instructed to walk at either of two speeds



Part Two: Research Project

(“normal, comfortable pace” or “as fast as you can without running”) on a 29-foot instrumented gait mat (GAITRite Platinum, CIR Systems Inc); (Figure 2.5). Changes in walking parameters on flat ground as well as crossing over a 12-inch obstacle were investigated in separate passes. At each testing period (baseline, pre-, post-firefighting), participants were tested in four conditions (with two passes per condition):

- Normal speed and no obstacle
- Normal speed and 12-inch obstacle
- Fast speed and no obstacle
- Fast speed and 12-inch obstacle

These four conditions were randomized for each participant to minimize timing effects of the analysis. Participants began walking 10 feet before, and continued walking 10 feet after reaching the gait mat to ensure the data were recorded from steady gait cycles. Participants were instructed to look straight ahead while walking. During obstacle trials, participants were told that they could look down while crossing over the obstacle. They were further told that if they made contact with the obstacle while crossing over it, they were to keep walking and not to look back.

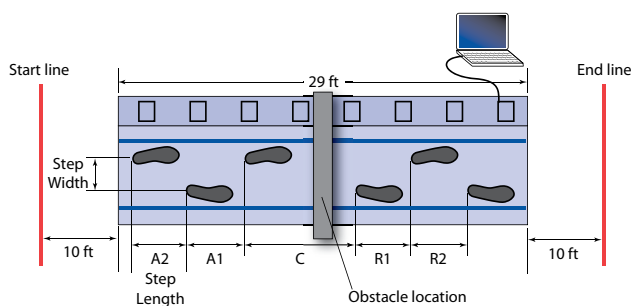
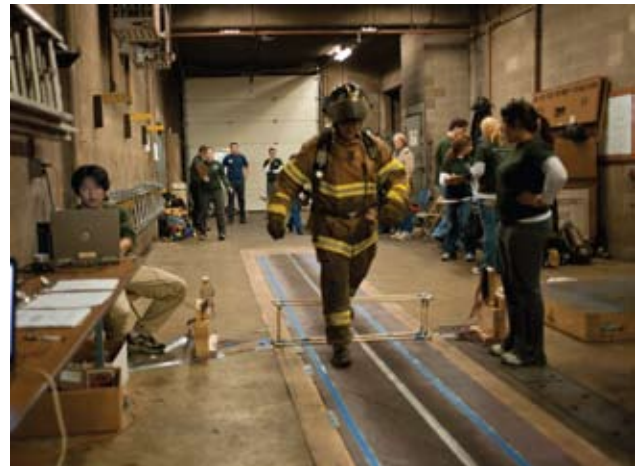

Figure 2.5. Gait analysis apparatus.

During these trials, at least four research staff members were present to provide individualized safety oversight for each subject, ensure repeatable conditions, collect data, and record errors



during each pass (stepping outside the lines, contacting the obstacle). Immediately prior to baseline gait testing, the subject’s right and left leg length was measured. “Leg length” is defined as the distance from the head of the greater trochanter to the floor, bisecting the lateral malleolus of the ankle.

Balance Protocol. To assess functional balance, a protocol similar to that developed by Punakallio (2004) was employed in this study (Figure 2.6). Participants began on a raised (6 inches tall) platform, stepped down and walked on a 6-inch wide, 10-foot long plank that was raised 1.5 inches from the ground, stepped up and turned around within a defined space (24×24 inches) on a sec-

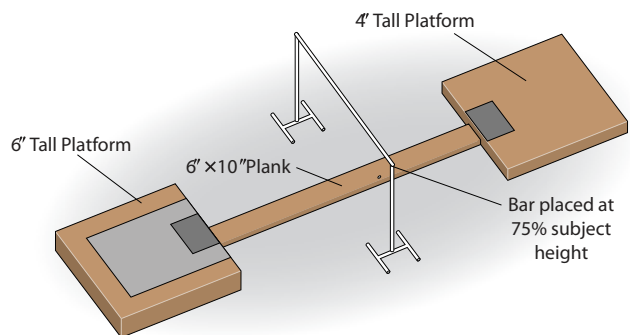

Figure 2.6. Functional balance assessment apparatus.

ond raised platform (4 inches tall), and walked back to stop within a defined 24×24 inch space on the original platform. Subjects were instructed to perform the task as quickly, but safely, as possible. On specific passes, the task was made more challenging by placing a horizontal obstacle overhead (a lightweight rod) across the center of the pathway and set at 75% of the subject's height. The obstacle was designed to fall away if contacted directly. The subjects performed two trials with no obstacle, four with the obstacle, and finally two trials with no obstacle. Each trial was timed by two investigators. Average time per trial was penalized by 5 seconds for a major error (obstacle fall) and 2 seconds per minor error (touching obstacle or floor, hand touching any part of the test apparatus, failure to turn or stop within defined space).

During these trials, at least three research staff members were present to provide individualized safety oversight for each subject, ensure repeatable conditions, collect data, and record errors during each pass. Two staff members used handheld stopwatches to record the time from the command “GO” until the participant returned to



the starting platform and both feet in contact with the marked area in the taller platform.

Post-data collection and performance times were calculated by summing the four adjusted trial times per obstacle condition. Performance time was examined as a function of PPE, obstacle presence, and test period.



Results and Discussion

This section details the results from laboratory testing conducted at the Cardiovascular and Exercise Research Laboratory and live-fire testing performed at the Illinois Fire Service Institute.

Cardiovascular and Exercise Research Laboratory Test Period

Descriptive Data

Table 2.3 presents data on the 110 firefighters who underwent testing at the Cardiovascular and Exercise Research Laboratory. Overall, our subjects were young (29.7 ± 8 years), apparently healthy firefighters. The exclusion criteria employed by this study (no known history of cardiovascular disease or use of prescription medication for blood pressure or cholesterol problems) resulted in a group of test subjects that were healthier than the general population.

This test population was screened for cardiovascular disease prior to testing, and thus the prevalence of actual cardiovascular dysfunction was low; however, the prevalence of risk factors associated with cardiovascular disease was high. In a few cases, data collection malfunctions occurred, so the total number of data points reported for each measure may be different than 110.

Measures of Cardiovascular Health

Nearly 75% (82/110) of the firefighters were classified as overweight ($BMI \geq 25.0$ kg/m²). More than a quarter of the firefighters (27/110) were classified as obese, having a body mass index ($BMI \geq 30.0$ kg/m²). Obesity is a primary risk factor for cardiovascular disease, while being overweight also increases the risk of premature

mortality; however, a substantially lower number (13/109) of firefighters had a waist circumference greater than 102 cm. A waist circumference of this size indicates central adiposity (increased fat in the midsection), and it is specifically linked to cardiovascular problems, diabetes, and premature mortality.



Hypertension (high blood pressure) is another primary risk factor for cardiovascular disease. Brachial blood pressures showed that 8 out of 110 of the firefighters showed a systolic reading classifying them as hypertensive (≥ 140 mmHg). More than 65% (76/110) of the firefighters had systolic blood pressure greater than 120 mmHg but still under 140 mmHg, which classifies them as pre-hypertensive – a state that can easily escalate to true hypertension. High central (aortic) blood pressure is also a concern as high cholesterol, smoking, and the metabolic syndrome may have greater effects on central blood pressure than on brachial blood pressure. Approximately one third of the firefighters (39 of 110) showed systolic central blood pressures greater than 110 mmHg.

Augmentation index (AIx) and pulse wave velocity (PWV) indicate systemic arterial stiffness and regional arterial stiffness, respectively. A higher AIx and PWV indicate higher arterial stiffness, which is linked with endothelial (vascular) dysfunction and is a precursor of cardiovascular disease. Proposed thresholds for AIx for men aged 30 and age 40 are 22% and 30%, respectively. Of the 110 firefighters, only 12 showed an AIx greater than 20%. Furthermore, even fewer (8/109) firefighters showed central PWVs of greater than 8.0 m/s, and none had central PWVs over 10.0

m/s. These values indicate a low prevalence of increased arterial stiffness in our cohort of relatively young, healthy firefighters.

Flow mediate dilation (FMD) indicates the brachial artery's ability to increase blood flow in response to occlusion, and reactive hyperemia (RH) indicates the capillaries' ability to increase blood flow in response to occlusion. Collectively, these measures represent endothelial function. Few firefighters (8/109 and 17/89, respectively) exhibited poor reactive hyperemia and flow mediate dilation.

Table 2.3. Cardiovascular health measures.

Variable	N	Mean	SD	Min	Max	Range	Healthy Ranges	# Outside Healthy Ranges	% Outside Healthy Ranges
Age	110	29.7	7.9	18	48	30	N/A	N/A	N/A
BMI	110	28.1	4.4	18.9	43	24.1	18.5-25.0	82	74.6%
Waist Circumference (cm)	109	85.5	10.1	65.5	125.5	60	≤102	13	11.9%
SBP (mmHg)	110	125.9	9.3	99	153	54	≤120	84	76.4%
DBP (mmHg)	110	70.4	9.3	55	106	51	≤80	16	14.6%
MAP (mmHg)	110	89	8.4	73	120	47	≤93.3	33	30.0%
Aortic SBP (mmHg)	110	106.5	10.3	85	140	55	≤110	39	35.5%
Aortic DBP (mmHg)	110	71	9.3	56	107	51	≤75	37	33.6%
AIx (%)	110	0.7	14.1	-37	37	74	≤20%	12	10.9%
Central PWV (m/s)	109	6.4	1	3.9	9.2	5.3	≤8.0	8	7.3%
Peak Forearm Blood Flow (ml/100 ml tissue/min)	109	30.16	8.11	10.04	52.76	47.7	≥20.0	8	7.3%
Reactive Hyperemia (AUC)	109	103.5	40.0	32.3	225.0	192.7	N/A	N/A	N/A
Beta Stiffness	110	5.26	1.88	2.40	15.3	12.9	N/A	N/A	N/A
Arterial Compliance	110	1.28	0.36	0.45	2.22	1.77	N/A	N/A	N/A
Carotid Intima Media Thickness (mm)	109	0.48	0.09	0.30	0.80	0.50	<1.0	0	0.0%
FMD - Percent Dilation (%)	89	7.01	3.76	1.08	21.1	20.06	≥4.0%	17	19.1%



Part Two: Research Project



The thickness of the lining of the carotid artery, known as the intima-media, indicates vascular hypertrophy, which is also an independent predictor of cardiovascular disease morbidity and mortality. None of the firefighters exhibited a value of 0.04 inches or greater. The values found in our sample of firefighters are typical for the age of the population studied.

CRP levels of the 122 firefighters who participated in the live fire testing period (described in the following section) were also tested as an early indicator of cardiovascular disease. The mean CRP values were 1.57 (range .01 -16.42). Twenty eight percent of the firefighters had a CRP level between 1.0 and 3.0 (moderate risk) and 14% had a CRP value greater than 3.0 (high risk).

In summary, this young, healthy population of firefighters exhibits few signs of cardiovascular disease but a high prevalence of obesity and prehypertension, which potentially increase the risk for cardiovascular disease later in life. Given the strenuous nature of firefighting combined with heat stress, and the high incidence of cardiovascular events while on duty, screening for these risk factors is important. Obesity and blood pressure are the first signs of cardiovascular risk in these firefighters.

Illinois Fire Service Institute Live Fire Test Period - Physiological and Perceptual Results

The results presented in this section detail the firefighting activities undertaken at the Fire Service Institute. The test population for this portion of the study was 122, most of whom participated in the Cardiovascular and Exercise Research Laboratory test period. Again, in a few cases data collection malfunctions occurred, so the total number of data points reported for each measure may be different than 122.

As one of the purposes of the investigation was to examine the effects of the different PPE configurations, analyses were conducted to examine both the effects of the gear itself (referred to herein as the Gear main effect), the effect of the firefighting activities (referred to as the Time main effect), and the interaction of the Gear with the firefighting activities (referred to as the Gear x Time interaction). The analyses are conducted in three steps: Descriptive analyses were assessed for each of the main outcome variables of interest; clusters of relevant variables (e.g., blood chemistry, hematological, perceptual) were analyzed together within a multivariate analytic framework to assess the Gear, Time, and Gear x Time effects; any significant multivariate effects were then further examined by analyzing individual outcome variables within a univariate analytic framework to determine which were driving the multivariate effects.

Overall, significant physiological effects were seen as a result of the firefighting activities performed in the hot environment; however, little overall difference was demonstrated between the two gear types as well as the gear types interacting with the firefighting activities.

Descriptive Data

Table 2.4 presents the descriptive data on 116 of the 122 firefighters who were tested under live fire conditions at the University of Illinois Fire Service Institute. The firefighters represented a mix of career (52%) and volunteer (48%) firefighters with a broad range of firefighting experience (from less than 1 to more than 30 years, with an average of 7.5 years).

Physiological Results

Temperature (core and skin – neck, arm) and heart rate responses are presented in Table 2.5. The multivariate analysis revealed significant effects of Time (i.e., firefighting activity; $p < 0.001$),

but no Gear effect and no Gear x Time interaction ($p > 0.05$). Univariate analyses revealed significant increases in each variable as a result of the firefighting activity (all $p < 0.001$). Post-trial core temperature was nearly identical for both gear types but also increased after the trial by an average of 1.3°F. Neck temperature increased by approximately 9°F for both gear types, and again there was no significant difference between the configurations. Arm temperature showed a higher increase in the Enhanced gear, as measured both in percentage and actual terms (11°F to 9.5°F). This increase can be explained by the thinner inner lining of the Enhanced gear.

Table 2.4. Descriptive variables for participants in live fire testing (mean \pm SD).

	Standard PPE ($n = 59$)	Enhanced PPE ($n = 57$)
Age (years)	29.5 \pm 7.5	29.4 \pm 8.5
Height (inches)	70.9 \pm 2.8	70.9 \pm 2.8
Weight (pounds)	191.8 \pm 32.1	195.6 \pm 36.4
BMI	27.6 \pm 4.0	28.6 \pm 4.9
Waist Circumference (inches)	34.9 \pm 3.8	35.6 \pm 4.4

Table 2.5. Physiological responses to firefighting activity to standard and enhanced PPE (mean \pm SD).

	Standard			Enhanced		
	Pre FF	Post FF	% Change	Pre FF	Post FF	% Change
Core Temperature (°F)	99.7 \pm 0.7	100.9 \pm 1.6	1.9	99.5 \pm 0.7	100.8 \pm 0.7	1.9
Neck Temperature (°F)	91.4 \pm 3.4	100.6 \pm 2.7	15.5	92.8 \pm 2.9	101.7 \pm 1.4	14.5
Arm Temperature (°F)	90.7 \pm 3.6	100.2 \pm 2.2	16.3	89.8 \pm 3.1	100.8 \pm 1.6	19.0
Heart Rate (bpm)	94.5 \pm 18.9	169.1 \pm 15.4	78.9	91.3 \pm 18.9	167.2 \pm 14.2	83.1



Part Two: Research Project

Firefighting activity also resulted in a significant increase in heart rate for both gear configurations. Post-trial heart rates increased significantly in both gear variations (an average peak HR of 168 beats per minute), an increase of 75 beats per minute from pre-trial to post-trial; however, there was no significant difference between the maximum heart rate for the two gear configurations (Standard PPE = 169.1, Enhanced PPE = 167.2 beats per minute).

The heart rates recorded post-firefighting were taken after the firefighters completed the four firefighter tasks, then rested for two minutes in the fire room. In most cases, these values were lower than the peak heart rate recorded during the firefighting task.

Blood Chemistry Results

Results from the blood chemistry data are presented in Table 2.6, along with the percentage of change within each gear configuration from pre- to post-firefighting activity. The multivariate analysis showed no effect of the gear configuration or the interaction of Gear with Time, but there was a significant effect of time (i.e., firefighting activity; $p < 0.001$). Following up on the multivariate effect of Time, univariate analyses revealed significant changes ($p < 0.001$) in each of the variables (potassium was significantly increased at $p = 0.001$), except for chloride and total bilirubin ($p > 0.05$). Glucose increased significantly in both gear types, reaching a mean peak of $105 \text{ mg} \cdot \text{dL}^{-1}$. The elevated glucose levels, which increased more than 25% from pre- to post-firefighting, was likely due to the observed hemoconcentration and increased sympathetic nervous and hypothalamo-pituitary-adrenal (HPA) system activation (Kjaer et al., 1991). An increase in creatinine levels of 18.2%, although peaking at only $1.3 \text{ mg} \cdot \text{dL}^{-1}$, along with concomitant increases in

total protein and albumin, indicate a fairly significant level of dehydration. All other measured variables (blood urea nitrogen, sodium, potassium, calcium, aspartate aminotransferase, alkaline phosphatase) demonstrated changes from pre- to post-firefighting measurements; however, they were not outside the normal clinical values and the general trend of increasing concentrations likely reflects hemoconcentration due to the overall decrease in plasma volume.

Hematological Results

Results of the hematological responses are presented in Table 2.7, along with the percentage of change within each gear configuration from pre- to post-firefighting activity. Once again, there was no significant effect of Gear or the interaction of Gear with Time. There was a significant effect of time ($p < 0.001$) on the hematological response,



Table 2.6. Blood chemistry response to firefighting activity in standard and enhanced PPE (mean \pm SD).

	Standard (<i>n</i> = 60)			Enhanced (<i>n</i> = 61)		
	Pre FF	Post FF	% Change	Pre FF	Post FF	% Change
Glucose (mg · dL⁻¹)	80.9 \pm 14.3	104.9 \pm 20.3	29.7	83.1 \pm 19.8	104.2 \pm 18.6	25.4
Blood Urea Nitrogen (mg · dL⁻¹)	15.2 \pm 3.7	14.8 \pm 3.6	-2.6	15.5 \pm 3.5	15.0 \pm 3.4	-3.2
Creatinine (mg · dL⁻¹)	1.13 \pm 0.15	1.34 \pm 0.18	18.2	1.12 \pm 0.15	1.31 \pm 0.17	18.2
Sodium (mmol · L⁻¹)	142.7 \pm 1.4	145.4 \pm 1.7	1.9	142.8 \pm 1.3	145.0 \pm 1.2	1.5
Potassium (mmol · L⁻¹)	4.01 \pm 0.33	4.14 \pm 0.30	2.5	4.1 \pm 0.4	4.21 \pm 0.23	2.4
Chloride (mmol · L⁻¹)	102.4 \pm 2.2	102.7 \pm 13.7	0.3	102.7 \pm 1.9	104.4 \pm 2.3	1.7
Total Bilirubin (mg · dL⁻¹)	0.49 \pm 0.32	0.57 \pm 0.34	0.2	0.57 \pm 0.36	2.08 \pm 0.43	2.5
Calcium (mg · dL⁻¹)	9.8 \pm 0.3	10.5 \pm 0.3	7.1	9.7 \pm 0.3	10.5 \pm 0.4	8.2
Total Protein (g · dL⁻¹)	7.5 \pm 0.4	8.3 \pm 0.4	10.7	7.4 \pm 0.4	8.2 \pm 0.4	10.8
Albumin (g · dL⁻¹)	4.75 \pm 0.24	5.36 \pm 0.27	14.9	4.63 \pm 0.23	5.3 \pm 0.26	15.2
Aspartate Aminotransferase (μ · L⁻¹)	31.8 \pm 10.6	34.5 \pm 11.7	8.5	29.7 \pm 8.7	32.6 \pm 10.1	9.8
Alanine Aminotransferase (μ · L⁻¹)	36.6 \pm 11.9	35.4 \pm 13.0	-3.3	35.3 \pm 12.9	34.1 \pm 14.1	-3.4
Alkaline Phosphatase (μ · L⁻¹)	77.6 \pm 14.7	81.5 \pm 17.0	5.0	83.7 \pm 19.0	88.7 \pm 19.1	6.0
Biocarbonate (mmol · L⁻¹)	27.2 \pm 2.0	19.1 \pm 2.7	-29.8	27.5 \pm 2.3	19.0 \pm 2.6	-30.9



Part Two: Research Project

demonstrating the effects of firefighting activity. There was an increase in red blood cells, hemoglobin and hematocrit of approximately 5%. The reduction in plasma volume, calculated using the Greenleaf Hgb/Hct method, was 9.1%.

There was a significant increase of total leuko-

cyte count from pre- to post-firefighting, with the number of leukocytes increasing by 38% in both gear configurations. The magnitude of exercise-induced leukocytosis is dependent on intensity of exercise, with increases of 20% to 50% being common for moderate intensity exercise. Increases in monocytes, lymphocytes and neutro-

Table 2.7. Hematological response to firefighting activity in standard and enhanced PPE (mean \pm SD).

	Standard (n = 60)			Enhanced (n = 61)		
	Pre FF	Post FF	% Change	Pre FF	Post FF	% Change
Red Blood Cells (M · μL⁻¹)	5.0 \pm 0.7	5.4 \pm 0.3	8.0	5.1 \pm 0.3	5.4 \pm 0.3	5.9
White Blood Cells (K · μL⁻¹)	7.1 \pm 1.6	9.8 \pm 2.2	38.0	7.5 \pm 2.3	10.4 \pm 2.9	38.7
Monocytes (K · μL⁻¹)	0.59 \pm 0.15	0.79 \pm 0.22	33.3	0.58 \pm 0.16	0.78 \pm 0.23	33.3
Lymphocytes (K · μL⁻¹)	2.5 \pm 0.9	3.7 \pm 1.2	48.0	2.2 \pm 0.6	3.5 \pm 1.1	59.1
Neutrophils (K · μL⁻¹)	3.7 \pm 1.4	4.9 \pm 1.5	32.4	4.5 \pm 1.8	5.8 \pm 2.1	28.9
Eosinophils (K · μL⁻¹)	0.19 \pm 0.15	0.21 \pm 0.17	10.5	0.14 \pm 0.15	0.20 \pm 0.18	5.3
Basophils (K · μL⁻¹)	0.10 \pm 0.03	0.15 \pm 0.05	50.0	0.09 \pm 0.05	0.19 \pm 0.06	55
Hemoglobin (g · dL⁻¹)	15.8 \pm 0.8	16.5 \pm 0.8	4.4	15.6 \pm 1.7	16.5 \pm 1.0	5.8
Hematocrit (%)	46.2 \pm 2.4	48.6 \pm 2.4	5.2	46.3 \pm 2.8	48.8 \pm 2.8	5.4
Platelets (K · μL⁻¹)	265 \pm 52	326 \pm 67	23.3	261 \pm 54	333 \pm 66	27.7
Mean Platelet Volume	9.5 \pm 1.7	9.4 \pm 1.7	-1.1	9.8 \pm 1.9	9.8 \pm 2.2	0

phils contributed to the overall leukocytosis. The increase in leukocytes is often attributed to the action of the sympathoadrenal-mediated stress hormones (Smith et al., 2001). Platelet number increased significantly in both PPE configurations. The increase in platelet number likely reflects a combination of hemoconcentration and a release of platelets from the spleen and lymph tissue secondary to sympathetic nerve stimulation.



Additionally, all of the peripheral smears (both pre- and post-firefighting samples for each subject) were morphologically evaluated by a board-certified pathologist. The pathologist found that for each of the blood smears, the morphological evaluation correlated with quantitative hematologic values. No significant hemolysis, red cell dysmorphism, white cell dysmorphism, or platelet dysmorphism were noted, and no circulating blasts were identified. In short, all peripheral smears were within normal limits.

Platelet Function Results

Platelet aggregation time, using a PFA-100 (Dade-Behring) was measured to assess platelet function. Blood was aspirated at high shear rates and exposed to two different membranes

that contain agents that activate platelets: one containing collagen and ADP and one containing collagen and epinephrine (EPI). Time to occlusion after being exposed to these membranes was measured in seconds. The platelet function responses are presented in Figure 2.7. As with all of the other analyses, the multivariate effects of Gear and the Gear x Time interaction were non-significant ($p > 0.05$). The Time main effect was significant ($p < 0.001$), indicating a significant effect of firefighting activity on the responses. Follow-up univariate analyses indicated that the ~4% decrease in closure time in the platelets exposed to collagen and ADP was not significant, whereas the response time to exposure to collagen and EPI response was significantly reduced ($p < 0.001$; ~13%) following firefighting activity.

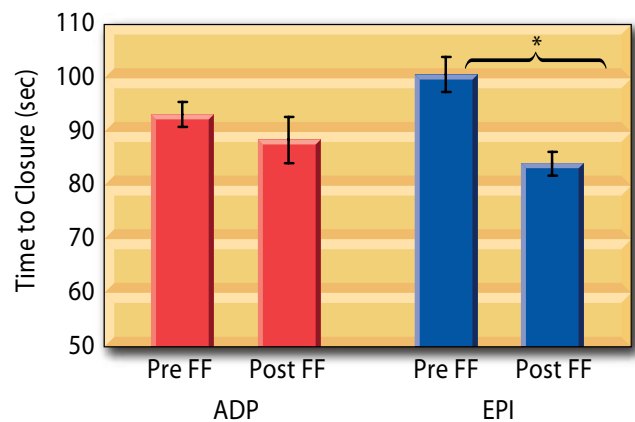

Figure 2.7. Platelet function response to firefighting activities (* $p < 0.001$).

Coagulatory Function Results

Under normal conditions there is a balance between coagulation (the forming of blood clots) and fibrinolysis (the breakdown of blood clots). An increased clotting potential, and thus, increased risk for clot formation and sudden cardiac event, can occur either because of an increase in coagulation or a decrease in fibrinolysis. Table 2.8 presents the changes in coagulatory and fi-



brinolytic variables following firefighting activity. Because there was no statistical difference detected for the PPE configuration, all data were combined and are presented as mean values pre vs post firefighting.

Prothrombin fragment 1.2 (PF1.2) – a marker of coagulation activation – increased significantly following firefighting activity, as did Factor VIII activity. Together, these results strongly suggest that there is an increased clotting potential following firefighting activity. On the other hand, the fibrinolytic factors provided a less clear response. Levels of tissue plasminogen activator (TPA), a fibrinolytic factor, increased significantly following firefighting activity; however, levels of plasminogen activator inhibitor (PAI-1), an inhibitor of fibrinolysis, also increased significantly following firefighting activity. Importantly, individuals at risk for future coronary thrombosis have been reported to have increased levels of resting TPA and PAI-1 (Ridker and Libby, 2005).

These results clearly demonstrate that the coagulatory and fibrinolytic systems are disrupted by

firefighting activities. While it is clear that the clotting potential is enhanced following firefighting activity, it is unclear if the fibrinolytic system balances this increase. Since PF1.2 and PAI-1 do not normally increase with physical activity, these results suggest a unique response of the coagulatory and fibrinolytic systems to firefighting, consistent with increased coagulatory potential.

Perceptual and Psychological Results

Results from the perceptual and psychological data are presented in Table 2.9, along with the percentage of change within each gear configuration from pre- to post-firefighting activity. Consistent with the analyses for the physiological variables presented earlier, there was virtually no difference seen for the perceptual and psychological variables between the two gear types (i.e., no Gear main effects or Gear x Time interaction effects). However, the firefighting activities undertaken in the trial resulted in significant perceptual and psychological effects as shown by significant Time (pre vs post) main effect ($p < 0.001$). Univariate analyses revealed significant increases ($p < 0.001$) for the perceptual variables of Thermal Sensations and Respiratory Distress follow-

Table 2.8. Coagulatory variable measurements in response to firefighting activity in standard and enhanced PPE.

	All Firefighters ($n=121$)	
	Pre FF	Post FF
Factor VIII act (iu/mL)	0.96 ± 0.33	1.71 ± 0.61*
PF1.2 (pmol/L)	143 ± 51	153 ± 49*
TPA-agn (ng/mL)	10.0 ± 10.7	19.2 ± 13.4*
PAI-1-agn (ng/mL)	31.1 ± 19.3	33.4 ± 19.2*

* $p < 0.05$

ing firefighting activities in both gear configurations. Thermal Sensations increased significantly in both gear variations, with a mean of 5.9 (increase of ~1.6 units) from pre-firefighting to post-firefighting (changing from “Comfortable” to “Hot”). Respiratory Distress increased significantly in both gear types, with post-trial ratings of 2.7 units (“I am starting to breathe hard”), an average increase of ~1.6 units (changing from “My breathing is OK right now”); there was again no difference between gear types. Finally, Ratings of Perceived Exertion were not different between gear configuration conditions, averaging 14.6 (Hard/heavy) immediately following the firefighting activities.

Examination of the psychological variables in the multivariate cluster again revealed no significant gear configuration effects. Overall, findings revealed a more negative psychological profile following firefighting activities compared to the pre-firefighting state. Feeling Scale ratings decreased ~1.8 units, revealing a decrease in pleasantness immediately following firefighting. Self-rated Energy also decreased significantly following firefighting (~6.5%); Self-rated Calmness showed a non-significant decrease. State Anxiety was increased significantly (increase of ~1.2 units) from pre-trial to post-trial; Self-rated Tension, a conceptual analogue to anxiety, also increased (~9%). Consistent with the de-

Table 2.9. Perceptual and psychological responses to firefighting activity in Standard and Enhanced PPE (mean ± SD).

	Standard PPE (n = 61)			Enhanced PPE (n = 61)		
	Pre FF	Post FF	% Change	Pre FF	Post FF	% Change
Thermal Sensation	4.3 ± 0.7	5.9 ± 0.6	39.2	4.3 ± 0.6	5.8 ± 1.04	34.6
Feeling Scale	3.7 ± 1.3	1.9 ± 1.7	-49.3	3.8 ± 1.2	1.9 ± 1.9	-48.4
Respiratory Distress	1.2 ± 0.5	2.7 ± 1.01	127.9	1.06 ± 0.2	2.8 ± 1.2	166.3
Perceived Exertion		14.8 ± 1.4			14.3 ± 2.6	
State Anxiety	15.3 ± 3.5	16.2 ± 3.5	5.9	15.4 ± 3.4	16.8 ± 3.3	2.3
Energy	14.4 ± 3.4	13.4 ± 3.2	-6.9	14.0 ± 3.3	13.1 ± 3.2	-6.4
Tiredness	7.5 ± 1.9	8.8 ± 2.5	17.3	7.5 ± 2.6	8.4 ± 2.1	12.0
Tension	7.5 ± 1.9	7.9 ± 2.2	5.3	7.2 ± 2.1	8.2 ± 2.1	13.9
Calmness	11.8 ± 3.4	11.8 ± 2.6	0	12.4 ± 2.8	11.3 ± 2.8	-8.9



Part Two: Research Project

crease in Energy, self-rated Tiredness increased significantly (~15%). Taken together, each of these psychological constructs indicate that the effects of the firefighting activities served to either decrease positive and/or increase negative feelings. It is worth noting that the psychological constructs (State Anxiety, Energy, Tension, Tiredness, Calmness) were all assessed ~20-30 minutes following completion of the firefighting activities (only Feeling Scale was assessed immediately following the activities). In spite of this relatively long lag time, these constructs still revealed a more dysphoric psychological profile following firefighting activities. It is reasonable to assume that this more negative profile was likely even more dysphoric in the time period immediately following the activities.

Illinois Fire Service Institute Live Fire Test Period – Biomechanical Results

Gait Study Results

Participants. Data from 49 male firefighters who participated in this portion of the study were analyzed and descriptive measures for this subgroup are presented in Table 2.10. One participant completed the gait study in the baseline and pre-firefighting condition but was too fatigued to continue with the gait protocol post-firefighting. In

addition, technical issues during data collecting resulted in loss of data from some of the original 60 tests. In the analysis that follows, we have analyzed data from 24 participants wearing Standard PPE and 25 participants in the Enhanced PPE.

Data Analysis. The following gait parameters were analyzed based on the average values over two trials per condition:

- Step length (SL)
- Step width (SW)
- Step speed (SS)
- Horizontal clearance for trailing leg (HCT)
- Horizontal clearance for leading leg (HCL)
- Average single leg stance time (SLST_cycle – amount of time in each step cycle in which the participant is standing only on one leg)
- Single leg stance time while crossing the obstacle (SLST_cross).

Step length, step width, and step speed were computed for each of following five-step positions based on heel strike events (see Figure 2.5):

- Two steps approaching the obstacle (Approach 2, Approach 1)
- Single step crossing the obstacle (Crossing)
- Two steps after the obstacle (Recovery 1, Recovery 2)

Table 2.10. Demographics of the PPE groups conducting the gait protocol (mean ± SD).

	Standard PPE (<i>n</i> = 24)	Enhanced PPE (<i>n</i> = 25)
Age (years)	33.2 ± 5.5	32.5 ± 9.5
Height (inches)	69.6 ± 2.8	68.1 ± 2.3
Weight (pounds)	201.1 ± 27.4	192.7 ± 39.9
BMI	29.1 ± 3.7	29.3 ± 5.2

The following measures were examined using repeated-measure multivariate analysis of variance (MANOVA) tests to assess the effect of Gear (Standard, Enhanced) and Time (baseline, pre-firefighting, post-firefighting) on average HCL, HCT and single leg stance time. To examine the effect of step position on gait parameters such as SL, SW, and SS, step position relative to each obstacle was additionally added into independent variables in statistical analysis.

Results and Discussion. The results from the gait portion of this study are summarized in Figure 2.8 and Table 2.11. Figure 2.8 (a) and (c) shows that the participants' step length was significantly reduced in the group wearing Standard PPE versus the group wearing Enhanced PPE

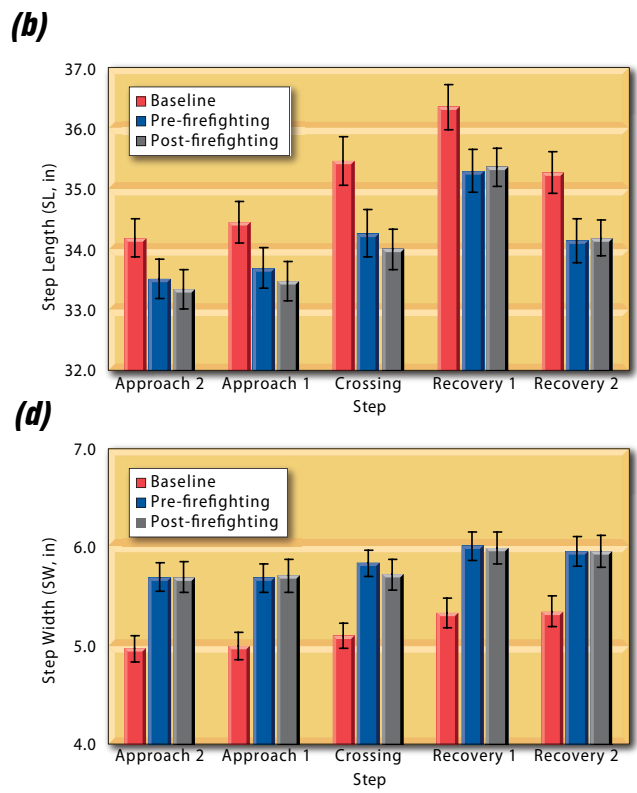
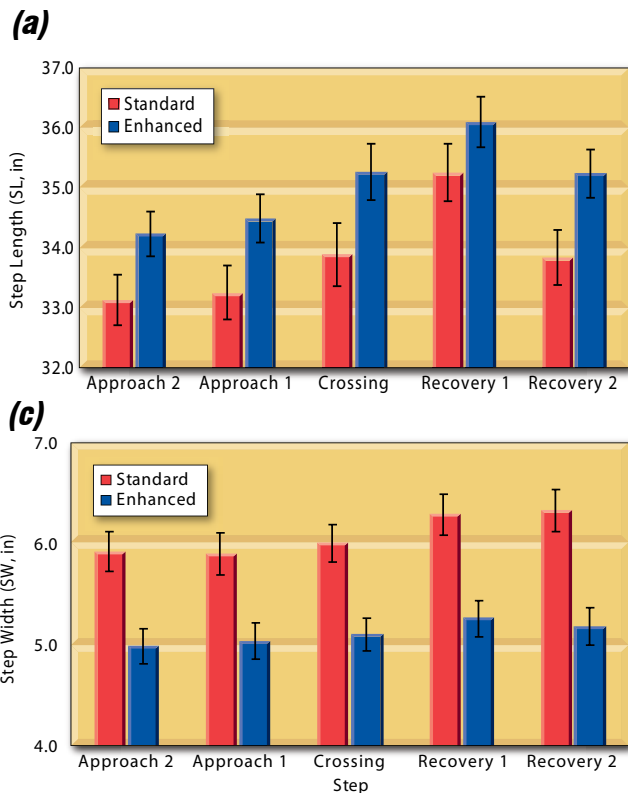

Figure 2.8. Step length and step width per step position with (a,b) PPE (standard vs. enhanced) and (c,d) testing period (baseline, pre-FF and post-FF).



Part Two: Research Project

($p=0.039$), while the step width was significantly wider wearing Standard PPE ($p<0.001$), indicating a significant Gear effect on these parameters. The additional bulk of the Standard PPE appears to force a wider stance than the Enhanced PPE, both of which are wider than that measured on participants in the baseline condition. The reduced step length may be attributed to the additional restrictiveness and weight of the Standard PPE. Thus, the same tasks are likely to be more taxing using the Standard gear than the Enhanced PPE.

Step length, step width, and step speed are all significantly influenced by putting on firefighting PPE of any kind. As Figure 2.8(b) indicates, step length is much smaller in the pre-firefighting measurements than in the baseline measurement ($p<0.001$). The only difference between these two conditions is the wearing of firefighting PPE in the pre-firefighting measurement, which appears to significantly alter the gait cycle from baseline. In this case, the Time effect is attributed to donning firefighting PPE, regardless of the type that is worn. On the other hand, there was no significant difference between the pre-firefighting and post-firefighting time periods for

any of these parameters (although there is a slight decrease in step length on the approach steps post-firefighting). These results suggest that the wearing of firefighting PPE causes a significantly more detrimental effect on the gait cycle than does fatigue from performing 18 minutes of firefighting activities.

No Gear main effects were found in the firefighter's ability to cross the obstacle in the path of the gait mat (Table 2.11), as there was no significant difference on the horizontal clearance of either the leading or trailing leg between the subjects wearing the Enhanced or the Standard PPE; however, there was again a significant decrease in the horizontal clearance of the leading leg when wearing PPE versus wearing station uniform ($p<0.001$), but no difference between pre- and post-firefighting activities. Again, the effect of wearing firefighting PPE appears much more detrimental in terms of safe obstacle crossing than the effect of fatigue from 18 minutes of firefighting activities.

Finally, there was no statistically significant Gear effect on single leg stance time, though there was a trend that the Enhanced PPE group had longer

Table 2.11. Average horizontal clearances (HCL and HCT) and single leg stance time (SLST) with standard errors as functions of Gear and Time. (mean \pm SD).

	Gear		Time		
	Standard	Enhanced	Baseline	Pre FF	Post FF
HCL (in)	12.54 \pm 0.48	12.41 \pm 0.46	13.82 \pm 0.46 ^{†‡}	11.60 \pm 0.35*	11.99 \pm 0.34*
HCT (in)	10.53 \pm 0.42	10.56 \pm 0.40	10.51 \pm 0.44	10.69 \pm 0.32	10.43 \pm 0.37
SLST_cycle (%)	38.20 \pm 0.22	38.72 \pm 0.19	39.49 \pm 0.17 ^{†‡}	38.08 \pm 0.15 ^{†‡}	37.82 \pm 0.16 ^{*†}
SLST_cross (sec)	0.548 \pm 0.010	0.530 \pm 0.010	0.527 \pm 0.007 [†]	0.553 \pm 0.009 ^{*‡}	0.539 \pm 0.009 [†]

* Different than baseline ($p<0.01$)

† Different than pre-firefighting ($p<0.01$)

‡ Different than post-firefighting ($p<0.01$)

SLST over the entire gait cycle ($p=0.086$). This result indicates that the participants may be more cautious in their gait cycle while wearing the Standard PPE. SLST over the entire gait cycle decreased with each testing period ($p<0.007$), indicating that the participants were taking a more cautious approach in their gait cycle as a result of donning PPE as well as after completing firefighting activities (both Gear and Time effect).

Conclusions. These results suggest that the use of Enhanced PPE may reduce firefighter fatigue while wearing PPE, as certain gait parameters such as step length and step width are changed less significantly from baseline than with the Standard PPE; however, no significant differences in terms of obstacle crossing safety were determined with the 12-inch obstacle used in this study. Wearing PPE of any type appeared to have the strongest affect on gait performance. Nearly all of the measured parameters showed statistically significant difference between the baseline condition and the pre-firefighting condition as well as baseline and post-firefighting. Thus, these results suggest that use of PPE affects firefighters' gait performance much more significantly than firefighting activity, even though the activities were strenuous enough to significantly raise the firefighters' core temperature in 18 minutes

and induced a high enough fatigue level in some participants that they were unable to complete the post-activity assessment. This result is important because it suggests that a firefighter's gait cycle will be significantly modified just by donning firefighting PPE. Thus, firefighters may be at an increased risk for falls due to the forced modification of their biomechanics on any response that requires wearing firefighting PPE (e.g. auto accidents, investigations, etc.), not just after firefighting activities.

Balance Study Results

Participants. Two participants completed the task in the baseline and pre-firefighting, but were too fatigued to continue with balance protocol post-firefighting. Of the 62 firefighters who completed the baseline functional balance task, we collected a full data set from 30 firefighters wearing Standard PPE control and 30 firefighters in the Enhanced PPE. Descriptive measures for this subgroup are presented in Table 2.12.

Data Analysis. Functional balance was quantified by measuring raw time and number of errors and calculating a performance index in the baseline (station uniform), pre-firefighting activity (wearing assigned PPE) and post-firefighting (wearing assigned PPE). Three-way repeated-measures

Table 2.12. Demographics of the PPE groups conducting the balance protocol. (mean \pm SD).

	Standard PPE ($n = 30$)	Enhanced PPE ($n = 30$)
Age (years)	26.2 \pm 6.5	28.2 \pm 6.5
Height (inches)	70.2 \pm 2.8	70.2 \pm 2.4
Weight (pounds)	186.6 \pm 30.1	193.8 \pm 28.8
BMI	26.6 \pm 3.5	27.9 \pm 4.0
Experience (months)	69.8 \pm 69.6	68.8 \pm 83.4



Part Two: Research Project



ANOVA tests were used to assess the effect of Gear (Standard and Enhanced), Time (baseline, pre-firefighting, post-firefighting), and obstacle presence on the parameters of raw time, number of errors, and performance index. The level of significance was set to $\alpha=0.05$.

Results and Discussion. Figure 2.9 (a) and (b) present raw times at each test condition (baseline, pre-firefighting, post-firefighting) for the two PPE conditions (Standard, Enhanced), with and without the presence of the obstacle at 75% of the participant's height (bar, no bar). The time required to complete the functional balance task increased significantly from baseline to pre-activity ($p<0.001$), suggesting that the Time effect (in this case, donning PPE) slows down movement speed. While a slight increase in raw time was observed from pre-firefighting to post-firefighting, there were no significant differences measured across this Time period. This result

suggests that the speed at which one can complete a complex balance task is less affected by firefighting activity than by wearing firefighting PPE. This parameter showed no significant Gear effect.

Figure 2.9 (b) also indicates that the existence of horizontal obstacle significantly slows the speed of movement ($p<0.001$) when wearing firefighting PPE, yet when participants were not wearing PPE (in the baseline condition), there is no significant effect of the obstacle. The simple task of ducking under a horizontal obstacle appears to be significantly more difficult while wearing PPE than while not wearing PPE, which has important implications both for safety and in affecting functional capabilities of the firefighter on the fireground, as well as any other response requiring firefighting PPE.

Figure 2.9 (c) and (d) present the number of major and minor errors at each test condition for the different PPE conditions and with and without the presence of the obstacle. Both major and minor errors increased significantly from baseline to pre-firefighting ($p<0.001$), but they appeared to decrease from pre-firefighting to post-firefighting (with no statistical significance). The act of wearing PPE not only increases the time to complete a task, but it also significantly increases the number of errors in the task. After completing the firefighting activities, the balance tasks took longer, yet the trend suggests that they were completed with fewer errors, possibly indicating that the firefighters may become more cautious as a result of their fatigued state. Again, there were no significant differences between Standard and Enhanced PPE in terms of number of errors.

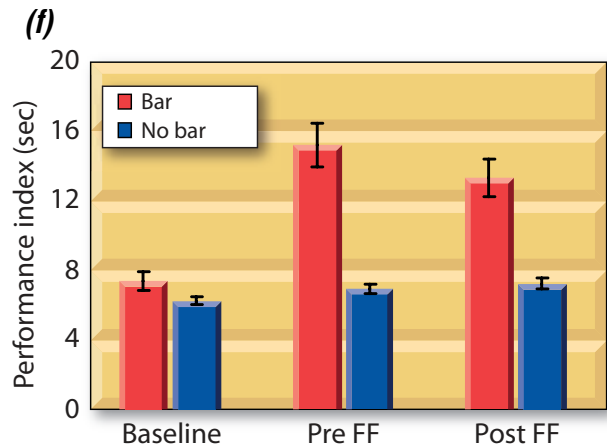
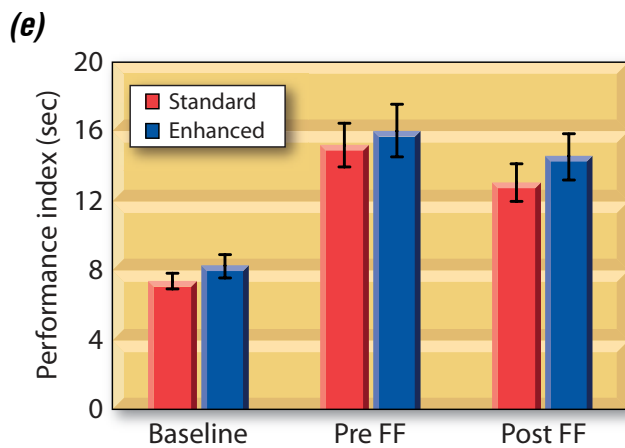
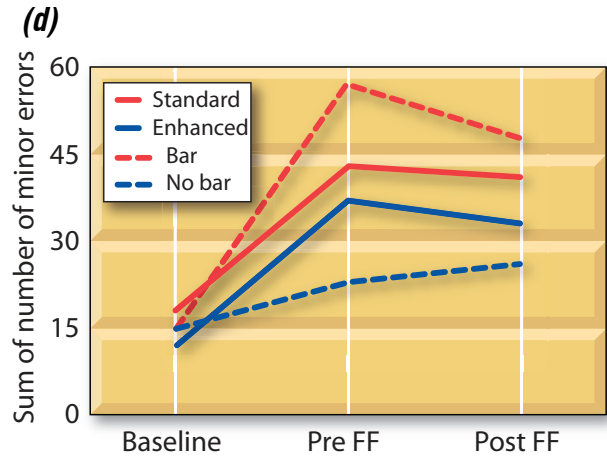
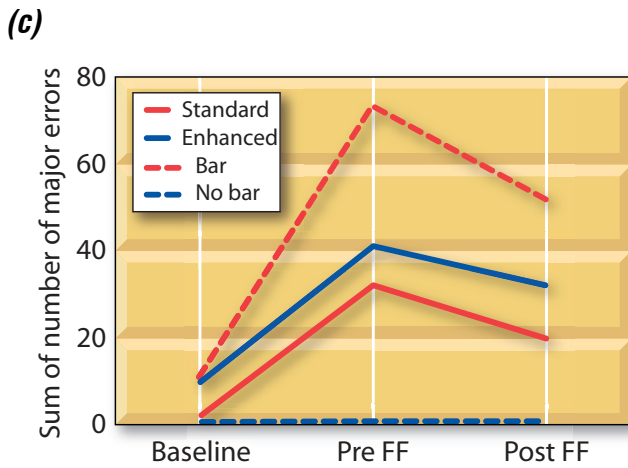
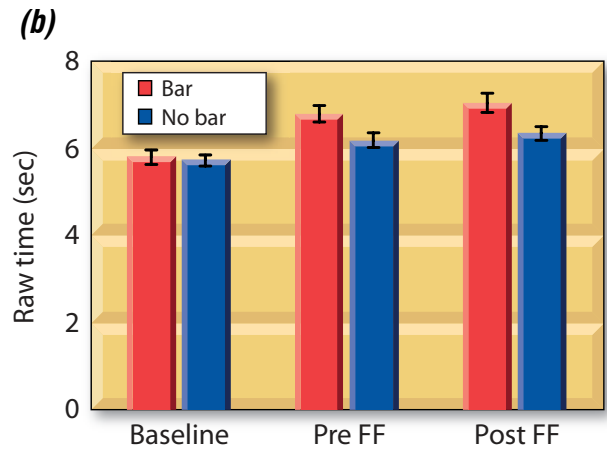
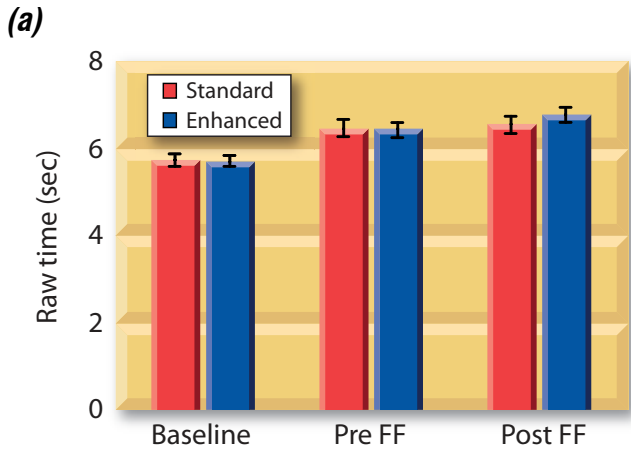

Figure 2.9. Plots of all parameters as a function of test condition; (a) raw time with different PPE, (b) raw time with existence of bar, (c) sum of number of major errors with PPE and bar conditions, (d) sum of number of minor errors with PPE and bar conditions, (e) performance index with different PPE, and (f) performance index with existence of bar. Standard error bars are included.



Part Two: Research Project

Figure 2.9 (e) and (f) show performance indices at each test condition for the different PPE conditions and with and without the presence of the obstacle. Performance indices increased from the baseline to pre-firefighting condition with statistical significance ($p < 0.001$) but decreased from pre-firefighting to post-firefighting with no statistical significance. This first result agrees with Punakallio et al. (2003) in suggesting that wearing PPE significantly impairs functional balance. It is important to note that the firefighters in the study wore carbon fiber SCBA (which are the lightest currently available) as opposed to the steel SCBA cylinders from the study in Finland. Even with this significant reduction in SCBA weight, a significant negative effect of wearing PPE was determined using the functional balance test.

The existence of horizontal obstacle significantly impairs functional balance as noted by the increased performance index. What is more interesting is that the variability significantly increased when the obstacle was present as seen in Figure 2.9 (f). Therefore, the existence of obstacle appears to reduce the consistency of movement. Previous studies (van Wegen et al., 2002) have shown that increased variability indicates instability. Therefore, the addition of the overhead obstacle might suggest decreased stability when ducking while wearing firefighting PPE.

On the other hand, the effect of firefighting activities on performance time was not significant, though the trend indicated a slight increase in time. This trend along with the completion time and number of errors indicates that the participants either used a more cautious approach after firefighting activities or were more focused on the

task at hand than prior to the firefighting activities. As with the gait results, the act of wearing PPE appears to create a more significant affect on the firefighter's functional balance than does the firefighting activities.

The initial data analysis may appear to indicate that there was no significant effect of the Enhanced PPE on functional balance; however, during the experiments, it was determined that the additional hose connecting the SCBA mask and bunker gear for air circulation in the Enhanced PPE was causing a significant number of the major errors when the mask was placed over the participant's shoulder (as is common on the fire-ground and standard in the test protocol). To test the balance performance of the Enhanced PPE without the effect of the mask causing errors, the final 10 participants in Enhanced PPE completed the experiments with their SCBA facepiece removed completely during the pre-firefighting and post-firefighting tests. For analysis purpose, those 10 participants were separated from the original Enhanced PPE group and a control group of 10 participants wearing Standard PPE was selected from the original 30 by matching first and second moments of statistics of ages, heights, weights, body mass index and experiences of the control group to those of 10 participants from the subgroup. Raw time results from this subgroup are shown in Figure 2.10.

Many results were similar to the case of original data set, with the exception of a reduction of raw time for Enhanced PPE compared to Standard PPE ($p > 0.05$, this value is non-significant in part due to the small sub-sample size). Also, the variability of the completion time in the Enhanced PPE was much smaller than that for Standard PPE. These results might suggest that Enhanced

PPE could potentially have some positive effects on firefighters' functional balance. These results also indicated that any gear redesign should minimize any feature that would effectively increase the height of the firefighter. As noted earlier, participants' scores were significantly affected by the presences of the obstacle causing them to duck but only when wearing the firefighting PPE. Thus, any additional height will make this task even more difficult.

Conclusions. This study found that wearing firefighting PPE significantly impairs dynamic functional balance. After strenuous firefighting activities, performance time increased slightly, but the number of errors decreased slightly, suggesting that participants were more cautious. Even though performance index did not show significant differences between Standard PPE and Enhanced PPE, the Enhanced PPE group indicated some positive effects on functional balance because it tended to reduce raw time and variability of raw time when the SCBA face mask was removed.

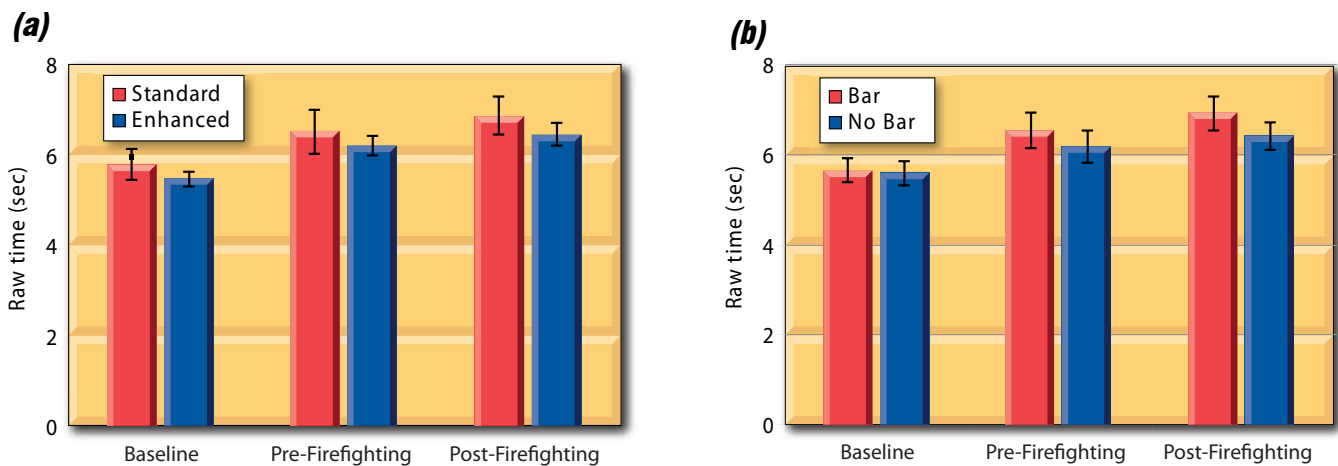

Figure 2.10. Raw time as a function of test condition with (a) different PPE, (b) existence of the obstacle.



Part Three: Recommendations

Firefighter Health and Safety Issues

The National Fallen Firefighter Foundation (NFFF) has led an effort to bring fire service organizations together to identify the most important initiatives to ensure that “Everyone Goes Home.” The amount of literature focused on investigating and understanding fatalities and injuries in the fire service is considerable. This project was designed to build on and add to this body

of research and information. It is appropriate to offer recommendations for the fire service that are founded in a careful review of the literature, supported by our research and aimed at reducing fatalities and injuries on the fireground. The authors of this report humbly submit the following lessons-learned from our present study and the legacy of research upon which it was built.

Medical Readiness for Duty

As outlined in Part 1 of this report, we know the following to be true:

- It has been conclusively demonstrated that the risk of cardiac death is directly correlated to the presence of cardiovascular risk factors (Kales et al., 2003; Holder et al., 2006; Geibe et al., 2008).
- It has been demonstrated convincingly that underlying cardiovascular disease, current smoking and hypertension were the major risk factors for an individual firefighter to experience sudden cardiac death (Fahy, 2005; Holder et al., 2006; Geibe et al., 2008). Along with a sedentary lifestyle and obesity, these risk factors were also identified by the American Heart Association as the major contribu-

tors to the epidemic of fatal coronary heart disease in America (AHA, 2008).

- There is evidence of a high prevalence of cardiovascular risk factors among firefighters in the United States, including high levels of obesity, smoking, hypertension, diabetes or pre-diabetes, and physical inactivity.

Obesity is associated with increased risk for cardiovascular disease, hypertension, high cholesterol, diabetes and cancer. Furthermore, excess body fat impairs physical performance and increases thermal strain. In light of these detrimental effects, the high prevalence of obesity is a major concern in the fire service. A BMI over 25 is considered overweight, and a BMI greater than 30 is considered obese. The risk of cardiac death



increases with increasing levels of BMI. In the sample of 110 relatively young, healthy firefighters participating in this study, the average BMI was 28.1.

While recent programs developed by NFFF, International Association of Fire Chiefs (IAFC), International Association of Firefighters (IAFF) and National Volunteer Fire Council (NVFC) have provided a sound foundation for interventions aimed at improving firefighter health, the entire fire service must take seriously a renewed effort to reduce the prevalence of cardiac risk factors in line firefighters.

Recommendation 1

As recommended by NFPA 1582, all firefighters should receive a medical evaluation before becoming a firefighter and should receive periodic medical examinations after joining the service. These exams should focus on cardiovascular health and cardiovascular risk factors and should be conducted by a physician who is familiar with the demands of firefighting.

Recommendation 2

Extreme obesity should be considered as a disqualifying condition to safely perform firefighting duties. Obesity should be addressed in the NFPA 1582 standard.

Recommendation 3

In recognition of the physiological strain incurred during structural firefighting, fire departments should include defined cardiovascular standards in their hiring and recruitment processes. Candidates who have uncontrolled hypertension or uncontrolled diabetes should be precluded from consideration as line firefighters until these risk factors are corrected. Firefighters who have multiple risk factors should receive additional screening and aggressive intervention given the greater risk associated with multiple risk factors.

Recommendation 4

Firefighters must be required to adhere to lifestyle standards that have been determined to reduce the development of cardiac risk factors. These include smoking cessation, sound nutritional habits and regular exercise. These interventions and programs should be aimed at supporting individual firefighters; however, the department (and union, IAFF), if appropriate may need to take action as needed to ensure compliance in cases where a firefighter does not voluntarily comply, or have the option of reassigning the firefighter to other duties. Volunteer departments must continue to pursue ways to ensure that necessary minimal requirements are met for medical readiness for duty.



Part Three: Recommendations

Physical Fitness Requirements

Firefighting can be incredibly strenuous. The physical and physiological demands of firefighting require a high degree of fitness in order to fulfill the responsibilities of the job safely and effectively. Firefighting may often push even the fittest individual to the extremes of his or her physical ability. Health and safety recommendations issued by the International Association of Firefighters, the International Association of Fire Chiefs, and the National Volunteer Fire Council currently consist of suggestions for fitness and nutritional programs. While these are well crafted and scientifically sound programs, there are still far too many fire departments in the United States that do not have adequate physical fitness programs.



Given the consistency of cardiac death rates among firefighters over the last decade, as well as the widespread knowledge of cardiac risk factors, it appears that voluntary fitness programs are not sufficient to ensure firefighters are taking the necessary steps to reduce the rate of cardiac events. Thus, departments may need to consider mandatory fitness and wellness programs. Many of these recommendations are incorporated in

NIOSH Publication No. 2007-133: *Preventing Fire Fighter Fatalities Due to Heart Attacks and Other Sudden Cardiovascular Events*. NIOSH acknowledged the inadequate enforcement of fitness and nutrition policies, finding that 39% of the fire departments where NIOSH investigated a cardiac-related fatality had voluntary fitness programs, but only 8% had mandatory participation. All of the major American fire service organizations have published health and safety guidelines of some type, and collectively have produced a comprehensive outline of the steps that a department should take to reduce the rate of cardiac death through improved physical fitness. The incongruence between the public discourse on firefighter cardiac fatalities and the consistency of the annual fatality statistics appears to be one of enforcement, not dissemination.

Similarly, physical fitness can influence a firefighter's likelihood of injury on the fireground. Over the past 15 years, more than half of the injuries occurring on the fireground are attributed to slip, trips and falls and overexertion/strain. These sources of injuries can be reduced by increasing stamina, strength, and balance through improved physical fitness.

Recommendation 5

The National Fire Protection Agency (NFPA) standard on physical fitness should be universally adopted. As recommended by NFPA 1583, all firefighters should participate in an organized physical fitness program. These physical fitness programs should emphasize cardiovascular (aerobic) fitness and include muscular fitness. Fire departments should include defined physical



fitness standards in their hiring and recruitment processes. Members should be required to adhere to designated fitness programs.

Recommendation 6

Firefighters must take personal initiative to ensure that they are fit for duty and do not present an undue cardiac risk to themselves or a liability to the firefighting mission. The voluntary fitness standards currently in place would likely be sufficient if individual firefighters understood the relevance of cardiac standards to their ability to safely and effectively perform their job requirements and acted accordingly.

Recommendation 7

To reduce slip, trip and fall injuries, training exercises that enhance balance abilities should be added to firefighters' training protocols. Considering the detrimental effects of wearing PPE on balance and gait, these exercises are particularly important for those new to the fire service, as well as for older firefighters.



Part Three: Recommendations

On-scene Rehabilitation and Hydration Strategies

Firefighting is strenuous work that is often performed in a hot and hostile environment, leading to considerable cardiovascular and thermal strain. While departmental enforcement of health and safety standards is a proactive approach to reduce the presence of cardiac risk factors and improve cardiovascular health in the fire service, it is still necessary to address the effects of firefighting activity in order to lessen risk and improve performance of individuals working at an incident. Therefore, it is important to discuss interventions that can be taken on the fireground to mitigate the inherent strain that firefighting places upon the system. Rehabilitation and hydration have been discussed in the fire service for several decades, largely beginning with the first edition of NFPA 1500: *Standard on Fire Department Occupational Safety and Health Program*. The USFA has recently published a manual on rehabilitation that provides a great deal of useful information (USDHS/USFA, 2008). Numerous studies, including this effort, have reported that a 10-minute period of rest, accompanied by rehydration and cooling, causes a marked decline in heart rate and core temperature for the majority of firefighters. Many fire departments currently follow NFPA guidelines and require firefighters



to participate in some form of rehab and hydration after participating in firefighting activities, but this practice should be universal.

Recommendation 8

Fire departments must adhere to the standards set forth in NFPA 1584: *Standard on the Rehabilitation Process for Members During Emergency Operations and Training Exercises*. Incident commanders must ensure adequate on-scene resources, either through additional mutual aid or increased staffing to allow all personnel to rotate through rehabilitation after completing a given assignment.

Personal Protective Equipment

The design of PPE must create a balance between thermal protection from the fire source, and thermo-regulation of the firefighter. As the thermal envelope has become more effective, today's PPE has become a major factor in the heat stress experienced by a firefighter, as it impedes the body's natural cooling mechanisms. Thus, PPE warrants further attention in terms of design and fabric properties. NFPA 1971: *Standard on Protective Ensembles for Structural Firefighting* first included a requirement for Total Heat Loss in its 2000 edition, creating a mandatory level of breathability that firefighting PPE must attain. There is substantial anecdotal evidence indicat-



ing that lighter gear alleviates heat stress and reduces perceived workload. This study found that lighter PPE had little or no effect on physiological or perceptual measures during short-duration (18 minutes) firefighting activities.

However, some biomechanical variables were significantly affected by the PPE intervention, indicating that selection of gear can influence fireground injury statistics. Regardless of the PPE worn, firefighters' ability to balance and walk with a normal gait cycle was significantly changed. PPE-based interventions are a promising concept, and there is a continuing need for the development of new technologies that can produce a measurable benefit on the heat stress variables of the firefighter while providing appropriate protection from burn injuries.

Recommendation 9

Manufacturers and fire service organizations should continue to identify and test designs, interventions, and strategies directed at producing lighter or more breathable and less restrictive PPE.



References

- Adams, D.R. (2000). *Protective Ensembles for Firefighting Challenge the Balance and Stability of Firefighters in Executive Fire Officer Program*. National Fire Academy.
- American Heart Association (AHA) (2008). "At a Glance." Americanheart.org.
- Ault, R. (2002). Assessing the need for footwear with protective toecaps for wildland fire operations in Alberta. *Advantage*. **3**(36): 1-8.
- Barnard, R. J. and Duncan, H. W. (1975). Heart rate and ECG responses of fire fighters. *Journal of Occupational Medicine*. **17**(4): 247-250.
- Bell, J.L., Gardner, L.I. and Landsittel, D.P. (2000). Slip and fall-related injuries in relation to environmental cold and work location in above-ground coal mining operations. *American Journal of Industrial Medicine*. **38**(1):40-48.
- Bentley, T.A. and Haslam, R.A. (2001). Identification of risk factors and countermeasures for slip, trip and fall accidents during the delivery of mail. *Applied Ergonomics*. **32**(2):127-134.
- Borg, G. (1998). *Perceived exertion and pain scales*. Human Kinetics Publishers, Champaign, Illinois.
- Clark, S., Rene, A., Theurer, W. M. and Marshall, M. (2002). Association of body mass index and health status in firefighters. *Journal of Occupational and Environmental Medicine*. **44**(10): 940-946.
- Cloutier, E. and Champoux, D. (2000). Injury risk profile and aging among Quebec firefighters. *Industrial Ergonomics*. **25**(5): 513-523.
- Davis, S. C., Jankovitz, K. Z. and Rein, S. (2002). Physical fitness and cardiac risk factors of professional firefighters across the career span. *Research Quarterly for Exercise and Sport*. **73**(3): 363-370.
- DiMarzo, M., Brown, J., Derchek, A., Edwards, S., and Bennett, A. (2006). *Health and Safety Guidelines for Firefighter Training*, Maryland Fire and Rescue Institute, College Park, MA.
- Duncan, H. W., Gardner, G. W. and Barnard, R. J. (1979). Physiological Responses of Men Working in Fire Fighting Equipment in the Heat. *Ergonomics*. **22**(5): 521-527.
- Dunn, V. (1994). "Slips, falls, and missed jumps," *Firehouse*. **19**: 20-21.
- Eglin, C. M., Coles, S. and Tipton, M. J. (2004). Physiological responses of fire-fighter instructors during training exercises. *Ergonomics*. **47**(5): 483-494.
- Fahy, R. (2005). U.S. Firefighter Fatalities Due to Sudden Cardiac Death 1995-2004. *NFPA Journal*. **99**(4): 44-47.
- Fahy, R.F. and LeBlanc, P.R. (2006). U.S. Firefighter Fatalities for 2005. *NFPA Journal*. **100**(4): 50-57.
- Fahy, R.F., LeBlanc, P.R. and Molis, J. L. (2007). Firefighter Fatalities 2006. *NFPA Journal*. **101**(4): 58-67 n.
- Fahy, R.F. and LeBlanc, P.R. (2000). 1999 Firefighter Fatalities. *NFPA Journal*. **94**(4): 46-61.
- Fahy, R. and LeBlanc, P.R. (2001). U.S. Firefighter Fatalities. *NFPA Journal*. **95**(4): 67-79.
- Fahy, R.F. and LeBlanc, P.R. (2002). Fire 2001 Fighter Fatalities. *NFPA Journal*. **96**(4): 69-80.
- Fahy, R. and LeBlanc, P. (2003). On-Duty Deaths Firefighter Fatalities 2002. *NFPA Journal*. **97**(4): 56-63.
- Fahy, R.F. and LeBlanc, P.R. (2004). Firefighter Fatalities in the United States 2003. *NFPA Journal*. **98**(4): 44-57.
- Fahy, R.F., LeBlanc, P.R. and Molis, J.L. (2007). Firefighter Fatalities Studies 1977-2006. What's Changed Over the Past Thirty Years? *NFPA Journal*. **101**(4): 49-55.

- Geibe, J. R., Holder, J., Peeples, L., Kinney, A. M., Burress, J. W. and Kales, S. N. (2008). Predictors of On-Duty Coronary Events in Male Firefighters in the United States. *American Journal of Cardiology*, **101**(5), 585-589.
- Holder J.D., Stallings L.A., Peeples L., Burress J.W. and Kales S.N. (2006). Firefighter heart presumption retirements in Massachusetts: 1997-2004. *Journal of Occupational and Environmental Medicine*. **48**(10):1047-1053.
- Holmér, I. and Gavhed, D. (2007). Classification of metabolic and respiratory demands in fire fighting activity with extreme workloads. *Applied Ergonomics*. **38**(1): 45-52.
- Houser, A.N., Jackson, B.A., Bartis, J.T. and Peterson, D. J. (2004). Emergency Responder Injuries and Fatalities: An Analysis of Surveillance Data: Rand Corporation.
- Kales, S. N., Soteriades, E. S., Christophi, C. A. and Christiani, D. C. (2007). Emergency duties and deaths from heart disease among firefighters in the United States. *New England Journal of Medicine*. **356**(12): 1207-1215.
- Kales, S. N., Soteriades, E. S., Christoudias, S. G. and Christiani, D. C. (2003). Firefighters and on-duty deaths from coronary heart disease: A case control study. *Environmental Health: A Global Access Science Source*, **2**(1): 1-13.
- Kaplan, N.M. (2005). Systemic Hypertension: Mechanisms and Diagnosis. In D.P. Zipes, P. Libby, R.O. Bonow, & E. Braunwald (Eds.), *Heart Disease* (pp. 959-987). Philadelphia, PA: Elsevier Saunders.
- Karter, M.J. (2003). Patterns of Firefighter Fire-ground Injuries. *National Fire Protection Association*, Quincy, MA.
- Karter, M.J. and Badger, S.G. (2000). 1999 United States Firefighter Injuries. *NFPA Journal*. **94**(6): 41-49.
- Karter, M.J. and Badger, S.G. (2001). U.S. Firefighter Injuries of 2000. *NFPA Journal*. **95**(6): 49-54.
- Karter, M.J. and LeBlanc, P.R. (1991). U.S. Firefighter Injuries-1990. *NFPA Journal*. **85**(6): 43-53.
- Karter, M.J. and LeBlanc, P.R. (1992). U.S. Firefighter Injuries in 1991. *NFPA Journal*. **86**(6): 56-65.
- Karter, M.J. and LeBlanc, P.R. (1993). U.S. Firefighter Injuries in 1992. *NFPA Journal*. **87**(6): 56-67.
- Karter, M.J. and LeBlanc, P.R. (1994). U.S. Firefighter Injuries in 1993. *NFPA Journal*. **88**(6): 57-66.
- Karter, M.J. and LeBlanc, P.R. (1995). Firefighter Injuries at an 18-Year Low. *NFPA Journal*. **89**(6): 63-70.
- Karter, M.J. and LeBlanc, P.R. (1996). 1995 U.S. Firefighter Injuries. *NFPA Journal*, **90**(6): 103-112.
- Karter, M.J. and LeBlanc, P.R. (1997). 1996 U.S. Firefighter Injuries. *NFPA Journal*, **91**(6): 66-77.
- Karter, M.J. and LeBlanc, P.R. (1998). 1997 U.S. Firefighter Injuries. *NFPA Journal*, **92**(6): 48-56.
- Karter, M.J. and LeBlanc, P.R. (1999). 1998 Firefighter Injuries. *NFPA Journal*, **93**(6): 46-56.
- Karter, M.J. and Molis, J.L. (2003). 2001 Firefighter Injuries. *NFPA Journal*. **97**(1): 62-65.
- Karter, M.J. and Molis, J.L., (2003). 2002 Firefighter Injuries. *NFPA Journal*. **97**(6): 64-72.



References

- Karter, M.J. and Molis, J.L. (2004). Firefighter Injuries for 2003. *NFPA Journal*. **98**(6): 58-63.
- Karter, M.J. and Molis, J.L. (2005). Firefighter Injuries for 2004. *NFPA Journal*. **99**(6): 50-57.
- Karter, M.J. and Molis, J.L. (2006). Firefighter Injuries for 2005. *NFPA Journal*. **100**(6): 76-81.
- Karter, M.J. and Molis, J.L. (2007). Firefighter Injuries for 2006. *NFPA Journal*. **101**(6): 84-89.
- Kincl, L.D., Bhattacharya, A., Succop, P.A. and Clark, C.S. (2002). Postural sway measurements: A potential safety monitoring technique for workers wearing personal protective equipment, *Applied Occupational and Environmental Hygiene*. **17**(4): 256-266.
- Kjaer, M., Kiens, B., Hargreaves, M. and Richter, E.A. (1991) Influence of active muscle mass on glucose homeostasis during exercise in humans. *Journal of Applied Physiology*. **71**(2): 552-557.
- Kung, H.C., Hoyert, D.L., Xu, J. and Murphy, S.L. (2008). Deaths: Final Data for 2005. *National Vital Statistics Reports*. **56**(10).
- LeBlanc, P.R. and Fahy, R.F. (2005). U.S. Firefighter Fatalities for 2004. *NFPA Journal*. **99**(4): 48-59.
- Louhevaara, V., Ilmarinen, R., Griefahn, B., Kunemund, C. and Makinen, H. (1995). Maximal physical work performance with European standard based fire-protective clothing system and equipment in relation to individual characteristics. *European Journal of Applied Physiology and Occupational Physiology*. **71**(2-3): 223-229.
- Manning, J. E. and Griggs, T. R. (1983). Heart rates in fire fighters using light and heavy breathing equipment: similar near-maximal exertion in response to multiple work load conditions. *Journal of Occupational Medicine*. **25**(3): 215-218.
- Morgan, W. P. and Raven, P. B. (1985). Prediction of distress for individuals wearing industrial respirators. *American Industrial Hygiene Association Journal*. **46**(7): 363-368.
- Myerburg, R.J. and Castellanos, A. (2005). Cardiac Arrest and Sudden Cardiac Death. In D.P. Zipes, P. Libby, R.O. Bonow, & E. Braunwald (Eds.), *Heart Disease* (pp. 865-908). Philadelphia, PA: Elsevier Saunders.
- Park, K., Rosengren, K.S., Horn, G.P., Schroeder, T., Ashton-Szabo, S.E. and Hsiao-Weckler, E.T. (2008). Effect of load carriage on ground reaction forces during obstacle crossing: an investigation of firefighter bottles. *17th Congress of the International Society of Electromyography and Kinesiology*, Niagara Falls, Ontario, Canada.
- Punakallio, A. (2003). Balance abilities of different-aged workers in physically demanding jobs, *Journal of Occupational Rehab*. **13**(1): 33-43.
- Punakallio, A. (2004). Trial-to-trial reproducibility and test-retest stability of two dynamic balance tests among male firefighters. *International Journal of Sports Medicine*. **25**(3):163-169.
- Punakallio, A. (2005). Balance abilities of workers in physically demanding jobs: with special reference to firefighters of different ages. *Journal of Sport Science Medicine*. **4**(SUPPL 8):.1-47.

- Punakallio, Hirovonen, M. and Gronqvist, R., (2005). Slip and fall risk among firefighters in relation to balance, muscular capacities and age. *Safety Science*. **43**(7): p. 455-468.
- Punakallio, A., Lusa, S. and Luukkonen, R., (2003). Protective equipment affects balance abilities differently in younger and older firefighters. *Aviation Space and Environmental Medicine*. **74**(11): 1151-1156.
- Punakallio, A., Lusa, S., and Luukkonen, R., (2004). Functional, postural and perceived balance for predicting the work ability of firefighters. *International Archives of Occupational and Environmental Health*. **77**(7): 482-490.
- Ridker, P.M. and Libby, P. (2005). Risk factors for atherothrombotic disease. In D.P. Zipes, P. Libby, R.O. Bonow, and E. Braunwald (Eds.), *Heart Disease* (pp. 939-958). Philadelphia, PA: Elsevier Saunders.
- Romet, T. T. and Frim, J. (1987) Physiological responses to fire fighting activities. *European Journal of Applied Physiology*. **56**: 633-638.
- Rossi, R. (2003). Fire fighting and its influence on the body. *Ergonomics*. **46**: 1017-1033.
- Rowell, L. B., Brengelmann, G.L. and Murray, J.A. (1969). Cardiovascular responses to sustained high skin temperature in resting man. *Journal of Applied Physiology*. **27**: 673-680.
- Sawka, M. N., Wenger, C. B. and Pandolf, K. B. (1993). *Human Responses to Exercise-Heat Stress*. Defense Technical Information Center.
- Selkirk, G. A. and McLellan, T. M. (2004). Physical work limits for Toronto firefighters in warm environments. *Journal of Occupational and Environmental Hygiene*. **1**(4): 199-212.
- Smith, D. L., Petruzzello, S. J., Kramer, J. M., Warner, S. E., Bone, B. G. and Misner, J. E. (1995). Selected physiological and psychological responses to physical activity in different configurations of firefighting gear. *Ergonomics*. **38**(10): 2065-2077.
- Smith, D. L., Petruzzello, S. J., Kramer, J. M. and Misner, J. E. (1997). The effects of different thermal environments on the physiological and psychological responses of firefighters to a training drill. *Ergonomics*, **40**(4): 500-510.
- Smith, D. L. and Petruzzello, S. J. (1998). Selected physiological and psychological responses to live-fire drills in different configurations of firefighting gear. *Ergonomics*, **41**(8), 1141-1154.
- Smith, D. L., Manning, T. S. and Petruzzello, S. J. (2001). Effect of strenuous live-fire drills on cardiovascular and psychological responses of recruit firefighters. *Ergonomics*. **44**(3): 244-254.
- Smith, D.L., Petruzzello, S.J., Chludzinski, M.A., Reed, J.J. and Woods, J.A. (2001). Effects of strenuous live-fire fire fighting drills on hematological, blood chemistry, and psychological measures. *Journal of Thermal Biology*. **26**(4-5): 375-380.
- Sobeih, T.M., Davis, K.G., Succop, P.A., Jetter, W.A. and Bhattacharya, A. (2006). Postural balance changes in on-duty firefighters: Effect of gear and long work shifts, *Journal of Occupational and Environmental Medicine*. **48**(1): 68-75.
- Soteriades, E. S., Kales, S. N., Liarokapis, D. and Christiani, D. C. (2003). Prospective surveillance of hypertension in firefighters. *Journal of Clinical Hypertension*. **5**(5): 315-320.



References

- Soteriades, E. S., Hauser, R., Kawachi, I., Liarokapis, D., Christiani, D. C. and Kales, S. N. (2005). Obesity and cardiovascular disease risk factors in firefighters: A prospective cohort study. *Obesity Research*. **13**(10): 1756-1763.
- Soteriades, E. S., Hauser, R., Kawachi, I., Christiani, D. C. and Kales, S. N. (2008). Obesity and risk of job disability in male firefighters. *Occupational Medicine*. **58**(4): 245-250.
- Sothmann, M. S., Saupe, K., Jasenof, D. and Blaney, J. (1992). Heart rate response of firefighters to actual emergencies: Implications for cardiorespiratory fitness. *Journal of Occupational Medicine*. **34**(8): 797-800.
- Spielberger, C. D., Jacobs, G., Russell, S. and Crane, R. S. (1983). Assessment of anger: The state-trait anger scale. *Advances in Personality Assessment*. **2**: 161-189.
- TriData Corp. (2002). *Firefighter Fatality Retrospective Study*. USFA-National Fire Data Center.
- U.S. Department of Homeland Security/United States Fire Administration. *Emergency Incident Rehabilitation*. February 2008, FA-314.
- U.S. Department of Labor: Bureau of Labor Statistics (2006). *Census of Fatal Occupational Injuries*. <http://www.bls.gov>.
- U.S. Fire Administration (USFA). (2002). *Firefighter Fatality Retrospective Study*.
- U.S. Fire Administration (USFA). (2004). *Firefighter Fatalities in the United States in 2003*.
- U.S. Fire Administration (USFA). (2006). *Firefighter Fatalities in the United States in 2005*.
- U.S. Fire Administration (USFA)/National Fire Data Center. (1997). *Fire in the United States: 1985-1994*. 9th Ed.
- U.S. Fire Administration(USFA)/National Fire Data Center. (1998). *Fire in the United States: 1986-1995*. 10th Ed.
- U.S. Fire Administration (USFA)/National Fire Data Center. (1999). *Fire in the United States: 1987-1996*. 11th Ed.
- U.S. Fire Administration (USFA)/National Fire Data Center. (2001). *Fire in the United States: 1989-1998*. 12th Ed.
- U.S. Fire Administration (USFA)/National Fire Data Center. (2004). *Fire in the United States: 1992-2001*. 13th Ed.
- van Wegen, E.E.H., van Emmerik, R.E.A. and Riccio, G.E. (2002). Postural orientation: age-related changes in variability and time-to-boundary. *Human Movement Science*, **21**: 61-84.
- Washburn, A.E., LeBlanc, P.R., and Fahy, R.F. (1991). Fire Fighter Fatalities 1990. *NFPA Journal*. **85**(4): 47-58, 90-91.
- Washburn, A.E., LeBlanc, P.R., and Fahy, R.F. (1992). Fire Fighter Fatalities. *NFPA Journal*. **86**(4): 40-54.
- Washburn, A.E., LeBlanc, P.R., and Fahy, R.F. (1993). Fire Fighter Fatalities in 1992. *NFPA Journal*. **87**(4): 44-53, 68-70.
- Washburn, A.E., LeBlanc, P.R., and Fahy, R.F. (1994). Firefighter Fatalities Remained Low in 1993. *NFPA Journal*. **88**(4): 55-70.
- Washburn, A.E., LeBlanc, P.R., and Fahy, R.F. (1995). Fire Fighter Fatalities in 1994. *NFPA Journal*. **89**(4): 83-93.
- Washburn, A.E., LeBlanc, P.R., and Fahy, R.F. (1996). 1995 Firefighter Fatalities. *NFPA Journal*. **90**(4): 63-77.
- Washburn, A.E., LeBlanc, P.R., and Fahy, R.F. (1997). 1996 Firefighter Fatalities. *NFPA Journal*. **91**(4): 46-60.



Washburn, A.E., LeBlanc, P.R., and Fahy, R.F. (1998). 1997 Firefighter Fatalities. *NFPA Journal*. 92(4): 51-62.

Washburn, A.E., LeBlanc, P.R., and Fahy, R.F. (1999). Firefighter Fatalities. *NFPA Journal*. 93(4): 54-70.

Wilkerson, D.P., Campbell, I.T. and Jones, A.T. (2004). Influence of nitric oxide synthase inhibition on pulmonary O₂ uptake kinetics during supra-maximal exercise in humans. *Journal of Physiology*. **561**(2): 623–635.

Young, A. A. (1987). Thermal sensations during simultaneous warming and cooling at the forearm: A human psychophysical study. *Journal of Thermal Biology*. **12**(4): 243-247.

**UNIVERSITY OF ILLINOIS
FIRE SERVICE INSTITUTE
FIREFIGHTER LIFE SAFETY
RESEARCH CENTER**

**11 Gerty Drive, Champaign, IL 61820
217/333-3800
800/437-5819**

www.fsi.uiuc.edu