

SL 9000 INDEX

CONSOLE:

- 1 CONSOLE OVERVIEW
- 2 BASIC ROUTING & SIGNAL FLOW
- 3 INPUT/OUTPUT MODULE
- 4 SIGNAL PROCESSOR ROUTING
- 5 CONSOLE CENTRE SECTION
- 6 THE PATCH



COMPUTER:

- 1 INTRODUCTION
- 2 PROJECTS
- 3 MACHINE CONTROL
- 4 CUE AND TRACK LISTS
- 5 THE MIX SYSTEM
- 6 TOTAL RECALL
- 7 MACHINES MENU
- 8 MACROS
- 9 MISCELLANEOUS SETUP OPTIONS

Solid State Logic

**SL 9000 J Series
Total Studio System**

Console Operator's Manual



82S6MGKC

Solid State Logic

Begbroke, Oxford, England OX5 1RU • +44 (0)1865 842300

1 rue Michael Faraday, 78180 Montigny le Bretonneux, France • +33 1 34 60 46 66

Via Pirandello 17, 20099 Sesto San Giovanni, Milan, Italy • +39 2 262 24956

320 West 46th Street, New York, NY 10036, USA • + 1 212 315 1111

6255 Sunset Boulevard, Los Angeles, California 90028, USA • +1 213 463 4444

702 Brimorton Drive, Scarborough, Ontario, Canada • +1 416 431 9131

3-55-14 Sendagaya, Shibuya-Ku, Tokyo 151, Japan • +81 (0)3 5474 1144

447A Macpherson Road, Singapore 368157 • +65 285 9300

A Carlton Company

© 1994 by Solid State Logic Limited

All Rights reserved under International and Pan-American Copyright Conventions
SSL, OmniMix, Scenaria, VisionTrack, ScreenSound and SoundNet are Registered Trademarks
of Solid State Logic Limited

Dolby Surround is a Registered Trademark of Dolby Laboratories Licencing Corp

No part of this publication may be reproduced in any form or
by any means, whether mechanical or electronic, without the
written permission of Solid State Logic Ltd., Oxford, England.

December 1994

*As research and development is a continual process, Solid State Logic reserves the right
to change the features and specifications described herein without notice or obligation.*

SL 9000 J Series

Console Operator's Manual

CONTENTS

- 1 Introduction**
System Overview
- 2 Basic Routing and Signal Flow**
- 3 The SL911 Input/Output Module**
- 4 Signal Processor Routing**
- 5 The Console Centre Section**
- 6 The Patch**

On the following pages you will find a full alphabetical Index. We have tried to make this Index as comprehensive as possible because we believe that, once you have become accustomed to the basic features of the SL 9000 J Series Console, you will only need to use this manual as a reference volume.

Entries shown in **Bold** denote front panel switches and controls.

+48V	3-2
2 CH, 4 CH Monitor Mode – SL952J Master Facilities Module	3-12, 3-17, 5-9
4-Channel Pan mode – SL911J I/O Module	3-11
A B C D Oscillator routing – SL952/953J Master Facilities Module	5-23
A, B, C and D buttons – SL911J I/O Module	3-22
A/PFL TO MINIS – SL952/953J Master Facilities Module	5-11
AFL – SL952/953J Master Facilities Module	3-12, 3-17
AFL – SL952/953J Master Facilities Module	5-11
ALT Solo mode – SL952/953J Master Facilities Module	5-12
Audio Subgrouping	2-21
AUTO CUE – SL952/953J Master Facilities Module	5-22
Aux Reassign System	2-25
Auxiliary Sends – SL911J I/O Module	3-9
Basic Routing and Signal Flow	Section 2
BELL switch – SL911J I/O Module EQ Section	3-7
Blank Panel in Centre Section	5-25
BUS trim control – SL911J I/O Module	3-23
Bus Mix Amp and Trim Control – SL911J I/O Module	3-23
BUSSES 1-48 Oscillator routing – SL952/953J Master Facilities Module	5-23
CAL METERS – SL952/953J Master Facilities Module	5-17
Centre Section Meters	5-15
Centre Section	Section 5
Centre Section – an overview	1-7
CH IN – SL911J Dynamics Section	3-3, Section 4
CH OUT – SL911J Dynamics Section	3-3, Section 4
CHANNEL IN TO METERS option switch	5-25
Channel Input Section – SL911J I/O Module	3-2
Channel Meter Controls	5-16
Channel Outputs – SL911J I/O Module	3-20
CLEAR PEAK Meter select – SL952/953J Master Facilities Module	5-16
Communications Section – SL952/953J Master Facilities Module	5-21
Compressor, Main Output – SL952/953J Master Facilities Module	5-6
Compressor/Limiter – SL911J I/O Module	3-3
Console Centre Section	5-1
Console Overview	Section 1
Control Group Faders	5-19
Control Room Monitoring System – SL952/953J Master Facilities Module	5-9
C/SECT SELECT Meter select – SL952/953J Master Facilities Module	5-17
CUE LIGHT switch – SL952/953J Master Facilities Module	5-21
Cue-FX Sends – SL952/953J Master Facilities Module	5-12
CUT – Large Fader SL911J I/O Module	3-18
CUT – Small Fader SL911J I/O Module	3-12
CUT, Monitor – SL952/953J Master Facilities Module	5-9

DESK OUTPUT Meter select – SL952/953J Master Facilities Module	5-15
DIM , Monitor – SL952/953J Master Facilities Module	5-9
DISPLAY PEAK Meter select – SL952/953J Master Facilities Module	5-16
DYN SC – SL911J I/O Module Filters Section	3-6, Section 4
Dynamics Section Routing Buttons	3-3, Section 4
Dynamics Section – SL911J I/O Module	3-3
E switch – SL911J I/O Module EQ Section	3-7
Echo Returns – SL952/953J Master Facilities Module	5-14
EFX EV(EN) – SL911J I/O Module Group Output Section	3-23
EFX EV(EN) – SL911J I/O Module Multitrack Routing Section	3-21
EFX EV(EN) – SL911J I/O Module Stereo Subgroup Routing Section	3-22
EFX Even – SL911J I/O Module	3-9
EFX ODD – SL911J I/O Group Output Section	3-23
EFX ODD – SL911J I/O Module Multitrack Routing Section	3-21
EFX ODD – SL911J I/O Module Stereo Subgroup Routing Section	3-22
EFX Odd – SL911J I/O Module	3-9
EFX – SL911J I/O Module Auxiliary Sends Section	3-9
EQ IN – SL911J I/O Module	3-6, Section 4
Equaliser and Filter Routing Buttons	3-6, Section 4
Equaliser and Filters Section – SL911J I/O Module	3-6
Expander/Gate – SL911J I/O Module	3-4
EXT 1, EXT 2 Meter select – SL952/953J Master Facilities Module	5-15
EXT 1, EXT 2 Monitor Mode – SL952/953J Master Facilities Module	5-11
EXT T/B – SL952/953J Master Facilities Module	5-21
External Source Selectors – SL952/953J Master Facilities Module	5-11
FADER – SL911J I/O Module Group Output Section	2-23, 3-22
Fader Subgrouping	3-19
F/B A, F/B B and F/B C – SL952/953J Master Facilities Module	5-22
Filters – SL911J I/O Module	3-8
FLEET Solo mode – SL952/953J Master Facilities Module	5-12
FLIP – SL911J I/O Module Input Section	3-2
Foldback Sends – SL952/953J Master Facilities Module	5-13
FOLLOW MONITOR Meter select – SL952/953J Master Facilities Module	5-15
FX Reassign System	2-25
FX Sends – SL952/953J Master Facilities Module	5-12
GROUP – SL911J I/O Module Monitor Section	3-10
Group Faders	5-19
Group Output Section – SL911J I/O Module	3-22
Group/Tape Selections and the Supercue System – SL911J Module	3-13
HARD GROUP SETUP – SL955J Motion Control Panel	3-19, 5-19
HIGH-Z – SL911J I/O Module Input Section	3-2
HOLD control – SL911J Dynamics Section	3-4-3-5

IN – SL911J Insert Point	3-8, Section 4
Input/Output Module	Section 3
Input/Output Module – an overview	1-3
Insert Point – SL911J I/O Module	3-8
ISO – SL911J I/O Module Small Fader Section	3-18
KEY – SL911J I/O Module Insert Point	3-3, 3-8, Section 4
Jackfield, The	Section 6
Large Fader Pan Control – SL911J I/O Module	3-17
Large Fader Subgrouping	3-19
Large Fader – SL911J I/O Module	3-17
LCR Pan Option – SL911J I/O Module	3-12, 3-17, 5-9
LF MIX Meter select – SL952/953J Master Facilities Module	5-17
LF – SL911J I/O Module Multitrack Routing Section	3-21
LF – SL911J I/O Module Stereo Subgroup Routing Section	3-22
LINE – SL911J I/O Module Input Section	3-2
LINK External Source Selector – SL952/953J Master Facilities Module	5-11
LINK – SL911J Dynamics Section	3-5
LISTEN – SL952/953J Master Facilities Module	5-22
Listen 1 and 2 Level controls – SL952/953J Master Facilities Module	5-21
Main Outputs	2-27, 5-5
MASTER CHANNEL INPUT FLIP option switch	5-25
MASTER INPUT FLIP – SL952/953J Master Facilities Module	2-13, 3-2, 5-3
MASTER READY GROUP – SL952/953J Master Facilities Module	5-3
Master Audio Facilities – an overview	1-9
Master Facilities Module	5-1
Master Fader – SL952/953J Master Facilities Module	5-5
Master Status Switching – an overview	1-2
METER INPUT Meter select – SL952/953J Master Facilities Module	5-17
Metering	5-15
Metering – an overview	1-2
Meters – Centre Section	5-15
Meters – Channel Meter Controls	5-16
Meters – PPM	5-16
Meters – VU	5-16
MIC – SL911J I/O Module Input Section	3-2
MINI A and MINI B – SL952/953J Master Facilities Module	5-9
MIX Meter select – SL952/953J Master Facilities Module	5-23
MIX Status	2-15, 5-3
MON – SL911J I/O Module Dynamics Section	3-6, Section 4
MON – SL911J I/O Module EQ Section	3-3, Section 4
Monitor CUT – SL952/953J Master Facilities Module	5-9
Monitor Cut and Solo – SL911J I/O Module	3-16
Monitor DIM – SL952/953J Master Facilities Module	5-9
Monitor External Source Selectors – SL952/953J Master Facilities Module	5-11
Monitor Input and Small Fader Section – SL911J I/O Module	3-10
Monitor Selection and Control	5-9

Monitoring System – SL952/953J Master Facilities Module	5-9
Monitoring – an overview	2-29
MONO Monitor Mode – SL952/953J Master Facilities Module	5-9
Motion Control Panel	5-25
Ø (Phase) – SL911J I/O Module Input Section	3-2
OFFSET control – SL952/953J Master Facilities Module	5-5
Option Switches – SL952/953J Master Facilities Module	5-25
Oscillator – SL952/953J Master Facilities Module	5-23
Output Compressor – SL952/953J Master Facilities Module	5-6
Output Routing with LCR Pan Option	2-29
Output Routing – Standard Systems	2-27
Outputs – Main	5-5
Overload Indicator – SL911J I/O Module	3-8
Patch, The	Section 6
P(O)ST LF – SL911J I/O Module Small Fader Section	3-10, 3-16, 3-20
Pan Control – SL911J I/O Module Large Fader	3-17
Pan Control – SL911J I/O Module Small Fader	3-12
Parametric Equaliser – SL911J I/O Module	3-7
PFL function – SL911J I/O Module	3-12, 3-17
PFL – SL952/953J Master Facilities Module	5-11
PK LED – SL911J I/O Module Dynamics Section	3-3
Power Supply Indicators – SL952/953J Master Facilities Module	5-1
PPM Meters	5-16
PRE LF – SL911J I/O Module Small Fader Section	3-10, 3-16, 3-20
PRE – SL911J I/O Module Insert Point	3-8-3-9, Section 4
RANGE control – SL911J I/O Module Dynamics Section	3-4
RATIO control – SL911J I/O Module Dynamics Section	3-3
RECORD + MIX Status	2-22, 5-3
RECORD + SMALL FADER TO MON(ITOR) Status	2-12, 5-3
RECORD Status	2-5, 5-3
Record button – SL911J I/O Module	3-10
RED LIGHT – SL952/953J Master Facilities Module	5-21
RELEASE control – SL911J I/O Module Dynamics Section	3-4, 3-5
REPLAY Status	2-13, 5-3
Routing and Signal Flow	Section 2
Routing Bank Select Switches – SL911J I/O Module	3-21
Routing Matrix – SL911J I/O Module	3-20
Routing Source Select Switches	3-21
SF MIX Meter select – SL952/953J Master Facilities Module	5-17
SF MIX – SL911J I/O Module Small Fader Section	3-13
SF – SL911J I/O Module Auxiliary Sends Section	3-9
SF – SL911J I/O Module Multitrack Routing Section	3-21
SF – SL911J I/O Module Stereo Subgroup Routing Section	3-22
SL 952/953J Master Facilities Module	5-1
SL 955J Motion Control Panel	5-25
SL911J Input/Output Module	Section 3

SLATE – SL952/953J Master Facilities Module	5-21
Slate Level control – SL952/953J Master Facilities Module	5-21
SLS – SL952/953J Master Facilities Module	5-22
SMALL FADER TO MON(ITOR) option switch	5-25
SMALL FADER TO MON(ITOR) Status button	2-12, 5-3
Small Fader Cut and Solo – SL911J I/O Module	3-12
Small Fader Pan Control – SL911J I/O Module	3-12
Small Fader Source and Destination	3-13
Small Fader – SL911J I/O Module	3-11
Small Faders as Additional Auxiliary Sends	2-19
Small Faders as Additional Inputs to the Mix	2-17
Small Faders as Extra Auxiliary Sends – SL911J I/O Module	3-16
SOLO/AFL/PFL	5-11
SOLO CLEAR – SL952/953J Master Facilities Module	5-12
SOLO IN FRONT – SL952/953J Master Facilities Module	3-17
SOLO ISOLATE option switch – SL952/953J Master Facilities Module	5-25
SOLO – SL911J I/O Module Large Fader	3-17
SOLO – SL911J I/O Module Small Fader	3-12
Solo Isolate – SL911J I/O Module	3-18
SOLO-IN-FRONT – SL952/953J Master Facilities Module	5-11
SPLT – SL911J I/O Module EQ and Filter Section	3-6, Section 4
STATUS LOCK – SL952/953J Master Facilities Module	5-5
STATUS – SL911J I/O Module Large Fader	3-18
Status Buttons – SL952/953J Master Facilities Module	5-3
Stereo Echo Returns – SL952/953J Master Facilities Module	5-14
Stereo Subgroups	2-27
Stereo Subgroup Master Controls – SL952/953J Master Facilities Module	5-7
STORE PEAK Meter select – SL952/953J Master Facilities Module	5-16
Studio Loudspeakers and Foldback Sends	5-13
SUB GP – SL911J I/O Module Input Section	3-2, 3-20, 3-23-3-23
Subgrouping	2-21
Subgrouping Large Faders	3-19
SUM External Source Selectors – SL952/953J Master Facilities Module	5-11
TAPE – SL911J I/O Module Monitor Section	3-10
TB to Foldback level control – SL952/953J Master Facilities Module	5-21
TB to SLS level control – SL952/953J Master Facilities Module	5-21
THRESHOLD control – SL911J I/O Module Dynamics Section	3-4
Track Bouncing	2-11
VU Meters	5-16

Solid State Logic
SL 9000 J Series
Total Studio System

Console Operator's Manual

SECTION 1

Console Overview



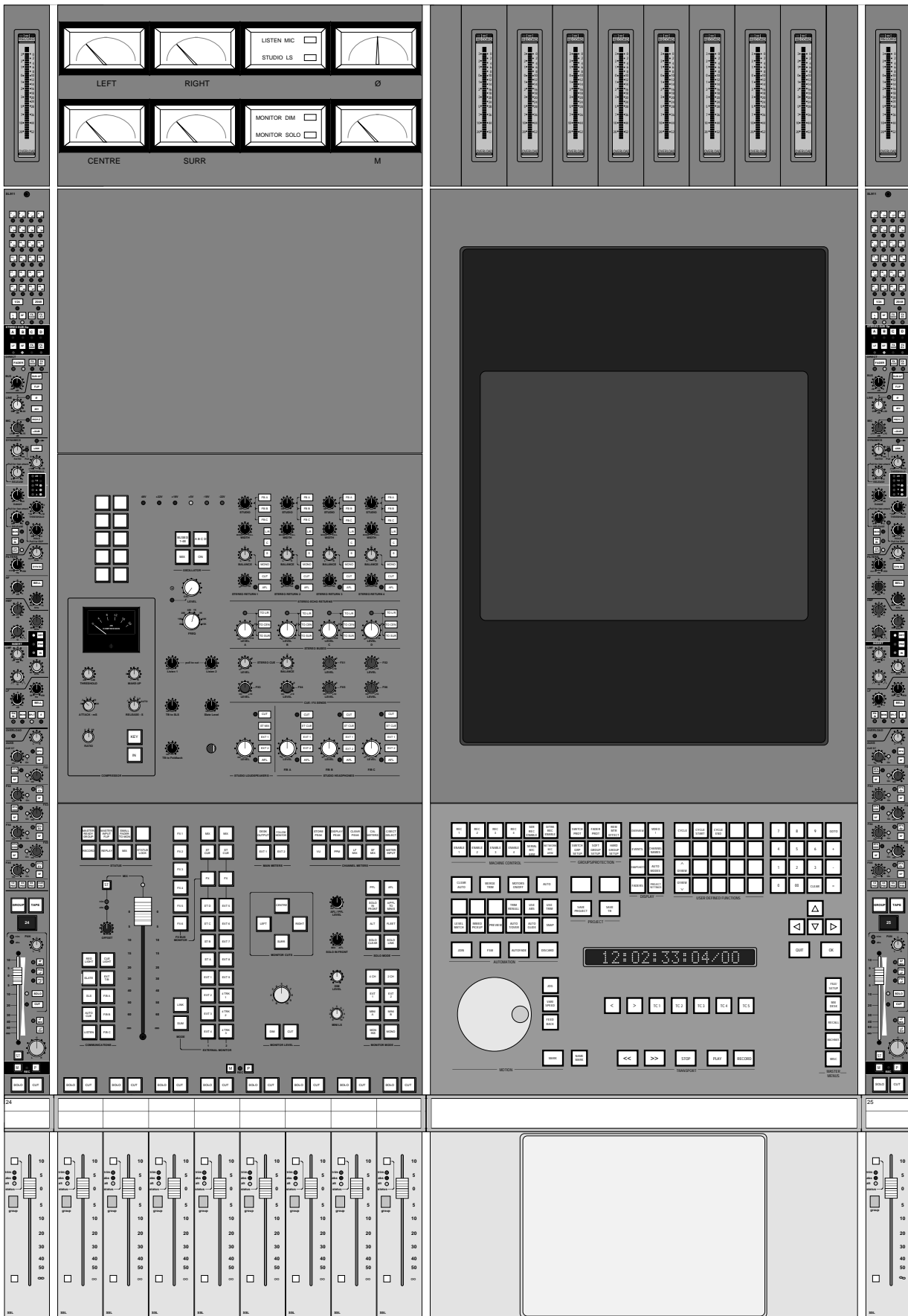

Console Overview

The SL 9000 J is the latest analogue mixing console from Solid State Logic. It draws on and develops many of the features of SSL's other music consoles, while retaining a control surface that will be familiar to any recording engineer familiar with SL4000, 6000 or 8000 Series systems.

The desk has an in-line signal path, with master status switching to quickly re-configure the console for particular tasks, but the signal routing can be overridden locally, providing even more flexibility than other SSL consoles.

The desk has 48 Multitrack busses, 4 Stereo busses, a Main Stereo (optionally LCR) bus and 8 Auxiliary busses, which are divided into 6 Mono FX sends and a Stereo Cue bus. The four Stereo busses can be used as subgroups, additional record feeds, to generate Surround or Centre signals, or as additional FX sends.

An ingenious reassign system allows Auxiliary send controls on individual channels to be disconnected from their own bus and routed to any of the Stereo or Multitrack busses, allowing up to 64 discrete FX send mixes to be generated.

As well as the Large Fader level and Cut, the following console channel functions are automated:

- Small Fader level
- Small Fader Cut
- EQ In/Out
- Insert In/Out
- Individual Aux On/Off switches

These functions are controlled from an entirely new automation computer, providing additional processing power, colour graphics, pop up menus etc. The J Series Computer also provides complete integration with SSL's digital product range, allowing random access multitrack recorders, digital work stations, random access video recorders and routing switchers to be controlled from the console. Further information on the automation system is contained in the J Series Computer Operator's Manual.

The following descriptions are intended for those engineers who are already familiar with SSL's SL4000/6000/8000 range of consoles. Those requiring a more detailed description of the console's features and functions should refer to the relevant sections of this manual.

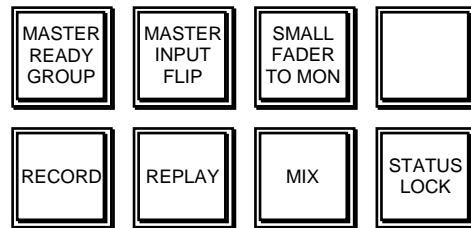

Master Status Switching

The console retains the familiar RECORD, REPLAY and MIX statuses. Note, however, that in RECORD or REPLAY Status, the Large Fader is in the Monitor path and the Small Fader is in the Channel path. This represents a logical change from SL4000/6000/8000 Series consoles where the additional selection of VCA TO MONITORS or FADER REVERSE is required to achieve the same signal flow.

To reverse faders in RECORD or REPLAY status, select SMALL FADER TO MON. Note that there is a great deal of flexibility in sourcing signals to feed to the various busses – either fader can be switched locally to feed any of the busses in any status.

Metering

Depending on the specification of the console you are working on, it may be fitted with standard VU metering or SSL's back lit LCD bargraphs. These can be switched between VU and digital Peak scales from the console's centre section. The 0dB points of the VU scale can be adjusted to read between 0 and +6dBu. Factory default is +4dBu. The 0dB point of the Peak scale can be adjusted from a terminal to read between +16dBu and +24dBu. Factory default is +18dBu (-6dBFS on a Sony multitrack).

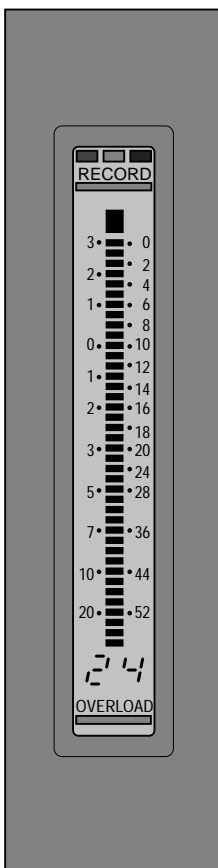

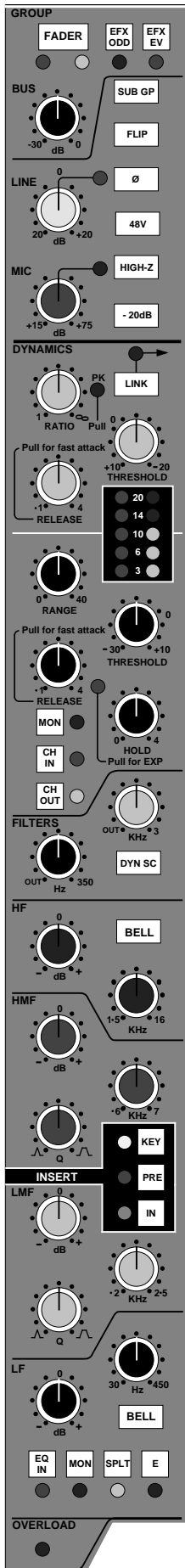

Input/Output Module

The input/output module bears a strong resemblance to the SL4000G module, but with a number of enhancements.

The differences are briefly as follows:

The channel input stage is similar to G Series. The **MIC** gain is a continuously variable control (from +15dB to +75dB) with a 20dB pad switch. The Mic input can also be switched to high impedance using the **HIGH-Z** switch, allowing the Mic input to be used for line level signals.

The Multitrack **BUS** trim control, which on SL4000/6000/8000 Series consoles is adjacent to the Group/Tape switches near the bottom of the module, is also located in this area.

The SL 9000 J Series Dynamics section is based on the classic G Series circuits, with the addition of a Peak detect option on the Compressor (selected by pulling the **RATIO** switch up) and a **HOLD** control for the Gate. The Expander/Gate section defaults to Gate, with Expand selected by pulling the **HOLD** control. As with G Series, the Dynamics section can be keyed from the Monitor path by selecting **MON** and either **CH IN** or **CH OUT**. It can also be keyed from the Insert Return by selecting **KEY** and **IN** for the channel insert point.

The Equaliser is a four band parametric, with variable Q on the mid bands and shelving/bell high and low bands. The normal curves of the equaliser are based on the G Series equaliser. The mid bands are constant Q, so the bandwidth increases as the gain is decreased. LF and HF **BELL** switches are provided as opposed to the LMF and HMF range shift switches found on G Series EQ.

The **E** switch selects an alternative set of EQ characteristics, based on the classic '242' E Series card. The mid bands have a constant bandwidth, so Q increases as gain is increased; the HF band has a shallower slope than in 'normal' mode. The bell curves are identical to the normal ones, ie. without **E** selected.

The Equaliser can be switched to the Monitor path using the **MON** switch. **SPLT** places the filters at the channel input, just as in G Series.

The **EQ IN** switch is automated.

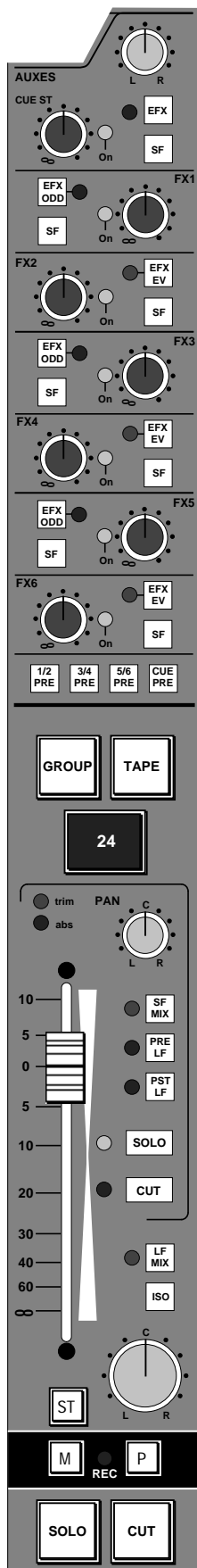

The Auxiliary send section includes one stereo and 6 mono aux send controls. The Aux On/Off function for each send is automated, with push/push switches on each control toggling between on and off. A yellow LED indicates that the send is On. Auxes can be sourced from either fader. The **SF** switch next to each send switches the source to the small fader. The **PRE** switches at the bottom of the section switch the aux source to pre-fader. There is a **PRE** switch for the Stereo Cue send and one **PRE** switch for each pair of mono sends.

A major advance on the SL4000 system is the FX send reassign system – EFX for short. This allows any two mono FX sends, or the stereo cue send, to be disconnected from their respective busses and used as sources for the channel's Group Output, the channel's Stereo bus routing and/or the channel's Multitrack routing.

Aux sends are assigned to the EFX system using the **EFX** switches by each one. FX1, 3 and 5 can be assigned to **EFX ODD**. FX 2, 4 and 6 can be assigned to **EFX EVEN**. Selecting **EFX** on the Stereo Cue send feeds Stereo Cue L to EFX ODD and Stereo Cue R to EFX EVEN. Note that only one odd and one even numbered FX send or Stereo Cue can be assigned. Red (EFX ODD) or green (EFX EVEN) LEDs indicate that a send is assigned to the EFX system.

GROUP, **TAPE** and the Record Enable switches function identically to the SL4000 system.

The Small Fader section is similar to that on an SL4000. Both the fader and **CUT** switch are automated. The Small Fader pan is located here and, unlike the SL4000, is *always* associated with the Small Fader. The pan is permanently in circuit. The Small Fader can be assigned to the Main Stereo mix bus using the **SF MIX** switch.

In MIX or RECORD/REPLAY + SMALL FADER TO MON(itor) status, the Small Fader is normally sourced from the Monitor input. In RECORD or REPLAY status the Small Fader is normally sourced from the channel input. This selection can be overridden by the **PRE LF/PST LF** fader switches. The **PRE LF** switch will pick up the channel signal immediately post input selection, or the channel signal post signal processing. Which signal is chosen is set by an internal link option. **PST LF** selects the post Large Fader signal.

The Small Fader has it's own automation status switch and LEDs.

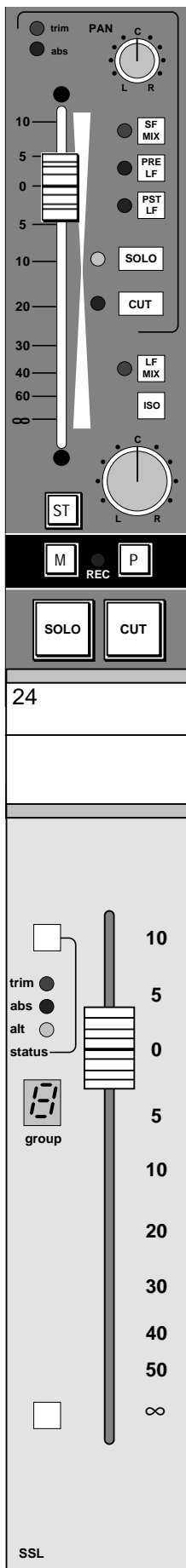

Below the Small Fader is the Large Fader pan control. This is always associated with the Large Fader and is always in circuit.

The Large Fader **CUT** switch is automated. This and all the other automated switch objects in the channel make use of the **Match** and **Play** switches fitted above the Large Fader **CUT** and **SOLO**. See the J Series Computer Operator's Manual for more details.

As with the Small Fader Solo switch, the Large Fader **SOLO** switch can act as a destructive solo, a post pan listen (AFL), a pre-fade listen (PFL) or as a Solo In Front function. This last mode provides a mix of the AFL signal and dimmed Main Mix to the monitors. The different solo functions are selected with the solo mode switches in the console's centre section. These switches also include a **SOLO CLEAR** switch, **ALT** which makes all solo switches intercanceling, **FLEET** which makes them momentary, and **SOLO LINK** which links Large and Small Fader Solo cut busses.

The Large Fader is motorised and, like all SSL Ultimatum systems, can switch the audio via a VCA to allow Trim updates etc. See the J Series Computer Operator's Manual for more details.

The Large Fader can be assigned to one of the 8 master control faders in the centre section, by using the group select switch at the bottom of the fader. Selecting **HARD GROUP SETUP** on the Motion Control panel enables the select switches. A short press of the individual select switches increments the group number in that fader's 7-segment display; a slightly longer press decrements.

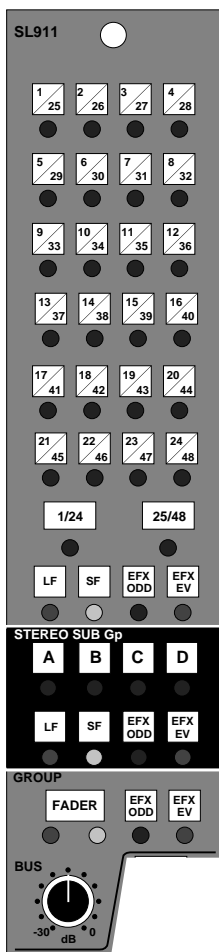

There are four possible outputs from the channel strip:

- The Main Mix stereo bus
- The four Stereo Subgroup busses (A, B, C and D)
- The 48 Multitrack busses
- The channel's Group Output

Either or both faders can feed the Main Mix bus via the **LF MIX** and **SF MIX** switches at the foot of the channel strip; the other three outputs each have a source selector.

The Multitrack and Stereo Subgroup busses can be fed by Large or Small Fader (post pan control) signals, or by one or both of the EFX ODD/EVEN signals. If one EFX switch is selected, then the corresponding routing output will be fed in mono by the selected source. Selecting both switches together will feed EFX ODD to left (odd) and EFX EVEN to right (even) bus. This enables any two Aux Send controls to be re-routed to the Multitrack or Stereo busses, allowing large numbers of separate mixes to be generated without using the Small Fader.

The 48-track routing is accessed via **1-24/25-48** bank select switches and signals are normally sourced from the Small Fader unless **RECORD/REPLAY + SMALL FADER TO MON(itor)** are selected.

The Stereo Subgroup bus routing has no source until one is selected.

The Group Output is normally fed by the multitrack bus Mix Amp, but this can be replaced with a post-fader channel signal by pressing **FADER**, or by the EFX ODD or EFX EVEN signals.

Centre Section

The SL 9000J centre section is logically divided into two main areas (see the picture on Page 1-ii). On the left, two panels provide master controls for the console's audio functions – console status switching, main outputs and monitoring, subgroup and auxiliary masters, meter switching, talkback, FX and cue send masters, echo returns, oscillator etc. Below these panels, eight master control faders are provided.

The right hand side of the centre section is taken up by a large colour video monitor and a panel housing controls associated with the J Series Computer. A jog wheel, a standard set of transport controls, five instant locate buttons and a large timecode display are provided for machine control. A pen and tablet interface for the computer is provided in the fader area. See the J Series Computer Operator's Manual for more details.

See over the page for a basic description of the centre section audio controls.

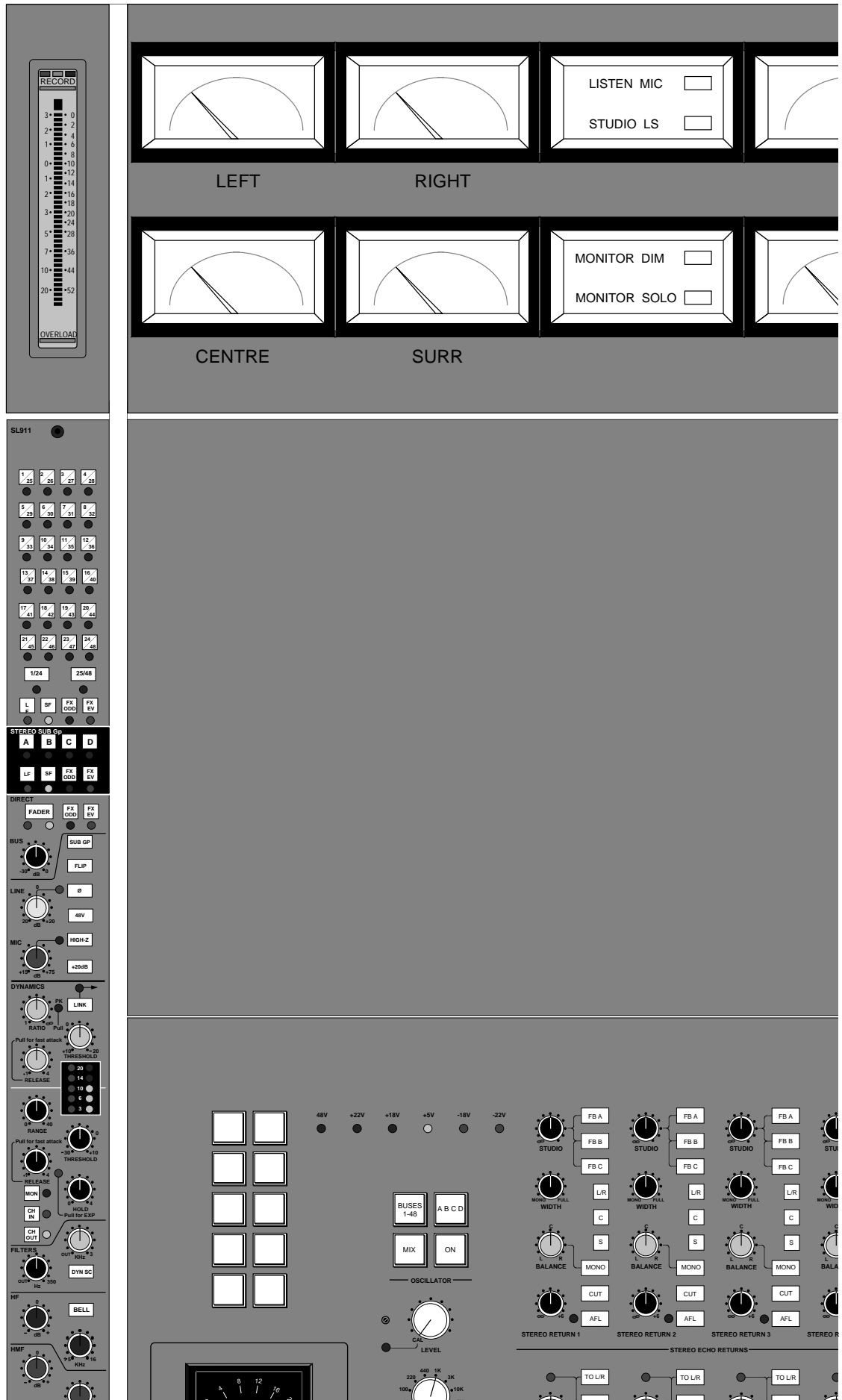

Master Audio Facilities

The SL 9000J master audio facilities are built to a completely new design, offering high performance, low noise, high bandwidth and low distortion. The controls provide all of the functionality of a G Series centre section, plus master facilities for the additional Auxiliary and Stereo Subgroup busses. The foldback and external source selection systems are substantially refined and extended. Additional switching for the new Solo modes is provided.

The main console output is 4-channel with a 4-channel fader and compressor. The output is provided with a pre-fade insert point. The compressor is identical to the design used in the G Series range. Selecting **KEY** bypasses the pre-fade insert point and allows the insert return to be used as a key input. The Master Fader has its own status button and LEDs. The **OFFSET** control allows the Master Fader level to be adjusted while still leaving the Master Fader at the top of its travel.

The Left and Right Main outputs are fed from console-wide busses. If the LCR Film Pan option is fitted, then the Centre bus can also be fed directly from the channels. The four Stereo Subgroup busses can also be re-routed back to the Left/Right, Centre and Surround outputs, allowing four-channel mixes to be built up even if the console does not have the LCR panning option fitted. The Centre and Surround outputs are fed by a mono sum of the selected Stereo Subgroup bus.

The main monitor output is 4-channel with a switchable insert point, pre the monitor level control, for Dolby Surround encoders/decoders. Two pairs of near-field monitor outputs are also available, and can be selected using the **MINI A** and **MINI B** buttons.

The monitors are normally fed by the desk main output, but this can be replaced by either one of two External Source selector banks by selecting **EXT 1** or **EXT 2**. The External Source selectors have independent sources, unlike the SL4000. The buttons are normally intercanceling, but selecting **SUM** allows several sources to be monitored together. **LINK** connects both source selectors together, for comprehensive multiple-source selection.

The Auxiliary bus outputs are provided with level control only.

The Studio monitor system has been substantially extended. Three stereo Foldback and one stereo Studio Loudspeaker outputs are provided. Each is provided with level control and can be fed by any one or a mix of External Source Selector 1, External Source Selector 2, or an external signal fed via the patchbay. For the Foldback outputs this is normally the Stereo Cue output, but this may vary from desk to desk. For the Studio Loudspeakers, the third source is always the stereo main Mix output.

The four stereo Echo Returns are similar to those fitted on the SL4000, with the addition of discrete routing switches to the main outputs. Note that the **STUDIO** level control feeds signal back to the Foldback outputs - not the Auxiliary busses.

Oscillator and Talkback level controls are similar to those found on the SL4000.

Solid State Logic
SL 9000 J Series
Total Studio System

Console Operator's Manual

SECTION 2

Basic Routing and Signal Flow



Basic Routing and Signal Flow

In order to understand signal flow through the console, it is probably best to start with the status buttons located on the SL952J Master Panel. These buttons determine basic signal paths in the SL911J I/O module, so they are very important. Exact details of each local control can be found in Sections 3 and 5.

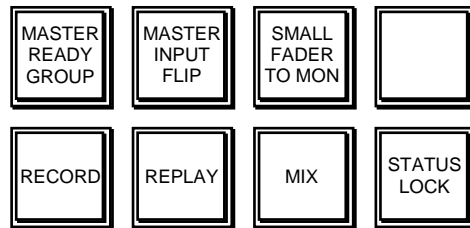

When first setting up the console, you should always check these buttons and select them correctly for the particular mode you wish to work in.

There are four basic desk statuses: RECORD, REPLAY, MIX and RECORD + MIX (overdub). The SMALL FADER TO MON(ITOR) and MASTER INPUT FLIP buttons also affect I/O module signal flow.

Each I/O module has two completely independent audio signal paths, the 'Channel' path and the 'Monitor' path (typical of an *In-Line* console). This gives the system flexibility, but may cause some confusion if you don't understand which areas of each module are dealing with each of these signals.

The Six Key Points in the SL911J

There are six key points in each I/O module which define the two separate audio paths: two inputs to the module, two faders and two outputs from the module. The status buttons determine how these elements are connected together to provide default configurations required for tackling various tasks from track laying through to final mixdown.

The six key elements in the signal paths are:

The Channel Input

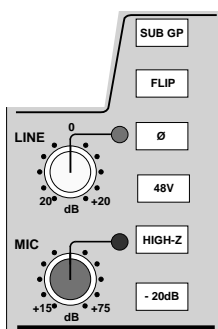

The Channel Input section can be found towards the top of the module and has three inputs: MIC, LINE and SUBGROUP. We will deal with the SUBGROUP input later. The **FLIP** button allows you to flip between MIC and LINE inputs. *All* inputs can be flipped by using the **MASTER INPUT FLIP** button located in the SL952J master status button group. The other controls on the input section are fairly obvious but are detailed in Section 3.

The Small Fader and Pan

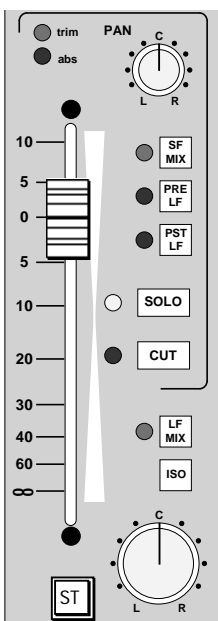

The Small Fader is linked to the computer automation system. Its associated pan control is mounted above and to the right of the fader. This will normally pan between Left/Right or Odd/Even busses unless the optional LCR panning system is fitted, in which case a separate Centre bus is also available.

The Routing Matrix

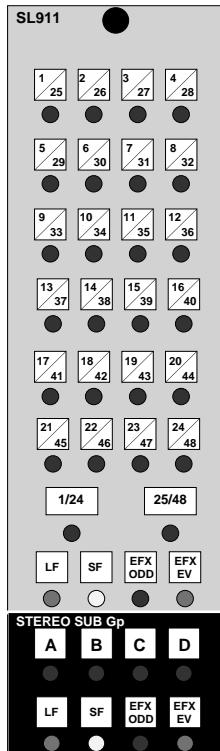

The Routing Matrix provides access to 48 Multitrack busses and four Stereo Subgroup busses. Bus selection is simple in operation, with two buttons determining the Multitrack bus selection for tracks 1-24 or 25-48.

Sources for the Multitrack and Stereo Subgroup busses are determined by the buttons beneath each section. Default selection of Large or Small Fader sources for the Multitrack busses is made by the master Status buttons on the SL952J but this can be overridden locally as required (see later).

Source selections for the Stereo Subgroup busses are independent of the master console status and may be chosen according to the job in hand. See Page 2- 25 for a description of the EFX re-assign system.

The Monitor Input Section

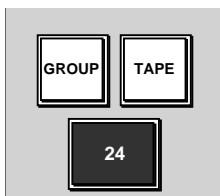

The Monitor Input buttons enable two sources to be selected for the monitor path. **GROUP** selects that module's Group Output, which also feeds the multitrack. **TAPE** selects the track output of the multitrack machine. It is possible to select both of these buttons together to get a mix of the two signals. You will find a more detailed account of this in Section 3.

The Large Fader and Pan

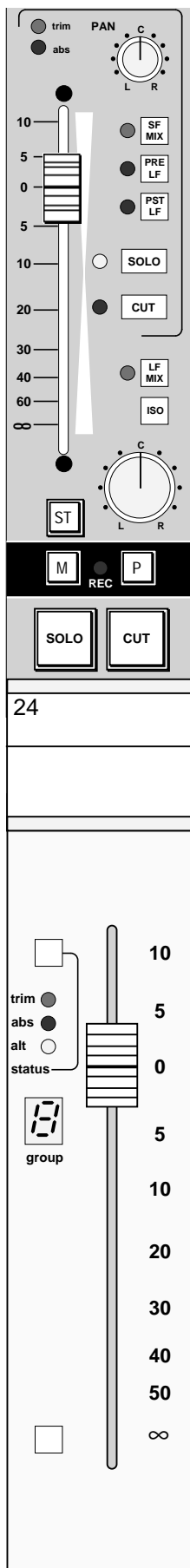

The Large Fader is linked to the computer automation system. Large Faders may be assigned for control by one of the eight group faders in the centre of the console.

An associated pan control is provided directly above the fader at the foot of the I/O module. This will normally pan between Left/Right or Odd/Even busses unless the optional LCR panning system is fitted, in which case a separate Centre bus is also available.

The Output to Mix Bus Controls

Two buttons, **LF MIX** (above the large Fader pan) and **SF MIX** (below the Small Fader pan) determine which fader will feed the console's main Mix bus.

Normally these are selected to a default condition by the master status buttons on the SL952J but may be overridden locally when the situation dictates.

Also in this area are the **PRE** and **POST LF** buttons. These are mainly used in mixdown (as we shall see later) to source pre- and post-Large Fader channel signals when the Monitor path and Routing Matrix provide a method of setting up additional Aux/FX sends.

In order to explain the console routing system, we will go through the master statuses in the most logical progression, from basic track laying to final mixing. The status buttons are designed to differentiate between the various phases of the recording process.

Record Status

Recording basic tracks onto a blank multitrack tape is the starting point! In the record mode, with the **RECORD** status button selected, the various elements in the module signal paths are connected as shown below.

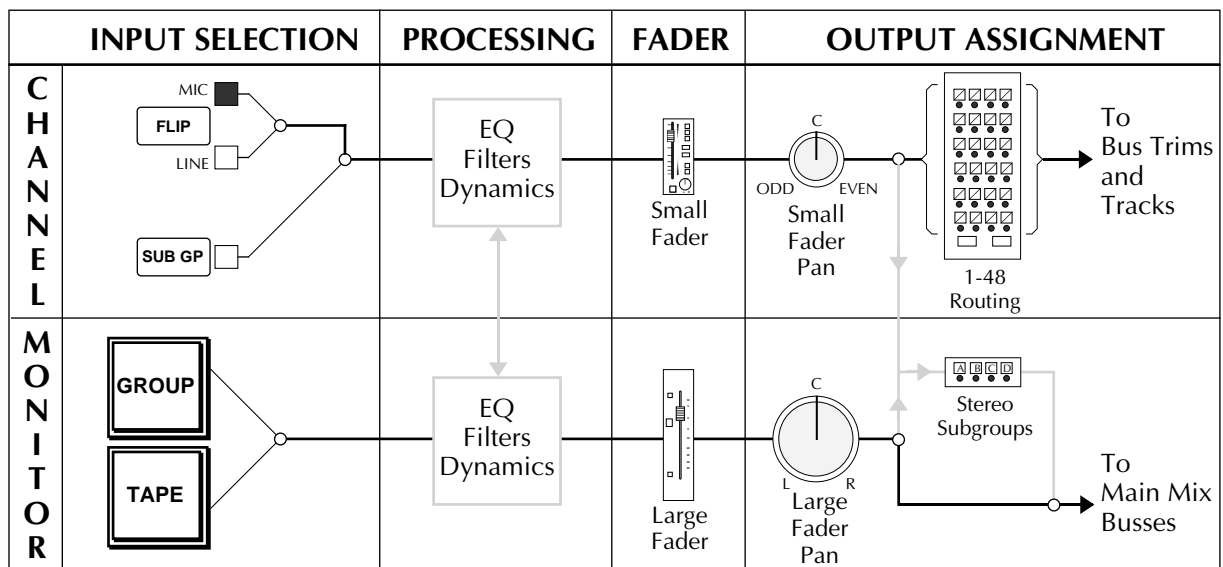
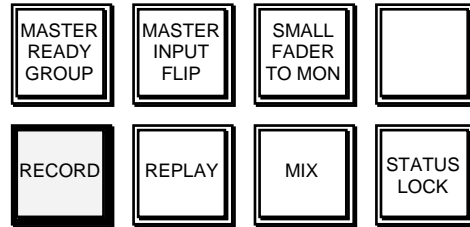

This will be the preferred recording mode for most engineers. If you have previously been using an SL4000 system, note that RECORD status on the SL9000 is equivalent to RECORD + VCA to MONITORS (FADER REVERSE on Ultimation and G+ consoles) status.

The Large Faders are much more useful if used as monitor faders during recording, as they can, if required, be automated for end-of-the-day monitor mixes.

The upper section of the diagram shows the 'Channel' signal path whilst the lower part shows the 'Monitor' signal path. The Channel signal path is that path which originates from the Channel Input section of the I/O module. The Monitor signal is derived from the Monitor Input section.

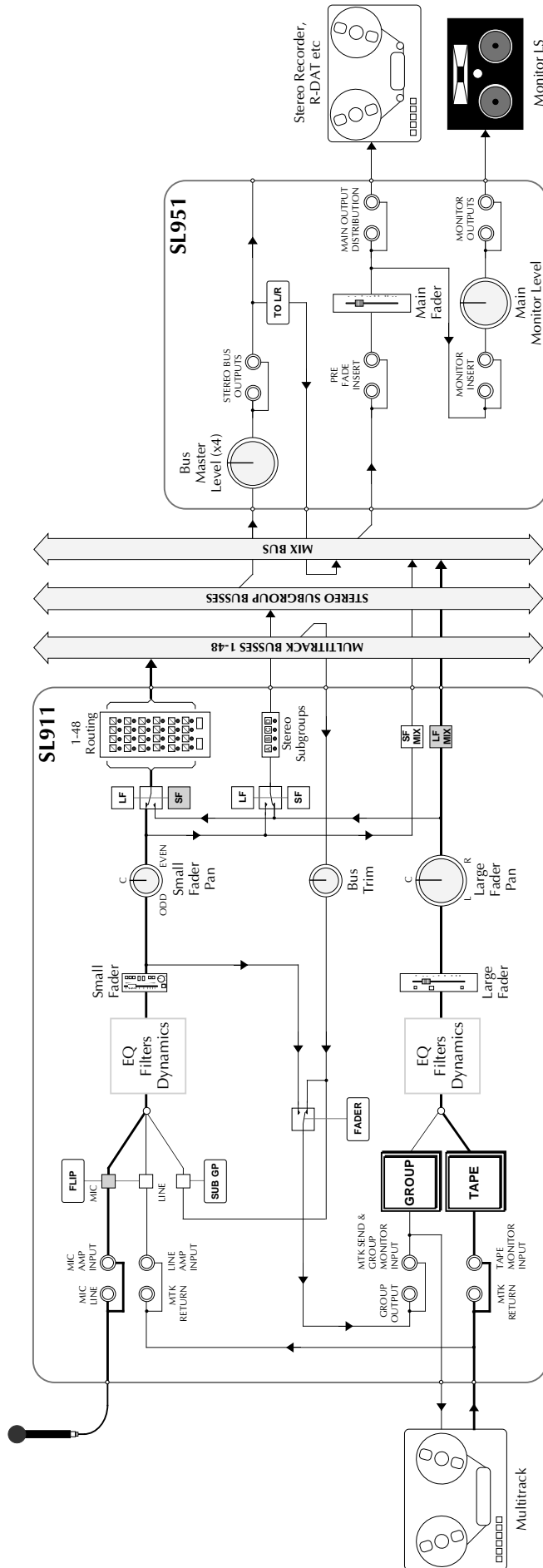

Record Status

The drawing opposite shows RECORD status routing in more detail and will give you a good idea of where the various controls appear in the signal path.

Before we go any further, it would be worth explaining some of the elements in the drawings opposite and on the following pages. This will enable you to more easily understand the default signal paths and the variations available.

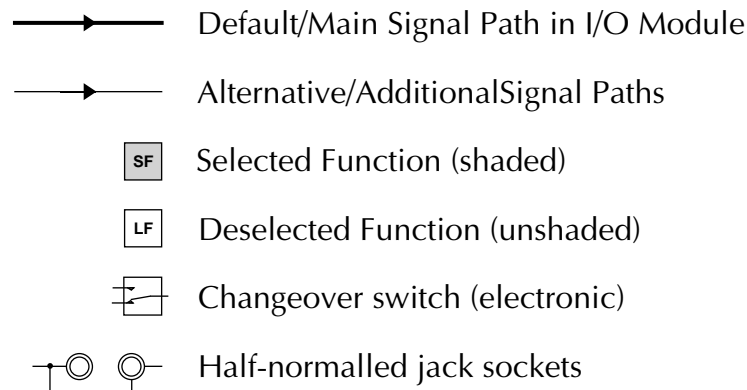

Note that most of the drawings are ‘single-line’ diagrams. This means that even stereo signal paths have been shown, for simplicity, as single lines. Just remember that the outputs of a pan control are always stereo, as are the Subgroup busses, main Mix bus and the Monitoring system.

Record Signal Flow Diagram

This diagram is fundamental to understanding the console signal flow, so it is worth while spending some time to look at it in detail. In this status, a Mic input is the standard selection and this signal will be fed, via the Mic gain control, to Channel path input. The **FLIP** button allows the Line input to be selected if you are sourcing from line level feeds rather than from microphones. The **SUB GP** (Subgroup) button overrides Mic and Line selections.

Normally the Subgroup button will be up and the Mic signal will pass to the phase reverse circuit (not shown). If **SUB GP** is pressed, the Channel signal path will derive its input from that module’s multitrack bus (Group) mix amp. This allows signals from other modules to be subgrouped through the channel, which is a very powerful feature while mixing. In the tracking mode this could be used to provide overall Dynamics or EQ to a group of signals prior to sending them to the multitrack. For more on this function, see Page 2- 21 and Section 3.

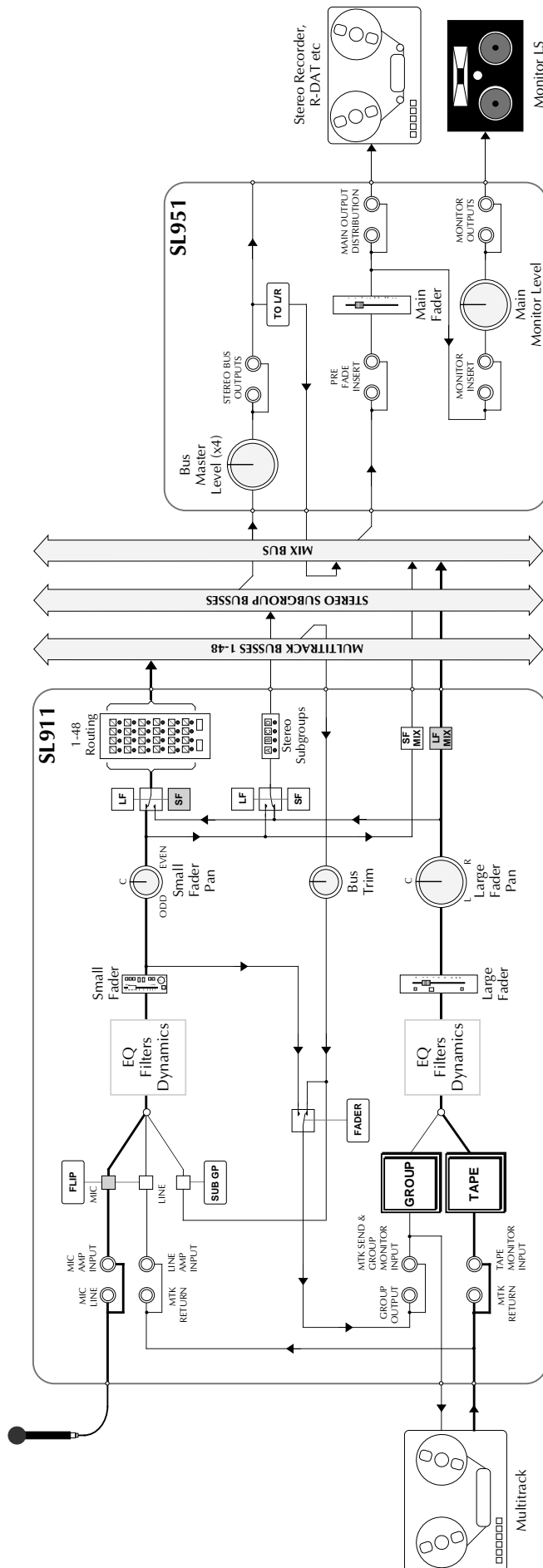

Record Status

Following the input stage, the signal passes via the EQ and Dynamics sections (if selected) to the Small Fader. The Channel signal can also be fed via the insert points to an external device (not shown on the diagram) which can be switched pre or post the EQ.

After passing through the Small Fader and associated pan, the signal is sent to the Multitrack Routing Matrix, via the default selection of the associated **SF** (Small Fader) routing source button. When recording to a stereo pair of tracks, the Small Fader pan can be used to pan source signals between odd and even multitrack busses.

From the Routing Matrix the Channel signal passes on to the multitrack busses, to be picked up by the bus mix amp associated with that multitrack bus/Group. The Bus Trim may be on another module if the channel has been routed to a bus other than its own (which is usually the case). The signal then passes (via the **FADER** switch) on to the Group Output patch point on Row G, where it is normalled to the Multitrack Send and Group Monitor Input on Row H. The Multitrack Return appears on Row J and is normalled to the Tape Monitor Input (Row K).

Both these Tape and Group Monitor signals feed a switching matrix which is controlled by the **GROUP** and **TAPE** buttons (see Section 3 for more details). Note that selection of **MASTER READY GROUP** on the SL952J selects all Monitor path inputs to **GROUP** automatically. This can be a useful starting point if you are recording to a large number of tracks simultaneously.

If required, the monitor signal can now be processed with the EQ and Dynamics sections (which can be switched into the Monitor or Channel signal paths, see Section 4). The signal passes on via the Large Fader and out of the module onto the Mix bus.

The Mix bus is fed into summing amps in the centre section and then passes via the Main Fader out to the monitor amps and ATRs.

Remember that, in **RECORD** status, the Large Faders relate to the monitoring of multitrack sends and returns, and the Small Faders relate to whatever source is being fed into that channel. Quite often these two signals may be completely different. For example, Track 7 may be fed from a mic plugged into Channel 1. The Small Fader on Channel 1 will control the level of that mic to the multitrack machine, the Large Fader on Channel 7 will control the level of Track 7 sends and returns as heard on the monitors.

Provision has been made for an analogue multitrack tape machine output to automatically switch to Sync whenever the **RECORD** status button is selected. This may, or may not, be wired in your studio.

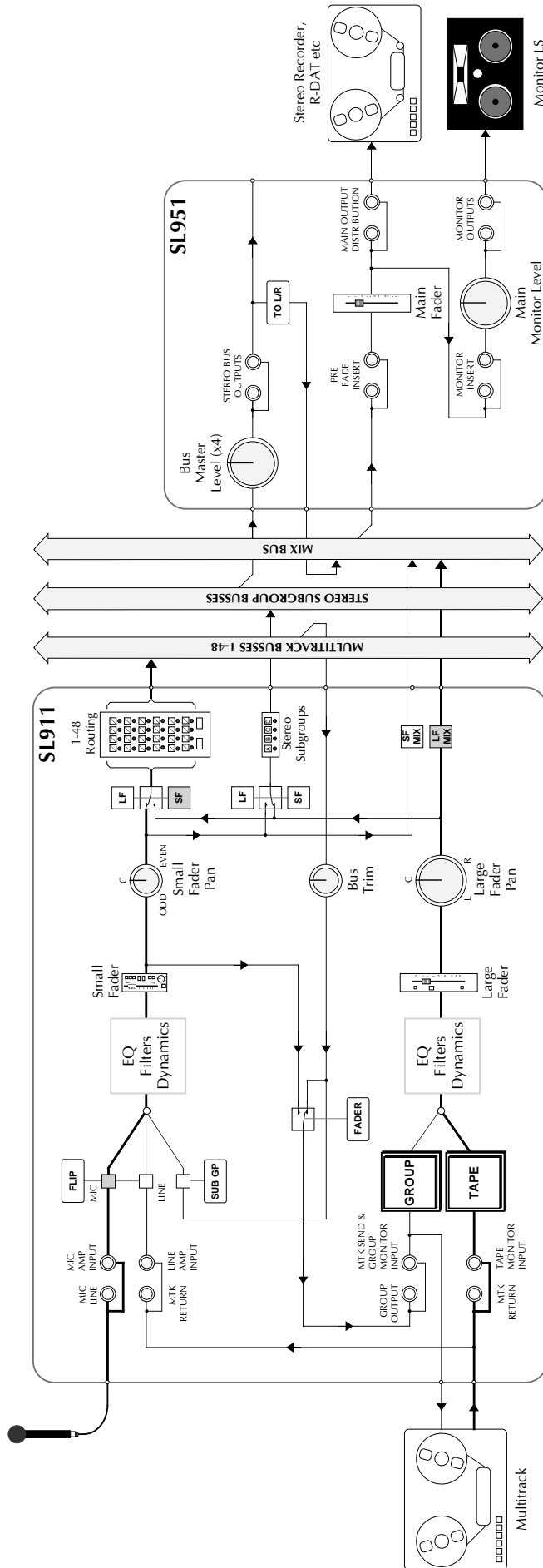

Record Status

From the diagram opposite you will see that, if required, the Large or Small Fader Pan outputs can be assigned to any one or more of the Stereo Subgroups. If you need to create audio subgroups of source signals, in order to apply overall signal processing, this can be very easily set up by using the Stereo Subgroups and outboard signal processors, or spare I/O modules (see Page 2- 25). For convenient level control, Monitor (Large in RECORD status) Faders can be assigned to the eight group control faders in the centre of the desk.

Track Bouncing

If you have previously been using an SL4000 desk, you will probably be familiar with the FLOAT function. Amongst other uses, this provided a simple method of setting up for track bouncing. The same effect can be just as easily obtained on the SL9000 but requires the selection/deselection of two switches.

As an example, say that we want to bounce Tracks 1, 2, 3 and 4 down to a stereo pair on Tracks 7 and 8, and we are still in RECORD status. First assign the Large Faders on Channels 1, 2, 3 and 4 to the Routing Matrix by selecting the associated **LF** button. Note that this toggles with the **SF** button. While in this area, select routing buttons 7 and 8 on each of these modules, having first ensured that the **1-24** routing bank switch is also selected.

Now move to the foot of the module and deselect the **LF MIX** button to prevent 'double monitoring' during the bounce. Select **GROUP** on Channels 7&8 and set the Large Fader pans on these channels to left and right. Set the Large Faders on 7 and 8 to unity gain.

Run the tape and balance the mix of tracks 1-4 on the Large (Monitor) Faders of those channels. If not already set, the Large Fader pans can be used to create the required stereo image.

For more experienced SSL users, this may at first seem over-complicated. However, unlike the SL4000 Series, the Small Fader remains available while track bouncing, and panning across the multitrack busses follows the Large Fader pan control. Think, moreover, of the potential available when you can freely assign Small or Large Fader outputs to the Routing or main Mix busses in any console status.

Record + Small Fader To Monitor

RECORD + SMALL FADER TO MON(ITOR) status provides an alternative record mode to basic RECORD status. Selection of **SMALL FADER TO MON** simply swaps the faders in the Channel and Monitor paths, and can be used in conjunction with both RECORD and REPLAY status.

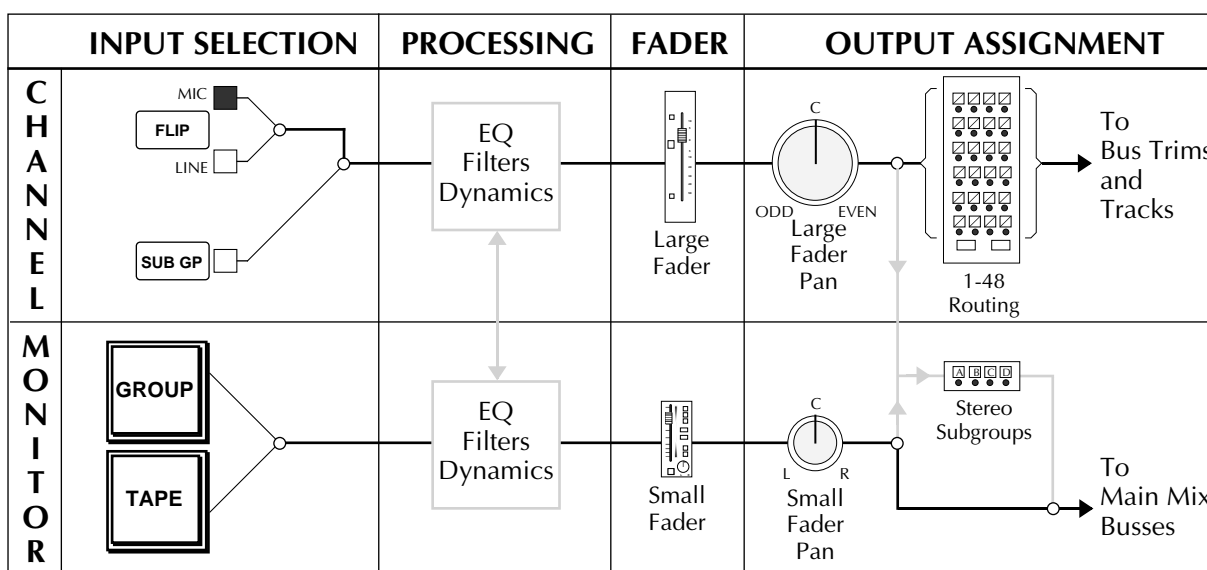
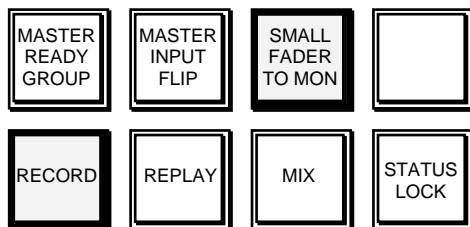

In this status, the Mic input is fed via the Large Fader and Pan to the Multitrack Routing Matrix (the 'Channel' signal path) and then to the multitrack itself via the module's Group mix amp and Trim control associated with that track of the machine (i.e. Track 7 is fed from Module 7's Group Output).

The Small Faders monitor the multitrack sends (GROUP) and returns (TAPE) and feed these signals to the main Mix outputs and monitoring of the desk, via the module's Small Fader pan (the 'Monitor' signal path), the Mix busses and the SL952J. Again, Track 7 will be monitored on Module 7's Small Fader.

This way of working is particularly suited where you need to handle a large number of sources simultaneously and want to have fader control of these as close to you as possible.

Some consoles may have local **SMALL FADER TO MON** buttons, allowing, for example, Channels 25-48 only to be switched to this mode. The Large Faders on these channels can then be used as input faders while the Large Faders on Channels 1-24 act as monitor faders. Note that **SMALL FADER TO MON** has no effect in MIX status.

Master Input Flip

This button works in any desk status and simply flips all channel inputs between Mic and Line inputs. Each channel can be flipped on an individual basis but it is simpler to hit MASTER INPUT FLIP to select the majority type of input. You would use this button if, for example, you are working in the RECORD status and wish to use Line inputs for synthesisers or samplers, rather than the Mic inputs.

Replay Status

This mode is used when working in RECORD, or RECORD + SMALL FADER TO MON status. The current console status is put on 'standby' and the tape returns are automatically routed to the Monitor faders. This allows a quick replay of the tape without disrupting the console setup. If the Sync/Replay option is wired, then an analogue multitrack machine will be switched to normal Replay.

This status is useful during track laying. For example, when operating in RECORD status, the time will come when a quick monitor mix is required. This can be accomplished in RECORD status by deselecting any **GROUP** buttons, switching the multitrack machine to Replay manually, and mixing down the monitor inputs via the main output busses onto a stereo ATR. REPLAY status does all this with one button. Any **GROUP** selections are temporarily disabled and the monitor inputs pick up multitrack returns from the Replay head.

Reselecting RECORD status will reinstate all the previous **GROUP** and **TAPE** button selections, and an analogue multitrack will switch back to Sync, ready for more recording.

REPLAY status is also useful for playback over the Studio Loudspeakers, as RECORD status prevents the SLS outputs from receiving signal.

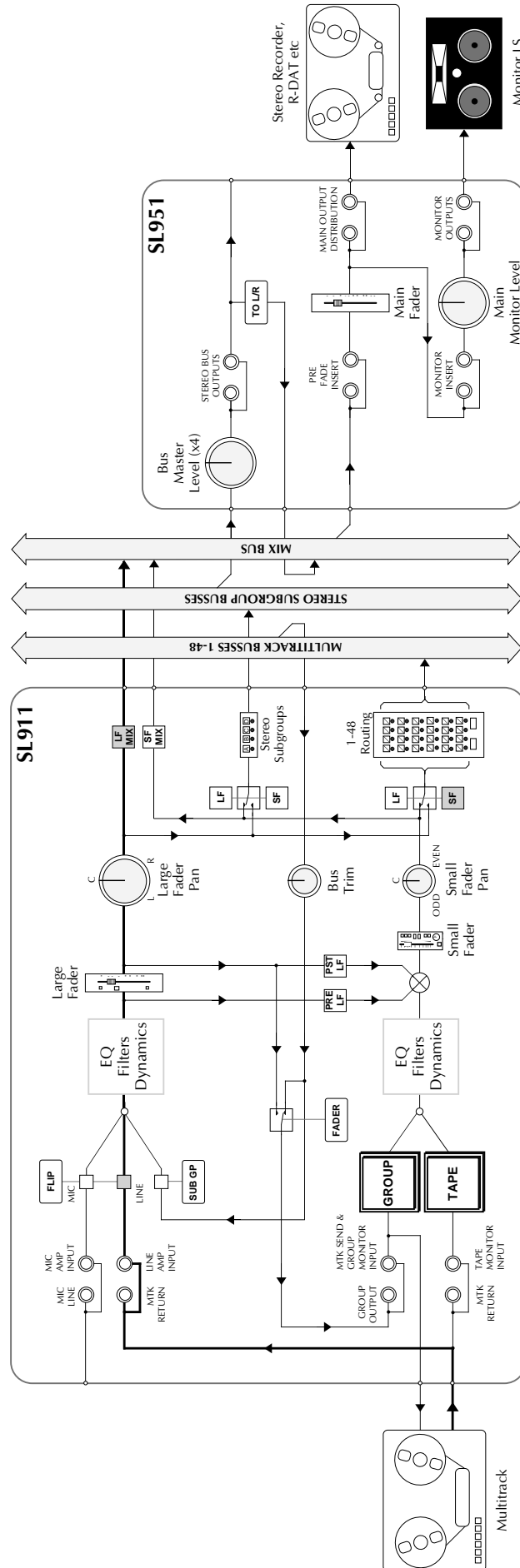

Mix Status

Mix Status

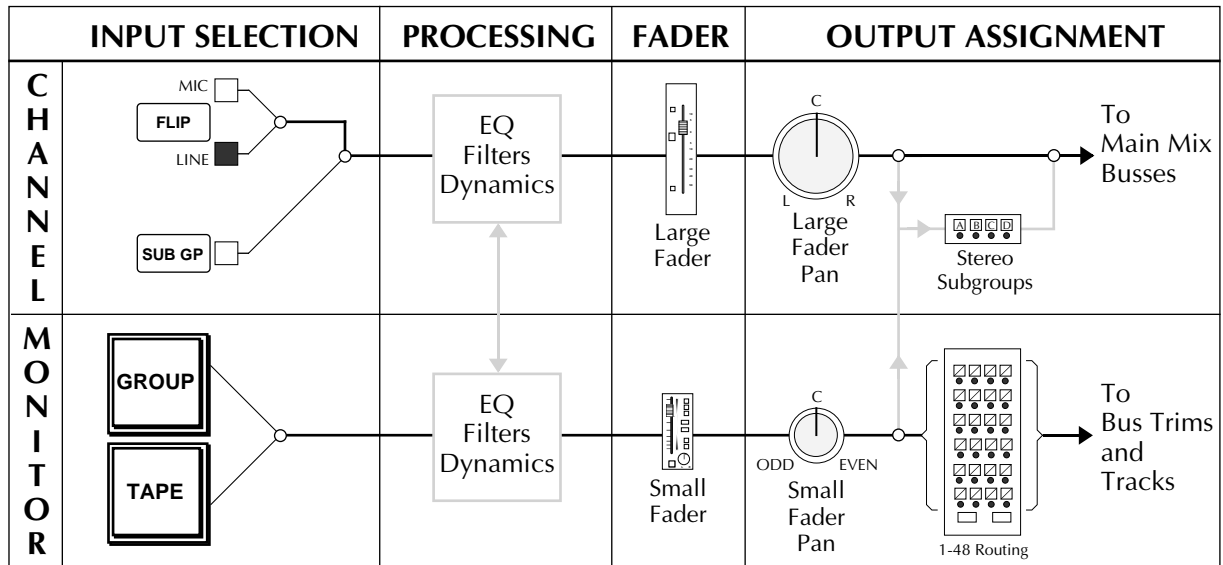
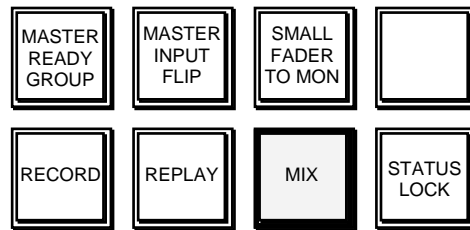

Line inputs are selected on the channels, sent via the Large Faders and Large Fader Pans to the main Mix bus and then, via the Master Fader on the SL 952, out to the mastering machine. The multitrack machine is usually normalled to the Line inputs, so this single status button will instantly set you up for a mixdown.

As described on the following pages, the Small Faders can be used for a variety of different purposes in MIX status. You will see from the drawings above and opposite that the default Monitor path in MIX status feeds the Tape Monitor Inputs via the Small Fader and Pan to the Multitrack Routing Matrix.

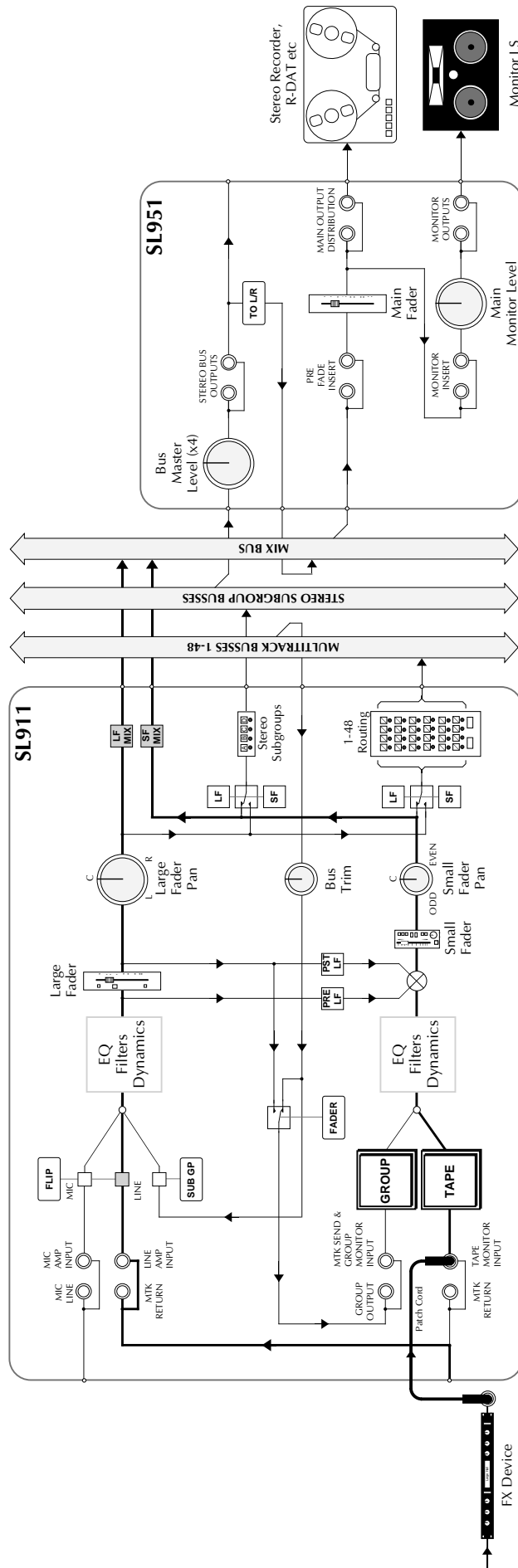

Small Faders as Inputs to the Mix

The Small Faders

Learning how to use the Small Faders in various console statuses is the key to getting the most out of the SL9000 system.

Small Faders as Additional Inputs to the Mix

By patching a line source into a Tape Monitor input jack on the patch, and with both **GROUP** and **TAPE** buttons deselected (ie. the Tape input default), this external signal will feed the Small Fader (see opposite). More information on **GROUP** and **TAPE** switching can be found in Section 3.

By selecting the **SF MIX** button (found on the upper right of the Small Fader), the Small Fader pan output will be added to the main mix. This instantly gives you double the number of inputs to the mix. For example, a 64 channel console can provide 128 inputs to the main outputs. As shown opposite, these Small Fader inputs provide an ideal way of returning multiple FX device outputs to the mix.

The Small Faders are automated on the SL9000, so level changes and cuts can be written to the mix data. Remember, however, that there is only one Dynamics and one EQ section per channel, so it is not possible to fully signal process every input. However, this facility allows smaller consoles to deal with the mega-mixdown situations which are becoming more and more frequent.

Note that the selection of **SF MIX** does not automatically deselect the Small Fader to Multitrack Routing Matrix switch (**SF** in the multitrack routing select buttons). This will not normally be a problem unless any routing buttons in the matrix are selected to undesired destinations.

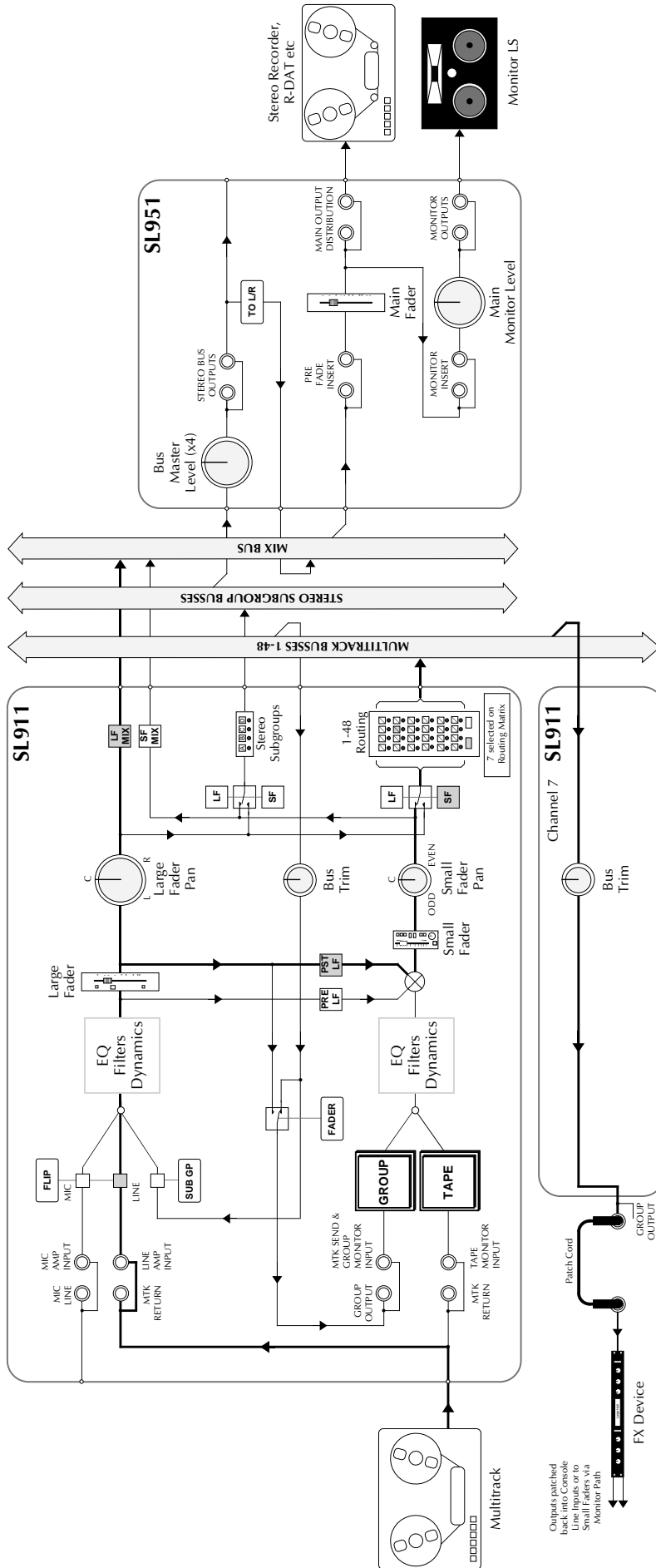

Small Faders as Additional Aux Sends

Small Faders as Additional Auxiliary Sends

In spite of being provided with six mono and one stereo Auxiliary/FX sends, there may be occasions, particularly in complex mixdown situations, where you need to be able to access large numbers of different FX devices. The SL9000 has an innovative auxiliary send reassign system which can provide up to 56 extra aux send busses. See Page 2- 25 for more details.

In addition, as those who have previously used an SL4000 will know, Small Faders and the Multitrack Routing Matrix can also be used to derive additional effects sends from each channel.

The channel signal can be picked up and fed to the Small Fader by selection of either the **PRE LF** or **P(O)ST LF** buttons (see opposite) which are located to the right of the Small Fader. In MIX status, the Small Fader pan feeds the Routing Matrix by default. Select an appropriate multitrack bus on the Routing Matrix which in turn will take the feed to the associated Group Output. Patching from there to the effects device input completes the chain. The level of this send can, of course, be automated.

Note that selection of **PRE LF** normally feeds a post-processing, pre-fader signal to the Small Fader; an internal link may be optionally set to derive this signal pre-processing.

When setting up for a mix, it's useful to patch from Group Outputs into the inputs of all the studio effects devices (apart from the primary reverbs and delays, which are usually fed from the dedicated sends). For example, you might patch delay lines to Groups 1, 2, 3, 4, extra reverbs to 5, 6, 7 etc.

Any channel can then access the input of the reverb connected to Group 7 via either the FX Reassign System (see Page 2-25) or by selecting the **PST LF** button (for a post-fader feed) and selecting 7 on the Routing Matrix. The send level will be controlled by the (automated) Small Fader. Where several channels are being fed to the same reverb, the overall send level can be controlled by the Bus Trim control on Module 7.

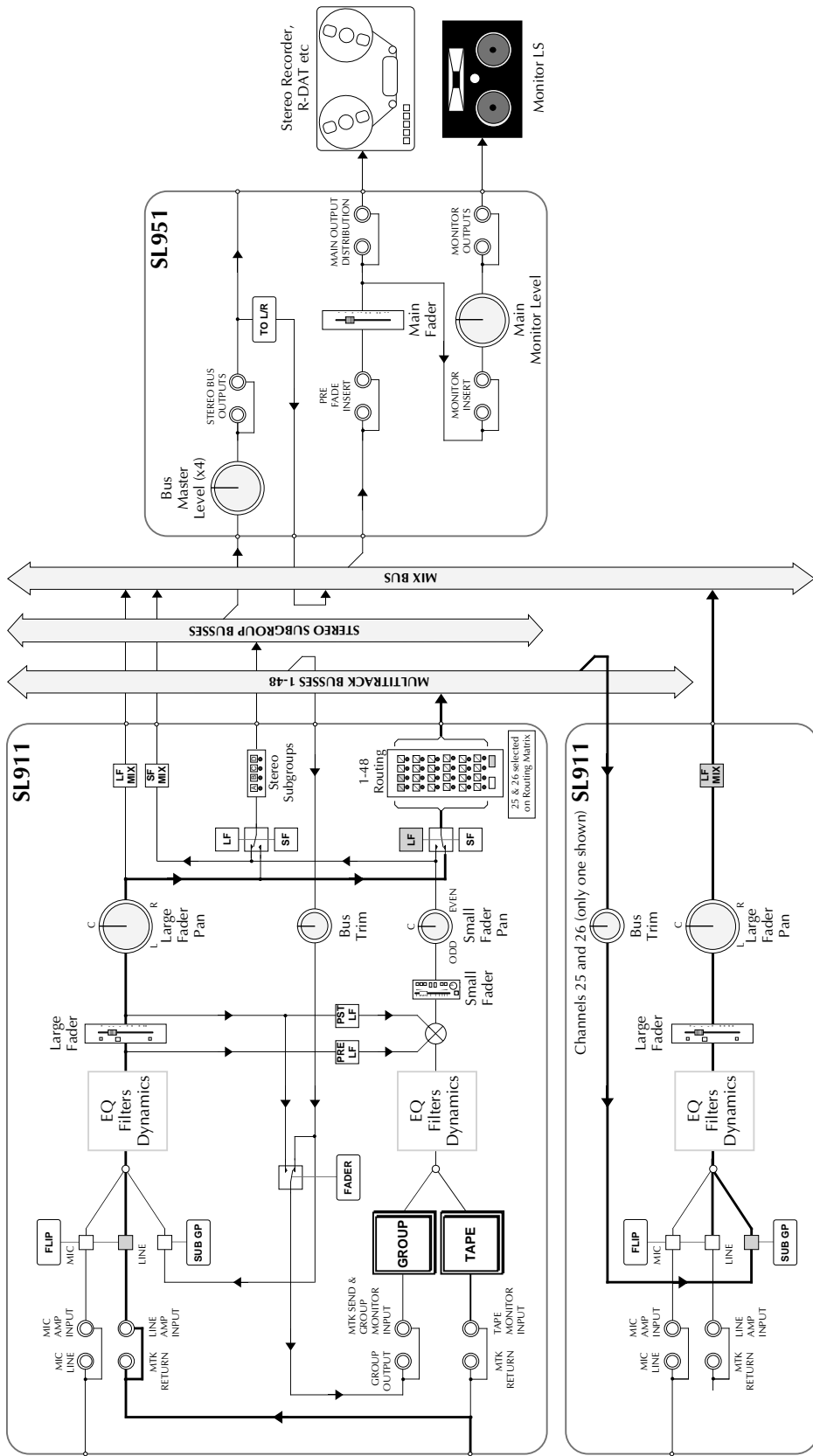

Large Faders Subgrouped to Large Faders

Subgrouping

When dealing with several channels of similar sources in a mix, eg. background vocals, it may be desirable to apply overall compression or other signal processing to a group of channels rather than to each individual source.

For level control alone, Large Faders can be subgrouped to one of the eight group control faders in the centre of the console. However, in order to apply overall signal processing to a group of sources, an audio subgroup must be set up. This can be achieved by routing signals to one of the Stereo Subgroups and inserting outboard processing at the Stereo Bus Output patch point (see opposite), before returning the subgroup back into the main mix (see also Page 2-27).

Alternatively spare I/O modules can be used to setup audio subgroups. This can be easily achieved without the use of patch cords, and in either stereo or mono. Say, for example, we have six backing vocal tracks returning on channels 43 to 48. Channels 25 and 26 are currently spare. By selecting the Large Fader to Multitrack Routing button (**LF**), the channel signal may be assigned to the Routing Matrix (see opposite). Select routing buttons 25 and 26 to feed a mix of these channels to Group Outputs 25 and 26.

If the **SUB GP** buttons on Channels 25 and 26 are now selected, the pre Group Output, post Bus Trim signals will be fed to the inputs of Channels 25 and 26. Pan the Large Faders on 25 and 26 left and right. The position of the source tracks in the stereo group can be set on the Large Fader pans of Channels 43 to 48. Overall processing can now be applied using the EQ and Dynamics sections of Channels 25 and 26.

If, instead of hitting the **SUB GP** buttons on channels 25 and 26, we select the **GROUP** buttons, the Small Faders will receive the grouped backing mix, as **GROUP** simply switches that module's Group Output to its Monitor fader. These two Small Faders can now contribute to the mix by pressing **SF MIX**.

By using Small Faders to act as audio subgroup masters, the Large Faders can still be used as normal, fed from the Channel path. Remember that, as with the use of Small Faders providing extra inputs to the mix described on Page 2-19, there will be a limit to the distribution of signal processing between the Small and Large Fader signal paths.

In fact it is possible to set up other variations on the above theme, i.e Small Fader to Large Fader and Small Fader to Small Fader subgroups. By the way, although we are describing all this in the MIX mode, the basic principles are exactly the same in the other desk statuses.

You can only route to the first 48 Groups via the Routing Matrix, but any channel above Channel 48 can be a subgroup master by patching from any of Group Outputs 1-48 into the Line Inputs (or Tape Monitor Inputs) of channels from 48 onwards.

Record + Mix Status (Overdub Mode)

This mode was designed for use in overdubbing but many engineers will use this status when laying basic tracks. Select this combined status by pressing the **RECORD** and **MIX** status buttons simultaneously.

The desk is basically in **MIX** status but an individual module may be put into the **RECORD** status, in order to record onto that track, if either the **TAPE** or the **GROUP** button is selected. The advantage of this mode is that the majority of modules will be in **MIX** status and you can mix with the Large Faders as if you were doing a final mix. In other words, the modules are not split into source signal paths and monitor signal paths unless you are recording from that module. You can work towards the final mix as you are tracking, using the mix capabilities to their full extent but with the ability to record onto the necessary tracks.

It is quite usual for the desk to be split for this way of working. The first 24 or 48 modules are dedicated to the multitrack, and modules upwards from 25 or 49 act as source channels, although this is not essential.

By way of an example, suppose you were overdubbing a vocal to several tracks at the very end of the recording process. You have four tracks free, 35 to 38. Select **RECORD + MIX** status and mix the rest of the tracks normally, as you would in basic **MIX** mode.

Plug the vocal mic into Channel 49, **FLIP** the input to Mic, and select **LF** to the Routing Matrix. Now deselect **LF MIX** on 49 to avoid feeding the mic direct to the Mix bus. By selecting routing button 35, the Large Fader on Channel 49 will feed the mic to Track 35.

Now select **GROUP** (and/or) **TAPE** on Module 35 to monitor the multitrack signal. This will put Module 35 into **RECORD** mode with the Large Fader monitoring the signal to the Mix bus. (the converse will be true with **SMALL FADER TO MON** also selected.)

Proceed with the overdub as if you were in basic **RECORD** status.

When you have completed the overdub, just deselect **GROUP** (and/or) **TAPE** on 35 and select **GROUP** (and/or) **TAPE** on 36 to continue recording onto Track 36. You will also need to select 36 on Module 49's Routing Matrix, unless all the overdub tracks have been preselected.

Just to add to the possibilities, you could carry out the same recording process in a slightly different way. Simply plug the mic to Channel 35 hit **GROUP** (and/or) **TAPE** to put 35 into **RECORD** mode. The Small Fader will feed the mic signal to the Routing Matrix, so select 35 and monitor the multitrack signal on the Large Fader using the **GROUP** and **TAPE** buttons.

The Fader Button

This leads us neatly into use of the **FADER** button. In the last example on the previous page, the Routing Matrix can be bypassed altogether by simply hitting **FADER**. This will send Channel 35's source mic, post-Small Fader, direct to Group 35 without going via the Routing Matrix. The benefit of this is that there will be fewer stages in the signal path. The disadvantage with this method of overdubbing is that you have to re-plug the mic each time you wish to move to another track.

Note that the **FADER** button on channels above Channel 48 can be used to feed post channel fader signals to the same numbered Group Outputs. These Group Outputs cannot, of course, be accessed via the Routing Matrix in the normal way. For more on the **FADER** button, see Section 3.

By the way, for analogue machines, the multitrack may be switched to the Replay head in MIX mode, if this facility has been wired; whenever the **RECORD** status button is selected, as in MIX + RECORD, the multitrack will be switched to the Sync head.

All this shows that there are many ways to carry out a particular task. If you are new to the system it may cause some confusion, but the whole philosophy behind the console is to provide alternatives and to allow an engineer, who knows the system well, some choice. A fixed routing path would be simpler to learn but would soon limit the engineer's ability to work quickly and get the best out of the equipment and the performer.

As you spend more and more time on the console, the many possibilities will start to become obvious and will allow you to work faster and with more options than any other system available.

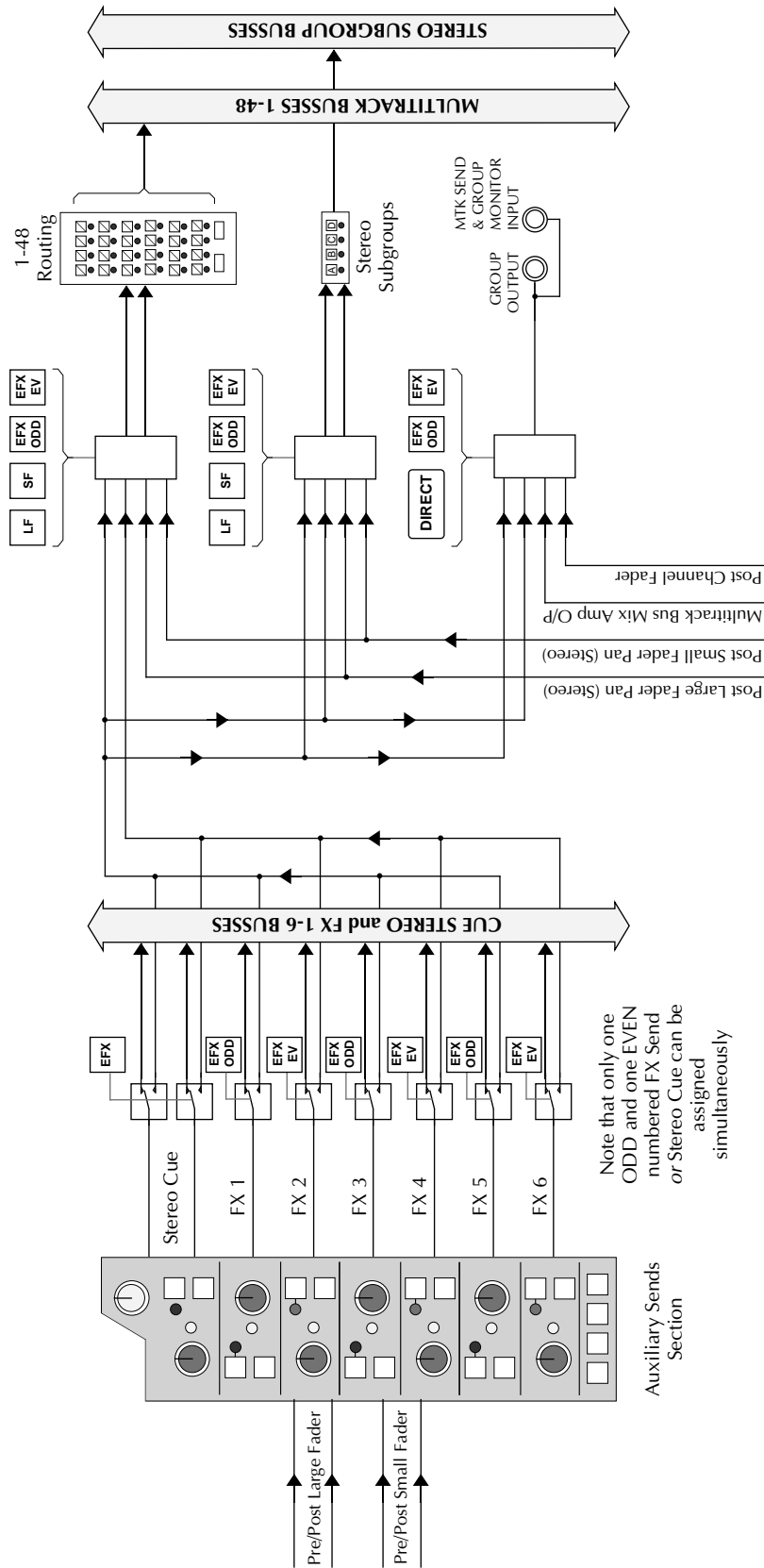

FX ODD and FX EVEN Routing

FX Reassign System

An innovative feature of the SL9000 is its FX Send reassign system – EFX for short, which provides an extended auxiliary send capability of up to 56 extra busses without using the Small Fader as a level control.

The Auxiliary Sends section of each I/O module includes one stereo and 6 mono aux send controls. Auxes can be sourced from pre or post the Large or Small Fader. For more details on this, see Section 3.

The reassign system allows any two mono FX sends, or the stereo cue send, to be disconnected from their respective busses and used as sources for the channel's Multitrack Routing Matrix, Stereo Subgroup bus routing and/or the channel's Group Output.

Aux sends are assigned to the EFX system using the **EFX** switches by each one. FX1, 3 and 5 can be assigned to **EFX ODD**. FX 2, 4 and 6 can be assigned to **EFX EVEN**. Selecting **EFX** on the Stereo Cue send feeds Stereo Cue L to EFX ODD and Stereo Cue R to EFX EVEN. Note that only one odd and one even numbered FX send or Stereo Cue can be assigned simultaneously. Lower numbered sends take priority over higher numbered ones, and Cue Stereo takes the highest priority. Red (EFX ODD) or green (EFX EVEN) LEDs indicate that a send is assigned to the EFX system.

The Multitrack Routing and Stereo Subgroup busses can be fed by Large or Small Fader (post pan control) signals, or by one or both of the EFX ODD/EVEN signals. If one EFX switch is selected, then the corresponding routing output will be fed in mono by the selected source. Selecting both switches together will feed EFX ODD to left (odd) and EFX EVEN to right (even) bus. This enables any two Aux Send controls to be re-routed to the Multitrack or Stereo busses, allowing large numbers of independent headphone or effects send mixes to be generated.

Connect FX device inputs to the appropriate Group Output jacks if sends are reassigned to the Multitrack Routing. In the case of Stereo Subgroups, connect devices to the appropriate Stereo Bus Output jacks.

The Group Output is normally fed by the multitrack bus Mix Amp, but this can be replaced with a post-fader channel signal by pressing **FADER**, or by the EFX ODD or EFX EVEN signals. Note that although Group Outputs above Channel 48 cannot be accessed via the Multitrack Routing Matrix, they can be accessed from the same numbered channel by selection of **EFX ODD** and **EFX EVEN** (or for a post channel fader signal, by **FADER**).

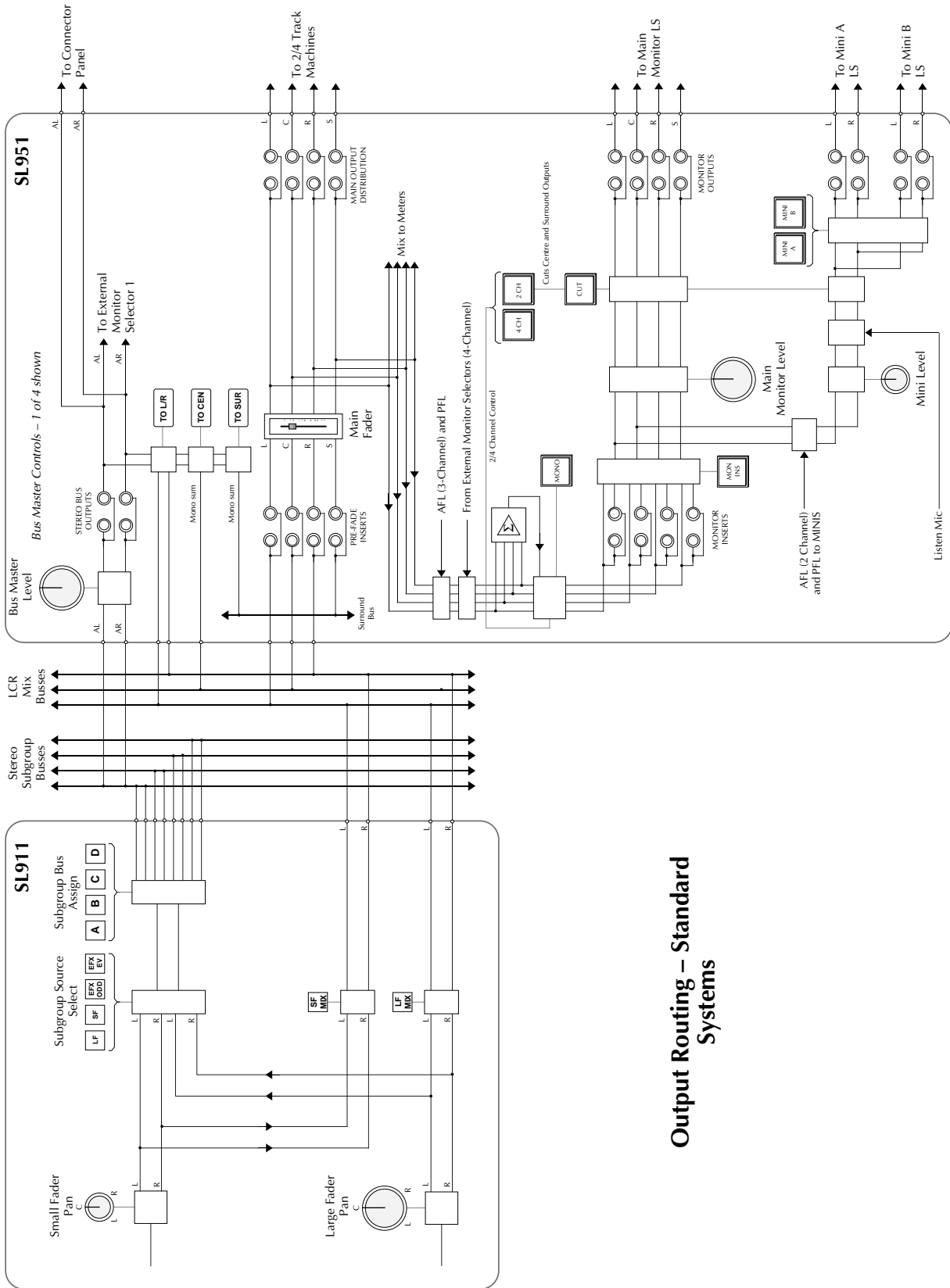

Output Routing – Standard Systems

Output Routing – Standard Systems

So far in this section we have only talked about the console's main outputs and monitoring in general terms. Now we should look at this in a little more detail. For full information on all the console's centre section controls, see Section 5. If your console is fitted with the LCR pan option, please read this page and the additional information over the page.

Stereo post-Large and Small Fader signals can be freely assigned to the Multitrack busses, the Stereo Subgroup busses and the main Mix busses. As standard, the console is fitted with LCR Mix busses (see opposite), but the Centre bus cannot be accessed directly from channels unless the LCR pan option is fitted (see over the page).

Stereo Subgroups

Signals assigned to the Subgroup busses, if being used for stereo stem mixes, can simply exit the console either via the connector panel or by patching out of the Stereo Bus output sockets on the patch. Your installation may have a multitrack layback machine normalled to these outputs.

In addition, Subgroup signals can be reassigned back, post insert point, onto the main Mix busses by selection of the **TO L/R**, **TO CEN(TRE)** or **TO SUR(ROUND)**. Note that the latter two functions feed a mono sum of Left and Right Subgroup bus signals to the respective main Mix busses, and that the Surround mix bus is internal to the centre section.

Using the functions described above, with two of the Subgroup busses dedicated to Centre and Surround mix paths, LCRS film or video mixes can be simply generated even if the console is not fitted with the LCR pan option.

The Stereo Subgroup bus outputs can be monitored on External Source Selector 1. See Section 5 for more details.

Main Outputs

Signals on the main LCRS busses pass via a pre-fader insert point before reaching the console's master (4-channel), VCA automated, fader. At this point the centre section's 4-channel Compressor (not shown in the diagram) can be switched in to control main output levels. This compressor is the classic SSL 'Quad' compressor, which will be well known to experienced SL4000 users.

The desk's main outputs are normalled to a series of Distribution jacks which, in turn, may be normalled to three 4-track and nine stereo machines.

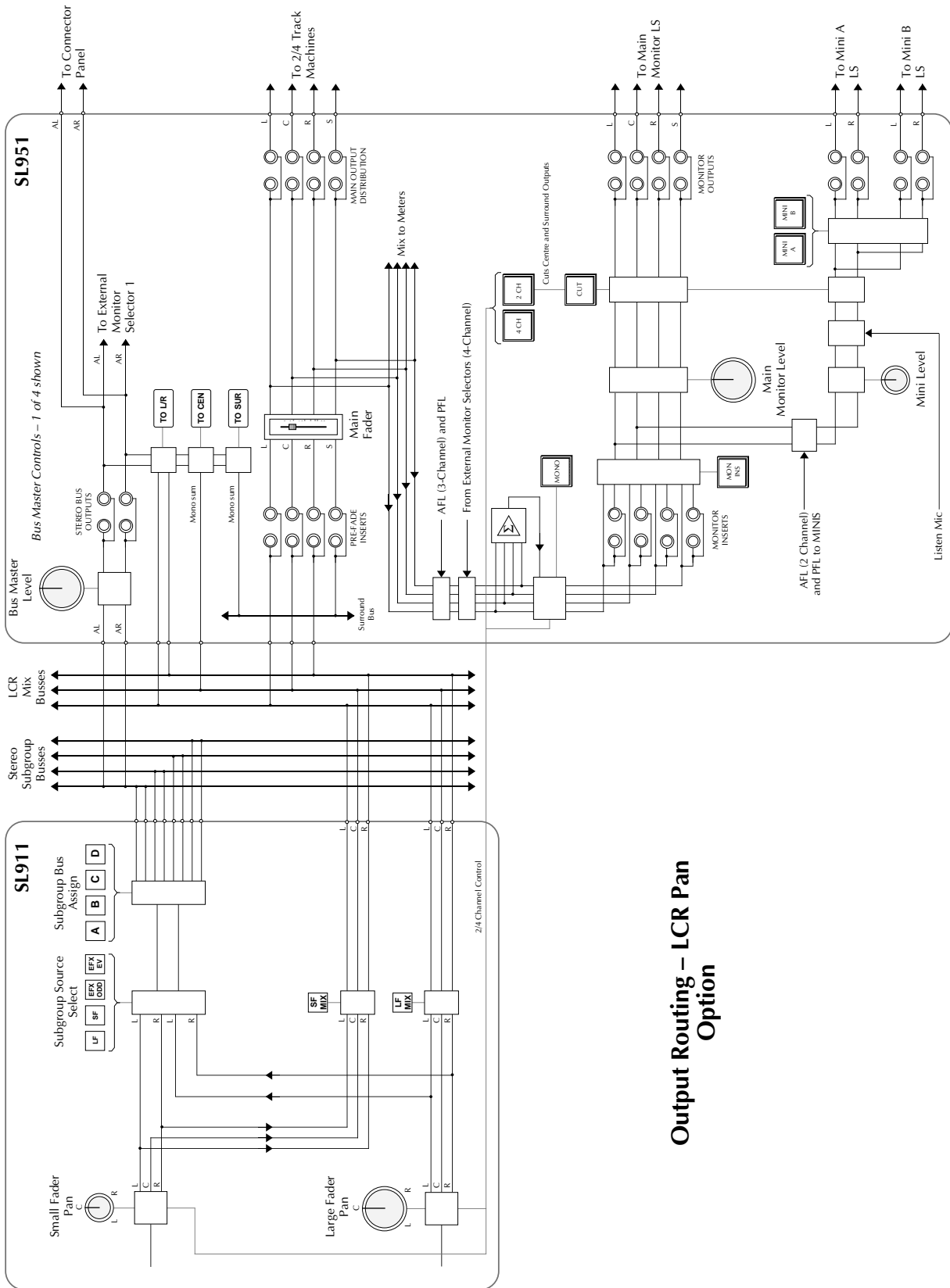

Output Routing – LCR Pan Option

Monitoring

Feeds to the desk's monitoring facilities are picked up post the Main Fader and Compressor. This point also feeds the main output meters when selected to **DESK OUTPUT**.

Following the injection of AFL, PFL and Solo-In-Front signals, the monitor feeds can also be interrupted by source selections from the two External Source Selectors (more on this in Section 5). **MONO** sums all four monitor busses and feeds the result equally to Left and Right monitor outputs or to the Centre output, subject to the selection of the **2 CH** or **4 CH** switches. Selecting **2 CH** also mutes the Centre and Surround monitor outputs.

A switchable Monitor Insert point is provided for the connection of Dolby Surround Encoders/Decoders.

Level controls are provided for both the Main and two pairs of Mini (near-field) loudspeakers. Inputs from two 'Listen Mic' circuits are fed to the Mini 'A' LS outputs. AFL, PFL and Solo-In-Front are also fed to the Mini 'A' LS outputs if **A/PFL TO MINIS** is selected. Note that this selection leaves the desk output on the Main monitors and the AFL/PFL level control is inactive.

Output Routing with LCR Pan Option

When the LCR pan option is fitted, the Centre Mix bus can be fed directly from the channels (see opposite). Selection of **2 CH** or **4 CH** in the centre section determines whether both Small and Large Fader pans will pan between Left and Right with a 'phantom' centre or from Left, through Centre, to Right. When selected to 4-Channel mode, the pans will still pan between odd/left and even/right Multitrack or Stereo Subgroup busses.

Apart from this simple but extremely useful and convenient function, the desk's main output and monitoring signal paths and facilities are as described above for standard systems.

Solid State Logic
SL 9000 J Series
Total Studio System

Console Operator's Manual

SECTION 3

The SL911 Input/Output Module





The SL911 Input/Output Module

The I/O module has two independent signal paths. Each path has its own input and fader. The module automatically powers up in a standard output routing configuration determined by the master desk status. The output routing, however, can be over-ridden locally at any time, to provide extra flexibility of operation.

The two inputs are the CHANNEL INPUT and the MONITOR input.

The two faders are the LARGE FADER and the SMALL FADER (LF and SF for short). Each fader has an associated pan control.

The path fed by the Channel Mic/Line Input stage is designated the 'CHANNEL' path. The path fed by the Tape/Group Monitor Input is designated the 'MONITOR' path.

The module's outputs are the main Stereo/LCR bus, the 48-track Routing Matrix at the top of the module, the four Stereo Subgroup busses A, B, C and D (immediately below the Multitrack Routing Matrix) and the channel Group Output.

Either or both faders can feed the main Stereo bus ('Mix').

Either fader can feed the Multitrack Routing Matrix and Stereo Subgroup busses or the Group Output.

On channels 1-48, the Group Output can also be fed by the multitrack mix bus corresponding to that channel.

The Multitrack and Stereo Subgroup busses can also be fed by any of the Auxiliary send controls, allowing additional effects sends or cue mixes to be generated.

EQ, Filters, Dynamics and Aux send controls can be switched into either signal path.

Obviously there are many possible permutations of signal routing, allowing an enormous number of creative possibilities. This section looks at each control on the SL911 module individually, with a brief summary of the routing possibilities. Section 2 describes these in more detail.

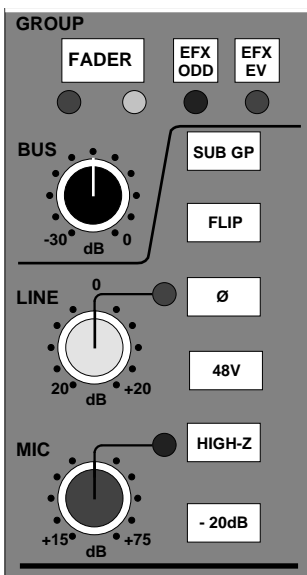

Channel Input Section

The channel input can receive any one of three inputs:

LINE – Selects a Line level input from patch row D via the LINE trim pot (+20dB to -20dB). The pot is indented at unity gain. A green LED indicates Line Input selection.

MIC – selects a Microphone input from Patch row B via the MIC trim control.. This is continuously variable from +15db to +75dB of gain, with a 20dB pad switch shifting the gain range to -5dB to +55dB. A red LED indicates Mic Input selection.

SUB GP – When this button is pressed, the above selections are overridden and the input of the channel is taken from that module's multitrack bus mix amp. This allows modules 1-48 to be used to as audio subgroups.

FLIP – This reverses the mic/line selection on individual channels.

∅ (Phase) – This reverses the phase of the selected channel input.

48V – When selected provides phantom power to the associated microphone.

HIGH-Z – Increase the input impedance of the microphone input from 1.2KΩ to 8KΩ. This allows the connection of line level outputs to the mic input if required, and provides an alternative input impedance for some dynamic microphones.

MIC or **LINE** inputs are automatically selected by the STATUS switches on the SL952 Master Facilities Module. In RECORD or REPLAY status, all inputs switch to **MIC**. In MIX, all inputs switch to **LINE**. The **FLIP** button reverses the input selection on individual channels. The **MASTER INPUT FLIP** button on the SL952 panel reverses the input selection on all channels.

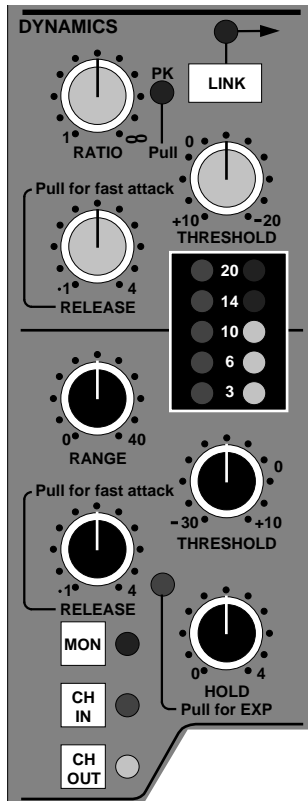

Dynamics Section

The Dynamics section comprises a compressor/limiter and an expander/gate, which use the same gain change element. Both sections work independently, but can be operational at the same time, providing sophisticated control of either the Channel or Monitor signal.

The Dynamics section has three routing buttons associated with it. Section 4 deals with Dynamics routing in more detail, but briefly these button function as follows:

MON – switches the Dynamics section into the Monitor path (Post EQ if the EQ has also been selected to the Monitor path).

CH IN – Switches the Dynamics section into the Channel audio path PRE EQ.

CH OUT – switches the Dynamics section into the Channel audio path POST EQ.

If both the **CH IN** (or **CH OUT**) and the **MON** buttons are selected, then the Dynamics section is switched to the Channel path but the Dynamics' side chain is fed from the Monitor path, post TAPE/GROUP selection. See Section 4 for more details. This allows the Dynamics to be keyed via either a multitrack bus or the patch bay.

The Channel Insert Return can also be used as a key input via the Insert **KEY** switch. See more on this under Insert Point on Page 3-8.

Compressor/Limiter

RATIO – When turned to 1:1 the Compressor/Limiter section is inactive. Turning the control clockwise increases the compression ratio to give a true limiter at the fully clockwise position. The compressor normally has an 'over-easy' characteristic. Pulling the **RATIO** switch up changes this to peak sensing, and replaces the 'over easy' characteristic with a hard knee, providing an alternative for some instruments. The **PK** LED lights to indicate that this option has been selected.

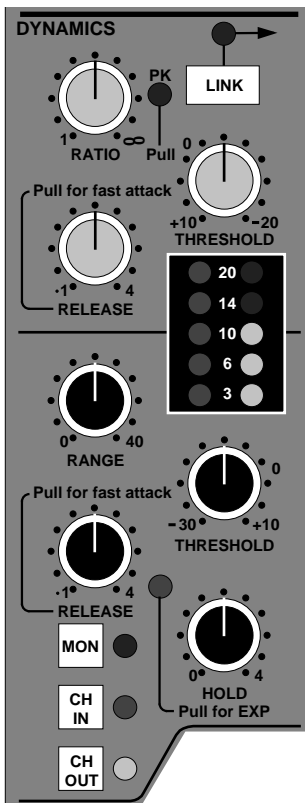

THRESHOLD – Whenever a signal exceeds the level set by this control, the compressor will start to act at the ratio set by the **RATIO** control. This control also provides automatic make-up gain, so as you lower the threshold and introduce more compression, the output level is increased, maintaining a steady output level regardless of the amount of compression.

RELEASE – Sets the time constant (speed) with which the compressor returns to normal gain settings once the signal has passed its maximum. The control also incorporates a pull switch which, when selected, provides a fast attack time (3mS for 20dB gain reduction). When down the attack time is program dependent (3mS - 30mS).

The yellow and red LEDs, on the right of the LED display area, indicate the amount of gain reduction (compression).

Expander/Gate

This section can act as a ∞ :1 Gate or as a 2:1 Expander when the **HOLD** pot is pulled upwards. A red LED indicates that Expand mode has been selected.

RANGE – Determines the depth of Gating or Expansion. When turned fully anti-clockwise (Range = 0), this section is inactive. When turned fully clockwise, a Range of 50dB can be obtained.

THRESHOLD – Variable hysteresis is incorporated in the Threshold circuitry. For any given 'open' setting, the Expander/Gate will have a lower 'close' threshold. The hysteresis value is increased as the Threshold is lowered. This is very useful in music recording as it allows instruments to decay below the open threshold before Gating or Expansion takes place.

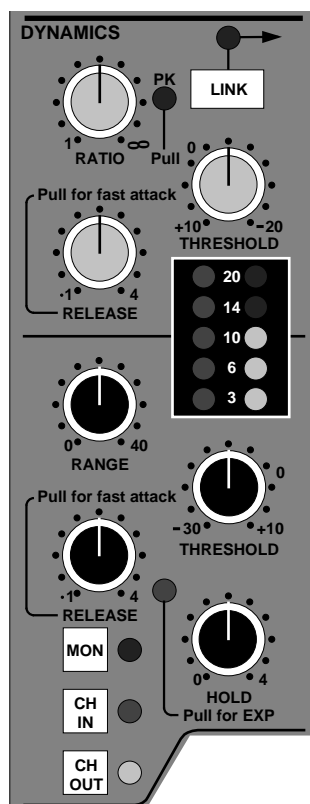

RELEASE – This determines the time constant (speed), variable from 0.1 - 4 seconds, at which the Gate/Expander reduces the signal level once it has passed below the threshold. This control also incorporates a switch which, when pulled up, provides a fast attack time (100µs per 40db). When down, a controlled linear attack time of 1.5ms per 40dB is selected. The attack time is the time taken for the Expander/Gate to ‘recover’ once the signal is above the threshold. When gating signals with a steep rising edge, such as drums, a slow attack may effectively mask the initial *THWACK*, so you should be aware of this when selecting the appropriate attack time.

HOLD – Determines the time after the signal has decayed below the threshold before the gate closes. Variable from 0 to 4 seconds. A pull switch on this control switches the section from gate to expand operation.

The green LEDs indicate Expander/Gate activity (the amount of gain reduction).

The **LINK** button at the top of the section links the side chain signal of that unit to the side chain of the next Dynamics section along to the right. When two Dynamics sections are linked, the control voltages of each section sum together, so that whichever section has the most gain reduction will control the other section.

Note that it is not possible to link two gates so that the signal on one opens the other. If you need to achieve this effect, take a keying signal from one section to trigger the other. The easiest way to do this is by patching from the Insert Send of the ‘source’ channel into the Insert Return of the ‘destination’ channel, and selecting **KEY** (see Page 3-8) on this channel.

Note that when the Dynamics section is not in circuit, its side chain input is also bypassed.

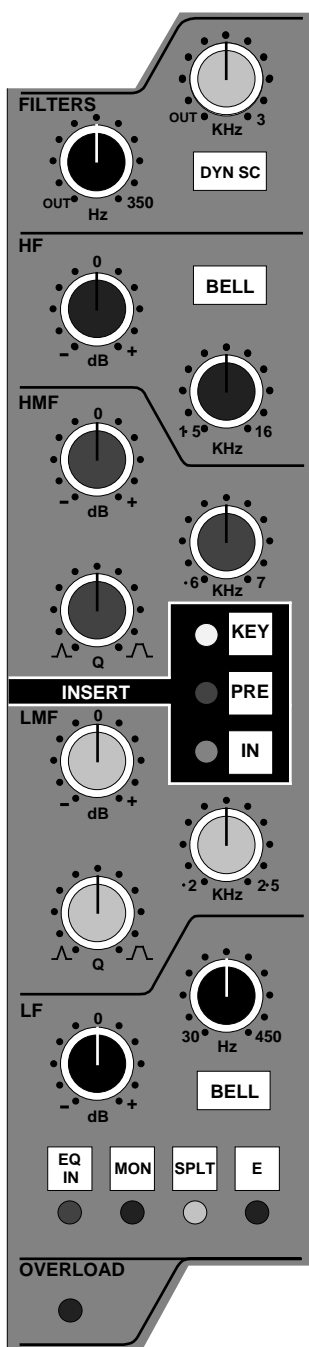

Filters and Parametric Equaliser Section

This section comprises a four band parametric Equaliser plus High and Low pass Filters. The EQ and Filters can be routed separately to different audio paths within the module.

Routing Buttons

There are four routing buttons associated with this section of the module. Section 4 describes the routing combinations in more detail but, briefly, these buttons function as described below.

EQ IN – Switches the section into circuit. If no other switches are pressed, the Equaliser is in the Channel path and the Filters are *post* the Equaliser. This switch is automated – see the J Series Computer Operator's Manual for more details.

DYN SC – The Filters are switched into the side chain of the Dynamics section. The Equaliser can be switched into the Channel or Monitor path independently. Note that **DYN SC** overrides the **SPLT** function (see below).

MON – The section is switched into the Monitor audio path. The Filters are *post* the Equaliser. Note that **EQ IN** must also be selected for the section to be active. The section is *pre* the Dynamics section if this has also been selected to the Monitor audio path.

SPLT – Can be operated in combination with the above selections and splits off the Filters to put them in circuit immediately after the Channel Input section.

This allows the Filters to be used in channels feeding the multitrack while in RECORD status, with the Equaliser being used on the monitors only. This is also useful in the MIX mode, when additional inputs are being brought into the mix via the Small Faders. The Filters can be used on the signal passing through the channel via the Large Fader, and the Equaliser used on the signal being fed via the Monitor Input and the Small Fader.

As with the Dynamics section, the Equaliser is completely bypassed when none of its routing buttons are pressed.

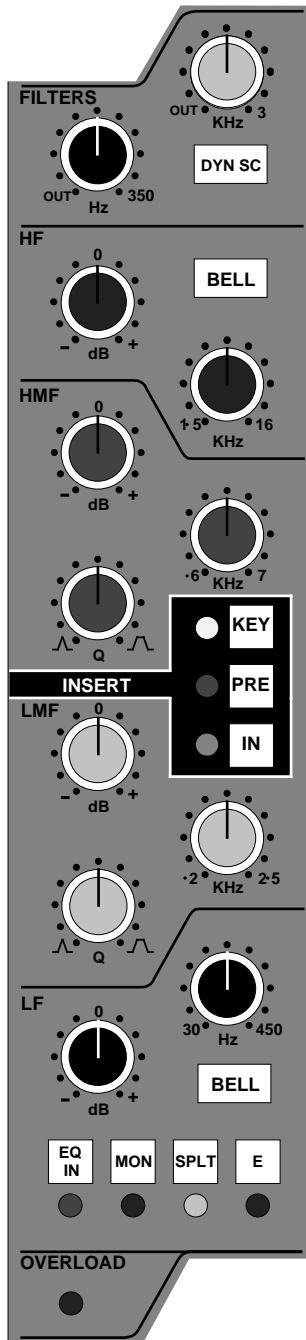

Parametric Equaliser

The equaliser can be switched between two different sets of curves, one based on the G Series equaliser and one based on the latest version of the classic E Series EQ.

HF Section:

Comprises a shelving filter with variable cutoff frequency and a boost/cut control. This is switchable to a shallower curve by selecting the 'E' switch. Selecting **BELL** in either mode switches the filter to a peaking curve.

HMF Section:

Continuously variable Q (filter width), gain ($\pm 20\text{dB}$) and centre frequency controls (600Hz-7kHz).

LMF Section:

Continuously variable Q (filter width), gain ($\pm 20\text{dB}$) and centre frequency (200Hz to 2.5kHz) controls.

In normal operation, the HMF and LMF bands of the equaliser have continuously variable bandwidth (Q). This is calculated as the ratio of gain/bandwidth so that as the gain is decreased the bandwidth increases. When the equaliser is switched to 'E' operation, the bandwidth remains constant at all gains, so at lower gains the EQ curves are narrower for a given Q setting.

LF Section:

Comprises a shelving filter with variable cutoff frequency and boost/cut control. This is switchable to a shallower curve by selecting the 'E' switch. Selecting **BELL** in either mode switches the filter to a peaking curve.

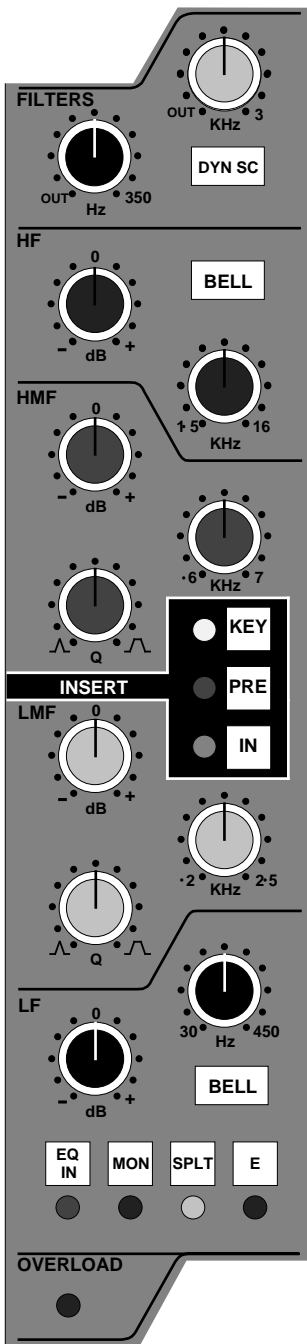

Filters

The Filters can be completely bypassed when the controls are turned fully anti-clockwise to the detented OUT position.

The High pass filter has a slope of 18dB per Octave and the Low pass filter has a slope of 12dB per octave.

Overload Indicator

The overload circuit monitors the signal in the Channel path at three different points. The level at which it lights can be adjusted from the centre section between +18dBu and +24dBu in 1dB steps. (See the SL9000J Service Manual for more details.) The monitor points are: post-channel fader, post-insert point and channel input pre any signal processing.

Insert Point

The insert point is switchable **PRE** or (normally) post the EQ and before the fader. The Insert Send jack (Row E) always carries the channel signal and is normalled down to the Insert Return jack (Row F). The **IN** button switches the return back into the signal path, hence switching in any device patched to the insert jacks.

The insert **IN** button is automated. See the J Series Computer Operator's manual for more details.

The Insert Return can also be used as a key input to the dynamics. Selecting **KEY** re-routes the insert return to feed the dynamics side chain. See also Dynamics Section, Page 3-3.

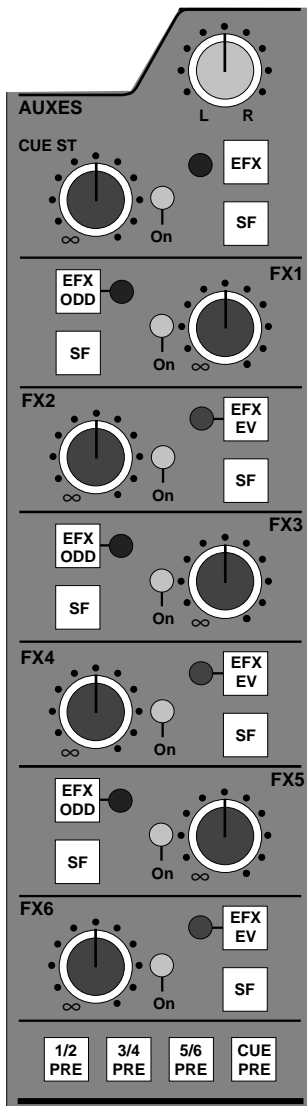

Auxiliary Sends

This section comprises one stereo and six mono sends. Either audio path, controlled by the Large or Small Fader within each module, may be routed to any of the send busses, in any pre or post-fader permutation.

Each send has a level control with a built-in push-on/push-off switch so that levels may be preset and easily switched in and out. These switches are automated and the On/Off switching is electronically latched. A yellow LED indicates that the send is ON. The stereo send also has a pan control.

The source select buttons for each send are:

SF (SMALL FADER) – When pushed down the send is derived from the Small Fader signal path and when up, the send is from the Large Fader signal path.

PRE – At the bottom of this section, four switches allow the aux sends to be switched in pairs to be pre-fader. When pushed down, the sends are derived pre-fader and when up, post-fader.

EFX – Each aux send control can be disconnected from its own bus and re-routed to any one of the four A, B, C, D stereo busses, the multitrack busses or the channel direct output via one of two 'EFX' busses which are internal to the module. Pressing the **EFX** button on even numbered aux sends (2, 4 and 6) routes that send onto the EFX EVEN bus. A green LED lights

to show that the switch is active. Pressing the EFX button on odd numbered aux sends (1, 3 and 5) routes that send onto the EFX ODD bus. A red LED lights to show that the switch is active. Pressing EFX on the stereo send routes Stereo Cue left to EFX ODD and Stereo Cue right to EFX EVEN. Only one aux send control can be assigned to an EFX bus at any one time, ie. a maximum of one odd and one even numbered aux, or the stereo aux. Lower numbered sends take priority over higher numbered ones. Cue Stereo takes priority over all mono auxes.

This feature allows a large number of independent headphone or effects send mixes to be generated, without using the Small Fader.

All the Aux send bus outputs appear on the jack field, and can be used as feeds to effects units. See Section 5 for details of the Foldback and Studio Loudspeaker systems.

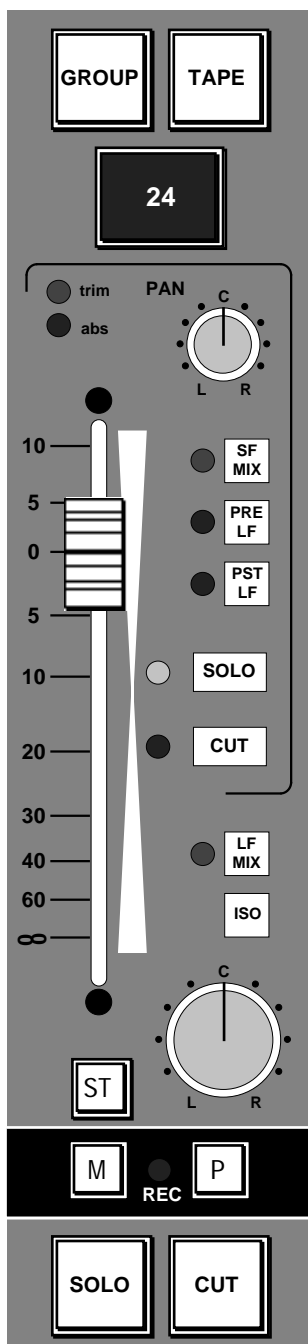

Monitor Input and Small Fader Section

Monitor Input Section

The source selected by the MONITOR INPUT SECTION is governed by the state of the **GROUP** and **TAPE** buttons, and the **PRE LF** (Large Fader) and **P(O)ST** buttons.

Note that the **PRE LF** and **P(O)ST** buttons override **TAPE** and **GROUP**, but for the time being we will assume that they have not been selected.

The **GROUP** and **TAPE** buttons serve two functions:

1. To select which input will be presented to the Monitor fader – the **GROUP** signal feeding the multitrack and/or the **TAPE** return from the multitrack machine.
2. To allow the large red **RECORD** button to function as a Track Ready button.

Each **RECORD** button is connected to the corresponding multitrack Track Ready remote, and is only *ready* (allowed) to prime a track for record if either **GROUP** or **TAPE** is selected. This acts as a safety feature to prevent accidental record arming.

The **RECORD** button is engraved with the module and track number to clearly indicate which tracks are being primed for record. If the module **RECORD** button is on, then that track on the multitrack will drop into record if the transport **RECORD** button, in the centre section of the console or on the machine itself, is pressed. Some machines allow the module **RECORD** button to drop the machine directly into record whilst the machine is running with its transport Record active. Other machines need a fresh transport record command before a

primed track will go into record. You should check the logic of this before dropping in for real!

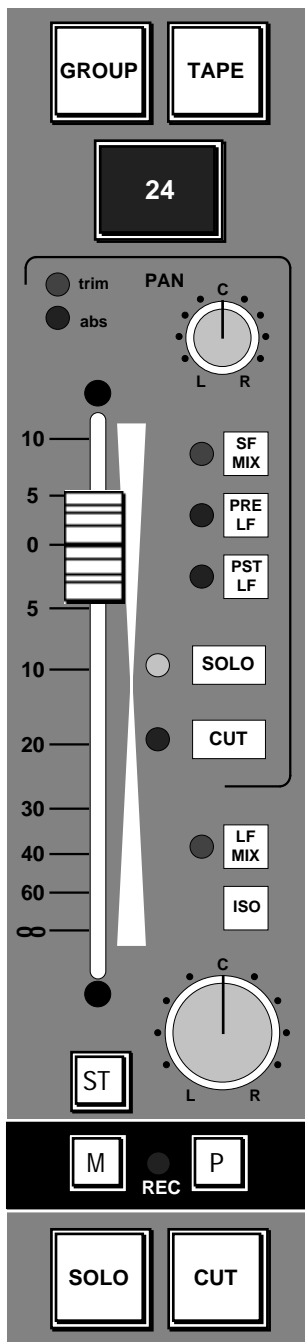

Machines that accept Sony 9-pin serial track ready commands can be controlled directly from the channel RECORD buttons via the J Series Computer. The computer can also light the RECORD button lamps to provide a direct tally from the machine's serial port. See the J Series Computer Operator's Manual for details of how to map channel record buttons to the appropriate serial machine control port. Links in the module need to be set to enable this option.

The RECORD button can also be used to ready tracks for record on SSL's DiskTrack hard disk multitrack recorder (if fitted). See the J Series Computer Operator's Manual for more details.

Small Fader

The 65mm 'Small Fader' can be in either the Channel or the Monitor path, depending on the master desk status. In either case it can be automated if required, in which case audio is switched to a VCA. It has its own automation Status (ST) switch and LEDs.

The Small Fader can also be used to provide an automated pan control between Large and Small Fader signal paths. This mode is selected from the J Series Computer by selecting '4 Channel Pan' in the Desk Setup menu. This allows any or all channels to be switched to this mode. In 4-Channel Pan mode the Large Fader controls the overall level of both signal paths while the Small Fader controls their relative levels.

4-Channel Pan mode can be used:

1. To generate mono or stereo surround mixes by routing the Small Fader to one of the Stereo Subgroup busses. The Small Fader will then provide panning from front to surround outputs while the Small Fader pan will pan across the stereo surround outputs.
2. To give automated left/right panning across the main Mix bus. If both faders are routed to the main stereo Mix bus and one is panned left and the other right, then the Small Fader will pan from left to right.

Note that, in 4-Channel Pan mode, the Small Fader cut switch is inactive and the Large Fader cut switch or a Large Fader solo will cut both faders.

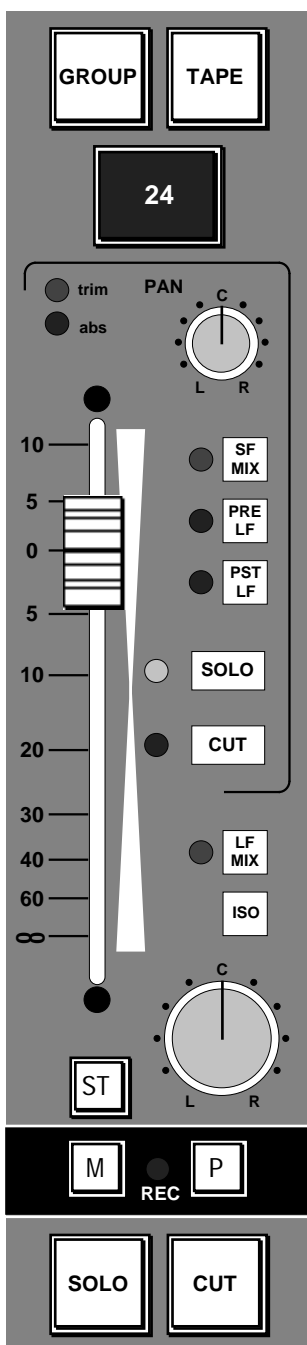

Small Fader Pan Control

The Small Fader pan control is always in circuit. When the Small Fader is routed to the Multitrack or Stereo Subgroup busses it pans between odd and even (or left and right) busses. When routed to the main Mix bus it pans between left and right unless the LCR pan option is fitted, in which case it will follow the **2 CH/4 CH** selection on the SL952 panel in the centre section, switching between left/right and LCR panning. In LCR mode the Small Fader will still pan between odd/left and even/right Multitrack or Stereo Subgroup busses.

Small Fader Cut and Solo

These **SOLO** and **CUT** buttons are always associated with the Small Fader, regardless of whether the Small Fader is a Channel fader or a Monitor fader (as in RECORD + SMALL FADER TO MON[ITOR] status).

Normally the **SOLO** buttons activate an 'in place' (destructive) Solo function. This is useful when using the Small Faders as Monitor faders in RECORD + SMALL FADER TO MON status. However, if the Small Faders are being used as Channel faders in RECORD status, the **SOLO** buttons can be switched to an AFL (After Fader Listen) function by selecting **AFL** (or **STATUS LOCK**) on the SL952 (See Section 5). The AFL signal follows left/right and LCR channel pan selection (see above), providing a true AFL-in-place function. The **SOLO** buttons can also be used to provide a PFL (Pre Fade Listen) function by selecting **PFL** on the SL952 panel in the centre section.

If **SOLO IN FRONT** is selected on the SL952, a mix of the AFL signal and the main Mix signal will be heard on the main monitors. A rotary control adjusts the balance between AFL and MIX.

The **CUT** button always cuts (mutes) the Small Fader. However, depending on the console Status and DIL switch and link settings in the module, it may or may not cut the Pre-Fader Cue/Aux sends. This is explained in more detail on Page 3-16.

Small Fader Source and Destination

The console STATUS buttons determine if the Small Fader is placed in the Monitor or Channel signal path. (See Section 2 for more details.)

The Small Fader can be routed direct to the main stereo Mix bus by selecting the **SF MIX** button.

For your reference, the sources and destinations of the Small Fader signal are shown below. The destinations shown are the default selections; these can be over-ridden locally at any time:

<i>Status Buttons Selected</i>	<i>Small Fader Input</i>	<i>Small Fader Output</i>
MIX	Monitor Input	Routing Matrix
RECORD	Channel Input	Routing Matrix
RECORD + SMALL FADER TO MON	Monitor Input	Stereo Mix Bus

Group/Tape Selections and the Supercue System

The GROUP and TAPE buttons are used to select monitor sources for the Monitor fader and to determine the Pre-Fader Cue feeds. As already described, these buttons also enable the module track RECORD facility. The table below lists the different combinations of buttons and the resultant signals that are fed to the Monitor fader and the Aux sends:

<i>Ready Button Selected</i>	<i>Monitor Fader Source</i>	<i>Pre-Fader Aux Feeds</i>	<i>Record Switch Enabled?</i>
None	TAPE	TAPE	NO
TAPE	TAPE	TAPE	YES
GROUP	GROUP	GROUP	YES
GROUP+TAPE	GROUP+TAPE	GROUP+TAPE	YES

As can be seen above, both Group Output and Tape Return can be monitored together, when both GROUP and TAPE buttons are selected. This is presented as a 1:1 mix. Note also that when the TAPE button is selected on its own, the Cue sends still receive a combination of Group *and* Tape, allowing the engineer to hear the drop-in while the artiste can hear both himself (or herself) as well as a feed from the Sync head of the ATR.

The table above applies while the multitrack is not running in Record. When the machine *is* in Record, the console senses the machine record line and then adjusts the monitor sources accordingly (see below). This facility of automatic source selection is called the SSL Supercue System.

Let's first look at the Monitor fader source before and during the drop-in. The following table shows the sources that will be selected:

<i>Ready Button Selected</i>	<i>Monitor Fader Source Pre-Drop-in</i>	<i>Monitor Fader Source During Drop-in</i>
TAPE	TAPE	GROUP †
GROUP	GROUP	GROUP
GROUP+TAPE	GROUP+TAPE	GROUP *

and for the Pre-Fader Cue feeds:

<i>Ready Button Selected</i>	<i>Pre-Fader Cue Source Pre-Drop-in</i>	<i>Pre-Fader Cue Source During Drop-in</i>
TAPE	GROUP+TAPE †	GROUP * †
GROUP	GROUP	GROUP
GROUP+TAPE	GROUP+TAPE	GROUP *

* The asterisk indicates that the Supercue System has switched from GROUP+TAPE to the GROUP signal only.

† Indicates that this condition will give TAPE if LK2 on the module's EQ/Dynamics card is set to ON (which forces Monitor Tape when TAPE is selected). This may have some ramifications in the following text.

In the Control Room

When laying fresh tracks it is possible to monitor either the GROUP or TAPE signal. GROUP allows you to meter signals going to the multitrack.

Remember that when TAPE only is selected, you will only hear a signal if the multitrack is playing, or if the multitrack automatically switches to Input when stopped. When the machine is in Record the monitoring automatically switches to GROUP. The metering however will continue to meter TAPE, which may in turn be effectively GROUP if the machine switches to Input when in record. TAPE will allow you to hear a “clean edit” when dropping in (i.e. the Sync output of the multitrack prior to the drop-in point and then the Group Output after the drop in point, switched when the track drops into record).

When over dubbing, selecting TAPE and GROUP together will allow you to hear the artiste playing along with the previously recorded track prior to the drop-in, and then the Group signal on its own during the drop-in.



It may seem like things are getting a little too complicated here. Don't you think it would be better if we all agreed to record direct to 2 Track?

In the Headphones

Let's assume that both TAPE and GROUP are selected. This means that the mic is always present in the headphones and allows the artiste to play or sing along with the previous take, and in many cases pick up any complex nuances that were in the original performance. The artiste will hear himself (or herself) as well as the machine Sync output up to the drop-in point.

After the drop-in point, the TAPE signal is switched off.

Monitor Cut and Solo

When laying tracks it is often preferable to be able to CUT and SOLO the Monitor feeds without cutting the Pre-Fader Cue sends to the studio headphones. There is a link option (LK3) on the upper module card which determines if the Monitor Pre-Fader Cue sends are cut by the Monitor Cut or not.

In RECORD or REPLAY status, Large fader Cuts do not cut the Pre-Fader Aux sends if this option has been selected.

In any other status, Pre-Small Fader Aux sends will not be cut by the Small Fader Cut button if this option has been selected.

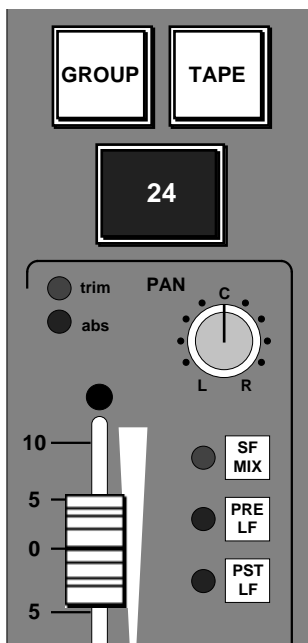

Small Faders as Extra Auxiliary Sends

The **PRE LF** and **P(O)ST LF** buttons, next to the **SMALL FADER**, provide a means of feeding the Channel signal into the Monitor path in place of the **GROUP** and **TAPE** selections.

Note that these two buttons *override* any **GROUP** or **TAPE** selection.

This is very useful in **MIX** status for deriving automated auxiliary sends or clean feeds (see Section 2). These can then be fed to the Routing Matrix and out to effects devices or cue lines e.g. Groups 25-48 can be used as clean feeds of a live mix, the Small Faders being used to send the Channel signal to as many of these clean feeds as required.

<i>Buttons Selected</i>	<i>Source of Small Fader Input</i>
PRE LF	Pre-Large Fader
POST LF	Post-Large Fader

Note that when 4-Channel Pan mode is selected from the computer screen, **POST LF** is selected automatically, although the LED does not light.

Large Fader

The LARGE FADER will usually be fed from the CHANNEL INPUT SECTION. However there are exceptions as this table shows:

<i>Status Buttons Selected</i>	<i>Large Fader Input</i>	<i>Large Fader Output</i>
MIX	Channel Input	Stereo Mix
RECORD	Monitor Input	Stereo Mix
RECORD + SMALL FADER TO MON	Channel Input	Routing Matrix

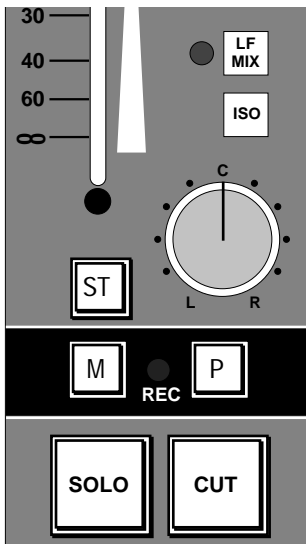

Large Fader Pan Control

The Large Fader pan control is always in circuit. When the Large Fader is routed to the Multitrack or Stereo Subgroup busses it pans between odd and even (or left and right) busses. When routed to the main Mix bus it pans between left and right unless the LCR pan option is fitted, in which case it will follow the 2 CH/4 CH selection on the SL952, switching between left/right and LCR panning. In LCR mode the Large Fader will still pan between odd/left and even/right Multitrack or Stereo Subgroup busses.

For information on the **ST**(atus), **M**(atch) and **P**(lay) buttons, please see the J Series Computer Operator's Manual.

The large illuminated **SOLO** and **CUT** buttons are always associated with the Large Fader.

SOLO – Normally the **SOLO** buttons activate an 'in place' (destructive) Solo function. This is useful when using the Large Faders as Monitor faders in RECORD status. However, if the Large Faders are being used as Channel faders in RECORD + SMALL FADER TO MON status, the **SOLO** buttons can be switched to an AFL (After Fader Listen) function by selecting **AFL** (or **STATUS LOCK**) on the SL952 (See Section 5). The AFL signal follows left/right and LCR channel pan position (see above), providing a true AFL-in-place function. The **SOLO** buttons can also be used to provide a PFL (Pre Fade Listen) function by selecting **PFL** on the SL952 panel in the centre section.

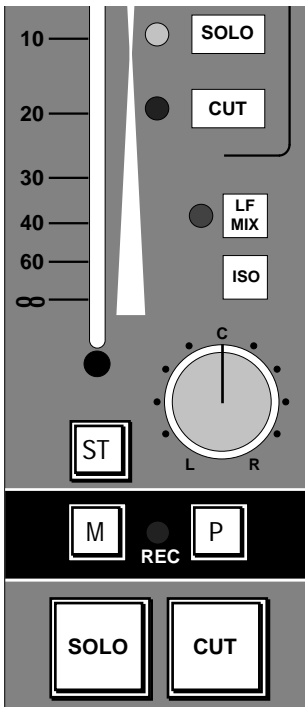

If **SOLO IN FRONT** is selected on the SL952, the **SOLO** buttons provide a mix of the AFL signal and the main Mix signal on the main monitors. A rotary control adjusts the balance between AFL and MIX.

Solo Isolate

If the module's **ISO** switch is selected, then the Large fader signal path will not be cut by another channel being Soloed. The **ISO** switch can also solo isolate the Small Fader. To do this hold down the Small Fader **SOLO** switch while selecting **ISO**. The solo isolate function will now always apply to the Small Fader. This link can be cleared by holding down the Large Fader **SOLO** switch and selecting **ISO** (or by turning the console off and on again).

CUT – When the Large Fader is used in the Channel signal path the **CUT** button normally cuts the channel in two places – at the input and immediately post the fader. This means that Pre-fade aux sends will be muted by the Cut switch or by a Destructive Solo

STATUS – This switch beside the Large Fader (see opposite) is related to the automation system, as are the **trim**, **abs** and **alt** LEDs. See the J Series Computer Operator's Manual for more details.

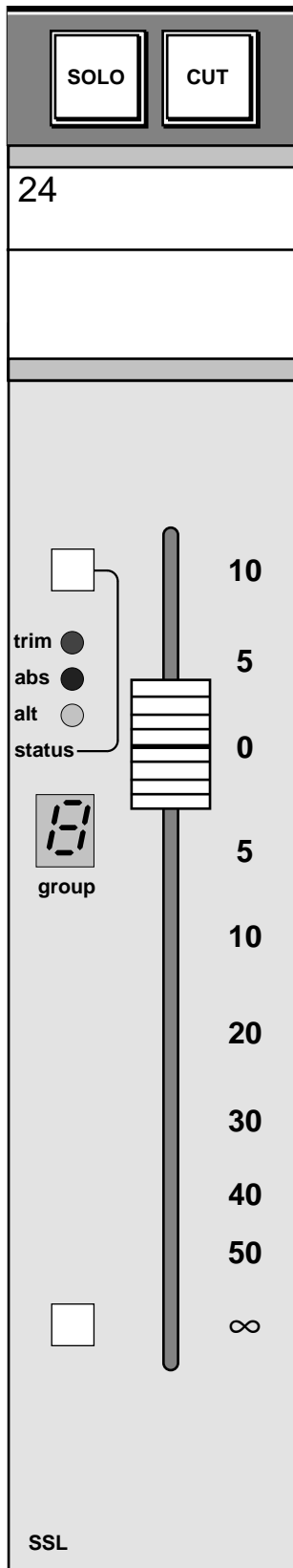

Large Fader Subgrouping

The Large Fader can be assigned to one of the eight GROUP FADERS located in the console centre section. The number of the Group fader to which a channel is assigned is displayed in a 7-segment LED display next to the fader (see opposite).

Group Faders can also be assigned to other Group Faders, so many combinations of subgrouping can be achieved.

To assign a Large Fader to a hardware group, select **HARD GROUP SETUP** on the SL955 Motion Control panel in the centre section. Now by quickly pressing the switch at the bottom of the fader, the 7-segment display will increment by one. If the switch is held down for a short period it will decrement the display by one.

If 0 is selected on the display, then the fader will be cut by Group Fader solos. If the display is blank then the fader is unaffected by group solos.

Both the Large Faders and the Group Faders are connected to the J Series Computer for automated mixing.

Channel Outputs

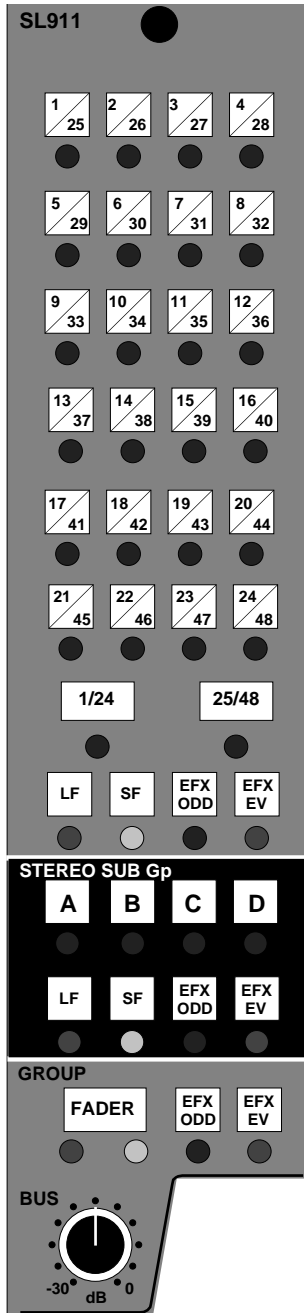

Routing Matrix

The console has as many Group Outputs as there are I/O modules. The Routing Matrix allows any module to route to any or all of the first 48 of these Group Outputs.

The matrix may be fed from either fader path depending on the console's master STATUS selection and the module's Routing Matrix source select switches.

There are four main uses for this matrix:

1. In RECORD or REPLAY status, the Channel signal can be fed to any multitrack group for track laying, usually from the SMALL FADER *or*, if **SMALL FADER TO MON(ITOR)** is selected, from the LARGE FADER. The PAN control of the source fader will pan between Odd and Even groups (the odd Group is the left of the pair and the even Group is the right).

2. In MIX status either the SMALL FADER signals (or the LARGE FADER if the default source selection is overridden locally) can be fed to the Routing Matrix for audio subgrouping on any of the first 48 channels. Having been routed to the selected bus(es), these signals can be picked up on the corresponding LARGE FADER by pressing the **SUB GP** button, or on the SMALL FADER via the Group Monitor input by selecting the **GROUP** button.

3. In MIX mode the SMALL FADER can be used as an additional, automated, send via a Multitrack bus. Using the **PRE LF** and **P(O)ST LF** buttons next to the SMALL FADER, the Channel signal, pre- or post-Large Fader, can be routed to a Multitrack bus and then patched, from Row G, to an effects unit input.

<i>Buttons Selected</i>	<i>Source of Small Fader Input</i>
PRE LF	Pre-Large Fader
POST LF	Post-Large Fader

Note that these buttons are also active in RECORD and REPLAY status.

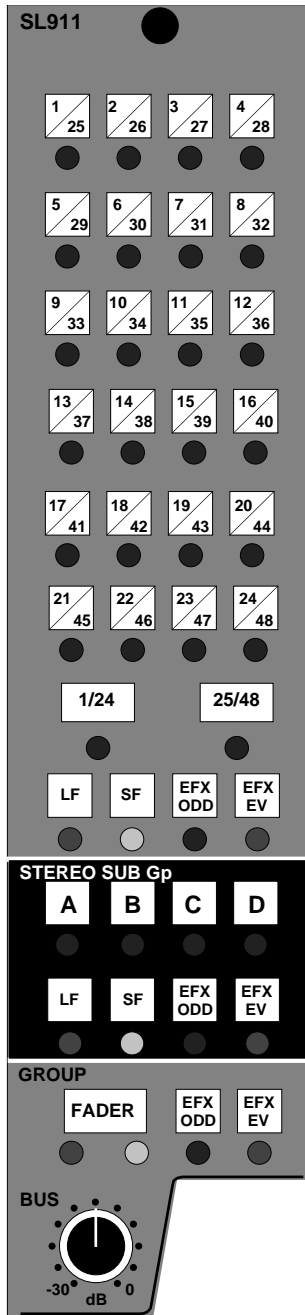

4. Any of the auxiliary send controls can be used as an additional send, via the 'EFX' system. See **Auxiliary Sends** on Page 3-9 for further details.

Routing Bank Select Switches

These two switches determine whether the 24 routing switches feed to busses 1-24 or 25-48, or both. If neither is pressed the Routing Matrix switches above are inactive.

The Routing Source Select Switches

The source for the multitrack Routing Matrix is determined by the four Source Select switches below the 48 bus routing switches. These are **LF**, **SF**, **EFX ODD** and **EFX EV(EN)**. **LF** and **SF** are inter-cancelling, electronically latched, switches. Pressing either one will toggle the source selection between Small and Large Fader.

Selecting **EFX ODD** will feed any aux signal routed to EFX ODD to both odd and even numbered busses. Selecting **EFX EV** will feed any aux signal routed to EFX EV to both odd and even numbered busses. Selecting both together will feed the EFX ODD signal to odd numbered busses and the EFX EV signal to even numbered busses. The **EFX** selections override the **LF** and **SF** switches.

The table below shows default source selection for the Routing Matrix according to console status. These selections can be overridden locally at any time.

<i>Status</i>	<i>Routing Matrix fed from</i>
RECORD/REPLAY	Channel Input via SMALL FADER
RECORD/REPLAY + SMALL FADER TO MON	Channel Input via LARGE FADER
MIX	Monitor Input via SMALL FADER

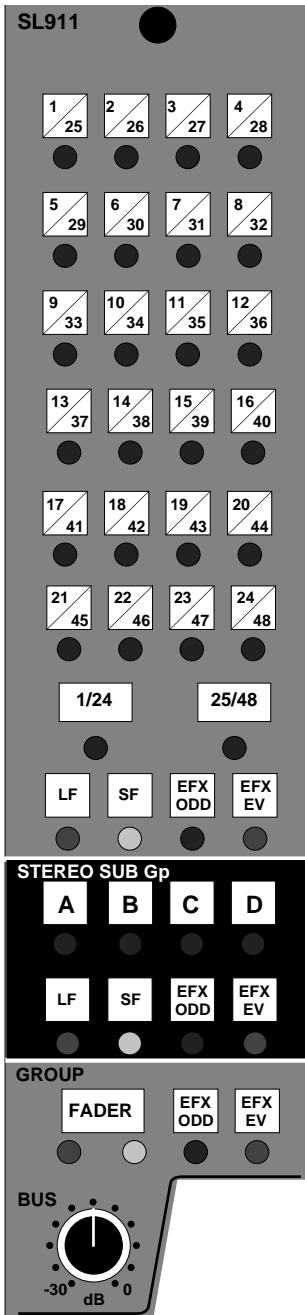

Stereo Subgroup Bus Routing

Four switches, **A**, **B**, **C** and **D**, route the module to any one or all of the four Stereo Subgroup busses. Sources for these Stereo Subgroup busses are determined by the four Source Select switches below the bus routing switches. These are **LF**, **SF**, **EFX ODD** and **EFX EV(EN)**. Selecting **LF** or **SF** will feed the post-pan control signal from the Large or Small Fader to the Stereo Subgroup bus routing. Selecting **EFX ODD** will feed any aux signal routed to EFX ODD to both left and right busses. Selecting **EFX EV** will feed any aux signal routed to EFX EV to both left and right busses. Selecting both together will feed the EFX ODD signal to left busses and the EFX EV signal to right busses. The **EFX** selections over ride the **LF** and **SF** switches.

Group Output Section

This section of the module, below the Routing Matrix, comprises a bus mixing amplifier with gain control and the source select buttons for the Group Output.

The Group Output can be sourced from four sources:

1. The corresponding Multitrack bus (all switches up).
2. **FADER** – This button provides a means of routing the post-channel fader signal on that module *directly* to the corresponding Multitrack Group Output. This bypasses the Routing Matrix, the track mix bus, the bus mix amp and the Bus Trim control. This routing selection improves noise figures but disables all other channels routed to that Group Output, as the Group mix amp is disconnected from the Group Output (see Section 2). The bus mix amp will, however, still feed the **SUB GP** button on the Channel Input Section. Either the green or yellow LED below the **FADER** switch will light to indicate which fader is the source; yellow indicates Small Fader, green indicates Large Fader.

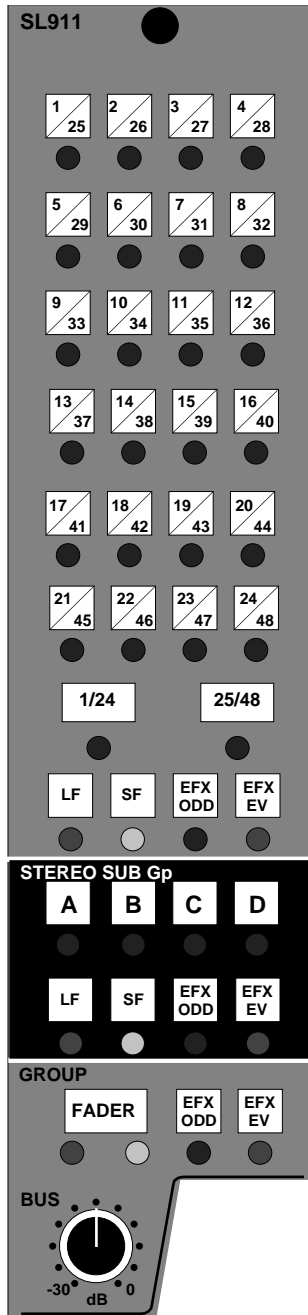

3 & 4. EFX ODD and **EFX EV(EN)** feed the corresponding EFX bus to the Group Output, allowing this output to be fed via an aux send control.

Bus Mix Amp and Trim Control

The mix amp takes its input from the associated Multitrack mix bus (e.g. all signals routed to Multitrack Bus 7 will be controlled by the bus mix amp on Module 7). The channel Group Output appears on patch row G where the signal is normalised down to the Multitrack Send (i.e. to the record inputs of the multitrack) and to the Group Monitor Input via the **GROUP** button, located at the top of the Small Fader section.

The **BUS** trim control attenuates the combined level of signals routed to that bus, and normally these controls are left fully up (clockwise). Their main use is for attenuating a Group Output when, for example, several channels have been assigned to a bus and a relative balance has been set on the faders. If the overall signal level is too high, then the **BUS** trim control can be adjusted to send an optimum level to the output and therefore to the multitrack.

When a track bus is not being used as a multitrack send, it may be routed to the corresponding **CHANNEL INPUT SECTION**, by pressing **SUB GP** on that module (see also Page 3-2). The channel will now act as an audio subgroup, and the **BUS** trim as the channel input gain control.

Solid State Logic
SL 9000 J Series
Total Studio System

Console Operator's Manual

SECTION 4

Signal Processor Routing



Signal Processor Routing

Each SL911J Input/Output module contains three separate signal processing devices:

- The 4-band Parametric Equaliser
- The High and Low Pass Filters
- The Dynamics Section comprising a compressor/limiter and expander/gate.

These processors can be used in either the Channel or the Monitor signal paths. Seven buttons are used to determine where each processor will be placed in the signal chain. Diagrams on the following pages show the various possible combinations.

Processor Routing Buttons

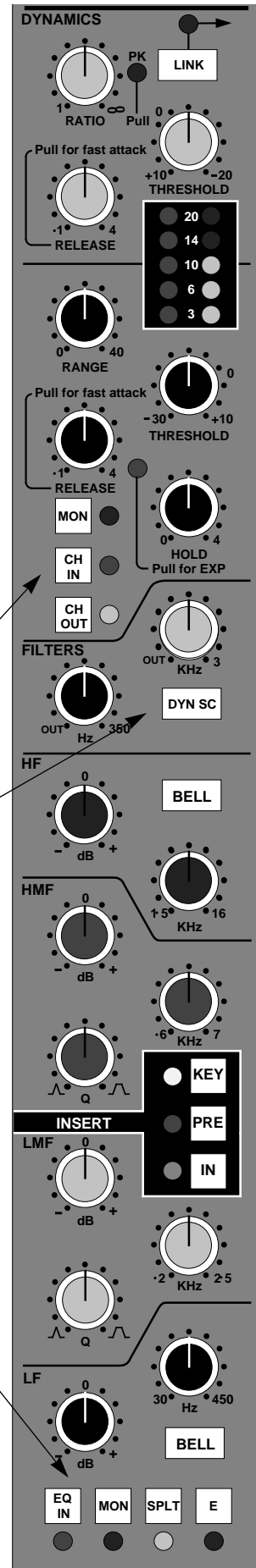

The first two examples show that the Equaliser and Filters are normally treated as a single unit, which may be switched into either the Channel or Monitor path. All these diagrams show input and fader selections for the RECORD status. Note that the Channel Input Section always feeds the Channel signal path and the Monitor Input Section always feeds the Monitor signal path.

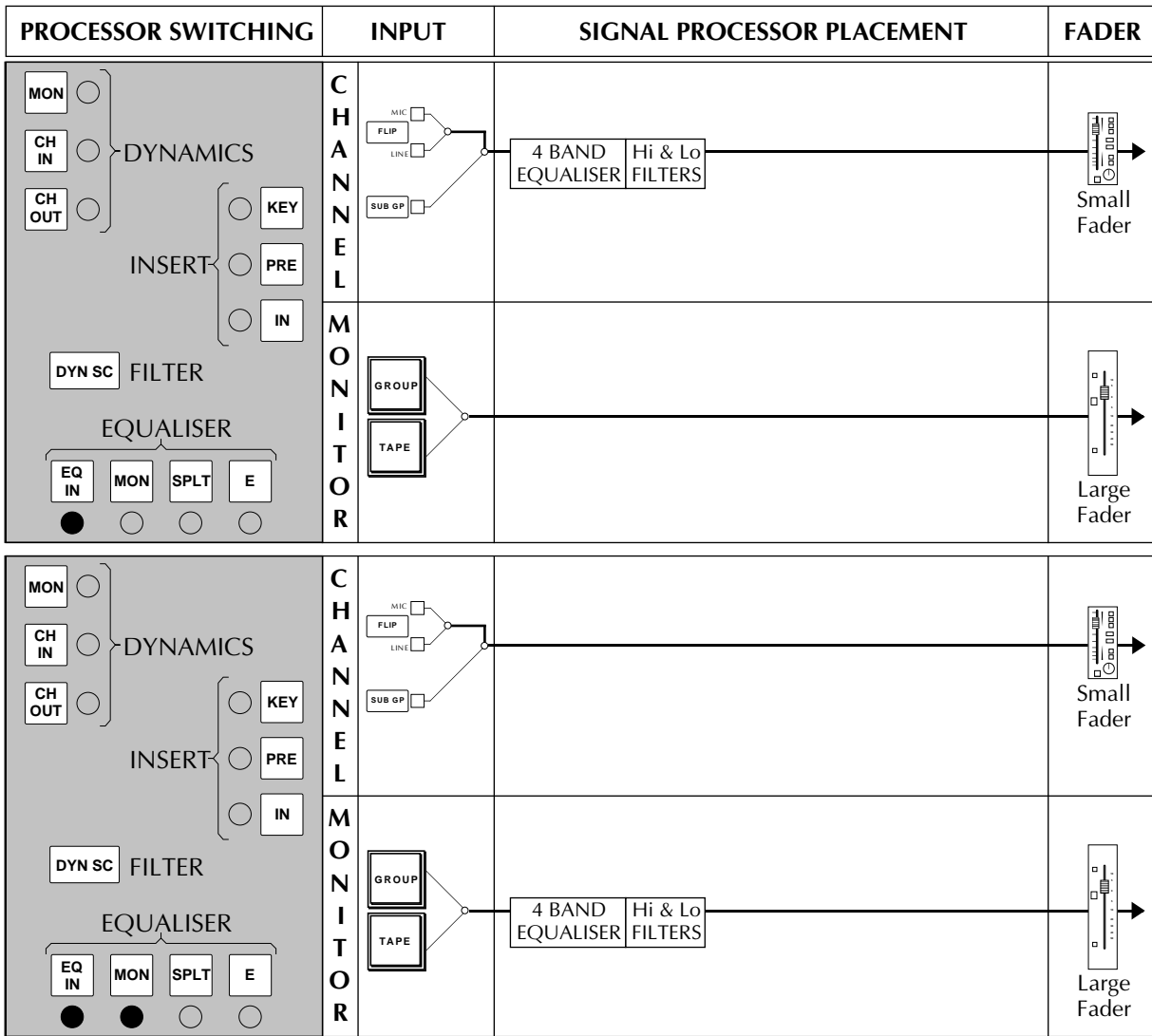

Note that the Filters normally follow the Equaliser, but see opposite page. The **E** button is used to select alternative parameters for the EQ, and has no effect on the position of the EQ in either signal path.

As well as the **MON** button, the **EQ IN** button must also be pressed to switch the EQ into circuit in the Monitor path. This represents a change from the SL4000, caused by the fact that the **EQ IN** button is automated and the EQ may be switched in or out of both the Channel and Monitor paths under computer control.

The **SPLT** Button always splits the Filters away from the Equaliser and places them directly after the input section. This allows the Equaliser to be placed in the Monitor path and the Filters in the Channel path:

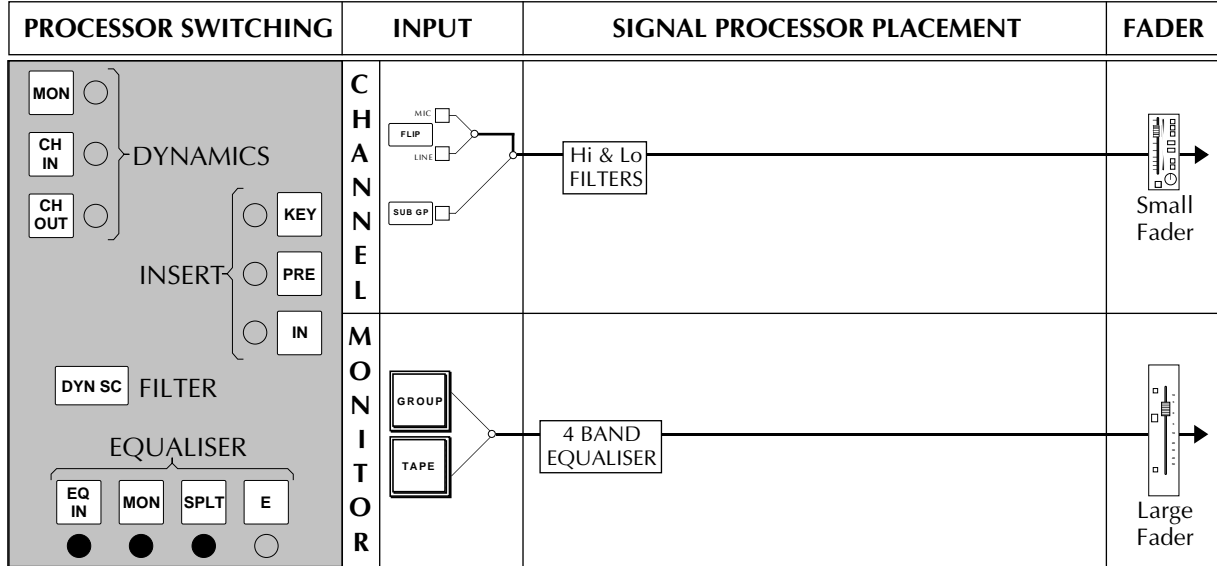

The Dynamics section can also be switched to either the Channel or Monitor path:

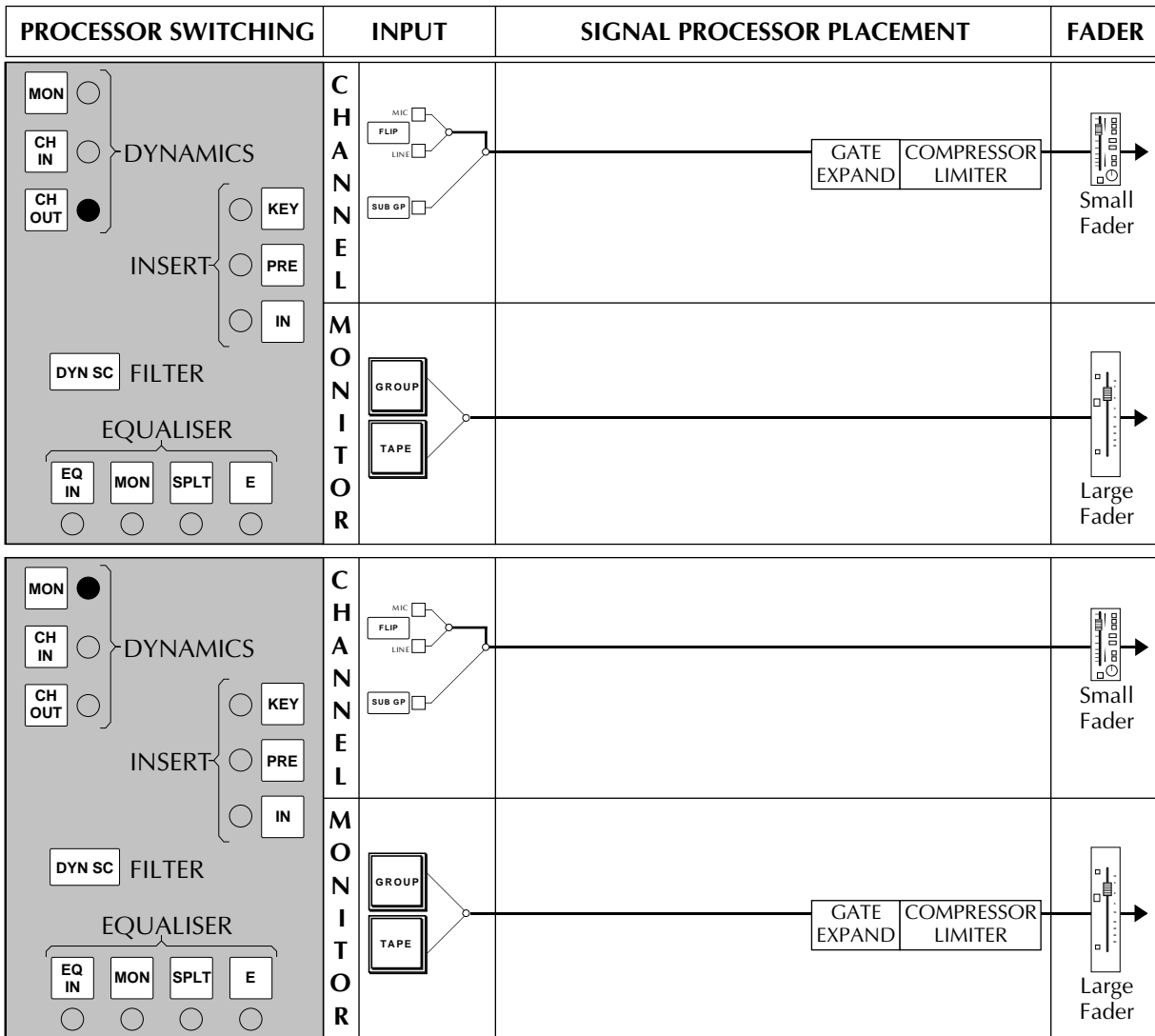

The Equaliser may be placed in the Channel path and the Dynamics in the Monitor path:

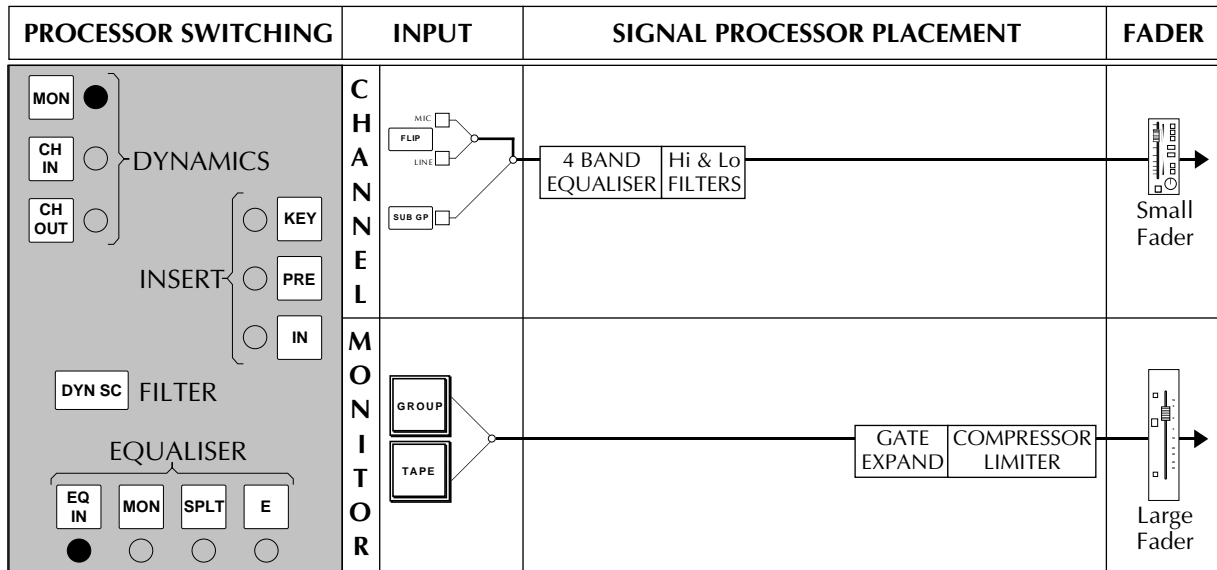

The Dynamics section may be placed pre or post the Equaliser in the Channel using the **CH IN** or **CH OUT** buttons:

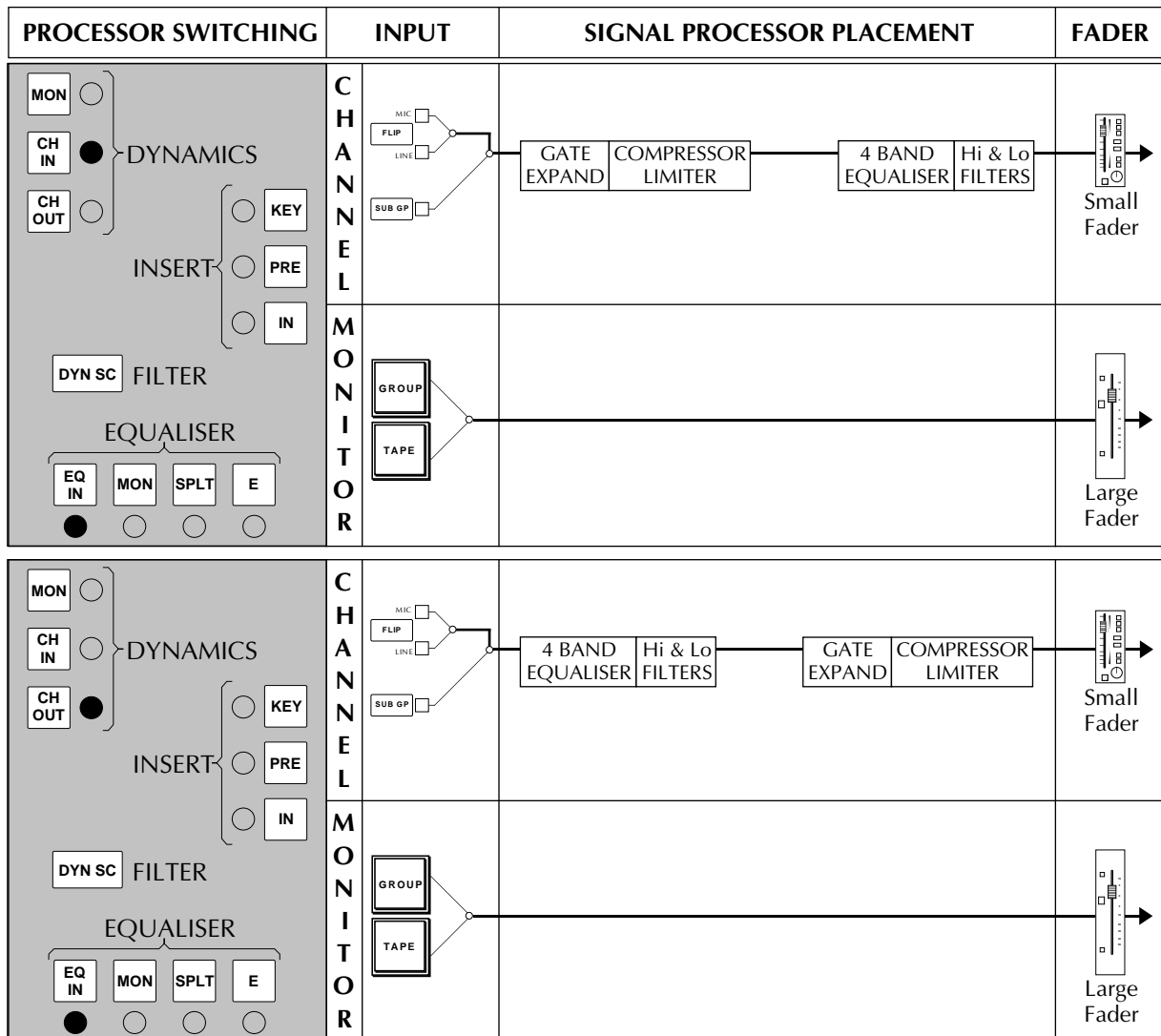

Using the **SPLT** button, the Filters may be placed pre-Dynamics and the Equaliser positioned post-Dynamics in the Channel.

It is also possible, using the **SPLT** button, to place the Filters in the Channel path while the Equaliser and Dynamics sections are in the Monitor path, although this is not shown. Note that the Dynamics section always follows the Equaliser when they are both placed in the Monitor path.

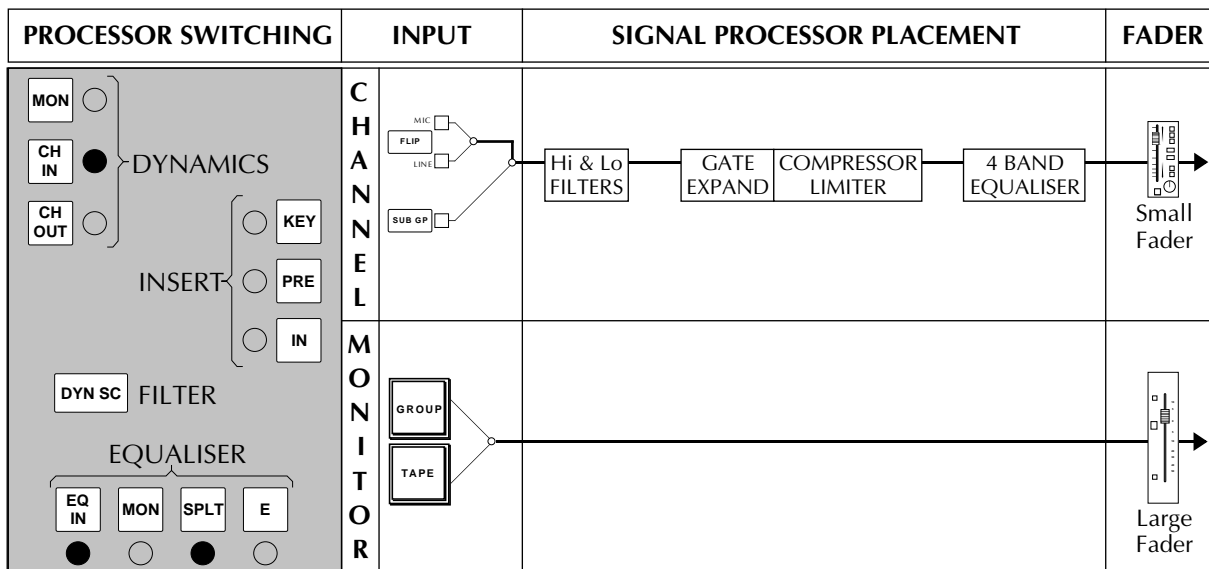

Access is also provided to the level sensing sidechain of the Dynamics section. The Filters may be placed in the sidechain, by the selection of the Filters' **DYN SC** button, with the Dynamics section in either the Channel or Monitor path. Frequency dependent effects such as stressing or de-essing are thus easily achieved. This is also useful for filtering out unwanted signals when gating. For example, when gating drums, the cymbal frequencies can be filtered out of the sidechain signal to prevent the gates on the drums from opening when the cymbals are played.

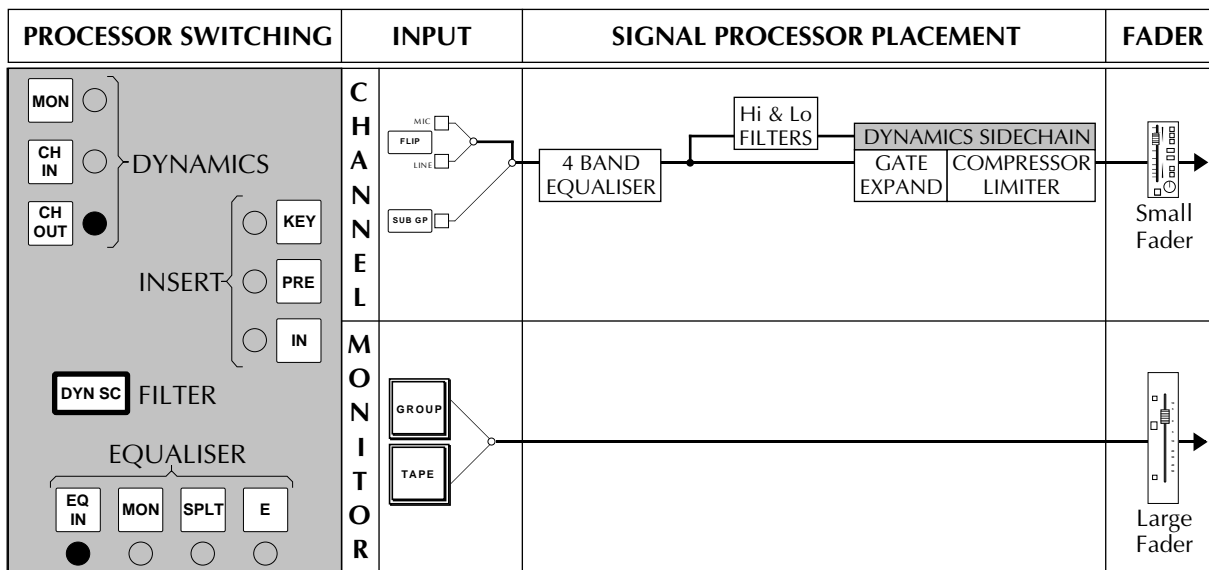

The Equaliser may be placed in the Channel, the Dynamics in the Monitor and the Filters switched to the sidechain input:

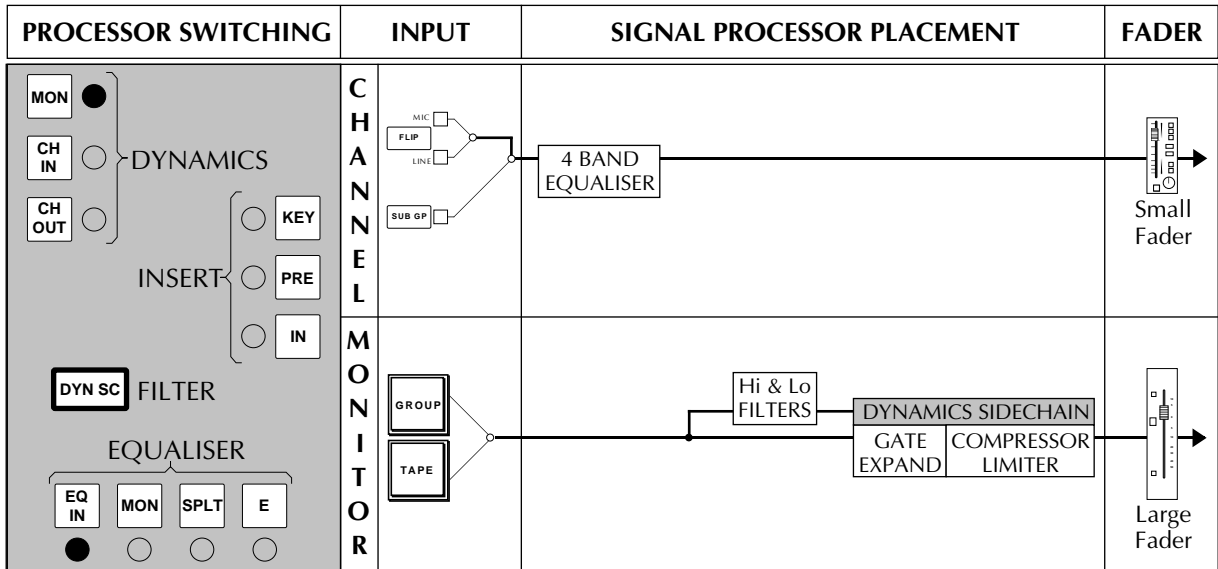

The Dynamics section can be 'keyed' from an external signal connected to the I/O module's Insert Return jack (Row F). Selecting the Insert Point's IN and KEY buttons re-routes the insert return to feed the Dynamics' sidechain input. This provides an easy method of setting up gated reverbs etc.

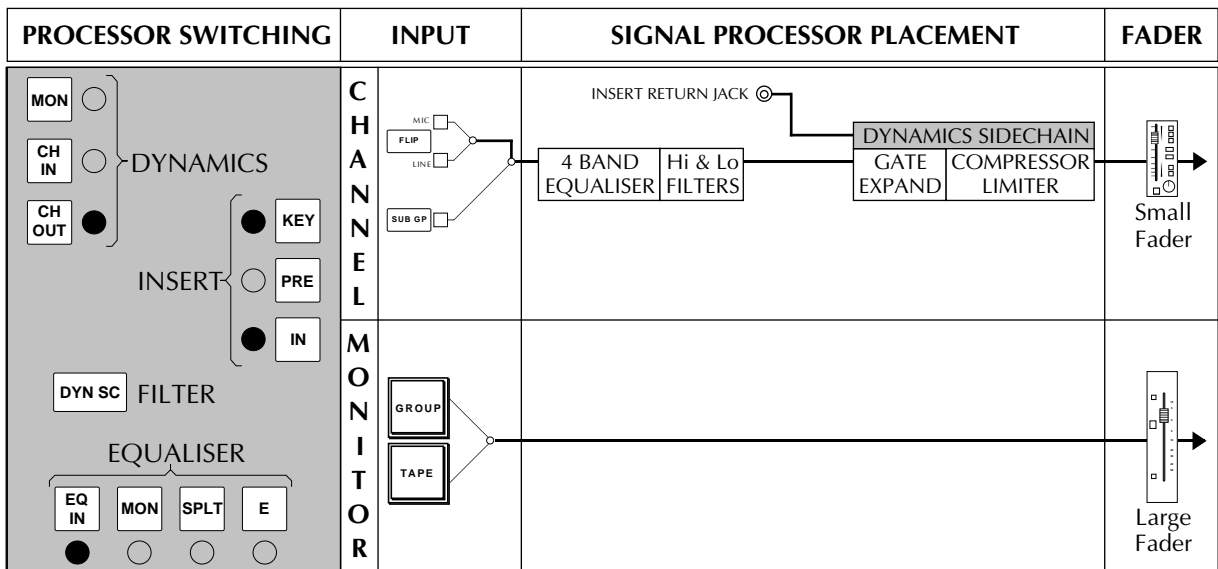

In addition to the 'keying' facility described above, the Dynamics section may also be keyed from an external signal by selecting either **CH IN** and **MON** or **CH OUT** and **MON**. The key signal is taken from the Monitor Input pre-fader, so patching into the Group Monitor Input or Tape Monitor Input will access the sidechain. As the Monitor Input can pick up the module's Group Output (ie. Module 21 can monitor Group Output 21) signals can be routed to the module's Group via the Routing Matrix and be selected to the sidechain input with the **GROUP** button. This application, especially useful when mixing, where a module's Dynamics section is keyed from another module, is covered in more detail in the applications guide.

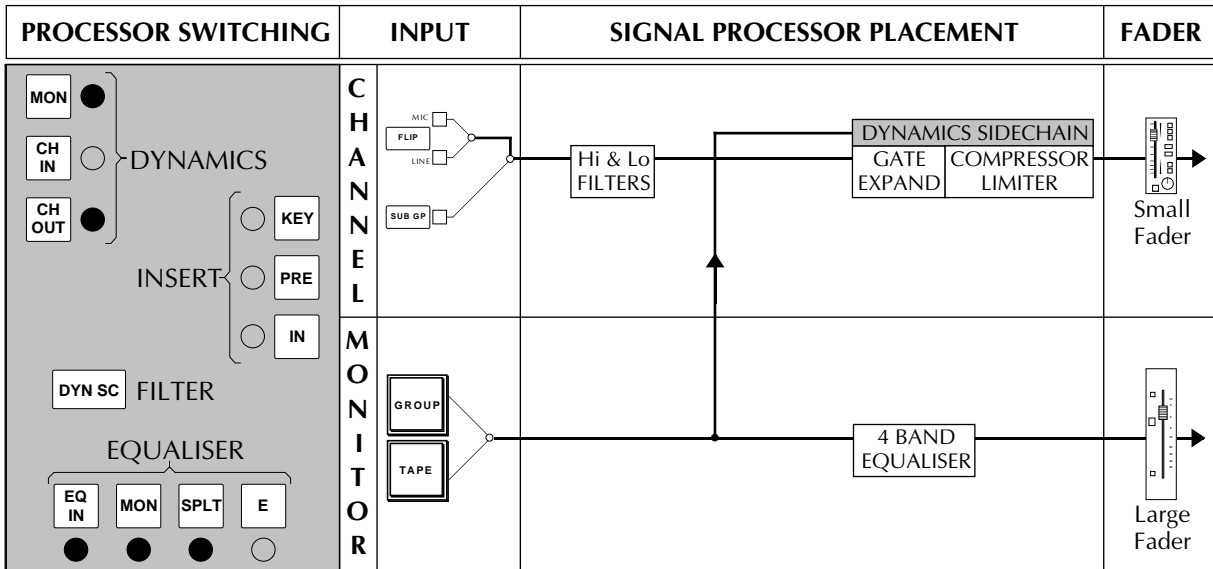

In addition to each module's internal signal processing, external processing devices may be connected into the Channel signal path via the Insert Send and Return points on the patchbay (Rows E and F). Note that the Insert **IN** switch is automated.

The Insert normally follows the Equaliser (and Filters if not split):

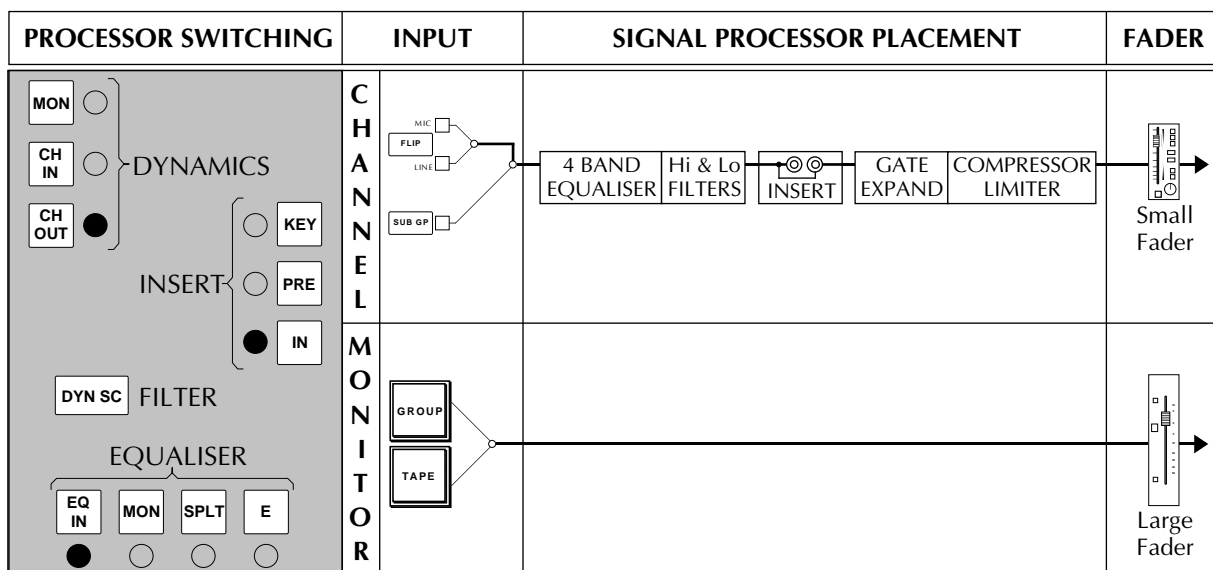

By selecting **PRE** and **IN**, the Insert may be placed before the Equaliser. Note that, in the following example **SPLT** has placed the Filters directly after the Channel Input:

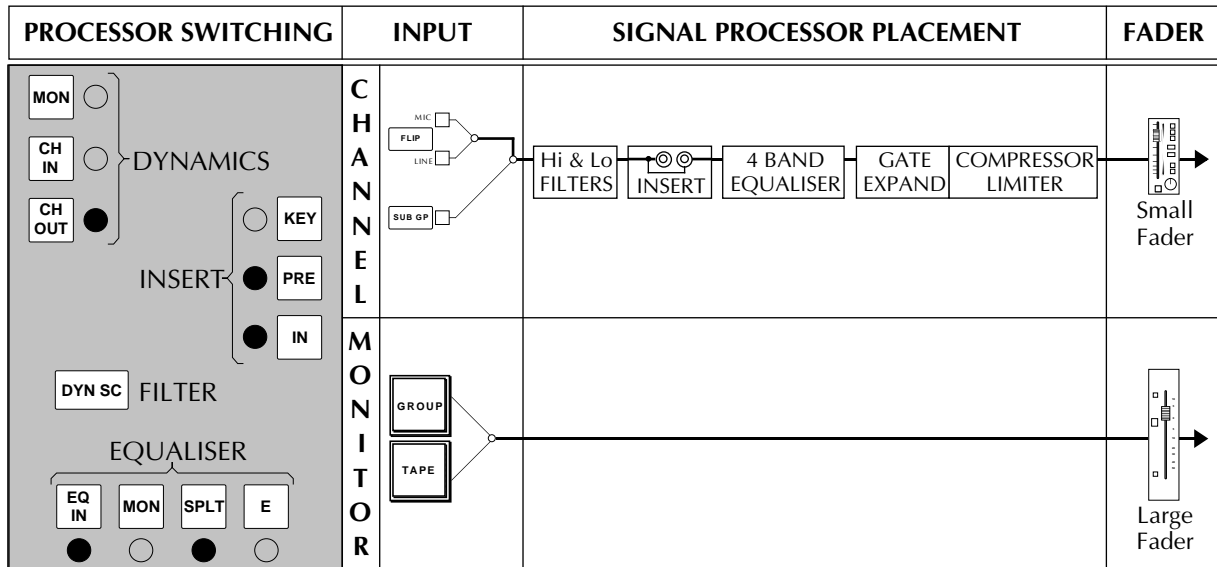

And finally, how about this:

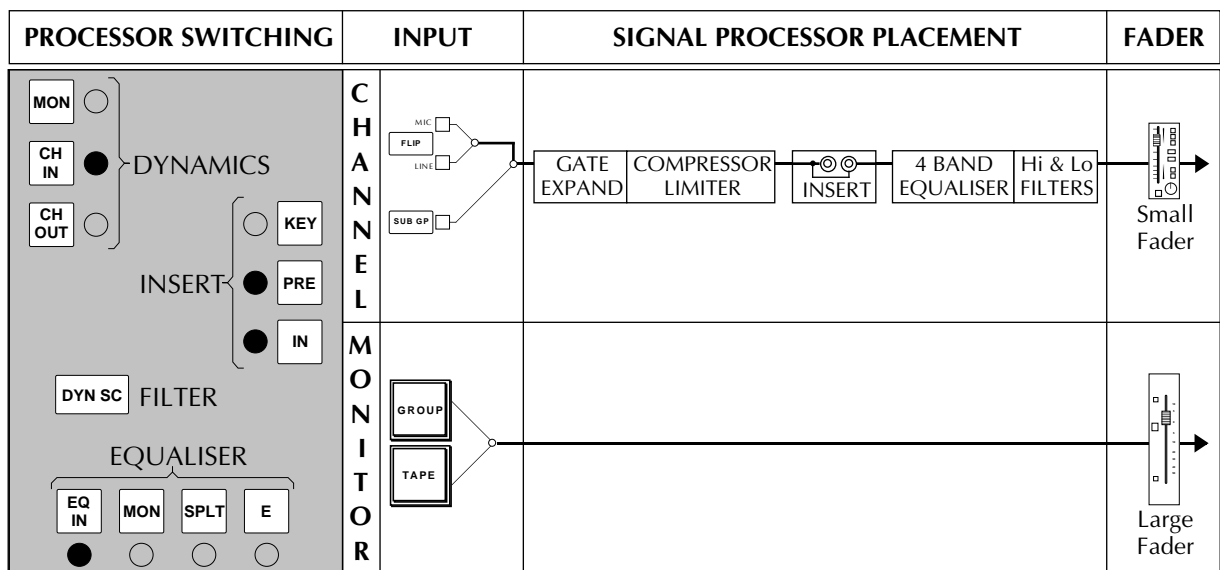

Solid State Logic
SL 9000 J Series
Total Studio System

Console Operator's Manual

SECTION 5

The Console Centre Section



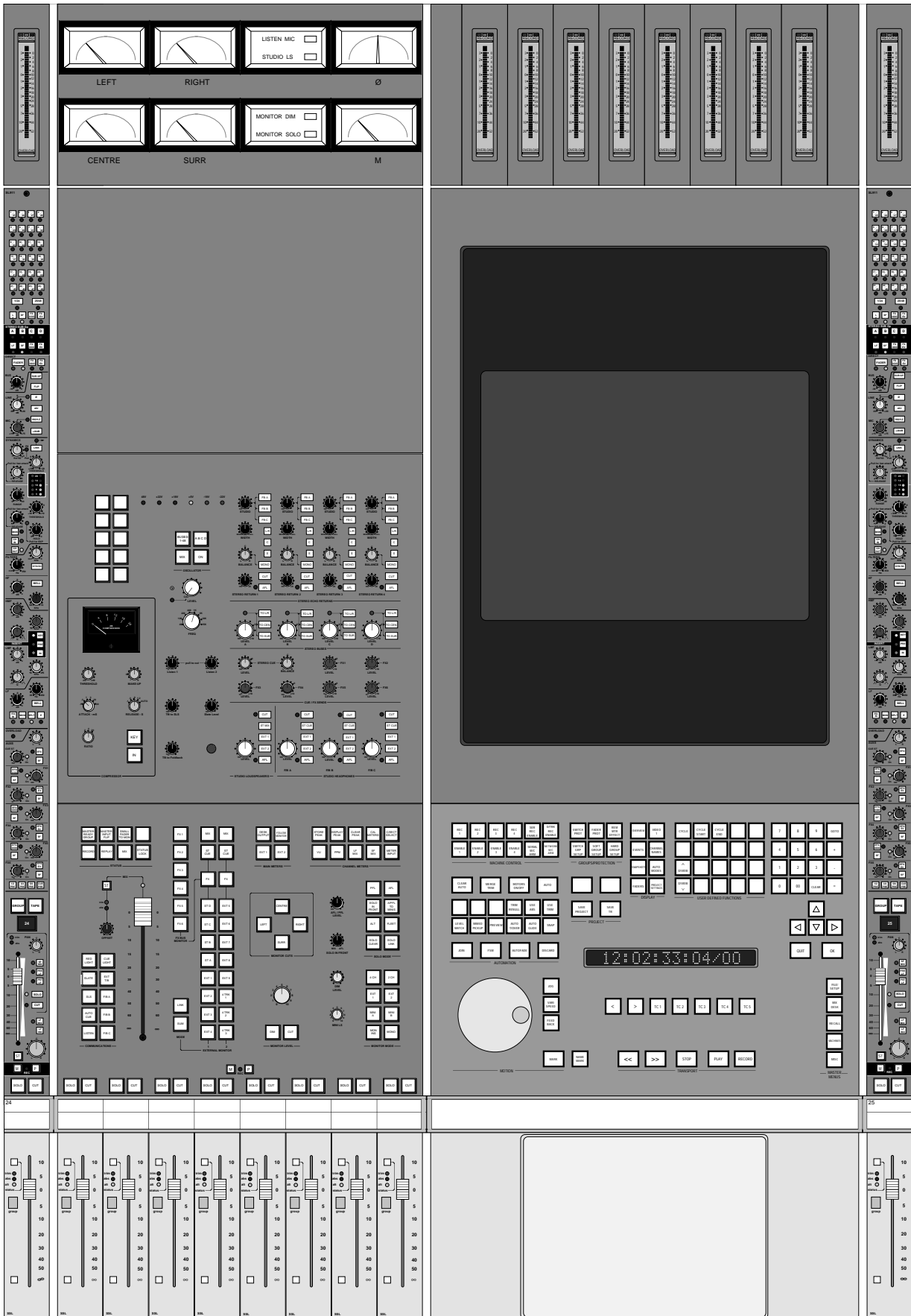

The Console Centre Section

The centre section of a J Series console is fitted, as standard, with two centre bays, one eight modules wide and one ten modules wide (see opposite).

Located to the left of the centre section, the SL 952/953J Master Facilities Module houses the master logic controls, monitoring and metering controls, auxiliary send and echo return masters, communications facilities, power supply rail indicators and a test oscillator.

Eight master control group faders are located below the SL952J.

The control panel and colour monitor for the J Series Studio Computer are mounted to the right of the centre section. A tablet and pen, for access to the computer's on-screen menus and functions, are fitted in the fader tray below the control panel. A QWERTY keyboard is provided in a pull-out drawer below the tablet. For more details please read the J Series Computer Operator's Manual.

The SL 952/953J Master Facilities Module

While reading this section you may like to refer to the fold-out drawing of the console layout, located at the front of this manual.

Power Supply Indicators

Working down from the top of the panels, one of the first sections you will meet has six LEDs which display the current state of power rails within the console.

The 48 volt supply provides phantom power to the mic lines; the bipolar 18 and 22 volt, and the 5 volt supplies are for audio and logic circuitry respectively.

±14 volt supplies provide power for the fader motors and the meter back lights. There are no LEDs to indicate the state of these rails, but the absence of meter illumination will provide a clue if they are missing!

All LEDs should normally be illuminated, if not – PANIC!

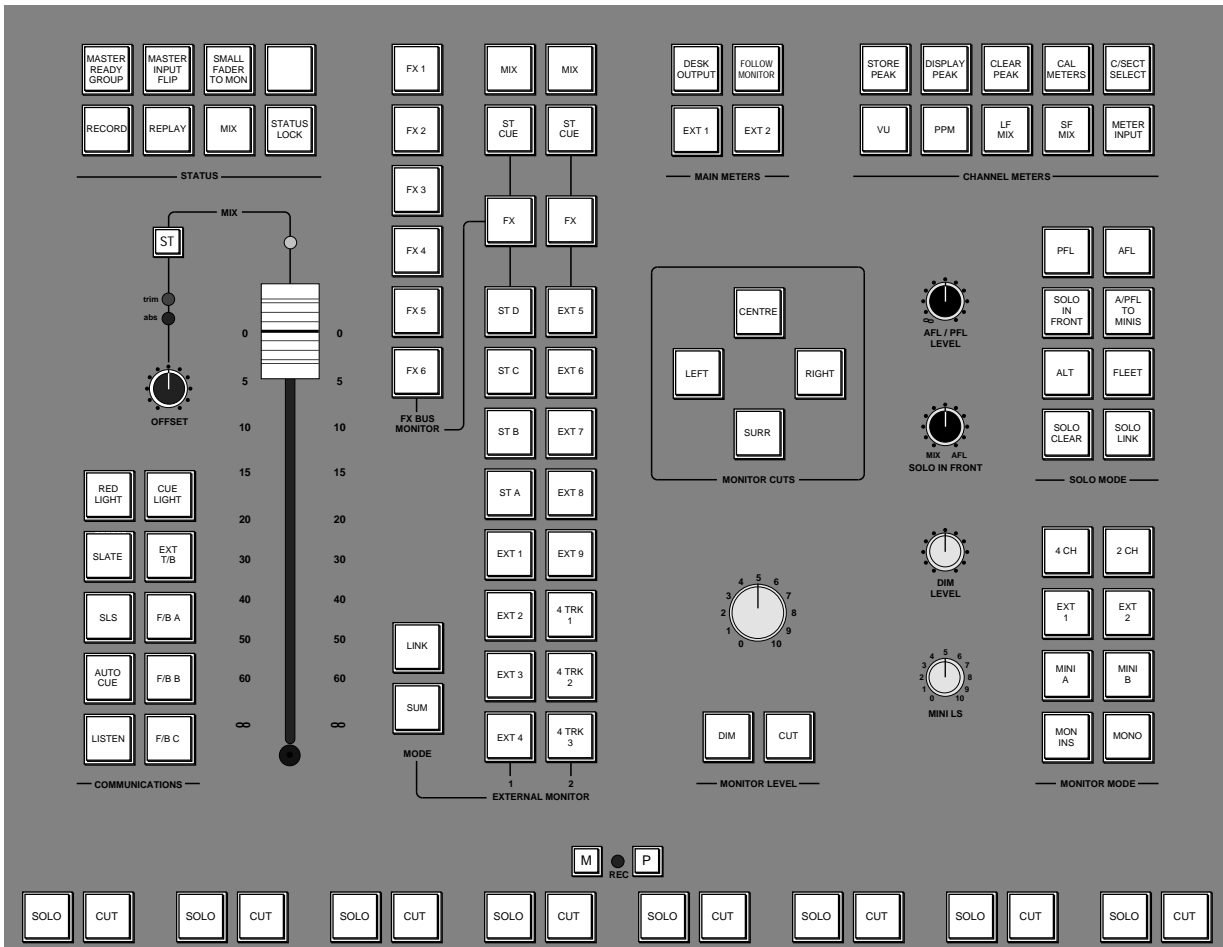

Status Buttons

This group of buttons, located in the upper left of the SL952 panel (see opposite), is extremely important as they control signal routing paths within the I/O modules. Four different status configurations are available. These are described in detail in Section 2 but briefly function as follows:

RECORD – This status is designed for recording sources to a multitrack machine. It switches all channel inputs to Mic and the multitrack machine (optionally) to Sync Replay. The channel inputs are fed via the Small faders to the multitrack Routing Matrix, and thus to the multitrack. The Large Faders take the multitrack returns and/or the group sends (depending on the selection of GROUP and TAPE buttons) and feed these to the main output busses for control room and studio monitoring.

REPLAY – The same routing configuration as **RECORD** status but (optionally) switches the multitrack to normal Replay. All Large Fader inputs switch to TAPE, overriding any GROUP selections. This allows for quick monitor mixes of the recorded tracks, via the main outputs.

MIX – This status switches the multitrack (optionally) to Replay. All channel inputs are switched to Line to pick up the multitrack returns and feed them to the Large Faders and then on to the main output busses for remixing. The Small Faders take their input from the GROUP/TAPE selections but now feed the multitrack Routing Matrix, and can be used for additional inputs to the mix. The Routing Matrix allows these faders to feed the multitrack busses or the stereo busses; the SF MIX button, on individual channels, allows Small Fader signals to directly feed the Main mix busses. The Small Faders can also be used as additional stereo or mono auxiliary sends from each channel.

RECORD + MIX – When the RECORD and MIX buttons are pressed together, the multitrack (optionally) switches to Sync replay. All channels behave as if they were in MIX status unless an I/O module's TAPE or GROUP button is pressed, which then makes that particular channel behave as if it were in RECORD status. This is a useful mode for overdubbing tracks.

The additional buttons within this section function as follows:

MASTER INPUT FLIP – Flips all channel inputs between Mic and Line.

SMALL FADER TO MON(ITOR) – In RECORD or REPLAY status, this flips the Small and Large Faders so that the Large Faders feed sources to the Routing Matrix and the Small Faders are used for the monitor mix.

MASTER READY GROUP – Selects all modules to GROUP. This allows you to quickly set up the desk so that the monitor faders and meters are fed from the modules' Group Outputs. It also provides a quick way to check the desk outputs when aligning the multitrack.

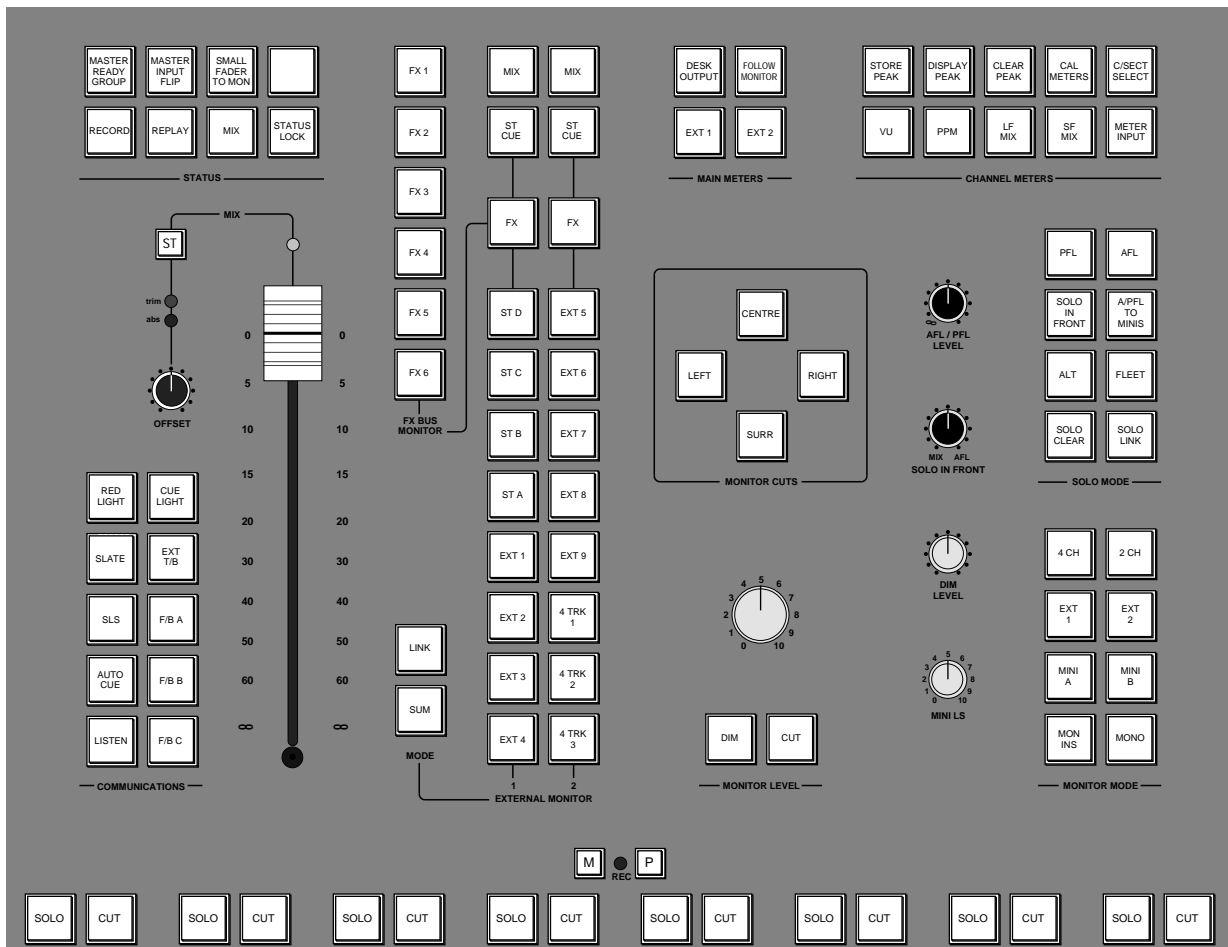

STATUS LOCK - For use in broadcast or live applications when changing statuses would cause havoc! It disables the following functions:

- STATUS BUTTON CHANGES:
 - RECORD
 - MIX
 - REPLAY
 - SMALL FADER TO MONITOR
 - MASTER INPUT FLIP
 - OSCILLATOR ON
 - SLATE TALKBACK
 - LISTEN MIC TO TAPE
 - AUTOCUE
 - SOLO IN PLACE
 - SLS OUTPUT
-
- AFL is selected and the RED LIGHT is switched on.

Main Outputs

The rest of the facilities on the SL952/953 modules will be discussed in a logical 'audio' order, starting with the console's main output controls.

Master Fader

The master fader is a four-channel fader controlling the level of the console's Left, Centre, Right and Surround outputs. When the fader is at the top of its travel, the main output VCAs are bypassed by relays, as indicated by a blue LED above the fader. Switching in the Output Compressor, moving the master fader down, or adjusting the associated Offset control (see below), switches the VCAs seamlessly back into circuit.

An automation status switch and LEDs are fitted next to the fader.

Offset control

This raises or lowers, by $\pm 20\text{dB}$, the level of the main output VCAs, allowing the master fader to be left at maximum while adjusting the gain of the main outputs.

Output Compressor

The main output compressor uses the same VCAs as the main fader. Switching the compressor **IN** introduces no additional audio circuitry to the main outputs.

This is a high quality 4-channel compressor with straightforward controls. The gain **MAKE-UP** simply acts as a level control to compensate for the lowered level which is a consequence of compressing the signal. This control may be set so as not to change the overall programme level when the compressor is switched in. The meter indicates dBs of gain reduction.

Insert points (patchrows L&M 1-4) are provided pre the VCAs. The compressor side chain is fed from the insert return. Selecting **KEY** bypasses the insert, allowing the insert return to be used as a key input. All four insert returns are summed to generate one sidechain control voltage, allowing the key input to be triggered by single or multiple signals.



Stereo Bus Master Controls

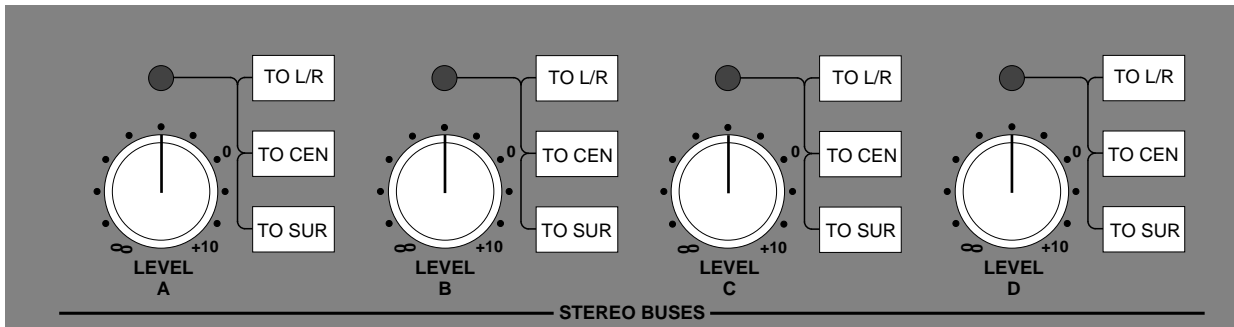

The level of the console's four stereo busses is set by four rotary controls to the right of the SL953 (see above). The bus outputs are fed to the patch (N 1-8), then normalled to the connector panel *and* to an insert return to the console (P 1-8). The insert return can be monitored via External Source Selector 1 (see Page 5-11) and may also be routed to the main mix busses using the reassign switches next to the level controls. Routing to Left and Right outputs is in stereo. Routing to Centre or Surround is in mono.

This allows the stereo busses to be used as audio subgroups, to generate centre or surround mixes, or to be normalled to an 8-track recorder, outboard effects equipment or foldback feeds.

The insert point enables audio groups to be processed before being mixed back onto the main outputs.

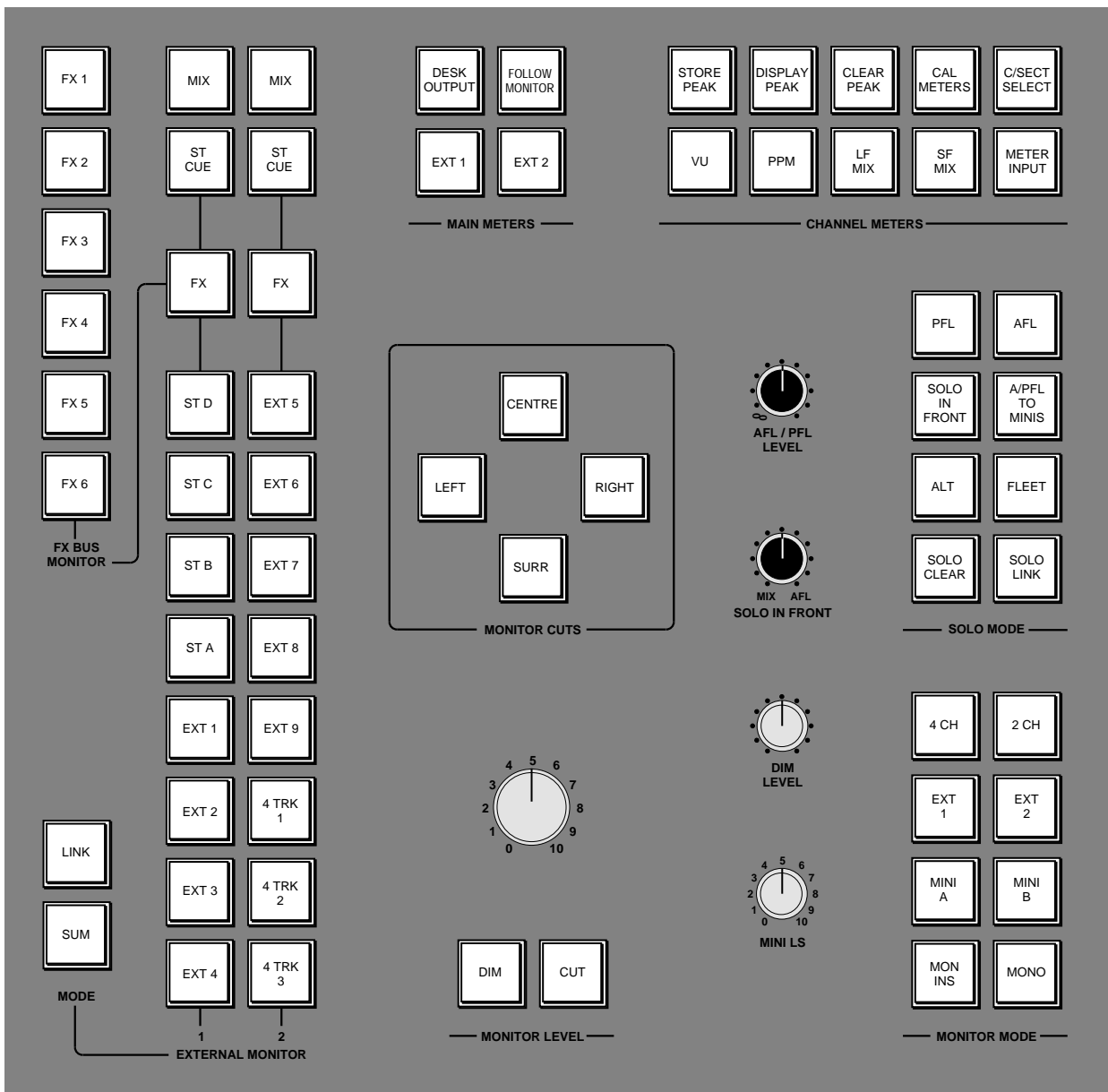

Control Room Monitoring System

Monitor Selection and Control

The large knob in the MONITOR LEVEL group of controls on the SL952 panel (see opposite) sets the level of the main control room monitors. The control room monitors are usually fed from the console's main outputs but alternative sources may be selected by the **EXT 1** or **EXT 2** buttons fitted in the MONITOR MODE group of switches. These buttons allows any one of the sources on the two 11-way EXTERNAL MONITOR selectors (see over the page), to be monitored.

DIM – The DIM button dims both Main and Mini loudspeaker outputs to a level preset by the DIM LEVEL pot. The DIM circuit is automatically activated when any of the following buttons are pressed: LISTEN MIC, FOLDBACK A, B or C, SLS, Oscillator to MIX, ABCD or BUSSES 1-48.

CUT – Cuts whichever pair of monitors have been selected. Activated automatically by the SLATE button.

The four *main* monitor outputs can be muted individually with the LEFT, CENTRE, RIGHT and SURR Monitor Cut switches.

The rest of the MONITOR MODE group of switches act as follows:

2 CH – Selects only the Left and Right bus signals to the monitor outputs. If the console is fitted with the LCR pan option, 2 CH will also switch the channel pan pots to two channel pan mode.

4 CH – Feeds Left, Right, Centre and Surround signals to their respective monitor outputs. If the console is fitted with the LCR pan option, 4 CH will also switch the channel pan pots to LCR pan mode.

MONO – Feeds a mono sum of the main bus to Left and Right monitor outputs in 2 CH mode, or to Centre in 4 CH mode.

MINI A and **MINI B** – When selected, the monitor bus is fed to the corresponding Mini Loudspeaker output via the MINI LS pot.

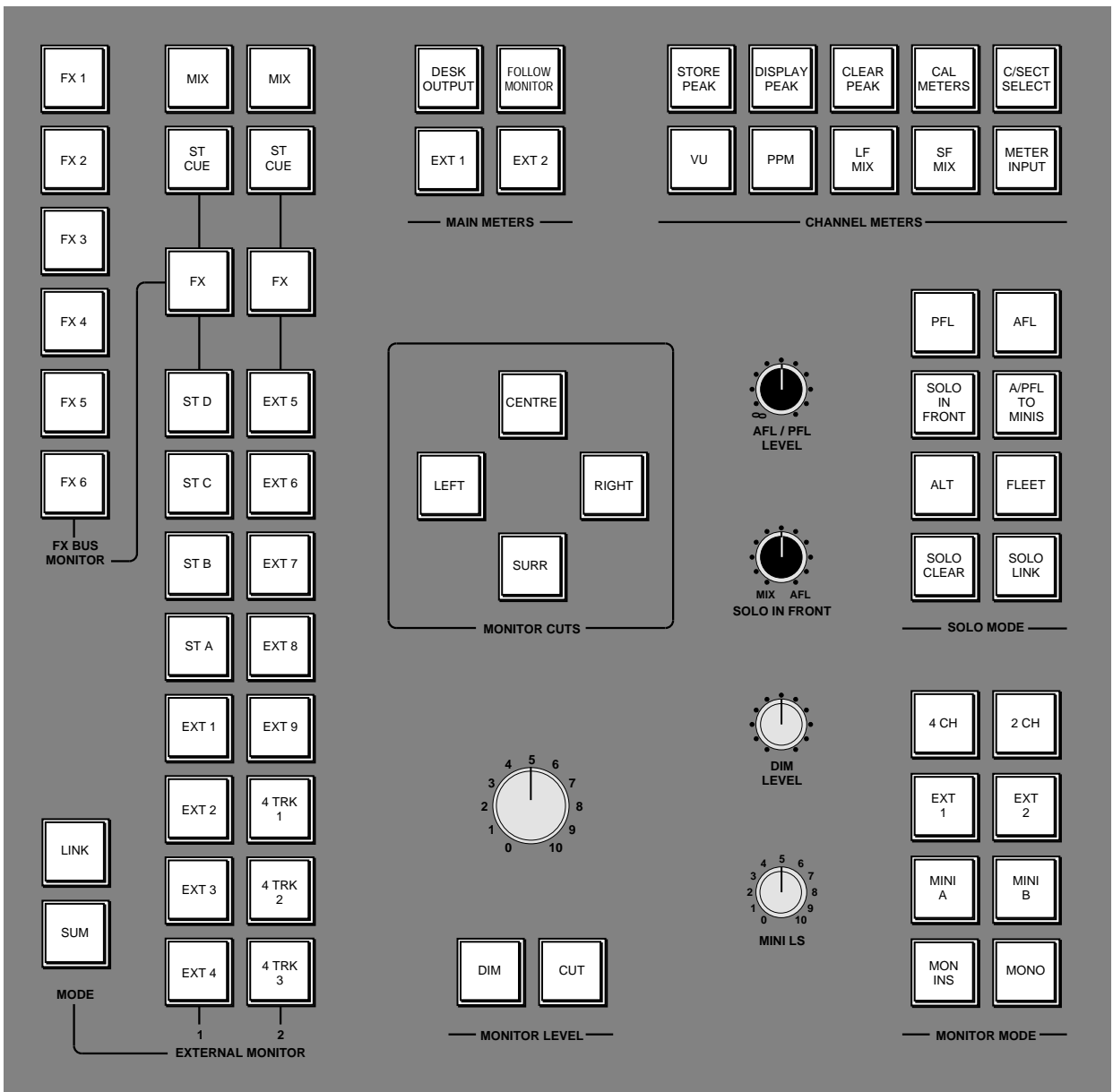

External Source Selectors

The console has two external source selectors, each fed by eleven sources. EXT 1 is a 2-channel selector and EXT 2 is a 4-channel selector. The first three sources are common to both selectors - **MIX** (desk output), the **ST(EREO) CUE** bus and the output of the **FX** (mono auxiliary) bus pre-selector.

EXT 1 can also monitor the four stereo busses, **ST A-D** (post insert point), and four stereo external sources, **EXT 1-4**.

EXT 2 can monitor five stereo, **EXT 5-9**, and three four channel external sources, **4 TRK 1-3**.

SUM allows sources to be summed together. This is particularly useful for generating complex foldback mixes or when stem mixing, as it allows the recorded stems to be monitored together with the current mix.

LINK links the two selectors together – selecting either one will light both **EXT 1** and **EXT 2** switches, and the two columns of source switches will intercancel.

SOLO/AFL/PFL

The console's default Solo mode is a destructive solo – soloing a channel cuts all other channels. The Large and Small Fader solo cut busses are normally separate but can be linked using the **SOLO LINK** switch.

AFL – When AFL is selected, pressing a channel solo switch routes the post pan signal, via the AFL bus and the AFL/PFL LEVEL control, to the monitor speakers. Note that, unlike on SL 4000 Series consoles, this signal is 'in-place' – that is it follows the position of the pan pot, even if the console is fitted with LCR panning.

PFL – When PFL is selected, pressing a channel solo switch routes a mono pre-fade signal, via the PFL bus and the AFL/PFL LEVEL control, to the monitor speakers. In 2 CH mode (see Page 5-9) this is routed to Left and Right speakers. In 4 CH mode it is routed to the Centre speaker.

A/PFL TO MINIS – Selection of this button routes the AFL or PFL signal to the MINI 'A' loudspeakers, leaving the desk output on the Main monitors. Note that the AFL/PFL LEVEL control has no effect in this mode; control the level on the MINI LS pot.

SOLO-IN-FRONT – With SOLO IN FRONT selected, pressing a channel solo switch routes a mix of the AFL signal and the desk output to the monitor outputs. The SOLO IN FRONT mix control adjusts the balance between AFL signal and desk output.

ALT – Selecting ALT makes the channel solo switches intercancel with each other, so that soloing one channel will clear any other solo switches.

FLEET – Selecting FLEET makes all channel solo switches momentary.

SOLO CLEAR – This turns off all channel and group solo switches whenever it is pressed. Note that centre section AFL switches (on Echo Returns, Foldback outputs etc.) are not cleared by this function, as these switches are mechanically latched.

Cue-FX Sends

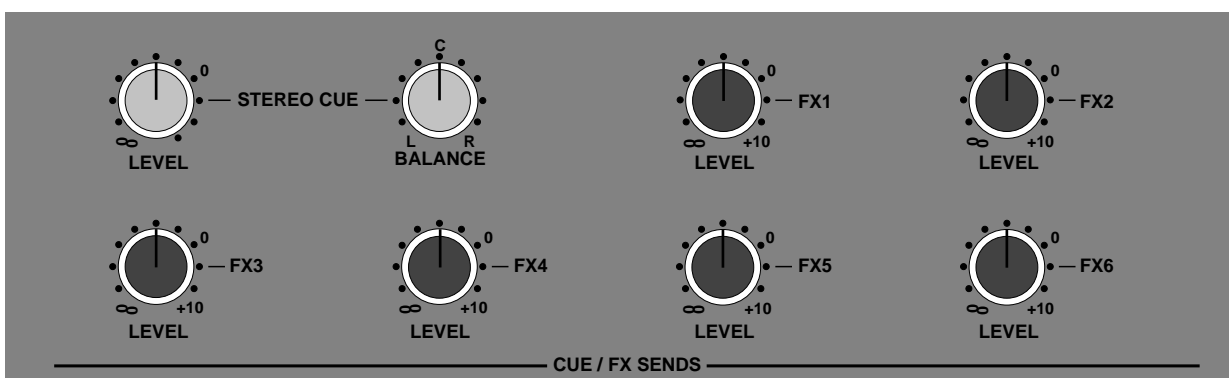

Each channel is fitted with one stereo and six mono auxiliary sends for use as foldback, echo sends or as mix-minus feeds. The master output LEVEL controls on the SL953 (see above) all have 10dB of gain when turned fully clockwise, and are indented at the unity gain position. The Stereo Cue output is additionally fitted with a BALANCE control.

FX sends 1 to 6 appear on the patch at R1-6, where they are normalled to effects units via S1-6.

The Cue Stereo send is normalled via jacks R&S7-12 to the external inputs of the Foldback circuitry (see over the page).

Studio Loudspeakers and Foldback Sends

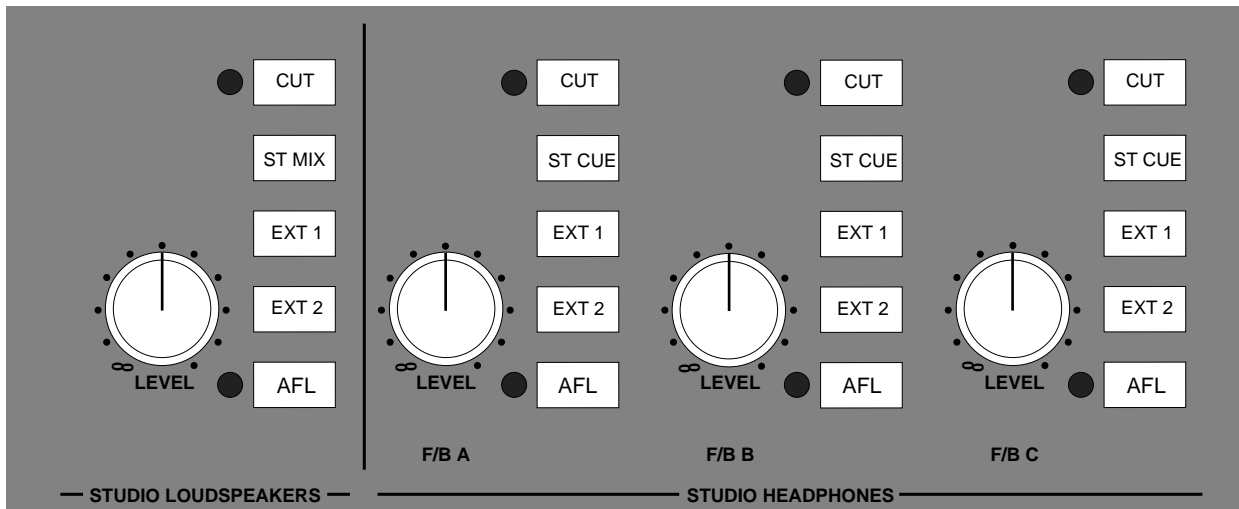

The console provides three stereo headphone outputs - FOLDBACK A, B and C plus a stereo STUDIO LOUDSPEAKERS (SLS) output (see above).

Each output has dedicated **LEVEL** control, **CUT**, **AFL** and three source selector switches. Sources can be selected separately or summed together by selecting one or more of the switches.

The sources for the Foldback outputs are the two external source selectors (**EXT 1** and **EXT 2**) plus a stereo input from the patch bay. This input is usually normalled from the Stereo Cue output, but individual consoles may be specified differently.

The sources for the SLS output are the two external source selectors (**EXT 1** and **EXT 2**) plus the Left and Right main outputs, pre-tone and talkback injection.

Note that the SLS feed is normally cut when the console is in RECORD status, to prevent speaker howlround.

The Foldback outputs are cut whenever the Oscillator to BUSSES 1-48 switch is selected.

Stereo Echo Returns

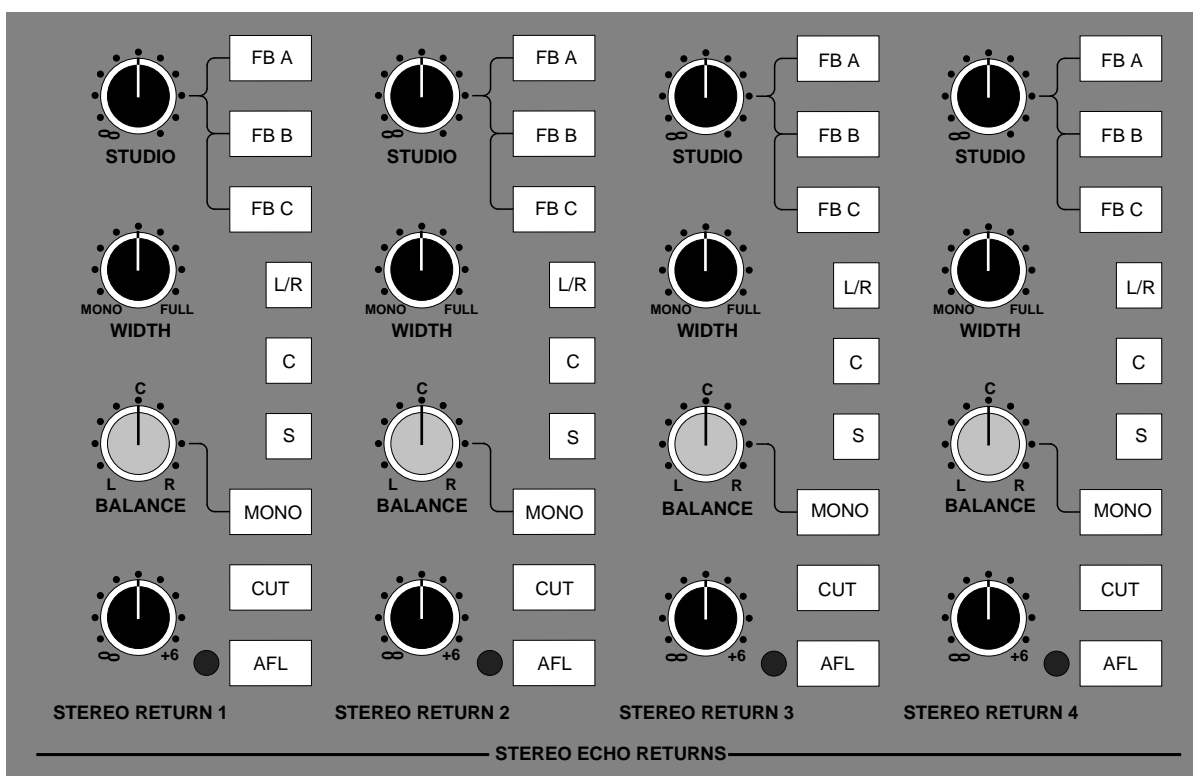

The four stereo Echo Returns are designed to be driven by the outputs of devices which have been fed from the corresponding mono FX busses described on Page 5-12.

STUDIO – The STUDIO level control and its three associated routing switches (**FB A-C**) allow Echo Return signals to be mixed with the three Foldback outputs.

WIDTH – Controls the stereo width of the return. Can be adjusted from full stereo to mono.

L/R, C, S – These switches route the Echo Return signals to the Main mix busses. Echo Return signals to Left and Right busses are fed in stereo. The Centre and Surround busses are fed by a mono sum of the left and right Echo Return signals. The rotary level controls at the foot of this section set levels to the Main mix busses.

MONO – When this switch is up, the BALANCE control will provide a balance between the left and right return signals. When MONO is selected, the Echo Return inputs are summed in mono, and the BALANCE control now acts as a pan control. This is very useful when you are using a mono FX device, as it saves having to parallel the Echo Return inputs on the patch.

CUT – Cuts both Left and Right inputs.

AFL – Feeds Echo Return signals (post pan control) to the AFL bus, and switches the bus output to the main monitors via the AFL level control.

Metering

Centre Section Meters

Fitted above the SL952/953 master panels are either four VU meters and an LCD phase 'scope or five VU meters, a phase meter and two indicator panels. In either case, four of the VU meters are dedicated to reading the LCRS meter outputs from the centre section.

If fitted, the phase 'scope is fed by the left and right meter outputs.

If fitted, the fifth VU meter is fed by a mono sum of the other four meter outputs, and the phase meter by left and right meter outputs. The two indicator panels provide LED tallies showing the state of the monitor Cut and Dim switches, whether Solo is selected, whether the SLS output is un-muted, and whether the Listen Mics are on.

Four MAIN METERS buttons assign signals to these meters:

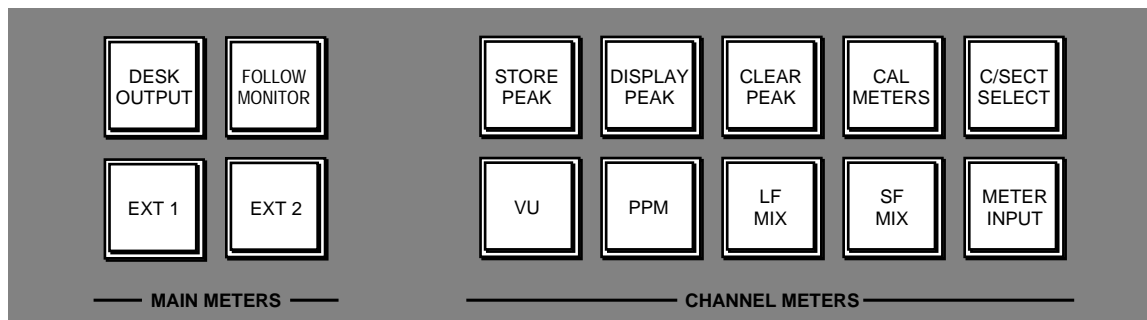

DESK OUTPUT – Selects the Main LCRS output to the main meters.

FOLLOW MONITOR – Whatever signal has been selected to the monitor loudspeakers will be displayed on the main meters.

EXT 1 – The main meters will display the level of an external source selected on External Source Selector 1, irrespective of whether it is being monitored or not. In other words, the console's main output can be monitored while the meters are used to check the returns from a stereo tape machine recording the desk output.

EXT 2 – The main meters will display the level of an external source selected on External Source Selector 2, irrespective of whether it is being monitored or not.

A bank of eight LCD meters is fitted above the computer monitor. The **C/SECT SELECT** switch, in the CHANNEL METERS bank of switches toggles the source for these meters between the four Stereo busses, the eight Auxiliary busses and the Main LCRS meter feeds. On some consoles the remaining four meters, when LCRS is selected, are fed from the patch. This allows, for example, master machine returns to be metered next to the desk output.

Channel Meter Controls

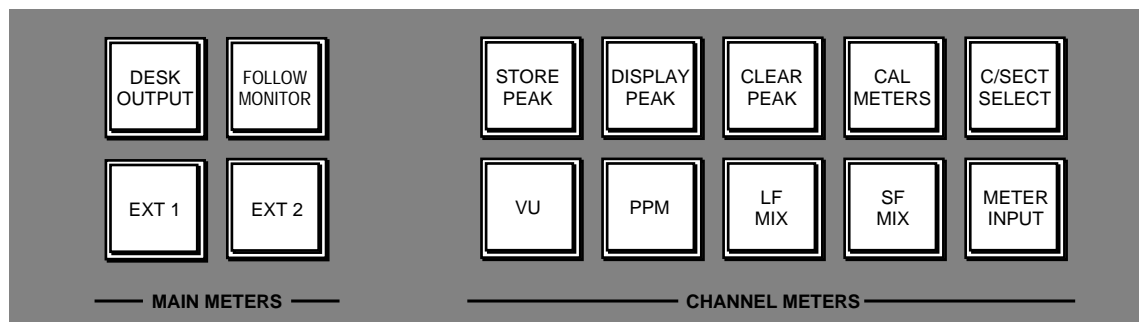

The switches in the CHANNEL METERS bank have the following functions:

PPM – Selects Peak Meter scale and ballistics. The peak scale is a fast attack (100 μ Sec) design, intended for use with both analogue and digital recorders. It is scaled from 0dB to -52dB. A reading of '0' normally corresponds to an input level of +18dBu – ie. 6dB below the digital clipping point on most professional digital recorders.

The Peak meter can be calibrated from a computer terminal to read '0' over the range +16dBu to +24dBu.

A single segment, which holds for 2 seconds, gives an indication of peak levels.

VU – Selects VU scale and ballistics. A reading of 0VU normally corresponds to a level of +4dBu but this can be changed from a terminal to give a reading of 0VU over the range 0dBu to +6dBu.

A single segment, which holds for 2 seconds, gives an indication of peak levels.

STORE PEAK – The peak level reaching each meter is stored whenever this button is pressed.

DISPLAY PEAK – When selected, the peak levels stored by the STORE PEAK button are displayed as a single segment which does not decay. This peak reading is updated as long as the STORE PEAK button is still selected.

Note that selecting DISPLAY PEAK in VU mode will turn on both Peak and VU meter scales. The peak segment is a true peak level and is shown against the Peak scale.

CLEAR PEAK – Clears the stored peak readings.

LF MIX and **SF MIX** – These select the meters to display the levels of the channels' Large and Small Fader VCA control voltages. This can be very useful during an automated mix if you are working with the Large Fader motors off, or simply to provide an indication of Small Fader VCA levels. These selections also apply if mechanical VU meters are fitted.

C/SECT SELECT – See Page 5-15.

METER INPUT – Forces all channel meters to display channel input signals.

CAL METERS – This function is provided for use on the odd occasion when the LCD meters may need calibrating. Calibration may drift with time and temperature, and this condition will be indicated by more than one segment showing at the foot of the meter (with no signal present). If you suspect that the meter calibration has drifted, press CAL METERS and hold it down until you hear the meter relays 'clunk' (approx 2 secs). The system will now carry out a self-calibration procedure and, after about 20 seconds, another clunk will indicate completion. Note that the channel number display on each meter extinguishes during the calibration procedure.

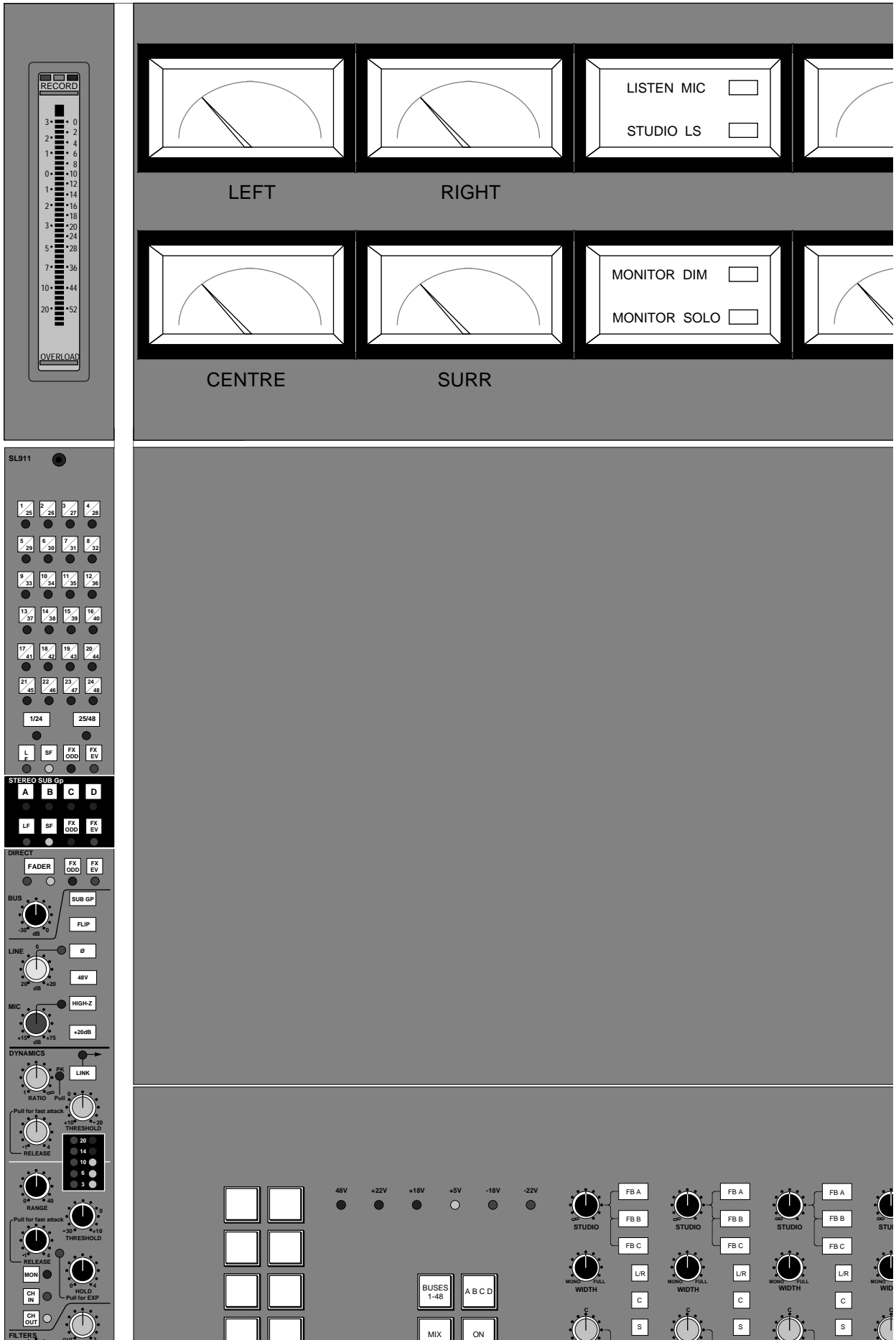

Group Faders

Eight Group Control Faders are located below the SL952 panel. These faders can control any number of channel faders that are assigned to them using the **HARD GROUP SETUP** function (on the top left of the SL955 Motion Control panel). Any Group may be assigned to another Group. For example, all Drum channels could be assigned to Group 1, Basses to Group 2, Keyboards to Group 3 and Guitars to Group 4. These four groups may then all be assigned to Group fader 5, which will now act as an overall backing level control.

See Section 3 of this manual, and the J Series Computer Operator's Manual, for more details on grouping assignments.

CUT – Will mute all faders assigned to that Group.

SOLO – The Group Solo works slightly differently to the Solo function on an I/O module, in that it cuts all Groups which are not soloed. The cuts thus generated will be read by the J Series Computer during an automated mix (Note that an I/O module Solo will cut all other channels not soloed but these cuts are *not* recorded by the computer).

This is extremely useful as it is possible to 'play' the Group Solo buttons during a mix and store the results. For example, if Groups 1 and 2 (as above) are soloed during an automated mix, the computer will store the cutting of all the other Groups. This will have the effect of reducing the backing track to Bass and Drums only

The Group Fader solo switches can be disconnected from the automation system in the J Series Computer's Switch Protection menu – see Computer Operator's Manual for more details.

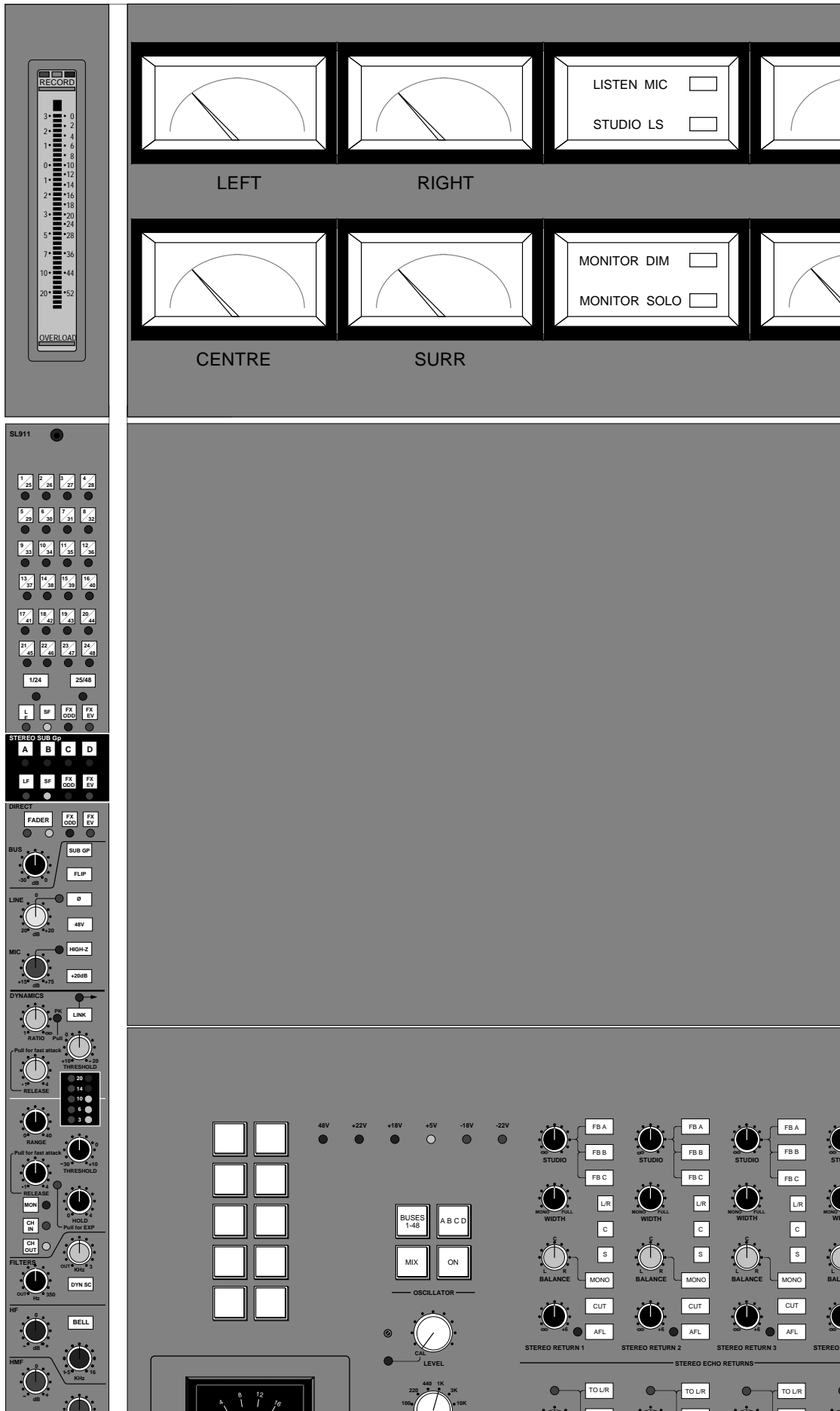

Communications

Talkback level controls are fitted on the SL953 panel, to the right of the main output compressor (see opposite). In addition to a built-in talkback microphone, the controls set the level of talkback to the studio loudspeakers (TB to SLS) and headphones (TB to Foldback), Slate Level and incoming Listen Mic levels. The talkback microphone is fitted flush into the control surface next to the TB to Foldback level control.

TB to Foldback and **TB to SLS** – These controls set the level of talkback to the Foldback (A, B and C) and the SLS (Studio Loudspeakers) outputs. Note that talkback is inserted after the Foldback and SLS level controls (see Page 5-13).

Slate Level – This control allows the level of talkback to tape to be adjusted. A low level 30Hz tone is added to the slate signal so that an ident may be easily located at high tape wind speeds.

Listen 1 and **2** – The Listen Mic gain controls have integral pull-for-off switches. Two listen mics can be placed in the studio and connected to the console's Listen Mic Inputs. These feed up to the patch and appear at N&P 41-42. The mic signals are mixed together via the level controls and fed to a compressor (more on this below).

The group of COMMUNICATIONS buttons (to the left of the Main Fader – see opposite) controls the switching and routing of Talkback and Listen Mic signals, as well as the switching of a Red Light.

RED LIGHT – Provides an isolated contact closure for hooking up to a studio red light or transmission light via an external relay box. When the AUTO CUE button is on (see below), the red light can be activated automatically when the multitrack goes into Record. (Internal links can be set to select this option from machine Play *or* Record).

CUE LIGHT – Provides an additional isolated relay closure for hooking up to studio cue lights etc.

SLATE – Cuts all loudspeakers and feeds the talkback mic to multitrack busses 1-48, Main output busses, Foldback sends and Studio Loudspeakers. A low level 30Hz tone is mixed in with the signal to tape so that the slate may be easily located at high wind speeds.

EXT T/B – Provides switched talkback which appears on the patchbay at N44, for use as an additional talkback send to the studio floor, the machine room or anywhere else you fancy!

The **SLS**, **F/B A**, **F/B B** and **F/B C** buttons send talkback to those respective outputs.

AUTO CUE – This activates an autocueing system, useful in an overdubbing situation. Talkback and optionally the Listen Mic switches, which are normally non-latching, can be latched on for constant two way communication when the multitrack is in Stop or Wind. The Talkback (and Listen Mic) signals are automatically switched off when the machine enters Play or Record.

LISTEN – Feeds the Listen Mics to Mini Loudspeakers 'A' and dims the Main Loudspeakers.

Oscillator

The oscillator section (see right) contains controls for frequency, level and routing of the oscillator to the Main outputs, the Stereo Subgroup outputs and the Multitrack Group outputs.

BUSSES 1-48 – Routes the oscillator to all multitrack Group outputs.

MIX – Routes the oscillator to the main LCRS outputs.

A B C D – Routes the oscillator to the four Stereo Subgroup outputs.

ON - Switches the oscillator on, would you believe. It's good practice to turn the oscillator off when recording, to prevent any leakage onto the desk outputs.

The rotary **FREQ** switch provides eight preset frequencies. The **LEVEL** control adjusts the output level from -25dB to +20dB. When fully anticlockwise, a preset level is selected which can be calibrated with the small multiturn pot located to the left of the main level control. A red LED lights to show when the level control is no longer in the calibrated position.



The oscillator output is available on the patch (jack N9) and is normalised to the tone distribution system (P9). This allows an external oscillator to be fed into the tone routing switches – very useful for injecting those odd frequencies or for pink (or red!) noise.

A second output, 60dB lower than main oscillator output, is available on jack N10 for testing microphone inputs etc.

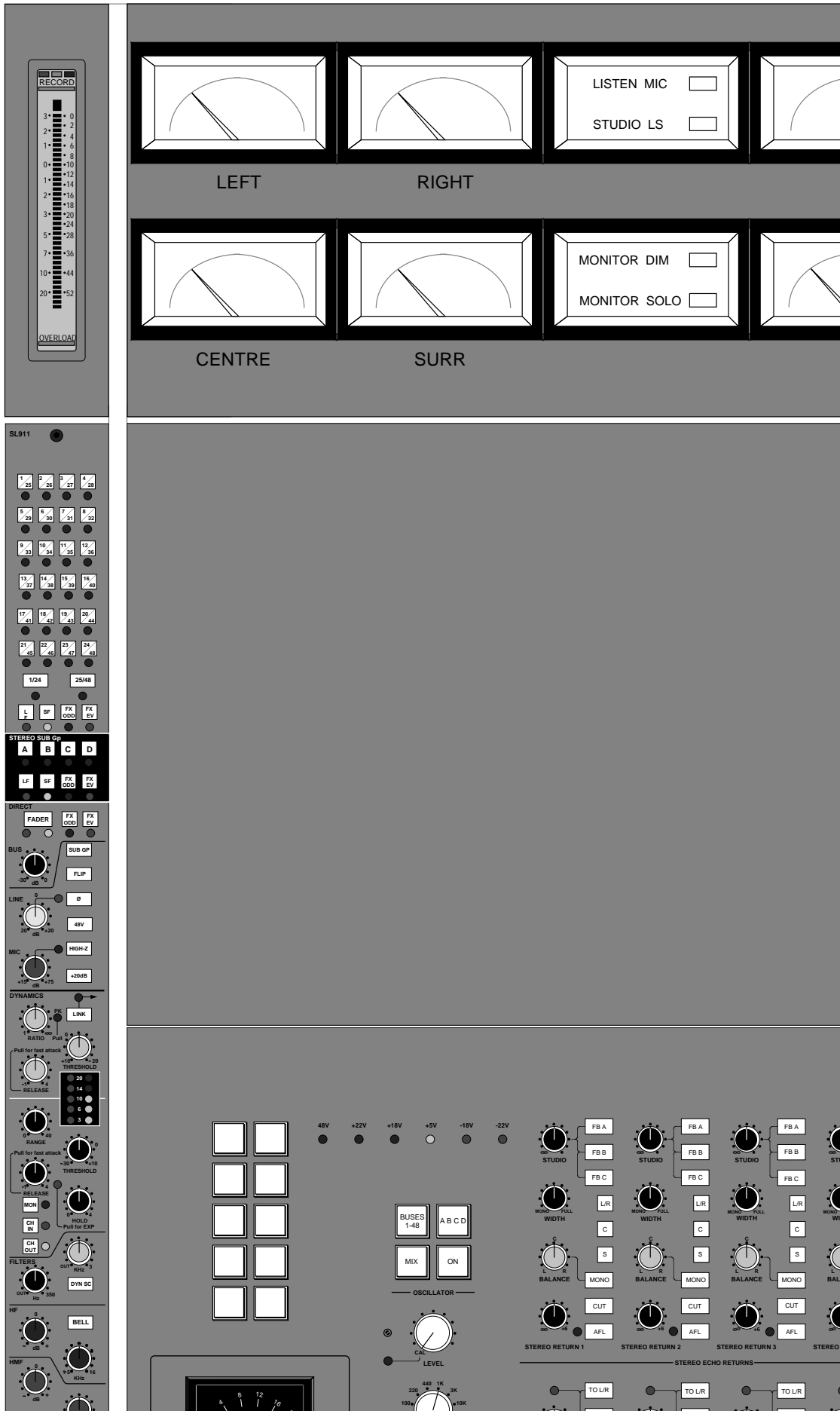

Option Switches

A variety of functions may be provided by the ten user option switches at the top left of the SL953 panel. Depending on the console specification, these can include:

SMALL FADER TO MONITOR – For 8-channel bays or groups of bays. This function forces channels in the designated bays to Small Fader to Monitor mode when the console is in Record status. This is useful when tracking, allowing the Large Faders on Modules 1-24, for example, to act as Monitor faders and the Large Faders on selected bays to act as Channel faders (see Section 2 for more on this).

SOLO ISOLATE – Isolates a designated 8-channel bay, or bays, from the Large and Small Fader solo cut busses.

CHANNEL IN TO METERS – Forces the designated bay or bays to meter channel input signals.

MASTER CHANNEL INPUT FLIP – Flips channel inputs in the designated bay or bays, provided the console-wide MASTER INPUT FLIP is not selected.

Blank Panel

A panel is available to mount custom options above the SL953. If this panel is currently blank, please contact your local SSL office or distributor to discuss the various possibilities.

The SL 955J Motion Control Panel

All the functions on this panel, situated below the computer monitor, are fully described in the J Series Computer Operator's Manual.

Solid State Logic
SL 9000 J Series
Total Studio System

Console Operator's Manual

SECTION 6

The Patch



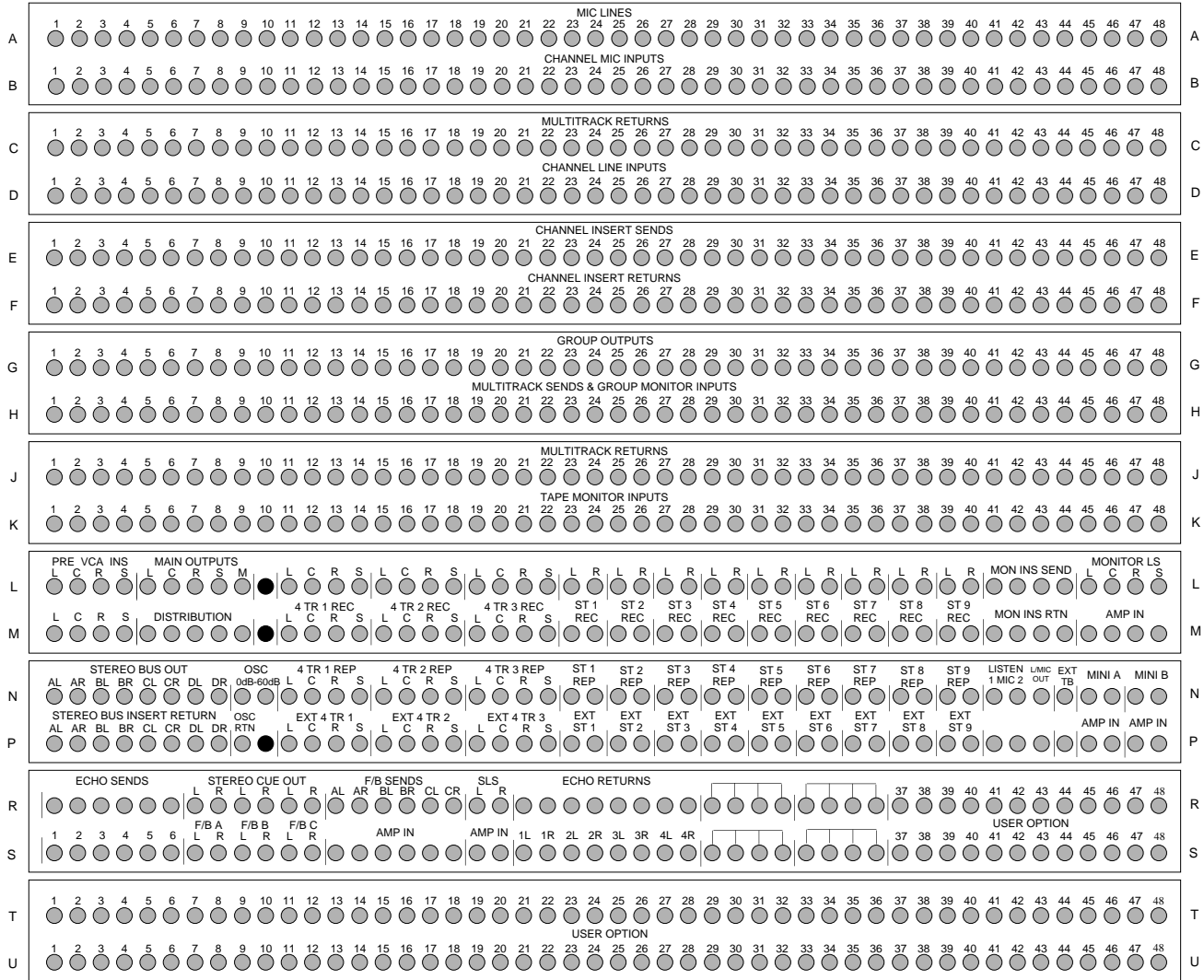

The Patch

The SL 9000 J Series patchbay is supplied with a minimum of nine, 1U (rack unit) high, panels of bantam (TT) mini-jacks, each with two rows of jacks.

Each row will contain a different number of jacks according to the number of I/O modules in the console. Consoles with more than 56 channels come with the patch split into two columns, ie. two columns of 32-wide rows for a 64 channel console, two columns of 40-wide rows for an 80 channel console etc. The majority of consoles are supplied with integral patchbays, however, as an option, versions with remote patchbays are available. The layout and normalling of a remote patchbay will be the same as that for an integral one of the same size.

The rows in each patch panel comprise a logical pair, the upper jack being an output feed and the lower jack being an input. There are two types of normalling used within the patch:

HALF-NORMALLED – The top row is an output listen (bridging) jack. If a jack is inserted into the top row it receives the feed on that socket but does not break the normalling to the row below. The outers are wired down to the inners (blades) of the row below. The bottom row is an input jack and when a patchcord is inserted, it breaks away the normalled feed from the row above.

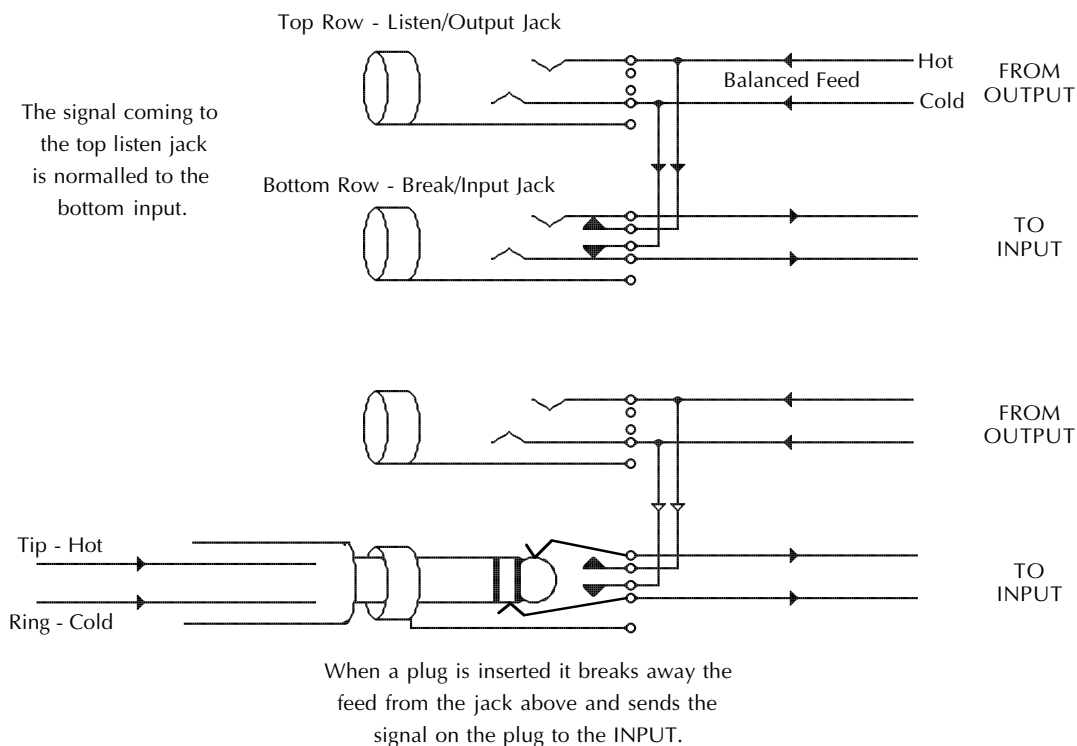

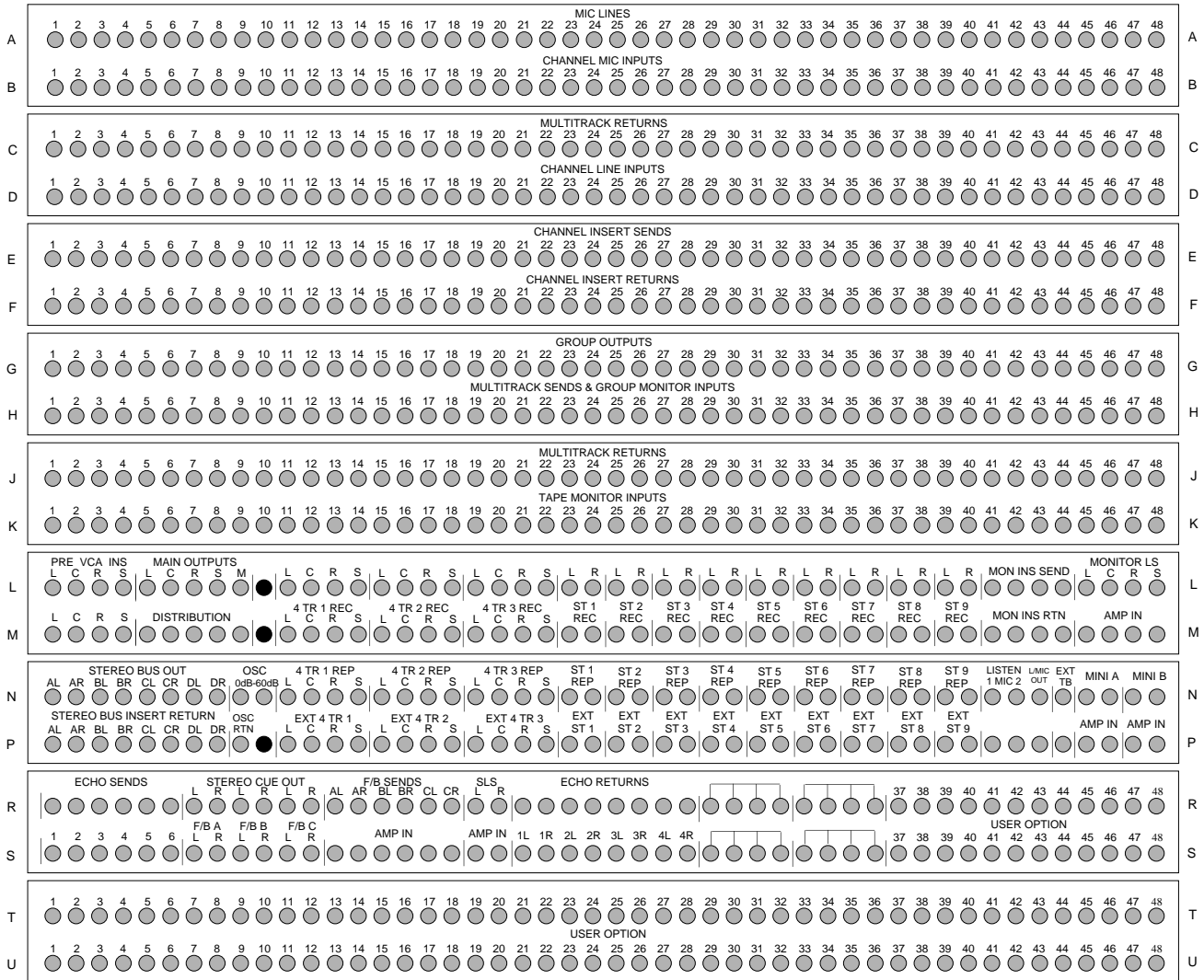

FULLY NORMALLED – The top row inners are wired to the bottom row inners. A jack plugged into either the top or bottom row will break the normalling.

Only the first two rows of jacks (the Mic Lines and Channel Mic Inputs) are fully normalled to prevent a microphone from being connected to two Channel Inputs simultaneously. Most of the other rows are half normalled, apart from the User Option jacks in Rows R, S, T & U (unless normalling was requested in the console specification). Any additional rows fitted may, or may not, be normalled and this should be checked locally with the facility.

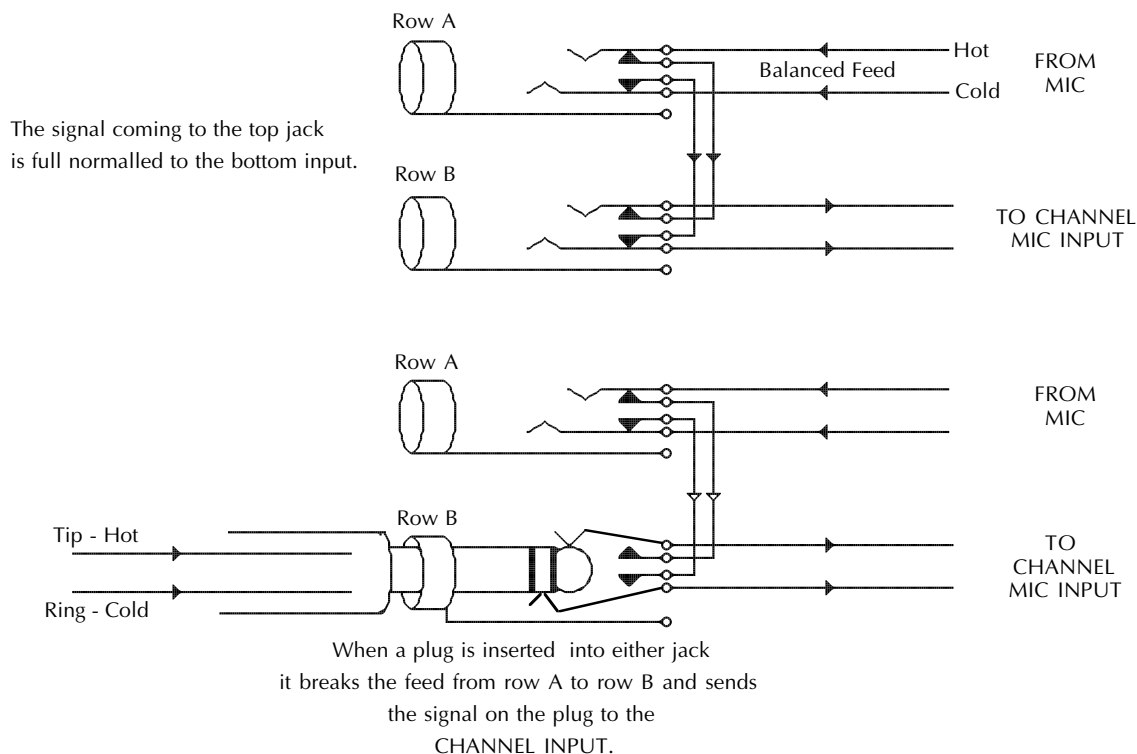

ROWS A to K are fairly obvious with these exceptions and notes:

The Multitrack Returns (ie. multitrack outputs) split on entering the console and feed identical signals to both Rows C and J.

Signal is always present at the Channel Insert Send jacks (Row E). It is the return signal path that is switched by the insert IN switch. This is useful for setting input levels on effects devices before switching them in, and also useful for picking up additional feeds from each module.

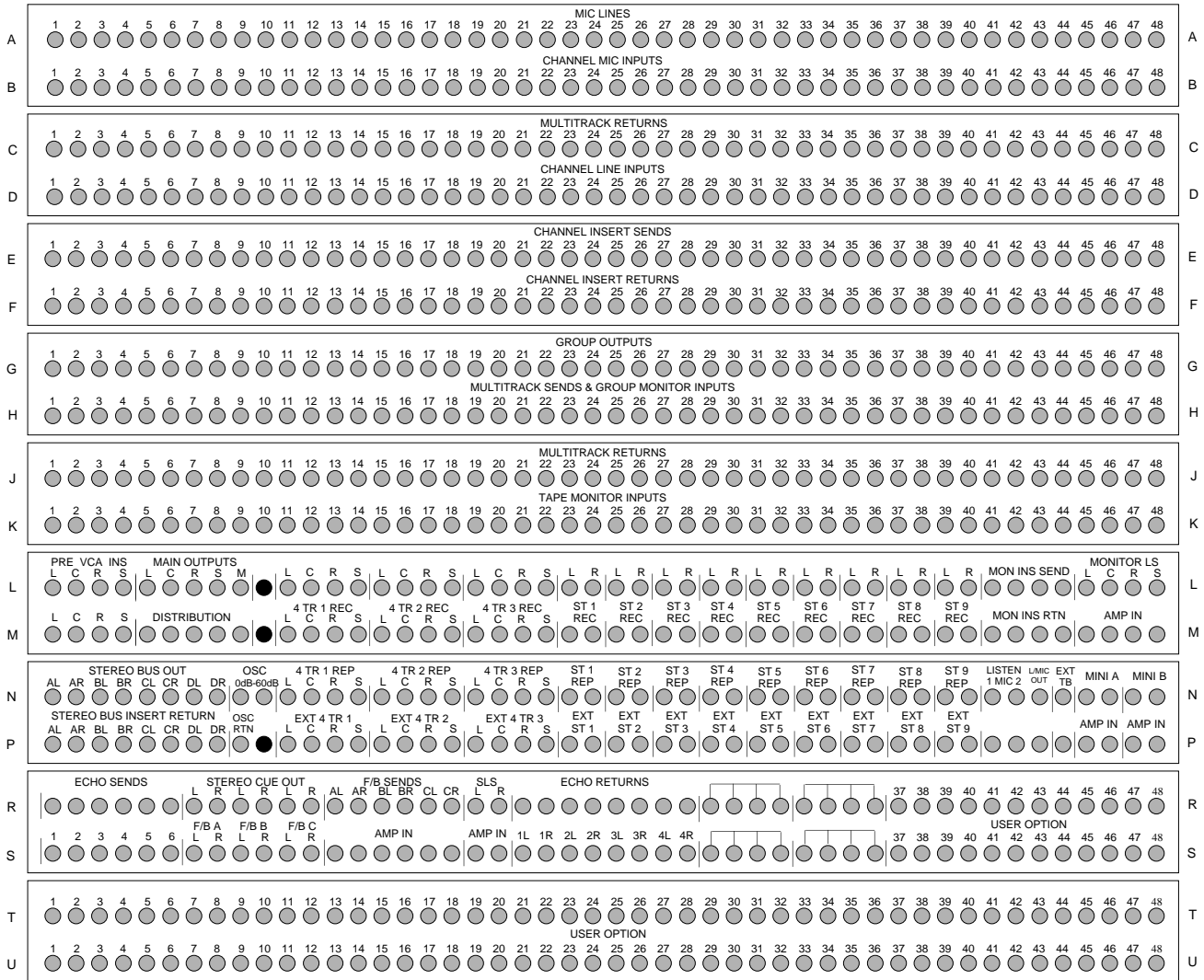

Group Outputs on Row G are after the I/O module Bus Trim control. These are normalled down to Row H. Row H feeds the Multitrack Sends (i.e. the multitrack inputs) and also the **GROUP** monitoring button. The **GROUP** button on a module will always monitor a Multitrack Send even if the Groups have been cross patched.

ROWS L to S – Some jacks are cross normalled and these are detailed below together with certain inputs and outputs, the wiring of which may not be immediately obvious. Note that the following descriptions are based on a 48-channel patchbay. According to the size of your console, there may be some variation in the layout of rows beyond Row K. Rest assured that all the functions and normalling described below will be the same for all consoles, regardless of the actual location of those functions.

PRE VCA INS (L1-4, M1-4) – Four insert points after the LCRS bus mix amps and before the Main Output VCA Fader (and 4-channel Compressor). These insert points can be used to insert other compressor/limiters or EQs into the main desk outputs.

MAIN OUTPUTS + DISTRIBUTION (L5-L9, M5-M9) – These are the main LCRS and Mono Outputs from the console. L5-8 carry the main LCRS Outputs which are normalled down to the main LCRS distribution jacks M5-8. These four jacks feed the 4-Track and Stereo Recorder jacks L11-L40. 4-Track 1 and Stereo 1 are fed directly from M5-8; all the other Recorder feeds are buffered. The three sets of 4-Track Recorder inputs (L11-22) are derived from the LCRS outputs (M5-8). The stereo machine inputs (L23-L40) are fed from the L and R Outputs, M5 & M7.

The four Distribution jacks (M5-8) can be useful for multi-machine tape copying. Plugging the source signal into M5 and M7, for example, will feed the inputs of all Stereo machines connected to jacks M23-40.

TAPE MACHINES (L, M, N, P 11-40) – Four jacks for each machine track. The top jack (Row L) provides the console main output which is normalled to the machine Record input (Row M). The machine Replay output comes up on Row N and is normalled down to the External Monitor Selector inputs (Row P). The inputs on Row P are very useful if you need to meter a signal. For example, patching into jack P23 and selecting **EXT 1** on the External Selector 1, with the main meters selected to **EXT 1**, will bring the source up on the Left main meter.

STEREO BUS OUTPUTS and INSERT RETURNS (N1-8 and P1-8) – These provide a post main level control Output/Insert for the four Stereo Subgroup busses, A, B, C and D. If used as an insert point for external limiters, EQ etc., the effect will be applied before the busses are folded back to the main LCRS mix busses (See Sections 2 and 5 for more on this). The Insert Return jacks (P1-8) feed External Monitor Selector 1 and also the console's connector panel for connection, if required, to an external layback machine.

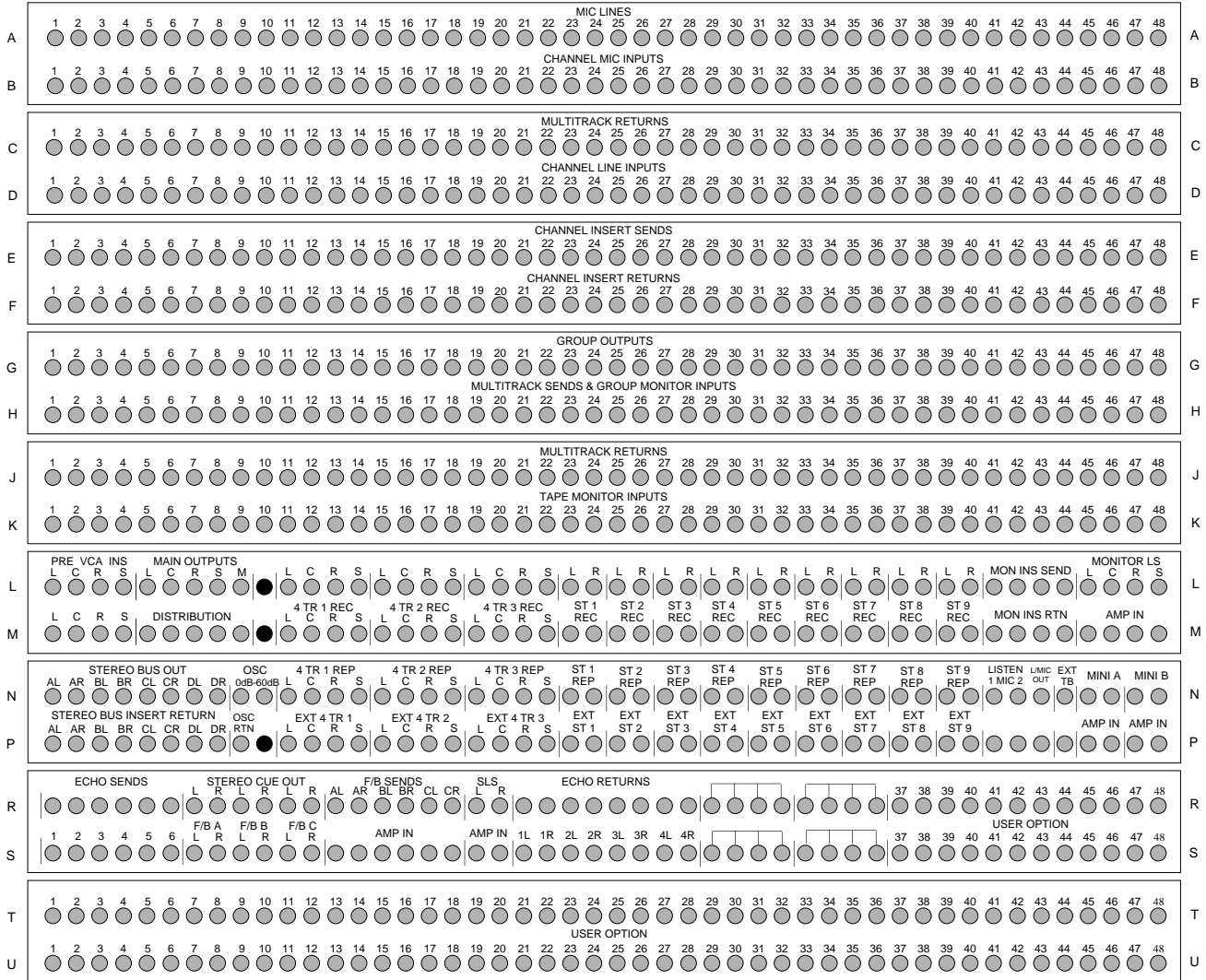

OSC (N9-10 & P9) – Yes, the oscillator! N9 provides the normal oscillator level signal and is normalled to P9, the console's tone distribution system. Oscillator distribution within the console is handled by the **BUSSES 1-48, ABCD** and **MIX** selection buttons in the centre section. If required, an external oscillator or pink noise source can be patched into P9 for distribution to the desk's Group Outputs, Stereo Subgroup Busses or Main LCRS Outputs. N10 provides an oscillator output at -60dB – useful for checking microphone inputs.

MONITOR INSERT (L41-44 & M41-44) – This is a switchable insert point, pre the main monitor level pot, provided for the connection of a Dolby Surround Encoder/Decoder.

MONITOR LS (L45-48 & M45-48) – L45-48 carry the Main monitor outputs which are normalled to M45-48 feeding into the Main monitor amps. **WARNING** – These jacks feed directly to power amps. Patching a standard line level signal into them will run the monitors flat out, probably causing damage to the speakers and your ears.

MINI A and MINI B (N45-48 & P45-48) – The feeds to two pairs of (near-field) monitors. Again remember that plugging line level sources into jacks P45-48 may blow the speakers.

LISTEN MICS (N41-43 and P41-42) – N41&42 should be wired to two mics hanging in the studio area. P41-42 are normalled from the mics and feed into the console Listen Mic inputs. Level controls and on/off switches for these mics can be found in the centre section. N43, L/MIC OUT, provides an output of the Listen Mic circuit post-compressor, the sound of which is much loved by many experienced SL4000 users. Note that a sum of both Listen Mic Inputs is fed via the compressor so you need to cut the other input if you only want a feed from one mic.

EXT TB (N44 & P44) – The External Talkback feed. The top jack carries a switched talkback feed from the mic in the console, activated by the **EXT TB** button on the SL 952. The bottom jack feeds this signal to a destination known only to the studio wiring staff.

ECHO SENDS (R1-6 & S1-6) – These carry the FX Send 1 to 6 outputs which are normalled to the effect send lines out of the console (S1-6).

STEREO CUE OUT (R7-12 & S7-12) – Three parallel outputs of the Cue Stereo Bus which are normalled to the switch selectable **STEREO CUE** inputs of the centre section's Studio Headphone circuits, F/B A, B and C.

F/B SENDS (R13-18 & S13-18) – Three stereo Studio Headphone outputs as described above. These can be fed from a choice of Cue Stereo or sources from the two External Monitor Selectors. The outputs in the upper row are normalled to foldback amp inputs in the lower row.

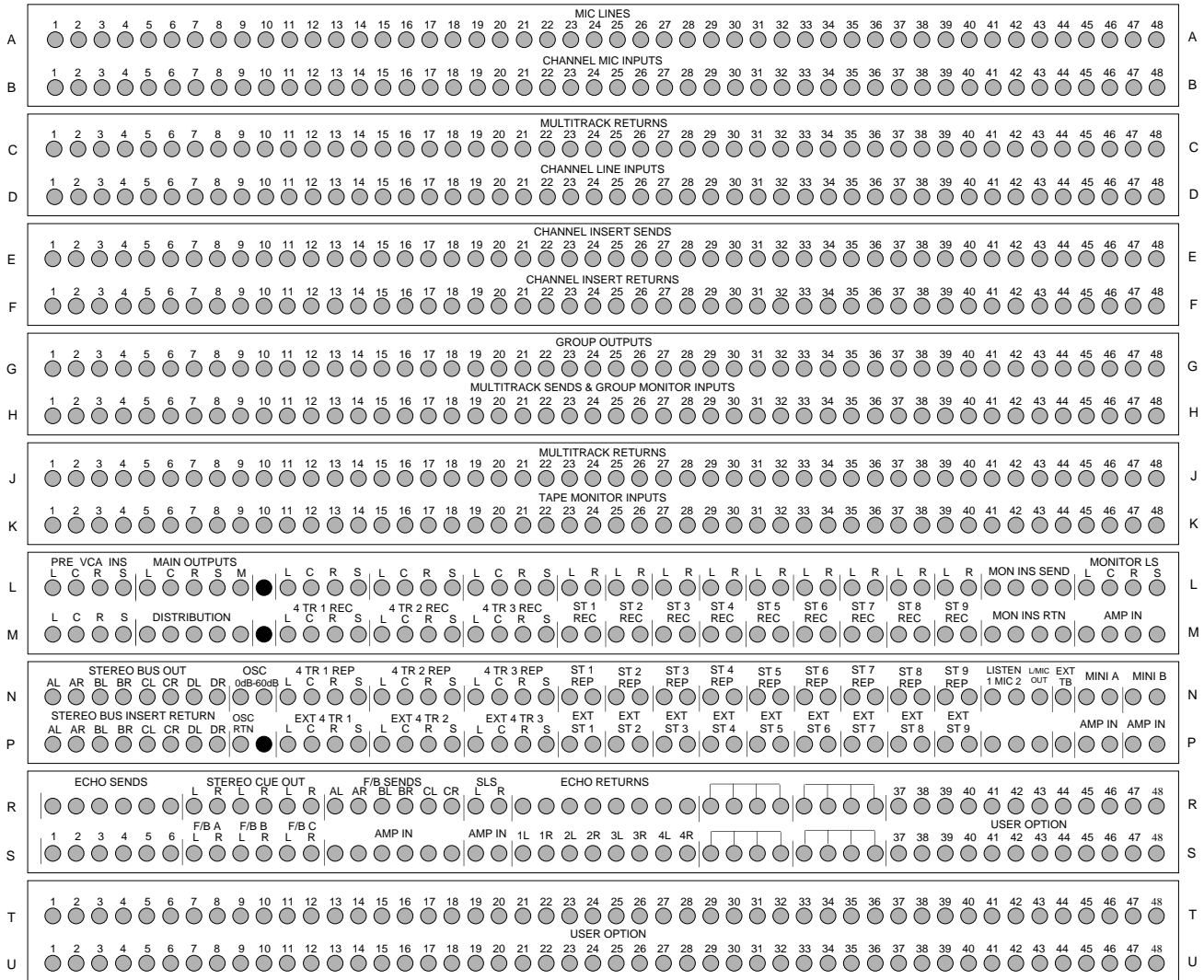

SLS (R19-20 & S19-20) – The Studio Loudspeaker outputs are normalled here to the power amp feed. Watch it!

ECHO RETURNS (R21-28 & S21-28) – R21-28 may be wired to the outputs of reverb or effects devices. They are normalled to the inputs of the four Stereo Echo Returns, situated in the console's centre section.

We are always interested to learn how many users actually read our operational manuals! If you are reading this, we would like to hear from you. If you are reading a paper version of the manual, write your name, facility name and address, in the space below and fax this page to +44 (0)1865 379100. If you have any comments to make about this manual, please fax them along with this sheet. If you are reading this from a CD-ROM, then e-mail steved@solid-state-logic.com. If you are reading from our www site, e-mail daveg@solid-state-logic.com. In either case, please include the information requested above. Multiple applications will be disqualified! The first five respondents will receive a small but useful gift from SSL; the first respondent will also receive additional goodies! This competition is not open to employees of SSL, their partners, relatives, pets or alter egos.

Solid State Logic

SL 9000 J Series Total Studio System

Computer Operator's Manual



82S6MGKD2A

21.8.96

Solid State Logic

Begbroke, Oxford, England OX5 1RU • +44 (0)1865 842300

1 rue Michael Faraday, 78180 Montigny le Bretonneux, France • +33 1 34 60 46 66

Via Pirandello 17, 20099 Sesto San Giovanni, Milan, Italy • +39 2 262 24956

320 West 46th Street, New York, NY 10036, USA • + 1 212 315 1111

6255 Sunset Boulevard, Los Angeles, California 90028, USA • +1 213 463 4444

702 Brimorton Drive, Scarborough, Ontario, Canada • +1 416 431 9131

3-55-14 Sendagaya, Shibuya-Ku, Tokyo 151, Japan • +81 (0)3 5474 1144

447A Macpherson Road, Singapore 368157 • +65 285 9300

Visit SSL on <http://www.solid-state-logic.com>

© 1996 by Solid State Logic Limited

All Rights reserved under International and Pan-American Copyright Conventions

SSL, Ultimation, Total Recall, Axiom, DiskTrack, OmniMix, Scenaria, VisionTrack, ScreenSound and SoundNet
are Registered Trademarks of Solid State Logic Limited

No part of this publication may be reproduced in any form or
by any means, whether mechanical or electronic, without the
written permission of Solid State Logic Ltd., Oxford, England.

First Edition – January 1995
Second Edition – September 1996

*As research and development is a continual process, Solid State Logic reserves the right
to change the features and specifications described herein without notice or obligation.*

CONTENTS

- 1 Introduction**
- 2 Projects**
- 3 Machine Control**
- 4 Cue and Track Lists**
- 5 The Mix System**
- 6 Total Recall**
- 7 The Machines Page**
- 8 Macros**
- 9 Miscellaneous Setup Options**

On the following pages you will find a full alphabetical Index. We have tried to make this Index as comprehensive as possible because we believe that, once you have become accustomed to the basic features of the J Series Computer, you will only need to use this manual as a reference volume.

Entries shown in **Bold** denote on-screen functions.

4 Channel Pan in Desk Setup menu	5-9
< and > boxes on MIX-DESK display	3-19, 4-7, 5-3
< and > buttons	3-19, 4-7, 5-3
< and > buttons, changing the function of	9-7
Absolute fader status	5-11
ALT and FLEET buttons	5-5
Always/New Pass – Play/New Pass in Fader Status menu	5-51, 5-83, 5-91
Arm box on MIX-DESK display	3-9
AUTO MODES button	5-27
AUTO T/OVER button	5-49
Auto Modes	5-27
Auto on Settings pop-up	2-9
AUTOFADE button	5-47
AutoFade in Fader Status menu	5-47
AUTOGLIDE button	5-47
Autoglide in Fader Status menu	5-47
Automation	see Section 5
Automation – An Introduction	5-11
Automation – Fader Data, Editing	5-83
Automation – Fader Protection	5-55
Automation – Switch Data, Editing	5-79
Automation – Switch Protection	5-59
Automation data in Settings list	5-41
Automation Modes – a description	5-15
Automation Modes – selecting	5-27
Automation Modes, More	5-85
Automation of Switches	5-35
Automation of the Small Fader	5-35
Autotakeover in Fader Status menu	5-49
Backing Up Projects	2-19
Basic Operational Techniques	1-3
Buttons, setting release option	9-7
Calculator in MISC/Tools menu	9-9
Calibration in MISC menu	9-9
Capture Clips	5-83
CHANNEL NAMES button	4-9
Channel Lists	4-9
Channel Names in FILE/SETUP/Desk Setup menu	4-9
Channel Selector pop-up	1-9
Channel settings – Copy and Swap	6-9
CLEAR AUTO button	5-27, 5-39
Clear Data in the Automation menu	5-27
Clip End automation mode	5-85
Clip Fill automation mode	5-85
Clock – Time and Date setting	9-15

Clr Chan Cuts in Groups menu	5-5
Clr Chan Solos in Groups menu	5-5
Clr Group Cuts in Groups menu	5-5
Clr Group Solos in Groups menu	5-5
Clr Hard Groups in Groups menu	5-5
Copy Project in Project menu	2-5
Copying Mix Data	5-91
Cue and Track Lists	Section 4
Cue Information, Editing	4-5
Cue List – Automatic Scrolling	4-3
Cue List, Creating a	4-3
Cues Lists and Project Files	4-9
Cues, Deleting	4-5
Cues, Locating to	4-7
Cues, Moving	4-5
Cues, Naming	4-3
Cues, Renaming	4-5
Cues, Renumbering	4-5
CYCLE button	3-19, 5-3
CYCLE START and END buttons	3-19, 5-3
Cycle End automation mode	5-87
Cycle Fill automation mode	5-87
Cycle Function	3-19
Cycle on the MIX-DESK display	5-3, 3-19
Data Storage	1-3
Data/Delete in FILE/SETUP menu	2-25
Define in FILE/SETUP/Desk Setup menu	8-1
Delete Proj in Project menu	2-17
Desk Config menu	9-5
Desk Here on Serial Machine Control Display	3-7
Desk Layout in Desk Config menu	9-7
Desk Setup menu	5-7, 9-3
Diagnostic in MISC menu	9-15
Disable Desk in MISC/System menu	9-11
Discard on the MIX-DESK display	5-15, 5-29
DiskTrack in MACHINES menu	7-15
DiskTrack Free in Desk Setup menu	9-3
Do Pre in Automation menu	5-39, 5-77
Edit in the MIX-DESK menu	5-25
Edit Mix in the Edit menu	5-25
Editing Fader Data	5-83
Editing Mix Data	5-79
Editing Switch Data	5-79
Enable in the Automation menu	5-27
Entering Names	1-5
Event Jogs	5-3

Events (Cues) Lists	4-1
Events (Cues) Lists and Project Files	4-9
Events in the MIX-DESK menu	4-1
FADER PROT button	5-55
FADER STATUS COPY button	5-53
Fader Groups – Hardware	5-5
Fader Groups – Software	5-65
Fader Macros in FILE/SETUP/Desk Setup menu	8-17
Fader motors, disabling	9-7
Fader Protection in Automation menu	5-55
Fader Protection – Protected Manual	5-55
Fader Status menu	5-45
Faders in MIX-DESK menu	5-57
FADER STATUS LOCK button	5-45
Fast Play Speed in Desk Setup menu	9-3
FEEDBACK button	3-21
File Copy in FILE/SETUP menu	2-21
File Selector Lists	1-11
FILE/SETUP menu	2-21
Final Mix Safe box on the MIX-DESK display	5-43
Floppy Disks, Remaining Space on	2-21
Follow Faders/Follow Output in Desk Setup menu	5-7, 5-57
Follow on Events List	4-3, 4-7
Format in MISC/Tools menu	9-9
Fr : and To : boxes on the MIX-DESK display	5-13, 5-29
Frame and Event Jogs	3-19, 5-3
Free Mem box on the MIX-DESK display	5-27
Front Panel in Desk Config menu	9-5
G Series Data, Importing	2-27
GOTO button	3-19
GOTO button and Event Locates	5-3
Group Solos Independent / linked to Desk in Groups menu	5-7
Groups in MIX-DESK menu	5-5, 5-65, 5-73
Groups, Hardware Fader	5-5
Groups, Software	5-65
Groups, Switch	5-73
HARD GROUP SETUP button	5-5
Hardware Fader Groups	5-5
Hardware in MISC/Diagnostic menu	9-15
Heap in MISC/Diagnostic menu	9-15
Hold Project on Settings pop-up	2-15
Immediate Pickup in Fader Status menu	5-49
IMMED PICKUP button	5-49
Import in FILE/SETUP menu	2-27
Importing G Series Data	2-27

INSERT MIXING ON button	5-33
Insert Mixing	5-33
Introduction	Section 1
JOG button	3-21
Jog Wheel	3-21, 5-3
JOIN Button	5-19
Join to Mix in Automation menu	5-89
Joining Mixes	5-89
Keep on the MIX-DESK display	5-13
Keyboard, dedicated	1-5
Keyboard, QWERTY pop-up	1-5
KeyPad	7-19
KeyPad Macros	8-15
LED alpha-numeric display, changing contents of	9-5
LED alpha-numeric display, setting brightness of	9-5
Level Match in Fader Status menu	5-51
Locating	3-17
Locating to Events (Cues)	5-3
Locating with < and > boxes on the MIX-DESK display	3-19
Locating with < and > buttons	3-19
Locating with Frame and Event Jogs	3-19
Locating with GOTO button	3-19
Locating with TC 1-5 buttons	3-17
Locating with Timecode Locates	3-17
LTC Gen	7-15
Machine Control	Section 3
Machine Control and DiskTrack	3-33
Machine Control and Project Files	3-17
Machine Control Display	3-5
Machine Control – Customising Enable Button Control	3-33
Machine Control – DCTM	3-5, 3-27
Machine Control – Getting a Machine On-Line	3-7
Machine Control – Master Modes	3-11
Machine Control – Offsets	3-13
Machine Control – Preroll	3-9
Machine Control – Record Arming	3-15, 3-31
Machine Control – Setting Up a New Machine	3-25
Machine Control – Setting up Multiple Machines	3-13
Machine Control – Sony 9-Pin	3-5, 3-31
Machine Control – Teac LV210	3-5
Machine Control – VPR3	3-5, 3-29
MACHINES menu	Section 7
Macros	Section 8
Macro Function List	8-5
Macro Setup Display	8-1

Macros and the Events List	8-17
Macros, Creating	8-11
Macros, Editing	8-13
Macros, Fader	8-17
Macros, KeyPad	8-15
Macros, Naming	8-15
Macros, Saving	8-17
Manual fader status	5-11, 5-29
MARK button	4-3
Mark and Delete Mark on Overview display	5-23
MATCH (M) and PLAY (P) buttons	5-35
Merge Trim in Fader Status menu	5-51
MERGE TRIM button	5-51
MIDI Timecode	7-17
Mini on Settings pop-up	2-13
MISC menu	9-9
Miscellaneous Setup Options	Section 9
Mix Data moves/doesn't move with Audio	5-25
Mix Data, Copying	5-91
Mix Data, Editing	5-79
Mix Data, Swapping	5-91
Mix List	5-43
Mix Options	5-45
Mix Pass List on the MIX-DESK display	5-13
Mix Pass Structure	5-13
Mix System	Section 5
Mix – Starting again	5-39
Mix – The first pass	5-29
Mix, Saving a	5-41
Mix, Starting a	5-27
Mix, Updating a	5-31
MIX-DESK display	5-13
Mixes – Discarding	5-13
Mixes – Keeping	5-13
Mixes – Making safe	5-43
Mixes – Naming	5-13
Mixes – Reverting	5-13
Mixes, Joining	5-89
Mixes, Loading	5-43
Mixes, Trimming off-line	5-87
Monitor in MISC/Diagnostic menu	9-15
MTC Gen	7-17
NAME MARK button	4-3
Name on the MIX-DESK display	5-13, 5-31
Names, Entering	1-5
Network Display	7-1
Network in MISC/Diagnostic menu	9-15
New Project in Project menu	2-3
Numbers and Timecodes	1-7

O/VIEW buttons	5-21
Off-Line Trim in Automation menu	5-87
Operational Techniques, Basic	1-3
Overview Display and Mix Data	5-25
Overview in MIX-DESK menu	5-21
Overwrite automation mode	5-15, 5-29
PatchBay	7-9
Pen and Tablet	1-3
Pen and Tablet (serially connected)	8-9
Pen and Tablet Swipe Control	7-5
Pen and Tablet – setting swipe sensitivity,	9-5
Pop-ups	1-5
Pre Enable snapshot	5-39, 5-77
PREVIEW button	5-49
Preview in Fader Status menu	5-49
Print box on Overview display	5-23
Proj. Title box in Project menu	2-5
PROJECT SETTINGS button	2-7
Project File Contents	2-11
Project in MIX-DESK menu	2-3
Project Information pop-up	2-17
Project Manager pop-up	2-7
Project Settings pop-up, More on the	2-13
Project, Creating a New	2-3
Project, The Current	2-3
Project, The Default	2-3
Projects	Section 2
Projects – Backup and Restore with 3.5” Floppy Disks	2-19
Projects – Backup and Restore with MO Discs	2-19
Projects, ‘Holding’	2-15
Projects, Backing Up and Restoring	2-19
Projects, Changing	2-5
Projects, Copying	2-5
Projects, Copying and Deleting Multiple	2-21, 2-25
Projects, Deleting	2-17
Projects, Loading	2-7
Projects, Loading Earlier Versions	2-15
Projects, Saving	2-9
Purge Proj in Project menu	2-29
QWERTY keyboard pop-up	1-5
REC 1-4 buttons	3-15
RECALL menu	6-5
Reference Mix box on the MIX-DESK display	5-13, 5-43
RelayBox in MACHINES menu	7-15
REM MTR EFFECT button	5-7
Reminder in Project menu	2-9

Remove Motor Group Effect in Groups menu	5-7
Renull in Fader Status menu	5-47
Replay fader status	5-11
Restoring Projects	2-19
Return Project on Settings pop-up	2-15
Revert on the MIX-DESK display	5-13, 5-31
RIO ADC/DAC gains, setting	9-11
Rollback automation mode	5-15
Rollback Points	5-17
Rollback/Join automation mode	5-15, 5-31
Routing in MACHINES menu	7-17
SAVE PROJECT button	2-9
SAVE TR button	6-1
Screens, Scrolling	1-9
Screensave in MISC/System menu	9-13
Screensave message, changing	9-13
ScreenSound Slaves	7-7
Scrolling Screens	1-9
SER REC ENABLE button	3-15
Serial in MACHINES menu	3-5
Serial Machine Control Display	3-5, 3-15, 3-25
Serial Machine Control	Section 3
Serial Xfer in FILE/SETUP/Data menu	9-1
Set Video ADCs in Desk Config menu	9-5
Settings in Project menu	2-7
Setup Options	Section 9
Shutdown in MISC/System menu	9-13
Sift in the Edit menu	5-25
SIO in MISC menu	9-13
SIO TC in FILE/SETUP/Desk Setup menu	3-3
Small Fader Automation	5-35
SNAP button	5-47
Snap in Fader Status menu	5-47
SNAPSHOTS button	5-77
Snapshots in MIX-DESK menu	5-77
SOFT GROUP SETUP button	5-65
Soft Groups in Groups menu	5-65
Software Groups	5-65
Software Groups and Automation	5-69
Software Groups – Applications	5-71
Software Groups – Indication of slave type	5-69
Software Groups – Merge & Dissolve	5-69
Software Groups, Creating	5-67
Software Installation	9-9
SSL Digital, changing the screensaver message	9-13
Static automation mode	5-15
Status Copy function	5-53

Status in MISC/Diagnostic menu	9-15
Status Lock in Fader Status menu	5-45
Status Messages	1-9
Swapping Mix Data	5-91
Swipe Control with Pen and Tablet	7-5
Swipe sensitivity setting	9-5
SWITCH GROUP SETUP button	5-73
SWITCH PROT button	5-59
Switch Automation	5-35
Switch Groups	5-73
Switch Groups in Groups menu	5-73
Switch Groups – An example	5-75
Switch Protection in Automation menu	5-59
Switch Protection – Protected Manual	5-59
Switch Protection – Protected Replay	5-59
Sync Standards	3-3
System in MISC menu	9-11
System Sync Standards	3-3
Tablet and Pen	1-3
TC 1-5 buttons	3-17, 5-1
TC Gen in MACHINES menu	7-15
Time and Date clock, setting	9-15
Timecode and Sync Standards	3-3
Timecode Calculator	1-7
Timecode Displays	3-23
Timecode Generation	7-15
Timecode in Desk Setup menu	5-7
Timecode in FILE/SETUP/Desk Setup menu	3-3
Timecode Locates	3-17, 5-1
Timecodes and Numbers	1-7
Timecodes, Copying	3-23
Tools in MISC menu	9-9
Total Recall	Section 6
Total Recall – Auto Calibrate/Manual Calibrate	6-11
Total Recall – Auto Compare	6-11
Total Recall – Autoscan	6-5
Total Recall – Centre	6-11
Total Recall – Centre Objects	6-7
Total Recall – Channel Objects	6-7
Total Recall – Channels	6-11
Total Recall – Copy and Swap	6-9
Total Recall – Groups	6-11
Total Recall – Hysteresis	6-11
Total Recall – Manual	6-3
Total Recall – Manual Resetting	6-7
Total Recall – Options menu	6-11
Total Recall – Recalling Setups	6-3

Total Recall – Saving Setups	6-1
Total Recall – Set Auto Objs	6-7
Total Recall – Set/Ignore Auto Objects	6-11
Total Recall – Setting the Level of Autoscan	6-7
Track and Channel Lists	4-9
Track List, Creating a	4-9
Track Lists, Copying	4-11
Transport Control	3-17
Transport Control	5-1
Transport Layout in FILE/SETUP/Desk Config menu	3-15, 9-7
TRIM RENUALL button	5-19
Trim Anlog in MISC/System menu	9-11
Trim fader status	5-11, 5-31
Trim Mix in Edit/Edit Mix menu	5-79
Trimming a mix off-line	5-87
TRIM RENUALL button	5-47
USE ABS and USE TRIM buttons	5-31
Use Abs/Use Trim in Fader Status menu	5-31
User-Defined Function Buttons	Section 8
VARISPEED button	3-21
Video Switcher Inputs	7-5
Video Sync, indication of	9-15
Warn on Settings pop-up	2-9

Solid State Logic
SL 9000 J Series
Total Studio System

Computer Operator's Manual

SECTION 1

Introduction



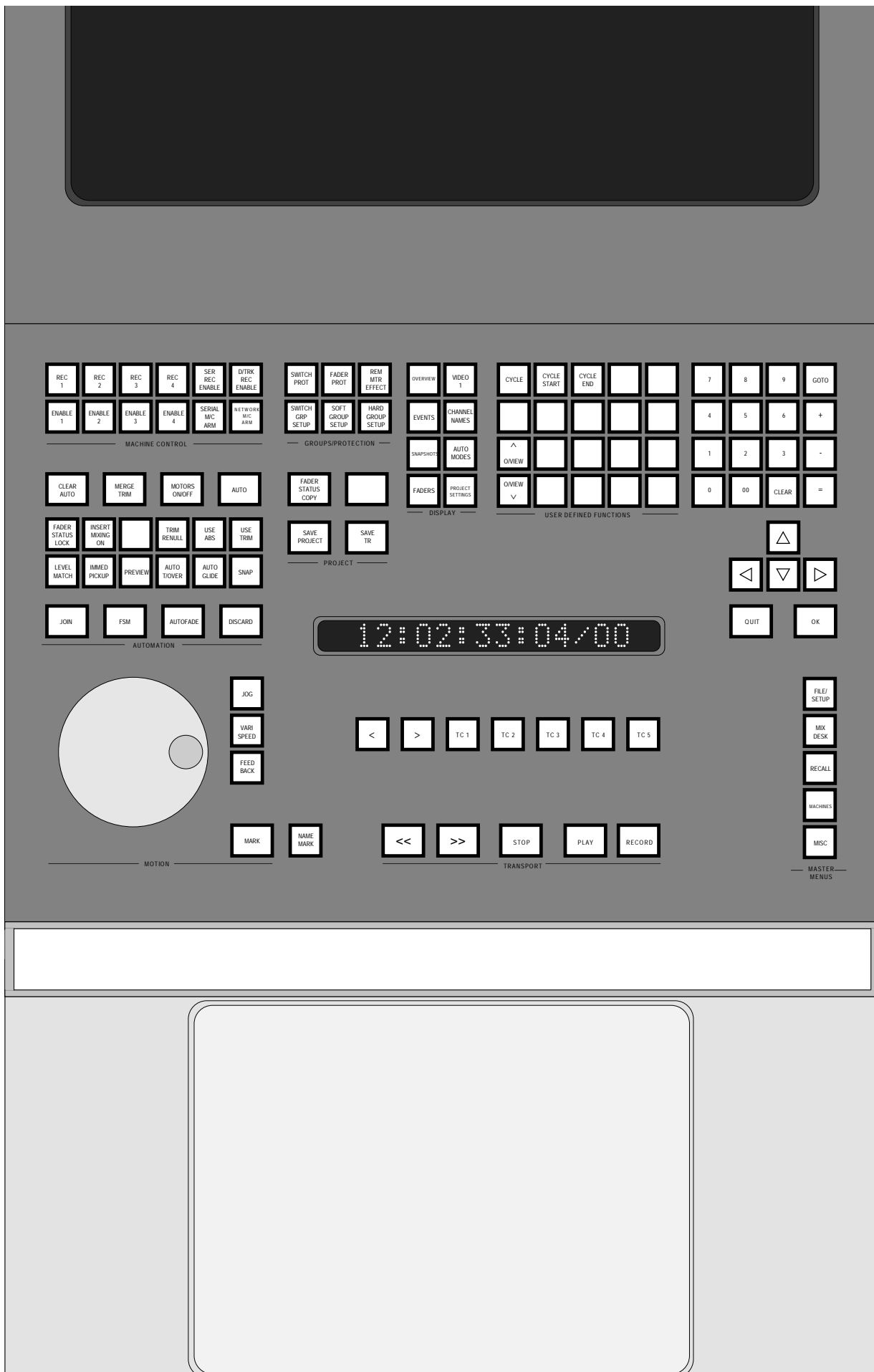

Introduction

The SL 9000 J Series Total Studio System combines a new and advanced analogue console with a powerful new computer. The system can be optionally provided with integral hard disk storage of both audio – with DiskTrack, and video – with VisionTrack. For operational details on these options, see the appropriate Operator's Manuals.

The J Series Computer features an entirely new automation system based on the advanced processing used in SSL's family of digital products. The result is a faster system, which provides automation of major console functions as well as comprehensive session management capabilities.

The computer uses an internal hard disk, known as the System Disk, to store data. The way that the data is stored is different from previous SSL computer systems, but the new system still retains the ability to store information such as Cues, Track Lists, Total Recall Setups and Mix Data. These files can be transferred to other storage mediums such as 650Mb Magneto-Optical or High Density, 1.44Mb, 3.5" Floppy disks for transfer between different studios.

Information stored on G Series Bernoulli Data Cartridges or 3.5" disks can be imported onto the computer's System Disk, and mix data saved with G Series software can be converted to play back on a J Series system.

The J Series Computer features a pen and tablet as its user interface. Although this type of interface may be new to you, the pen is an instrument that is a very natural tool to get to grips with – most of us have been using a pen since we were children – and you will soon get used to it (see over the page).

NB. If you are reading this manual away from the console, you may find it useful to remove the drawing at the end of this section, in order to verify the location of front panel buttons.

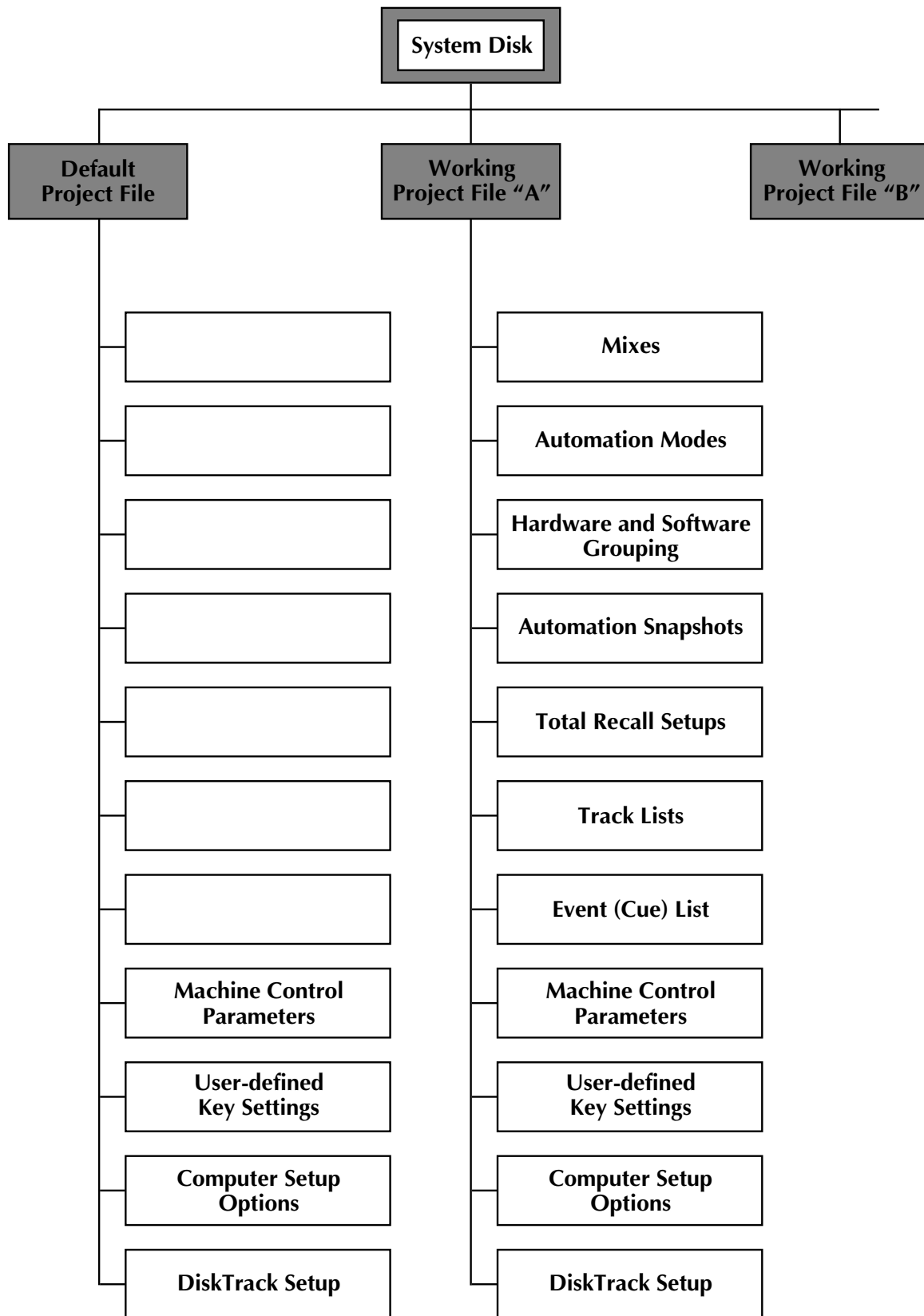

Data Storage

The J Series Computer handles session management in the form of a Project. Session data is stored in Project Files on the System Disk (see opposite). Studios will have a 'Default Project' from which they can simply build subsequent 'Working' Projects.

The Default Project, which will initially be created by SSL personnel, will contain all the basic setup information required to begin using the system. This may include, for example, basic console/computer setup parameters, tape machine control parameters, user-defined function keys (macros), etc.

Working with a Default Project makes the operator's life easier, as tiresome setup routines can all be loaded with a stab of the pen. Section 2 covers the creation and use of Project Files in detail.

Basic Operational Techniques

If you have not used any of SSL's digital products, some of the basic operational techniques required when using the J Series Computer will be new to you. Please take a little time to read through this section so that you will be prepared for the instructions that follow in the bulk of this manual.

Quite often you will find there are several different methods available to achieve the same result. The J Series Computer is designed to be as flexible as possible, and you will eventually settle on those methods which suit you best.

Note that, throughout this manual, on-screen functions are shown in **Bold** type, front panel buttons are referred to in UPPER CASE PLAIN type.

Pen and Tablet

The pen and tablet interface provides access to all on-screen functions. The more commonly used functions are duplicated in hardware switches on the computer front panel in the centre section of the console (see drawing at the end of this section). Once the system has been set up, and recording/mixing has begun, use of the pen will be quite limited.

Moving the pen lightly across the tablet produces a red cross-hair cursor on the computer screen which indicates the pen's location. Note that this is an 'absolute' system where the tablet area represents the screen area. Stabbing (pressing down) with the pen in a box on the screen selects individual functions or new menus.

Certain functions require a 'stab and drag' movement of the pen – for example, when changing numbers in the on-screen equivalent of a thumbwheel switch, or in the editing of mix data.



Finally, if you have additional SSL products, such as DiskTrack, interfaced to your SL 9000 J System 'network', quick access to their operating screens is provided by a pen 'swipe' facility. This requires a low pressure, fast action, swipe of the pen across the tablet in the direction assigned to that device. See Section 7 for more details.

Pop-ups

Very often, selecting a menu item or on-screen box produces a 'pop-up' menu or display. You will soon realise that these are referred to as pop-ups for good reason, as they are superimposed over the current screen information.

In many cases, selections can be made on a pop-up by means of the front panel cursor keys; alternatively you will need to use the pen. Once the appropriate item has been selected/entered, the selection is confirmed, or information saved, by stabbing on **OK**, **END**, etc. This also causes the pop-up to clear from the screen. If you don't want to save the changes you have made, select **QUIT**. Dedicated **QUIT** and **OK** buttons are provided on the front panel below the computer monitor.

Some pop-ups will clear automatically as soon as an item (or **QUIT**) has been selected. Note that most pop-ups can also be cleared by stabbing *outside* them, and this is normally equivalent to a **QUIT**. Some pop-ups which do not require an **OK**, **QUIT** or **END** must be cleared from the screen by stabbing outside them, and this will be made clear in subsequent sections of this manual.

Entering Names

Obviously you will need to enter names for Projects, Mixes, Cues, etc. This is normally carried out following the selection of an on-screen **Name** function, which produces a QWERTY pop-up (see opposite). The name may now be entered by either 'typing' with the pen on the pop-up or, more conventionally, by using the dedicated keyboard which can be found in a drawer beneath the tablet area. A keyboard connector is provided on the underside of the console's centre section should you wish to move the keyboard to an alternative location.

If you use the dedicated keyboard, complete and save entries by hitting the 'Enter' key. 'Back-Space' provides a single character backspace delete; the 'Del' key will delete a complete entry. If 'Num Lock' is selected, and by holding down the 'Fn' key, selected number and letter keys provide a numeric keypad, as indicated by subscript purple text on the keycaps.

If you use the QWERTY pop-up, characters are entered by simply stabbing on the appropriate 'key'. **UPPER** and **LOWER** toggle a choice of upper and lower cased letters along with other characters/symbols. **SHIFT** provides a range of symbols instead of numbers in the top row of keys. **OTHER** provides access to a further range of symbols.

The screenshot shows a control panel interface with a list of marked time points and track names. The interface includes a numeric keypad on the left and a list of marked time points on the right. The third item in the list, 'Mark 16:40:49:20/41 3 *Pipes', is highlighted in yellow.

Mark	Time	Track Name
Mark	16:39:51:10/34	1 *Top
Mark	16:40:11:11/12	2 *Phones
Mark	16:40:49:20/41	3 *Pipes
Mark	16:41:10:00/92	4 *Intro Chorus
Mark	16:41:35:14/89	5 *Band
Mark	16:41:45:02/63	6 *Verse 1
Mark	16:42:22:16/06	7 *Verse 2
Mark	16:42:42:08/23	8 *Bridge
Mark	16:43:00:07/00	9 *Chorus 1 (F Vox)

For fast naming, words can be selected from the 'keywords' list, to the left of the pop-up, by simply stabbing on them. We supply you with a default list of keywords, but new words can be easily added to the list by entering them via the keyboard and then stabbing on **COPY TO LIST**. You will be given the option to place the new word anywhere in the list, but note that it holds a maximum of 40 entries. To delete an entry, **CLEAR** the QWERTY pop-up, select **COPY TO LIST** and then stab on the entry you want to delete.

To make an insertion in an existing line of text, use the <- or -> boxes to move the cursor to the right spot. **BKSP** should be obvious, **CLEAR** deletes the entire current entry. Press **END** to clear the QWERTY pop-up and enter the name; use **QUIT** to clear the pop-up and not effect any change.

Numbers and Timecodes

When it comes to numbers and timecodes, sometimes these can be entered, or existing values can be modified, by simply stabbing on individual numbers and dragging the pen to increment or decrement the value. Alternatively, by stabbing (or stabbing and dragging) on a number or timecode box, you will be presented with a numeric keypad or timecode calculator (see opposite).

The timecode calculator comes complete with a mini 'Events List'. This is used to provide a simple way of locating to any pre-marked point in a recording. See Section 4 for more details.

Entries for both the numeric and timecode pop-ups can be made by stabbing with the pen on appropriate keys or by using the numeric keypad (situated to the upper right of the computer front panel below the computer monitor). If you use the numeric buttons on the front panel, complete an entry with the OK button.

The numeric pop-up should be self-explanatory. The timecode calculator (sometimes referred to as a T/C) has extra features worthy of explanation:

This pop-up provides the typical calculator memory functions **M+**, **MR** and **MC**. The upper timecode display shows the current value, the lower display shows the calculator's memory contents. Selection of **MS** allow absolute times to overwrite the contents of the memory (instead of just adding to it).

Stabbing on **Now** will enter the system's current timecode position. The < and > boxes nudge the current timecode entry in frames. The **Ng** function may be used to subtract an entered value from 00:00:00:00. Alternatively, to add a value to, or subtract from, the current value, select + (or -), enter the value and hit =.

If an invalid timecode value is entered, a warning message informs the operator that the value will be corrected. Stab on **OK** to complete the operation and clear the pop-up.

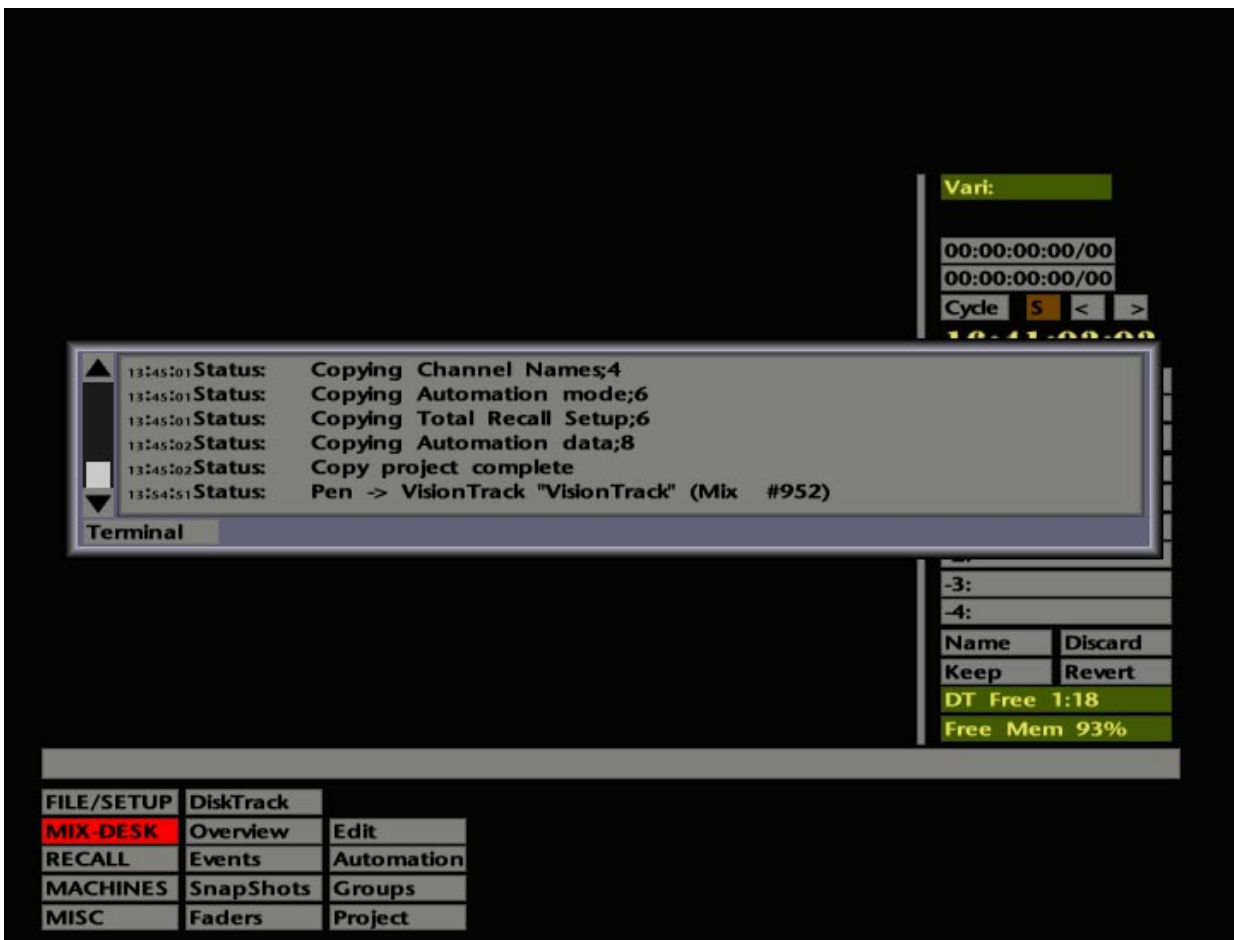

As with several similar pop-ups, the timecode calculator can be cleared, with or without effecting changes, by pressing the front panel OK or QUIT buttons. The Left/Right cursor keys (just above QUIT and OK on the computer front panel) will decrement/increment the current timecode frames value; the Up/Down keys adjust the current seconds value. Note that the numeric and cursor keys have an auto-repeat function – do not hold them down for two long unless you mean to!

Channel Selector Pop-up

This pop-up (see opposite) is called up every time a number of channels need to be chosen for a specific function. Channels can be individually selected by stabbing on the channel number, or by pressing the fader status button on that channel's Large Fader, to toggle the channel's entry to a Y (Yes). Holding one fader status button down while pressing another selects those channels, and all channels in between, to the required mode. Selections can be made left to right or right to left. The same function can, of course be used to deselect a range of channels from the currently selected mode.

Other options on the Channel Selector pop-up itself include stabbing on the channel numbers to toggle blocks of 8 on or off, **Set All** which selects all channels, **Flip All** which toggles the channel states on or off, and **Clear All** which clears down any current selections. Having selected the relevant channels, **OK** out of the pop-up.

Status Messages

Between the menus and the main display area on all the computer's screens you will notice a long grey bar (see opposite). This is known as the 'status' bar and provides a series of useful progress messages as the computer carries out various tasks such as loading or saving project data. If a warning or error message is necessary, the bar will turn red.

Stabbing on the bar will produce a scrolling 'history' list of status, prompt, warning and error messages created since the system was last booted up (up to 100 lines of the most recent messages). You may also need to select this pop-up in order to read messages that are too long to fit in the status bar. Access to the on-screen diagnostic **Terminal** display is provided here. Stab outside the pop-up to clear it.

Scrolling Screens

Selection of some menu items, for example **MIX-DESK/Faders** may require you to scroll the screen to reveal additional information. Because of this, the facility is provided to stab on any non-active (ie. black) area of the screen, and drag the display to move it to the required position.

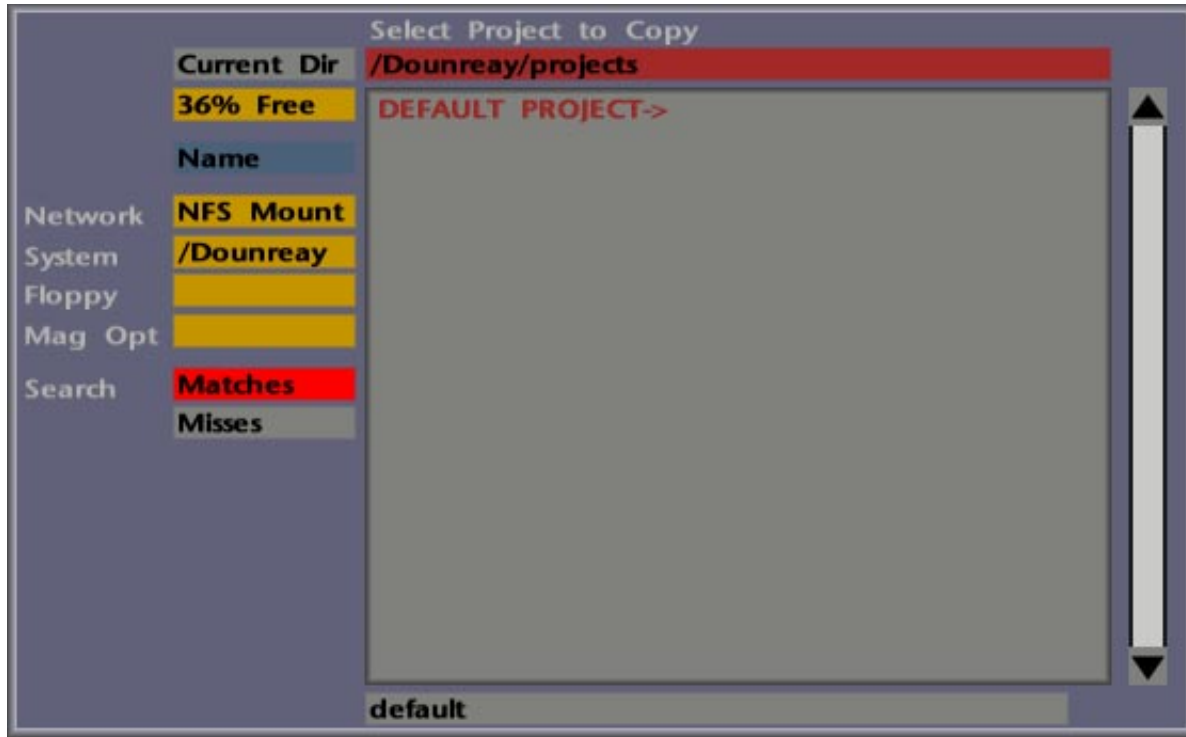

File Selector Lists

From time to time you will come across file selector lists. These are used to select files in order to copy, delete, load, etc. specific or multiple files. Sort and search routines are provided to enable you to locate the required file(s) in the minimum of time.

File selector lists come in two basic types. According to their function, the basic difference between them is that one is designed to deal with the selection of single directories/files (see upper screen opposite), the other can handle multiple directories/files, as in the 'file delete' pop-up shown in the lower screen opposite. Unless specified, the following descriptions apply to both types of pop-up.

The scrollable list shows file directories in red and single files in black. Directory names are also followed with a ->. To view the contents of a directory, simply stab on it and the red bar above the list will reflect your selection and its 'path'. In the example opposite, you are looking at the **projects** directory on a System Disk called **Dounreay**.

To view the contents of sub-directories, continue to stab on directory entries in the list. To work back up through the file storage tree, stab on the red bar at the top of the pop-up until you reach the required level.

The list can be sorted by Name, Type, Size, Date etc. by stabbing on the **Sort** box (showing **Name** in the example opposite), and making a selection on the resultant pop-up.

To search within the current directory for a particular directory or file, stab on the grey bar at the foot of the display to enter a search 'string' on the resultant QWERTY pop-up. Hit **END** and the search string will appear in the grey bar. You may now select **Matches** to find items which match the string, or **Misses** to find items that don't! In the example opposite, **default** has been used as the search string, in conjunction with **Matches**, to find the **DEFAULT PROJECT** directory.

To select a directory for the required process (eg. copy etc.), stab on its name in the list. With the required directory name shown in the red bar at the top of the list, stabbing on **Current Dir** will execute the process and clear the display. Files can be selected by simply stabbing on them.

On some lists you can view the contents of a loaded Magneto Optical (MO) or Floppy disk by stabbing in a yellow **Mag Opt** or **Floppy** box. A percentage of disk space free indicator (**xx% Free**) is provided for cases where you need to know whether there is room to copy a directory or files to an MO or Floppy, for example. The **Network** selection is not normally applicable in commercial installations.

On the multiple select pop-up (see lower screen opposite), select items as described above and, as you do so, they will be highlighted in yellow in the main list and also appear, complete with file path, in the smaller scrollable list below. This is the 'selected items' list, and contains the items that will be deleted, copied, etc.

Alternatively, where a large number of directories or files need to be selected, use the **All Dirs** or **All Files** function. Stabbing on either of these boxes, not surprisingly, selects all the directories or all the files in the currently selected directory (ie. the one in the red bar at the top of the list). You may now deselect the directories/files you are not interested in by stabbing on them in the 'selected items' list.

None deselects all current selections in the currently selected directory; **Clear** clears all entries from the 'selected items' list. A count of the number of selected items is displayed in the **Got x/xx** box.

To execute the function you have selected, hit the OK button on the front panel or stab on the **OK** box; if the function requires a two stage process then the system will lead you on to the next stage.

REC 1	REC 2	REC 3	REC 4	SER REC ENABLE	DTRK REC ENABLE
ENABLE 1	ENABLE 2	ENABLE 3	ENABLE 4	SERIAL M/C ARM	NETWORK M/C ARM

MACHINE CONTROL

CLEAR AUTO	MERGE TRIM	MOTORS ON/OFF	AUTO
FADER STATUS LOCK	INSERT MIXING ON	TRIM RENUILL	USE TRIM
LEVEL MATCH	IMMED PICKUP	AUTO TOWER	USE ABS
		PREVIEW	AUTO GLIDE
			SNAP

JOIN	FSM	AUTOFADE	DISCARD
------	-----	----------	---------

AUTOMATION

JOG	VARI SPEED	FEED BACK
-----	------------	-----------

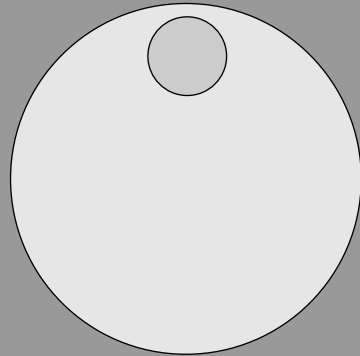

MARK

MOTION

CYCLE	CYCLE START	CYCLE END			
^ OVIEW					
OVIEW v					

USER DEFINED FUNCTIONS

0	00	3	CLEAR	△	▽	▽	△	QUIT	OK
---	----	---	-------	---	---	---	---	------	----

OVERVIEW	VIDEO 1				
EVENTS	CHANNEL NAMES				
SAMPLES	AUTO MODES				
FADERS	PROJECT SETTINGS				

DISPLAY

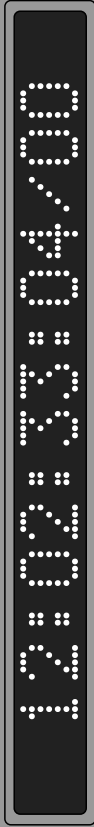

SWITCH PROT	FADER PROT	REM MTR EFFECT	SOFT GROUP SETUP	HARD GROUP SETUP
-------------	------------	----------------	------------------	------------------

GROUPS/PROTECTION

FADER STATUS COPY	SAVE PROJECT	SAVE TR
-------------------	--------------	---------

PROJECT

<	>	TC 1	TC 2	TC 3	TC 4	TC 5
---	---	------	------	------	------	------

<<	>>	STOP	PLAY	RECORD
----	----	------	------	--------

TRANSPORT

FILE/ SETUP	MIX DESK	RECALL	MACHINES	MISC	MASTER MENUS
-------------	----------	--------	----------	------	--------------

Solid State Logic
SL 9000 J Series
Total Studio System

Computer Operator's Manual

SECTION 2

Projects



The screenshot shows a computer interface with a menu on the left and a status panel on the right. The menu has five columns: FILE/SETUP, DiskTrack, Edit, Settings, and Info. The 'Project' option under 'MISC' is highlighted in red. The status panel on the right shows various system metrics and controls.

FILE/SETUP	DiskTrack		Proj. Title: BedBug	
MIX-DESK	Overview	Edit	Settings	Info
RECALL	Events	Automation	Load	New Project
MACHINES	SnapShots	Groups	Save	Copy Project
MISC	Faders	Project	Clear	Reminder

Vari:
 00:00:00:00/00
 00:00:00:00/00
 Cycle **S** < >
16:41:03:03
 Arm **Final Mix Safe**
 Fr :
 To:
 *:
 0:
 -1:
 -2:
 -3:
 -4:
 Name Discard
 Keep Revert
DT Free 1:18
Free Mem 97%

Projects

Project Files (commonly referred to as 'projects' in this manual) form the top level of the J Series Computer's filing system. If you have previously used SSL's G Series software, Titles in which you store different versions of Mixes, Total Recall Setups, Cues, Track Lists etc., will be familiar to you. Project Files have a similar, but greatly expanded, function in the J Series Computer and also cover system setup information relating to machine control, timecode standards, user-programmable keys and DiskTrack routing (if fitted).

All Automation Data, Track Lists, Events (Cue) Lists, etc., are held in memory until deliberately saved to the System Disk as an element within the current Project File. Note also that each time any element of a Project File is saved, it generates a new version of that element and does not overwrite the version previously saved to disk.

For normal music recording, we recommend using one Project File per title/song etc. If you are working with short recordings, such as 30 second stings or commercials, it may be more convenient to use one Project File for the complete project.

When the J Series Computer is booted up, the system's 'Default Project' will be automatically loaded, presenting the console in a fully configured state right from the start.

Beyond this point, three basic situations can occur:

- You are starting a brand new session and need to create a new Project File.
- You are starting a continuation session and wish to base a new Project File on a previously used Project File.
- You intend to continue working with the same Project File as on the day before.

In the first case, you will need to create a new Project File based on the Default Project, to which you can save data relating to that particular session. In the second case, a copy is made of the earlier Project File. In the third case, you simply need to load the relevant Project File. Full descriptions of all the procedures required can be found on the following pages.

In the following descriptions, menu selections and other boxes on the screen are shown in bold. Although some of these are available as hardware buttons/switches on the panel below the computer monitor, we advise you to initially use the pen and tablet interface, so that you become familiar with it.

OK. Let's get started.....



The Default Project

When a new SL 9000J Series system is installed, or a new software version is released, the software is provided with a 'standard' Default Project devised by SSL. This will contain basic setup information such as user-defined key functions, routing presets (if the system includes a DiskTrack), default automation settings, etc.

In order that the Default Project will be loaded on bootup, it must be saved with the name **Default Project**. To rename an existing project as the Default Project, use the copy function described on Page 2-5 and name the copy **Default Project**.

The Default Project should never be used to store session-specific information. If this happens, subsequent creation of new projects (see below) may result in unwanted default features being transferred to the new project.

To help prevent this, although the contents of the Default Project are loaded on bootup, the system remembers which project you were last using and makes that the 'current' project when the computer restarts. New information can only be saved to the current project. See also **Write Protect** on Page 2-15.

The Current Project

It is important to be aware, at any time, which project is the current project. When you save and load elements of any Project File, these are always saved to, and loaded from, the current project. The name of the current project is shown in the long **Proj. Title** box above the other **Project** menu entries (see opposite). However, just because the correct name appears in this box, it does not necessarily mean that the elements of this project have been loaded for use! (see Changing Projects on Page 2-5 and Loading Project Data on Page 2-7).

Creating a New Project

First of all you need to access the **Project** menu. This is located in the second column of the **MIX-DESK** menu. Note that all the main menu selections can be selected by pressing buttons on the lower right of the computer front panel.

To create a new project, stab on **New Project**. This will call up the QWERTY keyboard pop-up on which to enter the name of the new project (see opposite). Stab letters on the pop-up or use the dedicated QWERTY keyboard. When you hit **END** (or Enter), the system will automatically make a copy of the Default Project, give it the new name, and select that project as the current project. The name of your new project will appear in the **Proj. Title** box. If elements of the Default Project have more than one version, only the latest versions will be copied and reset to Version 1.

You now need to load your newly created project (see Loading Project Data on Page 2-7). Once loaded, you can proceed with the session and, at appropriate times, save new data to the project (see Saving Project Data on Page 2-9).



Copying Projects

If you wish to base a new project on a copy of a project other than the Default Project, select **Copy Project** followed by **Copy to ...**. You will now be presented with a list of Project Files (see opposite) from which you may select a project to duplicate. The list will initially show projects on the System Disk but you may elect to copy from Magneto Optical (MO) or floppy disk (see Page 2-19 for more on the use of MOs and floppy disks).

Having made your selection by stabbing on one of the project names, it will appear (along with its 'path' name) in the red box at the top of the pop-up. Hit the **Current Dir** box to confirm to the system that this is indeed the project you wish to copy. Another pop-up will appear, inviting you to choose the destination media/directory for the copy; once again this will default to the System Disk but, if required, you may choose an alternative destination. With the correct destination in the red bar at the top of the pop-up, stab on the **Current Dir** box.

If a project with the same name exists in the destination directory, a QWERTY pop-up will appear allowing you to rename the project before it is copied.

Finally, before the copying takes place, you will be asked if you wish to copy **All** versions of the project elements, the **Latest** versions only, or **None** (aborts the operation). If you are simply interested in the basic setup information plus, for example, the last Total Recall Setup and Mix, select **Latest**. **All** would normally be used if you wanted to copy the project to an archive MO or floppy (see also **To MO** and **To Floppy** on Page 2-19).

Stab outside the 'copy-from' or 'copy-to' pop-ups to clear them if you make a mistake in the selection process.

Note that, unlike **New Project**, the **Copy Project** function does not select the copied project to be the current project.

Changing Projects

If you wish to work with a previously created project, and it is not showing as the current project in the **Proj. Title** box, stab on the box to call up a list of available projects. Stab on the project you require, the pop-up disappears, and your chosen project name will appear in the **Proj. Title** box. This is now the current project.

Before this project can be used, the latest versions of the project elements must first be loaded (see over the page). Making a project current will *not* automatically load the project data.

Project Manager - BedBug

	✓	✓	✓	1	Safe X
Automation data	✓	✓	✓	1	X
Automation mode	✓	✓	✓	1	X
Channel Names	✓	✓	✓	1	X
Desk Setup	✓	✓	✓	1	X
Fader Protection	✓	✓	✓	1	X
Hard & Soft Groups	✓	✓	✓	1	X
Match & Play Switch Groups	✓	✓	✓	1	X
Snapshot Positions	✓	✓	✓	1	X
Switch Protection	✓	✓	✓	1	X
Timecode Memories	✓	✓	✓	1	X
Total Recall Setup	✓	✓	✓	1	✓

Hold Project Write Protected Load Save Clear Next Prev
 Return Project Mini Wam Auto Flip Flip Flip Go back 5

>
05
 safe
 /00
 /00
 ht
 rd
 rt
 line

LF RJ SF RJ GF RJ MF RJ LC RJ SC RJ GC RJ AU RJ GS RJ GL 50 FRAMES AF 10 SECS Free Mem 87%

FILE/SETUP	Proj. Title: BedBug			
MIX-DESK	Overview	Edit	Settings	Info
RECALL	Events	Automation	Load	New Project
MACHINES	SnapShots	Groups	Save	Copy Project
MISC	Faders	Project	Clear	Reminder

Loading Project Data

Loading information from (and saving information to) projects is all handled by the Project Manager pop-up. Stab on **Settings** in the **Project** menu or press the dedicated PROJECT SETTINGS button in the “DISPLAY” section of switches on the computer front panel. The screen will now look similar to that shown opposite.

The pop-up comprises of a list of elements stored within the current Project File with, to the right, the version numbers of these elements. To the left of the list is a scroll bar which provides access to more Project elements. For a description of all the elements held in a Project File, please see Page 2-11.

Note that the list can be shortened by use of the **Mini** function. See Page 2-13 for more details.

The right hand side of the pop-up comprises four columns that are used to select any or all of the elements for a **Load**, **Save**, or **Clear**, or to **Safe** (Write Protect) mode. **Clear** clears the data residing in RAM for any element, and sets the cleared element(s) back to a factory-set default (this can be extremely useful when you start working with Switch Groups – see Section 5). The purpose of **Load**, **Save** and **Safe** are all described in the following paragraphs.

Currently selected elements will show a box with a tick. Individual boxes will toggle their state (tick or cross) with each stab of the pen. The process that you action, eg. **Load**, **Save** etc., will ignore any element with a cross next to it. **Flip** provides a global switch between states.

Note that the state of ticks and crosses in the **Load**, **Save**, **Clear** and **Safe** columns is Project File specific. When you change to a different Project File, the last settings for that file will be restored.

If you wish to load all the elements of a Project File that you have selected to be current, check that they all have a tick in the **Load** column (remember to scroll to the hidden elements) and stab on **Load**. Progress and any problems with the loading process will be indicated in the status bar.

Note that there is a **Load** box in the **Project** menu that can be used without having to access the **Settings** pop-up. A pop-up will appear asking you to confirm your request. Unless you are absolutely sure, however, which elements you will load when you stab on this, you are advised to select PROJECT SETTINGS (or **Settings**) first. For more detail on the **Settings** pop-up see Page 2-13.

Project Manager - BedBug

	✓	✓	✓	1	X
Automation data	✓	✓	✓	1	X
Automation mode	✓	✓	✓	1	X
Channel Names	✓	✓	✓	1	X
Desk Setup	✓	✓	✓	1	X
Fader Protection	✓	✓	✓	1	X
Hard & Soft Groups	✓	✓	✓	1	X
Match & Play Switch Groups	✓	✓	✓	1	X
Snapshot Positions	✓	✓	✓	1	X
Switch Protection	✓	✓	✓	1	X
Timecode Memories	✓	✓	✓	1	X
Total Recall Setup	✓	✓	✓	1	✓

Safe

05

safe
/00
/00
ht
rd
rt
line

Hold Project
Write Protected
Load
Save
Clear
Next
Prev

Return Project
Mini Wam Auto
Flip
Flip
Flip
Go back 5

LF RJ | SF RJ | GF RJ | MF RJ | LC RJ | SC RJ | GC RJ | AU RJ | GS RJ | GL 50 FRAMES | AF 10 SECS | Free Mem 87%

FILE/SETUP	Proj. Title: BedBug			
MIX-DESK	Overview	Edit	Settings	Info
RECALL	Events	Automation	Load	New Project
MACHINES	SnapShots	Groups	Save	Copy Project
MISC	Faders	Project	Clear	Reminder

Enter Minutes

10

0

7	8	9	MR
4	5	6	Clear MC
1	2	3	Quit M-
0	=	OK	M+
+	-	*	/ Ng

Vari:

00:00:00:00/00

00:00:00:00/00

Cycle S < >

16:41:03:03

Arm Final Mix Safe

Fr :

To:

*:

0:

-1:

-2:

-3:

-4:

Name	Discard
Keep	Revert

DT Free 1:18

Free Mem 96%

FILE/SETUP	DiskTrack	Proj. Title: BedBug		
MIX-DESK	Overview	Edit	Settings	Info
RECALL	Events	Automation	Load	New Project
MACHINES	SnapShots	Groups	Save	Copy Project
MISC	Faders	Project	Clear	Save Now

Saving Project Data

Having selected a current project, and loaded the latest versions of the elements as necessary, further versions of any of the elements can be saved at any time. There are basically two methods available to do this. You can either use **Save** on the **Settings** pop-up or the SAVE PROJECT button on the computer front panel.

The function of the **Safe** column, on the **Settings** pop-up, is to prevent information being inadvertently saved from the front panel. Data for elements with a tick in the **Safe** column and a green box in the **Save** column can only be saved by using the **Save** function here or the **Save** box in the **Project** menu. If elements are flipped to a cross in the **Safe** column, the associated box in the **Save** column will turn red, indicating that the SAVE PROJECT button can now be used.

Once you are up and running, the SAVE PROJECT button will obviously provide the most convenient method. When mixing, for example, by selecting **Automation data** ready to save with the SAVE PROJECT button, mixes can be saved to disk with a simple press of the button. When you save **Automation data** or **Total Recall** setups, a QWERTY pop-up will appear, enabling you to name these items as they are saved.

If **Auto** is selected (red) only those elements that have changed since the last save will be saved by hitting **Save**. If the SAVE PROJECT button is used, then only those elements that are ticked with a red background (ie. not 'Safe'), and which have changed, will be saved.

Warn, used in conjunction with **Load**, is activated when elements of your project are unsaved and will be overridden by a subsequent load action. With **Warn** selected (red), when you stab on **Load** a pop-up will appear telling you that some data has not been saved. You now have the option of continuing the load or aborting in order to save the data. We suggest you leave **Warn** selected!

The **Reminder** box in the **Project** menu, can be used to warn the user to perform a project save after a specified timeout has expired. Stab on the box to set the timeout period between 0-1440 minutes – default value 10 minutes (see opposite). Progress of the countdown will be shown in the **Reminder** box. To indicate that the period has expired, and a save is necessary, the SAVE PROJECT button on the computer front panel will flash. In addition, the **Reminder** box will change to **Save Now** and flash pink/green; if the **Project** menu has been deselected then the **Project** box will also flash pink/green.

Each time you execute a save, the timeout period is reset and the countdown begins again. If you do not wish to save your data when the timeout period has expired, stab on the **Save Now** box and enter 0 on the pop-up; this will cancel the countdown. To reset the timeout once the countdown has started, simply stab on the reminder box, enter the new period and hit OK.

Progress and any problems with the saving process will be indicated in the status bar.

For more on the **Settings** pop-up, see Page 2-13.

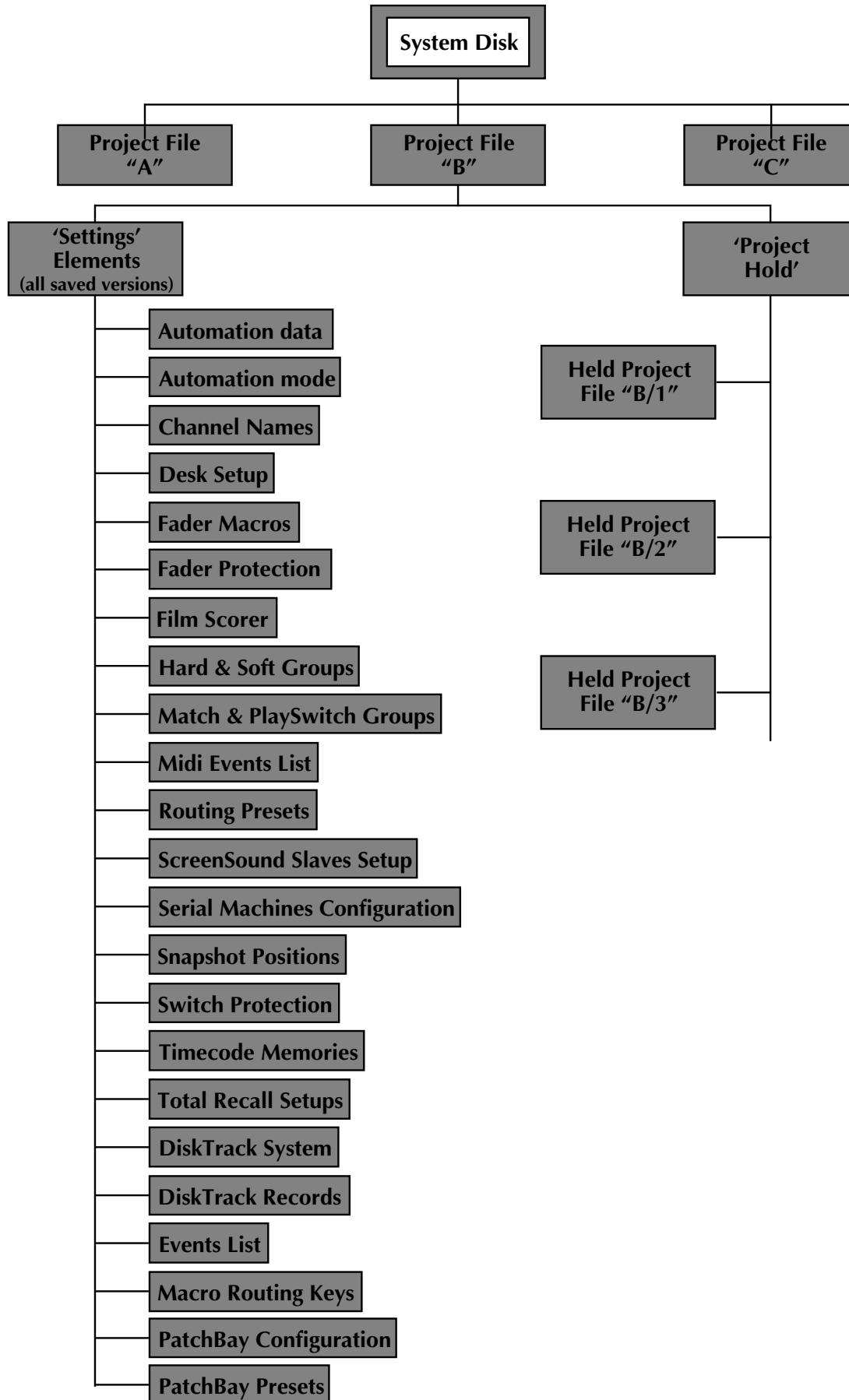

Project File Contents

A Project File holds a vast amount of useful information. Opposite you will see a diagram of Project File hierarchy; note that this is the only time you are likely to see all elements of a Project File listed simultaneously! Note also that, according to selections made in conjunction with the **Mini** function (see Page 2-13), you may not see all these elements listed on your screen. For more information on 'Held Project Files', see Page 2-15.

The individual elements of a Project File, and their contents, are as follows:

Automation data	Data for all saved mixes in the Mix List (see Section 5)
Automation mode	The modes selected for Faders, Cuts and other automated objects (see Section 5)
Channel Names	Channel <i>and</i> Track lists (see Section 4)
Desk Setup	In addition to items in the FILE/SETUP/Desk Setup menu (see Sections 5 and 9), this also covers items in the Automation/Fader Status pop-up (see Section 5), Motors On/Off (see Section 5), Events List filters (see Section 4), Snapshot Protection (see Section 5) and Group Solos linked to Desk/Independent (see Section 5)
Fader Macros	Data relating to the 8 pre-defined macros that can be triggered from a specific fader level (see Section 8)
Fader Protection	Fader Protection settings (see Section 5)
Hard & Soft Groups	Fader Grouping information (see Section 5)
Match & Play Switch Groups	Switch Grouping information (See Section 5)
Serial Machines Config	Serial machine control setup data (see Section 3)
Snapshot Positions	62 console-wide snapshots of automated objects (see Section 5)
Switch Protection	Switch Protection settings (see Section 5)
Timecode Memories	The timecode values stored with the instant locate buttons (TC1-5 on the front panel. (See Sections 3 and 5)
Total Recall Setup	Total Recall Setups (see Section 6)
Events List	Events List data, including Cues (see Section 4)but excluding 'filter' settings (see Desk Setup below)
Macro Routing Keys	Contents of the computer's user-programmable keys. These may be programmed with macros to perform a wide range of functions (see Section 8)

Project Manager - BedBug

	✓	✓	✓	1	X
Serial Machines Config	✓	✓	✓	1	X
Snapshot Positions	✓	✓	✓	1	X
Switch Protection	✓	✓	✓	1	X
Timecode Memories	✓	✓	✓	1	X
Total Recall Setup	✓	✓	✓	1	✓
DiskTrack System	X	X	X	1	X
DiskTrack number 2319 selected					
DiskTrack Records	X	X	X	1	X
Events List	✓	✓	✓	1	X
Macro routing keys	✓	✓	✓	1	X
Patch Bay configuration	X	X	X	1	X
PatchBay Presets	X	X	X	1	X

05

Safe
/00
/00
ht
rd
rt
line

LF RJ | SF RJ | GF RJ | MF RJ | LC RJ | SC RJ | GC RJ | AU RJ | GS RJ | GL 50 FRAMES | AF 10 SECS | Free Mem 87%

FILE/SETUP	Proj. Title: BedBug			
MIX-DESK	Overview	Edit	Settings	Info
RECALL	Events	Automation	Load	New Project
MACHINES	SnapShots	Groups	Save	Copy Project
MISC	Faders	Project	Clear	Reminder

Project Manager - BedBug

	✓	✓	✓	1	X
Automation data	✓	✓	✓	1	X
Automation mode	✓	✓	✓	1	X
Total Recall Setup	✓	✓	✓	1	✓

05

Safe
/00
/00
ht
rd
rt
line

LF RJ | SF RJ | GF RJ | MF RJ | LC RJ | SC RJ | GC RJ | AU RJ | GS RJ | GL 50 FRAMES | AF 10 SECS | Free Mem 87%

FILE/SETUP	Proj. Title: BedBug			
MIX-DESK	Overview	Edit	Settings	Info
RECALL	Events	Automation	Load	New Project
MACHINES	SnapShots	Groups	Save	Copy Project
MISC	Faders	Project	Clear	Reminder

The following elements all cover optional additions to a basic SL 9000J system:

Routing Presets	Presets used to select different routing requirements for DiskTrack
DiskTrack System	DiskTrack's audio routing and playlist information
DiskTrack Records	DiskTrack's record arm assignments made in the Configure menu

Please see the DiskTrack Operator's Manual for further details of the above items.

Film Scorer	If your console is fitted with the Film Scoring System, your manual will have been supplied with an additional section containing details.
PatchBay Configuration	Manually made crosspoint assignments for any automated SSL PatchBay unit on the J Series network (see Section 7)
PatchBay Presets	Up to 60 presets may be stored, each preset handling a single crosspoint assignment for any PatchBay (see Section 7)
ScreenSound Slaves Setup	All setups made in the ScreenSound Slaves menu (see Section 7)

The boxes under **Automation data** and **Total Recall Setup** are used to display the names of the last saved mix and Total Recall setup; stabbing on either box provides access to the Mix and Total Recall setup lists.

More on the Project Settings Pop-up

If you stab on an element name in the left hand column of the display, eg. **Desk Setup**, that line will turn grey and any ticks in columns to the right change to crosses (see upper screen opposite). This enables fast deselection or reselection of elements when setting up to use the SAVE PROJECT key, or for a local **Load**, **Save** or **Clear**.

If you deselect a number of elements in this way, the **Mini** function, when selected (red), can be used to remove them from the displayed list (see lower screen opposite, but note that this example may be a bit drastic for normal use!). Remember that, depending on the number of elements you remove, it still may still be necessary to scroll the list to view all the remaining elements. The truncated list is Project File specific so any deselections you make will not stay in place when you load a different project or create a new one. Deselect the **Mini** box to restore the list to its full length.

A combination of the above functions will obviously be useful for those facilities which are not equipped with DiskTrack, PatchBays or ScreenSounds.

Please make sure that every operator in your facility, as well as visiting freelance engineers, are familiar with the current **Mini** deselections. If items are deselected or removed from the list, you obviously cannot save or load data for those elements of the Project File.

Project Manager - BedBug

	✓	✓	✓	1	X
Automation data	✓	✓	✓	1	X
Automation mode	✓	✓	✓	1	X
Channel Names	✓	✓	✓	1	X
Desk Setup	✓	✓	✓	1	X
Fader Protection	✓	✓	✓	1	X
Hard & Soft Groups	✓	✓	✓	1	X
Match & Play Switch Groups	✓	✓	✓	1	X
Snapshot Positions	✓	✓	✓	1	X
Switch Protection	✓	✓	✓	1	X
Timecode Memories	✓	✓	✓	1	X
Total Recall Setup	✓	✓	✓	1	✓

LF RJ | SF RJ | GF RJ | MF RJ | LC RJ | SC RJ | GC RJ | AU RJ | GS RJ | GL 50 FRAMES | AF 10 SECS | Free Mem 87%

FILE/SETUP	Proj. Title: BedBug			
MIX-DESK	Overview	Edit	Settings	Info
RECALL	Events	Automation	Load	New Project
MACHINES	SnapShots	Groups	Save	Copy Project
MISC	Faders	Project	Clear	Reminder

Select Hold Project to load

/Dounreay/projects/BedBug/project_hold

36% Free	Name
	BedBug Special Stuff
	Captured Clips

Search: Matches: Misses:

default

36%

FILE/SETUP	DiskTrack	Proj. Title: BedBug		
MIX-DESK	Overview	Edit	Settings	Info
RECALL	Events	Automation	Load	New Project
MACHINES	SnapShots	Groups	Save	Copy Project
MISC	Faders	Project	Clear	Reminder

Write Protect

The **Write Protect** function on the **Settings** pop-up, when selected (red) prevents any new version of element data being saved to the current project. This is Project File specific and, once set, will apply to that project each time it is made current. **Write Protect** should always be set for the system's Default Project File (see Page 2-3).

Loading Earlier Versions

Below the **Automation data** and **Total Recall Setup** entries in the **Settings** pop-up (see opposite), you will see an additional line which is used to display the name (and date/time) of the currently loaded mix or setup. Stabbing on either of these lines calls up the Mix or Total Recall Setup List which contains all the previously saved versions plus the date/time of their creation. Stabbing on any item in the list makes that mix or setup current. See Sections 5 and 6 for more details.

You will also notice two boxes marked **Next** and **Prev** under the element version number column. These may conveniently be used to toggle backwards (**Prev**) and forwards (**Next**) through the various version levels held for any other Project File element. The **Go Back** box will indicate how many version levels you have stepped back through with the **Prev** function. By stabbing on the **Go Back** box, you may instantly specify the number of versions you wish to go back by entering the number on a numeric pop-up.

'Holding' Projects

When saving project data, the recommended procedure is to keep all items ticked in the **Save** column of the **Settings** pop-up, keep **Auto** selected, and make regular use of the SAVE PROJECT (and SAVE TR) front panel button(s). This will ensure that any changes made in RAM will be saved without generating new file versions for elements that haven't changed. Following this procedure speeds up the process of saving, as well as greatly reducing the number of different versions of any particular file type that are stored within a given project.

While it is possible to give unique names to different versions of Automation Data and Total Recall files, all other file types are simply given a version number. If you save frequently for safety's sake, you may find that it becomes difficult to relate differently numbered file types. For example, you may find yourself with 30 mixes while only having 3 versions of Hard & Soft Groups (more on these later!), and find it isn't clear to which of the 30 mixes each of the 3 Groups file versions relate.

Generally this won't present problems as, normally, you will only be concerned with the latest version of any file. However, on occasions when you might wish to return to the current settings, it becomes essential to remember version numbers in order to return your project to it's previous condition. For example, you have just completed a rough mix you might want to return to when you begin the final mix. It is of course always possible to make notes, using the project **Info** function (see Page 2-17).

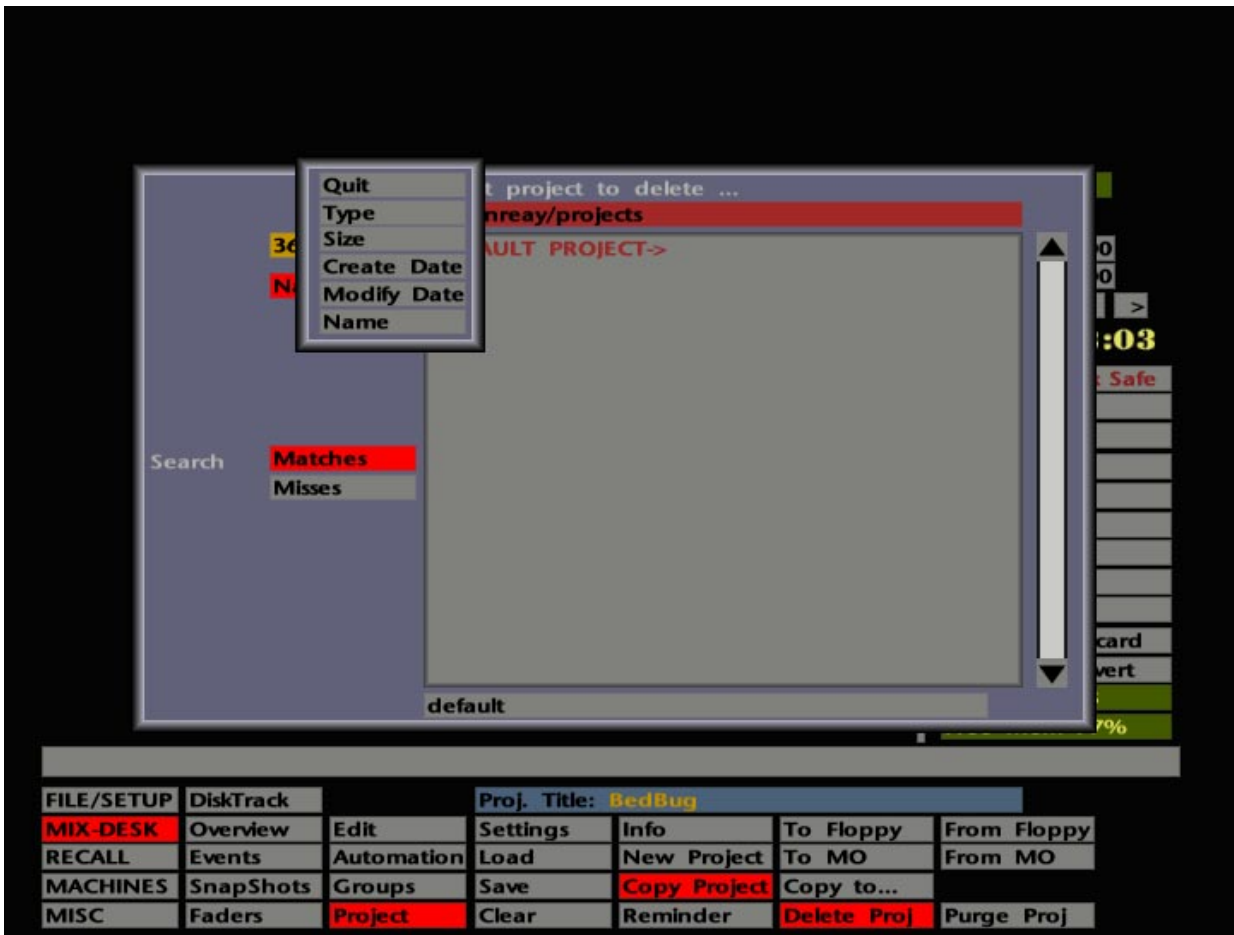
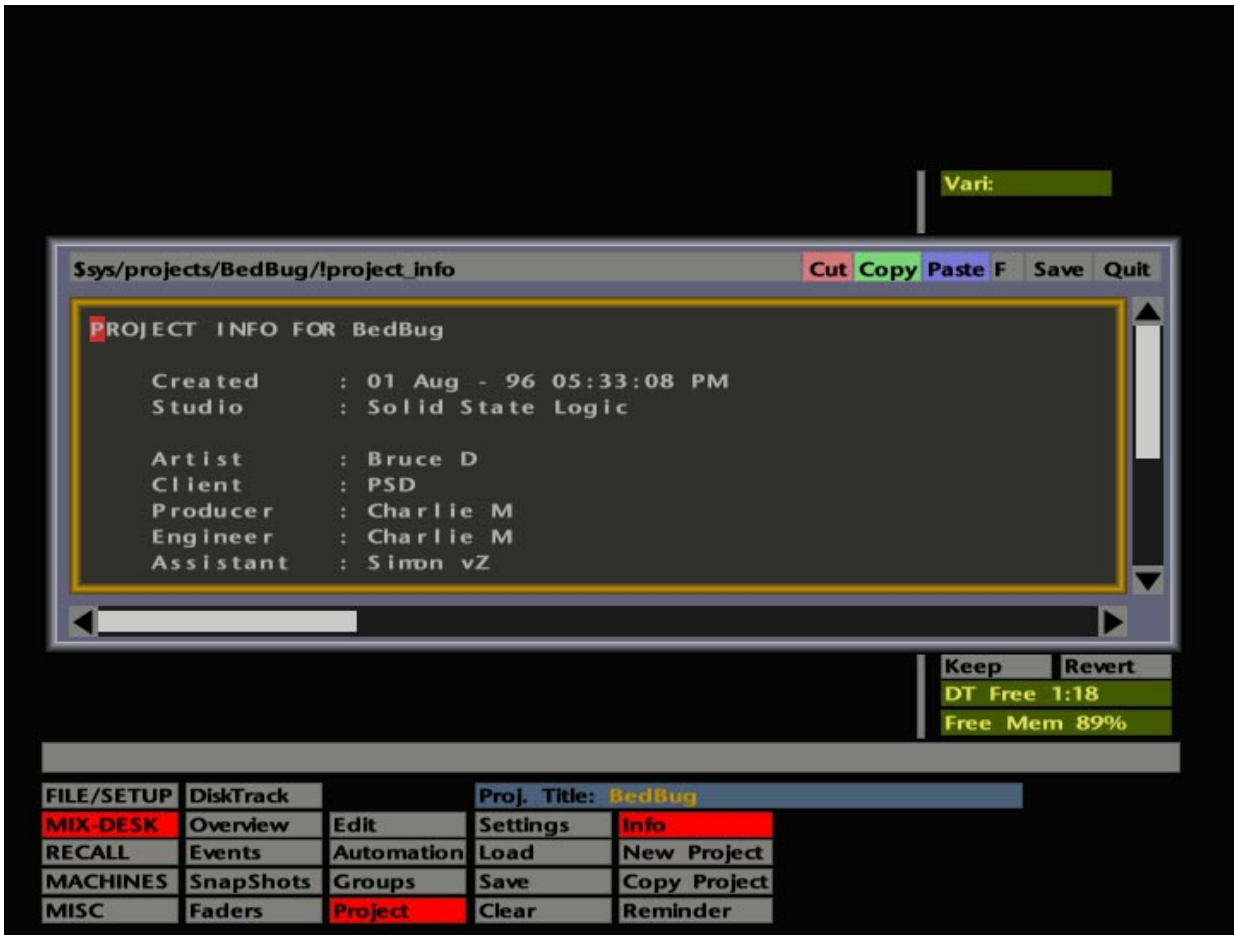

Hold Project on the **Settings** pop-up allows you to produce an 'inventory' file of the current (ie. latest) versions of every project element. Stab on **Hold Project** and a QWERTY pop-up will appear bearing the name of the current project. Append the name with a suitable entry, ROUGH MIX, FINAL, 12" MIX etc, and hit **END** or Enter. You may create as many 'held' files as necessary, each with an unique name.

To recall a 'held' file, first select the correct project (if necessary) by stabbing on the **Proj. Title:** box, select the **Settings** pop-up, and then select the correct file name from the list produced when you stab on **Return Project**. The element data will be loaded as normal, subject to the current state of ticks in the **Load** column (see Loading Project Data on Page 2-7). Note, however, that the version numbers will not change.

Project Information

Useful information may be appended to specific Project Files via the **Info** entry in the **MIX-DESK/Project** menu. Stab on the box and a text file pop-up will appear (see opposite). The default file includes a list of relevant categories (based on the G Series List page) which can be appended by placing the cursor to the right of the item and typing on the QWERTY keyboard.

Stab on **Edit** to access the **Cut**, **Paste** and **Copy** facilities. Select text, by dragging through it with the pen, in order to use the **Cut** and **Copy** functions. An option is provided to display the text with proportional spacing (**P**). **Save** changes before quitting. The project name and date is automatically set up when you create a new project (see Page 2-3).

Deleting Projects

It is good practice to only keep a limited number of Project Files on the System Disk. Once a recording project has been completed, the appropriate Project Files can be archived to MO or floppy disk (see Page 2-19) and the original versions of these files can then be deleted from the System Disk. Please use the following facility with care, and only when you wish to delete a complete Project File and all its versions. Select **Copy Project** in the **Project** menu, followed by **Delete Proj**, and a pop-up will appear with a list of Project Files on the System Disk.

By stabbing on the blue 'Sort' box you may reorder the list by Date, Size etc (see opposite). If the list is very long, you can search for a particular file by stabbing on the grey bar at the foot of the display to enter a search string on the resultant QWERTY pop-up. Hit **END** and the search string will appear in the bar. You may now select **Matches** to find items which match the string, or **Misses** to find items that don't!

Stab on the project you wish to delete and you will be asked if you definitely mean this. Select **Yes** or **No** accordingly. If you wish to delete a large number of Project Files, you may find the **FILE/SETUP** menu's **Data/Delete** function faster to use. See Page 2-25 for more details.

Progress and any problems with the deletion process will be indicated in the status bar.



Backing Up and Restoring Projects

Project Files may be backed up or archived onto MO discs or 3.5" floppy disks. Note that a floppy disk has a limited capacity for project information (see over the page) and we recommend that you use MOs if you need to walk away with a full set of your work.

All the facilities required for backup and restore of Project Files can be found in the **MIX-DESK/Project/Copy Project** menu.

Backup and Restore with MO Discs

Before a backup can be carried out, disc cartridges must first be formatted by using the **Format** function in the **MISC/Tools** menu (see Section 9).

With a formatted cartridge in the drive, select **To MO** in the **Copy Project** menu. You will now be presented with a list of projects which you may "select to archive" (see opposite). Stab on the file you wish to back up. The pop-up disappears and status messages indicate progress of the backup. Repeat the process for further projects. Note that the **FILE/SETUP/File Copy** function (see Page 2-21) provides a more convenient method of backing up a large number of projects.

The current contents and remaining data space on a MO can be determined by selecting **FILE/SETUP/Data/Inspect** and stabbing on the yellow **Mag. Opt.** box. Use **FILE/SETUP/Data/Delete** to clear unwanted files from a MO (see Page 2-25).

Backup MOs should be clearly labelled to indicate their contents as Project Data, together with the project name and date.

To restore previously backed up files, select **From MO** in the **Copy Project** menu. A similar pop-up list will appear, from which you may "select project to restore". Proceed as for the backup, and the files will be restored to the System Disk. Once restored, the files may be selected by stabbing on the **Project** menu's **Proj. Title:** box.

Backup and Restore with 3.5" Floppy Disks

It is also possible to store your Project data on floppy disk. Obviously you will first need a formatted disk; insert a disk in the computer's floppy drive and then select **MISC/Tools/Format** (see Section 9 for more details).

With a formatted disk in the floppy drive, a project can be backed up/archived at any time by selecting **To Floppy** in the **Copy Project** menu. You will be presented with a list of currently held Project Files. Select the file you wish to archive and the system will save the latest version of the file's elements to the floppy disk. Note that only the latest versions are archived, in order to prevent a situation where an over-large Project and all its element versions would not fit on the floppy! Note also that any 'Held' project data (see Page 2-15) will *not* be transferred using this method. Status bar messages will indicate progress as each element is copied.

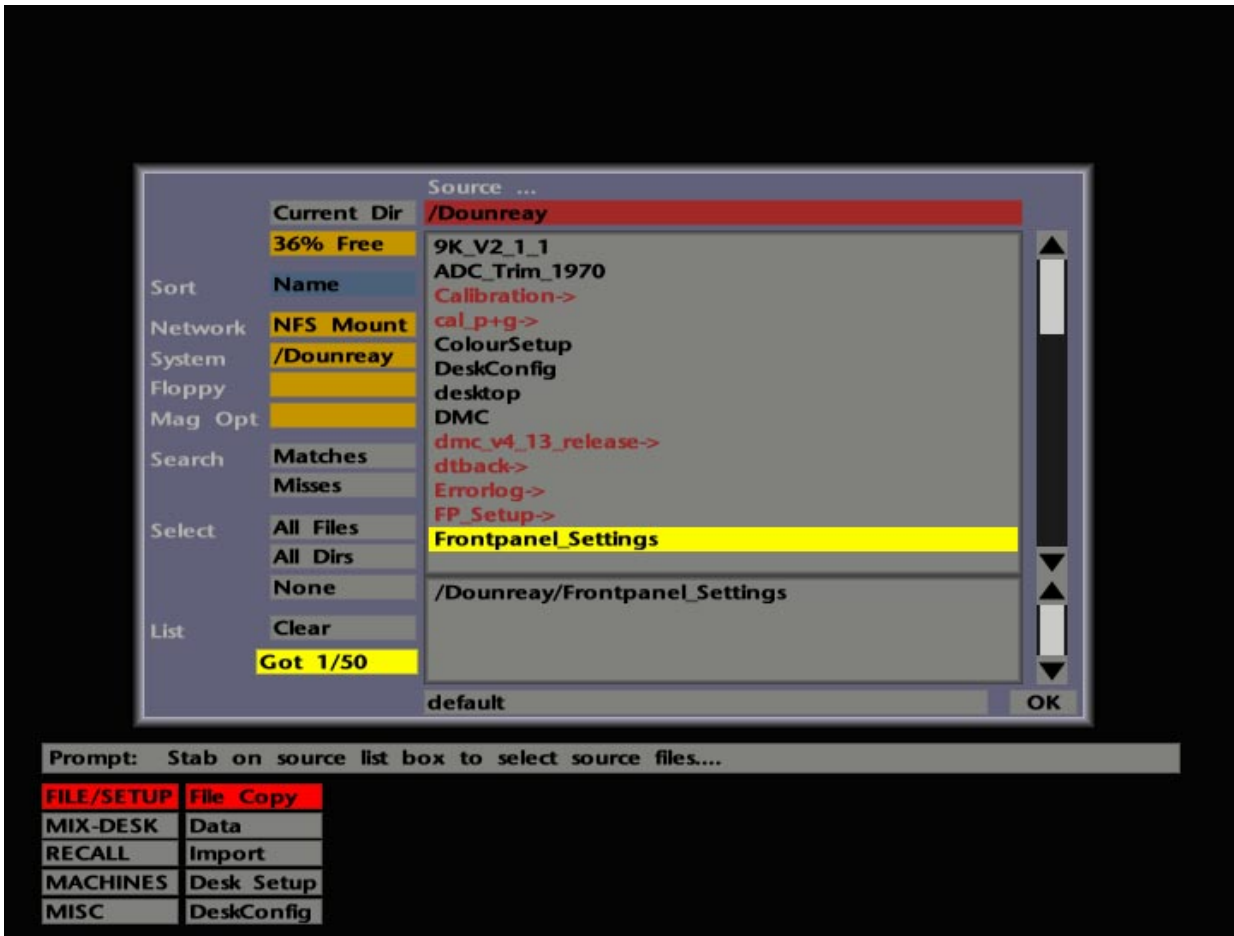

Since only the last version of Project File elements is saved with this process, the version number for each element will revert to 1 in the archived file, regardless of the version level reached prior to the archive. You should be able to archive at least one Project File per floppy. If you get a message, when subsequently archiving, saying that a file may not be archived, the most likely reason is that there is not enough room on the disk. Nevertheless, using floppy disks as an archive media for Project Files will provide considerable savings over the use of MOs for the same purpose.

The current contents and remaining data space of a floppy can be determined by selecting **FILE/SETUP/Data/Inspect** and stabbing on the yellow **Floppy** box. Use **FILE/SETUP/Data/Delete** to clear unwanted files from a floppy (see Page 2-25). To backup a Project File to floppy, including all versions and 'Held' project data, use the **FILE/SETUP/File Copy** function (see below).

To restore an archived Project File from floppy disk, select **From Floppy** in the **Copy Project** menu and you will be presented with a list of files on the currently loaded floppy disk. Select the relevant file and status messages will indicate progress as the elements are copied back to the computer's System Disk. Note that, if the same named file still exists on the System Disk, the file you wish to restore will automatically be tagged with a **(1)** to distinguish it from the original. See also Page 2-5 for an alternative method of restoring projects from floppy to the System Disk by using **Copy to ...**

Copying and Deleting Multiple Projects

We have already discussed the Project File copy and delete functions that can be found in the **Copy Project** menu. Both **Copy to ...** (see Page 2-5) and **Delete Proj** (see Page 2-17) are fine if you only want to copy or delete one or two projects. In cases where you may want to copy a large number of Project Files to/from an archive MO for example, or delete a large number of Project Files from an overcrowded System Disk, the **FILE/SETUP** menu offers a couple of facilities which will help speed the process.

File Copy

As well as providing the general means to copy files from any drive to the same or any other drive on the system, this function is particularly useful when backing up or restoring large numbers of Project Files to/from MO. The reason for this is that many files can be preselected before the transfer is initiated (the **Project** menu **To MO** and **From MO** functions require Project Files to be selected individually for transfer).

For the purposes of the following description, we will assume that you wish to copy a large number of Project Files from the System Disk to a MO.

Select **File Copy** in the **FILE/SETUP** menu. Stab on the large grey **Source ...** box to produce a file selection pop-up (see opposite). From bootup, the list will display the top level of the System Disk; from there on, the list will display the last selected directory. The name of this directory, plus its file path, will be shown in the red bar at the top of the pop-up. Stab on this bar repeatedly until you reach the top level directory – the System Disk. If the list has been left accessing the MO or floppy disk drives, first stab on the yellow **System** box to access files on the System Disk.

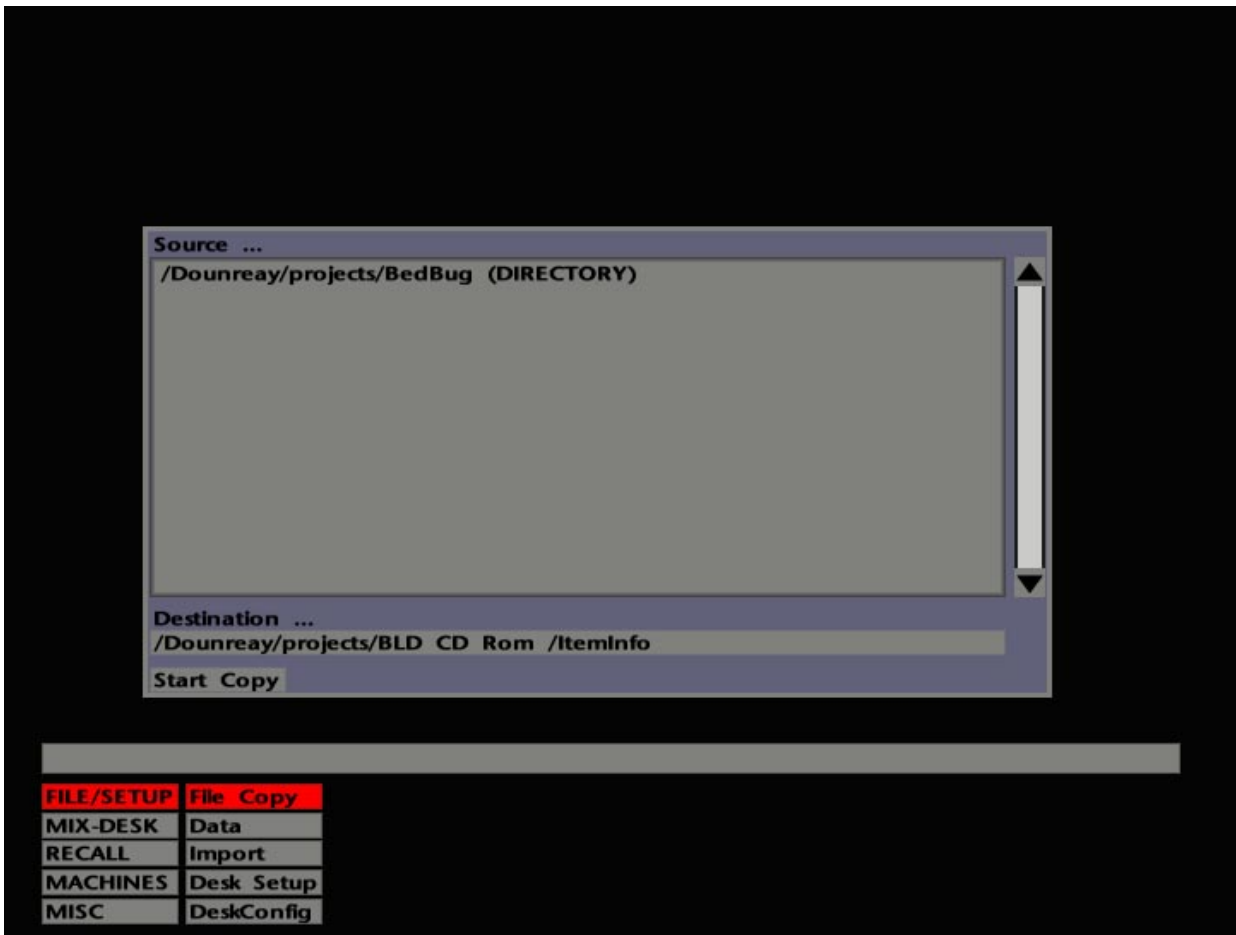

In the file list, directories are shown in red with a -> suffix; files are shown in black. To examine the contents of a directory, stab on that entry in the list. To access Project Files, scroll the list and select the **projects->** directory. You may choose to sort the list by Name, Type, Size or Date by stabbing in the **Sort** box.

Single projects may be selected for transfer by stabbing on them and then stabbing on the **Current Dir.** box. The selected items are highlighted in yellow in the main list and also appear, complete with file path, in the smaller scrollable list below. This is the 'selected file' list and holds the items that will be backed up/transferred. To select further projects, return to the main projects directory by stabbing on the red bar above the list.

Alternatively, multiple projects can be selected by stabbing on the **All Dirs** box. This, not surprisingly, selects all Project Files in the **projects->** directory; *deselect* the projects you don't wish to backup by stabbing on them in the 'selected file' list. Note that this method of selection will be most effective when you wish to back up a large proportion of Project Files in the list.

Having made your selections, stab on **OK** and you will find the selected files listed in the **Source ...** box. Now, with a formatted MO in the drive, stab in the **Destination ...** box and stab on the yellow **Mag Opt** box to select the MO as your destination.

To instigate the backup, select **Start Copy**. A **TO DO X, DONE X** tally at the bottom of the pop-up keeps you informed of the transfer progress. Note that the status bar below the pop-up also provides useful prompts at each stage of the transfer.

To search for a particular file (or directory), stab on the grey bar at the foot of the display to enter a search string on the resultant QWERTY pop-up. Hit **END** and the search string will appear in the bar. You may now select **Matches** to find items which match the string, or **Misses** to find items that don't!

To select only directories or only files in the currently selected directory, select the **All Dirs** or **All Files** box respectively. Once selected, individual files may be *deselected* by stabbing on them in the main list or the 'selected file' list. **None** deselects all current selections in the currently selected directory; **Clear** clears all entries from the 'selected' list. A count of the number of selected items is displayed in the **Got....** box.

To clear the Source/Destination display from the screen without effecting a transfer, deselect the **File Copy** box.

The **File Copy** function can of course be used to effect file transfer between any combination of System Disk, MO or Floppy. Simple select the correct drive by stabbing on the **System, Floppy** or **Mag Opt** box as required. (The **Network** selection is not applicable in commercial installations).

Use **File Copy** if you want to backup a Project File to floppy disk, including all the element versions and 'Held' project data. If all this data will not fit on the floppy, you can use **Purge Proj** (see Page 2-29) to limit the element data to the latest versions but retain any 'Held' project data. Always make a copy of a project (see Page 2-5) before using **Purge Proj**.

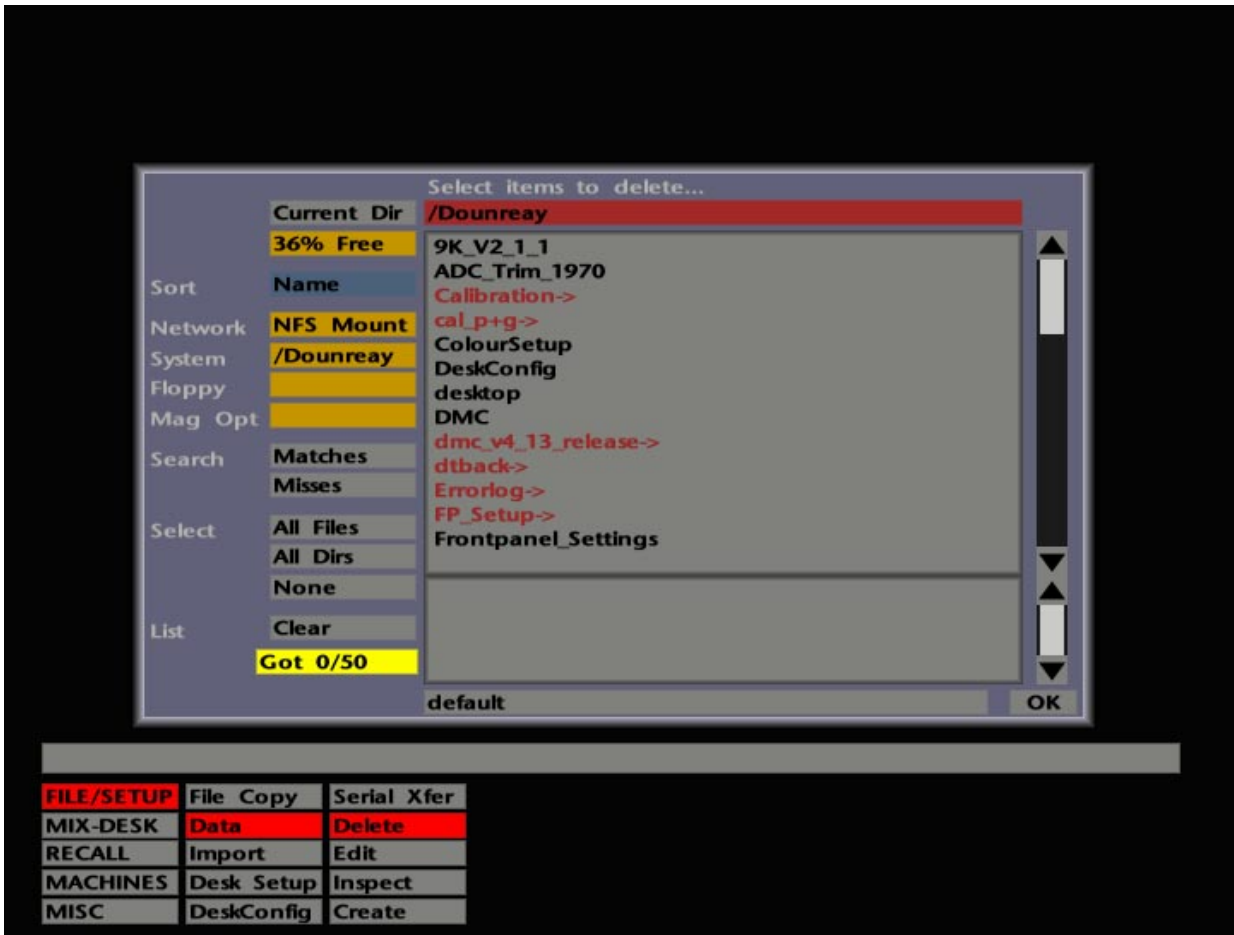

Data/Delete

As with **File Copy** (see Page 2-23), the **Delete** function in the **FILE/SETUP/Data** menu can be extremely useful when dealing with a large number of files. Typically this function will come into play when there has been little or no project management, and the System Disk has become cluttered with a mass of ancient projects.

Select **Delete** and a pop-up list of data files will appear (see opposite). From bootup, the list will display the top level of the System Disk; once it has been accessed, the list will display the last selected directory. The name of this directory, plus its file path, will be shown in the red bar at the top of the pop-up.

To list directories/files on a loaded floppy or MO disk, stab on the **Floppy** or **Mag Opt** boxes as appropriate. You may choose to sort the list by Name, Type, Size or Date by stabbing in the **Sort** box. Note that the box above **Sort**, displays the amount of free space available on each disk. Use the **Matches** and **Misses** functions as described for **File Copy** above.

The name in the long red bar at the top of the pop-up is the directory which you are currently looking at. The list itself shows directories in red, suffixed with -> and file names in black. To examine the contents of a directory, stab on the directory name. To return to the previous level, stab on the red bar above the list. To return to the top level, stab on the **System**, **Floppy** or **Mag Opt** box as required.

To delete multiple projects from the System Disk, first select the **projects->** directory. Now stab on the **All Dirs** box to select all the Project Files. Selected items are highlighted in yellow in the main list and also appear, complete with file path, in the smaller scrollable list below. This is the 'selected file' list and holds items that will be deleted. Deselect any projects you don't wish to delete by stabbing on them in the 'selected file' list.

Single files may be selected for deletion by simply stabbing on them. Multiple consecutive files can be selected by stabbing and dragging the pen up or down over the file names. To select only files in the current directory, select **All Files**. Once selected, individual files may be deselected by stabbing on them in the 'selected file' list.

None deselects all current selections in the currently selected directory; **Clear** clears all entries from the 'selected' list. A count of the number of selected items is displayed in the **Got...** box.

To delete the selected items, stab on **OK** and then confirm the deletion in the resulting **Yes/No** pop-up. To clear the delete pop-up without making a source selection, stab outside it.

The **FILE/SETUP/Data** menu also provides facilities to **Create** and **Edit** text files. The latter of these functions should be used with extreme caution. Do not attempt to edit any of the System files!

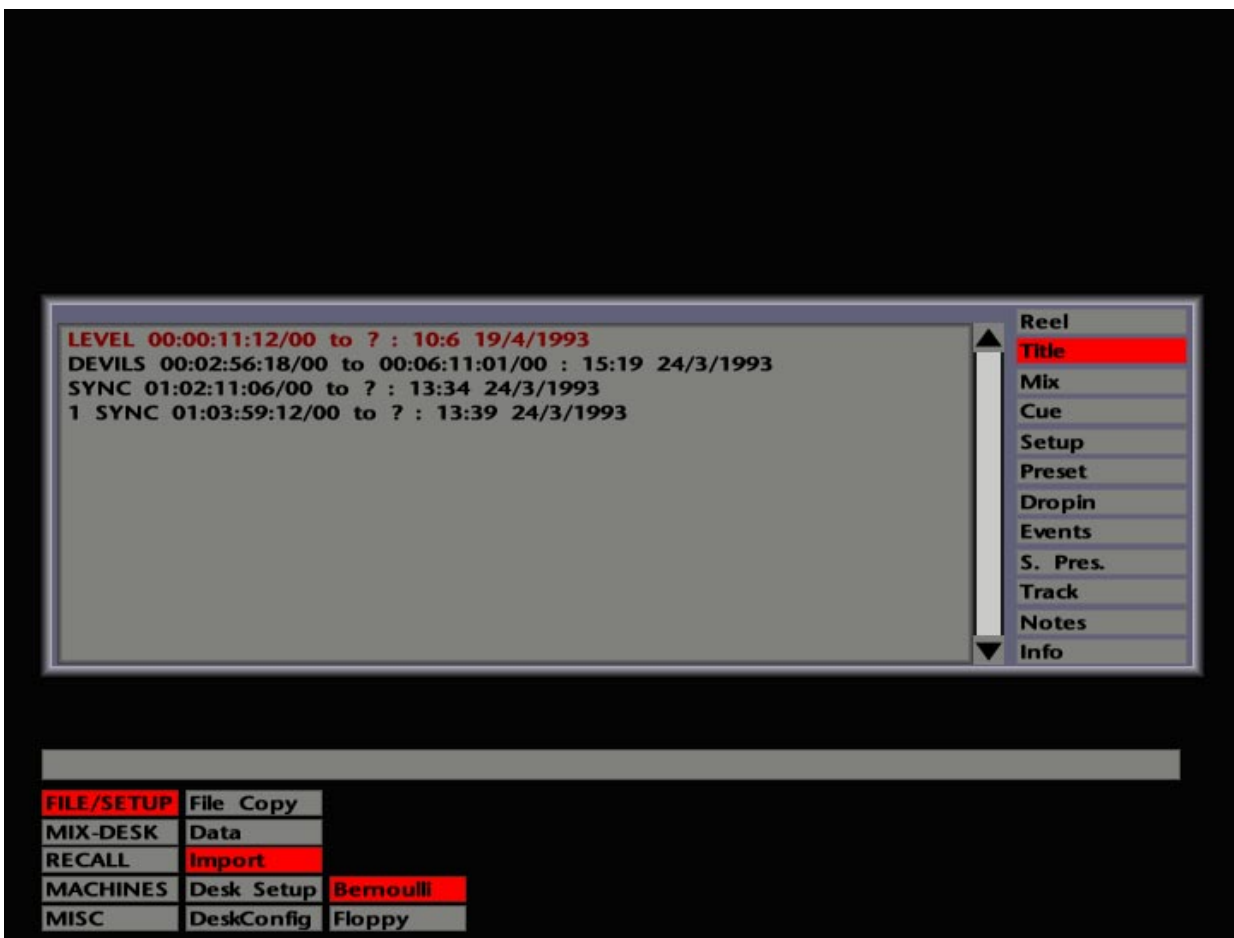

Importing G Series Data

G Series project data – Mixes (including software groups), Cues, and Track Lists may all be copied into the current J Series project. In addition, hardware group data can also be imported from G Series Total Recall setups. Data can be transferred from 3.5" Floppy Disks or 20Mb Data Cartridges.

Data on 3.5" Floppy Disks is loaded via the floppy drive unit on the front of the J Series Computer Processor. To import data from Data Cartridges, a set of drives must be connected via the SCSI port on the Processor's rear connector panel. Note that a SCSI terminator *must* be fitted to this connector when Data Cartridge drives are *not* connected.

Select the **FILE/SETUP/Import** menu. To access the disk you wish to import data from, stab on either **Bernoulli** or **Floppy**. After a few seconds, while the computer accesses the G Series disk, a pop-up appears (see opposite) that shows, on the right hand side, a column of boxes representing the different types of G Series data ('lists'). The area on the left is used to show the items/versions stored within those lists.

For example, if you are importing data from a 20Mb Data Cartridge, **Reel** will be highlighted at the top of the column on the right, and the area on the left will list the Reels you can access. Stab on a Reel name to select that Reel (the text turns red). Now select **Title** in the right hand column, and stab on a Title from the list that appears (see lower screen opposite).

Having accessed the required Title, items within that Title can be selected for transfer by stabbing on the appropriate box in the right hand column. Items that *can* be transferred will be listed, on the left of the pop-up, in black; items that appear in a sort of gold colour *cannot* be transferred. These include **Events**, **S. Pres** (Sync Presets), **Info** (the List Page), **Notes**, **Drop-Ins** and **Presets** (Real Time system). Although these items cannot be transferred, they may contain useful information that can be manually copied into the J Series project.

To transfer a single item from the **Mix** or (Total Recall) **Setup** lists, simply stab on it. To transfer entire lists, such as Cues or Track Lists, stab on the message "**STAB THIS LINE TO LOAD ALL ENTRIES**" that appears at the top of the left hand panel. Do not stab on an item more than once, as this will copy the data across twice (or even more times if you get frantic). The status bar will confirm that the transfer is taking place.

Note that items from the G Series Cue List will be added to any existing entries in the current Events List. If you only want to use the G Series Cues, remember to clear the Events List first. Use the **Project/Settings/Clear** function for this. For more on Events Lists, see Section 4.



If you import G Series data which has a Soft Group whose master was a hardware Group Fader, the Soft Group will be replicated exactly as it was on the G Series console, with the Group Fader as master (as seen in the Soft Group Setup pop-up). However, since this is not a valid selection on a J Series console (see Section 5), the Group Fader will not control the Soft Group, only any faders assigned to it in a hardware group.

All transferred data is simply copied into the computer's memory and will need to be saved to the System Disk with the **Project/Settings/Save** function (see Page 2-9).

Project Purge

Lurking in the **Copy Project** menu is a facility which deletes all the currently held versions of a Project File's elements except the last saved version in each case. Since this could be potentially dangerous, do not use this function on *any* Project File unless you are aware of the consequences. Better still, always make a copy of a project (see Page 2-5) before using **Purge Proj**.

Select **Purge Proj** and a list of currently stored Project Files will appear. Stab on the Project File you wish to purge. You will then be given one last chance to confirm that you wish to lose the previous versions. The remaining version for each element will retain its original version number and will not be reset to 1. Please note, however, if you check the Automation Data and Total Recall Setup lists in the **Settings** pop-up, you will find that the previous versions are still listed! This is also true if you use the **Prev** function (see Page 2-15) for other elements in the purged Project File. The reason for this is to safeguard any element versions that you may have saved in a 'Held' Project (see Page 2-15). If you try and load any of the earlier versions in the normal way (ie. not by using **Return Project**) the system will naturally tell you that they cannot be found.

Solid State Logic
SL 9000 J Series
Total Studio System

Computer Operator's Manual

SECTION 3

Machine Control



Serial Machine Control

Port	Key	Sync Point	Machine	Interface	State	Enables		
Local 1	1	00:00:00:00	Sony 3324S	DCTM	Off	Motn	Master	Rec
Local 2	2	00:00:00:00	MotionWork	MW DCTM	Off	Motn	Master	Rec
Local 3	3	00:00:00:00	Sony 3324S	VPR3	On	Motn	Master	Rec
Local 4	4	00:00:00:00	Sony 3324S	Sony 9 Pin	Off	Motn	Master	Rec

Desk 00:00:00:00 MRE

Preroll frames 0

00 : 00 : 00 : 00 / 00

<<
< >
Stop
>
>>

Clear

Revert

Offset Here

Desk Here

Load

Eject

FILE/SETUP	Network	DiskTrack
MIX-DESK	Serial	Relay Box
RECALL	SS Slaves	TC Gen
MACHINES	PatchBay	Routing
MISC	Scorer	KeyPad

Machine Control

If you have previously used SSL's G Series Computer, you will soon find that the J Series machine control facilities provide a great deal more flexibility. In a basic installation, the J Series Computer may simply control a single machine via a parallel link, much in the same way as G Series. In more complex installations the computer can control up to four machines as slaves, via either direct or serial control lines.

Basic setting up of machines is carried out via on-screen menus. In normal use, machines can be selected on and off-line, and record armed, by using dedicated machine enable buttons on the computer front panel.

When the system is booted up, the Default Project File will load the machine control settings that have been saved to that file during system commissioning. When you create a new project using the **New Project** function (see Section 2), the same settings will be copied to the new project. As long as you have a single machine in use with the system, and never hire in different machines, you can be happy in the knowledge that the correct machine control settings will always be present even from system bootup. The only thing you will need to do is match the desk timecode to the machine timecode whenever you load a different tape (see Page 3-3).

If, however, you are controlling a number of different machines, or change the master machine on a regular basis, you will need to have a basic understanding of the J Series Computer's machine control facilities.



Timecode and Sync Standards

Whether you are setting the system up for the first time, or simply dealing with tapes that have different timecode standards, you need to understand the relationship between the system 'sync' and tape machine timecodes.

All elements of a J Series system require a video sync source for the purpose of system timing; apart from the J Series Computer, your system may be fitted with a DiskTrack or VisionTrack. If you are working with digital tape machines then these should also be fed with the same video sync signal. Whether you use NTSC (525) or PAL (625) video sync will normally be down to the standard of the country. It also follows that, where NTSC is the video standard, tapes will be striped with some form of '30 fps' timecode (dropframe or non-dropframe); where PAL is the standard, 25fps (EBU) timecode normally prevails.

The J Series computer should always have its timecode standard set to match the timecode on tape. In the **FILE/SETUP/Desk Setup/Timecode** menu you can select from a choice of **SMPTE D/F**, **SMPTE 30**, **EBU 25**, **HDTV**, **NTSC FILM** and **PAL FILM** (see opposite). The latter three standards are explained in Section 9. Note that the setting here also governs the type of timecode that will be generated by the system (see Section 7).

If you are mixing *without* automation, you can select any of the above timecode standards regardless of whether the system is being fed by NTSC or PAL video sync.

If you are using the automation system, when system timing is that much more important, the video sync reference must be set to match the timecode on tape. For **SMPTE D/F**, **SMPTE 30**, **HDTV** and **NTSC FILM**, the video sync must be set to NTSC (525). For **EBU 25** and **PAL FILM**, the video sync must be PAL (625).

Depending on your installation, switching from one type of video sync to another may require changing the sync generator output on the rear of the J Series processor rack or re-plugging on a video sync patch. *Note that the J Series system elements, in common with most digital tape machines, must be restarted after changing the video sync standard.*

An additional entry in the **FILE/SETUP/Desk Setup** menu, **SIO TC:**, should normally be set to **Locked**. If, however, you want to work in feet/frames (**PAL FILM** or **NTSC FILM**) and are controlling an external machine with a different timecode standard, this entry should be set to the same timecode standard as the external machine (see opposite).

See Section 7 – The Machines Menu – for details of the J Series Computer's timecode generation facilities.

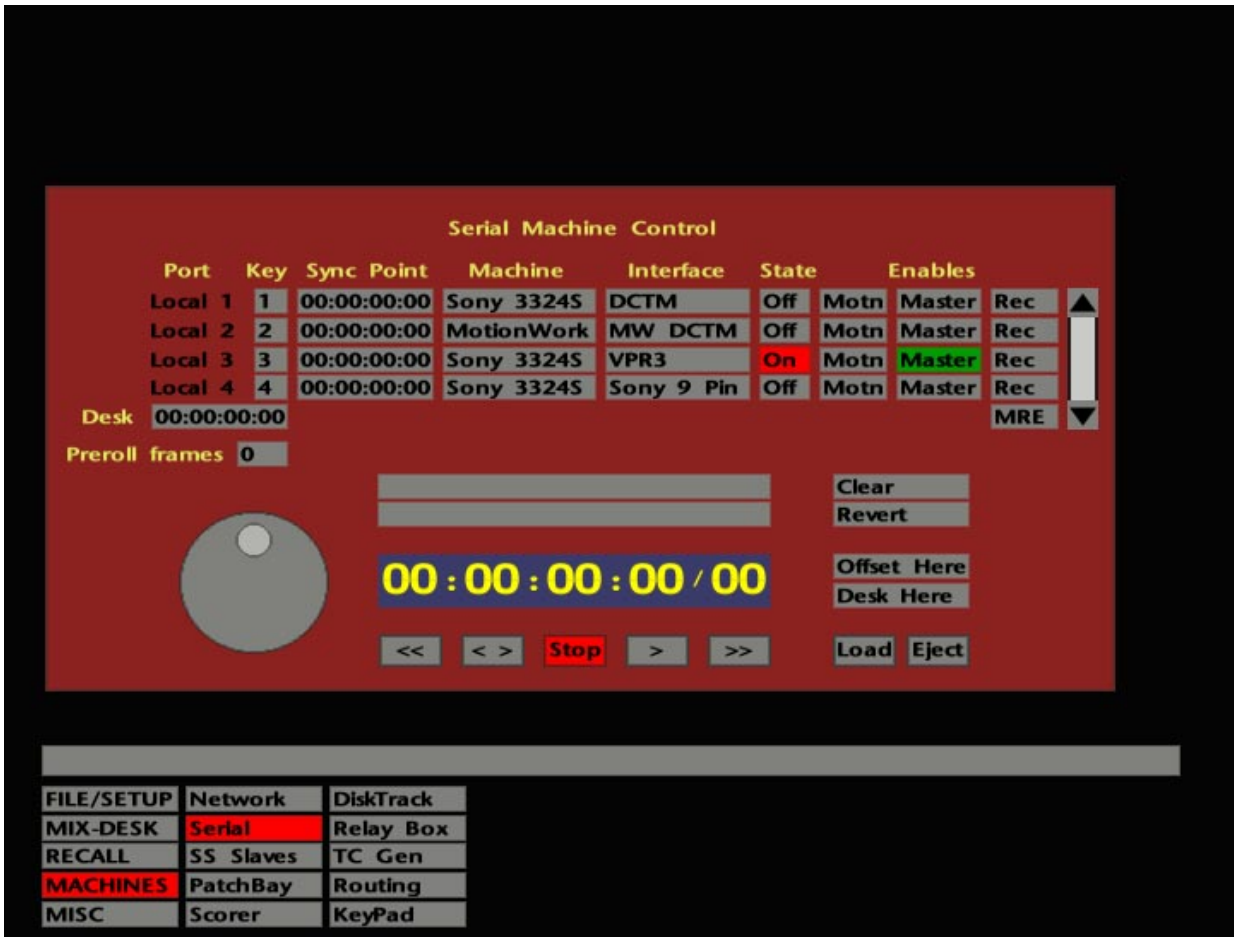

Serial Machine Control Display

Select the **MACHINES** menu followed by **Serial** and the Serial Machine Control display will appear (see opposite). Although unlikely at this stage, if a connected machine is in play or spool it will automatically stop as soon as you select **Serial**.

Four machine control ports on the computer rack unit are represented by the four lines of boxes in the upper half of the display; facilities in the lower half are used to locate individual machines to a suitable position before they are brought on-line.

The **Key** column of boxes enables ports to be controlled by different ENABLE buttons on the computer front panel. See Page 3-33 for more details.

The **Machine** column will list by type (name/number) those machines that have been setup, usually during the commissioning period, for use with the system. The **Interface** boxes show the specific type of control protocol being used for each machine. Do not change either of these selections unless you know what you are doing! Each machine type is associated with a set of control parameters devised specifically for that machine. If you change the **Machine** and/or **Interface** entries without changing the machine, don't be surprised if the machine behaves in a bizarre manner!

Entries in the **Machine** column should be entirely obvious. Entries in the **Interface** column may show any of the following control protocols:

DCTM – Stands for 'Direct Control Tape Machine'. A parallel interface which is the equivalent of SSL's 'S29' (25-way 'D' type connector) interface as used on SL4000/6000/8000 systems. The computer slaves to incoming timecode. Note that it is only possible to have one DCTM machine on-line at a time.

VPR3 – Used to control Timeline Lynx Modules (with the VSI option), as well as machines which can be directly controlled by this protocol.

Teac LV210 – Specifically designed for this Laserdisc player!

Sony 9-Pin – Provides direct machine control of VTRs, ATRs, as well as ADAT and R-DAT machines. Indirect control of ATRs, VTRs and film transports may also be effected via Motionworker and the Audio Kinetics ES 1.11 units.

If you are setting up the system for the first time, or wish to use a machine not currently showing in the **Machine** column, please turn to Page 3-25.

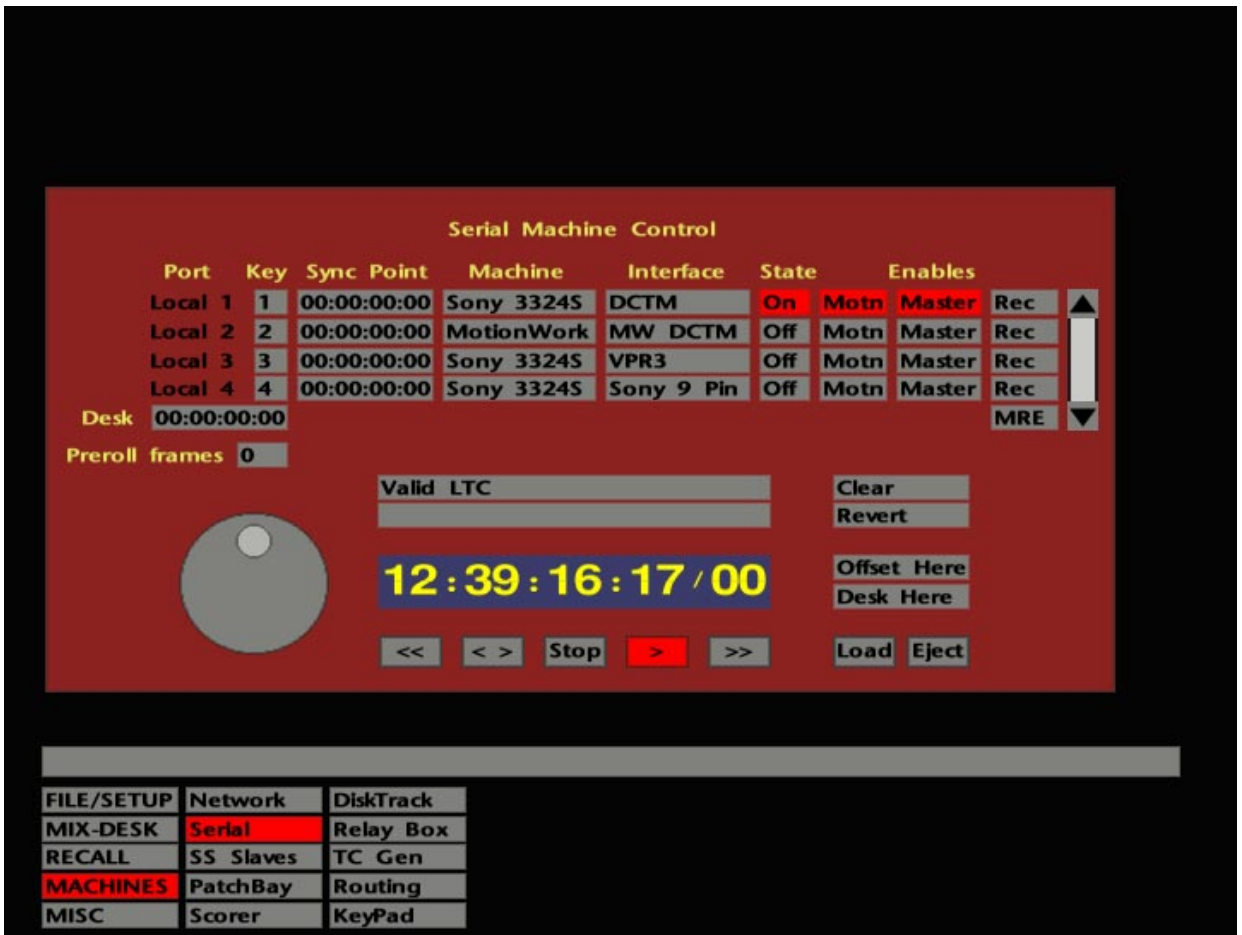
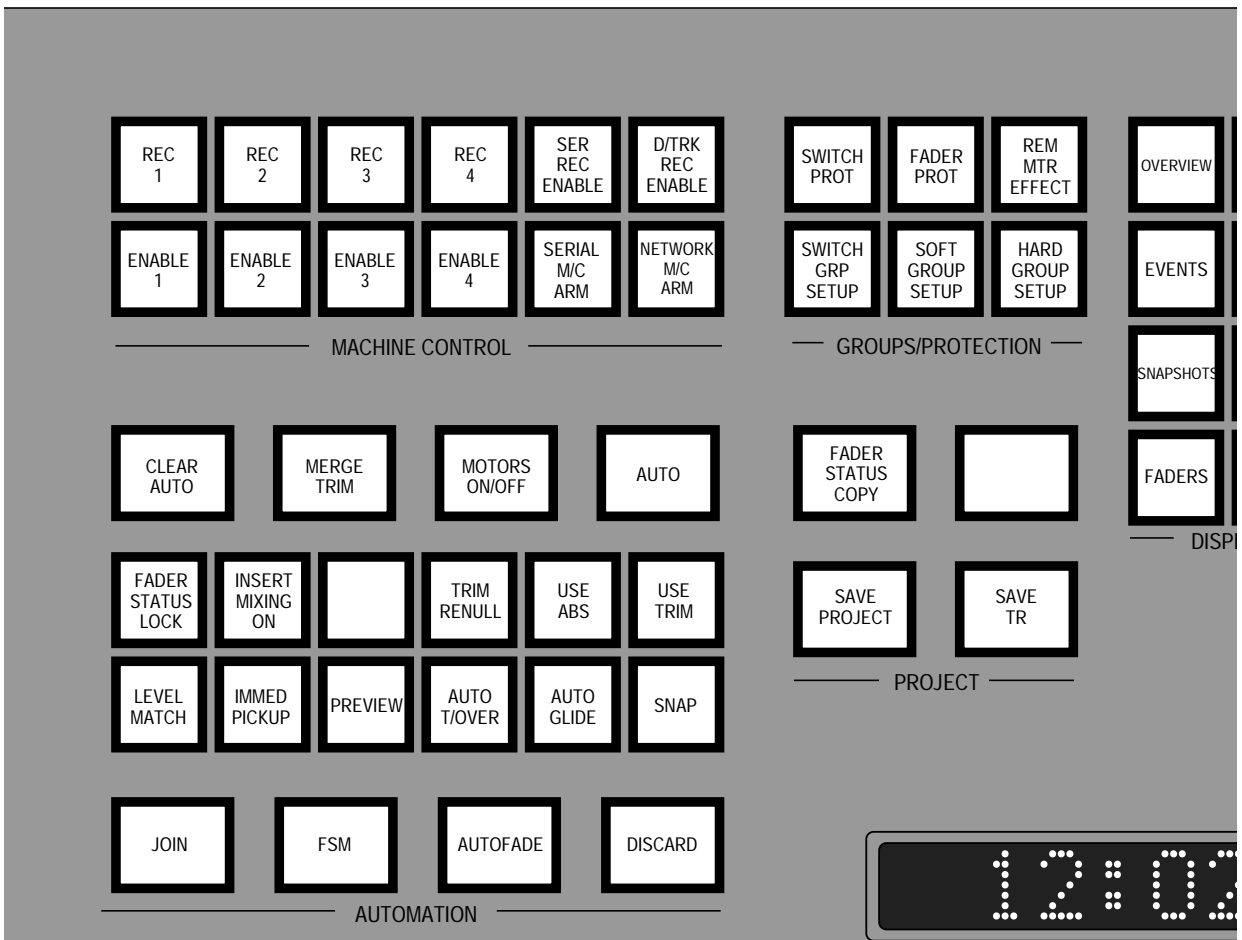

Getting a Machine On-Line

On the computer front panel, first check that none of the ENABLE 1-4 buttons, nor the SERIAL MACHINE ARM button, is selected. These buttons are located at the top left of the computer front panel under the computer monitor, in the group of "MACHINE CONTROL" buttons.

Now load a tape onto the machine.

Assuming that you are dealing with a single machine, on the port to which the machine is connected, select **State** to **On** to bring the machine on-line. The **State** function for each machine port is duplicated by the ENABLE 1-4 buttons on the front panel and as you stab on the **State** box you will see the appropriate button light up.

Now select **Motn** for the same port. If the machine has been interfaced correctly, its current timecode position will appear in the lower half of the **Serial** display. You can now control the machine from here by using the transport controls below. If **No comms** appears in the boxes above the timecode display, seek technical assistance.

Stab on the > box to put the machine into play. The machine will roll and useful messages will appear to confirm **Valid LTC** etc. Use the on-screen transport controls to position the tape machine at a sync point or at the beginning of the track you wish to work on. Stabbing and dragging left and right on the < > box will shuttle the machine backwards and forwards. By dragging the pen in a circular motion around the centre of the Jog Wheel you can jog a machine forward or back to the required position. Having done this, deselect **Motn**.

With the machine located to the chosen spot, you need to ensure that the Desk (computer) is set to the correct timecode value. If this is not the case, as soon as you return to the **MIX-DESK** display and bring the machine on-line, either it (or in the case of DCTM machines, the Desk) may rush off to match the Desk time (or the DCTM time).

Under most circumstances you will simply want the Desk to match the machine time. In this case, stab on **Desk Here** before leaving the Serial Machine Control display. This takes the current timecode from a selected machine and enters it as the Desk timecode position. You can confirm this by glancing at the Desk timecode display as you stab on **Desk Here**. Offsets between the machine and the Desk are discussed on Page 3-13.

You may wish to set a **Preroll** value before leaving the Serial Machine Control display. See Page 3-9 for more details.

Vari: 12:40:49:27

00:00:00:00/00

00:00:00:00/00

Cycle 5 < >

12:40:49:28

Arm Final Mix Safe

Fr : _____

To: _____

*: _____

0: _____

-1: _____

-2: _____

-3: _____

-4: _____

Name	Discard
Keep	Revert

DT Free 1:18

Free Mem 97%

FILE/SETUP	DiskTrack	
MIX-DESK	Overview	Edit
RECALL	Events	Automation
MACHINES	SnapShots	Groups
MISC	Faders	Project

Serial Machine Control

Port	Key	Sync Point	Machine	Interface	State	Enables		
Local 1	1	00:00:00:00	Sony 3324S	DCTM	On	Motn	Master	Rec
Local 2	2	00:00:00:00	MotionWork	MW DCTM	Off	Motn	Master	Rec
Local 3	3	00:00:00:00	Sony 3324S	VPR3	Off	Motn	Master	Rec
Local 4	4	00:00:00:00	Sony 3324S	Sony 9 Pin	Off	Motn	Master	Rec

Desk 00:00:00:00 MRE

Preroll frames 0

Valid LTC

Clear

Revert

Offset Here

Desk Here

Load

Eject

12:39:16:17 / 00

<<
< >
Stop
>
>>

FILE/SETUP	Network	DiskTrack
MIX-DESK	Serial	Relay Box
RECALL	SS Slaves	TC Gen
MACHINES	PatchBay	Routing
MISC	Scorer	KeyPad

With the **MIX-DESK** display on the screen, press the SERIAL M/C ARM button on the computer front panel and note that the grey **Arm** box underneath the **MIX-DESK** timecode readout turns blue (see opposite).

Press the PLAY button on the front panel and the **Arm** box will momentarily indicate **///**, followed by **Cue**, and finally **Loc** once the Desk and machine are in 'sync lock'. The **Vari:** box at the top right of the **MIX-DESK** display will indicate any percentage change of speed as the machine (or the machine defined as the master in multiple machine setups) slews to lock with the Desk.

Note that **Cue** will be indicated and individual machine ENABLE buttons will flash when a machine is locating.

If you are using a Sony 9-pin or DCTM machine, a green box underneath the **Vari:** box will display the machine's actual position at all times. If this box turns red, then the wrong timecode standard has been selected in the **FILE/SETUP/Desk Setup/Timecode** menu. If the box flickers, this indicates timecode errors, ie. drop-outs. See Page 3-3 for more on Timecode and System Sync standards.

Current selections of the **State/ENABLE** functions may be saved as part of a Project File under **Serial Machines Config** (see Section 2).

If you are dealing with multiple machines, see Page 3-13.

Preroll

The **Preroll** function on the Serial Machine Control display allows you to specify the amount of time by which the machine will position itself before a given locate point. Stab on the **Preroll** box and choose a time value between 0 and 750 frames (0-30 seconds in EBU land and 0-25 seconds when using SMPTE). The **Preroll** value may be saved as part of a Project File under **Serial Machines Config** (see Section 2).

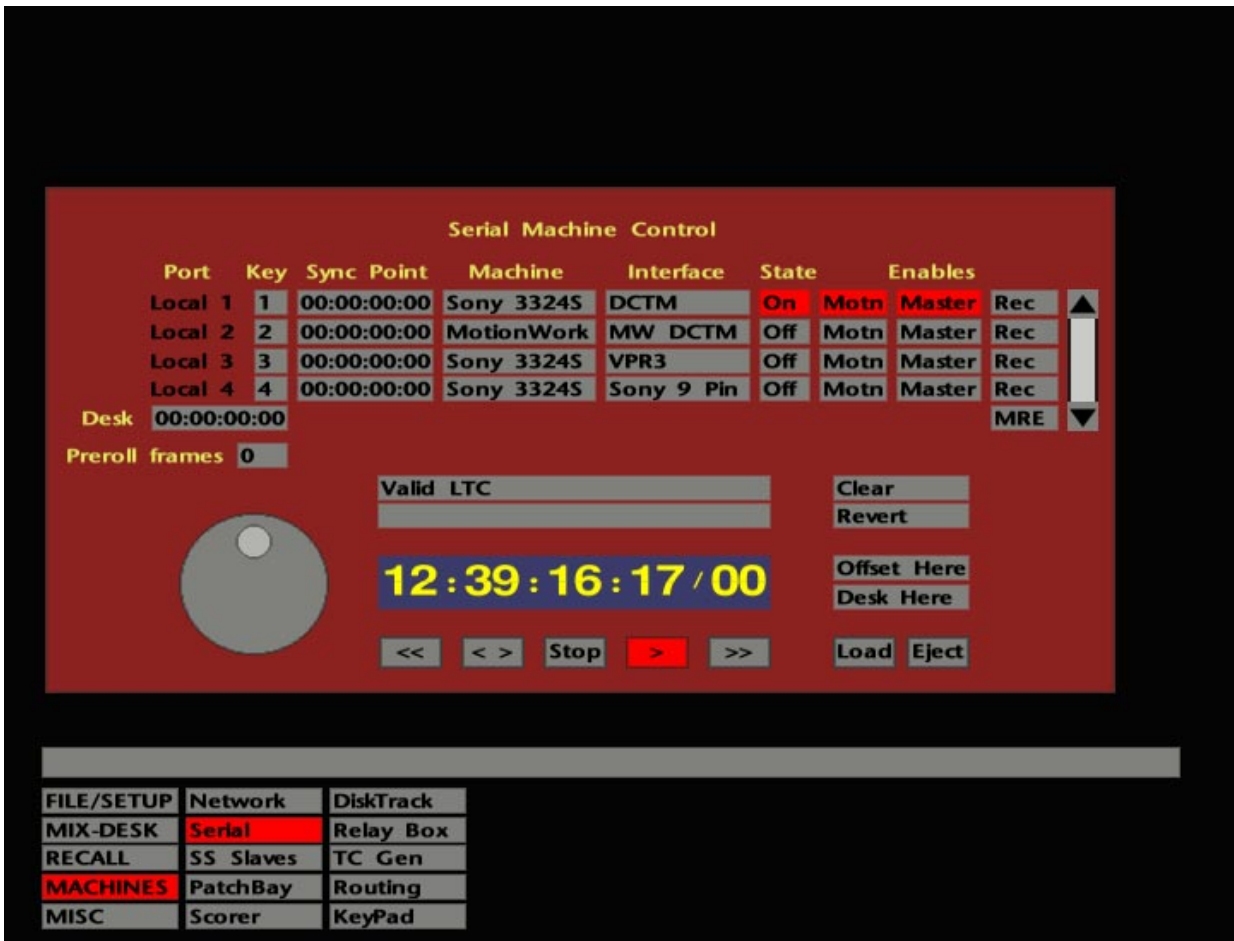

Master Modes

If a **DCTM** machine is selected on the Serial Machine Control display, the **Master** flag for that port (to the right of the **Motn** box) will automatically turn red. This indicates that the machine is in 'Red-Master' mode. In this mode, the Desk (computer) sends direct transport commands to the machine, then, once the machine is moving, slaves to the machine's timecode returned via the computer's timecode input connector. If you control a DCTM machine from its own transport buttons, the Desk will follow.

Sony 9-pin and **VPR3** protocols offer two types of master mode:

Stabbing on the **Master** box once selects 'Red-Master' mode (as above). In this mode, the Desk sends serial transport commands to the machine, then slaves to the machine's timecode returned via the serial port. When you press **PLAY** on the Desk, the play lamp will flash until the Desk has locked up to the machine. Hitting **STOP** during a locate will stop the machine and re-locate the Desk to the machine's current position. This mode is *not* recommended for use with **VPR3** and only recommended for use with **Sony 9-pin** when controlling fast-response transports such as video machines.

Stabbing on the **Master** box a second time selects 'Green-Master' mode. In this mode the machine will be slaved to the Desk. If you hit the front panel's Fast-Forward or Rewind buttons, positional information is sent back to the Desk to provide **FF** and **RW** speeds appropriate to the machine. Hitting **STOP** while the machine is in **FF** or **RW** will cause the Desk to locate to the machine's position. This mode has particular applications in film post-production where fast wind to a particular film frame is required.

When 'Red-Master' and 'Green-Master' are *not* selected for **Sony 9-pin** and **VPR3** controlled machines, the Desk acts as a master with the machines as slaves.

Note that only one machine port at a time can be selected to either **Master** mode.

Serial Machine Control

Port	Key	Sync Point	Machine	Interface	State	Enables		
Local 1	1	00:00:00:00	Sony 3324S	DCTM	On	Motn	Master	Rec
Local 2	2	00:00:00:00	MotionWork	MW DCTM	Off	Motn	Master	Rec
Local 3	3	00:00:00:00	Sony 3324S	VPR3	Off	Motn	Master	Rec
Local 4	4	00:00:00:00	Sony 3324S	Sony 9 Pin	Off	Motn	Master	Rec

Desk 00:00:00:00 MRE ▼

Preroll frames 0



Valid LTC

12:39:16:17 / 00

Clear

Revert

Offset Here

Desk Here

<<
< >
Stop
>
>>
Load
Eject

FILE/SETUP	Network	DiskTrack
MIX-DESK	Serial	Relay Box
RECALL	SS Slaves	TC Gen
MACHINES	PatchBay	Routing
MISC	Scorer	KeyPad

Offsets

There may be times when you wish to have the Desk timecode offset from the actual machine timecode. For example, a track on the machine starts at 2:54:36:02 and you would prefer the Desk timecode to have a more logical start time. With the Desk sitting at 00:00:00:00, and the machine at 2:54:36:02, you may introduce an offset between the Desk and machine by selecting **Offset Here** on the Serial Machine Control display. This takes the current timecode of the selected machine and enters it in the **Sync Point** box for that port.

Note that it is not advisable to have Desk timecode roll through the 'midnight' point, eg. during preroll before 00:00:00:00. If the Desk is offset to the machine timecode, as described above, and material on the tape is positioned such that this may occur, first set the Desk time to 01:00:00:00 (for example) and then, with the machine at a suitable start point, select **Offset Here**.

Note that the same principle applies if you use **Desk Here** to match the Desk timecode to the machine, and material on the tape starts very close to 00:00:00:00.

Offset information can be saved as part of a Project File under **Serial Machines Config** (see Section 2).

Setting up Multiple Machines

When dealing with more than one machine, bring each machine on-line separately by turning their **State** to **On** on the Serial Machine Control display. Do not be tempted to load the machine with tape and then simply select the machine ENABLE buttons and the SERIAL M/C ARM button. Unless all the machines have synchronous timecode, ie. the start time for material on audio and video tapes is identical, you will need to set up offsets between each machine and/or the Desk, to ensure that all the material plays correctly in sync.

First you need to decide whether the Desk timecode will match the nominal 'master' machine's timecode. If so, select **On** and **Motn** for that machine, followed by **Desk Here**. Now select **Motn** for the second machine, locate it to a suitable common sync point and stab on **Offset Here**. Repeat the process for additional machines.

Where you wish to set up a 'master' Desk time, preset this first and then select the **Offset Here** function for each machine in turn.

Once set, if you need to adjust offsets by a few frames, note that the timecode numbers for **Sync Points** and the **Desk** offset can be dragged to a new value. This saves having to bring up the timecode calculator, entering a new value and hitting **OK**, to try out each change.

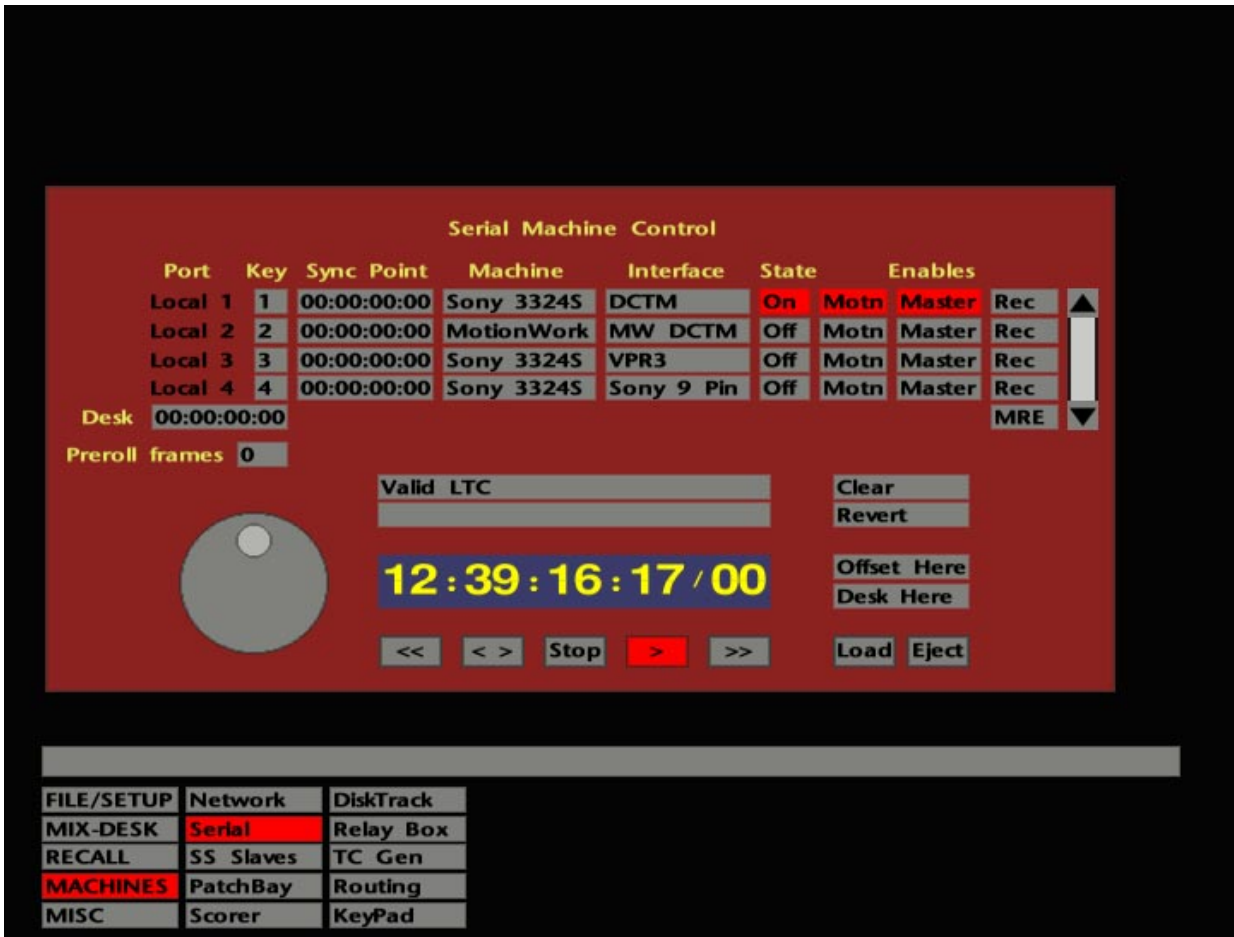

Record Arming

Before tape machines can be put into record from the master transport PLAY and RECORD keys, they must first be armed by means of the Serial Record Enable buttons. In addition, if you are working with a fully interfaced multitrack machine, individual tracks may be armed from the large red Record Enable button on each I/O module.

The REC 1-4 buttons on the computer front panel provide Record Enables for the four serial control ports. This function is duplicated on the Serial Machine Control display in the form of four **Rec** boxes. The SER REC ENABLE button provides a master Record Enable for any or all of the serial ports, and must be selected before individual REC buttons can be activated. This additional safety feature is duplicated on the Serial Machine Control display by the **MRE** box.

The on-screen Arm box will turn red when a machine is record enabled.

Do not try to put a machine into record while you have the Serial Machine Control display on-screen; the front panel's transport buttons will not control an external machine until you return to the basic displays.

See also **Track Enables** for Sony 9-pin machines on Page 3-31.

The master transport RECORD key will, by default, only operate if the PLAY key is first held down. In this mode you can drop out of record by hitting PLAY. Optionally, RECORD can be set to punch in and out without use of the PLAY key. In this mode, you will be pleased to hear that the RECORD button is inoperable except when the system is in Play! The default setting can be changed in the **FILE/SETUP/Desk Config/Transport Layout** menu (see Section 9 for more details).

Fast Forward, Rewind or any locate command will drop the system out of Record.

Other Boxes on the Serial Machine Control Display

- | | |
|---------------|--|
| Clear | Resets the display settings |
| Revert | Recalls the options previously set when you last entered the display |
| Load | Takes a machine out of standby mode or loads a laserdisc |
| Eject | Ejects a video cassette from its machine |

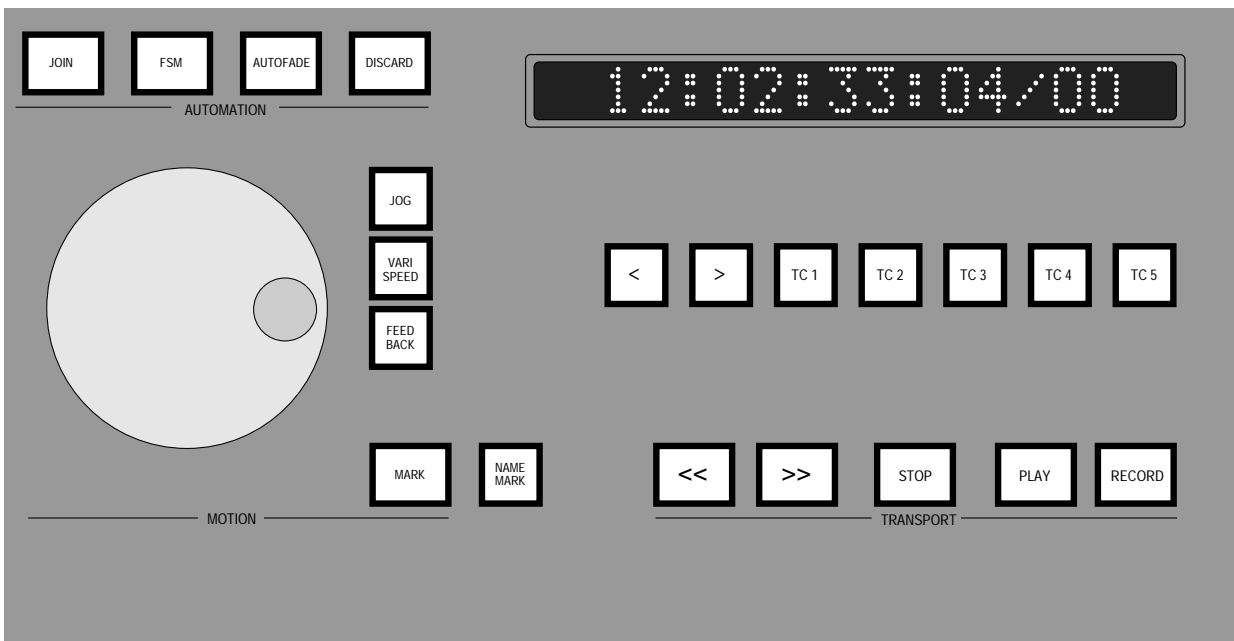

Machine Control and Project Files

The following information can all be saved on a per-project basis under **Serial Machines Config** in the Project File **Settings** pop-up:

- Entries in the **Machine** and **Interface** boxes on the Serial Machine Control display.
- Individual machine ENABLE 1-4 buttons (**State to On**).
- **Preroll** time.
- Offset information.

Transport Control

By now you may have realised that transport control of both Desk and external tape machines can be achieved in many ways. Note that, if any of the following methods are used to locate the system to a new position while it is in Play, it will resume playing once the target point has been reached.

Timecode Locates

The five buttons situated above the transport keys, labelled TC 1-5, provide five one-shot locate stores. The current Desk time can be entered into these stores by pressing and holding the relevant button until its lamp starts to flash.

Alternatively, by stabbing on the **S** box above the on-screen timecode readout, a pop-up will appear (see opposite) which not only displays the current values of the timecode locates, but also allows the entry of specific timecode values. You may either stab on the 1-5 boxes to enter the current Desk time as the locate point, or stab on the current timecode value and enter a new timecode from the pop-up calculator. As usual, timecode values can also be modified by dragging on the numbers.

As well as the default 'absolute' locates, you can also set up relative locates here (to roll back or forward 2 seconds etc. from the current Desk time). To select a relative + or relative - locate, stab on the **Abs** box and choose from **Rel +ve** or **Rel -ve**. Now stab on the timecode box to enter the required time.

Once timecode locates have been setup, they can be write-protected by changing the ticks to crosses on the right of the pop-up. This will prevent erroneous timecodes being entered if you hold down a TC1-5 button for too long when instigating a locate. Note that the write-protect does not prevent you entering locate times on the pop-up itself.

Five **Set Goto** macro functions provide an additional way of entering timecodes for the TC 1-5 locate functions. Once these function have been assigned to a front panel macro button, selection of that button will call up the timecode pop-up. Enter a timecode, hit OK and that time will become the new locate target for that store.

Note that the locate store timecodes can be saved as part of a Project File under **Timecode Memories** (see Section 2 for more details).

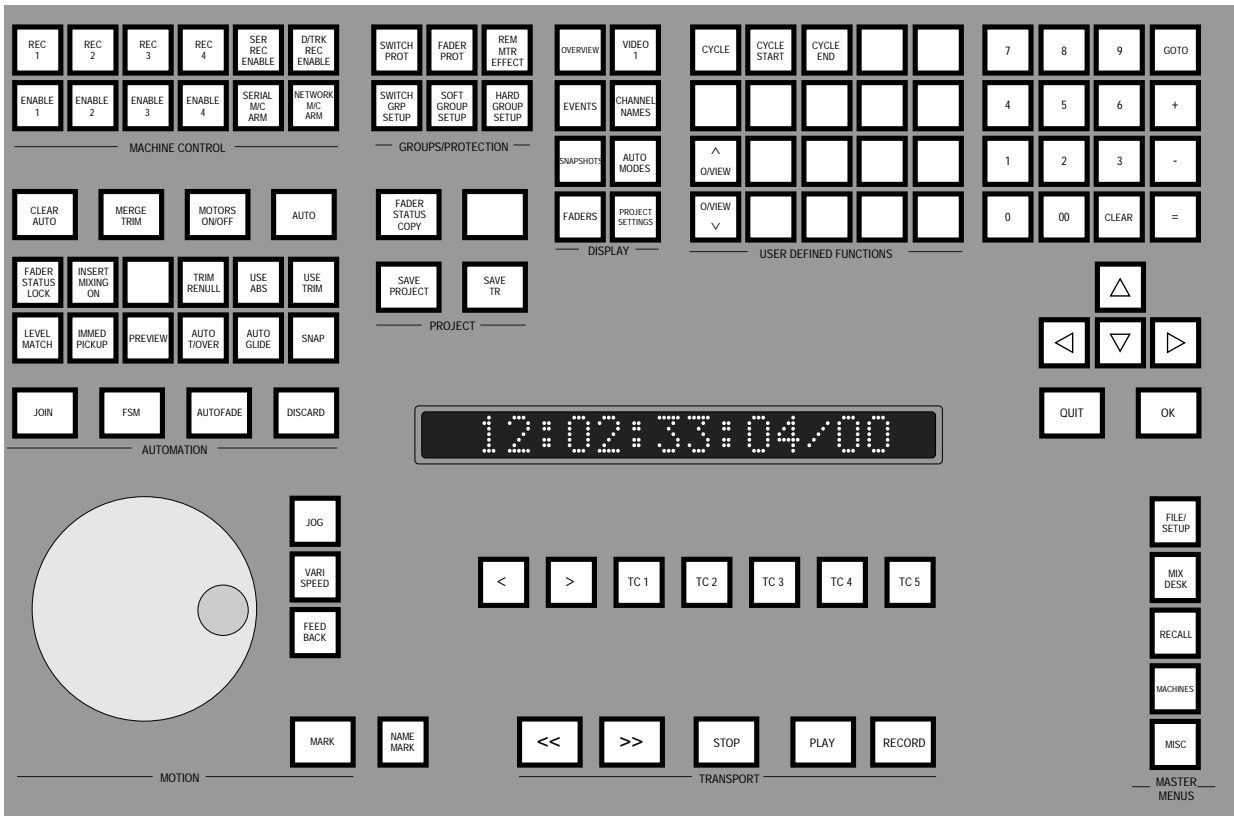

GOTO Function

At the top right of the computer front panel's numeric keypad you will find a GOTO button. Pressing this produces the timecode pop-up and mini Events List. Either stab on an event/cue (see Section 4 for more details) and hit OK to locate to that point, or enter a timecode from the numeric keypad, and hit OK. The CLEAR button can be used to clear an incorrect timecode entry. Use QUIT to clear the pop-up without effecting a change.

The GOTO function remembers the timecode of the last 'goto'. To repeat a locate simply press GOTO followed by OK.

Frame and Event Jogs

In addition to the conventional transport keys on the front panel, the < and > buttons, to the left of the TC 1-5 buttons, can be either used to provide a frame jog function, step from one event (mark/cue, DiskTrack audio clip etc.) to another, or move from the start of a mix to the mix end time (or vice versa). The choice is made in the **Desk Config/Transport Layout** entry of the **FILE/SETUP** menu. See Section 9 for more details.

The < and > boxes, above the timecode readout on the **MIX-DESK** display, step from one event to another (see Events List, Section 4).

Events List Locates

The Events List provides intuitive and simple ways to locate to specific marks or cues in the recorded material. See Section 4 for more details.

Overview Display Locates

The Overview display also provides a very simple way of locating, to any spot in a recording or mix, with a stab of the pen. See Section 5 for more details.

Cycle Function

The two timecode boxes above the **Cycle** box on the right of the **MIX-DESK** display are used to set up and display Cycle Start and End times. Times can be either entered 'on-the-fly' or off-line. Press the dedicated CYCLE START button on the front panel to capture the current Desk time as the Cycle Start time. Now move the system to the required Cycle End time and press the CYCLE END button.

To specify Cycle Start and End times off-line, stab on the timecode boxes (the upper box represents the Start; the lower box the End) to call up the timecode calculator and mini Events List. Either stab on events/cues to cycle between them or enter timecodes in the usual way.

Regardless of the system's current position, if you select the CYCLE button or stab on **Cycle**, the system will locate to the Cycle Start time, play forwards to the Cycle End time, rewind and repeat the process. If you need to adjust the Cycle Start or End time by a few frames or seconds, simply use the pen to drag the appropriate timecode numbers up or down.

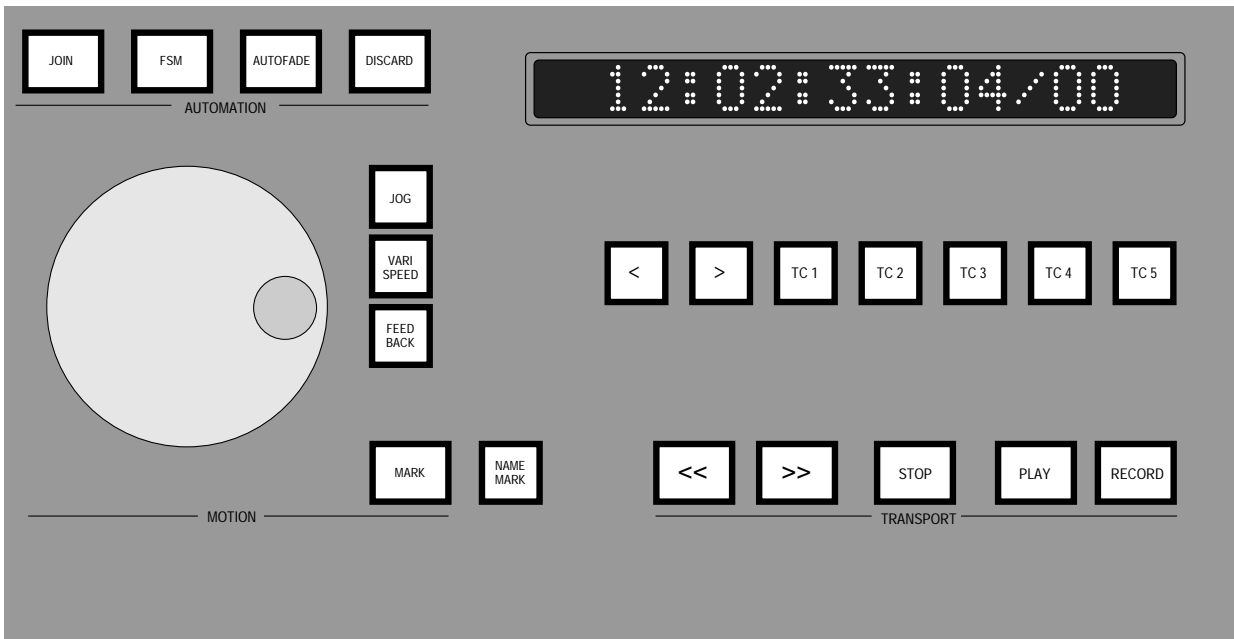

To cancel a cycle at any time, press STOP or deselect the CYCLE button or the Cycle box. If you pressed STOP, the cycle will resume if you subsequently press PLAY.

Note that the **Fr(om):** and **To:** timecode boxes below show the start and end times of an automated mix.

Jog Wheel

To the left of the transport control buttons is a Jog Wheel which can be used in three different modes:

With JOG, VARISPEED and FEEDBACK *not* selected, and the system in Stop, the Desk and any on-line external machines can be simultaneously moved, at any speed, forwards or backwards. One full turn of the wheel represents 20 seconds.

With JOG selected and the system in Stop, the wheel can be used to move backwards or forwards as above, but with much finer control. If JOG is selected and the system put into Play, the wheel will rotate and can be grabbed at any moment to move the Desk (computer) and slave machines back or forwards to any spot. Note that the system drops out of Play as soon as you grab the wheel.

With VARISPEED selected and the system in Play, the wheel will varispeed the Desk, and any machines currently selected as slaves, with a range from normal play (at the centre detent) up to 4 times play speed, or down to $\frac{1}{8}$ play speed, subject to the varispeed range of the slave machine(s). The **Vari:** box at the top right of the **MIX-DESK** display shows the current varispeed value as a percentage ranging from 12.5% up to 399.8%, where normal play speed is 100%.

FEEDBACK, if selected on its own, allows the Jog Wheel to provide a tactile frame jog facility. As you turn the wheel, you will feel a slight indent at each frame transition. JOG + FEEDBACK limits use of the Jog Wheel to a window defined by the current first and last events in the Events List (see Section 4). With VARISPEED + FEEDBACK selected, the Jog Wheel will spring back to normal play speed when released from a positive or negative varispeed position.

Note that the above descriptions apply in full where the J Series Computer is acting as the master to serially controlled slaves. If a tape machine is connected via the parallel port (DCTM), only the Jog function will be available.



Timecode Displays

The timecode readout on the **MIX-DESK** display always shows the current Desk time. If a Sony 9-pin or DCTM machine is in use, a green box, below the **Vari:** box, will show the current machine position. If this box turns red, the wrong timecode standard has been selected in the **FILE/SETUP/Desk Setup/Timecode** menu (see Page 3-3 and Section 9).

The large LED display on the front panel may be used to display Desk time or, alternatively, can be set to display Events/Cues (see Section 4), the date or time of day. The choice is made in the **FILE/SETUP/Desk Config/Front Panel** menu (see Section 9).

Individual numbers in the Desk timecode readout can be dragged up or down to move the system to a new position. Alternatively, stab to produce the timecode calculator (see Section 1) and enter a new timecode.

Copying Timecodes

Timecodes can be copied from the Desk readout to other timecode boxes. By simply stabbing on the current Desk time and then on the Cycle Start or End boxes, you can enter Desk times as cycle times. Note that the timecode calculator appears when you do this, should you wish to enter a time other than the Desk time. If you are simply transferring the existing Desk time to a Cycle box, ignore the timecode calculator – it will clear as soon as you stab on the Cycle box.



Setting Up a New Machine

If you are setting up the system for the first time, or need to get a hired-in machine on-line, proceed as follows:

First you must determine to which of the four ports the machine(s) that you need to set up have been connected. Note that machines which are connected via the 'DCTM' parallel interface (see below) may be picked up by any 'port' on the Serial Machine Control display.

Select **MACHINES/Serial** to call up the Serial Machine Control display.

Stab on the **Machine** box for that port and you will be presented with a list of machine types whose control parameters are currently saved on the System Disk (see opposite). If the machine you need is listed, select it by stabbing on that entry. If the machine is not listed, stab outside the list to clear it and proceed to the next stage.

Stab on the appropriate **Interface** box and the Machine Setup Options pop-up will appear (see lower screen opposite). To enter a new machine name, stab on **Machine Name** and type in a suitable name via the QWERTY pop-up. This can be carried out with the pen or by using the dedicated keyboard. Press **END** or Enter to complete the operation (see Section 1 for more details on using the QWERTY pop-up). Repeat the process if you are setting up for more than one machine.

Now stab on **Interface Type** in the Machine Setup Options pop-up, and the following list of protocols will appear:

DCTM – Stands for 'Direct Control Tape Machine'. A parallel interface which is the equivalent of SSL's 'S29' (29-way 'D' type connector) interface as used on SL4000/6000/8000 systems. The computer slaves to incoming timecode. Note that it is only possible to have one DCTM machine on-line at a time.

VPR3 – Used to control Timeline Lynx Modules (with the VSI option), as well as machines which can be directly controlled by this protocol.

Teac LV210 – Specifically designed for this Laserdisc player!

Sony 9-Pin – Provides direct machine control of VTRs, ATRs, as well as ADAT and R-DAT machines. Indirect control of ATRs, VTRs and film transports may also be effected via Motionworker and the Audio Kinetics ES 1.11 units.

Stab on the protocol you require. If you are not certain of which protocol to use, contact your local SSL office or distributor.



Further setup parameters will be listed on the Machine Setup Options pop-up, depending on which protocol has been selected. Note that electing Teac LV210 produces no other options.

DCTM Machines

Selecting **DCTM** produces the following list of parameters. If a machine has been selected from the Machines list, values for these parameters will be those recommended by SSL. If you are creating parameters for a new machine, seek help from your local SSL office or distributor if you are unclear as to the effect each parameter may have on the performance of the machine under J Series control.

Each time a major software update is released, an updated set of machine parameters will be provided. If you feel you have improved on the SSL settings, we would like to hear from you!

Pulses per Second – The machine's tachometer rate per second at standard play speed. Stabbing on the current entry gives you the option to have the computer put the machine into Play and measure the rate (select **Automatic**). Alternatively, select **Edit** and enter a known value.

Forward Direction Sense – Toggle this to the level, High or Low, on the direction sense line when the machine is in Play.

Note that a password protected facility in the **MISC/System/Diagnostic** menu can be used to determine the correct settings for the above parameters. Contact your local SSL office or distributor for more details.

Drop In with Play + Record – This should be set according to the requirements of this machine to enter record, ie. Play and Record simultaneously (**Yes**) or just Record (**No**). The selection toggles with each stab of the pen. Note that this option is not affected by the setting for record in the **Desk Config/Transport Layout** pop-up (see Page 3-15); that simply determines how the operator will punch in. The setting here must be set to match the machine requirements. Any difference between the two settings will be sorted out by the system.

Drop Out with Stop + Play – This should be set according to the requirements to drop out of Record, ie. Stop and Play (**Yes**) or Play only (**No**). The selection toggles with each stab of the pen.

Timecode from Input – There are four timecode inputs to the computer on a 25-way 'D' connector on the computer's rear panel. Stab to select the correct input for the current timecode source.

Target Window – This is the window in which the computer will park the machine at the target. Stab on the current entry to enter a new value.

Decision Interval – This is how often the chase algorithm checks where the machine is when locating. Stab on the current entry to enter a new value.

Note that the locate table (see Page 3-29) is automatically re-initialised when either **Target Window** or **Decision Interval** parameters are changed.



Save learnt behaviour – DCTM protocol software constantly learns from a machine's behaviour and the control parameters are updated until optimum performance is achieved. These parameters are held in a 'locate table' which represents the 'learnt behaviour'. Once you have set up the parameters for a particular machine, and having allowed sufficient time for the computer to learn the machine's behaviour, stab on **Stab here...** to save the current parameters to the System Disk and exit the **Machine Setup Options** pop-up. Note that a different set of parameters is, of course, stored for each DCTM machine that you set up.

Clear Learnt Behaviour – The locate table (see above) is automatically re-initialised when either **Target Window** or **Decision Interval** parameters are changed. **Clear Learnt Behaviour** can be stabbed to clear the locate table deliberately should you get into difficulties!. When you do this, the table, both on disk and in memory, is reset to the factory default values. The computer will then re-learn the machine's behaviour over the next few locates. Once the machine is locating satisfactory, the table should be saved to disk by stabbing on **Save Learnt Behaviour**.

Once set, hit **OK** to save parameters to the System Disk.

When a DCTM machine is selected on line, either with a front panel ENABLE button or by turning **State** to **On**, the **Master** flag for that port will automatically turn red. This indicates that the machine is in 'Red-Master' mode. In this mode, the Desk (computer) sends direct transport commands to the machine, then, once the machine is moving, slaves to the machine's timecode returned via the computer's timecode input connector. If you control a DCTM machine from its own transport buttons, the Desk will follow.

VPR3

Selecting **VPR3** produces the following:

Machine Option – This will be set to **A** and cannot be changed.

Frames to park ahead – This determines the distance that the VPR3-controlled system (or machine) parks ahead of the target after a Stop command has been issued from the front panel. The default value is 15 frames. For example, if the target time is 1.00.00.00, the default entry will park the VPR3-controlled machine(s) at 1.00.00.15.

Pre-sync frames – This determines the time at which the VPR3 system will issue a Play command, and should be set to allow slave machines to achieve play speed by the end of the **Frames to park ahead** period. The default value is 5 frames. For the example above, the default value would issue a Play command at 1.00.00.10. Note that the value of **Pre-sync** should always be less than the value of **Frames to park ahead**.

In both cases above, stabbing on the current frames value calls up a numerical pop-up. Once set, hit **OK** to save parameters to the System Disk.

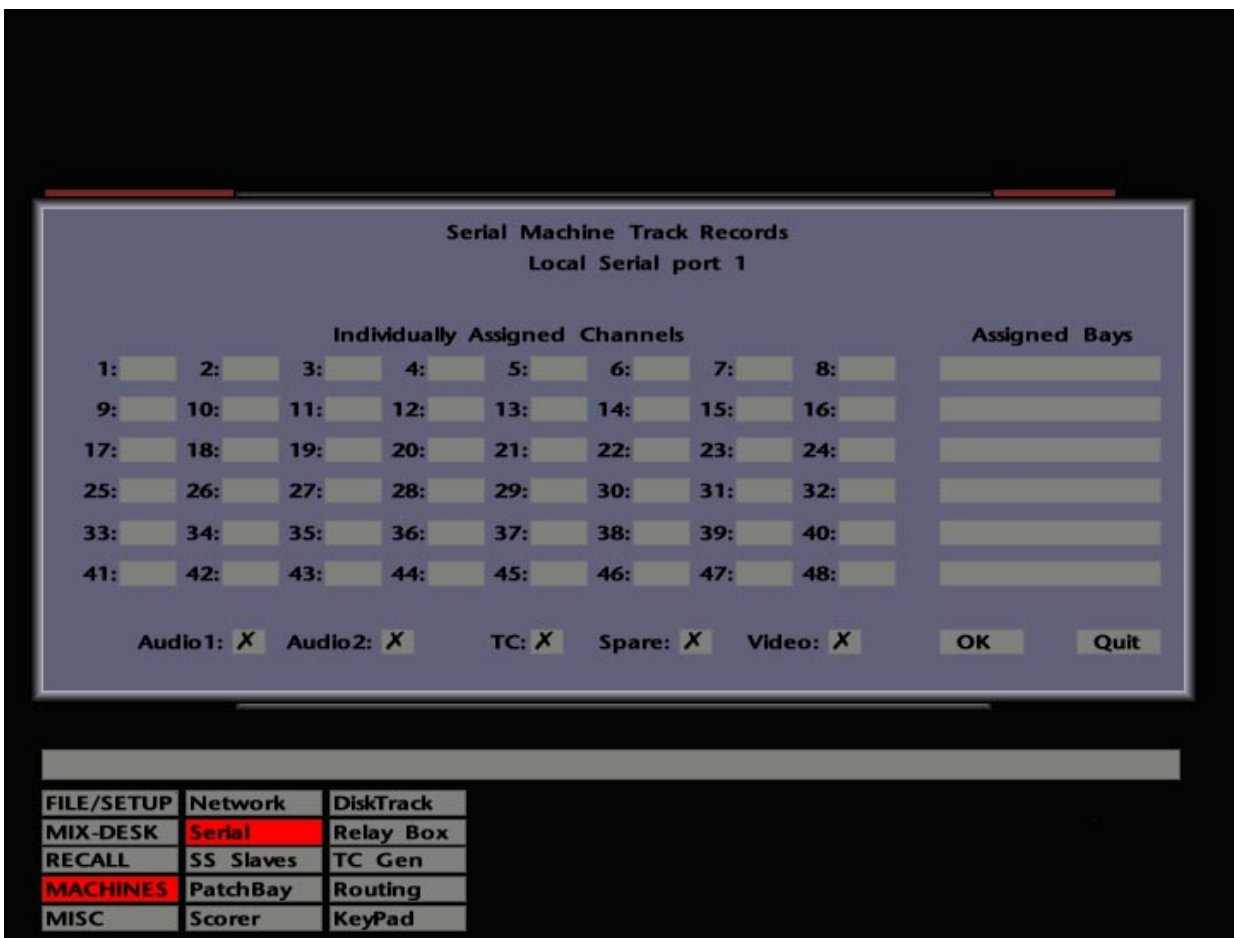

Sony 9-Pin Machines

Selecting **Sony 9-Pin** produces the following:

Machine Options – Choose from the following options **STD, A, B, C, D** and **E**. These adjust the response time of Sony 9-Pin machines to certain commands. Once again, contact SSL if you are unsure which option is best for the currently selected machine.

Track Enables – Stabbing on this provides access to the **Serial Machine Track Records** (see lower screen opposite). This is used to tell the computer how the desk channels' individual Record Enable buttons are wired to the tape machine. Usually the system is set up one-to-one, ie. if you arm Channel 1 on the front panel, you are arming Track 1 on the tape machine.

You can, however, set the system up so that Channel 9 on the console will arm Track 1 on the tape machine. If you do change the relationship here, please make sure you tell the operators! Once this menu is set up during system installation and commissioning, there should be no reason to alter it – unless you want to cause complete confusion and the possible destruction of a master tape!

Stabbing the grey boxes under **Assigned Bays** brings up a list of console 'bays' you can assign to channels for track arming. To choose a bay, simply stab on the one you require. The channel numbers of that bay will appear next to the track record numbers. To individually assign channels to record tracks, stab in the grey box next to the track number and a numerical keypad will appear. Enter the number and press **OK** to clear the keypad. **NC** on the keypad enables you to enter nothing in the display for that track, ie. no connection.

At the foot of the **Serial Machine Track Records** display are a number of additional boxes which represent tracks that can be put into record by the console's master record function, once they have been armed here. These include **Audio 1** and **2** (the analogue audio tracks for a VTR or 2 channel ATR), **TC** and **Video**. If selected, these items will be listed under **Control Enables** when you return to the **Machine Setup Options** pop-up.

The following three parameters defeat various parts of the adaptive lockup algorithm. These constants should only require adjustment when controlling 'perfect machines' such as Motionworker or the CB Electronics film interface. They should only be adjusted by experienced users who also understand the implications of their actions.

- | | |
|-------------------------------|--|
| Disable aim adjustment | No = normal behaviour. |
| Fixed adaptive lockup | 0 = normal, adaptive behaviour. 1-20 sets the adaptive scheme to the fixed value, and it is not adapted. The normal, adapted scheme starts with a value of 12, and generally adapts to around 8. |
| Frames to lock for | 0 = normal behaviour, which currently equates to 2 frames. 1-10 determines the number of frames that the machine is held locked for, before it is considered to be locked. |

Having set or changed any parameters on the Machine Setup Options pop-up, hit **OK** to save them to the System Disk and return to the Serial Machine Control display.

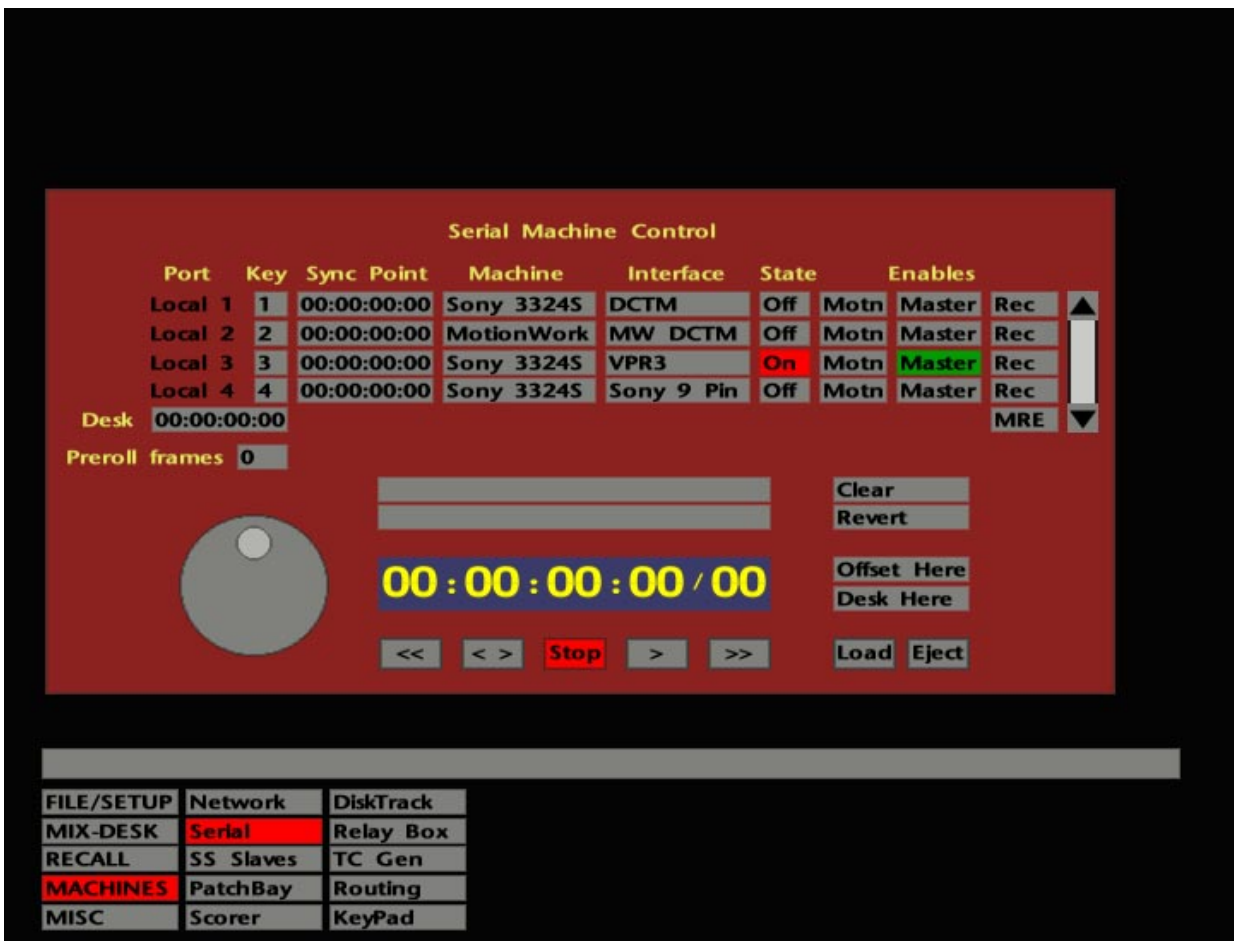

Customising Enable Button Control

The Serial Machine Control display provides a facility to customise the serial port-to-enable button relationship, if required. Normally, ENABLE 1 will control the machine on port 1, ENABLE 2 port 2, etc. By stabbing on the relevant box in the **Key** column, and entering the desired enable button number, a front panel enable button can be assigned to control more than one port. Remember that this not only means enabling transport control but will also affect record arming.

Machine Control and DiskTrack

If your system is fitted with DiskTrack, and you wish to transfer material to or from a multitrack tape machine, please read the DiskTrack Operator's Manual.

Solid State Logic
SL 9000 J Series
Total Studio System

Computer Operator's Manual

SECTION 4

Cue and Track Lists



Event Information

Clips	Edit	All Chans	Mark
Mark	16:38:51:12/66	1	*Top
Mark	16:39:11:13/00	2	*Phones
Mark	16:39:49:23/00	3	*Pipes
Mark	16:40:09:29/00	4	*Intro Chorus
Mark	16:40:35:15/00	5	*Band
Mark	16:40:45:00/00	6	*Verse 1
Mark	16:41:22:15/00	7	*Verse 2
Mark	16:41:42:05/00	8	*Bridge
Mark	16:42:00:03/00	9	*Chorus 1 (F Vox)
Mark	16:42:42:15/00	10	*Link
Mark	16:42:51:27/00	11	*Verse 3
Mark	16:43:10:19/00	12	*Bridge 2
Mark	16:43:29:13/00	13	*Chorus 2
Mark	16:44:11:27/00	14	*Drum Break

Vari:
12:40:49:27
00:00:00:00/00
00:00:00:00/00
Cycle S < >
12:40:49:28
Arm Final Mix Safe
Fr :
To :
*:
0:
-1:
-2:
-3:
-4:
Name Discard
Keep Revert
DT Free 1:18
Free Mem 97%

FILE/SETUP	DiskTrack	
MIX-DESK	Overview	Edit
RECALL	Events	Automation
MACHINES	SnapShots	Groups
MISC	Faders	Project

Event Information

Clips	Edit	All Chans	Mark
Mark	16:38:51:12/66	1	*Top
Mark	16:39:11:13/00	2	
Mark	16:39:49:23/00	3	
Mark	16:40:09:29/00	4	
Mark	16:40:35:15/00	5	
Mark	16:40:45:00/00	6	
Mark	16:41:22:15/00	7	
Mark	16:41:42:05/00	8	
Mark	16:42:00:03/00	9	
Mark	16:42:42:15/00	10	
Mark	16:42:51:27/00	11	
Mark	16:43:10:19/00	12	
Mark	16:43:29:13/00	13	*Chorus 2
Mark	16:44:11:27/00	14	*Drum Break

Vari:
12:40:49:27
00:00:00:00/00
00:00:00:00/00
Cycle S < >
12:40:49:28
Arm Final Mix Safe
Fr :
To :
*:
0:
-1:
-2:
-3:
-4:
Name Discard
Keep Revert
DT Free 1:18
Free Mem 96%

FILE/SETUP	DiskTrack	
MIX-DESK	Overview	Edit
RECALL	Events	Automation
MACHINES	SnapShots	Groups
MISC	Faders	Project

Cue Lists

After, or even during the recording of a track, you will probably want to create a cue list. The list will consist of a series of timecode-marked points, which enable you to easily identify, and locate to, different parts of the recording.

With the J Series Computer, the cue list forms part of what is known as the 'Events List' (see opposite). The Events List can contain **Mark** information, **Audio Clip Start** and **End** times (these times are generated by DiskTrack audio or the Capture Clip function – see Section 5), **On/Off Macro** events and **Remote On/Off** macro events (see Section 8).

The Events List may appear with all the above by default. However, the Default Project can be set up so that certain events are 'filtered out' of the list for clarity. The **Desk Setup** element of a Project File (see Section 2) stores the settings of the Events List filters (see below).

Select **MIX-DESK/Events**. This calls up a full-sized version of the Events List. A mini version of the list is provided when the **Overview** display (see Section 5) is selected and also when the Timecode Calculator is called up (see Section 1).

Regardless of settings in the Default Project, you can customise the list at any time, to have it display only the information you want to see. To do this, stab on the right hand box below "Event Information". This box is marked **Events All** by default, signifying that all types of events will be displayed. Stab on the box and a pop-up will appear containing a list of the various event types as described above (see lower screen opposite).

To limit the list to show only one or more event types, stab on their entries in the pop-up (they will turn blue). When you **OK** out of the pop-up, the **Event All** box will now reflect your choice – **Selection** if you have chosen more than one event type, or the event type itself, ie. **Mark, Clips** etc., if you have chosen a single type.

You can also limit the display to events on selected channels. This is more appropriate to those of you that have DiskTrack systems or who have used the Capture Clips function (see Section 5), and has no particular application when creating a Cue List. Stab on the (default) **All Chans** box to produce a Channel Selector pop-up. Deselect/select individual channels as required. Deselecting **Global** will remove global marks (made with the front panel **MARK** key) from the list. As you will see in a minute, deselecting **Global** is not a good idea as it is these marks that form the basis of a Cue List!

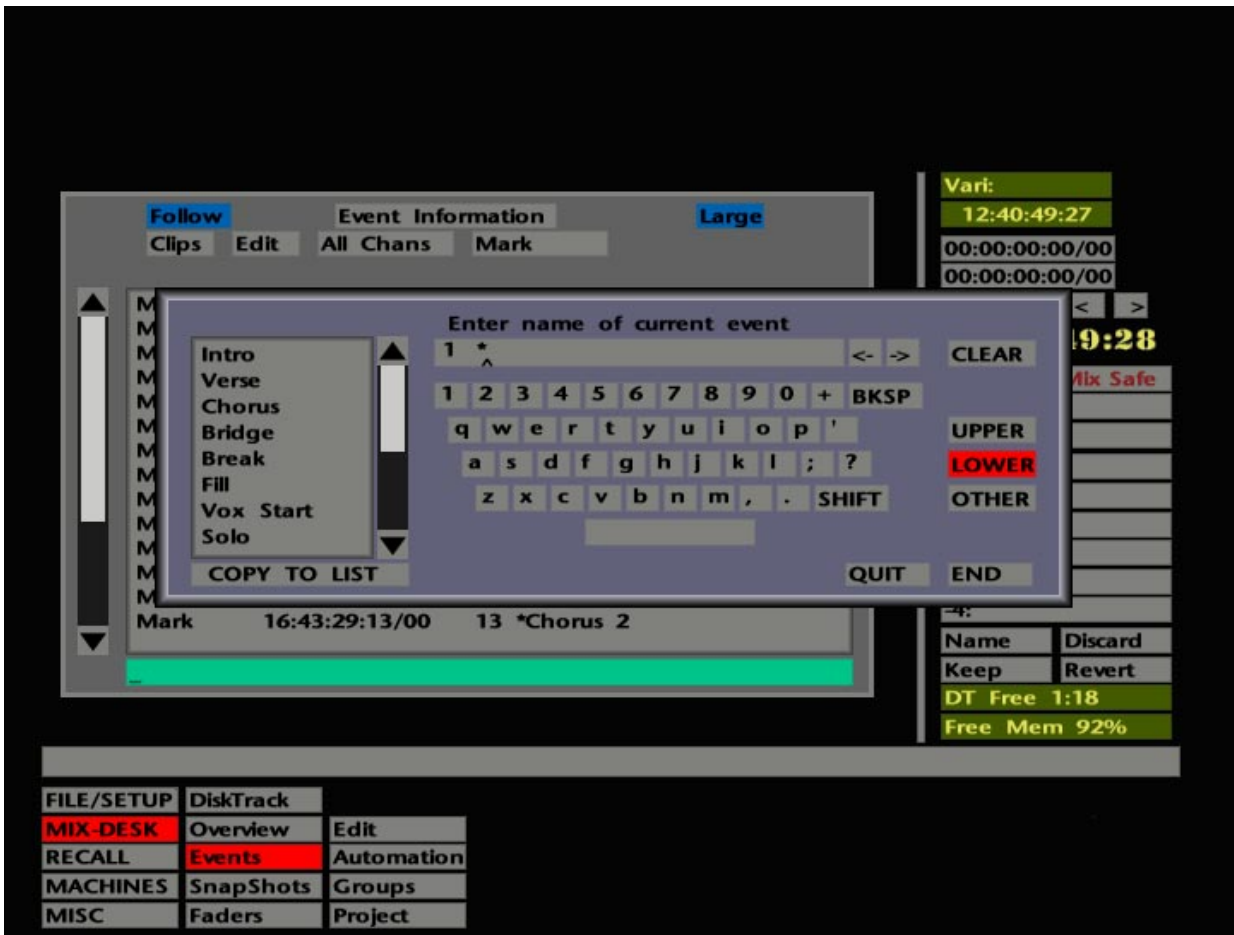
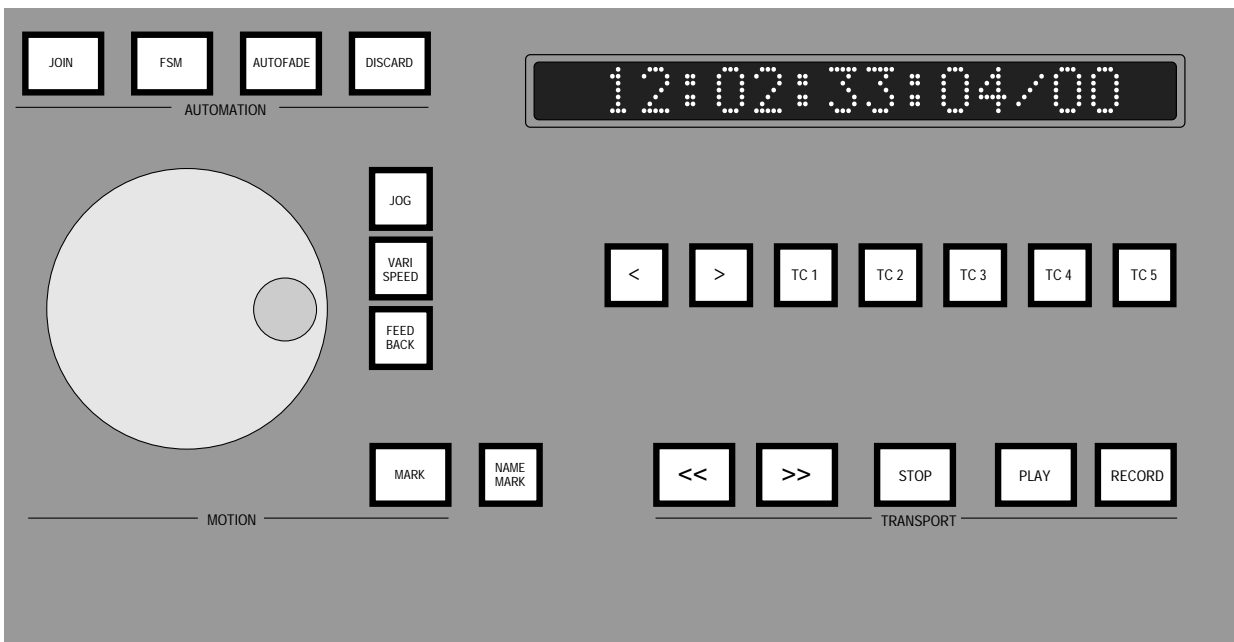

Creating a Cue List

To create a cue list proceed as follows:

Use the MARK button (located on the computer front panel to the left of the Transport Controls) to mark the position of the cues. You can do this 'on-the-fly' as the tape is running or, alternatively, locate to the correct timecode position and hit the MARK button. This will also place marks, represented by a horizontal black line, on the Overview display. Conversely, marks generated in the Overview display with the **Mark** function will appear in the Events List. See Section 5 for more on the Overview display.

You will notice (if the Events List is still on the screen) that when marks are generated with the MARK button, they are automatically numbered in the order they are created. These numbers are followed by an asterisk (1 *, 2 *, 3 * etc). The current event is highlighted in yellow. If **Follow** is selected (blue) then the list will scroll as the timecode advances.

Naming Cues

Automatically numbered cues are fine if you can remember what particular point in the recording is represented by that mark! It makes much more sense to name the marks as you create them so that you can instantly recognise the points they represent.

To do this, having hit the MARK button, press the NAME MARK button just to the right. This calls up the QWERTY pop-up to allow you to name the *current* mark, ie. the one highlighted in yellow in the Events List.

Pull out the dedicated QWERTY keyboard (in a drawer under the tablet), type an appropriate name and hit Enter. Note that when the QWERTY pop-up appears, the relevant mark number and asterisk (1 * etc) is provided in the 'name' box. Do not be tempted to delete these – simply add you name to them. As you will see later, the number provides a quick method of locating to that mark/cue.

If you have already made several marks and now wish to name them, select the mark first by stabbing on it (note that the system locates to that mark when you do this) and hit the NAME MARK button. Alternatively, you can use the **Name** function in the **Edit** menu on the Events List (see Page 4-5).

The QWERTY pop-up is fully described in Section 1. You may find the 'keyword' function useful for fast naming of Verse and Chorus cues, for example.

Note that the MARK and NAME MARK functions will still work whether the Events List is on the screen or not.

The screenshot displays the 'Event Information' window with a list of marks and a control panel on the right. Below the main window is a menu structure.

Follow	Event Information		Large
Clips	Edit	Name	Delete
Move	Insert	Renum	
Mark	16:38:51:12/66	1	*Top
Mark	16:39:11:13/00	2	*Phones
Mark	16:39:49:23/00	3	*Pipes
Mark	16:40:09:29/00	4	*Intro Chorus
Mark	16:40:35:15/00	5	*Band
Mark	16:40:45:00/00	6	*Verse 1
Mark	16:41:22:15/00	7	*Verse 2
Mark	16:41:42:05/00	8	*Bridge
Mark	16:42:00:03/00	9	*Chorus 1 (F Vox)
Mark	16:42:42:15/00	10	*Link
Mark	16:42:51:27/00	11	*Verse 3
Mark	16:43:10:19/00	12	*Bridge 2
Mark	16:43:29:13/00	13	*Chorus 2
Mark	16:44:11:27/00	14	*Drum Break

Control Panel (Right):

Vari: 12:40:49:27
 00:00:00:00/00
 00:00:00:00/00
 Cycle S < >
12:40:49:28
 Arm Final Mix Safe
 Fr :
 To:
 *:
 0:
 -1:
 -2:
 -3:
 -4:
 Name Discard
 Keep Revert
 DT Free 1:18
 Free Mem 97%

Menu Structure (Bottom):

FILE/SETUP	DiskTrack	
MIX-DESK	Overview	Edit
RECALL	Events	Automation
MACHINES	SnapShots	Groups
MISC	Faders	Project

This close-up shows the 'Event Information' window with the 'Pipes' mark selected. The timecode is 12:40:49:28.

00:00:00:00/00	▲	Mark	16:39:51:10/34	1	*Top
00:00:00:00/00		Mark	16:40:11:11/12	2	*Phones
		Mark	16:40:49:20/41	3	*Pipes
7 8 9 Clear MR		Mark	16:41:10:00/92	4	*Intro Chorus
4 5 6 Now MC		Mark	16:41:35:14/89	5	*Band
1 2 3 Quit MS		Mark	16:41:45:02/63	6	*Verse 1
0 00 = OK M+		Mark	16:42:22:16/06	7	*Verse 2
+ - < > Ng ▼		Mark	16:42:42:08/23	8	*Bridge
		Mark	16:43:00:07/00	9	*Chorus 1 (F Vox)

Editing Cue Information

Having created a reasonable number of cues, you may wish to edit some of the entries.

Renumbering Cues

First of all, it's possible that the auto numbering system (1 *, 2 *, 3 * etc) has got out of step. This will be simply because you have created further marks at earlier timecodes than the initial marks. Events are always listed in ascending timecode; to reset the numbers in ascending order, select **Edit** on the Events List and stab on the **Renum** box (see opposite). Note that this will only put the numbers into the correct sequence, it will not shuffle the actual marks or their names about in any way. If marks have been deleted (see below), the remaining events will be renumbered to provide a continuous sequence.

Renaming Cues

In addition to the NAME MARK button, cues can be named or renamed with the **Name** function in the Events List **Edit** menu.

Stab on the **Name** box (it goes red) and then stab on the mark/cue you wish to name. The QWERTY pop-up will appear. As before, use the dedicated QWERTY keyboard for convenience or since the pen is in your hand, use it on the QWERTY pop-up. The **Name** function will stay reselected for further naming/renaming. Deselect the box when finished.

Deleting Cues

All events can be deleted with the exception of audio clip starts and ends. Select **Delete** in the **Edit** menu and then stab on the event/cue you wish to delete. No confirmation will be requested so make sure you know what you are doing! The **Delete** function will stay reselected for further deletions. Deselect the box when finished.

Moving Cues

When a cue is *almost* in the right place, you may wish to nudge its timecode value by a few frames. Select **Move** in the **Edit** menu and then stab on the event/cue you wish to move. The timecode pop-up (and mini Events List) will appear (see opposite); enter a new time or nudge the existing time with the < or > frame jog boxes. Hit **OK** to effect the change. The **Move** function will stay reselected in case you wish to adjust more cues. Deselect the box when finished.

Entry of timecode, or nudging in seconds/frames, can also be carried out from the front panel by using the numeric keypad and/or the cursor keys (see Section 1 for more details).

Note that all of the above editing functions can be applied to other types of events, with the exception of audio clip Starts and Ends which cannot be named, moved or deleted, and Macro and Remote entries which cannot be named.

The **Insert** function in the **Edit** menu is used to enter macros into the events list. See Section 8 for more details.

Follow		Event Information		Large	
Clips	Edit	Name	Delete	Move	Insert Renum
▲	Mark	16:38:51:12/66	1	*Top	
	Mark	16:39:11:13/00	2	*Phones	
	Mark	16:39:49:23/00	3	*Pipes	
	Mark	16:40:09:29/00	4	*Intro Chorus	
	Mark	16:40:35:15/00	5	*Band	
	Mark	16:40:45:00/00	6	*Verse 1	
	Mark	16:41:22:15/00	7	*Verse 2	
	Mark	16:41:42:05/00	8	*Bridge	
	Mark	16:42:00:03/00	9	*Chorus 1 (F Vox)	
	Mark	16:42:42:15/00	10	*Link	
	Mark	16:42:51:27/00	11	*Verse 3	
	Mark	16:43:10:19/00	12	*Bridge 2	
	Mark	16:43:29:13/00	13	*Chorus 2	
▼	Mark	16:44:11:27/00	14	*Drum Break	

Vari:
12:40:49:27
00:00:00:00/00
00:00:00:00/00
Cycle S < >
12:40:49:28
Arm Final Mix Safe
Fr :
To:
*:
0:
-1:
-2:
-3:
-4:
Name Discard
Keep Revert
DT Free 1:18
Free Mem 97%

FILE/SETUP	DiskTrack	
MIX-DESK	Overview	Edit
RECALL	Events	Automation
MACHINES	SnapShots	Groups
MISC	Faders	Project

The **Clips** box at the top left of the Events List provides access to the Capture Clips function. See Section 5 for more details.

If **Follow** on the main Events List is selected (blue) then the list will scroll as timecode advances. Toggling the **Large/Small** box provides a normal or small typeface version of the list.

The mini Events List beneath the **Overview** display (see Section 5), and the Events List that appears with the timecode calculator, always reflect any changes made to the main Events List with the exception of the typeface size which remains normal on the mini lists.

Locating to Cue Points

Locating to cue points couldn't be easier. With either the main Events List or the **Overview** mini Events List on the screen, simply stab the pen on the cue you wish to locate to, and the system will locate to that position.

Alternatively, enter the cue's unique system-given number (**1 ***, **2 ***, **3 *** etc) via the numeric keypad on the computer front panel (no need to add the *), and hit OK to action the locate.

If you have the main Events List on-screen when you do this, you will see the number entered in the green bar at the foot of the list. If the number you enter does not exist, a **No Match** error message will appear in the Status bar (see Section 1 for more on the Status bar). Clear the bar with the computer front panel's down cursor key or the dedicated QWERTY keyboard's backspace delete key.

If the cue is *not* numbered as above, the first letter (or as many letters as are necessary to distinguish one cue from another) can be entered from the QWERTY keyboard followed by Enter, to locate to that cue. If there is any confusion with similarly named cues, you will be told the number of possible matches and you must try again with more identifying characters. As before, the green bar at the foot of the main Events List will reflect the search entry and the Status bar will relay any error messages.

Note that the Events List does not have to be on-screen to locate to a cue point by either of the above methods.

Pressing OK on the front panel (or Enter on the dedicated QWERTY keyboard) a second time will repeat the last locate command.

The < and > buttons, to the left of the TC 1-5 buttons on the front panel, can be used to step the system from one event to another if set up for this function in the **Desk Config/Transport Layout** entry of the **FILE/SETUP** menu (see Section 9 for more details). The < and > boxes, below the timecode readout on the **MIX-DESK** display, always step from one event to another.

Track List 1		Channel and Track Names	Delete	Copy Tracks
1 / Drum Sampler	9 New Gtr	17 L Leslie (See 47)		
2 \ Drum Sampler	10 New Gtr V2 etc.....	18 \ New JC Prophet		
3 Original Bass Gtr Clone	11 / Gtr	19 / JC Pads		
4 Bass Gtr / Dropped In	12 \ Gtr	20 \ JC Pads		
5 (Mix of PA)	13 Surdo	21 Prophet Loop Grunge		
6 (Mix of PA)	14 JC S1000	22 Trianglew		
7 Intro Phones FX/Timp	15 / JC Organ	23 / Egyptians		
8 Intro Drone	16 \ JC Organ	24 \ Egyptians		
25 New Master Vox	33 Kick	41 / O/H		
26 New Master Bruce Vox	34 ick	42 \ O/H		
27 Vocal Sub	35 Snr	43 / Audience		
28 Bruce Vox	36 Hat	44 \ Audience		
29 / New Hand Drums	37 Tom 1	45 / Audience		
30 \ New Hand Drums	38 Tom 2	46 \ Audience		
31 Click	39 Tom 3	47 R Leslie (see 17)		
32 EBU	40 Tom 4	48 Analogue Click		

FILE/SETUP	File Copy	SIO T/C: Locked	
MIX-DESK	Data	Timecode: SMPTE 30	
RECALL	Import	Fast Play Speed: 3.0	Midi
MACHINES	Desk Setup	Define	Fader Macros
MISC	DeskConfig	Channel Names	4 Channel Pan
			DiskTrack Free
			Follow faders

Events Lists and Project Files

All information in the Events List can be saved to a Project File, at any time, under **Events List!** The current selection of Events List 'filters' (ie. which channel/what type of events) can be saved under **Desk Setup**.

Track and Channel Lists

The J Series system provides the ability to create and store both Track and Channel Lists on a per-project basis. The Track List, not surprisingly, provides a record of which sources (instruments, vocals etc.) you have recorded onto which track of the tape machine. A Channel List provides a record of which console channels those tracks are feeding. If no 'machine outputs' to 'channel inputs' cross-patching has taken place, then the Channel List will be the same as the Track List. As soon as any feeds are cross-patched this should be reflected in the Channel List, as this information will be vital for a later mix or remix.

The principles used to enter information in either type of list are the same. As a typical example, we will describe how to create a Track List.

Creating a Track List

Press the CHANNEL NAMES button on the front panel or select **FILE/SETUP/Desk Setup/Channel Names** with the pen. A display, similar to that shown opposite, will appear on the screen. Stab on **Channel List 1-48** in the top left hand corner. This calls up a small pop-up enabling you to choose one of the following types of list: **Track Lists 1-4, Channel Lists 1-48, 49-96, 97-120**. The four Track Lists are designed to correspond to each of the four machines that can be brought on-line via the Serial Machine Control display (see Section 3).

As with many other J Series facilities, entries can be made on these pages either from the dedicated QWERTY keyboard, or by using the pen and tablet.

Initially, the Enter key on the QWERTY keyboard will toggle through all of the Track/Channel List pages. To enter names, use the arrow keys to locate to the relevant box (it will be outlined in white). Press Enter and the box will turn red (the QWERTY pop-up will appear), indicating that you can now type in a name. Typing in the name and pressing Enter will move the cursor to the next line. Hit the Enter key again to enable the new box and type in the next name.

To move to another list, cursor back up to the list type box (it will be outlined in white) and use the Enter key again to toggle to the required page.

The screenshot displays a software interface with a track list, channel names, and a copy configuration dialog box.

Track List 1

1 / Drum Sampler
2 \ Drum Sampler
3 Original Bass Gtr Clone
4 Bass Gtr / Dropped In
5 Guil. Tel L (Mix of PA)
6 Guil. Tel R (Mix Of PA)
7 Intro Telephones FX/Mi
8 Intro Drone
25 New Master PG Vox
26 New Master Paula Vox
27 PG Vocal Sub (Live Co
28 Paula Vox
29 / New Hand Drums
30 \ New Hand Drums
31 Click
32 EBU

Channel and Track Names

9 New Gtr
10 New Gtr V2 etc.....
11 / Gtr
12 \ Gtr
37 Tom 1
38 Tom 2
39 Tom 3
40 Tom 4

Delete

17 L Leslie (See 47)
18 \ LeslieNew JC Prophet
19 / JC Pads
20 \ JC Pads
21 Pr4ophet Loop Grunge
22 Trianglew
23 / Egyptians
24 \ Egyptians
41 / O/H
42 \ O/H
43 / Audience
44 \ Audience
45 / Audience
46 \ Audience
47 R Leslie (see 17)
48 Analogue Click

Copy Configuration

Port	Machine	Chan
Port 1	Direct (48)	1
Port 2	Unused	
Port 3	Unused	
Port 4	Unused	

Buttons: OK, QUIT

FILE/SETUP File Copy SIO T/C: Locked

MIX-DESK Data Timecode: SMPTE 30

RECALL Import Fast Play Speed: 3.0 Midi

MACHINES Desk Setup Define Fader Macros DiskTrack Free

MISC DeskConfig Channel Names 4 Channel Pan Follow faders

Alternatively stab in the box next to a Track/Channel number, and the QWERTY pop-up will appear. Enter a name and press **END**. Note that a useful list of keywords has been provided to save to much typing. See Section 1 for more on the QWERTY pop-up.

You can combine use of the computer front panel buttons with either of the methods above. The cursor keys move you around the list and the OK button is equivalent to the Enter key. If you are going to use the keywords list on the QWERTY pop-up as the basis of your list, operating the front panel buttons with your right hand and stabbing on keywords with the pen in your left hand makes for very quick name entry (*after a bit of practice! – ed.*).

The **Copy Tracks** function enables Track List information to be copied into a Channel List. Unless you have cross-patched the entire 48 tracks, this will make a useful starting point for the Channel List. Select **Copy Tracks** and a **Copy Configuration** pop-up will appear (see opposite). Stab on a box in the **Machine** column (one box for each machine port) that corresponds to the Track List you wish to copy. Select **Direct** for user-selectable mapping of the copy or **Sony 9-pin** for channel-to-record mapping from the **MACHINES/Serial** display pop-up. (If this latter statement confuses you, just select **Direct** and read on!)

If you select **Direct**, a numeric pop-up will appear allowing you to specify the number of tracks to copy. Enter the number (usually 48) and hit OK. Now stab on the relevant **Chan** box to enter the channel number into which the first copied track will be entered, or in other words, onto which of the three Channel Lists. Hit OK. Finally hit OK again to effect the copy.

To delete entries in the Track or Channel lists, select **Delete** and then stab on the entry you wish to delete. No confirmation will be requested. If you stab *and drag* to select multiple track/channel names for deletion, you will be asked to confirm.

To clear a Track or Channel List from the screen, simply stab outside the pop-up or deselect the CHANNEL NAMES button.

Other items in the **Desk Setup** menu will be described as and when necessary.

Solid State Logic
SL 9000 J Series
Total Studio System

Computer Operator's Manual

SECTION 5

The Mix System



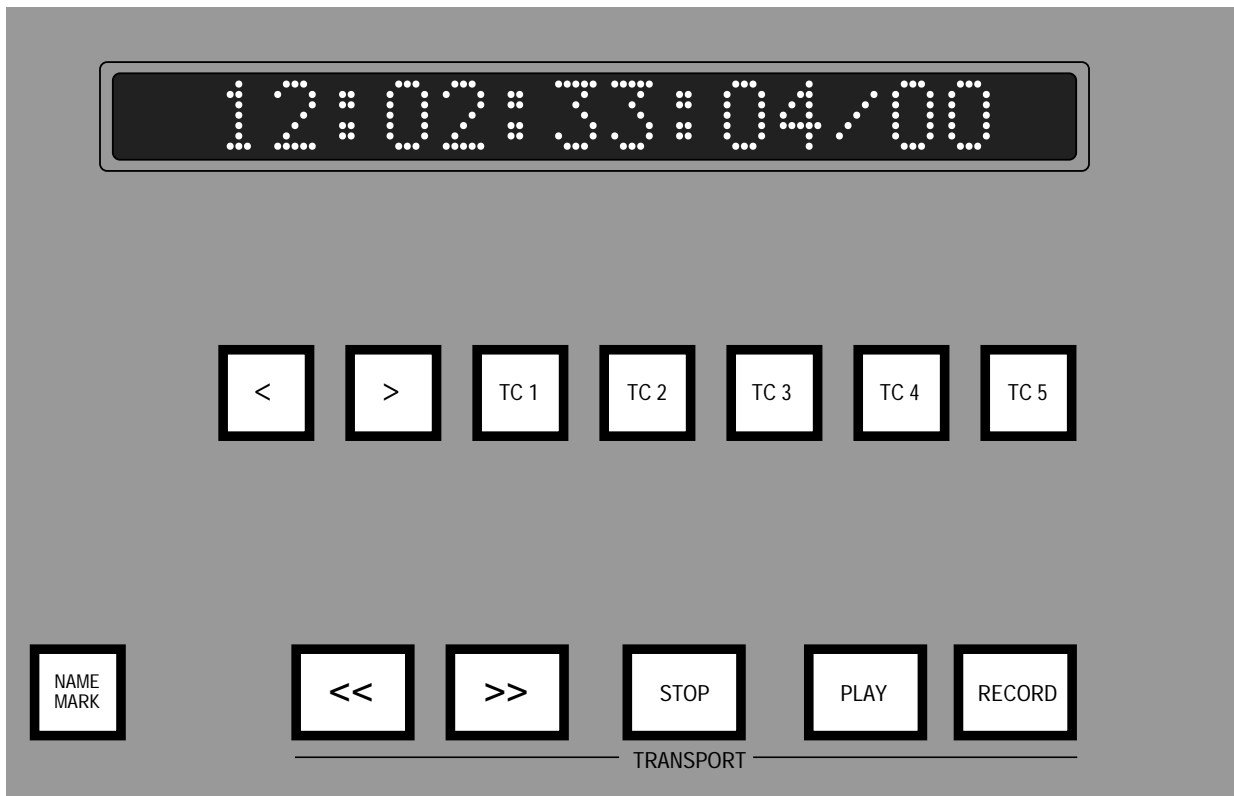

The Mix System

The SL 9000 J mix automation system incorporates many automation features that will be familiar to users of SSL's G Series mix system software. A big difference, however, lies in the *additional* features provided by the J Series Computer. For example, as well as the Large Fader and Cut being automated, the Small Fader and Cut, the FX Send On/Off buttons, Stereo Cue On/Off, Channel Insert In/Out and EQ In/Out are also automated. If that wasn't enough, you also have the ability to edit mix data via a graphic display.

You will find that this section is the longest in the manual – for fairly obvious reasons. However, before we dive into the automation system in detail, take a few moments to consider some other features that will be extremely useful during the mixing session.

Transport Control

There are many ways to move the Desk and external machines to specific timecode points. If you have read this manual from the beginning, you will be familiar with the locate facilities described in Section 3 (Machine Control) and Section 4 (Cue and Track Lists). For those who aren't, here is brief description of the most commonly used locate methods.

Timecode Locates

The five buttons situated above the transport keys on the computer front panel, labelled TC 1-5, provide five one-shot locate stores. The current Desk time can be entered into these stores by pressing and holding the relevant button until its lamp starts to flash.

Alternatively, by stabbing on the **S** box above the on-screen Desk timecode readout, a pop-up will appear (see opposite) which not only displays the current values of the timecode locates, but also allows the entry of specific timecode values. As well as the default 'absolute' locates, you can also set up relative locates here (to roll back or forward 2 seconds etc.). To select a relative + or relative - locate, stab on the **Abs** box and choose from **Rel +ve** or **Rel -ve**. Now stab on the timecode box to enter the required time.

Once timecode locates have been setup, they can be write-protected by changing the ticks to crosses on the right of the pop-up. This will prevent erroneous timecodes being entered if you hold down a TC1-5 button for too long when instigating a locate. Note that the write-protect does not prevent you entering locate times on the pop-up itself.

Note that these locate stores are saved as part of a Project File under **Timecode Memories** (see Section 2 for more details).

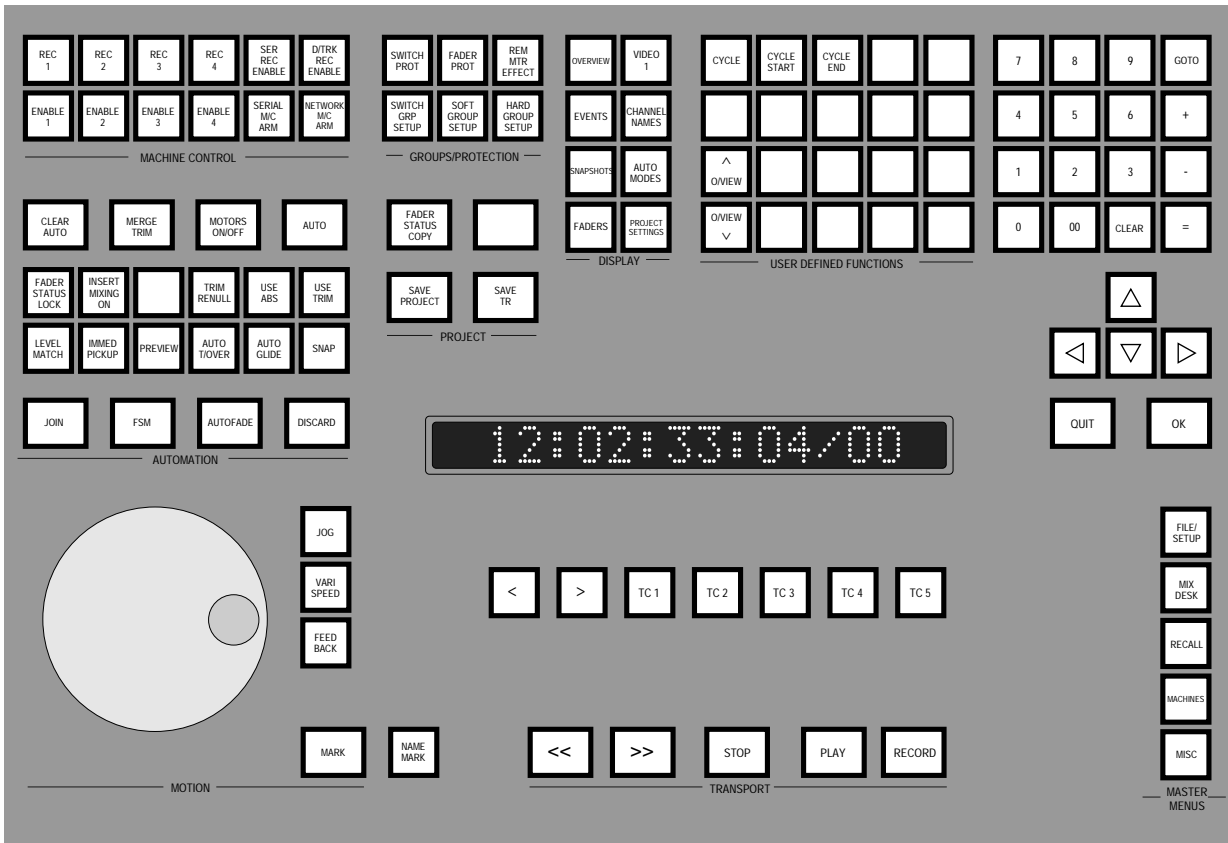

GOTO and Event Locates

At the top right of the front panel's numeric keypad you will find a GOTO button. Pressing this produces the timecode pop-up and mini Events List. Either stab on an event/cue to locate to that point or enter a timecode from the numeric keypad and hit OK. The CLEAR button can be used to clear an incorrect timecode entry. Use QUIT to clear the pop-up without effecting a change.

The GOTO function remembers the timecode of the last 'goto'. To repeat a locate simply press GOTO followed by OK.

Note that a mini Events List also appears under the **Overview** display (see Page 5-21). By having either this or the main **Events** list (see Section 4) on screen while mixing, you can locate very simply to any pre-marked spot in the mix by simply stabbing your pen on the appropriate cue. Alternatively, enter a cue's unique system-given number (**1 ***, **2 ***, **3 *** etc) via the numeric keypad on the computer front panel (no need to add the *), and hit the OK button to action the locate.

Frame and Event Jogs

The < and > buttons, to the left of the TC 1-5 buttons, can be either used to provide a frame jog function, step from one event (mark/cue, DiskTrack audio clip etc.) to another, or move from the start of a mix to the mix end time (or vice versa). The choice is made in the **Desk Config/Transport Layout** entry of the **FILE/SETUP** menu. See Section 9 for more details.

The < and > boxes, below the timecode readout on the **MIX-DESK** display, step from one event to another (see Events List, Section 4).

Cycle

Use the dedicated CYCLE START and END buttons on the front panel to capture the current Desk time as the Cycle Start/End times. The two timecode boxes below the **Cycle** box on the right of the **MIX-DESK** display are used to show these times. Stab on these boxes to enter known timecodes on the timecode calculator. Instigate the cycle by pressing the CYCLE button or stab on **Cycle**. If you need to adjust the Cycle Start or End time by a few frames or seconds, simply use the pen to drag the appropriate timecode numbers up or down.

To cancel a cycle at any time, press STOP or deselect the CYCLE button or the **Cycle** box. If you use STOP to do this, the cycle will resume if you subsequently press PLAY.

Jog Wheel

Finally, remember the Jog Wheel when you just want to wind back a few seconds. Once you get used to it, you may find you don't need to tap at the RW and FF buttons as much as you used to.

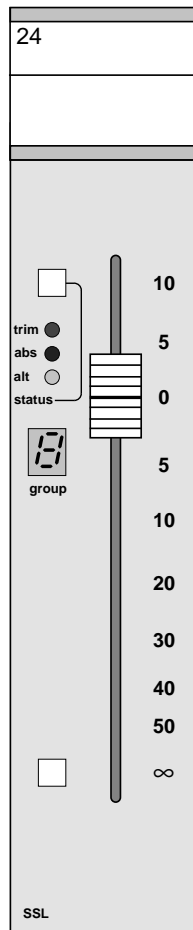

Vari: 12:40:49:27

00:00:00:00/00

00:00:00:00/00

Cycle **S** < >

12:40:49:28

Arm Final Mix Safe

Fr : _____

To: _____

*: _____

0: _____

-1: _____

-2: _____

-3: _____

-4: _____

Name	Discard
Keep	Revert

DT Free 1:18

Free Mem 97%

FILE/SETUP	DiskTrack			Clr Hard Groups
MIX-DESK	Overview	Edit	Switch Groups	Clr Chan Cuts
RECALL	Events	Automation	Soft Groups	Clr Group Cuts
MACHINES	SnapShots	Groups	Remove Motor-Group Effect	Clr Chan Solos
MISC	Faders	Project	Group Solos linked to Desk	Clr Group Solos

Hardware Fader Groups

Any 'large' channel fader can be assigned to one of the eight Group Control faders located below the console centre section. The number of the Group fader to which a channel is assigned is displayed in a local 7-segment LED display on the fader (see opposite).

Group faders can also be freely assigned to other Group Faders, so many combinations of subgrouping can be achieved. Note for Ultimition users – higher numbered Group faders *can* be assigned as masters to lower numbered Group faders.

To assign faders, select the HARD GROUP SETUP button on the front panel. Now by quickly pressing the switch at the bottom of a fader, the 7-segment display will increment by one. If the switch is held down for a short period it will decrement the display by one. If 0 is selected on the display, then the fader will be cut by Group Fader solos. If the display is blank then the fader is unaffected by group solos. Note that a fader must also be in this latter mode before it can be assigned to a Software Group (see below).

Current Group Fader assignments can be cleared via the **MIX-DESK/Groups** menu (see below).

In addition to the eight hardware groups, 32 Software Groups are also available (see Page 5-65).

The Groups Menu

As well as providing the means to clear down any Group Fader assignments – **Clr Hard Groups**, the **MIX-DESK/Groups** menu (see opposite) also contains the following useful functions:

Clr Chan Cuts	Clears any currently selected Large or Small Fader cuts
Clr Group Cuts	Clears any currently selected Group Fader cuts
Clr Chan Solos	Clears any currently selected Large or Small Fader solos
Clr Group Solos	Clears any currently selected Group Fader solos

If you stab any of the above boxes, the system will prompt you to confirm your selection.

Group Fader solos can be made to operate with, or independent of, the console's solo modes. These solo modes are: normal – where multiple solos may be selected or deselected consecutively; ALT – where the solos alternate, ie. when you press a solo it comes on and any other currently selected solo is cancelled; FLEET – where a channel is soloed for as long as you are holding the solo button down. Different modes may be selected in the console's audio centre section.

				Vari:
				12:40:49:27
				00:00:00:00/00
				00:00:00:00/00
				Cycle S < >
				12:40:49:28
				Arm Final Mix Safe
				Fr :
				To:
				*:
				0:
				-1:
				-2:
				-3:
				-4:
		Name		Discard
		Keep		Revert
				DT Free 1:18
				Free Mem 97%

FILE/SETUP	DiskTrack			Clr Hard Groups
MIX-DESK	Overview	Edit	Switch Groups	Clr Chan Cuts
RECALL	Events	Automation	Soft Groups	Clr Group Cuts
MACHINES	SnapShots	Groups	Remove Motor-Group Effect	Clr Chan Solos
MISC	Faders	Project	Group Solos linked to Desk	Clr Group Solos

				File Copy	SIO T/C: Locked
FILE/SETUP	Data	Timecode: SMPTE 30			
MIX-DESK	Import	Fast Play Speed: 3.0	Midi		
RECALL	Desk Setup	Define	Fader Macros	DiskTrack Free	
MACHINES	DeskConfig	Channel Names	4 Channel Pan	Follow faders	
MISC					

If **Group Solos linked to Desk** (in the **Groups** menu) is selected, then the currently selected solo mode will apply to the Group Fader solos. If selected to **Group Solos Independent** then the groups remain in normal solo mode regardless of the solo mode set for the rest of the console. Stab in the box to toggle the choice.

Note that changing this option will not take effect on currently selected group solos until you change the state of one of the solo buttons.

Remove Motor Group Effect – If a hardware group has been set up with the fader motors turned on, and you subsequently turn the motors off, this function should be selected in order to reset grouped fader levels to their original positions. For example, if you have a Group Fader sitting at -5dB and the potential slave sitting at -10dB, when you group the slave it moves to -15dB and the signal is passing through the fader at -15dB. When you turn the motors off and hit the REM MTR EFFECT button, the slave fader will move back to its original -10dB position and the signal on the slave will still be passing via the channel VCA at -15dB.

This feature enables you to keep slave faders at reasonable physical positions, without having to worry about the actual VCA level that the signal is governed by. Note that **Remove Motor Group Effect** has been provided as a dedicated function (ie. not incorporated with the MOTORS OFF function) as we believe it would be disconcerting to see the faders move when the motors are switched off – the last thing you might expect!

The **Switch Groups** and **Soft Groups** items in this menu are discussed on Pages 5-73 and 5-65 respectively.

The Desk Setup Menu

The **FILE/SETUP/Desk Setup** menu (see opposite) holds several items that may need checking before you start to mix.

Timecode – The correct timecode standard must be selected here to match the timecode on the tape. Details of both the video sync and timecode standard, that are in use when an automated mix is created, are saved as part of the automation data. Note that the setting here also governs the type of timecode that will be generated by the system (see Section 7). For more details on Timecode and Sync Standards, see Section 3.

Channel Names – This provides access to the Track/Channel Lists and is covered fully in Section 4.

Follow Faders/Follow Output – The levels of Large or Small Fader control voltages may be displayed on the console's channel meters by selection of the LF MIX or SF MIX meter selection buttons on the console's audio centre section. This toggling entry in the **Desk Setup** menu affects the **MIX-DESK/Faders** display (see Page 5-57) which provides an overall view of fader levels and cut states. **Follow Faders** displays input levels to the computer; **Follow Output** displays the computer's output levels, ie. the equivalent of G Series bargraphs.

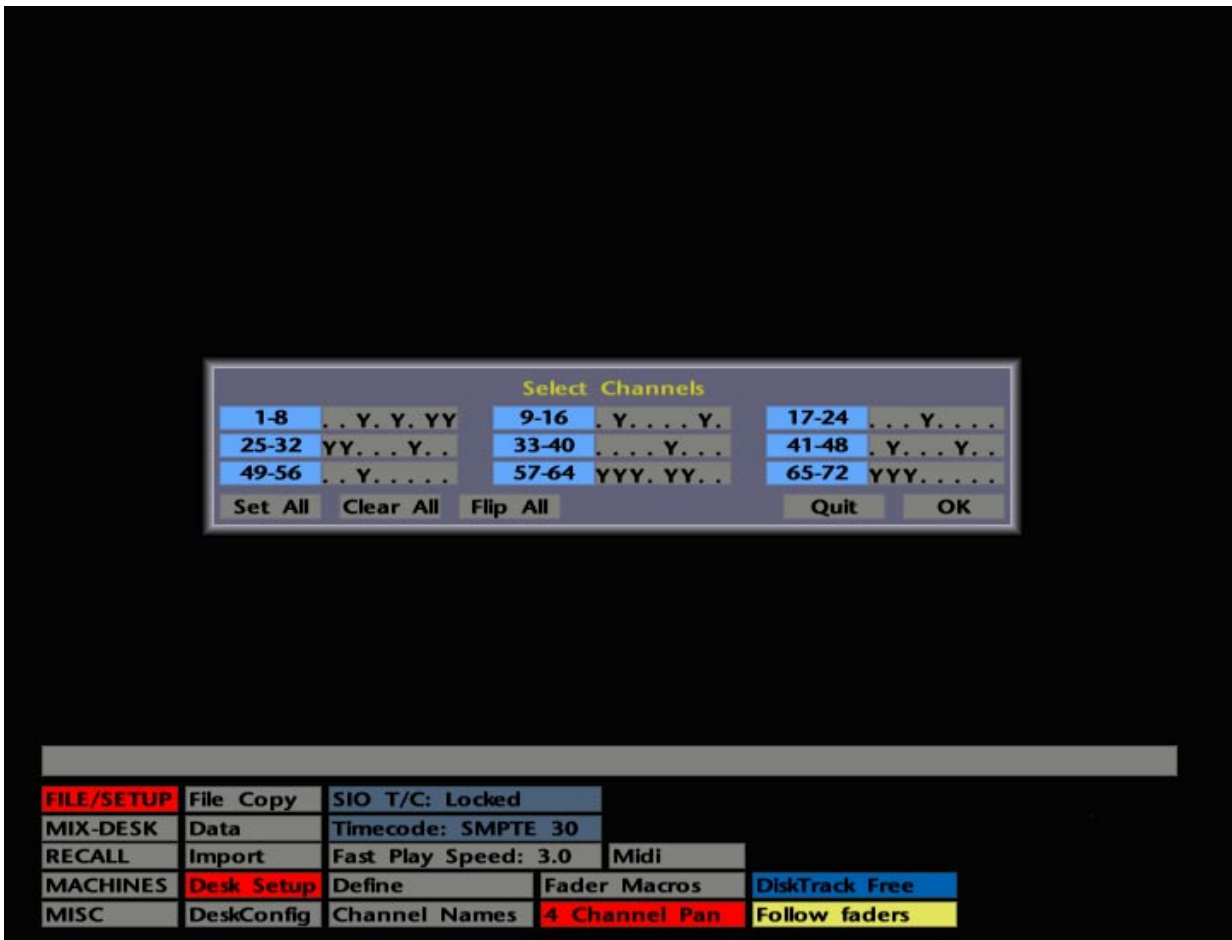

4 Channel Pan – The Small Fader can be used to provide an automated pan control between Large and Small Fader signal paths. On selection (red), **4 Channel Pan** provides a Channel Selector pop-up (see opposite) which allows any, or all, channels to be switched to this mode. (See Section 1 for instructions on how to use the Channel Selector). Once channels have been selected, the **4 Channel Pan** box turns blue.

In 4-Channel Pan mode the Large Fader controls the overall level of both signal paths while the Small Fader controls their relative levels. This effect can be used to generate mono or stereo surround mixes by routing the Small Fader to one of the Stereo Subgroup busses. The Small Fader will then provide panning from front to surround outputs while the Small Fader pan will pan across the stereo surround outputs. The console's output monitoring must be selected to 4CH mode.

Alternatively, **4-Channel Pan** can provide automated left/right panning across the main Mix bus. If both faders are routed to the main stereo mix bus and one is panned left and the other right, then the Small Fader will pan from left to right. Select the monitoring to 2CH for this mode.

Having selected **4-Channel Pan**, you need to return to the **MIX-DESK** display before you can hear the effect of either of the above modes. Note also that, when **4-Channel Pan** is active, the Small Fader cut switch is inactive and the Large Fader cut switch or a Large Fader solo will cut both faders.

Talking of panning, it's worth noting that if the console has been fitted with the LCR pan option, the Large and Small Fader pans can be selected to provide LR or LCR panning by selection of the 2CH or 4CH buttons on the SL952 Master Panel (see also the SL 9000J Console Operator's Manual).

None of the other items in the **Desk Setup** menu are relevant to the mixing process. Check their location in the Index if you want to know more about any of them.

The screenshot shows a computer interface with a menu on the left and a control panel on the right. The menu has four main categories: FILE/SETUP, MIX-DESK, RECALL, MACHINES, and MISC. Each category has several sub-items. The control panel on the right displays various status and control information, including a time display (12:40:49:27), a cycle display (S), and a large time display (12:40:49:28). It also has buttons for Arm, Final Mix, and Safe, and a list of parameters (Fr, To, *, 0, -1, -2, -3, -4) with corresponding input fields. At the bottom of the control panel, there are buttons for Name, Discard, Keep, and Revert, and two status displays: DT Free 1:18 and Free Mem 97%.

FILE/SETUP	DiskTrack		Enable	Do Pre	
MIX-DESK	Overview	Edit	Clear Data		
RECALL	Events	Automation	Fader Protection		Offline Trim
MACHINES	SnapShots	Groups	Switch Protection		Fader Status
MISC	Faders	Project	Join to Mix		Auto Modes

SL 9000J Automation – An Introduction

As discussed before, the J Series Computer provides automation facilities for the following:

- Large Channel Fader and Cut
- Small Channel Fader and Cut
- Group Fader Levels
- Group Fader Solos
- Channel FX Send On/Off buttons
- Channel Stereo Cue On/Off
- Channel Insert In/Out
- Channel EQ In/Out

In the following narrative, the automated switches may be referred to as 'objects'.

The Large Faders and Group Faders are automated using SSL's patented Ultimation system which provides the intuitive nature of moving faders, coupled with the flexibility of a VCA based system. Normally, the fader motors are turned on and channel audio passes through the fader, except when a specific automation mode dictates that audio should pass via the channel VCA. If the motors are turned off with the MOTORS ON/OFF button, audio will only pass via the channel VCAs whenever a fader is grouped or the automation is turned on.

Automation of the Small Faders is provided by separate VCAs. Note, however, that Small Fader audio will only pass via the VCA when the automation system is active. Even then, a specific automation mode (**Protect Manual** – see Page 5-55) may be selected to allow the audio to pass directly via the fader.

Regardless of the automation mode selected (see Page 5-15), there are two possible write statuses for faders – **Absolute** and **Trim**. When the system is playing back previously written data, the faders are in **Replay** status. At the start of a new mix only, faders can be set to **Manual**.

It is important to understand that, with the J Series mix system, Trim data is stored separately from Absolute data in RAM until the two data streams are merged. When a mix pass is saved to disk, an automatic merge takes place. Alternatively, an unsaved mix pass can have its Absolute and Trim data merged by using the **Merge Trim** function (see Page 5-51). Separate displays of Absolute and Trim data can be seen on the Overview display (see Page 5-25).

Unlike G Series, the Large Fader Cuts, along with all the other automated objects, are treated quite separately to the faders, and may be selected independently to any one of the automation modes. In any mode, objects can be in one of two statuses – Record or Play, ie. write or read. G Series users need not worry about complex cut editing statuses; all you'll ever need to edit mix data for cuts (and all the other automated switches) can be handled effortlessly with two new features – Match and Play (see Page 5-35) and the graphic mix data editing facilities (see Page 5-79).

Vari:
 12:40:49:27
 00:00:00:00/00
 00:00:00:00/00
 Cycle **S** < >
12:40:49:28
Arm Final Mix Safe
 Fr :
 To:
 *:
 0:
 -1:
 -2:
 -3:
 -4:
 Name Discard
 Keep Revert
 DT Free 1:18
 Free Mem 96%

LF OV SF RJ GF RJ MF RJ LC RJ SC RJ GC RJ AU RJ GS RJ GL 35 FRAMES AF 10 SECS

FILE/SETUP	DiskTrack		Enable	Do Pre	
MIX-DESK	Overview	Edit	Clear Data		
RECALL	Events	Automation	Fader Protection	Offline Trim	
MACHINES	SnapShots	Groups	Switch Protection	Fader Status	
MISC	Faders	Project	Join to Mix	Auto Modes	

The Mix Pass Structure

Compared to G Series, the J Series Computer has a new way of handling mix passes. Every time you roll back, having made updates to the mix, the system will store a new 'Mix Pass' in RAM (memory). Each new pass will update the previous pass, unless you elect to update a different pass (see **Revert** below).

The Mix Pass list is located to the right the main **MIX-DESK** display (see opposite). Note that this list is a permanent feature of the display, whether the automation system is active or not. Up to five mix passes can held in RAM; beyond this figure, the system operates on a first-in-first-out basis unless you elect to 'keep' a mix. In turn, this allows for four levels of undo. Note that your most recent mix will be designated pass **0** and the previous mixes will be designated **-1** to **-4**, where **-4** is the 'oldest'.

The box at the top of the list (with a * at the left hand end) is know as the Reference Mix box. This is used to display the name of the last mix saved to disk *or* loaded from disk. Apart from providing a local reference, this mix becomes important when you are working in 'Insert Mixing Off' mode (see Page 5-33).

A new mix pass is only created if you have updated the mix information. This means that just rolling back, and listening to your mix a number of times, does not create a new mix pass. Passes are automatically named with an incrementing number and time-stamped (stab on any Mix Pass box to toggle between Time and Name).

The actual mix pass start and end times will be shown in the **Fr :** and **To :** boxes above the Mix Pass list.

To name a mix pass, simply select **Name**, stab on the pass you wish to name and the QWERTY pop-up will appear. Type in the mix name using the pen or the dedicated keyboard.

As the Mix Pass list is updated, earlier mix passes will 'drop off' the list and are unrecoverable. It is therefore imperative that you put a hold on important mixes in the list (see **Keep** below) or save them to disk (see Saving Mixes on Page 5-41) otherwise you may run the risk of losing them as the Mix Pass list overflows. Unless you have used the **Revert** function (see below), the last pass (ie. the one you are be currently updating) is always highlighted in green in the pass **0** box.

To 'keep' a mix in the pass list, select **Keep** and stab on the relevant mix pass. The selected mix and the **Keep** box will be highlighted in yellow. As mix passes accumulate, the kept mix will reach pass **-4** and be held there. The rest of the list will update as normal. You can only keep one mix at any one time. To deselect a kept mix, stab on the **Keep** box and then on the kept mix. This will highlight the mix in green which signifies that this is the mix you are about to update. If you do not wish to update this mix use the **Revert** function described below.

If you wish to update another mix pass other than the mix you have just created, use **Revert** to choose an alternative. Simply select **Revert** and then stab on the mix you wish to update. The selected mix will be highlighted in green.



Selecting **Discard** (or hitting the DISCARD button on the front panel) will enable you to throw away the last pass you did. Note that you must press **Discard** *before* you roll back.

Automation Modes

The J Series automation system has eight different types of automation mode – **Overwrite**, **Rollback**, **Rollback/Join**, **Clip Fill**, **Clip End**, **Cycle Fill**, **Cycle End** and **Static**. Since these provide many possibilities, we will initially cover only those modes that you will find most useful when starting out. Note that each type of automated object can be assigned to different modes on an individual basis (see opposite and on Page 5-27 for details).

Overwrite – Having mixed some way into the track, as soon as the system is rewound, dynamic fader moves and switch object changes, up to the point of rollback, will be written to the current mix pass in RAM. Levels and switch settings at the point of rollback will be written to 23:59:59:24(:29), effectively overwriting any previous mix data. When you subsequently pass through the rollback point, faders and objects will remain in Replay until manually forced back into a write status on an individual basis. **Overwrite** provides an ideal mode for creating a new mix.

Static – Allows basic mix levels to be set up without being written to the mix, even though controls will be in a write status. As soon as the system is rolled back, the levels and switch settings at that point, as long as faders and switches are still in a write status, will be recorded for that mix pass, from the start of the mix to 23:59:59:24(:29). If a control is switched out of write (back to Replay) before the rollback point, the current mix data will be played back. This is a useful mode to use for switches when you are setting up FX sends etc. in a new mix.

Rollback/Join – Dynamic fader movements and switch changes before the rollback point will be stored. Any fader or switch that is in an active write status at the rollback point will automatically drop back into that status when the system next passes the rollback point. This mode approximates to the update process in G Series.

Rollback – Similar to **Rollback/Join** in that new information is written up to the point at which the system is rewound. However, when you subsequently play through the rollback point, previously active faders or switches continue to replay mix data from the previous mix pass, from the rollback point on.

Note that in **Rollback/Join** and **Rollback** faders will drop back into Absolute when the Mix To : time is crossed. Once this has happened, faders may not be dropped back out of Absolute.

Hitting **Discard** after the Mix To : time has been played through, with faders in **Rollback** and **Rollback/Join**, will switch faders into Absolute at the level they were at at the Mix To : time. If faders are selected to **Overwrite** or **Static** mode under the same circumstances, they will switch to Replay when you use **Discard**.

Clip Fill, **Clip End**, **Cycle Fill** and **Cycle End** are discussed on Page 5-85.

The screenshot displays a control interface for the SL 9000J. At the top, a status bar contains several indicators: LF OV, SF RJ, GF RJ, MF RJ, LC RJ, SC RJ, GC RJ, AU RJ, GS RJ, GL 35 FRAMES, and AF 10 SECS. On the right side, a vertical panel shows the time '12:40:49:27' and '12:40:49:28', along with '00:00:00:00/00' and '00:00:00:00/00'. Below these are 'Cycle' buttons with 'S', '<', and '>' symbols. A large 'Arm' button is highlighted in blue, with 'Final Mix Safe' in red text next to it. Below the 'Arm' button are several input fields labeled 'Fr:', 'To:', '*', '0:', '-1:', '-2:', '-3:', and '-4:'. Further down are 'Name' and 'Discard' buttons, and 'Keep' and 'Revert' buttons. At the bottom of this panel, 'DT Free 1:18' and 'Free Mem 96%' are displayed. At the bottom of the screen, a menu grid is visible:

FILE/SETUP	DiskTrack		Enable	Do Pre	
MIX-DESK	Overview	Edit	Clear Data		
RECALL	Events	Automation	Fader Protection	Offline Trim	
MACHINES	SnapShots	Groups	Switch Protection	Fader Status	
MISC	Faders	Project	Join to Mix	Auto Modes	

Rollback Points

Rollback points have an important role to play in the J Series automation system. If you have read through the section on Automation Modes (Page 5-15), you will know that a number of different things may happen at the rollback point, depending on which status and automation mode is currently selected for any automated control.

A rollback point is created, for any object in write, by using any method that moves the system backward by more than a frame. This can include the TC1-5 locate buttons, the Rewind key, the Jog Wheel or even Rewind on an external tape machine remote.

Unless no new mix data has been written, the action of rolling back will create a mix pass saved in RAM and the mix **To** : time will be updated. If you rewind before the current **Fr** : time and start writing new mix data, the next time you roll back, the **Fr** : time will be updated.

Rollback points are created whatever Automation Mode is in use, and each mix pass has its own set of rollback points. Each automated object can have one rollback point associated with it, ie. the point at which the system was rolled back with that object in write. As you mix, be aware that rollback points may be created at different times for different objects. If you **Discard** the current mix pass, or **Revert** to a different pass, the system will reinstate the rollback points from whichever pass you then choose to update.

If you change to a different Automation Mode, the rollback points for the current pass will still be in place. This is particularly relevant if you have made your first pass in **Overwrite** or **Static** (creating a number of different rollback points) and then switch to **Rollback/Join**.

Rollback points will be cancelled if you:

- Play through a rollback point
- Switch back into write before the rollback point
- Save a mix pass to disk

All of the above may seem unnecessarily complicated to you. Rest assured that rollback points are far more transparent when you are actually mixing!

See also the JOIN button on Page 5-19. Rollback points for faders faders are indicated on the Overview display (see Page 5-21).

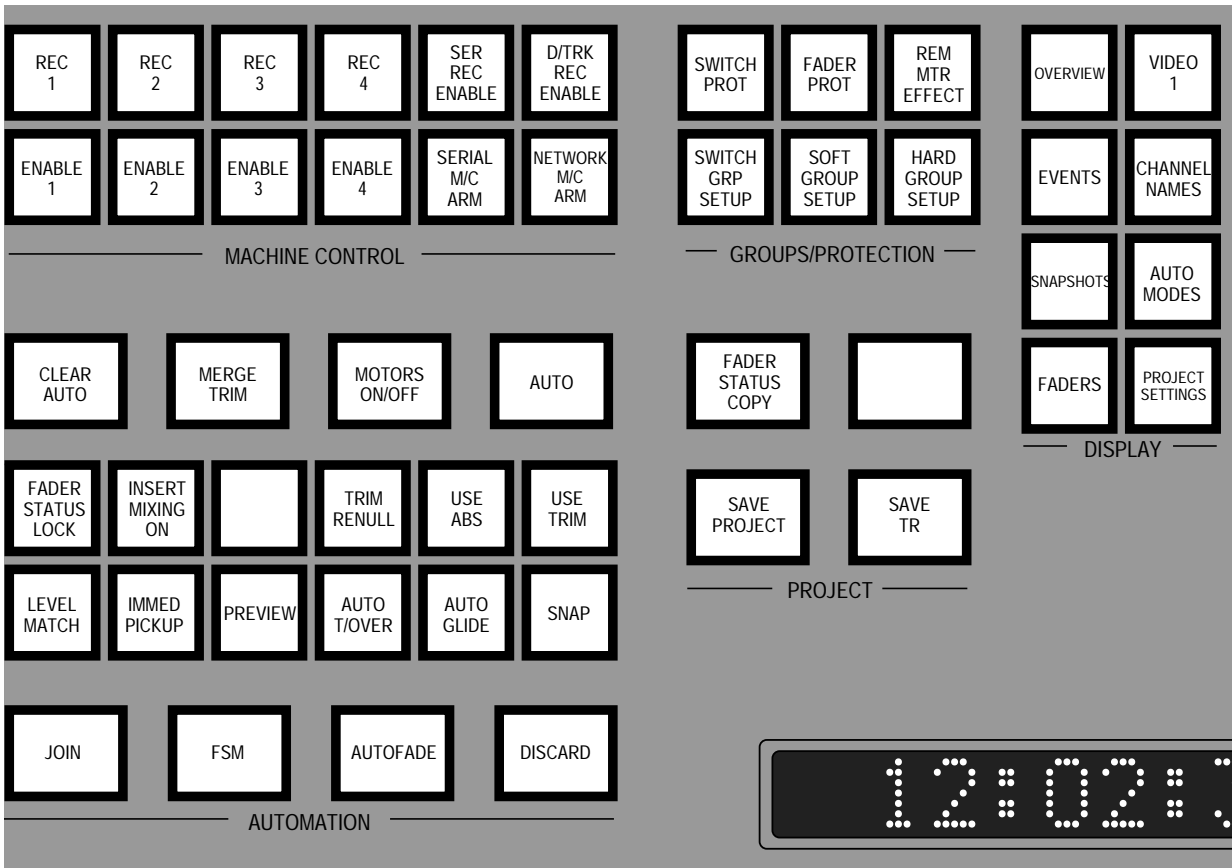

The JOIN Button

If a fader or automated switch object is in a write status when you roll back, and you want to drop it back into write *before* it reaches its rollback point (where this would automatically occur if you are using **Rollback/Join**) then you can, of course, press the fader status button, or switch the object into write (in conjunction with the Match facility, if necessary – see Page 5-35).

To achieve the same effect with multiple faders/switches, use the JOIN button which enables a number of automated objects to be dropped into write at the same time.

Any faders *physically* in the wrong position when you hit JOIN (this could be the case if you are working with the fader motors off), will drop into write with a level jump. Note that if TRIM RENUALL is selected (see Page 5-47), and you use JOIN to drop faders into Trim, the system will recalculate the null position to avoid a level jump.

Dropping switch objects back into write with JOIN will put them into write in the state they were in at the rollback point.

Any fader or object that was in Replay at the rollback point will be unaffected by the JOIN button.

Bearing in mind that you may have a number of rollback points for different objects, occurring at different times, JOIN will ‘play out’ rollback points in time order. For example, write a pass in **Overwrite** to 4:00 minutes and rewind to 1:00. Select **Rollback/Join**, play forward, and drop a single fader into write at 1:30. You then realise that you should have punched the fader into write at 1:20, so roll back, hit JOIN at 1:20 and that single fader will drop into write. If you hit the JOIN key again, once the single fader is in write, the system will have remembered the next rollback point at 4.00, and the JOIN key will switch the rest of the desk into write – logical, huh?

In all modes, the rollback point will be cancelled if played through. In other words, if you play past the last rollback point and hit JOIN, the system will not drop back into write. (Remember that, in **Rollback/Join**, the system automatically drops back into write at the rollback point.

See also Rollback Points on Page 5-17.

The screenshot displays a professional video editing software interface. At the top, a timeline shows 34 tracks with waveforms and a playhead at 12:40:52:27. Below the timeline are controls for 'Re-Center', 'Fit Audio', 'Zoom in', 'Zoom out', and 'Playhead'. A 'Marks' list shows four entries with timestamps and names like '*Top', '*Phones', '*Pipes', and '*Intro Chorus'. On the right, a 'Vari' panel shows '12:41:16:11' and 'Final Mix Safe'. At the bottom, a menu grid includes options like 'MIX-DESK', 'Automation', and 'Edit Mix'.

11	12	13	14	15	16	17	18	19	20	21	22	23	24	25	26	27	28	29	30	31	32	33	34	
[Waveform tracks]																							Print	

12:41:19:18	Re-Center	Fit Audio	Zoom in	Zoom out	Playhead	
▲	Mark	16:38:51:12/66	1	*Top		
■	Mark	16:39:11:13/00	2	*Phones		
■	Mark	16:39:49:23/00	3	*Pipes		
▼	Mark	16:40:09:29/00	4	*Intro Chorus		

LF RO	SF RJ	GF RJ	MF RJ	LC RJ	SC RJ	GC RJ	AU RJ	GS RJ	GL 35 FRAMES	AF 10 SECS
-------	-------	-------	-------	-------	-------	-------	-------	-------	--------------	------------

FILE/SETUP	DiskTrack			Trim Mix		
MIX-DESK	Overview	Edit		Ref: Ch 1		
RECALL	Events	Automation	Sift	L Fader	G Fader	M Fader
MACHINES	SnapShots	Groups	Edit Audio	I Cut	None	
MISC	Faders	Project	Edit Mix	None	Mix Data moves with Audio	

The Overview Display

The Overview display has a variety of different uses. One of these is to display mix data on a per-channel/per-object basis. If this is of interest, and you are familiar with the basic functions of the Overview display, turn to Page 5-25.

Select **Overview** from the **MIX-DESK** menu and the screen will look similar to that shown opposite.

The main part of the display consists of 24 vertical windows representing Channels 1-24; use the scroll bar below to view higher numbered channels, Groups 1-8 and the Master Fader. These windows are used to display marks, automation data, and a representation of audio (when **Capture Clips**, see Page 5-83, is in use) to assist in the editing of mix information. If your system is fitted with DiskTrack, SSL's hard disk recorder, then the Overview display takes on a new importance. See the DiskTrack Operator's Manual.

The timecode numbers, at the top and bottom left of the display, show the current range of the Overview display. Pressing either of the O/VIEW buttons on the front panel (in the User Defined Functions group) will move the display forward or back in time by half the size of the current window. The same effect can be obtained by stabbing in the bottom or top timecode boxes respectively. Stabbing and dragging on either box will call up the timecode calculator pop-up if you wish to enter new range times (but see below).

The broken red line across the display represents the current Desk ('playhead') position. You can locate the system, including external machines, to any timecode point within the Overview window by simply stabbing at the position you wish to be at, or by dragging the red line to a new locate point.

Marks (cues), created with the MARK button, are represented by horizontal black lines across all the channel windows.

Rollback points for faders are indicated by a coloured bar across any channels with a rollback point. If the bar is red, the write status at the rollback point was Absolute, green if it was Trim. Rollback indications are cleared from the screen when you stop, or roll back, after playing through them.

Other basic options available for the Overview display are:

Fit Audio Causes the display to re-size to the length of the Events List or, if applicable, Mix Start and End times and/or DiskTrack audio

Zoom In As implied. Stab on the area you wish to zoom in on

Zoom Out Stab on this box to zoom out

Playhead Centres the display on the current Desk position

Re-Center Re-centres the display on a pen stab point

The screenshot displays a professional video editing software interface. At the top, a timeline shows 34 tracks with waveforms and markers. Below the timeline is a 'Marks' list with the following entries:

▲	Mark	16:38:51:12/66	1	*Top
■	Mark	16:39:11:13/00	2	*Phones
■	Mark	16:39:49:23/00	3	*Pipes
▼	Mark	16:40:09:29/00	4	*Intro Chorus

Below the marks list is a row of transport controls: LF RO, SF RJ, GF RJ, MF RJ, LC RJ, SC RJ, GC RJ, AU RJ, GS RJ, GL 35 FRAMES, AF 10 SECS. The bottom section contains a menu grid:

FILE/SETUP	DiskTrack		Trim Mix			
MIX-DESK	Overview	Edit		Ref: Ch 1		
RECALL	Events	Automation	Sift	L Fader	G Fader	M Fader
MACHINES	SnapShots	Groups	Edit Audio	L Cut	None	
MISC	Faders	Project	Edit Mix	None	Mix Data moves with Audio	

On the right side, there is a 'Vari' panel with the following information:

- Vari: 12:41:16:11
- 00:00:00:00/00
- 00:00:00:00/00
- Cycle S < >
- 12:41:15:21
- Arm Final Mix Safe
- Fr : 12:40:49:27/14
- To: 12:41:16:11/84
- *:
- 0: Pass 2
- 1: Pass 1
- 2:
- 3:
- 4:
- Name Discard
- Keep Revert
- DT Free 1:18
- Free Mem 96%

Note that the channel number boxes above each window can be stabbed on to toggle through a palette of 16 different colours. If your system is fitted with DiskTrack, this provides up to 16 different audio edit groups. Non-DiskTrack users may find this function useful to identify specific channels by colour.

The two boxes above the display, **Mark** and **Del Mark** are used to make and delete individual marks used for editing DiskTrack audio. See the DiskTrack Operator's Manual for more details. Note that **Del Mark** cannot be used to delete marks made with the front panel MARK button.

The **Print** box at the top right of the Overview display calls up the Print Overview pop-up. With a suitable PostScript™ printer connected to the J Series Computer's 'Remote' port, a diagrammatic representation of the display, complete with listed details of all audio clips (if your system is equipped with DiskTrack) including start/end time, duration, name and mark information etc, may be printed out for reference.

For **Time per Page**, enter the amount of time to be displayed vertically per A4/US Letter landscape page. An entry here automatically updates the **Pages Used** (ie. the number of pages that will be printed) figure below. **Grid Spacing** may be set to taste – the grid provides a quick way of measuring time on the printed page. **Start** and **End Time** should be set to closely match the audio you are interested in, otherwise you will end up with wasted sheets of paper. The **Length** below will automatically be calculated from values entered here.

The **Print Destination** may be selected as direct to the printer or to a file on the J Series System Disk. Select **Page Size** from **A4** or (US) **Letter** as appropriate. **Default** resets to the pop-up's default settings. **Print** starts the print or file transfer process.

The correct parameters must be set up for the Remote port before printing. See **Serial Xfer** in the **MISC** menu – Section 9.

Mini Events List

Beneath the Overview channel display you will see a smaller, scrollable, version of the Events List (see Section 4 for more on the Events List). The provision of this list facilitates immediate locates by stabbing on Events List entries, and gives a clear indication of where in a track the system is positioned.

The screenshot displays a multi-track audio editing interface. At the top, there are timecode displays (12:40:52:27) and buttons for 'Mark', 'Del Mark', and 'Print'. Below these are 34 tracks, each with a vertical waveform and a red playhead line. A central control bar includes 'Re-Center', 'Fit Audio', 'Zoom in', 'Zoom out', and 'Playhead' buttons. A list of marks is shown below the tracks:

- ▲ Mark 16:38:51:12/66 1 *Top
- Mark 16:39:11:13/00 2 *Phones
- ▼ Mark 16:39:49:23/00 3 *Pipes
- ▼ Mark 16:40:09:29/00 4 *Intro Chorus

At the bottom, a menu is open with the following options:

FILE/SETUP	DiskTrack	Trim Mix
MIX-DESK	Overview	Ref: Ch 1
RECALL	Events	L Fader
MACHINES	SnapShots	G Fader
MISC	Faders	M Fader

Additional controls include 'Automation' (highlighted in green), 'Sift', 'L Cut', and 'None'. A status bar at the bottom right shows 'Free Mem 96%'.

This screenshot is similar to the one above, but with an 'Automation Type' dialog box open in the center. The dialog box contains a list of automation options:

- L Fader
- L Fader(Trim)
- S Fader
- S Fader(Trim)
- L Cut
- S Cut
- Eq
- Ins
- Cue
- Fx1

Buttons for 'None' and 'Cancel' are at the bottom of the dialog. The background interface shows the same tracks and menu as the previous screenshot, but the 'Automation' menu item is now highlighted in green. The status bar at the bottom right shows 'Free Mem 93%'.

The Overview Display and Mix Data

One of the most useful functions of the Overview display is to show the mix pass levels for faders and automated objects. Select **Edit** in the **MIX-DESK** menu, followed by **Edit Mix**. This will reveal three groups of boxes (see opposite) that enable colour overlays to be selected for the faders or objects of your choice. Mix data for the current mix (ie. the one in green in the Mix Pass list – see Page 5-13) will be displayed by a continuous coloured line, with excursions to the right indicating an increase in fader level or, in the case of switches, the 'on' condition.

Stab on a box in the chosen colour group and a list of items whose automation data can be displayed in that colour will appear, with the most commonly used items at the top of the list (see lower screen opposite). Channel module information can be represented with white, blue or yellow overlays showing mix data for **L(arge) Fader**, **L(arge) Fader (Trim)**, **S(mall) Fader**, **S(mall) Fader (Trim)**, **L(arge Fader) Cut**, **S(mall Fader) Cut**, **EQ (In/Out)**, **Ins(ert In/Out)**, **Cue (Stereo On/Off)**, and **FX1-6 (On/Off)**. Group information can be displayed with white or blue overlays representing **G(roup) Fader**, **G(roup) Fader (Trim)**, **G(roup) Cut** and **G(roup) Solo** data. Finally, **M(aster) Fader** or **M(aster) Fader (Trim)** data can be displayed in white.

For example, by selecting **L Fader** and **L Fader Trim** in two different colours, the display will show both your Large Fader Absolute mix levels as well as subsequent Trim levels (see also **Merge Trim** on Page 5-51). Default settings provide displays of **L(arge) Fader**, **L(arge Fader) Cut**, **G(roup) Fader** and **M(aster) Fader**.

Note that the mix data overlays only update when you roll back and create a mix pass.

The **Mix Data moves/doesn't move with Audio** entry in the **Edit Mix** menu is only applicable to systems fitted with DiskTrack. The same applies to the **Edit Audio** and **Sift** functions in the **Edit** menu. **Trim Mix** and **Ref: Ch 1** are described on Page 5-79.

12:40:52:27 Mark Del Mark ↑ ↓ Print

11 12 13 14 15 16 17 18 19 20 21 22 23 24 25 26 27 28 29 30 31 32 33 34

Do you really want to clear the mix data ?

Yes No

12:41:19:18 Re-Center Fit Audio Zoom in Zoom out Playhead

▲	Mark	16:38:51:12/66	1	*Top
■	Mark	16:39:11:13/00	2	*Phones
■	Mark	16:39:49:23/00	3	*Pipes
▼	Mark	16:40:09:29/00	4	*Intro Chorus

LF RO SF RJ GF RJ MF RJ LC RJ SC RJ GC RJ AU RJ GS RJ GL 35 FRAMES AF 10 SECS

FILE/SETUP	DiskTrack	Trim Mix
MIX-DESK	Overview Edit	Ref: Ch 1
RECALL	Events Automation Sift	L Fader G Fader M Fader
MACHINES	SnapShots Groups Edit Audio L Cut None	
MISC	Faders Project Edit Mix None	Mix Data moves with Audio

Vari: 12:41:16:11

00:00:00:00/00

00:00:00:00/00

Cycle 5 < >

12:41:15:21

Arm Final Mix Safe

Fr : 12:40:49:27/14

To: 12:41:16:11/84

*:

0: Pass 2

-1: Pass 1

-2:

-3:

-4:

Name Discard

Keep Revert

DT Free 1:18

Free Mem 94%

Automation Modes

Large Faders : Overwrite	Overwrite
Small Faders : Rollback/Join	Rollback
Group Faders : Rollback/Join	Rollback/Join
Master Fader : Rollback/Join	ClipFill
Large Cuts : Rollback/Join	ClipEnd
Small Cuts : Rollback/Join	CycleFill
Group Cuts : Rollback/Join	CycleEnd
Auxes : Rollback/Join	Static
Group Solos : Rollback/Join	

12:40:52:27 Mark Del Mark ↑ ↓ Print

11 12 13 14 15 16 17 18 19 20 21 22 23 24 25 26 27 28 29 30 31 32 33 34

12:41:19:18 Re-Center Fit Audio Zoom in Zoom out Playhead

LF OV SF RJ GF RJ MF RJ LC RJ SC RJ GC RJ AU RJ GS RJ GL 35 FRAMES AF 10 SECS

FILE/SETUP	DiskTrack	Enable Do Pre
MIX-DESK	Overview Edit	Clear Data
RECALL	Events Automation	Fader Protection Offline Trim
MACHINES	SnapShots Groups	Switch Protection Fader Status
MISC	Faders Project	Join to Mix Auto Modes

Vari: 12:40:49:27

00:00:00:00/00

00:00:00:00/00

Cycle 5 < >

12:40:49:28

Arm Final Mix Safe

Fr :

To:

*:

0:

-1:

-2:

-3:

-4:

Name Discard

Keep Revert

DT Free 1:18

Free Mem 93%

Starting a Mix

OK, let's start mixing! Locate to the start of the track. Store this point in one of the TC1-5 timecode stores, if you haven't already done so (see Section 3).

We'll assume you are going to mix with the fader motors on. Check that the MOTORS ON/OFF button on the front panel is lit. We also assume that you are in 'Insert Mixing On' mode; check that the INSERT MIXING ON button is lit (see Page 5-33 for more on Insert Mixing).

Note that when the mix system is enabled, if any previous automation settings have not been cleared in the Project File **Settings** pop-up, these settings will be restored to the console. This may have the alarming effect of destroying the basic fader balance you have just set up! To avoid this, hit the CLEAR AUTO button, *before you enable the automation*, to clear the automation RAM; you will be asked to confirm your request (see opposite) so hit the OK button. This function is replicated by **Clear Data** in the **Automation** menu.

Select **Automation** in the **MIX-DESK** menu and stab on **Auto Modes**. Alternatively press the AUTO MODES button on the front panel. The resultant pop up (see lower screen opposite) enables you to choose the type of automation mode, eg. **Overwrite**, **Rollback**, **Rollback/Join** etc., for different types of automated controls.

First select the control group, **Large Faders** etc., then select the mode; the pop-up will reflect your choice. The pop-up can be driven from the front panel cursor keys – the up/down keys cycle through **Large Faders**, **Small Faders**, **Group Faders** etc. and the left/right keys advance the current mode through **Overwrite**, **Rollback**, **Rollback/Join** etc. Note that the **Auxes** selection covers the EQ In/Out, Insert In/Out, Cue Stereo On/Off, and FX1-6 On/Off.

If this is your first attempt at a J Series automated mix, we recommend you select **Overwrite** for faders and cuts and **Static** for all the other automated switches.

Finally, enable the mix system by either pressing the AUTO button on the front panel or stabbing on **Enable** in the **Automation** menu. When you do this, the AUTO button on the front panel will flash to indicate that new mix data has been written to RAM. As this is a first pass, fader levels and object settings are stored by the computer to define the mix start time. Note also that the current Auto Modes are now displayed in a narrow strip above the status bar (see opposite). To change the current mode for any group of controls, stab on the appropriate box (**LF**, **LC** etc) to call up the **Auto Modes** pop-up (see above).

As soon as the mix system is enabled, the Large and Small Faders, Group Faders and Master Fader, will indicate that they are selected to Absolute status (red status LEDs lit). When faders are selected to Absolute they are ready to write new mix data. In other words, the moves you make will be recorded by the computer and the position of the fader is the actual level you are writing to the mix. As you will see later, this is not necessarily true of Trim status.



The First Mix Pass

Back to your first pass!

Before you put the Desk into play, note that faders can be selected to **Manual** (no LEDs lit) by pressing individual fader status buttons (or using the FSM button on the front panel to toggle all faders). Manual status (for faders only) enables dynamic moves to be made without writing those moves to the mix pass.

Once the mix has started, pressing the status button on faders in Absolute will have no effect. If you press the button on a fader in Manual, it will switch to Absolute.

When a fader in Manual is switched to Absolute after the start of a mix, its current level will be written back to the start of the mix. Starting a mix with all faders in Manual, and with **Overwrite** selected, provides a great way to build up a basic mix – simply pop faders into Absolute when you are happy with the level. Note that when a fader is switched from Manual to write, it will always be forced into Absolute, whether in a new mix or in a subsequent pass, even if USE TRIM (see Page 5-31) is selected.

Now press PLAY to move forward, and begin writing mix information. The fader moves (and data written with respect to any other automated objects) will be held in RAM. An indication of the memory currently available is displayed in the **Free Mem** box below the Mix Pass list.

At any time you can stop mixing, rewind the system, and this will create a mix pass. As soon as you rewind, all automated objects switch to Replay (known as Play for switches – see Page 5-35). If you have selected **Overwrite** as the automation mode for faders and cuts, all your mix moves up to the first rollback point will have been saved in RAM and will play out as you move forward again. The fader levels and cut states at the point of rollback will be written to 23:59:59:24(:29). The mix pass start and end times will be shown in the **Fr:** and **To:** boxes above the Mix Pass list.

If you decide that the movements in your first pass are not worth keeping, hit **Discard** before you roll back; the faders will remain in Absolute. If you then roll back (the faders switch to Replay), hit the JOIN button (see Page 5-19) to get them back into Absolute at the right levels. Alternatively use the 'Pre Enable' snapshot as described on Page 5-77.

You can, of course, rollback as many times as you like, as you work your way through the track. Remember though, that each time you rollback (unless you simply play back and do not touch any controls), a new mix pass will be created. If you wish to play back from the start of the pass, simply either hit the appropriate TC1-5 button, or stab in the **Fr:** box, to locate the system to that point.

As you play forward again and reach the previous rollback point, any faders and cuts that have not been selected to a write status will continue to play the previous mix levels/states. Simply move a fader or press a switch to start writing new information. When you reach the final rollback point, ie. the mix **To:** time, all faders will drop into Absolute.

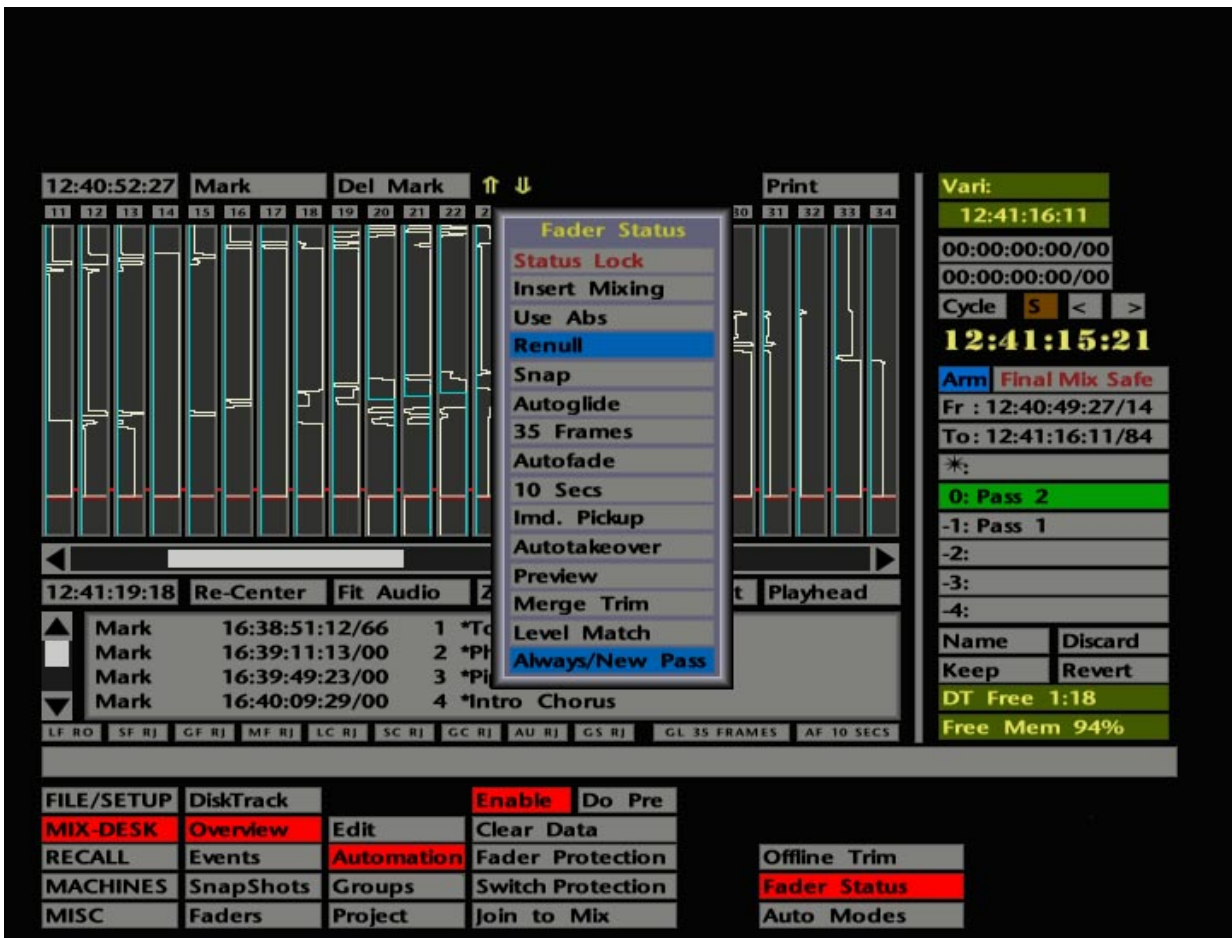

At any time, you may choose to name the current mix pass with the **Name** function (see Page 5-13). Having done so, note that this name, with a numbered suffix, is used for subsequent passes. If you name a pass which is *not* the current pass, that name will not be carried over to the next pass. Also, if you **Revert** to a previous pass, the name of that pass will be used for subsequent passes.

Updating a Mix Pass

Once you are happy with the basic mix, select faders and cuts to **Rollback/Join** mode. This will mean that, as you update your basic mix pass, new dynamic mix data will only be written to the point of rollback. When you rewind and play through the rollback point, any previously active faders will automatically drop back into write.

If you are ready to write dynamic switch ‘moves’, ie. punching inserts in/out or flipping FX sends on/off, then also select these objects (**Auxes**) to **Rollback/Join**. If you are still experimenting, leave them in **Static**. See Page 5-35 for more on Switch Automation.

At this stage you have a choice of write status for the faders – Absolute or Trim. The choice is made by pressing the USE ABS or USE TRIM buttons on the front panel, or on-screen by selecting the **Fader Status** pop-up (see opposite) in the **Automation** menu and toggling the **Use Abs/Use Trim** box. If you want to make any faders or switches ‘safe’ at this stage, to avoid new moves being written accidentally, select them to **Protect Replay** (see Pages 5-55 and 5-59 for more details).

If you wish to rewrite fader moves completely, select USE ABS and touch the fader (for Large Faders in Motors On) or press the fader status button to write information. The red LED will indicate that the fader is in Absolute. If moves have already been written but are just generally too loud or quiet, use Trim. Select USE TRIM and touch the fader or press the fader status button as above. The green LED will indicate that the fader is in Trim status. Large Faders use their VCA signal path for Trim status in Motors On, to provide total control without destroying previously written moves.

You can set up a mixture of Absolute and Trim statuses by first pressing USE ABS and switching selected faders to Absolute with their fader status buttons. Then select USE TRIM and repeat the process for Trim faders

When you use Trim status, the fader effectively becomes a gain control for any moves you have previously made. For example, if you have made some rides on a vocal and you decide that the actual rides are correct but you would like them all 2dB louder, you can put the fader into Trim and move it 2dB higher.

Note that faders in Trim will switch to Absolute when crossing the final active rollback point. In Motors On, a Trim fader will move to the actual mix level position as it switches to Absolute, so there is no change in level.

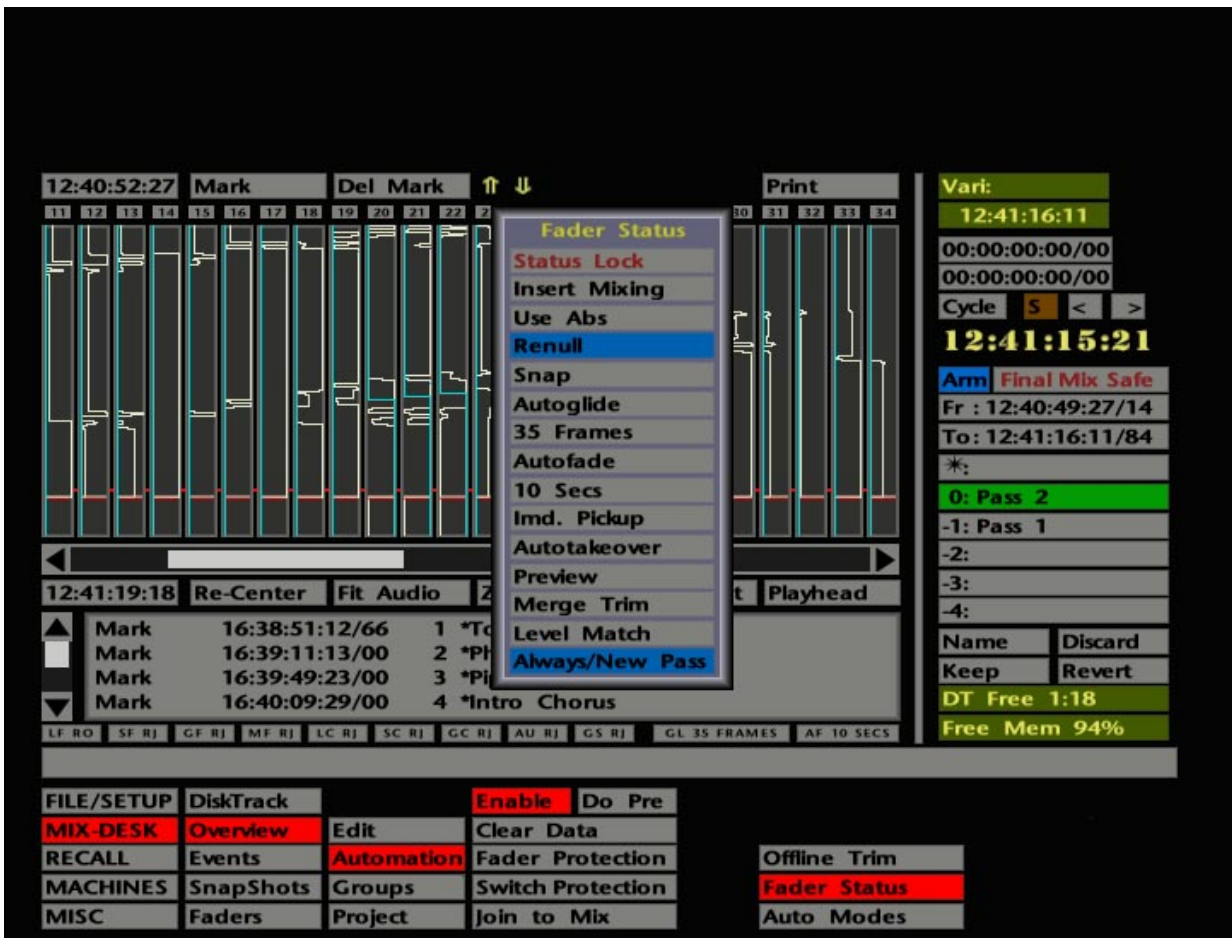

Insert Mixing

When it comes to updating previous mix data, the J Series Computer automation system can operate in one of two fundamentally different ways – Insert Mixing On or Off.

For those of you who were brought up on a diet of G Series software, the concept of Insert Mixing was introduced with G3.2 software and the means to turn Insert Mixing On or Off was provided in the Mix Options setup menu. If you have not previously used a G Series mix system, or were unaware that this facility existed, the basic differences between Insert Mixing On and Off are as follows:

Insert Mixing On (up until recently the only option in J Series) – When you update a section of mix (in Absolute or Trim) and return to Replay, you will always return to the previous pass levels. If a fader is switched to Trim for the update, you will be trimming levels written in the last Absolute pass, ie. whichever mix is highlighted in green in the Mix Pass list.

With Insert Mixing On, it is not essential to save a mix to disk before using Trim. Once a mix pass has been created, the written data can be trimmed.

Insert Mixing Off – When you update a section of mix (in Absolute or Trim) and return to Replay, you will always return to the Reference Mix, ie. the last mix saved to or loaded from disk as seen in the Reference Mix box (the one above the Mix Pass list which has a * at its left hand end). This is true regardless of the number of updates you make over the same spot. If a fader is switched to Trim for the update, you will be trimming levels written in the Reference Mix.

Insert Mixing can be switched on or off from the front panel by means of the INSERT MIXING ON button (when lit, Insert Mixing is on). This function is replicated in the **MIX-DESK/Automation/Fader Status** pop-up (see opposite). A default setting can be saved in a Project File under the **Desk Setup** entry.

Note that you cannot switch Insert Mixing On/Off while unsaved data is in the mix buffer, ie. when the AUTO lamp is flashing. If you attempt to do this, the INSERT MIXING ON button will flash until you roll back and save the data in a mix pass.

FILE/SETUP	File Copy	SIO T/C: Locked		
MIX-DESK	Data	Timecode: SMPTE 30		
RECALL	Import	Fast Play Speed: 3.0	Midi	
MACHINES	Desk Setup	Define	Fader Macros	DiskTrack Free
MISC	DeskConfig	Channel Names	4 Channel Pan	Follow faders

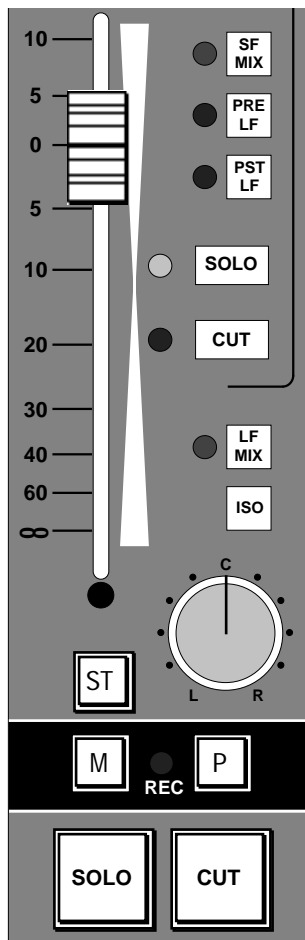

Small Fader Automation

To update mix data on the Small Fader, press the status button (ST), located just above the Match (M) and Play (P) buttons, and it will drop the fader into whichever status you have selected as the active write status (Abs or Trim).

Since Small Fader automation is VCA-based, you will find the 'SF MIX to meters' function useful. This displays the Small Fader control voltage levels (computer output) on the console's channel meters. A similar function (LF MIX) is provided for the Large Faders should you be working in Motors Off. SF MIX and LF MIX buttons can be found in the lower half of the audio centre section.

In addition, a toggling entry in the **FILE/SETUP/Desk Setup** menu (see opposite) determines whether the **MIX-DESK/Faders** display (see Page 5-57) displays the input levels to the computer – **Follow Faders**, or the computer's output levels returning to the console – **Follow Output**, ie. the equivalent of G Series bargraphs.

Immediate Pickup, Autotakeover (Page 5-49) and **Level Match** (Page 5-51) Mix Options are particularly useful for Small Fader automation.

Switch Automation

As previously discussed, the J Series Computer's switch automation system is totally independent of the fader automation, and even has dedicated status buttons, MATCH (M) and PLAY (P), located on each module above the Large Fader Solo and Cut buttons (see opposite). Between each pair of switches you will find the red Object 'REC' LED, which will light whenever switch data on that physical module is being written. The Group Faders in the centre of the console also have their own dedicated MATCH and PLAY buttons for the Group Solos and Cuts.

Automated switches have two possible statuses – Record and Replay. Note also that switch automation is subject to the effect of Automation Modes (see Page 5-15), and therefore Rollback Points (see Page 5-17). Furthermore, remember that switches may be subject to Switch Protection (see Page 5-59), Switch Groups (Page 5-73) and Hardware or Software Fader Groups (See Pages 5-5 and 5-65 respectively).

Recording Data

There are two possibilities when it comes to recording new data for the console's automated switches. The simplest is to press the switch, which changes the switch status from Replay to Record and illuminates the red REC LED on that module.

However, the action of pressing the switch also changes its state. For example, on a Large Fader which is already cut, pressing the Cut button will uncut it as well as putting the Cut into Record. Once in Record, all subsequent cut/uncut actions will be recorded, overwriting any previous switch data.

Note that while there is only one indicator for all the switches on each module, pressing an individual switch will only put that one switch into Record; all other switches will remain in Replay unless they are also pressed.

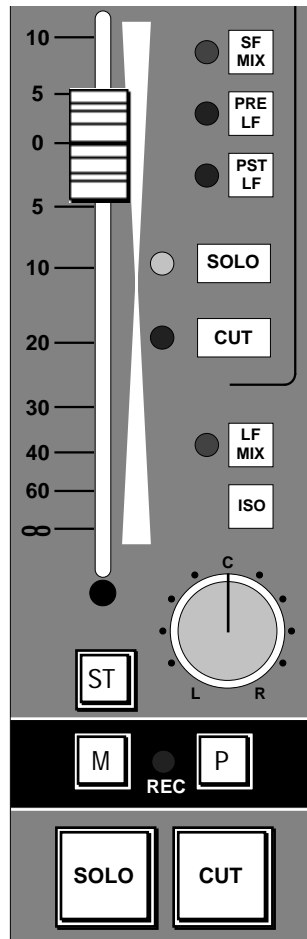

As an alternative to dropping in and changing the condition of a switch just by pressing it, selecting the MATCH (M) button and then the switch, will cause the switch to 'match' the current condition when going into (and remaining) in Record. For example, pressing MATCH (it lights up in yellow) while a Large fader is cut, and then pressing the Cut button will put the Cut into Record with the fader remaining cut (er..... matching! Got it ?)

Note that MATCH itself has no effect on the automation data and, if pressed in error, can be pressed again to cancel without any detrimental effect.

In order to drop out of Record, pressing the PLAY (P) button (which lights up in green) primes the system to drop back into Replay of any previous data the moment you press a switch that is in Record. This will cause the state of the switch to match the existing automation data, for example changing from cut to uncut if the original data has the switch uncut at the moment you dropped out.

If only one switch on this particular module is in Record, the REC LED will go out; if other switches are also in Record, they will continue to record and the REC LED will remain lit. Either way, the PLAY button lamp will go out. Note that PLAY itself has no effect on the automation data, and if pressed in error, can be pressed again to cancel without any detrimental effect.

Perhaps you have more than one switch in Record on a particular module, and want them all to simultaneously drop back to Replay.....No problem, just press the PLAY button twice in quick succession, causing all switches to drop back into Replay of existing data.

Revising Existing Data

The above methods will allow you to write entirely new data for cuts and switches, as well as extending and appending existing data in a simple and logical fashion. In the following descriptions, the word 'event' is used to describe the action of changing the state of a switch from On to Off (or vice versa), and the period of time the switch remains in the new condition.

What if you want to delete a single event which falls in the midst of a whole series of other events, all occurring in quick succession? In such instances, selecting both MATCH and PLAY before dropping in, will result in the following:

Both buttons will illuminate. Pressing a switch will cause it to 'match' the current condition already in mix data and enter Record status. The MATCH lamp will go out and the PLAY lamp will flash, indicating that the switch will remain in Record until such time as the original automation data once again matches the state the switch was in when you dropped in. At this point the PLAY button will go out, the REC LED will go out, and the switch will flip automatically into Replay, thereby replacing the single event.

The screenshot displays a computer interface with a dark background. At the top, a menu bar contains the following items: LF OV, SF RJ, GF RJ, MF RJ, LC RJ, SC RJ, GC RJ, AU RJ, GS RJ, GL 35 FRAMES, and AF 10 SECS. On the right side, there is a control panel with several sections:

- Vari:** 12:40:49:27
- 00:00:00:00/00
- 00:00:00:00/00
- Cycle **S** < >
- 12:40:49:28**
- Arm** Final Mix Safe
- Fr : _____
- To: _____
- *: _____
- 0: _____
- 1: _____
- 2: _____
- 3: _____
- 4: _____
- Name Discard
- Keep Revert
- DT Free 1:18
- Free Mem 96%

At the bottom, there is a grid of menu items:

FILE/SETUP	DiskTrack	Enable	Do Pre
MIX-DESK	Overview	Edit	Clear Data
RECALL	Events	Automation	Fader Protection
MACHINES	SnapShots	Groups	Switch Protection
MISC	Faders	Project	Join to Mix

Additional menu items are listed to the right of the grid:

- Offline Trim
- Fader Status
- Auto Modes

For example, a channel has a series of cuts, of which one uncut has been written in error. To overwrite one event without the risk of spoiling any subsequent data, prime both **MATCH** and **PLAY** before pressing the Cut. At the moment you wish the Cut to remain cut (instead of uncutting), press the Cut switch. Note that you can do this at any time after the cut that you want to extend has started to play through. The system will overwrite the original uncut command, and when the next cut command is remembered, that Cut will drop out of Record into Replay. All subsequent cuts/uncuts will remain unaltered.

An alternative method of editing switch automation data is provided by the **Trim Mix** facility (see Page 5-79).

Starting Again

If at any stage you decide to scrap the mix passes created so far, hit the **CLEAR AUTO** button on the front panel. If the automation system is enabled when you do this (ie. the **AUTO** button is lit), the entire desk will drop into Absolute, enabling you to begin mixing again straight away. Note that the same effect may be achieved by means of the **MIX-DESK/Project/Settings/Clear** function (see Section 2).

Each time that the automation system is enabled, a 'Pre-Enable' snapshot is taken of the levels (faders) and positions (switches) of all the console's automated objects. You can always get back to where you started from by stabbing on the **Do Pre** box (next to the **Enable** box) in the **Automation** menu (see opposite). Once again, faders will switch to Absolute, ready for a new mix.

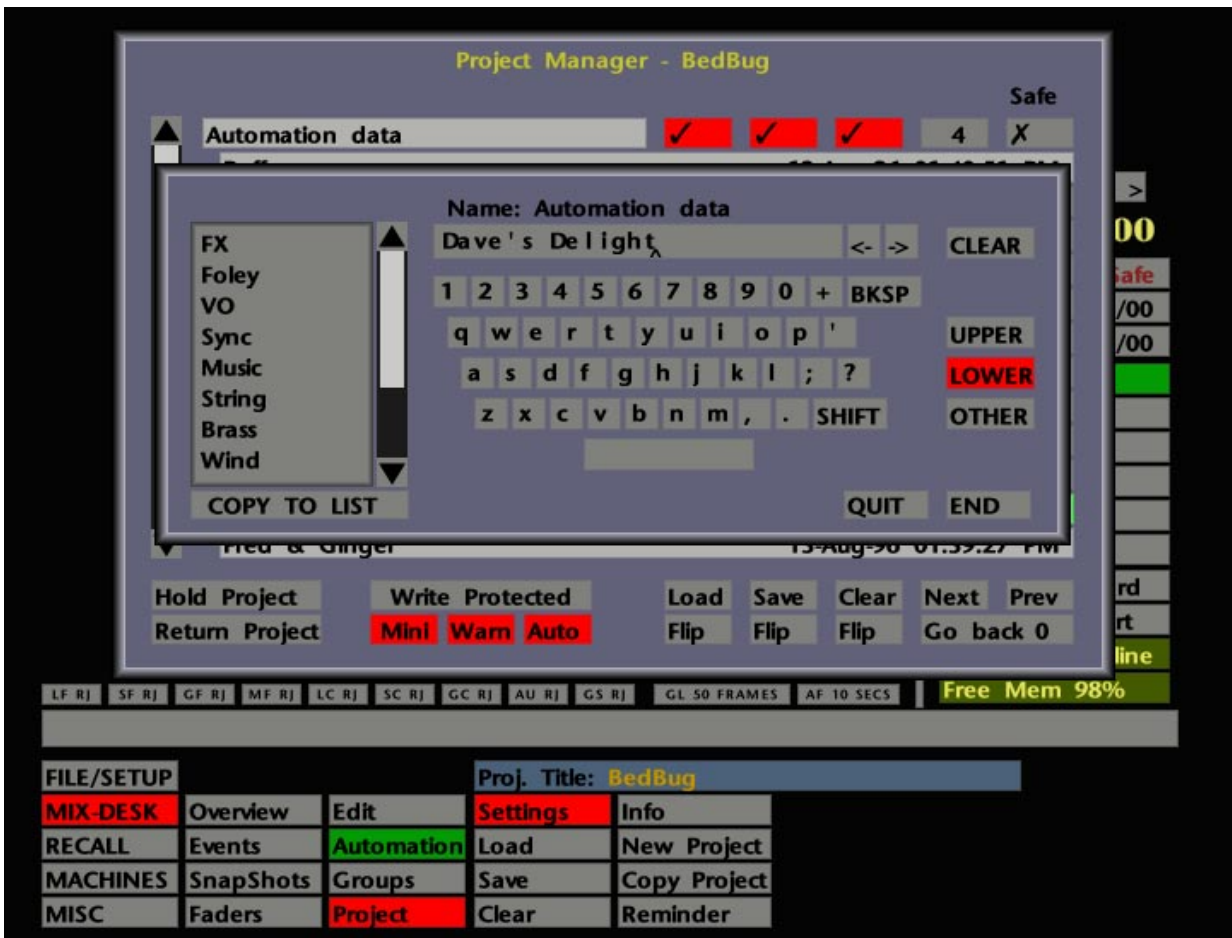
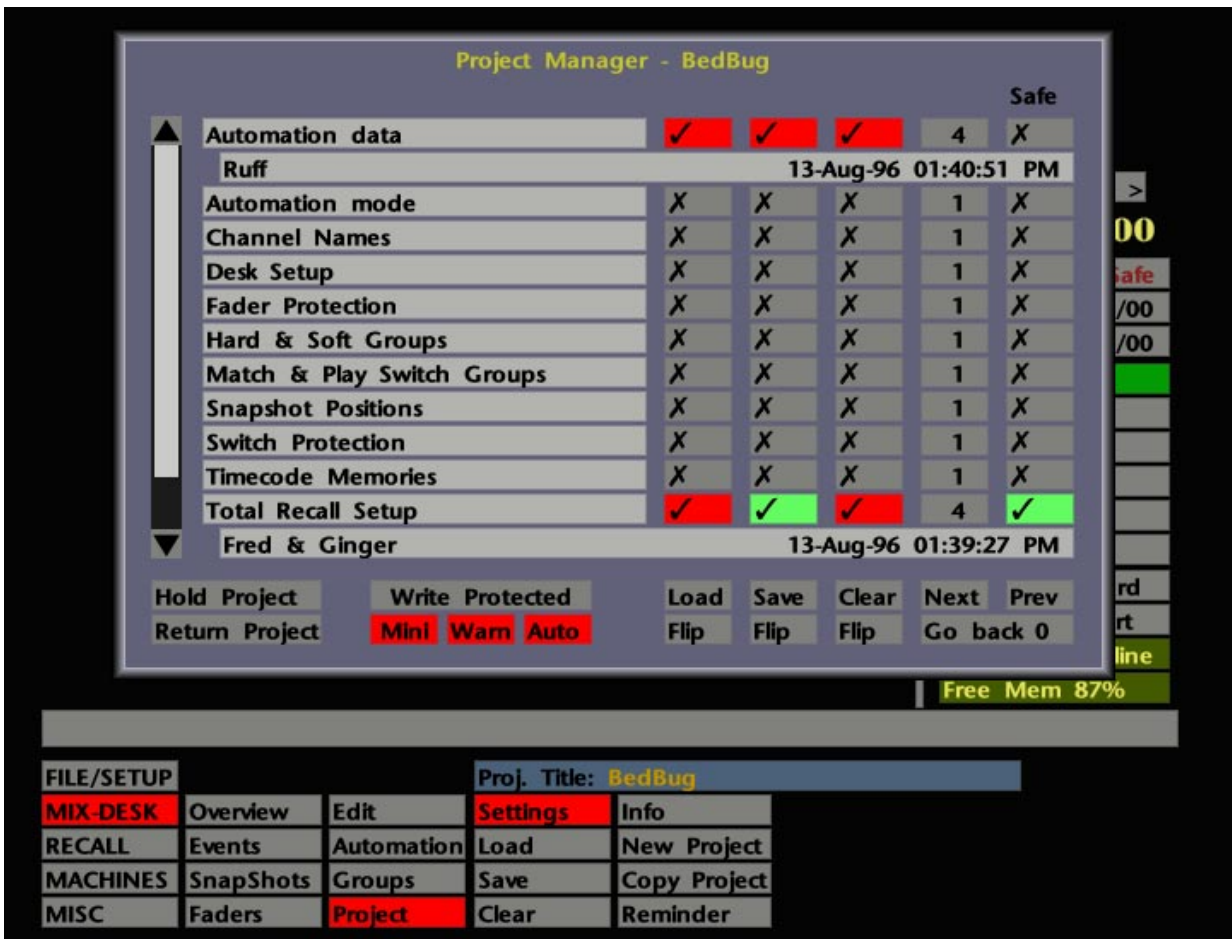

Saving Mixes

Remember that up to five mix passes may be held in RAM and, beyond use of the **Keep** function (see Page 5-13), you will soon reach a stage where you need to save your latest mix to hard disk. To do this, press the PROJECT SETTINGS button or select **MIX-DESK/Project/Settings**. Select a tick for **Automation data** in the Save column and hit **Save**. To speed up the operation you can preset the **Save** tick and subsequently use the SAVE PROJECT button on the front panel. Note that this method also requires **Safe** to be deselected for **Automation data**.

Additionally, you can use the **Settings** pop-up **Auto** function which, if selected, automatically sets ready for saving with the SAVE PROJECT button, any Project File elements that have changed since they were last saved.

Refer to Section 2 if you are uncertain about any of the above procedures. Note that the mix saved is always the last updated pass you made, ie. the pass that is highlighted in green in the Mix Pass list. To save a mix pass that is not the current mix, use the **Revert** function to select the pass of your choice (see Page 5-13).

If you attempt to save a mix before rolling back, the system will force a rollback and so save the latest mix you have held in RAM.

When you save a mix, using either the SAVE PROJECT button or **Save** in the **Settings** menu, a QWERTY pop-up appears onto which you can type a mix name (see opposite). Note that the QWERTY pop-up will come up with the name that mix had in the Mix Pass list, but with the pass number incremented (ie. START 1 in the Mix Pass list becomes START 2 on the QWERTY). Modify the name as required and hit **END** or **OK**.

The name of the saved mix will appear in the Reference Mix box (see Page 5-13) above the pass list, highlighted in green to show that this is the mix you will be updating on your next pass.

Note that, when a mix is saved to disk, all the rollback points in that mix pass will be discarded. See Page 5-17 for more on Rollback Points.

Info for Item: Automation data

5:	Dave's Delight	13-Aug-96 02:17:35 PM
4:	Ruff	13-Aug-96 01:40:51 PM
3:	Rough Mix Idea	13-Aug-96 01:40:39 PM
2:	Monitor Mix	13-Aug-96 01:40:25 PM
1:		

Ask for Info when Saving
Edit Info

FILE/SETUP		Proj. Title: BedBug		
MIX-DESK	Overview	Edit	Settings	Info
RECALL	Events	Automation	Load	New Project
MACHINES	SnapShots	Groups	Save	Copy Project
MISC	Faders	Project	Clear	Reminder

The saved mix name will also be displayed in the box directly underneath the **Automation data** entry in the **Settings** pop-up. To view a list of previously saved mixes, stab in this box and a Mix List pop-up will appear (see opposite). To change a mix name, hit **Edit Info** at the bottom of the pop-up and stab on the item you wish to rename. The QWERTY pop-up appears for entry of the new name.

Another option available here is the choice of whether or not the QWERTY pop-up appears when you save **Automation data**. Toggle the box on the bottom left of the Mix List pop-up to switch between **No Info when Saving** and **Ask for Info when Saving**. If you select **No Info when Saving**, the system either suffixes an existing name or increments an existing numerical value.

When you are happy with your latest mix, you may wish to select the **Final Mix Safe** box, above the Mix Pass list. This places the mix held in RAM into 'Protected Replay', and the touch sense function on the Large Faders is disabled. Both faders *and* switch objects are placed in Protected Replay status (see **Fader Protection** on Page 5-55).

Loading Mixes

Previously saved mixes can be loaded at a later date via the **Settings** pop-up. First of all, make sure you have selected the correct Project File, if the mix is not stored with the current project. If you are not familiar with this procedure, please refer to Section 2.

Now hit the PROJECT SETTINGS button, or select **Settings** from the **MIX-DESK/Project** menu, and stab on the box beneath the **Automation data** entry. This will call up the Mix List for the currently selected project (see opposite). Stab on the mix you require and a prompt will confirm that the system is loading your mix. Once loaded, stab outside the list to close the window, and then stab outside the **Settings** pop-up to close that.

The loaded mix name will appear in the Reference Mix box (see Page 5-13) on the **MIX-DESK** display, highlighted in green to show that this is the mix you will be updating on your next pass. This name will then be used as the 'stem' name for the automatic numbering of subsequent passes. Mix passes from the previous mix are left in the Mix Pass list, allowing mixes to be quickly compared with one another by use of the **Revert** function (see Page 5-13).

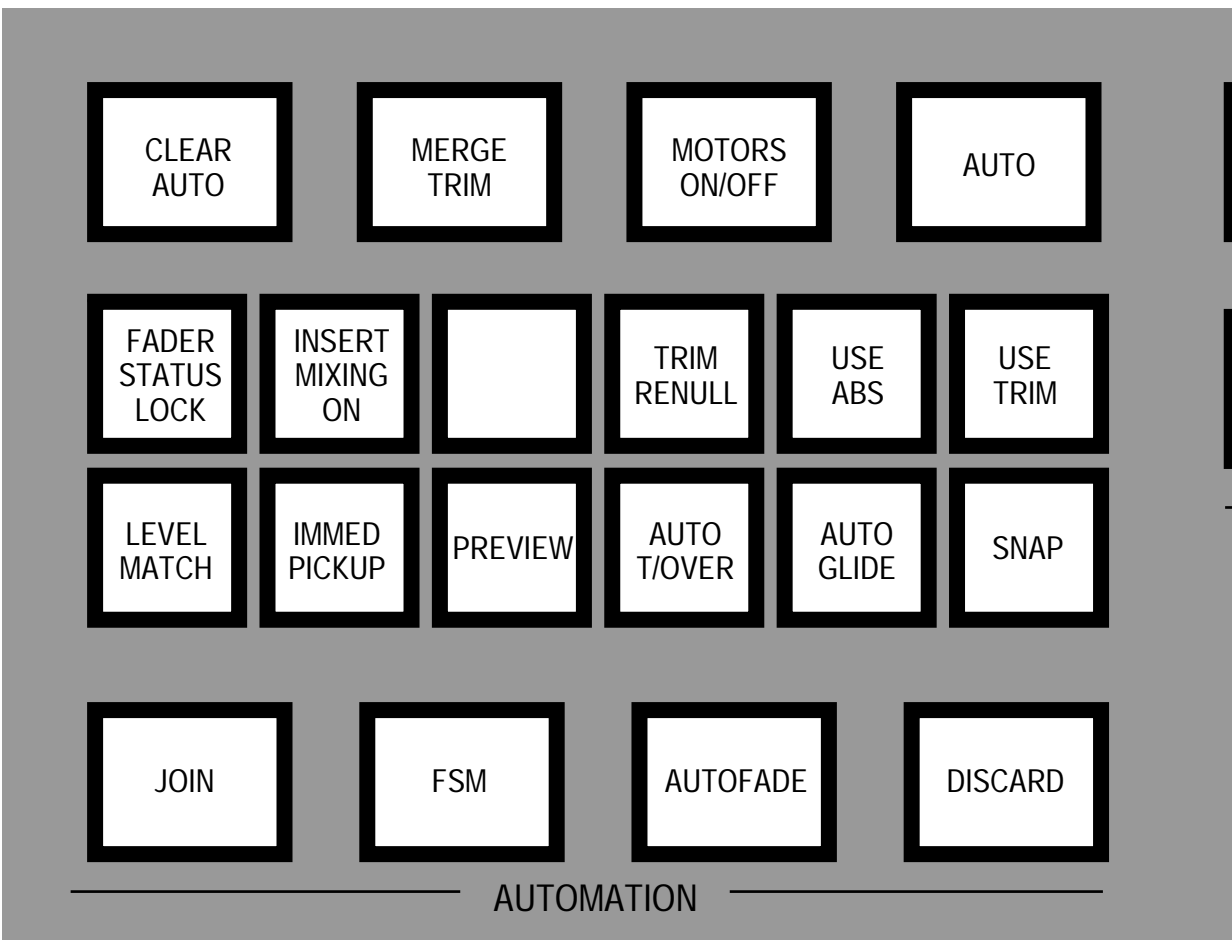
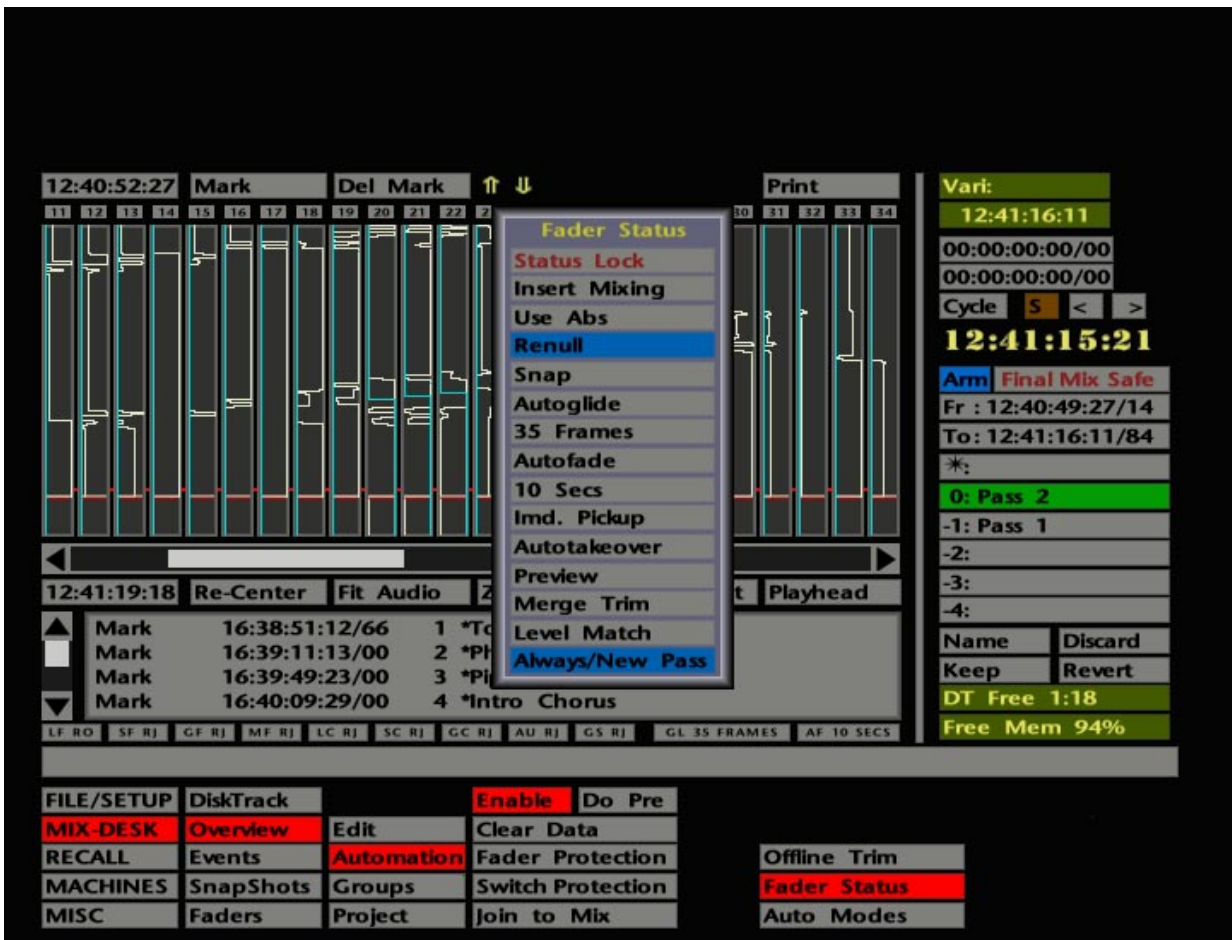

Mix Options

In addition to the choice of Absolute and Trim write statuses, a number of other mix options are available via the **Fader Status** pop-up menu (see opposite).

To activate any of the following functions, you can either stab on the relevant box or press the appropriate hardware button located on the computer front panel (also see opposite).

Status Lock

This feature allows the current selection of fader write statuses and Fader Status pop-up options to be stored, so that each time faders return to write, they will do so under the same conditions.

With FADER STATUS LOCK *not* selected, each time you put a fader into write, the Use Abs/Trim, Insert Mixing On/Off, Renuil On/Off, Snap On/Off, Autoglide On/Off, Immediate Pickup On/Off, Autotakeover On/Off and Preview On/Off conditions (see below) are logged by the system.

When you turn FADER STATUS LOCK on, these conditions will be locked and replicated each time you return a fader to write. Note that, with FADER STATUS LOCK selected, you will be unable to select or deselect any of the above options either from the front panel or the Fader Status pop-up. To modify the current store, turn FADER STATUS LOCK off, select the required options, and briefly switch a fader or faders to write under the new conditions. Now reselect FADER STATUS LOCK.

Note that this facility is not available in a first pass. Once set, the FADER STATUS LOCK store will remain across mix passes and even if you load a previous mix from disk. To clear the store, toggle the automation system off and on again with the AUTO button.

Insert Mixing

The effect of having Insert Mixing on or off is described on Page 5-33.

Use Abs/Trim

This provides the choice between Absolute and Trim write statuses. See Page 5-31 for more details.

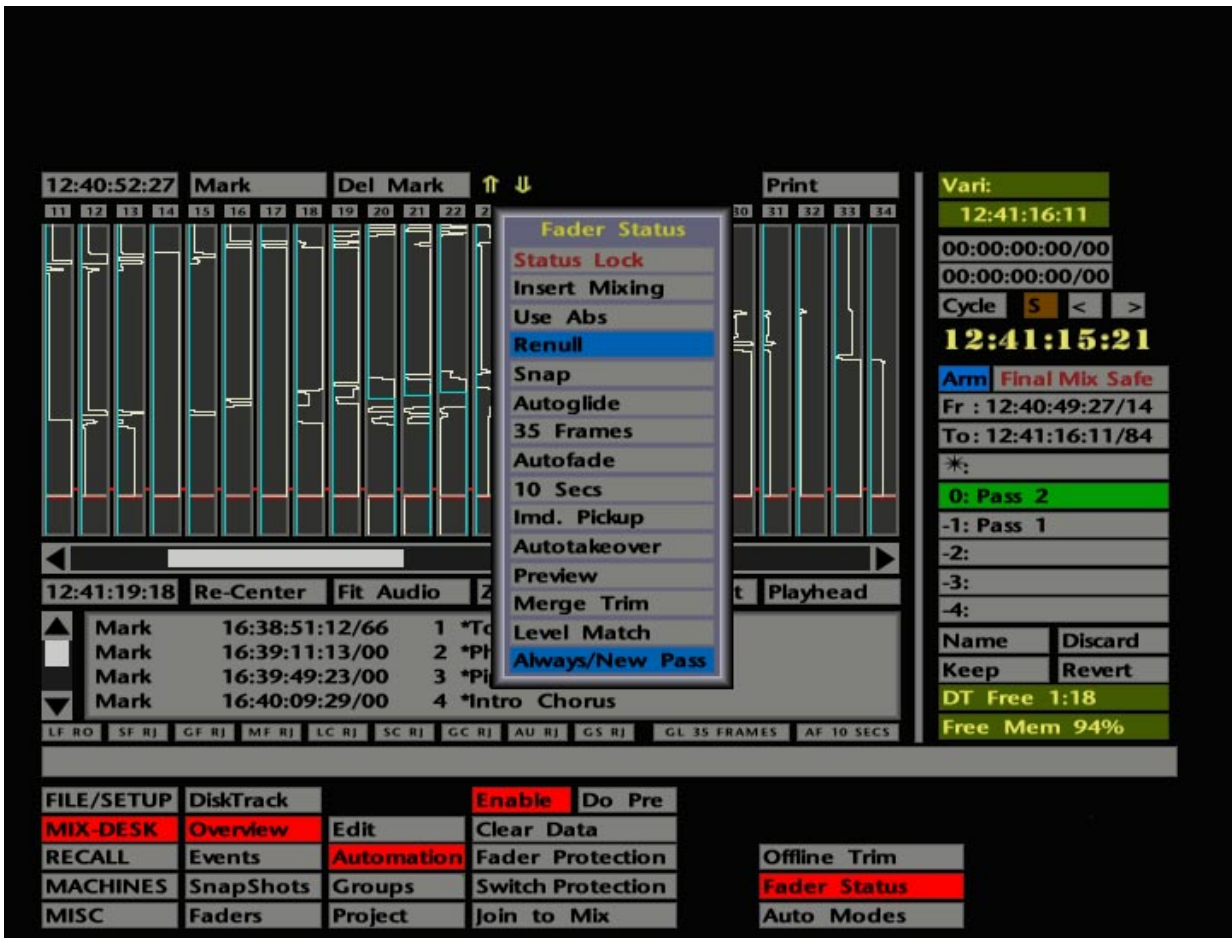

Renull

This provides the option to have faders enter Trim from Replay, with or without a level jump. (G Series users will recognise this option as the difference between 'Join' and 'Revise'.)

With TRIM RENUALL deselected, there will be a level jump which is the difference between the current absolute fader position and the replay mix level. For example, with a fader in Trim (the fader motors will be off), having rolled back you decide to drop the fader back into Trim before the rollback point. If the fader is in a different physical position to the written mix level then a level jump will occur when you punch into Trim. Note that the same effect will occur if you punch in to write after the rollback point. If you are still confused, try it for yourself – it's a lot easier to do than describe!

In Motors Off and with TRIM RENUALL selected, when you punch into Trim with the fader status button, there will be a seamless transition into write.

Snap

When a Large Fader is in Replay (in Motors on), as soon as you touch the fader it will switch to the selected write mode. With SNAP selected, a fader will stay in the write mode as long as you are still touching the fader. Once you let go, the fader will jump back to its null point (its replay position) and resume playing back mix data. This is ideal where you need to make minor adjustments to a number of faders sequentially.

Autoglide

Allows the computer to move the fader back to the null point when you have finished writing. Select AUTOGLIDE, make your update and then, when you are ready to return to Replay (the null point), hit the fader's status button and the fader will 'glide' back to the correct position. With **Autoglide** selected, the **Glide** time can be set from 1 frame up to 250 or 300 frames (ie. 10 seconds according to your timecode standard), by stabbing and dragging on the current value.

- With **Snap** and **Autoglide** both selected, releasing the fader will initiate a 'glide' back to the correct position.

AutoFade

This function, which affects the main mix bus outputs, can be used regardless of whether the automation system is turned on or not. Stab and drag in the time box to set the fade time between 1 and 60 seconds. Activate the fade by hitting the AUTOFADE button on the front panel. The button will flash when the fade is complete; hit it again to fade back up. Note that the Master Fader is inoperative while AUTOFADE is active and that the fade time cannot be modified during a fade.

- **AutoGlide** and **AutoFade** times are shown on the **MIX-DESK** display above the status bar (**GL** and **AF** – see opposite), as long as the automation system is enabled. These times can be altered from here by stabbing in the box and dragging on the numbers.

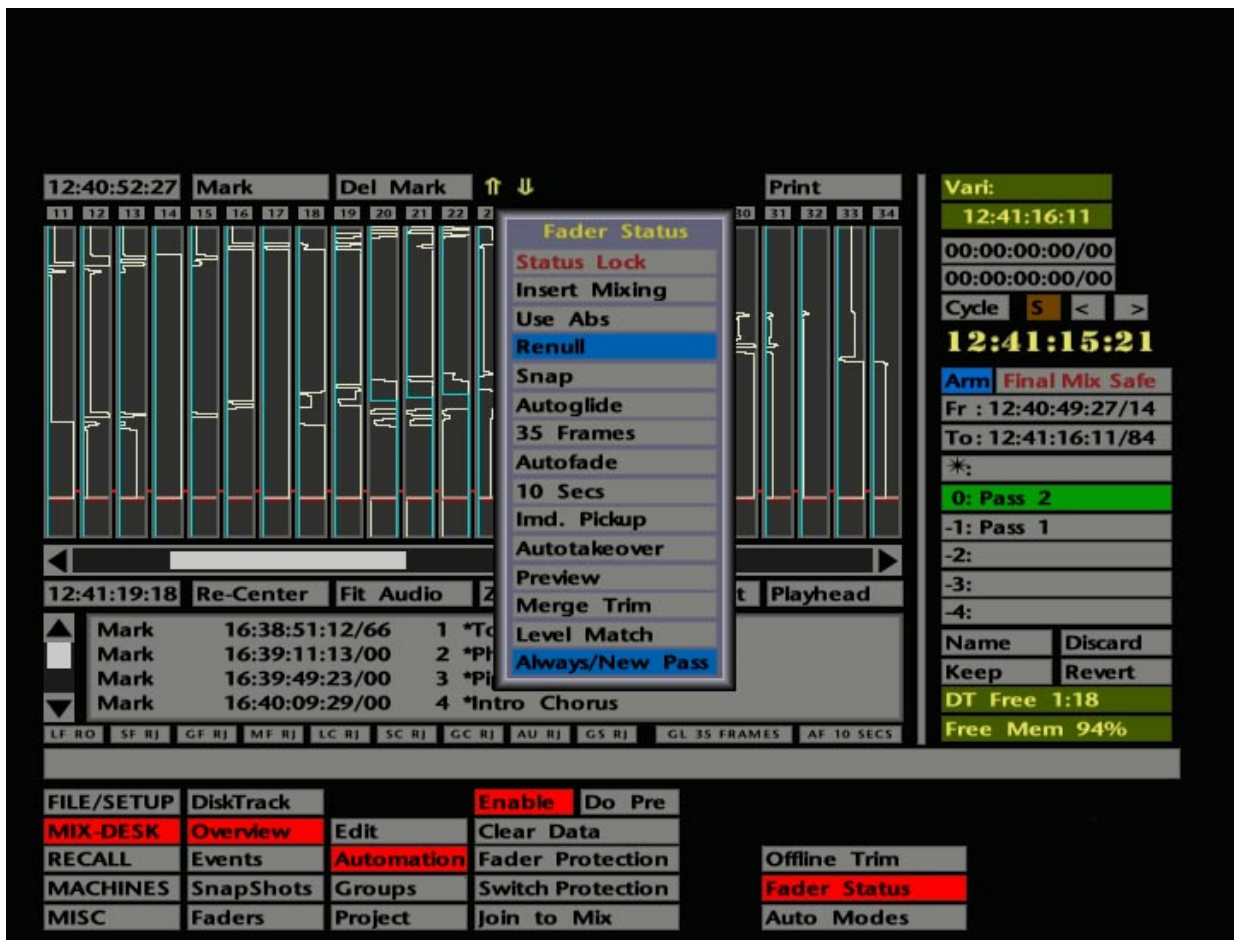

Immediate Pickup

This function is useful for Large Faders when you are working with the fader motors off, and simulates the touch sensitivity of moving faders. With IMMEDIATE PICKUP selected, moving the fader slightly will drop it into the currently selected write mode. Even when you are working with the motor faders on, Immediate Pickup can be used to intuitively drop Small Faders into write.

Autotakeover

This provides an indication of the direction you must move an update fader in a write mode, in order to return it to the null position. With the fader already in a write status, select AUTO T/OVER and make the update. Before you finish the move, press the fader's status button and the status LEDs will flash to indicate the direction you need to move the fader to return to the null point. Flashing green indicates that you should move up, flashing red to move down. When you reach the null point, the LEDs will go out and the fader will drop back into Replay, the movement to the null point having been recorded as mix data. This feature will be well known to G Series users, and provides an alternative to **Snap** or **Autoglide** (see Page 5-47), when you wish to carry out a manually controlled (and stylish!) return to Replay.

- Note that, if **Autoglide** and **Autotakeover** are both selected, **Autoglide** takes priority.

Preview

With either **Use Abs** or **Use Trim** selected this enables fader levels (only) to be rehearsed on monitor without affecting the underlying mix data. The rehearsed levels can then be selectively written to the mix.

Having first selected PREVIEW, press the fader status button once or twice (depending on whether the fader is currently in Replay or Absolute/Trim), or in Motors On touch the fader knob to select Preview Absolute or Preview Trim. A slow flashing LED on the fader indicates the selection of a Preview status. A fader will remain in Preview, regardless of the amount of times a section is rehearsed, until the fader status button is pressed again to switch the fader to Absolute or Trim.

As with G Series, pressing the FSM button on the front panel will toggle all faders in a Preview status between 'Preview On' and 'Preview Off' mode, ie. the current fader level to monitor or the previous Mix Pass level. The **Preview** entry in the Fader Status pop-up indicates **ON/OFF** and this is also reflected by the PREVIEW button on the front panel – the lamp is on solid in Preview On and flashes in Preview Off.

With Preview mode selected, the first press of the JOIN button (see Page 5-19) puts Preview faders into write; any subsequent presses cause the next intermediate rollback point to be played out, as usual.

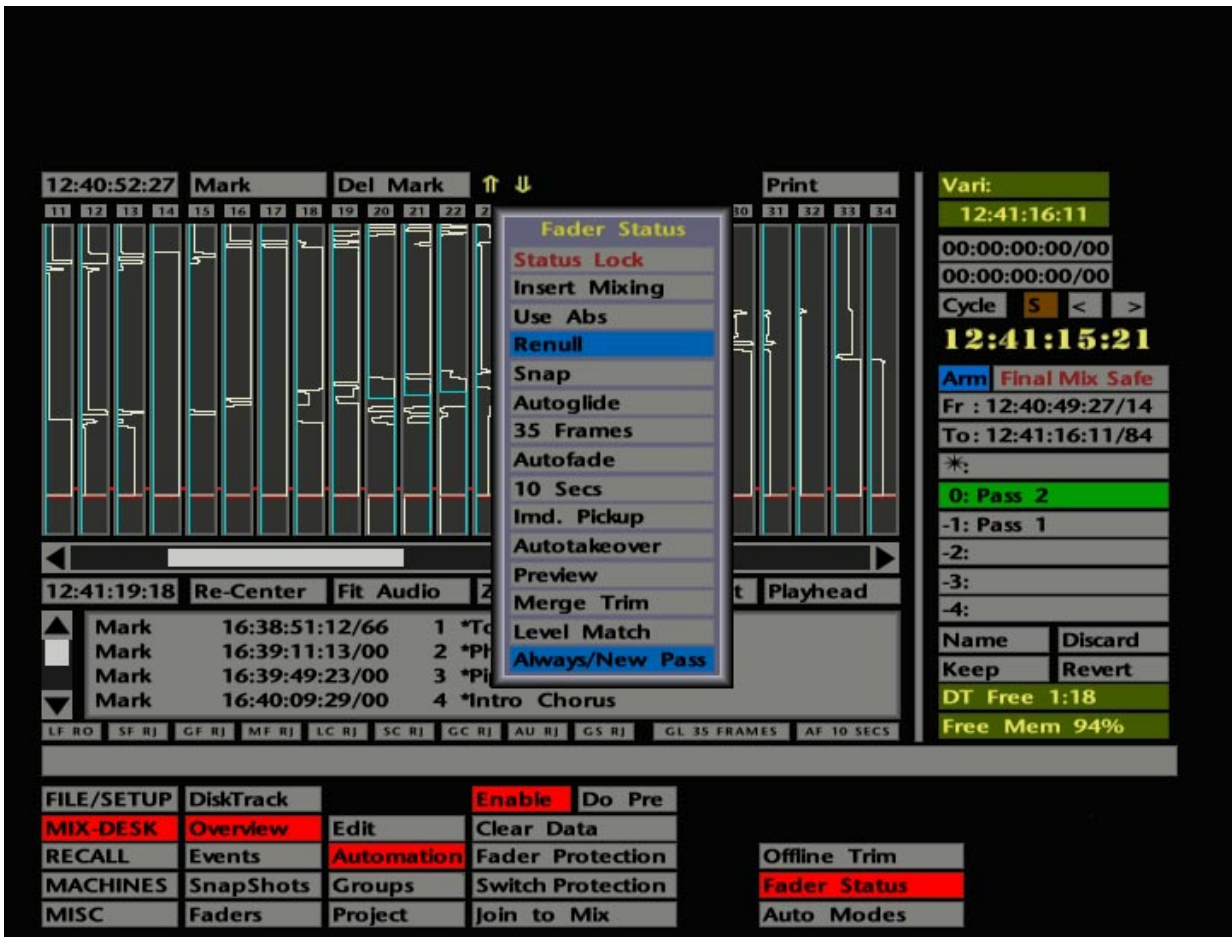

Merge Trim

With the J Series Computer, mix data is written in two automation streams – one for ‘absolute’ mix data and one for ‘trimmed’ mix data. When you make an update pass with faders selected to Trim, you are listening to the new trim data added to the ‘reference mix’ absolute data. This reference mix data could be the last mix pass you made with faders in Absolute or the last mix pass that you saved to disk.

When you roll back and make further trimming moves, you will still be trimming the reference mix, not adding new trims to the previously trimmed levels. Note that this is true whether you are working in Insert Mixing On or Insert Mixing Off mode (see Page 5-51). If you wish to add further trims to your last mix pass, press the MERGE TRIM button. This will merge the trim data with the absolute data to create a new mix pass (subject to the selection of **Always/New Pass**), prefixed by the letter **M**.

Alternatively in Insert Mixing On, and imperative if Insert Mixing is Off, the data can be automatically merged by saving a mix to disk.

The merging action is graphically demonstrated in the Overview display (see Page 5-25).

Level Match

This option only has an application with Large Faders and Group Faders when the fader motors are turned off. It can, however, be extremely useful for Small Faders, or even the Master Fader, at any time. Level Match gives an indication of where a fader should be positioned to match the written mix information (ie. the current null point), in order to avoid a level jump when switching from Replay to Absolute prior to a re-write.

Select LEVEL MATCH and then press the status button on the relevant fader. The fader status LEDs will flash to indicate which direction to move the fader to find the null point – green for up and red for down. Alternatively, all faders may be switched into Level Match by hitting the FSM button on the front panel. (Note that you cannot return to ‘Local Fader Level Match’ by pressing the FSM button again.) Once you are lined up (both LEDs solid), turn off LEVEL MATCH and drop the fader into write without any nasty surprises from level jumps.

Always/New Pass – Play/New Pass

With previous software, the Mix Pass list only updated when new data was written with the system in Play. Any mix data created with a **Join to Mix** (see Page 5-89), **Trim Mix** (see Page 5-79), or by using the pen to locate in the Overview display (see Page 5-21), did not create a new mix pass – it simply held the data as part of the current mix. The user now has a choice to always create a new mix pass regardless of how the data was written (**Always/New Pass**) or to continue to use the system in the original manner (**Play/New Pass**). Toggle the box to select the mode. When **Always/New Pass** is selected, and a mix is created using **Edit Mix** (see Page 5-79), **Offline Trim**, (see Page 5-87), **Join to Mix** (see Page 5-89), **Copy** or **Swap** (see Page 5-91), the pass number 0-4 is changed to a single letter. This initial (**E**, **O**, **J**, **C** or **S** respectively) prefixes the mix name.

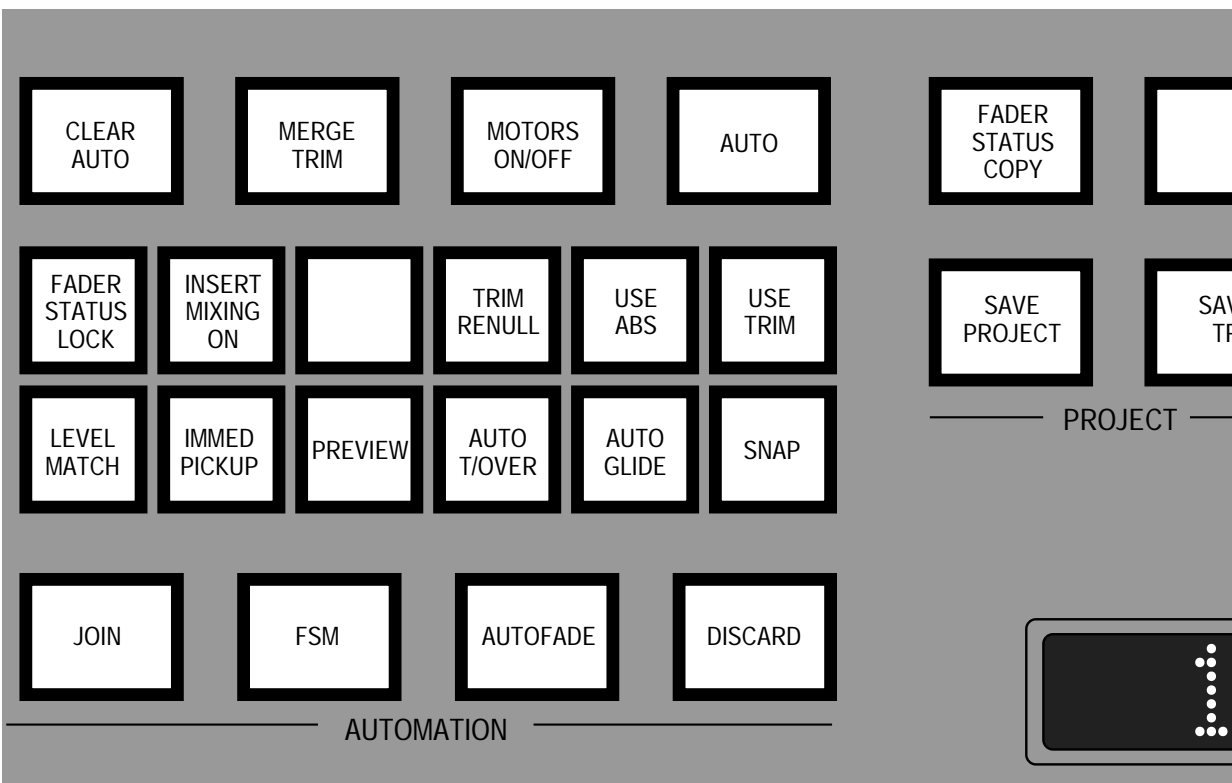
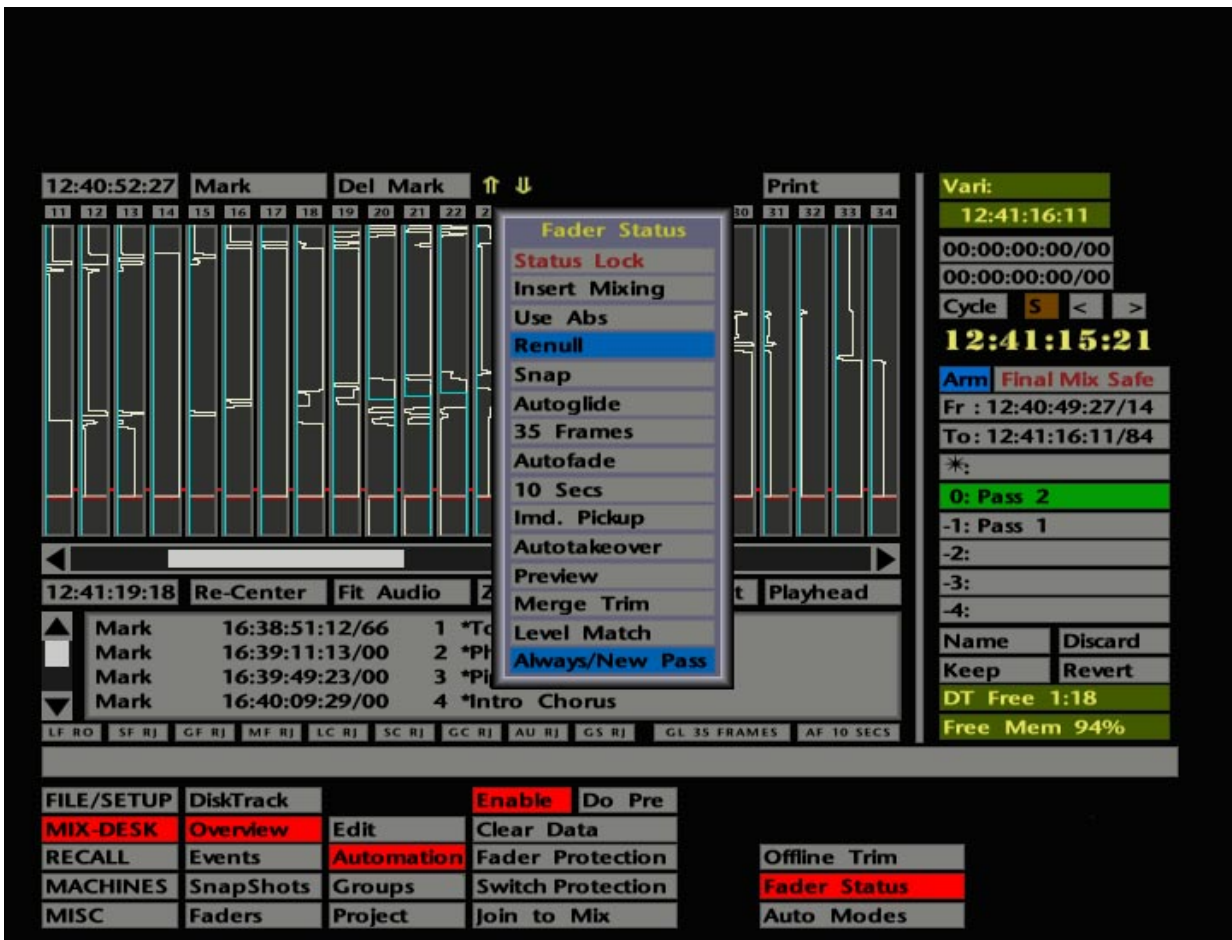

Note that the previous statement will also apply to **Merge Trim** (see Page 5-51), as long as **Always/New Pass** is selected, and you roll back before hitting MERGE TRIM. In this case, the pass prefix will be **M**. If you hit MERGE TRIM before rolling back, the system will first create another mix pass, and then merge the Trim data with that pass, creating a pass prefixed with **M**. Note that Merge Trim will not work while the system is in Play.

We recommend that **Always/New Pass** is used as the default setting for this option, in order that you never accidentally lose any data or the opportunity to revert to a previous pass, by combining a new modification with that existing data (as with **Play/New Pass**). There may be occasions, however, particularly with **Copy/Swap** (see Page 5-91), when you wish to repeat a procedure several times. In this case it would be better to select **Play/New Pass** in order to prevent the creation of a new mix pass after each operation, which may cause the previous pass to be forced from the Mix Pass list as it overflows. Remember that **Keep** (see Page 5-13) can be used to prevent this happening or, for total insurance, save the mix pass to disk before using **Edit Mix**, **Offline Trim**, **Join to Mix** etc.

The settings of the following items in the **Fader Status** pop-up may be saved to a Project File under **Desk Setup**: Status Lock On/Off, Insert Mixing On/Off, Use Abs/Trim, Renuil On/Off, Snap On/Off, Autoglide On/Off and Time, Autofade On/Off and Time, Immediate Pickup On/Off, Autotakeover On/Off, Preview On/Off and Always/New Pass – Play/New Pass.

Fader Status Copy

This useful feature enables the current selection of fader statuses to be stored and recalled at a later stage.

Select fader statuses as required, then press and hold the front panel FADER STATUS COPY button until it flashes. Now at any point, fader statuses and controls can be reset to the stored settings by a quick press of the FADER STATUS COPY button. The current status store can be cleared by turning AUTO off and on again.

Faders stored with a Preview status will be reset to their active status unless **Preview On** (see Page 5-49) is currently selected.

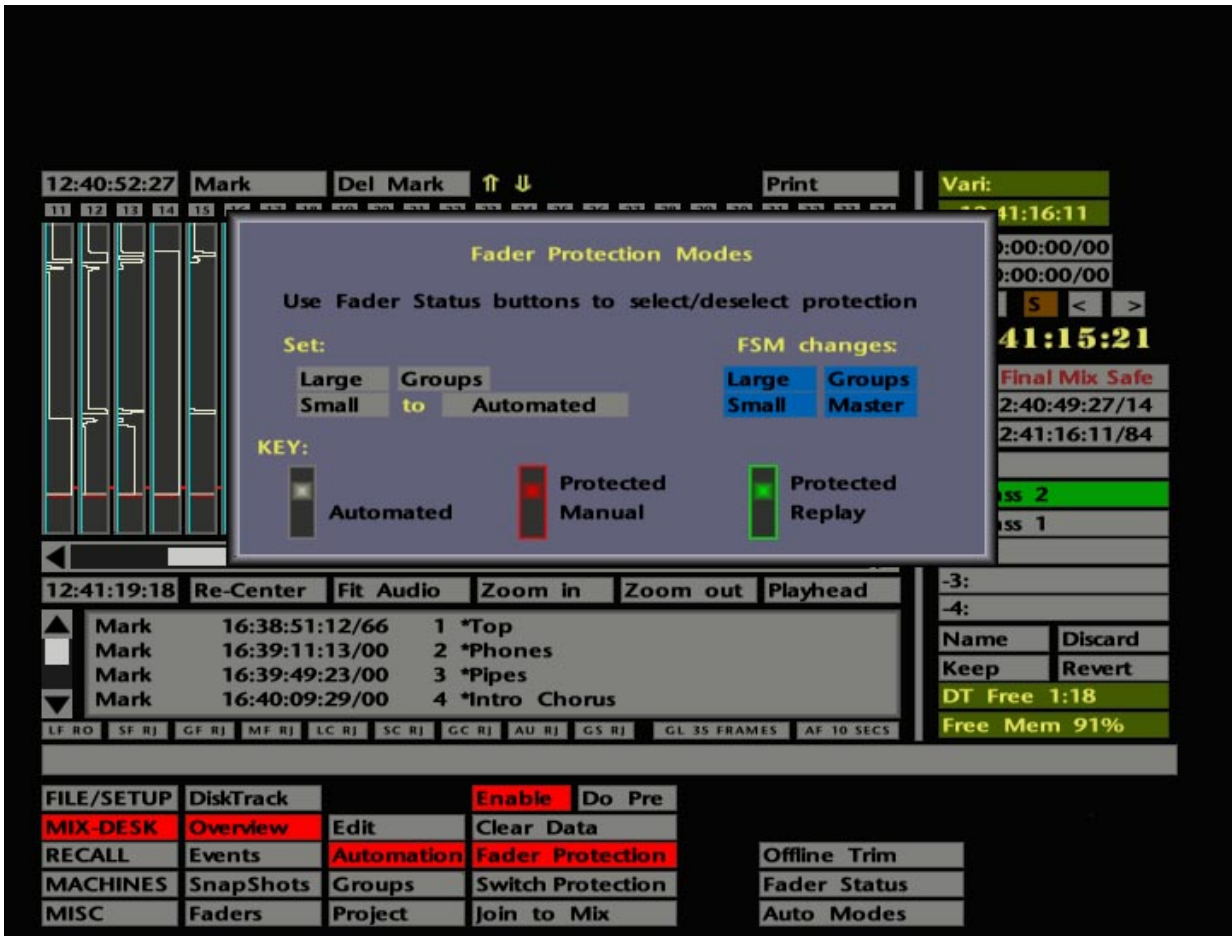

Fader Protection

Comprehensive facilities are available to select faders or objects to 'protected' modes so that valuable mix data is not overwritten accidentally. See Page 5-59 for Switch Protection.

Press the FADER PROT button on the front panel or select **MIX-DESK/Automation/Fader Protection**. This calls up the Fader Protection Modes pop-up (see opposite). There are three different modes available here, **Automated** (unprotected), **Protected Manual** and **Protected Replay**. Do not confuse **Protected Manual** with the **Manual** status for faders described on Page 5-29. Note also that the faders in the lower half of the Fader Protection pop-up simply act as a colour key to the different modes, and do not provide any active function.

To select individual Large or Small faders to the different modes, toggle the fader status key on the channel concerned. No LEDs lit indicates that the fader is in standard **Automated** mode. A red LED indicates **Protected Manual** – where new mix information cannot be written but moves made on that fader will be heard on the monitors. A green LED indicates that the fader is in **Protected Replay** – where no new information can be written to the mix, and moving the fader will have no effect on the monitoring.

Alternatively, you can assign any number of faders to protection modes by first toggling the grey box in the middle of the pop-up to the desired mode, and then selecting the **Large**, **Small** or **Groups** box on the left of the pop-up. Selecting **Large** or **Small** calls up the Channel Selector pop-up. Choose the faders you wish to protect (see Section 1 for instructions on how to use of this pop-up) and hit OK to confirm your choice. The LEDs on the faders you have protected will indicate the mode they are in. Selecting **Groups** calls up the Groups Selector, a similar but miniaturised version of the Channel Selector pop-up.

The FSM key can be used to toggle *all* faders through the various modes, subject to the **Large**, **Small**, **Groups** or **Master** boxes on the right of the pop-up being selected (blue).

When mixing, **Protected Manual** is a useful mode for selected Small Faders, where you want the audio to pass via the fader track (bypassing the VCA).

In Motors Off, when a fader is taken out of **Protected Replay** back to 'Automated', mode during a mix, its motor will be turned on so it can return to the correct automated position.

Deselect the FADER PROT button, hit OK (or stab outside the pop-up) to clear the Fader Protection Modes pop-up from the screen.

The **MIX-DESK/Faders** display provides an useful console-wide view of currently selected fader protection modes. See Page 5-57.

See over the page for some useful rules.....

The screenshot displays a complex digital audio workstation (DAW) interface for a mixing console. It features a grid of 72 faders (numbered 49-72 and 25-48) with various indicators and a central control area with buttons like 'LF RO', 'SF RJ', etc. A right-hand panel shows 'Vari: 12:41:16:11' and 'Cycle 5'. A bottom menu includes options like 'FILE/SETUP', 'MIX-DESK', 'RECALL', 'MACHINES', and 'MISC'.

FILE/SETUP	DiskTrack	Enable	Do Pre
MIX-DESK	Overview	Edit	Clear Data
RECALL	Events	Automation	Fader Protection
MACHINES	SnapShots	Groups	Switch Protection
MISC	Faders	Project	Join to Mix

To avoid any confusion as to what takes place when faders are switched between **Protected Manual** and **Automated** during a mix, here are a set of rules:

- For faders switching between Protected Manual and Automated, where no previous mix data exists for those faders:

In all automation modes, when Large and Small Faders are switched between Protected Manual and Automated, the faders instantly switch to Absolute and the AUTO lamp will start to flash. Current levels are written back to 00:00:00:00, so locating backwards will not cause the faders to close. At the Mix **To** : time, if faders are in **Rollback** or **Rollback/Join**, they will drop back into write as expected. If faders are in **Static** or **Overwrite** they will stay in, or switch to, Replay.

- For faders switching between Protected Manual and Automated, where previous mix data does exist for those faders:

In all automation modes, when Large and Small Faders are switched between Protected Manual and Automated, the faders will remain in position until you rollback. At this point they will move to the underlying mix levels. At the Mix **To** : time, if faders are in **Rollback** or **Rollback/Join**, they will drop back into write as expected. If faders are in **Static** or **Overwrite** they will stay in, or switch to, Replay.

The Faders Display

The **MIX-DESK/Faders** display (see opposite) will give you an overall view of the fader protection modes you have selected, according to the key at the foot of the Fader Protection Modes pop-up. Select **FADERS** followed by the **FADER PROT** button to view both displays together. Faders will be outlined in red if in Protected Manual, green if in Protected Replay and grey if Automated.

The **Faders** display indicates Large, Small, Group and Master Fader levels, Large, Small and Group Fader Cut states and Group Solos. An indication of Record Ready selection on the I/O modules is also provided, and if a Large Fader stalls, the fader knob (on this display!) will turn green.

The display can also be used to write cuts (or even fader moves) on large consoles – from your secure position in the centre of the desk. Simply hit cuts or Group solos with the pen, or stab and drag faders. Note that you cannot adjust Small Fader levels from this display.

The **FILE/SETUP/Desk Setup** menu's **Follow Faders/Follow Output** option affects fader levels on the **Faders** display. **Follow Faders** indicates the physical positions of all faders. **Follow Output** indicates the computer's output levels, ie. the equivalent of G Series bargraphs. Note that the console's meters, subject to selection of the LF MIX or SF MIX meter select buttons, will always show the true fader control voltage levels, ie. the computer output. This option must be set to **Follow Faders** if you wish to adjust Large and Group Fader levels from here.

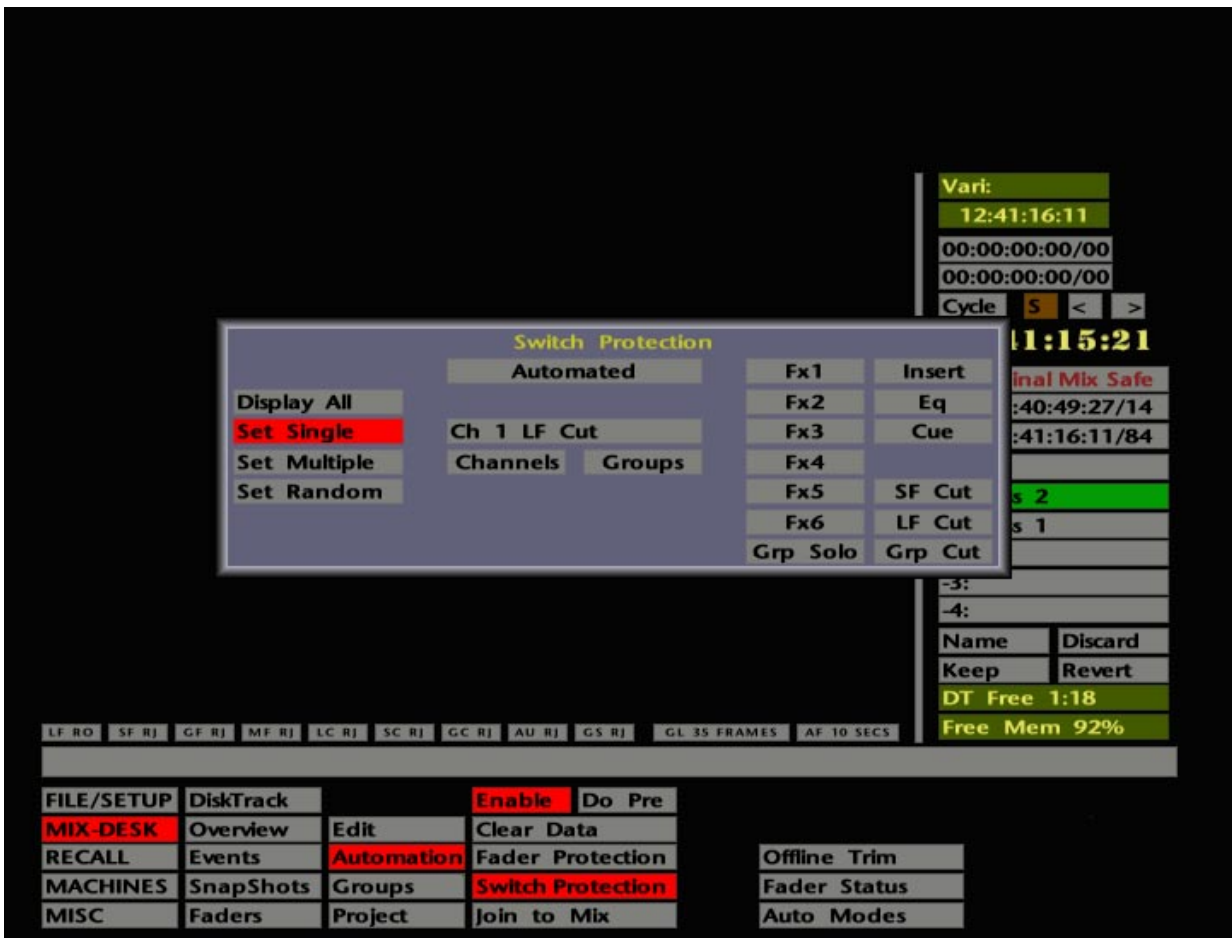

Switch Protection

As with faders (see Page 5-55), automated switches also have their own set of protection modes. When you first start mixing, it's a good idea to set all the switches to **Protected Manual** (see below), so that as you intuitively switch EQs in/out, Aux Sends on/off etc, you do not write these switch actions to the mix. Remember, however, that Channel Cuts and Group Cuts/Solos are also automated, and you may *not* wish to protect the Channel Cuts for example, in the early stages of the mix. As the mix progresses, groups of switches or single objects can be taken out of the protection mode as and when you wish to automate them.

To access the switch protection facilities, press the SWITCH PROT button on the front panel or select **Switch Protection** from the **MIX-DESK/Automation** menu, and the pop-up shown opposite will appear.

The **Display All** function enables you to check current protection settings for the whole console. If you believe that objects have already been selected to one of the two protection modes, use **Display All** to determine which modes have been used on which objects. If this is the first time you have used Switch Protection, use **Display All** to give yourself an illuminated demo while you check that all the object lamps/LEDs are working!

With **Automated** selected in the box in the top centre of the pop-up, stabbing on **Display All** will light the lamps/LEDs of all objects currently selected to Automated mode. If you stab on the grey box, you can toggle the entire console through the three available modes – **Automated** (unprotected), **Protected Manual**, and **Protected Replay**. With the channels' Match (M) buttons lit, any object whose LED/lamp is lit will be in **Protected Manual**, ie. any changes to the switch state will be heard on monitor but will not be written to the mix. With the Play (P) buttons lit, any object whose LED/lamp is lit will be in **Protected Replay**, ie. changes to the switch state will be neither heard nor written to the mix (see Page 5-35 for more on Switch Automation).

There are three basic ways to select objects to a protected mode. **Set Multiple** should be used where you need to set up a large number of objects, for example, all the Aux On/Off switches at the start of a mix. **Set Random** can be used to set up a small but varied number of objects within easy reach. **Set Single** is useful where you need to select a single object at the far end of the console and don't want to leave your seat!

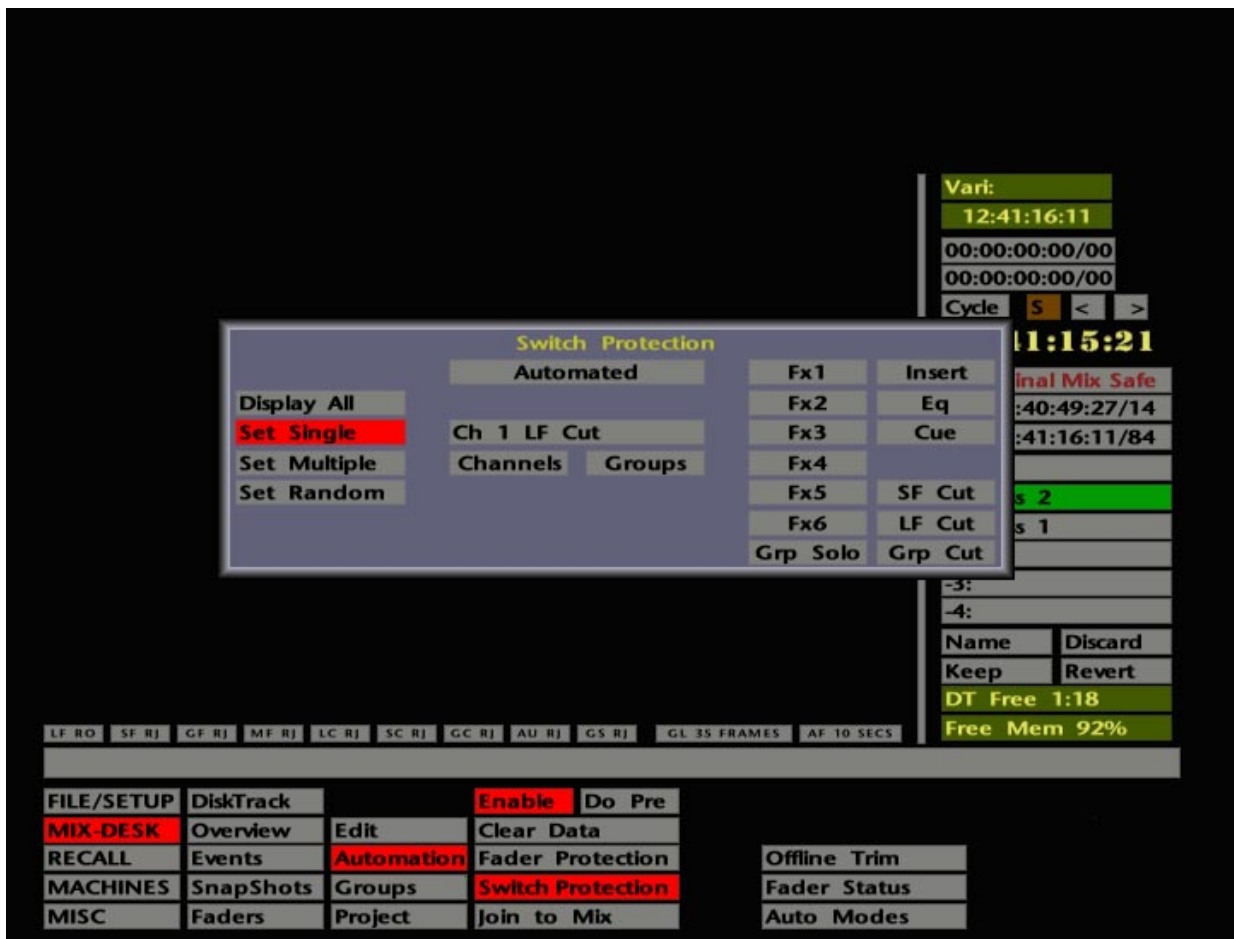

Set Multiple – Allows you to set up protection modes on different objects across the console. This applies to both channels and groups. Stab on **Set Multiple** and all the non-latching object LEDs/key caps will be lit. Stab on the **Channels** box and the Channel Selector pop-up will appear. Make your selections, as described in Section 1 of this manual, and then choose which objects you would like to protect – **FX1-6, Insert, EQ, Cue, SF Cut** and **LF Cut**, by selecting the appropriate box (blue), on the right of the pop-up. To protect Group Cuts and Solos, stab on the **Groups** box and the Groups Selector pop-up will appear. Make your selection and then select either **Grp Cut** or **Grp Solo**.

Now toggle to the protection mode you require (in the box at the top centre of the pop-up), and finally hit **Do Multiple** (this box only appears when **Set Multiple** is selected) to apply the protection.

Set Random – Use this for totally random selections. Stab on **Set Random**, toggle to the required protection mode, and then simply press the switches you wish to place in that mode. The associated LED/lamp will light to confirm the selection. Repeat the process if you want to have additional objects in the alternative protected mode.

Set Single – User this for single switches. Select **Set Single** and then press the switch that you wish to protect. Its LED/lamp will light and the name and number of that switch will appear in the box directly to the right of the **Set Single** box. If you continue to press the switch, it will toggle through the different protection modes.

If the switch is out of reach, stab on the switch identity box and a pop-up will appear (see opposite). To change the current channel number stab on the **Channel 1** box and use the numerical pop-up. Use the same procedure to change to a different **Group**. Now, by stabbing on the list of objects to the right of the pop-up, select (red) the switch you wish to assign to a protection mode. Note that these selections intercancel. Having made your choice, hit **OK**. Finally, select the protection mode as above, by stabbing in the box in the top centre of the Switch Protection pop-up.

Clear the Switch Protection pop-up by stabbing outside it or by deselecting the SWITCH PROT button.

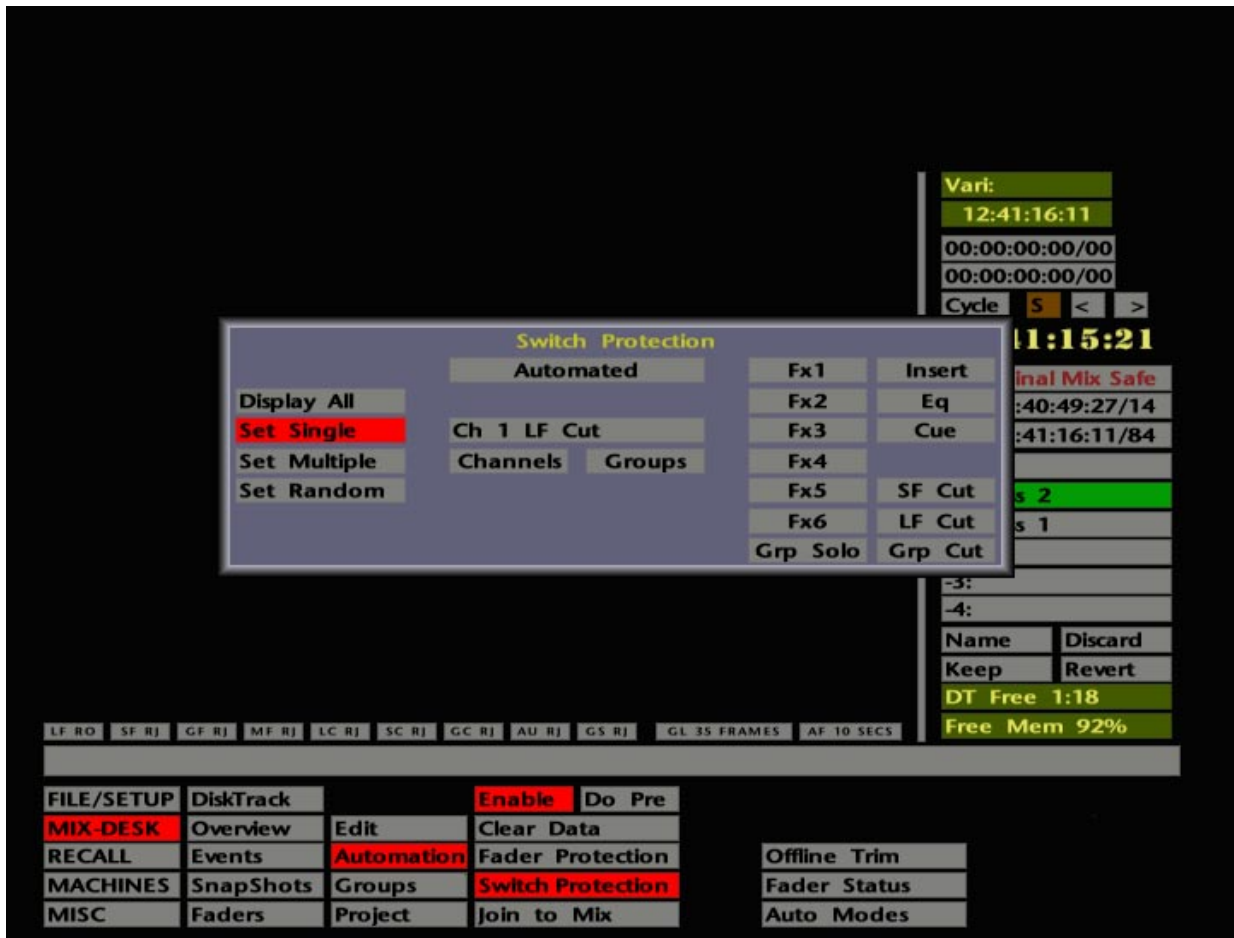

To avoid any confusion as to what takes place when objects are switched from **Protected Manual** to **Automated** during a mix, here are a set of rules:

- Objects switching from Protected Manual to Automated, where no previous mix data exists for those objects:
 - (a) If the objects were *on* before AUTO was enabled, when you switch from **Protected Manual** to **Automated** they will write their current state from zero to 23:59:59:24(:29).
 - (b) If the objects were *off* before AUTO was enabled, and you switch them on at say 1 minute into the mix, then switch from **Protected Manual** to **Automated** before 1 minute, the objects will remain off and then turn on at 1 minute.

Note that, if you hit **Discard** during the first pass, and objects are currently in write, the LED will go out but the objects state at that point will be automatically written to 23:59:59:24(:29).

- Objects switching from Protected Manual to Automated, where previous mix data does exist for those objects:
 - (a) If the objects were *on* before AUTO was enabled, when you switch from **Protected Manual** to **Automated** they will write their current state from zero to 23:59:59:24(:29).
 - (b) If the switches were *off* during the first few passes, when you turn them on and decide to switch between **Protected Manual** and **Automated**, they will turn off – effectively switching to Replay.
- We are always interested to learn how many users actually read our operational manuals! If you are reading this, we would like to hear from you. If you are reading a paper version of the manual, write your name, facility name and address, in the space below and fax this page to +44 (0)1865 379100. If you have any comments to make about this manual, please fax them along with this sheet. If you are reading this from a CD-ROM, then e-mail bruced@solid-state-logic.com. If you are reading from our www site, e-mail daveg@solid-state-logic.com. In either case, please include the information requested above. Multiple applications will be disqualified! The first five respondents will receive a small but useful gift from SSL; the first respondent will also receive additional goodies! This competition is not open to employees of SSL, their partners, relatives, pets or alter egos.

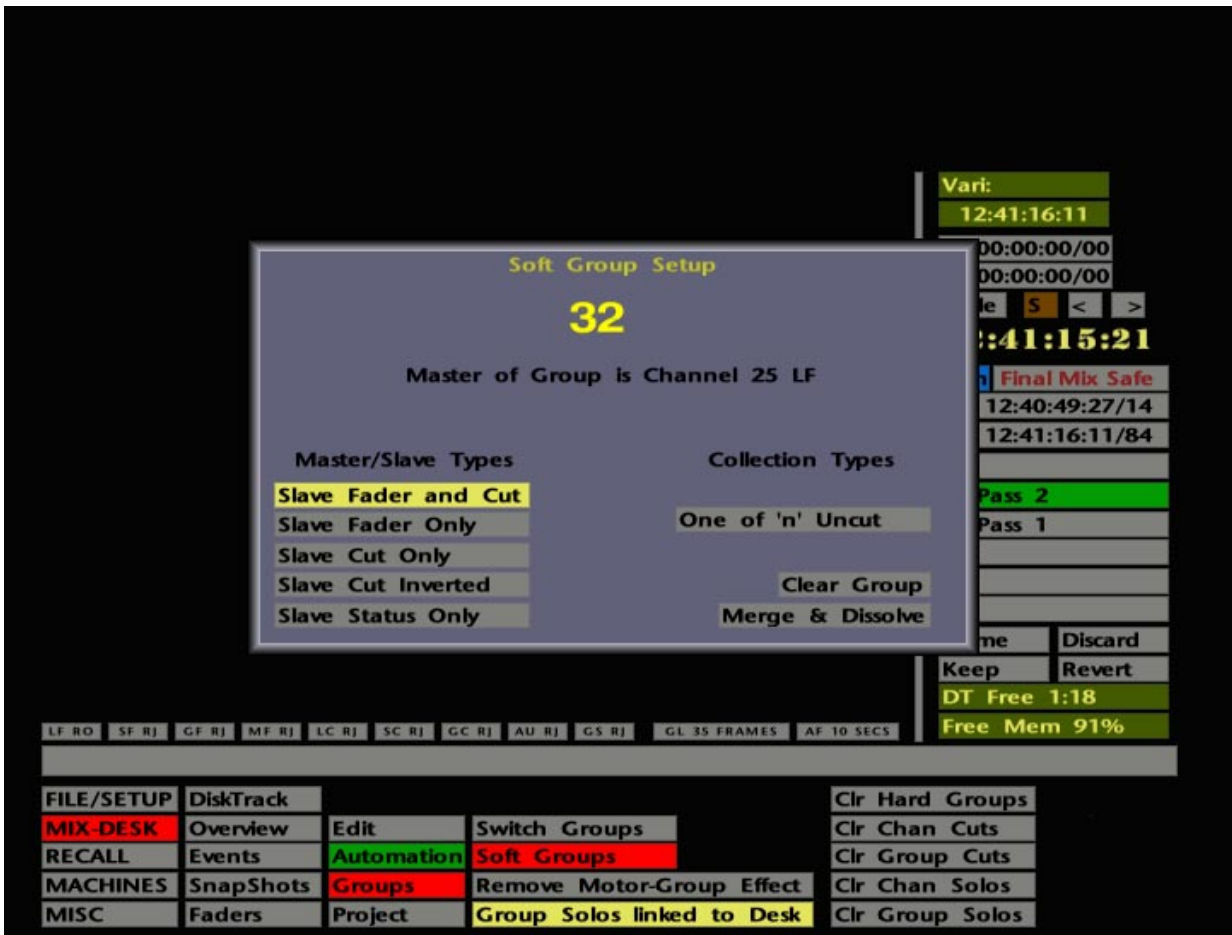

Software Groups

In addition to the eight Hardware Group faders in the centre of the console, and the Switch Group facility (see Page 5-73), the J Series Computer provides 32 Software Groups which can be used in or out of an automated mix.

Software Groups allow the free grouping of any fader to any other fader (large *or small*) on the console. Note, however, that while the master fader of a Software Group can be part of a Hardware Group, slave faders in a Hardware Group (including Group 0) cannot be slaves in a Software Group. Large faders may not be incorporated in a Software Group unless the group assignment display on the fader is blank. Cuts can be incorporated in a Switch Group at the same time as being part of a Software Group.

When used in an automated mix, Software Groups work primarily on the monitor side of the mix system. That is, you hear the effect of the grouping, but mix data is only written for the group master. Data for the slave faders can be written into the mix by using a 'Merge & Dissolve' function (more on this later). Once data has been written for the slaves, and the group has been dissolved, editing of fader information can be carried out in exactly the same way as if the data had been written on the slave faders themselves, and slave faders can be re-assigned to any other Hardware or Software Group.

Software Group information can be saved and recalled as part of the current Project File under **Hard & Soft Groups** (see Section 2).

Slave Types

The behaviour of a slave (in response to changes made to the group's master) is determined by its slave type. Note that behaviour types relate only to slaves, leaving the master unaffected. Once a fader becomes part of a Slave Fader type group (see below), its level is adjusted relative to the master position about the 0dB mark on the fader scale, exactly in the same way as for Hardware Groups.

Each slave in a group can be one of five types, and groups may contain slaves of mixed types.

Hit the SOFT GROUP SETUP button on the front panel or select **Soft Groups** from the **MIX-DESK/Groups** menu. This calls up the Soft Group Setup pop-up (see opposite). When you call up the pop-up for the first time, Group 1 will be selected by default. In the lower left corner of the pop-up you will see a series of Master/Slave Types boxes:

Slave Fader and Cut	The Slave follows the Master's level and Cut selection
Slave Fader Only	The Slave follows the Master's level only
Slave Cut Only	The Slave follows the Master Cut only
Slave Cut Inverted	The Slave Cut is inverted with respect to the Master Cut
Slave Status Only	The Slave follows the fader's automation status of the Master

See Page 5-67 for details on **One of 'n' Uncut**. The front panel's up/down cursor keys can be used to toggle between slave type selections.

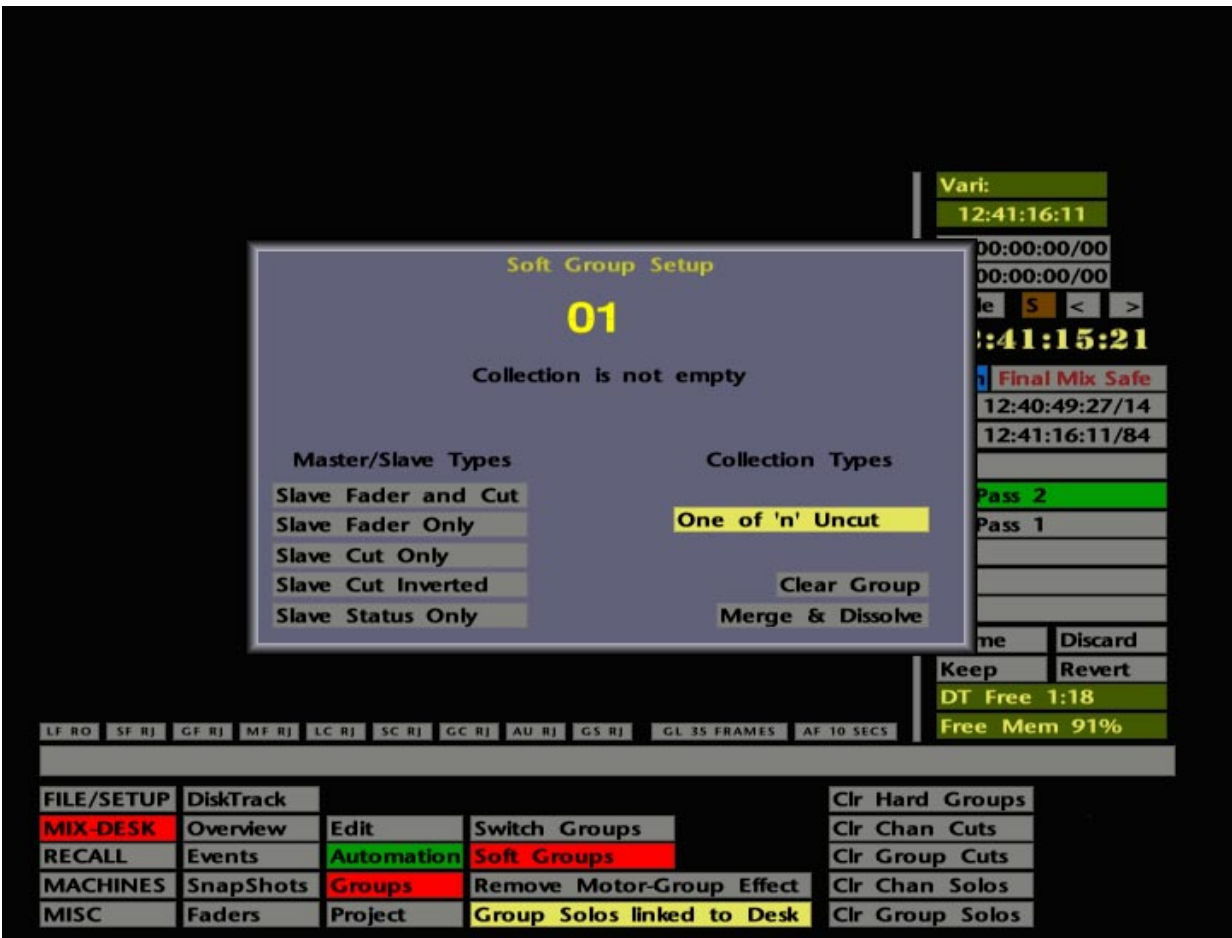
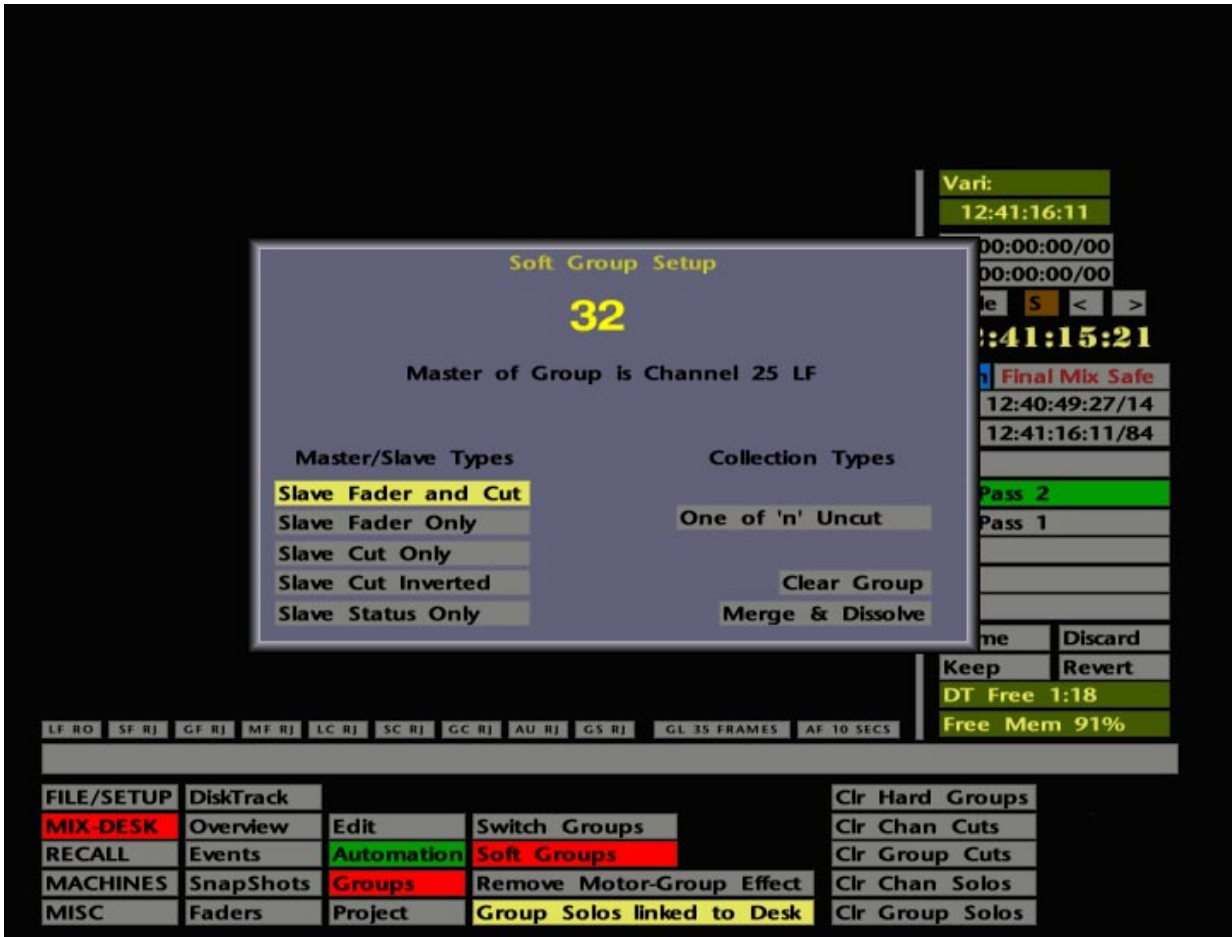

Creating a Group

To create a Software Group, press the fader status button of the fader you wish to be master. You will see a message appear under the Group number on screen indicating that “**Master of Group is Channel X LF/SF**”. The fader’s red LED will come on to confirm your choice. Should you make a mistake, pressing the status button again will deselect the fader and the LED will go off. Select another fader status button to make that fader the master.

Now press the fader status button of the first slave. Its green LED will come on to confirm that it has been selected as a slave. Repeat the process for further slaves. To deselect a slave from the group, simply press the status button again.

Note that slaves will be of the type currently selected in the Master/Slave Types menu. If you want to change a slave to a different type, first deselect it from the group. Now simply change the type by pressing the front panel’s up/down cursor keys or by stabbing on one of the other options, then reselect the slave to the group. To select a sequential range of faders as slaves, simply hold down the fader status button of the first and press the button on the last. The same procedure can also be used to *deselect* a range of faders.

Once slaves have been assigned to a master, all slaves must be cleared from that group before the master can be deselected.

You have now set up your first group – easy, isn’t it! To create additional groups, use the front panel’s left/right cursor keys to select the next group number you wish to use. The LEDs on the group you have just set up will start flashing to show that those faders belong to another group, and cannot be incorporated into a new one. Solid LEDs always show the slave and master selections of the current group. Flashing LEDs show the master(s) and slaves of all the other existing groups.

An additional type of group is shown under **Collection Types**, and offers a smarter version of **Slave Cut Inverted** – called **One of ‘n’ Uncut** (see lower screen opposite). Note that this is not included under Master/Slave Types as there is no absolute master in this type of group. Select **One of ‘n’ Uncut** and create your group as normal. If you now press any Cut within the group, it will uncut that Cut and cut all others. Yay!

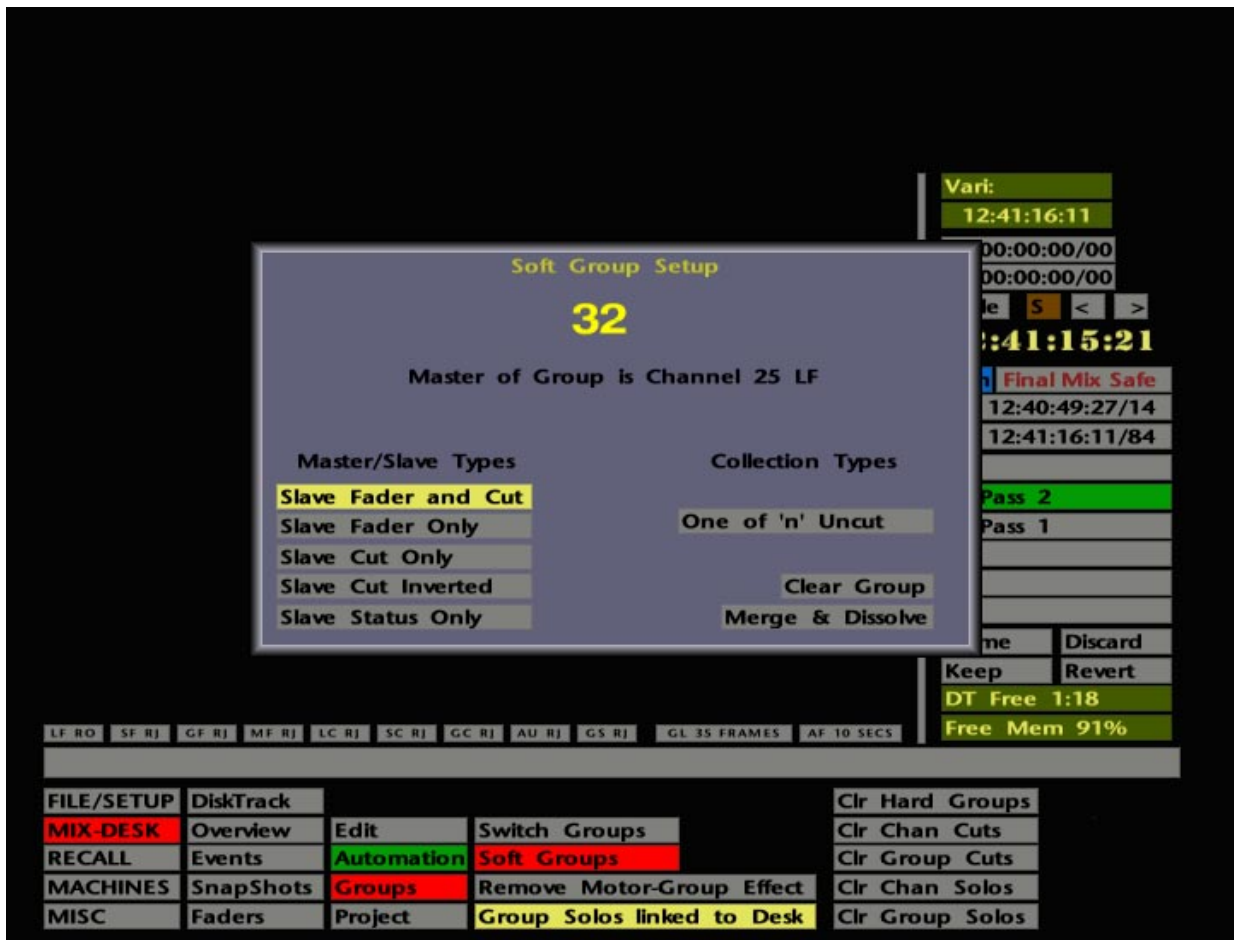

Indication of Slave Type

There may be occasions when you become confused as to which Slave Type faders have been set.

With the Group Setup menu on screen, make the group in question current by selecting it with the left/right cursor keys. slaves which are of the current type, as shown in the menu, will display a solid green LED as normal. slaves which are of a different type will show a solid green LED plus a slow flashing red LED.

Now move through the Master/Slave Types list with the left/right cursor keys to determine which faders are of which slave type. As a new type is selected, any of the current group that are of that type will show just the solid green LED.

Alternatively, you can proceed as follows. Pressing the status button on a channel that has both LEDs lit will cause the slave type of that channel to become the current type, and the Master/Slave Types list will confirm this. The flashing red LED on this channel will go out to show that the channel is now of the current type. Pressing the button again will remove that slave from the group. Remember that slaves can only be deselected individually if they are of the current type.

Clearing a group can be simply carried out by making the group current and then stabbing on **Clear Group**.

Software Groups and Automation

If Software Groups are used in an automated mix, there may be situations where you want to clear some, or all, of the current groups and set up new ones. **Merge & Dissolve** is provided for just such occasions. It merges the current group data with the mix data for the current pass in a new mix pass prefixed with the letter **G**, and then clears the grouping information for that Software Group. The fact that a new mix pass has been created provides a previously unavailable level of undo should you wish to return to the 'un-merged' mix.

An error message pop-up now appear if **Merge & Dissolve** is used on a **One of 'n'** **Uncut** type group. **Merge & Dissolve** does not work on a collection, as the mix data for the collection is not held on a single master channel, but collectively across all members of the collection.

Soft Group Setup

32

Master of Group is Channel 25 LF

Master/Slave Types

- Slave Fader and Cut
- Slave Fader Only
- Slave Cut Only
- Slave Cut Inverted
- Slave Status Only

Collection Types

- One of 'n' Uncut
- Clear Group
- Merge & Dissolve

LF RD | SF RJ | GF RJ | MF RJ | LC RJ | SC RJ | GC RJ | AU RJ | GS RJ | GL 35 FRAMES | AF 10 SECS

FILE/SETUP	DiskTrack			Clr Hard Groups
MIX-DESK	Overview	Edit	Switch Groups	Clr Chan Cuts
RECALL	Events	Automation	Soft Groups	Clr Group Cuts
MACHINES	SnapShots	Groups	Remove Motor-Group Effect	Clr Chan Solos
MISC	Faders	Project	Group Solos linked to Desk	Clr Group Solos

Vari: 12:41:16:11

00:00:00/00

00:00:00/00

le S < >

:41:15:21

Final Mix Safe

12:40:49:27/14

12:41:16:11/84

Pass 2

Pass 1

me Discard

Keep Revert

DT Free 1:18

Free Mem 91%

Operational Applications

As the grouping system works from the playback data of the master, it is very simple to add grouping onto something to see the effect, and then remove it if it is no good. For example, having written the cuts for one backing vocal track, that track can then be used as a master for the rest of the backing vocals. By using a Slave Cuts Only type group, only the cuts would affect the other slaves; any fader rides on the first vocal track would have no effect.

If the result of this is OK, just leave the group in place. If the effect is no good, dissolve the group and carry on. No mix information has been written, so there is nothing to delete or correct.

Note that it is not necessary to have grouping in place while fader moves are being written. Any existing moves can be later 'mapped' onto other faders.

Master and Slave Cuts – Any cut from the master is applied to the slave. If the master is uncut, the slave can be cut as normal (provided it is in a write status). It is not possible to uncut a master cut that is applied to a slave by using the slave's cut button. The way around this is to use **Merge and Dissolve**, then update the cut information on the slave fader as normal.

Using Inverted Cuts – Slave Inverted Cuts have the opposite effect to that applied from the master. Cut the master and the slave uncuts; uncut the master and the slave cuts.

Using Mixed Slave Types – Assume you have two stereo piano tracks and you need to switch between them several times during the mix. If the tracks are returning via Channels 25 & 26 and 27 & 28, set up the group so that Channel 25 is the master and Channel 26 a Slave Cut type slave. Now select Channels 26 and 27 to be Inverted Cut type slaves. Cutting Channel 25 cuts Channel 26 and uncuts Channels 27 and 28. Uncutting Channel 25 uncuts Channel 26 and cuts Channels 27 and 28. In this way you can simply switch between two stereo pairs with just one cut button.

We'll leave you to discover the many other possibilities!

Match And Play Switch Groups Setup

Ch 72 LF Cut
Ch 72 SF Cut
Ch 72 Fx6 In/Out
Ch 72 Fx5 In/Out
Ch 72 Fx4 In/Out
Ch 72 Fx3 In/Out
Ch 72 Fx2 In/Out
Ch 72 Fx1 In/Out
Ch 72 Cue In/Out
Ch 72 Eq In/Out
Ch 72 Ins In/Out

Master/Slave

1

Set Master

Clear Group

Select Group

Remove

Add

Vari:

12:41:16:11

00:00:00:00/00

00:00:00:00/00

Cycle **5** < >

12:41:15:21

Arm Final Mix Safe

Fr : 12:40:49:27/14

To: 12:41:16:11/84

*

0: Pass 2

-1: Pass 1

-2:

-3:

-4:

Name	Discard
Keep	Revert

DT Free 1:18

Free Mem 91%

LF RO SF RJ GF RJ MF RJ LC RJ SC RJ GC RJ AU RJ GS RJ GL 35 FRAMES AF 10 SECS

FILE/SETUP	DiskTrack			Clr Hard Groups
MIX-DESK	Overview	Edit	Switch Groups	Clr Chan Cuts
RECALL	Events	Automation	Soft Groups	Clr Group Cuts
MACHINES	SnapShots	Groups	Remove Motor-Group Effect	Clr Chan Solos
MISC	Faders	Project	Group Solos linked to Desk	Clr Group Solos

Match And Play Switch Groups Setup

Ch 72 LF Cut
Ch 72 SF Cut
Ch 72 Fx6 In/Out
Ch 72 Fx5 In/Out
Ch 72 Fx4 In/Out
Ch 72 Fx3 In/Out
Ch 72 Fx2 In/Out
Ch 72 Fx1 In/Out
Ch 72 Cue In/Out
Ch 72 Eq In/Out
Ch 72 Ins In/Out

All Masters

1

Set Master

Clear Group

Select Group

Remove

Add

Vari:

12:41:16:11

00:00:00:00/00

00:00:00:00/00

Cycle **5** < >

12:41:15:21

Arm Final Mix Safe

Fr : 12:40:49:27/14

To: 12:41:16:11/84

*

0: Pass 2

-1: Pass 1

-2:

-3:

-4:

Name	Discard
Keep	Revert

DT Free 1:18

Free Mem 91%

LF RO SF RJ GF RJ MF RJ LC RJ SC RJ GC RJ AU RJ GS RJ GL 35 FRAMES AF 10 SECS

FILE/SETUP	DiskTrack			Clr Hard Groups
MIX-DESK	Overview	Edit	Switch Groups	Clr Chan Cuts
RECALL	Events	Automation	Soft Groups	Clr Group Cuts
MACHINES	SnapShots	Groups	Remove Motor-Group Effect	Clr Chan Solos
MISC	Faders	Project	Group Solos linked to Desk	Clr Group Solos

Switch Groups

Switch Groups are used to group together automated objects on the console. Note that, as with software groups (see Page 5-65), this facility can be used in and out of an automated mix. By now you should be aware that the automated objects are FX1-6 On/Off, Cue Stereo On/Off, Insert In/Out, EQ In/Out, Large and Small Fader Cuts, Group Fader Cuts and Solos.

Up to 500 (yes, five hundred!) Switch Groups can be set up. Hit the SWITCH GROUP SETUP button on the front panel, or select **Switch Groups** from the **MIX-DESK/Groups** menu. This produces the Match and Play Switch Groups Setup menu (see opposite).

By stabbing on the yellow box at the top right of the pop-up, you can choose the group type from **Master/Slave** or **All Master**. Alternatively use the up/down cursor keys on the front panel to toggle the choice. A Master/Slave group has a single designated master object; activating a slave object will have no effect. With an All Master group, any object in the group will control all other objects in that group.

The yellow number below box indicates the group number. Groups must be set up sequentially, ie. you cannot create Group 2 without first creating Group 1. Once set up, you can move from group to group with the left/right cursor keys on the front panel, or by stabbing and dragging to change the number.

To assign objects to a group, simply press the object's button/switch. With a **Master/Slave** relationship selected, the first object pressed will become the master and it will appear highlighted in blue in the scrolling list to the left of the pop-up. Having selected the master object, subsequent selections will be designated slaves. When selected, these appear in the list below the master.

If, having selected a number of objects for the group, you decide to change the master, stab on the **Set Master** box. You can now select a new master by either stabbing in the list or simply pressing the relevant hardware control. Note that you cannot allocate a new master to the group if it does not already appear in the list.

Having set up a group, stab outside the pop-up and try it out. You will notice that you cannot switch object states individually if they are assigned to a group. If required, you can change a group to the **All Masters** type after you have created it. Also note that a Cut can be included in a Software Group (see Page 5-65) at the same time as being in a Switch Group.

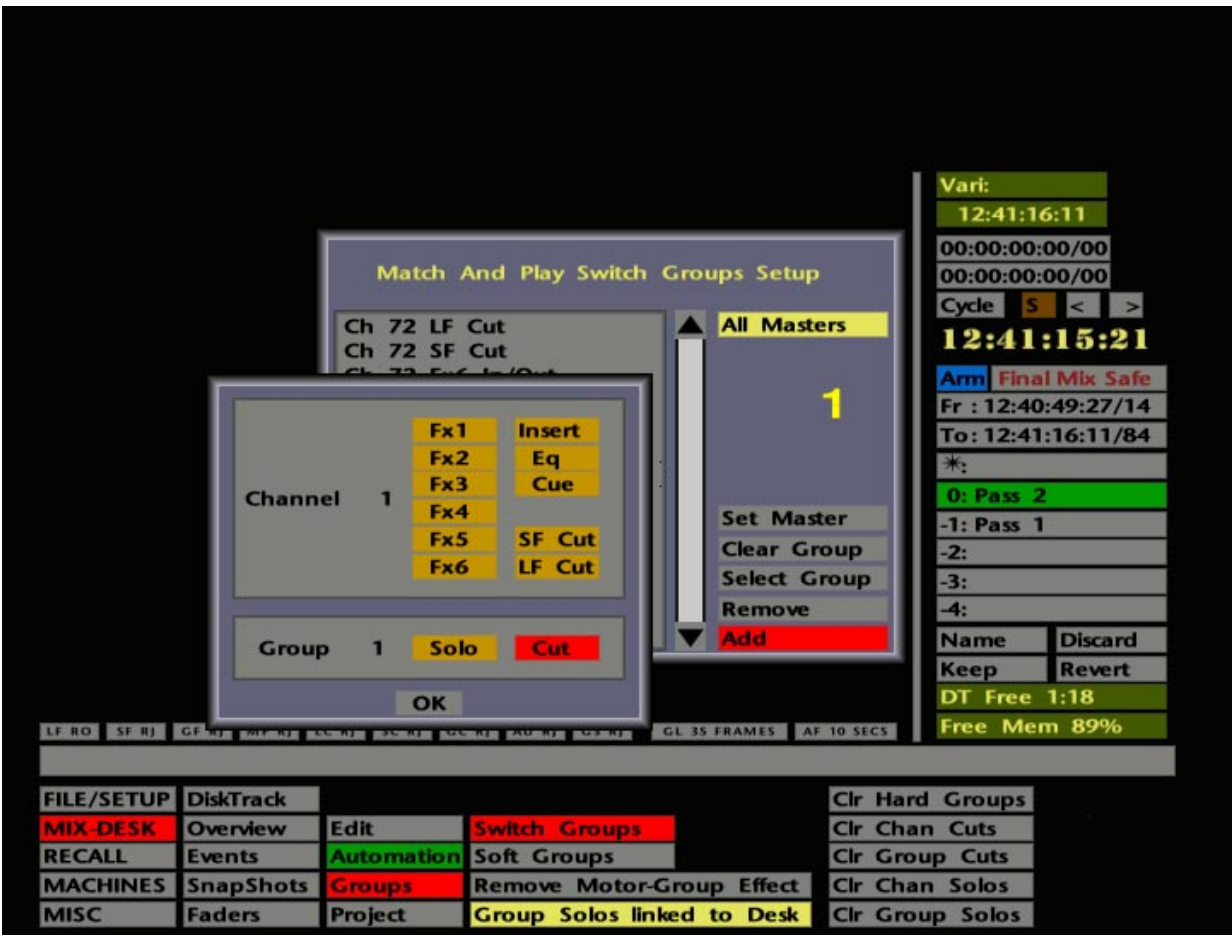
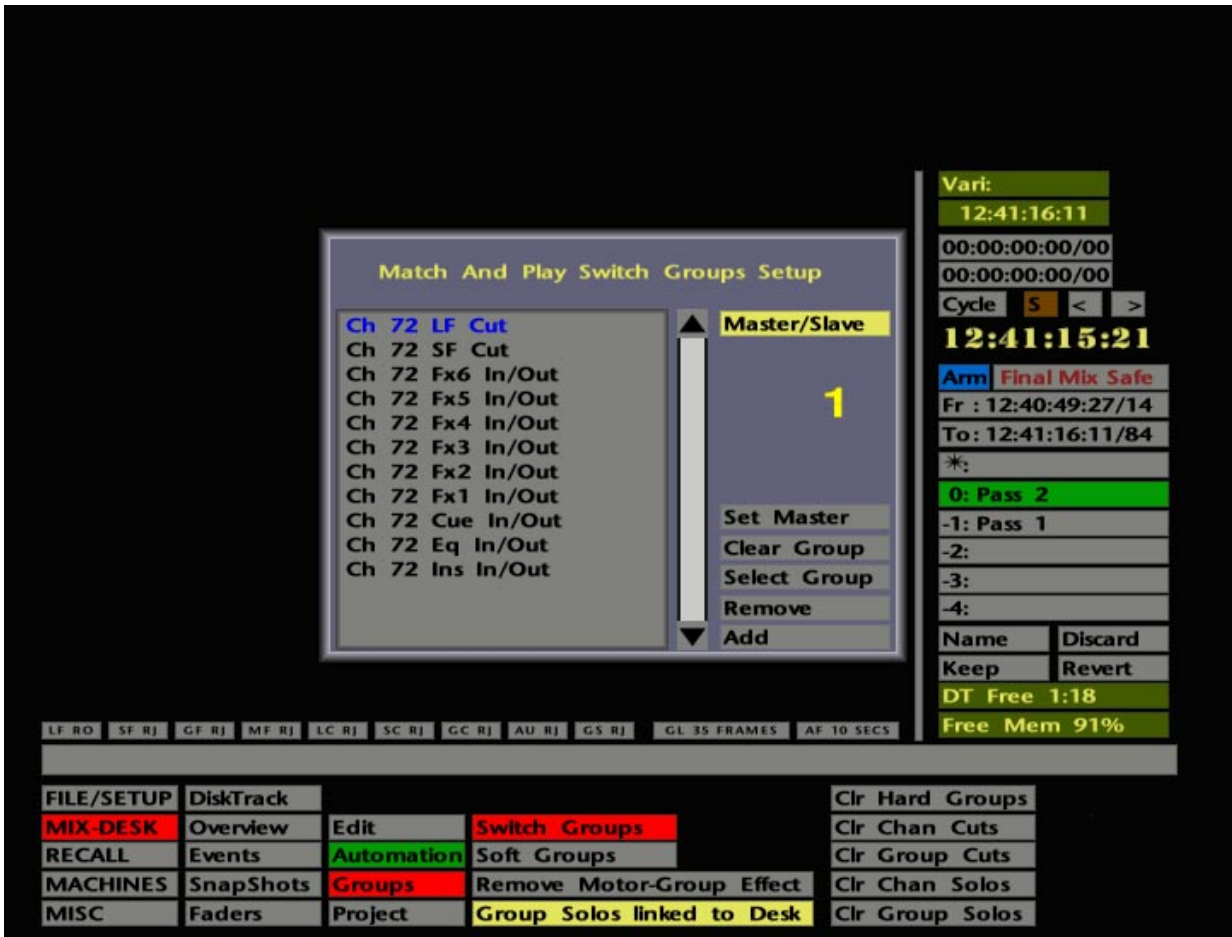

To remove an object from a group, first access the correct group and then either toggle the physical object, or press **Remove** and stab in the list on the offending item.

To add objects to the Switch Group you are creating, just hit the relevant switches. Alternatively, select **Add**, and the pop-up shown in the lower screen opposite will appear. Stab on the **Channel** or **Group** number to select the Channel/Group of your choice – a numerical keypad will appear for entry of the number required. Now select an object by stabbing on one of the yellow boxes (note that only one object can be selected at a time) and **OK** out of the pop-up. Repeat as necessary.

There is an alternative method of assigning objects and Hardware Group Solos and Cuts to Switch Groups. Hit **Select Group** and the same pop-up as used with **Add** (see above) will appear. Make your choice and **OK** out of the pop-up. Repeat as necessary.

Clear Group will clear down all selections for the currently displayed group.

When automated, switch group data is written directly to the mix for each object. Having written a series of master-controlled on/off states for a group of switches, data for individual switches in the group can be modified by simply removing them from the group, or by clearing the entire group down.

Switch Groups – An Example

One simple use of the Switch Group facility is in the switching of FX Sends in an automated mix. Assume you need to switch reverbs on a particular channel at the start of each chorus. Since you need one send to switch on as the other switches off, set them like this before you set up the group. Remember that once assigned to a group, objects may not individually change state, and if you do start with both switches on (or off), once in a group, both switches will change to the same state when either is pressed.

Back to the example. Now set up an **All Masters** group. This will save any confusion later, as you will be able to press either switch in order to execute the changeover. Once this is done, the required effect can be manually written to the mix.

Hopefully, this simple example will give you a taste of the unlimited possibilities that the combination of Switch Groups and automation can achieve. We'll leave the rest to you.

SnapShots					
Take	Inc	Do	Inc	Undo	Name
1	Clear Desk	17		33	49
2	Rough Mix	18		34	50
3	Final Master	19		35	51
4		20		36	52
5		21		37	53
6		22		38	54
7		23		39	55
8		24		40	56
9		25		41	Fred
10		26		42	Ginger
11		27		43	
12		28		44	
13		29		45	
14		30		46	
15		31		47	Pre enable
16		32		48	Undo
Auto Off: Ignore Protection		Auto On: Use Protection			

LF RO	SF RJ	GF RJ	MF RJ	LC RJ	SC RJ	GC RJ	AU RJ	GS RJ	GL 35 FRAMES	AF 10 SECS
-------	-------	-------	-------	-------	-------	-------	-------	-------	--------------	------------

FILE/SETUP	DiskTrack				Clr Hard Groups
MIX-DESK	Overview	Edit	Switch Groups		Clr Chan Cuts
RECALL	Events	Automation	Soft Groups		Clr Group Cuts
MACHINES	SnapShots	Groups	Remove Motor-Group Effect		Clr Chan Solos
MISC	Faders	Project	Group Solos linked to Desk		Clr Group Solos

Vari:	12:41:16:11
00:00:00:00/00	
00:00:00:00/00	
Cycle	S < >
12:41:15:21	
Arm	Final Mix Safe
Fr	: 12:40:49:27/14
To	: 12:41:16:11/84
*	
0:	Pass 2
-1:	Pass 1
-2:	
-3:	
-4:	
Name	Discard
Keep	Revert
DT Free	1:18
Free Mem	96%

Snapshots

In addition to all the dynamic automation options, the J Series Computer also offers a console-wide 'snapshot' facility for all automated objects.

Pre Enable Snapshot

Snapshots can be taken whether the dynamic automation system is enabled or not. However, each time you enable the mix system, a 'Pre Enable' snapshot of the state of the console just prior to the AUTO button or the **Enable** box being selected, will be taken. If previous automation settings have not been cleared, enabling the mix system may set up undesirable fader levels and switch states, and destroy your carefully prepared balance. Do NOT Panic! By recalling the Pre Enable snapshot, you will be able to get back instantly to the state before the automation system was enabled.

Note that, with the automation system enabled, recalling a Pre Enable snapshot will set the Small Fader VCAs to their stored levels, and these levels may not be reflected in the physical positions of the Small Faders.

To recall the Pre Enable snapshot, stab on the **Do Pre** box in the **MIX-DESK/Automation** menu. Note that when the text on this box is white, it indicates that there is no Pre Enable snapshot currently present.

As well as the automatic Pre Enable snapshot, you have the ability to save up to 62 additional snapshots. Hit the front panel SNAPSHOTS button, or select **Snapshots** from the **MIX-DESK** menu, to call up the Snapshots pop-up (see opposite).

To take a snapshot of the current automated object settings, select **Take** followed by a stab on one of the 62 grey boxes below. The box will turn yellow to indicate that a snapshot is present in that store. Note that 'occupied' stores can be over-written with ease and, if this happens, any existing name will be unchanged. This apparent oversight in the software can prove useful if you simply want to repeatedly update a fader balance snapshot while tracking.

Snapshots can be named (up to 11 characters) by selecting **Name** followed by a stab on the appropriate box.

To restore snapshot settings to the console, select **Do** followed by a stab on the appropriate yellow box.

An **Undo** function is provided at the top of the pop-up in case you recall the wrong snapshot. At the bottom right of the snapshot list you will see two boxes labelled **Undo** and **Pre Enable**. When these boxes are yellow, and if required, the associated snapshot may also be recalled from here with the **Do** function.

Snapshots are extremely useful as short term memories that can be used many times when mixing.

Note that the two **Inc** boxes on this pop-up have no function in this product (used on Axiom only).

SnapShots				
Take	Inc	Do	Inc	Undo
1	Clear Desk	17		33
2	Rough Mix	18		34
3	Final Master	19		35
4		20		36
5		21		37
6		22		38
7		23		39
8		24		40
9		25		41 Fred
10		26		42 Ginger
11		27		43
12		28		44
13		29		45
14		30		46
15		31		47 Pre enable
16		32		48 Undo

Auto Off: Ignore Protection Auto On: Use Protection

LF RO SF RJ GF RJ MF RJ LC RJ SC RJ GC RJ AU RJ GS RJ GL 35 FRAMES AF 10 SECS

Vari:

12:41:16:11

00:00:00:00/00

00:00:00:00/00

Cycle 5 < >

12:41:15:21

Arm Final Mix Safe

Fr : 12:40:49:27/14

To : 12:41:16:11/84

*

0: Pass 2

-1: Pass 1

-2:

-3:

-4:

Name	Discard
Keep	Revert

DT Free 1:18

Free Mem 96%

FILE/SETUP	DiskTrack			Clr Hard Groups
MIX-DESK	Overview	Edit	Switch Groups	Clr Chan Cuts
RECALL	Events	Automation	Soft Groups	Clr Group Cuts
MACHINES	SnapShots	Groups	Remove Motor-Group Effect	Clr Chan Solos
MISC	Faders	Project	Group Solos linked to Desk	Clr Group Solos

16:41:45:15 -∞dB Channel 13 +10dB Ch 1

16:41:48:23

16:42:00:03

16:42:04:16

16:42:05:26

Squash Shift Curve Wave Gain 4 Mark Cycle

L Fader Zoom in Zoom out Revert Edits OK

The two light yellow boxes at the foot of the snapshot list, determine whether faders or switches that have been set to **Protected Manual** mode (see Pages 5-55 and 5-59), will have their settings overwritten by a recalled snapshot or not. The choice can be made for when the automation system is on or off

Simply stab on the boxes to toggle between **Use Protection** and **Ignore Protection**. Note that any control in **Protected Replay** will be overwritten by a snapshot whether automation is on or not.

Editing Mix Data

Once you have automation data written for faders and objects, that data may be edited graphically with the pen and tablet interface. Select **Overview** from the **MIX-DESK** menu and scroll the Overview display horizontally so that the channel you wish to edit is in view. Now centre the playhead (Desk position) on the area you want to edit by stabbing on that spot. Select the **Edit** menu followed by **Edit Mix**. Now select **Trim Mix** and you will be prompted to stab on the channel you wish to edit; the Edit Mix Data pop-up will then appear (see lower screen opposite).

The two timecode boxes on the left hand side of the pop-up show the length of the edit window. Stabbing on the timecode displays moves the window up or down by half a window with each stab. You can also stab and drag on the timecodes to change the values.

To assist in the editing process, it is possible to create multiple generic 'SL 9000' marks, from this pop-up, at the playhead position. The positions of any Marks are indicated by blue lines across the display and timecode references to the left. If a mark represents a named event or cue, its name will be shown on the right hand side of the pop-up.

If there is a audio clip present on the Overview display in the area you wish to edit, the edit window will show this in blue; otherwise the window will have a black background. Audio clips on the Overview display may be generated by the **Capture Clips** facility (see Page 5-83) or if your system is fitted with a DiskTrack.

If the edit window is under 10 secs, the **Wave** function on the Edit Mix Data pop-up enables a waveform display of any DiskTrack audio clip present in the edit window. This provides an obvious advantage when editing mix data. The associated **Gain** function enables the amplitude (magnification) of the waveform to be adjusted within a range of 1-24.

In the bottom left hand corner of the pop-up is a box which, when stabbed, gives you a list of automated controls whose mix data you can edit on this display (the same as the list for Overview display). The currently selected item will be displayed in the box and the Edit Mix Data display will subtly alter if you change to a different selection.

For the time being, we will concentrate on the editing of switch data. Before moving on, select a switch object from the list. See Page 5-83 for information on editing fader data.

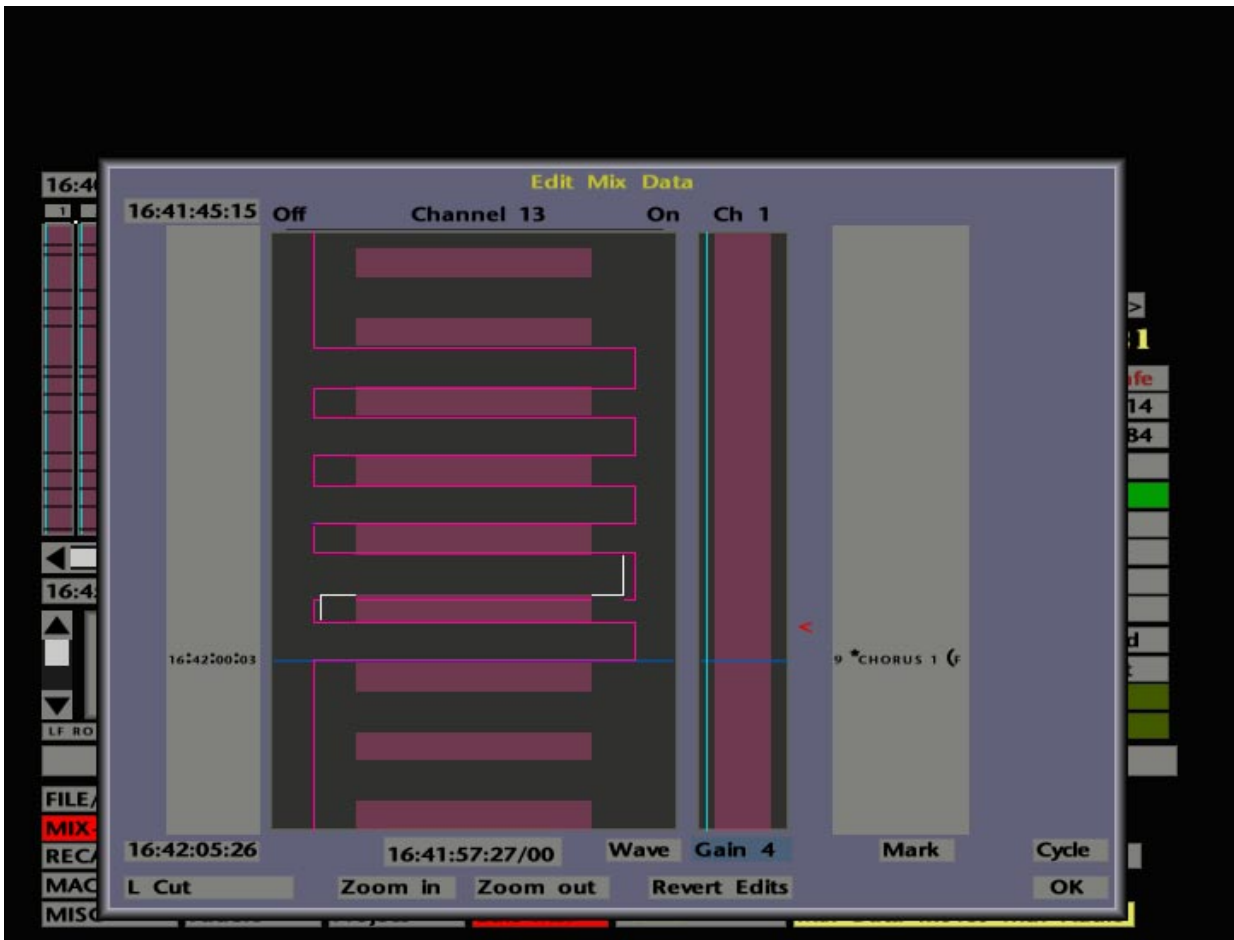

Editing Switch Data – We'll assume that you wish to create an 'on' condition for the switch where it is currently stored as 'off' in the mix data. The vertical red line on the left of the display indicates the current **Off** state. Press the pen on the line and a vertical yellow bar will appear. Now drag the pen to the right of the yellow bar. This produces a white line on the display that gives an indication of your edit (in this case, turning the switch state to on). Drag the pen down for your desired duration of the **On** state. Release the pen and a red outline will define the edited information. Note that you can write mix data 'On' in a forward and backward direction. When you press the pen to edit, a timecode box appears at the bottom of the pop-up, indicating the current pen position.

To write an **Off** state, stab the pen on the red line to the left before the start of an existing **On** state and drag downward for the length of the desired **Off** state. Take note that you can only write an **Off** state forwards in time. Once again, when you press the pen to edit, the timecode box the bottom of the screen, shows the current pen position.

Existing switch events can be edited in the same way by stabbing on the event boundary and dragging up or down to move the event start or end.

All this will seem a lot simpler when you actually try it yourself. Cuts/Uncuts/FX On/Off etc. can all be very simply written off-line with this facility, and then further modified to taste.

The **Ref** channel on the right hand side of the pop-up shows, as a guide, the written mix information for a channel you may wish to reference your edit to. This can be useful where you wish to match a cut on another channel, for example. The reference channel can be selected by stabbing on the **Ref: Ch 1** box in the **Edit Mix** menu. A pop-up will appear asking you to stab the channel on the Overview display that you would like as your new reference.

The boxes at the foot of the **Edit Mix Data** pop-up have the following functions:

Zoom In	As implied; stab on the area you wish to zoom in on
Zoom Out	Does just that
Revert Edits	Loses edits you made since entering the display
Cycle	Cycles the selected window with preroll
Mark	Places a Mark at the playhead position on the relevant channel. These marks can be used to specify edit points for audio (DiskTrack only)

The red < to the right of the pop-up gives an indication of the current Desk position, relative to the edit window. If the < is white, the playhead is out of range. When you stab on the <, a red line appears across the edit window so you can accurately position the playhead. Stabbing immediately to the right of the reference channel will move the Desk to the pen stab position.

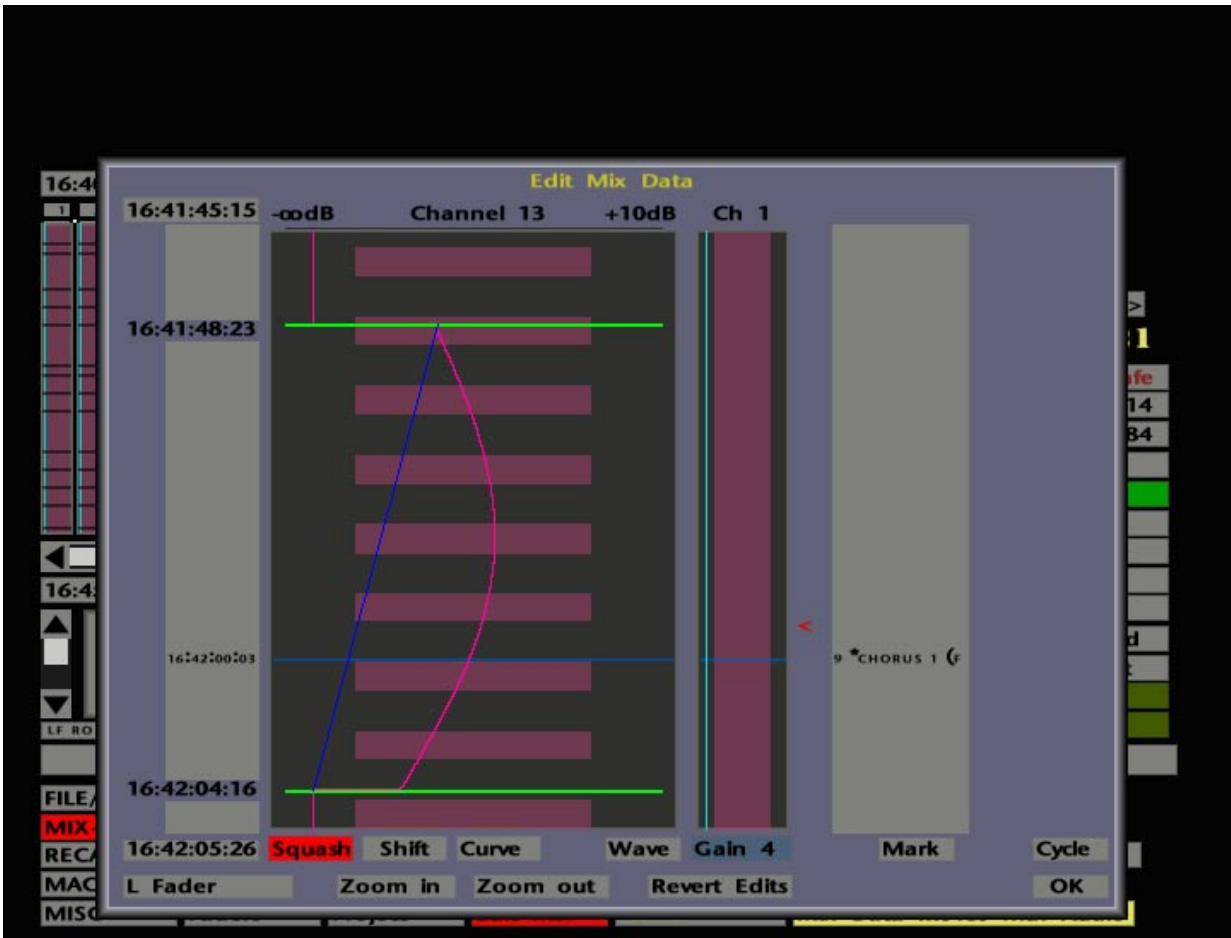

Editing Fader Data – If you choose to edit fader data, ∞ dB and +10dB scale markers appear at the top, and additional options appear at the foot of the Edit Mix Data pop-up. You will also notice two horizontal lines across the display which represent the edit boundaries, ie. the time limits within which editing can take place. The maximum allowable is two minutes; the timecode values of the current start and end of the band are shown to the left. If the edit boundaries are out of limits, they will be shown in red; once within the limit, they will turn green. To move the start or end times, stab on the relevant timecode number and drag. Once the boundaries are set, you can use the following functions:

Selecting **Shift** and dragging sideways will raise (to the right) or lower (to left) all the mix data between the markers. This allows a region of automation data to be trimmed in overall level. **Shifting** all the way to the left will close the fader as indicated by the scale at the top of the display.

Curve will introduce a dip or peak into the data. **Squash** will expand existing moves if the pen is dragged right, or compress if dragged to the left, eventually squashing the data to the blue line connecting the two boundaries.

When finished, hit OK to clear the Edit Mix Data pop-up. Subject to the setting of **Always/New Pass** – **Play/New Pass** in the **Fader Status** pop-up (see Page 5-51), the Edit Mix function will (**Always/New Pass**) create a new mix pass prefixed with the letter E. If this option is set to **Play/New Pass**, the system simply merges the modified data into your current mix. If you want to keep your current mix version, it should be saved to disk before using the Edit Mix function.

Capture Clips

Capture Clips is an innovative new feature which allows the system to capture audio 'clip' information from console channels, via the opening and closing of gates in the channels' dynamics sections. The system assumes that audio is present when no LEDs are lit on the gate meter. Once captured, an on-screen representation of the audio can be used as an aid to the editing of automation data (see Page 5-79).

First you need to set up the gates on those channels which have the necessary audio coming through them. If this is your first experience with Capture Clips, we suggest you read through this section before proceeding, so that you are aware of the potential benefits of the function.

Note that clips will be captured from the first time you play the tape after the Capture Clips function is armed. Make sure that the tape is located to the correct start point before you select channels as described below. To avoid capturing excessive material, you should start and end the run in silence. The simplest way to do this is to select a Solo button on an unused channel. If you don't start and end with the gates closed, the system may assume that there is a clip running from 00:00:00:00 up to the start of the track, and another clip running from the end of the track to 23:59:59:24(29)!

The screenshot shows the 'Event Information' window with a list of marks and a dialog box for selecting channels to capture. The dialog box has a grid of channel ranges and their corresponding status (YYYYYYYY).

Select channels to capture		
1-8	YYYYYYYY	9-16 YYYYYYYY
17-24	YYYYYYYY	41-48 YYYYYYYY
25-32	YYYYYYY.	33-40 YYYYYYYY
49-56	57-64

Buttons: Set All, Clear All, Flip All, Quit, OK

Event Information List:

- Mark 16:38:51:12/66 1 *Top
- Mark 16:39:11:13/00 2 *Phones
- Mark 16:39:49:23/00 3 *Pipes
- Mark 16:42:51:27/00 11 *Verse 3
- Mark 16:43:10:19/00 12 *Bridge 2
- Mark 16:43:29:13/00 13 *Chorus 2
- Mark 16:44:11:27/00 14 *Drum Break

Other interface elements include a 'Vari' section with timecode 16:41:58:29, a 'Cycle' control, and a 'Free Mem 93%' indicator.

The screenshot shows the 'Automation Modes' dialog box, which lists various automation modes for different faders and groups. The 'Large Faders' mode is currently selected as 'Overwrite'.

Automation Modes	
Large Faders : Overwrite	Overwrite
Small Faders : Rollback/Join	Rollback
Group Faders : Rollback/Join	Rollback/Join
Master Fader : Rollback/Join	ClipFill
Large Cuts : Rollback/Join	ClipEnd
Small Cuts : Rollback/Join	CycleFill
Group Cuts : Rollback/Join	CycleEnd
Auxes : Rollback/Join	Static
Group Solos : Rollback/Join	

The interface also shows a 'Vari' section with timecode 12:40:49:27, a 'Cycle' control, and a 'Free Mem 93%' indicator.

Now select **MIX-DESK/Events** and stab on the **Clips** box at the top left of the Events List. This produces two new boxes to the right – **Capture** and **Clear**.

To select the channels you want to capture clips on, stab on **Capture**. The Channel Selector pop-up will appear (see opposite). Select the relevant channels and OK out of the pop-up. To select a sequential range of channels, simply hold down the fader status button of the first and press the button on the last.

The **Clips** box should now be red, ie. armed. Play the multitrack. When you hit Stop, you will be given the option to **Save** or **Discard** the captured clips. If you save the clips, select the **Overview** page and you will see the captured audio for each channel represented by a series of pink blocks.

If you subsequently wish to discard the clips on one or more channels, select **Clips** followed by **Clear** on the Events List. This again calls up the Channel Selector pop-up. Choose the channels on which you want to clear the Captured Clips information, then press OK.

The J Series Computer's mix system provides a set of automation modes which are specifically designed for use with captured clips. See below.

More Automation Modes

Apart from **Overwrite**, **Static**, **Rollback/Join** and **Rollback** (see Page 5-15), the J Series mix system provides four other automation modes. These are: **Clip Fill**, **Clip End**, **Cycle Fill** and **Cycle End**. All these modes can use Absolute or Trim as their active write status, according to the current USE ABS/USE TRIM selection.

Different modes can be selected for groups of objects by selecting the AUTO MODES button or **Auto Modes** in the **Automation** menu (see opposite). Note that the **Auxes** selection covers all automated switches on the console's I/O channels, with the exception of the Large and Small Fader Cut buttons.

Clip Fill – This and the following mode are ideal for use with 'captured clips' (see above) or DiskTrack audio. **Clip Fill** is a clip-specific 'static' mode. If you operate automated objects as a channel's associated clip travels past the playhead, you can freely adjust switches or faders to set up satisfactory settings without having to worry about writing data to the mix. Only when you rewind the system will you write the current setting for that switch or fader for the length of the entire clip in which the rollback point is created.

Clip End – This is another clip-specific mode. You can dynamically write moves and, at the point of rollback, the last settings will be written to the end of the current clip, or the next clip if you have written moves in the gap between clips.

The screenshot displays the SL 9000J computer interface for audio editing. At the top, a timeline shows the current time as 16:40:12:08. Below the timeline are 24 tracks, with track 13 highlighted. A central dialog box titled "Offline Trim" is open, showing settings for Large Faders, Small Faders, Hard Groups, and Soft Groups. The Start Time is 12:40:49:27 and the End Time is 16:42:04:16. The Value is 0.00dB and the Do Trim option is selected. To the right, a "Vari:" panel shows cycle information, including "Cycle 5" and a large time display of "16:41:58:29". Below the dialog box, a menu bar contains options like "Re-Center", "Fit Audio", "Zoom in", "Zoom out", and "Playhead". A list of marks is visible, including "1 *Top", "2 *Phones", "3 *Pipes", and "4 *Intro Chorus". At the bottom, a menu bar includes "FILE/SETUP", "DiskTrack", "MIX-DESK", "RECALL", "MACHINES", and "MISC". The status bar at the very bottom shows "DT Free 1:18" and "Free Mem 94%".

Cycle Fill – This and the following mode are designed for use around the times set in the cycle ‘from’ and ‘to’ timecode boxes located on the right of the **MIX-DESK** display. Cycle Fill is cycle-specific ‘static’ mode. When you rollback (within the cycle window), the position of any switch or fader, which has been put into write, will be written for the length of the cycle window.

Cycle End – This is (not surprisingly) a cycle-specific mode. While you are dynamically writing data, the moves will be written to the mix. If you roll back before the cycle end, the last position you left the fader or object in will be written to the cycle end time.

Off-Line Trim

This useful facility enables fader levels to be trimmed, up or down, off-line. Select **Offline Trim** from the **MIX-DESK** menu and the pop-up shown opposite will appear. Stab on **Large Faders**, **Small Faders**, **Hard Groups** or **Soft Groups** to select the types of faders you wish to trim. Obviously you can select more than one fader type, if required. The relevant boxes turn blue once a selection is made. Use the channel selector to select individual faders. Enter in the trim start and end times (the times default to the current mix start and end times). Now enter the required trim value in dB, between -10 to +10 dB to two decimal places. To enter a negative trim, either press -, enter the value and then hit =, or enter the value and stab on the **Ng** box. Finally stab on **Do Trim**.

Subject to the setting of **Always/New Pass – Play/New Pass** in the **Fader Status** pop-up (see Page 5-51), the Off-line Trim function will (**Always/New Pass**) create a new mix pass prefixed with the letter **O**. If this option is set to **Play/New Pass**, the system simply merges the chosen data into your current mix. If you want to keep your current mix version, it should be saved to disk before using the Off-line Trim function.

Please note – **Offline Trim** adjusts the level of the trim data. If you subsequently want to trim the adjusted data, you must use **Merge Trim** (see Page 5-51) or the off-line trim information will be lost!

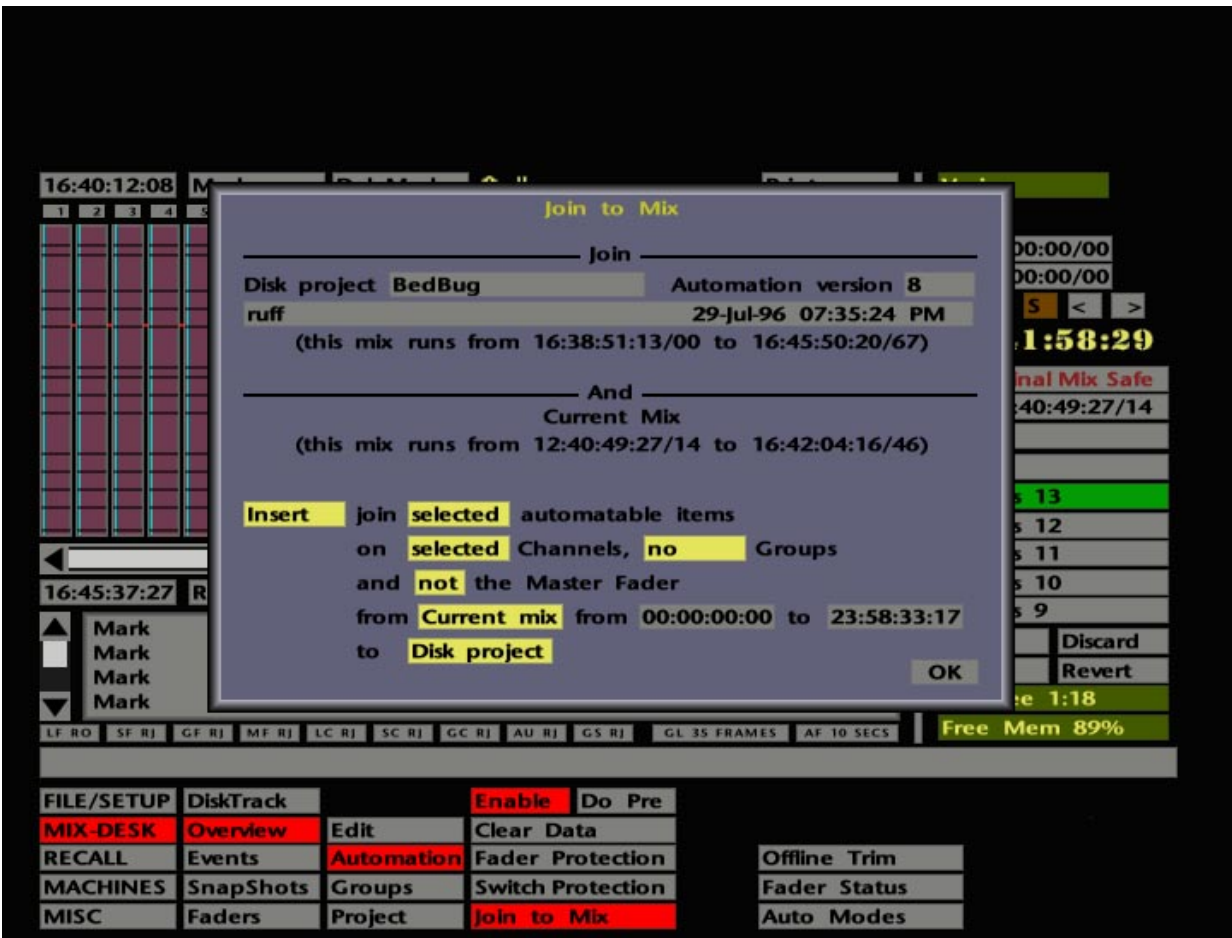
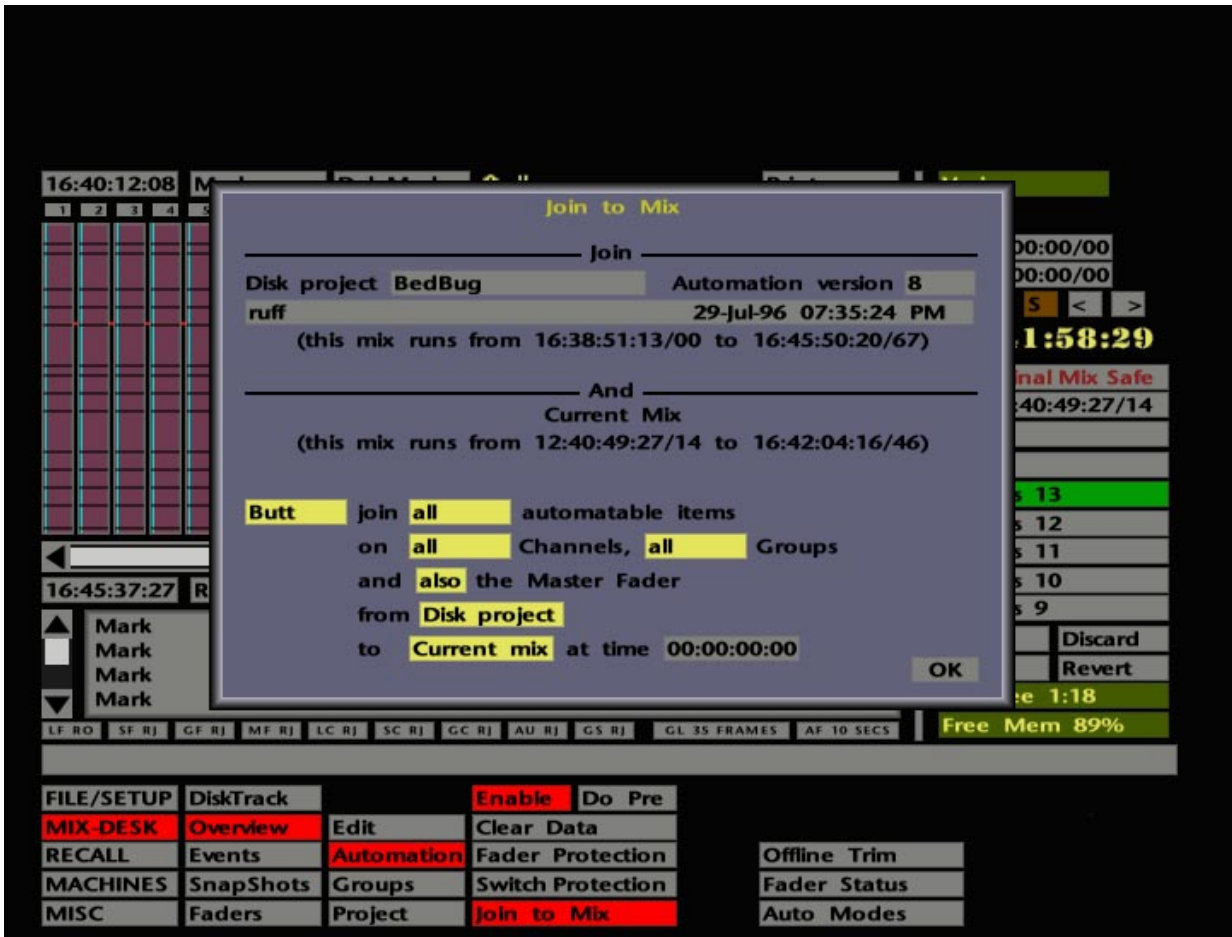

Joining Mixes

This feature allows you to join any mix from any Project to the current mix. Selected automated objects may be chosen from either mix. Stab on **Join to Mix** from the **MIX-DESK/Automation** menu, and this (not surprisingly) will produce the Join to Mix pop-up (see opposite).

First select the 'Project' mix. The box to the right of **Disk Project** will show the name of the current project. If the mix is not in this project, stab on the box to reveal a list of other Project Files. Select the project you want by stabbing on it.

The **Automation version** box to the right will display the last version number of automation data saved to the selected project. The mix name and creation date, and the mix start and end times, are shown on subsequent lines. To change to a different mix, stab on the version number box and enter the required number on the numerical pop-up.

Below the **And** bar you will see start and end times of the current mix.

In the lower half of the pop-up you will see what is effectively a sentence, punctuated with variables (the yellow boxes), describing the components of the join. The **Disk Project** and **Current Mix** boxes determine which mix you will join from and which mix you will join to. Stab on either box to toggle between joining selected objects from the Disk Project mix to the Current Mix or joining selected objects from the Current mix to the Disk Project mix. If all objects on all channels, all groups and the Master Fader are to be joined, then this selection becomes immaterial.

The variables can be modified as follows:

“Join **all** automatable items” – Stab on **all** to produce a pop-up from which **selected** objects can be chosen. Objects highlighted in red will be included in the join; objects in grey will be excluded. If you select none of the objects, the box will read **no**.

“on **all** Channels” – Stab on **all** and select the required channels from the Channel Selector.

“, **all** Groups” – Stab on **all** and select the required groups from the Group Selector.

“and **also** the Master Fader” – Stab on the box to toggle between **also** and **not**.

Now determine which type of join you require. You have a choice of **Butt**, **Insert** or **Timeshift**. The selection is toggled by stabbing in the box to the lower left of the pop-up. Appropriate timecode boxes appear in the lower right of the pop-up, according to your choice. A **Butt** join requires a single timecode entry of the join point. **Insert** requires the entry of insert **from** and **to** times. A **Timeshift** join is used where you wish to take a section of automation data from one mix and insert it at a different start point in the other mix. For example, you might want to take the saved mix data for the third chorus of a song and insert it in your current mix at the first chorus. Enter the start and end times of the section to be inserted in the **from** and **to** boxes; enter the insert start point in the **at time** box (see screen on Page 5-90).

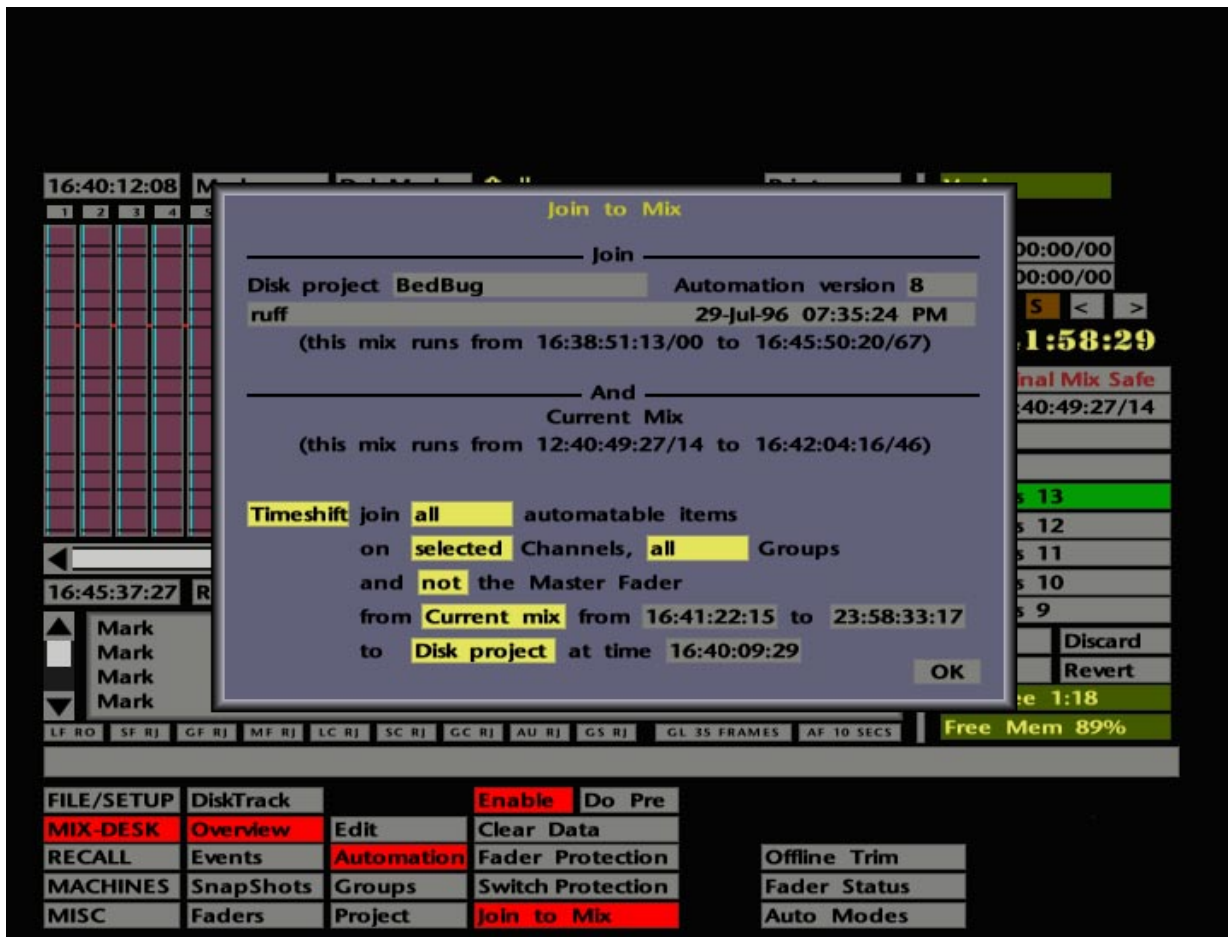

When you are satisfied that the join parameters have been set up correctly, stab on **OK** and **Joining ...** , plus a progress indicator, will appear in the status bar while the mix data is merged.

Subject to the setting of **Always/New Pass – Play/New Pass** in the **Fader Status** pop-up (see Page 5-51), the join function will (**Always/New Pass**) create a new mix pass prefixed with the letter **J**. If this option is set to **Play/New Pass**, the system simply merges the chosen data into your current mix. If you want to keep your current mix version, it should be saved to disk before using the Join to Mix function.

Copying and Swapping Mix Data

Mix data can be freely copied or swapped from one channel to another. This is carried out via the Copy And Swap Channel Data pop-up located under **Copy/Swap** in the **RECALL** menu.

Note that both Copy and Swap functions work with the current automation data, regardless of whether this has yet become a mix pass or not.

Select **Copy/Swap** and the screen will look similar to the lower screen opposite. Note that, in addition to mix data, various other types of channel information can be copied/swapped from here. Select a tick for **Automation data** and any other element(s) that you wish to be included in the copy/swap. Leave a cross for all other entries in the list.

If you have transferred data from one facility to another, you may well want to select additional elements to copy or swap. This is particularly relevant when the facility you are working in now has a different size of console, or the console has a different layout to the one you started out in.

You can elect to carry out a **Single** or **Multiple Copy** by toggling the box to the upper right of the pop-up. For a **Single Copy**, select the channel you wish to copy the data from by stabbing on the left hand **Channel** in the banner at the top of the pop-up. A numeric keypad will appear for entry of the channel number. Alternatively, press the Large Fader status button for the same result. Stab on the right hand **Channel** to enter the destination channel number, or use the Large Fader status button as before.

For a **Multiple Copy** of data from one channel to several others, enter the source channel as above. To specify the destination channels, stab on **Multiple Channels** and enter your selections into the **Channel Selector** (if you are not familiar with this pop-up, see Section 1). To select a sequential range of channels, simply hold down the fader status button of the first and press the button on the last.

When you are satisfied with your source and destination selection(s) stab on **Do It** to complete the operation.



To swap information from one channel to another, stab on **Copy** to toggle it to **Swap**. The selection procedure for channels is the same as described above for the **Single Copy** function.

Clear the **Copy/Swap** pop-up by stabbing outside it.

Subject to the setting of **Always/New Pass – Play/New Pass** in the **Fader Status** pop-up, the **Copy** or **Swap** functions will (**Always/New Pass**) create a new mix pass prefixed with the letter **C** or **S**. **Always/New Pass** is the recommended default. However, if you intend to use the **Copy/Swap** function repeatedly, when you are copying data to and from multiple sources for example, use **Keep** (see Page 5-13) to avoid the current mix pass being forced from the Mix Pass list as it overflows.

Alternatively, set this option to **Play/New Pass**, and the system will incorporate the modified data into your current mix. See Page 5-51 for more on **Always/New Pass – Play/New Pass**.

Phew!

Solid State Logic
SL 9000 J Series
Total Studio System

Computer Operator's Manual

SECTION 6

Total Recall



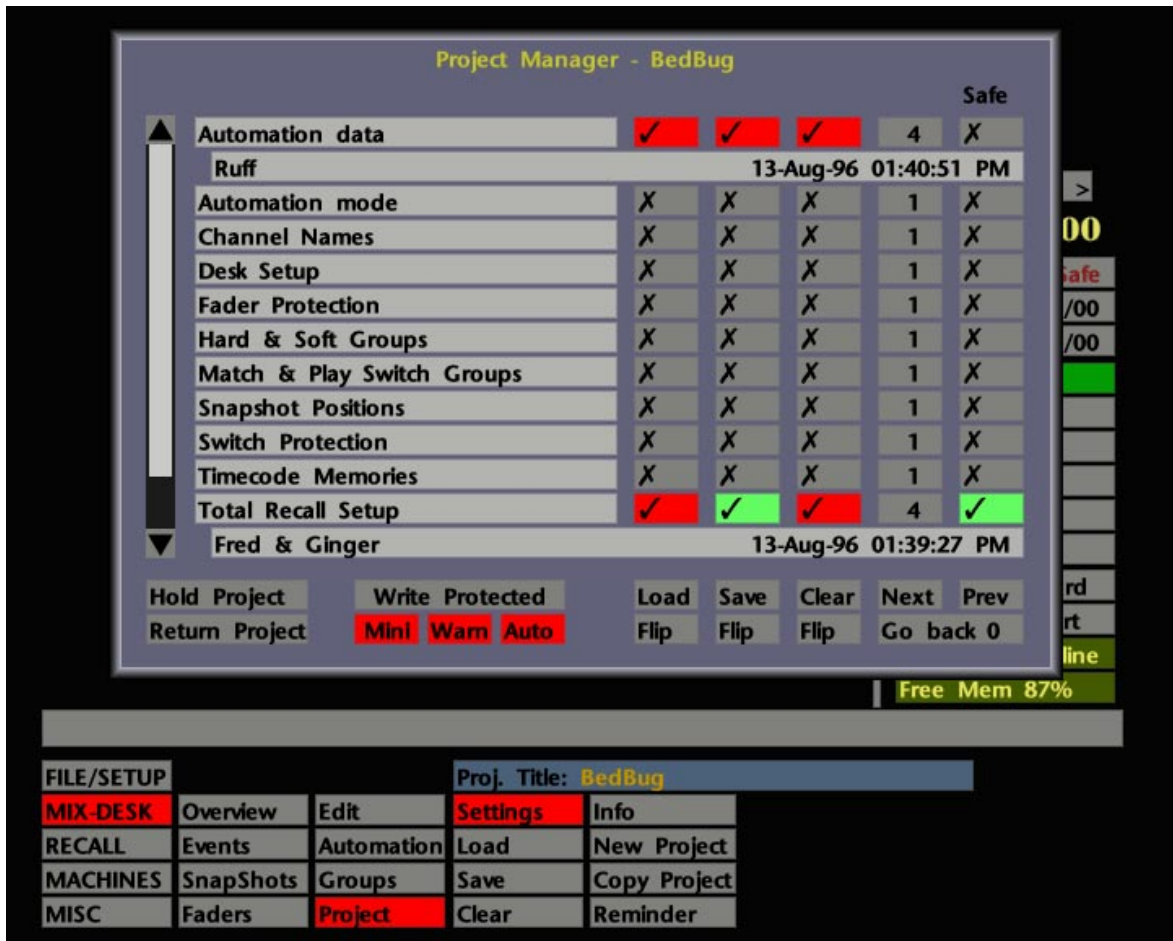

Total Recall

Total Recall records the position of all the switches and rotary controls in the console's channel modules and, additionally, the positions of controls in the centre section. Once stored, these 'setups' can be recalled, enabling the console to be reset to within 0.25dB tolerance.

The console controls are manually reset in conjunction with a graphic display (see Page 6-2) which compares the stored positions of controls with their current positions. To reduce the reset time, an Autoscan function can be used to rapidly locate those controls that are incorrectly set.

Total Recall can be equally used where you want to return to a specific setup stored earlier in the session or if you are moving your project to another studio. In the latter case, it makes no difference if the facility you are moving to has a larger or smaller console, or even a different layout. Total Recall information can be freely copied from one channel to another.

Saving Total Recall Setups

Total Recall setups are saved on a per-project basis under **Total Recall Setup** in the Project File **Settings** pop-up. Select **MIX-DESK/Project/Settings** or hit the dedicated PROJECT SETTINGS button. If you are not familiar with the **Settings** pop-up (see opposite), read Section 2 for more information.

Scroll the element list to reveal the box below the **Total Recall Setup** entry. When you save a Total Recall setup, the QWERTY pop-up will appear so you can enter a suitable name for the setup. Once entered, the name of the last setup saved will be displayed in this 'name' box. A saved setup is also automatically stamped with the current time and date, regardless of whether you give the setup a name or not.

Although you need to understand the connection between Total Recall setups and Project Files, saving a setup in practice is simply a matter of pressing the dedicated SAVE TR button on the computer front panel. This will save a Total Recall setup to disk, regardless of the state of the Save tick for **Total Recall Setup** in the **Settings** pop-up. Note that this function only works when the **MIX-DESK** display is on the screen.

Since this separate facility exists to save Total Recall setups, it makes sense to disable the **Total Recall Setup** entry from a save in the **Settings** pop-up, so that you will not accidentally take a new setup each time you save other project elements with the SAVE PROJECT function. If you *do* wish to save a TR setup from the SAVE PROJECT button, please note that, as well as having a cross in the Safe column and a tick in the Save column, **Auto** on the **Settings** page must be turned *off*.

Info for Item: Total Recall Setup

6:	ruff	29-Jul-96 07:35:09 PM
5:		29-Jul-96 12:44:48 PM
4:	Guide	27-Jul-96 02:01:06 PM
3:	SL9000 Product Guide	27-Jul-96 12:42:28 PM
2:	Product Demo	27-Jul-96 12:23:14 PM
1:		

Ask for Info when Saving
Edit Info

FILE/SETUP	DiskTrack	Proj. Title: BedBug		
MIX-DESK	Overview	Edit	Settings	Info
RECALL	Events	Automation	Load	New Project
MACHINES	Snapshots	Groups	Save	Copy Project
MISC	Faders	Project	Clear	Reminder

1

FILE/SETUP			
MIX-DESK	Autoscan	Auto Compare	
RECALL	Manual	Options	Set Auto Objs - This Channel
MACHINES	Calibrate	Channel Objects	Set Auto Objs - All Channels
MISC	Copy/Swap	Centre Objects	

To view a list of the setups you have previously saved, return to the **Settings** pop-up and stab in the 'name' box directly underneath the **Total Recall Setup** entry. A pop-up appears (see opposite), listing all the setups and their names. To change a setup's name, hit **Edit Info** at the bottom of the pop-up and stab on the item you wish to rename. Once again, the QWERTY pop-up appears for entry of the new name. Deselect **Edit Info** when finished.

Optionally, you can choose whether the QWERTY pop-up automatically appears when you save a setup or not. Toggle the box in the lower left of the setup list to switch between **No Info when Saving** and **Ask for Info when Saving**. Remember that if you do not name a setup, it will be automatically numbered and stamped with the current time and date.

Recalling Setups

Once Total Recall setups have been saved, they can also be recalled at any future time via the **Settings** pop-up. First of all, you must, of course, have selected the correct Project File, if this is not the current project. If you are not familiar with this procedure, please read Section 2.

Now select the PROJECT SETTINGS button (**MIX-DESK/Project/Settings**) and stab on the box beneath the **Total Recall Setup** entry. This will call up a list of Total Recall setups for the currently selected project. Stab on the setup you require and the status bar will confirm that the system is loading your setup. Once loaded, stab outside the list to clear it, and then deselect the PROJECT SETTINGS button.

Having loaded the correct setup you now need to access the **RECALL** menu. This can either be selected on the screen or by simply pressing the 'Master Menus' **RECALL** button on the computer front panel. Note that the blue box above the menu confirms the name of the setup you have selected. Select **Manual** and the screen will look similar to that shown opposite.

The main area of the display is taken up by a graphic representation of Channel 1. A normally blank area, to the right of the channel display, will show the Large Fader if you are working with the fader motors off. (Note that, in order to enable a display of the Large Fader, the 'not motorised' condition must be set in the **FILE/SETUP/Desk Config/Desk Layout** menu (see Section 9), and is not subject to the current selection of the front panel's **MOTORS ON/OFF** button.) When a Total Recall setup is associated with an automated mix, recalling that mix with the motors on will, of course, enable Large Fader levels to be reset automatically.

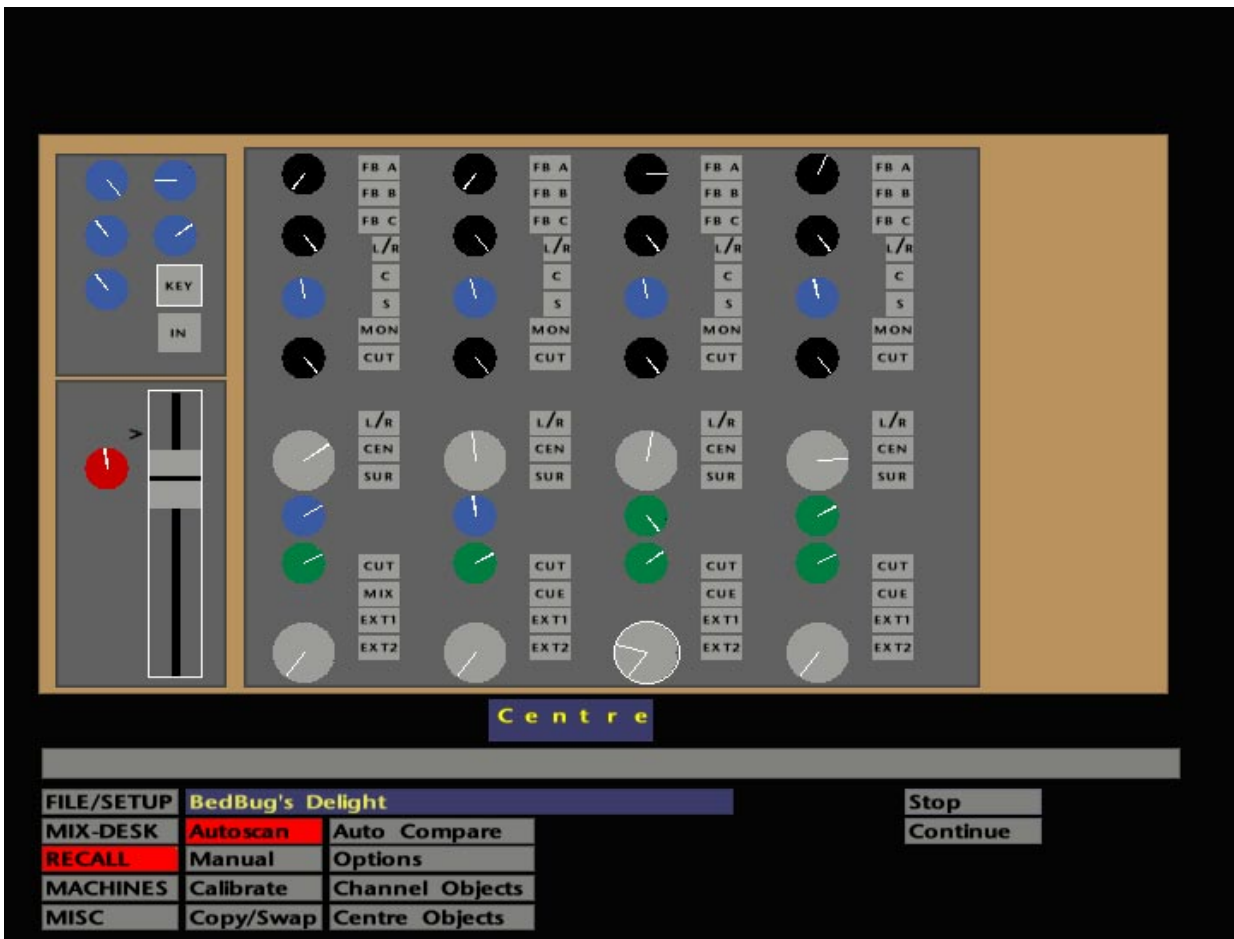

Before proceeding, check whether any of the controls on Channel 1 are incorrectly set. The chances are, if you have been experimenting as you read this manual, the setup you are currently viewing is the one you last saved, and no controls have changed in the intervening period! Move some of the controls on Channel 1 to see the effect.

Incorrectly set controls will be shown with a white outline. Rotary controls also indicate the current position and the stored position with two white lines; turn the control until the white outline disappears. Press incorrectly set switches to achieve the same result. Incorrectly set faders should be moved to the level marked by a little >, at which point the white outline will disappear.

If you have just set the controls correctly for Channel 1, you are now faced with the task of resetting controls on all the other channels *and* in the centre section. Before you faint at the prospect, read on and discover some of the useful entries in the **RECALL** menu.

The RECALL Menu

Several options are provided in this menu to speed, and generally aid, the reset process:

Autoscan

This extremely useful feature will scan through the desk, starting at Channel 1, looking for discrepancies between the stored and current positions of all controls. To start the scanning process, select the **Autoscan** box. When an incorrectly set control is located, that channel (or the centre section) will be displayed on the screen; reset the controls as described above. If required, you can choose to ignore sections of the console in the scanning process (see Page 6-7).

The scanning will continue automatically when an offending channel strip has been reset correctly. If you do not need to reset every control on a certain channel or channels, press **Continue** and the display will move on to the next offending control. To cancel out of **Autoscan** press **Stop**.

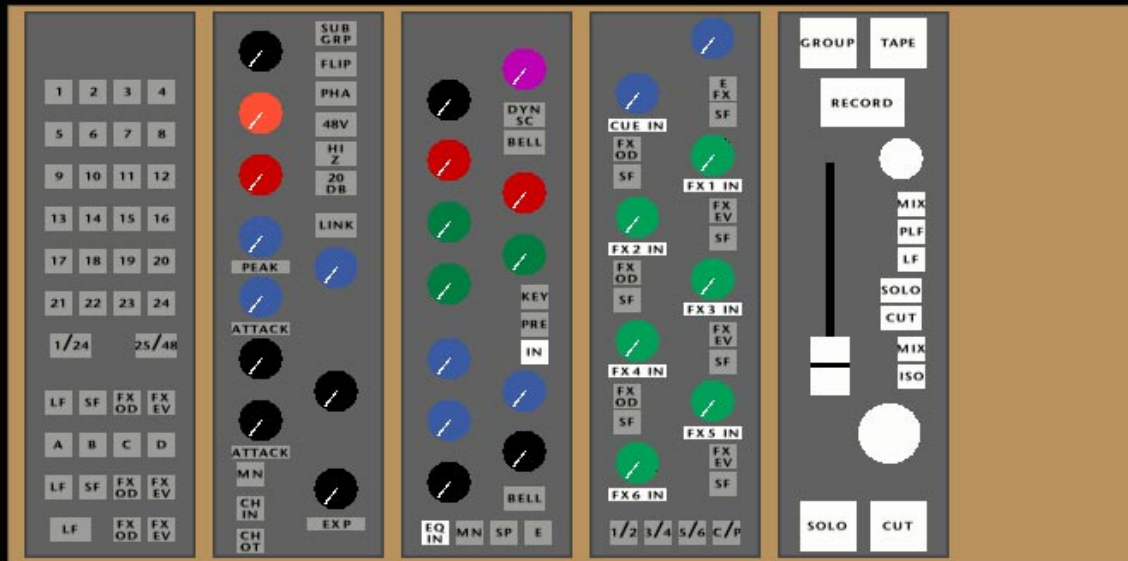

FILE/SETUP	BedBug's Delight			Routing	Flip	EQ	Flip
MIX-DESK	Autoscan	Auto Compare		Inputs	Flip	FX	Flip
RECALL	Manual	Options		Dynamics	Flip	Fader	Flip
MACHINES	Calibrate	Channel Objects					
MISC	Copy/Swap	Centre Objects					

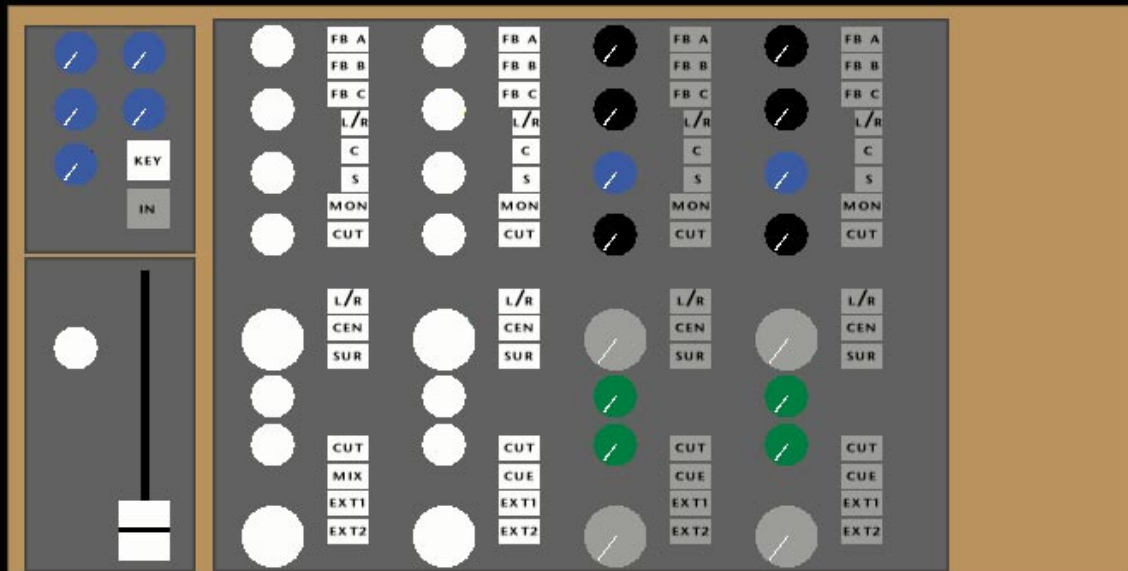

FILE/SETUP	BedBug's Delight		
MIX-DESK	Autoscan	Auto Compare	
RECALL	Manual	Options	
MACHINES	Calibrate	Channel Objects	
MISC	Copy/Swap	Centre Objects	

Setting the Level of Autoscan

To speed the Autoscan process, you can specify those sections of the channel strip and centre section that you are *not* interested in. For example, you may simply want to check/reset the EQ settings across the console, in case someone has tweaked them during your lunch break. In this case, you can specify that the system should ignore all other controls apart from the EQ.

Select **Channel Objects** and a graphic picture of a channel strip will appear (see opposite). The panel to the lower right of the display gives you the choice of ignoring the **Routing** section, the **Inputs** section, the **Dynamics**, **EQ**, **FX Sends**, **Small Fader**, and optionally the Large Fader when displayed. Stabbing on the **Flip** box for any section will toggle selected/deselected controls. Individual objects can be selected by simply stabbing on the display; stab again to deselect. Once selected, the controls to be ignored will be highlighted in white.

Selecting **Centre Objects** provides similar functions as above but for the centre section of the console (see lower screen opposite). Stab on the objects you wish to have Autoscan ignore, and they will be highlighted in white. The sections that are covered by Total Recall include: Echo Returns, the Stereo Busses, the Cue/FX Master Sends, Studio Loudspeakers and Studio Headphones controls, the Compressor, the Master Fader and associated Offset control.

Manual Resetting

There may well be occasions when you need to reset single controls, or just a few controls on a single channel. In this case, select **Manual** which, by default, will display the settings on Channel 1. If you are re-entering **Manual**, the system will display the last channel selected. To view another channel, either press that channel's Large Fader status button, or stab on the number below the channel display and drag the pen sideways to increment/decrement the channel number.

To access the centre section, either press the Master Fader's status button or stab on the channel number on the screen and drag the pen upwards. If you are working with the Large Fader motors turned off (see Page 6-3), dragging the pen further upwards will also give you a display of the Control Group Fader levels. To return to the channels display, stab on **Centre** or **Groups** and drag downward, or select a channel fader status button.

Note that, in **Manual** mode, objects that have been selected in the **Channel** and **Centre Objects** displays (see above), will appear as follows: deselected rotary controls still indicate their current and recorded settings but don't have white surrounds; switches, however, only indicate their status by a white surround and you will see no visual effect when you change their state.

The **Set Auto Objs - This Channel** box, when stabbed, will automatically reset all the automated objects for the currently selected channel. **Set Auto Objs - All Channels** does the same for all channels! See also **Set/Ignore Auto Objects** in the Total Recall **Options** menu (Page 6-11).



Copy and Swap

This enables you to copy or swap a variety of information from one channel to another. Select **Copy/Swap** and this calls up the Copy And Swap Channel Data pop-up.

The various types of items that can be dealt with here should be obvious from the screen shown opposite. By toggling a cross to a tick in the column to the right, you can select which types of information you wish to copy or swap. For example, if you are only interested in Total Recall, select a cross for all elements and a tick for **Total Recall Setup**.

If you have transferred data from one facility to another, you may well want to select additional elements to copy or swap. This is particularly relevant when the facility you are now working in has a different size of console, or the console has a different layout to the one you started out on.

You can elect to carry out a **Single** or **Multiple Copy** by toggling the box to the upper right of the pop-up. For a **Single Copy**, select the channel you wish to copy the data from by stabbing on the left hand **Channel** in the banner at the top of the pop-up. A numerical keypad will appear in which you enter the channel number. Alternatively, press the Large Fader status button for the same result. Stab on the right hand **Channel** to enter the destination channel number numerically, or simply press the Large Fader status button on the destination channel.

For a **Multiple Copy** of data from one channel to several others, enter the source channel as above. To specify the destination channels, stab on **Multiple Channels** and enter your selections into the **Channel Selector** (if you are not familiar with this pop-up, see Section 1).

When you are satisfied with your source and destination selection(s) stab on **Do It** to complete the operation. If you now do an **Autoscan** or select **Manual** for the relevant channels you will see the source settings displayed on the destination channels. Reset as necessary and then save a new setup to disk by pressing the SAVE TR button on the front panel.

To swap information from one channel to another, stab on **Copy** to toggle it to **Swap**. The selection procedure for channels is the same as described above for the **Single Copy** function.

Clear the **Copy/Swap** pop-up by stabbing outside it.

FILE/SETUP	BedBug's Delight			
MIX-DESK	Autoscan	Auto Compare	Hysteresis = 10	
RECALL	Manual	Options	Manual Calibrate	Channels
MACHINES	Calibrate	Channel Objects	Ignore Auto objects	Centre
MISC	Copy/Swap	Centre Objects		

Comparison of Computer-Data & Desk-State

1	2	3	4	5	6	7	8	9	10	11	12	13	14	15	16	17	18	19	20	21	22	23	24
25	26	27	28	29	30	31	32	33	34	35	36	37	38	39	40	41	42	43	44	45	46	47	48
49	50	51	52	53	54	55	56	57	58	59	60	61	62	63	64	65	66	67	68	69	70	71	72
73	74	75	76	77	78	79	80	81	82	83	84	85	86	87	88	89	90	91	92	93	94	95	96
97	98	99	100	101	102	103	104	105	106	107	108	109	110	111	112	113	114	115	116	117	118	119	120

SOLO CUT SOLO CUT SOLO CUT SOLO CUT SOLO CUT SOLO CUT SOLO CUT SOLO CUT

Summary Rescan Rewrite

FILE/SETUP	BedBug's Delight	
MIX-DESK	Autoscan	Auto Compare
RECALL	Manual	Options
MACHINES	Calibrate	Channel Objects
MISC	Copy/Swap	Centre Objects

The Options Menu

Hysteresis – The Hysteresis value determines the accuracy window when resetting controls. The default value is 10 and should not need changing unless instructed to do so by qualified SSL personnel.

Auto Calibrate/Manual Calibrate – With **Auto Calibrate** selected, the state of the desk is checked every time that Total Recall is activated. This effectively checks the reference voltages which are necessary for the accuracy of the Total Recall system. If set to **Manual Calibrate**, the desk will be checked the first time Total Recall is entered after the system has booted up, or when you hit **Calibrate** in the main **RECALL** menu. **Calibrate** can be selected at any time you feel there may be a problem with one of the channels. Report any resultant error messages to suitably qualified personnel.

Set/Ignore Auto Objects – This determines whether the channel strips' automated objects are reset or ignored when you play back data with either **Autoscan** or **Manual**. Just to remind you, the automated objects are: FX Sends 1-6 On/Off, Cue Stereo On/Off, Insert In/Out, EQ In/Out, Small Fader Cut and Large Fader Cut.

If **Channels** and **Centre** are selected (blue), this indicates that you wish them to be autoscanned. A **Groups** box will additionally appear here if **Large Faders Not Motorised** is set in the **FILE/SETUP/Desk Config/Desk Layout** pop-up (see Section 9). Stabbing on **Channels** or **Groups** will call up the Channel or Group Selector pop-up where you can select/deselect those channels/groups you wish to be included in an Autoscan. Do this by either toggling selections on the pop-ups or by pressing fader status buttons.

Auto Compare

Auto Compare (in the main **RECALL** menu) when selected, displays a grid of the potential 120 channels on your J Series Console (see opposite). This is a diagnostic tool used to check that the data held in the computer for automated switches, and the actual switch state on the console, are the same. The grid shows a comparison between the physical desk state and currently loaded computer data. Channels are represented by boxes – if the box is green, computer data and the desk state match. Red indicates that there is a mismatch.

Stabbing on a channel box brings up a pop-up which displays the various automated objects, shows in what state the computer says the object was last written and in, and in what state the console switch is currently positioned. The computer can only display what it thinks the Group Cut and Solo positions are; check visually for a mismatch.

Selecting **Summary** gives an overall itemised list of positions on the console. If there is a discrepancy, the computer and desk will only agree on 'nn' (being the correct channels) – this being less than the total channels. The mismatch will be highlighted in red.

Selecting **Rescan** re-reads the switch positions. Selecting **Rewrite** will store the switch positions again, thus creating a new reference between actual switch position and current computer data.

Solid State Logic
SL 9000 J Series
Total Studio System

Computer Operator's Manual

SECTION 7

The Machines Menu



The screenshot displays a terminal window with a list of services and a navigation menu. The service list has columns for ID #, Service, M S D, VID, Type, Info, and Name. The 'M S D' column contains yellow and red highlights. The 'VID' column has red arrows. The 'Name' column has a scroll bar. Below the list are buttons: Find, Save, Follow, Back, Clear, Revert, and Update.

ID #	Service	M	S	D	VID	Type	Info	Name
1833								TODDLER
2116	Store.Route	M	S	D	◀*	DiskTrack	V2.1/1	9K DiskTrac
1484	Disk	M	S	D		ScsiNet	V2.0/1	Dev 2
952	Mix	M	S	D	*▶	VisionTrack	V3.0/18	VisionTrack
490	Panel	M	S	D		NineK FP	V1.5/6	Host=1833
1970		M	S	D		Analogue rio	V1.0/0	9K ARIO
2077		M	S	D				
1645		M	S	D		KeyPad	V1.2/0	Host=1833
		M	S	D				
		M	S	D				
		M	S	D				
		M	S	D				

Buttons: Find, Save, Follow, Back, Clear, Revert, Update

FILE/SETUP	Network	DiskTrack
MIX-DESK	Serial	Relay Box
RECALL	SS Slaves	TC Gen
MACHINES	PatchBay	Routing
MISC	Scorer	KeyPad

The Machines Menu

The **MACHINES** menu provides access to a host of facilities. This section covers these in detail, unless discussed elsewhere in this manual.

Network

The **Network** page provides a table of SSL devices currently connected to the system 'network', and is used to set up control relationships between the J Series Computer and any interconnected SSL Digital Products. These may include ScsiNet (a remote magneto-optical disc drive – the 'MO'), DiskTrack, Remote I/O units, KeyPad, VisionTrack, SSL PatchBays, etc. Fast access to some of these devices is provided by the pen 'swipe' facility, which is also set up on this page.

The **Network** page will normally be configured on installation, but access may be required occasionally to reset various options or select devices on or off-line.

On selecting **MACHINES/Network** a display similar to that shown opposite will appear. The main area of the screen is taken up with the table of devices.

Processor ID and Name

Above the table to the left is a box showing the J Series processor's unique ID number. This cannot be changed and is entered on boot up. To the right is a box showing the name currently assigned to the processor. This can be changed by stabbing on the box and entering a new name on the QWERTY pop-up or on the dedicated QWERTY keyboard. Press **END** on the pop-up or Enter on the dedicated keyboard to confirm the entry.

Devices Table

On the left of the table, the first column shows the unique **ID#** of the device Type named to the right of the table, eg. ScsiNet, Keypad, etc. For a standard system, ie. no additional devices connected, the Network page will show the default devices: **NineK FP** (the computer front panel on the console) and **ScsiNet**.

The screenshot shows a computer interface with a menu on the left and a table of device information on the right. The menu is open, showing options like 'Film.Panel', 'ADR Visuals', 'Film.Scorer', 'Video Play/Rec', 'RemoteVideo', 'Master', 'Slave', 'Takes Swipe', 'Store.Route', 'Panel', 'AudioRouter', 'Mix', 'Edit', 'DiskRouter', and 'Disk'. The table has columns for ID #, VID, Type, Info, and Name. Below the table is a 'Find' field and an 'Update' button. At the bottom, there is a table with categories like FILE/SETUP, MIX-DESK, RECALL, MACHINES, and MISC, each with sub-items.

ID #	VID	Type	Info	Name
1833				TODDLER
2116	D	DiskTrack	V2.1/1	9K DiskTrac
1484	D	ScsiNet	V2.0/1	Dev 2
952	D	VisionTrack	V3.0/18	VisionTrack
490	D	NineK FP	V1.5/6	Host=1833
1970	D	Analogue rio	V1.0/0	9K ARIO
2077	D			
1645	D	KeyPad	V1.2/0	Host=1833
	D			
	D			
	D			
	D			
	D			

FILE/SETUP	Network	DiskTrack
MIX-DESK	Serial	Relay Box
RECALL	SS Slaves	TC Gen
MACHINES	PatchBay	Routing
MISC	Scorer	KeyPad

In the case of ScsiNet drives, if there is more than one on the network, a red box in the **Type** column indicates which device may be currently accessed. To change to another device, stab in the appropriate box, which will toggle red to show the new selection.

The **Info** column shows the software version being run on that device. Entries in the **ID**, **Type** and **Info** columns are automatically generated when the SL 9000 J system is initialised on commissioning.

Entries for individual devices in the **Name** column are either set up by the user in the case of ScreenSound and VisionTrack, or automatically generated as serial (**S/N**) or device (**Dev**) numbers by the devices themselves. None of the entries can be altered from this page.

In the **Service** column, you will see the function of the devices. Entries are made by stabbing on the box, and selecting the appropriate function, **Panel**, **Disk**, **Store Route**, etc., from a pop-up list (see opposite). When the pop-up appears, the function, as determined by the system, will be highlighted in bright red. To confirm, stab on the entry and press **OK**.

If DiskTrack is fitted to your system, note that **Store Route** must be present in the **Service** column for DiskTrack, in order to display DiskTrack entries in the J Series Computer's menus.

Master/Slave Selections

The next three columns indicate whether a device is currently a Master, a Slave, or capable of drop-in recording. The appropriate box, **M**, **S** or **D** will be highlighted to show the devices' relationship to the J Series Computer. In a SL 9000 J Series system, **D** is only applicable to DiskTrack. Master/Slave relationships affect transport control.

Normally, the J Series Computer will be the network Master. If, for example, a VisionTrack is connected as a Slave, this relationship can reverse when the pen and tablet are controlling VisionTrack, ie. VisionTrack becomes the Master and the J Series Computer becomes a Slave. (See also **Follow** on Page 7-5).

Regardless of pen and tablet control, Master/Slave relationships can be set up by simply selecting the appropriate box.

ID #	Service	M	S	D	VID	Type	Info	Name
1833								TODDLER
2116	Store.Route	M	S	D	✦	DiskTrack	V2.1/1	9K DiskTrac
1484	Disk	M	S	D		ScsiNet	V2.0/1	Dev 2
952	Mix	M	S	D	✦	VisionTrack	V3.0/18	VisionTrack
490	Panel	M	S	D		NineK FP	V1.5/6	Host=1833
1970		M	S	D		Analogue rio	V1.0/0	9K ARIO
2077		M	S	D				
1645		M	S	D		KeyPad	V1.2/0	Host=1833
		M	S	D				
		M	S	D				
		M	S	D				
		M	S	D				
		M	S	D				

Find Save Follow Back Update
Clear Revert

FILE/SETUP	Network	DiskTrack
MIX-DESK	Serial	Relay Box
RECALL	SS Slaves	TC Gen
MACHINES	PatchBay	Routing
MISC	Scorer	KeyPad

Swipe Control

The next column will show a combination of red asterisks and yellow chevrons (< > etc.). A red asterisk shows that the device is currently on line and that communications are working correctly. The chevrons indicate the 'swipe' direction. Swipes enable you to transfer pen control to other devices connected to the network. To set up a swipe, or change an existing swipe direction, press the pen in the box and make a short swipe in the required direction. A (new) yellow chevron will appear.

To remove a swipe chevron entirely, press the pen on the asterisk and move slowly and slightly in the current direction of the chevron.

Follow

Follow is designed to switch Master control to whichever device is currently being controlled by the pen and tablet.

For example, with **Follow** selected (red) on the J Series Computer, when you swipe to VisionTrack, it will automatically become the Master and the J Series Computer will become a Slave. When you swipe back to the J Series Computer, the system will revert to the J Series Computer being the Master and VisionTrack the Slave. If **Follow** is not selected, current Master/Slave relationships will remain unchanged when control is switched.

Back

Back is provided as a quick means (without swiping) to get back to the device you last had control of. This only applies to the J Series Computer and VisionTrack. The principle assumes that you will be displaying the Network page for both devices, and is normally only used in initial setting up, before swipe settings may have been established.

Video Switcher Inputs

The **VID** column in the table shows to which of the J Series Computer's two external video inputs that device is connected. The appropriate input will be selected automatically with a swipe as above, as long as the **VID** box is selected (red). Stab in the column to make a new entry on the numeric pop-up which appears. The video input selected will be displayed on the internal console monitor and its external duplicate monitor when the VIDEO 1 button on the front panel is selected.

Save and Revert

The current Network page parameters may be saved to the J Series Computer's system disk by selecting **Save**. Subsequent to any alteration, the last saved settings may be restored by selecting **Revert**.

Clear and Find

For a complete re-write of the Network page, select **Clear**, which clears all entries, followed by **Find**. When **Find** is selected, a pop-up allows the search of selected, or all, devices. Select those devices you wish to search for, or simply hit **OK** for all devices.

The system will then check that the appropriate devices are currently connected to the network, and automatically enter their details in the **ID#**, **Type**, and **Info** columns. **Clear** and **Find** are normally used only during installation or as maintenance tools.

Update

This is a useful service tool for the unlikely occasion when a device on the network has lost communications with the J Series Computer. Stab on the **Update** box to get the J Series Computer to poll the network for devices. As soon as communications have been re-established, that device will appear in the table.

Serial

The serial machine control facilities, available on selection of **Serial** in the **MACHINES** menu have been fully discussed in Section 3 – Machine Control.

SS Slaves

This menu is used to set up any ScreenSounds connected to the system. Normally this will be carried out by the SSL commissioning engineer and the following paragraphs are for information only.

Selecting **SS Slaves** in the **MACHINES** menu calls up the ScreenSounds Slaves Setup menu (see opposite). Stab on **Load Network**. This causes the system to check the network and display any connected ScreenSounds on this pop-up. Now the physical bay(s) of the console, to which the ScreenSound(s) is (are) connected, must be specified. Stab on the box to the right of the ScreenSound Serial Number, and another pop-up will appear with a list of console bays; stab on the required bay.

The **Disabled** box must be toggled to **Slave** to put ScreenSound on-line. To arm Screensound for record functions, toggle the **Rec** box to red (this turns ScreenSound's **Multi-In** on). Once all connected ScreenSounds are setup, hit **Initialise S/S**. This activates the ScreenSound **Multi Out** function. The system is now ready for use.

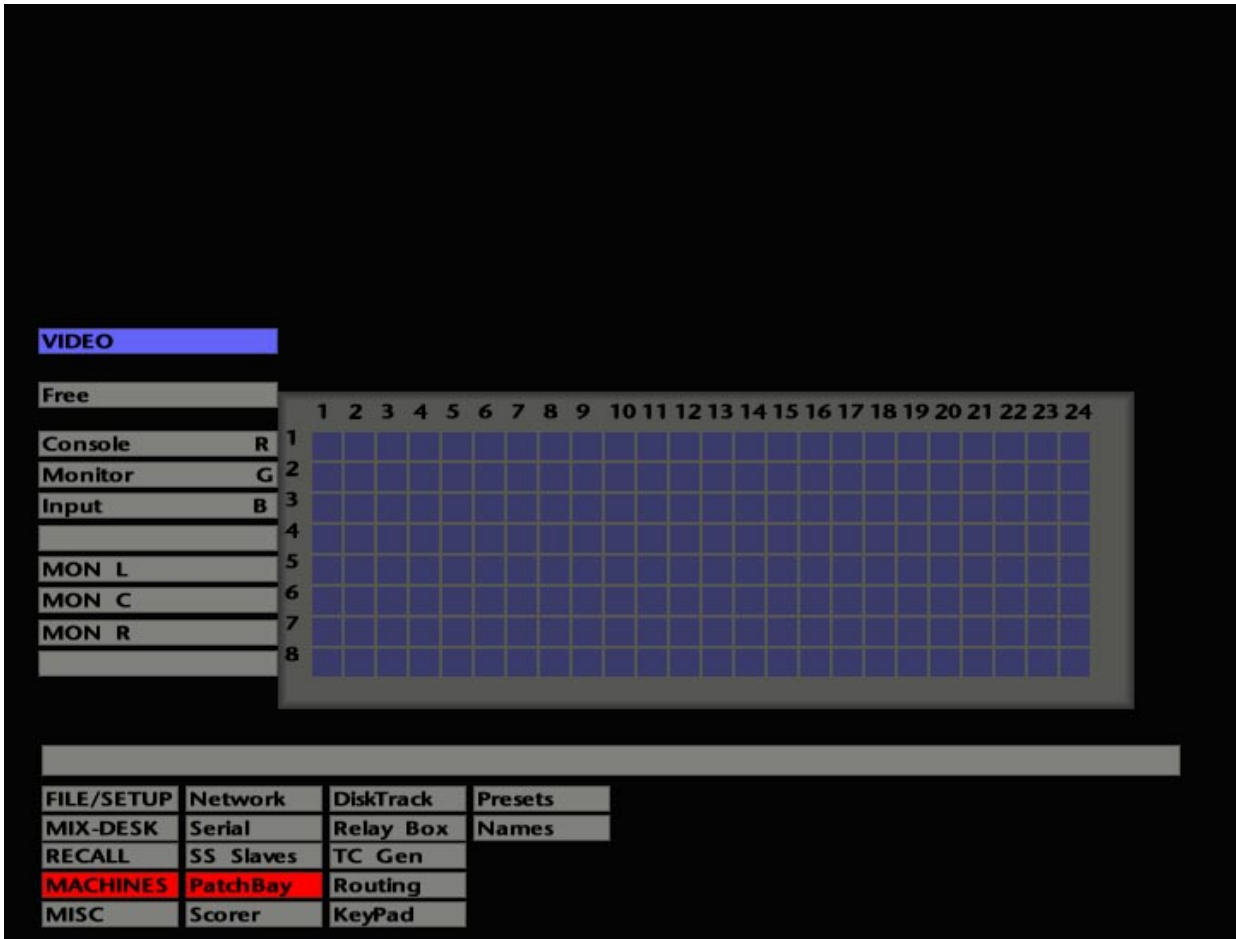

PatchBay

SSL's PatchBay is a 24 x 8 automated router unit, which may be controlled directly from the J Series Computer. Each crosspoint comprises a balanced relay closure to provide a true bi-directional selection. PatchBays can be equally used with analogue audio, AES/EBU digital audio or machine control lines. If PatchBays are currently not fitted in your system, contact your local SSL office or distributor for more details.

Select **MACHINES** followed by **PatchBay**. The screen will look similar to that shown opposite, and comprises three main areas. Note that this will show information for the last PatchBay on the system accessed via this display.

Input/Output Names

To the left of the crosspoint display you will see a column of 'row' boxes. These show the current assignments for the 8 inputs/outputs of that PatchBay.

Normally, the basic settings for this display will be established during the system commissioning period. The following instructions are provided should you wish to change the function of a particular PatchBay.

The legends in the 'row' boxes are selected for individual PatchBays by stabbing on the upper box (**Free** in the example opposite). This produces a pop-up from which alternative functions may be selected for the current PatchBay. If **Free** is selected on this pop-up, custom legends for the inputs/outputs may be entered by stabbing on individual row boxes. Enter the name on the QWERTY keyboard pop-up and press **END**.

If **Names** (in the lower half of the screen) is selected, the current assignments for the 24 inputs/outputs will be seen above the crosspoint display. New entries may be made, or existing entries changed, by stabbing on one of the boxes. Enter the name on the QWERTY keyboard pop-up and press **END**.

Do not attempt to change these input/output entries unless the installation has been altered.

The Crosspoint Display

Most of the screen is taken up with the crosspoint display, above and to the left of which you will see the name, eg. VIDEO, INPUTS or OUTPUTS etc., given to the PatchBay you are currently viewing.

Connections may be simply made by stabbing on the appropriate square in the grid. Each input-to-output assignment is unique; successful connections will show with a yellow square. If the PatchBay unit is local to your operating position, you will hear a faint mechanical click as each assignment is made and the corresponding red LEDs will light on PatchBay's front panel.

The screenshot shows a terminal window with a 'MACHINES' window open. The 'MACHINES' window has a table with the following data:

Serial	Name	Local
1211	VIDEO	X

Below the table are buttons: Quit, Delete, Show All, and Lock. To the left of the 'MACHINES' window is a 'VIDEO' window with a list of items:

- Free
- Console R
- Monitor G
- Input B
- MON L
- MON C
- MON R

At the bottom of the terminal window is a menu:

FILE/SETUP	Network	DiskTrack	Presets
MIX-DESK	Serial	Relay Box	Names
RECALL	SS Slaves	TC Gen	
MACHINES	PatchBay	Routing	
MISC	Scorer	KeyPad	

The screenshot shows a terminal window with a grid of 60 blocks. The blocks are arranged in a 6x10 grid:

12 Block 12	24 Block 24	36 Block 36	48 Block 48	60 Block 60
11 Block 11	23 Block 23	35 Block 35	47 Block 47	59 Block 59
10 Block 10	22 Block 22	34 Block 34	46 Block 46	58 Block 58
9 Block 9	21 Block 21	33 Block 33	45 Block 45	57 Block 57
8 Block 8	20 Block 20	32 Block 32	44 Block 44	56 Block 56
7 Block 7	19 Block 19	31 Block 31	43 Block 43	55 Block 55
6 Block 6	18 Block 18	30 Block 30	42 Block 42	54 Block 54
5 Block 5	17 Block 17	29 Block 29	41 Block 41	53 Block 53
4 Block 4	16 Block 16	28 Block 28	40 Block 40	52 Block 52
3 Block 3	15 Block 15	27 Block 27	39 Block 39	51 Block 51
2 Block 2	14 Block 14	26 Block 26	38 Block 38	50 Block 50
1 Block 1	13 Block 13	25 Block 25	37 Block 37	49 Block 49

Below the grid is a 'Make Block' button. To the left of the grid is a 'VIDEO' window with a list of items:

- Free
- Console R
- Monitor G
- Input B
- MON L
- MON C
- MON R

At the bottom of the terminal window is a grid with columns labeled 1 through 24 and rows labeled 1 through 8.

Accessing Other PatchBays

To access other PatchBay units, stab on the 'name' box. A pop-up will appear, listing those patchbays currently available (see opposite). Stab on the name or ID number of another unit, and the pop-up will clear to reveal that PatchBay's display.

Entries in the pop-up's **Local** column toggle between a tick or a cross. Subject to the setting of the **Show All/Show Local** box at the foot of the pop-up, the list may either show all PatchBays on the network or only those local to this J Series Computer.

The basic information on this pop-up will be set on installation, and should not require altering unless more PatchBays are added to the system. The PatchBay ID number is automatically entered on installation. If you wish to change the name of any PatchBay, stab on **Lock** to select **Edit** mode. Now by stabbing in the **Name** column, any PatchBay may be given a (meaningful) name via a QWERTY pop-up.

Entries for PatchBays which are no longer on the network, or erroneous entries, may be deleted by selecting **Delete**, followed by a stab on the appropriate entry in the **Serial** column.

Presets

By selecting **Presets**, the area above the crosspoint display will switch and scroll down automatically to show five columns of 60 numbered boxes (see opposite). These are used to set up preset routing assignments for use with the front panel's macro key function.

Once again, these assignments will normally be set up on installation, and the associated macro control button on the front panel may have been engraved with the name of the key's function. Alternatively, current macro key functions may be ascertained from the macro **Define** menu **Name** pop-up.

The small yellow box in each case shows the preset number. This box may also be used to activate the preset. The second larger box, which is used to enter the routing assignment information, may show "Block XX", unless a preset name has been entered (see below). Up to eight crosspoint assignments may be controlled by each preset.

Stabbing on one of these 'Block' boxes produces a pop-up which allows assignments to be made for the eight Inputs/Outputs represented by the vertical axis of the crosspoint display. The pop-up will show any existing assignments on the specified PatchBay for that preset and these should not be altered unless you have a clear understanding of the consequences.

12	Block 12	24	Block 24	36	Block 36	48	Block 48	60	Block 60
11	Block 11	23	Block 23	35	Block 35	47	Block 47	59	Block 59
10	Block 10	22	Block 22	34	Block 34	46	Block 46	58	Block 58
9	Block 9	21	Block 21	33	Block 33	45	Block 45	57	Block 57
8	Block 8	20	Block 20	32	Block 32	44	Block 44	56	Block 56
7	Block 7	19	Block 19	31	Block 31	43	Block 43	55	Block 55
6	Block 6	18	Block 18	30	Block 30	42	Block 42	54	Block 54
5	Block 5	17	Block 17	29	Block 29	41	Block 41	53	Block 53
4	Block 4	16	Block 16	28	Block 28	40	Block 40	52	Block 52
3	Block 3	15	Block 15	27	Block 27	39	Block 39	51	Block 51
2	Block 2	14	Block 14	26	Block 26	38	Block 38	50	Block 50
1	Block 1	13	Block 13	25	Block 25	37	Block 37	49	Block 49

VIDEO		Make Block																								
Free		1	2	3	4	5	6	7	8	9	10	11	12	13	14	15	16	17	18	19	20	21	22	23	24	
Console	R	1																								
Monitor	G	2																								
Input	B	3																								
		4																								
MON L		5																								
MON C		6																								
MON R		7																								
		8																								

The preset may be named by stabbing in the **Name** box and entering up to eight characters via the QWERTY pop-up or dedicated keyboard. To define or alter the serial number/name of the PatchBay to which the preset relates, stab on the **PatchBay S/N** box and select the required PatchBay via the pop-up. (This pop-up is the same as the one used to select different PatchBay crosspoint displays.)

The three boxes designated **1-8**, **9-16** and **17-24** enable 'block' assignment to be quickly set up. Simply stab on the box which will make the required connections (these selections toggle). For more specific assignments, stab on a box in the **Column** row and enter an appropriate Input/Output number (1-24) on the numeric pop-up. **Clear** may be used to clear any erroneous or existing assignments. **OK** out of the preset pop-up.

An alternative method is provided so that the assignments for each preset may be set up on the crosspoint display itself. It is advisable to check that the preset you intend to use is clear of any assignments before you carry out this procedure, as previous assignments will be ignored when entering new assignments by this method.

Select **Make Block**. Now stab on the crosspoint display to make up to eight assignments. To enter these into the required preset, stab on a 'Block' box. Stab on the 'Block' box again to check that the preset applies to the correct PatchBay, and enter a name if desired.

The action of any preset may be tested here by stabbing on the yellow box to the left of the 'Block' box, to toggle the preset on/off. You must of course have the relevant PatchBay display currently selected in order to see the result.

FILE/SETUP	Network	DiskTrack			
MIX-DESK	Serial	Relay Box	LTC Gen	Offset: +0:00:00:00	
RECALL	SS Slaves	TC Gen		LTC Gen when Stopped	
MACHINES	PatchBay	Routing	MTC Gen	Offset: +0:00:00:00	
MISC	Scorer	KeyPad		Midi zero now	Midi time now

DiskTrack

For those of you who have DiskTrack interfaced to your system, this entry in the **MACHINES** menu provides access to the **Configure** pop-up. This enables DiskTrack record arming and track record times to be configured. For more details see the DiskTrack Operator's Manual.

RelayBox

RelayBox offers 8 relay controlled Inputs and 8 Outputs, both linked to macros. Output relays may be triggered from the Events List. An unlimited number of RelayBoxes can be interfaced. Contact your local SSL office for more details.

Timecode Generation

The J Series Computer provides facilities for the generation of both Linear and MIDI timecode. Timecode outputs are provided on the rear of the J Series Computer's connector panel. Select **TC Gen** to access the timecode generation options (see opposite).

Longitudinal Timecode

Selecting **LTC Gen** will start the longitudinal timecode generator. The timecode standard will be as set in the **FILE/SETUP/Desk Setup/Timecode** menu (see Section 3). The timecode output will follow the current Desk position time, ie. the timecode value currently showing on the **MIX-DESK** timecode display.

The associated **Offset** box displays an offset between the Desk time and the start of the timecode being generated. If the required offset is known, stabbing on this box will produce a timecode calculator into which you can enter the offset. Note that this will also create an offset between LTC and MIDI timecode outputs.

The LTC output can be disabled, if required, after a pre-determined time (between 1 and 10 seconds) once the Desk has stopped. This prevents stationary timecode being sent to external devices that cannot accept it. Stab on the **LTC Gen when stopped** box and enter the required time (in seconds) on the numeric pop-up. The default setting of 0 (zero) permanently enables the LTC output.

Selecting **LTC Gen when stopped** does exactly that if you require timecode to be generated even if the Desk is put into Stop or fast wind. This will allow tape machines that incorporate timecode synchronisers to lock to the Desk.

MIDI Timecode

Selecting **MTC Gen** will start the MIDI timecode generator. As with LTC generation (see Page 7-15), the code will follow the current Desk time. Note that when the **MTC Gen** box is selected, the **LTC Gen** box will also be highlighted. The **Offset** box can be used as described for LTC generation.

Midi Zero Now zeros the MIDI timecode generator and effectively places an offset between the timecode start time and the current Desk time (unless already at 00:00:00:00). Note that this will also create an offset between MIDI and LTC.

By stabbing on **Midi Time Now** you can enter the time you wish the MIDI timecode to start. This again will effectively create an offset between MIDI time and the Desk time, *and* between MIDI and LTC.

Note that both MIDI and LTC timecode generators may be left permanently enabled, in order to run the computer as a virtual machine. This facilitates the slaving of hard disk recorder and sequencer packages to the computer.

Routing

Once again, this entry is only applicable to DiskTrack users. The Routing display (see opposite) is used to set up routes from the console to an Analogue RIO, and from the RIO to DiskTrack. The display comprises a 16 by 32 crosspoint grid with destinations for DiskTrack's outputs (another device or RIO outputs) listed across the top. Source inputs to DiskTrack (signals routed from another device, RIO inputs or remote mic pre-amps), are listed down the left hand side.

For further details, see the DiskTrack Operator's Manual.

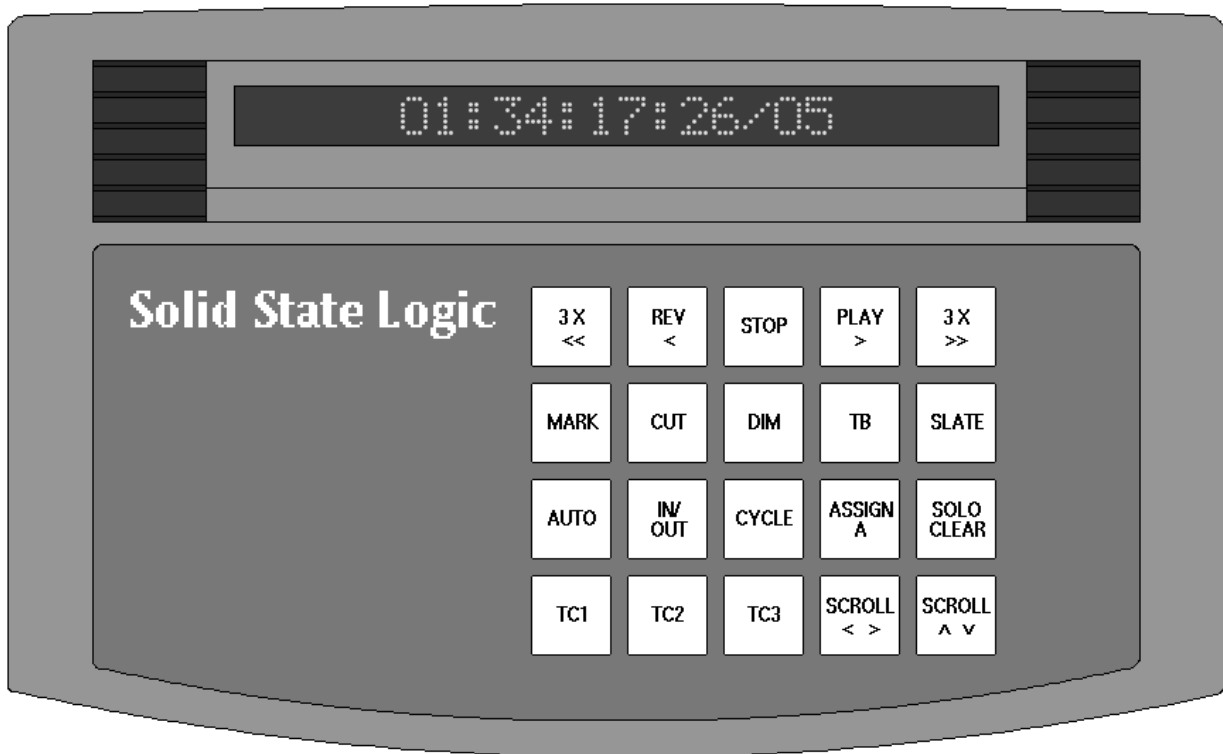

Keypad

The SSL Keypad is a small (but perfectly formed) box which connects to the SL 9000 J console via a single proprietary RJ45 cable. Up to five Keypads may be optionally connected to a single system.

Twenty keys on the Keypad can be used to mimic buttons on the console's front panel and, once programmed, provide full remote operation, with tallies back to the console buttons, and vice versa. In addition, any direct or indirect macro (see also Section 8) can be selected from the Keypad, in conjunction with layer selection by the operator, if required. Each Keypad may have its own keys programmed differently.

An LED display on the Keypad is used to show the system's current timecode position, the current Event (see Section 4), time of day and/or date, as well as providing a display of any Keypad switch name or function.

Typical Keypad key functions are shown in the drawing opposite. Many possibilities are available, and it is anticipated that these will be chosen during system specification. Any necessary macros to control these functions will be created during the system commissioning period. All you should need to do is select the appropriate key at the appropriate time!

If any key has been engraved SHOW NAME, then by holding this down and selecting any other key, the name/function of that key will be revealed in the LED display. This is particularly useful if key functions have not yet been finally decided upon, and key caps have therefore not been appropriately engraved.

Keypad Setup

Keypad switch functions and the choice of LED display content are selected via the **Keypad** display in the **MACHINES** menu. Note that a switch function should not be changed unless you have a clear idea of the consequences. The LED display, however, may be changed on a day-to-day basis, if required.

Select **Keypad** and the display will look similar to that shown opposite.

Stab on an entry in the list to the left of the display. This shows all Keypads available on the system by serial number and name (if named). Keypads can be named/renamed by selecting **Name** and stabbing on the appropriate entry in the list.

If no Keypads are listed, or an additional Keypad has been just been added to the system, select **Load Network**. Erroneous entries in the list may be removed by selecting **Delete**.



To change the LED display on a selected KeyPad, stab on the **Display** box and select, from the list which appears in the upper right of the display, a choice of:

Timecode
Time
Date
Date & Time
KeyPad S/N (Serial Number) and Name
Events

The **Show Name** function overrides any selection made here.

The lower half of the display shows the key function names for the currently selected KeyPad. Key functions are set up/changed by stabbing on the appropriate key and then selecting the required function from the scrolling list to the right of the display. Note that only one function can be assigned to any one key. Macros however (see Section 8), may comprise several different functions and, once assigned, can be actioned from a KeyPad key. Where entries in the function list are shown followed by an asterisk, you will be required to enter the number of the chosen function on a numeric pop-up.

The following functions (not listed in the same order as on screen, for clarity) are available:

The MASTER MENU buttons on the computer front panel.

The AUTOMATION buttons on the computer front panel.

The Serial Machine Control Enables and Record Arm buttons, including the **MIX-DESK** display **Arm** function (**Serial MC Arm**).

The JOG, VARISPEED, FEEDBACK and MARK (**Enter Mark**) buttons.

The TRANSPORT control buttons, **Rewind**, **Fast Fwd**, **Play** etc., including **Play x 3** and **Rev(erse) Play x 3**.

The GOTO function (**Goto TC Popup**), the five timecode locates (**GOTO 6 - 10**) and frame jog buttons (**Prev** and **Next Frame**).

All keys on the computer front panel's numeric keypad. The cursor keys below the numeric keypad and QUIT and OK buttons.

The Master Control panel DIM and Talkback Select buttons: EXT T/B, F/B A - C etc.

Macros as created in the **FILE/SETUP/Desk Setup/Define** pop-up (see Section 8).

Show Name enables other KeyPad keys to be interrogated for their name/function (see also Page 7-19).



As if all the above wasn't enough to keep you happily customising your KeyPad key functions for hours, the function list contains several other entries which we will leave you to discover for yourself.

If any of the functions are not clear, please contact your local SSL office or distributor. Many additional functions may be assigned to the KeyPad by means of macro selection (see Section 8).

Note that KeyPad programming is saved as part of the system information, not with a Project File, and cannot be overwritten by loading a new project. Custom KeyPad settings can be saved in a named file by stabbing on **Save**. First select the appropriate KeyPad from the list (or the only one if you only have one!) and hit **OK**. Name the file on the resultant QWERTY pop-up. Designate a file to be loaded at boot up by naming it **Boot_database**

To recall a file at any time, hit **Load** and select your chosen file from the resultant list. This produces a list of KeyPads; select the one you want to load the file to.

Clear may be used to clear an entry for the currently selected key or clear the currently selected LED display option. **Revert** will call up the last saved data for the currently selected KeyPad.

Solid State Logic
SL 9000 J Series
Total Studio System

Computer Operator's Manual

SECTION 8

Macros



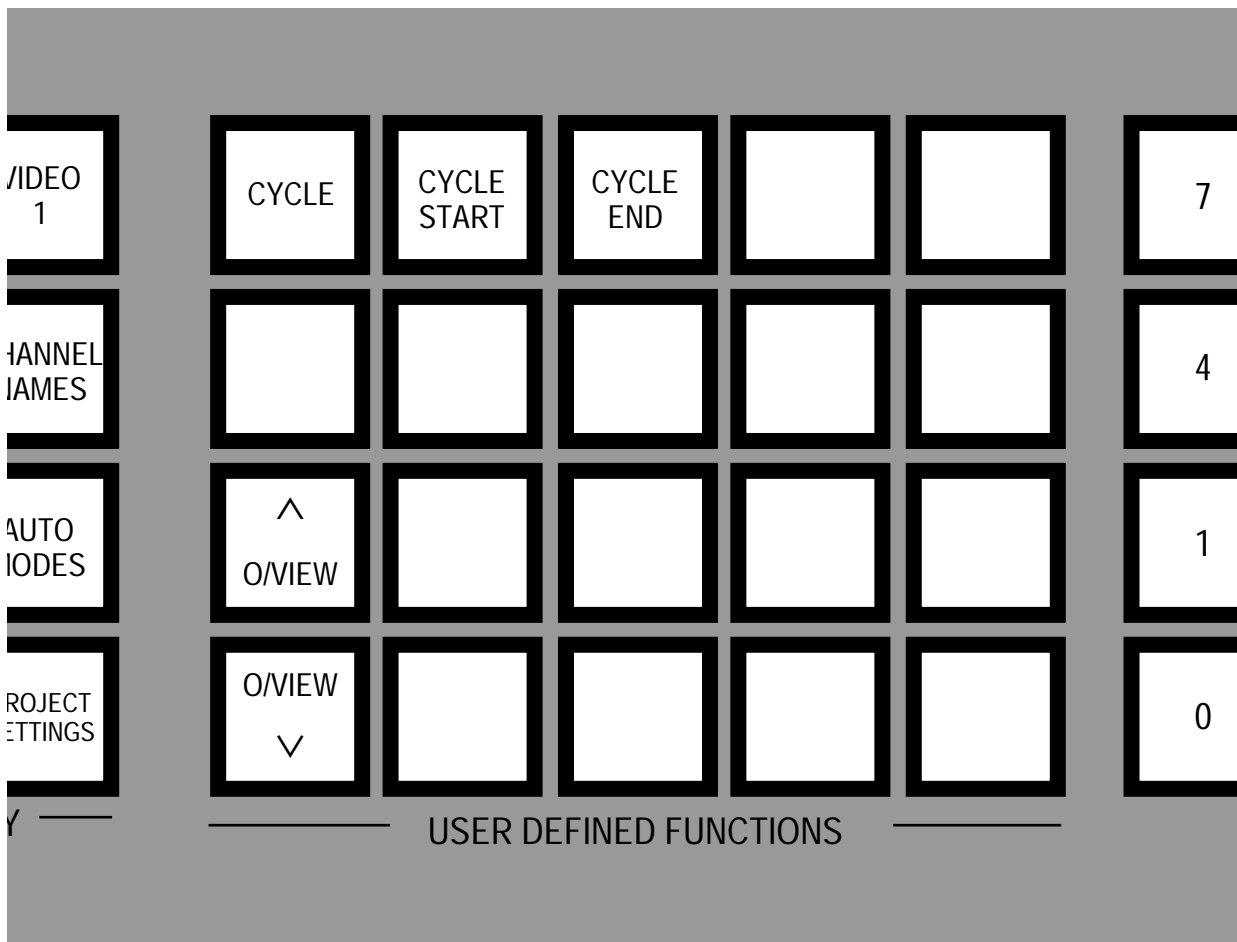

Setup Macros

Macro name

Stab numbered boxes to select macro to define. Stab 'On' to toggle state of subsequently entered instructions.

Always/New Pass
Auto Enable
Auto Modes
Autofade
Autoglide
Autotakeover
+
-
0
00
1
2
3

- Direct Access - - KeyPad Access -

1	2	3	4	5	1	2	3	4	5
6	7	8	9	10	6	7	8	9	10

- Indirect Access - Key

Indirect Bank 0

On Macro	Switch On
Copy Paste	After
Delete	Name
Push Down	Clear
Push Up	Print

FILE/SETUP	File Copy	SIO T/C: Locked
MIX-DESK	Data	Timecode: SMPTE 30
RECALL	Import	Fast Play Speed: 3.0 Midi
MACHINES	Desk Setup	Define
MISC	DeskConfig	Channel Names
		Fader Macros
		4 Channel Pan
		DiskTrack Free
		Follow faders

Macros

A macro is a string of user-programmable commands that may be executed with a single keystroke. Well defined macros can replace the tedium of many different, repetitious or complex keystroke/pen stabbing sequences, and thus may prove invaluable during a busy production.

Above the timecode display on the computer front panel you will see 20 buttons designated USER DEFINED FUNCTIONS (see opposite). Although, as the title suggests, the functions of these buttons are completely user-definable, you may well find that certain buttons have already been specified with a particular task prior to, or during the system installation. In this case, they should be clearly engraved to show their function.

The top two rows of buttons represent 'Direct Access' macros. Up to six different 'layers' can be selected for these buttons, thus providing up to six different functions for each button. The buttons in the bottom two rows can only have a single function.

Each of the buttons may be either momentary or electronically latching, depending on the way in which they are operated. If you press quickly on a button, it will latch on. If you press and hold down the button for more than a second, its action is momentary and the function will turn off as soon as the button is released.

As you become more familiar with the SL 9000 J system, you may wish to add to any existing macros assigned to these buttons, or even change their functions. This section is dedicated to the creation of macros and their use in practical situations.

The Macro Setup Display

To create a macro or determine the current function of any user-definable button, select **Define** from the **FILE/SETUP/Desk Setup** menu and the Macro Setup pop-up will appear (see opposite).

To the lower left of the display you will see ten boxes beneath **Direct Access**. These represent the top two rows of buttons on the computer front panel. The **Indirect** box below provides access to ten further macros (11-21) which may be actioned indirectly (ie not from the front panel). Macros 11-16 are provided for inclusion in nested macros; Macros 17-20 can be actioned from external switches wired to the J Series Computer's EXPANSION socket (see the SL 9000 J Series Installation Guide). Macro 21 will be actioned every time an element of a Project File is loaded. By stabbing on the numerical box next to **Bank**, up to six different layers (0-5) may be selected for Direct and Indirect Access macros.

The group of ten boxes in the centre of the pop-up (beneath **KeyPad Access**) represent the bottom two rows of buttons on the front panel. These buttons only have a single layer. Note that, in spite of the implication, these ten boxes/buttons are not associated with the SSL KeyPad device discussed in Section 7 (see Page 8-15 for details of KeyPad macros).

Setup Macros

Macro name

Stab numbered boxes to select macro to define. Stab 'On' to toggle state of subsequently entered instructions.

Always/New Pass
Auto Enable
Auto Modes
Autofade
Autoglide
Autotakeover
+
-
0
00
1
2
3

- Direct Access -

1	2	3	4	5
6	7	8	9	10

- Indirect Access -

Indirect Bank 0

- KeyPad Access -

1	2	3	4	5
6	7	8	9	10

Key

On Macro	Switch On
Copy Paste	After
Delete	Name
Push Down	Clear
Push Up	Print

FILE/SETUP	File Copy	SIO T/C: Locked	
MIX-DESK	Data	Timecode: SMPTE 30	
RECALL	Import	Fast Play Speed: 3.0	Midi
MACHINES	Desk Setup	Define	Fader Macros DiskTrack Free
MISC	DeskConfig	Channel Names	4 Channel Pan Follow faders

To determine the existing function for any button, select **Name**. The resultant pop-up should show a concise description for any pre-defined macros. By default, you will be looking at the macros in layer '0' (zero). Select different layers (if appropriate) by stabbing on the box next to **Bank** and entering a number between 1 and 5. Stab on **Quit** to clear the pop-up. See Page 8-15 for more details on the **Name** pop-up.

To examine or define the exact contents of a macro button function, first select the required layer, if necessary, by stabbing in the numerical box next to **Bank**. With zero in the box you are working in the top layer – 'Layer 0'.

If you now stab on any one of the 20 on-screen numbered boxes, the macro currently assigned to that button (and in the currently selected layer) will be displayed in the left hand list. Note that, when first accessed, the left hand list displays simple instructions for the setting up of macros (see opposite).

Each button has an 'on' macro and an 'off' macro, ie. a state actioned when a button is *selected* (lit) and another state actioned when the button is *deselected*. With **On Macro** selected (red), the list will display the 'on' macro function(s). Stab **On Macro** to toggle it to **Off Macro** (grey); the list will now display those functions which will be actioned when the button is deselected.

Furthermore, in either of the above conditions, you can determine whether a function will switch on or off when the button is selected or deselected. Those functions that will switch on will be listed in red; functions that will switch off will be shown in blue.



The Macro Function List

By now you will have realised that the list on the left of the **Macro Setup** display is used to display the contents of individual macros. The list on the right displays those functions that can be incorporated into a macro. The list is reproduced below (intentionally not in the same order as on screen), with definitions where necessary. An asterisk following an item indicates that a multiple choice is involved, and a number must be specified before that item can be included in a macro, eg. **Do Snap 32, Serial Record Enable 4** etc.

Always/New Pass	In the Auto Modes pop-up
Auto Enable	The Automation Enable box/AUTO button
Auto Modes	
Autofade	
Autoglide	
Autotakeover	
+, -, =, 0-9, 00	Calculator functions
Up, Down, Left, Right	Front panel cursor keys
Enter, OK, Quit	
Ch \$ Cue In/Out*	Activates that automated switch
Ch \$ EQ In/Out*	
Ch \$ Ins In/Out*	
Ch \$ FX1 In/Out*	
Ch \$ FX2 In/Out*	
Ch \$ FX3 In/Out*	
Ch \$ FX4 In/Out*	
Ch \$ FX5 In/Out*	
Ch \$ FX6 In/Out*	
Ch \$ LF Cut*	
Ch \$ SF Cut*	
Ch \$ Match*	The Channel strip Match
Ch \$ Play*	and Play buttons
Group \$ Cut*	
Group \$ Solo*	
Group Match	The Group Fader Match
Group Play	and Play buttons
Channel Names	
Clear Automation	
Clear Group Solos	
Cycle	
Cycle End Time	
Cycle Start Time	
Delay	Instigates a delay between the execution of macro functions
Discard	Mix Pass List function
DiskTrack	The DiskTrack box in the MIX-DESK menu
DiskTrack Rec Enable	
DiskTrack Transfer Records	On the MACHINES/DiskTrack/Configure pop-up



Do Pre	Restores the pre-automation Enable snapshot
Do Snap*	Recalls any of the 62 snapshots
Enter Mark	The same as pressing the MARK button
Ethernet Pen	See Note 1
Events	Access to the Events List
F.S.M	The Fader Status Master button
Fader Prot(ection) Setup	
Faders	The Faders entry in the MIX-DESK menu
Final Mix Safe	
GOTO 6-10	The TC 1-5 locate boxes/buttons
Goto TC Pop-up	
Hard Group Setup	
Ignore DCTM Varispeed	See Note 2
Insert Mixing	
IP	
KeyP Macro* (1-50)	KeyPad macros (see Page 8-15)
LTC Gen	
M/C Arm	
Macro Keys* (1-21)	These are used to build nested macros. For example, Key 3 may execute a sum of the functions stored in Keys 1 and 2 by selecting Macro 1 and Macro 2 for the entries in Key 3's macro. Or, Key 1 may turn off Keys 2 and 3, allowing intercanceling macros to be created. Keys may be de-latched by entering the key number as a 'Switch Off' function.
Manual Calibrate	In RECALL/Options menu
Master Rec Enable	
Midi zero now	
Mix Data moves with Audio	Applies to edited DiskTrack audio only
Mix To Time	
Mix From Time	
MotionWorker Diag	
MotionWorker Status	
MotionWorker Enable	
MotionWorker Master	
MotionWorker Rec Enable	
MotionWorker Diag	
Motors On/Off	
MSel Keys*	To select macros by 'layer' (1-5)
MTC Gen	
Name Current Event	As in the NAME MARK button
Next Event	The event jog keys next to the
Prev Event	TC 1-5 locate boxes/buttons
Now	On the T/C Calculator
Overview	Access to the Overview display
Project Settings	
Fast Forward	
Rewind	
Next Frame	Forward Frame Jog
Prev Frame	Reverse Frame Jog

Setup Macros

Macro name

Stab numbered boxes to select macro to define. Stab 'On' to toggle state of subsequently entered instructions.

Always/New Pass
Auto Enable
Auto Modes
Autofade
Autoglide
Autotakeover
+
-
0
00
1
2
3

- Direct Access -

1	2	3	4	5
6	7	8	9	10

- Indirect Access -

Indirect Bank 0

- KeyPad Access -

1	2	3	4	5
6	7	8	9	10

Key

On Macro	Switch On
Copy Paste	After
Delete	Name
Push Down	Clear
Push Up	Print

FILE/SETUP	File Copy	SIO T/C: Locked	
MIX-DESK	Data	Timecode: SMPTE 30	
RECALL	Import	Fast Play Speed: 3.0	Midi
MACHINES	Desk Setup	Define	Fader Macros DiskTrack Free
MISC	DeskConfig	Channel Names	4 Channel Pan Follow faders

Play	
Play x 3	
Rev Play	
Record	
Stop	
Remote Output Pulse*	RelayBox function
Remote Outputs*	RelayBox function
Routing Presets*	
Remove Motor Group Effect	
Save Project	
Save TR	
Scroll Overview Down	Change Overview display window range
Scroll Overview Up	by half existing range
Swipe UP	
Swipe DOWN	
Swipe LEFT	
Swipe RIGHT	
Serial Master MC*	The Serial display Master enables
Serial MC Arm	
Serial MC Enable*	
Serial Pen	See Note 1
Serial Rec Enable*	
Serial Desk Offset	
Set Goto 1-5	See Note 3
Set Overview Start	The start and end range of the Overview window
Set Overview End	
Snap	Automation Mode
Soft Group Setup	
Status Lock	
Switch Group Setup	
Switch Prot(ection) Setup	
Take Snap*	To take any one of the 62 Snapshots
Timecode	In the FILE/SETUP/Desk Setup menu
Trim Renuil	
Use Trim	

Notes

1. If, in addition to the local (ethernet connected) pen and tablet in the console, your system is fitted with an additional (serially connected) tablet, selection of either interface may be made via macro keys. With **Ethernet Pen** selected, the serial interface will be disabled. With **Serial Pen** active, the console tablet will be inoperative; the computer keyboard, however, may still be used for on-screen selections and data entry.
2. This function is useful when transferring audio from a DCTM machine to DiskTrack, and prevents DiskTrack trying to follow speed fluctuations in the machine. See the DiskTrack Operators Manual for more details.

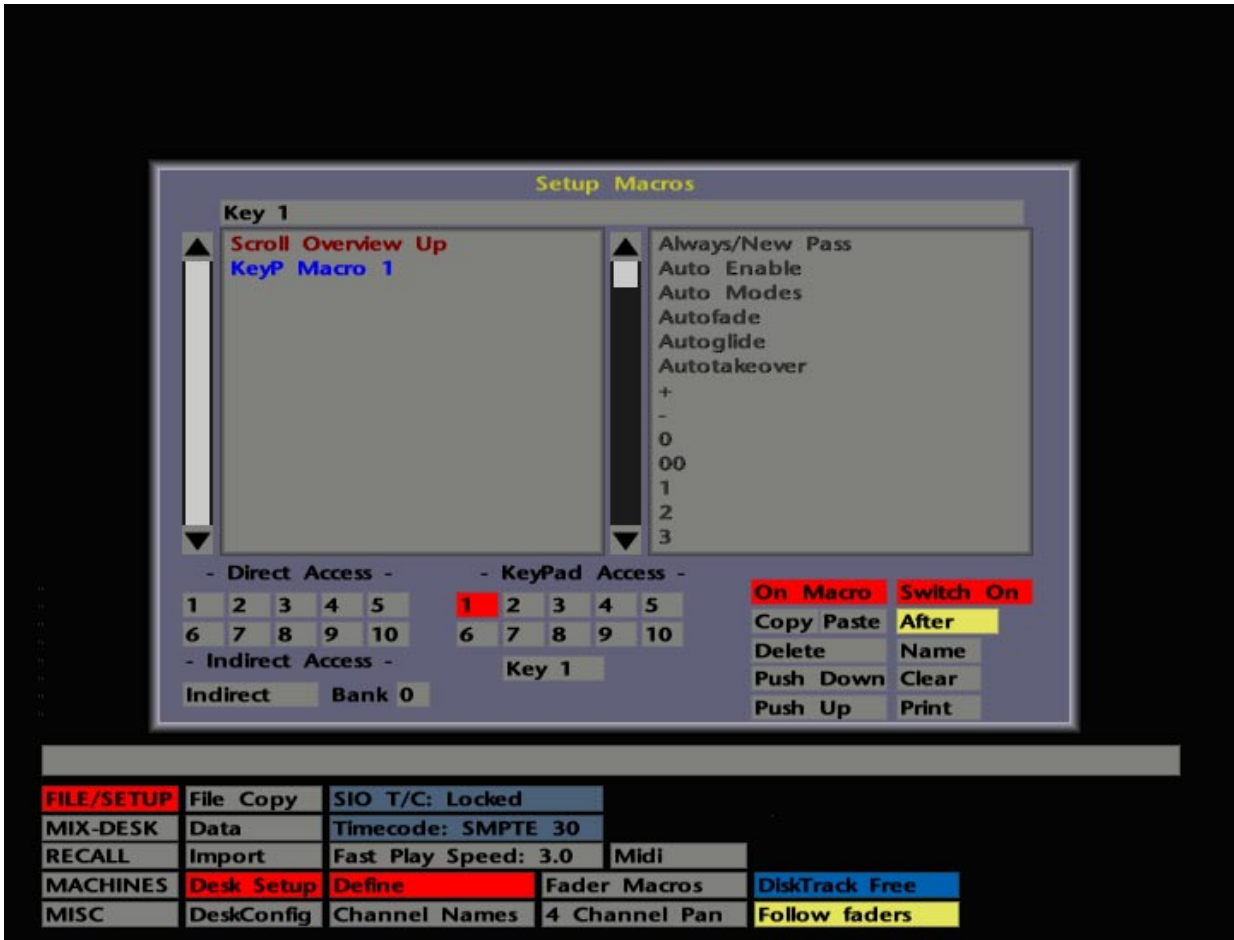

3. The five **Set Goto** entries provide an additional way of entering timecodes for the front panel TC1-5 locate functions. Once assigned to a macro button, selection of that button will call up the timecode pop-up. Enter a timecode, hit OK and that time will become the new locate target.

Creating a Macro

To create a macro, first select the required layer (if appropriate). For simplicity in use, the most used macro functions should always be stored in 'Layer 0' (**Bank 0**).

With **On Macro** selected, stab on the box whose button function you wish to define. This could be any box 1-10 beneath **Direct Access**, any box 1-10 beneath **KeyPad Access**, or stab on **Indirect** and enter a number between 11 and 21! The relevant box will turn red and the macro number (or name) will appear in the banner at the top of the pop-up. Any macro currently assigned to that button will now be displayed in the left hand list. To clear an existing macro select **Clear**.

The required functions for the 'on' stroke of the button may now be selected from the right hand list.

When selected, functions will appear in the left hand list in red to indicate that they will turn *on* when the button is selected. If you wish functions to turn *off* when the button is selected, stab on the **Switch On** box and toggle it to **Switch Off**, before selecting a function from the right hand list. Functions thus selected will appear in the left hand list in blue, to indicate that they will turn *off* when the button is selected. Having selected the required functions for the button's 'on' stroke, toggle **On Macro** to **Off Macro** and repeat the procedure for the 'off' stroke functions.

For example, we'll assume you wish to set up a single macro to capture cycle start and end times. Note that the following information is provided to serve as a simple example only; systems are normally shipped with pre-designated CYCLE START and CYCLE END macro buttons.

With 'Layer 0' and one of the numbered boxes selected, scroll through the right hand list until you find **Cycle Start Time**. Enter this as the function with **On Macro** and **Switch On** selected. Now select **Off Macro**, and stab on **Cycle End Time** to enter this for the button's 'off' stroke.

Now, with the system in Play, press the designated button to capture a cycle start time. When you stab on the button again, it will de-latch and capture the cycle end time. Alternatively, the same affect can be achieved by pressing and holding the button down at the start time and releasing the button at the cycle end time.

Note that, in this particular example, it is not necessary to enter a **Switch Off** function, as the cycle start and end timecode boxes provide a simple, non-latching 'grab' function. When you include a latching function in a macro, eg. to call up a screen display or pop-up, obviously it will need to be turned off when the macro button is deselected.

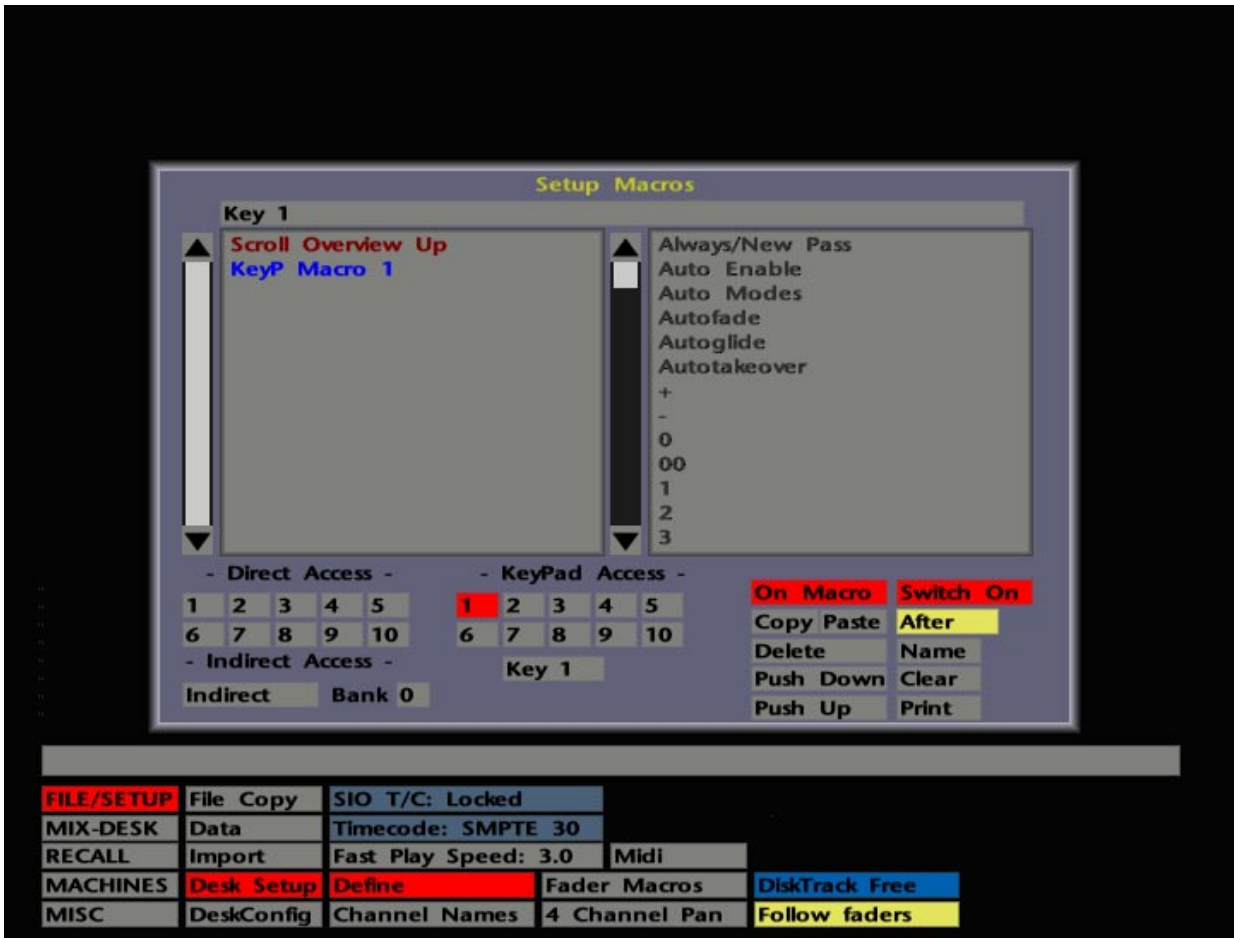

Also, for non-latching functions, you need to ensure that the physical macro button itself gets turned off after the function has been actioned. To do this, enter the appropriate **Macro Keys*** number (see Page 8-7) as a **Switch Off** function at the end of the macro.

Editing Macros

Comprehensive editing facilities are provided to facilitate the entry of macros.

When writing macros from scratch, the **After** function is selected by default. This means that each new entry for a macro appears below the one previously entered. If you toggle **After** to **Before**, a new entry will appear above the one previously entered. The macro list is always actioned top to bottom.

The **Copy** and **Paste** boxes allow the contents of an 'on' or 'off' macro entry to be copied and pasted from one button to another, thus forming the basis or the entire contents of another button's function. This can be extremely useful when you wish to re-arrange the macro button layout.

First select the layer and macro button you wish to copy from. The partial contents of a macro, above or below – but including, a specific entry, may be copied, by first selecting that entry (the entry turns brighter) followed by **Copy**. The entries you copy will be subject to selection of the **Before/After** function. If **Before** is on, you will copy the selected entry and all entries above; if **After** is on, the selected entry and all entries below will be copied. Alternatively, with no entries selected, the entire contents of the macro may be copied by stabbing on **Copy**.

Having selected **On Macro/Off Macro** as appropriate, select the layer and macro that you wish to copy to. If you are adding to existing functions, selection of **Before** will paste the new entries before existing entries; with **After** selected, not surprisingly, the new entries will be pasted after existing entries. Stab on **Paste** to complete the operation.

Functions can be simply inserted in an existing macro, following the same rules for **Before** and **After**. Highlight an existing entry, before or after which you wish to make the insertion. Now select a new entry from the function list.

By stabbing to select an entry in the left hand list (the entry turns brighter) the following functions may also be used:

Delete will delete the selected entry. **Push Up** and **Push Down** move the selected entry up or down the list as required. **Clear** removes all entries in a macro, subject to selection of the 'on' or 'off' functions by means of the **On Macro/Off Macro** box. Deselect **Clear** when finished.

FILE/SETUP	File Copy	SIO T/C: Locked
MIX-DESK	Data	Timecode: EBU 25
RECALL	Import	Fast Play Speed: 3.0 Midi
MACHINES	Desk Setup	Define Fader Macros
MISC	DeskConfig	Channel Names 4 Channel Pan Follow faders

FILE/SETUP	Network	DiskTrack
MIX-DESK	Serial	Relay Box
RECALL	SS Slaves	TC Gen
MACHINES	PatchBay	Routing
MISC	Scorer	KeyPad

Naming Macros

Macros can be named as you create them. Simply stab on the banner at the top of the Macro Setup display, and enter a name on the QWERTY keyboard.

Alternatively, select **Name** (to the lower right of the display). This will call up a pop-up showing, by default Direct Access Macros 1-10 and Indirect Access Macros 11-21, in Layer (Bank) 0 (see opposite). Stab on the required macro number and enter a name on the QWERTY keyboard. To name a macro in other layers, first select the appropriate **MSel 1-5** box; deselect the **MSel** box to return to Layer 0. This pop-up may of course be interrogated at any time to ascertain the function of pre-defined macros.

The contents of the **Name** list can be sent to a connected postscript printer by selecting **Print**.

Keypad Macros

As well as the 20 macros assigned to the front panel's macro keys, 40 additional 'Keypad' macros can be created. For total flexibility, *all* these macros can be executed from the optional SSL Keypad, or from any of the front panel buttons.

To create Keypad macros 11-50, stab on the **Key** box below the **Keypad Access** group of buttons in the lower centre of the Macro Setup pop-up. A numerical pop-up will appear asking you to select a number between 11 and 50. Having done this, create the contents of the macro in the normal way. The number of the Keypad macro that you are currently creating will be shown in the **Key** box. Note that Keypad macros may not be named.

To assign a macro to a Keypad button, select **MACHINES/Keypad** and the Keypad pop-up will appear (see opposite). You first need to select the Keypad you wish to use, should there be more than one connected to your system. Now select the key you wish to control the macro. Scroll down the **Select a Function** list until you find **KeyP Macro***. Stab on this and enter the number of the Keypad macro you have just created. **OK** out of the pop-up and the number of the Keypad macro will be displayed in the box for that key.

Note that the MSEL layer select function, for Direct and Indirect Access macros, can also be controlled from a Keypad.

See Section 7 for more on Keypads.



Saving Macros

Each Project may contain its own set of customised macros. Having made changes or additions, make sure you save them in the Project File **Settings** pop-up. See Section 2 for more details.

Fader Macros

This facility is designed to trigger up to eight pre-defined macros from a specific fader level. When the fader reaches that level, the macro will turn on; as soon as the fader moves below the level, the macro turns off. Only Direct and Indirect macros, numbered 1-21, can be used with this function.

Having first defined the macro, set the relevant fader to the required trigger point. Now select **Fader Macros** from the **FILE/SETUP/Desk Setup** menu (see opposite), and enter the Fader Number, Fader Type (Large or Small), the Macro Layer (Bank) and Macro Number. Fader Macros have their own entry in a Project File and can therefore be saved and restored at will. Channels can be disconnected from the macro function by selecting **Clear** and then stabbing on the fader number.

Macros and the Events List

Macros can be entered in the Events List so that they may be actioned at a specified timecode value. This will be extremely useful in a variety of applications. For example, console snapshots (see Section 5) can be recalled to provide a change in output routing or FX Send assignments. Note that only Direct and Indirect macros, numbered 1-21, can be used with this function.

Select **Events** from the **MIX-DESK** menu to reveal the Events List. Macros will be inserted in the list at the current Desk timecode position, so locate the point where you wish the macro to be actioned. Now stab on **Insert** in the Events List **Edit** menu.

You will be asked to select an 'action' to insert, either an **On Macro** or **Off Macro**, which represent the turning on or off of the macro at the selected timecode point. **Remote On** and **Off** relate to RelayBox closures (see Section 7).

Having made your choice, the **Macro Name** pop-up will appear, from which you may select the required bank (**MSEL 1-5**) and macro number. As soon as you make your selection, the pop-ups will clear to reveal your macro in the Events List (see opposite). The macro will now be actioned each time you pass that event time.

Solid State Logic
SL 9000 J Series
Total Studio System

Computer Operator's Manual

SECTION 9

Miscellaneous Setup Options





The image shows a terminal window with a dark background. At the bottom, there is a menu with four columns. The first column contains menu categories, and the other three columns contain sub-options. The 'FILE/SETUP' row is highlighted in red, and the 'Data' option under 'MIX-DESK' is highlighted in red. The 'Idle' option under 'MIX-DESK' is highlighted in blue. A horizontal grey bar is positioned above the menu.

FILE/SETUP	File Copy	Serial Xfer	
MIX-DESK	Data	Delete	Idle
RECALL	Import	Edit	Xfer Out
MACHINES	Desk Setup	Inspect	Xfer In
MISC	DeskConfig	Create	Settings

Miscellaneous Setup Options

This section is devoted to a number of setup options, tools and diagnostic facilities that have not yet been described in this manual. Mostly these facilities reside in the **MISC** menu; others can be found under **FILE/SETUP** in the **Desk Setup** and **Desk Config** menus.

Serial Xfer

This facility resides in the **FILE/SETUP/Data** menu, and is used for the transfer of files to/from the J Series Computer from/to a terminal or printer.

Select **Serial Xfer** and the screen display will look similar to that shown opposite. The option is provided to **Xfer files In** or **Out**. The blue box above the selection boxes shows the state of the transfer process, or “**Idle**”.

By selecting **Settings**, the serial port parameters for Channel A and B (which correspond respectively to the Bitpad and Remote RS422 ports on the J Series Computer’s connector panel) may be set up. Channel selection is made by stabbing on the toggling **Channel A/B** box. The other boxes allow customisation of: **Data Bits** (number of), **Parity**, **TX**, **RX** baud rate, **Bit 7 Remove/Allow**, **EOF**, **Backspace**, **Tabs**. Options are provided here for all normal situations.

Xfer In

Having set the port parameters, select **Xfer In** to import a file. A QWERTY pop-up will appear for the entry of the name of the file that you wish to import. You may leave the menu while the transfer continues. The transfer may be aborted at any time by stabbing on **Xfer In**.

Xfer Out

Selection of **Xfer Out** will produce a pop-up list of files. The source can be selected from the System Disk, a Floppy disk in the computer’s floppy drive or a loaded magneto-optical disc, by stabbing on the appropriate yellow box.

Single files are shown in black, directories in red. Stab on a directory name to reveal its sub-directories or files. Stab on the red box at the top of the list to return to the top level. Stabbing on a file name will immediately start the transfer process. Files will be exported in ASCII format. Progress will be shown in the blue (**Idle**) bar. You may leave the menu while the transfer continues. The transfer may be aborted at any time by stabbing on **Xfer Out**.

FILE/SETUP	File Copy	SIO T/C: Locked		
MIX-DESK	Data	Timecode: SMPTE 30		
RECALL	Import	Fast Play Speed: 3.0	Midi	
MACHINES	Desk Setup	Define	Fader Macros	DiskTrack Free
MISC	DeskConfig	Channel Names	4 Channel Pan	Follow faders

Desk Setup Menu

Most of the items in this menu (see opposite) have already been described in other sections of this manual (see below).

Fast Play Speed

This is set by default to **3.0**. You may be surprised to hear that a fast play function even exists but it does, hidden away in the **Desk Config** menu under **Transport Layout** (see Page 9-7). Basically you can configure the transport control keys on the front panel to provide the normal FF, RW, Stop, Play, Record functions but in a different layout to the norm. In addition, you may use one of the keys to provide a Fast Play function, up to 3 times normal play speed. Do not be tempted to set this up to fool your chums! Untold misery may ensue.

DiskTrack Free

This box will only be visible if your system is fitted with DiskTrack. It enables channels to be selected to FreePlay mode (see the DiskTrack Operator's Manual for more details). If you *do* have a DiskTrack and this box is not visible, access the J Series Computer's **MACHINES/Network** display, and check that **Store.Route** has been entered for DiskTrack in the **Service** column. Unless this is the case, DiskTrack facility boxes will not appear on the J Series screens. See Section 7 for more details on the Network display.

SIO TC: – See Section 3

Timecode: – See Section 3

Define – See Section 8

Channel Names – See Section 4

Fader Macros – See Section 8

4 Channel Pan – See Section 5

Follow Faders – See Section 5

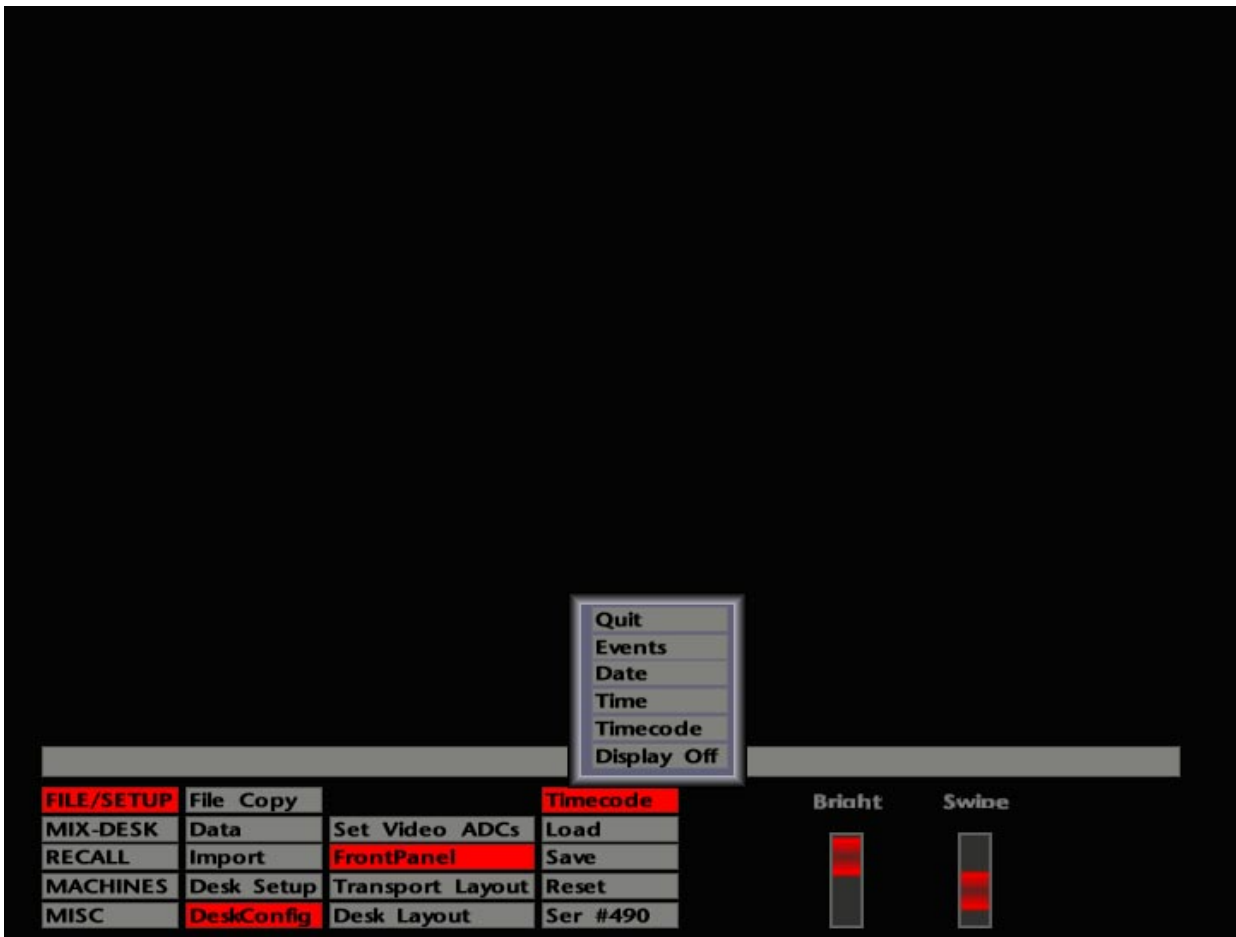
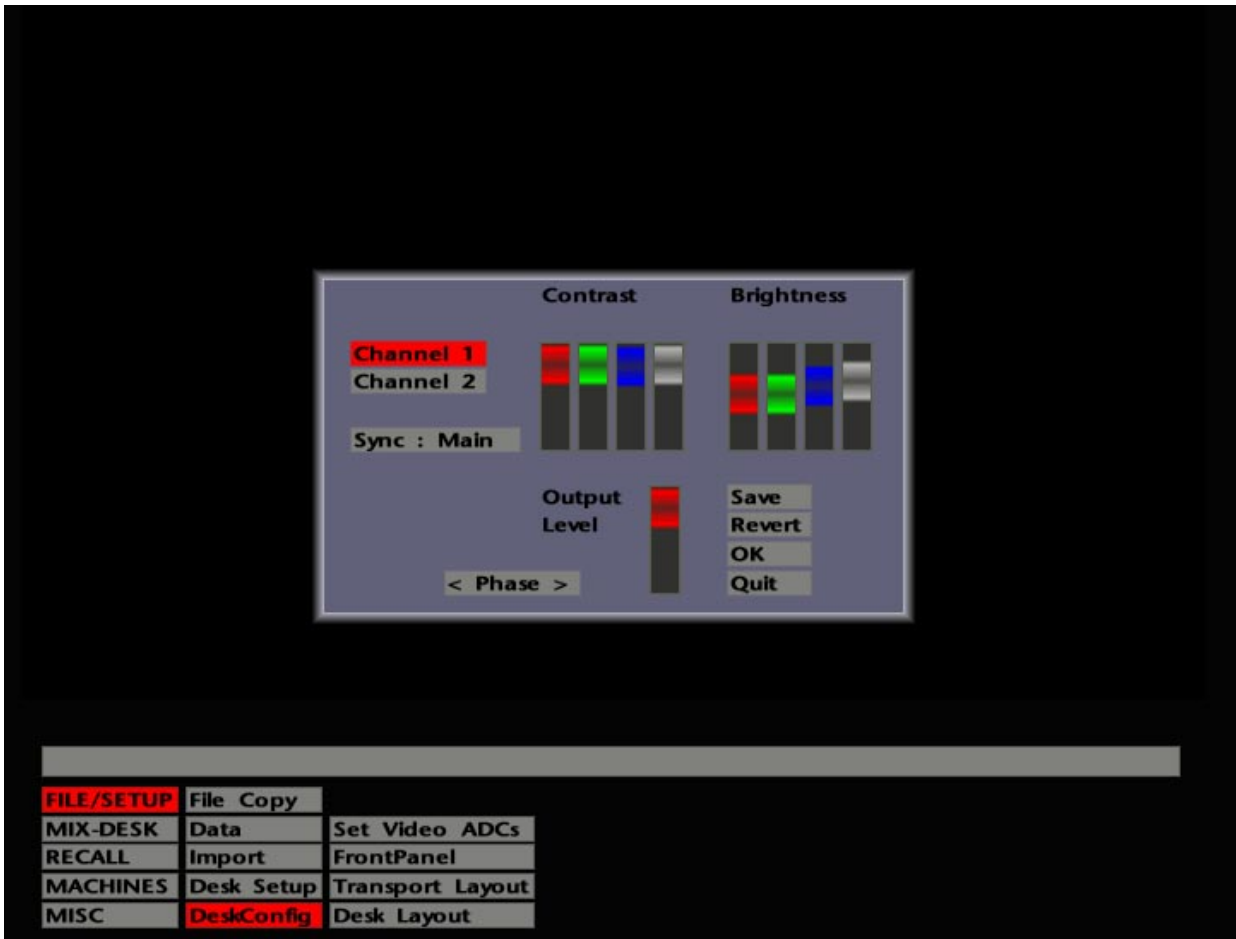

Desk Config Menu

This menu contains configuration and calibration facilities for the console. The items here will normally be set by SSL's Commissioning Engineer and should not be changed without due consideration, or at least not without first informing other console users.

Set Video ADCs

This calls up a panel where the colour balance of the ADCs for the J Series Computer's two video inputs may be adjusted (see opposite). Stab on **Channel 1** or **Channel 2** to select the input for adjustment. Note that the panel will be conveniently superimposed over the video source for that input.

Two sets of faders are provided for adjustment of the Contrast and Brightness of individual RGB inputs plus, in each case, an overall control.

The single red fader below adjusts the Output Level of the video card. Turn this up if your console monitor looks a bit dim.

Video Sync may be selected to **Main** (system/house sync), **Ref** (a separate external sync input) or sync on green (**G**).

Stab and drag on **Phase** to alter the horizontal screen position/phase of computer displays on an external monitor only. This may be used to optimise the displays for a particular video monitor. Nothing to do with audio!

Any new settings may be saved to the System Disk with **Save**. The last saved settings may be recalled with **Revert**. Stab **OK** to retain changes, or **Quit** to leave the panel without effecting any alterations.

Front Panel

This relates to the SL955 front panel beneath the computer monitor. The console's network ID number is shown, along with a **Reset** box and a control for the brightness of the LED alpha-numeric display on the panel.

The red fader to the right is used to set up the pen and tablet 'swipe' sensitivity (minimum sensitivity to the top, maximum at the bottom).

Save and **Load** (to load the last saved) are provided for the two fader settings.

To change the alpha-numeric display on the front panel, stab on the blue box above the **Load** box. This produces a pop-up (see opposite) with the following choices – **Events**, **Date**, **Time**, **Timecode**, and **Off**. Stab on the entry you wish to display.

REWIND FAST FWD STOP PLAY RECORD

Use Event Jogs Use Play + Record OK

FILE/SETUP	File Copy	
MIX-DESK	Data	Set Video ADCs
RECALL	Import	FrontPanel
MACHINES	Desk Setup	Transport Layout
MISC	DeskConfig	Desk Layout

Desk Layout Setup

Channels 65 72	Channels 1 8	Channels 9 16	Channels 17 24	Centre Sec	Channels 25 32	Channels 33 40	Channels 41 48	Channels 49 56	Channels 57 64					
On	On	On	On	On	On	On	On	On	On					

629955X3 Front Panel
629978X2 Faders

Hysteresis = 5

Large Faders have Motors Buttons release on Up

Save Revert
OK

FILE/SETUP	File Copy	
MIX-DESK	Data	Set Video ADCs
RECALL	Import	FrontPanel
MACHINES	Desk Setup	Transport Layout
MISC	DeskConfig	Desk Layout

Transport Layout

The transport control < and > buttons can be set here (see opposite) to provide an **Event Jog**, locate to **Mix Start and End Times**, or **Frame Jog** function. The other transport control buttons – Play, Stop, Fast Forward, Rewind, and Record can be configured with regard to their physical layout. Stab on a box and a pop-up will appear listing the possibilities; stab on a function to select it. When you have finished, a warning pop-up will appear to remind you that changes have been made, and that you must replace the now mismatched hardware button caps before total confusion occurs.

This pop-up also provides a choice as to how the system will be put into record – by pressing the Play + Record buttons, or the Record button only. Note that the setting here does not affect the similarly named parameters for DCTM machines in the Machine Setup Options pop-up (see Section 3).

Desk Layout

On system commissioning, this display (see opposite) is used to configure the layout of the console and its relationship to the computer. If you stab on an empty bay, you can see the pop-up list from which bay entries are drawn. The **On/Off** box beneath each bay confirms that power is present or not. **Hysteresis** has a default value of 5. Do not alter this unless advised to do so by qualified SSL personnel.

The Large Fader motors can be permanently disabled here by toggling **Large Faders have Motors** to **Not Motorised**. This selection overrides the console's MOTORS ON/OFF button. If the motors *are* disabled, the Total Recall display will include a Large Fader in the graphical channel strip display, and a **Groups** box in the **RECALL/Options** menu (see Section 6).

Buttons release on Up/Down relates to all non-latching switch objects. Basically, you have a choice as to whether a switch turns off as you push down on it, or as you release it. This is particularly important when it comes to automated mixing – think about it!

The correct layout configuration will have been saved to the System Disk during system commissioning. If you make any changes to **Large Faders have Motors** and/or **Buttons release on Up/Down**, **Save** them to the System Disk, as required. If you make erroneous changes, use **Revert** to return to the saved settings. Hit **OK** to clear the display.



The MISC Menu

The **MISC** menu provides access to a range of options which are used for basic setting up of the SL 9000 J system. In addition, facilities are provided here for diagnostic tests. Please note that these diagnostics routines should only be used by qualified personnel.

Calibration

Note that this menu selection is not normally available unless it has been activated by a qualified SSL Engineer. If it *is* present, do **NOT** mess with the **Fader Calibration Menu** unless you know what you are doing. Refer to the SL 9000 J Series Service Manual for further details. If in doubt, contact a qualified SSL Engineer.

Tools

Among other things, the Tools menu provides facilities for the installation of new software. Floppy disks are also formatted via this menu.

The **Install** pop-up is used for the installation of new or updated software. Before proceeding, please read carefully the installation instructions provided with each software update.

Laser Print prints a text file to a connected postscript printer.

Format (see opposite) enables new floppy disks, loaded in the computer's floppy drive, or Magneto-Optical discs to be formatted. These disks may then be used for file transfer, copies or backups as described earlier in this manual. Stab on the **Disk** box to toggle between **Mag Opt** or **Floppy**. Select the **Volume** box to enter a disk name. **END** or OK out of the QWERTY pop-up, then hit **DO IT** to start the formatting process.

Calculator provides a numeric calculator! Freelance mixers can use this to work out their expenses between takes.

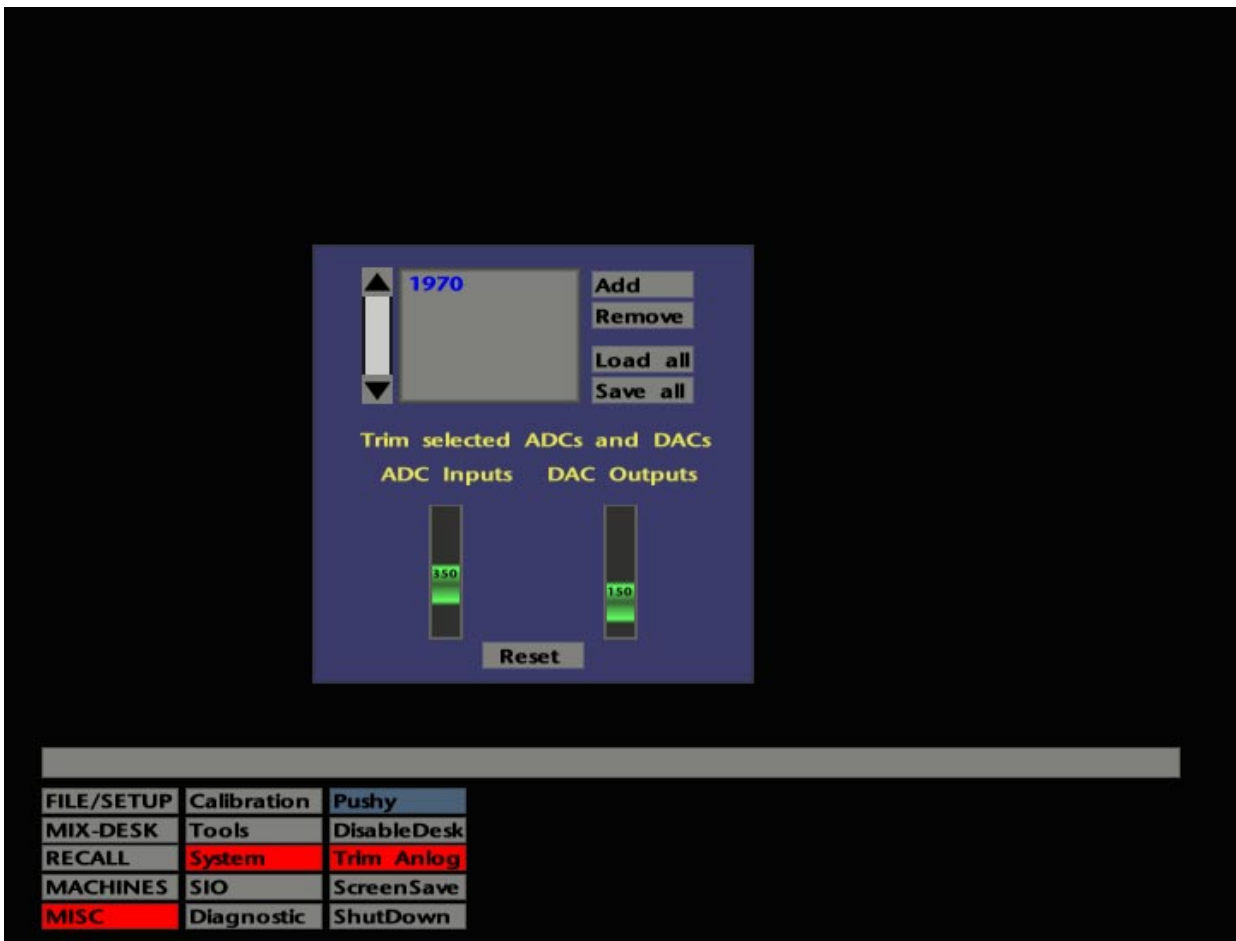

System

Selection of **System** calls up the following items:

Pushy calls up two options related to the screen 'drag' facility – **Pushy** and **Relative**. The default setting is **Pushy** – you'll see why once you've tried **Relative**!

Disable Desk effectively puts the console into a 'safe' mode and, when selected, the computer will not register any automated object moves or switch selections. Stab on the box to select **Disable Desk** and a warning message will flash on screen until you stab on the box again. The primary function of **Disable Desk** is to prevent spurious information being written to the computer if console bays need to be turned off for maintenance purposes. Alternatively, use this function (and remove the pen) when you go to lunch/dinner.

Trim Anlog

This is used to set RIO ADC/DAC gains for those systems equipped with DiskTrack. Select **Trim Anlog** (sic) and the resultant pop-up (see opposite) should list, by serial number, all the Analogue RIOs on your system. If the list is blank or incomplete, select **Add** and stab on entries in the resultant **Remote IO** pop-up to add them to the list. To remove RIOs from the list, select them (blue) first and then hit **Remove**.

The two faders are used to adjust the Input level pre A-D conversion, and Output level post D-A conversion, of any Analogue RIO selected (blue) in the list. Note that, until the correct settings have been saved (see below), a newly installed RIO will give a 3dB discrepancy between inputs and outputs. The following table gives fader settings for unity gain at a selection of operating levels:

Level for 0dBFS	ADC Inputs	DAC Outputs
16dBu	500	100
18dBu	350	150
20dBu	200	300
22dBu	120	500
25dBu	0	850

Stabbing on either fader produces a numeric pop-up on which to enter the fader setting. Note that the values entered here will simultaneously set the gain for all ADCs or DACs in the RIO.

Having achieved the correct settings for all RIOs on the system, hit **Save All**. Note that this is a 'one-shot' store that will be used to restore the settings after a reboot. **Load All** will load the last settings saved for all RIOs. **Reset** can be used to restore a single, selected, RIO's input and output settings to the default values of 350 and 150 respectively.

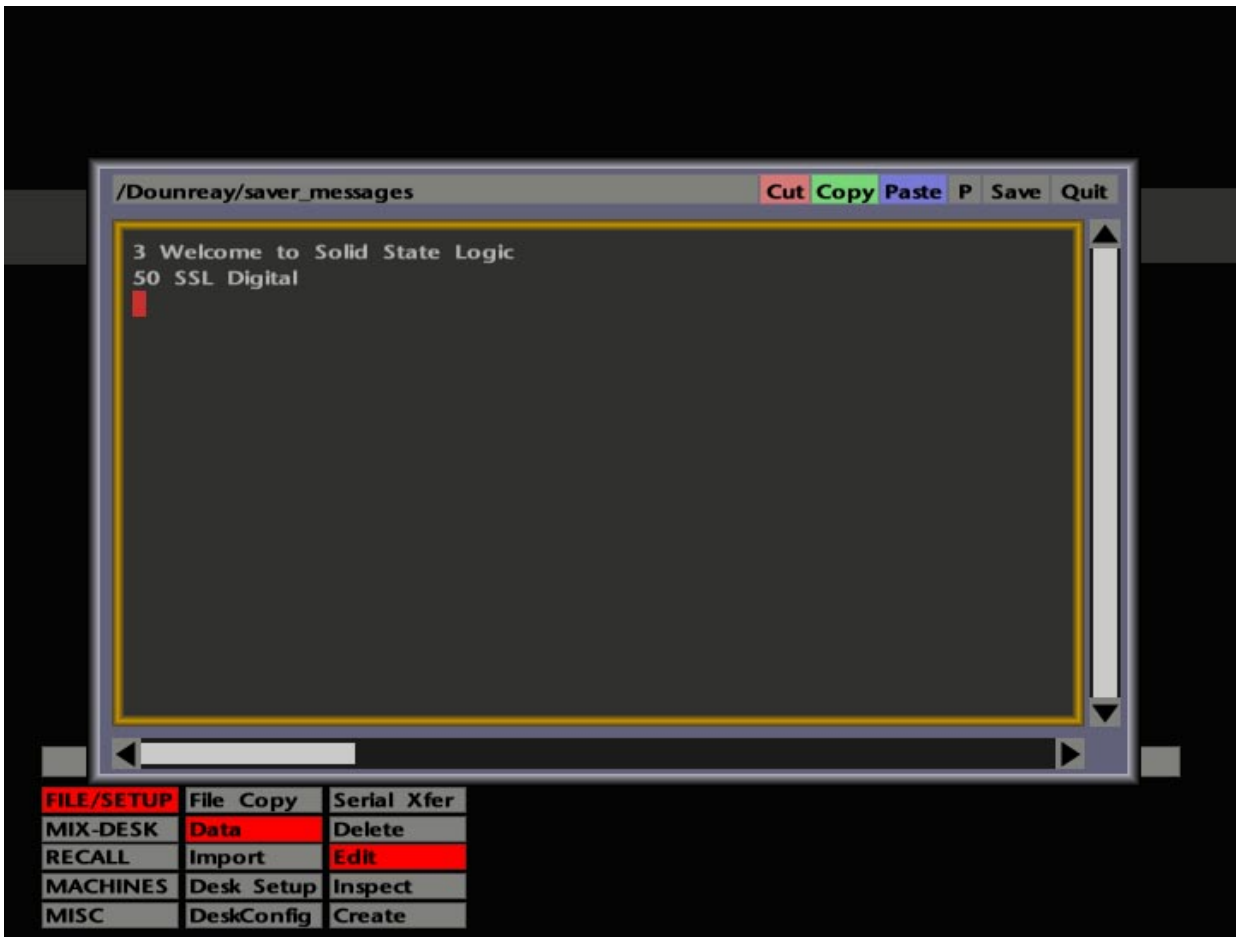

Screensave

Use this to set up options for the console's screensaver facility.

The upper box is used to set the inactivity window, after which the screensave function is activated. This can be set to **30 mins**, **5 mins**, **30 secs** or **5 secs**. Alternatively, select **Disabled**.

The screensave pattern (see opposite) may be selected from a choice of **Logo**, **Worms**, **Splash**, **Rings**, or **String Art**. We leave you to discover (or interpret) the meaning of most of these.

Instead of only "SSL Digital" appearing with the **Splash** screensaver, alternative custom text messages can be entered (see lower screen opposite). Access **FILE/SETUP/Data/Edit/saver_messages** and enter your text from the keyboard prefaced with n^{\wedge} (where n is any number between 1 and $2^{31}-1$, and \wedge is a space) and ending with a keyboard Enter. *Please try to avoid editing any other interesting files in the directory. The results may not be what you hoped for!* If you cannot locate the **saver_messages** file, first use **FILE/SETUP/Data/Create** to create one in the top level directory.

More than one message can be entered, provided they are each prefaced with a number. These numbers are used to dictate the probability of individual messages appearing when the screensaver is activated. For example, looking at the lower screen opposite, the probability of **SSL Digital** appearing will be 50 divided by 53 (the sum of all the prefaced numbers). The probability of **Welcome to Solid State Logic** appearing will be 3 divided by 53, and so on.

Shutdown

This provides a reboot function – initiating a **Cold Start** (reboot from the System Disk) or a **Warm Start** (reboot from RAM). You will only need to use this under abnormal circumstances and, if so, we recommend a **Cold Start**. If any elements of a Project File have not been saved since the last update, you will be warned.

SIO

This covers three items concerned with the computer's Serial Card, which is used for ethernet (network) communications. **Save** saves the Serial program, currently running in RAM, to the System Disk. This is only used under special circumstances.

Restart carries out a soft reboot of the Serial Card, without disturbing any other software. **Reboot** is for a hard restart from disk.

The screenshot displays the SL9000 V2.1/1 computer interface. At the top, a red box contains the following text: "SL9000 V2.1/1", "SIO 98, Serial #1833", "Compiled Mon 29 Jul 96, 10:38:05 by stuartt", and "Running since 02-Aug-96 02:54:18 PM". Below this, a blue box shows the date and time: "02 - Aug - 96 03 : 22 : 09 PM". A yellow progress bar is labeled "Mem Used". Two circular gauges are shown, each with a scale from 0 to 6 and letters A through F. To the right, a vertical list of system parameters is displayed in green boxes with red text: PLDT 500, GORT 6, MOTN ✓, CPUC -2, MCHN 13, SERN 1833, FPSN 490, SIO ✓, NTSC ✓, HDTV ✗, TIXX 60, DEVS ✗, and DEBG ✗.

FILE/SETUP	Calibration	Network
MIX-DESK	Tools	Monitor
RECALL	System	Status
MACHINES	SIO	Heap
MISC	Diagnostic	Hardware

Diagnostic

This provides five choices for diagnostic purposes and should be only used by qualified personnel. You may, however, be asked to refer to these displays in the case of a problem, under the guidance of an SSL Service Engineer.

Network – This provides a current status report for the system's ethernet network. The display shows Transmit and Receive packets, plus an Error and Overrun count.

Monitor – Confirms/assists in the correct connection of RGB inputs to the console's video monitor. A white border on this display shows the minimum screen area required for the displays. Stab anywhere on the screen to return to the menu.

Status – This selection calls up a display (see opposite) providing useful feedback on the status of the computer's current memory usage, and also what version of software the system is currently running. The system's time and date clock, for time stamping projects, mixes, TR setups, etc., is also set here. Stab and drag on each entry to make a change.

The panel on the right hand side is mainly used for system configuration, and will be set on installation. Do not attempt to alter any settings in these boxes unless requested to do so by SSL Personnel.

In the lower half of this area you will see **NTSC** and **HDTV**. A cross in both boxes shows that the system is receiving PAL (25Hz) video sync. A tick beside **NTSC** indicates that the system is set for 29.97Hz sync. With **NTSC** and **HDTV** both ticked, the system is set for 30Hz sync. Note that these entries are for information only and cannot be altered from here.

The panel in the lower half of the display shows the current settings of two rotary bit switches on the CPU Card. The hex number thus derived is used for program interpreted system options.

Heap – This provides a display of current program memory allocation in the 'heap'. A readout at the foot of the graph shows the current number of bytes in use.

Hardware – Note that the contents of this menu selection, which provides a series of diagnostic tests, are not normally available unless activated by a qualified SSL Engineer. If they are present, and you accidentally select **Faders**, **Lights** or **TR**, stab again on the box to clear the display and restore the full menu. See the SL 9000 J Service Manual for further details.

