



PEUGEOT

308
(T91 - T91MV)



308 SW
(T92 - T92MV)

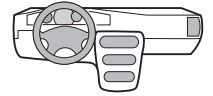

NOT : 3863
Réf. : 16 482 985 80

FR NOTICE DE POSE A USAGE PROFESSIONNEL / LES PHOTOS ET LES DESSINS NE SONT PAS CONTRACTUELS
 GB FITTING INSTRUCTIONS FOR PROFESSIONAL FITTERS / THE PHOTOGRAPHS AND THE DRAWINGS ARE NOT CONTRACTUAL
 ES INSTRUCCIONES DE MONTAJE PARA USO PROFESIONAL / LAS FOTOGRAFÍAS Y LOS DIBUJOS NO SON CONTRACTUALES
 P MANUAL DE MONTAGEM PARA UTILIZAÇÃO PROFISSIONAL / AS FOTOGRAFIAS E OS DESENHOS NÃO SÃO CONTRATUAIS
 DE MONTAGEANLEITUNG FÜR PROFESSIONNELLEN EINSATZ / DIE FOTOS UND DIE ZEICHNUNGEN SIND NICHT VERTRAGLICH
 IT ISTRUZIONI DI POSA AD USO PROFESSIONALE / LE FOTOGRAFIE ED I DISEGNI NON SONO CONTRATTUALI
 NL MONTAGEHANDLEIDING VOOR PROFESSIONEEL GEBRUIK / DE FOTO'S EN DE TEKENINGEN ZIJN NIET CONTRACTUEEL
 PL INSTRUKCJE INSTALACJI DO UŻYTKU PROFESJONALNEGO / OBRAZY I RYSUNKI NIE SĄ KONTRAKTU

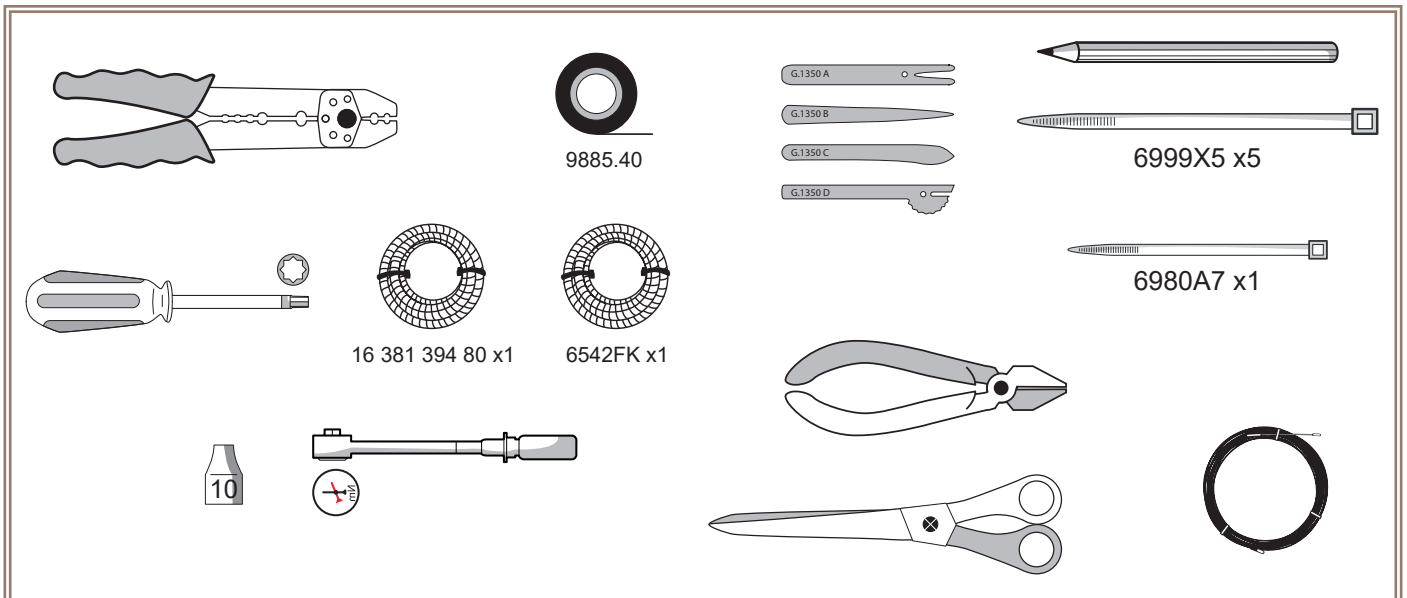

COLOR TABLE

	bk	wh	gy	gn	rd	bu	ye	bn	vt	og	bg
FR	noir	blanc	gris	vert	rouge	bleu	jaune	brun	violet	orange	beige
GB	black	white	grey	green	red	blue	yellow	brown	purple	orange	beige
ES	negro	blanco	gris	verde	rojo	azul	amarillo	marrón	violeta	anaranjado	beige
P	preto	branco	cinzento	verde	vermelho	azul	amarelo	castanho	violeta	laranja	beige
DE	schwarz	weiß	grau	grün	rot	blau	gelb	braun	violett	orange	beige
IT	nero	bianco	grigio	verde	rosso	blu	giallo	marrone	viola	arancione	beige
NL	zwart	wit	grijs	groen	rood	blauw	geel	bruin	violet	oranje	beige

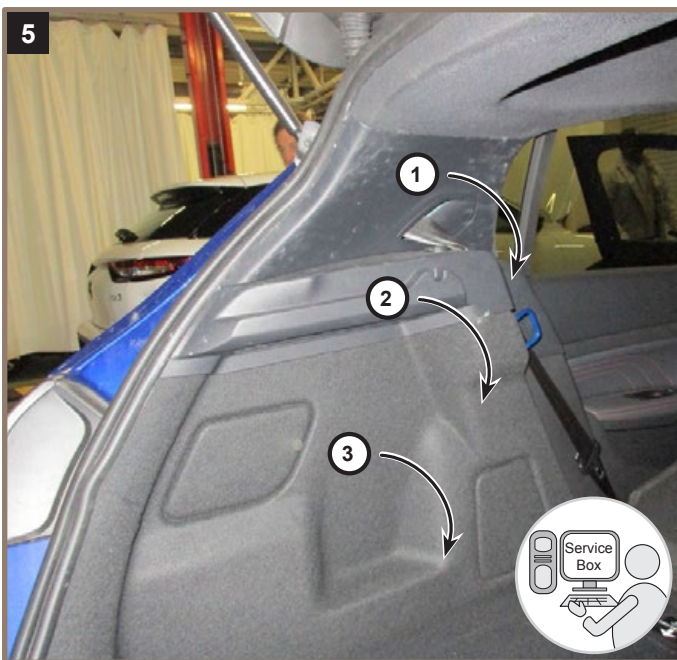
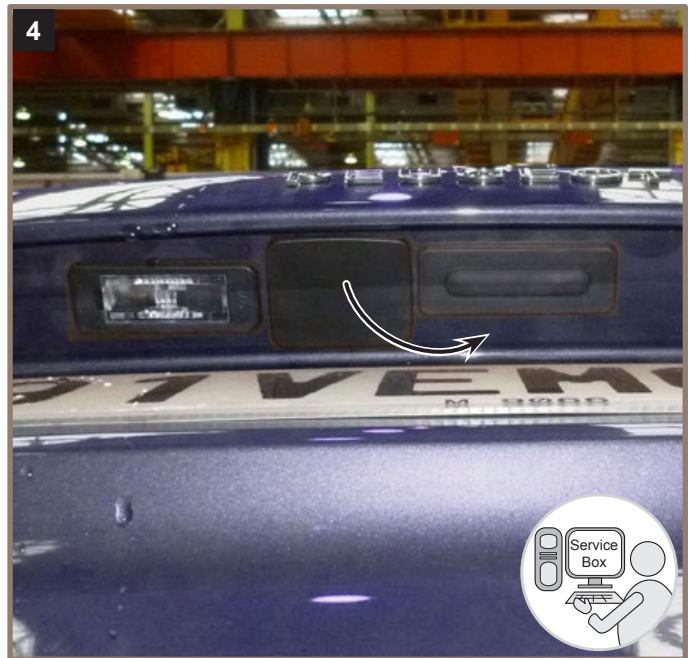
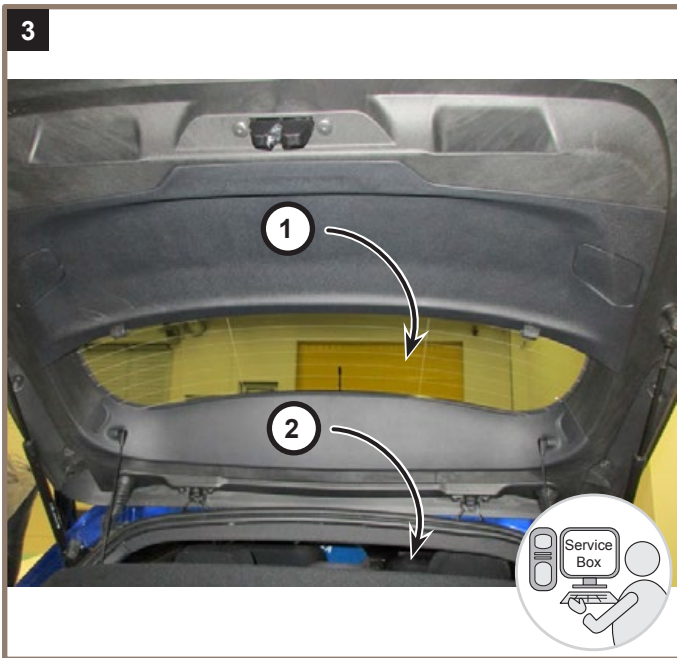
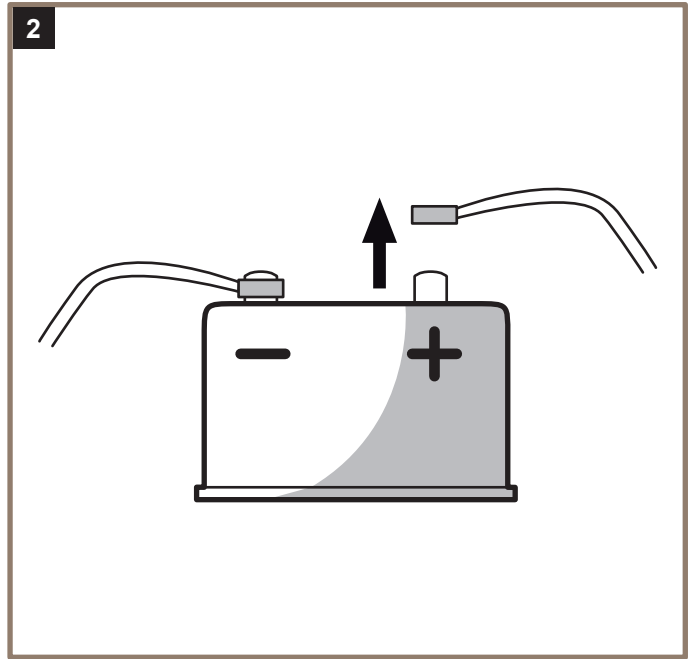
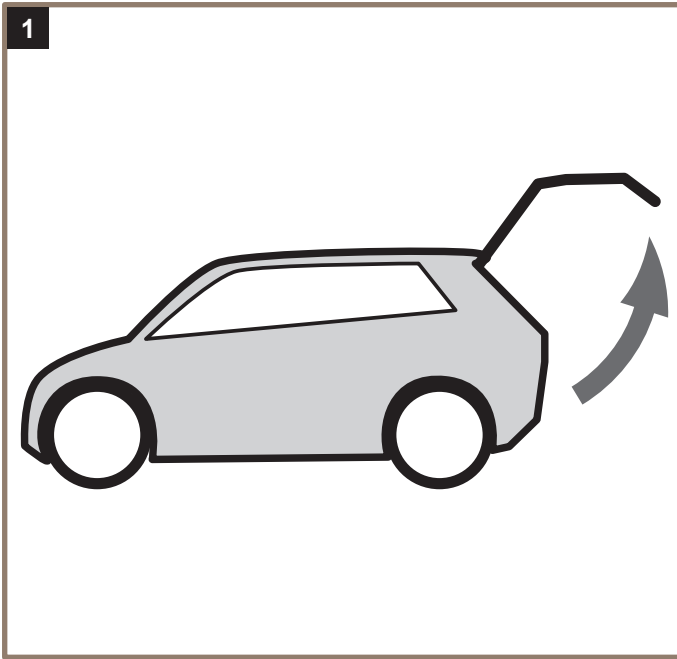

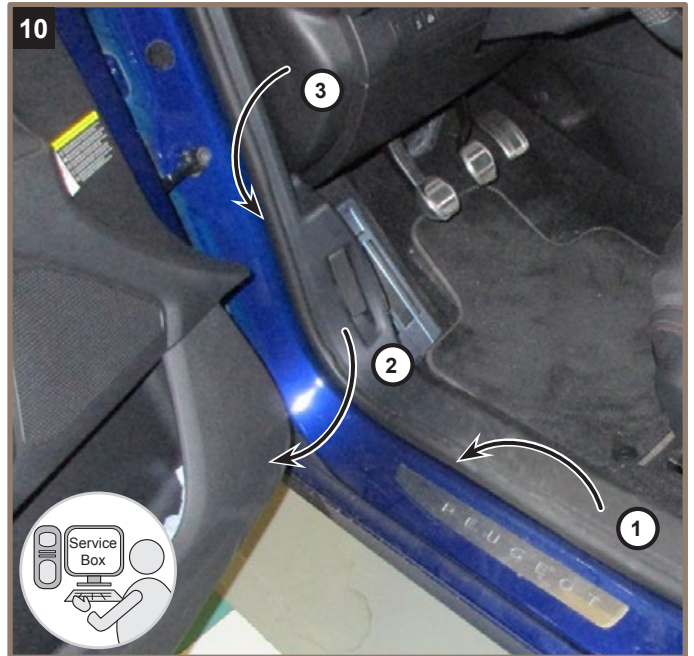

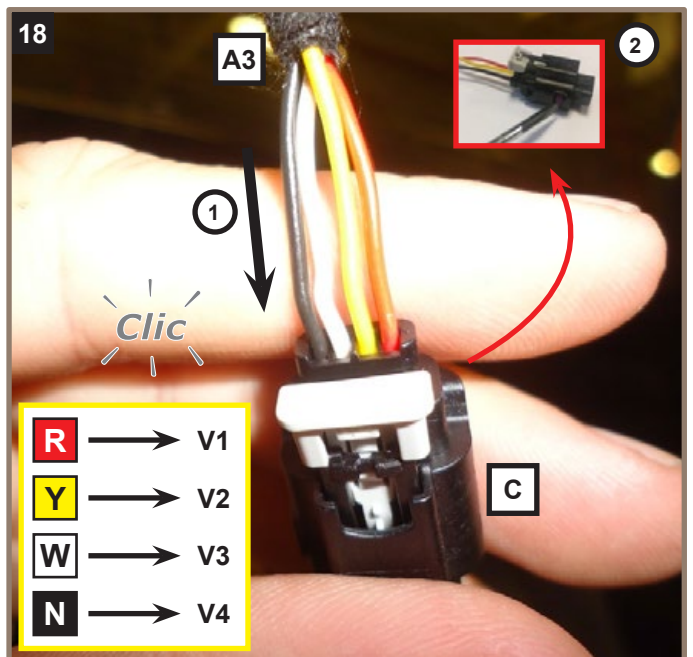
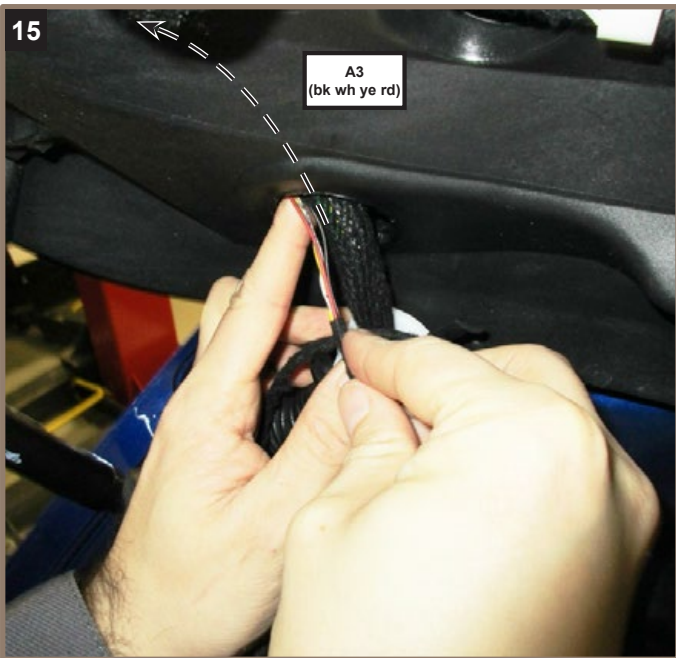
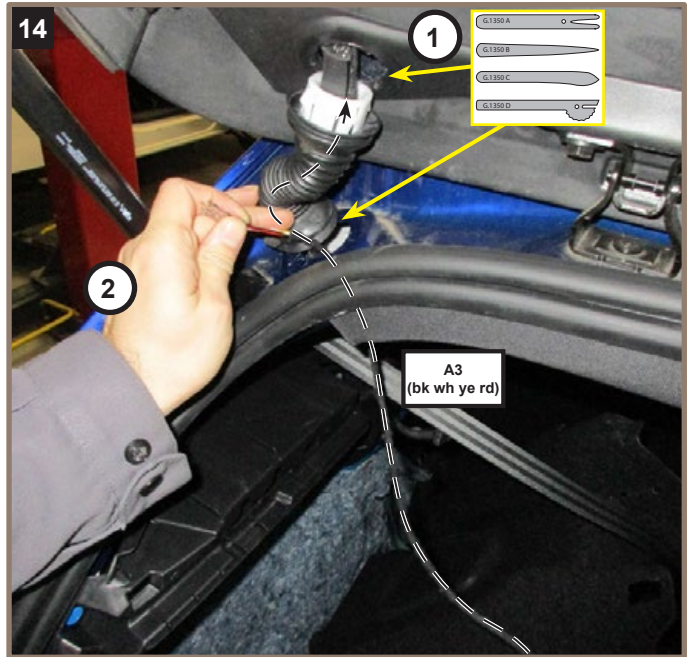

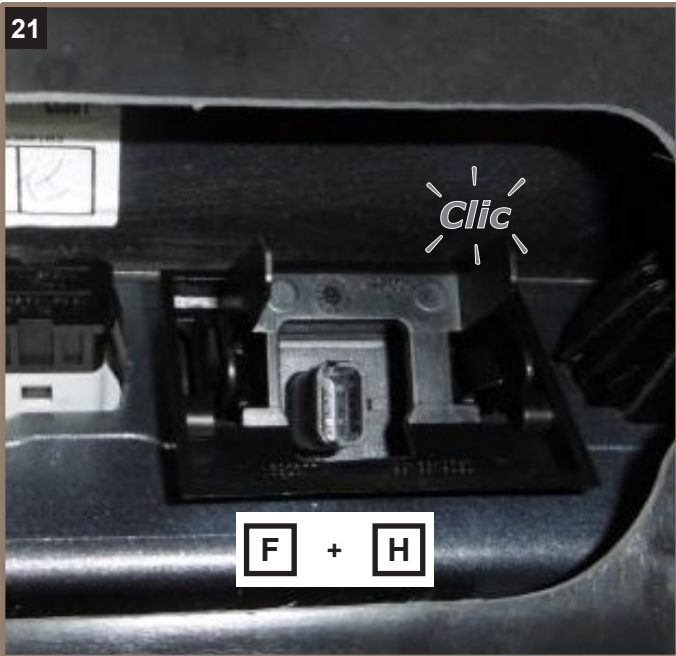
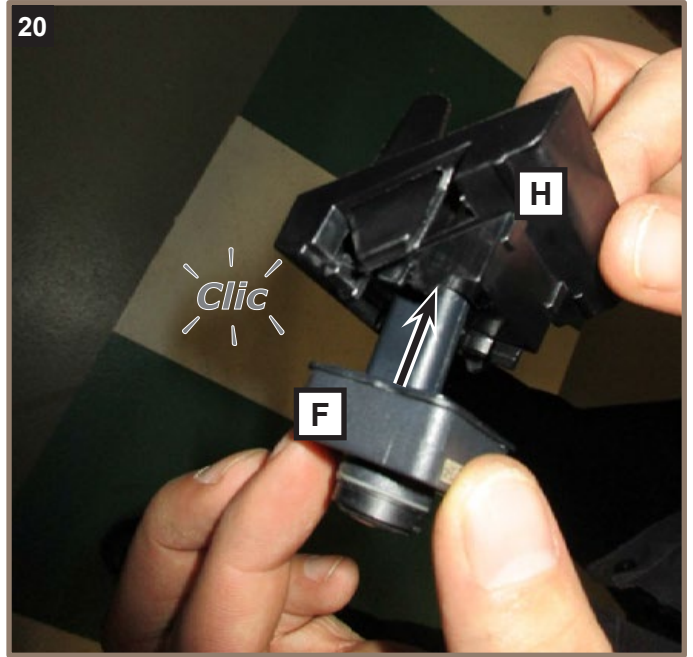

25

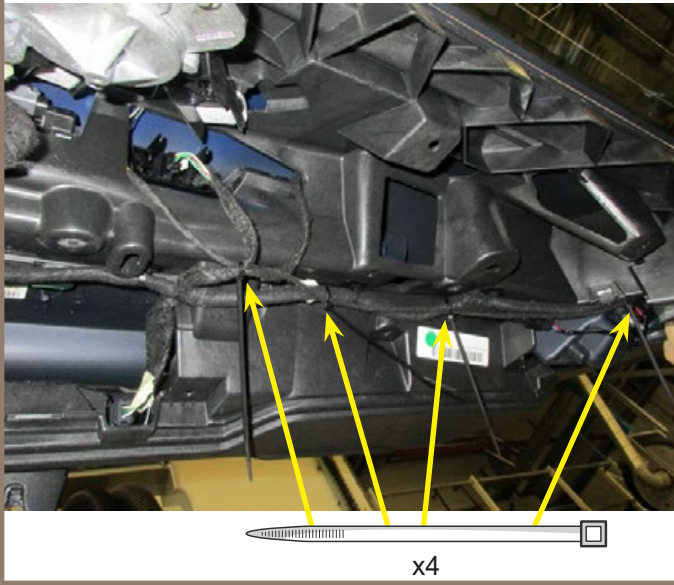

26



27

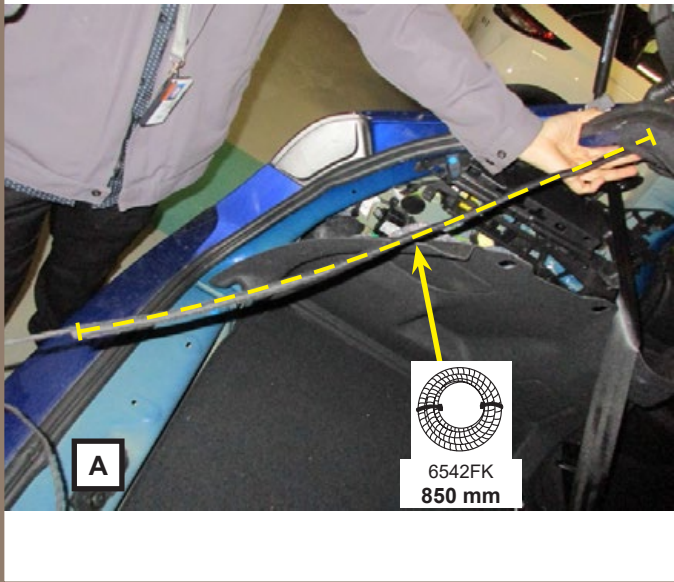

28

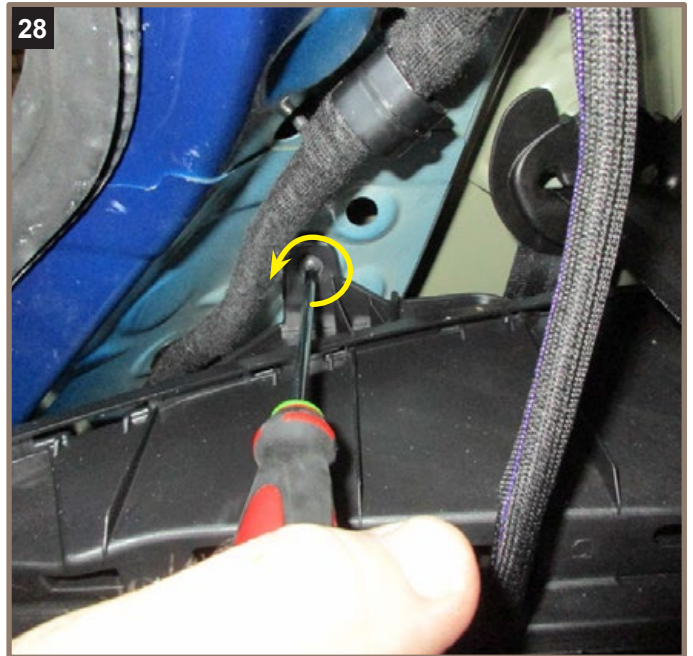

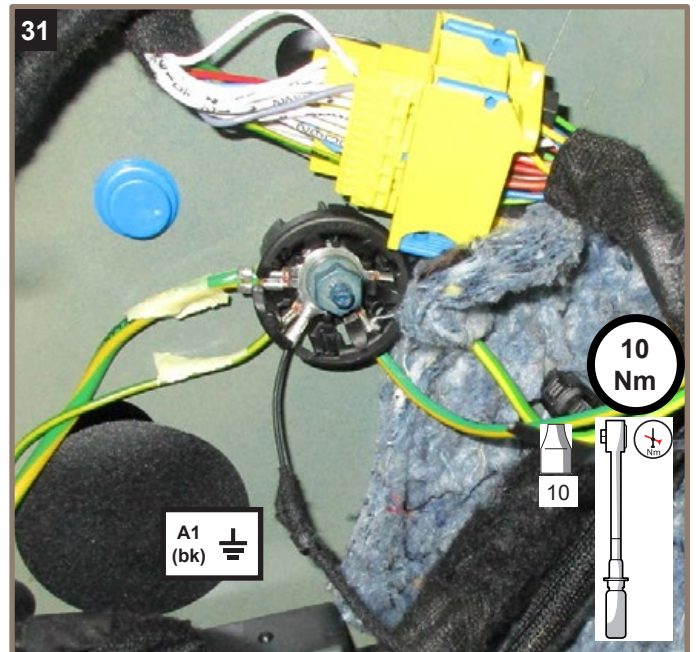
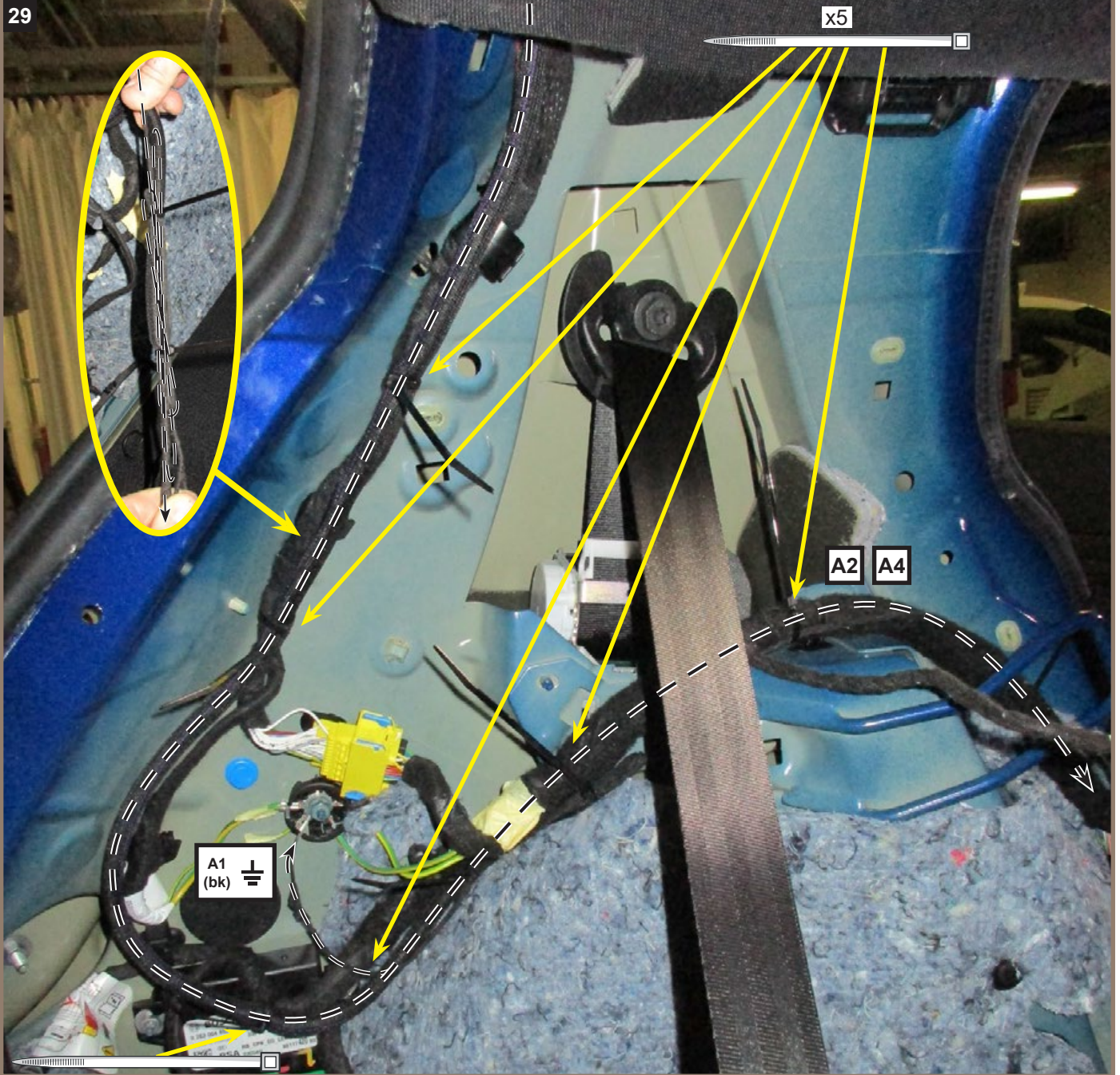

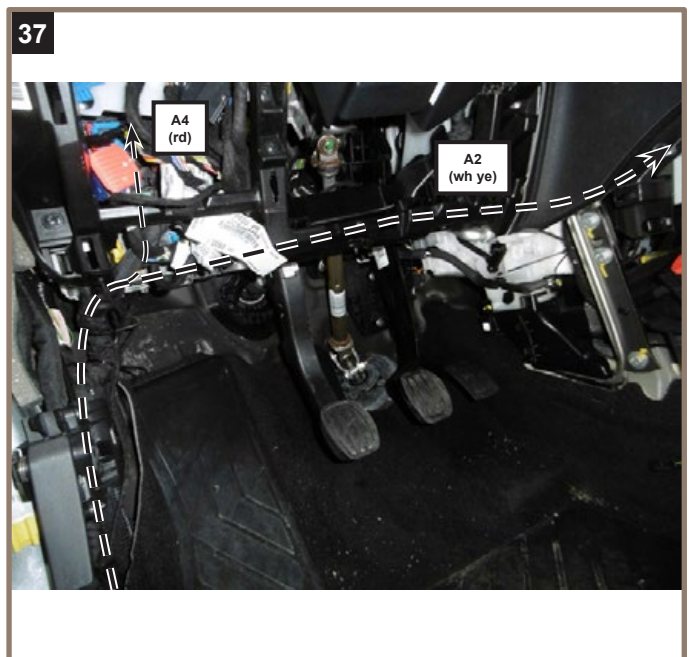
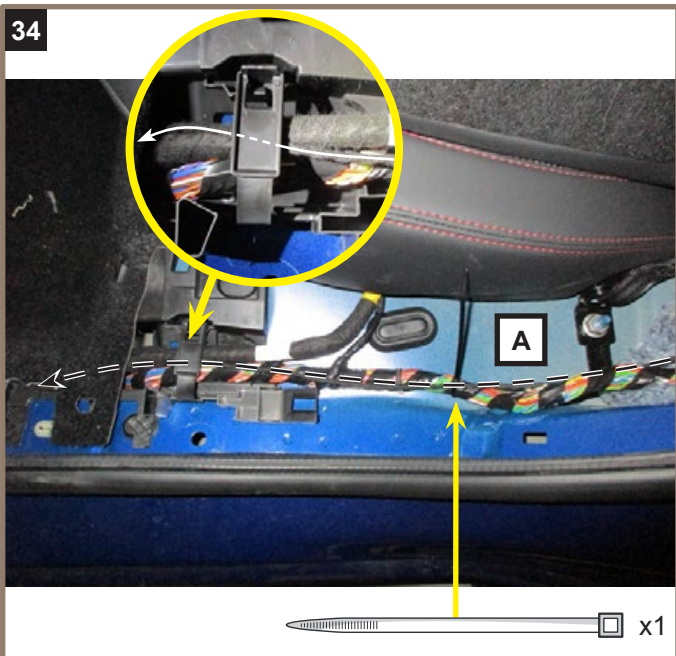
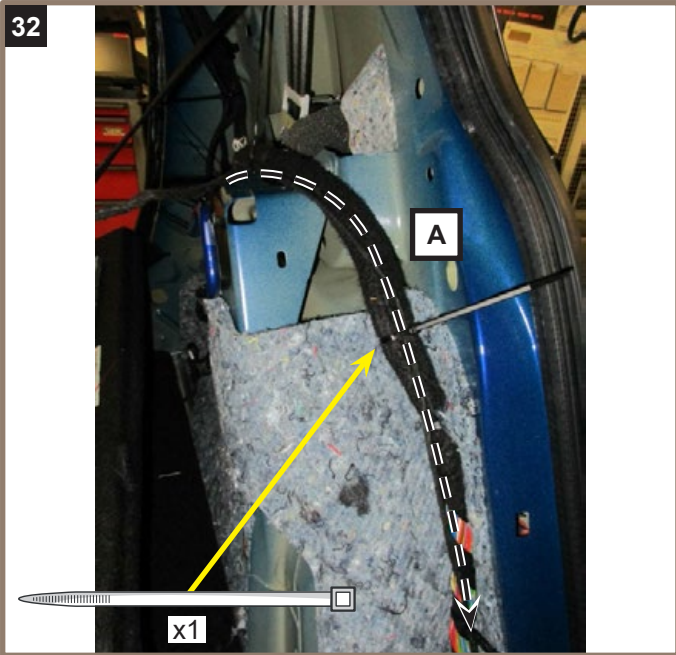

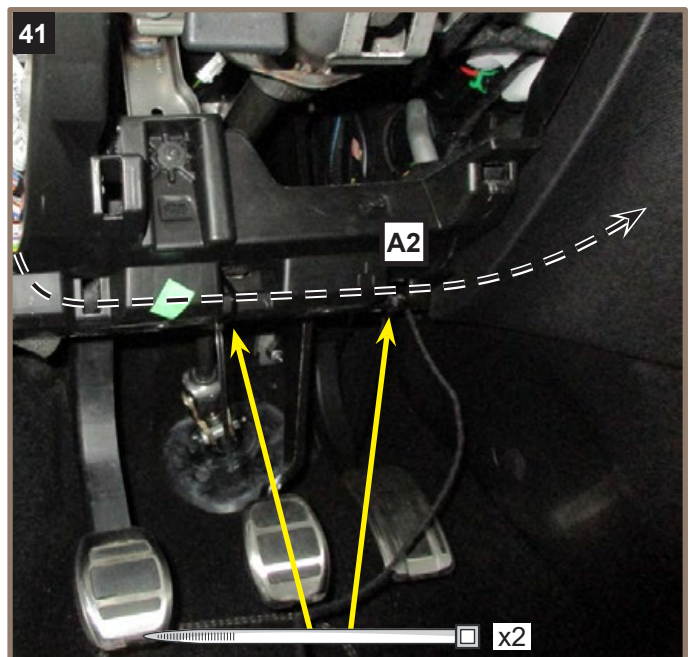
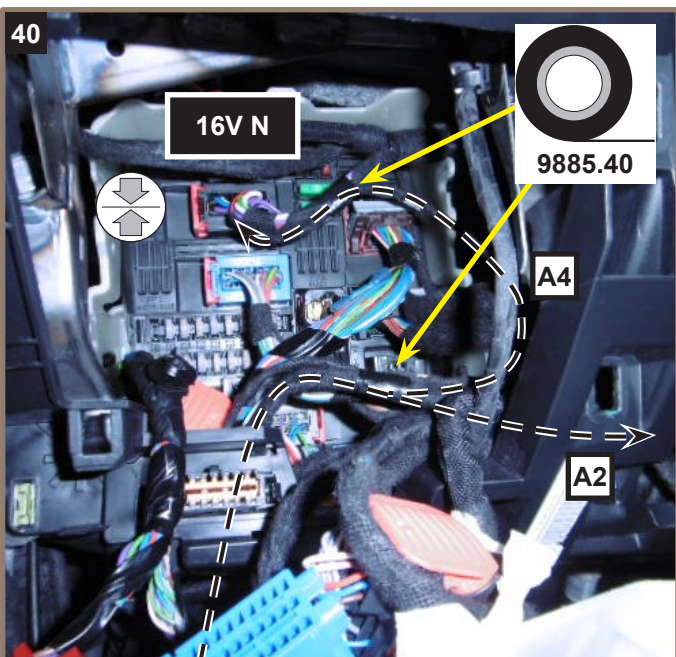
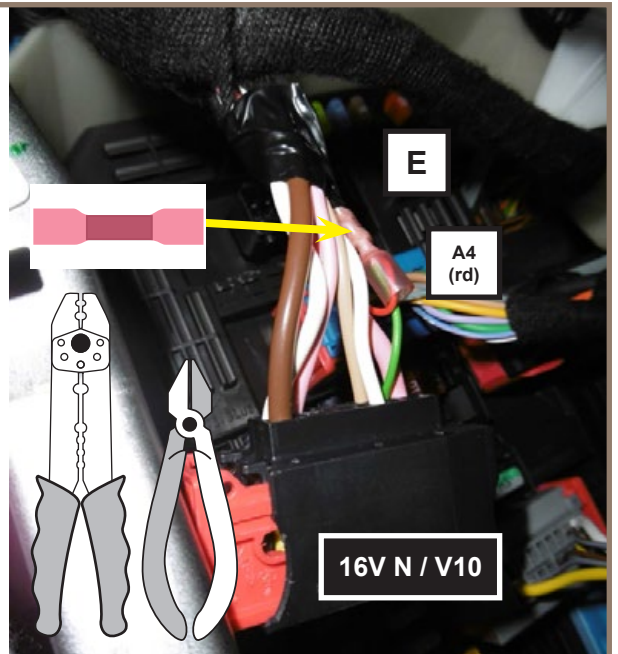
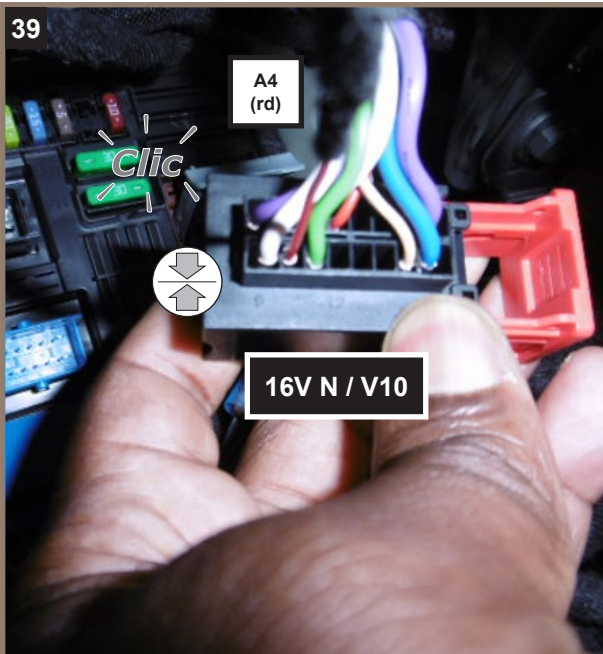
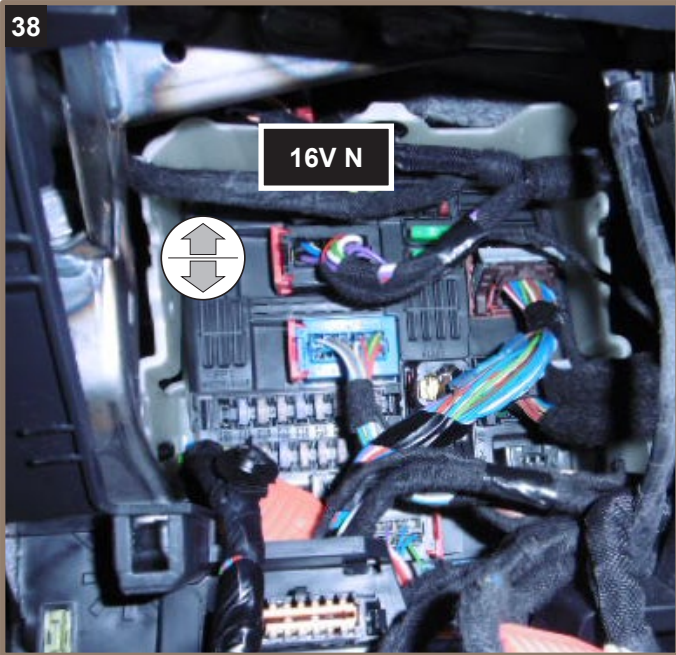

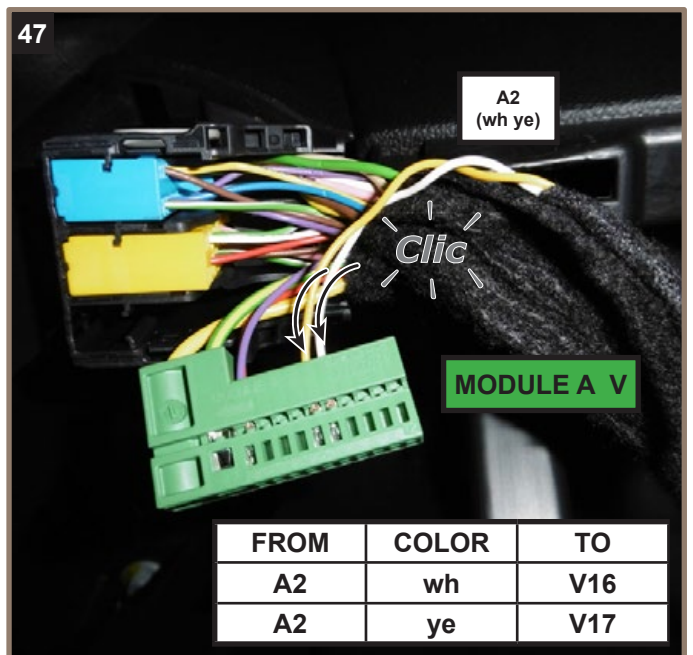
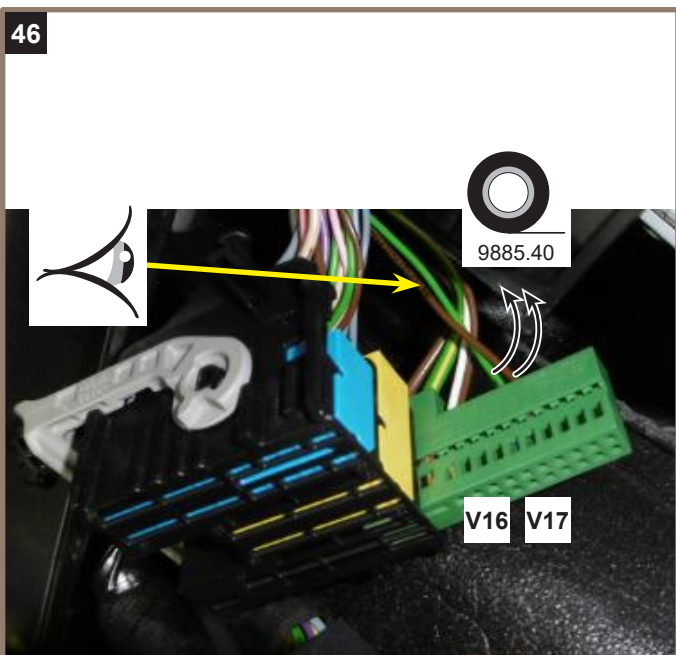
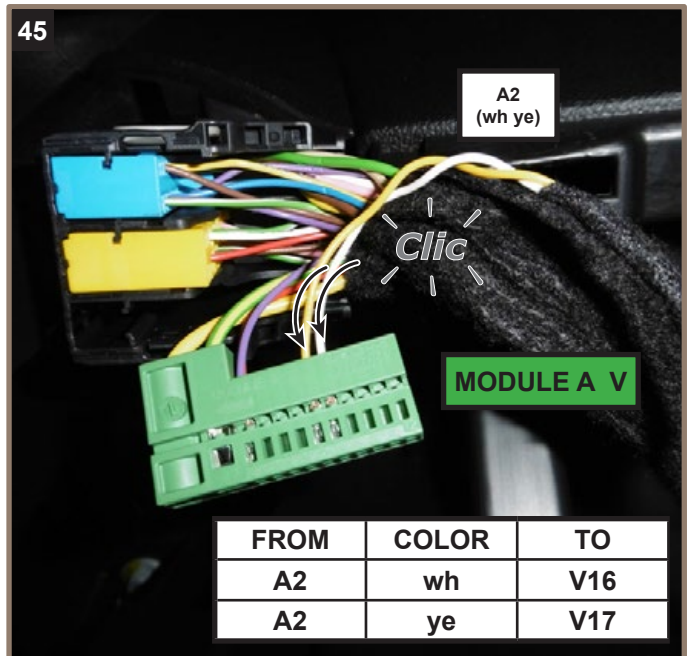
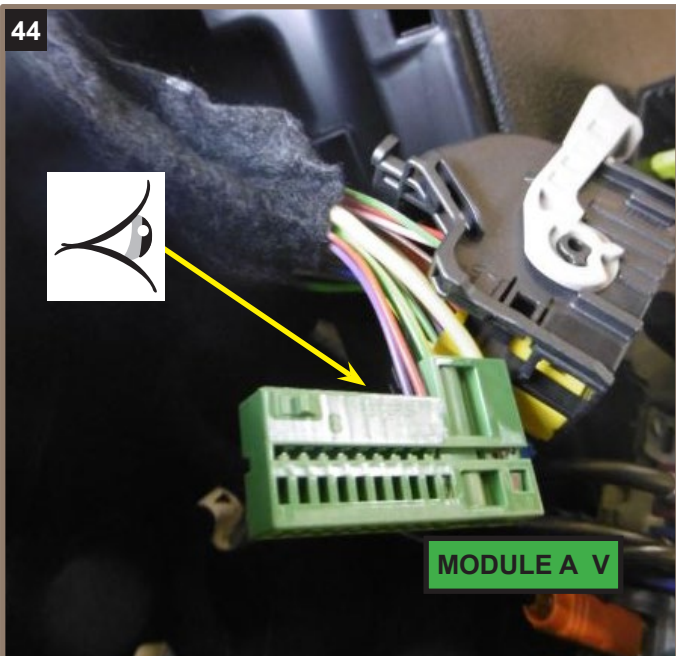
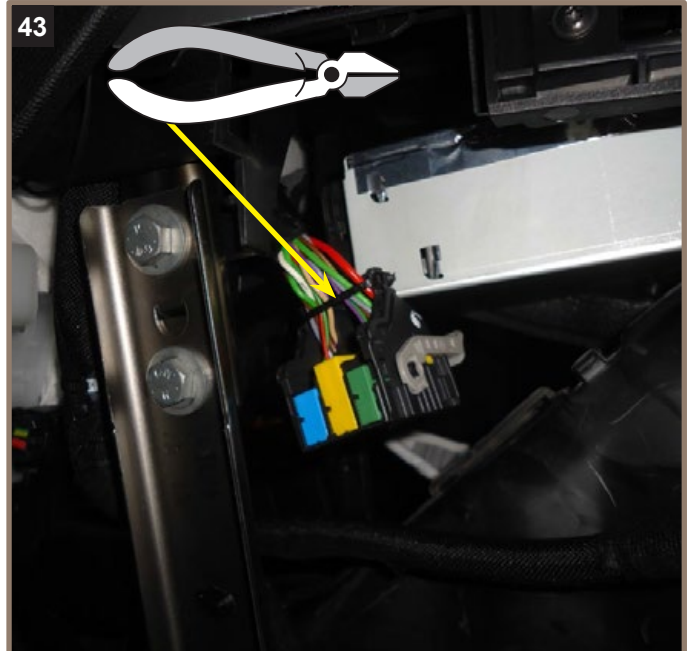
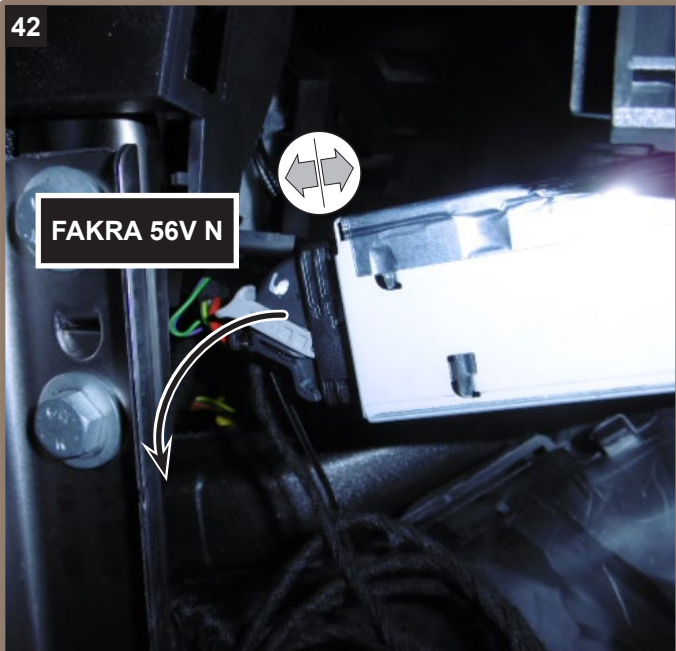

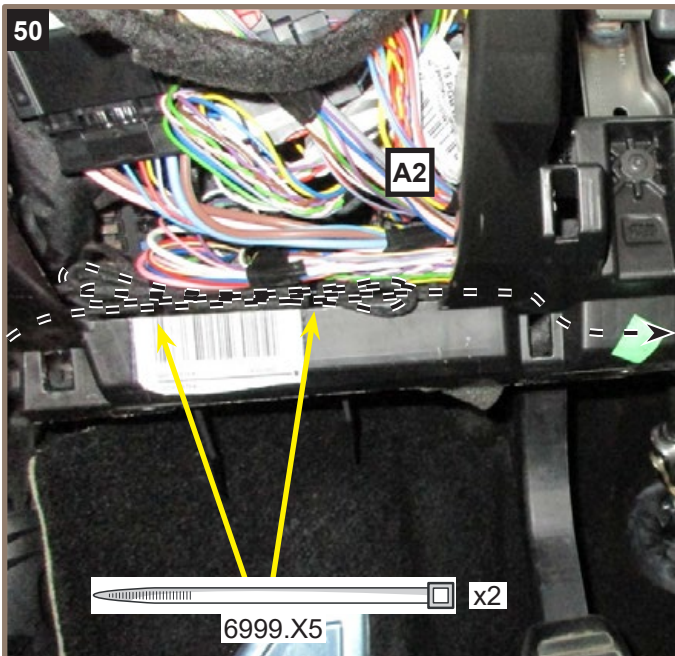
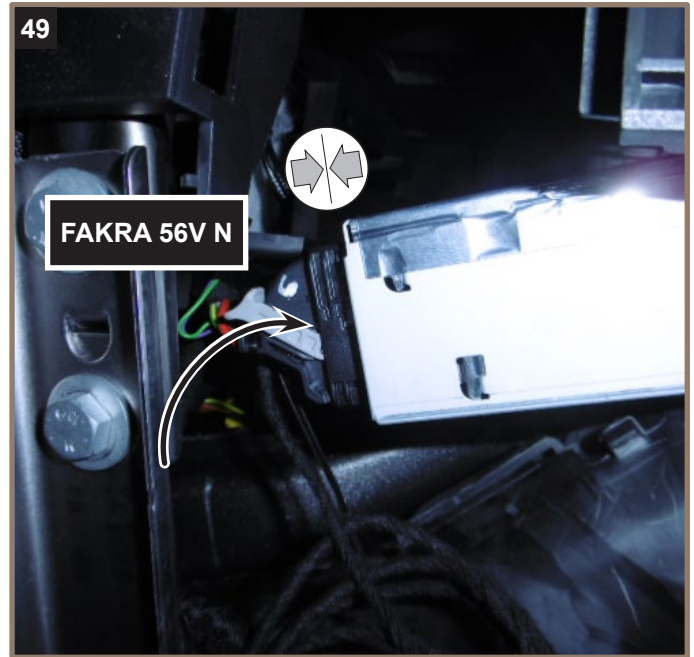
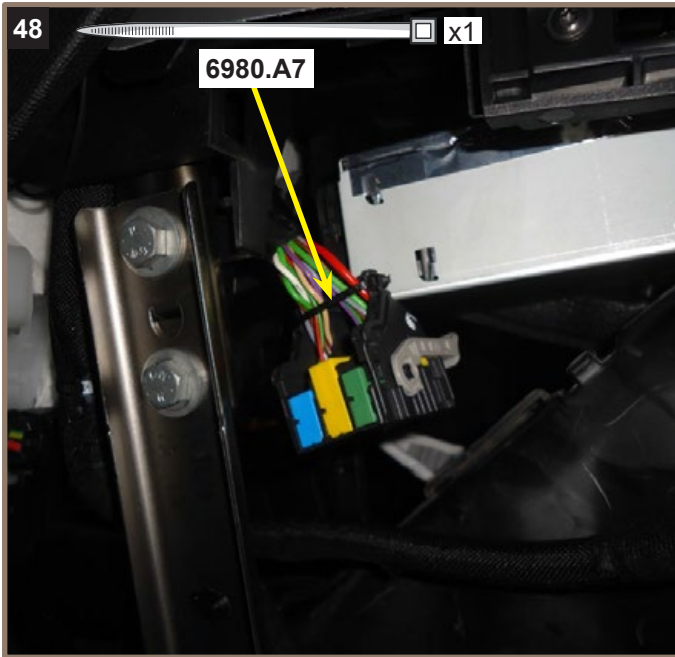

51

FR Repose. Procéder dans l'ordre inverse de la dépose.
GB Refitting. Proceed in the reverse order to removal.
ES Reposición. Proceder en el orden inverso de la extracción
P Reposição. Proceder no sentido inverso ao da extracção.
DE Einbau. In umgekehrter Ausbaureihenfolge vorgehen.
IT Rimontaggio. Procedere nell'ordine inverso rispetto allo smontaggio.
NL Inbouwen. Ga te werk in omgekeerde volgorde van uitbouwen.
PL Ponowny montaż. Wykonać czynności demontażu w odwrotnej kolejności.

52

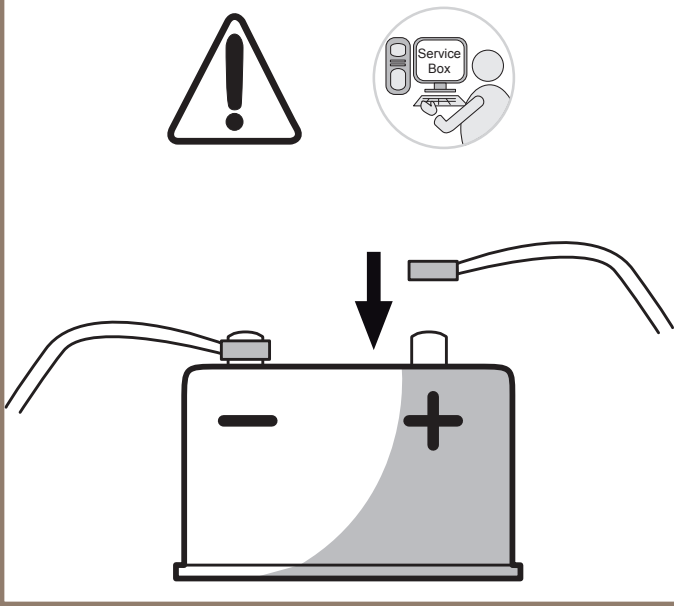

53



NOT_3809_DIAGBOX_Caméra_De_Recul_180°.pdf

