

# AUTOSPORT

DRAMATIC BRAZILIAN GP

# RAINMASTER

## LEWIS TAKES IT TO THE WIRE

“Nico is driving at his best, and he had nothing on me”



PLUS  
**VICTORY FOR BUEMI**  
AS FORMULA E HITS AFRICA

Nov 17 2016  
UK £3.80  
CAN \$8.99



9 770269 946272 46

A Very Special Lightweight Lister  
Limited to Just 10 Editions

# The Lister Knobbly Stirling Moss

For the first time in almost 60 years, two Great British racing legends have joined together. The result is simply the fastest racing car of the 1950's recreated using the same jigs, bucks and even some of the same engineers that built them in period.

*Sir Moss*  
LIMITED EDITION

**HANDCRAFTED TO THE ORIGINAL WORKS SPECIFICATION  
TO INCLUDE LIGHTWEIGHT CHASSIS AND MAGNESIUM BODY SHELL**



Available for road or historic race use.

Please call 0800 001 4998 or visit:

[WWW.LISTERCARS.COM](http://WWW.LISTERCARS.COM)

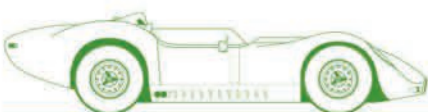

#### CONTACT US

George Lister Engineering Ltd  
Queens Business Park  
Wilbraham Road  
Fulbourn, Cambridge  
CB21 5GT, UK

#### LISTER GROUP OF COMPANIES

- The Lister Motor Company Ltd
- Brian Lister (Light Engineering) Ltd
- Lister Storm Racing Ltd
- Lister Storm LMP Ltd
- Lister Heritage Ltd

#### VIDEO CLIPS

SEE OUR MINI DOCUMENTARY  
Lister Sir Stirling Moss interview with Quentin Willson

 [www.youtube.com/listercars](http://www.youtube.com/listercars)



**LISTER**

All rights reserved. The Lister name and logo are registered trademarks - 2016



# Two wet-weather aces in a class of their own

IT'S ALWAYS FASCINATING TO SEE HOW DRIVERS GET on when rain arrives. Many of Formula 1's most memorable drives have come in the wet, and last weekend's Brazilian GP provided two.

Lewis Hamilton's appeared the more straightforward. With the title pressure still high, he was composed throughout. To look so comfortable in those circumstances underlined Hamilton's status as one of F1's all-time great wet-weather drivers.

Perhaps predictably, the next person on that list looks set to be Max Verstappen. His race was more spectacular than Lewis's and included several superb passes, the best of which was arguably going around the outside of Nico Rosberg at Turn 3. That confidence was reminiscent of Michael Schumacher's first victory for Ferrari, in the 1996 Spanish GP.

It was also interesting to note that, when asked if he thought he could have won without the unnecessary tyre stops, Verstappen was happy to admit that beating Hamilton would have been tough because "he was driving the right lines too", implying that nobody else was. The two really were on a different level at Interlagos.

• As you will all be aware, Autosport is now part of the Motorsport Network. On page 26, Motorsport Network Chairman Zak Brown outlines his vision for the future. It includes the welcome return of some old names, as well as new and exciting developments. We hope you will enjoy our fresh path.



**KEVIN TURNER EDITOR**

kevin.turner@haymarket.com

@KRT917



**COVER IMAGE**  
Batchelor/XPB Images

## COVER STORY

**4** Brazilian Grand Prix report and analysis

## PIT+PADDOCK

**22** Palmer secures 2017 Renault F1 seat

**24** Button closes on racing plan

**26** Letter from Zak Brown

**27** Feedback: your letters

**29** Lawrence Barretto: in the paddock

## REPORTS AND FEATURES

**30** MotoGP: Lorenzo signs off with a win

**36** Buemi's star turn in Marrakech Formula E

**42** Teddy Yip Jr and the Macau Grand Prix

**48** DTM's newest star: Marco Wittmann

## RACE CENTRE

**54** Japanese Super GT; NASCAR Sprint Cup

## CLUB AUTOSPORT

**67** Two Mercedes-AMGs set for British GT

**68** FF1600 ace gets Formula E run

**70** New races for Goodwood Members' event

**71** Humble Pye: the voice of club racing

**72** National reports: Brands Hatch; Anglesey Race of Remembrance

**74** BRDC F3 2016 season review

## FINISHING STRAIGHT

**78** What's on this week

**80** From the archive: 1984 Monte Carlo Rally

**82** Introducing: Richard Verschoor

## AUTOSPORT SUBSCRIPTION OFFER

**28** Sign up and get FREE KitSound wireless headphones

# FIND US ON

 [autosport.com](http://autosport.com)

 [twitter.com/autosport](https://twitter.com/autosport)

 [facebook.com/autosport](https://facebook.com/autosport)

 [instagram.com/autosportdotcom/](https://instagram.com/autosportdotcom/)

 [youtube.com/AUTOSPORTdotcom](https://youtube.com/AUTOSPORTdotcom)

 the Apple App Store

 [digitalmagazine.autosport.com](http://digitalmagazine.autosport.com)

 Apple News



express

RAUCH

PETRONAS  
SYNTIUM

PETRONAS

44

QUALCOMM

PIRELLI



# Lewis and Max star in the rain

By Edd Straw, Editor-in-Chief [@eddstrawF1](#)

**THE SODDEN PAULISTA CROWD MADE ITS FEELINGS EMPHATICALLY CLEAR.**

As the red flag flew for the second time, bookending a period of ‘racing’ comprising just eight laps – and all of that behind the safety car – they booed and gave the thumbs down. When things eventually resumed again, almost an hour and a half after the race had started under the safety car, they had seen a grand total of five racing laps, and a few accidents.

But while the action took time to get going, the crowd were rewarded with a chaotic race crowned by a virtuoso victory from Lewis Hamilton. They might not have appreciated the Mercedes driver leading from start to finish, and if you dig into the details his pace was more scintillating even than it appeared, but they certainly would have given their approval to his attitude.

“The track is fine,” complained leader Hamilton, in desperate need of a full-points victory to boost his title chances, over the radio when the second red flag came. “It’s not even wet now, I don’t know why we are stopping,” he added shortly after.

Some of his comrades agreed with him, some didn’t, but even though the world championship situation meant he would always want to be racing to give team-mate Nico Rosberg the chance to mess up, Hamilton again showed he has no fear in these conditions.

“I was generally just chillin’ up front,” he said on the podium – with the modesty of a true superhuman.

While the race situation, and the current regulations, meant Hamilton could not stamp his mark on this event in quite the same way as he did

in his truly great wet-weather victory in the 2008 British Grand Prix, the fact was he destroyed Rosberg. As the man himself put it, “Nico is driving at his best right now, and he had nothing on me”.

To put his dominance into context, if you take a sample set of their fastest 20 laps of the race, Hamilton’s lap time advantage over Rosberg was a massive 0.617 seconds. And a larger set of laps is even less favourable to the German. It was a display of rain mastery reminiscent of Hamilton’s victory in the 2014 Japanese Grand Prix, a duel between the two Mercedes drivers that was understandably forgotten amid the tragic circumstances of Jules Bianchi’s accident.

In that race, Hamilton ran second to Rosberg but showed far greater comfort with the rear end moving around than his team-mate before eventually overtaking him. The bottom line is that he’s just better than Rosberg in the wet. Not that he thought the conditions were even that bad.

“This is Formula 1 and the rain conditions are the trickiest conditions,” said Hamilton after his 52nd grand prix victory. “If everyone just went round and didn’t make mistakes, it would be too easy and then everyone could do it. We are going at some serious speeds and there is a lot of water to disperse by the tyres, and the tyre just struggles; the faster we go, the harder it is for the tyres. This wasn’t a particularly difficult race in terms of being wet, there have been much worse races in terms of aquaplaning.”

Tell that to Marcus Ericsson, Kimi Raikkonen or Felipe Massa, who all crashed into the wall and out of the race. Or, for that matter, Romain Grosjean, who managed to crash half an hour before the race even started! These were not easy conditions, no matter what Hamilton says, especially on Pirelli wets that some drivers believe don’t cut through the standing water quite as well

as they should do. What’s terrifying is that so comfortable was Hamilton that he might not even have been being modest. Perhaps it really was that easy for him.

And it’s not as if Hamilton has a great record at Interlagos. This was his first victory here

**“It’s probably the most smooth-sailing race I’ve had here in 10 years”**

in 10 attempts, so it’s not a track that has been kind to him, even though he did clinch his maiden title here back in 2008.

“It’s a hard grand prix to win and today was one of the most difficult [at this venue] in terms of being wet and aquaplaning and everything,” said Hamilton, who didn’t even make any pitstops during the race, relying simply on the rule allowing tyre changes under red-flag conditions to refresh his wets. “It’s probably the most smooth-sailing race I’ve had here in 10 years.”

Time and again he pulverised Rosberg. In each of the three segments the race was divided into, he crushed him. In the first five laps of green-flag racing before Ericsson’s shunt brought out the safety car again, he pulled 3.025s on him. After 16 laps of racing before Massa crashed, he was 18.534s clear. And in the final 16 laps of racing, the advantage was 11.455s. So over 37 racing laps, that adds up to an advantage of 33.014s. Mighty. >>



Raikkonen shunt brought the red flag out again

DUNBAR/LAT



Hamilton was more impressive in the wet than Rosberg



Verstappen made his team-mate look ordinary

And let's say the race had gone over 71 racing laps; that would have added up to an advantage of just over one minute, which is not far off Hamilton's 68-second win at Silverstone in 2008. While Rosberg's huge moment on the run out of Juncao on lap 44 cost him over four seconds and slightly distorts the picture, the two simply weren't in the same league.

But that doesn't mean Hamilton was in a class of his own in Brazil. As Hamilton's own team boss Toto Wolff suggested, another driver was "redefining physics" with his brilliance during the race. Max Verstappen also made his team-mate, Daniel Ricciardo, look ordinary and had to work a lot harder than Hamilton did.

Right from the 'start', Verstappen signalled his intent. He sailed past Raikkonen's Ferrari to take third place into the Senna S.

"I was trying some different lines and I found a good one, so I knew that if Kimi was not going to take that line, then I had a good chance of overtaking him," said Verstappen. "That worked out, he couldn't really see what was happening and I pulled out of the spray. Then I could brake on the inside line and pass him."

He then set about hounding Rosberg. An early switch to intermediates (after diving into the pits moments before they were closed because of Ericsson's shunt) wasn't the right call, but it didn't cost him much. Even less once Raikkonen crashed out of third place at the subsequent restart, putting Verstappen back up into third and behind Rosberg once more.

## "Kimi couldn't really see what was happening and I pulled out of the spray"

The ensuing red flags and safety car laps meant that he had to wait until lap 32 to overtake the Mercedes driver. If that sounds a bit slow, bear in mind it was only the sixth racing lap.

This time, the move showcased Verstappen's ability to find the grip — using what are traditionally described as wet lines. Rosberg was a little too greedy on the throttle into Turn 3 and had a wobble, so Verstappen simply went to the outside and flung his Red Bull past the Mercedes. It was a pass almost contemptuous in its execution, to the point where Verstappen might have well been breezing past Rosberg on a sunny day on the motorway.

What was even more miraculous was that when Verstappen did make a mistake — losing the rear at the kink by the pit entry on lap 38 — he managed to keep it out of the wall. He described it as a "50/50" moment, but nobody would

dispute that driver skill played a big part in his survival. Stunningly, it didn't even mean Rosberg got back past — Verstappen just hung on to second as the Mercedes loomed into the first corner.

There was even a point, shortly before that lurid slide, when it seemed Verstappen might even be able to bother Hamilton. On lap 34, he carved just over half-a-second out of the leader to close the gap to just one second. For a few tantalising moments, it seemed Verstappen and Hamilton might be on a collision course. But it was too good to be true and the Mercedes driver responded by banging in his fastest lap of the race so far, 0.669s faster than his previous lap. In fact, it was Verstappen's desire to make a race of



XPBIMAGES



XPBIMAGES

it that led to his massive moment, from which which he admitted he was lucky to escape without hitting the barrier.

But Verstappen had plenty of time to fight with Hamilton later. Or, at least, he might have done had he not dived into the pits for another set of intermediate tyres on lap 43, even though he had fallen just over nine seconds behind the leader. He emerged in fifth place having lost track position to Force India's Sergio Perez and Toro Rosso's Carlos Sainz Jr.

Red Bull expected conditions to ease. But they didn't. Even with the safety car being deployed on lap 48 because of Massa's crash in the very place Verstappen had dodged a bullet, it was clear the >>

Some drivers felt that the race was held for far too long behind the safety car

## QUALIFYING



COATES/LAT

THE OUTCOME OF THE BATTLE FOR POLE AT INTERLAGOS WAS utterly predictable – but what was less obvious was that Nico Rosberg missed a big chance to upset the form book of the previous day and a half. Lewis Hamilton always looked to have a slender advantage over Mercedes team-mate Rosberg, largely thanks to his storming pace in the long middle sector that makes up just over half of the lap at Interlagos.

All weekend, Rosberg had the edge in the short, sharp first sector that consists of the run through the Senna S and Turn 3 and the run down to the fourth corner, and on their final fliers in Q3 he was 0.072 seconds up by this point. This is where it gets interesting, for Rosberg was still in credit once the middle sector was complete, albeit by only 0.024s – and when Hamilton, who was running ahead on track, fell 0.067s short of his personal best in sector three to post a 1m10.736s, everyone held their breath.

Had Rosberg replicated his first-run pace through the final sector, he would have taken pole position. But he fell well short, ending up 0.102s off Hamilton.

**“Hamilton always looked to have a slender advantage over Rosberg”**

Looking at the onboard footage, it's likely that a slight moment of breaking traction off the final 'real' corner – Juncao – cost him time on the following straight. Much as Rosberg claimed otherwise, this was a chance squandered.

“It's just that I was quicker in sector one and Lewis was quicker in sector three,” said Rosberg. “So it didn't go away anywhere, even though that's how it might look.”

Of course, it might just have been that track conditions went away from the drivers. There was a brisk breeze, and several drivers, including both Red Bulls and Ferrari's Sebastian Vettel, failed to improve. But Kimi Raikkonen did manage to leapfrog from sixth to third, and Vettel was frustrated not to be there with him.

“We struggled to show our pace,” said Vettel. “We managed to split the Red Bulls but ideally we would have liked to have been ahead with both cars. I was not entirely happy with my final run, I messed up the last two corners a little bit.”

As expected, both the Force Indias made Q3 and qualified eighth and ninth, but the real surprise was that Romain Grosjean's Haas and Fernando Alonso's McLaren both made the top 10 while neither Williams did. Williams looked strong on Friday, but fell at Q2. This was suspected to be down to the track temperatures being around 25C lower on Saturday than on Friday, although the performance in Saturday morning practice was strong enough to suggest the explanation wasn't quite that simple. Either way, neither driver could get much grip.

As for Grosjean, he was delighted to match the Haas team's best qualifying result with a remarkable seventh. Given that was backed up by outgoing team-mate Esteban Gutierrez taking 12th, it was a massive turnaround from the dire performance in Mexico two weeks ago, when they were nowhere.



“VETTEL’S APPROACH SUMS UP A GENERAL MALAISE”



FORMULA 1 CIRCUITS ARE never quite the same from one year to the next. A glance at the ‘race director’s notes’ reveals item 2.1 that says “the kerbs on the apex of turns 2, 3, 4, 8 and 10 have been halved in width and are now conventional 50mm bevelled kerbs”. And that made a big difference.

Heading to the first sequence of corners for Friday morning practice – the Senna S left/right that plunges downhill and leads straight into the long Turn 3 left-hander – shows just how much this had changed things. Sebastian Vettel was

the highest-profile victim, taking far too much kerb in Turn 2, destabilising the car and struggling to get the power down quickly multiple times. He wasn’t the only one.

At one stage, Felipe Nasr had a particularly lairy ride after clouting the kerb, but most drivers quickly re-adjusted to the new reality that meant less kerb could be taken than was traditionally the case.

Vettel’s approach throughout the session sums up a general malaise in his driving right now, one that is seemingly connected to his state of mind and goings on at Ferrari. Coming into the Senna S, he



Vettel needs to adapt his driving style

opted for an aggressive turn-in, occasionally taking too much kerb even in Turn 1. That, in turn, sent the car wider and forced him to take more kerb in turn two.

By contrast Max Verstappen, fastest in sector one at this stage in proceedings, opted to square off the entry, setting

himself up perfectly for the second part of the S.

It seems a very different Vettel to the one that dominated with Red Bull. Yes, the car is inferior, but his determination to be aggressive on turn-in as a default style is at odds with the amount of work he did in the exhaust-blown era

to adapt to unusual throttle deployment to give him the maximum grip.

There is a needless belligerence here that does not do his ability justice. The best drivers adapt – Vettel did that once, and he needs to do it again.

**EDD STRAW**



Rosberg didn’t have to worry about Raikkonen for long

XPB IMAGES



gamble had failed. Verstappen lacked grip so pitted for wets.

He had a very simple challenge. When the race got back under way with 16 laps to go, he was down in 14th place. Those ahead rapidly fell by the wayside. Esteban Gutierrez, Pascal Wehrlein, Valtteri Bottas, Ricciardo, Daniil Kvyat, Esteban Ocon and Felipe Nasr fell at the rate of one a lap in the first seven laps of the run to the flag, Nico Hulkenberg's Force India took a little longer; Verstappen took sixth place with a move up the inside into the Turn 4 left-hander on lap 65 of 71.

The next target was Ferrari driver Sebastian Vettel, who had recovered well after an early spin. Verstappen made the move at Juncao, forcing Vettel off onto the grass, and, inevitably, triggering complaints over the radio that proved to be of no interest to the stewards. Verstappen then promptly dispatched Sainz for fourth a lap later into the Descida do Lago.

Again, a Force India proved challenging to overcome and Perez looked in no mood to cede third place. Verstappen made his move around the outside of the tight Bico do Pato right-hander. Perez gave him just enough room, and as Verstappen tried to complete the move on the exit kerb, the rear stepped out. For a moment, it seemed certain he would spear right into the Force India. But Verstappen was onto it in a flash, taking the battle through the Mergulho left-hander that followed immediately and then making sure of third place at Juncao.

It was a breathless charge, and the fact that he left Ricciardo

trailing nine seconds and five places in his wake, having overtaken him along the way, shows just how quick the fearless Verstappen was going. The two Mercedes were too far clear, with Rosberg 10s up the road. You can only imagine what might have happened had Verstappen not made that ill-fated stop for intermediates.

"I got the call to box because I heard Daniel was already gaining a second on the intermediate tyre, so we did a pitstop," said Verstappen of the move. "But then it started to rain a bit harder than before so the last sector was undrivable; so I had to pit again. I didn't know where I was. I started to pass people and it was very difficult. I couldn't see where I was going on the straight and at

such high speeds it's not nice, but we managed to pass a lot of them."

All of this was of little interest to Hamilton, who crossed the line 11.445s clear of Rosberg to make three victories in must-win races on the trot. But

the question of which of Hamilton or Verstappen had been the star of the race was the subject of many a discussion afterwards.

Both drove stellar races. But while Verstappen's was far more spectacular, what stood out about Hamilton is that he barely put a foot wrong. The Red Bull driver could easily have ended the race in the barrier, like so many others, suggesting he still needs to work on toeing the fine line between on the limit and over limit.

That was a tightrope that Hamilton walked brilliantly throughout the stop-start race. Don't believe his claim that it wasn't that difficult. After all, that's exactly what a genius would say about what they consider to be the everyday. ❄️

## **"I didn't know where I was. I couldn't see where I was going on the straight"**

# Rain causes delay and disruption

RAIN THROUGHOUT RACE day for the Brazilian Grand Prix caused extensive disruption, with a delayed start, two red flags and five appearances of the safety car.

The race got underway 10 minutes late, becoming the 12th world championship grand prix to start under the safety car. When it eventually finished, just over three hours had passed.

The first seven laps were run under the safety car, before the green flag was thrown at the start of lap eight. Marcus Ericsson's crash led to the safety car being redeployed after only five racing laps.

The attempt to get the race back underway on lap 20 led to the first red flag when Kimi Raikkonen crashed. When the race restarted, it was run under the safety car before being stopped again.

It restarted with another safety car period, before the green flag was thrown at the end of lap 31. There was one

more interruption when the safety car was deployed for eight laps after Felipe Massa crashed.

Many drivers were puzzled by the timing of the officials' decisions, as the conditions flitted between those suitable for intermediates and wets – although those who opted to stay on wets throughout were proved to have made the right choice.

"It's understandable with the first red flag because people were going off," said race winner Hamilton. "The second one, after we went back out, the track was ready for inters but the safety car stayed out for ages.

"The track was pretty much the same throughout. It was pointless to have the safety car come out; we could have kept going."

Nico Rosberg backed the decisions, saying that race control "did a good job judging it". He said that the Pirelli tyre's struggles with clearing standing water made conditions treacherous.



DUNBAR/LAT



XPB IMAGES

## Aquaplaning led to Raikkonen's shunt

KIMI RAIKKONEN CRASHED out of third place at Interlagos when the race was green-flagged for the second time.

He lost the rear of his Ferrari after aquaplaning, brushing the wall on the right side of the track before spearing back across it into the pitwall – fortunately without being collected by any following cars.

"It wasn't raining awfully heavy, but it was very easy to get aquaplaning," said Raikkonen. "The minute there are patches

[of water] you are just going to spin and aquaplane.

"Once you hit those patches, there is zero you can do. I spun, I almost got it back, but obviously I went off in a very bad place. I got aquaplaning in a place I didn't expect. Fortunately nobody hit me."

Raikkonen was one of three drivers to crash on the run from Juncao to the first corner, with Williams driver Felipe Massa and Sauber's Marcus Ericsson also shunting in similar circumstances – albeit earlier in the race and at

lower speed than Raikkonen.

"I don't know if it was the white line or a patch of water, but I was not the only one caught out up the hill," said Ericsson.

"It was strange, for some reason in the last couple of years when there's standing water we struggle to drive, whereas 10 years back people were driving in these conditions without a problem."

Romain Grosjean also crashed on the same part of the track, on his way to the grid before the race even got underway.

## Sainz stars in sixth place

CARLOS SAINZ JR MATCHED the best result of his Formula 1 career with a strong drive to sixth place.

The Toro Rosso driver started 15th, and climbed into the top 10 during the first five laps of green-flag running as others opted for intermediate rubber.

Sainz stayed with wets, changing tyres only under red-flag conditions, moving up to fourth place by the time Max Verstappen made his ill-fated switch to intermediates, then back to wets, in the second half of the race.

Sainz was able to keep Sebastian Vettel's Ferrari at bay for a long period, but was relegated to fifth by the charging Verstappen on lap 66. Vettel then found his way past with two laps remaining, giving Sainz his third sixth place of the season.

While Sainz benefited from the conditions, others did not – notably McLaren. Fernando Alonso recovered to 10th after spinning out of eighth place at the final restart, while Jenson Button had a torrid race to 16th.



## Fourth near cert for Force India

FORCE INDIA'S SERGIO PEREZ AND Nico Hulkenberg finished fourth and seventh respectively, effectively guaranteeing the team fourth place in the constructors' championship ahead of Williams.

Not only would this be the squad's best-ever position, but it would also secure it significantly more prize money, with the difference between fifth and fourth being \$13 million based on the 2015 season.

Perez narrowly missed out on a third podium finish of the season after being passed by the charging Max Verstappen with three laps remaining.

Hulkenberg had been running ahead of Perez earlier in the race, and was slightly quicker, only to pick up a puncture caused by debris and have to make a pitstop under the safety car, dropping him to 15th. He recovered to seventh.

Williams is now 27 points behind Force India heading into the Abu Dhabi finale, meaning it would need to have its best haul of the season in the race to reclaim fourth place even if Force India fails to score.

"In a normal race, it's going to be very, very difficult to get them," said Williams driver Valtteri Bottas. "They did a very good job today and we didn't."



XPB IMAGES

### Q&A

#### FELIPE MASSA WILLIAMS DRIVER



Felipe Massa crashed out of his final Brazilian Grand Prix – the penultimate race of his F1 career – while running 13th. This resulted in emotional scenes and tears as, draped in the Brazilian flag, he saluted his fans.

##### What was your experience of today?

It was heartbreaking, I didn't want it to finish like this. I wanted a good result for the fans, for Brazil, for my team, for me. I had an amazing feeling with the fans, I couldn't stop crying.

##### What happened when you crashed?

Suddenly I aquaplaned and I was sliding. I couldn't stop the car. When I hit the wall, it pushed me to the inside and the suspension broke, then I had another big crash on the other side.

##### What went through your mind?

I was quite sad. But then I thought about everything that happened after, it was an amazing feeling so I just started crying. The emotion from the people... it's difficult to explain.

##### You had rival teams, like Ferrari, coming out of the garage to see you...

It was so special to see these guys coming out in the middle of the race to see me passing after such a big crash. I will never forget this day.

##### What do you make of this response?

I'm so proud. I've never done anything different, I've just tried to be myself. F1 is sometimes a difficult world, but people are human. What I felt today, I will never forget in my whole life.

##### You have one race left in your F1 career – what do you expect?

I will try to enjoy my last race as best I can, hopefully with a podium or a great result.

HONE/LAT

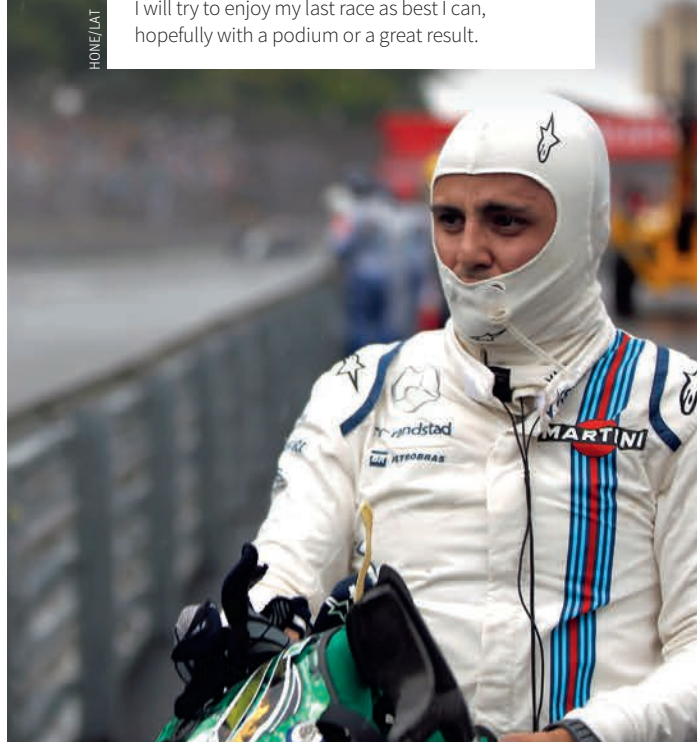

## Good design sometimes needs a little help...

...that's why global race teams use Sandwell as a prime supplier of performance engineering solutions.

- Controlled Shot Peening
- Superfinishing
- Low Friction Coatings
- Kephos Lightweight Coating
- Conductive Coatings
- Non Conductive Coatings

Sandwell works with design and development engineers throughout the world of manufacturing to improve component performance.

- Improve component fatigue life
- Increase component strength
- Improve reliability
- Reduce component weight
- Reduce surface friction
- Apply corrosion resistant coatings

### Latest News-

Sandwell's Technical Director Colin McGrory receives prestigious Shot Peener of The Year Award 2016!



## Nasr's ninth place sets up windfall for Sauber

FELIPE NASR'S FIRST points in over a year, for ninth place, lifts Sauber above Manor into 10th in the constructors' championship – a result that is set to net the team more than \$10 million.

The so-called 'Column 2' prize money

is paid to the top 10 constructors on a sliding scale, with 10th in last year's standings worth \$13.5m to Manor.

Unless Manor scores again in the Abu Dhabi season finale, this will provide a crucial cash boost to Sauber.

Nasr was slowest in qualifying, starting 21st after Manor driver Esteban Ocon was penalised for impeding Renault's Jolyon Palmer in Q1. But he climbed to ninth by the end of the initial five laps of green-flag running when others

pitted for intermediates.

From there he drove a superb race, keeping it clean while passing rival cars and keeping the Manor drivers, both of whom were in the points at one stage, at bay.

"It tastes like a victory," said the delighted Nasr.

Having a car that was super-difficult to drive, in terms of performance, it would have been impossible to be in the points.

"But in conditions like this, when the opportunity comes you have to be there to take it."



## Palmer retires after Kvyat collision

JOLYON PALMER, NEWLY re-signed as a Renault driver for 2017, retired from the race after hitting Daniil Kvyat's Toro Rosso.

Palmer was running 19th when the green flag was thrown for the second time – the restart at which Kimi Raikkonen crashed.

In the final kink on the run to the first corner by the pit entry, he attempted to take advantage of Kvyat

appearing to have to lift behind Esteban Gutierrez, losing momentum.

But Palmer's attempt to squeeze between the pit entry and Kvyat resulted in him hitting the Toro Rosso's sidepod. Although he was able to get the car back to the pits under the red-flag conditions that followed, he could not restart.

"I couldn't see a thing," said Palmer. "I was coming

up behind Kvyat and decided to go to the inside. I knew roughly where he was, but only from the low speed. As soon as we picked up speed, the spray was too much."

Kvyat continued and finished 13th, but said that the damage made his car "undriveable".

Palmer's team-mate, Kevin Magnussen, finished in 14th place.



## Grosjean crashes before race starts

ROMAIN GROSJEAN THREW AWAY HIS AND the Haas team's equal-best grid position of the year by crashing on a pre-race reconnaissance lap.

Grosjean lost the rear on the power coming out of the Juncao left-hander, effectively the final corner on the circuit that leads onto the three-part main straight.

"Hero to zero in 24 hours," said Grosjean. "I feel so bad for the team. I was not even flat out.

"I picked up wheelspin, like an on/off switch. I was not pushing at all. Very strange."

Grosjean had qualified seventh, matching his best result of the year set at Suzuka last month.

Team-mate Esteban Gutierrez was unable to salvage points from the race after starting 12th, dropping to 19th following a mistake when the race first went green and later retiring with an electronics problem.



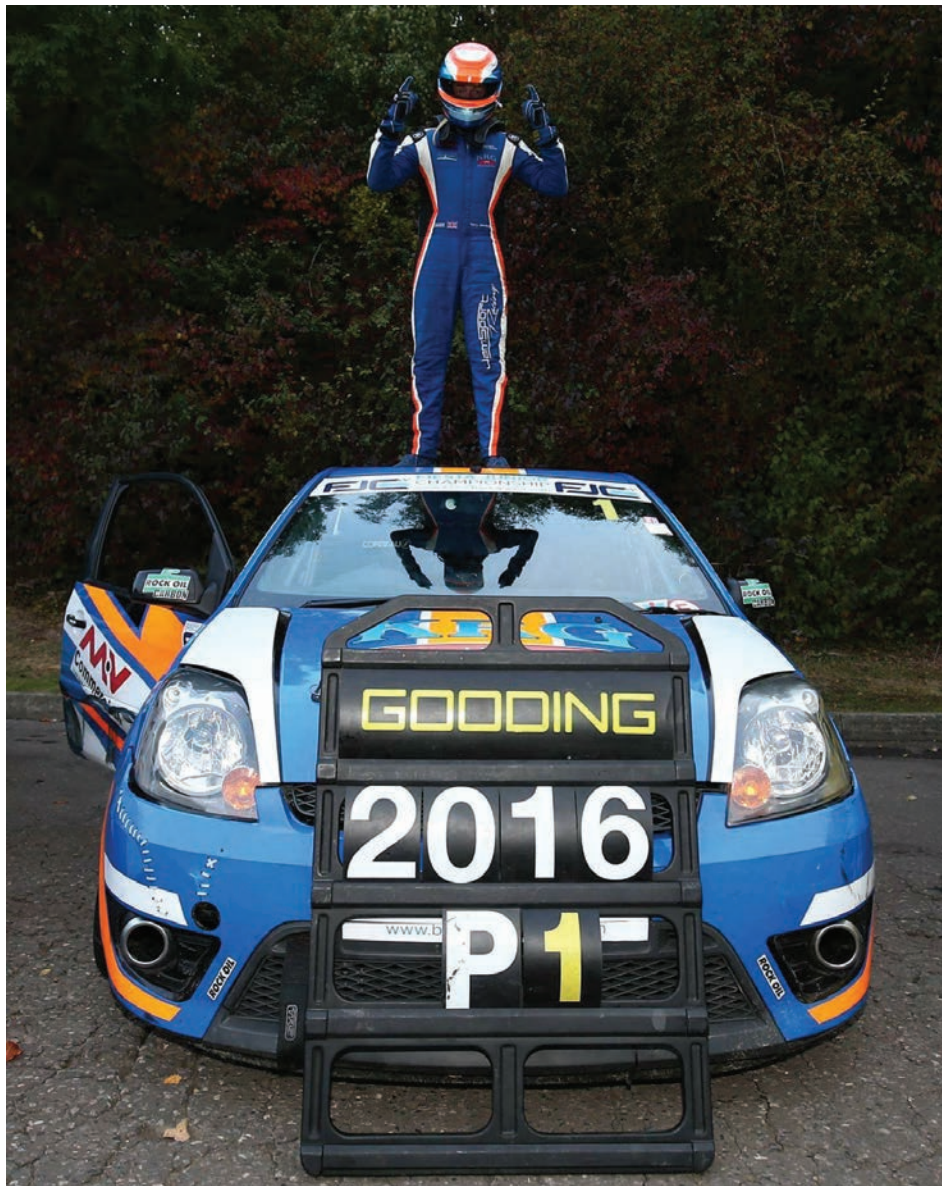

## **Congratulations to 14-year-old JamSport driver Harry Gooding on winning the BRSCC Fiesta Junior Championship at Brands Hatch.**

**Harry is the youngest winner of the BRSCC Fiesta Junior Championship and has taken 12 podiums with 6 wins in his first year along with taking the Rookie Cup.**

**If you would like to get involved with one of Britain's rising stars who is looking for sponsorship for the all new Renault Clio Junior Championship, please contact us at [jayne.gooding@btconnect.com](mailto:jayne.gooding@btconnect.com) for sponsorship information**



DRAWING BOARD

By Craig Scarborough

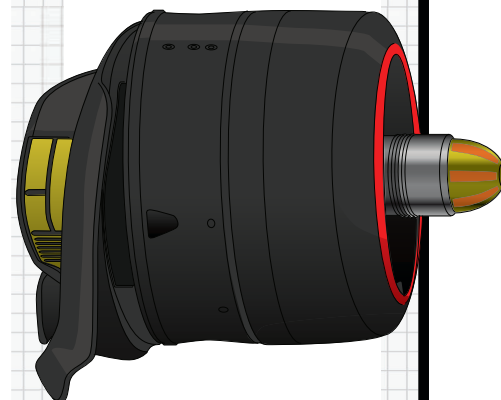
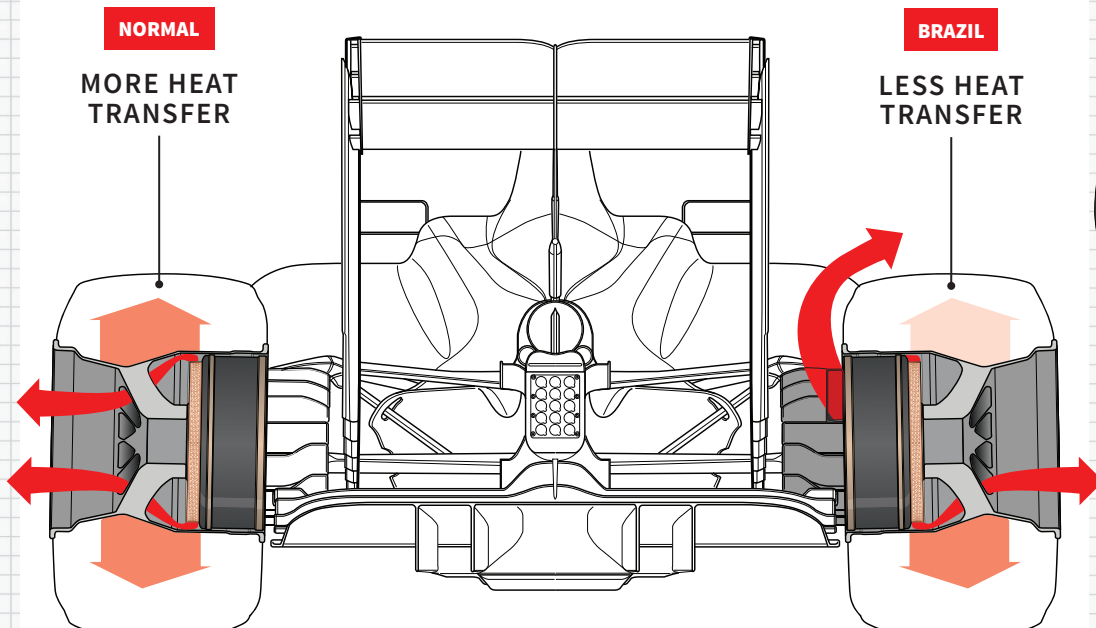

**McLAREN LOOKS AHEAD TO 2017 AGAIN**

McLaren tried two new ideas on its front brake ducts: a revised inlet scoop and closing off the blown open axle. Its brake ducts have been a key feature for development throughout the year, not so much as a brake cooling aid, but a critical part of the car's aerodynamics.

In the first change, the inlet scoop was opened up and dissected into four distinct sections, as opposed to the previous smaller sections.

An interesting development tested in free practice was the closing of the open axle.

Like several teams, McLaren deliberately blows air through the large-diameter hollow axle. This isn't a cooling flow, instead the blown effect works with the front wing to push airflow out around the front tyre. This set-up produces a little bit of drag, but this is counteracted with the downstream effect on the rear wing.

It's likely that, as with many of McLaren's recent free-practice tests, this is looking towards next season. With the larger 2017 tyres creating more drag, and less reliance on the rear wing for downforce, efforts to reduce drag will be important to maximise performance of the new package. Thus, the removal of the blown axle could be a beneficial change for next year.

**FERRARI AIMS TO CURE REAR-TYRE TEMPERATURE WOES**

Although not required in the damp of this year's Brazilian Grand Prix, Ferrari tried a brake-duct update aimed at improving its tyre use at hot races. This has been identified as a problem in higher temperatures, when the tyres overheat and lose

performance. A new vent has been added to the rear brake ducts to reduce heat transfer from the brakes into the wheel and tyre.

On the usual set-up, all the heat from the rear brakes (glowing at up to 1000C) passes out through

the wheel. With the rear wheel being so deep, this transfers a lot of heat from the brake into the wheel. This in turn heats up the rubber and contributes to Ferrari's tyre problems.

This new vent reverses some of the flow back out

from the inner side of the wheel, resulting in less brake heat passing through the wheel and thus less transfer to the tyres. This key tuning aid to rear tyre temperature in hot conditions is likely to be seen again at the final race in Abu Dhabi.

**WILLIAMS CHECKS ITS CALCULATIONS**

**BRAZIL  
SENSORS**

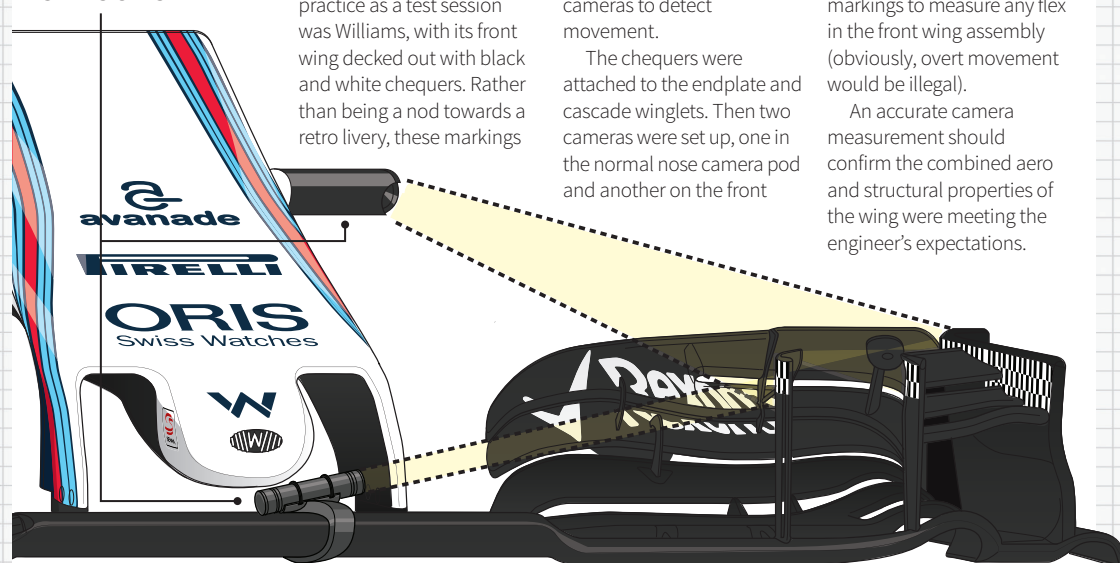

Another team using free practice as a test session was Williams, with its front wing decked out with black and white chequers. Rather than being a nod towards a retro livery, these markings

are a target for high-speed cameras to detect movement.

The chequers were attached to the endplate and cascade winglets. Then two cameras were set up, one in the normal nose camera pod and another on the front

wing. Both looked at the markings to measure any flex in the front wing assembly (obviously, overt movement would be illegal).

An accurate camera measurement should confirm the combined aero and structural properties of the wing were meeting the engineer's expectations.

# F1/BRAZILIAN GRAND PRIX RESULTS

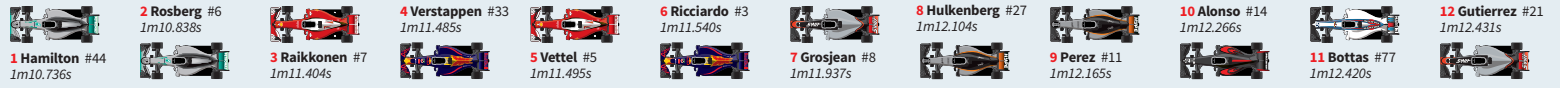

## Race results / 71 laps – 190.092 miles

POS	DRIVER	TEAM	FINISH TIME	LED	TYRES	TIME IN PITS
1	Lewis Hamilton	Mercedes	3h01m01.335s	71	●●●	58m12.409s
2	Nico Rosberg	Mercedes	+11.455s		●●●	58m11.371s
3	Max Verstappen	Red Bull-Renault	+21.481s		●●●●●	59m23.738s
4	Sergio Perez	Force India-Mercedes	+25.346s		●●●	58m10.688s
5	Sebastian Vettel	Ferrari	+26.334s		●●●●	58m44.541s
6	Carlos Sainz	Toro Rosso-Ferrari	+29.160s		●●●	58m11.881s
7	Nico Hulkenberg	Force India-Mercedes	+29.827s		●●●●	58m38.090s
8	Daniel Ricciardo	Red Bull-Renault	+30.486s		●●●●●	59m32.090s
9	Felipe Nasr	Sauber-Ferrari	+42.620s		●●●	58m11.420s
10	Fernando Alonso	McLaren-Honda	+44.432s		●●●●	58m37.428s
11	Valtteri Bottas	Williams-Mercedes	+45.292s		●●●●●	59m02.270s
12	Esteban Ocon	Manor-Mercedes	+45.809s		●●●	58m14.144s
13	Daniil Kvyat	Toro Rosso-Ferrari	+51.192s		●●●●●	59m06.767s
14	Kevin Magnussen	Renault	+51.555s		●●●●●	59m02.704s
15	Pascal Wehrlein	Manor-Mercedes	+1m00.498s		●●●●	58m38.952s
16	Jenson Button	McLaren-Honda	+1m21.994s		●●●●●	59m29.001s
R	Esteban Gutierrez	Haas-Ferrari	60 Laps-Electronics		●●●●●	58m58.573s
R	Felipe Massa	Williams-Mercedes	46 Laps-Accident		●●●●●	59m14.774s
R	Jolyon Palmer	Renault	20 Laps-Accident		●●●	49.401s
R	Kimi Raikkonen	Ferrari	19 Laps-Accident		●	-
R	Marcus Ericsson	Sauber-Ferrari	11 Laps-Accident		●●	25.395s
Ns	Romain Grosjean	Haas-Ferrari	0 Laps-Accident			-

## Fastest laps

POS	DRIVER	TIME	GAP	LAP
1	Verstappen	1m25.305s	-	67
2	Ricciardo	1m25.532s	+0.227s	42
3	Hamilton	1m25.639s	+0.334s	44
4	Bottas	1m26.062s	+0.757s	70
5	Vettel	1m26.195s	+0.890s	70
6	Rosberg	1m26.222s	+0.917s	47
7	Magnussen	1m26.524s	+1.219s	69
8	Hulkenberg	1m26.728s	+1.423s	69
9	Massa	1m26.767s	+1.462s	39
10	Button	1m26.983s	+1.678s	38
11	Perez	1m27.093s	+1.788s	41
12	Alonso	1m27.104s	+1.799s	70
13	Sainz	1m27.153s	+1.848s	38
14	Kvyat	1m27.476s	+2.171s	42
15	Nasr	1m27.547s	+2.242s	70
16	Ocon	1m27.796s	+2.491s	47
17	Gutierrez	1m27.805s	+2.500s	43
18	Wehrlein	1m27.919s	+2.614s	69
19	Raikkonen	1m28.847s	+3.542s	12
20	Ericsson	1m31.265s	+5.960s	11
21	Palmer	1m34.334s	+9.029s	11
22	Grosjean	-	-	-

WEATHER Wet; temperature 19C WINNER'S AVERAGE SPEED 63.003mph FASTEST LAP AVERAGE SPEED 112.994mph

● New ○ Used | ● Ultra Soft ● Super Soft ● Soft ● Medium ● Hard ● Wet ● Intermediate

2

Red Bull has now made sure of second place in the constructors' championship

7

Grosjean equalled the Haas team's best grid position – although he didn't take the start

13

Massa started from his lowest grid position in Brazil on his final appearance here at Interlagos

19

Mercedes has now set a new record for constructor pole positions during an F1 season

24

This was the 24th different track Hamilton has won on, beating Michael Schumacher's tally

52

Hamilton is now a clear second in the all-time winners list, one ahead of Alain Prost

250

Raikkonen started his 250th world championship race – only six drivers have started more

## Lap chart / What happened, when

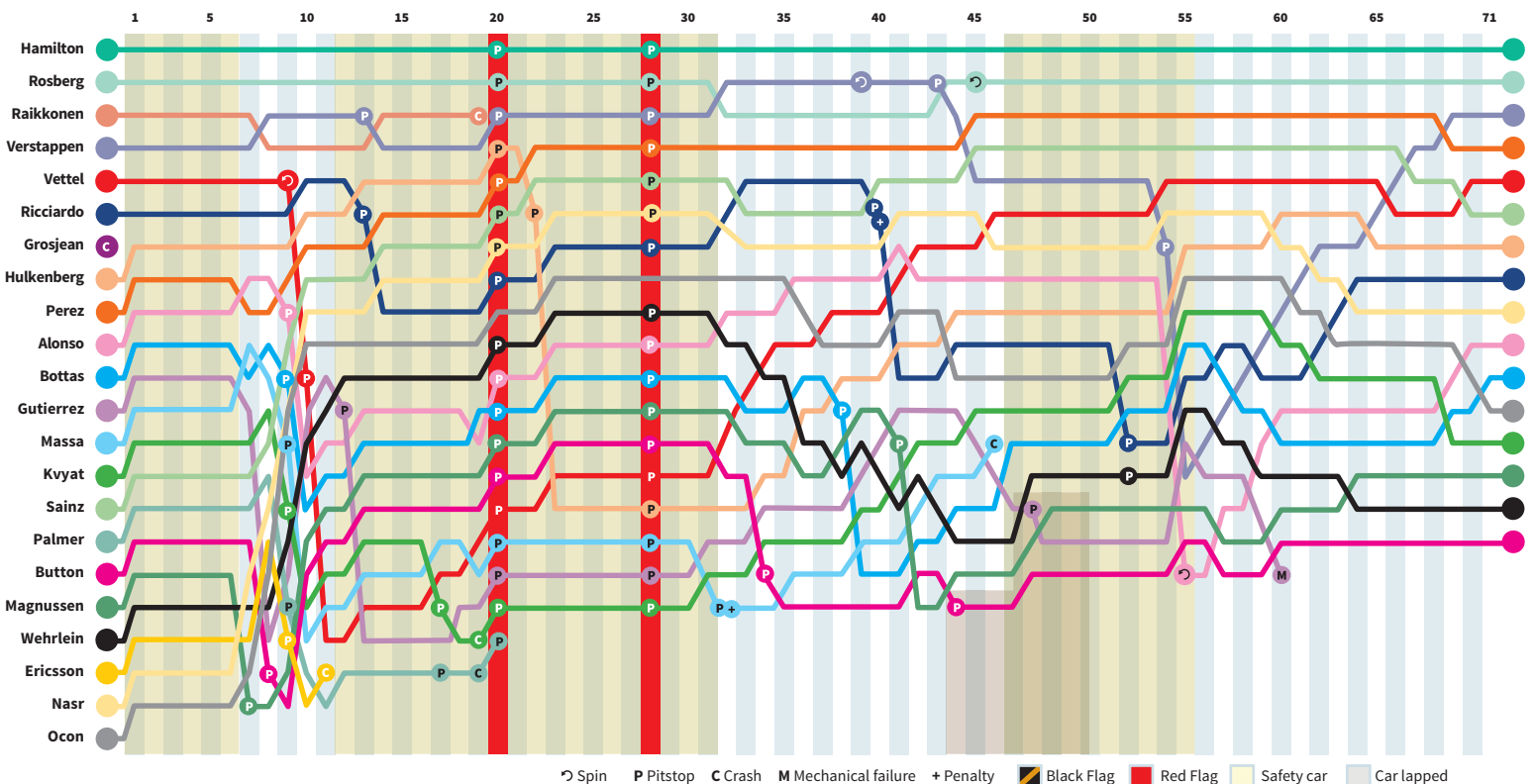



13 Massa #19  
1m12.521s



14 Kvyat #26  
1m12.726s



15 Sainz #55  
1m12.920s



16 Palmer #30  
1m13.258s



17 Button #22  
1m13.276s



18 Magnussen #20  
1m13.410s



19 Wehrlein #94  
1m13.427s



20 Ericsson #9  
1m13.623s



21 Nasr #12  
1m13.681s



22 Ocon #31  
1m13.432s

# SEASON STATS

## Drivers' championship

1	Rosberg	367
2	Hamilton	355
3	Ricciardo	246
4	Vettel	197
5	Verstappen	192
6	Raikkonen	178
7	Perez	97
8	Bottas	85
9	Hulkenberg	66
10	Alonso	53
11	Massa	51
12	Sainz	46
13	Grosjean	29
14	Kvyat	25
15	Button	21
16	Magnussen	7
17	Nasr	2
18	Palmer	1
19	Wehrlein	1
20	Vandoorne	1
21	Gutierrez	0
22	Ericsson	0
23	Ocon	0
24	Haryanto	0

## Constructors' championship

1	Mercedes	722
2	Red Bull	446
3	Ferrari	375
4	Force India	163
5	Williams	136
6	McLaren	75
7	Toro Rosso	63
8	Haas	29
9	Renault	8
10	Sauber	2
11	Manor	1

## Wins

Hamilton	9
Rosberg	9
Ricciardo	1
Verstappen	1

## Fastest laps

Rosberg	6
Ricciardo	4
Hamilton	3
Vettel	2
Alonso	1
Hulkenberg	1
Kvyat	1
Raikkonen	1
Verstappen	1

## Pole positions

Hamilton	11
Rosberg	8
Ricciardo	1

## Qualifying battle

ROS	9	11	HAM
VET	10	10	RAI
MAS	3	17	BOT
RIC	10	6	VES
RIC	4	0	KVY
PER	9	11	HUL
MAG	12	8	PAL
KVY	5	11	SAI
VES	3	1	SAI
ERI	13	7	NAS
ALO	14	5	BUT
BUT	0	1	VAN
OCO	2	6	WEH
HAR	5	7	WEH
GRO	12	8	GUT

## Qualifying 1

POS	DRIVER	TIME
1	Hamilton	1m11.511s
2	Rosberg	1m11.815s
3	Verstappen	1m11.957s
4	Raikkonen	1m12.100s
5	Vettel	1m12.159s
6	Ricciardo	1m12.409s
7	Hulkenberg	1m12.428s
8	Massa	1m12.432s
9	Bottas	1m12.680s
10	Perez	1m12.684s
11	Alonso	1m12.700s
12	Grosjean	1m12.893s
13	Sainz	1m12.950s
14	Gutierrez	1m13.052s
15	Kvyat	1m13.071s
16	Palmer	1m13.259s
17	Button	1m13.276s
18	Magnussen	1m13.410s
19	Wehrlein	1m13.427s
20	Ocon	1m13.432s
21	Ericsson	1m13.623s
22	Nasr	1m13.681s

## Qualifying 2

POS	DRIVER	TIME
1	Hamilton	1m11.238s
2	Rosberg	1m11.373s
3	Verstappen	1m11.834s
4	Vettel	1m12.010s
5	Ricciardo	1m12.047s
6	Raikkonen	1m12.301s
7	Alonso	1m12.312s
8	Perez	1m12.331s
9	Grosjean	1m12.343s
10	Hulkenberg	1m12.360s
11	Bottas	1m12.420s
12	Gutierrez	1m12.431s
13	Massa	1m12.521s
14	Kvyat	1m12.726s
15	Sainz	1m12.920s
16	Palmer	1m13.258s

## Qualifying 3

POS	DRIVER	TIME
1	Hamilton	1m10.736s
2	Rosberg	1m10.838s
3	Raikkonen	1m11.404s
4	Verstappen	1m11.485s
5	Vettel	1m11.495s
6	Ricciardo	1m11.540s
7	Grosjean	1m11.937s
8	Hulkenberg	1m12.104s
9	Perez	1m12.165s
10	Alonso	1m12.266s

WEATHER Dry, cloudy; temperature 20C

## Race briefing

### PRACTICE

CHARLES LECLERC replaced Gutierrez at Haas  
SERGEY SIROTKIN replaced Magnussen at Renault

### GRID PENALTIES

OCON 3 places for impeding another driver.

### RACE PENALTIES

MASSA 5 seconds for passing before safety car line.

RICCIARDO 5 seconds for entering the pitlane when pit entry was closed.

## Speed trap

Fastest for each constructor in qualifying

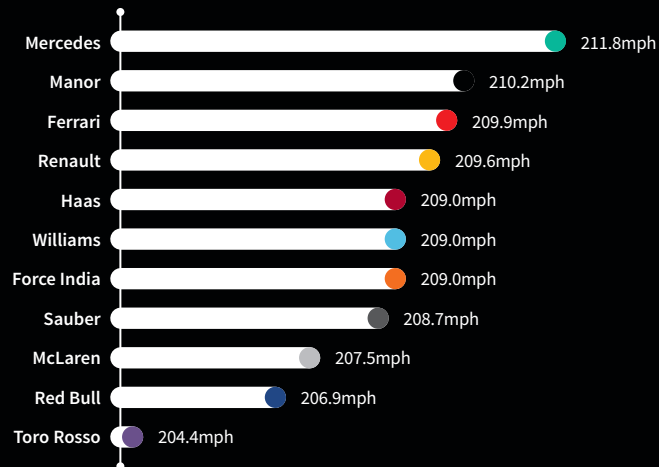

## Free practice 1

POS	DRIVER	TIME
1	Hamilton	1m11.895s
2	Verstappen	1m11.991s
3	Rosberg	1m12.125s
4	Ricciardo	1m12.371s
5	Bottas	1m13.129s
6	Perez	1m13.289s
7	Hulkenberg	1m13.293s
8	Massa	1m13.318s
9	Vettel	1m13.567s
10	Raikkonen	1m13.569s
11	Sainz	1m13.711s
12	Kvyat	1m14.090s
13	Button	1m14.252s
14	Alonso	1m14.296s
15	Grosjean	1m14.507s
16	Nasr	1m14.631s
17	Ericsson	1m14.654s
18	Ocon	1m14.827s
19	Palmer	1m14.908s
20	Wehrlein	1m14.948s
21	Leclerc	1m15.391s
22	Sirotkin	1m15.800s

WEATHER Dry, sunny; temperature 29C

## Free practice 2

POS	DRIVER	TIME
1	Hamilton	1m12.271s
2	Rosberg	1m12.301s
3	Bottas	1m12.761s
4	Massa	1m12.789s
5	Ricciardo	1m12.828s
6	Verstappen	1m12.928s
7	Vettel	1m13.002s
8	Raikkonen	1m13.047s
9	Hulkenberg	1m13.299s
10	Button	1m13.440s
11	Alonso	1m13.572s
12	Kvyat	1m13.689s
13	Sainz	1m13.801s
14	Perez	1m13.918s
15	Grosjean	1m14.074s
16	Magnussen	1m14.109s
17	Nasr	1m14.309s
18	Ocon	1m14.317s
19	Palmer	1m14.436s
20	Gutierrez	1m14.558s
21	Ericsson	1m14.695s
22	Wehrlein	1m14.958s

WEATHER Dry, sunny; temperature 32C

## Free practice 3

POS	DRIVER	TIME
1	Rosberg	1m11.740s
2	Hamilton	1m11.833s
3	Vettel	1m11.959s
4	Raikkonen	1m12.027s
5	Verstappen	1m12.077s
6	Ricciardo	1m12.287s
7	Bottas	1m12.614s
8	Palmer	1m12.968s
9	Massa	1m12.990s
10	Alonso	1m13.002s
11	Hulkenberg	1m13.203s
12	Perez	1m13.231s
13	Magnussen	1m13.255s
14	Sainz	1m13.293s
15	Grosjean	1m13.344s
16	Gutierrez	1m13.596s
17	Kvyat	1m13.609s
18	Button	1m13.750s
19	Wehrlein	1m13.972s
20	Nasr	1m13.992s
21	Ocon	1m14.222s
22	Ericsson	No Time

WEATHER Damp/drying, cloudy; temperature 18C

# Water off a Dutch back

Verstappen's skills shine in the wet; Hamilton makes winning look easy

By Edd Straw, Editor-in-Chief

[@eddstrawF1](#)

## MERCEDES



### 10 LEWIS HAMILTON

Winning grands prix in the wet is never easy, but Hamilton made it look that way after converting pole into a lights-to-flag victory. While not quite up there with his famous 2008 British GP victory, it was an exceptional performance as he barely put a foot wrong in conditions that caught out many.

### 7 NICO ROSBERG

Was not quite at Hamilton's level in qualifying, and a small error on his final Q3 lap meant he was unable to take advantage of his team-mate not hooking up the perfect lap to challenge for pole. While not able to lap as quickly as Hamilton in the race, he took a conservative approach and banked the result he needed.

## FERRARI



### 7 SEBASTIAN VETTEL

Was a little ragged in the dry and errors on his final Q3 lap left him lower on the grid than he should have been. Largely, he drove well in the wet, but his early spin was very costly. Recovered well, but you can't help feeling that he had the car under him to have more seriously challenged Perez's Force India. Must do better.

### 5 KIMI RAIKKONEN

Looked a little more under control than Vettel in practice, and nailed a good lap in Q3 to jump from sixth to third while his team-mate failed to improve on his second run. Had a conservative race, losing third to Verstappen at Turn 1 on the first racing lap before touching a white line and shunting at the second restart.

## WILLIAMS



### 7 VALTTERI BOTTAS

While he outqualified Massa, he wasn't quite so badly affected by the tyre troubles and made a few mistakes of his own, so played a part in the failure to reach Q3. From the moment he switched to intermediates the race was against him, but he showed some flashes of pace. A bad result, but not a bad drive.

### 4 FELIPE MASSA

Massa's final Brazilian GP was one of his worst, as he took his lowest home-grid position and failed to get to the chequered flag here for the first time since 2002. Struggled with the tyres and couldn't make Q3, while strategic gambles did nothing for him before he crashed out. A weekend of tough breaks and few highlights.

## RED BULL

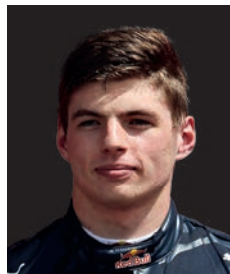

### 7 DANIEL RICCIARDO

There was nothing particularly wrong with Ricciardo's weekend, he just wasn't able to do what Verstappen did. The wrong strategy and a 5s penalty made life difficult, but a look at the closing stages of the race tells a story. He was passed by his team-mate with just over 13 laps to go and finished 9s, and five places, behind him.

### 10 MAX VERSTAPPEN

Shaded Ricciardo in dry conditions, but in the wet he was a cut above. Showed no fear as he scythed past Raikkonen into the first corner and, aside from the half spin he collected beautifully, drove a great race to make up for the wrong strategy. His pass for third reminded us why he's F1's most exciting driver.

## FORCE INDIA



### 8 SERGIO PEREZ

Considering Perez is a workmanlike, rather than a great, wet-weather driver, his performance to come so close to a podium was exceptional. Slightly slower than Hulkenberg in qualifying, in the race he kept it simple and stayed out of trouble. It's a shame he couldn't keep Verstappen at bay, but who could?

### 9 NICO HULKENBERG

Always goes well at Interlagos, and this was no exception. On paper, his result wasn't as strong as Perez's, but bearing in mind he was running ahead of his team-mate when he had a puncture, his claim that a podium was possible isn't too unreasonable. Was fractionally faster than Perez in the race as well, so deserved better.

## RENAULT

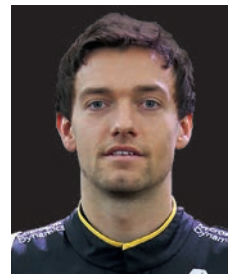

### 7 KEVIN MAGNUSSEN

Had a lacklustre qualifying and struggled to get the tyres working. Had what might be termed an unobtrusive race, finishing 14th, but at times showed a very good turn of pace. In a tricky-to-drive Renault, in low-grip conditions, you're on a hiding to nothing, especially given the early switch to intermediates didn't work out.

### 6 JOLYON PALMER

Seemingly buoyed by having a 2017 Renault deal in his pocket, Palmer took an aggressive approach to qualifying. It served him well in Q1, but less so in Q2 as he suffered several lock-ups. His race was shortlived as he clattered into Kyvyat; while circumstances and dire visibility played a big part, he still has to carry some responsibility.



Verstappen drove a great race in challenging conditions

## TORO ROSSO

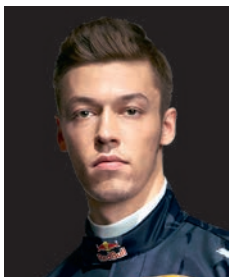

**7 DANIIL KVYAT**  
It's hard to judge his performance, as after a decent qualifying effort to beat Sainz by a couple of tenths he spent much of the race damaged. On top of that a puncture cost him positions, so he never really had a chance to make progress. Looked decent in the first four laps of green running, so gets benefit of the doubt.

**9 CARLOS SAINZ JR**  
Beaten by Kvyat in qualifying, but turned things around spectacularly on Sunday. Showed sound judgement not to switch to intermediates, and was rewarded by climbing as high as fourth. Lost two positions to Verstappen and Vettel, but similar pace overall to the Force Indias showed how well he was driving.

## SAUBER



**9 FELIPE NASR**  
Qualified just behind Ericsson, but starred in the race. Climbed into the top 10 during the green-flag stint between laps 8 and 12 and drove immaculately after that. Did particularly well to know when he was beaten as faster cars came through, and the reward for an intelligent drive in tough conditions was his first points in over a year.

**4 MARCUS ERICSSON**  
Had a difficult weekend. There wasn't anything especially wrong with qualifying, as he edged Nasr, but his race was shortlived. Was the first driver in race conditions to crash, and was baffled by the fact the grip level in the corners was fine, but the wets weren't clearing enough water on the straights.

## McLAREN



**4 JENSON BUTTON**  
There's a feeling of winding down surrounding Button, who failed to make Q2 and was unable to make progress in race conditions that he usually thrives in. Had it moved more into intermediate-tyre territory, where he excels, perhaps it would have been different. Overall, a lacklustre weekend at the scene of his 2009 title win.

**8 FERNANDO ALONSO**  
While Alonso grabbed the headlines on Friday with his trackside antics after stopping with an ERS problem, he was very much on form when in the car. Did a great job to get into Q3, but spinning out of eighth place at the final restart was costly. Recovered brilliantly to nick a point.

## MANOR



**5 PASCAL WEHRLEIN**  
Shaded it in the intra-team battle in qualifying, albeit by just five thousandths of a second. But in the race he struggled badly, with his pace generally around 1.5s per lap slower than Ocon, even after making a stop for fresh wets. He wasn't comfortable with the conditions, which was a surprise, but at least he finished.

**9 ESTEBAN OCON**  
It was the team, rather than Ocon, that was blamed for him baulking Palmer in Q1, which relegated him to the back of the grid. He just lost out to Wehrlein in qualifying but was in another league in the race. Came agonisingly close to a first point, before the charging Alonso proved too fast for him to keep at bay.

## HAAS

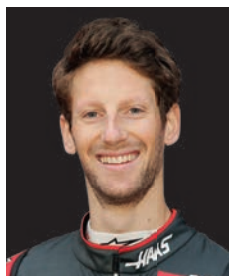

**3 ROMAIN GROSJEAN**  
Until half an hour before the race, Grosjean was having a spectacular weekend – bouncing back from qualifying last in Mexico to match his best grid position of the season in seventh. Yes, the wet conditions explain his crash while heading to the grid, but he was the only one to make such a mistake. Inexcusable.

**5 ESTEBAN GUTIERREZ**  
Did a decent job in qualifying and wasn't far off joining his team-mate in Q3. But the race immediately started to unravel, as when the initial safety car period ended he had a near-spin and dropped to 19th. From then on he was up against it, doubly so when electronics problems, which ultimately forced him to retire, set in.

## TOP 10 AVERAGE RATING

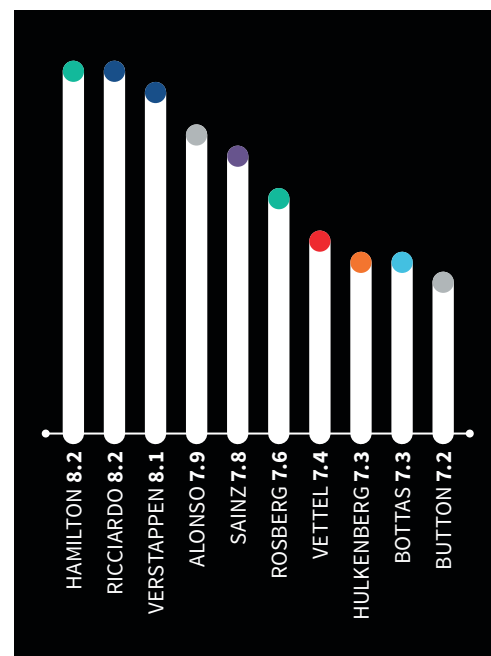



### FORMULA 1

## Palmer keeps Renault

WHETHER HE WAS FIRST, SECOND OR third choice, or somewhere behind the Pope – to paraphrase Kevin Magnussen – it was actually Jolyon Palmer who eventually secured the second Renault seat for 2017.

The French manufacturer was linked with numerous other drivers in recent months, to such an extent that it appeared at one stage as if neither Magnussen nor Palmer would stay on.

After managing to lure Nico Hulkenberg away from Force India, and after failing to sign his team-mate Sergio Perez or Toro Rosso's Carlos Sainz Jr, Renault cast its net wide for the second berth, with Magnussen, Palmer, Esteban Ocon, Esteban Gutierrez and Felipe Nasr all in the frame.

Ocon was thought to be the favourite, but he will now replace Hulkenberg at Force India. He was delighted to secure this deal ahead of the Brazilian Grand Prix, but was also surprised to not wind up back at Enstone.

"There were opportunities in Renault, but I don't know why I didn't go there," said Ocon, who was 'promoted' to Force India after just seven races with Manor, following his arrival during the August break.

"The important thing for me is to have a seat

next year. I'm very happy to go to Force India."

Renault turned back to Magnussen to partner Hulkenberg, but the Dane felt the team's commitment, or lack of in this instance in only offering him a one-year deal, was demeaning.

"If they'd committed to a longer contract I would probably have looked at that much more seriously," said Magnussen.

"It was more the feeling of them not committing, taking so long and offering to so many drivers – I think at one point the Pope had an offer! It was a bit messy, so it was better for me to leave."

Magnussen instead signed a multi-year deal with Haas, so Renault offered the one-year retainer to his team-mate Palmer, who accepted gratefully, suggesting Magnussen had erred in abandoning a chance with a manufacturer team.

"If Renault turned to Kevin then he's made a mistake to turn it down because I think they'll be ahead of Haas next year," Palmer countered. "It's a manufacturer team going places. If you get the choice to go to Red Bull for one year, it's better than going to Toro Rosso for two years."

Magnussen's response: "I think he should be happy I left."



**FORMULA 1**

**FERRARI APPEALS MEXICO RULINGS**

IT WAS AN UNUSUAL sight, but one the FIA thought was necessary in the wake of the furor that unfolded at the Mexican Grand Prix.

F1 race director Charlie Whiting joined the pre-Brazilian GP drivers' press conference to explain the reasoning behind the stewards' decisions made in Mexico.

Sebastian Vettel was the first driver penalised under new directives designed to outlaw "potentially dangerous" defensive manoeuvres.

Whiting insisted Vettel's driving satisfied the three criteria necessary to warrant a penalty, namely that it was "potentially dangerous" and an "abnormal change of direction" that "could have led to an accident".

Vettel disagreed, as did Ferrari, which lodged a claim for the verdict to be reconsidered in Brazil, citing "new elements" of evidence. These were dismissed by the FIA after a special teleconference hearing with the Mexico stewards, attended by Ferrari and Red Bull.

Ferrari said Whiting should have exercised his "absolute authority" to ask Max Verstappen to cede position to Vettel after going off-track, thus preventing the Daniel Ricciardo incident, and suggested there was GPS data to indicate Vettel did not move under braking.

The FIA disagreed. Ferrari lodged its intent to appeal and, at the time of going to press, had until Tuesday night (November 15) to proceed.

**IAN PARKES**

# seat as Magnussen leaves

Magnussen switching to Haas to drive alongside Romain Grosjean has left Gutierrez frozen out of the picture, and with precious few options left on the table given most seats are now taken for next year.

Autosport understands Marcus Ericsson has re-signed for Sauber which, although not confirmed by the team yet, is hardly a surprise given his sponsors are believed to have links to the team's new owner, Longbow Finance.

As for team-mate Nasr, whose drive to ninth in his home race in Brazil last Sunday has moved Sauber up to 10th place in the constructors' championship, his future remains uncertain.

High-profile changes behind the scenes at his sponsor Banco do Brasil have led to a delay in negotiations with his management company, and in turn Sauber, which is unwilling to wait too long to finalise its driver line-up.

There is a possibility Gutierrez could return to the team he left acrimoniously in 2014, although that is believed to be a long shot.

The only other seat seemingly available is the one to be vacated by Ocon at Manor, given Pascal Wehrlein is likely to remain with the team.

Wehrlein is unhappy at being overlooked by Force India. It is understood Force India rated Ocon more highly than Wehrlein, having tested both drivers in 2015.

"I don't know if it was the test why they decided, or something else," said Wehrlein. "I will ask why, or what happened, and what can I improve from my side."

Force India team principal Vijay Mallya suggested the test was a factor: "Ocon's performance convinced us he is more than capable of racing alongside Sergio."

Along with Gutierrez, Nasr is in the Manor frame, as is current reserve driver Rio Haryanto, who lost his seat to Ocon after running short of funds mid-season.

Manor is really the only player left with space available, as the 2017 driver market nears the end of trading hours.

**IAN PARKES**

**“At one point the Pope had an offer! It was better to leave”**



**BTCC**

## JORDAN TO RACE WSR BMW IN 2017 BTCC

ANDREW JORDAN WILL switch to his fourth different British Touring Car Championship team in four seasons in 2017, as he tries to regain his title-winning form. The 2013 champion has tied up a deal to join WSR for next season, at the wheel of a Pirtek-backed BMW 125i M Sport, the same type of car that Sam Tordoff took to second place in this year's contest. The BMW lifted the crown in 2014 with Colin Turkington behind the wheel.

Jordan, who will begin testing with the reigning constructors' championship squad, drove a factory MG in 2015, but the relationship with the Triple Eight team running the car broke down. He switched to a Motorbase Performance Ford Focus for 2016, but ended that relationship after a single season. He has only won two races since 2014, and is desperate to get back to the front.

Although he has been in the title showdown for four of the last five seasons, Jordan says that more preparation will help him reach the summit again.

"WSR has such desire and determination to win that it leaves no stone unturned," said Jordan, who has signed a two-year deal with the team. "That is the approach I have too, so we are a great fit."

WSR is scheduled to announce its other drivers for 2017 before the end of the month.

**MATT JAMES**



**FORMULA 1**

# Button looking at Super GT and rallycross outings for 2017

JENSON BUTTON IS CLOSING IN ON A SUPER GT one-off and an American-focused rallycross programme, but has ruled out taking on the Le Mans 24 Hours during his 2017 Formula 1 sabbatical season.

The 2009 F1 world champion, who will remain a McLaren-Honda ambassador next year, is keen to try other forms of motorsport. He suggested the Suzuka 1000Km – showpiece round of Japan's Super GT Championship – and the US-based Global Rallycross Championship as the most likely current options.

"I might do the Suzuka 1000Km in Super GT, it would be nice if that worked out but it's just logistics really," Button said. "Apart from that, I might do some rallycross in America and do some testing in something else in rallycross."

"I won't be racing at Le Mans next year. The right opportunity isn't there. But hopefully it will be in the future."

"There's lots I can do, and I've just got to choose how much I really want to do next year and if I want more of a rest. I don't want to do the whole season. I might as well be in Formula 1 [if I did that]."

Button will be replaced by Stoffel Vandoorne next year, and emphasised he still has plenty of motivation to continue racing next season, just not in F1 specifically.

"I'm very excited about racing in the future," added Button. "It's just got to be somewhere else. I've raced one thing for 17 years. I want to race something else. F1 is the pinnacle of motorsport, but sometimes you need a change."

**LAWRENCE BARRETTO**



**AUTOSPORT WILLIAMS ENGINEER OF THE FUTURE**

# Award finalists revealed

THE FINALISTS FOR THE 2017 Autosport Williams Engineer of the Future Award have been announced.

The annual award, introduced last year, brings an engineering student into Williams for an accelerated career development programme.

Eight UK universities were invited to nominate students for consideration.

University of Bath trio Mark Ascott, Robert Beynon and Oliver Cartledge, Oxford Brookes student Jonathan

Fernandez Hee, and Imperial College London's Sam O'Neill made the shortlist, and took part in an assessment workshop at Williams's Grove headquarters on Wednesday and Thursday this week.

They will be judged by a panel comprising Williams's chief technical officer Pat Symonds and HR director Nicola Salter, Autosport Editor-in-Chief Edd Straw, former Jaguar F1 team boss Tony Purnell, and former leading

Ford figure Richard Parry-Jones CBE.

"Last year we introduced this award to identify the UK's brightest and best engineering students, and give them a head start towards a career in F1," said Symonds. "Once again, the calibre of applications has been remarkable."

"The students will complete a number of tasks to demonstrate they have the raw skills to become a star."

The winner will be announced at the Autosport Awards on December 4.



**MOTO GP** Jorge Lorenzo (above) started his new life as a Ducati rider as Autosport went to press, less than 48 hours after winning his final race with Yamaha. Lorenzo tested at Valencia on Tuesday and Wednesday, with Lorenzo's replacement, Maverick Vinales, also turning his first Yamaha laps. Outgoing Ducati rider Andrea Iannone settled in at Suzuki, while the new factory KTM outfit, which made its race debut in MotoGP last weekend with Mika Kallio riding, welcomed 2017 race riders Bradley Smith and Pol Espargaro.

## FORMULAE

# Will Ferrari go electric?

FERRARI BECAME THE LATEST MAJOR manufacturer to enter the Formula E frame last week, after company CEO Sergio Marchionne outlined the requirements for a possible entry into the electric single-seater series.

Marchionne revealed a move into Formula E for Formula 1's most famous manufacturer was "possible", if the series drops car swaps and offers greater technical freedom.

Quite how much more he wants from FE to allow his company to create something "uniquely Ferrari" is difficult to determine.

While FE uses a single-make Spark chassis to keep costs down, the teams build their own motor, inverter and gearbox. It intends to open up battery development, which would offer another opportunity to move further away from standardisation.

But the uncertain timeframe for that could be one reason Marchionne stressed that "if it were to happen, it would happen a few years from now".

Ferrari's interest follows the news last month that current F1 champion Mercedes has secured an option to enter FE in 2018/19, while Honda revealed FE was on its radar earlier this year.

Before taking over Lotus in F1, Renault entered FE with the e.dams operation, won the 2015/16 drivers' and teams' titles, and has dominated the first two 2016/17 races with champion Sebastien Buemi.

BMW and Audi have both ramped up their involvement in a category that also boasts Jaguar among its notable

manufacturer participants.

Should Fiat enter FE through Ferrari or even Alfa Romeo, as some have suggested, it would become a window to showcase a new range of hybrid/electric road-car machinery that Marchionne claimed would become "mandatory" some time from 2019. But that probably means no road relevance for several years.

With F1 and FE being owned by respective Liberty factions (Media on the F1 side, Global in FE) perhaps it is less likely that bosses would rankle at the prospect of Ferrari contesting an alternative single-seater series.

The cost is also not prohibitive. It would be quite easy for a company of Ferrari's size to fund a Formula E project alongside F1. R&D costs in FE are around the €10 million mark at present. That pales in comparison to the near-£300m per season that Ferrari piles into its F1 operation.

Marchionne also said he had "thrown all the money I'd like to throw at that", indicating the F1 team could not rely on unlimited funding from the marque to try to get back to the top.

FE would offer a more cost-effective, forward-thinking alternative – and technology already exists within the company, as Fiat-owned Magneti Marelli entered the FE supply arena this season with its own bespoke motors.

It is still unlikely Ferrari will enter FE anytime soon. But longer-term a move is far from illogical.

**SCOTT MITCHELL**

## IN THE HEADLINES

### RON DENNIS SET TO LEAVE MCLAREN

Ron Dennis was poised to lose his positions as chairman and CEO of the McLaren Group this week, as Autosport closed for press. Dennis has been embroiled in a two-year power struggle behind the scenes of his team, and was recently informed his contract would not be renewed when it expires at the end of 2016.

### JAGUAR OUT OF SILVERSTONE TALKS

Jaguar Land Rover and Ginetta boss Lawrence Tomlinson have both dropped out of negotiations with Silverstone owner the British Racing Drivers' Club to buy the British Grand Prix venue. MotorSport Vision boss Jonathan Palmer and an unnamed overseas investor are the two parties still with offers on the table.

### HORNER SLAMS WOLFF INTERVENTION

Red Bull team boss Christian Horner was unhappy his Mercedes counterpart Toto Wolff called Max Verstappen's father Jos following the Mexican Grand Prix. Reports emerged that Wolff contacted Jos to encourage Max to curb his aggression when racing title challengers Nico Rosberg and Lewis Hamilton, following his collision with Rosberg on the opening lap in Mexico..

### LECLERC CLOSING ON GP2 DEAL

Ferrari junior Charles Leclerc is closing on a deal to graduate to GP2 in 2017. "It's more or less decided I will be in GP2, said Leclerc, who was overlooked for a Haas race seat in F1. Leclerc leads ART team-mate Alexander Albon by 29 points in GP3 with one round remaining.

### JONES LANDS COYNE INDYCAR SEAT

Indy Lights champion Ed Jones has secured a full-time IndyCar seat with Dale Coyne Racing for 2017. The 21-year-old joins Coyne returnee Sebastien Bourdais at the team. "IndyCar has been my goal ever since I left Europe," said Jones. "It's crazy to think I'll be joining the grid just two years after moving Stateside."

### LADA TO QUIT WTCC AT SEASON'S END

Lada will leave the World Touring Car Championship at the end of the 2016 season. Alexander Bredikhin, marketing director for Lada's parent company AvtoVAZ, formally confirmed the end of its five-year stint in the series. The exit of Lada and Citroen leaves Honda and Volvo as the WTCC's remaining factory participants for 2017.

### REBELLION CHOOSES ORECA FOR LMP2

LMP1 privateer Rebellion Racing will run ORECA chassis when it switches to the LMP2 category next year. ORECA designed and built the Anglo-Swiss squad's R-One P1 chassis (below), and will supply a new 07 coupe for Rebellion's change of class. The team hasn't confirmed a programme, but will likely remain in World Endurance.





# A letter from **Zak Brown**

Chairman of Motorsport Network

## DEAR READER,

What a fantastic year this has been for motorsport – full of thrills, intrigue and exciting twists in the plot. One in particular you might already have heard about: Autosport (including its Autosport International Show and the Autosport Awards), *F1 Racing*, *Motorsport News* and LAT Images are now part of the same family as Motorsport.com and its family of websites. As a loyal reader of one (if not all!) of these celebrated titles, I can imagine that you might be asking: ‘what does this mean for the magazine, website, or exhibition I know and love?’

Well, I’d like to take this opportunity to outline how we’re planning to offer much more to you, the reader and race fan, in the years ahead. In short, we aim to take these pillars of the sport to a higher level, expanding the way we deliver motorsport coverage with the clear ambition of bringing you, the fan, even closer to the action. And to allay any fears, that means keeping everything we’ve been lucky enough to bring into the Motorsport Network stable – but improving them wherever we can. So *F1 Racing* will continue to prosper as the international gospel of Formula 1 – expect to see the magazine promote more events and fan activities in the year ahead.

And I’m hugely excited to announce the return of the legendary Nigel Roebuck and his much-loved Fifth Column to Autosport, in print and online. We’ll be reuniting him with the peerless technical illustrator, Giorgio Piola. I hope you’ll agree that’s quite a ‘driver pairing’!

*Motorsport News*, meanwhile, will remain on the newsstand, but look out for a new digital presence soon. In addition, you’ll have easier access to bespoke coverage from an array of newly affiliated sister titles, such as Motorsport.com, Motor1.com

and FerrariChat. These last two will be of particular appeal to performance road car enthusiasts. Then there’s Motorstore, a destination website for any fan wanting to ‘show their colours’ through licensed racewear and merchandise. And that’s not the end of the journey. Driven by our fans’ desire to access not just the best news, features and photography, but also to witness live action and the very best highlights, we’re developing a major broadcasting initiative. Motorsport deserves a dedicated television ‘home’ and I’m thrilled to tell you about our plans to do just that – all driven by the knowledge and passion of the world’s finest motorsport journalists working for Motorsport.com and Autosport.com.

With all we have, and all we intend to do next year, Motorsport Network will be bringing you, the motor racing fan, an enriched motorsport experience. There will be no limits to our efforts to innovate and improve the way racing is covered, so look out for 360-degree onboard race coverage and compelling new live motorsport feeds straight to your mobile device.

We want to ‘think like a fan’ and provide access to motorsport in as many ways as you wish.

So that’s our mission: preserving the great names that have joined Motorsport Network this year, but never resting on our laurels – there’s much, much more to come. Strap in tight and enjoy the ride!

**ZAK BROWN CHAIRMAN**  
Motorsport Network

# FEEDBACK

## Will EVs render Formula 1 obsolete?

With all the hand-wringing about the future of Formula 1 and the direction it should take, the pink elephant lounging on the rug seems invisible (or deliberately missed/ignored).

It is now clear that electric vehicles (EVs) will form the basis of transport sooner rather than later — the consensus seems to be that the tipping point is less than 10 years away. Even Audi is now walking away from LMP1, and Formula E boasts far more works teams/manufacturers than F1 — surely this is indicative of their priorities?

So where will F1 be in, say, eight years? That is just around the corner with lead times on changes. Will FE be so developed by then that it will 'replace' F1 as the most intense and relevant motor racing series?

I can't imagine many engineering companies and manufacturers will be interested in developing petrol/diesel racing engines by the mid-2020s. They will belong in historic racing. What will



happen if Mercedes and Renault pull the plug on F1 when it is no longer relevant?

A suggested option: homologate one or more screaming ultra-reliable petrol engines, all with similar output. Then allow free engineering rein for the electric and battery components, with sensible cost restrictions. This would really test the tech aspect, push forward relevant development and benefit the future of transport and sustainable energy.

**Guy Dormehl**  
Garden Route, South Africa

### Highlights were a highlight

We stayed up to watch the highlights of the Brazilian GP and were ready for the struggle to stay awake. It was enthralling!

If it had been live, we would have struggled watching 30-odd laps behind the safety car, but because the 'boring bits' were chopped out we saw an excellent race. Well done Channel 4!

**Richard Hargrave**  
Hitchin

Hamilton's a true great; his car's reliability has not been so brilliant

### The great and the very good

The F1 world champion is usually the best driver in the best car. In 2016 the Mercedes has been the best car — it has qualified on the front row at every race and Rosberg's car has been 100% reliable.

However, we would not be in the current championship situation without Hamilton's car having been plagued by reliability problems. All things being equal, Hamilton is a class apart and a race such as Interlagos illustrates the gulf between the two drivers. Hamilton is a true great, Rosberg a very good driver.

Whatever the outcome in Abu Dhabi, I look forward to Autosport's top 10 F1 drivers of 2016.

**Graeme Lovell**  
Snitterfield

### What goes around comes around

There's been a lot of pearl-clutching in the wake of the news of Audi's withdrawal from the WEC and VW's similar exit from the WRC. Yes, it's a bit of a shock, but I can't help feeling it's all part of the ebb and flow that we've seen for decades throughout the sport. And yet we're all still here.

It's not too difficult to find good news — see the Blancpain season review in last week's Autosport, in which we read of massive grids, close racing and four manufacturers duking it out.

**Frances Stewart**  
London SE12

## HAVE YOUR SAY, GET IN TOUCH

Autosport editorial  
Bridge House  
69 London Road  
Twickenham  
TW1 3SP

@  
E-mail  
autosport@  
haymarket.com

Twitter  
twitter.com/  
autosport

f  
Facebook  
facebook.com/  
autosport

# FREE

## KITSOUND MANHATTAN HEADPHONES

WHEN YOU SUBSCRIBE TO



PLUS SAVE UP TO **61%** ON THE COVER PRICE

The Manhattan headphones allow you to stream music from your Bluetooth-enabled mobile phone, iPad, PC or Mac wirelessly. By simply moving the switch to the Bluetooth logo and selecting the Manhattan headphones in your device's Bluetooth settings, pairing is extremely easy.



- Wireless connectivity that pairs with your Bluetooth-enabled device
- Huge battery life with up to 18 hours of music play time
- Up to 30 hours of talk time
- Answer phone calls with the integrated touch controls



PRINT SUBSCRIPTION ACCESS  
+ FREE GIFT

UNLIMITED ACCESS FOR JUST AN EXTRA £6.20



- ✓ SPREAD THE COST - PAY JUST £34.99 EVERY 13 ISSUES BY DIRECT DEBIT
- ✓ GREAT SAVING - **29%** ON THE COVER PRICE
- ✓ **FREE P&P** - EVERY ISSUE DELIVERED TO YOUR DOOR



- ✓ FULL ACCESS TO autosport.com
- ✓ AUTOSPORT IPAD EDITION SUBSCRIPTION
- ✓ GREAT SAVINGS OF **61%**

SUBSCRIBE ONLINE AT  
[www.themagazineshop.com/asp/as1116m](http://www.themagazineshop.com/asp/as1116m)

QUOTE THE PROMOTIONAL CODE

**AS1116MP** FOR PRINT ONLY OR  
**AS1116MW** FOR PRINT AND DIGITAL ACCESS

OR CALL US ON  
0344 848 8817

**Terms and conditions:** This offer is open to UK residents only. Overseas rates are available on +44 (0)1604 251 451. Please allow 35 days for delivery of your first issue. Direct Debit rates are valid for one year after which they are subject to change - should prices change we will inform you in writing. Should you wish to cancel your subscription it will be cancelled on expiry of the current term, which will not be refundable other than in exceptional circumstances. Details of the Direct Debit Guarantee are available on request. If your subscription includes access to autosport.com and the Autosport digital magazine, you can set up your Autosport online account by visiting [www.autosport.com/subs/magazine.html](http://www.autosport.com/subs/magazine.html). You'll need to enter your subscriber number along with your email address to access your content. You will be emailed instructions on how to gain access to your iPad edition within 24 hours of your order being processed. The gift will be sent under separate cover from the magazine and will not be dispatched until your first payment has cleared. Should we run out of gifts, you will be offered an alternative gift - there is no cash alternative. Savings are based on standard UK print cover price of £3.80, digital cover price of £2.99 and autosport.com subscription rate of £5.50 a month. **Offer ends December 2 2016.**



# In Senna's footsteps

Lewis Hamilton has long spoken of how he is inspired by his hero, but it's the sport's youngest charger who's inherited the F1 legend's mantle

By Lawrence Barretto, F1 Reporter

[@lawrobarretto](#)

**LEWIS HAMILTON SAID VICTORY IN THE BRAZILIAN** Grand Prix was a dream come true as, after 10 attempts, he finally won at the home of his hero Ayrton Senna.

The reigning world champion dominated the race, further enhancing his credentials in the wet and delivering the kind of performance that was reminiscent of his idol.

Although Hamilton tried to play it down, suggesting he was just "chillin'" at the front, he was stunning. But despite his impressive drive in Brazil, it was his young rival Max Verstappen who emerged as the modern-day Senna.

After a Red Bull strategy call that didn't work out, the Dutchman pitted for extreme wet tyres with 16 laps to go, dropping him to 14th. He then made up a position on each of the next six laps and another five in the remaining 10 to grab a podium finish. All that came after he had pulled off a tremendous move on Nico Rosberg around the outside of Turn 3 and a spectacular save from a half-spin.

"They don't get much better than that," said his Red Bull boss, Christian Horner. "What we witnessed was something very special.

It was right up there [with Senna's drive at Monaco in 1984 or Michael Schumacher's drive in Spain in 1996]. You have to compare it to those great moments. You don't often witness a motor race like that. It demonstrated what a great talent he is."

Mercedes boss Toto Wolff said Verstappen is redefining physics in F1, while Williams performance chief Rob Smedley added he was "in a class of his own" and "incredible to watch".

Verstappen was fearless in the wet, using every moment behind the safety car to build his knowledge of the track and understand where the grip was in each corner. It looked like he was the only driver doing that.

His passes on Kimi Raikkonen and Rosberg were particularly impressive because they were completed on tyres that were in a similar condition, compared to having fresher rubber in the closing stages to help his fight up the field.

The performance highlighted his speed and his pure racer's instinct, not to mention his utter self-belief.

He has benefited from a great motor racing education, courtesy of his father Jos and the Red Bull junior programme, but there is no doubt he has that indefinable X-factor. His actions on track are the kinds of things you cannot teach.

Verstappen's driving has been under the spotlight this year, particularly the tendency to move under braking that has

drawn criticism from rivals and resulted in a tightening of the rules. But it is part of the same ruthless streak that Senna employed and echoes the Brazilian's desire to do everything in his power to win, regardless of the cost.

Verstappen demands respect on the track. He believes he is the best and is not afraid of any of his rivals, despite being the new kid on the block. He delivers strong drives with very few mistakes and rarely lets his form dip. When the pressure is on, Verstappen doesn't crack.

He cares little for criticism and staunchly refuses to change his style despite the complaints. If anything, he feeds off them.

His driving style, combined with a desire to speak his mind, has gone down well with fans. People turn up at races to watch him. He has star quality.

These are traits that Senna had in abundance.

Hamilton is equally hungry. His speed is unquestionable and he retains the belief – as did Senna when racing with Alain Prost – that when going wheel-to-wheel with Rosberg, his rival will cede position rather than risk an accident. Hamilton

has had no problem running Rosberg off the road over the course of their partnership at Mercedes and the strategy has mostly paid off.

The Briton has spoken at length about the impact Senna had on him growing up, adding that he was inspired

by the Brazilian because his driving style was different from his rivals. He described Senna as a "daredevil" who did what he needed to do to win and never seemed to be afraid of anything on track, always taking it to the edge.

Hamilton has modelled himself on that example, arriving in F1 and from the get-go asserting himself on track. But he has evolved over the course of his 10-year stint in F1. Experience has changed him. With experience comes knowledge and maturity. His approach to racing has softened and he has learned to play the long game.

The result is that Hamilton has arguably evolved into a driver that's better than Senna and is now echoing traits of his hero's great rival Prost.

This is intriguing development, which sets up the tantalising prospect of another 'Senna versus Prost' battle in 2017, with Verstappen going head-to-head with Hamilton.

Only Verstappen – at the start of his career – will enter the season in the role of Senna, while Hamilton – who is at the peak of his career – will take on the part of Prost. Now no-one saw that coming. 🏆

**“Hamilton has arguably evolved into a better driver than Senna”**



MONSTER

# Regular Jorge

Jorge Lorenzo ensured he finished his time with Yamaha in grand style, winning the MotoGP season finale

By Mitchell Adam, International Editor

🐦 @DrMitchellAdam





**S**entiment can be a strange thing in sport. Beyond the notion of having a favourite competitor, or patriotic ties, who really deserves anything? Especially in the modern age of professional sport, in which effort and dedication are taken as a given.

Sometimes, though, it can exist in various guises.

For instance, you could argue that Marc Marquez's 2016 MotoGP title was deserved based on his output. That Cal Crutchlow becoming the first British winner in 35 years was a good story. That Andrea Dovizioso had played a key role in pointing the Ducati ship in the right direction, and that his Sepang victory was a nice reward.

When it came to the end of Jorge Lorenzo's time with Yamaha, a good result – namely a win – was just going to feel right. Lorenzo is off to Ducati in 2017, and by the time you read this he will have already spent two days getting acquainted with its Desmosedici.

After nine years, three titles and 43 grand prix wins, Lorenzo bowing out of Yamaha with his head hung low was not really going to be fitting. But for much of the year, he looked set to leave at least frustrated, if not dejected, for it has not been a fond farewell tour.

Things started so well in 2016, with three wins in the first six races, a championship lead and that lucrative Ducati contract all in place by the end of May. But since beating Marquez at Mugello, Lorenzo had not won a race, has visibly struggled with Michelin's tyres in cold and/or wet conditions, lost confidence and generally had days where he has not looked like Jorge Lorenzo, one of MotoGP's absolute elite.

He also fell out of championship contention to the extent that team-mate Valentino Rossi had already sealed second place, and that Lorenzo's third was considered (remotely) under threat by the young man replacing him in 2017, Suzuki's Maverick Vinales.

Victory in Valencia's season finale won't mean people forget that it has not been smooth sailing for Lorenzo in 2016, but it does at least means it finishes with

**Lorenzo claimed three world titles for Yamaha and this win enabled him to sign off a troubled season on a positive note**

smiles on the podium, rather than furrowed brows, or in a gravel trap.

In conditions dry and warm enough, and on tyres with enough grip and feel, Lorenzo rolled back the months during his last weekend in blue. He topped both of Friday's practice sessions, then added a 39th and final Yamaha pole position with a commanding performance in qualifying, bashing in the circuit's first sub-1m30s MotoGP lap and improving twice more on his way to a new record.

But Marquez loomed as a threat. He was the fastest rider in both of Saturday's practice sessions, admittedly when Lorenzo was not pushing for a lap time, and then did it again in Sunday morning's warm-up.

Marquez knew he would have to stop Lorenzo clearing off into the distance at the start of Sunday's 30-lap race. So many of Lorenzo's victories have come after breaking the back of his opposition in the early laps. It has almost become a Lorenzo trademark.

When the lights went out on Sunday afternoon, Lorenzo enjoyed the smoothest of getaways, while Marquez dropped from second to sixth. In what



YAMAHA

he said was the “worst start of this year”, Marquez’s Honda hoisted its front wheel in the air almost in protest as he tried to feed power through the rear tyre.

Ducati’s Andrea Iannone went the other way to Marquez, vaulting from seventh to second. Both outcomes were good news for Lorenzo, who settled into a relentless march of low-1m31s laps at the front of the field.

While Lorenzo skipped away by a couple of tenths at a time, Rossi and then Marquez tried to get clear of Iannone to have a chance of chasing him. But the horsepower of the Ducati’s engine made life very hard work, enabling Iannone to undo several overtakes down the front straight the next time around.

It took Rossi three attempts before he got clear on lap 10, but by then Lorenzo was 3.9 seconds up the road. Rossi could not pull away or stay ahead of the Ducati, and Iannone soon pounced again. Marquez eventually found his way into second place on lap 20, and was 5.4s behind Lorenzo with 10 laps to go.

The notion that anybody would actually catch Lorenzo seemed far-fetched, but Marquez gave it >>

## ORANGE IS THE NEW BIKE

AT 5PM ON FRIDAY AFTERNOON AT VALENCIA, Jorge Lorenzo and Mika Kallio’s post-practice media sessions clashed. One was fastest, the other was last. One was a three-time world champion in his last weekend with Yamaha, the other last started a MotoGP race in 2010.

But Kallio got the lion’s share of the attention, such was the interest in KTM’s MotoGP debut (though KTM had a short-lived engine programme with Kenny Roberts’ team in 2005).

The Austrian manufacturer has spent the past year testing and developing its RC16, and elected to race as a wildcard with Kallio at Valencia, before Bradley Smith and Pol Espargaro join the team full-time in 2017.

KTM was arguably the biggest item of interest during the weekend, namely how the new package would fare in serious competition against its future rivals. Primary test rider Kallio vowed pre-event that he was “not going to be at the back of the pack”, but that was largely where the bike spent its time.

While KTM has shared circuits with MotoGP machinery at other tests, including at the Red Bull Ring in July, practice highlighted issues with rear grip. Keeping the rear tyre on the track surface entering the corner, and then delivering power from its highly regarded engine on the exit, proved challenging although the issues were thought to relate more to mechanical grip than to engine mapping. Kallio finished at the foot of the times, and admitted he was surprised to be more than three seconds off the pace.

Progress was made on Saturday and Kallio was able to qualify 20th, ahead of regulars Tito

Rabat and Yonny Hernandez. He was also half-a-second closer to the pace, 2.691s adrift of Lorenzo’s benchmark. The Finn maintained that 20th position early in the race, until a rear-wheel speed sensor for the electronics failed nearly a third of the way into the race.

Kallio persevered even though his pace fell away, but a second sensor failed and he retired after 19 of the 30 laps.

“Riding got much more complicated [after the first failure] and that was the point I started to lose the distance to the other guys and the lap time went the wrong way,” Kallio said.

“Even if that was of course a negative point, in general if we think how the weekend was going, I think we can be satisfied. We demonstrated that we are not miles away from the other bikes, we could be in the group when the bike was still OK in the race.

“I could follow the other guys, I could fight with them, so that’s absolutely positive and it’s good to know now for the future.”

Team manager Mike Leitner said the sensor failure was a new problem, and highlighted a lesson to be learned before KTM goes racing properly in 2017. Smith and Espargaro’s first tests will define KTM’s next development step.

“That’s why it was super important to come here, to do a race week with the rhythm of the GP, with the pressure with the other people on the track,” he said. “Of course we would like to finish the race. But on the other hand it is also a very big warning, that each small detail on these bikes is so important, otherwise you will not finish a race.”



REDBULL

a go. Lorenzo had started to run out of grip on the left of his rear tyre, and Marquez got within 1.2s by the time the chequered flag was shown, reckoning he would have needed “another two or three laps” to catch and pass.

That ensured Lorenzo took his fourth win of the season to leave Yamaha with a total of 44 victories, nearly six months after his last. “I couldn’t give a better present for Yamaha from these last nine years, achieving a lot of good things,” he said. “I’m very proud and very happy.”

“I suffered so much in the last 10 laps. I saw Marc in second place on the board and I knew he was going to try everything and be very, very quick. I knew he would have a better rear tyre because I was struggling so much in the middle of the race. I had to be very focused, very precise, not to lose the rear, especially in the last corner.

“I expected Marc to stay with me in the first lap. Luckily for me he had some problems with his clutch or his bike and that’s when my gap was done. We saw he had the pace, and had he been following all race I would’ve struggled and maybe not got the victory, so I was lucky.”

Asked to rate his performance in 2016, Lorenzo gave himself 6.5 out of 10, but perfect marks for the Valencia weekend itself. “It’s not because my motivation made me go faster but because my confidence finally matched my motivation and determination,” he said. “When I saw on Friday I had plenty of confidence, it gave me the conviction and the motivation to push harder through the weekend.”

Second for Marquez caps a season in which he won his third MotoGP championship with three races to spare – last month at Motegi – but then crashed in the following two GPs at Phillip Island and Sepang. He’s had a fine year, and got to celebrate his



championship on home soil post-race.

Marquez’s team-mate Dani Pedrosa returned to action after breaking his collarbone in Japan four weeks earlier, but crashed out of the race early. Honda won the manufacturers’ title but could not stop the factory Yamaha outfit in the teams’ championship.

“We did a great job, we did an incredible season, but we just did some mistakes – especially in the last two races,” Marquez said.

“OK, the championship was done but we had to be focused, and I did the same mistakes as in 2014 [Marquez’s second title, also sealed early]. It’s something I need to learn.”

It felt like Iannone and Rossi spent the whole race battling, with Iannone withstanding one last charge from his countryman – never quite on Lorenzo’s pace all weekend – in the closing laps.

That meant Iannone finished third in his final Ducati start, his second race

Marquez closed in on Lorenzo after falling back at the start

back from a fractured vertebra. The man staying to partner Lorenzo, Dovizioso, faded from running at the back of the early fight for second, to finish seventh.

“I pushed at 100% for all the race,” Iannone said. “I had a great battle with Marc, also with Vale, and everything was difficult but I put all of me into this race.”

“I didn’t think about my pain. I understood I have pain and less energy, but the bike helped me a lot on the straight because I had strong power. I judged the battle and when to stay in front. For half the race Vale had better pace compared with me but I overtook him every time. We had a great, great battle and a great result.

“It’s my last race with Ducati and I wanted to close it with this result.”

Vinales also drifted away from the tails of Iannone and Rossi, but not as much as Dovizioso, and brought his two Suzuki seasons to a close with fifth. The Espargaro brothers, Pol and Aleix, were just ahead and just behind Dovizioso in their last starts for Tech3 Yamaha and Suzuki before joining KTM and Aprilia respectively.

Bradley Smith, also moving from Tech3 to KTM, enjoyed his strongest weekend since returning from a knee injury last month to finish ninth. Smith wound up as the best of the Brits, with Cal Crutchlow crashing out and Scott Redding in 14th. Smith’s 10th in qualifying was also his best Saturday result since the Mugello event.

Alvaro Bautista crossed the line in 10th, capping Aprilia’s strong second half of the season with his sixth top 10 in the final seven races. With Bautista also on the move, to Aspar Ducati, only three of the riders in the top 10 – Marquez, Rossi and Dovizioso – are not changing teams in 2017.

Less than 48 hours later, they were all on different machinery, signalling the start of the new campaign. Time moves on quickly. Sometimes it’s nice when an era ends the way it should. ✨



Iannone and Rossi battled hard throughout the race



Lorenzo's victory was his 44th for Yamaha

**RESULTS** ROUND 18/18, VALENCIA, NOV 13 (30 LAPS - 74.658 MILES)

POS	DRIVER	TEAM	TIME
1	Jorge Lorenzo (E)	Yamaha	45m54.228s
2	Marc Marquez (E)	Honda	+1.185s
3	Andrea Iannone (I)	Ducati	+6.603s
4	Valentino Rossi (I)	Yamaha	+7.668s
5	Maverick Vinales (E)	Suzuki	+10.610s
6	Pol Espargaro (E)	Tech3 Yamaha	+18.378s
7	Andrea Dovizioso (I)	Ducati	+18.417s
8	Aleix Espargaro (E)	Suzuki	+18.678s
9	Bradley Smith (GB)	Tech3 Yamaha	+25.993s
10	Alvaro Bautista (E)	Aprilia	+35.065s
11	Hector Barbera (E)	Avintia Ducati	+36.425s
12	Danilo Petrucci (I)	Pramac Ducati	+42.415s
13	Stefan Bradl (D)	Aprilia	+49.823s
14	Scott Redding (GB)	Pramac Ducati	+52.035s
15	Jack Miller (AUS)	Marc VDS Honda	+55.625s
16	Eugene Laverty (IRL)	Pull & Bear Aspar	+58.254s
17	Tito Rabat (E)	Marc VDS Honda	+58.555s
18	Loris Baz (F)	Avintia Ducati	+1m06.164s
R	Mika Kallio (FIN)	Red Bull KTM	19 laps (sensor)
R	Cal Crutchlow (GB)	LCR Honda	16 laps (accident)
R	Dani Pedrosa (E)	Honda	6 laps (accident)
R	Yonny Hernandez (CO)	Pull & Bear Aspar	4 laps (accident)



**Winner's average speed** 97.583mph. **Fastest lap** Lorenzo 1m31.171s, 98.265mph.

**Qualifying 2** 1 Lorenzo 1m29.401s; 2 Marquez 1m29.741s; 3 Rossi 1m30.128s; 4 Vinales 1m30.276s; 5 Dovizioso 1m30.338s; 6 P Espargaro 1m30.392s; 7 Iannone 1m30.420s; 8 Pedrosa 1m30.574s; 9 A Espargaro 1m30.885s; 10 Smith 1m30.949s; 11 Crutchlow 1m31.030s; 12 Petrucci 1m31.203s.

**Qualifying 1** 1 Crutchlow 1m30.544s; 2 Petrucci 1m30.815s; 3 Barbera 1m30.894s; 4 Redding 1m31.406s; 5 Miller 1m31.686s; 6 Baz 1m31.749s; 7 Bradl 1m31.813s; 8 Bautista 1m31.847s; 9 Laverty 1m31.956s; 10 Kallio 1m32.092s; 11 Rabat 1m32.181s; 12 Hernandez 1m32.240s.

**Riders' Championship** 1 Marquez 298; 2 Rossi 249; 3 Lorenzo 233; 4 Vinales 202; 5 Dovizioso 171; 6 Pedrosa 155; 7 Crutchlow 141; 8 P Espargaro 134; 9 Iannone 112; 10 Barbera 102; 11 A Espargaro 93; 12 Bautista 82; 13 Laverty 77; 14 Petrucci 75; 15 Redding 74; 16 Bradl 63; 17 Smith 62; 18 Miller 57; 19 Pirro 36; 20 Baz 35; 21 Rabat 29; 22 Hernandez 20; 23 Nakasuga 5; 24 Lowes 3; 25 Aoyama 1; 26 Hayden 1; 27 Jones 1.

**Manufacturers' Championship** 1 Honda 369; 2 Yamaha 353; 3 Ducati 261; 4 Suzuki 208; 5 Aprilia 101.

**IN THE HEADLINES**



**ZARCO'S SWANSONG**

MotoGP-bound Johann Zarco capped his time in Moto2 – which has netted the 2015 and '16 titles – with a seventh victory of the year. From pole, Zarco withstood early pressure from Franco Morbidelli, then cruised away to win. Morbidelli ran out of rear grip late on, and lost second to Thomas Luthi.

**PETRUCCI WINS LORENZO'S BIKE**

A 12th-place finish for Danilo Petrucci and 14th for Scott Redding was enough to ensure Petrucci won the intra-Pramac battle to ride the team's single 2017-specification Ducati next year. Based on results in the second half of the season, Redding lost out but will still step up from a 2015 bike to a '16 model.

**BRADL AND LAVERTY SAY ADIOS**

Stefan Bradl was the top finisher of the riders leaving MotoGP, taking 13th in his final Aprilia start, three spots ahead of Aspar Ducati's Eugene Laverty. Both riders head to the World Superbike Championship in 2017, though Laverty will maintain a MotoGP involvement as an Aprilia tester. Stepping back to Moto2 next year, Laverty's team-mate Yonny Hernandez crashed out early.

**BRITISH RIDERS SIGN OFF**

Brits Sam Lowes and Danny Kent finished fourth and ninth in the Moto2 race, to end their campaigns fifth and 22nd in the points. Lowes is stepping up to MotoGP with Aprilia and Kent is staying in Moto2. Scottish rider John McPhee missed the end of the campaign after his crash at Phillip Island, unable to fly owing to lung damage.

**BINDING MEMORIES**

Champion Brad Binder signed off from Moto3 with his seventh victory of the season, despite dropping to 22nd when his engine cut out briefly on lap two. Binder took the lead with four laps to go, but an error one lap later meant he had to do it again. The South African passed Joan Mir at Turn 1 on the final lap and held on by 0.056s, with Andrea Migno third, only 0.081s behind Binder.



# Buemi stands alone

The reigning Formula E champion continued his perfect start to the 2016/17 season with a performance that should worry his rivals

By Scott Mitchell, Features Editor

[@ScottMitchell89](#)

**A**t the rate Sebastien Buemi is going, it's not going to matter whether he ends up having to miss two races in New York this season.

Victory in Marrakech made it two wins from two as the Renault e.dams driver bids to defend his Formula E crown. That's put him 22 points clear of his arch rival from last season Lucas di Grassi already — and while the Brazilian is still best of the rest, his Abt Audi Sport team is not definitively the second-quickest package as it was last season.

This season is much more competitive at the front. Part of what makes Buemi's early 100% record so impressive is he has had to fight for both wins. He's not started on the first two rows at either race, but that has not deterred him.

Buemi turned seventh on the grid in Marrakech into his eighth Formula E victory with a performance that lends weight to the theory that he is becoming a very complete driver. While set-up issues contributed to last season's numerous qualifying mistakes, Buemi now looks unflustered at all times. And the result is a man described by Sam Bird as "on his own little level at the moment".

Buemi did not shrug off a five-place grid penalty — earned after his Z.E.16's fire extinguisher emptied itself in qualifying and thus came in under the minimum weight — without effort. He made no ground on the first lap and, as he planned to run a lap longer in the opening stint, that forced him to be patient early on.

"I tried to go aggressive and I used

a lot of energy, but I didn't pass anyone so I had to get the energy back," he said. "Then I started to overtake people and the problem is really when you overtake you don't drive in an efficient way. You have to commit, stay flat out, and then it's very difficult to compensate. And when you do it hurts you hard."

Rookie poleman Felix Rosenqvist had bolted at the front, while Bird attempted to keep Nelson Piquet Jr and then Jean-Eric Vergne at bay. Vergne's delayed ascension to second allowed the Mahindra driver to build a 4.5-second lead, while in that time Buemi had passed team-mate Nico Prost, Daniel Abt and Piquet to run fourth. With Rosenqvist running a lap shorter in the opening stint, Buemi "knew I'd have the edge at the end", but the gap stood at 6.5s.

Rosenqvist and Vergne dived for the pitlane at the end of lap 16, and Buemi used his superior energy management to get ahead of Bird on his in-lap — though Buemi was lucky to get away with the only mistake of his race when he ran wide at the penultimate corner.

After the pitstops, Rosenqvist's lead over Vergne was 5.1s and Buemi was 10.9s in arrears thanks to a combination of losing a couple of seconds with the error on his in-lap — caused by a sudden loss of energy harvesting as the battery had reached too high a temperature — and Rosenqvist being on the offensive on his out-lap at the same time.

But that didn't matter. Whether it was an extreme reaction to needing to get an extra lap of energy than the first stint or just a bit of a disconnect with the car compared to the first one, Rosenqvist's second stint was not as effective as the first. This, combined with Buemi turning the wick up, transformed a probable >>



RENAULT  
e.dams

#LetsRaceTogether

Standard Sponsor  
RS 260  
e.dams  
Official of Motorsport from 2010



victory for the champion into an inevitable one.

Vergne was the obvious obstacle and Buemi's task was made easier when the Frenchman had to serve a drivethrough penalty for speeding in the pitlane (which he blamed on the speed limiter not activating, and later tumbled to eighth with energy management issues).

A freed Buemi reduced his five-second deficit to nothing in just over four laps. Rosenqvist put up a deliberately meek defence, covering the inside line on the run to Turn 11, but Buemi had the grunt to draw level on the outside and, when Rosenqvist lifted to coast into the corner, Buemi kept his foot down a fraction longer and made the move stick.

Bird had kept a watching brief on the lead battle throughout the race without ever really being a key protagonist, but Vergne's penalty and Piquet dropping out of the picture due to an electrical issue in the car swap meant he ran a comfortable third when the lead changed hands.

And as Rosenqvist was forced into a more aggressive energy-saving drive in the closing laps, Bird used his own extra lap's energy to catch and pass the Swede for second. It was not a particularly spectacular drive from the Briton, but it

## “There are 19 guys fighting for second at the moment”

was just reward after a victory shot was taken from his hands in Hong Kong.

One disappointing element was that Vergne's penalty meant the race, which had an interesting strategic plot without being a blockbuster, was robbed of a potentially thrilling three-way fight at the end. By lap 24, when Vergne stopped, Buemi had cut his gap from six to two seconds, while Vergne had cut his gap to Rosenqvist from five to three. The trio was converging, the lead two would have had been on similar energy and the man



in third would have been in attack mode – but with two cars to pass.

Vergne reckoned he would have won without it, Mahindra reckoned Rosenqvist would have won because Vergne would have held up Buemi. Sadly, that fascinating conclusion never played out, but in truth the end result would likely have been no different.

“It's going to be very difficult to compete with that level throughout the season,” said Bird of Buemi after the race. “There are 19 guys fighting

Rosenqvist led for the majority of the race, but Buemi hunted him down to snatch victory

for second place at the moment.”

It's difficult to spot a weakness in Buemi's game at the moment. Qualifying has not been perfect, but Hong Kong's group phase was an odd one (and the superpole was cancelled), and he should have started second here. That's the most minor of chinks in the armour.

Making up the ground early on included a fine aggressive move on Abt, but it is Buemi's blend of energy management and speed that is particularly remarkable. To make the progress he did in the opening stint while retaining energy, and to hack away so rapidly at Rosenqvist's gap in the opening laps of the second stint, was key.

There's no doubt Marrakech played to Renault's strengths. It is unconventional in the world of Formula E because it's conventional in the world of 'regular' series. While it is a street track, and dust rolling in from the desert made conditions tricky in practice and qualifying, it's a semi-permanent venue, wide in places and with two very long straights and a couple of long, fast corners leading into braking zones.

Buemi compared the pace advantage



Vergne dives past Piquet for third early on

ALL PICS: S BLOXHAM/LAT



enjoyed here to the Beijing opener in 2015. Marrakech's layout is different to the 90-degree turns and chicanes that made up the Beijing circuit, but the key similarity was a need to roll off the corner onto the long straights quickly.

"The car was amazing," Buemi enthused. "I was able to carry so much speed in the corner and then because of that I could save a lot of energy [on the straights] in comparison with the others.

"We were so quick in the second car. I'm very, very happy with how it's gone; after Beijing last year it's the race we've been quickest compared to the field.

"I'm looking forward to Buenos Aires [round three] and hopefully we can avoid mistakes and get some good points to make sure if the World Endurance clash still happens I can still fight for the title."

There's a three-month wait until Buenos Aires, which means more time than usual for Buemi's rivals to try to find a way to stop him, or at least limit the damage. If Buemi is not in contention for the 58 points on offer in New York next summer, it will give his rivals a glimmer of hope. But right now they need all the help they can get. ❄



## MIXED MARRAKECH

ALL THE TALK IN THE BUILD-UP TO THE Marrakech ePrix was that this race at the Moulay El Hassan Circuit in Morocco would be a one-off. Nothing more than a necessary addition to the calendar to plug the gap between the Buenos Aires round in late February and the immovable early October season opener in Hong Kong.

And it did fit quite nicely, what with the United Nations' climate change summit – COP 22 – taking place literally down the road from the track. But over the course of the event it became clear that this one-off might not be much of a one-off. Series CEO Alejandro Agag certainly suggested as much.

"It's important to be in Africa," he said. "This race is a one-off because of COP 22, but this is a good start and we're going to talk to the authorities to see if we can make this a permanent race on the calendar.

"This is a great place, Marrakech is a fantastic city, we have this track, which is great. Why not?"

Some in the paddock were keen to flag up a couple of reasons, but neither is significant enough to torpedo the event from being a regular fixture. First, there's the general location – it's surrounded by dirt roads and undeveloped land, and a far cry from the stunning backdrop that greeted the season opener in downtown Hong Kong.

But Agag rightly pointed out "we have to be all over the world and the places around the world are not the same". So that covers reason number one. Number two? The event was a bit of a non-event. If it returns, far more work/effort needs to be put into it.

The circuit was fine – better than fine, to be honest. It was a good race, the circuit lent itself nicely to overtaking and it is tricky both in design and because of the sand rolling in from the surrounding environment. Plus, even though it's not properly city-centre, it's still a street track within reasonable distance of a reasonably large African city. And there's something to be said for the backdrop of a 'proper' circuit set-up devoid of temporary garages (although not having enough space in the pitlane to avoid Renault e.dams, the champion team, being thrown in a pop-up set-up at the end was frankly ridiculous).

The main issue was the presentation, and what I believe the PR folk call 'activation'. There was little advertising around town – a street demo two days before doesn't cut it – and the crowd was very low, the official claim being an attendance of just over 7000. Although with very little signage on the way in, maybe there were a few thousand more who simply couldn't find where they needed to walk...

Maybe it's a good thing that not many people showed up, because little care had gone into the presentation. It's a dusty place, but there's no excuse for broken, glass-covered pavements.

I'm not being snobby. Formula E's on the radar of the world's biggest manufacturers and that means every event needs to be worthy of its place, and world class. Marrakech satisfies the first criterion, but there's definitely work to be done on the second.

Hong Kong highlighted the difference an invested local promoter can make, and that's what Marrakech needs if it is indeed to return.



Pre-event street demo  
enough to drum up a decent crowd



Featured product 0830310

Produced under license of Ferrari S.p.A. The name FERRARI, the PRANCING HORSE device, all associated logos and distinctive designs are property of Ferrari S.p.A.

**SCUDERIA**  
**FERRARI**

**Ferrari**  
OFFICIAL LICENSED PRODUCT

Available from the following



[www.ScuderiaFerrariWatches.co.uk](http://www.ScuderiaFerrariWatches.co.uk)



Superb rookie Rosenqvist laps up the plaudits



Minute's silence for NextEV man Martin Leach

## RESULTS ROUND 2/10, MARRAKECH (MA), NOVEMBER 12

POS	DRIVER	TEAM/CAR	TIME
1	Sebastien Buemi (CH)	Renault.e.dams · enault Z.E.16	47m40.840s
2	Sam Bird (GB)	DS Virgin Racing · Virgin DSV-02	+2.457s
3	Felix Rosenqvist (S)	Mahindra · Mahindra M3 ELECTRO	+7.195s
4	Nicolas Prost (F)	Renault.e.dams · Renault Z.E.16	+11.586s
5	Lucas di Grassi (BR)	Abt Audi Sport · Abt Schaeffler FE02	+13.771s
6	Daniel Abt (D)	Abt Audi Sport · Abt Schaeffler FE02	+18.233s
7	Oliver Turvey (GB)	NextEV · NextEV TCR002	+21.710s
8	Jean-Eric Vergne (F)	Techeetah · Renault Z.E.16	+28.011s
9	Nick Heidfeld (D)	Mahindra · Mahindra M3 ELECTRO	+33.699s
10	Jose Maria Lopez (RA)	DS Virgin Racing · Virgin DSV-02	+33.863s
11	Robin Frijns (NL)	Andretti · Andretti ATEC-02	+37.092s
12	Stephane Sarrazin (F)	Venturi · Venturi VM200-FE-02	+40.683s
13	Jerome d'Ambrosio (B)	Faraday Future Dragon · Penske 701-EV	+42.034s
14	Adam Carroll (GB)	Jaguar Racing · Jaguar I-type 1	+49.026s
15	Ma Qinghua (PRC)	Techeetah · Renault Z.E.16	+50.433s
16	Nelson Piquet Jr (BR)	NextEV · NextEV TCR002	+1m15.452s
17	Mitch Evans (NZ)	Jaguar Racing · Jaguar I-type 1	-1 lap
18	Loic Duval (F)	Faraday Future Dragon · Penske 701-EV	-3 laps
R	Maro Engel (D)	Venturi · Venturi VM200-FE-02	26 laps-unclassified
R	Antonio Felix da Costa (P)	Andretti · Andretti ATEC-02	21 laps-unclassified

**Winner's average speed** 76.661mph. **Fastest lap** Duval 1m22.600s, 80.459mph.

**Superpole 1** Rosenqvist 1m21.509s; 2 Buemi 1m21.546s\*; 3 Bird 1m21.686s; 4 Piquet 1m23.879s; 5 Vergne. \*Buemi given five-place grid penalty for fire extinguisher being under minimum weight limit.

**Qualifying 1** Vergne 1m20.993s; 2 Rosenqvist 1m21.175s; 3 Buemi 1m21.350s; 4 Bird 1m21.392s; 5 Piquet 1m21.651s; 6 Abt 1m21.725s; 7 Prost 1m21.777s; 8 Turvey 1m21.853s; 9 Frijns 1m21.912s; 10 da Costa 1m22.073s; 11 Heidfeld 1m22.074s; 12 di Grassi 1m22.081s; 13 Lopez 1m22.133s; 14 Engel 1m22.236s; 15 Sarrazin 1m22.270s; 16 Evans 1m22.355s; 17 d'Ambrosio 1m22.681s; 18 Ma 1m23.248s; 19 Duval 1m23.933s; 20 Carroll 1m25.695s.

**Championship 1** Buemi 50; 2 di Grassi 28; 3 Prost 24; 4 Rosenqvist 19; 5 Bird 18; 6 Heidfeld 17; 7 da Costa 10; 8 Turvey 10; 9 Frijns 8; 10 Abt 8.

## IN THE HEADLINES



### FIRST POINT STILL ELUDES JAGUAR

Jaguar got both drivers to the finish for the first time, but Adam Carroll and Mitch Evans (above) were a long way from breaking its points duck. Evans and Carroll started 16th and 20th in North Africa; Carroll rose to 14th, while contact at the start and a late-race off consigned Evans to a lapped 17th.

### ANOTHER DI GRASSI SALVAGE JOB

Lucas di Grassi had to carry out another rescue mission after his second troubled qualifying session in a row. A small mistake at Turn 1 consigned the Abt Audi Sport driver to 12th on the grid, but he rose steadily up the order in the race to finish fifth, one place ahead of team-mate Daniel Abt.

### NEXTEV PAYS TRIBUTE TO LEACH

The NextEV Formula E team paid tribute to former co-president Martin Leach with a minute's silence on Friday in Marrakech. Leach died from cancer earlier this month. Oliver Turvey claimed the team's second straight points finish with seventh in the race.

### ERRORS BLUNT ANDRETTI CHARGE

Andretti duo Robin Frijns and Antonio Felix da Costa failed to score points despite both starting in the top 10. Frijns had a spin in his first stint and finished 11th, while da Costa's first car switched off and stopped on track while he was running in the points.

### RAPID DUVAL CLAIMS CONSOLATION

Faraday Future Dragon Racing driver Loic Duval netted his first point of the season despite an on-track stoppage. The Frenchman stopped while running 13th, but managed to resume and pipped da Costa to the point for fastest lap.

### LOPEZ NETS FIRST FE POINT

Three-time World Touring Car champion Jose Maria Lopez (below) scored his first Formula E point with 10th in Marrakech. The DS Virgin Racing driver was in the spotlight owing to his WTCC experience of the Moroccan circuit, but crashed twice in FP1 and qualified down in 13th. He fell two tenths short of beating Nick Heidfeld to ninth at the flag.



# The man with Macau in his veins

Teddy Yip Jr has reignited a family passion with the Macau Grand Prix dating back six decades, and is becoming an increasingly significant player in junior single-seaters

Marcus Simmons, Deputy Editor

 @MarcusSimmons54

**THEODORE  
RACE**





XPBIMAGES

**T**here's a question that Teddy Yip Jr has often been asked since he entered the motorsport world in 2008. Initially that was as a new partner in the A1GP Team Ireland effort; now it's as the head of Theodore Racing, which has backed Prema Powerteam this season in the GP2 Series, the Formula 3 European Championship and its

German and Italian Formula 4 campaigns. That question? 'Why are you doing this?' Legend has it that this 34-year-old naturalised Canadian's answer is frequently: 'Does there have to be a reason?' When it's posed by Autosport, he responds: "I think that the simplest answer is that I love this sport. I guess it's part of my DNA. I've been around it since day one and, now that I'm in, there's no leaving it." When he talks of 'DNA' and 'since day one', of course he's referring to his late father Teddy Yip Sr, who to motorsport fans will be forever known as the godfather of the Macau Grand Prix. Born in Sumatra, Yip Sr's love affair with the race started in 1956 – its third running – when he drove a Jaguar XK120, but it was as a team owner that his influence would truly snowball. First that was with Formula Atlantic in the '70s – while at the same time he ran his Formula 1 team – and then it was as an associate and sponsorship finder for teams when the race switched to F3 rules in '83. Indeed, that first running of Macau for F3 machinery was won by Ayrton Senna in a West Surrey Racing-run, Theodore Racing-branded Ralt. Until three years ago, the last time the Theodore name had adorned a car in Macau was 1992, when Rubens Barrichello returned from Formula 3000 in a one-off for Edenbridge Racing. At that time Yip Jr was a young lad, wide-eyed about the motorsport world brought to him by his larger-than-life father, whose parties and energetic lifestyle were legendary.

"The earliest motorsport memory that I have is running around the garage of our house in Macau where they used to prepare the cars," he says. "They just used to prepare them there and drive them around to the pitlane. So I'd be in the garage, just being a kid, and everybody's around prepping the cars." Yip Sr died in 2003, and for the next few years there was very little contact with the motorsport world, although Yip Jr and his Canadian mother used to "get up together in the middle of the night to watch the F1 races". Then came a call from John Hynes, a former supporter of Theodore Racing who was now a partner in A1 Team Ireland along with ex-Theodore racer David Kennedy and Mark Gallagher. "It was a totally random call – I was a little bit dumbfounded to be honest," says Yip. "But I flew over, went to a race, and saw that I had an opportunity to get involved with a top-class team in a really enjoyable series, and that was that. A1 was a very cool concept and the racing was great." Adam Carroll brought A1GP title glory to Team Ireland, but the series didn't last into the next season. With Yip as team principal, the Silverstone-based Status squad refocused on the new GP3 Series for 2010, before expanding into Le Mans 24 Hours efforts in 2012-13, and then taking over Caterham Racing's GP2 entry and switching to that series (and leaving GP3) for '15. But with the driver market tough, the decision had to be taken for Status to close its doors earlier this year. In the meantime, Yip had brought the Theodore name back for the Macau GP as backer of Prema in 2013. On the 30th anniversary of Senna's victory for Theodore, Alex Lynn took a fairytale win as Yip and his mother looked on. "I'd always been resistant to using the Theodore name," he explains. "I didn't want to do business off the back of the achievements of somebody else, even if it was my old man. So until that point I always wanted to run everything under the Status brand. But by that point, after that many years, I felt I'd done that, and along with all those other factors it

Above: Lynn won in 2013 driving for Theodore Racing by Prema  
Right above: Yip Sr and Jr in the garage at Macau  
Right below: Yip may be planning to take a stake in "wonderful" Prema family squad



## “I’d be in the garage, just being a kid, and everyone’s around prepping the cars”

was the perfect storm of timelines, and it was received so well. That and seeing my mum in the garages at Macau when we did that was really special; she was quite emotional [Yip is too as he recounts the memory].”

Felix Rosenqvist brought another Macau win for Theodore and Prema last year and, with Status on ice, the decision was taken to become a full-season partner of the Italian team. Yip, who frequently attends GP2 and F3 races with Theodore associate Kennedy, attests: “Prema is a family run business and even as outsiders we’ve been welcomed into that family. They’ve been wonderful.”

So much so that whispers in the paddock indicate that Yip could take a stake in Prema for 2017. Although there has never been official confirmation, it is widely known that Lance Stroll’s father has had a share in the operation. With Stroll off to F1, the suggestion is that Yip and Theodore could take that place. Put that to Yip, and he pauses, before replying: “These guys have been great to work with and our current partnership is working really well. So, I’m happy to explore all options to keep this going, or expand it further. If that’s what it’s going to come to then fantastic; I’d be more than happy to explore that.”

Don’t be fooled into thinking that Yip’s participation is purely based on philanthropy. Yes, he loves helping drivers on their >>

# The Mercedes GT challenge

THE LONG-STANDING question of whether anything can beat a Mercedes around the streets of Macau has been turned on its head for this year.

The question now is whether Mercedes can challenge for a third straight victory in the event, now known as the FIA GT World Cup, on the Formula 3 Grand Prix undercard.

Mercedes factory driver Maro Engel has won the past two GT3 extravaganzas around the Guia circuit aboard the old SLS AMG GT3 – and would have won in 2013 but for a late puncture.

The German’s task of adding to his tally in the latest Mercedes-AMG GT3 is going to be made more difficult by the Balance of Performance, the mechanism by which the cars are meant to be equalised in GT3.

Straightline speed played a big role in Engel’s victories in

2014 and ’15. He jumped into the lead from the second row two years ago, and 12 months ago the pole winner lost the advantage at the start, but was back in front by the time the pack turned right at Lisboa and headed up the mountain.

Engel was never headed either time

**“We are expecting to be down on top speed this year”**

around a circuit on which overtaking a car with a top-speed advantage is notoriously difficult.

Mercedes might have a new car for this season, but it is powered by the same V8 as the SLS. The 38mm diameter engine air restrictors through which the engine breathed in 2015 have been

replaced by 34mm orifices this year.

“We’re expecting to be down on straightline speed from last year and on our competitors,” says Engel, who drives one of two HWA-run cars entered under the Mercedes-AMG Driving Academy banner.

“That will take a big toll, because the sprint down to Turn 3 [Lisboa] is so important.

“Everything depends on how big the deficit is in terms of top speed. It is difficult to overtake up on the mountain, but I’ve passed people up there and others have too.”

This is the second time the Macau GT Cup has had world status, and Audi, Porsche and Lamborghini join Mercedes as the registered manufacturers competing for the World Cup title.

**GARY WATKINS**





way – “It gives me a ton of satisfaction to be a part of any of those young guys’ success,” he says – but there are also sound commercial reasons. Macanese investment company SJM Holdings is fully involved with Theodore, a new association has been struck with Asian software giant BBIN, and Prema’s cars have been carrying slogans on behalf of the Macau Tourist Board.

That’s the business side of Yip, but the one more usually on show is the personality. This British-born, American-raised and now fully fledged Canadian (“I was on a skiing holiday there when I was 19 and just decided to stay”) couldn’t be further removed from his father’s character. He has a lot of friends and loves socialising, but instead of wild parties he’s more of a spiritual, freewheeling dude. On Twitter he describes himself as ‘a free-thinking person of earth,’ and outside of motorsport and business he’s a patron of the arts, including as a leading figure behind the local arts festival at his Victoria, British Columbia home. “It was live music, art, film...” he says of the event known as the Vancouver Island Cultural Festival (VIC Fest for short). “We’ve since stopped that. We are a very small player in the festival game and that eventually made it quite difficult for us to continue. Just very recently, in the last couple of weeks, I’ve joined a group to take over a concert hall at home in Victoria. We’re looking to make it Victoria’s premier live music venue, about 700 capacity – that’s big for Victoria!”

But for now, the focus is fully on Macau. The event is so indelibly part of the family’s story that it was also significant in Theodore’s other relationship this season – an IndyCar programme with Rahal Letterman Lanigan Racing. Although Bobby Rahal never drove for Theodore, he was one of the drivers invited to the 1991 Macau GP by Yip Sr to compete in the Macau Race of Champions in a one-make Mazda MX-5 race. Rahal partied with Yip Sr a quarter of a century ago, and the story went full circle in 2016 with Rahal’s son Graham in the cockpit and Yip Jr in the pits.

It’s fair to say that the Macau GP might not even exist as it does today without the influence of Yip’s family. His father was a friend of the secretary of a Surrey company called Motor Race Consultants, and that smoothed the wheels in 1983 for MRC’s Barry Bland to take over the role of coordinating the entry list and logistics for the first F3 Macau GP, a task Bland only relinquished two months ago after 33 years building it into the most prestigious single race on the junior single-seater calendar.

“Macau is the event I look forward to more than any other,” says Yip, whose team will field Rosenqvist (bidding for a hat-trick), Nick Cassidy and Maximilian Gunther this week. “It’s incredibly important to me and my family for many reasons. My father was instrumental in organising the inaugural Macau F3 Grand Prix and also passionate about putting Macau on the world map.

“Theodore was the first Asian team to go international – into F1 and Indycars – and I’m proud of that legacy, but I’m keen to make my own mark and achieve my own goals with the team.”

Yip is already doing that, and you wouldn’t rule out his mark becoming ever bigger in junior motorsport in years to come. ✨

Above: F1-bound Lance Stroll dominated Euro F3 in 2016 with Prema

Below left: Teddy Yip Sr, godfather of the Macau Grand Prix

Below: Prema’s Rene Rosin and Yip celebrate after Rosenqvist’s Macau win last year



# Serious fun for the returning F3 veterans

AT THE END OF LAST month, Antonio Felix da Costa, Felix Rosenqvist and Daniel Juncadella found themselves on track on the same day at the Red Bull Ring, testing Formula 3 cars in preparation for the Macau Grand Prix.

The trio, each a previous Macau winner, were all returning to F3 machinery, and seemed to spend most of the day gesticulating – with varying degrees of rudeness – to each other from the cockpit, then posting the onboard footage on Twitter. They are all mates, and it was a great little snapshot of racing fun, perfect fodder for the build-up to the big race in the east.

Rosenqvist bids for a third successive win in his Prema Powerteam car, 2012 victor da Costa returns with Carlin for his first Macau visit since '13, and '11

winner Juncadella switches to Hitech GP as he returns for a second year running. Add in Spa 24 Hours winner Alexander Sims with Double R Racing, and you have four factory-contracted professionals returning to F3, all of whom should run near the front.

It's not just about the old pros. Much as the participation of these guys is welcomed, it would be great for F3 if 2016 European championship stars George Russell (Hitech), Joel Eriksson (Motopark), Maximilian Gunther (Prema) or Callum Ilott (Van Amersfoort Racing) beat them all. But it'll be tough – only Ilott has been to Macau before, and had a difficult weekend in 2015.

Nick Cassidy has dovetailed his Lexus Super GT programme in Japan with Euro F3 with Prema this season, and has already

stood on the Macau podium, so he'll be a contender. The Kiwi also highly rates his successor as Japanese F3 champion, Kenta Yamashita, and it'll be interesting to see how the protege fares on a one-off outing with T-Sport.

Apart from Russell, Ilott and Sims, there's a bumper contingent of rapid Brits. Jann Mardenborough finished second in Japanese F3 this season with B-Max and makes his first Macau visit with the team; Formula Renault Eurocup champion Lando Norris and GP3 ace Jake Hughes will be there with Carlin after making a great impression on their FIA F3-spec debuts in the European finale at Hockenheim; Dan Ticktum also raced at Hockenheim and joins Sims at Double R; and Sam MacLeod was close to a podium last year and lines up this week with Fortec Motorsport.



Rosenqvist is aiming for a third consecutive Macau Grand Prix win

# The Brit on the brink of TCR title

WHILE TWO OF THE THREE MAIN ACTS AT MACAU HAVE 'World Cup' status, it's the third that has a season-long championship still to be decided.

After the World Touring Car Championship opted to up sticks and swap its long-standing Macau season finale for Qatar, the new-for-2015 TCR International Series stepped up to take on the Guia race naming rights last year and served up a thrilling pair of races.

Guest star Rob Huff won the first in a WestCoast Racing Honda Civic, while victory in the second guaranteed Swiss Stefano Comini the inaugural drivers' title ahead of Pepe Oriola.

One year on, there's a tight championship fight once again – although it's a more familiar name who this time can deny Comini in the Chinese Special Administrative Region.

"I've put in a lot of hard work to get to a position like this," says Briton James Nash, who heads to Macau within reach of the 2016 TCR crown.

As a British (2011) and World (2013) Touring Car Independents' champion, Nash has pedigree in tin-tops – but stands on the brink of securing his most significant title yet.

Nash sits 17 points clear in his SEAT Leon of nearest rival Comini, this year in a WRT-run Leopard Volkswagen Golf GTI. Despite being wary of the confines of Macau, Nash is clear about the approach to the final two races he needs to take to become champion.

"The whole way through the weekend I'll be very mindful of what the end game is," he says. "I probably won't race particularly hard in race one – I don't need to fight Stefano or [Craft-Bamboo team-mate] Pepe, I can let them battle it out. I just need to be in a clean position in both races.

"My weekend starts with qualifying – if I get that right, hopefully the rest will follow."

Of the rest of the runners, there's no return for 'Mr Macau' Huff, but his Honda WTCC team-mate Tiago Monteiro will make the trip, as will TCR Germany and 2013 Renault UK Clio Cup champion Josh Files, and British Touring Car driver Adam Morgan in one of six Chinese Touring Car entries that bolster the grid.

TCR won't return to Macau next year, but expect it to end its short stay on the billing in exciting fashion.

**JACK COZENS**





# Who needs Formula 1 anyway?

Marco Wittmann has twice triumphed in one of motorsport's toughest championships. And, as he says, there are no pay-drivers in the DTM

By Marcus Simmons, Deputy Editor

 @MarcusSimmons54

**A**t the age of 26, Marco Wittmann is already a two-time champion in arguably the most competitive series outside of the Formula 1 World Championship. As a BMW factory driver, his strike rate in just four seasons in the DTM is truly impressive, his second title coming a month ago in a gripping showdown at Hockenheim with charging Audi star Edoardo Mortara.

When we say it's the most competitive series outside F1, that's because all 24 of the drivers over the past season are professionals who were there on merit. And that, Wittmann argues, in some ways makes it perhaps even stronger than F1. Ask him whether, after clinching his first title in 2014 aged 24, he had thoughts of using it as a launchpad to the single-seater elite – as did Paul di Resta before him and Pascal Wehrlein afterwards – and he responds: “It definitely felt great to be champion, especially at that age. Of course there was always a bit of a thought, if there was a possibility to go to single-seaters, but I have to say I feel really comfortable in DTM together with BMW. And F1 has changed a bit – it's really tough to get a seat there if you don't have the money or the connections, like Pascal has with Mercedes. So yeah, times have changed and overall I'm pretty happy in DTM, and now I've claimed my second title it's even better.

“F1 is not always the way that is needed [for a driver]. I think DTM has the same competitiveness, maybe even better. F1 is more popular, no discussion, but I think from the sporting side, especially from the driving side, the competitiveness is even higher, because you don't have paying drivers, you have only factory drivers from manufacturers. That's something that really counts.”

So Wittmann is happy in the DTM, ready to become a talisman for BMW in a similar way that Bernd Schneider was for so many years with Mercedes. Perhaps that's partly a by-product of his youth spent in the Bavarian town of Furth – a stone's throw from Nuremberg, and of course the city's Norisring street circuit. So the young Wittmann grew up being entertained not by Schumacher and co in Formula 1, but by Schneider and the DTM old school.

“My parents were always involved with cars,” he recounts. “My father had his own garage, so there was a background of cars. When I was a child I always went to Norisring, to look especially at DTM and Formula 3. And at the age of

six I got my first go-kart and then everything started...”

Wittmann switched to cars in Formula BMW “at the age of 17, which is nowadays pretty late!” He raced in the German championship in 2007, then when that was replaced by a European series he continued into '08, finishing runner-up to current Haas F1 driver Esteban Gutierrez. Three seasons in the F3 Euro Series followed, with Wittmann finishing runner-up in '10 and '11.

After that came a tryout for BMW, which was returning to the DTM for 2012 but was doing so with only six cars for the first season. There was unlikely to be a race seat available straight away, but there could well be one for '13, when the manufacturer would expand its effort to an Audi and Mercedes-matching eight cars.

“I took the opportunity to do the test with BMW at the end of 2011,” says Wittmann. “I knew that it would have only six places instead of eight. I decided that I would go for the test, and maybe get a chance. In the end I had to wait one more year. In '12 I was the test and reserve driver for BMW, the seventh driver, which is always hard when you have to watch the others racing and be in the background. But of course I learned a lot. I was in all the meetings, I did some GT driving in endurance and 24-hour races that gave me some ‘touring car’ experience.

“At the end it was the right call – for the first year just watching the others, getting as much knowledge as possible – if I look at what happened in the last four years.”

Naturally, Wittmann had to impress sufficiently to be granted a race seat in 2013. “I thought it would happen,” he says. “But I was always waiting for the call from BMW, which came very, very late. I was waiting the whole season to get the answer for '13, but I knew anyway that BMW would have two more cars, so for me the focus was just to do a good job with the team in all the meetings, and show good speed on test days.”

The step up came with the MTEK team of Ernest Knoors, a brand new squad added to the BMW roster to run its additional two cars. In the sister M3 was ex-F1 racer Timo Glock, also new to the DTM.

Even so, Wittmann did a great job, finishing on the podium for the first time in his third outing at the Red Bull Ring, and grabbing his maiden pole position near the end of the season at Zandvoort. He finished eighth in the standings – one place ahead of Glock – and now was recognised as a proper young talent of the DTM.

Moreover, the relationship with Glock was – and remains – strong. Wittmann moved straight away to the RMG team, >>



Wittmann clinched first championship at the age of 24

XPB IMAGES

## Junior teams aid Wittmann's first steps



F3 2010: Wittmann is chased by Mortara and Valtteri Bottas

XPB IMAGES

GERMAN-RUN JUNIOR teams are nothing new. Think of the BMW youngsters of the '70s, or Mercedes' sportscar experiment that yielded Michael Schumacher, Heinz-Harald Frentzen and Karl Wendlinger.

Schumacher's manager Willi Weber also launched one a decade ago, with Nico Hulkenberg, Christian Vitoris and Marco Wittmann, the last-named entering his first season in Formula BMW with Josef Kaufmann Racing.

"Nico was already in F3, Christian had just won in Formula BMW and I was the youngest of the three," says Wittmann. "That was a great time actually. Willi definitely helped me to go from karting into single-seaters. At the end he stopped the programme. I think if he'd continued it

would have worked out, but at that time he was still perhaps a bit too focused on Schumacher."

Wittmann moved onto the Gravity scheme, very closely linked with the Renault/Lotus/Enstone F1 team, and that helped him through his F3 years.

During that time he would be team-mate in 2010 at Signature to future DTM foe Edoardo Mortara, the Italian winning the title and Wittmann finishing runner-up, as he would again in '11 to Roberto Merhi.

"Mortara was on his way to F1, but was not able to get in and stepped back from GP2 to F3," says Wittmann. "We had some good fights, but he was more experienced than me, and he was quicker to be honest, although I was able to beat him sometimes."

where he was partnered by Maxime Martin in 2014 and '15, but Glock was reshuffled into that squad this season to reform their partnership from three years earlier.

New to the DTM he might have been, but at least Glock had plenty of experience of working with big operations. That must have been useful to the rookie Wittmann.

"In some points definitely," he agrees. "It was useful to get some feedback, some experience from him. And at the end maybe he picked up a bit of speed from my side!"

"We had a great time [in 2013], and we were back together in 2016. It's working pretty well with Timo. He is a really honest guy who also comes to me and says, 'You really deserve it [success]'. The relationship is great, and we showed as well in '16 that we were the strongest BMW team."

With the RMG squad for 2014, Wittmann was now comfortable with his place in the DTM. And with BMW switching to the M4, he worked hard over the winter with his new team and enjoyed the benefits with his first DTM title: "You have to get to know and trust each other, so it's more work. I would call it extra motivation. We worked to find the right set-up for my driving style to get the full potential out of the car. We did a pretty good job over the winter and started the season with a win, which proved we made the right adjustments on the car. From that point onwards it was a great season."

What was impressive was that Wittmann never let up. Rather than sit on a points cushion, he went out to win whenever he could. It was a season of domination, remarkable in a series as close as the DTM.

"I'm a guy who doesn't think too much about the championship," he asserts. "I did it in the past, especially in karting, and I lost quite a few championships because I was just looking at the points, calculating. So I tried to change and just go race to race. But it's not always about a win. Sometimes you just have to try to get the maximum out of it – sometimes that's P3, sometimes it's a win, maybe sometimes it's just P7, but at the end it's points. That's the same approach I had in 2016."

The intermediate season, 2015, wasn't a great success for BMW, although Wittmann – who'd moved from the Munich marque's Ice Watch car to its Red Bull-liveried machine – was just 11 points adrift of the manufacturer's top-scoring driver, Bruno Spengler. But he did fulfil an ambition by completing more than 100 laps of the Red Bull Ring with Toro Rosso in the mid-season F1 test.

## “I’m a guy who doesn’t think too much about the championship”



F1 test outing with Toro Rosso fulfilled long-time dream

DUNBAR/LAT

This was no relaxed day of fun; Wittmann set a best lap that would have put him 10th in Q2 for the Austrian Grand Prix. "It was like a present from BMW, but also together with Red Bull because they are a partner with BMW," he says. "It was just a great experience – it was always a dream to run at least once in an F1 car. I enjoyed it a lot."

Wittmann always seems to shine at the Red Bull Ring, and it was his win there in 2016 that really kickstarted his bid for his second title. It was especially important as he had a disastrous opening round at Hockenheim, where he had expected to do well. With the third and fourth rounds at Lausitzring and Norisring – both circuits where BMW expected to struggle – he was not optimistic after that opener.

"We did not expect to fight for the championship after Hockenheim 1," he admits. "We had a pretty tough 2015 season and then starting in '16 with such a bad weekend..."

It was when he moved to the top of the points at the Norisring that momentum began to build: "We fought back, we had some good weekends, we collected a few good points, especially on tracks where we were not so strong in the past – Lausitzring and Norisring.

"Taking the lead of the championship at the Norisring was a bit of a surprise, because it was quite early and we'd just had the two race tracks where we had been bad in the past. It was somehow a good sign, and for us it was, 'OK, there could still be a chance to win it', and we then just tried to >>



Victory at the Red Bull Ring kickstarted 2016 championship push

XPBIMAGES



GRUPPECDE/DTM

get the maximum out of the car.

“We had definitely not the strongest race car, because if you look Audi won 10 of the 18 races, which was impressive, but we were probably the more clever ones, and collected the points when they really were needed.”

Wins at Moscow Raceway and the Nurburgring propelled Wittmann into a nice series lead, and things looked even better in the penultimate round at the Hungaroring when he was the only points-scoring survivor of a clash with main title rivals Mortara and Jamie Green at the start of race two.

Then came disaster for BMW, with Wittmann’s exclusion from fourth place because of insufficient thickness of the skid plate. “That was a bit tough,” he says. “Audi was pretty strong there, but we managed to claim some points in Saturday’s race. On Sunday we actually won the start, and then we had the crash with Mortara. I was able to finish the race in fourth with a pretty damaged and broken car, and actually I was happy to

somehow finish – collecting 12 points was like a win for me. And then three or four hours later, to get excluded from the race was a little punch in the face.

“A 26-point [advantage] going into Hockenheim would have been nicer than just 14. It’s always very tight there – anything can happen. But we had to take this decision, even if it’s something I don’t understand. We had a broken and slower car and OK, rules are rules, it happened.”

The irony was that the skid plate illegality was caused by the incident. “We checked the data and there was damage from the start crash with Mortara,” says Wittmann. “We went to the ITR [promoter] and showed them our data, which is probably why the decision was taken so late in the evening. But at the end we decided not to appeal, because from the perspective of the fans we didn’t want a decision to come after Hockenheim as to who becomes champion and who does not. BMW and I decided to have

**“Until the last lap it was not clear who was going to win. It was one of the closest championships in the DTM ever”**



Second championship victory was sealed in Hockenheim nail-biter

a clean championship fight at Hockenheim.”

The upshot was a Hockenheim thriller. Wittmann set himself up beautifully by staying just out of DRS reach of a charging Mortara to take second place in the first race of the weekend, then had his position protected in the finale by a flotilla of BMWs as the fiery Mortara stormed to the front.

“Until the last lap it was not clear who was going to win the championship,” Wittmann recalls. “Mortara was in the lead and I was fourth, but if I’d got a puncture he would have won the championship. It was one of the closest championship decisions in the DTM ever.”

How could that lad watching V6 Mercedes C-Classes, Opel Calibras and Alfa 155s at the Norisring in the ’90s have imagined he would twice be crowned king of the DTM? No wonder he’s happy there. He’s as much a part of BMW tin-top folklore as Hans Stuck and the CSL. ✘



Green’s ’16 title hopes were snuffed out in the first race of the Hockenheim finale

## Still the bridesmaid

JAMIE GREEN HAS probably heard the ‘close-but-no-cigar’ cliché so many times that he wants to throw every box of Hamlet he sees in the sea. After finishing runner-up in the DTM with Audi’s Team Rosberg squad in 2015, he was third this season, only conceding his last lingering title hopes in the first race of the Hockenheim finale.

The year started badly at Hockenheim when he qualified fourth but was pushed into the gravel in an early collision involving Marco Wittmann, and got caught out with the end of a slow zone and was given a drivethrough penalty: “We were not 100% sure of the rules.”

In race two he was Audi’s top qualifier in 11th after a failed tyre gamble, and got “wiped out in someone else’s crash”. No points.

An experimental set-up for the new track surface at the Red Bull Ring didn’t work but, when Audi returned to what it knew for Sunday, Green was on pole and finished third.

“From that point we were back in the mix,” he says of a run that included a consummate win at Zandvoort. “We got to Moscow only a few points behind Wittmann. We’d clawed our way back.”

After points in the first race in Russia, “we had a power-steering leak in free practice on Sunday morning. The mechanics had to rip the car to

pieces and it wasn’t completely ready for qualifying. Something came loose and that affected the rideheight, and I qualified 19th.

“I got help from my team-mates, but then I made a bad call on passing Antonio Felix da Costa – he’s the kind of guy who doesn’t see you coming or just turns in anyway. That resulted in a drivethrough for me, and even with that I would have got points, but I came too quickly into the pits and got another drivethrough! That was a big setback because Wittmann won.”

At the Nurburgring, another drivethrough cost points: “As I came out of the pits I was quite shocked that Gary Paffett aimed at the [Turn 1] apex. I tried to brake to avoid hitting him, but because the track drops away there it looked like I just locked the brakes and crashed into him.”

The main incident Green blames himself for is the Moscow pit-speeding, but admits: “I need to be a little bit smarter in future. When you have a quick car and a one-hour race, that’s a lot of time to gain back places.

“You keep learning and getting better and I think I’m still doing that. That should give me a good opportunity, assuming the car’s competitive. I’ve just got to crack on.”

**“You keep learning and getting better. I’ve just got to crack on”**



Green concedes he needs to be “a little bit smarter in future”

# RACE CENTRE

JAPANESE SUPER GT • NASCAR SERIES • JAPANESE F4

ISHIHARA/LAT



## Kovalainen claims Su

**SUPERGT**  
**MOTEGI (J)**  
**NOVEMBER 12-13**  
**ROUND 7/7**

HEIKKI KOVALAINEN AND KOHEI HIRATE claimed the Super GT championship in style with a breakthrough race victory in the final round of the season at Motegi.

The SARD Lexus pairing came into the double-header finale fourth in the standings, 11 points behind Nissan's reigning champion pairing Tsugio Matsuda and Ronnie Quintarelli.

But in the first race – run as a replacement for May's Autopolis round, which was cancelled due to an earthquake – they turned that into a three-point lead after finishing a close second to the Kondo Nissan of Daiki Sasaki and Masataka Yanagida, while Quintarelli/Matsuda were ninth.

Kovalainen had put the Lexus on pole in tricky conditions and Hirate led initially, but was reined back in by a safety car period. The Lexus then lost the lead in the pits, thanks to the Kondo crew not changing tyres. Kovalainen closed in,

but finished 0.239 seconds short of victory.

Seven crews headed into the final race of the year with a chance of the title, but this time the SARD crew enjoyed an unchallenged run to victory from pole position.

The Team Le Mans Lexus of Kazuya Oshima and Andrea Caldarelli was one of those title contenders heading into the race. Oshima closed in on Kovalainen towards the end, but the Finn held on for a narrow 0.472s victory to claim the crown by 13 points.

This was Kovalainen's first victory in Super GT, and gave Team SARD its first Super GT title in 23 seasons in the category – although it was Hirate's second, after his 2013 triumph.

Kovalainen last won a championship in 2004, taking the Nissan World Series crown before being pipped by Nico Rosberg in the inaugural GP2 title fight a year later.

"It was amazing weekend for us, thanks to Toyota, TRD and our team," said Kovalainen. "I was so happy to get the title with a great partner in Kohei."

Oshima and Caldarelli took second in the championship, with Matsuda and Quintarelli



Kovalainen (left) celebrates first car-racing title since '04

# per GT title

dropping to third after finishing seventh in the final race on a weekend when they struggled badly for speed.

Lexus dominated the final race of the year, with its cars filling all of the top-five places.

European Formula 3 frontrunner Nick Cassidy finished on the podium in the first race, before following up with fourth place later on.

Britain's James Rossiter recovered from a retirement in race one and, after qualifying on the front row, finished fifth in the finale.

**JIRO TAKAHASHI**

## RESULTS

**Race 1 1 Daiki Sasaki/Masataka Yanagida (Nissan GT-R)** 53 laps in 1h40m10.155s; 2 Heikki Kovalainen/Kohei Hirate (Lexus RC F) +0.239s; 3 Daisuke Ito/Nick Cassidy (Lexus); 4 Kazuya Oshima/Andrea Caldarelli (Lexus); 5 Yuhi Sekiguchi/Yuji Kunimoto (Lexus); 6 Yuji Tachikawa/Hiroaki Ishiura (Lexus).

**Race 2 1 Kovalainen/Hirate** 53 laps in 1h31m57.828s; 2 Oshima/Caldarelli +0.472s; 3 Sekiguchi/Kunimoto; 4 Ito/Cassidy; 5 James Rossiter/Ryo Hirakawa (Lexus); 6 Satoshi Motoyama/Katsumasa Chiyo (Nissan). **Points 1 Kovalainen/Hirate 82**; 2 Caldarelli/Oshima 69; 3 Tsugio Matsuda/Ronnie Quintarelli (Nissan) 62; 4 Kunimoto/Sekiguchi 58; 5 Ito/Cassidy 54; 6 Ishiura/Tachikawa 52.

# IN BRIEF

## JAPANESE FORMULA 4

The second season of the FIA's Japanese Formula 4 championship concluded with Kohta Kawaii, Sena Sakaguchi and Yuya Hiraki winning a race each at Motegi. Ritomo Miyata clinched the title despite a topsy-turvy weekend, in which he bookended a second-placed finish with a 22nd and an 11th in the other races. Race-two winner Sakaguchi took the runner-up spot in the standings, while Toshiki Oyu (a multiple race winner this year) completed the top three.

## NASCAR XFINITY SERIES

Kyle Busch scored a routine victory in the NASCAR Xfinity Series at Phoenix International Raceway, leading 190 of the 200 laps to extend his own series record to 86 career wins with his 10th of the season. Busch beat runner-up Austin Dillon to the finish by 6.115 seconds. Ricky Stenhouse Jr finished third on his first series start since 2013. Behind the top three raged a tense battle between eight drivers to make the final-four shootout. Justin Allgaier and Daniel Suarez secured their slots by finishing fourth and fifth. Erik Jones (10th) and Elliott Sadler (13th) also made the cut.



LABOUNTY/LAT

## NASCAR TRUCK SERIES

Prolific race winner William Byron (above) suffered the bitter disappointment of missing the cut for the four-way championship shootout after suffering engine failure while leading at Phoenix, handing a maiden series win to Daniel Suarez. Runner-up Johnny Sauter and third-placed finisher Matt Crafton join Timothy Peters (fifth) and Christopher Bell (seventh) in tomorrow's (Friday) title decider at Homestead.



KINRADE/LAT

Logano (right) and Bowman lead the field

# And then there were four

## NASCAR SPRINT CUP

PHOENIX (USA)

NOVEMBER 13

ROUND 35/36

AT THE END OF A WEEK IN WHICH A presidential race deemed too close to call concluded, the NASCAR Sprint Cup put on its own show to trump any political contest.

Dale Earnhardt Jr stand-in Alex Bowman spent the first half of the race driving with maturity well beyond his 23 years, with only Joey Logano able to challenge early on.

But a caution after Martin Truex Jr and Ryan Newman collided triggered pitstops and flipped the race on its head on lap 256.

The six Chase hangers-on (Logano, Matt Kenseth, the Busch brothers, Kevin Harvick and Denny Hamlin) opted for a variety of strategies, which set up a conclusion in which all six were in contention for the win.

Hamlin and Kurt Busch decided not to stop, while Kenseth went for fresh right tires only. Logano, Kyle Busch and Harvick opted for four tires.

The race became a case of points management, with only Kurt Busch not

in the cut-off at any point, such was the tight nature of the battle.

A spin by Michael McDowell further down the field just one lap from the white flag opened up overtime, and led to a restart a handful of laps later.

Kenseth had been leading from Bowman, but an ambitious lunge by reigning champion Kyle Busch tagged Bowman, which speared Busch's Joe Gibbs Racing team-mate Kenseth into the wall and out of the Chase.

That left another four-lap overtime finale, which Logano found himself at the front of, holding on to take the win from Kyle Busch for the pair to seal the two final Chase slots.

They will take on Jimmie Johnson and Carl Edwards at the Homestead finale on Sunday.

## RESULTS

**1 Joey Logano (Ford Fusion)** 324 laps in 3h08m59s; 2 Kyle Busch (Toyota Camry) +0.587s; 3 Kyle Larson (Chevrolet SS); 4 Kevin Harvick (Chevy); 5 Kurt Busch (Chevy); 6 Alex Bowman (Chevy); 7 Denny Hamlin (Toyota); 8 Ryan Blaney (Ford); 9 Chase Elliott (Chevy); 10 Paul Menard (Chevy). **Chase 1 Logano 1** win/5000 points; 2 Jimmie Johnson (Chevy) 1/5000; 3 Carl Edwards (Toyota) 1/5000; 4 Kyle Busch 0/5000.

# WEB DIRECTORY

## AWNINGS



No1 for Inflatable Structures.  
With you from the Paddock to the Podium.  
[www.aireshelta.com](http://www.aireshelta.com)

## EXHAUSTS

*Inconel & Stainless Steel Specialists*  
**SIMPSON**  
*Race Exhausts*  
Tel: 01753 532222  
[www.simpsonraceexhausts.com](http://www.simpsonraceexhausts.com)

## GEARBOXES

**Gearboxman.com**  
COMPETITION TRANSMISSION SERVICES  
Gearboxes & Axles for Road, Race, Rally and more  
Telephone: 01582 840008 Fax: 01582 840007

## HELMET GRAPHICS

Visit: [www.liquidcolourdesign.com](http://www.liquidcolourdesign.com)  
Studio: +44 028 93378525  
Mob: +44 0770 9442894  
**liquidcolourdesign**  
Helmet Paint | Design | Airbrush | Custom Paint

**Mike Fairholme Designs**  
Sole approved painter of Arai helmets.  
Silver Birches, Corby Birkholme, Nr Grantham, Lincs NG33 4LE.  
Tel: 01476 550630. Fax: 01476 550029.  
email: [fairholmedesigns@btconnect.com](mailto:fairholmedesigns@btconnect.com)  
[www.fairholmedesigns.co.uk](http://www.fairholmedesigns.co.uk)

## MEMORABILIA

**FINAL LAP**  
For Everything Formula One  
[www.finallap.net](http://www.finallap.net) **WE BUY AND SELL**  
+44 (0) 1245 287588 / 07771 920345

## MOTORSPORT LEGAL ADVICE

**MOTORSPORT LAWYER**  
**JAMIE CHAMPKIN LL.B**  
National and International  
CALL +44(0)1386 871287 ANYTIME  
[www.champkin.uk.com](http://www.champkin.uk.com) email: [info@champkin.uk.com](mailto:info@champkin.uk.com)

Motor Sport Legal Advice  
Tudor Alexander, LL.B Solicitor  
[tudor@fletcherday.co.uk](mailto:tudor@fletcherday.co.uk) 07887 713512  
Fletcher Day 56 Conduit St  
Mayfair London W1S 2YZ

## RACE PARTS

**JJC** race and rally  
PASSIONATE ABOUT MOTORSPORT  
[www.jjcraceandrally.com](http://www.jjcraceandrally.com)

## RACE PARTS

**ARE DRY SUMP SYSTEMS**  
ARMSTRONG RACE ENGINEERING INC.  
[WWW.DRYSUMP.COM](http://WWW.DRYSUMP.COM) (916) 652-5282

## RACE RADIO

Pit to Car **Autotel**  
Radio solutions **Digital Race Radio**  
0044(0)1508 528837  
[www.raceradio.co.uk](http://www.raceradio.co.uk)

## RACING

**demon tweeks**  
MOTORSPORT  
[www.demon-tweeks.co.uk](http://www.demon-tweeks.co.uk)

## RACING

AUTHORISED DISTRIBUTOR  
**OMP** **YBRACING**  
MOTORSPORT & PERFORMANCE  
[WWW.YBRACING.COM](http://WWW.YBRACING.COM)

**PORSCHE SHOP**  
10% off with website  
voucher code **AUTOTEN**  
Or Call: 0121 585 6088

**CARTEK**  
MOTORSPORT ELECTRONICS  
Info@cartekmotorsport.com  
023 80 457747  
[WWW.CARTEKMOTORSPORT.COM](http://WWW.CARTEKMOTORSPORT.COM)

## RACING

**MARDI GRAS MOTORSPORT**  
[www.mardigras.co.uk](http://www.mardigras.co.uk)

**exe-tc competition SUSPENSION**  
World Championship winning suspension - designed and built in UK  
Including: Porsche GT3 996/997 - Class: Porsche 911  
Ford Escort MKII  
Mitsubishi Evo - Subaru - Mini - Skoda - Toyota  
VW - Subaru - JZ - GTR and Open applications  
All suspension supplied with technical set-up  
Web: [exe-tc.co.uk](http://exe-tc.co.uk) Email: [julie.delamare@exe-tc.co.uk](mailto:julie.delamare@exe-tc.co.uk)  
Tel: +44(0)1392 444199 join us on Facebook and Twitter

## TRAILERS & TRANSPORTERS

Committed to Quality  
[www.iwt.co.uk](http://www.iwt.co.uk)  
**For Williams Trailers**  
BRITAIN'S LEADING TRAILER MANUFACTURER

## TRAILERS & TRANSPORTERS

**BRIAN JAMES TRAILERS**  
» Connected to you  
[www.brianjames.co.uk](http://www.brianjames.co.uk)

**JORDAN RV**  
[WWW.RENTAMERICANMOTORHOMES.COM](http://WWW.RENTAMERICANMOTORHOMES.COM)  
**08703 008008**

## WHEELS & TYRES

**Image**® Manufacturers of bespoke split rim alloy wheels  
[www.imagewheels.co.uk](http://www.imagewheels.co.uk)  
IMAGE WHEELS INTERNATIONAL LTD.



TO ADVERTISE IN THE WEB DIRECTORY  
PLEASE CALL **020 8267 5389**  
OR EMAIL [autosport.ads@haymarket.com](mailto:autosport.ads@haymarket.com)

**BRIAN JAMES TRAILERS**

»» Connected to you



[www.brianjames.co.uk](http://www.brianjames.co.uk)

## Black-and-White

The benefit of a protective transport is always valued when moving precious vehicles. Its now over 20 years since Brian James Trailers were the first to design a stylish, light and durable enclosed trailer using a GRP body construction, the original Race Shuttle.

The Race Transporter range is the third generation in the lineage and for the double decade landmark in MY2017 trailers we have introduced a host of new features, including a professional vehicle restraint system as well as fresh external styling.

Choosing a Brian James Trailer as your enclosed transport solution has always guaranteed black-and-white certainty.

Race Transporters are now available in Black or White.

Range starts from £ 6,750 + vat

BJT also offers a wide range of open trailers.  
For more information on our trailer range or to find your nearest dealer visit:

[www.brianjames.co.uk/dealer](http://www.brianjames.co.uk/dealer)



**T +44 (0)1327 308 833**

For more information and details on the Brian James Trailers range, please contact our head office.

**RACE TRANSPORTER 6**



www.**WOODFORDTRAILERS**.com

HIGH QUALITY TRAILERS FOR CLUB, PRIVATE AND PRO MOTORSPORTS

**DEVELOPED BY PROFESSIONALS, FOR PROFESSIONALS**



**DEALERS WANTED**

**All Woodford Trailers have full European Type Approval**

We have been designing and building our extensive range of high-quality, adaptable vehicle trailers from our Northamptonshire home for over 20 years, selling at highly competitive prices to suit a wide range of requirements. Please get in touch with us to discuss your needs.

**Tel: 01327 263384 ● Mob: 07434 940 693**

**● E-mail: [sales@woodfordtrailers.com](mailto:sales@woodfordtrailers.com)**

**● Web: [www.woodfordtrailers.com](http://www.woodfordtrailers.com)**

# TRAILERS & TRANSPORTERS



**DON'T WASTE MONEY RENTING USED RVs,  
WHEN YOU CAN BUY A NEW RV FOR LESS**

10yr Financing Available • Monthly Payments To Suit Every Budget • High Residual Value • Low Deposit



**2017 Thor Vegas European Size American A Class Features 3.6t Towing Capacity.**



**2017 Thor Ace The UK's Only A Class RV Under 7.5t, Full Wall and Double Slide Out Floor Plans.**



**2017 Thor Aria Luxury Diesel Pusher, Double Bathrooms, 340hp Cummins® Diesel.**

**Signature motorhomes Ltd**

01902 725394 [www.signaturerv.co.uk](http://www.signaturerv.co.uk)

Large Selection Of Both New & Used RVs Serving The Motorsport Industry For Over 25 Years.



**PRG TRAILERS**

*Finest Built British Trailers.*



PRG Trailers | Cheshire | UK | Tel: +44 (0) 1270812402  
Web: [www.prgtrailers.co.uk](http://www.prgtrailers.co.uk) | Email: [info@prgtrailers.co.uk](mailto:info@prgtrailers.co.uk)



**Weatherweave**  
Awnings & Tarpaulins

» WORKING WITH YOU

ESSENTIAL FOR MOTORSPORT TEAMS & COMPETITORS

**MAKE TRANSPORTING AND STORING EASY WITH  
A WEATHERWEAVE CONVERTED TRAILER**

Weatherweave is the UK's leading specialist in bespoke awnings and trailer conversions. Featuring high specification PVC covers in a wide range of colours with artwork of your choice. Simple to use, durable, long-lasting and fire retardant to a British Standard, with an anti fungal lacquered finish. Our customer base spans from the general public, to international race teams and multi-global firms giving us experience second to none.

call us on: + 44 (0) 1268 774 141 or visit: [www.weatherweave.co.uk](http://www.weatherweave.co.uk)

**AUTOSPORT**

**IF YOU'D LIKE TO ADVERTISE  
YOUR PRODUCTS AND SERVICES  
PLEASE CALL**

**020 8267 5389**

# CARS FOR SALE

**DPE 810B, Probably the fastest Lotus Cortina being offered for sale. As driven by Steve Soper in 2016. Run and Developed over the last 3 years by Team Dynamics arguably the best BTCC Team around winning the BTCC Drivers Championship 6 times and constructors Championship 4 times.**

Some of DPE 810B race results for the last 2 years below:

- 2015 SILVERSTONE CLASSIC WINNER OF U2TC RACE WITH GORDON SHEDDEN AND MATT NEAL.
- 2015 GOODWOOD REVIVAL RACE 1 POLE POSITION, 2nd IN RACE ONLY BEATEN BY TOM KRISTENSEN IN A 600 BHP FORD FAIRLINE THUNDERBOLT. Driver GORDON SHEDDEN
- 2015 GOODWOOD REVIVAL RACE 2 POLE POSITIONS, 2nd IN RACE AGAIN ONLY BEATEN BY HENRY MANN IN 600 BHP FORD FAIRLINE THUNDERBOLT. Driver MATT NEAL
- 2016 GOODWOOD MEMBERS MEETING FRONT ROW OF GRID Driver STEVE SOPER.
- 2016 DIJON U2TC RACE WIN AND POLE Drivers STEVE SOPER & DAVID CUFF
- 2016 SILVERSTONE CLASSIC U2TC FASTEST LAP OF RACE. Driver STEVE SOPER
- 2016 SPA U2TC RACE FRONT ROW OF GRID AND 2nd POSITION IN RACE DESPITE DRIVE THROUGH PENALTY. Driver STEVE SOPER.
- 2016 IMOLA U2TC RACE FRONT ROW OF GRID RACE 1 RACE 2 STARTED FROM BACK OF GRID AND FINISHED 2nd PLACE WITH FASTEST LAP. Driver STEVE SOPER



This car above is a 1963 Mk1 pre air-flow, with A frame rear end, NEIL BROWN 2016 latest spec engine, on the weight of 750KG, top class repaint at start of 2016 season. Comes with 4 sets of wheels and tyres, different diff ratios, FIA papers and a V5. Ready to go racing in 2017

Suitable for U2TC, Masters, HSCC and Goodwood Revival.

**£125,000** no time wasters.

Please call James Rodgers at team Dynamics on 01386 556122 or email Steve Soper at sopersteve@gmail.com

## DRIVES AVAILABLE



### YOU CAN AFFORD TO RACE !!

Track Attack Race Club  
in association with JJ Motor sport  
and supported by justmotorsportads.com

#### Your choice

- Toyota Mr2 roadster sports car
- Peugeot 206Gti hot hatch
- Toyota Celica Coupe

Newly built turn key race cars from only £2950  
Or car and a seasons entry fees from £3950 inclusive.

Buy, Lease or Arrive & Drive & track side support  
Contact Jon 07790495231 Steve 01646 601908



## THINK AUTOMOTIVE

t: 0208 568 1172 e: info@thinkauto.com



World's leading  
Oil Cooler specialist

Experts in all automotive plumbing

Huge range of hose & fittings

The major supplier of filler caps

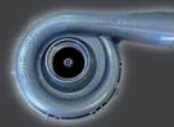

Oil Pumps - Water Pumps - Filler Caps



Heat Exchangers - Hose & Fittings

And many other automotive plumbing components

# AUTOSPORT

IF YOU'D LIKE TO ADVERTISE  
YOUR PRODUCTS AND SERVICES  
PLEASE CALL

**020 8267 5389**

# MARKETPLACE

## ARRIVE & DRIVE

**CARBON8** 

*Coupe Cup*

*Looking To Race in 2016...*

*...3 Ways To Play*

[www.coupecup.com](http://www.coupecup.com)

- 1 Build your own race car using the series control parts and be on track for around £2500.
- 2 Buy a turn key, good to go, new build race car bespoke to you from £4295. Full support, transport and storage available too!
- 3 Arrive & Drive race hire with us for a single event or a whole season. Tailored packages available.

*Where Racing Is Serious Fun...!*

**EXIT 13** 01908 415979 07714 291417  
[www.exit13.biz](http://www.exit13.biz) sales@exit13.biz

## RACE PRODUCTS

**demon tweeks** MOTORSPORT 

EXPERT ADVICE • MASSIVE STOCK • RAPID DELIVERY

**0844 375 2196**  
[www.demon-tweeks.co.uk](http://www.demon-tweeks.co.uk)

MEDIA CODE: L2252A  
 LOW CALL RATE CALLS MAY BE RECORDED FOR TRAINING PURPOSES

## MEMORABILIA

**F1 COLLECTORS .COM**

**#1 FOR F1 MEMORABILIA & AUTOGRAPHS**

We buy and sell F1 items  
**AYRTON SENNA specialists**

Call CHRIS GRINT  
**01763 274448**  
 email:- sales@f1collectors.com

## TYRES

FOR ALL YOUR

**AVON**  
 TYRES  
 MOTORSPORT

RACING TYRES  
 Inc. ACB 10 Formula Ford  
 Contact

**BMTR LTD**

Tel: 0121 331 1122  
 Fax: 0121 331 1144  
 email: sales@bmtr.co.uk  
 see our new website at [www.bmtr.co.uk](http://www.bmtr.co.uk)

## RACE PRODUCTS

**CARTEK**  
 MOTORSPORT ELECTRONICS

**INNOVATION  
 QUALITY  
 RELIABILITY  
 SAFETY**

SUPPLIERS TO:



**BATTERY ISOLATORS  
 FIA RAIN LIGHTS  
 POWER DISTRIBUTION  
 COOLANT LEVEL SENSORS  
 WIRELESS STEERING  
 WHEEL CONTROLS  
 SHIFT LIGHTS**

GET IN CONTACT:

[www.CARTEKMOTORSPORT.com](http://www.CARTEKMOTORSPORT.com)  
 +44 (0) 2380 457747  
[info@cartekmotorsport.com](mailto:info@cartekmotorsport.com)

## RACE PRODUCTS

**Elite Carbon Fibre**  
 Carbon fibre race car component manufacturer

EliteCarbonFibre Ltd.  
 Units 20-22 Norwich Road Ind. Est.  
 Watton, Thetford, Norfolk IP25 6DR

Contact – Dave Greenwood 07809390316  
 Email – [davecarbonelite@googlemail.com](mailto:davecarbonelite@googlemail.com)  
 Website – [elitecarbonfibre.co.uk](http://elitecarbonfibre.co.uk)

**Carbon Composite Wings, Bodywork & Repairs**

# MARKETPLACE

RACE PRODUCTS

# Team



# Club

Championship

Race Numbers

Nationality

# Name Sponsors

Blood Groups

Nomex Motorsport badges for Race & Rally

No Minimum Order Charge

Nomex Sewing Kit Included

Easy Online Ordering

Quick Turnaround

UK Manufactured

No Set-Up Fees



[WWW.HOT-STITCH.COM](http://WWW.HOT-STITCH.COM) 01559 372 356

All copyrights & registered trademarks respected

RACEWEAR



Made in the USA



UK distributor

[www.glencoeld.co.uk](http://www.glencoeld.co.uk)

Tel: +44 (0)1784 493 555

**MOTORSPORT**  
‘OUT OF TANK’  
**325** LTRS/HR  
5 BAR FUEL PUMP  
(270 LTR / HR @ 3 BAR)

**400** LTRS/HR  
**MOTORSPORT**  
Upto 600 BHP  
Pt.No. GST400 (PUMP ONLY)  
GST400K (PUMP KIT)

- BUGATTI VEYRON
- KONEIGSEGG ONE
- DODGE VIPER
- DODGE HELLCAT(S)

TI Automotive/Walbro fuel pumps, original equipment on the worlds highest performing production vehicles

**MOTORSPORT**  
‘IN TANK PUMP’  
**190** LTRS/HR  
UPTO 350 BHP  
**255** LTRS/HR  
UPTO 500 BHP

**450** LTRS/HR  
**MOTORSPORT**  
ORIGINAL EQUIPMENT ON DODGE HELLCAT 700+ BHP - ON YOU TUBE  
Upto 750 BHP  
Pt.No. GST450 (PUMP ONLY)  
GST450K (PUMP KIT)



MARKETPLACE

MARKETPLACE

# MARKETPLACE

## STORAGE

**Work More Efficiently with an Affordable Workshop Upgrade**  
**The NewAge Professional 3.0 Series from GaragePride.**



Depth  
610mm

Height  
2100mm

Width  
4.88 metres

Heavy Duty  
1.2mm steel

Soft Close  
Hinges

Drawer dividers  
and mats

**Only  
£2530**

plus VAT  
for this set  
Free delivery  
to UK mainland

See this and more at  
[www.GaragePride.co.uk](http://www.GaragePride.co.uk) 0800-206-2303



## FLOORING

# Turn your garage into a showroom



Robust interlocking  
floor tiles  
No messy adhesives  
Installation service  
available  
Call **01676 523386**  
for your no obligation  
quotation

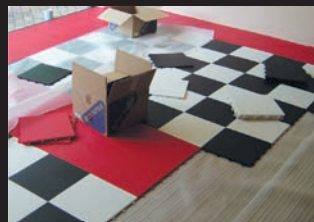

**CHOICE  
OF 11  
ATTRACTIVE  
COLOURS**

**DYNOTILE**

Typical 20ft x 17ft garage supplied and installed with skirting for less than £1500.00.  
Installation service not available in all areas of the UK - contact Dynotile for details.

**WWW.DYNOTILE.CO.UK**

# MOTORSPORT JOBS



Want to advertise a motorsport job?  
If you are recruiting in motorsport and  
wish to advertise with  
Autosport in print and online  
please contact  
[Jonathan.King@haymarket.com](mailto:Jonathan.King@haymarket.com)  
by email  
or call **020 8267 5992**.

For all current vacancies advertised  
please visit our website  
[www.autosport.com](http://www.autosport.com)



**Bespoke Florist with both  
Motorsport Hospitality  
and Product Launch Experience.  
Prepared to travel throughout UK  
and Europe, leaving your team to do  
what they do best.**

Contact Julie on  
Mobile **07957831398** • Office **01538 308259** or  
email [Julie@floralevents.co.uk](mailto:Julie@floralevents.co.uk)  
[www.floralevents.co.uk](http://www.floralevents.co.uk)



## DESIGN ENGINEER / PROJECT MANAGER

Mygale has a new opportunity for **graduate engineer in mechanical/aeronautical/automotive engineering**. The candidate will have a minimum of **5 years work experience in motorsport mechanical design**.

You will create parts drawings and product lifecycle documentation for a **single-seater new project**. Mobility to attend tests and to assist clients.

- Self motivated, capable of working from a design brief with a minimum of supervision for component design and calculation, you must show the potential to **manage timing plans, resources and budgets**.
- Good knowledge of small batch machining, fabrication and composite production
- **Catia V5** for mechanical design and surfacing.
- The working language is **French**. A good level of **English** is necessary to communicate with clients and suppliers.
- Job located in **Magny-Cours/France**, available **asap** for a **long contract**.

Please send your resume with salary expectations to [jobs@mygale.fr](mailto:jobs@mygale.fr)  
More details on [mygale.fr](http://mygale.fr) or [mygale-cars.com](http://mygale-cars.com)



## HR021116 – GARAGE ELECTRICAL TECHNICIAN

### About Us

For many fans of Formula One the sport exists between lights and chequered flag on a Sunday afternoon, but this is merely the tip of the spear. The reality of modern F1 is that of a complex and intertwined operation, every part of which needs to perform near its limit if success is to be achieved. Formula One is a team sport in a very literal sense, we win and lose together – That's why We Love What We Do.

### The Role

We have an opportunity for a highly capable and motivated Garage Technician to join our team.

This is a highly specialised role where you will be responsible for the electrical installation for all the power needs for our race garage at races and tests. Ideally you will have the latest City & Guilds electrical qualification (17th edition). You will also be working within a highly motivated team responsible for the build, maintenance, reliability and safe transportation of Red Bull Racing's pit and garage equipment. This challenging role will involve working to support global remote events whilst setting the highest industry standards in all areas.

The successful candidate must have previous Motorsport experience in F1, GP2, FR3.5 or WEC along with excellent attention to detail. Candidates will be enthusiastic with a flexible attitude to working hours and be able to work under the minimum of supervision to meet deadlines in high pressure situations without compromising on quality. A current and clean HGV 1 licence would be an advantage as occasional driving may be required.

### What can we offer you?

Not only are these fantastic roles, it is also a fantastic team to work for. A good salary is just the start, there are many other benefits too, such as health care, company contributed pension, on site gym, constructors' bonus scheme, child care vouchers, cycle to work and of course Red Bull to see you through those extended stints!

To apply for this vacancy please visit [www.redbullracing.com](http://www.redbullracing.com)

**APPLICATION CLOSING DATE SUNDAY 20<sup>TH</sup> NOVEMBER 2016**



## HR081116 – NUMBER 2 CAR BUILD MECHANIC

### About Us

Formula 1 is the highest class of single seat racing in the world where the difference between being on the podium and just being part of the pack is measured in fractions of seconds. It is a team sport in every sense and demands the highest levels of collaboration, speed of information and innovation possible.

### The Role

We have an opportunity for a Number 2 Car Build Mechanic to join our Car Build Team.

The role will involve the assembly, disassembly, pre-fitting and turnaround of Red Bull Racing cars, chassis and pit equipment. You will also ensure that the spare chassis is kept in the most up to date specification, carry our car related pre-fits and ensure that pit equipment is built, serviced and functioning correctly as required after each event.

Previous motorsport experience is vital, with the ideal candidate having worked as a Number 2 Mechanic within Formula 1, GP2, F3 or similar formula. A broad motorsport mechanical background and a basic understanding of hydraulics and gearbox functions are preferable but not essential.

You must be able to work closely with other team members, and enjoy the challenge of working in a high pressured, time sensitive environment. You will have a flexible attitude to working hours and have the ability to work to tight deadlines, without compromising the highest industry standards. Computer literacy would be advantageous to assist with the use of our communication, workflow and logistics tools.

### What can we offer you?

Not only is this a fantastic role, it is also a fantastic company to work for. A good salary is just the start, there are many other benefits too such as health care, company contributed pension, on site gym, constructors' bonus scheme, child care vouchers, cycle to work and of course Red Bull to see you through those extended stints!

To apply for this vacancy please visit [www.redbullracing.com](http://www.redbullracing.com)

**APPLICATION CLOSING DATE SUNDAY 27<sup>TH</sup> NOVEMBER 2016**

# MOTORSPORT JOBS

We are currently recruiting for the following positions within our organization:

## Race Team

We are searching for candidates to join our race team. Essential requirements for all positions include the ability to work and prioritize within a high-pressure, time-sensitive environment while maintaining a methodical approach. The role requires extensive worldwide travel and a willingness to work long and flexible hours including weekends. Opportunities include:

**Spares Coordinator**

**Garage Technician**

**#1 Sub Assembly**

## Engineering

We are expanding our Vehicle Performance Group. Positions are all based in the UK with occasional worldwide travel. Available opportunities include:

**Vehicle Dynamicist**

**Vehicle Simulation Engineer**

**Software Engineer**

**Mathematical Modeller**

## Factory

We are recruiting for positions supporting our race team in UK-based factory roles with occasional worldwide travel. These opportunities include:

**IT System Technician**

**Quality Inspector**

Successful candidates for all of the above positions will be self-motivated and proactive with the ability to work within a team environment with tight deadlines. Excellent communication skills and working with minimal supervision are also required.

Visit [www.HaasF1Team.com](http://www.HaasF1Team.com) for details and requirements, to see other available positions, and to submit your CV and relevant documentation. **NOTE: No agencies, please.**



**Haas**  
F1 Team

**Progressive Motorsport** is a leading motorsport engineering company.

As part of our continued expansion, we are looking for:

**Senior Design Engineers**

**Race Engineers**

**Aerodynamicist**

**Simulation Engineer**

**Transmission Designer**

**IT / Data Engineer**

**Senior Mechanics**

Candidates must have a minimum of 5 years experience in LMP, F1 or equivalent

Previous motorsport experience and knowledge of Catia V5 CAD is essential.

This position is based in Northants. You may be required to occasionally travel to customer sites and track events/tests. All applicants must have the right to work in the UK on application. **NO AGENCIES.** Please state your current salary and notice periods.

Please apply by sending your CV together with a covering letter to;

[info@progressive-motorsport.com](mailto:info@progressive-motorsport.com)

m  
o  
t  
o  
r  
s  
p  
o  
r  
t  
**Progressive**

# Liquid Level Sensors

GS level

**NEW** TEMPERATURE OUTPUT

COMPATIBLE WITH FUEL, OIL & COOLANT

VOLUMETRIC OUTPUT OPTION

SUPER LIGHTWEIGHT

FLEXIBLE MOUNTING

FIA HOMOLOGATED



GS level 4223

Proven racing pedigree:

**F1, LMP1, LMP2, GT, Rally, V8, Indy, NASCAR, RSR** plus others

Get a quote at [gillsc.com/racing](http://gillsc.com/racing) or call **+44 (0)1590 613900**

**GILL**

Sensors & Controls

## THE BRITISH DMAX CHAMPIONSHIP

**THE UK'S FASTEST  
ARRIVE & DRIVE KART  
RACING SERIES**

**WE ARE PROUD TO ANNOUNCE OUR  
FABULOUS 2017 RACE CALENDAR,  
WITH AN OPPORTUNITY TO  
EXPERIENCE DMAX STILL THIS YEAR  
AT OUR FINAL ROUND ON 20/11 AT  
DAYTONA MILTON KEYNES**

**DAYTONA** >>>

	Date	Venue	Circuit
1	19/02/17	Daytona Milton Keynes Buckinghamshire	International Circuit (1200m)
2	19/03/17	Daytona Sandown Park Surrey	GP Circuit (900m)
3	23/04/17	PF International Lincolnshire	International Extended (1500m)
4	14/05/17	Buckmore Park Kent	Full Circuit (1200m)
5	11/06/17	Shenington Oxfordshire	Full Circuit (1200m)
6	16/07/17	Whilton Mill Northamptonshire	International Circuit (1200m)
7	20/08/17	Daytona Sandown Park Surrey	GP Alternate (900m)
8	17/09/17	Clay Pigeon Dorset	Full Circuit (900m)
9	14-15/10/17	Daytona Tamworth North Warwickshire	GP Circuit (1000m)
10	19/11/17	Daytona Milton Keynes Buckinghamshire	International Cliff (1200m)
Awards	02/12/17	Daytona Milton Keynes	Daytona Pavilion

To find out more or to book please call Mark Wimblett  
on 033 033 278 70 (opt 9) [www.daytonamax.co.uk](http://www.daytonamax.co.uk)

Regus

claranet  
hosting | communications | networks

GoPro  
Be a HERO.

POWER  
MAXED

box

# CLUB AUTOSPORT

NATIONAL RACING • HISTORICS • HILLCLIMB • TRACK TESTS • FEATURES

AmD is expected to run new AMG GT3 in Britain and Europe



## Mercedes-AMG GT3 to race in British GT

THE LATEST MERCEDES-AMG GT3 will be seen in British GT for the first time next year, with two cars set to race in the championship.

Race-winning team Rollcentre Racing has confirmed an entry for Martin Short/Richard Neary, while AmD Tuning is close to announcing its drivers for a 2017 assault.

Rollcentre is planning a full winter testing programme in the UK and Spain as the AMG replaces Neary and Short's ageing BMW Z4 GT3.

"This is the first AMG GT3 that will race in Britain and it's an impressive machine," said Short. "We considered other brands, but the package Mercedes offers with spares and support surpassed that of any of the other manufacturers."

Short/Neary are the first pairing to sign up to British GT's remodelled all-Bronze Am-Am category for 2017, which features dedicated trophies at each round. They will



also score bonus points towards the Pro-Am championship for finishing inside the top 10 in races.

AmD Tuning has yet to confirm its British GT drivers, but will expand into European GT competition next year with British championship regulars Lee Mowle and Phil Keen.

Mowle has placed an order for the car, and is due to take delivery early next year. Mowle and team-mate Joe Osborne took their AmD BMW Z4 to

Left: Rollcentre has signed up for British GT and will campaign AMG for Short and Neary

sixth in the 2016 British GT drivers' standings, but missed the season finale after a dispute with officials.

Mowle will contest the pan-European Michelin GT3 Cup class, and has recruited Keen to share the car as Osborne has clashing commitments.

"The new AMG is a big step forward because the new-generation GT3 cars are much faster and more advanced," said AmD team boss Shaun Hollamby.

"The car will also run in British GT and we're in talks with two driver pairings over the entry."

Mowle added: "This season was a tough one with the older BMW, but we did a phenomenal job with the package we had. I feel we've chosen a car that ticks all of the boxes."

Although Fortec Motorsport and 2009 British GT champions David and Godfrey Jones have previously campaigned SLS AMGs, Mercedes has yet to score a series victory.

Comprehensive motorsport insurance products to keep you on track;

- ✓ Accident damage On Track
- ✓ Rally damage On Event
- ✓ Storage and Transit
- ✓ Liability
- ✓ Personal Accident
- ✓ Track day

Log on to [www.ryanmi.com](http://www.ryanmi.com) to obtain your online quote  
Email – [info@ryanmi.com](mailto:info@ryanmi.com) Tel – +44 (0)1799 524202

Ryan Motorsport Insurance Limited is an appointed representative (557405) of Independent Broking Solutions Limited who are authorised and regulated by the Financial Conduct Authority. Its Financial Services Register number is 312026

**RYAN**  
MOTORSPORT INSURANCE



SIMRACING

# Carroll gets Formula E prize drive

WALTER HAYES TROPHY WINNER GRAHAM Carroll drove a Formula E car in the build-up to last weekend's Marrakech ePrix as a reward for winning the series' first major sim racing event.

Carroll won the inaugural bout in the electric single-seater series' Road to Vegas eSports competition, which will pit 10 members of the public against the 20 Formula E drivers in a sim racing shootout in Las Vegas for a total prize pot of \$1million.

The 26-year-old swapped his regular Ralph Firman-designed RF16 for the Spark SRT\_01E on his trip to the Moroccan FE event, and described it as "like Christmas day".

"The carbon brakes were really different

and the regen [the ability to harvest energy off throttle] really affects the brakes," he said.

"It's just been awesome. I've never really got any major break, but this was unbelievable."

Dedicated sim racer Carroll set up the iRacing team Apex, which boasts Formula Renault Eurocup champion Lando Norris and Ginetta Junior champion Will Tregurtha as members.

The qualifying races for the Las Vegas competition use rFactor 2 PC software, with each competitor requiring a steering wheel as well as a pedal set-up.

Carroll's victory in the first of the four Road to Vegas races means he is in contention for one of the 10 slots available for the showpiece event

in January, despite encountering a steering-wheel issue in the second race.

The winner of the Las Vegas event will earn \$200,000, while just starting nets \$20,000 and there are also bonuses for pole position and fastest lap.

Carroll said he thought sim racing had the potential to grow into its own professionalised area of motorsport.

"I've not qualified yet [for Vegas], I'll believe it when I see it," he said. "I think if I get a top-five in one of the two remaining races I'll be locked in. I've been treating it like a job. Where can you win \$200k in prize money? I think it's the future, to be honest."

SCOTTISH MINI COOPER CUP

## Team Dynamics test for Scottish Mini stars



DAVE YOUNG PHOTOGRAPHICS

THE CHAMPIONS OF this year's Scottish Mini Cooper Cup will each get a test in a Mini Challenge JCW racer with top touring car squad Team Dynamics.

Both overall Scottish champion Paul Bell and Rookie Cup winner Dylan O'Donnell will receive funded test days in one of the British series' two-litre 255bhp cars next week.

The test has been arranged partly via reigning British Touring Car champion Gordon

Shedden, who is Knockhill Circuit's commercial director.

Shedden said: "I thought it would be great to give the top guy in the Scottish series some proper recognition.

"We couldn't arrange anything in a BTCC car, so I got on to Team Dynamics [which runs the Honda BTCC programme] and we talked about the Gen-3 Mini they had been running for Henry [Neal, son of Matt]."

GINETTA GT4 SUPERCUP

## Major expansion for Xentek squad

TITLE-WINNING GINETTA GT5 CHALLENGE team Xentek Motorsport will launch a four-car assault on the GT4 Supercup next season.

The team won the GT5 crown with Ollie Chadwick this year, but will now step up to the TOCA support category. Chadwick completed a toe-in-the-water weekend in the series for the team at Silverstone and now the squad's GT5 racers Jac Constable and Alex Taylor will move up.

Xentek will also run race winner Carl Boardley in partnership with his own team, as well as a yet to be confirmed fourth driver.

"It [the Supercup] will be the best bet to move in the right way for us with bigger cars and a higher-level championship," said team co-owner Chris Richards. "Nick [Hart, co-owner] has run GT4 cars before with JHR, so we've got quite a bit of experience with them."



**RACE OF REMEMBRANCE**

## Paralympic cyclist partners Hoy

PARALYMPIC GOLD MEDAL-WINNING cyclist Jon-Allan Butterworth made his car racing debut at Anglesey's Race of Remembrance last weekend, sharing a VW Golf with fellow Olympian Sir Chris Hoy.

KPM Racing fitted hand controls to enable Butterworth to race the car he also shared with Tom Onslow-Cole, Jade Edwards and Paul White. The quintet led initially before

ABS problems and other maladies delayed them and they finished 19th.

"I only did my ARDS test three days before the race," said Butterworth. "My first racing laps were in the dark too, but I have always been a motorsport fan and once Rio was out of the way I had time to think about it."

"I would like to do more and if I succeed maybe British GT could be a target."

**IN BRIEF**



**IN2 RACING PLOTS MCLAREN GT ENTRY**

Porsche Carrera Cup GB squad In2 Racing plans to run two McLaren 570S GT4s in British GT in 2017. The team has competed in Porsches for the past 11 years, winning the Pro-Am 1 title with Euan McKay this season, and has previously won championships in Radicals and Formula Renault BARC. It now plans to branch into British GT if it can get an entry to the oversubscribed GT4 class.

**MACMILLAN TO RACE IN GT3 AND GT4**

The MacMillan Racing team will run a dual assault on British GT next year after adding an Aston Martin Vantage GT3 to its stable and signing Jack Mitchell to race it. The team ran a single Vantage in the GT4 division this year for Mitchell and Matthew Graham.

**PROTOTYPE CUP CALENDAR REVEALED**

The inaugural season of the Prototype Cup series will feature a calendar scheduled in partnership with Le Mans organiser the Automobile Club de l'Ouest in an effort to maximize entries. Bute Motorsport has worked with the ACO to put together non-clashing calendars for both the domestic LMP3 class and the European Le Mans Series. The calendar features six rounds, with a showpiece event at Spa-Francorchamps in June.

**CLUB TEAM FINSPORT TO CLIO JUNIORS**

Club racing outfit Finsport is the latest team to announce it will compete in the new Renault UK Clio Cup Junior category next year. The team has run drivers in Ford Fiestas and Classic Touring Cars in the past, but will now run at least one Clio in the series.

**BROWN WINS YOUNG DRIVER AWARD**

Ginetta Junior race winner Lewis Brown (below) won the MSA Young Driver of the Year award last week after impressing judges at Silverstone. Five drivers from the AASE education programme at Loughborough College were chosen, and Brown came out ahead of Formula Jedi racer Zach Anderton, Quaife Fiestas' Nathan Edwards, Ginetta Supercup frontrunner Ben Green and karter Emily Rogers. The prize is a cheque for £1000.



**GINETTA JUNIOR**

## Priaulx targets switch to F4 next year

SEBASTIAN PRIAULX IS considering a move into British F4 for 2017 instead of contesting a second season in Ginetta Junior, despite

winning the Winter Series at Brands Hatch last weekend. Son of three-time World Touring Car champion Andy, Priaulx won the event with

two victories last Sunday (see report, p72), with the title giving him a half-price entry for a campaign in either the Junior series or GT5 Challenge.

But after winning the title, Priaulx said he was still weighing up his options for 2017, admitting that he had hopes to race in F4.

"Even after this I'm not sure I'll be here next year," he said. "The Ginettas are great, but I would like to do F4."

"Unfortunately it's just so expensive, and you have expenses like tyres, which you just throw money at. You don't have that in Ginettas, so that's always a factor."



**JUNIORSALOONS**

## Milner wins JSCC title after appeal

KATIE MILNER HAS WON HER APPEAL against a technical exclusion from the Knockhill round of the Junior Saloon Car Championship season, confirming her as the 2016 champion.

Milner was provisionally beaten to the title by Matteo Zanetti at Silverstone last month, pending an appeal against her exclusion from the Knockhill meeting for an engine-seal irregularity.

A Motor Sports Association appeals

court hearing last Tuesday overturned that exclusion, handing back 16-year-old Milner's victory and fourth place at the Scottish circuit, and confirming the daughter of two-time British Rally Championship winner Jonny as the JSCC champion.

"It was really tough having to go through the appeal and we almost pulled it as it was so much hassle," she said. "But we felt we couldn't do that as we'd worked so hard and we deserved to win the title."



Mustangs will race in Pierpoint Cup at Members' Meeting

HISTORIC FORMULA FORD

# HSCC SEEKS FF CHAMPS FOR 50TH FESTIVITIES

THE HSCC HOPES TO arrange the biggest ever gathering of Formula Ford champions to cap the category's 50th anniversary celebration during the Legends of Brands Hatch meeting next summer.

The club has started its search to find as many Formula Ford champions as it can to attend the Grand Prix Circuit meeting on July 1-2.

The gathering will also include winners of the knockout events, like the Formula Ford Festival, Walter Hayes Trophy and Castle Combe Carnival.

"Our calculations suggest that as many as 500 drivers have won Formula Ford titles over 50 years and we're keen to invite them all," said Graham White of the HSCC.

"When we include the annual knockout competitions, we'd love to get up to 200 Formula Ford stars to join in."

The first Formula Ford race ran at Brands Hatch on July 2, 1967 and the celebration of the category, topped by races for the HSCC's Historic Formula Ford Championship, will be a feature of the weekend.

MEMBERS' MEETING

# Goodwood adds new races

FOUR NEW RACES WILL FEATURE AT THE Goodwood Members' Meeting next March, capped by the Pierpoint Cup for pre-1967 American V8 saloon cars.

The race is named after 1965 British Saloon Car champion Roy Pierpoint, who took the title in an Alan Mann Racing-prepared Ford Mustang.

The Varzi Trophy will be for pre-Second World War French and Italian grand prix and Voiturette cars (pictured below right) and is named after Italian ace Achille Varzi, who was a GP star in the '30s.

The memory of '50s British racer Archie Scott Brown will be honoured by a new contest for all models of Lister sportscars that raced up to 1966, while the Weslake Cup caters for A-Series-engined sports and GT cars that raced between '58 and '66.

Races for the SF Edge Trophy (pre-1923 Edwardian specials), Gerry Marshall Trophy (Group 1 saloons, 1970-82), Hailwood Trophy (250cc and 350cc GP motorcycles, 1970-84), Graham Hill Trophy (1960-66 GTs), Derek Bell Cup (one-litre F3), Brabham Trophy

(rear-engined GP cars 1954-60) and Surtees Trophy (1963-66 sports-prototypes) are also on the bill.

There will also be three sets of high-speed demonstrations. One will be for three-litre sports-prototypes of the '70s, including the Ferrari 312 PB, Matra MS670 and Alfa Romeo T33. The Legends of GT1 will showcase the top GT cars of the '90s, including the McLaren F1 GTR, while there will also be runs for Group A touring cars, such as the BMW 635CSi and Jaguar XJS.



BRISCA F1

# Clio Cup champion Whorton-Eales wins on BriSCA F1 debut

RENAULT UK CLIO CUP champion Ant Whorton-Eales made a cameo BriSCA F1 stock car appearance last weekend, winning on his debut.

Whorton-Eales, nephew of BriSCA F1 champion Murray Harrison, claimed victory in the under-25 showdown race at the Birmingham Wheels venue last Saturday night.

The 22-year-old then finished third in his heat in the main section of the meeting, before being taken out during

the final while running in second place.

"What a mega evening that was," said Whorton-Eales. "It was always an ambition of mine to race an F1 car, and to win the under-25 section was amazing. I managed to keep calm among the backmarkers and brought it home. I definitely want to do more of this in the future."

European Formula 3 racer Ben Barnicoat also took part in the event. The 19-year-old,

whose father Paul is a former racer in the category, was offered a run in friend Jordan Falding's car.

"I have been around BriSCA paddocks for a while, so I knew what to expect," said Barnicoat. "It was fantastic fun, and I got to grips with the car pretty well."

Barnicoat finished fifth in the under-25 race, which marked his first run in the car, and won his heat in the main event, before he too was taken out of the final in a tangle.



First-time BriSCA F1 winner Whorton-Eales wants more



# Formula Ford's jubilee misses Goodwood cut

By Marcus Pye, the voice of club racing

[@Autosport](#)

**THE EAGERLY AWAITED RACECARD FOR GOODWOOD'S** 75th Members' Meeting is a mouthwatering menu, offering much to look forward to on March 18-19, 2017.

Nonetheless, grassroots racing enthusiasts (many doubtless Goodwood Road Racing Club members) hoping that Formula Ford's 50th anniversary season would kick off memorably at the fourth 'second tier' event of the celebrated motor circuit's modern era might be slightly disappointed by its omission from what some regulars call "a dress rehearsal for the Revival".

FF races at the Legends of Brands Hatch Superprix on July 1-2 – precisely half a century since soldier Ray Allen won the class's inaugural one there – and the Silverstone Classic will thus be beacons of a special year!

I should declare my hand in that, subsequent to Goodwood's decision, I acquired a 1971 Merlyn Mk20 to return to my racing roots – although I'll probably lend it out more than I race it.

The Historic Formula Ford Association spied an opportunity, having started chasing its goal early last year and submitted a properly researched proposal aimed at earning Britain's best-supported historic class (entries currently average towards 40) a coveted Members' Meeting invitation for the landmark year. Having provided great, safe, well-policed racing among drivers from 16 to 70-plus, with a family focused and friendly paddock (few cars are professionally prepared and run) reflecting the original MM ethos, the world's greatest training formula's credentials looked to fit the criteria.

Formula Fords were tested and developed extensively at the Sussex circuit during its July 1966-September '98 closure. Two small marques were based there: the Castle Combe championship-winning Martlet, designed by F1 privateer Ian Raby's mechanic of the '60s David Martin, was crafted in what

is now the ticket office inside the front gate, while Alan Langridge's later Image cars were fabricated in the famous old Super Shell Building, backdrop still to Woodcote corner.

The aesthetics and dynamics of early FFs, which form the HSCC-badged (pre-'72) championship – overseen by club supremo Grahame White, the period BARC Goodwood race starter – are entirely complementary to its MM bill that, unlike the Revival's, is permitted to embrace post-'66 machinery. Performance was not the arbiter, for the cars' lap times are similar to those of wide-tyred 1000cc F3 and FJunior, which is having a break from the MM on a three-year Diamond Jubilee world tour but returns to September's showpiece.

Having witnessed from the commentary box this March's alarming accident in the Brooks Trophy Grand Prix race, in which competitor Stephen Bond's car was tripped by a spinning rival, cartwheeled and landed in the spectator tunnel, I can absolutely understand why the Motor Sports Association (which licenses British circuits and sanctions events) and Goodwood might be twitchy. Particularly, I'm told, about single-seaters, which have the potential to interlock wheels.

The incident was both a lucky escape for the driver and a wake-up call, triggered by a freak and unprecedented set of circumstances. Measures were subsequently taken to prevent a repetition, however unlikely. Accidents on race tracks are inevitable, no matter how good the drivers are. Indeed, Goodwood's most successful alumnus by far, (Sir) Stirling Moss, had the closest of shaves there on Easter Monday 1962.

The statistics demonstrate, however, that none of the nine recorded fatalities that occurred over 120 or so Goodwood race events between 1948 and '66 (71 of them Members' Meetings) involved a single-seater! 🍷



## PORSCHE BRITS REUNITED

Tony Dron and Andy Rouse were reunited with the Porsche 924 Carrera GT in which they finished 12th at Le Mans in 1980 at last week's Classic Motor Show at the NEC. Newly rebuilt by the UK's Porsche Classic Partner Centres, its bodywork is by racer John Bradshaw's Road and Race Restorations concern in Manchester.

## DEREK McMAHON 1940-2016

One of Irish motorsport's greatest characters, Derek McMahon, passed away last weekend in Donegal. 'Big D' was a legend, not least for his storytelling and extraordinary capacity in bars. McMahon excelled at rugby before turning to rallying an Imp and racing an MGB, switching to a Chevron B8, Royale RP10 and Ford Escorts. He subsequently backed Alec Poole, then Derek Daly and Bernard Devaney. Having eschewed the opportunity to sponsor Daly's sensational 1976 Formula Ford season, McMahon picked the Dubliner up the following year, equipping him with a Chevron B38 in which he won the British F3 championship. He then supported DD all the way to F1. Big D's funeral was held on Wednesday in Milford. Autosport offers its condolences to his sons, daughters and extended family.



## MAYNARD MARCHES INTO F2

Julian Maynard will contest next year's HSCC Historic F2 championship with a March 742 prepared by Dean Forward Motorsport. The 1000cc F3 Chevron B17 graduate has tested the car at Silverstone and Donington. Following a promising debut season, Forward will continue to race his 782.

Priaulx turned his fortunes around on Sunday

HAWKINS



**BRANDS HATCH**  
MSVR NOVEMBER 12-13

# Priaulx Jr storms to Winter victory

SEBASTIAN PRIAULX SWEEP ASIDE title rival and early points leader Dave Wooder with a brace of wins at Brands Hatch last Sunday to clinch the Ginetta Junior Winter Series crown.

Priaulx was initially thwarted by Wooder's back-to-back victories on Saturday, able only to follow him across the line twice as he ended the first day behind in the points. Wooder had starred in the wet opener after advancing from fourth, then started from pole in the second race and was forced to defend throughout from Priaulx, who briefly led on the opening lap, until a red flag (for a beached Charlie Digby) sealed the result.

But what a difference a day makes. Wooder's title rival arrived on Sunday and stormed to pole position, which proved to be crucial. That front-row start allowed Priaulx to lead from pole to flag in race three as the track dried, while Wooder's second-row start meant he was embroiled in a midfield battle and came home third.

That left the pair level on points going into the dry finale, but a repeat of their race-three finishing positions – with Priaulx again leading from start to finish and Wooder third – handed JHR man Priaulx the title.

Darkness then fell on the Indy circuit as the Britcar Endurance field came out for the headlining three-hour race to close the Brands Hatch season. A chaotic event featured several safety cars and offs, rewarding those who stayed clear of trouble – including Phil Hanson and



Nigel Moore, who sealed the title in their Audi R8 by one point.

It could have been even sweeter after Moore stepped into the Audi and hounded Javier Morcillo's Mosler through the final minutes, but he fell short of making a pass. Morcillo instead sealed victory for himself and Manuel Cintrano ahead of the Tockwith Audi, with Ian Lawson and Kevin Clarke (BMW Z4 GT3) a lonely third.

The Britcar GT and Production finale took place in the first hour of the Enduro, but with most of its grid opting to do the full three hours, there were few contenders. Peter Rowbottom (Ferrari 458 Challenge) won, topping Rob Young/Neil Garnham and Ollie Withington

Trackday Trophy had a varied grid, with Burstow's BMW taking the win

and Martin Parsons.

Saturday's opener was more engrossing, with Bonamy Grimes and Johnny Mowlem's Ferrari battling hard against the similar GT3 machine of Calum Lockie and David Mason. That duel ended when Mason stalled in the pits, allowing Grimes to run to the flag unchallenged ahead of the Cintrano/Morcillo Mosler.

Earlier, Rod Birley sealed a brace of wins in the MSVR Allcomers to claim a 599th career victory, despite fears of a forced retirement after the lights on his Ford Escort WRC initially refused to turn on.

There was also a double winner in the Champion of Brands, with Chase Owen crowned despite a controversial opener. Owen made a superb getaway to grab the lead in his Ray, but was then judged to have jumped the start.

Having crossed the line first, a 10-second penalty post-race dropped him to third – although an appeal was successful and reinstated Owen as victor, meaning Luke Cooper (Swift SC16) was second ahead of the Ray of Jake Byrne. Owen then made it two from two after again seeing off Byrne and Cooper.

The MSVT Trackday championship had an eventful mini-enduro, with Simon Clark's Porsche Boxster coming out on top after a late move on Dylan Brychta's SEAT Ibiza. The following Trackday Trophy race was won by Gary Burstow after his BMW defeated Mark Penny's Vauxhall VX220.

**TOM ERRINGTON**

## RESULTS

**GINETTA JUNIOR WINTER SERIES (12 LAPS) 1 Dave Woolder;** 2 Sebastian Priaulx +0.256s; 3 Charlie Fagg; 4 Daniel Harper; 5 Connor Grady; 6 Harry King. **Fastest lap** King 1m04.515s (67.40mph). **Pole** Harper. **Starters** 17.

**RACE 2 (11 LAPS) 1 Woolder;** 2 Priaulx +0.192s; 3 Harper; 4 Fagg; 5 King; 6 Tom Gamble. **FL** King 1m04.246s (67.68mph). **P** Woolder **S** 17.

**RACE 3 (16 LAPS) 1 Priaulx;** 2 Harper +0.507s; 3 Woolder; 4 Harry Dyson; 5 Gamble; 6 Fagg. **FL** Harper 57.970s (75.01mph). **P** Priaulx. **S** 17.

**RACE 4 (16 LAPS) 1 Priaulx;** 2 Gamble +3.429s; 3 Woolder; 4 Harper; 5 Fagg; 6 King. **FL** Priaulx 56.764s (76.60mph). **P** Priaulx. **S** 17.

**BRITCAR ENDURANCE (192 LAPS) 1 Manuel Cintrano/Javier Morcillo (Mosler MT900);** 2 Phil Hanson/Nigel Moore (Audi R8) +0.557s; 3 Ian Lawson/Kevin Clarke (BMW Z4 GT3); 4 Bonamy Grimes/Johnny Mowlem (Ferrari 458 Challenge); 5 David Mason/Calum Lockie (458 GT3); 6 Shaun Hollamby/Andrew Wilmot/Scott Adam (BMW M3 E46). **Class winners** Grimes/Mowlem; Hollamby/Wilmot/Adam; Darron Lewis/Daniel Wylie (Ginetta G55 GT4); Matt Lebreton/Rob Young/Neil Garnham (458 Challenge); Jacob Mathiassen/Steve Fresle (G55 GT4); David Birrell/Daniel Woodward (Mini JCW Challenge R56). **FL** Moore 46.142s (94.24mph). **P** Hanson/Moore. **S** 20.

**BRITCAR GT AND PRODUCTION (50 LAPS) 1 Bonamy Grimes/Johnny Mowlem (Ferrari 458 Challenge);** 2 Manuel Cintrano/Javier Morcillo (Mosler MT900); 3 Dan Stringfellow (BMW M3 E92 V8); 4 Edward Moore (Ginetta G50 GT4); 5 Shaun Hollamby (BMW M3 E46); 6 Johnny Guindi (Nissan 370Z GT4). **CW** Cintrano/Morcillo; Stringfellow; Moore; Hollamby; Mike Moss/Tom Howard (M3 E46); Steve Fresle/Jacob Mathiassen (Ginetta G55 GT4); Barry McMahon (Alfa 156); Rob Baker/Rob Hedley (Smart). **FL** Grimes/Mowlem 54.518s (79.76mph).

**P** Grimes/Mowlem. **S** 19. **RACE 2 (51 LAPS) 1 Peter Rowbottom (458 Challenge);** 2 Rob Young/Neil Garnham (360 Challenge) -2 laps; 3 Martin Parsons/Ollie Withington (SEAT Supercopa); 4 Baker/Hedley; no other finishers. **FL** Rowbottom 50.031s (86.91mph). **P** Rowbottom. **S** 6. **MSVR ALLCOMERS (BOTH 15 LAPS) 1 Rod Birley (Ford Escort WRC);** 2 Andy Thompson (SEAT Toledo) +2.029s; 3 Anthony Bennett (Caterham R300); 4 JJ Ross (Renault Clio); 5 Dean Cook (TVR Sagaris); 6 Johnny Guindi (Nissan GT). **CW** Thompson. **FL** Thompson 59.014s (73.68mph). **P** Birley. **S** 21. **RACE 2 1 Birley;** 2 Thompson +8.274s; 3 Bennett; 4 Ross; 5 Cook; 6 Guindi. **CW** Thompson. **FL** Birley 59.169s (73.49mph). **P** Birley **S** 21.

**CHAMPION OF BRANDS (BOTH 15 LAPS) 1 Chase Owen (Ray GR);** 2 Luke Cooper (Swift SC16) +2.670s; 3 Jake Byrne (Ray); 4 Thomas Capezone (Swift SC16); 5 Andy Charsley (Ray GR15); 6 Henry Chart (Mygale). **FL** Owen 1m01.336s (70.89mph). **P** Cooper. **S** 9. **RACE 2 1 Owen;** 2 Byrne +5.948s; 3 Cooper; 4 Charsley; 5 Capezone; 6 Chart. **FL** Owen 1m01.334s (70.90mph). **P** Owen. **S** 9.

**TRACKDAY CHAMPIONSHIP (37 LAPS) 1 Simon Clark (Porsche Boxster S);** 2 Dylan Brychta (SEAT Ibiza) +1.344s; 3 Kester Cook (Ford Fiesta); 4 Darren Goes (SEAT Cup); 5 Ryan Steel (Citroen Saxo); 6 Jamie McHugh (Porsche 944 Turbo). **CW** Cook; Lewis Denslow (Ford Fiesta); John Lyne (VW Golf); Colin Tester (Toyota MR2); Oliver O'Neill (Fiesta). **FL** Clark 1m03.892s (68.06mph). **P** Clark. **S** 25.

**TRACKDAY TROPHY (38 LAPS) 1 Gary Burstow (BMW 328i);** 2 Mark Penny (Vauxhall VX220) +18.244s; 3 Nick White (Renault Clio); 4 Callum McDougall/Ben Simonds (MR2); 5 Simon Gerrard/Giles Lock (VW Golf); 6 Oliver Owen (Clio). **CW** Penny; Owen; Gerrard/Lock; Alex and Gavin Hearnden (Alfa Romeo 156); Jason Gregory/Colin Tester (Ford Puma). **FL** David Marcussen/Karl Weaver (Porsche Cayman) 55.989s (77.66mph). **P** Marcussen/Weaver. **S** 34.

## ANGLESEY

RACE OF REMEMBRANCE NOVEMBER 11-13



# James/Wheeler in Sync to take win

AN EARLY-PITSTOP STRATEGY PROVED to be the winning formula for last year's runner-up, the Synchro Motorsport Honda Civic of Alyn James and Dan Wheeler, in the 2016 edition of the Race of Remembrance.

James led from pole until Jade Edwards' Hand Controlled Volkswagen Golf surged ahead through Church on the opening lap. As James came under pressure from James Beardwell in the Sofa King Fast Caterham, Edwards had a turbo problem, dropping the VW to third.

It took 16 laps for Edwards to fight back to the front, and after the first hour she had a lead of more than a minute, with the Synchro Honda down in 14th after its early stop during the first safety car period.

Pitstops and driver changes soon began to take an effect on the leaderboard and after 50 laps Rob Boston's Lotus Elise led the way, until he stopped and handed over to Peter Mansfield, who was then collected after a spin.

It was still an Elise in front, however, as Wade Eastwood took charge in the Datum car, a lead that was retained until the sixth hour. Charles Graham had a short stint, then Eastwood finished the night section of the race with just over a minute's lead over Synchro's second car – a Honda Jazz – started by Brian Love before Martin Byford took it to the first halt.

The Sofa King Caterhams, which were running as a relay team, were still third, while Simon Andrews' Spinal Track Golf, Ben and Lee Brooks' Datum Elise and SBP's Caterham completed the early top six.

Eastwood/Graham increased their lead by another 34s during the stint that preceded the Remembrance service, then Byford was

given a stop/go penalty for a safety car infringement that was later rescinded.

By now the fight for outright victory had started to become a two-horse race, with James in the Synchro Civic catching Graham in the lead Elise, with Love, having taken over the Jazz from Byford, a distant third.

Graham pitted after 168 laps, which handed the lead to James for the first time since lap 15. When Eastwood took over in the Elise again, it was soon back in second, aided by Love pitting when the Jazz had a manifold problem.

Six hours in, Sofa King was back up to third behind the Synchro Civic and Datum Elise. The dramas were only just beginning, though, and with three hours left to run the lead crews began to suffer. The Synchro Civic managed to retain the lead for a well-deserved victory, despite Wheeler having to complete the final stint on a set of road tyres.

Into the final hour Datum was still a solid second, but after Eastwood took over for the last stint he headed pitwards again with a broken gear linkage, which was repaired with cable ties.

The SBP Caterhams of Paul Aram/Steve McCulley/Barry Moore finished strongly to secure second, ahead of Sofa King's Beardwell/Caroline Everitt/Jason McCormack, while Eastwood managed to nurse his Lotus to the flag in fourth.

The rest of the top six was settled by another Caterham fight, with Mad Cat Racing's Douglas Thain/Matthew Welch edging away from APB's Andrew Burd/Andy Johnson/Peter Reynolds/Rob Watts in the final hours.

**PETER SCHERER**

## RESULTS

### RACE OF REMEMBRANCE (281 LAPS)

**1 Synchro Motorsport 2 (Alyn James/Dan Wheeler) (Honda Civic);** 2 SBP Racing (Paul Aram/Steve McCulley/Barry Moore) (Caterham Tracksport) -1 lap; 3 Sofa King Fast (James Beardwell/Caroline Everitt/Jason

McCormack) (Caterham Roadsport); 4 Datum Motorsport 2 (Wade Eastwood/Charles Graham) (Lotus Elise); 5 Mad Cat Racing (Douglas Thain/Matthew Welch) (Caterham Roadsport); 6 APB Racing (Andrew Burd/Andy Johnson/Peter Reynolds/Rob Watts) (Caterham Roadsport). **CW** SBP Racing; Datum Motorsport 2;

360MRC (Duncan Rogers/Claire Smith) (BMW Mini); KC Motorsport (Jeffery Clark/Ruaridh Clark/Steven Dailly) (BMW Compact); MX-5 Owners Club 1 (Andy Balfour/John Chambers/Sebastian Fisher/Tim Storrar) (Mazda MX-5). **FL** Jade Edwards (VW Golf) 1m40.117s (75.51mph). **P** Synchro Motorsport 2. **S** 41.

# Leist tops a crucial campaign for British motorsport

A Brazilian beat a Brit to domestic F3 honours, but 2016 was about more than just a championship battle

Jack Cozens, BRDC F3 Correspondent

🐦 @JHCozens



**T**his year was a significant one for single-seater racing in Britain. Just a season after going some way towards effectively killing off regional Formula 3, the FIA reached an agreement with the Motor Sports Association and MotorSport Vision to upgrade the BRDC British Formula 4 championship to F3 (national) status on the eve of the season's start.

New cars supplied by Tatuus, with much improved aerodynamic and mechanical performance, had moved the championship closer to the

Dallara-spec European F3 counterpart. A renaming made sense, paving the way for MSA Formula, Britain's de facto FIA F4 championship, to take up F4 naming rights.

For all the significance of a change in name, though, there was fundamentally a championship at stake and, while the on-track action did not always live up to expectations, the title fight was one fitting of the category's heightened status. Double R's Matheus Leist eventually ran out champion in a tense final race at Donington Park, while Ricky Collard endured agony once again, for a second year in a row having to settle for runner-up spot in a British single-seater championship.

Leist leads the field at the start of race one at Brands Hatch

Although the finale was dramatic, the championship took its time to come to the boil and was still only simmering by the time teams headed to Snetterton for the penultimate round of the season. After a tentative start to the year, Collard had taken control of the championship fight by the midway point – which included a spectacular double win at Oulton Park – and still led despite below-par events at Silverstone and Spa.

Collard headed to Norfolk with a slender four-point lead over Leist, who had steered clear of problems to win at Silverstone and claim a brace of second-place finishes at Spa as he closed in on the leader. Lanan's Toby Sowery and Australian Thomas Randle – with the



Collard put himself in driving seat with Snetterton double

wheel, which had caused a small misfire and necessitated a change. That made his pole lap all the more impressive, with minimal time to head back on track before the end of qualifying, let alone focus on setting himself up for a fast run.

For the rest of the weekend Collard had the mark of a man free from the shackles of pressure – demonstrating none of the signs of unease that had contributed to an indifferent start to the season at the Norfolk circuit four-and-a-bit months earlier.

A lightning start set him on his way to a commanding race-one win ahead of Leist, and anything the Brazilian did in race two, Collard proved he could do just as well; two laps after Leist had put a buffer between himself and Collard in the form of Double R team-mate Aleksanteri Huovinen, Collard produced a stunning overtake up the inside of the Finn at Riches to negate the points loss to sixth-placed Leist.

A second win followed later in the day for Collard, who carried the swagger of a man full of confidence – and certainly had main rival Leist on the back foot. “I think I was as fast as Ricky, but obviously he got the jump with qualifying, which was frustrating,” he said.

The 15-point advantage that Collard left Snetterton with by no means guaranteed the title, but a stunning weekend served as a great statement of intent, and effectively wiped two of his rivals (Sowery and Randle) out of the reckoning.

But then came a disastrous Donington finale. A flying Leist was unlucky to miss out on pole – owing to a badly timed red flag in a wet qualifying session – while Collard was perhaps fortunate to grab fourth after getting stuck in traffic.

Any fortune Collard had stumbled upon soon deserted him, though, as the real fragility of his championship lead was exposed as quickly as that of his right-rear suspension. After dropping to 14th at the start thanks to a clash, Collard began a recovery drive through the field but then, having made it to sixth, came a nightmare moment as he

collided with Leist’s team-mate Enzo Bortoletto at Redgate, taking both out.

As well-timed as his move on Huovinen had been a round earlier, Collard’s attempt to pass Bortoletto looked messy. He made his intentions clear by tailing the Double R driver down the Wheatcroft straight, but never looked as though he had enough of a gap to lunge and instead collected the Brazilian. In his defence, Collard pointed to damage sustained in the earlier incident as the reason for locking up.

As the causes of the resulting red flag, Collard and Bortoletto were discounted from the countback result. Collard thus scored zero, and Leist’s luck was in. He gained back the win despite a mistake on lap 10, which had allowed Harrison Scott into the lead, after the result went back a lap – and assumed a 20-point lead.

Collard and Bortoletto disagreed about

## “The real fragility of Collard’s lead was exposed”

who was at fault, but the stewards had no such argument, laying the blame squarely at Collard’s door and handing the Carlin man a five-place grid penalty for race two.

Collard returned defiant and rejuvenated a day later, adamant that the title was not beyond him. But while his pressing of the reset button was impressive, deep down he surely knew the title was a tall order. A decent race-two fightback – despite another collision with Bortoletto – still only netted 10th, five spots behind his main rival.

Leist thus entered the final race with 25 points in hand, needing only a 10th-place finish to seal the deal. Crucially, where Collard had flapped under >>

ever-impressive Douglas Motorsport squad – had also muscled their way into the title fight, both within a main-race victory of the points leader.

The chasing trio must have sensed an opportunity in qualifying, too, as Collard struggled to make an impact at the head of the order, but how disappointed they were to be a matter of minutes later.

Collard, son of British Touring Car driver Rob, languished in the lower reaches of the top 10 but returned to the pits before heading out for a second and final run in a bid to improve his time. The result? A second pole of the season, a mere 0.059 seconds ahead of Leist.

Collard’s sluggish start to the session had been the result of a faulty steering

pressure, Leist kept his cool – fending off his rival for fifth in the final race to confirm his championship success.

The 19-year-old hadn't led the championship before the visit to Donington, and didn't hit the same highs as Collard managed throughout the year, but his consistency was impressive. The feel for conditions Leist demonstrated in the wet in qualifying at Donington, and his judgement of events across the weekend thereafter, put Collard in the shade – and with four victories, too, he walked away a deserving champion.

That's not to say Collard wouldn't have been a fitting winner. With the equal-highest number of race wins (five), he could and perhaps should have sealed the deal – but his lowest-scoring round of the season came at the worst possible time as the championship slipped from his grasp.

Sowery's title challenge didn't quite have enough puff, but he still ended up a fine third after ending the season with a double win. He did lead the championship after April's visit to Brands Hatch, but ground lost at Rockingham in particular, thanks in part to a downshift issue in qualifying, proved too much to claw back.

Randle made a strong impression in his first season in the UK and ended up fourth, one place ahead of Douglas team-mate Enaam Ahmed – who won a race and led after the opening weekend but faded thereafter. Carlin's Lando Norris, who completed half the rounds, ended up eighth with four wins, though on average scores would have snatched the title by a point had he contested the full season rather than focusing on Formula Renault Eurocup and NEC campaigns (both of which he won).

And what of the state of the competition? The 2016 season was important not only for re-establishing a single-seater ladder in the UK, but also for safeguarding its future health.

There's some way to go before Britain's junior rungs have as much depth as they did 10 years ago, and the formula isn't without its flaws. That top dogs Carlin and Double R were able to set the pace in their first year was slightly disconcerting (though the field being 'reset' by the introduction of the F3-016 played some part in that), as was the exit of one of the championship's leading teams, HHC Motorsport. Will F3 go the same way of British Formula Ford/MSA Formula/British F4 in losing its smaller teams? Or go the way of the original British F3, which died due to spiralling costs? It's too early to tell.

But measuring the success of the rebadged championship against the goals it set at the start of its second era – producing a competitive, entertaining championship, between European F3 and F4 pace barriers, which could be contested at a competitive price – means the 2016 BRDC British F3 campaign has to go down as a resounding success. ✨



Sowery (main) and Randle both had fine campaigns

**BRDC F3 DRIVERS' CHAMPIONSHIP**

POS	DRIVER	TEAM	1	2	3	4	5	6	7	8	9	10
1	Matheus Leist (BR)	Double R Racing	10	1	4	1	DNF	DNF	3	4	2	4
2	Ricky Collard (GB)	Carlin	5	DNF	8	2	4	2	2	7	1	1
3	Toby Sowery (GB)	Lanan Racing	4	3	2	3	1	13	14	8	6	7
4	Tom Randle (AUS)	Douglas Motorsport	20	9	5	4	5	3	4	1	4	2
5	Enaam Ahmed (GB)	Douglas Motorsport	3	2	1	DNF	17	14	6	18	5	8
6	Tarun Reddy (IND)	Fortec Motorsports	16	DNF	12	5	2	EXC	8	6	8	15
7	Thomas Maxwell (AUS)	Sean Walkinshaw Racing	11	7	9	9	8	7	9	9	9	9
8	Lando Norris (GB)	Carlin	1	6	3	-	-	-	1	3	3	-
9	Aleksanteri Huovinen (FIN)	Double R Racing	2	4	6	DNF	13	5	5	5	7	14
10	Ben Hingeley (GB)	HHC Motorsport	6	14	DNF	15	16	11	11	13	15	11

11 Enzo Bortoleto (Double R Racing) 220; 12 Faisal Al Zubair (Fortec Motorsports) 196; 13 Eugene Denyssen (Sean Walkinshaw Racing) 194; 14 Sisa Ngebulana (HHC Motorsport) 176; 15 Quinlan Lall (Chris Dittmann Racing) 149; 16 Jan Jonck (Sean Walkinshaw Racing) 142; 17 Harrison Scott (HHC Motorsport) 130; 18 Akhil Rabindra (Lanan Racing) 124; 19 Colton Herta (Carlin) 109; 20 Krishnaraaj Mahadik (Chris Dittmann Racing) 104;

The defining moment? Collard lost points lead after clash with Bortoletto



EBREY/LAT



Norris was supreme in select outings with four victories

HOYER/BRD/CF3

## AUTOSPORT'S TOP 5 DRIVERS



EBREY/LAT

### 1 MATHEUS LEIST

*Double R Racing*

Mr Consistent throughout the season, Leist put a topsy-turvy MSA Formula campaign a year earlier well behind him and proved how adept he was at coping with pretty much any eventuality. Four wins also showed he could do the business at the front.



EBREY/LAT



EBREY/LAT

### 2 RICKY COLLARD

*Carlin*

At his best, Collard had the legs on the rest. His sensational double victories at Oulton Park and Snetterton proved his capabilities. But his peaks were matched by troughs – it's just a shame that his title hopes were effectively ended by one over-ambitious move.

### 3 TOBY SOWERY

*Lanan Racing*

Having started the year without a full-time deal in place, third overall has to go down as a great achievement for Sowery. His title hopes rested a little too heavily on the less rewarding reversed-grid races, but he ended with joint-highest number of wins (five) alongside Collard.

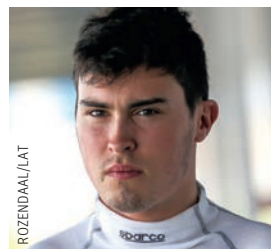

ROZENDAAU/LAT



EBREY/LAT

### 4 THOMAS RANDLE

*Douglas Motorsport*

Randle came into the season as the potential joker in the pack. His campaign didn't start in the auspicious fashion that might have indicated a title tilt, but he grew stronger as the year went on. Two wins and fourth overall represented a strong haul for the Aussie, who will move on next year.

### 5 LANDO NORRIS

*Carlin*

Yes, Norris contested only half a season, but his record was good enough that he may well have won the title had he completed the full campaign (did he *really* need two Formula Renault crowns?). It may be a while before he races again in the UK, so his F3 outings were ones to be cherished.

11	12	13	14	15	16	17	18	19	20	21	22	23	24	PTS
4	5	1	3	-	2	5	2	2	6	2	1	5	5	493
8	1	4	13	-	3	6	6	1	7	1	DNF	10	6	466
1	7	7	1	-	5	2	4	3	5	7	4	1	1	457
7	2	2	4	-	9	1	5	6	4	6	DNF	8	3	424
2	4	5	5	-	4	4	19	DNF	17	4	6	6	2	349
21	14	3	7	-	6	3	9	7	2	9	12	7	7	284
10	12	9	16	-	15	13	7	13	14	12	5	3	9	265
-	-	DNF	2	-	1	19	1	-	-	-	-	-	-	247
19	11	16	10	-	DNF	15	16	9	8	11	7	DNF	14	245
14	15	13	6	-	7	8	10	4	19	3	3	14	DNF	232

21 Jeremy Wahome (Chris Dittmann Racing) 98; 22 Ameya Vaidyanathan (Carlin) 95; 23 Nikita Mazepin (Carlin) 51; 24 Omar Ismail (HHC/Chris Dittmann Racing) 47; 25 Will Palmer (HHC Motorsport) 39; 26 James Pull (Carlin) 33; 27 Raoul Hyman (HHC Motorsport) 15; 28 Paul Sjeljes (Chris Dittmann Racing) 10.

# WHAT'S ON

## Is Formula 1 TV any good?



FOR THE PAST TWO RACES OF THIS season I have tag-teamed out of the Formula 1 paddock with my Grand Prix Editor predecessor Edd Straw, helping to cover the Mexican and Brazilian Grands Prix remotely for Autosport.com.

This means tuning in to the live coverage of each session from the UK, which in turn means watching F1 on either Channel 4 or Sky Sports, something I don't usually have the opportunity to do.

Mexico was one of the 10 races C4 gets to show live this season, and as a boy brought up on BBC and ITV F1 coverage the hollowed husk that is terrestrial TV is where I'm instinctively drawn.

Although C4 has stepped in to fill the BBC void, and cater for the 'casual' F1 viewer, the coverage is pleasingly expert in tone. During free practice C4 does a good job of focusing on what's actually happening in the sessions – discussing what's transpiring within the context of track characteristics, engine settings and tyre behaviour.

This is where analyst Karun Chandhok comes into his own. The ex-F1 driver is well plugged in to grand prix racing's

inner workings, and explains with authority why certain teams and drivers are performing well and others aren't.

Discussion of off-track matters is of course necessary during what are essentially televised test sessions, but C4 tends to keep this chat focused on race-relevant topics, and doesn't veer off on too many tangents.

Qualifying and racing kind of takes care of itself – let it flow and say what you see without getting overexcited and talking too much. Lead commentator Ben Edwards is a real underrated star, with a calm and authoritative style. Not too colloquial, but not too stuffy either.

Sky's Simon Lazenby and Johnny Herbert quiz Sergio Perez



Co-commentator David Coulthard is a bit hit-and-miss – good on driver mindset and incidents, but with a tendency to use too many jargon phrases and forced humour. Where DC does fine work is counteracting some of Eddie Jordan's more lurid moments during the pre- and post-session analyses.

The ad breaks are annoying, and C4 loses points for declaring on its website that practice will be shown live on its main channel, when in fact for the Mexican Grand Prix it's on More4, but generally speaking it's hard to find fault.

Sky Sports is now the permanent home of F1 coverage in the UK, with a subscription model designed to cater for the hardcore fan. Sky's style is far more colloquial, with a 'mates down the pub' feel. I can understand as well as anyone that free practice is not made for TV, but there is a frustrating lack of focus on the on-track action.

FP1 coverage is dominated by talk of what's going on in the paddock, and every discussion is laboured to death. It feels like more of a Graham Norton sofa chatshow than sports programming.

Consequently, it doesn't appear as

## GET AUTOSPORT ON THE MOVE

DOWNLOAD IT NOW FROM AUTOSPORT.COM



Lewis Hamilton gives the lowdown to C4's Steve Jones and DC

informed or expert as it should, and plenty of mistakes creep in.

Things improve greatly in second practice, where David Croft and Paul di Resta focus more on the track action. This is all interspersed with useful trackside insight from Martin Brundle.

For me, he is Sky F1's biggest asset – an immensely knowledgeable pundit, with a calm and smooth presentational style, which really comes into its own at the business end of the weekend.

His authoritative 'driver's-eye-view' blends quite nicely with Croft's 'fan-in-the-commentary-box' shtick, helping to counterbalance Croft's excitable delivery.

C4 and Sky clearly have very different styles, and on balance I'd say Sky's coverage is a slow starter that recovers from a few early off-track excursions to get right on the pace when it really counts; C4 is more consistent, delivering lap after lap throughout the weekend in the Fernando Alonso style.

Is F1 TV any good? It all depends on what you are watching and when. But with the right people and focus in place, it most definitely can be.

**BEN ANDERSON**



## HOT ON THE WEB THIS WEEK

YouTube **WHY MACAU IS STREETS AHEAD**

**Search for: 2016 Macau Grand Prix – Get Ready**

Check out the official plug for this weekend's 63rd Macau Grand Prix, featuring the best up-and-coming single-seater drivers, as well as the FIA GT World Cup. The FIA's channel also has interviews with Felix Rosenqvist, Lucas di Grassi and Mike Conway, explaining what makes this event so special.

**TV PICK OF THE WEEK**

**MACAU GRAND PRIX**  
MOTORS TV, Sunday 1735

OK, so the coverage isn't live. So what? A host of single-seater talent, including past winners of the event, descend on the streets of Macau for the famous F3 grand prix, with as-live coverage of all the thrills and spills available on Sunday evening. There's also delayed coverage of the GT and TCR races to whet the appetite beforehand, and why not build up to it all with our preview (page 42)?

## INTERNATIONAL MOTORSPORT

### WORLD ENDURANCE CHAMPIONSHIP

**Rd 9/9**  
Bahrain International Circuit

**November 19**

**WATCH ON TV**

**Live** Motors TV, Saturday 1230

**Live** Eurosport 1, Saturday from 1600

### MRF CHALLENGE

**Rd 1/4**  
Bahrain Int Circuit  
**November 17-19**

### RALLY AUSTRALIA

World Rally Championship  
**Rd 13/13**  
Coffs Harbour, New South Wales, Australia

**November 17-20**

**WATCH ON TV**

**Live** BT Sport 1, Saturday 2230, Sunday 0200

**Highlights** Channel 5, Monday 1900

### MACAU GRAND PRIX

Formula 3 World Cup  
Macau, China  
**November 19-20**

### WATCH ON TV

See above

### GT WORLD CUP

Macau, China  
**November 19-20**  
**WATCH ON TV**  
**Delayed** Motors TV, Sunday 1515

### TCR INTERNATIONAL

**Rd 11/11**  
Macau, China  
**November 20**  
**WATCH ON TV**  
**Delayed** Motors TV,

Sunday 1640

### NASCAR SPRINT CUP

**Rd 36/36**  
Homestead, Florida, USA  
**November 20**  
**WATCH ON TV**  
**Live** Premier Sports, Sunday 1900

### V8 STOCK CAR

**Rd 11/12**  
Curvelo, Brazil  
**November 20**

## UK MOTORSPORT

### ANGLESEY BRSCC

**November 20**  
Single-seaters, Sports/Saloons/Caterhams, Irish Global Lights, Endurance race

### MONDELLO PARK

**November 20**  
Six-Hour Fiesta race



MONDELLO PARK

CHESTER



MARTINI  
RACING

MARTINI  
RACING



## THE ARCHIVE

A blur of activity surrounds Markku Alen's Lancia 037 during night-time service at the 1984 Monte Carlo Rally. Alen finished eighth in an event dominated by Audi – the Quattros of Walter Rohrl, Stig Blomqvist and Hannu Mikkola were 1-2-3.

[www.mcklein.de](http://www.mcklein.de)  
[@mcklein\\_rally](https://twitter.com/mcklein_rally)

# INTRODUCING



# RICHARD VERSCHOOOR

**R**ICHARD VERSCHOOOR DOES NOT TURN 16 until next month, but he's already won two junior single-seater titles and is making a name as Red Bull's latest racing prodigy.

The Dutch youngster's early racing CV looks pretty conventional, but motorsport was not his first sporting love.

"No-one in my family ever had any involvement in motorsport before me – in fact I was more keen on football at the start," says Verschoor, who currently attends a sports academy in Eindhoven.

"There are students from lots of other sports at the academy, and I think this is good. If I fail at motorsport and I know I have given it my best, I will have no regrets at all."

Failure, however, isn't something Verschoor's had to become accustomed to. His graduation through karting took him to the German title, as well as sixth in the senior KF category's world final and third in the European championship.

His Red Bull opportunity arose after his first race weekend in a car, the SMP F4 opener this year in Russia.

"I had gone through the karting categories fairly quickly, so decided to move to cars this season. I debuted at Sochi and from pole I won my first race," he explains. The result prompted Red Bull to bring him into the fold.

Verschoor contested the SMP and Spanish F4 series this season, and had outings in the German and Italian categories. In total he took part in 49 F4 races across the four championships, won 28 of them and earned numerous other podium finishes. He was an utterly dominant champion in Spain and the SMP category, and in the latter enjoyed a mid-season run of 10 straight wins.

"It was hard for me leaving home at my age, but I am dedicated to succeeding," he says. "Winning the titles has been great, but it's only the start."

"I know what I will racing in next year too, but it hasn't been made official yet so I can't say!"

One thing is certain, though: with his obvious talent and Red Bull backing, Verschoor has all the makings of the next Dutch rising star. ✎

PETER SCHERER



- Age** 15
- 2016** Spanish F4 champion  
SMP F4 champion
- 2015** 3rd in Euro KF (karting)  
6th in World KF (karting)
- 2014** CIK-FIA Academy Trophy champion (karting)
- 2011-13** National and international karting



Autosport Network UK Ltd, Bridge House, 69 London Road, Twickenham TW1 3SP Tel +44 (0) 20 8267 5998  
Email [autosport@haymarket.com](mailto:autosport@haymarket.com) Website [www.autosport.com](http://www.autosport.com)  
Individual email [firstname.surname@haymarket.com](mailto:firstname.surname@haymarket.com)

#### Editorial

Editor-in-Chief **Edd Straw**  
Editor **Kevin Turner**  
Deputy Editor **Marcus Simmons**  
Chief F1 Correspondent **Ian Parkes**  
Grand Prix Editor **Ben Anderson**  
F1 Reporter **Lawrence Barretto**  
Features Editor **Scott Mitchell**  
Chief Sub-Editor **Peter Hodges**  
Executive Editor **Stuart Codling**  
Group National Editor **Jack Benyon**  
Rallies Editor **David Evans**  
BTCC Correspondent **Matt James**  
Art Editor **Michael Cavalli**  
Office Manager **Joanne Grove**

#### Autosport.com

Editor **Glenn Freeman**  
Deputy Editor **Matt Beer**  
International Editor **Mitchell Adam**  
Technical Team Leader **Geoff Creighton**  
Senior Digital Designer **Amar Vijay**

#### Photography LAT Images

Steven Tee, Glenn Dunbar, Sam Bloxham, Zack Mauger

#### Special Contributors

Gary Anderson, Jack Cozens, Alan Eldridge, Mark Glendenning, Stephen Lickorish, Marcus Pye, Dieter Rencken, Gary Watkins

#### Correspondents

**Argentina** Tony Watson **Australia** Phil Branagan **Austria** Gerhard Kuntschik **Belgium** Gordon McKay **Brazil** Lito Cavalcanti **Finland** Esa Illoinen **Germany** Rene de Boer **Greece** Dimitris Papadopoulos **Italy** Roberto Chinchero **Japan** Jiro Takahashi **New Zealand** Bernard Carpenter **Russia** Gregory Golyshv **Spain** Raimon Duran **Sweden** Tege Tornvall **USA** Bruce Martin, Jeremy Shaw **UK & Ireland** Pete Allen, Lee Bonham, Stephen Brunsdon, Jonathan Crawford, Dom D'Angelillo, Kerry Dunlop, Tom Errington, Charlie Eustice, Jake Jones, Esa Kalinauckas, Samarth Kanal, Lewis Larkam, Mark Libbeter, Dan Mason, Damian Meaden, Rory Mitchell, Lucy Morson, James Newbold, Jason Noble, Brian Phillips, Graham Read, Hal Ridge, Peter Scherer, Ian Sowman, Oliver Timson, Ian Titchmarsh, Eddie Walder, Richard Young

#### Advertising

Tel +44 (0) 20 8267 5271 Email [autosport.ads@haymarket.com](mailto:autosport.ads@haymarket.com)  
Sales Manager **James Robinson**  
Display Advertising **Don Rupal, Karen Reilly, Jamie Brooker**  
Classified Advertising Team Leader **Jonathan King**  
Classified Advertising **Ben Kavanah**  
Autosport.com Sales Manager **Fiona Bain**  
Sales Director **Matthew Witham**

#### Advertising Production

Tel +44 (0) 20 8267 5588 Fax +44 (0) 20 8267 5320  
Production Controller **Abbey Gunner** [abbey.gunner@haymarket.com](mailto:abbey.gunner@haymarket.com)

#### Subscriptions

UK +44 (0) 344 848 8817 Overseas +44 (0) 1604 251451  
Email [help@autosport.themagazineshop.com](mailto:help@autosport.themagazineshop.com)  
Back issues 0344 8488817

Direct Marketing Executive **Maria Fernandez** +44 (0)20 8267 8254

Autosport, ISSN number 0269946X, is published weekly by Autosport Network UK Ltd, Bridge House, 69 London Road, Twickenham TW1 3SP, United Kingdom. Airfreight and mailing in the USA by agent named Air Business Ltd, c/o Worldnet Shipping Inc., 156-15, 146th Avenue, 2nd Floor, Jamaica, NY 11434, USA. Periodicals postage paid at Jamaica NY 11431. Subscription records are maintained at Haymarket Media Group, Bridge House, 69 London Road, Twickenham TW1 3SP. Air Business Ltd is acting as our mailing agent.

#### Licensing and Syndication

Stuart Williams

#### Management

Managing Director **Tim Bulley**  
Publishing Director **Stuart Williams**  
Editorial Director **Anthony Rowlinson**  
Group Publishing Manager **Sunita Davies**  
Special Events Manager **Laura Coppin**  
Digital Product Manager **Simon Grayson**

We abide by the Editors' Code of Practice and are committed to upholding the highest standards of journalism. If you think we haven't met those standards and want to make a complaint, contact 0208 267 5000.

#### © 2016, AUTOSPORT NETWORK UK LTD

Publishing, trade and further subscription details on [www.autosport.com](http://www.autosport.com). While due care is taken to ensure the contents of Autosport are accurate, the publishers and printers cannot accept liability for errors and omissions. Advertisements are accepted for publication in Autosport only upon Autosport Network UK Ltd's Standard Terms of Acceptance of Advertising, copies of which are available from the Advertising Sales Department of Autosport.

#### CIRCULATION TRADE ENQUIRIES

Frontline Ltd, Park House, 117 Park Road, Peterborough, Cambs, PE21 2TS.  
Tel: +44 (0) 1733 555161. Printed by William Gibbons & Sons Ltd, 28 Planetary Road, Willenhall, Wolverhampton WV13 3XT.  
ISSN 0269-946X. Autosport, is published weekly by Autosport Network UK Ltd, Bridge House, 69 London Road, Twickenham TW1 3SP.



Autosport Network UK Limited is a division of Motorsport Network LLC



THE 2016 PERFORMANCE RACING INDUSTRY TRADE SHOW



# THE BUSINESS OF RACING STARTS HERE

**PRI**2016  
Indianapolis  
December 8-10, 2016



CONNECT WITH MORE THAN 1,200 RACING INDUSTRY SUPPLIERS

Discover new racing products & business opportunities at PRI, the world's largest gathering of motorsports professionals.



TECHNOLOGY



IDEAS



BUSINESS

**RACE  
ONLY**  
CREDENTIALS REQUIRED

Learn More at [www.pri2016.com](http://www.pri2016.com)

