

DENSO

Свечи зажигания и Свечи накаливания

| 01-2020



Driven by
Quality

Свечи зажигания и Свечи накаливания | Обзор

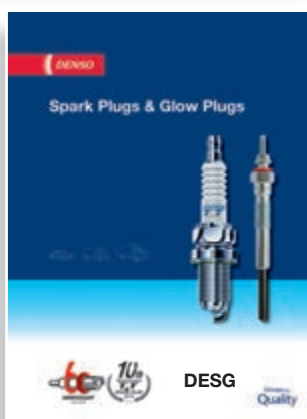
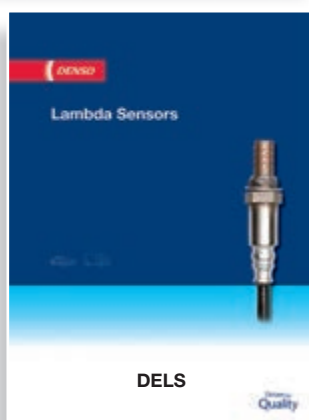

Свечи зажигания и Свечи накаливания

Содержание

RU

4	Ассортимент
6	Установка
7	Устройство
8	Система обозначений
10	Введение и установка
11	Характеристики
12	Обновления в ассортименте
19	Таблицы применений
415	Руководство покупателя
517	Таблица взаимозаменяемости
597	Руководство- фотогид
619	Технический обзор

RU

Преимущества DENSO

DENSO устанавливает стандарты в технологии производства свечей зажигания с 1959 года. Мы сами разрабатываем все типы свечей и производим их на собственных заводах, сертифицированных по QS 9000 и ISO 9000, и нашим стандартом является «ноль дефектов». Мы обеспечиваем высочайшие эксплуатационные характеристики и для рынка автозапчастей. Свечи зажигания DENSO: стандартные, платиновые, иридиевые и ТТ – покрывают весь постоянно расширяющийся диапазон применения. Чтобы обеспечить оптимальные рабочие характеристики двигателя, выбирайте свечи зажигания DENSO для любых автомобилей, мотоциклов, водного транспорта и малых моторов.

Ассортимент

Свечи с улучшенными характеристиками

Nickel TT

- > Центральный и боковой электрод с выступом из никелевого сплава
- > Низкая токсичность выхлопных газов
- > Экономия топлива
- > Ровная работа двигателя даже в экстремальных ситуациях
- > Наилучшее соотношение цена/качество среди свечей зажигания

Iridium TT

- > Улучшенный, более надежный запуск
- > Характеристики зажигания (стабильность искры, стойкость к воздействию низких температур), улучшенные на 20 % по сравнению со стандартными иридиевыми свечами
- > Межсервисный пробег — до 120 000 км
- > Премиум-технология, доступная теперь для более широкого модельного ряда
- > Экономичность — снижение расхода топлива в крейсерских режимах

Информация в настоящем каталоге действительна на дату выпуска. Пожалуйста, обратитесь к нашему электронному каталогу для получения более актуальной информации.

Рекомендации в настоящем каталоге основаны на последней информации от производителей для работы в стандартных условиях. Мы не принимаем правовые претензии, возникающие из содержания настоящего списка.

Информация по перекрестным ссылкам должна использоваться только для справки. Различия в конструкции и материалах между производителями могут варьироваться в тепловом диапазоне. Смотрите раздел рекомендации для конкретных применений двигателя.

Если указываются имена и/или номера производителей, то они даются только для справочных целей и не указывают на источник производства или какую-либо торговую связь с упомянутыми производителями. Для того, чтобы найти правильную свечу зажигания, пожалуйста, обратитесь к оригинальному номеру детали (OEM) на детали и найдите соответствующий номер детали DENSO в таблице перекрестных ссылок.

Свечи, идентичные оригинальным

Nickel

- > Медно-стеклянное уплотнение обеспечивает рассеивание тепла
- > Стандартный U-образный паз
- > Глубоко вставленный медный сердечник
- > Теплостойкое никелевое покрытие
- > В ассортименте есть свечи с несколькими боковыми электродами

Double Platinum (Longlife)

- > Улучшенный, более надежный запуск
- > Более полное сгорание (уменьшение выбросов)
- > Лучшая способность преодолевать неточности настройки
- > Великолепные приемистость и ускорение
- > Технология, испытанная в гонках

Iridium Power

- > Великолепная воспламеняемость
- > Низкое требуемое напряжение
- > Лучше динамика и стабильность работы
- > Меньший расход топлива

Iridium Longlife, Iridium Tough

- > Великолепная воспламеняемость
- > Низкое требуемое напряжение
- > Лучше динамика и стабильность работы
- > Меньший расход топлива
- > Более продолжительный срок службы

Super Ignition Plug (SIP)

- > Два супертонких долговечных электрода – центральный и боковой
- > Новейшая технология свечей зажигания
- > Используются как OE в автомобилях Honda, Hyundai, Kia, Lexus, Nissan, Mitsubishi, Mazda, Subaru, Toyota и Volvo
- > Наивысшая эффективность
- > Продолжительный срок службы

Свечи для высокофорсированных моторов

Iridium Racing

- > Технология Формулы-1
- > Максимальное ускорение
- > Высокая надежность
- > Повышенная эффективность

Компания DENSO разрабатывает свечи зажигания для использования в автомобильных, мотоциклетных, лодочных и сельскохозяйственных двигателях, а также для двигателей садовой техники и энергетических установок.

Свечи зажигания DENSO не предназначены для использования в авиационных двигателях.

RU

Ассортимент	Свечи ТТ		Идентичные оригинальным						Racing
	Nickel	Iridium	Nickel	Platinum	Iridium			Iridium	
Тип	Nickel ТТ	Iridium ТТ	Nickel	Platinum	Iridium OEM ⁵	Iridium Power	Iridium Tough	Свеча супер-зажигания (SIP)	Iridium Racing
U-образный паз	-	-	+ ¹	-	-	+ ²	-	-	-
Конический боковой электрод	-	-	Некоторые типы ³	-	-	+ ²	-	Некоторые типы	-
Материал заземляющего электрода	Ø 1.5 мм, никель	Ø 0.7 мм, платина	Обычный	Платиновая накладка	Платиновая накладка	Обычный	Платиновая накладка ⁷	Ø 0.7 мм, платина	Полностью платиновый
Диаметр центрального электрода	Ø 1.5 мм	Ø 0.4 мм	Ø 2.5 мм	Ø 1.1 мм	Ø 0.55 или 0.7 мм	Ø 0.4 мм	Ø 0.4 мм	Ø 0.55 мм	Ø 0.4 мм ⁴
Доступные калильные числа	16-22	16-22	9-31	16-22	16-27	16-34	16-27	16-24	24-35
Резистор	Все типы	Все типы	Большинство типов	Все типы	Все типы	Все типы	Все типы	Все типы	Все типы
КПД	+++	+++++	+	++	++++	++++	++++	+++++	+++++
Экономия топлива	Лучше	Наилучшая	Хорошая	Лучше	Наилучшая	Наилучшая	Наилучшая	Наилучшая	-
Долговечность	Обычная	Долговечная	Обычная	Долговечная	Долговечная	Обычная	Долговечная	Долговечная	Только для гонок

¹ Типы свечей зажигания без U в наименовании типа не имеют U-образного паза

² Не применяются для IU24A, IU27A, IU31A, IUF27A и IUF31A

³ Типы свечей зажигания с Z в наименовании имеют заземляющий электрод конической формы

⁴ За исключением типов с поверхностным зазором

⁵ Типы OEM, только для некоторых машин

⁶ Ø 0.7 мм Platinum needle available



Осторожно! (Запрещенное использование свечей зажигания)

- > Никогда не используйте свечи зажигания DENSO с двигателями любых летательных аппаратов, включая самолеты, вертолеты, планёры и дроны. Свечи DENSO не предназначены и не производятся для самолетных двигателей: их использование может привести к авиакатастрофе или другим несчастным случаям, произошедшим из-за неисправности двигателя.
- > Никогда не используйте свечи зажигания DENSO в двигателях для генераторов и газовых теплоносных систем кондиционирования воздуха. Эти свечи не предназначены и не производятся для такого использования, которое может привести к несчастному случаю, в том числе, к остановке работы двигателя или прекращению выработки тепла. В наличии имеются отдельные каталоги DENSO со свечами зажигания для газотурбинной установки (для газовых двигателей). Пожалуйста, обратитесь к представителю DENSO для получения дополнительной информации
- > Никогда не используйте свечи зажигания DENSO для работы с обогревателями, использующими газовые горелки. Свечи зажигания DENSO не предназначены и не производятся для такого рода использования, т.к. оно может привести к неисправностям зажигания или повреждению оборудования из-за перегрева двигателя.

RU

Установка свечей зажигания

Рекомендуемые момент и угол затяжки для свечей DENSO.

1. Используйте гаечный ключ, соответствующий шестиграннику свечи, и будьте осторожны, чтобы не повредить изолятор.
2. При замене свечей следите за тем, чтобы масло и прочие загрязнения на наружной части свечи не попали внутрь двигателя.
3. При установке свечей очистите сторону фланца двигателя и устанавливайте свечи зажигания, убедившись в наличии прокладки на ее фланце.
4. Убедитесь в том, что свечи зажигания расположены вертикально, и затяните их усилием руки до тех пор, пока их более завернуть нельзя (A+B).
5. Затем используйте динамометрический ключ для затягивания свечи моментом, точно соответствующим величине, указанной в таблице. Если динамометрический ключ отсутствует, используйте свечной ключ и рекомендации по затяжке свечи на угол, указанный в таблице. Подробная информация о моментах затяжки для разных типов свечей приведена в нашем электронном каталоге (C+D).

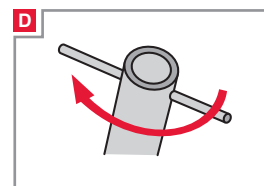
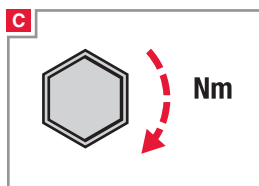
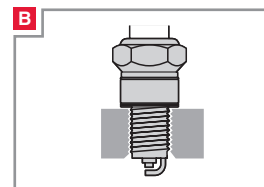
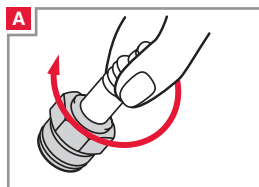

<http://www.denso-am.ru/elektronnyi-katalog/>

РЕКОМЕНДУЕМЫЕ ВЕЛИЧИНЫ МОМЕНТОВ ЗАТЯЖКИ ПРИ УСТАНОВКЕ

Размер резьбы	Рекомендуемый момент	Рекомендуемое число оборотов		
		Новая свеча зажигания	Использ. свеча зажигания	
Прокладка	M8 Тип Y	8-10 Нм	± 1 обор.	± 1/12 обор.
	M10 Тип U, N	10-15 Нм	± 2/3 обор.	± 1/12 обор.
	M10 Прокладка из нержавеющей стали	10-15 Нм	± 3/4 обор.	± 1/12 обор.
	M12 Тип SXU, X, XE, XU, ZXE, Z XU	15-20 Нм	± 1/3 обор.	± 1/12 обор.
	M14 Тип FK, J, K, KJ, P, PK, PKJ, PQ, Q, QJ, QL, S, SF, SK, SKJ, SV, SVK, VK, VKJ, W, ZT	20-25 Нм	± 1/2 обор.	± 1/12 обор.
	M14 Прокладка из нержавеющей стали	20-25 Нм	± 2/3 обор.	± 1/12 обор.
	M18 Тип L, M, MA, MW	30-40 Нм	± 1/4 обор.	± 1/12 обор.
Коническое гнездо	M14 Тип PT, PTJ, T	20-30 Нм	± 1/16 обор.	± 1/16 обор.
	M18 Тип MA	30-40 Нм	± 1/4 обор.	± 1/12 обор.



Если нити резьбы покрыты густой смазкой, то затяжка до рекомендуемого момента приведет к излишней затяжке; это связано с вытеканием смазки. Не используйте смазку для резьбы.

Затяжка моментами и углами, превосходящими те, которые показаны справа, может привести к повреждению двигателя и в дальнейшем к тому, что свеча зажигания может вырваться из резьбы.

RU

Устройство свечи зажигания

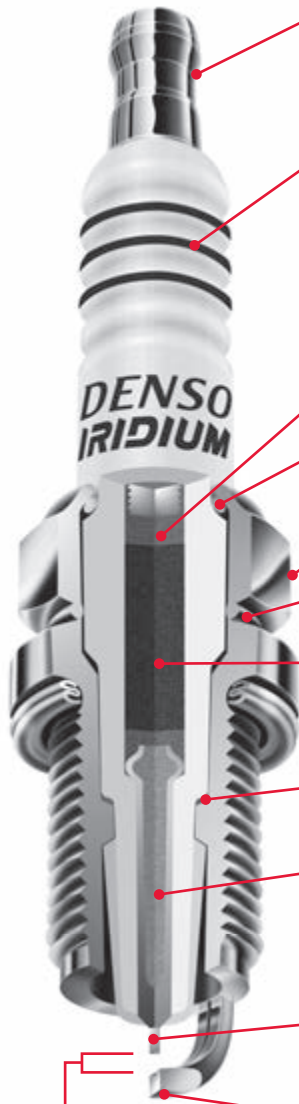

Клемма

- > С резьбой, съёмный, съёмная, обжатая или цельная

Керамический изолятор

- > На его поверхности имеются пять ребер
- > Это снижает потери напряжения и предотвращает пропуски искровых разрядов
- > Используется оксид алюминия высокой чистоты
- > Хорошая электрическая изоляция, долговечность и теплопроводность
- > Химическая стабильность

Специальное медно-стеклянное уплотнение

- > Хорошие газонепроницаемость, долговечность и теплопроводность

Кольцо

Корпус

- > Никелевое покрытие с высокими антикоррозийными свойствами

Запрессовка при электрическом нагреве

- > Термостойкость, хорошая герметичность и малые изменения в диапазоне нагрева

Резистор

- > Сопротивление 5 ком, снижает радиопомехи

Уплотнение

Центральный электрод с сердечником из меди

- > По сравнению с другими производителями, DENSO использует сплавы с большим содержанием меди для улучшения тепловых характеристик
- > Мощная устойчивая искра в диапазоне от малых до высоких скоростей

Центральный электрод

- > Свечи зажигания DENSO IRIDIUM имеют самый тонкий в мире центральный электрод диаметром 0,4 мм

Заземляющий электрод

- > Доступны с U-образным пазом, обеспечивающим более полное сгорание горючего
- > Конусообразная форма гарантирует стабильность зажигания
- > Доступны с платиновыми наконечниками, увеличивающими срок службы
- > Доступны с игольчатыми наконечниками, обеспечивающими более длительный срок службы и наилучшую воспламеняемость

Искровой зазор

- > Большинство свечей зажигания DENSO поставляются с отрегулированным искровым зазором, поэтому вам не нужно его регулировать самостоятельно

RU

Иридиевые / Платиновые / Стандартные

ОБОЗНАЧЕНИЕ СВЕЧЕЙ ЗАЖИГАНИЯ DENSO																																																														
	W	16	E	XR	-U	11																																																								
S	K	20		PR	-A	11																																																								
S	XU	22	H	CR	-11S																																																									
Тип благородного металла	Диаметр резьбы и размер шестигранника	Калильное число	Длина резьбы	Тип электрода	Конфигурация зазора	Зазор																																																								
DИридиевый центральный электрод диаметром 0.7 мм с платиновой иглой на боковом электроде диаметром 0.7 мм (SIP) EИридиевый центральный электрод диаметром 0.7 мм с платиновой иглой на боковом электроде диаметром 1.0 мм (SIP) FИридиевый центральный электрод диаметром 0.55 мм с платиновой иглой на боковом электроде (SIP) PИПлатиновый центральный электрод диаметром 1.1 мм с платиновой накладкой на боковом электроде SИридиевый центральный электрод диаметром 0.7 мм с платиновой накладкой на боковом электроде SVИридиевый центральный электрод диаметром 0.4 мм с платиновой накладкой на боковом электроде ZИридиевый центральный электрод диаметром 0.55 мм с платиновой накладкой на боковом электроде	C12x14.0 L18x22.2 (Длина резьбы: 12.7 мм) M18x25.4 (Длина резьбы: 12 мм) MA18x20.6 (Коническое гнездо, длина резьбы: 12 мм) MW18x20.6 (Длина резьбы: 12 мм) J14x20.6 (Выступающая свеча) K14x16.0 KJ14x16.0 (Выступающая свеча) LP14x20.6 (Свеча для двигателей, работающих на СПГ) Q14x16.0 QJ14x16.0 (Выступающая свеча) QL14x20.6 (Длинный цилиндрический корпус) S14x20.6 (Свеча с поверхностным зазором) T14x16.0 (Коническое гнездо) W14x20.6 X12x18.0 XE12x14.0 XU12x16.0 N10x16.0 U10x16.0 Y8x13.0	<table border="1"> <tr> <th>DENSO</th> <th>NGK</th> <th>CHAMPION</th> <th>BOSCH</th> </tr> <tr> <td>4</td> <td></td> <td></td> <td></td> </tr> <tr> <td>9</td> <td>2</td> <td>18</td> <td>10</td> </tr> <tr> <td>14</td> <td>4</td> <td>16,14</td> <td>9</td> </tr> <tr> <td>16</td> <td>5</td> <td>12,11</td> <td>8</td> </tr> <tr> <td>20</td> <td>6</td> <td>10,9</td> <td>7,6</td> </tr> <tr> <td>22</td> <td>7</td> <td>8,7</td> <td>5</td> </tr> <tr> <td>24</td> <td>8</td> <td>6,63,61</td> <td>4</td> </tr> <tr> <td>27</td> <td>9</td> <td>4,59</td> <td>3</td> </tr> <tr> <td>29</td> <td>9.5</td> <td>57</td> <td></td> </tr> <tr> <td>31</td> <td>10</td> <td>55</td> <td>2</td> </tr> <tr> <td>32</td> <td>10.5</td> <td>53</td> <td></td> </tr> <tr> <td>34</td> <td>11</td> <td></td> <td></td> </tr> <tr> <td>35</td> <td>11.5</td> <td></td> <td></td> </tr> </table>	DENSO	NGK	CHAMPION	BOSCH	4				9	2	18	10	14	4	16,14	9	16	5	12,11	8	20	6	10,9	7,6	22	7	8,7	5	24	8	6,63,61	4	27	9	4,59	3	29	9.5	57		31	10	55	2	32	10.5	53		34	11			35	11.5			A19.0 mm (Выступ электродов: 7.0 mm) J16AR-U11 A21.5 mm S29A B19.0 mm (Выступ электродов: 9.5 mm) J16BR-U C19.0 mm (Выступ электродов: 5.0 mm) KJ20CR-L11 D19.0 mm (Экран 2) K20DTR-S11 E (Прокладка) ... 19.0 mm W16EX-U E (Прокладка) ... 20.0 mm W25EBR E (Коническое гнездо) ... 19.0 mm T16EPR-U F12.7 mm W20FP-U FE19.0 mm (Резьба на половину длины) U24FER9 G19.0 mm (Экран 3.5) PK20GR8 G19.0 mm (Экран 3) X27GPR-U H26.5 mm QJ16HR-U H19.0 mm (Выступ электродов: 8.5 mm) K16HPR-U11 L11.2 mm W14L N (Коническое гнездо, резьба на половину длины) ... 17.5 mm T20NR-U11 V (Коническое гнездо) ... 25.0 mm PT16VR13 Нет9.5 mm W14M-U 11.2 mm L14-U, M24S 19.0 mm SK20R11 21.5 mm S29A Нет (Коническое гнездо) ... 8.3 mm T20M-U 11.2 mm T16PR-U	AДвойные заземляющие электроды W22EA AYДвойные заземляющие электроды; наклонные J16AY BТройные заземляющие электроды W22EB BGТройные заземляющие электроды (экранированная) SK20BGR11 CЭкран 1.5 mm SXU22HCR11 D4 заземляющих электрода W27EDR DВыступающая (1.5 mm выступ, выступ электродов 3.5 mm) XU22HDR9 EЭкран: 2.0 mm FXE20HE11 KВыступающая (1 mm выступ) W16EKR-S11 LMКомпактный тип (Размер шестигранника 20.6 mm) W14LM-U MУкороченная головка изолятора W27EMR-C MКомпактный тип (размер шестигранника 19.0 mm) W20M-U PВыступающая (1.5 mm выступ) W16EP-U QВыступающая 2 mm, выступ электродов 3.5 mm R5 кОм резистор K16R-U SПолуповерхностный зазор (0 mm выступ) W22ES-U SИридий на одной стороне KJ20SR11 TДвойные заземляющие электроды K16TR11 TMДвойные заземляющие электроды K22TMR11 TNДвойные заземляющие электроды K22TNR-S XСильно выступающая (2.5 mm выступ) W16EX-U	-AСпециальная характеристика SK16PR-A11 -BСпециальная характеристика K16PSR-B8 -CСрезанный заземляющий электрод W27EMR-C -DЗаземляющий электрод с медным сердечником DK20PR-D13 -EСпециальная характеристика SK16PR-E11 -FСпециальная характеристика SK16PR-F11 -GСмазанная резьба (для двигателей СПГ) SK20R8-G -GLПлатиновый центральный электрод X22EPR-GL -LТермостойкий заземляющий электрод K20PR-L11 -L3.5 mm выступ изолятора свечи для мотоциклов W20FP-UL -LЗаглубленный изолятор для мотоциклов W20FR-L -MУвеличенный заземляющий SK20PR-M11S -NДля Yamaha и Kawasaki U27ESR-N -PДвойной слой платины на заземляющем электроде SK20R-P11 -PОдносторонняя платиновая свеча K16PR-P11 -R10K ом резистор K22PR-UR -SПолуплоскостной зазор W20EP-S11 -SПрокладка из нержавеющей стали U27FER9S -TДля СПГ SK20HR8-T -TСпециальная характеристика FK20HBR11-T -TPПлатиновый центральный электрод; конический заземляющий K20PR-TP11 -UU-образный паз в заземляющем электроде K16PR-U -USЗвездообразный центральный электрод W20M-US -V1.3 mm диаметр, никелевый центральный электрод W27ES-V	50.5 mm (.020") 80.8 mm (.032") 90.9 mm (.035") 101.0 mm (.040") 111.1 mm (.044") 131.3 mm (.050") 141.4 mm (.055") 151.5 mm (.060") <Нет> Авто: 0.8 mm Мото: 0.7 mm <Исключения> P16R, PQ16R, PQ20R - 1.1 mm
DENSO	NGK	CHAMPION	BOSCH																																																											
4																																																														
9	2	18	10																																																											
14	4	16,14	9																																																											
16	5	12,11	8																																																											
20	6	10,9	7,6																																																											
22	7	8,7	5																																																											
24	8	6,63,61	4																																																											
27	9	4,59	3																																																											
29	9.5	57																																																												
31	10	55	2																																																											
32	10.5	53																																																												
34	11																																																													
35	11.5																																																													

RU

IRIDIUM POWER® Серия Iridium Power (Power, Tough, Plus)

ОБОЗНАЧЕНИЕ СВЕЧЕЙ ЗАЖИГАНИЯ DENSO																																															
I	U	27	A																																												
VF	KH	20																																													
																																															
Высокоэффективные свечи	Диаметр, длина резьбы, размер шестигранника	Калильное число	Тип																																												
<p>I..... Иридиевый центральный электрод диаметром 0.4 mm</p> <p>V..... Иридиевый центральный электрод диаметром 0.4 mm с платиновой накладкой на боковом электроде</p> <p>VF..... Иридиевый диаметр 0.4 mm с платиновой иглой на боковом электроде диаметром 0.7 mm (SIP)</p> <p>VD..... Иридиевый диаметр 0.4 mm с платиновой иглой на боковом электроде диаметром 0.7 mm (SIP)</p>	<p>< Диаметр резьбы X длина резьбы X размер шестигранника ></p> <p>CH ... 12x26.5x14.0</p> <p>K..... 14x19.0x16.0</p> <p>KA ... 14x19.0 (Экранированная, новые тройные электроды)x16.0</p> <p>KV ... 14x19.0 (Новые тройные электроды)x16.0</p> <p>KVH · 14x26.5 (Новые тройные электроды)x16.0</p> <p>KD ... 14x19.0 (Экранированная)x16.0</p> <p>KH ... 14x26.5x16.0</p> <p>NH ... 10x19.0 (Резьба на половину длины)x16.0</p> <p>T..... 14x17.5 (Коническое гнездо)x16.0</p> <p>TF ... 14x11.2 (Коническое гнездо)x16.0</p> <p>TL ... 14x25.0 (Коническое гнездо, длинный изолятор)x16.0</p> <p>TV ... 14x25.0 (Коническое гнездо)x16.0</p> <p>Q ... 14x19.0x16.0</p> <p>U..... 10x19.0x16.0</p> <p>UF..... 10x12.7x16.0</p> <p>UH ... 10x19.0 (Резьба на половину длины)x16.0</p> <p>W..... 14x19.0x20.6</p> <p>WF ... 14x12.7x20.6</p> <p>WM ... 14x19.0x20.6 (Компактный изолятор)</p> <p>X..... 12x19.0x18.0</p> <p>XEN · 12x26.5 (Экран 2.0)x14.0</p> <p>XG ... 12x19.0 (Экран 3.0)x18.0</p> <p>XU ... 12x19.0x16.0</p> <p>XUH · 12x26.5x16.0</p> <p>Y..... 8x19.0 (Резьба на половину длины)x13.0</p>	<table border="1"> <thead> <tr> <th>DENSO</th> <th>NGK</th> <th>CHAMPION</th> <th>BOSCH</th> </tr> </thead> <tbody> <tr> <td>16</td> <td>5</td> <td>12,11</td> <td>8</td> </tr> <tr> <td>20</td> <td>6</td> <td>10,9</td> <td>7,6</td> </tr> <tr> <td>22</td> <td>7</td> <td>8,7</td> <td>5</td> </tr> <tr> <td>24</td> <td>8</td> <td>6,63,61</td> <td>4</td> </tr> <tr> <td>27</td> <td>9</td> <td>4,59</td> <td>3</td> </tr> <tr> <td>29</td> <td>9.5</td> <td>57</td> <td></td> </tr> <tr> <td>31</td> <td>10</td> <td>55</td> <td>2</td> </tr> <tr> <td>32</td> <td>10.5</td> <td>53</td> <td></td> </tr> <tr> <td>34</td> <td>11</td> <td></td> <td></td> </tr> <tr> <td>35</td> <td>11.5</td> <td></td> <td></td> </tr> </tbody> </table>	DENSO	NGK	CHAMPION	BOSCH	16	5	12,11	8	20	6	10,9	7,6	22	7	8,7	5	24	8	6,63,61	4	27	9	4,59	3	29	9.5	57		31	10	55	2	32	10.5	53		34	11			35	11.5			<p>A..... Наклонный электрод, без U-образного паза, форма не конусообразная</p> <p>B..... Изолятор, выступающий на 1.5 mm</p> <p>C..... Без U-образной выемки</p> <p>D..... Без U-образной выемки, заземляющий электрод из инконеля</p> <p>E..... Экран: 2 mm</p> <p>ES... Прокладка из нерж. стали</p> <p>F..... Специальная характеристика</p> <p>G..... Прокладка из нерж. стали</p> <p>I..... Выступ электродов: 4 mm; Изолятор, выступающий на 1.5 mm</p> <p>J..... Выступ электродов: 5 mm</p> <p>K..... Выступ электродов: 4 mm; Изолятор, выступающий на 2.5 mm</p> <p>L..... Выступ электродов: 5 mm</p> <p>T..... Для использования в газовых двигателях</p> <p>Y..... Зазор 0.8 mm</p> <p>Z..... Конусообразная форма</p>
DENSO	NGK	CHAMPION	BOSCH																																												
16	5	12,11	8																																												
20	6	10,9	7,6																																												
22	7	8,7	5																																												
24	8	6,63,61	4																																												
27	9	4,59	3																																												
29	9.5	57																																													
31	10	55	2																																												
32	10.5	53																																													
34	11																																														
35	11.5																																														

TT

ОБОЗНАЧЕНИЕ СВЕЧЕЙ ЗАЖИГАНИЯ DENSO																			
I	W	16	TT																
	XEN	20	ETT																
																			
Тип драгоценного металла	Диаметр, длина резьбы, размер шестигранника	Калильное число	Тип																
<p>I..... Иридиевый центральный электрод диаметром 0.4 mm с платиновой иглой 0.7 mm на боковом электроде</p>	<p>< Диаметр резьбы X длина резьбы X размер шестигранника ></p> <p>K..... 14x19.0x16.0</p> <p>KVH · 14x26.5 (новые тройные электроды)x16.0</p> <p>KH ... 14x26.5x16.0</p> <p>Q ... 14x19.0x16.0</p> <p>T..... 14x17.5 (с конической посадочной поверхностью)x16.0</p> <p>TF ... 14x11.2 (с конической посадочной поверхностью)x16.0</p> <p>TL ... 14x25.0 (с конической посадочной поверхностью, удлиненным изолятором)x16.0</p> <p>TV ... 14x25.0 (с конической посадочной поверхностью)x16.0</p> <p>W..... 14x19.0x20.6</p> <p>WF ... 14x12.7x20.6</p> <p>XEN · 12x26.5 (Shroud 2.0)x14.0</p> <p>XU ... 12x19.0x16.0</p> <p>XUH · 12x26.5x16.0</p>	<table border="1"> <thead> <tr> <th>DENSO</th> <th>NGK</th> <th>CHAMPION</th> <th>BOSCH</th> </tr> </thead> <tbody> <tr> <td>16</td> <td>5</td> <td>12,11</td> <td>8</td> </tr> <tr> <td>20</td> <td>6</td> <td>10,9</td> <td>7,6</td> </tr> <tr> <td>22</td> <td>7</td> <td>8,7</td> <td>5</td> </tr> </tbody> </table>	DENSO	NGK	CHAMPION	BOSCH	16	5	12,11	8	20	6	10,9	7,6	22	7	8,7	5	<p>E..... Экран: 2 mm IXEN20ETT</p> <p>TT... Nickel TT (центральный электрод диаметром 1.5 mm, боковой электрод диаметром 1.5 mm) W16TT</p> <p>TT... Iridium TT (центральный электрод диаметром 0.4 mm, боковой электрод диаметром 0.7 mm) IW16TT</p> <p>I..... Искровой зазор: 4 mm Выступающий изолятор (1.5 mm) XUH20TTI</p>
DENSO	NGK	CHAMPION	BOSCH																
16	5	12,11	8																
20	6	10,9	7,6																
22	7	8,7	5																

RU

Ассортимент свечей накаливания

Свечи накаливания DENSO соответствуют качеству оригинального оборудования и пригодны для использования во всех автомобилях.

Инновационность продукции обусловлена богатым опытом корпорации DENSO, являющейся одним из ведущих мировых поставщиков оригинальных свечей накаливания для производителей автомобилей во всем мире. Наш ассортимент для рынка запчастей по свечам накаливания включает в себя 138 моделей, обеспечивающих более 4800 вариантов применения, что соответствует 98% автопарка Европы. Продолжающиеся доработки призваны постоянно улучшать и обновлять ассортимент.

Программа свечей накаливания DENSO объединяет все новейшие технологии производства и включает следующие типы свечей накаливания: с одной спиралью, с двумя спиральями, с продолжительным послепусковым нагревом, керамические и мгновенного нагрева.

Преимущества свечей накаливания DENSO:

- > Свечи накаливания соответствуют качеству оригинального оборудования, что отвечает требованиям производителей или даже превышает их
- > Более быстрое время разогрева и безотказный запуск холодного двигателя
- > Повышенная температура подогрева для снижения выбросов
- > Широкая применимость гарантирует возможность установки практически на любой двигатель в Европе
- > Более широкий диапазон применения с меньшим количеством разновидностей
- > Простота системы обозначения деталей
- > Соответствует стандартам ISO TS 16949, ISO 14001 и OHSAS 18001

Сравнение типов свечей накаливания DENSO

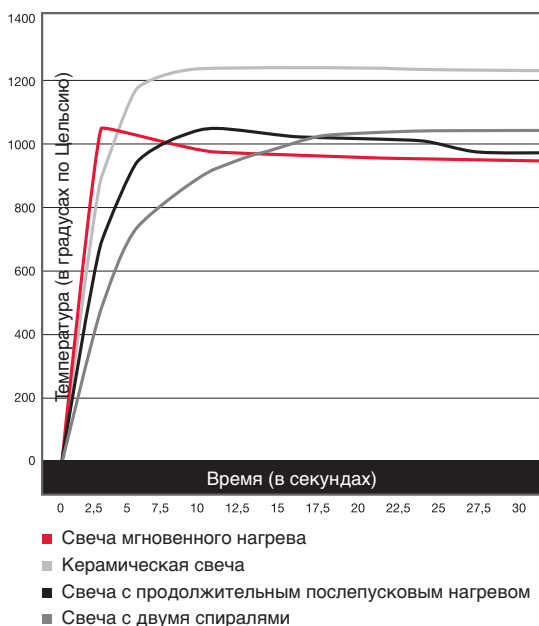

Как устанавливать свечи накаливания

Рекомендуемые технические данные затяжки свечей DENSO:

1. Используйте надлежащий ключ для свечи накаливания и клеммы.
2. При замене свечей накаливания следите за тем, чтобы при демонтаже свечи масло, загрязнения с наружной поверхности свечи и т.д. не попадали в цилиндр.
3. При монтаже свечи накаливания очистите фланец двигателя и установите свечу вровень с головкой цилиндра.
4. Убедитесь в том, что свеча установлена правильно, и закрутите ее вручную до упора.
5. После этого затяните ее ключом в точном соответствии с моментом затяжки, указанным в таблице ниже.

РЕКОМЕНДУЕМЫЕ ВЕЛИЧИНЫ МОМЕНТОВ ЗАТЯЖКИ ПРИ УСТАНОВКЕ		
Диаметр резьбы	Рекомендуемый момент	
Свечи накаливания	M8x1.00	8-10 Nm
	M9x1.00	8-10 Nm
	M10x1.00	10-12 Nm
	M10x1.25	10-12 Nm
	M12x1.25	15-20 Nm
	M14x1.25	20-25 Nm
Клемма	M4x0.7	1-1.5 Nm
	M5x0.8	3-4 Nm

⚠ НЕЛЬЗЯ СМАЗЫВАТЬ РЕЗЬБУ! При смазке резьбы трение между свечой накаливания и головкой цилиндра уменьшается; в результате возникает чрезмерная затяжка.

⚠ Затяжка с моментом, превышающим значения из вышестоящей таблицы, может привести к поломке свечи накаливания или двигателя.

⚠ Неисправность свечей накаливания чаще всего вызвана слишком высоким напряжением и/или высокой температурой. Свечи накаливания разработаны для эксплуатации в диапазоне температур от 850°C до 1100°C. В случае подачи электрического тока на свечу накаливания в течение слишком долгого времени (что может быть вызвано неисправностью блока управления или реле накаливания) может произойти перегревание свечи, которое приведет к увеличению ее размера, расслоению или разрушению и в итоге к выходу свечи из строя. В связи с этим рекомендуется проверить все электрооборудование перед заменой свечей накаливания. Ранний момент впрыска, неправильная установка инжектора или прямое попадание топлива в камеру сгорания двигателя вызывают чрезмерное увеличение температуры сгорания, что также приводит к повреждению свечей накаливания. **Неисправное реле или контроллер также могут вызвать повреждение свечей накаливания,** поэтому рекомендуется проверять всю систему впрыска перед заменой свечей накаливания на новые.

RU

Конструкция свечи накаливания

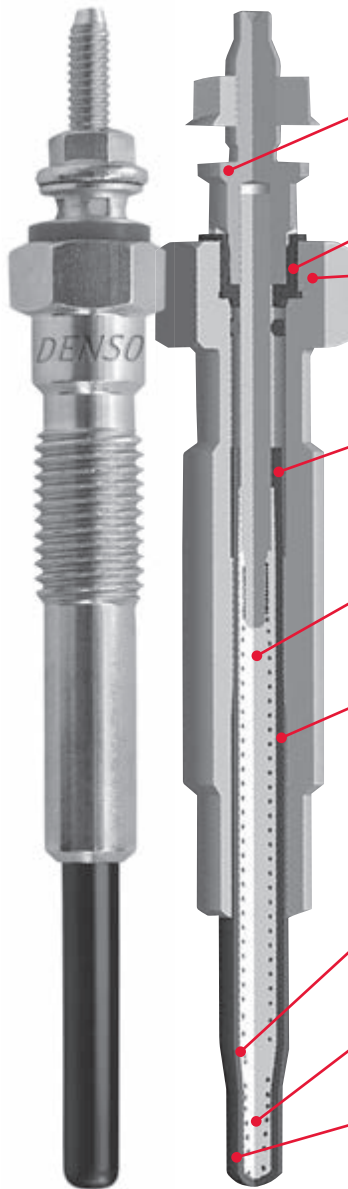

Контактный стержень и корпус

> Корпус и контактный стержень снаружи имеют покрытие из цинка для коррозионной стойкости.

Изолятор

> Изолятор свечи накаливания обладает исключительной прочностью, изоляцией и теплопроводностью, что полностью исключает возможность возникновения короткого замыкания.

Оболочка

> Оболочка из сплава металлов защищает свечу накаливания, обеспечивая ее жаропрочность при любых погодных условиях.

Уплотнение

> Резиновое уплотнение защищает от проникновения воздуха и предохраняет спираль от коррозии.

Изоляция

> Электрическая изоляция спирали обеспечивается благодаря плотно запрессованному порошку из окиси магния, который также является эффективным теплопроводником.

Регулирующая спираль

> Главная спираль контролирует и поддерживает рост температуры, а также гарантирует быстрое нагревание.

Соединение спиралей

> Лазерная сварка соединяет нагревательную и регулировочную спирали, что придает стабильность их положению в любой момент и обеспечивает устойчивые характеристики сопротивления.

Нагревательная спираль

> Более короткая витая спираль, расположенная в самом конце свечи накаливания, обеспечивает быстрый запуск двигателя (всего за 3 секунды) даже в холодных условиях. Она может сохранять остаточный накал до шести минут после холодного запуска. Это способствует снижению выбросов в выхлопных газах двигателя.

Наконечник

> Зауженный наконечник свечи гарантирует повышенный тепловой КПД и превосходные эксплуатационные характеристики.

Выпуск прекращен/Заменена

Артикул DENSO	ЗАМЕНЕНА НА	ВЫПУСК ПРЕКРАЩЕН
DXE22HCR11S	VFXEHC22G	
FC16HR-C9	FC16HR-CY9	
FC20HPR8	IXEH22TT	
FK16HQR11	IKH16TT	
FK16PR11	IK16TT	
FK16R-AL8	FK16BR-AL8	
FK20HBR11-T	IKBH20TT	
FK20HBR-TJ8	IKBH20TT	
FK20HQR10	IKH20TT	
FK20HQR8	IKH20TT	
IK20C11	IK20TT	
IKH16	IKH16TT	
IKH20	IKH20TT	
IQ16	IQ16TT	
IQ20	IQ20TT	
IRE01-35		x
IT16	IT16TT	
IT20	IT20TT	
ITF16	ITF16TT	
ITF20	ITF20TT	
ITL16	ITL16TT	
ITV16	ITV16TT	
ITV20	ITV20TT	
IU22D	IU22	
IU31D	IU31	
IUH22D	IUH24D	
IXU22C	IXU22	
IXU22HPR	VXUH22	
J14CR-U	J16CR-U	
J14C-U	J16CR-U	
J16A-U11	J16AR-U11	
J16AY		x
J16AYR		x
J16BR-U11	J16BR-U	
J16B-U11	J16BR-U	
J16C-U	J16CR-U	
J16HR-U10	J16BR-U	
J20AY		x
K16DTR-S11		x
K16PR-P11	IK16TT	
K16PR-TP11	IK16TT	
K16PR-UR	IK16TT	
K16PR-ZU11	IK16TT	
K16P-U	K16PR-U	
K16P-U11	K16PR-U11	
K16PZR13	IK16TT	
K16R-ZU11	IK16TT	
K16SR14	IK16TT	
K16-U	K16R-U	
K16-U11	K16R-U11	
K20DTR-S11		x
K20PR-L11S		x
K20PR-SU9	IK20TT	
K20PR-TP11	IK20TT	
K20PR-U9S	IK20G	
K20PR-UR	IK20TT	
K20PR-ZU11	IK20TT	
K20PTR-S	IK20TT	

Артикул DENSO	ЗАМЕНЕНА НА	ВЫПУСК ПРЕКРАЩЕН
K20P-U11	K20PR-U11	
K20R-ZU11	IK20TT	
K20SR11	IK20TT	
K20SR14	IK20TT	
K20-U	K20R-U	
K20-U11	K20R-U11	
K22P11	IK22	
K22PB	K22PBR-S	
K22PR-UR	IK22	
K22PR-ZU	IK22	
K22TM11	IK22	
K22TMR11	IK22	
K22TNR	K22TNR-S	
K24PR-ZU	IK24	
K27A-Z	IK27	
K27PR-ZU	IK27	
K29A-Z	IK31	
K31A-Z	IK31	
KJ14CR11	KJ14CR-L11	
KJ16CR	KJ16CR-U11	
KJ16CR11	KJ16CR-U11	
KJ20CR11	KJ20CR-U11	
KJ20DR-M11S	SKJ20DR-M11S	
KJ20SR11	IK20L	
KJ22CR11	KJ22CR-L11	
LP20R-U	VW20T	
LP20-U	VW20T	
MA16PR-U11	MA16PR-U	
MA16PR-U15	MA16PR-U	
MA16P-U	MA16PR-U	
MA16R-U	MA16PR-U	
MA20R-U	MA20PR-U	
MA20R-U11	MA20PR-U	
MA9PR-U	MA9P-U	
MW22		x
MW9	MW17	
P16PR8	P16PR11	
P16R8	IW16TT	
P20PR8	IW20TT	
P20PR-P8	IW20TT	
P20PR-S11	P20PR11	
P20R11	IW20TT	
P20R8	VW20T	
PK16R8	PK16R11	
PK20R-P8	IK20TT	
PK22PR11	PK22PR8	
PK22PR-L11	PK22PR-L11S	
PKJ16CR-L13	PKJ16CR-L11	
PKJ20CR-L13	PKJ20CR-L11	
PQ16R13	IQ16TT	
PQ16R8	IQ16TT	
PQ16R-P11	IQ16TT	
PQ20R13	PQ20R	
PQ20R8	PQ20R	
PQ20R-P11	IQ20TT	
PT16EPR10	PT16EPR-L13	
PT16EPR13	PT16EPR-L13	
PT16EPR-C13	IT16TT	

Выпуск прекращен/Заменена

АРТИКУЛ DENSO	ЗАМЕНЕНА НА	ВЫПУСК ПРЕКРАЩЕН
PTJ14R15	IT16TT	
Q16PR-TP11	IQ16TT	
Q16PR-U15	Q16PR-U11	
Q16PR-ZU11	IQ16TT	
Q16R-ZU11	IQ16TT	
Q16-U	Q16R-U	
Q16-U11	Q16R-U11	
Q16-ZU11	IQ16TT	
Q20PR-P11	IQ20TT	
Q20PR-ZU11	IQ20TT	
Q20R-ZU11	IQ20TT	
Q20-U	Q20R-U	
Q20-U11	Q20R-U11	
Q20-ZU11	IQ20TT	
Q22PR-P11	IQ22	
Q22PR-ZU	IQ22	
Q22PR-ZU11	IQ22	
Q24PR-ZU	IQ24	
Q27PR-ZU	IQ27	
Q29A-Z	IQ31	
Q31A-Z	IQ31	
QJ14C11	QJ16CR11	
QJ16AR-U11	QJ16AR-U	
QJ16C11	QJ16CR11	
QJ16HR-U9	QJ16HR-U	
QL20PR-U		x
QL20TR-S		x
QL22TR-S		x
QL22VR-ZU		x
S20R8-G	VW20T	
S-25	IRE01-27	
S-27	IRE01-27	
S-29	IRE01-27	
S-29A	IRE01-27	
SC20HR11	SC16HR11	
SF-10	SF-50	
SK16PR-E13	SK16PR-E11	
SK16PR-F8	IK16TT	
SK16R8-PG	VK20Y	
SK20HPR-L11	IKH20TT	
SK20HR-GT8	VKH20Y	
SK20PR-B8	VK20Y	
SK20PR-F8	IK20TT	
SK20PR-L9S	VK20G	
SK20R5		x
SK20R8	VK20Y	
SK20R8-G	VK20Y	
SVK20RZ11	IK20TT	
SVK20RZ8	VK20Y	
SXE24HCR8S	VXEHC24G	
SXU16HPR9		x
SXU20HPR11	VXUH20I	
SXU22HPR9	VXUH22I	
SXU22HR9	VXUH22I	
SXU22PR-A9	VXU22	
T14PR-U15	T14PR-U	
T16EX-U	T16EPR-U	
T16PR-U15	T16PR-U11	

АРТИКУЛ DENSO	ЗАМЕНЕНА НА	ВЫПУСК ПРЕКРАЩЕН
T16PR-U20	T16PR-U11	
T16P-U	T16PR-U	
T16R-U15	T16R-U	
T16-U15	T16R-U	
T20EP-U15	T20EPR-U15	
T20EX-U	T20EP-U	
T20PR-U15	T20PR-U11	
T20P-U	T20PR-U	
TJ14R-P15	IT16TT	
TJ16R15	PTJ16R15	
TR20	W20FS-U	
TR22	W22FS-U	
TR24	W24FS-U	
TR24-10	W24FS-U10	
U14FS-UB	U14FSR-UB	
U16FS-L	U16FS-U	
U20FER9		x
U20FS-ZU	IUF22	
U20M-U		x
U22ES-N	U22ESR-N	
U22FS-ZU	IUF22	
U24ES-N	U24ESR-N	
U24ESR-NZU	IU24	
U24FE9	U24FER9	
U24FER9S	IUH24	
U24FER-ZU9	IUH24	
U24FE-ZU9	IUH24	
U24FS-C	U24FS-U	
U24FS-L	U24FS-U	
U24FSR-C	U24FSR-U	
U27EPR-N9	U27EPR9	
U27ESR-NZU	IU27	
U27FE9	U27FER9	
U27FER-ZU9	IUH27	
U31ESR-NZU	IU31	
U31ESR-PT	IU01-31	
U31FER9	U31ESR-N	
U31FER-ZU9	IU31	
U31FS-ZU		x
U34ES-NZU	IU01-34	
U34ESR-PT	IU01-34	
U34FER-ZU9	IU01-34	
U34FS-ZU		x
U37ESR-PT		x
VCH16	IXEH20TT	
VCH20	IXEH22TT	
VFCH16	IXEH20TT	
VFK16	IK16TT	
VFKBH20	IKBH20TT	
VFKH16	IKH16TT	
VFKH20	IKH20TT	
VFXEH20	IXEH20TT	
VFXEH20E	IXEH20ETT	
VFXEH22	IXEH22TT	
VK16	IK16TT	
VK20	IK20TT	
VK20T	VK20Y	
VKH16	IKH16TT	

Выпуск прекращен/Заменена

Артикул DENSO	ЗАМЕНЕНА НА	ВЫПУСК ПРЕКРАЩЕН
VKH20	IKH20TT	
VKH20T	VKH20Y	
VQ16	IQ16TT	
VQ20	IQ20TT	
VT16	IT16TT	
VT20	IT20TT	
VW16	IW16TT	
VW16R-A13	IW16TT	
VW20	IW20TT	
W14		x
W14EKR-S11		x
W14EP	W14EPR-U	
W14EPR	W14EPR-U	
W14EPR11	W14EXR-U11	
W14EP-U	W14EPR-U	
W14EXR-U13	W14EXR-U11	
W14EXR-U15	W14EXR-U11	
W14EXR-ZU	IW16TT	
W14EX-U11	W14EXR-U11	
W14EX-U13	W14EXR-U11	
W14FP	W14FPR-U	
W14FP-L	W14FPR-UL	
W14FPR	W14FPR-U	
W14FPR-L	W14FPR-UL	
W14FPR-UL10	W14FPR-UL	
W14FP-UL	W14FPR-UL	
W14FP-UL10	W14FPR-UL	
W14F-U10	W14F-U	
W14LMR-US	W14LM-U	
W14LM-US	W14LM-U	
W14MP-U10	W14MPR-U10	
W14M-U	W14MR-U	
W14M-U10	W14MR-U	
W14M-US	W14MR-U	
W14PR-U15	W14PR-U	
W14P-U	W14PR-U	
W14-U	W14PR-U	
W14-U10	W14PR-U	
W14-US	W14PR-U	
W16DTR-S		x
W16EK-S11	W16EKR-S11	
W16EP	W16EP-U	
W16EP11	W16EPR-U11	
W16EPR	W16EPR-U	
W16EPR11	W16EPR-U11	
W16EPR-S11	W16EPR-U11	
W16EPR-U10	W16EPR-U11	
W16EP-U11	W16EPR-U11	
W16EP-ZU	IW16TT	
W16ES-L	W16ESR-U	
W16ESR-L	W16ESR-U	
W16ES-U	W16ESR-U	
W16ET-L	W16ETR-S	
W16ET-S	W16ETR-S	
W16EX-GU	IW16TT	
W16EXR-U13	W16EXR-U11	
W16EXR-ZU	IW16TT	
W16EX-U11	W16EXR-U11	

Артикул DENSO	ЗАМЕНЕНА НА	ВЫПУСК ПРЕКРАЩЕН
W16EX-U13	W16EXR-U11	
W16EX-ZU	IW16TT	
W16FP	W16FP-U	
W16FP-L	W16FP-U	
W16FPR	W16FPR-U	
W16FP-U10	W16FPR-U	
W16FP-UL	W16FP-U	
W16FS-ZU		x
W16PR-U15	W16PR-U	
W16P-U	W16PR-U	
W20DTR-S		x
W20DTR-SA		x
W20EA		x
W20EAR		x
W20EBR	W22EBR	
W20EK-S11	W20EKR-S11	
W20EP	W20EP-U	
W20EP11	W20EPR-U11	
W20EPR	W20EPR-U	
W20EPR11	W20EPR-U11	
W20EPR-U10	W20EPR-U11	
W20EPR-ZU	IW20TT	
W20EPR-ZU11	IW20TT	
W20EP-S11	W20EPR-S11	
W20EP-U11	W20EPR-U11	
W20EP-ZU	IW20TT	
W20ES-L	W20EKR-S11	
W20ES-L11	W20EKR-S11	
W20ESR-L	W20EKR-S11	
W20ESR-L11	W20EKR-S11	
W20ES-ZU		x
W20ET-L	W20ETR-L	
W20ETR	W20ETR-L	
W20ETR-L8	W20ETR-L	
W20ETR-S	IW20TT	
W20ET-S	IW20TT	
W20EVR-ZU	IW20TT	
W20EXR-U13	W20EXR-U11	
W20EXR-ZU	IW20TT	
W20EX-U11	W20EXR-U11	
W20EX-U13	W20EXR-U11	
W20EX-ZU	IW20TT	
W20FP	W20FP-U	
W20FP-L	W20FR-L	
W20FPR	W20FPR-U	
W20FPR-L	W20FR-L	
W20FPR-U10	W20FPR-U	
W20FPR-ZU	IWF20	
W20FP-U10	W20FP-U	
W20FR-L9	W20FR-L	
W20FS	W20FS-U	
W20FSR	W20FSR-U	
W20FS-U10	W20FS-U	
W20FS-ZU	IWF20	
W20FT-U	W20FP-U	
W20MP-U10	W20MPR-U10	
W20M-U	W20MR-U	
W20P-U	W20PR-U	

Выпуск прекращен/Заменена

АРТИКУЛ DENSO	ЗАМЕНЕНА НА	ВЫПУСК ПРЕКРАЩЕН
W20SR-U	W20S-U	
W21ES-L11	W20EKR-S11	
W21ESR-L11	W20EKR-S11	
W22EA	W22EBR	
W22EAR	W22EBR	
W22EB	W22EBR	
W22EDR	IRE01-27	
W22EDR14	IRE01-27	
W22EKR-S11	IW22	
W22EK-S11	IW22	
W22EP	W22EP-U	
W22EP11	W22EPR-U11	
W22EPB	W22TT	
W22EPR	W22EPR-U	
W22EPR11	W22EPR-U11	
W22EPR-S11	IW22	
W22EPR-ZU	IW22	
W22EPR-ZU11	IW22	
W22EP-S11	IW22	
W22EP-U11	W22EPR-U11	
W22EP-ZU	IW22	
W22ES	W22ES-U	
W22ES-L	IW22	
W22ES-L11	IW22	
W22ESR	W22ESR-U	
W22ESR-L	IW22	
W22ESR-L11	IW22	
W22ES-U11	W22ES-U	
W22ES-ZU	IW24	
W22ET-L	W22TT	
W22ETR-L	W22TT	
W22ETR-L8	W22TT	
W22EXR-U	W22EPR-U	
W22EXR-U11	W22EPR-U11	
W22EX-U	W22EP-U	
W22FP	W22FP-U	
W22FPR	W22FPR-U	
W22FPR-ZU	IWF22	
W22FP-U10	W22FP-U	
W22FS-U10	W22FS-U	
W22FS-ZU	IWF22	
W22MP-US	W22MP-U	
W22M-US	W22M-U	
W24EMR-C	IWM24	
W24EP	W24EPR-U	
W24EP11	W24EP-U	
W24EPR	W24EPR-U	
W24EPR-ZU	IW24	
W24ES	W24ES-U	
W24ESR-ZU	IW24	
W24ES-ZU	IW24	
W24FP	W24FP-U	
W24FPR	W24FPR-U10	
W24FPR-L	W24FPR-U10	
W24FS	W24FS-U	
W24FSR-U10	W24FSR	
W24FS-ZU	IWF24	
W25EA	W27EBR	

АРТИКУЛ DENSO	ЗАМЕНЕНА НА	ВЫПУСК ПРЕКРАЩЕН
W25EAR	W27EBR	
W25EB	W27EBR	
W25EBR	W27EBR	
W25EDR	IRE01-27	
W25EDR14	IRE01-27	
W25EN	IW01-24	
W25EPT	IW01-24	
W25FN	IWF24	
W27A-Z	IW27	
W27EDR14	IRE01-27	
W27EMR-C	IWM27	
W27EMR-ZU	IWM27	
W27EN	IW01-27	
W27EPT	IW01-27	
W27ES	W27ES-U	
W27ES-C	W27ES-U	
W27ESR-ZU	IW27	
W27ES-ZU	IW27	
W27FN	IWF27	
W27FS-ZU	IWF27	
W29A-Z	IW29	
W29EPT	IW01-29	
W29ESR-V	IW29	
W29ES-V	IW29	
W29ES-ZU	IW29	
W31A-Z	IW31	
W31EMR-C	IWM31	
W31EMR-ZU	IWM31	
W31EN	IW01-31	
W31EPT	IW01-31	
W31ESR-ZU	IW31	
W31ES-U	W31ESR-U	
W31ES-ZU	IW31	
W31FN		x
W31FPT		x
W31FS-ZU		x
W31S-U		x
W32EPT	IW01-32	
W34EMR-ZU	IWM01-34	
W34EN	IW01-34	
W34ES-ZU	IW34	
W34FN		x
W34FPT		x
W35EPT	IW01-34	
W37EPT		x
W37FN		x
W37FPT		x
W9EPR	W9EXR-U	
W9FP-L	W9FP-UL	
W9PR-U15	W9PR-U	
W9PR-U20	W9PR-U	
W9P-U	W9PR-U	
X16EP-U9	X16EPR-U9	
X16FS-U	X16FSR-U	
X20EP-U9	X20EPR-U9	
X20ES-U	X20ESR-U	
X20FS-U	X20FSR-U	
X20FS-ZU	X20FSR-U	

Новые типы свечей зажигания

Артикул DENSO	ЗАМЕНЕНА НА	ВЫПУСК ПРЕКРАЩЕН
X22EPR-GL	IX22B	
X22EPR-ZU9	IX22B	
X22EP-U	X22EPR-U9	
X22EP-U9	X22EPR-U9	
X22ESR-UB	IX22	
X22ES-ZU	IX22	
X22GPR-U	IXG24	
X22GP-U	IXG24	
X24EPR-GL	IX24B	
X24EPR-ZU9	IX24B	
X24EP-U	X24EPR-U9	
X24EP-U9	X24EPR-U9	
X24ESR-ZU	IX24	
X24ES-ZU	IX24	
X24FSR-U	X24FS-U	
X24FS-ZU		x
X24GP-U	X24GPR-U	
X27EPR-ZU9	IX27B	
X27EP-U9	X27EPR-U9	
X27ESR-ZU	IX27	
X27ES-ZU	IX27	
X27GP-U	X27GPR-U	
X29ES-ZU		x
X31ES-U	X31ESR-U	
X31ETR		x
X34ES-ZU	IXU01-34	
XU20EPR-ZU	IXU22	
XU20EP-U	XU20EPR-U	
XU20EP-ZU	IXU22	
XU22EP-P	IXU22	
XU22EPR-ZU	IXU22	
XU22EP-U	XU22EPR-U	
XU22HR9	XU22HDR9	
XU24EPR-ZU	IXU24	
XU24EP-U	XU24EPR-U	
XU24EP-ZU	IXU24	
XU27EPR-ZU	IXU27	
Y24ESR-NZU		x
Y24FER-C	IY24	
Y27FER	IY27	
Y27FER-C	IY27	
Y31FER-C	IY31	
Z4		x
Z4K		x
Z9		x
ZC20HPR11	IXEH22TT	
ZK20R11	IK20TT	
ZK20R13	IK20TT	
ZK20R7	VK20Y	
ZK20R9	VK20Y	
ZT16EPR11	IT16TT	
ZTJ16R10	IT16TT	
ZXE20HR13	IXEH20TT	
ZXE27HBR8	VXEBH27	
ZXU22HPR8	VXUH22	
ZXU22PR11	VXU22	

Артикул DENSO	МАРКА АВТОМОБИЛЯ	МОДЕЛЬ
FC16HR8	SUBARU	TREZIA (11-)
	TOYOTA	SIENTA (15-), YARIS (10-), RACTIS (10-)
FC16HR-CY9	TOYOTA	PRIUS (W5) (15-), C-HR (16-)
FK16BR-AL8	TOYOTA	COROLLA Axio (12-), COROLLA Fielder (12-), SIENTA (15-), YARIS (10-)
FK16HBR-J8	LEXUS	ES (12-)
	TOYOTA	CAMRY (V5) (11-)
FK16HR-A8	LEXUS	ES (12-)
	TOYOTA	AVALON (X4) (12-), HARRIER (13-), RAV 4 IV (12-)
SK20HR-A11	TOYOTA	FORTUNER (04-15)
VFXEHC22G	HONDA	ACCORD IX (12-), GRACE (14-), JAZZ IV (13-), ODYSSEY (RC1, RC2) (13-), SHUTTLE (15-), VEZEL (13-)
		NISSAN
	RENAULT	ESPACE V (15-), KADJAR (15-), MEGANE IV (15-), TALISMAN (15-)
VFXUHC22FG	HONDA	LEGEND V (14-)
VXEHC24G	ACURA	CDX (16-)
VDCH22F	HONDA	AVANCIER (16-), JADE (15-), CIVIC IX (12-), CIVIC X (16-), CR-V V (16-), STEPWAGON (15-), CIVIC X (16-)
	NISSAN	GT-R (09-)
VDKH22F	TOYOTA	AURIS (E18) (12-), C-HR (16-)
	LEXUS	GS (12-), IS III (13-), NX (14-), RC (14-), RX (15-),

Выпуск прекращен/Заменена

АРТИКУЛ DENSO	ЗАМЕНЕНА НА	ВЫПУСК ПРЕКРАЩЕН
DG-219	DG-651	
DG-221	DG-647	
DG-222		✗
DG-223	DG-652	
DG-224		✗
DG-226		✗
DG-227		✗
DG-233		✗
DG-234		✗
DG-236		✗
DG-306	DG-643	
DG-312	DG-646	
DG-401		✗

Новые типы свечей накаливания

АРТИКУЛ DENSO	МАРКА АВТОМОБИЛЯ	МОДЕЛЬ
DG-613	ALPINA	XD3 (F25) (13-) D3 (F31) (14-) D3 (E91) (05-12) D5 (F11) (11-) D3 (E90) (05-11)
		3 (E90, E91) (05-12) 5 (F10, F11) (10-16) 3 (F30, F31) (11-) 1 (E81, E87) (03-12) X1 (E84) (09-15)
	MINI	MINI Clubman (F54) (14-) MINI (F55, F56) (13-) MINI Convertible (F57) (14-) MINI Countryman (F60) (16-)
		TOYOTA
DG-616	MERCEDES-BENZ	C-CLASS (204) (07-14) E-CLASS (211) (02-09)
DG-617	MERCEDES-BENZ	SPRINTER 3,5 (906) (06-) E-CLASS (212) (09-) C-CLASS (204) (07-14) C-CLASS (205) (13-) GLK (X204) (08-15)
DG-620	CHRYSLER	300 C (11-)
	JEEP	Grand CHEROKEE IV (10-)
	LANCIA	THEMA (11-)
	RAM	1500 (DS) (10-)
	VOLVO	XC60 I (08-) V60 I (10-) V70 III (07-) XC70 II (07-) V40 (12-)
DG-622	AUDI	A4 (8E, B7) (04-08) A6 (4F, C6) (04-11) A3 (8P) (03-13)
	MITSUBISHI	GRANDIS (04-11)
	SEAT	LEON (1P) (05-12) ALTEA (XL) (5P) (04-) TOLEDO III (5P) (04-09)
	SKODA	OCTAVIA II (1Z) (04-13)
	VW	PASSAT (3C) (05-11) TOURAN (1T1, 1T2) (03-10) GOLF V (1K) (03-09) JETTA III (1K2) (05-10)
DG-641	HONDA	CIVIC
	OPEL	ASTRA COMBO CORSA MERIVA ZAFIRA
	VAUXHALL	ASTRA COMBO CORSA MERIVA ZAFIRA
DG-646	OPEL	SIGNUM VECTRA
	RENAULT	ESPACE VEL SATIS
	SAAB	9-5
	VAUXHALL	SIGNUM VECTRA

Новые типы свечей накаливания

АРТИКУЛ DENSO	МАРКА АВТОМОБИЛЯ	МОДЕЛЬ
DG-665	MERCEDES-BENZ	E-CLASS (212) (09-) C-CLASS (205) (13-) C-CLASS (204) (07-14) GLA (X156) (13-) GLC (X253) (15-)
DG-667	MAZDA	CX-5 (11-17) 6 (12-) 3 (13-)
DG-669	HYUNDAI	ix35 (09-) SANTA FÉ III (12-) SANTA FÉ II (06-12)
	KIA	SPORTAGE III (10-) SORENTO II (09-) CARNIVAL III (06-)

DENSO Таблица применения



Свечи зажигания и Свечи накаливания

Таблица применения

KW	KW	KW	KW	KW	СТАНДАРТНЫЕ			Twin Tip		QTY	
					STANDARD	STANDARD	STANDARD	TWIN TIP	TWIN TIP		
ABARTH											
124 Spider (348) (16-)											
1.4	125	55253268	40000km Lifetime	03/16-	IXU27	5337	0.9	-	-	4	
500 / 595 (C) (312) (07-)											
1.4	99/ 103/ 107/ 118/ 121/ 132/ 140	312 A1.000; 312 A3.000; 312 A9.000; 312 B3.000; 312 B4.000; 312 B6.000	40000km Lifetime	05/08-	IXU27	5337	0.9	-	-	4	
Grande PUNTO (05-12)											
1.4	114/ 132	199 A8.000; 955 A8.000	40000km Lifetime	12/07-12/12	IXU27	5337	0.9	-	-	4	
PUNTO Evo (08-12)											
1.4	120/ 132	199 A8.000; 955 A8.000	40000km Lifetime	03/12-02/12	IXU27	5337	0.9	-	-	4	
RITMO (78-88)											
2.0 125 TC	92	138 AR1.000		11/81-12/87	W22EPR-U	3088	0.8	W22TT	-	VW22	4
2.0 130 TC	96	138 AR2.000		04/83-12/87	W22EPR-U	3088	0.8	W22TT	-	VW22	4
AC											
ACE (95-98)											
4.9	191	99E		01/95-10/98	T16PR-U11	5026	1.1	-	ITF16TT	ITF16TT	8
ACE (98-)											
4.9	179	99E		10/98-	T16PR-U11	5026	1.1	-	ITF16TT	ITF16TT	8
4.9 Supercharger	239	99E		10/98-	T16PR-U11	5026	1.1	-	ITF16TT	ITF16TT	8
ACECA (93-01)											
4.9	179	99E		09/93-12/97	T16PR-U11	5026	1.1	-	ITF16TT	ITF16TT	8
4.9 Supercharger	239	99E		10/98-12/01	T16PR-U11	5026	1.1	-	ITF16TT	ITF16TT	8
COBRA IV (90-)											
4.9	184/ 250	99F; 99UM		01/90-10/97	T16PR-U11	5026	1.1	-	ITF16TT	ITF16TT	8
4.9 Roadster	168	99H		09/97-08/99	T16PR-U11	5026	1.1	-	ITF16TT	ITF16TT	8
4.9 Supercharger	239	99F		10/97-	T16PR-U11	5026	1.1	-	ITF16TT	ITF16TT	8
5.8	412	99F/ 99UM		01/90-10/97	T16PR-U11	5026	1.1	-	ITF16TT	ITF16TT	8
ME (79-86)											
3000	103	LO6		01/79-12/86	W20EPR-U	3047	0.8	W20TT	IW20TT	IW20TT	6
ACURA											
CDX (16-)											
1.5	134	L15B9		07/16-	VXEHC24G	5660	1.1	-	-	VXEHC24G	4
1.5 AWD	134	L15B9		07/16-	VXEHC24G	5660	1.1	-	-	VXEHC24G	4
INTEGRA (85-90)											
1.5	63	D15A1		01/85-12/90	W20EXR-U	3066	0.8	W20TT	IW20TT	IW20TT	4
1.6	74	D16A1; D16A3		01/85-12/90	Q20PR-U11	3008	1.1	Q20TT	IQ20TT	IQ20TT	4
1.6 i	88	D16A8		01/85-12/90	Q20PR-U11	3008	1.1	Q20TT	IQ20TT	IQ20TT	4
LEGEND I (86-91)											
2.0	107	C20A		01/88-08/91	Q20PR-U11	3008	1.1	Q20TT	IQ20TT	IQ20TT	6
2.5	113/ 122	C25A1		01/86-12/87	Q20PR-U11	3008	1.1	Q20TT	IQ20TT	IQ20TT	6
2.7	123/ 130	C27A1		01/87-08/91	Q20PR-U11	3008	1.1	Q20TT	IQ20TT	IQ20TT	6
LEGEND II (91-96)											
3.2	151	C32A; C32A2		08/91-08/96	PK20PR-L11	3142	1.1	-	IK20TT	IK20TT	6
MDX (00-05)											
3.5 AWD	179/ 186/ 193	J35A3; J35A4		08/00-09/06	SKJ16DR-M11	3422	1.1	-	-	SKJ16DR-M11	6
MDX (06-)											
3.7 AWD	220/ 227	J37A1; J37A2		10/06-	SXU22HCR11S	3461	1.1	-	-	VXUHC22G	6
NSX (90-05)											
3.0	201	C30A3		01/90-08/97	PK16PR-L11	3275	1.1	-	IK16TT	IK16TT	6
3.0 R	188	C30A4		01/92-08/97	PK16PR-L11	3275	1.1	-	IK16TT	IK16TT	6
3.2	206	C32B2		08/97-12/05	PK20PR-L11	3142	1.1	-	IK20TT	IK20TT	6
NSX Targa (95-97)											
3.0 T	188	C30A4		01/95-12/97	PK16PR-L11	3275	1.1	-	IK16TT	IK16TT	6
RL (95-04)											
3.5	153	C35A5		10/00-09/04	PK16PR-L11	3275	1.1	-	IK16TT	IK16TT	6
RSX (01-06)											
2.0 Sport	118	K20A3		10/01-10/06	KJ20DR-M11	3374	1.1	-	-	SKJ20DR-M11	4

Свечи зажигания и Свечи накаливания

Таблица применения





	KW				СТАНДАРТНЫЕ				Twin Tip			QTY
ACURA продолжение												
TL (98-03)												
3.2 Type S	191	J32A4		06/01-09/03	PKJ20CR-M11	3392	1.1	-	IK20TT	IK20TT		6
TL (09-)												
3.7 AWD	227	J37A4		01/12-	SXU22HCR11S	3461	1.1	-	-	VXUHC22G		6
TSX (09-)												
2.4	150	K24Z3		09/10-	KJ20DR-M11	3374	1.1	-	-	SKJ20DR-M11		4
VIGOR (91-94)												
2.5	140	G25A		09/91-09/94	K20PR-L11	3144	1.1	K20TT	IK20TT	IK20TT		5
ZDX (10-)												
3.7 AWD	227	J37A5		11/11-	SXU22HCR11S	3461	1.1	-	-	VXUHC22G		6
ALFA ROMEO												
8C (07-10)												
4.7 (920AXA1A)	331	AR8C		01/07-10/09	IU24	5362	0.9	-	-			8
4.7 (920BXA1A)	331	AR8C		01/08-10/10	IU24	5362	0.9	-	-			8
33 (83-93)												
1.2	50	AR 30585		06/83-12/89	W22EPR-U	3088	0.8	W22TT	-	VW22		4
1.3	55/ 63/66	AR 30168; AR 30587; AR30168/AS30568; AR30512		06/83-06/90	W22EPR-U	3088	0.8	W22TT	-	VW22		4
1.3 (905A1)	58	AR 30502		05/83-12/89	W22EPR-U	3088	0.8	W22TT	-	VW22		4
1.4 (905A1H)	66	AS30168/AS30587		07/88-12/88	W22EPR-U	3088	0.8	W22TT	-	VW22		4
1.5	62/ 66/75	AR 30520; AR30146/AR30182; AR30504		05/83-12/89	W22EPR-U	3088	0.8	W22TT	-	VW22		4
1.5 (905A1)	70	AR30514/AR30526		05/83-07/87	W22EPR-U	3088	0.8	W22TT	-	VW22		4
1.5 4x4	62/ 66/ 70/77	AR 30520; AR30146/AR30182/ AS30508; AR30146; AR30504; AR30514/AR30526		11/83-12/89	W22EPR-U	3088	0.8	W22TT	-	VW22		4
1.5 QV	77	AR30146/AR30182/ AR30526		06/84-07/86	W22EPR-U	3088	0.8	W22TT	-	VW22		4
1.7 (905B3C)	87	AS30550/AS30558		03/88-12/89	W22EPR-U	3088	0.8	W22TT	-	VW22		4
1.7 i.e.	77	AR 30558		09/88-12/89	W22EPR-U	3088	0.8	W22TT	-	VW22		4
1.7 i.e. 4x4 (905A3G, 905B3F)	77	AS30558		09/88-12/89	W22EPR-U	3088	0.8	W22TT	-	VW22		4
1.7 QV	84	AR 30550		03/88-12/89	W22EPR-U	3088	0.8	W22TT	-	VW22		4
1.8 TD (905A4)	54	VM 82 A	Double Coil	01/86-06/90	DG-202		11V					3
1.8 TD (905B4, 905A4)	62	VM 96 A	Double Coil	01/86-12/89	DG-202		11V					3
33 (90-94)												
1.4 i.e.	66	AR 30753; AR 30755; AR30732		06/91-09/94	W22EPR-U	3088	0.8	W22TT	-	VW22		4
1.4 i.e. (907B3B)	66	AR 30755; AR30732		06/91-09/94	W22EPR-U	3088	0.8	W22TT	-	VW22		4
1.5 (907A2)	77	AR 30734		01/90-04/93	W22EPR-U	3088	0.8	W22TT	-	VW22		4
1.5 i.e (907A2B)	71	AR30750/AR30751		01/90-09/94	W22EPR-U	3088	0.8	W22TT	-	VW22		4
1.5 i.e (907B2B)	71	AR 30751		01/90-09/94	W22EPR-U	3088	0.8	W22TT	-	VW22		4
1.7 16V	95/ 97/ 101	AR 30746; AR 30747		01/90-09/94	K20PBR	5060	0.85	K20TT	IK20TT	IK20TT		4
1.7 16V (907B1B)	101	AR 30746		07/90-09/94	K20PBR	5060	0.85	K20TT	IK20TT	IK20TT		4
1.7 16V 4x4	95/ 97/ 101	AR 30746; AR 30747		01/90-09/94	K20PBR	5060	0.85	K20TT	IK20TT	IK20TT		4
1.7 i.e.	77/79	AR 30736; AR 30737 A; AR 30737		01/90-09/94	W22EPR-U	3088	0.8	W22TT	-	VW22		4
1.7 i.e. 4x4	79	AR 30736; AR 30737		01/90-03/92	W22EPR-U	3088	0.8	W22TT	-	VW22		4
1.8 TD	62	VM 96 A	Double Coil	07/90-09/94	DG-202		11V					3
75 (85-92)												
1.6	81	AR 06100		05/85-09/89	W22EPR-U	3088	0.8	W22TT	-	VW22		4
1.6 (162B2)	76	AR61102		05/85-09/89	W20EPR-U	3047	0.8	W20TT	IW20TT	IW20TT		4
1.6 Cat	81	AR 61101		05/89-02/92	W22EPR-U	3088	0.8	W22TT	-	VW22		4
1.8	85/ 88/ 90/95	AR 06168; AR 06202; AR 61102; AR 61201; AR 67101		09/85-02/92	W22EPR-U	3088	0.8	W22TT	-	VW22		4
1.8 Turbo	110	AR 06134		09/86-02/92	W22EPR-U	3088	0.8	W22TT	-	VW22		4
1.8 Turbo i.e.	114	AR 06134; AR 06158		02/86-01/90	W22EPR-U	3088	0.8	W22TT	-	VW22		4
2.0	94	AR 06212		05/85-07/87	W22EPR-U	3088	0.8	W22TT	-	VW22		4











Таблица применения

A

Свечи зажигания и Свечи накаливания

Таблица применения

Таблица применения

	KW				СТАНДАРТНЫЕ			Twin Tip			QTY
											
ALFA ROMEO продолжение											
75 (85-92) продолжение											
2.0 T.Spark	107	AR 06166; AR 06224		01/87-02/92	K20PBR	5060	0.85	K20TT	IK20TT	IK20TT	4
2.0 T.Spark Cat	109	AR 06224		09/88-02/92	K20PBR	5060	0.85	K20TT	IK20TT	IK20TT	4
2.0 TD	70	VM 80 A	Double Coil Std(LPH)	05/85-09/92	DG-202		11V				4
2.4 TD (162B5)	82	VM 81 A	Double Coil Standard	01/89-02/92	DG-202		11V				4
2.5 V6	110	AR01646		05/85-08/86	W22EPR-U	3088	0.8	W22TT	-	VW22	6
3.0 V6	141	AR 61503		02/90-02/92	W20EPR-U	3047	0.8	W20TT	IW20TT	IW20TT	6
3.0 V6	141	AR61503		02/90-02/92	W22EPR-U	3088	0.8	W22TT	-	VW22	6
3.0 V6 Cat	136	AR 06124		09/88-02/92	W20EPR-U	3047	0.8	W20TT	IW20TT	IW20TT	6
3.0 V6 Cat	136	AR06120		09/88-02/92	W22EPR-U	3088	0.8	W22TT	-	VW22	6
90 (84-87)											
1.8	85	AR 06202		10/84-07/87	W22EPR-U	3088	0.8	W22TT	-	VW22	4
1.8 (162A1)	89	AR 06202		10/84-07/87	W22EPR-U	3088	0.8	W22TT	-	VW22	4
2.0 i.e.	94	AR 01713; AR 06212		10/84-07/87	W22EPR-U	3088	0.8	W22TT	-	VW22	4
2.0 i.e. (162A2B)	97	AR 06210		06/86-07/87	W22EPR-U	3088	0.8	W22TT	-	VW22	6
2.4 TD	81	VM 81 A	Double Coil Standard	10/84-07/87	DG-202		11V				4
2.5 i.e. V6	110	AR 01646; AR 01911		10/84-07/87	W22EPR-U	3088	0.8	W22TT	-	VW22	6
145 / 146 (94-01)											
1.4 i.e.	66	AR 33501		07/94-12/96	W22EPR-U	3088	0.8	W22TT	-	VW22	4
1.4 i.e. 16V T.Spark	76	AR 33503; AR 38501	10 mm diameter+	11/96-01/01	IU22	5361	0.9	-	-		4
1.4 i.e. 16V T.Spark	76	AR 33503; AR 38501	14 mm diameter+	11/96-01/01	PK20TR11	3253	1.1	K20TT	IK20TT	IK20TT	4
1.6 16V T.Spark	82	AR 32102	10 mm diameter+	09/97-12/00	IU22	5361	0.9	-	-		4
1.6 16V T.Spark	82	AR 32102	14 mm diameter+	09/97-12/00	PK20TR11	3253	1.1	K20TT	IK20TT	IK20TT	4
1.6 i.e.	76	AR 33201		10/94-12/96	W22EPR-U	3088	0.8	W22TT	-	VW22	4
1.6 i.e. 16V T.Spark	88	AR 38201; AR 67601	10 mm diameter+	11/96-10/01	IU22	5361	0.9	-	-		4
1.6 i.e. 16V T.Spark	88	AR 38201; AR 67601	14 mm diameter+	11/96-10/01	PK20TR11	3253	1.1	K20TT	IK20TT	IK20TT	4
1.7 i.e. 16V	95	AR 33401		10/94-12/96	PK20PR-P8	3245	0.8	-	IK20TT	IK20TT	4
1.8 i.e. 16V	106	AR 32201	10 mm diameter+	03/98-01/01	IU22	5361	0.9	-	-		4
1.8 i.e. 16V	106	AR 32201	14 mm diameter+	03/98-01/01	PK20TR11	3253	1.1	K20TT	IK20TT	IK20TT	4
1.8 i.e. 16V T.Spark	103/ 106	AR 32201; AR 38401; AR 67106; AR 67199	10 mm diameter+	11/96-01/01	IU22	5361	0.9	-	-		4
1.8 i.e. 16V T.Spark	103/ 106	AR 32201; AR 38401; AR 67106; AR 67199	14 mm diameter+	11/96-01/01	PK20TR11	3253	1.1	K20TT	IK20TT	IK20TT	4
1.9 JTD	77	AR 32302	Double Coil(LPH)	02/99-01/01	DG-122		11V				4
1.9 JTD	77	AR 32302	Double Coil(LPH)	02/99-01/01	DG-127		11V				4
1.9 TD	66	AR 33601; AR 67501	Double Coil(LPH)	10/94-02/99	DG-001		11V				4
2.0 16V	114	AR 32301	10 mm diameter+	03/97-10/01	IU22	5361	0.9	-	-		4
2.0 16V	114	AR 32301	14 mm diameter+	03/97-10/01	PK20TR11	3253	1.1	K20TT	IK20TT	IK20TT	4
2.0 16V T.Spark	110	AR67204/AR67299	10 mm diameter+	10/95-01/01	IU22	5361	0.9	-	-		4
2.0 16V T.Spark	110	AR67204/AR67299	14 mm diameter+	10/95-01/01	PK20TR11	3253	1.1	K20TT	IK20TT	IK20TT	4
147 (00-10)											
1.6 16V T.Spark	88	AR 32104	10 mm diameter+	01/01-03/10	IU22	5361	0.9	-	-		4
1.6 16V T.Spark	88	AR 32104	14 mm diameter+	01/01-03/10	PK20TR11	3253	1.1	K20TT	IK20TT	IK20TT	4
1.6 16V T.Spark eco	77	AR 37203	10 mm diameter+	01/01-03/10	U22ETR	4201	0.7	-	-		4
1.6 16V T.Spark eco	77	AR 37203	14 mm diameter+	01/01-03/10	K20PBR-S10	5061	1.0	K20TT	IK20TT	IK20TT	4
1.9 JTD 8V	74/85	182 B9.000; 937 A2.000	Double Coil(LPH)	04/01-03/10	DG-122		11V				4

Свечи зажигания и Свечи накаливания

Таблица применения

	KW				СТАНДАРТНЫЕ			Twin Tip			QTY
											
ALFA ROMEO продолжение											
147 (00-10) продолжение											
1.9 JTD 16V	93/100/103	192 A5.000; 192 B1.000; 937 A4.000	Double Coil(LPH)	11/02-03/10	DG-170		11V				4
1.9 JTDM 8V	85	939 A7.000		10/04-09/05	DG-122		11V				4
1.9 JTDM 8V	88	937 A3.000	Double Coil(LPH)	07/05-03/10	DG-196		11V				4
1.9 JTDM 16V	110	937 A5.000	Double Coil(LPH)	09/04-03/10	DG-170		11V				4
1.9 JTDM 16V	125	937 A6.000		06/08-11/08	DG-629		11V				4
2.0 16V T.Spark	110	AR 32310	10 mm diameter+	01/01-03/10	IU22	5361	0.9	-	-		4
2.0 16V T.Spark	110	AR 32310	14 mm diameter+	01/01-03/10	PK20TR11	3253	1.1	K20TT	IK20TT	IK20TT	4
3.2 GTA	184	932 A.000		02/03-03/10	PK20PR-P8	3245	0.8	-	IK20TT	IK20TT	6
155 (92-97)											
1.6 16V T.Spark	88	AR 67601	10 mm diameter+	05/96-12/97	IU22	5361	0.9	-	-		4
1.6 16V T.Spark	88	AR 67601	14 mm diameter+	05/96-12/97	PK20TR11	3253	1.1	K20TT	IK20TT	IK20TT	4
1.7 T.Spark	83/85	AR 67103; AR 67105		04/93-04/96	Q22PR-U	3010	0.8	-	-	VQ22	4
1.7 T.Spark	103	AR 67106	10 mm diameter+	05/96-12/97	IU22	5361	0.9	-	-		4
1.7 T.Spark	103	AR 67106	14 mm diameter+	05/96-12/97	PK20TR11	3253	1.1	K20TT	IK20TT	IK20TT	4
1.8 T.Spark	95	AR 67101; AR 67102		02/92-03/95	Q22PR-U	3010	0.8	-	-	VQ22	4
1.9 TD	66	AR 67501	Double Coil(LPH)	04/93-12/97	DG-001		11V				4
2.0 16V Turbo Q4	137/140	AR 67203		01/92-12/97	W20EPB	5065	0.85	W20TT	IW20TT	IW20TT	4
2.0 T.Spark	104/106	AR 67201; AR 67202	14 mm diameter+	02/92-05/95	Q22PR-U	3010	0.8	-	-	VQ22	4
2.0 T.Spark	110	AR 67204; AR 67299	10 mm diameter+	03/95-12/97	IU22	5361	0.9	-	-		4
2.0 T.Spark	110	AR 67204; AR 67299	14 mm diameter+	03/95-12/97	PK20TR11	3253	1.1	K20TT	IK20TT	IK20TT	4
2.5 TD	92	VM 07 B; VM 31 B	Double Coil(LPH)	04/93-04/95	DG-001		11V				4
2.5 TD	92	VM 07 B; VM 31 B	Double Coil(LPH)	05/95-12/97	DG-109		11V				4
2.5 V6	121	AR 67301; AR 67302; AR 67303		03/92-12/97	W22EPR-U	3088	0.8	W22TT	-	VW22	6
156 (97-06)											
1.6 16V T.Spark	82/88	AR 32102; AR 32103; AR 32104; AR 67601	10 mm diameter+	09/97-05/06	IU22	5361	0.9	-	-		4
1.6 16V T.Spark	82/88	AR 32102; AR 32103; AR 32104; AR 67601	14 mm diameter+	09/97-05/06	PK20TR11	3253	1.1	K20TT	IK20TT	IK20TT	4
1.8 16V T.Spark	103/106	AR 32201; AR 32205	10 mm diameter+	02/97-05/06	IU22	5361	0.9	-	-		4
1.8 16V T.Spark	103/106	AR 32201; AR 32205	14 mm diameter+	02/97-05/06	PK20TR11	3253	1.1	K20TT	IK20TT	IK20TT	4
1.9 JTD	77	AR 32302	Double Coil(LPH)	09/97-10/00	DG-127		11V				4
1.9 JTD	81/85	937 A2.000; AR 37101	Double Coil(LPH)	10/00-05/06	DG-122		11V				4
1.9 JTD	110	937 A5.000		07/04-09/05	DG-170		11V				4
1.9 JTD (932AXE00)	93/100	192 B1.000; 937 A4.000		11/02-09/05	DG-170		11V				4
1.9 JTD (932BXE00)	93/100	192 B1.000; 937 A4.000		11/02-05/06	DG-170		11V				4
1.9 JTD (932BXE00, 932BXN00)	110	937 A5.000		03/05-05/06	DG-170		11V				4
1.9 JTD 16V (932AXE00)	103	192 A5.000	Double Coil(LPH)	11/02-09/05	DG-170		11V				4
1.9 JTD 16V (932BXE00)	103	192 A5.000	Double Coil(LPH)	11/02-05/06	DG-170		11V				4
1.9 JTD 16V Q4 (932BXN20)	110	937 A5.000	Double Coil(LPH)	07/04-05/06	DG-170		11V				4
2.0 16V T.Spark	110/114	AR 32301; AR 32310	10 mm diameter+	09/97-06/02	IU22	5361	0.9	-	-		4
2.0 16V T.Spark	110/114	AR 32301; AR 32310	14 mm diameter+	09/97-06/02	PK20TR11	3253	1.1	K20TT	IK20TT	IK20TT	4











Таблица применения

A

Свечи зажигания и Свечи накаливания

Таблица применения

Таблица применения

	KW				СТАНДАРТНЫЕ			Twin Tip			QTY
											
ALFA ROMEO продолжение											
156 (97-06) продолжение											
2.0 JTS	119/122	932 A2.000; 937 A1.000		03/02-05/06	PK20TR11	3253	1.1	K20TT	IK20TT	IK20TT	4
2.0 JTS (932AXD00, 932AXD01)	119	932 A2.000		03/01-09/05	PK20TR11	3253	1.1	K20TT	IK20TT	IK20TT	4
2.4 JTD	100	AR 32501	Double Coil(LPH)	09/97-09/03	DG-127		11V				5
2.4 JTD	100/103/110	839 A6.000; 841 C000; AR 32501	Double Coil(LPH)	11/99-05/06	DG-122		11V				5
2.4 JTD (932AXF00)	129	841 G.000	Double Coil(LPH)	10/03-09/05	DG-122		11V				5
2.4 JTD (932BXF00)	120	841 M.000; 841 N.000		06/03-05/06	DG-170		11V				4
2.4 JTD (932BXF00)	129	841 G.000	Double Coil(LPH)	10/03-05/06	DG-122		11V				5
2.5 V6 24V	140	AR 32401; AR 32402; AR 32405		02/97-05/06	PK20PR-P8	3245	0.8	-	IK20TT	IK20TT	6
3.2 GTA	184	932 A.000		03/02-05/06	PK20PR-P8	3245	0.8	-	IK20TT	IK20TT	6
159 (05-11)											
1.8 MPI	103	939 A4.000		06/05-11/11	KJ16CR-L11	3132	1.1	K16TT	IK16TT	IK16TT	4
1.9 JTDM 8V	88	939 A1.000		09/05-02/08	DG-127		11V				4
1.9 JTDM 8V	88	939 A1.000		02/08-06/10	DG-170		11V				4
1.9 JTDM 8V	88	939 A1.000		06/10-11/11	DG-629		11V				4
1.9 JTDM 8V	88	939 A1.000	Double Coil(LPH)	02/08-06/10	DG-170		11V				4
1.9 JTDM 8V (939AXE1B, 939BXE1B, 939BXH1B)	85	937 A7.000; 939 A7.000		02/08-06/10	DG-170		11V				4
1.9 JTDM 8V (939AXE1B, 939BXE1B, 939BXH1B)	85	937 A7.000; 939 A7.000		06/10-11/11	DG-629		11V				4
1.9 JTDM 8V (939AXE1B, 939BXE1B, 939BXH1B)	85	939A7.000		09/05-02/08	DG-127		11V				4
1.9 JTDM 8V (939AXH1B, 939BXH1B)	85	937 A7.000		03/06-02/08	DG-127		11V				4
1.9 JTDM 8V (939AXH1B, 939BXH1B)	85	937 A7.000		02/08-06/10	DG-170		11V				4
1.9 JTDM 8V (939AXH1B, 939BXH1B)	85	937 A7.000		06/10-11/11	DG-629		11V				4
1.9 JTDM 16V	100/110	937 A8.000; 939 A2.000		09/05-06/10	DG-170		11V				4
1.9 JTDM 16V	110	939 A2.000	Double Coil(LPH)	09/05-11/11	DG-170		11V				4
1.9 JTS	118	939 A6.000		09/05-11/11	K16TT	4603	1.0	K16TT	IK16TT	IK16TT	4
2.0 JTDM	100/120/125	844 A2.000; 939 B3.000; 939 B4.000		05/09-11/11	DG-608		4.4V				4
2.2 JTS	136	939 A5.000		09/05-11/11	K16TT	4603	1.0	K16TT	IK16TT	IK16TT	4
2.4 JTDM	147	939 A3.000		09/05-11/11	DG-170		11V				5
2.4 JTDM	154	939 A9.000		05/07-12/12	DG-629		11V				5
2.4 JTDM Q4	154	939 A9.000		05/07-11/11	DG-170		11V				5
2.4 JTDM Q4	154	939 A9.000		05/07-11/11	DG-629		11V				5
3.2 JTS	191	939 A.000		01/08-11/11	PT16VR13	5068	1.3	TV16TT	ITV16TT	ITV16TT	6
3.2 JTS Q4	191	939 A.000		12/05-11/11	PT16VR13	5068	1.3	TV16TT	ITV16TT	ITV16TT	6
164 (87-98)											
2.0 (164A2C, 164A2L, 164A2H)	105	AR06416		10/90-10/92	K20PBR	5060	0.85	K20TT	IK20TT	IK20TT	4
2.0 T.Spark	106/109	AR 64103; AR06420	14 mm diameter+	06/87-09/98	K20PBR	5060	0.85	K20TT	IK20TT	IK20TT	4
2.0 Turbo (164A2B)	129	AR 06476		10/87-09/98	W20EPB	5065	0.85	W20TT	IW20TT	IW20TT	4
2.0 V6 Turbo	148/150	AR 64102; AR64101/AR64102		03/91-09/98	W22EPR-U	3088	0.8	W22TT	-	VW22	6
2.5 TD	84	VM 84 A	Double Coil Standard	06/87-09/92	DG-202		11V				4
2.5 TD	92	VM 08 B; VM 32 B	Double Coil(LPH)	09/92-04/95	DG-001		11V				4
2.5 TD	92	VM 08 B; VM 32 B	Double Coil(LPH)	05/95-09/98	DG-109		11V				4
3.0 (164A)	138	AR 06410		11/87-09/91	W20EPR-U	3047	0.8	W20TT	IW20TT	IW20TT	6
3.0 24V	155	AR64306/AR66301/ AR66302		09/92-09/98	PK20PR-P8	3245	0.8	-	IK20TT	IK20TT	6
3.0 24V Q4	170	AR64307/AR64308/ AR66304		02/94-09/98	PK20PR-P8	3245	0.8	-	IK20TT	IK20TT	6
3.0 24V QV	171	AR 64304		09/92-09/98	PK20PR-P8	3245	0.8	-	IK20TT	IK20TT	6
3.0 i.e. QV	147	AR 06430; AR 64301		09/90-09/92	W20EPR-U	3047	0.8	W20TT	IW20TT	IW20TT	6
3.0 i.e. QV	147	AR64301		09/90-09/92	W22EPR-U	3088	0.8	W22TT	-	VW22	6

Свечи зажигания и Свечи накаливания

Таблица применения





	KW				СТАНДАРТНЫЕ			Twin Tip			QTY
ALFA ROMEO продолжение											
164 (87-98) продолжение											
3.0 V6	132/ 135/ 141	AR 06410; AR 06412; AR 64303; AR 64305; AR 64399; AR 66303		06/87-09/98	W20EPR-U	3047	0.8	W20TT	IW20TT	IW20TT	6
3.0 V6	132/ 135/ 141	AR06410; AR06412; AR64305/AR66303		06/87-09/98	W22EPR-U	3088	0.8	W22TT	-	VW22	6
166 (98-07)											
2.0 T.Spark	110/ 114	AR 34103; AR 36301	10 mm diameter+	09/98-06/07	IU22	5361	0.9	-	-		4
2.0 T.Spark	110/ 114	AR 34103; AR 36301	14 mm diameter+	09/98-06/07	PK20TR11	3253	1.1	K20TT	IK20TT	IK20TT	4
2.0 V6	151	AR 34102		09/98-10/00	W22EPR-U	3088	0.8	W22TT	-	VW22	6
2.4 JTD	100	AR 34202	Double Coil(LPH)	09/98-10/00	DG-127		11V				5
2.4 JTD	103	839 A6.000	Double Coil(LPH)	10/00-06/07	DG-122		11V				5
2.4 JTD (936AXA00, 936A3B00)	110	841 C000	Double Coil(LPH)	04/02-06/07	DG-122		11V				5
2.4 JTD (936AXC00)	132	841 M.000		07/06-06/07	DG-170		11V				4
2.4 JTD (936AXC00, 936AXD01)	129	841 G.000; 841 H.000	Double Coil(LPH)	10/03-06/07	DG-170		11V				5
2.4 JTD (936AXC00, 936AXG00)	136	936 B.000		07/05-06/07	DG-170		11V				5
2.4 JTD (936AXD01, 936AXC00)	120	841 M.000; 841 N.000		10/03-06/07	DG-170		11V				4
2.5 V6 24V	138/ 140	AR 34201; AR 36201		09/98-06/07	PK20PR-P8	3245	0.8	-	IK20TT	IK20TT	6
3.0 V6 24V	162/ 166	AR 34301; AR 34302; AR 36101		09/98-06/07	PK20PR-P8	3245	0.8	-	IK20TT	IK20TT	6
3.2 V6 24V (936AXB00, 936AXA00)	176	936 A.000		10/03-06/07	PK20PR-P8	3245	0.8	-	IK20TT	IK20TT	6
1750-2000 (68-75)											
1.7	80	AR 10525		04/68-11/71	W22EPR-U	3088	0.8	W22TT	-	VW22	4
1750	83	AR 00548		03/68-10/72	W22EPR-U	3088	0.8	W22TT	-	VW22	4
2000	97	AR 10520		10/71-07/75	W20EPR-U	3047	0.8	W20TT	IW20TT	IW20TT	4
ALFASUD (72-89)											
1.2	46	AS30100/AS30102		06/72-09/84	W22EPR-U	3088	0.8	W22TT	-	VW22	4
1.2 (904A)	46	AS30102/AS30110		01/78-01/79	W22EPR-U	3088	0.8	W22TT	-	VW22	4
1.2 ti	50	AS30104/AS30110/ AS30111		11/73-09/84	W22EPR-U	3088	0.8	W22TT	-	VW22	4
1.3	50/55	AS30180; AS30184		09/76-04/80	W22EPR-U	3088	0.8	W22TT	-	VW22	4
1.3 (904B)	50	AS30180		01/78-07/79	W22EPR-U	3088	0.8	W22TT	-	VW22	4
1.3 (904B2)	50	AS30160		03/80-12/81	W22EPR-U	3088	0.8	W22TT	-	VW22	4
1.3 SC/ti Super (901F3C, 901G2)	55	AS30156/AS30164		09/77-09/84	W22EPR-U	3088	0.8	W22TT	-	VW22	4
1.3 Super	51	AS30160		01/79-03/80	W22EPR-U	3088	0.8	W22TT	-	VW22	4
1.3 ti	55/63	AS30168; AS30184/AS30190		09/77-12/84	W22EPR-U	3088	0.8	W22TT	-	VW22	4
1.4 (902A)	55/63	AS30164; AS30168		05/78-12/89	W22EPR-U	3088	0.8	W22TT	-	VW22	4
1.5	61/ 70/77	AR30146/AR30182; AR30198/AR30520/ AS30126, AS30128, AS30133; AS30124		06/79-12/88	W22EPR-U	3088	0.8	W22TT	-	VW22	4
1.5 ti	61	AS30124/AS30126		01/79-09/84	W22EPR-U	3088	0.8	W22TT	-	VW22	4
1.5 ti (901G5A, 901F4D)	70	AS30126/AS30128/ AS30133		05/80-06/84	W22EPR-U	3088	0.8	W22TT	-	VW22	4
1.5 ti Sprint (901G5A, 901G5C, 901F4D)	77	AS30146/AS30198		01/83-12/84	W22EPR-U	3088	0.8	W22TT	-	VW22	4
1.7 (902C2E)	87	AR30550		04/88-12/89	W22EPR-U	3088	0.8	W22TT	-	VW22	4
1.7 i.e. (902C2D)	77	AR30558		10/87-12/89	W22EPR-U	3088	0.8	W22TT	-	VW22	4
ALFETTA (74-84)											
1.6	79	AR01600		01/75-12/84	W22EPR-U	3088	0.8	W22TT	-	VW22	4
1.8	89	AR 01678		10/79-12/84	W22EPR-U	3088	0.8	W22TT	-	VW22	4
1.8 (11608)	89	AR 01608		10/79-12/84	W22EPR-U	3088	0.8	W22TT	-	VW22	4
1.8 (11608, 11642)	85	AR 01608 X		07/74-04/82	W22EPR-U	3088	0.8	W22TT	-	VW22	4
2.0	89/97	AR01334/AR01655/ AR01674, AR01713; AR01605/AR01615/ AR01623		03/77-12/84	W22EPR-U	3088	0.8	W22TT	-	VW22	4
2.0 TD	60	VM4HT/2	Double Coil Std(LPH)	10/79-03/83	DG-202		11V				4

Таблица применения

A

Свечи зажигания и Свечи накаливания

Таблица применения

Таблица применения

KW	KW	KW	NOTE	21	СТАНДАРТНЫЕ			Twin Tip			QTY
					STANDARD	STANDARD	STANDARD	TWIN TIP	TWIN TIP	TWIN TIP	
ALFA ROMEO продолжение											
ALFETTA (74-84) продолжение											
2.4 TD	70	VM4HT 2.4	Double Coil Std(LPH)	04/83-12/84	DG-202		11V				4
ALFETTA GT (74-86)											
1.6 (11604)	79	AR01600		01/76-02/80	W22EPR-U	3088	0.8	W22TT	-	VW22	4
1.8 (11610)	85	AR 01608 X		01/74-12/76	W22EPR-U	3088	0.8	W22TT	-	VW22	4
1.8 (11610, 11654)	89	AR 01608		06/74-12/76	W22EPR-U	3088	0.8	W22TT	-	VW22	4
2.0	96	AR01655		06/77-06/80	W22EPR-U	3088	0.8	W22TT	-	VW22	4
2.0 (11610)	89	AR01623		07/78-01/86	W22EPR-U	3088	0.8	W22TT	-	VW22	4
AR 6 (79-89)											
1.9 D (280)	51	160 D100	Double Coil(LPH)	04/85-12/89	DG-001		11V				4
2.0 (119AA)	99	AR01932		07/81-01/84	W22EPR-U	3088	0.8	W22TT	-	VW22	6
2.5 D (280)	55	8144.67.220	Double Coil(LPH)	03/86-12/89	DG-001		11V				4
2.5 i.e.	110	AR01928		10/83-12/86	W22EPR-U	3088	0.8	W22TT	-	VW22	6
2.5 i.e. (119AA, 119AB)	116	AR01913		08/79-06/84	W22EPR-U	3088	0.8	W22TT	-	VW22	6
2.5 TD (119AA)	77	VM-HR 588 HT	Double Coil Std(LPH)	07/81-05/86	DG-202		11V				5
AR 8 (78-89)											
2.4 D (280)	53	8140.61.200	Double Coil(LPH)	04/78-08/86	DG-001		11V				4
2.5 D (280)	55	8144.67.220	Double Coil(LPH)	09/86-12/89	DG-001		11V				4
ARNA (83-86)											
1.2	44/50	AR30500		01/85-12/86	W22EPR-U	3088	0.8	W22TT	-	VW22	4
1.2 (920AC, 920AA)	46	AR31000		03/83-12/84	W22EPR-U	3088	0.8	W22TT	-	VW22	4
1.3 (920AC, 920A1B)	58	AR31006		01/85-12/86	W22EPR-U	3088	0.8	W22TT	-	VW22	4
1.3 TI	63	AR30512/AR31010		03/83-12/86	W22EPR-U	3088	0.8	W22TT	-	VW22	4
1.5 (920A2B)	70	AR31124		01/85-12/86	W22EPR-U	3088	0.8	W22TT	-	VW22	4
BRERA (06-10)											
2.0 JTDM (939DXP1B)	125	939 B3.000		05/09-06/10	DG-608		4.4V				4
2.0 JTDM (939DXQ1B)	120	844 A2.000		03/08-06/10	DG-608		4.4V				4
2.2 JTS	136	939 A5.000		01/06-05/11	K16TT	4603	1.0	K16TT	IK16TT	IK16TT	4
2.4 JTDM 20V (939DXD1B, 939DXD12)	147	939 A3.000		01/06-03/11	DG-170		11V				5
2.4 JTDM 20V (939DXD1B, 939DXM1B)	154	939 A9.000		05/07-03/11	DG-629		11V				5
3.2 JTS (939DXG2B, 939DXG1B)	191	939 A.000		03/08-06/10	PT16VR13	5068	1.3	TV16TT	ITV16TT	ITV16TT	6
3.2 JTS Q4	191	939 A.000		01/06-05/11	PT16VR13	5068	1.3	TV16TT	ITV16TT	ITV16TT	6
GIULIA (62-79)											
1300 Super	64	AR 00530		01/74-12/78	W20EPR-U	3047	0.8	W20TT	IW20TT	IW20TT	4
1600 Super	71	AR 00526		06/64-08/69	W22EPR-U	3088	0.8	W22TT	-	VW22	4
1600 Super	76	AR 00526		01/74-12/78	W20EPR-U	3047	0.8	W20TT	IW20TT	IW20TT	4
GIULIETTA (77-85)											
1.3	66	AR 01644		10/77-06/83	W22EPR-U	3088	0.8	W22TT	-	VW22	4
1.6	79	AR 01600		10/77-04/85	W22EPR-U	3088	0.8	W22TT	-	VW22	4
1.8	90	AR 01678		04/79-04/85	W22EPR-U	3088	0.8	W22TT	-	VW22	4
1.8 Turbo (116)	110	AR 01354		01/84-12/85	W22EPR-U	3088	0.8	W22TT	-	VW22	4
2.0	96	AR01655		06/80-04/85	W22EPR-U	3088	0.8	W22TT	-	VW22	4
2.0 TD (116A2)	61	VM 4 HT	Double Coil Standard	01/83-12/85	DG-202		11V				4
2.0 TD (116A2)	61	VM 4 HT	Single Coil	01/83-12/85	DG-198		11V				4
2.0 Turbo (116)	125	AR 01699		04/83-06/85	W22ESR-U	3098	0.8	-	-		4
GIULIETTA (10-)											
1.4 BiFuel (940FXA1A, 940FXT1A)	88	198 A4.000	40000km Lifetime	12/11-02/17	IXU27	5337	0.9	-	-		4
1.4 TB	88/120/125	198 A4.000; 940 A2.000; 940 B7.000; 955 A8.000	40000km Lifetime	04/10-	IXU27	5337	0.9	-	-		4
1.4 TB (940.FYA1A)	110	940 A2.000; 940 C2.000	40000km Lifetime	09/14-	IXU27	5337	0.9	-	-		4
1.4 TB (940FXF1A)	85	940 A6.000	40000km Lifetime	04/10-02/16	IXU27	5337	0.9	-	-		4
1.4 TB (940FXN1A, 940FXU1A)	77	940 B1.000; 940 B8.000	40000km Lifetime	04/11-	IXU27	5337	0.9	-	-		4
1.6 JTDM	77	940 A3.000		04/10-	DG-608		4.4V				4
2.0 JTDM	103/110/129	940 A5.000; 940 B4.000; 940 B5.000; 940 C3.000		04/10-	DG-608		4.4V				4

Свечи зажигания и Свечи накаливания

Таблица применения













	KW				СТАНДАРТНЫЕ			Twin Tip			QTY
											
ALFA ROMEO продолжение											
GIULIETTA (10-) продолжение											
2.0 JTDM (940FXE1A)	125	940 A4.000; 940 B4.000		04/10-	DG-608		4.4V				4
2.0 JTDM (940FXH1A, 940FXH11, 940.FXZ11, 940.FXZ1A)	120	940 A7.000; 940 B9.000		04/10-	DG-608		4.4V				4
2.0 JTDM (940FXM1A, 940FXS1A, 940FYD1A)	100	940 A8.000; 940 B6.000; 940 C4.000		04/10-02/16	DG-608		4.4V				4
GT (63-77)											
1.7	80	AR 10525		04/68-11/71	W22EPR-U	3088	0.8	W22TT	-	VW22	4
1300 Junior	64	AR 00530		01/66-12/77	W20EPR-U	3047	0.8	W20TT	IW20TT	IW20TT	4
1600	75	AR 00526 S		09/72-12/77	W22EPR-U	3088	0.8	W22TT	-	VW22	4
V 1750	83	AR 00548		01/67-12/72	W22EPR-U	3088	0.8	W22TT	-	VW22	4
V 2000	96	AR 10527		01/71-12/77	W20EPR-U	3047	0.8	W20TT	IW20TT	IW20TT	4
GT (03-10)											
1.8 T.Spark	103	AR 32205	10 mm diameter+	11/03-09/10	IU22	5361	0.9	-	-		4
1.8 T.Spark	103	AR 32205	14 mm diameter+	11/03-09/10	PK20TR11	3253	1.1	K20TT	IK20TT	IK20TT	4
1.9 JTD (937CXN1B)	110	937 A5.000	Double Coil(LPH)	11/03-09/10	DG-170		11V				4
1.9 JTD (937CXN1B, 937CXZ1B)	125	937 A6.000		05/08-01/10	DG-170		11V				4
2.0 JTS	121	932 A2.000; 937 A1.000		11/03-09/10	PK20TR11	3253	1.1	K20TT	IK20TT	IK20TT	4
2.0 JTS (937CXH11, 937CXH1A, 937CXT1A)	119	932 A2.000		12/06-09/10	PK20TR11	3253	1.1	K20TT	IK20TT	IK20TT	4
3.2 GTA (937CXP1B)	176	936 A.000		11/03-09/10	PK20PR-P8	3245	0.8	-	IK20TT	IK20TT	6
GTV (78-87)											
2.0	94	AR 06212		01/85-12/85	W22EPR-U	3088	0.8	W22TT	-	VW22	4
2.0 (11636)	96	AR01655		12/80-01/86	W22EPR-U	3088	0.8	W22TT	-	VW22	4
2.5 V6	116	AR01646/AR01911		11/80-02/87	W22EPR-U	3088	0.8	W22TT	-	VW22	6
GTV (95-05)											
1.8 16V	106	AR 32201	10 mm diameter+	05/98-10/05	IU22	5361	0.9	-	-		4
1.8 16V	106	AR 32201	14 mm diameter+	05/98-10/05	PK20TR11	3253	1.1	K20TT	IK20TT	IK20TT	4
2.0 JTS (916CXA00)	121	937 A1.000		04/03-10/05	PK20TR11	3253	1.1	K20TT	IK20TT	IK20TT	4
2.0 T.Spark 16V	110/ 114	AR 16201; AR 32301; AR 32310	10 mm diameter+	06/95-10/05	IU22	5361	0.9	-	-		4
2.0 T.Spark 16V	110/ 114	AR 16201; AR 32301; AR 32310	14 mm diameter+	06/95-10/05	PK20TR11	3253	1.1	K20TT	IK20TT	IK20TT	4
2.0 V6 Turbo	148	AR 16202		06/95-09/98	W22EPR-U	3088	0.8	W22TT	-	VW22	6
3.0 V6 24V	160/ 162	AR 16102; AR 16105		10/96-10/05	PK20PR-P8	3245	0.8	-	IK20TT	IK20TT	6
3.2 V6 24V (916CXB00)	176	936 A6.000		04/03-10/05	PK20PR-P8	3245	0.8	-	IK20TT	IK20TT	6
MITO (08-)											
1.3 D Multijet	59/ 62/70	199 B1.000; 199 B4.000; 199 B8.000; 330 A1.000	Euro-5,OE: 55210051	09/09-	DG-621		4.4V				4
1.3 D Multijet	59/ 62/70	199 B1.000; 199 B4.000; 199 B8.000; 330 A1.000	Euro-6,OE: 12 14 106/ 55238404 (RP 9016)	09/09-	DG-658		5V				4
1.3 D Multijet	59/ 66/70	199 A3.000; 199 B1.000; 199 B8.000; 330 A1.000; 955 B2.000	Euro-4,OE: 55200755	08/08-	DG-171		11V				4
1.4	58	350 A1.000; 955 A1.000		08/08-	XU22EPR-U	3179	0.9	XU22TT	IXU22TT	VXU22	4
1.4 (955AXB1B, 955.AXF1B)	70	199 A6.000		09/08-08/13	XU22EPR-U	3179	0.9	XU22TT	IXU22TT	VXU22	4
1.4 (955AXV1A)	51	955 A9.000		05/11-	XU22EPR-U	3179	0.9	XU22TT	IXU22TT	VXU22	4
1.4 BiFuel	88	198 A4.000	40000km Lifetime	01/09-	IXU27	5337	0.9	-	-		4
1.4 MultiAir	77	955 A6.000		09/09-08/13	XU22EPR-U	3179	0.9	XU22TT	IXU22TT	VXU22	4
1.4 MultiAir	99/ 120/ 125	940 A2.000; 955 A2.000; 955 A7.000; 955 A8.000	40000km Lifetime	09/09-	IXU27	5337	0.9	-	-		4
1.4 TB (955.AYB11, 955.AXB1B)	103	955 B1.000	40000km Lifetime	12/13-	IXU27	5337	0.9	-	-		4

Таблица применения

A

Свечи зажигания и Свечи накаливания

Таблица применения

Таблица применения

KW	KW	KW	NOTE	21	СТАНДАРТНЫЕ			Twin Tip			QTY
					1	2	3	1	2	3	
ALFA ROMEO продолжение											
MITO (08-) продолжение											
1.4 TJet	88/ 114	198 A4.000; 199 A8.000	40000km Lifetime	08/08-	IXU27	5337	0.9	-	-	-	4
1.4 TJet (955AXD1B)	110	198 A1.000	40000km Lifetime	09/08-06/11	IXU27	5337	0.9	-	-	-	4
1.6 JTDM	88	198 A2.000; 955 A3.000		08/08-	DG-608		4.4V				4
1.6 JTDM (955AXE1B)	85	955 A4.000		08/08-	DG-608		4.4V				4
RZ (92-94)											
3.0 V6 Zagato (162D1)	152	AR 61501		01/92-12/94	W20EPR-U	3047	0.8	W20TT	IW20TT	IW20TT	6
3.0 V6 Zagato (162D1)	152	AR61501		01/92-12/94	W22EPR-U	3088	0.8	W22TT	-	VW22	6
SPIDER (66-77)											
1.7	80	AR 10525		04/68-11/71	W22EPR-U	3088	0.8	W22TT	-	VW22	4
1750 (10557)	83	AR 00548		01/67-12/71	W22EPR-U	3088	0.8	W22TT	-	VW22	4
2000 (10512, 10524)	96	AR00512		07/74-12/77	W22EPR-U	3088	0.8	W22TT	-	VW22	4
SPIDER (71-93)											
1600 (115A2)	79	AR01563		01/90-12/93	W22EPR-U	3088	0.8	W22TT	-	VW22	4
1600 (11535)	75	AR00526A		06/80-12/90	W22EPR-U	3088	0.8	W22TT	-	VW22	4
2000 (115A1A)	88	AR01588		01/90-12/93	W22EPR-U	3088	0.8	W22TT	-	VW22	4
2000 (11538, 115A1)	93	AR00515; AR01590		01/77-12/93	W22EPR-U	3088	0.8	W22TT	-	VW22	4
2000 (11538, 115661)	93	AR00515		08/86-12/90	W22EPR-U	3088	0.8	W22TT	-	VW22	4
2000 (115680, 115681)	85	AR01544		08/86-12/90	W22EPR-U	3088	0.8	W22TT	-	VW22	4
SPIDER (94-05)											
1.8 16V	106	AR 32201	10 mm diameter+	05/98-04/05	IU22	5361	0.9	-	-	-	4
1.8 16V	106	AR 32201	14 mm diameter+	05/98-04/05	PK20TR11	3253	1.1	K20TT	IK20TT	IK20TT	4
2.0 JTS (916SXA00)	121	937 A1.000		04/03-04/05	PK20TR11	3253	1.1	K20TT	IK20TT	IK20TT	4
2.0 T.Spark 16V	110/ 114	AR 16201; AR 32301; AR 32310	10 mm diameter+	06/95-04/05	IU22	5361	0.9	-	-	-	4
2.0 T.Spark 16V	110/ 114	AR 16201; AR 32301; AR 32310	14 mm diameter+	06/95-04/05	PK20TR11	3253	1.1	K20TT	IK20TT	IK20TT	4
2.0 V6 Turbo	148	AR 16202		05/98-04/05	W22EPR-U	3088	0.8	W22TT	-	VW22	6
3.0 V6	141	AR 16101		06/95-04/05	W20EPR-U	3047	0.8	W20TT	IW20TT	IW20TT	6
3.0 V6	160	AR 16105		09/94-04/05	PK20PR-P8	3245	0.8	-	IK20TT	IK20TT	6
3.0 V6 24V	162	AR 16102		01/99-10/03	PK20PR-P8	3245	0.8	-	IK20TT	IK20TT	6
3.2 V6 24V (916SXB00)	176	936 A6.000		04/03-04/05	PK20PR-P8	3245	0.8	-	IK20TT	IK20TT	6
SPIDER (06-10)											
2.0 JTDM (939DXP1B, 939EXP1B)	125	939 B3.000		05/09-06/10	DG-608		4.4V				4
2.0 JTDM (939DXQ1B)	120	844 A2.000		04/09-03/11	DG-608		4.4V				4
2.2 JTS (939EXB1B, 939EXB11)	136	939 A5.000		03/06-03/11	K16TT	4603	1.0	K16TT	IK16TT	IK16TT	4
2.4 JTDM (939DXM1B, 939EXM1B)	154	939 A3.000		03/08-03/10	DG-170		11V				5
2.4 JTDM (939EXD1B, 939EXD12)	147	939 A3.000		03/06-03/11	DG-170		11V				5
3.2 JTS	191	939 A.000		03/08-03/11	PT16VR13	5068	1.3	TV16TT	ITV16TT	ITV16TT	6
3.2 JTS Q4 (939EXG2B, 939EXG22)	191	939 A.000		03/06-03/11	PT16VR13	5068	1.3	TV16TT	ITV16TT	ITV16TT	6
SZ (88-94)											
3.0 V6 Zagato (162C1)	152	AR 61501		09/88-08/94	W20EPR-U	3047	0.8	W20TT	IW20TT	IW20TT	6
3.0 V6 Zagato (162C1)	152	AR61501		09/88-12/91	W22EPR-U	3088	0.8	W22TT	-	VW22	6
ALPINA											
B3 (E30) (87-92)											
2.7	150	M20 B27 (27EH2)		09/87-06/92	J16CR-U	3256	0.8	W16TT	IW16TT	IW16TT	6
2.7 AWD	150	M20 B27 (27EH2)		09/87-06/92	J16CR-U	3256	0.8	W16TT	IW16TT	IW16TT	6
B3 (E36) (93-99)											
3.0	184	M60 B30 (308S1K)		04/93-02/96	K20TXR	5063	1.0	K20TT	IK20TT	IK20TT	8
3.2	195	M60 B30 (308S); M60 B30 (308S6K)		04/96-04/99	K20TXR	5063	1.0	K20TT	IK20TT	IK20TT	8
B3 (E46) (99-06)											
3.3	206	M52 B28 (286S); M52 B28 (286S7T)		03/99-07/02	K20TXR	5063	1.0	K20TT	IK20TT	IK20TT	6
3.3 AWD	206	M52 B28 (286S7T)		11/01-01/05	K20TXR	5063	1.0	K20TT	IK20TT	IK20TT	6
3.4 S	224	M52 B28 (286ST5)		08/02-01/06	K20TXR	5063	1.0	K20TT	IK20TT	IK20TT	6
B5 (E60, E61) (05-10)											
4.4	368	N62B44A19		03/05-09/10	K20TXR	5063	1.0	K20TT	IK20TT	IK20TT	8
4.4	368	N62B44A19		03/05-09/10	PK22PR8	3273	0.8	-	IK22TT	VK22	8
4.4 S	390	N62 B44 FB		10/07-03/10	K20TXR	5063	1.0	K20TT	IK20TT	IK20TT	8

Свечи зажигания и Свечи накаливания

Таблица применения











	KW				СТАНДАРТНЫЕ			Twin Tip			QTY
											
ALPINA продолжение											
B6 (E21) (78-83)											
2.8	147/ 160	M30 B28 (286EA2); M30 B28 (28EK0)		03/78-03/83	W16EPR-U	3021	0.8	W16TT	IW16TT	IW16TT	6
B6 (E30) (83-90)											
2.8	154	M30 B28 (28EP2)		11/83-07/86	W16EPR-U	3021	0.8	W16TT	IW16TT	IW16TT	6
3.4	187/ 192	M30 B34 (34C20)		08/84-12/90	W16EPR-U	3021	0.8	W16TT	IW16TT	IW16TT	6
B6 (E36) (92-93)											
2.8	177	M30 B28 (28C40)		03/92-07/93	J16CR-U	3256	0.8	W16TT	IW16TT	IW16TT	6
B6 (E63, E64) (06-10)											
4.4	368/ 390	N62 B44 A		04/06-08/10	K20TXR	5063	1.0	K20TT	IK20TT	IK20TT	8
B7 (E12) (78-82)											
3.0	221	M30 B30 (30ED1)		12/78-02/82	W16EPR-U	3021	0.8	W16TT	IW16TT	IW16TT	6
3.5	243	M30 B34 (34EP1)		11/81-05/82	W16EPR-U	3021	0.8	W16TT	IW16TT	IW16TT	6
B7 (E24) (78-88)											
3.0	221	M30 B30 (30ED1)		12/78-02/82	W16EPR-U	3021	0.8	W16TT	IW16TT	IW16TT	6
3.4	235/ 243	M30 B34 (34EP3); M30 B34 (34EP4)		05/82-06/88	W16EPR-U	3021	0.8	W16TT	IW16TT	IW16TT	6
B7 (E28) (84-87)											
3.0	221	M30 B30 (30ED1)		04/84-07/87	W16EPR-U	3021	0.8	W16TT	IW16TT	IW16TT	6
3.5	235	M30 B34 (34EP3)		08/86-12/87	W16EPR-U	3021	0.8	W16TT	IW16TT	IW16TT	6
B7 (E65) (03-08)											
4.4	368	N62B44A19		12/03-06/08	K20TXR	5063	1.0	K20TT	IK20TT	IK20TT	8
4.4	368	N62B44A19		12/03-06/08	PK22PR8	3273	0.8	-	IK22TT	VK22	8
B8 (E36) (95-98)											
4.6	245	F2/1 (M60 B46)		01/95-11/98	K20TXR	5063	1.0	K20TT	IK20TT	IK20TT	8
B9 (E24) (82-85)											
3.4	180	M30 B30 (306EA2)		07/82-12/85	W16EPR-U	3021	0.8	W16TT	IW16TT	IW16TT	6
3.4	180	M30 B30 (306EA2)		07/82-12/85	W20EP-U	3043	0.8	W20TT	IW20TT	IW20TT	6
B9 (E28) (81-85)											
3.4	180	M30 B30 (306EA2)		11/81-12/85	W16EPR-U	3021	0.8	W16TT	IW16TT	IW16TT	6
3.4	180	M30 B30 (306EA2)		11/81-12/85	W20EP-U	3043	0.8	W20TT	IW20TT	IW20TT	6
B10 (E34) (88-96)											
3.0 AWD	170	M30 B30 (30C20)		10/93-04/96	J16CR-U	3256	0.8	W16TT	IW16TT	IW16TT	6
3.4	187	M30 B34 (34C20)		04/88-12/92	J16CR-U	3256	0.8	W16TT	IW16TT	IW16TT	6
3.4	187	M30 B34 (34C20)		04/88-12/92	W20EP-U	3043	0.8	W20TT	IW20TT	IW20TT	6
3.4 Bi-Turbo	265	M30 B34 (34T36)		01/89-06/93	J16CR-U	3256	0.8	W16TT	IW16TT	IW16TT	6
4.0	232	M60 B40 (408S1K)		04/93-11/94	K20TXR	5063	1.0	K20TT	IK20TT	IK20TT	8
4.6	250	M62 B46 (468S4K)		03/94-06/95	K20TXR	5063	1.0	K20TT	IK20TT	IK20TT	8
B10 (E39) (96-04)											
3.2	191	M60 B30 (308S6K)		08/97-12/98	K20TXR	5063	1.0	K20TT	IK20TT	IK20TT	8
3.3	206	M52 B28 (286S7T)		01/99-10/03	K20TXR	5063	1.0	K20TT	IK20TT	IK20TT	6
4.6 V8	250/ 255	M62 B46 (468S72)		12/96-09/02	K20TXR	5063	1.0	K20TT	IK20TT	IK20TT	8
4.8 V8	276	N62 B48 AK2		01/02-05/04	IK20TT	4702	1.0	-	IK20TT	IK20TT	8
B11 (E32) (87-94)											
3.4	177/ 184/ 187	M30 B34 (34C20); M30 B34 (34E20)		01/87-12/93	J16CR-U	3256	0.8	W16TT	IW16TT	IW16TT	6
4.0	232	M60 B40 (408S1K)		05/93-02/94	K20TXR	5063	1.0	K20TT	IK20TT	IK20TT	8
B12 (E31) (90-96)											
5.0	258	M70 B50 (5012KA)		06/90-05/94	K20R-U	3122	0.8	K20TT	IK20TT	IK20TT	12
5.0	258	M70 B50 (5012KA)		06/90-05/94	KJ16CR-L11	3132	1.1	K16TT	IK16TT	IK16TT	12
5.6	306	M70 B57 (5714KA)		11/92-12/96	KJ16CR-L11	3132	1.1	K16TT	IK16TT	IK16TT	12
B12 (E32) (88-94)											
5.0	258	M70 B50 (5012KA)		07/88-01/94	KJ16CR-L11	3132	1.1	K16TT	IK16TT	IK16TT	12
B12 (E38) (95-01)											
5.7	285	M70 B57 (5714K2)		12/95-09/98	K20TXR	5063	1.0	K20TT	IK20TT	IK20TT	12
5.7	285	M70 B57 (5714K2)		12/95-09/98	KJ16CR-L11	3132	1.1	K16TT	IK16TT	IK16TT	12
6.0	316	M73 B54 (5412AG)		07/99-07/01	K20TXR	5063	1.0	K20TT	IK20TT	IK20TT	12
C1 (E30) (83-88)											
2.5	140	M20 B25 (256KE1)		10/86-06/88	J16CR-U	3256	0.8	W16TT	IW16TT	IW16TT	6
C2 (E30) (85-88)											
2.5	136	M20 B25 (256KE1)		07/85-03/88	J16CR-U	3256	0.8	W16TT	IW16TT	IW16TT	6
2.7	150/ 154	M20 B27 (276KE1)		02/86-08/87	J16CR-U	3256	0.8	W16TT	IW16TT	IW16TT	6
2.7 AWD	154	M20 B27 (276KE1)		02/86-07/87	J16CR-U	3256	0.8	W16TT	IW16TT	IW16TT	6











Таблица применения

A

Свечи зажигания и Свечи накаливания

Таблица применения

Таблица применения

	KW				СТАНДАРТНЫЕ			Twin Tip			QTY
											
ALPINA продолжение											
D3 (E90) (05-11)											
2.0	147	M47 D20 (204D4)		12/05-04/08	DG-178		5V				4
2.0 Bi-Turbo	157	N47 D20 D		07/08-05/13	DG-613		7V				4
D3 (E91) (05-12)											
2.0	147	M47 D20 (204D4)		12/05-04/08	DG-178		5V				4
2.0 Bi-Turbo	157	N47 D20 D		07/08-05/13	DG-613		7V				4
D3 (E92) (10-14)											
2.0 Bi-Turbo	157	N47 D20 D		07/08-05/13	DG-613		7V				4
D3 (F30) (14-)											
3.0 Bi-Turbo	257	N57 D30 B	OE: 12237803368; 12230035934	07/13-07/18	DG-613		7V				6
D3 (F31) (14-19)											
3.0 Bi-Turbo	257	N57 D30 B	OE: 12237803368; 12230035934	07/13-07/18	DG-613		7V				6
3.0 Bi-Turbo AWD	257	N57 D30 B	OE: 12237803368; 12230035934	07/13-07/18	DG-613		7V				6
D4 (F32, F33) (14-)											
3.0 Bi-Turbo	257	N57 D30 B	OE: 12237803368; 12230035934	09/14-	DG-613		7V				6
D5 (F10, F11) (11-16)											
3.0 Bi-Turbo	257	N57 D30 B	OE: 12237803368; 12230035934	09/11-12/16	DG-613		7V				6
D10 (E39) (00-03)											
3.0 D Bi-Turbo	180	M57 D30 (306DE1)		04/00-10/03	DG-145		11V				6
RLE (Z1) (90-91)											
2.7	147	M20 B27		08/90-09/91	J16CR-U	3256	0.8	W16TT	IW16TT	IW16TT	6
ROADSTER (Z8) (02-03)											
4.8 V8	280	M62 B48 (488S2)		06/02-10/03	K20TXR	5063	1.0	K20TT	IK20TT	IK20TT	8
ROADSTER S (Z4) (03-05)											
3.3	221	E 5/2		07/03-12/05	IXU24	5309	0.9	-	-	VXU24	6
3.3	221	S54327S7		07/03-12/05	K20TXR	5063	1.0	K20TT	IK20TT	IK20TT	6
XD3 (F25) (13-18)											
3.0 Bi-Turbo AWD	257	N57 D30 B	OE: 12237803368; 12230035934	04/13-06/18	DG-613		7V				6
ALPINE											
1600 (69-75)											
1.6 SC-SI	93			01/73-12/75	IW27	5317	0.7	-	-		4
A310 (71-84)											
2.7 V6	110			01/76-12/84	T20EPR-U	5032	0.8	T20TT	IT20TT	IT20TT	6
A610 (91-95)											
3.0 TURBO	184	Z7X 744		01/91-04/95	K22PB	5069	0.85	-	IKB22TT	VK22	6
V6 (85-90)											
GT	116	Z6W		01/85-12/90	T22EP-U	5040	0.8	-	-		6
TURBO	136	Z7U-734		01/85-12/90	IT22	5327	0.8	-	-		6
TURBO	147	Z7U		01/88-12/90	T22EP-U	5040	0.8	-	-		6
ARO											
10 (80-06)											
1.6 D	40	F8M 700		09/86-10/99	DG-001		11V				4
1.9 D	48	F8QA6	Double Coil(LPH)	09/92-10/06	DG-001		11V				4
1.9 TD	69	F8QT	Double Coil(LPH)	06/97-10/06	DG-012		11V				4
1.3	40	810-02		06/80-11/86	W16EPR-U	3021	0.8	W16TT	IW16TT	IW16TT	4
1.4	46	IAP 810-R-99		06/84-10/99	W16EPR-U	3021	0.8	W16TT	IW16TT	IW16TT	4
240-244 (78-06)											
2.5	59	Aro L25		01/80-12/98	W22FPR-U	4022	0.7	-	-		4
2.5 D	52	XD3P	Double Coil Std(LPH)	01/83-12/98	DG-001		11V				4
2.5 TD	70/74	VM-425HLT; XD3TP	Double Coil Std(LPH)	01/92-12/06	DG-001		11V				4
2.7 D	50/ 52/60	Aro L-27D	Double Coil Std(LPH)	01/83-12/98	DG-001		11V				4
SPARTANA (99-06)											
1.2	40	C3G 702		01/99-10/06	W16EPR-U	3021	0.8	W16TT	IW16TT	IW16TT	4

Свечи зажигания и Свечи накаливания

Таблица применения





	KW				СТАНДАРТНЫЕ				Twin Tip			QTY
ASIA MOTORS												
HI-TOPIC (93-99)												
2.7 D RWD	55	SS	Double Coil(LPH)	10/96-12/99	DG-626		11V					4
ROCSTA (89-99)												
1.8 i 4x4	57	F804		06/93-12/99	W16EPR-U	3021	0.8	W16TT	IW16TT	IW16TT		4
2.2 D 4x4	45	R2	Single Coil	06/93-12/99	DG-114		11V					4
ASTON MARTIN												
CYGNET (11-13)												
1.3	72	1NR-FE		04/11-10/13	SC16HR11	3499	1.1	-	IXEH20TT	IXEH20TT		4
DB6 (64-70)												
4.0	210/ 243	AJ6		10/64-12/70	W20EPR-U	3047	0.8	W20TT	IW20TT	IW20TT		6
DB7 (94-03)												
3.2	233/ 250	AJ6HT		05/94-10/03	Q22PR-U	3010	0.8	-	-	VQ22		6
5.9	309/ 320	AM2		03/99-10/03	PT16EPR-L13	5070	1.3	-	IT16TT	IT16TT		12
DB9 (04-16)												
6.0	331	AM3		04/04-07/12	ZT20EPR11	5087	1.1	T20TT	IT20TT	IT20TT		12
6.0 V12	331/ 350	AM3		01/04-10/16	ZT20EPR11	5087	1.1	T20TT	IT20TT	IT20TT		12
DBS (66-72)												
4.0	210	AJ6		01/66-12/72	W20EPR-U	3047	0.8	W20TT	IW20TT	IW20TT		6
LAGONDA (76-97)												
5.3	228/ 250/ 262	40HCA; 40HEL; 40HES		01/76-12/97	W20EXR-U	3066	0.8	W20TT	IW20TT	IW20TT		8
V8 (69-93)												
5.3	376	40HE		01/69-12/89	IW22	5307	0.8	-	-	VW22		8
VANQUISH (01-07)												
6.0 V12	338	AM 702		05/01-08/07	ZT20EPR11	5087	1.1	T20TT	IT20TT	IT20TT		12
VIRAGE (87-92)												
5.3	246	40HTA; 40HTE		01/88-12/92	Q20PR-U	3007	0.8	Q20TT	IQ20TT	IQ20TT		8
VIRAGE (90-00)												
5.3	246	40HTE		09/90-12/95	Q20PR-U	3007	0.8	Q20TT	IQ20TT	IQ20TT		8
5.3	410	40HG4; 40HTE		10/92-12/00	IQ24	5314	0.8	-	-			8
ZAGATO (86-89)												
5.3	228/ 322	40HCA; 40HCD		01/86-12/89	W22EPR-U	3088	0.8	W22TT	-	VW22		8
AUDI												
50 (86) (74-78)												
1.1	37	HB		08/74-07/78	W20EP-U	3043	0.8	W20TT	IW20TT	IW20TT		4
1.3	43	HH		08/77-07/78	W20EP-U	3043	0.8	W20TT	IW20TT	IW20TT		4
80 (80, 82, B1) (72-78)												
1.3	44	ZF		05/72-07/78	W20EP-U	3043	0.8	W20TT	IW20TT	IW20TT		4
1.6	53	FS/WP/ YY		01/76-07/78	W20EPR-U	3047	0.8	W20TT	IW20TT	IW20TT		4
1.6	55/63	YN; YP		09/75-07/78	W20EP-U	3043	0.8	W20TT	IW20TT	IW20TT		4
1.6	63	YP		09/75-07/78	W20EPB	5065	0.85	W20TT	IW20TT	IW20TT		4
80 (81, 85, B2) (78-86)												
1.3	40/44	FY; FZ/ ZA		09/78-07/81	W20EPR-U	3047	0.8	W20TT	IW20TT	IW20TT		4
1.3	44	EP		09/78-07/86	W20EP-U	3043	0.8	W20TT	IW20TT	IW20TT		4
1.3	44	EP	Ch:>F-220 000	08/81-07/86	W20EPR-U	3047	0.8	W20TT	IW20TT	IW20TT		4
1.3	44	EP	Ch:G-000 001>	08/85-07/86	W16EPB10	5064	1.0	W16TT	IW16TT	IW16TT		4
1.6	51/55	DT; WY/ WZ/ YN; YT; YY		08/78-07/86	W20EPR-U	3047	0.8	W20TT	IW20TT	IW20TT		4
1.6	51/ 55/63	DT; WV; YN; YP; YT; YY		08/78-07/86	W20EP-U	3043	0.8	W20TT	IW20TT	IW20TT		4
1.6	55	DT		08/85-07/86	W16EPB10	5064	1.0	W16TT	IW16TT	IW16TT		4
1.6	55	SA		02/86-07/86	IW16TT	4708	1.0	-	IW16TT			4
1.6 D	40	CR; JK	Double Coil(LPH)	08/80-08/86	DG-012		11V					4
1.6 GLE	81	YZ		08/78-07/82	W22EP-U	3085	0.8	W22TT	-	VW22		4
1.6 TD	51	CY	Double Coil(LPH)	08/81-05/86	DG-012		11V					4
1.8	66	DS		01/83-08/86	W20EPB	5065	0.85	W20TT	IW20TT	IW20TT		4
1.8	66/68	JN; SF		08/83-08/86	W20EPBR-S	5067	0.85	W20TT	IW20TT	IW20TT		4
1.8 CC quattro	66	NE		08/84-08/86	W20EPB	5065	0.85	W20TT	IW20TT	IW20TT		4
1.8 CC quattro	68	JN		08/85-08/86	W20EPBR-S	5067	0.85	W20TT	IW20TT	IW20TT		4
1.8 GTE	82	DZ; PV		10/84-08/86	W20EPB	5065	0.85	W20TT	IW20TT	IW20TT		4
1.8 GTE quattro	82	DZ; PV		08/84-08/86	W20EPB	5065	0.85	W20TT	IW20TT	IW20TT		4

Таблица применения

A

Свечи зажигания и Свечи накаливания

Таблица применения

Таблица применения

KW	KW	KW	NOTE	21	СТАНДАРТНЫЕ			Twin Tip		QTY	
					STANDARD	STANDARD	STANDARD	TWIN TIP	TWIN TIP		
AUDI продолжение											
80 (81, 85, B2) (78-86) продолжение											
1.9 CD-5S	85	WN		09/81-07/83	W22EP-U	3085	0.8	W22TT	-	WV22	5
2.0	85	JS		10/83-09/84	W20EPB	5065	0.85	W20TT	IW20TT	IW20TT	5
2.0 quattro	85	JS		10/83-09/84	W20EPR-U	3047	0.8	W20TT	IW20TT	IW20TT	5
2.2	85	WE		10/80-07/81	W20EP-U	3043	0.8	W20TT	IW20TT	IW20TT	5
2.2 quattro	96	KL		08/82-07/84	W20EPR-U	3047	0.8	W20TT	IW20TT	IW20TT	5
2.2 quattro	100	KK		08/82-07/84	W22EP-U	3085	0.8	W22TT	-	WV22	5
80 (89, 8A, B3) (86-91)											
1.4	48	SE		08/86-07/88	W16EPB10	5064	1.0	W16TT	IW16TT	IW16TT	4
1.6	51	PP		08/87-09/91	W20EPBR-S	5067	0.85	W20TT	IW20TT	IW20TT	4
1.6	55	RN		09/86-08/91	W16EPB10	5064	1.0	W16TT	IW16TT	IW16TT	4
1.6	75	ABB		08/90-10/91	W20EPB	5065	0.85	W20TT	IW20TT	IW20TT	4
1.6 D	40	JK	Double Coil(LPH)	02/87-07/89	DG-012		11V				4
1.6 TD	59	RA; SB	Double Coil(LPH)	09/86-08/91	DG-012		11V				4
1.8	55/83	RU; SD		09/86-01/90	W20EPBR-S	5067	0.85	W20TT	IW20TT	IW20TT	4
1.8 E	82	DZ		06/86-08/91	W20EPB	5065	0.85	W20TT	IW20TT	IW20TT	4
1.8 E quattro	82	DZ		09/86-08/91	W20EPB	5065	0.85	W20TT	IW20TT	IW20TT	4
1.8 quattro	83	SD		09/86-08/90	W20EPBR-S	5067	0.85	W20TT	IW20TT	IW20TT	4
1.8 S	66	JN; JV; NE; PM		09/86-10/91	W20EPB	5065	0.85	W20TT	IW20TT	IW20TT	4
1.8 S	66	SF		08/86-01/90	W20EPBR-S	5067	0.85	W20TT	IW20TT	IW20TT	4
1.8 S quattro	66	JN; NE; PM; SF		09/86-09/91	W20EPB	5065	0.85	W20TT	IW20TT	IW20TT	4
1.9 D	50	1Y		08/89-08/91	DG-012		11V				4
2.0	82	AAD		10/90-08/91	W20EPB	5065	0.85	W20TT	IW20TT	IW20TT	4
2.0 E	83	3A		08/88-10/90	W20EPBR-S	5067	0.85	W20TT	IW20TT	IW20TT	4
2.0 E 16V	101	6A		03/90-09/91	K20PBR-S10	5061	1.0	K20TT	IK20TT	IK20TT	4
2.0 E 16V	101	6A		03/90-09/91	K22PBR-S	5062	0.85	-	IKB22TT	VK22	4
2.0 E 16V quattro	101	6A		03/90-08/91	K20PBR-S10	5061	1.0	K20TT	IK20TT	IK20TT	4
2.0 E 16V quattro	101	6A		03/90-08/91	K22PBR-S	5062	0.85	-	IKB22TT	VK22	4
2.0 E quattro	83	3A		08/88-09/90	W20EPBR-S	5067	0.85	W20TT	IW20TT	IW20TT	4
2.0 quattro	85	AAD		10/90-08/91	W20EPB	5065	0.85	W20TT	IW20TT	IW20TT	4
80 (8C, B4) (91-96)											
1.6	52	ABM		09/91-12/94	W20EPBR-S	5067	0.85	W20TT	IW20TT	IW20TT	4
1.6 E	74	ADA		06/93-01/96	W20EPBR-S	5067	0.85	W20TT	IW20TT	IW20TT	4
1.9 TD	55	AAZ		09/91-12/94	DG-012		11V				4
1.9 TDI	66	1Z		09/91-01/96	DG-005		11V				4
2.0	66	ABT		09/91-01/96	W20EPBR-S	5067	0.85	W20TT	IW20TT	IW20TT	4
2.0 E	85	ABK		09/91-01/96	W20EPBR-S	5067	0.85	W20TT	IW20TT	IW20TT	4
2.0 E 16V	101/103	6A; ACE		09/91-01/96	K20PBR-S10	5061	1.0	K20TT	IK20TT	IK20TT	4
2.0 E 16V	103	ACE		08/92-12/94	K22PBR-S	5062	0.85	-	IKB22TT	VK22	4
2.0 E 16V	103	ACE		02/93-01/96	IK22	5310	0.8	-	IK22TT	VK22	4
2.0 E 16V quattro	103	ACE		04/92-07/95	K20PBR-S10	5061	1.0	K20TT	IK20TT	IK20TT	4
2.0 E 16V quattro	103	ACE		04/92-07/95	K22PBR-S	5062	0.85	-	IKB22TT	VK22	4
2.0 E quattro	85	ABK		09/91-12/94	W20EPBR-S	5067	0.85	W20TT	IW20TT	IW20TT	4
2.0 quattro	79	ADW		11/93-01/96	W20EPBR-S	5067	0.85	W20TT	IW20TT	IW20TT	4
2.2 RS2 quattro	232	ADU		03/94-05/95	PK22PR8	3273	0.8	-	IK22TT	VK22	5
2.2 S2 quattro	169	ABY		02/93-07/95	PK22PR8	3273	0.8	-	IK22TT	VK22	5
2.3 E	98	NG		09/91-01/96	W16ETR-S	3285	1.0	W16TT	IW16TT	IW16TT	5
2.3 E quattro	98	NG		09/91-12/94	W16ETR-S	3285	1.0	W16TT	IW16TT	IW16TT	5
2.6	110	ABC		07/92-01/96	K20PBR-S10	5061	1.0	K20TT	IK20TT	IK20TT	6
2.6 quattro	110	ABC		06/92-07/95	K20PBR-S10	5061	1.0	K20TT	IK20TT	IK20TT	6
2.8	128	AAH; AFC		09/91-01/96	K20PBR-S10	5061	1.0	K20TT	IK20TT	IK20TT	6
2.8 quattro	128	AAH; AFC		09/91-07/95	K20PBR-S10	5061	1.0	K20TT	IK20TT	IK20TT	6
90 (81, 85, B2) (84-87)											
1.6 TD	51	CY	Double Coil(LPH)	10/85-01/87	DG-012		11V				4
2.0	83/85	JS; SK		10/84-03/87	W20EPB	5065	0.85	W20TT	IW20TT	IW20TT	5
2.0 quattro	85	JS		08/84-08/86	W20EPB	5065	0.85	W20TT	IW20TT	IW20TT	5
2.2	100	KV		10/84-03/87	W20EPB	5065	0.85	W20TT	IW20TT	IW20TT	5
2.2 E quattro	88/100	JT; KV		11/84-03/87	W20EPB	5065	0.85	W20TT	IW20TT	IW20TT	5
90 (89, 8A, B3) (87-91)											
1.6 TD	59	RA; SB	Double Coil(LPH)	04/87-09/91	DG-012		11V				4
2.0	85	PS		07/88-09/91	W20EPBR-S	5067	0.85	W20TT	IW20TT	IW20TT	5
2.0 20 V	118	NM		08/89-07/91	K22PB	5069	0.85	-	IKB22TT	VK22	5
2.0 20 V quattro	118	NM		08/88-09/91	K22PB	5069	0.85	-	IKB22TT	VK22	5

Свечи зажигания и Свечи накаливания

Таблица применения





	KW				СТАНДАРТНЫЕ			Twin Tip			QTY
											
AUDI продолжение											
90 (89, 8A, B3) (87-91) продолжение											
2.0 quattro	101	6A		08/89-07/90	K20PBR-S10	5061	1.0	K20TT	IK20TT	IK20TT	4
2.2 E	100	KV		04/87-07/91	W20EPB	5065	0.85	W20TT	IW20TT	IW20TT	5
2.2 E quattro	100	KV		04/87-09/91	W20EPB	5065	0.85	W20TT	IW20TT	IW20TT	5
2.3 E	98/ 100	NG		04/87-09/91	W16ETR-S	3285	1.0	W16TT	IW16TT	IW16TT	5
2.3 E 20V	125	7A		08/88-07/91	K22PBR-S	5062	0.85	-	IKB22TT	VK22	5
2.3 E quattro	98/ 100	NG		04/87-09/91	W16ETR-S	3285	1.0	W16TT	IW16TT	IW16TT	5
100 (43, C2) (76-83)											
1.6	63	YV		08/76-07/82	W20EP-U	3043	0.8	W20TT	IW20TT	IW20TT	4
1.9	74	WH		08/80-07/82	W20EP-U	3043	0.8	W20TT	IW20TT	IW20TT	5
2.0	85	WA		06/76-07/80	W22EP-U	3085	0.8	W22TT	-	VW22	4
2.0 D	51	CN	Double Coil(LPH)	08/78-02/83	DG-012		11V				5
2.1	85	WE		07/77-02/83	W20EP-U	3043	0.8	W20TT	IW20TT	IW20TT	5
2.1	100	WG		03/77-02/83	W20EPB	5065	0.85	W20TT	IW20TT	IW20TT	5
100 (44, C3) (82-91)											
1.8	55	DR	Ch:H084706> K100614	01/86-12/87	W16EPB10	5064	1.0	W16TT	IW16TT	IW16TT	4
1.8	55	DR; RS		08/82-12/87	W20EPR-U	3047	0.8	W20TT	IW20TT	IW20TT	4
1.8	66	NP		08/83-07/89	W20EPB	5065	0.85	W20TT	IW20TT	IW20TT	4
1.8	66	SH		02/86-07/90	W20EPBR-S	5067	0.85	W20TT	IW20TT	IW20TT	4
1.8 Cat	66	4B		03/85-11/90	W20EPBR-S	5067	0.85	W20TT	IW20TT	IW20TT	4
1.8 Cat quattro	66	4B		08/85-11/90	W20EPBR-S	5067	0.85	W20TT	IW20TT	IW20TT	4
1.8 quattro	65	NP		10/84-07/88	W20EPB	5065	0.85	W20TT	IW20TT	IW20TT	4
1.8 quattro	65	SH		08/86-07/90	W20EPBR-S	5067	0.85	W20TT	IW20TT	IW20TT	4
1.9	74	WH		08/82-07/84	W20EP-U	3043	0.8	W20TT	IW20TT	IW20TT	5
2.0	83/85	KP; SL		08/86-12/87	W20EPB	5065	0.85	W20TT	IW20TT	IW20TT	5
2.0 Cat	85	RT		01/88-11/90	W20EPBR-S	5067	0.85	W20TT	IW20TT	IW20TT	5
2.0 D	51	CN	Double Coil(LPH)	08/82-11/90	DG-012		11V				5
2.0 D Turbo	64/74	DE; NC	Double Coil(LPH)	08/82-11/90	DG-012		11V				5
2.0 E	85	KP		08/86-12/87	W20EPB	5065	0.85	W20TT	IW20TT	IW20TT	5
2.0 E Cat	85	RT		01/88-11/90	W20EPBR-S	5067	0.85	W20TT	IW20TT	IW20TT	5
2.0 TD	64/74	DE; NC	Double Coil(LPH)	03/83-11/90	DG-012		11V				5
2.1	100	WC		08/82-07/84	W20EPB	5065	0.85	W20TT	IW20TT	IW20TT	5
2.2	79	WU		08/82-07/84	W20EPR-U	3047	0.8	W20TT	IW20TT	IW20TT	5
2.2	85/ 96/ 101	KF; KU; KZ		08/82-12/88	W20EPB	5065	0.85	W20TT	IW20TT	IW20TT	5
2.2 Cat	101	KU		06/89-11/90	W20EPB	5065	0.85	W20TT	IW20TT	IW20TT	5
2.2 E Turbo quattro	121	MC		08/86-11/90	W20EPB	5065	0.85	W20TT	IW20TT	IW20TT	5
2.2 quattro	101	KU		08/84-12/88	W20EPB	5065	0.85	W20TT	IW20TT	IW20TT	5
2.2 Turbo	121	MC		08/86-11/90	W20EPB	5065	0.85	W20TT	IW20TT	IW20TT	5
2.2 Turbo quattro	121	MC		08/86-11/90	W20EPB	5065	0.85	W20TT	IW20TT	IW20TT	5
2.3	100	NF		08/86-11/90	W20EPB	5065	0.85	W20TT	IW20TT	IW20TT	5
2.3 E	98	NF		01/90-11/90	W16ETR-S	3285	1.0	W16TT	IW16TT	IW16TT	5
2.3 E	100	NF		10/86-11/90	W20EPB	5065	0.85	W20TT	IW20TT	IW20TT	5
2.3 E quattro	100	NF		08/86-11/90	W20EPB	5065	0.85	W20TT	IW20TT	IW20TT	5
2.4 D	60	3D	Double Coil(LPH)	08/89-07/91	DG-012		11V				5
2.5 TDI	88	1T	Double Coil(LPH)	01/90-11/90	DG-005		11V				5
100 (4A, C4) (90-94)											
2.0	74	AAE		12/90-07/94	W20EPBR-S	5067	0.85	W20TT	IW20TT	IW20TT	4
2.0	103	ACE		08/92-07/93	K20PBR-S10	5061	1.0	K20TT	IK20TT	IK20TT	4
2.0 E	74/85	AAE; ABK		12/90-07/94	W20EPBR-S	5067	0.85	W20TT	IW20TT	IW20TT	4
2.0 E 16V	103	ACE		01/92-07/94	K20PBR-S10	5061	1.0	K20TT	IK20TT	IK20TT	4
2.0 E 16V	103	ACE		01/92-07/94	K22PBR-S	5062	0.85	-	IKB22TT	VK22	4
2.0 E 16V quattro	103	ACE		07/92-07/94	K20PBR-S10	5061	1.0	K20TT	IK20TT	IK20TT	4
2.0 E 16V quattro	103	ACE		07/92-07/94	K22PBR-S	5062	0.85	-	IKB22TT	VK22	4
2.0 E quattro	85	AAD		12/90-07/92	W20EPB	5065	0.85	W20TT	IW20TT	IW20TT	4
2.0 quattro	103	ACE		08/92-07/93	K20PBR-S10	5061	1.0	K20TT	IK20TT	IK20TT	4
2.2 S4 Turbo quattro	169	AAN		08/91-07/94	PK22PR8	3273	0.8	-	IK22TT	VK22	5
2.3 E	98	AAR		12/90-07/94	W20EPBR-S	5067	0.85	W20TT	IW20TT	IW20TT	5
2.3 E quattro	98	AAR		12/90-07/94	W16ETR-S	3285	1.0	W16TT	IW16TT	IW16TT	5
2.4 D	60	AAS		12/90-07/94	DG-012		11V				5











Таблица применения

A

Свечи зажигания и Свечи накаливания

Таблица применения

Таблица применения

	KW				СТАНДАРТНЫЕ				Twin Tip			QTY
												
AUDI продолжение												
100 (4A, C4) (90-94) продолжение												
2.5 TDI	85	AAT; ABP	Double Coil(LPH)	12/90-07/94	DG-005		11V					5
2.6	102/110	ABC; ACZ		03/92-07/94	K20PBR-S10	5061	1.0	K20TT	IK20TT	IK20TT		6
2.6 E quattro	102	ACZ		08/93-07/94	K20PBR-S10	5061	1.0	K20TT	IK20TT	IK20TT		6
2.6 quattro	110	ABC		04/92-07/94	K20PBR-S10	5061	1.0	K20TT	IK20TT	IK20TT		6
2.8 E	128	AAH		12/90-07/94	K20PBR-S10	5061	1.0	K20TT	IK20TT	IK20TT		6
2.8 E quattro	128	AAH		12/90-07/94	K20PBR-S10	5061	1.0	K20TT	IK20TT	IK20TT		6
4.2 S4 V8 quattro	206	ABH		10/92-07/94	T20EPR-U	5032	0.8	T20TT	IT20TT	IT20TT		8
100 (C1) (68-76)												
1.8	66	ZX		11/68-11/71	W20EPR-U	3047	0.8	W20TT	IW20TT	IW20TT		4
200 (43) (79-82)												
2.1 5E	100	WC		10/79-09/82	W20EPB	5065	0.85	W20TT	IW20TT	IW20TT		5
2.1 5T	125	WJ		10/79-08/82	IW22	5307	0.8	-	-	VW22		5
200 (44) (83-91)												
2.1 5E	100	WC		08/83-07/84	W20EPB	5065	0.85	W20TT	IW20TT	IW20TT		5
2.1 Turbo	134	KG		08/85-01/88	W20EPB	5065	0.85	W20TT	IW20TT	IW20TT		5
2.1 Turbo quattro	134	JY; KG		10/84-01/88	W20EPB	5065	0.85	W20TT	IW20TT	IW20TT		5
2.2	101	KU		08/84-07/85	W20EPB	5065	0.85	W20TT	IW20TT	IW20TT		5
2.2 20V Turbo quattro	162	3B		03/89-12/90	PK22PR8	3273	0.8	-	IK22TT	VK22		5
2.2 Turbo	121/140/147	1B; 2B; MC		08/85-09/91	W20EPB	5065	0.85	W20TT	IW20TT	IW20TT		5
2.2 Turbo quattro	121/147	1B; MC		09/83-12/91	W20EPB	5065	0.85	W20TT	IW20TT	IW20TT		5
2.3	100	NF		11/86-09/91	W20EPB	5065	0.85	W20TT	IW20TT	IW20TT		5
A1 (8X) (10-18)												
1.4 TDI	66	CUSB	Pressure sensor(-)	11/14-10/18	DG-193		4.4V					2
1.4 TFSI	90/136	CAVG; CAXA; CTHG; CTJA		05/10-04/15	PKJ20CR8	3173	0.8	-	IK20TT	IK20TT		4
1.4 TFSI	136	CAVG; CTHG; CTJA		02/11-04/15	SKJ20CR-A8	3371	0.8	-	-	SKJ20CR-A8		4
1.6 TDI	66/77	CAYB; CAYC		05/10-04/15	DG-193		4.4V					4
1.6 TDI	85	CXMA	Pressure sensor(-)	11/14-10/18	DG-193		4.4V					3
2.0 TDI	100/105	CFHB; CFHD		09/11-04/15	DG-193		4.4V					4
2.0 TFSI quattro	188	CDLH		03/12-11/12	PK22PR8	3273	0.8	-	IK22TT	VK22		4
A2 (8Z) (00-05)												
1.2 TDI	45	ANY	Double Coil(LPH)	03/01-08/05	DG-109		11V					3
1.4	55	AUA; BBY		02/00-08/05	K20PBR-S10	5061	1.0	K20TT	IK20TT	IK20TT		4
1.4 TDI	55	AMF; BHC	Double Coil(LPH)	02/00-08/05	DG-109		11V					3
1.4 TDI	66	ATL		11/03-08/05	DG-177		5V					3
1.6 FSI	81	BAD		05/02-08/05	K20PBR-S10	5061	1.0	K20TT	IK20TT	IK20TT		4
A3 (8L) (96-03)												
1.6	75	AEH; AVU		09/96-05/03	K20PBR-S10	5061	1.0	K20TT	IK20TT	IK20TT		4
1.8	92	AGN		09/96-05/03	K20PBR-S10	5061	1.0	K20TT	IK20TT	IK20TT		4
1.8 S3 quattro	154/165	AMK; BAM		03/99-05/03	PK20PR-P8	3245	0.8	-	IK20TT	IK20TT		4
1.8 T	110/132	AGU; AUQ		12/96-05/03	PK20PR-P8	3245	0.8	-	IK20TT	IK20TT		4
1.8 T quattro	110/132	AQA; ARY		12/96-05/03	PK20PR-P8	3245	0.8	-	IK20TT	IK20TT		4
1.9 TDI	66/81	AGR; AHF; ALH; ASV	Auxiliary Heater	09/96-07/01	DG-628		11V					3
1.9 TDI	66/81	AGR; AHF; ALH; ASV	Double Coil(LPH)	09/96-07/01	DG-005		11V					4
1.9 TDI	74	AXR		10/00-05/03	DG-109		11V					4
1.9 TDI	74/96	ASZ; ATD	Ch:> 8L-2-037 877	08/00-10/01	DG-005		11V					4
1.9 TDI	74/96	ASZ; ATD	Ch: 8L-2-037 878>	11/01-05/03	DG-109		11V					4
1.9 TDI quattro	96	ASZ	Ch:> 8L-2-037 877	08/00-10/01	DG-005		11V					4
1.9 TDI quattro	96	ASZ	Ch: 8L-2-037 878>	11/01-05/03	DG-109		11V					4
A3 (8P) (03-13)												
1.4 TFSI	92	CAXC; CMSA		09/07-03/13	PKJ20CR8	3173	0.8	-	IK20TT	IK20TT		4
1.6	75	BGU/ BSE/ BSF/ CCSA		05/03-12/10	K20PBR-S10	5061	1.0	K20TT	IK20TT	IK20TT		4

Свечи зажигания и Свечи накаливания

Таблица применения





	KW				СТАНДАРТНЫЕ			Twin Tip			QTY
AUDI продолжение											
A3 (8P) (03-13) продолжение											
1.6 E-Power	75	CCSA; CMXA		01/11-03/13	K20PBR-S10	5061	1.0	K20TT	IK20TT	IK20TT	4
1.6 FSI	85	BAG; BLF; BLP		08/03-09/07	K20PBR-S10	5061	1.0	K20TT	IK20TT	IK20TT	4
1.6 TDI	66/77	CAYB; CAYC		05/09-03/13	DG-193		4.4V				4
1.8 TFSI	118	BYT; BZB; CDAA		11/06-03/13	PK22PR8	3273	0.8	-	IK22TT	VK22	4
1.8 TFSI quattro	118	CDAA		07/08-03/13	PK22PR8	3273	0.8	-	IK22TT	VK22	4
1.9 TDI	77	BKC; BLS; BXE		05/03-05/10	DG-177		5V				4
2.0 FSI	110	AXW/ BLR/ BLX/ BVY		05/03-06/08	VKA16	5622	1.1	-	-	VKA16	4
2.0 FSI	110	BLY/ BMB/ BVZ		05/03-06/08	K20PR-U	3145	0.8	K20TT	IK20TT	IK20TT	4
2.0 S3 quattro	188/195	BHZ; BZC; CDLA; CDLC		11/06-03/13	PK22PR8	3273	0.8	-	IK22TT	VK22	4
2.0 TDI	100/103	AZV; BKD		05/03-03/13	DG-190		4.4V				4
2.0 TDI	100/103/125	CBAA; CBAB; CBBB; CFFA; CFFB; CFGB; CLJA		05/03-03/13	DG-193		4.4V				4
2.0 TDI	120/125	BMN; BUY	OE: N 105 798 03/ N 105 798 05, Ceramic	03/06-03/13	DG-622		7V				4
2.0 TDI 8V	103	BMM	Ch: 6A138001 or 6B019001>, OE: A 105 916 02/ A 105 916 03	01/06-06/08	DG-177		5V				4
2.0 TDI 8V quattro	103	BMM	Ch: 6A138001 or 6B019001>, OE: A 105 916 02/ A 105 916 03	01/06-06/08	DG-177		5V				4
2.0 TDI quattro	100/103	AZV; BKD		05/03-03/13	DG-190		4.4V				4
2.0 TDI quattro	103/125	CBAB; CBBB; CFFB; CFGB		08/04-03/13	DG-193		4.4V				4
2.0 TDI quattro	125	BMN	OE: N 105 798 03/ N 105 798 05, Ceramic	03/06-03/13	DG-622		7V				4
2.0 TFSI	147	AXX; BPY; BWA; CAWB; CBFA; CCTA; CCZA		09/04-03/13	PK22PR8	3273	0.8	-	IK22TT	VK22	4
2.0 TFSI quattro	147	AXX; BPY; BWA; CCTA; CCZA		09/04-03/13	PK22PR8	3273	0.8	-	IK22TT	VK22	4
2.5 RS3 quattro	250	CEPA		01/11-12/12	VKH22	5619	0.8	-	-	VKH22	5
A3 (8V) (12-)											
1.6 TDI	77/81	CLHA; CRKB; CXXB; DBKA	Pressure sensor(-)	10/12-	DG-193		4.4V				3
1.6 TDI quattro	81	CXXB	Pressure sensor(-)	05/15-	DG-193		4.4V				3
2.0 TDI	81/100/105/110/135	CRBC; CRBD; CRFA; CRFC; CRLB; CRLC; CRUA; CUNA; DBGA; DCYA; DEJA; DEJB; DFGA	Pressure sensor(-)	04/12-	DG-193		4.4V				3
2.0 TDI quattro	110/135	CRBC; CRLB; CUNA; DCYA; DGCA	Pressure sensor(-)	10/12-	DG-193		4.4V				3
A3 Convertible (8P7) (08-13)											
1.4 TFSI	92	CAXC		02/11-05/13	PKJ20CR8	3173	0.8	-	IK20TT	IK20TT	4
1.6	75	BSE		09/08-05/10	K20PBR-S10	5061	1.0	K20TT	IK20TT	IK20TT	4
1.6 TDI	77	CAYC		05/09-05/13	DG-193		4.4V				4
1.8 TFSI	118	BZB; CDAA		04/08-05/13	PK22PR8	3273	0.8	-	IK22TT	VK22	4
1.9 TDI	77	BLS		04/08-10/09	DG-177		5V				4
2.0 TDI	100/103	CBAA; CBAB; CFFA; CFFB		04/08-05/13	DG-193		4.4V				4
2.0 TFSI	147	CAWB; CCZA		04/08-05/13	PK22PR8	3273	0.8	-	IK22TT	VK22	4
A3 Convertible (8V7) (13-)											
1.6 TDI	81	CRKB; CXXB	Pressure sensor(-)	02/14-	DG-193		4.4V				3
2.0 TDI	100/110/135	CRLB; CRLC; CUNA; DCYA	Pressure sensor(-)	10/13-	DG-193		4.4V				3
2.0 TDI quattro	110/135	CRLB; CUNA; DCYA; DGCA	Pressure sensor(-)	03/14-	DG-193		4.4V				3
A4 (8D, B5) (94-01)											
1.6	75	ADP; AHL; ALZ; ANA; ARM		11/94-09/01	K20PBR-S10	5061	1.0	K20TT	IK20TT	IK20TT	4
1.8	85/92	ADR; AFY		11/94-09/01	K20PBR-S10	5061	1.0	K20TT	IK20TT	IK20TT	4

Таблица применения

A

Свечи зажигания и Свечи накаливания

Таблица применения

Таблица применения

KW	KW	NOTE	21	СТАНДАРТНЫЕ			Twin Tip		QTY		
				1	2	3	4	5			
AUDI продолжение											
A4 (8D, B5) (94-01) продолжение											
1.8 quattro	92	ADR		01/95-09/01	K20PBR-S10	5061	1.0	K20TT	IK20TT	IK20TT	4
1.8 T	110	AEB		01/95-11/00	K20PBR-S10	5061	1.0	K20TT	IK20TT	IK20TT	4
1.8 T	110/ 132	AEB; AJL		03/96-09/01	PK20PR-P8	3245	0.8	-	IK20TT	IK20TT	4
1.8 T quattro	110/ 132	AEB; AJL; ANB		01/95-09/01	PK20PR-P8	3245	0.8	-	IK20TT	IK20TT	4
1.9 DUO	66	AHU	Auxiliary Heater	03/98-09/01	DG-012		11V				3
1.9 DUO	66	AHU	Double Coil(LPH)	03/98-09/01	DG-005		11V				4
1.9 TDI	55/ 66/81	AFF; AFN; AHH; AHU; AVG	Auxiliary Heater	01/95-09/01	DG-012		11V				3
1.9 TDI	55/ 66/ 81/85	1Z; AFF; AFN; AHH; AHU; AJM; AVG	Double Coil(LPH)	01/95-09/01	DG-005		11V				4
1.9 TDI	85	AJM	Auxiliary Heater	03/00-09/01	DG-628		11V				3
1.9 TDI quattro	81	AFN; AVG	Auxiliary Heater	09/96-09/01	DG-012		11V				3
1.9 TDI quattro	81/85	AFN; AJM; ATJ; AVG	Double Coil(LPH)	09/96-09/01	DG-005		11V				4
1.9 TDI quattro	85	AJM; ATJ	Auxiliary Heater	03/00-09/01	DG-628		11V				3
2.4	121	AGA; AMM		03/97-09/01	K20TXR	5063	1.0	K20TT	IK20TT	IK20TT	6
2.4 quattro	121	AGA; AJG; APZ		03/97-09/01	K20TXR	5063	1.0	K20TT	IK20TT	IK20TT	6
2.5 TDI	110	AFB; AKN	Double Coil(LPH)	09/97-09/01	DG-144		11V				6
2.5 TDI quattro	110	AFB; AKN	Double Coil(LPH)	09/97-09/01	DG-144		11V				6
2.6	110	ABC		01/95-09/01	K20PBR-S10	5061	1.0	K20TT	IK20TT	IK20TT	6
2.6 quattro	110	ABC		01/95-09/01	K20PBR-S10	5061	1.0	K20TT	IK20TT	IK20TT	6
2.7 RS4	280	ASJ		05/00-09/01	PK22PR8	3273	0.8	-	IK22TT	VK22	6
2.7 S4 quattro	195	AGB; AZB		09/97-09/01	PK20PR-P8	3245	0.8	-	IK20TT	IK20TT	6
2.8	128	AAH		09/95-07/97	K20PBR-S10	5061	1.0	K20TT	IK20TT	IK20TT	6
2.8	140/ 142	ALG; ATX		10/96-09/01	K20TXR	5063	1.0	K20TT	IK20TT	IK20TT	6
2.8 quattro	128	AAH		01/95-07/97	K20PBR-S10	5061	1.0	K20TT	IK20TT	IK20TT	6
2.8 quattro	140/ 142	ALG; ATX		10/96-09/01	K20TXR	5063	1.0	K20TT	IK20TT	IK20TT	6
A4 (8E, B6) (00-04)											
1.6	75	ALZ		11/00-12/04	K20PBR-S10	5061	1.0	K20TT	IK20TT	IK20TT	4
1.6	75	ALZ	OEM Optional	11/00-12/04	PK20PR-P8	3245	0.8	-	IK20TT	IK20TT	4
1.8 T	110/ 120/ 125/ 140	AMB; AVJ; BEX; BFB		11/00-12/04	PK20PR-P8	3245	0.8	-	IK20TT	IK20TT	4
1.8 T quattro	110/ 120/ 125/ 140	AMB; AVJ; BEX; BFB		11/00-12/04	PK20PR-P8	3245	0.8	-	IK20TT	IK20TT	4
1.9 TDI	74	AVB	Double Coil(LPH)	11/01-12/04	DG-109		11V				4
1.9 TDI	74/96	AVB; AVF; AWX	Ch:> 8E-2-148 697, Double Coi l(LPH)	11/00-10/01	DG-005		11V				4
1.9 TDI	74/96	AVB; AVF; AWX	Ch: 8E-2-148 698> ,Double Coi l(LPH)	11/01-12/04	DG-109		11V				4
1.9 TDI	85	BKE	Ch: 8E-5-070 251>	08/04-12/04	DG-177		5V				4
1.9 TDI quattro	96	AVF	Double Coil(LPH)	11/01-12/04	DG-109		11V				4
2.0	96	ALT		11/00-12/04	K16TNR-S9	3329	0.9	K16TT	IK16TT	IK16TT	4
2.0 FSI	110	AWA		07/02-12/04	VKA16	5622	1.1	-	-	VKA16	4
2.4	120/ 125	AMM; BDV		09/01-12/04	K20TXR	5063	1.0	K20TT	IK20TT	IK20TT	6
2.5 D	132	AKE	Double Coil(LPH)	10/00-05/03	DG-144		11V				6
2.5 TDI	114/ 120	AYM; BCZ; BDG; BFC	Double Coil(LPH)	08/01-12/04	DG-144		11V				6
2.5 TDI quattro	132	AKE; BAU; BDH	Double Coil(LPH)	11/00-12/04	DG-144		11V				6
3.0	160/ 162	ASN/ BBJ; ASN; BBJ		11/00-12/04	K20TXR	5063	1.0	K20TT	IK20TT	IK20TT	6
3.0	162	AVK		11/00-06/02	PK20PR-L11	3142	1.1	-	IK20TT	IK20TT	6
3.0 quattro	160/ 162	ASN/ BBJ; BBJ		11/00-12/04	K20TXR	5063	1.0	K20TT	IK20TT	IK20TT	6
3.0 quattro	162	AVK		11/00-06/02	PK20PR-L11	3142	1.1	-	IK20TT	IK20TT	6

Свечи зажигания и Свечи накаливания

Таблица применения





	KW				СТАНДАРТНЫЕ			Twin Tip			QTY
AUDI продолжение											
A4 (8E, B6) (00-04) продолжение											
4.2 S4 quattro	253	BBK		03/03-12/04	K20PBR-S10	5061	1.0	K20TT	IK20TT	IK20TT	8
4.2 S4 quattro	253	BBK		03/03-12/04	K20TXR	5063	1.0	K20TT	IK20TT	IK20TT	8
A4 (8E, B7) (04-08)											
1.6	75	ALZ		11/04-06/08	K20PBR-S10	5061	1.0	K20TT	IK20TT	IK20TT	4
1.8 T	120	BFB		11/04-06/08	PK20PR-P8	3245	0.8	-	IK20TT	IK20TT	4
1.8 T quattro	120	BFB		11/04-06/08	PK20PR-P8	3245	0.8	-	IK20TT	IK20TT	4
1.9 TDI	85	BKE		11/04-06/08	DG-177		5V				4
2.0	96	ALT		11/04-06/08	K16TNR-S9	3329	0.9	K16TT	IK16TT	IK16TT	4
2.0 TDI	89/ 93/ 100/ 103/ 120/ 125	BRD; BRE; BRF; BVA; BVF; BVG	OE: N 105 798 03/ N 105 798 05, Ceramic	11/04-06/08	DG-622		7V				4
2.0 TDI	100/ 103	BLB; BNA		11/04-06/08	DG-190		4.4V				4
2.0 TDI quattro	120/ 125	BRD; BVA	OE: N 105 798 03/ N 105 798 05, Ceramic	06/06-06/08	DG-622		7V				4
2.0 TFSI	125/ 147/ 162	BGB/ BWE; BGB; BPJ; BUL; BWE		11/04-06/08	PK22PR8	3273	0.8	-	IK22TT	VK22	4
2.0 TFSI quattro	147/ 162	BGB/ BWE; BUL		11/04-06/08	PK22PR8	3273	0.8	-	IK22TT	VK22	4
2.5 TDI	120	BDG	Double Coil(LPH)	11/04-05/06	DG-144		11V				6
2.7 TDi	120/ 132	BPP; BSG		11/05-06/08	DG-193		4.4V				6
3.0	160	BBJ		11/04-05/06	K20TXR	5063	1.0	K20TT	IK20TT	IK20TT	6
3.0 quattro	160	BBJ		11/04-07/06	K20TXR	5063	1.0	K20TT	IK20TT	IK20TT	6
3.0 TDI quattro	150/ 171	ASB; BKN		11/04-06/08	DG-193		4.4V				6
3.2 FSI	188	AUK		01/05-06/08	IK22	5310	0.8	-	IK22TT	VK22	6
3.2 FSI quattro	188	AUK; BKH		01/05-06/08	IK22	5310	0.8	-	IK22TT	VK22	6
4.2 RS4	309	BNS		09/05-06/08	IK22	5310	0.8	-	IK22TT	VK22	8
4.2 RS4	309	BNS		09/05-06/08	PK22PR8	3273	0.8	-	IK22TT	VK22	8
4.2 RS4	309	BNS		09/05-06/08	VKB20	5625	1.1	-	-	VKB20	8
4.2 S4 quattro	253	BBK; BHF		11/04-06/08	K20PBR-S10	5061	1.0	K20TT	IK20TT	IK20TT	8
4.2 S4 quattro	253	BBK; BHF		11/04-06/08	K20TXR	5063	1.0	K20TT	IK20TT	IK20TT	8
A4 (8K, B8) (07-15)											
1.8 TFSI	88/ 118	CABA; CABB; CDHA; CDHB		11/07-12/15	PK22PR8	3273	0.8	-	IK22TT	VK22	4
1.8 TFSI quattro	118	CDHB		09/08-03/12	PK22PR8	3273	0.8	-	IK22TT	VK22	4
2.0 TDI	88/ 100/ 105/ 110/ 120/ 125/ 130	CAGA; CAGB; CAGC; CAHA; CAHB; CGLC; CGLD; CJCA; CJCB; CJCC; CJCD; CMEA; CMFA; CMGB; CNHC		11/07-12/15	DG-193		4.4V				4
2.0 TDI	100/ 105/ 110/ 120/ 140	CAHB; CGLD; CMEA; CMFA; CMFB; CNHA; CNHC; CSUA; CSUB	Pressure sensor(-)	11/07-12/15	DG-193		4.4V				3
2.0 TDI quattro	105/ 110/ 125/ 130	CAGA; CAHA; CGLC; CJCA; CJCD		01/08-12/15	DG-193		4.4V				4
2.0 TDI quattro	110/ 140	CNHA; CSUA	Pressure sensor(-)	05/13-12/15	DG-193		4.4V				3
2.0 TFSI	132/ 155	CAEA; CAEB; CDNB; CDNC; CFKA		06/08-12/15	PK22PR8	3273	0.8	-	IK22TT	VK22	4
2.0 TFSI FlexFuel	132	CFKA		11/09-12/15	PK22PR8	3273	0.8	-	IK22TT	VK22	4
2.0 TFSI FlexFuel quattro	132	CFKA		11/09-12/15	PK22PR8	3273	0.8	-	IK22TT	VK22	4
2.0 TFSI quattro	155/ 162	CAEB; CAED; CDNC; CPMA; CPMB		06/08-12/15	PK22PR8	3273	0.8	-	IK22TT	VK22	4
2.7 TDI	120/ 140	CAMA; CAMB; CGKA; CGKB		11/07-03/12	DG-193		4.4V				6
3.0 S4 quattro	245	CAKA; CCBA; CGWC; CGXC; CREC; CTUB		11/08-12/15	IK24	5311	0.8	-	-		6
3.0 TDI	150	CLAB		11/11-12/15	DG-193		4.4V				6
3.0 TDI quattro	155/ 176/ 180	CAPA; CCWA; CCWB; CDUC		11/07-12/15	DG-193		4.4V				6











Таблица применения

A

Свечи зажигания и Свечи накаливания

Таблица применения

Таблица применения

	KW				СТАНДАРТНЫЕ				Twin Tip		QTY
											
AUDI продолжение											
A4 (8K, B8) (07-15) продолжение											
3.0 TDI quattro	176/180	CCLA; CKVB; CKVC	Pressure sensor(-)	11/07-12/15	DG-193		4.4V				4
3.2 FSI	195	CALA		09/08-03/12	PK20PR-L11	3142	1.1	-	IK20TT	IK20TT	6
3.2 FSI	195	CALA	OEM Optional	09/08-03/12	IK20TT	4702	1.0	-	IK20TT	IK20TT	6
3.2 FSI quattro	195	CALA		05/09-03/12	PK20PR-L11	3142	1.1	-	IK20TT	IK20TT	6
3.2 FSI quattro	195	CALA	OEM Optional	11/07-03/12	IK20TT	4702	1.0	-	IK20TT	IK20TT	6
4.2 RS4 quattro	331	CFSA		05/12-08/15	PK22PR8	3273	0.8	-	IK22TT	VK22	8
A4 (8W, B9) (15-)											
2.0 TDI	90/100/110/140	CZHA; DESA; DETA; DEUA; DEUB; DEUC; DFVA	Pressure sensor(-)	05/15-	DG-193		4.4V				3
2.0 TDI quattro	140	DESA; DETA; DFVA	Pressure sensor(-)	09/15-	DG-193		4.4V				3
3.0 TDI	160	CSWB		09/15-08/18	DG-193		4.4V				6
3.0 TDI quattro	160	CSWB		09/15-08/18	DG-193		4.4V				6
3.0 TDI quattro	200	CRTC	Pressure sensor(-)	05/15-08/18	DG-193		4.4V				4
A4 Allroad (8KH) (09-16)											
2.0 TDI quattro	100/105/110/120/125/130	CAGA; CAGB; CAHA; CAHB; CGLC; CGLD; CJCA; CJCB; CJCD; CNHC		04/09-05/16	DG-193		4.4V				4
2.0 TDI quattro	100/110/120/140	CAHB; CGLD; CNHA; CNHC; CSUA; CSUB	Pressure sensor(-)	04/09-05/16	DG-193		4.4V				3
2.0 TFSI quattro	155/162	CDNC; CPMA; CPMB		04/09-05/16	PK22PR8	3273	0.8	-	IK22TT	VK22	4
3.0 TDI quattro	174/176/180	CCWA; CDUC		04/09-05/16	DG-193		4.4V				6
3.0 TDI quattro	180	CKVB; CKVC	Pressure sensor(-)	01/12-05/16	DG-193		4.4V				5
A4 Allroad (8WH) (16-)											
2.0 TDI quattro	120/140	DESA; DETA; DETB; DFVA	Pressure sensor(-)	01/16-	DG-193		4.4V				3
3.0 TDI quattro	160	CSWB		01/16-08/18	DG-193		4.4V				6
3.0 TDI quattro	200	CRTC	Pressure sensor(-)	01/16-08/18	DG-193		4.4V				4
A4 Convertible (8H, B6, B7) (02-09)											
1.8 T	120	BFB		07/02-03/09	PK20PR-P8	3245	0.8	-	IK20TT	IK20TT	4
1.8 T quattro	120	BFB		05/03-12/05	PK20PR-P8	3245	0.8	-	IK20TT	IK20TT	4
2.0	96	ALT		09/04-12/05	K16TNR-S9	3329	0.9	K16TT	IK16TT	IK16TT	4
2.0 TFSI 16V	147	BWE		01/06-03/09	PK22PR8	3273	0.8	-	IK22TT	VK22	4
2.4	120/125	AMM; BDV		04/02-12/05	K20TXR	5063	1.0	K20TT	IK20TT	IK20TT	6
2.5 TDI	120	BCZ; BDG; BFC	Double Coil(LPH)	08/02-12/05	DG-144		11V				6
2.7 TDI	132	BPP		06/06-03/09	DG-193		4.4V				6
3.0	162	ASN/ BBJ		04/02-12/05	K20TXR	5063	1.0	K20TT	IK20TT	IK20TT	6
3.0 quattro	162	ASN		05/03-12/05	K20TXR	5063	1.0	K20TT	IK20TT	IK20TT	6
3.0 TDI quattro	150/171	ASB; BKN		01/06-03/09	DG-193		4.4V				6
3.2 FSI	188	AUK		01/06-03/09	IK22	5310	0.8	-	IK22TT	VK22	6
3.2 FSI quattro	188	AUK		01/06-03/09	IK22	5310	0.8	-	IK22TT	VK22	6
4.2 RS4 quattro	309	BNS		06/06-03/09	IK22	5310	0.8	-	IK22TT	VK22	8
4.2 RS4 quattro	309	BNS		06/06-03/09	PK22PR8	3273	0.8	-	IK22TT	VK22	8
4.2 RS4 quattro	309	BNS		06/06-03/09	VKB20	5625	1.1	-	-	VKB20	8
4.2 S4 quattro	253	BBK		03/04-03/09	K20PBR-S10	5061	1.0	K20TT	IK20TT	IK20TT	8
4.2 S4 quattro	253	BBK		03/04-03/09	K20TXR	5063	1.0	K20TT	IK20TT	IK20TT	8
A5 (8T, 8F) (07-17)											
1.8 TFSI	118/125	CABD; CDHB		10/07-01/17	PK22PR8	3273	0.8	-	IK22TT	VK22	4
2.0 TDI	100/105/120/125/130	CAGA; CAGB; CAHA; CAHB; CGLC; CGLD; CJCA; CJCB; CMEA; CMFA; CNHC; CSUB		08/08-01/17	DG-193		4.4V				4
2.0 TDI	105/110/140	CJCD; CMEA; CMFA; CMFB; CNHA; CSUA	Pressure sensor(-)	09/09-01/17	DG-193		4.4V				3
2.0 TDI quattro	125/130	CAHA; CGLC		08/08-01/17	DG-193		4.4V				4

Свечи зажигания и Свечи накаливания

Таблица применения









	KW				СТАНДАРТНЫЕ			Twin Tip		QTY	
											
AUDI продолжение											
A5 (8T, 8F) (07-17) продолжение											
2.0 TDI quattro	140	CNHA	Pressure sensor(-)	09/13-01/17	DG-193		4.4V			3	
2.0 TFSI	132/155/162	CAEA; CAEB; CAED; CDNB; CDNC		06/08-12/14	PK22PR8	3273	0.8	-	IK22TT	VK22	4
2.0 TFSI quattro	155/162	CAEB; CAED; CDNC; CPMA; CPMB		06/08-01/17	PK22PR8	3273	0.8	-	IK22TT	VK22	4
2.7 TDI	120/140	CAMA; CAMB; CGKA; CGKB		06/07-01/17	DG-193		4.4V				6
3.0 S4 quattro	245	CAKA; CCBA; CGWC; CGXC; CREC; CTDA; CTUB		06/09-01/17	IK24	5311	0.8	-	-		6
3.0 TDI	150	CLAB		10/11-01/17	DG-193		4.4V				6
3.0 TDI quattro	155/176/180	CAPA; CCWA; CCWB; CDUC		06/07-01/17	DG-193		4.4V				6
3.0 TDI quattro	160/180	CKVB; CKVC; CKVD	Pressure sensor(-)	10/11-01/17	DG-193		4.4V				5
3.0 TFSI quattro	200	CMUA; CRED		11/11-01/17	IK24	5311	0.8	-	-		6
3.2 FSI	195	CALA		06/07-03/12	PK20PR-L11	3142	1.1	-	IK20TT	IK20TT	6
3.2 FSI	195	CALA	OEM Optional	06/07-03/12	IK20TT	4702	1.0	-	IK20TT	IK20TT	6
3.2 FSI quattro	195	CALA		06/07-03/12	PK20PR-L11	3142	1.1	-	IK20TT	IK20TT	6
3.2 FSI quattro	195	CALA	OEM Optional	06/07-03/12	IK20TT	4702	1.0	-	IK20TT	IK20TT	6
4.2 RS5 quattro	331	CFSA		03/10-01/17	PK22PR8	3273	0.8	-	IK22TT	VK22	8
4.2 RS5 quattro	331	CFSA		03/10-01/17	VK22	5610	0.8	-	IK22TT	VK22	8
4.2 S5 quattro	260	CAUA		06/07-03/12	VKB20	5625	1.1	-	-	VKB20	8
A5 (F5) (16-)											
2.0 TDI	140	DESA; DETA	Pressure sensor(-)	07/16-	DG-193		4.4V				3
3.0 TDI quattro	160	CSWB		07/16-	DG-193		4.4V				6
A6 (4A, C4) (94-97)											
1.8	92	ADR		12/95-12/97	K20PBR-S10	5061	1.0	K20TT	IK20TT	IK20TT	4
1.8 quattro	92	ADR		12/95-12/97	K20PBR-S10	5061	1.0	K20TT	IK20TT	IK20TT	4
1.9 TDI	66	1Z; AHU	Double Coil(LPH)	06/94-12/97	DG-005		11V				4
2.0	74/85	AAE; ABK		06/94-12/97	W20EPBR-S	5067	0.85	W20TT	IW20TT	IW20TT	4
2.0 16V	103	ACE		06/94-12/97	K20PBR-S10	5061	1.0	K20TT	IK20TT	IK20TT	4
2.0 16V	103	ACE		06/94-12/97	K22PBR-S	5062	0.85	-	IKB22TT	VK22	4
2.0 16V quattro	103	ACE		06/94-12/97	K20PBR-S10	5061	1.0	K20TT	IK20TT	IK20TT	4
2.0 16V quattro	103	ACE		06/94-12/97	K22PBR-S	5062	0.85	-	IKB22TT	VK22	4
2.2 S6 Turbo quattro	169	AAN		06/94-12/97	PK22PR8	3273	0.8	-	IK22TT	VK22	5
2.3	98	AAR		06/94-12/95	W16ETR-S	3285	1.0	W16TT	IW16TT	IW16TT	5
2.3 quattro	98	AAR		06/94-12/95	W16ETR-S	3285	1.0	W16TT	IW16TT	IW16TT	5
2.5 TDI	85/103	AAT; AEL	Double Coil(LPH)	06/94-12/97	DG-005		11V				5
2.5 TDI quattro	103	AEL	Double Coil(LPH)	07/95-12/97	DG-005		11V				5
2.6	102/110	ABC; ACZ		06/94-12/97	K20PBR-S10	5061	1.0	K20TT	IK20TT	IK20TT	6
2.6 quattro	110	ABC		06/94-12/97	K20PBR-S10	5061	1.0	K20TT	IK20TT	IK20TT	6
2.8	128	AAH; AFC		06/94-12/97	K20PBR-S10	5061	1.0	K20TT	IK20TT	IK20TT	6
2.8	142	ACK		12/95-12/97	K20TXR	5063	1.0	K20TT	IK20TT	IK20TT	6
2.8 quattro	128	AAH		06/94-12/97	K20PBR-S10	5061	1.0	K20TT	IK20TT	IK20TT	6
2.8 quattro	142	ACK		12/95-12/97	K20TXR	5063	1.0	K20TT	IK20TT	IK20TT	6
4.2 S6 Plus quattro	240	AHK		04/96-12/97	T20EPR-U	5032	0.8	T20TT	IT20TT	IT20TT	8
4.2 S6 quattro	213	AEC		06/94-12/97	T20EPR-U	5032	0.8	T20TT	IT20TT	IT20TT	8
A6 (4B, C5) (97-05)											
1.8	85/92	AFY; AJP		05/97-01/05	K20PBR-S10	5061	1.0	K20TT	IK20TT	IK20TT	4
1.8 T	110/132	AEB; AJL		01/97-01/05	PK20PR-P8	3245	0.8	-	IK20TT	IK20TT	4
1.8 T quattro	110/132	AEB; AJL; APU		02/97-01/05	PK20PR-P8	3245	0.8	-	IK20TT	IK20TT	4
1.9 TDI	81	AFN; AVG	Double Coil(LPH)	04/97-04/01	DG-005		11V				4
1.9 TDI	85/96	AJM; AVF; AWX	Double Coil(LPH)	07/00-01/05	DG-109		11V				4
2.0	96	ALT		08/01-01/05	K20PBR-S10	5061	1.0	K20TT	IK20TT	IK20TT	4
2.4	100	ALW		07/98-01/05	K20PBR-S10	5061	1.0	K20TT	IK20TT	IK20TT	6
2.4	115/121/125	AML; AMM; APC; APZ; ARJ; BDV		02/97-01/05	K20TXR	5063	1.0	K20TT	IK20TT	IK20TT	6

Таблица применения

A

Свечи зажигания и Свечи накаливания











Таблица применения

Таблица применения

KW	AG	NOTE	21	СТАНДАРТНЫЕ				Twin Tip			QTY
				Spark Plug	Coil	Ignition	Lightning	Coil	Coil	Coil	
AUDI продолжение											
A6 (4B, C5) (97-05) продолжение											
2.4 quattro	115/121/125	AGA; APC; APZ; BDV		02/97-01/05	K20TXR	5063	1.0	K20TT	IK20TT	IK20TT	6
2.5 TDI	110/114/120/132	AFB; AKE; AKN; AYM; BAU; BCZ; BDG; BDH; BFC; BND	Double Coil(LPH)	07/97-01/05	DG-144		11V				6
2.5 TDI quattro	110/132	AFB; AKE; AKN; BAU; BDH	Double Coil(LPH)	07/97-01/05	DG-144		11V				6
2.7 T	169	AJK		02/99-01/05	PK20PR-P8	3245	0.8	-	IK20TT	IK20TT	6
2.7 T quattro	169/184	AJK; ARE; AZA		12/97-01/05	PK20PR-P8	3245	0.8	-	IK20TT	IK20TT	6
2.8	132/140/142	AGE; ALG; AMX; ATX		02/97-01/05	K20TXR	5063	1.0	K20TT	IK20TT	IK20TT	6
2.8 quattro	132/140/142	AGE; ALG; APR; ATX		02/97-01/05	K20TXR	5063	1.0	K20TT	IK20TT	IK20TT	6
3.0	162	ASN		08/01-01/05	K20TXR	5063	1.0	K20TT	IK20TT	IK20TT	6
3.0 quattro	160/162	ASN; BBJ		06/01-01/05	K20TXR	5063	1.0	K20TT	IK20TT	IK20TT	6
4.2 quattro	220	ARS		11/98-01/05	PK20PTR-S9	3380	0.9	K20TT	IK20TT	IK20TT	8
4.2 RS6 plus quattro	353	BRV		04/04-01/05	PK22PR8	3273	0.8	-	IK22TT	VK22	8
4.2 RS6 quattro	331	BCY		07/02-01/05	PK22PR8	3273	0.8	-	IK22TT	VK22	8
4.2 S6 quattro	250	AQJ		09/99-01/05	K20TXR	5063	1.0	K20TT	IK20TT	IK20TT	8
A6 (4F, C6) (04-11)											
2.0 TDI	89/100/103	BRE; BRF; BVG	OE: N 105 798 03/ N 105 798 05, Ceramic	07/04-08/11	DG-622		7V				4
2.0 TDI	100/103	BLB; BNA		07/04-08/11	DG-190		4.4V				4
2.0 TDI	100/120/125	CAGB; CAHA; CAHB		07/04-08/11	DG-193		4.4V				4
2.0 TFSI	125	BPJ		06/05-08/11	PK22PR8	3273	0.8	-	IK22TT	VK22	4
2.4	130	BDW		05/04-10/08	PK20PR-L11	3142	1.1	-	IK20TT	IK20TT	6
2.4 quattro	130	BDW		01/05-10/08	PK20PR-L11	3142	1.1	-	IK20TT	IK20TT	6
2.7 TDI	120/132/140	BPP; BSG; CANA; CANB		11/04-08/11	DG-193		4.4V				6
2.7 TDI quattro	120/132/140	BPP; BSG; CANC; CAND		11/04-08/11	DG-193		4.4V				6
2.8 FSI	140/154/162	BDX; CCDA; CCEA		11/06-08/11	PK20PR-L11	3142	1.1	-	IK20TT	IK20TT	6
2.8 FSI quattro	140/154/162	BDX; CCDA; CCEA		06/07-08/11	PK20PR-L11	3142	1.1	-	IK20TT	IK20TT	6
3.0	160	BBJ		03/05-05/06	PK20PR-L11	3142	1.1	-	IK20TT	IK20TT	6
3.0 quattro	160	BBJ		05/04-05/06	PK20PR-L11	3142	1.1	-	IK20TT	IK20TT	6
3.0 TDI quattro	155/165/171/176	ASB; BMK; BNG; CDYA; CDYB; CDYC		05/04-08/11	DG-193		4.4V				6
3.0 TFSI quattro	213/220	CAJA; CCAA		10/08-01/11	VK22	5610	0.8	-	IK22TT	VK22	6
3.0 TFSI quattro	213/220	CAJA; CCAA		10/08-08/11	IK24	5311	0.8	-	-		6
3.2 FSI	188	AUK; BKH		05/04-05/09	IK22	5310	0.8	-	IK22TT	VK22	6
3.2 FSI quattro	188	AUK; BKH		05/04-10/08	IK22	5310	0.8	-	IK22TT	VK22	6
4.2 FSI quattro	257	BVJ		06/06-08/11	VKB20	5625	1.1	-	-	VKB20	8
4.2 quattro	246	BAT		05/04-05/06	K20PBR-S10	5061	1.0	K20TT	IK20TT	IK20TT	8
4.2 quattro	246	BAT		05/04-05/06	K20TXR	5063	1.0	K20TT	IK20TT	IK20TT	8
5.0 RS6 quattro	426	BUH		04/08-08/10	PK20PR-P8	3245	0.8	-	IK20TT	IK20TT	10
5.2 S6 quattro	315/320	BXA		03/06-08/11	VKB20	5625	1.1	-	-	VKB20	10
A6 (4G, C7) (10-18)											
2.0 TDI	100/110/140	CNHA; CSUD; CSUE; CZJA; DDCB; DDDA	Pressure sensor(-)	01/12-09/18	DG-193		4.4V				3
2.0 TDI	100/120/130	CGLC; CGLD; CGLE; CMGB		03/11-09/18	DG-193		4.4V				4
2.0 TDI quattro	140	CNHA; DDDA	Pressure sensor(-)	04/15-09/18	DG-193		4.4V				3

Свечи зажигания и Свечи накаливания

Таблица применения

	KW				СТАНДАРТНЫЕ				Twin Tip		QTY	
												
AUDI продолжение												
A6 (4G, C7) (10-18) продолжение												
2.0 TFSI	132/ 155	CAEB; CDNB		03/11-09/18	PK22PR8	3273	0.8	-		IK22TT	VK22	4
2.0 TFSI hybrid	155	CHJA		11/11-09/18	PK22PR8	3273	0.8	-		IK22TT	VK22	4
2.0 TFSI quattro	155	CAEB		05/12-05/13	PK22PR8	3273	0.8	-		IK22TT	VK22	4
2.8 FSI	150	CHVA		11/10-04/15	IK20TT	4702	1.0	-		IK20TT	IK20TT	6
2.8 FSI quattro	150	CHVA		11/10-04/15	IK20TT	4702	1.0	-		IK20TT	IK20TT	6
3.0 TDI	150/ 155/ 160	CLAB; CTCB; CTCC		11/10-09/18	DG-193		4.4V					6
3.0 TDI	155/ 160	CZVB; CZVD	Pressure sensor(-)	09/14-09/18	DG-193		4.4V					5
3.0 TDI quattro	150/ 180/ 230/ 240	CDUC; CDUD; CGQB; CLAA; CVUB		03/11-09/18	DG-193		4.4V					6
3.0 TDI quattro	155/ 160/ 180/ 200/ 200/ 235	CKVB; CKVC; CRTD; CRTE; CRTF; CVUA; CZVA; CZVC	Pressure sensor(-)	03/11-09/18	DG-193		4.4V					4
3.0 TFSI quattro	220	CGWB		11/10-05/12	IK24	5311	0.8	-	-			6
3.0 TFSI quattro	228	CGWD; CGXB; CTUA	40000km Lifetime	03/11-09/18	IK24	5311	0.8	-	-			6
4.0 RS6 performance quattro	445	CWUC		11/15-08/16	IKH24	5346	0.8	-	-			8
4.0 RS6 quattro	412	CRDB; CWUB		01/13-08/16	IKH24	5346	0.8	-	-			8
4.0 S6 quattro	309/ 331	CEUC; CTGE		02/12-08/16	IKH24	5346	0.8	-	-			8
A6 Allroad (4FH) (06-11)												
2.7 TDI quattro	120/ 132/ 140	BPP; BSG; CANC; CAND		03/06-08/11	DG-193		4.4V					6
3.0 TDI quattro	155/ 171/ 176	ASB; BNG; CDYA; CDYB; CDYC		05/06-08/11	DG-193		4.4V					6
3.0 TFSI quattro	213	CAJA		10/08-01/11	VK22	5610	0.8	-	-	IK22TT	VK22	6
3.0 TFSI quattro	213	CAJA		10/08-08/11	IK24	5311	0.8	-	-			6
3.2 FSI quattro	188	AUK		05/06-10/08	IK22	5310	0.8	-	-	IK22TT	VK22	6
4.2 FSI quattro	257	BVJ		05/06-12/10	VKB20	5625	1.1	-	-		VKB20	8
A6 Allroad (4GH) (12-18)												
3.0 TDI quattro	140/ 155/ 160/ 180/ 200/ 200/ 235	CKVC; CRTD; CRTE; CRTF; CVUA; CZVA; CZVC; CZVF	Pressure sensor(-)	01/12-09/18	DG-193		4.4V					5
3.0 TDI quattro	150/ 180/ 230	CDUC; CGQB; CLAA		01/12-06/16	DG-193		4.4V					6
A7 (4GA) (10-18)												
2.8 FSI	150	CHVA		02/11-03/15	IK20TT	4702	1.0	-	-	IK20TT	IK20TT	6
2.8 FSI quattro	150	CHVA		10/10-03/15	IK20TT	4702	1.0	-	-	IK20TT	IK20TT	6
3.0 TDI	140/ 155	CZVD; CZVE	Pressure sensor(-)	11/15-05/18	DG-193		4.4V					5
3.0 TDI	150/ 160	CLAB; CTCC; CZVB		11/10-05/18	DG-193		4.4V					6
3.0 TDI quattro	140/ 155/ 160/ 176/ 180/ 200/ 200/ 235	CKVB; CKVC; CPNB; CRTD; CRTE; CRTF; CVUA; CZVA; CZVF	Pressure sensor(-)	10/10-05/18	DG-193		4.4V					5
3.0 TDI quattro	150/ 155/ 180/ 230/ 240	CDUC; CDUD; CGQB; CLAA; CTCB; CVUB		10/10-05/18	DG-193		4.4V					6
3.0 TFSI quattro	220/ 228	CGWB; CGXB; CHMA		10/10-03/15	IK24	5311	0.8	-	-			6
4.0 RS7 performance quattro	445	CWUC		11/15-04/18	IKH24	5346	0.8	-	-			8
4.0 RS7 quattro	412	CRDB; CWUB		10/13-04/18	IKH24	5346	0.8	-	-			8
4.0 S7 quattro	309/ 331	CEUC; CTGE		02/12-05/18	IKH24	5346	0.8	-	-			8
A8 (4D) (94-02)												
2.5 TDI	110/ 132	AFB; AKE; AKN	Double Coil(LPH)	01/97-09/02	DG-144		11V					6

Свечи зажигания и Свечи накаливания

Таблица применения

KW	KW	KW	NOTE	21	СТАНДАРТНЫЕ				Twin Tip		QTY
					STANDARD	STANDARD	STANDARD	STANDARD	TWIN TIP	TWIN TIP	
AUDI продолжение											
A8 (4D) (94-02) продолжение											
2.5 TDI quattro	110/132	AFB; AKE; AKN	Double Coil(LPH)	07/97-09/02	DG-144		11V				6
2.8	120	AEJ		07/95-03/96	K16PR-U	3191	0.8	K16TT	IK16TT	IK16TT	6
2.8	128	AAH		03/94-03/96	K20PBR-S10	5061	1.0	K20TT	IK20TT	IK20TT	6
2.8	142	ALG		04/96-09/02	K20TXR	5063	1.0	K20TT	IK20TT	IK20TT	6
2.8 quattro	120	AEJ		07/95-03/96	K16PR-U	3191	0.8	K16TT	IK16TT	IK16TT	6
2.8 quattro	128	AAH		03/94-03/96	K20PBR-S10	5061	1.0	K20TT	IK20TT	IK20TT	6
2.8 quattro	142	AMX		04/96-09/02	K20TXR	5063	1.0	K20TT	IK20TT	IK20TT	6
3.3 TDI quattro	165	AKF	Double Coil(LPH)	06/00-09/02	DG-144		11V				8
3.7	169	AEW		07/95-12/98	T20EPR-U	5032	0.8	T20TT	IT20TT	IT20TT	8
3.7	191	AKC		11/98-09/02	PK20PTR-S9	3380	0.9	K20TT	IK20TT	IK20TT	8
3.7 quattro	169	AEW		07/95-11/98	T20EPR-U	5032	0.8	T20TT	IT20TT	IT20TT	8
3.7 quattro	191	AKC		11/98-09/02	PK20PTR-S9	3380	0.9	K20TT	IK20TT	IK20TT	8
4.2 quattro	175/228	AQF; ARU		11/98-09/02	PK20PTR-S9	3380	0.9	K20TT	IK20TT	IK20TT	8
4.2 quattro	180/220	ABZ; AEM		03/94-11/98	T20EPR-U	5032	0.8	T20TT	IT20TT	IT20TT	8
4.2 S8 quattro	250	AKH		07/96-06/99	T20EPR-U	5032	0.8	T20TT	IT20TT	IT20TT	8
4.2 S8 quattro	265	AVP		06/99-09/02	K20TXR	5063	1.0	K20TT	IK20TT	IK20TT	8
6.0 W12 quattro	309	AZC		01/01-09/02	PKJ20CR-L11	3247	1.1	-	IK20TT	IK20TT	12
A8 (4E) (02-10)											
2.8 FSI	154	BDX		08/07-07/10	PK20PR-L11	3142	1.1	-	IK20TT	IK20TT	6
3.0	160/162	ASN; BBJ		07/03-05/06	K20TXR	5063	1.0	K20TT	IK20TT	IK20TT	6
3.0 TDI quattro	155/171	ASB; BNG		08/03-07/10	DG-193		4.4V				6
3.2 FSI	191	BPK		06/05-10/07	IK22	5310	0.8	-	IK22TT	VK22	6
3.2 FSI quattro	191	BPK		06/05-07/10	IK22	5310	0.8	-	IK22TT	VK22	6
3.7 quattro	206	BFL		10/02-05/06	K20PBR-S10	5061	1.0	K20TT	IK20TT	IK20TT	8
4.0 TDI quattro	202	ASE	Double Coil(LPH)	05/03-07/05	DG-144		11V				8
4.2 FSI quattro	257	BVJ		06/06-07/10	VKB20	5625	1.1	-	-	VKB20	8
4.2 quattro	246	BFM		10/02-05/06	K20PBR-S10	5061	1.0	K20TT	IK20TT	IK20TT	8
4.2 TDI quattro	235/240/254	BMC; BVN		01/05-07/10	DG-193		4.4V				8
5.2 S8 quattro	324/331	BSM		06/06-07/10	VKB20	5625	1.1	-	-	VKB20	10
6.0 W12 quattro	331	BHT/ BTE		12/03-07/10	PKJ20CR-L11	3247	1.1	-	IK20TT	IK20TT	12
A8 (4H) (09-18)											
2.0 TFSI hybrid	155	CHJA		02/12-11/15	PK22PR8	3273	0.8	-	IK22TT	VK22	4
3.0 TDI	150	CLAB		09/11-09/13	DG-193		4.4V				6
3.0 TDI quattro	155/184/190/193	CDTA; CDTB; CDTG; CTBA; CTBB; CTBD		07/10-01/18	DG-193		4.4V				6
3.0 TDI quattro	176/184	CMHA; CPNA	Pressure sensor(-)	07/10-01/18	DG-193		4.4V				5
3.0 TFSI quattro	213/245	CGWA; CGXC		06/10-01/18	IK24	5311	0.8	-	-		6
4.2 FSI quattro	273	CDRA		11/09-12/12	VKB20	5625	1.1	-	-	VKB20	8
4.2 TDI quattro	258/283	CDSB; CTEC		11/09-01/18	DG-193		4.4V				8
6.3 W12 quattro	368	CEJA; CTNA		01/11-01/18	VXUH22I	5656	0.9	-	IXUH22TT	VXUH22I	12
ALLROAD (4BH) (00-05)											
2.5 TDI quattro	120/132	AKE; BAU; BCZ	Double Coil(LPH)	05/00-08/05	DG-144		11V				6
2.7 T quattro	184	ARE; BES		05/00-08/05	PK20PR-P8	3245	0.8	-	IK20TT	IK20TT	6
4.2 V8 quattro	220	BAS		07/02-08/05	K20PBR-S10	5061	1.0	K20TT	IK20TT	IK20TT	8
4.2 V8 quattro	220	BAS		07/02-08/05	K20TXR	5063	1.0	K20TT	IK20TT	IK20TT	8
CABRIOLET (8G7) (91-00)											
1.8	92	ADR		01/97-08/00	K20PBR-S10	5061	1.0	K20TT	IK20TT	IK20TT	4
1.9 TDI	66	1Z; AHU	Auxiliary Heater	06/95-08/00	DG-012		11V				3
1.9 TDI	66	1Z; AHU	Double Coil(LPH)	06/95-08/00	DG-005		11V				4
2.0 16V	103	ACE		06/95-07/96	K20PBR-S10	5061	1.0	K20TT	IK20TT	IK20TT	4
2.0 16V	103	ACE		06/95-07/96	K22PBR-S	5062	0.85	-	IKB22TT	VK22	4
2.0 E	85	ABK		01/93-07/98	W20EPBR-S	5067	0.85	W20TT	IW20TT	IW20TT	4
2.3 E	98	NG		05/91-07/94	W16ETR-S	3285	1.0	W16TT	IW16TT	IW16TT	5
2.6	110	ABC		06/93-08/00	K20PBR-S10	5061	1.0	K20TT	IK20TT	IK20TT	6

Свечи зажигания и Свечи накаливания

Таблица применения





















	KW				СТАНДАРТНЫЕ			Twin Tip			QTY
											
AUDI продолжение											
CABRIOLET (8G7) (91-00) продолжение											
2.8	128	AAH		11/92-08/00	K20PBR-S10	5061	1.0	K20TT	IK20TT	IK20TT	6
COUPE (81, 85) (80-88)											
1.6	55	YN		07/80-08/81	W20EPR-U	3047	0.8	W20TT	IW20TT	IW20TT	4
1.6	55	YN		07/80-08/81	W20EP-U	3043	0.8	W20TT	IW20TT	IW20TT	4
1.8	55	DD		08/81-07/83	W20EP-U	3043	0.8	W20TT	IW20TT	IW20TT	4
1.8 GT	65	SF		04/86-10/88	IW20TT	4709	1.0	-	IW20TT		4
1.8 GT	65/82	DZ; JV		09/82-10/88	W20EPB	5065	0.85	W20TT	IW20TT	IW20TT	4
1.8 GT	68	JN		01/85-07/88	W20EPBR-S	5067	0.85	W20TT	IW20TT	IW20TT	4
1.9	85	WN		08/80-07/83	W22EPB	5066	0.85	W22TT	-	VW22	5
2.0	85	JS		09/83-07/86	W20EPB	5065	0.85	W20TT	IW20TT	IW20TT	5
2.1 GT	79	WE		01/81-07/83	W20EPR-U	3047	0.8	W20TT	IW20TT	IW20TT	5
2.1 GT	96	KL		09/82-10/87	W20EPB	5065	0.85	W20TT	IW20TT	IW20TT	5
2.2 GT	85/ 100	KV; KX		07/81-10/88	W20EPB	5065	0.85	W20TT	IW20TT	IW20TT	5
2.2 quattro	88/ 100	JT; KV		10/84-10/88	W20EPB	5065	0.85	W20TT	IW20TT	IW20TT	5
2.3	100	NG		01/87-10/88	W16ETR-S	3285	1.0	W16TT	IW16TT	IW16TT	5
2.3 quattro	100	NG		01/87-10/88	W20EPB	5065	0.85	W20TT	IW20TT	IW20TT	5
COUPE (89, 8B) (88-96)											
1.8	82	DZ		08/89-07/91	W20EPB	5065	0.85	W20TT	IW20TT	IW20TT	4
2.0	83/85	3A; ABK		05/89-12/96	W20EPBR-S	5067	0.85	W20TT	IW20TT	IW20TT	4
2.0 16 V	101	6A		01/92-07/92	K22PBR-S	5062	0.85	-	IKB22TT	VK22	4
2.0 16 V	101/ 103	6A; ACE		01/92-12/96	K20PBR-S10	5061	1.0	K20TT	IK20TT	IK20TT	4
2.0 16 V	103	ACE		08/92-12/96	IK22	5310	0.8	-	IK22TT	VK22	4
2.0 20 V	118	NM		08/89-07/91	K22PB	5069	0.85	-	IKB22TT	VK22	5
2.0 20 V quattro	118	NM		08/89-07/91	K22PB	5069	0.85	-	IKB22TT	VK22	5
2.2 quattro	100	KV		11/88-07/91	W20EPB	5065	0.85	W20TT	IW20TT	IW20TT	5
2.2 S2 quattro	162/ 169	3B; ABY		09/90-12/96	PK22PR8	3273	0.8	-	IK22TT	VK22	5
2.3	98/ 100	NG		10/88-12/96	W20EPBR-S	5067	0.85	W20TT	IW20TT	IW20TT	5
2.3 20V	123/ 125	7A		08/89-07/91	K22PBR-S	5062	0.85	-	IKB22TT	VK22	5
2.3 20V quattro	123/ 125	7A		11/88-12/96	K22PBR-S	5062	0.85	-	IKB22TT	VK22	5
2.3 quattro	98	NG		05/90-12/96	W16ETR-S	3285	1.0	W16TT	IW16TT	IW16TT	5
2.3 quattro	100	NG		11/88-12/92	W20EPBR-S	5067	0.85	W20TT	IW20TT	IW20TT	5
2.6	110	ABC		08/92-12/96	K20PBR-S10	5061	1.0	K20TT	IK20TT	IK20TT	6
2.6 quattro	110	ABC		08/92-12/96	K20PBR-S10	5061	1.0	K20TT	IK20TT	IK20TT	6
2.8	128	AAH		09/91-12/96	K20PBR-S10	5061	1.0	K20TT	IK20TT	IK20TT	6
2.8 quattro	128	AAH		08/91-12/96	K20PBR-S10	5061	1.0	K20TT	IK20TT	IK20TT	6
Q3 (8U) (11-18)											
2.0 TDI	88/ 110/ 130/ 135	CFGC; CUVC; CUVD; CUWA; DBBA; DFTA; DFTC; DFUA	Pressure sensor(-)	06/11-10/18	DG-193		4.4V				3
2.0 TDI	100/ 103	CFFA; CFFB; CLJA; CUVB; DFTB		09/11-10/18	DG-193		4.4V				4
2.0 TDI quattro	103/ 120/ 130	CFFB; CFGD; CLLB		06/11-10/18	DG-193		4.4V				4
2.0 TDI quattro	110/ 130/ 135	CFGC; CLLB; CUVC; CUWA; CYLA; DFTA; DFUA	Pressure sensor(-)	06/11-10/18	DG-193		4.4V				3
2.0 TFSI quattro	125/ 155	CCZC; CPSA		06/11-04/15	PK22PR8	3273	0.8	-	IK22TT	VK22	4
Q5 (8R) (08-)											
2.0 TDI	100/ 105/ 110	CJCA; CJCB; CJCD		11/10-05/17	DG-193		4.4V				4
2.0 TDI	100/ 110/ 140	CNHA; CSUA; CSUB	Pressure sensor(-)	11/10-05/17	DG-193		4.4V				3
2.0 TDI quattro	100/ 105/ 110/ 120/ 125/ 130	CAGA; CAGB; CAHA; CAHB; CGLA; CGLB; CGLC; CGLD; CJCA; CJCB; CJCD; CMGA; CMGB; CNHC		11/08-05/17	DG-193		4.4V				4
2.0 TDI quattro	100/ 110/ 120/ 140	CAHB; CGLA; CGLD; CNHA; CNHC; CSUA; CSUB	Pressure sensor(-)	11/08-05/17	DG-193		4.4V				3

Таблица применения

A

Свечи зажигания и Свечи накаливания

Таблица применения

	KW				СТАНДАРТНЫЕ				Twin Tip		QTY
											
AUDI продолжение											
Q5 (8R) (08-) продолжение											
2.0 TFSI hybrid quattro	155	CHJA		06/11-06/16	PK22PR8	3273	0.8	-	IK22TT	VK22	4
2.0 TFSI quattro	132/ 155/ 162	CAEB; CDNБ; CDNC; CPMA; CPMB		11/08-05/17	PK22PR8	3273	0.8	-	IK22TT	VK22	4
3.0 SQ5 TDI quattro	230/ 240/ 250	CGQB; CVUB; CVUC; DEHA		12/12-05/17	DG-193		4.4V				6
3.0 TDI quattro	155/ 176/ 180/ 184/ 190	CCWA; CCWB; CDUD; CTBA; CTBC		11/08-05/17	DG-193		4.4V				6
3.0 TDI quattro	176	CPNB	Pressure sensor(-)	11/08-05/17	DG-193		4.4V				5
3.2 FSI quattro	199	CALB		11/08-12/12	PK20PR-L11	3142	1.1	-	IK20TT	IK20TT	6
3.2 FSI quattro	199	CALB	OEM Optional	11/08-12/12	IK20TT	4702	1.0	-	IK20TT	IK20TT	6
Q7 (4L) (06-15)											
3.0 TDI quattro	150/ 155/ 171/ 176/ 180	BUG; BUN; CASA; CASB; CJGC; CJMA; CRCA		03/06-08/15	DG-193		4.4V				6
3.0 TDI quattro	165	CATA	Pressure sensor(-)	06/09-05/12	DG-193		4.4V				4
3.0 TDI quattro	176/ 180	CASA; CCMA; CJGA; CJGD; CLZB; CNRB	Euro-5	11/07-08/15	DG-193		4.4V				6
3.0 TDI quattro	176/ 180	CASA; CCMA; CJGA; CJGD; CLZB; CNRB	Euro-6	11/07-08/15	DG-193		4.4V				4
3.0 TFSI quattro	200/ 206/ 245	CJTB; CJTC; CJWB; CJWC; CJWE; CNAА; CTWA; CTWB		05/10-08/15	IK24	5311	0.8	-	-		6
3.0 TFSI quattro	200/ 245	CJTB; CJTC; CJWB; CJWC; CNAА; CTWA		05/10-01/11	VK22	5610	0.8	-	IK22TT	VK22	6
3.6 FSI quattro	206	BHK		08/06-05/10	VXUHC22G	5652	0.8	-	-	VXUHC22G	6
4.2 FSI quattro	257	BAR		03/06-05/10	VKB20	5625	1.1	-	-	VKB20	8
4.2 TDI	246			04/09-08/15	DG-193		4.4V				8
4.2 TDI quattro	240/ 250	BTR; CCFA; CCFC		03/07-08/15	DG-193		4.4V				8
6.0 TDI quattro	368	CCGA		09/08-05/14	DG-193		4.4V				12
Q7 (4M) (15-)											
3.0 TDI e-tron quattro	190	CVZA	Pressure sensor(-)	08/15-	DG-193		4.4V				4
3.0 TDI quattro	155/ 160/ 183/ 190/ 200	CRTC; CRTE; CUEA; CVMD; CZZA; CZZB; DDEA	Pressure sensor(-)	05/15-	DG-193		4.4V				4
4.0 SQ7 TDI quattro	320	CZAC	Euro-5	04/16-	DG-193		4.4V				6
4.0 SQ7 TDI quattro	320	CZAC	Euro-6	04/16-	DG-193		4.4V				8
QUATTRO (85) (80-91)											
2.1 Turbo	147	GV; WR		07/80-07/87	W22EPR-U	3088	0.8	W22TT	-	WV22	5
2.2 20V Turbo	162	RR		08/89-07/91	PK22PR8	3273	0.8	-	IK22TT	VK22	5
2.2 Turbo	147	1B		08/87-07/89	W20EPB	5065	0.85	W20TT	IW20TT	IW20TT	5
R8 (42) (07-15)											
4.2 FSI quattro	309	BYH		04/07-09/10	VK22	5610	0.8	-	IK22TT	VK22	8
4.2 FSI quattro	309/ 316	BYH; CNDA		04/07-07/15	VKB20	5625	1.1	-	-	VKB20	8
4.2 FSI quattro	316	CNDA		07/10-07/15	PK22PR8	3273	0.8	-	IK22TT	VK22	8
5.2 FSI quattro	386	BUJ		04/09-09/10	VK22	5610	0.8	-	IK22TT	VK22	10
5.2 FSI quattro	386/ 404/ 412/ 419	BUJ; CMPA; CTPA; CTPB; CTYA		04/09-07/15	PK22PR8	3273	0.8	-	IK22TT	VK22	10
5.2 quattro	381	BUJ; CTYA		10/09-07/15	PK22PR8	3273	0.8	-	IK22TT	VK22	10
R8 (4S) (15-)											
5.2 FSI quattro	397/ 449	CSPA; CSPB; DKAA; DKAB		07/15-06/17	PK22PR8	3273	0.8	-	IK22TT	VK22	10
TT (8J) (06-14)											
1.8 TFSI	118	CDAА		06/08-06/14	PK22PR8	3273	0.8	-	IK22TT	VK22	4
2.0 TDI quattro	125	CBBB; CFGB		06/08-06/14	DG-193		4.4V				4
2.0 TFSI	147/ 155	BPY; BWA; CCTA; CESA		08/06-06/14	PK22PR8	3273	0.8	-	IK22TT	VK22	4
2.0 TFSI quattro	147/ 155	BWA; CCZA; CESA; CETA		06/08-06/14	PK22PR8	3273	0.8	-	IK22TT	VK22	4
2.0 TTS quattro	195/ 200	CDLA; CDLB; CDMA		05/08-06/14	PK22PR8	3273	0.8	-	IK22TT	VK22	4

Свечи зажигания и Свечи накаливания

Таблица применения





















	KW				СТАНДАРТНЫЕ				Twin Tip		QTY
											
AUDI продолжение											
TT (8J) (06-14) продолжение											
2.5 RS quattro	250/265	CEPA; CEPB		07/09-06/14	VKH22	5619	0.8	-	-	VKH22	5
TT (8N) (98-06)											
1.8 T	110/120/132/140	AJQ/ APP/ AUQ; AUM; BVP; BVR		10/99-06/06	PK20PR-P8	3245	0.8	-	IK20TT	IK20TT	4
1.8 T	132	AJQ	Ch:>X-015 500	10/98-01/99	K20PBR-S10	5061	1.0	K20TT	IK20TT	IK20TT	4
1.8 T quattro	132/140/165/180	AJQ; APX; ARY; AUQ; BAM; BFV; BVR		10/99-06/06	PK20PR-P8	3245	0.8	-	IK20TT	IK20TT	4
1.8 T quattro	132/165	AJQ; APX	Ch:>X-015 500	10/98-01/99	K20PBR-S10	5061	1.0	K20TT	IK20TT	IK20TT	4
1.8 T quattro	132/165	AJQ; APX; ARY; AUQ; BAM	Ch:X-015 501>	10/98-06/06	PK20PR-P8	3245	0.8	-	IK20TT	IK20TT	4
TT (FV) (14-)											
2.0 TDI	135	CUNA	Pressure sensor(-)	07/14-	DG-193		4.4V				3
2.0 TFSI quattro	169	CHHC		07/14-	PK22PR8	3273	0.8	-	IK22TT	VK22	4
V8 (44, 4C) (88-94)											
3.6 quattro	180/184	PT		10/88-02/94	T20EPR-U	5032	0.8	T20TT	IT20TT	IT20TT	8
4.2 quattro	206	ABH		10/91-02/94	T20EPR-U	5032	0.8	T20TT	IT20TT	IT20TT	8
AUSTIN											
1000-Series (70-74)											
1100	32			01/70-12/74	Q20PR-U	3007	0.8	Q20TT	IQ20TT	IQ20TT	4
1300	39			01/70-12/74	W20EP-U	3043	0.8	W20TT	IW20TT	IW20TT	4
1300 GT	50			01/70-12/74	W20EP-U	3043	0.8	W20TT	IW20TT	IW20TT	4
ALLEGRO (73-84)											
1.0	33	99 H		01/80-10/83	W20EPR-U	3047	0.8	W20TT	IW20TT	IW20TT	4
1.1	33/36	10H		05/73-10/81	W20EPR-U	3047	0.8	W20TT	IW20TT	IW20TT	4
1.3	40/43/46	12 L; 12H		05/73-10/83	W20EPR-U	3047	0.8	W20TT	IW20TT	IW20TT	4
1.5 Super	50	14H		05/73-03/82	W20EPR-U	3047	0.8	W20TT	IW20TT	IW20TT	4
1750	67	17LA		01/75-10/79	W20EPR-U	3047	0.8	W20TT	IW20TT	IW20TT	4
AMBASSADOR (82-84)											
1.7	62	17H979		03/82-02/84	T20EPR-U	5032	0.8	T20TT	IT20TT	IT20TT	4
2.0	69	20H979		03/82-10/84	T20EPR-U	5032	0.8	T20TT	IT20TT	IT20TT	4
MAESTRO (83-92)											
1.3	46	12HA20		03/83-08/85	W20EP-U	3043	0.8	W20TT	IW20TT	IW20TT	4
1.3 LS	49	12H959/12HA04/ 12HA20, 12HC32, 12HC34, 12HE		03/83-04/87	W20EP-U	3043	0.8	W20TT	IW20TT	IW20TT	4
1.6	59	16HA01/16HA03		03/83-10/84	K20PR-U	3145	0.8	K20TT	IK20TT	IK20TT	4
1.6 Mayfair HLS	61	16H/16HA03/ 16HA36, 16HB77, 16HC37, 16HC38	Check Hex size	03/83-08/90	K20PR-U	3145	0.8	K20TT	IK20TT	IK20TT	4
1.6 Mayfair HLS	61	16H/ROVE10	Check Hex size	03/83-01/86	W20EP-U	3043	0.8	W20TT	IW20TT	IW20TT	4
1.6 MG	72	16H		01/86-08/90	K20PR-U	3145	0.8	K20TT	IK20TT	IK20TT	4
1.6 MG	72	16H956/16H		03/83-01/86	W20EP-U	3043	0.8	W20TT	IW20TT	IW20TT	4
2.0 Efi	83	20HA51/20HC78		10/84-08/90	W20EPR-U	3047	0.8	W20TT	IW20TT	IW20TT	4
MAXI (69-82)											
1500	50	14H(68)		01/77-07/80	W20EPR-U	3047	0.8	W20TT	IW20TT	IW20TT	4
1750	53	17H(72)		01/77-06/81	W20EPR-U	3047	0.8	W20TT	IW20TT	IW20TT	4
1750 HL	66	17H(72)		01/77-10/80	W20EPR-U	3047	0.8	W20TT	IW20TT	IW20TT	4
METRO (80-90)											
1.0	30	99H		10/84-04/90	W16EPR-U	3021	0.8	W16TT	IW16TT	IW16TT	4
1.0	30/33	99H/99H907P/ 99H929P, 99H962P; 99H962P		10/80-04/90	W20EP-U	3043	0.8	W20TT	IW20TT	IW20TT	4
1.0 Surf HLE	35	99H/99H907P/ 99H929P, 99H962P		10/80-09/84	W20EP-U	3043	0.8	W20TT	IW20TT	IW20TT	4
1.3	46/51	12H/12H907AA/ 12H996AA; 12H907AA		10/80-04/90	W20EX-U	3062	0.8	W20TT	IW20TT	IW20TT	4
1.3 L,HLE,S	44	12H/12H907AA/ 12H996AA, 12HC14		05/82-04/90	W20EX-U	3062	0.8	W20TT	IW20TT	IW20TT	4
1.3 Surf (XF)	44	12H		11/85-04/90	W20EX-U	3062	0.8	W20TT	IW20TT	IW20TT	4
1.3 Turbo	66	12H959AA/12HC15		10/83-04/90	W20EX-U	3062	0.8	W20TT	IW20TT	IW20TT	4
MINI (60-93)											
1.0	44			09/62-08/69	W20EPR-U	3047	0.8	W20TT	IW20TT	IW20TT	4
1.1	46			11/62-08/64	W20EPR-U	3047	0.8	W20TT	IW20TT	IW20TT	4

Таблица применения

A









Свечи зажигания и Свечи накаливания

Таблица применения

	KW				СТАНДАРТНЫЕ			Twin Tip			QTY
											
AUSTIN продолжение											
MINI (60-93) продолжение											
1.3	48/ 53/57	12 H; 12 HC		09/62-09/80	W20EPR-U	3047	0.8	W20TT	IW20TT	IW20TT	4
850	25	BMC Serie A		06/59-10/86	W20EPR-U	3047	0.8	W20TT	IW20TT	IW20TT	4
1000	26/28	99 H		10/67-09/84	W20EPR-U	3047	0.8	W20TT	IW20TT	IW20TT	4
1000 Mayfair	31	99 H997P; 99 HA53P; 99 HC20P		08/82-06/93	W20EPR-U	3047	0.8	W20TT	IW20TT	IW20TT	4
1000 Mayfair Sport	30	99 HD81		09/88-06/93	W20EPR-U	3047	0.8	W20TT	IW20TT	IW20TT	4
1100 Special	33	10 H		01/76-08/81	W20EPR-U	3047	0.8	W20TT	IW20TT	IW20TT	4
1275 GT	39	12 H		10/69-08/80	W20EPR-U	3047	0.8	W20TT	IW20TT	IW20TT	4
Cooper	41	99 H		01/61-12/67	W20EPR-U	3047	0.8	W20TT	IW20TT	IW20TT	4
Cooper S	57			09/62-12/71	W20EPR-U	3047	0.8	W20TT	IW20TT	IW20TT	4
MONTEGO (84-92)											
1.3	50	12 HL		10/84-08/88	W20EPR-U	3047	0.8	W20TT	IW20TT	IW20TT	4
1.6 LS	61	16HA35/16HA35S		10/84-08/88	K20PR-U	3145	0.8	K20TT	IK20TT	IK20TT	4
1.6 LS,HL	61	16HA35		04/84-08/88	K20PR-U	3145	0.8	K20TT	IK20TT	IK20TT	4
2.0	74	20HA30/20HB43; 20HB59		04/84-08/91	W20EPR-U	3047	0.8	W20TT	IW20TT	IW20TT	4
2.0 HLI	83	20 H		10/84-09/92	W20EPR-U	3047	0.8	W20TT	IW20TT	IW20TT	4
2.0 Mayfair	83	20 H(EFI)		04/84-08/88	W20EPR-U	3047	0.8	W20TT	IW20TT	IW20TT	4
2.0 Turbo	110	20HA30		04/84-01/86	W20EPR-U	3047	0.8	W20TT	IW20TT	IW20TT	4
PRINCESS (76-82)											
1800 HL	60	18H		04/76-09/78	W20EPR-U	3047	0.8	W20TT	IW20TT	IW20TT	4
2200	82	23H		10/78-10/82	W20EPR-U	3047	0.8	W20TT	IW20TT	IW20TT	6
2200 HLS	81	23H		04/76-09/78	W20EPR-U	3047	0.8	W20TT	IW20TT	IW20TT	6
AUSTIN-HEALEY											
3000 III (64-68)											
3.0 Sport	110			03/64-10/68	W20EP-U	3043	0.8	W20TT	IW20TT	IW20TT	6
SPRITE III (64-66)											
1.1	41			03/64-09/66	W20EP-U	3043	0.8	W20TT	IW20TT	IW20TT	4
SPRITE IV (66-71)											
1.3	48	12CC		03/66-10/71	W20EX-U	3062	0.8	W20TT	IW20TT	IW20TT	4
AUTO UNION											
AU 1000 (58-65)											
1.0 S	37			08/59-03/64	MW17	5088	0.7	-	-		3
DKW F11 (59-66)											
0.7 Junior	25			02/59-08/61	MW17	5088	0.7	-	-		3
AUTOBIANCHI											
A 112 (69-85)											
0.9	32	A112A200		10/69-12/72	W20EPR-U	3047	0.8	W20TT	IW20TT	IW20TT	4
0.9 Junior	31	A112A000/A112A200		07/79-12/85	W20EPR-U	3047	0.8	W20TT	IW20TT	IW20TT	4
1.0 Abarth	51	A112AB2C0		06/75-12/84	W22EPR-U	3088	0.8	W22TT	-	WV22	4
1.0 E,Elite,LX	35	A112B1000		11/77-12/85	W20EPR-U	3047	0.8	W20TT	IW20TT	IW20TT	4
Y10 (85-95)											
1.0	32	156A2.000		03/85-09/92	K20PR-U	3145	0.8	K20TT	IK20TT	IK20TT	4
1.0	41	156A.000		03/85-12/88	W20EPR-U	3047	0.8	W20TT	IW20TT	IW20TT	4
1.0 4WD	37	156A3.000		12/86-12/88	K20PR-U	3145	0.8	K20TT	IK20TT	IK20TT	4
1.0 Cat	33	156A2.246		01/89-09/92	K20PR-U	3145	0.8	K20TT	IK20TT	IK20TT	4
1.0 Turbo	63	156A1.000		03/85-12/88	W24ESR-U	4033	0.8	-	-		4
1.1	37/42	156C.000		06/89-12/94	K20PR-U	3145	0.8	K20TT	IK20TT	IK20TT	4
1.1 4WD	42	156C.000; 176B2.000		06/89-10/95	K20PR-U	3145	0.8	K20TT	IK20TT	IK20TT	4
1.1 i.e. Cat	42	156C.046/176B2.000		09/90-10/95	K20PR-U	3145	0.8	K20TT	IK20TT	IK20TT	4
1.3 i.e. GT	54/57	146A5.046; 156B.000		06/89-10/95	W20EPR-U	3047	0.8	W20TT	IW20TT	IW20TT	4
BAW											
LANDKING (LUBA) (02-07)											
3.0	118	3VFE		05/02-09/07	K16R-U	3119	0.8	K16TT	IK16TT	IK16TT	6
BEDFORD											
ASTRA VAN (82-91)											
1.3	44/55	13 NB; 13 S		09/84-09/89	W22EPR-U	3088	0.8	W22TT	-	WV22	4
1.6	66	16 SV		09/84-08/91	W22EPR-U	3088	0.8	W22TT	-	WV22	4
BLITZ (69-87)											
2.0 D	44	20 DTr	Double Coil(LPH)	10/80-10/83	DG-001		11V				4
2.1 D	44	21D	Double Coil(LPH)	09/81-10/87	DG-012		11V				4

Свечи зажигания и Свечи накаливания

Таблица применения







	KW				СТАНДАРТНЫЕ			Twin Tip			QTY
											
BEDFORD продолжение											
BLITZ (69-87) продолжение											
2.3 D	46	23D	Double Coil(LPH)	01/73-10/87	DG-001		11V				4
KB (72-88)											
1.6	48/53	G161		05/72-12/88	W16EXR-U11	3032	1.1	W16TT	IW16TT	IW16TT	4
1.6 AWD	59	G161		12/86-12/88	W16EXR-U11	3032	1.1	W16TT	IW16TT	IW16TT	4
2.0 D AWD	58	G200Z		01/85-12/88	W16EXR-U11	3032	1.1	W16TT	IW16TT	IW16TT	4
MIDI (84-92)											
1.0 AWD	34	CB		07/86-10/88	K20TXR	5063	1.0	K20TT	IK20TT	IK20TT	3
1.8	56/63	4ZB1		09/84-07/90	W16EXR-U11	3032	1.1	W16TT	IW16TT	IW16TT	4
1.8	63	4FB1/4ZB1; 4FB1		09/84-05/88	W20EPR-U	3047	0.8	W20TT	IW20TT	IW20TT	4
1.8 4WD	56	4ZB1		09/88-07/90	W16EXR-U11	3032	1.1	W16TT	IW16TT	IW16TT	4
2.0	60/62	4ZC1		09/84-08/92	W16EXR-U11	3032	1.1	W16TT	IW16TT	IW16TT	4
2.0	62	4ZC1		06/88-08/92	W20EPR-U	3047	0.8	W20TT	IW20TT	IW20TT	4
2.0 4WD	62	4ZC1		06/88-08/92	W16EXR-U11	3032	1.1	W16TT	IW16TT	IW16TT	4
2.0 4WD	62	4ZC1		06/88-08/92	W20EPR-U	3047	0.8	W20TT	IW20TT	IW20TT	4
2.0 4x4	60	4ZC1		09/84-08/92	W16EXR-U11	3032	1.1	W16TT	IW16TT	IW16TT	4
2.0 D	42			08/84-05/88	DG-001		11V				4
2.2 D 4WD	45	4FD1		06/88-05/90	DG-159		5V				4
RASCAL (86-90)											
1.0 AWD	34	CB		07/86-06/90	K20TXR	5063	1.0	K20TT	IK20TT	IK20TT	3
BENTLEY											
ARNAGE I (98-09)											
4.4 V8	260	M62448S3		03/98-12/13	K20TXR	5063	1.0	K20TT	IK20TT	IK20TT	8
BROOKLANDS (92-97)											
6.7 Long	177	L 410 I		10/92-09/97	IW16TT	4708	1.0	-	IW16TT		8
CONTINENTAL (84-95)											
6.7	158/160	L 410 A; L 410 I		07/84-04/95	W16EPR-U	3021	0.8	W16TT	IW16TT	IW16TT	8
6.7 (SCBZD)	166/176	L 410 I		01/86-09/92	W16EPR-U	3021	0.8	W16TT	IW16TT	IW16TT	8
CONTINENTAL (91-02)											
6.7 Turbo R	235	L 410 IT		10/91-12/02	W16EPR-U	3021	0.8	W16TT	IW16TT	IW16TT	8
6.75 V8 R	265	L 410 IT		10/91-08/99	W20EPR-U	3047	0.8	W20TT	IW20TT	IW20TT	8
6.75 V8 R	300	L 410 M1T2		08/99-10/02	IK20TT	4702	1.0	-	IK20TT	IK20TT	8
6.75 V8 S	286	L 410 M1T		05/94-12/95	IK16TT	4701	1.0	-	IK16TT	IK16TT	8
6.75 V8 T Mulliner	313	L 410 M1T3		08/99-10/02	IK20TT	4702	1.0	-	IK20TT	IK20TT	8
CONTINENTAL (03-)											
6.0	412	BEB; BWR		06/03-05/06	PK20PR-P8	3245	0.8	-	IK20TT	IK20TT	12
6.0	412/449	BEB; BWR; BWRA		05/06-01/10	VKA20	5623	1.1	-	-	VKA20	12
6.0 AWD	412/448	BEB; BWR; BWRA; CKHC; CKHD; MTBHT		06/06-01/10	VKA20	5623	1.1	-	-	VKA20	12
CONTINENTAL Flying Spur (05-)											
6.0	412	BEB; BWR; CKHD; MTBHT		03/05-	PK20PR-P8	3245	0.8	-	IK20TT	IK20TT	12
EIGHT (84-92)											
6.7	166	L 410 I		10/89-09/92	IW16TT	4708	1.0	-	IW16TT		8
MULSANNE (80-92)											
6.7 S	160	L 410 I		10/89-09/92	IW16TT	4708	1.0	-	IW16TT		8
TURBO R (88-98)											
6.7	286	L 410 IT		09/94-02/98	W16EPR-U	3021	0.8	W16TT	IW16TT	IW16TT	8
6.7	286	L 410 IT		06/95-02/98	IK16TT	4701	1.0	-	IK16TT	IK16TT	8
6.7 (SCBZR)	235	L 410 IT		10/85-06/97	W16EPR-U	3021	0.8	W16TT	IW16TT	IW16TT	8
6.7 S	300	L 410 IT		01/94-12/95	W20EPR-U	3047	0.8	W20TT	IW20TT	IW20TT	8
BERTONE											
FREELIMBER (89-99)											
2.0	95	BMW M20 B20		12/90-12/93	J16CR-U	3256	0.8	W16TT	IW16TT	IW16TT	6
2.0 Cat	95	BMW M20 B20 Kat		12/90-12/93	J16CR-U	3256	0.8	W16TT	IW16TT	IW16TT	6
2.4 TD	85	BMW M 21 D 24	Double Coil(LPH)	06/89-12/93	DG-001		11V				6
2.7	95	BMW M20 B27		06/89-12/93	J16CR-U	3256	0.8	W16TT	IW16TT	IW16TT	6
BMW											
1 (E81, E87) (03-12)											
3.0	190	N52B30A		03/05-07/05	IKH20TT	4704	1.0	-	IKH20TT		6
116 d	66/85	N47 D20 A; N47 D20 C		11/08-12/11	DG-613		7V				4
116 i 1.6	85	N45 B16 A		06/04-12/11	K20TXR	5063	1.0	K20TT	IK20TT	IK20TT	4

Свечи зажигания и Свечи накаливания

Таблица применения

Таблица применения

В

	KW				СТАНДАРТНЫЕ				Twin Tip		QTY
											
BMW продолжение											
1 (E81, E87) (03-12) продолжение											
118 d	90/ 100/ 105	M47 D20 (204D4)		06/04-06/11	DG-178		5V				4
118 d	90/ 100/ 105	N47 D20 A; N47 D20 C		06/04-12/11	DG-613		7V				4
118 i	95/ 100	N46 B20 B		07/04-12/11	IK20TT	4702	1.0	-	IK20TT	IK20TT	4
120 d	120/ 130	M47 D20 (204D4)		06/04-06/11	DG-178		5V				4
120 d	120/ 130	N47 D20 A; N47 D20 C		06/04-12/11	DG-613		7V				4
120 i	110/ 115	N46 B20 A; N46 B20 B; N46 B20 BD; N46 B20 C; N46 B20 CC		06/04-12/11	IK20TT	4702	1.0	-	IK20TT	IK20TT	4
123 d	150	N47 D20 B; N47 D20 C; N47 D20 D		03/07-09/12	DG-613		7V				4
130 i	190/ 195	N52 B30 A; N52 B30 AF; N52 B30 B; N52 B30 BF		09/05-12/11	IKH20TT	4704	1.0	-	IKH20TT		6
1 (F20, F21) (10-)											
114 d 1.6	70	N47 D16 A		07/12-	DG-613		7V				4
114 i 1.6	75	N13 B16 A	Use narrow 16mm Hex socket	12/11-	VXUH22I	5656	0.9	-	IXUH22TT	VXUH22I	4
116 d 1.6	85	N47 D16 A		12/11-	DG-613		7V				4
116 d 2.0	85	N47 D20 C	OE: 12 23 7 803 368; 12 23 0 035 934	07/11-	DG-613		7V				4
116 i 1.6	100	N13 B16 A	Use narrow 16mm Hex socket	07/11-	VXUH22I	5656	0.9	-	IXUH22TT	VXUH22I	4
118 d	100/ 105/ 110	B47 D20 A; N47 D20 C		07/11-	DG-613		7V				4
118 d	110	B47 D20 A	Pressure sensor (-)	03/15-07/16	DG-613		7V				3
118 i 1.6	100/ 125	N13 B16 A	Use narrow 16mm Hex socket	07/11-	VXUH22I	5656	0.9	-	IXUH22TT	VXUH22I	4
118 xd	105/ 110	B47 D20 A; N47 D20 C		05/13-	DG-613		7V				4
118 xd	110	B47 D20 A	Pressure sensor (-)	03/15-07/16	DG-613		7V				3
120 d	120/ 135/ 140/ 147	B47 D20 A; N47 D20 C		07/11-	DG-613		7V				4
120 d	140	B47 D20 A	Pressure sensor (-)	03/15-07/16	DG-613		7V				3
120 i 1.6	130	N13 B16 A	Use narrow 16mm Hex socket	03/15-	VXUH22I	5656	0.9	-	IXUH22TT	VXUH22I	4
120 xd	135/ 140/ 147	B47 D20 A; N47 D20 C		01/12-	DG-613		7V				4
120 xd	140	B47 D20 A	Pressure sensor (-)	03/15-07/16	DG-613		7V				3
125 d	155/ 160/ 165	B47 D20 B; N47 D20 D		12/11-	DG-613		7V				4
125 d	165	B47 D20 B	Pressure sensor (-)	03/15-07/16	DG-613		7V				3
1 Coupe/Convertible (E82, E88) (07-13)											
118 d	100/ 105	N47 D20 A; N47 D20 C		09/08-12/13	DG-613		7V				4
118 i	100	N46 B20 B		09/08-12/13	IK20TT	4702	1.0	-	IK20TT	IK20TT	4
120 d	120/ 130/ 145	N47 D20 A; N47 D20 C		09/07-12/13	DG-613		7V				4
120 i	115	N46 B20 B; N46 B20 BD; N46 B20 C; N46 B20 E		03/08-12/13	IK20TT	4702	1.0	-	IK20TT	IK20TT	4
123 d	150	N47 D20 B; N47 D20 D		10/07-12/13	DG-613		7V				4

Свечи зажигания и Свечи накаливания

Таблица применения









	KW				СТАНДАРТНЫЕ			Twin Tip			QTY
											
BMW продолжение											
1 Coupe/Convertible (E82, E88) (07-13) продолжение											
125 i	160	N52 B30 A		10/07-12/09	IKH20TT	4704	1.0	-	IKH20TT		6
128 i	171	N51 B30 A; N52 B30 A		12/07-12/09	IKH20TT	4704	1.0	-	IKH20TT		6
02 (E6, E10) (67-77)											
1502	55	M10 B16		01/75-07/77	W16EPR-U	3021	0.8	W16TT	IW16TT	IW16TT	4
1502	55	M10 B16		01/75-07/77	W16EP-U	3018	0.8	W16TT	IW16TT	IW16TT	4
1600	63	M10 B16		05/71-04/73	W16EPR-U	3021	0.8	W16TT	IW16TT	IW16TT	4
1600	63	M10 B16		05/71-04/73	W16EP-U	3018	0.8	W16TT	IW16TT	IW16TT	4
1600/2	63	M10 B16 A		12/67-12/71	W16EPR-U	3021	0.8	W16TT	IW16TT	IW16TT	4
1600/2	63	M10 B16 A		12/67-12/71	W16EP-U	3018	0.8	W16TT	IW16TT	IW16TT	4
1600 Ti	77	M10 B16		09/67-11/69	W16EPR-U	3021	0.8	W16TT	IW16TT	IW16TT	4
1600 Ti	77	M10 B16		09/67-11/69	W16EP-U	3018	0.8	W16TT	IW16TT	IW16TT	4
1600-2	63	M10 B16		12/67-10/71	W16EPR-U	3021	0.8	W16TT	IW16TT	IW16TT	4
1600-2	63	M10 B16		12/67-10/71	W16EP-U	3018	0.8	W16TT	IW16TT	IW16TT	4
1602	63	M10 B16 A		04/71-07/75	W16EPR-U	3021	0.8	W16TT	IW16TT	IW16TT	4
1602	63	M10 B16 A		04/71-07/75	W16EP-U	3018	0.8	W16TT	IW16TT	IW16TT	4
1802	66	M10 B18		05/71-07/75	W16EP-U	3018	0.8	W16TT	IW16TT	IW16TT	4
2002	74	M10 B20 A; M10 B20		02/68-07/75	W16EP-U	3018	0.8	W16TT	IW16TT	IW16TT	4
2002	74	M10 B20 A; M10 B20		02/68-07/75	W20EP-U	3043	0.8	W20TT	IW20TT	IW20TT	4
2002 Ti	88	M10 B20		06/68-04/72	W16EP-U	3018	0.8	W16TT	IW16TT	IW16TT	4
2002 Ti	88	M10 B20		06/68-04/72	W20EP-U	3043	0.8	W20TT	IW20TT	IW20TT	4
2002 Tii	96	M10 B20 (23E A); M10 B20		01/71-07/75	W16EP-U	3018	0.8	W16TT	IW16TT	IW16TT	4
2002 Tii	96	M10 B20 (23E A); M10 B20		01/71-07/75	W20EP-U	3043	0.8	W20TT	IW20TT	IW20TT	4
2002 Turbo	125	M10 B20 (22T A)		01/74-07/75	W16EP-U	3018	0.8	W16TT	IW16TT	IW16TT	4
2 Active Tourer (F45) (14-)											
218 d	100/ 110	B47 C20 A; B47 C20 B		07/16-	DG-613		7V				4
218 d	100/ 110	B47 C20 A; B47 C20 B	Pressure sensor (-)	11/13-07/16	DG-613		7V				3
218 xd	100/ 110	B47 C20 A; B47 C20 B		07/16-	DG-613		7V				4
218 xd	100/ 110	B47 C20 A; B47 C20 B	Pressure sensor (-)	12/14-07/16	DG-613		7V				3
220 d	120/ 140	B47 C20 A; B47 C20 B		07/16-	DG-613		7V				4
220 d	120/ 140	B47 C20 A; B47 C20 B	Pressure sensor (-)	03/14-07/16	DG-613		7V				3
220 xd	120/ 140	B47 C20 A; B47 C20 B		07/16-	DG-613		7V				4
220 xd	120/ 140	B47 C20 A; B47 C20 B	Pressure sensor (-)	03/14-07/16	DG-613		7V				3
2 Coupe/Convertible (F22, F23) (13-)											
218 d	100/ 105/ 110	B47 D20 A; N47 D20 C		01/14-	DG-613		7V				4
218 d	100/ 110	B47 D20 A; N47 D20 C	Pressure sensor (-)	07/15-07/16	DG-613		7V				3
220 d	120/ 135/ 140/ 147	B47 D20 A; N47 D20 C		10/12-	DG-613		7V				4
220 d	120/ 140	B47 D20 A; N47 D20 C	Pressure sensor (-)	03/14-07/16	DG-613		7V				3
220 xd	120/ 140	B47 D20 A		07/16-	DG-613		7V				4
220 xd	120/ 140	B47 D20 A	Pressure sensor (-)	06/14-07/16	DG-613		7V				3
225 d	160/ 165	B47 D20 B; N47 D20 D		01/14-	DG-613		7V				4
225 d	165	B47 D20 B	Pressure sensor (-)	07/15-07/16	DG-613		7V				3
2 Gran Tourer (F46) (15-)											
218 d	100/ 110	B47 C20 A; B47 C20 B		07/16-	DG-613		7V				4
218 d	100/ 110	B47 C20 A; B47 C20 B	Pressure sensor (-)	07/14-07/16	DG-613		7V				3
218 xd	100/ 110	B47 C20 A; B47 C20 B		07/16-	DG-613		7V				4
218 xd	100/ 110	B47 C20 A; B47 C20 B	Pressure sensor (-)	03/15-07/16	DG-613		7V				3

Таблица применения











В

Свечи зажигания и Свечи накаливания

Таблица применения

Таблица применения

В

	KW				СТАНДАРТНЫЕ			Twin Tip			QTY
											
BMW продолжение											
2 Gran Tourer (F46) (15-) продолжение											
220 d	120/140	B47 C20 A; B47 C20 B		07/16-	DG-613		7V				4
220 d	120/140	B47 C20 A; B47 C20 B	Pressure sensor (-)	09/14-07/16	DG-613		7V				3
220 xd	120/140	B47 C20 A; B47 C20 B		07/16-	DG-613		7V				4
220 xd	120/140	B47 C20 A; B47 C20 B	Pressure sensor (-)	03/15-07/16	DG-613		7V				3
3 (E21) (75-84)											
315	55	M10 B16 (164VB)		03/81-03/84	W16EPR-U	3021	0.8	W16TT	IW16TT	IW16TT	4
315	55	M10 B16 (164VB)		03/81-03/84	W16EP-U	3018	0.8	W16TT	IW16TT	IW16TT	4
316	66	M10 B16 (164VA)		08/75-08/80	W16EPR-U	3021	0.8	W16TT	IW16TT	IW16TT	4
316	66	M10 B16 (164VA); M10 B18 (184VC)		08/75-12/82	W16EP-U	3018	0.8	W16TT	IW16TT	IW16TT	4
318	72	M10 B18 (184VA)		08/75-08/80	W16EP-U	3018	0.8	W16TT	IW16TT	IW16TT	4
318 i	77	M10 B18 (184VA)		11/79-08/82	W16EP-U	3018	0.8	W16TT	IW16TT	IW16TT	4
320	80	M10 B20		06/75-07/79	W16EPR-U	3021	0.8	W16TT	IW16TT	IW16TT	4
320	80	M10 B20		06/75-07/79	W16EP-U	3018	0.8	W16TT	IW16TT	IW16TT	4
320/6	90	M20 B20 (206VA)		08/77-10/82	W16EPR-U	3021	0.8	W16TT	IW16TT	IW16TT	6
320/6	90	M20 B20 (206VA)		08/77-10/82	W16EP-U	3018	0.8	W16TT	IW16TT	IW16TT	6
320 i	92	M10 B20		06/75-08/82	W16EP-U	3018	0.8	W16TT	IW16TT	IW16TT	4
320 i	92	M10 B20		06/75-08/82	W20EPR-U	3047	0.8	W20TT	IW20TT	IW20TT	4
323 i	105	M20 B23 (236EA)		01/78-10/82	W16EP-U	3018	0.8	W16TT	IW16TT	IW16TT	6
3 (E30) (82-94)											
315	55	M10 B16		09/82-12/91	W16EPR-U	3021	0.8	W16TT	IW16TT	IW16TT	4
315	55	M10 B16		09/82-12/91	W16EP-U	3018	0.8	W16TT	IW16TT	IW16TT	4
316	66	M10 B18 (184VD)		09/83-06/88	W16EP-U	3018	0.8	W16TT	IW16TT	IW16TT	4
316 Ecotronic	66	M10 B18 (184VD)		09/83-06/88	W16EP-U	3018	0.8	W16TT	IW16TT	IW16TT	4
316 i 1.6	73	M40 B16 (164E1)		09/87-06/91	K16R-U	3119	0.8	K16TT	IK16TT	IK16TT	4
316 i 1.6	73	M40 B16 (164E1)		09/91-06/94	K16PR-U	3191	0.8	K16TT	IK16TT	IK16TT	4
316 i 1.6	73/75	M40 B16 (164E1)		09/87-06/94	K20TXR	5063	1.0	K20TT	IK20TT	IK20TT	4
316 i 1.8	75	M10 B18 (184KA)		08/87-08/88	W16EPR-U	3021	0.8	W16TT	IW16TT	IW16TT	4
316 i 1.8	75	M10 B18 (184KA)		08/87-08/88	W16EP-U	3018	0.8	W16TT	IW16TT	IW16TT	4
318 i	75/77	M10 B18 (184EA); M10 B18 (184EB); M10 B18 (184EZ); M10 B18 (184KA)		09/82-08/88	W16EP-U	3018	0.8	W16TT	IW16TT	IW16TT	4
318 i	83	M40 B18 (184E1)		04/89-06/94	K16PR-U	3191	0.8	K16TT	IK16TT	IK16TT	4
318 i	83/85	M40 B18 (184E1)		06/87-10/93	K16R-U	3119	0.8	K16TT	IK16TT	IK16TT	4
318 i	83/85	M40 B18 (184E1)		06/87-06/94	K20TXR	5063	1.0	K20TT	IK20TT	IK20TT	4
318 is	100	M42 B18 (184S1)		09/89-08/91	K20TXR	5063	1.0	K20TT	IK20TT	IK20TT	4
320 i	92	M20 B20 (206EB)		09/82-12/91	W16EPR-U	3021	0.8	W16TT	IW16TT	IW16TT	6
320 i	92/95	M20 B20 (206EB); M20 B20 (206KA)		09/82-12/91	W16EP-U	3018	0.8	W16TT	IW16TT	IW16TT	6
320 i	92/95	M20 B20 (206KA)		01/88-11/93	J16CR-U	3256	0.8	W16TT	IW16TT	IW16TT	6
320 is	141	S14 B20 (204EA)		05/88-12/90	X22ESR-U	4091	0.7	-	-	-	4
323 i	102/110	M20 B23 (236EB); M20 B23 (236EC); M20 B23 (236EW)		09/82-09/86	W16EP-U	3018	0.8	W16TT	IW16TT	IW16TT	6
324 d	63	M21 D24 (246DA); M21 D24 (246DB)		09/85-12/90	DG-001		11V				6
324 td	85	M21 D24 (246TB)		09/87-06/93	DG-001		11V				6
325 e	90/95	M20 B27 (276KA); M20 B27 (276KB)		10/83-01/88	W16EP-U	3018	0.8	W16TT	IW16TT	IW16TT	6
325 e	90/95	M20 B27 (276KA); M20 B27 (276KB)		01/85-12/88	J16CR-U	3256	0.8	W16TT	IW16TT	IW16TT	6
325 i	125	M20 B25 (256E1); M20 B25 (256E2); M20 B25 (256EX); M20 B25 (256K1)		09/83-01/88	W16EP-U	3018	0.8	W16TT	IW16TT	IW16TT	6
325 i	125	M20 B25 (256E1); M20 B25 (256E2); M20 B25 (256EX); M20 B25 (256K1)		09/83-11/93	W20EPR-U	3047	0.8	W20TT	IW20TT	IW20TT	6
325 i	125	M20 B25 (256E1); M20 B25 (256E2); M20 B25 (256EX); M20 B25 (256K1)		01/88-11/93	J16CR-U	3256	0.8	W16TT	IW16TT	IW16TT	6
325 i X	125	M20 B25 (256E1); M20 B25 (256E2); M20 B25 (256EX); M20 B25 (256K1)		03/86-12/87	W20EPR-U	3047	0.8	W20TT	IW20TT	IW20TT	6

Свечи зажигания и Свечи накаливания

Таблица применения











	KW				СТАНДАРТНЫЕ				Twin Tip		QTY	
												
BMW продолжение												
3 (E30) (82-94) продолжение												
325 i X	125	M20 B25 (256E1); M20 B25 (256E2); M20 B25 (256EX); M20 B25 (256K1)		03/86-01/88	W16EP-U	3018	0.8		W16TT	IW16TT	IW16TT	6
325 i X	125	M20 B25 (256E1); M20 B25 (256E2); M20 B25 (256EX); M20 B25 (256K1)		01/88-10/93	J16CR-U	3256	0.8		W16TT	IW16TT	IW16TT	6
M3	143/ 147	S14 B23 (234EA); S14 B23 (234S1); S14 B23 (234S2)		07/86-06/91	X24EP-U9	4093	0.9	-	-			4
M3	143/ 147/ 158	S14 B23 (234EA); S14 B23 (234S1); S14 B23 (234S2)		01/86-06/91	X22ESR-U	4091	0.7	-	-			4
M3 EVO I 2.3	162	S14 B23 (234EA)		10/88-10/90	X22ESR-U	4091	0.7	-	-			4
M3 EVO I 2.3	162	S14 B23 (234EA)		10/88-10/90	X24EP-U9	4093	0.9	-	-			4
M3 EVO II 2.5	175	S14 B25 (254S1)		01/90-01/92	X22ESR-U	4091	0.7	-	-			4
M3 EVO II 2.5	175	S14 B25 (254S1)		01/90-01/92	X24EP-U9	4093	0.9	-	-			4
3 (E36) (90-00)												
316 g	75	M43 B16 (164E2)		02/96-08/00	IK20TT	4702	1.0	-	IK20TT	IK20TT		4
316 g	75	M43 B16 (164E2)		02/96-08/00	K20TXR	5063	1.0	K20TT	IK20TT	IK20TT		4
316 i 1.6	73/75	M40 B16 (164E1); M43 B16 (164E2)		03/91-08/00	K20TXR	5063	1.0	K20TT	IK20TT	IK20TT		6
316 i 1.9	77	M43 B19 (194E1)		01/99-08/00	K20TXR	5063	1.0	K20TT	IK20TT	IK20TT		4
318 i	83/85	M40 B18 (184E1); M43 B18 (184E2)		09/90-11/99	K20TXR	5063	1.0	K20TT	IK20TT	IK20TT		6
318 is 1.8	103	M42 B18 (184S1)		01/92-12/95	K20TXR	5063	1.0	K20TT	IK20TT	IK20TT		4
318 is 1.9	103	M44 B19 (194S1)		09/95-04/99	K20TXR	5063	1.0	K20TT	IK20TT	IK20TT		4
318 tds	66	M41 D17 (174T1)		01/95-08/00	DG-001		11V					4
318 ti 1.8	103	M42 B18 (184S1)		09/94-12/95	K20TXR	5063	1.0	K20TT	IK20TT	IK20TT		4
318 ti 1.9	103	M44 B19 (194S1)		01/96-08/99	K20TXR	5063	1.0	K20TT	IK20TT	IK20TT		4
320 i	110	M50 B20 (206S1); M50 B20 (206S2); M52 B20 (206S3)		01/91-11/99	K20TXR	5063	1.0	K20TT	IK20TT	IK20TT		6
323 i	125	M52 B25 (256S3)		07/97-11/99	K20TXR	5063	1.0	K20TT	IK20TT	IK20TT		6
323 ti	120/ 125	M52 B25 (256S3)		09/97-08/00	K20TXR	5063	1.0	K20TT	IK20TT	IK20TT		6
325 i	141	M50 B25 (256S1); M50 B25 (256S2)		09/90-12/95	K20TXR	5063	1.0	K20TT	IK20TT	IK20TT		6
325 td	85	M51 D25 (256T1)		09/91-02/98	DG-001		11V					6
325 tds	105	M51 D25 (256T1)		05/93-04/99	DG-001		11V					6
328 i	142	M52 B28 (286S1)		01/95-11/99	K20TXR	5063	1.0	K20TT	IK20TT	IK20TT		6
M3 3.0	210/ 217	S50 B30 (306S1)		11/92-07/95	XU22EPR-U	3179	0.9	XU22TT	IXU22TT	VXU22		6
M3 3.0	210/ 217	S50/ S52		11/92-07/95	K20TXR	5063	1.0	K20TT	IK20TT	IK20TT		6
M3 3.2	236	S50 B32 (326S1)		10/95-09/99	XU22EPR-U	3179	0.9	XU22TT	IXU22TT	VXU22		6
M3 3.2	236	S50/ S52		10/95-09/99	K20TXR	5063	1.0	K20TT	IK20TT	IK20TT		6
3 (E46) (98-06)												
316 Ci	85	N45 B16 A		06/02-07/06	IK20TT	4702	1.0	-	IK20TT	IK20TT		4
316 Ci	85	N45 B16 A		06/02-07/06	K20TXR	5063	1.0	K20TT	IK20TT	IK20TT		4
316 Ci 1.6	77	M43 B16 (164E3)		04/00-07/06	K20TXR	5063	1.0	K20TT	IK20TT	IK20TT		4
316 i 1.6	77/85	M43 B16 (164E3); N40 B16 A		04/00-02/05	K20TXR	5063	1.0	K20TT	IK20TT	IK20TT		4
316 i 1.6	85	N45 B16 A		09/03-02/05	IK20TT	4702	1.0	-	IK20TT	IK20TT		4
316 i 1.8	85	N42 B18 A		02/02-02/04	K20TXR	5063	1.0	K20TT	IK20TT	IK20TT		4
316 i 1.8	85	N46 B18 A		09/03-02/05	IK20TT	4702	1.0	-	IK20TT	IK20TT		4
316 i 1.9	77	M43 B19 (194E1)		12/98-02/02	K20TXR	5063	1.0	K20TT	IK20TT	IK20TT		4
316 ti 1.6	77/85	N40 B16 A		06/02-02/05	K20TXR	5063	1.0	K20TT	IK20TT	IK20TT		4
316 ti 1.6	85	N45 B16 A		09/03-02/05	IK20TT	4702	1.0	-	IK20TT	IK20TT		4
316 ti 1.8	85	N42 B18 A		06/01-02/04	K20TXR	5063	1.0	K20TT	IK20TT	IK20TT		4
316 ti 1.8	85	N46 B18 A		09/03-02/05	IK20TT	4702	1.0	-	IK20TT	IK20TT		4
318 Ci 1.9	85/87	M43 B19 (194E1)		12/99-08/01	K20TXR	5063	1.0	K20TT	IK20TT	IK20TT		4
318 Ci 2.0	100/ 105	N42 B20 A		12/00-02/04	K20TXR	5063	1.0	K20TT	IK20TT	IK20TT		4
318 Ci 2.0	100/ 105/ 110	N46 B20 A/ N46 B20 C; N46 B20 A; N46 B20 B		09/03-12/07	IK20TT	4702	1.0	-	IK20TT	IK20TT		4
318 d	85	M47 D20 (204D1)		09/01-03/03	DG-145		11V					4
318 d	85	M47 D20 (204D4)		03/03-02/05	DG-178		5V					4
318 i 1.9	85/87	M43 B19 (194E1)		12/97-09/01	K20TXR	5063	1.0	K20TT	IK20TT	IK20TT		4
318 i 2.0	100/ 105	N42 B20 A		09/01-02/05	K20TXR	5063	1.0	K20TT	IK20TT	IK20TT		4
318 i 2.0	105	N46 B20 A		09/03-02/05	IK20TT	4702	1.0	-	IK20TT	IK20TT		4

Таблица применения

В

Свечи зажигания и Свечи накаливания

Таблица применения

Таблица применения

В

KW	KW	KW	NOTE	21	СТАНДАРТНЫЕ				Twin Tip		QTY
					STANDARD	STANDARD	STANDARD	STANDARD	Twin Tip	Twin Tip	
BMW продолжение											
3 (E46) (98-06) продолжение											
318 td	85	M47 D20 (204D4)		03/03-02/05	DG-178		5V				4
318 ti	100/ 105	N42 B20 A		03/01-02/04	K20TXR	5063	1.0	K20TT	IK20TT	IK20TT	4
318 ti	100/ 105	N46 B20 A		09/03-12/04	IK20TT	4702	1.0	-	IK20TT	IK20TT	4
320 Cd	110	M47 D20 (204D4)		11/03-12/07	DG-178		5V				4
320 Ci 2.0	110	M52 B20 (206S4)		02/99-08/01	K20TXR	5063	1.0	K20TT	IK20TT	IK20TT	6
320 Ci 2.2	120/ 125	M54 B22 (226S1)		01/00-12/07	K20TXR	5063	1.0	K20TT	IK20TT	IK20TT	6
320 d	95/ 100	M47 D20 (204D1)		02/98-09/01	DG-145		11V				4
320 d	110	M47 D20 (204D4)		09/01-05/05	DG-178		5V				4
320 i 2.0	110	M52 B20 (206S4)		03/98-09/00	K20TXR	5063	1.0	K20TT	IK20TT	IK20TT	6
320 i 2.2	120/ 125	M54 B22 (226S1)		09/00-02/05	K20TXR	5063	1.0	K20TT	IK20TT	IK20TT	6
320 td	110	M47 D20 (204D4)		09/01-02/05	DG-178		5V				4
323 Ci	120/ 125	M52 B25 (256S4)		04/99-09/00	K20TXR	5063	1.0	K20TT	IK20TT	IK20TT	6
323 i	120/ 125	M52 B25 (256S4)		03/98-09/00	K20TXR	5063	1.0	K20TT	IK20TT	IK20TT	6
325 Ci	141	M54 B25 (256S5)		09/00-08/06	K20TXR	5063	1.0	K20TT	IK20TT	IK20TT	6
325 i	141	M54 B25 (256S5)		09/00-02/05	K20TXR	5063	1.0	K20TT	IK20TT	IK20TT	6
325 ti	141	M54 B25 (256S5)		04/01-12/04	K20TXR	5063	1.0	K20TT	IK20TT	IK20TT	6
325 xi	141	M54 B25 (256S5)		09/00-02/05	K20TXR	5063	1.0	K20TT	IK20TT	IK20TT	6
328 Ci	142	M52 B28 (286S2)		12/98-05/00	K20TXR	5063	1.0	K20TT	IK20TT	IK20TT	6
328 i	142	M52 B28 (286S2)		02/98-06/00	K20TXR	5063	1.0	K20TT	IK20TT	IK20TT	6
330 Cd	150	M57 D30 (306D2)		03/03-12/07	DG-178		5V				6
330 Ci	170	M54 B30 (306S3)		06/00-08/06	K20TXR	5063	1.0	K20TT	IK20TT	IK20TT	6
330 d 2.9	135	M57 D30 (306D1)		10/99-02/05	DG-145		11V				6
330 d 3.0	150	M57 D30 (306D2)		03/03-02/05	DG-178		5V				6
330 i	168/ 170	M54 B30 (306S3)		06/00-04/05	K20TXR	5063	1.0	K20TT	IK20TT	IK20TT	6
330 xd 2.9	135	M57 D30 (306D1)		01/00-03/03	DG-145		11V				6
330 xd 3.0	150	M57 D30 (306D2)		08/02-05/05	DG-178		5V				6
330 xi	170	M54 B30 (306S3)		06/00-07/06	K20TXR	5063	1.0	K20TT	IK20TT	IK20TT	6
M3	252/ 265	S54 B32 (326S4)		07/00-08/06	IXU24	5309	0.9	-	-	VXU24	6
M3	252/ 265	S54 B32 (326S4)		07/00-08/06	VXU24	5609	0.9	-	-	VXU24	6
3 (E90, E91) (05-12)											
316 d	85	N47 D20 C	OE: 12 23 7 803 368; 12 23 0 035 934	07/09-06/12	DG-613		7V				4
316 i	85	N45 B16 A; N45 B16 AC		09/05-10/11	K20TXR	5063	1.0	K20TT	IK20TT	IK20TT	4
318 d	90	M47 D20 (204D4)		03/05-08/07	DG-178		5V				4
318 d	100/ 105	N47 D20 A; N47 D20 C	OE: 12 23 7 803 368; 12 23 0 035 934	02/07-06/12	DG-613		7V				4
318 i	95/ 100	N46 B20 B; N46 B20 C; N46 B20 CC; N46 B20 CD; N46 B20 E		09/05-03/12	IK20TT	4702	1.0	-	IK20TT	IK20TT	4
320 d	110/ 120	M47 D20 (204D4)		12/04-06/12	DG-178		5V				4
320 d	120/ 130/ 135	N47 D20 A; N47 D20 C		12/04-06/12	DG-613		7V				4
320 d	145/ 147	N47 D20 A; N47 D20 C	OE: 12 23 7 803 368; 12 23 0 035 934	02/07-05/12	DG-613		7V				4
320 i	110/ 115	N46 B20 B; N46 B20 BD; N46 B20 C; N46 B20 CB; N46 B20 CC; N46 B20 CD; N46 B20 E		12/04-06/12	IK20TT	4702	1.0	-	IK20TT	IK20TT	4
320 xd	120/ 130/ 135	N47 D20 A; N47 D20 C		09/08-06/12	DG-613		7V				4

Свечи зажигания и Свечи накаливания

Таблица применения











	KW				СТАНДАРТНЫЕ			Twin Tip			QTY
											
BMW продолжение											
3 (E90, E91) (05-12) продолжение											
320 xd	145/ 147	N47 D20 C	OE: 12 23 7 803 368; 12 23 0 035 934	02/08-05/12	DG-613		7V				4
323 i	130/ 140	N52 B25 A; N52 B25 B; N52 B25 BE; N52 B25 BF		09/05-12/09	IKH20TT	4704	1.0	-	IKH20TT		6
325 d	145	M57 D30 (306D3)		09/06-06/12	DG-178		5V				6
325 d	150	N57 D30 A		02/10-06/12	DG-613		7V				6
325 i 2.5	155/ 160	N52 B25 A; N52 B25 AF; N52 B25 B; N52 B25 BF		12/04-12/09	IKH20TT	4704	1.0	-	IKH20TT		6
325 xi 2.5	160	N52 B25 A		03/05-12/09	IKH20TT	4704	1.0	-	IKH20TT		6
328 i	172	N51 B30 A		09/06-12/09	IKH20TT	4704	1.0	-	IKH20TT		6
330 d	170	M57 D30 (306D3)		12/04-09/08	DG-178		5V				6
330 d	180	N57 D30 A		02/08-05/12	DG-613		7V				6
330 i	190/ 200	N52 B30 A; N52 B30 BF		12/04-10/11	IKH20TT	4704	1.0	-	IKH20TT		6
330 xd	170	M57 D30 (306D3)		09/05-06/12	DG-178		5V				6
330 xd	180	N57 D30 A		09/08-06/12	DG-613		7V				6
330 xi	190	N52 B30 A		09/05-08/07	IKH20TT	4704	1.0	-	IKH20TT		6
335 d	210	M57 D30 (306D5)		09/06-06/12	DG-178		5V				6
3 (F30, F31) (11-19)											
316 d	85	B47 D20 A		07/16-06/19	DG-613		7V				4
316 d	85	B47 D20 A	Pressure sensor (-)	03/12-07/16	DG-613		7V				3
316 d	85	N47 D20 C	OE: 12 23 7 803 368; 12 23 0 035 934	03/12-06/19	DG-613		7V				4
316 i	100	N13 B16 A	Use narrow 16mm Hex socket	07/12-08/16	VXUH22I	5656	0.9	-	IXUH22TT	VXUH22I	4
318 d	100/ 105	B47 D20 A; N47 D20 C	OE: 12 23 7 803 368; 12 23 0 035 934	03/12-06/19	DG-613		7V				4
318 d	110	B47 D20 A		07/16-06/19	DG-613		7V				4
318 d	110	B47 D20 A	Pressure sensor (-)	07/15-07/16	DG-613		7V				3
318 xd	105	N47 D20 C	OE: 12 23 7 803 368; 12 23 0 035 934	07/13-06/15	DG-613		7V				4
318 xd	110	B47 D20 A		07/16-02/18	DG-613		7V				4
318 xd	110	B47 D20 A	Pressure sensor (-)	07/15-07/16	DG-613		7V				3
320 d	120/ 135/ 147	N47 D20 C	OE: 12 23 7 803 368; 12 23 0 035 934	11/11-06/19	DG-613		7V				4
320 d	120/ 140	B47 D20 A		07/16-06/19	DG-613		7V				4
320 d	120/ 140	B47 D20 A	Pressure sensor (-)	11/11-07/16	DG-613		7V				3
320 i 1.6	125	N13 B16 A	Use narrow 16mm Hex socket	11/12-06/16	VXUH22I	5656	0.9	-	IXUH22TT	VXUH22I	4
320 xd	120/ 135/ 147	B47 D20 A; N47 D20 C	OE: 12 23 7 803 368; 12 23 0 035 934	08/12-06/19	DG-613		7V				4
320 xd	140	B47 D20 A		07/16-06/19	DG-613		7V				4
320 xd	140	B47 D20 A	Pressure sensor (-)	07/15-07/16	DG-613		7V				3
325 d	155/ 160	N47 D20 D	OE: 12 23 7 803 368; 12 23 0 035 934	03/13-02/16	DG-613		7V				4
325 d	165	B47 D20 B		07/16-02/18	DG-613		7V				4
325 d	165	B47 D20 B	Pressure sensor (-)	03/16-07/16	DG-613		7V				3

Таблица применения











В

Свечи зажигания и Свечи накаливания

Таблица применения

Таблица применения

В

	KW				СТАНДАРТНЫЕ				Twin Tip		QTY
											
BMW продолжение											
3 (F30, F31) (11-19) продолжение											
330 d	190/ 210	N57 D30 A	OE: 12 23 7 803 368; 12 23 0 035 934	07/12-06/19	DG-613		7V				6
330 xd	190/ 210	N57 D30 A	OE: 12 23 7 803 368; 12 23 0 035 934	03/13-06/19	DG-613		7V				6
335 xd	230	N57 D30 B	OE: 12 23 7 803 368; 12 23 0 035 934	07/13-06/19	DG-613		7V				6
3 Coupe/Convertible (E92, E93) (06-13)											
320 d	120/ 130/ 135/ 145/ 147	N47 D20 A; N47 D20 C		09/06-12/13	DG-613		7V				4
320 i	115	N46 B20 B		01/07-12/13	IKH20TT	4702	1.0	-	IKH20TT	IKH20TT	4
320 xd	120/ 130/ 135/ 145/ 147	N47 D20 C		09/08-06/13	DG-613		7V				4
320xd	130	N47 D20 A; N47 D20 C		03/07-12/13	DG-613		7V				4
323 i	140	N52 B25 A; N52 B25 AE; N52 B25 BE		04/06-12/09	IKH20TT	4704	1.0	-	IKH20TT		6
325 d	145/ 155	M57 D30 (306D3)		02/07-12/10	DG-178		5V				6
325 d	150	N57 D30 A		09/09-12/13	DG-613		7V				6
325 i 2.5	160	N52 B25 A; N52 B25 AF; N52 B25 BF		06/06-12/09	IKH20TT	4704	1.0	-	IKH20TT		6
325 xi 2.5	160	N52 B25 A		09/06-12/09	IKH20TT	4704	1.0	-	IKH20TT		6
328 i	172	N51 B30 A; N52 B30 A		06/06-12/09	IKH20TT	4704	1.0	-	IKH20TT		6
328 xi	172	N51 B30 A		09/09-06/13	IKH20TT	4704	1.0	-	IKH20TT		6
330 d	170	M57 D30 (306D3)		03/06-12/13	DG-178		5V				6
330 d	180	N57 D30 A		01/09-12/13	DG-613		7V				6
330 i	190/ 200	N52 B30 A; N52 B30 AF; N52 B30 BF		09/06-10/13	IKH20TT	4704	1.0	-	IKH20TT		6
330 xd	170	M57 D30 (306D3)		03/06-08/08	DG-178		5V				6
330 xd	180	N57 D30 A		03/08-06/13	DG-613		7V				6
330 xi	200	N52 B30 A		09/06-08/07	IKH20TT	4704	1.0	-	IKH20TT		6
335 d	210	M57 D30 (306D5)		03/06-03/13	DG-178		5V				6
3 Gran Turismo (F34) (13-)											
318 d	100/ 105	N47 D20 C	OE: 12 23 7 803 368; 12 23 0 035 934	03/13-	DG-613		7V				4
318 d	110	B47 D20 A		07/16-	DG-613		7V				4
318 d	110	B47 D20 A	Pressure sensor (-)	07/15-07/16	DG-613		7V				3
320 d	120/ 135/ 147	B47 D20 A; N47 D20 C	OE: 12 23 7 803 368; 12 23 0 035 934	03/13-	DG-613		7V				4
320 d	140	B47 D20 A		07/16-	DG-613		7V				4
320 d	140	B47 D20 A	Pressure sensor (-)	07/15-07/16	DG-613		7V				3
320 xd	120/ 135/ 147	B47 D20 A; N47 D20 C	OE: 12 23 7 803 368; 12 23 0 035 934	03/13-	DG-613		7V				4
320 xd	140	B47 D20 A		07/16-	DG-613		7V				4
320 xd	140	B47 D20 A	Pressure sensor (-)	07/15-07/16	DG-613		7V				3
325 d	155/ 160	N47 D20 D	OE: 12 23 7 803 368; 12 23 0 035 934	03/13-	DG-613		7V				4

Свечи зажигания и Свечи накаливания











Таблица применения

	KW				СТАНДАРТНЫЕ			Twin Tip			QTY
BMW продолжение											
3 Gran Turismo (F34) (13-) продолжение											
325 d	165	B47 D20 B		07/16-	DG-613		7V				4
330 d	190/ 210	N57 D30 A		01/14-	DG-613		7V				6
330 xd	190/ 210	N57 D30 A		01/14-	DG-613		7V				6
335 xd	230	N57 D30 B		01/14-	DG-613		7V				6
4 Coupe/Convertible (F32, F33) (13-)											
418 d	100/ 110	B47 D20 A		07/16-10/17	DG-613		7V				4
418 d	100/ 110	B47 D20 A	Pressure sensor (-)	03/15-07/16	DG-613		7V				3
420 d	120/ 135/ 147	N47 D20 C	OE: 12 23 7 803 368; 12 23 0 035 934	07/13-	DG-613		7V				4
420 d	120/ 140	B47 D20 A		07/16-	DG-613		7V				4
420 d	120/ 140	B47 D20 A	Pressure sensor (-)	07/13-07/16	DG-613		7V				3
420 xd	120/ 135/ 147	N47 D20 C	OE: 12 23 7 803 368; 12 23 0 035 934	11/13-	DG-613		7V				4
420 xd	120/ 140	B47 D20 A		07/16-	DG-613		7V				4
420 xd	120/ 140	B47 D20 A	Pressure sensor (-)	11/13-07/16	DG-613		7V				3
425 d	155/ 160	N47 D20 D	OE: 12 23 7 803 368; 12 23 0 035 934	03/14-02/16	DG-613		7V				4
425 d	165	B47 D20 B		07/16-02/18	DG-613		7V				4
425 d	165	B47 D20 B	Pressure sensor (-)	03/16-07/16	DG-613		7V				3
430 d	190/ 210	N57 D30 A		11/13-	DG-613		7V				6
430 xd	190/ 210	N57 D30 A		03/14-	DG-613		7V				6
435 xd	230	N57 D30 B	OE: 12 23 7 803 368; 12 23 0 035 934	11/13-	DG-613		7V				6
4 Gran Coupe (F36) (14-)											
418 d	100/ 105	N47 D20 C	OE: 12 23 7 803 368; 12 23 0 035 934	03/14-	DG-613		7V				4
418 d	100/ 110	B47 D20 A		07/16-	DG-613		7V				4
418 d	100/ 110	B47 D20 A	Pressure sensor (-)	03/14-07/16	DG-613		7V				3
420 d	120/ 135/ 147	N47 D20 C	OE: 12 23 7 803 368; 12 23 0 035 934	03/14-	DG-613		7V				4
420 d	120/ 140	B47 D20 A		07/16-	DG-613		7V				4
420 d	120/ 140	B47 D20 A	Pressure sensor (-)	03/14-07/16	DG-613		7V				3
420 xd	120/ 135/ 147	N47 D20 C	OE: 12 23 7 803 368; 12 23 0 035 934	03/14-	DG-613		7V				4
420 xd	120/ 140	B47 D20 A		07/16-	DG-613		7V				4
420 xd	120/ 140	B47 D20 A	Pressure sensor (-)	03/14-07/16	DG-613		7V				3
425 d	155/ 165	B47 D20 B		07/16-02/18	DG-613		7V				4
425 d	155/ 165	B47 D20 B	Pressure sensor (-)	03/16-07/16	DG-613		7V				3
430 d	190/ 210	N57 D30 A		07/14-	DG-613		7V				6

Свечи зажигания и Свечи накаливания

Таблица применения

Таблица применения

	KW				СТАНДАРТНЫЕ				Twin Tip			QTY
												
BMW продолжение												
4 Gran Coupe (F36) (14-) продолжение												
430 xd	190/ 210	N57 D30 A		07/14-	DG-613		7V					6
435 xd	230	N57 D30 B	OE: 12 23 7 803 368; 12 23 0 035 934	07/14-	DG-613		7V					6
5 (E12) (72-81)												
518	66	M10 B18 (184VB)		07/74-05/81	W16EP-U	3018	0.8	W16TT	IW16TT	IW16TT		4
518 i	75	M10 B18 (184EB)		06/79-06/81	W16EP-U	3018	0.8	W16TT	IW16TT	IW16TT		4
520 i l-4	92/96	M10 B20		03/72-07/79	W16EP-U	3018	0.8	W16TT	IW16TT	IW16TT		4
520 i l-6	90	M20 B20 (206VA)		03/77-06/81	J16CR-U	3256	0.8	W16TT	IW16TT	IW16TT		6
520 i l-6	90	M20 B20 (206VA)		03/77-06/81	W16EP-U	3018	0.8	W16TT	IW16TT	IW16TT		6
520 l-4	85	M10 B20		06/72-07/75	W20EP-U	3043	0.8	W20TT	IW20TT	IW20TT		4
520 l-4	85	M10 B20		06/72-01/79	W16EP-U	3018	0.8	W16TT	IW16TT	IW16TT		4
525	107	M30 B25 A		10/73-08/76	W16EP-U	3018	0.8	W16TT	IW16TT	IW16TT		6
525	107/ 110	M30 B25 (256VA); M30 B25 A		10/73-06/81	W16EPR-U	3021	0.8	W16TT	IW16TT	IW16TT		6
525	110	M30 B25 (256VA)		08/75-06/81	W20EP-U	3043	0.8	W20TT	IW20TT	IW20TT		6
528	121/ 125	M30 B28		01/75-07/77	W16EPR-U	3021	0.8	W16TT	IW16TT	IW16TT		6
528 i	130/ 135	M30 B28		03/77-06/81	W16EPR-U	3021	0.8	W16TT	IW16TT	IW16TT		6
528 i	135	M30 B28		08/79-06/81	W16EP-U	3018	0.8	W16TT	IW16TT	IW16TT		6
M 535 i	160	M30 B35 (356EA)		04/80-05/81	W16EPR-U	3021	0.8	W16TT	IW16TT	IW16TT		6
M 535 i	160	M30 B35 (356EA)		04/80-05/81	W20EP-U	3043	0.8	W20TT	IW20TT	IW20TT		6
5 (E28) (81-87)												
518	66	M10 B18 (184VC); M10 B18 (184VD)		06/81-09/84	W16EP-U	3018	0.8	W16TT	IW16TT	IW16TT		4
518 i	75/77	M10 B18 (184EB)		05/81-12/87	W16EP-U	3018	0.8	W16TT	IW16TT	IW16TT		4
520 i	92/95	M20 B20 (206EA); M20 B20 (206EB); M20 B20 (206EC); M20 B20 (206EZ); M20 B20 (206KA)		06/81-12/87	W16EP-U	3018	0.8	W16TT	IW16TT	IW16TT		6
520 i	92/ 95/ 110	M20 B20 (206EA); M20 B20 (206EB); M20 B20 (206EC); M20 B20 (206EZ); M20 B20 (206KA)		09/82-12/87	J16CR-U	3256	0.8	W16TT	IW16TT	IW16TT		6
520 i	110	M20 B20 (206KA)		12/86-12/87	K20TXR	5063	1.0	K20TT	IK20TT	IK20TT		6
524 d	63	M21 D24 (246DA)		03/86-12/87	DG-001		11V					6
524 td	85	M21 D24 (246TA)		09/83-12/87	DG-001		11V					6
525 e	90	M20 B27 (276EB); M20 B27 (276KA); M20 B27 (276KB)		09/81-09/82	W16EP-U	3018	0.8	W16TT	IW16TT	IW16TT		6
525 e	90/ 92/95	M20 B27 (276EA); M20 B27 (276EB); M20 B27 (276KA); M20 B27 (276KB)		09/82-12/87	J16CR-U	3256	0.8	W16TT	IW16TT	IW16TT		6
525 i	110	M30 B25 (256EA)		06/81-12/87	W16EPR-U	3021	0.8	W16TT	IW16TT	IW16TT		6
525 i	110	M30 B25 (256EA)		06/81-12/87	W16EP-U	3018	0.8	W16TT	IW16TT	IW16TT		6
528 i	135	M30 B28 (286EA)		06/81-12/87	W16EPR-U	3021	0.8	W16TT	IW16TT	IW16TT		6
528 i	135	M30 B28 (286EA)		06/81-12/87	W16EP-U	3018	0.8	W16TT	IW16TT	IW16TT		6
535 i	135/ 141/ 162	M30 B34 (346EC); M30 B34 (346KA)		01/85-12/87	J16CR-U	3256	0.8	W16TT	IW16TT	IW16TT		6
535 i	135/ 141/ 162	M30 B34 (346EC); M30 B34 (346KA)		01/85-12/87	W16EPR-U	3021	0.8	W16TT	IW16TT	IW16TT		6
M5	210	S38 B35 (356ED)		08/85-12/87	IX22B	5375	0.9	-	-			6
M5	210	S38 B35 (356ED)		08/85-12/87	X22EPR-U9	4086	0.9	-	-			6
5 (E34) (87-97)												
518 g	85	M43 B18 (184E2)		02/96-07/96	K20TXR	5063	1.0	K20TT	IK20TT	IK20TT		4
518 i	83/85	M40 B18 (184E1); M43 B18 (184E2)		09/91-07/96	K20TXR	5063	1.0	K20TT	IK20TT	IK20TT		4
520 i 12V	95/ 110	M20 B20 (206KA)		06/87-09/90	J16CR-U	3256	0.8	W16TT	IW16TT	IW16TT		6
520 i 24V	110	M50 B20 (206S1); M50 B20 (206S2)		04/90-07/96	K20TXR	5063	1.0	K20TT	IK20TT	IK20TT		6
524 td	85	M21 D24 (246TB)		03/88-08/91	DG-001		11V					6
525 i 12V	125	M20 B25 (256K1)		02/88-08/90	J16CR-U	3256	0.8	W16TT	IW16TT	IW16TT		6
525 i 12V	125	M20 B25 (256K1)		02/88-08/90	W20EPR-U	3047	0.8	W20TT	IW20TT	IW20TT		6
525 i 24V	141	M50 B25 (256S1); M50 B25 (256S2)		03/90-07/96	K20TXR	5063	1.0	K20TT	IK20TT	IK20TT		6

Свечи зажигания и Свечи накаливания

Таблица применения











	KW				СТАНДАРТНЫЕ			Twin Tip			QTY
											
BMW продолжение											
5 (E34) (87-97) продолжение											
525 ix 24V	141	M50 B25 (256S1); M50 B25 (256S2)		10/91-03/96	K20TXR	5063	1.0	K20TT	IK20TT	IK20TT	6
525 td	85	M51 D25 (256T1)		03/93-07/96	DG-001		11V				6
525 tds	105	M51 D25 (256T1)		09/91-07/96	DG-001		11V				6
530 i l6	138	M30 B30 (306KA)		01/88-04/90	J16CR-U	3256	0.8	W16TT	IW16TT	IW16TT	6
530 i V8	160	M60 B30 (308S1)		09/92-07/96	K20TXR	5063	1.0	K20TT	IK20TT	IK20TT	8
535 i	155	M30 B34 (346KB)		11/87-02/93	J16CR-U	3256	0.8	W16TT	IW16TT	IW16TT	6
540 i	210	M60 B40 (408S1)		09/92-07/96	K20TXR	5063	1.0	K20TT	IK20TT	IK20TT	8
M5 3.6	232	S38 B36 (366S1)		09/88-03/92	X22EPR-U9	4086	0.9	-	-		6
M5 3.6	232	S38 B36 (366S1)		09/88-03/92	XU20EPR-U	3178	0.9	-	-	VXU22	6
M5 3.8	250	S38 B38 (386S1)		01/92-07/95	X22EPR-U9	4086	0.9	-	-		6
M5 3.8	250	S38 B38 (386S1)		01/92-07/95	XU22EPR-U	3179	0.9	XU22TT	IXU22TT	VXU22	6
5 (E39) (95-04)											
520 d	100	M47 D20 (204D1)		02/00-09/03	DG-145		11V				4
520 i 2.0	100/ 110	M52 B20 (206S3); M52 B20 (206S4)		01/96-06/03	K20TXR	5063	1.0	K20TT	IK20TT	IK20TT	6
520 i 2.2	120/ 125	M54 B22 (226S1)		09/00-12/03	K20TXR	5063	1.0	K20TT	IK20TT	IK20TT	6
523 i	120/ 125	M52 B25 (256S3); M52 B25 (256S4)		09/95-08/00	K20TXR	5063	1.0	K20TT	IK20TT	IK20TT	6
525 d	120	M57 D25 (256D1)		02/00-05/04	DG-145		11V				6
525 i	141	M54 B25 (256S5)		09/00-05/04	K20TXR	5063	1.0	K20TT	IK20TT	IK20TT	6
525 td	85	M51 D25 (256T1)		01/97-06/03	DG-001		11V				6
525 tds	105	M51 D25 (256T1)		01/96-05/04	DG-001		11V				6
528 i	142	M52 B28 (286S1); M52 B28 (286S2)		09/95-08/00	K20TXR	5063	1.0	K20TT	IK20TT	IK20TT	6
530 d	135/ 142	M57 D30 (306D1)		08/98-05/04	DG-145		11V				6
530 i	170	M54 B30 (306S3)		09/00-12/03	K20TXR	5063	1.0	K20TT	IK20TT	IK20TT	6
535 i	173/ 180	M62 B35 (358S1); M62 B35 (358S2)		06/96-06/03	K20TXR	5063	1.0	K20TT	IK20TT	IK20TT	8
540 i	210	M62 B44 (448S1); M62 B44 (448S2)		03/96-12/03	K20TXR	5063	1.0	K20TT	IK20TT	IK20TT	8
M5	294	S62 B50 (508S1)		10/98-06/03	K20TXR	5063	1.0	K20TT	IK20TT	IK20TT	8
5 (E60, E61) (03-10)											
520 d	110/ 120	M47 D20 (204D4)		04/05-05/10	DG-178		5V				4
520 d	110/ 120/ 130	N47 D20 A; N47 D20 C		04/05-05/10	DG-613		7V				4
520 i 2.0	115	N46 B20 B		04/06-12/09	IK20TT	4702	1.0	-	IK20TT	IK20TT	4
520 i 2.2	125	M54 B22 (226S1)		07/03-03/10	K20TXR	5063	1.0	K20TT	IK20TT	IK20TT	6
523 i	130/ 140	N52 B25 A; N52 B25 B; N52 B25 BE		10/04-03/10	IKH20TT	4704	1.0	-	IKH20TT		6
525 d 2.5	120/ 130	M57 D25 (256D2)		03/04-03/10	DG-178		5V				6
525 d 3.0	145	M57 D30 (306D3)		01/07-05/10	DG-178		5V				6
525 i 2.5	141	M54 B25 (256S5)		09/03-12/10	K20TXR	5063	1.0	K20TT	IK20TT	IK20TT	6
525 i 2.5	155/ 160	N52 B25 A; N52 B25 B; N52 B25 BF		03/05-05/10	IKH20TT	4704	1.0	-	IKH20TT		6
525 xd	145	M57 D30 (306D3)		11/06-05/10	DG-178		5V				6
525 xi 2.5	160	N52 B25 A		04/05-12/10	IKH20TT	4704	1.0	-	IKH20TT		6
530 d	155/ 160/ 170/ 173	M57 D30 (306D2); M57 D30 (306D3)		09/02-05/10	DG-178		5V				6
530 i	170	M54 B30 (306S3)		12/01-02/05	K20TXR	5063	1.0	K20TT	IK20TT	IK20TT	6
530 i	187/ 190/ 200	N52 B30 A; N52 B30 BF		09/04-12/09	IKH20TT	4704	1.0	-	IKH20TT		6
530 xd	170/ 173	M57 D30 (306D3)		02/05-05/10	DG-178		5V				6
530 xi	190/ 200	N52 B30 A		09/04-12/09	IKH20TT	4704	1.0	-	IKH20TT		6
535 d	200/ 210	M57 D30 (306D4); M57 D30 (306D5)		09/04-12/10	DG-178		5V				6
540 i	225	N62 B40 A		09/05-12/09	IK20TT	4702	1.0	-	IK20TT	IK20TT	8
545 i	245	N62 B44 A		09/03-12/10	K20TXR	5063	1.0	K20TT	IK20TT	IK20TT	8
550 i	270	N62 B48 A; N62 B48 B		07/05-12/10	IK20TT	4702	1.0	-	IK20TT	IK20TT	8











Таблица применения

В

Свечи зажигания и Свечи накаливания





Таблица применения

Таблица применения

	KW				СТАНДАРТНЫЕ				Twin Tip		QTY
											
BMW продолжение											
5 (F10, F11) (10-16)											
518 d	100/ 105/ 110	B47 D20 A; N47 D20 C		07/13-02/17	DG-613		7V				4
518 d	100/ 110	B47 D20 A	Pressure sensor (-)	07/13-07/16	DG-613		7V				3
520 d	100/ 120/ 135/ 140/ 147/ 155	B47 D20 A; N47 D20 C		06/10-02/17	DG-613		7V				4
520 d	120/ 140/ 155	B47 D20 A	Pressure sensor (-)	06/10-02/17	DG-613		7V				3
520 xd	100/ 120/ 135/ 140/ 147/ 155	B47 D20 A; N47 D20 C		01/13-02/17	DG-613		7V				4
520 xd	120/ 140/ 155	B47 D20 A	Pressure sensor (-)	10/13-02/17	DG-613		7V				3
523 i 2.5	150	N52 B25 A; N52 B25 AF; N52 B25 B; N52 B25 BF		11/09-08/11	IKH20TT	4704	1.0	-	IKH20TT		6
525 d 2.0	155	B47 D20 A	Pressure sensor (-)	09/11-07/16	DG-613		7V				3
525 d 2.0	155/ 160	B47 D20 A; N47 D20 D		09/11-02/17	DG-613		7V				4
525 d 3.0	150	N57 D30 A		03/10-08/11	DG-613		7V				6
525 xd	155	B47 D20 A	Pressure sensor (-)	07/13-07/16	DG-613		7V				3
525 xd	155/ 160	B47 D20 A; N47 D20 D		09/11-02/17	DG-613		7V				4
530 d	180/ 190/ 210	N57 D30 A	OE: 12 23 7 803 368; 12 23 0 035 934	01/10-02/17	DG-613		7V				6
530 i	190	N52 B30 A; N52 B30 AF; N52 B30 BF		03/10-06/13	IKH20TT	4704	1.0	-	IKH20TT		6
530 xd	190/ 210	N57 D30 A	OE: 12 23 7 803 368; 12 23 0 035 934	03/11-02/17	DG-613		7V				6
535 d	220/ 230	N57 D30 B	OE: 12 23 7 803 368; 12 23 0 035 934	09/10-02/17	DG-613		7V				6
535 xd	230	N57 D30 B	OE: 12 23 7 803 368; 12 23 0 035 934	09/11-02/17	DG-613		7V				6
M 550 xd	280	N57 D30 C	OE: 12 23 7 803 368; 12 23 0 035 934	03/12-02/17	DG-613		7V				6
5 (G30, G31) (16-)											
520 d	120/ 140	B47 D20 A; B47 D20 B		09/16-	DG-613		7V				4
520 xd	120/ 140	B47 D20 A		09/16-	DG-613		7V				4
530 d	195	B57 D30 A	OE: 12 23 0 035 934	09/16-	DG-613		7V				6
530 xd	195	B57 D30 A	OE: 12 23 0 035 934	09/16-	DG-613		7V				6
5 Gran Turismo (F07) (09-17)											
520 d	120/ 135	N47 D20 C		04/11-02/17	DG-613		7V				4
530 d	155/ 180/ 190	N57 D30 A	OE: 12 23 7 803 368; 12 23 0 035 934	08/09-02/17	DG-613		7V				6



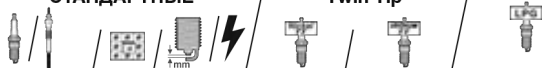

Свечи зажигания и Свечи накаливания

Таблица применения

	KW				СТАНДАРТНЫЕ			Twin Tip			QTY
											
BMW продолжение											
5 Gran Turismo (F07) (09-17) продолжение											
530 xd	180/ 190	N57 D30 A	OE: 12 23 7 803 368; 12 23 0 035 934	06/10-02/17	DG-613		7V				6
535 d	220/ 230	N57 D30 B	OE: 12 23 7 803 368; 12 23 0 035 934	03/10-02/17	DG-613		7V				6
535 xd	220/ 230	N57 D30 B	OE: 12 23 7 803 368; 12 23 0 035 934	03/10-02/17	DG-613		7V				6
6 (E24) (76-90)											
628 CSi	135	M30 B28		09/79-08/87	W16EPR-U	3021	0.8	W16TT	IW16TT	IW16TT	6
630 CS	136	M30 B30		04/76-08/79	W16EPR-U	3021	0.8	W16TT	IW16TT	IW16TT	6
633 CSi	145	M30 B32		09/78-08/84	W16EP-U	3018	0.8	W16TT	IW16TT	IW16TT	6
633 CSi	145/ 147	M30 B32		10/75-08/84	W16EPR-U	3021	0.8	W16TT	IW16TT	IW16TT	6
635 CSi 3.4	136/ 141/ 155/ 162	M30 B34 (346EC); M30 B34 (346KA); M30 B34 (346KB)		12/77-04/89	W16EPR-U	3021	0.8	W16TT	IW16TT	IW16TT	6
635 CSi 3.4	136/ 155	M30 B34 (346KA); M30 B34 (346KB)		06/86-04/89	J16CR-U	3256	0.8	W16TT	IW16TT	IW16TT	6
635 CSi 3.5	160	M30 B35 (346EC); M30 B35 (L- Jetronic,10: 1); M30 B35 (Motronic,10:1)		06/78-03/82	W16EPR-U	3021	0.8	W16TT	IW16TT	IW16TT	6
635 CSi 3.5	160	M30 B35 (346EC); M30 B35 (L- Jetronic,10: 1); M30 B35 (Motronic,10:1)		06/78-03/82	W16EP-U	3018	0.8	W16TT	IW16TT	IW16TT	6
M 635 CSi 3.5	191/ 210	S38 B35 (356ED)		04/84-02/89	X22EPR-U9	4086	0.9	-	-		6
6 (E63, E64) (04-10)											
630 i	190/ 200	N52 B30 A; N52 B30 B; N52 B30 BF		09/04-12/09	IKH20TT	4704	1.0	-	IKH20TT		6
635 d	210	M57 D30 (306D5)		07/07-07/10	DG-178		5V				6
645 Ci	245	N62 B44 A		09/03-08/05	K20TXR	5063	1.0	K20TT	IK20TT	IK20TT	8
650 i	270	N62 B48 B		09/05-08/10	IK20TT	4702	1.0	-	IK20TT	IK20TT	8
6 Coupe/Convertible (F12, F13) (10-18)											
640 d	230	N57 D30 B	OE: 12 23 7 803 368; 12 23 0 035 934	09/11-06/18	DG-613		7V				6
640 xd	230	N57 D30 B	OE: 12 23 7 803 368; 12 23 0 035 934	03/12-06/18	DG-613		7V				6
6 Gran Coupe (F06) (11-18)											
640 d	230	N57 D30 B	OE: 12 23 7 803 368; 12 23 0 035 934	03/12-10/18	DG-613		7V				6
640 xd	230	N57 D30 B	OE: 12 23 7 803 368; 12 23 0 035 934	03/13-10/18	DG-613		7V				6
7 (E23) (77-86)											
725 i	110	M30 B25		07/77-06/86	W16EPR-U	3021	0.8	W16TT	IW16TT	IW16TT	6
728	125	M30 B28		05/77-08/79	W16EPR-U	3021	0.8	W16TT	IW16TT	IW16TT	6
728 i	135	M30 B28		09/77-08/86	W16EPR-U	3021	0.8	W16TT	IW16TT	IW16TT	6
730	135	M30 B30		05/77-08/79	W16EPR-U	3021	0.8	W16TT	IW16TT	IW16TT	6
732 i	145	M30 B32		09/79-08/86	W16EPR-U	3021	0.8	W16TT	IW16TT	IW16TT	6
733 i	145	M30 B32		05/77-08/86	W16EPR-U	3021	0.8	W16TT	IW16TT	IW16TT	6
735 i	136/ 141/ 160	M30 B34 (346EC); M30 B34 (346KA); M30 B35 (346EC)		09/79-09/86	W16EPR-U	3021	0.8	W16TT	IW16TT	IW16TT	6
745 i	185	M30 B32 (326TA); M30 B34 (346TA)		04/80-08/86	W16EPR-U	3021	0.8	W16TT	IW16TT	IW16TT	6

Свечи зажигания и Свечи накаливания

Таблица применения





	KW				СТАНДАРТНЫЕ			Twin Tip			QTY
BMW продолжение											
7 (E32) (86-94)											
730 i i6	138/ 145	M30 B30 (306EA); M30 B30 (306KA)		07/86-09/94	J16CR-U	3256	0.8	W16TT	IW16TT	IW16TT	6
730 i V8	160	M60 B30 (308S1)		04/92-09/94	K20TXR	5063	1.0	K20TT	IK20TT	IK20TT	8
735 i	155/ 162	M30 B34 (346KB); M30 B35 (Motronic,9.2:1)		06/86-06/92	J16CR-U	3256	0.8	W16TT	IW16TT	IW16TT	6
740 i	210	M60 B40 (408S)		05/92-03/94	K20TXR	5063	1.0	K20TT	IK20TT	IK20TT	8
750 i	220	M70 B50 (5012A)		09/87-09/94	K16R-U	3119	0.8	K16TT	IK16TT	IK16TT	12
750 i	220	M70 B50 (5012A)		09/87-09/94	KJ16CR-L11	3132	1.1	K16TT	IK16TT	IK16TT	12
7 (E38) (94-01)											
725 tds	105	M51 D25 (256T1)		04/96-11/01	DG-001		11V				6
728 i	142	M52 B28 (286S1); M52 B28 (286S2)		08/95-11/01	K20TXR	5063	1.0	K20TT	IK20TT	IK20TT	6
728i X	142	M52 B28 (286S1)		11/95-09/01	K20TXR	5063	1.0	K20TT	IK20TT	IK20TT	6
730 d	135/ 142	M57 D30 (306D1)		08/98-11/01	DG-145		11V				6
730 i	155/ 160	M60 B30 (308S1)		03/94-11/01	K20TXR	5063	1.0	K20TT	IK20TT	IK20TT	8
735 i	173/ 175	M62 B35 (358S1); M62 B35 (358S2)		03/96-07/01	K20TXR	5063	1.0	K20TT	IK20TT	IK20TT	8
740 d	180	M67 D39 (398D1)		05/99-11/01	DG-118		11V				8
740 i 4.0	210	M60 B40 (408S1)		03/94-02/96	K20TXR	5063	1.0	K20TT	IK20TT	IK20TT	8
740 i 4.4	210	M62 B44 (448S1); M62 B44 (448S2)		02/96-07/01	K20TXR	5063	1.0	K20TT	IK20TT	IK20TT	8
750 i	240	M73 B54 (54121)		11/94-09/98	KJ14CR-L11	3167	1.1	-	-	VK16	12
750 i	240	M73 B54 (54122)		02/98-07/01	K20TXR	5063	1.0	K20TT	IK20TT	IK20TT	12
7 (E65, E66) (01-08)											
730 d	150/ 155/ 160/ 170	M57 D30 (306D2); M57 D30 (306D3)		06/02-08/08	DG-178		5V				6
730 i	170	M54 B30 (306S3)		03/03-07/08	K20TXR	5063	1.0	K20TT	IK20TT	IK20TT	6
730 i	190	N52 B30 A		03/05-07/08	IKH20TT	4704	1.0	-	IKH20TT		6
735 i	200	N62 B36 A		11/01-02/05	K20TXR	5063	1.0	K20TT	IK20TT	IK20TT	8
740 d	190	M67 D39 (398D1)		10/02-02/05	DG-191		5V				8
740 i	225	N62 B40 A		03/05-08/08	IK20TT	4702	1.0	-	IK20TT	IK20TT	8
745 d	220/ 242	M67 D44 (448D1)		03/05-07/08	DG-191		5V				8
745 i	245	N62 B44 A		07/01-03/05	K20TXR	5063	1.0	K20TT	IK20TT	IK20TT	8
750 i	270	N62 B48 B		03/05-08/08	IK20TT	4702	1.0	-	IK20TT	IK20TT	8
760 i	327	N73 B60 A; N73 B60 B		11/01-12/09	K20TXR	5063	1.0	K20TT	IK20TT	IK20TT	12
7 (F01, F02, F03, F04) (08-15)											
730 d	155/ 180/ 190	N57 D30 A	OE: 12 23 7 803 368; 12 23 0 035 934	02/08-05/15	DG-613		7V				6
730 i	190	N52 B30 A; N52 B30 BF		06/09-12/09	IKH20TT	4704	1.0	-	IKH20TT		6
730 xd	155/ 190	N57 D30 A	OE: 12 23 7 803 368; 12 23 0 035 934	11/11-05/15	DG-613		7V				6
740 d	225/ 230	N57 D30 B	OE: 12 23 7 803 368; 12 23 0 035 934	09/09-06/15	DG-613		7V				6
740 xd	225/ 230	N57 D30 B	OE: 12 23 7 803 368; 12 23 0 035 934	09/10-06/15	DG-613		7V				6
750 xd	280	N57 D30 C	OE: 12 23 7 803 368; 12 23 0 035 934	07/12-12/15	DG-613		7V				6
7 (G11, G12) (15-)											
725 d	170	B47 D20 B		07/16-02/19	DG-613		7V				4
725 d	170	B47 D20 B	Pressure sensor (-)	07/16-02/19	DG-613		7V				3
730 d	155/ 195	B57 D30 A	OE: 12 23 0 035 934	07/15-	DG-613		7V				6

Свечи зажигания и Свечи накаливания

Таблица применения

Таблица применения

В









	KW				СТАНДАРТНЫЕ			Twin Tip				QTY
BMW продолжение												
7 (G11, G12) (15-) продолжение												
730 xd	155/ 195/ 235	B57 D30 A; B57 D30 B	OE: 12 23 0 035 934	09/15-	DG-613		7V					6
750 xd	294	B57 D30 C	OE: 12 23 0 035 934	07/16-	DG-613		7V					6
8 (E31) (90-99)												
840 Ci	210	M62 B44 (448S1)		03/96-06/99	K20TXR	5063	1.0	K20TT	IK20TT	IK20TT		8
840 i	210	M60 B40 (408S1)		03/93-02/96	K20TXR	5063	1.0	K20TT	IK20TT	IK20TT		8
850 Ci	240	M73 B54 (54121)		09/94-12/99	KJ14CR-L11	3167	1.1	-	-	VK16		12
850 CSi	277/ 280	S70 B56 (56121)		11/92-12/96	KJ16CR-L11	3132	1.1	K16TT	IK16TT	IK16TT		12
850 CSi	280	S70B56	OEM Optional	11/92-12/96	K20TXR	5063	1.0	K20TT	IK20TT	IK20TT		12
850 i,Ci	220	M70 B50 (5012A)		01/90-08/94	KJ16CR-L11	3132	1.1	K16TT	IK16TT	IK16TT		12
1500-2000 (62-72)												
1500	59	M10 B15; M10 B16		10/62-07/66	W16EP-U	3018	0.8	W16TT	IW16TT	IW16TT		4
1500	59	M10 B16		09/63-07/66	W16EPR-U	3021	0.8	W16TT	IW16TT	IW16TT		4
1600	61	M10 B16		04/64-04/68	W16EPR-U	3021	0.8	W16TT	IW16TT	IW16TT		4
1600	61	M10 B16		04/64-04/68	W16EP-U	3018	0.8	W16TT	IW16TT	IW16TT		4
1800	66	M10 B18		07/69-09/71	W16EP-U	3018	0.8	W16TT	IW16TT	IW16TT		4
2000	66/74	M10 B18; M10 B20		09/68-11/72	W16EP-U	3018	0.8	W16TT	IW16TT	IW16TT		4
2000	74	M10 B20		09/68-07/72	W20EP-U	3043	0.8	W20TT	IW20TT	IW20TT		4
2000 Ti / Tilux	88	M10 B20		01/66-07/72	W16EP-U	3018	0.8	W16TT	IW16TT	IW16TT		4
2000 Ti / Tilux	88	M10 B20		01/66-07/72	W20EP-U	3043	0.8	W20TT	IW20TT	IW20TT		4
2000 Tii	96	M10 B20		12/69-07/72	W16EP-U	3018	0.8	W16TT	IW16TT	IW16TT		4
2000 Tii	96	M10 B20		12/69-07/72	W20EP-U	3043	0.8	W20TT	IW20TT	IW20TT		4
1600 GT (67-69)												
1.6	77	M10 B16		10/67-05/69	W16EPR-U	3021	0.8	W16TT	IW16TT	IW16TT		4
1.6	77	M10 B16		10/67-05/69	W16EP-U	3018	0.8	W16TT	IW16TT	IW16TT		4
2000 (E9) (65-76)												
2.5 CS	110	M30 B25		09/74-03/76	W16EPR-U	3021	0.8	W16TT	IW16TT	IW16TT		6
3.0 CS	132	M30 B30		05/71-03/76	W16EPR-U	3021	0.8	W16TT	IW16TT	IW16TT		6
3.0 CSi	147	M30 B30		07/71-03/76	W16EPR-U	3021	0.8	W16TT	IW16TT	IW16TT		6
3.0 CSL	152	M30 B32 (L-Jetronic)		01/74-11/75	W16EPR-U	3021	0.8	W16TT	IW16TT	IW16TT		6
2000 C/CA	74	M10 B20		10/65-06/70	W16EP-U	3018	0.8	W16TT	IW16TT	IW16TT		4
2000 C/CA	74	M10 B20		10/65-06/70	W20EP-U	3043	0.8	W20TT	IW20TT	IW20TT		4
2000 CS	88	M10 B20		10/65-06/70	W16EP-U	3018	0.8	W16TT	IW16TT	IW16TT		4
2000 CS	88	M10 B20		10/65-06/70	W20EP-U	3043	0.8	W20TT	IW20TT	IW20TT		4
2800 CS	125	M30 B28		01/69-04/71	W16EPR-U	3021	0.8	W16TT	IW16TT	IW16TT		6
2500 (E3) (68-77)												
2.8 L	125	M30 B28		02/75-04/77	W16EPR-U	3021	0.8	W16TT	IW16TT	IW16TT		6
3.0 L	132	M30 B30		02/75-04/77	W16EPR-U	3021	0.8	W16TT	IW16TT	IW16TT		6
3.0 S	132	M30 B30		05/71-04/77	W16EPR-U	3021	0.8	W16TT	IW16TT	IW16TT		6
3.0 Si	143/ 147	M30 B30		07/71-04/77	W16EPR-U	3021	0.8	W16TT	IW16TT	IW16TT		6
3.2 Li	147	M30 B32; M30 B32 (330EL)		10/75-04/77	W16EPR-U	3021	0.8	W16TT	IW16TT	IW16TT		6
3.3 L	140	M30 B33 (35/40 INAT)		01/74-09/76	W16EPR-U	3021	0.8	W16TT	IW16TT	IW16TT		6
2500	110	M30 B25		10/68-04/77	W16EPR-U	3021	0.8	W16TT	IW16TT	IW16TT		6
2800	125	M30 B28		10/68-07/75	W16EPR-U	3021	0.8	W16TT	IW16TT	IW16TT		6
M1 (79-83)												
3.5	204	M88		05/79-05/83	IX24	5372	0.8	-	-			6
3.5	204	S38		05/79-05/83	X22EPR-U9	4086	0.9	-	-			6
X1 (E84) (09-15)												
16 d	85	N47 D20 C		04/12-06/15	DG-613		7V					4
18 d	100/ 105	N47 D20 C	OE: 12 23 7 803 368; 12 23 0 035 934	03/09-06/15	DG-613		7V					4
18 i	100/ 110	N46 B20 B; N46 B20 BD; N46 B20 C; N46 B20 CC; N46 B20 CD; N46 B20 E		03/10-06/15	IK20TT	4702	1.0	-	IK20TT	IK20TT		4
18 xd	100/ 105	N47 D20 C	OE: 12 23 7 803 368; 12 23 0 035 934	03/09-06/15	DG-613		7V					4

Свечи зажигания и Свечи накаливания

Таблица применения











Таблица применения

В

	KW				СТАНДАРТНЫЕ				Twin Tip		QTY
											
BMW продолжение											
X1 (E84) (09-15) продолжение											
20 d	120/ 130/ 135	N47 D20 C		10/09-06/15	DG-613		7V				4
20 xd	120/ 130/ 135	N47 D20 C		09/09-06/15	DG-613		7V				4
23 xd	150	N47 D20 D		10/09-06/15	DG-613		7V				4
25 xd	160	N47 D20 D		10/09-06/15	DG-613		7V				4
28 xi 3.0	190	N52 B30 A		09/09-12/09	IKH20TT	4704	1.0	-	IKH20TT		6
X1 (F48) (15-)											
18 d	100/ 110	B47 C20 A; B47 C20 B		07/16-	DG-613		7V				4
18 d	100/ 110	B47 C20 A; B47 C20 B	Pressure sensor (-)	07/15-07/16	DG-613		7V				3
18 xd	100/ 110	B47 C20 A; B47 C20 B		07/16-	DG-613		7V				4
18 xd	100/ 110	B47 C20 A; B47 C20 B	Pressure sensor (-)	11/14-07/16	DG-613		7V				3
20 d	120/ 140	B47 C20 A; B47 C20 B		07/16-	DG-613		7V				4
20 d	120/ 140	B47 C20 A; B47 C20 B	Pressure sensor (-)	11/15-07/16	DG-613		7V				3
20 xd	120/ 140	B47 C20 A; B47 C20 B		07/16-	DG-613		7V				4
20 xd	120/ 140	B47 C20 A; B47 C20 B	Pressure sensor (-)	07/15-07/16	DG-613		7V				3
25 xd	170	B47 C20 B		07/16-	DG-613		7V				4
25 xd	170	B47 C20 B	Pressure sensor (-)	11/14-07/16	DG-613		7V				3
X3 (E83) (04-11)											
2.0 d	110	M47 D20 (204D4)		09/04-08/07	DG-178		5V				4
2.0 d	130	N47 D20 A; N47 D20 C		09/07-08/08	DG-613		7V				4
2.0 i	110	N46 B20 B		07/05-08/08	IK20TT	4702	1.0	-	IK20TT	IK20TT	4
2.5 i	141	M54 B25 (256S5)		03/04-07/06	K20TXR	5063	1.0	K20TT	IK20TT	IK20TT	6
2.5 si	160	N52 B25 A		08/06-08/08	IKH20TT	4704	1.0	-	IKH20TT		6
2.5 sxi	155	N52 B25 A; N52 B25 AF; N52 B25 BF		08/06-08/08	IKH20TT	4704	1.0	-	IKH20TT		6
3.0 d	150/ 160	M57 D30 (306D2); M57 D30 (306D3)		01/04-08/08	DG-178		5V				6
3.0 sd	210	M57 D30 (306D5)		09/06-08/08	DG-178		5V				6
3.0 si	200	N52 B30 A		08/06-08/08	IKH20TT	4704	1.0	-	IKH20TT		6
3.0 xi	170	M54 B30 (306S3)		09/03-07/06	K20TXR	5063	1.0	K20TT	IK20TT	IK20TT	6
18 xd	100/ 105	N47 D20 C		09/08-12/11	DG-613		7V				4
20 xd	120/ 130	N47 D20 C		09/08-08/10	DG-613		7V				4
20 xi	110	N46 B20 B		09/08-08/11	IK20TT	4702	1.0	-	IK20TT	IK20TT	4
25 xi	160	N52 B25 A		09/08-12/09	IKH20TT	4704	1.0	-	IKH20TT		6
30 xd	155/ 160	M57 D30 (306D3)		09/08-08/10	DG-178		5V				6
30 xi	200	N52 B30 A		09/08-12/09	IKH20TT	4704	1.0	-	IKH20TT		6
35 xd	210	M57 D30 (306D5)		09/08-08/11	DG-178		5V				6
X3 (F25) (10-17)											
18 d	100/ 105	N47 D20 C	OE: 12 23 7 803 368; 12 23 0 035 934	10/12-03/14	DG-613		7V				4
18 d	110	B47 D20 A		07/16-08/17	DG-613		7V				4
18 d	110	B47 D20 A	Pressure sensor (-)	04/14-07/16	DG-613		7V				3
20 xd	120/ 135	N47 D20 C	OE: 12 23 7 803 368; 12 23 0 035 934	09/10-03/14	DG-613		7V				4
20 xd	140	B47 D20 A		07/16-08/17	DG-613		7V				4
20 xd	140	B47 D20 A	Pressure sensor (-)	04/14-07/16	DG-613		7V				3
30 xd	155/ 183/ 190/ 204/ 210	N57 D30 A	OE: 12 23 7 803 368; 12 23 0 035 934	04/11-08/17	DG-613		7V				6

Свечи зажигания и Свечи накаливания

Таблица применения











	KW				СТАНДАРТНЫЕ			Twin Tip			QTY
											
BMW продолжение											
X3 (F25) (10-17) продолжение											
35 xd	230	N57 D30 B	OE: 12 23 7 803 368; 12 23 0 035 934	10/11-08/17	DG-613		7V				6
X4 (F26) (14-18)											
20 xd	120/ 140	B47 D20 A		07/16-03/18	DG-613		7V				4
20 xd	120/ 140	B47 D20 A	Pressure sensor (-)	04/14-07/16	DG-613		7V				3
30 xd	155/ 183/ 190/ 204/ 210	N57 D30 A	OE: 12 23 7 803 368; 12 23 0 035 934	04/14-03/18	DG-613		7V				6
35 xd	230	N57 D30 B	OE: 12 23 7 803 368; 12 23 0 035 934	04/14-03/18	DG-613		7V				6
X5 (E53) (00-06)											
3.0 d	135	M57 D30 (306D1)		04/01-09/03	DG-145		11V				6
3.0 d	155/ 160	M57 D30 (306D2)		10/03-09/06	DG-178		5V				6
3.0 i	170	M54 B30 (306S3)		04/00-10/06	K20TXR	5063	1.0	K20TT	IK20TT	IK20TT	6
4.4 i	210/ 235	M62 B44 (448S2); N62 B44 A; N62 B44		01/00-10/06	K20TXR	5063	1.0	K20TT	IK20TT	IK20TT	8
4.6 is	255	M62 B46 (468S1)		10/01-09/03	K20TXR	5063	1.0	K20TT	IK20TT	IK20TT	8
4.8 is	265	N62 B48 A		04/04-09/06	IK20TT	4702	1.0	-	IK20TT	IK20TT	8
X5 (E70) (07-13)											
3.0 d	155/ 173	M57 D30 (306D3)		02/07-09/08	DG-178		5V				6
3.0 sd	210	M57 D30 (306D5)		10/07-09/08	DG-178		5V				6
3.0 si	200	N52 B30 A; N52 B30 AF; N52 B30 B; N52 B30 BF		10/06-09/08	IKH20TT	4704	1.0	-	IKH20TT		6
30 xd	155/ 173/ 180	M57 D30 (306D3); N57 D30 A		10/08-07/13	DG-613		7V				6
30 xi	200	N52 B30 A		10/08-12/09	IKH20TT	4704	1.0	-	IKH20TT		6
35 xd	210	M57 D30 (306D5)		10/08-07/13	DG-178		5V				6
40 xd	225	N57 D30 B		09/10-06/13	DG-613		7V				6
48 xi	261	N62 B48 B		10/06-03/10	IK20TT	4702	1.0	-	IK20TT	IK20TT	8
M 50 d	280	N57 D30 C	OE: 12 23 7 803 368; 12 23 0 035 934	08/11-06/13	DG-613		7V				6
X5 (F15) (12-18)											
25 d	155/ 160/ 170	B47 D20 B; N47 D20 D		12/13-07/18	DG-613		7V				4
25 d	170	B47 D20 B	Pressure sensor (-)	08/15-07/16	DG-613		7V				3
25 xd 2.0	155/ 160/ 170	B47 D20 B; N47 D20 D		12/13-07/18	DG-613		7V				4
25 xd 2.0	170	B47 D20 B	Pressure sensor (-)	08/15-07/16	DG-613		7V				3
25 xd 3.0	160	N57 D30 A	OE: 12 23 7 803 368; 12 23 0 035 934	04/14-07/18	DG-613		7V				6
30 xd	183/ 190/ 204/ 210	N57 D30 A		08/13-07/18	DG-613		7V				6
40 xd	230	N57 D30 B	OE: 12 23 7 803 368; 12 23 0 035 934	12/13-07/18	DG-613		7V				6
M 50 d	280	N57 D30 C	OE: 12 23 7 803 368; 12 23 0 035 934	12/13-07/18	DG-613		7V				6

Свечи зажигания и Свечи накаливания

Таблица применения





Таблица применения

В

	KW				СТАНДАРТНЫЕ				Twin Tip		QTY
											
BMW продолжение											
X6 (E71, E72) (08-14)											
30 xd	155/180	N57 D30 A		04/10-07/14	DG-613		7V				6
30 xd	173	M57 D30 (306D3)		04/08-03/10	DG-178		5V				6
35 xd	210	M57 D30 (306D5)		01/08-03/10	DG-178		5V				6
40 xd	225	N57 D30 B		07/09-06/14	DG-613		7V				6
M 50 d	280	N57 D30 C	OE: 12 23 7 803 368; 12 23 0 035 934	08/11-06/14	DG-613		7V				6
X6 (F16) (14-19)											
30 xd	155/183/190/204	N57 D30 A		08/14-07/19	DG-613		7V				6
40 xd	230	N57 D30 B	OE: 12 23 7 803 368; 12 23 0 035 934	12/14-07/19	DG-613		7V				6
M 50 d	280	N57 D30 C	OE: 12 23 7 803 368; 12 23 0 035 934	08/14-07/19	DG-613		7V				6
Z1 (88-91)											
2.5	125	M20 B25 (256K1)		06/88-06/91	J16CR-U	3256	0.8	W16TT	IW16TT	IW16TT	6
Z3 (E36) (95-03)											
1.8 i	85	M43 B18 (184E2)		10/95-10/98	K20TXR	5063	1.0	K20TT	IK20TT	IK20TT	4
1.9 i	85/87/103	M43 B19 (194E1); M44 B19 (194S1)		11/95-01/03	K20TXR	5063	1.0	K20TT	IK20TT	IK20TT	4
2.0 i	110	M52 B20 (206S4)		04/99-01/03	K20TXR	5063	1.0	K20TT	IK20TT	IK20TT	6
2.2 i	120/125	M54 B22 (226S1)		08/00-01/03	K20TXR	5063	1.0	K20TT	IK20TT	IK20TT	6
2.8 i	142	M52 B28 (286S1); M52 B28 (286S2)		01/96-07/00	K20TXR	5063	1.0	K20TT	IK20TT	IK20TT	6
3.0 i	170	M54 B30 (306S3)		06/00-06/03	K20TXR	5063	1.0	K20TT	IK20TT	IK20TT	6
3.2 M	236	S50 B32 (326S1); S50 B32 (326S3)		01/97-06/01	VXU22	5608	0.9	-	IXU22TT	VXU22	6
3.2 M	236	S50/ S52		01/97-06/01	K20TXR	5063	1.0	K20TT	IK20TT	IK20TT	6
3.2 M	239	S54 B32 (326S4)		06/01-01/03	VXU24	5609	0.9	-	-	VXU24	6
3.2 M	239	S54 B32 (326S4)		06/01-06/03	IXU24	5309	0.9	-	-	VXU24	6
Z4 (E85, E86) (03-09)											
2.0 i	110	N46 B20 A; N46 B20 B		03/05-02/09	IK20TT	4702	1.0	-	IK20TT	IK20TT	4
2.2 i	125	M54 B22 (226S1)		10/03-10/05	K20TXR	5063	1.0	K20TT	IK20TT	IK20TT	6
2.5 i	130	N52 B25 A		09/05-02/09	IKH20TT	4704	1.0	-	IKH20TT		6
2.5 i	141	M54 B25 (256S5)		02/03-12/05	K20TXR	5063	1.0	K20TT	IK20TT	IK20TT	6
2.5 si	155/160	N52 B25 A; N52 B25 AF		09/05-02/09	IKH20TT	4704	1.0	-	IKH20TT		6
3.0 i	170	M54 B30 (306S3)		09/02-12/05	K20TXR	5063	1.0	K20TT	IK20TT	IK20TT	6
3.0 si	195	N52 B30 A; N52 B30 BF		01/06-08/08	IKH20TT	4704	1.0	-	IKH20TT		6
3.2 M	252	S54 B32 (326S4)		01/06-08/08	IXU24	5309	0.9	-	-	VXU24	6
3.2 M	252	S54 B32 (326S4)		01/06-08/08	VXU24	5609	0.9	-	-	VXU24	6
Z4 (E89) (09-16)											
23 i	150	N52 B25 A		03/09-12/09	IKH20TT	4704	1.0	-	IKH20TT		6
30 i	190	N52 B30 A		02/09-12/09	IKH20TT	4704	1.0	-	IKH20TT		6
Z8 (E52) (00-03)											
4.9	294	S62 B50 (508S1)		06/00-06/03	K20TXR	5063	1.0	K20TT	IK20TT	IK20TT	8
BMW (BRILLIANCE)											
3 (E90) (05-12)											
325 i	160	N52 B25 BF		06/05-12/09	IKH20TT	4704	1.0	-	IKH20TT		6
BOGDAN											
2110 (10-14)											
1.6	60/65/66	VAZ-21114; VAZ-21124		01/10-12/14	W20EPR-U	3047	0.8	W20TT	IW20TT	IW20TT	4
2111 (10-14)											
1.6	60/65/66	VAZ-21114; VAZ-21124		01/10-12/14	W20EPR-U	3047	0.8	W20TT	IW20TT	IW20TT	4
2310 (10-14)											
1.6	59/60/66	VAZ-21114; VAZ-21124		01/10-12/14	W20EPR-U	3047	0.8	W20TT	IW20TT	IW20TT	4

Свечи зажигания и Свечи накаливания

Таблица применения

	KW				СТАНДАРТНЫЕ			Twin Tip			QTY
BUICK											
LE SABRE (91-95)											
3.8	127	L27		10/91-09/95	T16EPR-U15	5023	1.5	T16TT	IT16TT	IT16TT	6
PARK AVENUE (90-96)											
3.8	127	L27		01/91-10/96	T16EPR-U15	5023	1.5	T16TT	IT16TT	IT16TT	6
RENDEZVOUZ (00-06)											
3.4 AWD	138	LA1		04/00-09/06	T16EPR-U15	5023	1.5	T16TT	IT16TT	IT16TT	6
SKYLARK (89-99)											
2.4	112	LD9(146CUL4)		01/95-12/99	T16EPR-U15	5023	1.5	T16TT	IT16TT	IT16TT	4
BYD											
F3 (05-13)											
1.6	74	DA4G18		09/05-12/13	K20PR-U11	3121	1.1	K20TT	IK20TT	IK20TT	4
F3R (07-)											
1.6	74	DA4G18		09/07-	K20PR-U11	3121	1.1	K20TT	IK20TT	IK20TT	4
CADILLAC											
ALLANTE (85-93)											
4.5	150	LQ6		10/88-09/92	T16EPR-U15	5023	1.5	T16TT	IT16TT	IT16TT	8
4.6	220	L37		10/92-09/93	PT16EPR-L13	5070	1.3	-	IT16TT	IT16TT	8
BLS (06-)											
1.9 D	110	Z19DTH	Double Coil(LPH)	04/06-	DG-170		11V				4
1.9 D	132	Z 19 DTR		12/07-	DG-608		4.4V				4
2.0 T	129/ 154	B207L; B207R; LK9(122CUL4); Z 20 NER; Z 20 NET		04/06-09/10	PK20PR-L11	3142	1.1	-	IK20TT	IK20TT	4
2.0 T AWD	154	B207R; LK9(122CUL4)		04/06-09/10	PK20PR-L11	3142	1.1	-	IK20TT	IK20TT	4
2.0 T Flexpower	147	Z 20 LER		12/07-	KJ16CR-L11	3132	1.1	K16TT	IK16TT	IK16TT	4
2.8 T	188	B284L; Z 28 NET		04/06-08/08	IKH20TT	4704	1.0	-	IKH20TT		6
CTS (02-07)											
2.6	133	Y26S		04/03-01/04	K20PBR-S10	5061	1.0	K20TT	IK20TT	IK20TT	6
2.8	158	LP1		03/05-09/07	IKH20TT	4704	1.0	-	IKH20TT		6
3.2	160	LA3		03/02-09/07	K20PBR-S10	5061	1.0	K20TT	IK20TT	IK20TT	6
3.6	189	LY7		03/05-09/07	PT16VR13	5068	1.3	TV16TT	ITV16TT	ITV16TT	6
5.7 V8	294	LS6(346CUV8)		03/05-09/07	IT16TT	4713	1.0	-	IT16TT		8
CTS (08-)											
3.6	229	LLT		01/08-09/10	PT16VR13	5068	1.3	TV16TT	ITV16TT	ITV16TT	6
3.6 AWD	229	LLT		01/08-09/10	PT16VR13	5068	1.3	TV16TT	ITV16TT	ITV16TT	6
DEVILLE (89-93)											
4.9 Touring	149	L26(299CUV8)		10/90-09/93	T16EPR-U15	5023	1.5	T16TT	IT16TT	IT16TT	8
DEVILLE (93-99)											
4.6	224	L37		10/93-09/99	PT16EPR-L13	5070	1.3	-	IT16TT	IT16TT	8
4.6 Concours	205	LD8		10/93-09/99	PT16EPR-L13	5070	1.3	-	IT16TT	IT16TT	8
4.9	149	L26(299CUV8)		10/93-09/95	T16EPR-U15	5023	1.5	T16TT	IT16TT	IT16TT	8
DEVILLE (99-04)											
4.6	205/ 224	L37; LD8		10/99-12/05	PT16EPR-L13	5070	1.3	-	IT16TT	IT16TT	8
ELDORADO (85-91)											
4.5	115	LR6		10/87-09/89	T16EPR-U15	5023	1.5	T16TT	IT16TT	IT16TT	8
4.9	149	L26(299CUV8)		10/90-09/91	T16EPR-U15	5023	1.5	T16TT	IT16TT	IT16TT	8
ELDORADO (91-02)											
4.6	220/ 224	L37; LD8		09/91-09/02	PT16EPR-L13	5070	1.3	-	IT16TT	IT16TT	8
ESCALADE (98-06)											
5.7 AWD	190	LO5		10/98-10/06	PT16EPR-L13	5070	1.3	-	IT16TT	IT16TT	8
FLEETWOOD (84-93)											
5.7 Brougham	130	LO5		10/89-09/93	T20PR-U	5035	0.9	-	ITF20TT	ITF20TT	8
FLEETWOOD (93-97)											
5.7	138/ 194	LO5; LT1(350CUV8)		09/92-09/97	PT16EPR-L13	5070	1.3	-	IT16TT	IT16TT	8
SEVILLE II (K) (79-93)											
4.5	115	LR6		10/87-09/89	T16EPR-U15	5023	1.5	T16TT	IT16TT	IT16TT	8
4.5 V8	134	LW2(273CUV8)		09/87-09/90	T16EPR-U15	5023	1.5	T16TT	IT16TT	IT16TT	8
4.9	150	L26(299CUV8)		10/90-12/91	T16EPR-U15	5023	1.5	T16TT	IT16TT	IT16TT	8
SEVILLE III (6K) (92-97)											
4.6	205/ 220/ 224	L37; LD8		06/92-09/97	PT16EPR-L13	5070	1.3	-	IT16TT	IT16TT	8

Свечи зажигания и Свечи накаливания





Таблица применения

Таблица применения

KW	KW	KW	NOTE	21	СТАНДАРТНЫЕ				Twin Tip			QTY
					STANDARD	STANDARD	STANDARD	STANDARD	TWIN TIP	TWIN TIP	TWIN TIP	
CADILLAC продолжение												
SEVILLE IV (97-04)												
4.6	220	L37		10/00-09/04	PT16EPR-L13	5070	1.3	-	IT16TT	IT16TT	8	
4.6 SLS V8	205	LH2		09/97-09/04	PT16EPR-L13	5070	1.3	-	IT16TT	IT16TT	8	
4.6 STS V8	224	LH2		09/97-09/04	PT16EPR-L13	5070	1.3	-	IT16TT	IT16TT	8	
SRX (04-08)												
3.6	190	LY7		01/04-12/04	KH20TT	4618	1.0	KH20TT	IKH20TT	IKH20TT	6	
3.6	190	LY7		01/05-12/08	PT16VR13	5068	1.3	TV16TT	ITV16TT	ITV16TT	6	
3.6 AWD	190	LY7		07/04-12/04	KH20TT	4618	1.0	KH20TT	IKH20TT	IKH20TT	6	
3.6 AWD	190	LY7		01/05-12/08	PT16VR13	5068	1.3	TV16TT	ITV16TT	ITV16TT	6	
4.6 AWD	239	LH2		09/03-12/09	PT16EPR-L13	5070	1.3	-	IT16TT	IT16TT	8	
STS (04-12)												
3.6	189	LY7		05/05-12/05	KH20TT	4618	1.0	KH20TT	IKH20TT	IKH20TT	6	
3.6	189/ 229	LLT; LY7		01/06-12/12	PT16VR13	5068	1.3	TV16TT	ITV16TT	ITV16TT	6	
4.6	239	LH2		05/05-10/07	PT16EPR-L13	5070	1.3	-	IT16TT	IT16TT	8	
4.6 AWD	239	LH2		09/04-12/05	PT16EPR-L13	5070	1.3	-	IT16TT	IT16TT	8	
XLR (04-09)												
4.4	331	LC3(267CUV8)		06/07-09/09	PT16EPR-L13	5070	1.3	-	IT16TT	IT16TT	8	
4.6	240	LH2		03/04-09/09	PT16EPR-L13	5070	1.3	-	IT16TT	IT16TT	8	
CARBODIES												
FX FAIRWAY (87-96)												
2.7 TD	63	TD27		01/87-12/96	DG-001		11V				4	
FX4 (59-89)												
2.3 D	44	22E		09/72-08/85	DG-001		11V				4	
2.5 D	50	25V		09/85-12/89	DG-001		11V				4	
FX4R (82-85)												
2.25 D	44	22E	Double Coil(LPH)	01/82-12/85	DG-101		11V				4	
FX4S (86-89)												
2.5 D	49	25V		01/86-12/89	DG-001		11V				4	
CATERHAM												
21 (94-02)												
1.6 i	86	16 K4F		01/94-12/02	K20PR-U	3145	0.8	K20TT	IK20TT	IK20TT	4	
1.6 i Supersport	103	16 K4F		01/96-12/98	Q22PR-U	3010	0.8	-	-	VQ22	4	
SUPER SEVEN (80-)												
0.7	60	K6A		12/13-	IXUH22	5353	0.9	-	IXUH22TT	VXUH22	3	
1.4 i	97	14 K4F		01/92-09/95	IK22	5310	0.8	-	IK22TT	VK22	4	
1.6	86	16 K4F		01/95-12/06	K20PR-U	3145	0.8	K20TT	IK20TT	IK20TT	4	
1700 Super Sprint	99	TL17HT		01/90-12/95	W24ESR-U	4033	0.8	-	-		4	
CHANGAN (CHANA)												
GAZELLE (99-04)												
1.3 GL	50	G13BA		04/99-08/04	K20PR-U	3145	0.8	K20TT	IK20TT	IK20TT	4	
CHANGHE												
BEIDOUXING (04-)												
1.0 GX	48	K10A		08/04-	XU22EPR-U	3179	0.9	XU22TT	IXU22TT	VXU22	4	
1.4	67	K14B		08/05-	ZXU20PR11	3452	1.1	-	-	VXU20	3	
WAGON R (99-04)												
1.0 FX	48	K10A		08/99-07/04	XU22EPR-U	3179	0.9	XU22TT	IXU22TT	VXU22	4	
CHERY												
A1 (06-14)												
1.3	61	SQR473F		08/06-12/14	Q20R-U	3140	0.8	Q20TT	IQ20TT	IQ20TT	4	
A3 (08-14)												
1.6	88/93	SQR481F; SQR481FD; SQRD4S13; SQRE4G16		09/08-12/14	K20PR-U	3145	0.8	K20TT	IK20TT	IK20TT	4	
1.8	97	SQR481FC		11/08-12/14	K20PR-U	3145	0.8	K20TT	IK20TT	IK20TT	4	
2.0	102	SQR484F		04/09-08/10	K20PR-U	3145	0.8	K20TT	IK20TT	IK20TT	4	
A5 (06-)												
1.6	88	SQR481F		01/06-	K20PR-U	3145	0.8	K20TT	IK20TT	IK20TT	4	
1.6 LPG	88	SQR481F		01/06-01/09	K20PR-U	3145	0.8	K20TT	IK20TT	IK20TT	4	
1.8	97	SQR481F		02/07-	K20PR-U	3145	0.8	K20TT	IK20TT	IK20TT	4	
2.0	95/ 102	SQR484F		01/06-	K20PR-U	3145	0.8	K20TT	IK20TT	IK20TT	4	
A11 (00-)												
1.6	62	SQR480		03/00-	K20PR-U	3145	0.8	K20TT	IK20TT	IK20TT	4	
ARRIZO 7 (13-)												
1.6	93	SQRE4G16		07/13-	K20PR-U	3145	0.8	K20TT	IK20TT	IK20TT	4	

Свечи зажигания и Свечи накаливания

Таблица применения

	KW				СТАНДАРТНЫЕ			Twin Tip			QTY
CHERY продолжение											
BEAT (10-)											
1.3	61	SQR738		01/10-	K20PR-U	3145	0.8	K20TT	IK20TT	IK20TT	4
EASTAR CROSS (07-)											
2.0	100	SQR484F		06/07-	K20PR-U	3145	0.8	K20TT	IK20TT	IK20TT	4
FULWIN (06-)											
1.5	80	SQR477F		04/06-	K20R-U	3122	0.8	K20TT	IK20TT	IK20TT	4
INDIS (10-)											
1.3	61	SQR738		01/10-	K20PR-U	3145	0.8	K20TT	IK20TT	IK20TT	4
QIYUN (03-10)											
1.3	60			09/06-12/10	K20PR-U	3145	0.8	K20TT	IK20TT	IK20TT	4
QIYUN (10-15)											
1.5	80	SQR477F		05/10-12/14	K20R-U	3122	0.8	K20TT	IK20TT	IK20TT	4
1.8	97	SQR481FC		05/10-12/15	K20PR-U	3145	0.8	K20TT	IK20TT	IK20TT	4
2.0	102	SQR484F		05/10-12/12	K20PR-U	3145	0.8	K20TT	IK20TT	IK20TT	4
QQ3 (03-14)											
0.8	38	SQR372		03/04-12/12	K16PR-U	3191	0.8	K16TT	IK16TT	IK16TT	3
QQ6 (06-13)											
1.3	61			09/06-12/13	Q20R-U	3140	0.8	Q20TT	IQ20TT	IQ20TT	4
TAXIM MPV (07-)											
1.5	78	SQR477F		01/09-	K20R-U	3122	0.8	K20TT	IK20TT	IK20TT	4
1.5 LPG	78	SQR477F		01/09-	K20R-U	3122	0.8	K20TT	IK20TT	IK20TT	4
TIGGO 5 (13-)											
2.0	102	SQR484F		11/13-	K20PR-U	3145	0.8	K20TT	IK20TT	IK20TT	4
TIGGO (05-09)											
1.6	80	SQR481F		07/06-12/10	K20PR-U	3145	0.8	K20TT	IK20TT	IK20TT	4
2.0	95/ 102	SQR484F		09/06-12/09	K20PR-U	3145	0.8	K20TT	IK20TT	IK20TT	4
2.4	95	4G64-S4M		03/05-12/08	K16PR-U11	3130	1.1	K16TT	IK16TT	IK16TT	4
2.4 AWD	95	4G64-S4M		11/05-12/08	K16PR-U11	3130	1.1	K16TT	IK16TT	IK16TT	4
TIGGO (10-)											
1.6	88/93	SQR481F; SQRE4G16		09/10-12/14	K20PR-U	3145	0.8	K20TT	IK20TT	IK20TT	4
1.8	97	SQR481FC		04/10-12/14	K20PR-U	3145	0.8	K20TT	IK20TT	IK20TT	4
2.0	101	SQR484F		01/10-	K20PR-U	3145	0.8	K20TT	IK20TT	IK20TT	4
2.0 AWD	102	SQR484F		09/10-12/14	K20PR-U	3145	0.8	K20TT	IK20TT	IK20TT	4
S 1.6	110	SQR481FG		09/10-12/13	K20PR-U	3145	0.8	K20TT	IK20TT	IK20TT	4
TIGGO FL (13-)											
1.6	93	SQRE4G16		10/13-	K20PR-U	3145	0.8	K20TT	IK20TT	IK20TT	4
1.8	97	SQR481FC		10/13-	K20PR-U	3145	0.8	K20TT	IK20TT	IK20TT	4
2.0 AWD	100	SQR484F		10/13-	K20PR-U	3145	0.8	K20TT	IK20TT	IK20TT	4
X1 (10-)											
1.3	62	SQR473; SQR473F		01/10-	K20PR-U	3145	0.8	K20TT	IK20TT	IK20TT	4
XCROSS (10-)											
1.3	61	SQR738		01/10-	K20PR-U	3145	0.8	K20TT	IK20TT	IK20TT	4
1.5	79	SQR477F		06/13-	K20R-U	3122	0.8	K20TT	IK20TT	IK20TT	4
CHEVROLET											
ALERO (99-04)											
2.4 16V	104	LD9(146CUL4)		03/99-09/04	T16EPR-U15	5023	1.5	T16TT	IT16TT	IT16TT	4
3.4 V6	130	LA1		03/99-09/04	T16EPR-U15	5023	1.5	T16TT	IT16TT	IT16TT	6
ASTRO (84-94)											
4.3	112/ 119	LB4		10/84-09/94	T16PR-U11	5026	1.1	-	ITF16TT	ITF16TT	6
4.3 AWD	107/ 112/ 119	LB4		10/89-09/94	T16PR-U11	5026	1.1	-	ITF16TT	ITF16TT	6
4.3 Luxury	119	LB4		10/86-09/94	T16PR-U11	5026	1.1	-	ITF16TT	ITF16TT	6
4.3 Luxury AWD	119	LB4		10/89-09/94	T16PR-U11	5026	1.1	-	ITF16TT	ITF16TT	6
AVALANCHE (00-06)											
5.3 AWD	220	LM7		10/00-09/06	T20EPR-U15	5033	1.5				8
AVEO (T300) (11-)											
1.2	51/63	LDC; LWD		03/11-	KJ20CR-L11	3169	1.1	K20TT	IK20TT	IK20TT	4
1.2 LPG	63	LDC		11/12-12/15	VK20Y	5620	0.8	-	-	VK20Y	4
1.3 D	55/70	LDV; LSF		07/11-	DG-621		4.4V				4
1.4	74	LDD		03/11-	KJ20CR-L11	3169	1.1	K20TT	IK20TT	IK20TT	4
1.4 Turbo	103	LUJ		08/13-	VK22	5610	0.8	-	IK22TT	VK22	4
1.6	85	LDE		03/11-	KJ20CR-U11	3451	1.1	K20TT	IK20TT	IK20TT	4
AVEO / KALOS (T200) (03-08)											
1.4	61	LX5(85CUL4)		03/05-05/08	W20EPR-U	3047	0.8	W20TT	IW20TT	IW20TT	4

Свечи зажигания и Свечи накаливания









Таблица применения

Таблица применения

KW	KW	KW	KW	KW	СТАНДАРТНЫЕ			Twin Tip		QTY	
					STANDARD	STANDARD	STANDARD	TWIN TIP	TWIN TIP		
CHEVROLET продолжение											
AVEO / KALOS (T200) (03-08) продолжение											
1.4 16V	69	L14(85CUL4)		05/03-05/08	K20PR-U11	3121	1.1	K20TT	IK20TT	IK20TT	4
AVEO / KALOS (T250, T255) (05-)											
1.2	53	LY4		03/05-	W16EPR-U11	3201	1.1	W16TT	IW16TT	IW16TT	4
1.2	55	B12S1; LY4		01/07-	W20EPR-U11	3049	1.1	W20TT	IW20TT	IW20TT	4
1.2	55/62	LMU		01/08-	XU22EPR-U	3179	0.9	XU22TT	IXU22TT	VXU22	4
1.2 LPG	62	LMU		04/08-	XU22EPR-U	3179	0.9	XU22TT	IXU22TT	VXU22	4
1.4	61	LX5(85CUL4)		03/05-	W20EPR-U	3047	0.8	W20TT	IW20TT	IW20TT	4
1.4	69	L14(85CUL4)		03/05-12/07	K20PR-U11	3121	1.1	K20TT	IK20TT	IK20TT	4
1.4	74	LDT		04/08-	KJ20CR-L11	3169	1.1	K20TT	IK20TT	IK20TT	4
1.4	74	LDT		09/08-06/11	KJ20CR-U11	3451	1.1	K20TT	IK20TT	IK20TT	4
1.5	62	F15S3; LX6		05/05-	W20EPR-U	3047	0.8	W20TT	IW20TT	IW20TT	4
BLAZER (S10) (82-94)											
2.8	83	LR2		09/82-09/85	T16PR-U11	5026	1.1	-	ITF16TT	ITF16TT	6
2.8 AWD	93	LR2		09/82-12/89	T16PR-U11	5026	1.1	-	ITF16TT	ITF16TT	6
4.3	115/ 119	LB4		04/88-09/94	T16PR-U11	5026	1.1	-	ITF16TT	ITF16TT	6
4.3 AWD	119	LB4		10/86-09/94	T16PR-U11	5026	1.1	-	ITF16TT	ITF16TT	6
BLAZER (S10) (94-05)											
4.3	142	L35(262CUL6)		10/94-05/05	T16EPR-U15	5023	1.5	T16TT	IT16TT	IT16TT	6
4.3 AWD	119	LB4		10/94-09/95	T16PR-U11	5026	1.1	-	ITF16TT	ITF16TT	6
4.3 AWD	142	L35(262CUL6)		10/97-09/04	T16EPR-U15	5023	1.5	T16TT	IT16TT	IT16TT	6
4.3 V6 AWD	142	L35(262CUL6)		01/94-09/05	T16EPR-U15	5023	1.5	T16TT	IT16TT	IT16TT	6
C1500 (91-00)											
4.3	119	LB4		10/91-09/96	T16PR-U11	5026	1.1	-	ITF16TT	ITF16TT	6
6.5 TDiC	135	L56		10/96-12/00	DG-001		11V				8
C2500 (91-96)											
4.3	119	LB4		10/91-09/96	T16PR-U11	5026	1.1	-	ITF16TT	ITF16TT	6
C2500 (96-01)											
5.7 RC	190	L31		10/96-04/00	T20PR-U	5035	0.9	-	ITF20TT	ITF20TT	8
6.5 TDiC	135	L56	Double Coil(LPH)	10/96-12/01	DG-175		10.5V				8
C3500 (93-96)											
6.5 TDiC	135	L56		10/93-09/96	DG-001		11V				8
CAMARO (70-81)											
5.0	110	LG4		01/70-12/81	T16PR-U11	5026	1.1	-	ITF16TT	ITF16TT	8
CAMARO (81-92)											
5.0	112	LG4		12/81-12/92	T16PR-U11	5026	1.1	-	ITF16TT	ITF16TT	8
CAMARO (92-02)											
3.4	119	L32		10/92-09/95	T20PR-U	5035	0.9	-	ITF20TT	ITF20TT	6
3.4 V6	119	L32		12/92-07/98	T20PR-U	5035	0.9	-	ITF20TT	ITF20TT	6
CAPRICE (90-96)											
5.7	138	LO5		10/90-09/93	K16PR-U11	3130	1.1	K16TT	IK16TT	IK16TT	8
5.7	194/ 207	LT1(350CUL8)		10/93-09/96	PT16EPR-L13	5070	1.3	-	IT16TT	IT16TT	8
5.7 LS	183	LT1(350CUL8)		10/93-09/96	PT16EPR-L13	5070	1.3	-	IT16TT	IT16TT	8
CAPTIVA (06-)											
2.0 D	93/ 110	LLW		10/06-	DG-604		4.4V				4
2.0 D AWD	93/ 110	LLW		10/06-	DG-604		4.4V				4
2.2 D	120	LNQ		03/11-	DG-653		4.4V				4
2.2 D AWD	120/ 135	LNQ		03/11-	DG-653		4.4V				4
2.4	100	LD9(147CUL4)		06/06-02/11	K20TXR	5063	1.0	K20TT	IK20TT	IK20TT	4
2.4	123	LE5/2.44		03/11-	ITL16TT	4717	1.0	-	ITL16TT	ITL16TT	4
2.4 AWD	100	LD9(147CUL4)		06/06-02/11	K20TXR	5063	1.0	K20TT	IK20TT	IK20TT	4
2.4 AWD	123	LE5/2.44		03/11-	ITL16TT	4717	1.0	-	ITL16TT	ITL16TT	4
2.4 LPG	100	LD9//2.4F(GPL)	LPG / GPL	01/07-09/09	VK20Y	5620	0.8	-	-	VK20Y	4
2.4 LPG AWD	100	LD9//2.4F(GPL)	LPG / GPL	01/07-09/09	VK20Y	5620	0.8	-	-	VK20Y	4
3.0 AWD	190	LF1/3.0C		02/11-09/18	ITV20TT	4719	1.0	-	ITV20TT	ITV20TT	6
3.2 AWD	169	LU1/3.2G(Z32SE)		06/06-09/09	PK16PR-L11	3275	1.1	-	IK16TT	IK16TT	6













Свечи зажигания и Свечи накаливания

Таблица применения

	KW				СТАНДАРТНЫЕ			Twin Tip			QTY
											
CHEVROLET продолжение											
CAPTIVA (06-) продолжение											
3.2 AWD	169	LU1/3.2G(Z32SE)		09/09-02/11	PT16VR13	5068	1.3	TV16TT	ITV16TT	ITV16TT	6
CAVALIER (89-03)											
2.4	112	LD9(146CUL4)		09/93-09/94	T16EPR-U15	5023	1.5	T16TT	IT16TT	IT16TT	4
2.4 LT	112	LD9(146CUL4)		10/95-09/03	T16EPR-U15	5023	1.5	T16TT	IT16TT	IT16TT	4
C-K SERIE (94-00)											
5.7	190	L31		10/96-04/00	T20PR-U	5035	0.9	-	ITF20TT	ITF20TT	8
5.7 AWD	190	L31		10/96-04/00	T20PR-U	5035	0.9	-	ITF20TT	ITF20TT	8
CRUZE (09-)											
1.4	74	LDD		07/13-	KJ20CR-L11	3169	1.1	K20TT	IK20TT	IK20TT	4
1.4	103	LUJ		09/10-	VK22	5610	0.8	-	IK22TT	VK22	4
1.6	80	LXT		05/09-	K20PR-U11	3121	1.1	K20TT	IK20TT	IK20TT	4
1.6	83/ 86/91	LDE		05/09-	KJ20CR-U11	3451	1.1	K20TT	IK20TT	IK20TT	4
1.7 D	96	LUD		01/12-	DG-625		4.4V				4
1.7 TD	96	LUD		08/12-	DG-625		4.4V				4
1.8	104	2H0		05/09-	KJ20CR-U11	3451	1.1	K20TT	IK20TT	IK20TT	4
1.8	104	LUW; LWE		11/09-	KJ16CR-L11	3132	1.1	K16TT	IK16TT	IK16TT	4
1.8 LPG	104	2H0		06/11-	IK20TT	4702	1.0	-	IK20TT	IK20TT	4
2.0 CDI	92/ 110	LLW		05/09-	DG-604		4.4V				4
2.0 CDI	120	LNP	OE:48 02 239; 25181860; (RP8480); GE127;GLP253 / 0 250 403 019	08/10-	DG-653		4.4V				4
EPICA (05-)											
2.0	105	XKL6		06/06-09/09	K20PBR-S10	5061	1.0	K20TT	IK20TT	IK20TT	6
2.0 D	110	LLW		01/07-	DG-604		4.4V				4
2.5	115	LF4(152CUL6)		06/06-09/09	PK20PR-L11	3142	1.1	-	IK20TT	IK20TT	6
EVANDA (05-)											
2.0	96	C20SED		03/05-06/07	K20TXR	5063	1.0	K20TT	IK20TT	IK20TT	4
2.0	96	C20SED(GPL)	Flexible fuel	03/05-06/07	VK20Y	5620	0.8	-	-	VK20Y	4
HHR (06-11)											
2.2	107	L61		01/06-12/11	ITL16TT	4717	1.0	-	ITL16TT		4
2.4	125/ 128	LE5		01/06-12/11	ITL16TT	4717	1.0	-	ITL16TT		4
IMPALA (99-05)											
3.4 V6	134	LA1		01/99-12/05	T16EPR-U15	5023	1.5	T16TT	IT16TT	IT16TT	6
LACETTI (05-)											
1.4 16V	70	L14(85CUL4)		03/05-	K20PR-U11	3121	1.1	K20TT	IK20TT	IK20TT	4
1.6	80	L44(96CUL4); LXT		03/05-	K20PR-U11	3121	1.1	K20TT	IK20TT	IK20TT	4
1.6 LPG	80	LXT		06/09-12/11	K20TT	4604	1.0	K20TT	IK20TT	IK20TT	4
1.8	90	H18D		08/05-01/07	K20PBR-S10	5061	1.0	K20TT	IK20TT	IK20TT	4
1.8	90	LDA		08/03-	K20TXR	5063	1.0	K20TT	IK20TT	IK20TT	4
2.0 D	89	LMN		01/07-	DG-604		4.4V				4
LANOS (05-)											
1.4	55	L13(82CUL4)		11/05-	W20EPR-U	3047	0.8	W20TT	IW20TT	IW20TT	4
1.5	64	A15SMS(86-LX6)		11/05-	W20EPR-U	3047	0.8	W20TT	IW20TT	IW20TT	4
1.6 16V	78	L44(96CUL4)		11/05-	K20PR-U11	3121	1.1	K20TT	IK20TT	IK20TT	4
LUMINA (89-94)											
3.4	157	LQ1		01/91-09/94	T20EPR-U15	5033	1.5				6
3.4 Z34	149	LQ1		10/89-09/94	T20EPR-U15	5033	1.5				6
LUMINA APV (89-96)											
3.4	134	LA1		10/95-07/96	T16EPR-U15	5023	1.5	T16TT	IT16TT	IT16TT	6
MALIBU (77-83)											
5.0	110	LG4		01/80-12/83	T16PR-U11	5026	1.1	-	ITF16TT	ITF16TT	8
MALIBU (96-03)											
2.4	112	LD9(146CUL4)		08/96-09/02	T16EPR-U15	5023	1.5	T16TT	IT16TT	IT16TT	4
MATIZ (05-)											
0.8	38	LBF(49CUL3); LQ2(49CUL3)		03/05-12/13	Q16R-U11	3006	1.1	Q16TT	IQ16TT	IQ16TT	3
0.8 LPG	38	LBF(49CUL3); LQ2(49CUL3)	LPG / GPL	03/05-	IQ16TT	4706	1.0	-	IQ16TT		3
1.0	47/49	LQ4(61CUL4)		03/05-	Q16R-U11	3006	1.1	Q16TT	IQ16TT	IQ16TT	4
1.0 LPG	49	L11(61CUL4); LA2; LQ4(61CUL4)	LPG / GPL	03/05-03/11	IQ16TT	4706	1.0	-	IQ16TT		4





Свечи зажигания и Свечи накаливания

Таблица применения

	KW				СТАНДАРТНЫЕ				Twin Tip			QTY
												
CHEVROLET продолжение												
MW (00-10)												
1.3	65	M13A		09/00-12/10	SK16PR-A11	3356	1.1	-	IK16TT	IK16TT	4	
NIVA (2123) (02-)												
1.7 4x4	59			09/02-	W20EPR-U	3047	0.8	W20TT	IW20TT	IW20TT	4	
NUBIRA (05-11)												
1.4	69	F14D3		01/05-12/07	K20PR-U11	3121	1.1	K20TT	IK20TT	IK20TT	4	
1.6	80	F16D3		03/05-12/11	K20PR-U11	3121	1.1	K20TT	IK20TT	IK20TT	4	
1.8	90	F18D3; T18SED		03/05-12/11	K20TXR	5063	1.0	K20TT	IK20TT	IK20TT	4	
2.0 D	89	LMN		01/05-12/11	DG-604		4.4V				4	
OPTRA (03-08)												
1.6	78/80	L44(96CUL4); LXT		08/03-12/08	K20PR-U11	3121	1.1	K20TT	IK20TT	IK20TT	4	
1.8	90	LDA		08/03-12/08	K20TXR	5063	1.0	K20TT	IK20TT	IK20TT	4	
ORLANDO (11-)												
1.4	103	LUJ		06/12-	VK22	5610	0.8	-	IK22TT	VK22	4	
1.8	104	2H0		02/11-	KJ20CR-U11	3451	1.1	K20TT	IK20TT	IK20TT	4	
1.8 LPG	104	2H0		06/11-	IK20TT	4702	1.0	-	IK20TT	IK20TT	4	
2.0 D	96/ 120	LNP	OE:48 02 239; 25181860; (RP8480); GE127;GLP253 / 0 250 403 019	02/11-	DG-653		4.4V				4	
REZZO (05-)												
1.6	77/79	L44(96CUL4)		03/05-06/08	K20PR-U11	3121	1.1	K20TT	IK20TT	IK20TT	4	
2.0	89	X20SED(121)		03/05-06/08	K20TXR	5063	1.0	K20TT	IK20TT	IK20TT	4	
2.0	89	X20SED-G(121)	Flexible fuel	03/05-06/08	VK20Y	5620	0.8	-	-	VK20Y	4	
S10 Pick Up (82-94)												
4.3 AWD	119	LB4		10/87-09/91	T16PR-U11	5026	1.1	-	ITF16TT	ITF16TT	6	
S10 Pick Up (93-05)												
4.3	142	L35(262CUL6)		10/94-12/04	T16EPR-U15	5023	1.5	T16TT	IT16TT	IT16TT	6	
4.3 4x4	119	LB4		10/94-09/95	T16PR-U11	5026	1.1	-	ITF16TT	ITF16TT	6	
4.3 4x4	142	L35(262CUL6)		10/94-08/02	T16EPR-U15	5023	1.5	T16TT	IT16TT	IT16TT	6	
SILVERADO (99-07)												
5.3 AWD	201/ 212	LM7		10/99-12/07	T20EPR-U15	5033	1.5				8	
6.0	224	LQ4(364CUL8)		10/99-	PTJ16R15	5077	1.5	-	IT16TT	IT16TT	8	
6.0 AWD	224	LQ4(364CUL8)		10/99-	PTJ16R15	5077	1.5	-	IT16TT	IT16TT	8	
SPARK (00-04)												
0.8	38	F8CV		09/00-12/04	W16EPR-U11	3201	1.1	W16TT	IW16TT	IW16TT	3	
SPARK (05-)												
0.8	37	LBF(49CUL3); LQ2(49CUL3)		05/05-02/10	W16EPR-U11	3201	1.1	W16TT	IW16TT	IW16TT	3	
1.0 SX	46/49	B10S; LA2; LQ4(61CUL4)		05/05-	W16EPR-U11	3201	1.1	W16TT	IW16TT	IW16TT	4	
SPARK (10-)												
1.0	50	LMT		03/10-	XU22EPR-U	3179	0.9	XU22TT	IXU22TT	VXU22	4	
1.0 LPG	48/50	LMT		03/10-	VXU22	5608	0.9	-	IXU22TT	VXU22	4	
1.2	60	LMU		03/10-	XU22EPR-U	3179	0.9	XU22TT	IXU22TT	VXU22	4	
1.2 LPG	60	LMU		03/10-	XU22EPR-U	3179	0.9	XU22TT	IXU22TT	VXU22	4	
SUBURBAN (91-00)												
5.7	157/ 190	L31; LO5		10/91-04/00	T20PR-U	5035	0.9	-	ITF20TT	ITF20TT	8	
5.7 AWD	157/ 190	L31; LO5		10/91-04/00	T20PR-U	5035	0.9	-	ITF20TT	ITF20TT	8	
TAHOE (94-96)												
5.7	184			10/95-09/96	T20PR-U	5035	0.9	-	ITF20TT	ITF20TT	8	
5.7 AWD	147/ 184	LO5		10/94-09/96	T20PR-U	5035	0.9	-	ITF20TT	ITF20TT	8	
5.7 V8	190	L31		10/94-09/96	T20PR-U	5035	0.9	-	ITF20TT	ITF20TT	8	
5.7 V8 AWD	190	L31		10/94-09/96	T20PR-U	5035	0.9	-	ITF20TT	ITF20TT	8	
6.5 TDiC	135	L56	Double Coil(LPH)	10/94-09/96	DG-175		10.5V				8	
6.5 TDiC AWD	135	L56	Double Coil(LPH)	10/94-09/96	DG-175		10.5V				8	
TAHOE (99-06)												
4.8 V8	205	LR4		12/99-12/06	T20EPR-U15	5033	1.5				8	
5.3	201/ 213/ 220	L59; LM7		05/00-12/06	T20EPR-U15	5033	1.5				8	
5.3 AWD	213	L59		10/02-12/06	T20EPR-U15	5033	1.5				8	
5.3 V8 AWD	201	LM7		12/99-12/06	T20EPR-U15	5033	1.5				8	

Свечи зажигания и Свечи накаливания











Таблица применения

	KW				СТАНДАРТНЫЕ				Twin Tip			QTY
CHEVROLET продолжение												
ТАНОЕ (99-06) продолжение												
6.0 V8	224	LQ4(364CUV8)		12/99-12/06	PTJ16R15	5077	1.5	-	IT16TT	IT16TT	8	
TRACKER (98-08)												
2.0	95	L34(122CUL4)		09/98-10/08	IK20TT	4702	1.0	-	IK20TT	IK20TT	4	
2.0	95	L34(122CUL4)		09/98-10/08	K20PR-U11	3121	1.1	K20TT	IK20TT	IK20TT	4	
TRAILBLAZER (01-08)												
4.2 AWD	201	LL8(254CUL6)		09/01-09/08	PT16VR13	5068	1.3	TV16TT	ITV16TT	ITV16TT	6	
TRANS SPORT (96-05)												
3.4	137	LA1		08/96-09/05	T16EPR-U15	5023	1.5	T16TT	IT16TT	IT16TT	6	
3.4 V6	138	LA1		10/00-09/05	T16EPR-U15	5023	1.5	T16TT	IT16TT	IT16TT	6	
3.4 V6 AWD	138	LA1		10/01-09/05	T16EPR-U15	5023	1.5	T16TT	IT16TT	IT16TT	6	
TRAX (12-)												
1.4	103	LUJ		12/12-	VK22	5610	0.8	-	IK22TT	VK22	4	
1.4 AWD	103	LUJ		12/12-	VK22	5610	0.8	-	IK22TT	VK22	4	
1.4 LPG	103	LUJ		04/13-	VK22	5610	0.8	-	IK22TT	VK22	4	
1.6	85	LDE		12/12-	KJ20CR-U11	3451	1.1	K20TT	IK20TT	IK20TT	4	
1.7 TD	96	LUD		12/12-	DG-625		4.4V				4	
1.7 TD AWD	96	LUD		12/12-	DG-625		4.4V				4	
CHRYSLER												
300 C (04-12)												
2.7	130/142	2.7FX; EER; EES		09/04-11/12	ITL20	5350	1.1	-	-		6	
3.0 CRD	160	EXL		09/05-11/12	DG-194		4.4V				6	
5.7	250	EZB		09/04-12/05	ITL16TT	4717	1.0	-	ITL16TT		8	
5.7	250	EZD/EZH	Twin Spark	01/06-12/08	ITL16TT	4717	1.0	-	ITL16TT		16	
5.7	250/265	EZD/EZH	Twin Spark	01/09-12/10	K16HPR-U11	6076	1.1	KH16TT	IKH16TT	IKH16TT	16	
5.7 AWD	250	EZB		04/05-12/05	ITL16TT	4717	1.0	-	ITL16TT		8	
5.7 AWD	250	EZH	Twin Spark	01/06-12/08	ITL16TT	4717	1.0	-	ITL16TT		16	
5.7 AWD	250	EZH	Twin Spark	01/09-12/10	K16HPR-U11	6076	1.1	KH16TT	IKH16TT	IKH16TT	16	
6.1 SRT8	317	ESF		06/05-11/12	ITL20	5350	1.1	-	-		16	
300 C (11-)												
3.0 CRD	176	EXF	OE:68211173A A	09/11-	DG-620		7V				6	
3.6	210/215	ERB	Check Thread size	07/11-	ITV20TT	4719	1.0	-	ITV20TT		6	
3.6	210/215	ERB	Check Thread size	07/11-	SXU22HCR11S	3461	1.1	-	-	VXUHC22G	6	
6.4	347	ESG		09/11-	ITL20	5350	1.1	-	-		16	
300 M (98-04)												
2.7 V6 24V	150	EER		11/98-09/04	ITL20	5350	1.1	-	-		6	
3.5 V6 24V	185/187	EGC; EGG		07/98-04/03	PKJ16CR-L11	3246	1.1	-	IK16TT	IK16TT	6	
ASPEN (06-)												
5.7	280	EZD	Twin Spark	04/08-12/08	ITL16TT	4717	1.0	-	ITL16TT		16	
5.7	293	EZE	Twin Spark	04/08-	K16HPR-U11	6076	1.1	KH16TT	IKH16TT	IKH16TT	16	
5.7 4x4	293	EZE	Twin Spark	04/08-	K16HPR-U11	6076	1.1	KH16TT	IKH16TT	IKH16TT	16	
5.7 AWD	280	EZD	Twin Spark	04/08-12/08	ITL16TT	4717	1.0	-	ITL16TT		16	
CIRRUS (94-00)												
2.0 LX	96/98	ECB		05/94-09/00	K20PR-U	3145	0.8	K20TT	IK20TT	IK20TT	4	
2.4 LX	103	EDZ		05/94-09/00	K16R-U11	3120	1.1	K16TT	IK16TT	IK16TT	4	
CONCORDE (97-03)												
2.7 LX	149	EER		10/97-09/03	ITL16TT	4717	1.0	-	ITL16TT		6	
2.7 LX	149	R		10/97-09/03	ITL20	5350	1.1	-	-		6	
CROSSFIRE (03-07)												
3.2	160	EGX		07/03-12/08	SK20PR-L9	3307	0.9	-	IK20TT	IK20TT	6	
3.2 SRT-6	246	EGZ		09/04-12/07	SK20PR-L9	3307	0.9	-	IK20TT	IK20TT	6	
DELTA (11-)												
1.4	88	198 A4.000	40000km Lifetime	08/11-	IXU27	5337	0.9	-	-		4	
1.4 16V	103	198 A7.000	40000km Lifetime	08/11-	IXU27	5337	0.9	-	-		4	
1.6 D Multijet	88	198 A2.000		08/11-	DG-608		4.4V				4	
2.0 D Multijet	121	198 A5.000		08/11-	DG-608		4.4V				4	
Grand VOYAGER V (07-)												
2.8 CRD	120	ENS	OE:68029497A A	10/07-	DG-633		4.4V				4	
3.3	125	EGA		01/08-02/08	ITL16TT	4717	1.0	-	ITL16TT		6	

Свечи зажигания и Свечи накаливания

Таблица применения

Таблица применения

	KW				СТАНДАРТНЫЕ				Twin Tip			QTY
												
CHRYSLER продолжение												
Grand VOYAGER V (07-) продолжение												
3.6	208/211	ERB	Check Thread size	02/11-	ITV20TT	4719	1.0	-	ITV20TT		6	
3.6	208/211	ERB	Check Thread size	02/11-	SXU22HCR11S	3461	1.1	-	-	VXUHC22G	6	
3.8	142	EGL		10/07-	ITL16TT	4717	1.0	-	ITL16TT		6	
LE BARON (86-96)												
2.2 i Turbo	109/130	CHRY02		09/86-01/91	W16EPR-U	3021	0.8	W16TT	IW16TT	IW16TT	4	
2.5 i	75	EDM		09/86-12/94	W16EPR-U	3021	0.8	W16TT	IW16TT	IW16TT	4	
2.5 i Turbo	112	CHRY03		01/89-12/94	W16EPR-U	3021	0.8	W16TT	IW16TT	IW16TT	4	
3.0 i V6	105	6G72; EFA		01/90-12/96	W16EPR-U	3021	0.8	W16TT	IW16TT	IW16TT	6	
NEON I (94-00)												
1.8 16V	85	EBD		09/97-08/99	K20PR-U	3145	0.8	K20TT	IK20TT	IK20TT	4	
2.0 16V	98/107/109	ECB; ECC; ECM		05/94-08/99	K20PR-U	3145	0.8	K20TT	IK20TT	IK20TT	4	
NEON II (99-06)												
1.6	85	EJD		11/01-09/05	K20PR-U	3145	0.8	K20TT	IK20TT	IK20TT	4	
2.0 16V	98	ECB		08/99-12/06	K20PR-U	3145	0.8	K20TT	IK20TT	IK20TT	4	
2.0 16V R/T	110	ECH		10/01-09/05	K20PR-U	3145	0.8	K20TT	IK20TT	IK20TT	4	
NEW YORKER (92-98)												
3.5 i 24V	155	EGE		04/93-09/98	QJ16HR-U	5018	0.9	-	-		6	
PT CRUISER (00-10)												
1.6	85	EJD		11/01-09/04	K20R-U	3122	0.8	K20TT	IK20TT	IK20TT	4	
2.0	100/104	ECC		06/00-12/10	ITL16TT	4717	1.0	-	ITL16TT		4	
2.2 CRD	89/110	EDJ	Double Coil(LPH)	03/02-12/10	DG-117		11.5V				4	
2.4	105/110	EDZ(143); EDZ		06/00-12/10	ITL16TT	4717	1.0	-	ITL16TT		4	
2.4 GT	164	EDV-223		08/03-03/08	ITL16TT	4717	1.0	-	ITL16TT		4	
SARATOGA (89-95)												
3.0	105	6G72		09/89-12/95	W16EXR-U13	3213	1.3	W16TT	IW16TT	IW16TT	6	
SEBRING (01-07)												
2.0	104	ECC		04/01-06/07	ITL16TT	4717	1.0	-	ITL16TT		4	
2.4	105/112	EDZ		04/01-06/07	ITL16TT	4717	1.0	-	ITL16TT		4	
2.7 V6 24V	149	EER; EES		04/01-06/07	ITL20	5350	1.1	-	-		6	
SEBRING (07-10)												
2.0 CRD	103	ECD		03/09-12/10	DG-190		4.4V				4	
2.0 VVT	115	ECN		07/07-12/10	KJ16CR-U11	3311	1.1	K16TT	IK16TT	IK16TT	4	
2.4 VVT	125	ED3		07/07-12/10	KJ16CR-U11	3311	1.1	K16TT	IK16TT	IK16TT	4	
2.4 VVT	125	EDG		07/07-12/10	PKJ16CR8	3175	0.8	-	-		4	
2.7	137	EER		07/07-12/10	ITL16TT	4717	1.0	-	ITL16TT		6	
2.7 VVT	137/141	EER		09/06-12/10	ITL16TT	4717	1.0	-	ITL16TT		6	
STRATUS (95-01)												
2.0 16V	98	ECB		12/95-04/01	K20PR-U	3145	0.8	K20TT	IK20TT	IK20TT	4	
2.0 LE	96	420X; ECB		12/95-04/01	K20PR-U	3145	0.8	K20TT	IK20TT	IK20TT	4	
2.4 16 V	103	EDZ		12/95-04/01	K16R-U11	3120	1.1	K16TT	IK16TT	IK16TT	4	
2.4 16V	112	EDZ		12/95-04/01	K16R-U11	3120	1.1	K16TT	IK16TT	IK16TT	4	
2.5 LX	120	625H		04/96-04/01	PK16PR-L11	3275	1.1	-	IK16TT	IK16TT	6	
2.5 LX V6	120	EEB		12/95-04/01	PK16PR-L11	3275	1.1	-	IK16TT	IK16TT	6	
2.5 V6	125	H00		12/95-04/01	PK16PR-L11	3275	1.1	-	IK16TT	IK16TT	6	
VISION (93-97)												
3.5 TSi	155	EGE		09/93-12/97	QJ16HR-U	5018	0.9	-	-		6	
VOYAGER I (87-90)												
3.0	100	EFA		10/87-09/90	W16EXR-U11	3032	1.1	W16TT	IW16TT	IW16TT	6	
3.3	112	EGA		10/89-09/90	W16EXR-U13	3213	1.3	W16TT	IW16TT	IW16TT	6	
VOYAGER II (90-95)												
2.5 i	72/74	EDM		08/90-09/95	W16EPR-U	3021	0.8	W16TT	IW16TT	IW16TT	4	
2.5 TD	87	09B; M00	Double Coil(LPH)	01/92-09/95	DG-001		11V				4	
3.0	104	EFA		10/90-09/95	W16EPR-U	3021	0.8	W16TT	IW16TT	IW16TT	6	
3.0 i	108	6G72; 300		01/91-09/95	W16EPR-U	3021	0.8	W16TT	IW16TT	IW16TT	6	
3.3 i	110/120	EGA		08/90-09/95	W16EXR-U13	3213	1.3	W16TT	IW16TT	IW16TT	6	
3.3 i AWD	110/120	EGA(U3); EGA		08/90-09/95	W16EXR-U13	3213	1.3	W16TT	IW16TT	IW16TT	6	

Свечи зажигания и Свечи накаливания

Таблица применения











	KW				СТАНДАРТНЫЕ			Twin Tip			QTY
											
CHRYSLER продолжение											
VOYAGER III (95-01)											
2.0 i	98	C00		01/95-03/01	K20PR-U	3145	0.8	K20TT	IK20TT	IK20TT	4
2.4 AWD	111	EDZ		02/97-03/01	K16R-U11	3120	1.1	K16TT	IK16TT	IK16TT	4
2.4 i	111	B00		01/95-03/01	K16R-U11	3120	1.1	K16TT	IK16TT	IK16TT	4
2.5 TD	85	425 CLIRS/X; ENC	Double Coil(LPH)	01/95-04/95	DG-001		11V				4
2.5 TD	85	425 CLIRS/X; ENC	Double Coil(LPH)	05/95-03/01	DG-109		11V				4
2.5 TDiC AWD	85	ENC	Double Coil(LPH)	10/95-03/01	DG-109		11V				4
3.0	112	EFA		01/95-03/01	W16EPR-U	3021	0.8	W16TT	IW16TT	IW16TT	6
3.3 i	116	R00		01/95-09/96	W16EXR-U13	3213	1.3	W16TT	IW16TT	IW16TT	6
3.3 i	116	R00		10/96-03/01	P16R13	3239	1.3	W20TT	IW20TT	IW20TT	6
3.8 i AWD	122/ 131	EGH; L00		01/95-03/01	W16EXR-U11	3032	1.1	W16TT	IW16TT	IW16TT	6
VOYAGER IV (00-08)											
2.4	108	EDZ		02/00-12/08	ITL16TT	4717	1.0	-	ITL16TT		4
2.5 CRD	88	EDK		08/05-12/08	DG-176		11.5V				4
2.5 CRD	105	ENJ	Double Coil(LPH)	02/00-12/08	DG-176		11.5V				4
2.8 CRD	110	ENR		06/04-12/06	DG-176		11.5V				4
2.8 CRD	110	ENR	OE:68029497A A	01/07-12/08	DG-633		4.4V				4
2.8 CRD	110	ENR	OE: 68090 434AA, applicatio n unsure	06/04-12/08	DG-660		5V				4
3.3	128	EGA; EGM		02/00-12/08	ITL16TT	4717	1.0	-	ITL16TT		6
3.3 AWD	128	EGA		02/00-12/08	ITL16TT	4717	1.0	-	ITL16TT		6
3.8	160	EGH		02/00-12/08	W16EXR-U11	3032	1.1	W16TT	IW16TT	IW16TT	6
3.8	160	L00		02/00-12/08	ITL16TT	4717	1.0	-	ITL16TT		6
3.8 AWD	160	EGH		02/00-12/08	W16EXR-U11	3032	1.1	W16TT	IW16TT	IW16TT	6
3.8 AWD	160	L00		02/00-12/08	ITL16TT	4717	1.0	-	ITL16TT		6
YPSILON (846) (11-)											
1.2	51	169 A4.000		05/11-	XU22EPR-U	3179	0.9	XU22TT	IXU22TT	VXU22	4
1.3 D Multijet	70	199 B1.000		05/11-	DG-621		4.4V				4
CITROËN											
2 CV (63-90)											
4	12	A 53		03/63-02/70	W20FSR-U	6053	0.7	WF20TT	-		2
4	17	A79/1 (AYA2)		01/70-12/75	W20FPR-U	3070	0.7	WF20TT	-		2
6	18/21	A06/635; A06/664		02/70-07/90	W20FSR-U	6053	0.7	WF20TT	-		2
ACADIANE (78-88)											
6	22	M28 (AM2)		08/78-10/88	W20FSR-U	6053	0.7	WF20TT	-		2
AMI (63-77)											
8	24	M28 (AM2)		07/69-12/77	W20FSR-U	6053	0.7	WF20TT	-		2
AX (86-98)											
1.4 GTi	66/ 69/74	KFY (TU3FJ2); KFZ (TU3FJ2)		06/91-12/96	K22PBR-S	5062	0.85	-	IKB22TT	VK22	4
10	33	C1A		09/86-06/92	Q20P-U	3125	0.8	Q20TT	IQ20TT	IQ20TT	4
10	33/37	CDY (TU9M); CDZ (TU9M)		07/86-12/98	K20TXR	5063	1.0	K20TT	IK20TT	IK20TT	4
10 E	30	C3A		12/86-12/88	Q20P-U	3125	0.8	Q20TT	IQ20TT	IQ20TT	4
11	40/44	H1A; H1B; HDZ (TU1M)		09/86-12/97	K20TXR	5063	1.0	K20TT	IK20TT	IK20TT	4
11 4x4	40	H1A		06/91-07/92	K20TXR	5063	1.0	K20TT	IK20TT	IK20TT	4
11 Cat	40	HAZ (TU1CP)		09/88-12/89	K20PR-U	3145	0.8	K20TT	IK20TT	IK20TT	4
14	44	KAY (TU3CP)		12/86-12/88	Q20PR-U	3007	0.8	Q20TT	IQ20TT	IQ20TT	4
14	49	K1F	Ch: Org Nr.4193>	06/88-12/89	Q20P-U	3125	0.8	Q20TT	IQ20TT	IQ20TT	4
14	51/55	KDX (TU3M/Z); KDY (TU3FM); KDY (TU3M); KDZ (TU3M/Z); TU3A(K1G) - K		04/87-04/97	K20PR-U	3145	0.8	K20TT	IK20TT	IK20TT	4
14	61	K2A; K2B		01/88-12/92	Q22PR-U	3010	0.8	-	-	VQ22	4
14 4x4	55	KDX (TU3M/Z); KDY (TU3FM); KDY (TU3M); KDZ (TU3M/Z)		08/91-12/96	Q16PR-U	3137	0.8	Q16TT	IQ16TT	IQ16TT	4
14 D	37	K9A (TUD3); K9Y (TUD3Y)	Double Coil(LPH)	09/88-12/97	DG-004		11V				4
14 GT	59	KDZ (TU3M/Z)		01/89-12/91	Q20PR-U	3007	0.8	Q20TT	IQ20TT	IQ20TT	4
15 D	40/43	VJY (TUD5); VJZ (TUD5)		08/94-12/97	DG-003		11V				4

Таблица применения

C

Свечи зажигания и Свечи накаливания

Таблица применения

Таблица применения

KW	KW	KW	NOTE	21	СТАНДАРТНЫЕ				Twin Tip		QTY
					STANDARD	STANDARD	STANDARD	STANDARD	Twin Tip	Twin Tip	
CITROËN продолжение											
AXEL (81-91)											
11	42	G11/631		01/84-06/89	T22EP-U	5040	0.8	-	-		4
BERLINGO (B9) (08-)											
1.6	66	NFR (TU5JP4B)	OEM Optional	04/08-	K16HPR-U11	6076	1.1	KH16TT	IKH16TT	IKH16TT	4
1.6	80	NFU (TU5JP4)		04/08-	K16HPR-U11	6076	1.1	KH16TT	IKH16TT	IKH16TT	4
1.6 BlueHdi 100	73	BHY (DV6FD)		12/14-	DG-603		5V				4
1.6 BlueHdi 120	88	BHZ (DV6FC)		12/14-	DG-603		5V				4
1.6 HDi 75 8V / BlueHdi 75	55	9HN (DV6ETED); BHW (DV6FE)		04/08-	DG-603		5V				4
1.6 HDi 75 16V	55	9HN (DV6ETED4)		04/08-	DG-603		5V				4
1.6 HDi 75 16V	55	9HT (DV6BTED4); 9HT (DV6BUTED4)		04/08-	DG-180		11V				4
1.6 HDi 90	66	9HE (DV6DBM); 9HF (DV6DTE); 9HJ (DV6DTE); 9HP (DV6DTE)		07/10-	DG-603		5V				4
1.6 HDi 90	66	9HX (DV6ATED4)		04/08-	DG-180		11V				4
1.6 HDi 90 16V	66	9HS (DV6TED4BU); 9HX (DV6ATED4); 9HX (DV6AUTED4)		04/08-	DG-180		11V				4
1.6 HDi 92	68	9HJ (DV6DTE)		07/10-	DG-603		5V				4
1.6 HDi 110	80	9HZ (DV6TED4)		04/08-	DG-180		11V				4
1.6 HDi 110	82	9HL (DV6C); 9HR (DV6C)		07/10-	DG-603		5V				4
1.6 HDi 115	84	9HL (DV6C); 9HR (DV6C)		07/10-	DG-603		5V				4
1.6 VTi 95	72	5FK (EP6CB)	Use narrow 16mm Hex socket	07/10-	VXUH22I	5656	0.9	-	IXUH22TT	VXUH22I	4
1.6 VTi 120	88	5FS (EP6C)	Use narrow 16mm Hex socket	11/09-	VXUH22I	5656	0.9	-	IXUH22TT	VXUH22I	4
BERLINGO (MF) (96-11)											
1.1 i	44	HDZ (TU1M)		07/96-05/08	K20TXR	5063	1.0	K20TT	IK20TT	IK20TT	4
1.4	53	KFW (TU3JP)		11/02-10/05	K20PR-U	3145	0.8	K20TT	IK20TT	IK20TT	4
1.4 bivalent	48	KFW (TU3JP)		11/02-12/11	K20PR-U	3145	0.8	K20TT	IK20TT	IK20TT	4
1.4 i	55	KFW (TU3JP); KFX (TU3JP)		07/96-12/11	K20PR-U	3145	0.8	K20TT	IK20TT	IK20TT	4
1.4 i bivalent	55	KFW (TU3JP)		04/03-10/08	K20PR-U	3145	0.8	K20TT	IK20TT	IK20TT	4
1.6 16V	80	NFU (TU5JP4)		10/00-12/11	K16HPR-U11	6076	1.1	KH16TT	IKH16TT	IKH16TT	4
1.6 HDi 75	55	9HW (DV6BTED4); DV6B; DV6BTED4 (9HT)	Ch:> ORP 10783, M4 Thread	07/05-05/06	DG-113		11V				4
1.6 HDi 75	55	9HW (DV6BTED4); DV6B; DV6BTED4 (9HT)	Ch:ORP 10784> ,Pin	05/06-12/11	DG-180		11V				4
1.6 HDi 90	66	9HX (DV6ATED4)	Ch:> ORP 10783, M4 Thread	07/05-05/06	DG-113		11V				4
1.6 HDi 90	66	9HX (DV6ATED4)	Ch:ORP 10784> ,Pin	05/06-12/11	DG-180		11V				4
1.8 D	43	A9A (XUD7)		07/96-10/02	DG-001		11V				4
1.8 i	66	LFX (XU7JB)		05/97-10/02	K20TXR	5063	1.0	K20TT	IK20TT	IK20TT	4
1.8 i 4WD	66	LFX (XU7JB)		04/97-10/01	K20TXR	5063	1.0	K20TT	IK20TT	IK20TT	4
1.9 D	51	D9B (XUD9A/L); DJY (XUD9A)		07/96-12/03	DG-001		11V				4
1.9 D	51	WJY (DW8B); WJZ (DW8)		07/98-10/05	DG-003		11V				4
1.9 D 4WD	51	WJY (DW8B); WJZ (DW8)		07/98-10/05	DG-003		11V				4
1.9 D 70	51	WJY (DW8B); WJZ (DW8)		04/99-12/11	DG-003		11V				4
1.9 D 70 4WD	51	WJY (DW8B); WJZ (DW8)		07/98-03/06	DG-003		11V				4
2.0 HDi 4x4	66	RHY (DW10TD)		11/02-10/05	DG-116		11V				4
2.0 HDi 90	66	RHY (DW10TD)		12/99-12/11	DG-116		11V				4
2.0 HDi 90 4WD	66	RHY (DW10TD)		11/00-10/05	DG-116		11V				4
BX (82-94)											
1.4	44	XY7CP(KAZ) - Z		01/87-04/88	K20PR-U	3145	0.8	K20TT	IK20TT	IK20TT	4
1.4	52	150C	Ch:> Org Nr.4192	01/87-01/92	T20EP-U	5031	0.8	T20TT	IT20TT	IT20TT	4
1.8 D	44	161 (XUD7)		10/85-09/93	DG-001		11V				4
1.8 TRD Turbo	66	A8A (XUD7TE); AJZ (XUD7TE)		03/88-12/94	DG-001		11V				4
1.9 AWD	92			02/92-06/94	Q22P-U	3255	0.8	-	-	VQ22	4

Свечи зажигания и Свечи накаливания

Таблица применения











KW	KW	KW	KW	KW	СТАНДАРТНЫЕ			Twin Tip			QTY
					STANDARD	STANDARD	STANDARD	TWIN TIP	TWIN TIP	TWIN TIP	
CITROËN продолжение											
BX (82-94) продолжение											
1.9 D	52	D9B (XUD9A/L)		01/87-01/92	DG-001		11V				4
1.9 DT TXD	66			02/92-12/94	DG-001		11V				4
1.9 RD 4x4	52			01/87-01/92	DG-001		11V				4
1.9 TZi	92	D6A (XU9J2)		02/92-12/94	Q22P-U	3255	0.8	-	-	VQ22	4
11	40	HDZ (TU1M)		10/88-06/92	K20TXR	5063	1.0	K20TT	IK20TT	IK20TT	4
11	42	XW7B2(109LA)		10/86-06/88	T20EPR-U	5032	0.8	T20TT	IT20TT	IT20TT	4
14	47	K1H (TU3A)		01/89-12/89	Q20P-U	3125	0.8	Q20TT	IQ20TT	IQ20TT	4
14	53	150C	Ch: Org Nr.4193>	01/86-02/93	Q20P-U	3125	0.8	Q20TT	IQ20TT	IQ20TT	4
14	55	KDY (TU3M)		01/89-02/93	Q16PR-U	3137	0.8	Q16TT	IQ16TT	IQ16TT	4
14	55	KDZ (TU3M/Z)		01/89-02/93	K20TXR	5063	1.0	K20TT	IK20TT	IK20TT	4
14 E	45/52	150A; 150C	Ch:> Org Nr.4192	10/82-02/93	T20EP-U	5031	0.8	T20TT	IT20TT	IT20TT	4
14 E	49	150F		09/85-02/93	Q20P-U	3125	0.8	Q20TT	IQ20TT	IQ20TT	4
14 E	52	K1G	Ch: Org Nr.4193>	04/83-07/89	Q20P-U	3125	0.8	Q20TT	IQ20TT	IQ20TT	4
14 E	59			10/85-05/89	Q20PR-U	3007	0.8	Q20TT	IQ20TT	IQ20TT	4
15	59	B1E (XU51C)		10/87-05/92	Q20P-U	3125	0.8	Q20TT	IQ20TT	IQ20TT	4
16	53/65	171D; B1E (XU51C)		07/85-12/94	Q20P-U	3125	0.8	Q20TT	IQ20TT	IQ20TT	4
16	55	BAZ (XU5CP)		09/88-12/94	Q22PR-U	3010	0.8	-	-	VQ22	4
16	58/ 65/68	B1A (XU51C/K); BDY (XU5M); XU52C		09/87-12/94	Q20PR-U	3007	0.8	Q20TT	IQ20TT	IQ20TT	4
16	65	171C	Ch:> Org Nr.4157	10/82-06/88	T22EP-U	5040	0.8	-	-		4
16	65	171C	Ch: Org Nr.4158>	06/85-06/88	Q20P-U	3125	0.8	Q20TT	IQ20TT	IQ20TT	4
16	76	180Z		03/86-12/94	Q22P-U	3255	0.8	-	-	VQ22	4
16 E	65	BDY (XU5M)		05/89-02/93	Q20PR-U	3007	0.8	Q20TT	IQ20TT	IQ20TT	4
18 D	44	161A (XUD7)		10/85-09/93	DG-001		11V				4
19	70	D2C (XU92C)	Ch:> Org Nr.4578	12/87-12/89	T22EP-U	5040	0.8	-	-		4
19	70	D2C (XU92C)	Ch: Org Nr.4579>	09/86-11/89	IQ22	5313	0.8	-	-	VQ22	4
19	75	159A		07/86-05/89	T22EP-U	5040	0.8	-	-		4
19	75/ 78/ 80/88	D2A (XU92C); DDZ (XU9M); DKZ (XU9JA)		07/86-12/94	Q20PR-U	3007	0.8	Q20TT	IQ20TT	IQ20TT	4
19 4x4	78/80	D2E; DDZ (XU9M)		06/89-05/91	Q20PR-U	3007	0.8	Q20TT	IQ20TT	IQ20TT	4
19 Cat	75	DFZ (XU9J1)	Ch: Org Nr.4228>	07/86-12/94	Q20PR-U	3007	0.8	Q20TT	IQ20TT	IQ20TT	4
19 D	47/51	162 (XUD9); D9A (XUD9); D9B (XUD9A/U); DJZ (XUD9A)		09/83-12/94	DG-001		11V				4
19 E	80	DDZ (XU9M)		06/88-02/93	Q20PR-U	3007	0.8	Q20TT	IQ20TT	IQ20TT	4
19 E 4x4	80	D2F		04/89-02/93	Q20PR-U	3007	0.8	Q20TT	IQ20TT	IQ20TT	4
19 GTi	88	DKZ (XU9JA)		06/88-02/93	Q20PR-U	3007	0.8	Q20TT	IQ20TT	IQ20TT	4
19 GTi	90	D6A (XU9J2)		07/86-02/93	Q22P-U	3255	0.8	-	-	VQ22	4
19 GTi 4x4	88	DKZ (XU9JA)		06/88-02/93	Q20PR-U	3007	0.8	Q20TT	IQ20TT	IQ20TT	4
19 GTi 16V	108	DFW (XU9J4)		03/88-02/93	K22PBR-S	5062	0.85	-	IKB22TT	VK22	4
C1 I (05-14)											
1.0	50	CFB (1KR)		06/05-09/14	K16HR-U11	3482	1.1	KH16TT	IKH16TT	IKH16TT	3
1.4 HDi	40	8HT (DV4TD)		06/05-09/14	DG-180		11V				4
C1 II (14-)											
1.0	51	1KR-FE		07/14-	SC16HR11	3499	1.1	-	IXEH20TT	IXEH20TT	3
1.0 VTi 68	51	CFB (1KR)		04/14-	SC16HR11	3499	1.1	-	IXEH20TT	IXEH20TT	3
1.0 VTi 72	53	1KR-FE	Eng: 1KR-FE>	06/18-	SC16HR11	3499	1.1	-	IXEH20TT	IXEH20TT	4
1.2 VTi 82	60	HMT (EB2D)		04/14-	IXUH22I	5356	0.9	-	IXUH22TT	VXUH22I	3
C2 (03-)											
1.1	44	HFX (TU1JP)		09/03-01/10	K20PR-U	3145	0.8	K20TT	IK20TT	IK20TT	4
1.4	54	KFV (TU3A); KFV (TU3JP)		09/03-01/10	K20PR-U	3145	0.8	K20TT	IK20TT	IK20TT	4
1.4 16V	65	KFU (ET3J4)		06/06-01/10	XE20HR-U9	3427	0.9	-	IXEH20TT	IXEH20TT	4
1.4 HDi	50	8HX (DV4TD); 8HZ (DV4TD)		09/03-	DG-113		11V				4
1.6	80	NFU (TU5JP4)		09/03-	K16HPR-U11	6076	1.1	KH16TT	IKH16TT	IKH16TT	4
1.6 HDi	80	9HZ (DV6TED4)	Ch:> RPO 10783, M4 Thread	09/05-05/06	DG-113		11V				4
1.6 HDi	80	9HZ (DV6TED4)	Ch:RPO 10784> ,Pin	05/06-	DG-180		11V				4

Таблица применения

C











Свечи зажигания и Свечи накаливания

Таблица применения

	KW				СТАНДАРТНЫЕ				Twin Tip			QTY
												
CITROËN продолжение												
C2 (03-) продолжение												
1.6 VTS	90	NFS (TU5JP4S)	OEM Optional	01/05-	K16HPR-U11	6076	1.1		KH16TT	IKH16TT	IKH16TT	4
C3 Aircross (17-)												
1.2 PureTech 82	60	HMZ (EB2F)/HMR (EB2FA)/(2RHMRC)/(2RHMZB)		06/17-	IXUH22I	5356	0.9			IXUH22TT	VXUH22I	3
C3 I (02-)												
1.1 i	44	HFX (TU1A); HFX (TU1JP)		02/02-10/09	K20PR-U	3145	0.8		K20TT	IK20TT	IK20TT	4
1.4 16V	65	KFU (ET3J4)		12/03-10/09	XE20HR-U9	3427	0.9			IXEH20TT	IXEH20TT	4
1.4 16V HDi	66	8HY (DV4TED4)		02/02-	DG-113		11V					4
1.4 HDi	50/52/55	8HX (DV4TD); 8HZ (DV4TD)		02/02-	DG-113		11V					4
1.4 i	54	KFV (TU3A); KFV (TU3JP)		02/02-10/09	K20PR-U	3145	0.8		K20TT	IK20TT	IK20TT	4
1.4 i Bivalent	54	KFV (TU3JP)	Flexible fuel	02/02-10/09	K20PR-U	3145	0.8		K20TT	IK20TT	IK20TT	4
1.6 16V	80	NFU (TU5JP4)		02/02-08/10	K16HPR-U11	6076	1.1		KH16TT	IKH16TT	IKH16TT	4
1.6 16V HDi	66	9HX (DV6ATED4)	Ch:> ORP 10783, M4 Thread	10/05-05/06	DG-113		11V					4
1.6 16V HDi	66	9HX (DV6ATED4)	Ch:ORP 10784> ,Pin	05/06-	DG-180		11V					4
1.6 16V HDi	80	9HZ (DV6TED4)	Ch:> RPO 10783, M4 Thread	09/05-05/06	DG-113		11V					4
1.6 16V HDi	80	9HZ (DV6TED4)	Ch:RPO 10784> ,Pin	05/06-	DG-180		11V					4
C3 II (09-)												
1.0 VTi 68	50	ZMZ (EB0)		08/12-	IXUH22I	5356	0.9			IXUH22TT	VXUH22I	3
1.1 BiFuel	44	HFX (TU1A)		11/10-01/11	K20PR-U	3145	0.8		K20TT	IK20TT	IK20TT	4
1.1 i	44	HFX (TU1A)		11/09-01/13	K20PR-U	3145	0.8		K20TT	IK20TT	IK20TT	4
1.2 VTi 82	60	HMZ (EB2); HMZ (EB2F)		06/12-09/16	IXUH22I	5356	0.9			IXUH22TT	VXUH22I	3
1.4	54	K6E (TU3A); KFT (TU3A); KFT (TU3AE5)		11/09-09/16	K20PR-U	3145	0.8		K20TT	IK20TT	IK20TT	4
1.4 HDi 70	50	8HR (DV4C)		11/09-	DG-603		5V					4
1.4 HDi 70	50	8HZ (DV4TD)		11/09-	DG-180		11V					4
1.4 LPG	54	KFT (TU3A)		07/10-	K20PR-U	3145	0.8		K20TT	IK20TT	IK20TT	4
1.4 LPG	70	8FN (EP3)	Use narrow 16mm Hex socket	06/13-	VXUH22I	5656	0.9			IXUH22TT	VXUH22I	4
1.4 VTi	72	8FR (EP3)	Use narrow 16mm Hex socket	11/09-	VXUH22I	5656	0.9			IXUH22TT	VXUH22I	4
1.4 VTi 95	70	8FP (EP3C)	Use narrow 16mm Hex socket	11/09-	VXUH22I	5656	0.9			IXUH22TT	VXUH22I	4
1.6 BlueHDi 75	55	9HK (DV6ETEDM); BHW (DV6FE)		04/15-	DG-603		5V					4
1.6 BlueHDi 100	73	BHY (DV6FD)		07/14-	DG-603		5V					4
1.6 HDi	68	9HJ (DV6DTEDM); 9HP (DV6DTE)		11/09-09/16	DG-603		5V					4
1.6 HDi 90	66	9HX (DV6ATED4)		11/09-	DG-180		11V					4
1.6 HDi 110	82	9HR (DV6C)		11/09-	DG-603		5V					4
1.6 HDi 115	84	9HD (DV6C)		09/12-	DG-603		5V					4
1.6 VTi 120	88	5FS (EP6C)	Use narrow 16mm Hex socket	11/09-	VXUH22I	5656	0.9			IXUH22TT	VXUH22I	4
C3 III (16-)												
1.2 PureTech 82	60	HMR (EB2FA)		05/18-	IXUH22I	5356	0.9			IXUH22TT	VXUH22I	3
1.2 VTi 82	60	HMZ (EB2F)		07/16-	IXUH22I	5356	0.9			IXUH22TT	VXUH22I	4
C3 Picasso (09-)												
1.4 VTi 95	70	8FN (EP3); 8FP (EP3C); 8FS (EP3)	Use narrow 16mm Hex socket	02/09-	VXUH22I	5656	0.9			IXUH22TT	VXUH22I	4
1.4 VTi 95 LPG	70	8FN (EP3)	Use narrow 16mm Hex socket	01/12-	VXUH22I	5656	0.9			IXUH22TT	VXUH22I	4
1.6 BlueHDi 100	73	BHY (DV6FD)		01/15-	DG-603		5V					4
1.6 HDi	66/80	9HX (DV6ATED4); 9HZ (DV6TED4)		02/09-	DG-180		11V					4
1.6 HDi 90	66	9HP (DV6DTE)		07/10-	DG-603		5V					4
1.6 HDi 110	82	9HR (DV6C)		05/10-	DG-603		5V					4
1.6 HDi 115	84	9HD (DV6C)		01/13-	DG-603		5V					4

Свечи зажигания и Свечи накаливания











Таблица применения

	KW				СТАНДАРТНЫЕ				Twin Tip		QTY
											
CITROËN продолжение											
C3 Picasso (09-) продолжение											
1.6 VTi 120	88	5FS (EP6C); 5FW (EP6)	Use narrow 16mm Hex socket	02/09-	VXUH22I	5656	0.9	-	IXUH22TT	VXUH22I	4
C3 Pluriel (03-)											
1.4	54	KFV (TU3A); KFV (TU3JP)		05/03-01/11	K20PR-U	3145	0.8	K20TT	IK20TT	IK20TT	4
1.4 HDi	50	8HX (DV4TD)		04/04-	DG-113		11V				4
1.6	80	NFU (TU5JP4)		05/03-	K16HPR-U11	6076	1.1	KH16TT	IKH16TT	IKH16TT	4
C4 (Grand) Picasso I (06-13)											
1.6 16V	103/ 110	5FT (EP6DT); 5FX (EP6DT)	Use narrow 16mm Hex socket	07/08-08/13	VXUH22I	5656	0.9	-	IXUH22TT	VXUH22I	4
1.6 HDi	80	9HY (DV6TED4); 9HZ (DV6TED4)		10/06-08/13	DG-180		11V				4
1.6 HDi 110	82	9HR (DV6C)		09/10-08/13	DG-603		5V				4
1.6 THP 140	103	5FT (EP6DT)	Use narrow 16mm Hex socket	07/08-08/13	VXUH22I	5656	0.9	-	IXUH22TT	VXUH22I	4
1.6 THP 155	115	5FV (EP6CDT)	Use narrow 16mm Hex socket	09/10-08/13	VXUH22I	5656	0.9	-	IXUH22TT	VXUH22I	4
1.6 VTi 120	88	5FW (EP6)	Use narrow 16mm Hex socket	07/08-08/13	VXUH22I	5656	0.9	-	IXUH22TT	VXUH22I	4
1.8 Bifuel	92	6FY (EW7A)		01/09-10/12	K16HPR-U11	6076	1.1	KH16TT	IKH16TT	IKH16TT	4
1.8 i 16V	92	6FY (EW7A)		10/06-12/11	K16HPR-U11	6076	1.1	KH16TT	IKH16TT	IKH16TT	4
2.0 HDi 138	103	RHJ (DW10BTED4); RHR (DW10BTED4)		10/06-12/13	DG-181		11V				4
2.0 HDi 150	110	RHE (DW10CTED4)		07/09-08/13	DG-603		5V				4
2.0 HDi 165	120	RHH (DW10CTED4)		09/10-08/13	DG-603		5V				4
2.0 i 16V	103/ 105	RFJ (EW10A); RFN (EW10J4)		10/06-08/13	K16HPR-U11	6076	1.1	KH16TT	IKH16TT	IKH16TT	4
C4 (Grand) Picasso II (13-)											
1.6 BlueHDi 100	73	BHY (DV6FD)		12/14-	DG-603		5V				4
1.6 BlueHDi 120	88	BHZ (DV6FC)		07/14-	DG-603		5V				4
1.6 HDi / BlueHDi 115	85	9HC (DV6C); BHX (DV6FC)		02/13-	DG-603		5V				4
1.6 HDi 90	66	9HP (DV6DTED)		02/13-	DG-603		5V				4
1.6 THP 150	110	5FX (EP6DT)	Use narrow 16mm Hex socket	09/14-	VXUH22I	5656	0.9	-	IXUH22TT	VXUH22I	4
1.6 THP 155	115	5FV (EP6CDT)	Use narrow 16mm Hex socket	02/13-	VXUH22I	5656	0.9	-	IXUH22TT	VXUH22I	4
1.6 THP 165	121	5GZ (EP6FDT)	Use narrow 16mm Hex socket	07/14-	VXUH22I	5656	0.9	-	IXUH22TT	VXUH22I	4
1.6 VTi 120	88	5FS (EP6C)	Use narrow 16mm Hex socket	02/13-	VXUH22I	5656	0.9	-	IXUH22TT	VXUH22I	4
2.0 BlueHDi 135	100	AHV (DW10FD); RHD (DW10CB)		09/13-	DG-603		5V				4
2.0 BlueHDi 150	110	AHE (DW10FD); AHR (DW10FD); AHX (DW10FD)		06/13-	DG-603		5V				4
C4 Aircross (12-)											
1.6	86	4A92		04/12-	IKH16TT	4703	1.0	-	IKH16TT		4
1.6 HDi 115	84	9HD (DV6C)		04/12-	DG-603		5V				4
1.6 HDi 115 AWC	84	9HL (DV6C)		05/12-	DG-603		5V				4
1.8 HDi 150	110	4N13	OE:160784998 0; 1820-A019; RP8488;GN123	04/12-	DG-656		11V				4
1.8 HDi 150 AWC	110	4N13	OE:160784998 0; 1820-A019; RP8488;GN123	04/12-	DG-656		11V				4
2.0	110	4B11		04/12-	VFK20F	5648	1.1	-	IK20TT	VFK20F	4
2.0 AWC	110	4B11		04/12-	VFK20F	5648	1.1	-	IK20TT	VFK20F	4
C4 Cactus (14-)											
1.2 VTi 75 / PureTech 75	55	HMU (EB2D); HMU (EB2FD)		09/14-	IXUH22I	5356	0.9	-	IXUH22TT	VXUH22I	3
1.2 VTi 82	60	HMZ (EB2F)		09/14-	IXUH22I	5356	0.9	-	IXUH22TT	VXUH22I	3
1.6 BlueHDi 100	73	BHY (DV6FD)		09/14-	DG-603		5V				4
1.6 HDi 90	66	9HP (DV6DTED)		09/14-	DG-603		5V				4

Свечи зажигания и Свечи накаливания





Таблица применения

Таблица применения

	KW				СТАНДАРТНЫЕ				Twin Tip		QTY
											
CITROËN продолжение											
C4 Coupe (04-11)											
1.4 16V	65	KFU (ET3J4)		11/04-06/10	XE20HR-U9	3427	0.9	-	IXEH20TT	IXEH20TT	4
1.6 16V	80	NFU (TU5JP4)		11/04-07/11	K16HPR-U11	6076	1.1	KH16TT	IKH16TT	IKH16TT	4
1.6 HDi	66	9HX (DV6ATED4)	Ch:> ORP 10783, M4 Thread	11/04-05/06	DG-113		11V				4
1.6 HDi	66	9HX (DV6ATED4)	Ch:ORP 10784> ,Pin	05/06-07/11	DG-180		11V				4
1.6 HDi	80	9HY (DV6TED4); 9HZ (DV6TED4)	Ch:> RPO 10783, M4 Thread	11/04-05/06	DG-113		11V				4
1.6 HDi	80	9HY (DV6TED4); 9HZ (DV6TED4)	Ch:RPO 10784> ,Pin	05/06-07/11	DG-180		11V				4
1.6 THP 150	110	5FX (EP6DT)	Use narrow 16mm Hex socket	07/08-07/11	VXUH22I	5656	0.9	-	IXUH22TT	VXUH22I	4
1.6 VTi 120	88	5FW (EP6)	Use narrow 16mm Hex socket	07/08-07/11	VXUH22I	5656	0.9	-	IXUH22TT	VXUH22I	4
2.0 16V	100	RFN (EW10J4)		11/04-07/07	K16HPR-U11	6076	1.1	KH16TT	IKH16TT	IKH16TT	4
2.0 16V	130	RFK (EW10J4S)		11/04-12/10	K20HR-U11	3381	1.1	KH20TT	IKH20TT	IKH20TT	4
2.0 HDi	100/103	RHF (DW10BTED4); RHR (DW10BTED4)		11/04-07/11	DG-181		11V				4
2.0 VTR	103	RFJ (EW10A)		10/06-12/07	K16HPR-U11	6076	1.1	KH16TT	IKH16TT	IKH16TT	4
C4 I (LC, LR) (04-11)											
1.4 16V	65	KFU (ET3J4)		11/04-01/11	XE20HR-U9	3427	0.9	-	IXEH20TT	IXEH20TT	4
1.6 16V	80	NFU (TU5JP4)		11/04-07/11	K16HPR-U11	6076	1.1	KH16TT	IKH16TT	IKH16TT	4
1.6 16V Bio-Flex	80	NFU (TU5JP4)		09/07-07/08	K20HR-U11	3381	1.1	KH20TT	IKH20TT	IKH20TT	4
1.6 HDi	66	9HX (DV6ATED4)	Ch:> ORP 10783, M4 Thread	11/04-05/06	DG-113		11V				4
1.6 HDi	66	9HX (DV6ATED4)	Ch:ORP 10784> ,Pin	05/06-07/11	DG-180		11V				4
1.6 HDi	80	9HY (DV6TED4); 9HZ (DV6TED4)		07/06-07/11	DG-180		11V				4
1.6 HDi	80	9HY (DV6TED4); 9HZ (DV6TED4)	Ch:> RPO 10783, M4 Thread	11/04-05/06	DG-113		11V				4
1.6 HDi	80	9HY (DV6TED4); 9HZ (DV6TED4)	Ch:RPO 10784> ,Pin	05/06-07/11	DG-180		11V				4
1.6 THP 140	103	5FT (EP6DT)	Use narrow 16mm Hex socket	07/08-07/11	VXUH22I	5656	0.9	-	IXUH22TT	VXUH22I	4
1.6 THP 150	110	5FX (EP6DT)	Use narrow 16mm Hex socket	07/08-07/11	VXUH22I	5656	0.9	-	IXUH22TT	VXUH22I	4
1.6 VTi 120	88	5FW (EP6)	Use narrow 16mm Hex socket	07/08-07/11	VXUH22I	5656	0.9	-	IXUH22TT	VXUH22I	4
2.0 16V	100/103/105	RFJ (EW10A); RFN (EW10J4)		11/04-07/11	K16HPR-U11	6076	1.1	KH16TT	IKH16TT	IKH16TT	4
2.0 16V	130	RFK (EW10J4S)		11/04-07/08	K20HR-U11	3381	1.1	KH20TT	IKH20TT	IKH20TT	4
2.0 HDi	81/100/103	RHF (DW10BTED4); RHR (DW10BTED4); RHZ (DW10ATED)		11/04-07/11	DG-181		11V				4
C4 II (B7, NC) (09-)											
1.4 VTi 95	70	8FP (EP3C)	Use narrow 16mm Hex socket	11/09-	VXUH22I	5656	0.9	-	IXUH22TT	VXUH22I	4
1.6 BlueHDi 100	73	BHY (DV6FD)		07/14-	DG-603		5V				4
1.6 BlueHDi 115	85	BHX (DV6FC)		08/14-	DG-603		5V				4
1.6 BlueHDi 120	88	BHZ (DV6FC)		02/15-	DG-603		5V				4
1.6 HDi 90	66	9HJ (DV6DTEDM); 9HP (DV6DTE)		11/09-	DG-603		5V				4
1.6 HDi 110	82	9HR (DV6C)		11/09-	DG-603		5V				4
1.6 HDi 115	84	9HD (DV6C)		07/12-	DG-603		5V				4
1.6 THP 155	115	5FV (EP6CDT)	Use narrow 16mm Hex socket	11/09-12/16	VXUH22I	5656	0.9	-	IXUH22TT	VXUH22I	4
1.6 VTi 120	88	5FS (EP6C)	Use narrow 16mm Hex socket	11/09-12/16	VXUH22I	5656	0.9	-	IXUH22TT	VXUH22I	4
1.6 VTi 120 LPG	88	5FS (EP6C)	Use narrow 16mm Hex socket	09/11-	VXUH22I	5656	0.9	-	IXUH22TT	VXUH22I	4











Свечи зажигания и Свечи накаливания

Таблица применения

	KW				СТАНДАРТНЫЕ				Twin Tip		QTY
											
CITROËN продолжение											
C4 II (B7, NC) (09-) продолжение											
2.0 HDi / BlueHDi 150	110	AHR (DW10FD); RHE (DW10CTED4)		11/09-	DG-603		5V				4
C5 I (01-04)											
1.8 16V	85	6FZ (EW7J4)		03/01-08/04	K16HPR-U11	6076	1.1	KH16TT	IKH16TT	IKH16TT	4
2.0 16V	100	RFN (EW10J4)		03/01-08/04	K16HPR-U11	6076	1.1	KH16TT	IKH16TT	IKH16TT	4
2.0 16V HPI	103	RLZ (EW10D)		03/01-08/04	K16HPR-U11	6076	1.1	KH16TT	IKH16TT	IKH16TT	4
2.0 HDi	66	RHY (DW10TD)		03/01-08/04	DG-116		11V				4
2.0 HDi	80	RHS (DW10ATED); RHZ (DW10ATED)	Ch:>RPO 9666	03/01-04/03	DG-116		11V				4
2.0 HDi	80	RHS (DW10ATED); RHZ (DW10ATED)	Ch:RPO 9667>	04/03-08/04	DG-181		11V				4
2.0 HDi (DERHZB, DERHZE)	80	RHZ (DW10ATED)	Ch:>RPO 9666	06/01-04/03	DG-116		11V				4
2.0 HDi (DERHZB, DERHZE)	80	RHZ (DW10ATED)	Ch:RPO 9667>	04/03-08/04	DG-181		11V				4
2.2 HDi	98	4HX (DW12TED4)	Ch:>RPO 09666	03/01-04/03	DG-116		11V				4
2.2 HDi	98	4HX (DW12TED4)	Ch:RPO 09667>	04/03-08/04	DG-181		11V				4
3.0 Carlsson	173	XFJ (ES9J4S)		09/03-08/04	IKH16TT	4703	1.0	-	IKH16TT		6
3.0 V6	152	XFJ (ES9J4S)		03/01-08/04	IKH16TT	4703	1.0	-	IKH16TT		6
C5 II (04-)											
1.6 HDi	80	9HY (DV6TED4); 9HZ (DV6TED4)	Ch:> RPO 10783, M4 Thread	09/04-05/06	DG-113		11V				4
1.6 HDi	80	9HY (DV6TED4); 9HZ (DV6TED4)	Ch:RPO 10784> ,Pin	05/06-	DG-180		11V				4
1.8 16V	85/92	6FY (EW7A); 6FZ (EW7J4)		09/04-	K16HPR-U11	6076	1.1	KH16TT	IKH16TT	IKH16TT	4
2.0 16V	103	RFJ (EW10A)		09/04-	K16HPR-U11	6076	1.1	KH16TT	IKH16TT	IKH16TT	4
2.0 HDi	100	RHR (DW10BTED4)		09/04-	DG-181		11V				4
2.2 HDi	98	4HX (DW12TED4)		09/04-	DG-181		11V				4
2.2 HDi	120/ 125	4HP (DW12BTED4); 4HR (DW12BTED4); 4HT (DW12BTED4)		04/06-	DG-614		11V				4
3.0	173	XFJ (ES9J4S)		09/04-	IKH16TT	4703	1.0	-	IKH16TT		6
3.0 V6	152/ 155	XFU (ES9A); XFV (ES9A); XFJ (ES9J4S)		09/04-	IKH16TT	4703	1.0	-	IKH16TT		6
C5 III (08-)											
1.6 HDi 110	80	9HZ (DV6TED4)		02/08-	DG-180		11V				4
1.6 HDi 110	82	9HL (DV6C); 9HR (DV6C)		07/10-	DG-603		5V				4
1.6 HDi 115	84	9HL (DV6C); 9HR (DV6C)		01/12-	DG-603		5V				4
1.6 THP 150	110	5FN (EP6CDT)	Use narrow 16mm Hex socket	04/09-	VXUH22I	5656	0.9	-	IXUH22TT	VXUH22I	4
1.6 THP 155	115	5FV (EP6CDT)	Use narrow 16mm Hex socket	04/09-	VXUH22I	5656	0.9	-	IXUH22TT	VXUH22I	4
1.6 VTi 120	88	5FS (EP6C)	Use narrow 16mm Hex socket	07/10-	VXUH22I	5656	0.9	-	IXUH22TT	VXUH22I	4
1.8 16V	92	6FY (EW7A)		02/08-	K16HPR-U11	6076	1.1	KH16TT	IKH16TT	IKH16TT	4
2.0 16V	103	RFJ (EW10A)		02/08-	K16HPR-U11	6076	1.1	KH16TT	IKH16TT	IKH16TT	4
2.0 16V BioFlex	103	RFJ (EW10A)		02/08-	K16HPR-U11	6076	1.1	KH16TT	IKH16TT	IKH16TT	4
2.0 16V BioFlex	103	RFJ (EW10A)		02/08-	K20HR-U11	3381	1.1	KH20TT	IKH20TT	IKH20TT	4
2.0 HDi	100	RHF (DW10BTED4); RHR (DW10BTED4)		02/08-	DG-181		11V				4
2.0 HDi 140	103	RHF (DW10BTED4)		11/08-	DG-181		11V				4
2.0 HDi 150 / BlueHDi 150	110	AHR (DW10FD); RHE (DW10CTED4)		04/09-	DG-603		5V				4
2.0 HDi 165	120	RHH (DW10CTED4)		04/09-	DG-603		5V				4
2.0 HDi 180	133	AHW (DW10FC)		03/15-	DG-603		5V				4
2.2 HDi	125	4HT (DW12BTED4)		02/08-	DG-614		11V				4
2.2 HDi 165	120	4HP (DW12BTED4)		02/08-	DG-614		11V				4
2.2 HDi 200	150	4HL (DW12C)		07/10-	DG-632		5V				4
2.7 HDi	150	UHZ (DT17TED4)		02/08-	DG-140		11V				6
3.0 V6	155	XFU (ES9A); XFV (ES9A)		02/08-	IKH16TT	4703	1.0	-	IKH16TT		6
C6 (05-14)											
2.2 HDi	120	4HP (DW12BTED4)		06/06-12/10	DG-614		11V				4
2.7 HDi	150	UHZ (DT17TED4)		09/05-12/11	DG-140		11V				6

Свечи зажигания и Свечи накаливания

Таблица применения

	KW				СТАНДАРТНЫЕ				Twin Tip			QTY
												
CITROËN продолжение												
C6 (05-14) продолжение												
3.0 V6	155	XFV (ES9A); XFX (ES9J4S)		09/05-12/12	IKH16TT	4703	1.0	-		IKH16TT		6
C8 (02-)												
2.0	100	RFN (EW10J4)		07/02-	K16HPR-U11	6076	1.1		KH16TT	IKH16TT	IKH16TT	4
2.0 16V	103	RFJ (EW10A)		09/05-	K16HPR-U11	6076	1.1		KH16TT	IKH16TT	IKH16TT	4
2.0 HDi	79	RHM (DW10ATED4); RHT (DW10ATED4); RHW (DW10ATED4)	Ch:>RPO 9666	07/02-04/03	DG-116		11V					4
2.0 HDi	79	RHM (DW10ATED4); RHT (DW10ATED4); RHW (DW10ATED4)	Ch:RPO 9667>	04/03-	DG-181		11V					4
2.0 HDi	88	RHK (DW10UTED4)		07/06-	DG-181		11V					4
2.0 HDi 135	103	RHD (DW10CB); RHD (DW10CTED4)		03/06-	DG-603		5V					4
2.0 HDi 135	103	RHR (DW10BTED4)		03/06-	DG-181		11V					4
2.0 HDi 165	120	RHH (DW10CTED4)		03/06-	DG-603		5V					4
2.2	116	3FZ (EW12J4)		07/02-09/05	K20HR-U11	3381	1.1		KH20TT	IKH20TT	IKH20TT	4
2.2 HDi	94	4HW (DW12TED4)	Ch:>RPO 09666	07/02-04/03	DG-116		11V					4
2.2 HDi	94	4HW (DW12TED4)	Ch:RPO 09667>	04/03-	DG-181		11V					4
2.2 HDi	120/ 125	4HP (DW12BTED4); 4HR (DW12BTED4); 4HT (DW12BTED4)		06/06-	DG-614		11V					4
3.0 V6	150	XFX (ES9J4S)		07/02-	IKH16TT	4703	1.0	-		IKH16TT		6
C15 (84-05)												
1.0	33	TU9		10/84-12/97	Q20PR-U	3007	0.8		Q20TT	IQ20TT	IQ20TT	4
1.1	35	109K		10/84-12/96	T20EP-U	5031	0.8		T20TT	IT20TT	IT20TT	4
1.1	40	H1A	Ch: Org Nr.4205>	11/88-07/96	Q20P-U	3125	0.8		Q20TT	IQ20TT	IQ20TT	4
1.1	40/44	HDZ (TU1M); TU1(H1A) - K		10/88-07/96	K20PR-U	3145	0.8		K20TT	IK20TT	IK20TT	4
1.1 i	44	HDZ (TU1M)		07/88-12/96	K20TXR	5063	1.0		K20TT	IK20TT	IK20TT	4
1.3	47	G1A		07/87-05/88	K20PR-U	3145	0.8		K20TT	IK20TT	IK20TT	4
1.4	49	K1H (TU3A)		07/87-12/96	Q20P-U	3125	0.8		Q20TT	IQ20TT	IQ20TT	4
1.4	49/55	TU3.2(K2D) - K; TU3A(K1G) - K		05/87-07/96	K20PR-U	3145	0.8		K20TT	IK20TT	IK20TT	4
1.4 E	40	K3A		07/87-12/96	Q20P-U	3125	0.8		Q20TT	IQ20TT	IQ20TT	4
1.4 E	44	150D (XY7)		05/87-09/87	T20EP-U	5031	0.8		T20TT	IT20TT	IT20TT	4
1.4 i	55	KDY (TU3M)		05/91-12/96	Q20PR-U	3007	0.8		Q20TT	IQ20TT	IQ20TT	4
1.8 D	44	161A (XUD7)		07/86-12/00	DG-001		11V					4
1.9 D	44	WJX (DW8B)		12/00-12/05	DG-003		11V					4
C25 (81-94)												
1.8	50	169 (XM7T)		07/87-01/94	W20EP-U	3043	0.8		W20TT	IW20TT	IW20TT	4
1.8 E	51	169 (XM7T)		07/87-02/94	IW20TT	4709	1.0	-		IW20TT		4
1.9 D	51	D9B (XUD9A/U)		07/87-02/94	DG-001		11V					4
1.9 D 1400	51	DJY (XUD9A)		01/88-01/94	DG-001		11V					4
1.9 DT	60	M705	Double Coil(LPH)	10/91-01/94	DG-001		11V					4
1.9 TD	60	M705	Double Coil(LPH)	04/92-02/94	DG-001		11V					4
2.0	57	XN1T(106)		11/81-12/86	IW20TT	4709	1.0	-		IW20TT		4
2.0	62	170C (XN1T)		01/87-03/94	W20EP-U	3043	0.8		W20TT	IW20TT	IW20TT	4
2.0 E	58	170A (XN1T); 170B (XN1T)		07/83-03/94	IW20TT	4709	1.0	-		IW20TT		4
2.0 E	58	170B		09/81-12/86	W20EP-U	3043	0.8		W20TT	IW20TT	IW20TT	4
2.5 D	54	CRD93L (U25-661)	Double Coil(LPH)	11/81-02/94	DG-001		11V					4
2.5 D 4x4	55	CRD93L (U25-661)	Double Coil(LPH)	11/83-02/94	DG-001		11V					4
2.5 D Turbo	70	CRD93LS (U25-673)	Double Coil(LPH)	08/87-02/94	DG-001		11V					4
2.5 D Turbo 4x4	70	CRD93LS (U25-673)	Double Coil(LPH)	08/87-02/94	DG-001		11V					4
2.5 DT	70	CRD93LS (U25-673)	Double Coil(LPH)	01/87-01/94	DG-001		11V					4
2.5 DT 4x4	70	CRD93LS (U25-673)	Double Coil(LPH)	08/91-01/94	DG-001		11V					4
C35 (73-94)												
2.0	65	B20614		11/73-01/94	W20FP-U	3068	0.7		WF20TT	-		4
2.2 D	45	B22615		11/73-01/80	DG-001		11V					4
2.5 D	51	B25637	Double Coil(LPH)	02/80-01/94	DG-001		11V					4

Свечи зажигания и Свечи накаливания

Таблица применения

	KW				СТАНДАРТНЫЕ			Twin Tip			QTY
CITROËN продолжение											
C-CROSSER (07-)											
2.2 HDi	115	4HK (DW12ME5); 4HN (DW12MTED4)		02/07-	DG-614		11V				4
2.4 16V	125	4B12; SFZ (4B12 MMC)	Euro-4	08/08-06/10	K16PSR-B8	3437	0.8	-	IK16TT	IK16TT	4
2.4 16V	125	4B12; SFZ (4B12 MMC)	Euro-5	07/10-	IK16TT	4701	1.0	-	IK16TT	IK16TT	4
C-ELYSEE (12-)											
1.2 VTi 72	53	HMY (EB2M)		11/12-	IXUH22I	5356	0.9	-	IXUH22TT	VXUH22I	3
1.2 VTi 82	60	HMZ (EB2); HMZ (EB2F)		12/14-	IXUH22I	5356	0.9	-	IXUH22TT	VXUH22I	3
1.6 BlueHDi 100	73	BHY (DV6FD)		11/14-	DG-603		5V				4
1.6 HDi 92	68	9HJ (DV6DTEDM); 9HP (DV6DTEED)		11/12-	DG-603		5V				4
1.6 VTi 115	85	NFP (EC5)		11/12-	K16HPR-U11	6076	1.1		KH16TT	IKH16TT	4
CX I (74-85)											
25 D Turbo	70	M25-648	Double Coil Std(LPH)	04/83-08/85	DG-001		11V				4
25 TRi	100	M25-659		07/83-08/85	W20FP-U	3068	0.7	WF20TT	-		4
25 TRI	100	M25-659		07/83-08/85	W22FPR-U	4022	0.7	-	-		4
2000	75	M20-616		09/75-05/79	W20FP-U	3068	0.7	WF20TT	-		4
2000	78	829 A5		06/79-08/85	T20EP-U	5031	0.8	T20TT	IT20TT	IT20TT	4
2200	82	M20/616		09/74-07/76	W20FPR-U	3070	0.7	WF20TT	-		4
2200	82	M22-617		09/74-07/76	DG-001		11V				4
2200	85	J6T A500		06/81-08/85	T22EP-U	5040	0.8	-	-		4
2200 D	49	M22-621		10/75-02/79	DG-001		11V				4
2400	85/88	M23-623; M23-639		08/76-05/82	W20FP-U	3068	0.7	WF20TT	-		4
2400 GTi	94/96	M23-622		06/77-06/82	W20FP-U	3068	0.7	WF20TT	-		4
2500 D	55	M25-629	Double Coil(LPH)	02/78-08/85	DG-001		11V				4
2500 D Turbo	70	M25-648	Double Coil(LPH)	04/83-08/85	DG-001		11V				4
CX II (85-92)											
20	78	829 A5		08/85-08/86	T20EP-U	5031	0.8	T20TT	IT20TT	IT20TT	4
20 RE	78	829 A5		08/85-12/92	T20EP-U	5031	0.8	T20TT	IT20TT	IT20TT	4
22 TRS	83/85	J6T A500		07/85-12/92	T22EP-U	5040	0.8	-	-		4
22TRS	85	J6T A500		07/85-07/89	T22EP-U	5040	0.8	-	-		4
25 D	54	M25-660	Double Coil Std(LPH)	08/85-12/92	DG-001		11V				4
25 D Turbo	70/88	M25-648; M25-669	Double Coil(LPH)	08/85-12/92	DG-001		11V				4
25 D Turbo 2	88	M25-669	Double Coil(LPH)	01/87-12/92	DG-001		11V				4
25 GTi	89	M25-668		05/86-12/86	W20FPR-U	3070	0.7	WF20TT	-		4
25 i	89	M25-668		05/86-12/92	W20FPR-U	3070	0.7	WF20TT	-		4
25 TRI	100	M25-659		08/85-07/87	W22FPR-U	4022	0.7	-	-		4
25 TRi	100	M25-659		08/85-07/89	W20FP-U	3068	0.7	WF20TT	-		4
2500 D Turbo	70	M25-648	Double Coil Std(LPH)	08/85-12/86	DG-001		11V				4
DS (56-75)											
2.2	102	B22627		02/69-06/72	DG-001		11V				4
21	74/ 76/ 78/88	B22627; B22644		09/65-08/75	DG-001		11V				4
DS3 (09-15)											
1.2 VTi 82	60	HMZ (EB2); HMZ (EB2F)		01/13-07/15	IXUH22I	5356	0.9	-	IXUH22TT	VXUH22I	3
1.4 HDi 70	50	8HR (DV4C)		04/10-07/15	DG-603		5V				4
1.4 VTi 95	70	8FP (EP3C)	Use narrow 16mm Hex socket	04/10-07/15	VXUH22I	5656	0.9	-	IXUH22TT	VXUH22I	4
1.4 VTi 95 LPG	70	8FR (EP3C)	Use narrow 16mm Hex socket	08/12-07/15	VXUH22I	5656	0.9	-	IXUH22TT	VXUH22I	4
1.4 VTi 98	72	8FR (EP3C)	Use narrow 16mm Hex socket	11/09-07/15	VXUH22I	5656	0.9	-	IXUH22TT	VXUH22I	4
1.6	120	5FM (EP6DT)	Use narrow 16mm Hex socket	01/12-07/15	VXUH22I	5656	0.9	-	IXUH22TT	VXUH22I	4
1.6 BlueHDi 75	55	BHW (DV6FE)		03/15-07/15	DG-603		5V				4
1.6 BlueHDi 100	73	BHY (DV6FD)		07/14-07/15	DG-603		5V				4
1.6 BlueHDi 115	85	BHX (DV6FC)		10/13-07/15	DG-603		5V				4
1.6 BlueHDi 120	88	BHZ (DV6FC)		10/13-07/15	DG-603		5V				4

Свечи зажигания и Свечи накаливания

Таблица применения

Таблица применения

	KW				СТАНДАРТНЫЕ			Twin Tip			QTY
											
CITROËN продолжение											
DS3 (09-15) продолжение											
1.6 HDi 90	66	9HP (DV6DTE)		11/09-07/15	DG-603		5V				4
1.6 HDi 110	82	9HR (DV6C)		11/09-07/15	DG-603		5V				4
1.6 HDi 115	84	9HD (DV6C); BHX (DV6FC)		08/12-07/15	DG-603		5V				4
1.6 Racing	149	5FF (EP6DTS)	Use narrow 16mm Hex socket	02/11-07/15	VXUH22I	5656	0.9	-	IXUH22TT	VXUH22I	4
1.6 THP 150	110	5FN (EP6CDT); 5FX (EP6DT)	Use narrow 16mm Hex socket	01/10-07/15	VXUH22I	5656	0.9	-	IXUH22TT	VXUH22I	4
1.6 THP 155	115	5FR (EP6DT); 5FV (EP6CDT)	Use narrow 16mm Hex socket	04/10-07/15	VXUH22I	5656	0.9	-	IXUH22TT	VXUH22I	4
1.6 THP 165	121	5GZ (EP6FDT)	Use narrow 16mm Hex socket	10/14-07/15	VXUH22I	5656	0.9	-	IXUH22TT	VXUH22I	4
1.6 VTi 120	88	5FS (EP6C)	Use narrow 16mm Hex socket	04/10-07/15	VXUH22I	5656	0.9	-	IXUH22TT	VXUH22I	4
DS4 (11-15)											
1.6 BlueHDi 115	85	BHX (DV6FC)		07/14-07/15	DG-603		5V				4
1.6 BlueHDi 120	88	BHZ (DV6FC)		07/14-07/15	DG-603		5V				4
1.6 HDi 90	66	9HP (DV6DTE)		05/11-07/15	DG-603		5V				4
1.6 HDi 110	82	9HR (DV6C)		04/11-07/15	DG-603		5V				4
1.6 HDi 115	84	9HD (DV6C)		08/12-07/15	DG-603		5V				4
1.6 THP 155	115	5FV (EP6CDT)	Use narrow 16mm Hex socket	04/11-07/15	VXUH22I	5656	0.9	-	IXUH22TT	VXUH22I	4
1.6 THP 160	120	5FM (EP6CDTM)	Use narrow 16mm Hex socket	04/12-07/15	VXUH22I	5656	0.9	-	IXUH22TT	VXUH22I	4
1.6 THP 165	121	5FM (EP6CDTM); 5GZ (EP6FDT)	Use narrow 16mm Hex socket	01/12-07/15	VXUH22I	5656	0.9	-	IXUH22TT	VXUH22I	4
1.6 VTi 120	88	5FS (EP6C)	Use narrow 16mm Hex socket	04/11-07/15	VXUH22I	5656	0.9	-	IXUH22TT	VXUH22I	4
2.0 BlueHDi 150	110	AHX (DW10FD)		07/14-07/15	DG-603		5V				4
2.0 BlueHDi 180	132	AHW (DW10FC)		07/14-07/15	DG-603		5V				4
2.0 HDi / BlueHDi 135	100	AHS (DW10FD); AHV (DW10FD); RHD (DW10CB); RHD (DW10CTED4)		09/11-07/15	DG-603		5V				4
2.0 HDi 165	120	RHH (DW10CTED4)		04/11-07/15	DG-603		5V				4
DS5 (11-15)											
1.6 BlueHDi 120	88	BHZ (DV6FC)		07/14-07/15	DG-603		5V				4
1.6 HDi	85	BHX (DV6FC)		11/13-07/15	DG-603		5V				4
1.6 HDi 110	82	9HR (DV6C)		11/11-07/15	DG-603		5V				4
1.6 HDi 115	84	9HD (DV6C)		06/12-07/15	DG-603		5V				4
1.6 THP 155	115	5FV (EP6CDT)	Use narrow 16mm Hex socket	11/11-07/15	VXUH22I	5656	0.9	-	IXUH22TT	VXUH22I	4
1.6 THP 165	121	5FM (EP6CDTM); 5FM (EP6DT); 5GZ (EP6FDT)	Use narrow 16mm Hex socket	01/12-07/15	VXUH22I	5656	0.9	-	IXUH22TT	VXUH22I	4
1.6 THP 165 Hybrid	121	5GZ (EP6FDT)	Use narrow 16mm Hex socket	06/12-07/15	VXUH22I	5656	0.9	-	IXUH22TT	VXUH22I	4
2.0 BlueHDi 150	110	AHX (DW10FD)		07/14-07/15	DG-603		5V				4
2.0 BlueHDi 180	132	AHW (DW10FC)		08/13-07/15	DG-603		5V				4
2.0 HDi 135	103	RHD (DW10CB)		11/11-07/15	DG-603		5V				4
2.0 HDi 165	120	RHH (DW10CTED4)		11/11-07/15	DG-603		5V				4
2.0 HDi 165 Hybrid4 4x4	120	RHC (DW10CTED4)		12/11-07/15	DG-603		5V				4
2.0 HDi 200 Hybrid4 AWD	147	AHS (DW10FD)		12/11-07/15	DG-603		5V				4
DYANE (67-84)											
6	21	M28 (AM2)		12/68-10/84	W20FPR-U	3070	0.7	WF20TT	-		2
6	24	M28/1 (AK2)		05/72-12/80	W20FSR-U	6053	0.7	WF20TT	-		2
EVASION (94-02)											
1.8	73/76	LFZ (XU7JP)		02/96-07/02	K20TXR	5063	1.0	K20TT	IK20TT	IK20TT	4
1.9 TD	66/68	D8B (XUD9TF); DHX (XUD9TF/BTF)		11/94-07/02	DG-001		11V				4
2.0	89	RFU (XU10J2/C)		06/94-07/02	Q20PR-U	3007	0.8	Q20TT	IQ20TT	IQ20TT	4
2.0 16V	97	RFV (XU10J4R)		05/98-04/00	K20TXR	5063	1.0	K20TT	IK20TT	IK20TT	4
2.0 16V	100	RFN (EW10J4)		05/00-07/02	K16HPR-U11	6076	1.1	KH16TT	IKH16TT	IKH16TT	4
2.0 HDi	80	RHZ (DW10ATED)		08/89-07/02	DG-116		11V				4

Свечи зажигания и Свечи накаливания

Таблица применения











	KW				СТАНДАРТНЫЕ			Twin Tip			QTY
											
CITROËN продолжение											
EVASION (94-02) продолжение											
2.0 HDI 16V	80	RHW (DW10ATED4)		09/99-07/02	DG-116		11V				4
2.0 Turbo C.T.	108	RGX (XU10J2TE)		06/94-07/02	K20PR-U	3145	0.8	K20TT	IK20TT	IK20TT	4
2.1 TD	80	P8C (XUD11BTE)		05/96-07/02	DG-001		11V				4
GS (70-86)											
1.0	40	G10/612; G10		09/70-09/77	W20EPR-U	3047	0.8	W20TT	IW20TT	IW20TT	4
1.2	43	G12/611; G12/612		04/73-06/79	T20EPR-U	5032	0.8	T20TT	IT20TT	IT20TT	4
1.2 A	43	G12/611; G12/612		04/73-06/79	T20EPR-U	5032	0.8	T20TT	IT20TT	IT20TT	4
1.2 X2	46	G12/619		09/75-07/79	T20EPR-U	5032	0.8	T20TT	IT20TT	IT20TT	4
1.3 A	48	G11/646/G13/625		07/78-07/86	T20EPR-U	5032	0.8	T20TT	IT20TT	IT20TT	4
HY (69-77)											
1.9	41	1911		11/69-08/77	W20FPR-U	3070	0.7	WF20TT	-		4
ID (56-75)											
21 F	74/76	B22604; B22644		04/66-11/72	DG-001		11V				4
JUMPER (94-02)											
1.9 D	51	D9B (XUD9A/U); DJY (XUD9A)		02/94-04/02	DG-001		11V				4
1.9 TD	66/68	D8C (XUD9UTF); DHX (XUD9TF/BTF)		02/94-04/02	DG-001		11V				4
1.9 TD 4x4	68	D8C (XUD9UTF)		08/96-04/02	DG-001		11V				4
2.0	80	RFW (XU10J2U)		02/94-04/02	K20TXR	5063	1.0	K20TT	IK20TT	IK20TT	4
2.0	80	RFW (XU10J2U)		03/94-04/02	Q20PR-U	3007	0.8	Q20TT	IQ20TT	IQ20TT	4
2.0 4x4	80	RFW (XU10J2U)		08/96-04/02	Q20PR-U	3007	0.8	Q20TT	IQ20TT	IQ20TT	4
2.0 4x4	80	RFW (XU10J2U)		10/96-01/02	K20PR-U	3145	0.8	K20TT	IK20TT	IK20TT	4
2.0 HDI	62	RHV (DW10TD)		11/01-04/02	DG-116		11V				4
2.5 D	63	T9A (DJ5)	Double Coil(LPH)	03/94-04/02	DG-001		11V				4
2.5 D 4x4	63	T9A (DJ5)	Double Coil(LPH)	08/96-04/02	DG-001		11V				4
2.5 DT 4x4	76	THZ (DJ5T)	Double Coil(LPH)	10/96-08/97	DG-001		11V				4
2.5 TD	76	T8A (DJ5T)	Double Coil(LPH)	03/94-04/02	DG-001		11V				4
2.5 TD 4x4	76	T8A (DJ5T)	Double Coil(LPH)	08/96-04/02	DG-001		11V				4
2.5 TDi	79	THX (DJ5TED)	Double Coil(LPH)	12/96-04/02	DG-161		11V				4
2.5 TDi 4x4	79	THX (DJ5TED)	Double Coil(LPH)	12/96-04/02	DG-161		11V				4
2.8 D	64	8140.63 (F28D)		01/99-02/02	DG-111		11V				4
2.8 HDi	94	8140.43S	Double Coil(LPH)	09/00-04/02	DG-111		11V				4
2.8 HDi 4x4	94	8140.43S	Double Coil(LPH)	09/00-04/02	DG-111		11V				4
JUMPER (02-)											
2.0	81	XU10J2U(RFW)		04/02-06/06	K20PR-U	3145	0.8	K20TT	IK20TT	IK20TT	4
2.0 bivalent	81	XU10J2U/RFW(GNV)	Flexible fuel	02/03-06/06	K20PR-U	3145	0.8	K20TT	IK20TT	IK20TT	4
2.0 HDi	62	RHV (DW10UTD)		04/02-	DG-116		11V				4
2.2 HDi	74	4HY (DW12UTED)	Ch:>RPO 09666	02/02-04/03	DG-116		11V				4
2.2 HDi	74	4HY (DW12UTED)	Ch:RPO 09667>	04/03-	DG-181		11V				4
2.8 HDi	94/ 107	8140.43N; 8140.43S	Double Coil(LPH)	04/02-	DG-111		11V				4
2.8 HDi 4x4	94	8140.43S; F28TDCR	Double Coil(LPH)	02/02-	DG-111		11V				4
2.8 HDi AWD	94	8140.43S	Double Coil(LPH)	04/02-	DG-111		11V				4
JUMPER (06-)											
2.0 BlueHdi 110	81	DW10FUE		07/15-09/19	DG-603		5V				4
2.0 BlueHdi 130	96	AHN (DW10FUD)		07/15-09/19	DG-603		5V				4
2.0 BlueHdi 160	120	AHP (DW10FUC)		07/15-09/19	DG-603		5V				4
2.2 HDi 100	74	4HV (P22DTE)		04/06-	DG-130		11.5V				4
2.2 HDi 110	81	4HG (P22DTE)		07/11-	DG-611		4.4V				4
2.2 HDi 120	88	4HU (P22DTE)		04/06-	DG-130		11.5V				4
2.2 HDi 130	96	4HH (P22DTE)		07/11-	DG-611		4.4V				4
2.2 HDi 150	110	4HJ (P22DTE)		07/11-	DG-611		4.4V				4
3.0 HDi 145	107	F30DTE (F1CE3481N)		07/10-	DG-195		11V				4
3.0 HDi 155	115	F1CE0481D (F30DT)		07/10-	DG-195		11V				4
3.0 HDi 160	116	F1CE0481D (F30DT)		09/06-	DG-195		11V				4
3.0 HDi 180	130	F1CE3481E (F30DTE)		07/11-	DG-195		11V				4











Таблица применения

C

Свечи зажигания и Свечи накаливания









Таблица применения

Таблица применения

	KW				СТАНДАРТНЫЕ			Twin Tip			QTY
											
CITROËN продолжение											
JUMPY (95-06)											
1.6	58	160A - L/160A - L3/ 160A - W2, 160A - W3		10/95-08/00	Q20PR-U	3007	0.8	Q20TT	IQ20TT	IQ20TT	4
1.6 i	58	220 A2.000		10/95-08/00	Q20PR-U	3007	0.8	Q20TT	IQ20TT	IQ20TT	4
1.9 D	51	D9B (XUD9A/U)		10/95-08/98	DG-001		11V				4
1.9 D 70	51	WJY (DW8B); WJZ (DW8)		04/98-10/06	DG-003		11V				4
1.9 DT	65			10/95-08/00	DG-001		11V				4
1.9 TD	66/68	D8B (XUD9TE); D8B (XUD9TF); DHX (XUD9TF/BTF)		10/95-10/06	DG-001		11V				4
2.0	100	RFN (EW10J4)		04/00-12/06	K16HPR-U11	6076	1.1	KH16TT	IKH16TT	IKH16TT	4
2.0 HDi 95	69	RHX (DW10BTED)		10/99-10/06	DG-181		11V				4
2.0 HDi 110	80	RHW (DW10ATED4); RHZ (DW10ATED); RHZ (DW10BTED); RHZ (DW10BTED+); RHZ (DW10CTED); RHZ (DW10CTED+)	Ch:>RPO 9666	03/00-04/03	DG-116		11V				4
2.0 HDi 110	80	RHW (DW10ATED4); RHZ (DW10ATED); RHZ (DW10BTED); RHZ (DW10BTED+); RHZ (DW10CTED); RHZ (DW10CTED+)	Ch:RPO 9667>	04/03-10/06	DG-181		11V				4
2.0 HDi 110	80	RHZ (DW10ATED); RHZ (DW10BTED); RHZ (DW10BTED+); RHZ (DW10CTED); RHZ (DW10CTED+)		12/03-10/06	DG-181		11V				4
2.0 HDi 110 16V	80	RHW (DW10ATED4)		12/03-10/06	DG-181		11V				4
2.0 i 16V	102	RFN (EW10J4)		03/00-10/06	K16HPR-U11	6076	1.1	KH16TT	IKH16TT	IKH16TT	4
JUMPY (07-)											
1.6 HDi 90 8V	66	9HH (DV6DUM); 9HM (DV6UC)		01/07-	DG-603		5V				4
1.6 HDi 90 16V	66	9HU (DV6UTED4)		01/07-	DG-180		11V				4
2.0 HDi 95	72	AHY (DW10CE)		07/11-	DG-603		5V				4
2.0 HDi 120	88	RHK (DW10UTED4)		01/07-	DG-181		11V				4
2.0 HDi 120 4x4	88	RHK (DW10UTED4)		01/10-	DG-181		11V				4
2.0 HDi 125	94	AHZ (DW10CD)		07/11-	DG-603		5V				4
2.0 HDi 140	103	RHR (DW10BTED4)		01/07-	DG-181		11V				4
2.0 HDi 165	120	RHH (DW10CTED4)		07/10-	DG-603		5V				4
2.0 i	103	EW10A(RFJ); RFH (EW10A)		01/07-	K20HR-U11	3381	1.1	KH20TT	IKH20TT	IKH20TT	4
2.0 i	103	RFH (EW10A)		01/07-	K16HPR-U11	6076	1.1	KH16TT	IKH16TT	IKH16TT	4
JUMPY (16-)											
1.6 BlueHDi 115	85	DV6C; DV6FC		04/16-	DG-603		5V				4
2.0 BlueHDi 120	90	DW10FE		04/16-	DG-603		5V				4
2.0 BlueHDi 180	132	AHW (DW10FC)		04/16-	DG-603		5V				4
LNA (76-86)											
0.6	25	R06 627		11/76-07/79	W20FS-U	3073	0.7	WF20TT	-		2
0.6	25	V06 630; V06 644		11/78-07/86	T20EPR-U	5032	0.8	T20TT	IT20TT	IT20TT	2
1.1	37	109/5E		07/82-04/85	T20EP-U	5031	0.8	T20TT	IT20TT	IT20TT	4
MEHARI (68-87)											
4x4	21	A06/635		10/79-10/87	W20FSR-U	6053	0.7	WF20TT	-		2
NEMO (08-)											
1.3 BlueHDi 80	59	FHY (F13DTE6)	Euro-5,OE: 5960 L4	02/16-	DG-621		4.4V				4
1.3 BlueHDi 80	59	FHY (F13DTE6)	Euro-6,OE: 1616317380 (R P9016)	02/16-	DG-658		5V				4
1.3 HDi 75	55	FHZ (F13DTE5)	Euro-5,OE: 5960 L4	10/10-	DG-621		4.4V				4
1.3 HDi 75	55	FHZ (F13DTE5)	Euro-6,OE: 1616317380 (R P9016)	10/10-	DG-658		5V				4
1.3 HDi 80	59	FHY (F13DTE6)	Euro-5,OE: 5960 L4	10/15-	DG-621		4.4V				4
1.3 HDi 80	59	FHY (F13DTE6)	Euro-6,OE: 1616317380 (R P9016)	10/15-	DG-658		5V				4
1.4	54	KFT (TU3A); KFV (TU3A)		02/08-	K20PR-U	3145	0.8	K20TT	IK20TT	IK20TT	4
1.4 HDi	50	8HS (DV4TED)		02/08-	DG-180		11V				4

Свечи зажигания и Свечи накаливания

Таблица применения

	KW				СТАНДАРТНЫЕ			Twin Tip		QTY	
											
CITROËN продолжение											
SAXO (96-04)											
1.0 X	33/37	CDZ (TU9M)		05/96-06/03	K20TXR	5063	1.0	K20TT	IK20TT	IK20TT	4
1.1 X,SX	40/44	HDZ (TU1M)		05/96-09/03	K20TXR	5063	1.0	K20TT	IK20TT	IK20TT	4
1.4 VTS	55	KFX (TU3JP)		05/96-06/03	K20PR-U	3145	0.8	K20TT	IK20TT	IK20TT	4
1.5 D	40/43	VJX (TUD5); VJY (TUD5); VJZ (TUD5)		09/96-04/04	DG-003		11V				4
1.6	66	NFZ (TU5JP)		02/96-06/03	K20TXR	5063	1.0	K20TT	IK20TT	IK20TT	4
1.6	74	NFT (TU5JP)		02/01-04/04	K20TNR	3304	1.0	K20TT	IK20TT	IK20TT	4
1.6	88	NFX (TU5JP4)		02/96-04/04	K20TNR-S9	3305	0.9	K20TT	IK20TT	IK20TT	4
1.6 VTL,VTR	65	NFZ (TU5JP)		05/96-06/03	K20TXR	5063	1.0	K20TT	IK20TT	IK20TT	4
1.6 VTS	72	NFT (TU5JP)		09/00-09/03	K20PR-U	3145	0.8	K20TT	IK20TT	IK20TT	4
1.6 VTS	87	NFX (TU5JP4)		06/96-09/03	K20TXR	5063	1.0	K20TT	IK20TT	IK20TT	4
SPACETOURER (16-)											
1.6 BlueHdi 115	85	DV6C; DV6FC		04/16-	DG-603		5V				4
2.0 BlueHdi 180	132	AHW (DW10FC)		04/16-	DG-603		5V				4
VISA (78-91)											
0.6	25	V06 630; V06/665		09/78-06/88	T22EP-U	5040	0.8	-	-		2
1.0	33	XV8		09/84-06/88	T20EP-U	5031	0.8	T20TT	IT20TT	IT20TT	4
11 E	36/42	109/5F; 109K		09/78-03/91	T20EP-U	5031	0.8	T20TT	IT20TT	IT20TT	4
11 RE	37	109/5F		03/83-10/88	T20EP-U	5031	0.8	T20TT	IT20TT	IT20TT	4
14	44	150D (XY7)		07/84-03/91	T22EP-U	5040	0.8	-	-		4
14 GT	55/58	150B (XY8)		03/82-03/91	T22EP-U	5040	0.8	-	-		4
16 GTI	76	180A (XU5J)		01/85-06/86	T22EP-U	5040	0.8	-	-		4
16 GTI	83	B6D		06/86-03/91	Q22P-U	3255	0.8	-	-	VQ22	4
17 D	44	161A (XUD7)		04/84-03/91	DG-001		11V				4
Il Super X	47	129/5		07/80-06/82	T20EP-U	5031	0.8	T20TT	IT20TT	IT20TT	4
XANTIA (93-03)											
1.6 i	65	BFZ (XU5JP)		03/93-03/01	K20TXR	5063	1.0	K20TT	IK20TT	IK20TT	4
1.8 i	66/74	LFX (XU7JB); LFZ (XU7JP)		03/93-04/03	K20TXR	5063	1.0	K20TT	IK20TT	IK20TT	4
1.8 i 16V	81	LFY (XU7JP4)		06/95-04/03	K20TXR	5063	1.0	K20TT	IK20TT	IK20TT	4
1.9 D	50	D9B (XUD9A/L); DJZ (XUD9A)		06/94-01/98	DG-001		11V				4
1.9 SD	55	DHW (XUD9SD)		02/96-04/03	DG-001		11V				4
1.9 Turbo D	66	D8B (XUD9TF); DHX (XUD9TF/ BTF); DHY (XUD9TE/Y)		05/93-04/03	DG-001		11V				4
2.0 HDI 90	66	RHY (DW10TD)		03/99-04/03	DG-116		11V				4
2.0 HDI 109	80	RHZ (DW10ATED)		02/99-04/03	DG-116		11V				4
2.0 i	89	RFX (XU10J2C)		03/93-04/03	K20TXR	5063	1.0	K20TT	IK20TT	IK20TT	4
2.0 i 16V	97	RFV (XU10J4R)		06/95-04/03	K20TXR	5063	1.0	K20TT	IK20TT	IK20TT	4
2.0 i 16V	110/ 112	RFT (XU10J4/Z); RFY (XU10J4/Z)		03/93-01/98	K20PR-U	3145	0.8	K20TT	IK20TT	IK20TT	4
2.0 Turbo	108	RGX (XU10J2TE)		06/95-04/03	K20PR-U	3145	0.8	K20TT	IK20TT	IK20TT	4
2.1 Turbo D 12V	80	P8C (XUD11BTE)		06/95-02/99	DG-001		11V				4
3.0 i 24V	140	XFZ (ES9J4)		01/97-04/03	K20TXR	5063	1.0	K20TT	IK20TT	IK20TT	6
3.0 V6	140	XFZ (ES9J4)		01/98-04/03	K20TXR	5063	1.0	K20TT	IK20TT	IK20TT	6
XM (89-94)											
2.0	85			05/89-12/92	Q22PR-U	3010	0.8	-	-	VQ22	4
2.0	94	XU10J2(R6A) - K		05/89-06/94	Q20PR-U	3007	0.8	Q20TT	IQ20TT	IQ20TT	4
2.0 i	79/89	RDZ (XU10MZ); RFZ (XU10J2)		05/89-06/94	Q20PR-U	3007	0.8	Q20TT	IQ20TT	IQ20TT	4
2.1 D 12V	60	P9A (XUD11A)		05/89-06/94	DG-001		11V				4
2.1 TD 12V	80	P8A (XUD11ATE); P8C (XUD11BTE); PHZ (XUD11ATE); PJZ (XUD11ATE)		05/89-06/94	DG-001		11V				4
3.0	123	ZPJ(S6A) - K		05/89-05/94	K20PBR	5060	0.85	K20TT	IK20TT	IK20TT	6
3.0 V6	123	UFZ (ZPJ/Z)		05/89-06/94	K20PBR	5060	0.85	K20TT	IK20TT	IK20TT	6
3.0 V6	123	UFZ (ZPJ/Z)		11/91-04/94	K22PBR-S	5062	0.85	-	IKB22TT	VK22	6
3.0 V6 24V	147	UKZ (ZPJ4/Z)		07/90-06/94	K20PBR	5060	0.85	K20TT	IK20TT	IK20TT	6
XM (94-00)											
2.0 i 16V	97	RFV (XU10J4R)		07/95-10/00	K20TXR	5063	1.0	K20TT	IK20TT	IK20TT	4
2.0 Turbo	108	RGX (XU10J2TE); RGY (XU10J2TE/Z)		05/94-10/00	K20PR-U	3145	0.8	K20TT	IK20TT	IK20TT	4
2.1 D12	60	P9A (XUD11A)		07/94-06/96	DG-001		11V				4
2.1 D12 VSX	60	P9A (XUD11A)		03/96-08/96	DG-001		11V				4

Свечи зажигания и Свечи накаливания











Таблица применения

Таблица применения

KW	KW	NOTE	21	СТАНДАРТНЫЕ			Twin Tip			QTY
				1mm	1mm	1mm	1mm	1mm	1mm	
CITROËN продолжение										
XM (94-00) продолжение										
2.1 TD 12V	80	P8A (XUD11ATE); P8C (XUD11BTE); PHZ (XUD11ATE); PJZ (XUD11ATE)		05/94-10/00	DG-001		11V			4
2.5 TD	95	THY (DK5ATE)	Double Coil(LPH)	05/94-10/00	DG-001		11V			4
3.0 V6	123	UFZ (ZPJ/Z)		05/94-12/98	K20PBR	5060	0.85	K20TT	IK20TT	6
3.0 V6	140	XFZ (ES9J4)		04/97-10/00	K20TXR	5063	1.0	K20TT	IK20TT	6
3.0 V6 24V	147	UKZ (ZPJ4/Z)		05/94-04/97	K20PBR	5060	0.85	K20TT	IK20TT	6
XSARA (97-05)										
1.4 HDi	50	8HX (DV4TD)		01/03-08/05	DG-113		11V			4
1.4 i	55	KFX (TU3JP)		04/97-08/05	K20PR-U	3145	0.8	K20TT	IK20TT	4
1.4 i	55	KFX (TU3JP)		03/98-03/05	K20TXR	5063	1.0	K20TT	IK20TT	4
1.5 D	42	VJZ (TUD5)		04/97-09/00	DG-003		11V			4
1.6 16V	80	NFU (TU5JP4)		09/00-08/05	K16HPR-U11	6076	1.1	KH16TT	IKH16TT	4
1.6 i	65	NFZ (TU5JP)		04/97-09/00	K16PR-U	3191	0.8	K16TT	IK16TT	4
1.8 D	43	161A (XUD7); A9A (XUD7)		04/97-09/00	DG-001		11V			4
1.8 i	66/74	LFZ (XU7JB); LFZ (XU7JP)		04/97-09/00	K20TXR	5063	1.0	K20TT	IK20TT	4
1.8 i 16V	81	LFY (XU7JP4)		04/97-09/00	K20TXR	5063	1.0	K20TT	IK20TT	4
1.8 i Aut.	74	LFZ (XU7JP)		04/97-09/00	K20TXR	5063	1.0	K20TT	IK20TT	4
1.8 VTS	85	6FZ (EW7J4)		08/98-10/04	K16HPR-U11	6076	1.1	KH16TT	IKH16TT	4
1.9 D	51	WJY (DW8B); WJZ (DW8)		07/98-08/05	DG-003		11V			4
1.9 D	51/55	DHV (XUD9BSD); DJY (XUD9A)		04/97-09/00	DG-001		11V			4
1.9 SD	55	DHV (XUD9BSD)		01/98-09/00	DG-001		11V			4
1.9 TD	66	DHY (XUD9TE/Y)		04/97-09/00	DG-001		11V			4
2.0 16V	97	RFV (XU10J4R)		07/98-09/00	K20TXR	5063	1.0	K20TT	IK20TT	4
2.0 16V	100	RFN (EW10J4)		09/00-08/05	K16HPR-U11	6076	1.1	KH16TT	IKH16TT	4
2.0 HDi	66	RHY (DW10TD)		04/01-03/05	DG-116		11V			4
2.0 HDi 90	66	RHY (DW10TD)		02/99-08/05	DG-116		11V			4
2.0 HDi 109	80	RHZ (DW10ATED)	Ch:>RPO 9666	05/01-04/03	DG-116		11V			4
2.0 HDi 109	80	RHZ (DW10ATED)	Ch:RPO 9667>	04/03-08/05	DG-181		11V			4
2.0 i 16V	120	RFS (XU10J4RS)		02/98-11/98	K20PBR	5060	0.85	K20TT	IK20TT	4
2.0 i 16V	120	RFS (XU10J4RS)		11/98-03/05	K20PR-U	3145	0.8	K20TT	IK20TT	4
XSARA Picasso (99-11)										
1.6	65/ 67/70	NFV (TU5JP); NFZ (TU5JP)		12/99-12/10	K16PR-U	3191	0.8	K16TT	IK16TT	4
1.6 16V	80	NFU (TU5JP4)		06/05-12/11	K16HPR-U11	6076	1.1	KH16TT	IKH16TT	4
1.6 Chrono	74	NFV (TU5JP)		04/01-10/04	K16PR-U	3191	0.8	K16TT	IK16TT	4
1.6 HDi	66	9HX (DV6ATED4)	Ch:> ORP 10783, M4 Thread	09/05-05/06	DG-113		11V			4
1.6 HDi	66	9HX (DV6ATED4)	Ch:ORP 10784> ,Pin	05/06-12/11	DG-180		11V			4
1.6 HDi	80	9HY (DV6TED4); 9HZ (DV6TED4)	Ch:> RPO 10783, M4 Thread	05/04-05/06	DG-113		11V			4
1.6 HDi	80	9HY (DV6TED4); 9HZ (DV6TED4)	Ch:RPO 10784> ,Pin	05/06-12/11	DG-180		11V			4
1.8 16V	85	6FZ (EW7J4)		02/00-08/05	K16HPR-U11	6076	1.1	KH16TT	IKH16TT	4
2.0 16V	100	RFN (EW10J4)		12/99-06/12	K16HPR-U11	6076	1.1	KH16TT	IKH16TT	4
2.0 HDi	66	RHY (DW10TD)		12/99-12/11	DG-116		11V			4
ZX (91-98)										
1.1	44	HDZ (TU1M)		03/91-06/97	K20TXR	5063	1.0	K20TT	IK20TT	4
1.4	55	KDZ (TU3M/Z)		03/91-06/97	Q20PR-U	3007	0.8	Q20TT	IQ20TT	4
1.4 D	37	K9Y (TUD3Y)	Double Coil(LPH)	07/94-10/97	DG-004		11V			4
1.4 i	55	KFX (TU3JP)		03/91-06/97	K20TXR	5063	1.0	K20TT	IK20TT	4
1.4 i	55	KFX (TU3JP)		10/93-10/97	K20PR-U	3145	0.8	K20TT	IK20TT	4
1.6	66	BDY (XU5M); BFZ (XU5JP)		07/94-10/97	K20TXR	5063	1.0	K20TT	IK20TT	4
1.6 i	65	BDY (XU5M); BFZ (XU5JP)		03/91-10/97	Q20PR-U	3007	0.8	Q20TT	IQ20TT	4
1.8	76	LFZ (XU7JP)		03/91-10/97	K20PR-U	3145	0.8	K20TT	IK20TT	4
1.8	82	LFY (XU7JP4)		04/96-10/97	K20TXR	5063	1.0	K20TT	IK20TT	4
1.8 D	44	161A (XUD7)		06/93-10/97	DG-001		11V			4
1.8 i	74	LFZ (XU7JP)		07/92-10/97	K20TXR	5063	1.0	K20TT	IK20TT	4
1.8 i 16V	81	LFY (XU7JP4)		01/96-02/98	K20TXR	5063	1.0	K20TT	IK20TT	4

Свечи зажигания и Свечи накаливания











Таблица применения

	KW				СТАНДАРТНЫЕ			Twin Tip			QTY
											
CITROËN продолжение											
ZX (91-98) продолжение											
1.9	93	D6E (XU9JA)		03/91-08/92	K20PR-U	3145	0.8	K20TT	IK20TT	IK20TT	4
1.9 D	47/50	D9B (XUD9A/U); DJY (XUD9A); DJZ (XUD9A)		03/91-10/97	DG-001		11V				4
1.9 DT	65/68	DHY (XUD9TE/Y)		06/92-10/97	DG-001		11V				4
1.9 i	88	DKZ (XU9JA)		03/91-06/94	Q20PR-U	3007	0.8	Q20TT	IQ20TT	IQ20TT	4
1.9 TD	66	DHY (XUD9TE/Y)		07/92-10/97	DG-001		11V				4
1,1	40	H1B	Ch: Org Nr.4205>	03/91-08/93	Q20P-U	3125	0.8	Q20TT	IQ20TT	IQ20TT	4
2.0	90	RFX (XU10J2C)		07/94-10/97	K20TXR	5063	1.0	K20TT	IK20TT	IK20TT	4
2.0	122	RFS (XU10J4RS)		09/96-10/97	K20PBR	5060	0.85	K20TT	IK20TT	IK20TT	4
2.0 i	89	RFX (XU10J2C)		07/92-06/97	K20TXR	5063	1.0	K20TT	IK20TT	IK20TT	4
2.0 i 16V	110/ 112/ 114	RFT (XU10J4/Z)		07/92-10/97	Q22PR-U	3010	0.8	-	-	VQ22	4
2.0 i 16V	112/ 114	RFY (XU10J4/Z)		07/92-10/97	K20PR-U	3145	0.8	K20TT	IK20TT	IK20TT	4
2.0 i 16V	120	RFS (XU10J4RS)		05/96-06/97	K20PBR	5060	0.85	K20TT	IK20TT	IK20TT	4
DACIA											
1210 (83-94)											
1.2	36	103-00		06/83-12/94	W20FPR-U	3070	0.7	WF20TT	-		4
1300 (72-83)											
1.3	40	810-02/-99		12/72-05/83	W20FPR-U	3070	0.7	WF20TT	-		4
1304 (83-04)											
1.3	41	810-02/-99		06/83-04/04	W20FPR-U	3070	0.7	WF20TT	-		4
1307 (84-94)											
1.4	48			06/84-11/94	W20FPR-U	3070	0.7	WF20TT	-		4
1309 (90-01)											
1.4	48			09/90-11/94	W20FPR-U	3070	0.7	WF20TT	-		4
1.6	53			12/94-08/01	W20FPR-U	3070	0.7	WF20TT	-		4
1310 (81-04)											
1.3	40	810-02/-99		05/83-07/04	W20FPR-U	3070	0.7	WF20TT	-		4
1.4	46/48			09/85-07/04	W20FPR-U	3070	0.7	WF20TT	-		4
1.4	50			06/00-07/04	W16FPR-U	4192	0.7	-	-		4
1.4 Classic	46			01/95-07/04	W20FPR-U	3070	0.7	WF20TT	-		4
1410 (85-98)											
1.4	48	102-00		09/85-12/98	W20FPR-U	3070	0.7	WF20TT	-		4
DOKKER (12-)											
1.5 dCi	55/66	K9K 612; K9K 626; K9K 872	Instant heating (ISS)	11/12-	DG-609		4.4V				4
1.5 dCi (FEAJ)	66	K9K 612; K9K 626	Instant heating (ISS)	12/12-	DG-609		4.4V				4
1.5 dCi 75 / Blue dCi 75 (FEJW, FEAH)	55	K9K 612; K9K 626; K9K 872	Instant heating (ISS)	12/12-	DG-609		4.4V				4
1.6	61/75	K7M 812; K7M 828		11/12-	K20TXR	5063	1.0	K20TT	IK20TT	IK20TT	4
1.6 LPG	61/75	K7M 812; K7M 828		11/13-	K20TXR	5063	1.0	K20TT	IK20TT	IK20TT	4
DUSTER (10-)											
1.5 dCi	63/ 66/80	K9K 612; K9K 666; K9K 667; K9K 830; K9K 856; K9K 858; K9K 884; K9K 892; K9K 896	Instant heating (ISS)	04/10-	DG-609		4.4V				4
1.5 dCi	63/80	K9K 796; K9K 896	Double Coil(LPH)	04/10-01/18	DG-005		11V				4
1.5 dCi 4x4	66/80	K9K 658; K9K 856; K9K 858; K9K 884; K9K 892; K9K 894; K9K 898	Instant heating (ISS)	10/10-	DG-609		4.4V				4
1.6 16V	77	K4M 690; K4M 696		04/10-01/18	K20PR-U	3145	0.8	K20TT	IK20TT	IK20TT	4
1.6 16V 4x4	77	K4M 606		06/10-	K20PR-U	3145	0.8	K20TT	IK20TT	IK20TT	4
1.6 16V Hi-Flex	77	K4M 696		08/10-	K20PR-U	3145	0.8	K20TT	IK20TT	IK20TT	4
1.6 16V LPG	77	K4M 616; K4M 642		04/11-01/18	K20PR-U	3145	0.8	K20TT	IK20TT	IK20TT	4
1.6 16V LPG	77	K4M 616; K4M 642	LPG / GPL	04/11-01/18	IK20TT	4702	1.0	-	IK20TT	IK20TT	4
LODGY (12-)											
1.5 dCi	66/79	K9K 612; K9K 626; K9K 846	Instant heating (ISS)	03/12-	DG-609		4.4V				4
1.6	61	K7M 812; K7M 828		03/12-	K20PR-U	3145	0.8	K20TT	IK20TT	IK20TT	4
1.6	61	K7M 812; K7M 828		03/12-	K20TXR	5063	1.0	K20TT	IK20TT	IK20TT	4

Свечи зажигания и Свечи накаливания





Таблица применения

Таблица применения

	KW				СТАНДАРТНЫЕ			Twin Tip			QTY
											
DACIA продолжение											
LODGY (12-) продолжение											
1.6 LPG	61/75	K7M 812; K7M 828		11/13-	K20TXR	5063	1.0	K20TT	IK20TT	IK20TT	4
LOGAN I (04-)											
1.2 16V	55	D4F 732		02/06-	XE20HR-U9	3427	0.9	-	IXEH20TT	IXEH20TT	4
1.2 16V LPG	55	D4F 734		02/06-	XE20HR-U9	3427	0.9	-	IXEH20TT	IXEH20TT	4
1.4	55	K7J 710		09/04-	K20PR-U	3145	0.8	K20TT	IK20TT	IK20TT	4
1.4 MPI LPG	55	K7J 710; K7J 714	Flexible fuel	02/06-	K20TXR	5063	1.0	K20TT	IK20TT	IK20TT	4
1.5 dCi	48/ 50/63	K9K 790; K9K 792; K9K 796	Double Coil(LPH)	09/05-	DG-005		11V				4
1.5 dCi	55/65	K9K 892	Instant heating (ISS)	05/10-	DG-609		4.4V				4
1.6	64	K7M 710		09/04-	K20PR-U	3145	0.8	K20TT	IK20TT	IK20TT	4
1.6	64	K7M 710		09/04-	K20TXR	5063	1.0	K20TT	IK20TT	IK20TT	4
1.6 16V	77	K4M 690; K4M 694; K4M 696; K4M 697; K4M 698		02/06-	K20PR-U	3145	0.8	K20TT	IK20TT	IK20TT	4
1.6 16V FlexFuel	77	K4M 696		07/10-	K20PR-U	3145	0.8	K20TT	IK20TT	IK20TT	4
1.6 Bifuel	62	K7M 718; K7M 800		05/10-	K20PR-U	3145	0.8	K20TT	IK20TT	IK20TT	4
1.6 Bifuel	62	K7M 718; K7M 800		05/10-	K20TXR	5063	1.0	K20TT	IK20TT	IK20TT	4
1.6 MPI 85	62	K7M 800		05/10-	K20PR-U	3145	0.8	K20TT	IK20TT	IK20TT	4
1.6 MPI 85	62	K7M 800		05/10-	K20TXR	5063	1.0	K20TT	IK20TT	IK20TT	4
LOGAN II (12-)											
1.2	55	D4F 732		10/12-	XE20HR-U9	3427	0.9	-	IXEH20TT	IXEH20TT	4
1.2 LPG	55	D4F 734		10/12-	XE20HR-U9	3427	0.9	-	IXEH20TT	IXEH20TT	4
1.5 dCi	63/66	K9K 612; K9K 626; K9K 830; K9K 838	Instant heating (ISS)	10/12-	DG-609		4.4V				4
1.5 dCi / Blue dCi 75	55	K9K 612; K9K 626; K9K 872	Instant heating (ISS)	10/12-	DG-609		4.4V				4
1.6 16V	77	K4M 842		01/13-	K20PR-U	3145	0.8	K20TT	IK20TT	IK20TT	4
LOGAN MCV I (07-)											
1.4	55	K7J 710		02/07-	K20PR-U	3145	0.8	K20TT	IK20TT	IK20TT	4
1.5 dCi	50/63	K9K 792; K9K 796	Double Coil(LPH)	02/07-	DG-005		11V				4
1.5 dCi	55/65	K9K 892	Instant heating (ISS)	05/10-	DG-609		4.4V				4
1.6	64	K7M 710		02/07-	K20PR-U	3145	0.8	K20TT	IK20TT	IK20TT	4
1.6	64	K7M 710		02/07-	K20TXR	5063	1.0	K20TT	IK20TT	IK20TT	4
1.6 16V	77	K4M 690; K4M 696; K4M 697		02/07-	K20PR-U	3145	0.8	K20TT	IK20TT	IK20TT	4
1.6 16V Hi-Flex	77	K4M 690		11/09-	K20PR-U	3145	0.8	K20TT	IK20TT	IK20TT	4
1.6 Bifuel	62/64	K7M 710; K7M 718		11/08-	K20TXR	5063	1.0	K20TT	IK20TT	IK20TT	4
1.6 MPI 85	62	K7M 800		05/10-	K20TXR	5063	1.0	K20TT	IK20TT	IK20TT	4
LOGAN MCV II (13-)											
1.2	55	D4F 732		02/13-	XE20HR-U9	3427	0.9	-	IXEH20TT	IXEH20TT	4
1.2 LPG	55	D4F 734		02/13-	XE20HR-U9	3427	0.9	-	IXEH20TT	IXEH20TT	4
1.5 dCi	55/ 63/66	K9K 612; K9K 626; K9K 830; K9K 838	Instant heating (ISS)	02/13-	DG-609		4.4V				4
1.6	62	K7M 812		06/13-	K20TXR	5063	1.0	K20TT	IK20TT	IK20TT	4
NOVA (96-03)											
1.4	48	C2J		04/96-03/01	W16EPR-U	3021	0.8	W16TT	IW16TT	IW16TT	4
1.6	53			04/96-08/98	W20EPR-U	3047	0.8	W20TT	IW20TT	IW20TT	4
PICK UP (89-08)											
1.4	48			09/89-09/00	W20FPR-U	3070	0.7	WF20TT	-		4
SANDERO I (Stepway) (08-)											
1.2 16V	55	D4F 732		11/08-	XE20HR-U9	3427	0.9	-	IXEH20TT	IXEH20TT	4
1.2 16V LPG	55	D4F 732		11/08-	XE20HR-U9	3427	0.9	-	IXEH20TT	IXEH20TT	4
1.4	55	K7J 710		06/08-	K20TXR	5063	1.0	K20TT	IK20TT	IK20TT	4
1.4 MPI LPG	53	K7J 714	Flexible fuel	01/09-	K20TXR	5063	1.0	K20TT	IK20TT	IK20TT	4
1.5 dCi	50/63	K9K 792; K9K 796	Double Coil(LPH)	11/08-	DG-005		11V				4
1.5 dCi	55/65	K9K 892	Instant heating (ISS)	05/10-	DG-609		4.4V				4
1.6	64	K7M 710		06/08-	K20TXR	5063	1.0	K20TT	IK20TT	IK20TT	4
1.6 16V	77	K4M 690; K4M 694		07/11-	K20PR-U	3145	0.8	K20TT	IK20TT	IK20TT	4
1.6 16V Bifuel	77	K4M 690; K4M 694; K4M 696		01/11-	K20PR-U	3145	0.8	K20TT	IK20TT	IK20TT	4
1.6 Hi-Flex	64	K7M 732		06/08-12/12	K20TXR	5063	1.0	K20TT	IK20TT	IK20TT	4
1.6 LPG	60/62	K7M 818		05/10-12/12	K20TXR	5063	1.0	K20TT	IK20TT	IK20TT	4
1.6 MPI 85	62	K7M 800		05/10-	K20TXR	5063	1.0	K20TT	IK20TT	IK20TT	4
SANDERO II (Stepway) (12-)											
1.2	54	D4F 732		10/12-	XE20HR-U9	3427	0.9	-	IXEH20TT	IXEH20TT	4

Свечи зажигания и Свечи накаливания

Таблица применения

	KW				СТАНДАРТНЫЕ			Twin Tip			QTY
DACIA продолжение											
SANDERO II (Stepway) (12-) продолжение											
1.2 LPG	55	D4F 732		10/12-	XE20HR-U9	3427	0.9	-	IXEH20TT	IXEH20TT	4
1.5 dCi	63/66	K9K 612; K9K 626; K9K 830	Instant heating (ISS)	10/12-	DG-609		4.4V				4
1.5 dCi 75 / Blue dCi 75 (B8JW, B8M4, B8AH, B8M7, B8M6)	55	K9K 612; K9K 626; K9K 838; K9K 872	Instant heating (ISS)	10/12-	DG-609		4.4V				4
1.6	61	K7M 812		11/12-	K20TXR	5063	1.0	K20TT	IK20TT	IK20TT	4
SOLENZA (03-)											
1.4	55	E7J 262		02/03-	K20PR-U	3145	0.8	K20TT	IK20TT	IK20TT	4
1.9 D	46	F8Q.630	Double Coil(LPH)	02/03-	DG-008		11V				4
SUPERNOVA (00-03)											
1.4	55	E7J 262		04/00-03/03	K20PR-U	3145	0.8	K20TT	IK20TT	IK20TT	4
DAEWOO											
CIELO (94-98)											
1.5	55	Y15L		04/95-07/97	W20EPR-U	3047	0.8	W20TT	IW20TT	IW20TT	4
ESPERO (91-99)											
1.5 16V	66	A15MF		10/93-06/99	K20PR-U11	3121	1.1	K20TT	IK20TT	IK20TT	4
1.8	66/70	C18LE		02/95-09/99	W20EPR-U	3047	0.8	W20TT	IW20TT	IW20TT	4
2.0	74/ 77/81	C20LE; C20LZ		10/91-06/99	W20EPR-U	3047	0.8	W20TT	IW20TT	IW20TT	4
EVANDA (02-)											
2.0	96	C20SED		08/02-05/05	K20TXR	5063	1.0	K20TT	IK20TT	IK20TT	4
GENTRA (13-)											
1.5	79	B 15 D2		06/13-	XU22EPR-U	3179	0.9	XU22TT	IXU22TT	VXU22	4
KALOS (02-)											
1.2	53	B12S1; F12S3		04/03-	W16EPR-U	3021	0.8	W16TT	IW16TT	IW16TT	4
1.4	61	F14S3		09/02-	W20EPR-U	3047	0.8	W20TT	IW20TT	IW20TT	4
1.4	69	F14D3		05/03-12/04	K20PR-U11	3121	1.1	K20TT	IK20TT	IK20TT	4
1.4 16V	69	F14D3		04/03-	K20PR-U11	3121	1.1	K20TT	IK20TT	IK20TT	4
KORANDO (99-)											
2.0 16V	94	M 161.950		02/99-	K20PBR-S10	5061	1.0	K20TT	IK20TT	IK20TT	4
2.3	105	M 161.970		01/99-	K20PBR-S10	5061	1.0	K20TT	IK20TT	IK20TT	4
2.9 D	72	MB-OM 662	Double Coil(LPH)	01/99-	DG-010		11.5V				5
2.9 TD	88	MB-OM 601 29TD	Double Coil(LPH)	01/99-	DG-010		11.5V				5
3.2 4x4	156	M 104.995		01/99-	K16PR-U	3191	0.8	K16TT	IK16TT	IK16TT	6
LACETTI (04-)											
1.4	70	F14D3		02/04-	K20TXR	5063	1.0	K20TT	IK20TT	IK20TT	4
1.6	80	F16D3		02/04-	K20PR-U11	3121	1.1	K20TT	IK20TT	IK20TT	4
1.8	90	T18SED		02/04-	K20TXR	5063	1.0	K20TT	IK20TT	IK20TT	4
LANOS (97-)											
1.3	55	A13SMS		05/97-07/05	W20EPR-U	3047	0.8	W20TT	IW20TT	IW20TT	4
1.5	63/73	A15SMS; LX6(91CUL4)		05/97-	W20EPR-U	3047	0.8	W20TT	IW20TT	IW20TT	4
1.6 16V	78	L44(98CUL4)		02/97-07/05	K20PR-U11	3121	1.1	K20TT	IK20TT	IK20TT	4
LEGANZA (97-04)											
2.0 16V	93/98	X20SED(127); X20SED(133)		06/97-01/03	K20TXR	5063	1.0	K20TT	IK20TT	IK20TT	4
2.2 16V	100	X22SED		04/99-12/02	K20TXR	5063	1.0	K20TT	IK20TT	IK20TT	4
MATIZ (98-04)											
0.8	38	F8CV		09/98-12/04	W16EXR-U11	3032	1.1	W16TT	IW16TT	IW16TT	3
1.0	47	B10S		01/03-02/05	W16EPR-U	3021	0.8	W16TT	IW16TT	IW16TT	4
MUSSO (99-)											
2.2 TD	74	MB OM 601	Double Coil(LPH)	09/99-	DG-010		11.5V				4
2.3	103	M 111.970		01/99-	K20PBR-S10	5061	1.0	K20TT	IK20TT	IK20TT	4
2.9 D 4x4	73	MB-OM 662	Double Coil(LPH)	01/99-09/99	DG-010		11.5V				5
2.9 TD 4x4	88	MB-OM 601 29TD	Double Coil(LPH)	01/99-	DG-010		11.5V				5
3.2 4x4	162	M 104.992		01/99-	K16PR-U	3191	0.8	K16TT	IK16TT	IK16TT	6
NEXIA (95-08)											
1.5	44/ 52/ 55/59	G15MF		02/95-06/08	W20EPR-U	3047	0.8	W20TT	IW20TT	IW20TT	4
1.5 16V	66	A15MF		02/95-08/97	K20PR-U11	3121	1.1	K20TT	IK20TT	IK20TT	4
NEXIA (08-)											
1.5	59	Y15L		07/08-	W20EPR-U	3047	0.8	W20TT	IW20TT	IW20TT	4

Свечи зажигания и Свечи накаливания

Таблица применения

Таблица применения

KW	KW	KW	NOTE	21	СТАНДАРТНЫЕ			Twin Tip			QTY
					STANDARD	STANDARD	STANDARD	TWIN TIP	TWIN TIP	TWIN TIP	
DAEWOO продолжение											
NEXIA (08-) продолжение											
1.6	80	F16D3		07/08-	K20PR-U11	3121	1.1	K20TT	IK20TT	IK20TT	4
NUBIRA (97-)											
1.6 16V	66/76/78	A16DMS; A16SMS		05/97-	K20PR-U11	3121	1.1	K20TT	IK20TT	IK20TT	4
2.0 16V	93/98	DTEC20(133)/X20NED/X20S; X20SED(133); DTEC20(133)/X20S/X20SED(133); X20SED(127)		05/97-09/04	K20TXR	5063	1.0	K20TT	IK20TT	IK20TT	4
NUBIRA (03-)											
1.6	80	F16D3		07/03-	K20PR-U11	3121	1.1	K20TT	IK20TT	IK20TT	4
1.8	90	T18SED		07/03-07/05	K20TXR	5063	1.0	K20TT	IK20TT	IK20TT	4
RACER (95-97)											
1.5	52	G15MF		03/95-12/97	W20EPR-U	3047	0.8	W20TT	IW20TT	IW20TT	4
REXTON (02-)											
2.3 RX230 4x4	110	M 161.974		05/02-	K20PBR-S10	5061	1.0	K20TT	IK20TT	IK20TT	4
2.9 TD	88	OM 662.983	Double Coil(LPH)	04/02-	DG-010		11.5V				5
3.2 V6	162	M 162.992		04/02-	PK16PR-L11	3275	1.1	-	IK16TT	IK16TT	12
TACUMA / REZZO (00-)											
1.6	77	A16DMS		09/00-	K20PR-U11	3121	1.1	K20TT	IK20TT	IK20TT	4
1.8	72/74	F18S2(100)		09/00-07/05	W20EPR-U	3047	0.8	W20TT	IW20TT	IW20TT	4
2.0	89/94	X 20 SED; X20SED(127)		09/00-07/05	K20TXR	5063	1.0	K20TT	IK20TT	IK20TT	4
TICO (95-00)											
0.8	35	H800		02/95-12/00	W16EPR-U	3021	0.8	W16TT	IW16TT	IW16TT	3
0.8	38	F8CV		01/96-12/00	W16EPR-U11	3201	1.1	W16TT	IW16TT	IW16TT	3
DAF											
55 (67-72)											
1.1	33	110E		10/67-09/72	W16FPR-U	4192	0.7	-	-	-	4
1.1 MARATHON	40	110E		12/71-09/72	W16FPR-U	4192	0.7	-	-	-	4
66 (72-75)											
1.1	35	110E		10/72-08/75	W16FPR-U	4192	0.7	-	-	-	4
1.1 MARATHON	40	110G		10/72-08/75	W16FPR-U	4192	0.7	-	-	-	4
1.1 SL	40	110G		10/72-08/75	W16FPR-U	4192	0.7	-	-	-	4
1300 MARATHON	42	B13/0S		09/73-08/75	W20FPR-U	3070	0.7	WF20TT	-	-	4
400-Serie (89-97)											
428-435 2.5 D	53	BN 52; EN 55	Double Coil Std(LPH)	04/89-08/93	DG-001		11V				4
428-435 2.5 TD	71	ET 70	Double Coil Std(LPH)	04/89-08/93	DG-001		11V				4
DAIHATSU											
1000 (86-97)											
1.0	33	CB 10		07/86-10/97	W16EXR-U	3031	0.8	W16TT	IW16TT	IW16TT	3
1.0 4x4	33	CB 10		07/86-12/89	W16EXR-U	3031	0.8	W16TT	IW16TT	IW16TT	3
APPLAUSE I (89-97)											
1.6 16V (A101)	66/77	HD; HD-E		06/89-07/97	K20PR-U11	3121	1.1	K20TT	IK20TT	IK20TT	4
1.6 16V (A101)	77	HD-E		06/89-07/97	K20TNR-S	3196	1.0	K20TT	IK20TT	IK20TT	4
1.6 16V 4WD (A111)	77	HD-E		06/89-07/97	K20PR-U11	3121	1.1	K20TT	IK20TT	IK20TT	4
1.6 16V 4WD (A111)	77	HD-E		06/89-07/97	K20TNR-S	3196	1.0	K20TT	IK20TT	IK20TT	4
APPLAUSE II (97-00)											
1.6 16V (A101)	73	HD-E		07/97-05/00	K20TNR-S	3196	1.0	K20TT	IK20TT	IK20TT	4
1.6 16V (A101)	73	HD-E		07/97-05/00	K20TNR-S9	3305	0.9	K20TT	IK20TT	IK20TT	4
ATRIA WAGON (92-99)											
0.7	32	EF-RS		06/92-07/99	K20TNR-S9	3305	0.9	K20TT	IK20TT	IK20TT	3
0.7 4x4	32	EF-RS		06/92-07/99	K20TNR-S9	3305	0.9	K20TT	IK20TT	IK20TT	3
BEGO (05-)											
1.3 DVVT 4x4	63	K3-VE		11/05-	SXU22PR9	3434	0.9	-	IXU22TT	VXU22I	4
CAST (15-)											
0.66	38	KF-VE		09/15-	XU20HR9	3486	0.9	-	-	VXUH20I	3
0.66 AWD	38	KF-VE		09/15-	XU20HR9	3486	0.9	-	-	VXUH20I	3
CHARADE I (77-83)											
1.0	37	CB 20; CB 22		10/77-02/83	W16EXR-U	3031	0.8	W16TT	IW16TT	IW16TT	3
CHARADE II (83-87)											
1.0 (G11)	38	CB 22		10/83-03/87	W16EXR-U	3031	0.8	W16TT	IW16TT	IW16TT	3
1.0 D (G30)	27	CL 10	Single Coil	10/83-03/87	DG-652		7V				3

Свечи зажигания и Свечи накаливания

Таблица применения









	KW				СТАНДАРТНЫЕ			Twin Tip			QTY
											
DAIHATSU продолжение											
CHARADE II (83-87) продолжение											
1.0 TD (G30)	34	CL 60	Single Coil	02/85-03/87	DG-652		7V				3
1.0 Turbo (G11)	50	CB 60		10/83-03/87	W20ETR-L	3277	1.0	-	IW20TT	IW20TT	3
1.0 Turbo (G11)	50	CB 60		10/83-03/87	W20EXR-U	3066	0.8	W20TT	IW20TT	IW20TT	3
CHARADE III (87-93)											
1.0 (G100)	40	CB 23		03/87-12/92	W16EXR-U	3031	0.8	W16TT	IW16TT	IW16TT	3
1.0 (G100)	40	CB 90		04/89-12/92	W16EXR-U11	3032	1.1	W16TT	IW16TT	IW16TT	3
1.0 D (G101)	27	CL 11		03/87-12/92	DG-216		11V				3
1.0 GTi (G100)	74	CB 80 T		03/87-12/92	W20ETR-L	3277	1.0	-	IW20TT	IW20TT	3
1.0 TD (G101)	35	CL; CL 61		03/87-12/92	DG-216		11V				3
1.0 Turbo (G100)	50	CB 61		03/87-10/90	W20ETR-L	3277	1.0	-	IW20TT	IW20TT	3
1.0 Turbo (G100)	50	CB 61		03/87-10/90	W20EXR-U	3066	0.8	W20TT	IW20TT	IW20TT	3
1.3	56/66	HC-C; HCE		09/88-02/93	K20PR-U11	3121	1.1	K20TT	IK20TT	IK20TT	4
1.3 i (G102)	66	HCE		06/88-12/92	K20TNR-S	3196	1.0	K20TT	IK20TT	IK20TT	4
1.3 i 4WD (G102)	66	HCE		06/88-01/93	K20TNR-S	3196	1.0	K20TT	IK20TT	IK20TT	4
CHARADE IV (93-00)											
1.0	38	CB 22		09/94-03/96	W16EXR-U	3031	0.8	W16TT	IW16TT	IW16TT	3
1.3	44	HC		09/96-11/99	K20TNR-S	3196	1.0	K20TT	IK20TT	IK20TT	4
1.3 16V	55	HC-E		05/96-11/99	K20PR-U11	3121	1.1	K20TT	IK20TT	IK20TT	4
1.3 i 16V	62	HC		01/93-09/00	K20TNR-S	3196	1.0	K20TT	IK20TT	IK20TT	4
1.5 16V	55	HEE		10/94-01/01	K20PR-U11	3121	1.1	K20TT	IK20TT	IK20TT	4
1.5 HG	55	HEE		06/94-03/96	K20PR-U11	3121	1.1	K20TT	IK20TT	IK20TT	4
1.5 i 16V	66	HEE		06/94-11/99	K20PR-U11	3121	1.1	K20TT	IK20TT	IK20TT	4
1.6 GTi	77	HD-E		03/93-11/99	K20PR-U11	3121	1.1	K20TT	IK20TT	IK20TT	4
1.6 GTi	77	HD-E		03/93-11/99	K20TNR-S	3196	1.0	K20TT	IK20TT	IK20TT	4
CHARADE VI (11-)											
1.33 16V	73	1NR-FE		05/11-	SC16HR11	3499	1.1	-	IXEH20TT	IXEH20TT	4
CHARMANT (81-87)											
1.3 (A35)	48	4K		11/81-07/87	W16EX-U	3027	0.8	W16TT	IW16TT	IW16TT	4
1.6 (A45)	55	2T		12/81-08/83	W16EXR-U	3031	0.8	W16TT	IW16TT	IW16TT	4
1.6 (A45)	55	2T		12/81-09/84	W16EX-U	3027	0.8	W16TT	IW16TT	IW16TT	4
1.6 (A60)	60	4A		08/83-07/87	W16EXR-U	3031	0.8	W16TT	IW16TT	IW16TT	4
COPEN (03-12)											
0.7	47	JB-DET		09/03-08/10	SK20PR-A8	3403	0.8	-	IK20TT	IK20TT	4
0.7	47	JB-DET		09/03-08/10	VK20Y	5620	0.8	-	-	VK20Y	4
0.7 (L880)	50	JB; JB-DET		09/03-12/07	SK20PR-A8	3403	0.8	-	IK20TT	IK20TT	4
0.7 (L880)	50	JB; JB-DET		09/03-12/07	VK20Y	5620	0.8	-	-	VK20Y	4
1.3	64	K3-VE		03/06-09/12	K20R-U11	3139	1.1	K20TT	IK20TT	IK20TT	4
1.3	64	K3-VE		03/06-09/12	SXU22PR9	3434	0.9	-	IXU22TT	VXU22I	4
CUORE I (80-85)											
0.5 (L55)	20	AB 30		10/80-09/85	W20EP-U	3043	0.8	W20TT	IW20TT	IW20TT	2
0.5 (L55)	20	AB 30		10/80-09/85	W20EXR-U	3066	0.8	W20TT	IW20TT	IW20TT	2
0.6 (L60)	22	AD 10		08/82-09/85	W20EXR-U	3066	0.8	W20TT	IW20TT	IW20TT	2
CUORE II (85-90)											
0.8 (L80)	29/32	ED 10		09/85-12/90	W20EXR-U	3066	0.8	W20TT	IW20TT	IW20TT	3
0.8 4WD (L81)	32	ED 10		09/86-10/88	W20EXR-U	3066	0.8	W20TT	IW20TT	IW20TT	3
CUORE III (90-94)											
0.8	30	ED 10 K		10/90-12/94	W20EXR-U	3066	0.8	W20TT	IW20TT	IW20TT	3
CUORE IV (94-99)											
0.8	31	EF-EL		11/96-10/98	W20EXR-U	3066	0.8	W20TT	IW20TT	IW20TT	3
0.8	32	ED 20		01/95-08/98	W16EXR-U11	3032	1.1	W16TT	IW16TT	IW16TT	3
CUORE V (89-03)											
1.0	40	EJ-DE		11/98-09/00	K16PR-U11	3130	1.1	K16TT	IK16TT	IK16TT	3
1.0 DVVT	43	EJ-VE		10/00-02/03	K16TNR-S9	3329	0.9	K16TT	IK16TT	IK16TT	3
1.0 i (L701)	41	EJ-DE		10/98-05/00	K16PR-U11	3130	1.1	K16TT	IK16TT	IK16TT	3
1.0 i (L701)	41	EJ-DE; EJ-VE		10/98-05/03	K16TNR-S9	3329	0.9	K16TT	IK16TT	IK16TT	3
CUORE VI (03-)											
1.0	43	EJ-VE		05/03-	K16TNR-S9	3329	0.9	K16TT	IK16TT	IK16TT	3
CUORE VII (06-)											
1.0	51	1KR-FE		04/07-	SK20HR11	3421	1.1	-	IKH20TT	IKH20TT	3
DELTA (84-87)											
3.0 D	53			09/84-08/87	DG-222		14V				4
DELTA (89-01)											
1.8	58	2Y		01/89-12/91	W16EX-U	3027	0.8	W16TT	IW16TT	IW16TT	4
1.8	58	2Y		01/92-12/96	P16R	3004	1.0	W20TT	IW20TT	IW20TT	4
2.2	69	4Y		09/91-04/99	W16EXR-U	3031	0.8	W16TT	IW16TT	IW16TT	4











Таблица применения

D

Свечи зажигания и Свечи накаливания

Таблица применения

Таблица применения

	KW				СТАНДАРТНЫЕ				Twin Tip		QTY
											
DAIHATSU продолжение											
DELTA Wide (84-99)											
2.2 TD	74		Ceramic(LPH)	10/92-11/96	DG-671		11V				4
2.8 D	54			09/87-05/95	DG-652		7V				4
3.0 D	53			09/84-08/87	DG-222		14V				4
EXTOL (00-)											
1.3	63	K3-VE		01/04-12/06	IK20TT	4702	1.0	-	IK20TT	IK20TT	4
1.3	63	K3-VE		01/04-12/06	SVK20RZ11	3449	1.1	-	IK20TT	IK20TT	4
1.3	63/66	K3-VE		07/00-12/05	K20R-U11	3139	1.1	K20TT	IK20TT	IK20TT	4
1.3	63/66	K3-VE		12/05-	SXU22PR9	3434	0.9	-	IXU22TT	VXU22I	4
1.3 4x4	66/68	K3-VE		07/00-12/05	K20R-U11	3139	1.1	K20TT	IK20TT	IK20TT	4
FEROZA (88-99)											
1.6 16V	63	HD-C		10/88-12/97	K20PR-U11	3121	1.1	K20TT	IK20TT	IK20TT	4
1.6 16V 4x4	62	HD-C		10/88-12/97	K20PR-U11	3121	1.1	K20TT	IK20TT	IK20TT	4
1.6 i 16V	70	HD-E		10/88-12/99	K20PR-U11	3121	1.1	K20TT	IK20TT	IK20TT	4
1.6 i 16V 4x4	70	HD-E		10/88-12/99	K20PR-U11	3121	1.1	K20TT	IK20TT	IK20TT	4
GRAN MOVE (96-02)											
1.5 16V (G303)	66	HEE		10/96-07/98	K20PR-U11	3121	1.1	K20TT	IK20TT	IK20TT	4
1.6 16V (G301)	67	HD-EP		05/98-07/02	K20PR-U11	3121	1.1	K20TT	IK20TT	IK20TT	4
HIJET (86-90)											
0.8	29	CD		06/86-10/90	W16EXR-U	3031	0.8	W16TT	IW16TT	IW16TT	3
1.0 (S85)	33	CB		06/86-12/89	W16EXR-U	3031	0.8	W16TT	IW16TT	IW16TT	3
1.0 4x4	33	CB 10		07/86-10/90	W16EXR-U	3031	0.8	W16TT	IW16TT	IW16TT	3
1.0 Touring 4x4	33	CB 10		07/86-10/90	W16EXR-U	3031	0.8	W16TT	IW16TT	IW16TT	3
HIJET (92-)											
1.0	34	CB41		12/92-05/98	W16EXR-U	3031	0.8	W16TT	IW16TT	IW16TT	3
1.0 i	35	CB42		07/94-05/98	W16EXR-U11	3032	1.1	W16TT	IW16TT	IW16TT	3
1.2 D	26	LDW12		05/95-03/98	DG-001		11V				4
1.3	48	HC-E		08/98-	K20TNR-S	3196	1.0	K20TT	IK20TT	IK20TT	4
1.3 4WD	48	HC-E		10/01-	K20TNR-S	3196	1.0	K20TT	IK20TT	IK20TT	4
1.3 i 16V	48	HC-E		05/98-10/05	K20TNR-S	3196	1.0	K20TT	IK20TT	IK20TT	4
HIJET (98-)											
1.3	48	HC-E		06/98-	K20PR-U11	3121	1.1	K20TT	IK20TT	IK20TT	4
HIJET (15-)											
0.66	47	KF-VE		04/15-	XU20HR9	3486	0.9	-	-	VXUH20I	3
0.66 AWD	47	KF-VE		04/15-	XU20HR9	3486	0.9	-	-	VXUH20I	3
MATERIA (06-)											
1.3	67	K3-VE		10/06-	SXU22PR9	3434	0.9	-	IXU22TT	VXU22I	4
1.5	76	3SZ-VE		10/06-	SXU22PR9	3434	0.9	-	IXU22TT	VXU22I	4
1.5 ECO 4WD	76	3SZ-VE		10/06-	SXU22PR9	3434	0.9	-	IXU22TT	VXU22I	4
MIDGET (93-02)											
0.7	30	EF-CL		02/93-12/02	W16EXR-U	3031	0.8	W16TT	IW16TT	IW16TT	3
MIRA VII (06-)											
0.66	43	KF-VE		12/06-	XU20HR9	3486	0.9	-	-	VXUH20I	3
0.66 AWD	43	KF-VE		12/06-	XU20HR9	3486	0.9	-	-	VXUH20I	3
MOVE (94-02)											
0.8 (L601)	31	ED 20		01/97-11/99	W16EXR-U11	3032	1.1	W16TT	IW16TT	IW16TT	3
1.0 i	41	EJ-DE		10/98-05/00	K16PR-U11	3130	1.1	K16TT	IK16TT	IK16TT	3
1.0 i	41	EJ-DE		05/00-09/02	K16TNR-S9	3329	0.9	K16TT	IK16TT	IK16TT	3
MOVE (02-07)											
0.66	43	EF-VE		10/02-10/06	K20TNR-S9	3305	0.9	K20TT	IK20TT	IK20TT	3
0.66 Turbo	47	JB-DET		10/02-09/03	VK20Y	5620	0.8	-	-	VK20Y	4
0.66 Turbo	47	JB-DET		10/03-12/07	SK20PR-A8	3403	0.8	-	IK20TT	IK20TT	4
MOVE (08-10)											
0.66	47	KF-VE		01/08-06/10	XU20HR9	3486	0.9	-	-	VXUH20I	3
0.66 AWD	47	KF-VE		01/08-06/10	XU20HR9	3486	0.9	-	-	VXUH20I	3
MOVE (10-14)											
0.66	38	KF-VE		06/11-11/14	XU20HR9	3486	0.9	-	-	VXUH20I	3
0.66 AWD	38	KF-VE		06/11-11/14	XU20HR9	3486	0.9	-	-	VXUH20I	3
MOVE (14-)											
0.66	38	KF-VE		12/14-	XU20HR9	3486	0.9	-	-	VXUH20I	3
0.66 AWD	38	KF-VE		12/14-	XU20HR9	3486	0.9	-	-	VXUH20I	3
MOVE Conte (08-)											
0.66	38	KF-VE		06/11-	XU20HR9	3486	0.9	-	-	VXUH20I	3
0.66 AWD	38	KF-VE		06/11-	XU20HR9	3486	0.9	-	-	VXUH20I	3
NAKED (99-05)											
0.7	34	EF-VE		11/99-02/05	K20TNR-S9	3305	0.9	K20TT	IK20TT	IK20TT	3

Свечи зажигания и Свечи накаливания

Таблица применения











	KW				СТАНДАРТНЫЕ			Twin Tip			QTY
											
DAIHATSU продолжение											
NAKED (99-05) продолжение											
0.7 Turbo AWD	47	EF-DET		11/99-02/05	K20TNR-S9	3305	0.9	K20TT	IK20TT	IK20TT	3
OPTI (92-98)											
0.7	41	EF-EL		10/95-10/98	K22TNR-S	3197	1.0	-	-	VK22	3
ROCKY (85-98)											
1.6 4x4	70	HD-E		09/89-12/92	K20PR-U11	3121	1.1	K20TT	IK20TT	IK20TT	4
2.0 (F70, F75, F80, F85)	65	3Y		02/85-08/91	W16EXR-U	3031	0.8	W16TT	IW16TT	IW16TT	4
2.0 (F70, F75, F80, F85)	65	3Y		02/85-04/93	W16EX-U	3027	0.8	W16TT	IW16TT	IW16TT	4
2.0 4x4 (F70, F75, F80, F85)	65	3Y		02/85-08/91	W16EXR-U	3031	0.8	W16TT	IW16TT	IW16TT	4
2.0 4x4 (F70, F75, F80, F85)	65	3Y		02/85-04/93	W16EX-U	3027	0.8	W16TT	IW16TT	IW16TT	4
2.2 4x4	67	4Y		09/91-04/93	W16EXR-U	3031	0.8	W16TT	IW16TT	IW16TT	4
2.8 D (F70, F75, F80, F85)	54	DL	Single Coil	02/85-12/98	DG-652		7V				4
2.8 TD	67/72/75	DL 51; DL 52; DLT-C	Single Coil	12/87-12/98	DG-652		7V				4
2.8 TD (F70, F75, F80, F85)	67/75	DL 51; DL 52; DLT	Single Coil	12/87-12/98	DG-652		7V				4
RUGGER (84-93)											
2.0 4x4	65	3Y		04/84-10/88	W16EX-U	3027	0.8	W16TT	IW16TT	IW16TT	4
2.2 4x4	67	4Y		09/91-04/93	W16EXR-U	3031	0.8	W16TT	IW16TT	IW16TT	4
2.8 D 4x4	54	DL		04/84-04/93	DG-652		7V				4
SIRION (98-05)											
1.0	40	EJ-DE		04/98-10/00	K16PR-U11	3130	1.1	K16TT	IK16TT	IK16TT	3
1.0 i (M100)	41	EJ-DE		04/98-09/00	K16PR-U11	3130	1.1	K16TT	IK16TT	IK16TT	3
1.0 i (M101)	43	EJ-VE		09/00-01/05	K16TNR-S9	3329	0.9	K16TT	IK16TT	IK16TT	3
1.0 i 4WD	41	EJ-DE		04/99-09/00	K16PR-U11	3130	1.1	K16TT	IK16TT	IK16TT	3
1.0 i 4WD	43	EJ-VE		09/00-01/05	K16TNR-S9	3329	0.9	K16TT	IK16TT	IK16TT	3
1.3 Rally	81	K3-VE2		06/02-03/05	K20R-U11	3139	1.1	K20TT	IK20TT	IK20TT	4
1.3 Rally 4WD	81	K3-VE2		06/02-03/05	K20R-U11	3139	1.1	K20TT	IK20TT	IK20TT	4
1.3 Sport	75	K3-VE/102e2		08/00-01/05	K20BR-S10	3330	1.0	K20TT	IK20TT	IK20TT	4
1.3 Sport	75	K3-VE2		08/00-01/05	K20R-U11	3139	1.1	K20TT	IK20TT	IK20TT	4
1.3 Sport 4WD	75	K3-VE2		08/00-03/05	K20PBR-S10	5061	1.0	K20TT	IK20TT	IK20TT	4
1.3 Sport 4WD	75	K3-VE2		08/00-03/05	K20R-U11	3139	1.1	K20TT	IK20TT	IK20TT	4
SIRION (05-)											
1.0	51	1KR-FE		01/05-06/13	SK20HR11	3421	1.1	-	IKH20TT	IKH20TT	3
1.3	67	K3-VE		03/08-	XU22PR9	3448	0.9	XU22TT	IXU22TT	VXU22I	4
1.3 (M301)	64	K3-VE		01/05-12/06	SVK20RZ11	3449	1.1	-	IK20TT	IK20TT	4
1.3 (M301)	64	K3-VE		01/05-06/07	K20R-U11	3139	1.1	K20TT	IK20TT	IK20TT	4
1.3 (M301)	64	K3-VE		01/05-	SXU22PR9	3434	0.9	-	IXU22TT	VXU22I	4
1.3 (M301)	64	K3-VE		06/07-	XU22PR9	3448	0.9	XU22TT	IXU22TT	VXU22I	4
1.3 4WD	64	K3-VE		04/05-12/06	SVK20RZ11	3449	1.1	-	IK20TT	IK20TT	4
1.3 4WD	64	K3-VE		04/05-	K20R-U11	3139	1.1	K20TT	IK20TT	IK20TT	4
1.3 4WD	64	K3-VE		12/06-06/07	SXU22PR9	3434	0.9	-	IXU22TT	VXU22I	4
1.3 4WD	64/67	K3-VE		06/07-	XU22PR9	3448	0.9	XU22TT	IXU22TT	VXU22I	4
1.5	76	3SZ-VE		03/08-	XU22PR9	3448	0.9	XU22TT	IXU22TT	VXU22I	4
SPARCAR (83-86)											
1.0 (S75)	33	CB		09/83-05/86	W16EXR-U	3031	0.8	W16TT	IW16TT	IW16TT	3
TAFT (76-85)											
2.5 D 4x4 (F50, F55)	45	DG	Single Coil	08/78-08/82	DG-234		8.5V				4
2.8 D 4x4 (F60, F65)	51	DL		08/82-04/84	DG-652		7V				4
TAFT (84-93)											
2.0 4x4	65	3Y		04/84-04/93	W16EX-U	3027	0.8	W16TT	IW16TT	IW16TT	4
TANTO (07-13)											
0.66	38/43	KF-VE		12/07-10/13	XU20HR9	3486	0.9	-	-	VXUH20I	3
0.66 AWD	38/43	KF-VE		12/07-10/13	XU20HR9	3486	0.9	-	-	VXUH20I	3
TANTO (13-)											
0.66	38	KF-VE		11/13-	XU20HR9	3486	0.9	-	-	VXUH20I	3
0.66 AWD	38	KF-VE		11/13-	XU20HR9	3486	0.9	-	-	VXUH20I	3
TERIOS (97-05)											
0.7	44	EF-DEM		09/00-10/05	K20TNR-S9	3305	0.9	K20TT	IK20TT	IK20TT	3
0.7 4WD	44	EF-DEM		10/98-10/05	K20TNR-S9	3305	0.9	K20TT	IK20TT	IK20TT	3
1.3	63	K3-VE		09/01-10/05	K20PBR-S10	5061	1.0	K20TT	IK20TT	IK20TT	4
1.3	63	K3-VE		09/01-10/05	K20R-U11	3139	1.1	K20TT	IK20TT	IK20TT	4
1.3 4WD (J100)	61	HC-EJ		10/97-10/00	K20TNR-S	3196	1.0	K20TT	IK20TT	IK20TT	4
1.3 4WD (J102)	63	K3-VE		10/00-10/05	K20PBR-S10	5061	1.0	K20TT	IK20TT	IK20TT	4
1.3 4WD (J102)	63	K3-VE		10/00-10/05	K20R-U11	3139	1.1	K20TT	IK20TT	IK20TT	4
1.3 VVT-i Turbo 4WD	103	K3-VET		10/02-10/05	VK20Y	5620	0.8	-	-	VK20Y	4











Таблица применения

D

Свечи зажигания и Свечи накаливания

Таблица применения

Таблица применения

	KW				СТАНДАРТНЫЕ				Twin Tip		QTY
											
DAIHATSU продолжение											
TERIOS (05-)											
1.3 VVT-i 4x4	63	K3-VE		11/05-	K20PBR-S10	5061	1.0	K20TT	IK20TT	IK20TT	4
1.3 VVT-i 4x4	63	K3-VE		11/05-	SXU22PR9	3434	0.9	-	IXU22TT	VXU22I	4
1.5 4x4	77	3SZ-VE		05/06-	SXU22PR9	3434	0.9	-	IXU22TT	VXU22I	4
1.5 VVT-i 4x4	75	3SZ-VE		09/10-	SXU22PR9	3434	0.9	-	IXU22TT	VXU22I	4
1.5 VVT-i RWD	75/77	3SZ-VE		11/05-	SXU22PR9	3434	0.9	-	IXU22TT	VXU22I	4
TREVIS (06-)											
1.0	43	EJ-VE		06/06-	K16TNR-S9	3329	0.9	K16TT	IK16TT	IK16TT	3
WAKE (14-)											
0.66	38	KF-VE		11/14-	XU20HR9	3486	0.9	-	-	VXUH20I	3
0.66 AWD	38	KF-VE		11/14-	XU20HR9	3486	0.9	-	-	VXUH20I	3
WILDCAT / ROCKY (85-87)											
2.8 D	54	DL	Single Coil	02/85-03/87	DG-652		7V				4
2.8 TD	65	DL 50	Single Coil	09/85-04/87	DG-652		7V				4
YRV (01-)											
1.0	43	EJ-VE		02/01-	K16TNR-S9	3329	0.9	K16TT	IK16TT	IK16TT	3
1.3 (M201)	64	K3-VE		02/01-07/05	K20PBR-S10	5061	1.0	K20TT	IK20TT	IK20TT	4
1.3 (M201)	64	K3-VE		02/01-07/05	K20R-U11	3139	1.1	K20TT	IK20TT	IK20TT	4
1.3 (M201)	64	K3-VE		07/05-	SXU22PR9	3434	0.9	-	IXU22TT	VXU22I	4
1.3 4WD	64	K3-VE		02/01-07/05	K20BR-S10	3330	1.0	K20TT	IK20TT	IK20TT	4
1.3 4WD	64	K3-VE		02/01-07/05	K20R-U11	3139	1.1	K20TT	IK20TT	IK20TT	4
1.3 4WD	64	K3-VE		07/05-	SXU22PR9	3434	0.9	-	IXU22TT	VXU22I	4
1.3 GTi	95	K3-VET		07/02-	VK20Y	5620	0.8	-	-	VK20Y	4
DAIMLER											
2.8 - 5.3 (69-93)											
3.6	156			10/86-09/89	W16EPR-U	3021	0.8	W16TT	IW16TT	IW16TT	6
Double Six / Vanden 5.3	186/ 198			07/72-05/75	W16EPR-U	3021	0.8	W16TT	IW16TT	IW16TT	12
Double Six 5.3	194/ 197	7P; V 12 (90-93)		07/81-02/93	T22EP-U	5040	0.8	-	-		12
Double Six 5.3	211	V 12 (75-79)		05/75-07/81	W16EPR-U	3021	0.8	W16TT	IW16TT	IW16TT	12
Double Six H.E. 5.3	217	V 12 (82-90)		07/81-10/86	T22EP-U	5040	0.8	-	-		12
Sovereign 2.8	110			10/69-05/75	W16EPR-U	3021	0.8	W16TT	IW16TT	IW16TT	6
Sovereign 3.4	120	XK		05/75-12/78	W16EPR-U	3021	0.8	W16TT	IW16TT	IW16TT	6
Sovereign 4.2	124/ 127/ 137/ 151	XK 4.2 (-79); XK 4.2 (82-87)		10/69-10/86	W16EPR-U	3021	0.8	W16TT	IW16TT	IW16TT	6
COUPE (73-77)											
Double Six 5.3	213			05/75-12/77	W16EPR-U	3021	0.8	W16TT	IW16TT	IW16TT	12
Sovereign 4.2	127			09/73-12/77	W16EPR-U	3021	0.8	W16TT	IW16TT	IW16TT	6
DAIMLER XJ (94-03)											
Double Six 6.0	229	8E		10/94-06/03	T22EP-U	5040	0.8	-	-		12
LANDAULETTE (74-91)											
4.2	123/ 131			03/74-12/91	W16EPR-U	3021	0.8	W16TT	IW16TT	IW16TT	6
LIMOUSINE (68-91)											
4.2	123/ 131	XK 4.2 (-79)		06/68-12/91	W16EPR-U	3021	0.8	W16TT	IW16TT	IW16TT	6
DALLAS											
FUN (94-98)											
1.8 D	43	161 (XUD7)	Double Coil Std(LPH)	01/94-12/98	DG-001		11V				4
DATSUN											
MI-DO (14-)											
1.6	64	16LW; 16LW8V; VAZ-11186		08/14-	W20EPR-U11	3049	1.1	W20TT	IW20TT	IW20TT	4
ON-DO (14-)											
1.6	60/64	16HW; 16LW; 16LW8V; VAZ-11186		08/14-	W20EPR-U11	3049	1.1	W20TT	IW20TT	IW20TT	4
DE LOREAN											
DMC-12 (81-83)											
2.9	97	PRV28		01/81-12/83	IT20TT	4714	1.0	-	IT20TT		6
DF CITROEN											
C-TRIOMPHE (09-)											
2.0	108	EW10A		01/09-	K16HPR-U11	6076	1.1	KH16TT	IKH16TT	IKH16TT	4

Свечи зажигания и Свечи накаливания

Таблица применения









	KW				СТАНДАРТНЫЕ			Twin Tip			QTY
											
DODGE											
AVENGER (07-14)											
2.0	115	ECN		06/07-11/10	KJ16CR-U11	3311	1.1	K16TT	IK16TT	IK16TT	4
2.0 CRD	103	ECD		06/07-11/10	DG-190		4.4V				4
2.4	125/ 129	EDG		06/07-12/14	PKJ16CR8	3175	0.8	-	-		4
2.4	129	ED3		06/07-12/14	KJ16CR-U11	3311	1.1	K16TT	IK16TT	IK16TT	4
2.7	137	EER/ D		06/07-12/11	ITL16TT	4717	1.0	-	ITL16TT		6
2.7	137	R		06/07-12/11	ITL20	5350	1.1	-	-		6
2.7 FlexFuel	139	EER/ D		06/07-12/09	ITL16TT	4717	1.0	-	ITL16TT		6
2.7 FlexFuel	139	R		06/07-12/09	ITL20	5350	1.1	-	-		6
3.6	211	ERB	Check Thread size	01/12-12/14	ITV20TT	4719	1.0	-	ITV20TT		6
3.6	211	ERB	Check Thread size	01/12-12/14	SXU22HCR11S	3461	1.1	-	-	VXUHC22G	6
CALIBER (06-)											
1.8	110	EBA		06/06-12/09	IK16TT	4701	1.0	-	IK16TT	IK16TT	4
2.0	115	ECN		06/06-05/11	IK16TT	4701	1.0	-	IK16TT	IK16TT	4
2.0 CRD	103	ECD		09/06-05/11	DG-190		4.4V				4
2.4	125	ED3		10/06-	KJ16CR-U11	3311	1.1	K16TT	IK16TT	IK16TT	4
2.4 AWD	125	ED3		10/06-	KJ16CR-U11	3311	1.1	K16TT	IK16TT	IK16TT	4
2.4 SRT4 AWD	223	ED4		10/06-	IK20L	5358	1.1	-	IK20TT	IK20TT	4
2.4 Turbo	217	ED4		12/07-	IK20L	5358	1.1	-	IK20TT	IK20TT	4
CARAVAN (95-02)											
2.0 i	98			01/95-03/01	K20PR-U	3145	0.8	K20TT	IK20TT	IK20TT	4
2.4 i	111	EDZ		01/95-03/01	K16R-U11	3120	1.1	K16TT	IK16TT	IK16TT	4
2.5 TD	85	ENC	Double Coil(LPH)	01/95-04/95	DG-001		11V				4
2.5 TD	85	ENC	Double Coil(LPH)	05/95-10/02	DG-109		11V				4
3.0	112	EFA		01/95-06/00	W16EPR-U	3021	0.8	W16TT	IW16TT	IW16TT	6
3.3 i	116	EGP		01/95-09/96	W16EXR-U13	3213	1.3	W16TT	IW16TT	IW16TT	6
3.3 i	116	EGP		10/96-03/01	P16R13	3239	1.3	W20TT	IW20TT	IW20TT	6
3.8 i	122/ 131	EGH		01/95-03/01	W16EXR-U11	3032	1.1	W16TT	IW16TT	IW16TT	6
3.8 i AWD	122/ 131	EGH		01/95-03/01	W16EXR-U11	3032	1.1	W16TT	IW16TT	IW16TT	6
CARAVAN (00-07)											
2.4	112	EDZ		02/00-12/07	ITL16TT	4717	1.0	-	ITL16TT		4
3.3	128	EGA		02/00-12/07	ITL16TT	4717	1.0	-	ITL16TT		6
3.3 AWD	128	EGA		02/00-12/07	ITL16TT	4717	1.0	-	ITL16TT		6
3.8	160	EGH		02/00-12/07	W16EXR-U11	3032	1.1	W16TT	IW16TT	IW16TT	6
3.8	160	L00		02/00-12/07	ITL16TT	4717	1.0	-	ITL16TT		6
3.8 AWD	160	EGH		02/00-12/07	W16EXR-U11	3032	1.1	W16TT	IW16TT	IW16TT	6
3.8 AWD	160	L00		02/00-12/07	ITL16TT	4717	1.0	-	ITL16TT		6
3.8 Turbo AWD	153	EGH		04/01-12/07	W16EXR-U11	3032	1.1	W16TT	IW16TT	IW16TT	6
3.8 Turbo AWD	153	L00		04/01-12/07	ITL16TT	4717	1.0	-	ITL16TT		6
CHALLENGER (07-)											
3.6	227	ERB	Check Thread size	01/11-	ITV20TT	4719	1.0	-	ITV20TT		6
3.6	227	ERB	Check Thread size	01/11-	SXU22HCR11S	3461	1.1	-	-	VXUHC22G	6
5.7	277/ 280	EZC; EZH	Twin Spark	01/09-	K16HPR-U11	6076	1.1	KH16TT	IKH16TT	IKH16TT	16
6.1 SRT8	317	ESF		09/07-	ITL20	5350	1.1	-	-		16
6.4 SRT8	346/ 351	ESG; ESH		01/11-	ITL20	5350	1.1	-	-		16
CHARGER (05-10)											
2.7	141	EER		04/06-12/10	ITL20	5350	1.1	-	-		6
5.7 R/T	254	EZA		06/05-12/05	ITL16TT	4717	1.0	-	ITL16TT		8
5.7 R/T	254	EZA	Twin Spark	01/06-12/08	ITL16TT	4717	1.0	-	ITL16TT		16
6.1 SRT8	317	ESF		09/05-12/10	ITL20	5350	1.1	-	-		16
CHARGER (11-)											
3.6	218	ERB	Check Thread size	09/11-12/14	ITV20TT	4719	1.0	-	ITV20TT		6
3.6	218	ERB	Check Thread size	09/11-12/14	SXU22HCR11S	3461	1.1	-	-	VXUHC22G	6
5.7 Flexfuel AWD	276	EZH	Twin Spark	11/11-	K16HPR-U11	6076	1.1	KH16TT	IKH16TT	IKH16TT	16
5.7 R/T	276	EZH	Twin Spark	09/11-	K16HPR-U11	6076	1.1	KH16TT	IKH16TT	IKH16TT	16
5.7 R/T	276	EZH	Twin Spark	09/11-	SK16HR11	3417	1.1	-	IKH16TT	IKH16TT	16
5.7 R/T AWD	276	EZH	Twin Spark	09/11-	K16HPR-U11	6076	1.1	KH16TT	IKH16TT	IKH16TT	16
5.7 R/T AWD	276	EZH	Twin Spark	09/11-	SK16HR11	3417	1.1	-	IKH16TT	IKH16TT	16





Таблица применения

D

Свечи зажигания и Свечи накаливания











Таблица применения

Таблица применения

	KW				СТАНДАРТНЫЕ				Twin Tip			QTY
												
DODGE продолжение												
CHARGER (11-) продолжение												
6.4 SRT8	351/ 362	ESG		09/11-	ITL20	5350	1.1	-	-			16
DART (12-)												
1.4 T	119	EAF	40000km Lifetime	04/12-	IXU27	5337	0.9	-	-			4
DURANGO (03-10)												
5.7 AWD	257	EZA		11/03-12/05	ITL16TT	4717	1.0	-		ITL16TT		8
5.7 AWD	257	EZA	Twin Spark	01/06-12/10	ITL16TT	4717	1.0	-		ITL16TT		16
DURANGO (11-)												
3.6	216	ERB	Check Thread size	01/11-	ITV20TT	4719	1.0	-		ITV20TT		6
3.6	216	ERB	Check Thread size	01/11-	SXU22HCR11S	3461	1.1	-		-	VXUHC22G	6
3.6 AWD	216	ERB	Check Thread size	01/11-	ITV20TT	4719	1.0	-		ITV20TT		6
3.6 AWD	216	ERB	Check Thread size	01/11-	SXU22HCR11S	3461	1.1	-		-	VXUHC22G	6
5.7	268	EZH		01/11-	ITL16TT	4717	1.0	-		ITL16TT		8
5.7	268	EZH	Twin Spark	01/11-	K16HPR-U11	6076	1.1	KH16TT		IKH16TT	IKH16TT	16
5.7 AWD	268	EZH		01/11-	ITL16TT	4717	1.0	-		ITL16TT		8
5.7 AWD	268	EZH	Twin Spark	01/11-	K16HPR-U11	6076	1.1	KH16TT		IKH16TT	IKH16TT	16
JOURNEY (08-)												
2.0 CRD	103	ECE		06/08-05/11	DG-190		4.4V					4
2.4	125/ 129	ED3; EDG		09/08-	KJ16CR-U11	3311	1.1	K16TT		IK16TT	IK16TT	4
2.4	129	EDG		09/08-	PKJ16CR8	3175	0.8	-		-		4
2.4 ECO+	125	EDG		06/08-	IK16TT	4701	1.0	-		IK16TT	IK16TT	4
2.7	136	EER		01/09-	ITL20	5350	1.1	-		-		6
2.7 FLEXFUEL	136	EER		01/09-	ITL20	5350	1.1	-		-		6
3.5	173	EGF		06/08-	VXUH22I	5656	0.9	-		IXUH22TT	VXUH22I	6
3.5 AWD	173	EGF		06/08-	VXUH22I	5656	0.9	-		IXUH22TT	VXUH22I	6
3.6	211	ERB		01/12-	VXUH22I	5656	0.9	-		IXUH22TT	VXUH22I	6
3.6	211	ERB	Check Thread size	01/12-	SXU22HCR11S	3461	1.1	-		-	VXUHC22G	6
NEON I (94-99)												
2.0 16V	98	ECB		05/94-08/99	K20PR-U	3145	0.8	K20TT		IK20TT	IK20TT	4
2.0 Highline	98	ECB		01/94-09/99	K20PR-U	3145	0.8	K20TT		IK20TT	IK20TT	4
NEON II (99-06)												
2.0 16V	98	ECB		08/99-12/06	K20PR-U	3145	0.8	K20TT		IK20TT	IK20TT	4
NITRO (06-12)												
2.8 CRD	130	ENR; ENS	OE:68029497A A	06/07-12/12	DG-633		4.4V					4
2.8 CRD	130	ENR; ENS	OE: 68090 434AA, applicatio n unsure	06/07-12/12	DG-660		5V					4
2.8 CRD 4WD	130	ENR; ENS	OE:68029497A A	06/07-12/12	DG-633		4.4V					4
2.8 CRD 4WD	130	ENR; ENS	OE: 68090 434AA, applicatio n unsure	06/07-12/12	DG-660		5V					4
3.7	157	EKG		09/06-12/12	KJ20CR-L11	3169	1.1	K20TT		IK20TT	IK20TT	6
3.7 4WD	157	EKG		09/06-12/12	KJ20CR-L11	3169	1.1	K20TT		IK20TT	IK20TT	6
3.7 V6 4WD	151	EKG		06/07-12/12	KJ20CR-L11	3169	1.1	K20TT		IK20TT	IK20TT	6
4.0 4WD	191	EGS		09/06-12/07	IK16L	5357	1.1	-		IK16TT	IK16TT	6
RAM (01-09)												
3.7	157	EKG		06/01-09/08	KJ20CR-L11	3169	1.1	K20TT		IK20TT	IK20TT	6
5.7	257	EZA	Twin Spark	01/06-12/09	ITL16TT	4717	1.0	-		ITL16TT		16
5.7	257	EZA; EZB		06/01-12/07	ITL16TT	4717	1.0	-		ITL16TT		8
5.7 4WD	257	EZA	Twin Spark	01/06-12/09	ITL16TT	4717	1.0	-		ITL16TT		16
5.7 4WD	257	EZA; EZB		01/02-12/08	ITL16TT	4717	1.0	-		ITL16TT		8
RAM (08-)												
5.7	287/ 291	EZD; EZE; EZH	Twin Spark	09/08-	K16HPR-U11	6076	1.1	KH16TT		IKH16TT	IKH16TT	16
5.7 4WD	257/ 287/ 291	EZD; EZE; EZH	Twin Spark	09/08-	K16HPR-U11	6076	1.1	KH16TT		IKH16TT	IKH16TT	16
RAM 4000 (05-)												
5.7	282	EZC	Twin Spark	01/07-12/08	ITL16TT	4717	1.0	-		ITL16TT		16
5.7	282	EZC	Twin Spark	01/09-	K16HPR-U11	6076	1.1	KH16TT		IKH16TT	IKH16TT	16
5.7 4WD	282	EZC	Twin Spark	01/07-12/08	ITL16TT	4717	1.0	-		ITL16TT		16

Свечи зажигания и Свечи накаливания

Таблица применения

	KW				СТАНДАРТНЫЕ			Twin Tip			QTY	
												
DODGE продолжение												
RAM 4000 (05-) продолжение												
5.7 4WD	282	EZC		Twin Spark	01/09-	K16HPR-U11	6076	1.1	KH16TT	IKH16TT	IKH16TT	16
STRATUS (95-01)												
2.0 16V	98	ECB			12/95-04/01	K20PR-U	3145	0.8	K20TT	IK20TT	IK20TT	4
2.4 16 V	103	EDZ			12/95-04/01	K16R-U11	3120	1.1	K16TT	IK16TT	IK16TT	4
2.4 16V	112	EDZ			12/95-04/01	K16R-U11	3120	1.1	K16TT	IK16TT	IK16TT	4
VIPER (02-10)												
8.3 SRT-10	372	EWC			09/02-12/06	QJ16AR-U	3235	0.8	-	-		10
DONGFENG HONDA												
CIVIC X (16-)												
1.5 220 Turbo	162	L15B8			04/16-	VXEHC24G	5660	1.1	-	-	VXEHC24G	4
CR-V IV (07-)												
2.4 AWD	118/ 125	K24A1; K24Z1			03/07-	KJ20DR-M11	3374	1.1	-	-	SKJ20DR-M11	4
GIENIA (16-)												
1.5	96	L15B5			10/16-	VFXEHC22G	5659	0.8	-	-	VFXEHC22G	4
GREIZ (15-)												
1.5	96	L15B5			10/15-	VFXEHC22G	5659	0.8	-	-	VFXEHC22G	4
JADE (15-)												
1.5	115	L15BF			12/16-	VXEHC24G	5660	1.1	-	-	VXEHC24G	4
1.8	104	R18Z6			09/15-	DXU22HCR-D11S	3483	1.1	-	-	VFXUHC22FG	4
XR-V (14-)												
1.5	96	L15B5			06/15-	VFXEHC22G	5659	0.8	-	-	VFXEHC22G	4
1.8	100	R18ZA			11/14-	DXU22HCR-D11S	3483	1.1	-	-	VFXUHC22FG	4
DR												
DR 1 (10-14)												
1.0	50	SQR472F			03/10-12/14	K20PR-U	3145	0.8	K20TT	IK20TT	IK20TT	4
1.0 CNG	50	SQR472F			03/10-12/14	K20PR-U	3145	0.8	K20TT	IK20TT	IK20TT	4
1.0 LPG	50	SQR472F			03/10-12/14	K20PR-U	3145	0.8	K20TT	IK20TT	IK20TT	4
1.3	61	SQR473			03/10-12/14	K20PR-U	3145	0.8	K20TT	IK20TT	IK20TT	4
1.3 CNG	61	SQR473			03/10-12/14	K20PR-U	3145	0.8	K20TT	IK20TT	IK20TT	4
1.3 LPG	61	SQR473			03/10-12/14	K20PR-U	3145	0.8	K20TT	IK20TT	IK20TT	4
DR 2 (10-14)												
1.3	61	SQR473			09/10-12/14	K20PR-U	3145	0.8	K20TT	IK20TT	IK20TT	4
1.3 CNG	61	SQR473			09/10-12/11	K20PR-U	3145	0.8	K20TT	IK20TT	IK20TT	4
1.3 LPG	61	SQR473			09/10-12/14	K20PR-U	3145	0.8	K20TT	IK20TT	IK20TT	4
DR 5 (11-)												
1.6	80/87	SQR481F			01/07-	K20PR-U	3145	0.8	K20TT	IK20TT	IK20TT	4
1.6 CNG	80	SQR481F			01/07-	K20PR-U	3145	0.8	K20TT	IK20TT	IK20TT	4
1.6 LPG	80/87	SQR481F			01/07-	K20PR-U	3145	0.8	K20TT	IK20TT	IK20TT	4
1.8	97	SQR481FC			01/11-	K20PR-U	3145	0.8	K20TT	IK20TT	IK20TT	4
2.0	94/ 102	SQR484F			01/07-	K20PR-U	3145	0.8	K20TT	IK20TT	IK20TT	4
2.0 4WD	102	SQR484F			01/11-	K20PR-U	3145	0.8	K20TT	IK20TT	IK20TT	4
2.0 CNG	94	SQR484F			01/07-	K20PR-U	3145	0.8	K20TT	IK20TT	IK20TT	4
2.0 LPG	94	SQR484F			01/07-	K20PR-U	3145	0.8	K20TT	IK20TT	IK20TT	4
DS												
DS3 (15-)												
1.2 VTi 82	60	HMZ (EB2); HMZ (EB2F)			04/15-	IXUH22I	5356	0.9	-	IXUH22TT	VXUH22I	3
1.6 BlueHDi 75	55	BHW (DV6FE)			07/15-	DG-603		5V				4
1.6 BlueHDi 100	73	BHY (DV6FD)			04/15-	DG-603		5V				4
1.6 BlueHDi 120	88	BHZ (DV6FC)			07/15-	DG-603		5V				4
DS4 (Crossback) (15-)												
1.6 BlueHDi 100	73	BHY (DV6FD)			04/16-	DG-603		5V				4
1.6 BlueHDi 120	88	BHZ (DV6FC)			07/15-	DG-603		5V				4
2.0 BlueHDi 150	110	AHR (DW10FD)			07/15-	DG-603		5V				4
2.0 BlueHDi 180	132	AHW (DW10FC)			07/15-	DG-603		5V				4
DS5 (15-)												
1.6 BlueHDi 120	88	BHZ (DV6FC)			06/15-	DG-603		5V				4
2.0 BlueHDi 150	110	AHR (DW10FD)			04/15-	DG-603		5V				4
2.0 BlueHDi 180	132	AHW (DW10FC)			04/15-	DG-603		5V				4
2.0 Hybrid4 4x4	120	RHC (DW10CTED4)			04/15-	DG-603		5V				4
EMGRAND												
EC7 (09-)												
1.5	72/80	JL4G15D; JLY-4G15			07/09-	K16PR-U	3191	0.8	K16TT	IK16TT	IK16TT	4

Свечи зажигания и Свечи накаливания









Таблица применения

Таблица применения

KW	KW	KW	KW	KW	СТАНДАРТНЫЕ			Twin Tip		QTY	
					STANDARD	STANDARD	STANDARD	TWIN TIP	TWIN TIP		
EMGRAND продолжение											
EC7 (09-) продолжение											
1.5	72/80	JL4G15D; JLY-4G15		07/09-	K20PR-U	3145	0.8	K20TT	IK20TT	IK20TT	4
1.8	93	JL4G18		07/09-	K16PR-U11	3130	1.1	K16TT	IK16TT	IK16TT	4
ENGLON											
SC7 (10-17)											
1.5	80	JLY-4G15		11/10-12/17	KH20TT	4618	1.0	KH20TT	IKH20TT	IKH20TT	4
FAW											
V2 (13-)											
1.3i	67	CA4GA1		10/13-	K20R-U11	3139	1.1	K20TT	IK20TT	IK20TT	4
V5 (12-)											
1.5i	75			01/12-	XU22EPR-U	3179	0.9	XU22TT	IXU22TT	VXU22	4
FAW-AUDI											
A6L (C6) (05-11)											
4.2 Turbo quattro	246	BBK/ BHF		09/05-12/11	K20PBR-S10	5061	1.0	K20TT	IK20TT	IK20TT	8
4.2 Turbo quattro	246	BBK/ BHF		09/05-12/11	K20TXR	5063	1.0	K20TT	IK20TT	IK20TT	8
4.2 Turbo quattro	253	BVJ		09/05-12/11	VKB20	5625	1.1	-	-	VKB20	8
FENGSHEN											
SUNNY (03-)											
2.0	107	SR20DE		06/03-	K16R-U11	3120	1.1	K16TT	IK16TT	IK16TT	4
FERRARI											
208 / 308 (75-89)											
208 Turbo	162	F 106 D..		06/82-10/89	IW29	5318	0.7	-	-	-	8
308 GTB Qv	177	F 105 A..		09/82-06/85	IW24	5316	0.7	-	-	-	8
308 GTS Qv	177	F 105 A..		09/82-06/85	IW24	5316	0.7	-	-	-	8
328 GTB (85-89)											
3.2	199	F 105 C..		09/85-09/89	IX24	5372	0.8	-	-	-	8
328 GTS (85-89)											
3.2	199	F 105 C..		09/85-09/89	IX24	5372	0.8	-	-	-	8
348 Spider (93-95)											
3.4	235	V834		03/93-12/95	IX24	5372	0.8	-	-	-	8
348 TB / GTB (90-94)											
3.4	221/ 235	F 119 D 040; F 119 F 000		02/90-04/94	IX24	5372	0.8	-	-	-	8
348 TS / GTS (90-95)											
3.4	221/ 235	F 119 D 040; F 119 F 000		08/90-12/95	IX24	5372	0.8	-	-	-	8
360 Modena (99-05)											
3.6	294	F 131 B40		02/00-08/05	IJ24	5362	0.9	-	-	-	8
3.6 Challenge	305	F 131 B44		05/01-03/05	IJ24	5362	0.9	-	-	-	8
3.6 Challenge Stradale	313			05/03-03/05	IJ24	5362	0.9	-	-	-	8
3.6 Modena	294/ 316	F 131 B40; F 131 B44		03/99-03/05	IJ24	5362	0.9	-	-	-	8
400 i (79-85)											
4.8	232	F 101..		05/79-03/85	W22EPR-U	3088	0.8	W22TT	-	VW22	12
412 i (85-88)											
4.9	250	F 101 E..		04/85-12/88	IW24	5316	0.7	-	-	-	12
456 GT / GTA (93-04)											
5.5 (F116)	325	F 116 B 00		01/93-06/04	IXU27	5337	0.9	-	-	-	12
550 BARCETTA (00-05)											
5.5	357	F 133		10/00-01/05	IXU27	5337	0.9	-	-	-	12
550 Maranello (96-02)											
550	357	F 133		04/96-12/01	IXU27	5337	0.9	-	-	-	12
575 Maranello (02-06)											
575 M	380	F133C47		04/02-12/06	IXU27	5337	0.9	-	-	-	12
599 GTB / GTO (06-)											
6.0 GTB	450/ 456	F134FB61		06/06-	IJ24	5362	0.9	-	-	-	12
6.0 GTO	489/ 493	F134FB61; F140CE		04/10-	IJ24	5362	0.9	-	-	-	12
612 SCAGLIETTI (04-11)											
5.7	397	F 118 B 42		04/04-06/11	IXU27	5337	0.9	-	-	-	12
DINO GT4 (74-80)											
308	188			02/74-06/80	W22EPR-U	3088	0.8	W22TT	-	VW22	8
ENZO (02-03)											
6.0	485	F 140 B49		10/02-12/03	IJ24	5362	0.9	-	-	-	12
F40 (88-92)											
3.0	352	F 120 A		02/88-06/92	U24ES-N	4196	0.8	-	-	-	8

Свечи зажигания и Свечи накаливания

Таблица применения

	KW				СТАНДАРТНЫЕ			Twin Tip		QTY
										
FERRARI продолжение										
F50 (95-97)										
4.7	383	F 130 B12		05/95-10/97	IU22	5361	0.9	-	-	12
F355 (94-00)										
3.5	280	F 129B/40		05/94-12/00	IU22	5361	0.9	-	-	8
F430 (Spider) (05-09)										
4.3	357/ 360/ 372/ 375	F 131 B43; F 131 B47; F 136 ED		03/05-12/09	IU24	5362	0.9	-	-	8
MONDIAL (80-93)										
3.2	188	V832C		10/87-09/89	IX24	5372	0.8	-	-	8
3.2 Quattrovalvole	199	F 105 C..		09/85-12/88	IX24	5372	0.8	-	-	8
3.4 T	221	F 119 D		01/89-12/93	IX24	5372	0.8	-	-	8
8	158	F 105 A..		07/80-09/83	IW24	5316	0.7	-	-	8
8 Quattrovalvole	177	F 105 A..		10/82-07/87	IW24	5316	0.7	-	-	8
TESTAROSSA (84-91)										
5.0	272/ 287	F 113 A..; F 113 B..		05/84-12/91	IX24	5372	0.8	-	-	12
FIAT										
124 (66-85)										
1600 Sport	82	125 B.000		11/69-08/73	W22EPR-U	3088	0.8	W22TT	-	VW22
124 Spider (348) (16-)										
1.4	103	55253268	40000km Lifetime	03/16-	IXU27	5337	0.9	-	-	4
125 (67-74)										
1.6	66/74	125 A.000; 125 B.000		07/67-03/74	W22EPR-U	3088	0.8	W22TT	-	VW22
126 (72-00)										
600	17	126 A.000		09/72-06/77	W22FPR-U	4022	0.7	-	-	2
650	18	126 A1.048		07/77-09/87	W20FP-U	3068	0.7	WF20TT	-	2
650	18	126 A1.048		07/81-12/87	W22EP-U	3085	0.8	W22TT	-	VW22
700	19	126 A2.048		09/87-12/93	W20EPR-U	3047	0.8	W20TT	IW20TT	IW20TT
127 (71-86)										
0.9	29/33	100 GL.048; 127GL.000		06/71-12/84	W20EPR-U	3047	0.8	W20TT	IW20TT	IW20TT
1.0	37	127 A.000		04/77-06/81	IW20TT	4709	1.0	-	IW20TT	4
1.0	37	127A.000		01/86-12/86	W20EPR-U	3047	0.8	W20TT	IW20TT	IW20TT
1.0 Sport	51	127A1.000		07/78-02/82	W20EPR-U	3047	0.8	W20TT	IW20TT	IW20TT
1.3 D	33	127 A5.000	Double Coil(LPH)	06/81-12/86	DG-001		11V			4
1.3 Diesel	33	127 A5.000	Double Coil(LPH)	04/81-12/86	DG-001		11V			4
1.3 Sport	55	127A3.000		12/81-05/83	W20EPR-U	3047	0.8	W20TT	IW20TT	IW20TT
128 (69-84)										
1.1	33/ 40/48	128A.000		02/75-09/81	W20EPR-U	3047	0.8	W20TT	IW20TT	IW20TT
1.1 (128A)	40	128A.000		03/69-08/81	W20EPR-U	3047	0.8	W20TT	IW20TT	IW20TT
1.3	55	128A1.000		03/72-12/79	W20EPR-U	3047	0.8	W20TT	IW20TT	IW20TT
1.3 Berlinetta	54	128A1.000		06/75-12/79	W20EPR-U	3047	0.8	W20TT	IW20TT	IW20TT
131 (74-84)										
1.3 Mirafiori	40/48	131A.000		09/77-09/81	W20EPR-U	3047	0.8	W20TT	IW20TT	IW20TT
1.3 Mirafiori (131A)	48	131B.000		03/78-02/81	W20EPR-U	3047	0.8	W20TT	IW20TT	IW20TT
1.3 Super Mirafiori	57	131B.000		03/78-12/80	W20EPR-U	3047	0.8	W20TT	IW20TT	IW20TT
1.4 Mirafiori	51	131C1.000		11/80-01/84	W20EPR-U	3047	0.8	W20TT	IW20TT	IW20TT
1.4 Super Mirafiori	55	131C1.000		04/81-01/82	W20EPR-U	3047	0.8	W20TT	IW20TT	IW20TT
1.6	55/63	131 A1.000; 131A1.000/ 131B1.000; 131A1.000		10/74-12/84	W20EPR-U	3047	0.8	W20TT	IW20TT	IW20TT
1.6 CL	55	131 A1.000		03/75-12/78	W20EPR-U	3047	0.8	W20TT	IW20TT	IW20TT
1.6 Super	72	131A1.000/131B1.000		03/78-02/81	W20EPR-U	3047	0.8	W20TT	IW20TT	IW20TT
1.6 Super Mirafiori	72	131 B1.000		03/79-07/80	IW20TT	4709	1.0	-	IW20TT	4
2.0 D	44	8144.65	Double Coil(LPH)	03/78-03/87	DG-001		11V			4
2.0 Super	83	131C4.000		01/81-01/82	W20EPR-U	3047	0.8	W20TT	IW20TT	IW20TT
2.5 D	53	8144.61	Double Coil(LPH)	06/78-02/84	DG-001		11V			4
2.5 Super Diesel	53	8144.61	Double Coil(LPH)	03/79-12/84	DG-001		11V			4

Свечи зажигания и Свечи накаливания

Таблица применения

Таблица применения

KW	KW	KW	NOTE	21	СТАНДАРТНЫЕ			Twin Tip		QTY	
					STANDARD	STANDARD	STANDARD	TWIN TIP	TWIN TIP		
FIAT продолжение											
132 (72-82)											
1.6	65/72	132C.000		03/77-12/81	W20EPR-U	3047	0.8	W20TT	IW20TT	IW20TT	4
2.0	83	132C2.000		01/76-06/81	W20EPR-U	3047	0.8	W20TT	IW20TT	IW20TT	4
2.0 D	44	8144.65	Double Coil(LPH)	07/78-07/82	DG-001		11V				4
2.0 i.e.	90	132C2.000/132DB.2A0		01/80-08/81	W20EPR-U	3047	0.8	W20TT	IW20TT	IW20TT	4
2.5 D	53	8144.61	Double Coil(LPH)	07/78-07/82	DG-001		11V				4
147 (76-96)											
1.3 D	33	127 A5.000	Double Coil Std(LPH)	07/82-06/84	DG-001		11V				4
1.3 D	36	127 A5.000	Double Coil(LPH)	10/80-10/95	DG-001		11V				4
242-SERIE (75-82)											
2.5 D	52	B 25.637	Double Coil(LPH)	08/80-07/82	DG-001		11V				4
500 (C) (312) (07-)											
0.9 (312AXH1A)	48	312 A4.000		09/12-	IXUH22	5353	0.9	-	IXUH22TT	VXUH22	2
0.9 (312AXP1A)	44	312 A4.000; 312 A6.000		12/13-	IXUH22	5353	0.9	-	IXUH22TT	VXUH22	2
1.2 (312AXA1A)	51	169 A4.000		07/07-	XU22EPR-U	3179	0.9	XU22TT	IXU22TT	VXU22	4
1.2 (312CXA1A, 312AXA1A)	51	169 A4.000		09/09-	XU22EPR-U	3179	0.9	XU22TT	IXU22TT	VXU22	4
1.2 LPG (312AXA1A)	51	169 A4.000		12/10-	VXU22	5608	0.9	-	IXU22TT	VXU22	4
1.3 D Multijet (312AXB1A)	55	169 A1.000	OE: 46796050	10/07-	DG-171		11V				4
1.3 D Multijet (312AXE1A)	70	199 B1.000; 312 B1.000	Euro-5, OE: 55210051	12/09-	DG-621		4.4V				4
1.3 D Multijet (312AYA1A)	57	312 B5.000	Euro-5, OE: 55210051	06/16-	DG-621		4.4V				4
1.3 D Multijet (312AYA1A)	57	312 B5.000	Euro-6, OE: 12 14 106/ 55238404 (RP 9016)	06/16-	DG-658		5V				4
1.3 D Multijet (312CXB1A)	55	169 A1.000	OE: 46796050	09/09-	DG-171		11V				4
1.3 D Multijet (312CXE1A, 312AXE1A)	70	199 B1.000; 312 B1.000	Euro-5, OE: 55210051	09/09-	DG-621		4.4V				4
1.4 (301J410)	74	169 A3.000; EAB		09/11-	XU22EPR-U	3179	0.9	XU22TT	IXU22TT	VXU22	4
1.4 (312AXC1B, 312CXC1B)	74	169 A3.000		10/07-	XU22EPR-U	3179	0.9	XU22TT	IXU22TT	VXU22	4
1.4 (312CXC1B, 312AXC1B)	74	169 A3.000		09/09-	XU22EPR-U	3179	0.9	XU22TT	IXU22TT	VXU22	4
500 (57-76)											
0.5	13	110 F.000; 120.000		01/65-12/75	W20FSR-U	6053	0.7	WF20TT	-		2
500L (12-)											
1.3 D Multijet	70	330 A1.000	Euro-5, OE: 55210051	06/14-	DG-621		4.4V				4
1.3 D Multijet	70	330 A1.000	Euro-6, OE: 12 14 106/ 55238404 (RP 9016)	06/14-	DG-658		5V				4
1.3 D Multijet (199LXY1A, 199LXY11)	62	199 B4.000	Euro-5, OE: 55210051	09/12-	DG-621		4.4V				4
1.3 D Multijet (199LXY1A, 199LXY11)	62	199 B4.000	Euro-6, OE: 12 14 106/ 55238404 (RP 9016)	09/12-	DG-658		5V				4
1.4	70	843 A1.000		09/12-	XU22EPR-U	3179	0.9	XU22TT	IXU22TT	VXU22	4
1.4 (199LYF1B)	88	940 B7.000	40000km Lifetime	10/13-	IXU27	5337	0.9	-	-		4
1.4 LPG (199LYF1B)	88	940 B7.000	40000km Lifetime	02/14-	IXU27	5337	0.9	-	-		4
1.6 D Multijet	77/88	199 B5.000; 940 C1.000; 955 A3.000		09/12-	DG-608		4.4V				4
500X (14-)											
1.3 D Multijet (334AXH1A)	70	55266963	Euro-6, OE: 12 14 106/ 55238404 (RP 9016)	11/14-	DG-658		5V				4
1.4	103	55263624	40000km Lifetime	09/14-	IXU27	5337	0.9	-	-		4
1.4 (334AXC1B)	100	55263624	40000km Lifetime	09/14-	IXU27	5337	0.9	-	-		4
1.4 4x4 (334AXF22)	120/ 125	55263623	40000km Lifetime	02/15-	IXU27	5337	0.9	-	-		4

Свечи зажигания и Свечи накаливания











Таблица применения

KW	KW	KW	NOTE	21	СТАНДАРТНЫЕ			Twin Tip			QTY
					STANDARD	STANDARD	STANDARD	TWIN TIP	TWIN TIP	TWIN TIP	
FIAT продолжение											
500X (14-) продолжение											
1.6 D Multijet (334AXA1B)	84	55260384		09/14-	DG-608		4.4V				4
1.6 D Multijet (334AXA1B, 334AXA11)	88	55260384		09/14-	DG-608		4.4V				4
2.0 D Multijet 4x4 (334AXB22, 334AXD2B)	100/103	55263087; 55263088		09/14-	DG-608		4.4V				4
900 T/E Panorama (78-86)											
0.9	26	100 GF 000		01/78-12/81	W20EPR-U	3047	0.8	W20TT	IW20TT	IW20TT	4
900 T/E Pulmino (78-86)											
0.9	26	100 GF 000		01/78-12/81	W20EPR-U	3047	0.8	W20TT	IW20TT	IW20TT	4
ALBEA / SIENA (96-11)											
1.2	59	188 A5.000		09/01-12/09	XU24EPR-U	3312	0.9	-	-	VXU24	4
1.2 (178CXG1AAM, 178CXG1AAP, 178CXG1AAT)	54	178 B5.000		09/98-12/02	K20TNR	3304	1.0	K20TT	IK20TT	IK20TT	4
1.2 (178CXS1AAI, 178BYA1AAT, 178CYA1AAT)	44	178 C4.066		09/01-12/12	K16PR-U	3191	0.8	K16TT	IK16TT	IK16TT	4
1.2 (178CXS1AAI, 178BYA1AAT, 178CYA1AAT)	44	188 A4.000	Eng: 2533529>	09/01-12/12	XU22EPR-U	3179	0.9	XU22TT	IXU22TT	VXU22	4
1.3 JTD	51	188 A9.000	OE: 46796050	09/03-12/09	DG-171		11V				4
1.4	51	178 B2.000		04/96-12/09	K16TNR-S9	3329	0.9	K16TT	IK16TT	IK16TT	4
1.4	57	178 F3.011; 350 A1.000		01/07-12/09	XU22EPR-U	3179	0.9	XU22TT	IXU22TT	VXU22	4
1.4 Cat	51	178 B2.016		04/96-12/09	K16TNR-S9	3329	0.9	K16TT	IK16TT	IK16TT	4
1.5	62	178 E5.022		06/04-12/09	K20PR-U	3145	0.8	K20TT	IK20TT	IK20TT	4
1.6 (178CYC1AAT)	76	182 B6.000		11/00-12/12	K16PR-U	3191	0.8	K16TT	IK16TT	IK16TT	4
1.6 16V	74	178 B3.000		09/98-12/09	K16PR-U	3191	0.8	K16TT	IK16TT	IK16TT	4
ARGENTA (78-86)											
1600	72	132 D.000		04/81-12/85	W20EPR-U	3047	0.8	W20TT	IW20TT	IW20TT	4
1600 i.e	66	132D3.000		04/81-12/85	W20EPR-U	3047	0.8	W20TT	IW20TT	IW20TT	4
2000	83	132 C2.000		01/81-12/85	W20EPR-U	3047	0.8	W20TT	IW20TT	IW20TT	4
2000 i.e.	90	132 C3.000		01/83-07/86	W20EPR-U	3047	0.8	W20TT	IW20TT	IW20TT	4
2000 Volumex	99	132E		06/84-07/85	W20EPR-U	3047	0.8	W20TT	IW20TT	IW20TT	4
2500 Diesel	53	8144.61	Double Coil(LPH)	06/81-11/85	DG-001		11V				4
2500 Turbodiesel	66	8144.61.500.81	Double Coil(LPH)	07/83-08/85	DG-001		11V				4
BARCETTA (95-05)											
1.8 16V	96	183 A1.000		04/95-05/05	K20TNR	3304	1.0	K20TT	IK20TT	IK20TT	4
1.8 16V	96	183 A6.000	Eng: >1945438	04/95-05/05	K20TNR	3304	1.0	K20TT	IK20TT	IK20TT	4
1.8 16V	96	188 A6.000	Eng: 1945438>	04/95-05/05	K20PR-U	3145	0.8	K20TT	IK20TT	IK20TT	4
BRAVA (95-02)											
1.2 16V 80	59	182 B2.000; 188 A5.000		12/98-12/02	XU24EPR-U	3312	0.9	-	-	VXU24	4
1.4	55	182 A5.000		10/95-10/01	K20TNR	3304	1.0	K20TT	IK20TT	IK20TT	4
1.4 12 V	59	182 A3.000		10/95-08/98	K20TNR	3304	1.0	K20TT	IK20TT	IK20TT	4
1.6 16V	66/76	182 A4.000; 182 A6.000; 182 B6.000		10/95-12/02	K20PR-U	3145	0.8	K20TT	IK20TT	IK20TT	4
1.8 GT 16V	83	182 A2.000		10/95-08/01	K20TNR	3304	1.0	K20TT	IK20TT	IK20TT	4
1.9 D	48	160 A7.000	Double Coil Std(LPH)	10/95-03/96	DG-001		11V				4
1.9 JTD	74	182 B9.000	Double Coil(LPH)	09/00-10/01	DG-122		11V				4
1.9 JTD 105	77	182 B4.000	Double Coil(LPH)	12/98-10/99	DG-127		11V				4
1.9 JTD 105	77	182 B4.000	Double Coil(LPH)	11/99-10/01	DG-122		11V				4
1.9 TD 75 S	55	182 A8.000	Double Coil(LPH)	03/96-10/01	DG-102		11V				4
1.9 TD 100 S	74	182 A7.000	Double Coil(LPH)	03/96-10/01	DG-102		11V				4
BRAVO I (95-01)											
1.2 16V 80	59	182 B2.000; 188 A5.000		12/98-10/01	XU24EPR-U	3312	0.9	-	-	VXU24	4
1.4	55/59	182 A3.000; 182 A5.000		10/95-10/01	K20TNR	3304	1.0	K20TT	IK20TT	IK20TT	4
1.6	76	182 B6.000		09/00-10/01	K16PR-U	3191	0.8	K16TT	IK16TT	IK16TT	4
1.6 16V	66/76	182 A4.000; 182 A6.000		10/95-10/01	K20PR-U	3145	0.8	K20TT	IK20TT	IK20TT	4
1.8 GT	83	182 A2.000		10/95-10/01	K20TNR	3304	1.0	K20TT	IK20TT	IK20TT	4
1.9 D	48	160 A7.000	Double Coil Std(LPH)	10/95-03/96	DG-001		11V				4

Свечи зажигания и Свечи накаливания

Таблица применения

Таблица применения

	KW				СТАНДАРТНЫЕ				Twin Tip			QTY
												
FIAT продолжение												
BRAVO I (95-01) продолжение												
1.9 JTD	74	182 B9.000	Double Coil(LPH)	09/00-10/01	DG-122		11V					4
1.9 JTD 105	77	182 B4.000	Double Coil(LPH)	12/98-10/99	DG-127		11V					4
1.9 JTD 105	77	182 B4.000	Double Coil(LPH)	11/99-10/01	DG-122		11V					4
1.9 TD 75 S	55	182 A8.000	Double Coil(LPH)	03/96-10/01	DG-102		11V					4
1.9 TD 100 S	74	182 A7.000	Double Coil(LPH)	03/96-10/01	DG-102		11V					4
2.0 HGT 20V	108/ 113	182 A1.000; 182 B7.000		10/95-10/01	K20TNR	3304	1.0	K20TT	IK20TT	IK20TT		4
BRAVO II (06-14)												
1.4	66	192 B2.000		04/07-12/14	XU22EPR-U	3179	0.9	XU22TT	IXU22TT	VXU22		4
1.4 16V	103	198 A7.000	40000km Lifetime	04/10-12/14	IXU27	5337	0.9	-	-			4
1.4 LPG	66	192 B2.000		12/08-12/14	XU22EPR-U	3179	0.9	XU22TT	IXU22TT	VXU22		4
1.4 T-Jet	88/ 110	198 A1.000; 198 A4.000	40000km Lifetime	09/07-12/14	IXU27	5337	0.9	-	-			4
1.6 D Multijet	66/ 77/88	198 A2.000; 198 A3.000; 198 A6.000; 844 A3.000		03/08-12/14	DG-608		4.4V					4
1.9 D Multijet	85/88	192 A1.000; 192 A8.000; 192 B4.000	Double Coil(LPH)	11/06-12/09	DG-196		11V					4
1.9 D Multijet	110	937 A5.000		04/07-12/14	DG-170		11V					4
2.0 D Multijet	121	198 A5.000; 198 A8.000; 844 A2.000		09/08-12/14	DG-608		4.4V					4
CAMPAGNOLA (74-89)												
2.4 D	53	8144.61.200	Double Coil(LPH)	06/74-10/89	DG-001		11V					4
CINQUECENTO (91-99)												
0.7	23	170 A.000		12/91-01/96	W20EPR-U	3047	0.8	W20TT	IW20TT	IW20TT		2
0.7 i	22	170 A.046		07/94-01/98	W20EPR-U	3047	0.8	W20TT	IW20TT	IW20TT		2
0.9	30	170 A1.000		07/91-12/93	W20EPR-U	3047	0.8	W20TT	IW20TT	IW20TT		4
0.9 i.e.	30	170 A1.046		07/91-09/94	W20EPR-U	3047	0.8	W20TT	IW20TT	IW20TT		4
0.9 i.e. S	29	1170 A1.000; 1170 A1.046		07/91-07/99	W20EPR-U	3047	0.8	W20TT	IW20TT	IW20TT		4
1.1 Sporting	40	176 B2.000		10/94-01/98	K20PR-U	3145	0.8	K20TT	IK20TT	IK20TT		4
1.1 Sporting	40	176 B2.000		10/94-01/98	K20TNR	3304	1.0	K20TT	IK20TT	IK20TT		4
COUPE (93-00)												
1.8 16V	96	183 A1.000		03/96-08/00	K20TNR	3304	1.0	K20TT	IK20TT	IK20TT		4
2.0 16V	102	836 A3.000		11/93-08/96	W22EPR-U	3088	0.8	W22TT	-	VW22		4
2.0 16V Turbo	140	175 A1.000		11/93-08/96	W20EPB	5065	0.85	W20TT	IW20TT	IW20TT		4
2.0 16V Turbo	140	175 A1.000		11/93-08/96	W22EPB	5066	0.85	W22TT	-	VW22		4
2.0 20V	108/ 113	182 A1.000; 182 B3.000		08/96-08/00	K20TNR	3304	1.0	K20TT	IK20TT	IK20TT		4
2.0 20V Turbo	162	175 A3.000		08/96-08/00	K20PBR-S10	5061	1.0	K20TT	IK20TT	IK20TT		5
CROMA (85-96)												
1600	61	154A.000/154A.048		12/85-12/90	W22EPR-U	3088	0.8	W22TT	-	VW22		4
1900 Turbo D i.d.	66/69	154 C6.000; 154 D1.000	Double Coil	08/87-12/96	DG-132		11V					4
2000 16V	101	154 E1.000		08/92-08/96	W22EPR-U	3088	0.8	W22TT	-	VW22		4
2000 CHT	66/74	154 A1.000; 154 C5.000		12/85-09/92	W22EPR-U	3088	0.8	W22TT	-	VW22		4
2000 i.e.	83/ 85/88	154 C3.046; 154C; 834B.000		03/86-12/93	W22EPR-U	3088	0.8	W22TT	-	VW22		4
2000 i.e. Turbo	110	154 C4.046; 834 C.146		11/86-08/96	W20EPBR-S	5067	0.85	W20TT	IW20TT	IW20TT		4
2000 i.e. Turbo	114	154A2.000		12/85-06/90	W22EPR-U	3088	0.8	W22TT	-	VW22		4
2500 D	55	8144.67	Double Coil Std(LPH)	12/85-12/89	DG-001		11V					4
2500 TD	74/85	8144.91.2000; 8144.97.2400; 8144.97	Double Coil(LPH)	12/85-12/93	DG-001		11V					4
2500 TDE	77	8144.97 S	Double Coil(LPH)	12/91-08/96	DG-001		11V					4
2500 V6	119	834 G.000		06/93-08/96	W22EPR-U	3088	0.8	W22TT	-	VW22		6
CROMA (05-)												
1.8 16V	103	939 A4.000		12/05-	KJ16CR-L11	3132	1.1	K16TT	IK16TT	IK16TT		4
1.9 D Multijet	85	939 A7.000		06/05-	DG-122		11V					4
1.9 D Multijet	88	939 A1.000	Double Coil(LPH)	06/05-12/11	DG-196		11V					4

Свечи зажигания и Свечи накаливания

Таблица применения

	KW				СТАНДАРТНЫЕ			Twin Tip			QTY
FIAT продолжение											
CROMA (05-) продолжение											
1.9 D Multijet	110	939 A2.000	Double Coil(LPH)	06/05-12/11	DG-170		11V				4
2.2 16V	108	194 A1.000		06/05-	PT16VR13	5068	1.3	TV16TT	ITV16TT	ITV16TT	4
2.4 D Multijet	147	939 A3.000	Double Coil(LPH)	06/05-	DG-170		11V				5
DOBLO (01-)											
1.2	48	223 A5.000		03/01-	K16PR-U	3191	0.8	K16TT	IK16TT	IK16TT	4
1.3 D Multijet	55/62	199 A2.000; 223 A9.000	OE: 46796050	10/05-	DG-171		11V				4
1.3 JTD	55	199 A2.000	OE: 46796050	05/05-	DG-171		11V				4
1.3 JTD 16V	51	188 A8.000; 188 A9.000	OE: 46796050	05/04-12/06	DG-171		11V				4
1.4	57	350 A1.000		10/05-	XU22EPR-U	3179	0.9	XU22TT	IXU22TT	VXU22	4
1.6 16V	76	182 B6.000		10/01-	K16PR-U	3191	0.8	K16TT	IK16TT	IK16TT	4
1.6 Natural Power	76	182 B6.000		09/02-	IK20TT	4702	1.0	-	IK20TT	IK20TT	4
1.9 D	46	223 A6.000	Double Coil(LPH)	03/01-	DG-129		11V				4
1.9 D Multijet	88	186 A9.000	Double Coil(LPH)	10/05-	DG-196		11V				4
1.9 JTD	74/77	182 B9.000; 223 A7.000; 223 B1.000; 223 B2.000	Double Coil(LPH)	10/01-	DG-122		11V				4
DOBLO (10-)											
1.3 D Multijet	55/ 59/ 66/70	199 A3.000; 225 A2.000; 263 A2.000; 263 A6.000; 330 A1.000	Euro-5,OE: 55210051	02/10-	DG-621		4.4V				4
1.3 D Multijet	66	199 A3.000; 263 A2.000	Euro-4,OE: 46796050	02/10-	DG-171		11V				4
1.3 D Multijet (263AXC1A)	66	199 A3.000; 263 A2.000	Euro-4,OE: 46796050	02/10-	DG-171		11V				4
1.3 D Multijet (263AXC1A)	66	199 A3.000; 263 A2.000	Euro-5,OE: 55210051	02/10-	DG-621		4.4V				4
1.3 D Multijet (263AXU1A)	70	330 A1.000	Euro-5,OE: 55210051	03/16-	DG-621		4.4V				4
1.4	70	843 A1.000		02/10-	XU22EPR-U	3179	0.9	XU22TT	IXU22TT	VXU22	4
1.4	88	198 A4.000	40000km Lifetime	10/11-	IXU27	5337	0.9	-	-		4
1.4 (263AXG1B, 263AXG1A)	88	198 A4.000	40000km Lifetime	10/11-	IXU27	5337	0.9	-	-		4
1.4 Natural Power	88	198 A4.000	40000km Lifetime	02/10-	IXU27	5337	0.9	-	-		4
1.6 D Multijet	66/ 74/77	198 A3.000; 263 A3.000; 263 A4.000; 263 A5.000; 263 A8.000; 263 A9.000		02/10-	DG-608		4.4V				4
1.6 D Multijet (263AXD1B)	77	198 A3.000; 263 A8.000		01/10-	DG-608		4.4V				4
1.6 D Multijet (263AXH1A, 263AXL11, 263AXH1B)	66	263 A4.000		02/10-	DG-608		4.4V				4
2.0 D Multijet	99	263 A1.000		01/10-	DG-608		4.4V				4
DUCATO (230) (94-02)											
1.9 D	50	230 A2.000	Double Coil(LPH)	03/94-04/02	DG-001		11V				4
1.9 D	50	D9B (XUD9A); D9B; DJY	Double Coil(LPH)	04/98-04/02	DG-003		11V				4
1.9 D Combinato	51	230 A2.000	Double Coil(LPH)	06/95-04/02	DG-001		11V				4
1.9 TD	60/66	230 A3.000; DHX (XUD9TF/L)	Double Coil(LPH)	03/94-04/02	DG-001		11V				4
1.9 TD CAT	59	230 A4.000	Double Coil(LPH)	08/94-04/02	DG-001		11V				4
1.9 TD Combinato	59	230 A4.000	Double Coil(LPH)	08/94-04/02	DG-001		11V				4
1.9 TD Panorama/Combinato	60	230 A3.000	Double Coil(LPH)	03/94-04/02	DG-001		11V				4
2.0	80	RFW		03/94-03/95	K20PR-U	3145	0.8	K20TT	IK20TT	IK20TT	4
2.0	80	RFW		03/95-04/02	K20TXR	5063	1.0	K20TT	IK20TT	IK20TT	4
2.0 4x4	80	RFW		11/94-03/95	K20PR-U	3145	0.8	K20TT	IK20TT	IK20TT	4
2.0 4x4	80	RFW		03/95-04/02	K20TXR	5063	1.0	K20TT	IK20TT	IK20TT	4
2.0 JTD	62	RHV (DW10)	Double Coil(LPH)	07/01-04/02	DG-116		11V				4

Таблица применения

F

Свечи зажигания и Свечи накаливания

Таблица применения

Таблица применения

	KW				СТАНДАРТНЫЕ			Twin Tip			QTY
FIAT продолжение											
DUCATO (230) (94-02) продолжение											
2.0 Panorama/Combinato	80	RFW		03/94-03/95	K20PR-U	3145	0.8	K20TT	IK20TT	IK20TT	4
2.0 Panorama/Combinato	80	RFW		03/95-04/02	K20TXR	5063	1.0	K20TT	IK20TT	IK20TT	4
2.5 D	62	8140.67	Double Coil(LPH)	03/94-04/02	DG-004		11V				4
2.5 D 4x4	62	8140.67	Double Coil(LPH)	03/94-04/02	DG-004		11V				4
2.5 D Combinato	62	8140.67	Double Coil(LPH)	08/94-04/02	DG-004		11V				4
2.8 D	64	8140.63	Double Coil(LPH)	02/98-04/02	DG-111		11V				4
2.8 D 4x4	64	8140.63	Double Coil(LPH)	08/98-04/02	DG-111		11V				4
2.8 JTD	94	8140.43S	Double Coil(LPH)	11/00-04/02	DG-111		11V				4
2.8 JTD 4x4	94	8140.43S	Double Coil(LPH)	11/00-04/02	DG-111		11V				4
2.8 TD 4x4	64	8140.63	Double Coil(LPH)	05/98-11/01	DG-111		11V				4
2.8 TDI	90	8140.43	Double Coil(LPH)	10/97-04/02	DG-111		11V				4
2.8 TDI 4x4	90	8140.43	Double Coil(LPH)	06/99-04/02	DG-111		11V				4
DUCATO (244) (02-)											
2.0	81	RFL (XU10J2U)		04/02-	K20PR-U	3145	0.8	K20TT	IK20TT	IK20TT	4
2.0 4x4	81	RFL (XU10J2U)		05/02-07/06	K20PR-U	3145	0.8	K20TT	IK20TT	IK20TT	4
2.0 Bipower	81	RFL (XU10J2U)		11/02-	K20PR-U	3145	0.8	K20TT	IK20TT	IK20TT	4
2.0 JTD	62	RHV (DW10)	Double Coil(LPH)	04/02-	DG-116		11V				4
2.3 JTD	81	F1AE0481C	Double Coil(LPH)	04/02-	DG-195		11V				4
2.8 JTD	94/ 107	8140.43N; 8140.43S	Double Coil(LPH)	04/02-	DG-111		11V				4
2.8 JTD 4x4	94	8140.43S	Double Coil(LPH)	07/02-	DG-111		11V				4
2.8 JTD Power	107	8140.43N	Double Coil(LPH)	05/04-	DG-111		11V				4
DUCATO (250, 290) (06-)											
2.0 D Multijet 115	85	250 A1.000; 250 A2.000		06/11-	DG-608		4.4V				4
2.2 D Multijet 100	74	4HV (P22DTE)		07/06-	DG-130		11.5V				4
2.3 D Multijet 110	83	F1AE3481G	Double Coil(LPH)	10/11-	DG-195		11V				4
2.3 D Multijet 120	88	F1AE0481D; F1AGL4114; FPT		07/06-	DG-195		11V				4
2.3 D Multijet 120 4x4	88	F1AE0481D	Double Coil(LPH)	03/10-	DG-195		11V				4
2.3 D Multijet 130	93/96	F1AE0481N; F1AE0481T; F1AE3481D; F1AGL411D; F1AGL411M	Double Coil(LPH)	01/10-	DG-195		11V				4
2.3 D Multijet 130	96	F1AE3481D		07/06-	DG-195		11V				4
2.3 D Multijet 150	109	F1AE3481E		06/11-	DG-195		11V				4
2.3 D Multijet 150	109	F1AE3481E	Double Coil(LPH)	06/11-	DG-195		11V				4
3.0 D Multijet 150	107	F1CE3481N		04/10-	DG-195		11V				4
3.0 D Multijet 150	107	F1CE3481N	Double Coil(LPH)	04/10-	DG-195		11V				4
3.0 D Multijet 160	116	F1CE0481D; F1CE3481M		07/06-	DG-195		11V				4
3.0 D Multijet 160	116	F1CE0481D; F1CE3481M	Double Coil(LPH)	07/06-	DG-195		11V				4
3.0 D Multijet 180	130	F1CE3481E		06/11-	DG-195		11V				4
3.0 D Multijet 180	130	F1CE3481E	Double Coil(LPH)	06/11-	DG-195		11V				4
3.0 Natural Power 140	100	F1CE0441A; F1CFA401A		04/09-	K22PBR-S	5062	0.85	-	IKB22TT	VK22	4
DUCATO (280) (82-90)											
1.8	49/51	169 B; 169B		01/82-12/88	W20EPR-U	3047	0.8	W20TT	IW20TT	IW20TT	4
1.9 D	52	149 B1.000	Double Coil Std(LPH)	02/87-08/90	DG-001		11V				4
1.9 TD	60	280 A1.000	Double Coil(LPH)	03/89-08/90	DG-001		11V				4
2.0	55	170 B; XN 1T		07/85-08/90	W20EP-U	3043	0.8	W20TT	IW20TT	IW20TT	4
2.0	58	XN 1T		01/82-08/90	W20EPR-U	3047	0.8	W20TT	IW20TT	IW20TT	4
2.0	62	170D-U8		07/90-08/90	W16EPR-U	3021	0.8	W16TT	IW16TT	IW16TT	4

Свечи зажигания и Свечи накаливания

Таблица применения



	KW				СТАНДАРТНЫЕ			Twin Tip			QTY
											
FIAT продолжение											
DUCATO (280) (82-90) продолжение											
2.4 D	53	8144.61	Double Coil(LPH)	01/82-08/90	DG-001		11V				4
2.5 D	55	8144.67; CRD93L (U25-661)	Double Coil(LPH)	01/86-08/90	DG-001		11V				4
2.5 D 4x4	55	8144.67	Double Coil(LPH)	01/87-08/90	DG-001		11V				4
2.5 TD	68	8144.21.220; 8144.21	Double Coil(LPH)	01/86-08/90	DG-001		11V				4
2.5 TD 4x4	68	8144.21	Double Coil(LPH)	01/86-08/90	DG-001		11V				4
DUCATO (290) (89-94)											
1.9 D	52	149 B1.000	Double Coil Std(LPH)	07/90-03/94	DG-001		11V				4
1.9 D	52	149 B1.000	Double Coil(LPH)	07/90-03/94	DG-001		11V				4
1.9 TD	60	280 A1.000	Double Coil(LPH)	03/89-03/94	DG-001		11V				4
2.0	62	170 D		06/90-05/94	W16EPR-U	3021	0.8	W16TT	IW16TT	IW16TT	4
2.0 4x4	63	170 D		06/90-05/94	W16EPR-U	3021	0.8	W16TT	IW16TT	IW16TT	4
2.5 D	55	8144.67	Double Coil(LPH)	03/89-03/94	DG-001		11V				4
2.5 D 4x4	55	8144.67	Double Coil(LPH)	07/90-03/94	DG-001		11V				4
2.5 TD	70	8140.27	Double Coil(LPH)	06/90-05/94	DG-001		11V				4
2.5 TD 4x4	70	8140.27	Double Coil(LPH)	07/90-03/94	DG-001		11V				4
DUNA (87-91)											
1.1 60	43	146 A6.000		01/87-12/91	W20EPR-U	3047	0.8	W20TT	IW20TT	IW20TT	4
1.3 70	49	146 A5.000		01/87-12/91	W20EPR-U	3047	0.8	W20TT	IW20TT	IW20TT	4
1.7 DS	44	146 B2.000; 149 B3.000	Double Coil Std(LPH)	01/87-12/91	DG-001		11V				4
DUNA (91-96)											
1.1	43	146 A4.048		07/91-07/96	W20EPR-U	3047	0.8	W20TT	IW20TT	IW20TT	4
ELBA (85-97)											
1.3	49	146 A5.000		04/91-02/95	W20EPR-U	3047	0.8	W20TT	IW20TT	IW20TT	4
1.4	49	146 D5.000		10/93-02/95	K20PR-U	3145	0.8	K20TT	IK20TT	IK20TT	4
1.6	69	146 C6.000		01/94-12/96	W22EPR-U	3088	0.8	W22TT	-	VW22	4
1.6	69	146 D6.000		01/94-12/96	K22PR-U	3165	0.8	-	IK22TT	VK22	4
1.6	69	146D6.000		01/94-12/96	Q22PR-U	3010	0.8	-	-	VQ22	4
1.7 D	42	146 B2.000	Double Coil Std(LPH)	04/89-12/96	DG-001		11V				4
FIORINO (77-87)											
900	33	127GL.000		10/77-10/86	W20EPR-U	3047	0.8	W20TT	IW20TT	IW20TT	4
1050	37	127 A.000		01/80-12/87	IW20TT	4709	1.0	-	IW20TT		4
FIORINO (80-93)											
1.0	37/41	127 A.000; 127A.046; 156 A.000		01/80-10/89	W20EPR-U	3047	0.8	W20TT	IW20TT	IW20TT	4
1.1 60	43	146 A9.000		11/86-04/88	W20EPR-U	3047	0.8	W20TT	IW20TT	IW20TT	4
1.3	49	146 A5.000		12/87-08/93	W20EPR-U	3047	0.8	W20TT	IW20TT	IW20TT	4
1.3 D	33	127 A5.000	Double Coil Std(LPH)	05/84-12/88	DG-001		11V				4
1.3 D	33	127 A5.000	Double Coil(LPH)	03/82-01/88	DG-001		11V				4
FIORINO (88-01)											
1.1 60	43	146 A9.000		05/88-12/93	W20EPR-U	3047	0.8	W20TT	IW20TT	IW20TT	4
1.3	49	146 A5.000		01/88-12/94	W20EPR-U	3047	0.8	W20TT	IW20TT	IW20TT	4
1.3 70	49	146 A5.000		01/88-12/94	W20EPR-U	3047	0.8	W20TT	IW20TT	IW20TT	4
1.4	49	146 D5.000		05/94-05/01	K20PR-U	3145	0.8	K20TT	IK20TT	IK20TT	4
1.4	52	146 C5.000		11/92-10/96	W20EPR-U	3047	0.8	W20TT	IW20TT	IW20TT	4
1.4 i.e. 70	51	146 C5.000		05/94-05/01	W20EPR-U	3047	0.8	W20TT	IW20TT	IW20TT	4
1.4 i.e. 70	51	146 D5.000		05/94-05/01	K20PR-U	3145	0.8	K20TT	IK20TT	IK20TT	4
1.5 i.e. 75	55	149 C1.000		05/88-12/93	W22EPR-U	3088	0.8	W22TT	-	VW22	4
1.5 iE	55	149 C1.000		01/88-10/92	W22EPR-U	3088	0.8	W22TT	-	VW22	4
1.6	55	146 C6.000		01/94-05/01	W22EPR-U	3088	0.8	W22TT	-	VW22	4
1.6	55	146 D6.000		01/94-05/01	K22PR-U	3165	0.8	-	IK22TT	VK22	4
1.6 i.e. 75	55	146 C6.000		10/93-05/01	W22EPR-U	3088	0.8	W22TT	-	VW22	4
1.6 i.e. 75	55	146 D6.000		10/93-05/01	K22PR-U	3165	0.8	-	IK22TT	VK22	4
1.7 D	42/44	146 B2.000; 149 B3.000	Double Coil Std(LPH)	05/88-10/99	DG-001		11V				4

Таблица применения











F

Свечи зажигания и Свечи накаливания

Таблица применения

Таблица применения

F

	KW				СТАНДАРТНЫЕ			Twin Tip			QTY
											
FIAT продолжение											
FIORINO (88-01) продолжение											
1.7 D 60	44	146 B2.000; 149 B3.000	Double Coil Std(LPH)	05/88-05/00	DG-001		11V				4
1.7 TD	46	146 D7.000	Double Coil(LPH)	01/97-05/01	DG-001		11V				4
1.7 TD 65	46	146 D7.000	Double Coil(LPH)	01/97-05/01	DG-001		11V				4
FIORINO (07-)											
1.3 D Multijet (225BXD1A, 225BXB1A, 225BXB11)	55	199 A2.000; 199 A9.000	Euro-4,OE: 46796050	11/07-	DG-171		11V				4
1.3 D Multijet (225BXD1A, 225BXB1A, 225BXB11)	55	199 A2.000; 199 A9.000	Euro-5,OE: 55210051	11/07-	DG-621		4.4V				4
1.3 D Multijet (225BXD1A, 225BXB1A, 225BXB11)	55	199 A2.000; 199 A9.000	Euro-6,OE: 12 14 106/ 55238404 (RP 9016)	11/07-	DG-658		5V				4
1.3 D Multijet (225BXE1A)	70	199 B1.000; 330 A1.000	Euro-5,OE: 55210051	07/09-	DG-621		4.4V				4
1.3 D Multijet (225BXE1A)	70	199 B1.000; 330 A1.000	Euro-6,OE: 12 14 106/ 55238404 (RP 9016)	07/09-	DG-658		5V				4
1.3 D Multijet (225CXG1A)	59	225 A2.000	Euro-5,OE: 55210051	03/15-	DG-621		4.4V				4
1.3 D Multijet (225CXG1A)	59	225 A2.000	Euro-6,OE: 12 14 106/ 55238404 (RP 9016)	03/15-	DG-658		5V				4
1.4 (225AXA1A, 225BXA1A)	57	350 A1.000		10/09-	XU22EPR-U	3179	0.9	XU22TT	IXU22TT	VXU22	4
1.4 (225BXA1A, 225BXF1A)	54	KFT; KfV		11/07-	K20PR-U	3145	0.8	K20TT	IK20TT	IK20TT	4
1.4 Natural Power	57	350 A1.000		06/08-	XU22EPR-U	3179	0.9	XU22TT	IXU22TT	VXU22	4
FREEMONT (11-)											
2.0 JTD	100/ 103/ 120/ 125	939 B5.000; 940 A5.000		08/11-	DG-608		4.4V				4
2.0 JTD 4x4	120/ 125	939 B5.000; 940 A5.000		08/11-	DG-608		4.4V				4
2.4	125	ED3		08/11-	KJ16CR-U11	3311	1.1	K16TT	IK16TT	IK16TT	4
2.4	125	EDG		08/11-	PKJ16CR8	3175	0.8	-	-	-	4
3.6	206	ERB	Check Thread size	08/11-	ITV20TT	4719	1.0	-	ITV20TT	-	6
3.6	206	ERB	Check Thread size	08/11-	SXU22HCR11S	3461	1.1	-	-	VXUHC22G	6
3.6 4x4	206	ERB	Check Thread size	08/11-	ITV20TT	4719	1.0	-	ITV20TT	-	6
3.6 4x4	206	ERB	Check Thread size	08/11-	SXU22HCR11S	3461	1.1	-	-	VXUHC22G	6
FULLBACK (16-)											
2.4 D	113	4N15	OE:160784998 0; 1820-A019; RP8488;GN123	01/16-	DG-656		11V				4
2.4 D 4x4	110/ 113/ 133	4N15	OE:160784998 0; 1820-A019; RP8488;GN123	01/16-	DG-656		11V				4
Grande PUNTO (05-)											
1.2	48/51	169 A4.000; 199 A4.000		10/05-	XU22EPR-U	3179	0.9	XU22TT	IXU22TT	VXU22	4
1.2 LPG	51	199 A4.000		07/08-	VXU22	5608	0.9	-	IXU22TT	VXU22	4
1.3 D Multijet	51/ 55/ 62/70	199 A2.000; 199 A9.000; 199 B1.000; 199 B2.000; 199 B4.000; 223 A9.000	Euro-5,OE: 55210051	10/05-	DG-621		4.4V				4
1.3 D Multijet	51/ 55/ 62/70	199 A2.000; 199 A9.000; 199 B1.000; 199 B2.000; 199 B4.000; 223 A9.000	Euro-6,OE: 12 14 106/ 55238404 (RP 9016)	10/05-	DG-658		5V				4
1.3 D Multijet	55/66	199 A2.000; 199 A3.000; 199 A9.000	Euro-4,OE: 46796050	10/05-	DG-171		11V				4
1.4	55/57	199 A7.000; 350 A1.000		06/05-	XU22EPR-U	3179	0.9	XU22TT	IXU22TT	VXU22	4
1.4 16V	70	199 A6.000		10/05-	XU22EPR-U	3179	0.9	XU22TT	IXU22TT	VXU22	4

Свечи зажигания и Свечи накаливания

Таблица применения

	KW				СТАНДАРТНЫЕ			Twin Tip			QTY
FIAT продолжение											
Grande PUNTO (05-) продолжение											
1.4 16V	112	198 A1.000	40000km Lifetime	09/07-07/12	IXU27	5337	0.9	-	-		4
1.4 LPG	57	350 A1.000		12/08-	XU22EPR-U	3179	0.9	XU22TT	IXU22TT	VXU22	4
1.4 Natural Power	57	350 A1.000		07/08-	XU22EPR-U	3179	0.9	XU22TT	IXU22TT	VXU22	4
1.4 T-Jet	88	198 A4.000	40000km Lifetime	09/07-	IXU27	5337	0.9	-	-		4
1.6 D Multijet	88	955 A3.000		07/08-	DG-608		4.4V				4
1.9 D Multijet	85/ 88/96	199 A5.000; 939 A1.000; 939 A7.000	Double Coil(LPH)	10/05-	DG-122		11V				4
IDEA (03-)											
1.2 16V	59	188 A5.000		01/04-	XU24EPR-U	3312	0.9	-	-	VXU24	4
1.3 D Multijet	51/ 66/70	188 A9.000; 199 A3.000; 199 B1.000	Euro-4,OE: 46796050	01/04-12/10	DG-171		11V				4
1.3 D Multijet	70	199 B1.000	Euro-5,OE: 55210051	05/08-12/12	DG-621		4.4V				4
1.4	57/66	192 B2.000; 350 A1.000		12/03-	XU22EPR-U	3179	0.9	XU22TT	IXU22TT	VXU22	4
1.4 16V	70	843 A1.000		01/04-	XU22EPR-U	3179	0.9	XU22TT	IXU22TT	VXU22	4
1.4 LPG	57	350 A1.000		03/09-	XU22EPR-U	3179	0.9	XU22TT	IXU22TT	VXU22	4
1.6 D Multijet	88	350 A2.000		05/08-	DG-608		4.4V				4
1.9 JTD	74	188 B2.000	Double Coil(LPH)	01/04-	DG-122		11V				4
LINEA (07-)											
1.3 D Multijet	66/70	199 A3.000	OE:46796050, Double Coil(LPH)	06/07-	DG-171		11V				4
1.4	57	350 A1.000		06/07-	XU22EPR-U	3179	0.9	XU22TT	IXU22TT	VXU22	4
1.4 T-Jet	88	198 A4.000	40000km Lifetime	09/07-	IXU27	5337	0.9	-	-		4
1.6 D Multijet	77	198 A3.000		06/09-	DG-608		4.4V				4
MAREA (96-07)											
1.2 16V	60	182 B2.000		10/98-05/02	XU24EPR-U	3312	0.9	-	-	VXU24	4
1.4 80 12V	59	182 A3.000		09/96-05/02	K20TNR	3304	1.0	K20TT	IK20TT	IK20TT	4
1.6	68/76	182 B6.000; 185 A3.000		03/99-08/02	K16PR-U	3191	0.8	K16TT	IK16TT	IK16TT	4
1.6 16V	75	185 A3.000		04/97-02/99	K16PR-U	3191	0.8	K16TT	IK16TT	IK16TT	4
1.6 100 16V	76	182 A4.000		09/96-05/02	K20PR-U	3145	0.8	K20TT	IK20TT	IK20TT	4
1.6 100 16V Bipower	76	185 A3.000; 186 A4.000		04/99-05/02	K16PR-U	3191	0.8	K16TT	IK16TT	IK16TT	4
1.6 SX	72	182 B5.098		09/00-08/02	K20PR-U	3145	0.8	K20TT	IK20TT	IK20TT	4
1.8 115 16V	83	182 A2.000		09/96-05/02	K20TNR	3304	1.0	K20TT	IK20TT	IK20TT	4
1.9 JTD 105	77	182 B4.000	Double Coil(LPH)	12/98-10/99	DG-127		11V				4
1.9 JTD 105	77	182 B4.000	Double Coil(LPH)	11/99-12/02	DG-122		11V				4
1.9 JTD 110	81	186 A6.000	Double Coil(LPH)	09/00-08/02	DG-122		11V				4
1.9 TD 75	55	182 A8.000	Double Coil(LPH)	09/96-05/02	DG-102		11V				4
1.9 TD 100	74	182 A7.000; 182 B9.000	Double Coil(LPH)	05/96-06/03	DG-102		11V				4
2.0 150 20V	110	182 A1.000; 185 A8.000		09/96-05/02	K20TNR	3304	1.0	K20TT	IK20TT	IK20TT	4
2.0 155 20V	113	182 B7.000		04/99-02/03	K20TNR	3304	1.0	K20TT	IK20TT	IK20TT	4
2.4 JTD 130	96	185 A6.000; 839 A5.000	Double Coil(LPH)	04/99-10/99	DG-127		11V				5
2.4 JTD 130	96	185 A6.000; 839 A5.000	Double Coil(LPH)	11/99-05/02	DG-122		11V				5
2.4 TD 125	91	185 A2.000	Double Coil(LPH)	09/96-04/99	DG-102		11V				5
MULTIPLA (99-10)											
1.6 (186AXC1A, 186BMC1A, 186BXC1A)	76	182 B6.000		09/00-06/10	K16PR-U	3191	0.8	K16TT	IK16TT	IK16TT	4
1.6 16V	70	182 B6.000		04/02-06/10	K16PR-U	3191	0.8	K16TT	IK16TT	IK16TT	4
1.6 16V Bipower	76	182 B6.000		10/01-06/10	IK20TT	4702	1.0	-	IK20TT	IK20TT	4
1.6 16V Bipower	76	186 A4.000		04/99-06/10	K16PR-U	3191	0.8	K16TT	IK16TT	IK16TT	4
1.6 16V Blupower	70	186 A3.000		04/99-06/10	K20PR-U	3145	0.8	K20TT	IK20TT	IK20TT	4
1.6 16V GPL	76	182 B6.000		10/01-06/10	IK20TT	4702	1.0	-	IK20TT	IK20TT	4
1.6 100 16V	76	182 A4.000		04/99-06/10	K20PR-U	3145	0.8	K20TT	IK20TT	IK20TT	4
1.9 JTD	88	186 A9.000	Double Coil(LPH)	04/02-06/10	DG-122		11V				4

Таблица применения

F

Свечи зажигания и Свечи накаливания

Таблица применения

Таблица применения

KW	KW	KW	NOTE	21	СТАНДАРТНЫЕ				Twin Tip			QTY
					1	2	3	4	1	2	3	
FIAT продолжение												
MULTIPLA (99-10) продолжение												
1.9 JTD 105	77	182 B4.000	Double Coil(LPH)	04/99-10/99	DG-127		11V				4	
1.9 JTD 105	77	182 B4.000	Double Coil(LPH)	11/99-06/10	DG-122		11V				4	
1.9 JTD 110	81	186 A6.000	Double Coil(LPH)	03/01-07/02	DG-122		11V				4	
1.9 JTD 115	85	186 A8.000	Double Coil(LPH)	07/02-06/10	DG-122		11V				4	
PALIO (96-)												
1.0	45/56	178 A1.000; 178 A3.011		04/96-10/03	K20PR-U	3145	0.8	K20TT	IK20TT	IK20TT	4	
1.1	40	178 B9.033		07/97-10/03	K20TNR	3304	1.0	K20TT	IK20TT	IK20TT	4	
1.2	44	188 A4.000		07/97-10/04	K16PR-U	3191	0.8	K16TT	IK16TT	IK16TT	4	
1.2	44/ 50/54	176 A8.000; 178 B5.000; 178 B7.045/ 178 C4.066; 178 E2.000		04/96-	K20TNR	3304	1.0	K20TT	IK20TT	IK20TT	4	
1.2	59	188 A5.000		03/00-	XU24EPR-U	3312	0.9	-	-	VXU24	4	
1.3 JTD Multijet	51	188 A9.000	Euro-4, OE: 46796050	06/03-12/10	DG-171		11V				4	
1.4	51	178 B2.000		04/96-10/02	K16TNR-S9	3329	0.9	K16TT	IK16TT	IK16TT	4	
1.4	57	178 F3.011; 350 A1.000		10/05-	XU22EPR-U	3179	0.9	XU22TT	IXU22TT	VXU22	4	
1.4 Cat	51	178 B2.016		04/96-08/01	K16TNR-S9	3329	0.9	K16TT	IK16TT	IK16TT	4	
1.5	62	178 E5.022		02/02-	K20PR-U	3145	0.8	K20TT	IK20TT	IK20TT	4	
1.6	78	178 B3.000		02/01-	K16PR-U	3191	0.8	K16TT	IK16TT	IK16TT	4	
1.6 16V	74/76	178 B3.000; 182 B6.000		04/96-01/12	K16PR-U	3191	0.8	K16TT	IK16TT	IK16TT	4	
1.7 TD	51	176 A3.000	Double Coil(LPH)	04/96-03/01	DG-001		11V				4	
1.9 D	46	223 A6.000	Double Coil(LPH)	03/01-	DG-129		11V				4	
PANDA (80-04)												
1.1	37	156 C.046		05/91-03/95	Q20PR-U	3007	0.8	Q20TT	IQ20TT	IQ20TT	4	
1.1	37/40	156 C.046; 187 A1.000		05/91-02/04	K16PR-U	3191	0.8	K16TT	IK16TT	IK16TT	4	
1.1 4x4	40	187 A1.000		09/00-02/04	K16PR-U	3191	0.8	K16TT	IK16TT	IK16TT	4	
650	22	141 A.000		01/82-07/04	W20FPR-U	3070	0.7	WF20TT	-		2	
750	25	141 B.000		01/86-07/92	K20PR-U	3145	0.8	K20TT	IK20TT	IK20TT	4	
750	25	141B.000; 156 A4.000		01/86-10/03	W20EPR-U	3047	0.8	W20TT	IW20TT	IW20TT	4	
750	25	156A4.000		01/86-02/91	K16PR-U	3191	0.8	K16TT	IK16TT	IK16TT	4	
800	25	100 GL6.000		02/81-12/85	W20EPR-U	3047	0.8	W20TT	IW20TT	IW20TT	4	
900	29/33	100 GL3.000; 146 A.000; 1170 A1.046		10/80-12/96	W20EPR-U	3047	0.8	W20TT	IW20TT	IW20TT	4	
900	33	100 GL3.000		10/80-12/85	W20EP-U	3043	0.8	W20TT	IW20TT	IW20TT	4	
950	35	A 112 B1.054		09/82-08/83	W20EPR-U	3047	0.8	W20TT	IW20TT	IW20TT	4	
950 4x4	35	A 112 B1.054		09/83-12/86	W20EPR-U	3047	0.8	W20TT	IW20TT	IW20TT	4	
1000	32/37	156 A2.100; 156 A3.000		01/85-12/92	Q20PR-U	3007	0.8	Q20TT	IQ20TT	IQ20TT	4	
1000	32/37	156 A2.100; 156 A3.000; 156 A3.100		01/85-12/92	K20PR-U	3145	0.8	K20TT	IK20TT	IK20TT	4	
1000 4x4	32/37	141 C2.000; 156 A2.100; 156 A2.246; 156 A3.000; 156 A3.100		01/86-12/92	K20PR-U	3145	0.8	K20TT	IK20TT	IK20TT	4	
1000 4x4	32/37	156 A2.100; 156 A2.246; 156 A3.000		01/86-12/92	Q20PR-U	3007	0.8	Q20TT	IQ20TT	IQ20TT	4	
1000 i.e. Cat	33	141 C2.000; 156 A2.246		10/87-08/98	K20PR-U	3145	0.8	K20TT	IK20TT	IK20TT	4	
1000 i.e. Cat	33	156 A2.246		10/87-08/98	Q20PR-U	3007	0.8	Q20TT	IQ20TT	IQ20TT	4	
1000 i.e	33	156 A2.246		08/92-02/04	K20PR-U	3145	0.8	K20TT	IK20TT	IK20TT	4	
1100	37	156 C.046		05/91-12/99	Q20PR-U	3007	0.8	Q20TT	IQ20TT	IQ20TT	4	
1100	37/40	156 C.046; 187 A1.000		05/91-09/03	K16PR-U	3191	0.8	K16TT	IK16TT	IK16TT	4	
1100	40	176 B2.000		02/95-09/03	K20PR-U	3145	0.8	K20TT	IK20TT	IK20TT	4	
1100 4x4	40	176 B2.000		02/95-07/04	K20PR-U	3145	0.8	K20TT	IK20TT	IK20TT	4	
1100 Trekking 4x4	37	156 C.046		10/91-07/04	K16PR-U	3191	0.8	K16TT	IK16TT	IK16TT	4	
1300 D	27	156 A5.000	Double Coil Std(LPH)	04/86-12/92	DG-001		11V				4	

Свечи зажигания и Свечи накаливания

Таблица применения











	KW				СТАНДАРТНЫЕ			Twin Tip			QTY
											
FIAT продолжение											
PANDA (03-)											
1.1	40	187 A1.000	Ch:>C9081, Eng:>2533528	09/03-12/04	K16PR-U	3191	0.8	K16TT	IK16TT	IK16TT	4
1.1	40	187 A1.000	Ch:D9081>, Eng:2533529>	01/05-	XU22EPR-U	3179	0.9	XU22TT	IXU22TT	VXU22	4
1.2	44	188 A4.000	Ch:>C9081, Eng:>2533528	09/04-	K16PR-U	3191	0.8	K16TT	IK16TT	IK16TT	4
1.2	44	188 A4.000	Ch:D9081>, Eng:2533529>	09/04-	XU22EPR-U	3179	0.9	XU22TT	IXU22TT	VXU22	4
1.2	44	188 A4.000	Eng: >2533528	09/03-	K16PR-U	3191	0.8	K16TT	IK16TT	IK16TT	4
1.2	44	188 A4.000	Eng: 2533529>	09/03-	XU22EPR-U	3179	0.9	XU22TT	IXU22TT	VXU22	4
1.2	51	169 A4.000		03/10-	XU22EPR-U	3179	0.9	XU22TT	IXU22TT	VXU22	4
1.2 4x4	44	188 A4.000	Ch:>C9081, Eng:>2533528	09/04-	K16PR-U	3191	0.8	K16TT	IK16TT	IK16TT	4
1.2 4x4	44	188 A4.000	Ch:D9081>, Eng:2533529>	09/04-	XU22EPR-U	3179	0.9	XU22TT	IXU22TT	VXU22	4
1.2 4x4	51	169 A4.000		11/09-	XU22EPR-U	3179	0.9	XU22TT	IXU22TT	VXU22	4
1.2 LPG	44	188 A4.000	Ch:>C9081, Eng:>2533528	04/09-	K16PR-U	3191	0.8	K16TT	IK16TT	IK16TT	4
1.2 LPG	44	188 A4.000	Ch:D9081>, Eng:2533529>	04/09-	XU22EPR-U	3179	0.9	XU22TT	IXU22TT	VXU22	4
1.2 LPG	44/51	169 A4.000; 188 A4.000		04/09-	VXU22	5608	0.9	-	IXU22TT	VXU22	4
1.2 Natural Power	44	188 A4.000		01/07-12/11	VXU22	5608	0.9	-	IXU22TT	VXU22	4
1.2 Natural Power	44	188 A4.000	Ch:>C9081, Eng:>2533528	01/07-12/11	K16PR-U	3191	0.8	K16TT	IK16TT	IK16TT	4
1.2 Natural Power	44	188 A4.000	Ch:D9081>, Eng:2533529>	01/07-12/11	XU22EPR-U	3179	0.9	XU22TT	IXU22TT	VXU22	4
1.3 D Multijet	51/55	169 A1.000; 169 A5.000; 188 A8.000	OE:46796050, Double Coi I(LPH)	09/03-	DG-171		11V				4
1.3 D Multijet 4x4	51/55	169 A1.000; 169 A5.000; 188 A8.000	OE:46796050, Double Coi I(LPH)	10/04-	DG-171		11V				4
1.4	74	169 A3.000		10/06-	XU22EPR-U	3179	0.9	XU22TT	IXU22TT	VXU22	4
1.4 Natural Power	57	350 A1.000		10/09-	XU22EPR-U	3179	0.9	XU22TT	IXU22TT	VXU22	4
PANDA (12-)											
0.9	48	312 A4.000		02/12-	IXUH22	5353	0.9	-	IXUH22TT	VXUH22	2
0.9 (312PXH1A)	48	312 A4.000		02/12-	IXUH22	5353	0.9	-	IXUH22TT	VXUH22	2
0.9 (312PXP1A)	44	312 A4.000; 312 A6.000		12/13-	IXUH22	5353	0.9	-	IXUH22TT	VXUH22	2
1.2	51	169 A4.000		02/12-	XU22EPR-U	3179	0.9	XU22TT	IXU22TT	VXU22	4
1.2 (312PXA1A)	51	169 A4.000		02/12-	XU22EPR-U	3179	0.9	XU22TT	IXU22TT	VXU22	4
1.2 LPG	51	169 A4.000		06/12-	VXU22	5608	0.9	-	IXU22TT	VXU22	4
1.2 LPG (312PXA1A)	51	169 A4.000		06/12-	VXU22	5608	0.9	-	IXU22TT	VXU22	4
1.3 D Multijet	55/59	199 A9.000; 225 A2.000; 312 A8.000; 312 B2.000	Euro-5,OE: 55210051	02/12-	DG-621		4.4V				4
1.3 D Multijet	55/59	199 A9.000; 225 A2.000; 312 A8.000; 312 B2.000	Euro-6,OE: 12 14 106/ 55238404 (RP 9016)	02/12-	DG-658		5V				4
1.3 D Multijet (312PXL1A)	55	199 A1.000; 199 A9.000	Euro-5,OE: 55210051	02/12-	DG-621		4.4V				4
1.3 D Multijet (312PXL1A)	55	199 A1.000; 199 A9.000	Euro-6,OE: 12 14 106/ 55238404 (RP 9016)	02/12-	DG-658		5V				4
1.3 D Multijet (312PXU1A, 312PXW1A)	70	199 B1.000; 312 B1.000; 330 A1.000	Euro-5,OE: 55210051	04/15-	DG-621		4.4V				4
1.3 D Multijet (312PXU1A, 312PXW1A)	70	199 B1.000; 312 B1.000; 330 A1.000	Euro-6,OE: 12 14 106/ 55238404 (RP 9016)	04/15-	DG-658		5V				4
1.3 D Multijet 4x4	55/59	199 A9.000; 225 A2.000	Euro-5,OE: 55210051	06/12-	DG-621		4.4V				4
1.3 D Multijet 4x4	55/59	199 A9.000; 225 A2.000	Euro-6,OE: 12 14 106/ 55238404 (RP 9016)	06/12-	DG-658		5V				4
1.3 D Multijet 4x4 (312PXL1A)	55	199 A1.000; 199 A9.000	Euro-5,OE: 55210051	06/12-	DG-621		4.4V				4
1.3 D Multijet 4x4 (312PXL1A)	55	199 A1.000; 199 A9.000	Euro-6,OE: 12 14 106/ 55238404 (RP 9016)	06/12-	DG-658		5V				4











Таблица применения

F

Свечи зажигания и Свечи накаливания











Таблица применения

Таблица применения

	KW				СТАНДАРТНЫЕ				Twin Tip			QTY
												
FIAT продолжение												
PANDA (12-) продолжение												
1.3 D Multijet 4x4 (312PXS2A)	59	199 A9.000; 225 A2.000; 312 A8.000; 312 B2.000	Euro-5,OE: 55210051	06/14-	DG-621		4.4V					4
1.3 D Multijet 4x4 (312PXS2A)	59	199 A9.000; 225 A2.000; 312 A8.000; 312 B2.000	Euro-6,OE: 12 14 106/ 55238404 (RP 9016)	06/14-	DG-658		5V					4
1.3 D Multijet 4x4 (312PXU1A)	70	199 B1.000; 312 B1.000; 330 A1.000	Euro-5,OE: 55210051	04/15-	DG-621		4.4V					4
1.3 D Multijet 4x4 (312PXU1A)	70	199 B1.000; 312 B1.000; 330 A1.000	Euro-6,OE: 12 14 106/ 55238404 (RP 9016)	04/15-	DG-658		5V					4
PENNY (86-90)												
1.1	43	146 A6.000		01/86-12/90	W20EPR-U	3047	0.8	W20TT	IW20TT	IW20TT		4
1.3	49	146 A5.000		01/86-12/90	W20EPR-U	3047	0.8	W20TT	IW20TT	IW20TT		4
PUNTO (93-00)												
1.1	40	176 B2.000		04/96-02/00	K20PR-U	3145	0.8	K20TT	IK20TT	IK20TT		4
1.1 55	40	176 A6.000; 176 B2.000		09/93-09/99	K20PR-U	3145	0.8	K20TT	IK20TT	IK20TT		4
1.2 16V	63	176 B9.000		04/97-09/99	K20PR-U	3145	0.8	K20TT	IK20TT	IK20TT		4
1.2 16V	63	176 B9.000		04/97-09/99	XU24EPR-U	3312	0.9	-	-	VXU24		4
1.2 16V 85	63	176 B9.000		04/97-06/00	K20PR-U	3145	0.8	K20TT	IK20TT	IK20TT		4
1.2 60	43	176 A7.000		01/94-09/99	Q20PR-U	3007	0.8	Q20TT	IQ20TT	IQ20TT		4
1.2 60	43	176 A7.000		01/94-06/00	K20PR-U	3145	0.8	K20TT	IK20TT	IK20TT		4
1.2 75	54	176 A8.000		10/93-09/99	K20PR-U	3145	0.8	K20TT	IK20TT	IK20TT		4
1.2 75	54	176 A8.000		10/93-09/99	Q20PR-U	3007	0.8	Q20TT	IQ20TT	IQ20TT		4
1.4 GT Turbo	96	176 B6.000		09/96-07/99	K22PBR-S	5062	0.85	-	IKB22TT	VK22		4
1.4 GT Turbo	98	176 A4.000		10/93-03/97	K20PBR	5060	0.85	K20TT	IK20TT	IK20TT		4
1.6	65	176 A9.000		01/94-04/97	Q22PR-U	3010	0.8	-	-	VQ22		4
1.6 90	65	176 A9.000		04/94-04/97	Q22PR-U	3010	0.8	-	-	VQ22		4
1.7 D	42	176 B3.000	Double Coil Std(LPH)	04/94-02/00	DG-001		11V					4
1.7 TD	46/51	176 A3.000; 176 A5.000; 176 B7.000	Double Coil(LPH)	01/94-02/00	DG-001		11V					4
60 1.2	44	176 B1.000; 176 B4.000		09/93-06/00	K20PR-U	3145	0.8	K20TT	IK20TT	IK20TT		4
60 1.2	44	176 B4.000		09/93-09/99	Q20PR-U	3007	0.8	Q20TT	IQ20TT	IQ20TT		4
PUNTO (99-12)												
1.2 16V 80	59	188 A5.000		09/99-04/06	XU24EPR-U	3312	0.9	-	-	VXU24		4
1.2 60	44	188 A4.000	Eng: >2533528	09/99-12/10	K16PR-U	3191	0.8	K16TT	IK16TT	IK16TT		4
1.2 60	44	188 A4.000	Eng: 2533529>	09/99-12/10	XU22EPR-U	3179	0.9	XU22TT	IXU22TT	VXU22		4
1.2 Bifuel	44	188 A4.000	Eng: 2533529>	08/07-03/12	XU22EPR-U	3179	0.9	XU22TT	IXU22TT	VXU22		4
1.2 Natural Power	44	188 A4.000	Eng: >2533528	09/03-09/04	K16PR-U	3191	0.8	K16TT	IK16TT	IK16TT		4
1.2 Natural Power	44	188 A4.000	Eng: 2533529>	10/04-03/12	XU22EPR-U	3179	0.9	XU22TT	IXU22TT	VXU22		4
1.3 JTD	51	188 A9.000	OE: 46796050	06/03-10/05	DG-171		11V					4
1.3 JTD 16V	51	188 A9.000	OE: 46796050	06/03-03/12	DG-171		11V					4
1.4	70	843 A1.000		09/03-03/12	XU22EPR-U	3179	0.9	XU22TT	IXU22TT	VXU22		4
1.4 (188AXM1A, 188BXM1A)	70	199 A6.000; 843 A1.000		11/05-03/12	XU22EPR-U	3179	0.9	XU22TT	IXU22TT	VXU22		4
1.8 130 HGT	96	183 A1.000		09/99-03/12	K20TNR	3304	1.0	K20TT	IK20TT	IK20TT		4
1.8 130 HGT	96	183 A6.000	Eng: 1945438>	09/99-03/12	K20PR-U	3145	0.8	K20TT	IK20TT	IK20TT		4
1.9 D 60	44	188 A3.000	Double Coil(LPH)	02/00-10/09	DG-129		11V					4
1.9 DS 60	44	188 A3.000	Double Coil(LPH)	09/99-03/12	DG-129		11V					4
1.9 JTD	63/74	188 A7.000; 188 B2.000	Double Coil(LPH)	02/00-03/12	DG-122		11V					4
1.9 JTD 80	59	188 A2.000	Double Coil(LPH)	09/99-03/12	DG-122		11V					4
PUNTO (12-)												
1.2	49/51	169 A4.000; 199 B9.000		03/12-	XU22EPR-U	3179	0.9	XU22TT	IXU22TT	VXU22		4
1.3 D Multijet	55/ 59/ 62/ 66/70	199 A2.000; 199 A9.000; 199 B1.000; 199 B4.000; 199 B8.000; 330 A1.000; 955 B2.000	Euro-5,OE: 55210051	03/12-	DG-621		4.4V					4

Свечи зажигания и Свечи накаливания

Таблица применения

	KW				СТАНДАРТНЫЕ			Twin Tip			QTY
											
FIAT продолжение											
PUNTO (12-) продолжение											
1.3 D Multijet	55/ 59/ 62/ 66/70	199 A2.000; 199 A9.000; 199 B1.000; 199 B4.000; 199 B8.000; 330 A1.000; 955 B2.000	Euro-6,OE: 12 14 106/ 55238404 (RP 9016)	03/12-	DG-658		5V				4
1.3 D Multijet	55/ 59/ 66/70	199 A2.000; 199 A9.000; 199 B1.000; 199 B8.000; 330 A1.000; 955 B2.000	Euro-4,OE: 46796050	03/12-	DG-171		11V				4
1.4	55	199 A7.000		03/12-	XU22EPR-U	3179	0.9	XU22TT	IXU22TT	VXU22	4
1.4 (199AXB1A)	57	350 A1.000		03/12-	XU22EPR-U	3179	0.9	XU22TT	IXU22TT	VXU22	4
1.4 Bifuel	57	350 A1.000		03/12-	XU22EPR-U	3179	0.9	XU22TT	IXU22TT	VXU22	4
1.4 MultiAir	77	955 A6.000		03/12-	XU22EPR-U	3179	0.9	XU22TT	IXU22TT	VXU22	4
1.4 MultiAir	99	955 A2.000	40000km Lifetime	03/12-	IXU27	5337	0.9	-	-		4
1.4 Natural Power	57	350 A1.000		03/12-	XU22EPR-U	3179	0.9	XU22TT	IXU22TT	VXU22	4
PUNTO Evo (08-12)											
1.2	48/51	169 A4.000; 199 A4.000		10/09-02/12	XU22EPR-U	3179	0.9	XU22TT	IXU22TT	VXU22	4
1.3 D Multijet	51/ 55/ 62/70	199 A2.000; 199 A9.000; 199 B1.000; 199 B2.000; 199 B4.000; 223 A9.000	Euro-5,OE: 55210051	07/08-02/12	DG-621		4.4V				4
1.3 D Multijet	51/ 55/ 62/70	199 A2.000; 199 A9.000; 199 B1.000; 199 B2.000; 199 B4.000; 223 A9.000	Euro-6,OE: 12 14 106/ 55238404 (RP 9016)	07/08-02/12	DG-658		5V				4
1.3 D Multijet	51/ 55/ 66/70	199 A2.000; 199 A3.000; 199 A9.000; 199 B1.000; 199 B2.000	Euro-4,OE: 46796050	07/08-02/12	DG-171		11V				4
1.4 (199AXB1A)	57	350 A1.000		10/09-02/12	XU22EPR-U	3179	0.9	XU22TT	IXU22TT	VXU22	4
1.4 (199AXH1A)	55	199 A7.000		07/09-02/12	XU22EPR-U	3179	0.9	XU22TT	IXU22TT	VXU22	4
1.4 16V	77	955 A6.000		10/09-02/12	XU22EPR-U	3179	0.9	XU22TT	IXU22TT	VXU22	4
1.4 16V	99	955 A2.000	40000km Lifetime	10/09-02/12	IXU27	5337	0.9	-	-		4
1.4 LPG	57	350 A1.000		06/09-02/12	XU22EPR-U	3179	0.9	XU22TT	IXU22TT	VXU22	4
1.4 Natural Power	57	350 A1.000		10/09-02/12	XU22EPR-U	3179	0.9	XU22TT	IXU22TT	VXU22	4
1.6 D Multijet	88	955 A3.000		10/09-02/12	DG-608		4.4V				4
QUBO (08-)											
1.3 D Multijet	55		Euro-4,OE: 46796050	01/09-	DG-171		11V				4
1.3 D Multijet	55		Euro-5,OE: 55210051	01/09-	DG-621		4.4V				4
1.3 D Multijet	55		Euro-6,OE: 12 14 106/ 55238404 (RP 9016)	01/09-	DG-658		5V				4
1.3 D Multijet (225AXE1A, 225CXE1A)	70	199 B1.000	Euro-5,OE: 55210051	07/10-	DG-621		4.4V				4
1.3 D Multijet (225AXE1A, 225CXE1A)	70	199 B1.000	Euro-6,OE: 12 14 106/ 55238404 (RP 9016)	07/10-	DG-658		5V				4
1.3 D Multijet (225AXG1A, 225CXG1A, 225AXG11, 225CXG11)	59	225 A2.000	Euro-5,OE: 55210051	03/15-	DG-621		4.4V				4
1.3 D Multijet (225AXG1A, 225CXG1A, 225AXG11, 225CXG11)	59	225 A2.000	Euro-6,OE: 12 14 106/ 55238404 (RP 9016)	03/15-	DG-658		5V				4
1.3 D Multijet (225CXB1A, 225AXB1A, 225CXB11, 225AXB11,...)	55	199 A2.000; 199 A9.000	Euro-4,OE: 46796050	02/08-	DG-171		11V				4
1.3 D Multijet (225CXB1A, 225AXB1A, 225CXB11, 225AXB11,...)	55	199 A2.000; 199 A9.000	Euro-5,OE: 55210051	02/08-	DG-621		4.4V				4
1.3 D Multijet (225CXB1A, 225AXB1A, 225CXB11, 225AXB11,...)	55	199 A2.000; 199 A9.000	Euro-6,OE: 12 14 106/ 55238404 (RP 9016)	02/08-	DG-658		5V				4
1.4	54			01/09-	K20PR-U	3145	0.8	K20TT	IK20TT	IK20TT	4
1.4 (225AXA1A)	54	KFT; KfV		02/08-	K20PR-U	3145	0.8	K20TT	IK20TT	IK20TT	4

Свечи зажигания и Свечи накаливания

Таблица применения

Таблица применения

	KW				СТАНДАРТНЫЕ			Twin Tip			QTY
FIAT продолжение											
QUBO (08-) продолжение											
1.4 (225AXA1A, 225CXA1A)	57	350 A1.000		10/09-	XU22EPR-U	3179	0.9	XU22TT	IXU22TT	VXU22	4
1.4 Natural Power	57	350 A1.000		10/09-	XU22EPR-U	3179	0.9	XU22TT	IXU22TT	VXU22	4
REGATA (83-90)											
1.3 70	48/50	138 B2.000; 149 A7.000		09/83-07/89	W20EPR-U	3047	0.8	W20TT	IW20TT	IW20TT	4
1.5 75	55	138 C3.048		12/83-07/89	W22EPR-U	3088	0.8	W22TT	-	VW22	4
1.5 85	63	138 B3.000		09/83-04/85	W20EPR-U	3047	0.8	W20TT	IW20TT	IW20TT	4
1.5 85	63	138 B3.000; 149 A5.000		07/86-04/89	W22EPR-U	3088	0.8	W22TT	-	VW22	4
1.6 85	60	149 A.000		10/83-12/88	W20EPR-U	3047	0.8	W20TT	IW20TT	IW20TT	4
1.6 100	74	149 A4.000; 149 C3.000		01/85-07/89	W20EPR-U	3047	0.8	W20TT	IW20TT	IW20TT	4
1.6 i.e. 90	66	149 C2.000		01/87-07/89	W20EPR-U	3047	0.8	W20TT	IW20TT	IW20TT	4
1.7 D 60	44	138 B6.000; 149 B3.000	Double Coil Std(LPH)	09/83-12/89	DG-001		11V				4
1.9 D 65	48	149 A1.000	Double Coil Std(LPH)	04/84-07/89	DG-001		11V				4
1.9 TD 80	59	831 D1.000	Double Coil Std(LPH)	05/86-07/89	DG-001		11V				4
RF) 100	74	149 A4.000		09/84-12/90	W22EPR-U	3088	0.8	W22TT	-	VW22	4
RITMO (78-88)											
1.0	44	127 A6.000		02/80-09/82	W20EPR-U	3047	0.8	W20TT	IW20TT	IW20TT	4
1.1	40/43	138 B1.000; 146 A4.048		10/82-12/87	W20EPR-U	3047	0.8	W20TT	IW20TT	IW20TT	4
1.3	48/ 50/55	138 A3.000; 138 B2.000; 138A1.000		01/78-08/85	W20EPR-U	3047	0.8	W20TT	IW20TT	IW20TT	4
1.5	55/ 58/60	138 B3.000; 138 C3.048; 149 A5.000		01/78-12/88	W22EPR-U	3088	0.8	W22TT	-	VW22	4
1.5	63	138 A4.000		01/81-05/87	W20EPR-U	3047	0.8	W20TT	IW20TT	IW20TT	4
1.6	66	149C2.000	Ch:>4.880.207	12/85-12/87	W20EPR-U	3047	0.8	W20TT	IW20TT	IW20TT	4
1.6	66	149C2.000	Ch:4.880.208>	12/85-12/87	W22EPR-U	3088	0.8	W22TT	-	VW22	4
1.6	74/77	138 AR.000; 138AR.000		05/81-12/87	W20EPR-U	3047	0.8	W20TT	IW20TT	IW20TT	4
1.7 Diesel	40	138 A5.000	Double Coil(LPH)	10/79-09/82	DG-001		11V				4
1.7 Diesel	44	138 C.000; 149 B3.000	Double Coil Std(LPH)	05/85-12/87	DG-001		11V				4
1.9 TD	59	831 D1.000	Double Coil Std(LPH)	12/85-12/87	DG-001		11V				4
RITMO Bertone (79-89)											
1.5 85	63	138 A4.000; 138 B3.000		03/83-01/88	W22EPR-U	3088	0.8	W22TT	-	VW22	4
1.5 85	63	138A2.000		11/82-03/85	W20EPR-U	3047	0.8	W20TT	IW20TT	IW20TT	4
1.6 10	74/77	149A4.048	Ch:>4.880.207	10/85-12/87	W20EPR-U	3047	0.8	W20TT	IW20TT	IW20TT	4
1.6 10	74/77	149A4.048	Ch:4.880.208>	10/85-12/87	W22EPR-U	3088	0.8	W22TT	-	VW22	4
SCUDO (220) (96-06)											
1.6	58	220 A 2.000		02/96-12/06	Q22PR-U	3010	0.8	-	-	VQ22	4
1.9 D	51	D9B	Double Coil(LPH)	02/96-12/06	DG-001		11V				4
1.9 D	51	WJY (DW8B); WJZ (DW8)	Double Coil(LPH)	04/98-12/06	DG-003		11V				4
1.9 TD	66/68	D8B; DHX (XUD9TF/L)	Double Coil(LPH)	02/96-12/06	DG-001		11V				4
1.9 TD Eco	66	DHX (XUD9TF/L)	Double Coil(LPH)	02/96-12/06	DG-001		11V				4
2.0	100	RFN (EW10J4)		05/00-12/06	K20HR-U11	3381	1.1	KH20TT	IKH20TT	IKH20TT	4
2.0 16V	100	RFN (EW10J4)		06/00-12/06	K20HR-U11	3381	1.1	KH20TT	IKH20TT	IKH20TT	4
2.0 JTD	69	RHX		01/04-12/06	DG-116		11V				4
2.0 JTD	69/80	RHX; RHZ	Double Coil(LPH)	10/99-12/06	DG-116		11V				4
2.0 JTD 16V	80	RHK (DW10UTED4); RHM (DW10ATED4); RHW (DW10ATED4)		05/99-12/03	DG-181		11V				4
2.0 JTD 16V	80	RHK (DW10UTED4); RHM (DW10ATED4); RHW (DW10ATED4)		01/04-12/06	DG-116		11V				4
SCUDO (270) (07-)											
1.6 D Multijet	66	9H07 (DV6UC); 9HM (DV6UC)		02/11-	DG-603		5V				4
1.6 D Multijet	66	9HU		01/07-	DG-180		11V				4
2.0 D Multijet	88/ 100	RHK; RHR		01/07-	DG-116		11V				4

Свечи зажигания и Свечи накаливания

Таблица применения





	KW				СТАНДАРТНЫЕ			Twin Tip			QTY
FIAT продолжение											
SCUDO (270) (07-) продолжение											
2.0 D Multijet	88/ 94/ 100/ 120	DW10BTED4; RH02; RHH; RHK; RHR		01/07-	DG-181		11V				4
SEDICI (06-14)											
1.6 16V	79/88	M16A	Check Thread size	06/06-06/09	IK20TT	4702	1.0	-	IK20TT	IK20TT	4
1.6 16V	79/88	M16A	Check Thread size	06/06-06/09	SVK20RZ11	3449	1.1	-	IK20TT	IK20TT	4
1.6 16V	79/88	M16A	Check Thread size	06/09-10/14	IKH20TT	4704	1.0	-	IKH20TT		4
1.6 16V 4x4	79/88	M16A	Check Thread size	06/06-10/14	IK20TT	4702	1.0	-	IK20TT	IK20TT	4
1.6 16V 4x4	79/88	M16A	Check Thread size	06/06-10/14	SVK20RZ11	3449	1.1	-	IK20TT	IK20TT	4
1.6 16V 4x4	79/88	M16A	Check Thread size	06/09-10/14	IKH20TT	4704	1.0	-	IKH20TT		4
1.9 D Multijet	88	D19AA		06/06-10/11	DG-196		11V				4
1.9 D Multijet 4x4	88	D19AA		06/06-10/11	DG-196		11V				4
2.0 D Multijet	99	D20AA		06/06-10/14	DG-608		4.4V				4
2.0 D Multijet 4x4	99	D20AA		06/06-10/14	DG-608		4.4V				4
SEICENTO (98-10)											
0.9	29	1170 A1.046		11/97-01/10	W20EPR-U	3047	0.8	W20TT	IW20TT	IW20TT	4
1.1	40	176 B2.000		01/98-01/10	K20PR-U	3145	0.8	K20TT	IK20TT	IK20TT	4
1.1	40	187 A1.000	Eng: >2543171	01/98-10/04	K16PR-U	3191	0.8	K16TT	IK16TT	IK16TT	4
1.1	40	187 A1.000	Eng: 2543171>	11/04-01/10	XU22EPR-U	3179	0.9	XU22TT	IXU22TT	VXU22	4
STILO (01-08)											
1.2 16V	59	188 A5.000		02/02-11/06	XU24EPR-U	3312	0.9	-	-	VXU24	4
1.4 16V	66/70	192 B2.000; 843 A1.000		01/04-08/08	XU22EPR-U	3179	0.9	XU22TT	IXU22TT	VXU22	4
1.4 16V (192AXH1B, 192BXH1B)	70	843 A1.000		10/03-12/06	XU22EPR-U	3179	0.9	XU22TT	IXU22TT	VXU22	4
1.6	100	182 B6.000		04/05-11/06	K16PR-U	3191	0.8	K16TT	IK16TT	IK16TT	4
1.6 16V	76	182 B6.000		10/01-08/08	K16PR-U	3191	0.8	K16TT	IK16TT	IK16TT	4
1.6 16V	76	192 B3.000		03/05-12/07	KJ16CR-L11	3132	1.1	K16TT	IK16TT	IK16TT	4
1.8 16V	98	192 A4.000		10/01-08/08	K16PR-U	3191	0.8	K16TT	IK16TT	IK16TT	4
1.9 D Multijet	74	192 A9.000	Double Coil(LPH)	09/05-08/08	DG-122		11V				4
1.9 D Multijet	88	192 A8.000	Double Coil(LPH)	09/05-08/08	DG-196		11V				4
1.9 D Multijet	110	937 A5.000	Double Coil(LPH)	09/05-08/08	DG-170		11V				4
1.9 JTD	59/ 66/85	192 A1.000; 192 A3.000; 192 B5.000; 937 A7.000	Double Coil(LPH)	10/01-08/08	DG-122		11V				4
1.9 JTD	93/ 100	192 B1.000; 937 A4.000		09/03-08/08	DG-170		11V				4
1.9 JTD	103	192 A5.000	Double Coil(LPH)	01/04-08/08	DG-170		11V				4
2.4 20V	125	192 A2.000		10/01-04/07	K20TNR	3304	1.0	K20TT	IK20TT	IK20TT	5
STRADA (99-)											
1.2	44	188 A4.000	Eng: >2533528	04/03-	K16PR-U	3191	0.8	K16TT	IK16TT	IK16TT	4
1.2	44	188 A4.000	Eng: 2533529>	04/03-	XU22EPR-U	3179	0.9	XU22TT	IXU22TT	VXU22	4
1.2	54	178 B5.000		06/99-12/06	K20TNR	3304	1.0	K20TT	IK20TT	IK20TT	4
1.2 Trekking	60	178 B7.045		11/05-	K20TNR	3304	1.0	K20TT	IK20TT	IK20TT	4
1.3 D Multijet	62	223 A9.000	Euro-4,OE: 46796050	05/06-	DG-171		11V				4
1.3 D Multijet	62	223 A9.000	Euro-5,OE: 55210051	05/06-	DG-621		4.4V				4
1.3 D Multijet	62	223 A9.000	Euro-6,OE: 12 14 106/ 55238404 (RP 9016)	05/06-	DG-658		5V				4
1.7 TD	51	176 A3.000	Double Coil(LPH)	06/99-12/06	DG-001		11V				4
1.9 D	46	223 A6.000	Double Coil(LPH)	12/00-	DG-129		11V				4
1.9 JTD	59	188 A2.000	Double Coil(LPH)	04/03-	DG-122		11V				4
STRADA (10-)											
1.3 D Multijet	70	199 B1.000	Euro-4,OE: 46796050	10/10-	DG-171		11V				4
1.3 D Multijet	70	199 B1.000	Euro-5,OE: 55210051	10/10-	DG-621		4.4V				4











Таблица применения

F

Свечи зажигания и Свечи накаливания









Таблица применения

Таблица применения

	KW				СТАНДАРТНЫЕ			Twin Tip			QTY
											
FIAT продолжение											
STRADA (10-) продолжение											
1.3 D Multijet	70	199 B1.000	Euro-6,OE: 12 14 106/ 55238404 (RP 9016)	10/10-	DG-658		5V				4
TALENTO (290) (89-94)											
1.9 D	52	149 B1.000	Double Coil Std(LPH)	03/89-03/94	DG-001		11V				4
2.0	55	170 B		03/89-03/94	W20EP-U	3043	0.8	W20TT	IW20TT	IW20TT	4
TEMPRA (90-96)											
1.4 i.e.	51/57	159 A2.000; 160 A1.046; 836 A4.000		04/90-08/96	W20EPR-U	3047	0.8	W20TT	IW20TT	IW20TT	4
1.6	51/63	159 A3.000; 159 A3.048; 159 B9.000		03/90-07/96	W22EPR-U	3088	0.8	W22TT	-	VW22	4
1.6	63	159 A3.000		03/90-12/91	W20EPR-U	3047	0.8	W20TT	IW20TT	IW20TT	4
1.6 i.e.	55/ 57/ 63/66	159 A3.046; 159 A3.048; 159 B9.000; 159B9.000		10/90-08/96	Q22PR-U	3010	0.8	-	-	VQ22	4
1.6 i.e.	55/ 57/ 63/66	159 A3.046; 159 A3.048; 159 B9.000; 835 C1.000		06/90-08/96	W22EPR-U	3088	0.8	W22TT	-	VW22	4
1.6 i.e.	57	159 A3.046		06/90-07/92	W20EPR-U	3047	0.8	W20TT	IW20TT	IW20TT	4
1.8 i.e.	66/74	835C2.000; 835C4.000; 836A5.000		09/93-08/96	W20EPR-U	3047	0.8	W20TT	IW20TT	IW20TT	4
1.8 i.e.	66/ 74/ 77/81	159 A4.000; 159 A4.046; 835 C2.000; 835 C4.000; 836 A5.000		03/90-08/96	W22EPR-U	3088	0.8	W22TT	-	VW22	4
1.9 D	48	160 A7.000	Double Coil(LPH)	07/91-08/96	DG-001		11V				4
1.9 TD	59/66	160 A6.000; 160 B6.046; 160 D1.000	Double Coil(LPH)	05/90-08/96	DG-001		11V				4
2.0	80	159 A6.046		04/90-12/98	W22EPR-U	3088	0.8	W22TT	-	VW22	4
2.0 i.e.	83	159 A6.046		10/90-09/96	W22EPR-U	3088	0.8	W22TT	-	VW22	4
2.0 i.e. 4x4	83	159 A6.046		03/92-03/95	W22EPR-U	3088	0.8	W22TT	-	VW22	4
TIPO (160) (87-95)											
1.1	41	160 A3.000		01/88-10/91	Q20PR-U	3007	0.8	Q20TT	IQ20TT	IQ20TT	4
1.4	52	160 A1.048		07/87-12/89	W20EPR-U	3047	0.8	W20TT	IW20TT	IW20TT	4
1.4 i.e.	51	160 A1.046		05/89-04/95	W20EPR-U	3047	0.8	W20TT	IW20TT	IW20TT	4
1.4 i.e.	57	159 A2.000		11/92-04/95	IW20TT	4709	1.0	-	IW20TT		4
1.6	56/ 58/61	159A3.000; 160 A2.000		01/88-10/95	W22EPR-U	3088	0.8	W22TT	-	VW22	4
1.6 i.e.	55/57	159 A3.046; 159 A3.048		07/90-04/95	Q22PR-U	3010	0.8	-	-	VQ22	4
1.6 i.e.	66	149 C2.046		02/88-05/91	W22EPR-U	3088	0.8	W22TT	-	VW22	4
1.6 SX DGT	66	159 A3.000		05/89-10/95	W22EPR-U	3088	0.8	W22TT	-	VW22	4
1.7 D	43	149 B4.000	Double Coil Std(LPH)	01/88-10/94	DG-001		11V				4
1.7 D	45	149 B4.000		01/88-10/95	DG-001		11V				4
1.8 i.e.	66	835C4.000		09/93-04/95	W20EPR-U	3047	0.8	W20TT	IW20TT	IW20TT	4
1.8 i.e.	74/81	159 A4.000		10/90-10/95	W20EP-U	3043	0.8	W20TT	IW20TT	IW20TT	4
1.8 i.e.	77	159 A4.046; 835 C2.000		11/92-04/95	W22EPR-U	3088	0.8	W22TT	-	VW22	4
1.8 i.e.16V Sport	100	160 A5.000		11/89-06/92	W20EPBR-S	5067	0.85	W20TT	IW20TT	IW20TT	4
1.9 TD	59	160 B6.046	Double Coil(LPH)	03/92-06/93	DG-001		11V				4
1.9 TD	66	160 A6.000; 160 A6.046; 160 D1.000	Double Coil Std(LPH)	09/90-04/95	DG-001		11V				4
2.0	104	836 A3.011		03/93-04/95	W22EPR-U	3088	0.8	W22TT	-	VW22	4
2.0 16V	107	160 A8.046		07/91-04/95	W22EPR-U	3088	0.8	W22TT	-	VW22	4
2.0 i.e.	80/83	159 A5.046; 159A6.046		03/90-04/95	W22EPR-U	3088	0.8	W22TT	-	VW22	4
2.0 i.e. 16V Sport	102	836 A3.000		03/93-04/95	W22EPR-U	3088	0.8	W22TT	-	VW22	4
TIPO (356) (15-)											
1.3 D	70	199 B1.000; 55266963; 55283775	Euro-6,OE: 12 14 106/ 55238404 (RP 9016)	10/15-	DG-658		5V				4
1.4	70	843 A1.000		10/15-	XU22EPR-U	3179	0.9	XU22TT	IXU22TT	VXU22	4

Свечи зажигания и Свечи накаливания

Таблица применения

	KW				СТАНДАРТНЫЕ			Twin Tip			QTY
											
FIAT продолжение											
TIPO (356) (15-) продолжение											
1.4	88	940 B7.000	40000km Lifetime	03/16-	IXU27	5337	0.9	-	-		4
1.4 LPG	88	940 B7.000	40000km Lifetime	05/16-	IXU27	5337	0.9	-	-		4
1.6 D	84/88	940 C1.000; 55260384; 55280444	OE: 55200755	10/15-	DG-608		4.4V				4
ULYSSE (94-02)											
1.8	73	LFW		05/97-08/02	K20PR-U	3145	0.8	K20TT	IK20TT	IK20TT	4
1.9 TD	66	DHX (XUD9TF/L)	Double Coil(LPH)	02/95-08/02	DG-001		11V				4
2.0	89	RFU (XU10J2C)		06/94-08/02	K20TXR	5063	1.0	K20TT	IK20TT	IK20TT	4
2.0 16V	97	RFV		05/98-09/00	K20TXR	5063	1.0	K20TT	IK20TT	IK20TT	4
2.0 16V	100	RFN (EW10J4)		09/00-08/02	K20HR-U11	3381	1.1	KH20TT	IKH20TT	IKH20TT	4
2.0 JTD	80	RHZ	Double Coil(LPH)	10/99-08/02	DG-116		11V				4
2.0 JTD 16V	80	RHW (DW10ATED4)		05/99-08/02	DG-116		11V				4
2.0 Turbo	108	RGX (XU10J2CTE)		06/94-08/02	K20TXR	5063	1.0	K20TT	IK20TT	IK20TT	4
2.1 TD	80	P8C	Double Coil(LPH)	03/96-10/99	DG-001		11V				4
ULYSSE (02-11)											
2.0	100	RFN (EW10J4)		08/02-06/11	K20HR-U11	3381	1.1	KH20TT	IKH20TT	IKH20TT	4
2.0 D Multijet	88/ 100	RHK; RHR	OE:965102978 0, Particlef ilter-	05/06-06/11	DG-116		11V				4
2.0 D Multijet	88/ 100	RHK; RHR	OE:965158368 0, Particlef ilter+	05/06-06/11	DG-181		11V				4
2.0 JTD	80	RHM (DW10ATED4); RHW (DW10ATED4)	Double Coil(LPH)	08/02-08/06	DG-116		11V				4
2.2 JTD	94	4HW (DW12ATED4)		08/02-05/03	DG-116		11V				4
2.2 JTD	94	4HW (DW12ATED4)		06/03-08/06	DG-181		11V				4
3.0	150	XFW		08/02-06/11	IKH16TT	4703	1.0	-	IKH16TT		4
UNO (146) (83-00)											
0.9 45	33	146 A.1000		01/89-12/89	W20EPR-U	3047	0.8	W20TT	IW20TT	IW20TT	4
1.0 i.e. 45	33	156 A2.000; 156 A2.246		01/92-10/95	Q20PR-U	3007	0.8	Q20TT	IQ20TT	IQ20TT	4
1.1	41/43	160 A3.000		04/86-06/06	Q20PR-U	3007	0.8	Q20TT	IQ20TT	IQ20TT	4
1.1	43	146 A4.048		10/88-06/06	W20EPR-U	3047	0.8	W20TT	IW20TT	IW20TT	4
1.1 50	37	146 A4.044		01/86-12/89	W20EPR-U	3047	0.8	W20TT	IW20TT	IW20TT	4
1.1 50	37	156 C.046		01/90-12/93	Q20PR-U	3007	0.8	Q20TT	IQ20TT	IQ20TT	4
1.1 55	40	138 B.000		01/83-12/85	W20EPR-U	3047	0.8	W20TT	IW20TT	IW20TT	4
1.1 60	43	160 A3.000		04/89-12/92	Q20PR-U	3007	0.8	Q20TT	IQ20TT	IQ20TT	4
1.1 i.e. 50	36	146 C3.000		06/92-12/93	Q20PR-U	3007	0.8	Q20TT	IQ20TT	IQ20TT	4
1.3 70	48	149 A7.000		05/85-08/89	W20EPR-U	3047	0.8	W20TT	IW20TT	IW20TT	4
1.3 70	50	138 B2.000		01/83-04/85	W22EPR-U	3088	0.8	W22TT	-	VW22	4
1.3 Super Diesel	33	127 A5.000; 146 B1.000	Double Coil Std(LPH)	06/83-03/92	DG-001		11V				4
1.3 Turbo i.e.	74/77	146 A2.000; 146 A2.146; 146 A2.246		04/85-03/91	K22PBR-S	5062	0.85	-	IKB22TT	VK22	4
1.4 70	52	160 A1.046; 160 A1.048		10/88-06/06	W20EPR-U	3047	0.8	W20TT	IW20TT	IW20TT	4
1.4 i.e. 70	51	146 C1.000; 160 A1.046		09/89-07/96	W20EPR-U	3047	0.8	W20TT	IW20TT	IW20TT	4
1.4 TD 70	52	146 B.000; 146 B3.000	Double Coil Std(LPH)	10/86-10/90	DG-001		11V				4
1.4 Turbo i.e.	82/87	146 A8.000; 146 A8.046		09/89-12/93	K22PBR-S	5062	0.85	-	IKB22TT	VK22	4
1.5 i.e. 75	55	149 C1.000		10/85-12/93	W22EPR-U	3088	0.8	W22TT	-	VW22	4
1.7 D 60	44	146 B2.000; 149 B3.000	Double Coil Std(LPH)	07/86-12/93	DG-001		11V				4
1.9 D	44	149 B5.046	Double Coil Std(LPH)	09/89-03/94	DG-001		11V				4
45 1.0	32	156 A2.048		06/86-12/93	Q20PR-U	3007	0.8	Q20TT	IQ20TT	IQ20TT	4
60 1.1	43	146 A4.048		05/85-08/89	W20EPR-U	3047	0.8	W20TT	IW20TT	IW20TT	4
X 1/9 (73-89)											
1.3	55	128A1.000		05/73-06/78	W20EPR-U	3047	0.8	W20TT	IW20TT	IW20TT	4
1.5	56/63	138A2.000		11/78-12/89	W20EPR-U	3047	0.8	W20TT	IW20TT	IW20TT	4
FORD											
B-MAX (12-)											
1.4	66	RTJC/SPJD		10/12-	T16VR-U10	5086	1.0	TV16TT	ITV16TT	IV16TT	4

Свечи зажигания и Свечи накаливания

Таблица применения

Таблица применения

KW	KW	NOTE	21	СТАНДАРТНЫЕ				Twin Tip			QTY
				5V	11V	10V	1.1	1.1	1.1		
FORD продолжение											
B-MAX (12-) продолжение											
1.5 TDCi	55	UGJC; UGJG; XUJA; XUJB	Instant heating	10/12-	DG-603		5V				4
1.6 TDCi	70	T3JB		10/12-	DG-603		5V				4
1.6 TDCi	70	T3JB	Instant heating	10/12-	DG-603		5V				4
1.6 Ti	77	IQJA		10/12-	ITV20TT	4719	1.0	-	ITV20TT		4
1.6 Ti	77	IQJA		10/12-	T16VR-U10	5086	1.0	TV16TT	ITV16TT	ITV16TT	4
CAPRI (68-74)											
1300	38/43/53	EV 13 H; EV 13 L; JA; KL 13 HC; KL 13 L		12/68-12/73	W20EP-U	3043	0.8	W20TT	IW20TT	IW20TT	4
1500	44/48	EV 15 H; EX		12/68-02/74	W20EP-U	3043	0.8	W20TT	IW20TT	IW20TT	4
1600	53/65	LE; OHC TL 16 H		08/72-02/74	MA20P-U	5012	0.9	-	-		4
1600 GT	60			01/69-10/72	MA20P-U	5012	0.9	-	-		4
1700	55	TV 17 H		12/68-08/72	MA20P-U	5012	0.9	-	-		4
2000	63/66	High Compression (9.0 : 1)		02/69-02/74	W22EPR-U	3088	0.8	W22TT	-	VW22	6
2000	63/66	Low Compression (8.0 : 1)		02/69-02/74	W20EP-U	3043	0.8	W20TT	IW20TT	IW20TT	6
2300	79/92	TV 23 H; YY		02/69-02/74	W22EPR-U	3088	0.8	W22TT	-	VW22	6
2600	92	UY		08/70-02/74	W24EPR-U	4136	0.8	-	-		6
2600 RS	110	OZ		08/70-02/74	W24EPR-U	4136	0.8	-	-		6
3000	94/101/103	HY; TV30LY		01/70-02/74	W20EP-U	3043	0.8	W20TT	IW20TT	IW20TT	6
CAPRI (74-77)											
1.3	40/42	J1E		02/74-08/77	W22EPR-U	3088	0.8	W22TT	-	VW22	4
1.6	50/53/65	LAC; LCE; LEC		02/74-12/77	MA20P-U	5012	0.9	-	-		4
2.0	66	High Compression (9.0 : 1)		04/76-12/77	W22EPR-U	3088	0.8	W22TT	-	VW22	6
2.0	72	OHC TL 20 H		04/74-12/77	MA20P-U	5012	0.9	-	-		4
2.3	79	YYE		02/74-12/77	W22EPR-U	3088	0.8	W22TT	-	VW22	6
3.0	101	HYF		02/74-12/77	W22EPR-U	3088	0.8	W22TT	-	VW22	6
CAPRI (78-87)											
1.3	40	J1E		01/78-06/85	W22EPR-U	3088	0.8	W22TT	-	VW22	4
1.6	54	LCN		01/78-04/87	MA20P-U	5012	0.9	-	-		4
2.0	64/74	NEN; OHC TL 20 H		01/78-12/85	MA20P-U	5012	0.9	-	-		4
2.0	66	High Compression (9.0 : 1)		01/78-12/82	W22EPR-U	3088	0.8	W22TT	-	VW22	6
2.3 Super	84	YYN		06/79-12/85	W22EPR-U	3088	0.8	W22TT	-	VW22	6
2.8 i Turbo	138	PYN		01/82-04/87	IW24	5316	0.7	-	-		6
2.8 Super Injection	118	PRN		01/81-04/87	W22EPR-U	3088	0.8	W22TT	-	VW22	6
3.0	101	HYF		01/78-12/81	W20EPR-U	3047	0.8	W20TT	IW20TT	IW20TT	6
C-MAX I (07-10)											
1.6	74/85	HWDA; HWDB; HXDA; HXDB; SHDA; SHDB; SHDC; SIDA		02/07-09/10	T16VR-U10	5086	1.0	TV16TT	ITV16TT	ITV16TT	4
1.6 TDCi	66/74/80	G8DA; G8DB; G8DC; G8DD; GPDA; HHDA; HHDB; MTDA	Double Coil(LPH)	02/07-09/10	DG-180		11V				4
1.6 TDCi	74	G8DC; MTDA	Instant heating	08/10-09/10	DG-603		5V				4
1.8	92	QQDA; QQDB		02/07-09/10	ZT20EPR11	5087	1.1	T20TT	IT20TT	IT20TT	4
1.8 FlexFuel	92	Q7DA		02/07-08/10	ZT20EPR11	5087	1.1	T20TT	IT20TT	IT20TT	4
1.8 TDCi	85	KKDA	Double Coil(LPH)	02/07-09/10	DG-121		10V				4
2.0	107	AODA; AODB; AODE; SYDA		02/07-09/10	ZT20EPR11	5087	1.1	T20TT	IT20TT	IT20TT	4
2.0 CNG	107	SYDA		04/09-09/10	ZT20EPR11	5087	1.1	T20TT	IT20TT	IT20TT	4
2.0 LPG	107	SYDA		06/08-09/10	ZT20EPR11	5087	1.1	T20TT	IT20TT	IT20TT	4
2.0 TDCi	81/98	G6DC; G6DE; G6DF; IXDA		02/07-08/10	DG-181		11V				4
2.0 TDCi	100	G6DA; G6DB; G6DD; G6DG	Double Coil(LPH)	02/07-09/10	DG-181		11V				4
C-MAX II (10-)											
1.5 TDCi	70/88	XWDA; XWDB; XWDC; XWDD; XWDE; XXDA	Instant heating	03/15-	DG-603		5V				4
1.5 TDCi ECONetic	77	AEDA	Instant heating	03/15-	DG-603		5V				4
1.6 EcoBoost	110	JQDA; JQDB		12/10-	ITV20TT	4719	1.0	-	ITV20TT		4
1.6 FlexFuel	88	MUDA; MUDD	40000km Lifetime	02/11-	ITV22	5340	0.8	-	-		4

Свечи зажигания и Свечи накаливания

Таблица применения











	KW				СТАНДАРТНЫЕ			Twin Tip			QTY
											
FORD продолжение											
C-MAX II (10-) продолжение											
1.6 LPG	86/88	MUDA; MUDD	40000km Lifetime	02/12-	ITV22	5340	0.8	-	-	-	4
1.6 TDCi	70/85	T1DA; T1DB; T3DA; T3DB	Instant heating	12/10-	DG-603		5V				4
1.6 TDCi	85	T1DA; T1DB		12/10-	DG-603		5V				4
1.6 Ti	63/77	IQDA; IQDB; XTDA		12/10-	T16VR-U10	5086	1.0	TV16TT	ITV16TT	ITV16TT	4
1.6 Ti	77/88/92	IQDA; IQDB; MUDA; MUDD; PNDA		12/10-	ITV20TT	4719	1.0	-	ITV20TT		4
2.0 TDCi	85/100/103/120	TXDB; TYDA; UFDB; UKDB		04/10-	DG-603		5V				4
2.0 TDCi	85/110/120/125	T7DB; T8DE; TXDB; TYDA	Instant heating	12/10-	DG-603		5V				4
COUGAR (98-01)											
2.0 16V	96	EDB(ZH20)		08/98-12/01	T16VR-U10	5086	1.0	TV16TT	ITV16TT	ITV16TT	4
2.5 ST 200	151	MABA		01/00-12/01	PT16EPR-L13	5070	1.3	-	IT16TT	IT16TT	6
2.5 V6 24V	125	LCBA(MP25); LCBE(MP25)		08/98-12/01	PT16EPR-L13	5070	1.3	-	IT16TT	IT16TT	6
ECONOVAN (85-92)											
2.0 D	41	RF	Single Coil	03/86-03/92	DG-114		11V				4
ECOSPORT (12-)											
1.5 TDCi	66	UGJE	Instant heating	10/13-	DG-603		5V				4
ESCORT II (73-81)											
1.1	35	G2		12/74-08/80	W22EP-U	3085	0.8	W22TT	-	VW22	4
1.6 RS	62	L3(KL16G)		12/74-08/80	K20PR-U	3145	0.8	K20TT	IK20TT	IK20TT	4
2.0 RS	73/80	NE(TL20)		08/75-08/80	MA20P-U	5012	0.9	-	-		4
ESCORT III (80-86)											
1.1	37	GLB; GSE		03/81-02/86	T20EP-U	5031	0.8	T20TT	IT20TT	IT20TT	4
1.1	40	GMA		09/80-08/83	Q20PR-U	3007	0.8	Q20TT	IQ20TT	IQ20TT	4
1.1	43	GPA		09/80-08/83	Q22PR-U	3010	0.8	-	-	VQ22	4
1.3	51	JPA		09/80-02/86	Q20PR-U	3007	0.8	Q20TT	IQ20TT	IQ20TT	4
1.6	48	CHT 1600		05/83-07/86	Q20PR-U	3007	0.8	Q20TT	IQ20TT	IQ20TT	4
1.6	58/61/71	LP1; LPA; LUA		09/80-02/86	Q22PR-U	3010	0.8	-	-	VQ22	4
1.6 D	40	LTA	Double Coil Standard	02/84-02/86	DG-123		11V				4
1.6 i	66	L4B		07/85-12/85	Q20PR-U	3007	0.8	Q20TT	IQ20TT	IQ20TT	4
1.6 i	77	LRA		09/83-12/85	Q22PR-U	3010	0.8	-	-	VQ22	4
1.6 RS Turbo	97	LNA		11/84-12/85	IQ24	5314	0.8	-	-		4
1.6 XR3i	77	LRA		10/82-12/85	Q22P-U	3255	0.8	-	-	VQ22	4
RS 1600i	85	LUE		05/82-07/84	Q22PR-U	3010	0.8	-	-	VQ22	4
ESCORT IV (85-90)											
1.1	37	GSG		12/85-07/90	T20EPR-U	5032	0.8	T20TT	IT20TT	IT20TT	4
1.3	44/46	JBA; JBB; JLA		01/86-10/90	T20EPR-U	5032	0.8	T20TT	IT20TT	IT20TT	4
1.4	55	F6B; FUC		01/86-07/90	Q20PR-U11	3008	1.1	Q20TT	IQ20TT	IQ20TT	4
1.4	55	FUA		01/86-07/90	Q20PR-U	3007	0.8	Q20TT	IQ20TT	IQ20TT	4
1.4 i	54	FUC		02/86-07/90	Q20PR-U11	3008	1.1	Q20TT	IQ20TT	IQ20TT	4
1.6	58/65	LP2; LUG		01/86-07/90	Q20PR-U11	3008	1.1	Q20TT	IQ20TT	IQ20TT	4
1.6	60	LUC(HL16)		02/86-07/90	K20PR-U	3145	0.8	K20TT	IK20TT	IK20TT	4
1.6 D	40	LTA; LTC	Double Coil Standard	01/86-07/90	DG-123		11V				4
1.6 i	66	L4B		01/86-07/90	Q20PR-U	3007	0.8	Q20TT	IQ20TT	IQ20TT	4
1.6 i	75	LJB		08/89-07/90	Q20PR-U11	3008	1.1	Q20TT	IQ20TT	IQ20TT	4
1.6 Turbo RS	97	LNB		01/86-07/90	Q22PR-U	3010	0.8	-	-	VQ22	4
1.6 XR3i	77	LRB		01/86-07/90	Q22P-U	3255	0.8	-	-	VQ22	4
1.8 D	44	RTA; RTB	Double Coil(LPH)	07/88-07/90	DG-004		11V				4
ESCORT V (90-95)											
1.3	44/46	J6A; JBD		07/90-01/95	T20EPR-U	5032	0.8	T20TT	IT20TT	IT20TT	4
1.4	52/55	F4B; F6G		07/90-01/95	Q20PR-U11	3008	1.1	Q20TT	IQ20TT	IQ20TT	4
1.4	55	FUH		09/90-01/95	Q20PR-U	3007	0.8	Q20TT	IQ20TT	IQ20TT	4
1.4 i	55	F4B		07/93-01/95	Q20PR-U11	3008	1.1	Q20TT	IQ20TT	IQ20TT	4
1.6	66	LUK		07/90-08/92	Q20PR-U	3007	0.8	Q20TT	IQ20TT	IQ20TT	4
1.6	77	LJF		07/90-08/93	Q20PR-U11	3008	1.1	Q20TT	IQ20TT	IQ20TT	4
1.6 16V XR3i	66	L1E		12/92-01/95	PT16VR10	5093	1.0	TV16TT	ITV16TT	ITV16TT	4
1.6 i 16V	65	L1E; L1H		09/92-01/95	PT16VR10	5093	1.0	TV16TT	ITV16TT	ITV16TT	4
1.8 16V	77	RDA		02/92-01/95	PT16VR10	5093	1.0	TV16TT	ITV16TT	ITV16TT	4

Таблица применения

F

Свечи зажигания и Свечи накаливания

Таблица применения

Таблица применения

KW	KW	NOTE	21	СТАНДАРТНЫЕ				Twin Tip		QTY	
				STANDARD	STANDARD	STANDARD	STANDARD	TWIN TIP	TWIN TIP		
FORD продолжение											
ESCORT V (90-95) продолжение											
1.8 16V XR3i	77/96	RDA; RQB		02/92-01/95	PT16VR10	5093	1.0	TV16TT	ITV16TT	ITV16TT	4
1.8 D	44	RTA; RTE; RTF; RTH	Double Coil(LPH)	07/90-01/95	DG-004		11V				4
1.8 i 16V	77/96	RDA; RQB		02/93-01/95	PT16VR10	5093	1.0	TV16TT	ITV16TT	ITV16TT	4
1.8 TD	66	RFD; RFK; RFS	Double Coil(LPH)	02/93-01/95	DG-004		11V				4
1.8 XR3i 16V 4x4	77/96	RDA; RQB		08/93-01/95	PT16VR10	5093	1.0	TV16TT	ITV16TT	ITV16TT	4
RS 2000	110	N7A		05/91-01/95	PK22PR11	3265	1.1	-	IK22TT	VK22	4
RS Cosworth 4x4	162	N5F		10/91-12/93	PK20PR-P8	3245	0.8	-	IK20TT	IK20TT	4
ESCORT VI (95-01)											
1.3	44	J6A		01/95-02/99	T20EPR-U	5032	0.8	T20TT	IT20TT	IT20TT	4
1.4	55	F4B		01/95-08/00	Q20PR-U11	3008	1.1	Q20TT	IQ20TT	IQ20TT	4
1.6 16V	66	L1E		01/95-07/00	PT16VR10	5093	1.0	TV16TT	ITV16TT	ITV16TT	4
1.6 16V 4x4	66	L1E		01/95-10/98	PT16VR10	5093	1.0	TV16TT	ITV16TT	ITV16TT	4
1.6 16V XR3i	66	L1E; L1H		02/95-09/99	PT16VR10	5093	1.0	TV16TT	ITV16TT	ITV16TT	4
1.6 i 16V	65	L1E; L1H		01/95-02/99	PT16VR10	5093	1.0	TV16TT	ITV16TT	ITV16TT	4
1.8 16V	77/85	RDA; RKC		01/95-02/99	PT16VR10	5093	1.0	TV16TT	ITV16TT	ITV16TT	4
1.8 16V XR3i	77/85/96	RDA; RKC; RQB		02/95-08/00	PT16VR10	5093	1.0	TV16TT	ITV16TT	ITV16TT	4
1.8 D	44	RTE; RTF; RTH	Double Coil(LPH)	01/95-08/00	DG-004		11V				4
1.8 TD	66	RFD; RFK; RFS	Double Coil(LPH)	01/95-08/00	DG-004		11V				4
1.8 Turbo D	51	RVA	Double Coil(LPH)	12/95-06/01	DG-007		11.5V				4
RS 2000	110	N7A		02/95-02/98	K20PR-U11	3121	1.1	K20TT	IK20TT	IK20TT	4
RS 2000 4x4	110	N7A(DH20)		02/95-08/96	Q20PR-U11	3008	1.1	Q20TT	IQ20TT	IQ20TT	4
RS Cosworth 4x4	162	N5F		02/95-10/98	PK22PR11	3265	1.1	-	IK22TT	VK22	4
FIESTA I (76-86)											
0.9	29/33	TKW; TLA		05/76-08/83	IT20TT	4714	1.0	-	IT20TT		4
1.0	29	TKA		10/77-08/83	T20EPR-U	5032	0.8	T20TT	IT20TT	IT20TT	4
1.1	40	GL1; GLA; GLW		10/77-08/83	T20EPR-U	5032	0.8	T20TT	IT20TT	IT20TT	4
1.1	40	GLA		05/76-08/83	IT20TT	4714	1.0	-	IT20TT		4
1.3	49	J3E		08/77-08/83	Q22PR-U	3010	0.8	-	-	VQ22	4
1.6 XR2	62	L3E		08/81-08/83	Q22PR-U	3010	0.8	-	-	VQ22	4
FIESTA II (83-95)											
1.0	33	TKB; TLB		08/83-11/89	T20EPR-U	5032	0.8	T20TT	IT20TT	IT20TT	4
1.1	36	GSF; GSH		09/83-02/89	T20EPR-U	5032	0.8	T20TT	IT20TT	IT20TT	4
1.4	52	F6A; F6C		09/86-09/89	K20PR-U	3145	0.8	K20TT	IK20TT	IK20TT	4
1.4	52	F6C		10/86-02/89	Q20PR-U11	3008	1.1	Q20TT	IQ20TT	IQ20TT	4
1.4	55	FUD		02/87-02/89	IK20TT	4702	1.0	-	IK20TT	IK20TT	4
1.6 D	40	LTB	Double Coil Standard	04/84-02/89	DG-123		11V				4
1.6 XR2	71	LUB; LUD		03/84-02/89	Q20PR-U	3007	0.8	Q20TT	IQ20TT	IQ20TT	4
1.8 D	43	RTC; RTD; RTG	Double Coil(LPH)	03/89-12/95	DG-004		11V				4
FIESTA III (89-97)											
1.0	33	TLB		03/89-12/95	T20EPR-U	5032	0.8	T20TT	IT20TT	IT20TT	4
1.1	37/40	G6A; GUE		03/89-12/95	T20EPR-U	5032	0.8	T20TT	IT20TT	IT20TT	4
1.3	44	J6B; JBB; JBC		03/89-02/96	T20EPR-U	5032	0.8	T20TT	IT20TT	IT20TT	4
1.3 Cat	44	J6B		05/91-01/97	T20EPR-U	5032	0.8	T20TT	IT20TT	IT20TT	4
1.4	52	F6E		03/89-12/95	Q20PR-U11	3008	1.1	Q20TT	IQ20TT	IQ20TT	4
1.4	55	FUF		03/89-12/95	K20PR-U	3145	0.8	K20TT	IK20TT	IK20TT	4
1.4 Cat	54	F4A		03/89-12/95	Q20PR-U11	3008	1.1	Q20TT	IQ20TT	IQ20TT	4
1.6	65	LUH		03/89-12/92	Q20PR-U	3007	0.8	Q20TT	IQ20TT	IQ20TT	4
1.6 i 16V	65	L1G		01/94-12/95	PT16VR10	5093	1.0	TV16TT	ITV16TT	ITV16TT	4
1.6 Turbo	96	LHA		03/90-10/92	IQ24	5314	0.8	-	-		4
1.6 XR2i	76/81	LJC; LJD		03/89-01/94	Q20PR-U11	3008	1.1	Q20TT	IQ20TT	IQ20TT	4
1.8 16V	77	RDB		02/92-12/95	PT16VR10	5093	1.0	TV16TT	ITV16TT	ITV16TT	4
1.8 D	44	RTC; RTD; RTG	Double Coil(LPH)	03/89-02/96	DG-004		11V				4
1.8 XR2i 16V	96	RQC		02/92-12/95	PT16VR10	5093	1.0	TV16TT	ITV16TT	ITV16TT	4
FIESTA IV (95-03)											
1.0 i	38/48	TD(ZL10); ZH10JRB		02/97-01/02	T20EPR-U	5032	0.8	T20TT	IT20TT	IT20TT	4
1.25 i 16V	55	DHA; DHB; DHC; DHD; DHE; DHF; DHG		08/95-01/02	PT16VR10	5093	1.0	TV16TT	ITV16TT	ITV16TT	4
1.3	44	J4C		02/96-08/03	T20EPR-U	5032	0.8	T20TT	IT20TT	IT20TT	4

Свечи зажигания и Свечи накаливания

Таблица применения





	KW				СТАНДАРТНЫЕ			Twin Tip			QTY
FORD продолжение											
FIESTA IV (95-03) продолжение											
1.3 i	37/44	J4C; J4J; J4L; J4Q; J4R; J4T; JBC; JJA; JJC; JJE; JJJ; JJK; JJM		08/95-01/02	PT16EPR-L13	5070	1.3	-	IT16TT	IT16TT	4
1.4 i	66	FHA		04/96-10/99	PT16VR10	5093	1.0	TV16TT	ITV16TT	ITV16TT	4
1.4 i 16V	66	FHA		04/96-01/02	PT16VR10	5093	1.0	TV16TT	ITV16TT	ITV16TT	4
1.6 16V Sport	76	L1T; L1V		02/00-01/02	PT16VR10	5093	1.0	TV16TT	ITV16TT	ITV16TT	4
1.8 D	44	RTJ; RTK	Double Coil(LPH)	08/95-04/02	DG-007		11.5V				4
1.8 DI	55	RTN; RTP; RTQ	Double Coil(LPH)	04/00-08/03	DG-007		11.5V				4
1.8 TD	55	RTN; RTP; RTQ	Double Coil(LPH)	03/00-08/03	DG-121		10V				4
FIESTA V (01-08)											
1.25 16V	51/55	FUJA; FUJB; M7JA; M7JB		05/02-06/08	T16VR-U10	5086	1.0	TV16TT	ITV16TT	ITV16TT	4
1.3	44/51	A9JA; A9JB; BAJA		11/01-06/08	T16VR-U10	5086	1.0	TV16TT	ITV16TT	ITV16TT	4
1.4 16V	59	FXJA; FXJB		11/01-06/08	T16VR-U10	5086	1.0	TV16TT	ITV16TT	ITV16TT	4
1.4 TDCi	50	F6JA		10/03-11/04	DG-113		11V				4
1.4 TDCi	50	F6JA; F6JB	M4 Thread	11/01-11/04	DG-113		11V				4
1.4 TDCi	50	F6JA; F6JB	Pin	11/04-06/08	DG-180		11V				4
1.4 TDCi	50	F6JB		11/04-12/10	DG-180		11V				4
1.6 16V	74	FYJA; FYJB		11/01-06/08	T16VR-U10	5086	1.0	TV16TT	ITV16TT	ITV16TT	4
1.6 TDCi	66	HHJA	Double Coil(LPH)	11/04-06/07	DG-113		11V				4
1.6 TDCi	66	HHJB		06/07-06/08	DG-180		11V				4
2.0 ST150	110	N4JB		03/05-06/08	IT20TT	4714	1.0	-	IT20TT		4
FIESTA VI (08-)											
1.25	44/60	SNJA; SNJB; SNJC; SNJD; STJA; STJB; STJC		06/08-	T16VR-U10	5086	1.0	TV16TT	ITV16TT	ITV16TT	4
1.4	71	SPJA; SPJC		06/08-	ITV20TT	4719	1.0	-	ITV20TT		4
1.4 LPG	68/71	RTJA; RTJB	40000km Lifetime	01/09-	ITV22	5340	0.8	-	-		4
1.4 TDCi	50	F6JB; F6JD; KVJA		01/09-	DG-180		11V				4
1.5 TDCi	55	UGJC; XUJA; XUJB		09/12-	DG-603		5V				4
1.6	62	XTJA		03/15-	T16VR-U10	5086	1.0	TV16TT	ITV16TT	ITV16TT	4
1.6 ST	134	JTJA; JTJB		03/13-	ITV20TT	4719	1.0	-	ITV20TT		4
1.6 TDCi	55/ 66/70	HHJC; HHJD; HHJE; HHJF; T3JA; TZJA; TZJB; UBJA		06/08-	DG-180		11V				4
1.6 Ti	77	IQJA; IQJC		09/12-	T16VR-U10	5086	1.0	TV16TT	ITV16TT	ITV16TT	4
1.6 Ti	77/ 88/99	HXJA; HXJB; IQJA; IQJC; U5JA		06/08-	ITV20TT	4719	1.0	-	ITV20TT		4
FOCUS C-MAX (03-07)											
1.6	74	HWDA; HWDB; SHDA; SHDB; SHDC		10/03-03/07	T16VR-U10	5086	1.0	TV16TT	ITV16TT	ITV16TT	4
1.6 TDCi	66	HHDA; HHDB	Double Coil(LPH)	02/05-02/06	DG-113		11V				4
1.6 TDCi	66	HHDA; HHDB	Double Coil(LPH)	02/06-03/07	DG-180		11V				4
1.6 TDCi	80	G8DA; G8DB	M4 Thread	10/03-02/06	DG-113		11V				4
1.6 TDCi	80	G8DA; G8DB	Pin	02/06-03/07	DG-180		11V				4
1.6 Ti	85	HXDA; SIDA		08/04-03/07	T16VR-U10	5086	1.0	TV16TT	ITV16TT	ITV16TT	4
1.8	88	CSDA(Duratec HE 120)	OEM Optional	10/03-03/04	IT20TT	4714	1.0	-	IT20TT		4
1.8	92	Q7DA; QQDA; QQDB		04/04-08/05	IT20TT	4714	1.0	-	IT20TT		4
1.8	92	Q7DA; QQDA; QQDB		09/05-03/07	ZT20EPR11	5087	1.1	T20TT	IT20TT	IT20TT	4
1.8 FlexFuel	92	Q7DA		01/06-03/07	ZT20EPR11	5087	1.1	T20TT	IT20TT	IT20TT	4
1.8 TDCi	85	KKDA; KKDB	Double Coil(LPH)	01/05-03/07	DG-121		10V				4
2.0	107	AODA; AODB; AODE; SYDA		03/04-03/07	ZT20EPR11	5087	1.1	T20TT	IT20TT	IT20TT	4
2.0 TDCi	98/ 100	G6DA; G6DB; G6DC; G6DD; G6DE; G6DF; G6DG	Double Coil(LPH)	10/03-03/07	DG-181		11V				4
FOCUS I (98-05)											
1.4 16V	55	FXDA; FXDB; FXDC; FXDD		10/98-11/04	T16VR-U10	5086	1.0	TV16TT	ITV16TT	ITV16TT	4
1.6 16V	74	FYDA; FYDB; FYDC; FYDD; FYDH		10/98-11/04	T16VR-U10	5086	1.0	TV16TT	ITV16TT	ITV16TT	4
1.6 16V FlexFuel	75	FYDH		01/02-11/04	T16VR-U10	5086	1.0	TV16TT	ITV16TT	ITV16TT	4

Таблица применения

F

Свечи зажигания и Свечи накаливания









Таблица применения

Таблица применения

KW	KW	NOTE	21	СТАНДАРТНЫЕ			Twin Tip			QTY	
				STANDARD	STANDARD	STANDARD	TWIN TIP	TWIN TIP	TWIN TIP		
FORD продолжение											
FOCUS I (98-05) продолжение											
1.8 16V	85	EYDB; EYDC; EYDD; EYDE; EYDF; EYDG; EYDI; EYDJ; EYDL		10/98-11/04	T16VR-U10	5086	1.0	TV16TT	ITV16TT	ITV16TT	4
1.8 16V	85	ZH18(GPL)	Flexible fuel	10/98-11/04	IT20TT	4714	1.0	-	IT20TT		4
1.8 BiFuel	82	EYDL		02/03-01/05	T16VR-U10	5086	1.0	TV16TT	ITV16TT	ITV16TT	4
1.8 BiFuel	82	EYDL	Flexible fuel	02/03-01/05	IT20TT	4714	1.0	-	IT20TT		4
1.8 DI / TDDi	55	BHDA; BHDB	Double Coil(LPH)	08/99-11/04	DG-101		11V				4
1.8 DI / TDDi	55	BHDA; BHDB	Double Coil(LPH)	08/99-11/04	DG-121		10V				4
1.8 TDCi	74/85	F9DA; F9DB; FFDA	Double Coil(LPH)	03/01-11/04	DG-121		10V				4
1.8 Turbo DI / TDDi	55/66	BHDA; BHDB; C9DA; C9DB; C9DC	Double Coil(LPH)	10/98-03/05	DG-121		10V				4
2.0 16V	96	EDDB; EDDC; EDDD; EDDF		10/98-11/04	T16VR-U10	5086	1.0	TV16TT	ITV16TT	ITV16TT	4
2.0 RS	158	HMDA		10/02-11/04	ITV22	5340	0.8	-	-		4
2.0 ST170	127	ALDA		03/02-11/04	ITV20TT	4719	1.0	-	ITV20TT		4
FOCUS II (04-12)											
1.4	59	ASDA; ASDB		07/04-09/12	T16VR-U10	5086	1.0	TV16TT	ITV16TT	ITV16TT	4
1.6	74	HWDA; HWDB; SHDA; SHDB; SHDC		07/04-09/12	T16VR-U10	5086	1.0	TV16TT	ITV16TT	ITV16TT	4
1.6 LPG	85	SIDA	40000km Lifetime	10/09-09/12	ITV22	5340	0.8	-	-		4
1.6 TDCi	66/ 74/80	G8DA; G8DB; G8DC; G8DD; G8DE; G8DF; GPDA; GPDB; GPDC; HHDA; HHDB; MTDA	Double Coil(LPH)	07/04-02/06	DG-113		11V				4
1.6 TDCi	66/ 74/80	G8DA; G8DB; G8DC; G8DD; G8DE; G8DF; GPDA; GPDB; GPDC; HHDA; HHDB; MTDA	Double Coil(LPH)	02/06-09/12	DG-180		11V				4
1.6 Ti	85	HXDA; HXDB; SIDA		07/04-09/12	T16VR-U10	5086	1.0	TV16TT	ITV16TT	ITV16TT	4
1.8	92	Q7DA; QQDA; QQDB		03/06-09/12	ZT20EPR11	5087	1.1	T20TT	IT20TT	IT20TT	4
1.8 FlexFuel	92	Q7DA		01/06-12/07	IT20TT	4714	1.0	-	IT20TT		4
1.8 FlexFuel	92	Q7DA		12/07-08/10	ZT20EPR11	5087	1.1	T20TT	IT20TT	IT20TT	4
1.8 FlexFuel	92/96	DURA18CNG(125); Q7DA(DURA18FLEX)	Flexible fuel	12/05-12/07	IT20TT	4714	1.0	-	IT20TT		4
1.8 TDCi	85	KKDA	Double Coil(LPH)	07/04-09/12	DG-121		10V				4
2.0	104/ 107	AODA; AODB; AODE; SYDA		07/04-09/12	ZT20EPR11	5087	1.1	T20TT	IT20TT	IT20TT	4
2.0 CNG	107	SYDA		04/09-07/11	ZT20EPR11	5087	1.1	T20TT	IT20TT	IT20TT	4
2.0 LPG	107	SYDA		06/08-07/11	ZT20EPR11	5087	1.1	T20TT	IT20TT	IT20TT	4
2.0 TDCi	81/98	G6DE; G6DF; IXDA		07/04-08/10	DG-181		11V				4
2.0 TDCi	100	G6DA; G6DB; G6DD; G6DG	Double Coil(LPH)	07/04-09/12	DG-181		11V				4
2.5 RS	224	JZDA		01/09-08/10	IKH22	5345	0.8	-	-	VKH22	5
2.5 RS	224	JZDA		01/09-07/11	VKH22	5619	0.8	-	-	VKH22	5
2.5 RS 500	257	JZDA		05/10-07/11	IKH24	5346	0.8	-	-		5
2.5 ST	166	HYDA		10/05-12/07	IKH22	5345	0.8	-	-	VKH22	5
2.5 ST	166	HYDA		10/05-09/12	VKH22	5619	0.8	-	-	VKH22	5
FOCUS III (10-)											
1.5 TDCi	70/88	XWDA; XWDB; XWDC; XWDD; XWDE; XXDA; XXDC	Instant heating	09/14-	DG-603		5V				4
1.5 TDCi ECONetic	77	XXDB	Instant heating	09/14-	DG-603		5V				4
1.6 EcoBoost	110/ 134	JQDA; JQDB; JTDA; JTDB; YUDA		07/10-	ITV20TT	4719	1.0	-	ITV20TT		4
1.6 FlexFuel	88/ 110	MUDA; YUDA	40000km Lifetime	07/10-	ITV22	5340	0.8	-	-		4
1.6 LPG	86/88	MUDA	40000km Lifetime	02/12-	ITV22	5340	0.8	-	-		4
1.6 TDCi	70/85	T1DA; T1DB; T3DA; T3DB	Instant heating	07/10-	DG-603		5V				4
1.6 TDCi ECONetic	77	NGDA; NGDB	Instant heating	05/12-	DG-603		5V				4
1.6 Ti	63/77	IQDB; XTDA		07/10-	T16VR-U10	5086	1.0	TV16TT	ITV16TT	ITV16TT	4
1.6 Ti	77/ 88/92	IQDB; MUDA; PNDA; PNDD		07/10-	ITV20TT	4719	1.0	-	ITV20TT		4
2.0 ST	184	R9DA; R9DB; R9DC; R9DD	40000km Lifetime	07/12-	ITV22	5340	0.8	-	-		4

Свечи зажигания и Свечи накаливания

Таблица применения

	KW				СТАНДАРТНЫЕ			Twin Tip			QTY
											
FORD продолжение											
FOCUS III (10-) продолжение											
2.0 TDCi	85/ 100/ 103/ 120	TXDB; TYDA; UFDB; UKDB		07/10-	DG-603		5V				4
2.0 TDCi	110	T7DB	Instant heating	11/14-	DG-603		5V				4
2.0 TDCi ST	136	T8DA	Instant heating	11/14-	DG-603		5V				4
2.3 RS AWD	257	YVDA	40000km Lifetime	07/15-	ITV22	5340	0.8	-	-		4
FUSION (02-12)											
1.25	55	FUJA/FUJB		08/04-12/12	T16VR-U10	5086	1.0	TV16TT	ITV16TT	ITV16TT	4
1.4	59	FXJA; FXJB; FXJC		08/02-12/12	T16VR-U10	5086	1.0	TV16TT	ITV16TT	ITV16TT	4
1.4 LPG	59	UTJA		01/10-12/12	ITV20TT	4719	1.0	-	ITV20TT		4
1.4 TDCi	50	F6JA	Double Coil(LPH)	08/02-11/04	DG-113		11V				4
1.4 TDCi	50	F6JB		11/04-12/12	DG-180		11V				4
1.6	74	FYJA; FYJB; FYJC		08/02-11/08	T16VR-U10	5086	1.0	TV16TT	ITV16TT	ITV16TT	4
1.6 TDCi	66	HHJA	Double Coil(LPH)	11/04-06/07	DG-113		11V				4
1.6 TDCi	66	HHJB		06/07-12/12	DG-180		11V				4
GALAXY (95-06)											
1.9 TDI	66/ 81/85	1Z; AFN; AHU; ANU; AUJ; AVG	Double Coil(LPH)	03/95-10/01	DG-005		11V				4
1.9 TDI	66/ 85/ 96/ 110	1Z; AHU; ANU; ASZ; AUJ; BTB	Double Coil(LPH)	10/01-05/06	DG-109		11V				4
2.0 i	85	NSE; ZVSA		11/95-12/00	IK20TT	4702	1.0	-	IK20TT	IK20TT	4
2.0 i	85	NSE; ZVSA		11/95-12/00	SVK20RZ11	3449	1.1	-	IK20TT	IK20TT	4
2.0 i	85	NSE; ZVSA		01/01-05/06	PK22PR-L11S	3284	1.1	-	-	VK22G	4
2.3 16V	103/ 107	E5SB; Y5(DH23)		01/97-05/06	IK20TT	4702	1.0	-	IK20TT	IK20TT	4
2.3 16V	103/ 107	E5SB; Y5(DH23)		01/97-05/06	SVK20RZ11	3449	1.1	-	IK20TT	IK20TT	4
2.8 i V6	128	AAA; AMY		11/95-04/00	K20TXR	5063	1.0	K20TT	IK20TT	IK20TT	6
2.8 i V6 4x4	128	AAA; AMY		04/96-04/00	K20TXR	5063	1.0	K20TT	IK20TT	IK20TT	6
2.8 V6	150	AYL		04/00-05/06	PKJ16CR-L11	3246	1.1	-	IK16TT	IK16TT	6
GALAXY (06-15)											
1.6 EcoBoost	118	JTWA; JTWB		11/10-06/15	ITV20TT	4719	1.0	-	ITV20TT		4
1.6 TDCi	85	T1WA; T1WB		02/11-06/15	DG-603		5V				4
1.8 TDCi	74/92	FFWA; QYWA	Double Coil(LPH)	05/06-06/15	DG-121		10V				4
2.0	107	AOWA; AOWB		05/06-06/15	ZT20EPR11	5087	1.1	T20TT	IT20TT	IT20TT	4
2.0 EcoBoost	146/ 149	TNWA; TNWB	40000km Lifetime	03/10-06/15	ITV22	5340	0.8	-	-		4
2.0 FlexFuel	107	TBWA; TBWB		05/06-06/15	ZT20EPR11	5087	1.1	T20TT	IT20TT	IT20TT	4
2.0 TDCi	85	KLWA; TYWA	OE:1427905, Double Coi l(LPH)	11/07-06/15	DG-181		11V				4
2.0 TDCi	96/ 103	AZWA; QXWA; QXWB; QXWC	Double Coil(LPH)	05/06-06/15	DG-181		11V				4
2.0 TDCi	100	AZWC		05/06-06/15	DG-181		11V				4
2.0 TDCi	100/ 120	TXWA; UKWA		05/06-06/15	DG-603		5V				4
2.0 TDCi	103	UFWA	Instant heating	05/06-06/15	DG-603		5V				4
2.2 TDCi	129/ 147	KNWA; Q4WA		03/08-06/15	DG-614		11V				4
2.3	118	SEWA		09/07-06/15	ITV16TT	4718	1.0	-	ITV16TT		4
GALAXY (15-)											
2.0 EcoBoost	176	R9CD; R9CI	40000km Lifetime	01/15-	ITV22	5340	0.8	-	-		4
2.0 TDCi	88/ 110/ 132	T7CI; T7CJ; T7CK; T7CL; T8CG; T8CH; T8CI; T8CJ; UFCA; UFCB	Instant heating	01/15-06/18	DG-603		5V				4
2.0 TDCi Bi-Turbo	154	T9CB; T9CC	Instant heating	01/15-06/18	DG-603		5V				4
GRANADA (72-85)											
1.9 D	40		Double Coil(LPH)	08/77-08/82	DG-001		11V				4
2.0	66	NYP		08/77-08/85	W22EPR-U	3088	0.8	W22TT	-	VW22	6
2.0	74/77	NC/NE/NS; NEK		08/79-08/85	MA20PR-U	5013	0.9	-	-		4
2.1 D	46	WTA	Double Coil(LPH)	08/77-08/82	DG-001		11V				4

Свечи зажигания и Свечи накаливания

Таблица применения

KW	KW	NOTE	21	СТАНДАРТНЫЕ			Twin Tip		QTY		
				STANDARD	1mm	⚡	Twin Tip	Twin Tip			
FORD продолжение											
GRANADA (72-85) продолжение											
2.3	79/82/84	YY; YYH; YYP; YYU		01/72-08/85	W20EPR-U	3047	0.8	W20TT	IW20TT	IW20TT	6
2.5 D	51	STP	Double Coil(LPH)	08/82-08/85	DG-001		11V				4
2.8 i	108/110	PRC; PRD		08/77-08/85	W22EPR-U	3088	0.8	W22TT	-	WV22	6
Grand C-MAX (10-)											
1.5 TDCi	70/88	XWDA; XWDB; XWDD; XXDA; XXDC	Instant heating	03/15-	DG-603		5V				4
1.6 EcoBoost	110/134	JQDA; JQDB; JTDA; JTDB		12/10-	ITV20TT	4719	1.0	-	ITV20TT		4
1.6 TDCi	70/85	T1DA; T1DB; T3DA; T3DB		12/10-	DG-603		5V				4
1.6 TDCi	70/85	T1DA; T1DB; T3DA; T3DB	Instant heating	12/10-	DG-603		5V				4
1.6 Ti	77	IQDA; IQDB		12/10-	T16VR-U10	5086	1.0	TV16TT	ITV16TT	ITV16TT	4
1.6 Ti	77/92	IQDA; IQDB; PNDA		12/10-	ITV20TT	4719	1.0	-	ITV20TT		4
2.0 TDCi	85/100/103/120	TXDB; TYDA; UFDB; UKDB		12/10-	DG-603		5V				4
2.0 TDCi	85/110/120/125	T7DB; T8DE; TXDB; TYDA	Instant heating	12/10-	DG-603		5V				4
GT (03-06)											
5.4	368			08/06-12/06	IT20TT	4714	1.0	-	IT20TT		8
GT (16-)											
3.5 EcoBoost V6	483			09/16-	ITV20TT	4719	1.0	-	ITV20TT		6
KA (96-08)											
1.0 i	38/48	ZH10JRB		07/97-11/08	T16EPR-U	5022	0.8	T16TT	IT16TT	IT16TT	4
1.3 i	36/44	J4 D/K/M/N/P/S/ Endura E SEFI; JJB; JJD; JJF; JJG; JJH; JJJ		09/96-11/08	T16EPR-U	5022	0.8	T16TT	IT16TT	IT16TT	4
1.3 i	44/51	A9B; BAA(BL13EFIN)/BAJA(DURA13-60)/J4N(BL13EFIN), J4P(BL13EFIN), J4S(BL13EFIN); BAA		09/96-11/08	T16VR-U10	5086	1.0	TV16TT	ITV16TT	ITV16TT	4
1.6 i	70	CDB; CDC		02/01-11/08	ITV20TT	4719	1.0	-	ITV20TT		4
KA (08-)											
1.2	51	169 A4.000; AAAA; FP4		10/08-	XU22EPR-U	3179	0.9	XU22TT	IXU22TT	VXU22	4
1.3 TDCi	55	169A1000; BAAA; FD4	OE: 1542845	10/08-11/10	DG-171		11V				4
1.3 TDCi	55	169A1000; BAAA; FD4	OE: 1724842	11/10-	DG-621		4.4V				4
KUGA I (08-12)											
2.0 TDCi	100/103	G6DG; UFDA		03/08-11/12	DG-181		11V				4
2.0 TDCi 4x4	100/103/120	G6DG; TXDA; UFDA		03/08-11/12	DG-181		11V				4
2.5	147	HYDB; HYDC		03/09-11/12	IKH20TT	4704	1.0	-	IKH20TT		5
2.5	147	HYDB; HYDC		03/09-11/12	VKH22	5619	0.8	-	-	VKH22	5
2.5 4x4	147	HYDB		02/08-11/12	IKH20TT	4704	1.0	-	IKH20TT		5
2.5 4x4	147	HYDB		02/08-11/12	VKH22	5619	0.8	-	-	VKH22	5
KUGA II (12-)											
1.6 EcoBoost	110	JQMA; JQMB		03/13-	ITV20TT	4719	1.0	-	ITV20TT		4
1.6 EcoBoost 4x4	110/134	JQMA; JQMB; JTMA		03/13-	ITV20TT	4719	1.0	-	ITV20TT		4
2.0 TDCi	88/100/103/110	T7MA; T7MB; UFMA; UKMA; XRMA; XRMB	Instant heating	03/13-	DG-603		5V				4
2.0 TDCi 4x4	100/103/110/120/132	T7MA; T7MB; T8MA; T8MB; TXDA; TXMA; UFMA; UKMA	Instant heating	03/13-	DG-603		5V				4
2.5	110/125			09/13-	ITV16TT	4718	1.0	-	ITV16TT		4

Свечи зажигания и Свечи накаливания

Таблица применения

	KW				СТАНДАРТНЫЕ				Twin Tip		QTY
											
FORD продолжение											
MAVERICK (93-98)											
2.4 i	85/ 87/91	KA24; KA24E		02/93-04/98	K16GPR-U11	3135	1.1	-	-		4
2.7 TD	74/92	TD27; TD27E	Double Coil(LPH)	02/93-04/98	DG-626		11V				4
MAVERICK (01-)											
2.0 16V	91	YF		02/01-	PT16VR13	5068	1.3	TV16TT	ITV16TT	ITV16TT	4
2.3 16V	110	GZ		03/04-	ZT20EPR11	5087	1.1	T20TT	IT20TT	IT20TT	4
3.0 V6 24V	145/ 149	AJ		02/01-	IT20TT	4714	1.0	-	IT20TT		6
MONDEO I (93-98)											
1.6 i 16V	66	L1F; L1J		02/93-08/96	PT16VR10	5093	1.0	TV16TT	ITV16TT	ITV16TT	4
1.8 i 16V	82/85	RKA; RKB		02/93-08/96	PT16VR10	5093	1.0	TV16TT	ITV16TT	ITV16TT	4
1.8 i 16V 4x4	85	RKA		02/93-08/96	PT16VR10	5093	1.0	TV16TT	ITV16TT	ITV16TT	4
1.8 TD	66	RFM; RFN	Double Coil(LPH)	06/93-08/96	DG-004		11V				4
2.0 i 16V	97	NGA		12/94-08/96	PT16VR13	5068	1.3	TV16TT	ITV16TT	ITV16TT	4
2.0 i 16V	97/ 100	NGA		01/93-08/96	PT16VR10	5093	1.0	TV16TT	ITV16TT	ITV16TT	4
2.0 i 16V 4x4	97/ 100	NGA		04/93-08/96	PT16VR10	5093	1.0	TV16TT	ITV16TT	ITV16TT	4
2.5 i 24V	125	SEA		07/94-08/96	PT16EPR-L13	5070	1.3	-	IT16TT	IT16TT	6
MONDEO II (96-00)											
1.6 i	66	L1J		08/96-09/00	PT16VR10	5093	1.0	TV16TT	ITV16TT	ITV16TT	4
1.6 i 16V	70	L1L; L1N; L1Q		05/98-09/00	PT16VR10	5093	1.0	TV16TT	ITV16TT	ITV16TT	4
1.8 i	85	RKB		08/96-09/00	PT16VR10	5093	1.0	TV16TT	ITV16TT	ITV16TT	4
1.8 TD	66	RFN	Double Coil(LPH)	08/96-09/00	DG-007		11.5V				4
2.0 i	96	NGA		08/96-09/00	PT16VR10	5093	1.0	TV16TT	ITV16TT	ITV16TT	4
2.5 24V	125	SEA; SEC		08/96-09/00	PT16EPR-L13	5070	1.3	-	IT16TT	IT16TT	6
2.5 ST 200	151	SGA		05/99-09/00	PT16EPR-L13	5070	1.3	-	IT16TT	IT16TT	6
MONDEO III (00-07)											
1.8 16V	81/92	CGBA; CGBB; CHBA; CHBB		10/00-03/07	ZT20EPR11	5087	1.1	T20TT	IT20TT	IT20TT	4
1.8 SCi	96	CFBA		06/03-03/07	ZT20EPR11	5087	1.1	T20TT	IT20TT	IT20TT	4
2.0 16V	107	CJBA; CJBB		10/00-09/05	ZT20EPR11	5087	1.1	T20TT	IT20TT	IT20TT	4
2.0 16V	107	CJBA; CJBB		09/05-03/07	IT20TT	4714	1.0	-	IT20TT		4
2.0 16V DI / TDDi / TDCi	66	D5BA; SDBA	Double Coil(LPH)	10/00-03/07	DG-130		11.5V				4
2.0 16V TDDi / TDCi	85	D6BA; HJBA; HJBB; HJBC	Double Coil(LPH)	10/00-03/07	DG-130		11.5V				4
2.0 TDCi	96	FMBA; N7BA	Double Coil(LPH)	10/01-03/07	DG-130		11.5V				4
2.2 TDCi	110	QJBC; QJBD		09/04-03/07	DG-130		11.5V				4
2.2 TDCi	114	QJBA; QJBB	Double Coil(LPH)	09/04-03/07	DG-130		11.5V				4
2.5 V6 24V	125	LCBD		10/00-04/05	PT16EPR-L13	5070	1.3	-	IT16TT	IT16TT	6
3.0 ST220	166	MEBA		04/02-03/07	ZT20EPR11	5087	1.1	T20TT	IT20TT	IT20TT	6
3.0 V6 24V	150	DURA30(204)		09/04-04/05	PT16EPR-L13	5070	1.3	-	IT16TT	IT16TT	6
MONDEO IV (07-15)											
1.6 EcoBoost	118	JTBA; JTBB		02/11-01/15	ITV20TT	4719	1.0	-	ITV20TT		4
1.6 TDCi	85	T1BA; T1BB; T1BC		02/11-01/15	DG-603		5V				4
1.6 TDCi	85	T1BA; T1BB; T1BC	Instant heating	12/10-01/15	DG-603		5V				4
1.6 Ti	81/ 88/92	KGBA; PNBA; RHBA		03/07-01/15	ITV20TT	4719	1.0	-	ITV20TT		4
1.8 TDCi	74/92	FFBA; KHBA; QYBA	Double Coil(LPH)	03/07-01/15	DG-121		10V				4
2.0	107	AOBA; AOBC; TBBA		03/07-09/10	ZT20EPR11	5087	1.1	T20TT	IT20TT	IT20TT	4
2.0 EcoBoost	176	TPBA	40000km Lifetime	07/10-01/15	ITV22	5340	0.8	-	-		4
2.0 FlexFuel	107	TBBA; TBBB		03/09-01/15	ZT20EPR11	5087	1.1	T20TT	IT20TT	IT20TT	4
2.0 LPG	107	TBBA		07/09-01/15	IT20TT	4714	1.0	-	IT20TT		4
2.0 SCTi	149	TNBA	40000km Lifetime	03/10-01/15	ITV22	5340	0.8	-	-		4
2.0 TDCi	85/ 103	TYBA; UFBA	Instant heating	03/07-01/15	DG-603		5V				4
2.0 TDCi	85/ 96/ 103	AZBA; KLBA; LPBA; QXBA; QXBB	Double Coil(LPH)	03/07-01/15	DG-181		11V				4
2.0 TDCi	100	AZBC		03/07-12/14	DG-181		11V				4
2.0 TDCi	100/ 120	TXBA; TXBB; UKBA		03/07-01/15	DG-603		5V				4
2.2 TDCi	129	Q4BA		03/08-04/10	DG-614		11V				4

Таблица применения

F

Свечи зажигания и Свечи накаливания

Таблица применения











Таблица применения

F

KW	KW	KW	NOTE	21	СТАНДАРТНЫЕ				Twin Tip		QTY
					STANDARD	STANDARD	STANDARD	STANDARD	Twin Tip	Twin Tip	
FORD продолжение											
MONDEO IV (07-15) продолжение											
2.2 TDCi	147	KNBA	Instant heating	07/10-01/15	DG-603		5V				4
2.3	118	SEBA		07/07-01/15	ITV16TT	4718	1.0	-	ITV16TT		4
2.5	162	HUBA		03/07-03/10	IKH22	5345	0.8	-	-	VKH22	5
2.5	162	HUBA		03/07-03/10	VKH20Y	5639	0.8	-	-	VKH20Y	5
2.5	162	HUBA		03/07-01/15	VKH22	5619	0.8	-	-	VKH22	5
MONDEO V (14-)											
1.5 TDCi	88	UGCC; XUCA	Instant heating	03/15-	DG-603		5V				4
1.6 TDCi	85	NGCA; U3CA	Instant heating	09/14-	DG-603		5V				4
2.0 EcoBoost	149/ 176	R9CB; R9CF; R9CH; TNCD; TNCF	40000km Lifetime	09/14-	ITV22	5340	0.8	-	-		4
2.0 Hybrid	130/ 140		40000km Lifetime	09/14-	ITV22	5340	0.8	-	-		4
2.0 TDCi	110/ 132	T7CA; T7CC; T7CD; T7CE; T7CF; T7CN; T7CP; T7CQ; T8CA; T8CC; T8CD; T8CL	Instant heating	09/14-	DG-603		5V				4
2.0 TDCi 4x4	110/ 132	T7CA; T7CC; T7CD; T7CE; T7CF; T7CN; T7CP; T7CQ; T8CC	Instant heating	02/15-	DG-603		5V				4
2.0 TDCi Bi-Turbo	154	T9CA	Instant heating	03/15-	DG-603		5V				4
ORION I (83-86)											
1.3	51	JPA		07/83-03/86	Q20PR-U	3007	0.8	Q20TT	IQ20TT	IQ20TT	4
1.6	58	LPA		07/83-03/86	Q22PR-U	3010	0.8	-	-	VQ22	4
1.6 D	40	LTA	Double Coil Standard	02/84-03/86	DG-123		11V				4
1.6 i	77	LRA		07/83-03/86	Q22P-U	3255	0.8	-	-	VQ22	4
ORION II (85-90)											
1.3	44/51	JBB; JP		12/85-07/90	T20EPR-U	5032	0.8	T20TT	IT20TT	IT20TT	4
1.4	52	FUAA		03/86-07/90	IK20TT	4702	1.0	-	IK20TT	IK20TT	4
1.4	54	FUA		12/85-07/90	Q20PR-U	3007	0.8	Q20TT	IQ20TT	IQ20TT	4
1.4	54	FUC		01/86-07/90	Q20PR-U11	3008	1.1	Q20TT	IQ20TT	IQ20TT	4
1.4 Cat	54	F6D		02/87-07/90	Q20PR-U11	3008	1.1	Q20TT	IQ20TT	IQ20TT	4
1.6	65	LUC		12/85-07/90	Q20PR-U	3007	0.8	Q20TT	IQ20TT	IQ20TT	4
1.6 D	40	LTC	Double Coil Standard	12/85-01/89	DG-123		11V				4
1.6 i	77	LRB		03/86-07/90	Q22PR-U	3010	0.8	-	-	VQ22	4
1.6 i Cat	66	L4B		03/86-07/90	Q20PR-U	3007	0.8	Q20TT	IQ20TT	IQ20TT	4
1.8 D	44	RTA; RTB	Double Coil(LPH)	01/89-07/90	DG-004		11V				4
ORION III (90-93)											
1.3	44	J6A		07/90-12/93	T20EPR-U	5032	0.8	T20TT	IT20TT	IT20TT	4
1.4	52	F6G		07/90-12/93	Q20PR-U11	3008	1.1	Q20TT	IQ20TT	IQ20TT	4
1.4	54	FUH		07/90-12/93	K20PR-U	3145	0.8	K20TT	IK20TT	IK20TT	4
1.6	66	LUK		07/90-12/92	Q20PR-U	3007	0.8	Q20TT	IQ20TT	IQ20TT	4
1.6 i	77	LJF		07/90-09/92	Q20PR-U11	3008	1.1	Q20TT	IQ20TT	IQ20TT	4
1.6 i 16V	66	L1E		07/92-12/93	PT16VR10	5093	1.0	TV16TT	ITV16TT	ITV16TT	4
1.8 D	44	RTE; RTF; RTH	Double Coil(LPH)	11/90-12/93	DG-004		11V				4
1.8 i 16V	77/96	RDA; RQB		01/92-12/93	PT16VR10	5093	1.0	TV16TT	ITV16TT	ITV16TT	4
1.8 TD	66	RFD; RFK	Double Coil(LPH)	03/92-12/93	DG-004		11V				4
P 100 (87-92)											
1.8 TD	55	RFA	Double Coil(LPH)	10/87-12/92	DG-004		11V				4
2.0	57	NAE		10/87-12/92	T16VR-U10	5086	1.0	TV16TT	ITV16TT	ITV16TT	4
PUMA (97-02)											
1.4 16V	66	FHD(ZH14S)/FHF(ZH 14S)		11/97-10/00	T16VR-U10	5086	1.0	TV16TT	ITV16TT	ITV16TT	4
1.6 16V	76	ZH16S		08/00-12/01	T16VR-U10	5086	1.0	TV16TT	ITV16TT	ITV16TT	4
1.7 16V	92	MHA(ZH17)		03/97-12/01	PT16VR13	5068	1.3	TV16TT	ITV16TT	ITV16TT	4
1.7 Racing ST 160	114	MHA-160(ZH17)		06/99-10/00	PT16VR13	5068	1.3	TV16TT	ITV16TT	ITV16TT	4
RANGER (99-06)											
2.5 D	57	WL	Ceramic	10/99-04/02	DG-645		11V				4
2.5 D	57	WL	Double Coil	10/99-04/02	DG-146		11V				4
2.5 D 4x4	57	WL	Ceramic	10/99-04/02	DG-645		11V				4
2.5 D 4x4	57	WL	Double Coil	10/99-04/02	DG-146		11V				4
2.5 TD	62	WL-T	Ceramic	04/02-06/06	DG-645		11V				4
2.5 TD	62	WL-T	Double Coil	04/02-06/06	DG-146		11V				4

Свечи зажигания и Свечи накаливания

Таблица применения

	KW				СТАНДАРТНЫЕ			Twin Tip			QTY
											
FORD продолжение											
RANGER (99-06) продолжение											
2.5 TD 4x4	62/80	WL-T	Ceramic	10/99-06/06	DG-645		11V				4
2.5 TD 4x4	62/80	WL-T	Double Coil	10/99-06/06	DG-146		11V				4
2.9 D	70	D29UYT		06/99-02/02	DG-146		11V				4
RANGER (06-12)											
2.5 TDCi 4x4	105	WLAA		05/06-12/10	DG-630		11V				4
2.5 TDdi	105	WLAA		05/06-12/10	DG-630		11V				4
3.0 TDCi 4x4	115	WEC		05/06-07/12	DG-630		11V				4
RANGER (11-)											
2.2 TDCi	88/ 92/ 110	GBVAJPF; GBVAJQJ; GBVAJQW		04/11-	DG-611		4.4V				4
2.2 TDCi 4x4	92/ 110	GBVAJQJ; GBVAJQW		04/11-	DG-611		4.4V				4
3.2 TDCi 4x4	147	ENSA; SA2R; SA2S; SA2W; SAFA		04/11-	DG-611		4.4V				5
SCORPIO I (85-94)											
1.8	66	REC(TL18)		04/85-08/88	MA20P-U	5012	0.9	-	-		4
2.0	77	NEL(TL20H)		04/85-08/89	MA20PR-U	5013	0.9	-	-		4
2.0	80	N8A; N8B		11/88-03/93	Q20PR-U	3007	0.8	Q20TT	IQ20TT	IQ20TT	4
2.0 i	74	NRC		10/85-12/90	MA20P-U	5012	0.9	-	-		4
2.0 i	85	NRI		04/85-09/94	MA20PR-U	5013	0.9	-	-		4
2.0 i	85/88	N9D; N9F		05/89-09/94	Q20PR-U	3007	0.8	Q20TT	IQ20TT	IQ20TT	4
2.0 i	92	N9B(DL20EFI)		05/89-02/92	K20PR-U	3145	0.8	K20TT	IK20TT	IK20TT	4
2.4 i	92	ARD		10/88-10/94	T20EPR-U	5032	0.8	T20TT	IT20TT	IT20TT	6
2.4 i	96	ARC		09/86-09/88	Q20PR-U	3007	0.8	Q20TT	IQ20TT	IQ20TT	6
2.4 i Cat	92	ARD		10/88-09/94	T20EPR-U	5032	0.8	T20TT	IT20TT	IT20TT	6
2.5 D	51	STR	Double Coil(LPH)	12/85-12/94	DG-001		11V				4
2.5 TD	68/85	SCB; SFA; SFB	Double Coil(LPH)	06/88-09/94	DG-001		11V				4
2.8 i	110	PRE		04/85-11/86	W22EPR-U	3088	0.8	W22TT	-	VW22	6
2.8 i 4x4	110	PRE		10/85-11/86	W22EPR-U	3088	0.8	W22TT	-	VW22	6
2.9 24V	143	BOA		08/93-09/94	PK20PR11	3168	1.1	K20TT	IK20TT	IK20TT	6
2.9 i	107	BRD		09/86-12/94	T16EPR-U	5022	0.8	T16TT	IT16TT	IT16TT	6
2.9 i	110	BRC		09/86-09/94	Q20PR-U	3007	0.8	Q20TT	IQ20TT	IQ20TT	6
2.9 i 4x4	107	BRD		05/88-10/94	T16EPR-U	5022	0.8	T16TT	IT16TT	IT16TT	6
2.9 i 4x4	110	BRC		09/86-09/94	Q20PR-U	3007	0.8	Q20TT	IQ20TT	IQ20TT	6
2.9 i 24V	143	BOA		04/91-09/94	PK20PR11	3168	1.1	K20TT	IK20TT	IK20TT	6
2.9 i Cat	107	BRE		10/87-09/94	T16EPR-U	5022	0.8	T16TT	IT16TT	IT16TT	6
SCORPIO II (94-98)											
2.0 i	85	NSD		10/94-08/98	PK20PR11	3168	1.1	K20TT	IK20TT	IK20TT	4
2.0 i 16V	100	N3A		10/94-08/98	PK20PR11	3168	1.1	K20TT	IK20TT	IK20TT	4
2.3 i 16V	108	Y5A(DH23); Y5A		06/96-08/98	IK20TT	4702	1.0	-	IK20TT	IK20TT	4
2.3 i 16V	108	Y5A(DH23); Y5A		06/96-08/98	SVK20RZ11	3449	1.1	-	IK20TT	IK20TT	4
2.5 TD	85/92	SCC; VM	Double Coil(LPH)	10/94-08/98	DG-109		11V				4
2.9 i	110	BRG		02/95-08/98	Q20PR-U11	3008	1.1	Q20TT	IQ20TT	IQ20TT	6
2.9 i 24V	152	BOB		10/94-08/98	PK20PR11	3168	1.1	K20TT	IK20TT	IK20TT	6
SIERRA (82-87)											
1.3	44	JCT		08/82-01/85	MA20P-U	5012	0.9	-	-		4
1.6	55	LCS		08/82-12/86	MA20PR-U	5013	0.9	-	-		4
1.6	55/58	LCT/LSD(TL16)/ LSE(TL16); LPA		08/82-12/86	MA20P-U	5012	0.9	-	-		4
1.8	66	REB(TL18)/ RED(TL18); REB(TL18)		10/84-12/86	MA20P-U	5012	0.9	-	-		4
2.0	66	NYT		08/82-10/84	W22EPR-U	3088	0.8	W22TT	-	VW22	6
2.0	74	NRD		10/85-12/86	W20EXR-U	3066	0.8	W20TT	IW20TT	IW20TT	4
2.0	74/77	NET; NRD		08/82-12/86	MA20PR-U	5013	0.9	-	-		4
2.0	85	NRB(TL20INJ)		03/85-12/86	MA20P-U	5012	0.9	-	-		4
2.0 i	85	NRB(TL20INJ)		03/85-12/86	MA20P-U	5012	0.9	-	-		4
2.3	84	YYT		08/82-12/86	W22EPR-U	3088	0.8	W22TT	-	VW22	6
2.3 D	49	YTT	Double Coil(LPH)	08/82-12/86	DG-001		11V				4
2.8 i 4x4	105	PR6		08/82-12/86	W22EPR-U	3088	0.8	W22TT	-	VW22	6
2.8 i 4x4	107	PR7(TV28EFI)/PRT		08/82-12/86	W24EPR-U	4136	0.8	-	-		6
2.8 i XR 4x4	107	PR6		09/83-12/86	W22EPR-U	3088	0.8	W22TT	-	VW22	6
2.8 XR 4x4	110	PRT		02/85-12/86	W22EPR-U	3088	0.8	W22TT	-	VW22	6
2.8 XR4i	107	PR5		08/82-12/86	W22EPR-U	3088	0.8	W22TT	-	VW22	6

Свечи зажигания и Свечи накаливания











Таблица применения

Таблица применения

KW	KW	NOTE	21	СТАНДАРТНЫЕ				Twin Tip			QTY
				MA20PR-U	5013	0.9	-	-	-	-	
FORD продолжение											
SIERRA (87-93)											
1.6	53/55	LSE(TL16); LSF		01/87-02/93	MA20PR-U	5013	0.9	-	-		4
1.6	55	LSE(TL16)		01/87-02/93	MA20P-U	5012	0.9	-	-		4
1.6 i	59	L6B		10/89-02/93	Q20PR-U11	3008	1.1	Q20TT	IQ20TT	IQ20TT	4
1.8	59	RED; REF		10/87-05/88	MA20PR-U	5013	0.9	-	-		4
1.8	64/66	R2A; R6A		01/87-02/93	Q20PR-U11	3008	1.1	Q20TT	IQ20TT	IQ20TT	4
1.8 TD	55	RFA; RFB; RFL	Double Coil(LPH)	08/88-02/93	DG-004		11V				4
1.9	80	N8A(DL20H)		10/88-09/91	MA20PR-U	5013	0.9	-	-		4
2.0	77	NES		01/87-02/93	MA20PR-U	5013	0.9	-	-		4
2.0	77/80	N8A; N8C		01/87-02/93	Q20PR-U	3007	0.8	Q20TT	IQ20TT	IQ20TT	4
2.0 4x4	88/92	N9C		05/89-03/93	Q20PR-U	3007	0.8	Q20TT	IQ20TT	IQ20TT	4
2.0 16V Cosworth 4x4	162	N5C; N5D		01/90-02/93	IQ27	5315	0.8	-	-		4
2.0 16V Cosworth Cat 4x4	162	N5C		01/90-02/93	IQ27	5315	0.8	-	-		4
2.0 i	74/85	N4A; N4I; NE5; NEJ		01/87-02/93	MA20PR-U	5013	0.9	-	-		4
2.0 i	80/88/90/92	N8A; N9A; N9B; N9C		05/89-02/93	Q20PR-U	3007	0.8	Q20TT	IQ20TT	IQ20TT	4
2.0 i Cat	74	N4B		01/87-02/93	MA20PR-U	5013	0.9	-	-		4
2.0 i DOHC	85	N9E		12/91-02/93	Q20PR-U	3007	0.8	Q20TT	IQ20TT	IQ20TT	4
2.0 RS Cosworth	150	N5B; YBB		01/87-12/90	IQ24	5314	0.8	-	-		4
2.0 RS500 Cosworth	167	YBD		07/87-12/87	IQ27	5315	0.8	-	-		4
2.3 D	49	YTR; YTT	Double Coil(LPH)	01/87-02/93	DG-001		11V				4
2.8 4x4	110	PRG		01/87-08/88	W22EPR-U	3088	0.8	W22TT	-	WV22	6
2.8 i	105/107	PR7; PR8		01/87-02/93	W22EPR-U	3088	0.8	W22TT	-	WV22	6
2.8 i 4x4	107	PR7		01/87-02/93	W22EPR-U	3088	0.8	W22TT	-	WV22	6
2.8 i XR 4x4	107/110	PR7; PRG		01/87-02/93	W22EPR-U	3088	0.8	W22TT	-	WV22	6
2.9	107	B4C		08/88-02/93	T16EPR-U	5022	0.8	T16TT	IT16TT	IT16TT	6
2.9 4x4	107/110	B4C		08/88-02/93	T16EPR-U	5022	0.8	T16TT	IT16TT	IT16TT	6
2.9 i	107/110	B4B; B4C		08/88-02/93	T16EPR-U	5022	0.8	T16TT	IT16TT	IT16TT	6
2.9 i XR 4x4	107	B4B		08/88-02/93	T16EPR-U	5022	0.8	T16TT	IT16TT	IT16TT	6
2.9 i XR 4x4	110	B4A		08/88-02/93	Q20PR-U	3007	0.8	Q20TT	IQ20TT	IQ20TT	6
S-MAX (06-14)											
1.6 EcoBoost	118	JTWA; JTWB		02/11-12/14	ITV20TT	4719	1.0	-	ITV20TT		4
1.6 TDCi	85	T1WA; T1WB		02/11-12/14	DG-603		5V				4
1.8 TDCi	74/92	FFWA; QYWA	Double Coil(LPH)	05/06-12/14	DG-121		10V				4
2.0	107	AOWA; AOWB		05/06-12/14	ZT20EPR11	5087	1.1	T20TT	IT20TT	IT20TT	4
2.0 EcoBoost	146/149/176	TNWA; TNWB; TPWA	40000km Lifetime	03/10-12/14	ITV22	5340	0.8	-	-		4
2.0 FlexFuel	107	TBWA; TBWB	Flexible fuel	03/08-12/14	ZT20EPR11	5087	1.1	T20TT	IT20TT	IT20TT	4
2.0 TDCi	85	KLWA; TYWA	OE: 1427905	11/07-12/14	DG-181		11V				4
2.0 TDCi	96/120	AZWA; TXWA		03/07-12/14	DG-181		11V				4
2.0 TDCi	100/103	AZWC; QXWA; QXWB; QXWC; UFWA; UKWA	Double Coil(LPH)	05/06-06/10	DG-181		11V				4
2.2 TDCi	129/147	KNWA; Q4WA		03/08-12/14	DG-614		11V				4
2.3	118	SEWA		07/07-12/14	ITV16TT	4718	1.0	-	ITV16TT		4
2.5 ST	162	HUWA		05/06-06/10	IKH20TT	4704	1.0	-	IKH20TT		5
2.5 ST	162	HUWA		05/06-12/14	VKH22	5619	0.8	-	-	VKH22	5
S-MAX (15-)											
2.0 EcoBoost	176	R9CD; R9CI	40000km Lifetime	01/15-	ITV22	5340	0.8	-	-		4
STREET KA (03-05)											
1.6	70	CDRA; CDRB		05/03-07/05	ITV20TT	4719	1.0	-	ITV20TT		4
TAUNUS (70-76)											
1300	40	JAC		01/70-05/75	MA20P-U	5012	0.9	-	-		4
1600	53	LCJ		01/70-02/76	MA20P-U	5012	0.9	-	-		4
TAUNUS (75-79)											
1.3	40/43	JAC		05/75-07/79	MA20P-U	5012	0.9	-	-		4
1.6	50/53	LAD; LCJ		05/75-07/79	MA20P-U	5012	0.9	-	-		4
2.0	66	NX(TV20)		05/75-07/79	W20EXR-U	3066	0.8	W20TT	IW20TT	IW20TT	6

Свечи зажигания и Свечи накаливания

Таблица применения

	KW				СТАНДАРТНЫЕ			Twin Tip			QTY
											
FORD продолжение											
TAUNUS (79-82)											
1.3	43	JCC		07/79-07/82	MA20PR-U	5013	0.9	-	-		4
1.6	54	LCJ		07/79-07/82	MA20P-U	5012	0.9	-	-		4
2.0	74	NER		07/79-07/82	MA20P-U	5012	0.9	-	-		4
TOURNEO Connect (02-13)											
1.8 16V	85	EYPA(ZH18 115)		06/02-06/06	T16VR-U10	5086	1.0	TV16TT	ITV16TT	ITV16TT	4
1.8 TDCi	66/81	HCPA; HCPB; HCPC; HCPD; P9PA; P9PB; P9PC; P9PD; R3PA; RWPA; RWPB; RWPC; RWPD; RWPE; RWPF	Double Coil(LPH)	06/02-12/13	DG-121		10V				4
1.8 TDCi /TDDi /DI	55	BHPA; P7PA; P7PB; R2PA	Double Coil(LPH)	06/02-12/13	DG-121		10V				4
TOURNEO Connect (13-)											
1.6 EcoBoost	110	JQGA		11/13-	ITV20TT	4719	1.0	-	ITV20TT		4
1.6 TDCi	55/ 70/85	T1GA; TZGA; TZGB; UBGA		09/13-	DG-603		5V				4
TOURNEO Courier (14-)											
1.5 TDCi	55	UGCA; UGCB; XUCC; XUCD; XUCE; XWCA; XWCB	Instant heating	02/14-	DG-603		5V				4
1.6 TDCi	70	T3CA; T3CB; T3CC		02/14-	DG-603		5V				4
TOURNEO Custom (12-)											
2.2 TDCi	74/ 92/ 114	CVFF; CYF4; CYFF; DRF4; DRFF; DRFG		04/12-	DG-611		4.4V				4
TRANSIT (77-86)											
1.6	48	4RB		11/77-10/86	MA20P-U	5012	0.9	-	-		4
2.0	43	4RC		11/77-07/82	MA20PR-U	5013	0.9	-	-		4
2.0	43/57	4RC; NAW(TL20)		11/77-10/86	MA20P-U	5012	0.9	-	-		4
2.0	55/57	4RC		11/77-10/86	MA16PR-U	5008	0.9	-	-		4
2.4 D	46	4AA	Double Coil(LPH)	11/77-10/86	DG-012		11V				4
TRANSIT (85-92)											
1.6	46	LAT		09/85-09/92	MA20P-U	5012	0.9	-	-		4
2.0	57	N6T; NAT(TL20)		10/88-09/92	MA20PR-U	5013	0.9	-	-		4
2.0 Cat	57	NAT(TL20)		12/85-09/92	MA20PR-U	5013	0.9	-	-		4
TRANSIT (91-94)											
2.0	66/72	NBA(TL20S); NCA(TL20EFI)		09/91-09/94	MA20PR-U	5013	0.9	-	-		4
2.0 i	72	NCA(TL20EFI)		09/91-07/94	MA20PR-U	5013	0.9	-	-		4
2.9 i	107	BRT		01/91-09/94	Q20PR-U11	3008	1.1	Q20TT	IQ20TT	IQ20TT	6
TRANSIT (94-00)											
2.0	84	NSF(DL20)/NSG(DL20)		06/94-03/00	K20PR-U	3145	0.8	K20TT	IK20TT	IK20TT	4
2.0	84	NSF(DL20)/NSG(DL20)	OEM Optional	06/94-03/00	PK22PR-L11S	3284	1.1	-	-	VK22G	4
2.0 CNG	84	NSH		06/94-03/00	K20PR-U	3145	0.8	K20TT	IK20TT	IK20TT	4
2.0 CNG	84	NSH	OEM Optional	06/94-03/00	PK22PR-L11S	3284	1.1	-	-	VK22G	4
TRANSIT (00-06)											
2.0 DI	55/ 63/74	ABFA; D3FA; F3FA	Double Coil(LPH)	08/00-05/06	DG-130		11.5V				4
2.0 TDCi	92	FIFA	Double Coil(LPH)	08/02-05/06	DG-130		11.5V				4
2.3 16V	107	E5FA(145)		04/01-05/06	IK20TT	4702	1.0	-	IK20TT	IK20TT	4
2.3 16V RWD	107	E5FA(145)		08/00-05/06	IK20TT	4702	1.0	-	IK20TT	IK20TT	4
2.3 16V RWD	107	E5FC(145)		04/01-01/03	PK20PR11	3168	1.1	K20TT	IK20TT	IK20TT	4
2.4 DI	55/ 66/88	D2FA; D2FB; D2FE; D4FA; F4FA	Double Coil(LPH)	01/00-05/06	DG-130		11.5V				4
2.4 DI RWD	55/88	D4FA; F4FA	Double Coil(LPH)	01/00-05/06	DG-130		11.5V				4
2.4 TDCi	101	H9FA	Double Coil(LPH)	03/04-05/06	DG-130		11.5V				4
2.4 TDE	85/92	DOFA; FXFA	Double Coil(LPH)	07/01-05/06	DG-130		11.5V				4

Свечи зажигания и Свечи накаливания

Таблица применения

Таблица применения

KW	NOTE	21	СТАНДАРТНЫЕ				Twin Tip			QTY	
			1	2	3	4	1	2	3		
FORD продолжение											
TRANSIT (06-14)											
2.2 TDCi	63/ 74/ 81/ 85/ 92/ 96/ 103	CYFA; CYFB; CYFC; CYFD; DRFA; DRFB; DRFC; DRFD; DRFE; P8FA; P8FB; PGFA; PGFB; QVFA; QVFA; SRFA; SRFB; SRFC; SRFD; SRFE; UHFA; UHFB; UHFC		10/11-08/14	DG-611		4.4V				4
2.2 TDCi	63/ 81/ 85/ 96/ 103	P8FA; P8FB; PGFA; PGFB; QVFA; QWFA; SRFA; SRFB; SRFC; SRFD; SRFE; UHFA; UHFB; UHFC		04/06-10/11	DG-130		11.5V				4
2.2 TDCi 4x4	92	CYRB; CYRC		10/11-08/14	DG-611		4.4V				4
2.2 TDCi RWD	74/ 92/ 100/ 114	CVRA; CVRB; CVRC; CYRA; CYRB; DRRA; DRRB; DRRC; USRA; USRB		09/11-12/14	DG-611		4.4V				4
2.2 TDCi RWD	100	USRA; USRB		09/11-10/11	DG-130		11.5V				4
2.3 16V RWD	107	GZFA; GZFB; GZFC		04/06-08/14	IT20TT	4714	1.0	-	IT20TT		4
2.4 TDCi	74/ 85/ 103	H9FD; JXFA; JXFC; PHFA; PHFC		04/06-08/14	DG-130		11.5V				4
2.4 TDCi 4x4	103	H9FB		11/06-08/14	DG-130		11.5V				4
2.4 TDCi RWD	74/ 85/ 103	H9FB; H9FD; JXFA; JXFC; PHFA; PHFC		04/06-08/14	DG-130		11.5V				4
3.2 TDCi	147	SAFA; SAFB		02/08-08/14	DG-130		11.5V				5
3.2 TDCi RWD	147	SAFA; SAFB		09/07-08/14	DG-130		11.5V				5
TRANSIT (13-)											
2.2 TDCi	74/ 92/ 114	CVF5; CY14; CYF5; CYFG; DRF5; DRFF; DRFG; USF6		08/13-	DG-611		4.4V				4
2.2 TDCi 4x4	92/ 114	CV24; CVR5; CY24; CYR5		08/13-	DG-611		4.4V				4
2.2 TDCi RWD	74/ 92/ 114	CV24; CVR5; CYR5; DRR5; USR6; UYR6		08/13-	DG-611		4.4V				4
TRANSIT Connect (02-13)											
1.8 16V	85	EYPA(ZH18 115)		06/02-06/06	T16VR-U10	5086	1.0	TV16TT	ITV16TT	ITV16TT	4
1.8 Di	55	BHPA; P7PA; P7PB; R2PA	Double Coil(LPH)	06/02-12/13	DG-121		10V				4
1.8 TDCi	66/81	HCPA; HCPB; HCPC; HCPD; P9PA; P9PB; P9PC; P9PD; R3PA; RWPA; RWPB; RWPC; RWPD; RWPE; RWPF	Double Coil(LPH)	06/02-12/13	DG-121		10V				4
TRANSIT Connect (13-)											
1.6 EcoBoost	110	JQGA		11/13-	ITV20TT	4719	1.0	-	ITV20TT		4
1.6 TDCi	55	UBGA	Instant heating	02/13-	DG-603		5V				4
1.6 TDCi	55/ 70/85	T1GA; TZGA; TZGB; UBGA		02/13-	DG-603		5V				4
TRANSIT Courier (14-)											
1.5 TDCi	55	UGCA; UGCB; XUCC; XUCD; XUCE; XWCA; XWCB	Instant heating	02/14-	DG-603		5V				4
1.6 TDCi	70	T3CA; T3CB; T3CC		02/14-	DG-603		5V				4
TRANSIT Custom (12-)											
2.2 TDCi	74/ 92/ 114	CVFF; CYF4; CYFF; DRF4; DRFF; DRFG		04/12-	DG-611		4.4V				4
TRANSIT Tourneo (94-00)											
2.0	84	NSG(DL20)		11/94-12/00	K20PR-U	3145	0.8	K20TT	IK20TT	IK20TT	4
2.0	84	NSG(DL20)	OEM Optional	11/94-12/00	PK22PR-L11S	3284	1.1	-	-	VK22G	4
TRANSIT Tourneo (06-14)											
2.2 TDCi	81/ 85/ 96/ 103	PGFA; PGFB; QVFA; QWFA; SRFA; SRFB; SRFC; SRFD; SRFE; UHFA; UHFB; UHFC		07/06-08/14	DG-130		11.5V				4

Свечи зажигания и Свечи накаливания

Таблица применения











	KW				СТАНДАРТНЫЕ			Twin Tip			QTY
											
FORD OTOSAN											
TAUNUS (89-94)											
1.6	52			01/89-10/94	MA20PR-U	5013	0.9	-	-		4
FORD USA											
AEROSTAR (85-97)											
3.0 i V6	108			09/85-12/97	PT16EPR-L13	5070	1.3	-	IT16TT	IT16TT	6
4.0 i V6 4WD	115			09/89-12/97	PT16EPR-L13	5070	1.3	-	IT16TT	IT16TT	6
BRONCO II (85-90)											
2.9 i V6 4x4	104			09/85-08/90	T16EPR-U	5022	0.8	T16TT	IT16TT	IT16TT	6
ECONOLINE (76-92)											
5.0	136			10/85-09/91	T16PR-U11	5026	1.1	-	ITF16TT	ITF16TT	8
ESCAPE (01-07)											
2.0	91			01/01-02/04	PT16VR13	5068	1.3	TV16TT	ITV16TT	ITV16TT	4
EXCURSION (99-05)											
6.8 4WD	231			08/99-09/05	T20EPR-U	5032	0.8	T20TT	IT20TT	IT20TT	10
EXPLORER (90-94)											
4.0 V6 4WD	121			01/93-12/94	T20EPR-U15	5033	1.5				6
EXPLORER (94-01)											
4.0 V6 4WD	115/ 150/ 152			03/95-12/01	PT16EPR-L13	5070	1.3	-	IT16TT	IT16TT	6
F150 (96-03)											
4.2	157			09/98-10/01	PT16EPR-L13	5070	1.3	-	IT16TT	IT16TT	6
MUSTANG (93-04)											
3.8	112			09/93-07/99	PT16EPR-L13	5070	1.3	-	IT16TT	IT16TT	6
4.6	160/ 165/ 192/ 225/ 228/ 236	99W		11/95-12/04	PT16EPR-L13	5070	1.3	-	IT16TT	IT16TT	8
MUSTANG (04-)											
4.6 V8	224			12/04-	PT16EPR-L13	5070	1.3	-	IT16TT	IT16TT	8
MUSTANG (14-)											
2.3 EcoBoost	231/ 233	N38H; N48H	40000km Lifetime	01/15-	ITV22	5340	0.8	-	-		4
PROBE I (88-93)											
3.0 V6	104			08/88-07/93	T20EPR-U15	5033	1.5				6
PROBE II (93-98)											
2.0 16V	85	FS		10/93-03/98	Q20PR-U11	3008	1.1	Q20TT	IQ20TT	IQ20TT	4
2.5 V6 24V	120	KL		10/93-03/98	KJ20CR-U11	3451	1.1	K20TT	IK20TT	IK20TT	6
TAURUS (85-92)											
3.8	104			02/88-10/92	T16NR-U11	5047	1.1	-	IT16TT	IT16TT	6
TAURUS (91-95)											
3.0	164			10/91-09/95	T16EPR-U	5022	0.8	T16TT	IT16TT	IT16TT	6
TAURUS (95-07)											
3.0	95/ 108			09/95-12/99	PT16EPR-L13	5070	1.3	-	IT16TT	IT16TT	6
3.0 24V	130/ 149			09/95-12/99	PT16EPR-L13	5070	1.3	-	IT16TT	IT16TT	6
3.0 FlexFuel	108			09/95-12/99	PT16EPR-L13	5070	1.3	-	IT16TT	IT16TT	6
3.0 V6	115			03/99-12/99	PT16EPR-L13	5070	1.3	-	IT16TT	IT16TT	6
THUNDERBIRD (93-97)											
3.8	104			01/93-12/96	T16NR-U11	5047	1.1	-	IT16TT	IT16TT	6
WINDSTAR (95-04)											
3.0 V6	109			01/95-12/00	T20EPR-U	5032	0.8	T20TT	IT20TT	IT20TT	6
3.0 V6	109			03/95-02/99	PT16EPR-L13	5070	1.3	-	IT16TT	IT16TT	6
FSO											
125P (67-92)											
1.3	47	116 C 076		10/67-08/92	W20EP-U	3043	0.8	W20TT	IW20TT	IW20TT	4
1.3 1300	47	116 C 076		10/67-08/92	W20EP-U	3043	0.8	W20TT	IW20TT	IW20TT	4
1.5	55	115 C 076		10/67-08/92	W20EP-U	3043	0.8	W20TT	IW20TT	IW20TT	4
1.5 1500	55	115 C 076		10/67-08/92	W20EP-U	3043	0.8	W20TT	IW20TT	IW20TT	4
126P (72-00)											
0.6	17/22	126 A1.048		09/72-12/91	W22FPR-U	4022	0.7	-	-		2
650	18	126 A1.048		07/81-09/00	W20EPR-U	3047	0.8	W20TT	IW20TT	IW20TT	2
127P (69-76)											
0.9	33	127GL.000		03/71-10/76	W20EPR-U	3047	0.8	W20TT	IW20TT	IW20TT	4
LANOS (04-08)											
1.4	55	A13SM		05/04-10/08	W20EPR-U	3047	0.8	W20TT	IW20TT	IW20TT	4

Таблица применения

F

Свечи зажигания и Свечи накаливания

Таблица применения

Таблица применения

KW	KW	KW	NOTE	21	СТАНДАРТНЫЕ			Twin Tip		QTY	
					W20EPR-U	3047	0.8	W20TT	IW20TT		IW20TT
FSO продолжение											
LANOS (04-08) продолжение											
1.5	63	A15SMS		05/04-07/05	W20EPR-U	3047	0.8	W20TT	IW20TT	IW20TT	4
1.6 16V	78	A16DMS		05/04-10/08	K20PR-U11	3121	1.1	K20TT	IK20TT	IK20TT	4
POLONEZ I (77-91)											
1.3	48	116 C 076		01/78-12/80	W20EP-U	3043	0.8	W20TT	IW20TT	IW20TT	4
1.5	55/60	AA		10/77-08/88	W20EP-U	3043	0.8	W20TT	IW20TT	IW20TT	4
1.5 Turbo	70	AA		01/78-12/91	W20EP-U	3043	0.8	W20TT	IW20TT	IW20TT	4
1.6	64	CB		08/86-08/88	W22EPR-U	3088	0.8	W22TT	-	VW22	4
POLONEZ II (88-92)											
1.5	55	AA		08/88-08/92	W20EP-U	3043	0.8	W20TT	IW20TT	IW20TT	4
1.5 i	55	115 C.074		08/88-08/92	W20EP-U	3043	0.8	W20TT	IW20TT	IW20TT	4
1.6	64	CB		08/88-08/92	W22EPR-U	3088	0.8	W22TT	-	VW22	4
1.9 D	51	XUD 9A	Double Coil Std(LPH)	12/91-08/92	DG-001		11V				4
POLONEZ III (92-02)											
1.4 i 16V	76	Rover K16 DOHC		09/92-03/02	K20PR-U	3145	0.8	K20TT	IK20TT	IK20TT	4
1.6 i	57	147CK46		09/92-03/02	W22EPR-U	3088	0.8	W22TT	-	VW22	4
1.9 D	51	XUD 9A	Double Coil Std(LPH)	09/92-03/02	DG-001		11V				4
GAZ											
66 (64-98)											
4.3	92	ZMZ-66-06		01/64-12/98	W14F-U	4012	0.7	-	-		8
GAZELLE (2705, 3221, 3302) (93-02)											
2.3	72/ 74/ 81/96	ZMZ-4061.10 / ZMZ-4062.10; ZMZ-4061.10; ZMZ-4063.10		10/93-12/02	W16EPR-U	3021	0.8	W16TT	IW16TT	IW16TT	4
2.3 4x4	81	ZMZ-4061.10 / ZMZ-4062.10		01/94-12/02	W16EPR-U	3021	0.8	W16TT	IW16TT	IW16TT	4
2.4	66	ZMZ-402.10		10/93-12/97	W16FPR-U	4019	0.7	-	-		4
2.4	66	ZMZ-402.10		12/97-08/01	W16FPR-U	4192	0.7	-	-		4
2.5	66/74	ZMZ-4025.10; ZMZ-4026.10		01/94-12/97	W16FPR-U	4019	0.7	-	-		4
2.5	66/74	ZMZ-4025.10; ZMZ-4026.10		12/97-12/02	W16FPR-U	4192	0.7	-	-		4
2.5	112	ZMZ-40522.10		01/98-12/02	W16EPR-U	3021	0.8	W16TT	IW16TT	IW16TT	4
2.5 D	67	ZMZ- 20ZLT		10/93-08/01	DG-005		11V				4
2.8 TD	88	ZMZ-4061.10 / ZMZ-4062.10		01/94-12/02	W16EPR-U	3021	0.8	W16TT	IW16TT	IW16TT	4
2.9	65/71	UMZ-4215.10; UMZ-4215.10-30		01/94-12/01	W16FPR-U	4192	0.7	-	-		4
GAZELLE (03-13)											
2.3	104	ZMZ-4063.10		01/03-01/10	W16EPR-U	3021	0.8	W16TT	IW16TT	IW16TT	4
2.3 4x4	104/ 112	ZMZ-4063.10		01/03-01/10	W16EPR-U	3021	0.8	W16TT	IW16TT	IW16TT	4
2.4	63/66	ZMZ-4021.10; ZMZ-4025.10		01/03-03/13	W16FPR-U	4192	0.7	-	-		4
2.9	75	UMZ-4215.10		01/03-01/10	W16FPR-U	4192	0.7	-	-		4
2.9	78	UMZ4216		01/05-03/13	Q16PR-U	3137	0.8	Q16TT	IQ16TT	IQ16TT	4
2.9 4x4	78/79	UMZ4216		01/05-03/13	Q16PR-U	3137	0.8	Q16TT	IQ16TT	IQ16TT	4
SOBOL (2217, 2310, 2752) (97-)											
2.3	72/81	ZMZ-4062.10; ZMZ-4063.10		09/97-04/13	W16EPR-U	3021	0.8	W16TT	IW16TT	IW16TT	4
2.4	56/ 63/66	ZMZ-402.10; ZMZ-4021.10		01/97-	W16FPR-U	4192	0.7	-	-		4
2.5	56/63	ZMZ-4026.10		09/97-04/13	W16FPR-U	4192	0.7	-	-		4
2.5 i	91/ 98/ 103/ 112	ZMZ-40522.10		09/01-	W16EPR-U	3021	0.8	W16TT	IW16TT	IW16TT	4
2.5 i	91/ 98/ 103/ 112	ZMZ-40524.10		09/01-	Q16PR-U	3137	0.8	Q16TT	IQ16TT	IQ16TT	4
2.5 i 4X4	98	ZMZ-40522.10		07/10-	W16EPR-U	3021	0.8	W16TT	IW16TT	IW16TT	4
2.5 i 4X4	98	ZMZ-40524.10		07/10-	Q16PR-U	3137	0.8	Q16TT	IQ16TT	IQ16TT	4
2.9	71	UMZ-4215.10		01/99-04/13	W16FPR-U	4192	0.7	-	-		4
VOLGA (21) (56-70)											
2.5	55	ZMZ-21		05/56-12/70	W14F-U	4012	0.7	-	-		4
VOLGA (24) (67-92)											
2.5	63	ZMZ-24		01/72-12/85	W14F-U	4012	0.7	-	-		4

Свечи зажигания и Свечи накаливания

Таблица применения















	KW				СТАНДАРТНЫЕ			Twin Tip			QTY
GAZ продолжение											
VOLGA (24) (67-92) продолжение											
2.5	63/ 66/74	ZMZ-1402.10; ZMZ-4021.10; ZMZ-4027.10		01/86-12/92	W16FP-U	4019	0.7	-	-		4
2.5	70	ZMZ-24		01/70-12/85	W20FP-U	3068	0.7	WF20TT	-		4
VOLGA (3102) (72-09)											
2.3	107	ZMZ-4062.10		02/72-12/09	W16EPR-U	3021	0.8	W16TT	IW16TT	IW16TT	4
2.5	63/ 67/ 74/77	ZMZ-4021.17; ZMZ-4021.19; ZMZ-4022.10; ZMZ-4027.10		02/72-12/97	W16FP-U	4019	0.7	-	-		4
2.5	63/74	ZMZ-4022.10; ZMZ-4027.10		12/97-12/09	W16FPR-U	4192	0.7	-	-		4
VOLGA (3110, 3111) (93-10)											
2.3	96/ 107	ZMZ-4052.10; ZMZ-4062.10		02/93-12/10	W16EPR-U	3021	0.8	W16TT	IW16TT	IW16TT	4
2.3	107	ZMZ-40525		01/00-12/04	Q16PR-U	3137	0.8	Q16TT	IQ16TT	IQ16TT	4
2.4	59/66	ZMZ-4021.10		02/93-12/97	W16FP-U	4019	0.7	-	-		4
2.4	59/ 66/74	ZMZ-4021.10		01/97-12/10	W16FPR-U	4192	0.7	-	-		4
2.5	112	ZMZ-4062.10		01/00-12/04	W16EPR-U	3021	0.8	W16TT	IW16TT	IW16TT	4
3.0	163	3M3-4062.10		04/00-09/04	W16EPR-U	3021	0.8	W16TT	IW16TT	IW16TT	4
GEELY											
BL (05-)											
1.3	63	MR479Q		09/05-	K20PR-U	3145	0.8	K20TT	IK20TT	IK20TT	4
1.5	69	MR479QA		09/05-	K16R-U11	3120	1.1	K16TT	IK16TT	IK16TT	4
CK (05-)											
1.3	63	8A-FE; MR479Q		09/05-	K20PR-U	3145	0.8	K20TT	IK20TT	IK20TT	4
1.5	69	5A-FE; MR479QA		09/05-	K16R-U11	3120	1.1	K16TT	IK16TT	IK16TT	4
1.6	79	MR481QA		09/05-	K20PR-U	3145	0.8	K20TT	IK20TT	IK20TT	4
HISOON (04-)											
1.3	63	MR479Q		07/04-	K20PR-U	3145	0.8	K20TT	IK20TT	IK20TT	4
1.5	69	MR479QA		07/04-12/09	K16R-U11	3120	1.1	K16TT	IK16TT	IK16TT	4
MARINDO (05-)											
1.5	69	MR479QA		03/05-	K16R-U11	3120	1.1	K16TT	IK16TT	IK16TT	4
MK (05-13)											
1.5	69	MR479QA		06/05-12/13	K16R-U11	3120	1.1	K16TT	IK16TT	IK16TT	4
MK (12-)											
1.5	69	MR479QA		01/12-	K16R-U11	3120	1.1	K16TT	IK16TT	IK16TT	4
MR (05-)											
1.3	63	MR479Q		09/05-	K20PR-U	3145	0.8	K20TT	IK20TT	IK20TT	4
1.5	69	MR479QA		09/05-	K16R-U11	3120	1.1	K16TT	IK16TT	IK16TT	4
PANDA (08-)											
1.3	63	MR479Q		11/08-	K20PR-U	3145	0.8	K20TT	IK20TT	IK20TT	4
PU (05-)											
1.3	63	MR479Q		09/05-	K20PR-U	3145	0.8	K20TT	IK20TT	IK20TT	4
URBAN NANNY (04-)											
1.3	63	MR479Q		05/04-	K20PR-U	3145	0.8	K20TT	IK20TT	IK20TT	4
VISION (06-)											
1.5	78	JL4G15D		05/09-	K16R-U11	3120	1.1	K16TT	IK16TT	IK16TT	4
1.5	78/ 102	JL4G15D		05/09-	K20PR-U	3145	0.8	K20TT	IK20TT	IK20TT	4
GEO											
METRO (88-98)											
1.3 GTI	74	G13B		01/89-12/98	W22EPR-U	3088	0.8	W22TT	-	VW22	4
1.3 i	52	G13BA		01/89-12/98	K20PR-U	3145	0.8	K20TT	IK20TT	IK20TT	4
STORM (89-93)											
1.6 i 16V	97	4XE1U		01/89-12/93	K20PR-U11	3121	1.1	K20TT	IK20TT	IK20TT	4
TRACKER (88-98)											
1.6 i	59	G16A		01/88-12/98	W16EPR-U	3021	0.8	W16TT	IW16TT	IW16TT	4
1.6 i 16V	71	G16B		01/88-12/98	K20PR-U	3145	0.8	K20TT	IK20TT	IK20TT	4
GMC											
G SERIE (75-84)											
5.0	114	LG4		10/78-03/84	T16PR-U11	5026	1.1	-	ITF16TT	ITF16TT	8
JIMMY (94-02)											
4.3	142	L35(262CUL6)		10/94-09/02	T16EPR-U15	5023	1.5	T16TT	IT16TT	IT16TT	6
4.3 AWD	142	L35		10/94-09/02	T16EPR-U15	5023	1.5	T16TT	IT16TT	IT16TT	6
SIERRA (97-07)											
5.3	213	LM7		10/98-12/07	T20EPR-U15	5033	1.5				8

Таблица применения

G

Свечи зажигания и Свечи накаливания

Таблица применения

	KW				СТАНДАРТНЫЕ			Twin Tip			QTY
											
GMC продолжение											
SIERRA (97-07) продолжение											
5.3 4x4	213	LM7		10/98-12/07	T20EPR-U15	5033	1.5				8
6.0 AWD	224	LQ4(364CUV8)		10/98-12/07	PTJ16R15	5077	1.5	-	IT16TT	IT16TT	8
YUKON (91-00)											
5.7 AWD	149/ 157	LO5		04/91-08/96	T20PR-U	5035	0.9	-	ITF20TT	ITF20TT	8
GREAT WALL											
COOLBEAR (08-13)											
1.5	77	GW4G15		03/09-12/13	K16PR-U11	3130	1.1	K16TT	IK16TT	IK16TT	4
HOVER H5 (10-)											
2.4	93	4G69-S4N		01/13-	K20PR-U11	3121	1.1	K20TT	IK20TT	IK20TT	4
2.4 4WD	93	4G69-S4N		01/13-	K20PR-U11	3121	1.1	K20TT	IK20TT	IK20TT	4
2.4 4WD (CC6461)	100	4G69-S4N		06/10-	K20PR-U11	3121	1.1	K20TT	IK20TT	IK20TT	4
HOVER H6 (11-)											
1.5	105	GW4G15B		08/11-	K22PR-U	3165	0.8	-	IK22TT	VK22	4
1.5 4WD	105	GW4G15B		08/11-	K22PR-U	3165	0.8	-	IK22TT	VK22	4
HOVER M4 (12-)											
1.5	78	GW4G15		05/12-	K16PR-U11	3130	1.1	K16TT	IK16TT	IK16TT	4
SAIFU (00-03)											
2.2 DX	68	4YE		03/00-08/03	P16R	3004	1.0	W20TT	IW20TT	IW20TT	4
2.2 DX AWD	68	4YE		03/00-08/03	P16R	3004	1.0	W20TT	IW20TT	IW20TT	4
TENGYI (10-)											
1.5	71	GW4G15		01/10-	K16PR-U11	3130	1.1	K16TT	IK16TT	IK16TT	4
HOLDEN											
FRONTERA (B) (98-04)											
3.2 i 4x4	151	6VD1 (DOHC)		08/98-04/04	IK16TT	4701	1.0	-	IK16TT	IK16TT	6
3.2 i 4x4	151	6VD1 (DOHC)		08/98-04/04	K16TT	4603	1.0	K16TT	IK16TT	IK16TT	6
3.2 i 4x4	151	6VD1 (DOHC)		08/98-04/04	PK16PR11	3264	1.1	K16TT	IK16TT	IK16TT	6
HONDA											
ACCORD I (78-83)											
1.6 L/EX	59	EL		01/78-09/83	W16EXR-U	3031	0.8	W16TT	IW16TT	IW16TT	4
ACCORD II (83-85)											
1.6 EX	65	EZ		09/83-10/85	W20EXR-U11	3067	1.1	W20TT	IW20TT	IW20TT	4
1.8 EX	74	ET1		09/83-10/85	W16EXR-U	3031	0.8	W16TT	IW16TT	IW16TT	4
ACCORD III (85-89)											
1.6 L	65	A16A1		11/85-12/89	W20EXR-U11	3067	1.1	W20TT	IW20TT	IW20TT	4
2.0	101	A20A2		01/86-12/86	W16EXR-U11	3032	1.1	W16TT	IW16TT	IW16TT	4
2.0 EX	75/78	A20A1; A20A2		11/85-12/89	W16EXR-U11	3032	1.1	W16TT	IW16TT	IW16TT	4
2.0 EX	75/78	A20A1; A20A2		11/85-12/89	W20EXR-U11	3067	1.1	W20TT	IW20TT	IW20TT	4
2.0 EXi	85/90	A20A3; A20A4		11/85-12/89	W16EXR-U11	3032	1.1	W16TT	IW16TT	IW16TT	4
2.0 EXi	85/90	A20A3; A20A4		11/85-12/89	W20EXR-U11	3067	1.1	W20TT	IW20TT	IW20TT	4
2.0 i 16V	98/ 101	B20A2; B20A8		01/87-12/89	Q20PR-U11	3008	1.1	Q20TT	IQ20TT	IQ20TT	4
ACCORD IV (90-94)											
1.8	77	F18A2		01/90-12/91	KJ20CR-L11	3169	1.1	K20TT	IK20TT	IK20TT	4
2.0 16V	66/81	F20A (excl. TCS)		01/90-03/93	KJ20CR-L11	3169	1.1	K20TT	IK20TT	IK20TT	4
2.0 16V	66/81	F20A (with TCS)		01/90-03/93	SKJ16CR-L11	3396	1.1	-	IK16TT	IK16TT	4
2.0 i	99	F20A (excl. TCS)		09/90-04/93	KJ20CR-L11	3169	1.1	K20TT	IK20TT	IK20TT	4
2.0 i	99	F20A (with TCS)		09/90-04/93	SKJ16CR-L11	3396	1.1	-	IK16TT	IK16TT	4
2.0 i 16V	98	F20A (excl. TCS); F20Z3		01/90-12/93	KJ20CR-L11	3169	1.1	K20TT	IK20TT	IK20TT	4
2.0 i 16V	98	F20A (with TCS)		01/90-09/93	SKJ16CR-L11	3396	1.1	-	IK16TT	IK16TT	4
2.2	103	F22A6; F22A9		10/91-12/93	KJ16CR-L11	3132	1.1	K16TT	IK16TT	IK16TT	4
2.2 i 16V	108/ 110	F22A3; F22A7; F22A8		01/90-12/93	KJ16CR-L11	3132	1.1	K16TT	IK16TT	IK16TT	4
2.2 i 16V	108/ 110	F22A3; F22A7; F22A8		01/90-12/93	KJ20CR-L11	3169	1.1	K20TT	IK20TT	IK20TT	4
ACCORD IX (12-)											
2.0	114	R20A	Japan	09/13-	SKJ20DR-M11S	3432	1.1	-	-	SKJ20DR-M11S	4
2.0 Hybrid	105/ 146	LFA-MF8/ LFA-H4		01/13-	VFXEHC22G	5659	0.8	-	-	VFXEHC22G	4
2.4	129/ 138/ 141	K24A	Japan	09/12-	SKJ20DR-M11S	3432	1.1	-	-	SKJ20DR-M11S	4
2.4	129/ 138/ 141	K24W; K24W1, K24Z3	USA	09/12-	IXEH22TT	4712	1.0	-	-	IXEH22TT	4
3.5	204/ 207	J35Y1; J35Z1; J35Z2	USA	09/12-	SXU22HCR11S	3461	1.1	-	-	VXUHC22G	6

Свечи зажигания и Свечи накаливания

Таблица применения

Таблица применения

KW	KW	KW	KW	KW	СТАНДАРТНЫЕ			Twin Tip			QTY
					STANDARD	STANDARD	STANDARD	TWIN TIP	TWIN TIP	TWIN TIP	
HONDA продолжение											
ACCORD V (93-98)											
1.9 i	85	F18A3		02/96-10/98	KJ16CR-L11	3132	1.1	K16TT	IK16TT	IK16TT	4
1.9 i	85	F18A3		02/96-10/98	KJ20CR-L11	3169	1.1	K20TT	IK20TT	IK20TT	4
2.0	100	F20B3		09/93-12/97	KJ16CR-L11	3132	1.1	K16TT	IK16TT	IK16TT	4
2.0	100	F20B3		09/93-12/97	KJ20CR-L11	3169	1.1	K20TT	IK20TT	IK20TT	4
2.0 i	85	F20Z2		03/93-01/96	KJ20CR-L11	3169	1.1	K20TT	IK20TT	IK20TT	4
2.0 i LS	96	F20Z1		02/96-10/98	KJ20CR-L11	3169	1.1	K20TT	IK20TT	IK20TT	4
2.0 i LS 16V	100	F20B3		09/93-02/98	KJ16CR-L11	3132	1.1	K16TT	IK16TT	IK16TT	4
2.0 i LS 16V	100	F20B3		09/93-02/98	KJ20CR-L11	3169	1.1	K20TT	IK20TT	IK20TT	4
2.0 i S	96	F20Z1		03/93-01/96	KJ20CR-L11	3169	1.1	K20TT	IK20TT	IK20TT	4
2.0 TDi	77	20T2N	Double Coil(LPH)	04/96-10/98	DG-101		11V				4
2.2 i ES	110	F22B5		09/93-02/98	KJ16CR-L11	3132	1.1	K16TT	IK16TT	IK16TT	4
2.2 i ES	110	F22B5		09/93-02/98	KJ20CR-L11	3169	1.1	K20TT	IK20TT	IK20TT	4
2.2 i-VTEC	110	F22Z2		02/96-10/98	KJ20CR-U11	3451	1.1	K20TT	IK20TT	IK20TT	4
2.2 Vti (SV4)	108	F22B1; F22B4		01/94-12/97	KJ16CR-L11	3132	1.1	K16TT	IK16TT	IK16TT	4
2.3 i SR	116	Except TCS		03/93-01/96	KJ20CR-L11	3169	1.1	K20TT	IK20TT	IK20TT	4
2.3 i SR	116	With TCS		03/93-01/96	PKJ20CR-L11	3247	1.1	-	IK20TT	IK20TT	4
ACCORD VI (97-05)											
1.6	85	D16B6		12/99-12/02	KJ16CR-L11	3132	1.1	K16TT	IK16TT	IK16TT	4
1.6 i	85	D16B6		10/98-12/02	KJ16CR-L11	3132	1.1	K16TT	IK16TT	IK16TT	4
1.6 LS	79	D16B7		10/98-12/02	KJ16CR-L11	3132	1.1	K16TT	IK16TT	IK16TT	4
1.6 LS	79	D16B7		10/98-12/02	KJ16CR-U11	3311	1.1	K16TT	IK16TT	IK16TT	4
1.8 i	100	F18B2		10/98-12/02	KJ20CR-L11	3169	1.1	K20TT	IK20TT	IK20TT	4
1.8 i	100	F18B2		10/98-12/02	PKJ16CR-L11	3246	1.1	-	IK16TT	IK16TT	4
2.0	108	F20B6		12/99-12/02	KJ20CR-L11	3169	1.1	K20TT	IK20TT	IK20TT	4
2.0	108	F20B6; F20B7		11/99-12/02	KJ16CR-L11	3132	1.1	K16TT	IK16TT	IK16TT	4
2.0 i	108	F20B6		10/98-01/01	IK20L	5358	1.1	-	IK20TT	IK20TT	4
2.0 i	108	F20B6		10/98-01/01	KJ16CR-L11	3132	1.1	K16TT	IK16TT	IK16TT	4
2.0 i 16V	108	F20B5		02/98-06/03	KJ20CR-L11	3169	1.1	K20TT	IK20TT	IK20TT	4
2.0 i 16V	108	F20B5; F20B7		02/98-06/03	KJ16CR-L11	3132	1.1	K16TT	IK16TT	IK16TT	4
2.0 TDi	77	20T2N	Double Coil(LPH)	12/99-10/00	DG-101		11V				4
2.0 Turbo Di	77	20T2N	Double Coil(LPH)	02/99-12/02	DG-101		11V				4
2.2 Type-R	156	H22A7		02/99-12/02	PKJ20CR-L11	3247	1.1	-	IK20TT	IK20TT	4
2.3	110/ 113	F23A1; F23Z5		03/97-06/03	KJ16CR-L11	3132	1.1	K16TT	IK16TT	IK16TT	4
2.3	113	F23Z5		11/00-06/03	KJ20CR-L11	3169	1.1	K20TT	IK20TT	IK20TT	4
3.0 V6 24V	147	J30A1		02/98-06/03	KJ16CR-L11	3132	1.1	K16TT	IK16TT	IK16TT	6
ACCORD VII (03-08)											
2.0	114	K20A6		02/03-05/08	KJ20DR-M11	3374	1.1	-	-	SKJ20DR-M11	4
2.0 AWD	114	K20A6		02/03-05/08	KJ20DR-M11	3374	1.1	-	-	SKJ20DR-M11	4
2.2 i-CTDi	103	N22A1		01/04-05/08	DG-601		11V				4
2.4	140	K24A; K24A3		02/03-05/08	SKJ20DR-M11	3377	1.1	-	-	SKJ20DR-M11	4
2.4 VTEC E	118	K24A2; K24A4		09/02-12/05	KJ20DR-M11	3374	1.1	-	-	SKJ20DR-M11	4
2.4 VTEC E	118	K24A2; K24A4		09/02-12/05	SKJ20DR-M11	3377	1.1	-	-	SKJ20DR-M11	4
2.4 Vtec T	147	K24A1		09/03-05/08	SKJ20DR-M11	3377	1.1	-	-	SKJ20DR-M11	4
3.0	177	J30A4		05/03-12/05	SKJ20DR-M11	3377	1.1	-	-	SKJ20DR-M11	6
ACCORD VIII (08-)											
2.0 i	115	R20A3		04/10-	SKJ20DR-M11S	3432	1.1	-	-	SKJ20DR-M11S	4
2.2 i-DTEC	110/ 132	N22B1; N22B2		07/08-	DG-601		11V				4
2.4 i	148	K24Z3		07/08-	SXU22HCR11S	3461	1.1	-	-	VXUHC22G	4
ACTY (78-87)											
0.6	23	EH		08/79-06/86	W20EXR-U	3066	0.8	W20TT	IW20TT	IW20TT	2
ASCOT (90-97)											
2.5	132	G25A		04/95-10/97	K20PR-L11	3144	1.1	K20TT	IK20TT	IK20TT	5
AVANCIER (99-03)											
2.3 4x4	110	F23A		09/99-09/03	KJ16CR-L11	3132	1.1	K16TT	IK16TT	IK16TT	4
3.0 4x4	158	J30A		09/99-09/03	KJ16CR-L11	3132	1.1	K16TT	IK16TT	IK16TT	6
BEAT (91-96)											
0.7	47	E07A		05/91-09/96	K20PR-U11	3121	1.1	K20TT	IK20TT	IK20TT	3
CAPA (98-02)											
1.5 16V	72	D15B		04/98-09/02	KJ16CR-L11	3132	1.1	K16TT	IK16TT	IK16TT	4
CITY (99-04)											
1.5 Vtec	65	L15A4		08/00-09/03	SKJ20DR-M13	3401	1.3	-	-	SKJ20DR-M11	4
CITY (01-08)											
1.3	60	i-DSI	Twin Spark	10/05-07/08	K20PR-U11	3121	1.1	K20TT	IK20TT	IK20TT	8

Свечи зажигания и Свечи накаливания











Таблица применения

Таблица применения

KW	KW	KW	KW	KW	СТАНДАРТНЫЕ			Twin Tip			QTY
					mm	mm	mm	mm	mm	mm	
HONDA продолжение											
CITY (08-)											
1.4 i-VTEC	73	L13Z1		09/08-	DK20PR-D13	3476	1.3	-	-	VFK20F	4
CIVIC I (72-84)											
1200	40	EB1; EB2		07/72-12/80	W20EPR-U	3047	0.8	W20TT	IW20TT	IW20TT	4
1300 L	33/44	EN1; EN2		09/80-09/83	W20EPR-U	3047	0.8	W20TT	IW20TT	IW20TT	4
1300 S	52	EN4		10/79-12/84	W20EPR-U	3047	0.8	W20TT	IW20TT	IW20TT	4
CIVIC II (79-83)											
1300	44	EN1		09/79-09/83	W20EPR-U	3047	0.8	W20TT	IW20TT	IW20TT	4
1300 L	44	EN1		09/79-09/83	W20EPR-U	3047	0.8	W20TT	IW20TT	IW20TT	4
CIVIC III (83-87)											
1.2	40	D12B1		01/84-10/87	Q16PR-U11	5016	1.1	Q16TT	IQ16TT	IQ16TT	4
1.2	40	ZA2		01/84-10/87	W20EXR-U11	3067	1.1	W20TT	IW20TT	IW20TT	4
1.3	52	EV2		10/83-10/87	W16EKR-S11	3016	1.1	W16TT	IW16TT	IW16TT	4
1.3	52	EV2		10/83-10/87	W20EXR-U11	3067	1.1	W20TT	IW20TT	IW20TT	4
1.5	63	EW2		10/83-10/87	W20EXR-U11	3067	1.1	W20TT	IW20TT	IW20TT	4
1.5	63/69	EW2; EW4		10/83-10/87	W16EKR-S11	3016	1.1	W16TT	IW16TT	IW16TT	4
1.5 4WD	63	EW2		01/85-10/87	W16EKR-S11	3016	1.1	W16TT	IW16TT	IW16TT	4
1.5 4WD	63	EW2		01/85-10/87	W20EXR-U11	3067	1.1	W20TT	IW20TT	IW20TT	4
1.5 GL	63	EW2		10/83-10/87	W16EKR-S11	3016	1.1	W16TT	IW16TT	IW16TT	4
1.5 GL	63	EW2		10/83-10/87	W20EXR-U11	3067	1.1	W20TT	IW20TT	IW20TT	4
1.5 GT	74	EW3		01/85-10/87	IW22	5307	0.8	-	-	VW22	4
1.5 GT	74	EW3		01/85-10/87	W20EXR-U11	3067	1.1	W20TT	IW20TT	IW20TT	4
1.5 GTI	66	EW4		03/86-10/87	W16EKR-S11	3016	1.1	W16TT	IW16TT	IW16TT	4
1.5 GTI	66	EW4		03/86-10/87	W20EXR-U11	3067	1.1	W20TT	IW20TT	IW20TT	4
CIVIC IV (87-95)											
1.2	41	D12B1		01/88-12/91	Q16PR-U11	5016	1.1	Q16TT	IQ16TT	IQ16TT	4
1.3	55	D13B1		10/87-12/89	Q20PR-U11	3008	1.1	Q20TT	IQ20TT	IQ20TT	4
1.3 16V Cat	55	D13B2		09/89-09/91	K20PR-U11	3121	1.1	K20TT	IK20TT	IK20TT	4
1.3 16V Cat	55	D13B2		09/89-09/91	Q20PR-U11	3008	1.1	Q20TT	IQ20TT	IQ20TT	4
1.4 i 16V	66	D14A1		01/88-12/92	Q20PR-U11	3008	1.1	Q20TT	IQ20TT	IQ20TT	4
1.4 L	66	D14A1		10/87-12/89	Q20PR-U11	3008	1.1	Q20TT	IQ20TT	IQ20TT	4
1.5	60	D15B1		01/88-12/89	Q20PR-U11	3008	1.1	Q20TT	IQ20TT	IQ20TT	4
1.5	74	EW3		01/88-08/88	IW22	5307	0.8	-	-	VW22	4
1.5 i 16V	66/69	D15B2		10/87-11/91	Q20PR-U11	3008	1.1	Q20TT	IQ20TT	IQ20TT	4
1.5 i 16V	66/69	D15B2		10/88-09/91	K20PR-U11	3121	1.1	K20TT	IK20TT	IK20TT	4
1.6 4x4	85	D16A; D16A7		01/88-12/92	Q20PR-U11	3008	1.1	Q20TT	IQ20TT	IQ20TT	4
1.6 16V 4x4	79	D16A6		11/87-09/91	Q20PR-U11	3008	1.1	Q20TT	IQ20TT	IQ20TT	4
1.6 i 16V	81/ 91/96	D16A6; D16A7; D16A9; D16Z2		09/87-12/91	Q20PR-U11	3008	1.1	Q20TT	IQ20TT	IQ20TT	4
1.6 i 16V 4WD	81	D16A6		01/88-02/95	Q20PR-U11	3008	1.1	Q20TT	IQ20TT	IQ20TT	4
1.6 i 16V 4x4	81	D16A6		10/89-09/91	Q20PR-U11	3008	1.1	Q20TT	IQ20TT	IQ20TT	4
1.6 i 16V VTEC	110	B16A1		10/89-09/91	K20PR-L11	3144	1.1	K20TT	IK20TT	IK20TT	4
CIVIC IX (12-)											
1.4 i-VTEC	73	L13Z4		02/12-	SKJ20DR-M13	3401	1.3	-	-	SKJ20DR-M11	4
1.6 i-DTEC	88	N16A1		02/13-	DG-601		11V				4
1.8	104	R18Z1; R18Z4		02/12-	DXU22HCR-D11S	3483	1.1	-	-	VFXUHC22FG	4
1.8 i-VTEC	104	R18Z4		02/12-	DXU22HCR-D11S	3483	1.1	-	-	VFXUHC22FG	4
2.0 i-VTEC Type R	228	K20C1		08/15-	VXEHC24G	5660	1.1	-	-	VXEHC24G	4
2.2 i-DTEC	110	N22B4		02/12-	DG-601		11V				4
CIVIC V (91-97)											
1.3	55	D13B2		01/92-12/92	K20PR-U11	3121	1.1	K20TT	IK20TT	IK20TT	4
1.3 16V	55	D13B2		10/91-11/95	K20PR-U11	3121	1.1	K20TT	IK20TT	IK20TT	4
1.5	66	D15B2		10/93-12/95	Q20PR-U11	3008	1.1	Q20TT	IQ20TT	IQ20TT	4
1.5	66	D15B7		10/93-12/95	KJ20CR-L11	3169	1.1	K20TT	IK20TT	IK20TT	4
1.5 i 16V	66/69	D15B2		10/91-11/95	Q20PR-U11	3008	1.1	Q20TT	IQ20TT	IQ20TT	4
1.5 i 16V	66/69	D15Z1; D15Z2		10/91-11/95	KJ16CR-L11	3132	1.1	K16TT	IK16TT	IK16TT	4
1.5 i LSi	74	D15B7		08/93-11/95	KJ20CR-L11	3169	1.1	K20TT	IK20TT	IK20TT	4
1.6 4x4	92	D16Z7		01/92-10/95	K20PR-U11	3121	1.1	K20TT	IK20TT	IK20TT	4
1.6 16V VTEC	92	D16Z6		10/91-11/95	K20PR-L11	3144	1.1	K20TT	IK20TT	IK20TT	4
1.6 i-VTEC	92	D16Y6; D16Z9		01/94-03/96	KJ16CR-L11	3132	1.1	K16TT	IK16TT	IK16TT	4
1.6 i-VTEC	92	D16Z9		01/94-03/96	K20PR-U11	3121	1.1	K20TT	IK20TT	IK20TT	4
1.6 si 16V	90	D16A8		10/91-10/93	KJ16CR-L11	3132	1.1	K16TT	IK16TT	IK16TT	4
1.6 VTi	118	B16A2		10/91-11/95	K20PR-L11	3144	1.1	K20TT	IK20TT	IK20TT	4
1.6 VTi 16V	118	B16A2		10/91-11/95	K20PR-L11	3144	1.1	K20TT	IK20TT	IK20TT	4
1.6 VTi 16V	118	B16A2		10/91-11/95	K22PR-L11	3299	1.1	-	IK22TT	VK22	4
CIVIC VI (94-01)											
1.4 16V	55/66	D14A7; D14A8		04/98-02/01	KJ16CR-L11	3132	1.1	K16TT	IK16TT	IK16TT	4

Свечи зажигания и Свечи накаливания

Таблица применения

	KW				СТАНДАРТНЫЕ			Twin Tip			QTY
											
HONDA продолжение											
CIVIC VI (94-01) продолжение											
1.4 i	55/66	D14A2; D14A3; D14A5		06/95-02/01	K20PR-U11	3121	1.1	K20TT	IK20TT	IK20TT	4
1.4 i	66	D14A4		11/95-02/01	K20PR-L11	3144	1.1	K20TT	IK20TT	IK20TT	4
1.4 i S	66	D14A4		11/95-02/01	K20PR-L11	3144	1.1	K20TT	IK20TT	IK20TT	4
1.5 16V	84	D15Z8		01/97-02/01	KJ16CR-L11	3132	1.1	K16TT	IK16TT	IK16TT	4
1.5 i	84	D15Z6		11/95-02/01	KJ16CR-L11	3132	1.1	K16TT	IK16TT	IK16TT	4
1.5 i-VTEC-E	66	D15Z3		09/94-01/97	KJ16CR-L11	3132	1.1	K16TT	IK16TT	IK16TT	4
1.6	79/92	D16W4; D16Y2; D16Y7		10/95-10/00	KJ16CR-L11	3132	1.1	K16TT	IK16TT	IK16TT	4
1.6 16V	85	D16B2		01/97-02/01	Q20PR-U11	3008	1.1	Q20TT	IQ20TT	IQ20TT	4
1.6 16V	85/92	D16B2; D16W4		01/97-02/01	KJ16CR-L11	3132	1.1	K16TT	IK16TT	IK16TT	4
1.6 i	77/84	D16Y3; D16Y5; D16Y7		09/94-02/01	KJ16CR-L11	3132	1.1	K16TT	IK16TT	IK16TT	4
1.6 i	84	D16Y3		09/94-01/97	K20PR-L11	3144	1.1	K20TT	IK20TT	IK20TT	4
1.6 i-VTEC	93	D16Y2; D16Y6; D16Y8		09/94-02/01	KJ16CR-L11	3132	1.1	K16TT	IK16TT	IK16TT	4
1.6 i-VTEC	93/ 118	B16A2; D16Y2		09/94-12/00	K20PR-L11	3144	1.1	K20TT	IK20TT	IK20TT	4
1.6 i-VTEC	118	B16A2		04/99-12/00	K22PR-L11	3299	1.1	-	IK22TT	VK22	4
1.6 VTi	118	B16A2		11/95-02/01	K20PR-L11	3144	1.1	K20TT	IK20TT	IK20TT	4
1.6 VTi	118	B16A2		11/95-02/01	K22PR-L11	3299	1.1	-	IK22TT	VK22	4
1.8 16V	124	B18C4		01/97-02/01	K20PR-L11	3144	1.1	K20TT	IK20TT	IK20TT	4
1.8 16V	124	B18C4		01/97-02/01	PK22PR-L11S	3284	1.1	-	-	VK22G	4
2.0 i D	77	20T2N	Double Coil(LPH)	04/98-02/01	DG-101		11V				4
2.0 i TD	63	20T2R	Double Coil(LPH)	01/97-02/01	DG-101		11V				4
2.0 TDiC	77	20T2N		11/98-10/00	DG-101		11V				4
CIVIC VII (00-05)											
1.3 IMA	61	LDA1	Twin Spark	10/03-09/05	SK16PR-L11	3395	1.1	-	IK16TT	IK16TT	8
1.4	66	D14Z5		12/00-09/05	KJ16CR-L11	3132	1.1	K16TT	IK16TT	IK16TT	4
1.4 i	55	D14Z6		02/01-09/05	KJ16CR-L11	3132	1.1	K16TT	IK16TT	IK16TT	4
1.4 iS	66	D14Z5; D14Z6		02/01-09/05	KJ16CR-L11	3132	1.1	K16TT	IK16TT	IK16TT	4
1.6	81	D16V1		02/01-09/05	KJ16CR-L11	3132	1.1	K16TT	IK16TT	IK16TT	4
1.6 i	81	D16V1; D16W7		02/01-12/05	KJ16CR-L11	3132	1.1	K16TT	IK16TT	IK16TT	4
1.7	85	D17A6		02/01-09/05	KJ20CR-L11	3169	1.1	K20TT	IK20TT	IK20TT	4
1.7 CTDi	74	4EE-2	Ceramic(LPH)	01/02-09/05	DG-302		11V				4
1.7 CTDi	74	4EE-2	Ceramic(LPH)	01/02-09/05	DG-641		11V				4
1.7 i	88	D17A8		05/01-12/05	KJ20CR-L11	3169	1.1	K20TT	IK20TT	IK20TT	4
1.7 i-VTEC	92	D17A5; D17A9		05/01-12/05	KJ20CR-L11	3169	1.1	K20TT	IK20TT	IK20TT	4
2.0 i Sport	118	K20A3		09/01-09/05	KJ20DR-M11	3374	1.1	-	-	SKJ20DR-M11	4
2.0 i Sport	118	K20A3		09/01-09/05	SK22PR-M11S	3419	1.1	-	-	VK22G	4
2.0 Type-R	147	K20A2		09/01-09/05	SK22PR-M11S	3419	1.1	-	-	VK22G	4
CIVIC VIII Hatchback (05-)											
1.4	61	i-DSI	Twin Spark	09/05-10/07	K20PR-U11	3121	1.1	K20TT	IK20TT	IK20TT	8
1.4	61	i-VTEC		10/07-	DK20PR-D13	3476	1.3	-	-	VFK20F	4
1.4	61/73	L13A7; L13Z1		09/05-	KJ20CR-L11	3169	1.1	K20TT	IK20TT	IK20TT	4
1.4	73	L13Z1	OEM Optional	10/08-	SKJ20DR-M13	3401	1.3	-	-	SKJ20DR-M11	4
1.8	103	R18A2		09/05-	SKJ20DR-M11S	3432	1.1	-	-	SKJ20DR-M11S	4
2.0 Type R	148	K20Z4		09/06-	SK22PR-M11S	3419	1.1	-	-	VK22G	4
2.2 CTDi	103	N22A2		09/05-	DG-601		11V				4
CIVIC VIII Saloon (05-)											
1.3 Hybrid	70/85	LDA2	Twin Spark	01/06-	IKH20TT	4704	1.0	-	IKH20TT		8
1.6	84	R16A1		09/05-06/09	SKJ20DR-M11	3377	1.1	-	-	SKJ20DR-M11	4
1.8	103	R18A1; R18A2		09/05-02/12	SKJ20DR-M11S	3432	1.1	-	-	SKJ20DR-M11S	4
1.8 EXS Flex	103	R18A1		11/06-	SKJ20DR-M11S	3432	1.1	-	-	SKJ20DR-M11S	4
CIVIC X (16-)											
1.5	130	L15B7		09/15-	VXEHC24G	5660	1.1	-	-	VXEHC24G	4
1.5 RS Turbo	127	L15B7		06/16-	VXEHC24G	5660	1.1	-	-	VXEHC24G	4
1.5 VTEC	130/ 134	L15B7		09/16-	VXEHC24G	5660	1.1	-	-	VXEHC24G	4
1.8	104	R18Z1		06/16-	DXU22HCR-D11S	3483	1.1	-	-	VFXUHC22FG	4
CONCERTO (89-96)											
1.4	66	D14A1		08/89-10/91	Q20PR-U11	3008	1.1	Q20TT	IQ20TT	IQ20TT	4
1.5 i 16V	66	D15B2		08/89-05/95	Q20PR-U11	3008	1.1	Q20TT	IQ20TT	IQ20TT	4
1.6	96	D16A9		10/89-10/92	Q20PR-U11	3008	1.1	Q20TT	IQ20TT	IQ20TT	4
1.6 16V	78	D16Z2		08/89-03/95	Q20PR-U11	3008	1.1	Q20TT	IQ20TT	IQ20TT	4
1.6 i 16V	82/90	D16A8; D16Z2; D16Z4		08/89-03/95	Q20PR-U11	3008	1.1	Q20TT	IQ20TT	IQ20TT	4

Свечи зажигания и Свечи накаливания

Таблица применения

Таблица применения

KW	KW	KW	KW	KW	СТАНДАРТНЫЕ				Twin Tip		QTY
					STANDARD	STANDARD	STANDARD	STANDARD	Twin Tip	Twin Tip	
HONDA продолжение											
CROSSTOUR (09-)											
2.4	143	K24Y2		09/12-	SXU22HCR11S	3461	1.1	-	-	VXUHC22G	4
3.5 4WD	202/ 207	J35Y1; J35Z2		01/12-	SXU22HCR11S	3461	1.1	-	-	VXUHC22G	6
CR-V I (95-02)											
2.0	98	B20B/B20Z1		04/99-02/02	KJ16CR-L11	3132	1.1	K16TT	IK16TT	IK16TT	4
2.0	98	B20Z1	LPG / GPL	04/99-02/02	KJ20CR-U11	3451	1.1	K20TT	IK20TT	IK20TT	4
2.0 16V 4WD	94	B20B		12/98-12/01	KJ20CR-L11	3169	1.1	K20TT	IK20TT	IK20TT	4
2.0 16V 4WD	94/ 108	B20B/B20Z1		10/95-02/02	KJ16CR-L11	3132	1.1	K16TT	IK16TT	IK16TT	4
2.0 16V 4WD	108	B20Z1	LPG / GPL	01/99-02/02	KJ20CR-U11	3451	1.1	K20TT	IK20TT	IK20TT	4
CR-V II (01-06)											
2.0	110	K20A4		09/01-03/07	KJ20DR-M11	3374	1.1	-	-	SKJ20DR-M11	4
2.2 CTDi	103	N22A2		02/05-09/06	DG-601		11V				4
2.4 VTEC 4WD	118	K24A1		09/01-09/06	KJ20DR-M11	3374	1.1	-	-	SKJ20DR-M11	4
CR-V III (06-)											
2.0 i-VTEC	110	R20A1; R20A2		04/10-06/12	SKJ20DR-M11S	3432	1.1	-	-	SKJ20DR-M11S	4
2.0 i-VTEC 4WD	110	R20A1; R20A2		10/06-04/10	KJ20DR-M11	3374	1.1	-	-	SKJ20DR-M11	4
2.0 i-VTEC 4WD	110	R20A1; R20A2		04/10-06/12	SKJ20DR-M11	3377	1.1	-	-	SKJ20DR-M11	4
2.0 i-VTEC 4WD	110	R20A1; R20A2		04/10-06/12	SKJ20DR-M11S	3432	1.1	-	-	SKJ20DR-M11S	4
2.2 i-CTDi 4WD	103	N22A2		01/07-	DG-601		11V				4
2.2 i-DTEC 4WD	110	N22B3		01/07-	DG-601		11V				4
2.4 (RE4)	125	K24A1		04/07-	KJ20DR-M11	3374	1.1	-	-	SKJ20DR-M11	4
2.4 4WD	124	K24A; K24Z1		09/06-	KJ20DR-M11	3374	1.1	-	-	SKJ20DR-M11	4
2.4 i-VTEC 4WD	118/ 122	K24Z1; K24Z4		10/06-	SKJ20DR-M11	3377	1.1	-	-	SKJ20DR-M11	4
2.4 i-VTEC 4WD	118/ 122/ 125	K24Z1; K24Z4		10/06-	KJ20DR-M11	3374	1.1	-	-	SKJ20DR-M11	4
CR-V IV (12-)											
1.6 i-DTEC	88	N16A1		10/13-	DG-601		11V				4
1.6 i-DTEC 4WD	118	N16A4		02/15-	DG-601		11V				4
2.0	114	R20A6; R20A9		10/12-	SXU22HCR11S	3461	1.1	-	-	VXUHC22G	4
2.0 AWD	114	R20A6; R20A9		10/12-	SXU22HCR11S	3461	1.1	-	-	VXUHC22G	4
2.2 i-DTEC 4WD	110	N22B4		10/12-	DG-601		11V				4
2.4 AWD	132/ 140	K24Z6; K24Z9		01/12-	SXU22HCR11S	3461	1.1	-	-	VXUHC22G	4
CR-V V (16-)											
1.5	142	L15BE		12/16-	VXEHC24G	5660	1.1	-	-	VXEHC24G	4
1.5 4WD	142	L15BE		12/16-	VXEHC24G	5660	1.1	-	-	VXEHC24G	4
CRX I (83-87)											
1.3	52	EV2		10/83-10/87	W16EKR-S11	3016	1.1	W16TT	IW16TT	IW16TT	4
1.5 i	74	EW3		10/83-11/86	IW22	5307	0.8	-	-	VW22	4
1.5 i	74	EW3		10/83-11/86	W20EXR-U11	3067	1.1	W20TT	IW20TT	IW20TT	4
1.6 i 16V	92	ZC1		03/86-10/87	Q20PR-U11	3008	1.1	Q20TT	IQ20TT	IQ20TT	4
CRX II (87-92)											
1.6 i 16V	79/ 91/96	D16A; D16A6; D16A8; D16A9; D16Z5		10/87-02/92	Q20PR-U11	3008	1.1	Q20TT	IQ20TT	IQ20TT	4
1.6 i 16V VTEC	110	B16A1		10/89-02/92	K20PR-L11	3144	1.1	K20TT	IK20TT	IK20TT	4
CRX III (92-98)											
1.5	77	D15B7		01/94-04/98	KJ20CR-L11	3169	1.1	K20TT	IK20TT	IK20TT	4
1.6 ESi	92	D16Y8; D16Z6		03/92-12/98	KJ16CR-L11	3132	1.1	K16TT	IK16TT	IK16TT	4
1.6 ESi	92	D16Z6		03/92-12/98	K20PR-L11	3144	1.1	K20TT	IK20TT	IK20TT	4
1.6 i VTi	118	B16A2		03/92-12/98	K20PR-L11	3144	1.1	K20TT	IK20TT	IK20TT	4
1.6 i VTi	118	B16A2		03/92-12/98	K22PR-L11	3299	1.1	-	IK22TT	VK22	4
CR-Z (10-)											
1.5 Hybrid	84/ 89/91	LEA1; LEA3		06/10-	DK20PR-D13	3476	1.3	-	-	VFK20F	4
1.5 Hybrid	89	LEA1; LEA3		11/12-	SKJ20DR-M13	3401	1.3	-	-	SKJ20DR-M11	4
DOMANI (88-00)											
1.5	69	D15B3		10/92-09/95	KJ16CR-L11	3132	1.1	K16TT	IK16TT	IK16TT	4
1.6	88	D16A; D16Z2		10/95-09/99	KJ16CR-L11	3132	1.1	K16TT	IK16TT	IK16TT	4
1.6 AWD	88	D16A; D16Z2		10/95-09/99	KJ16CR-L11	3132	1.1	K16TT	IK16TT	IK16TT	4
ELEMENT (02-11)											
2.4 Vtec	118	K24A6		07/02-12/11	KJ20DR-M11	3374	1.1	-	-	SKJ20DR-M11	4
2.4 Vtec	118	K24A6		07/02-12/11	SKJ20DR-M11	3377	1.1	-	-	SKJ20DR-M11	4
2.4 Vtec 4x4	118	K24A6		07/02-12/11	KJ20DR-M11	3374	1.1	-	-	SKJ20DR-M11	4
2.4 Vtec 4x4	118	K24A6		07/02-12/11	SKJ20DR-M11	3377	1.1	-	-	SKJ20DR-M11	4

Свечи зажигания и Свечи накаливания

Таблица применения











	KW				СТАНДАРТНЫЕ				Twin Tip		QTY
											
HONDA продолжение											
ELYSION (04-)											
2.4 i-VTEC	118	K24A1		05/04-	KJ20DR-M11	3374	1.1	-	-	SKJ20DR-M11	4
2.4 i-VTEC	118	K24A1		05/04-	SKJ20DR-M11	3377	1.1	-	-	SKJ20DR-M11	4
FIT IV (13-)											
1.3	73	L13B		09/13-	VFXEHC22G	5659	0.8	-	-	VFXEHC22G	4
1.3 4WD	73	L13B		09/13-	VFXEHC22G	5659	0.8	-	-	VFXEHC22G	4
1.5	97	L15B		09/14-	VFXEHC22G	5659	0.8	-	-	VFXEHC22G	4
1.5 4WD	97	L15B		12/13-	VFXEHC22G	5659	0.8	-	-	VFXEHC22G	4
1.5 CVT	85	L15A		04/14-	SKJ20DR-M13	3401	1.3	-	-	SKJ20DR-M11	4
1.5 Hybrid	81	LEB-H1		09/13-	VFXEHC22G	5659	0.8	-	-	VFXEHC22G	4
1.5 Hybrid 4WD	81	LEB-H1		09/13-	VFXEHC22G	5659	0.8	-	-	VFXEHC22G	4
FREED I (08-16)											
1.5	97	L15A		06/08-08/16	SKJ20DR-M13	3401	1.3	-	-	SKJ20DR-M11	4
1.5 4WD	97	L15A		10/10-08/16	SKJ20DR-M13	3401	1.3	-	-	SKJ20DR-M11	4
1.5 Hybrid	97	LEA-MF6	Twin Spark	10/11-08/16	IKH20TT	4704	1.0	-	IKH20TT		8
FREED II (16-)											
1.5	96	L15B		09/16-	VFXEHC22G	5659	0.8	-	-	VFXEHC22G	4
1.5 4WD	96	L15B		09/16-	VFXEHC22G	5659	0.8	-	-	VFXEHC22G	4
1.5 Hybrid	81	LEB-H1		09/16-	VFXEHC22G	5659	0.8	-	-	VFXEHC22G	4
1.5 Hybrid 4WD	81	LEB-H1		09/16-	VFXEHC22G	5659	0.8	-	-	VFXEHC22G	4
FR-V (04-)											
1.7	92	D17A2		08/04-	KJ20CR-L11	3169	1.1	K20TT	IK20TT	IK20TT	4
1.8	103	R18A1		01/07-	SKJ20DR-M11S	3432	1.1	-	-	SKJ20DR-M11S	4
2.0	110	K20A9		02/05-01/07	KJ20DR-M11	3374	1.1	-	-	SKJ20DR-M11	4
2.2 i CTDi	103	N22A1		07/05-	DG-601		11V				4
GRACE (14-)											
1.5	97	L15B		06/15-	VFXEHC22G	5659	0.8	-	-	VFXEHC22G	4
1.5 4WD	97	L15B		06/15-	VFXEHC22G	5659	0.8	-	-	VFXEHC22G	4
1.5 Hybrid	81	LEB-H1		12/14-	VFXEHC22G	5659	0.8	-	-	VFXEHC22G	4
1.5 Hybrid 4WD	81	LEB-H1		12/14-	VFXEHC22G	5659	0.8	-	-	VFXEHC22G	4
HR-V (99-)											
1.6 16V	77	D16W1		03/99-	KJ16CR-L11	3132	1.1	K16TT	IK16TT	IK16TT	4
1.6 16V 4WD	77/91	D16W1; D16W5		03/99-	KJ16CR-L11	3132	1.1	K16TT	IK16TT	IK16TT	4
HR-V (15-)											
1.6 i-DTEC	88			08/15-	DG-601		11V				4
INSIGHT (00-06)											
1.0 Hybrid	56	ECA1		04/00-12/06	IKH20TT	4704	1.0	-	IKH20TT		3
INSIGHT (09-)											
1.3 Hybrid	65/73	LDA3	Twin Spark	04/09-	FK20HR11	3426	1.1	-	IKH20TT	IKH20TT	8
INSPIRE (91-98)											
2.0 GX	118	G20A		09/89-05/95	K20PR-L11	3144	1.1	K20TT	IK20TT	IK20TT	4
2.5	132	G25A		06/95-08/98	K20PR-L11	3144	1.1	K20TT	IK20TT	IK20TT	5
2.5 GX	129/ 140	G25A		09/91-08/98	K20PR-L11	3144	1.1	K20TT	IK20TT	IK20TT	5
3.2 GX	155	C32A		06/95-08/98	PK16PR-L11	3275	1.1	-	IK16TT	IK16TT	6
INSPIRE (98-03)											
2.5 GX	147	J25A		06/95-08/03	PKJ20CR-L11	3247	1.1	-	IK20TT	IK20TT	6
3.2	191	J32A		09/98-03/01	SKJ16CR-L11	3396	1.1	-	IK16TT	IK16TT	6
3.2	191	J32A		09/98-08/03	PKJ20CR-M11	3392	1.1	-	IK20TT	IK20TT	6
INTEGRA (85-93)											
1.5	63	D15A1		10/85-08/89	W20EXR-U	3066	0.8	W20TT	IW20TT	IW20TT	4
1.6	88	D16A3		03/86-08/89	Q20PR-U11	3008	1.1	Q20TT	IQ20TT	IQ20TT	4
1.6	88	D16A3		03/86-08/89	Q20R-U11	3009	1.1	Q20TT	IQ20TT	IQ20TT	4
INTEGRA (93-01)											
1.6	88	ZC1		09/93-08/01	KJ16CR-L11	3132	1.1	K16TT	IK16TT	IK16TT	4
1.8	107	B18B2		07/93-11/01	KJ16CR-L11	3132	1.1	K16TT	IK16TT	IK16TT	4
1.8 Type-R	140	B18C6		11/97-10/01	PK22PR-L11S	3284	1.1	-	-	VK22G	4
INTEGRA (02-)											
2.0	118	K20A3		02/02-	KJ20DR-M11	3374	1.1	-	-	SKJ20DR-M11	4
2.0 16V Type-R	162	K20Z1		02/02-	SK22PR-M11S	3419	1.1	-	-	VK22G	4
JADE (15-)											
1.5	110	L15B		02/15-	VXEHC24G	5660	1.1	-	-	VXEHC24G	4
1.5 Hybrid	118	LEB-H1		02/15-	VFXEHC22G	5659	0.8	-	-	VFXEHC22G	4
JAZZ I (83-86)											
45 1.2	33	ER2		02/84-10/86	W16EXR-U11	3032	1.1	W16TT	IW16TT	IW16TT	4
45 1.2	33	ER2		02/84-10/86	W20EKR-S11	3041	1.1	-	IW20TT	IW20TT	4

Таблица применения

H

Свечи зажигания и Свечи накаливания

Таблица применения

Таблица применения

KW	KW	KW	NOTE	21	СТАНДАРТНЫЕ				Twin Tip		QTY
					W16EXR-U11	3032	1.1	W16TT	W16TT	W16TT	
HONDA продолжение											
JAZZ I (83-86) продолжение											
55 1.2	40	ER4		09/84-10/86	W16EXR-U11	3032	1.1	W16TT	IW16TT	IW16TT	4
55 1.2	40	ER4		09/84-10/86	W20EKR-S11	3041	1.1	-	IW20TT	IW20TT	4
56 1.2	41	ER1		10/83-10/86	W16EXR-U11	3032	1.1	W16TT	IW16TT	IW16TT	4
56 1.2	41	ER1		10/83-10/86	W20EKR-S11	3041	1.1	-	IW20TT	IW20TT	4
JAZZ II (02-08)											
1.2 i-DSI	57	L12A1; L12A4		03/02-07/08	K20PR-U11	3121	1.1	K20TT	IK20TT	IK20TT	4
1.3	61	i-DSI	Twin Spark	03/02-07/08	K20PR-U11	3121	1.1	K20TT	IK20TT	IK20TT	8
1.3 iDSi	63	i-DSI	Twin Spark	03/02-09/07	K20PR-U11	3121	1.1	K20TT	IK20TT	IK20TT	8
1.4	59	i-DSI	Twin Spark	12/06-10/08	K20PR-U11	3121	1.1	K20TT	IK20TT	IK20TT	8
1.4 iDSi	61	i-DSI	Twin Spark	12/06-10/08	K20PR-U11	3121	1.1	K20TT	IK20TT	IK20TT	8
JAZZ III (08-)											
1.2	66	L12B1		07/08-	DK20PR-D13	3476	1.3	-	-	VFK20F	4
1.3 HYBRID	65	LDA3	Twin Spark	04/11-	FK20HR11	3426	1.1	-	IKH20TT	IKH20TT	8
1.3 i	73	L13Z1; L13Z2		07/08-	DK20PR-D13	3476	1.3	-	-	VFK20F	4
1.4	74	L13Z1		11/08-	DK20PR-D13	3476	1.3	-	-	VFK20F	4
1.5 4WD	88	L15A3		10/07-03/14	SKJ20DR-M13	3401	1.3	-	-	SKJ20DR-M11	4
1.5 i-VTEC (GE8)	88	L15A3; L15A7		07/08-06/14	SKJ20DR-M13	3401	1.3	-	-	SKJ20DR-M11	4
JAZZ IV (13-)											
1.3	73/75	L13B; L13B2		09/13-	VFXEHC22G	5659	0.8	-	-	VFXEHC22G	4
1.5	88	L15A		09/14-	SKJ20DR-M13	3401	1.3	-	-	SKJ20DR-M11	4
1.5	96	L15B		09/14-	VFXEHC22G	5659	0.8	-	-	VFXEHC22G	4
JAZZ Saloon (03-08)											
1.3	63	i-DSI	Twin Spark	05/03-07/08	K20PR-U11	3121	1.1	K20TT	IK20TT	IK20TT	8
1.5 i-DSI	66/81	L15A2		12/02-07/08	SKJ20DR-M13	3401	1.3	-	-	SKJ20DR-M11	4
1.5 i-DSI	81	L15A2	Twin Spark	10/04-07/08	K20PR-U11	3121	1.1	K20TT	IK20TT	IK20TT	8
JAZZ Shuttle (11-14)											
1.5	88	L15A		03/11-03/14	SKJ20DR-M13	3401	1.3	-	-	SKJ20DR-M11	4
1.5 4WD	88	L15A		03/11-03/14	SKJ20DR-M13	3401	1.3	-	-	SKJ20DR-M11	4
LAGREAT (98-02)											
3.5 EX	151	J35A		11/98-06/02	KJ16CR-L11	3132	1.1	K16TT	IK16TT	IK16TT	6
3.5 EX	151	J35A		11/98-06/02	SKJ20DR-M11	3377	1.1	-	-	SKJ20DR-M11	6
LEGEND I (86-90)											
2.5 i	110/ 127	C25A1; C25A2		01/86-06/88	Q20PR-U11	3008	1.1	Q20TT	IQ20TT	IQ20TT	6
2.5 i	127	C25A2		02/87-06/88	Q20R-U11	3009	1.1	Q20TT	IQ20TT	IQ20TT	4
2.7 i 24V	124/ 130	C27A1; C27A2		10/87-12/90	Q20PR-U11	3008	1.1	Q20TT	IQ20TT	IQ20TT	6
2.7 i 24V	124/ 130	C27A1; C27A2		10/87-12/90	Q20R-U11	3009	1.1	Q20TT	IQ20TT	IQ20TT	6
LEGEND II (91-96)											
3.2 i 24V	151	C32A2		01/91-02/96	PK20PR-L11	3142	1.1	-	IK20TT	IK20TT	6
LEGEND III (96-06)											
3.5 i 24V	151	C35A2		02/96-10/97	PK20PR-L11	3142	1.1	-	IK20TT	IK20TT	6
3.5 i 24V	151/ 153	C35A2		02/96-09/04	PK16PR-L11	3275	1.1	-	IK16TT	IK16TT	6
LEGEND IV (06-12)											
3.5 V6 4WD	217	C35A		05/06-12/12	PK16PR-L11	3275	1.1	-	IK16TT	IK16TT	6
3.5 V6 4WD	217	C35A8; J35A8		05/06-12/12	SKJ20DR-M11	3377	1.1	-	-	SKJ20DR-M11	6
3.5 V6 4WD	217	J35A		05/06-12/12	SKJ16DR-M11	3422	1.1	-	-	SKJ16DR-M11	6
3.7 VTEC V6 4WD	217	J37A2; J37A3		07/08-12/12	SXU22HCR11S	3461	1.1	-	-	VXUHC22G	6
LEGEND V (14-)											
3.5 Hybrid AWD	231	JNB		11/14-	VFXUHC22FG	5653	1.1	-	-	VFXUHC22FG	6
LIFE (97-01)											
0.7	35	E07A		05/97-08/01	K20PR-U11	3121	1.1	K20TT	IK20TT	IK20TT	3
LIFE (01-03)											
0.7	47	E07ZT		09/01-08/03	SK20PR-L9	3307	0.9	-	IK20TT	IK20TT	3
0.7 G 4x4	38	E07Z		09/01-08/03	K20PR-U11	3121	1.1	K20TT	IK20TT	IK20TT	3
LIFE (03-)											
0.7 iDSi	38	P07A	Twin Spark	09/03-	IK20G	5352	1.1	-	-	VK20G	6
LOGO (99-02)											
1.3	48	D13B7		03/99-03/02	KJ16CR-L11	3132	1.1	K16TT	IK16TT	IK16TT	4
N (68-74)											
600	31	N600E		05/68-08/74	W24ESR-U	4033	0.8	-	-		2
N-BOX + (12-)											
0.7	43	S07A		12/13-	VFXEHC22G	5659	0.8	-	-	VFXEHC22G	3
0.7	47	S07A T/C		12/13-	VXEHC24G	5660	1.1	-	-	VXEHC24G	3
0.7 4WD	43	S07A		12/13-	VFXEHC22G	5659	0.8	-	-	VFXEHC22G	3

Свечи зажигания и Свечи накаливания

Таблица применения











KW	KW	KW	KW	KW	СТАНДАРТНЫЕ				Twin Tip		QTY
					STANDARD	STANDARD	STANDARD	STANDARD	TWIN TIP	TWIN TIP	
HONDA продолжение											
N-BOX + (12-) продолжение											
0.7 4WD	47	S07A T/C		12/13-	VXEHC24G	5660	1.1	-	-	VXEHC24G	3
N-BOX (11-)											
0.7	47	S07A T/C		12/13-	VXEHC24G	5660	1.1	-	-	VXEHC24G	3
0.7 4WD	47	S07A T/C		12/13-	VXEHC24G	5660	1.1	-	-	VXEHC24G	3
N-ONE (12-)											
0.7	43	S07A		05/14-	VFXEHC22G	5659	0.8	-	-	VFXEHC22G	3
0.7	47	S07A T/C		05/14-	VXEHC24G	5660	1.1	-	-	VXEHC24G	3
0.7 4WD	43	S07A		05/14-	VFXEHC22G	5659	0.8	-	-	VFXEHC22G	3
0.7 4WD	47	S07A T/C		05/14-	VXEHC24G	5660	1.1	-	-	VXEHC24G	3
NSX (90-05)											
3.0 24V VTEC	188/201	C30A3; C30A4		06/90-09/99	PK16PR-L11	3275	1.1	-	IK16TT	IK16TT	6
3.0 24V VTEC	188/201	C30A3; C30A4		09/99-09/05	PK20PR-L11	3142	1.1	-	IK20TT	IK20TT	6
3.2 24V VTEC	206	C32B2		01/97-09/05	PK20PR11	3168	1.1	K20TT	IK20TT	IK20TT	6
3.2 24V VTEC	206	C32B2		01/97-09/05	PK20PR-L11	3142	1.1	-	IK20TT	IK20TT	6
N-WGN (13-)											
0.7	43	S07A		11/13-	VFXEHC22G	5659	0.8	-	-	VFXEHC22G	3
0.7	47	S07A T/C		11/13-	VXEHC24G	5660	1.1	-	-	VXEHC24G	3
0.7 4WD	43	S07A		11/13-	VFXEHC22G	5659	0.8	-	-	VFXEHC22G	3
0.7 4WD	47	S07A T/C		11/13-	VXEHC24G	5660	1.1	-	-	VXEHC24G	3
ODYSSEY (RA) (95-00)											
2.3	110	F23A7		10/97-12/99	KJ16CR-L11	3132	1.1	K16TT	IK16TT	IK16TT	4
2.3 4x4	110	F23A		10/97-12/99	KJ16CR-L11	3132	1.1	K16TT	IK16TT	IK16TT	4
ODYSSEY (RC) (13-)											
2.0 Hybrid	107	LFA-MF8/ LFA-H4		02/16-	VFXEHC22G	5659	0.8	-	-	VFXEHC22G	4
2.4 i-VTEC	140	K24W		12/13-	DXE22HQR-D11S	3492	1.1	-	-	DXE22HQR-D11S	4
2.4 i-VTEC 4WD	140	K24W		12/13-	DXE22HQR-D11S	3492	1.1	-	-	DXE22HQR-D11S	4
ODYSSEY (RL1) (02-)											
2.3 (RA6)	110	F23A		07/02-09/03	KJ16CR-L11	3132	1.1	K16TT	IK16TT	IK16TT	4
3.5	171/182	J35A; J35A8		07/02-	SKJ16DR-M11	3422	1.1	-	-	SKJ16DR-M11	6
3.5	171/182	J35A; J35A8		07/02-	SKJ20DR-M11	3377	1.1	-	-	SKJ20DR-M11	6
ORTHIA (95-02)											
1.5	77	D15B		10/95-09/02	K16PR-U11	3130	1.1	K16TT	IK16TT	IK16TT	4
PILOT (08-)											
3.5	186	J35Z4		09/08-	SXU22HCR11S	3461	1.1	-	-	VXUHC22G	6
3.5 4WD	183/186	J35Z4		09/08-	SXU22HCR11S	3461	1.1	-	-	VXUHC22G	6
PRELUDE I (78-82)											
1.6	59	EL		11/78-10/82	W16EPR-U	3021	0.8	W16TT	IW16TT	IW16TT	4
PRELUDE II (83-87)											
1.8 EX	74/77	ET2; ET4		11/83-04/87	W20EXR-U	3066	0.8	W20TT	IW20TT	IW20TT	4
PRELUDE III (86-92)											
2.0	84	B20A4		08/87-01/92	Q16PR-U11	5016	1.1	Q16TT	IQ16TT	IQ16TT	4
2.0	84	B20A4		08/87-01/92	Q20PR-U11	3008	1.1	Q20TT	IQ20TT	IQ20TT	4
2.0	84	B20A4		08/87-01/92	Q20R-U11	3009	1.1	Q20TT	IQ20TT	IQ20TT	4
2.0 EX	80	B2A03		04/87-01/92	Q20R-U11	3009	1.1	Q20TT	IQ20TT	IQ20TT	4
2.0 EX	80	B20A3		04/87-01/92	Q16PR-U11	5016	1.1	Q16TT	IQ16TT	IQ16TT	4
2.0 EX	80	B20A3		04/87-01/92	Q20PR-U11	3008	1.1	Q20TT	IQ20TT	IQ20TT	4
2.0 i EX 16V	101/103/110	B20A1; B20A7; B20A9		04/86-01/92	Q20PR-U11	3008	1.1	Q20TT	IQ20TT	IQ20TT	4
2.0 i EX 16V	103/110	B2A09; B20A7		10/87-01/92	Q20R-U11	3009	1.1	Q20TT	IQ20TT	IQ20TT	4
2.0 i EX 16V Cat	101	B2A05		04/87-01/92	Q20R-U11	3009	1.1	Q20TT	IQ20TT	IQ20TT	4
2.0 i EX 16V Cat	101	B20A5		04/87-01/92	Q20PR-U11	3008	1.1	Q20TT	IQ20TT	IQ20TT	4
PRELUDE IV (92-96)											
2.0 i 16V	98	F20A (excl. TCS)		02/92-09/96	KJ20CR-L11	3169	1.1	K20TT	IK20TT	IK20TT	4
2.0 i 16V	98	F20A (with TCS)		02/92-09/96	SKJ16CR-L11	3396	1.1	-	IK16TT	IK16TT	4
2.2 i 16V VTEC	136	H22A2		02/93-09/96	PKJ20CR-L11	3247	1.1	-	IK20TT	IK20TT	4
2.3 i 16V	118	Except TCS		02/92-09/96	KJ20CR-L11	3169	1.1	K20TT	IK20TT	IK20TT	4
2.3 i 16V	118	With TCS		02/92-09/96	PKJ20CR-L11	3247	1.1	-	IK20TT	IK20TT	4
PRELUDE V (96-00)											
2.0 16V	98	F20A (excl. TCS)		10/96-10/00	KJ20CR-L11	3169	1.1	K20TT	IK20TT	IK20TT	4
2.0 16V	98	F20A (with TCS)		10/96-10/00	SKJ16CR-L11	3396	1.1	-	IK16TT	IK16TT	4

Таблица применения

H

Свечи зажигания и Свечи накаливания

Таблица применения

	KW				СТАНДАРТНЫЕ			Twin Tip			QTY
											
HONDA продолжение											
PRELUDE V (96-00) продолжение											
2.2 16V	136/147	H22A2; H22A5		10/96-10/00	PKJ20CR-L11	3247	1.1	-	IK20TT	IK20TT	4
QUINTET (80-84)											
1.6 EX	59	EL		02/80-12/84	W16EPR-U	3021	0.8	W16TT	IW16TT	IW16TT	4
RIDGELINE (05-14)											
3.5 4x4	188	J35A9		03/05-12/14	SKJ16DR-M11	3422	1.1	-	-	SKJ16DR-M11	6
3.5 4x4	188	J35A9		03/05-12/14	SKJ20DR-M11	3377	1.1	-	-	SKJ20DR-M11	6
S660 (15-)											
0.7	47	S07A		05/15-	VXEHC24G	5660	1.1	-	-	VXEHC24G	3
S2000 (99-)											
2.0	177	F20C VTEC		06/99-	PK22PR-L11S	3284	1.1	-	-	VK22G	4
2.0 VTEC	184	F20C3		10/03-	PK22PR-L11S	3284	1.1	-	-	VK22G	4
2.2 Vtec	176	F22C1		10/03-	PK22PR-L11S	3284	1.1	-	-	VK22G	4
SHUTTLE (94-04)											
2.2 16V	110	F22B8		10/94-02/98	KJ16CR-L11	3132	1.1	K16TT	IK16TT	IK16TT	4
2.2 16V	110	F22B8		10/94-02/98	KJ20CR-L11	3169	1.1	K20TT	IK20TT	IK20TT	4
2.3 16V	110	F23A7		10/97-06/04	KJ16CR-L11	3132	1.1	K16TT	IK16TT	IK16TT	4
2.3 16V	110	F23A7		10/97-06/04	KJ22CR-L11	3348	1.1	-	-	VK22	4
3.0	154	J30A		10/97-06/04	KJ16CR-L11	3132	1.1	K16TT	IK16TT	IK16TT	6
3.0 4x4	154	J30A		10/97-06/02	KJ16CR-L11	3132	1.1	K16TT	IK16TT	IK16TT	6
SHUTTLE (15-)											
1.5	97	L15B		05/15-	VFXEHC22G	5659	0.8	-	-	VFXEHC22G	4
1.5 4WD	97	L15B		05/15-	VFXEHC22G	5659	0.8	-	-	VFXEHC22G	4
1.5 Hybrid	81	LEB-H1		05/15-	VFXEHC22G	5659	0.8	-	-	VFXEHC22G	4
1.5 Hybrid 4WD	81	LEB-H1		05/15-	VFXEHC22G	5659	0.8	-	-	VFXEHC22G	4
SMX (96-02)											
2.0 4WD	96	B20B		01/96-09/99	KJ16CR-L11	3132	1.1	K16TT	IK16TT	IK16TT	4
2.0 4WD	96	B20B		09/99-12/01	KJ20CR-L11	3169	1.1	K20TT	IK20TT	IK20TT	4
2.0 Lowdown	103	B20BI		10/99-09/02	KJ20CR-L11	3169	1.1	K20TT	IK20TT	IK20TT	4
STEPWAGON (96-00)											
2.0	99	B20B		05/96-05/99	KJ16CR-L11	3132	1.1	K16TT	IK16TT	IK16TT	4
2.0	99	B20B		05/99-09/00	KJ20CR-L11	3169	1.1	K20TT	IK20TT	IK20TT	4
STEPWAGON (00-05)											
2.0	118	K20A9		10/00-09/05	KJ20DR-M11	3374	1.1	-	-	SKJ20DR-M11	4
2.0 4WD	118	K20A9		10/00-09/05	KJ20DR-M11	3374	1.1	-	-	SKJ20DR-M11	4
STEPWAGON (15-)											
1.5	110	L15B		04/15-	VXEHC24G	5660	1.1	-	-	VXEHC24G	4
1.5 4WD	110	L15B		04/15-	VXEHC24G	5660	1.1	-	-	VXEHC24G	4
STREAM (01-)											
1.7 16V	92	D17A2; D17A5		05/01-09/06	KJ20CR-L11	3169	1.1	K20TT	IK20TT	IK20TT	4
2.0 16V	115	K20A1; K20A5		05/01-09/06	KJ20DR-M11	3374	1.1	-	-	SKJ20DR-M11	4
VEZEL (13-)											
1.5	97	L15B		09/13-	VFXEHC22G	5659	0.8	-	-	VFXEHC22G	4
1.5 4WD	97	L15B		09/13-	VFXEHC22G	5659	0.8	-	-	VFXEHC22G	4
1.5 Hybrid	81	LEB-H1		09/13-	VFXEHC22G	5659	0.8	-	-	VFXEHC22G	4
1.5 Hybrid 4WD	81	LEB-H1		09/13-	VFXEHC22G	5659	0.8	-	-	VFXEHC22G	4
1.5 VTEC Flex	85	L15A		09/13-	SKJ20DR-M13	3401	1.3	-	-	SKJ20DR-M11	4
HONDA (GAC)											
AVANCIER (16-)											
2.0	200	K20C3		10/16-	VXEHC24G	5660	1.1	-	-	VXEHC24G	4
2.0 AWD	200	K20C3		10/16-	VXEHC24G	5660	1.1	-	-	VXEHC24G	4
CITY (15-)											
1.5	96	L15B		08/15-	VFXEHC22G	5659	0.8	-	-	VFXEHC22G	4
FIT IV (13-)											
1.3	73	L13Z1		05/14-	SKJ20DR-M13	3401	1.3	-	-	SKJ20DR-M11	4
1.5	96	L15B3		05/14-	VFXEHC22G	5659	0.8	-	-	VFXEHC22G	4
ODYSSEY (02-09)											
2.3	110	F23Z4		04/02-12/04	KJ16CR-L11	3132	1.1	K16TT	IK16TT	IK16TT	4
2.4	118	K24A6		03/05-08/09	SKJ20DR-M11	3377	1.1	-	-	SKJ20DR-M11	4
ODYSSEY (09-14)											
2.4	133	K24Z2		08/09-12/14	KJ20DR-M11	3374	1.1	-	-	SKJ20DR-M11	4
VEZEL (13-)											
1.5	96	L15B		10/14-	VFXEHC22G	5659	0.8	-	-	VFXEHC22G	4
1.8	100	R18Z7		10/14-	DXU22HCR-D11S	3483	1.1	-	-	VFXUHC22FG	4
1.8 AWD	100	R18Z7		10/14-	DXU22HCR-D11S	3483	1.1	-	-	VFXUHC22FG	4

Свечи зажигания и Свечи накаливания

Таблица применения

KW	KW	KW	KW	KW	СТАНДАРТНЫЕ			Twin Tip			QTY
					STANDARD	STANDARD	STANDARD	TWIN TIP	TWIN TIP	TWIN TIP	
HUMMER											
HUMMER H1 (92-06)											
6.5 D	125		Double Coil(LPH)	01/92-09/97	DG-175		10.5V				8
6.5 Turbo D	145		Double Coil(LPH)	01/92-12/04	DG-175		10.5V				8
HUMMER H2 (02-)											
6.0 AWD	232/ 237	LQ4(364CUV8)		09/02-	PTJ16R15	5077	1.5	-	IT16TT	IT16TT	8
HUMMER H3 (05-)											
3.5	162	L52		04/05-	PT16VR13	5068	1.3	TV16TT	ITV16TT	ITV16TT	5
5.3 V8 AWD	224	LH8(325CUV8)		10/08-	IT16TT	4713	1.0	-	IT16TT		8
HYUNDAI											
ACCENT I (94-00)											
1.3	44/55	G4EH		10/94-01/00	K16PR-U11	3130	1.1	K16TT	IK16TT	IK16TT	4
1.3 i 12V	62	G4EH		10/94-01/00	K16PR-U11	3130	1.1	K16TT	IK16TT	IK16TT	4
1.5	63	G4EK		10/94-07/99	K16PR-U11	3130	1.1	K16TT	IK16TT	IK16TT	4
1.5 i 12V	65	G4EK		10/94-01/00	K16PR-U11	3130	1.1	K16TT	IK16TT	IK16TT	4
1.5 i 16V	73	G4FK-99		10/95-01/00	K16PR-U11	3130	1.1	K16TT	IK16TT	IK16TT	4
1.5 i 16V	73	G4FK-99	OEM Optional	12/95-01/00	K20PR-U11	3121	1.1	K20TT	IK20TT	IK20TT	4
ACCENT II (99-06)											
1.3	55/62	G4EA; G4EH		01/00-11/05	K16PR-U11	3130	1.1	K16TT	IK16TT	IK16TT	4
1.5	66/75	G4EC-G; G4EK; G4EK-90/G4FK- 102; G4EK-90		09/99-11/05	K16PR-U11	3130	1.1	K16TT	IK16TT	IK16TT	4
1.5 CRDi	60	D3EA	Double Coil(LPH)	01/02-11/05	DG-173		11V				3
1.6	77	G4ED(105)		12/02-11/05	K16PR-U11	3130	1.1	K16TT	IK16TT	IK16TT	4
1.6	77	G4ED(105)	OEM Optional	12/02-11/05	K20PR-U	3145	0.8	K20TT	IK20TT	IK20TT	4
ACCENT III (05-10)											
1.4 GL	71	G4EE		11/05-11/10	K16PR-U11	3130	1.1	K16TT	IK16TT	IK16TT	4
1.4 GL	71	G4EE	OEM Optional	11/05-11/10	K20PR-U	3145	0.8	K20TT	IK20TT	IK20TT	4
1.5 CRDi GLS	81	D4FA		11/05-11/10	DG-602		11V				4
1.6 GLS	82	G4EB(112)		11/05-11/10	K16PR-U11	3130	1.1	K16TT	IK16TT	IK16TT	4
ACCENT IV / SOLARIS (10-)											
1.4	74	KAPPA		11/10-	XUH20TTi	7006	0.8	XUH20TTi	-	VXUH20I	4
1.4	80	GAMMA		11/10-	XU22HDR9	3445	0.9	XUH22TT	IXUH22TT	VXUH22I	4
1.6	91	GAMMA		11/10-	XU22HDR9	3445	0.9	XUH22TT	IXUH22TT	VXUH22I	4
1.6 CRDi	94/ 100	D4FB	OE: 36710-2A700/ 36710-4A710 (R P8490)	11/10-	DG-657		11V				4
ATOS (98-14)											
1.0 i	40/43	G4HC; G4HC-E		02/98-07/03	K16PR-U11	3130	1.1	K16TT	IK16TT	IK16TT	4
1.1	43/46	G4HD; G4HG		06/03-12/08	K16PR-U11	3130	1.1	K16TT	IK16TT	IK16TT	4
COUPE (96-02)											
1.6 16V	85	G4GR		03/98-04/02	K16PR-U11	3130	1.1	K16TT	IK16TT	IK16TT	4
1.6 i 16V	79/84	G4ED-G; G4GR		12/96-04/02	K16PR-U11	3130	1.1	K16TT	IK16TT	IK16TT	4
2.0	101	G4DF		08/99-01/02	W20EPR-U11	3049	1.1	W20TT	IW20TT	IW20TT	4
2.0 16V	99	G4DF		03/01-04/02	W20EPR-U11	3049	1.1	W20TT	IW20TT	IW20TT	4
2.0 16V	102	G4GF		08/96-04/02	K16PR-U11	3130	1.1	K16TT	IK16TT	IK16TT	4
2.0 F2 Evolution	115	G4GF		01/99-12/01	K16PR-U11	3130	1.1	K16TT	IK16TT	IK16TT	4
COUPE (01-09)											
1.6 16V	77/79	G4ED-G		03/02-08/06	K16PR-U11	3130	1.1	K16TT	IK16TT	IK16TT	4
1.6 16V	77/79	G4ED-G		09/06-08/09	SK16PR-L11	3395	1.1	-	IK16TT	IK16TT	4
2.0	100/ 102	G4GC-G		08/01-12/06	K16PR-U11	3130	1.1	K16TT	IK16TT	IK16TT	4
2.0	100/ 102	G4GC-G		09/06-08/09	SK16PR-L11	3395	1.1	-	IK16TT	IK16TT	4
2.0 GLS	105	G4GC-G		02/03-12/06	K16PR-U11	3130	1.1	K16TT	IK16TT	IK16TT	4
2.0 GLS	105	G4GC-G		09/06-08/09	SK16PR-L11	3395	1.1	-	IK16TT	IK16TT	4
2.7 V6	121	2.7L-DELTA		01/01-08/09	SK16PR-L11	3395	1.1	-	IK16TT	IK16TT	6
2.7 V6	123	G6BA-G-167		03/02-12/06	PK16PR-L11	3275	1.1	-	IK16TT	IK16TT	6
CRETA (16-)											
1.6	90	G4FG		01/16-	VXUH22I	5656	0.9	-	IXUH22TT	VXUH22I	4
1.6 4WD	90	G4FG		08/16-	VXUH22I	5656	0.9	-	IXUH22TT	VXUH22I	4
2.0	110	G4FG		01/16-	VXUH22I	5656	0.9	-	IXUH22TT	VXUH22I	4
2.0 4WD	110	G4FG		01/16-	VXUH22I	5656	0.9	-	IXUH22TT	VXUH22I	4
ELANTRA (00-06)											
1.6	66/ 77/79	G4ED-G; G4GR		06/00-07/06	K16PR-U11	3130	1.1	K16TT	IK16TT	IK16TT	4

Свечи зажигания и Свечи накаливания









Таблица применения

Таблица применения

HYUNDAI	KW	ENGINE	NOTE	21	СТАНДАРТНЫЕ			Twin Tip			QTY
					SPARK PLUG	RESISTANCE	LEAKAGE	SPARK PLUG	SPARK PLUG	SPARK PLUG	
HYUNDAI продолжение											
ELANTRA (00-06) продолжение											
1.8	97	G4GM-132		06/00-07/06	K16PR-U11	3130	1.1	K16TT	IK16TT	IK16TT	4
2.0	102/105	G4GC-G		06/00-07/06	K16PR-U11	3130	1.1	K16TT	IK16TT	IK16TT	4
2.0 CRDi	83	D4EA	Double Coil(LPH)	04/01-07/06	DG-173		11V				4
ELANTRA (05-11)											
1.6 CRDi	85	D4FB		11/05-12/11	DG-602		11V				4
1.6 CVVT	90	G4FC		02/09-06/11	XU22HDR9	3445	0.9	XUH22TT	IXUH22TT	VXUH22I	4
1.6 CVVT	90	G4FC	14 mm diameter+	06/06-01/09	KJ16CR-U11	3311	1.1	K16TT	IK16TT	IK16TT	4
2.0 CVVT	103	G4GC		06/06-12/06	K16PR-U11	3130	1.1	K16TT	IK16TT	IK16TT	4
2.0 CVVT	103	G4GC		09/06-05/10	SK16PR-L11	3395	1.1	-	IK16TT	IK16TT	4
ELANTRA (11-)											
1.6	94/97	GAMMA		04/11-04/16	XU22HDR9	3445	0.9	XUH22TT	IXUH22TT	VXUH22I	4
1.6 CRDi	94/100	D4FB		02/11-	DG-602		11V				4
1.8	108/110	NU		09/10-	VXUH22I	5656	0.9	-	IXUH22TT	VXUH22I	4
2.0	124/129	NU		09/13-	VXUH22I	5656	0.9	-	IXUH22TT	VXUH22I	4
2.0 Flex	131	NU		10/11-	VXUH22I	5656	0.9	-	IXUH22TT	VXUH22I	4
ELANTRA (15-)											
1.6	94	GAMMA		02/16-	XU22HDR9	3445	0.9	XUH22TT	IXUH22TT	VXUH22I	4
2.0	112	NU		10/15-	VXUH22I	5656	0.9	-	IXUH22TT	VXUH22I	4
EQUUS / CENTENNIAL (99-09)											
3.5	155	G6CU		10/99-03/09	PK16PR-L11	3275	1.1	-	IK16TT	IK16TT	6
EQUUS / CENTENNIAL (09-)											
3.8	213	G6DA		03/09-03/14	VXUH20I	5650	0.9	-	-	VXUH20I	6
3.8	213	G6DA		03/14-	VXUH22I	5656	0.9	-	IXUH22TT	VXUH22I	6
3.8 GDi	246	G6DJ		03/09-	VXUH22I	5656	0.9	-	IXUH22TT	VXUH22I	6
4.6 V8	269/274	G8BA		03/09-	IKH16TT	4703	1.0	-	IKH16TT		8
5.0 GDi	316	G8BE		03/09-	VXUH22I	5656	0.9	-	IXUH22TT	VXUH22I	8
GALLOPER (91-98)											
2.5 TD	62	4D56T	Double Coil(LPH)	08/91-07/98	DG-174		11V				4
2.5 TD intercooler	70	4D56T	Double Coil(LPH)	08/91-07/98	DG-174		11V				4
3.0 V6	104	G6A		08/91-07/98	W16EXR-U11	3032	1.1	W16TT	IW16TT	IW16TT	6
GALLOPER (98-03)											
2.5 Tci D	77	D4BH	Ceramic(LPH)	08/98-12/03	DG-301		11V				4
2.5 Tci D	77	D4BH	Double Coil(LPH)	08/98-12/03	DG-174		11V				4
2.5 TD	65	D4BA; D4BF	Ceramic	08/98-12/03	DG-301		11V				4
2.5 TD	65	D4BA; D4BF	Double Coil(LPH)	08/98-12/03	DG-174		11V				4
2.5 TD	65	D4BA; D4BF	Single Coil	08/98-12/03	DG-198		11V				4
2.5 TD intercooler	73	D4BH	Double Coil(LPH)	08/98-12/03	DG-174		11V				4
3.0 V6	104	G6A		08/98-06/02	W16EXR-U11	3032	1.1	W16TT	IW16TT	IW16TT	6
GENESIS (08-)											
2.0 CVVT	154/184	G4KF		06/08-02/14	FK20HR11	3426	1.1	-	IKH20TT	IKH20TT	4
2.0 T	157/202/204	G4KF		01/08-12/14	FK20HR11	3426	1.1	-	IKH20TT	IKH20TT	4
3.3 24V	171/221	G6DB; G6DH		01/08-12/14	SK16PR-L11	3395	1.1	-	IK16TT	IK16TT	6
3.8 V6	213/223/246/255/260	G6DA; G6DJ		01/08-12/14	VXUH20I	5650	0.9	-	-	VXUH20I	6
3.8 V6	260	G6DJ		03/14-	VXUH22I	5656	0.9	-	IXUH22TT	VXUH22I	6
GENESIS (14-)											
3.0 GDI	183	G6DG		06/14-	VXUH22I	5656	0.9	-	IXUH22TT	VXUH22I	6
3.0 GDI 4WD	183	G6DG		06/14-	VXUH22I	5656	0.9	-	IXUH22TT	VXUH22I	6
3.8 GDI	232	G6DJ		06/14-	VXUH22I	5656	0.9	-	IXUH22TT	VXUH22I	6
3.8 GDI 4WD	232	G6DJ		06/14-	VXUH22I	5656	0.9	-	IXUH22TT	VXUH22I	6
GETZ (02-09)											
1.1	46/49	1.1L-EPSILON; G4H46		09/02-06/09	K16PR-U11	3130	1.1	K16TT	IK16TT	IK16TT	4



Свечи зажигания и Свечи накаливания

Таблица применения

	KW				СТАНДАРТНЫЕ			Twin Tip		QTY	
											
HYUNDAI продолжение											
GETZ (02-09) продолжение											
1.3	61/63	G4EA		09/03-06/09	K16PR-U11	3130	1.1	K16TT	IK16TT	IK16TT	4
1.3 i	60	G4EA		09/02-03/04	K16PR-U11	3130	1.1	K16TT	IK16TT	IK16TT	4
1.4 i	71	1.4L-ALPHA		11/06-12/10	K16PR-U11	3130	1.1	K16TT	IK16TT	IK16TT	4
1.5 CRDi	60	D3EA	Double Coil(LPH)	03/03-09/05	DG-173		11V				3
1.5 CRDi	65	D4FA		08/05-06/09	DG-602		11V				4
1.5 CRDi GLS	75	D4FA		07/04-08/05	DG-173		11V				4
1.5 CRDi GLS	81	D4FA		08/05-06/09	DG-602		11V				4
1.6	77	G4ED-G		09/02-08/06	K16PR-U11	3130	1.1	K16TT	IK16TT	IK16TT	4
1.6	77	G4ED-G		09/06-12/06	SK16PR-L11	3395	1.1	-	IK16TT	IK16TT	4
GRANDEUR / XG (98-05)											
30	138	G6AT/G6AT(IF/ G6CT		12/98-12/05	PK16PR-L11	3275	1.1	-	IK16TT	IK16TT	6
250	120	G6AV/G6BV		12/98-12/05	PK16PR-L11	3275	1.1	-	IK16TT	IK16TT	6
350	145	G6CU		10/02-12/05	PK16PR-L11	3275	1.1	-	IK16TT	IK16TT	6
GRANDEUR (05-11)											
2.2 CRDi	110/ 114	D4EB		06/06-12/11	DG-173		11V				4
2.4	121	G4KC		09/06-12/07	K16PR-U11	3130	1.1	K16TT	IK16TT	IK16TT	4
2.4	121	G4KC		12/07-12/08	K16HPR-U11	6076	1.1	KH16TT	IKH16TT	IKH16TT	4
2.7	141	2.7L-MU		05/06-10/10	IKH16TT	4703	1.0	-	IKH16TT		6
3.3	173/ 191	G6DB		04/05-12/11	SK16PR-L11	3395	1.1	-	IK16TT	IK16TT	6
GRANDEUR (11-)											
2.4	132	THETA 2 GDI		07/11-	FXU16HR11	3478	1.1	-	-	FXU16HR11	4
2.4	132	THETA 2 MPI		07/11-	K16HPR-U11	6076	1.1	KH16TT	IKH16TT	IKH16TT	4
2.4 16V	148	THETA 2 GDI		01/11-	FXU16HR11	3478	1.1	-	-	FXU16HR11	4
2.4 16V	148	THETA 2 MPI		01/11-	K16HPR-U11	6076	1.1	KH16TT	IKH16TT	IKH16TT	4
2.7	141	2.7L-MU		06/11-	IKH16TT	4703	1.0	-	IKH16TT		4
H-1 / STAREX (97-07)											
2.4	82	G4CS		06/97-04/04	W20EPR-U	3047	0.8	W20TT	IW20TT	IW20TT	4
2.4	101/ 107	G4JS		11/01-04/04	P16PR11	3114	1.1	W16TT	IW16TT	IW16TT	4
2.4 4WD	82	G4CS		02/98-04/04	W20EPR-U	3047	0.8	W20TT	IW20TT	IW20TT	4
2.4 4WD	99	G4JS		06/01-04/04	P16PR11	3114	1.1	W16TT	IW16TT	IW16TT	4
2.5 CRDi	81/ 103/ 120	D4CB	Double Coil(LPH)	07/01-	DG-189		11V				4
2.5 CRDi 4WD	103	D4CB	Double Coil(LPH)	12/02-04/04	DG-189		11V				4
2.5 D	57/73	D4BF; D4BH	Double Coil(LPH)	10/97-10/06	DG-172		11V				4
2.5 TCi	74	D4BH	Ceramic(LPH)	10/97-12/07	DG-301		11V				4
2.5 TCi	74	D4BH	Double Coil(LPH)	10/97-12/07	DG-174		11V				4
2.5 TD	59/74	D4BF; D4BH	Double Coil(LPH)	06/97-08/07	DG-172		11V				4
2.5 TD 4WD	59/74	D4BF; D4BH	Double Coil(LPH)	02/98-04/04	DG-172		11V				4
H-1 (08-)											
2.4	129	G4KC		01/10-	IKH16TT	4703	1.0	-	IKH16TT		4
2.4 i	126	G4KC		02/08-	IKH16TT	4703	1.0	-	IKH16TT		4
2.5 CRDi	81/ 100/ 120/ 125	D4CB; D4CB-L; D4CB-W	Double Coil(LPH)	02/08-04/11	DG-189		11V				4
2.5 CRDi	81/ 85/ 100/ 120/ 125	D4CB; D4CB-L; D4CB-W	OE: 36710-2A700/ 36710-4A710 (R P8490)	01/09-	DG-657		11V				4
H100 (93-04)											
2.4	82/ 84/90	G4CS		07/93-12/04	W20EPR-U	3047	0.8	W20TT	IW20TT	IW20TT	4
2.4 TD	90	G4CS		07/93-07/97	W20EPR-U	3047	0.8	W20TT	IW20TT	IW20TT	4
2.5 D	55/ 57/59	D4BA; D4BF; D4BX	Double Coil(LPH)	07/93-10/01	DG-172		11V				4
2.5 TD	59	D4BF	Double Coil(LPH)	07/93-03/00	DG-172		11V				4
2.5 TDiC	59	D4BF	Double Coil(LPH)	06/98-10/03	DG-172		11V				4











Свечи зажигания и Свечи накаливания

Таблица применения

	KW				СТАНДАРТНЫЕ				Twin Tip			QTY
												
HYUNDAI продолжение												
H350 (15-)												
2.5 CRDi	110/125	D4CB	OE: 36710-2A700/ 36710-4A710 (R P8490)	04/15-	DG-657		11V					4
HIGHWAY VAN (00-04)												
2.0 16V	100	G4JP		03/00-02/04	K16PR-U11	3130	1.1	K16TT	IK16TT	IK16TT		4
2.0 CRDi	83	D4EA	Double Coil(LPH)	03/01-03/04	DG-173		11V					4
2.0 CVT	104	G4GC		11/03-03/04	K16PR-U11	3130	1.1	K16TT	IK16TT	IK16TT		4
2.7 V6 24V	127	G6BA		03/00-02/04	K16PR-U11	3130	1.1	K16TT	IK16TT	IK16TT		6
2.7 V6 24V	127	G6BA	OEM Optional	03/00-02/04	PK16PR-L11	3275	1.1	-	IK16TT	IK16TT		6
i10 (07-13)												
1.0	51	G3LA		01/11-12/17	XUH20TTi	7006	0.8	XUH20TTi	-	VXUH20i		3
1.1	48	G4HG		12/07-11/10	K16PR-U11	3130	1.1	K16TT	IK16TT	IK16TT		4
1.1	51	G4HG		04/11-11/13	K16PR-U	3191	0.8	K16TT	IK16TT	IK16TT		4
1.1 CRDi	55	D3FA		01/08-12/11	DG-602		11V					3
1.2	57/63	G4LA		11/08-12/13	XUH20TTi	7006	0.8	XUH20TTi	-	VXUH20i		4
1.2	57/63	G4LA	OEM Optional	11/08-12/13	IXUH20i	5354	0.9	-	-	VXUH20i		4
i10 (13-)												
1.0	49	G3LA		08/13-	XUH20TTi	7006	0.8	XUH20TTi	-	VXUH20i		3
1.0 LPG	49	B3LA		02/14-	XUH20TTi	7006	0.8	XUH20TTi	-	VXUH20i		3
1.2	64	G4LA		12/13-	XUH20TTi	7006	0.8	XUH20TTi	-	VXUH20i		4
1.2	64	G4LA	OEM Optional	12/13-	IXUH20i	5354	0.9	-	-	VXUH20i		4
i20 (08-15)												
1.1 CRDi	55	D3FA		03/12-12/15	DG-602		11V					3
1.2	57/63	G4LA		09/08-12/15	XUH20TTi	7006	0.8	XUH20TTi	-	VXUH20i		4
1.2	57/63	G4LA	OEM Optional	09/08-12/15	IXUH20i	5354	0.9	-	-	VXUH20i		4
1.4	74	G4FA		09/08-12/15	XU22HDR9	3445	0.9	XUH22TT	IXUH22TT	VXUH22i		4
1.4 CRDi	55/66	D4FC		08/08-12/15	DG-602		11V					4
1.6	93	G4FC		06/09-12/12	XU22HDR9	3445	0.9	XUH22TT	IXUH22TT	VXUH22i		4
1.6	93	G4FC	14 mm diameter+	09/08-06/09	KJ16CR-U11	3311	1.1	K16TT	IK16TT	IK16TT		4
1.6 CRDi	85/94	D4FB	Euro-4	09/08-12/12	DG-602		11V					4
1.6 CRDi	85/94	D4FB	OE: 36710-2A700/ 36710-4A710 (R P8490),Euro-5	09/08-12/12	DG-657		11V					4
i20 (14-)												
1.2	55/62	G4LA		11/14-	XUH20TTi	7006	0.8	XUH20TTi	-	VXUH20i		4
1.2	55/62	G4LA	OEM Optional	11/14-	IXUH20i	5354	0.9	-	-	VXUH20i		4
1.2 LPGi	61	G4LA		11/14-	XUH20TTi	7006	0.8	XUH20TTi	-	VXUH20i		4
1.2 LPGi	61	G4LA	OEM Optional	11/14-	VXUH20i	5650	0.9	-	-	VXUH20i		4
1.4	74	G4LC		11/14-	XUH20TTi	7006	0.8	XUH20TTi	-	VXUH20i		4
i20 Coupe (15-)												
1.2	62	G4LA		05/15-	XUH20TTi	7006	0.8	XUH20TTi	-	VXUH20i		4
1.2	62	G4LA	OEM Optional	05/15-	IXUH20i	5354	0.9	-	-	VXUH20i		4
1.4	74	G4LC		05/15-	XUH20TTi	7006	0.8	XUH20TTi	-	VXUH20i		4
i30 (07-12)												
1.4	77/80	G4FA		02/09-06/12	XU22HDR9	3445	0.9	XUH22TT	IXUH22TT	VXUH22i		4
1.4	77/80	G4FA	14 mm diameter+	10/07-01/09	KJ16CR-U11	3311	1.1	K16TT	IK16TT	IK16TT		4
1.6	85/90/93	G4FC		02/09-06/12	XU22HDR9	3445	0.9	XUH22TT	IXUH22TT	VXUH22i		4
1.6	85/90/93	G4FC	14 mm diameter+	10/07-01/09	KJ16CR-U11	3311	1.1	K16TT	IK16TT	IK16TT		4
1.6 CRDi	66/85/94	D4FB	Euro-4	10/07-06/12	DG-602		11V					4
1.6 CRDi	66/85/94	D4FB	OE: 36710-2A700/ 36710-4A710 (R P8490),Euro-5	10/07-06/12	DG-657		11V					4
2.0	105	G4GC; G4GC-G		10/07-06/12	SK16PR-L11	3395	1.1	-	IK16TT	IK16TT		4
2.0 CRDi	100/103	D4EA-F	Double Coil(LPH)	10/07-06/12	DG-173		11V					4
i30 (11-)												
1.4	73	G4FA		12/11-12/15	XU22HDR9	3445	0.9	XUH22TT	IXUH22TT	VXUH22i		4
1.4	73	G4LC		12/14-	XUH20TTi	7006	0.8	XUH20TTi	-	VXUH20i		4
1.4	73	G4LC		01/15-	VXUH20i	5650	0.9	-	-	VXUH20i		4
1.4 CRDi	66	D4FC		12/11-12/14	DG-602		11V					4

Свечи зажигания и Свечи накаливания











Таблица применения

	KW				СТАНДАРТНЫЕ			Twin Tip			QTY
											
HYUNDAI продолжение											
i30 (11-) продолжение											
1.6	88/95	G4FC; GDI		12/11-	XU22HDR9	3445	0.9	XUH22TT	IXUH22TT	VXUH22I	4
1.6	88/95	MPI		12/11-	VXUH20I	5650	0.9	-	-	VXUH20I	4
1.6 CRDi	81/ 94/ 100	D4FB; D4FB-5P		11/11-12/14	DG-602		11V				4
1.6 CRDi	100	D4FB	OE: 36710-2A700/ 36710-4A710 (R P8490)	01/15-	DG-657		11V				4
1.6 GDI	99	G4FD		12/11-	VXUH20I	5650	0.9	-	-	VXUH20I	4
i30 (16-)											
1.4 MPI	73			11/16-	VXUH20I	5650	0.9	-	-	VXUH20I	4
i30 Coupe (13-)											
1.4	73	G4FA		05/13-	XU22HDR9	3445	0.9	XUH22TT	IXUH22TT	VXUH22I	4
1.4	73	G4LC		12/14-	XUH20TTi	7006	0.8	XUH20TTi	-	VXUH20I	4
1.4 CRDi	66	D4FC		05/13-12/14	DG-602		11V				4
1.6 CRDi	81/ 100	D4FB	OE: 36710-2A700/ 36710-4A710 (R P8490)	12/14-	DG-657		11V				4
1.6 CRDi	94	D4FB		05/13-12/14	DG-602		11V				4
1.6 GDI	99	G4FD		05/13-	VXUH20I	5650	0.9	-	-	VXUH20I	4
i40 (11-)											
1.6 GDI	99	G4FD		07/11-	VXUH20I	5650	0.9	-	-	VXUH20I	4
1.7 CRDi	85/ 100/ 104	D4FD	OE: 36710-2A700/ 36710-4A710 (R P8490)	07/11-	DG-657		11V				4
2.0 CVVT	110	G4NA		10/12-	VXUH22I	5656	0.9	-	IXUH22TT	VXUH22I	4
2.0 GDi	121/ 130	G4NC		07/11-	VXUH22I	5656	0.9	-	IXUH22TT	VXUH22I	4
ix20 (10-)											
1.4	66	G4FA		11/10-	XU22HDR9	3445	0.9	XUH22TT	IXUH22TT	VXUH22I	4
1.4 CRDi	57/66	D4FC-M		11/10-11/15	DG-602		11V				4
1.6	92	G4FC		11/10-	XU22HDR9	3445	0.9	XUH22TT	IXUH22TT	VXUH22I	4
1.6 CRDi	85/94	D4FB		06/11-11/15	DG-602		11V				4
ix35 (09-)											
1.6	99	G4FD		11/10-	VXUH20I	5650	0.9	-	-	VXUH20I	4
1.7 CRDi	85	D4FD	OE: 36710-2A700/ 36710-4A710 (R P8490)	11/10-	DG-657		11V				4
2.0	120/ 122	G4KD		01/10-	K16HPR-U11	6076	1.1	KH16TT	IKH16TT	IKH16TT	4
2.0 4WD	116	NU MPI/GDI		09/14-	VXUH22I	5656	0.9	-	IXUH22TT	VXUH22I	4
2.0 4WD	120	G4KD		01/10-	K16HPR-U11	6076	1.1	KH16TT	IKH16TT	IKH16TT	4
2.0 4WD	114	G4KD		11/13-	K16HPR-U11	6076	1.1	KH16TT	IKH16TT	IKH16TT	4
2.0 CRDi	100	D4HA	OE:36710-2F100	01/10-02/12	DG-624		4.4V				4
2.0 CRDi	100/ 130/ 135	D4HA	OE: 36710-2F000/ 36710-2F001/ 36710-2F101	01/10-	DG-669		7V				4
2.0 CRDi 4WD	100/ 135	D4HA	OE: 36710-2F000/ 36710-2F001/ 36710-2F101	01/10-	DG-669		7V				4
2.0 CRDi 4WD	100/ 135	D4HA	OE:36710-2F100	01/10-02/12	DG-624		4.4V				4
2.0 CVVT	110	G4KD		08/09-	K16HPR-U11	6076	1.1	KH16TT	IKH16TT	IKH16TT	4
2.0 CVVT	110	NU MPI/GDI		08/13-12/15	VXUH22I	5656	0.9	-	IXUH22TT	VXUH22I	4
2.0 CVVT 4WD	110/ 122	NU MPI/GDI		08/09-	VXUH22I	5656	0.9	-	IXUH22TT	VXUH22I	4
2.0 CVVT 4WD	122	G4KD; THETA 2 MPI		08/09-	K16HPR-U11	6076	1.1	KH16TT	IKH16TT	IKH16TT	4
2.0 CVVT AWD	110	G4KD		08/09-	K16HPR-U11	6076	1.1	KH16TT	IKH16TT	IKH16TT	4
2.0 GDI	110/ 122	NU MPI/GDI		08/13-	VXUH22I	5656	0.9	-	IXUH22TT	VXUH22I	4
2.0 GDI 4WD	110/ 122	NU MPI/GDI		08/13-	VXUH22I	5656	0.9	-	IXUH22TT	VXUH22I	4
2.4 4WD	129	G4KE		01/10-	K16HPR-U11	6076	1.1	KH16TT	IKH16TT	IKH16TT	4
2.4 DCVVT-I 4WD	128	G4KE		07/10-12/13	K16HPR-U11	6076	1.1	KH16TT	IKH16TT	IKH16TT	4

Свечи зажигания и Свечи накаливания

Таблица применения

Таблица применения

	KW				СТАНДАРТНЫЕ				Twin Tip			QTY
												
HYUNDAI продолжение												
ix55 (06-)												
3.8 V6	194	G6DA		01/11-03/14	VXUH20I	5650	0.9	-	-	VXUH20I	6	
3.8 V6	194	G6DA		03/14-	VXUH22I	5656	0.9	-	IXUH22TT	VXUH22I	6	
3.8 V6 4WD	194	G6DA		01/11-03/14	VXUH20I	5650	0.9	-	-	VXUH20I	6	
3.8 V6 4WD	194	G6DA		03/14-	VXUH22I	5656	0.9	-	IXUH22TT	VXUH22I	6	
LANTRA I (90-95)												
1.5 i.e.	63	G4DJ; G15B		10/90-11/95	W20EPR-U11	3049	1.1	W20TT	IW20TT	IW20TT	4	
1.6 i.e. 16V	78/84	G4CR		10/90-11/95	W20EPR-U11	3049	1.1	W20TT	IW20TT	IW20TT	4	
1.8 i.e. 16V	93	G4CN		06/92-11/95	W20EPR-U11	3049	1.1	W20TT	IW20TT	IW20TT	4	
LANTRA II (95-00)												
1.5 12V	65	G4EK		12/96-10/00	K16PR-U11	3130	1.1	K16TT	IK16TT	IK16TT	4	
1.5 12V	65	G4EK	OEM Optional	04/97-10/00	K20PR-U11	3121	1.1	K20TT	IK20TT	IK20TT	4	
1.6 16V	84	G4GR		11/95-10/00	K16PR-U11	3130	1.1	K16TT	IK16TT	IK16TT	4	
1.6 i	66	G4GR		11/95-10/00	K16PR-U11	3130	1.1	K16TT	IK16TT	IK16TT	4	
1.8 16V	94	G4GM-128		11/95-10/00	K16PR-U11	3130	1.1	K16TT	IK16TT	IK16TT	4	
1.9 D	50	DJY		03/98-10/00	DG-001		11V				4	
2.0	100	G4JP		04/97-05/00	K16PR-U11	3130	1.1	K16TT	IK16TT	IK16TT	4	
2.0 16V	102	G4GF		11/95-10/00	K16PR-U11	3130	1.1	K16TT	IK16TT	IK16TT	4	
MATRIX (01-10)												
1.5 CRDi	60	D3EA	Double Coil(LPH)	10/01-08/10	DG-173		11V				3	
1.5 CRDi	75	D4FA		12/04-08/05	DG-173		11V				4	
1.5 CRDi	75	D4FA		08/05-08/10	DG-602		11V				4	
1.5 CRDi VGT	81	D4FA		08/05-08/10	DG-602		11V				4	
1.6	66/76	G4(90); G4ED-G		06/01-08/06	K16PR-U11	3130	1.1	K16TT	IK16TT	IK16TT	4	
1.6	76	G4ED-G		09/06-08/10	SK16PR-L11	3395	1.1	-	IK16TT	IK16TT	4	
1.8	90	G4GB-G		06/01-08/06	K16PR-U11	3130	1.1	K16TT	IK16TT	IK16TT	4	
PONY / EXCEL (89-95)												
1.3	43/49/51	G4DG		09/89-01/95	W20EPR-U11	3049	1.1	W20TT	IW20TT	IW20TT	4	
1.5	53	G4DJ; G15B		10/89-01/95	W20EPR-U11	3049	1.1	W20TT	IW20TT	IW20TT	4	
1.5 i	61	G4DJ; G15B		10/89-01/95	W20EPR-U11	3049	1.1	W20TT	IW20TT	IW20TT	4	
PONY (74-82)												
1.4	50	HYUN04		08/77-06/86	W20EPR-U	3047	0.8	W20TT	IW20TT	IW20TT	4	
PONY (85-89)												
1.3	50	G13B		10/85-09/89	W20EPR-U	3047	0.8	W20TT	IW20TT	IW20TT	4	
1.3	50	G13B		10/85-09/89	W20EPR-U11	3049	1.1	W20TT	IW20TT	IW20TT	4	
1.5	51/53	G4AJ; G4DJ; G15B		10/85-09/89	W20EPR-U11	3049	1.1	W20TT	IW20TT	IW20TT	4	
PORTER (94-04)												
2.4	82	G4CS		03/96-04/04	W20EPR-U	3047	0.8	W20TT	IW20TT	IW20TT	4	
2.5 CRDi	103	D4CB	Double Coil(LPH)	02/03-04/04	DG-189		11V				4	
2.5 TD	57/73	D4BA; D4BH	Double Coil(LPH)	07/94-04/04	DG-172		11V				4	
PORTER (04-)												
2.5 D	99	D4CB	OE: 36710-2A700/36710-4A710 (R P8490)	01/12-	DG-657		11V				4	
S COUPE (90-96)												
1.5 GS	57	G4DJ		03/90-12/92	W20EPR-U11	3049	1.1	W20TT	IW20TT	IW20TT	4	
1.5 i	62	G4DJ; G15B		02/90-05/96	W20EPR-U11	3049	1.1	W20TT	IW20TT	IW20TT	4	
1.5 i	65	G4EK		04/92-05/96	K16PR-U11	3130	1.1	K16TT	IK16TT	IK16TT	4	
1.5 i Turbo	85	G4EK-TC		04/91-05/96	K20PR-U	3145	0.8	K20TT	IK20TT	IK20TT	4	
SANTA FÉ I (00-06)												
2.0	99	G4JP		08/01-03/06	W20EPR-U11	3049	1.1	W20TT	IW20TT	IW20TT	4	
2.0 CRDi	83	D4EA	Double Coil(LPH)	08/01-03/06	DG-173		11V				4	
2.0 CRDi 4x4	83/92	D4EA; D4EA-V	Double Coil(LPH)	04/01-03/06	DG-173		11V				4	
2.0 CRDi AWD	107	D4EA-F	Double Coil(LPH)	11/03-02/06	DG-173		11V				4	
2.4 16V	100/107	G4JS-G		02/01-03/06	P16PR11	3114	1.1	W16TT	IW16TT	IW16TT	4	
2.4 16V 4x4	100/107	G4JS-G		02/01-03/06	P16PR11	3114	1.1	W16TT	IW16TT	IW16TT	4	
2.7	129	G6EA		08/04-03/06	IKH16TT	4703	1.0	-	IKH16TT		6	
2.7 4x4	132	G6EA		11/00-03/06	PK16PR-L11	3275	1.1	-	IK16TT	IK16TT	6	
2.7 4x4	132	G6EA	OEM Optional	11/00-03/06	SK16PR-L11	3395	1.1	-	IK16TT	IK16TT	6	
2.7 V6 4x4	127	G6BA-G		02/01-03/06	K16PR-U11	3130	1.1	K16TT	IK16TT	IK16TT	6	

Свечи зажигания и Свечи накаливания

Таблица применения











	KW				СТАНДАРТНЫЕ				Twin Tip		QTY
											
HYUNDAI продолжение											
SANTA FÉ I (00-06) продолжение											
2.7 V6 4x4	127	G6BA-G	OEM Optional	02/01-03/06	PK16PR-L11	3275	1.1	-	IK16TT	IK16TT	6
SANTA FÉ II (06-12)											
2.0 CRDi	110	D4HA	OE: 36710-2F000/ 36710-2F001/ 36710-2F101	02/12-12/12	DG-669		7V				4
2.0 CRDi	110	D4HA	OE:36710-2F100	12/10-02/12	DG-624		4.4V				4
2.0 CRDi 4x4	85	D4EA	Double Coil(LPH)	03/06-12/12	DG-173		11V				4
2.0 CRDi 4x4	110/ 135	D4HA	OE: 36710-2F000/ 36710-2F001/ 36710-2F101	02/12-12/12	DG-669		7V				4
2.0 CRDi 4x4	110/ 135	D4HA	OE:36710-2F100	03/06-02/12	DG-624		4.4V				4
2.2 CRDi	102/ 114	D4EB		03/06-12/12	DG-173		11V				4
2.2 CRDi	145	D4HB	OE:36710-2F100	01/09-06/12	DG-624		4.4V				4
2.2 CRDi 4x4	102/ 114	D4EB		03/06-12/12	DG-173		11V				4
2.2 CRDi 4x4	145	D4HB	OE:36710-2F100	01/09-06/12	DG-624		4.4V				4
2.2 CRDi GLS	110	D4EB		03/06-12/09	DG-173		11V				4
2.2 CRDi GLS 4x4	110	D4EB		03/06-12/09	DG-173		11V				4
2.4	128	G4KE		11/10-12/12	K16HPR-U11	6076	1.1	KH16TT	IKH16TT	IKH16TT	4
2.4 4x4	128	G4KE		07/10-12/12	K16HPR-U11	6076	1.1	KH16TT	IKH16TT	IKH16TT	4
2.7	125	G6BA		03/06-09/09	IKH16TT	4703	1.0	-	IKH16TT		6
2.7 4x4	125	G6BA		03/06-09/09	IKH16TT	4703	1.0	-	IKH16TT		6
2.7 V6 GLS	139	G6EA		03/06-12/09	IKH16TT	4703	1.0	-	IKH16TT		6
2.7 V6 GLS 4x4	139	G6EA		03/06-12/09	IKH16TT	4703	1.0	-	IKH16TT		6
SANTA FÉ III (12-)											
2.0 CRDi	110	D4HA	OE: 36710-2F000/ 36710-2F001/ 36710-2F101	09/12-	DG-669		7V				4
2.0 CRDi 4WD	110	D4HA	OE: 36710-2F000/ 36710-2F001/ 36710-2F101	09/12-	DG-669		7V				4
2.4	141	THETA 2 GDI		09/12-12/15	FXU16HR11	3478	1.1	-	-	FXU16HR11	4
2.4	141	THETA 2 MPI		09/12-12/15	IKH16TT	4703	1.0	-	IKH16TT		4
2.4 4WD	141	THETA 2 GDI		09/12-	FXU16HR11	3478	1.1	-	-	FXU16HR11	4
2.4 4WD	141	THETA 2 MPI		09/12-	IKH16TT	4703	1.0	-	IKH16TT		4
2.4 CCVT	129	THETA 2 GDI		09/12-	FXU16HR11	3478	1.1	-	-	FXU16HR11	4
2.4 CCVT	129	THETA 2 MPI		09/12-	IKH16TT	4703	1.0	-	IKH16TT		4
2.4 CCVT AWD	129	THETA 2 GDI		09/12-	FXU16HR11	3478	1.1	-	-	FXU16HR11	4
2.4 CCVT AWD	129	THETA 2 MPI		09/12-	IKH16TT	4703	1.0	-	IKH16TT		4
2.4 GDI	138	G4KJ		05/15-	VXUH22I	5656	0.9	-	IXUH22TT	VXUH22I	4
2.4 GDI	138	THETA 2 GDI		05/15-	FXU16HR11	3478	1.1	-	-	FXU16HR11	4
2.4 GDI 4WD	138	G4KJ		05/15-	VXUH22I	5656	0.9	-	IXUH22TT	VXUH22I	4
2.4 GDI 4WD	138	THETA 2 GDI		05/15-	FXU16HR11	3478	1.1	-	-	FXU16HR11	4
3.0 GDI	194	LAMBDA 2		01/13-	VXUH22I	5656	0.9	-	IXUH22TT	VXUH22I	6
3.0 GDI 4WD	194	LAMBDA 2		01/13-	VXUH22I	5656	0.9	-	IXUH22TT	VXUH22I	6
3.3	199/ 216	LAMBDA 2		09/12-	VXUH22I	5656	0.9	-	IXUH22TT	VXUH22I	6
3.3 4WD	199/ 216	LAMBDA 2		09/12-	VXUH22I	5656	0.9	-	IXUH22TT	VXUH22I	6
3.3 GDI	213	LAMBDA 2		06/17-	VXUH22I	5656	0.9	-	IXUH22TT	VXUH22I	6
3.3 GDI 4WD	199/ 213	LAMBDA 2		03/14-	VXUH22I	5656	0.9	-	IXUH22TT	VXUH22I	6
SANTAMO (98-02)											
2.0 16V	102	I4-DOHC		05/99-12/02	W16EXR-U11	3032	1.1	W16TT	IW16TT	IW16TT	4
2.0 16V	102	I4-DOHC	OEM Optional	05/99-12/01	W20EPR-U11	3049	1.1	W20TT	IW20TT	IW20TT	4
2.0 16V 4x4	102	I4-DOHC		05/99-12/02	W16EXR-U11	3032	1.1	W16TT	IW16TT	IW16TT	4
2.0 16V 4x4	102	I4-DOHC	OEM Optional	05/99-12/01	W20EPR-U11	3049	1.1	W20TT	IW20TT	IW20TT	4
SONATA II (88-93)											
1.8 i	70	G4CM		09/88-10/93	W20EPR-U11	3049	1.1	W20TT	IW20TT	IW20TT	4
2.0 i	74/80	G4CP		09/88-10/93	W20EPR-U11	3049	1.1	W20TT	IW20TT	IW20TT	4
2.0 i 16V	96	G4CPD		01/91-10/93	W20EPR-U11	3049	1.1	W20TT	IW20TT	IW20TT	4
2.4 i	83	G4CS		09/88-08/91	W20EPR-U	3047	0.8	W20TT	IW20TT	IW20TT	4
3.0 i V6	107	G6AT		01/91-10/93	P16PR11	3114	1.1	W16TT	IW16TT	IW16TT	6

Таблица применения

Н

Свечи зажигания и Свечи накаливания

Таблица применения

Таблица применения

HYUNDAI	KW	ENGINE	NOTE	21	СТАНДАРТНЫЕ			Twin Tip			QTY
					SPARK PLUG	RESISTANCE	LEAKAGE	SPARK PLUG	SPARK PLUG	SPARK PLUG	
HYUNDAI продолжение											
SONATA III (93-98)											
1.8 GLS	63	G4DM		07/96-05/98	W20EPR-U11	3049	1.1	W20TT	IW20TT	IW20TT	4
1.8 i	72	G4CM		05/93-06/98	W20EPR-U11	3049	1.1	W20TT	IW20TT	IW20TT	4
2.0 i	70/77	G4CP		06/94-06/98	W20EPR-U11	3049	1.1	W20TT	IW20TT	IW20TT	4
2.0 i 16V	92/ 102	G4CP-D(139); G4CPD		09/94-06/98	W20EPR-U11	3049	1.1	W20TT	IW20TT	IW20TT	4
3.0 i V6	107	G6AT		05/93-06/93	P16PR11	3114	1.1	W16TT	IW16TT	IW16TT	6
SONATA IV (98-05)											
2.0 16V	96/ 100/ 106	G4JP-EG; G4JP-G		06/98-11/04	W20EPR-U11	3049	1.1	W20TT	IW20TT	IW20TT	4
2.4 16V	105	G4DS		03/98-10/01	P16PR11	3114	1.1	W16TT	IW16TT	IW16TT	4
2.5 V6 24V	118	G6AV		06/98-10/01	PK16PR-L11	3275	1.1	-	IK16TT	IK16TT	6
2.7 i V6	132	G6BA-Y		10/01-05/05	PK16PR-L11	3275	1.1	-	IK16TT	IK16TT	6
2.7 V6	127/ 129	G6BA-G		10/01-11/04	PK16PR-L11	3275	1.1	-	IK16TT	IK16TT	6
SONATA V (05-10)											
2.0 CRDi	100/ 103/ 110	D4EA-F	Double Coil(LPH)	02/06-12/10	DG-173		11V				4
2.0 GLSi	119	G4KD		07/08-12/10	K16HPR-U11	6076	1.1	KH16TT	IKH16TT	IKH16TT	4
2.0 VVTi GLS	106	G4KA		05/05-12/07	K16PR-U11	3130	1.1	K16TT	IK16TT	IK16TT	4
2.0 VVTi GLS	106/ 121	G4KA; G4KD		12/07-12/10	K16HPR-U11	6076	1.1	KH16TT	IKH16TT	IKH16TT	4
2.4	119	G4KC		01/05-12/07	K16PR-U11	3130	1.1	K16TT	IK16TT	IK16TT	4
2.4	119/ 128	G4KC; G4KE		12/07-12/10	K16HPR-U11	6076	1.1	KH16TT	IKH16TT	IKH16TT	4
3.3	171/ 173/ 184	G6DB		01/05-12/10	SK16PR-L11	3395	1.1	-	IK16TT	IK16TT	6
SONATA VI (09-15)											
2.0	110/ 115/ 126/ 204	NU		10/12-12/15	VXUH22I	5656	0.9	-	IXUH22TT	VXUH22I	4
2.0	110/ 115/ 204	Theta 2		01/09-09/12	K16HPR-U11	6076	1.1	KH16TT	IKH16TT	IKH16TT	4
2.0 GDI	199	NU		10/12-06/14	VXUH22I	5656	0.9	-	IXUH22TT	VXUH22I	4
2.0 GDI	199	Theta 2		01/11-09/12	K16HPR-U11	6076	1.1	KH16TT	IKH16TT	IKH16TT	4
2.0 Hybrid	110	NU		10/12-06/14	VXUH22I	5656	0.9	-	IXUH22TT	VXUH22I	4
2.0 Hybrid	110	Theta 2		01/11-09/12	K16HPR-U11	6076	1.1	KH16TT	IKH16TT	IKH16TT	4
2.0 i	121	NU		10/12-06/14	VXUH22I	5656	0.9	-	IXUH22TT	VXUH22I	4
2.0 i	121	Theta 2		01/11-09/12	K16HPR-U11	6076	1.1	KH16TT	IKH16TT	IKH16TT	4
2.0 LPG	126	NU		10/12-06/14	VXUH22I	5656	0.9	-	IXUH22TT	VXUH22I	4
2.0 LPG	126	Theta 2		01/12-09/12	K16HPR-U11	6076	1.1	KH16TT	IKH16TT	IKH16TT	4
2.4	128/ 130/ 133/ 142/ 149	Theta 2		01/09-12/15	K16HPR-U11	6076	1.1	KH16TT	IKH16TT	IKH16TT	4
2.4 GDI	148	Theta 2		01/09-06/14	K16HPR-U11	6076	1.1	KH16TT	IKH16TT	IKH16TT	4
2.4 Hybrid	153	G4KK		09/10-12/15	ZXU20HCR8	3479	0.8	-	-	ZXU20HCR8	4
SONATA VII (14-)											
2.0 CVT	110	G4NA		11/18-	VXUH22I	5656	0.9	-	IXUH22TT	VXUH22I	4
STELLAR (83-91)											
1.4	50	HYUN04		10/83-08/86	W20EPR-U	3047	0.8	W20TT	IW20TT	IW20TT	4
2.0 GSL	61	4G63		09/86-12/89	W20EPR-U	3047	0.8	W20TT	IW20TT	IW20TT	4
TERRACAN (01-06)											
2.5 TD	74	D4BH	Double Coil(LPH)	12/01-12/06	DG-172		11V				4
2.9 CRDi	110	J3	Ceramic(LPH)	11/01-07/03	DG-301		11V				4
2.9 CRDi 4WD	110/ 120	J3	Ceramic(LPH)	12/01-12/06	DG-301		11V				4
3.5 i V6 4WD	143	G674	OEM Optional	12/01-02/02	K16PR-U11	3130	1.1	K16TT	IK16TT	IK16TT	6
3.5 i V6 4WD	143/ 147	G6CU; G674		12/01-12/06	PK16PR-L11	3275	1.1	-	IK16TT	IK16TT	6
TIBURON (06-)											
2.0 CVT	105	G4GC		10/06-12/08	SK16PR-L11	3395	1.1	-	IK16TT	IK16TT	4
TRAJECT (00-08)											
2.0	100	G4JP-G		03/00-07/08	W20EPR-U11	3049	1.1	W20TT	IW20TT	IW20TT	4
2.0	103	G4GC; G4GC-G		11/03-12/06	K16PR-U11	3130	1.1	K16TT	IK16TT	IK16TT	4
2.0	103	G4GC; G4GC-G		09/06-07/08	SK16PR-L11	3395	1.1	-	IK16TT	IK16TT	4

Свечи зажигания и Свечи накаливания

Таблица применения





	KW				СТАНДАРТНЫЕ			Twin Tip			QTY
HYUNDAI продолжение											
TRAJECT (00-08) продолжение											
2.0 CRDi	83/92	D4EA; D4EA-V	Double Coil(LPH)	04/01-07/08	DG-173		11V				4
2.7 V6	127	G6BA(172)/G6BA-G-173	OEM Optional	09/00-06/07	PK16PR-L11	3275	1.1	-	IK16TT	IK16TT	6
2.7 V6	127	G6BA-G-173		03/04-06/07	K16PR-U11	3130	1.1	K16TT	IK16TT	IK16TT	6
TUCSON (04-10)											
2.0	104	G4GC		08/04-01/12	K16PR-U11	3130	1.1	K16TT	IK16TT	IK16TT	4
2.0	104	G4GC		09/06-	SK16PR-L11	3395	1.1	-	IK16TT	IK16TT	4
2.0 AWD	104	G4GC		08/04-12/06	K16PR-U11	3130	1.1	K16TT	IK16TT	IK16TT	4
2.0 AWD	104	G4GC		09/06-11/10	SK16PR-L11	3395	1.1	-	IK16TT	IK16TT	4
2.0 CRDi	83/88/100/103/110	D4EA-F	Double Coil(LPH)	08/04-03/10	DG-173		11V				4
2.0 CRDi AWD	83/88/100/103/110	D4EA-F	Double Coil(LPH)	08/04-03/10	DG-173		11V				4
2.7 AWD	129	G6BA(175)		08/04-09/06	PK16PR-L11	3275	1.1	-	IK16TT	IK16TT	6
2.7 AWD	129	G6BA(175)		09/06-11/10	SK16PR-L11	3395	1.1	-	IK16TT	IK16TT	6
TUCSON (15-)											
1.6 GDi	97	G4FD		06/15-	VXUH20I	5650	0.9	-	-	VXUH20I	4
1.7 CRDi	85/104	D4FD	OE: 36710-2A700/ 36710-4A710 (R P8490)	06/15-	DG-657		11V				4
2.0	114	G4NA		06/15-09/17	VXUH22I	5656	0.9	-	IXUH22TT	VXUH22I	4
2.0 CVT	110	G4NA		06/15-09/17	VXUH22I	5656	0.9	-	IXUH22TT	VXUH22I	4
VELOSTER (11-)											
1.6 GDI	103	G4FD		03/11-12/17	VXUH20I	5650	0.9	-	-	VXUH20I	4
1.6 MPI	97	MPI		04/11-12/17	XU22HDR9	3445	0.9	XUH22TT	IXUH22TT	VXUH22I	4
INFINITI											
EX (07-)											
25	175	VQ25HR		04/10-	FXE22HR11	3442	1.1	-	IXEH22TT	IXEH22TT	6
25	175	VQ25HR		04/10-	IXEH22TT	4712	1.0	-	IXEH22TT		6
35	221	VQ35HR		10/08-	FXE22HR11	3442	1.1	-	IXEH22TT	IXEH22TT	6
35	221	VQ35HR		10/08-	IXEH22TT	4712	1.0	-	IXEH22TT		6
37	228/235	VQ37VHR		10/08-	FXE24HR11	3457	1.1	-	-	FXE24HR11	6
FX (02-08)											
35	206	VQ35DE		02/03-12/08	IKH16TT	4703	1.0	-	IKH16TT		6
35	206	VQ35DE		02/03-12/08	IKH20TT	4704	1.0	-	IKH20TT		6
35 AWD	206	VQ35DE		01/03-12/08	IKH16TT	4703	1.0	-	IKH16TT		6
35 AWD	206	VQ35DE		01/03-12/08	IKH20TT	4704	1.0	-	IKH20TT		6
45	232	VK45DE		02/03-12/08	IKH16TT	4703	1.0	-	IKH16TT		8
45 AWD	232	VK45DE		01/03-12/08	IKH16TT	4703	1.0	-	IKH16TT		8
FX (08-)											
35	226	VQ35HR		10/08-12/11	FXE22HR11	3442	1.1	-	IXEH22TT	IXEH22TT	6
35	226	VQ35HR		10/08-12/11	IXEH22TT	4712	1.0	-	IXEH22TT		6
35 AWD	223	VQ35HR		01/12-	FXE22HR11	3442	1.1	-	IXEH22TT	IXEH22TT	6
35 AWD	223	VQ35HR		01/12-	IXEH22TT	4712	1.0	-	IXEH22TT		6
37 AWD	235/242	VQ37VHR		10/08-	FXE24HR11	3457	1.1	-	-	FXE24HR11	6
50 AWD	287/309	VK50VE		10/08-	FXE22HR11	3442	1.1	-	IXEH22TT	IXEH22TT	8
50 AWD	287/309	VK50VE		10/08-	IXEH22TT	4712	1.0	-	IXEH22TT		8
G (02-07)											
3.5	209	VQ35DE		09/02-12/06	IKH16TT	4703	1.0	-	IKH16TT		6
3.5	209	VQ35DE		09/02-12/06	IKH20TT	4704	1.0	-	IKH20TT		6
35	191	VQ35DE		10/02-	IKH16TT	4703	1.0	-	IKH16TT		6
35	191	VQ35DE		10/02-	IKH20TT	4704	1.0	-	IKH20TT		6
G (07-)											
25	163	VQ25HR		01/11-	FXE22HR11	3442	1.1	-	IXEH22TT	IXEH22TT	6
25	163	VQ25HR		01/11-	IXEH22TT	4712	1.0	-	IXEH22TT		6
35 X	228	VQ35HR		01/07-12/08	FXE22HR11	3442	1.1	-	IXEH22TT	IXEH22TT	6
35 X	228	VQ35HR		01/07-12/08	IXEH22TT	4712	1.0	-	IXEH22TT		6

Таблица применения

Н

1

Свечи зажигания и Свечи накаливания





Таблица применения

Таблица применения

INFINITI	KW	KW	NOTE	21	СТАНДАРТНЫЕ				Twin Tip			QTY
					1	2	3	4	1	2	3	
INFINITI продолжение												
G (07-) продолжение												
37	235/ 243/ 245	VQ37VHR		09/07-	FXE24HR11	3457	1.1	-	-	FXE24HR11	6	
37 X	235/ 245	VQ37VHR		09/08-	FXE24HR11	3457	1.1	-	-	FXE24HR11	6	
G20 (90-97)												
2.0	85	SR20DE		01/90-12/97	K16R-U11	3120	1.1	K16TT	IK16TT	IK16TT	4	
2.0	85	SR20DE		01/90-12/97	K20R-U	3122	0.8	K20TT	IK20TT	IK20TT	4	
I30 (97-)												
3.0	142	VQ30DE		01/97-	PK20PR11	3168	1.1	K20TT	IK20TT	IK20TT	6	
I35 (95-04)												
3.5	188	VQ35DE		07/01-12/04	IKH16TT	4703	1.0	-	IKH16TT		6	
3.5	188	VQ35DE		07/01-12/04	IKH20TT	4704	1.0	-	IKH20TT		6	
J30 (92-97)												
3.0	157	VG30DE		01/92-12/97	IQ20TT	4707	1.0	-	IQ20TT		6	
JX (12-)												
3.5 AWD	198	VQ35DE		09/12-	FXE22HR11	3442	1.1	-	IXEH22TT	IXEH22TT	6	
3.5 AWD	198	VQ35DE		09/12-	IXEH22TT	4712	1.0	-	IXEH22TT		6	
M (10-)												
35h	225	VQ35HR		04/11-	FXE22HR11	3442	1.1	-	IXEH22TT	IXEH22TT	6	
35h	225	VQ35HR		04/11-	IXEH22TT	4712	1.0	-	IXEH22TT		6	
37	235	VQ37VHR		03/10-	FXE24HR11	3457	1.1	-	-	FXE24HR11	6	
37 X	246	VQ37VHR		09/10-	FXE24HR11	3457	1.1	-	-	FXE24HR11	6	
56	309	VK56VD		01/12-	IXEH22TT	4712	1.0	-	IXEH22TT		8	
M30 (89-93)												
3.0	121	VG30E		01/89-12/93	Q16PR-U11	5016	1.1	Q16TT	IQ16TT	IQ16TT	6	
M35 (05-)												
3.5	226	VQ35HR		09/08-12/10	FXE22HR11	3442	1.1	-	IXEH22TT	IXEH22TT	6	
3.5	226	VQ35HR		09/08-12/10	IXEH22TT	4712	1.0	-	IXEH22TT		6	
3.5 Luxury Hybrid	268	VQ35HR		01/10-	FXE22HR11	3442	1.1	-	IXEH22TT	IXEH22TT	6	
3.5 Luxury Hybrid	268	VQ35HR		01/10-	IXEH22TT	4712	1.0	-	IXEH22TT		6	
3.5 X	226	VQ35HR		09/08-12/10	FXE22HR11	3442	1.1	-	IXEH22TT	IXEH22TT	6	
3.5 X	226	VQ35HR		09/08-12/10	IXEH22TT	4712	1.0	-	IXEH22TT		6	
M37 (10-)												
3.7	243	VQ37VHR		01/10-	FXE24HR11	3457	1.1	-	-	FXE24HR11	6	
3.7 Allrad	243	VQ37VHR		01/10-	FXE24HR11	3457	1.1	-	-	FXE24HR11	6	
Q30 (15-)												
1.5 D	80			11/15-	DG-609		4.4V				4	
Q45 I (89-97)												
4.1	205	VH41DE		01/93-12/96	IK16TT	4701	1.0	-	IK16TT	IK16TT	8	
4.5	205	VH45DE		01/89-12/93	IK20TT	4702	1.0	-	IK20TT	IK20TT	8	
Q45 II (97-01)												
4.1	205	VH41DE		01/97-01/01	IK16TT	4701	1.0	-	IK16TT	IK16TT	8	
Q45 III (01-)												
4.5	250	VK45DE		02/01-	IKH16TT	4703	1.0	-	IKH16TT		8	
Q50 (13-)												
50 Hybrid	225/ 268	VQ35HR		04/13-	FXE22HR11	3442	1.1	-	IXEH22TT	IXEH22TT	6	
50 Hybrid	225/ 268	VQ35HR		04/13-	IXEH22TT	4712	1.0	-	IXEH22TT		6	
50 Hybrid AWD	225/ 268	VQ35HR		04/13-	FXE22HR11	3442	1.1	-	IXEH22TT	IXEH22TT	6	
50 Hybrid AWD	225/ 268	VQ35HR		04/13-	IXEH22TT	4712	1.0	-	IXEH22TT		6	
Q60 (13-)												
3.7	235	VQ37VHR		10/13-	FXE24HR11	3457	1.1	-	-	FXE24HR11	6	
Q70 (Y51) (13-)												
3.5 Hybrid	225	VQ35HR		03/13-	FXE22HR11	3442	1.1	-	IXEH22TT	IXEH22TT	6	
3.5 Hybrid	225	VQ35HR		03/13-	IXEH22TT	4712	1.0	-	IXEH22TT		6	
3.7	235	VQ37VHR		03/13-	FXE24HR11	3457	1.1	-	-	FXE24HR11	6	
QX4 (97-)												
3.3	125	VG33E		01/97-	K16PR-U11	3130	1.1	K16TT	IK16TT	IK16TT	6	
QX50 (13-)												
37 AWD	235	VQ37VHR		08/13-	FXE24HR11	3457	1.1	-	-	FXE24HR11	6	
QX56 (10-)												
56	294	VK56VD		01/12-	IXEH22TT	4712	1.0	-	IXEH22TT		8	

Свечи зажигания и Свечи накаливания

Таблица применения

	KW				СТАНДАРТНЫЕ				Twin Tip			QTY
INFINITI продолжение												
QX60 (12-)												
3.5 AWD	195	VQ35DE		04/12-	FXE22HR11	3442	1.1	-	IXEH22TT	IXEH22TT		6
3.5 AWD	195	VQ35DE		04/12-	IXEH22TT	4712	1.0	-	IXEH22TT			6
QX70 (13-)												
3.7 AWD	235	VQ37VHR		08/13-	FXE24HR11	3457	1.1	-	-	FXE24HR11		6
50 AWD	287	VK50VE		08/13-	FXE22HR11	3442	1.1	-	IXEH22TT	IXEH22TT		8
50 AWD	287	VK50VE		08/13-	IXEH22TT	4712	1.0	-	IXEH22TT			8
QX80 (13-)												
5.6 AWD	298	VK56VD		09/13-	IXEH22TT	4712	1.0	-	IXEH22TT			8
INNOCENTI												
ELBA (91-96)												
1.3 (146CW)	49	146 A5.000		08/91-12/96	W20EPR-U	3047	0.8	W20TT	IW20TT	IW20TT		4
1.4 i.e. (146EN, 146EQ)	49	146 C5.000		09/94-12/96	W20EPR-U	3047	0.8	W20TT	IW20TT	IW20TT		4
1.4 i.e. (146EN, 146EQ)	49	146 D5.000		09/94-12/96	K20PR-U	3145	0.8	K20TT	IK20TT	IK20TT		4
1.5 i.e. (146C9)	55	149C1.000		08/92-09/94	W22EPR-U	3088	0.8	W22TT	-	VW22		4
1.6 i.e. (146EO, 146ER)	55	146 C6.000		09/94-12/96	W22EPR-U	3088	0.8	W22TT	-	VW22		4
1.6 i.e. (146EO, 146ER)	55	146 D6.000		09/94-12/96	K22PR-U	3165	0.8	-	IK22TT	VK22		4
1.7 D (146DI, 146EI)	42	146 B2.000	Double Coil Std(LPH)	08/91-12/96	DG-001		11V					4
KORAL (90-92)												
45	33	100GL.000/100GL.064		01/90-12/92	W22EPR-U	3088	0.8	W22TT	-	VW22		4
55	40	128A.000		01/90-12/92	W22EPR-U	3088	0.8	W22TT	-	VW22		4
55	40	146 A6.000		01/90-12/92	W20EPR-U	3047	0.8	W20TT	IW20TT	IW20TT		4
MINI (74-95)												
0.65	23	EF-CL		01/90-01/95	W16EXR-U	3031	0.8	W16TT	IW16TT	IW16TT		3
1.0	32/ 35/39	99H		05/74-02/82	W16EPR-U	3021	0.8	W16TT	IW16TT	IW16TT		4
1.3	47	12H		08/76-02/82	W20EX-U	3062	0.8	W20TT	IW20TT	IW20TT		4
1.3 De Tomaso	51	12H		08/76-02/82	W20EX-U	3062	0.8	W20TT	IW20TT	IW20TT		4
ISH												
2125 (73-97)												
1.5	51	412		06/73-06/97	W22ES-U	3093	0.8	-	-			4
2715 (72-01)												
1.5	49/ 53/ 55/62	408; 412		12/72-12/01	W22ES-U	3093	0.8	-	-			4
1.5 4x4	49/ 53/62	408; 412		12/75-12/01	W22ES-U	3093	0.8	-	-			4
Oda (2717) (97-)												
1.5	53	412		04/85-	W22ES-U	3093	0.8	-	-			4
1.6	56	BA3 2106		01/06-	W20EPR-U	3047	0.8	W20TT	IW20TT	IW20TT		4
1.7	63	VAZ-2121.3		06/05-	W20EPR-U	3047	0.8	W20TT	IW20TT	IW20TT		4
1.8	63	UZAM 3317		01/98-	W22ESR-U	3098	0.8	-	-			4
1.8	79	VAZ-2130		01/98-	W20EPR-U	3047	0.8	W20TT	IW20TT	IW20TT		4
2.0	85	UZAM-3320		01/98-	W20EPR-U	3047	0.8	W20TT	IW20TT	IW20TT		4
ORBITA (2126) (87-)												
1.5	53	412		04/87-	W22ES-U	3093	0.8	-	-			4
1.7 4x4	60	VAZ-2121.3		08/98-	W20EPR-U	3047	0.8	W20TT	IW20TT	IW20TT		4
1.8 4x4	97	UZAM 331		06/00-	W22ESR-U	3098	0.8	-	-			4
ISUZU												
117 (72-76)												
1.8	81	G180; G180-Z		11/72-02/76	W16EX-U	3027	0.8	W16TT	IW16TT	IW16TT		4
CAMPO (77-91)												
2.0	48/ 52/58	4ZC1; G200N; G200Z		04/77-12/88	W16EXR-U11	3032	1.1	W16TT	IW16TT	IW16TT		4
2.0	52/58	4ZC1; G200Z		01/83-12/88	W20EPR-U	3047	0.8	W20TT	IW20TT	IW20TT		4
2.0 4WD	48/ 52/58	4ZC1; G200N; G200Z		04/77-12/88	W16EXR-U11	3032	1.1	W16TT	IW16TT	IW16TT		4
2.0 4WD	52/58	4ZC1; G200Z		01/83-12/88	W20EPR-U	3047	0.8	W20TT	IW20TT	IW20TT		4
2.2	66	4ZD1		01/89-12/90	W20EPR-U11	3049	1.1	W20TT	IW20TT	IW20TT		4
2.2 D	39/45	C223	Single Coil	01/83-08/87	DG-124		11V					4
2.2 D	39/45	C223	Single Coil	09/87-12/91	DG-143		5V					4
2.2 D 4WD	39	C223	Single Coil	01/83-08/87	DG-124		11V					4
2.2 D 4WD	39	C223	Single Coil	09/87-12/90	DG-143		5V					4
2.5 D	55	4JA1		01/83-12/88	DG-001		11V					4
2.5 D 4WD	55	4JA1		01/83-12/88	DG-001		11V					4
D-MAX I (02-12)												
2.5 DiTD	74	4JA1-TC		10/02-06/12	DG-001		11V					4

Свечи зажигания и Свечи накаливания

Таблица применения





Таблица применения

ISUZU	KW	KW	NOTE	21	СТАНДАРТНЫЕ			Twin Tip			QTY
					1	2	3	1	2	3	
ISUZU продолжение											
D-MAX I (02-12) продолжение											
2.5 DiTD	100	4JK1-TC	OE: 0-9820-0051-0; 8-9801-3392-0; 8-9817-4898-0; RP8494;GN095 ; Y-1001J1	10/06-06/12	DG-635		11V				4
2.5 DiTD 4x4	74	4JA1-TC		05/02-06/12	DG-001		11V				4
2.5 DiTD 4x4	100	4JK1-TC	OE: 0-9820-0051-0; 8-9801-3392-0; 8-9817-4898-0; RP8494;GN095 ; Y-1001J1	01/07-06/12	DG-635		11V				4
3.0 D 4x4	120	4JJ1-TC	OE: 0-9820-0051-0; 8-9801-3392-0; 8-9817-4898-0; RP8494;GN095 ; Y-1001J1	01/07-06/12	DG-635		11V				4
3.0 DiTD	120	4JJ1E4C-L; 4JJ1-TC	OE: 0-9820-0051-0; 8-9801-3392-0; 8-9817-4898-0; RP8494;GN095 ; Y-1001J1	01/07-06/12	DG-635		11V				4
3.0 DiTD 4x4	96	4JH1-TC		05/02-06/12	DG-001		11V				4
3.0 DiTD 4x4	120	4JJ1E4C-L; 4JJ1-TC	OE: 0-9820-0051-0; 8-9801-3392-0; 8-9817-4898-0; RP8494;GN095 ; Y-1001J1	01/07-06/12	DG-635		11V				4
FARGO (82-88)											
1.8	56	4ZB1		01/83-12/86	W16EXR-U11	3032	1.1	W16TT	IW16TT	IW16TT	4
2.0	62/69	4ZC1		08/82-12/88	W16EXR-U11	3032	1.1	W16TT	IW16TT	IW16TT	4
FLORIAN (67-83)											
1.6	62/65	G161-A; G161-D		04/67-03/83	W16EXR-U11	3032	1.1	W16TT	IW16TT	IW16TT	4
GEMINI (74-85)											
1.8	81	G180-Z		09/77-12/85	W16EX-U	3027	0.8	W16TT	IW16TT	IW16TT	4
GEMINI (84-90)											
1.5	52/ 56/88	4ZE1		09/84-12/90	W20EXR-U11	3067	1.1	W20TT	IW20TT	IW20TT	4
1.5 D	37	4EC1	Eng:>804794, Single Coil	02/88-11/88	DG-143		5V				4
1.5 D	37	4EC1	Eng:804795>, Single Coil	12/88-12/90	DG-124		11V				4
1.5 TD	49	4EC1T	Single Coil	02/88-11/88	DG-159		5V				4
1.5 TD	49	4EC1T	Single Coil	12/88-12/90	DG-104		11V				4
1.6	93	4XE1		09/88-12/89	K20PR-U11	3121	1.1	K20TT	IK20TT	IK20TT	4
1.6 GTI 16V	84/92	4XE1		03/88-12/90	K20PR-U11	3121	1.1	K20TT	IK20TT	IK20TT	4
GEMINI (90-93)											
1.5	73	4ZE1		01/90-12/93	W16EXR-U11	3032	1.1	W16TT	IW16TT	IW16TT	4
1.5 i	73	4ZE1		01/90-12/93	W16EXR-U11	3032	1.1	W16TT	IW16TT	IW16TT	4
1.6	97	4XE1-WU		01/90-12/93	K20PR-U11	3121	1.1	K20TT	IK20TT	IK20TT	4
1.6	132	4XE1-WUT		01/90-12/93	K20PR-U	3145	0.8	K20TT	IK20TT	IK20TT	4
1.6 i	71/97	4XE1-V; 4XE1-WU		01/90-12/93	K20PR-U11	3121	1.1	K20TT	IK20TT	IK20TT	4
1.6 i Turbo	132	4XE1-WUT		01/90-12/93	K20PR-U	3145	0.8	K20TT	IK20TT	IK20TT	4
1.8	105	4XF1		01/90-12/93	K20PR-U11	3121	1.1	K20TT	IK20TT	IK20TT	4
IMPULSE (90-93)											
1.6	71/97	4XE1-V		01/90-12/93	K20PR-U11	3121	1.1	K20TT	IK20TT	IK20TT	4
1.6	120	4XE1-XUT		01/90-12/93	K20PR-U	3145	0.8	K20TT	IK20TT	IK20TT	4
KB (80-90)											
2.0 4WD	52	4ZC1		01/83-03/88	W16EXR-U11	3032	1.1	W16TT	IW16TT	IW16TT	4
KB (02-)											
3.0 D-TEQ 4WD	120	4JJ1-TC	OE: 0-9820-0051-0; 8-9801-3392-0; 8-9817-4898-0; RP8494;GN095 ; Y-1001J1	08/10-	DG-635		11V				4

Свечи зажигания и Свечи накаливания

Таблица применения





Таблица применения

	KW				СТАНДАРТНЫЕ			Twin Tip			QTY
ISUZU продолжение											
MIDI (88-96)											
2.0	61	4ZC1		06/88-08/92	W16EXR-U11	3032	1.1	W16TT	IW16TT	IW16TT	4
2.0	61	4ZC1		06/88-08/92	W20EPR-U	3047	0.8	W20TT	IW20TT	IW20TT	4
2.0 4WD	61	4ZC1		06/88-08/92	W16EXR-U11	3032	1.1	W16TT	IW16TT	IW16TT	4
2.0 4WD	61	4ZC1		06/88-08/92	W20EPR-U	3047	0.8	W20TT	IW20TT	IW20TT	4
2.0 TD	51	4FC1T	Single Coil	01/89-08/92	DG-104		11V				4
2.0 TD	51	4FC1T	Single Coil	01/89-08/92	DG-159		5V				4
2.2 D	45	4FD1	Single Coil	06/88-08/92	DG-104		11V				4
2.2 D 4WD	45	4FD1	Single Coil	06/88-08/92	DG-104		11V				4
2.4 D	56	4FG1T	Single Coil	01/94-07/96	DG-104		11V				4
2.4 D	56	4FG1T	Single Coil	01/94-07/96	DG-159		5V				4
2.4 TD	56	4FG1T	Single Coil	09/92-07/96	DG-104		11V				4
2.4 TD	56	4FG1T	Single Coil	09/92-07/96	DG-159		5V				4
MU (89-02)											
2.6 4x4	89	4ZE1		02/89-07/94	W16EXR-U11	3032	1.1	W16TT	IW16TT	IW16TT	4
PIAZZA (81-90)											
2.0	99	G200W		06/81-02/89	W20EXR-U11	3067	1.1	W20TT	IW20TT	IW20TT	4
2.0 Turbo	104	4ZC1-T		06/85-12/90	IW20TT	4709	1.0	-	IW20TT		4
2.0 Turbo	104/110	4ZC1-T		06/85-12/90	W20EXR-U11	3067	1.1	W20TT	IW20TT	IW20TT	4
PICK UP (87-96)											
2.3	70	4ZD1		10/87-08/96	W20EPR-U	3047	0.8	W20TT	IW20TT	IW20TT	4
2.3 4x4	70	4ZD1		10/87-08/96	W20EPR-U11	3049	1.1	W20TT	IW20TT	IW20TT	4
2.6 LS	84/90	4ZE1		10/87-08/96	W16EXR-U11	3032	1.1	W16TT	IW16TT	IW16TT	4
2.6 LS	84/90	4ZE1		10/87-08/96	W20EPR-U	3047	0.8	W20TT	IW20TT	IW20TT	4
TFR / TFS (88-02)											
2.3	110	F23A7		09/94-08/99	KJ16CR-L11	3132	1.1	K16TT	IK16TT	IK16TT	4
3.5	158	6VE1		09/95-12/02	IK16TT	4701	1.0	-	IK16TT	IK16TT	6
3.5	158	6VE1		09/95-12/02	K16TT	4603	1.0	K16TT	IK16TT	IK16TT	6
3.5	158	6VE1		09/95-12/02	PK16PR11	3264	1.1	K16TT	IK16TT	IK16TT	6
3.5 4WD	158	6VE1		09/95-12/02	IK16TT	4701	1.0	-	IK16TT	IK16TT	6
3.5 4WD	158	6VE1		09/95-12/02	K16TT	4603	1.0	K16TT	IK16TT	IK16TT	6
3.5 4WD	158	6VE1		09/95-12/02	PK16PR11	3264	1.1	K16TT	IK16TT	IK16TT	6
TROOPER I (83-91)											
2.0	58	G200Z		01/83-12/85	W16EXR-U11	3032	1.1	W16TT	IW16TT	IW16TT	4
2.0	58	G200Z		01/83-12/85	W20EPR-U	3047	0.8	W20TT	IW20TT	IW20TT	4
2.2 D	45	C223-T	Single Coil	01/83-12/83	DG-124		11V				4
2.2 D 4WD	39	C223	Single Coil	05/84-07/87	DG-143		5V				4
2.2 D 4WD	39	C223	Single Coil	08/87-12/89	DG-124		11V				4
2.2 D 4x4	39	C223	Single Coil	05/84-07/87	DG-143		5V				4
2.2 D 4x4	39	C223	Single Coil	08/87-07/89	DG-124		11V				4
2.2 TD	53	C223-T	Single Coil	03/84-07/87	DG-143		5V				4
2.2 TD	53	C223-T	Single Coil	08/87-12/91	DG-124		11V				4
2.3	66	4ZD1		11/85-12/91	W20EPR-U	3047	0.8	W20TT	IW20TT	IW20TT	4
2.6 4WD	85	4ZE1		11/86-07/91	W16EXR-U11	3032	1.1	W16TT	IW16TT	IW16TT	4
2.6 4WD	85	4ZE1		11/86-07/91	W20EPR-U11	3049	1.1	W20TT	IW20TT	IW20TT	4
2.6 i	85	4ZE1		10/87-12/91	W16EXR-U11	3032	1.1	W16TT	IW16TT	IW16TT	4
2.6 i	85	4ZE1		10/87-12/91	W20EX-U	3062	0.8	W20TT	IW20TT	IW20TT	4
2.8 TD	71/78	4JB1-T; 4JB1-TC	Double Coil(LPH)	10/87-12/91	DG-108		11V				4
TROOPER II (91-98)											
3.1 TD	84	4JG2 T		08/91-12/97	DG-104		11V				4
3.2	130	6VD1 (SOHC)		08/91-07/98	K16TT	4603	1.0	K16TT	IK16TT	IK16TT	6
3.2	130	6VD1 (SOHC)		08/91-07/98	PK16PR11	3264	1.1	K16TT	IK16TT	IK16TT	6
3.2	130	6VD1 (SOHC); 6VDI		08/91-07/98	IK16TT	4701	1.0	-	IK16TT	IK16TT	6
3.2	130	6VDI		07/95-07/98	K20PR-U11	3121	1.1	K20TT	IK20TT	IK20TT	6
TROOPER III (98-04)											
3.0 DTI	117	4JX1; 4JX1T	Double Coil(LPH)	05/98-08/04	DG-186		11V				4
3.5 V6 24V	158	6VE1		04/00-08/04	IK16TT	4701	1.0	-	IK16TT	IK16TT	6
3.5 V6 24V	158	6VE1		04/00-08/04	K16TT	4603	1.0	K16TT	IK16TT	IK16TT	6
3.5 V6 24V	158	6VE1		04/00-08/04	PK16PR11	3264	1.1	K16TT	IK16TT	IK16TT	6
3.5 V6 24V	158	6VE1		01/03-08/04	PK16PR-L11	3275	1.1	-	IK16TT	IK16TT	6
3.5 V6 24V AWD	158	6VE1		04/00-08/04	IK16TT	4701	1.0	-	IK16TT	IK16TT	6
3.5 V6 24V AWD	158	6VE1		04/00-08/04	K16TT	4603	1.0	K16TT	IK16TT	IK16TT	6
3.5 V6 24V AWD	158	6VE1		04/00-08/04	PK16PR11	3264	1.1	K16TT	IK16TT	IK16TT	6
3.5 V6 24V AWD	158	6VE1		01/03-08/04	PK16PR-L11	3275	1.1	-	IK16TT	IK16TT	6

Свечи зажигания и Свечи накаливания











Таблица применения

Таблица применения

	KW				СТАНДАРТНЫЕ			Twin Tip			QTY
ISUZU продолжение											
VEHICROSS (97-00)											
3.2 4x4	158	6VD1 (DOHC)		04/97-12/00	IK16TT	4701	1.0	-	IK16TT	IK16TT	6
3.2 4x4	158	6VD1 (DOHC)		04/97-12/00	K16TT	4603	1.0	K16TT	IK16TT	IK16TT	6
3.2 4x4	158	6VD1 (DOHC)		04/97-12/00	PK16PR11	3264	1.1	K16TT	IK16TT	IK16TT	6
WIZARD (98-02)											
3.2 4x4	158	6VD1 (DOHC)		06/98-08/02	IK16TT	4701	1.0	-	IK16TT	IK16TT	6
3.2 4x4	158	6VD1 (DOHC)		06/98-08/02	K16TT	4603	1.0	K16TT	IK16TT	IK16TT	6
3.2 4x4	158	6VD1 (DOHC)		06/98-08/02	PK16PR11	3264	1.1	K16TT	IK16TT	IK16TT	6
IVECO											
DAILY I (78-89)											
2.4 D	68	8140.21.200		01/85-12/89	DG-111		11V				4
DAILY II (89-99)											
2.5 D	60	8140.67F.; 8140.67F.3701; 8140.67F.3710; 8140.67F.3711; 8140.67F.3713; 8140.67F.3721		04/96-08/98	DG-111		11V				4
2.5 D	68	8140.97.2781		01/89-03/96	DG-001		11V				4
2.8 D	62	8140.63		09/98-05/99	DG-111		11V				4
DAILY III (97-06)											
2.3 29 L 10	70	F1AE0481A		09/02-04/06	DG-195		11V				4
2.3 29 L 10 V	70	F1AE0481A		09/02-07/07	DG-195		11V				4
2.3 29 L 12	85	F1AE0481B		09/02-04/06	DG-195		11V				4
2.3 29 L 12 V	85	F1AE0481B		09/02-07/07	DG-195		11V				4
2.3 29 L 14	100	F1AE0481M		11/05-04/06	DG-195		11V				4
2.3 35 C 10 V, 35 S 10 V	70	F1AE0481A		09/02-04/06	DG-195		11V				4
2.3 35 C 12, 35 S 12	85	F1AE0481B		09/02-04/06	DG-195		11V				4
2.3 35 C 12 V, 35 S 12 V	85	F1AE0481B		09/02-07/07	DG-195		11V				4
2.3 35 S 10	70	F1AE0481A		09/02-07/07	DG-195		11V				4
2.3 D	85	F1AE0481B	Double Coil(LPH)	01/03-05/06	DG-195		11V				4
2.3 D	100	F1AE0481M		01/05-04/06	DG-195		11V				4
2.8 D	62/ 107	8140.43N; 8140.63		05/99-07/07	DG-111		11V				4
2.8 D	66/ 78/ 92/ 107	8140.43B; 8140.43C; 8140.43N; 8140.43R; 8140.43S	Double Coil(LPH)	05/99-07/07	DG-111		11V				4
3.0 D	100/ 122	F1CE0481A; F1CE0481B		07/99-04/06	DG-195		11V				4
3.0 D	100/ 122	F1CE0481A; F1CE0481B	Double Coil(LPH)	01/04-05/06	DG-195		11V				4
DAILY IV (06-11)											
2.3 D	70/ 78/ 85/ 93/ 100	F1AE0481FA; F1AE0481GA; F1AE0481HA		05/06-08/11	DG-195		11V				4
3.0 D	103/ 107/ 110/ 125/ 130	F1CE0481FA; F1CE0481HA; F1CE0481HC; F1CE0481L; F1CE3481LC		05/06-08/11	DG-195		11V				4
3.0 D	125	F1CE3481C	Double Coil(LPH)	08/07-03/12	DG-195		11V				4
DAILY V (11-14)											
2.3 D	78/ 93/ 107	F1AE3481A; F1AE3481B; F1AE3481C		09/11-02/14	DG-195		11V				4
3.0 D	107/ 125/ 150	F1CE3481B; F1CE3481C; F1CE3481D; F1CE3481J; F1CE3481K; F1CE3481L		09/11-02/14	DG-195		11V				4
MASSIF (08-11)											
3.0 HPI	107	F1CE0481FA		10/08-02/11	DG-195		11V				4
3.0 HPT	130	F1CE0481HA		10/08-02/11	DG-195		11V				4
JAGUAR											
E-TYPE 2+2 (66-75)											
4.2	127/ 195			06/66-04/75	W16EPR-U	3021	0.8	W16TT	IW16TT	IW16TT	6
5.3 V12	203			03/71-04/75	W16EPR-U	3021	0.8	W16TT	IW16TT	IW16TT	12

Свечи зажигания и Свечи накаливания

Таблица применения

	KW				СТАНДАРТНЫЕ			Twin Tip			QTY
											
JAGUAR продолжение											
E-TYPE (61-75)											
4.2	127/ 195/ 198	8L (85-87); XK 4.2 (82-87)		05/64-04/75	W16EPR-U	3021	0.8	W16TT	IW16TT	IW16TT	6
5.3 V12	203			03/71-04/75	W16EPR-U	3021	0.8	W16TT	IW16TT	IW16TT	12
Mk X (61-70)											
4.2	198			09/61-07/68	W16EPR-U	3021	0.8	W16TT	IW16TT	IW16TT	6
420	183			09/67-10/69	W16EPR-U	3021	0.8	W16TT	IW16TT	IW16TT	6
420G	190	7L		09/66-10/70	W16EPR-U	3021	0.8	W16TT	IW16TT	IW16TT	6
S-TYPE (99-08)											
2.5 V6	147	AJ25; JB (AJ-V6)		04/02-10/07	T20TT	4617	1.0	T20TT	IT20TT	IT20TT	6
2.7 D	152	AJD		06/04-10/07	DG-140		11V				6
3.0 V6	175	AJ-V6; FB		01/99-10/07	T20TT	4617	1.0	T20TT	IT20TT	IT20TT	6
4.0 V8	203	AJ-V8		01/99-04/02	PK16PR-L11	3275	1.1	-	IK16TT	IK16TT	8
4.2 R	291	AJ8FT		04/02-10/07	ZT20EPR11	5087	1.1	T20TT	IT20TT	IT20TT	8
4.2 V8	219	AJ8FT		04/02-10/07	ZT20EPR11	5087	1.1	T20TT	IT20TT	IT20TT	8
XF (08-15)											
2.0	177	204PT	40000km Lifetime	06/12-04/15	ITV22	5340	0.8	-	-		4
2.2 D	120/ 140/ 147	224DT	OE: JDE13601	04/11-04/15	DG-632		5V				4
2.7 D	152	AJD		03/08-03/09	DG-140		11V				6
3.0	175	AJ6WG		03/08-04/15	T20TT	4617	1.0	T20TT	IT20TT	IT20TT	6
4.2	219	SV82G		03/08-03/09	SK16PR-A11	3356	1.1	-	IK16TT	IK16TT	8
4.2 Kompressor	306	SV8TS		03/08-03/09	SK16PR-A11	3356	1.1	-	IK16TT	IK16TT	8
5.0	283	AJ-V8-5.0		03/09-04/15	SK16PR-A11	3356	1.1	-	IK16TT	IK16TT	8
5.0 Kompressor	375	AJ-V8-5.0C		03/09-04/15	SK16PR-A11	3356	1.1	-	IK16TT	IK16TT	8
XJ (68-93)											
4.2 6	124/ 127/ 130/ 133/ 137/ 151	8L (85-87); XK 4.2 (-79); XK 4.2 (82-87)		10/69-12/87	W16EPR-U	3021	0.8	W16TT	IW16TT	IW16TT	6
5.3 V12	187	7P		08/86-09/89	T22EP-U	5040	0.8	-	-		12
5.3 V12	187/ 198/ 211	7P; V 12 (75-79)		06/72-02/93	W16EPR-U	3021	0.8	W16TT	IW16TT	IW16TT	12
5.3 V12 H.E.	217	7P; 8S (86-88)		05/81-12/92	T22EP-U	5040	0.8	-	-		12
5.3 V12 Sovereign	194/ 197	7P; V 12 (90- 93, 197KW)		07/85-12/92	T22EP-U	5040	0.8	-	-		12
XJ (86-94)											
3.2 6	146	9BPMNA		09/90-11/94	Q20PR-U	3007	0.8	Q20TT	IQ20TT	IQ20TT	6
4.0 6	163	9EPCNA		09/89-11/94	K20PR-U	3145	0.8	K20TT	IK20TT	IK20TT	6
XJ (94-97)											
3.2 6	155	9JPGRB		11/94-07/97	Q20PR-U	3007	0.8	Q20TT	IQ20TT	IQ20TT	6
4.0 6 Sovereign	177	9JPF RB		09/94-07/97	K20PR-U	3145	0.8	K20TT	IK20TT	IK20TT	6
4.0 R Supercharger	235	9KPD RB		11/94-07/97	K22PR-U	3165	0.8	-	IK22TT	VK22	6
6.0 V12	229	8E		09/94-09/97	T20EPR-U	5032	0.8	T20TT	IT20TT	IT20TT	12
XJ (97-03)											
3.2	174			07/97-03/98	IK20TT	4702	1.0	-	IK20TT	IK20TT	8
3.2	174			07/97-05/03	PK16PR-L11	3275	1.1	-	IK16TT	IK16TT	8
4.0	209	BC		07/97-05/03	SK16PR-A11	3356	1.1	-	IK16TT	IK16TT	8
4.0	267	AJ-V8-4.0R(363)	Ch: 878717>	07/97-05/03	PK20PR-L13	3172	1.3	-	IK20TT	IK20TT	8
XJ (03-09)											
3.0	175/ 179	AJ-V6		05/03-03/09	T20TT	4617	1.0	T20TT	IT20TT	IT20TT	6
3.6	190	RG (AJ-V8)		05/03-03/09	SK16PR-A11	3356	1.1	-	IK16TT	IK16TT	8
4.2	219	AJ8FT		05/03-03/09	SK16PR-A11	3356	1.1	-	IK16TT	IK16TT	8
4.2 R	291	AJ8FT; AJ33SC		03/03-03/09	SK16PR-A11	3356	1.1	-	IK16TT	IK16TT	8
D 2.7	152	AJD		10/05-03/09	DG-140		11V				6
XJ (09-)											
2.0 Ti4	177	204PT	40000km Lifetime	05/12-	ITV22	5340	0.8	-	-		4
5.0 SCV8	346	508PS	Ch: B16769>	10/09-	SK16PR-A11	3356	1.1	-	IK16TT	IK16TT	8
5.0 SCV8	375	AJ-V8-5.0C		10/09-	SK16PR-A11	3356	1.1	-	IK16TT	IK16TT	8
5.0 V8	283	AJ-V8-5.0	Ch: B16769>	10/09-	SK16PR-A11	3356	1.1	-	IK16TT	IK16TT	8
XJ Coupe (73-96)											
3.6	162	AJ 6 (3.6, 162KW)		10/83-12/88	K20PR-U	3145	0.8	K20TT	IK20TT	IK20TT	6
4.0	163	9EPCNA		05/91-09/94	Q20PR-U	3007	0.8	Q20TT	IQ20TT	IQ20TT	6

Свечи зажигания и Свечи накаливания











Таблица применения

Таблица применения

KW	KW	NOTE	21	СТАНДАРТНЫЕ			Twin Tip			QTY	
				STANDARD	1mm	⚡	T20TT	IT20TT	IT20TT		
JAGUAR продолжение											
XJ Coupe (73-96) продолжение											
5.3	197/202/207/211/213	8C (88-92); 8S (92-93); V 12 (90-93, 197KW); V 12 (90-93, 211KW)		09/73-08/93	T22EP-U	5040	0.8	-	-	12	
5.3 H.E.	194/217	8S (86-88); V 12 (82-90)		07/81-09/92	T22EP-U	5040	0.8	-	-	12	
6.0	222	8D		11/94-03/96	T20EPR-U	5032	0.8	T20TT	IT20TT	12	
6.0	222/238/248	8C (92-94); 8D		09/89-11/94	T22EP-U	5040	0.8	-	-	12	
XJSC (85-96)											
5.3	197/202/207/211	8C (88-92); 8S (92-93); V 12 (90-93, 197KW); V 12 (90-93, 211KW)		01/86-08/93	T22EP-U	5040	0.8	-	-	12	
5.3 H.E.	194/217	8S (86-88); V 12 (82-90)		07/85-05/92	T22EP-U	5040	0.8	-	-	12	
6.0	222	8D		05/93-11/94	T22EP-U	5040	0.8	-	-	12	
6.0	222	8D		11/94-03/96	T20EPR-U	5032	0.8	T20TT	IT20TT	12	
XK 8 (96-05)											
4.0	209/216	AJ26; AJ27; AJ-V8; CC; CE		03/96-07/05	PK16PR-L11	3275	1.1	-	IK16TT	IK16TT	8
4.0	267	EC		02/98-07/05	PK20PR-L13	3172	1.3	-	IK20TT	IK20TT	8
4.0 XKR	276	AJ27S		05/98-07/05	PK20PR-L13	3172	1.3	-	IK20TT	IK20TT	8
4.2	219	AJ8FT		08/02-07/05	PK20PR-L13	3172	1.3	-	IK20TT	IK20TT	8
4.2	219	AJ8FT		08/02-12/06	SK16PR-A11	3356	1.1	-	IK16TT	IK16TT	8
4.2 R	291	AJ8FT		08/02-07/05	ZT20EPR11	5087	1.1	T20TT	IT20TT	8	
4.2 R	291	AJ8FT		08/02-12/06	SK16PR-A11	3356	1.1	-	IK16TT	IK16TT	8
XK (06-14)											
4.2 XK8	219	AJ8FT		03/06-07/14	SK16PR-A11	3356	1.1	-	IK16TT	IK16TT	8
4.2 XKR	306	SV8TS		03/06-07/14	SK16PR-A11	3356	1.1	-	IK16TT	IK16TT	8
5.0 V8	283	AJ-V8-5.0	Ch: B16769>	01/09-07/14	SK16PR-A11	3356	1.1	-	IK16TT	IK16TT	8
X-TYPE (01-09)											
2.0 D	96	FMBA; FMBB; R4-X404	Double Coil(LPH)	07/03-12/09	DG-130		11.5V			4	
2.1 V6	115	YB (AJ-V6)		03/02-11/09	T20TT	4617	1.0	T20TT	IT20TT	6	
2.2 D	107/110/114	QJBA		10/05-12/09	DG-130		11.5V			4	
2.5	144	XB (AJ-V6)		02/04-12/09	T20TT	4617	1.0	T20TT	IT20TT	6	
2.5 V6 AWD	144	XB (AJ-V6)		06/01-11/09	T20TT	4617	1.0	T20TT	IT20TT	6	
3.0	169	AJ-V6		02/04-12/09	T20TT	4617	1.0	T20TT	IT20TT	6	
3.0 V6 AWD	169	AJ-V6		06/01-12/08	T20TT	4617	1.0	T20TT	IT20TT	6	
JEEP											
CHEROKEE (KL) (13-)											
2.0 CRD 4x4	125	EBS; EBT	OE: 68021306AA/ 68021306AB, 6809621AA	04/14-08/18	DG-190		4.4V			4	
CHEROKEE (XJ) (84-01)											
2.1 TD	59/64	J8S	Double Coil Standard	06/89-09/01	DG-006		11V			4	
2.1 TD	59/64	J8S	Double Coil(LPH)	10/84-03/92	DG-001		11V			4	
2.5	89	EPE		10/86-09/01	KJ16CR-L11	3132	1.1	K16TT	IK16TT	4	
2.5 4x4	87/89	EPE		10/84-09/90	KJ16CR-L11	3132	1.1	K16TT	IK16TT	4	
2.5 i 4x4	87/90	EPE; HX		10/84-09/01	KJ16CR-L11	3132	1.1	K16TT	IK16TT	4	
2.5 SE	87	EPE		10/96-09/99	KJ16CR-L11	3132	1.1	K16TT	IK16TT	4	
2.5 TD 4x4	85	ENC	Double Coil(LPH)	01/88-12/95	DG-001		11V			4	
2.5 Tdi 4x4	85	ENC		01/97-09/01	DG-109		11V			4	
2.5 Tdi 4x4	85	ENC	Double Coil(LPH)	10/96-12/96	DG-001		11V			4	
4.0	131	M400L		10/86-09/90	K20PR-U	3145	0.8	K20TT	IK20TT	6	
4.0 4x4	131	M400L		10/86-09/90	K20PR-U	3145	0.8	K20TT	IK20TT	6	
4.0 i	127/135	ERH; MX		01/88-09/01	KJ16CR-L11	3132	1.1	K16TT	IK16TT	6	
4.0 i 4x4	131	ERH		01/95-09/01	KJ16CR-L11	3132	1.1	K16TT	IK16TT	6	
CHEROKEE / LIBERTY (KJ) (01-08)											
2.4 4x4	108	ED1		09/01-09/03	ITL16TT	4717	1.0	-	ITL16TT	4	

Свечи зажигания и Свечи накаливания





Таблица применения

	KW				СТАНДАРТНЫЕ			Twin Tip			QTY
											
JEEP продолжение											
CHEROKEE / LIBERTY (KJ) (01-08) продолжение											
2.5 CRD 4x4	105	R 425 DOHC	Double Coil(LPH)	09/01-01/08	DG-176		11.5V				4
2.8 CRD 4x4	110/120	ENR		11/02-12/06	DG-176		11.5V				4
2.8 CRD 4x4	110/120	ENR	OE:68029497A A	01/07-01/08	DG-633		4.4V				4
2.8 CRD 4x4	110/120	ENR	OE: 68090 434AA, application unsure	11/02-01/08	DG-660		5V				4
3.7 4x4	150/155	EKG		09/01-01/08	KJ20CR-L11	3169	1.1	K20TT	IK20TT	IK20TT	6
3.7 Laredo	150	EKG		10/01-09/04	KJ20CR-L11	3169	1.1	K20TT	IK20TT	IK20TT	6
CHEROKEE / LIBERTY (KK) (08-)											
2.8 CRD 4x4	130	ENS	OE:68029497A A	05/08-	DG-633		4.4V				4
3.7 V6	157	EKG		01/08-	KJ20CR-L11	3169	1.1	K20TT	IK20TT	IK20TT	6
3.7 V6 4x4	151	EKG-204		01/08-01/09	KJ20CR-L11	3169	1.1	K20TT	IK20TT	IK20TT	6
3.7 V6 All-wheel Drive	157	EKG		01/08-08/12	KJ20CR-L11	3169	1.1	K20TT	IK20TT	IK20TT	6
CHEROKEE (80-86)											
2.5	81			10/83-09/86	QJ16HR-U	5018	0.9	-	-		4
5.9 4x4	128			10/80-09/86	W16EPR-U	3021	0.8	W16TT	IW16TT	IW16TT	8
CJ5 - CJ8 (66-87)											
2.5	78			01/84-12/87	KJ16CR-L11	3132	1.1	K16TT	IK16TT	IK16TT	4
4.2	76			01/72-12/87	QJ16CR11	3295	1.1	Q16TT	IQ16TT	IQ16TT	6
COMANCHE (86-96)											
2.5	90	EPE		10/86-09/90	KJ16CR-L11	3132	1.1	K16TT	IK16TT	IK16TT	4
2.5 4x4	90	EPE		10/86-09/90	KJ16CR-L11	3132	1.1	K16TT	IK16TT	IK16TT	4
COMMANDER (05-10)											
3.0 CRD 4x4	160	EXL		04/06-04/10	DG-194		4.4V				6
3.7 V6 4x4	157	EKG		09/05-12/10	KJ20CR-L11	3169	1.1	K20TT	IK20TT	IK20TT	6
4.7 V8 4x4	170	EVA-231		09/05-12/10	KJ16CR-L11	3132	1.1	K16TT	IK16TT	IK16TT	8
5.7 V8 4x4	240	EZB		09/05-12/10	ITL16TT	4717	1.0	-	ITL16TT		8
COMPASS (06-)											
2.0	115	ECN		05/11-	KJ16CR-U11	3311	1.1	K16TT	IK16TT	IK16TT	4
2.0 CRD	103	ECD; ECE		08/06-	DG-190		4.4V				4
2.0 CRD 4x4	103	ECE		09/06-	DG-190		4.4V				4
2.4	125	ED3; EDG		08/06-	KJ16CR-U11	3311	1.1	K16TT	IK16TT	IK16TT	4
2.4 4x4	125	ED3		09/06-	KJ16CR-U11	3311	1.1	K16TT	IK16TT	IK16TT	4
Grand CHEROKEE I (91-99)											
2.5 TD 4x4	85	ENC	88900716	10/95-04/99	DG-109		11V				4
4.0 i 4x4	130/132/135	ERH; MX; S01		09/91-04/99	KJ20CR-L11	3169	1.1	K20TT	IK20TT	IK20TT	6
4.0 Laredo	131	ERH		10/96-09/98	KJ20CR-L11	3169	1.1	K20TT	IK20TT	IK20TT	6
5.2	164	ELF		10/96-09/98	QJ16HR-U	5018	0.9	-	-		8
5.2 4x4	156/164	ELF; Y01		10/95-04/99	QJ16HR-U	5018	0.9	-	-		8
5.2 i 4x4	155/158	ELF; Y		01/92-04/99	QJ16HR-U	5018	0.9	-	-		8
5.2 Limited 4x4	136	ELF		10/96-09/98	QJ16HR-U	5018	0.9	-	-		8
5.9 i 4x4	177	JEEO2		08/97-04/99	QJ16HR-U	5018	0.9	-	-		8
Grand CHEROKEE II (98-05)											
2.7 CRD 4x4	120	ENF	Double Coil(LPH)	10/01-09/05	DG-109		11V				5
3.1 TD 4x4	103	EXA	OE: 5175756AA	04/99-12/01	DG-194		4.4V				5
3.1 TD 4x4	103	EXA	OE: 88900716	04/99-12/01	DG-109		11V				5
4.0	140	ERH		10/98-09/04	KJ16CR-L11	3132	1.1	K16TT	IK16TT	IK16TT	6
4.0 4x4	140	ERH		04/99-09/05	KJ16CR-L11	3132	1.1	K16TT	IK16TT	IK16TT	6
4.7 V8 4x4	162/164	EVA	Flexible fuel	04/99-04/03	IK20TT	4702	1.0	-	IK20TT	IK20TT	8
4.7 V8 4x4	162/167/190	EVA; EVC		04/99-09/05	KJ16CR-L11	3132	1.1	K16TT	IK16TT	IK16TT	8
Grand CHEROKEE III (05-10)											
3.0 CRD 4x4	155/160	EXL		06/05-12/10	DG-194		4.4V				6
3.7 V6 4x4	148/157	EKG		10/04-12/10	KJ20CR-L11	3169	1.1	K20TT	IK20TT	IK20TT	6
4.7 V8 4x4	170	EVA-231		06/05-05/07	KJ16CR-L11	3132	1.1	K16TT	IK16TT	IK16TT	8
5.7	240	EZB		06/05-12/08	ITL16TT	4717	1.0	-	ITL16TT		8

Свечи зажигания и Свечи накаливания











Таблица применения

Таблица применения

	KW				СТАНДАРТНЫЕ				Twin Tip			QTY
												
JEEP продолжение												
Grand CHEROKEE III (05-10) продолжение												
5.7 V8 4x4	240/ 259	EZB; EZD/EZH		06/05-12/10	ITL16TT	4717	1.0	-	ITL16TT			8
5.7 V8 4x4	259	EZD; EZH	Twin Spark	01/09-12/10	K16HPR-U11	6076	1.1	KH16TT	IKH16TT	IKH16TT		16
6.1 SRT8 4x4	313	ESF		03/06-12/10	ITL20	5350	1.1	-	-			16
Grand CHEROKEE IV (10-)												
3.0 CRD	179	EXF	OE:68211173A A	09/13-	DG-620		7V					6
3.0 CRD V6 4x4	140/ 177/ 184	EXF	OE:68211173A A	02/11-	DG-620		7V					6
3.6 V6 4x4	210	ERB	Check Thread size	11/10-	ITV20TT	4719	1.0	-	ITV20TT			6
3.6 V6 4x4	210	ERB	Check Thread size	11/10-	SXU22HCR11S	3461	1.1	-	-	VXUHC22G		6
3.6 V6 FlexFuel 4x4	210	ERB	Check Thread size	11/10-	ITV20TT	4719	1.0	-	ITV20TT			6
3.6 V6 FlexFuel 4x4	210	ERB	Check Thread size	11/10-	SXU22HCR11S	3461	1.1	-	-	VXUHC22G		6
3.6 VVT 4x4	213	ERB	Check Thread size	04/16-	ITV20TT	4719	1.0	-	ITV20TT			6
3.6 VVT 4x4	213	ERB	Check Thread size	04/16-	SXU22HCR11S	3461	1.1	-	-	VXUHC22G		6
5.7 V8 4x4	259	EZH		11/10-	ITL16TT	4717	1.0	-	ITL16TT			16
5.7 V8 4x4	259	EZH	Twin Spark	11/10-	K16HPR-U11	6076	1.1	KH16TT	IKH16TT	IKH16TT		16
6.4 SRT8 4x4	344	ESG		03/11-	ITL20	5350	1.1	-	-			16
PATRIOT (07-)												
2.0 CRD	103	ECD; ECE	Particle filter(-)	02/07-12/17	DG-190		4.4V					4
2.0 CRD 4x4	103	ECD; ECE	Particle filter(-)	02/07-12/17	DG-190		4.4V					4
2.4	125	ED3; EDG		06/09-12/17	KJ16CR-U11	3311	1.1	K16TT	IK16TT	IK16TT		4
2.4 4x4	125	ED3; EDG		01/08-12/17	KJ16CR-U11	3311	1.1	K16TT	IK16TT	IK16TT		4
2.4 Eco + 4x4	125	ED3		07/08-12/17	IK16TT	4701	1.0	-	IK16TT	IK16TT		4
2.4 Eco + 4x4	125	ED3		07/08-12/17	KJ16CR-U11	3311	1.1	K16TT	IK16TT	IK16TT		4
RENEGADE (14-)												
1.4	103	55263624; EAM	40000km Lifetime	07/14-	IXU27	5337	0.9	-	-			4
1.4 4x4	125	55263623; EAM	40000km Lifetime	07/14-	IXU27	5337	0.9	-	-			4
1.6 CRD	88	55263113; EJK		07/14-	DG-608		4.4V					4
2.0 CRD 4x4	103/ 125	55263087; 55263088; EBT		07/14-	DG-608		4.4V					4
WRANGLER I (86-96)												
2.5	76/89	EPE		01/88-08/96	KJ16CR-L11	3132	1.1	K16TT	IK16TT	IK16TT		4
4.0	131	ERH		12/91-08/96	KJ16CR-L11	3132	1.1	K16TT	IK16TT	IK16TT		6
4.2	84	6L <C 2V>		08/86-08/89	QJ16AR-U	3235	0.8	-	-			6
4.2 2WD	82			10/86-09/90	QJ16AR-U	3235	0.8	-	-			6
WRANGLER II (96-08)												
2.4	105	ED		11/02-04/07	ITL16TT	4717	1.0	-	ITL16TT			4
2.5	87	P00		08/96-04/07	KJ16CR-L11	3132	1.1	K16TT	IK16TT	IK16TT		4
4.0	124/ 130	ERH(169)		08/96-04/07	KJ16CR-L11	3132	1.1	K16TT	IK16TT	IK16TT		6
4.0 Rubicon	128	ERH-177		08/03-04/07	KJ16CR-L11	3132	1.1	K16TT	IK16TT	IK16TT		6
WRANGLER III (07-)												
2.8 CRD	130	ENS	OE:68029497A A	04/07-	DG-633		4.4V					4
2.8 CRD RWD	130	ENS	OE:68029497A A	04/07-02/10	DG-633		4.4V					4
3.6 V6	209	ERB	Check Thread size	10/11-	ITV20TT	4719	1.0	-	ITV20TT			6
3.6 V6	209	ERB	Check Thread size	10/11-	SXU22HCR11S	3461	1.1	-	-	VXUHC22G		6
3.8	146	EGT		04/07-	ITL20	5350	1.1	-	-			6
KIA												
AVELLA (95-01)												
1.3	55	B3		11/95-12/01	W16EPR-U11	3201	1.1	W16TT	IW16TT	IW16TT		4
1.5	55	B5-16V		12/98-12/99	W16EPR-U11	3201	1.1	W16TT	IW16TT	IW16TT		4
BESTA (92-03)												
2.2 D	48	R2	Double Coil(LPH)	07/92-12/03	DG-146		11V					4

Свечи зажигания и Свечи накаливания

Таблица применения

	KW				СТАНДАРТНЫЕ			Twin Tip			QTY
											
KIA продолжение											
BONGO (03-)											
2.5 CRDi	98	D4CB	OE: 36710-2A700/ 36710-4A710 (R P8490)	01/12-	DG-657		11V				4
2.9 TDiC	90	HJ3	OE:36710 4X900	10/03-	DG-661		11V				4
2.9 TDiC 4WD	90	HJ3	OE:36710 4X900	10/03-	DG-661		11V				4
CARENS I (00-02)											
1.8 i	81	T8		11/00-07/02	K20PR-U	3145	0.8	K20TT	IK20TT	IK20TT	4
CARENS II (02-)											
1.6	77	GA6D		07/02-05/06	K20PR-U11	3121	1.1	K20TT	IK20TT	IK20TT	4
1.8	93	TB		07/02-	K20PR-U	3145	0.8	K20TT	IK20TT	IK20TT	4
2.0 CRDi	83/ 103	D4EA-F	Double Coil(LPH)	07/02-	DG-173		11V				4
2.0 CVVT	102	G4GC		08/04-12/06	K16PR-U11	3130	1.1	K16TT	IK16TT	IK16TT	4
2.0 CVVT	102	G4GC		09/06-	SK16PR-L11	3395	1.1	-	IK16TT	IK16TT	4
CARENS III (06-)											
1.6 CRDi 110	85	D4FB		10/10-	DG-602		11V				4
1.6 CRDi 128	94	D4FB		10/10-	DG-602		11V				4
1.6 CVVT	93/97	G4FC		08/09-	XU22HDR9	3445	0.9	XUH22TT	IXUH22TT	VXUH22I	4
2.0 CRDi 115	85	D4EA	Double Coil(LPH)	05/07-	DG-173		11V				4
2.0 CRDi 135	100	D4EA	Double Coil(LPH)	08/09-	DG-173		11V				4
2.0 CRDi 140	103	D4EA-F	Double Coil(LPH)	09/06-	DG-173		11V				4
2.0 CVVT	106	G4KA		09/06-	K16PR-U11	3130	1.1	K16TT	IK16TT	IK16TT	4
CARENS IV (13-)											
1.6 GDi	99	G4FD		03/13-	VXUH20I	5650	0.9	-	-	VXUH20I	4
1.7 CRDi	85/ 100/ 104	D4FD	OE: 36710-2A700/ 36710-4A710 (R P8490)	03/13-	DG-657		11V				4
2.0 GDi	122/ 130	G4NC		03/13-	VXUH22I	5656	0.9	-	IXUH22TT	VXUH22I	4
CARNIVAL I (99-01)											
2.5 V6	121	KRV6		08/99-10/01	PK20PR-L11	3142	1.1	-	IK20TT	IK20TT	6
2.9 TD	93	J3		08/99-10/01	DG-172		11V				4
2.9 TD	93	J3	OE: 3671042500	08/99-10/01	DG-174		11V				4
CARNIVAL II (99-07)											
2.5 V6	110	K5		10/01-06/06	PK20PR-L11	3142	1.1	-	IK20TT	IK20TT	6
2.9 CRDi	106	J3	OE: 3671042500	10/01-06/06	DG-174		11V				4
2.9 CRDi	106	J3	OE: 3671042510	10/01-06/06	DG-172		11V				4
2.9 TD	93	J3	OE: 3671042500	01/99-09/07	DG-174		11V				4
2.9 TD	93	J3	OE: 3671042510	01/99-09/07	DG-172		11V				4
3.5	143	6G72		07/02-02/06	PK16PR-L11	3275	1.1	-	IK16TT	IK16TT	6
CARNIVAL III (06-)											
2.2 CRDi	110/ 143	D4HB	OE: 36710-2F000/ 36710-2F001/ 36710-2F101	01/10-	DG-669		7V				4
2.7 V6	139	G6EA(188)		06/06-	SK16PR-L11	3395	1.1	-	IK16TT	IK16TT	6
2.9 CRDi	136	J3	OE:36710 4X900	06/06-	DG-661		11V				4
2.9 CRDi LX	141	J3	OE:36710 4X900	09/06-	DG-661		11V				4
CEED (06-12)											
1.4	77/80	G4FA		02/09-12/12	XU22HDR9	3445	0.9	XUH22TT	IXUH22TT	VXUH22I	4
1.4	77/80	G4FA	14 mm diameter+	12/06-01/09	KJ16CR-U11	3311	1.1	K16TT	IK16TT	IK16TT	4
1.4 CVVT	66	G4FA		07/09-12/12	XU22HDR9	3445	0.9	XUH22TT	IXUH22TT	VXUH22I	4
1.6	85/ 90/93	G4FC		02/09-12/12	XU22HDR9	3445	0.9	XUH22TT	IXUH22TT	VXUH22I	4
1.6	85/ 90/93	G4FC	14 mm diameter+	12/06-01/09	KJ16CR-U11	3311	1.1	K16TT	IK16TT	IK16TT	4
1.6 CRDi 90	66	D4FB-L		12/06-11/11	DG-173		11V				4
1.6 CRDi 115	85	D4FB		12/06-11/09	DG-173		11V				4

Свечи зажигания и Свечи накаливания

Таблица применения

Таблица применения

KW	KW	KW	NOTE	21	СТАНДАРТНЫЕ			Twin Tip		QTY
					STANDARD	STANDARD	STANDARD	TWIN TIP	TWIN TIP	
KIA продолжение										
CEED (06-12) продолжение										
1.6 CRDi 128	94	D4FB		10/10-12/12	DG-602		11V			4
1.6 CVT	92	G4FC		06/09-12/12	XU22HDR9	3445	0.9	XUH22TT	IXUH22TT	VXUH22I
2.0	105	G4GC		12/06-12/12	SK16PR-L11	3395	1.1	-	IK16TT	IK16TT
2.0 CRDi	100	D4EA	Double Coil(LPH)	06/07-12/12	DG-173		11V			4
2.0 CRDi 140	103	D4EA	Double Coil(LPH)	07/07-12/12	DG-173		11V			4
CEED (12-)										
1.4 CRDi 90	66	D4FC		05/12-07/15	DG-602		11V			4
1.4 CRDi 90	66	D4FC	OE: 36710-2A700/ 36710-4A710 (R P8490),Euro-5	07/15-	DG-657		11V			4
1.4 CVT	66/73	G4FA		05/12-	XU22HDR9	3445	0.9	XUH22TT	IXUH22TT	VXUH22I
1.4 MPI	74	G4LC		04/15-	XUH20TTi	7006	0.8	XUH20TTi	-	VXUH20I
1.6 CRDi 110	81	D4FB		05/12-07/15	DG-602		11V			4
1.6 CRDi 110	81	D4FB	OE: 36710-2A700/ 36710-4A710 (R P8490),Euro-5	07/15-	DG-657		11V			4
1.6 CRDi 128	94	D4FB		05/12-07/15	DG-602		11V			4
1.6 CRDi 128	94	D4FB	OE: 36710-2A700/ 36710-4A710 (R P8490),Euro-5	07/15-	DG-657		11V			4
1.6 CRDi 136	100	D4FB	OE: 36710-2A700/ 36710-4A710 (R P8490)	07/15-	DG-657		11V			4
1.6 CVT	92	G4FC		05/12-	XU22HDR9	3445	0.9	XUH22TT	IXUH22TT	VXUH22I
1.6 GDI	99	G4FD		05/12-	VXUH20I	5650	0.9	-	-	VXUH20I
CERATO (18-)										
2.0 MPi	110	G4NA		02/18-	VXUH22I	5656	0.9	-	IXUH22TT	VXUH22I
CERATO (01-04)										
1.8	85	T8		10/01-07/04	K20PR-U	3145	0.8	K20TT	IK20TT	IK20TT
CERATO (04-)										
1.5 CRDi	75	D4FA		07/05-	DG-602		11V			4
1.6	77	G4ED		04/04-12/08	K16PR-U11	3130	1.1	K16TT	IK16TT	IK16TT
1.6	90	G4FC		01/08-	XU22HDR9	3445	0.9	XUH22TT	IXUH22TT	VXUH22I
1.6	90	G4FC	14 mm diameter+	05/06-01/08	KJ16CR-U11	3311	1.1	K16TT	IK16TT	IK16TT
1.6 CRDi	85	D4FB		06/05-	DG-602		11V			4
2.0	105	G4GC		03/04-12/08	K16PR-U11	3130	1.1	K16TT	IK16TT	IK16TT
2.0 CRDi	83	D4EA	Double Coil(LPH)	04/04-	DG-173		11V			4
CERATO (09-)										
1.6	90/93	G4FC		01/10-	XU22HDR9	3445	0.9	XUH22TT	IXUH22TT	VXUH22I
1.6 CVT	91	G4FC		02/09-	XU22HDR9	3445	0.9	XUH22TT	IXUH22TT	VXUH22I
1.6 MPi	96	MPI		06/13-	XU22HDR9	3445	0.9	XUH22TT	IXUH22TT	VXUH22I
2.0	115	THETA 2		01/09-	K16HPR-U11	6076	1.1	KH16TT	IKH16TT	IKH16TT
2.0 CVT	115	THETA 2		01/09-	K16HPR-U11	6076	1.1	KH16TT	IKH16TT	IKH16TT
2.0 MPi	110/ 112	G4NA; NU		06/13-	VXUH22I	5656	0.9	-	IXUH22TT	VXUH22I
CLARUS (96-)										
1.8 i 16V	85	T8		07/96-	K16PR-U	3191	0.8	K16TT	IK16TT	IK16TT
2.0 i 16V	98	FE (16V)		07/96-	K20PR-U11	3121	1.1	K20TT	IK20TT	IK20TT
ELAN (96-99)										
1.8	103			03/96-11/99	K20PR-U	3145	0.8	K20TT	IK20TT	IK20TT
JOICE (00-)										
2.0	88/ 102	G4; G4CPD		02/00-03/03	W20EPR-S11	3046	1.1	W20TT	IW20TT	IW20TT
K2500 (03-)										
2.5 CRDi	96	D4CB	OE: 36710-2A700/ 36710-4A710 (R P8490)	01/10-	DG-657		11V			4
2.5 D	69	D4BH		01/03-09/07	DG-172		11V			4
2.5 D	69	D4BH		10/07-	DG-198		11V			4

Свечи зажигания и Свечи накаливания

Таблица применения











	KW				СТАНДАРТНЫЕ				Twin Tip			QTY
												
KIA продолжение												
K2700 (97-09)												
2.7 D	59	J2		10/99-09/04	DG-146		11V					4
K2900 (08-)												
2.9 D	92	J3	OE:36710 4X900	01/08-	DG-661		11V					4
MAGENTIS (01-)												
2.0	100	G4JP		05/01-09/05	W20EPR-U11	3049	1.1	W20TT	IW20TT	IW20TT		4
2.5 V6	124	G6BV		05/01-12/05	PK16PR-L11	3275	1.1	-	IK16TT	IK16TT		6
MAGENTIS (05-)												
2.0	106	G4KA		11/05-08/08	K16PR-U11	3130	1.1	K16TT	IK16TT	IK16TT		4
2.0	106	G4KA(144)	OEM Optional	11/05-05/08	PK16PR-L11	3275	1.1	-	IK16TT	IK16TT		4
2.0	106/121	G4KA; G4KD		08/08-	K16HPR-U11	6076	1.1	KH16TT	IKH16TT	IKH16TT		4
2.0 CRDi	100/103/110	D4EA	Double Coil(LPH)	11/05-	DG-173		11V					4
2.7	138	G6EA(188)		11/05-05/08	IKH16TT	4703	1.0	-	IKH16TT			6
2.7 V6	142	G6EA(193)		07/09-08/10	IKH16TT	4703	1.0	-	IKH16TT			6
OPIRUS (03-)												
3.5	149	6G74(197)/6G74(203)		09/03-10/06	PK16PR-L11	3275	1.1	-	IK16TT	IK16TT		6
3.8 V6	196	G6DA		10/06-03/14	VXUH20I	5650	0.9	-	-	VXUH20I		6
3.8 V6	196	G6DA		03/14-	VXUH22I	5656	0.9	-	IXUH22TT	VXUH22I		6
OPTIMA (10-)												
1.7 CRDi	100	D4FD	OE: 36710-2A700/ 36710-4A710 (R P8490)	03/12-	DG-657		11V					4
2.0	125	G4KD		03/12-	K16HPR-U11	6076	1.1	KH16TT	IKH16TT	IKH16TT		4
2.0	125	G4KD		03/12-	VXUH22I	5656	0.9	-	IXUH22TT	VXUH22I		4
2.0 CVVL	121	G4KD		03/12-	K16HPR-U11	6076	1.1	KH16TT	IKH16TT	IKH16TT		4
2.0 CVVL	121	G4KD		03/12-	VXUH22I	5656	0.9	-	IXUH22TT	VXUH22I		4
2.0 CVVT	121	G4NA		03/13-12/15	VXUH22I	5656	0.9	-	IXUH22TT	VXUH22I		4
2.0 CVVT Hybrid	110/140	G4NE		03/12-	VXUH20I	5650	0.9	-	-	VXUH20I		4
2.4	129/132	THETA 2 GDI		06/10-	FXU16HR11	3478	1.1	-	-	FXU16HR11		4
2.4	129/132	THETA 2 MPI		06/10-	K16HPR-U11	6076	1.1	KH16TT	IKH16TT	IKH16TT		4
2.4 Hybrid	154			09/11-	K16HPR-U11	6076	1.1	KH16TT	IKH16TT	IKH16TT		4
OPTIMA (15-)												
1.7 CRDi	104	D4FD	OE: 36710-2A700/ 36710-4A710 (R P8490)	11/15-	DG-657		11V					4
2.4 GDI	138	G4KJ		09/15-	VXUH22I	5656	0.9	-	IXUH22TT	VXUH22I		4
PICANTO (04-)												
1.0	45	G4HE		04/04-04/11	K16PR-U11	3130	1.1	K16TT	IK16TT	IK16TT		4
1.1	48	G4HG		04/04-01/11	K16PR-U11	3130	1.1	K16TT	IK16TT	IK16TT		4
1.1 CRDi	55	D3FA		11/05-	DG-602		11V					3
PICANTO (11-)												
1.0	49	G3LA		04/15-	VXUH20I	5650	0.9	-	-	VXUH20I		3
1.0	51	G3LA		05/11-	XUH20TTi	7006	0.8	XUH20TTi	-	VXUH20I		3
1.0 BiFuel	60	B3LA		05/11-	XUH20TTi	7006	0.8	XUH20TTi	-	VXUH20I		3
1.0 LPG	49	B3LA		08/13-	XUH20TTi	7006	0.8	XUH20TTi	-	VXUH20I		3
1.2	63	G4LA		09/11-	XUH20TTi	7006	0.8	XUH20TTi	-	VXUH20I		4
1.2	63	G4LA	OEM Optional	09/11-	IXUH20I	5354	0.9	-	-	VXUH20I		4
PREGIO (95-)												
2.5 D	69	D4BH	Ceramic(LPH)	08/95-09/04	DG-301		11V					4
2.5 Tci D	69	D4BH	Ceramic(LPH)	09/02-	DG-301		11V					4
2.5 Tci D	69	D4BH	Double Coil(LPH)	09/02-	DG-174		11V					4
2.7 D	60	J2	Double Coil(LPH)	10/97-	DG-146		11V					4
PRIDE (90-)												
1.1 i	38	B1		02/94-09/94	W16EPR-U11	3201	1.1	W16TT	IW16TT	IW16TT		4
1.3	44/47/54	B3A5		01/90-05/01	W16EPR-U11	3201	1.1	W16TT	IW16TT	IW16TT		4
1.3 16V	44/47/53			01/90-09/01	W16EPR-U11	3201	1.1	W16TT	IW16TT	IW16TT		4
1.3 i	51			01/90-05/97	W16EPR-U11	3201	1.1	W16TT	IW16TT	IW16TT		4

Таблица применения

K

Свечи зажигания и Свечи накаливания

Таблица применения

KW	KW	NOTE	21	СТАНДАРТНЫЕ				Twin Tip		QTY	
				STANDARD	STANDARD	STANDARD	STANDARD	TWIN TIP	TWIN TIP		
KIA продолжение											
PRO CEED (03-13)											
1.4	77/80	G4FA		02/09-09/12	XU22HDR9	3445	0.9	XUH22TT	IXUH22TT	VXUH22I	4
1.4	77/80	G4FA	14 mm diameter+	02/08-01/09	KJ16CR-U11	3311	1.1	K16TT	IK16TT	IK16TT	4
1.4 CVVT	66	G4FA		06/10-09/12	XU22HDR9	3445	0.9	XUH22TT	IXUH22TT	VXUH22I	4
1.6	90/93	G4FC		02/08-11/09	KJ16CR-U11	3311	1.1	K16TT	IK16TT	IK16TT	4
1.6	90/93	G4FC		12/09-09/12	XU22HDR9	3445	0.9	XUH22TT	IXUH22TT	VXUH22I	4
1.6 CRDi 90	66	D4FB-L		02/08-11/09	DG-173		11V				4
1.6 CRDi 115	85	D4FB		02/08-11/09	DG-173		11V				4
1.6 CRDi 128	94	D4FB		10/10-09/12	DG-602		11V				4
1.6 CVVT	92	G4FC		10/10-02/13	XU22HDR9	3445	0.9	XUH22TT	IXUH22TT	VXUH22I	4
2.0	105	G4GC		02/08-09/12	SK16PR-L11	3395	1.1	-	IK16TT	IK16TT	4
2.0 CRDi 140	103	D4EA	Double Coil(LPH)	02/08-09/12	DG-173		11V				4
2.0 LPG	105	G4GC		01/09-12/09	SK16PR-L11	3395	1.1	-	IK16TT	IK16TT	4
PRO CEED (13-)											
1.4 CRDi 90	66	D4FC		03/13-07/15	DG-602		11V				4
1.4 CRDi 90	66	D4FC	OE: 36710-2A700/36710-4A710 (R P8490),Euro-5	07/15-	DG-657		11V				4
1.4 CVVT	73	G4FA		03/13-	XU22HDR9	3445	0.9	XUH22TT	IXUH22TT	VXUH22I	4
1.4 MPI	74	G4LC		04/15-	XUH20TTi	7006	0.8	XUH20TTi	-	VXUH20I	4
1.6 CRDi 110	81	D4FB		03/13-07/15	DG-602		11V				4
1.6 CRDi 110	81	D4FB	OE: 36710-2A700/36710-4A710 (R P8490),Euro-5	07/15-	DG-657		11V				4
1.6 CRDi 128	94	D4FB		03/13-07/15	DG-602		11V				4
1.6 CRDi 128	94	D4FB	OE: 36710-2A700/36710-4A710 (R P8490),Euro-5	07/15-	DG-657		11V				4
1.6 CRDi 136	100	D4FB	OE: 36710-2A700/36710-4A710 (R P8490)	07/15-	DG-657		11V				4
1.6 GDI	99	G4FD		03/13-	VXUH20I	5650	0.9	-	-	VXUH20I	4
RETONA (99-)											
2.0 16V	94	FE (16V)		05/00-12/01	K20PR-U11	3121	1.1	K20TT	IK20TT	IK20TT	4
2.0 TD	61	RF	Double Coil(LPH)	06/99-12/01	DG-146		11V				4
RIO I (00-05)											
1.3	55/60	MI-TECH-S82; MI-TECH-SOH		09/00-02/05	W16EXR-U11	3032	1.1	W16TT	IW16TT	IW16TT	4
1.5	70	A5D		09/02-02/05	K20PR-U	3145	0.8	K20TT	IK20TT	IK20TT	4
1.5	70	MI-TECH-DOH		09/02-02/05	W16EXR-U11	3032	1.1	W16TT	IW16TT	IW16TT	4
1.5 16V	72	A5D		08/00-02/05	K20PR-U	3145	0.8	K20TT	IK20TT	IK20TT	4
1.5 16V	72	MI-TECH-DOH		08/00-02/05	W16EXR-U11	3032	1.1	W16TT	IW16TT	IW16TT	4
RIO II (05-)											
1.4 16V	71	1.4L-ALPHA/G4EE; G4EE/1.4L-ALPHA(97)		03/05-	K16PR-U11	3130	1.1	K16TT	IK16TT	IK16TT	4
1.5 CRDi	65/81	D4FA		03/05-	DG-602		11V				4
1.6 16V	82	1.6L-ALPHA/G4GD		03/05-	K16PR-U11	3130	1.1	K16TT	IK16TT	IK16TT	4
1.6 CVVT	82	1.6L-ALPHA/G4GD		03/05-	K16PR-U11	3130	1.1	K16TT	IK16TT	IK16TT	4
RIO III (11-)											
1.1 CRDi	55	D3FA		09/11-11/14	DG-602		11V				3
1.2 CVVT	62/64	G4LA		11/14-	XUH20TTi	7006	0.8	XUH20TTi	-	VXUH20I	4
1.2 CVVT	62/64	G4LA	OEM Optional	11/14-	IXUH20I	5354	0.9	-	-	VXUH20I	4
1.25 CVVT	63/65	G4LA		09/11-	XUH20TTi	7006	0.8	XUH20TTi	-	VXUH20I	4
1.25 CVVT	63/65	G4LA	OEM Optional	09/11-	IXUH20I	5354	0.9	-	-	VXUH20I	4
1.25 LPG	63	G4LA		09/11-	XUH20TTi	7006	0.8	XUH20TTi	-	VXUH20I	4
1.25 LPG	63	G4LA	OEM Optional	09/11-	VXUH20I	5650	0.9	-	-	VXUH20I	4
1.4 CRDi	66	D4FC		09/11-11/14	DG-602		11V				4
1.4 CVVT	79	G4FA		09/11-	XU22HDR9	3445	0.9	XUH22TT	IXUH22TT	VXUH22I	4
1.6 CVVT	90	G4FC		06/12-	XU22HDR9	3445	0.9	XUH22TT	IXUH22TT	VXUH22I	4
RIO IV (17-)											
1.4	73	G4LC		01/17-	VXUH20I	5650	0.9	-	-	VXUH20I	4

Свечи зажигания и Свечи накаливания

Таблица применения











	KW				СТАНДАРТНЫЕ			Twin Tip			QTY
											
KIA продолжение											
ROADSTER (99-)											
1.8	100			08/99-	K20PR-U	3145	0.8	K20TT	IK20TT	IK20TT	4
SEPHIA (93-97)											
1.5 i	59	B5		02/96-10/97	W16EPR-U11	3201	1.1	W16TT	IW16TT	IW16TT	4
1.6 i	59	B6		09/93-10/97	W16EPR-U11	3201	1.1	W16TT	IW16TT	IW16TT	4
1.8 i 16V	82	OK24N; OK26Y		01/95-10/97	K16PR-U	3191	0.8	K16TT	IK16TT	IK16TT	4
SHUMA I (96-01)											
1.5	59	B5		09/98-12/98	K16PR-U11	3130	1.1	K16TT	IK16TT	IK16TT	4
1.5 i 16V	65	B5-16V		10/97-10/01	K16PR-U11	3130	1.1	K16TT	IK16TT	IK16TT	4
1.6	75	GA6D		01/01-12/01	K16PR-U11	3130	1.1	K16TT	IK16TT	IK16TT	4
1.8 i 16V	81	T8		10/97-08/98	K16PR-U	3191	0.8	K16TT	IK16TT	IK16TT	4
1.8 i 16V	81	T8		09/98-03/01	K20PR-U	3145	0.8	K20TT	IK20TT	IK20TT	4
SHUMA II (01-04)											
1.6	75	GA6D		05/01-08/04	K16PR-U11	3130	1.1	K16TT	IK16TT	IK16TT	4
1.8	81/84	T8		05/01-08/04	K20PR-U	3145	0.8	K20TT	IK20TT	IK20TT	4
SORENTO I (02-)											
2.4	102	G4JS		08/02-	P16PR11	3114	1.1	W16TT	IW16TT	IW16TT	4
2.5 CRDi	103/ 120/ 125	D4CB	Double Coil(LPH)	08/02-	DG-189		11V				4
3.3 V6	177			12/06-	SK16PR-L11	3395	1.1	-	IK16TT	IK16TT	6
3.3 V6 4WD	182	G6DB		02/07-	SK16PR-L11	3395	1.1	-	IK16TT	IK16TT	6
3.5 V6 4WD	143	G6CU		08/02-05/06	PK16PR-L11	3275	1.1	-	IK16TT	IK16TT	6
SORENTO II (09-)											
2.0 CRDi	110	D4HA	OE: 36710-2F000/ 36710-2F001/ 36710-2F101	02/12-	DG-669		7V				4
2.0 CRDi	110	D4HA	OE:36710-2F100	11/10-02/12	DG-624		4.4V				4
2.0 CRDi 4WD	110	D4HA	OE: 36710-2F000/ 36710-2F001/ 36710-2F101	02/12-	DG-669		7V				4
2.0 CRDi 4WD	110	D4HA	OE:36710-2F100	11/10-02/12	DG-624		4.4V				4
2.2 CRDi	145/ 147	D4HB	OE: 36710-2F000/ 36710-2F001/ 36710-2F101	02/12-	DG-669		7V				4
2.2 CRDi	145/ 147	D4HB	OE:36710-2F100	11/09-02/12	DG-624		4.4V				4
2.2 CRDi 4WD	145	D4HB	OE: 36710-2F000/ 36710-2F001/ 36710-2F101	02/12-	DG-669		7V				4
2.2 CRDi 4WD	145	D4HB	OE:36710-2F100	11/09-02/12	DG-624		4.4V				4
2.4 CVVT	128/ 141	G4KE; THETA 2 MPI		11/09-	K16HPR-U11	6076	1.1	KH16TT	IKH16TT	IKH16TT	4
2.4 CVVT	141	THETA 2 GDI		10/12-	FXU16HR11	3478	1.1	-	-	FXU16HR11	4
2.4 CVVT 4WD	128/ 141	G4KE; THETA 2 MPI		11/09-	K16HPR-U11	6076	1.1	KH16TT	IKH16TT	IKH16TT	4
2.4 CVVT 4WD	141	THETA 2 GDI		10/12-	FXU16HR11	3478	1.1	-	-	FXU16HR11	4
2.4 GDI	141	G4KJ		10/12-	FXU16HR11	3478	1.1	-	-	FXU16HR11	4
2.4 GDI 4WD	141	G4KJ		10/12-	FXU16HR11	3478	1.1	-	-	FXU16HR11	4
3.5	204	G6DC		05/13-	VXUH22I	5656	0.9	-	IXUH22TT	VXUH22I	6
3.5 4WD	204	G6DC		05/13-	VXUH22I	5656	0.9	-	IXUH22TT	VXUH22I	6
SORENTO III (15-)											
2.4	129	THETA 2 GDI		01/15-	VXUH22I	5656	0.9	-	IXUH22TT	VXUH22I	4
2.4	129	THETA 2 MPI		01/15-	K16HPR-U11	6076	1.1	KH16TT	IKH16TT	IKH16TT	4
2.4 4WD	129	THETA 2 GDI		01/15-	VXUH22I	5656	0.9	-	IXUH22TT	VXUH22I	4
2.4 4WD	129	THETA 2 MPI		01/15-	K16HPR-U11	6076	1.1	KH16TT	IKH16TT	IKH16TT	4
2.4 GDI	138	G4KJ		01/15-	FXU16HR11	3478	1.1	-	-	FXU16HR11	4
2.4 GDI	138	G4KJ		01/15-	VXUH22I	5656	0.9	-	IXUH22TT	VXUH22I	4
2.4 GDI 4WD	138	G4KJ		01/15-	FXU16HR11	3478	1.1	-	-	FXU16HR11	4
2.4 GDI 4WD	138	G4KJ		01/15-	VXUH22I	5656	0.9	-	IXUH22TT	VXUH22I	4
3.3	199			04/15-	SK16PR-L11	3395	1.1	-	IK16TT	IK16TT	6
SOUL I (09-)											
1.6	91	G4FG		09/09-12/14	XU22HDR9	3445	0.9	XUH22TT	IXUH22TT	VXUH22I	4
1.6 CRDi 115	85	D4FB	Euro-3; Euro-4	02/09-	DG-602		11V				4

Таблица применения

K

Свечи зажигания и Свечи накаливания

Таблица применения

Таблица применения

KW	KW	KW	NOTE	21	СТАНДАРТНЫЕ			Twin Tip			QTY
					STANDARD	STANDARD	STANDARD	TWIN TIP	TWIN TIP	TWIN TIP	
KIA продолжение											
SOUL I (09-) продолжение											
1.6 CRDi 115	85	D4FB	OE: 36710-2A700/ 36710-4A710 (R P8490),Euro-5	02/09-	DG-657		11V				4
1.6 CRDi 128	94	D4FB	Euro-3; Euro-4	02/09-	DG-602		11V				4
1.6 CRDi 128	94	D4FB	OE: 36710-2A700/ 36710-4A710 (R P8490),Euro-5	02/09-	DG-657		11V				4
1.6 CVVT	77/ 93/95	G4FC		02/09-	XU22HDR9	3445	0.9	XUH22TT	IXUH22TT	VXUH22I	4
1.6 GDI	103	G4FD		06/11-	VXUH20I	5650	0.9	-	-	VXUH20I	4
SOUL II (14-)											
1.6 CRDi 128	94	D4FB	OE: 36710-2A100/ 36710-2A200	02/14-08/16	DG-602		11V				4
1.6 CRDi 136	100	D4FB	OE: 36710-2A100/ 36710-2A200	04/15-08/16	DG-602		11V				4
1.6 CVVT	91	GDI		12/14-06/16	VXUH20I	5650	0.9	-	-	VXUH20I	4
1.6 CVVT	91	MPI		03/15-12/16	XU22HDR9	3445	0.9	XUH22TT	IXUH22TT	VXUH22I	4
1.6 GDI	97	G4FD		02/14-	VXUH20I	5650	0.9	-	-	VXUH20I	4
2.0 CVVT	110/ 113	G4NA		02/14-	VXUH22I	5656	0.9	-	IXUH22TT	VXUH22I	4
SOUL III (19-)											
2.0 MPI	110	G4NA		01/19-	VXUH22I	5656	0.9	-	IXUH22TT	VXUH22I	4
SPORTAGE I (94-04)											
2.0	87	FE (16V)		10/00-08/03	K20PR-U11	3121	1.1	K20TT	IK20TT	IK20TT	4
2.0 4WD	87	FE (16V)		10/00-08/03	K20PR-U11	3121	1.1	K20TT	IK20TT	IK20TT	4
2.0 i 4WD	70	FE (8V)		04/94-08/99	K16PR-U	3191	0.8	K16TT	IK16TT	IK16TT	4
2.0 i 16V	94	FE (16V)		10/99-08/03	K20PR-U11	3121	1.1	K20TT	IK20TT	IK20TT	4
2.0 i 16V 4WD	94	FE (16V)		04/94-08/04	K20PR-U11	3121	1.1	K20TT	IK20TT	IK20TT	4
2.0 TD 4WD	61	RF	Double Coil(LPH)	10/97-08/03	DG-146		11V				4
SPORTAGE II (04-)											
2.0 16V 4WD	104	G4GC		09/04-12/06	K16PR-U11	3130	1.1	K16TT	IK16TT	IK16TT	4
2.0 16V 4WD	104	G4GC		09/06-	SK16PR-L11	3395	1.1	-	IK16TT	IK16TT	4
2.0 CRDi	83/ 100/ 103/ 110	D4EA; D4EA-F	Double Coil(LPH)	02/05-	DG-173		11V				4
2.0 CRDi 4WD	83/ 100/ 103/ 110	D4EA; D4EA-F	Double Coil(LPH)	09/04-	DG-173		11V				4
2.0 i 16V	104	G4GC		09/04-12/06	K16PR-U11	3130	1.1	K16TT	IK16TT	IK16TT	4
2.0 i 16V	104	G4GC		09/06-	SK16PR-L11	3395	1.1	-	IK16TT	IK16TT	4
2.7 V6 4WD	129	G6BA(175)		09/04-08/06	PK16PR-L11	3275	1.1	-	IK16TT	IK16TT	6
2.7 V6 4WD	129	G6BA(175)		09/06-	SK16PR-L11	3395	1.1	-	IK16TT	IK16TT	6
SPORTAGE III (10-)											
1.6 GDI	99	G4FD		02/11-	VXUH20I	5650	0.9	-	-	VXUH20I	4
1.7 CRDi	85	D4FD	OE: 36710-2A700/ 36710-4A710 (R P8490)	12/10-	DG-657		11V				4
2.0 CRDi	100/ 135	D4HA	OE: 36710-2F000/ 36710-2F001/ 36710-2F101	02/12-	DG-669		7V				4
2.0 CRDi	100/ 135	D4HA	OE:36710-2F100	07/10-02/12	DG-624		4.4V				4
2.0 CRDi AWD	100/ 135	D4HA	OE: 36710-2F000/ 36710-2F001/ 36710-2F101	02/12-	DG-669		7V				4
2.0 CRDi AWD	100/ 135	D4HA	OE:36710-2F100	07/10-02/12	DG-624		4.4V				4
2.0 CVVT	110	G4NA		01/14-12/15	VXUH22I	5656	0.9	-	IXUH22TT	VXUH22I	4
2.0 CVVT	110/ 120/ 122	G4KD		06/10-	K16HPR-U11	6076	1.1	KH16TT	IKH16TT	IKH16TT	4
2.0 CVVT AWD	110/ 113	G4NA		01/14-12/15	VXUH22I	5656	0.9	-	IXUH22TT	VXUH22I	4

Свечи зажигания и Свечи накаливания

Таблица применения

KW	KW	KW	KW	KW	СТАНДАРТНЫЕ			Twin Tip		QTY	
					mm	mm	mm	mm	mm		
KIA продолжение											
SPORTAGE III (10-) продолжение											
2.0 CVVT AWD	120/122	G4KD		07/10-	K16HPR-U11	6076	1.1	KH16TT	IKH16TT	IKH16TT	4
2.0 GDI	122	NU MPI/GDI		02/14-	VXUH22I	5656	0.9	-	IXUH22TT	VXUH22I	4
2.0 GDI	122	THETA 2 MPI		02/14-	K16HPR-U11	6076	1.1	KH16TT	IKH16TT	IKH16TT	4
2.0 GDI AWD	122	NU MPI/GDI		02/14-	VXUH22I	5656	0.9	-	IXUH22TT	VXUH22I	4
2.0 GDI AWD	122	THETA 2 MPI		02/14-	K16HPR-U11	6076	1.1	KH16TT	IKH16TT	IKH16TT	4
SPORTAGE IV (15-)											
1.6 GDI	97	G4FD		09/15-	VXUH20I	5650	0.9	-	-	VXUH20I	4
1.7 CRDi	85	D4FD	OE: 36710-2A700/ 36710-4A710 (R P8490)	09/15-	DG-657		11V				4
2.0	110/114	G4NA		12/15-	VXUH22I	5656	0.9	-	IXUH22TT	VXUH22I	4
2.0 AWD	110/114	G4NA		12/15-	VXUH22I	5656	0.9	-	IXUH22TT	VXUH22I	4
VENGA (10-)											
1.4 CRDi 75	55/57	D4FC		02/10-10/14	DG-602		11V				4
1.4 CRDi 90	66	D4FC		02/10-10/14	DG-602		11V				4
1.4 CVVT	66	G4FA		02/10-	XU22HDR9	3445	0.9	XUH22TT	IXUH22TT	VXUH22I	4
1.6 CRDi 115	85	D4FB		02/10-10/14	DG-602		11V				4
1.6 CRDi 128	94	D4FB		02/10-10/14	DG-602		11V				4
1.6 CVVT	92	G4FC		02/10-	XU22HDR9	3445	0.9	XUH22TT	IXUH22TT	VXUH22I	4
KTM											
X-BOW (08-)											
2.0	177	CAEB		07/08-	PK22PR8	3273	0.8	-	IK22TT	VK22	4
2.0 R	220	CDLA		07/10-	PK22PR8	3273	0.8	-	IK22TT	VK22	4
LADA											
110 (2110) (95-12)											
1.5	52/54/57	BA3 2110; BA3 2111; VAZ-2111		01/95-12/12	W20EPR-U	3047	0.8	W20TT	IW20TT	IW20TT	4
1.5 16V	67/70	VAZ-2112		01/95-12/10	Q20PR-U11	3008	1.1	Q20TT	IQ20TT	IQ20TT	4
1.6	60/72	VAZ-21114		01/95-12/12	W20EPR-U	3047	0.8	W20TT	IW20TT	IW20TT	4
1.6	66	VAZ-21124		01/00-04/07	Q20PR-U11	3008	1.1	Q20TT	IQ20TT	IQ20TT	4
1.6 16V	67	VAZ-21124		10/04-12/10	Q20PR-U11	3008	1.1	Q20TT	IQ20TT	IQ20TT	4
1.6 LPG	60	VAZ-21114		10/04-03/07	W20TT	4602	0.8	W20TT	IW20TT	IW20TT	4
2.0 i (21106)	110	C 20 XE		08/96-07/00	K20PR-U	3145	0.8	K20TT	IK20TT	IK20TT	4
1300 Wankel	88	VAZ-415		06/97-09/04	W22ETR-L	3315	1.0	W22TT	-	VW22	4
111 (2111) (95-13)											
1.5	52/57	BA3 2110; BA3 2111; VAZ-2111		01/96-12/13	W20EPR-U	3047	0.8	W20TT	IW20TT	IW20TT	4
1.5 16V	67/70	VAZ-2112		01/95-12/05	Q20PR-U11	3008	1.1	Q20TT	IQ20TT	IQ20TT	4
1.6	60	VAZ-21114		09/04-02/09	W20EPR-U	3047	0.8	W20TT	IW20TT	IW20TT	4
1.6	66	VAZ-21124		09/04-12/13	Q20PR-U11	3008	1.1	Q20TT	IQ20TT	IQ20TT	4
1.7	59	BA3 21214		01/98-12/13	W20EPR-U11	3049	1.1	W20TT	IW20TT	IW20TT	4
1.8	60	VAZ-2130		01/98-12/13	W20EPR-U	3047	0.8	W20TT	IW20TT	IW20TT	4
112 (2112) (95-13)											
1.5	57	VAZ-2111		01/95-12/05	W20EPR-U	3047	0.8	W20TT	IW20TT	IW20TT	4
1.5 16V	67/70	VAZ-2112		01/95-12/05	Q20PR-U11	3008	1.1	Q20TT	IQ20TT	IQ20TT	4
1.6	60	VAZ-21114		01/05-12/11	W20EPR-U	3047	0.8	W20TT	IW20TT	IW20TT	4
1.6	66	VAZ-21124		03/06-12/08	Q20PR-U11	3008	1.1	Q20TT	IQ20TT	IQ20TT	4
GRANTA (2190, 2191, 2349) (11-)											
1.6	78	VAZ-21127		07/13-	Q20PR-U11	3008	1.1	Q20TT	IQ20TT	IQ20TT	4
1.6 (21901)	64	VAZ-11186; VAZ-21116		10/11-	W20EPR-U11	3049	1.1	W20TT	IW20TT	IW20TT	4
1.6 (21902)	72	K4M		10/11-	K20PR-U	3145	0.8	K20TT	IK20TT	IK20TT	4
1.6 (21902)	72	VAZ-21126		10/11-	Q20PR-U11	3008	1.1	Q20TT	IQ20TT	IQ20TT	4
1.6 (21906)	60	VAZ-11183		10/11-	W20EPR-U11	3049	1.1	W20TT	IW20TT	IW20TT	4
1.6 (21907)	78	VAZ-21127		07/13-	Q20PR-U11	3008	1.1	Q20TT	IQ20TT	IQ20TT	4
1.6 (21911)	64	VAZ-11186		08/14-	W20EPR-U11	3049	1.1	W20TT	IW20TT	IW20TT	4
1.6 (21921)	64	VAZ-11186		08/18-	W20EPR-U11	3049	1.1	W20TT	IW20TT	IW20TT	4
1.6 (21922)	72	VAZ-21126		08/18-	K20PR-U	3145	0.8	K20TT	IK20TT	IK20TT	4
1.6 (21922)	72	VAZ-21126		08/18-	Q20PR-U11	3008	1.1	Q20TT	IQ20TT	IQ20TT	4
1.6 (21941)	64	VAZ-11186		08/18-	W20EPR-U11	3049	1.1	W20TT	IW20TT	IW20TT	4
1.6 (21942)	72	VAZ-21126		08/18-	K20PR-U	3145	0.8	K20TT	IK20TT	IK20TT	4
1.6 (21942)	72	VAZ-21126		08/18-	Q20PR-U11	3008	1.1	Q20TT	IQ20TT	IQ20TT	4
1.6 Sport	84	VAZ-21126		04/16-01/19	K20PR-U	3145	0.8	K20TT	IK20TT	IK20TT	4

Свечи зажигания и Свечи накаливания

Таблица применения

Таблица применения

KW	KW	NOTE	21	СТАНДАРТНЫЕ			Twin Tip			QTY	
				Q20PR-U11	3008	1.1	Q20TT	IQ20TT	IQ20TT		
LADA продолжение											
GRANTA (2190, 2191, 2349) (11-) продолжение											
1.6 Sport	84/87	VAZ-21126; VAZ-21127		08/14-	Q20PR-U11	3008	1.1	Q20TT	IQ20TT	IQ20TT	4
1.6 Sport (21905)	87	VAZ-21127		07/13-09/18	Q20PR-U11	3008	1.1	Q20TT	IQ20TT	IQ20TT	4
KALINA (1117, 1118, 1119) (04-)											
1.4 16V	66	VAZ-11194		11/08-12/13	Q20PR-U11	3008	1.1	Q20TT	IQ20TT	IQ20TT	4
1.4 16V LPG	65	VAZ-11194		11/08-12/13	Q20TT	4608	1.0	Q20TT	IQ20TT	IQ20TT	4
1.6	60	VAZ-21114		10/04-12/13	W20EPR-U	3047	0.8	W20TT	IW20TT	IW20TT	4
1.6	60/66	VAZ-11186; VAZ-21124		10/04-12/13	Q20PR-U11	3008	1.1	Q20TT	IQ20TT	IQ20TT	4
1.6	62/66	VAZ-11186; VAZ-21124		10/04-12/13	Q20P-U11	3136	1.1	Q20TT	IQ20TT	IQ20TT	4
KALINA (2192, 2194) (13-)											
1.6	72	VAZ-21126		06/13-	Q20PR-U11	3008	1.1	Q20TT	IQ20TT	IQ20TT	4
1.6	72	VAZ-21126		11/13-	K20PR-U	3145	0.8	K20TT	IK20TT	IK20TT	4
1.6 NFR	100	VAZ-21126		09/16-	K20PR-U	3145	0.8	K20TT	IK20TT	IK20TT	4
1.6 NFR	100	VAZ-21126		09/16-	Q20PR-U11	3008	1.1	Q20TT	IQ20TT	IQ20TT	4
1.6 Sport	87	VAZ-21126		06/13-	K20PR-U	3145	0.8	K20TT	IK20TT	IK20TT	4
1.6 Sport	87	VAZ-21126		06/13-	Q20PR-U11	3008	1.1	Q20TT	IQ20TT	IQ20TT	4
LARGUS (12-)											
1.6 (FS035)	64	VAZ-11189		06/16-	W20EPR-U11	3049	1.1	W20TT	IW20TT	IW20TT	4
1.6 (KS0Y5, RS0Y5)	77	VAZ- K4M		03/12-	K20PR-U	3145	0.8	K20TT	IK20TT	IK20TT	4
1.6 (KS015, RS015)	62	VAZ-K7M		03/12-	K20TXR	5063	1.0	K20TT	IK20TT	IK20TT	4
1.6 (KS015, RS015)	62	VAZ-K7M	Flexible fuel	03/12-	K20PR-U	3145	0.8	K20TT	IK20TT	IK20TT	4
1.6 (KS035, RS035)	64	VAZ-11189		06/16-	W20EPR-U11	3049	1.1	W20TT	IW20TT	IW20TT	4
NADESHDA (2120) (97-06)											
1.7	60	VAZ-2121.3		12/97-12/06	W20EPR-U	3047	0.8	W20TT	IW20TT	IW20TT	4
1.7 i	59	BA3 21214		12/97-12/06	W20EPR-U11	3049	1.1	W20TT	IW20TT	IW20TT	4
1.8	60	VAZ-2130		12/97-12/06	W20EPR-U	3047	0.8	W20TT	IW20TT	IW20TT	4
1.8 i	67	VAZ-2130.1		12/97-12/06	W20EPR-U	3047	0.8	W20TT	IW20TT	IW20TT	4
NIVA I (2121) (76-)											
1300	45	VAZ-21211		01/81-12/87	W20EP-U	3043	0.8	W20TT	IW20TT	IW20TT	4
1600	56	BA3 2121		12/76-12/93	W20EPR-U	3047	0.8	W20TT	IW20TT	IW20TT	4
1600 4x4	54	BA3 2121		01/87-03/95	W20EPR-U	3047	0.8	W20TT	IW20TT	IW20TT	4
1700	59	BA3 21213		01/93-	W20EPR-U	3047	0.8	W20TT	IW20TT	IW20TT	4
1700 i	59	VAZ-2121.3; VAZ-2123; VAZ-21044		06/96-12/06	W20EPR-U	3047	0.8	W20TT	IW20TT	IW20TT	4
1700 i	59	VAZ-21214		06/96-12/06	W20EPR-U11	3049	1.1	W20TT	IW20TT	IW20TT	4
1700 i 4x4	61	VAZ-2121.3; VAZ-2123		10/00-12/10	W20EPR-U	3047	0.8	W20TT	IW20TT	IW20TT	4
1700 i 4x4	61	VAZ-21044; VAZ-21214		10/00-	W20EPR-U11	3049	1.1	W20TT	IW20TT	IW20TT	4
1800	60	VAZ-2130		01/95-	W20EPR-U	3047	0.8	W20TT	IW20TT	IW20TT	4
1900 Diesel	55	XUD9SD	Double Coil(LPH)	01/99-12/06	DG-001		11V				4
1900 Diesel (21215)	48	XUD9A	Double Coil Std(LPH)	01/93-08/99	DG-001		11V				4
NIVA II (2123) (02-)											
1.7	59	BA3 21214		09/02-	W20EPR-U11	3049	1.1	W20TT	IW20TT	IW20TT	4
1.7	61	VAZ21044		08/04-	W20EPR-U	3047	0.8	W20TT	IW20TT	IW20TT	4
1.7 LPG	57	BA3 21214	LPG / GPL	09/02-	W20TT	4602	0.8	W20TT	IW20TT	IW20TT	4
NOVA (2104, 2105) (81-12)											
1.5 1500	55	BA3 2103		10/86-04/98	W20EPR-U	3047	0.8	W20TT	IW20TT	IW20TT	4
1.6	54/57	BA3 2106		10/86-04/12	W20EPR-U	3047	0.8	W20TT	IW20TT	IW20TT	4
1200 Junior/L	44	BA3 2101		09/81-01/86	W20EP-U	3043	0.8	W20TT	IW20TT	IW20TT	4
1200 Junior/L	44	BA3 2101		01/86-04/12	W20EPR-U	3047	0.8	W20TT	IW20TT	IW20TT	4
1300	48	BA3 2105		09/83-12/97	W20EP-U	3043	0.8	W20TT	IW20TT	IW20TT	4
1300	48	VAZ-2105; VAZ-21011		09/85-12/94	W20EPR-U	3047	0.8	W20TT	IW20TT	IW20TT	4
1300 Spezial/L	48	VAZ-2105; VAZ-21011		05/81-04/12	W20EP-U	3043	0.8	W20TT	IW20TT	IW20TT	4
1500	49/55	BA3 2103		09/85-04/12	W20EPR-U	3047	0.8	W20TT	IW20TT	IW20TT	4
1500 S	52	BA3 21083		06/89-04/12	W20EPR-U	3047	0.8	W20TT	IW20TT	IW20TT	4
1500 Special	55	BA3 2103		03/85-04/12	W20EPR-U	3047	0.8	W20TT	IW20TT	IW20TT	4
1600	54/56	BA3 2106		01/88-10/01	W20EPR-U	3047	0.8	W20TT	IW20TT	IW20TT	4
1700 (21044)	62	VAZ21044	Check Hex size	08/94-04/12	W20EPR-U	3047	0.8	W20TT	IW20TT	IW20TT	4
1700 i Classic	62	VAZ21044		06/96-04/12	W20EPR-U	3047	0.8	W20TT	IW20TT	IW20TT	4
OKA (1111) (88-08)											
0.6	22	VAZ-1111	Check Hex size	02/88-12/08	W20EPR-U	3047	0.8	W20TT	IW20TT	IW20TT	4
0.8	26	B6113E		02/88-12/08	Q20R-U	3140	0.8	Q20TT	IQ20TT	IQ20TT	2

Свечи зажигания и Свечи накаливания

Таблица применения





	KW				СТАНДАРТНЫЕ			Twin Tip			QTY
LADA продолжение											
ОКА (1111) (88-08) продолжение											
0.8	26	VAZ-11113		02/88-12/08	W20EPR-U	3047	0.8	W20TT	IW20TT	IW20TT	2
PICKUP (2329) (98-)											
1.5	60	VAZ-2130		01/98-	W20EPR-U	3047	0.8	W20TT	IW20TT	IW20TT	4
1.7	59	BA3 21214		01/98-	W20EPR-U11	3049	1.1	W20TT	IW20TT	IW20TT	4
PICKUP (2345) (97-04)											
1.5	52	BA3 2103; BA3 21083		12/97-12/06	W20EPR-U	3047	0.8	W20TT	IW20TT	IW20TT	4
1.6	88	VAZ-2112		01/00-12/06	Q20PR-U11	3008	1.1	Q20TT	IQ20TT	IQ20TT	4
1.7	60	BA3 21213		01/98-12/06	W20EPR-U	3047	0.8	W20TT	IW20TT	IW20TT	4
1.7	60	BA3 21214		01/99-12/06	W20EPR-U11	3049	1.1	W20TT	IW20TT	IW20TT	4
PRIORA (2170, 2171, 2172) (08-)											
1.6	60	VAZ-21114		12/08-12/13	W20EPR-U11	3049	1.1	W20TT	IW20TT	IW20TT	4
1.6	60/ 72/78	VAZ-21114; VAZ-21126; VAZ-21127		04/07-	Q20PR-U11	3008	1.1	Q20TT	IQ20TT	IQ20TT	4
1.6 LPG	71	VAZ-21126		12/08-	Q20TT	4608	1.0	Q20TT	IQ20TT	IQ20TT	4
1.8	88	VAZ-21128		12/08-	W20EPR-U11	3049	1.1	W20TT	IW20TT	IW20TT	4
SAMARA (2108, 2109, 2113, 2114, 2115) (86-13)											
1.3 Rotor	99	VAZ-415		06/97-12/13	W22ETR-L	3315	1.0	W22TT	-	VW22	4
1.5	53/ 56/59	BA3 21083; VAZ-2111		04/96-12/13	W20EPR-U	3047	0.8	W20TT	IW20TT	IW20TT	4
1.5 16V	68	VAZ-2112		01/95-12/13	Q20PR-U11	3008	1.1	Q20TT	IQ20TT	IQ20TT	4
1.6	60	VAZ-11183		01/07-12/13	W20EPR-U11	3049	1.1	W20TT	IW20TT	IW20TT	4
1100	39/43	BA3 21081		02/88-08/99	W20EPR-U	3047	0.8	W20TT	IW20TT	IW20TT	4
1300	46/ 48/50	BA3 2108; BA3 21115		01/86-12/99	W20EPR-U	3047	0.8	W20TT	IW20TT	IW20TT	4
1500	50/ 52/55	BA3 21083; BA3 2111		01/86-12/06	W20EPR-U	3047	0.8	W20TT	IW20TT	IW20TT	4
1700	59	BA3 21214		01/98-12/13	W20EPR-U11	3049	1.1	W20TT	IW20TT	IW20TT	4
1800	65	VAZ-2130		12/97-12/13	W20EPR-U	3047	0.8	W20TT	IW20TT	IW20TT	4
SAMARA Forma (21099) (87-12)											
1.5	57/59	VAZ-2111		01/00-12/06	W20EPR-U	3047	0.8	W20TT	IW20TT	IW20TT	4
1.6	60	VAZ-11183		02/09-12/12	W20EPR-U11	3049	1.1	W20TT	IW20TT	IW20TT	4
1100	39	BA3 21081		07/91-08/99	W20EPR-U	3047	0.8	W20TT	IW20TT	IW20TT	4
1300	46/ 48/50	BA3 2108; BA3 21115		05/89-12/06	W20EPR-U	3047	0.8	W20TT	IW20TT	IW20TT	4
1400	48	BA3 2109		01/88-12/98	W20EPR-U	3047	0.8	W20TT	IW20TT	IW20TT	4
1500	50/53	BA3 21083; BA3 2111		07/91-12/06	W20EPR-U	3047	0.8	W20TT	IW20TT	IW20TT	4
TOSCANA (2107) (82-12)											
1.5	54			05/82-05/12	W20EPR-U	3047	0.8	W20TT	IW20TT	IW20TT	4
1.7	59	VAZ-2121.3		05/82-05/12	W20EPR-U	3047	0.8	W20TT	IW20TT	IW20TT	4
1.7	59	VAZ-21073.40		05/82-05/12	W20EPR-U11	3049	1.1	W20TT	IW20TT	IW20TT	4
1300	48	VAZ-2105; VAZ-21011		12/85-05/12	W20EPR-U	3047	0.8	W20TT	IW20TT	IW20TT	4
1500	55	BA3 2103		09/83-10/86	W20EP-U	3043	0.8	W20TT	IW20TT	IW20TT	4
1500	55	BA3 2103		10/86-02/93	W20EPR-U	3047	0.8	W20TT	IW20TT	IW20TT	4
VESTA (15-)											
1.6	78	VAZ-2129		11/15-	K20PR-U	3145	0.8	K20TT	IK20TT	IK20TT	4
1.6 (GFL11)	78	BA3 21129		11/15-	K20PR-U	3145	0.8	K20TT	IK20TT	IK20TT	4
X-RAY (16-)											
1.6	79	VAZ-2129; VAZ-2179		01/16-	K20PR-U	3145	0.8	K20TT	IK20TT	IK20TT	4
XRAY (16-)											
1.6 (GAB43)	81	K4M		02/16-	K20PR-U	3145	0.8	K20TT	IK20TT	IK20TT	4
ZHIGULI (70-93)											
1.3 2106	49	BA3 2105		04/76-12/05	W20EPR-U	3047	0.8	W20TT	IW20TT	IW20TT	4
1.5	49	BA3 2103		03/72-12/83	W20EPR-U	3047	0.8	W20TT	IW20TT	IW20TT	4
1200	44	BA3 2101		01/73-12/84	W20EP-U	3043	0.8	W20TT	IW20TT	IW20TT	4
1200 L/S	44	BA3 2101		01/70-06/86	W20EP-U	3043	0.8	W20TT	IW20TT	IW20TT	4
1300	47	BA3 21011		01/86-12/88	W20EPR-U	3047	0.8	W20TT	IW20TT	IW20TT	4
1300	47/51	BA3 21011; BA3 2105; VAZ-21011		01/72-01/87	W20EP-U	3043	0.8	W20TT	IW20TT	IW20TT	4
1500	52	BA3 2103		10/86-02/93	W20EPR-U	3047	0.8	W20TT	IW20TT	IW20TT	4
1500	52/55	BA3 2103		07/70-10/86	W20EP-U	3043	0.8	W20TT	IW20TT	IW20TT	4
1500 N/S	55	BA3 2103		11/75-10/86	W20EP-U	3043	0.8	W20TT	IW20TT	IW20TT	4
1600	56	BA3 2106		12/86-02/93	W20EPR-U	3047	0.8	W20TT	IW20TT	IW20TT	4
1600	56/58	BA3 2106		09/72-12/86	W20EP-U	3043	0.8	W20TT	IW20TT	IW20TT	4
1600 N/L	57	BA3 2106		03/79-12/05	W20EP-U	3043	0.8	W20TT	IW20TT	IW20TT	4

Таблица применения











Свечи зажигания и Свечи накаливания

Таблица применения

KW	KW	KW	NOTE	21	СТАНДАРТНЫЕ			Twin Tip		QTY	
					1	2	3	1	2		
LAMBORGHINI											
COUNTACH (74-91)											
LP400	283			01/74-12/82	IW24	5316	0.7	-	-	12	
LP500 S	276			01/82-12/85	IW24	5316	0.7	-	-	12	
S Quattrovalvole	313	L 507		01/85-12/91	IX24	5372	0.8	-	-	12	
DIABLO (90-03)											
5.7	361/390			03/90-12/00	IXU27	5337	0.9	-	-	12	
6.0	434			04/00-08/03	IXU27	5337	0.9	-	-	12	
GT 2	470			01/98-08/03	IXU27	5337	0.9	-	-	12	
GT 5.9	423			10/99-08/03	IXU27	5337	0.9	-	-	12	
SE	386			01/94-12/96	IXU27	5337	0.9	-	-	12	
SV	390			01/98-08/03	IXU27	5337	0.9	-	-	12	
VT	390			08/98-08/03	IXU27	5337	0.9	-	-	12	
VT AWD	361			01/90-08/98	IXU27	5337	0.9	-	-	12	
ESPADA (68-81)											
400 GT	257			01/68-12/81	IW24	5316	0.7	-	-	12	
GALLARDO (03-)											
5.0	368/382	L 510		08/03-	IK27	5312	0.8	-	-	10	
5.2 LP560-4	412	CMPA		09/10-	PK22PR8	3273	0.8	-	IK22TT	VK22	
LM-002 (83-92)											
5.2	330			08/85-12/92	IX24	5372	0.8	-	-	12	
MIURA (69-72)											
P400 S	272			01/69-12/72	IW27	5317	0.7	-	-	12	
LANCIA											
BETA (73-86)											
2000	85/88	828 B1.000		04/76-12/84	W20EPR-U	3047	0.8	W20TT	IW20TT	IW20TT	4
2000 i.e.	90	828 B4.000		12/81-12/84	W20EPR-U	3047	0.8	W20TT	IW20TT	IW20TT	4
2000 Volumex	99	828 B7.000		07/83-09/84	W20EPR-U	3047	0.8	W20TT	IW20TT	IW20TT	4
BETA Monte Carlo (75-81)											
2.0	88	134 A5.000		09/75-05/81	W20EPR-U	3047	0.8	W20TT	IW20TT	IW20TT	4
DEDRA (89-99)											
1.6	66	159 B9.000		10/94-07/99	Q22PR-U	3010	0.8	-	-	VQ22	4
1.6 16V	76	182 A4.000		01/96-07/99	K16PR-U	3191	0.8	K16TT	IK16TT	IK16TT	4
1.6 16V	76	182 A4.000		01/96-07/99	K20PR-U	3145	0.8	K20TT	IK20TT	IK20TT	4
1.6 i.e.	55	835 C1.000		04/93-07/99	Q22PR-U	3010	0.8	-	-	VQ22	4
1.6 i.e.	57	835 A1.046		08/89-03/93	W20EPR-U	3047	0.8	W20TT	IW20TT	IW20TT	4
1.6 i.e.	66	835 A1.000		08/89-06/94	W22EPR-U	3088	0.8	W22TT	-	VW22	4
1.6 LE Cat	66	159 B9.000		07/94-07/99	Q22PR-U	3010	0.8	-	-	VQ22	4
1.8 16V LE	83	182 A2.000		03/96-07/99	K20TNR	3304	1.0	K20TT	IK20TT	IK20TT	4
1.8 GT 16V	96	183 A1.000		03/96-07/99	K20TNR	3304	1.0	K20TT	IK20TT	IK20TT	4
1.8 i.e.	66/74	835 C5.000; 836 A5.000		08/93-07/99	Q22PR-U	3010	0.8	-	-	VQ22	4
1.8 i.e.	77/80	835 A2.000; 835 A2.046		09/89-07/99	W20EPR-U	3047	0.8	W20TT	IW20TT	IW20TT	4
1.9 TDS	66	160 D1.000; 835 A4.000; 835 A4.046	Double Coil(LPH)	04/89-07/99	DG-001		11V				4
2.0 16V	102	836 A3.000		07/94-07/99	W22EPR-U	3088	0.8	W22TT	-	VW22	4
2.0 HF Integrale	124	835 A7.046		11/90-07/94	W20EPB	5065	0.85	W20TT	IW20TT	IW20TT	4
2.0 i.e.	83/86	835 A5.000; 835 A5.046		09/89-07/99	W20EPR-U	3047	0.8	W20TT	IW20TT	IW20TT	4
2.0 i.e. Turbo	119	835 A8.046		04/91-07/99	W20EPB	5065	0.85	W20TT	IW20TT	IW20TT	4
2.0 i.e. Turbo Integrale	121	835 A7.000		04/90-08/91	K22PBR-S	5062	0.85	-	IKB22TT	VK22	4
2.0 Integrale	102	836 A3.000		07/94-07/99	W22EPR-U	3088	0.8	W22TT	-	VW22	4
2.0 Turbo	130	835 A8.000		11/90-06/94	K22PBR-S	5062	0.85	-	IKB22TT	VK22	4
DELTA I (79-94)											
1.1	47	831 B8.000		01/86-12/90	W20EPR-U	3047	0.8	W20TT	IW20TT	IW20TT	4
1.3	58	831 A2.000		09/83-08/92	W20EPR-U	3047	0.8	W20TT	IW20TT	IW20TT	4
1.5	63	831 B1.000		09/79-12/92	W22EPR-U	3088	0.8	W22TT	-	VW22	4
1.6 GT	77	831A4.000		11/82-04/86	W22EPR-U	3088	0.8	W22TT	-	VW22	4
1.6 GT i.e.	66	149 C2.000		05/87-08/92	W20EPR-U	3047	0.8	W20TT	IW20TT	IW20TT	4
1.6 GT i.e.	80	831 B7.000		08/86-08/88	W22EPR-U	3088	0.8	W22TT	-	VW22	4
1.6 HF Turbo	97	831 B7.046		04/87-03/89	W20EPBR-S	5067	0.85	W20TT	IW20TT	IW20TT	4
1.6 HF Turbo	97/ 103	831 A7.000; 831B3.000		10/83-08/88	W22EPR-U	3088	0.8	W22TT	-	VW22	4
1.9 Turbo DS	59	831 D1.000	Double Coil Std(LPH)	10/86-12/89	DG-001		11V				4
2.0 16V HF Evo Integrale	155	831 E5.046		06/93-01/94	W20EPBR-S	5067	0.85	W20TT	IW20TT	IW20TT	4
2.0 16V HF Integrale	144	831 D5.000		03/89-09/91	W22EPB	5066	0.85	W22TT	-	VW22	4

Свечи зажигания и Свечи накаливания

Таблица применения

	KW				СТАНДАРТНЫЕ			Twin Tip			QTY
											
LANCIA продолжение											
DELTA I (79-94) продолжение											
2.0 HF Integrale	122/ 133	831 B5.000; 831 C5.000		11/86-12/91	W22EPB	5066	0.85	W22TT	-	VW22	4
2.0 HF Integrale	130	831C5.046		08/88-12/92	W20EPB	5065	0.85	W20TT	IW20TT	IW20TT	4
DELTA II (93-99)											
1.4 i.e.	51	160 A1.046		10/94-08/99	W20EPR-U	3047	0.8	W20TT	IW20TT	IW20TT	4
1.6 i.e.	55	835 C1.000		06/93-08/99	K22PBR-S	5062	0.85	-	IKB22TT	VK22	4
1.6 i.e.	66	182 A6.000		03/96-08/99	K20PR-U	3145	0.8	K20TT	IK20TT	IK20TT	4
1.6 i.e.	66	182 A6.000		03/96-08/99	K20TNR	3304	1.0	K20TT	IK20TT	IK20TT	4
1.6 i.e. 16V	76	182 A4.000		01/96-08/99	K20PR-U	3145	0.8	K20TT	IK20TT	IK20TT	4
1.6 i.e. 16V	76	182 A4.000		01/96-08/99	K22PBR-S	5062	0.85	-	IKB22TT	VK22	4
1.8 i.e.	66	836 A6.000		07/94-08/99	W20EPR-U	3047	0.8	W20TT	IW20TT	IW20TT	4
1.8 i.e.	76	835 C2.000		06/93-08/99	W22EPR-U	3088	0.8	W22TT	-	VW22	4
1.8 i.e. 16V	83	182 A2.000		03/96-08/99	K20TNR	3304	1.0	K20TT	IK20TT	IK20TT	4
1.8 i.e. 16V GT	96	183 A1.000		03/96-08/99	K20TNR	3304	1.0	K20TT	IK20TT	IK20TT	4
1.9 TD	66	160 D1.000; 835 A4.000	Double Coil(LPH)	10/94-08/99	DG-102		11V				4
2.0 16V	102	836 A3.000		06/93-08/99	W22EPR-U	3088	0.8	W22TT	-	VW22	4
2.0 16V Turbo	137	836 A2.000		06/93-08/99	W22EPB	5066	0.85	W22TT	-	VW22	4
2.0 16V Turbo	142	175 A4.000		07/96-08/99	K20PBR	5060	0.85	K20TT	IK20TT	IK20TT	4
DELTA III (08-14)											
1.4	88/ 110	198 A1.000; 198 A4.000	40000km Lifetime	09/08-08/14	IXU27	5337	0.9	-	-		4
1.4 16V	103	198 A7.000	40000km Lifetime	07/10-08/14	IXU27	5337	0.9	-	-		4
1.4 Bifuel	88	198 A4.000	40000km Lifetime	07/11-08/14	IXU27	5337	0.9	-	-		4
1.6 D Multijet	77/ 85/88	198 A2.000; 944 A 3.000; 955 A4.000		08/08-08/14	DG-608		4.4V				4
1.9 D Multijet	140	844 A1.000		01/09-08/14	DG-608		4.4V				4
2.0 D Multijet	121	198 A5.000; 198 A8.000; 844 A2.000		09/08-08/14	DG-608		4.4V				4
FLAVIA (12-14)											
2.4	125/ 129	EDG		03/12-12/14	PKJ16CR8	3175	0.8	-	-		4
GAMMA (81-84)											
2500	103	830A/830A000		09/77-10/86	W22EPR-U	3088	0.8	W22TT	-	VW22	4
KAPPA (94-01)											
2.0 16V Turbo	151	838 A4.000		02/95-10/01	K20PBR-S10	5061	1.0	K20TT	IK20TT	IK20TT	5
2.0 20V	107/ 114	838 A1.000; 838 A6.000		10/94-10/01	K20TNR	3304	1.0	K20TT	IK20TT	IK20TT	5
2.0 20V Turbo	162	175 A3.000		06/98-10/01	K20PBR-S10	5061	1.0	K20TT	IK20TT	IK20TT	5
2.4 20V	129	838 A2.000/ 838 B2.000; 838 A2.000; 838 A2.027		08/94-10/01	K20TNR	3304	1.0	K20TT	IK20TT	IK20TT	5
2.4 JTD	100	838 A8.000	Double Coil(LPH)	06/98-10/01	DG-122		11V				5
2.4 T.DS	91	838 A3.000; 838 A7.000	Double Coil(LPH)	08/94-10/01	DG-102		11V				5
3.0 24V	150	838 B.000		10/94-10/01	PK20PR-P8	3245	0.8	-	IK20TT	IK20TT	6
LYBRA (99-05)											
1.6	76	182 B6.000		10/00-10/05	K16PR-U	3191	0.8	K16TT	IK16TT	IK16TT	4
1.6 16V	76	182 A4.000		07/99-10/05	K20PR-U	3145	0.8	K20TT	IK20TT	IK20TT	4
1.8 16V	96	839 A4.000; 839 A7.000; 839 A9.000		07/99-10/05	K20TNR	3304	1.0	K20TT	IK20TT	IK20TT	4
1.9 JTD	77/ 81/85	937 A2.000; AR 32302; AR 37101	Double Coil(LPH)	07/99-10/05	DG-122		11V				4
2.0 20V	110/ 113	182 B7.000; 185 A8.000		07/99-10/05	K20TNR	3304	1.0	K20TT	IK20TT	IK20TT	4
2.4 20V	125	192 A2.000		10/01-10/05	K20TNR	3304	1.0	K20TT	IK20TT	IK20TT	5
2.4 JTD	99/ 103/ 110	839 A5.000; 839 A6.000; 841 C.000; AR 32501	Double Coil(LPH)	07/99-10/05	DG-122		11V				5
MUSA (04-12)											
1.3 D Multijet	51/ 66/70	188 A9.000; 199 A3.000; 199 B1.000	Euro-4.OE: 46796050, Double Coi l(LPH)	10/04-12/10	DG-171		11V				4

Свечи зажигания и Свечи накаливания

Таблица применения

KW	KW	NOTE	21	СТАНДАРТНЫЕ				Twin Tip			QTY
				STANDARD	STANDARD	STANDARD	STANDARD	TWIN TIP	TWIN TIP	TWIN TIP	
LANCIA продолжение											
MUSA (04-12) продолжение											
1.3 D Multijet	51/66/70	188 A9.000; 199 A3.000; 199 B1.000	Euro-5,OE: 55210051	10/04-09/12	DG-621		4.4V				4
1.4	57/66/70	192 B2.000; 350 A1.000; 843 A 1.000		10/04-09/12	XU22EPR-U	3179	0.9	XU22TT	IXU22TT	VXU22	4
1.4 LPG	57	350 A1.000		11/10-09/12	XU22EPR-U	3179	0.9	XU22TT	IXU22TT	VXU22	4
1.6 D Multijet	85/88	350 A2.000; 350 A3.000		07/08-09/12	DG-608		4.4V				4
1.9 D Multijet	74	188 B2.000	Double Coil(LPH)	10/04-09/12	DG-122		11V				4
PHEDRA (02-10)											
2.0	100	RFN (EW10J4)		09/02-11/10	K20HR-U11	3381	1.1	KH20TT	IKH20TT	IKH20TT	4
2.0 D Multijet	100	RHR (DW10BTED4)	Ch: >C6991	07/06-11/10	DG-116		11V				4
2.0 D Multijet	100	RHR (DW10BTED4)	Ch:D6991> OE:965254828 0	07/06-11/10	DG-181		11V				4
2.0 JTD	80	RHM (DW10ATED4); RHW (DW10ATED4)	Double Coil(LPH)	09/02-11/10	DG-116		11V				4
2.0 JTD	88	RHK (DW10UTED4)	Ch: >C6991	06/06-11/10	DG-116		11V				4
2.0 JTD	88	RHK (DW10UTED4)	Ch:D6991> OE:965254828 0	06/06-11/10	DG-181		11V				4
2.2 D Multijet	125	4HS; 4HT		03/08-11/10	DG-614		11V				4
2.2 JTD	94	4HW (DW12ATED4)	Ch:>C6991, OE:965102978 0; 9638985980; 9623638380	09/02-02/04	DG-116		11V				4
2.2 JTD	94	4HW (DW12ATED4)	OE: 9652548280	09/02-11/10	DG-181		11V				4
2.2 JTD	120	4HP; 4HR		04/06-11/10	DG-614		11V				4
3.0 V6	150	ES9 J4S		09/02-11/10	IKH16TT	4703	1.0	-	IKH16TT		6
PRISMA (83-92)											
1.3 (831AB)	58	831 A2.000		01/83-12/89	W22EPR-U	3088	0.8	W22TT	-	VW22	4
1.5 (831AB)	59	831 B1.000		05/86-07/89	W22EPR-U	3088	0.8	W22TT	-	VW22	4
1.6 (831AB)	73	831 B6.000		08/86-12/89	W22EPR-U	3088	0.8	W22TT	-	VW22	4
1.6 i.e. (831AB)	80	831 B7.000		05/86-12/89	W22EPR-U	3088	0.8	W22TT	-	VW22	4
1.9 Diesel (831AB)	48	831 D.000	Double Coil Std(LPH)	01/83-02/92	DG-001		11V				4
1.9 Turbo Diesel (831AB)	59	831 D1.000	Double Coil Std(LPH)	05/85-12/89	DG-001		11V				4
2.0 i.e. AWD	85	831 B4.000		04/86-12/89	W22EPR-U	3088	0.8	W22TT	-	VW22	4
THEMA (84-94)											
8.32	151	F 105 L.046		10/87-05/92	XU27EPR-U	3313	0.9	-	-		8
8.32	158	F 105 L		09/87-05/89	X24ESR-U	4101	0.7	-	-		8
2000 16V	112	834 F1.000		05/92-07/94	W20EPR-U	3047	0.8	W20TT	IW20TT	IW20TT	4
2000 16V Turbo	133	834 C1.000		12/88-06/90	W22EPR-U	3088	0.8	W22TT	-	VW22	4
2000 16V Turbo	148	834 F2.000		10/92-07/94	K22PBR-S	5062	0.85	-	IKB22TT	VK22	4
2000 i.e.	85	834 B.146		09/87-05/92	W22EPR-U	3088	0.8	W22TT	-	VW22	4
2000 i.e.	88	834 B.000		11/84-09/88	W20EPR-U	3047	0.8	W20TT	IW20TT	IW20TT	4
2000 i.e. 16V	104/ 108	834 B2.000; 834 B2.246		05/88-08/92	W20EPR-U	3047	0.8	W20TT	IW20TT	IW20TT	4
2000 i.e. 16V Turbo	130	834 C1.246		04/89-03/93	W20EPB	5065	0.85	W20TT	IW20TT	IW20TT	4
2000 i.e. 16V Turbo	133	834 C1.000		12/88-06/90	K22PBR-S	5062	0.85	-	IKB22TT	VK22	4
2000 i.e. Turbo	110/ 122	834 C.000; 834 C.146		11/84-05/90	K22PBR-S	5062	0.85	-	IKB22TT	VK22	4
2000 i.e	86	834 B1.000		09/88-05/92	W22EPR-U	3088	0.8	W22TT	-	VW22	4
2000 Turbo	110	834 C.146		12/88-03/92	K22PBR-S	5062	0.85	-	IKB22TT	VK22	4
2000 Turbo 16V	148	834 F2.000		11/92-07/94	K22PBR-S	5062	0.85	-	IKB22TT	VK22	4
2500 Turbo D	74	8144.91	Double Coil(LPH)	11/84-09/88	DG-001		11V				4
2500 Turbo DS	74/ 77/85	8144. 97S; 8144.91; 8144.97 Y; 8144.97	Double Coil(LPH)	03/87-07/94	DG-001		11V				4
2850 V6 i.e.	108/ 110	834 E.000; 834 E.146		11/84-05/92	T20EPR-U	5032	0.8	T20TT	IT20TT	IT20TT	6
3000 V6	126	834 F.000		08/92-07/94	W20EPR-U	3047	0.8	W20TT	IW20TT	IW20TT	6
THEMA (11-)											
3.0 D	140/ 176	EXF	OE:68211173A A	09/11-10/14	DG-620		7V				6
3.6	210	ERB	Check Thread size	09/11-10/14	ITV20TT	4719	1.0	-	ITV20TT		6

Свечи зажигания и Свечи накаливания

Таблица применения





















	KW				СТАНДАРТНЫЕ				Twin Tip			QTY
												
LANCIA продолжение												
THEMA (11-) продолжение												
3.6	210	ERB	Check Thread size	09/11-10/14	SXU22HCR11S	3461	1.1	-	-	VXUHC22G	6	
3.6 4WD	210	ERB	Check Thread size	09/11-10/14	ITV20TT	4719	1.0	-	ITV20TT		6	
3.6 4WD	210	ERB	Check Thread size	09/11-10/14	SXU22HCR11S	3461	1.1	-	-	VXUHC22G	6	
THEESIS (02-09)												
2.0 Turbo	136	841 E.000		07/02-07/09	K20PBR-S10	5061	1.0	K20TT	IK20TT	IK20TT	5	
2.4	125	841D.000		07/02-07/09	K20TNR	3304	1.0	K20TT	IK20TT	IK20TT	5	
2.4 D Multijet	136	841 P.000		04/06-07/09	DG-170		11V				5	
2.4 JTD	110	841 C.000	Double Coil(LPH)	07/02-07/09	DG-122		11V				5	
2.4 JTD	120	841 M.000; 841 N.000		09/03-07/09	DG-170		11V				5	
2.4 JTD	129	841 G.000	Double Coil(LPH)	05/03-07/09	DG-170		11V				5	
3.0 V6	158	841 A.000		07/02-07/09	PK20PR-P8	3245	0.8	-	IK20TT	IK20TT	6	
3.2 V6	169	841 L.000		05/03-07/09	PK20PR-P8	3245	0.8	-	IK20TT	IK20TT	6	
TREVI (80-87)												
2000 i.e.	90	828 B1.000		07/81-01/85	W20EPR-U	3047	0.8	W20TT	IW20TT	IW20TT	4	
2000 Volumex	99	828 B7.000		08/83-05/85	W20EPR-U	3047	0.8	W20TT	IW20TT	IW20TT	4	
VOYAGER (11-14)												
3.6 V6	208	ERB	Check Thread size	09/11-12/14	ITV20TT	4719	1.0	-	ITV20TT		6	
3.6 V6	208	ERB	Check Thread size	09/11-12/14	SXU22HCR11S	3461	1.1	-	-	VXUHC22G	6	
Y (95-03)												
1.1	40	176 B2.000		11/95-09/03	K20PR-U	3145	0.8	K20TT	IK20TT	IK20TT	4	
1.2	44	188 A4.000		03/96-09/03	K16PR-U	3191	0.8	K16TT	IK16TT	IK16TT	4	
1.2	44	840 A3.000		03/96-09/03	Q20PR-U	3007	0.8	Q20TT	IQ20TT	IQ20TT	4	
1.2 16V	59	188 A5.000		10/00-09/03	XU24EPR-U	3312	0.9	-	-	VXU24	4	
1.2 16V	63	176 B9.000		04/97-09/03	K20PR-U	3145	0.8	K20TT	IK20TT	IK20TT	4	
1.4 12V	55/59	840 A2.000; 840 A4.000		03/96-09/03	K20TNR	3304	1.0	K20TT	IK20TT	IK20TT	4	
Y10 (85-95)												
1.0 Fire	32	156 A 2.000; 156 A2.100		03/85-06/91	Q20PR-U	3007	0.8	Q20TT	IQ20TT	IQ20TT	4	
1.0 Fire (156AA, 156AD)	37	156 A 2.000		03/85-02/90	Q20PR-U	3007	0.8	Q20TT	IQ20TT	IQ20TT	4	
1.0 Fire AWD	37	156 A 2.000		12/87-02/90	Q20PR-U	3007	0.8	Q20TT	IQ20TT	IQ20TT	4	
1.0 Fire AWD (156AE)	33	156 A2.246		12/87-02/92	Q20PR-U	3007	0.8	Q20TT	IQ20TT	IQ20TT	4	
1.0 Fire Catalytic-Conv	33	156 A2.246		10/87-06/89	Q20PR-U	3007	0.8	Q20TT	IQ20TT	IQ20TT	4	
1.1 Fire	40	176 B2.000		01/95-12/95	K20PR-U	3145	0.8	K20TT	IK20TT	IK20TT	4	
1.1 Fire	40	176 B2.000		01/95-12/95	Q20PR-U	3007	0.8	Q20TT	IQ20TT	IQ20TT	4	
1.1 Fire AWD (156AG)	40	176 B2.000		01/95-12/95	K20PR-U	3145	0.8	K20TT	IK20TT	IK20TT	4	
1.1 Fire AWD (156AG)	40	176B2.000		01/95-12/95	K16PR-U	3191	0.8	K16TT	IK16TT	IK16TT	4	
1.1 i.e. Fire	37	156 C.046		07/89-09/95	Q20PR-U	3007	0.8	Q20TT	IQ20TT	IQ20TT	4	
1.1 i.e. Fire AWD (156AG)	37	156 C.046		09/92-12/95	Q20PR-U	3007	0.8	Q20TT	IQ20TT	IQ20TT	4	
1.1 i.e. Fire	42	156 C.000		08/89-06/92	Q20PR-U	3007	0.8	Q20TT	IQ20TT	IQ20TT	4	
1.1 i.e. Fire AWD (156AC)	42	156 C.000		08/89-06/92	Q20PR-U	3007	0.8	Q20TT	IQ20TT	IQ20TT	4	
1.3 i.e.	53/56	146 A 5.046; 156 B.000		11/87-12/95	W20EPR-U	3047	0.8	W20TT	IW20TT	IW20TT	4	
YPSILON (312/846) (11-)												
1.2	51	169 A4.000		05/11-	XU22EPR-U	3179	0.9	XU22TT	IXU22TT	VXU22	4	
1.2 BiFuel	49/51	169 A4.000		05/11-	VXU22	5608	0.9	-	IXU22TT	VXU22	4	
1.3 D Multijet	70	199 B1.000; 312 B1.000	Euro-5,OE: 55210051	05/11-	DG-621		4.4V				4	
1.3 D Multijet	70	199 B1.000; 312 B1.000	Euro-6,OE: 12 14 106/ 55238404 (RP 9016)	05/11-	DG-658		5V				4	
YPSILON (843) (03-11)												
1.2	44	188 A4.000	Eng: >2533528	10/03-09/04	K16PR-U	3191	0.8	K16TT	IK16TT	IK16TT	4	
1.2	44	188 A4.000	Eng: 2533529>	10/04-12/11	XU22EPR-U	3179	0.9	XU22TT	IXU22TT	VXU22	4	
1.2	51	169 A4.000		08/10-12/11	XU22EPR-U	3179	0.9	XU22TT	IXU22TT	VXU22	4	
1.2	59	188 A5.000		10/03-12/11	XU24EPR-U	3312	0.9	-	-	VXU24	4	
1.3 D Multijet	55	199 A2.000	Euro-4,OE: 46796050, Double Coi l(LPH)	09/06-12/10	DG-171		11V				4	
1.3 D Multijet	55	199 A2.000	Euro-5,OE: 55210051	09/06-12/11	DG-621		4.4V				4	

Таблица применения

Свечи зажигания и Свечи накаливания

Таблица применения

Таблица применения

	KW				СТАНДАРТНЫЕ				Twin Tip			QTY
												
LANCIA продолжение												
YPSILON (843) (03-11) продолжение												
1.3 D Multijet	66/77	199 A3.000	OE:46796050, Double Coi I(LPH)	09/06-12/11	DG-171		11V					4
1.3 JTD	51	188 A9.000	OE:46796050, Double Coi I(LPH)	10/03-12/11	DG-171		11V					4
1.4	57	350 A1.000		02/06-12/11	XU22EPR-U	3179	0.9	XU22TT	IXU22TT	VXU22		4
1.4 16V	70	843 A 1.000		10/03-12/11	XU22EPR-U	3179	0.9	XU22TT	IXU22TT	VXU22		4
1.4 LPG	57	350 A1.000		11/10-12/11	XU22EPR-U	3179	0.9	XU22TT	IXU22TT	VXU22		4
ZETA (95-02)												
2.0 16V	97	RFV (XU10J4R)		05/98-07/00	K20TXR	5063	1.0	K20TT	IK20TT	IK20TT		4
2.0 16V	100	RFN		07/00-09/02	K20HR-U11	3381	1.1	KH20TT	IKH20TT	IKH20TT		4
2.0 JTD	80	RHZ (DW10ATED)		09/99-09/02	DG-116		11V					4
2.0 JTD 16V	80	RHW (DW10ATED4)	Double Coi I(LPH)	09/99-09/02	DG-116		11V					4
2.0 Turbo	108	RGX (XU10J2TE)		05/95-09/02	K20TXR	5063	1.0	K20TT	IK20TT	IK20TT		4
2.1 TD	80	P 8 C	Double Coi I(LPH)	05/96-09/99	DG-001		11V					4
LAND ROVER												
88 / 109 (61-86)												
2.3 4x4	51	11G	LPG / GPL	11/79-10/83	W20ESR-U	3057	0.8	-	-			4
2.3 4x4	51/57	11/11H		10/71-10/83	W20ESR-U	3057	0.8	-	-			4
2.3 D 4x4	46	10 J; 23 J	Eng:10J01175>, Double Coi I(LPH)	09/83-12/86	DG-001		11V					4
2.3 D 4x4	46	10 J; 23 J	Eng:36623972B>, Double Coi I(LPH)	09/71-08/83	DG-001		11V					4
3.5 4x4	68	15G		01/80-12/83	W16EPR-U	3021	0.8	W16TT	IW16TT	IW16TT		8
90 / 110 (83-90)												
2.3 4x4	52	10 H		01/84-08/87	W16ESR-U	3110	0.8	-	-			4
2.5 4x4	61	17 H; 17 J		09/85-08/90	W16EPR-U	3021	0.8	W16TT	IW16TT	IW16TT		4
2.5 D 4x4	51	12 J		09/83-07/90	DG-001		11V					4
2.5 TD 4x4	63	19 J	Double Coi I(LPH)	09/86-07/90	DG-001		11V					4
DEFENDER (90-16)												
2.2 Td4 4x4	90/110	DT224		08/11-02/16	DG-611		4.4V					4
2.4 Td4 4x4	90	DT244	Double Coi I(LPH)	10/06-02/16	DG-130		11.5V					4
2.5 4x4	61	17H		09/90-12/94	W20EX-U	3062	0.8	W20TT	IW20TT	IW20TT		4
2.5 D 4x4	51	12 J		09/90-02/94	DG-001		11V					4
2.5 Td5 4x4	90	10 P; 14 P; 15 P		06/98-11/07	DG-182		11V					5
2.5 TDI 4x4	83	11 L; 16 L; 23 L		08/90-12/98	DG-115		11.5V					4
2.5 TDI 4x4	83	11 L; 16 L; 23 L	Double Coi I(LPH)	08/90-12/98	DG-115		11.5V					4
3.5 4x4	86	11 D; 21 G		09/90-08/93	W16EPR-U	3021	0.8	W16TT	IW16TT	IW16TT		8
3.9 V8 4x4	136	36D		11/98-05/00	W16EXR-U	3031	0.8	W16TT	IW16TT	IW16TT		8
DISCOVERY I (89-98)												
2.0 16 V 4x4	99	20 T4H		06/89-10/98	K20PR-U	3145	0.8	K20TT	IK20TT	IK20TT		4
2.5 D 4x4	90	19L		01/96-10/98	DG-115		11.5V					4
2.5 TDI 4x4	83	12 L; 17 L; 19 L; 21 L	Double Coi I(LPH)	10/89-10/98	DG-115		11.5V					4
3.5 4x4	98/113/122	15G; 22 D		06/89-06/94	W20EPR-U	3047	0.8	W20TT	IW20TT	IW20TT		8
4.0 4x4	134	35 D; 36 D		09/93-10/98	W20EPR-U	3047	0.8	W20TT	IW20TT	IW20TT		8
DISCOVERY II (98-04)												
2.5 Td5 4x4	102	10 P; 15 P	Double Coi I(LPH)	11/98-06/04	DG-182		11V					5
2.5 TDI	83/90	12 L; 17 L; 19 L; 21 L; 22 L	Double Coi I(LPH)	10/95-06/04	DG-115		11.5V					4
4.0 V8 4x4	136	35 D; 56 D; 94 D		11/98-06/04	PK16PR-L11	3275	1.1	-	IK16TT	IK16TT		8
DISCOVERY III (04-09)												
2.7 TD 4x4	140	276DT	Euro 4	07/04-09/09	DG-140		11V					6
4.4 4x4	220	448PN		07/04-09/09	IK16TT	4701	1.0	-	IK16TT	IK16TT		8
DISCOVERY IV (09-)												
2.7 TD 4x4	140	276DT	Euro 4	09/09-	DG-140		11V					6
3.0 4x4	250	306PS		08/13-	IK24	5311	0.8	-	-			6
5.0 V8 4x4	276	508PN		09/09-	PK20PR-L11	3142	1.1	-	IK20TT	IK20TT		8

Свечи зажигания и Свечи накаливания

Таблица применения





	KW				СТАНДАРТНЫЕ				Twin Tip			QTY
LAND ROVER продолжение												
DISCOVERY Sport (14-)												
2.2 D 4x4	110/ 140	224DT	OE: LR022300	09/14-	DG-632		5V					4
FREELANDER I (98-06)												
1.8 16V 4x4	86	18 K4F		04/98-10/06	PK20PR-L11	3142	1.1	-		IK20TT	IK20TT	4
1.8 i 16V 4x4	88	18 K4F		02/98-10/06	PK20PR-L11	3142	1.1	-		IK20TT	IK20TT	4
2.0 DI 4x4	72	20 T2N	Double Coil(LPH)	02/98-10/06	DG-101		11V					4
2.0 Td4 4x4	80/82	204D3; M 47	Double Coil(LPH)	11/00-10/06	DG-145		11V					4
2.5 V6 4x4	130	25 K4F		11/00-10/06	PK20PR-L11	3142	1.1	-		IK20TT	IK20TT	6
FREELANDER II (06-14)												
2.0 Si4 4x4	177	204PT	40000km Lifetime	10/11-10/14	ITV22	5340	0.8	-	-			4
2.2 eD4	110	224DT; DW12BTED4	Ch:>AH999999, OE:LR001302	08/10-10/14	DG-614		11V					4
2.2 eD4	110	224DT; DW12BTED4	Ch:BH000001> , OE:LR022300	08/10-10/14	DG-632		5V					4
2.2 SD4 4x4	140	224DT	Ch:>AH999999, OE:LR001302	08/10-10/14	DG-614		11V					4
2.2 SD4 4x4	140	224DT	Ch:BH000001> , OE:LR022300	08/10-10/14	DG-632		5V					4
2.2 TD4 4x4	110/ 112/ 115/ 118	224DT; DW12BTED4	Ch:>AH999999, OE:LR001302	10/06-10/14	DG-614		11V					4
2.2 TD4 4x4	110/ 112/ 115/ 118	224DT; DW12BTED4	Ch:BH000001> , OE:LR022300	10/06-10/14	DG-632		5V					4
3.2 4x4	171	B 6324 S		10/06-10/14	IKH20TT	4704	1.0	-		IKH20TT		6
3.2 4x4	171	B 6324 S		10/06-10/14	VKH20Y	5639	0.8	-	-		VKH20Y	6
RANGE ROVER Evoque (11-)												
2.0 4x4	177	204PT	40000km Lifetime	06/11-	ITV22	5340	0.8	-	-			4
2.2 D	110	224DT	OE: LR022300	06/11-	DG-632		5V					4
2.2 D 4x4	110/ 140	224DT	OE: LR022300	06/11-	DG-632		5V					4
RANGE ROVER I (70-95)												
2.4 TD 4x4	78	11 A	Double Coil Standard	04/86-12/90	DG-202		11V					4
2.4 TD 4x4	83	11 A		04/86-12/90	DG-202		11V					4
2.5 TD 4x4	89	14 L; 21 L		10/89-10/92	DG-202		11V					4
3.5 4x4	96	11 D		10/69-08/91	W16EPR-U	3021	0.8		W16TT	IW16TT	IW16TT	8
3.5 4x4	96	11 D	Eng: >12/1975	07/70-08/81	W16FPR-U	4192	0.7		-	-		8
3.5 4x4	96	11 D	Eng: 01/1976>	07/70-08/81	W16EPR-U	3021	0.8		W16TT	IW16TT	IW16TT	8
3.5 4x4	107	31 D		01/87-09/90	W20EPR-U	3047	0.8		W20TT	IW20TT	IW20TT	8
3.5 Vogue 4x4	93	11 D		08/81-09/90	W16EPR-U	3021	0.8		W16TT	IW16TT	IW16TT	8
3.5 Vogue 4x4	120	24 D; 25 D		10/85-09/90	W20EX-U	3062	0.8		W20TT	IW20TT	IW20TT	8
3.9 Cat 4x4	127	37 D; 38 D		11/88-07/94	W20EX-U	3062	0.8		W20TT	IW20TT	IW20TT	8
3.9 Vogue SEI 4x4	134	35 D; 36 D		11/88-07/94	W20EX-U	3062	0.8		W20TT	IW20TT	IW20TT	8
4.3 Vogue LSE 4x4	149	40D		09/92-07/94	W16EXR-U	3031	0.8		W16TT	IW16TT	IW16TT	8
RANGE ROVER II (94-02)												
2.5 D 4x4	100	25 6T (BMW)	Double Coil(LPH)	07/94-03/02	DG-001		11V					6
3.9 4x4	140	42D(190)		07/94-12/98	W16EXR-U	3031	0.8		W16TT	IW16TT	IW16TT	8
3.9 4x4	140	42D(190)		01/99-03/02	PK16PR-L11	3275	1.1	-		IK16TT	IK16TT	8
4.0 4x4	136	42D(185) - E97		01/95-12/98	W16EXR-U	3031	0.8		W16TT	IW16TT	IW16TT	8
4.0 4x4	136	42D(185) - E97		01/95-03/02	PK16PR-L11	3275	1.1	-		IK16TT	IK16TT	8
4.6 4x4	160/ 165	46D(218); 46D(224)		06/98-03/02	PK16PR-L11	3275	1.1	-		IK16TT	IK16TT	8
4.6 4x4	165	46D(224)		07/94-12/98	W16EXR-U	3031	0.8		W16TT	IW16TT	IW16TT	8
RANGE ROVER III (02-12)												
3.0 D 4x4	130	306D1	Double Coil(LPH)	03/02-08/12	DG-145		11V					6
3.6 D 4x4	200	368DT	Euro 4	04/06-08/12	DG-140		11V					8
4.2 4x4	291	428PS		05/05-08/12	SK16R11	3324	1.1	-		IK16TT	IK16TT	8
4.4 4x4	210	M62 B44		03/02-08/05	K20TXR	5063	1.0		K20TT	IK20TT	IK20TT	8
4.4 4x4	225	448PN		05/05-08/12	SK16R11	3324	1.1	-		IK16TT	IK16TT	8
RANGE ROVER Sport (05-13)												
2.7 D 4x4	140	276DT	Euro 4	02/05-03/13	DG-140		11V					6
3.6 D 4x4	200	368DT	Euro 4	04/06-03/13	DG-140		11V					8





Таблица применения

L

Свечи зажигания и Свечи накаливания

Таблица применения

Таблица применения

	KW				СТАНДАРТНЫЕ				Twin Tip			QTY
LAND ROVER продолжение												
RANGE ROVER Sport (05-13) продолжение												
4.2 4x4	287	428PS		02/05-03/13	SK16R11	3324	1.1	-	IK16TT	IK16TT		8
4.4 4x4	220	448PN		02/05-03/13	SK16R11	3324	1.1	-	IK16TT	IK16TT		8
LDV												
200 (89-96)												
1.9 D	47	XUD9		10/94-03/96	DG-001		11V					4
400 (86-98)												
2.5 D	53	EN 55	Double Coil Std(LPH)	04/89-10/96	DG-001		11V					4
2.5 D	71	ET 70		04/89-03/96	DG-001		11V					4
2.5 TD	71	ET 70	Double Coil Std(LPH)	11/95-10/98	DG-001		11V					4
CONVOY (96-09)												
2.5 D	53	EN 55	Double Coil Std(LPH)	04/96-02/02	DG-001		11V					4
2.5 D	53/71	EN 55; ET 70		04/96-06/06	DG-001		11V					4
2.5 DI	56	EN 55;4HB; EN 55		10/98-12/06	DG-001		11V					4
2.5 TDI	74	ET 70		10/98-10/06	DG-001		11V					4
CUB (98-01)												
2.3 D	53	LD23		08/98-09/01	DG-137		11V					4
MAXUS (05-09)												
2.5 D	70/88/99	BS580VM; BS582VM; VM39C; VM40C; VMR425		02/05-12/09	DG-176		11.5V					4
PILOT (96-05)												
1.9 D	52	XUD9		04/96-10/05	DG-001		11V					4
SHERPA (74-89)												
1.6	48	G16A		01/83-09/88	W16EPR-U	3021	0.8	W16TT	IW16TT	IW16TT		4
1.7	54	KB17		10/78-12/82	T20EPR-U	5032	0.8	T20TT	IT20TT	IT20TT		4
2.0	64	G20A		04/85-03/89	K20PR-L11	3144	1.1	K20TT	IK20TT	IK20TT		4
3.5	103			01/83-09/88	W16EPR-U	3021	0.8	W16TT	IW16TT	IW16TT		6
LEXUS												
CT (10-)												
200h	73	2ZR-FXE; 5ZR-FXE		12/10-	SC16HR11	3499	1.1	-	IXEH20TT	IXEH20TT		4
ES (89-97)												
250	118	2VZ-FE		12/89-12/91	PQ20R	3117	1.1	Q20TT	IQ20TT	IQ20TT		6
300	138	3VZ-FE		09/91-12/97	PQ20R	3117	1.1	Q20TT	IQ20TT	IQ20TT		6
ES (96-08)												
3.0	140/157	1MZ-FE		10/96-10/06	SK20R11	3297	1.1	-	IK20TT	IK20TT		6
3.3	168	3MZ-FE		06/03-10/06	SK20R11	3297	1.1	-	IK20TT	IK20TT		6
ES (06-12)												
3.5	204	2GR-FE		05/06-06/12	FK20HR11	3426	1.1	-	IKH20TT	IKH20TT		6
ES (12-)												
200	110/123	6AR-FSE		08/15-	FK16HBR-J8	3508	0.8	-	-	FK16HBR-J8		4
250	135	2AR-FE		06/12-06/18	SK16HR11	3417	1.1	-	IKH16TT	IKH16TT		4
300h	118	2AR-FXE		06/12-06/18	FK16HR-A8	3484	0.8	-	-	FK16HR-A8		4
350	183/204	2GR-FE		06/12-06/18	FK20HR11	3426	1.1	-	IKH20TT	IKH20TT		6
GS (93-97)												
300	156	2JZ-GE		01/93-08/95	PK16R11	3134	1.1	K16TT	IK16TT	IK16TT		6
300	156	2JZ-GE		01/95-08/97	PK16TR11	3289	1.1	K16TT	IK16TT	IK16TT		6
300	156	2JZ-GE-221		01/95-08/97	PK20R11	3128	1.1	K20TT	IK20TT	IK20TT		6
GS (97-05)												
300	161	2JZ-GE		10/00-12/04	SK20R-P11	3335	1.1	-	IK20TT	IK20TT		6
300	161/163	2JZ-GE		08/97-12/04	PK16TR11	3289	1.1	K16TT	IK16TT	IK16TT		6
300	163	2JZ-GE		08/97-10/00	PK20TR11	3253	1.1	K20TT	IK20TT	IK20TT		6
400	216	1UZ-FE		12/97-11/00	SK20R11	3297	1.1	-	IK20TT	IK20TT		8
430	208	3UZ-FE		11/00-12/04	SK20R11	3297	1.1	-	IK20TT	IK20TT		8
GS (05-11)												
3.0	170	3GR-FE		04/05-05/05	SK20HR11	3421	1.1	-	IKH20TT	IKH20TT		6
3.0	170	3GR-FE		05/05-11/11	FK20HR11	3426	1.1	-	IKH20TT	IKH20TT		6
300	183	3GR-FSE		04/05-09/07	FK20HBR11	3473	1.1	-	IKBH20TT	IKBH20TT		6
300	183	3GR-FSE		09/07-11/11	FK20HR11	3426	1.1	-	IKH20TT	IKH20TT		6
350 AWD	226	2GR-FSE		09/06-11/11	FK20HBR11	3473	1.1	-	IKBH20TT	IKBH20TT		6
430	208	3UZ-FE		04/05-11/11	SK20R11	3297	1.1	-	IK20TT	IK20TT		8

Свечи зажигания и Свечи накаливания

Таблица применения

















	KW				СТАНДАРТНЫЕ				Twin Tip		QTY
											
LEXUS продолжение											
GS (05-11) продолжение											
450h	218/ 254	2GR-FSE		02/06-11/11	FK20HBR11	3473	1.1	-	IKBH20TT	IKBH20TT	6
460	255	1UR-FSE		09/07-11/11	FK20HBR11	3473	1.1	-	IKBH20TT	IKBH20TT	8
GS (12-)											
200t	180	8AR-FTS		09/15-	VDKH22F	5662	0.9	-	-	VDKH22F	4
250	154	4GR-FSE		01/12-	FK20HBR11	3473	1.1	-	IKBH20TT	IKBH20TT	6
350 AWD	234	2GR-FSE		12/11-	FK20HBR11	3473	1.1	-	IKBH20TT	IKBH20TT	6
GS F	351	2UR-GSE		09/15-	FK20HBR-J8	3515	0.8	-	IKBH20TT	IKBH20TT	8
GX (01-09)											
470	175/ 199	2UZ-FE		11/01-11/09	SK20R11	3297	1.1	-	IK20TT	IK20TT	8
i V-8 32V	200	2UR-GSE		11/02-11/09	FK20HBR11	3473	1.1	-	IKBH20TT	IKBH20TT	8
GX (09-)											
470	218	1UR-FE		01/10-	SK16HR11	3417	1.1	-	IKH16TT	IKH16TT	8
470	218	1UR-FE		01/10-	SK20HR11	3421	1.1	-	IKH20TT	IKH20TT	8
IS C (09-)											
250	153	4GR-FSE		04/09-06/15	FK20HBR11	3473	1.1	-	IKBH20TT	IKBH20TT	6
IS I (99-05)											
200	114	1G-FE		04/99-10/05	K20R-U11	3139	1.1	K20TT	IK20TT	IK20TT	6
200	114	1G-FE		04/99-10/05	SK20R11	3297	1.1	-	IK20TT	IK20TT	6
300	157	2JZ-GE		09/01-10/05	PK16TR11	3289	1.1	K16TT	IK16TT	IK16TT	6
300	157	2JZ-GE		09/01-10/05	SK20R-P11	3335	1.1	-	IK20TT	IK20TT	6
IS II (05-13)											
200d	110	2AD-FTV		07/10-07/12	DG-600		11V				4
220d	130	2AD-FHV		08/05-07/12	DG-600		11V				4
250	153	4GR-FSE		08/05-03/13	FK20HBR11	3473	1.1	-	IKBH20TT	IKBH20TT	6
250 AWD	158	4GR-FSE		11/10-03/13	FK20HBR11	3473	1.1	-	IKBH20TT	IKBH20TT	6
IS F	311	2UR-GSE		11/07-03/13	FK20HBR11	3473	1.1	-	IKBH20TT	IKBH20TT	8
IS III (13-)											
200t	180	8AR-FTS		08/15-	VDKH22F	5662	0.9	-	-	VDKH22F	4
250	153	4GR-FSE		04/13-	FK20HBR11	3473	1.1	-	IKBH20TT	IKBH20TT	6
LC (16-)											
500	351	2UR-GSE		11/16-	FK20HBR-J8	3515	0.8	-	IKBH20TT	IKBH20TT	8
LS (89-94)											
400	180	1UZ-FE		12/89-12/95	PK20R11	3128	1.1	K20TT	IK20TT	IK20TT	8
LS (94-00)											
400	194	1UZ-FE		12/94-08/97	PK20R11	3128	1.1	K20TT	IK20TT	IK20TT	8
400	203/ 209/ 216	1UZ-FE		09/97-12/00	SK20R11	3297	1.1	-	IK20TT	IK20TT	8
LS (00-06)											
430	207	3UZ-FE		08/00-08/06	SK20R11	3297	1.1	-	IK20TT	IK20TT	8
LS (06-)											
460	255	1UR-FE		08/06-	SK20HR11	3421	1.1	-	IKH20TT	IKH20TT	8
460	280/ 283/ 285	1UR-FSE		04/06-	FK20HBR11	3473	1.1	-	IKBH20TT	IKBH20TT	8
460 4WD	280	1UR-FSE		08/06-	FK20HBR11	3473	1.1	-	IKBH20TT	IKBH20TT	8
460 AWD	270	1UR-FE		12/08-	SK20HR11	3421	1.1	-	IKH20TT	IKH20TT	8
460 AWD	270/ 272	1UR-FSE		12/08-	FK20HBR11	3473	1.1	-	IKBH20TT	IKBH20TT	8
600h AWD	290	2UR-FSE		04/07-	FK20HBR11	3473	1.1	-	IKBH20TT	IKBH20TT	8
LX (95-97)											
450 4WD	151	1FZ-FE		09/95-12/97	PK16R11	3134	1.1	K16TT	IK16TT	IK16TT	6
LX (98-08)											
470	170/ 173	2UZ-FE		05/98-03/08	SK20R11	3297	1.1	-	IK20TT	IK20TT	8
LX (07-)											
570	270	3UR-FE		11/07-	SK20HR11	3421	1.1	-	IKH20TT	IKH20TT	8
NX (14-)											
200	110	3ZR-FAE		11/14-	SC16HR11	3499	1.1	-	IXEH20TT	IXEH20TT	4
200t	175	8AR-FTS		07/14-	VDKH22F	5662	0.9	-	-	VDKH22F	4
200t AWD	175	8AR-FTS		07/14-	VDKH22F	5662	0.9	-	-	VDKH22F	4
300h	114	2AR-FXE		07/14-	FK16HR-A8	3484	0.8	-	-	FK16HR-A8	4
300h AWD	114	2AR-FXE		07/14-	FK16HR-A8	3484	0.8	-	-	FK16HR-A8	4
RC (14-)											
200t	180	8AR-FTS		08/15-	VDKH22F	5662	0.9	-	-	VDKH22F	4
350	234	2GR-FSE		08/14-	FK20HBR11	3473	1.1	-	IKBH20TT	IKBH20TT	6

Таблица применения

Свечи зажигания и Свечи накаливания

Таблица применения

Таблица применения

	KW				СТАНДАРТНЫЕ				Twin Tip		QTY
											
LEXUS продолжение											
RC (14-) продолжение											
RC F	330/ 344/ 351	2UR-GSE		08/14-	FK20HBR-J8	3515	0.8	-	IKBH20TT	IKBH20TT	8
RX (98-03)											
300	148	1MZ-FE		01/98-02/03	SK20R11	3297	1.1	-	IK20TT	IK20TT	6
300 AWD	148/ 164	1MZ-FE		01/98-05/03	SK20R11	3297	1.1	-	IK20TT	IK20TT	6
RX (03-08)											
3.3	171	3MZ-FE		04/03-01/06	SK20R11	3297	1.1	-	IK20TT	IK20TT	6
300	150	1MZ-FE		05/03-12/08	SK20R11	3297	1.1	-	IK20TT	IK20TT	6
330 AWD	171	3MZ-FE		04/03-12/08	SK20R11	3297	1.1	-	IK20TT	IK20TT	6
350 AWD	203	2GR-FE		02/06-12/08	FK20HR11	3426	1.1	-	IKH20TT	IKH20TT	6
400h	155	3MZ-FE		09/05-12/08	SK20R11	3297	1.1	-	IK20TT	IK20TT	6
400h AWD	155	3MZ-FE		09/04-12/08	SK20R11	3297	1.1	-	IK20TT	IK20TT	6
RX (08-15)											
3.5 AWD	183	2GR-FXE		04/09-10/15	FK20HR11	3426	1.1	-	IKH20TT	IKH20TT	6
350	202	2GR-FE		12/08-08/11	FK20HR11	3426	1.1	-	IKH20TT	IKH20TT	6
350 AWD	204	2GR-FE; 2GR-FXE		12/08-08/15	FK20HR11	3426	1.1	-	IKH20TT	IKH20TT	6
450h	183	2GR-FXE		12/08-10/15	FK20HR11	3426	1.1	-	IKH20TT	IKH20TT	6
450h AWD	183	2GR-FXE		12/08-10/15	FK20HR11	3426	1.1	-	IKH20TT	IKH20TT	6
RX (15-)											
200t	175	8AR-FTS		10/15-12/17	VDKH22F	5662	0.9	-	-	VDKH22F	4
200t AWD	175	8AR-FTS		10/15-12/17	VDKH22F	5662	0.9	-	-	VDKH22F	4
SC (91-00)											
300	162	2JZ-GE		01/95-08/95	PK16R11	3134	1.1	K16TT	IK16TT	IK16TT	6
300	162	2JZ-GE		01/95-03/00	PK16TR11	3289	1.1	K16TT	IK16TT	IK16TT	6
400	187/ 194	1UZ-FE		08/91-07/00	PK20R11	3128	1.1	K20TT	IK20TT	IK20TT	8
400	187/ 194	1UZ-FE		09/91-07/00	SK20R11	3297	1.1	-	IK20TT	IK20TT	8
SC (01-10)											
430	210/ 215	3UZ-FE		01/01-07/10	SK20R11	3297	1.1	-	IK20TT	IK20TT	8
LOTUS											
2 ELEVEN (07-11)											
1.8	142/ 188	2ZZ-GE		04/07-07/11	PK22PR8	3273	0.8	-	IK22TT	VK22	4
1.8	142/ 188	2ZZ-GE		04/07-07/11	SK20R11	3297	1.1	-	IK20TT	IK20TT	4
ECLAT (75-86)											
2.0	119	907		10/75-05/80	W22EPR-U	3088	0.8	W22TT	-	VW22	4
2.2	119	912		05/80-08/86	W20EPR-U	3047	0.8	W20TT	IW20TT	IW20TT	4
ELAN (89-95)											
1.6 i 16V	97	4XE1		09/89-11/95	K20PR-U	3145	0.8	K20TT	IK20TT	IK20TT	4
1.6 i 16V	97	4XE1		09/89-11/95	K20PR-U11	3121	1.1	K20TT	IK20TT	IK20TT	4
1.6 i 16V Turbo	115/ 123	4XE1-T		09/89-11/95	K20PR-U	3145	0.8	K20TT	IK20TT	IK20TT	4
ELISE 340R (00-01)											
1.8	132			03/00-02/01	PK20PR-L11	3142	1.1	-	IK20TT	IK20TT	4
ELISE (95-01)											
1.8	88	18 K4F		08/95-11/00	PK20PR-L11	3142	1.1	-	IK20TT	IK20TT	4
ELISE (00-)											
1.6	100	1ZR-FAE		06/07-	SC16HR11	3499	1.1	-	IXEH20TT	IXEH20TT	4
1.8	99	1ZZ-FE		10/03-	K20R-U11	3139	1.1	K20TT	IK20TT	IK20TT	4
1.8	118/ 141	2ZZ-GE		05/02-	PK22PR8	3273	0.8	-	IK22TT	VK22	4
1.8	118/ 141/ 162	2ZR-FE; 2ZZ-GE		05/02-	SK20R11	3297	1.1	-	IK20TT	IK20TT	4
1.8	162	2ZR-FE		06/07-	SC16HR11	3499	1.1	-	IXEH20TT	IXEH20TT	4
ELITE (74-82)											
2.0	119	907		05/74-05/80	W22EPR-U	3088	0.8	W22TT	-	VW22	4
2.2	119	912		05/80-12/82	W20EPR-U	3047	0.8	W20TT	IW20TT	IW20TT	4
ESPRIT S2 (75-88)											
2.0	119	907		10/75-05/80	W20EPR-U	3047	0.8	W20TT	IW20TT	IW20TT	4
2.2 Turbo	157	910		02/80-08/88	IW22	5307	0.8	-	-	VW22	4
ESPRIT S3 (80-88)											
2.2	119	912		05/80-08/86	W20EPR-U	3047	0.8	W20TT	IW20TT	IW20TT	4

Свечи зажигания и Свечи накаливания

Таблица применения











	KW				СТАНДАРТНЫЕ				Twin Tip		QTY
											
LOTUS продолжение											
ESPRIT S4 (89-03)											
2.2	221			11/94-07/96	W20ETR-L	3277	1.0	-	IW20TT	IW20TT	4
2.2 16V Turbo SE	197	910 S		05/89-09/96	W20ETR-L	3277	1.0	-	IW20TT	IW20TT	4
3.5 V8 32V Turbo	260	618		02/96-06/03	K20TNR-S9	3305	0.9	K20TT	IK20TT	IK20TT	8
EUROPA S (06-)											
2.0 Turbo	147	Z 20 LER		07/06-	KJ16CR-L11	3132	1.1	K16TT	IK16TT	IK16TT	4
2.0 Turbo	165	Z 20 LER		09/08-	KJ20CR-L11	3169	1.1	K20TT	IK20TT	IK20TT	4
EVORA (09-)											
3.5	206	2GR-FE		05/09-04/16	FK20HR11	3426	1.1	-	IKH20TT	IKH20TT	6
3.5	206	2GR-FE		05/09-04/16	VKH22	5619	0.8	-	-	VKH22	6
3.5 400	298	2GR-FE		09/15-	VKH22	5619	0.8	-	-	VKH22	6
3.5 S	258	2GR-FE		12/10-04/16	VKH22	5619	0.8	-	-	VKH22	6
EXCEL (83-91)											
2.2	119	912		10/83-08/86	W20EPR-U	3047	0.8	W20TT	IW20TT	IW20TT	4
2.2 SE/SA	135	912 S		10/84-08/91	W20ETR-L	3277	1.0	-	IW20TT	IW20TT	4
EXIGE (00-12)											
1.8 16V	132/ 141/ 163	2ZZ-GE		05/00-06/12	PK22PR8	3273	0.8	-	IK22TT	VK22	4
1.8 16V	132/ 141/ 163	2ZZ-GE		05/00-06/12	SK20R11	3297	1.1	-	IK20TT	IK20TT	4
1.8 265 E	197	2ZZ-GE		08/06-06/12	PK22PR8	3273	0.8	-	IK22TT	VK22	4
1.8 265 E	197	2ZZ-GE		08/06-06/12	SK20R11	3297	1.1	-	IK20TT	IK20TT	4
1.8 Cup 240	181	2ZZ-GE		04/06-06/12	PK22PR8	3273	0.8	-	IK22TT	VK22	4
1.8 Cup 240	181	2ZZ-GE		04/06-06/12	SK20R11	3297	1.1	-	IK20TT	IK20TT	4
1.8 Cup 260	191	2ZZ-GE		04/06-06/12	PK22PR8	3273	0.8	-	IK22TT	VK22	4
1.8 Cup 260	191	2ZZ-GE		04/06-06/12	SK20R11	3297	1.1	-	IK20TT	IK20TT	4
1.8 GT3	202	2ZZ-GE		08/06-06/12	PK22PR8	3273	0.8	-	IK22TT	VK22	4
1.8 GT3	202	2ZZ-GE		08/06-06/12	SK20R11	3297	1.1	-	IK20TT	IK20TT	4
1.8 S	179	2ZZ-GE		01/08-04/11	PK22PR8	3273	0.8	-	IK22TT	VK22	4
1.8 S	179	2ZZ-GE		01/08-04/11	SK20R11	3297	1.1	-	IK20TT	IK20TT	4
EXIGE (12-)											
3.5 350 S	257	2GR-FE		06/12-	FK20HR11	3426	1.1	-	IKH20TT	IKH20TT	6
3.5 350 S	257	2GR-FE		06/12-	VKH22	5619	0.8	-	-	VKH22	6
LTI											
TX (97-)											
2.4 i	112	4G69		04/09-	IKH20TT	4704	1.0	-	IKH20TT		4
2.4 TDi	66	D2FA	Double Coil(LPH)	10/02-	DG-130		11.5V				4
2.5 TD	75	R 425 DOHC	Double Coil(LPH)	01/06-	DG-176		11.5V				4
2.7 TD	60	TD27		01/97-	DG-198		11V				4
LUAZ											
969 (75-96)											
1.2	29	MEMZ-969		01/75-12/96	W22FS-U	4025	0.7	-	-		4
MAHINDRA											
CJ 3 (88-92)											
2.1 D	46	XDP 290	Double Coil Std(LPH)	10/88-09/92	DG-001		11V				4
2.1 D AWD	46	XDP 290	Double Coil Std(LPH)	10/88-09/92	DG-001		11V				4
CJ5 (87-16)											
2.1 D 4x4	44	XDP 290	Double Coil Std(LPH)	10/87-12/16	DG-001		11V				4
MAN											
TGE (16-)											
2.0 TDI	75/ 103/ 130	DAUA; DAUB; DAVA	Pressure sensor(-)	11/16-	DG-193		4.4V				3
2.0 TDI AWD	103/ 130	DAUA; DAVA	Pressure sensor(-)	03/17-	DG-193		4.4V				3
MARUTI											
800 (83-06)											
0.8	26	SUZUKI-FI		10/93-12/06	W16EPR-U	3021	0.8	W16TT	IW16TT	IW16TT	3
MARUTI SUZUKI											
ALTO (12-)											
1.0 CNG	43	K10B		11/14-	ZXU20PR11	3452	1.1	-	-	VXU20	4

Таблица применения

L M

Свечи зажигания и Свечи накаливания

Таблица применения

Таблица применения

KW	KW	KW	KW	KW	СТАНДАРТНЫЕ			Twin Tip		QTY
					mm	mm	mm	mm	mm	
MASERATI										
228 (86-93)										
2.8	182	473		07/87-12/90	W24EPR-U	4136	0.8	-	-	6
420 / 430 (85-94)										
420	133	452..		03/85-12/86	IW22	5307	0.8	-	-	6
430 i 2.8	182	473		02/88-12/94	W24EPR-U	4136	0.8	-	-	6
3200 GT (98-02)										
3.2 Biturbo V8 32V	250/ 271	AM 585		10/98-03/02	IU27	5363	0.9	-	-	8
4200 GT (01-)										
4.2	287/ 291	M 138		10/01-	IU24	5362	0.9	-	-	8
BITURBO (81-94)										
2.0	136	452..		07/85-04/87	IW24	5316	0.7	-	-	6
2.24V	180	475		03/89-12/94	XU24EPR-U	3312	0.9	-	-	6
2.5	147	453..		09/83-12/86	IW24	5316	0.7	-	-	6
2.8	165	473		01/89-12/94	IW22	5307	0.8	-	-	6
4.24V	180	475		04/90-12/94	XU27EPR-U	3313	0.9	-	-	6
222	162	471..		01/89-12/92	W24EPR-U	4136	0.8	-	-	6
222 E	182	473		01/89-10/89	W24EPR-U	4136	0.8	-	-	6
222 SE	165	473		11/89-12/94	IW22	5307	0.8	-	-	6
425	140/ 147	453..		06/84-08/87	W24EPR-U	4136	0.8	-	-	6
S 2.0	151	454		12/81-02/87	W24EPR-U	4136	0.8	-	-	6
Si 2.0	151	471..		09/87-12/88	W24EPR-U	4136	0.8	-	-	6
BORA (71-80)										
4.7	228	107/47		01/71-05/80	IW20TT	4709	1.0	-	IW20TT	8
GHIBLI I (67-73)										
4.7	228	107/47		01/67-12/73	IW20TT	4709	1.0	-	IW20TT	8
GHIBLI II (92-97)										
2.0 24V Bi-Turbo	225	AM 496		05/92-12/97	XU27EPR-U	3313	0.9	-	-	6
2.8 24V Bi-Turbo	209	AM 574		06/92-12/97	XU27EPR-U	3313	0.9	-	-	6
GRANCABRIO (10-)										
4.7	323/ 331	M 139 S; M 145 S		06/10-	IU24	5362	0.9	-	-	8
GRANSPORT (03-)										
4.2	295	M 138 P		06/04-	IU24	5362	0.9	-	-	8
GRANTURISMO (08-)										
4.2	298	M 139 P		08/08-	IU24	5362	0.9	-	-	8
4.7	331	M 145 T		09/10-	IU24	5362	0.9	-	-	8
4.7 S	323	M 139 S; M 145		08/08-12/12	IU24	5362	0.9	-	-	8
INDY (69-74)										
4.7	213			01/72-12/74	IW20TT	4709	1.0	-	IW20TT	8
MC 12 (04-)										
6.0	464			08/04-	IU24	5362	0.9	-	-	12
MEXICO (67-72)										
4.7	213			01/67-12/72	IW20TT	4709	1.0	-	IW20TT	8
QUATTROPORTE III (79-90)										
4.7	188			06/79-10/85	IW20TT	4709	1.0	-	IW20TT	8
QUATTROPORTE IV (94-01)										
2.0 Bi-Turbo	211	24V DOHC		03/94-09/98	XU27EPR-U	3313	0.9	-	-	6
2.8 Bi-Turbo	209	AM 574; AM 574 A		03/94-09/98	XU27EPR-U	3313	0.9	-	-	6
3.2 V8 32V	247	AM 578		12/95-05/01	IU27	5363	0.9	-	-	8
QUATTROPORTE V (04-)										
4.2	295	M139 A		03/04-	IU24	5362	0.9	-	-	8
4.7 GT S	323/ 331	M 139 L; M 139 S; M 145 T		06/08-	IU24	5362	0.9	-	-	8
4.7 S	317	M 139 R		06/08-	IU24	5362	0.9	-	-	8
SHAMAL (89-95)										
3.2	240			12/89-11/95	XU24EPR-U	3312	0.9	-	-	8
MAYBACH										
57 (02-12)										
5.5 (240.078)	405	M 285.950		09/02-12/12	IK20TT	4702	1.0	-	IK20TT	12
6.0	471	M 285.980		06/09-12/12	IK20TT	4702	1.0	-	IK20TT	12
6.0 (240.079)	463	M 285.980		01/11-12/12	IK20TT	4702	1.0	-	IK20TT	12
S 6.0 (240.079, 240.077)	450	M 285.980		09/05-12/12	IK20TT	4702	1.0	-	IK20TT	12

Свечи зажигания и Свечи накаливания

Таблица применения











	KW				СТАНДАРТНЫЕ				Twin Tip		QTY
											
MAZDA											
2 (03-07)											
1.2	55	FUJA		02/03-08/05	SK16PR-E11	3412	1.1	-	IK16TT	IK16TT	4
1.2	55	FUJA		09/05-06/07	PT16VR13	5068	1.3	TV16TT	ITV16TT	ITV16TT	4
1.25	55	FUJA		04/03-08/05	SK16PR-E11	3412	1.1	-	IK16TT	IK16TT	4
1.25	55	FUJA		09/05-06/07	PT16VR13	5068	1.3	TV16TT	ITV16TT	ITV16TT	4
1.4	59	FXJA		02/03-06/07	T16VR-U10	5086	1.0	TV16TT	ITV16TT	ITV16TT	4
1.4 CD	50	F6JA; F6JB		09/05-06/07	DG-180		11V				4
1.4 CD	50	F6JA; F6JB	Double Coil(LPH)	04/03-08/05	DG-113		11V				4
1.6	74	DURA16		02/03-08/05	SK16PR-E11	3412	1.1	-	IK16TT	IK16TT	4
1.6	74	FYJA		09/05-06/07	PT16VR13	5068	1.3	TV16TT	ITV16TT	ITV16TT	4
2 (07-15)											
1.3	55/63	ZJ-VE		10/07-06/15	IK16TT	4701	1.0	-	IK16TT	IK16TT	4
1.3	55/63	ZJ-VE		10/07-06/15	SK16PR-E11	3412	1.1	-	IK16TT	IK16TT	4
1.3 BiFuel	55/62	ZJ-46		05/11-11/14	IK20TT	4702	1.0	-	IK20TT	IK20TT	4
1.3 MZR	62	ZJ-VE		01/10-06/15	IK16TT	4701	1.0	-	IK16TT	IK16TT	4
1.3 MZR	62	ZJ-VE		01/10-06/15	SK16PR-E11	3412	1.1	-	IK16TT	IK16TT	4
1.4 MZR-CD	50	Y404		01/08-06/15	DG-180		11V				4
1.5	76	ZY-DE; ZY-VE		10/07-06/15	IK16TT	4701	1.0	-	IK16TT	IK16TT	4
1.5 MZR	75	ZY05; ZY66		06/11-06/15	IK16TT	4701	1.0	-	IK16TT	IK16TT	4
1.6 MZ-CD	66	Y406; Y646		10/08-06/15	DG-180		11V				4
1.6 MZ-CD	70	Y655; Y661		06/11-06/15	DG-603		5V				4
2 (14-)											
1.5	55/66/85	P5X0; P5X2; P5Y5; P5Y6; P5Y8; P5Z2; P5Z3; P5Z7; P5Z8; P5Z9		08/14-	IXEH22TT	4712	1.0	-	IXEH22TT		4
3 (00-09)											
1.4	62	ZJ-VE		10/03-02/06	SK16PR-E11	3412	1.1	-	IK16TT	IK16TT	4
1.4	62	ZJ-VE		10/03-07/07	K16PR-U11	3130	1.1	K16TT	IK16TT	IK16TT	4
1.4	62	ZJ-VE		07/07-06/09	IK16TT	4701	1.0	-	IK16TT	IK16TT	4
1.6	77	B6ZE; Z6		10/03-02/06	SK16PR-E11	3412	1.1	-	IK16TT	IK16TT	4
1.6	77	B6ZE; Z6		03/06-06/09	K16PR-U11	3130	1.1	K16TT	IK16TT	IK16TT	4
1.6 DI Turbo	80	Y601	Double Coil(LPH)	06/04-06/09	DG-113		11V				4
2.0	104/110	LF17; LF50; LF72; LF-DE; LFN7; LFN8; LF-VE		10/03-03/06	IT16TT	4713	1.0	-	IT16TT		4
2.0	104/110	LF17; LF50; LF72; LF-DE; LFN7; LFN8; LF-VE		03/06-12/09	ITV16TT	4718	1.0	-	ITV16TT		4
2.0	110	LF50; LF72; LF-DE; LFN7; LFN8; LF-VE	Ch: >144579	10/03-12/09	ZT20EPR11	5087	1.1	T20TT	IT20TT	IT20TT	4
2.0 MZR-CD	105	RF7J		12/06-12/08	DG-627		11V				4
2.3	118	L3-VE		03/04-03/09	ZT20EPR11	5087	1.1	T20TT	IT20TT	IT20TT	4
2.3 DiSi Turbo MPS	184	L3YH		06/06-06/09	ITV22	5340	0.8	-	-		4
2.3 MPS Turbo	191	L3N9; L3-VDT		12/06-06/09	ITV22	5340	0.8	-	-		4
2.3 MZR	115	L3-VE		03/04-02/05	ZT20EPR11	5087	1.1	T20TT	IT20TT	IT20TT	4
2.3 MZR	115	L3-VE		03/05-03/09	ITV20TT	4719	1.0	-	ITV20TT		4
3 (09-14)											
1.6 MZR	77	MZR16		11/11-09/14	K16PR-U11	3130	1.1	K16TT	IK16TT	IK16TT	4
1.6 MZR	77	MZR16(105)		12/08-09/14	SK16PR-E11	3412	1.1	-	IK16TT	IK16TT	4
1.6 MZR	77	MZR16(105)	OEM Optional	12/08-09/14	SK16PR-E11	3412	1.1	-	IK16TT	IK16TT	4
1.6 MZR CD	80	Y642		12/08-07/11	DG-180		11V				4
1.6 MZR CD	80/85	Y601; Y642; Y650; Y655		12/08-05/13	DG-113		11V				4
2.0	113	PEY7		09/11-09/14	IXEH22TT	4712	1.0	-	IXEH22TT		4
2.0 MZR	108/110	LF-5H; LF-5W; LF17; LF-DE		01/09-09/14	ITV16TT	4718	1.0	-	ITV16TT		4
2.0 MZR DISI	111	LF-Z2		12/08-05/13	ITV16TT	4718	1.0	-	ITV16TT		4
2.2 MZR CD	110/136	R2AA		01/09-10/11	DG-627		11V				4
2.3 MPS Turbo	191	L3Y7		06/09-09/14	ITV22	5340	0.8	-	-		4
3 (13-)											
1.5	74/88	P5Y1; P5Y4; P5Y5; P5Z3		09/13-	IXEH22TT	4712	1.0	-	IXEH22TT		4
2.0	88/110/121	PEX2; PEXL; PEY5; PEY7		09/13-	IXEH22TT	4712	1.0	-	IXEH22TT		4

Таблица применения

M

Свечи зажигания и Свечи накаливания

Таблица применения

Таблица применения

MAZDA	KW	KW	NOTE	21	СТАНДАРТНЫЕ				Twin Tip			QTY
					STANDARD	STANDARD	STANDARD	STANDARD	TWIN TIP	TWIN TIP	TWIN TIP	
MAZDA продолжение												
3 (13-) продолжение												
2.2 D	110	SHY1; SHY4; SHY6	Ch:>-178450, OE: SH01-18-601A; CZ163/DP82/92703	09/13-08/14	DG-667		7V					4
5 (05-10)												
1.8	85	MZR18(115)		02/05-05/10	IT16TT	4713	1.0	-	IT16TT			4
2.0	107	LFF7		02/05-08/07	IT16TT	4713	1.0	-	IT16TT			4
2.0	107	LFF7		09/07-05/10	ITV16TT	4718	1.0	-	ITV16TT			4
2.0 CD	81/105	RF7J	OE: RF2A-18-601	02/05-05/10	DG-502		11V					4
2.3	122			02/05-09/08	ZT20EPR11	5087	1.1	T20TT	IT20TT	IT20TT		4
2.3	122			03/05-09/08	ITV20TT	4719	1.0	-	ITV20TT			4
5 (10-)												
1.6 CD	85	Y6Y1; Y650; Y655		09/10-	DG-603		5V					4
2.0	106/108/110	LF-5H; LF-ZB	With Start/Stop,Ch:>135524	06/10-02/12	ITV20TT	4719	1.0	-	ITV20TT			4
2.0	106/108/110	LF-5H; LF-ZB	With Start/Stop,Ch:135524>	02/12-	ITV20TT	4719	1.0	-	ITV20TT			4
2.0	106/108/110	LF-5H; LF-ZB	Without Start/Stop,Ch:>135524	06/10-02/12	IT16TT	4713	1.0	-	IT16TT			4
2.0	106/108/110	LF-5H; LF-ZB	Without Start/Stop,Ch:>135524	06/10-02/12	ITV16TT	4718	1.0	-	ITV16TT			4
2.0	106/108/110	LF-5H; LF-ZB	Without Start/Stop,Ch:135524>	02/12-	IT16TT	4713	1.0	-	IT16TT			4
2.0	106/108/110	LF-5H; LF-ZB	Without Start/Stop,Ch:135524>	02/12-	ITV16TT	4718	1.0	-	ITV16TT			4
6 (02-07)												
1.8	88	L813; L823; L828		03/05-08/07	IT16TT	4713	1.0	-	IT16TT			4
1.8	88	L813; L823; L828	Ch:>GG1* -242690	08/02-04/04	ZT20EPR11	5087	1.1	T20TT	IT20TT	IT20TT		4
1.8	88	L813; L823; L828	Ch:GG1* 242690->	04/04-03/05	T20EPR-U15	5033	1.5					4
1.8	88	L813; L823; L828	Russia	03/05-08/07	T16EPR-U15	5023	1.5	T16TT	IT16TT	IT16TT		4
2.0	104	LF17; LF18	Ch: >242690	06/02-04/04	ZT20EPR11	5087	1.1	T20TT	IT20TT	IT20TT		4
2.0	104	LF17; LF18	Ch: 242690->	04/04-03/05	T20EPR-U15	5033	1.5					4
2.0	104/108	LF17; LF18; LFF7		03/05-08/07	ITV16TT	4718	1.0	-	ITV16TT			4
2.0 DI	89	RF5C		08/02-08/07	DG-502		11V					4
2.0 DI	89/100	RF5C	Double Coil(LPH)	06/02-08/07	DG-502		11V					4
2.0 DI	105	RF7J	OE: RF2A-18-601	06/05-08/07	DG-502		11V					4
2.3	120/122	L3C1	Russia	03/05-02/08	T16VR-U10	5086	1.0	TV16TT	ITV16TT	ITV16TT		4
2.3	120/122	MZR20(147)		03/05-02/08	ITV16TT	4718	1.0	-	ITV16TT			4
2.3	122	L3C1	Ch:>GG1* -242690	01/02-04/04	ZT20EPR11	5087	1.1	T20TT	IT20TT	IT20TT		4
2.3	122	L3C1	Ch:GG1* 242690->	04/04-03/05	T20EPR-U15	5033	1.5					4
2.3 AWD	119	L3C1	Ch:>GG1* -242690	11/02-04/04	ZT20EPR11	5087	1.1	T20TT	IT20TT	IT20TT		4
2.3 AWD	119	L3C1	Ch:GG1* 242690->	04/04-03/05	T20EPR-U15	5033	1.5					4
2.3 AWD	119	L3C1	Russia	03/05-08/07	T16VR-U10	5086	1.0	TV16TT	ITV16TT	ITV16TT		4
2.3 AWD	119	MZR20(147)		03/05-08/07	ITV16TT	4718	1.0	-	ITV16TT			4
2.3 MPS Turbo	191	L3KG		12/05-08/07	ITV22	5340	0.8	-	-			4
3.0	162/164	AJ		01/04-12/07	IT20TT	4714	1.0	-	IT20TT			6
6 (07-13)												
1.8 MZR	88	L813		08/07-07/13	IT16TT	4713	1.0	-	IT16TT			4
1.8 MZR	88	L813	Ch:>GH1* -501301, Russia	08/07-02/12	T16EPR-U15	5023	1.5	T16TT	IT16TT	IT16TT		4
2.0 MZR	108	LF17		08/07-10/09	ITV16TT	4718	1.0	-	ITV16TT			4
2.0 MZR	108/114	LF17; LF-DE		11/09-07/13	ITV20TT	4719	1.0	-	ITV20TT			4
2.0 MZR	108/114	LF17; LF-DE	Ch:>GH1* -501301, Russia	08/07-02/12	T16VR-U10	5086	1.0	TV16TT	ITV16TT	ITV16TT		4

Свечи зажигания и Свечи накаливания

Таблица применения











	KW				СТАНДАРТНЫЕ				Twin Tip		QTY
											
MAZDA продолжение											
6 (07-13) продолжение											
2.0 MZR	108/114	LF17; LF-DE	Ch: GH1* 501301-> ,Russia	02/12-07/13	ITV16TT	4718	1.0	-	ITV16TT		4
2.2 D	95/132	R2AA; R2BF		01/10-12/12	DG-627		11V				4
2.2 MZR-CD	92/120/132/136	R2AA; R2BF		08/08-12/12	DG-627		11V				4
2.5 MZR	125	L5-VE		08/07-07/13	ITV16TT	4718	1.0	-	ITV16TT		4
2.5 MZR	125	L5-VE	Ch:> GH1* -501301, Russia	08/07-02/12	T16VR-U10	5086	1.0	TV16TT	ITV16TT	ITV16TT	4
6 (12-)											
2.0	107/110/121	PEXB; PEXL; PEY5; PEY7		12/12-	IXEH22TT	4712	1.0	-	IXEH22TT		4
2.2 D	110/129	SHY1; SHY4; SHY6; SHY8	Ch:>-185759, OE: SH01-18-601A; CZ163/DP82/92703	12/12-08/14	DG-667		7V				4
2.5	141	PYY1; PY-Y8; PY-ZA		12/12-	IXEH22TT	4712	1.0	-	IXEH22TT		4
121 I (87-90)											
1.1	42	B1		10/87-10/90	W16EPR-U11	3201	1.1	W16TT	IW16TT	IW16TT	4
1.3	40/44	B3		10/87-06/91	W16EPR-U	3021	0.8	W16TT	IW16TT	IW16TT	4
121 II (90-97)											
1.1	40	B1		11/90-10/93	W16EPR-U	3021	0.8	W16TT	IW16TT	IW16TT	4
1.3 16V	39	B3 (16V)		11/90-03/96	W16EPR-U	3021	0.8	W16TT	IW16TT	IW16TT	4
1.3 i 16V	53	B3 (16V)		11/90-03/96	K16PR-U11	3130	1.1	K16TT	IK16TT	IK16TT	4
121 III (96-03)											
1.25	55	DHF; DHG		03/96-04/03	PT16VR10	5093	1.0	TV16TT	ITV16TT	ITV16TT	4
1.3	37/44	J4R; J4T; JJK; JJM		03/96-04/03	PT16EPR-L13	5070	1.3	-	IT16TT	IT16TT	4
1.8 D	44	RTJ; RTK	Double Coil(LPH)	03/96-04/03	DG-007		11.5V				4
323 C IV (89-00)											
1.3	49	B3E		09/89-07/94	W16EPR-U	3021	0.8	W16TT	IW16TT	IW16TT	4
1.3 16V	54	B3 (16V)		09/89-07/94	K16PR-U11	3130	1.1	K16TT	IK16TT	IK16TT	4
1.6	62	B6E		09/89-06/91	K16PR-U	3191	0.8	K16TT	IK16TT	IK16TT	4
1.6 16V	65	B6		03/91-10/94	W20EPR-U11	3049	1.1	W20TT	IW20TT	IW20TT	4
1.7 D	41	PN54	Ceramic(LPH)	08/89-07/94	DG-645		11V				4
1.8 16V	103	BP31		09/89-03/93	K20PR-U	3145	0.8	K20TT	IK20TT	IK20TT	4
1.8 16V 4WD	76	BP		11/91-12/93	K20PR-U11	3121	1.1	K20TT	IK20TT	IK20TT	4
1.8 16V GT	94	BP (DOHC)		09/89-03/93	K16PR-U11	3130	1.1	K16TT	IK16TT	IK16TT	4
1.8 16V Turbo 4WD	120/136	BP Turbo		09/90-07/94	IK20TT	4702	1.0	-	IK20TT	IK20TT	4
323 C V (94-98)											
1.3 16V	54	B3 (16V)		08/94-09/98	K16PR-U11	3130	1.1	K16TT	IK16TT	IK16TT	4
1.5 16V	65	Z5-DE		08/94-09/98	K16PR-U11	3130	1.1	K16TT	IK16TT	IK16TT	4
1.8 16V	84	BP-ZE		08/94-09/98	K16PR-U11	3130	1.1	K16TT	IK16TT	IK16TT	4
323 F IV (87-94)											
1.6	62	B6E		09/89-06/91	K20PR-U11	3121	1.1	K20TT	IK20TT	IK20TT	4
1.6	77	B6 (SOHC)		04/87-08/93	W16EXR-U	3031	0.8	W16TT	IW16TT	IW16TT	4
1.6 16V	65	B6		03/91-10/94	K16PR-U	3191	0.8	K16TT	IK16TT	IK16TT	4
1.8 4WD	76	BPC		01/91-04/94	K20PR-U11	3121	1.1	K20TT	IK20TT	IK20TT	4
1.8 16V	76	BP		08/89-07/94	K20PR-U11	3121	1.1	K20TT	IK20TT	IK20TT	4
1.8 16V	103	BP31		09/89-03/93	K20PR-U	3145	0.8	K20TT	IK20TT	IK20TT	4
1.8 16V GT	94	BP (DOHC)		08/89-07/94	K20PR-U11	3121	1.1	K20TT	IK20TT	IK20TT	4
323 F V (94-98)											
1.5 16V	65	Z5-DE		07/94-09/98	K16PR-U11	3130	1.1	K16TT	IK16TT	IK16TT	4
1.8 16V	84	BP-ZE		08/94-09/98	K16PR-U11	3130	1.1	K16TT	IK16TT	IK16TT	4
2.0 24V	106	KF		08/94-09/98	K20PR-U11	3121	1.1	K20TT	IK20TT	IK20TT	6
323 F VI (98-04)											
1.4	53	B3-ME		01/01-05/04	K16PR-U11	3130	1.1	K16TT	IK16TT	IK16TT	4
1.4 16V	54	B3-BJ		09/98-01/01	K16PR-U11	3130	1.1	K16TT	IK16TT	IK16TT	4
1.5 16V	65	ZL		09/98-01/01	K16PR-U11	3130	1.1	K16TT	IK16TT	IK16TT	4
1.6	70/72	ZM		01/01-05/04	SKJ16CR-A8	3370	0.8	-	-	SKJ16CR-A8	4
1.6	70/72	ZM	OEM Optional	01/01-05/04	SKJ20CR-A8	3371	0.8	-	-	SKJ20CR-A8	4
1.9 16V	84	FP-18		09/98-01/01	K16PR-U11	3130	1.1	K16TT	IK16TT	IK16TT	4

Таблица применения

M

Свечи зажигания и Свечи накаливания

Таблица применения

Таблица применения

MAZDA	KW	ENGINE	NOTE	21	СТАНДАРТНЫЕ			Twin Tip		QTY	
					SPARK PLUG	RESISTOR	WIRE	SPARK PLUG	SPARK PLUG		
MAZDA продолжение											
323 F VI (98-04) продолжение											
2.0	96	FS-7		01/01-05/04	KJ16CR-U11	3311	1.1	K16TT	IK16TT	IK16TT	4
2.0	96	FS-7	OEM Optional	01/01-05/04	KJ20CR-U11	3451	1.1	K20TT	IK20TT	IK20TT	4
2.0 D	52	RF1G	Double Coil(LPH)	09/98-05/04	DG-502		11V				4
2.0 TD	66/74	RF4F	Double Coil(LPH)	09/98-05/04	DG-502		11V				4
323 I (77-86)											
1.0	33	PC		06/77-05/80	K16PR-U11	3130	1.1	K16TT	IK16TT	IK16TT	4
1.3	44	TC		01/77-05/80	W20EP-U	3043	0.8	W20TT	IW20TT	IW20TT	4
1.3	44	TC		05/78-05/86	W16EPR-U	3021	0.8	W16TT	IW16TT	IW16TT	4
1.4	51	UC		05/78-05/80	W16EXR-U	3031	0.8	W16TT	IW16TT	IW16TT	4
1.5	52	D5		04/82-05/86	W16EPR-U	3021	0.8	W16TT	IW16TT	IW16TT	4
323 II (80-89)											
1.1	40	E1		11/80-10/85	W16EPR-U	3021	0.8	W16TT	IW16TT	IW16TT	4
1.3	44/50	E3		11/80-10/89	K16PR-U	3191	0.8	K16TT	IK16TT	IK16TT	4
1.5	55/ 59/ 63/65	D5; E5		11/80-09/86	W16EPR-U	3021	0.8	W16TT	IW16TT	IW16TT	4
323 III (85-95)											
1.1	40	E1		08/85-04/90	W16EXR-U	3031	0.8	W16TT	IW16TT	IW16TT	4
1.3	44/ 50/52	B315; B335; E3		08/85-04/90	W16EXR-U	3031	0.8	W16TT	IW16TT	IW16TT	4
1.3 i	49	B3E		09/85-08/89	W16EXR-U	3031	0.8	W16TT	IW16TT	IW16TT	4
1.4	44	B3		04/87-10/89	W20EPR-U	3047	0.8	W20TT	IW20TT	IW20TT	4
1.5	54	B5; B50; B53; E5		08/85-09/91	W16EXR-U	3031	0.8	W16TT	IW16TT	IW16TT	4
1.5 i	70	E5E3		08/85-05/89	W16EXR-U	3031	0.8	W16TT	IW16TT	IW16TT	4
1.5 i Turbo	85	E5E2		08/85-05/89	W16EXR-U	3031	0.8	W16TT	IW16TT	IW16TT	4
1.6	54/63	B6 (SOHC); B6E; B65M; B68		09/86-10/95	W16EXR-U	3031	0.8	W16TT	IW16TT	IW16TT	4
1.6 4x4	63	B6E; B65M		05/90-03/93	W16EXR-U	3031	0.8	W16TT	IW16TT	IW16TT	4
1.6 GT	63/77	B6 (SOHC)		08/85-08/93	W16EXR-U	3031	0.8	W16TT	IW16TT	IW16TT	4
1.6 GT Turbo	103	B6		10/85-08/93	Q20PR-U	3007	0.8	Q20TT	IQ20TT	IQ20TT	4
1.6 GT Turbo 4WD	103/ 110	B6		08/87-11/91	Q20PR-U	3007	0.8	Q20TT	IQ20TT	IQ20TT	4
1.7 D	41	PN26; PN27; PN46; PN54	Ceramic(LPH)	04/86-03/93	DG-645		11V				4
323 P V (96-98)											
1.3 16V	54	B3 (16V)		10/96-09/98	K20PR-U11	3121	1.1	K20TT	IK20TT	IK20TT	4
1.5 16V	65	Z5-DE		10/96-09/98	K20PR-U11	3121	1.1	K20TT	IK20TT	IK20TT	4
2.0 D	52	RF1G	Double Coil(LPH)	10/96-09/98	DG-502		11V				4
323 S IV (89-94)											
1.3	49	B3E		09/89-06/91	W16EPR-U	3021	0.8	W16TT	IW16TT	IW16TT	4
1.3 16V	54	B3 (16V)		04/91-07/94	K16PR-U11	3130	1.1	K16TT	IK16TT	IK16TT	4
1.6	62	B6E		09/89-06/91	W16EPR-U11	3201	1.1	W16TT	IW16TT	IW16TT	4
1.6 16V	65	B6		08/89-10/96	W20EPR-U11	3049	1.1	W20TT	IW20TT	IW20TT	4
1.7 D	41	PN46; PN54; PN62	Ceramic(LPH)	08/89-07/94	DG-645		11V				4
1.8 16V GT	94	BP (DOHC)		06/89-07/94	K20PR-U11	3121	1.1	K20TT	IK20TT	IK20TT	4
1.8 16V Turbo 4WD	120	BP Turbo		01/91-07/94	IK20TT	4702	1.0	-	IK20TT	IK20TT	4
323 S V (94-98)											
1.3 16V	54	B3 (16V)		08/94-09/98	K16PR-U11	3130	1.1	K16TT	IK16TT	IK16TT	4
1.5 16V	65	Z5-DE		08/94-09/98	K16PR-U11	3130	1.1	K16TT	IK16TT	IK16TT	4
1.6 TD	60	4EE1-T		05/94-09/96	DG-645		11V				4
1.8 16V	84	BP-ZE		08/94-09/98	K16PR-U11	3130	1.1	K16TT	IK16TT	IK16TT	4
2.0 D	52	RF1G	Double Coil(LPH)	10/96-09/98	DG-502		11V				4
323 S VI (98-04)											
1.3	53	B3-ME		01/01-05/04	K16PR-U11	3130	1.1	K16TT	IK16TT	IK16TT	4
1.3 16V	54	B3-ME		09/98-01/01	K16PR-U11	3130	1.1	K16TT	IK16TT	IK16TT	4
1.3 16V	54	B3-ME	OEM Optional	09/98-01/01	K16PR-U11	3130	1.1	K16TT	IK16TT	IK16TT	4
1.5 16V	65	ZL		09/98-01/01	K16PR-U11	3130	1.1	K16TT	IK16TT	IK16TT	4
1.6	70/72	ZM		01/01-05/04	SKJ20CR-A8	3371	0.8	-	-	SKJ20CR-A8	4
1.9 16V	84	FP-18		09/98-05/04	K16PR-U11	3130	1.1	K16TT	IK16TT	IK16TT	4
2.0	96	FS7E; FS7G		01/01-05/04	KJ20CR-U11	3451	1.1	K20TT	IK20TT	IK20TT	4
2.0 D	52	RF1G	Double Coil(LPH)	09/98-05/04	DG-502		11V				4
2.0 DiTD	74	RF4F		10/00-10/02	DG-502		11V				4
2.0 TD	66	RF3F	Double Coil(LPH)	09/98-05/04	DG-502		11V				4

Свечи зажигания и Свечи накаливания

Таблица применения











	KW				СТАНДАРТНЫЕ			Twin Tip			QTY
											
MAZDA продолжение											
616 (73-78)											
1.6	55	NA		06/73-02/78	W16EPR-U	3021	0.8	W16TT	IW16TT	IW16TT	4
626 I (78-82)											
1.6	55	NA		05/79-05/82	W20EPR-U	3047	0.8	W20TT	IW20TT	IW20TT	4
2.0	66	M		03/79-05/82	W16EPR-U	3021	0.8	W16TT	IW16TT	IW16TT	4
626 II (82-87)											
1.6	55/59	F603; F658		11/82-09/87	W16EXR-U13	3213	1.3	W16TT	IW16TT	IW16TT	4
1.6	59	F6		11/82-09/87	W16EPR-U	3021	0.8	W16TT	IW16TT	IW16TT	4
2.0	68/ 70/ 74/ 81/88	FE (8V); FE-3L; FE-3M		02/83-01/90	Q20PR-U	3007	0.8	Q20TT	IQ20TT	IQ20TT	4
2.0	68/ 70/ 74/ 81/88	FE (8V); FE-3L; FE-3M		02/83-01/90	W16EXR-U	3031	0.8	W16TT	IW16TT	IW16TT	4
2.0	68/ 70/ 74/ 81/88	FE (8V); FE-3L; FE-3M		02/83-01/90	W20EXR-U	3066	0.8	W20TT	IW20TT	IW20TT	4
2.0 D	46	RF46	Double Coil(LPH)	08/85-06/87	DG-146		11V				4
2.0 D	46	RF46	Single Coil	01/83-08/85	DG-114		11V				4
2.0 i Turbo	87	FE-EGI		01/86-10/87	W16EXR-U	3031	0.8	W16TT	IW16TT	IW16TT	4
626 III (87-97)											
1.6	60	F6		06/87-05/92	W16EPR-U	3021	0.8	W16TT	IW16TT	IW16TT	4
1.6	60	F6		06/87-05/92	W16EXR-U13	3213	1.3	W16TT	IW16TT	IW16TT	4
1.8	65	F8		11/87-05/92	K20PR-U	3145	0.8	K20TT	IK20TT	IK20TT	4
1.8	69	F8 (12V)		11/87-05/92	W16EPR-U	3021	0.8	W16TT	IW16TT	IW16TT	4
2.0	66	FE (8V); FE (12V)		09/87-09/97	Q20PR-U	3007	0.8	Q20TT	IQ20TT	IQ20TT	4
2.0	66	FE (8V); FE (12V)		09/87-09/97	W16EXR-U	3031	0.8	W16TT	IW16TT	IW16TT	4
2.0	66	FE (8V); FE (12V)		09/87-09/97	W20EXR-U	3066	0.8	W20TT	IW20TT	IW20TT	4
2.0 4x4	110	FE-FL		08/89-07/91	W16EXR-U	3031	0.8	W16TT	IW16TT	IW16TT	4
2.0 12V	79/81	FE (12V)		09/87-05/92	Q20PR-U	3007	0.8	Q20TT	IQ20TT	IQ20TT	4
2.0 12V	79/81	FE (12V)		09/87-05/92	W16EXR-U	3031	0.8	W16TT	IW16TT	IW16TT	4
2.0 12V	79/81	FE (12V)		09/87-05/92	W20EXR-U	3066	0.8	W20TT	IW20TT	IW20TT	4
2.0 16V	103/ 109	FE (16V)		06/87-05/92	Q20PR-U11	3008	1.1	Q20TT	IQ20TT	IQ20TT	4
2.0 D	44/60	RFG5; RF-N	Double Coil(LPH)	07/87-09/97	DG-146		11V				4
2.0 D Complex	55	RF-CX	Double Coil(LPH)	05/93-11/96	DG-146		11V				4
2.0 GLX	86	FS		04/92-02/95	K20PR-U11	3121	1.1	K20TT	IK20TT	IK20TT	4
2.0 i 16V	110	FECM		10/88-09/97	K20PR-U11	3121	1.1	K20TT	IK20TT	IK20TT	4
2.2 12V	85	F2		11/87-11/96	W16EPR-U	3021	0.8	W16TT	IW16TT	IW16TT	4
2.2 12V 4WD	85	F2		11/87-11/92	W16EPR-U	3021	0.8	W16TT	IW16TT	IW16TT	4
2.2 12V 4WD	85	F2	Ch: >200000	01/90-05/92	QJ20CR11	3112	1.1	Q20TT	IQ20TT	IQ20TT	4
2.2 12V 4WD	85	F2	Ch: 200001>	01/90-05/92	KJ16CR-U11	3311	1.1	K16TT	IK16TT	IK16TT	4
626 IV (91-97)											
1.8	66	FP01LP		08/94-04/97	K20PR-U11	3121	1.1	K20TT	IK20TT	IK20TT	4
1.8	77	FP		08/91-04/97	K16PR-U11	3130	1.1	K16TT	IK16TT	IK16TT	4
1.8 i	66	FP01LP		08/94-04/97	K20PR-U11	3121	1.1	K20TT	IK20TT	IK20TT	4
1.8 i	77	FP		01/92-06/97	K16PR-U11	3130	1.1	K16TT	IK16TT	IK16TT	4
2.0 D GLX Complex	55	RF55	Double Coil(LPH)	10/92-12/95	DG-146		11V				4
2.0 i	85	FS		08/91-04/97	K20PR-U11	3121	1.1	K20TT	IK20TT	IK20TT	4
2.0 i 4WD	85	FS		04/92-04/97	K20PR-U11	3121	1.1	K20TT	IK20TT	IK20TT	4
2.5 24V	121	KL; KL-ZE		01/92-04/97	KJ16CR-U11	3311	1.1	K16TT	IK16TT	IK16TT	6
626 V (97-02)											
1.8	66	FP	OEM Optional	10/99-01/00	PKJ20CR8	3173	0.8	-	IK20TT	IK20TT	4
1.8	66/74	FP; FP9A; FPY3		05/97-10/02	PKJ16CR8	3175	0.8	-	-	-	4
1.8	66/74	FP9A; FPY3		05/97-10/02	PKJ20CR8	3173	0.8	-	IK20TT	IK20TT	4
2.0	85/ 100	FS-115; FS-136		02/98-10/02	PKJ16CR8	3175	0.8	-	-	-	4
2.0	85/ 100	FS-115; FS-136	OEM Optional	05/97-10/02	PKJ20CR8	3173	0.8	-	IK20TT	IK20TT	4
2.0 DITD	66	RF3F	Double Coil(LPH)	04/98-10/02	DG-502		11V				4
2.0 H.P.	100	FS-136		02/98-10/02	PKJ16CR8	3175	0.8	-	-	-	4
2.0 H.P.	100	FS-136	OEM Optional	06/00-10/02	PKJ20CR8	3173	0.8	-	IK20TT	IK20TT	4
2.0 TD	81	RF4F	Double Coil(LPH)	10/00-10/02	DG-502		11V				4

Таблица применения

M

Свечи зажигания и Свечи накаливания

Таблица применения

Таблица применения

MAZDA	KW	KW	NOTE	21	СТАНДАРТНЫЕ			Twin Tip			QTY
					1	2	3	1	2	3	
MAZDA продолжение											
626 V (97-02) продолжение											
2.0 Turbo DI	74	RF4F	Double Coil(LPH)	04/98-10/02	DG-502		11V				4
818 (72-78)											
1.3	44	TC		01/74-10/78	W20EPR-U	3047	0.8	W20TT	IW20TT	IW20TT	4
1.6	55	NA		01/77-10/78	W20EPR-U	3047	0.8	W20TT	IW20TT	IW20TT	4
929 I (78-88)											
2.0	66	MA		05/79-07/86	W20EPR-U	3047	0.8	W20TT	IW20TT	IW20TT	4
929 II (82-87)											
2.0	66/74	FE; MA		05/82-12/87	W20EPR-U	3047	0.8	W20TT	IW20TT	IW20TT	4
2.0	74	FE		03/84-07/87	K20PR-U	3145	0.8	K20TT	IK20TT	IK20TT	4
2.0 i GLX	88	FE		10/84-07/87	W20EPR-U	3047	0.8	W20TT	IW20TT	IW20TT	4
2.0 i Turbo	88	FE		10/84-07/87	W20EPR-U	3047	0.8	W20TT	IW20TT	IW20TT	4
929 III (87-91)											
2.2 12V	85	F2E		01/88-04/89	Q20PR-U	3007	0.8	Q20TT	IQ20TT	IQ20TT	4
2.2 12V	94	F2-C		04/89-06/91	KJ20CR-U11	3451	1.1	K20TT	IK20TT	IK20TT	4
2.2 i	100	F2-EGl		05/87-12/88	W16EPR-U11	3201	1.1	W16TT	IW16TT	IW16TT	4
3.0	125/140	JE3		06/87-06/91	QJ20CR11	3112	1.1	Q20TT	IQ20TT	IQ20TT	6
3.0	140	JE	Ch: 631983>	06/87-06/91	KJ16CR-U11	3311	1.1	K16TT	IK16TT	IK16TT	6
3.0 i	123	JE3		01/90-06/91	KJ16CR-L11	3132	1.1	K16TT	IK16TT	IK16TT	6
3.0 i	123	JE3		01/90-06/91	KJ16CR-U11	3311	1.1	K16TT	IK16TT	IK16TT	6
929 IV (90-96)											
3.0	123	JE34; JE35		12/90-09/92	KJ16CR-L11	3132	1.1	K16TT	IK16TT	IK16TT	6
3.0	123	JE34; JE35		12/90-09/92	KJ16CR-U11	3311	1.1	K16TT	IK16TT	IK16TT	6
1300 (75-77)											
1.3	44	TC		02/71-01/77	W20EPR-U	3047	0.8	W20TT	IW20TT	IW20TT	4
AZOFFROAD (98-)											
0.7 AWD	47	K6A		10/98-09/08	IXU22	5308	0.9	-	IXU22TT	VXU22	3
0.7 AWD	47	K6A		09/08-	IXUH22	5353	0.9	-	IXUH22TT	VXUH22	3
B-SERIE (77-82)											
1.6	55	NA		02/77-09/78	W16EPR-U	3021	0.8	W16TT	IW16TT	IW16TT	4
1.8	60	VC		02/77-01/82	W16EPR-U	3021	0.8	W16TT	IW16TT	IW16TT	4
B-SERIE (81-85)											
1.8	62	H817		10/81-08/85	IW16TT	4708	1.0	-	IW16TT		4
B-SERIE (85-99)											
1.6	60	F6		01/85-03/96	W16EXR-U13	3213	1.3	W16TT	IW16TT	IW16TT	4
2.0	62/65	FE (8V)		01/85-03/96	W16EPR-U	3021	0.8	W16TT	IW16TT	IW16TT	4
2.2	68	F2L8		08/91-12/96	IW16TT	4708	1.0	-	IW16TT		4
2.2 D	47	R290		11/89-03/96	DG-146		11V				4
2.5 D	63		Double Coil(LPH)	02/96-06/99	DG-146		11V				4
2.5 D 4WD	57/63	WL; WL31	Double Coil(LPH)	02/96-06/99	DG-146		11V				4
2.6 4WD	73	4G54		01/87-10/90	W16EPR-U	3021	0.8	W16TT	IW16TT	IW16TT	4
2.6 12V 4WD	90	G6MPV		08/91-06/99	KJ16CR-U11	3311	1.1	K16TT	IK16TT	IK16TT	4
B-SERIE (99-06)											
2.2	68	F2R4	OEM Optional	11/99-08/02	W20EPR-U11	3049	1.1	W20TT	IW20TT	IW20TT	4
2.2 4WD	60	R5-A2	OEM Optional	02/99-11/06	W20EPR-U11	3049	1.1	W20TT	IW20TT	IW20TT	4
2.2 8V 4WD	68	F2-R4	OEM Optional	06/99-11/06	W20EPR-U11	3049	1.1	W20TT	IW20TT	IW20TT	4
2.5 D	57/62	MD25NA; WLE7		06/99-11/06	DG-146		11V				4
2.5 D	62	WLE7		12/02-11/06	DG-645		11V				4
2.5 D 4WD	57/62	MD25NA; WLE7		06/99-11/06	DG-146		11V				4
2.5 D 4WD	62	WLE7		12/02-11/06	DG-645		11V				4
2.5 TD 4WD	80	MD25TI	Double Coil(LPH)	06/99-07/06	DG-146		11V				4
BT-50 (06-)											
2.5 MRZ-CD 4x4	105	WLAA		12/06-12/10	DG-630		11V				4
3.0 CDVi 4x4	115	WEAT		10/06-12/12	DG-630		11V				4
CAROL (89-98)											
0.7	38	F6A		10/89-10/98	XU22EPR-U	3179	0.9	XU22TT	IXU22TT	VXU22	3
CAROL (98-04)											
0.7	34	F6A		11/98-03/04	XU22EPR-U	3179	0.9	XU22TT	IXU22TT	VXU22	3
CAROL (04-10)											
0.7	40	K6A		04/04-04/10	XU22EPR-U	3179	0.9	XU22TT	IXU22TT	VXU22	3
0.7	40	K6A	LEAN BURN	04/04-04/10	IXU22	5308	0.9	-	IXU22TT	VXU22	3
CAROL (10-)											
0.7	40	K6A		01/10-	IXUH22	5353	0.9	-	IXUH22TT	VXUH22	3

Свечи зажигания и Свечи накаливания

Таблица применения











	KW				СТАНДАРТНЫЕ			Twin Tip			QTY
											
MAZDA продолжение											
CAROL (10-) продолжение											
0.7	40	K6A		01/10-	XU22EPR-U	3179	0.9	XU22TT	IXU22TT	VXU22	3
CAROL (15-)											
0.7	36/38	R06A		01/15-	VXUH22	5611	0.9	-	IXUH22TT	VXUH22	3
0.7 4WD	38	R06A		01/15-	VXUH22	5611	0.9	-	IXUH22TT	VXUH22	3
CX-3 (15-)											
2.0	88	PEX3		05/15-01/18	IXEH22TT	4712	1.0	-	IXEH22TT		4
2.0 AWD	110	PE-VPS; PEX3; PEXB; PEXT		05/15-	IXEH22TT	4712	1.0	-	IXEH22TT		4
CX-5 (11-17)											
2.0	113/ 121	PEY4; PEY5; PEY6; PEY7		11/11-02/17	IXEH22TT	4712	1.0	-	IXEH22TT		4
2.0 AWD	118	PEY6; PEY7		11/11-02/17	IXEH22TT	4712	1.0	-	IXEH22TT		4
2.2 D	110	SHY1	Ch:>-316446, OE: SH01-18-601A; CZ163/DP82/ 92703	04/12-08/14	DG-667		7V				4
2.2 D AWD	110/ 129	SHY1	Ch:>-316446, OE: SH01-18-601A; CZ163/DP82/ 92703	04/12-08/14	DG-667		7V				4
2.5 AWD	141	PYY1		02/15-02/17	IXEH22TT	4712	1.0	-	IXEH22TT		4
CX-7 (07-14)											
2.2 MZR-CD AWD	127	R2AA		07/09-03/13	DG-627		11V				4
2.3 MZR DISI Turbo AWD	190	L3-VDT		10/07-03/13	ITV22	5340	0.8	-	-		4
2.5 MZR	120	L5-VE		07/09-03/13	ITV16TT	4718	1.0	-	ITV16TT		4
CX-9 (07-)											
3.5	193	CYC4		09/06-12/07	ITV16TT	4718	1.0	-	ITV16TT		6
3.5 AWD	193	CYC4		01/07-	ITV16TT	4718	1.0	-	ITV16TT		6
3.7	204	CAY1; CAY5; CAY6		01/07-	ITV22	5340	0.8	-	-		6
3.7 AWD	204	CA; CAY1; CAY5; CAY6		01/07-	ITV22	5340	0.8	-	-		6
DEMIO (98-03)											
1.3 16V	46	B3 ME		08/98-07/03	K16PR-U11	3130	1.1	K16TT	IK16TT	IK16TT	4
1.3 i 16V	53	B3 (16V)		08/98-04/00	K16PR-U11	3130	1.1	K16TT	IK16TT	IK16TT	4
1.5 16V	55	B5 E		04/00-07/03	K16PR-U11	3130	1.1	K16TT	IK16TT	IK16TT	4
E-SERIE (SD) (83-04)											
E2000	60/65	FEBN; FE-BN		01/83-05/95	W16EXR-U	3031	0.8	W16TT	IW16TT	IW16TT	4
E2200 D	47	R281	Single Coil	07/89-03/97	DG-114		11V				4
E2200 D	52	R21N		09/99-04/02	DG-146		11V				4
E-SERIE (SG) (95-06)											
2.5 i	117	J5DE		06/95-02/99	IK16	5303	1.1	-	IK16TT	IK16TT	6
E-SERIE (SR) (83-04)											
2200 D 4WD	47	R203; R207	Single Coil	03/91-05/03	DG-114		11V				4
E2000	60/ 63/ 65/70	FE (8V); FE60; FE61		01/84-05/03	W16EXR-U	3031	0.8	W16TT	IW16TT	IW16TT	4
E2000	60/ 65/70	FE (8V); FE60; FE61		01/84-05/03	Q20PR-U	3007	0.8	Q20TT	IQ20TT	IQ20TT	4
E2000	60/ 65/70	FE (8V); FE60; FE61		01/84-05/03	W20EXR-U	3066	0.8	W20TT	IW20TT	IW20TT	4
E2000	63	FE-BN/FE-EP	OEM Optional	12/87-04/89	W16EXR-U	3031	0.8	W16TT	IW16TT	IW16TT	4
E2000 4WD	60	FE-BN	OEM Optional	10/88-09/89	W16EXR-U	3031	0.8	W16TT	IW16TT	IW16TT	4
E2000 4WD	65	FE-BN		01/88-07/91	W16EXR-U	3031	0.8	W16TT	IW16TT	IW16TT	4
E2200 D	47	R203; R207	Single Coil	01/84-12/03	DG-114		11V				4
E2200 D	52	R2	Double Coil(LPH)	02/97-08/02	DG-146		11V				4
E2200 D 4WD	47	R2	Single Coil	01/87-05/03	DG-114		11V				4
E2200 D 4WD	52	R2	Double Coil(LPH)	02/97-05/03	DG-146		11V				4
E-SERIE (80-84)											
E1600	51	NA		08/80-06/84	W16EPR-U	3021	0.8	W16TT	IW16TT	IW16TT	4
LUCE (89-92)											
3.0	123			06/89-09/92	IK16	5303	1.1	-	IK16TT	IK16TT	6
MPV I (88-99)											
2.5 TD	85	WL11	Double Coil(LPH)	05/96-09/99	DG-146		11V				4
3.0	112	JE94		09/88-12/91	KJ16CR-L11	3132	1.1	K16TT	IK16TT	IK16TT	6
3.0	112	JE94		09/88-12/91	KJ16CR-U11	3311	1.1	K16TT	IK16TT	IK16TT	6
3.0 4WD	112	JE94		09/88-12/91	KJ16CR-L11	3132	1.1	K16TT	IK16TT	IK16TT	6

Таблица применения

M

Свечи зажигания и Свечи накаливания

Таблица применения

Таблица применения

MAZDA	KW	ENGINE	NOTE	21	СТАНДАРТНЫЕ			Twin Tip		QTY	
					SPARK	GLAND	W	SPARK	GLAND		
MAZDA продолжение											
MPV I (88-99) продолжение											
3.0 4WD	112	JE94		09/88-12/91	KJ16CR-U11	3311	1.1	K16TT	IK16TT	IK16TT	6
3.0 i V6	109/ 113	JE94; JE96		11/88-10/95	KJ16CR-L11	3132	1.1	K16TT	IK16TT	IK16TT	6
3.0 i V6	109/ 113	JE94; JE96		11/88-10/95	KJ16CR-U11	3311	1.1	K16TT	IK16TT	IK16TT	6
3.0 i V6	109/ 113	JE94; JE96		10/95-09/99	K16PR-U11	3130	1.1	K16TT	IK16TT	IK16TT	6
MPV II (99-06)											
2.0	88/90	FS-D		09/99-07/02	KJ16CR-U11	3311	1.1	K16TT	IK16TT	IK16TT	4
2.0 DI	100	RF5C	Double Coil(LPH)	07/02-02/06	DG-502		11V				4
2.3	104	L3		07/02-02/06	ZT20EPR11	5087	1.1	T20TT	IT20TT	IT20TT	4
2.3	104	L3	OEM Optional	07/02-02/06	IT16TT	4713	1.0	-	IT16TT		4
2.5 V6	125	GY-DE		09/99-11/01	PT16EPR-L13	5070	1.3	-	IT16TT	IT16TT	6
2.5 V6	125	GY-DE		12/01-03/02	ZT20EPR11	5087	1.1	T20TT	IT20TT	IT20TT	6
3.0 i V6	147	AJ		01/02-12/06	IT20TT	4714	1.0	-	IT20TT		6
MX-3 (91-98)											
1.6	66	B69		05/91-10/93	K16PR-U11	3130	1.1	K16TT	IK16TT	IK16TT	4
1.6 i	79	B6D		11/93-09/98	K16PR-U11	3130	1.1	K16TT	IK16TT	IK16TT	4
1.8 i V6	95	K838		01/94-10/97	IK16TT	4701	1.0	-	IK16TT	IK16TT	6
1.8 i V6	98	K819		01/92-01/94	K16PR-U11	3130	1.1	K16TT	IK16TT	IK16TT	6
MX-5 I (90-98)											
1.6	66/85	8AN1; B64F		05/90-04/98	K20PR-U11	3121	1.1	K20TT	IK20TT	IK20TT	4
1.8	96	BPF1		01/93-04/98	IK20TT	4702	1.0	-	IK20TT	IK20TT	4
MX-5 II (98-05)											
1.6 16V	81	B6-4J		05/98-10/05	K16PR-U11	3130	1.1	K16TT	IK16TT	IK16TT	4
1.8	103	BPD		01/98-07/02	K20PR-U11	3121	1.1	K20TT	IK20TT	IK20TT	4
1.8 16V	103/ 107	BPD; BP-ZE		05/98-10/05	K20PR-U11	3121	1.1	K20TT	IK20TT	IK20TT	4
1.8 i Turbo	136	BP Turbo		04/02-10/05	IK20TT	4702	1.0	-	IK20TT	IK20TT	4
MX-5 III (05-14)											
1.8	93	MZR18(126)		03/05-12/14	IT16TT	4713	1.0	-	IT16TT		4
2.0	118	LFG7; LFG8; LFG7; LFYK; LFZ8		07/05-12/14	ITV20TT	4719	1.0	-	ITV20TT		4
MX-5 IV (15-)											
1.5	96	P5-VPR		06/15-	IXEH22TT	4712	1.0	-	IXEH22TT		4
2.0	118	PEX4; PEX6		06/15-	IXEH22TT	4712	1.0	-	IXEH22TT		4
MX-6 (92-97)											
2.0	85	FS-19		02/92-02/97	K16PR-U11	3130	1.1	K16TT	IK16TT	IK16TT	4
2.5	122	KL		09/92-01/97	KJ16CR-U11	3311	1.1	K16TT	IK16TT	IK16TT	6
2.5 24V	121/ 123	KL		02/92-09/97	KJ16CR-U11	3311	1.1	K16TT	IK16TT	IK16TT	6
2.5 i 24V	120	KL		08/94-02/97	KJ16CR-U11	3311	1.1	K16TT	IK16TT	IK16TT	6
PREMACY (99-05)											
1.9	74/84	FP; FP-18		07/99-06/01	K16PR-U11	3130	1.1	K16TT	IK16TT	IK16TT	4
1.9	84	FP-E1		07/01-03/05	KJ16CR-U11	3311	1.1	K16TT	IK16TT	IK16TT	4
2.0	96	FS-7E/FS-7G		11/01-03/05	KJ16CR-U11	3311	1.1	K16TT	IK16TT	IK16TT	4
2.0 TD	66/74	RF3F; RF4F	Double Coil(LPH)	10/99-03/05	DG-502		11V				4
RX 5 (75-81)											
1.1	92	12A(125)/13B		06/75-12/79	W22EBR	3082	1.1	-	-		2
RX 7 I (79-86)											
1.0	77	12AN2		05/79-05/81	W22EBR	3082	1.1	-	-		2
1.1	83	12AN2		03/84-03/86	W27EBR	3107	1.1	-	-		2
1.1	85	12A(115)		01/81-01/83	W22EBR	3082	1.1	-	-		2
RX 7 II (85-91)											
1.3	110	RE13B		11/85-04/89	W29EBR	3310	1.1	-	-		4
1.3 Turbo	133	RE13B		06/87-11/89	S-31A	3111	1.95	-	-		4
1.3 Turbo	147	13B-MSP; RE13B		03/89-12/91	IRE01-27	5719	0.7	-	-		4
RX 7 III (92-02)											
1.3 Twin Turbo	176	RE13B		07/92-08/02	IRE01-27	5719	0.7	-	-		4
RX 8 (03-12)											
1.3	141/ 170/ 177	13B-MSP		10/03-03/08	IRT01-31	5752	1.1	-	-		2
1.3	141/ 170/ 177	13B-MSP	Twin Spark Exhaust side	04/08-06/12	IRT01-31	5752	1.1	-	-		2

Свечи зажигания и Свечи накаливания

Таблица применения











	KW				СТАНДАРТНЫЕ				Twin Tip		QTY
											
MAZDA продолжение											
RX 8 (03-12) продолжение											
1.3	141/ 170/ 177	13B-MSP	Twin Spark Intake side	04/08-06/12	IRL01-27	5754	1.1	-	-		2
SCRUM (05-15)											
0.7	35	K6A		05/10-02/15	IXUH22	5353	0.9	-	IXUH22TT	VXUH22	3
0.7	35	K6A	LEAN BURN	01/05-05/10	IXU22	5308	0.9	-	IXU22TT	VXU22	3
0.7	35/47	F6A; K6A		01/05-05/10	XU22EPR-U	3179	0.9	XU22TT	IXU22TT	VXU22	3
0.7	47	F6A-T/C		01/05-04/09	IXU22	5308	0.9	-	IXU22TT	VXU22	3
0.7 4WD	36	K6A		01/05-05/10	XU22EPR-U	3179	0.9	XU22TT	IXU22TT	VXU22	3
0.7 4WD	36	K6A		05/10-02/15	IXUH22	5353	0.9	-	IXUH22TT	VXUH22	3
0.7 4WD	36	K6A	LEAN BURN	01/05-05/10	IXU22	5308	0.9	-	IXU22TT	VXU22	3
TOWN BOX (98-)											
1.1	57	4A31		11/98-07/03	XU22EPR-U	3179	0.9	XU22TT	IXU22TT	VXU22	4
TRIBUTE (00-08)											
2.0	91	YF		03/00-02/05	PT16VR13	5068	1.3	TV16TT	ITV16TT	ITV16TT	4
2.0 4WD	91	YF		03/00-12/03	PT16VR13	5068	1.3	TV16TT	ITV16TT	ITV16TT	4
2.3 AWD	110	L3	OEM Optional	04/04-05/08	IT16TT	4713	1.0	-	IT16TT		4
2.3 AWD	110	L3-VE		04/04-05/08	ZT20EPR11	5087	1.1	T20TT	IT20TT	IT20TT	4
2.3 GX	110	L3-VE		12/03-10/04	ZT20EPR11	5087	1.1	T20TT	IT20TT	IT20TT	4
3.0 V6 24V 4WD	145	AJ		03/00-05/08	IT20TT	4714	1.0	-	IT20TT		6
3.0 V6 AWD	149	AJ		04/04-05/08	IT20TT	4714	1.0	-	IT20TT		6
XEDOS 6 (92-99)											
1.6 16V	79	B6		04/94-10/99	K16PR-U11	3130	1.1	K16TT	IK16TT	IK16TT	4
1.6 16V	83	B69		01/92-03/94	K20PR-U11	3121	1.1	K20TT	IK20TT	IK20TT	4
2.0 V6	103/ 106	KF1		01/92-10/99	K20PR-U11	3121	1.1	K20TT	IK20TT	IK20TT	6
XEDOS 9 (93-02)											
2.0 24V	105	KF		08/93-01/00	K16PR-U11	3130	1.1	K16TT	IK16TT	IK16TT	6
2.3 24V	155	KJ -ZEM		02/95-01/00	PKJ16CR8	3175	0.8	-	-		6
2.5 24V	123	K8-ZE25		07/93-07/00	KJ20CR-U11	3451	1.1	K20TT	IK20TT	IK20TT	6
2.5 24V	123	K8-ZE25	OEM Optional	07/93-07/00	KJ16CR-U11	3311	1.1	K16TT	IK16TT	IK16TT	6
2.5 V6	120	K8-ZE25		07/00-09/02	KJ20CR-U11	3451	1.1	K20TT	IK20TT	IK20TT	6
2.5 V6	120	K8-ZE25	OEM Optional	07/00-09/02	KJ16CR-U11	3311	1.1	K16TT	IK16TT	IK16TT	6
MERCEDES-BENZ											
/8 (W114) (68-77)											
230.6 (114.015)	88	M 180.954		01/68-11/76	W20EP-U	3043	0.8	W20TT	IW20TT	IW20TT	6
250	96	M 114.920		07/68-08/72	W20EP-U	3043	0.8	W20TT	IW20TT	IW20TT	6
250 (114.010)	85	M 114.920		01/68-08/72	W20EP-U	3043	0.8	W20TT	IW20TT	IW20TT	6
250 2.8 (114.011)	96	M 130.923		06/72-11/76	W20EP-U	3043	0.8	W20TT	IW20TT	IW20TT	6
250 C (114.021)	96	M 114.920		04/69-06/72	W20EP-U	3043	0.8	W20TT	IW20TT	IW20TT	6
250 C 2.8 (114.023)	96	M 130.923		06/72-11/76	W20EP-U	3043	0.8	W20TT	IW20TT	IW20TT	6
250 CE (114.022)	110	M 114.980		04/69-04/72	W20EP-U	3043	0.8	W20TT	IW20TT	IW20TT	6
280 (114.060)	118	M 110.921		06/72-11/76	W20EP-U	3043	0.8	W20TT	IW20TT	IW20TT	6
280 C (114.073)	118	M 110.921		06/72-02/77	W20EP-U	3043	0.8	W20TT	IW20TT	IW20TT	6
280 CE (114.072)	136	M 110.981		06/72-01/77	W20EP-U	3043	0.8	W20TT	IW20TT	IW20TT	6
280 E (114.062)	136	M 110.981		06/72-11/76	W20EP-U	3043	0.8	W20TT	IW20TT	IW20TT	6
/8 (W115) (68-77)											
200	70	M 115.923; M 115.926		01/68-01/77	W20EP-U	3043	0.8	W20TT	IW20TT	IW20TT	4
200 (115.015)	63	M 115.923; M 115.926		01/68-01/77	W20EP-U	3043	0.8	W20TT	IW20TT	IW20TT	4
200 D (115.115)	40	OM 615.913		01/68-01/77	DG-001		11V				4
220 (115.010)	66/77	M 115.920; M 115.924		01/68-07/73	W20EP-U	3043	0.8	W20TT	IW20TT	IW20TT	4
220 D (115.110)	44	OM 615.912		01/68-01/77	DG-001		11V				4
230.4 (115.017)	81	M 115.951		08/73-12/76	W20EP-U	3043	0.8	W20TT	IW20TT	IW20TT	4
240 D 3.0 (115.114)	59	OM 617.910	Double Coil(LPH)	08/74-11/76	DG-001		11V				5
100 (631) (88-96)											
2.0 D	45	OM 615.963; OM 615.970		04/88-04/96	DG-001		11V				4
D	41	OM 616	Double Coil(LPH)	12/90-02/91	DG-001		11V				4
D	41	OM 616	Double Coil(LPH)	02/91-12/94	DG-010		11.5V				4
D (631...0)	53/55	OM 616.963	Double Coil(LPH)	02/88-02/91	DG-001		11V				4
D (631...0)	53/55	OM 616.963	Double Coil(LPH)	02/89-02/96	DG-010		11.5V				4











Таблица применения

M

Свечи зажигания и Свечи накаливания

Таблица применения

Таблица применения

	KW				СТАНДАРТНЫЕ				Twin Tip			QTY
												
MERCEDES-BENZ продолжение												
100 (631) (88-96) продолжение												
D (631...2)	53/55	OM 616.963	Double Coil(LPH)	02/88-02/91	DG-001		11V					4
D (631...2)	53/55	OM 616.963	Double Coil(LPH)	02/91-02/96	DG-010		11.5V					4
D (631...3, 631...4)	53/55	OM 616.963; OM 616	Double Coil(LPH)	02/88-02/91	DG-001		11V					4
D (631...3, 631...4)	53/55	OM 616.963; OM 616	Double Coil(LPH)	02/91-02/96	DG-010		11.5V					4
190 (W201) (82-93)												
D 2.0	53/55	OM 601.911	Double Coil(LPH)	08/83-08/93	DG-001		11V					4
D 2.5	66	OM 602.911	Double Coil(LPH)	04/85-01/89	DG-001		11V					5
D 2.5	66/69	OM 602.911	Double Coil(LPH)	02/89-08/93	DG-010		11.5V					5
E 1.8	80	M 102.910		04/90-08/93	T20EP-U	5031	0.8	T20TT	IT20TT	IT20TT		4
E 2.0	66/ 76/ 83/ 85/ 87/ 90/93	M 102.921; M 102.924; M 102.961; M 102.962		10/82-08/93	T20EP-U	5031	0.8	T20TT	IT20TT	IT20TT		4
E 2.3	97/ 100	M 102.985		10/82-08/93	T20EP-U	5031	0.8	T20TT	IT20TT	IT20TT		4
E 2.3-16	125/ 130/ 136	M 102.983		04/84-08/88	T20EP-U	5031	0.8	T20TT	IT20TT	IT20TT		4
E 2.5 Evolution II	173	M 102.992		05/90-08/93	T20EP-U	5031	0.8	T20TT	IT20TT	IT20TT		4
E 2.5-16	143/ 150	M 102.990; M 102.991		09/88-08/93	T20EP-U	5031	0.8	T20TT	IT20TT	IT20TT		4
E 2.6	118/ 120	M 103.942		10/82-08/93	T20EP-U	5031	0.8	T20TT	IT20TT	IT20TT		6
Turbo-D 2.5 (201.128)	92	OM 602.961	Double Coil(LPH)	02/88-08/93	DG-010		11.5V					5
A-CLASS (W168) (97-04)												
A 140 (168...31)	60	M 166.940; M 166.960		07/97-08/04	K20PBR-S10	5061	1.0	K20TT	IK20TT	IK20TT		4
A 160 (168...33)	75	M 166.960		07/97-08/04	K20PBR-S10	5061	1.0	K20TT	IK20TT	IK20TT		4
A 160 CDI (168...06)	55	OM 668.940	Double Coil(LPH)	02/01-08/04	DG-155		11.5V					4
A 160 CDI (168...07)	44	OM 668.941	Double Coil(LPH)	07/98-02/01	DG-155		11.5V					4
A 170 CDI (168...08)	66	OM 668.940	Double Coil(LPH)	07/98-02/01	DG-155		11.5V					4
A 170 CDI (168...09)	70	OM 668.942	Double Coil(LPH)	02/01-08/04	DG-155		11.5V					4
A 190 (168...32)	92	M 166.990		03/99-08/04	K20PBR-S10	5061	1.0	K20TT	IK20TT	IK20TT		4
A 210 (168...35)	103	M 166.995		12/01-08/04	K20PBR-S10	5061	1.0	K20TT	IK20TT	IK20TT		4
A-CLASS (W169) (04-12)												
A 150 (169...31)	70	M 266.920		09/04-06/12	K20PR-U11	3121	1.1	K20TT	IK20TT	IK20TT		4
A 160 (169...31)	70	M 266.920		04/09-06/12	K20PR-U11	3121	1.1	K20TT	IK20TT	IK20TT		4
A 160 CDI (169...06)	60	OM 640.942	Instant heating (ISS)	09/04-06/12	DG-194		4.4V					4
A 170 (169...32)	85	M 266.940		09/04-06/12	K20PR-U11	3121	1.1	K20TT	IK20TT	IK20TT		4
A 180 (169...32)	85	M 266.940		04/09-06/12	K20PR-U11	3121	1.1	K20TT	IK20TT	IK20TT		4
A 180 CDI (169...07)	80	OM 640.940	Instant heating (ISS)	09/04-06/12	DG-194		4.4V					4
A 200 (169...33)	100	M 266.960		09/04-06/12	K20PR-U11	3121	1.1	K20TT	IK20TT	IK20TT		4
A 200 CDI (169...08)	102	OM 640.941	Instant heating (ISS)	09/04-06/12	DG-194		4.4V					4
A 200 Turbo (169...34)	142	M 266.980		09/05-06/12	IK20TT	4702	1.0	-	IK20TT	IK20TT		4
A-CLASS (W176) (12-)												
A 160 CDI / d (176.011)	66	OM 607.951	Instant heating (ISS)	06/13-05/18	DG-609		4.4V					4
A 180 CDI / d 1.5 (176.012)	80	OM 607.951	Instant heating (ISS)	06/12-05/18	DG-609		4.4V					4
A 180 CDI / d 1.8 (176.000)	80	OM 651.901	OE: A 001 159 57 01; A 001 159 58 01; A 001 159 6601	06/12-10/14	DG-617		7V					4
A 200 CDI / d 1.8 (176.001)	100	OM 651.901	OE: A 001 159 57 01; A 001 159 58 01; A 001 159 6601	06/12-10/14	DG-617		7V					4

Свечи зажигания и Свечи накаливания

Таблица применения





	KW				СТАНДАРТНЫЕ				Twin Tip			QTY
MERCEDES-BENZ продолжение												
A-CLASS (W176) (12-) продолжение												
A 200 CDI / d 2.1 (176.008)	100	OM 651.930	OE: A0011597301/A0011598001	02/14-05/18	DG-665		7V					4
A 200 CDI / d 2.1 4-matic (176.002)	100	OM 651.930	OE: A0011597301/A0011598001	02/14-05/18	DG-665		7V					4
A 220 CDI (176.003)	120/125	OM 651.930	OE: A0011597301/A0011598001	09/12-05/18	DG-665		7V					4
A 220 CDI 4-matic (176.005)	125	OM 651.930	OE: A0011597301/A0011598001	02/14-05/18	DG-665		7V					4
A 220 d (176.003)	130	OM 651.930	OE: A0011597301/A0011598001	07/15-05/18	DG-665		7V					4
A 220 d 4-matic (176.005)	130	OM 651.930	OE: A0011597301/A0011598001	07/15-05/18	DG-665		7V					4
B-CLASS (W242, W246) (11-)												
B 160 CDI / d (246.211)	66	OM 607.951	Instant heating (ISS)	05/13-12/18	DG-609		4.4V					4
B 180 CDI / d 1.5 (246.212)	80	OM 607.951	Instant heating (ISS)	02/13-12/18	DG-609		4.4V					4
B 180 CDI / d 1.8 (246.200)	80	OM 651.901	OE: A 001 159 57 01; A 001 159 58 01; A 001 159 6601	11/11-08/14	DG-617		7V					4
B 200 CDI / d 1.8 (246.201)	100	OM 651.901	OE: A 001 159 57 01; A 001 159 58 01; A 001 159 6601	11/11-08/14	DG-617		7V					4
B 200 CDI / d 2.1 (246.208)	100	OM 651.930	OE: A0011597301/A0011598001	08/14-12/18	DG-665		7V					4
B 200 CDI / d 2.1 4-matic (246.202)	100	OM 651.930	OE: A0011597301/A0011598001	08/14-12/18	DG-665		7V					4
B 220 CDI / d (246.203)	120/125/130	OM 651.930	OE: A0011597301/A0011598001	11/11-12/18	DG-665		7V					4
B 220 CDI / d 4-matic (246.205)	130	OM 651.930	OE: A0011597301/A0011598001	08/14-12/18	DG-665		7V					4
B-CLASS (W245) (05-11)												
B 150 (245.231)	70	M 266.920		03/05-11/11	K20PR-U11	3121	1.1	K20TT	IK20TT	IK20TT		4
B 160 (245.231)	70	M 266.920		04/09-11/11	K20PR-U11	3121	1.1	K20TT	IK20TT	IK20TT		4
B 170 (245.232)	85	M 266.940		03/05-11/11	K20PR-U11	3121	1.1	K20TT	IK20TT	IK20TT		4
B 170 NGT (245.233)	85	M 266.960		04/08-11/11	K20PR-U11	3121	1.1	K20TT	IK20TT	IK20TT		4
B 180 (245.232)	85	M 266.940		04/09-11/11	K20PR-U11	3121	1.1	K20TT	IK20TT	IK20TT		4
B 180 CDI (245.207)	80	OM 640.940	Euro 4/ Not Euro5, Instant heating (ISS)	03/05-11/11	DG-194		4.4V					4
B 180 NGT (245.233)	85	M 266.960		04/08-11/11	K20PR-U11	3121	1.1	K20TT	IK20TT	IK20TT		4
B 200 (245.233)	100	M 266.960		03/05-11/11	K20PR-U11	3121	1.1	K20TT	IK20TT	IK20TT		4
B 200 CDI (245.208)	100/103	OM 640.941	Instant heating (ISS)	03/05-11/11	DG-194		4.4V					4
B 200 TURBO (245.234)	142	M 266.980		03/05-11/11	IK20TT	4702	1.0	-	IK20TT	IK20TT		4
CABRIOLET (A124) (92-93)												
300 CE-24 (124.061)	162/170	M 104.980		04/92-06/93	K16PR-U	3191	0.8	K16TT	IK16TT	IK16TT		6
CABRIOLET (W111) (69-71)												
280 SE 3.5 (111.025)	147	M 116.980		04/68-12/71	W20EP-U	3043	0.8	W20TT	IW20TT	IW20TT		8
C-CLASS (202) (93-01)												
C 36 AMG (202.028)	206	M 104.941 (AMG 3.6)		05/94-05/00	K16PR-U	3191	0.8	K16TT	IK16TT	IK16TT		6
C 43 AMG (202.033)	225	M 113.944		08/97-05/00	PK16PR-L11	3275	1.1	-	IK16TT	IK16TT		16
C 43 AMG (202.093)	225	M 113.944		08/97-03/01	PK16PR-L11	3275	1.1	-	IK16TT	IK16TT		16
C 180 (202.018)	90	M 111.920		03/93-05/00	K16PR-U	3191	0.8	K16TT	IK16TT	IK16TT		4
C 180 (202.018)	90	M 111.921		03/93-05/00	K20PBR-S10	5061	1.0	K20TT	IK20TT	IK20TT		4
C 180 T (202.078)	90	M 111.920		06/96-09/00	K16PR-U	3191	0.8	K16TT	IK16TT	IK16TT		4
C 180 T (202.078)	90	M 111.921		06/96-09/00	K20PBR-S10	5061	1.0	K20TT	IK20TT	IK20TT		4
C 180 T (202.081)	95	M 111.952		09/00-03/01	SK20PR-L9	3307	0.9	-	IK20TT	IK20TT		4
C 180 T (202.081)	95	M 111.952	OEM Optional	09/00-03/01	PK20PR11	3168	1.1	K20TT	IK20TT	IK20TT		4
C 200 (202.020)	100	M 111.941		01/94-05/00	K16PR-U	3191	0.8	K16TT	IK16TT	IK16TT		4











Таблица применения

M

Свечи зажигания и Свечи накаливания











Таблица применения

Таблица применения

	KW				СТАНДАРТНЫЕ				Twin Tip			QTY
												
MERCEDES-BENZ продолжение												
C-CLASS (202) (93-01) продолжение												
C 200 (202.020)	100	M 111.945		01/94-05/00	K20PBR-S10	5061	1.0	K20TT	IK20TT	IK20TT	4	
C 200 CDI (202.134)	75	OM 611.960	Double Coil(LPH)	03/98-05/00	DG-117		11.5V				4	
C 200 D (202.120)	55	OM 601.913	Double Coil(LPH)	03/93-05/00	DG-010		11.5V				4	
C 200 D (202.122)	65	OM 604.915		10/96-05/00	DG-106		11.5V				4	
C 200 Kompressor (202.025)	132/141	M 111.944		10/95-05/00	K16PR-U	3191	0.8	K16TT	IK16TT	IK16TT	4	
C 200 T (202.080)	100	M 111.941		06/96-03/01	K16PR-U	3191	0.8	K16TT	IK16TT	IK16TT	4	
C 200 T (202.080)	100	M 111.945		06/96-03/01	K20PBR-S10	5061	1.0	K20TT	IK20TT	IK20TT	4	
C 200 T CDI (202.194)	75	OM 611.960	Double Coil(LPH)	03/98-03/01	DG-117		11.5V				4	
C 200 T D (202.180)	65	OM 604.915		10/96-03/01	DG-106		11.5V				4	
C 200 T Kompressor (202.082)	141	M 111.944		11/96-03/01	K16PR-U	3191	0.8	K16TT	IK16TT	IK16TT	4	
C 200 T Kompressor (202.087)	120	M 111.956		09/00-03/01	SK20PR-L9	3307	0.9	-	IK20TT	IK20TT	4	
C 220 (202.022)	110	M 111.961		03/93-05/00	K16PR-U	3191	0.8	K16TT	IK16TT	IK16TT	4	
C 220 CDI (202.133)	92	OM 611.960	Double Coil(LPH)	09/97-05/00	DG-117		11.5V				4	
C 220 D (202.021)	55	OM 604.910	OE: A 001 159 15 01; A 001 159 1601	07/96-05/00	DG-119		11.5V				4	
C 220 D (202.021)	55	OM 604.910	OE: A 001 159 20 01; A 001 159 2101	07/96-05/00	DG-106		11.5V				4	
C 220 D (202.121)	70	OM 604.910	OE: A 001 159 15 01; A 001 159 1601	08/93-05/00	DG-119		11.5V				4	
C 220 D (202.121)	70	OM 604.910	OE: A 001 159 20 01; A 001 159 2101	08/93-05/00	DG-106		11.5V				4	
C 220 T CDI (202.193)	92	OM 611.960	Double Coil(LPH)	09/97-03/01	DG-117		11.5V				4	
C 220 T D (202.182)	55/70	OM 604.910	OE: A 001 159 15 01; A 001 159 1601	06/96-03/01	DG-119		11.5V				4	
C 220 T D (202.182)	55/70	OM 604.910	OE: A 001 159 20 01; A 001 159 2101	06/96-03/01	DG-106		11.5V				4	
C 230 (202.023)	110	M 111.974		06/96-06/97	K20PBR-S10	5061	1.0	K20TT	IK20TT	IK20TT	4	
C 230 Kompressor (202.024)	142	M 111.975		10/95-05/00	K20PBR-S10	5061	1.0	K20TT	IK20TT	IK20TT	4	
C 230 T (202.083)	110	M 111.974		06/96-06/98	K20PBR-S10	5061	1.0	K20TT	IK20TT	IK20TT	4	
C 230 T Kompressor (202.085)	142	M 111.975		06/97-09/00	K20PBR-S10	5061	1.0	K20TT	IK20TT	IK20TT	4	
C 240 (202.026)	125	M 112.910		06/97-05/00	PK16PR-L11	3275	1.1	-	IK16TT	IK16TT	12	
C 240 T (202.086)	125	M 112.910		06/97-09/00	PK16PR-L11	3275	1.1	-	IK16TT	IK16TT	12	
C 240 T (202.088)	125	M 112.915		09/00-03/01	PK16PR-L11	3275	1.1	-	IK16TT	IK16TT	12	
C 250 D (202.125)	83	OM 605.910	OE: A 001 159 15 01; A 001 159 1601	05/93-05/00	DG-119		11.5V				5	
C 250 D (202.125)	83	OM 605.910	OE: A 001 159 20 01; A 001 159 2101	05/93-05/00	DG-106		11.5V				5	
C 250 T Turbo-D (202.188)	110	OM 605.960		06/96-03/01	DG-106		11.5V				5	
C 250 Turbo-D (202.128)	110	OM 605.960		10/95-05/00	DG-106		11.5V				5	
C 280 (202.028)	142	M 104.941		05/93-05/00	K16PR-U	3191	0.8	K16TT	IK16TT	IK16TT	6	
C 280 (202.029)	145	M 112.920		06/97-05/00	PK16PR-L11	3275	1.1	-	IK16TT	IK16TT	12	
C 280 T (202.089)	145	M 112.920		06/97-03/01	PK16PR-L11	3275	1.1	-	IK16TT	IK16TT	12	
C-CLASS (203) (00-07)												
C 30 CDI AMG (203_18)	170	OM 612.990	Instant heating (ISS)	01/03-08/07	DG-192		5V				5	
C 32 AMG Kompressor (203_65)	260	M 112.961		02/01-08/07	SK20PR-L9	3307	0.9	-	IK20TT	IK20TT	12	
C 55 AMG (203_76)	270	M 113.988		02/04-08/07	PK16PR-L11	3275	1.1	-	IK16TT	IK16TT	16	
C 180 (203_35)	95	M 111.951		10/00-05/02	SK20PR-L9	3307	0.9	-	IK20TT	IK20TT	4	
C 180 (203_35)	95	M 111.951	OEM Optional	10/00-05/02	PK20PR11	3168	1.1	K20TT	IK20TT	IK20TT	4	

Свечи зажигания и Свечи накаливания





Таблица применения

	KW				СТАНДАРТНЫЕ			Twin Tip			QTY
											
MERCEDES-BENZ продолжение											
C-CLASS (203) (00-07) продолжение											
C 180 Kompressor (203_46)	105	M 271.946	Eng:>30099998	05/02-08/07	VKH20Y	5639	0.8	-	-	VKH20Y	4
C 200 CDI (203_04)	75/85	OM 611.962; OM 646.962	Double Coil(LPH)	09/00-08/07	DG-117		11.5V				4
C 200 CDI (203_07)	90	OM 646.962; OM 646.963	Double Coil(LPH)	04/03-08/07	DG-117		11.5V				4
C 200 CGI Kompressor (203_43)	125	M 271.942	Eng:>30099998	07/03-08/07	VKH20Y	5639	0.8	-	-	VKH20Y	4
C 200 Kompressor (203_42)	120	M 271.940	Eng:>30099998	05/02-08/07	VKH20Y	5639	0.8	-	-	VKH20Y	4
C 200 Kompressor (203_45)	120	M 111.955		05/00-06/02	SK20PR-L9	3307	0.9	-	IK20TT	IK20TT	4
C 200 Kompressor (203_45)	120	M 111.955	OEM Optional	05/00-06/02	PK20PR11	3168	1.1	K20TT	IK20TT	IK20TT	4
C 220 CDI (203_06)	100/ 105	OM 611.962; OM 646.963	Double Coil(LPH)	05/00-08/07	DG-117		11.5V				4
C 220 CDI (203_08)	110	OM 646.963	Double Coil(LPH)	02/03-08/07	DG-117		11.5V				4
C 230 (203_52)	150	M 272.920		01/05-08/07	SXU22HDR8	3441	0.8	-	IXUH22TT	VXUH22I	6
C 230 (203_52)	150	M 272.920	OEM Optional	01/05-08/07	VXUH22	5611	0.9	-	IXUH22TT	VXUH22	6
C 230 Kompressor (203_40)	141	M 271.948	Eng:>30099998	02/04-08/07	VKH20Y	5639	0.8	-	-	VKH20Y	4
C 240 (203_61)	125	M 112.912		05/00-08/07	PK16PR-L11	3275	1.1	-	IK16TT	IK16TT	12
C 240 4-matic (203_81)	125	M 112.916		07/02-08/07	PK16PR-L11	3275	1.1	-	IK16TT	IK16TT	12
C 270 CDI (203_16)	120/ 125	OM 612.962		12/00-08/07	DG-117		11.5V				5
C 280 (203_54)	170	M 272.940		01/05-08/07	SXU22HDR8	3441	0.8	-	IXUH22TT	VXUH22I	6
C 280 (203_54)	170	M 272.940	OEM Optional	01/05-08/07	VXUH22	5611	0.9	-	IXUH22TT	VXUH22	6
C 280 4-matic (203_92)	170	M 272.941		01/05-08/07	SXU22HDR8	3441	0.8	-	IXUH22TT	VXUH22I	6
C 280 4-matic (203_92)	170	M 272.941	OEM Optional	01/05-08/07	VXUH22	5611	0.9	-	IXUH22TT	VXUH22	6
C 320 (203_64)	160	M 112.946		05/00-08/07	PK16PR-L11	3275	1.1	-	IK16TT	IK16TT	12
C 320 4-matic (203_84)	160	M 112.953		07/02-08/07	PK16PR-L11	3275	1.1	-	IK16TT	IK16TT	12
C 320 CDI (203_20)	165	OM 642.910	OE: A 001 159 50 01; A 001 159 7101	01/05-08/07	DG-194		4.4V				6
C 350 (203_56)	200	M 272.960		01/05-08/07	SXU22HDR8	3441	0.8	-	IXUH22TT	VXUH22I	6
C 350 (203_56)	200	M 272.960	OEM Optional	01/05-08/07	VXUH22	5611	0.9	-	IXUH22TT	VXUH22	6
C 350 4-matic (203_87)	200	M 272.960; M 272.970		01/05-08/07	SXU22HDR8	3441	0.8	-	IXUH22TT	VXUH22I	6
C 350 4-matic (203_87)	200	M 272.960; M 272.970	OEM Optional	01/05-08/07	VXUH22	5611	0.9	-	IXUH22TT	VXUH22	6
C-CLASS (204) (07-14)											
C 63 AMG (204_77)	336/ 358/ 373/ 383	M 156.985		02/08-08/14	IXEH22TT	4712	1.0	-	IXEH22TT		8
C 180 CDI (204_00)	88	OM 651.913	OE: A 001 159 57 01; A 001 159 58 01; A 001 159 66 01, F166 Discon tinuationo f impact pl ate	01/11-08/14	DG-617		7V				4
C 180 CDI (204_00)	88	OM 651.913	OE: A0011597301/ A0011598001, -F166 Disco ntinuation of impactp late	01/11-08/14	DG-665		7V				4
C 180 CGI (204_49)	115	M 271.820		01/07-08/14	VXUH22	5611	0.9	-	IXUH22TT	VXUH22	4
C 180 Kompressor (204_44)	115	M 271.910	Eng:30099999>	01/08-01/14	VXUH22	5611	0.9	-	IXUH22TT	VXUH22	4
C 180 Kompressor (204_45)	115	M 271.910	Eng:30099999>	01/08-08/14	VXUH22	5611	0.9	-	IXUH22TT	VXUH22	4
C 180 Kompressor (204_46)	115	M 271.952	Eng:>30099998	01/07-08/07	VKH20Y	5639	0.8	-	-	VKH20Y	4
C 180 Kompressor (204_46)	115	M 271.952	Eng:30099999>	08/07-08/14	VXUH22	5611	0.9	-	IXUH22TT	VXUH22	4
C 200 (204_48)	137	M 271.820		05/11-01/14	VXUH22	5611	0.9	-	IXUH22TT	VXUH22	4

Свечи зажигания и Свечи накаливания











Таблица применения

Таблица применения

	KW				СТАНДАРТНЫЕ			Twin Tip			QTY
MERCEDES-BENZ продолжение											
C-CLASS (204) (07-14) продолжение											
C 200 CDI (204._01)	100	OM 651.913	OE: A 001 159 57 01; A 001 159 58 01; A 001 159 66 01, F166 Discontinuation of impact plate	08/10-08/14	DG-617		7V				4
C 200 CDI (204._01)	100	OM 651.913	OE: A0011597301/ A0011598001, -F166 Discontinuation of impact plate	08/10-08/14	DG-665		7V				4
C 200 CDI (204._07)	100	OM 646.811	OE: A0011595601/ A0011596801	08/07-12/09	DG-616		7V				4
C 200 CDI (204._07, 204._06)	100	OM 646.811; OM 646.812	OE: A0011595601/ A0011596801	01/07-12/09	DG-616		7V				4
C 200 CGI (204._48)	135	M 271.820; M 271.860		01/07-08/14	VXUH22	5611	0.9	-	IXUH22TT	VXUH22	4
C 200 Kompressor (204._41)	135	M 271.950	Eng:>30099998	01/07-08/07	VKH20Y	5639	0.8	-	-	VKH20Y	4
C 200 Kompressor (204._41)	135	M 271.950	Eng:30099999>	08/07-08/14	VXUH22	5611	0.9	-	IXUH22TT	VXUH22	4
C 220 CDI (204._02)	120/ 125	OM 651.911	OE: A 001 159 57 01; A 001 159 58 01; A 001 159 6601	10/08-08/14	DG-617		7V				4
C 220 CDI (204._08)	120/ 125	OM 646.811	OE: A0011595601/ A0011596801	01/07-11/08	DG-616		7V				4
C 220 CDI 4-matic (204._84)	125	OM 651.912	OE: A 001 159 57 01; A 001 159 58 01; A 001 159 6601	02/13-08/14	DG-617		7V				4
C 230 (204._52)	150	M 272.921		01/07-08/14	SXU22HDR8	3441	0.8	-	IXUH22TT	VXUH22I	6
C 230 (204._52)	150	M 272.921	OEM Optional	01/07-08/14	VXUH22	5611	0.9	-	IXUH22TT	VXUH22	6
C 230 4-matic (204._85)	150	M 272.911		07/07-01/14	SXU22HDR8	3441	0.8	-	IXUH22TT	VXUH22I	6
C 230 4-matic (204._85)	150	M 272.911	OEM Optional	07/07-01/14	VXUH22	5611	0.9	-	IXUH22TT	VXUH22	6
C 250 CDI (204._03)	150	OM 651.911	OE: A 001 159 57 01; A 001 159 58 01; A 001 159 6601	08/08-08/14	DG-617		7V				4
C 250 CDI 4-matic (204._82)	150	OM 651.912	OE: A 001 159 57 01; A 001 159 58 01; A 001 159 6601	04/10-08/14	DG-617		7V				4
C 250 CGI (204._47)	150	M 271.860		07/09-08/14	VXUH22	5611	0.9	-	IXUH22TT	VXUH22	4
C 280 (204._54)	170	M 272.947		01/07-08/14	SXU22HDR8	3441	0.8	-	IXUH22TT	VXUH22I	6
C 280 (204._54)	170	M 272.947	OEM Optional	01/07-08/14	VXUH22	5611	0.9	-	IXUH22TT	VXUH22	6
C 280 4-matic (204._81)	170	M 272.948		07/07-01/14	SXU22HDR8	3441	0.8	-	IXUH22TT	VXUH22I	6
C 280 4-matic (204._81)	170	M 272.948	OEM Optional	07/07-01/14	VXUH22	5611	0.9	-	IXUH22TT	VXUH22	6
C 300 (204._54)	170	M 272.947		08/07-08/14	SXU22HDR8	3441	0.8	-	IXUH22TT	VXUH22I	6
C 300 (204._54)	170	M 272.947	OEM Optional	08/07-08/14	VXUH22	5611	0.9	-	IXUH22TT	VXUH22	6
C 300 4-matic (204._81)	170	M 272.948		07/07-01/14	SXU22HDR8	3441	0.8	-	IXUH22TT	VXUH22I	6
C 300 4-matic (204._81)	170	M 272.948	OEM Optional	07/07-01/14	VXUH22	5611	0.9	-	IXUH22TT	VXUH22	6
C 300 CDI 4-matic (204._92)	170	OM 642.832	OE: A 001 159 57 01; A 001 159 58 01; A 001 159 6601	01/11-01/14	DG-617		7V				6
C 320 CDI (204._22)	165	OM 642.960	OE: A 001 159 50 01; A 001 159 7101	01/07-08/14	DG-194		4.4V				6

Свечи зажигания и Свечи накаливания

Таблица применения

	KW				СТАНДАРТНЫЕ				Twin Tip		QTY
											
MERCEDES-BENZ продолжение											
C-CLASS (204) (07-14) продолжение											
C 320 CDI (204._22)	165	OM 642.960	OE: A 001 159 57 01; A 001 159 58 01; A 001 159 6601	01/07-08/14	DG-617		7V				6
C 320 CDI 4-matic (204._89)	165	OM 642.961	OE: A 001 159 50 01; A 001 159 7101	07/07-01/14	DG-194		4.4V				6
C 320 CDI 4-matic (204._89)	165	OM 642.961	OE: A 001 159 57 01; A 001 159 58 01; A 001 159 6601	07/07-01/14	DG-617		7V				6
C 350 (204._56)	200	M 272.961		01/07-08/14	SXU22HDR8	3441	0.8	-	IXUH22TT	VXUH22I	6
C 350 (204._56)	200	M 272.961	OEM Optional	01/07-08/14	VXUH22	5611	0.9	-	IXUH22TT	VXUH22	6
C 350 4-matic (204._87)	200	M 272.971		07/07-01/14	SXU22HDR8	3441	0.8	-	IXUH22TT	VXUH22I	6
C 350 4-matic (204._87)	200	M 272.971	OEM Optional	07/07-01/14	VXUH22	5611	0.9	-	IXUH22TT	VXUH22	6
C 350 CDI (204._22)	165	OM 642.960	OE: A 001 159 50 01; A 001 159 7101	07/09-01/14	DG-194		4.4V				6
C 350 CDI (204._22)	165	OM 642.960	OE: A 001 159 57 01; A 001 159 58 01; A 001 159 6601	07/09-01/14	DG-617		7V				6
C 350 CDI (204._23)	195	OM 642.834	Eng:41324859> .OE: A0011597301/ A0011598001, Ceramic	06/11-08/14	DG-665		7V				6
C 350 CDI (204._25)	165/ 170	OM 642.830	OE: A 001 159 57 01; A 001 159 58 01; A 001 159 6601	08/07-08/14	DG-617		7V				6
C 350 CDI 4-matic (204._89)	165	OM 642.961	OE: A 001 159 50 01; A 001 159 7101	07/09-01/14	DG-194		4.4V				6
C 350 CDI 4-matic (204._89)	165	OM 642.961	OE: A 001 159 57 01; A 001 159 58 01; A 001 159 6601	07/09-01/14	DG-617		7V				6
C 350 CDI 4-matic (204._92)	170	OM 642.832	OE: A 001 159 57 01; A 001 159 58 01; A 001 159 6601	10/09-08/14	DG-617		7V				6
C 350 CGI (204._65)	215	M 272.982		09/08-01/14	SXU22HDR8	3441	0.8	-	IXUH22TT	VXUH22I	6
C 350 CGI (204._65)	215	M 272.982	OEM Optional	09/08-01/14	VXUH22I	5656	0.9	-	IXUH22TT	VXUH22I	6
C-CLASS (205) (13-)											
C 180 BlueTEC / d (205._36)	85	OM 626.951	OE: A 622 159 0001	05/14-05/18	DG-631		4.5V				4
C 200 BlueTEC / d (205._37)	100	OM 626.951	OE: A 622 159 0001	05/14-05/18	DG-631		4.5V				4
C 200 d (205._07)	100	OM 651.921	OE: A 001 159 57 01; A 001 159 58 01; A 001 159 66 01, F166 Discontinuation of impact plate	10/15-05/18	DG-617		7V				4
C 200 d (205._07)	100	OM 651.921	OE: A0011597301/ A0011598001, -F166 Discontinuation of impact plate	10/15-05/18	DG-665		7V				4

Свечи зажигания и Свечи накаливания











Таблица применения

Таблица применения

	KW				СТАНДАРТНЫЕ			Twin Tip			QTY
MERCEDES-BENZ продолжение											
C-CLASS (205) (13-) продолжение											
C 220 BlueTEC / d (205_03)	120	OM 651.921	OE: A 001 159 57 01; A 001 159 58 01; A 001 159 66 01, F166 Discontinuation of impact plate	03/14-05/16	DG-617		7V				4
C 220 BlueTEC / d (205_03)	120	OM 651.921	OE: A0011597301/ A0011598001, -F166 Discontinuation of impact plate	03/14-05/16	DG-665		7V				4
C 220 BlueTEC / d (205_04)	120/ 125	OM 651.921	OE: A 001 159 57 01; A 001 159 58 01; A 001 159 66 01, F166 Discontinuation of impact plate	02/14-05/18	DG-617		7V				4
C 220 BlueTEC / d (205_04)	120/ 125	OM 651.921	OE: A0011597301/ A0011598001, -F166 Discontinuation of impact plate	02/14-05/18	DG-665		7V				4
C 220 d 4-matic (205_05)	125	OM 651.921	OE: A 001 159 57 01; A 001 159 58 01; A 001 159 66 01, F166 Discontinuation of impact plate	04/15-05/18	DG-617		7V				4
C 220 d 4-matic (205_05)	125	OM 651.921	OE: A0011597301/ A0011598001, -F166 Discontinuation of impact plate	04/15-05/18	DG-665		7V				4
C 250 BlueTEC / d (205_08)	150	OM 651.921	OE: A 001 159 57 01; A 001 159 58 01; A 001 159 66 01, F166 Discontinuation of impact plate	02/14-05/18	DG-617		7V				4
C 250 BlueTEC / d (205_08)	150	OM 651.921	OE: A0011597301/ A0011598001, -F166 Discontinuation of impact plate	02/14-05/18	DG-665		7V				4
C 250 BlueTEC / d 4-matic (205_09)	150	OM 651.921	OE: A 001 159 57 01; A 001 159 58 01; A 001 159 66 01, F166 Discontinuation of impact plate	02/14-05/18	DG-617		7V				4
C 250 BlueTEC / d 4-matic (205_09)	150	OM 651.921	OE: A0011597301/ A0011598001, -F166 Discontinuation of impact plate	02/14-05/18	DG-665		7V				4

Свечи зажигания и Свечи накаливания



Таблица применения

	KW				СТАНДАРТНЫЕ				Twin Tip		QTY
											
MERCEDES-BENZ продолжение											
C-CLASS (205) (13-) продолжение											
C 300 BlueTEC Hybrid / h (205_12)	150	OM 651.921	OE: A 001 159 57 01; A 001 159 58 01; A 001 159 66 01, F166 Discontinuation of impact plate	05/14-05/18	DG-617		7V				4
C 300 BlueTEC Hybrid / h (205_12)	150	OM 651.921	OE: A0011597301/ A0011598001, -F166 Discontinuation of impact plate	05/14-05/18	DG-665		7V				4
C-CLASS Coupe (C204) (11-)											
C 63 AMG (204_77)	336/ 358/ 373/ 380	M 156.985		06/11-	IXEH22TT	4712	1.0	-	IXEH22TT		8
C 180 (204_49)	115	M 271.820		06/11-	VXUH22	5611	0.9	-	IXUH22TT	VXUH22	4
C 200 CGI (204_48)	135	M 271.860		06/11-	VXUH22	5611	0.9	-	IXUH22TT	VXUH22	4
C 220 CDI (204_02)	120/ 125	OM 651.911	OE: A 001 159 57 01; A 001 159 58 01; A 001 159 6601	06/11-	DG-617		7V				4
C 250 (204_47)	150	M 271.860		06/11-	VXUH22	5611	0.9	-	IXUH22TT	VXUH22	4
C 250 CDI (204_03)	150	OM 651.911	OE: A 001 159 57 01; A 001 159 58 01; A 001 159 6601	06/11-	DG-617		7V				4
C-CLASS Coupe (CL203) (01-08)											
C 30 CDI AMG (203_18)	170	OM 612.990	Instant heating (ISS)	09/02-05/08	DG-192		5V				5
C 32 AMG Kompressor (203_65)	260	M 112.961		05/02-05/08	SK20PR-L9	3307	0.9	-	IK20TT	IK20TT	12
C 160 Kompressor (203_30)	90	M 271.921	Eng:>30099998	05/02-08/07	VKH20Y	5639	0.8	-	-	VKH20Y	4
C 160 Kompressor (203_30)	90	M 271.921	Eng:>30099999	08/07-05/08	VXUH22	5611	0.9	-	IXUH22TT	VXUH22	4
C 180 (203_35)	95	M 111.951		03/01-05/02	SK20PR-L9	3307	0.9	-	IK20TT	IK20TT	4
C 180 (203_35)	95	M 111.951	OEM Optional	03/01-05/02	PK20PR11	3168	1.1	K20TT	IK20TT	IK20TT	4
C 180 Kompressor (203_46)	105	M 271.946	Eng:>30099998	05/02-08/07	VKH20Y	5639	0.8	-	-	VKH20Y	4
C 180 Kompressor (203_46)	105	M 271.946	Eng:>30099999	08/07-05/08	VXUH22	5611	0.9	-	IXUH22TT	VXUH22	4
C 200 CDI (203_07)	90	OM 646.962	Double Coil(LPH)	03/03-05/08	DG-117		11.5V				4
C 200 CGI Kompressor (203_43)	125	M 271.942	Eng:>30099998	03/03-08/07	VKH20Y	5639	0.8	-	-	VKH20Y	4
C 200 CGI Kompressor (203_43)	125	M 271.942	Eng:>30099999	08/07-05/08	VXUH22	5611	0.9	-	IXUH22TT	VXUH22	4
C 200 Kompressor (203_42)	120	M 271.940	Eng:>30099998	05/02-08/07	VKH20Y	5639	0.8	-	-	VKH20Y	4
C 200 Kompressor (203_42)	120	M 271.940	Eng:>30099999	08/07-05/08	VXUH22	5611	0.9	-	IXUH22TT	VXUH22	4
C 200 Kompressor (203_45)	120	M 111.955		03/01-05/02	SK20PR-L9	3307	0.9	-	IK20TT	IK20TT	4
C 200 Kompressor (203_45)	120	M 111.955	OEM Optional	03/01-05/02	PK20PR11	3168	1.1	K20TT	IK20TT	IK20TT	4
C 220	120	M 271.940	Eng:>30099998	05/02-08/07	VKH20Y	5639	0.8	-	-	VKH20Y	4
C 220	120	M 271.940	Eng:>30099999	08/07-05/08	VXUH22	5611	0.9	-	IXUH22TT	VXUH22	4
C 220 CDI	100	OM 611.962	Double Coil(LPH)	03/01-01/04	DG-117		11.5V				4
C 220 CDI (203_06)	105	OM 611.962	Double Coil(LPH)	03/01-01/04	DG-117		11.5V				4
C 220 CDI (203_08)	110	OM 646.963	Double Coil(LPH)	02/04-05/08	DG-117		11.5V				4
C 230 (203_52)	150	M 272.920		01/05-05/08	SXU22HDR8	3441	0.8	-	IXUH22TT	VXUH22I	6
C 230 (203_52)	150	M 272.920	OEM Optional	01/05-05/08	VXUH22	5611	0.9	-	IXUH22TT	VXUH22	6
C 230 Kompressor (203_40)	141	M 271.948	Eng:>30099998	05/02-08/07	VKH20Y	5639	0.8	-	-	VKH20Y	4
C 230 Kompressor (203_40)	141	M 271.948	Eng:>30099999	08/07-05/08	VXUH22	5611	0.9	-	IXUH22TT	VXUH22	4

Свечи зажигания и Свечи накаливания











Таблица применения

Таблица применения

	KW				СТАНДАРТНЫЕ				Twin Tip		QTY
											
MERCEDES-BENZ продолжение											
C-CLASS Coupe (CL203) (01-08) продолжение											
C 230 Kompressor (203_47)	145	M 111.981		03/01-05/02	SK20PR-L9	3307	0.9	-	IK20TT	IK20TT	4
C 320 (203_64)	160	M 112.946		09/02-05/08	PK16PR-L11	3275	1.1	-	IK16TT	IK16TT	12
C 350 (203_56)	200	M 272.960		01/05-05/08	SXU22HDR8	3441	0.8	-	IXUH22TT	VXUH22I	6
C 350 (203_56)	200	M 272.960	OEM Optional	01/05-05/08	VXUH22	5611	0.9	-	IXUH22TT	VXUH22	6
C-CLASS Coupe / Convertible (205) (16-)											
C 220 d (205_04)	120/ 125	OM 651.921	OE: A 001 159 57 01; A 001 159 58 01; A 001 159 66 01, F166 Discontinuation of impact plate	10/15-05/18	DG-617		7V				4
C 220 d (205_04)	120/ 125	OM 651.921	OE: A0011597301/ A0011598001, -F166 Discontinuation of impact plate	10/15-05/18	DG-665		7V				4
C 220 d 4-matic (205_05)	125	OM 651.921	OE: A 001 159 57 01; A 001 159 58 01; A 001 159 66 01, F166 Discontinuation of impact plate	04/16-05/18	DG-617		7V				4
C 220 d 4-matic (205_05)	125	OM 651.921	OE: A0011597301/ A0011598001, -F166 Discontinuation of impact plate	04/16-05/18	DG-665		7V				4
C 250 d (205_08)	150	OM 651.921	OE: A 001 159 57 01; A 001 159 58 01; A 001 159 66 01, F166 Discontinuation of impact plate	10/15-05/18	DG-617		7V				4
C 250 d (205_08)	150	OM 651.921	OE: A0011597301/ A0011598001, -F166 Discontinuation of impact plate	10/15-05/18	DG-665		7V				4
C 250 d 4-matic (205_09)	150	OM 651.921	OE: A 001 159 57 01; A 001 159 58 01; A 001 159 66 01, F166 Discontinuation of impact plate	04/16-05/18	DG-617		7V				4
C 250 d 4-matic (205_09)	150	OM 651.921	OE: A0011597301/ A0011598001, -F166 Discontinuation of impact plate	04/16-05/18	DG-665		7V				4
CITAN (415) (12-)											
108 CDI	55	OM 607.951	Instant heating (ISS)	11/12-	DG-609		4.4V				4
109 CDI	66	OM 607.951	Instant heating (ISS)	11/12-	DG-609		4.4V				4
111 CDI	81	OM 607.951	Instant heating (ISS)	06/13-	DG-609		4.4V				4

Свечи зажигания и Свечи накаливания









Таблица применения

	KW				СТАНДАРТНЫЕ				Twin Tip		QTY
											
MERCEDES-BENZ продолжение											
CLA Coupe (C117) (13-)											
CLA 180 CDI / d (117.312)	80	OM 607.951	Instant heating (ISS)	10/13-05/18	DG-609		4.4V				4
CLA 200 CDI / d 1.8 (117.301)	100	OM 651.901	OE: A 001 159 57 01; A 001 159 58 01; A 001 159 6601	06/13-08/14	DG-617		7V				4
CLA 200 CDI / d 2.1 (117.308)	100	OM 651.930	OE: A0011597301/ A0011598001	07/14-03/19	DG-665		7V				4
CLA 200 CDI / d 2.1 4-matic (117.302)	100	OM 651.930	OE: A0011597301/ A0011598001	07/14-03/19	DG-665		7V				4
CLA 220 CDI / d (117.303)	120/ 125/ 130	OM 651.930	OE: A0011597301/ A0011598001	01/13-03/19	DG-665		7V				4
CLA 220 CDI / d 4-matic (117.305)	120/ 125/ 130	OM 651.930	OE: A0011597301/ A0011598001	07/14-03/19	DG-665		7V				4
CLA Shooting Brake (X117) (15-)											
CLA 180 d (117.912)	80	OM 607.951	Instant heating (ISS)	07/15-05/18	DG-609		4.4V				4
CLA 200 CDI / d (117.908)	100	OM 651.930	OE: A0011597301/ A0011598001	01/15-03/19	DG-665		7V				4
CLA 200 CDI / d 4-matic (117.902)	100	OM 651.930	OE: A0011597301/ A0011598001	01/15-03/19	DG-665		7V				4
CLA 220 CDI / d (117.903)	120/ 130	OM 651.930	OE: A0011597301/ A0011598001	01/15-03/19	DG-665		7V				4
CLA 220 CDI / d 4-matic (117.905)	120/ 130	OM 651.930	OE: A0011597301/ A0011598001	01/15-03/19	DG-665		7V				4
CLC (CL203) (08-11)											
CLC 160 (203.731)	95	M 271.911	Eng:30099999>	02/09-06/11	VXUH22	5611	0.9	-	IXUH22TT	VXUH22	4
CLC 180 Kompressor (203.746)	105	M 271.946	Eng:30099999>	05/08-06/11	VXUH22	5611	0.9	-	IXUH22TT	VXUH22	4
CLC 200 CDI (203.707)	90	OM 646.962	Double Coil(LPH)	05/08-06/11	DG-117		11.5V				4
CLC 200 Kompressor (203.741)	135	M 271.957	Eng:30099999>	05/08-06/11	VXUH22	5611	0.9	-	IXUH22TT	VXUH22	4
CLC 220 CDI (203.708)	110	OM 646.963	Double Coil(LPH)	05/08-06/11	DG-117		11.5V				4
CLC 230 (203.752)	150	M 272.920		05/08-06/11	SXU22HDR8	3441	0.8	-	IXUH22TT	VXUH22I	6
CLC 230 (203.752)	150	M 272.920	OEM Optional	05/08-06/11	VXUH22	5611	0.9	-	IXUH22TT	VXUH22	6
CLC 350 (203.756)	200	M 272.960		05/08-06/11	SXU22HDR8	3441	0.8	-	IXUH22TT	VXUH22I	6
CLC 350 (203.756)	200	M 272.960	OEM Optional	05/08-06/11	VXUH22	5611	0.9	-	IXUH22TT	VXUH22	6
CLK (208) (97-02)											
CLK 55 AMG (208._74)	255	M 113.981; M 113.984		08/99-06/02	PK16PR-L11	3275	1.1	-	IK16TT	IK16TT	16
CLK 200 (208._35)	100	M 111.941		03/98-03/02	K16PR-U	3191	0.8	K16TT	IK16TT	IK16TT	4
CLK 200 (208._35)	100	M 111.945		06/97-06/02	K20PBR-S10	5061	1.0	K20TT	IK20TT	IK20TT	4
CLK 200 Kompressor (208._44)	120	M 111.956		06/00-06/02	SK20PR-L9	3307	0.9	-	IK20TT	IK20TT	4
CLK 200 Kompressor (208._45)	141	M 111.944		06/97-06/00	K16PR-U	3191	0.8	K16TT	IK16TT	IK16TT	4
CLK 230 Kompressor (208._47)	142	M 111.973; M 111.975		06/97-06/00	K20PBR-S10	5061	1.0	K20TT	IK20TT	IK20TT	4
CLK 230 Kompressor (208._48)	145	M 111.982		06/00-06/02	SK20PR-L9	3307	0.9	-	IK20TT	IK20TT	4
CLK 320 (208._65)	160	M 112.940		06/97-06/02	PK16PR-L11	3275	1.1	-	IK16TT	IK16TT	12
CLK 430 (208._70)	205	M 113.943		07/98-06/02	PK16PR-L11	3275	1.1	-	IK16TT	IK16TT	16
CLK (209) (02-10)											
CLK 55 AMG (209._76)	270	M 113.987		06/02-03/10	PK16PR-L11	3275	1.1	-	IK16TT	IK16TT	16
CLK 63 AMG (209._77)	354/ 373	M 156.982		04/06-03/10	IXEH22TT	4712	1.0	-	IXEH22TT		8
CLK 200 CGI (209._43)	125	M 271.942	Eng:->30099998	07/03-08/07	VKH20Y	5639	0.8	-	-	VKH20Y	4
CLK 200 CGI (209._43)	125	M 271.942	Eng:30099999>	08/07-03/10	VXUH22	5611	0.9	-	IXUH22TT	VXUH22	4
CLK 200 Kompressor (209._41)	135	M 271.955	Eng:->30099998	10/06-08/07	VKH20Y	5639	0.8	-	-	VKH20Y	4
CLK 200 Kompressor (209._41)	135	M 271.955	Eng:30099999>	08/07-03/10	VXUH22	5611	0.9	-	IXUH22TT	VXUH22	4
CLK 200 Kompressor (209._42)	120	M 271.940	Eng:->30099998	09/02-08/07	VKH20Y	5639	0.8	-	-	VKH20Y	4

Свечи зажигания и Свечи накаливания

Таблица применения

Таблица применения

	KW				СТАНДАРТНЫЕ				Twin Tip		QTY
											
MERCEDES-BENZ продолжение											
CLK (209) (02-10) продолжение											
CLK 200 Kompressor (209_42)	120	M 271.940	Eng:30099999>	08/07-03/10	VXUH22	5611	0.9	-	IXUH22TT	VXUH22	4
CLK 220 CDI (209_08)	100/110	OM 646.966	Double Coil(LPH)	01/05-05/09	DG-117		11.5V				4
CLK 220 CDI (209_08)	120/125	OM 612.962; OM 612.967		10/02-05/09	DG-117		11.5V				5
CLK 220 CDI (209_08)	165	OM 642.910	OE: A 001 159 50 01; A 001 159 7101	01/05-05/09	DG-194		4.4V				6
CLK 240 (209_61)	120/125	M 112.912		06/02-03/10	PK16PR-L11	3275	1.1	-	IK16TT	IK16TT	12
CLK 280 (209_54)	170	M 272.940		01/05-03/10	SXU22HDR8	3441	0.8	-	IXUH22TT	VXUH22I	6
CLK 280 (209_54)	170	M 272.940	OEM Optional	01/05-03/10	VXUH22	5611	0.9	-	IXUH22TT	VXUH22	6
CLK 320 (209_65)	160	M 112.955		06/02-03/10	PK16PR-L11	3275	1.1	-	IK16TT	IK16TT	12
CLK 320 CDI (209_20)	165	OM 642.910	OE: A 001 159 50 01; A 001 159 7101	03/05-03/10	DG-194		4.4V				6
CLK 350 (209_56)	200	M 272.960		01/05-03/10	SXU22HDR8	3441	0.8	-	IXUH22TT	VXUH22I	6
CLK 350 (209_56)	200	M 272.960	OEM Optional	01/05-03/10	VXUH22	5611	0.9	-	IXUH22TT	VXUH22	6
CLK 500 (209_72)	285	M 273.965; M 273.967		06/06-03/10	SXU22HDR8	3441	0.8	-	IXUH22TT	VXUH22I	8
CLK 500 (209_72)	285	M 273.965; M 273.967	OEM Optional	06/06-03/10	VXUH22	5611	0.9	-	IXUH22TT	VXUH22	8
CLK 500 (209_75)	225	M 113.968		06/02-03/10	PK16PR-L11	3275	1.1	-	IK16TT	IK16TT	16
CLK AMG DTM	428	M 113.994		06/04-10/05	VKH20Y	5639	0.8	-	-	VKH20Y	16
CLS (218) (11-)											
CLS 220 BlueTEC / d (218_01)	120/125/130	OM 651.924	OE: A 001 159 57 01; A 001 159 58 01; A 001 159 66 01, F166 Discontinuation of impact plate	05/14-12/17	DG-617		7V				4
CLS 220 BlueTEC / d (218_01)	120/125/130	OM 651.924	OE: A0011597301/ A0011598001, -F166 Discontinuation of impact plate	05/14-12/17	DG-665		7V				4
CLS 250 BlueTEC / d 4-matic (218_97)	150	OM 651.924	OE: A 001 159 57 01; A 001 159 58 01; A 001 159 66 01, F166 Discontinuation of impact plate	05/14-12/17	DG-617		7V				4
CLS 250 BlueTEC / d 4-matic (218_97)	150	OM 651.924	OE: A0011597301/ A0011598001, -F166 Discontinuation of impact plate	05/14-12/17	DG-665		7V				4
CLS 250 CDI / BlueTEC / d (218_03, 218_04)	150	OM 651.924	OE: A 001 159 57 01; A 001 159 58 01; A 001 159 66 01, F166 Discontinuation of impact plate	04/11-12/17	DG-617		7V				4
CLS 250 CDI / BlueTEC / d (218_03, 218_04)	150	OM 651.924	OE: A0011597301/ A0011598001, -F166 Discontinuation of impact plate	04/11-12/17	DG-665		7V				4

Свечи зажигания и Свечи накаливания

Таблица применения











	KW				СТАНДАРТНЫЕ				Twin Tip		QTY
											
MERCEDES-BENZ продолжение											
CLS (C218) (11-) продолжение											
CLS 350 BlueTEC / d (218._26)	185/190	OM 642.852; OM 642.853	Eng:41324859> .OE: A0011597301/ A0011598001, Ceramic	02/13-12/17	DG-665		7V				6
CLS 350 BlueTEC / d 4-matic (218._94)	185	OM 642.854; OM 642.858	Eng:41324859> .OE: A0011597301/ A0011598001, Ceramic	02/13-12/17	DG-665		7V				6
CLS 350 CDI / d (218._23)	195	OM 642.852; OM 642.853	Eng:41324859> .OE: A0011597301/ A0011598001, Ceramic	06/12-08/14	DG-665		7V				6
CLS 350 CDI / d 4-matic (218._93)	195	OM 642.853; OM 642.854; OM 642.858	Eng:41324859> .OE: A0011597301/ A0011598001, Ceramic	06/12-08/14	DG-665		7V				6
CLS 350 d 4-matic (218._94)	190	OM 642.854; OM 642.858	Eng:41324859> .OE: A0011597301/ A0011598001, Ceramic	04/15-12/17	DG-665		7V				6
CLS (C219) (04-10)											
CLS 55 AMG (219.376)	350	M 113.990		01/05-12/10	VKH20Y	5639	0.8	-	-	VKH20Y	16
CLS 63 AMG (219.377)	378	M 156.983		04/06-12/10	IXEH22TT	4712	1.0	-	IXEH22TT		8
CLS 280 (219.354)	170	M 272.943		07/08-12/10	SXU22HDR8	3441	0.8	-	IXUH22TT	VXUH22I	6
CLS 280 (219.354)	170	M 272.943	OEM Optional	07/08-12/10	VXUH22	5611	0.9	-	IXUH22TT	VXUH22	6
CLS 300 (219.354)	170	M 272.943		04/09-12/10	SXU22HDR8	3441	0.8	-	IXUH22TT	VXUH22I	6
CLS 300 (219.354)	170	M 272.943	OEM Optional	04/09-12/10	VXUH22	5611	0.9	-	IXUH22TT	VXUH22	6
CLS 320 CDI	155	OM 642.920	OE: A 001 159 50 01; A 001 159 7101	01/05-12/10	DG-194		4.4V				6
CLS 320 CDI (219.322)	165	OM 642.920	OE: A 001 159 50 01; A 001 159 7101	01/05-12/10	DG-194		4.4V				6
CLS 350 (219.356)	200	M 272.964		10/04-12/10	SXU22HDR8	3441	0.8	-	IXUH22TT	VXUH22I	6
CLS 350 (219.356)	200	M 272.964	OEM Optional	10/04-12/10	VXUH22	5611	0.9	-	IXUH22TT	VXUH22	6
CLS 350 (219.357)	215	M 272.985		04/06-12/10	SXU22HDR8	3441	0.8	-	IXUH22TT	VXUH22I	6
CLS 350 (219.357)	215	M 272.985	OEM Optional	04/06-12/10	VXUH22I	5656	0.9	-	IXUH22TT	VXUH22I	6
CLS 350 CDI	200	OM 642.920	OE: A 001 159 50 01; A 001 159 7101	04/09-12/10	DG-194		4.4V				6
CLS 350 CDI (219.322)	165	OM 642.920	OE: A 001 159 50 01; A 001 159 7101	04/09-12/10	DG-194		4.4V				6
CLS 500 (219.372)	285	M 273.960		04/06-12/10	SXU22HDR8	3441	0.8	-	IXUH22TT	VXUH22I	8
CLS 500 (219.372)	285	M 273.960	OEM Optional	04/06-12/10	VXUH22	5611	0.9	-	IXUH22TT	VXUH22	8
CLS 500 (219.375)	225	M 113.967		10/04-12/10	PK16PR-L11	3275	1.1	-	IK16TT	IK16TT	16
COUPE (C123) (77-85)											
230 C (123.043)	80	M 115.954		05/77-04/80	W20EP-U	3043	0.8	W20TT	IW20TT	IW20TT	4
230 CE (123.243)	100	M 102.980		04/80-12/85	T20EP-U	5031	0.8	T20TT	IT20TT	IT20TT	4
280 C (123.050)	115	M 110.923		03/77-03/80	W20EP-U	3043	0.8	W20TT	IW20TT	IW20TT	6
280 CE	130/ 136	M 110.988		03/77-11/85	W20EP-U	3043	0.8	W20TT	IW20TT	IW20TT	6
300 C Turbo-D (123.153)	92	OM 617.952	Double Coil(LPH)	09/81-07/85	DG-001		11V				5
COUPE (C124) (87-93)											
220 CE (124.042)	110	M 111.960		10/92-05/93	K16PR-U	3191	0.8	K16TT	IK16TT	IK16TT	4
230 CE (124.043)	97/ 100	M 102.982		03/87-12/92	T20EP-U	5031	0.8	T20TT	IT20TT	IT20TT	4
230 CE Cat (124.043)	97	M 102.982		06/89-12/92	T20EP-U	5031	0.8	T20TT	IT20TT	IT20TT	4
300 CE	138	M 103.983		03/87-12/89	T20EP-U	5031	0.8	T20TT	IT20TT	IT20TT	6
300 CE (124.050)	132	M 103.983		03/87-05/93	T20EP-U	5031	0.8	T20TT	IT20TT	IT20TT	6
300 CE-24 (124.051)	162/ 170	M 104.980		09/89-12/92	K16PR-U	3191	0.8	K16TT	IK16TT	IK16TT	6
320 CE (124.052)	162	M 104.992		10/92-05/93	K16PR-U	3191	0.8	K16TT	IK16TT	IK16TT	6
COUPE (W111) (61-71)											
250 SE (111.021)	110	M 129.980; M 129.981		01/65-12/67	W22EPR-U	3088	0.8	W22TT	-	VW22	6
280 SE (111.024)	118	M 130.980; M 130.984		01/67-12/71	W20EP-U	3043	0.8	W20TT	IW20TT	IW20TT	6











Таблица применения

M

Свечи зажигания и Свечи накаливания

Таблица применения

Таблица применения

	KW				СТАНДАРТНЫЕ			Twin Tip			QTY
											
MERCEDES-BENZ продолжение											
COUPE (W111) (61-71) продолжение											
280 SE 3.5 (111.026)	147	M 116.980		01/69-12/71	W20EP-U	3043	0.8	W20TT	IW20TT	IW20TT	8
E-CLASS (124) (92-96)											
E 36 AMG (124.092)	200	M 104.992 (AMG 3.6)		05/94-06/96	K16PR-U	3191	0.8	K16TT	IK16TT	IK16TT	6
E 60 AMG (124.036)	280	M 119.974 (AMG 6.0)		05/94-06/95	K20PR-U11	3121	1.1	K20TT	IK20TT	IK20TT	8
E 200 (124.019)	100	M 111.940		06/93-06/95	K16PR-U	3191	0.8	K16TT	IK16TT	IK16TT	4
E 200 D (124.120)	55	OM 601.912	Double Coil(LPH)	06/93-06/95	DG-010		11.5V				4
E 200 D (124.120)	55	OM 601.912	Double Coil(LPH)	06/93-06/95	DG-106		11.5V				4
E 200 T (124.079)	100	M 111.940		06/93-06/96	K16PR-U	3191	0.8	K16TT	IK16TT	IK16TT	4
E 220 (124.022)	110	M 111.960		06/93-06/95	K16PR-U	3191	0.8	K16TT	IK16TT	IK16TT	4
E 220 T (124.082)	110	M 111.960		06/93-06/96	K16PR-U	3191	0.8	K16TT	IK16TT	IK16TT	4
E 250 D (124.126, 124.129)	83	OM 605.911		07/93-06/95	DG-119		11.5V				5
E 250 TD (124.186)	83	OM 605.911		06/93-06/96	DG-119		11.5V				5
E 250 Turbo-D (124.128)	93	OM 602.962	Double Coil(LPH)	06/93-06/96	DG-010		11.5V				5
E 280 (124.028)	145	M 104.942		06/93-06/95	K16PR-U	3191	0.8	K16TT	IK16TT	IK16TT	6
E 280 (124.029)	142	M 104.942		06/93-06/95	K16PR-U	3191	0.8	K16TT	IK16TT	IK16TT	6
E 280 T (124.088)	142/ 145	M 104.942		06/93-06/96	K16PR-U	3191	0.8	K16TT	IK16TT	IK16TT	6
E 300 4-matic (124.230)	132	M 103.985		06/93-06/95	T20EP-U	5031	0.8	T20TT	IT20TT	IT20TT	6
E 300 D (124.131)	100	OM 606.910		07/93-06/95	DG-119		11.5V				6
E 300 T 4-matic (124.290)	132	M 103.985		06/93-06/96	T20EP-U	5031	0.8	T20TT	IT20TT	IT20TT	6
E 300 T Turbo-D (124.193)	108	OM 603.960	Double Coil(LPH)	06/93-06/96	DG-001		11V				6
E 300 T Turbo-D 4-matic (124.393)	108	OM 603.963	Double Coil(LPH)	06/93-06/96	DG-001		11V				6
E 300 TD (124.191)	100	OM 606.910		06/93-06/96	DG-119		11.5V				6
E 300 Turbo-D (124.133)	108	OM 603.960	Double Coil(LPH)	06/93-06/95	DG-001		11V				6
E 300 Turbo-D 4-matic (124.333)	108	OM 603.963	Double Coil(LPH)	06/93-06/95	DG-001		11V				6
E 320 (124.032)	162	M 104.992		06/93-06/95	K16PR-U	3191	0.8	K16TT	IK16TT	IK16TT	6
E 320 T (124.092)	162	M 104.992		06/93-06/96	K16PR-U	3191	0.8	K16TT	IK16TT	IK16TT	6
E 420 (124.034)	205	M 119.975		06/93-06/95	K20PR-U11	3121	1.1	K20TT	IK20TT	IK20TT	8
E 500 (124.036)	235	M 119.974		06/93-06/95	K20PR-U11	3121	1.1	K20TT	IK20TT	IK20TT	8
E-CLASS (210) (95-03)											
E 36 AMG	200			04/96-01/98	K16PR-U	3191	0.8	K16TT	IK16TT	IK16TT	6
E 50 AMG (210_72)	255	M 119.985 (AMG 5.0)		02/96-08/97	K20PR-U11	3121	1.1	K20TT	IK20TT	IK20TT	8
E 55 AMG (210_74)	260	M 113.980		08/97-03/03	PK16PR-L11	3275	1.1	-	IK16TT	IK16TT	16
E 200 (210_35)	100	M 111.942		06/95-08/00	K20PBR-S10	5061	1.0	K20TT	IK20TT	IK20TT	4
E 200 CDI (210_07)	75/85	OM 611.961	Double Coil(LPH)	06/98-03/02	DG-117		11.5V				4
E 200 D (210_03)	65	OM 604.917		01/96-03/02	DG-106		11.5V				4
E 200 Kompressor (210_45)	137	M 111.947		06/97-03/03	K20PBR-S10	5061	1.0	K20TT	IK20TT	IK20TT	4
E 200 Kompressor (210_48)	120	M 111.957		08/00-03/03	SK20PR-L9	3307	0.9	-	IK20TT	IK20TT	4
E 220 CDI (210_06)	92/ 100/ 105	OM 611.961	Double Coil(LPH)	06/98-03/03	DG-117		11.5V				4
E 220 D	55	OM 604.912		05/96-03/02	DG-106		11.5V				4
E 220 D (210_04)	70	OM 604.912		06/95-07/99	DG-106		11.5V				4
E 230 (210_37)	110	M 111.970		06/95-06/97	K20PBR-S10	5061	1.0	K20TT	IK20TT	IK20TT	4
E 240 (210_61)	125	M 112.911		06/97-03/03	PK16PR-L11	3275	1.1	-	IK16TT	IK16TT	12
E 240 (210_62)	125	M 112.914		08/00-03/03	PK16PR-L11	3275	1.1	-	IK16TT	IK16TT	12
E 250 D (210_10)	83	OM 605.912		06/95-07/99	DG-106		11.5V				5
E 250 Turbo-D (210_15)	110	OM 605.962		06/97-07/99	DG-106		11.5V				5
E 270 CDI	120	OM 612.961		02/00-03/03	DG-117		11.5V				5
E 270 CDI (210_16)	120/ 125	OM 612.961		07/99-03/03	DG-117		11.5V				5
E 280 (210_53)	142	M 104.945		01/96-06/97	K16PR-U	3191	0.8	K16TT	IK16TT	IK16TT	6
E 280 (210_63)	150	M 112.921		12/96-03/03	PK16PR-L11	3275	1.1	-	IK16TT	IK16TT	12
E 280 4-matic (210_81)	150	M 112.921		12/96-03/03	PK16PR-L11	3275	1.1	-	IK16TT	IK16TT	12
E 290 Turbo-D (210_17)	95	OM 602.982	Double Coil(LPH)	03/96-07/99	DG-110		11.5V				5
E 290 Turbo-D (210_17)	95	OM 602.982	Double Coil(LPH)	06/96-07/99	DG-117		11.5V				5
E 300 D (210_20)	100	OM 606.912	With Immobilizer, Double Coil(LPH)	06/95-06/97	DG-106		11.5V				6

Свечи зажигания и Свечи накаливания

Таблица применения









	KW				СТАНДАРТНЫЕ			Twin Tip		QTY	
											
MERCEDES-BENZ продолжение											
E-CLASS (210) (95-03) продолжение											
E 300 Turbo-D (210_25)	130	OM 606.962		12/96-07/99	DG-106		11.5V			6	
E 320 (210_55)	162	M 104.995		06/95-06/97	K16PR-U	3191	0.8	K16TT	IK16TT	6	
E 320 (210_65)	165	M 112.941		12/96-03/03	PK16PR-L11	3275	1.1	-	IK16TT	12	
E 320 4-matic (210_82)	165	M 112.941		12/96-03/03	PK16PR-L11	3275	1.1	-	IK16TT	12	
E 320 CDI (210_26)	145	OM 613.961		07/99-03/03	DG-117		11.5V			6	
E 420 (210_72)	205	M 119.985		01/96-06/97	K20PR-U11	3121	1.1	K20TT	IK20TT	8	
E 430 (210_70)	205	M 113.940		06/97-03/03	PK16PR-L11	3275	1.1	-	IK16TT	16	
E 430 4-matic (210_83)	205	M 113.940		05/99-03/03	PK16PR-L11	3275	1.1	-	IK16TT	16	
E-CLASS (211) (02-09)											
E 55 AMG Kompressor (211_76)	350	M 113.990		10/02-07/09	VKH20Y	5639	0.8	-	-	VKH20Y	16
E 63 AMG (211_77)	378	M 156.983		03/06-07/09	IXEH22TT	4712	1.0	-	IXEH22TT	8	
E 200 CDI (211_04)	75/90	OM 646.951	Double Coil(LPH)	07/02-12/08	DG-117		11.5V			4	
E 200 CDI (211_07)	100	OM 646.820; OM 646.821	OE: A0011595601/ A0011596801	04/06-07/09	DG-616		7V			4	
E 200 Kompressor (211_41)	135	M 271.956	Eng:>30099998	04/06-08/07	VKH20Y	5639	0.8	-	-	VKH20Y	4
E 200 Kompressor (211_41)	135	M 271.956	Eng:30099999>	08/07-07/09	VXUH22	5611	0.9	-	IXUH22TT	VXUH22	4
E 200 Kompressor (211_42)	120	M 271.941	Eng:>30099998	11/02-08/07	VKH20Y	5639	0.8	-	-	VKH20Y	4
E 200 Kompressor (211_42)	120	M 271.941	Eng:30099999>	08/07-07/09	VXUH22	5611	0.9	-	IXUH22TT	VXUH22	4
E 200 NGT (211_42)	120	M 271.941	Eng:>30099998	03/04-08/07	VKH20Y	5639	0.8	-	-	VKH20Y	4
E 200 NGT (211_42)	120	M 271.941	Eng:30099999>	08/07-12/08	VXUH22	5611	0.9	-	IXUH22TT	VXUH22	4
E 220 CDI	120	OM 646.821	OE: A0011595601/ A0011596801	03/03-07/09	DG-616		7V			4	
E 220 CDI (211_06)	100/ 110	OM 646.961	Double Coil(LPH)	03/02-07/09	DG-117		11.5V			4	
E 220 CDI (211_08)	125	OM 646.821	OE: A0011595601/ A0011596801	04/06-07/09	DG-616		7V			4	
E 230 (211_52)	150	M 272.922		05/07-07/09	SXU22HDR8	3441	0.8	-	IXUH22TT	VXUH22I	6
E 230 (211_52)	150	M 272.922	OEM Optional	05/07-07/09	VXUH22	5611	0.9	-	IXUH22TT	VXUH22	6
E 240 (211_61)	130	M 112.913; M 112.917		03/02-07/09	PK16PR-L11	3275	1.1	-	IK16TT	IK16TT	12
E 240 4-matic (211_80)	130	M 112.917		03/03-07/09	PK16PR-L11	3275	1.1	-	IK16TT	IK16TT	12
E 270 CDI (211_16)	120/ 130	OM 647.961		03/02-07/09	DG-117		11.5V			5	
E 280 (211_54)	170	M 272.943		03/05-07/09	SXU22HDR8	3441	0.8	-	IXUH22TT	VXUH22I	6
E 280 (211_54)	170	M 272.943	OEM Optional	03/05-07/09	VXUH22	5611	0.9	-	IXUH22TT	VXUH22	6
E 280 4-matic (211_92)	170	M 272.943; M 272.944		03/05-07/09	SXU22HDR8	3441	0.8	-	IXUH22TT	VXUH22I	6
E 280 4-matic (211_92)	170	M 272.943; M 272.944	OEM Optional	03/05-07/09	VXUH22	5611	0.9	-	IXUH22TT	VXUH22	6
E 280 CDI (211_20)	140	OM 642.920	OE: A 001 159 50 01; A 001 159 7101	03/05-07/09	DG-194		4.4V			6	
E 280 CDI (211_23)	130	OM 648.961		05/04-07/09	DG-117		11.5V			6	
E 280 CDI 4-matic (211_84)	140	OM 642.921	OE: A 001 159 50 01; A 001 159 7101	03/05-07/09	DG-194		4.4V			6	
E 300 BlueTEC (211_24)	155	OM 642.920	OE: A 001 159 50 01; A 001 159 7101	09/07-12/08	DG-194		4.4V			6	
E 320 (211_65)	165	M 112.949		03/02-07/09	PK16PR-L11	3275	1.1	-	IK16TT	IK16TT	12
E 320 4-matic (211_82)	165	M 112.954		03/03-07/09	PK16PR-L11	3275	1.1	-	IK16TT	IK16TT	12
E 320 CDI (211_22)	165	OM 642.920	OE: A 001 159 50 01; A 001 159 7101	03/05-07/09	DG-194		4.4V			6	
E 320 CDI (211_26)	150	OM 648.961		11/02-07/09	DG-117		11.5V			6	
E 320 CDI 4-matic (211_89)	165	OM 642.910; OM 642.921	OE: A 001 159 50 01; A 001 159 7101	03/05-07/09	DG-194		4.4V			6	
E 350 (211_56)	200	M 272.964		03/05-07/09	SXU22HDR8	3441	0.8	-	IXUH22TT	VXUH22I	6
E 350 (211_56)	200	M 272.964	OEM Optional	03/05-07/09	VXUH22	5611	0.9	-	IXUH22TT	VXUH22	6
E 350 4-matic (211_87)	200	M 272.972		03/05-07/09	SXU22HDR8	3441	0.8	-	IXUH22TT	VXUH22I	6
E 350 4-matic (211_87)	200	M 272.972	OEM Optional	03/05-07/09	VXUH22	5611	0.9	-	IXUH22TT	VXUH22	6
E 350 CGI (211_57)	215	M 272.985		05/06-07/09	SXU22HDR8	3441	0.8	-	IXUH22TT	VXUH22I	6











Таблица применения

M

Свечи зажигания и Свечи накаливания

Таблица применения

Таблица применения

	KW				СТАНДАРТНЫЕ				Twin Tip		QTY
											
MERCEDES-BENZ продолжение											
E-CLASS (211) (02-09) продолжение											
E 350 CGI (211._57)	215	M 272.985	OEM Optional	05/06-07/09	VXUH22I	5656	0.9	-	IXUH22TT	VXUH22I	6
E 400 CDI (211._28)	191	OM 628.961	Double Coil(LPH)	02/03-12/08	DG-117		11.5V				8
E 420 CDI (211._29)	231	OM 629.910		01/06-12/08	DG-194		4.4V				8
E 500 (211._70)	225	M 113.967		03/02-07/09	PK16PR-L11	3275	1.1	-	IK16TT	IK16TT	16
E 500 (211._72)	285	M 273.960		04/06-07/09	SXU22HDR8	3441	0.8	-	IXUH22TT	VXUH22I	8
E 500 (211._72)	285	M 273.960	OEM Optional	04/06-07/09	VXUH22	5611	0.9	-	IXUH22TT	VXUH22	8
E 500 4-matic (211._83)	225	M 113.969		10/03-07/09	PK16PR-L11	3275	1.1	-	IK16TT	IK16TT	16
E 500 4-matic (211._90)	285	M 273.962		04/06-07/09	SXU22HDR8	3441	0.8	-	IXUH22TT	VXUH22I	8
E 500 4-matic (211._90)	285	M 273.962	OEM Optional	04/06-07/09	VXUH22	5611	0.9	-	IXUH22TT	VXUH22	8
E-CLASS (212) (09-)											
E 63 AMG (212._77)	386	M 156.985		08/09-12/15	IXEH22TT	4712	1.0	-	IXEH22TT		8
E 200 CDI / BlueTEC (212._05, 212._06)	100	OM 651.925	OE: A 001 159 57 01; A 001 159 58 01; A 001 159 66 01, F166 Discontinuation of impact plate	01/09-12/16	DG-617		7V				4
E 200 CDI / BlueTEC (212._05, 212._06)	100	OM 651.925	OE: A0011597301/ A0011598001, -F166 Discontinuation of impact plate	01/09-12/16	DG-665		7V				4
E 200 CGI (212._48)	135	M 271.860		11/09-12/16	VXUH22	5611	0.9	-	IXUH22TT	VXUH22	4
E 200 CGI (212._48, 212._48)	135	M 271.820; M 271.860		08/09-12/15	VXUH22	5611	0.9	-	IXUH22TT	VXUH22	4
E 200 NGT (212._41)	120	M 271.958	Eng:30099999>	03/11-12/15	VXUH22	5611	0.9	-	IXUH22TT	VXUH22	4
E 220 BlueTEC	130	OM 651.924	OE: A 001 159 57 01; A 001 159 58 01; A 001 159 66 01, F166 Discontinuation of impact plate	05/15-12/16	DG-617		7V				4
E 220 BlueTEC	130	OM 651.924	OE: A0011597301/ A0011598001, -F166 Discontinuation of impact plate	05/15-12/16	DG-665		7V				4
E 220 BlueTEC (212._01)	130	OM 651.924	OE: A 001 159 57 01; A 001 159 58 01; A 001 159 66 01, F166 Discontinuation of impact plate	05/14-12/15	DG-617		7V				4
E 220 BlueTEC (212._01)	130	OM 651.924	OE: A0011597301/ A0011598001, -F166 Discontinuation of impact plate	05/14-12/15	DG-665		7V				4
E 220 BlueTEC 4-matic (212._11)	125	OM 651.924	OE: A 001 159 57 01; A 001 159 58 01; A 001 159 66 01, F166 Discontinuation of impact plate	12/14-12/16	DG-617		7V				4

Свечи зажигания и Свечи накаливания

Таблица применения



	KW				СТАНДАРТНЫЕ			Twin Tip			QTY
MERCEDES-BENZ продолжение											
E-CLASS (212) (09-) продолжение											
E 220 BlueTEC 4-matic (212._11)	125	OM 651.924	OE: A0011597301/A0011598001, -F166 Discontinuation of impact plate	12/14-12/16	DG-665		7V				4
E 220 CDI (212._02)	120	OM 651.924	OE: A 001 159 57 01; A 001 159 58 01; A 001 159 66 01, F166 Discontinuation of impact plate	01/09-12/15	DG-617		7V				4
E 220 CDI (212._02)	120	OM 651.924	OE: A0011597301/A0011598001, -F166 Discontinuation of impact plate	01/09-12/15	DG-665		7V				4
E 220 CDI / BlueTEC (212._01, 212._02)	125	OM 651.924	OE: A 001 159 57 01; A 001 159 58 01; A 001 159 66 01, F166 Discontinuation of impact plate	01/09-12/16	DG-617		7V				4
E 220 CDI / BlueTEC (212._01, 212._02)	125	OM 651.924	OE: A0011597301/A0011598001, -F166 Discontinuation of impact plate	01/09-12/16	DG-665		7V				4
E 220 CDI / BlueTEC (212._02, 212._01)	125	OM 651.924	OE: A 001 159 57 01; A 001 159 58 01; A 001 159 66 01, F166 Discontinuation of impact plate	11/09-12/16	DG-617		7V				4
E 220 CDI / BlueTEC (212._02, 212._01)	125	OM 651.924	OE: A0011597301/A0011598001, -F166 Discontinuation of impact plate	11/09-12/16	DG-665		7V				4
E 250 CDI / BlueTEC (212._03, 212._04)	150	OM 651.924	OE: A 001 159 57 01; A 001 159 58 01; A 001 159 66 01, F166 Discontinuation of impact plate	01/09-12/16	DG-617		7V				4
E 250 CDI / BlueTEC (212._03, 212._04)	150	OM 651.924	OE: A0011597301/A0011598001, -F166 Discontinuation of impact plate	01/09-12/16	DG-665		7V				4
E 250 CDI / BlueTEC 4-matic (212._82, 212._97)	150	OM 651.924	OE: A 001 159 57 01; A 001 159 58 01; A 001 159 66 01, F166 Discontinuation of impact plate	07/10-12/16	DG-617		7V				4











Таблица применения

M

Свечи зажигания и Свечи накаливания











Таблица применения

Таблица применения

	KW				СТАНДАРТНЫЕ				Twin Tip		QTY
											
MERCEDES-BENZ продолжение											
E-CLASS (212) (09-) продолжение											
E 250 CDI / BlueTEC 4-matic (212._82, 212._97)	150	OM 651.924	OE: A0011597301/A0011598001, -F166 Discontinuation of impact plate	07/10-12/16	DG-665		7V				4
E 250 CGI (212._47)	150	M 271.860		11/09-12/13	VXUH22	5611	0.9	-	IXUH22TT	VXUH22	4
E 250 CGI (212._47, 212._47)	150	M 271.860		01/09-12/15	VXUH22	5611	0.9	-	IXUH22TT	VXUH22	4
E 300 (212._54)	170	M 272.952		01/09-12/13	SXU22HDR8	3441	0.8	-	IXUH22TT	VXUH22I	6
E 300 (212._54)	170	M 272.952	OEM Optional	01/09-12/13	VXUH22	5611	0.9	-	IXUH22TT	VXUH22	6
E 300 CDI (212._20)	150	OM 642.850	Eng:> 41330713, Steel version	12/09-12/10	DG-194		4.4V				6
E 300 CDI / BlueTEC (212._20, 212._21, 212._27)	170	OM 642.850	Eng:> 41330713, Steel version	03/11-06/12	DG-194		4.4V				6
E 300 CDI / BlueTEC (212._20, 212._21, 212._27)	170	OM 642.850	Eng:41330714>,OE: A 001 159 57 01; A 001 159 58 01; A 001 159 66 01,Ceramic	06/12-12/15	DG-617		7V				6
E 300 CDI / BlueTEC (212._20, 212._21, 212._27)	170	OM 642.852	Eng:41324859>,OE: A0011597301/A0011598001, Ceramic	06/12-12/15	DG-665		7V				6
E 300 CDI / BlueTEC (212._27, 212._21)	170	OM 642.850	Eng:> 41330713, Steel version	11/09-06/12	DG-194		4.4V				6
E 300 CDI / BlueTEC (212._27, 212._21)	170	OM 642.850	Eng:41330714>,OE: A 001 159 57 01; A 001 159 58 01; A 001 159 66 01,Ceramic	06/12-12/16	DG-617		7V				6
E 300 CDI / BlueTEC (212._27, 212._21)	170	OM 642.852	Eng:41324859>,OE: A0011597301/A0011598001, Ceramic	06/12-12/16	DG-665		7V				6
E 300 Hybrid / BlueTEC Hybrid (212._98)	150	OM 651.924	OE: A 001 159 57 01; A 001 159 58 01; A 001 159 66 01, F166 Discontinuation of impact plate	12/11-12/16	DG-617		7V				4
E 300 Hybrid / BlueTEC Hybrid (212._98)	150	OM 651.924	OE: A0011597301/A0011598001, -F166 Discontinuation of impact plate	12/11-12/16	DG-665		7V				4
E 350 (212._56)	200	M 272.980		01/09-12/13	SXU22HDR8	3441	0.8	-	IXUH22TT	VXUH22I	6
E 350 (212._56)	200	M 272.980	OEM Optional	01/09-12/13	VXUH22	5611	0.9	-	IXUH22TT	VXUH22	6
E 350 4-matic (212._87)	200	M 272.977		01/09-12/11	SXU22HDR8	3441	0.8	-	IXUH22TT	VXUH22I	6
E 350 4-matic (212._87)	200	M 272.977	OEM Optional	01/09-12/11	VXUH22	5611	0.9	-	IXUH22TT	VXUH22	6
E 350 BlueTEC	185	OM 642.852	Eng:41324859>,OE: A0011597301/A0011598001, Ceramic	11/12-12/16	DG-665		7V				6
E 350 BlueTEC (212._24)	155	OM 642.850	Eng:> 41330713, Steel version	01/09-06/12	DG-194		4.4V				6

Свечи зажигания и Свечи накаливания











Таблица применения

	KW				СТАНДАРТНЫЕ			Twin Tip			QTY	
												
MERCEDES-BENZ продолжение												
E-CLASS (212) (09-) продолжение												
E 350 BlueTEC (212._24)	155	OM 642.850	Eng:41330714> .OE: A 001 159 57 01; A 001 159 58 01; A 001 159 66 01,Ceramic	06/12-12/15	DG-617		7V				6	
E 350 BlueTEC (212._26)	190	OM 642.852	Eng:41324859> .OE: A0011597301/ A0011598001, Ceramic	05/14-12/16	DG-665		7V				6	
E 350 BlueTEC 4-matic (212._94)	185/ 190	OM 642.852; OM 642.858	Eng:41324859> .OE: A0011597301/ A0011598001, Ceramic	01/13-12/16	DG-665		7V				6	
E 350 BlueTEC 4-matic (212.294)	185	OM 642.858	Eng:41324859> .OE: A0011597301/ A0011598001, Ceramic	11/12-12/16	DG-665		7V				6	
E 350 CDI (212._23)	195	OM 642.852	Eng:41324859> .OE: A0011597301/ A0011598001, Ceramic	06/12-12/15	DG-665		7V				6	
E 350 CDI (212._25)	170	OM 642.850	Eng:> 41330713, Steel vers ion	01/09-06/12	DG-194		4.4V				6	
E 350 CDI (212._25)	170	OM 642.850	Eng:41330714> .OE: A 001 159 57 01; A 001 159 58 01; A 001 159 66 01,Ceramic	06/12-12/15	DG-617		7V				6	
E 350 CDI 4-matic (212._89)	170	OM 642.856	OE: A 001 159 57 01; A 001 159 58 01; A 001 159 66 01,Ceramic	09/09-12/11	DG-617		7V				6	
E 350 CDI 4-matic (212._93)	195	OM 642.858	Eng:41324859> .OE: A0011597301/ A0011598001, Ceramic	06/12-12/15	DG-665		7V				6	
E 350 CGI (212._57)	215	M 272.982; M 272.983		01/09-12/11	SXU22HDR8	3441	0.8	-	IXUH22TT	VXUH22I	6	
E 350 CGI (212._57)	215	M 272.983	OEM Optional	01/09-12/11	VXUH22	5611	0.9	-	IXUH22TT	VXUH22	6	
E 500 (212._72)	285	M 273.971		01/09-12/11	SXU22HDR8	3441	0.8	-	IXUH22TT	VXUH22I	8	
E 500 (212._72)	285	M 273.971	OEM Optional	01/09-12/11	VXUH22	5611	0.9	-	IXUH22TT	VXUH22	8	
E 500 4-matic (212._90)	285	M 273.970		01/09-12/11	SXU22HDR8	3441	0.8	-	IXUH22TT	VXUH22I	8	
E 500 4-matic (212._90)	285	M 273.970	OEM Optional	01/09-12/11	VXUH22	5611	0.9	-	IXUH22TT	VXUH22	8	
E-CLASS (213) (16-)												
E 200 d (213._13)	110	OM 654.920	OE: A0011597301/ A0011598001	07/16-	DG-665		7V				4	
E 220 d (213._04)	120/ 143	OM 654.920	OE: A0011597301/ A0011598001	01/16-	DG-665		7V				4	
E 350 d (213._33)	190	OM 642.855	Eng:41324859> .OE: A0011597301/ A0011598001, Ceramic	01/16-05/18	DG-665		7V				6	
E-CLASS Coupe / Convertible (124) (93-98)												
E 36 AMG (124._52)	195/ 200	M 104.992 (AMG 3.6)		06/93-06/97	K16PR-U	3191	0.8		K16TT	IK16TT	IK16TT	6
E 36 AMG (124._66)	200	M 104.992 (AMG 3.6)		05/94-03/98	K16PR-U	3191	0.8		K16TT	IK16TT	IK16TT	6
E 200 (124._40)	100	M 111.940		06/93-06/97	K16PR-U	3191	0.8		K16TT	IK16TT	IK16TT	4
E 200 (124._60)	100	M 111.940		06/93-03/98	K16PR-U	3191	0.8		K16TT	IK16TT	IK16TT	4
E 220 (124._42)	110	M 111.960		06/93-06/97	K16PR-U	3191	0.8		K16TT	IK16TT	IK16TT	4
E 220 (124._62)	110	M 111.960		06/93-03/98	K16PR-U	3191	0.8		K16TT	IK16TT	IK16TT	4
E 320 (124._52)	162	M 104.992		06/93-06/97	K16PR-U	3191	0.8		K16TT	IK16TT	IK16TT	6
E 320 (124._66)	162	M 104.992		06/93-03/98	K16PR-U	3191	0.8		K16TT	IK16TT	IK16TT	6

Свечи зажигания и Свечи накаливания











Таблица применения

Таблица применения

	KW				СТАНДАРТНЫЕ				Twin Tip			QTY
												
MERCEDES-BENZ продолжение												
E-CLASS Coupe / Convertible (207) (09-)												
E 200 CGI (207._48)	135	M 271.820; M 271.860		01/10-12/16	VXUH22	5611	0.9	-	IXUH22TT	VXUH22	4	
E 220 BlueTEC (207._01)	130	OM 651.911	OE: A 001 159 57 01; A 001 159 58 01; A 001 159 6601	05/14-12/16	DG-617		7V				4	
E 220 CDI (207._02)	120	OM 651.911	OE: A 001 159 57 01; A 001 159 58 01; A 001 159 6601	02/10-12/16	DG-617		7V				4	
E 220 CDI / BlueTEC / d (207._02, 207._01)	125	OM 651.911	OE: A 001 159 57 01; A 001 159 58 01; A 001 159 6601	01/10-12/16	DG-617		7V				4	
E 250 CDI / BlueTEC / d (207._03, 207._04)	150	OM 651.911	OE: A 001 159 57 01; A 001 159 58 01; A 001 159 6601	01/09-12/16	DG-617		7V				4	
E 250 CGI (207._47)	150	M 271.860		01/09-12/16	VXUH22	5611	0.9	-	IXUH22TT	VXUH22	4	
E 350 (207._56)	200	M 272.961; M 272.988		01/10-12/11	SXU22HDR8	3441	0.8	-	IXUH22TT	VXUH22I	6	
E 350 (207._56)	200	M 272.961; M 272.988	OEM Optional	01/10-12/11	VXUH22	5611	0.9	-	IXUH22TT	VXUH22	6	
E 350 BlueTEC (207._26)	185	OM 642.838	Eng:41324859> ,OE: A0011597301/ A0011598001, Ceramic	06/13-12/16	DG-665		7V				6	
E 350 BlueTEC / d (207._26)	190	OM 642.838	Eng:41324859> ,OE: A0011597301/ A0011598001, Ceramic	05/14-12/16	DG-665		7V				6	
E 350 CDI (207._22)	170	OM 642.836	OE: A 001 159 57 01; A 001 159 58 01; A 001 159 6601	01/09-12/11	DG-617		7V				6	
E 350 CDI (207.323)	195	OM 642.838	Eng:41324859> ,OE: A0011597301/ A0011598001, Ceramic	06/12-06/13	DG-665		7V				6	
E 350 CDI (207.423)	195	OM 642.838	Eng:41324859> ,OE: A0011597301/ A0011598001, Ceramic	06/12-12/13	DG-665		7V				6	
E 350 CGI (207._57)	215	M 272.982; M 272.984		01/09-12/14	SXU22HDR8	3441	0.8	-	IXUH22TT	VXUH22I	6	
E 350 CGI (207._57)	215	M 272.982; M 272.984	OEM Optional	01/09-12/14	VXUH22I	5656	0.9	-	IXUH22TT	VXUH22I	6	
E 500 (207._72)	285	M 273.966		01/09-12/16	SXU22HDR8	3441	0.8	-	IXUH22TT	VXUH22I	8	
E 500 (207._72)	285	M 273.966	OEM Optional	01/09-12/16	VXUH22	5611	0.9	-	IXUH22TT	VXUH22	8	
G-CLASS (W460) (79-93)												
230 G	66/75	M 115.973		03/79-07/93	W20EP-U	3043	0.8	W20TT	IW20TT	IW20TT	4	
230 GE	90/92	M 102.979; M 102.981; M 102.987; M 102.989		04/82-08/92	T20EP-U	5031	0.8	T20TT	IT20TT	IT20TT	4	
240 GD	53	OM 616.936	Double Coil(LPH)	08/80-08/87	DG-001		11V				4	
250 GD	62	OM 602.930	Double Coil(LPH)	10/87-01/89	DG-001		11V				5	
250 GD	62/68	OM 602.930	Double Coil(LPH)	12/88-12/92	DG-010		11.5V				5	
280 GE	110/ 115	M 110.994		11/79-08/89	W20EP-U	3043	0.8	W20TT	IW20TT	IW20TT	6	
300 GD	65	OM 617.931	Double Coil(LPH)	12/79-12/91	DG-001		11V				5	
300 GD	65	OM 617.931	Double Coil(LPH)	12/79-12/91	DG-010		11.5V				5	

Свечи зажигания и Свечи накаливания











Таблица применения

	KW				СТАНДАРТНЫЕ			Twin Tip			QTY
											
MERCEDES-BENZ продолжение											
G-CLASS (W461) (90-)											
230 GE	90/92	M 102.979; M 102.996; M 102.997		09/89-07/00	T20EP-U	5031	0.8	T20TT	IT20TT	IT20TT	4
250 GD	68	OM 602.939	Double Coil(LPH)	02/90-05/93	DG-010		11.5V				5
290 GD/G 290 D	70	OM 602.942	Double Coil(LPH)	06/93-07/00	DG-010		11.5V				5
G 270 CDI	115	OM 612.966		01/03-	DG-117		11.5V				5
G 280 CDI	135	OM 642.884; OM 642.975	Eng:> 41330713,OE: A 001 159 50 01; A 001 159 7101	04/09-06/12	DG-194		4.4V				6
G 280 CDI	135	OM 642.884; OM 642.975	Eng:41330714> ,OE: A 001 159 57 01; A 001 159 58 01; A 001 159 6601	06/12-	DG-617		7V				6
G 290 TD	88	OM 602.983	Double Coil(LPH)	07/97-	DG-010		11.5V				5
G 300 CDI	135	OM 642.884	Eng:> 41330713,OE: A 001 159 50 01; A 001 159 7101	04/10-06/12	DG-194		4.4V				6
G 300 CDI	135	OM 642.884	Eng:41330714> ,OE: A 001 159 57 01; A 001 159 58 01; A 001 159 6601	06/12-	DG-617		7V				6
G-CLASS (W463) (89-)											
200 GE (463.200)	80/85	M 102.965		01/90-07/93	T20EP-U	5031	0.8	T20TT	IT20TT	IT20TT	4
200 GE (463.220)	85	M 102.965		01/90-07/93	T20EP-U	5031	0.8	T20TT	IT20TT	IT20TT	4
230 GE (463.204)	93	M 102.989		06/90-02/93	T20EP-U	5031	0.8	T20TT	IT20TT	IT20TT	4
230 GE (463.224, 463.225)	93	M 102.989		06/90-06/93	T20EP-U	5031	0.8	T20TT	IT20TT	IT20TT	4
250 GD (463.324, 463.325)	69	OM 602.931	Double Coil(LPH)	06/90-10/92	DG-010		11.5V				5
300 GD / G 300 (463.307)	83	OM 603.931		12/90-09/97	DG-001		11V				6
300 GD / G 300 (463.327, 463.328)	83	OM 603.931		09/89-06/93	DG-001		11V				6
300 GE (463.207)	125	M 103.987		09/89-09/97	T20EP-U	5031	0.8	T20TT	IT20TT	IT20TT	6
300 GE (463.227, 463.228)	125/ 128	M 103.987		09/89-08/97	T20EP-U	5031	0.8	T20TT	IT20TT	IT20TT	6
320 GE (463.208)	155	M 104.996		09/94-11/97	K16PR-U	3191	0.8	K16TT	IK16TT	IK16TT	6
350 G Turbo-D (463.300)	100	OM 603.972	Double Coil(LPH)	09/91-09/97	DG-001		11V				6
350 Turbo GD (463.320, 463.321)	100	OM 603.972	Double Coil(LPH)	09/91-08/96	DG-001		11V				6
500 GE (463.228)	177	M 117.965		09/93-12/94	W20EP-U	3043	0.8	W20TT	IW20TT	IW20TT	8
G 36 AMG (463.230)	200	M 104.996 (AMG 3.6)		01/95-07/98	K16PR-U	3191	0.8	K16TT	IK16TT	IK16TT	6
G 55 AMG (463.243, 463.246)	260	M 113.982		04/99-	PK16PR-L11	3275	1.1	-	IK16TT	IK16TT	16
G 55 AMG (463.270, 463.271)	350/ 368/ 373	M 113.993		06/04-	VKH20Y	5639	0.8	-	-	VKH20Y	16
G 65 AMG	450	M 279.982		05/12-	VK20Y	5620	0.8	-	-	VK20Y	24
G 65 AMG (463.274, 463.275)	463	M 279.982		06/15-	VK20Y	5620	0.8	-	-	VK20Y	24
G 270 CDI (463.322, 463.323)	115	OM 612.965		10/01-	DG-117		11.5V				5
G 300 TD (463.308)	130	OM 606.964		09/96-07/00	DG-106		11.5V				6
G 300 TD (463.330, 463.331)	130	OM 606.964		08/96-07/00	DG-106		11.5V				6
G 320 (463.209)	158	M 112.945		11/97-	PK16PR-L11	3275	1.1	-	IK16TT	IK16TT	12
G 320 (463.230, 463.231)	155	M 104.996		09/94-12/97	K16PR-U	3191	0.8	K16TT	IK16TT	IK16TT	6
G 320 (463.232, 463.233, 463.244, 463.245, 463.250)	158	M 112.945		07/97-	PK16PR-L11	3275	1.1	-	IK16TT	IK16TT	12
G 320 CDI (463.303)	165	OM 642.970	OE: A 001 159 57 01; A 001 159 58 01; A 001 159 6601	09/06-	DG-617		7V				6

Свечи зажигания и Свечи накаливания









Таблица применения

Таблица применения

	KW				СТАНДАРТНЫЕ			Twin Tip			QTY
											
MERCEDES-BENZ продолжение											
G-CLASS (W463) (89-) продолжение											
G 320 CDI (463.340, 463.341, 463.343)	165	OM 642.970	OE: A 001 159 57 01; A 001 159 58 01; A 001 159 6601	09/06-	DG-617		7V				6
G 350 CDI	155	OM 642.886	OE: A 001 159 57 01; A 001 159 58 01; A 001 159 6601	07/11-	DG-617		7V				6
G 350 d (463.348)	180	OM 642.887	Eng:41324859> ,OE: A0011597301/ A0011598001	06/15-	DG-665		7V				6
G 400 CDI (463.309)	184	OM 628.962	Double Coil(LPH)	12/00-	DG-117		11.5V				8
G 400 CDI (463.332, 463.333)	184	OM 628.962	Double Coil(LPH)	12/00-	DG-117		11.5V				8
G 500 (463.202)	285	M 273.963; M 273.969		12/09-	SXU22HDR8	3441	0.8	-	IXUH22TT	VXUH22I	8
G 500 (463.202)	285	M 273.963; M 273.969	OEM Optional	12/09-	VXUH22	5611	0.9	-	IXUH22TT	VXUH22	8
G 500 (463.222, 463.236, 463.237, 463.242)	285	M 273.963; M 273.969		05/08-	SXU22HDR8	3441	0.8	-	IXUH22TT	VXUH22I	8
G 500 (463.222, 463.236, 463.237, 463.242)	285	M 273.963; M 273.969	OEM Optional	05/08-	VXUH22	5611	0.9	-	IXUH22TT	VXUH22	8
G 500 (463.247, 463.248, 463.249, 463.240, 463.241)	218	M 113.962		04/98-	PK16PR-L11	3275	1.1	-	IK16TT	IK16TT	16
G 500 (463.247, 463.248, 463.249, 463.240, 463.241, ...)	218	M 113.962		04/98-	PK16PR-L11	3275	1.1	-	IK16TT	IK16TT	16
GLA (X156) (13-)											
GLA 180 CDI / d (156.912)	80	OM 607.951	Instant heating (ISS)	07/14-	DG-609		4.4V				4
GLA 200 CDI / d (156.908)	100	OM 651.930	OE: A0011597301/ A0011598001	12/13-	DG-665		7V				4
GLA 200 CDI / d 4-matic (156.902)	100	OM 651.930	OE: A0011597301/ A0011598001	12/13-	DG-665		7V				4
GLA 220 CDI (156.903)	125	OM 651.930	OE: A0011597301/ A0011598001	12/13-	DG-665		7V				4
GLA 220 CDI / d (156.903)	120	OM 651.930	OE: A0011597301/ A0011598001	12/13-	DG-665		7V				4
GLA 220 CDI / d 4-matic (156.905)	120	OM 651.930	OE: A0011597301/ A0011598001	12/13-	DG-665		7V				4
GLA 220 CDI 4-matic (156.905)	125	OM 651.930	OE: A0011597301/ A0011598001	12/13-	DG-665		7V				4
GLA 220 d (156.903)	130	OM 651.930	OE: A0011597301/ A0011598001	07/15-	DG-665		7V				4
GLA 220 d 4-matic (156.905)	130	OM 651.930	OE: A0011597301/ A0011598001	07/15-	DG-665		7V				4
GLC (X253) (15-)											
220 d 4-matic (253.905, 253.903)	120/ 125	OM 651.921	OE: A 001 159 57 01; A 001 159 58 01; A 001 159 66 01, F166 Discon tinuationo f impact pl ate	06/15-04/19	DG-617		7V				4
220 d 4-matic (253.905, 253.903)	120/ 125	OM 651.921	OE: A0011597301/ A0011598001, -F166 Disco ntinuation of impact late	06/15-04/19	DG-665		7V				4

Свечи зажигания и Свечи накаливания











Таблица применения

	KW				СТАНДАРТНЫЕ			Twin Tip		QTY	
											
MERCEDES-BENZ продолжение											
GLC (X253) (15-) продолжение											
250 d 4-matic (253.909)	150	OM 651.921	OE: A 001 159 57 01; A 001 159 58 01; A 001 159 66 01, F166 Discontinuation of impact plate	06/15-04/19	DG-617		7V			4	
250 d 4-matic (253.909)	150	OM 651.921	OE: A0011597301/ A0011598001, -F166 Discontinuation of impact plate	06/15-04/19	DG-665		7V			4	
GLC Coupe (C253) (16-)											
220 d 4-matic (253.303, 253.305)	125	OM 651.921	OE: A 001 159 57 01; A 001 159 58 01; A 001 159 66 01, F166 Discontinuation of impact plate	06/16-04/19	DG-617		7V			4	
220 d 4-matic (253.303, 253.305)	125	OM 651.921	OE: A0011597301/ A0011598001, -F166 Discontinuation of impact plate	06/16-04/19	DG-665		7V			4	
250 d 4-matic (253.309)	150	OM 651.921	OE: A 001 159 57 01; A 001 159 58 01; A 001 159 66 01, F166 Discontinuation of impact plate	06/16-04/19	DG-617		7V			4	
250 d 4-matic (253.309)	150	OM 651.921	OE: A0011597301/ A0011598001, -F166 Discontinuation of impact plate	06/16-04/19	DG-665		7V			4	
GL-CLASS (X164) (06-)											
GL 320 CDI / 350 BlueTEC 4-matic (164.824, 164.825)	155	OM 642.820	OE: A 001 159 57 01; A 001 159 58 01; A 001 159 6601	12/09-08/12	DG-617		7V			6	
GL 320 CDI 4-matic (164.822)	165	OM 642.940	OE: A 001 159 50 01; A 001 159 7101	09/06-05/09	DG-194		4.4V			6	
GL 350 CDI 4-matic (164.822)	165	OM 642.940	OE: A 001 159 50 01; A 001 159 7101	05/09-08/12	DG-194		4.4V			6	
GL 350 CDI 4-matic (164.822)	165	OM 642.940	OE: A 001 159 57 01; A 001 159 58 01; A 001 159 6601	05/09-08/12	DG-617		7V			6	
GL 350 CDI 4-matic (164.823)	195	OM 642.822	OE: A0011597301/ A0011598001, Ceramic	10/10-08/12	DG-665		7V			6	
GL 420 CDI 4-matic (164.828)	225	OM 629.912		09/06-05/09	DG-194		4.4V			8	
GL 450 4-matic (164.871)	250	M 273.923		09/06-08/12	SXU22HDR8	3441	0.8	-	IXUH22TT	VXUH22I	8
GL 450 4-matic (164.871)	250	M 273.923	OEM Optional	09/06-08/12	VXUH22	5611	0.9	-	IXUH22TT	VXUH22	8
GL 450 CDI 4-matic (164.828)	225	OM 629.912		05/09-08/12	DG-194		4.4V			8	
GL 500 4-matic (164.886)	285	M 273.963		09/06-12/12	SXU22HDR8	3441	0.8	-	IXUH22TT	VXUH22I	8

Свечи зажигания и Свечи накаливания











Таблица применения

Таблица применения

	KW				СТАНДАРТНЫЕ			Twin Tip			QTY
											
MERCEDES-BENZ продолжение											
GL-CLASS (X164) (06-) продолжение											
GL 500 4-matic (164.886)	285	M 273.963	OEM Optional	09/06-12/12	VXUH22	5611	0.9	-	IXUH22TT	VXUH22	8
GL-CLASS (X166) (12-)											
GL 350 CDI / BlueTec 4-matic (166.823, 166.824)	190	OM 642.826	Eng:41324859>,OE:A0011597301/A0011598001,Ceramic	07/12-10/15	DG-665		7V				6
GLE (W166) (15-)											
250 d (166.006)	150	OM 651.960	OE:A 001 159 57 01;A 001 159 58 01;A 001 159 66 01,F166 Discontinuation of impact plate	04/15-10/18	DG-617		7V				4
250 d 4-matic (166.004)	150	OM 651.960	OE:A 001 159 57 01;A 001 159 58 01;A 001 159 66 01,F166 Discontinuation of impact plate	04/15-10/18	DG-617		7V				4
350 d 4-matic (166.024)	190	OM 642.826	Eng:41324859>,OE:A0011597301/A0011598001,Ceramic	04/15-10/18	DG-665		7V				6
GLE Coupe (C292) (15-)											
350 d 4-matic (292.323, 292.324)	190	OM 642.824; OM 642.826	Eng:41324859>,OE:A0011597301/A0011598001,Ceramic	03/15-10/19	DG-665		7V				6
GLK (X204) (08-15)											
200 CDI (204.901)	100/105	OM 651.913; OM 651.916	OE:A 001 159 57 01;A 001 159 58 01;A 001 159 66 01,F166 Discontinuation of impact plate	07/10-06/15	DG-617		7V				4
200 CDI (204.901)	100/105	OM 651.913; OM 651.916	OE:A0011597301/A0011598001,-F166 Discontinuation of impact plate	07/10-06/15	DG-665		7V				4
220 CDI (204.902)	120/125	OM 651.916	OE:A 001 159 57 01;A 001 159 58 01;A 001 159 66 01,F166 Discontinuation of impact plate	12/08-06/15	DG-617		7V				4
220 CDI (204.902)	120/125	OM 651.916	OE:A0011597301/A0011598001,-F166 Discontinuation of impact plate	12/08-06/15	DG-665		7V				4
220 CDI 4-matic (204.984)	120	OM 651.912	OE:A 001 159 57 01;A 001 159 58 01;A 001 159 66 01	12/08-06/15	DG-617		7V				4

Свечи зажигания и Свечи накаливания











Таблица применения

	KW				СТАНДАРТНЫЕ				Twin Tip		QTY
											
MERCEDES-BENZ продолжение											
GLK (X204) (08-15) продолжение											
220 CDI 4-matic (204.984, 204.997)	125	OM 651.912	OE: A 001 159 57 01; A 001 159 58 01; A 001 159 6601	12/08-06/15	DG-617		7V				4
250 CDI 4-matic (204.982, 204.904)	150	OM 651.912	OE: A 001 159 57 01; A 001 159 58 01; A 001 159 6601	09/09-06/15	DG-617		7V				4
280 4-matic (204.981)	170	M 272.948		06/08-06/09	SXU22HDR8	3441	0.8	-	IXUH22TT	VXUH22I	6
280 4-matic (204.981)	170	M 272.948	OEM Optional	06/08-06/09	VXUH22	5611	0.9	-	IXUH22TT	VXUH22	6
300 4-matic (204.981)	170	M 272.948		07/09-12/15	SXU22HDR8	3441	0.8	-	IXUH22TT	VXUH22I	6
300 4-matic (204.981)	170	M 272.948	OEM Optional	07/09-12/15	VXUH22	5611	0.9	-	IXUH22TT	VXUH22	6
320 CDI 4-matic (204.983)	165	OM 642.961	OE: A 001 159 50 01; A 001 159 7101	06/08-08/13	DG-194		4.4V				6
320 CDI 4-matic (204.983)	165	OM 642.961	OE: A 001 159 57 01; A 001 159 58 01; A 001 159 6601	08/13-06/15	DG-617		7V				6
350 (204.956)	200	M 272.991		04/09-06/15	SXU22HDR8	3441	0.8	-	IXUH22TT	VXUH22I	6
350 (204.956)	200	M 272.991	OEM Optional	04/09-06/15	VXUH22	5611	0.9	-	IXUH22TT	VXUH22	6
350 4-matic (204.987)	200	M 272.971		06/08-04/11	SXU22HDR8	3441	0.8	-	IXUH22TT	VXUH22I	6
350 4-matic (204.987)	200	M 272.971	OEM Optional	06/08-04/11	VXUH22	5611	0.9	-	IXUH22TT	VXUH22	6
350 CDI 4-matic (204.992)	165/ 170	OM 642.832	OE: A 001 159 57 01; A 001 159 58 01; A 001 159 6601	07/09-06/15	DG-617		7V				6
350 CDI 4-matic (204.993)	195	OM 642.835	Eng:41324859> .OE: A0011597301/ A0011598001, Ceramic	07/12-06/15	DG-665		7V				6
GLS (X166) (15-)											
350 d 4-matic (166.824)	190	OM 642.826	Eng:41324859> .OE: A0011597301/ A0011598001, Ceramic	11/15-04/19	DG-665		7V				6
HECKFLOSSE (W110) (61-68)											
190 C (110.010)	59	M 121.924		04/61-08/65	W20EP-U	3043	0.8	W20TT	IW20TT	IW20TT	4
200	70	M 115.926		07/65-02/68	W20EP-U	3043	0.8	W20TT	IW20TT	IW20TT	4
200 (110.010)	61	M 121.940		07/65-02/68	W20EP-U	3043	0.8	W20TT	IW20TT	IW20TT	4
230	88	M 180.950		06/66-12/67	W22EP-U	3085	0.8	W22TT	-	VW22	6
230 (110.011)	77	M 180.945; M 180.949		07/65-02/68	W22EP-U	3085	0.8	W22TT	-	VW22	6
HECKFLOSSE (W111, W112) (59-68)											
220 B (111.010)	70	M 180.940		08/59-08/65	W22EP-U	3085	0.8	W22TT	-	VW22	6
220 SB (111.012)	81	M 180.941		08/59-08/65	W22EP-U	3085	0.8	W22TT	-	VW22	6
230 S (111.010)	88	M 180.947; M 180.950		07/65-01/68	W22EP-U	3085	0.8	W22TT	-	VW22	6
300 SE (112.014, 112.015)	118	M 189.984; M 189.986		02/61-02/64	W22EP-U	3085	0.8	W22TT	-	VW22	6
300 SE (112.021, 112.023)	125	M 189.985; M 189.987		02/64-07/65	W22EP-U	3085	0.8	W22TT	-	VW22	6
HENSCHEL 2-t (73-77)											
206 D 2.2	44	OM 615.917; OM 615.937; OM 615.939		02/73-12/77	DG-001		11V				4
KOMBI (S123) (77-85)											
200 T	80	M 102.920		11/80-11/85	T20EP-U	5031	0.8	T20TT	IT20TT	IT20TT	4
200 T (123.280)	74	M 102.939		11/80-11/85	T20EP-U	5031	0.8	T20TT	IT20TT	IT20TT	4
230 T (123.083)	80	M 115.954		09/77-03/80	W20EP-U	3043	0.8	W20TT	IW20TT	IW20TT	4
230 TE (123.283)	100	M 102.980		04/80-11/85	T20EP-U	5031	0.8	T20TT	IT20TT	IT20TT	4
240 T D (123.183)	53	OM 616.912	Double Coil(LPH)	08/80-12/85	DG-001		11V				4
250 T (123.086)	95/ 103	M 123.921		05/78-08/82	W20EP-U	3043	0.8	W20TT	IW20TT	IW20TT	6
280 TE (123.093)	136	M 110.988		09/77-11/85	W20EP-U	3043	0.8	W20TT	IW20TT	IW20TT	6

Свечи зажигания и Свечи накаливания





Таблица применения

Таблица применения

	KW				СТАНДАРТНЫЕ				Twin Tip			QTY
												
MERCEDES-BENZ продолжение												
КОМБИ (S123) (77-85) продолжение												
300 T D (123.190)	59/65	OM 617.912	Double Coil(LPH)	09/77-11/85	DG-001		11V					5
300 T Turbo-D (123.193)	92	OM 617.952	Double Coil(LPH)	10/80-11/85	DG-001		11V					5
КОМБИ (S124) (85-93)												
200 T (124.080)	77/80	M 102.922		09/85-05/90	T20EP-U	5031	0.8	T20TT	IT20TT	IT20TT		4
200 T D (124.180)	53	OM 601.912	Double Coil(LPH)	09/85-01/89	DG-001		11V					4
200 T D (124.180)	53/55	OM 601.912	Double Coil(LPH)	02/89-08/91	DG-010		11.5V					4
200 TE	90	M 102.962		09/88-12/89	T20EP-U	5031	0.8	T20TT	IT20TT	IT20TT		4
200 TE (124.079)	100	M 111.940		05/86-06/93	K16PR-U	3191	0.8	K16TT	IK16TT	IK16TT		4
200 TE (124.081)	87	M 102.963		09/88-08/92	T20EP-U	5031	0.8	T20TT	IT20TT	IT20TT		4
220 TE (124.082)	110	M 111.960		10/92-05/93	K16PR-U	3191	0.8	K16TT	IK16TT	IK16TT		4
230 TE (124.083)	97/100	M 102.982		09/85-08/92	T20EP-U	5031	0.8	T20TT	IT20TT	IT20TT		4
230 TE Cat (124.083)	97	M 102.982		06/89-08/92	T20EP-U	5031	0.8	T20TT	IT20TT	IT20TT		4
250 T D (124.185)	66	OM 602.912	Double Coil(LPH)	09/85-01/89	DG-001		11V					5
250 T D (124.185)	66/69	OM 602.912	Double Coil(LPH)	01/89-06/93	DG-010		11.5V					5
250 TD Turbo (124.188)	93	OM 602.962	Double Coil(LPH)	03/88-01/89	DG-001		11V					5
250 TD Turbo (124.188)	93	OM 602.962	Double Coil(LPH)	02/89-07/93	DG-010		11.5V					5
260 TE FGST.	118/122	M 103.940		09/85-08/92	T20EP-U	5031	0.8	T20TT	IT20TT	IT20TT		6
280 TE (124.088)	145	M 104.942		10/92-06/93	K16PR-U	3191	0.8	K16TT	IK16TT	IK16TT		6
300 T D (124.190)	80/83	OM 603.912	Double Coil(LPH)	09/86-06/93	DG-001		11V					6
300 T Turbo-D	105	OM 603.960; OM 603.963	Double Coil(LPH)	09/86-01/89	DG-001		11V					6
300 T Turbo-D (124.193)	108	OM 603.960	Double Coil(LPH)	01/89-06/93	DG-001		11V					6
300 T Turbo-D 4-matic (124.393)	105/108	OM 603.960; OM 603.963	Double Coil(LPH)	09/86-06/93	DG-001		11V					6
300 TE (124.090)	132/138	M 103.983		01/86-08/92	T20EP-U	5031	0.8	T20TT	IT20TT	IT20TT		6
300 TE 4-matic (124.290)	132/138	M 103.983; M 103.985		09/86-06/93	T20EP-U	5031	0.8	T20TT	IT20TT	IT20TT		6
300 TE-24 (124.091)	162/170	M 104.980		09/89-08/92	K16PR-U	3191	0.8	K16TT	IK16TT	IK16TT		6
320 TE (124.092)	162	M 104.992		10/92-06/93	K16PR-U	3191	0.8	K16TT	IK16TT	IK16TT		6
M-CLASS (W163) (98-05)												
ML 55 AMG (163.174)	255	M 113.981		02/00-06/05	PK16PR-L11	3275	1.1	-	IK16TT	IK16TT		16
ML 230 (163.136)	110	M 111.977		02/98-06/05	K20PBR-S10	5061	1.0	K20TT	IK20TT	IK20TT		4
ML 270 CDI (163.113)	120	OM 612.963		12/99-06/05	DG-117		11.5V					5
ML 320 (163.154)	160	M 112.942		02/98-08/02	PK16PR-L11	3275	1.1	-	IK16TT	IK16TT		12
ML 350	173	M 112.970		02/03-06/05	PK16PR-L11	3275	1.1	-	IK16TT	IK16TT		12
ML 350 (163.157)	180	M 112.970		08/02-06/05	PK16PR-L11	3275	1.1	-	IK16TT	IK16TT		12
ML 400 CDI (163.128)	184	OM 628.963	Double Coil(LPH)	09/01-06/05	DG-117		11.5V					8
ML 430 (163.172)	200	M 113.942		02/98-06/05	PK16PR-L11	3275	1.1	-	IK16TT	IK16TT		16
ML 500 (163.175)	215	M 113.964; M 113.965		09/01-06/05	PK16PR-L11	3275	1.1	-	IK16TT	IK16TT		16
M-CLASS (W164) (05-11)												
ML 63 AMG 4-matic (164.177)	375	M 156.980		01/06-12/11	IXEH22TT	4712	1.0	-	IXEH22TT			8
ML 280 CDI 4-matic (164.120)	140	OM 642.940	OE: A 001 159 50 01; A 001 159 7101	07/05-07/09	DG-194		4.4V					6
ML 300 CDI 4-matic (164.120)	140	OM 642.940	OE: A 001 159 50 01; A 001 159 7101	07/09-12/11	DG-194		4.4V					6
ML 300 CDI 4-matic (164.121)	150	OM 642.820	OE: A 001 159 57 01; A 001 159 58 01; A 001 159 6601	02/10-12/11	DG-617		7V					6
ML 320 CDI 4-matic (164.122)	165	OM 642.940	OE: A 001 159 50 01; A 001 159 7101	07/05-07/09	DG-194		4.4V					6

Свечи зажигания и Свечи накаливания











Таблица применения

	KW				СТАНДАРТНЫЕ				Twin Tip			QTY
MERCEDES-BENZ продолжение												
M-CLASS (W164) (05-11) продолжение												
ML 350 4-matic (164.186)	200	M 272.967		02/05-12/11	SXU22HDR8	3441	0.8	-	IXUH22TT	VXUH22I		6
ML 350 4-matic (164.186)	200	M 272.967	OEM Optional	02/05-12/11	VXUH22	5611	0.9	-	IXUH22TT	VXUH22		6
ML 350 CDI 4-matic (164.122)	165	OM 642.940	OE: A 001 159 50 01; A 001 159 7101	07/09-12/11	DG-194		4.4V					6
ML 350 CDI 4-matic (164.125, 164.124)	155/ 170	OM 642.820	OE: A 001 159 57 01; A 001 159 58 01; A 001 159 6601	09/09-12/11	DG-617		7V					6
ML 420 CDI 4-matic (164.128)	225	OM 629.912		02/06-09/09	DG-194		4.4V					8
ML 450 CDI 4-matic (164.128)	225	OM 629.912		09/09-12/11	DG-194		4.4V					8
ML 500 4-matic (164.172)	285	M 273.963		12/07-12/11	SXU22HDR8	3441	0.8	-	IXUH22TT	VXUH22I		8
ML 500 4-matic (164.172)	285	M 273.963	OEM Optional	12/07-12/11	VXUH22	5611	0.9	-	IXUH22TT	VXUH22		8
ML 500 4-matic (164.175)	225	M 113.964		07/05-12/11	PK16PR-L11	3275	1.1	-	IK16TT	IK16TT		16
M-CLASS (W166) (11-15)												
ML 250 CDI / BlueTEC 4-matic (166.004, 166.003)	150	OM 651.960	OE: A 001 159 57 01; A 001 159 58 01; A 001 159 66 01, F166 Discontinuation of impact plate	06/11-12/15	DG-617		7V					4
ML 350 BlueTEC 4-matic (166.024)	190	OM 642.826; OM 642.864	Eng:41324859> .OE: A0011597301/ A0011598001, Ceramic	06/12-02/15	DG-665		7V					6
PAGODE (W113) (63-71)												
250 SL (113.043)	110	M 129.982		01/66-01/68	W20EP-U	3043	0.8	W20TT	IW20TT	IW20TT		6
280 SL (113.044)	125	M 130.983		01/68-03/71	W20EP-U	3043	0.8	W20TT	IW20TT	IW20TT		6
PONTON (W121) (59-61)												
190 b (121.010)	59	M 121.920		06/59-12/61	W20EP-U	3043	0.8	W20TT	IW20TT	IW20TT		4
PULLMANN (64-79)												
600	184	M 100.980; M 100.982		09/64-01/79	W16EPR-U	3021	0.8	W16TT	IW16TT	IW16TT		8
R-CLASS (251) (06-)												
R 63 AMG 4-matic (251..77)	375	M 156.980		02/06-12/10	IXEH22TT	4712	1.0	-	IXEH22TT			8
R 280 (251..54)	170	M 272.945		01/07-12/14	SXU22HDR8	3441	0.8	-	IXUH22TT	VXUH22I		6
R 280 (251..54)	170	M 272.945	OEM Optional	01/07-12/14	VXUH22	5611	0.9	-	IXUH22TT	VXUH22		6
R 280 4-matic (251..62)	170	M 272.945		05/07-12/11	SXU22HDR8	3441	0.8	-	IXUH22TT	VXUH22I		6
R 280 4-matic (251..62)	170	M 272.945	OEM Optional	05/07-12/11	VXUH22	5611	0.9	-	IXUH22TT	VXUH22		6
R 280 CDI (251..21, 251..26)	140	OM 642.870; OM 642.950	OE: A 001 159 57 01; A 001 159 58 01; A 001 159 6601	05/06-12/12	DG-617		7V					6
R 280 CDI (251..21, 251..26)	140	OM 642.872	Eng:41324859> .OE: A0011597301/ A0011598001	06/12-12/12	DG-665		7V					6
R 280 CDI (251..21, 251..26)	140	OM 642.950	OE: A 001 159 50 01; A 001 159 7101	05/06-08/13	DG-194		4.4V					6
R 280 CDI 4-matic (251..20)	140	OM 642.950	OE: A 001 159 50 01; A 001 159 7101	05/06-08/13	DG-194		4.4V					6
R 280 CDI 4-matic (251..20)	140	OM 642.950	OE: A 001 159 57 01; A 001 159 58 01; A 001 159 6601	08/13-12/12	DG-617		7V					6
R 300 (251..54)	170	M 272.945		07/09-12/14	SXU22HDR8	3441	0.8	-	IXUH22TT	VXUH22I		6
R 300 (251..54)	170	M 272.945	OEM Optional	07/09-12/14	VXUH22	5611	0.9	-	IXUH22TT	VXUH22		6

Свечи зажигания и Свечи накаливания











Таблица применения

Таблица применения

	KW				СТАНДАРТНЫЕ				Twin Tip			QTY
												
MERCEDES-BENZ продолжение												
R-CLASS (251) (06-) продолжение												
R 300 CDI (251._21, 251._26)	140	OM 642.870; OM 642.950	OE: A 001 159 57 01; A 001 159 58 01; A 001 159 6601	07/09-12/12	DG-617		7V					6
R 300 CDI (251._21, 251._26)	140	OM 642.872	Eng:41324859> .OE: A0011597301/ A0011598001	06/12-12/12	DG-665		7V					6
R 300 CDI (251._21, 251._26)	140	OM 642.950	OE: A 001 159 50 01; A 001 159 7101	07/09-08/13	DG-194		4.4V					6
R 300 CDI 4-matic (251._20)	140	OM 642.950	OE: A 001 159 50 01; A 001 159 7101	07/09-08/13	DG-194		4.4V					6
R 300 CDI 4-matic (251._20)	140	OM 642.950	OE: A 001 159 57 01; A 001 159 58 01; A 001 159 6601	08/13-12/12	DG-617		7V					6
R 320 CDI 4-matic (251._22)	165	OM 642.950	OE: A 001 159 50 01; A 001 159 7101	01/06-08/13	DG-194		4.4V					6
R 320 CDI 4-matic (251._22)	165	OM 642.950	OE: A 001 159 57 01; A 001 159 58 01; A 001 159 6601	08/13-07/10	DG-617		7V					6
R 350 (251._56)	200	M 272.967		01/07-12/12	SXU22HDR8	3441	0.8	-	IXUH22TT	VXUH22I		6
R 350 (251._56)	200	M 272.967	OEM Optional	01/07-12/12	VXUH22	5611	0.9	-	IXUH22TT	VXUH22		6
R 350 4-matic (251._65)	200	M 272.967		08/05-12/12	SXU22HDR8	3441	0.8	-	IXUH22TT	VXUH22I		6
R 350 4-matic (251._65)	200	M 272.967	OEM Optional	08/05-12/12	VXUH22	5611	0.9	-	IXUH22TT	VXUH22		6
R 350 CDI 4-matic (251._22)	165	OM 642.950	OE: A 001 159 50 01; A 001 159 7101	07/09-08/13	DG-194		4.4V					6
R 350 CDI 4-matic (251._22)	165	OM 642.950	OE: A 001 159 57 01; A 001 159 58 01; A 001 159 6601	08/13-12/12	DG-617		7V					6
R 350 CDI 4-matic (251._23)	195	OM 642.872	Ch:41324859> .OE: A0011597301/ A0011598001	06/12-12/14	DG-665		7V					6
R 350 CDI 4-matic (251._24, 251._25)	155	OM 642.870; OM 642.950	OE: A 001 159 57 01; A 001 159 58 01; A 001 159 6601	01/06-12/14	DG-617		7V					6
R 350 CDI 4-matic (251._24, 251._25)	155	OM 642.950	OE: A 001 159 50 01; A 001 159 7101	01/06-08/13	DG-194		4.4V					6
R 500 4-matic (251._72)	285	M 273.963		05/07-12/14	SXU22HDR8	3441	0.8	-	IXUH22TT	VXUH22I		8
R 500 4-matic (251._72)	285	M 273.963	OEM Optional	05/07-12/14	VXUH22	5611	0.9	-	IXUH22TT	VXUH22		8
R 500 4-matic (251._75)	225	M 113.960; M 113.971		08/05-12/14	PK16PR-L11	3275	1.1	-	IK16TT	IK16TT		16
Saloon (W123) (76-85)												
200	62	M 115.938; M 115.939		02/76-08/80	W20EP-U	3043	0.8		W20TT	IW20TT	IW20TT	4
200	74	M 102.939		06/80-11/85	T20EP-U	5031	0.8		T20TT	IT20TT	IT20TT	4
200 (123.020)	69	M 115.938; M 115.939		02/76-08/80	W20EP-U	3043	0.8		W20TT	IW20TT	IW20TT	4
200 (123.220)	80	M 102.920		06/80-11/85	T20EP-U	5031	0.8		T20TT	IT20TT	IT20TT	4
200 D	44	OM 615.940		03/79-11/85	DG-001		11V					4
200 D (123.120)	40	OM 615.940		07/76-02/79	DG-001		11V					4
220 D	49	OM 615.941		01/77-03/79	DG-001		11V					4
220 D (123.126)	44	OM 615.941		01/76-02/79	DG-001		11V					4
230 (123.023)	80	M 115.954		02/76-03/81	W20EP-U	3043	0.8		W20TT	IW20TT	IW20TT	4
230 E (123.223)	100	M 102.980		04/80-12/85	T20EP-U	5031	0.8		T20TT	IT20TT	IT20TT	4
240 D (123.123)	53	OM 616.912	Double Coil(LPH)	08/80-11/85	DG-001		11V					4

Свечи зажигания и Свечи накаливания

Таблица применения

	KW				СТАНДАРТНЫЕ			Twin Tip			QTY
											
MERCEDES-BENZ продолжение											
Saloon (W123) (76-85) продолжение											
250 (123.026)	95/103	M 123.921		02/76-07/85	W20EP-U	3043	0.8	W20TT	IW20TT	IW20TT	6
280 (123.030)	115	M 110.923		02/76-08/81	W20EP-U	3043	0.8	W20TT	IW20TT	IW20TT	6
280 E	130	M 110.988		08/76-08/81	W20EP-U	3043	0.8	W20TT	IW20TT	IW20TT	6
280 E (123.033)	136	M 110.984; M 110.988		02/76-11/85	W20EP-U	3043	0.8	W20TT	IW20TT	IW20TT	6
300 D (123.130)	59/65	OM 617.912	Double Coil(LPH)	02/76-11/85	DG-001		11V				5
300 Turbo-D (123.133)	92	OM 617.952	Double Coil(LPH)	08/81-07/85	DG-001		11V				5
Saloon (W124) (84-93)											
200	77	M 102.922		01/86-10/92	T20EP-U	5031	0.8	T20TT	IT20TT	IT20TT	4
200 (124.020)	75/80	M 102.922		12/85-05/90	T20EP-U	5031	0.8	T20TT	IT20TT	IT20TT	4
200 D (124.120)	53	OM 601.912	Double Coil(LPH)	12/84-01/89	DG-001		11V				4
200 D (124.120)	53/55	OM 601.912	Double Coil(LPH)	02/89-06/93	DG-010		11.5V				4
200 E (124.019)	100	M 111.940		10/92-06/93	K16PR-U	3191	0.8	K16TT	IK16TT	IK16TT	4
200 E (124.021)	87/90	M 102.963		09/88-08/93	T20EP-U	5031	0.8	T20TT	IT20TT	IT20TT	4
220 E (124.022)	110	M 111.960		10/92-06/93	K16PR-U	3191	0.8	K16TT	IK16TT	IK16TT	4
230 E (124.023)	97/ 100	M 102.982		12/84-06/93	T20EP-U	5031	0.8	T20TT	IT20TT	IT20TT	4
230 E Cat (124.023)	97	M 102.982		06/89-06/93	T20EP-U	5031	0.8	T20TT	IT20TT	IT20TT	4
250 D (124.125)	66	OM 602.912	Double Coil(LPH)	04/85-12/87	DG-001		11V				5
250 D (124.125)	66/69	OM 602.912	Double Coil(LPH)	01/88-06/93	DG-010		11.5V				5
250 Turbo-D (124.128)	93	OM 602.962	Double Coil(LPH)	09/88-06/93	DG-010		11.5V				5
260 E (124.026)	118/ 122	M 103.940		09/85-08/92	T20EP-U	5031	0.8	T20TT	IT20TT	IT20TT	6
260 E 4-matic (124.226)	118/ 122	M 103.940; M 103.943		09/86-08/92	T20EP-U	5031	0.8	T20TT	IT20TT	IT20TT	6
280 E (124.028)	145	M 104.942		10/92-06/93	K16PR-U	3191	0.8	K16TT	IK16TT	IK16TT	6
300 D (124.130)	80/83	OM 603.912	Double Coil(LPH)	12/84-06/93	DG-001		11V				6
300 D 4-matic (124.330)	80/83	OM 603.913	Double Coil(LPH)	09/86-06/93	DG-001		11V				6
300 E	138	M 103.980; M 103.983		01/85-08/92	T20EP-U	5031	0.8	T20TT	IT20TT	IT20TT	6
300 E (124.030)	132	M 103.983		08/85-08/92	T20EP-U	5031	0.8	T20TT	IT20TT	IT20TT	6
300 E 4-matic	138	M 103.983		09/86-02/92	T20EP-U	5031	0.8	T20TT	IT20TT	IT20TT	6
300 E 4-matic (124.230)	132	M 103.985		09/86-06/93	T20EP-U	5031	0.8	T20TT	IT20TT	IT20TT	6
300 E-24 (124.031)	162/ 170	M 104.980		09/88-08/92	K16PR-U	3191	0.8	K16TT	IK16TT	IK16TT	6
300 Turbo-D (124.133)	105/ 108	OM 603.960; OM 603.963	Double Coil(LPH)	09/86-06/93	DG-001		11V				6
300 Turbo-D 4-matic (124.333)	105/ 108	OM 603.960; OM 603.963	Double Coil(LPH)	09/86-06/93	DG-001		11V				6
320 E (124.032)	162	M 104.992		10/92-06/93	K16PR-U	3191	0.8	K16TT	IK16TT	IK16TT	6
400 E 4.2 (124.034)	205	M 119.975		10/92-06/93	K20PR-U11	3121	1.1	K20TT	IK20TT	IK20TT	8
500 E (124.036)	240	M 119.974		01/91-06/93	K20PR-U11	3121	1.1	K20TT	IK20TT	IK20TT	8
S-CLASS (222) (13-)											
S 65 AMG (222_79)	463	M 279.980		02/14-	VK20Y	5620	0.8	-	-	VK20Y	24
S 300 BlueTEC Hybrid / h (222_04)	150/ 170	OM 651.921	OE: A 001 159 57 01; A 001 159 58 01; A 001 159 66 01, F166 Discontinuation of impact plate	02/14-05/17	DG-617		7V				4
S 300 BlueTEC Hybrid / h (222_04)	150/ 170	OM 651.921	OE: A0011597301/ A0011598001, -F166 Discontinuation of impact plate	02/14-05/17	DG-665		7V				4

Свечи зажигания и Свечи накаливания

Таблица применения

Таблица применения

KW	KW	NOTE	21	СТАНДАРТНЫЕ				Twin Tip			QTY
				STANDARD	STANDARD	STANDARD	STANDARD	TWIN TIP	TWIN TIP	TWIN TIP	
MERCEDES-BENZ продолжение											
S-CLASS (222) (13-) продолжение											
S 350 BlueTEC / d (222._32, 222._32, 222._23)	190	OM 642.861	Eng:41324859>,OE: A0011597301/A0011598001, Ceramic	05/13-05/17	DG-665		7V				6
S 350 BlueTEC / d 4-matic (222._33)	190	OM 642.861; OM 642.867	OE: A0011597301/A0011598001, Ceramic	02/14-05/17	DG-665		7V				6
S 350 BlueTEC 4-matic (222._33)	185	OM 642.867	OE: A0011597301/A0011598001, Ceramic	02/14-05/17	DG-665		7V				6
S 600 (222._76)	390	M 277.980		02/14-	VK20Y	5620	0.8	-	-	VK20Y	24
S-CLASS (W108, W109) (66-72)											
250 S (108.012)	96	M 108.920		01/66-12/69	W20EP-U	3043	0.8	W20TT	IW20TT	IW20TT	6
250 SE (108.014)	110	M 129.980		01/66-12/67	W22EPR-U	3088	0.8	W22TT	-	VW22	6
280 S (108.016)	103	M 130.920		10/67-07/72	W20EP-U	3043	0.8	W20TT	IW20TT	IW20TT	6
280 SE,SEL (108.018, 108.019)	118	M 130.980		01/68-08/72	W20EP-U	3043	0.8	W20TT	IW20TT	IW20TT	6
280 SE,SEL 3.5 (108.057, 108.058)	147	M 116.980		03/71-08/72	W20EP-U	3043	0.8	W20TT	IW20TT	IW20TT	8
300 SEL (109.016)	118	M 130.981		01/68-08/72	W20EP-U	3043	0.8	W20TT	IW20TT	IW20TT	6
300 SEL 3.5 (109.056)	147	M 116.981		01/70-07/72	W20EP-U	3043	0.8	W20TT	IW20TT	IW20TT	8
300 SEL 6.3 (109.018)	184	M 100.981		03/68-08/72	W16EPR-U	3021	0.8	W16TT	IW16TT	IW16TT	8
S-CLASS (W116) (72-80)											
280 S (116.020)	115/118	M 110.922		08/72-07/80	W20EP-U	3043	0.8	W20TT	IW20TT	IW20TT	6
280 SE,SEL (116.024)	130/136	M 110.983; M 110.985		08/72-07/80	W20EP-U	3043	0.8	W20TT	IW20TT	IW20TT	6
350 SE,SEL (116.028, 116.029)	143/147/151	M 116.983; M 116.985		08/72-03/80	W20EP-U	3043	0.8	W20TT	IW20TT	IW20TT	8
450 SE	143	M 117.983		08/72-12/76	W20EP-U	3043	0.8	W20TT	IW20TT	IW20TT	8
450 SE,SEL (116.032)	165	M 117.983; M 117.986		01/73-04/80	W20EP-U	3043	0.8	W20TT	IW20TT	IW20TT	8
450 SE,SEL (116.033)	160	M 117.983; M 117.986		12/75-04/80	W20EP-U	3043	0.8	W20TT	IW20TT	IW20TT	8
450 SEL 6.9 (116.036)	210	M 100.985		07/75-03/80	W16EPR-U	3021	0.8	W16TT	IW16TT	IW16TT	8
S-CLASS (W126) (79-91)											
3.8	160	M 116.961		08/80-08/84	W20EP-U	3043	0.8	W20TT	IW20TT	IW20TT	8
260 SE (126.020)	118/122	M 103.941		09/85-06/91	T20EP-U	5031	0.8	T20TT	IT20TT	IT20TT	6
280 S (126.021)	115	M 110.924; M 110.926		12/79-07/85	W20EP-U	3043	0.8	W20TT	IW20TT	IW20TT	6
280 SE, SEL (126.022, 126.023)	136	M 110.987; M 110.989		10/79-07/85	W20EP-U	3043	0.8	W20TT	IW20TT	IW20TT	6
300 SE, SEL (126.024, 126.025)	132/138	M 103.981		09/85-06/91	T20EP-U	5031	0.8	T20TT	IT20TT	IT20TT	6
380 SE, SEL (126.032)	150	M 116.963		10/81-08/85	W20EP-U	3043	0.8	W20TT	IW20TT	IW20TT	8
380 SE, SEL (126.032, 126.033)	160	M 116.961		09/80-10/81	W20EP-U	3043	0.8	W20TT	IW20TT	IW20TT	8
420 SE, SEL	165/170	M 116.965		10/85-06/91	W20EP-U	3043	0.8	W20TT	IW20TT	IW20TT	8
420 SE, SEL (126.034)	160	M 116.965		10/85-12/87	W20EP-U	3043	0.8	W20TT	IW20TT	IW20TT	8
420 SE, SEL (126.034, 126.035)	150	M 116.965		10/85-06/91	W20EP-U	3043	0.8	W20TT	IW20TT	IW20TT	8
500 SE, SEL	185/195	M 117.965		09/87-06/91	W20EP-U	3043	0.8	W20TT	IW20TT	IW20TT	8
500 SE, SEL (126.036)	164/170/177/180	M 117.961; M 117.963; M 117.965		12/79-06/91	W20EP-U	3043	0.8	W20TT	IW20TT	IW20TT	8
500 SE, SEL Cat	185	M 117.965		06/89-06/91	W20EP-U	3043	0.8	W20TT	IW20TT	IW20TT	8
560 SE, SEL	205/220	M 117.968		10/85-06/91	W20EP-U	3043	0.8	W20TT	IW20TT	IW20TT	8
560 SE, SEL (126.038)	200	M 117.968		10/85-12/87	W20EP-U	3043	0.8	W20TT	IW20TT	IW20TT	8
560 SE, SEL (126.038, 126.039)	178	M 117.968		10/85-06/91	W20EP-U	3043	0.8	W20TT	IW20TT	IW20TT	8
S-CLASS (W140) (91-98)											
300 SE, SEL/S320 (140.032, 140.033)	170	M 104.990; M 104.994		03/91-10/98	K16PR-U	3191	0.8	K16TT	IK16TT	IK16TT	6
300 SE 2.8 (140.028)	145	M 104.944		01/93-10/98	K16PR-U	3191	0.8	K16TT	IK16TT	IK16TT	6
400 SE, SEL/S420 (140.042, 140.043)	210	M 119.971		02/91-10/98	K20PR-U11	3121	1.1	K20TT	IK20TT	IK20TT	8
500 SE, SEL (140.050, 140.051)	240	M 119.970		02/91-10/98	K20PR-U11	3121	1.1	K20TT	IK20TT	IK20TT	8

Свечи зажигания и Свечи накаливания

Таблица применения





	KW				СТАНДАРТНЫЕ			Twin Tip			QTY
MERCEDES-BENZ продолжение											
S-CLASS (W140) (91-98) продолжение											
S 600 SE, SEL (140.056, 140.057)	300	M 120.980; M 120.982		04/91-12/92	K16PR-U11	3130	1.1	K16TT	IK16TT	IK16TT	12
S 280 (140.028)	142	M 104.944		02/93-10/98	K16PR-U	3191	0.8	K16TT	IK16TT	IK16TT	6
S 300 Turbo-D (140.135)	130	OM 606.961		05/96-10/98	DG-106		11.5V				6
S 350 Turbo-D (140.134)	110	OM 603.971	Double Coil(LPH)	01/93-10/98	DG-001		11V				6
S 420 (140.042)	205	M 119.971		01/93-10/98	K20PR-U11	3121	1.1	K20TT	IK20TT	IK20TT	8
S 500 (140.050, 140.051)	235	M 119.970; M 119.980		01/93-10/98	K20PR-U11	3121	1.1	K20TT	IK20TT	IK20TT	8
S 600 (140.056, 140.057)	290	M 120.980; M 120.982		01/93-10/98	K16PR-U11	3130	1.1	K16TT	IK16TT	IK16TT	12
S-CLASS (W220) (98-05)											
S 55 AMG (220._73)	265	M 113.986		04/99-08/05	PK16PR-L11	3275	1.1	-	IK16TT	IK16TT	16
S 55 AMG Kompressor (220._74)	368	M 113.991		06/02-08/05	VKH20Y	5639	0.8	-	-	VKH20Y	16
S 63 AMG	326	M 137.980		09/01-08/05	SK20PR-L9	3307	0.9	-	IK20TT	IK20TT	24
S 65 AMG (220._79)	450	M 275.980		03/04-08/05	VK20Y	5620	0.8	-	-	VK20Y	24
S 280 (220._63)	150	M 112.922		10/98-08/05	PK16PR-L11	3275	1.1	-	IK16TT	IK16TT	12
S 320 (220._65)	165	M 112.944		10/98-08/05	PK16PR-L11	3275	1.1	-	IK16TT	IK16TT	12
S 320 CDI (220._25)	150	OM 648.960		09/02-08/05	DG-117		11.5V				6
S 320 CDI (220._26)	145	OM 613.960		08/99-09/02	DG-117		11.5V				6
S 350 (220._67)	180	M 112.972		09/02-08/05	PK16PR-L11	3275	1.1	-	IK16TT	IK16TT	12
S 350 4-matic (220._87)	180	M 112.975		06/03-08/05	PK16PR-L11	3275	1.1	-	IK16TT	IK16TT	12
S 400 CDI (220._28)	184/ 191	OM 628.960	Double Coil(LPH)	06/00-08/05	DG-117		11.5V				8
S 430 (220._70)	205	M 113.941		10/98-08/05	PK16PR-L11	3275	1.1	-	IK16TT	IK16TT	16
S 430 4-matic (220._83)	205	M 113.948		09/02-08/05	PK16PR-L11	3275	1.1	-	IK16TT	IK16TT	16
S 500 (220._75)	225	M 113.960; M 113.966		10/98-08/05	PK16PR-L11	3275	1.1	-	IK16TT	IK16TT	16
S 500 4-matic (220._84)	225	M 113.966		09/02-08/05	PK16PR-L11	3275	1.1	-	IK16TT	IK16TT	16
S 600 (220._76)	368	M 275.950		09/02-08/05	VK20Y	5620	0.8	-	-	VK20Y	24
S 600 (220._78)	270	M 137.970		01/00-08/05	SK20PR-L9	3307	0.9	-	IK20TT	IK20TT	24
S-CLASS (W221) (05-13)											
S 63 AMG (221._77)	386	M 156.984		10/06-12/13	IXEH22TT	4712	1.0	-	IXEH22TT		8
S 65 AMG (221._79)	450/ 463	M 275.982		12/05-12/13	VK20Y	5620	0.8	-	-	VK20Y	24
S 250 CDI (221._03)	150	OM 651.961	OE: A 001 159 57 01; A 001 159 58 01; A 001 159 66 01; F166 Discon tinuationo f impact pl ate	01/11-12/13	DG-617		7V				4
S 280 (221._54)	170	M 272.946		08/06-12/13	SXU22HDR8	3441	0.8	-	IXUH22TT	VXUH22I	6
S 280 (221._54)	170	M 272.946	OEM Optional	08/06-12/13	VXUH22	5611	0.9	-	IXUH22TT	VXUH22	6
S 300 (221._54)	170	M 272.946		08/06-12/13	SXU22HDR8	3441	0.8	-	IXUH22TT	VXUH22I	6
S 300 (221._54)	170	M 272.946	OEM Optional	08/06-12/13	VXUH22	5611	0.9	-	IXUH22TT	VXUH22	6
S 320 CDI (221._22)	155	OM 642.930	OE: A 001 159 57 01; A 001 159 58 01; A 001 159 6601	08/13-12/13	DG-617		7V				6
S 320 CDI (221._22)	155/ 173	OM 642.930	OE: A 001 159 50 01; A 001 159 7101	10/05-08/13	DG-194		4.4V				6
S 320 CDI 4-matic (221._80)	155/ 173	OM 642.932	OE: A 001 159 50 01; A 001 159 7101	10/05-08/13	DG-194		4.4V				6
S 320 CDI 4-matic (221._80)	155/ 173	OM 642.932	OE: A 001 159 57 01; A 001 159 58 01; A 001 159 6601	08/13-12/13	DG-617		7V				6
S 350 (221._56)	200	M 272.965		10/05-12/13	SXU22HDR8	3441	0.8	-	IXUH22TT	VXUH22I	6
S 350 (221._56)	200	M 272.965	OEM Optional	10/05-12/13	VXUH22	5611	0.9	-	IXUH22TT	VXUH22	6
S 350 4-matic (221._87)	200	M 272.975		02/08-12/13	SXU22HDR8	3441	0.8	-	IXUH22TT	VXUH22I	6
S 350 4-matic (221._87)	200	M 272.975	OEM Optional	02/08-12/13	VXUH22	5611	0.9	-	IXUH22TT	VXUH22	6











Таблица применения

M

Свечи зажигания и Свечи накаливания









Таблица применения

Таблица применения

	KW				СТАНДАРТНЫЕ				Twin Tip		QTY
											
MERCEDES-BENZ продолжение											
S-CLASS (W221) (05-13) продолжение											
S 350 BlueTec (221._26)	190	OM 642.862	Eng:41324859> ,OE: A0011597301/ A0011598001, Ceramic	06/12-12/13	DG-665		7V				6
S 350 BlueTEC 4-matic (221._83)	190	OM 642.868	Eng:41324859> ,OE: A0011597301/ A0011598001, Ceramic	06/12-12/13	DG-665		7V				6
S 350 CDI	173	OM 642.930	OE: A 001 159 50 01; A 001 159 7101	06/09-08/13	DG-194		4.4V				6
S 350 CDI	173	OM 642.930	OE: A 001 159 57 01; A 001 159 58 01; A 001 159 6601	08/13-12/13	DG-617		7V				6
S 400 Hybrid (221._95)	205	M 272.974		01/09-12/13	SXU22HDR8	3441	0.8	-	IXUH22TT	VXUH22I	6
S 400 Hybrid (221._95)	205	M 272.974	OEM Optional	01/09-12/13	VXUH22	5611	0.9	-	IXUH22TT	VXUH22	6
S 420 CDI (221._28)	235	OM 629.911		10/06-06/09	DG-194		4.4V				8
S 450 (221._70)	250	M 273.922		12/05-12/13	SXU22HDR8	3441	0.8	-	IXUH22TT	VXUH22I	8
S 450 (221._70)	250	M 273.922	OEM Optional	12/05-12/13	VXUH22	5611	0.9	-	IXUH22TT	VXUH22	8
S 450 4-matic (221._84)	250	M 273.924		12/05-12/13	SXU22HDR8	3441	0.8	-	IXUH22TT	VXUH22I	8
S 450 4-matic (221._84)	250	M 273.924	OEM Optional	12/05-12/13	VXUH22	5611	0.9	-	IXUH22TT	VXUH22	8
S 500 (221._71)	285	M 273.961		10/05-12/13	SXU22HDR8	3441	0.8	-	IXUH22TT	VXUH22I	8
S 500 (221._71)	285	M 273.961	OEM Optional	10/05-12/13	VXUH22	5611	0.9	-	IXUH22TT	VXUH22	8
S 500 4-matic (221._86)	285	M 273.961; M 273.968		10/05-12/13	SXU22HDR8	3441	0.8	-	IXUH22TT	VXUH22I	8
S 500 4-matic (221._86)	285	M 273.961; M 273.968	OEM Optional	10/05-12/13	VXUH22	5611	0.9	-	IXUH22TT	VXUH22	8
S 600 (221._76)	380	M 275.953		12/05-12/13	VK20Y	5620	0.8	-	-	VK20Y	24
S-CLASS Coupe (C126) (80-91)											
380 SEC (126.043)	150	M 116.963		10/81-07/85	W20EP-U	3043	0.8	W20TT	IW20TT	IW20TT	8
420 SEC (126.046)	150/ 160/ 165	M 116.965		10/85-06/91	W20EP-U	3043	0.8	W20TT	IW20TT	IW20TT	8
500 SEC (126.044)	164/ 170/ 177/ 180/ 185/ 195	M 117.963; M 117.965		08/80-06/91	W20EP-U	3043	0.8	W20TT	IW20TT	IW20TT	8
560 SEC (126.045)	178/ 200/ 205/ 220	M 117.968		10/85-06/91	W20EP-U	3043	0.8	W20TT	IW20TT	IW20TT	8
S-CLASS Coupe (C140) (92-99)											
500 SEC / CL 500 (140.070)	235	M 119.970; M 119.980		10/92-12/99	K20PR-U11	3121	1.1	K20TT	IK20TT	IK20TT	8
SEC/CL 420 (140.063)	205	M 119.971; M 119.981		10/94-02/99	K20PR-U11	3121	1.1	K20TT	IK20TT	IK20TT	8
SEC/CL 600 (140.076)	290	M 120.980; M 120.982		09/92-02/99	K16PR-U11	3130	1.1	K16TT	IK16TT	IK16TT	12
S-CLASS Coupe (C215) (99-06)											
CL 55 AMG (215.373)	265	M 113.986		10/99-03/06	PK16PR-L11	3275	1.1	-	IK16TT	IK16TT	16
CL 55 AMG Kompressor (215.374)	368	M 113.991		06/02-03/06	VKH20Y	5639	0.8	-	-	VKH20Y	16
CL 63 AMG	326	M 137.980		09/01-03/06	SK20PR-L9	3307	0.9	-	IK20TT	IK20TT	24
CL 65 AMG (215.379)	450	M 275.980		09/03-03/06	VK20Y	5620	0.8	-	-	VK20Y	24
CL 500 (215.375)	225	M 113.960		03/99-03/06	PK16PR-L11	3275	1.1	-	IK16TT	IK16TT	16
CL 600 (215.376)	368	M 275.950		09/02-03/06	VK20Y	5620	0.8	-	-	VK20Y	24
CL 600 (215.378)	270	M 137.970		03/99-03/06	SK20PR-L9	3307	0.9	-	IK20TT	IK20TT	24
S-CLASS Coupe (C216) (06-13)											
CL 63 AMG (216.377)	386	M 156.984		10/06-12/13	IXEH22TT	4712	1.0	-	IXEH22TT		8
CL 65 AMG (216.379)	450/ 463	M 275.982		10/06-12/13	VK20Y	5620	0.8	-	-	VK20Y	24
CL 500 (216.371)	285	M 273.961		06/06-12/13	SXU22HDR8	3441	0.8	-	IXUH22TT	VXUH22I	8
CL 500 (216.371)	285	M 273.961	OEM Optional	06/06-12/13	VXUH22	5611	0.9	-	IXUH22TT	VXUH22	8
CL 500 4-matic (216.386)	285	M 273.968		02/08-12/13	SXU22HDR8	3441	0.8	-	IXUH22TT	VXUH22I	8
CL 500 4-matic (216.386)	285	M 273.968	OEM Optional	02/08-12/13	VXUH22	5611	0.9	-	IXUH22TT	VXUH22	8
CL 600 (216.376)	380	M 275.953		05/06-12/13	VK20Y	5620	0.8	-	-	VK20Y	24
S-CLASS Coupe / Convertible (217) (14-)											
S 65 AMG (217._79)	463	M 279.980		07/14-05/19	VK20Y	5620	0.8	-	-	VK20Y	24

Свечи зажигания и Свечи накаливания











Таблица применения

	KW				СТАНДАРТНЫЕ			Twin Tip		QTY	
											
MERCEDES-BENZ продолжение											
SL (R107) (71-89)											
280 SL (107.042)	130/ 136	M 110.982; M 110.986; M 110.990		08/74-07/85	W20EP-U	3043	0.8	W20TT	IW20TT	IW20TT	6
300 SL (107.041)	132/ 138	M 103.982		09/85-08/89	T20EP-U	5031	0.8	T20TT	IT20TT	IT20TT	6
350 SL (107.043)	143	M 116.982; M 116.984		05/71-02/80	W20EP-U	3043	0.8	W20TT	IW20TT	IW20TT	8
380 SL (107.045)	150/ 160	M 116.960; M 116.962		09/80-08/85	W20EP-U	3043	0.8	W20TT	IW20TT	IW20TT	8
420 SL (107.047)	150/ 160	M 116.964		01/86-08/89	W20EP-U	3043	0.8	W20TT	IW20TT	IW20TT	8
450 SL (107.044)	160/ 165	M 117.982; M 117.985		10/72-10/80	W20EP-U	3043	0.8	W20TT	IW20TT	IW20TT	8
500 SL (107.046)	164/ 170/ 177/ 180	M 117.960; M 117.962; M 117.964		05/80-08/89	W20EP-U	3043	0.8	W20TT	IW20TT	IW20TT	8
560 SL (107.048)	169	M 117.967		09/85-12/89	W20EP-U	3043	0.8	W20TT	IW20TT	IW20TT	8
SL (R129) (89-01)											
55 AMG	260	M 113.985		03/00-10/01	PK16PR-L11	3275	1.1	-	IK16TT	IK16TT	16
60 AMG (129.067)	280	M 119.972 (AMG 6.0); M 119.982 (AMG 6.0)		05/97-10/01	Q20P-U	3125	0.8	Q20TT	IQ20TT	IQ20TT	8
73 AMG (129.076)	386			01/99-12/01	K16PR-U11	3130	1.1	K16TT	IK16TT	IK16TT	12
280 (129.058)	142	M 104.943		08/93-10/01	K16PR-U	3191	0.8	K16TT	IK16TT	IK16TT	6
280 (129.059)	150	M 112.923		05/98-10/01	PK16PR-L11	3275	1.1	-	IK16TT	IK16TT	12
300 (129.060)	140	M 103.984		03/89-08/93	T20EP-U	5031	0.8	T20TT	IT20TT	IT20TT	6
300-24 (129.061)	170	M 104.981		03/89-07/93	K16PR-U	3191	0.8	K16TT	IK16TT	IK16TT	6
320 (129.063)	170	M 104.991		09/93-10/01	K16PR-U	3191	0.8	K16TT	IK16TT	IK16TT	6
320 (129.064)	165	M 112.943		05/98-10/01	PK16PR-L11	3275	1.1	-	IK16TT	IK16TT	12
500 (129.066)	240	M 119.960		09/89-08/92	K20PR-U	3145	0.8	K20TT	IK20TT	IK20TT	8
500 (129.066)	240	M 119.972		09/89-08/92	K20PR-U11	3121	1.1	K20TT	IK20TT	IK20TT	8
500 (129.067)	235	M 119.972; M 119.982		09/92-10/01	K20PR-U11	3121	1.1	K20TT	IK20TT	IK20TT	8
500 (129.068)	225	M 113.961		05/98-10/01	PK16PR-L11	3275	1.1	-	IK16TT	IK16TT	16
600 (129.076)	290	M 120.981; M 120.983		07/92-10/01	K16PR-U11	3130	1.1	K16TT	IK16TT	IK16TT	12
SL (R230) (01-12)											
55 AMG (230.472)	380	M 113.995		03/06-01/12	VKH20Y	5639	0.8	-	-	VKH20Y	16
55 AMG (230.474)	350	M 113.992		10/01-06/02	VKH20Y	5639	0.8	-	-	VKH20Y	16
55 AMG Kompressor (230.474)	368	M 113.992		06/02-01/12	VKH20Y	5639	0.8	-	-	VKH20Y	16
63 AMG (230.470)	386	M 156.981		03/08-01/12	IXEH22TT	4712	1.0	-	IXEH22TT		8
65 AMG (230.479)	450	M 275.981		03/04-01/12	VK20Y	5620	0.8	-	-	VK20Y	24
65 AMG Black Series (230.479)	493	M 275.983		07/08-01/12	VK20Y	5620	0.8	-	-	VK20Y	24
280 (230.454)	170	M 272.949		03/08-01/12	SXU22HDR8	3441	0.8	-	IXUH22TT	VXUH22I	6
280 (230.454)	170	M 272.949	OEM Optional	03/08-01/12	VXUH22	5611	0.9	-	IXUH22TT	VXUH22	6
300 (230.454)	170	M 272.949		04/09-01/12	SXU22HDR8	3441	0.8	-	IXUH22TT	VXUH22I	6
300 (230.454)	170	M 272.949	OEM Optional	04/09-01/12	VXUH22	5611	0.9	-	IXUH22TT	VXUH22	6
350 (230.456)	200	M 272.966		03/06-01/12	SXU22HDR8	3441	0.8	-	IXUH22TT	VXUH22I	6
350 (230.456)	200	M 272.966	OEM Optional	03/06-01/12	VXUH22	5611	0.9	-	IXUH22TT	VXUH22	6
350 (230.458)	232	M 272.968		04/08-01/12	SXU22HDR8	3441	0.8	-	IXUH22TT	VXUH22I	6
350 (230.458)	232	M 272.968	OEM Optional	04/08-01/12	VXUH22	5611	0.9	-	IXUH22TT	VXUH22	6
350 (230.467)	180	M 112.973		03/03-01/12	PK16PR-L11	3275	1.1	-	IK16TT	IK16TT	12
500 (230.471)	285	M 273.965		03/06-01/12	SXU22HDR8	3441	0.8	-	IXUH22TT	VXUH22I	8
500 (230.471)	285	M 273.965	OEM Optional	03/06-01/12	VXUH22	5611	0.9	-	IXUH22TT	VXUH22	8
500 (230.475)	225	M 113.963		10/01-01/12	PK16PR-L11	3275	1.1	-	IK16TT	IK16TT	16
600 (230.476)	368	M 275.951		04/03-01/12	VK20Y	5620	0.8	-	-	VK20Y	24
600 (230.477)	380	M 275.954		03/06-01/12	VK20Y	5620	0.8	-	-	VK20Y	24
SL (R231) (12-)											
65 AMG (231.479)	463	M 279.981		05/12-	VK20Y	5620	0.8	-	-	VK20Y	24
SL (W121) (55-63)											
190 SL (121.042, 121.040)	77	M 121.921; M 121.928		01/55-12/63	W20EP-U	3043	0.8	W20TT	IW20TT	IW20TT	4
SLC (C107) (72-84)											
280 SLC (107.022)	130/ 136	M 110.982; M 110.986; M 110.990		08/74-09/81	W20EP-U	3043	0.8	W20TT	IW20TT	IW20TT	6
350 SLC (107.023)	143/ 147	M 116.982; M 116.984		01/72-02/80	W20EP-U	3043	0.8	W20TT	IW20TT	IW20TT	8
380 SLC	150	M 116.962		08/81-08/84	W20EP-U	3043	0.8	W20TT	IW20TT	IW20TT	8
380 SLC (107.025)	160	M 116.960		07/80-08/81	W20EP-U	3043	0.8	W20TT	IW20TT	IW20TT	8

Свечи зажигания и Свечи накаливания





Таблица применения

Таблица применения

	KW				СТАНДАРТНЫЕ			Twin Tip			QTY
											
MERCEDES-BENZ продолжение											
SLC (C107) (72-84) продолжение											
450 SLC (107.024)	160/ 165	M 117.982; M 117.985		01/73-08/79	W20EP-U	3043	0.8	W20TT	IW20TT	IW20TT	8
450 SLC 5.0 (107.026)	177	M 117.960		06/78-02/80	W20EP-U	3043	0.8	W20TT	IW20TT	IW20TT	8
SLC (R172) (16-)											
250 d (172.404)	150	OM 651.980	OE: A 001 159 57 01; A 001 159 58 01; A 001 159 66 01, F166 Discon tinuationo f impact pl ate	01/16-10/17	DG-617		7V				4
250 d (172.404)	150	OM 651.980	OE: A0011597301/ A0011598001, -F166 Disco ntinuation of impactp late	01/16-10/17	DG-665		7V				4
SLK (R170) (96-04)											
32 AMG Kompressor (170.466)	260	M 112.960		03/01-04/04	SK20PR-L9	3307	0.9	-	IK20TT	IK20TT	12
200 (170.435)	100	M 111.946	Eng:2090, 4775>	09/96-03/00	K20PBR-S10	5061	1.0	K20TT	IK20TT	IK20TT	4
200 Kompressor (170.444)	120	M 111.958		03/00-04/04	SK20PR-L9	3307	0.9	-	IK20TT	IK20TT	4
200 Kompressor (170.445)	141	M 111.943		10/96-03/00	K16PR-U	3191	0.8	K16TT	IK16TT	IK16TT	4
230 Kompressor (170.447)	142	M 111.973		09/96-03/00	K20PBR-S10	5061	1.0	K20TT	IK20TT	IK20TT	4
230 Kompressor (170.449)	145	M 111.983		03/00-04/04	SK20PR-L9	3307	0.9	-	IK20TT	IK20TT	4
320 (170.465)	160	M 112.947		03/00-04/04	PK16PR-L11	3275	1.1	-	IK16TT	IK16TT	12
SLK (R171) (04-11)											
55 AMG (171.473)	265/ 294	M 113.989		06/04-02/11	PK16PR-L11	3275	1.1	-	IK16TT	IK16TT	16
200 Kompressor (171.442)	120	M 271.944	Eng:>30099998	03/04-08/07	VKH20Y	5639	0.8	-	-	VKH20Y	4
200 Kompressor (171.442)	120	M 271.944	Eng:30099999>	08/07-02/11	VXUH22	5611	0.9	-	IXUH22TT	VXUH22	4
200 Kompressor (171.445)	135	M 271.954	Eng:30099999>	01/08-02/11	VXUH22	5611	0.9	-	IXUH22TT	VXUH22	4
280 (171.454)	170	M 272.942		01/05-02/11	SXU22HDR8	3441	0.8	-	IXUH22TT	VXUH22I	6
280 (171.454)	170	M 272.942	OEM Optional	01/05-02/11	VXUH22	5611	0.9	-	IXUH22TT	VXUH22	6
300 (171.454)	170	M 272.942		04/09-02/11	SXU22HDR8	3441	0.8	-	IXUH22TT	VXUH22I	6
300 (171.454)	170	M 272.942	OEM Optional	04/09-02/11	VXUH22	5611	0.9	-	IXUH22TT	VXUH22	6
350 (171.456)	200	M 272.963		06/04-02/11	SXU22HDR8	3441	0.8	-	IXUH22TT	VXUH22I	6
350 (171.456)	200	M 272.963	OEM Optional	06/04-02/11	VXUH22	5611	0.9	-	IXUH22TT	VXUH22	6
350 (171.458)	224	M 272.969		01/08-02/11	SXU22HDR8	3441	0.8	-	IXUH22TT	VXUH22I	6
350 (171.458)	224	M 272.969	OEM Optional	01/08-02/11	VXUH22	5611	0.9	-	IXUH22TT	VXUH22	6
SLK (R172) (11-)											
200 (172.448)	135	M 271.860; M 271.861		02/11-	VXUH22	5611	0.9	-	IXUH22TT	VXUH22	4
250 (172.447)	150	M 271.860; M 271.861		02/11-	VXUH22	5611	0.9	-	IXUH22TT	VXUH22	4
250 CDI / d (172.403)	150	OM 651.980	OE: A 001 159 57 01; A 001 159 58 01; A 001 159 66 01, F166 Discon tinuationo f impact pl ate	01/12-	DG-617		7V				4
250 CDI / d (172.403)	150	OM 651.980	OE: A0011597301/ A0011598001, -F166 Disco ntinuation of impactp late	01/12-	DG-665		7V				4
SLR (R199) (04-)											
5.4	460/ 478	M 155.980		04/04-	VKH20Y	5639	0.8	-	-	VKH20Y	16
5.4 722 Edition	478	M 155.980		10/06-	VKH20Y	5639	0.8	-	-	VKH20Y	16
SPRINTER 2-t (901, 902) (95-06)											
2.1 208 CDI	60	OM 611.987	Double Coil(LPH)	04/00-05/06	DG-117		11.5V				4
2.1 211 CDI	80	OM 611.981	Double Coil(LPH)	04/00-05/06	DG-117		11.5V				4

Свечи зажигания и Свечи накаливания









Таблица применения

	KW				СТАНДАРТНЫЕ			Twin Tip				QTY
MERCEDES-BENZ продолжение												
SPRINTER 2-t (901, 902) (95-06) продолжение												
2.1 213 CDI	95	OM 611.981	Double Coil(LPH)	04/00-05/06	DG-117		11.5V					4
2.3 208 D	58/60	OM 601.943	Double Coil(LPH)	01/95-04/00	DG-010		11.5V					4
2.3 214	105	M 111.979; M 111.984		02/95-05/06	K20PBR-S10	5061	1.0	K20TT	IK20TT	IK20TT		4
2.3 214	105	M 111.984		02/95-05/06	SK20PR-L9	3307	0.9	-	IK20TT	IK20TT		4
2.3 214 NGT	95	M 111.979; M 111.984		02/95-05/06	SK20PR-L9	3307	0.9	-	IK20TT	IK20TT		4
2.7 216 CDI	115	OM 612.981		04/00-05/06	DG-117		11.5V					5
2.9 210 D	75	OM 602.980	Double Coil(LPH)	01/97-04/00	DG-110		11.5V					5
2.9 212 D	90	OM 602.980	Eng.:>9849, Double Coi l(LPH)	02/95-04/00	DG-001		11V					5
2.9 212 D	90	OM 602.980	Eng:9850>, Double Coi l(LPH)	02/95-04/00	DG-110		11.5V					5
SPRINTER 3,5-t (906) (06-)												
1.8 316	115	M 271.951	Eng:30099999>	09/08-	VXUH22	5611	0.9	-	IXUH22TT	VXUH22		4
1.8 316 LGT	115	M 271.951	Eng:30099999>	09/08-	VXUH22	5611	0.9	-	IXUH22TT	VXUH22		4
1.8 316 NGT	115	M 271.951	Eng:30099999>	09/08-	VXUH22	5611	0.9	-	IXUH22TT	VXUH22		4
2.1 309 CDI	65	OM 646.984		06/06-12/09	DG-117		11.5V					4
2.1 310 CDI	70	OM 651.955; OM 651.956	OE: A 001 159 57 01; A 001 159 58 01; A 001 159 66 01, F166 Discon tinuationo f impact pl ate	03/09-	DG-617		7V					4
2.1 311 CDI	80	OM 646.985		06/06-12/09	DG-117		11.5V					4
2.1 311 CDI	84	OM 651.955	OE: A 001 159 57 01; A 001 159 58 01; A 001 159 66 01, F166 Discon tinuationo f impact pl ate	05/16-	DG-617		7V					4
2.1 311 CDI 4x4	80	OM 646.985		02/08-12/09	DG-117		11.5V					4
2.1 313 CDI	95	OM 646.986		06/06-	DG-117		11.5V					4
2.1 313 CDI	95	OM 651.940; OM 651.955; OM 651.956	OE: A 001 159 57 01; A 001 159 58 01; A 001 159 66 01, F166 Discon tinuationo f impact pl ate	06/06-	DG-617		7V					4
2.1 313 CDI 4x4	95	OM 651.955	OE: A 001 159 57 01; A 001 159 58 01; A 001 159 66 01, F166 Discon tinuationo f impact pl ate	06/06-	DG-617		7V					4
2.1 314 CDI	105	OM 651.955	OE: A 001 159 57 01; A 001 159 58 01; A 001 159 66 01, F166 Discon tinuationo f impact pl ate	05/16-	DG-617		7V					4

Свечи зажигания и Свечи накаливания





Таблица применения

Таблица применения

	KW				СТАНДАРТНЫЕ			Twin Tip		QTY
										
MERCEDES-BENZ продолжение										
SPRINTER 3,5-t (906) (06-) продолжение										
2.1 314 CDI 4x4	105	OM 651.955	OE: A 001 159 57 01; A 001 159 58 01; A 001 159 66 01, F166 Discontinuationo f impact pl ate	05/16-	DG-617		7V			4
2.1 315 CDI	110	OM 646.986; OM 646.989; OM 646.990		06/06-12/09	DG-117		11.5V			4
2.1 315 CDI 4x4	110	OM 646.986; OM 646.989; OM 646.990		02/08-12/09	DG-117		11.5V			4
2.1 316 CDI	120	OM 651.955; OM 651.957	OE: A 001 159 57 01; A 001 159 58 01; A 001 159 66 01, F166 Discontinuationo f impact pl ate	03/09-	DG-617		7V			4
2.1 316 CDI 4x4	120	OM 651.955; OM 651.957	OE: A 001 159 57 01; A 001 159 58 01; A 001 159 66 01, F166 Discontinuationo f impact pl ate	03/09-	DG-617		7V			4
3.0 318 CDI	135	OM 642.896	Eng:> 41330713,OE: A 001 159 50 01; A 001 159 7101	06/06-12/09	DG-194		4.4V			6
3.0 318 CDI	135	OM 642.992; OM 642.993	OE: A 001 159 50 01; A 001 159 7101	06/06-12/09	DG-194		4.4V			6
3.0 318 CDI 4x4	135	OM 642.896	Eng:> 41330713,OE: A 001 159 50 01; A 001 159 7101	02/08-12/09	DG-194		4.4V			6
3.0 318 CDI 4x4	135	OM 642.992; OM 642.993	OE: A 001 159 50 01; A 001 159 7101	02/08-12/09	DG-194		4.4V			6
3.0 319 CDI / BlueTEC	140	OM 642.896; OM 642.898	Eng:> 41330713,OE: A 001 159 50 01; A 001 159 7101	03/09-06/12	DG-194		4.4V			6
3.0 319 CDI / BlueTEC	140	OM 642.896; OM 642.898	Eng:41330714> ,OE: A 001 159 57 01; A 001 159 58 01; A 001 159 6601	06/12-	DG-617		7V			6
3.0 319 CDI / BlueTEC	140	OM 642.992	OE: A 001 159 50 01; A 001 159 7101	03/09-08/13	DG-194		4.4V			6
3.0 319 CDI / BlueTEC	140	OM 642.992	OE: A 001 159 57 01; A 001 159 58 01; A 001 159 6601	08/13-	DG-617		7V			6
3.0 319 CDI / BlueTEC 4x4	140	OM 642.896; OM 642.898	Eng:> 41330713,OE: A 001 159 50 01; A 001 159 7101	03/09-06/12	DG-194		4.4V			6

Свечи зажигания и Свечи накаливания





Таблица применения

	KW				СТАНДАРТНЫЕ			Twin Tip			QTY
MERCEDES-BENZ продолжение											
SPRINTER 3,5-t (906) (06-) продолжение											
3.0 319 CDI / BlueTEC 4x4	140	OM 642.896; OM 642.898	Eng:41330714> ,OE: A 001 159 57 01; A 001 159 58 01; A 001 159 6601	06/12-	DG-617		7V				6
3.0 319 CDI / BlueTEC 4x4	140	OM 642.992	OE: A 001 159 50 01; A 001 159 7101	03/09-08/13	DG-194		4.4V				6
3.0 319 CDI / BlueTEC 4x4	140	OM 642.992	OE: A 001 159 57 01; A 001 159 58 01; A 001 159 6601	08/13-	DG-617		7V				6
3.5 324	190	M 272.979		06/06-12/13	SXU22HDR8	3441	0.8	-	IXUH22TT	VXUH22I	6
3.5 324	190	M 272.979	OEM Optional	06/06-12/13	VXUH22	5611	0.9	-	IXUH22TT	VXUH22	6
SPRINTER 3-t (903) (95-06)											
2.1 308 CDI	60	OM 611.987	Double Coil(LPH)	04/00-05/06	DG-117		11.5V				4
2.1 311 CDI	80	OM 611.981	Double Coil(LPH)	04/00-05/06	DG-117		11.5V				4
2.1 311 CDI 4x4	80	OM 611.981	Double Coil(LPH)	08/02-05/06	DG-117		11.5V				4
2.1 313 CDI	95	OM 611.981	Double Coil(LPH)	04/00-05/06	DG-117		11.5V				4
2.1 313 CDI 4x4	95	OM 611.981	Double Coil(LPH)	08/02-05/06	DG-117		11.5V				4
2.3 308 D 2.3	58/60	OM 601.943	Double Coil(LPH)	02/95-04/00	DG-010		11.5V				4
2.3 314	105	M 111.979		02/95-05/06	K20PBR-S10	5061	1.0	K20TT	IK20TT	IK20TT	4
2.3 314	105	M 111.979; M 111.984		02/95-05/06	SK20PR-L9	3307	0.9	-	IK20TT	IK20TT	4
2.3 314 4x4	105	M 111.984		08/02-05/06	SK20PR-L9	3307	0.9	-	IK20TT	IK20TT	4
2.3 314 NGT	95	M 111.979; M 111.984		02/95-05/06	SK20PR-L9	3307	0.9	-	IK20TT	IK20TT	4
2.7 316 CDI	115	OM 612.981; OM 647.981		04/00-05/06	DG-117		11.5V				5
2.7 316 CDI 4x4	115	OM 612.981; OM 647.981		08/02-05/06	DG-117		11.5V				5
2.9 310 D 2.9	75	OM 602.980	Double Coil(LPH)	02/95-04/00	DG-001		11V				5
2.9 310 D 2.9	75	OM 602.980	Double Coil(LPH)	02/95-04/00	DG-110		11.5V				5
2.9 310 D 4x4	75	OM 602.980	Double Coil(LPH)	05/97-08/02	DG-001		11V				5
2.9 310 D 4x4	75	OM 602.980	Double Coil(LPH)	05/97-08/02	DG-110		11.5V				5
2.9 312 D 2.9	85	OM 602.980	Double Coil(LPH)	12/98-09/01	DG-001		11V				5
2.9 312 D 2.9	85	OM 602.980	Double Coil(LPH)	12/98-09/01	DG-110		11.5V				5
2.9 312 D 2.9	90	OM 602.980	Eng:>9849, Double Coi l(LPH)	02/95-04/00	DG-001		11V				5
2.9 312 D 2.9	90	OM 602.980	Eng:9850>, Double Coi l(LPH)	02/95-04/00	DG-110		11.5V				5
2.9 312 D 2.9 4x4	90	OM 602.980	Double Coil(LPH)	05/97-08/02	DG-001		11V				5
2.9 312 D 2.9 4x4	90	OM 602.980	Double Coil(LPH)	05/97-08/02	DG-110		11.5V				5
2.9 312 D 2.9 4x4	90	OM 602.980	Eng:>9849, Double Coi l(LPH)	05/97-08/02	DG-001		11V				5
2.9 312 D 2.9 4x4	90	OM 602.980	Eng:9850>, Double Coi l(LPH)	05/97-08/02	DG-110		11.5V				5
SPRINTER 3-t (906) (06-)											
1.8 216	115	M 271.951	Eng:30099999>	09/08-	VXUH22	5611	0.9	-	IXUH22TT	VXUH22	4
2.1 209 CDI	65	OM 646.984		06/06-12/09	DG-117		11.5V				4

Свечи зажигания и Свечи накаливания





Таблица применения

Таблица применения

	KW				СТАНДАРТНЫЕ			Twin Tip			QTY
MERCEDES-BENZ продолжение											
SPRINTER 3-t (906) (06-) продолжение											
2.1 210 CDI	70	OM 651.955	OE: A 001 159 57 01; A 001 159 58 01; A 001 159 66 01, F166 Discontinuation for impact plate	03/09-	DG-617		7V				4
2.1 211 CDI	80	OM 646.985		06/06-12/09	DG-117		11.5V				4
2.1 211 CDI	84	OM 651.955	OE: A 001 159 57 01; A 001 159 58 01; A 001 159 66 01, F166 Discontinuation for impact plate	04/16-	DG-617		7V				4
2.1 213 CDI	95	OM 646.986		06/06-12/09	DG-117		11.5V				4
2.1 213 CDI	95	OM 651.955; OM 651.957	OE: A 001 159 57 01; A 001 159 58 01; A 001 159 66 01, F166 Discontinuation for impact plate	06/06-	DG-617		7V				4
2.1 214 CDI	105	OM 651.955	OE: A 001 159 57 01; A 001 159 58 01; A 001 159 66 01, F166 Discontinuation for impact plate	04/16-	DG-617		7V				4
2.1 215 CDI	110	OM 646.986; OM 646.989; OM 646.990		06/06-12/09	DG-117		11.5V				4
2.1 216 CDI	120	OM 651.955; OM 651.957	OE: A 001 159 57 01; A 001 159 58 01; A 001 159 66 01, F166 Discontinuation for impact plate	06/06-	DG-617		7V				4
3.0 218 CDI	135	OM 642.896	Eng:> 41330713,OE: A 001 159 50 01; A 001 159 7101	06/06-12/09	DG-194		4.4V				6
3.0 218 CDI	135	OM 642.992; OM 642.993	OE: A 001 159 50 01; A 001 159 7101	06/06-12/09	DG-194		4.4V				6
3.0 219 CDI / BlueTEC	140	OM 642.896	Eng:> 41330713,OE: A 001 159 50 01; A 001 159 7101	03/09-06/12	DG-194		4.4V				6
3.0 219 CDI / BlueTEC	140	OM 642.896	Eng:41330714> ,OE: A 001 159 57 01; A 001 159 58 01; A 001 159 6601	06/12-	DG-617		7V				6
3.0 219 CDI / BlueTEC	140	OM 642.992	OE: A 001 159 50 01; A 001 159 7101	03/09-08/13	DG-194		4.4V				6
3.0 219 CDI / BlueTEC	140	OM 642.992	OE: A 001 159 57 01; A 001 159 58 01; A 001 159 6601	08/13-	DG-617		7V				6

Свечи зажигания и Свечи накаливания

Таблица применения

	KW				СТАНДАРТНЫЕ			Twin Tip			QTY
MERCEDES-BENZ продолжение											
SPRINTER 3-t (906) (06-) продолжение											
3.5 224	190	M 272.979		06/06-	SXU22HDR8	3441	0.8	-	IXUH22TT	VXUH22I	6
3.5 224	190	M 272.979	OEM Optional	06/06-	VXUH22	5611	0.9	-	IXUH22TT	VXUH22	6
SPRINTER 4,6-t (906) (06-)											
2.1 411 CDI	80	OM 646.985		06/09-12/18	DG-117		11.5V				4
2.1 413 CDI	95	OM 651.955; OM 651.956	OE: A 001 159 57 01; A 001 159 58 01; A 001 159 66 01, F166 Discon tinuationo f impact pl ate	06/06-05/16	DG-617		7V				4
2.1 414 CDI	105	OM 651.955	OE: A 001 159 57 01; A 001 159 58 01; A 001 159 66 01, F166 Discon tinuationo f impact pl ate	05/16-	DG-617		7V				4
2.1 415 CDI	110	OM 646.986; OM 646.989; OM 646.990		06/06-12/09	DG-117		11.5V				4
2.1 416 CDI	120	OM 651.955; OM 651.957	OE: A 001 159 57 01; A 001 159 58 01; A 001 159 66 01, F166 Discon tinuationo f impact pl ate	03/09-	DG-617		7V				4
3.0 418 CDI	135	OM 642.896	Eng:> 41330713,OE: A 001 159 50 01; A 001 159 7101	06/06-06/12	DG-194		4.4V				6
3.0 418 CDI	135	OM 642.896	Eng:41330714> ,OE: A 001 159 57 01; A 001 159 58 01; A 001 159 6601	06/12-05/16	DG-617		7V				6
3.0 418 CDI	135	OM 642.992; OM 642.993	OE: A 001 159 50 01; A 001 159 7101	06/06-08/13	DG-194		4.4V				6
3.0 419 CDI	140	OM 642.896; OM 642.898	Eng:> 41330713,OE: A 001 159 50 01; A 001 159 7101	03/09-06/12	DG-194		4.4V				6
3.0 419 CDI	140	OM 642.896; OM 642.898	Eng:41330714> ,OE: A 001 159 57 01; A 001 159 58 01; A 001 159 6601	06/12-	DG-617		7V				6
3.0 419 CDI	140	OM 642.896; OM 642.992	OE: A 001 159 50 01; A 001 159 7101	03/09-08/13	DG-194		4.4V				6
3.0 419 CDI	140	OM 642.896; OM 642.992	OE: A 001 159 57 01; A 001 159 58 01; A 001 159 6601	08/13-	DG-617		7V				6
3.5 424	190	M 272.979		06/06-12/13	SXU22HDR8	3441	0.8	-	IXUH22TT	VXUH22I	6
3.5 424	190	M 272.979	OEM Optional	06/06-12/13	VXUH22	5611	0.9	-	IXUH22TT	VXUH22	6
SPRINTER 4-t (904) (96-06)											
2.1 408 CDI	60	OM 611.987	Double Coil(LPH)	04/00-05/06	DG-117		11.5V				4
2.1 411 CDI	80	OM 611.981	Double Coil(LPH)	04/00-05/06	DG-117		11.5V				4
2.1 411 CDI 4x4	80	OM 611.981	Double Coil(LPH)	04/00-05/06	DG-117		11.5V				4

Свечи зажигания и Свечи накаливания





Таблица применения

Таблица применения

KW	KW	NOTE	21	СТАНДАРТНЫЕ				Twin Tip			QTY
				STANDARD	STANDARD	STANDARD	STANDARD	TWIN TIP	TWIN TIP	TWIN TIP	
MERCEDES-BENZ продолжение											
SPRINTER 4-t (904) (96-06) продолжение											
2.1 413 CDI	95	OM 611.981	Double Coil(LPH)	04/00-05/06	DG-117		11.5V				4
2.1 413 CDI 4x4	95	OM 611.981	Double Coil(LPH)	04/00-05/06	DG-117		11.5V				4
2.3 408 D	58	OM 601.943	Double Coil(LPH)	02/96-05/06	DG-010		11.5V				4
2.3 414	105	M 111.979; M 111.984		02/95-05/06	K20PBR-S10	5061	1.0	K20TT	IK20TT	IK20TT	4
2.3 414	105	M 111.984		02/95-05/06	SK20PR-L9	3307	0.9	-	IK20TT	IK20TT	4
2.3 414 4x4	105	M 111.979; M 111.984		05/97-05/06	K20PBR-S10	5061	1.0	K20TT	IK20TT	IK20TT	4
2.7 416 CDI	115	OM 612.981; OM 647.981		04/00-05/06	DG-117		11.5V				5
2.7 416 CDI 4x4	115	OM 612.981; OM 647.981		04/00-05/06	DG-117		11.5V				5
2.9 410 D	75	OM 602.980	Double Coil(LPH)	02/96-05/06	DG-010		11.5V				5
2.9 410 D	75	OM 602.980	Double Coil(LPH)	02/96-05/06	DG-110		11.5V				5
2.9 410 D 4x4	75	OM 602.980	Double Coil(LPH)	05/97-05/06	DG-010		11.5V				5
2.9 410 D 4x4	75	OM 602.980	Double Coil(LPH)	05/97-05/06	DG-110		11.5V				5
2.9 412 D	85/90	OM 602.980	Double Coil(LPH)	02/96-05/06	DG-110		11.5V				5
2.9 412 D	90	OM 602.980	Double Coil(LPH)	02/96-05/06	DG-001		11V				5
2.9 412 D 4x4	85/90	OM 602.980	Double Coil(LPH)	05/97-05/06	DG-110		11.5V				5
2.9 412 D 4x4	90	OM 602.980	Double Coil(LPH)	05/97-05/06	DG-001		11V				5
SPRINTER 5-t (905) (01-)											
2.7 616 CDI	115	OM 612.981		04/01-	DG-117		11.5V				5
SPRINTER 5-t (906) (06-)											
1.8 516	115	M 271.951	Eng:30099999>	09/08-	VXUH22	5611	0.9	-	IXUH22TT	VXUH22	4
1.8 516 NGT	115	M 271.951	Eng:30099999>	09/08-	VXUH22	5611	0.9	-	IXUH22TT	VXUH22	4
2.1 509 CDI	65	OM 646.984		06/06-12/09	DG-117		11.5V				4
2.1 510 CDI	70	OM 651.955	OE: A 001 159 57 01; A 001 159 58 01; A 001 159 66 01, F166 Discontinuation of impact plate	03/09-	DG-617		7V				4
2.1 511 CDI	80	OM 646.985		06/06-12/09	DG-117		11.5V				4
2.1 511 CDI	84	OM 651.955	OE: A 001 159 57 01; A 001 159 58 01; A 001 159 66 01, F166 Discontinuation of impact plate	05/16-	DG-617		7V				4
2.1 511 CDI 4x4	80	OM 646.985		06/06-12/09	DG-117		11.5V				4
2.1 513 CDI	95	OM 646.986		06/06-	DG-117		11.5V				4
2.1 513 CDI	95	OM 651.955; OM 651.957	OE: A 001 159 57 01; A 001 159 58 01; A 001 159 66 01, F166 Discontinuation of impact plate	06/06-	DG-617		7V				4
2.1 513 CDI 4x4	95	OM 651.955; OM 651.957	OE: A 001 159 57 01; A 001 159 58 01; A 001 159 66 01, F166 Discontinuation of impact plate	06/06-	DG-617		7V				4

Свечи зажигания и Свечи накаливания











Таблица применения

	KW				СТАНДАРТНЫЕ			Twin Tip			QTY
MERCEDES-BENZ продолжение											
SPRINTER 5-t (906) (06-) продолжение											
2.1 514 CDI	105	OM 651.955	OE: A 001 159 57 01; A 001 159 58 01; A 001 159 66 01, F166 Discon tinuationo f impact pl ate	05/16-	DG-617		7V				4
2.1 514 CDI 4x4	105	OM 651.955	OE: A 001 159 57 01; A 001 159 58 01; A 001 159 66 01, F166 Discon tinuationo f impact pl ate	05/16-	DG-617		7V				4
2.1 515 CDI	110	OM 646.986; OM 646.989; OM 646.990		06/06-12/09	DG-117		11.5V				4
2.1 515 CDI 4x4	110	OM 646.986; OM 646.989; OM 646.990		06/06-12/09	DG-117		11.5V				4
2.1 516 CDI	120	OM 651.955; OM 651.957	OE: A 001 159 57 01; A 001 159 58 01; A 001 159 66 01, F166 Discon tinuationo f impact pl ate	03/09-	DG-617		7V				4
2.1 516 CDI 4x4	120	OM 651.955; OM 651.957	OE: A 001 159 57 01; A 001 159 58 01; A 001 159 66 01, F166 Discon tinuationo f impact pl ate	06/06-	DG-617		7V				4
3.0 518 CDI	135	OM 642.896	Eng:> 41330713,OE: A 001 159 50 01; A 001 159 7101	06/06-12/09	DG-194		4.4V				6
3.0 518 CDI	135	OM 642.992; OM 642.993	OE: A 001 159 50 01; A 001 159 7101	06/06-12/09	DG-194		4.4V				6
3.0 518 CDI 4x4	135	OM 642.896	Eng:> 41330713,OE: A 001 159 50 01; A 001 159 7101	06/06-12/09	DG-194		4.4V				6
3.0 518 CDI 4x4	135	OM 642.992; OM 642.993	OE: A 001 159 50 01; A 001 159 7101	06/06-12/09	DG-194		4.4V				6
3.0 519 CDI / BlueTEC	140	OM 642.896; OM 642.898	Eng:> 41330713,OE: A 001 159 50 01; A 001 159 7101	03/09-06/12	DG-194		4.4V				6
3.0 519 CDI / BlueTEC	140	OM 642.896; OM 642.898	Eng:41330714> ,OE: A 001 159 57 01; A 001 159 58 01; A 001 159 6601	06/12-	DG-617		7V				6
3.0 519 CDI / BlueTEC	140	OM 642.992	OE: A 001 159 50 01; A 001 159 7101	03/09-08/13	DG-194		4.4V				6
3.0 519 CDI / BlueTEC	140	OM 642.992	OE: A 001 159 57 01; A 001 159 58 01; A 001 159 6601	08/13-	DG-617		7V				6

Свечи зажигания и Свечи накаливания





Таблица применения

Таблица применения

	KW				СТАНДАРТНЫЕ				Twin Tip			QTY
												
MERCEDES-BENZ продолжение												
SPRINTER 5-t (906) (06-) продолжение												
3.0 519 CDI / BlueTEC 4x4	140	OM 642.896; OM 642.898	Eng:> 41330713,OE: A 001 159 50 01; A 001 159 7101	03/09-06/12	DG-194		4.4V					6
3.0 519 CDI / BlueTEC 4x4	140	OM 642.896; OM 642.898	Eng:41330714> ,OE: A 001 159 57 01; A 001 159 58 01; A 001 159 6601	06/12-	DG-617		7V					6
3.0 519 CDI / BlueTEC 4x4	140	OM 642.992	OE: A 001 159 50 01; A 001 159 7101	03/09-08/13	DG-194		4.4V					6
3.0 519 CDI / BlueTEC 4x4	140	OM 642.992	OE: A 001 159 57 01; A 001 159 58 01; A 001 159 6601	08/13-	DG-617		7V					6
3.5 524	190	M 272.979		06/06-12/13	SXU22HDR8	3441	0.8	-	IXUH22TT	VXUH22I		6
3.5 524	190	M 272.979	OEM Optional	06/06-12/13	VXUH22	5611	0.9	-	IXUH22TT	VXUH22		6
SPRINTER Classic (909) (13-)												
2.1 311 CDI	80	OM 646.701		09/13-	DG-117		11.5V					4
2.1 411 CDI	80	OM 646.701		09/13-	DG-117		11.5V					4
T1 (601) (77-96)												
2.3 208	63	M 115.955; M 115.972		05/77-12/82	W20EP-U	3043	0.8	W20TT	IW20TT	IW20TT		4
2.3 210	63	M 115.955		04/77-10/89	W20EP-U	3043	0.8	W20TT	IW20TT	IW20TT		4
2.3 210	70/77	M 102.942; M 102.945; M 102.946		04/77-02/96	T20EP-U	5031	0.8	T20TT	IT20TT	IT20TT		4
2.3 D 208	58/60	OM 601.940	Double Coil(LPH)	10/88-02/96	DG-010		11.5V					4
2.4 D 407	53	OM 616.937; OM 616.939	Double Coil(LPH)	06/82-01/90	DG-001		11V					4
2.9 D 209	65	OM 617.913	Double Coil(LPH)	12/82-01/90	DG-001		11V					5
2.9 D 210	70/72	OM 602.940	Double Coil(LPH)	10/88-02/96	DG-010		11.5V					5
T1 (602) (77-96)												
2.3 310	70/77	M 102.942; M 102.945		01/82-02/96	T20EP-U	5031	0.8	T20TT	IT20TT	IT20TT		4
2.3 D 308	58/60	OM 601.940	Double Coil(LPH)	11/88-02/96	DG-010		11.5V					4
2.4 D 307	48/53	OM 616.937; OM 616.939	Double Coil(LPH)	06/82-01/90	DG-001		11V					4
2.9 D 310	70/72	OM 602.940	Double Coil(LPH)	06/89-02/96	DG-010		11.5V					5
3.0 D 309	65	OM 617.913	Double Coil(LPH)	10/82-01/90	DG-001		11V					5
T1 / TN (611) (81-95)												
2.3 408 D	58/60	OM 601.940	Double Coil(LPH)	11/88-06/95	DG-010		11.5V					4
2.3 410	70/77	M 102.942; M 102.945		08/82-06/95	T20EP-U	5031	0.8	T20TT	IT20TT	IT20TT		4
2.4 407 D	53	OM 616.913; OM 616.939	Double Coil(LPH)	07/81-01/89	DG-001		11V					4
2.9 410 D	70/72	OM 602.940	Double Coil(LPH)	11/88-06/95	DG-010		11.5V					5
3.0 409 D	65	OM 617.913	Double Coil(LPH)	04/82-01/89	DG-001		11V					5
T2 / L (309, 310, 328) (68-88)												
2.0 L 408 G	55/63	M 115.11		01/68-12/72	W20EP-U	3043	0.8	W20TT	IW20TT	IW20TT		4
2.2 L 405 D	44	OM 615		01/72-12/80	DG-001		11V					4
2.2 L 406 DG	44	OM 615.910		01/68-12/74	DG-001		11V					4
2.2 L 408 G	55/63	M 115.921; M 115.928		08/72-12/74	W20EP-U	3043	0.8	W20TT	IW20TT	IW20TT		4
2.2 LF 408 G	55/63	M 115.927; M 115.929		08/72-12/74	W20EP-U	3043	0.8	W20TT	IW20TT	IW20TT		4
2.2 LK 408 G	63	M 115.921		01/68-12/74	W20EP-U	3043	0.8	W20TT	IW20TT	IW20TT		4
2.3 L 409	66	M 115.952		01/75-08/82	W20EP-U	3043	0.8	W20TT	IW20TT	IW20TT		4
2.3 L 410	70	M 102.943		08/82-12/88	T20EP-U	5031	0.8	T20TT	IT20TT	IT20TT		4
2.3 LF 409 G	66	M 115.952; M 115.970; M 115.971		01/75-08/82	W20EP-U	3043	0.8	W20TT	IW20TT	IW20TT		4

Свечи зажигания и Свечи накаливания











Таблица применения

	KW				СТАНДАРТНЫЕ			Twin Tip			QTY
MERCEDES-BENZ продолжение											
T2 / L (309, 310, 328) (68-88) продолжение											
2.3 LK 408 G, LK 409	66	M 115.952		01/75-08/82	W20EP-U	3043	0.8	W20TT	IW20TT	IW20TT	4
2.3 LK 408 G, LK 409	70	M 102.943		08/82-09/83	T20EP-U	5031	0.8	T20TT	IT20TT	IT20TT	4
2.4 L 407 D	48/53	OM 616.910; OM 616.917	Double Coil(LPH)	09/82-12/88	DG-001		11V				4
T2 / LN1 (86-94)											
2.3 508 D	58	OM 601.941	Double Coil(LPH)	03/89-12/94	DG-010		11.5V				4
2.3 510	70/77	M 102.946		04/86-12/94	T20EP-U	5031	0.8	T20TT	IT20TT	IT20TT	4
2.4 507 D	53	OM 616.914	Double Coil(LPH)	04/86-04/89	DG-001		11V				4
VANEO (414) (02-05)											
1.6 (414.700)	60/75	M 166.961		02/02-07/05	K20PBR-S10	5061	1.0	K20TT	IK20TT	IK20TT	4
1.7 CDI (414.700)	55/67	OM 668.914	Double Coil(LPH)	02/02-07/05	DG-155		11.5V				4
1.9 (414.700)	92	M 166.991		02/02-07/05	K20PBR-S10	5061	1.0	K20TT	IK20TT	IK20TT	4
VARIO (96-)											
2.9 512 D	90	OM 602.984	Double Coil(LPH)	09/96-12/10	DG-110		11.5V				5
2.9 612 D	90	OM 602.984; OM 602.985	Double Coil(LPH)	09/96-12/10	DG-110		11.5V				5
2.9 812 D	90	OM 602.984; OM 602.985	Double Coil(LPH)	09/96-12/10	DG-110		11.5V				5
2.9 O 812	90	OM 602.984; OM 602.985	Double Coil(LPH)	09/96-12/10	DG-110		11.5V				5
V-CLASS (638/2) (96-03)											
V 200	95	M 111.948; M 111.950		02/97-07/03	K20PBR-S10	5061	1.0	K20TT	IK20TT	IK20TT	4
V 200 CDI	75	OM 611.980	Double Coil(LPH)	03/99-07/03	DG-117		11.5V				4
V 220 CDI	90	OM 611.980	Double Coil(LPH)	03/99-07/03	DG-117		11.5V				4
V 230	105	M 111.978; M 111.980		10/96-07/03	K20PBR-S10	5061	1.0	K20TT	IK20TT	IK20TT	4
V 230 TD	72	OM 601.970	Double Coil(LPH)	09/96-07/03	DG-010		11.5V				4
V 280	128	M 104.900		08/97-07/03	K20TXR	5063	1.0	K20TT	IK20TT	IK20TT	6
V-CLASS (14-)											
V 200 CDI / d	100	OM 651.950	OE: A 001 159 57 01; A 001 159 58 01; A 001 159 66 01, F166 Discon tinuatio natio f impact pl ate	03/14-	DG-617		7V				4
V 200 CDI / d 4-matic	100	OM 651.950	OE: A 001 159 57 01; A 001 159 58 01; A 001 159 66 01, F166 Discon tinuatio natio f impact pl ate	04/15-	DG-617		7V				4
V 220 CDI / d	120	OM 651.950	OE: A 001 159 57 01; A 001 159 58 01; A 001 159 66 01, F166 Discon tinuatio natio f impact pl ate	03/14-	DG-617		7V				4
V 220 CDI / d 4-matic	120	OM 651.950	OE: A 001 159 57 01; A 001 159 58 01; A 001 159 66 01, F166 Discon tinuatio natio f impact pl ate	04/15-	DG-617		7V				4

Свечи зажигания и Свечи накаливания

Таблица применения

Таблица применения

	KW				СТАНДАРТНЫЕ			Twin Tip			QTY
											
MERCEDES-BENZ продолжение											
V-CLASS (14-) продолжение											
V 250 BlueTEC / d	140	OM 651.950	OE: A 001 159 57 01; A 001 159 58 01; A 001 159 66 01, F166 Discontinuation for impact plate	03/14-	DG-617		7V				4
V 250 BlueTEC / d 4-matic	140	OM 651.950	OE: A 001 159 57 01; A 001 159 58 01; A 001 159 66 01, F166 Discontinuation for impact plate	12/14-	DG-617		7V				4
VIANO (W639) (03-)											
2.0 CDI	80/85	OM 646.982		09/03-	DG-117		11.5V				4
2.0 CDI	100	OM 651.940	OE: A 001 159 57 01; A 001 159 58 01; A 001 159 66 01, F166 Discontinuation for impact plate	07/10-	DG-617		7V				4
2.0 CDI 4-matic	80	OM 646.982		07/05-	DG-117		11.5V				4
2.0 CDI 4-matic	100	OM 651.940	OE: A 001 159 57 01; A 001 159 58 01; A 001 159 66 01, F166 Discontinuation for impact plate	07/10-	DG-617		7V				4
2.2 CDI	110	OM 646.980; OM 646.982		09/03-	DG-117		11.5V				4
2.2 CDI	120	OM 651.940	OE: A 001 159 57 01; A 001 159 58 01; A 001 159 66 01, F166 Discontinuation for impact plate	07/10-	DG-617		7V				4
2.2 CDI 4-matic	110	OM 646.982		07/05-	DG-117		11.5V				4
2.2 CDI 4-matic	120	OM 651.940	OE: A 001 159 57 01; A 001 159 58 01; A 001 159 66 01, F166 Discontinuation for impact plate	07/10-	DG-617		7V				4
3.0	140	M 112.951		09/03-	PK16PR-L11	3275	1.1	-	IK16TT	IK16TT	12
3.0 CDI	150/ 165	OM 642.992	OE: A 001 159 50 01; A 001 159 7101	03/06-08/13	DG-194		4.4V				6
3.0 CDI	150/ 165	OM 642.992	OE: A 001 159 57 01; A 001 159 58 01; A 001 159 6601	08/13-	DG-617		7V				6
3.2	160	M 112.951		09/03-	PK16PR-L11	3275	1.1	-	IK16TT	IK16TT	12
3.5	190	M 272.978		09/07-	SXU22HDR8	3441	0.8	-	IXUH22TT	VXUH22I	6
3.5	190	M 272.978	OEM Optional	09/07-	VXUH22	5611	0.9	-	IXUH22TT	VXUH22	6
3.7	165/ 170	M 112.976		06/04-	PK16PR-L11	3275	1.1	-	IK16TT	IK16TT	12

Свечи зажигания и Свечи накаливания











Таблица применения

	KW				СТАНДАРТНЫЕ			Twin Tip			QTY
											
MERCEDES-BENZ продолжение											
VITO (638) (96-03)											
2.0 113	95	M 111.948; M 111.950		02/96-07/03	K20PBR-S10	5061	1.0	K20TT	IK20TT	IK20TT	4
2.1 108 CDI	60	OM 611A (60 KW CDI)	Double Coil(LPH)	03/99-07/03	DG-117		11.5V				4
2.1 110 CDI	75	OM 611LA (75 KW CDI)	Double Coil(LPH)	03/99-07/03	DG-117		11.5V				4
2.2 108 CDI	60	OM 611A (60 KW CDI)	Double Coil(LPH)	03/99-07/03	DG-117		11.5V				4
2.2 110 CDI	75	OM 611LA (75 KW CDI)	Double Coil(LPH)	03/99-07/03	DG-117		11.5V				4
2.2 112 CDI	90	OM 611.980	Double Coil(LPH)	03/99-07/03	DG-117		11.5V				4
2.3 108 D	58	OM 601.942	Double Coil(LPH)	02/96-07/03	DG-010		11.5V				4
2.3 110 D	72	OM 601.970	Double Coil(LPH)	03/97-07/03	DG-010		11.5V				4
2.3 110 TD	72	OM 601.970	Double Coil(LPH)	02/96-07/03	DG-010		11.5V				4
2.3 114	105	M 111.978; M 111.980		12/96-07/03	K20PBR-S10	5061	1.0	K20TT	IK20TT	IK20TT	4
VITO (W447) (14-)											
1.6 109 CDI / BlueTEC	65	OM 622.951		10/14-	DG-631		4.5V				4
1.6 111 CDI / BlueTEC	84	OM 622.951		10/14-	DG-631		4.5V				4
2.1 114 CDI / BlueTEC	100	OM 651.950	OE: A 001 159 57 01; A 001 159 58 01; A 001 159 66 01, F166 Discon tinuationo f impact pl ate	10/14-	DG-617		7V				4
2.1 114 CDI / BlueTEC 4x4	100	OM 651.950	OE: A 001 159 57 01; A 001 159 58 01; A 001 159 66 01, F166 Discon tinuationo f impact pl ate	07/15-	DG-617		7V				4
2.1 116 CDI / BlueTEC	120	OM 651.950	OE: A 001 159 57 01; A 001 159 58 01; A 001 159 66 01, F166 Discon tinuationo f impact pl ate	10/14-	DG-617		7V				4
2.1 116 CDI / BlueTEC 4x4	120	OM 651.950	OE: A 001 159 57 01; A 001 159 58 01; A 001 159 66 01, F166 Discon tinuationo f impact pl ate	07/15-	DG-617		7V				4
2.1 119 CDI / BlueTEC	140	OM 651.950	OE: A 001 159 57 01; A 001 159 58 01; A 001 159 66 01, F166 Discon tinuationo f impact pl ate	10/14-	DG-617		7V				4
2.1 119 CDI / BlueTEC 4x4	140	OM 651.950	OE: A 001 159 57 01; A 001 159 58 01; A 001 159 66 01, F166 Discon tinuationo f impact pl ate	12/14-	DG-617		7V				4

Свечи зажигания и Свечи накаливания

Таблица применения

Таблица применения

	KW				СТАНДАРТНЫЕ				Twin Tip		QTY
											
MERCEDES-BENZ продолжение											
VITO / MIXTO (W639) (03-)											
2.1 109 CDI	65/70	OM 646.980; OM 646.981; OM 646.983		09/03-	DG-117		11.5V				4
2.1 109 CDI 4x4	70	OM 646.981		09/07-	DG-117		11.5V				4
2.1 110 CDI	70	OM 651.940	OE: A 001 159 57 01; A 001 159 58 01; A 001 159 66 01, F166 Discontinuation for impact plate	09/10-	DG-617		7V				4
2.1 111 CDI	80/85	OM 646.980; OM 646.982		09/03-	DG-117		11.5V				4
2.1 111 CDI 4x4	80	OM 646.982		09/07-	DG-117		11.5V				4
2.1 113 CDI	100	OM 651.940	OE: A 001 159 57 01; A 001 159 58 01; A 001 159 66 01, F166 Discontinuation for impact plate	09/10-	DG-617		7V				4
2.1 113 CDI 4x4	100	OM 651.940	OE: A 001 159 57 01; A 001 159 58 01; A 001 159 66 01, F166 Discontinuation for impact plate	09/10-	DG-617		7V				4
2.1 115 CDI	110	OM 646.980; OM 646.982		09/03-	DG-117		11.5V				4
2.1 115 CDI 4x4	110	OM 646.982		07/06-	DG-117		11.5V				4
2.1 116 CDI	120	OM 651.940	OE: A 001 159 57 01; A 001 159 58 01; A 001 159 66 01, F166 Discontinuation for impact plate	09/10-	DG-617		7V				4
2.1 116 CDI 4x4	120	OM 651.940	OE: A 001 159 57 01; A 001 159 58 01; A 001 159 66 01, F166 Discontinuation for impact plate	09/10-	DG-617		7V				4
3.0 120 CDI	150	OM 642.992	OE: A 001 159 50 01; A 001 159 7101	07/06-08/13	DG-194		4.4V				6
3.0 120 CDI	150	OM 642.992	OE: A 001 159 57 01; A 001 159 58 01; A 001 159 6601	08/13-	DG-617		7V				6
3.0 122 CDI	165	OM 642.890	OE: A 001 159 57 01; A 001 159 58 01; A 001 159 6601	09/10-	DG-617		7V				6
3.2 119	140	M 112.951		09/03-	PK16PR-L11	3275	1.1	-	IK16TT	IK16TT	12
3.2 122	160	M 112.951		09/03-	PK16PR-L11	3275	1.1	-	IK16TT	IK16TT	12
3.5 126	190	M 272.978		09/07-	SXU22HDR8	3441	0.8	-	IXUH22TT	VXUH22I	6
3.5 126	190	M 272.978	OEM Optional	09/07-	VXUH22	5611	0.9	-	IXUH22TT	VXUH22	6
3.7 123	165/ 170	M 112.976		06/04-	PK16PR-L11	3275	1.1	-	IK16TT	IK16TT	12





Свечи зажигания и Свечи накаливания

Таблица применения

KW	KW	KW	KW	KW	СТАНДАРТНЫЕ			Twin Tip			QTY
					STANDARD	STANDARD	STANDARD	TWIN TIP	TWIN TIP	TWIN TIP	
MERCURY											
Grand MARQUIS (91-97)											
4.6	157			01/91-12/97	T20EPR-U15	5033	1.5				8
MG											
MAESTRO (83-90)											
2.0 EFi	86	20HA51/20HC78		10/84-09/90	W20EPR-U	3047	0.8	W20TT	IW20TT	IW20TT	4
2.0 Turbo	112	20HB63		10/88-09/90	W20EPR-U	3047	0.8	W20TT	IW20TT	IW20TT	4
1600	76	16H956		03/83-09/84	W20EPR-U	3047	0.8	W20TT	IW20TT	IW20TT	4
METRO (82-90)											
1.3 Turbo	69	12H959AA/12HC15		10/82-09/90	W20EPR-U	3047	0.8	W20TT	IW20TT	IW20TT	4
1300	54	12HD26		11/87-09/90	W20EX-U	3062	0.8	W20TT	IW20TT	IW20TT	4
MG 6 (10-)											
1.8 T	118	18 K4G		11/10-	PK20PR-L11	3142	1.1	-	IK20TT	IK20TT	4
MG TF (02-09)											
115	85	16K4F4		03/02-04/05	PK16PR-L11	3275	1.1	-	IK16TT	IK16TT	4
120	88	18 K4F		03/02-04/05	PK16PR-L11	3275	1.1	-	IK16TT	IK16TT	4
135	100	18 K4F		03/02-04/05	PK16PR-L11	3275	1.1	-	IK16TT	IK16TT	4
160	118	18 K4K		03/02-04/05	PK20PR-L11	3142	1.1	-	IK20TT	IK20TT	4
MG X-POWER (03-08)											
5.0 SV-R	294	50K5F		01/05-04/08	PK20PR-P8	3245	0.8	-	IK20TT	IK20TT	8
MG ZR (01-05)											
2.0 TD	74/83	20 T2N	Double Coil(LPH)	06/01-04/05	DG-101		11V				4
105	76	14K4F4		06/01-04/05	PK20PR-P8	3245	0.8	-	IK20TT	IK20TT	4
120	86	18 K4F		06/01-04/05	PK16PR-L11	3275	1.1	-	IK16TT	IK16TT	4
160	118	18K4K		06/01-04/05	PK20PR-L11	3142	1.1	-	IK20TT	IK20TT	4
MG ZS (01-05)											
1.6	79/82	16 K4F; 16K4F4		11/01-04/05	PK20PR-L11	3142	1.1	-	IK20TT	IK20TT	4
1.6	79/82	16 K4F; 16K4F4		07/03-10/05	PK16PR-L11	3275	1.1	-	IK16TT	IK16TT	4
2.0 TD	74/83	20 T2N	Double Coil(LPH)	01/04-10/05	DG-101		11V				4
120	86	18 K4F; 18K4F		07/01-10/05	PK16PR-L11	3275	1.1	-	IK16TT	IK16TT	4
180	130	25KV6-177		07/01-10/05	PK16PR-L11	3275	1.1	-	IK16TT	IK16TT	6
180	130	25KV6-177	Flexible fuel	07/01-10/05	PK20PR-L11	3142	1.1	-	IK20TT	IK20TT	6
MG ZT (01-05)											
1.8 16V	88	18 K4F	Flexible fuel	01/03-07/05	PK20PR-L11	3142	1.1	-	IK20TT	IK20TT	4
1.8 16V	88	18 K4F; 18K4F		01/03-07/05	PK16PR-L11	3275	1.1	-	IK16TT	IK16TT	4
1.8 T 16V	118	18K4T		01/03-07/05	PK16PR-L11	3275	1.1	-	IK16TT	IK16TT	4
1.8 T 16V	118	18K4T	Flexible fuel	01/03-07/05	PK20PR-L11	3142	1.1	-	IK20TT	IK20TT	4
2.0 CDTi	85/96	204D2	Double Coil(LPH)	06/02-07/05	DG-145		11V				4
160	118	25K6(160)		01/03-07/05	PK16PR-L11	3275	1.1	-	IK16TT	IK16TT	6
160	118	25K6(160)	Flexible fuel	01/03-07/05	PK20PR-L11	3142	1.1	-	IK20TT	IK20TT	6
180	130	25KV6-177		02/04-10/05	PK16PR-L11	3275	1.1	-	IK16TT	IK16TT	6
180	130	25KV6-177	Flexible fuel	02/04-10/05	PK20PR-L11	3142	1.1	-	IK20TT	IK20TT	6
190	140	25K6(190)		06/01-07/05	PK16PR-L11	3275	1.1	-	IK16TT	IK16TT	6
190	140	25K6(190)	Flexible fuel	06/01-07/05	PK20PR-L11	3142	1.1	-	IK20TT	IK20TT	6
MGA (55-62)											
1.5	51	15GB		05/55-04/60	W20ESR-U	3057	0.8	-	-		4
1.6	59	16GA		01/58-04/60	W20ESR-U	3057	0.8	-	-		4
1.6	81	16GB		01/58-05/60	W22ESR-U	3098	0.8	-	-		4
MGB (66-80)											
1.8	71	18GB		06/75-01/80	W20EPR-U	3047	0.8	W20TT	IW20TT	IW20TT	4
1.8 (D3)	68	18G		07/65-11/80	W20EPR-U	3047	0.8	W20TT	IW20TT	IW20TT	4
1.8 (D3, GHD5L)	71	18G		07/65-11/80	W20EPR-U	3047	0.8	W20TT	IW20TT	IW20TT	4
1.8 (N3)	68/71	18G		05/62-12/80	W20EPR-U	3047	0.8	W20TT	IW20TT	IW20TT	4
3.5 (D1)	101	15G		10/72-12/77	W16FPR-U	4192	0.7	-	-		8
MGC (67-69)											
3.0	108	29GH		01/67-09/69	W20EPR-U	3047	0.8	W20TT	IW20TT	IW20TT	6
MGF (95-02)											
1.6	82	16K4F4		02/00-03/02	PK20PR-P8	3245	0.8	-	IK20TT	IK20TT	4
1.8 i 16V	88	18 K4F		03/95-03/02	PK20PR-P8	3245	0.8	-	IK20TT	IK20TT	4
1.8 i VVC	107	18 K4K		03/95-03/02	PK20PR-L11	3142	1.1	-	IK20TT	IK20TT	4
1.8 i VVC	118	18 K4K		10/01-03/02	PK20PR-P8	3245	0.8	-	IK20TT	IK20TT	4
MIDGET (64-79)											
1.1	41	10CG		01/64-12/66	W16EPR-U	3021	0.8	W16TT	IW16TT	IW16TT	4
1.3	48	12 H		01/67-09/74	W16EPR-U	3021	0.8	W16TT	IW16TT	IW16TT	4
1.5	49	15CE		09/74-12/79	W16EPR-U	3021	0.8	W16TT	IW16TT	IW16TT	4





Свечи зажигания и Свечи накаливания

Таблица применения

	KW				СТАНДАРТНЫЕ			Twin Tip			QTY
MG продолжение											
MONTEGO (84-90)											
2.0 EFI	86	20HA/20HB55/ 20HB59, 20HB60, 20HB69/B78, 20HD55		04/84-09/90	W20EPR-U	3047	0.8	W20TT	IW20TT	IW20TT	4
MINI											
MINI (F55, F56) (13-)											
2.0 Cooper SD	120/ 125	B47 C20 A; B47 C20 B		07/16-	DG-613		7V				4
2.0 Cooper SD	120/ 125	B47 C20 A; B47 C20 B	Pressure sensor (-)	09/13-07/16	DG-613		7V				3
MINI (R50, R53) (01-06)											
1.4 One	55	W10 B14 A		04/03-09/06	K20TXR	5063	1.0	K20TT	IK20TT	IK20TT	4
1.4 One D	55/65	1ND; W17 D14 (1ND)	Double Coil(LPH)	06/03-09/06	DG-240		11V				4
1.6 Cooper	85	W10 B16 A		06/01-09/06	K20TXR	5063	1.0	K20TT	IK20TT	IK20TT	4
1.6 Cooper S	120/ 125	W11 B16 A		03/02-09/06	K20TXR	5063	1.0	K20TT	IK20TT	IK20TT	4
1.6 John Cooper Works	160	W11 B16 A		03/06-09/06	IK22	5310	0.8	-	IK22TT	VK22	4
1.6 One	66	W10 B16 A		06/01-09/06	K20TXR	5063	1.0	K20TT	IK20TT	IK20TT	4
1.6 S Works	149	W11 B16 A		11/03-06/05	IK22	5310	0.8	-	IK22TT	VK22	4
1.6 Works	155	W11 B16 A		11/03-09/06	IK22	5310	0.8	-	IK22TT	VK22	4
MINI (R56) (06-13)											
1.4 One	55/70	N12 B14 A	Use narrow 16mm Hex socket	11/06-03/10	VXUH22I	5656	0.9	-	IXUH22TT	VXUH22I	4
1.6 Cooper	85/ 88/90	N12 B16 A; N16 B16 A	Use narrow 16mm Hex socket	09/06-11/13	VXUH22I	5656	0.9	-	IXUH22TT	VXUH22I	4
1.6 Cooper D	80	9HZ (DV6TED4); W16 D16 (9HZ)	Double Coil(LPH)	11/06-09/10	DG-180		11V				4
1.6 Cooper D	82	N47 C16 A	OE:122377980 01	06/10-11/13	DG-607		4.4V				4
1.6 Cooper D	82	N47 C16 A	OE:122377980 01	06/10-11/13	DG-623		5.4V				4
1.6 Cooper S	120/ 128/ 135/ 147	N14 B16 A; N14 B16 AB; N18 B16 A	Use narrow 16mm Hex socket	10/06-11/13	VXUH22I	5656	0.9	-	IXUH22TT	VXUH22I	4
1.6 Cooper S John Cooper Works	141	N14 B16 A; N14 B16 AB	Use narrow 16mm Hex socket	11/06-02/10	VXUH22I	5656	0.9	-	IXUH22TT	VXUH22I	4
1.6 John Cooper Works	155	N14 B16 C; N18 B16 C	Use narrow 16mm Hex socket	11/07-11/13	VXUH22I	5656	0.9	-	IXUH22TT	VXUH22I	4
1.6 John Cooper Works GP	160	N14 B16 C; N18 B16 C	Use narrow 16mm Hex socket	09/12-11/13	VXUH22I	5656	0.9	-	IXUH22TT	VXUH22I	4
1.6 One	55/72	N16 B16 A	Use narrow 16mm Hex socket	03/10-11/13	VXUH22I	5656	0.9	-	IXUH22TT	VXUH22I	4
1.6 One D	66	9HZ (DV6TED4)	Double Coil(LPH)	06/09-07/10	DG-180		11V				4
1.6 One D	66	N47 C16 A	OE:122377980 01	07/10-11/13	DG-607		4.4V				4
1.6 One D	66	N47 C16 A	OE:122377980 01	07/10-11/13	DG-623		5.4V				4
2.0 Cooper D	82	N47 C20 A	OE:122377980 01	02/11-11/13	DG-607		4.4V				4
2.0 Cooper D	82	N47 C20 A	OE:122377980 01	02/11-11/13	DG-623		5.4V				4
2.0 Cooper SD	100/ 105	N47 C20 A	OE:122377980 01	02/11-11/13	DG-607		4.4V				4
2.0 Cooper SD	100/ 105	N47 C20 A	OE:122377980 01	02/11-11/13	DG-623		5.4V				4
MINI Clubman (F54) (14-)											
2.0 Cooper D	100/ 110	B47 C20 A; B47 C20 B		07/16-	DG-613		7V				4
2.0 Cooper D	100/ 110	B47 C20 A; B47 C20 B	Pressure sensor (-)	12/14-07/16	DG-613		7V				3
2.0 Cooper SD	120/ 140	B47 C20 A; B47 C20 B		07/16-	DG-613		7V				4
2.0 Cooper SD	120/ 140	B47 C20 A; B47 C20 B	Pressure sensor (-)	02/15-07/16	DG-613		7V				3
2.0 Cooper SD ALL4	120/ 140	B47 C20 A; B47 C20 B		07/16-	DG-613		7V				4
2.0 Cooper SD ALL4	120/ 140	B47 C20 A; B47 C20 B	Pressure sensor (-)	04/15-07/16	DG-613		7V				3

Свечи зажигания и Свечи накаливания





Таблица применения

	KW				СТАНДАРТНЫЕ			Twin Tip			QTY
MINI продолжение											
MINI Clubman (R55) (07-14)											
1.4 One	70	N12 B14 A	Use narrow 16mm Hex socket	03/09-02/10	VXUH22I	5656	0.9	-	IXUH22TT	VXUH22I	4
1.6 Cooper	85/ 88/90	N12 B16 A; N16 B16 A	Use narrow 16mm Hex socket	10/07-06/14	VXUH22I	5656	0.9	-	IXUH22TT	VXUH22I	4
1.6 Cooper D	80	9HZ (DV6TED4)	Double Coil(LPH)	10/07-02/10	DG-180		11V				4
1.6 Cooper D	82	N47 C16 A	OE:122377980 01	03/10-06/14	DG-607		4.4V				4
1.6 Cooper D	82	N47 C16 A	OE:122377980 01	03/10-06/14	DG-623		5.4V				4
1.6 Cooper S	120/ 128/ 135/ 147	N14 B16 A; N14 B16 AB; N18 B16 A	Use narrow 16mm Hex socket	08/07-06/14	VXUH22I	5656	0.9	-	IXUH22TT	VXUH22I	4
1.6 Cooper S John Cooper Works	141	N14 B16 AB	Use narrow 16mm Hex socket	10/08-02/10	VXUH22I	5656	0.9	-	IXUH22TT	VXUH22I	4
1.6 John Cooper Works	155	N14 B16 C; N18 B16 C	Use narrow 16mm Hex socket	11/07-06/14	VXUH22I	5656	0.9	-	IXUH22TT	VXUH22I	4
1.6 One	72	N16 B16 A	Use narrow 16mm Hex socket	03/10-06/14	VXUH22I	5656	0.9	-	IXUH22TT	VXUH22I	4
1.6 One D	66	N47 C16 A	OE:122377980 01	03/10-06/14	DG-607		4.4V				4
1.6 One D	66	N47 C16 A	OE:122377980 01	03/10-06/14	DG-623		5.4V				4
2.0 Cooper D	82	N47 C20 A	OE:122377980 01	02/11-06/14	DG-607		4.4V				4
2.0 Cooper D	82	N47 C20 A	OE:122377980 01	02/11-06/14	DG-623		5.4V				4
2.0 Cooper SD	100/ 105	N47 C20 A	OE:122377980 01	02/11-06/14	DG-607		4.4V				4
2.0 Cooper SD	100/ 105	N47 C20 A	OE:122377980 01	02/11-06/14	DG-623		5.4V				4
MINI Convertible (F57) (14-)											
2.0 Cooper SD	120/ 125	B47 C20 A; B47 C20 B		07/16-	DG-613		7V				4
2.0 Cooper SD	120/ 125	B47 C20 A; B47 C20 B	Pressure sensor (-)	05/15-07/16	DG-613		7V				3
MINI Convertible (R52) (04-07)											
1.6 Cooper	85	W10 B16 A		07/04-11/07	K20TXR	5063	1.0	K20TT	IK20TT	IK20TT	4
1.6 Cooper S	120/ 125	W11 B16 A		07/04-11/07	K20TXR	5063	1.0	K20TT	IK20TT	IK20TT	4
1.6 John Cooper Works	155	W11 B16 A		07/04-11/07	IK22	5310	0.8	-	IK22TT	VK22	4
1.6 One	66	W10 B16 A		07/04-11/07	K20TXR	5063	1.0	K20TT	IK20TT	IK20TT	4
MINI Convertible (R57) (07-15)											
1.6 Cooper	85/ 88/90	N12 B16 A; N16 B16 A	Use narrow 16mm Hex socket	10/07-06/15	VXUH22I	5656	0.9	-	IXUH22TT	VXUH22I	4
1.6 Cooper D	82	N47 C16 A	OE:122377980 01	05/09-11/13	DG-607		4.4V				4
1.6 Cooper D	82	N47 C16 A	OE:122377980 01	05/09-11/13	DG-623		5.4V				4
1.6 Cooper S	120/ 128/ 135/ 147	N14 B16 A; N14 B16 AB; N18 B16 A	Use narrow 16mm Hex socket	10/07-06/15	VXUH22I	5656	0.9	-	IXUH22TT	VXUH22I	4
1.6 John Cooper Works	155	N14 B16 C; N18 B16 C	Use narrow 16mm Hex socket	08/08-05/15	VXUH22I	5656	0.9	-	IXUH22TT	VXUH22I	4
1.6 One	72	N16 B16 A	Use narrow 16mm Hex socket	09/09-06/15	VXUH22I	5656	0.9	-	IXUH22TT	VXUH22I	4
2.0 Cooper D	82	N47 C20 A	OE:122377980 01	02/11-05/15	DG-607		4.4V				4
2.0 Cooper D	82	N47 C20 A	OE:122377980 01	02/11-05/15	DG-623		5.4V				4
2.0 Cooper SD	105	N47 C20 A	OE:122377980 01	06/09-05/15	DG-607		4.4V				4
2.0 Cooper SD	105	N47 C20 A	OE:122377980 01	06/09-05/15	DG-623		5.4V				4
MINI Countryman (F60) (16-)											
2.0 Cooper D	100/ 110	B47 C20 A		10/16-	DG-613		7V				4
2.0 Cooper D ALL4	100/ 110	B47 C20 A		10/16-	DG-613		7V				4

Свечи зажигания и Свечи накаливания

Таблица применения

Таблица применения

	KW				СТАНДАРТНЫЕ				Twin Tip			QTY
MINI продолжение												
MINI Countryman (F60) (16-) продолжение												
2.0 Cooper SD	120/ 140	B47 C20 A		10/16-	DG-613		7V					4
2.0 Cooper SD ALL4	120/ 140	B47 C20 A		10/16-	DG-613		7V					4
MINI Countryman (R60) (10-16)												
1.6 Cooper	85/ 88/90	N16 B16 A	Use narrow 16mm Hex socket	08/10-10/16	VXUH22I	5656	0.9	-	IXUH22TT	VXUH22I		4
1.6 Cooper ALL4	90	N16 B16 A; N18 B16 A	Use narrow 16mm Hex socket	11/12-10/16	VXUH22I	5656	0.9	-	IXUH22TT	VXUH22I		4
1.6 Cooper D	82	N47 C16 A	OE:122377980 01	08/10-10/16	DG-607		4.4V					4
1.6 Cooper D	82	N47 C16 A	OE:122377980 01	08/10-10/16	DG-623		5.4V					4
1.6 Cooper D ALL4	82	N47 C16 A	OE:122377980 01	08/10-10/16	DG-607		4.4V					4
1.6 Cooper D ALL4	82	N47 C16 A	OE:122377980 01	08/10-10/16	DG-623		5.4V					4
1.6 Cooper S	135/ 140/ 147	N18 B16 A	Use narrow 16mm Hex socket	08/10-10/16	VXUH22I	5656	0.9	-	IXUH22TT	VXUH22I		4
1.6 Cooper S ALL4	120/ 135/ 140	N18 B16 A	Use narrow 16mm Hex socket	08/10-10/16	VXUH22I	5656	0.9	-	IXUH22TT	VXUH22I		4
1.6 John Cooper Works ALL4	160	N18 B16 C	Use narrow 16mm Hex socket	11/12-10/16	VXUH22I	5656	0.9	-	IXUH22TT	VXUH22I		4
1.6 One	72	N16 B16 A	Use narrow 16mm Hex socket	08/10-10/16	VXUH22I	5656	0.9	-	IXUH22TT	VXUH22I		4
1.6 One D	66	N47 C16 A	OE:122377980 01	08/10-10/16	DG-607		4.4V					4
1.6 One D	66	N47 C16 A	OE:122377980 01	08/10-10/16	DG-623		5.4V					4
2.0 Cooper D	82	N47 C20 A	OE:122377980 01	03/11-10/16	DG-607		4.4V					4
2.0 Cooper D	82	N47 C20 A	OE:122377980 01	03/11-10/16	DG-623		5.4V					4
2.0 Cooper D ALL4	82	N47 C20 A	OE:122377980 01	03/11-10/16	DG-607		4.4V					4
2.0 Cooper D ALL4	82	N47 C20 A	OE:122377980 01	03/11-10/16	DG-623		5.4V					4
2.0 Cooper SD	105	N47 C20 A	OE:122377980 01	03/11-10/16	DG-607		4.4V					4
2.0 Cooper SD	105	N47 C20 A	OE:122377980 01	03/11-10/16	DG-623		5.4V					4
2.0 Cooper SD ALL4	100/ 105	N47 C20 A	OE:122377980 01	03/11-10/16	DG-607		4.4V					4
2.0 Cooper SD ALL4	100/ 105	N47 C20 A	OE:122377980 01	03/11-10/16	DG-623		5.4V					4
MINI Coupe (R58) (10-15)												
1.6 Cooper	85/90	N16 B16 A	Use narrow 16mm Hex socket	12/10-04/15	VXUH22I	5656	0.9	-	IXUH22TT	VXUH22I		4
1.6 Cooper S	120/ 135	N14 B16 A; N18 B16 A	Use narrow 16mm Hex socket	12/10-04/15	VXUH22I	5656	0.9	-	IXUH22TT	VXUH22I		4
1.6 Cooper S JCW	147	N18 B16 A	Use narrow 16mm Hex socket	12/10-04/15	VXUH22I	5656	0.9	-	IXUH22TT	VXUH22I		4
1.6 John Cooper Works	155	N14 B16 C; N18 B16 C	Use narrow 16mm Hex socket	12/10-05/15	VXUH22I	5656	0.9	-	IXUH22TT	VXUH22I		4
2.0 Cooper SD	100/ 105	N47 C20 A	OE:122377980 01	12/10-05/15	DG-607		4.4V					4
2.0 Cooper SD	100/ 105	N47 C20 A	OE:122377980 01	12/10-05/15	DG-623		5.4V					4
MINI Paceman (R61) (12-16)												
1.6 Cooper	88/90	N16 B16 A	Use narrow 16mm Hex socket	04/12-09/16	VXUH22I	5656	0.9	-	IXUH22TT	VXUH22I		4
1.6 Cooper ALL4	90	N16 B16 A; N18 B16 A	Use narrow 16mm Hex socket	11/12-09/16	VXUH22I	5656	0.9	-	IXUH22TT	VXUH22I		4
1.6 Cooper D	82	N47 C16 A	OE:122377980 01	04/12-09/16	DG-607		4.4V					4
1.6 Cooper D	82	N47 C16 A	OE:122377980 01	04/12-09/16	DG-623		5.4V					4

Свечи зажигания и Свечи накаливания

Таблица применения











	KW				СТАНДАРТНЫЕ				Twin Tip		QTY
											
MINI продолжение											
MINI Paceman (R61) (12-16) продолжение											
1.6 Cooper D ALL4	82	N47 C16 A	OE:122377980 01	04/12-09/16	DG-607		4.4V				4
1.6 Cooper D ALL4	82	N47 C16 A	OE:122377980 01	04/12-09/16	DG-623		5.4V				4
1.6 Cooper S	135/ 140	N18 B16 A	Use narrow 16mm Hex socket	11/12-10/16	VXUH22I	5656	0.9	-	IXUH22TT	VXUH22I	4
1.6 Cooper S ALL4	120/ 135/ 140	N18 B16 A	Use narrow 16mm Hex socket	03/12-09/16	VXUH22I	5656	0.9	-	IXUH22TT	VXUH22I	4
1.6 John Cooper Works	160	N18 B16 C	Use narrow 16mm Hex socket	03/13-10/16	VXUH22I	5656	0.9	-	IXUH22TT	VXUH22I	4
2.0 Cooper D	82	N47 C20 A	OE:122377980 01	07/12-09/16	DG-607		4.4V				4
2.0 Cooper D	82	N47 C20 A	OE:122377980 01	07/12-09/16	DG-623		5.4V				4
2.0 Cooper D ALL4	82	N47 C20 A	OE:122377980 01	03/12-09/16	DG-607		4.4V				4
2.0 Cooper D ALL4	82	N47 C20 A	OE:122377980 01	03/12-09/16	DG-623		5.4V				4
2.0 Cooper SD	105	N47 C20 A	OE:122377980 01	03/12-09/16	DG-607		4.4V				4
2.0 Cooper SD	105	N47 C20 A	OE:122377980 01	03/12-09/16	DG-623		5.4V				4
2.0 Cooper SD ALL4	100/ 105	N47 C20 A	OE:122377980 01	04/12-09/16	DG-607		4.4V				4
2.0 Cooper SD ALL4	100/ 105	N47 C20 A	OE:122377980 01	04/12-09/16	DG-623		5.4V				4
MINI Roadster (R59) (11-15)											
1.6 Cooper	85/90	N16 B16 A	Use narrow 16mm Hex socket	11/11-04/15	VXUH22I	5656	0.9	-	IXUH22TT	VXUH22I	4
1.6 Cooper S	120/ 135	N18 B16 A	Use narrow 16mm Hex socket	11/11-04/15	VXUH22I	5656	0.9	-	IXUH22TT	VXUH22I	4
1.6 Cooper S JCW	147	N18 B16 A	Use narrow 16mm Hex socket	11/11-04/15	VXUH22I	5656	0.9	-	IXUH22TT	VXUH22I	4
1.6 John Cooper Works	155	N14 B16 C; N18 B16 C	Use narrow 16mm Hex socket	11/11-04/15	VXUH22I	5656	0.9	-	IXUH22TT	VXUH22I	4
2.0 Cooper SD	100/ 105	N47 C20 A	OE:122377980 01	11/11-04/15	DG-607		4.4V				4
2.0 Cooper SD	100/ 105	N47 C20 A	OE:122377980 01	11/11-04/15	DG-623		5.4V				4
MITSUBISHI											
3000 GT (89-99)											
3.0 i 24V 4WD	210	6G72-4H/6G72-4V/ 6G72-GG		01/90-08/99	PK20PR-P11	3141	1.1	K20TT	IK20TT	IK20TT	6
ASX (10-)											
1.6 DI-D	84	9HD		07/15-	DG-603		5V				4
1.6 DI-D 4WD	84	9HD		07/15-	DG-603		5V				4
1.6 MIVEC	86	4A92		05/10-	IKH16TT	4703	1.0	-	IKH16TT		4
1.8	102	4B10		02/10-	SK20PR-A8	3403	0.8	-	IK20TT	IK20TT	4
1.8 DI-D	85/ 110	4N13	OE:160784998 0; 1820-A019; RP8488;GN123	06/10-	DG-656		11V				4
1.8 DI-D 4WD	85/ 110	4N13	OE:160784998 0; 1820-A019; RP8488;GN123	06/10-	DG-656		11V				4
2.0 i 4WD	110	4B11		06/10-	SK20PR-A8	3403	0.8	-	IK20TT	IK20TT	4
2.2 Di-D 4WD	110	4N14	OE:160784998 0; 1820-A019; RP8488;GN123	04/13-	DG-656		11V				4
CARISMA (95-06)											
1.6	66/ 70/ 73/76	4G92 (SOHC 16V)		07/95-06/06	K20PR-U11	3121	1.1	K20TT	IK20TT	IK20TT	4
1.8	85	4G93 (SOHC 16V)		07/95-04/96	K20PR-U11	3121	1.1	K20TT	IK20TT	IK20TT	4
1.8	85	4G93 (SOHC 16V)		05/96-09/97	VKB20	5625	1.1	-	-	VKB20	4
1.8 16V GDI	92	4G93 (GDI)		09/97-12/97	PKJ20CR8	3173	0.8	-	IK20TT	IK20TT	4
1.8 16V GDI	92	4G93 (GDI)	Direct Injection	12/97-06/06	VKB20	5625	1.1	-	-	VKB20	4
1.8 GDI	90	4G93 (GDI)		10/00-06/06	VKB20	5625	1.1	-	-	VKB20	4
1.8 MSX - 16V	103	4G93 (DOHC 16V)		07/95-07/97	PKJ20CR8	3173	0.8	-	IK20TT	IK20TT	4











Таблица применения

M

Свечи зажигания и Свечи накаливания

Таблица применения

Таблица применения

	KW				СТАНДАРТНЫЕ				Twin Tip			QTY
												
МИТСУБИШИ продолжение												
CARISMA (95-06) продолжение												
1.9 DI-D	75/85	F9Q1; F9Q2	Double Coil(LPH)	09/00-06/06	DG-005		11V					4
1.9 TD	66	F8QT	Double Coil(LPH)	10/96-09/00	DG-012		11V					4
2.0 16V GT EVO VI/VII	206	4G63 Turbo		11/99-06/06	P22PR8	3302	0.8	-	-		W22	4
COLT CZC (06-09)												
1.5	80	4A91		05/06-07/09	K20HR-U11	3381	1.1	KH20TT	IKH20TT	IKH20TT		4
1.5 Turbo	110	4G15T		05/06-07/09	IKH20TT	4704	1.0	-	IKH20TT			4
1.5 Turbo	110	4G15T		05/06-07/09	VKH20Y	5639	0.8	-	-	VKH20Y		4
COLT I (78-84)												
1.2 GL	40	4 G 11		12/78-01/84	W16EPR-U	3021	0.8	W16TT	IW16TT	IW16TT		4
1.4 GLX,GT	51	4 G 12		05/79-01/84	W16EPR-U	3021	0.8	W16TT	IW16TT	IW16TT		4
1.4 Turbo	77	4 G 12 T		09/81-01/84	W20EPR-U	3047	0.8	W20TT	IW20TT	IW20TT		4
COLT II (84-88)												
1.2 EL,GL	40/44	4G16		02/84-04/88	W20EPR-U	3047	0.8	W20TT	IW20TT	IW20TT		4
1.3 EL,GL	49	G13B		06/86-04/88	W20EPR-U11	3049	1.1	W20TT	IW20TT	IW20TT		4
1.5 GLX	51	G15B		09/85-04/88	W20EPR-U11	3049	1.1	W20TT	IW20TT	IW20TT		4
1.5 GLX	55	4G15 (8V)		09/84-04/88	W20EPR-U	3047	0.8	W20TT	IW20TT	IW20TT		4
1.6 Turbo ECi	77	4G32T		07/86-04/88	W22EPR-U	3088	0.8	W22TT	-	W22		4
1.6 Turbo ECi	92	4 G 32 T/C		02/84-04/88	W20EPR-U	3047	0.8	W20TT	IW20TT	IW20TT		4
1.8 GL Diesel	44	4D65	Single Coil	02/84-04/88	DG-198		11V					4
COLT III (88-92)												
1.3	51	4G13 (8V)		04/88-06/90	W20EPR-U	3047	0.8	W20TT	IW20TT	IW20TT		4
1.3 12V	55	4 G 13 (12V)		04/88-05/92	W20EPR-U11	3049	1.1	W20TT	IW20TT	IW20TT		4
1.3 GL	44	4 G 13		04/88-12/90	W16EPR-U	3018	0.8	W16TT	IW16TT	IW16TT		4
1.5 Cat	66	4G15 (12V)		07/90-04/91	W20EPR-U11	3049	1.1	W20TT	IW20TT	IW20TT		4
1.5 Cat	66	4G15 (12V)		05/91-05/92	W16EPR-U11	3201	1.1	W16TT	IW16TT	IW16TT		4
1.5 GLXi	62	4G15 (8V)		04/88-05/92	W20EPR-U	3047	0.8	W20TT	IW20TT	IW20TT		4
1.6 GTi 16V	91	4G61		04/88-05/90	W20EPR-U	3047	0.8	W20TT	IW20TT	IW20TT		4
1.8 Diesel GLX	44	4D65	Single Coil	04/88-05/92	DG-198		11V					4
1.8 GTi 16V Cat	100	4G67		06/90-05/92	W20EPR-U11	3049	1.1	W20TT	IW20TT	IW20TT		4
COLT IV (92-96)												
1.3 GLi 12V	55	4 G 13(BJ92-../12V)		04/92-04/96	W16EPR-U11	3201	1.1	W16TT	IW16TT	IW16TT		4
1.6	66	4G92 (SOHC 16V)		02/94-04/96	K20PR-U11	3121	1.1	K20TT	IK20TT	IK20TT		4
1.6	66	4G92 MVV	LEAN BURN	02/94-04/96	K16PR-U11	3130	1.1	K16TT	IK16TT	IK16TT		4
1.6 4WD	84	4G92 (SOHC 16V)		08/93-08/95	K20PR-U11	3121	1.1	K20TT	IK20TT	IK20TT		4
1.6 4WD	84	4G92 MVV	LEAN BURN	08/93-11/93	K20PR-U11	3121	1.1	K20TT	IK20TT	IK20TT		4
1.6 4WD	84	4G92 MVV	LEAN BURN	12/93-08/95	K16PR-U11	3130	1.1	K16TT	IK16TT	IK16TT		4
1.6 GLXi 16V	83	4G92 (SOHC 16V)		04/92-04/96	K20PR-U11	3121	1.1	K20TT	IK20TT	IK20TT		4
1.6 GLXi 16V	83	4G92 MVV	LEAN BURN	04/92-11/93	K20PR-U11	3121	1.1	K20TT	IK20TT	IK20TT		4
1.6 GLXi 16V	83	4G92 MVV	LEAN BURN	12/93-04/96	K16PR-U11	3130	1.1	K16TT	IK16TT	IK16TT		4
1.8 GTi 16V	103	4G93		04/92-04/96	K20PR-U11	3121	1.1	K20TT	IK20TT	IK20TT		4
COLT V (95-03)												
1.5 16V	69	4G15		10/99-05/00	W16EPR-U	3021	0.8	W16TT	IW16TT	IW16TT		4
1.5 16V	69	4G15 (16V)		10/99-09/03	W16EPR-U11	3201	1.1	W16TT	IW16TT	IW16TT		4
1300	60	4G13-6		06/00-09/03	W16EPR-U11	3201	1.1	W16TT	IW16TT	IW16TT		4
1300 GL, GLX	55	4G13-38/4G13-380		05/96-06/00	W16EPR-U11	3201	1.1	W16TT	IW16TT	IW16TT		4
1600	76	4G92 (SOHC 16V)		09/00-09/03	K20PR-U11	3121	1.1	K20TT	IK20TT	IK20TT		4
1600	76	4G92 MVV	LEAN BURN	09/00-09/03	K20PR-U11	3121	1.1	K20TT	IK20TT	IK20TT		4
1600 GLX	66	4G92 (SOHC 16V)		05/96-09/00	K20PR-U11	3121	1.1	K20TT	IK20TT	IK20TT		4
1600 GLX	66	4G92 MVV	LEAN BURN	05/96-05/99	K16PR-U11	3130	1.1	K16TT	IK16TT	IK16TT		4
1600 GLX	66	4G92 MVV	LEAN BURN	06/99-09/00	K20PR-U11	3121	1.1	K20TT	IK20TT	IK20TT		4
COLT VI (04-12)												
1.1	55	3A91		10/04-06/12	K20HR-U11	3381	1.1	KH20TT	IKH20TT	IKH20TT		3
1.1 LPG	55	3A91		10/04-06/12	K20HR-U11	3381	1.1	KH20TT	IKH20TT	IKH20TT		3
1.3	68/70	4A90		06/04-06/12	IKH20TT	4704	1.0	-	IKH20TT			4
1.3	68/70	4A90	Japan	06/10-06/12	IKH16TT	4703	1.0	-	IKH16TT			4
1.3 LPG	70	4A90		06/04-06/12	IKH20TT	4704	1.0	-	IKH20TT			4
1.3 LPG	70	4A90	Japan	06/10-06/12	IKH16TT	4703	1.0	-	IKH16TT			4
1.5	80	4A91		06/04-06/12	K20HR-U11	3381	1.1	KH20TT	IKH20TT	IKH20TT		4
1.5	80	4A91	OEM Optional	06/04-06/12	IKH20TT	4704	1.0	-	IKH20TT			4
1.5 CZT	110	4G15T		03/05-06/12	IKH20TT	4704	1.0	-	IKH20TT			4
1.5 CZT	110	4G15T		03/05-06/12	VKH20Y	5639	0.8	-	-	VKH20Y		4
1.5 DI-D	50/70	OM 639.939		08/04-06/12	DG-606		11.5V					3
CORDIA (82-89)												
1.6 GSL	55	4G32		10/82-12/86	W20EPR-U	3043	0.8	W20TT	IW20TT	IW20TT		4
1.6 Turbo	85	4G32 T		10/82-05/85	W20EPR-U	3047	0.8	W20TT	IW20TT	IW20TT		4

Свечи зажигания и Свечи накаливания

Таблица применения











	KW				СТАНДАРТНЫЕ			Twin Tip			QTY
											
MITSUBISHI продолжение											
CORDIA (82-89) продолжение											
1.8 Turbo ECi	100	4G62 T		10/84-07/89	W22ESR-U	3098	0.8	-	-		4
DIAMANTE (99-05)											
2.5	147/ 151	6G72		09/99-11/05	VKA16	5622	1.1	-	-	VKA16	6
ECLIPSE I (89-95)											
1.8	68	4G37		12/89-03/94	W20EPR-U11	3049	1.1	W20TT	IW20TT	IW20TT	4
2.0 i 16V	110	4G63 (DOHC 16V)		04/91-11/95	W20EPR-U	3047	0.8	W20TT	IW20TT	IW20TT	4
2.0 i 16V 4WD	110	4G63 (DOHC 16V)		04/91-11/95	W20EPR-U	3047	0.8	W20TT	IW20TT	IW20TT	4
2.0 Turbo	147	4G63-T (DOHC 16V)		12/89-03/94	W20EPR-U	3047	0.8	W20TT	IW20TT	IW20TT	4
ECLIPSE II (94-99)											
2000 GS 16V	107	4 G 63		12/95-04/99	W20EPR-U	3047	0.8	W20TT	IW20TT	IW20TT	4
2000 GT 16V	157	4G63-7L		12/95-04/99	W20EPR-U11	3049	1.1	W20TT	IW20TT	IW20TT	4
2000 GT 16V	157	4G63-7L	OEM Optional	12/95-04/99	W22EPR-U	3088	0.8	W22TT	-	WV22	4
ECLIPSE IV (05-12)											
2.4 GS	120	4G69		04/05-12/11	IKH20TT	4704	1.0	-	IKH20TT		4
GALANT I (77-80)											
1.6	55	4G32		01/77-08/80	W20EP-U	3043	0.8	W20TT	IW20TT	IW20TT	4
2.0	72	4G52		01/79-08/80	W20EP-U	3043	0.8	W20TT	IW20TT	IW20TT	4
GALANT II (80-84)											
1.6 GLX	55	4G32		09/80-05/84	W16EPR-U	3021	0.8	W16TT	IW16TT	IW16TT	4
2.0 GLS	75	4G63		09/80-05/84	W20EPR-U	3047	0.8	W20TT	IW20TT	IW20TT	4
2.0 Turbo ECi	125	4 G 63 T (ECi)		05/82-05/84	W22ESR-U	3098	0.8	-	-		4
2.3 Turbo-D	62	4D55 T	Single Coil	09/80-05/84	DG-162		6V				4
2.3 Turbo-D	62	4D55 T	Single Coil	09/80-05/84	DG-198		11V				4
GALANT III (84-90)											
1.6 GLX	55	4G32		06/84-04/90	W16EPR-U	3021	0.8	W16TT	IW16TT	IW16TT	4
1.8 Turbo-D	60	4D65 T	Single Coil	06/84-04/90	DG-198		11V				4
2.0 GLS	66	G63B		06/86-04/90	W20EPR-U11	3049	1.1	W20TT	IW20TT	IW20TT	4
2.0 GLS	75	4G63		06/84-04/90	W20EPR-U	3047	0.8	W20TT	IW20TT	IW20TT	4
2.0 Turbo ECi	110	4 G 63 T		06/84-04/90	W22ESR-U	3098	0.8	-	-		4
2.4 GLS	82	G64B		07/85-04/90	W20EPR-U11	3049	1.1	W20TT	IW20TT	IW20TT	4
GALANT IV (87-92)											
1.6	55	4G32		01/88-10/92	W20EPR-U	3047	0.8	W20TT	IW20TT	IW20TT	4
1.8	63	4G37		11/87-08/90	W20EPR-U11	3049	1.1	W20TT	IW20TT	IW20TT	4
1.8	66	4G37		11/87-10/92	W20EPR-U	3047	0.8	W20TT	IW20TT	IW20TT	4
1.8 Turbo-D	55	4D65 T	Single Coil	12/87-10/92	DG-198		11V				4
2.0	80	4G63		11/87-10/92	W20EPR-U	3047	0.8	W20TT	IW20TT	IW20TT	4
2.0 4WD	80	4G63		12/88-10/92	W20EPR-U	3047	0.8	W20TT	IW20TT	IW20TT	4
2.0 GTi 16V	107	4 G 63; 4G63 (DOHC 16V)		11/87-10/92	W20EPR-U	3047	0.8	W20TT	IW20TT	IW20TT	4
2.0 GTi 16V 4WD	106	4 G 63; 4G63 (DOHC 16V)		06/88-12/92	W20EPR-U	3047	0.8	W20TT	IW20TT	IW20TT	4
GALANT V (92-96)											
1.8	85	4G93		02/94-08/96	K16PR-U11	3130	1.1	K16TT	IK16TT	IK16TT	4
1.8	85	4G93		02/94-08/96	K20PR-U11	3121	1.1	K20TT	IK20TT	IK20TT	4
1.8 GLSi	93	4G93		11/92-08/96	K20PR-U11	3121	1.1	K20TT	IK20TT	IK20TT	4
2.0 GLSi	101	4G63		11/92-08/96	W20EPR-U	3047	0.8	W20TT	IW20TT	IW20TT	4
2.0 GLSi 4WD	101	4G63		11/92-08/96	W20EPR-U	3047	0.8	W20TT	IW20TT	IW20TT	4
2.0 GLSTD	66	4D68 T	Double Coil(LPH)	11/92-08/96	DG-174		11V				4
2.0 V6-24	110	6A12		11/92-08/96	K20PR-U11	3121	1.1	K20TT	IK20TT	IK20TT	6
2.0 V6-24	110	6A12		11/92-08/96	PK20PR-P11	3141	1.1	K20TT	IK20TT	IK20TT	6
2.5 V6-24 4WD	125	6G73		11/92-08/96	PK20PR-P11	3141	1.1	K20TT	IK20TT	IK20TT	6
GALANT VI (96-04)											
2.0	98/ 100	4G63-6G/4G63- 6GR/ 4G63- 6M, 4G63- 6T; 4G63-6G/4G63- 6GR/ 4G63-6T		09/96-05/03	K20PR-U11	3121	1.1	K20TT	IK20TT	IK20TT	4
2.0 TDI	66	4D68 T	Double Coil(LPH)	09/96-10/04	DG-174		11V				4
2.4 GDI	106/ 110	4G64-41/4G64- 41R/ 4G64- 43; 4G64-418		02/99-10/03	VKB16	5624	1.1	-	-	VKB16	4
2.5 V6 24V	118/ 120	6A13-41/6A13-48; 6A13-4E/6A13-4F		09/96-05/03	PK20PR11	3168	1.1	K20TT	IK20TT	IK20TT	6
2.8 TD	92	4M40-T		10/96-07/01	DG-643		11V				4
GALANT VII (03-)											
2.4	116	4G69		10/03-	IKH20TT	4704	1.0	-	IKH20TT		4











Таблица применения

M

Свечи зажигания и Свечи накаливания

Таблица применения

Таблица применения

	KW				СТАНДАРТНЫЕ				Twin Tip			QTY
												
MITSUBISHI продолжение												
GALLOPER (98-03)												
2.5 TD	65	D4BF		09/98-12/03	DG-301		11V					4
2.5 TD intercooler	73	D4BH		09/98-12/03	DG-301		11V					4
GRANDIS (04-11)												
2.0 DI-D	100/103	BSY; BWC	OE: MN980234	09/05-05/07	DG-190		4.4V					4
2.0 DI-D	100/103	BSY; BWC	OE: MN980406	05/07-03/10	DG-622		7V					4
2.4	130	4G69		04/04-12/11	IKH20TT	4704	1.0	-	IKH20TT			4
2.4 MIVEC	121	4G69		04/04-12/11	IKH20TT	4704	1.0	-	IKH20TT			4
i-MiEV (06-)												
0.7	38	3B20		02/07-	XU22HDR9	3445	0.9	XUH22TT	IXUH22TT	VXUH22I		3
0.7	42	3B20 T		01/06-	SXU22HDR8	3441	0.8	-	IXUH22TT	VXUH22I		3
L 200 / TRITON (05-15)												
2.5 DI-D	94/100/123	4D56 (16V); 4D56 HP	OE:1820-A009; RP8486;GN121 ; GLP252;CZ251	11/05-08/11	DG-655		11V					4
2.5 DI-D	94/100/123	4D56 (16V); 4D56 HP	OE: 1820A020	08/11-12/15	DG-662		11V					4
2.5 DI-D 4WD	100/123/131	4D56 HP	OE:1820-A009; RP8486;GN121 ; GLP252;CZ251	11/05-08/11	DG-655		11V					4
2.5 DI-D 4WD	100/123/131	4D56 HP	OE: 1820A020	08/11-12/15	DG-662		11V					4
2.5 DI-D 16V 4WD	98	4D56 (16V)	OE:1820-A009; RP8486;GN121 ; GLP252;CZ251	04/07-08/11	DG-655		11V					4
2.5 DI-D 16V 4WD	98	4D56 (16V)	OE: 1820A020	08/11-12/15	DG-662		11V					4
L 200 / TRITON (14-)												
2.4 DI-D	113	4N15	OE:160784998 0; 1820-A019; RP8488;GN123	09/15-	DG-656		11V					4
2.4 DI-D 4WD	113	4N15	OE:160784998 0; 1820-A019; RP8488;GN123	09/15-	DG-656		11V					4
2.4 DI-D 4WD (KL1T)	133	4N15	OE:160784998 0; 1820-A019; RP8488;GN123	11/14-	DG-656		11V					4
L 200 (80-86)												
1.6	60	4G32		03/80-08/84	W20EP-U	3043	0.8	W20TT	IW20TT	IW20TT		4
2.3 D 4WD	62	4D55	Single Coil	01/83-10/86	DG-162		6V					4
2.3 D 4WD	62	4D55	Single Coil	01/83-10/86	DG-198		11V					4
L 200 (86-96)												
2.0	75	4G63		11/86-08/96	W20EPR-U	3047	0.8	W20TT	IW20TT	IW20TT		4
2.0 4WD	75	4G63		11/86-08/96	W20EPR-U	3047	0.8	W20TT	IW20TT	IW20TT		4
2.5 D	51	4D56 (8V)	Double Coil(LPH)	11/86-10/96	DG-174		11V					4
2.5 D	51	4D56 (8V)	Single Coil	11/86-10/96	DG-198		11V					4
2.5 D 4WD	51	4D56 (8V)	Double Coil(LPH)	12/87-05/93	DG-174		11V					4
2.5 D 4WD	51	4D56 (8V)	Single Coil	12/87-05/93	DG-198		11V					4
2.5 TD 4WD	64	4D56 T	Double Coil(LPH)	11/92-08/96	DG-174		11V					4
2.5 TD 4WD	64	4D56 T	Single Coil	11/92-08/96	DG-198		11V					4
2.6 4WD	76	G54B		11/89-05/95	W20EPR-U11	3049	1.1	W20TT	IW20TT	IW20TT		4
L 200 (96-07)												
2.0	90	4G63-6H		06/96-06/01	K16PR-U11	3130	1.1	K16TT	IK16TT	IK16TT		4
2.4 4WD	97	4G64		06/96-11/97	W20EPR-U11	3049	1.1	W20TT	IW20TT	IW20TT		4
2.4 4WD	97	4G64-2G		06/96-12/07	K16PR-U11	3130	1.1	K16TT	IK16TT	IK16TT		4
2.5 D	55	4D56 (8V)	Double Coil(LPH)	06/96-12/07	DG-174		11V					4
2.5 D	55	4D56 (8V)	Single Coil	06/96-12/07	DG-198		11V					4
2.5 TD	66	4D56 T	Double Coil(LPH)	08/01-11/05	DG-174		11V					4
2.5 TD	66	4D56 T	Single Coil	08/01-11/05	DG-198		11V					4
2.5 TD 4WD	73/85/98	4D56 TD	Double Coil(LPH)	06/96-12/07	DG-174		11V					4

Свечи зажигания и Свечи накаливания

Таблица применения











	KW				СТАНДАРТНЫЕ			Twin Tip			QTY
											
MITSUBISHI продолжение											
L 200 (96-07) продолжение											
2.5 TD 4WD	73/ 85/98	4D56 TD	Single Coil	06/96-12/07	DG-198		11V				4
2.8 TD 4WD (K77T)	92	4M40-T		04/03-06/06	DG-643		11V				4
L 300 (80-87)											
1.6	48/51	4G32		05/80-04/94	W20EP-U	3043	0.8	W20TT	IW20TT	IW20TT	4
1.6	51	4G32		11/84-02/87	W16EPR-U	3021	0.8	W16TT	IW16TT	IW16TT	4
2.3 D	50	4D55	Single Coil	04/83-10/86	DG-162		6V				4
2.3 D	50	4D55	Single Coil	04/83-10/86	DG-198		11V				4
2.5 D	51	4D56 (8V)	Double Coil(LPH)	11/86-04/94	DG-174		11V				4
2.5 D	51	4D56 (8V)	Single Coil	11/86-04/94	DG-198		11V				4
L 300 (86-06)											
1.6	51	4G32		11/86-05/04	W16EPR-U	3021	0.8	W16TT	IW16TT	IW16TT	4
2.0	66	G63B		11/86-05/96	W20EPR-U11	3049	1.1	W20TT	IW20TT	IW20TT	4
2.0	66/ 82/85	4G63 (SOHC 16V); 4G63; G63B		11/86-05/04	W20EPR-U	3047	0.8	W20TT	IW20TT	IW20TT	4
2.0 4WD	65	4G63		11/86-05/04	W20EPR-U	3047	0.8	W20TT	IW20TT	IW20TT	4
2.0 i	83	4G63		06/94-08/97	K16PR-U11	3130	1.1	K16TT	IK16TT	IK16TT	4
2.4	82	4G64 (8V)		11/90-05/04	P22PR8	3302	0.8	-	-	VW22	4
2.4 4WD	80	G64B		11/86-12/90	W20EPR-U11	3049	1.1	W20TT	IW20TT	IW20TT	4
2.5 D	51/55	4D56 (8V)	Double Coil(LPH)	11/86-02/06	DG-174		11V				4
2.5 D	51/55	4D56 (8V)	Single Coil	11/86-02/06	DG-198		11V				4
2.5 TD	64	4D56 T	Double Coil(LPH)	02/87-05/03	DG-174		11V				4
2.5 TD	64	4D56 T	Single Coil	02/87-05/03	DG-198		11V				4
2.5 TD 4WD	64	4D56 T	Double Coil(LPH)	11/88-05/04	DG-174		11V				4
2.5 TD 4WD	64	4D56 T	Single Coil	11/88-05/04	DG-198		11V				4
L 400 / SPACE GEAR (95-05)											
2.0	83	4G63 (SOHC 16V)		12/94-10/02	W20EPR-U	3047	0.8	W20TT	IW20TT	IW20TT	4
2.0 16V	85	4G63 (SOHC 16V)		05/95-05/00	W20EPR-U	3047	0.8	W20TT	IW20TT	IW20TT	4
2.4	97	4G64-2		06/96-01/01	K16PR-U11	3130	1.1	K16TT	IK16TT	IK16TT	4
2.4 i 4WD	97	4G64-2		05/95-11/98	K16PR-U11	3130	1.1	K16TT	IK16TT	IK16TT	4
2.5 TD	73	4D56 TD	Double Coil(LPH)	05/95-05/00	DG-174		11V				4
2.5 TD 4WD	73	4D56 TD	Single Coil	05/95-05/00	DG-198		11V				4
2500 TD	64	4D56 T	Double Coil(LPH)	05/95-06/05	DG-174		11V				4
2500 TD 4WD	64	4D56 T	Double Coil(LPH)	09/96-06/05	DG-174		11V				4
LANCER Evo I (92-93)											
EVO I	184	4G63 Turbo		10/92-12/93	W22EPR-U	3088	0.8	W22TT	-	VW22	4
LANCER Evo II (94-95)											
EVO II	192	4G63 Turbo		01/94-07/95	W22EPR-U	3088	0.8	W22TT	-	VW22	4
LANCER Evo III (95-96)											
EVO III	198	4G63 Turbo		08/95-07/96	W22ETR-L	3315	1.0	W22TT	-	VW22	4
LANCER Evo IV (96-97)											
EVO IV	206	4G63 Turbo		08/96-12/97	P22PR8	3302	0.8	-	-	VW22	4
LANCER Evo IX (05-07)											
EVO IX	206/ 213	4G63 Turbo		01/05-09/07	VKH22	5619	0.8	-	-	VKH22	4
EVO IX - FQ-300	227	4G63 Turbo		06/05-12/06	VKH22	5619	0.8	-	-	VKH22	4
EVO IX - FQ-340	257	4G63 Turbo		06/05-12/07	VKH22	5619	0.8	-	-	VKH22	4
EVO IX - FQ-360	273	4G63 Turbo		07/06-12/07	VKH22	5619	0.8	-	-	VKH22	4
LANCER Evo V (98)											
EVO V	206	4G63 Turbo		01/98-12/98	P22PR8	3302	0.8	-	-	VW22	4
LANCER Evo VI (99-01)											
EVO VI	207	4G63 Turbo		01/99-01/00	P22PR8	3302	0.8	-	-	VW22	4
LANCER Evo VII (01-03)											
EVO VII	206	4G63 Turbo		01/01-01/03	VW22	5607	0.8	-	-	VW22	4
LANCER Evo VIII (03-05)											
EVO VIII	206	4G63 Turbo		04/03-03/05	VW22	5607	0.8	-	-	VW22	4
EVO VIII - 260	195	4G63 Turbo		03/04-07/05	P22PR8	3302	0.8	-	-	VW22	4
EVO VIII - 260	195	4G63 Turbo		03/04-07/05	VW22	5607	0.8	-	-	VW22	4
EVO VIII - FQ-300	225/ 227	4G63 Turbo		04/03-04/04	VW22	5607	0.8	-	-	VW22	4
EVO VIII - FQ-320	243	4G63 Turbo		04/04-08/06	VW22	5607	0.8	-	-	VW22	4
EVO VIII - FQ-330	246	4G63 Turbo		10/03-08/06	VW22	5607	0.8	-	-	VW22	4











Таблица применения

M

Свечи зажигания и Свечи накаливания

Таблица применения

Таблица применения

	KW				СТАНДАРТНЫЕ				Twin Tip			QTY
												
MITSUBISHI продолжение												
LANCER Evo VIII (03-05) продолжение												
EVO VIII - FQ-340	255	4G63 Turbo		04/04-03/05	VW22	5607	0.8	-	-	VW22	4	
EVO VIII - FQ-400	302	4G63 Turbo		10/04-08/06	VW22	5607	0.8	-	-	VW22	4	
LANCER Evo X (07-15)												
EVO X	206/ 217/ 221	4B11-T/C		10/07-09/10	GX8-1	3462	0.8	-	-	GX8-1	4	
EVO X - FQ330	242	4B11-FQ30		03/08-09/10	GX8-1	3462	0.8	-	-	GX8-1	4	
EVO X - FQ360	264	4B11-FQ60		03/08-09/10	GX8-1	3462	0.8	-	-	GX8-1	4	
EVO X - FQ400	301	4B11-T/C		05/09-09/10	GX8-1	3462	0.8	-	-	GX8-1	4	
LANCER I (79-83)												
1.2	40	4 G 11		01/80-12/81	W16EPR-U	3021	0.8	W16TT	IW16TT	IW16TT	4	
1.4 GLX	50	4 G 12		09/79-02/83	W16EPR-U	3021	0.8	W16TT	IW16TT	IW16TT	4	
1.6	62	4G32 GS		01/81-02/83	W16EPR-U	3021	0.8	W16TT	IW16TT	IW16TT	4	
2.0 Turbo Eci	125	4G63-T (SOHC 8V)		03/81-02/83	W20EPR-U	3047	0.8	W20TT	IW20TT	IW20TT	4	
LANCER II (83-84)												
1.2 GLX	40	4 G 11		03/83-01/84	W16EPR-U	3021	0.8	W16TT	IW16TT	IW16TT	4	
1.4 GLX	51	4 G 12		03/83-01/84	W16EPR-U	3021	0.8	W16TT	IW16TT	IW16TT	4	
LANCER III (83-92)												
1.2	44	4G16		08/86-04/88	W20EPR-U	3047	0.8	W20TT	IW20TT	IW20TT	4	
1.2 GL	40	4G16		01/84-10/86	W20EPR-U	3047	0.8	W20TT	IW20TT	IW20TT	4	
1.5	51	G15B		09/85-08/89	W20EPR-U11	3049	1.1	W20TT	IW20TT	IW20TT	4	
1.5	55	4 G 15		09/85-12/87	K20PR-U11	3121	1.1	K20TT	IK20TT	IK20TT	4	
1.5	55/61	4G15 (8V)		09/85-12/90	W20EPR-U	3047	0.8	W20TT	IW20TT	IW20TT	4	
1.5 12V	66	4G15 (12V)		09/90-04/91	W20EPR-U11	3049	1.1	W20TT	IW20TT	IW20TT	4	
1.5 12V	66	4G15 (12V)		09/90-12/91	W20EPR-U	3047	0.8	W20TT	IW20TT	IW20TT	4	
1.5 12V	66	4G15 (12V)		05/91-12/91	W16EPR-U11	3201	1.1	W16TT	IW16TT	IW16TT	4	
1.5 GLX	55	4 G 15		11/83-04/88	K20PR-U11	3121	1.1	K20TT	IK20TT	IK20TT	4	
1.5 GLX	55	4G15 (8V)		11/83-07/84	W16EPR-U	3021	0.8	W16TT	IW16TT	IW16TT	4	
1.5 GLX	55	4G15 (8V)		08/84-04/88	W20EPR-U	3047	0.8	W20TT	IW20TT	IW20TT	4	
1.8 4WD	61/ 63/ 66/69	4G37; G37B		01/87-06/92	W20EPR-U11	3049	1.1	W20TT	IW20TT	IW20TT	4	
1.8 D	44	4D65	Single Coil	01/84-06/92	DG-198		11V				4	
LANCER IV (88-94)												
1.3	44	4 G 13		04/88-05/92	W20EPR-U	3047	0.8	W20TT	IW20TT	IW20TT	4	
1.3	51	G13B		08/88-05/92	W20EPR-U11	3049	1.1	W20TT	IW20TT	IW20TT	4	
1.3 12V	55	4 G 13 (12V); 4G13-ESI		07/90-05/94	W16EPR-U11	3201	1.1	W16TT	IW16TT	IW16TT	4	
1.3 12V	55	4G13-ESI		07/90-04/91	W20EPR-U11	3049	1.1	W20TT	IW20TT	IW20TT	4	
1.5	56/62	4G15 (8V)		06/88-05/92	W20EPR-U	3047	0.8	W20TT	IW20TT	IW20TT	4	
1.5	62	4 G 15		04/88-05/92	K20PR-U11	3121	1.1	K20TT	IK20TT	IK20TT	4	
1.5	62/65	4G15 (12V)		04/88-04/91	W20EPR-U11	3049	1.1	W20TT	IW20TT	IW20TT	4	
1.5	62/65	4G15 (12V)		05/91-09/92	W16EPR-U11	3201	1.1	W16TT	IW16TT	IW16TT	4	
1.5 12V	66	4G15 (12V)		05/89-04/91	W20EPR-U11	3049	1.1	W20TT	IW20TT	IW20TT	4	
1.5 12V	66	4G15 (12V)		06/90-05/92	IW20TT	4709	1.0	-	IW20TT		4	
1.5 12V	66	4G15 (12V)		05/91-05/92	W16EPR-U11	3201	1.1	W16TT	IW16TT	IW16TT	4	
1.5 GLS	63	4G15 (12V)		08/89-04/91	W20EPR-U11	3049	1.1	W20TT	IW20TT	IW20TT	4	
1.5 GLS	63	4G15 (12V)		05/91-08/92	W16EPR-U11	3201	1.1	W16TT	IW16TT	IW16TT	4	
1.6 4WD	84	4G92 (SOHC 16V)		06/92-11/93	K20PR-U11	3121	1.1	K20TT	IK20TT	IK20TT	4	
1.6 16V	83	4G92 (SOHC 16V)		06/92-05/94	K20PR-U11	3121	1.1	K20TT	IK20TT	IK20TT	4	
1.6 GLX	91	4G61		08/89-08/92	W20EPR-U	3047	0.8	W20TT	IW20TT	IW20TT	4	
1.6 GTi	91	4G61		05/88-05/90	W20EPR-U	3047	0.8	W20TT	IW20TT	IW20TT	4	
1.8 4WD	71	4G37		09/89-06/92	W20EPR-U11	3049	1.1	W20TT	IW20TT	IW20TT	4	
1.8 D	44	4D65	Single Coil	04/88-05/92	DG-198		11V				4	
1.8 GLX Diesel	44	4D65	Single Coil	04/88-05/92	DG-198		11V				4	
1.8 GTi 16V	100	4G67		11/89-05/92	W20EPR-U	3047	0.8	W20TT	IW20TT	IW20TT	4	
1.8 GTi 16V	103	4G93		06/92-12/93	K20PR-U11	3121	1.1	K20TT	IK20TT	IK20TT	4	
2.0 D	50	4D68	Double Coil(LPH)	06/92-07/93	DG-174		11V				4	
LANCER V (91-03)												
1.3	55	4G13-2J		06/92-12/96	W16EPR-U11	3201	1.1	W16TT	IW16TT	IW16TT	4	
1.5	65	4G15 (12V)		09/92-07/96	W16EPR-U11	3201	1.1	W16TT	IW16TT	IW16TT	4	
1.6	66	4G92 MVV	LEAN BURN	02/94-12/96	K16PR-U11	3130	1.1	K16TT	IK16TT	IK16TT	4	
1.6	66/ 103	4G92 (SOHC 16V)		09/92-12/96	K20PR-U11	3121	1.1	K20TT	IK20TT	IK20TT	4	
1.6 16V	83	4G92 (SOHC 16V)		06/92-10/03	K20PR-U11	3121	1.1	K20TT	IK20TT	IK20TT	4	
1.6 16V	83	4G92 MVV	LEAN BURN	06/92-11/93	K20PR-U11	3121	1.1	K20TT	IK20TT	IK20TT	4	
1.6 16V	83	4G92 MVV	LEAN BURN	12/93-10/03	K16PR-U11	3130	1.1	K16TT	IK16TT	IK16TT	4	
1.6 16V 4WD	83	4G92 (SOHC 16V)		06/92-10/03	K20PR-U11	3121	1.1	K20TT	IK20TT	IK20TT	4	

Свечи зажигания и Свечи накаливания

Таблица применения











	KW				СТАНДАРТНЫЕ			Twin Tip			QTY
											
MITSUBISHI продолжение											
LANCER V (91-03) продолжение											
1.6 16V 4WD	83	4G92 MVV	LEAN BURN	06/92-11/93	K20PR-U11	3121	1.1	K20TT	IK20TT	IK20TT	4
1.6 16V 4WD	83	4G92 MVV	LEAN BURN	12/93-10/03	K16PR-U11	3130	1.1	K16TT	IK16TT	IK16TT	4
1.8 16V	103	4G93-1		06/92-12/93	K20PR-U11	3121	1.1	K20TT	IK20TT	IK20TT	4
2.0 D	50/65	4D68 T; 4D68	Double Coil(LPH)	06/92-10/03	DG-174		11V				4
LANCER VI (95-03)											
1.3 12V	55	4G13-38		12/95-01/00	W16EPR-U11	3201	1.1	W16TT	IW16TT	IW16TT	4
1.6 16V	66	4G92 (SOHC 16V)		12/95-08/03	K20PR-U11	3121	1.1	K20TT	IK20TT	IK20TT	4
1.6 16V	66	4G92 MVV	LEAN BURN	12/95-05/99	K16PR-U11	3130	1.1	K16TT	IK16TT	IK16TT	4
1.6 16V	66	4G92 MVV	LEAN BURN	06/99-08/03	K20PR-U11	3121	1.1	K20TT	IK20TT	IK20TT	4
2.0 D	50	4D68	Double Coil(LPH)	09/95-08/03	DG-174		11V				4
LANCER VII (03-)											
1.3	60	4G13-6		09/03-12/13	K20PR-U11	3121	1.1	K20TT	IK20TT	IK20TT	4
1.6	72	4G18-6		09/03-12/13	K20PR-U11	3121	1.1	K20TT	IK20TT	IK20TT	4
2.0	99	4G63 (DOHC 16V)		09/03-12/13	IW20TT	4709	1.0	-	IW20TT		4
2.0 i	113	4B11		10/07-12/13	VW20	5606	1.1	-	IW20TT	IW20TT	4
LANCER VIII (07-)											
1.5	80	4A91		06/08-	IKH20TT	4704	1.0	-	IKH20TT		4
1.5 Bifuel	80	4A91		02/10-	IKH20TT	4704	1.0	-	IKH20TT		4
1.6 MIVEC	86	4A92		05/10-	IKH16TT	4703	1.0	-	IKH16TT		4
1.8	103/105	4B10		02/08-	K20PSR-B8	3431	0.8	-	IK20TT	IK20TT	4
1.8	103/105	4B10		04/09-09/11	IK16TT	4701	1.0	-	IK16TT	IK16TT	4
1.8 Bifuel	105	4B10		01/10-09/11	IK16TT	4701	1.0	-	IK16TT	IK16TT	4
1.8 Bifuel	105	4B10	Ch: 4B10>	02/10-	IXUH20I	5354	0.9	-	-	VXUH20I	4
1.8 Bifuel	105	4B10; CX3A		10/11-	K20PSR-B8	3431	0.8	-	IK20TT	IK20TT	4
1.8 DI-D	85/110	4N13	OE:160784998 0; 1820-A019; RP8488;GN123	05/10-	DG-656		11V				4
1.8 Flex	103	4B10		03/09-09/11	IK16TT	4701	1.0	-	IK16TT	IK16TT	4
1.8 Flex	103	4B10		10/11-	K20PSR-B8	3431	0.8	-	IK20TT	IK20TT	4
1.8 Flexfuel	103	4B10		03/09-09/11	IK16TT	4701	1.0	-	IK16TT	IK16TT	4
1.8 Flexfuel	103/105	4B10		01/10-	K20PSR-B8	3431	0.8	-	IK20TT	IK20TT	4
1.8 MIVEC	103	4B10		03/09-09/11	IK16TT	4701	1.0	-	IK16TT	IK16TT	4
1.8 MIVEC	103	4B10	Ch: CX6A>	03/09-	IXUH20I	5354	0.9	-	-	VXUH20I	4
1.8 MIVEC	103	CX3A		10/11-	K20PSR-B8	3431	0.8	-	IK20TT	IK20TT	4
2.0	108	4B11		01/09-	K20PSR-B8	3431	0.8	-	IK20TT	IK20TT	4
2.0 DI-D	103	BKD; BWC	OE: MN980406	01/08-	DG-190		4.4V				4
2.0 i Ralliart 4WD	177	4B11		10/08-	K20PSR-B8	3431	0.8	-	IK20TT	IK20TT	4
2.0 i Ralliart 4WD	177	4B11-T/C		10/08-09/10	GX8-1	3462	0.8	-	-	GX8-1	4
2.0 Ralliart 4WD	177	4B11		10/08-	K20PSR-B8	3431	0.8	-	IK20TT	IK20TT	4
2.0 Ralliart 4WD	177	4B11-T/C		10/08-09/10	GX8-1	3462	0.8	-	-	GX8-1	4
MAGNA (96-05)											
3.0 i	140	6G72 (SOHC 24V)		04/96-06/97	PK16PR-P11	3174	1.1	K16TT	IK16TT	IK16TT	6
MIRAGE (88-91)											
1.6 Gti	92	4G61		06/88-11/91	W20EPR-U	3047	0.8	W20TT	IW20TT	IW20TT	4
MIRAGE (91-03)											
1.5	69/81	4G15 (12V); 4G15 (16V)		09/95-12/00	W16EPR-U11	3201	1.1	W16TT	IW16TT	IW16TT	4
OUTLANDER I (03-06)											
2.0	100	4G63 (DOHC 16V)		05/03-10/06	IW20TT	4709	1.0	-	IW20TT		4
2.0 4WD	100	4G63-7T3		05/03-10/06	IW20TT	4709	1.0	-	IW20TT		4
2.0 Turbo 4WD	148	4G63-T (DOHC 16V)		04/04-10/06	VW22	5607	0.8	-	-	VW22	4
2.4 4WD	103/118	4G64 (16V); 4G69		05/03-10/06	IKH20TT	4704	1.0	-	IKH20TT		4
2.4 MIVEC	118	4G69		03/01-12/06	IKH20TT	4704	1.0	-	IKH20TT		4
OUTLANDER II (06-12)											
2.0	108	4B11		11/06-11/12	VFK20F	5648	1.1	-	IK20TT	VFK20F	4
2.0 4WD	108	4B11		11/06-11/12	VFK20F	5648	1.1	-	IK20TT	VFK20F	4
2.0 DI-D	103	BSY	OE: MN980234	02/07-11/12	DG-190		4.4V				4
2.2 DI-D	130	4N14	OE:160784998 0; 1820-A019; RP8488;GN123	11/06-11/12	DG-656		11V				4
2.2 DI-D	130	4N14	OE: MN982294	11/06-11/12	DG-614		11V				4

Таблица применения

M

Свечи зажигания и Свечи накаливания

Таблица применения

Таблица применения

KW	KW	KW	NOTE	21	СТАНДАРТНЫЕ				Twin Tip			QTY
					1	2	3	4	1	2	3	
МИТСУБИСИ продолжение												
OUTLANDER II (06-12) продолжение												
2.2 DI-D 4WD	103/130	4N14	OE:160784998 O: 1820-A019; RP8488;GN123	11/06-11/12	DG-656		11V					4
2.2 DI-D 4WD	103/130	4N14	OE: MN982294	11/06-11/12	DG-614		11V					4
2.2 DI-D 4WD	115	4HK; 4HN		08/07-11/12	DG-614		11V					4
2.4	125	4B12		11/06-06/10	K16PSR-B8	3437	0.8	-	IK16TT	IK16TT		4
2.4	125	4B12		07/10-11/12	IK16TT	4701	1.0	-	IK16TT	IK16TT		4
2.4 4WD	125	4B12		09/07-06/10	K16PSR-B8	3437	0.8	-	IK16TT	IK16TT		4
2.4 4WD	125	4B12		07/10-11/12	IK16TT	4701	1.0	-	IK16TT	IK16TT		4
2.4 Flex 4WD	125	4B12		09/07-06/10	K16PSR-B8	3437	0.8	-	IK16TT	IK16TT		4
2.4 Flex 4WD	125	4B12		07/10-11/12	IK16TT	4701	1.0	-	IK16TT	IK16TT		4
3.0 4WD	162	6B31		11/06-11/12	SXU22HDR8	3441	0.8	-	IXUH22TT	VXUH22I		6
OUTLANDER III (12-)												
2.0	107/110	4B11; 4J11	Europe	08/12-	IXUH20I	5354	0.9	-	-	VXUH20I		4
2.0	107/110	4B11; 4J11	Russia	08/12-	K20PSR-B8	3431	0.8	-	IK20TT	IK20TT		4
2.0	118	4B11		09/13-	K20PSR-B8	3431	0.8	-	IK20TT	IK20TT		4
2.0 4WD	107/110	4B11; 4J11	Europe	08/12-	IXUH20I	5354	0.9	-	-	VXUH20I		4
2.0 4WD	107/110	4B11; 4J11	Russia	08/12-	K20PSR-B8	3431	0.8	-	IK20TT	IK20TT		4
2.0 Hybrid 4WD	87/89/139	4B11; S61; Y61		12/12-	IK16TT	4701	1.0	-	IK16TT	IK16TT		4
2.2 DI-D	110	4N14	OE:160784998 O: 1820-A019; RP8488;GN123	08/12-	DG-656		11V					4
2.2 DI-D 4WD	110	4N14	OE:160784998 O: 1820-A019; RP8488;GN123	08/12-	DG-656		11V					4
2.4 4WD	123	4B12		10/12-07/16	K16PSR-B8	3437	0.8	-	IK16TT	IK16TT		4
PAJERO Classic (02-)												
2.5 TD	85	4D56 T	Double Coil(LPH)	07/01-	DG-174		11V					4
2.5 TD	85	4D56 T	Single Coil	07/01-	DG-198		11V					4
3.2 DI-D	125	4M41	OE:1820-A009; RP8486;GN121 ; GLP252;CZ251	09/06-	DG-655		11V					4
PAJERO I (82-91)												
2.3 D	62	4D55	Single Coil	10/84-09/86	DG-162		6V					4
2.3 D	62	4D55	Single Coil	10/84-09/86	DG-198		11V					4
2.3 TD	62	4D55 T	Single Coil	12/82-04/86	DG-162		6V					4
2.3 TD	62	4D55 T	Single Coil	12/82-04/86	DG-198		11V					4
2.5 TD	62/64/70	4D56 T	Double Coil(LPH)	05/86-12/91	DG-174		11V					4
2.5 TD	62/64/70	4D56 T	Single Coil	05/86-12/91	DG-198		11V					4
2.5 TD 4WD	62	4D56 T	Double Coil(LPH)	10/86-05/91	DG-174		11V					4
2.5 TD 4WD	62	4D56 T	Single Coil	10/86-05/91	DG-198		11V					4
2.6	76	4G54		01/83-11/90	W16EPR-U	3021	0.8	W16TT	IW16TT	IW16TT		4
2.6 4WD	79	4G54-1G		10/86-05/91	W16EPR-U	3021	0.8	W16TT	IW16TT	IW16TT		4
3.0 i 4WD	105	6G72		05/88-05/91	W16EPR-U11	3201	1.1	W16TT	IW16TT	IW16TT		6
3.0 V6	104	6G72		11/88-11/90	PK20PR-P11	3141	1.1	K20TT	IK20TT	IK20TT		6
PAJERO II (90-00)												
2.4	82	4G64		04/91-04/00	K16PR-U11	3130	1.1	K16TT	IK16TT	IK16TT		4
2.5 TD 4WD	73	4D56 TD		12/90-10/93	DG-198		11V					4
2.5 TD 4WD	73	4D56 TD	Double Coil(LPH)	10/93-04/00	DG-174		11V					4
2.5 TDiC	73	4D56 T		03/91-10/93	DG-198		11V					4
2.5 TDiC	73	4D56 T	Double Coil(LPH)	10/93-08/99	DG-174		11V					4
2.8 TD	92	4M40-T		06/94-10/99	DG-643		11V					4
2.8 TD	92	4M40-T	Ceramic(LPH)	06/94-10/99	DG-643		11V					4
3.0 V6	110	6G72 (SOHC 12V)		12/90-12/95	W16EPR-U11	3201	1.1	W16TT	IW16TT	IW16TT		6
3.0 V6 4WD	110	6G72 (SOHC 12V)		12/90-12/95	W16EPR-U11	3201	1.1	W16TT	IW16TT	IW16TT		6
3.0 V6 24V	130/133	6G72 (SOHC 24V)		06/94-04/00	PK16PR-P11	3174	1.1	K16TT	IK16TT	IK16TT		6

Свечи зажигания и Свечи накаливания

Таблица применения





	KW				СТАНДАРТНЫЕ			Twin Tip			QTY
MITSUBISHI продолжение											
PAJERO II (90-00) продолжение											
3.5 V6 24V	143/153	6G74 DOHC; 6G74		06/94-10/99	PK16PR-P11	3174	1.1	K16TT	IK16TT	IK16TT	6
PAJERO III (00-07)											
2.5 TDi	73/85	4D56 T	Double Coil(LPH)	04/00-12/06	DG-174		11V				4
2.5 TDi	73/85	4D56 T	Single Coil	04/00-12/06	DG-198		11V				4
3.2 DI-D	118/121	4M41		04/00-12/06	DG-187		11V				4
3.5	149	6G74 (DOHC 24V)		04/00-01/07	VKB16	5624	1.1	-	-	VKB16	6
3.5 V6 GDI	149	6G74 (GDI)		04/00-12/06	VKB16	5624	1.1	-	-	VKB16	6
PAJERO IV (06-)											
3.2 DI-D	118/123/125	4M41	OE:1820-A009; RP8486;GN121; GLP252;CZ251	11/06-	DG-655		11V				4
3.2 DI-D 4WD	140/147	4M41	OE:1820-A009; RP8486;GN121; GLP252;CZ251	02/07-	DG-655		11V				4
3.2 DI-D GLS	124	4M41	OE:1820-A009; RP8486;GN121; GLP252;CZ251	02/07-	DG-655		11V				4
3.2 TD 4WD	147	4M41	OE:1820-A009; RP8486;GN121; GLP252;CZ251	01/10-	DG-655		11V				4
3.8 V6	182/184	6G75		10/06-	SK20PR-A8	3403	0.8	-	IK20TT	IK20TT	6
PAJERO Junior (95-98)											
1.1 4WD	59	4A31		10/95-04/98	XU22EPR-U	3179	0.9	XU22TT	IXU22TT	VXU22	4
PAJERO Mini (94-12)											
0.7	37	4A30		10/94-08/02	XU22EPR-U	3179	0.9	XU22TT	IXU22TT	VXU22	4
0.7	37	4A30		09/02-08/12	VXU22	5608	0.9	-	IXU22TT	VXU22	4
0.7 4WD	38/47	4A30; 4A30T		10/94-08/02	XU22EPR-U	3179	0.9	XU22TT	IXU22TT	VXU22	4
0.7 4WD	38/47	4A30; 4A30T		09/02-08/12	VXU22	5608	0.9	-	IXU22TT	VXU22	4
PAJERO Pinin (99-07)											
1.8	84	4G93-D		11/01-02/05	K16PR-U11	3130	1.1	K16TT	IK16TT	IK16TT	4
1.8 GDI	88	4G93 (GDI)		10/99-10/01	VKB20	5625	1.1	-	-	VKB20	4
2.0 GDI	95	4G94-H		10/00-02/05	VKB16	5624	1.1	-	-	VKB16	4
PAJERO Sport I (97-)											
2.5 TD	73/85/98	4D56 T	Double Coil(LPH)	11/98-	DG-174		11V				4
2.5 TD	73/85/98	4D56 T	Single Coil	11/98-	DG-198		11V				4
2.5 TD 4WD	83	4D56 T	Double Coil(LPH)	11/97-10/98	DG-174		11V				4
2.5 TD 4WD	83	4D56 T	Single Coil	11/97-10/98	DG-198		11V				4
2.8 TDi	92	4M40-T		11/98-10/03	DG-643		11V				4
2.8 TDi	92	4M40-T	Ceramic(LPH)	11/98-10/03	DG-643		11V				4
3.0 4WD	129	6G72 (SOHC 24V)		09/96-12/01	PK16PR-P11	3174	1.1	K16TT	IK16TT	IK16TT	6
3.0 V6	125/130	6G72 (SOHC 24V)		11/98-	PK16PR-P11	3174	1.1	K16TT	IK16TT	IK16TT	6
3.0 V6 4WD	123	6G72 (SOHC 24V)		03/03-	PK16PR-P11	3174	1.1	K16TT	IK16TT	IK16TT	6
PAJERO Sport II (08-)											
2.5 DI-D 4WD	131	4D56 HP	OE:1820-A009; RP8486;GN121; GLP252;CZ251	07/08-08/11	DG-655		11V				4
2.5 DI-D 4WD	131	4D56 HP	OE: 1820A020	08/11-	DG-662		11V				4
3.0 4WD	162	6B31		09/08-	SXU22HDR8	3441	0.8	-	IXUH22TT	VXUH22I	6
PAJERO Sport III (15-)											
2.4 DI-D 4x4 (KS1W)	133	4N15	OE:1607849980; 1820-A019; RP8488;GN123	08/15-	DG-656		11V				4
SANTAMO (99-04)											
2.0 16V	102	I4-DOHC		05/99-12/01	W20EPR-U11	3049	1.1	W20TT	IW20TT	IW20TT	4
SAPORO I (78-80)											
1.6 SL, GL	55	4G32		04/78-07/80	W20EP-U	3043	0.8	W20TT	IW20TT	IW20TT	4
SAPORO II (80-84)											
1.6 GLX	55	4G32		08/80-09/84	W20EP-U	3043	0.8	W20TT	IW20TT	IW20TT	4
SAPORO III (87-90)											
2.4	91	4G64		06/87-08/90	K16PR-U11	3130	1.1	K16TT	IK16TT	IK16TT	4

Таблица применения

M

Свечи зажигания и Свечи накаливания

Таблица применения

Таблица применения

KW	KW	KW	NOTE	21	СТАНДАРТНЫЕ			Twin Tip		QTY	
					W20EPR-U11	3049	1.1	W20TT	IW20TT		IK20TT
MITSUBISHI продолжение											
SIGMA (90-96)											
3.0	125	6G721		06/92-01/94	W20EPR-U11	3049	1.1	W20TT	IW20TT	IK20TT	6
3.0 V6	130	6G72		12/90-07/96	W20EPR-U11	3049	1.1	W20TT	IW20TT	IK20TT	6
3.0 V6	151	6G72		12/90-07/96	PK20PR-P11	3141	1.1	K20TT	IK20TT	IK20TT	6
SPACE RUNNER (91-99)											
1.8	85	4G93		06/96-08/99	K20PR-U	3145	0.8	K20TT	IK20TT	IK20TT	4
1.8	90	4G93		10/91-08/99	K20PR-U11	3121	1.1	K20TT	IK20TT	IK20TT	4
1.8 4WD	85/90	4G93		10/91-08/99	K20PR-U11	3121	1.1	K20TT	IK20TT	IK20TT	4
2.0 TD	60	4D68 T	Double Coil(LPH)	10/92-08/99	DG-174		11V				4
SPACE RUNNER (99-02)											
2.0	100	4 G 63		08/99-08/02	K16PR-U	3191	0.8	K16TT	IK16TT	IK16TT	4
2.4 GDI	110	4G64 (GDI)		08/99-01/03	VKB16	5624	1.1	-	-	VKB16	4
SPACE STAR / MIRAGE (12-)											
1.0	52	3A90		05/12-	FK20HR11	3426	1.1	-	IKH20TT	IKH20TT	3
1.2	56/59	3A92		01/12-	FK20HR11	3426	1.1	-	IKH20TT	IKH20TT	3
SPACE STAR (98-04)											
1.3 16V	60/63	4G13-16		06/98-05/00	K16PR-U11	3130	1.1	K16TT	IK16TT	IK16TT	4
1.3 16V	60/63	4G13-16		06/00-12/04	K20PR-U11	3121	1.1	K20TT	IK20TT	IK20TT	4
1.6	72	4G92 (SOHC 16V)		04/01-12/04	K20PR-U11	3121	1.1	K20TT	IK20TT	IK20TT	4
1.6 16V	72	4G18		01/01-12/04	K20PR-U11	3121	1.1	K20TT	IK20TT	IK20TT	4
1.8 GDI	87/90	4G93-H		06/98-08/02	VKB20	5625	1.1	-	-	VKB20	4
1.8 MPI	82	4G93		10/02-12/04	K16PR-U11	3130	1.1	K16TT	IK16TT	IK16TT	4
1.9 DI-D	75/85	F9Q1; F9Q2	Double Coil(LPH)	02/01-12/04	DG-005		11V				4
SPACE WAGON (83-92)											
1.8 GLX	66	4G37		01/84-12/88	W20EPR-U11	3049	1.1	W20TT	IW20TT	IW20TT	4
1.8 TD	55	4D65 T	Single Coil	06/86-04/91	DG-198		11V				4
2.0 4WD	75	4G63		03/85-04/91	W20EPR-U	3047	0.8	W20TT	IW20TT	IW20TT	4
2.0 GLX	62	G63B		06/86-05/88	W20EPR-U	3047	0.8	W20TT	IW20TT	IW20TT	4
2.0 GLX 4WD	62	G63B		06/86-05/88	W20EPR-U	3047	0.8	W20TT	IW20TT	IW20TT	4
2.0 GLXi	74	4G63		06/88-04/91	W20EPR-U	3047	0.8	W20TT	IW20TT	IW20TT	4
2.0 GLXi 4WD	74	4G63		06/88-04/91	W20EPR-U	3047	0.8	W20TT	IW20TT	IW20TT	4
SPACE WAGON (91-98)											
1.8	90	4G93		10/91-10/98	K20PR-U	3145	0.8	K20TT	IK20TT	IK20TT	4
1.8 4WD	90	4G93		10/91-10/98	K20PR-U	3145	0.8	K20TT	IK20TT	IK20TT	4
1.8 TD	55	4D65 T	Single Coil	10/91-10/98	DG-198		11V				4
2.0	98	4G63 (SOHC 16V)		10/92-10/98	K20PR-U11	3121	1.1	K20TT	IK20TT	IK20TT	4
2.0 4WD	98	4 G 63		10/92-10/98	W20EPR-U	3047	0.8	W20TT	IW20TT	IW20TT	4
2.0 TD	60	4D68 T	Double Coil(LPH)	10/92-10/98	DG-174		11V				4
2.4 i	102	4G64		10/92-05/96	K20PR-U11	3121	1.1	K20TT	IK20TT	IK20TT	4
SPACE WAGON (98-04)											
2.0	98	4G63-MPI		10/98-12/04	K20PR-U11	3121	1.1	K20TT	IK20TT	IK20TT	4
2.4 GDI	108/110	4G64 (GDI); 4G64-412/4G64-481	Direct Injection	10/98-12/04	VKB16	5624	1.1	-	-	VKB16	4
2.4 GDI	110	4G64-412		10/98-04/02	K16PR-U	3191	0.8	K16TT	IK16TT	IK16TT	4
2.4 GDI 4WD	108/110	4G64-412; 4G64-481	Direct Injection	10/98-12/04	VKB16	5624	1.1	-	-	VKB16	4
STARION (82-90)											
2.0 Turbo ECi	125/132	4G63-0R/4G63-0W		06/82-08/87	W22ESR-U	3098	0.8	-	-		4
2.6 Turbo ECi	114	G54B-1J		09/87-06/90	W20EPR-U11	3049	1.1	W20TT	IW20TT	IW20TT	4
MITSUOKA											
HIMIKO (08-)											
2.0	119/125	LF-VE		09/09-	ITV20TT	4719	1.0	-	ITV20TT		4
OROCHI (06-)											
3.3 L V6	171	3MZ-FE		09/06-	SK20R11	3297	1.1	-	IK20TT	IK20TT	6
MORGAN											
AERO 8 (00-)											
4.4	210/245	M62448S2; N62B44A		10/00-	K20TXR	5063	1.0	K20TT	IK20TT	IK20TT	8
4.8	270	N62 B48 B		10/08-	IK20TT	4702	1.0	-	IK20TT	IK20TT	8
AERO (12-)											
4.8 V8	270	N62 B48 B		10/12-	IK20TT	4702	1.0	-	IK20TT	IK20TT	8
AERO Supersports (10-)											
4.8 V8	270	N62 B48 B		03/10-	IK20TT	4702	1.0	-	IK20TT	IK20TT	8

Свечи зажигания и Свечи накаливания

Таблица применения











	KW				СТАНДАРТНЫЕ			Twin Tip			QTY
											
MORGAN продолжение											
AEROMAX (07-09)											
4.4	239/ 245	N62B44A		03/07-08/09	K20TXR	5063	1.0	K20TT	IK20TT	IK20TT	8
FOUR FOUR (68-)											
1.6 CVH/OHV	71	LUA		08/82-09/91	Q20PR-U	3007	0.8	Q20TT	IQ20TT	IQ20TT	4
1.6 i Kat	77	LJA		08/91-12/93	Q20PR-U	3007	0.8	Q20TT	IQ20TT	IQ20TT	4
1.8 i	92	ZH18P		01/93-01/05	PT16VR10	5093	1.0	TV16TT	ITV16TT	ITV16TT	4
PLUS EIGHT (68-)											
3.5	115	486		01/68-12/86	W20EPR-U	3047	0.8	W20TT	IW20TT	IW20TT	8
4.8 V8	270	N62 B48 B		03/10-	IK20TT	4702	1.0	-	IK20TT	IK20TT	8
PLUS FOUR (85-)											
1.8 i	96	RQB		01/93-06/99	PT16VR10	5093	1.0	TV16TT	ITV16TT	ITV16TT	4
2.0 i	99/ 103	M16i; T16F		08/88-12/00	Q20PR-U	3007	0.8	Q20TT	IQ20TT	IQ20TT	4
ROADSTER (04-)											
2.0 Plus4	106	AODA		01/04-	ZT20EPR11	5087	1.1	T20TT	IT20TT	IT20TT	4
MORRIS											
ITAL (80-84)											
1.3	44			07/80-03/84	Q20PR-U	3007	0.8	Q20TT	IQ20TT	IQ20TT	4
1.7	58	17V		07/80-03/84	T20EPR-U	5032	0.8	T20TT	IT20TT	IT20TT	4
MARINA (71-80)											
1,3	42			10/78-10/80	W20EP-U	3043	0.8	W20TT	IW20TT	IW20TT	4
1300	43			10/75-09/78	W20EP-U	3043	0.8	W20TT	IW20TT	IW20TT	4
MINI (60-81)											
850	25			01/60-08/79	W20EPR-U	3047	0.8	W20TT	IW20TT	IW20TT	4
1000	28			01/69-12/80	W20EPR-U	3047	0.8	W20TT	IW20TT	IW20TT	4
1100 Special	33	10 H		01/76-08/81	W20ESR-U	3057	0.8	-	-	-	4
Cooper	41			01/61-12/67	W20EPR-U	3047	0.8	W20TT	IW20TT	IW20TT	4
MINOR (55-71)											
0.9	28			11/55-12/62	W20ESR-U	3057	0.8	-	-	-	4
1.1	37			01/62-10/71	W20ESR-U	3057	0.8	-	-	-	4
OXFORD (59-70)											
1.7	63			05/62-04/70	W20ESR-U	3057	0.8	-	-	-	4
MOSKVICH											
407 (58-69)											
1.4	33			08/58-09/69	W22EPR-U	3088	0.8	W22TT	-	VW22	4
412 (71-88)											
1.5	55/59			03/71-10/88	W22ES-U	3093	0.8	-	-	-	4
427 (69-79)											
1.5	55	412		01/69-09/79	W22ES-U	3093	0.8	-	-	-	4
2137 (76-01)											
1.5	55			07/76-08/87	W22EPR-U	3088	0.8	W22TT	-	VW22	4
2140 (76-88)											
1.5	55			03/76-10/88	W22EPR-U	3088	0.8	W22TT	-	VW22	4
2141 (89-01)											
1.5	51			05/89-12/01	W22EPR-U	3088	0.8	W22TT	-	VW22	4
1.6	56/59			05/94-12/01	W20EPR-U	3047	0.8	W20TT	IW20TT	IW20TT	4
1.7	63			03/95-12/01	W22ES-U	3093	0.8	-	-	-	4
1.8	66	UZAM 3313		01/88-12/01	W20EPR-U	3047	0.8	W20TT	IW20TT	IW20TT	4
2.0	77	UZAM 248		01/88-12/01	W22ES-U	3093	0.8	-	-	-	4
2335 (95-01)											
1.6	56	VAZ 2106		01/95-12/01	W20EPR-U	3047	0.8	W20TT	IW20TT	IW20TT	4
1.8	63	VAZ 2106		01/95-12/01	W20EPR-U	3047	0.8	W20TT	IW20TT	IW20TT	4
2901 (98-01)											
1.6	55	VAZ 2106		06/98-12/01	W20EPR-U	3047	0.8	W20TT	IW20TT	IW20TT	4
1.8	63	UZAM 3317		06/98-12/01	W22ESR-U	3098	0.8	-	-	-	4
NANJING FIAT											
PALIO (03-05)											
1.2	59	188 A5.000		06/03-08/05	XU24EPR-U	3312	0.9	-	-	VXU24	4
NISSAN											
100 NX (90-94)											
1.6	66	GA16DS		03/90-10/92	K16PR-U	3191	0.8	K16TT	IK16TT	IK16TT	4
1.6	66	GA16DS		03/90-10/94	K16PR-U11	3130	1.1	K16TT	IK16TT	IK16TT	4
1.6 SR	75	GA16DE		09/93-10/94	K20PR-U	3145	0.8	K20TT	IK20TT	IK20TT	4
2.0 GTI	105	SR20DE		03/91-10/94	K16R-U	3119	0.8	K16TT	IK16TT	IK16TT	4
2.0 GTI	105	SR20DE		03/91-10/94	K16R-U11	3120	1.1	K16TT	IK16TT	IK16TT	4

Таблица применения

M
N

Свечи зажигания и Свечи накаливания

Таблица применения

Таблица применения

KW	KW	KW	NOTE	21	СТАНДАРТНЫЕ			Twin Tip			QTY
					STANDARD	STANDARD	STANDARD	TWIN TIP	TWIN TIP	TWIN TIP	
NISSAN продолжение											
200 SX (88-94)											
1.8	99	CA18DE		09/88-03/94	PQ20R	3117	1.1	Q20TT	IQ20TT	IQ20TT	4
1.8 Turbo	122/ 124	CA18DET; CA18DT		07/88-09/94	PQ20R	3117	1.1	Q20TT	IQ20TT	IQ20TT	4
200 SX (93-99)											
2.0 i 16V	118	SR20DE		10/93-12/99	K16R-U11	3120	1.1	K16TT	IK16TT	IK16TT	4
2.0 i 16V	118	SR20DE		10/93-12/99	K20R-U	3122	0.8	K20TT	IK20TT	IK20TT	4
2.0 i 16V Turbo	147	SR20DET		10/93-12/99	PK20PR-P8	3245	0.8	-	IK20TT	IK20TT	4
2.0 i 16V Turbo	147	SR20DET		10/93-12/99	PK22PR8	3273	0.8	-	IK22TT	VK22	4
2.0 Turbo	162	SR20DET		04/94-09/99	PK20PR-P8	3245	0.8	-	IK20TT	IK20TT	4
200 SX Coupe (79-81)											
2.0	88	Z20E		01/79-06/81	W20EX-U	3062	0.8	W20TT	IW20TT	IW20TT	4
240 SX (93-97)											
2.4	112/ 115	KA24DE		04/93-08/97	K16PR-U11	3130	1.1	K16TT	IK16TT	IK16TT	4
300 ZX (84-90)											
3.0	125	VG30E		01/84-12/87	Q16PR-U11	5016	1.1	Q16TT	IQ16TT	IQ16TT	6
3.0	125	VG30E		01/84-12/87	Q16R-U11	3006	1.1	Q16TT	IQ16TT	IQ16TT	6
3.0	125	VG30E		02/87-12/87	Q20PR-U11	3008	1.1	Q20TT	IQ20TT	IQ20TT	6
3.0 Turbo	149/ 168	VG30ET; VG30T		04/84-10/90	Q20PR-U11	3008	1.1	Q20TT	IQ20TT	IQ20TT	6
3.0 Turbo	149/ 168	VG30ET; VG30T	OEM Optional	04/84-10/90	Q22PR-U11	3257	1.1	-	-	VQ22	6
300 ZX (90-95)											
3.0 Twin Turbo	197/ 208	VG30DETT		05/90-09/95	IQ16TT	4706	1.0	-	IQ16TT		6
350 Z (02-)											
3.5	206/ 214/ 221	VQ35DE		09/02-12/08	IKH16TT	4703	1.0	-	IKH16TT		6
3.5	206/ 214/ 221	VQ35DE		09/02-12/08	IKH20TT	4704	1.0	-	IKH20TT		6
3.5	230	VQ35HR		09/05-12/09	FXE22HR11	3442	1.1	-	IXEH22TT	IXEH22TT	6
3.5	230	VQ35HR		09/05-12/09	IXEH22TT	4712	1.0	-	IXEH22TT		6
370 Z (09-)											
3.7	241/ 243/ 248	VQ37HR; VQ37VHR		04/09-	FXE24HR11	3457	1.1	-	-	FXE24HR11	6
NISMO 3.7	253	VQ37VHR		06/13-	FXE24HR11	3457	1.1	-	-	FXE24HR11	6
ALMERA Classic (06-)											
1.6 16V	79	QG16; QG16DE		03/06-	K16HPR-U11	6076	1.1	KH16TT	IKH16TT	IKH16TT	4
1.6 16V	79	QG16; QG16DE	OEM Optional	05/10-	IKH16TT	4703	1.0	-	IKH16TT		4
ALMERA I (95-00)											
1.4	64	GA14DE		09/95-07/00	K16PR-U	3191	0.8	K16TT	IK16TT	IK16TT	4
1.4	64	GA14DE		09/95-07/00	K20PR-U	3145	0.8	K20TT	IK20TT	IK20TT	4
1.4 GX,LX	55	GA14DE		09/95-07/00	K16PR-U	3191	0.8	K16TT	IK16TT	IK16TT	4
1.4 GX,LX	55	GA14DE		09/95-07/00	K20PR-U	3145	0.8	K20TT	IK20TT	IK20TT	4
1.4 S,GX,LX	55	GA14DE		09/95-03/00	K16PR-U	3191	0.8	K16TT	IK16TT	IK16TT	4
1.4 S,GX,LX	55	GA14DE		09/95-03/00	K20PR-U	3145	0.8	K20TT	IK20TT	IK20TT	4
1.5	77	GA15DE		07/95-05/00	K20PR-U	3145	0.8	K20TT	IK20TT	IK20TT	4
1.6	73/75	GA16DE		07/95-07/00	K20PR-U	3145	0.8	K20TT	IK20TT	IK20TT	4
1.6 SLX	66	GA16DE		09/95-07/00	K20PR-U	3145	0.8	K20TT	IK20TT	IK20TT	4
1.6 SR,SLX	66	GA16DE		09/95-03/00	K20PR-U	3145	0.8	K20TT	IK20TT	IK20TT	4
2.0 D	55	CD20	Ceramic(LPH)	11/95-07/00	DG-642		11V				4
2.0 GTi	105	SR20DE		07/96-03/00	K16R-U11	3120	1.1	K16TT	IK16TT	IK16TT	4
2.0 GTi	105	SR20DE		07/96-03/00	K20R-U11	3139	1.1	K20TT	IK20TT	IK20TT	4
ALMERA II (00-)											
1.5	66	QG15DE		03/00-09/02	K16PR-U11	3130	1.1	K16TT	IK16TT	IK16TT	4
1.5	66/72	QG15DE		09/02-11/06	K16HPR-U11	6076	1.1	KH16TT	IKH16TT	IKH16TT	4
1.5 dCi	60	K9K 722	Double Coil(LPH)	01/03-09/06	DG-005		11V				4
1.8	85	QG18DE		01/00-09/02	K16PR-U11	3130	1.1	K16TT	IK16TT	IK16TT	4
1.8	85	QG18DE		09/02-09/06	K16HPR-U11	6076	1.1	KH16TT	IKH16TT	IKH16TT	4
2.2 dCi	82/ 100	YD22DDTi	Double Coil(LPH)	09/03-09/06	DG-197		11V				4
2.2 Di	81	YD22DDT	Double Coil(LPH)	03/00-04/03	DG-197		11V				4
ALMERA TINO (00-)											
1.8	85	QG18DE		08/00-09/02	K16PR-U11	3130	1.1	K16TT	IK16TT	IK16TT	4

Свечи зажигания и Свечи накаливания











Таблица применения

KW	KW	KW	NOTE	21	СТАНДАРТНЫЕ			Twin Tip		QTY	
					STANDARD	STANDARD	STANDARD	TWIN TIP	TWIN TIP		
NISSAN продолжение											
ALMERA TINO (00-) продолжение											
1.8	85	QG18DE		09/02-02/06	K16HPR-U11	6076	1.1	KH16TT	IKH16TT	IKH16TT	4
2.0	100	SR20DE		08/00-01/03	K16R-U11	3120	1.1	K16TT	IK16TT	IK16TT	4
2.0	100	SR20DE		08/00-01/03	PK20PR-L11	3142	1.1	-	IK20TT	IK20TT	4
2.2 dCi	82/ 84/ 100	YD22DDTi	Double Coil(LPH)	08/00-02/06	DG-197		11V				4
ALTIMA (93-01)											
2.4	112	KA24DE		06/97-08/01	K16PR-U11	3130	1.1	K16TT	IK16TT	IK16TT	4
ALTIMA (01-06)											
2.5	121	QR25DE		08/01-09/06	K16HPR-U11	6076	1.1	KH16TT	IKH16TT	IKH16TT	4
3.5	180	VQ35DE		08/01-09/06	IKH16TT	4703	1.0	-	IKH16TT		6
3.5	180	VQ35DE		08/01-09/06	IKH20TT	4704	1.0	-	IKH20TT		6
ALTIMA (06-13)											
3.5	201	VQ35DE		10/06-07/13	IKH16TT	4703	1.0	-	IKH16TT		6
3.5	201	VQ35DE		10/06-07/13	IKH20TT	4704	1.0	-	IKH20TT		6
ALTIMA (12-)											
2.5	127/ 132/ 134/ 136	QR25DE		05/12-	VFXEH20E	5644	1.1	-	IXEH20ETT	IXEH20ETT	4
3.5	183/ 201	VQ35DE		08/12-	FXE22HR11	3442	1.1	-	IXEH22TT	IXEH22TT	6
3.5	183/ 201	VQ35DE		08/12-	IXEH22TT	4712	1.0	-	IXEH22TT		6
AVENIR (86-97)											
2.0 TD	66	CD20T	Ceramic(LPH)	11/92-10/97	DG-642		11V				4
AVENIR (97-05)											
1.8	92	QG18DE		11/97-09/02	K16PR-U11	3130	1.1	K16TT	IK16TT	IK16TT	4
1.8	92	QG18DE		09/02-12/05	K16HPR-U11	6076	1.1	KH16TT	IKH16TT	IKH16TT	4
2.0	107	SR20DE		11/97-08/01	K16R-U11	3120	1.1	K16TT	IK16TT	IK16TT	4
2.0	107	SR20DE		11/97-08/01	K20R-U11	3139	1.1	K20TT	IK20TT	IK20TT	4
2.0	110	QR20DE		09/01-12/05	K16HPR-U11	6076	1.1	KH16TT	IKH16TT	IKH16TT	4
2.0 4x4	107	SR20DE		11/97-12/05	K16R-U11	3120	1.1	K16TT	IK16TT	IK16TT	4
2.0 Turbo 4x4	147	SR20DET		08/98-12/05	PK20PR-P8	3245	0.8	-	IK20TT	IK20TT	4
BLUEBIRD (80-86)											
1.6	60	L16		01/80-11/83	W20EP-U	3043	0.8	W20TT	IW20TT	IW20TT	4
1.8	65	L18S; L18T		01/80-05/84	W20EPR-U	3047	0.8	W20TT	IW20TT	IW20TT	4
1.9 i	80	Z20E		01/82-05/84	W20EX-U	3062	0.8	W20TT	IW20TT	IW20TT	4
2.0	80	Z20E		01/82-01/83	W20EX-U	3062	0.8	W20TT	IW20TT	IW20TT	4
2.0 D	44	LD20	Double Coil(LPH)	01/80-05/84	DG-012		11V				4
2.0 i	80	Z20E		01/82-12/83	W20EPR-U11	3049	1.1	W20TT	IW20TT	IW20TT	4
2.0 i	80	Z20E		01/82-12/83	W20EX-U	3062	0.8	W20TT	IW20TT	IW20TT	4
BLUEBIRD (83-90)											
1.8	66	CA18S		11/83-06/88	W20EPR-U	3047	0.8	W20TT	IW20TT	IW20TT	4
1.8 Turbo	99	CA18T		04/84-05/90	Q20PR-U11	3008	1.1	Q20TT	IQ20TT	IQ20TT	4
2.0	75	CA20S		04/86-09/90	W20EPR-U11	3049	1.1	W20TT	IW20TT	IW20TT	4
2.0 i	77/85	CA20E		04/84-12/90	Q20PR-U11	3008	1.1	Q20TT	IQ20TT	IQ20TT	4
2.0 LX	66	CA20S		12/85-02/90	W20EPR-U11	3049	1.1	W20TT	IW20TT	IW20TT	4
BLUEBIRD (85-92)											
1.6	61/66	CA16S		12/85-06/91	Q16PR-U11	5016	1.1	Q16TT	IQ16TT	IQ16TT	4
1.6	61/66	CA16S		03/86-06/91	Q20PR-U	3007	0.8	Q20TT	IQ20TT	IQ20TT	4
1.8	61/65	CA18N		05/86-11/92	Q16PR-U11	5016	1.1	Q16TT	IQ16TT	IQ16TT	4
1.8 i 16V	95	CA18D		02/89-12/90	PQ20R	3117	1.1	Q20TT	IQ20TT	IQ20TT	4
1.8 Turbo	99	CA18T		12/85-11/92	Q20PR-U11	3008	1.1	Q20TT	IQ20TT	IQ20TT	4
2.0	75	CA20S		12/85-12/87	W16EPR-U11	3201	1.1	W16TT	IW16TT	IW16TT	4
2.0	75	CA20S		12/85-12/87	W20EPR-U11	3049	1.1	W20TT	IW20TT	IW20TT	4
2.0 D	49	LD20	Ceramic(LPH)	03/86-12/90	DG-644		11V				4
2.0 i	77	CA20E; CA20S		12/85-12/90	Q16PR-U11	5016	1.1	Q16TT	IQ16TT	IQ16TT	8
2.0 i	77/85	CA20E		12/85-12/90	Q20PR-U11	3008	1.1	Q20TT	IQ20TT	IQ20TT	8
BLUEBIRD Sylphy (12-)											
1.6	75	K4M		12/12-	K20PR-U	3145	0.8	K20TT	IK20TT	IK20TT	4
CABSTAR (F22) (82-93)											
1.6	62	Z16		10/86-09/92	W16EX-U	3027	0.8	W16TT	IW16TT	IW16TT	4
2.0	64/66	Z20; Z20S		01/82-09/86	W20EX-U	3062	0.8	W20TT	IW20TT	IW20TT	4
2.0	64/66	Z20; Z20S		09/86-09/88	W16EX-U	3027	0.8	W16TT	IW16TT	IW16TT	4
2.0	64/66	Z20; Z20S		09/88-06/92	W16EXR-U	3031	0.8	W16TT	IW16TT	IW16TT	4
2.2	71	Z22		10/86-06/92	W20EP-U	3043	0.8	W20TT	IW20TT	IW20TT	4

Свечи зажигания и Свечи накаливания

Таблица применения

Таблица применения

	KW				СТАНДАРТНЫЕ				Twin Tip			QTY
												
NISSAN продолжение												
CABSTAR (F22) (82-93) продолжение												
2.5 TD	55	TD25	Double Coil(LPH)	01/89-12/92	DG-626		11V					4
CABSTAR (F23) (92-00)												
2.0	66	Z20S		07/92-05/94	W16EPR-U	3021	0.8	W16TT	IW16TT	IW16TT		4
2.0	66	Z20S		07/92-05/94	W16EXR-U	3031	0.8	W16TT	IW16TT	IW16TT		4
2.5 D	56	TD25	Double Coil(LPH)	07/92-12/00	DG-626		11V					4
CABSTAR (F24) (06-13)												
2.5	81/90/96/100	YD25DDTI; YD25K3LD-5MI	Double Coil(LPH)	09/06-01/10	DG-197		11V					4
2.5	81/90/96/100	YD25DDTI; YD25K3LD-5MI	OE: 11065-00Q0H; 11065-00Q0L	11/11-12/13	DG-631		4.5V					4
CEDRIC (83-87)												
3.0	110/132	VG30E		10/83-08/87	Q16PR-U11	5016	1.1	Q16TT	IQ16TT	IQ16TT		6
3.0	132	VG30E		10/83-08/87	Q20P-U11	3136	1.1	Q20TT	IQ20TT	IQ20TT		6
3.0	132	VG30E	OEM Optional	07/85-08/87	Q20PR-U11	3008	1.1	Q20TT	IQ20TT	IQ20TT		6
3.0 i	113	VG30E		05/84-05/88	Q16PR-U11	5016	1.1	Q16TT	IQ16TT	IQ16TT		6
CEDRIC (87-97)												
3.0	118	VG30E		09/87-05/91	Q16PR-U11	5016	1.1	Q16TT	IQ16TT	IQ16TT		6
CEDRIC (91-99)												
2.5	140	VQ25DE		06/96-04/99	IK16TT	4701	1.0	-	IK16TT	IK16TT		6
3.0	118	VG30E		06/91-10/95	Q16R-U11	3006	1.1	Q16TT	IQ16TT	IQ16TT		6
3.0	118	VG30E		06/91-10/95	Q20PR-U11	3008	1.1	Q20TT	IQ20TT	IQ20TT		6
3.0	118	VG30E		06/91-10/97	Q16PR-U11	5016	1.1	Q16TT	IQ16TT	IQ16TT		6
3.0	147/162	VQ30DE		06/91-10/95	PK20PR11	3168	1.1	K20TT	IK20TT	IK20TT		6
3.0 S	118	VG30E		11/95-10/97	Q16PR-U11	5016	1.1	Q16TT	IQ16TT	IQ16TT		6
3.0 Turbo	199	VQ30DET		10/92-10/95	IK20TT	4702	1.0	-	IK20TT	IK20TT		6
CEDRIC (96-04)												
3.0 Ultima	206	VQ30DET		08/00-08/04	IK20TT	4702	1.0	-	IK20TT	IK20TT		6
CEFIRO II (94-99)												
3.0	142	VQ30DE		10/94-12/99	PK20PR11	3168	1.1	K20TT	IK20TT	IK20TT		6
CEFIRO III (00-04)												
3.0	147	VQ30DE		01/00-09/03	PK20PR11	3168	1.1	K20TT	IK20TT	IK20TT		6
CHERRY I (E10) (70-78)												
1.0	33	A10		11/75-09/78	W14EPR-U	6011	0.8	-	IW16TT	IW16TT		4
CHERRY II (N10) (78-83)												
1.0	33	A10; A10S		08/78-07/81	W14EPR-U	6011	0.8	-	IW16TT	IW16TT		4
1.2	38	A12		08/78-07/81	W20EPR-U	3047	0.8	W20TT	IW20TT	IW20TT		4
1.2	38	A12		10/78-07/81	W14EPR-U	6011	0.8	-	IW16TT	IW16TT		4
1.3	44	E13		08/81-09/82	W20EPR-U	3047	0.8	W20TT	IW20TT	IW20TT		4
1.3	44	E13		08/81-12/83	W16EXR-U11	3032	1.1	W16TT	IW16TT	IW16TT		4
1.4	59	A14S		08/80-07/81	W16EPR-U	3021	0.8	W16TT	IW16TT	IW16TT		4
1.4 i.e.	59	A14S		08/80-07/81	W16EPR-U	3021	0.8	W16TT	IW16TT	IW16TT		4
1.5	51	E15		08/81-12/82	W16EPR-U11	3201	1.1	W16TT	IW16TT	IW16TT		4
CHERRY III (N12) (82-86)												
1.0	37	E10		05/82-05/86	W16EPR-U	3021	0.8	W16TT	IW16TT	IW16TT		4
1.3	44	E13		05/82-10/86	W16EXR-U11	3032	1.1	W16TT	IW16TT	IW16TT		4
1.3	44	E13		05/82-10/86	W20EPR-U	3047	0.8	W20TT	IW20TT	IW20TT		4
1.5	55	E15S		11/83-10/86	W16EPR-U	3021	0.8	W16TT	IW16TT	IW16TT		4
1.5 ET Turbo	77	E15ET		01/83-12/85	W20EPR-U	3047	0.8	W20TT	IW20TT	IW20TT		4
1.6	51	E16		06/85-07/86	W16EXR-U11	3032	1.1	W16TT	IW16TT	IW16TT		4
CIMA (91-96)												
4.1	198	VH41DE		09/91-06/96	IK16TT	4701	1.0	-	IK16TT	IK16TT		8
CIMA (96-01)												
4.1	198	VH41DE		07/96-02/01	IK16TT	4701	1.0	-	IK16TT	IK16TT		8
CUBE (03-05)												
1.4	72	CR14DE		01/03-09/05	IKH16TT	4703	1.0	-	IKH16TT			4
1.4	72	CR14DE		01/03-09/05	KH16TT	4605	1.0	KH16TT	IKH16TT	IKH16TT		4
1.5	80	HR15DE		01/03-09/05	FXE20HE11	3436	1.1	-	IXEH20ETT	IXEH20ETT		4
1.5	80	HR15DE		01/03-09/05	K16HPR-U11	6076	1.1	KH16TT	IKH16TT	IKH16TT		4
CUBE (10-)												
1.5 dCi	78/81	K9K 270; K9K	Instant heating (ISS)	03/10-	DG-609		4.4V					4

Свечи зажигания и Свечи накаливания

Таблица применения











	KW				СТАНДАРТНЫЕ				Twin Tip		QTY
											
NISSAN продолжение											
CUBE (10-) продолжение											
1.6 16V	81	HR16DE		03/10-	FXE20HR11	3439	1.1	-	IXEH20TT	IXEH20TT	4
DATSUN 100 A (74-80)											
1.0 F-II	33	A10		12/75-01/79	W14EPR-U	6011	0.8	-	IW16TT	IW16TT	4
DATSUN 120 (74-80)											
1.2 A F-II	38	A12		11/77-07/80	W14EPR-U	6011	0.8	-	IW16TT	IW16TT	4
1.2 Y	38	A12		11/77-07/80	W14EPR-U	6011	0.8	-	IW16TT	IW16TT	4
DATSUN 120 Y (62-80)											
1.2	38	A12		11/77-07/80	W14EPR-U	6011	0.8	-	IW16TT	IW16TT	4
1.2 A F-II	38	A12		11/77-08/80	W14EPR-U	6011	0.8	-	IW16TT	IW16TT	4
DATSUN 180 B (77-81)											
1.8	65	L18; L18S; L18T		04/80-01/81	W20EPR-U	3047	0.8	W20TT	IW20TT	IW20TT	4
ELGRAND (95-02)											
3.3	125	VG33E		04/96-04/02	K16PR-U11	3130	1.1	K16TT	IK16TT	IK16TT	6
3.3 4x4	125	VG33E		04/96-08/01	K16PR-U11	3130	1.1	K16TT	IK16TT	IK16TT	6
3.5 AWD	177	VQ35DE		08/00-04/02	IKH16TT	4703	1.0	-	IKH16TT		6
3.5 AWD	177	VQ35DE		08/00-04/02	IKH20TT	4704	1.0	-	IKH20TT		6
ELGRAND (02-10)											
2.5	137	VQ25DE		12/04-12/10	IKH16TT	4703	1.0	-	IKH16TT		6
2.5 AWD	137	VQ25DE		12/04-12/10	IKH16TT	4703	1.0	-	IKH16TT		6
3.5	177	VQ35DE		05/02-12/10	IKH16TT	4703	1.0	-	IKH16TT		6
3.5	177	VQ35DE		05/02-12/10	IKH20TT	4704	1.0	-	IKH20TT		6
3.5 AWD	177	VQ35DE		05/02-12/10	IKH16TT	4703	1.0	-	IKH16TT		6
3.5 AWD	177	VQ35DE		05/02-12/10	IKH20TT	4704	1.0	-	IKH20TT		6
FIGARO (91-92)											
1.0	56	MA10ET		02/91-04/92	W20EXR-U11	3067	1.1	W20TT	IW20TT	IW20TT	4
GT-R (09-)											
3.8 NISMO	441	VR38DETT		07/14-	VDCH22F	5663	0.9	-	-	VDCH22F	6
3.8 V6	357/ 390/ 404/ 419	VR38DETT		12/07-	VDCH22F	5663	0.9	-	-	VDCH22F	6
INFINITY Q45 (93-97)											
4.5 i	207	VH45DE		07/93-01/97	IK16TT	4701	1.0	-	IK16TT	IK16TT	8
INTERSTAR (02-)											
1.9 dCi 80	60	F9Q 772; F9Q 774	Double Coil(LPH)	04/02-08/06	DG-005		11V				4
2.2 dCi 90	66	G9T 722	Double Coil(LPH)	07/02-	DG-126		11V				4
2.5 dCi 100	73	G9U 650; G9U 720; G9U 754	OE: 11065-00Q0A, Double Coi l(LPH)	11/03-12/11	DG-126		11V				4
2.5 dCi 120	84/88	G9U 650; G9U 720; G9U 724; G9U 750	OE: 11065-00Q0A, Double Coi l(LPH)	04/02-12/11	DG-126		11V				4
2.5 dCi 150	107	G9U 632	OE: 11065-00Q0A, Double Coi l(LPH)	10/06-	DG-126		11V				4
3.0 dCi 140	100	ZD30	Double Coil(LPH)	11/03-09/06	DG-005		11V				4
JUKE (10-)											
1.5 dCi	81	K9K 410; K9K 636; K9K 646; K9K 896	Instant heating (ISS)	06/10-12/12	DG-609		4.4V				4
1.6	69	HR16DE	Japan	01/13-	IKH16TT	4703	1.0	-	IKH16TT		4
1.6	86	HR16DE		06/10-	FXE20HE11	3436	1.1	-	IXEH20ETT	IXEH20ETT	4
1.6 DIG-T	140	MR16DDT		05/14-	VFXEHC22G	5659	0.8	-	-	VFXEHC22G	4
1.6 DIG-T 4x4	140	MR16DDT		05/14-	VFXEHC22G	5659	0.8	-	-	VFXEHC22G	4
KUBISTAR (03-)											
1.2 16V	55	D4F 712		04/06-	XE20HR-U9	3427	0.9	-	IXEH20TT	IXEH20TT	4
1.5 dCi	45/ 48/60	K9K 704; K9K 710; K9K 714; K9K 722	Double Coil(LPH)	08/03-	DG-005		11V				4
1.5 dCi 70	50	K9K 700; K9K 716	Double Coil(LPH)	09/05-10/09	DG-005		11V				4
1.6 16V	70	K4M 752		08/03-	K20PR-U	3145	0.8	K20TT	IK20TT	IK20TT	4
LAUREL (77-83)											
2.0	71	L20A		03/77-05/81	W16EPR-U	3021	0.8	W16TT	IW16TT	IW16TT	6
2.4	83	L24		12/77-05/83	W20EPR-U	3047	0.8	W20TT	IW20TT	IW20TT	6
LAUREL (81-85)											
2.0	71	L20A		01/81-01/84	W16EPR-U	3021	0.8	W16TT	IW16TT	IW16TT	6

Таблица применения

N

Свечи зажигания и Свечи накаливания











Таблица применения

Таблица применения

KW	KW	KW	NOTE	21	СТАНДАРТНЫЕ			Twin Tip		QTY	
					W20EPR-U	3047	0.8	W20TT	IW20TT		IW20TT
NISSAN продолжение											
LAUREL (81-85) продолжение											
2.4	83/88	L24		01/81-12/85	W20EPR-U	3047	0.8	W20TT	IW20TT	IW20TT	6
2.8 D	62	LD28	Double Coil(LPH)	01/81-10/85	DG-012		11V				6
LAUREL (84-89)											
2.4	94	L24E; L24S		01/85-12/87	W16EPR-U	3021	0.8	W16TT	IW16TT	IW16TT	6
2.8 D	62	LD28	Double Coil(LPH)	01/85-12/87	DG-012		11V				6
2.8 D	66	RD28	Ceramic(LPH)	01/85-12/89	DG-644		11V				6
MAXIMA III (88-94)											
3.0	128	VG30E		10/88-06/94	K20PR-U11	3121	1.1	K20TT	IK20TT	IK20TT	6
3.0 i	125	VG30E		10/88-06/94	K20PR-U11	3121	1.1	K20TT	IK20TT	IK20TT	6
3.0 i	125	VG30E		10/88-06/94	PK16PR-L11	3275	1.1	-	IK16TT	IK16TT	6
MAXIMA IV (95-00)											
2.0	103	VQ20DE		02/95-08/00	PK20PR11	3168	1.1	K20TT	IK20TT	IK20TT	6
2.5 V6 24V	140	VQ25DE		02/95-12/00	IK16TT	4701	1.0	-	IK16TT	IK16TT	6
3.0	142	VQ30DE		01/95-08/00	PK20PR11	3168	1.1	K20TT	IK20TT	IK20TT	6
3.0 QX	142	VQ30DE		10/97-12/00	PK20PR11	3168	1.1	K20TT	IK20TT	IK20TT	6
MAXIMA V (99-03)											
2.0 V6 24V	103	VQ20DE		03/00-11/03	PK16PR-L11	3275	1.1	-	IK16TT	IK16TT	6
2.5 V6 24V	154	VQ25DE		03/00-11/03	IK16TT	4701	1.0	-	IK16TT	IK16TT	6
3.0 V6 24V	147	VQ30DE		03/00-11/03	PK20PR11	3168	1.1	K20TT	IK20TT	IK20TT	6
3.5	188/ 190	VQ35DE		08/01-11/03	IKH16TT	4703	1.0	-	IKH16TT		6
3.5	188/ 190	VQ35DE		08/01-11/03	IKH20TT	4704	1.0	-	IKH20TT		6
MICRA C+C (05-)											
1.4 16V	65	CR14DE		08/05-	IKH16TT	4703	1.0	-	IKH16TT		4
1.4 16V	65	CR14DE		08/05-	KH16TT	4605	1.0	KH16TT	IKH16TT	IKH16TT	4
1.6 160 SR	81	HR16DE		08/05-	FXE20HR11	3439	1.1	-	IXEH20TT	IXEH20TT	4
MICRA I (K10) (82-92)											
1.0	37/40	MA10S		12/82-12/89	W14EXR-U11	3014	1.1	-	IW16TT	IW16TT	4
1.0	37/40	MA10S		12/82-12/89	W16EPR-U	3021	0.8	W16TT	IW16TT	IW16TT	4
1.2	40/44	MA12S		07/86-07/92	W16EPR-U	3021	0.8	W16TT	IW16TT	IW16TT	4
MICRA II (K11) (92-03)											
1.0 i 16V	40/44	CG10DE		08/92-02/03	K16PR-U11	3130	1.1	K16TT	IK16TT	IK16TT	4
1.3 i 16V	55	CG13DE		08/92-09/00	K16PR-U11	3130	1.1	K16TT	IK16TT	IK16TT	4
1.4 i 16V	60	CGA3DE		09/00-02/03	K16PR-U11	3130	1.1	K16TT	IK16TT	IK16TT	4
1.5 D	42	TD15	Double Coil(LPH)	02/98-02/03	DG-003		11V				4
MICRA III (K12) (03-10)											
1.0 16V	48	CG10DE		01/03-05/05	IKH16TT	4703	1.0	-	IKH16TT		4
1.0 16V	48	CG10DE		01/03-06/10	KH16TT	4605	1.0	KH16TT	IKH16TT	IKH16TT	4
1.2 16V	48/59	CG12DE; CR12DE		01/03-06/10	K16HR-U11	3482	1.1	KH16TT	IKH16TT	IKH16TT	4
1.2 16V	48/59	CG12DE; CR12DE		01/03-06/10	KH16TT	4605	1.0	KH16TT	IKH16TT	IKH16TT	4
1.2 LPG	59	CR12DE		10/02-06/10	KH16TT	4605	1.0	KH16TT	IKH16TT	IKH16TT	4
1.4 16V	65	CR14DE		01/03-04/09	IKH16TT	4703	1.0	-	IKH16TT		4
1.4 16V	65	CR14DE		01/03-04/09	KH16TT	4605	1.0	KH16TT	IKH16TT	IKH16TT	4
1.5 dCi	48/ 50/ 60/63	K9K 276; K9K 704; K9K 708; K9K 722	Double Coil(LPH)	01/03-06/10	DG-005		11V				4
160 SR	81	HR16DE		05/05-06/10	FXE20HR11	3439	1.1	-	IXEH20TT	IXEH20TT	4
MICRA IV (K13) (10-)											
1.2	56/59	HR12DE		05/10-	FXE20HR11	3439	1.1	-	IXEH20TT	IXEH20TT	3
MOCO I (02-06)											
0.7	40/44	K6A		04/02-01/06	XU22EPR-U	3179	0.9	XU22TT	IXU22TT	VXU22	3
0.7	40/44	K6A	LEAN BURN	04/02-01/06	IXU22	5308	0.9	-	IXU22TT	VXU22	3
0.7 4WD	40/44	K6A		04/02-01/06	XU22EPR-U	3179	0.9	XU22TT	IXU22TT	VXU22	3
0.7 4WD	40/44	K6A	LEAN BURN	04/02-01/06	IXU22	5308	0.9	-	IXU22TT	VXU22	3
MOCO II (06-10)											
0.7	40/44	K6A		03/06-12/10	XU22EPR-U	3179	0.9	XU22TT	IXU22TT	VXU22	3
0.7	40/44	K6A		06/09-12/10	IXUH22	5353	0.9	-	IXUH22TT	VXUH22	3
0.7	40/44	K6A; K6A-T		03/06-12/10	IXU22	5308	0.9	-	IXU22TT	VXU22	3
0.7 4WD	40/44	K6A		03/06-12/10	XU22EPR-U	3179	0.9	XU22TT	IXU22TT	VXU22	3
0.7 4WD	40/44	K6A		06/09-12/10	IXUH22	5353	0.9	-	IXUH22TT	VXUH22	3
0.7 4WD	40/44	K6A; K6A-T		03/06-12/10	IXU22	5308	0.9	-	IXU22TT	VXU22	3
MURANO I (03-08)											
3.5 4x4	170/ 172	VQ35DE		08/03-09/08	IKH16TT	4703	1.0	-	IKH16TT		6

Свечи зажигания и Свечи накаливания

Таблица применения

	KW				СТАНДАРТНЫЕ				Twin Tip			QTY
												
NISSAN продолжение												
MURANO I (03-08) продолжение												
3.5 4x4	170/ 172	VQ35DE		08/03-09/08	IKH20TT	4704	1.0	-	IKH20TT			6
MURANO II (07-14)												
2.5 dCi 4x4	140	YD25DDTi	OE: 11065-00Q0H; 11065-00Q0L	11/11-09/14	DG-631		4.5V					4
3.5 4x4	183/ 188/ 191	VQ35; VQ35DE		10/08-09/14	FXE22HR11	3442	1.1	-	IXEH22TT	IXEH22TT		6
3.5 4x4	183/ 188/ 191	VQ35; VQ35DE		10/08-09/14	IXEH22TT	4712	1.0	-	IXEH22TT			6
MURANO III (14-)												
3.5 V6 4x4	188	VQ35DE		10/14-	FXE22HR11	3442	1.1	-	IXEH22TT	IXEH22TT		6
3.5 V6 4x4	188	VQ35DE		10/14-	IXEH22TT	4712	1.0	-	IXEH22TT			6
NAVARA (D21) (86-08)												
2.0	66	Z20		01/86-09/86	W20EX-U	3062	0.8	W20TT	IW20TT	IW20TT		4
2.0	66	Z20		09/86-09/88	W16EX-U	3027	0.8	W16TT	IW16TT	IW16TT		4
2.0	66	Z20		09/88-08/91	W16EXR-U	3031	0.8	W16TT	IW16TT	IW16TT		4
NAVARA (D22) (97-)												
2.5 D 4x4	98	YD25DDTi	Double Coil(LPH)	11/01-	DG-197		11V					4
2.5 dCi	98	YD25DDTi	Double Coil(LPH)	04/08-	DG-197		11V					4
2.5 dCi 4x4	98	YD25DDTi	Double Coil(LPH)	04/08-	DG-197		11V					4
2.5 Di	98	YD25DDTi	Double Coil(LPH)	02/02-	DG-197		11V					4
2.5 Di 4WD	98	YD25DDTi	Double Coil(LPH)	02/02-	DG-197		11V					4
3.3 4x4	125	VG33E		11/01-04/07	K16PR-U11	3130	1.1	K16TT	IK16TT	IK16TT		6
NAVARA (D40) (05-)												
2.5 dCi	106/ 120/ 128	YD25DDTi	Double Coil(LPH)	07/05-01/10	DG-197		11V					4
2.5 dCi	106/ 120/ 128/ 140	YD25DDTi	OE: 11065-00Q0H; 11065-00Q0L	11/11-	DG-631		4.5V					4
2.5 dCi 4WD	106/ 126/ 128/ 140	YD25DDTi	Double Coil(LPH)	07/05-01/10	DG-197		11V					4
2.5 dCi 4WD	106/ 126/ 128/ 140	YD25DDTi	OE: 11065-00Q0H; 11065-00Q0L	11/11-	DG-631		4.5V					4
NOTE (E11) (06-12)												
1.4	65	CR14DE		03/06-06/12	IKH16TT	4703	1.0	-	IKH16TT			4
1.4	65	CR14DE		03/06-06/12	KH16TT	4605	1.0	KH16TT	IKH16TT	IKH16TT		4
1.5 dCi	50/ 63/ 66/76	K9K 276; K9K 292; K9K 700	Instant heating (ISS)	09/10-06/12	DG-609		4.4V					4
1.5 dCi	50/ 63/76	K9K 276; K9K 292; K9K 700	Double Coil(LPH)	10/10-06/12	DG-005		11V					4
1.6	81	HR16DE		03/06-06/12	FXE20HR11	3439	1.1	-	IXEH20TT	IXEH20TT		4
NOTE (E12) (13-)												
1.2	59	HR12DE		06/13-	FXE20HR11	3439	1.1	-	IXEH20TT	IXEH20TT		3
1.2 LPG	56	HR12DE		03/15-	FXE20HR11	3439	1.1	-	IXEH20TT	IXEH20TT		3
1.5 dCi	66	K9K 608; K9K 892	Instant heating (ISS)	06/13-	DG-609		4.4V					4
NT100 Clipper (03-13)												
0.7	35	3G83		04/03-05/13	KJ20CR-U11	3451	1.1	K20TT	IK20TT	IK20TT		3
0.7 4WD	35	3G83		04/03-05/13	KJ20CR-U11	3451	1.1	K20TT	IK20TT	IK20TT		3
NT400 Cabstar (14-)												
2.5	90	YD25K3LD-5LO	OE: 11065-00Q0H; 11065-00Q0L	01/14-	DG-631		4.5V					4
2.5 D	100/ 107	YD25K3LD-5HO; YD25K3LD-5MI	OE: 11065-00Q0H; 11065-00Q0L	01/14-	DG-631		4.5V					4
NV200 (10-)												
1.5 dci	63	K9K 400; K9K 608; K9K 628	Double Coil(LPH)	10/10-	DG-005		11V					4

Свечи зажигания и Свечи накаливания

Таблица применения

Таблица применения

KW	KW	KW	NOTE	21	СТАНДАРТНЫЕ			Twin Tip		QTY	
					STANDARD	STANDARD	STANDARD	TWIN TIP	TWIN TIP		
NISSAN продолжение											
NV200 (10-) продолжение											
1.5 dci	63/66/81	K9K 400; K9K 608; K9K 628; K9K 636; K9K 646; K9K 892	Instant heating (ISS)	11/10-	DG-609		4.4V			4	
1.6 16V	81	HR16DE		02/10-	FXE20HR11	3439	1.1	-	IXEH20TT	IXEH20TT	4
NV2500 (11-)											
5.6	236	VK56DE		09/11-	IKH16TT	4703	1.0	-	IKH16TT		8
PATHFINDER I (86-95)											
2.4 4WD	74	Z24i		07/86-04/92	W20EPR-U	3047	0.8	W20TT	IW20TT	IW20TT	4
3.0 4WD	95	VG30E; VG30I		07/86-08/95	K20PR-U11	3121	1.1	K20TT	IK20TT	IK20TT	6
PATHFINDER II (97-04)											
2.7 TD 4WD	96	TD27ETi	Single Coil	09/97-12/04	DG-198		11V				4
3.3 V6 4WD	110/125	VG33E		09/97-08/03	K16PR-U11	3130	1.1	K16TT	IK16TT	IK16TT	6
3.3 V6 4WD	110/125	VG33E		09/97-08/03	Q20PR-U11	3008	1.1	Q20TT	IQ20TT	IQ20TT	6
3.5 V6 4WD	162	VQ35		11/00-12/04	IKH16TT	4703	1.0	-	IKH16TT		6
3.5 V6 4WD	162	VQ35	OEM Optional	11/00-12/04	IKH20TT	4704	1.0	-	IKH20TT		6
PATHFINDER III (05-)											
2.5 dCi	128	YD25DDTi	Double Coil(LPH)	01/05-01/10	DG-197		11V				4
2.5 dCi	128	YD25DDTi	OE: 11065-00Q0H; 11065-00Q0L	11/11-	DG-631		4.5V				4
2.5 dCi 4WD	120/126/128	YD25DDTi	Double Coil(LPH)	01/05-01/10	DG-197		11V				4
2.5 dCi 4WD	120/126/128/140	YD25DDTi	OE: 11065-00Q0H; 11065-00Q0L	11/11-	DG-631		4.5V				4
4.0 4WD	198	VQ40DE		09/05-	IKH20TT	4704	1.0	-	IKH20TT		6
PATROL (79-88)											
2.8	88	L28		07/80-08/88	W20EPR-U	3047	0.8	W20TT	IW20TT	IW20TT	6
3.2 D	70	SD33		11/79-08/88	DG-702		24V				6
3.2 D	70	SD33	Single Coil	07/85-08/88	DG-157		11V				6
3.2 TD	81	SD33T		07/83-08/88	DG-702		24V				6
3.2 TD	81	SD33T	Single Coil	07/85-08/88	DG-157		11V				6
3.3 D 4x4	70	SD33		06/80-12/87	DG-702		24V				6
3.3 D 4x4	70	SD33	Single Coil	07/85-12/87	DG-157		11V				6
3.3 TD 4x4	81	SD33T		01/84-12/87	DG-702		24V				6
3.3 TD 4x4	81	SD33T	Single Coil	07/85-12/87	DG-157		11V				6
PATROL (84-96)											
2.8	88	L28		05/86-02/89	W16EPR-U	3021	0.8	W16TT	IW16TT	IW16TT	6
3.2 D	81	SD33T		08/88-06/90	DG-702		24V				6
3.2 D	81	SD33T	Single Coil	08/88-06/90	DG-157		11V				6
PATROL GR I (87-98)											
4.2 Cat	121	TB42E		11/88-02/98	W16EPR-U	3021	0.8	W16TT	IW16TT	IW16TT	6
4.2 D	85	TD42	Single Coil	11/88-06/97	DG-198		11V				6
PATROL GR II (97-)											
2.8 TD	95	RD28Ti	Ceramic(LPH)	06/97-05/00	DG-643		11V				6
2.8 TD	95	RD28Ti	Double Coil(LPH)	06/97-05/00	DG-643		11V				6
2.8 TDIC	96	RD28Ti	Ceramic(LPH)	10/97-02/00	DG-643		11V				6
2.8 TDIC	96	RD28Ti	Double Coil(LPH)	10/97-02/00	DG-643		11V				6
3.0 DTi	116/118	ZD30DDTi	Double Coil(LPH)	05/00-	DG-605		11V				4
3.2 D	70	SD33		05/98-06/01	DG-702		24V				6
4.8	180	TB48DE		10/02-07/04	IKH20TT	4704	1.0	-	IKH20TT		6
PATROL III (10-)											
5.6	298	VK56VD		04/10-	IXEH22TT	4712	1.0	-	IXEH22TT		8
PICK UP (720) (80-86)											
1.6	51	J16		12/80-05/84	W16EPR-U	3021	0.8	W16TT	IW16TT	IW16TT	4
1.8	59	L18		01/83-03/86	W16EPR-U	3021	0.8	W16TT	IW16TT	IW16TT	4
2.2 4WD	71	Z22		04/83-03/86	W20EP-U	3043	0.8	W20TT	IW20TT	IW20TT	4
2.3 D	51	SD23	OE:11065T820 2. Single Coil	04/83-03/86	DG-157		11V				4
2.5 D 4WD	53	SD25	Single Coil	10/85-03/86	DG-157		11V				4

Свечи зажигания и Свечи накаливания

Таблица применения

KW	KW	KW	KW	KW	СТАНДАРТНЫЕ			Twin Tip		QTY	
					STANDARD	STANDARD	STANDARD	TWIN TIP	TWIN TIP		
NISSAN продолжение											
PICK UP (D21) (85-98)											
2.0	64	Z20		09/85-09/86	W20EX-U	3062	0.8	W20TT	IW20TT	IW20TT	4
2.0	64	Z20		09/86-07/88	W16EX-U	3027	0.8	W16TT	IW16TT	IW16TT	4
2.0	64/66	Z20		09/85-08/91	W16EP-U	3018	0.8	W16TT	IW16TT	IW16TT	4
2.3 D	51	SD23	Single Coil	09/85-10/87	DG-157		11V				4
2.4 4WD	74	Z24i		03/86-04/92	W16EPR-U	3021	0.8	W16TT	IW16TT	IW16TT	4
2.4 i 12V	91	KA24E		04/92-02/98	K16GPR-U11	3135	1.1	-	-		4
2.4 i 12V 4WD	93	KA24E		04/92-02/98	K16GPR-U11	3135	1.1	-	-		4
2.5 D	55/ 59/61	TD25	Single Coil	09/87-02/98	DG-198		11V				4
2.5 D 4WD	53/55	SD25	Single Coil	09/85-08/91	DG-157		11V				4
2.5 D 4WD	59/61	TD25	Single Coil	08/87-02/98	DG-198		11V				4
2.7 D 4WD	73	TD27	Single Coil	08/87-02/98	DG-198		11V				4
PICK UP (D22) (97-05)											
2.4	110	KA24DE		01/03-	K16PR-U11	3130	1.1	K16TT	IK16TT	IK16TT	4
2.4 4WD	110	KA24DE		11/01-	K16PR-U11	3130	1.1	K16TT	IK16TT	IK16TT	4
2.4 i	88	KA24E		02/98-04/05	K16GPR-U11	3135	1.1	-	-		4
2.4 i	88	KA24E		11/01-04/05	K16PR-U11	3130	1.1	K16TT	IK16TT	IK16TT	4
2.4 i 4WD	88	KA24E		02/98-04/05	K16GPR-U11	3135	1.1	-	-		4
2.4 i 4WD	98	KA24DE		03/02-04/05	K16PR-U11	3130	1.1	K16TT	IK16TT	IK16TT	4
2.5 D	61	TD25	Double Coil(LPH)	02/98-07/02	DG-626		11V				4
2.5 D 4WD	61	TD25	Double Coil(LPH)	02/98-07/02	DG-626		11V				4
2.5 Di	98	YD25DDTi	Double Coil(LPH)	03/02-12/10	DG-197		11V				4
2.5 TD 4WD	76	TD25Ti	Double Coil(LPH)	05/98-11/01	DG-626		11V				4
3.2 D 4WD	76	QD32	Cold climates(-)	12/98-04/05	DG-198		11V				4
3.2 D 4WD	76	QD32	Cold Climates(+)	12/98-04/05	DG-644		11V				4
PIXO (09-)											
1.0	50	K10 B		06/09-	ZXU20PR11	3452	1.1	-	-	VXU20	3
PRAIRIE (M10) (83-88)											
1.5 S	55	E15S		01/84-12/87	W20EPR-U	3047	0.8	W20TT	IW20TT	IW20TT	4
1.8 SGL	66	CA18S		07/83-10/87	W20EPR-U	3047	0.8	W20TT	IW20TT	IW20TT	4
2.0 4x4	68	CA20S		06/86-09/88	Q20PR-U	3007	0.8	Q20TT	IQ20TT	IQ20TT	4
2.0 4x4	77	CA20E		01/86-09/88	K16PR-U11	3130	1.1	K16TT	IK16TT	IK16TT	4
PRAIRIE Pro (M11) (88-94)											
2.0 i	72	CA20E		10/88-04/92	Q20PR-U11	3008	1.1	Q20TT	IQ20TT	IQ20TT	8
2.0 i 4x4	72	CA20E		10/88-12/92	Q20PR-U11	3008	1.1	Q20TT	IQ20TT	IQ20TT	8
2.4 i	98	KA24E		01/90-07/94	K16GPR-U11	3135	1.1	-	-		4
2.4 i 4x4	98	KA24E		04/92-07/94	K16GPR-U11	3135	1.1	-	-		4
PRIMASTAR (01-)											
1.9 dCi 80	60	F9Q 762	Double Coil(LPH)	03/01-	DG-005		11V				4
1.9 dCi 100	74	F9Q 760	Double Coil(LPH)	03/01-	DG-005		11V				4
2.0	86/88	F4R 720; F4R 722; F4R 820		03/01-	PK20PR-P8	3245	0.8	-	IK20TT	IK20TT	4
2.0	88	F4R.7.20		03/01-	K20R-U	3122	0.8	K20TT	IK20TT	IK20TT	4
2.5 dCi 140	99	G9U 730	Double Coil(LPH)	07/03-	DG-126		11V				4
2.5 dCi 150	107	G9U 632	OE: 11065-00Q0A, Double Coi l(LPH)	10/06-	DG-126		11V				4
PRIMERA (P10) (90-98)											
1.6	66/71	GA16DS		06/90-01/96	K16PR-U11	3130	1.1	K16TT	IK16TT	IK16TT	4
1.6	66/ 71/75	GA16DE; GA16DS		06/90-01/96	K20PR-U	3145	0.8	K20TT	IK20TT	IK20TT	4
1.6 i	66	GA16DS		07/90-03/98	K16PR-U11	3130	1.1	K16TT	IK16TT	IK16TT	4
1.6 i	66/75	GA16DE; GA16DS		07/90-03/98	K20PR-U	3145	0.8	K20TT	IK20TT	IK20TT	4
2.0	96/ 105/ 110/ 112	SR20DE		06/90-01/98	K16R-U11	3120	1.1	K16TT	IK16TT	IK16TT	4
2.0	110	SR20DE		06/90-01/96	K20PR-U	3145	0.8	K20TT	IK20TT	IK20TT	4
2.0 4x4	110	SR20DE		03/91-04/93	K16R-U11	3120	1.1	K16TT	IK16TT	IK16TT	4
2.0 4x4	110	SR20DE		03/91-04/93	K20R-U	3122	0.8	K20TT	IK20TT	IK20TT	4
2.0 16V	85	SR20DI		06/90-01/96	K16R-U	3119	0.8	K16TT	IK16TT	IK16TT	4
2.0 16V 4x4	85	SR20DI		04/91-06/96	K16R-U	3119	0.8	K16TT	IK16TT	IK16TT	4
2.0 D	55	CD20	Ceramic(LPH)	07/90-01/96	DG-642		11V				4

Таблица применения

N

Свечи зажигания и Свечи накаливания

Таблица применения

Таблица применения

KW	KW	KW	NOTE	21	СТАНДАРТНЫЕ				Twin Tip		QTY
					1	2	3	4	1	2	
NISSAN продолжение											
PRIMERA (P10) (90-98) продолжение											
2.0 GT	110	SR20DE		06/90-01/96	K16R-U11	3120	1.1	K16TT	IK16TT	IK16TT	4
2.0 GT	110	SR20DE		06/90-01/96	K20PR-U	3145	0.8	K20TT	IK20TT	IK20TT	4
2.0 GT 4x4	105	SR20DE		03/91-04/93	K16R-U11	3120	1.1	K16TT	IK16TT	IK16TT	4
2.0 i	85	SR20DI		07/90-03/98	K16R-U	3119	0.8	K16TT	IK16TT	IK16TT	4
2.0 i	92	SR20DE		01/95-06/96	K16R-U11	3120	1.1	K16TT	IK16TT	IK16TT	4
2.0 i	92	SR20DE		01/95-06/96	K20R-U	3122	0.8	K20TT	IK20TT	IK20TT	4
2.0 i	92	SR20DE		01/95-06/96	Q16PR-U11	5016	1.1	Q16TT	IQ16TT	IQ16TT	4
PRIMERA (P11) (96-02)											
1.6 16V	66/73	GA16DE		09/96-07/02	K20PR-U	3145	0.8	K20TT	IK20TT	IK20TT	4
1.6 16V	78	QG16DE		06/96-07/02	K16HPR-U11	6076	1.1	KH16TT	IKH16TT	IKH16TT	4
1.8 16V	84	QG18DE		08/99-07/02	K16PR-U11	3130	1.1	K16TT	IK16TT	IK16TT	4
2.0 16V	85	SR20De		09/96-07/02	K20R-U11	3139	1.1	K20TT	IK20TT	IK20TT	4
2.0 16V	85/ 96/ 103/ 110	SR20De; SR20DE		06/96-07/02	K16R-U11	3120	1.1	K16TT	IK16TT	IK16TT	4
2.0 16V	96/ 103/ 110	SR20DE		09/96-07/02	K20R-U	3122	0.8	K20TT	IK20TT	IK20TT	4
2.0 TD	66	CD20T	Ceramic(LPH)	09/96-07/02	DG-642		11V				4
PRIMERA (P12) (02-)											
1.6	78/80	QG16DE		01/02-08/08	K16HPR-U11	6076	1.1	KH16TT	IKH16TT	IKH16TT	4
1.6 Visia	80	QG16DE		01/02-04/06	K16HPR-U11	6076	1.1	KH16TT	IKH16TT	IKH16TT	4
1.8	85	QG18DE		03/02-10/08	K16HPR-U11	6076	1.1	KH16TT	IKH16TT	IKH16TT	4
1.9 dCi	85/88	F9Q	Double Coil(LPH)	08/02-	DG-005		11V				4
2.0	103	QR20DE		03/02-	K16HPR-U11	6076	1.1	KH16TT	IKH16TT	IKH16TT	4
2.0	103	QR20DE		03/02-	K20HR-U11	3381	1.1	KH20TT	IKH20TT	IKH20TT	4
2.0	103	QR20DE	OEM Optional	03/02-01/06	K16HPR-U11	6076	1.1	KH16TT	IKH16TT	IKH16TT	4
2.2 dCi	102	YD22DDT	Double Coil(LPH)	04/03-	DG-197		11V				4
2.2 Di	93	YD22DDT	Double Coil(LPH)	03/02-05/07	DG-197		11V				4
PULSAR (C13) (12-)											
1.5 dCi	81	K9K	Instant heating (ISS)	10/14-	DG-609		4.4V				4
1.6 DIG-T	140	MR16DDT		02/15-	VFXEHC22G	5659	0.8	-	-	VFXEHC22G	4
QASHQAI I (+2) (07-13)											
1.5 dCi	76/78	K9K 282; K9K 292	Double Coil(LPH)	02/07-01/10	DG-005		11V				4
1.5 dCi	76/ 78/81	K9K 282; K9K 292; K9K 430	Instant heating (ISS)	01/10-12/13	DG-609		4.4V				4
1.6	84/86	HR16DE	Euro-4	02/07-12/13	FXE20HR11	3439	1.1	-	IXEH20TT	IXEH20TT	4
1.6	84/86	HR16DE	Euro-5	02/07-12/13	FXE20HE11	3436	1.1	-	IXEH20ETT	IXEH20ETT	4
1.6 dCi	96	R9M		10/11-12/13	DG-631		4.5V				4
1.6 dCi AWD	96	R9M		10/11-12/13	DG-631		4.5V				4
2.0	104	MR20DE		02/07-12/13	FXE20HR11	3439	1.1	-	IXEH20TT	IXEH20TT	4
2.0 AWD	104	MR20DE		02/07-12/13	FXE20HR11	3439	1.1	-	IXEH20TT	IXEH20TT	4
2.0 dCi	110	M1D; M9R	Double Coil(LPH)	02/07-01/10	DG-005		11V				4
2.0 dCi AWD	110	M1D; M9R	Double Coil(LPH)	02/07-01/10	DG-005		11V				4
QASHQAI II (13-)											
1.5 dCi	81	K9K 636; K9K 646	Instant heating (ISS)	11/13-	DG-609		4.4V				4
1.6 dCi	96	R9M		11/13-	DG-631		4.5V				4
1.6 dCi 4x4	96	R9M		11/13-	DG-631		4.5V				4
1.6 DIG-T	120	MR16DDT		10/14-	VFXEHC22G	5659	0.8	-	-	VFXEHC22G	4
QUEST (92-98)											
3.0	113	VG30E		05/92-09/98	K20PR-U11	3121	1.1	K20TT	IK20TT	IK20TT	6
QUEST (03-)											
3.5	176	VQ35DE		05/03-	IKH16TT	4703	1.0	-	IKH16TT		6
3.5	176	VQ35DE		05/03-	IKH20TT	4704	1.0	-	IKH20TT		6
ROGUE (T31) (07-13)											
2.5	127	QR25DE		01/07-12/13	FXE20HR11	3439	1.1	-	IXEH20TT	IXEH20TT	4
2.5 AWD	127	QR25DE		09/07-12/13	FXE20HR11	3439	1.1	-	IXEH20TT	IXEH20TT	4
ROGUE (T32) (13-)											
2.5 4x4	126	QR25DE		12/13-	FXE20HE11	3436	1.1	-	IXEH20ETT	IXEH20ETT	4
2.5 4x4	126	QR25DE		12/13-	VFXEH20E	5644	1.1	-	IXEH20ETT	IXEH20ETT	4

Свечи зажигания и Свечи накаливания

Таблица применения

KW	KW	KW	KW	KW	СТАНДАРТНЫЕ			Twin Tip		QTY	
					mm	mm	mm	mm	mm		
NISSAN продолжение											
SENTRA V (00-06)											
1.8	88/93	QG18DE		01/00-09/02	K16PR-U11	3130	1.1	K16TT	IK16TT	IK16TT	4
1.8	88/93	QG18DE		09/02-08/06	K16HPR-U11	6076	1.1	KH16TT	IKH16TT	IKH16TT	4
2.0	107	SR20DE		01/00-12/06	K16R-U11	3120	1.1	K16TT	IK16TT	IK16TT	4
2.5	129	QR25DE		06/02-01/06	K16HPR-U11	6076	1.1	KH16TT	IKH16TT	IKH16TT	4
2.5	129	QR25DE		01/06-08/06	FXE20HR11	3439	1.1	-	IXEH20TT	IXEH20TT	4
SENTRA VII (12-)											
1.6	86	HR16DE		08/14-	FXE20HE11	3436	1.1	-	IXEH20ETT	IXEH20ETT	4
1.8	96	MRA8DE		08/12-	FXE20HR11	3439	1.1	-	IXEH20TT	IXEH20TT	4
SERENA (92-01)											
1.6	71	GA16DE		02/93-09/01	K20PR-U	3145	0.8	K20TT	IK20TT	IK20TT	4
2.0	93	SR20DE		11/92-09/01	K16R-U11	3120	1.1	K16TT	IK16TT	IK16TT	4
2.0	93	SR20DE		11/92-09/01	K20R-U	3122	0.8	K20TT	IK20TT	IK20TT	4
2.0 D	49	LD20	Ceramic(LPH)	06/91-09/94	DG-644		11V				4
2.3 D	55	LD23	Double Coil(LPH)	01/95-09/01	DG-137		11V				4
SERENA (99-05)											
2.0 SGX	107	SR20DE		09/00-09/05	K16R-U11	3120	1.1	K16TT	IK16TT	IK16TT	4
2.0 SGX 4x4	107	SR20DE		09/00-09/05	K16R-U11	3120	1.1	K16TT	IK16TT	IK16TT	4
2.5 DCi SGX	110	YD25DDTi	Double Coil(LPH)	06/99-09/05	DG-197		11V				4
2.5 DCi SGX 4x4	110	YD25DDTi	Double Coil(LPH)	06/99-09/05	DG-197		11V				4
SILVIA (S12) (84-88)											
1.8	90	CA18ET		06/84-12/88	Q20PR-U11	3008	1.1	Q20TT	IQ20TT	IQ20TT	4
2.0 GP	107	FJ20E		04/84-09/88	W20EPR-U11	3049	1.1	W20TT	IW20TT	IW20TT	4
SILVIA (S15) (99-03)											
2000	118/121	SR20DE		09/99-08/02	K16R-U11	3120	1.1	K16TT	IK16TT	IK16TT	4
2000 Turbo	165/184	SR20DET		11/00-12/03	PK20PR-P8	3245	0.8	-	IK20TT	IK20TT	4
SKYLINE (R32) (89-93)											
2.6 Twin Turbo 4x4	206	RB26DETT		04/89-06/93	PQ20R	3117	1.1	Q20TT	IQ20TT	IQ20TT	6
SKYLINE (R33) (93-00)											
2.5	140	RB25DE		07/93-05/98	PK16PR-L11	3275	1.1	-	IK16TT	IK16TT	6
2.5	184	RB25DET		01/94-07/00	IK16TT	4701	1.0	-	IK16TT	IK16TT	6
2.5 4x4	140	RB25DE		07/93-05/98	PK16PR-L11	3275	1.1	-	IK16TT	IK16TT	6
2.6 Twin Turbo 4x4	206	RB26DETT		07/94-09/99	PQ20R	3117	1.1	Q20TT	IQ20TT	IQ20TT	6
SKYLINE (R34) (98-08)											
2.0	114	RB20DE		06/98-07/00	IK16TT	4701	1.0	-	IK16TT	IK16TT	6
2.5	147	RB25DEH		06/98-07/00	IK16TT	4701	1.0	-	IK16TT	IK16TT	6
2.5 4x4	147	RB25DEH		06/98-07/00	IK16TT	4701	1.0	-	IK16TT	IK16TT	6
2.5 Turbo	206	RB25DET		05/98-01/06	IK16TT	4701	1.0	-	IK16TT	IK16TT	6
2.6 Turbo 4x4	245	RB26DETT		01/99-02/08	IQ20TT	4707	1.0	-	IQ20TT		6
SKYLINE (V35) (03-07)											
3.0	191	VQ30DD		08/03-12/06	IKH16TT	4703	1.0	-	IKH16TT		6
STANZA (81-85)											
1.6	60	CA16S		08/81-12/85	Q16PR-U11	5016	1.1	Q16TT	IQ16TT	IQ16TT	4
1.6	60	CA16S		08/81-12/85	Q20PR-U	3007	0.8	Q20TT	IQ20TT	IQ20TT	4
1.8	65	CA18; CA18S		08/81-12/85	W20EPR-U	3047	0.8	W20TT	IW20TT	IW20TT	4
1.8 SGL	66	CA18S		03/83-12/85	W20EPR-U	3047	0.8	W20TT	IW20TT	IW20TT	4
STANZA (89-92)											
2.4	103	KA24E		09/89-12/92	K16GPR-U11	3135	1.1	-	-		4
SUNNY (70-82)											
1.2	38	A12		11/77-02/82	W14EPR-U	6011	0.8	-	IW16TT	IW16TT	4
1.4	48	A14		11/77-02/82	W20EPR-U	3047	0.8	W20TT	IW20TT	IW20TT	4
SUNNY I (82-90)											
1.3	44	E13		03/82-08/90	W16EXR-U11	3032	1.1	W16TT	IW16TT	IW16TT	4
1.3	44	E13		03/82-08/90	W20EPR-U	3047	0.8	W20TT	IW20TT	IW20TT	4
1.5	55	E15S		03/82-10/86	W16EPR-U	3021	0.8	W16TT	IW16TT	IW16TT	4
SUNNY II (86-91)											
1.0	37	E10S		07/86-09/90	W16EPR-U	3021	0.8	W16TT	IW16TT	IW16TT	4
1.3	44	E13S		06/86-10/91	W16EXR-U11	3032	1.1	W16TT	IW16TT	IW16TT	4
1.3	44	E13S		06/86-10/91	W20EPR-U	3047	0.8	W20TT	IW20TT	IW20TT	4
1.4 LX	55	GA14S		10/88-08/91	Q20PR-U	3007	0.8	Q20TT	IQ20TT	IQ20TT	4
1.5	52	E15S		06/86-10/88	W16EPR-U	3021	0.8	W16TT	IW16TT	IW16TT	4
1.5	52	E15S	OEM Optional	06/86-06/87	W16EPR-U	3021	0.8	W16TT	IW16TT	IW16TT	4
1.6	62	E16S		06/86-10/88	W20EPR-U	3047	0.8	W20TT	IW20TT	IW20TT	4

Таблица применения

N

Свечи зажигания и Свечи накаливания

Таблица применения

Таблица применения

KW	KW	NOTE	21	СТАНДАРТНЫЕ				Twin Tip		QTY	
				STANDARD	STANDARD	STANDARD	STANDARD	STANDARD	STANDARD		
NISSAN продолжение											
SUNNY II (86-91) продолжение											
1.6	88	GA16DE		02/87-10/88	K20PR-U	3145	0.8	K20TT	IK20TT	IK20TT	4
1.6 4x4	66	GA16S		07/86-10/88	K16PR-U11	3130	1.1	K16TT	IK16TT	IK16TT	4
1.6 GTI 16V	81	CA16D		02/87-10/88	Q14R-U11	3183	1.1	-	IQ16TT	IQ16TT	4
1.6 GTI 16V	81	CA16D		02/87-05/89	PQ20R	3117	1.1	Q20TT	IQ20TT	IQ20TT	4
1.6 i	54	E16i		06/86-10/90	W16EPR-U11	3201	1.1	W16TT	IW16TT	IW16TT	4
1.6 i 4x4	54	E16i		06/86-10/90	W16EPR-U11	3201	1.1	W16TT	IW16TT	IW16TT	4
1.6 i 12V	66	GA16i; GA16S		06/86-06/91	Q20PR-U11	3008	1.1	Q20TT	IQ20TT	IQ20TT	4
1.6 i 12V 4x4	66	GA16i		10/88-08/90	Q20PR-U11	3008	1.1	Q20TT	IQ20TT	IQ20TT	4
1.6 SGX	70	GA16S		10/88-09/90	K16PR-U11	3130	1.1	K16TT	IK16TT	IK16TT	4
1.7 D	40	CD17	Ceramic(LPH)	01/86-06/91	DG-644		11V				4
1.8 GTI 16V	92	CA18D		01/89-06/91	PQ20R	3117	1.1	Q20TT	IQ20TT	IQ20TT	4
SUNNY III (90-00)											
1.4 i	55	GA14DE; GA14DS		10/90-05/95	K20PR-U	3145	0.8	K20TT	IK20TT	IK20TT	4
1.4 i 16V	64	GA14DE		10/90-06/95	K16PR-U	3191	0.8	K16TT	IK16TT	IK16TT	4
1.4 i 16V	64	GA14DE		10/90-06/95	K20PR-U	3145	0.8	K20TT	IK20TT	IK20TT	4
1.6	70/75	GA16DE		09/92-03/00	K20PR-U	3145	0.8	K20TT	IK20TT	IK20TT	4
1.6 16V 4x4	66	GA16DS		11/90-05/95	K16PR-U11	3130	1.1	K16TT	IK16TT	IK16TT	4
1.6 i	66	GA16DE/ GA16DEL		10/90-03/00	K20PR-U	3145	0.8	K20TT	IK20TT	IK20TT	4
1.6 i	66	GA16DS		10/90-03/00	K16PR-U11	3130	1.1	K16TT	IK16TT	IK16TT	4
1.6 i 16V	66/75	GA16DE		10/92-03/00	K20PR-U	3145	0.8	K20TT	IK20TT	IK20TT	4
1.6 i 16V 4WD	66	GA16DS		10/90-05/95	K16PR-U11	3130	1.1	K16TT	IK16TT	IK16TT	4
1.6 i 16V 4WD	66	GA16DS		10/90-05/95	K20PR-U	3145	0.8	K20TT	IK20TT	IK20TT	4
1.6 i 16V 4x4	75	GA16DE		10/92-03/00	K20PR-U	3145	0.8	K20TT	IK20TT	IK20TT	4
1.6 L	75	GA16DE		11/92-04/96	K20PR-U	3145	0.8	K20TT	IK20TT	IK20TT	4
1.7 D	40	CD17	Ceramic(LPH)	11/90-03/00	DG-644		11V				4
2.0 D	55	CD20	Ceramic(LPH)	10/90-03/00	DG-642		11V				4
2.0 GTI 16V	105	SR20DE		10/90-05/95	K16R-U11	3120	1.1	K16TT	IK16TT	IK16TT	4
2.0 GTI 16V	105	SR20DE		10/90-05/95	PK20PR-L11	3142	1.1	-	IK20TT	IK20TT	4
2.0 GTI-R 4x4	162	SR20DET		10/90-05/95	PK20PR-P8	3245	0.8	-	IK20TT	IK20TT	4
2.0 i 16V	105	SR20DE		10/90-05/95	K16R-U11	3120	1.1	K16TT	IK16TT	IK16TT	4
2.0 i 16V	105	SR20DE		10/90-05/95	Q16PR-U11	5016	1.1	Q16TT	IQ16TT	IQ16TT	4
TEANA I (03-08)											
2.0	103	QR20DE		10/03-06/08	K16HPR-U11	6076	1.1	KH16TT	IKH16TT	IKH16TT	4
2.0	103	QR20DE		10/03-06/08	K20HR-U11	3381	1.1	KH20TT	IKH20TT	IKH20TT	4
2.0	103	QR20DE		04/06-06/08	IKH20TT	4704	1.0	-	IKH20TT	IKH20TT	4
2.3	127	VQ23DE		04/06-06/08	IKH16TT	4703	1.0	-	IKH16TT	IKH16TT	6
3.5	170	VQ35DE		10/03-06/08	IKH16TT	4703	1.0	-	IKH16TT	IKH16TT	6
3.5	170	VQ35DE		10/03-06/08	IKH20TT	4704	1.0	-	IKH20TT	IKH20TT	6
TEANA II (08-13)											
2.5	134	VQ25DE		07/08-09/13	FXE20HR11	3439	1.1	-	IXEH20TT	IXEH20TT	6
3.5	183	VQ35DE		07/08-09/13	FXE22HR11	3442	1.1	-	IXEH22TT	IXEH22TT	6
3.5	183	VQ35DE		07/08-09/13	IXEH22TT	4712	1.0	-	IXEH22TT	IXEH22TT	6
TEANA III (13-)											
2.5	127	QR25DE		09/13-	FXE20HE11	3436	1.1	-	IXEH20ETT	IXEH20ETT	4
TERRANO I (87-96)											
2.4 i 4WD	76	Z24i		10/87-02/93	W16EPR-U	3021	0.8	W16TT	IW16TT	IW16TT	4
2.7 TD 4WD	73	TD27T	Double Coil(LPH)	02/89-02/96	DG-137		11V				4
3.0 i 4WD	109	VG30E		01/90-12/95	K20R-U	3122	0.8	K20TT	IK20TT	IK20TT	6
TERRANO II (92-07)											
2.4 4WD	85/87	KA24E		05/96-09/07	K16GPR-U11	3135	1.1	-	-	-	4
2.4 i 12V 4WD	91	KA24E		02/93-12/97	K16GPR-U11	3135	1.1	-	-	-	4
2.7 TD 4WD	74	TD27T	Double Coil(LPH)	02/93-01/02	DG-137		11V				4
2.7 TDi 4WD	92	TD27Ti	Ceramic(LPH)	05/96-06/06	DG-644		11V				4
2.7 TDi 4WD	92	TD27Ti	Double Coil(LPH)	05/96-06/06	DG-626		11V				4
3.0 Di 4WD	113	ZD30	Double Coil(LPH)	05/02-09/07	DG-605		11V				4
3.3	125	VG33E		10/92-12/04	K16PR-U11	3130	1.1	K16TT	IK16TT	IK16TT	6
3.3 4WD	125	VG33E		10/92-10/97	K16PR-U11	3130	1.1	K16TT	IK16TT	IK16TT	6
TIIDA (04-12)											
1.5	80	HR15DE		05/04-08/12	FXE16HE11	3438	1.1	-	-	FXE16HE11	4
1.5	80	HR15DE		05/04-08/12	FXE20HE11	3436	1.1	-	IXEH20ETT	IXEH20ETT	4
1.5 dCi	76/78	K9K 278; K9K	Double Coil(LPH)	01/07-12/12	DG-005		11V				4
1.6	81	HR16DE		09/07-12/12	FXE20HR11	3439	1.1	-	IXEH20TT	IXEH20TT	4
1.8	93	MR18DE		09/07-12/12	FXE20HR11	3439	1.1	-	IXEH20TT	IXEH20TT	4

Свечи зажигания и Свечи накаливания

Таблица применения





	KW				СТАНДАРТНЫЕ				Twin Tip		QTY
											
NISSAN продолжение											
TIIDA (11-)											
1.6	85	HR16DE		08/12-	FXE20HE11	3436	1.1	-	IXEH20ETT	IXEH20ETT	4
TITAN (03-)											
5.6	227	VK56DE		10/03-	IKH16TT	4703	1.0	-	IKH16TT		8
5.6 4x4	227	VK56DE		10/03-	IKH16TT	4703	1.0	-	IKH16TT		8
5.6 FlexFuel 4WD	227	VK56DE		10/03-12/06	IKH16TT	4703	1.0	-	IKH16TT		8
TRADE (93-98)											
2.0 D	49	LD20	Ceramic(LPH)	04/93-10/98	DG-644		11V				4
3.0 D	63/78	BD30II; BD-30Ti	Double Coil(LPH)	04/93-12/98	DG-005		11V				4
TRADE (96-04)											
2.3 D	55	LD23	Double Coil(LPH)	06/96-10/01	DG-137		11V				4
3.0 TD	81	BD-30Ti	Double Coil(LPH)	11/98-09/04	DG-005		11V				4
3.0 TDiC	78	BD-30Ti	Double Coil(LPH)	06/96-10/01	DG-005		11V				4
75	55	LD23	Double Coil(LPH)	05/97-12/00	DG-137		11V				4
100	78	BD-30Ti	Double Coil(LPH)	01/96-12/98	DG-005		11V				4
URVAN (81-98)											
2.0	55	H20		07/81-11/82	W20EPR-U	3047	0.8	W20TT	IW20TT	IW20TT	4
2.0	65	Z20		12/82-05/97	W16EPR-U	3021	0.8	W16TT	IW16TT	IW16TT	4
2.0	65	Z20; Z20S		12/82-09/86	W20EX-U	3062	0.8	W20TT	IW20TT	IW20TT	4
2.0	65	Z20; Z20S		09/86-09/88	W16EX-U	3027	0.8	W16TT	IW16TT	IW16TT	4
2.0	65	Z20; Z20S		09/88-11/98	W16EXR-U	3031	0.8	W16TT	IW16TT	IW16TT	4
2.3 D	51	TD23	Single Coil	01/88-05/97	DG-198		11V				4
2.5 D	59	TD25	Single Coil	12/88-05/97	DG-198		11V				4
VANETTE (C12) (81-87)											
1.5	51	A15		01/83-09/86	W20EPR-U	3047	0.8	W20TT	IW20TT	IW20TT	4
1.5	51	A15		04/87-12/87	W16EPR-U	3021	0.8	W16TT	IW16TT	IW16TT	4
2.0	66	Z20S		09/82-09/86	W20EX-U	3062	0.8	W20TT	IW20TT	IW20TT	4
2.0	66	Z20S		09/86-12/87	W16EX-U	3027	0.8	W16TT	IW16TT	IW16TT	4
VANETTE (C22) (86-95)											
1.5	51	A15S		10/86-11/94	W16EPR-U	3021	0.8	W16TT	IW16TT	IW16TT	4
2.0	66	Z20S		07/87-09/88	W16EX-U	3027	0.8	W16TT	IW16TT	IW16TT	4
2.0	66	Z20S		07/87-01/90	W16EPR-U	3021	0.8	W16TT	IW16TT	IW16TT	4
2.0	66	Z20S		09/88-08/94	W16EXR-U	3031	0.8	W16TT	IW16TT	IW16TT	4
2.0	66	Z20S		01/90-08/94	W20EPR-U	3047	0.8	W20TT	IW20TT	IW20TT	4
2.0 D	47/49	LD20; LD20II	Ceramic(LPH)	10/86-12/95	DG-644		11V				4
2.4 i	74/77	Z24i		10/86-11/94	W16EPR-U	3021	0.8	W16TT	IW16TT	IW16TT	4
VANETTE Cargo (C23) (94-02)											
1.6	75	GA16DE		09/94-05/01	K20PR-U	3145	0.8	K20TT	IK20TT	IK20TT	4
1.6 i	72	GA16DE		09/94-05/01	K20PR-U	3145	0.8	K20TT	IK20TT	IK20TT	4
2.0 D	49	LD20	Ceramic(LPH)	01/96-05/01	DG-644		11V				4
2.3 D	55	LD23	Double Coil(LPH)	09/94-05/02	DG-137		11V				4
X-TRAIL (T30) (01-13)											
2.0	103/110	QR20DE		07/01-01/13	K16HPR-U11	6076	1.1	KH16TT	IKH16TT	IKH16TT	4
2.0	103/110	QR20DE		07/01-01/13	K20HR-U11	3381	1.1	KH20TT	IKH20TT	IKH20TT	4
2.0 4x4	103/110	QR20DE		07/01-01/13	K16HPR-U11	6076	1.1	KH16TT	IKH16TT	IKH16TT	4
2.0 4x4	103/110	QR20DE		07/01-01/13	K20HR-U11	3381	1.1	KH20TT	IKH20TT	IKH20TT	4
2.2 dCi	100	YD22DDTi; YD22ETI	Double Coil(LPH)	12/03-01/13	DG-197		11V				4
2.2 dCi 4x4	100	YD22DDTi; YD22ETI	Double Coil(LPH)	06/01-12/08	DG-197		11V				4
2.2 DCi FWD	84	YD22ETI	Double Coil(LPH)	06/01-09/04	DG-197		11V				4
2.2 Di 4x4	84	YD22DDTi; YD22ETI	Double Coil(LPH)	07/01-10/05	DG-197		11V				4
2.5 4x4	121/132	QR25DE		09/02-01/13	K16HPR-U11	6076	1.1	KH16TT	IKH16TT	IKH16TT	4
2.5 4x4	121/132	QR25DE		09/02-01/13	K20HR-U11	3381	1.1	KH20TT	IKH20TT	IKH20TT	4
2.5 4x4	121/132	QR25DE		01/06-01/13	FXE20HR11	3439	1.1	-	IXEH20TT	IXEH20TT	4

Таблица применения

N

Свечи зажигания и Свечи накаливания





Таблица применения

Таблица применения

KW	KW	KW	NOTE	21	СТАНДАРТНЫЕ				Twin Tip		QTY
					STANDARD	STANDARD	STANDARD	STANDARD	TWIN TIP	TWIN TIP	
NISSAN продолжение											
X-TRAIL (T31) (07-13)											
2.0	101/104	MR20DE		06/07-11/13	FXE20HR11	3439	1.1	-	IXEH20TT	IXEH20TT	4
2.0 FWD	103	MR20DE		03/07-11/13	FXE20HR11	3439	1.1	-	IXEH20TT	IXEH20TT	4
2.5 4x4	124	QR25DE		06/07-11/13	FXE20HR11	3439	1.1	-	IXEH20TT	IXEH20TT	4
2.5 4x4	124	QR25DE		06/07-11/13	K16HPR-U11	6076	1.1	KH16TT	IKH16TT	IKH16TT	4
X-TRAIL (T32) (13-)											
1.6 dCi	96	R9M		04/14-	DG-631		4.5V				4
1.6 dCi 4x4	96	R9M		04/14-	DG-631		4.5V				4
1.6 DIG-T	120	MR16DDT		06/15-	VFXEHC22G	5659	0.8	-	-	VFXEHC22G	4
2.5	126	QR25DE		12/13-	FXE20HE11	3436	1.1	-	IXEH20ETT	IXEH20ETT	4
2.5 4x4	126	QR25DE		12/13-	FXE20HE11	3436	1.1	-	IXEH20ETT	IXEH20ETT	4
NISSAN (DFAC)											
TEANA (J31) (06-08)											
2.0	100	HR20DE		04/06-06/08	FXE20HR11	3439	1.1	-	IXEH20TT	IXEH20TT	4
2.0	100	QR 20 DE		04/06-06/08	IKH16TT	4703	1.0	-	IKH16TT		4
2.0	100	QR 20 DE	OEM Optional	04/06-06/08	IKH20TT	4704	1.0	-	IKH20TT		4
3.5	180	VQ35DE		09/04-06/08	IKH16TT	4703	1.0	-	IKH16TT		6
3.5	180	VQ35DE		09/04-06/08	IKH20TT	4704	1.0	-	IKH20TT		6
TEANA (J32) (10-)											
2.0	104	MR20DE		11/10-12/13	FXE20HR11	3439	1.1	-	IXEH20TT	IXEH20TT	4
2.5	136	VQ25DE		11/10-12/13	FXE20HR11	3439	1.1	-	IXEH20TT	IXEH20TT	6
3.5	185	VQ35DE		06/08-11/10	FXE22HR11	3442	1.1	-	IXEH22TT	IXEH22TT	6
3.5	185	VQ35DE		06/08-11/10	IXEH22TT	4712	1.0	-	IXEH22TT		6
TIIDA (11-)											
1.6	93	HR16DE		05/11-	FXE20HE11	3436	1.1	-	IXEH20ETT	IXEH20ETT	4
1.6 GTS	140	MR16		06/11-12/15	VFXEHC22G	5659	0.8	-	-	VFXEHC22G	4
TIIDA QIDA (05-)											
1.6	80	HR16DE		07/05-	FXE20HR11	3439	1.1	-	IXEH20TT	IXEH20TT	4
TIIDA YIDA (05-)											
1.6	80	HR16DE		04/05-	FXE20HR11	3439	1.1	-	IXEH20TT	IXEH20TT	4
NSU											
TT (65-71)											
1.2	48			07/65-11/71	W22ESR-U	3098	0.8	-	-		4
TTS (70-71)											
1.0	51			02/67-11/71	W22ESR-U	3098	0.8	-	-		4
OPEL											
ADAM (12-)											
1.2	51	A 12 XEL; B 12 XEL		10/12-	KJ20CR-L11	3169	1.1	K20TT	IK20TT	IK20TT	4
1.4	64/74	A 14 XEL; A 14 XER; B 14 XEL; B 14 XER		10/12-	KJ20CR-L11	3169	1.1	K20TT	IK20TT	IK20TT	4
1.4 LPG	64	A 14 XEL; B 14 XEL		07/13-	VK20Y	5620	0.8	-	-	VK20Y	4
1.4 S	110	B 14 NEH		11/14-	VK22	5610	0.8	-	IK22TT	VK22	4
AGILA A (00-07)											
1.0	44	Z10XEP(60)		08/03-12/07	KJ16CR-L11	3132	1.1	K16TT	IK16TT	IK16TT	3
1.0 12V	43	Z 10 XE		09/00-12/07	K20TXR	5063	1.0	K20TT	IK20TT	IK20TT	3
1.2 16V	55	Z 12 XE		09/00-12/07	K20TXR	5063	1.0	K20TT	IK20TT	IK20TT	4
1.2 16V Twinport	59	Z 12 XEP		07/04-12/07	KJ16CR-L11	3132	1.1	K16TT	IK16TT	IK16TT	4
1.3 CDTI	51	Z 13 DT	OE:12 14 032; 12 14 070, Double Coi I(LPH)	08/03-12/07	DG-171		11V				4
AGILA B (08-14)											
1.0	48/50	K10B		04/08-07/14	ZXU20PR11	3452	1.1	-	-	VXU20	3
1.0 LPG	48	K10B		01/10-06/11	ZXU20PR11	3452	1.1	-	-	VXU20	3
1.2	63/69	K12B		04/08-10/14	ZXU20PR11	3452	1.1	-	-	VXU20	4
1.2 LPG	63	K12B		04/08-10/10	ZXU20PR11	3452	1.1	-	-	VXU20	4
1.3 CDTI	55	D13A; Z 13 DTJ	OE:12 14 032; 12 14 070; 47 08 970, Double Coi I(LPH)	04/08-04/10	DG-171		11V				4
AMPERA (11-)											
EV150	111	A 14 XFL		11/11-03/15	VXUH20I	5650	0.9	-	-	VXUH20I	4











Свечи зажигания и Свечи накаливания

Таблица применения

	KW				СТАНДАРТНЫЕ			Twin Tip			QTY
OPEL продолжение											
ANTARA (06-)											
2.0 CDTi	93/110	Z 20 DMH; Z 20 S		08/06-12/11	DG-604		4.4V				4
2.0 CDTi 4x4	110	Z 20 DMH; Z 20 S		07/06-12/11	DG-604		4.4V				4
2.2 CDTi	120	A 22 DM	OE:48 02 239; 25181860; (RP8480); GE127;GLP253 / 0 250 403 019	12/10-12/15	DG-653		4.4V				4
2.2 CDTi 4x4	120/135	A 22 DM; A 22 DMH	OE:48 02 239; 25181860; (RP8480); GE127;GLP253 / 0 250 403 019	12/10-12/15	DG-653		4.4V				4
2.4	103	Z 24 XE; Z 24 XED		07/06-12/11	K20TXR	5063	1.0	K20TT	IK20TT	IK20TT	4
2.4	123	A24XE		12/10-	ITL16TT	4717	1.0	-	ITL16TT		4
2.4 4x4	103	Z 24 XE		08/06-02/11	K20TXR	5063	1.0	K20TT	IK20TT	IK20TT	4
2.4 4x4	123	A24XE		12/10-	ITL16TT	4717	1.0	-	ITL16TT		4
2.4 LPG	103	Z 24 XE	LPG / GPL	10/08-	IK20TT	4702	1.0	-	IK20TT	IK20TT	4
2.4 LPG 4x4	103	Z 24 XE	LPG / GPL	08/06-12/10	IK20TT	4702	1.0	-	IK20TT	IK20TT	4
3.0	190	A 30 XH		11/10-12/15	PT16VR13	5068	1.3	TV16TT	ITV16TT	ITV16TT	6
3.2 V6	167	10 HM; Z 32 SEE		07/06-12/11	PT16VR13	5068	1.3	TV16TT	ITV16TT	ITV16TT	6
ARENA (97-01)											
1.9 D	44	F8Q 600; F8Q 606	Double Coil(LPH)	03/98-08/01	DG-008		11V				4
2.5 D	55	S8U 758; S8U 780; S8U 782		03/98-08/01	DG-004		11V				4
ASCONA A (70-75)											
1.9 SR	66	19 S		10/70-08/75	W20FPR-U	3070	0.7	WF20TT	-		4
ASCONA B (75-81)											
1.3 N	44	13 N		03/79-08/81	W20EPR-U	3047	0.8	W20TT	IW20TT	IW20TT	4
1.3 S	55	13 S		08/79-08/81	W20EPR-U	3047	0.8	W20TT	IW20TT	IW20TT	4
1.6 N	44	16 N		09/75-08/81	W20FP-U	3068	0.7	WF20TT	-		4
1.6 S	55	16 S		09/75-08/81	W20FP-U	3068	0.7	WF20TT	-		4
1.9 N	55	19 N		08/76-08/81	W20FP-U	3068	0.7	WF20TT	-		4
1.9 S	66	19 S		09/75-08/81	W20FP-U	3068	0.7	WF20TT	-		4
2.0 D	43	20 D	Eng:90310>, Double Coi l(LPH)	11/79-08/81	DG-001		11V				4
2.0 E	81	20 E		08/79-08/81	W20FP-U	3068	0.7	WF20TT	-		4
2.0 N	66	20 N		08/77-08/81	W20FPR-U	3070	0.7	WF20TT	-		4
2.0 S	74	20 S		08/77-08/81	W20FPR-U	3070	0.7	WF20TT	-		4
ASCONA C (81-88)											
1.3 N	44	13 N		09/81-08/86	W20EPR-U	3047	0.8	W20TT	IW20TT	IW20TT	4
1.3 S	55	13 S		09/81-08/88	W20EPR-U	3047	0.8	W20TT	IW20TT	IW20TT	4
1.6	55	16 N		09/81-08/88	W20FP-U	3068	0.7	WF20TT	-		4
1.6	60	16 SV		09/86-08/88	W20EPR-U	3047	0.8	W20TT	IW20TT	IW20TT	4
1.6 D	40	16 D; 16 DA	Double Coil(LPH)	03/82-08/88	DG-001		11V				4
1.6 i	55	E 16 NZ		09/87-08/88	W16EPR-U	3021	0.8	W16TT	IW16TT	IW16TT	4
1.6 i Cat	55	C 16 NZ		09/86-08/88	K20TXR	5063	1.0	K20TT	IK20TT	IK20TT	4
1.6 S	66	16 SH		09/81-08/86	W20EPR-U	3047	0.8	W20TT	IW20TT	IW20TT	4
1.8	62	E 18 NV		09/87-08/88	W20EPR-U	3047	0.8	W20TT	IW20TT	IW20TT	4
1.8 E	74	C 18 NE; S 18 NV		01/85-08/86	W20EPR-U	3047	0.8	W20TT	IW20TT	IW20TT	4
1.8 i	85	18 E		09/82-08/86	W20EPR-U	3047	0.8	W20TT	IW20TT	IW20TT	4
2.0 i	74	C20NE(100)		08/87-08/88	W20EPR-U	3047	0.8	W20TT	IW20TT	IW20TT	4
2.0 i	85	20 NE	Ch:P7000001, R1000001, R5000001>	09/86-08/88	K20TXR	5063	1.0	K20TT	IK20TT	IK20TT	4
2.0 i	85	20 NE	Ch:P7000001, R5000001, R1000001>	09/86-08/88	K20TXR	5063	1.0	K20TT	IK20TT	IK20TT	4
2.0 i Cat	85	C 20 NE	Ch:P7000001, R1000001, R5000001>	09/86-08/88	K20TXR	5063	1.0	K20TT	IK20TT	IK20TT	4
2.0 i Cat	85	C 20 NE	Ch:R5000001, R1000001, P7000001>	09/86-08/88	K20TXR	5063	1.0	K20TT	IK20TT	IK20TT	4
2.0 i GT	95	20 SEH		03/87-08/88	W20EPR-U	3047	0.8	W20TT	IW20TT	IW20TT	4
ASTRA F (91-01)											
1.4	55/60	14 NV; 14 SE	Ch: >02BF1476	09/91-09/98	W20EPR-U	3047	0.8	W20TT	IW20TT	IW20TT	4
1.4	55/60	14 NV; 14 SE	Ch: 02BF1477>	09/91-09/98	K20TXR	5063	1.0	K20TT	IK20TT	IK20TT	4





Свечи зажигания и Свечи накаливания

Таблица применения

	KW				СТАНДАРТНЫЕ			Twin Tip			QTY
											
ОPEL продолжение											
ASTRA F (91-01) продолжение											
1.4 i	44	C 14 NZ; X 14 NZ	Ch: >02BF1476	09/91-01/99	W20EPR-U	3047	0.8	W20TT	IW20TT	IW20TT	4
1.4 i	44	C 14 NZ; X 14 NZ	Ch: 02BF1477>	09/91-01/99	K20TXR	5063	1.0	K20TT	IK20TT	IK20TT	4
1.4 i 16V	66	X 14 XE		01/96-03/01	K20TXR	5063	1.0	K20TT	IK20TT	IK20TT	4
1.4 Si	60	C 14 SE	Ch: >02BF1476	03/92-03/01	W20EPR-U	3047	0.8	W20TT	IW20TT	IW20TT	4
1.4 Si	60	C 14 SE	Ch: 02BF1477>	03/92-03/01	K20TXR	5063	1.0	K20TT	IK20TT	IK20TT	4
1.6	55	16 LZ2; 16 NZR		09/95-09/98	K20TXR	5063	1.0	K20TT	IK20TT	IK20TT	4
1.6 i	52/55	C 16 NZ; X 16 SZ; X 16 SZR	Ch: >02BF1476	09/91-03/01	W20EPR-U	3047	0.8	W20TT	IW20TT	IW20TT	4
1.6 i	52/55	C 16 NZ; X 16 SZ; X 16 SZR	Ch: 02BF1477>	09/91-03/01	K20TXR	5063	1.0	K20TT	IK20TT	IK20TT	4
1.6 i 16V	74	X 16 XEL		08/94-09/98	K20TXR	5063	1.0	K20TT	IK20TT	IK20TT	4
1.6 i 16V	74	X 16 XEL	Ch: >02BF1476	08/94-03/98	W20EPR-U	3047	0.8	W20TT	IW20TT	IW20TT	4
1.6 i 16V	74	X 16 XEL	Ch: 02BF1477>	08/94-03/98	K20TXR	5063	1.0	K20TT	IK20TT	IK20TT	4
1.6 Si	74	C 16 SE	Ch: >02BF1476	03/92-12/94	W20EPR-U	3047	0.8	W20TT	IW20TT	IW20TT	4
1.6 Si	74	C 16 SE	Ch: 02BF1477>	03/92-12/94	K20TXR	5063	1.0	K20TT	IK20TT	IK20TT	4
1.7 D	42/50	17 D; X 17 DTL	Double Coil(LPH)	12/91-08/96	DG-001		11V				4
1.7 D	44	17 DR	Double Coil Std(LPH)	07/92-01/99	DG-001		11V				4
1.7 TD	50	X 17 DTL	Double Coil(LPH)	08/94-01/99	DG-001		11V				4
1.7 TDS	60	17 DT (TC4EE1)	Eng:>956632, Single Coil	12/91-09/98	DG-104		11V				4
1.7 TDS	60	17 DT (TC4EE1)	Eng: 956633>	12/91-01/98	DG-300		11V				4
1.7 TDS	60	17 DT (TC4EE1)	Eng: 956633>	12/91-01/98	DG-640		11V				4
1.7 TDS	60	17 DT (TC4EE1)	Eng:956633>, Ceramic(LP H)	12/91-09/98	DG-300		11V				4
1.7 TDS	60	17 DT (TC4EE1)	Eng:956633>, Ceramic(LP H)	12/91-09/98	DG-640		11V				4
1.8 i	66	C 18 NZ	Ch: >02BF1476	09/91-09/98	W20EPR-U	3047	0.8	W20TT	IW20TT	IW20TT	4
1.8 i	66	C 18 NZ	Ch: 02BF1477>	09/91-09/98	K20TXR	5063	1.0	K20TT	IK20TT	IK20TT	4
1.8 i 16V	82/ 85/92	18 SE; C 18 SEL; C 18 XEL; X 18 XE		06/93-03/01	K20TXR	5063	1.0	K20TT	IK20TT	IK20TT	4
2.0 GSI 16V	110	C 20 XE	Ch: >02BF1476	09/91-01/98	W20EPR-U	3047	0.8	W20TT	IW20TT	IW20TT	4
2.0 GSI 16V	110	C 20 XE	Ch: 02BF1477>	09/91-01/98	K20TXR	5063	1.0	K20TT	IK20TT	IK20TT	4
2.0 i	85	C 20 NE	Ch: >02BF1476	09/91-09/98	W20EPR-U	3047	0.8	W20TT	IW20TT	IW20TT	4
2.0 i	85	C 20 NE	Ch: 02BF1477>	09/91-09/98	K20TXR	5063	1.0	K20TT	IK20TT	IK20TT	4
2.0 i 16V	100	X 20 XEV		02/95-09/98	K20TXR	5063	1.0	K20TT	IK20TT	IK20TT	4
2.0 i 16V	100/ 110	C 20 XE; X 20 XEV	Ch: >02BF1476	03/93-01/98	W20EPR-U	3047	0.8	W20TT	IW20TT	IW20TT	4
2.0 i 16V	100/ 110	C 20 XE; X 20 XEV	Ch: 02BF1477>	03/93-01/98	K20TXR	5063	1.0	K20TT	IK20TT	IK20TT	4
ASTRA F CLASSIC (98-05)											
1.4 i	44	X 14 NZ		01/98-01/05	K20TXR	5063	1.0	K20TT	IK20TT	IK20TT	4
1.6 i	55	X 16 SZR		01/98-01/05	K20TXR	5063	1.0	K20TT	IK20TT	IK20TT	4
1.6 i 16V	74	X 16 XEL		01/98-01/05	K20TXR	5063	1.0	K20TT	IK20TT	IK20TT	4
ASTRA G (98-09)											
1.2 16V	48/55	X 12 XE; Z 12 XE		02/98-01/05	K20TXR	5063	1.0	K20TT	IK20TT	IK20TT	4
1.4	66	Z 14 XEP		10/04-12/09	K20TXR	5063	1.0	K20TT	IK20TT	IK20TT	4
1.4 16V	66	X 14 XE; Z 14 XE	Ch:>42000000, 45000000, 48000000, 4B000000	02/98-01/05	K20TXR	5063	1.0	K20TT	IK20TT	IK20TT	4
1.4 16V	66	X 14 XE; Z 14 XE	Ch:42000001, 45000001, 46000001, 48000001, 4B000001>	02/98-01/05	KJ16CR-L11	3132	1.1	K16TT	IK16TT	IK16TT	4
1.6	55/ 62/76	X 16 SZR; Z 16 SE; Z 16 XEP; Z16SE/E2(85)		02/98-12/09	K20TXR	5063	1.0	K20TT	IK20TT	IK20TT	4
1.6	76	Z 16 XEP	Ch:>42000000, 45000000, 48000000, 4B000000	12/02-12/09	K20TXR	5063	1.0	K20TT	IK20TT	IK20TT	4
1.6	76	Z 16 XEP	Ch:42000001, 45000001, 46000001, 48000001, 4B000001>	12/02-12/09	KJ16CR-L11	3132	1.1	K16TT	IK16TT	IK16TT	4
1.6 16V	74	C 16 SEL; X 16 XEL; Z 16 XE		02/98-05/05	K20TXR	5063	1.0	K20TT	IK20TT	IK20TT	4

Свечи зажигания и Свечи накаливания

Таблица применения

	KW				СТАНДАРТНЫЕ			Twin Tip			QTY
OPEL продолжение											
ASTRA G (98-09) продолжение											
1.6 16V	74/76	Z 16 XE; Z 16 XEP	Ch:>42000000, 45000000, 48000000, 4B000000	03/00-10/05	K20TXR	5063	1.0	K20TT	IK20TT	IK20TT	4
1.6 16V	74/76	Z 16 XE; Z 16 XEP	Ch:42000001, 45000001, 46000001, 48000001, 4B000001>	03/00-10/05	KJ16CR-L11	3132	1.1	K16TT	IK16TT	IK16TT	4
1.6 CNG	71	Z 16 YNG		03/03-07/04	IK20L	5358	1.1	-	IK20TT	IK20TT	4
1.6 LPG	74	X 16 XEL; Z 16 XE		03/98-01/05	K20TXR	5063	1.0	K20TT	IK20TT	IK20TT	4
1.7 CDTi	59	Z 17 DTL	Ceramic(LPH)	04/03-12/09	DG-302		11V				4
1.7 CDTi	59	Z 17 DTL	Ceramic(LPH)	04/03-12/09	DG-641		11V				4
1.7 DTi 16V	55	Y 17 DT	Ceramic(LPH)	02/00-04/05	DG-302		11V				4
1.7 DTi 16V	55	Y 17 DT	Ceramic(LPH)	02/00-04/05	DG-641		11V				4
1.7 TD	50	X 17 DTL	Double Coil(LPH)	02/98-04/05	DG-001		11V				4
1.8 16V	85/92	X 18 XE1; Z 18 XE		02/98-10/05	K20TXR	5063	1.0	K20TT	IK20TT	IK20TT	4
2.0 16V	100	C 20 SEL; X 20 XEV		02/98-01/05	K20TXR	5063	1.0	K20TT	IK20TT	IK20TT	4
2.0 16V OPC	118	X 20 XER		11/99-09/02	K20TXR	5063	1.0	K20TT	IK20TT	IK20TT	4
2.0 16V Turbo	141/ 147	Z 20 LET		09/00-10/05	K20TXR	5063	1.0	K20TT	IK20TT	IK20TT	4
2.0 DI	60	X 20 DTL; Y 20 DTL	Double Coil(LPH)	02/98-04/05	DG-118		11V				4
2.0 DTi 16V	74	Y 20 DTH		08/99-08/02	DG-118		11V				4
2.0 DTi 16V	74	Y 20 DTH		09/02-01/05	DG-142		11V				4
2.0 OPC	141/ 147	Z 20 LET		03/02-10/05	K20TXR	5063	1.0	K20TT	IK20TT	IK20TT	4
2.2 16V	108	Z 22 SE		06/00-10/05	PT16VR13	5068	1.3	TV16TT	ITV16TT	ITV16TT	4
2.2 DTi	86/92	Y 22 DTR	Double Coil(LPH)	09/02-10/05	DG-142		11V				4
ASTRA G CLASSIC (09-)											
1.3 CDTi	66	Z 13 DTH	OE:12 14 032; 12 14 070, Double Coi l(LPH)	01/09-	DG-171		11V				4
ASTRA H (04-14)											
1.2	59	Z 12 XEP		08/05-10/10	KJ16CR-L11	3132	1.1	K16TT	IK16TT	IK16TT	4
1.3 CDTi	66	Z 13 DTH	OE:12 14 032; 12 14 070, Double Coi l(LPH)	04/05-10/10	DG-171		11V				4
1.4	55/66	Z 14 XEL; Z 14 XEP; Z14XEL		03/04-10/10	KJ16CR-L11	3132	1.1	K16TT	IK16TT	IK16TT	4
1.4 LPG	66	Z 14 XEP		08/09-10/10	KJ20CR-L11	3169	1.1	K20TT	IK20TT	IK20TT	4
1.6	77	Z 16 XE1; Z 16 XEP		03/04-10/10	KJ20CR-L11	3169	1.1	K20TT	IK20TT	IK20TT	4
1.6	85	A 16 XER; Z 16 XER	Ch:>9xxxxxxx	12/06-05/14	KJ16CR-L11	3132	1.1	K16TT	IK16TT	IK16TT	4
1.6	85	A 16 XER; Z 16 XER	Ch: Axxxxxxx>	12/06-05/14	KJ20CR-L11	3169	1.1	K20TT	IK20TT	IK20TT	4
1.6	85	Z 16 XER	Ch:>92999999/ 95999999/ 98999999/ 9G999999/ 9B999999	12/06-05/14	KJ16CR-L11	3132	1.1	K16TT	IK16TT	IK16TT	4
1.6	85	Z 16 XER	Ch:A2000001/ A8000001/ AG000001>	12/06-05/14	KJ20CR-L11	3169	1.1	K20TT	IK20TT	IK20TT	4
1.6 EcoTec	76	Z 16 XEP		02/04-11/04	KJ20CR-L11	3169	1.1	K20TT	IK20TT	IK20TT	4
1.6 LPG	85	Z 16 XER	Ch:>92999999/ 95999999/ 98999999/ 9G999999/ 9B999999	08/09-10/10	KJ16CR-L11	3132	1.1	K16TT	IK16TT	IK16TT	4
1.6 LPG	85	Z 16 XER	Ch:A2000001/ A8000001/ AG000001>	08/09-10/10	KJ20CR-L11	3169	1.1	K20TT	IK20TT	IK20TT	4
1.6 Turbo	132	Z 16 LET; Z16LET(180)		02/07-09/10	IK20L	5358	1.1	-	IK20TT	IK20TT	4
1.6 Turbo	132	Z 16 LET; Z16LET(180)		02/07-10/10	KJ16CR-L11	3132	1.1	K16TT	IK16TT	IK16TT	4
1.7 CDTi	59/74	Z 17 DTH; Z 17 DTL	Ceramic(LPH)	03/04-10/10	DG-302		11V				4
1.7 CDTi	59/74	Z 17 DTH; Z 17 DTL	Ceramic(LPH)	03/04-10/10	DG-641		11V				4

Свечи зажигания и Свечи накаливания











Таблица применения

Таблица применения

KW	KW	NOTE	21	СТАНДАРТНЫЕ				Twin Tip			QTY
				1mm	1mm	1mm	1mm	1mm	1mm	1mm	
OPEL продолжение											
ASTRA H (04-14) продолжение											
1.7 CDTI	59/74/81/92	A 17 DTJ; A 17 DTR; Z 17 DTH; Z 17 DTJ; Z 17 DTL; Z 17 DTR		03/04-05/14	DG-302		11V				4
1.7 CDTI	59/74/81/92	A 17 DTJ; A 17 DTR; Z 17 DTH; Z 17 DTJ; Z 17 DTL; Z 17 DTR		03/04-05/14	DG-641		11V				4
1.8	92	Z 18 XE		01/04-10/10	KJ16CR-L11	3132	1.1	K16TT	IK16TT	IK16TT	4
1.8	103	A 18 XER; Z 18 XER	Ch:>D2999999/ D5999999/ D8999999/ DG999999/ 9B999999	08/05-05/14	KJ16CR-L11	3132	1.1	K16TT	IK16TT	IK16TT	4
1.8	103	A 18 XER; Z 18 XER	Ch:E2000001/ E8000001/ EG000001>	08/05-05/14	KJ20CR-L11	3169	1.1	K20TT	IK20TT	IK20TT	4
1.9 CDTI	74/88	Z 19 DTL	Ch:>72045139; 75030986; 78007391, Double Coi l(LPH)	06/04-10/10	DG-122		11V				4
1.9 CDTI	74/88	Z 19 DTL	Ch:72045140: 75030987; 78007392; 8B000001>, Double Coi l(LPH)	06/04-10/10	DG-196		11V				4
1.9 CDTI	110	Z 19 DTH		09/04-10/10	DG-170		11V				4
1.9 CDTi	110	Z 19 DTH	Double Coil(LPH)	09/04-10/10	DG-170		11V				4
1.9 CDTi 16V	88	Z 19 DTJ	Double Coil(LPH)	04/04-10/10	DG-170		11V				4
2.0 Turbo	125/ 147	Z 20 LEL; Z 20 LER		03/04-10/10	KJ16CR-L11	3132	1.1	K16TT	IK16TT	IK16TT	4
2.0 Turbo	177	Z 20 LEH		03/05-10/10	PK20PR-P8	3245	0.8	-	IK20TT	IK20TT	4
ASTRA J (09-)											
1.3 CDTI	70	A 13 DTE	Ch:C*000001-> ,OE:18 26 357	01/11-10/15	DG-621		4.4V				4
1.3 CDTI	70	A 13 DTE	For cylinde r no 2,3,Ch: >-B*999999, OE:18 26 357, Pressures ensor (-)	12/09-12/11	DG-621		4.4V				2
1.4	64/74	A 14 XEL; A 14 XER; B 14 XER		12/09-10/15	KJ20CR-L11	3169	1.1	K20TT	IK20TT	IK20TT	4
1.4	88/ 103	A 14 NEL; A 14 NET; B 14 NEL; B 14 NET		10/11-	VK22	5610	0.8	-	IK22TT	VK22	4
1.4 LPG	103	A 14 NET		12/11-	VK22	5610	0.8	-	IK22TT	VK22	4
1.4 Turbo	88/ 103	A 14 NEL; A 14 NET; B 14 NEL; B 14 NET		12/09-	VK22	5610	0.8	-	IK22TT	VK22	4
1.6	85	A 16 XER; B 16 XER		12/09-	KJ20CR-L11	3169	1.1	K20TT	IK20TT	IK20TT	4
1.6	132	A16LET		10/11-	IK20L	5358	1.1	-	IK20TT	IK20TT	4
1.6 CDTi	81/ 100	B 16 DTH; B 16 DTL	OE: 1214098	11/13-	DG-634		4.4V				4
1.6 Turbo	132	A 16 LET; A16LET		12/09-	IK20L	5358	1.1	-	IK20TT	IK20TT	4
1.7 CDTI	74/ 81/92	A 17 DTJ; A 17 DTL; A 17 DTN; A 17 DTR		09/09-10/15	DG-302		11V				4
1.7 CDTI	74/ 81/92	A 17 DTJ; A 17 DTL; A 17 DTN; A 17 DTR		09/09-10/15	DG-641		11V				4
1.7 CDTI	81/96	A 17 DTC; A 17 DTS		09/09-10/15	DG-625		4.4V				4
1.8	103	A 18 XER		10/11-10/15	KJ20CR-L11	3169	1.1	K20TT	IK20TT	IK20TT	4
2.0	206	A 20 NFT; B 20 NFT		04/12-	ITV16TT	4718	1.0	-	ITV16TT		4











Свечи зажигания и Свечи накаливания

Таблица применения

	KW				СТАНДАРТНЫЕ			Twin Tip			QTY
											
ОPEL продолжение											
ASTRA J (09-) продолжение											
2.0 Bi-Turbo CDTI	143	A 20 DTR	Stop & Start (-), Ch: > B3999999; B8999999; B9999999	09/12-10/15	DG-608		4.4V				4
2.0 CDTI	118/121	A 20 DTH	Stop & Start (-), Ch: > B3999999; B8999999; B9999999	09/09-10/15	DG-608		4.4V				4
ASTRA K (15-)											
1.6 CDTi	70/81/100/118	B 16 DTE; B 16 DTH; B 16 DTR; B 16 DTU; D 16 DTH; D 16 DTI	OE: 1214098	06/15-	DG-634		4.4V				4
CALIBRA (90-97)											
2.0 i	85	C 20 NE		08/89-06/93	W16EPR-U	3021	0.8	W16TT	IW16TT	IW16TT	4
2.0 i	85	C 20 NE		07/93-12/96	K20TXR	5063	1.0	K20TT	IK20TT	IK20TT	4
2.0 i 4x4	85	C 20 NE		06/90-06/93	W16EPR-U	3021	0.8	W16TT	IW16TT	IW16TT	4
2.0 i 4x4	85	C 20 NE		07/93-07/97	K20TXR	5063	1.0	K20TT	IK20TT	IK20TT	4
2.0 i 16V	100/110	C 20 XE; X 20 XEV		06/90-07/97	K20TXR	5063	1.0	K20TT	IK20TT	IK20TT	4
2.0 i 16V 4x4	100/110	C 20 XE; X 20 XEV		06/90-07/97	K20TXR	5063	1.0	K20TT	IK20TT	IK20TT	4
2.0 i Turbo 4x4	150	C 20 LET		08/91-07/97	KJ20CR-U11	3451	1.1	K20TT	IK20TT	IK20TT	4
2.5 i V6	125	C 25 XE; X 25 XE		04/93-07/97	K20TXR	5063	1.0	K20TT	IK20TT	IK20TT	6
CAMPO (87-01)											
2.2 D	45	C223		08/87-08/90	DG-124		11V				4
2.2 D 4x4	45	C223		08/87-08/90	DG-124		11V				4
2.3	69/72	4ZDI		08/91-09/96	W20EPR-U11	3049	1.1	W20TT	IW20TT	IW20TT	4
2.3 4x4	69/72	4ZDI		08/91-09/96	W20EPR-U11	3049	1.1	W20TT	IW20TT	IW20TT	4
2.5 D	56	4JA1		08/91-06/94	DG-108		11V				4
2.5 D 4x4	56	4JA1		08/91-06/94	DG-108		11V				4
2.5 DTI	74	4JA1		07/01-12/01	DG-108		11V				4
2.5 DTI 4x4	74	4JA1		07/01-12/01	DG-108		11V				4
2.5 TD	56	4JA1-T	Double Coil(LPH)	07/94-06/01	DG-108		11V				4
2.5 TD 4x4	56	4JA1-T	Double Coil(LPH)	07/94-06/01	DG-108		11V				4
3.1 TD	80	4 JG2T	Single Coil	12/92-06/01	DG-104		11V				4
3.1 TD 4x4	80	4 JG2T	Single Coil	12/92-06/01	DG-104		11V				4
CASCADA (13-)											
1.4	88	A 14 NEL; B 14 NEL		04/13-	VK22	5610	0.8	-	IK22TT	VK22	4
1.4 Turbo	103	A 14 NET; B 14 NET		03/13-	VK22	5610	0.8	-	IK22TT	VK22	4
COMBO B (94-01)											
1.4	44/60	C 14 NZ; C 14 SE; X 14 SZ		07/94-10/01	K20TXR	5063	1.0	K20TT	IK20TT	IK20TT	4
1.4 16V	66	X 14 XE		08/99-10/01	K20TXR	5063	1.0	K20TT	IK20TT	IK20TT	4
1.7 D	44	17 D (4EE1); X 17 D (4EE1)	Ceramic(LPH)	07/94-10/01	DG-300		11V				4
1.7 D	44	17 D (4EE1); X 17 D (4EE1)	Ceramic(LPH)	07/94-10/01	DG-640		11V				4
COMBO C (01-)											
1.3 CDTI 16V	51/55	Y 13 DT; Z 13 DT; Z 13 DTJ	OE:12 14 032; 12 14 070; 47 08 970, Double Coi l(LPH)	06/04-	DG-171		11V				4
1.4	66	Z 14 XEP		10/04-12/11	KJ16CR-L11	3132	1.1	K16TT	IK16TT	IK16TT	4
1.4 16V	66	Z 14 XEP		08/05-	KJ16CR-L11	3132	1.1	K16TT	IK16TT	IK16TT	4
1.6	64	Z 16 SE		10/01-	K20TXR	5063	1.0	K20TT	IK20TT	IK20TT	4
1.6 CNG	69/71	Z 16 YNG	LPG / GPL	04/05-12/11	PK20PR-P8	3245	0.8	-	IK20TT	IK20TT	4
1.6 CNG 16V	69	Z 16 YNG		06/06-	PK20PR-P8	3245	0.8	-	IK20TT	IK20TT	4
1.6 CNG 16V	69/71	Z 16 YNG; Z16YNG(96)	LPG / GPL	04/05-	PK20PR-P8	3245	0.8	-	IK20TT	IK20TT	4
1.7 CDTI 16V	74	Z 17 DTH		07/04-	DG-302		11V				4
1.7 CDTI 16V	74	Z 17 DTH		07/04-	DG-641		11V				4
1.7 DI 16V	48	Y 17 DTL		10/01-	DG-302		11V				4
1.7 DI 16V	48	Y 17 DTL		10/01-	DG-641		11V				4
1.7 DTI 16V	55	Y 17 DT	Ceramic(LPH)	10/01-	DG-302		11V				4
1.7 DTI 16V	55	Y 17 DT	Ceramic(LPH)	10/01-	DG-641		11V				4

Свечи зажигания и Свечи накаливания

Таблица применения

	KW				СТАНДАРТНЫЕ				Twin Tip			QTY
												
ОPEL продолжение												
COMBO D (12-)												
1.3 CDTI	66/70	A 13 FD	Euro-5,OE: 12 14 090	02/12-	DG-621		4.4V					4
1.3 CDTI	66/70	A 13 FD	Euro-6,OE: 12 14 106/ 55238404 (RP 9016)	02/12-	DG-658		5V					4
1.4	70/88	A 14 FC; A 14 FP		02/12-	XU22EPR-U	3179	0.9	XU22TT	IXU22TT	VXU22		4
1.4	88	A 14 FC	40000km Lifetime	02/12-	IXU27	5337	0.9	-	-			4
1.4 CNG	88	A 14 FC		02/12-	VXU22	5608	0.9	-	IXU22TT	VXU22		4
1.4 CNG	88	A 14 FC	40000km Lifetime	02/12-	IXU27	5337	0.9	-	-			4
1.6 CDTI	66/ 74/77	A 16 FDH; A 16 FDL	OE: 1214094	02/12-	DG-608		4.4V					4
1.6 CDTI	70/88	B 16 DTC; B 16 DTE; B 16 DTJ	OE: 1214098	03/15-	DG-634		4.4V					4
2.0 CDTI	99	A 20 FD		02/12-	DG-608		4.4V					4
COMBO E (18-)												
1.2	33	C12NZ/X12SZ	Ch: 19K87118>	07/94-10/01	K20TXR	5063	1.0	K20TT	IK20TT	IK20TT		4
1.2	33	X12SZ	Ch:>19334656, 19341712	07/94-10/01	W16EPR-U	3021	0.8	W16TT	IW16TT	IW16TT		4
COMMODORE C (78-82)												
2.5 E	96	25E		12/80-12/82	W16EPR-U	3021	0.8	W16TT	IW16TT	IW16TT		6
2.5 S	85	25S		08/78-12/82	W16EPR-U	3021	0.8	W16TT	IW16TT	IW16TT		6
CORSA A (82-93)												
1.0	33	10 S		09/82-03/93	W20FP-U	3068	0.7	WF20TT	-			4
1.0	33	10 S		02/86-04/89	W20FPR-U	3070	0.7	WF20TT	-			4
1.2	33	E 12 GV		09/82-08/90	W20FPR-U	3070	0.7	WF20TT	-			4
1.2	40	12 ST		02/86-04/89	W20EPR-U	3047	0.8	W20TT	IW20TT	IW20TT		4
1.2	44	12 S		09/82-08/90	W20FP-U	3068	0.7	WF20TT	-			4
1.2 i	33	C 12 NZ	Eng:19341713>	09/89-03/93	K20TXR	5063	1.0	K20TT	IK20TT	IK20TT		4
1.2 N	33	E 12 GV		01/85-10/87	W20FPR-U	3070	0.7	WF20TT	-			4
1.2 N	38	12 NV		01/90-03/93	W16EPR-U	3021	0.8	W16TT	IW16TT	IW16TT		4
1.2 S	40	12 ST		09/82-03/93	W20EPR-U	3047	0.8	W20TT	IW20TT	IW20TT		4
1.3	44/51	13 NB; 13 SB; C 13 N		09/85-10/89	W20EPR-U	3047	0.8	W20TT	IW20TT	IW20TT		4
1.3 i	44	C 13 N		09/86-09/90	W20EPR-U	3047	0.8	W20TT	IW20TT	IW20TT		4
1.3 S	51	13 SB		09/82-10/89	W20EPR-U	3047	0.8	W20TT	IW20TT	IW20TT		4
1.4 i	44	C 14 NZ	Eng:02BF1476/ 19241623>	10/89-03/93	K20TXR	5063	1.0	K20TT	IK20TT	IK20TT		4
1.4 S	53	14 NV	Eng:>02BF147 6	09/89-03/93	W20EPR-U	3047	0.8	W20TT	IW20TT	IW20TT		4
1.4 Si	60	C 14 SE	Eng:02BD1414 >	09/91-03/93	K20TXR	5063	1.0	K20TT	IK20TT	IK20TT		4
1.5 D	37	15 D (4EC1)	Eng:>804794, Single Coil	06/87-03/93	DG-143		5V					4
1.5 D	37	15 D (4EC1)	Eng:804795>, Single Coil	06/87-03/93	DG-124		11V					4
1.5 TD	49	15 DT (T4EC1)	Eng: >804794	03/88-03/93	DG-159		5V					4
1.5 TD	49	15 DT (T4EC1)	Eng:>804794, Single Coil	10/87-03/93	DG-159		5V					4
1.5 TD	49	15 DT (T4EC1)	Eng: 804795>	03/88-03/93	DG-104		11V					4
1.5 TD	49	15 DT (T4EC1)	Eng:804795>, Single Coil	10/87-03/93	DG-104		11V					4
1.6 GSI	55/ 72/74	C 16 NZ; C 16 SEI; E 16 SE		05/88-03/93	W20EPR-U	3047	0.8	W20TT	IW20TT	IW20TT		4
1.6 GSI Cat	74	C 16 SE		02/92-03/93	W20EPR-U	3047	0.8	W20TT	IW20TT	IW20TT		4
CORSA B (93-02)												
1.0 i 12V	40	X 10 XE		11/96-09/00	K20TXR	5063	1.0	K20TT	IK20TT	IK20TT		3
1.2 i	33	12 NZ; C 12 NZ; X 12 SZ	Ch:>19334656, 19341717	03/93-09/00	W16EPR-U	3021	0.8	W16TT	IW16TT	IW16TT		4
1.2 i	33	12 NZ; C 12 NZ; X 12 SZ	Ch: 19K87118>	03/93-09/00	K20TXR	5063	1.0	K20TT	IK20TT	IK20TT		4
1.2 i 16V	48	X 12 XE		03/98-09/00	K20TXR	5063	1.0	K20TT	IK20TT	IK20TT		4
1.4 i	40/44	C 14 NZ; C14NZ/X14SZ; X 14 SZ		08/95-09/00	K20TXR	5063	1.0	K20TT	IK20TT	IK20TT		4
1.4 i	40/44	C14NZ		03/93-07/95	W16EPR-U	3021	0.8	W16TT	IW16TT	IW16TT		4
1.4 i 16V	63/66	C 14 SEL; X 14 XE		09/94-12/02	K20TXR	5063	1.0	K20TT	IK20TT	IK20TT		4
1.4 Si	60	C 14 SE	Ch:>02BD1413 19263161	03/93-09/00	W16EPR-U	3021	0.8	W16TT	IW16TT	IW16TT		4

Свечи зажигания и Свечи накаливания

Таблица применения





















	KW				СТАНДАРТНЫЕ			Twin Tip			QTY
											
ОPEL продолжение											
CORSA B (93-02) продолжение											
1.4 Si	60	C 14 SE	Ch:02LP3953, 19K87118, X6000001>	03/93-09/00	K20TXR	5063	1.0	K20TT	IK20TT	IK20TT	4
1.5 D	37	15 D (4EC1)	Ceramic(LPH)	03/93-09/00	DG-300		11V				4
1.5 D	37	15 D (4EC1)	Ceramic(LPH)	03/93-09/00	DG-640		11V				4
1.5 TD	49	15 DT (T4EC1); X 15 DT (T4EC1)	Ceramic(LPH)	03/93-09/00	DG-300		11V				4
1.5 TD	49	15 DT (T4EC1); X 15 DT (T4EC1)	Ceramic(LPH)	03/93-09/00	DG-640		11V				4
1.6 GSI 16V	80	C 16 XE		03/93-09/00	K20TXR	5063	1.0	K20TT	IK20TT	IK20TT	4
1.6 i 16V	74/78	C 16 SEL; X 16 XE		09/94-09/00	K20TXR	5063	1.0	K20TT	IK20TT	IK20TT	4
1.7 D	44	17 D (4EE1); X 17 D (4EE1)	Ceramic(LPH)	02/96-09/00	DG-300		11V				4
1.7 D	44	17 D (4EE1); X 17 D (4EE1)	Ceramic(LPH)	02/96-09/00	DG-640		11V				4
CORSA C (00-09)											
1.0	44	Z 10 XE		09/00-06/03	K20TXR	5063	1.0	K20TT	IK20TT	IK20TT	3
1.0	44	Z 10 XEP		06/03-12/09	KJ16CR-L11	3132	1.1	K16TT	IK16TT	IK16TT	3
1.2	55	Z 12 XE		09/00-12/09	K20TXR	5063	1.0	K20TT	IK20TT	IK20TT	4
1.2	59	Z 12 XEP		07/05-12/09	KJ16CR-L11	3132	1.1	K16TT	IK16TT	IK16TT	4
1.2 16V	55	Z 12 XE		09/00-12/09	K20TXR	5063	1.0	K20TT	IK20TT	IK20TT	4
1.2 Twinport	59	Z 12 XEP		07/04-12/09	KJ16CR-L11	3132	1.1	K16TT	IK16TT	IK16TT	4
1.3 CDTi	51	Z 13 DT	OE:12 14 032; 12 14 070, Double Coi (LPH)	06/03-12/09	DG-171		11V				4
1.3 CDTi 16V	51	Z 13 DT	OE:12 14 032; 12 14 070, Double Coi (LPH)	07/05-12/09	DG-171		11V				4
1.4	66	Z 14 XE		09/00-12/09	K20TXR	5063	1.0	K20TT	IK20TT	IK20TT	4
1.4	66	Z 14 XEP		08/03-12/09	KJ16CR-L11	3132	1.1	K16TT	IK16TT	IK16TT	4
1.4 Twinport	66	Z 14 XEP		06/03-12/09	KJ16CR-L11	3132	1.1	K16TT	IK16TT	IK16TT	4
1.7 CDTi	74	Z 17 DTH		08/03-12/09	DG-302		11V				4
1.7 CDTi	74	Z 17 DTH		08/03-12/09	DG-641		11V				4
1.7 CDTi	74	Z 17 DTH	Ceramic(LPH)	06/03-12/09	DG-302		11V				4
1.7 CDTi	74	Z 17 DTH	Ceramic(LPH)	06/03-12/09	DG-641		11V				4
1.7 DI	48	Y 17 DTL	Ceramic(LPH)	09/00-12/09	DG-302		11V				4
1.7 DI	48	Y 17 DTL	Ceramic(LPH)	09/00-12/09	DG-641		11V				4
1.7 DI 16V	48	Y 17 DTL	Ceramic(LPH)	09/00-12/09	DG-302		11V				4
1.7 DI 16V	48	Y 17 DTL	Ceramic(LPH)	09/00-12/09	DG-641		11V				4
1.7 DTi	55	Y 17 DT	Ceramic(LPH)	09/00-12/09	DG-302		11V				4
1.7 DTi	55	Y 17 DT	Ceramic(LPH)	09/00-12/09	DG-641		11V				4
1.7 DTi 16V	55	Y 17 DT	Ceramic(LPH)	09/00-12/09	DG-302		11V				4
1.7 DTi 16V	55	Y 17 DT	Ceramic(LPH)	09/00-12/09	DG-641		11V				4
1.8	92	Z 18 XE		09/00-12/09	K20TXR	5063	1.0	K20TT	IK20TT	IK20TT	4
CORSA D (06-14)											
1.0	44	Z 10 XEP		07/06-12/10	KJ20CR-L11	3169	1.1	K20TT	IK20TT	IK20TT	3
1.0	44/48	A 10 XEP		08/06-08/14	KJ16CR-L11	3132	1.1	K16TT	IK16TT	IK16TT	3
1.2	51/63	A 12 XEL; A 12 XER		12/09-08/14	KJ20CR-L11	3169	1.1	K20TT	IK20TT	IK20TT	4
1.2	59	Z 12 XEP		07/06-08/14	KJ16CR-L11	3132	1.1	K16TT	IK16TT	IK16TT	4
1.2 LPG	59	Z 12 XEP		08/06-08/14	KJ20CR-L11	3169	1.1	K20TT	IK20TT	IK20TT	4
1.2 LPG	61/63	A 12 XER		06/11-08/14	VK20Y	5620	0.8	-	-	VK20Y	4
1.3 CDTi	55	A 13 DTC	For cylinder no 2,3,OE: 18 26 357, Pressures ensor (-)	07/06-08/14	DG-621		4.4V				2
1.3 CDTi	55/66	Z 13 DTH; Z 13 DTJ	OE:12 14 032; 12 14 070	07/06-08/14	DG-171		11V				4
1.3 CDTi	70	A 13 DTE; A 13 DTR; Z 13 DTE	OE: 18 26 357	06/09-08/14	DG-621		4.4V				4
1.4	64/74	A 14 XEL; A 14 XER		09/09-08/14	KJ20CR-L11	3169	1.1	K20TT	IK20TT	IK20TT	4
1.4	66	Z 14 XEP		07/06-08/14	KJ16CR-L11	3132	1.1	K16TT	IK16TT	IK16TT	4
1.4	88	A 14 NEL		07/12-08/14	VK22	5610	0.8	-	IK22TT	VK22	4
1.4 LPG	64	A 14 XEL		09/09-08/14	VK20Y	5620	0.8	-	-	VK20Y	4
1.4 LPG	66	Z 14 XEP		08/06-12/11	KJ20CR-L11	3169	1.1	K20TT	IK20TT	IK20TT	4
1.6 Turbo	110/ 141/ 155	A 16 LES; A16LEL; A16LER		11/06-08/14	IK20L	5358	1.1	-	IK20TT	IK20TT	4
1.6 Turbo	141	Z16LER(192)		11/06-08/14	PK20PR-L11	3142	1.1	-	IK20TT	IK20TT	4

Таблица применения

Свечи зажигания и Свечи накаливания

Таблица применения

Таблица применения

	KW				СТАНДАРТНЫЕ			Twin Tip			QTY
											
ОPEL продолжение											
CORSA D (06-14) продолжение											
1.7 CDTI	92/96	A 17 DTS; Z 17 DTR	Ceramic(LPH)	08/06-12/11	DG-302		11V				4
1.7 CDTI	92/96	A 17 DTS; Z 17 DTR	Ceramic(LPH)	08/06-12/11	DG-641		11V				4
1.7 CDTI	96	A 17 DTS		12/09-08/14	DG-625		4.4V				4
CORSA E (14-)											
1.3 CDTI	55/70	B 13 DTC; B 13 DTE; B 13 DTN; B 13 DTR	Euro-6,OE: 12 14 106/ 55238404 (RP 9016)	09/14-	DG-658		5V				4
1.4 Turbo	74/ 110	B 14 NEH; B 14 NEJ; D 14 NEH		09/14-	VK22	5610	0.8	-	IK22TT	VK22	4
FRONTERA A (92-98)											
2.0 i	85	C 20 NE; X 20 SE	Ch:P7000001, R1000001, R5000001>	03/92-10/98	K20TXR	5063	1.0	K20TT	IK20TT	IK20TT	4
2.2 i	100	X 22 XE		03/95-10/98	K20TXR	5063	1.0	K20TT	IK20TT	IK20TT	4
2.3 TD	74	23 DTR	Double Coil(LPH)	03/92-10/98	DG-001		11V				4
2.4 i	92	C 24 NE		03/92-02/95	W20FPR-U	3070	0.7	WF20TT	-		4
2.5 TDS	85	25TDS (VM41B)	Double Coil(LPH)	09/96-10/98	DG-109		11V				4
2.8 TD	83	28 TDI (4JB1-T)	Double Coil(LPH)	03/95-08/98	DG-108		11V				4
FRONTERA B (98-04)											
2.2 DTI	85	X22DTH	Ch:>YV699999, Double Coi l(LPH)	10/98-09/02	DG-118		11V				4
2.2 DTI	85/88	Y 22 DTH; Y22DTH	Ch:1V500001>, Double Coi l(LPH)	10/98-07/04	DG-142		11V				4
2.2 i	100	X22SE/Y22SE		10/98-07/05	K16PR-U11	3130	1.1	K16TT	IK16TT	IK16TT	4
3.2 i	151	6VD1/Y32NE		10/98-07/05	PK16PR-L11	3275	1.1	-	IK16TT	IK16TT	6
GT (68-73)											
1.9	66	19 S		09/68-08/73	W20FPR-U	3070	0.7	WF20TT	-		4
GT (07-)											
2.0	194	LNF; Z 20 NHH		06/07-12/11	ITV20TT	4719	1.0	-	ITV20TT		4
INSIGNIA (A) (08-17)											
1.4	103	A 14 NET; B 14 NET		04/11-03/17	VK22	5610	0.8	-	IK22TT	VK22	4
1.4 LPG	103	A 14 NET; B 14 NET		07/12-03/17	VK22	5610	0.8	-	IK22TT	VK22	4
1.6	85	A 16 XER	Ch:>9xxxxxxx	07/08-03/17	KJ16CR-L11	3132	1.1	K16TT	IK16TT	IK16TT	4
1.6	85	A 16 XER	Ch: Axxxxxxx>	07/08-03/17	KJ20CR-L11	3169	1.1	K20TT	IK20TT	IK20TT	4
1.6 CDTi	88/ 100	B 16 DTH; B 16 DTJ	OE: 1214098	07/15-03/17	DG-634		4.4V				4
1.6 Turbo	132	A16LET		07/08-03/17	IK20L	5358	1.1	-	IK20TT	IK20TT	4
1.8	103	A 18 XER; B 18 XER		07/08-03/17	KJ20CR-L11	3169	1.1	K20TT	IK20TT	IK20TT	4
2.0 Bi-Turbo CDTI 4x4	140	A 20 DTR	Pressure sensor (-)	07/08-03/17	DG-608		4.4V				2
2.0 CDTI	81/ 96/ 118/ 120	A 20 DT; A 20 DTC; A 20 DTH; A 20 DTJ; A 20 DTL	Pressure sensor (-)	07/08-03/17	DG-608		4.4V				2
2.0 CDTI 4x4	118/ 120	A 20 DTH	Pressure sensor (-)	06/10-03/17	DG-608		4.4V				2
2.0 E85 Turbo	162	A 20 NFT		09/10-11/11	ITV16TT	4718	1.0	-	ITV16TT		4
2.0 E85 Turbo	162	A 20 NFT; A 20 NHT		10/10-03/17	ITV20TT	4719	1.0	-	ITV20TT		4
2.0 Turbo	162/ 184	A 20 NFT; A 20 NHT; B 20 NHT		07/08-03/17	ITV20TT	4719	1.0	-	ITV20TT		4
2.0 Turbo 4x4	162/ 184	A 20 NHT; B 20 NHT		07/08-03/17	ITV20TT	4719	1.0	-	ITV20TT		4
2.0 Turbo 4x4	184	A 20 NFT; A 20 NHT; B 20 NHT		07/11-03/17	ITV16TT	4718	1.0	-	ITV16TT		4
2.0 Turbo E85	162	A 20 NFT		07/08-03/17	ITV16TT	4718	1.0	-	ITV16TT		4
KADETT B (65-73)											
1.1	33/ 37/ 40/44	11 N; 11 S; 11 SR		09/65-08/73	W20FPR-U	3070	0.7	WF20TT	-		4
1.1 S	40	11 S		09/65-07/71	W20FPR-U	3070	0.7	WF20TT	-		4

Свечи зажигания и Свечи накаливания

Таблица применения





















	KW				СТАНДАРТНЫЕ			Twin Tip			QTY
											
ОPEL продолжение											
КАДЕТТ В (65-73) продолжение											
1.1 SR	44	11 SR		11/66-07/71	W20FPR-U	3070	0.7	WF20TT	-		4
1.9	66	19 S		08/67-08/73	W20FPR-U	3070	0.7	WF20TT	-		4
КАДЕТТ С (73-79)											
1.2	38/40	12 N		08/73-07/79	W20FP-U	3068	0.7	WF20TT	-		4
1.2 S	44	12 S		08/73-07/79	W20FP-U	3068	0.7	WF20TT	-		4
КАДЕТТ D (79-84)											
1.0	30/33	10 N; 10 S; 10S(50)		09/79-08/84	W20FPR-U	3070	0.7	WF20TT	-		4
1.2	39	12 N; 12 ST; 12N		08/79-08/84	W20FPR-U	3070	0.7	WF20TT	-		4
1.2 S	44	12 S; 12S		08/79-08/84	W20FPR-U	3070	0.7	WF20TT	-		4
1.3 N	44	13N		08/79-08/84	W20EPR-U	3047	0.8	W20TT	IW20TT	IW20TT	4
1.3 S	55	13S		08/79-08/84	W20EPR-U	3047	0.8	W20TT	IW20TT	IW20TT	4
1.6 D	40	16 D	Double Coil(LPH)	03/82-08/84	DG-001		11V				4
1.6 S	66	16 SH		09/81-08/84	W20EPR-U	3047	0.8	W20TT	IW20TT	IW20TT	4
1.8 GT/E	85	18E		02/83-08/84	W20EPR-U	3047	0.8	W20TT	IW20TT	IW20TT	4
КАДЕТТ E (84-94)											
1.2	40	12S/12ST		09/84-07/86	W20EPR-U	3047	0.8	W20TT	IW20TT	IW20TT	4
1.3 i Cat	44	C13N		09/85-08/91	W20EPR-U	3047	0.8	W20TT	IW20TT	IW20TT	4
1.3 N	44	13N/13NB; 13N/C13N; 13N		09/84-08/91	W20EPR-U	3047	0.8	W20TT	IW20TT	IW20TT	4
1.3 S	55	13S		09/84-12/89	W20EPR-U	3047	0.8	W20TT	IW20TT	IW20TT	4
1.4 i	44	C14NZ		01/90-03/93	W20EPR-U	3047	0.8	W20TT	IW20TT	IW20TT	4
1.4 S	55	14NV		07/89-08/91	W20EPR-U	3047	0.8	W20TT	IW20TT	IW20TT	4
1.5 TD	53	15 DT (T4EC1)	Eng:>817252, Single Coil	07/88-08/91	DG-159		5V				4
1.5 TD	53	15 DT (T4EC1)	Eng:817253>, Single Coil	07/88-08/91	DG-104		11V				4
1.6	60	16SV		09/86-12/91	W20EPR-U	3047	0.8	W20TT	IW20TT	IW20TT	4
1.6 D	40	16 D; 16 DA	Double Coil(LPH)	08/84-12/89	DG-001		11V				4
1.6 i	55/60	16SV; C16LZ/E16NZ; C16NZ		09/86-03/93	W20EPR-U	3047	0.8	W20TT	IW20TT	IW20TT	4
1.6 i Cat	55	16SV; C16LZ/C16NZ; C16LZ		09/86-08/91	W20EPR-U	3047	0.8	W20TT	IW20TT	IW20TT	4
1.6 S	60/66	16S-OHC; 16SV		09/84-08/91	W20EPR-U	3047	0.8	W20TT	IW20TT	IW20TT	4
1.7 D	42/44	17 D; 17 DR	Double Coil Std(LPH)	08/88-07/94	DG-001		11V				4
1.8	84	18SE		09/87-08/90	W20EPR-U	3047	0.8	W20TT	IW20TT	IW20TT	4
1.8 E	74	C18NE		10/85-08/86	W20EPR-U	3047	0.8	W20TT	IW20TT	IW20TT	4
1.8 GSI	85	18E/18SE		09/84-08/86	W20EPR-U	3047	0.8	W20TT	IW20TT	IW20TT	4
1.8 i	66/ 74/85	18E/18SE; C18NE; C18NZ/S18NV; C18NZ		09/84-08/91	W20EPR-U	3047	0.8	W20TT	IW20TT	IW20TT	4
1.8 i	85	18 E; 18 SE		09/84-08/86	W20PR-U	5046	0.7	-	-		4
1.8 S	62	18SE; E 18 NV		09/87-08/91	W20EPR-U	3047	0.8	W20TT	IW20TT	IW20TT	4
2.0 GSI	85/95	20NE; 20SEH		09/86-08/91	W20EPR-U	3047	0.8	W20TT	IW20TT	IW20TT	4
2.0 GSI 16V	110/ 115	C20XE		12/87-08/91	K20PR-U	3145	0.8	K20TT	IK20TT	IK20TT	4
2.0 GSI 16V Cat	110	C20XE		03/88-08/91	K20PR-U	3145	0.8	K20TT	IK20TT	IK20TT	4
2.0 GSI Cat	85	C20NE(115)		09/86-08/91	W20EPR-U	3047	0.8	W20TT	IW20TT	IW20TT	4
2.0 i	85	20NE		10/86-05/92	W20EPR-U	3047	0.8	W20TT	IW20TT	IW20TT	4
2.0 i Cat	85	C20NE(115)		10/86-05/92	W20EPR-U	3047	0.8	W20TT	IW20TT	IW20TT	4
MANTA A (70-75)											
1.6	55	16 S		02/75-08/75	W20EPR-U	3047	0.8	W20TT	IW20TT	IW20TT	4
1.9 S	66	19 S		09/70-08/75	W20FPR-U	3070	0.7	WF20TT	-		4
MANTA B (75-88)											
1.3 N	44	13N		03/79-12/80	W20EPR-U	3047	0.8	W20TT	IW20TT	IW20TT	4
1.3 S	55	13S		08/79-08/86	W20EPR-U	3047	0.8	W20TT	IW20TT	IW20TT	4
1.6 N	44	16N		09/75-12/80	W20EPR-U	3047	0.8	W20TT	IW20TT	IW20TT	4
1.6 S	55	16S-CVH		09/75-12/81	W20EPR-U	3047	0.8	W20TT	IW20TT	IW20TT	4
1.8 S	66	18S		07/82-07/86	W20EPR-U	3047	0.8	W20TT	IW20TT	IW20TT	4
1.9 S	66	19 S		09/75-12/80	W20FPR-U	3070	0.7	WF20TT	-		4
2.0 E	81	20E		08/77-08/88	W20FPR-U	3070	0.7	WF20TT	-		4
2.0 S	74	20S		08/77-08/84	W20FPR-U	3070	0.7	WF20TT	-		4
MERIVA A (03-10)											
1.3 CDTI	51/55	Y 13 DT; Z 13 DT; Z 13 DTJ	OE:12 14 032; 12 14 070	09/03-05/10	DG-171		11V				4
1.4 16V Twinport	66	Z 14 XEP		07/04-05/10	KJ16CR-L11	3132	1.1	K16TT	IK16TT	IK16TT	4

Таблица применения

Свечи зажигания и Свечи накаливания











Таблица применения

Таблица применения

	KW				СТАНДАРТНЫЕ				Twin Tip			QTY
												
ОPEL продолжение												
MERIVA A (03-10) продолжение												
1.4 16V Twinport LPG	66	Z 14 XEP		07/04-05/10	KJ20CR-L11	3169	1.1	K20TT	IK20TT	IK20TT	4	
1.6	64	Z 16 SE		05/03-05/10	K20TXR	5063	1.0	K20TT	IK20TT	IK20TT	4	
1.6	77	Z16XEP(105)		01/06-05/10	KJ16CR-L11	3132	1.1	K16TT	IK16TT	IK16TT	4	
1.6 16V	74	Z16XE(100)		05/03-01/06	K20TXR	5063	1.0	K20TT	IK20TT	IK20TT	4	
1.6 Turbo	132	Z 16 LET		09/05-05/10	PK20PR-L11	3142	1.1	-	IK20TT	IK20TT	4	
1.7 CDTI	74/92	A 17 DTR; Z 17 DT; Z 17 DTH; Z 17 DTR	Ceramic(LPH)	09/03-05/10	DG-302		11V				4	
1.7 CDTI	74/92	A 17 DTR; Z 17 DT; Z 17 DTH; Z 17 DTR	Ceramic(LPH)	09/03-05/10	DG-641		11V				4	
1.7 DTI	55	Y 17 DT	Ceramic(LPH)	09/03-05/10	DG-302		11V				4	
1.7 DTI	55	Y 17 DT	Ceramic(LPH)	09/03-05/10	DG-641		11V				4	
1.8	92	Z 18 XE		05/03-05/10	K20TXR	5063	1.0	K20TT	IK20TT	IK20TT	4	
MERIVA B (10-)												
1.3 CDTI	55/70	A 13 DTC; A 13 DTE	For cylinder no 2,3,OE: 18 26 357, Pressuresensor (-)	06/10-11/14	DG-621		4.4V				2	
1.4	74	A 14 XER; B 14 XER		06/10-03/17	KJ20CR-L11	3169	1.1	K20TT	IK20TT	IK20TT	4	
1.4	88/ 103	A 14 NEL; A 14 NET; B 14 NEL; B 14 NET		06/10-03/17	VK22	5610	0.8	-	IK22TT	VK22	4	
1.4 LPG	88	A 14 NEL; B 14 NEL		06/11-03/17	VK22	5610	0.8	-	IK22TT	VK22	4	
1.6 CDTi	70/ 81/ 100	B 16 DTC; B 16 DTE; B 16 DTH; B 16 DTL; B 16 DTN	OE: 1214098	08/13-03/17	DG-634		4.4V				4	
1.7 CDTI	74	A 17 DT	Ceramic(LPH)	06/10-01/17	DG-302		11V				4	
1.7 CDTI	74	A 17 DT	Ceramic(LPH)	06/10-01/17	DG-641		11V				4	
1.7 CDTI	81/96	A 17 DTC; A 17 DTS		06/10-10/13	DG-625		4.4V				4	
МОККА (12-)												
1.4	103	A 14 NET; B 14 NET; D 14 NET		04/13-	VK22	5610	0.8	-	IK22TT	VK22	4	
1.4 4x4	103	A 14 NET; B 14 NET; D 14 NET		06/12-	VK22	5610	0.8	-	IK22TT	VK22	4	
1.4 LPG	103	A 14 NET; B 14 NET; D 14 NET		04/13-	VK22	5610	0.8	-	IK22TT	VK22	4	
1.6	85	A16XER		06/12-	KJ16CR-L11	3132	1.1	K16TT	IK16TT	IK16TT	4	
1.6 CDTI	81/ 100	B 16 DTH; B 16 DTN; B 16 DTU; D 16 DTH	OE: 1214098	01/15-	DG-634		4.4V				4	
1.6 CDTI 4x4	100	B 16 DTH; D 16 DTH	OE: 1214098	01/15-	DG-634		4.4V				4	
1.7 CDTI	96	A 17 DTS	Instant heating (ISS)	06/12-	DG-625		4.4V				4	
1.7 CDTI 4x4	96	A 17 DTS	Instant heating (ISS)	06/12-	DG-625		4.4V				4	
1.8	103	A 18 XER		01/13-	KJ20CR-L11	3169	1.1	K20TT	IK20TT	IK20TT	4	
1.8 4x4	103	A 18 XER		01/13-	KJ20CR-L11	3169	1.1	K20TT	IK20TT	IK20TT	4	
MONTEREY A (91-98)												
3.1 TD	84	4 JG2TC	Single Coil	09/91-07/98	DG-104		11V				4	
3.2	130	6VDI		08/91-03/94	Q20PR-U	3007	0.8	Q20TT	IQ20TT	IQ20TT	6	
MONTEREY B (98-99)												
3.0 DTI	117	4 JX1	Double Coil(LPH)	07/98-08/99	DG-186		11V				4	
3.5 V6 24V	158	6 VE1		07/98-08/99	PK16PR-L11	3275	1.1	-	IK16TT	IK16TT	6	
MONZA A (78-86)												
2.0 E	85	20E		03/83-10/84	W20FPR-U	3070	0.7	WF20TT	-		4	
2.2 E	85	22E		11/84-08/86	W20FPR-U	3070	0.7	WF20TT	-		4	
2.5 E	103	25E		06/84-08/86	W20FPR-U	3070	0.7	WF20TT	-		6	
2.8	103	28H		02/78-04/81	W20FPR-U	3070	0.7	WF20TT	-		6	
3.0 GSE	132	30E/C30NE		06/81-08/86	W20FPR-U	3070	0.7	WF20TT	-		6	

Свечи зажигания и Свечи накаливания

Таблица применения

	KW				СТАНДАРТНЫЕ			Twin Tip			QTY
											
ОPEL продолжение											
MOVANO A (98-)											
1.9 DTI	60	F9Q 770; F9Q 772; F9Q 774	Double Coil(LPH)	09/00-	DG-005		11V				4
2.2 DTI	66	G9T 720; G9T 722; G9T 750		09/00-	DG-126		11V				4
2.5 CDTI	74/88/107	G9U 632; G9U 650		10/03-	DG-126		11V				4
2.5 D	59	S8U 770; S8U 772	Double Coil(LPH)	07/98-09/00	DG-004		11V				4
2.5 DTi	73/84	G9U 720; G9U 724; G9U 750; G9U 754		10/01-	DG-126		11V				4
3.0 DTI	100	ZD3 200; ZD3 202		10/03-	DG-605		11V				4
OLYMPIA A (67-71)											
1.9	66	19 S		08/67-08/71	W20FPR-U	3070	0.7	WF20TT	-		4
OMEGA A (86-94)											
1.8	65/85	18 SEH; 18SEH; E 18 NVR		09/86-03/94	W20EPR-U	3047	0.8	W20TT	IW20TT	IW20TT	4
1.8 N	60	18 NV		09/86-08/87	W20EPR-U	3047	0.8	W20TT	IW20TT	IW20TT	4
1.8 S	66	18 SV		09/86-03/94	W20EPR-U	3047	0.8	W20TT	IW20TT	IW20TT	4
2.0	73	C 20 NEJ		09/90-03/94	K20TXR	5063	1.0	K20TT	IK20TT	IK20TT	4
2.0	73	C20NE(100)		09/90-03/94	W16EPR-U	3021	0.8	W16TT	IW16TT	IW16TT	4
2.0	90	20 SE		09/86-03/94	W20EPR-U	3047	0.8	W20TT	IW20TT	IW20TT	4
2.0 i	85	C 20 NE	Ch:R1000001, R5000001, P7000001>	09/86-03/94	K20TXR	5063	1.0	K20TT	IK20TT	IK20TT	4
2.0 i	85	C 20 NE	Ch:R5000001, R1000001, P7000001>	09/86-04/94	K20TXR	5063	1.0	K20TT	IK20TT	IK20TT	4
2.3 D	54	23 YD	Double Coil(LPH)	09/86-03/94	DG-001		11V				4
2.3 TD	66	23 YDT	Double Coil(LPH)	09/86-08/88	DG-001		11V				4
2.3 TD Interc.	74	23 DTR	Double Coil(LPH)	08/88-03/94	DG-001		11V				4
2.4 i	92	C 24 NE		09/88-03/94	W20FPR-U	3070	0.7	WF20TT	-		4
2.6 i	110	C 26 NE		09/90-03/94	W20FPR-U	3070	0.7	WF20TT	-		6
3.0	115/130	30 NE; C 30 LE		03/87-03/94	W20FPR-U	3070	0.7	WF20TT	-		6
3.0	130	C 30 NE		03/88-03/94	W20FP-U	3068	0.7	WF20TT	-		6
3.0 24V	147/150	C 30 SEJ		09/89-03/94	K20TXR	5063	1.0	K20TT	IK20TT	IK20TT	6
3.0 Cat	130	C 30 NE		03/87-03/94	W20FP-U	3068	0.7	WF20TT	-		6
OMEGA B (94-03)											
2.0	85	20 SE; X 20 SE		03/94-12/00	K20TXR	5063	1.0	K20TT	IK20TT	IK20TT	4
2.0 16V	100	X 20 XEV		03/94-09/99	K20TXR	5063	1.0	K20TT	IK20TT	IK20TT	4
2.0 DTI 16V	74	X 20 DTH		09/97-09/00	DG-118		11V				4
2.2 16V	106	Y 22 XE; Z 22 XE		09/99-07/03	K20TXR	5063	1.0	K20TT	IK20TT	IK20TT	4
2.2 DTI 16V	81	Y 22 DTH		09/00-07/03	DG-142		11V				4
2.2 DTI 16V	88	Y 22 DTH	Double Coil(LPH)	09/00-07/03	DG-142		11V				4
2.5 D	96	X 25 DT; X 25 TD		05/94-05/99	DG-001		11V				6
2.5 DTI	110	Y 25 DT; Y 25 TD	Double Coil(LPH)	09/01-07/03	DG-145		11V				6
2.5 TD	96	U 25 DT; U 25 TD; X 25 DT; X 25 TD	Double Coil(LPH)	04/94-07/03	DG-001		11V				6
2.5 V6	125	X 25 XE		03/94-09/00	K20TNR	3304	1.0	K20TT	IK20TT	IK20TT	6
2.6 V6	132	Y 26 SE		09/00-07/03	K20TNR	3304	1.0	K20TT	IK20TT	IK20TT	6
3.0 V6	155	X 30 XE		04/94-02/01	K20TNR	3304	1.0	K20TT	IK20TT	IK20TT	6
3.2 V6	160	Y 32 SE		02/01-07/03	K20TNR	3304	1.0	K20TT	IK20TT	IK20TT	6
REKORD B (65-67)											
1.9	66	19 S		08/65-02/67	W20FPR-U	3070	0.7	WF20TT	-		4
REKORD C (66-71)											
1.9	66	19 S		08/66-12/71	W20FPR-U	3070	0.7	WF20TT	-		4
REKORD D (72-77)											
1.7	44/49	17 N		01/72-08/77	W20FPR-U	3070	0.7	WF20TT	-		4
1.7 S	61	17 S		01/72-02/75	W20FPR-U	3070	0.7	WF20TT	-		4
1.9	55/66	19 N; 19 SH		03/75-08/77	W20FPR-U	3070	0.7	WF20TT	-		4
1.9 S	71	19 SH		01/72-02/75	W20FPR-U	3070	0.7	WF20TT	-		4
2.0	74	20 S		09/75-08/77	W20FPR-U	3070	0.7	WF20TT	-		4
2.0 S	74	20 S		09/75-08/77	W20FPR-U	3070	0.7	WF20TT	-		4
REKORD E (77-86)											
1.7	44	17N		09/77-07/81	W20FPR-U	3070	0.7	WF20TT	-		4

Свечи зажигания и Свечи накаливания

Таблица применения

Таблица применения

KW	KW	KW	NOTE	21	СТАНДАРТНЫЕ			Twin Tip		QTY	
					1	2	3	4	5		
ОPEL продолжение											
REKORD E (77-86) продолжение											
1.8	55	18N		11/82-07/84	W20EPR-U	3047	0.8	W20TT	IW20TT	IW20TT	4
1.8 E	74	C18NV		05/85-08/86	W20EPR-U	3047	0.8	W20TT	IW20TT	IW20TT	4
1.8 S	66	18 S		11/82-08/86	W20EPR-U	3047	0.8	W20TT	IW20TT	IW20TT	4
1.9	55	19 N		09/77-10/82	W20FP-U	3068	0.7	WF20TT	-		4
2.0 D	43	20 D		09/77-10/82	DG-001		11V				4
2.0 E	81	20 E; 20E		09/77-10/84	W20FPR-U	3070	0.7	WF20TT	-		4
2.0 S	74	20 S		08/77-08/86	W20FPR-U	3070	0.7	WF20TT	-		4
2.1 D	44	21 D		09/77-07/78	DG-001		11V				4
2.2 D	48	23 D	Single Coil	08/78-08/83	DG-001		11V				4
2.2 D	48/52	23 D	Double Coil(LPH)	08/78-08/86	DG-001		11V				4
2.2 E	85	22 E		11/84-08/86	W20FPR-U	3070	0.7	WF20TT	-		4
2.2 TD	63	23 TD	Double Coil(LPH)	06/84-08/86	DG-001		11V				4
2.3 D	52	23 D	Double Coil(LPH)	11/82-08/86	DG-001		11V				4
SENATOR A (78-87)											
2.0 E	85	20E		03/83-10/84	W20FPR-U	3070	0.7	WF20TT	-		4
2.2 E	85	22 E		11/84-08/87	W20FPR-U	3070	0.7	WF20TT	-		4
2.2 TD	63	23 TD	Double Coil(LPH)	11/84-02/87	DG-001		11V				4
2.5 E	103	25 E		09/84-08/87	W20FP-U	3068	0.7	WF20TT	-		6
2.8	103	28 H		02/78-04/81	W20FP-U	3068	0.7	WF20TT	-		6
3.0 E	132	30 E		02/78-12/86	W20FP-U	3068	0.7	WF20TT	-		6
SENATOR B (87-93)											
2.5 i	103	25NE		09/90-09/93	W20FPR-U	3070	0.7	WF20TT	-		6
2.6 i	110	C 26 NE		09/90-09/93	W20FPR-U	3070	0.7	WF20TT	-		6
3.0	115/ 130	30 NE; C 30 LE		09/87-09/93	W20FPR-U	3070	0.7	WF20TT	-		6
3.0 24V	150	C 30 SE		09/89-09/93	K20TXR	5063	1.0	K20TT	IK20TT	IK20TT	6
3.0 i Cat	130	C 30 NE		01/88-09/93	W20FP-U	3068	0.7	WF20TT	-		6
SIGNUM (03-)											
1.8	90	Z 18 XE	Ch: >31999999	05/03-07/05	K20TXR	5063	1.0	K20TT	IK20TT	IK20TT	4
1.8	90	Z 18 XE	Ch: 41000001>	05/03-07/05	KJ16CR-L11	3132	1.1	K16TT	IK16TT	IK16TT	4
1.8	103	Z 18 XER		09/05-12/08	KJ16CR-L11	3132	1.1	K16TT	IK16TT	IK16TT	4
1.9 CDTI	74/88	Z 19 DTL	Ch:>71021891, Double Coi l(LPH)	04/04-02/08	DG-122		11V				4
1.9 CDTI	74/88	Z 19 DTL	Ch:71021892>, Double Coi l(LPH)	04/04-02/08	DG-196		11V				4
1.9 CDTI	110	Z 19 DTH	Double Coil(LPH)	04/04-02/08	DG-170		11V				4
2.0 DTI	74	Y 20 DTH	Double Coil(LPH)	05/03-04/04	DG-142		11V				4
2.0 Turbo	129	Z20NET(MY6A)		05/03-11/08	PK20PR-L11	3142	1.1	-	IK20TT	IK20TT	4
2.2 direct	114	Z22YH(P2CA)/Z22YH (P35A)		05/03-11/08	K20PBR	5060	0.85	K20TT	IK20TT	IK20TT	4
2.2 DTI	92	Y 22 DTR	Double Coil(LPH)	05/03-04/04	DG-142		11V				4
2.8 V6 Turbo	169/ 184	Z 28 NEL; Z 28 NET		09/05-08/08	IKH20TT	4704	1.0	-	IKH20TT		6
3.0 V6 CDTI	130/ 135	Y 30 DT; Z 30 DT		05/03-12/08	DG-646		11V				6
3.2 V6	155	Z32SE(211)		05/03-09/05	K20TXR	5063	1.0	K20TT	IK20TT	IK20TT	6
SINTRA (96-99)											
2.2 DTI	85	X 22 DTH	Double Coil(LPH)	07/97-04/99	DG-118		11V				4
2.2 i 16V	104	X 22 XE		11/96-04/99	K20TXR	5063	1.0	K20TT	IK20TT	IK20TT	4
3.0 i 24V	148	X 30 XE		11/96-04/99	K20TXR	5063	1.0	K20TT	IK20TT	IK20TT	6
SPEEDSTER (00-)											
2.0 Turbo	147	Z 20 LET		08/02-08/06	K20TXR	5063	1.0	K20TT	IK20TT	IK20TT	4
2.2	108	Z 22 SE		06/00-08/05	PT16VR13	5068	1.3	TV16TT	ITV16TT	ITV16TT	4
TIGRA (94-00)											
1.4 16V	63/66	X 14 XE		07/94-12/00	K20TXR	5063	1.0	K20TT	IK20TT	IK20TT	4
1.6 16V	74/78	C 16 SEL; X 16 XE		07/94-08/98	K20TXR	5063	1.0	K20TT	IK20TT	IK20TT	4
TIGRA TwinTop (04-)											
1.3 CDTI	51	Z 13 DT	OE:12 14 032; 12 14 070	06/04-12/10	DG-171		11V				4
1.4	66	Z 14 XEP		06/04-12/10	KJ16CR-L11	3132	1.1	K16TT	IK16TT	IK16TT	4
1.8	92	Z 18 XE		06/04-08/09	KJ16CR-L11	3132	1.1	K16TT	IK16TT	IK16TT	4

Свечи зажигания и Свечи накаливания

Таблица применения



















	KW				СТАНДАРТНЫЕ			Twin Tip		QTY	
											
OPEL продолжение											
VECTRA A (88-95)											
1.4 S	55	14 NV	Eng:>02BF1476	04/88-06/92	W20EPR-U	3047	0.8	W20TT	IW20TT	IW20TT	4
1.6	60	16 SV		09/88-05/93	W20EPR-U	3047	0.8	W20TT	IW20TT	IW20TT	4
1.6 i	52/55	16 LZ2; X 16 SZ		09/93-11/95	K20TXR	5063	1.0	K20TT	IK20TT	IK20TT	4
1.6 i	55	C 16 NZ; C 16 NZ2; E 16 NZ	Check Hex size	09/88-08/93	W16EPR-U	3021	0.8	W16TT	IW16TT	IW16TT	4
1.6 i	55	C 16 NZ; C 16 NZ2; E 16 NZ	Check Hex size	09/93-11/95	K20TXR	5063	1.0	K20TT	IK20TT	IK20TT	4
1.6 i Cat	55	C 16 NZ; C 16 NZ2	Check Hex size	09/88-08/93	W16EPR-U	3021	0.8	W16TT	IW16TT	IW16TT	4
1.6 i Cat	55	C 16 NZ; C 16 NZ2	Check Hex size	09/93-11/95	K20TXR	5063	1.0	K20TT	IK20TT	IK20TT	4
1.6 S	60	16 SV		09/88-05/93	W20EPR-U	3047	0.8	W20TT	IW20TT	IW20TT	4
1.7 D	42/44	17 D; 17 DR	Double Coil(LPH)	09/88-11/95	DG-001		11V				4
1.7 TD	60	17 DT (TC4EE1)	Eng: >731417	03/90-11/95	DG-124		11V				4
1.7 TD	60	17 DT (TC4EE1)	Eng: 731418>	03/90-11/95	DG-300		11V				4
1.7 TD	60	17 DT (TC4EE1)	Eng: 731418>	03/90-11/95	DG-640		11V				4
1.8 i	66	18 SV		09/88-10/90	W20EPR-U	3047	0.8	W20TT	IW20TT	IW20TT	4
1.8 i Cat	66	C 18 NZ		03/90-11/95	W16EPR-U	3021	0.8	W16TT	IW16TT	IW16TT	4
1.8 S	66	18 SV; E 18 NVR		09/88-10/90	W20EPR-U	3047	0.8	W20TT	IW20TT	IW20TT	4
1.8 S 4x4	65	E 18 NVR		01/89-07/89	W20EPR-U	3047	0.8	W20TT	IW20TT	IW20TT	4
2.0	74	C 20 NEF		09/88-09/89	IW16TT	4708	1.0	-	IW16TT		4
2.0	74	C20NE(100)		04/88-09/89	W16EPR-U	3021	0.8	W16TT	IW16TT	IW16TT	4
2.0 i	85	20 NE	Ch:P7000001, R1000001, R5000001>	09/88-10/90	K20TXR	5063	1.0	K20TT	IK20TT	IK20TT	4
2.0 i	95	20 SEH		09/88-09/92	W20EPR-U	3047	0.8	W20TT	IW20TT	IW20TT	4
2.0 i 4x4	85	20 NE	Ch:P7000001, R1000001, R5000001>	01/89-10/90	K20TXR	5063	1.0	K20TT	IK20TT	IK20TT	4
2.0 i 4x4	95	20 SEH		08/89-07/92	W20EPR-U	3047	0.8	W20TT	IW20TT	IW20TT	4
2.0 i 16V	100	X 20 XEV		08/92-08/95	K20TXR	5063	1.0	K20TT	IK20TT	IK20TT	4
2.0 i 16V 4x4	100	X 20 XEV		06/94-11/95	K20TXR	5063	1.0	K20TT	IK20TT	IK20TT	4
2.0 i 16V Cat	110	C 20 XE	Eng:14002935/ 14104355>	02/90-11/95	K20TXR	5063	1.0	K20TT	IK20TT	IK20TT	4
2.0 i Cat	85	C 20 NE	Ch:R1000001, R5000001, P7000001>	09/88-11/95	K20TXR	5063	1.0	K20TT	IK20TT	IK20TT	4
2.0 i Cat	85	C 20 NE	Ch:R5000001, R1000001, P7000001>	09/88-11/95	K20TXR	5063	1.0	K20TT	IK20TT	IK20TT	4
2.0 i Cat 4x4	85	C 20 NE	Ch:P7000001, R1000001, R5000001>	01/89-11/95	K20TXR	5063	1.0	K20TT	IK20TT	IK20TT	4
2.0 i GT	95	20 SEH		09/88-11/95	W20EPR-U	3047	0.8	W20TT	IW20TT	IW20TT	4
2.0 i Turbo 4x4	150	C 20 LET		06/94-11/95	K20R-U	3122	0.8	K20TT	IK20TT	IK20TT	4
2.5 V6	125	C 25 XE		02/93-11/95	K20TXR	5063	1.0	K20TT	IK20TT	IK20TT	6
2000/GT 16V	110	20 XEJ		01/89-06/94	Q20PR-U	3007	0.8	Q20TT	IQ20TT	IQ20TT	4
2000/GT 16V 4x4	110	20 XEJ		01/89-10/90	Q20PR-U	3007	0.8	Q20TT	IQ20TT	IQ20TT	4
2000/GT 16V Cat	110	C 20 XE	Eng:14002935/ 14104355>	02/90-11/95	K20TXR	5063	1.0	K20TT	IK20TT	IK20TT	4
2000/GT 16V Cat 4x4	110	C 20 XE	Eng:14104355/ 14002935>	02/90-11/95	K20TXR	5063	1.0	K20TT	IK20TT	IK20TT	4
VECTRA B (95-03)											
1.6 GL	60	16 SV		09/95-08/96	K20TXR	5063	1.0	K20TT	IK20TT	IK20TT	4
1.6 i	55	16 LZ2; X 16 SZR		10/95-07/03	K20TXR	5063	1.0	K20TT	IK20TT	IK20TT	4
1.6 i 16V	74	X 16 XEL; Y 16 XE; Z 16 XE		10/95-07/02	K20TXR	5063	1.0	K20TT	IK20TT	IK20TT	4
1.7 TD	60	X 17 DT (TC4EE1)	Ceramic(LPH)	10/95-12/98	DG-300		11V				4
1.7 TD	60	X 17 DT (TC4EE1)	Ceramic(LPH)	10/95-12/98	DG-640		11V				4
1.8 i 16V	85/92	X 18 XE; X 18 XE1; Z 18 XEL		10/95-07/03	K20TXR	5063	1.0	K20TT	IK20TT	IK20TT	4
2.0 DI 16V	60	X 20 DTL	Ch:>V1;V5; V7;VL;VP;VS	11/96-04/02	DG-133		11V				4
2.0 DI 16V	60	X 20 DTL	Ch:W1;W5;W7; XL;WP;WS>	11/96-04/02	DG-118		11V				4
2.0 DTI 16V	74	X 20 DTH	Ch:W1;W5;W7; XL;WP;WS>	06/97-07/03	DG-118		11V				4
2.0 DTI 16V	74	Y 20 DTH		06/97-07/03	DG-142		11V				4
2.0 i	82	20 NEJ		10/95-04/02	K20TXR	5063	1.0	K20TT	IK20TT	IK20TT	4
2.0 i 16V	100	C 20 SEL; X 20 XEV		10/95-09/00	K20TXR	5063	1.0	K20TT	IK20TT	IK20TT	4

Таблица применения

Свечи зажигания и Свечи накаливания

Таблица применения

Таблица применения

	KW				СТАНДАРТНЫЕ			Twin Tip			QTY
											
ОPEL продолжение											
VECTRA B (95-03) продолжение											
2.2 DTI 16V	88/92	Y 22 DTR	Double Coil(LPH)	09/00-07/03	DG-142		11V				4
2.2 i 16V	108	Z 22 SE		09/00-07/03	PT16VR13	5068	1.3	TV16TT	ITV16TT	ITV16TT	4
2.5	144	X 25 XE		10/99-06/00	K20TXR	5063	1.0	K20TT	IK20TT	IK20TT	6
2.5 i 500	143	X 25 XE		05/98-09/00	K20TXR	5063	1.0	K20TT	IK20TT	IK20TT	6
2.5 i V6	125	X 25 XE		10/95-09/00	K20TXR	5063	1.0	K20TT	IK20TT	IK20TT	6
2.6 i V6	125	Y 26 SE		09/00-07/03	K20TXR	5063	1.0	K20TT	IK20TT	IK20TT	6
VECTRA C (02-08)											
1.6	74/77	Z16XE(100); Z16XEP(105)		08/05-02/09	KJ16CR-L11	3132	1.1	K16TT	IK16TT	IK16TT	4
1.6	77	Z16XEP(105)	Ch:>31999999, 38999999	08/05-08/08	K20TXR	5063	1.0	K20TT	IK20TT	IK20TT	4
1.6 16V	74	Z16XE(100)		06/04-09/05	K20TXR	5063	1.0	K20TT	IK20TT	IK20TT	4
1.6 16V	74	Z16XE(100)		10/05-02/09	KJ16CR-L11	3132	1.1	K16TT	IK16TT	IK16TT	4
1.6 16V	74	Z16XEP(105)	Ch:>31999999, 38999999	06/04-09/05	K20TXR	5063	1.0	K20TT	IK20TT	IK20TT	4
1.6 16V	74	Z16XEP(105)	Ch:41000001, 48000001>	06/04-09/05	KJ16CR-L11	3132	1.1	K16TT	IK16TT	IK16TT	4
1.8	81	Z18XEL(110)	Flexible fuel	04/02-09/05	K20TXR	5063	1.0	K20TT	IK20TT	IK20TT	4
1.8	81/90/103	Z18XE(122); Z18XEL(110); Z18XER(140)		04/02-02/09	KJ16CR-L11	3132	1.1	K16TT	IK16TT	IK16TT	4
1.8 16V	90	Z18GPL	Flexible fuel	04/02-01/03	K20TXR	5063	1.0	K20TT	IK20TT	IK20TT	4
1.8 16V	90	Z18XE(122)/Z18XE(125); Z18XE(122)		04/02-02/09	KJ16CR-L11	3132	1.1	K16TT	IK16TT	IK16TT	4
1.8 16V	90	Z18XEL(110). Z18GPL		08/02-09/05	K20TXR	5063	1.0	K20TT	IK20TT	IK20TT	4
1.9 CDTI	74/88	Z 19 DTL	Ch:>71021891; 48999999	04/04-01/09	DG-122		11V				4
1.9 CDTI	74/88	Z 19 DTL	Ch:71021892; 78>	04/04-01/09	DG-196		11V				4
1.9 CDTI	110	Z 19 DTH	Double Coil(LPH)	04/04-08/08	DG-170		11V				4
2.0 16V Turbo	129	Z20NET(MY6A)		03/03-02/09	PK20PR-L11	3142	1.1	-	IK20TT	IK20TT	4
2.0 DTI	74	Y 20 DTH	Double Coil(LPH)	10/03-08/05	DG-142		11V				4
2.0 DTI 16V	74	Y 20 DTH	Double Coil(LPH)	04/02-08/06	DG-142		11V				4
2.0 Turbo	129	Z20NET(MY6A)		10/03-02/09	PK20PR-L11	3142	1.1	-	IK20TT	IK20TT	4
2.2 16V	108	Z 22 SE		04/02-12/08	PT16VR13	5068	1.3	TV16TT	ITV16TT	ITV16TT	4
2.2 DGi	114	Z22YH(P2CA)		10/03-02/09	K20PBR	5060	0.85	K20TT	IK20TT	IK20TT	4
2.2 direct	114	Z22YH(P2CA)		10/03-02/09	K20PBR	5060	0.85	K20TT	IK20TT	IK20TT	4
2.2 DTI	92	Y 22 DTR	Double Coil(LPH)	10/03-12/05	DG-142		11V				4
2.2 DTI 16V	92	Y 22 DTR	Double Coil(LPH)	04/02-07/06	DG-142		11V				4
2.8 V6 Turbo	169/184/188/206	Z 28 NEL; Z 28 NET		08/05-08/08	IKH20TT	4704	1.0	-	IKH20TT		6
2.8 V6 Turbo OPC	206	Z 28 NET		09/06-08/08	IKH20TT	4704	1.0	-	IKH20TT		6
3.0 CDTI	130/135	Y 30 DT; Z 30 DT		02/03-08/08	DG-646		11V				6
3.0 V6 CDTI	130/135	Y 30 DT; Z 30 DT		10/03-08/08	DG-646		11V				6
3.2 V6	155	Z32SE(210)		08/02-09/05	K20TXR	5063	1.0	K20TT	IK20TT	IK20TT	6
VIVARO A (01-)											
1.9 Di	60	F9Q 762		08/01-	DG-005		11V				4
1.9 DI	60	F9Q 762	Double Coil(LPH)	08/01-	DG-005		11V				4
1.9 DTI	74	F9Q 760		08/06-	DG-005		11V				4
1.9 DTI	74	F9Q 760	Double Coil(LPH)	08/01-	DG-005		11V				4
2.0 16V	88	F4R 720		08/01-	PK20PR-P8	3245	0.8	-	IK20TT	IK20TT	4
2.0 CDTI	84	M9R 692		12/11-	DG-631		4.5V				4
2.0 ECOTEC	86	F4R 820		08/06-	K20TXR	5063	1.0	K20TT	IK20TT	IK20TT	4
2.0 ECOTEC	86	F4R 820		08/06-	PK20PR-P8	3245	0.8	-	IK20TT	IK20TT	4
2.5 CDTI	84/107	G9U 630		08/06-	DG-126		11V				4
2.5 DTI	99	G9U 730		05/03-	DG-126		11V				4

Свечи зажигания и Свечи накаливания

Таблица применения











	KW				СТАНДАРТНЫЕ			Twin Tip			QTY
											
OPEL продолжение											
VIVARO B (14-)											
1.6 CDTI	66/ 70/ 85/ 88/ 92/ 103/ 107	R9M-MA, R9M-MB, R9M-MC, R9M-MD, R9M-ME	Without cyl inder press ure sensor, OE:95518024/ 44 23 206, Marking = Yellow	06/14-	DG-631		4.5V				4
1.6 CDTI	88/ 92/ 103/ 107	R9M-MG, R9M-MH, R9M-MJ, R9M-MK	Vehicle wit h cylinder pressure se nsor, OE: 95518024/ 44 23 206, Cylindern r 2,3,4; marking = Yellow	06/14-	DG-631		4.5V				3
ZAFIRA A (99-05)											
1.6 16V	74	X16XEL		04/99-06/05	KJ20CR-L11	3169	1.1	K20TT	IK20TT	IK20TT	4
1.6 16V	74	Z 16 XE		04/99-06/05	K20TXR	5063	1.0	K20TT	IK20TT	IK20TT	4
1.6 CNG	71	Z16YNG(96)	Flexible fuel	09/01-06/05	PK20PR-P8	3245	0.8	-	IK20TT	IK20TT	4
1.8 16V	85/92	X 18 XE1; Z 18 XE		04/99-06/05	K20TXR	5063	1.0	K20TT	IK20TT	IK20TT	4
2.0 DI 16V	60	X 20 DTL	Double Coil(LPH)	07/99-06/05	DG-118		11V				4
2.0 DTI 16V	74	Y 20 DTH	Ch:>22999999; 25999999; 26999999; 28999999; 2B999999; 2H999999;2G, Double Coi l(LPH)	09/00-06/05	DG-118		11V				4
2.0 DTI 16V	74	Y 20 DTH	Ch:32000001; 35000001; 36000001; 38000001; 3B000001; 3H000001; 4G000001>	09/00-06/05	DG-142		11V				4
2.0 OPC	141/ 147	Z 20 LET		09/01-06/05	K20TXR	5063	1.0	K20TT	IK20TT	IK20TT	4
2.0 OPC	147	Z 20 LER		11/02-06/05	KJ16CR-L11	3132	1.1	K16TT	IK16TT	IK16TT	4
2.2 16V	108	Z 22 SE		09/00-06/05	PT16VR13	5068	1.3	TV16TT	ITV16TT	ITV16TT	4
2.2 DTI 16V	86	Y 22 DTR		01/02-06/05	DG-142		11V				4
2.2 DTI 16V	92	Y 22 DTR	Double Coil(LPH)	01/02-06/05	DG-142		11V				4
ZAFIRA B (05-14)											
1.6	77	Z16XEP(105)		07/05-07/08	KJ16CR-L11	3132	1.1	K16TT	IK16TT	IK16TT	4
1.6	85	A 16 XER; Z 16 XER	Ch:>9xxxxxxx	01/08-04/15	KJ16CR-L11	3132	1.1	K16TT	IK16TT	IK16TT	4
1.6	85	A 16 XER; Z 16 XER	Ch: Axxxxxxx>	01/08-04/15	KJ20CR-L11	3169	1.1	K20TT	IK20TT	IK20TT	4
1.6 CNG	69	Z16YNG(94)	Flexible fuel	07/08-04/15	PK20PR-P8	3245	0.8	-	IK20TT	IK20TT	4
1.7 CDTI	81/92	A 17 DTJ; A 17 DTR; Z 17 DTJ		01/08-04/15	DG-302		11V				4
1.7 CDTI	81/92	A 17 DTJ; A 17 DTR; Z 17 DTJ		01/08-04/15	DG-641		11V				4
1.8	103	A 18 XER; Z 18 XER	Ch:>D2999999/ AG999999	07/05-04/15	KJ16CR-L11	3132	1.1	K16TT	IK16TT	IK16TT	4
1.8	103	A 18 XER; Z 18 XER	Ch: E2000001>	07/05-04/15	KJ20CR-L11	3169	1.1	K20TT	IK20TT	IK20TT	4
1.9 CDTI	74/88	Z 19 DTL	Ch:>62999999; 6G999999, Double Coi l(LPH)	07/05-04/15	DG-122		11V				4
1.9 CDTI	74/88	Z 19 DTL	Ch:72000001; 7G000001>, Double Coi l(LPH)	07/05-04/15	DG-196		11V				4
1.9 CDTI	110	Z 19 DTH	Double Coil(LPH)	07/05-04/15	DG-170		11V				4
2.0	147	Z 20 LER		07/05-12/10	KJ16CR-L11	3132	1.1	K16TT	IK16TT	IK16TT	4
2.0	177	Z 20 LEH		01/06-12/10	PK20PR-P8	3245	0.8	-	IK20TT	IK20TT	4
2.2	110	Z22YH(150)		07/08-12/12	K20PBR	5060	0.85	K20TT	IK20TT	IK20TT	4
2.2	110	Z22YH(P35A)		07/05-07/08	KJ16CR-L11	3132	1.1	K16TT	IK16TT	IK16TT	4
ZAFIRA Tourer C (11-)											
1.4	88/ 103	A 14 NEL; A 14 NET; B 14 NEL; B 14 NET		10/11-	VK22	5610	0.8	-	IK22TT	VK22	4

Таблица применения

Свечи зажигания и Свечи накаливания

Таблица применения

KW	NOTE	21	СТАНДАРТНЫЕ				Twin Tip		QTY		
			5610	3132	3169	4.4V	IK22TT	VK22			
ОPEL продолжение											
ZAFIRA Tourer C (11-) продолжение											
1.4 LPG	103	A 14 NET; B 14 NET		10/11-	VK22	5610	0.8	-	IK22TT	VK22	4
1.6 CDTI	88/ 100	B 16 DTH; B 16 DTJ	OE:1214098, Pressures ensor (-)	02/13-	DG-634		4.4V				2
1.8	85	A 18 XEL		10/11-	KJ16CR-L11	3132	1.1	K16TT	IK16TT	IK16TT	4
1.8	103	A 18 XER		10/11-	KJ20CR-L11	3169	1.1	K20TT	IK20TT	IK20TT	4
2.0 CDTi	96	A 20 DT	Start stop system (-), Manual Tra nsmission, Pressures ensor (-)	10/11-	DG-608		4.4V				2
2.0 CDTi	121	A 20 DTH	Pressure sensor (-)	01/12-	DG-608		4.4V				2
PANTHER											
KALLISTA (82-93)											
1.6	71			01/82-12/92	K20PR-U	3145	0.8	K20TT	IK20TT	IK20TT	4
PERODUA											
ALZA (09-)											
1.5 (M502)	76	3SZ-VE		03/09-	SXU22PR9	3434	0.9	-	IXU22TT	VXU22I	4
KANCIL (94-)											
0.7	23	EF-CL		08/94-07/09	W16EXR-U	3031	0.8	W16TT	IW16TT	IW16TT	3
0.7	33	EF-SE		10/98-07/09	K20PR-U11	3121	1.1	K20TT	IK20TT	IK20TT	3
KELISA (02-)											
1.0 (L701)	40	EJ-DE		02/02-12/09	K16TNR-S9	3329	0.9	K16TT	IK16TT	IK16TT	3
1.0 DVVT	43	EJ-VE		02/02-06/07	K16TNR-S9	3329	0.9	K16TT	IK16TT	IK16TT	3
KENARI (00-)											
1.0 (L902)	41	EJ-DE		10/00-12/09	K16TNR-S9	3329	0.9	K16TT	IK16TT	IK16TT	3
MYVI (06-11)											
1.0 DVVT (M302)	43	EJ-VE		01/06-06/11	K16TNR-S9	3329	0.9	K16TT	IK16TT	IK16TT	3
1.3 (M301)	63	K3-VE		01/06-06/11	K20R-U11	3139	1.1	K20TT	IK20TT	IK20TT	4
1.3 (M301)	63	K3-VE		01/06-06/11	SXU22PR9	3434	0.9	-	IXU22TT	VXU22I	4
VIVA (07-)											
0.66 (L250)	35	EF-VE		07/07-06/14	IK20TT	4702	1.0	-	IK20TT	IK20TT	3
1.0 (L251)	45	EJ-VE		07/07-06/14	K16TNR-S9	3329	0.9	K16TT	IK16TT	IK16TT	3
PEUGEOT											
104 (72-88)											
0.9	33	108 (XV3); 108 (XV5)		07/74-10/83	T20EPR-U	5032	0.8	T20TT	IT20TT	IT20TT	4
1.0	32	108C (XV8)		09/83-06/88	T20EPR-U	5032	0.8	T20TT	IT20TT	IT20TT	4
1.1	37/42	109 (XW3); 109F (XW7)		07/76-06/88	T20EP-U	5031	0.8	T20TT	IT20TT	IT20TT	4
1.1	49	121 (XW3S)		08/75-06/80	T20EPR-U	5032	0.8	T20TT	IT20TT	IT20TT	4
1.1	49	XW3S		09/73-09/79	T22EP-U	5040	0.8	-	-	-	4
1.2	42	129 (XZ5)		08/79-06/83	T20EP-U	5031	0.8	T20TT	IT20TT	IT20TT	4
1.4	53	150 (XY6B)		08/79-06/84	T20EP-U	5031	0.8	T20TT	IT20TT	IT20TT	4
106 I (91-96)											
1.0	33/37	CDY (TU9M); CDZ (TU9M); TU9		09/91-04/96	Q16PR-U	3137	0.8	Q16TT	IQ16TT	IQ16TT	4
1.1	44	HDZ (TU1M)		07/95-04/96	K20TXR	5063	1.0	K20TT	IK20TT	IK20TT	4
1.3	72	TU2J2		10/93-04/96	K22PBR-S	5062	0.85	-	IKB22TT	VK22	4
1.4	51	K5A (TU3)		08/91-03/96	K20PR-U	3145	0.8	K20TT	IK20TT	IK20TT	4
1.4	55	KDY (TU3M)		03/95-04/96	K20TXR	5063	1.0	K20TT	IK20TT	IK20TT	4
1.4	69	KFZ (TU3J2/Z)		09/91-04/96	IK22	5310	0.8	-	IK22TT	VK22	4
1.4 D	37	K9Y (TUD3Y)	Double Coil(LPH)	09/92-04/96	DG-004		11V				4
1.5 D	40/43	VJY (TUD5); VJZ (TUD5)		06/94-04/96	DG-003		11V				4
1.6	65	NFZ (TU5JP)		06/93-04/96	K16PR-U	3191	0.8	K16TT	IK16TT	IK16TT	4
1.6	76	NFY (TU5J2)		01/94-04/96	K20TNR-S	3196	1.0	K20TT	IK20TT	IK20TT	4
106 II (96-04)											
1.0 i	33/37	CDY (TU9M); CDZ (TU9M)		04/96-03/01	K20TXR	5063	1.0	K20TT	IK20TT	IK20TT	4
1.1 i	40/44	HDY (TU1M+); HDZ (TU1M+); HFX (TU1JP)		05/96-07/04	K20TXR	5063	1.0	K20TT	IK20TT	IK20TT	4
1.4 i	55	KFX (TU3JP)		05/96-07/04	K20TXR	5063	1.0	K20TT	IK20TT	IK20TT	4
1.5 D	40/42	VJX (TUD5); VJY (TUD5); VJZ (TUD5)		05/96-12/04	DG-003		11V				4

Свечи зажигания и Свечи накаливания

Таблица применения





	KW				СТАНДАРТНЫЕ			Twin Tip			QTY
PEUGEOT продолжение											
106 II (96-04) продолжение											
1.6 i	65	NFZ (TU5JP)		05/96-10/99	K16PR-U	3191	0.8	K16TT	IK16TT	IK16TT	4
1.6 i	74	NFW (TU5J2); NFY (TU5J2)		05/96-01/01	K20TNR-S	3196	1.0	K20TT	IK20TT	IK20TT	4
1.6 S16	87	NFX (TU5J4)		05/96-07/04	K16PR-U	3191	0.8	K16TT	IK16TT	IK16TT	4
107 (05-)											
1.0	50	CFA (384F); CFB (1KR)		06/05-05/14	K16HR-U11	3482	1.1	KH16TT	IKH16TT	IKH16TT	3
1.4 HDi	40	8HT (DV4TD)		06/05-05/14	DG-113		11V				4
108 (14-)											
1.0	51	1KR-FE		07/14-	SC16HR11	3499	1.1	-	IXEH20TT	IXEH20TT	3
1.0 VTi	51	CFB (1KR)		05/14-	SC16HR11	3499	1.1	-	IXEH20TT	IXEH20TT	3
1.2	60	HMT (EB2D)		05/14-	IXUH22I	5356	0.9	-	IXUH22TT	VXUH22I	3
205 I (83-94)											
1.0	33	108C (XV8)		02/83-10/87	T20EP-U	5031	0.8	T20TT	IT20TT	IT20TT	4
1.1	36	109F (XW7); 109N (XW7)		02/83-10/87	T20EP-U	5031	0.8	T20TT	IT20TT	IT20TT	4
1.1 CJ	44	HDZ (TU1M)		10/89-12/94	Q16PR-U	3137	0.8	Q16TT	IQ16TT	IQ16TT	4
1.3	47	G1A		02/84-10/87	Q20P-U	3125	0.8	Q20TT	IQ20TT	IQ20TT	4
1.4	44	150D (XY7); 150G (XY7)		02/83-10/87	T20EP-U	5031	0.8	T20TT	IT20TT	IT20TT	4
1.4	53/59	150 (XY6B); 150H (XY8)		02/83-10/87	T22EP-U	5040	0.8	-	-		4
1.4	62	K2B (TU3S)		08/87-07/88	K20PR-U	3145	0.8	K20TT	IK20TT	IK20TT	4
1.4 CJ	44	150D (XY7); 150G (XY7)		03/88-05/89	T20EP-U	5031	0.8	T20TT	IT20TT	IT20TT	4
1.4 CJ	49	K1D (TU3A)		03/89-12/94	Q20PR-U	3007	0.8	Q20TT	IQ20TT	IQ20TT	4
1.4 CJ	55	KDY (TU3M)		07/92-12/94	Q16PR-U	3137	0.8	Q16TT	IQ16TT	IQ16TT	4
1.4 CJ Cat	44	KAY (TU3CP)		01/89-09/93	Q16P-U11	3254	1.1	Q16TT	IQ16TT	IQ16TT	4
1.4 CT	58	150B (XY8); 150H (XY8)		04/86-07/87	T22EP-U	5040	0.8	-	-		4
1.5	63	Y2/K		02/84-10/87	K20PR-U	3145	0.8	K20TT	IK20TT	IK20TT	4
1.6	53	B1E (XU51C)		03/87-10/87	Q20P-U	3125	0.8	Q20TT	IQ20TT	IQ20TT	4
1.6	55	B1A (XU51C); BAZ (XU5CP)		08/86-10/87	T20EP-U	5031	0.8	T20TT	IT20TT	IT20TT	4
1.6	85	B6D (XU5JA)		08/87-07/92	K20PR-U	3145	0.8	K20TT	IK20TT	IK20TT	4
1.6 CJ	65	BDY (XU5M3Z)		08/92-12/94	Q16PR-U	3137	0.8	Q16TT	IQ16TT	IQ16TT	4
1.6 CTI	76	180Z (XU5J)		03/86-07/87	T22EP-U	5040	0.8	-	-		4
1.6 GTI	76	180A (XU5J)		12/84-10/87	T22EP-U	5040	0.8	-	-		4
1.7 Diesel	44	161A (XUD7)		08/83-10/87	DG-001		11V				4
1.8 D	44	A9A (XUD7)		02/83-07/90	DG-001		11V				4
1.8 Rally	147			07/84-02/86	T20EPR-U	5032	0.8	T20TT	IT20TT	IT20TT	4
1.9 CTI	74	DFZ (XU9J1)		11/89-12/94	Q16PR-U	3137	0.8	Q16TT	IQ16TT	IQ16TT	4
1.9 CTi	74/92	DFZ (XU9J1); DKZ (XU9JAZ)		08/87-07/92	K20PR-U	3145	0.8	K20TT	IK20TT	IK20TT	4
1.9 GTI	94	D6B (XU9JA)		10/86-10/87	IK22	5310	0.8	-	IK22TT	VK22	4
205 II (87-98)											
1.0	33	TU9		10/87-09/98	Q20P-U	3125	0.8	Q20TT	IQ20TT	IQ20TT	4
1.1	36	109N (XW7)		10/87-10/90	Q16P-U11	3254	1.1	Q16TT	IQ16TT	IQ16TT	4
1.1	40	H1B (TU1)		10/87-07/92	Q20PR-U	3007	0.8	Q20TT	IQ20TT	IQ20TT	4
1.1	44	HDZ (TU1M)		07/89-05/97	IK16TT	4701	1.0	-	IK16TT	IK16TT	4
1.1 XA	40	E1		07/87-10/88	Q20PR-U	3007	0.8	Q20TT	IQ20TT	IQ20TT	4
1.2	47	F1		01/87-12/90	Q20P-U	3125	0.8	Q20TT	IQ20TT	IQ20TT	4
1.3	47	G1A		08/90-07/92	Q20P-U	3125	0.8	Q20TT	IQ20TT	IQ20TT	4
1.3 Rallye	74	TU24		10/87-10/90	K22PBR-S	5062	0.85	-	IKB22TT	VK22	4
1.4	44	150D (XY7); 150G (XY7)		10/87-05/89	T20EP-U	5031	0.8	T20TT	IT20TT	IT20TT	4
1.4	49	K1D (TU3A)		10/87-10/90	Q16P-U11	3254	1.1	Q16TT	IQ16TT	IQ16TT	4
1.4	53	150 (XY6B)		01/87-07/88	T20EPR-U	5032	0.8	T20TT	IT20TT	IT20TT	4
1.4	55	TU32		07/88-05/97	K20TXR	5063	1.0	K20TT	IK20TT	IK20TT	4
1.4	55/ 58/63	150B (XY8); 150H (XY8); K2B (TU3S); KFX (TU3JP)		06/87-05/97	IK20TT	4702	1.0	-	IK20TT	IK20TT	4
1.4	63	Y2/K		06/87-07/87	K20PR-U	3145	0.8	K20TT	IK20TT	IK20TT	4
1.4 Cat	44	KAY (TU3CP)		08/87-07/90	Q20PR-U	3007	0.8	Q20TT	IQ20TT	IQ20TT	4
1.6	53	B1E (XU51C)		10/87-09/98	T22EP-U	5040	0.8	-	-		4
1.6	55	BAZ (XU5CP)		10/87-09/98	Q20P-U	3125	0.8	Q20TT	IQ20TT	IQ20TT	4
1.6	66	171 (XU5S)		08/90-07/92	Q20PR-U	3007	0.8	Q20TT	IQ20TT	IQ20TT	4
1.6 Aut.	58	B1E (XU51C)		10/87-12/90	Q20P-U	3125	0.8	Q20TT	IQ20TT	IQ20TT	4
1.6 Aut.	65	BDY (XU5M2Z)		05/90-09/98	Q20PR-U	3007	0.8	Q20TT	IQ20TT	IQ20TT	4
1.6 GTI	76	180Z (XU5J)		10/87-12/89	Q22P-U	3255	0.8	-	-	VQ22	4

Таблица применения

P





Свечи зажигания и Свечи накаливания

Таблица применения

PEUGEOT	KW	KW	NOTE	21	СТАНДАРТНЫЕ			Twin Tip		QTY	
					1	2	3	1	2		
PEUGEOT продолжение											
205 II (87-98) продолжение											
1.6 GTI	85	B6D (XU5JA)		10/87-12/89	Q20PR-U	3007	0.8	Q20TT	IQ20TT	IQ20TT	4
1.6 GTX	69	J2		01/87-10/91	K20PR-U	3145	0.8	K20TT	IK20TT	IK20TT	4
1.7 Diesel	44	161A (XUD7)		07/87-09/98	DG-001		11V				4
1.8 TD	57	A8B (XUD7TE)		01/90-09/98	DG-001		11V				4
1.8 XDT	58	XUD7T		08/90-05/97	DG-001		11V				4
1.9 Diesel	47	DJZ (XUD9A)		10/87-09/98	DG-001		11V				4
1.9 GTI	88	DKZ (XU9JAZ)		10/87-07/90	IK20TT	4702	1.0	-	IK20TT	IK20TT	4
1.9 GTI	94	D6B (XU9JA)		10/87-12/92	Q20P-U	3125	0.8	Q20TT	IQ20TT	IQ20TT	4
206 (98-)											
1.1	40/44	HFX (TU1JP); HFY (TU1JP)		08/98-	K20PR-U	3145	0.8	K20TT	IK20TT	IK20TT	4
1.1 i	44	HFX (TU1JP); HFZ (TU1JP)		09/98-02/07	K20PR-U	3145	0.8	K20TT	IK20TT	IK20TT	4
1.4	55	KFV (TU3A); KFW (TU3JP)		07/02-	K20PR-U	3145	0.8	K20TT	IK20TT	IK20TT	4
1.4 16V	65	KFU (ET3J4)		10/03-02/07	XE20HR-U9	3427	0.9	-	IXEH20TT	IXEH20TT	4
1.4 HDi	50	8HX (DV4TD); 8HZ (DV4TD)		09/01-	DG-113		11V				4
1.4 HDi eco 70	50	8HX (DV4TD); 8HZ (DV4TD)		09/01-	DG-113		11V				4
1.4 i	55	KFV (TU3A); KFW (TU3JP); KFX (TU3JP)		09/98-12/12	K20PR-U	3145	0.8	K20TT	IK20TT	IK20TT	4
1.4 LPG	55	KFV (TU3JP)		05/06-09/07	K20PR-U	3145	0.8	K20TT	IK20TT	IK20TT	4
1.6	81	NFU (TU5JP4)		05/05-07/08	K16HPR-U11	6076	1.1	KH16TT	IKH16TT	IKH16TT	4
1.6 16V	80	NFU (TU5JP4)		07/00-	K16HPR-U11	6076	1.1	KH16TT	IKH16TT	IKH16TT	4
1.6 HDi 110	80	9HY (DV6TED4); 9HZ (DV6TED4)	Ch:> RPO 10783, M4 Thread	05/04-05/06	DG-113		11V				4
1.6 HDi 110	80	9HY (DV6TED4); 9HZ (DV6TED4)	Ch:RPO 10784> ,Pin	05/06-	DG-180		11V				4
1.6 i	65	NFZ (TU5JP)		09/98-12/00	K16PR-U	3191	0.8	K16TT	IK16TT	IK16TT	4
1.9 D	51	WJY (DW8B); WJZ (DW8)		09/98-05/07	DG-003		11V				4
2.0 16V	100	RFN (EW10J4)		07/02-02/07	K16HPR-U11	6076	1.1	KH16TT	IKH16TT	IKH16TT	4
2.0 HDi	66	RHY (DW10TD)		07/02-	DG-116		11V				4
2.0 HDi 90	66	RHY (DW10TD)		12/99-09/09	DG-116		11V				4
2.0 RC	130	RFK (EW10J4S)		07/03-12/07	K20HR-U11	3381	1.1	KH20TT	IKH20TT	IKH20TT	4
2.0 S16	100	RFN (EW10J4); RFR (EW10J4)		04/99-02/07	K16HPR-U11	6076	1.1	KH16TT	IKH16TT	IKH16TT	4
206 CC (00-)											
1.6 16V	80	NFU (TU5JP4)		09/00-12/07	K16HPR-U11	6076	1.1	KH16TT	IKH16TT	IKH16TT	4
1.6 HDi 110	80	9HZ (DV6TED4)	Ch:> RPO 10783, M4 Thread	04/05-05/06	DG-113		11V				4
1.6 HDi 110	80	9HZ (DV6TED4)	Ch:RPO 10784> ,Pin	05/06-02/07	DG-180		11V				4
2.0 S16	100	RFN (EW10J4)		09/00-12/07	K16HPR-U11	6076	1.1	KH16TT	IKH16TT	IKH16TT	4
206+ (09-)											
1.1	44	HFX (TU1A)		01/09-06/13	K20PR-U	3145	0.8	K20TT	IK20TT	IK20TT	4
1.4 HDi eco 70	50	8HR (DV4C); 8HZ (DV4TD)		01/09-06/13	DG-113		11V				4
1.4 i	55	KFT (TU3AE5); KFW (TU3A)		01/09-08/13	K20PR-U	3145	0.8	K20TT	IK20TT	IK20TT	4
207 (06-)											
1.4	54	KFT (TU3A); KFT (TU3AE5); KFV (TU3A); KFW (TU3A)		02/06-12/15	K20PR-U	3145	0.8	K20TT	IK20TT	IK20TT	4
1.4 16V	65	KFU (ET3J4)		02/06-10/13	XE20HR-U9	3427	0.9	-	IXEH20TT	IXEH20TT	4
1.4 16V	70/72	8FR (EP3); 8FS (EP3); EP3; EP3C	Use narrow 16mm Hex socket	06/07-10/13	VXUH22I	5656	0.9	-	IXUH22TT	VXUH22I	4
1.4 HDi	50	8HR (DV4C)		02/06-12/15	DG-603		5V				4
1.4 HDi	50	8HZ (DV4TD)		02/06-12/15	DG-180		11V				4
1.4 HDi	50	8HZ (DV4TD)		04/07-	DG-113		11V				4
1.6	81	N6A (TU5JP4)		08/08-12/13	K16HPR-U11	6076	1.1	KH16TT	IKH16TT	IKH16TT	4
1.6 16V	80	NFU (TU5JP4)		02/06-10/13	K16HPR-U11	6076	1.1	KH16TT	IKH16TT	IKH16TT	4
1.6 16V	88	5FS (EP6C); 5FW (EP6); EP6	Use narrow 16mm Hex socket	02/07-10/13	VXUH22I	5656	0.9	-	IXUH22TT	VXUH22I	4

Свечи зажигания и Свечи накаливания

Таблица применения

	KW				СТАНДАРТНЫЕ			Twin Tip			QTY
PEUGEOT продолжение											
207 (06-) продолжение											
1.6 16V RC	128	5FY (EP6DTS)	Use narrow 16mm Hex socket	02/07-12/12	VXUH22I	5656	0.9	-	IXUH22TT	VXUH22I	4
1.6 16V Turbo	110/115	5FR (EP6DT); 5FV (EP6CDT); 5FX (EP6DT)	Use narrow 16mm Hex socket	02/06-12/13	VXUH22I	5656	0.9	-	IXUH22TT	VXUH22I	4
1.6 16V VTi	88	5FS (EP6C); 5FW (EP6); EP6	Use narrow 16mm Hex socket	02/07-12/12	VXUH22I	5656	0.9	-	IXUH22TT	VXUH22I	4
1.6 HDi	66/80	9HV (DV6TED4B); 9HV (DV6TED4BU); 9HX (DV6ATED4); 9HY (DV6TED4); 9HZ (DV6TED4)	Ch: > RPO 10783, M4 Thread	02/06-05/06	DG-113		11V				4
1.6 HDi	66/80	9HV (DV6TED4B); 9HV (DV6TED4BU); 9HX (DV6ATED4); 9HY (DV6TED4); 9HZ (DV6TED4)	Ch: RPO 10784 > ,Pin	05/06-10/13	DG-180		11V				4
1.6 HDi	66/80	9HV (DV6TED4B); 9HV (DV6TED4BU); 9HX (DV6ATED4); 9HZ (DV6TED4)		02/07-01/15	DG-180		11V				4
1.6 HDi	68/82	9HP (DV6DTED); 9HR (DV6C)		08/09-	DG-603		5V				4
1.6 HDi 110	82	9HR (DV6C)		08/09-12/12	DG-603		5V				4
208 I (12-)											
1.0	50	ZMZ (EB0)		03/12-	IXUH22I	5356	0.9	-	IXUH22TT	VXUH22I	3
1.2	60	HMZ (EB2); HMZ (EB2F)		03/12-	IXUH22I	5356	0.9	-	IXUH22TT	VXUH22I	3
1.2 GPL	60	HMZ (EB2F)		06/15-	IXUH22I	5356	0.9	-	IXUH22TT	VXUH22I	3
1.2 PureTech 82	60	HMR (EB2FA)		03/18-	IXUH22I	5356	0.9	-	IXUH22TT	VXUH22I	3
1.2 VTi 68 / PureTech 68	50	HMM (EB2FAD); HMP (EB2FB)		08/16-	IXUH22I	5356	0.9	-	IXUH22TT	VXUH22I	4
1.4 GPL	70	EP3C	Use narrow 16mm Hex socket	10/13-	VXUH22I	5656	0.9	-	IXUH22TT	VXUH22I	4
1.4 HDi	50	8HP (DV4C); 8HR (DV4C)		03/12-	DG-603		5V				4
1.4 VTi	70	8FS (EP3); EP3C	Use narrow 16mm Hex socket	03/12-	VXUH22I	5656	0.9	-	IXUH22TT	VXUH22I	4
1.6	88/115	5FS (EP6C); 5FV (EP6CDT)	Use narrow 16mm Hex socket	03/12-	VXUH22I	5656	0.9	-	IXUH22TT	VXUH22I	4
1.6 BlueHDi 100	73	BHY (DV6FD)		01/15-	DG-603		5V				4
1.6 BlueHDi 120	88	BHZ (DV6FC)		11/13-	DG-603		5V				4
1.6 GTi	147	5FU (EP6CDTX)	Use narrow 16mm Hex socket	08/12-	VXUH22I	5656	0.9	-	IXUH22TT	VXUH22I	4
1.6 HDi	68/85	9HD (DV6C); 9HJ (DV6DTEDM); 9HP (DV6DTED); BHX (DV6FC)		03/12-	DG-603		5V				4
1.6 HDi / BlueHDi 75	55	9HK (DV6ETEDM); BHW (DV6FE)		01/13-	DG-603		5V				4
301 (12-)											
1.2 VTi 72	53	HMY (EB2M)		11/12-	IXUH22I	5356	0.9	-	IXUH22TT	VXUH22I	3
1.2 VTi 82	60	HMZ (EB2F)		12/14-	IXUH22I	5356	0.9	-	IXUH22TT	VXUH22I	3
1.6 BlueHDi 100	73	BHY (DV6FD)		04/14-	DG-603		5V				4
1.6 HDi 90	66	9HF (DV6DTED); 9HJ (DV6DTEDM)		11/12-	DG-603		5V				4
304 (69-80)											
1.5 Diesel	36	149 (XID)	Double Coil(LPH)	10/69-10/79	DG-001		11V				4
305 I (77-82)											
1.3	44	118 (XL5)		11/77-09/82	T20EPR-U	5032	0.8	T20TT	IT20TT	IT20TT	4
1.3	48	XL5		11/77-09/82	T20EP-U	5031	0.8	T20TT	IT20TT	IT20TT	4
1.5	54/65	117 (XR5S); 142 (XR5)		11/79-09/82	T20EP-U	5031	0.8	T20TT	IT20TT	IT20TT	4
1.5 Diesel	36	149 (XID)	Double Coil(LPH)	11/77-09/82	DG-001		11V				4
305 II (82-90)											
1.1	43	XK5		11/82-12/88	T20EP-U	5031	0.8	T20TT	IT20TT	IT20TT	4
1.3	44	118 (XL5)		10/82-08/86	T20EPR-U	5032	0.8	T20TT	IT20TT	IT20TT	4
1.5	50/54	142 (XR5); 142 (XR5A)		10/82-10/86	T20EP-U	5031	0.8	T20TT	IT20TT	IT20TT	4

Свечи зажигания и Свечи накаливания

Таблица применения

Таблица применения

KW	KW	KW	KW	KW	СТАНДАРТНЫЕ			Twin Tip		QTY	
					STANDARD	STANDARD	STANDARD	TWIN TIP	TWIN TIP		
PEUGEOT продолжение											
305 II (82-90) продолжение											
1.6	55	B1A (XU51C); BAZ (XU5CP)		11/86-12/88	Q20PR-U	3007	0.8	Q20TT	IQ20TT	IQ20TT	4
1.6	66/ 69/71	171 (XU5S)		10/82-06/88	T22EP-U	5040	0.8	-	-		4
1.8 D	44	161A (XUD7)		11/82-12/88	DG-001		11V				4
1.9	72	DFZ (XU9J1)		11/86-07/87	T20EP-U	5031	0.8	T20TT	IT20TT	IT20TT	4
1.9	72	DFZ (XU9J1)		11/86-12/88	Q20PR-U	3007	0.8	Q20TT	IQ20TT	IQ20TT	4
1.9	75	159 (XU9S)		10/82-10/87	T20EPR-U	5032	0.8	T20TT	IT20TT	IT20TT	4
1.9 D	47	162 (XUD9); D9A (XUD9)		10/82-12/88	DG-001		11V				4
306 (93-02)											
1.1	44	HDZ (TU1M)		06/94-06/95	Q16PR-U	3137	0.8	Q16TT	IQ16TT	IQ16TT	4
1.1	44	HDZ (TU1M)		07/95-05/01	K20TXR	5063	1.0	K20TT	IK20TT	IK20TT	4
1.4	55	KFX (TU3JP)		07/95-04/02	K20TXR	5063	1.0	K20TT	IK20TT	IK20TT	4
1.4 SL	55	KFX (TU3JP)		07/95-05/01	K20TXR	5063	1.0	K20TT	IK20TT	IK20TT	4
1.6	65/72	NFT (TU5JP); NFZ (TU5JP)		05/93-04/02	K20PR-U	3145	0.8	K20TT	IK20TT	IK20TT	4
1.6 SR	65	NFZ (TU5JP)		06/94-10/00	K20PR-U	3145	0.8	K20TT	IK20TT	IK20TT	4
1.8	74	L6A (XU7JP); LFZ (XU7JP)		07/95-04/02	K20TXR	5063	1.0	K20TT	IK20TT	IK20TT	4
1.8	74	LFZ (XU7JP)		05/93-06/95	Q20PR-U	3007	0.8	Q20TT	IQ20TT	IQ20TT	4
1.8 16V	81	LFY (XU7JP4)		03/97-04/02	K20TXR	5063	1.0	K20TT	IK20TT	IK20TT	4
1.8 D	44	A9A (XUD7)		05/93-05/01	DG-001		11V				4
1.8 ST	74	LFZ (XU7JP)		06/94-06/95	Q20PR-U	3007	0.8	Q20TT	IQ20TT	IQ20TT	4
1.9 D	47/ 51/ 55/69	D8A (XUD9TE); D9B (XUD9A); DHV (XUD9BSD); DJY (XUD9A); DJZ (XUD9A); XUD9		01/93-04/02	DG-001		11V				4
1.9 D	51	WJY (DW8B); WJZ (DW8)		09/98-08/02	DG-003		11V				4
1.9 DT	66	DHY (XUD9TE)		05/93-05/01	DG-001		11V				4
1.9 SLD	47/50	DJY (XUD9A); DJZ (XUD9A)		06/94-05/01	DG-001		11V				4
1.9 SRDT	66	DHY (XUD9TE)		06/94-05/01	DG-001		11V				4
1.9 STD	51	D9B (XUD9A); XUD9		02/94-05/99	DG-001		11V				4
1.9 TD	66	D8A (XUD9TE); DHY (XUD9TE)		02/97-04/02	DG-001		11V				4
2.0	89/97	RFV (XU10J4R); RFX (XU10J2)		03/97-04/02	K20TXR	5063	1.0	K20TT	IK20TT	IK20TT	4
2.0 16V	97/99	RFV (XU10J4R)		03/97-04/02	K20TXR	5063	1.0	K20TT	IK20TT	IK20TT	4
2.0 HDI 90	66	RHY (DW10TD)		06/99-12/02	DG-116		11V				4
2.0 S16	110/ 112	RFT (XU10J4); RFY (XU10J4Z)		05/93-05/01	Q22PR-U	3010	0.8	-	-	VQ22	4
2.0 S16	120	RFS (XU10J4RS)		06/96-11/98	K20PBR	5060	0.85	K20TT	IK20TT	IK20TT	4
2.0 S16	120	RFS (XU10J4RS)		11/98-05/01	K20PR-U	3145	0.8	K20TT	IK20TT	IK20TT	4
2.0 ST	89	RFX (XU10J2)		07/94-05/01	K20TXR	5063	1.0	K20TT	IK20TT	IK20TT	4
2.0 XSi	89	RFX (XU10J2)		05/93-05/01	K20TXR	5063	1.0	K20TT	IK20TT	IK20TT	4
307 (00-)											
1.4	55	KFW (TU3JP)		09/01-06/05	K20PR-U	3145	0.8	K20TT	IK20TT	IK20TT	4
1.4 16V	65	KFU (ET3J4)		11/03-01/08	XE20HR-U9	3427	0.9	-	IXEH20TT	IXEH20TT	4
1.4 HDi	50	8HX (DV4TD); 8HZ (DV4TD)		10/01-06/05	DG-113		11V				4
1.6	81	NFU (TU5JP4)		07/06-04/12	K16HPR-U11	6076	1.1	KH16TT	IKH16TT	IKH16TT	4
1.6 16V	80	NFU (TU5JP4)		08/00-04/09	K16HPR-U11	6076	1.1	KH16TT	IKH16TT	IKH16TT	4
1.6 BioFlex	80	NFU (TU5JP4)		09/07-04/09	K20HR-U11	3381	1.1	KH20TT	IKH20TT	IKH20TT	4
1.6 HDi	66	9HV (DV6TED4B); 9HV (DV6TED4BU); 9HX (DV6ATED4)	Ch:> RPO 10783, M4 Thread	04/05-05/06	DG-113		11V				4
1.6 HDi	66	9HV (DV6TED4B); 9HV (DV6TED4BU); 9HX (DV6ATED4)	Ch:RPO 10784> ,Pin	05/06-03/09	DG-180		11V				4
1.6 HDi	66	9HV (DV6TED4B); 9HV (DV6TED4BU); 9HX (DV6ATED4); 9HX (DV6AUTED4)	Ch:> ORP 10783, M4 Thread	04/05-05/06	DG-113		11V				4
1.6 HDi	66	9HV (DV6TED4B); 9HV (DV6TED4BU); 9HX (DV6ATED4); 9HX (DV6AUTED4)	Ch:ORP 10784> ,Pin	05/06-04/08	DG-180		11V				4
1.6 HDi 90	66	9HV (DV6TED4B); 9HV (DV6TED4BU); 9HX (DV6ATED4); 9HX (DV6AUTED4)		04/05-04/08	DG-180		11V				4

Свечи зажигания и Свечи накаливания

Таблица применения











	KW				СТАНДАРТНЫЕ			Twin Tip			QTY
											
PEUGEOT продолжение											
307 (00-) продолжение											
1.6 HDi 110	80	9HY (DV6TED4); 9HZ (DV6TED4)	Ch:> RPO 10783, M4 Thread	11/03-05/06	DG-113		11V				4
1.6 HDi 110	80	9HY (DV6TED4); 9HZ (DV6TED4)	Ch:RPO 10784> ,Pin	05/06-03/09	DG-180		11V				4
2.0	100/ 105	RFJ (EW10A); RFN (EW10J4)		03/02-12/11	K16HPR-U11	6076	1.1	KH16TT	IKH16TT	IKH16TT	4
2.0 16V	100/ 103	RFJ (EW10A); RFN (EW10J4)		08/00-04/09	K16HPR-U11	6076	1.1	KH16TT	IKH16TT	IKH16TT	4
2.0 16V	103/ 130	RFK (EW10J4S); RFN (EW10J4)		10/03-04/09	K20HR-U11	3381	1.1	KH20TT	IKH20TT	IKH20TT	4
2.0 HDi 90	66	RHY (DW10TD)		08/00-04/08	DG-116		11V				4
2.0 HDi 110	79	RHS (DW10ATED)	Ch:>RPO 9666	08/00-04/03	DG-116		11V				4
2.0 HDi 110	79	RHS (DW10ATED)	Ch:RPO 9667>	04/03-12/09	DG-181		11V				4
2.0 HDi 135	103	RHR (DW10BTED4)		10/03-04/09	DG-181		11V				4
308 CC (07-)											
1.6 16V	88/ 103/ 110/ 115	5FT (EP6DT); 5FV (EP6CDT); 5FX (EP6DT)	Use narrow 16mm Hex socket	06/09-12/14	VXUH22I	5656	0.9	-	IXUH22TT	VXUH22I	4
1.6 HDi	82/84	9HD (DV6C); 9HR (DV6C)		06/09-12/14	DG-603		5V				4
1.6 THP	147	EP6CDTX	Use narrow 16mm Hex socket	10/10-12/14	VXUH22I	5656	0.9	-	IXUH22TT	VXUH22I	4
2.0 CVVT	103	RFJ (EW10A)		07/09-12/14	K16HPR-U11	6076	1.1	KH16TT	IKH16TT	IKH16TT	4
2.0 CVVT	103	RFJ (EW10A)		07/09-12/14	K20HR-U11	3381	1.1	KH20TT	IKH20TT	IKH20TT	4
2.0 HDi	100/ 103	RHF (DW10BTED4); RHR (DW10BTED4)		04/09-12/14	DG-181		11V				4
2.0 HDi	120	RHH (DW10CTED4)		06/09-12/14	DG-603		5V				4
308 I (07-)											
1.4 16V	70/72	8FR (EP3); 8FS (EP3); EP3	Use narrow 16mm Hex socket	09/07-10/14	VXUH22I	5656	0.9	-	IXUH22TT	VXUH22I	4
1.6	120		Use narrow 16mm Hex socket	01/12-12/15	VXUH22I	5656	0.9	-	IXUH22TT	VXUH22I	4
1.6 16V	88/ 103/ 110/ 115/ 128	5FT (EP6DT); 5FV (EP6CDT); 5FW (EP6); 5FX (EP6DT); 5FY (EP6DTS); EP6	Use narrow 16mm Hex socket	09/07-10/14	VXUH22I	5656	0.9	-	IXUH22TT	VXUH22I	4
1.6 BioFlex	80/82	NFU (TU5JP4)		04/08-10/14	K20HR-U11	3381	1.1	KH20TT	IKH20TT	IKH20TT	4
1.6 GTi	147	EP6CDTX	Use narrow 16mm Hex socket	07/10-10/14	VXUH22I	5656	0.9	-	IXUH22TT	VXUH22I	4
1.6 HDi	66/ 68/ 82/84	9HD (DV6C); 9HJ (DV6DTEDM); 9HP (DV6DTED); 9HR (DV6C); 9HV (DV6TED4B); 9HV (DV6TED4BU); 9HX (DV6ATED4)		09/07-10/14	DG-603		5V				4
1.6 HDi	66/80	9HV (DV6TED4BU); 9HX (DV6ATED4); 9HZ (DV6TED4)		09/07-10/14	DG-180		11V				4
2.0 Bioflex	103	RFJ (EW10A)		01/08-12/12	K16HPR-U11	6076	1.1	KH16TT	IKH16TT	IKH16TT	4
2.0 Bioflex	103	RFJ (EW10A)		01/08-12/12	K20HR-U11	3381	1.1	KH20TT	IKH20TT	IKH20TT	4
2.0 HDi	100/ 103	RHR (DW10BTED4); RHR (DW10CB)		09/07-10/14	DG-181		11V				4
2.0 HDi	110/ 120	RHE (DW10CTED4); RHH (DW10CTED4)		06/09-10/14	DG-603		5V				4
308 II (13-)											
1.2 VTi 72	60	HMZ (EB2F)		09/13-	IXUH22I	5356	0.9	-	IXUH22TT	VXUH22I	3
1.6	115	5FV (EP6CDT)	Use narrow 16mm Hex socket	09/13-	VXUH22I	5656	0.9	-	IXUH22TT	VXUH22I	4
1.6 BlueHDi 100	73	BHY (DV6FD)		04/14-	DG-603		5V				4
1.6 BlueHDi 120	88	BHZ (DV6FC)		11/13-	DG-603		5V				4
1.6 HDi	68	9HP (DV6DTED)		09/13-	DG-603		5V				4
1.6 HDi / BlueHDi 115	85	9HC (DV6C); BHZ (DV6FC)		09/13-	DG-603		5V				4
1.6 HDi 92	68	9HP (DV6DTED)		03/14-	DG-603		5V				4
1.6 HDi 100	73	BHY (DV6FD)		04/14-	DG-603		5V				4
1.6 THP 155	115	5FV (EP6CDT)	Use narrow 16mm Hex socket	03/14-	VXUH22I	5656	0.9	-	IXUH22TT	VXUH22I	4











Таблица применения

P

Свечи зажигания и Свечи накаливания

Таблица применения

Таблица применения

	KW				СТАНДАРТНЫЕ			Twin Tip			QTY
											
PEUGEOT продолжение											
308 II (13-) продолжение											
1.6 THP 163	120	5FM (EP6CDTM)	Use narrow 16mm Hex socket	06/14-	VXUH22I	5656	0.9	-	IXUH22TT	VXUH22I	4
2.0 BlueHdi 150	110	AHX (DW10FCD); AHX (DW10FD)		11/13-	DG-603		5V				4
2.0 GT HDi 180 / BlueHdi 180	132	AHW (DW10FC)		06/14-	DG-603		5V				4
309 I (85-89)											
1.1	40	E1		10/85-07/89	Q20PR-U	3007	0.8	Q20TT	IQ20TT	IQ20TT	4
1.3	47	G1A		10/85-07/89	Q20P-U	3125	0.8	Q20TT	IQ20TT	IQ20TT	4
1.4	48	K1D (TU3A)		03/89-07/89	Q20P-U	3125	0.8	Q20TT	IQ20TT	IQ20TT	4
1.4	55	KDY (TU3M); KDZ (TU3M)		03/89-07/89	K20PR-U	3145	0.8	K20TT	IK20TT	IK20TT	4
1.4	61	K2B (TU3S)		08/88-08/89	Q22P-U	3255	0.8	-	-	VQ22	4
1.5	63	Y2/K		06/87-12/89	Q20PR-U	3007	0.8	Q20TT	IQ20TT	IQ20TT	4
1.6	53/76	180Z (XU5J); B1E (XU51C)		07/87-07/89	Q20PR-U	3007	0.8	Q20TT	IQ20TT	IQ20TT	4
1.6	55/59	B1A (XU51C); B1D (XU51C)		10/85-07/89	T22EP-U	5040	0.8	-	-		4
1.6	69			01/86-07/89	Q20P-U	3125	0.8	Q20TT	IQ20TT	IQ20TT	4
1.6	83			07/86-06/89	K20PR-U	3145	0.8	K20TT	IK20TT	IK20TT	4
1.6 Cat	55	BAZ (XU5CP)		09/86-12/89	Q20PR-U	3007	0.8	Q20TT	IQ20TT	IQ20TT	4
1.9	72/80	DDZ (XU9M); DFZ (XU9J1)		07/87-07/89	Q20PR-U	3007	0.8	Q20TT	IQ20TT	IQ20TT	4
1.9	75	D2B (XU9S)		10/85-07/89	T20EP-U	5031	0.8	T20TT	IT20TT	IT20TT	4
1.9 D	47	162 (XUD9); D9A (XUD9)		06/86-07/89	DG-001		11V				4
1.9 GTI	88/94	D6B (XU9JA); DKZ (XU9JAZ)		10/86-07/89	Q20PR-U	3007	0.8	Q20TT	IQ20TT	IQ20TT	4
309 II (89-93)											
1.1	40	H1B (TU1)		09/89-10/93	Q20R-U	3140	0.8	Q20TT	IQ20TT	IQ20TT	4
1.1	44	HDZ (TU1M)		08/90-12/93	Q20PR-U	3007	0.8	Q20TT	IQ20TT	IQ20TT	4
1.4	49	K1D (TU3A)		07/90-10/92	Q20PR-U	3007	0.8	Q20TT	IQ20TT	IQ20TT	4
1.4	55	KDY (TU3M); KDZ (TU3M)		07/89-12/93	K20PR-U	3145	0.8	K20TT	IK20TT	IK20TT	4
1.6	65/69	B2A (XU52C/K); BDY (XU5M2Z)		07/89-12/93	Q20PR-U	3007	0.8	Q20TT	IQ20TT	IQ20TT	4
1.6	69	B2A (XU52C/K)		07/89-12/91	Q20P-U	3125	0.8	Q20TT	IQ20TT	IQ20TT	4
1.8 Diesel	44	161A (XUD7)		07/89-12/93	DG-001		11V				4
1.8 TD	57	A8B (XUD7TE)		08/89-12/93	DG-001		11V				4
1.9	72/80	DDZ (XU9M); DFZ (XU9J1)		08/89-12/93	Q20PR-U	3007	0.8	Q20TT	IQ20TT	IQ20TT	4
1.9 D	50			09/89-10/93	DG-001		11V				4
1.9 Diesel	47	162 (XUD9); D9A (XUD9); DJZ (XUD9A)		07/89-12/93	DG-001		11V				4
1.9 GTI	85			09/89-10/93	K20PR-U	3145	0.8	K20TT	IK20TT	IK20TT	4
1.9 GTI	88	DKZ (XU9JAZ)		07/89-12/93	Q20PR-U	3007	0.8	Q20TT	IQ20TT	IQ20TT	4
1.9 GTI 16V	108/ 116	D6C (XU9J4); DFW (XU9J4Z)		08/89-12/93	K22PBR-S	5062	0.85	-	IKB22TT	VK22	4
405 I (87-93)											
1.4	47	K5A (TU3)		01/87-07/92	Q20P-U	3125	0.8	Q20TT	IQ20TT	IQ20TT	4
1.6	53/ 55/ 65/69	B1E (XU51C); B2A (XU52C/K); BAZ (XU5CP); BDY (XU5M2Z); BDZ (XU5M)		01/87-12/92	Q20PR-U	3007	0.8	Q20TT	IQ20TT	IQ20TT	4
1.6	65	BDZ (XU5M)		10/88-08/92	Q20P-U	3125	0.8	Q20TT	IQ20TT	IQ20TT	4
1.6	69	B2A (XU52C/K); BDZ (XU5M)		05/88-08/92	K20PR-U	3145	0.8	K20TT	IK20TT	IK20TT	4
1.8 D	44			04/90-07/92	DG-001		11V				4
1.8 DT 4x4	66	A8A (XUD7TE)		05/90-07/92	DG-001		11V				4
1.8 GLD	44			04/90-07/92	DG-001		11V				4
1.8 TD	66	A8A (XUD7TE); AJZ (XUD7TEY)		10/88-08/92	DG-001		11V				4
1.8 Turbo Diesel	66	A8A (XUD7TE); AJZ (XUD7TEY)		03/88-12/92	DG-001		11V				4
1.9	70/ 72/ 80/ 90/93	D2C (XU92C); D6A (XU9J2); DDZ (XU9M); DFZ (XU9J1)		07/87-12/92	Q20P-U	3125	0.8	Q20TT	IQ20TT	IQ20TT	4
1.9	77/ 80/88	DDZ (XU9M); DFZ (XU9J1); DKZ (XU9JAZ)		06/87-08/92	Q20PR-U	3007	0.8	Q20TT	IQ20TT	IQ20TT	4
1.9 4x4	80	DDZ (XU9M)		07/88-12/92	Q20PR-U	3007	0.8	Q20TT	IQ20TT	IQ20TT	4

Свечи зажигания и Свечи накаливания

Таблица применения











	KW				СТАНДАРТНЫЕ			Twin Tip			QTY
											
PEUGEOT продолжение											
405 I (87-93) продолжение											
1.9 4x4	80	DDZ (XU9M)		10/88-08/92	Q20P-U	3125	0.8	Q20TT	IQ20TT	IQ20TT	4
1.9 4x4	88/93	DKZ (XU9JAZ)		07/90-07/92	K20PR-U	3145	0.8	K20TT	IK20TT	IK20TT	4
1.9 D	47/51	D9B (XUD9A); DJY (XUD9A); DJZ (XUD9A)		10/88-08/92	DG-001		11V				4
1.9 Diesel	47/51	D9B (XUD9A); DJZ (XUD9A)		03/88-12/92	DG-001		11V				4
1.9 Injection	77	DFZ (XU9J1)		07/87-12/92	Q20PR-U	3007	0.8	Q20TT	IQ20TT	IQ20TT	4
1.9 Sport MI-16	108/ 116	D6C (XU9J4); DFW (XU9J4Z)		06/87-11/92	K22PBR-S	5062	0.85	-	IKB22TT	VK22	4
1.9 SPort MI-16 4x4	108	DFW (XU9J4Z)		06/87-07/92	K22PBR-S	5062	0.85	-	IKB22TT	VK22	4
405 II (92-99)											
1.4	55	KDX (TU3MC)		08/92-10/96	Q20PR-U	3007	0.8	Q20TT	IQ20TT	IQ20TT	4
1.4	58	TU3.2(K2D)		07/93-06/94	K20PR-U	3145	0.8	K20TT	IK20TT	IK20TT	4
1.6	66	BDY (XU5M2Z)		08/92-10/96	Q20PR-U	3007	0.8	Q20TT	IQ20TT	IQ20TT	4
1.8	74	LFZ (XU7JP)		08/92-10/96	Q20PR-U	3007	0.8	Q20TT	IQ20TT	IQ20TT	4
1.9 D	47/51	D9B (XUD9A); DJY (XUD9A); DJZ (XUD9)		08/92-11/99	DG-001		11V				4
1.9 TD	66/69	DHY (XUD9TE)		08/92-05/97	DG-001		11V				4
2.0	89	RFX (XU10J2)		08/92-10/96	Q20PR-U	3007	0.8	Q20TT	IQ20TT	IQ20TT	4
2.0 4x4	89	RFX (XU10J2)		08/92-10/96	Q16PR-U	3137	0.8	Q16TT	IQ16TT	IQ16TT	4
2.0 MI-16	112	RFY (XU10J4Z)		08/92-10/95	K20PBR	5060	0.85	K20TT	IK20TT	IK20TT	4
2.0 T 16 X4	144	RGZ (XU10J4TE/Z)		08/92-10/95	K20TXR	5063	1.0	K20TT	IK20TT	IK20TT	4
2.0 X4	89	RFX (XU10J2)		08/92-10/95	Q16PR-U	3137	0.8	Q16TT	IQ16TT	IQ16TT	4
406 (95-04)											
1.6	65	BFZ (XU5JP)		11/95-03/99	K20TXR	5063	1.0	K20TT	IK20TT	IK20TT	4
1.8	66	LFX (XU7JB)		05/97-03/99	K20TXR	5063	1.0	K20TT	IK20TT	IK20TT	4
1.8 16V	81	LFY (XU7JP4)		11/95-10/00	K20TXR	5063	1.0	K20TT	IK20TT	IK20TT	4
1.8 16V	85	6FZ (EW7J4)		10/00-10/04	K16HPR-U11	6076	1.1	KH16TT	IKH16TT	IKH16TT	4
1.9 D	55	DHW (XUD9SD)		10/96-10/04	DG-001		11V				4
1.9 TD	66/68	DHX (XUD9TE); DHY (XUD9TE)		01/96-10/04	DG-001		11V				4
2.0	104	RGY (XU10J2TE)		11/96-03/99	K20TXR	5063	1.0	K20TT	IK20TT	IK20TT	4
2.0 16V	97/ 100	RFR (EW10J4); RFV (XU10J4R)		11/95-10/04	K20PR-U	3145	0.8	K20TT	IK20TT	IK20TT	4
2.0 16V	100	RFN (EW10J4)		08/00-10/04	K16HPR-U11	6076	1.1	KH16TT	IKH16TT	IKH16TT	4
2.0 16V HPI	103	RLZ (EW10D)		05/01-10/04	K16HPR-U11	6076	1.1	KH16TT	IKH16TT	IKH16TT	4
2.0 HDI 90	66	RHY (DW10TD)		02/99-10/04	DG-116		11V				4
2.0 HDi 110	79	RHS (DW10ATED); RHZ (DW10ATED)	Ch:>RPO 9666	02/99-04/03	DG-116		11V				4
2.0 HDi 110	79	RHS (DW10ATED); RHZ (DW10ATED)	Ch:RPO 9667>	04/03-10/04	DG-181		11V				4
2.0 HDI 110	79	RHZ (DW10ATED)		06/98-08/01	DG-116		11V				4
2.0 Turbo	108	RGX (XU10J2TE)		04/96-10/04	K20TXR	5063	1.0	K20TT	IK20TT	IK20TT	4
2.1 TD 12V	80	P8C (XUD11BTE)		01/96-10/04	DG-001		11V				4
2.2	116	3FZ (EW12J4)		07/00-10/04	K16HPR-U11	6076	1.1	KH16TT	IKH16TT	IKH16TT	4
2.2 HDi	98	4HX (DW12TED4)	Ch:>RPO 09666	03/00-04/03	DG-116		11V				4
2.2 HDi	98	4HX (DW12TED4)	Ch:RPO 09667>	04/03-10/04	DG-181		11V				4
3.0 24V	140/ 143	XFZ (ES9J4)		10/96-10/04	K20TXR	5063	1.0	K20TT	IK20TT	IK20TT	6
3.0 V6	152	XFJ (ES9J4S)		03/00-10/04	IKH16TT	4703	1.0	-	IKH16TT		6
406 Coupe (97-04)											
2.0 16V	97/ 100	RFR (EW10J4); RFV (XU10J4R)		03/97-12/04	K20PR-U	3145	0.8	K20TT	IK20TT	IK20TT	4
2.0 16V	100	RFN (EW10J4)		10/00-12/04	K16HPR-U11	6076	1.1	KH16TT	IKH16TT	IKH16TT	4
2.2	116	EW12J4		03/02-12/04	K16HPR-U11	6076	1.1	KH16TT	IKH16TT	IKH16TT	4
2.2 HDI	98	4HX (DW12TED4)	Ch:>RPO 09666	03/00-04/03	DG-116		11V				4
2.2 HDI	98	4HX (DW12TED4)	Ch:RPO 09667>	04/03-12/04	DG-181		11V				4
3.0 24V	143	XFZ (ES9J4)		05/97-06/99	K20TXR	5063	1.0	K20TT	IK20TT	IK20TT	6
3.0 V6	152	XFJ (ES9J4S)		03/00-12/04	IKH16TT	4703	1.0	-	IKH16TT		6
3.0 V6 24V	140	XFZ (ES9J4)		03/97-12/04	K20TXR	5063	1.0	K20TT	IK20TT	IK20TT	6
407 (04-)											
1.6 HDi 110	80	9HZ (DV6TED4)	Ch:> RPO 10783, M4 Thread	05/04-05/06	DG-113		11V				4
1.6 HDi 110	80	9HZ (DV6TED4)	Ch:RPO 10784> ,Pin	05/06-12/10	DG-180		11V				4

Таблица применения

P

Свечи зажигания и Свечи накаливания

Таблица применения

Таблица применения

KW	KW	KW	NOTE	21	СТАНДАРТНЫЕ			Twin Tip			QTY
					1	2	3	1	2	3	
PEUGEOT продолжение											
407 (04-) продолжение											
1.8	85	6FZ (EW7J4)		03/04-07/05	K16HPR-U11	6076	1.1	KH16TT	IKH16TT	IKH16TT	4
1.8 16V	92	6FY (EW7A)		08/05-12/10	K16HPR-U11	6076	1.1	KH16TT	IKH16TT	IKH16TT	4
2.0	100	RFN (EW10J4)		03/04-07/05	K16HPR-U11	6076	1.1	KH16TT	IKH16TT	IKH16TT	4
2.0 16V	103	RFJ (EW10A)		08/05-12/10	K16HPR-U11	6076	1.1	KH16TT	IKH16TT	IKH16TT	4
2.0 Bioflex	103	RFJ (EW10A)		09/07-02/11	K16HPR-U11	6076	1.1	KH16TT	IKH16TT	IKH16TT	4
2.0 HDi	103	RHR (DW10BTED4)		08/08-12/10	DG-181		11V				4
2.0 HDi	120	RHH (DW10CTED4)		06/09-12/10	DG-603		5V				4
2.0 HDi 135	103	RHR (DW10BTED4)		05/04-12/10	DG-181		11V				4
2.2	116	3FZ (EW12J4)		03/04-10/05	K16HPR-U11	6076	1.1	KH16TT	IKH16TT	IKH16TT	4
2.2 16V	120	3FY (EW12J4)		08/05-03/09	K16HPR-U11	6076	1.1	KH16TT	IKH16TT	IKH16TT	4
2.2 HDi	120	4HP (DW12BTED4)		03/06-12/10	DG-614		11V				4
2.2 HDi 170	125	4HT (DW12BTED4)		03/06-12/10	DG-614		11V				4
2.7 HDi	150	UHZ (DT17TED4)		10/05-12/10	DG-140		11V				6
3.0	155	XFV (ES9A)		03/04-12/10	IKH16TT	4703	1.0	-	IKH16TT		6
407 Coupe (05-)											
2.0 HDi	100	RHR (DW10BTED4)		10/05-	DG-181		11V				4
2.0 HDi	120	RHH (DW10CTED4)		06/09-	DG-603		5V				4
2.2 16V	120	3FY (EW12J4)		10/05-03/09	K16HPR-U11	6076	1.1	KH16TT	IKH16TT	IKH16TT	4
2.7 HDi	150	UHZ (DT17TED4)		10/05-	DG-140		11V				6
3.0 V6	155	XFV (ES9A)		10/05-	IKH16TT	4703	1.0	-	IKH16TT		6
504 (68-89)											
1.6	46	XC7P		01/80-06/87	W20EP-U	3043	0.8	W20TT	IW20TT	IW20TT	4
1.8	54	XM7		08/81-07/85	W20EPR-U	3047	0.8	W20TT	IW20TT	IW20TT	4
1.8	54/58	XM7		01/71-12/89	W20EP-U	3043	0.8	W20TT	IW20TT	IW20TT	4
1.9 D	40	XD4x88		03/73-12/89	DG-001		11V				4
2.0	69	XN1		04/71-07/86	W20EP-U	3043	0.8	W20TT	IW20TT	IW20TT	4
2.0	71/ 75/78	106 (XN1); 107 (XN2)		03/71-06/86	Q20PR-U	3007	0.8	Q20TT	IQ20TT	IQ20TT	4
2.0 TI	78	107 (XN2)		01/75-06/83	W20EP-U	3043	0.8	W20TT	IW20TT	IW20TT	4
2.1 D	43/48	XD4x90; XD90	Double Coil(LPH)	02/71-07/86	DG-001		11V				4
2.3 D	51	134 (XD2)		07/75-12/89	DG-001		11V				4
2.7	106	140 (ZMJ)		10/77-08/84	T20EP-U	5031	0.8	T20TT	IT20TT	IT20TT	6
505 (79-95)											
1.8	55/ 60/62	105 (XM7); 105C (XM7A)		06/81-10/86	Q20PR-U	3007	0.8	Q20TT	IQ20TT	IQ20TT	4
2.0	60/72	106 (XN1)		11/80-11/87	Q20PR-U	3007	0.8	Q20TT	IQ20TT	IQ20TT	4
2.0	69/72	106 (XN1); 106E (XN1A)		08/83-09/95	W20EP-U	3043	0.8	W20TT	IW20TT	IW20TT	4
2.0 TI,STI	81	829 (ZEJ)		08/79-10/86	T22EP-U	5040	0.8	-	-		4
2.2	84	851X (ZDJL)		01/86-12/93	T22EP-U	5040	0.8	-	-		4
2.2 GTI	90/96	851B (ZDJL)		08/83-12/93	T22EP-U	5040	0.8	-	-		4
2.2 Turbo Injection	110/ 114	176B (N9TE); 176X (N9TE)		03/84-10/88	W22EP-U	3085	0.8	W22TT	-	VW22	4
2.2 Turbo Injection	128	N9T/N9TE		06/87-12/88	W20EPB	5065	0.85	W20TT	IW20TT	IW20TT	4
2.3 D	51	XD2		05/79-09/84	DG-001		11V				4
2.3 Diesel	59	147 (XD2S)		04/82-06/86	DG-001		11V				4
2.3 Turbo Diesel	59	147 (XD2S)		09/80-06/86	DG-001		11V				4
2.5 D	70	XD3T	Double Coil(LPH)	10/85-08/91	DG-001		11V				4
2.5 Diesel	51/55	155 (XD3)	Double Coil(LPH)	06/81-12/93	DG-001		11V				4
2.5 Turbo Diesel	66/ 70/77	152A (XD3T); 152B (XD3TE)	Double Coil(LPH)	10/83-12/93	DG-001		11V				4
2.8 GTI V6	105	154X (ZN3J)		06/86-12/93	T20EPR-U	5032	0.8	T20TT	IT20TT	IT20TT	6
508 I (10-)											
1.6 BlueHDi 120	88	BHZ (DV6FC)		03/14-12/18	DG-603		5V				4
1.6 HDi	82/84	9HD (DV6CTED); 9HL (DV6C); 9HR (DV6C); BHX (DV6FC)		11/10-12/18	DG-603		5V				4
1.6 THP	110/ 115/ 121	5FE (EP6CDTM); 5FN (EP6CDT); 5FV (EP6CDT); 5GZ (EP6FDT)	Use narrow 16mm Hex socket	11/10-12/18	VXUH22I	5656	0.9	-	IXUH22TT	VXUH22I	4
1.6 VTi	85/88	5FH (EP6C); 5FS (EP6C)	Use narrow 16mm Hex socket	11/10-12/18	VXUH22I	5656	0.9	-	IXUH22TT	VXUH22I	4
2.0 BlueHDi 150	110	AHX (DW10FD)		04/14-12/18	DG-603		5V				4
2.0 BlueHDi 180	132	AHW (DW10FC)		04/14-12/18	DG-603		5V				4

Свечи зажигания и Свечи накаливания

Таблица применения







	KW				СТАНДАРТНЫЕ			Twin Tip			QTY
											
PEUGEOT продолжение											
508 I (10-) продолжение											
2.0 HDi	100/103	RHA (DW10CTED4); RHF (DW10BTED4); RHR (DW10BTED4)		11/10-12/18	DG-181		11V				4
2.0 HDi	120	RHH (DW10CTED4)		11/10-12/18	DG-603		5V				4
2.0 HDi 180 RXH	133	RHC (DW10CTED4)		10/14-12/18	DG-603		5V				4
2.0 HDi Hybrid4 AWC	120/147	RHC (DW10CTED4)		11/10-12/18	DG-603		5V				4
2.0 HDi RXH Hybrid4	120	RHC (DW10CTED4)		11/10-12/18	DG-603		5V				4
2.2 HDi	150	4HL (DW12C)		11/10-12/18	DG-632		5V				4
604 (77-87)											
2.0	70			03/83-01/84	K20PR-U	3145	0.8	K20TT	IK20TT	IK20TT	4
2.3 TD	59	147 (XD2S)		09/79-05/83	DG-001		11V				4
2.5 TD	66	152A (XD3T)	Double Coil(LPH)	08/83-12/86	DG-001		11V				4
2.7 SL	100	112 (ZM)		08/77-05/83	T20EPR-U	5032	0.8	T20TT	IT20TT	IT20TT	6
2.7 TI,STI	106	140 (ZMJ)		08/77-05/83	T20EPR-U	5032	0.8	T20TT	IT20TT	IT20TT	6
2.8 GTI	110	154A (ZMJK)		09/83-07/87	T20EPR-U	5032	0.8	T20TT	IT20TT	IT20TT	6
605 (89-99)											
2.0	79/89	RFZ (XU10J2Z)		06/89-09/99	Q20PR-U	3007	0.8	Q20TT	IQ20TT	IQ20TT	4
2.0	84	R5A (XU102C)		06/89-06/94	Q22PR-U	3010	0.8	-	-	VQ22	4
2.0 16V	97	RFV (XU10J4R)		07/94-09/99	K20TXR	5063	1.0	K20TT	IK20TT	IK20TT	4
2.0 Turbo	104/108	RGX (XU10J2TE); RGY (XU10J2TE)		07/91-09/99	K20TXR	5063	1.0	K20TT	IK20TT	IK20TT	4
2.1 D	60	P9A (XUD11A)		06/89-07/95	DG-001		11V				4
2.1 TD 12V	80	P8C (XUD11BTE); PHZ (XUD11ATE)		08/94-09/99	DG-001		11V				4
2.1 Turbo Diesel	80	PHZ (XUD11ATE)		06/89-09/99	DG-001		11V				4
2.5 Turbo Diesel	95	THY (DK5ATE)	Double Coil(LPH)	07/94-09/99	DG-001		11V				4
3.0	123/147	SFZ (ZPJ/Z); SKZ (ZPJ4/Z); UFZ (ZPJ); UKZ (ZPJ4/Z)		08/89-09/99	K20PBR	5060	0.85	K20TT	IK20TT	IK20TT	6
3.0 SV 24	147	UKZ (ZPJ4/Z)		08/89-09/99	K20PBR	5060	0.85	K20TT	IK20TT	IK20TT	6
3.0 V6	140	XFZ (ES9J4)		04/97-09/99	K20TXR	5063	1.0	K20TT	IK20TT	IK20TT	6
607 (00-)											
2.0	100	RFN (EW10J4)		02/00-08/05	K16HPR-U11	6076	1.1	KH16TT	IKH16TT	IKH16TT	4
2.0 HDi	79	RHS (DW10ATED); RHZ (DW10ATED)	Ch:>RPO 9666	05/00-04/03	DG-116		11V				4
2.0 HDi	79	RHS (DW10ATED); RHZ (DW10ATED)	Ch:RPO 9667>	04/03-09/05	DG-181		11V				4
2.0 HDI	100	RHR (DW10BTED4)		09/05-07/11	DG-181		11V				4
2.2 16V	116/120	3FY (EW12J4); 3FZ (EW12J4)		02/00-11/07	K16HPR-U11	6076	1.1	KH16TT	IKH16TT	IKH16TT	4
2.2 HDi	98	4HX (DW12TED4)	Ch:>RPO 09666	02/00-04/03	DG-116		11V				4
2.2 HDi	98	4HX (DW12TED4)	Ch:RPO 09667>	04/03-02/06	DG-181		11V				4
2.2 HDi	125	4HT (DW12BTED4)		05/06-06/10	DG-614		11V				4
2.7 HDi 24V	150	DT17TED4		12/04-07/11	DG-140		11V				6
3.0 V6 24V	152/155	XFV (ES9A); XFX (ES9J4S)		02/00-07/11	IKH16TT	4703	1.0	-	IKH16TT		6
806 (94-02)											
1.8	73	LFW (XU7JP)		07/95-08/02	K20PR-U	3145	0.8	K20TT	IK20TT	IK20TT	4
1.8	73	LFW (XU7JP)		07/95-08/02	K20TXR	5063	1.0	K20TT	IK20TT	IK20TT	4
1.9 TD	66/68	D8B (XUD9TE); DHX (XUD9TE)		07/95-08/02	DG-001		11V				4
2.0	89	RFU (XU10J2)		06/94-08/02	K20TXR	5063	1.0	K20TT	IK20TT	IK20TT	4
2.0 16V	97	RFV (XU10J4R)		05/98-09/00	K20TXR	5063	1.0	K20TT	IK20TT	IK20TT	4
2.0 16V	100	RFN (EW10J4)		09/00-08/02	K16HPR-U11	6076	1.1	KH16TT	IKH16TT	IKH16TT	4
2.0 HDI	80	RHZ (DW10ATED)		08/99-08/02	DG-116		11V				4
2.0 HDI 16V	80	RHW (DW10ATED4)		08/99-08/02	DG-116		11V				4
2.0 Turbo	108	RGX (XU10J2TE)		06/94-08/02	K20TXR	5063	1.0	K20TT	IK20TT	IK20TT	4
2.1 td 12V	80	P8C (XUD11BTE)		06/96-08/99	DG-001		11V				4
807 (02-)											
2.0	100	RFN (EW10J4)		06/02-	K16HPR-U11	6076	1.1	KH16TT	IKH16TT	IKH16TT	4
2.0 16V	103	RFJ (EW10A)		09/05-	K16HPR-U11	6076	1.1	KH16TT	IKH16TT	IKH16TT	4
2.0 HDi	79	RHM (DW10ATED4); RHT (DW10ATED4); RHW (DW10ATED4)	Ch:>RPO 9666	06/02-04/03	DG-116		11V				4











Таблица применения

P

Свечи зажигания и Свечи накаливания

Таблица применения

Таблица применения

	KW				СТАНДАРТНЫЕ				Twin Tip			QTY
												
PEUGEOT продолжение												
807 (02-) продолжение												
2.0 HDi	79	RHM (DW10ATED4); RHT (DW10ATED4); RHW (DW10ATED4)	Ch:RPO 9667>	04/03-	DG-181		11V					4
2.0 HDi	79/ 88/ 100	RHD (DW10CTED4); RHK (DW10UTED4); RHR (DW10BTED4); RHS (DW10CB); RHW (DW10ATED4)		04/04-	DG-181		11V					4
2.0 HDi	120	RHH (DW10CTED4)		06/09-	DG-603		5V					4
2.2	116	3FZ (EW12J4)		06/02-09/05	K16HPR-U11	6076	1.1	KH16TT	IKH16TT	IKH16TT		4
2.2 HDi	94	4HX (DW12TED4/FAP)	Ch:>RPO 09666	06/02-04/03	DG-116		11V					4
2.2 HDi	94	4HX (DW12TED4/FAP)	Ch:RPO 09667>	04/03-	DG-181		11V					4
2.2 HDi	94/ 120/ 125	4HR (DW12BTED4); 4HT (DW12BTED4); 4HW (DW12BTED4)		06/02-	DG-614		11V					4
2.2 HDi	100	4HW (DW12TED4)		04/04-	DG-181		11V					4
3.0 V6	150	XFX (ES9J4S)		06/02-	IKH16TT	4703	1.0	-	IKH16TT			6
1007 (05-)												
1.4	54	KFV (TU3A); KFV (TU3JP)		04/05-07/10	K20PR-U	3145	0.8	K20TT	IK20TT	IK20TT		4
1.4 16V	65	KFU (ET3J4)		10/05-07/07	XE20HR-U9	3427	0.9	-	IXEH20TT	IXEH20TT		4
1.4 HDi	50	8HX (DV4TD); 8HZ (DV4TD)		04/05-	DG-113		11V					4
1.6 16V	80	NFU (TU5JP4)		04/05-	K16HPR-U11	6076	1.1	KH16TT	IKH16TT	IKH16TT		4
1.6 HDi	80	9HZ (DV6TED4)		06/07-	DG-180		11V					4
2008 (13-)												
1.2 VTi	60	HMZ (EB2); HMZ (EB2F)		03/13-	IXUH22I	5356	0.9	-	IXUH22TT	VXUH22I		3
1.4 HDi	50	8HR (DV4C)		06/13-	DG-603		5V					4
1.6 BlueHDi	85	BHX (DV6FC)		07/14-	DG-603		5V					4
1.6 BlueHDi 75	55	BHW (DV6FE)		01/15-	DG-603		5V					4
1.6 BlueHDi 100	73	BHY (DV6FD)		01/15-	DG-603		5V					4
1.6 BlueHDi 120	88	BHZ (DV6FC)		07/14-	DG-603		5V					4
1.6 HDi	68/84	9HD (DV6C); 9HP (DV6DTE)		03/13-	DG-603		5V					4
1.6 VTi	88	5FS (EP6C)	Use narrow 16mm Hex socket	03/13-	VXUH22I	5656	0.9	-	IXUH22TT	VXUH22I		4
3008 (09-)												
1.6 BlueHDi 120	88	BHZ (DV6FC)		05/14-08/16	DG-603		5V					4
1.6 HDi	80	9HZ (DV6TED4)		06/09-08/16	DG-180		11V					4
1.6 HDi	82/84	9HD (DV6CTED); 9HR (DV6C)		12/09-08/16	DG-603		5V					4
1.6 THP	110/ 115	5FE (EP6CDTM); 5FE (EP6CDTMD); 5FV (EP6CDT); 5FX (EP6DT)	Use narrow 16mm Hex socket	06/09-08/16	VXUH22I	5656	0.9	-	IXUH22TT	VXUH22I		4
1.6 Turbo	121	5GZ (EP6FDT)	Use narrow 16mm Hex socket	05/14-08/16	VXUH22I	5656	0.9	-	IXUH22TT	VXUH22I		4
1.6 VTi	88	5FS (EP6C); 5FW (EP6); EP6	Use narrow 16mm Hex socket	06/09-08/16	VXUH22I	5656	0.9	-	IXUH22TT	VXUH22I		4
2.0 HDi	100/ 120	RHD (DW10CB); RHH (DW10CTED4)		06/09-08/16	DG-603		5V					4
2.0 HDi 150 / BlueHDi 150	110	AHX (DW10FD); RHE (DW10CTED4)		06/09-08/16	DG-603		5V					4
2.0 HDi Hybrid4	120/ 147	RHC (DW10CTED4)		02/11-08/16	DG-603		5V					4
3008 SUV (16-)												
1.6 BlueHDi 120	88	BHZ (DV6FC)		05/16-	DG-603		5V					4
2.0 BlueHDi 180	132	AHW (DW10FC)		05/16-	DG-603		5V					4
4007 (07-)												
2.2 HDi	115	4HK (DW12ME5); 4HN (DW12MTED4)		02/07-03/13	DG-614		11V					4
2.4 16V	125	SFZ (4B12-MMC); SFZ (4B12-MMC)	Euro-4	02/07-06/10	K16PSR-B8	3437	0.8	-	IK16TT	IK16TT		4
2.4 16V	125	SFZ (4B12-MMC); SFZ (4B12-MMC)	Euro-5	07/10-03/13	IK16TT	4701	1.0	-	IK16TT	IK16TT		4
4008 (12-)												
1.6 HDi	84	9HD (DV6C)		05/12-	DG-603		5V					4
1.6 HDi AWC	84	9HD (DV6C)		05/12-	DG-603		5V					4

Свечи зажигания и Свечи накаливания

Таблица применения

















	KW				СТАНДАРТНЫЕ			Twin Tip			QTY
PEUGEOT продолжение											
4008 (12-) продолжение											
1.8 HDi	110		OE:160784998 0/ 1820-A019	05/12-	DG-656		11V				4
1.8 HDi AWC	110	6HZ (4N13)	OE:160784998 0/ 1820-A019	05/12-	DG-656		11V				4
2.0	110	4B11		05/13-	VFK20F	5648	1.1	-	IK20TT	VFK20F	4
2.0 AWC	110	4B11		05/12-	VFK20F	5648	1.1	-	IK20TT	VFK20F	4
5008 I (09-)											
1.6 16V	88/ 115	5FS (EP6C); 5FV (EP6CDT); 5FW (EP6); EP6	Use narrow 16mm Hex socket	09/09-03/17	VXUH22I	5656	0.9	-	IXUH22TT	VXUH22I	4
1.6 BlueHDi 120	88	BHZ (DV6FC)		05/14-03/17	DG-603		5V				4
1.6 HDi	80	9HZ (DV6TED4)		09/09-03/17	DG-180		11V				4
1.6 HDi	82/84	9HD (DV6C); 9HR (DV6C)		08/10-03/17	DG-603		5V				4
1.6 THP 163	120	5GZ (EP6FDT)	Use narrow 16mm Hex socket	02/12-03/17	VXUH22I	5656	0.9	-	IXUH22TT	VXUH22I	4
1.6 THP 165	121	5GZ (EP6FDT)	Use narrow 16mm Hex socket	02/12-03/17	VXUH22I	5656	0.9	-	IXUH22TT	VXUH22I	4
2.0 HDi	120	RHH (DW10CTED4)		09/09-03/17	DG-603		5V				4
2.0 HDi 136 / BlueHDi 136	100	AHV (DW10FD); RHD (DW10CB); RHD (DW10CTED4)		02/12-03/17	DG-603		5V				4
2.0 HDi 150 / BlueHDi 150	110	AHR (DW10FD); AHX (DW10FD); RHE (DW10CTED4)		06/09-03/17	DG-603		5V				4
BIPPER (08-)											
1.3 HDi 75	55	FHZ (F13DTE5)	Euro-5,OE: 5960 L4	10/10-	DG-621		4.4V				4
1.3 HDi 75	55	FHZ (F13DTE5)	Euro-6,OE: 1616317380 (R P9016)	10/10-	DG-658		5V				4
1.3 HDi 80	59	FHY (F13DTE6)	Euro-5,OE: 5960 L4	12/15-	DG-621		4.4V				4
1.3 HDi 80	59	FHY (F13DTE6)	Euro-6,OE: 1616317380 (R P9016)	12/15-	DG-658		5V				4
1.4	54	KFV (TU3A)		02/08-	K20PR-U	3145	0.8	K20TT	IK20TT	IK20TT	4
1.4 HDi	50	8HS (DV4TED)		02/08-	DG-180		11V				4
BOXER (94-02)											
1.9 D	50	D9B (XUD9AU); DJY (XUD9A)		03/94-04/02	DG-001		11V				4
1.9 DT 4x4	66	XUD9TE		03/96-09/98	DG-001		11V				4
1.9 TD	66/68	D8C (XUD9UTF); DHY (XUD9TE); XUD9TE		03/94-04/02	DG-001		11V				4
1.9 TD 4x4	68	D8C (XUD9UTF)		07/96-04/02	DG-001		11V				4
2.0	81	RFL (XU10J2U)		12/01-04/02	K20PR-U	3145	0.8	K20TT	IK20TT	IK20TT	4
2.0 4x4	80	RFW (XU10J2)		03/96-09/98	K20TXR	5063	1.0	K20TT	IK20TT	IK20TT	4
2.0 HDI	62	RHV (DW10UTD)		08/01-04/02	DG-116		11V				4
2.0 i	80	RFW (XU10J2)		03/94-03/95	Q20PR-U	3007	0.8	Q20TT	IQ20TT	IQ20TT	4
2.0 i	80	RFW (XU10J2)		06/94-04/02	K20TXR	5063	1.0	K20TT	IK20TT	IK20TT	4
2.0 i 4x4	80	RFW (XU10J2)		08/96-04/02	K20TXR	5063	1.0	K20TT	IK20TT	IK20TT	4
2.5 D	63	T9A (DJ5)	Double Coil(LPH)	03/94-04/02	DG-001		11V				4
2.5 D 4x4	63	T9A (DJ5)	Double Coil(LPH)	07/96-04/02	DG-001		11V				4
2.5 DT	62		Double Coil(LPH)	10/97-11/01	DG-001		11V				4
2.5 TD	76	T8A (DJ5T)	Double Coil(LPH)	03/94-04/02	DG-001		11V				4
2.5 TD 4x4	76	T8A (DJ5T)	Double Coil(LPH)	07/96-04/02	DG-001		11V				4
2.5 TDI	79	THX (DJ5TED)	Double Coil(LPH)	01/97-04/02	DG-161		11V				4
2.5 TDI 4x4	79	THX (DJ5TED)	Double Coil(LPH)	01/97-04/02	DG-161		11V				4
2.8 D	64	8140.63 (F28D)		01/99-02/02	DG-111		11V				4
2.8 HDi	94	8140.43S (F28DTCR)	Double Coil(LPH)	10/00-04/02	DG-111		11V				4
2.8 HDi 4x4	94	8140.43S (F28DTCR)	Double Coil(LPH)	10/00-04/02	DG-111		11V				4
2.8 HDi AWD	93	8140.43S (F28DTCR)	Double Coil(LPH)	10/00-11/01	DG-111		11V				4

Таблица применения

P

Свечи зажигания и Свечи накаливания

Таблица применения

	KW				СТАНДАРТНЫЕ				Twin Tip			QTY
												
PEUGEOT продолжение												
BOXER (02-)												
2.0	81	RFL (XU10J2U)		04/02-06/06	K20PR-U	3145	0.8		K20TT	IK20TT	IK20TT	4
2.0 HDi	62	RHV (DW10TD); RHV (DW10UTD)		04/02-	DG-116		11V					4
2.2 HDi	74	4HY (DW12UTED)	Ch:>RPO 09666	04/02-04/03	DG-116		11V					4
2.2 HDi	74	4HY (DW12UTED)	Ch:RPO 09667>	04/03-	DG-181		11V					4
2.8 HDi	94/ 107	8140.43N; 8140.43S (F28DTCR)	Double Coil(LPH)	04/02-	DG-111		11V					4
2.8 HDi 4x4	94	8140.43S (F28DTCR)	Double Coil(LPH)	04/02-	DG-111		11V					4
BOXER (06-)												
2.0 BlueHDi 110	81	DW10FUE		07/15-09/19	DG-603		5V					4
2.0 BlueHDi 130	96	AHN (DW10FUD)		07/15-09/19	DG-603		5V					4
2.0 BlueHDi 160	120	AHP (DW10FUC)		07/15-09/19	DG-603		5V					4
2.2 HDi 100	74	4HV (P22DTE)		04/06-	DG-130		11.5V					4
2.2 HDi 110	81	4HG (P22DTE)		03/11-	DG-611		4.4V					4
2.2 HDi 120	88	4HU (P22DTE)		04/06-	DG-130		11.5V					4
2.2 HDi 130	96	4HH (P22DTE)		03/11-	DG-611		4.4V					4
2.2 HDi 150	110	4HJ (P22DTE)		03/11-	DG-611		4.4V					4
3.0 D	116			09/08-12/09	DG-195		11V					4
3.0 HDi	115	F1CE0481D (F30DT)		07/06-	DG-195		11V					4
3.0 HDi 145	107	F1CE3481N (F30DTE)		04/10-	DG-195		11V					4
3.0 HDi 160	116	F1CE0481D (F30DT)		04/06-	DG-195		11V					4
3.0 HDi 175	130	F1CE3481E (F30DTE)		03/11-	DG-195		11V					4
EXPERT (96-06)												
1.6	58	222A2 (1580 SPI)		02/96-09/00	Q22PR-U	3010	0.8	-	-		VQ22	4
1.8	74	LFZ (XU7JP)		10/96-09/00	K16HPR-U11	6076	1.1	KH16TT	IKH16TT	IKH16TT		4
1.9 D	51	D9B (XUD9AU)		02/96-12/98	DG-001		11V					4
1.9 D	51	WJY (DW8B); WJZ (DW8)		06/98-12/06	DG-003		11V					4
1.9 D 70	51	WJY (DW8B); WJZ (DW8)		12/98-12/06	DG-003		11V					4
1.9 TD	66/68	D8B (XUD9TE); DHX (XUD9TE)		02/96-09/00	DG-001		11V					4
2.0	100	RFN (EW10J4)		07/00-12/06	K16HPR-U11	6076	1.1	KH16TT	IKH16TT	IKH16TT		4
2.0 HDi	69	RHX (DW10BTED)		07/00-12/06	DG-181		11V					4
2.0 HDi	80	RHW (DW10ATED4)	Ch:>RPO 9666	07/00-04/03	DG-116		11V					4
2.0 HDi	80	RHW (DW10ATED4)	Ch:RPO 9667>	04/03-12/06	DG-181		11V					4
2.0 HDi	80	RHZ (DW10ATED)	Ch:> RPO 9666, Double Coi l(LPH)	07/00-04/03	DG-116		11V					4
2.0 HDi	80	RHZ (DW10ATED)	Ch:RPO 9667> ,Double Coi l(LPH)	04/03-12/06	DG-181		11V					4
2.0 HDi	80	RHZ (DW10BTED)	Double Coil(LPH)	07/00-12/06	DG-181		11V					4
2.0 HDi	80	RHZ (DW10CTED)	Double Coil(LPH)	07/00-12/06	DG-603		5V					4
2.0 HDi 16V	80	RHW (DW10ATED4)	Ch:>RPO 9666	07/00-04/03	DG-116		11V					4
2.0 HDi 16V	80	RHW (DW10ATED4)	Ch:RPO 9667>	04/03-12/06	DG-181		11V					4
EXPERT (07-)												
1.6 HDi 90 8V	66	9HH (DV6DUM); 9HM (DV6UC)		01/07-	DG-603		5V					4
1.6 HDi 90 16V	66	9HU (DV6UTED4)		01/07-	DG-180		11V					4
2.0 16V	103	RFH (EW10A); RFJ (EW10A)		01/07-	K16HPR-U11	6076	1.1	KH16TT	IKH16TT	IKH16TT		4
2.0 HDi 100	72	AHY (DW10CE)		03/11-	DG-603		5V					4
2.0 HDi 120	88	RHK (DW10UTED4)		01/07-	DG-181		11V					4
2.0 HDi 120 4x4	88	RHK (DW10UTED4)		01/07-	DG-181		11V					4
2.0 HDi 130	94	AHZ (DW10CD)		03/11-	DG-603		5V					4
2.0 HDi 130 4x4	94	AHZ (DW10CD)		03/11-	DG-603		5V					4
2.0 HDi 140	103	RHR (DW10BTED4)		01/07-	DG-181		11V					4
2.0 HDi 165	120	RHH (DW10CTED4)		09/09-	DG-603		5V					4
EXPERT (16-)												
1.6 BlueHDi 115	85	DV6C; DV6FC		04/16-	DG-603		5V					4
2.0 BlueHDi 120	90	DW10FE		04/16-	DG-603		5V					4
2.0 BlueHDi 180	132	AHW (DW10FC)		04/16-	DG-603		5V					4
J5 (81-90)												
1.8	51	169B (XM7T)		01/83-11/88	Q20PR-U	3007	0.8	Q20TT	IQ20TT	IQ20TT		4

Свечи зажигания и Свечи накаливания

Таблица применения

	KW				СТАНДАРТНЫЕ			Twin Tip			QTY
											
PEUGEOT продолжение											
J5 (81-90) продолжение											
1.8	51	169B (XM7T)	Flexible fuel	01/83-11/88	W20EPR-U	3047	0.8	W20TT	IW20TT	IW20TT	4
1.9 D	51	D9B (XUD9A); XUD9		09/87-08/90	DG-001		11V				4
2.0	55/58	170 (XN1T); 170B (XN1T)		09/81-09/90	Q20PR-U	3007	0.8	Q20TT	IQ20TT	IQ20TT	4
2.0	58	170 (XN1T)	LPG / GPL	01/83-11/88	Q20PR-U	3007	0.8	Q20TT	IQ20TT	IQ20TT	4
2.0	58	XN1P		09/81-08/90	W20EP-U	3043	0.8	W20TT	IW20TT	IW20TT	4
2.5 D	54	CRD93 (U25/661); CRD93	Double Coil(LPH)	09/81-09/90	DG-001		11V				4
2.5 D 4x4	54	CRD93	Double Coil(LPH)	09/81-08/90	DG-001		11V				4
2.5 DT	70	CRD93L; CRD93LS (U25/ 673)	Double Coil(LPH)	09/81-08/90	DG-001		11V				4
2.5 DT AWD	70	CRD93L	Double Coil(LPH)	09/81-08/90	DG-001		11V				4
J5 (90-94)											
1.8	51	169B (XM7T)		09/90-01/94	Q20PR-U	3007	0.8	Q20TT	IQ20TT	IQ20TT	4
1.9 D	51	D9B (XUD9A)		10/90-03/94	DG-001		11V				4
2.0	62	170D (XN1TACP)		10/90-02/94	Q20PR-U	3007	0.8	Q20TT	IQ20TT	IQ20TT	4
2.0	62	170D (XN1TACP); XN1TA		09/90-01/94	W20EP-U	3043	0.8	W20TT	IW20TT	IW20TT	4
2.5 D	54	CRD93 (U25/661); CRD93	Double Coil(LPH)	09/90-02/94	DG-001		11V				4
2.5 D 4x4	54	CRD93 (U25/661)	Double Coil(LPH)	10/90-03/94	DG-001		11V				4
2.5 DT	70	CRD93L	Double Coil(LPH)	09/90-01/94	DG-001		11V				4
2.5 TD	70	CRD93LS (U25/673)	Double Coil(LPH)	10/90-02/94	DG-001		11V				4
2.5 TD 4x4	70	CRD93LS (U25/673)	Double Coil(LPH)	10/90-03/94	DG-001		11V				4
J7 (68-80)											
1.6	44	XC7P		08/68-03/80	W20EP-U	3043	0.8	W20TT	IW20TT	IW20TT	4
1.8	48	XM7P		04/72-03/80	W20EPR-U	3047	0.8	W20TT	IW20TT	IW20TT	4
2.3 D	49	XD2P94		07/77-03/80	DG-001		11V				4
J9 (80-87)											
1.6	44	XC7P		03/80-06/87	W20EP-U	3043	0.8	W20TT	IW20TT	IW20TT	4
2.0	57	XN1P		03/80-06/87	W20EP-U	3043	0.8	W20TT	IW20TT	IW20TT	4
2.1 D	41	XD2PX90	Double Coil(LPH)	03/80-06/87	DG-001		11V				4
2.3 D	49	XD2PX94		03/80-07/82	DG-001		11V				4
2.5 D	53	XD3P	Double Coil(LPH)	07/82-06/87	DG-001		11V				4
PARTNER / RANCH (96-15)											
1.1	44	HDZ (TU1M); HFX (TU1JP)		06/96-09/05	K20TXR	5063	1.0	K20TT	IK20TT	IK20TT	4
1.4	55	KFV (TU3A); KFW (TU3JP)		11/02-10/06	K20PR-U	3145	0.8	K20TT	IK20TT	IK20TT	4
1.4	55	KFW (TU3JP)	Flexible fuel	11/02-10/06	K20PR-U	3145	0.8	K20TT	IK20TT	IK20TT	4
1.4	55	TU32		06/96-12/15	K20TXR	5063	1.0	K20TT	IK20TT	IK20TT	4
1.4	55	TU32		06/96-12/15	Q20PR-U	3007	0.8	Q20TT	IQ20TT	IQ20TT	4
1.4 BiFuel	55	KFW (TU3JP)	Flexible fuel	04/03-10/06	K20PR-U	3145	0.8	K20TT	IK20TT	IK20TT	4
1.6	80	NFU (TU5JP4)		09/00-10/02	K16HPR-U11	6076	1.1	KH16TT	IKH16TT	IKH16TT	4
1.6 16V	80	NFU (TU5JP4)		07/01-03/08	K16HPR-U11	6076	1.1	KH16TT	IKH16TT	IKH16TT	4
1.6 HDi / BlueHDi 75	55	9HW (DV6BTED4)	Ch:> RPO 10783, M4 Thread	08/05-05/06	DG-113		11V				4
1.6 HDi / BlueHDi 75	55	9HW (DV6BTED4)	Ch:RPO 10784> ,Pin	05/06-07/08	DG-180		11V				4
1.6 HDi 90	66	9HX (DV6ATED4)	Ch:> ORP 10783, M4 Thread	08/05-05/06	DG-113		11V				4
1.6 HDi 90	66	9HX (DV6ATED4)	Ch:ORP 10784> ,Pin	05/06-12/15	DG-180		11V				4
1.8	66	LFX (XU7JB)		05/97-08/00	K20TXR	5063	1.0	K20TT	IK20TT	IK20TT	4
1.8 D	43	A9A (XUD7)		06/96-12/02	DG-001		11V				4
1.9 D	51	DJY (XUD9A)		05/96-12/02	DG-001		11V				4
1.9 D	51	WJY (DW8B); WJZ (DW8)		06/96-12/15	DG-003		11V				4
1.9 D 4x4	51	WJY (DW8B)		04/04-07/11	DG-003		11V				4
2.0 HDI	66	RHY (DW10TD)		02/00-07/08	DG-116		11V				4
2.0 HDi 4x4	66	RHY (DW10TD)		04/04-08/05	DG-116		11V				4

Свечи зажигания и Свечи накаливания

Таблица применения

Таблица применения

KW	KW	KW	KW	KW	СТАНДАРТНЫЕ			Twin Tip		QTY	
					STANDARD	STANDARD	STANDARD	TWIN TIP	TWIN TIP		
PEUGEOT продолжение											
PARTNER / RANCH (08-)											
1.6	66/80	NFR (TU5JP4B); NFU (TU5JP4)		04/08-	K16HPR-U11	6076	1.1	KH16TT	IKH16TT	IKH16TT	4
1.6	72/88	5FK (EP6CB); 5FS (EP6C)	Use narrow 16mm Hex socket	04/10-	VXUH22I	5656	0.9	-	IXUH22TT	VXUH22I	4
1.6 BlueHdi 100	73	BHY (DV6FD)		12/14-	DG-603		5V				4
1.6 BlueHdi 120	88	BHZ (DV6FC)		12/14-	DG-603		5V				4
1.6 Hdi	55/80	9HT (DV6BTED4); 9HT (DV6BUTED4); 9HW (DV6BTED4); 9HZ (DV6TED4)		04/08-	DG-180		11V				4
1.6 Hdi	66/ 82/84	9HF (DV6DTED); 9HL (DV6C)		08/10-	DG-603		5V				4
1.6 Hdi / BlueHdi 75	55	9HK (DV6ETEDM); 9HN (DV6ETED); BHW (DV6FE)		06/08-	DG-603		5V				4
1.6 Hdi 16V	66	9HS (DV6TED4BU); 9HV (DV6TED4B); 9HV (DV6TED4BU); 9HX (DV6ATED4); 9HX (DV6AUTED4)		04/08-	DG-180		11V				4
1.6 Hdi 16V 4x4	66	9HS (DV6TED4BU); 9HX (DV6ATED4); 9HX (DV6AUTED4)		04/12-	DG-180		11V				4
1.6 Hdi 90	66	9HJ (DV6DTEDM); 9HP (DV6DTED)		04/10-	DG-603		5V				4
1.6 VTi	66/80	NFR (TU5JP4B); NFU (TU5JP4)		04/08-	K16HPR-U11	6076	1.1	KH16TT	IKH16TT	IKH16TT	4
1.6 VTi	72/88	5FK (EP6CB); 5FS (EP6C)	Use narrow 16mm Hex socket	09/09-	VXUH22I	5656	0.9	-	IXUH22TT	VXUH22I	4
RCZ (10-)											
1.6 16V	115/ 147	5FV (EP6CDT); EP6CDTX	Use narrow 16mm Hex socket	03/10-12/15	VXUH22I	5656	0.9	-	IXUH22TT	VXUH22I	4
2.0 Hdi	120	RHH (DW10CTED4)		03/10-12/15	DG-603		5V				4
TRAVELLER (16-)											
1.6 BlueHdi 115	85	DV6C; DV6FC		04/16-	DG-603		5V				4
2.0 BlueHdi 180	132	AHW (DW10FC)		04/16-	DG-603		5V				4
PGO											
CEVENNES (06-)											
1.6	135	N14 B16 A	Use narrow 16mm Hex socket	01/06-	VXUH22I	5656	0.9	-	IXUH22TT	VXUH22I	4
HAMERA (08-)											
1.6	135	N14 B16 A	Use narrow 16mm Hex socket	05/08-	VXUH22I	5656	0.9	-	IXUH22TT	VXUH22I	4
SPEEDSTER (10-)											
1.6	135	N14 B16 A	Use narrow 16mm Hex socket	01/10-	VXUH22I	5656	0.9	-	IXUH22TT	VXUH22I	4
PIAGGIO											
PORTER (93-)											
1.0	33/35	CB41; CB42		02/93-	W20EPR-U	3047	0.8	W20TT	IW20TT	IW20TT	3
1.2 D	26	LDW1204	Double Coil(LPH)	05/95-	DG-001		11V				4
1.3 16V	48	HC-EL		06/98-	K20TNR-S	3196	1.0	K20TT	IK20TT	IK20TT	4
1.3 16V 4x4	48	HC-EL		06/98-	K20TNR-S	3196	1.0	K20TT	IK20TT	IK20TT	4
1.3 i 16V	48			05/98-	K20TNR-S	3196	1.0	K20TT	IK20TT	IK20TT	4
1.3 i 16V 4x4	48			05/98-	K20TNR-S	3196	1.0	K20TT	IK20TT	IK20TT	4
1.3 LPG	48	HC-EL		06/98-	K20TNR-S	3196	1.0	K20TT	IK20TT	IK20TT	4
PININFARINA											
SPIDEREUROPA (82-85)											
2000	76	132C3.031		03/82-11/85	W20EPR-U	3047	0.8	W20TT	IW20TT	IW20TT	4
2000 Volumex	99	232R14		06/83-11/85	W20EPR-U	3047	0.8	W20TT	IW20TT	IW20TT	4
PLYMOUTH											
BREEZE (95-01)											
2.0 16V	98	ECB		12/95-04/01	K20PR-U	3145	0.8	K20TT	IK20TT	IK20TT	4
2.4 16V	103/ 112	EDZ		12/95-04/01	K16R-U11	3120	1.1	K16TT	IK16TT	IK16TT	4
NEON I (94-99)											
2.0	98	ECB		10/94-09/99	K20PR-U	3145	0.8	K20TT	IK20TT	IK20TT	4
2.0 16V	98	ECB		05/94-08/99	K20PR-U	3145	0.8	K20TT	IK20TT	IK20TT	4

Свечи зажигания и Свечи накаливания

Таблица применения











	KW				СТАНДАРТНЫЕ			Twin Tip			QTY
											
PLYMOUTH продолжение											
NEON II (99-06)											
2.0 16V	98	ECB		08/99-12/06	K20PR-U	3145	0.8	K20TT	IK20TT	IK20TT	4
SUNDANCE (86-94)											
3.0 Duster	104	EFA		10/91-09/94	W16EPR-U	3021	0.8	W16TT	IW16TT	IW16TT	6
VOYAGER (89-95)											
3.3 LE	112	EGA		10/89-09/90	W16EXR-U13	3213	1.3	W16TT	IW16TT	IW16TT	6
VOYAGER (95-01)											
3.0	112	EFA		01/95-03/01	W16EPR-U	3021	0.8	W16TT	IW16TT	IW16TT	6
3.3 FlexFuel	116	EGM		01/98-03/01	P16R13	3239	1.3	W20TT	IW20TT	IW20TT	6
3.3 i	116	EGM		01/95-03/01	P16R13	3239	1.3	W20TT	IW20TT	IW20TT	6
3.8 i	122/ 131	EGH		01/95-03/01	W16EXR-U11	3032	1.1	W16TT	IW16TT	IW16TT	6
3.8 i AWD	122/ 131	EGH		01/95-03/01	W16EXR-U11	3032	1.1	W16TT	IW16TT	IW16TT	6
PONTIAC											
BONNEVILLE (86-99)											
3.8 V6	123	LN3		09/86-12/91	T16EPR-U	5022	0.8	T16TT	IT16TT	IT16TT	6
FIREBIRD (81-92)											
5.0	112	LG4		12/81-10/89	T16PR-U11	5026	1.1	-	ITF16TT	ITF16TT	8
5.0	127	E-TBI		09/87-12/89	T16PR-U	5025	0.9	-	ITF16TT	ITF16TT	8
FIREBIRD (92-02)											
3.4	119	L32		11/92-12/95	T20PR-U	5035	0.9	-	ITF20TT	ITF20TT	6
MONTANA (98-05)											
3.4	138	LA1		04/98-08/05	T16EPR-U15	5023	1.5	T16TT	IT16TT	IT16TT	6
TRANS SPORT (89-97)											
2.3	101/ 108	LGO		01/93-03/97	Q20PR-U	3007	0.8	Q20TT	IQ20TT	IQ20TT	4
3.1	90	LG6		07/89-03/97	T16PR-U11	5026	1.1	-	ITF16TT	ITF16TT	6
3.8	112/ 123/ 127	L27		07/89-03/97	T20EPR-U15	5033	1.5				6
TRANS SPORT (97-99)											
3.4	137	LA1		09/98-12/99	PT16EPR-L13	5070	1.3	-	IT16TT	IT16TT	6
PORSCHE											
356 (50-68)											
1100	29	369		01/50-12/55	W22FS-U	4025	0.7	-	-		4
1300	32	506/1; 506/2; 506		01/50-12/55	W22FS-U	4025	0.7	-	-		4
1300 S	44	589/2; 589		01/50-12/55	W22FS-U	4025	0.7	-	-		4
1500	40/44	527; 528; 546/2; 546		01/50-12/55	W22FS-U	4025	0.7	-	-		4
1500 S	51	528/2; 528		01/50-12/55	W22FS-U	4025	0.7	-	-		4
A 1500 GS Carrera	73/81	547/1	Twin Spark	01/55-12/61	W24ES-U	4030	0.8	-	-		8
A 1600	44	616/1		01/55-12/59	W22FS-U	4025	0.7	-	-		4
A 1600 GS Carrera	77/85	692/2	Twin Spark	01/55-12/61	W24ES-U	4030	0.8	-	-		8
A 1600 S	55	616.15		01/55-12/59	W22FS-U	4025	0.7	-	-		4
A 1600 Super	55	616.15		01/55-12/59	W22FS-U	4025	0.7	-	-		4
B 1600	44	616/1		09/59-08/63	W22FP-U	4021	0.7	-	-		4
B 1600 Super 75	55	616.15		01/59-12/63	W22FP-U	4021	0.7	-	-		4
B 1600 Super 90	66	616/7		01/59-12/63	W22FP-U	4021	0.7	-	-		4
B 2000 GS Carrera 2	96/ 103	587/1	Twin Spark	01/59-12/64	W24ES-U	4030	0.8	-	-		8
C 1600	55	616.15		01/63-12/65	W22FS-U	4025	0.7	-	-		4
C 1600 SC	70	616/16		01/63-12/65	W22FS-U	4025	0.7	-	-		4
C 2000 GS Carrera 2	96/ 103	587/1	Twin Spark	01/61-03/68	W24ES-U	4030	0.8	-	-		8
911 (901, 911) (63-79)											
2.0 E	103	901.09; 901.11		09/68-02/72	IW27	5317	0.7	-	-		6
2.0 L	96/ 110	901.01; 901.05; 901.06; 901.07; 901.14; 901.17		01/63-12/68	W24EP-U	4028	0.8	-	-		6
2.0 S	118/ 125	901.02; 901.08; 901.10		07/66-02/72	IW27	5317	0.7	-	-		6
2.0 T	81	901.03; 901.13		06/67-12/68	W22EP-U	3085	0.8	W22TT	-	VW22	6
2.0 T	81	901.03; 901.13		08/68-02/72	IW24	5316	0.7	-	-		6
2.2 E	114	911.01; 911.04		09/69-02/72	IW24	5316	0.7	-	-		6
2.2 S	132	911.02		09/69-02/72	IW24	5316	0.7	-	-		6
2.2 T	92	911.03; 911.06; 911.07; 911.08		01/70-12/72	IW24	5316	0.7	-	-		6
2.3 E	121	911.52; 911.62		08/71-12/73	W27ES-U	4046	0.7	-	-		6
2.3 S	140	911.53; 911.63		08/71-08/73	W27ES-U	4046	0.7	-	-		6





Таблица применения

P

Свечи зажигания и Свечи накаливания

Таблица применения

Таблица применения

	KW				СТАНДАРТНЫЕ			Twin Tip				QTY
PORSCHE продолжение												
911 (901, 911) (63-79) продолжение												
2.3 T	96/103	911.51; 911.57; 911.61; 911.67; 911.91; 911.96		08/71-12/73	IW22	5307	0.8	-	-	WV22		6
2.7	110/121	911.41; 911.43; 911.46; 911.48; 911.81; 911.82; 911.84; 911.85; 911.86; 911.89; 911.90; 911.92; 911.94; 911.97; 911.99		09/73-06/77	IW22	5307	0.8	-	-	WV22		6
2.7 S	129	911.42; 911.47; 911.93; 911.98		08/73-01/76	IW22	5307	0.8	-	-	WV22		6
2.7 S Carrera	129	911.42; 911.47; 911.93; 911.98		08/73-01/76	W27ES-U	4046	0.7	-	-			6
2.7 SC Carrera RS	154	911.83		08/72-01/79	W27ES-U	4046	0.7	-	-			6
911 (930) (75-90)												
3.0 SC	150	930.10		08/80-07/83	W27ES-U	4046	0.7	-	-			6
3.0 SC Carrera	132/138/147/154	930.02; 930.03; 930.09; 930.12; 930.13; 930.19		03/74-10/83	W27ES-U	4046	0.7	-	-			6
3.0 Turbo	174/191	930.50/ 930.52		01/75-12/77	IW27	5317	0.7	-	-			6
3.2	160	930.25		08/86-08/89	W20EPR-U	3047	0.8	W20TT	IW20TT	IW20TT		6
3.2 Carrera Speedster	160	930.25		08/86-08/89	W20EPR-U	3047	0.8	W20TT	IW20TT	IW20TT		6
3.2 Carrera Speedster	170	930.20		08/86-08/89	W24ESR-U	4033	0.8	-	-			6
3.2 SC Carrera	152	930.21		02/84-08/89	W20EPR-U	3047	0.8	W20TT	IW20TT	IW20TT		6
3.2 SC Carrera	170	930.20; 930.26		08/83-08/89	W24ESR-U	4033	0.8	-	-			6
3.3 SC Turbo	221	930.60; 930.66		09/77-06/87	IW27	5317	0.7	-	-			6
3.3 Turbo	221/243	930.60; 930.66		06/86-11/90	IW27	5317	0.7	-	-			6
911 (964) (88-94)												
3.3 Turbo	235	M 30.69		08/90-09/93	IW24	5316	0.7	-	-			6
3.3 Turbo S	261	M 30.69S		06/91-12/92	IW24	5316	0.7	-	-			6
3.6 Carrera	184	M 64.01; M 64.02	Twin Spark	12/88-06/94	K22PBR-S	5062	0.85	-	IKB22TT	VK22		12
3.6 Carrera 4	184	M 64.01	Twin Spark	12/88-05/94	K22PBR-S	5062	0.85	-	IKB22TT	VK22		12
3.6 Carrera RS	191	M 64.03	Twin Spark	06/91-09/93	K22PBR-S	5062	0.85	-	IKB22TT	VK22		12
3.6 Turbo	265	M 64.50		01/93-09/93	K22TNR-S	3197	1.0	-	-	VK22		6
911 (991) (11-)												
3.8 Turbo	383/397	MA1.71; MDA.BA		09/13-	VKH22	5619	0.8	-	-	VKH22		6
3.8 Turbo S	412/427/446	MA1.71; MDB.CA		09/13-	VKH22	5619	0.8	-	-	VKH22		6
911 (993) (93-97)												
3.6 Carrera	200/210	M 64.05; M 64.06; M 64.07; M 64.08; M 64.21; M 64.22; M 64.23; M 64.24	Twin Spark	10/93-09/97	K22PBR-S	5062	0.85	-	IKB22TT	VK22		12
3.6 Carrera 4	200/210	M 64.05; M 64.07; M 64.21; M 64.23	Twin Spark	07/94-09/97	K22PBR-S	5062	0.85	-	IKB22TT	VK22		12
3.6 Turbo 4	300	M 64.60		03/95-09/97	K22TNR-S	3197	1.0	-	-	VK22		6
3.6 Turbo GT2	316	M 64.60R		03/95-09/97	K22TNR-S	3197	1.0	-	-	VK22		6
3.6 Turbo GT2 4	316/331	M 64.60R; M 64.60RS		08/95-09/97	K22TNR-S	3197	1.0	-	-	VK22		6
3.8 Carrera	210/221	M 64.05S; M 64.06S; M 64.21S	Twin Spark	06/95-09/97	K22PBR-S	5062	0.85	-	IKB22TT	VK22		12
3.8 Carrera 4	210/221	M 64.05S; M 64.06S; M 64.21S	Twin Spark	06/95-09/97	K22PBR-S	5062	0.85	-	IKB22TT	VK22		12
3.8 Carrera RS	221	M 64.20	Twin Spark	06/95-09/97	K22PBR-S	5062	0.85	-	IKB22TT	VK22		12
911 (996) (97-05)												
3.4 Carrera	221/235	M 96.01; M 96.02; M 96.04		09/97-08/05	K20PBR-S10	5061	1.0	K20TT	IK20TT	IK20TT		6
3.4 Carrera 4	221/235	M 96.01; M 96.02; M 96.04		09/97-08/05	K20PBR-S10	5061	1.0	K20TT	IK20TT	IK20TT		6
3.6	235	M 96.03		12/01-08/05	IK22	5310	0.8	-	IK22TT	VK22		6
3.6 Carrera	235	M 96.03		10/01-08/05	IK22	5310	0.8	-	IK22TT	VK22		6
3.6 Carrera 4	235	M 96.03		10/01-08/05	IK22	5310	0.8	-	IK22TT	VK22		6
3.6 Carrera 4S	254	M 96.03		06/02-08/05	IK22	5310	0.8	-	IK22TT	VK22		6
3.6 Carrera S	254	M 96.03		06/02-08/05	IK22	5310	0.8	-	IK22TT	VK22		6

Свечи зажигания и Свечи накаливания

Таблица применения











	KW				СТАНДАРТНЫЕ				Twin Tip		QTY
											
PORSCHE продолжение											
911 (996) (97-05) продолжение											
3.6 GT2	340/ 355	M 96.70		04/01-08/05	K22TNR-S	3197	1.0	-	-	VK22	6
3.6 GT3	265/ 280	M 96.76; M 96.79		03/99-08/05	K22TNR-S	3197	1.0	-	-	VK22	6
3.6 GT3	280	M 96.79		01/04-08/05	XU22EPR-U	3179	0.9	XU22TT	IXU22TT	VXU22	6
3.6 S	331	M 96.70		08/04-08/05	K22TNR-S	3197	1.0	-	-	VK22	6
3.6 Turbo 4	309	M 96.70		06/00-08/05	K22TNR-S	3197	1.0	-	-	VK22	6
3.6 Turbo 4S	331	M 96.70		02/03-08/05	K22TNR-S	3197	1.0	-	-	VK22	6
911 (997) (04-12)											
3.6 Carrera	235/ 239	M 96.05		07/04-12/08	IK22	5310	0.8	-	IK22TT	VK22	6
3.6 Carrera 4	239	M 96.05		07/04-12/08	IK22	5310	0.8	-	IK22TT	VK22	6
3.6 GT 2	390	M 97.70S		09/07-12/12	PK20R11	3128	1.1	K20TT	IK20TT	IK20TT	6
3.6 GT2 RS	456	M 97.70		05/10-12/12	PK20R11	3128	1.1	K20TT	IK20TT	IK20TT	6
3.6 GT3	305	M 97.76		03/06-12/09	XU22EPR-U	3179	0.9	XU22TT	IXU22TT	VXU22	6
3.6 S	331	M 97.70		08/04-12/12	PK20R11	3128	1.1	K20TT	IK20TT	IK20TT	6
3.6 Turbo	353	M 97.70		03/06-12/09	PK20R11	3128	1.1	K20TT	IK20TT	IK20TT	6
3.8 Carrera 4S	261/ 264/ 280	M 97.01; M 97.01S		07/04-12/10	IK22	5310	0.8	-	IK22TT	VK22	6
3.8 Carrera S	261/ 280	M 97.01; M 97.01S		07/04-12/08	IK22	5310	0.8	-	IK22TT	VK22	6
3.8 GT3	320	M 97.77		05/09-12/11	XU22EPR-U	3179	0.9	XU22TT	IXU22TT	VXU22	6
3.8 GT3 RS	331	M 97.77R		08/09-12/11	XU22EPR-U	3179	0.9	XU22TT	IXU22TT	VXU22	6
3.8 Turbo	368	MA1.70		09/09-12/12	VKH22	5619	0.8	-	-	VKH22	6
3.8 Turbo S	390	MA1.70		02/10-12/12	VKH22	5619	0.8	-	-	VKH22	6
4.0 GT3 RS	368	M 97.74		07/11-12/12	XU22EPR-U	3179	0.9	XU22TT	IXU22TT	VXU22	6
912 (65-70)											
1.6	66	616.36; 616.39; 616.40		01/65-02/70	W22FS-U	4025	0.7	-	-		4
914 (69-76)											
1.7	59	W		01/69-12/73	W20ES-U	3051	0.8	-	-		4
1.8	56/63	AN; EC		08/73-02/76	W20ES-U	3051	0.8	-	-		4
2.0	70/74	GA; GB		01/72-12/75	W20ES-U	3051	0.8	-	-		4
2.0 /6	81	901.36; 901.37		11/69-12/73	W22EP-U	3085	0.8	W22TT	-	VW22	6
924 (75-89)											
2.0	92	XJ; XK		11/75-08/89	W22EPR-U	3088	0.8	W22TT	-	VW22	4
2.0 Carrera GT	154	M 31.50		06/80-10/86	IW24	5316	0.7	-	-		4
2.0 Turbo	125/ 130	M 31.01; M 31.03		11/78-10/86	IW24	5316	0.7	-	-		4
2.5 S	110/ 118	M 44.07; M 44.08; M 44.09; M 44.10		09/85-07/88	W20EPR-U	3047	0.8	W20TT	IW20TT	IW20TT	4
928 (77-95)											
4.5	177	M 28.01; M 28.02; M 28.09; M 28.10		09/77-08/82	W16EP-U	3018	0.8	W16TT	IW16TT	IW16TT	8
4.7 S	221/ 228	M 28.11; M 28.12; M 28.21; M 28.22		09/79-07/86	W20EPR-U	3047	0.8	W20TT	IW20TT	IW20TT	8
5.0 GT	243	M 28.47		01/89-07/91	W20EPR-U	3047	0.8	W20TT	IW20TT	IW20TT	8
5.0 S	212	M 28.45; M 28.46		09/85-12/86	W20EPR-U	3047	0.8	W20TT	IW20TT	IW20TT	8
5.0 S,S4	235	M 28.41; M 28.42		08/86-07/91	W20EPR-U	3047	0.8	W20TT	IW20TT	IW20TT	8
5.0 S4 Cat	235	M 28.41; M 28.42		08/86-07/91	W20EPR-U	3047	0.8	W20TT	IW20TT	IW20TT	8
5.4 GTS	257	M 28.49; M 28.50		08/91-11/95	W20EPR-U11	3049	1.1	W20TT	IW20TT	IW20TT	8
944 (81-91)											
2.5	110/ 118/ 120	M 44.01; M 44.02; M 44.03; M 44.04; M 44.05; M 44.06; M 44.07; M 44.08; M 44.09; M 44.10		06/81-12/90	W20EPR-U	3047	0.8	W20TT	IW20TT	IW20TT	4
2.5 S	140	M 44.40		08/86-07/88	W20EPR-U	3047	0.8	W20TT	IW20TT	IW20TT	4
2.5 Turbo	162/ 184	M 44.50; M 44.51; M 44.52		08/85-07/91	W20EPR-U	3047	0.8	W20TT	IW20TT	IW20TT	4
2.5 Turbo	162/ 184	M44.12		08/85-07/91	W22EPR-U	3088	0.8	W22TT	-	VW22	4
2.7	121	M 44.11; M 44.12		11/88-08/89	W20EPR-U	3047	0.8	W20TT	IW20TT	IW20TT	4
2.7	121	M44.12		11/88-08/89	W22EPR-U	3088	0.8	W22TT	-	VW22	4
3.0 S2	155	M 44.41		12/88-07/91	W22EPR-U	3088	0.8	W22TT	-	VW22	4
959 (86-91)											
2.8	330	959.50		01/86-04/91	X24ESR-U	4101	0.7	-	-		6











Таблица применения

P

Свечи зажигания и Свечи накаливания











Таблица применения

Таблица применения

	KW				СТАНДАРТНЫЕ			Twin Tip			QTY
											
PORSCHE продолжение											
968 (91-95)											
3.0	176	M 44.43		06/91-11/95	W20EPBR-S	5067	0.85	W20TT	IW20TT	IW20TT	4
3.0	176	M 44.43; M 44.44		06/91-11/95	W20EPR-U11	3049	1.1	W20TT	IW20TT	IW20TT	4
3.0 Turbo S	224			03/93-11/95	W20EPR-U11	3049	1.1	W20TT	IW20TT	IW20TT	4
BOXSTER (981) (12-)											
2.7	195	MA1.22		04/12-	IKH22	5345	0.8	-	-	VKH22	6
3.4 GTS	243	MA1.23		02/14-	IKH22	5345	0.8	-	-	VKH22	6
3.4 S	232	MA1.23		04/12-	IKH22	5345	0.8	-	-	VKH22	6
3.8	276	MDB.XA		07/15-	IKH22	5345	0.8	-	-	VKH22	6
BOXSTER (986) (96-04)											
2.5	150	M 96.20		09/96-08/99	K20TNR	3304	1.0	K20TT	IK20TT	IK20TT	6
2.7	155/ 162/ 168	M 96.22/ M 96.23		06/99-12/04	K20PBR-S10	5061	1.0	K20TT	IK20TT	IK20TT	6
3.2 S	185/ 191/ 196	M 96.21; M 96.24		08/99-12/04	K20PBR-S10	5061	1.0	K20TT	IK20TT	IK20TT	6
BOXSTER (987) (04-11)											
2.7	176/ 180	M 96.25; M 97.20		11/04-12/09	IK22	5310	0.8	-	IK22TT	VK22	6
2.9	188	MA1.20		06/09-03/12	IKH22	5345	0.8	-	-	VKH22	6
3.2 S	206	M 96.26		11/04-12/06	IK22	5310	0.8	-	IK22TT	VK22	6
3.4	235	MA1.21		06/10-12/11	IKH22	5345	0.8	-	-	VKH22	6
3.4 RS 60	223	M 97.22		09/07-12/08	IK22	5310	0.8	-	IK22TT	VK22	6
3.4 S	217/ 223	M 97.21; M 97.22		07/06-12/09	IK22	5310	0.8	-	IK22TT	VK22	6
3.4 S	228	MA1.21		06/09-12/11	IKH22	5345	0.8	-	-	VKH22	6
CARRERA GT (03-06)											
5.7	450	M 80.01		07/03-12/06	IK24	5311	0.8	-	-		10
CAYENNE (92A) (10-)											
3.0 Diesel	155/ 176/ 180/ 184/ 193	M 05.9E; MCN.RB; MCR.C; MCR.CA; MCR.CB; MCV.VA; MCV.VB; MCV.VC		06/10-	DG-193		4.4V				6
3.0 S E-Hybrid	245/ 306	M 06.EC; MCG.E; MCG.EA; MCG.FA		06/10-	VK22	5610	0.8	-	IK22TT	VK22	6
3.6 GTS	324	MCX.ZA		02/15-	VKH22	5619	0.8	-	-	VKH22	6
3.6 S	309	MCU.RA		10/14-	VKH22	5619	0.8	-	-	VKH22	6
4.2 S Diesel	281/ 283	MCU.DB; MCU.DC		10/12-	DG-193		4.4V				8
4.8 GTS	309	M 48.02		06/12-	IKH22	5345	0.8	-	-	VKH22	8
4.8 S	294	M 48.02		06/10-	IKH22	5345	0.8	-	-	VKH22	8
4.8 Turbo	368/ 382/ 397	M 48.52; MCF.TB		06/10-	VKH22	5619	0.8	-	-	VKH22	8
4.8 Turbo S	405/ 419	M 48.52; MCV.XA		10/12-	VKH22	5619	0.8	-	-	VKH22	8
CAYENNE (955) (02-10)											
3.0 TDI	176	M 05.9D		02/09-09/10	DG-193		4.4V				6
3.6	213	M 55.01		02/07-09/10	VXUHC22G	5652	0.8	-	-	VXUHC22G	6
4.5 S	250	M 48.00		09/02-09/07	K20PBR-S10	5061	1.0	K20TT	IK20TT	IK20TT	8
4.5 Turbo	331	M 48.50		09/02-09/07	VK22	5610	0.8	-	IK22TT	VK22	8
4.5 Turbo S	368/ 383	M 48.50S; M 48.50T		01/04-09/07	VK22	5610	0.8	-	IK22TT	VK22	8
4.8 GTS	298	M 48.01		10/07-09/10	IKH22	5345	0.8	-	-	VKH22	8
4.8 S	283	M 48.01		02/07-09/10	IKH22	5345	0.8	-	-	VKH22	8
4.8 Turbo S	368/ 397/ 404	M 48.51		02/07-09/10	VKH22	5619	0.8	-	-	VKH22	8
CAYMAN (981) (13-)											
2.7	202	MA1.22		03/13-	IKH22	5345	0.8	-	-	VKH22	6
3.4 GTS	250	MA1.23		02/14-	IKH22	5345	0.8	-	-	VKH22	6
3.4 S	239	MA1.23		03/13-	IKH22	5345	0.8	-	-	VKH22	6
3.8 GT4	283	MDB.XA		01/15-	IKH22	5345	0.8	-	-	VKH22	6
CAYMAN (987) (05-12)											
2.7	180	M 97.20		07/06-12/09	IK22	5310	0.8	-	IK22TT	VK22	6
2.9	195	MA1.20		02/09-12/12	IKH22	5345	0.8	-	-	VKH22	6
3.4 R	243	MA1.21		11/10-12/12	IKH22	5345	0.8	-	-	VKH22	6
3.4 S	217	M 97.21		11/05-12/09	IK22	5310	0.8	-	IK22TT	VK22	6
3.4 S	235	MA1.21		02/09-06/13	IKH22	5345	0.8	-	-	VKH22	6
3.4 S Sport	223	M 97.22		08/08-12/12	IK22	5310	0.8	-	IK22TT	VK22	6

Свечи зажигания и Свечи накаливания

Таблица применения

	KW				СТАНДАРТНЫЕ				Twin Tip		QTY
											
PORSCHE продолжение											
MACAN (14-)											
3.0 GTS	265	MDC.NA		10/15-09/18	VKH22	5619	0.8	-	-	VKH22	6
3.0 S	250	MCT.MA		02/14-09/18	VKH22	5619	0.8	-	-	VKH22	6
3.0 S Diesel	155/ 184/ 190	MCT.BA; MCT.BB; MCT.BC		02/14-09/18	DG-193		4.4V				6
3.6 Turbo	294/ 324	MCT.LA; MDH.KA		02/14-	VKH22	5619	0.8	-	-	VKH22	6
PANAMERA (970) (09-)											
3.0 4S	309	MCW.DA		07/13-10/16	VKH22	5619	0.8	-	-	VKH22	6
3.0 D	155/ 184/ 221	MCR.CB; MCR.CC; MCW.JA		08/11-10/16	DG-193		4.4V				6
3.0 S	309	MCW.DA		07/13-10/16	VKH22	5619	0.8	-	-	VKH22	6
3.0 S E-Hybrid	245/ 279/ 306	MCG.EA; MCG.FA		03/11-10/16	VK22	5610	0.8	-	IK22TT	VK22	6
3.6	220/ 228	M 46.20; MCW.AA		05/10-10/16	IKH22	5345	0.8	-	-	VKH22	6
3.6 4	220/ 228	M 46.40; MCW.AA		05/10-10/16	IKH22	5345	0.8	-	-	VKH22	6
4.8 4S	294	M 48.40		09/09-07/13	IKH22	5345	0.8	-	-	VKH22	8
4.8 GTS	316/ 324	M 48.40; MCX.PA		01/12-10/16	IKH22	5345	0.8	-	-	VKH22	8
4.8 S	294	M 48.20		09/09-07/13	IKH22	5345	0.8	-	-	VKH22	8
4.8 Turbo	368/ 382/ 397	M 48.70; MCW.BA		09/09-10/16	VKH22	5619	0.8	-	-	VKH22	8
4.8 Turbo S	404/ 419	M 48.70; MCW.CA		05/11-10/16	VKH22	5619	0.8	-	-	VKH22	8
PROTON											
AEROBACK (88-96)											
1.3	50/55	4 G 13		10/88-12/02	W20EPR-U	3047	0.8	W20TT	IW20TT	IW20TT	4
1.5	55	4 G 15		01/91-09/93	W20EPR-U	3047	0.8	W20TT	IW20TT	IW20TT	4
1.5	66			01/91-11/96	IW16TT	4708	1.0	-	IW16TT		4
1.5 LX	66	4 G 15 M		10/88-11/96	IW16TT	4708	1.0	-	IW16TT		4
GEN 2 (04-)											
1.3 (CM3L)	70	S4PE		06/04-12/09	T20EPR-U	5032	0.8	T20TT	IT20TT	IT20TT	4
1.6 (CM6L)	82	S4PH		06/04-	T20EPR-U	5032	0.8	T20TT	IT20TT	IT20TT	4
IMPIAN (01-)											
1.6 (CF1S)	76	4 G 18 P		09/01-06/07	K20PR-U11	3121	1.1	K20TT	IK20TT	IK20TT	4
JUMBUCK (02-)											
1.5 (C97PN)	64	4 G 15		05/02-12/08	W16EPR-U	3021	0.8	W16TT	IW16TT	IW16TT	4
PERSONA 300 (96-04)											
313i	55	G 13 B		03/96-01/00	W20EPR-U	3047	0.8	W20TT	IW20TT	IW20TT	4
315 GLi/GLSi	66	4 G 15 M		03/96-07/00	IW20TT	4709	1.0	-	IW20TT		4
315 GLSi	64	G 15 B		09/96-07/00	W20EPR-U	3047	0.8	W20TT	IW20TT	IW20TT	4
316	70	4 G 92		03/96-07/04	K20PR-U11	3121	1.1	K20TT	IK20TT	IK20TT	4
316 GLXi	83	4 G 92		03/96-07/00	K20PR-U11	3121	1.1	K20TT	IK20TT	IK20TT	4
318 16V GTI	99	4 G 93		03/96-07/00	IK20TT	4702	1.0	-	IK20TT	IK20TT	4
PERSONA 400 (94-03)											
413	55	4G13- P		01/94-06/03	W16EPR-U11	3201	1.1	W16TT	IW16TT	IW16TT	4
413 GLSi	55	4 G 13		01/94-01/00	W16EPR-U11	3201	1.1	W16TT	IW16TT	IW16TT	4
415 GLi/GLSi	66	4 G 15		01/94-07/00	W20EPR-U11	3049	1.1	W20TT	IW20TT	IW20TT	4
416	70	4 G 92		08/00-02/02	K20PR-U11	3121	1.1	K20TT	IK20TT	IK20TT	4
416 GLXi	83	4 G 92		01/94-07/00	K20PR-U11	3121	1.1	K20TT	IK20TT	IK20TT	4
416 i	70	4 G 92		12/95-07/00	K20PR-U11	3121	1.1	K20TT	IK20TT	IK20TT	4
418	85	4 G 93 (DOHC)		05/96-07/00	K20PR-U11	3121	1.1	K20TT	IK20TT	IK20TT	4
418 GLXi	85	4 G 93 (DOHC)		05/96-07/00	K20PR-U11	3121	1.1	K20TT	IK20TT	IK20TT	4
420 GLS D	48	4 D 68	Ceramic(LPH)	05/96-04/99	DG-301		11V				4
SALOON (91-96)											
1.3	50	4 G 13		01/91-09/93	W20EPR-U	3047	0.8	W20TT	IW20TT	IW20TT	4
1.5	66			01/91-11/96	W20EPR-U	3047	0.8	W20TT	IW20TT	IW20TT	4
SATRIA (96-06)											
1.5 (C97M)	64	4 G 15		07/00-05/06	W16EPR-U	3021	0.8	W16TT	IW16TT	IW16TT	4
WIRA (00-)											
1.3	55	4 G 13		08/00-	W16EPR-U	3021	0.8	W16TT	IW16TT	IW16TT	4
1.5	64	4 G 15		08/00-	W16EPR-U	3021	0.8	W16TT	IW16TT	IW16TT	4
1.6	70	4 G 92		08/00-02/02	K20PR-U11	3121	1.1	K20TT	IK20TT	IK20TT	4

Свечи зажигания и Свечи накаливания





Таблица применения

Таблица применения

KW	KW	KW	NOTE	21	СТАНДАРТНЫЕ			Twin Tip			QTY
					W20EP-U	3043	0.8	W20TT	IW20TT	IW20TT	
PUCH											
G-MODELL (W460) (79-92)											
230 G (460.230, 460.231)	75	M 115.973		03/79-08/85	W20EP-U	3043	0.8	W20TT	IW20TT	IW20TT	4
230 GE (460.238, 460.239)	92	M 102.981; M 102.987		03/79-12/91	T20EP-U	5031	0.8	T20TT	IT20TT	IT20TT	4
240 GD (460.330, 460.331)	53	OM 616.936; OM 616.938	Double Coil Std(LPH)	03/79-09/87	DG-001		11V				4
250 GD (460.337, 460.338)	62	OM 602.930	Double Coil(LPH)	10/87-12/91	DG-010		11.5V				5
280 GE (460.232, 460.233)	110	M 110.994		01/86-12/91	W20EP-U	3043	0.8	W20TT	IW20TT	IW20TT	6
300 GD (460.332, 460.333)	65	OM 617.931; OM 617.932	Double Coil Std(LPH)	09/79-12/91	DG-001		11V				5
G-MODELL (W461) (91-00)											
290 GD (461.338, 461.337)	70	OM 602.942; OM 602.947	Double Coil(LPH)	10/91-12/97	DG-010		11.5V				5
290 GD Turbodiesel (461.335, 461.336)	88	OM 602.983	Double Coil(LPH)	04/97-12/01	DG-010		11.5V				5
G-MODELL (W463) (89-00)											
230 GE (463.224, 463.225)	93	M 102.989		07/89-08/93	T20EP-U	5031	0.8	T20TT	IT20TT	IT20TT	4
300 GD (463.327, 463.328)	83	OM 603.931		06/89-08/93	DG-001		11V				6
300 GE (463.227, 463.228)	125	M 103.987		06/89-08/93	T20EP-U	5031	0.8	T20TT	IT20TT	IT20TT	6
350 GD Turbo (463.320, 463.321)	100	OM 603.972	Double Coil(LPH)	08/91-08/93	DG-001		11V				6
G 36 AMG (463.230, 463.231)	200	M 104.952 (AMG 3.6)		01/95-04/98	K16PR-U	3191	0.8	K16TT	IK16TT	IK16TT	6
G 55 AMG (463.240, 463.241)	260	M 113.982		04/99-03/01	PK16PR-L11	3275	1.1	-	IK16TT	IK16TT	16
G 300 Turbodiesel (463.330, 463.331)	130	OM 606.964		01/96-11/00	DG-106		11.5V				6
G 320 (463.230, 463.231)	155	M 104.996		02/94-12/97	K16PR-U	3191	0.8	K16TT	IK16TT	IK16TT	6
G 500 (463.240, 463.241)	218	M 113.962		12/97-11/00	PK16PR-L11	3275	1.1	-	IK16TT	IK16TT	16
RAM											
1500 (DS) (10-)											
3.0 TD 4WD	179	EXF	OE:68211173A A	09/13-	DG-620		7V				6
3.6 4WD	227		Check Thread size	09/14-	ITV20TT	4719	1.0	-	ITV20TT		6
3.6 4WD	227		Check Thread size	09/14-	SXU22HCR11S	3461	1.1	-	-	VXUHC22G	6
5.7	295	EZH	Twin Spark	09/12-	K16HPR-U11	6076	1.1	KH16TT	IKH16TT	IKH16TT	16
5.7 4WD	291/ 295	EZH	Twin Spark	09/10-	K16HPR-U11	6076	1.1	KH16TT	IKH16TT	IKH16TT	16
2500 (DJ) (10-)											
5.7 4WD	286	EZC	Twin Spark	09/10-	K16HPR-U11	6076	1.1	KH16TT	IKH16TT	IKH16TT	16
5.7 CNG 4WD	286	EZF	Twin Spark	09/13-	K16HPR-U11	6076	1.1	KH16TT	IKH16TT	IKH16TT	16
RANGER											
REKORD (72-78)											
1700	61	17 S		02/72-12/78	W20FPR-U	3070	0.7	WF20TT	-		4
1900	71	19 SH		02/72-12/78	W20FPR-U	3070	0.7	WF20TT	-		4
2500	85	25 S		02/72-12/78	W20FPR-U	3070	0.7	WF20TT	-		6
2500 GTS	96	25 H		02/72-12/78	W20FPR-U	3070	0.7	WF20TT	-		6
RELIANT											
KITTEN (75-83)											
850	30			01/75-12/83	W16EPR-U	3021	0.8	W16TT	IW16TT	IW16TT	4
SCIMITAR (68-90)											
2.8 GTC	99			01/80-12/85	IW20TT	4709	1.0	-	IW20TT		6
1300	51			01/85-12/87	Q20PR-U	3007	0.8	Q20TT	IQ20TT	IQ20TT	4
1800 Ti	99	CA18ET		01/86-08/90	Q20PR-U11	3008	1.1	Q20TT	IQ20TT	IQ20TT	4
SCIMITAR Sabre (92-95)											
1800 Ti	99	CA18ET		01/92-08/94	Q20PR-U11	3008	1.1	Q20TT	IQ20TT	IQ20TT	4
RENAULT											
4 (62-93)											
0.8	19/ 21/25	800 705; 800.7.05/ B1B.7.07; 800.7.05; 800; 839.7.06; B1B.7.07		10/62-06/86	W20EPR-U	3047	0.8	W20TT	IW20TT	IW20TT	4
1.0	25	C1C 708		06/87-01/92	W20EPR-U	3047	0.8	W20TT	IW20TT	IW20TT	4





Свечи зажигания и Свечи накаливания

Таблица применения

	KW				СТАНДАРТНЫЕ			Twin Tip			QTY
RENAULT продолжение											
4 (62-93) продолжение											
1.1	25/33	688 712; 688.7.11/ C1E.7.14/ C1E.7.18; 688.7.12/ C1E.7.14/ C1E.7.18, C1E.7.19; C1E.7.18/C1E.7.19		10/76-06/90	W20EPR-U	3047	0.8	W20TT	IW20TT	IW20TT	4
1.1	25/33	C1E 714		10/76-06/90	W16FP-U	4019	0.7	-	-		4
5 (72-85)											
0.8	26	800 710; 800.7.02/ 800.7.10; 800.7.02/ 800.7.10/ 839.7.01		10/72-12/84	W20EPR-U	3047	0.8	W20TT	IW20TT	IW20TT	4
1.0	32	689 710		01/72-12/85	W20EPR-U	3047	0.8	W20TT	IW20TT	IW20TT	4
1.1	33	688.7.13/ C1E.7.26; 688.7.13		09/80-12/85	W20EPR-U	3047	0.8	W20TT	IW20TT	IW20TT	4
1.3	32/47	810.7.19/ 810.7.29; 810.7.25; 810.7.26		09/75-09/84	W20EPR-U	3047	0.8	W20TT	IW20TT	IW20TT	4
1.3 Automatik	40	810.7.29		06/79-09/84	W20EPR-U	3047	0.8	W20TT	IW20TT	IW20TT	4
1.4	46	847 725		01/82-12/85	W20EP-U	3043	0.8	W20TT	IW20TT	IW20TT	4
1.4	46	847.7.12/C2J.7.13		01/82-12/85	W20EPR-U	3047	0.8	W20TT	IW20TT	IW20TT	4
1.4	81	840.26/C6J.7.50		06/84-01/85	IT27	5329	0.8	-	-		4
1.4 Alpine A5	68	840.25		09/77-09/81	T20EPR-U	5032	0.8	T20TT	IT20TT	IT20TT	4
1.4 Alpine Turbo	79	840.26/C6J.7.28/ C6J.7.50		10/81-01/85	IT27	5329	0.8	-	-		4
1.4 Automatik	43	847.7.12/C2J.7.13		06/82-09/84	W20EPR-U	3047	0.8	W20TT	IW20TT	IW20TT	4
6 (69-87)											
0.8	25	800.02		10/69-04/80	W20EPR-U	3047	0.8	W20TT	IW20TT	IW20TT	4
1.1	33/35	688.10		08/70-04/80	W20EPR-U	3047	0.8	W20TT	IW20TT	IW20TT	4
8 (62-72)											
1.1	33	688.01		11/62-10/72	W20EPR-U	3047	0.8	W20TT	IW20TT	IW20TT	4
9 (81-89)											
1.1	35	C1E.7.15		09/81-05/87	W20EPR-U	3047	0.8	W20TT	IW20TT	IW20TT	4
1.2	40	C1G.7.00/C1G.7.10		09/85-12/88	W20EPR-U	3047	0.8	W20TT	IW20TT	IW20TT	4
1.4	44/ 49/53	C1J 715/ C2J 730; C2J.7.17/ C2J.7.20/ C2J.7.66, C2J.7.68, C2J.7.94, C2J.7.95, C2J.7.97; C2J.7.17/ C2J.7.56/ C2J.7.66		09/81-12/88	W20EPR-U	3047	0.8	W20TT	IW20TT	IW20TT	4
1.4 Automatik	50	C2J.7.17/C2J.7.18/ C2J.7.57, C2J.7.67		09/81-12/85	W20EPR-U	3047	0.8	W20TT	IW20TT	IW20TT	4
1.4 Turbo	77/85	C1J 760; C1J 764; C1J 770		04/84-09/88	IW24	5316	0.7	-	-		4
1.6 D	40	F8M 700; F8M 720; F8M 730	Double Coil(LPH)	10/82-12/88	DG-001		11V				4
1.7	55/59	F2N.7.00/ F2N.7.04; F2N.7.30		09/84-12/89	W24EPR-U	4136	0.8	-	-		4
1.7	55/59	F2N.7.97; F3N 718		10/86-12/89	W20EPR-U	3047	0.8	W20TT	IW20TT	IW20TT	4
1.7	65/69	F2N 710; F3N 708		10/86-12/88	W22EP-U	3085	0.8	W22TT	-	VW22	4
10 (66-72)											
1.1	33	688.01		05/66-10/72	W20EPR-U	3047	0.8	W20TT	IW20TT	IW20TT	4
11 (83-88)											
1.1	35	C1E 715		03/83-06/86	W20EPR-U	3047	0.8	W20TT	IW20TT	IW20TT	4
1.2	40	C1G 700		10/84-12/88	W20EPR-U	3047	0.8	W20TT	IW20TT	IW20TT	4
1.4	44	C1J 715		03/83-12/88	W16EPR-U	3021	0.8	W16TT	IW16TT	IW16TT	4
1.4	50/53	C2J 717; C2J 768; C2J.7.17/ C2J.7.18		03/83-12/88	W20EPR-U	3047	0.8	W20TT	IW20TT	IW20TT	4
1.4 Turbo	77/85	C1J.7.60/ C1J.7.64; C1J.7.70		04/84-12/88	IW24	5316	0.7	-	-		4
1.6 D	40	F8M 700; F8M 720; F8M 730	Double Coil(LPH)	08/83-12/88	DG-001		11V				4

Свечи зажигания и Свечи накаливания

Таблица применения

	KW				СТАНДАРТНЫЕ			Twin Tip			QTY
RENAULT продолжение											
11 (83-88) продолжение											
1.7	55	F2N.7.17/ F2N.7.30; F3N 718		10/84-12/88	W20EPR-U	3047	0.8	W20TT	IW20TT	IW20TT	4
1.7	59/ 65/69	F2N 704; F2N 708; F2N 742; F3N 708		10/83-12/88	W22EP-U	3085	0.8	W22TT	-	VW22	4
12 (69-84)											
1.3	37	810-02		07/75-04/80	W20EPR-U	3047	0.8	W20TT	IW20TT	IW20TT	4
1.3	40	810-02/97		08/75-07/77	W20EP-U	3043	0.8	W20TT	IW20TT	IW20TT	4
1.3	40/44	810.05; 810.06; 810-02/97		10/70-08/80	W20FP-U	3068	0.7	WF20TT	-		4
1.3 TS	44	810-06		08/72-08/80	W20EPR-U	3047	0.8	W20TT	IW20TT	IW20TT	4
1.4	49	C1J 791		08/76-08/80	W20EP-U	3043	0.8	W20TT	IW20TT	IW20TT	4
1.6	50	821.10; 821.11		08/70-08/76	W20EP-U	3043	0.8	W20TT	IW20TT	IW20TT	4
1.6	75			08/70-08/76	W27ES-V	4047	0.6	-	-		4
1.6 Gordini	83	807.20; 821.20		08/70-12/74	W27ES-V	4047	0.6	-	-		4
12 (83-95)											
1.4	53	C1J 791		04/83-12/89	W20EP-U	3043	0.8	W20TT	IW20TT	IW20TT	4
12 Toros (89-00)											
1.4	53	C1J 791		04/89-10/00	W20EP-U	3043	0.8	W20TT	IW20TT	IW20TT	4
14 (76-83)											
1.2	43	129		05/76-12/83	T20EPR-U	5032	0.8	T20TT	IT20TT	IT20TT	4
1.4	44/52	150; X5J		09/79-12/83	T20EPR-U	5032	0.8	T20TT	IT20TT	IT20TT	4
16 (65-80)											
1.5	40	697.01		09/65-10/75	W16EPR-U	3021	0.8	W16TT	IW16TT	IW16TT	4
1.6 TA	52			01/69-08/80	W20EPR-U	3047	0.8	W20TT	IW20TT	IW20TT	4
1.6 TL	40/48	821.02/821.03; 821		01/71-08/80	W20EPR-U	3047	0.8	W20TT	IW20TT	IW20TT	4
1.6 TS	61	807; 807.04; 807.05		09/68-08/80	W20EPR-U	3047	0.8	W20TT	IW20TT	IW20TT	4
1.6 TX	68	843.01		06/74-08/80	W20EPR-U	3047	0.8	W20TT	IW20TT	IW20TT	4
17 (72-80)											
1.6 Gordini	79	843.13		09/75-10/80	W24EPR-U	4136	0.8	-	-		4
18 (78-93)											
1.4	47	847 720		04/78-07/86	W20EP-U	3043	0.8	W20TT	IW20TT	IW20TT	4
1.6	52/58	841.7.17/ 841.7.18/ 841.7.26, A2M.7.95; A2M.7.23/ A2M.7.95; A2M.7.23		04/78-11/93	W20EPR-U	3047	0.8	W20TT	IW20TT	IW20TT	4
1.6	54	A2M 723		01/82-07/86	W20EP-U	3043	0.8	W20TT	IW20TT	IW20TT	4
1.6 4x4	54	A2M 723		01/83-07/86	W20EP-U	3043	0.8	W20TT	IW20TT	IW20TT	4
1.6 TS	71	A6M 725		05/82-07/86	W20EP-U	3043	0.8	W20TT	IW20TT	IW20TT	4
1.6 Turbo	80/92	A5L.7.17/ A7L.7.52; A5L.7.17		10/80-07/86	IW24	5316	0.7	-	-		4
1.6 Turbo Inj.	82	A7L.7.52		09/82-07/86	IW24	5316	0.7	-	-		4
2.0	77	J6R.7.11/ J6R.7.14/ J6R.7.15, J6R.7.16; J6R.7.11/ J6R.7.14/ J6R.7.16		10/81-07/86	T20EPR-U	5032	0.8	T20TT	IT20TT	IT20TT	4
2.0 4x4	76	J6R.7.14/J6R.7.16		05/83-12/86	T20EPR-U	5032	0.8	T20TT	IT20TT	IT20TT	4
2.1 Diesel	49/53	852 710; J8S 711	Double Coil(LPH)	05/79-07/86	DG-001		11V				4
2.1 TD	65	J8S 712	Double Coil(LPH)	11/81-07/86	DG-001		11V				4
19 I (88-92)											
1.2	40	C1G 730		01/88-12/92	W16EP-U	3018	0.8	W16TT	IW16TT	IW16TT	4
1.4	43	C2J 772		01/89-05/93	W16EP-U	3018	0.8	W16TT	IW16TT	IW16TT	4
1.4	43	C3J 710		07/88-04/92	W16EPR-U	3021	0.8	W16TT	IW16TT	IW16TT	4
1.4	55/58	E6J 700; E7J 700		01/88-12/92	Q20P-U	3125	0.8	Q20TT	IQ20TT	IQ20TT	4
1.4 Cat	43	C3J 710		01/89-04/92	W16EPR-U	3021	0.8	W16TT	IW16TT	IW16TT	4
1.7	54	F2N 724; F3N 740		09/88-04/92	W20EPR-U	3047	0.8	W20TT	IW20TT	IW20TT	4
1.7	66/ 69/79	F2N 720; F2N 721; F3N 742; F3N 746		07/88-12/92	W22EPR-U	3088	0.8	W22TT	-	VW22	4
1.7	69	F2N 720		09/88-04/92	W24EPR-U	4136	0.8	-	-		4
1.8 16V	99/ 101	F7P 700; F7P 704		06/89-04/92	K20PBR-S10	5061	1.0	K20TT	IK20TT	IK20TT	4
1.8 16V	101	F7P 700		06/89-08/90	PT16VR13	5068	1.3	TV16TT	ITV16TT	ITV16TT	4

Свечи зажигания и Свечи накаливания

Таблица применения











	KW				СТАНДАРТНЫЕ			Twin Tip			QTY
											
RENAULT продолжение											
19 I (88-92) продолжение											
1.9 D	47	F8Q 706; F8Q 742	Double Coil(LPH)	01/88-12/92	DG-001		11V				4
1.9 DT	68	F8Q.7.40	Double Coil(LPH)	09/90-04/92	DG-012		11V				4
1.9 TD	68	F8Q 740	Double Coil(LPH)	09/90-04/92	DG-012		11V				4
19 II (92-01)											
1.2	40	C1G 730		03/92-12/95	W16EP-U	3018	0.8	W16TT	IW16TT	IW16TT	4
1.2	44	E7F 730		05/92-09/94	Q16P-U11	3254	1.1	Q16TT	IQ16TT	IQ16TT	4
1.4	43	C1J.7.42		05/92-09/94	W14EPR-U	6011	0.8	-	IW16TT	IW16TT	4
1.4	43	C3J 710		04/92-12/95	W16EPR-U	3021	0.8	W16TT	IW16TT	IW16TT	4
1.4	55	E7J 742		11/93-12/95	Q16P-U11	3254	1.1	Q16TT	IQ16TT	IQ16TT	4
1.4	55/ 57/60	E6J 700; E7J 742		01/92-12/95	Q20P-U	3125	0.8	Q20TT	IQ20TT	IQ20TT	4
1.4	60	E7J.7.00/E7J.7.07		10/94-11/95	K20PR-U	3145	0.8	K20TT	IK20TT	IK20TT	4
1.7	55	F3N 740		04/92-12/95	W20EPR-U	3047	0.8	W20TT	IW20TT	IW20TT	4
1.7	66/79	F3N 742; F3N 743; F3N 746		04/92-12/95	W22EPR-U	3088	0.8	W22TT	-	VW22	4
1.7	69	F2N 720		01/93-08/95	W22EP-U	3085	0.8	W22TT	-	VW22	4
1.8	66	F3P 760		04/92-06/96	IW20TT	4709	1.0	-	IW20TT		4
1.8	66	F3P 760; F3P 765		04/92-09/94	W20EP-U	3043	0.8	W20TT	IW20TT	IW20TT	4
1.8	66/ 79/81	F3P 682; F3P 700; F3P 704; F3P.7.06/ F3P.7.07		04/92-06/96	W20EPR-U	3047	0.8	W20TT	IW20TT	IW20TT	4
1.8 16V	99	F7P 704		04/92-12/95	K20PBR	5060	0.85	K20TT	IK20TT	IK20TT	4
1.8 16V	99/ 101	F7P 704		04/92-06/96	K20PBR-S10	5061	1.0	K20TT	IK20TT	IK20TT	4
1.9 D	47	F8Q 706; F8Q 742	Double Coil(LPH)	03/92-12/95	DG-001		11V				4
1.9 D	68	F8Q 740; F8Q 744	Double Coil(LPH)	05/92-11/95	DG-012		11V				4
1.9 dT	66/68	F8Q 740; F8Q 744	Double Coil(LPH)	03/92-12/95	DG-012		11V				4
20 (75-83)											
1.6	66/71	843.20/843.21		10/75-12/81	W20EPR-U	3047	0.8	W20TT	IW20TT	IW20TT	4
2.0	76/80	829.00/829.01; 829.02/829.03		10/77-12/83	T20EPR-U	5032	0.8	T20TT	IT20TT	IT20TT	4
2.1 Diesel	47	852	Double Coil(LPH)	10/80-12/83	DG-001		11V				4
2.1 TD	63	J8S 702	Double Coil(LPH)	01/82-12/83	DG-001		11V				4
2.2	85	851.00/851.01		10/80-12/83	T20EPR-U	5032	0.8	T20TT	IT20TT	IT20TT	4
21 (86-95)											
1.4	51	C2J.7.17/ C2J.7.70/ C2L.7.14, C2L.7.17; C2J.7.70/C2L.7.17		06/88-10/93	W20EPR-U	3047	0.8	W20TT	IW20TT	IW20TT	4
1.7	55/65	F2N 752; F3N 726		06/87-10/92	W20EPR-U	3047	0.8	W20TT	IW20TT	IW20TT	4
1.7	55/ 65/69	F2N 710; F2N 712; F2N 750; F3N 722		03/86-04/95	W22EP-U	3085	0.8	W22TT	-	VW22	4
1.7	65	F2N 752; F2N.7.11/ F2N.7.58		06/87-05/93	W24EPR-U	4136	0.8	-	-		4
1.7 Cat	54	F3N 726		09/89-06/93	W20EPR-U	3047	0.8	W20TT	IW20TT	IW20TT	4
1.9 D	47	F8Q 710	Double Coil(LPH)	03/86-08/94	DG-001		11V				4
2.0	75/85	J6R 758; J6R 759; J6R 792; J7R 750; J7R.7.50/ J7R.7.51		03/86-10/93	T22EP-U	5040	0.8	-	-		4
2.0	78/88	J6R 758; J7R 746		03/86-12/93	T20EP-U	5031	0.8	T20TT	IT20TT	IT20TT	4
2.0	99	J7R 740		02/90-06/94	K20PBR	5060	0.85	K20TT	IK20TT	IK20TT	4
2.0 4x4	88	J7R 746		03/89-12/93	T20EP-U	5031	0.8	T20TT	IT20TT	IT20TT	4
2.0 4x4	99	J7R 740		12/89-02/94	K20PBR	5060	0.85	K20TT	IK20TT	IK20TT	4
2.0 Turbo	119	J7R 756		02/90-10/92	IT22	5327	0.8	-	-		4
2.0 Turbo	129	J7R 752		04/87-03/90	T22EP-U	5040	0.8	-	-		4
2.0 Turbo 4x4	119	J7R 756		02/90-10/92	IT22	5327	0.8	-	-		4
2.0 Turbo 4x4	129	J7R 752		08/89-10/93	T22EP-U	5040	0.8	-	-		4
2.0 TXi	100	J7R 740		07/89-05/93	K20PBR	5060	0.85	K20TT	IK20TT	IK20TT	4
2.1 D	48/ 51/53	J8S 600; J8S 704; J8S 740; J8S 784	Double Coil(LPH)	03/86-09/95	DG-001		11V				4











Таблица применения

R

Свечи зажигания и Свечи накаливания

Таблица применения

Таблица применения

	KW				СТАНДАРТНЫЕ				Twin Tip			QTY
												
RENAULT продолжение												
21 (86-95) продолжение												
2.1 D 4x4	48	J8S 704	Double Coil(LPH)	10/88-05/92	DG-001		11V					4
2.1 TD	50	J8S 704	Double Coil(LPH)	04/86-06/89	DG-001		11V					4
2.1 Turbo-D	65	J8S 714; J8S 786; J8S 788	Double Coil(LPH)	03/86-06/94	DG-001		11V					4
2.2	79/81	J7R.7.50/ J7R.7.51; J7T 755		04/86-06/94	T22EP-U	5040	0.8	-	-			4
2.2 4x4	79	J7T 754; J7T 755		06/86-12/93	T22EP-U	5040	0.8	-	-			4
25 (84-93)												
2.0	74	J6R 706; J6R 707; J6R 760; J6R 762; J6R 763		04/84-12/92	T20EPR-U	5032	0.8	T20TT	IT20TT	IT20TT		4
2.0	88	J7R 722		03/87-12/93	T22EP-U	5040	0.8	-	-			4
2.0 12V	99/103	J7R 721; J7R 726		06/88-12/93	K20PBR	5060	0.85	K20TT	IK20TT	IK20TT		4
2.1 Diesel	46/51	J8S 706; J8S 736	Double Coil(LPH)	04/84-12/92	DG-001		11V					4
2.1 Turbo-D FWD	63	J8S 708; J8S 738	Double Coil(LPH)	04/84-12/92	DG-001		11V					4
2.2	76	J7T.7.08		11/85-08/86	T20EPR-U	5032	0.8	T20TT	IT20TT	IT20TT		4
2.2	76/79/89/91	J7T 706; J7T 731; J7T 732; J7T.7.32		04/84-12/92	T22EP-U	5040	0.8	-	-			4
2.4 V6 Turbo	133	Z7U 702		10/84-05/90	T22EP-U	5040	0.8	-	-			6
2.5 V6 Turbo	151	Z7U 700		01/90-12/92	T22EP-U	5040	0.8	-	-			6
2.7 V6 Injection	104	Z7V 708; Z7V 709; Z7V 711		04/84-08/89	T20EPR-U	5032	0.8	T20TT	IT20TT	IT20TT		6
2.8 V6	115	Z7W 700		06/87-02/90	T22EP-U	5040	0.8	-	-			6
2.8 V6 Injection	110	Z7W 706; Z7W 707; Z7W 709		06/87-12/92	T22EP-U	5040	0.8	-	-			6
30 (75-86)												
2.1 Turbo-D	63	J8S 702	Double Coil(LPH)	02/82-03/86	DG-001		11V					4
2.6 TS	94	144		07/78-01/82	T20EPR-U	5032	0.8	T20TT	IT20TT	IT20TT		6
2.6 TX	105	140		10/78-12/83	T20EPR-U	5032	0.8	T20TT	IT20TT	IT20TT		6
AVANTIME (01-03)												
2.0 16V Turbo	120	F4R 760; F4R 761		11/01-05/03	PK20PR-P8	3245	0.8	-	IK20TT	IK20TT		4
2.2 dCi	110	G9T 712	Double Coil(LPH)	05/02-05/03	DG-126		11V					4
3.0 V6	152	L7X.7.20		09/01-05/03	PK20PR-L11	3142	1.1	-	IK20TT	IK20TT		6
3.0 V6	152	L7X.7.21		09/01-05/03	IKH16TT	4703	1.0	-	IKH16TT			6
CAPTUR (13-)												
1.5 dCi 90	66	K9K 608; K9K 609; K9K 628; K9K 629; K9K 838	Instant heating (ISS)	06/13-	DG-609		4.4V					4
CLIO I (90-98)												
1.1	34	C1E 700		01/91-09/98	W16EPR-U	3021	0.8	W16TT	IW16TT	IW16TT		4
1.1	36	C1E.7.00		04/92-08/92	W14EPR-U	6011	0.8	-	IW16TT	IW16TT		4
1.2	40	C3G 720		06/94-02/98	W16EPR-U	3021	0.8	W16TT	IW16TT	IW16TT		4
1.2	40/43	D7F 730; E5F 710; E7F 700; E7F 706		05/90-09/98	Q16PR-U	3137	0.8	Q16TT	IQ16TT	IQ16TT		4
1.2	43	E7F.7.00/E7F.7.04		01/91-02/96	Q16R-U	3129	0.8	Q16TT	IQ16TT	IQ16TT		4
1.4	55/58	E7J 710; E7J 718; E7J 757		01/91-09/98	Q16PR-U	3137	0.8	Q16TT	IQ16TT	IQ16TT		4
1.4	58	E6J 712; E6J 713; E6J 760		05/90-02/98	K20PR-U	3145	0.8	K20TT	IK20TT	IK20TT		4
1.7	68	F2N 770		01/91-12/93	W22EPR-U	3088	0.8	W22TT	-	VW22		4
1.8	66	F3P 754		08/94-09/98	W20EP-U	3043	0.8	W20TT	IW20TT	IW20TT		4
1.8	66/70	F3P 710		01/91-09/98	W20EPR-U	3047	0.8	W20TT	IW20TT	IW20TT		4
1.8 16V	99	F7P 722		01/91-03/96	K20PBR-S10	5061	1.0	K20TT	IK20TT	IK20TT		4
1.8 Rsi	79	F3P 712		01/93-08/95	W20EPR-U	3047	0.8	W20TT	IW20TT	IW20TT		4
1.8 Rsi	79	F3P 758		08/95-09/98	W22EP-U	3085	0.8	W22TT	-	VW22		4
1.9 D	40/47	F8Q 678; F8Q 730; F8Q 732	Double Coil(LPH)	01/91-09/98	DG-001		11V					4
1.9 D	47	F8Q 676	Double Coil(LPH)	05/96-02/98	DG-009		11V					4
1.9 RND	40	F8Q 678	Double Coil(LPH)	04/96-02/98	DG-001		11V					4
2.0 Williams	108	F7R 700		01/94-09/98	K20BR-S10	3330	1.0	K20TT	IK20TT	IK20TT		4
CLIO II (98-)												
1.0	40	CG10DE		02/00-05/01	KH16TT	4605	1.0	KH16TT	IKH16TT	IKH16TT		4

Свечи зажигания и Свечи накаливания

Таблица применения





	KW				СТАНДАРТНЫЕ			Twin Tip				QTY
RENAULT продолжение												
CLIO II (98-) продолжение												
1.2	43	D7F 710; D7F 720; D7F 722; D7F 726; D7F 746; D7F 764; D7F 766		09/98-	K20TXR	5063	1.0	K20TT	IK20TT	IK20TT		4
1.2 16V	55	D4F 712		06/01-	XE20HR-U9	3427	0.9	-	IXEH20TT	IXEH20TT		4
1.2 LPG	43	D7F 722; D7F 764; D7F 766		09/98-10/07	K20TXR	5063	1.0	K20TT	IK20TT	IK20TT		4
1.4	55	E7J 634; E7J 635; E7J 780; K7J 700		09/98-05/05	K20TXR	5063	1.0	K20TT	IK20TT	IK20TT		4
1.4 16V	70	K4J 712; K4J 713		10/99-09/04	K20TXR	5063	1.0	K20TT	IK20TT	IK20TT		4
1.4 16V	72	K4J 710		02/00-07/08	K20PR-U	3145	0.8	K20TT	IK20TT	IK20TT		4
1.5 dCi	42/ 48/ 50/ 59/ 62/74	K9K 700; K9K 702; K9K 704; K9K 712; K9K 714; K9K 716; K9K 718; K9K 740	Double Coil(LPH)	06/01-	DG-005		11V					4
1.6	66	K7M 744; K7M 745; K7M 746		09/98-05/05	K20TXR	5063	1.0	K20TT	IK20TT	IK20TT		4
1.6	79/81	K4M 740; K4M 746; K4M 748		11/03-	K20PR-U	3145	0.8	K20TT	IK20TT	IK20TT		4
1.6 16V	79	K4M 708; K4M 740; K4M 742; K4M 743; K4M 744; K4M 745; K4M 748		09/98-	K20PR-U	3145	0.8	K20TT	IK20TT	IK20TT		4
1.6 16V	79	K4M 708; K4M 740; K4M 742; K4M 743; K4M 744; K4M 745; K4M 748		09/98-	K20TXR	5063	1.0	K20TT	IK20TT	IK20TT		4
1.6 Flex	81	K4M 740; K4M 748		05/00-12/06	K20PR-U	3145	0.8	K20TT	IK20TT	IK20TT		4
1.6 Hi-Flex	86	K4M 748		01/05-02/10	K20PR-U	3145	0.8	K20TT	IK20TT	IK20TT		4
1.9 D	40/47	F8Q 662; F8Q.630	Double Coil(LPH)	09/98-05/05	DG-008		11V					4
1.9 D	47	F8Q 630; F8Q 632	Double Coil(LPH)	02/00-05/01	DG-112		11V					4
1.9 DTi	59	F9Q 780; F9Q 782	Double Coil(LPH)	12/99-05/05	DG-005		11V					4
2.0 16V Sport	124/ 132	F4R 730; F4R 736; F4R 738		02/00-	PK20PR11	3168	1.1	K20TT	IK20TT	IK20TT		4
3.0 V6 Sport	166/ 187	L7X 760; L7X 762		11/00-05/05	IKH20TT	4704	1.0	-	IKH20TT			6
CLIO III (05-)												
1.2	57	D4F 764		10/05-	XE20HR-U9	3427	0.9	-	IXEH20TT	IXEH20TT		4
1.2 16V	43/ 48/ 55/58	D4F 706; D4F 740; D4F 764		06/05-	XE20HR-U9	3427	0.9	-	IXEH20TT	IXEH20TT		4
1.2 16V Hi-Flex	55	D4F 740		07/08-04/09	XE20HR-U9	3427	0.9	-	IXEH20TT	IXEH20TT		4
1.2 16V Hi-Flex	55	D4F 740	Flexible fuel	07/08-	XE20HR-U9	3427	0.9	-	IXEH20TT	IXEH20TT		4
1.2 Ethanol	55	D4F 742		07/08-	XE20HR-U9	3427	0.9	-	IXEH20TT	IXEH20TT		4
1.4 16V	72	K4J 780		06/05-	K20PR-U	3145	0.8	K20TT	IK20TT	IK20TT		4
1.5 dCi	47/ 50/ 60/ 63/ 76/78	K9K 714; K9K 750; K9K 752; K9K 764; K9K 766; K9K 768; K9K 772; K9K 774	Double Coil(LPH)	05/05-	DG-005		11V					4
1.5 dCi	55/65	K9K 766; K9K 770; K9K 772	Instant heating (ISS)	08/10-	DG-609		4.4V					4
1.6 16V	65/ 80/82	K4M 800; K4M 801; K4M 804		06/05-	K20PR-U	3145	0.8	K20TT	IK20TT	IK20TT		4
1.6 16V	94	K4M 862		11/08-	VK22	5610	0.8	-	IK22TT	VK22		4
1.6 16V GT	94	K4M 862		06/09-	VK22	5610	0.8	-	IK22TT	VK22		4
2.0 16V	102	M4R 700; M4R 701		09/06-	FXE20HR11	3439	1.1	-	IXEH20TT	IXEH20TT		4
2.0 16V Sport	145/ 148	F4R 830; F4R 832		02/06-	VK22	5610	0.8	-	IK22TT	VK22		4
CLIO IV (12-)												
1.2 16V	54	D4F 728; D4F 740		11/12-	XE20HR-U9	3427	0.9	-	IXEH20TT	IXEH20TT		4
1.5 dCi	62	K9K 830; K9K 838	OE:820068259 2, Instant He ating (ISS)	11/12-	DG-609		4.4V					4
1.5 dCi 75	55	K9K 612; K9K 628	OE:820068259 2, Instant He ating (ISS)	11/12-	DG-609		4.4V					4











Таблица применения

R

Свечи зажигания и Свечи накаливания

Таблица применения

Таблица применения

	KW				СТАНДАРТНЫЕ			Twin Tip			QTY
											
RENAULT продолжение											
CLIO IV (12-) продолжение											
1.5 dCi 90	66	K9K 608; K9K 628	OE:820068259 2. Instant He ating (ISS)	11/12-	DG-609		4.4V				4
1.5 dCi 110	81	K9K 646	OE:820068259 2. Instant He ating (ISS)	06/16-	DG-609		4.4V				4
DUSTER (09-)											
1.6 16V	75	K4M 616		02/12-	K20PR-U	3145	0.8	K20TT	IK20TT	IK20TT	4
2.0	98	F4R 403; F4R 405		02/12-	K20PR-U	3145	0.8	K20TT	IK20TT	IK20TT	4
2.0 4x4	99	F4R		02/12-	K20PR-U	3145	0.8	K20TT	IK20TT	IK20TT	4
ESPACE I (84-92)											
2.0	74/80	J6R 234; J6R 734		07/84-12/90	T20EP-U	5031	0.8	T20TT	IT20TT	IT20TT	4
2.0 i	87	J7R 760		01/89-12/90	T22EP-U	5040	0.8	-	-	-	4
2.0 i Quadra	87	J7R 760		03/88-12/92	T22EP-U	5040	0.8	-	-	-	4
2.1 TD	65	J8S 240; J8S 774; J8S 776	Double Coil(LPH)	10/84-12/90	DG-001		11V				4
2.2	79	J7T 770		07/86-12/90	T22EP-U	5040	0.8	-	-	-	4
2.2 Quadra	79	J7T 770		01/88-12/90	T22EP-U	5040	0.8	-	-	-	4
ESPACE II (91-96)											
2.0	76	J7R 768		01/91-10/96	T20EP-U	5031	0.8	T20TT	IT20TT	IT20TT	4
2.1 RTDT Quadra	65	J8S 772	Double Coil(LPH)	01/91-05/92	DG-001		11V				4
2.1 TD	66	J8S 610; J8S 612; J8S 772; J8S 776; J8S 778	Double Coil(LPH)	01/91-10/96	DG-001		11V				4
2.2	79	J7T 772		01/91-10/96	T22EP-U	5040	0.8	-	-	-	4
2.2 4x4	79	J7T 772; J7T 773		03/91-12/96	T22EP-U	5040	0.8	-	-	-	4
2.8 V6	110	Z7W 712; Z7W 713; Z7W 717		01/91-10/96	T22EP-U	5040	0.8	-	-	-	6
ESPACE III (96-02)											
1.9 dTi	72	F9Q 722	Double Coil(LPH)	02/99-10/02	DG-005		11V				4
2.0	84	F3R 728		11/96-10/00	W16EPR-U	3021	0.8	W16TT	IW16TT	IW16TT	4
2.0	102	F4R 700; F4R 701		09/01-10/02	K20PR-U	3145	0.8	K20TT	IK20TT	IK20TT	4
2.0 16V	103	F4R 700; F4R 701		10/98-10/02	K20PR-U	3145	0.8	K20TT	IK20TT	IK20TT	4
2.2 12V TD	83	G8T 714; G8T 716; G8T 760	Double Coil(LPH)	11/96-10/00	DG-101		11V				4
2.2 D	84	G8T 716	Double Coil(LPH)	11/97-01/00	DG-101		11V				4
2.2 dCi	85/95	G9T 642; G9T 710	Double Coil(LPH)	07/00-10/02	DG-126		11V				4
3.0	123	Z7X 775		11/96-10/98	K20TXR	5063	1.0	K20TT	IK20TT	IK20TT	6
3.0 V6 24V	140	L7X 727		10/98-10/02	PK20PR11	3168	1.1	K20TT	IK20TT	IK20TT	6
ESPACE IV (02-)											
1.9 dCi	85/88	F9Q 680; F9Q 820; F9Q 826	Double Coil(LPH)	11/02-	DG-005		11V				4
2.0	98/ 100	F4R 790; F4R 792		11/02-	K20PR-U	3145	0.8	K20TT	IK20TT	IK20TT	4
2.0	100/ 125	F4R.7.90/ F4R.7.91/ F4R.7.92; F4R.7.96/F4R.7.97		11/02-	PK20PR-P8	3245	0.8	-	IK20TT	IK20TT	4
2.0	125	F4R 796; F4R 797; F4R 896; F4R 897		04/05-	VK22	5610	0.8	-	IK22TT	VK22	4
2.0 Turbo	120	F4R 794; F4R 795; F4R 796; F4R 797		11/02-	VK22	5610	0.8	-	IK22TT	VK22	4
2.0 Turbo	120	F4R.7.94/F4R.7.95		11/02-02/06	PK20PR-P8	3245	0.8	-	IK20TT	IK20TT	4
2.2 dCi	102/ 110	G9T 645; G9T 742; G9T 743	Double Coil(LPH)	11/02-	DG-126		11V				4
3.0 dCi	130/ 133	P9X 701; P9X 715		11/02-	DG-646		11V				6
3.5 V6	177	V4Y 711; V4Y 715		11/02-	IKH16TT	4703	1.0	-	IKH16TT		6
ESPACE V (15-)											
1.6 dCi 130	96	R9M 409	Without cyl inder press ure sensor, OE:110650819 R	06/15-	DG-631		4.5V				4
1.6 dCi 160	118	R9M 452	Without cyl inder press ure sensor, OE:110650819 R	06/15-	DG-631		4.5V				4
1.6 TCe 200	147	M5M 450		02/15-	VFXHC22G	5659	0.8	-	-	VFXHC22G	4

Свечи зажигания и Свечи накаливания

Таблица применения











	KW				СТАНДАРТНЫЕ			Twin Tip			QTY
											
RENAULT продолжение											
ESTAFETTE (62-81)											
1.1	29	688.01		02/62-12/81	W20EPR-U	3047	0.8	W20TT	IW20TT	IW20TT	4
1.3	29	810.01		08/69-01/80	W20EPR-U	3047	0.8	W20TT	IW20TT	IW20TT	4
EXPRESS (95-99)											
1.9 D	40/47	F8Q 640; F8Q 724; F8Q 776	Double Coil(LPH)	07/95-10/99	DG-001		11V				4
FLUENCE (10-)											
1.5 dCi	63/66/70/78/81	K9K 656; K9K 657; K9K 826; K9K 830; K9K 832; K9K 834; K9K 836; K9K 837	Instant heating (ISS)	02/10-	DG-609		4.4V				4
1.6 16V	78/81	K4M 838; K4M 839		02/10-	K20PR-U	3145	0.8	K20TT	IK20TT	IK20TT	4
1.6 dCi	96	R9M 402	Without cyl inder press ure sensor, OE:110650819 R	07/14-	DG-631		4.5V				4
1.6 LPG 16V	81	K4M 839		01/12-	K20PR-U	3145	0.8	K20TT	IK20TT	IK20TT	4
2.0 16V	103	M4R 714; M4R 751		02/10-	FXE20HR11	3439	1.1	-	IXEH20TT	IXEH20TT	4
FUEGO (80-85)											
1.4 TL/GTL	47	847 720		02/80-10/85	W20EP-U	3043	0.8	W20TT	IW20TT	IW20TT	4
1.4 TL/GTL	47	847.7.20		02/80-10/85	W14EPR-U	6011	0.8	-	IW16TT	IW16TT	4
1.6	52	A2M 723		04/83-10/85	W20EP-U	3043	0.8	W20TT	IW20TT	IW20TT	4
1.6 TS/GTS	71	A6M 725		10/80-10/85	W20EP-U	3043	0.8	W20TT	IW20TT	IW20TT	4
1.6 TS/GTS	71	A6M.1.25/A6M.7.25/A6M.7.26		10/80-10/85	W24EPR-U	4136	0.8	-	-		4
1.6 Turbo	97	A5L.7.50/A7L.23		08/83-10/85	IW24	5316	0.7	-	-		4
2.0 TX/GTX	81	829 710		10/80-10/85	T20EPR-U	5032	0.8	T20TT	IT20TT	IT20TT	4
2.1 TD	65	J8S 712	Double Coil(LPH)	08/82-10/85	DG-001		11V				4
Grand SCÉNIC II (04-)											
1.5 dCi	74/76/78	K9K 728; K9K 732; K9K 734	Double Coil(LPH)	04/04-01/09	DG-005		11V				4
1.6	77/83	K4M 761/ K4M 782/ K4M 812; K4M 788		04/04-11/08	K20PR-U	3145	0.8	K20TT	IK20TT	IK20TT	4
1.6 Flex	82	K4M 766		06/06-06/09	K20PR-U	3145	0.8	K20TT	IK20TT	IK20TT	4
1.9 dCi	81/85/88/96	F9Q 803; F9Q 804; F9Q 812; F9Q 816; F9Q 818; F9Q E 804; F9Q EE 804; F9Q J 803	Double Coil(LPH)	03/04-01/09	DG-005		11V				4
2.0	99/120	F4R 770; F4R 771; F4R 776		04/04-06/09	K20PR-U	3145	0.8	K20TT	IK20TT	IK20TT	4
2.0	120	F4R 776		04/04-06/09	PK20PR-P8	3245	0.8	-	IK20TT	IK20TT	4
Grand SCÉNIC III (09-)											
1.5 dCi	63/70/78/81	K9K 830; K9K 832; K9K 836; K9K 837; K9K 846	Instant heating (ISS)	02/09-	DG-609		4.4V				4
1.6 16V	81	K4M 858		02/09-	K20PR-U	3145	0.8	K20TT	IK20TT	IK20TT	4
1.6 16V Bifuel	79/81	K4M 866		02/09-	K20PR-U	3145	0.8	K20TT	IK20TT	IK20TT	4
1.6 dCi	96	R9M 402; R9M 404; R9M 414	Without cyl inder press ure sensor, OE:110650819 R	04/11-	DG-631		4.5V				4
1.6 E85	81	K4M 866		02/09-	K20PR-U	3145	0.8	K20TT	IK20TT	IK20TT	4
1.9 dCi	96	F9Q 870; F9Q 872	Instant heating (ISS)	02/09-	DG-619		4.4V				4
2.0 16V	103	M4R 711		02/09-	FXE20HR11	3439	1.1	-	IXEH20TT	IXEH20TT	4
2.0 dCi	110/118	M9R 610; M9R 615	Instant heating (ISS)	02/09-	DG-619		4.4V				4
KADJAR (15-)											
1.5 dCi 110	81	K9K 646	OE:OE: 8200682592	06/15-	DG-609		4.4V				4
1.6 dCi 130	96	R9M 414	Without cyl inder press ure sensor, OE:110650819 R	06/15-	DG-631		4.5V				4
1.6 dCi 130 4x4	96	R9M 414	Without cyl inder press ure sensor, OE:110650819 R	06/15-	DG-631		4.5V				4
1.6 TCe 165	120	M5M		11/16-	VFXEHC22G	5659	0.8	-	-	VFXEHC22G	4











Таблица применения

R

Свечи зажигания и Свечи накаливания

Таблица применения

Таблица применения

	KW				СТАНДАРТНЫЕ				Twin Tip		QTY
											
RENAULT продолжение											
KANGOO (97-)											
1.0	50	D4D 700; D4D 720		01/02-01/07	XE20HR-U9	3427	0.9	-	IXEH20TT	IXEH20TT	4
1.2	43	D7F 710; D7F 720; D7F 722; D7F 726; D7F 744; D7F 746; D7F 764; D7F 766		08/97-	K20TXR	5063	1.0	K20TT	IK20TT	IK20TT	4
1.2 16V	55	D4F 712		06/01-	XE20HR-U9	3427	0.9	-	IXEH20TT	IXEH20TT	4
1.2 BiFuel	43	D7F 710; D7F 744		07/98-07/01	XE20HR-U9	3427	0.9	-	IXEH20TT	IXEH20TT	4
1.4	55	E7J 634		08/97-06/08	K20PR-U	3145	0.8	K20TT	IK20TT	IK20TT	4
1.4	55	K7J 700		08/97-	K20TXR	5063	1.0	K20TT	IK20TT	IK20TT	4
1.5 dCi	42/ 45/ 48/ 50/ 60/62	K9K 700; K9K 702; K9K 704; K9K 710; K9K 714; K9K 716; K9K 718	Double Coil(LPH)	12/01-	DG-005		11V				4
1.6	66	K7M 746		09/99-06/01	K20TXR	5063	1.0	K20TT	IK20TT	IK20TT	4
1.6 16V	70	K4M 706; K4M 730; K4M 750; K4M 752; K4M 753		06/01-	K20PR-U	3145	0.8	K20TT	IK20TT	IK20TT	4
1.6 16V 4x4	70	K4M 750; K4M 752; K4M 753		10/01-	K20PR-U	3145	0.8	K20TT	IK20TT	IK20TT	4
1.6 16V bivalent	60	K4M 761/ K4M 782/ K4M 812		06/05-	K20PR-U	3145	0.8	K20TT	IK20TT	IK20TT	4
1.9 D	48	F8Q 632	Double Coil(LPH)	09/99-06/03	DG-112		11V				4
1.9 D 55	40	F8Q 662	Double Coil(LPH)	08/97-	DG-008		11V				4
1.9 D 65	47	F8Q.630	Double Coil(LPH)	08/97-	DG-008		11V				4
1.9 D 65	47	F8Q.632	Double Coil(LPH)	08/97-	DG-112		11V				4
1.9 dCi	62	F9Q 782; F9Q 790	Double Coil(LPH)	07/03-	DG-005		11V				4
1.9 dCi 4x4	59/62	F9Q 782; F9Q 790	Double Coil(LPH)	10/01-	DG-005		11V				4
1.9 dTi	59	F9Q 780	Double Coil(LPH)	02/00-02/03	DG-005		11V				4
1.9 RXED	48	F8Q 632	Double Coil(LPH)	09/99-06/01	DG-112		11V				4
KANGOO (08-)											
1.5 dCi	50/ 63/ 66/ 76/ 78/80	K9K 800; K9K 802; K9K 804; K9K 806; K9K 808; K9K 812	Double Coil(LPH)	02/08-02/11	DG-005		11V				4
1.5 dCi	50/ 63/ 66/ 76/ 78/80	K9K 800; K9K 802; K9K 804; K9K 806; K9K 808; K9K 812	Instant heating (ISS)	03/11-	DG-609		4.4V				4
1.5 dCi (FW0A, KW0V)	50	K9K 800	Double Coil(LPH)	02/08-02/11	DG-005		11V				4
1.5 dCi (FW0A, KW0V)	50	K9K 800	Instant heating (ISS)	03/11-	DG-609		4.4V				4
1.5 dCi (KW04, KW05, KW08, KW0G, KW11)	66	K9K 608; K9K 628; K9K 808	Instant heating (ISS)	06/08-	DG-609		4.4V				4
1.5 dCi (KW07, KW10)	55	K9K 608; K9K 628	Instant heating (ISS)	11/12-	DG-609		4.4V				4
1.5 dCi 75	55	K9K 802	Double Coil(LPH)	09/10-02/11	DG-005		11V				4
1.5 dCi 75	55	K9K 802	Instant heating (ISS)	03/11-	DG-609		4.4V				4
1.5 dCi 75 (FW07, FW10)	55	K9K 608; K9K 628	Double Coil(LPH)	09/10-02/11	DG-005		11V				4
1.5 dCi 75 (FW07, FW10)	55	K9K 608; K9K 628	Instant heating (ISS)	03/11-	DG-609		4.4V				4
1.5 dCi 85	63	K9K 812	Double Coil(LPH)	02/08-02/11	DG-005		11V				4
1.5 dCi 85	63	K9K 812	Instant heating (ISS)	03/11-	DG-609		4.4V				4
1.5 dCi 90	66	K9K 608; K9K 628; K9K 808	Double Coil(LPH)	06/09-02/11	DG-005		11V				4
1.5 dCi 90	66	K9K 608; K9K 628; K9K 808	Instant heating (ISS)	03/11-	DG-609		4.4V				4
1.5 dCi 110 (FW0C, FW0H)	81	K9K 804; K9K 816	Double Coil(LPH)	09/10-02/11	DG-005		11V				4
1.5 dCi 110 (FW0C, FW0H)	81	K9K 804; K9K 816	Instant heating (ISS)	03/11-	DG-609		4.4V				4

Свечи зажигания и Свечи накаливания

Таблица применения











	KW				СТАНДАРТНЫЕ				Twin Tip			QTY
												
RENAULT продолжение												
KANGOO (08-) продолжение												
1.5 dCi 110 (FW06, FW12)	81	K9K 636; K9K 646; K9K 647; K9K 648	Instant heating (ISS)	09/13-	DG-609		4.4V					4
1.5 dCi 110 (KW0C, KW0H)	81	K9K 804; K9K 816	Double Coil(LPH)	09/10-02/11	DG-005		11V					4
1.5 dCi 110 (KW0C, KW0H)	81	K9K 804; K9K 816	Instant heating (ISS)	03/11-	DG-609		4.4V					4
1.5 dCi 110 (KW06, KW12)	81	K9K 636; K9K 646; K9K 647; K9K 648	Instant heating (ISS)	03/13-	DG-609		4.4V					4
1.6	64	K7M 750		02/08-	K20TXR	5063	1.0	K20TT	IK20TT	IK20TT		4
1.6	64/78	K4M 830; K7M 750		02/08-	K20PR-U	3145	0.8	K20TT	IK20TT	IK20TT		4
1.6 (FW00, FW0E, FW0N, FW0P, FW0Y)	64	K7M 750		02/08-	K20PR-U	3145	0.8	K20TT	IK20TT	IK20TT		4
1.6 (FW00, FW0E, FW0N, FW0P, FW0Y)	64	K7M 750		02/08-	K20TXR	5063	1.0	K20TT	IK20TT	IK20TT		4
1.6 16V	78	K4M 761/ K4M 782/ K4M 812		02/08-	K20PR-U	3145	0.8	K20TT	IK20TT	IK20TT		4
1.6 16V Flex	72	K4M 834		02/08-	K20PR-U	3145	0.8	K20TT	IK20TT	IK20TT		4
1.6 16V Flex (FW01, FW0U, FW13, FW03, FW09, FW0W)	78	K4M 761/ K4M 782/ K4M 812; K4M 834; K4M 835; K4M 836		02/08-	K20PR-U	3145	0.8	K20TT	IK20TT	IK20TT		4
1.6 16V Hi-Flex (KW01, KW03, KW09, KW0U, KW0W, KW13)	78	K4M 834; K4M 835		02/08-	K20PR-U	3145	0.8	K20TT	IK20TT	IK20TT		4
KOLEOS I (08-)												
2.5	126	2TR 700; 2TR 702; 2TR 703		09/08-	FXE20HR11	3439	1.1	-	IXEH20TT	IXEH20TT		4
2.5 4x4	126	2TR 700; 2TR 702; 2TR 703		09/08-	FXE20HR11	3439	1.1	-	IXEH20TT	IXEH20TT		4
LAGUNA I (93-01)												
1.6 16V	79	K4M 720; K4M 724		11/97-03/01	K20PR-U	3145	0.8	K20TT	IK20TT	IK20TT		4
1.6 16V	79	K4M 720; K4M 724		11/97-03/01	K20TXR	5063	1.0	K20TT	IK20TT	IK20TT		4
1.8	66/69	F3P 674; F3P 676; F3P 678; F3P 724		11/93-03/01	W20EPR-U	3047	0.8	W20TT	IW20TT	IW20TT		4
1.8	69	F3P 724		08/95-08/99	IW20TT	4709	1.0	-	IW20TT			4
1.8	69	F3P 724		09/95-03/01	W20EP-U	3043	0.8	W20TT	IW20TT	IW20TT		4
1.8 16V	88	F4P 760; F4P 770		04/98-03/01	K20TXR	5063	1.0	K20TT	IK20TT	IK20TT		4
1.9 dCi	79	F9Q 718	Double Coil(LPH)	09/99-03/01	DG-005		11V					4
1.9 dTi	72	F9Q 710; F9Q 716; F9Q 717	Double Coil(LPH)	10/97-03/01	DG-005		11V					4
1.9 dTi	72	F9Q 716	Double Coil(LPH)	10/97-03/01	DG-101		11V					4
2.0	80/83	F3R 611; F3R 722; F3R 723; F3R 728; F3R 768		11/93-03/01	W20EPR-U	3047	0.8	W20TT	IW20TT	IW20TT		4
2.0	103	F4R 780		09/99-02/01	K20PR-U	3145	0.8	K20TT	IK20TT	IK20TT		4
2.0	103	N7Q 700; N7Q 704		06/95-02/01	K20PBR-S10	5061	1.0	K20TT	IK20TT	IK20TT		4
2.0 16V	102	F4R 780		09/99-03/01	K20PR-U	3145	0.8	K20TT	IK20TT	IK20TT		4
2.0 16V	102	N7Q 700; N7Q 704		06/95-03/01	K20PBR-S10	5061	1.0	K20TT	IK20TT	IK20TT		4
2.2 D	61	G8T 706; G8T 752; G8T 790; G8T 794	Double Coil(LPH)	11/93-03/01	DG-101		11V					4
2.2 dT	83	G8T 760	Double Coil(LPH)	03/96-03/01	DG-101		11V					4
3.0	123	Z7X 765		11/93-06/98	K20PBR	5060	0.85	K20TT	IK20TT	IK20TT		6
3.0	123	Z7X 765		02/96-03/01	K20TXR	5063	1.0	K20TT	IK20TT	IK20TT		6
3.0 24V	140	L7X 701		03/97-03/01	K20TXR	5063	1.0	K20TT	IK20TT	IK20TT		6
3.0 24V	140	L7X.7.00/L7X.7.01		03/97-03/01	PK20PR-P8	3245	0.8	-	IK20TT	IK20TT		6
LAGUNA II (01-)												
1.6	76	K4M 710		03/01-10/05	K20PR-U	3145	0.8	K20TT	IK20TT	IK20TT		4
1.6 16V	79/82	K4M 710; K4M 714; K4M 716; K4M 761/ K4M 782/ K4M 812		03/01-12/07	K20PR-U	3145	0.8	K20TT	IK20TT	IK20TT		4
1.6 Bifuel	79	K4M 714		06/05-12/07	K20PR-U	3145	0.8	K20TT	IK20TT	IK20TT		4
1.6 LPG	79	K4M 714		03/01-05/05	K20PR-U	3145	0.8	K20TT	IK20TT	IK20TT		4

Таблица применения

R

Свечи зажигания и Свечи накаливания

Таблица применения

Таблица применения

RENAULT продолжение	KW	KW	NOTE	21	СТАНДАРТНЫЕ			Twin Tip			QTY
					STANDARD	STANDARD	STANDARD	TWIN TIP	TWIN TIP	TWIN TIP	
LAGUNA II (01-) продолжение											
1.8 16V	85/88	F4P.7.70/ F4P.7.71/ F4P.7.74/ F4P.7.75; F4P.7.70/ F4P.7.71/ F4P.7.74; F4P.7.75; F4P.7.70/ F4P.7.72/ F4P.7.73; F4P.7.70/ F4P.7.74; F4P.7.71/ F4P.7.72/ F4P.7.74, F4P.7.75		03/01-09/07	K20PR-U	3145	0.8	K20TT	IK20TT	IK20TT	4
1.9 dCi	66/ 68/ 74/ 77/ 79/ 81/ 85/ 88/ 92/96	F9Q 650; F9Q 664; F9Q 670; F9Q 674; F9Q 718; F9Q 750; F9Q 752; F9Q 754; F9Q 758; F9Q 759	Double Coil(LPH)	03/01-12/07	DG-005		11V				4
2.0 16V	99/ 125	F4R 712; F4R 713; F4R 714; F4R 715; F4R.7.87		08/02-12/07	K20PR-U	3145	0.8	K20TT	IK20TT	IK20TT	4
2.0 16V	125/ 150	F4R 784; F4R 786; F4R 787; F4R.7.86(205)		01/05-09/07	PK20PR-P8	3245	0.8	-	IK20TT	IK20TT	4
2.0 16V	150	F4R 886; F4R 887		01/05-09/07	VK22	5610	0.8	-	IK22TT	VK22	4
2.0 16V	150	F4R.7.86(205)	OEM Optional	01/05-09/07	PK20PR-P8	3245	0.8	-	IK20TT	IK20TT	4
2.0 16V IDE	103	F5R 700; F5R 701		04/01-09/07	K16HPR-U11	6076	1.1	KH16TT	IKH16TT	IKH16TT	4
2.0 16V Turbo	120	F4R 764; F4R 765		01/03-08/05	PK20PR-P8	3245	0.8	-	IK20TT	IK20TT	4
2.2 dCi	85/ 102	G9T 600; G9T 605; G9T 706; G9T 707	Double Coil(LPH)	04/04-12/07	DG-005		11V				4
2.2 dCi	110	G9T 700; G9T 702	Double Coil(LPH)	10/01-08/06	DG-126		11V				4
3.0 V6 24V	152	L7X 731		03/05-09/07	IKH20TT	4704	1.0	-	IKH20TT		6
LAGUNA III (07-)											
1.5 dCi	81	K9K 780; K9K 782; K9K 846	Double Coil(LPH)	10/07-12/15	DG-005		11V				4
1.5 dCi	81	K9K 780; K9K 782; K9K 846	Instant heating (ISS)	11/10-12/15	DG-609		4.4V				4
1.6 16V	81	K4M 824		10/07-12/15	K20PR-U	3145	0.8	K20TT	IK20TT	IK20TT	4
2.0 16V	103	M4R 704		10/07-12/15	FXE20HR11	3439	1.1	-	IXEH20TT	IXEH20TT	4
2.0 16V Hi-Flex	103	M4R 704; M4R 726		10/07-12/15	FXE20HR11	3439	1.1	-	IXEH20TT	IXEH20TT	4
2.0 16V Turbo	125	F4R 811; F4Rt 811		10/07-12/15	PK20PR-P8	3245	0.8	-	IK20TT	IK20TT	4
2.0 16V Turbo	125	F4R 811; F4Rt 811		10/07-12/15	VK22	5610	0.8	-	IK22TT	VK22	4
2.0 GT	150	F4R 800		03/08-12/15	VK22	5610	0.8	-	IK22TT	VK22	4
3.5 V6	175	V4Y 713		09/08-12/15	FXE20HR11	3439	1.1	-	IXEH20TT	IXEH20TT	6
LATITUDE (10-)											
1.5 dCi	81	K9K 782	Instant heating (ISS)	07/10-	DG-609		4.4V				4
2.0 16V	102	M4R 746		02/11-	FXE20HR11	3439	1.1	-	IXEH20TT	IXEH20TT	4
2.0 16V eco2 Flexfuel	103	M4R 746		02/11-	FXE20HR11	3439	1.1	-	IXEH20TT	IXEH20TT	4
LOGAN I (04-)											
1.4	55	K7J 710		09/04-	K20PR-U	3145	0.8	K20TT	IK20TT	IK20TT	4
1.5 dCi	48/ 50/ 63/66	K9K 700; K9K 790; K9K 792; K9K 794; K9K 796	Double Coil(LPH)	04/07-	DG-005		11V				4
1.5 dCi	63	K9K 796	Instant heating (ISS)	11/12-06/15	DG-609		4.4V				4
1.6	64	K7M 710		09/04-	K20TXR	5063	1.0	K20TT	IK20TT	IK20TT	4
1.6	64/77	K4M 690; K4M 694; K4M 696; K4M 697; K4M 698; K7M 710		09/04-	K20PR-U	3145	0.8	K20TT	IK20TT	IK20TT	4
LOGAN II (13-)											
1.2	55	D4F 732		11/13-	XE20HR-U9	3427	0.9	-	IXEH20TT	IXEH20TT	4
1.6	60	K7M 812		04/14-	K20TXR	5063	1.0	K20TT	IK20TT	IK20TT	4
1.6 (L8A9, L8J0)	75	K4M 842; K4M 845		04/14-	K20PR-U	3145	0.8	K20TT	IK20TT	IK20TT	4
MASTER I (80-98)											
2.0 28-35	59	829 730; 829 731; J5R 718; J5R.7.18		08/80-07/98	W20EPR-U	3047	0.8	W20TT	IW20TT	IW20TT	4

Свечи зажигания и Свечи накаливания

Таблица применения





	KW				СТАНДАРТНЫЕ			Twin Tip			QTY
RENAULT продолжение											
MASTER I (80-98) продолжение											
2.1 D	44/46	J8S 330	Double Coil(LPH)	11/89-04/95	DG-001		11V				4
2.1 D 28-35	44	J8S 330	Double Coil(LPH)	08/80-07/98	DG-001		11V				4
2.2	71	J7T 788		08/93-02/98	T20EPR-U	5032	0.8	T20TT	IT20TT	IT20TT	4
2.2 30	67	J7T 782		08/80-07/98	T20EPR-U	5032	0.8	T20TT	IT20TT	IT20TT	4
2.4 D	52	S8U 731	Double Coil(LPH)	09/86-10/89	DG-001		11V				4
2.4 D 28-35	52	8140.61.2300; S8U 731	Double Coil(LPH)	08/80-08/89	DG-001		11V				4
2.5 D 28-35	52/55	8140.61.2300; S8U 731; S8U 742	Double Coil(LPH)	09/80-07/98	DG-001		11V				4
2.5 DT	69	S9U 702	Double Coil(LPH)	11/89-10/93	DG-001		11V				4
2.5 DT	69	S9U 740	Double Coil(LPH)	08/93-02/98	DG-004		11V				4
2.5 TD 28-35	72	Sofim-8140.27.2580	Double Coil(LPH)	08/89-07/98	DG-001		11V				4
2.5 TD 35	69	8140.27.2500; 8140.27.2510; S9U 714; S9U 740	Double Coil(LPH)	08/89-07/98	DG-004		11V				4
MASTER II (98-)											
1.9 dCi 80	60	F9Q 772; F9Q 774	Double Coil(LPH)	11/01-	DG-005		11V				4
1.9 dTi	59	F9Q 770	Double Coil(LPH)	09/00-	DG-005		11V				4
2.2 dCi 90	66	G9T 720; G9T 722; G9T 750	Double Coil(LPH)	09/00-	DG-126		11V				4
2.5 D	59	S8U 770; S8U 772	Double Coil(LPH)	07/98-01/01	DG-111		11V				4
2.5 dCi	74/ 88/ 107	G9U 632; G9U 650	Double Coil(LPH)	08/06-	DG-126		11V				4
2.5 dCi 100	73	G9U 754	Double Coil(LPH)	10/03-	DG-126		11V				4
2.5 dCi 120	84	G9U 720; G9U 724; G9U 750; G9U 754	Double Coil(LPH)	10/01-09/03	DG-126		11V				4
2.8 dTi	84	S9W 702	Double Coil(LPH)	07/98-10/01	DG-111		11V				4
3.0 dCi 120	85	ZD3 600	Double Coil(LPH)	06/05-	DG-605		11V				4
3.0 dCi 140	100	ZD3 200; ZD3 202	Double Coil(LPH)	10/03-	DG-605		11V				4
3.0 dCi 160	115	ZD3 A 604	Double Coil(LPH)	06/05-	DG-605		11V				4
MASTER III (10-)											
2.3 dCi 125 FWD	92	M9T.8.70		05/14-	DG-631		4.5V				4
MEGANE CC (10-)											
1.5 dCi	81	K9K 837	Instant heating (ISS)	06/10-	DG-609		4.4V				4
1.6 16V	81	K4M 858		06/10-	K20PR-U	3145	0.8	K20TT	IK20TT	IK20TT	4
1.6 dCi	96	R9M 402	Without cyl inder press ure sensor, OE:110650819 R	04/11-	DG-631		4.5V				4
1.9 dCi	96	F9Q 870	Instant heating (ISS)	06/10-	DG-619		4.4V				4
2.0 CVT	103	M4R 711; M4R 713		06/10-	FXE20HR11	3439	1.1	-	IXEH20TT	IXEH20TT	4
2.0 dCi	118	M9R 610	Instant heating (ISS)	06/10-	DG-619		4.4V				4
2.0 TCe	132	F4R 870; F4R 872		06/10-	PK20PR-P8	3245	0.8	-	IK20TT	IK20TT	4
2.0 TCe	132	F4R 870; F4R 872		06/10-	VK22	5610	0.8	-	IK22TT	VK22	4
2.0 Turbo	195	F4R 874		10/11-	VK22	5610	0.8	-	IK22TT	VK22	4
MEGANE I (96-03)											
1.4	55	E7J 626; E7J 764		09/96-08/03	Q16PR-U	3137	0.8	Q16TT	IQ16TT	IQ16TT	4
1.4 16V	70	K4J 700; K4J 714; K4J 750		03/99-08/03	K20PR-U	3145	0.8	K20TT	IK20TT	IK20TT	4
1.4 e	55	E7J 626; E7J 764		01/96-08/03	Q16PR-U	3137	0.8	Q16TT	IQ16TT	IQ16TT	4
1.4 Eco	52	E7J 624		01/96-03/99	Q16PR-U	3137	0.8	Q16TT	IQ16TT	IQ16TT	4
1.6	64	K7M 704		02/00-09/00	K20TXR	5063	1.0	K20TT	IK20TT	IK20TT	4
1.6 16V	79	K4M 704		03/99-08/02	Q16PR-U	3137	0.8	Q16TT	IQ16TT	IQ16TT	4
1.6 16V	79/81	K4M 700; K4M 701; K4M 706; K4M 708; K4M 709		03/99-12/04	K20PR-U	3145	0.8	K20TT	IK20TT	IK20TT	4
1.6 Bifuel	80	K4M 704		03/99-09/00	K20PR-U	3145	0.8	K20TT	IK20TT	IK20TT	4











Таблица применения

R

Свечи зажигания и Свечи накаливания











Таблица применения

Таблица применения

	KW				СТАНДАРТНЫЕ			Twin Tip			QTY
											
RENAULT продолжение											
MEGANE I (96-03) продолжение											
1.6 e	66	K7M 702		03/99-08/03	K20PR-U	3145	0.8	K20TT	IK20TT	IK20TT	4
1.6 e	66	K7M 702; K7M 703; K7M 790		01/96-08/03	K20TXR	5063	1.0	K20TT	IK20TT	IK20TT	4
1.6 e	66	K7M 702; K7M 790		01/96-03/99	Q16PR-U	3137	0.8	Q16TT	IQ16TT	IQ16TT	4
1.6 i	55	K7M 720		01/96-03/99	K20TXR	5063	1.0	K20TT	IK20TT	IK20TT	4
1.6 i	55	K7M 720		01/96-03/99	Q16PR-U	3137	0.8	Q16TT	IQ16TT	IQ16TT	4
1.6 LPG	66	K7M 702		08/95-03/99	K20TXR	5063	1.0	K20TT	IK20TT	IK20TT	4
1.6 LPG	80	K4M 704; K4M 712		10/00-08/02	K20PR-U	3145	0.8	K20TT	IK20TT	IK20TT	4
1.8 16V	85	F4P 720; F4P 722		01/01-08/03	K20PR-U	3145	0.8	K20TT	IK20TT	IK20TT	4
1.9 D	47	F8Q 620; F8Q 622; F8Q 624	Double Coil(LPH)	09/96-08/03	DG-009		11V				4
1.9 D	47	F8Q 622; F8Q 790	Double Coil(LPH)	04/99-08/03	DG-112		11V				4
1.9 D	69	F8Q 784	Double Coil(LPH)	04/96-02/01	DG-012		11V				4
1.9 D Eco	47	F8Q 620; F8Q 622; F8Q 624	Double Coil(LPH)	01/96-08/03	DG-009		11V				4
1.9 dCi	75/77	F9Q 732; F9Q 733; F9Q 738	Double Coil(LPH)	03/99-08/03	DG-005		11V				4
1.9 dT	66	F8Q 784; F8Q 786	Double Coil(LPH)	01/96-08/03	DG-012		11V				4
1.9 dTi	59/72	F9Q 730; F9Q 731; F9Q 736; F9Q 731; F9Q 734; F9Q 736; F9Q 744	Double Coil(LPH)	03/97-08/03	DG-005		11V				4
1.9 dTi	72	F9Q 730, F9Q 734	Double Coil(LPH)	03/97-02/01	DG-101		11V				4
1.9 dTi	72	F9Q 734	Double Coil(LPH)	03/97-02/01	DG-010		11.5V				4
1.9 TDi	69	F8Q 784	Double Coil(LPH)	09/96-08/03	DG-012		11V				4
2.0	84	F3R 750; F3R 751; F3R 752; F3R 791; F3R 796; F3R 797; F3R 798		05/98-05/01	W16EPR-U	3021	0.8	W16TT	IW16TT	IW16TT	4
2.0	84	F3R 750; F3R 798		04/97-08/03	W20EPR-U	3047	0.8	W20TT	IW20TT	IW20TT	4
2.0 16V	102	F4R 746; F4R 770		01/02-08/03	K20PR-U	3145	0.8	K20TT	IK20TT	IK20TT	4
2.0 16V	108	F7R 710		03/96-08/03	K20PBR	5060	0.85	K20TT	IK20TT	IK20TT	4
2.0 16V IDE	103	F5R 740		11/99-08/03	K16HPR-U11	6076	1.1	KH16TT	IKH16TT	IKH16TT	4
2.0 i	80	F3R 752		03/99-08/03	K20PR-U	3145	0.8	K20TT	IK20TT	IK20TT	4
2.0 i	80	F3R 791; F3R 796		03/99-08/03	W20EPR-U	3047	0.8	W20TT	IW20TT	IW20TT	4
2.0 i	80	F5R.7.40		03/99-10/00	K16HPR-U11	6076	1.1	KH16TT	IKH16TT	IKH16TT	4
2.0 i	80/84	F3R 750		01/96-08/03	W20EP-U	3043	0.8	W20TT	IW20TT	IW20TT	4
2.0 RT	103	F4R 747; F5R 740		03/01-08/03	K20PR-U	3145	0.8	K20TT	IK20TT	IK20TT	4
MEGANE II (02-12)											
1.4	60/72	K4J 732; K4J.7.30(98)/ K4J.7.40(98)		08/03-10/08	K20PR-U	3145	0.8	K20TT	IK20TT	IK20TT	4
1.4 16V	60/72	K4J 732; K4J.7.30(98)/ K4J.7.40(98)		11/02-02/08	K20PR-U	3145	0.8	K20TT	IK20TT	IK20TT	4
1.5 dCi	60/ 63/ 74/ 76/78	K9K 722; K9K 724; K9K 728; K9K 729; K9K 732; K9K 734	Double Coil(LPH)	09/02-12/10	DG-005		11V				4
1.6	77/ 81/83	K4M 760; K4M 761; K4M 762; K4M 788		08/03-	K20PR-U	3145	0.8	K20TT	IK20TT	IK20TT	4
1.6 16V	75/ 77/82	K4M 760; K4M 761; K4M 762; K4M 768; K4M 812; K4M 813		11/02-	K20PR-U	3145	0.8	K20TT	IK20TT	IK20TT	4
1.6 16V Hi-Flex	77	K4M 856		02/08-07/09	K20PR-U	3145	0.8	K20TT	IK20TT	IK20TT	4
1.6 Bifuel	77	K4M 788		06/05-02/08	K20PR-U	3145	0.8	K20TT	IK20TT	IK20TT	4
1.6 FlexFuel	77	K4M 788		01/07-02/08	K20PR-U	3145	0.8	K20TT	IK20TT	IK20TT	4
1.6 FlexFuel	77	K4M 788		01/07-02/08	PK20PR-P8	3245	0.8	-	IK20TT	IK20TT	4
1.6 LPG 16V	82	K4M 760		01/06-08/09	K20PR-U	3145	0.8	K20TT	IK20TT	IK20TT	4
1.9 dCi	66/ 68/ 81/ 85/ 88/96	F9Q 800; F9Q 803; F9Q 804; F9Q 808; F9Q 816; F9Q 818	Double Coil(LPH)	11/02-	DG-005		11V				4
2.0	99/ 102	F4R 770; F4R 771		08/03-	K20PR-U	3145	0.8	K20TT	IK20TT	IK20TT	4
2.0	169	F4R 774		08/06-02/08	VK22	5610	0.8	-	IK22TT	VK22	4
2.0 16V	99	F4R 770		11/02-02/08	K20PR-U	3145	0.8	K20TT	IK20TT	IK20TT	4

Свечи зажигания и Свечи накаливания











Таблица применения

	KW				СТАНДАРТНЫЕ			Twin Tip			QTY
											
RENAULT продолжение											
MEGANE II (02-12) продолжение											
2.0 16V Turbo	120	F4R 776		05/04-01/09	VK22	5610	0.8	-	IK22TT	VK22	4
2.0 Renault Sport	165	F4R 774; F4Rt 774		05/04-10/09	VK22	5610	0.8	-	IK22TT	VK22	4
2.0 Renault Sport	165	F4Rt 774		05/04-12/06	PK22PR8	3273	0.8	-	IK22TT	VK22	4
MEGANE III (08-)											
1.5 dCi	63/ 66/ 70/ 78/81	K9K 636; K9K 830; K9K 832; K9K 834; K9K 836; K9K 837; K9K 846	Instant heating (ISS)	11/08-	DG-609		4.4V				4
1.6 16V	74/ 81/85	K4M 838; K4M 848; K4M 858; K4M 866		11/08-	K20PR-U	3145	0.8	K20TT	IK20TT	IK20TT	4
1.6 16V BiFuel	81	K4M 858; K4M 866		11/08-	K20PR-U	3145	0.8	K20TT	IK20TT	IK20TT	4
1.6 16V BiFuel	81	K4M 858; K4M 866		11/08-	PK20PR-P8	3245	0.8	-	IK20TT	IK20TT	4
1.6 BiFuel	81	K4M 866		11/08-	K20PR-U	3145	0.8	K20TT	IK20TT	IK20TT	4
1.6 BiFuel	81	K4M 866		11/08-	PK20PR-P8	3245	0.8	-	IK20TT	IK20TT	4
1.6 dCi	96	R9M 402; R9M 404; R9M 414	Without cyl inder press ure sensor, OE:110650819 R	04/11-	DG-631		4.5V				4
1.9 dCi	96	F9Q 870; F9Q 872	Instant heating (ISS)	11/08-	DG-619		4.4V				4
2.0 CVT	103	M4R 711; M4R 713; M4R F 713		02/09-	FXE20HR11	3439	1.1	-	IXEH20TT	IXEH20TT	4
2.0 dCi	110/ 118/ 120	M9R 610; M9R 615	Instant heating (ISS)	04/09-	DG-619		4.4V				4
2.0 R.S.	195/ 201	F4R 874		11/08-	VK22	5610	0.8	-	IK22TT	VK22	4
2.0 TCe	132	F4R 870; F4R 872		11/08-	PK20PR-P8	3245	0.8	-	IK20TT	IK20TT	4
2.0 TCe	132/ 140/ 162/ 184	F4R 870; F4R 872; F4R 874		11/08-	VK22	5610	0.8	-	IK22TT	VK22	4
2.0 TCe 220	162	F4R 874		11/13-	VK22	5610	0.8	-	IK22TT	VK22	4
MEGANE IV (15-)											
1.6 16V	84	K4M		11/15-	K20PR-U	3145	0.8	K20TT	IK20TT	IK20TT	4
1.6 dCi 130	96	R9M 409	Without cyl inder press ure sensor, OE:110650819 R	11/15-	DG-631		4.5V				4
1.6 TCe 205	151	M5M 450		11/15-	VFXEHC22G	5659	0.8	-	-	VFXEHC22G	4
MEGANE Scénic (96-99)											
1.4 i	55	E7J 764		01/97-09/99	Q16PR-U	3137	0.8	Q16TT	IQ16TT	IQ16TT	4
1.6 16V	79	K4M 700; K4M 701; K4M 704; K4M 708		04/98-10/99	K20PR-U	3145	0.8	K20TT	IK20TT	IK20TT	4
1.6 16V	79	K4M 700; K4M 701; K4M 704; K4M 708		04/98-10/99	K20TXR	5063	1.0	K20TT	IK20TT	IK20TT	4
1.6 e	66	K7M 702; K7M 703		10/96-10/99	K20TXR	5063	1.0	K20TT	IK20TT	IK20TT	4
1.6 e	66	K7M 703		10/96-10/99	Q16PR-U	3137	0.8	Q16TT	IQ16TT	IQ16TT	4
1.6 i	55	K7M 720		01/97-09/99	K20TXR	5063	1.0	K20TT	IK20TT	IK20TT	4
1.6 i	55	K7M 720		01/97-09/99	Q16PR-U	3137	0.8	Q16TT	IQ16TT	IQ16TT	4
1.9 D	47	F8Q 620, 624	Double Coil(LPH)	03/97-09/99	DG-009		11V				4
1.9 D	47	F8Q 622, 790	Double Coil(LPH)	03/97-09/99	DG-112		11V				4
1.9 D	47	F8Q 788	Double Coil(LPH)	03/97-09/99	DG-008		11V				4
1.9 dT	66	F8Q 784; F8Q 786	Double Coil(LPH)	01/97-09/99	DG-012		11V				4
1.9 dTi	72	F9Q 730; F9Q 734	Double Coil(LPH)	04/97-09/99	DG-101		11V				4
2.0 i	80/84	F3R 750; F3R 791; F3R 796		01/97-09/99	W20EP-U	3043	0.8	W20TT	IW20TT	IW20TT	4
MODUS (04-)											
1.2	48/ 55/58	D4F 740; D4F 764		12/04-	XE20HR-U9	3427	0.9	-	IXEH20TT	IXEH20TT	4
1.2 16V Hi-Flex	55	D4F 740		10/08-	XE20HR-U9	3427	0.9	-	IXEH20TT	IXEH20TT	4
1.4	72	K4J 770; K4J 780		12/04-	K20PR-U	3145	0.8	K20TT	IK20TT	IK20TT	4
1.5 dCi	48/ 50/ 60/ 63/ 76/78	K9K 750; K9K 752; K9K 760; K9K 764; K9K 766; K9K 768; K9K 772	Double Coil(LPH)	09/04-	DG-005		11V				4
1.5 dCi	76	K9K 772	Instant heating (ISS)	11/10-	DG-609		4.4V				4

Свечи зажигания и Свечи накаливания





Таблица применения

Таблица применения

	KW				СТАНДАРТНЫЕ			Twin Tip			QTY
											
RENAULT продолжение											
MODUS (04-) продолжение											
1.5 dCi 75	55	K9K 770	Instant heating (ISS)	10/10-	DG-609		4.4V				4
1.5 dCi 90	65	K9K 750; K9K 770	Instant heating (ISS)	10/10-	DG-609		4.4V				4
1.6	65/82	K4M 790; K4M 791; K4M 794; K4M 800; K4M 801		12/04-	K20PR-U	3145	0.8	K20TT	IK20TT	IK20TT	4
RAPID (85-98)											
1.0	27	C1C 706		02/86-05/92	W20EPR-U	3047	0.8	W20TT	IW20TT	IW20TT	4
1.1	34	C1E 750; C1E 756; C1E 762		07/85-04/95	W16EPR-U	3021	0.8	W16TT	IW16TT	IW16TT	4
1.1	34	C1E.7.56; C1E.7.62/ C1E.7.64		06/87-04/95	W14EPR-U	6011	0.8	-	IW16TT	IW16TT	4
1.2	40	C1G.7.26		09/91-08/93	W14EPR-U	6011	0.8	-	IW16TT	IW16TT	4
1.2	40	C3G.7.10/C3G.7.12		07/93-03/98	W16EXR-U	3031	0.8	W16TT	IW16TT	IW16TT	4
1.4	43	C1J.7.68		07/85-08/91	W20EPR-U	3047	0.8	W20TT	IW20TT	IW20TT	4
1.4	43/55/59	C2J 784; E7J 726; E7J 728		03/86-03/98	Q16P-U11	3254	1.1	Q16TT	IQ16TT	IQ16TT	4
1.4	59	E6J.7.34/E6J.7.38/ E7J.7.20, E7J.7.24, E7J.7.26, E7J.7.28		05/95-08/97	K20PR-U	3145	0.8	K20TT	IK20TT	IK20TT	4
1.4 Cat	43	C3J 700		08/88-03/98	Q16P-U11	3254	1.1	Q16TT	IQ16TT	IQ16TT	4
1.4 Cat	43	C3J.7.00/C3J.7.02/ C3J.7.60, C3J.7.62		08/88-08/94	W14EPR-U	6011	0.8	-	IW16TT	IW16TT	4
1.6 D	40	F8M 720; F8M 730; F8M 736	Double Coil(LPH)	03/86-08/98	DG-001		11V				4
1.9 D	40/47	F8Q 640; F8Q 646; F8Q 722; F8Q 724; F8Q 774; F8Q 776	Double Coil(LPH)	09/91-03/98	DG-001		11V				4
RODEO 4 (71-81)											
0.8	25	800 01		08/71-11/81	W20FP-U	3068	0.7	WF20TT	-		4
RODEO 5 (81-87)											
1.1	35	688 712		11/81-12/87	W16FP-U	4019	0.7	-	-		4
RODEO 6 (70-81)											
0.8	25	800.02		05/70-08/73	W20EPR-U	3047	0.8	W20TT	IW20TT	IW20TT	4
1.1	35	688.10		08/73-11/81	W20EPR-U	3047	0.8	W20TT	IW20TT	IW20TT	4
SAFRANE I (92-96)											
2.0	77	J7R 732		11/92-07/96	T20EPR-U	5032	0.8	T20TT	IT20TT	IT20TT	4
2.0 12V	97	J7R 734		04/92-07/96	K20PBR	5060	0.85	K20TT	IK20TT	IK20TT	4
2.1 dT	65	J8S 760	Double Coil(LPH)	11/93-07/96	DG-001		11V				4
2.2	79	J7T 762		04/92-07/96	T20EPR-U	5032	0.8	T20TT	IT20TT	IT20TT	4
2.2	101	J7T 760		04/92-07/96	K20PBR	5060	0.85	K20TT	IK20TT	IK20TT	4
2.5 dT	83	S8U 762; S8U 763	Double Coil(LPH)	12/92-07/96	DG-001		11V				4
3.0 Bi-Turbo 4x4	193	Z7X 726		02/93-07/96	K22PBR-S	5062	0.85	-	IKB22TT	VK22	6
3.0 V6	123	Z7X 721; Z7X 722; Z7X 723; Z7X 753		12/92-07/96	K20PBR-S10	5061	1.0	K20TT	IK20TT	IK20TT	6
SAFRANE II (96-00)											
2.0 16V	100	N7Q 710; N7Q 711		07/96-12/00	K20PBR-S10	5061	1.0	K20TT	IK20TT	IK20TT	4
2.2 dT	83	G8T 740	Double Coil(LPH)	07/96-12/00	DG-101		11V				4
2.5 20V	121	N7U 700; N7U 701		07/96-12/00	K20PR-U	3145	0.8	K20TT	IK20TT	IK20TT	5
2.9 24V	140	L7X 713		03/99-12/00	PK20PR11	3168	1.1	K20TT	IK20TT	IK20TT	6
3.0 V6	123	Z7X 755		07/96-12/00	K20PBR	5060	0.85	K20TT	IK20TT	IK20TT	6
SANDERO I (Stepway) (07-)											
1.4	55	K7J 710		02/09-	K20PR-U	3145	0.8	K20TT	IK20TT	IK20TT	4
1.6	64/75	K7M 710		12/07-	K20TXR	5063	1.0	K20TT	IK20TT	IK20TT	4
SANDERO II (Stepway) (13-)											
1.6	60			11/13-	K20PR-U	3145	0.8	K20TT	IK20TT	IK20TT	4
1.6	60	K7M		11/13-	K20TXR	5063	1.0	K20TT	IK20TT	IK20TT	4
1.6 16V	75			04/14-	K20PR-U	3145	0.8	K20TT	IK20TT	IK20TT	4
1.6 16V	75	K7M		04/14-	K20TXR	5063	1.0	K20TT	IK20TT	IK20TT	4
SCÉNIC I (99-03)											
1.4 16V	70	K4J 714; K4J 750		09/99-08/03	K20TXR	5063	1.0	K20TT	IK20TT	IK20TT	4
1.6	75/79	K4M 700; K4M 706; K4M 707; K4M 708; K4M 709; K4M 776		09/99-09/03	K20PR-U	3145	0.8	K20TT	IK20TT	IK20TT	4
1.6 BiFuel	75/79	K4M 704; K4M 712; K4M		09/99-08/03	K20PR-U	3145	0.8	K20TT	IK20TT	IK20TT	4

Свечи зажигания и Свечи накаливания











Таблица применения

	KW				СТАНДАРТНЫЕ			Twin Tip			QTY
RENAULT продолжение											
SCÉNIC I (99-03) продолжение											
1.6 BiFuel	79	K4M 704; K4M 712		09/99-04/01	IK20TT	4702	1.0	-	IK20TT	IK20TT	4
1.8 4x4	85	F4P 722		07/00-04/01	K20PR-U	3145	0.8	K20TT	IK20TT	IK20TT	4
1.8 16V	85	F4P 720; F4P 722		01/01-08/03	K20PR-U	3145	0.8	K20TT	IK20TT	IK20TT	4
1.9 D	47	F8Q 788; F8Q 790	Double Coil(LPH)	09/99-03/01	DG-112		11V				4
1.9 dCi	75	F9Q 732; F9Q 733	Double Coil(LPH)	09/99-08/03	DG-005		11V				4
1.9 dCi RX4	74	F9Q 732; F9Q 740; F9Q 748; F9Q 796	Double Coil(LPH)	11/00-08/03	DG-005		11V				4
1.9 dTi	59/72	F9Q 731; F9Q 736; F9Q 744	Double Coil(LPH)	09/99-08/03	DG-005		11V				4
1.9 dTi	72	F9Q 734	Double Coil(LPH)	09/99-08/03	DG-101		11V				4
2.0 16V	102	F4R 740; F4R 741; F4R 744; F4R 746; F4R 747		09/99-08/03	K20PR-U	3145	0.8	K20TT	IK20TT	IK20TT	4
2.0 16V RX4	102	F4R 744; F4R 746		06/00-08/03	K20PR-U	3145	0.8	K20TT	IK20TT	IK20TT	4
SCÉNIC II (03-)											
1.4	72	K4J.7.30(98)/K4J.7.40(98)		06/03-09/06	K20PR-U	3145	0.8	K20TT	IK20TT	IK20TT	4
1.5 dCi	60/63/74/76/78	K9K 722; K9K 724; K9K 728; K9K 729; K9K 732; K9K 734	Double Coil(LPH)	06/03-11/08	DG-005		11V				4
1.6	77/83	K4M 761; K4M 782; K4M 788		06/03-11/08	K20PR-U	3145	0.8	K20TT	IK20TT	IK20TT	4
1.6 16V	82	K4M 706; K4M 766; K4M 812; K4M 813		10/05-11/08	K20PR-U	3145	0.8	K20TT	IK20TT	IK20TT	4
1.6 BiFuel	83	K4M 764		08/03-05/06	K20PR-U	3145	0.8	K20TT	IK20TT	IK20TT	4
1.6 Hi-Flex	81	K4M 766		03/05-07/10	K20PR-U	3145	0.8	K20TT	IK20TT	IK20TT	4
1.9 D	85	F9Q 812; F9Q J 803	Double Coil(LPH)	06/06-11/08	DG-005		11V				4
1.9 dCi	81/88/92/96	F9Q 804; F9Q 812; F9Q 816; F9Q 818; F9Q J 803	Double Coil(LPH)	06/03-11/08	DG-005		11V				4
2.0	99/101/103	F4R 746; F4R 770; F4R 771		06/03-07/10	K20PR-U	3145	0.8	K20TT	IK20TT	IK20TT	4
2.0 16V Turbo	120	F4R 776		05/04-11/08	K20PR-U	3145	0.8	K20TT	IK20TT	IK20TT	4
SCÉNIC III (09-)											
1.5 dCi	63/70/78/81	K9K 830; K9K 832; K9K 836; K9K 837; K9K 846	Instant heating (ISS)	02/09-	DG-609		4.4V				4
1.6 16V	81	K4M 858; K4M R 858		02/09-	K20PR-U	3145	0.8	K20TT	IK20TT	IK20TT	4
1.6 16V Bifuel	79/81	K4M 866		02/09-	K20PR-U	3145	0.8	K20TT	IK20TT	IK20TT	4
1.6 dCi	96	R9M 402; R9M 404; R9M 414	Without cylinder pressure sensor, OE:110650819 R	04/11-	DG-631		4.5V				4
1.6 E85	81	K4M 866		02/09-	K20PR-U	3145	0.8	K20TT	IK20TT	IK20TT	4
1.9 dCi	96	F9Q 870; F9Q 872	Instant heating (ISS)	02/09-	DG-619		4.4V				4
2.0 16V	103	M4R 710; M4R 711; M4R 713		02/09-	FXE20HR11	3439	1.1	-	IXEH20TT	IXEH20TT	4
2.0 dCi	110/118	M9R 610; M9R 615	Instant heating (ISS)	02/09-	DG-619		4.4V				4
SPORT Spider (95-99)											
2.0	108	F7R 710		12/95-08/96	K20PBR	5060	0.85	K20TT	IK20TT	IK20TT	4
2.0 16V	110	F7R 710		03/95-10/99	K20PBR	5060	0.85	K20TT	IK20TT	IK20TT	4
SUPER 5 (84-96)											
1.0	30	C1C 700		10/84-10/88	W20EPR-U	3047	0.8	W20TT	IW20TT	IW20TT	4
1.1	34	C1E.7.50/ C1E.7.52; C1E.7.50; C1E.7.54		10/84-06/89	W20EPR-U	3047	0.8	W20TT	IW20TT	IW20TT	4
1.1	34	C1E.7.56; C1E.7.60		06/87-01/91	W14EPR-U	6011	0.8	-	IW16TT	IW16TT	4
1.2	40	C1G.7.22		03/90-08/90	W14EPR-U	6011	0.8	-	IW16TT	IW16TT	4
1.2	40/44	C1G.7.02/ C1G.7.20; C1G.7.20/C3J.7.60		01/87-12/96	W20EPR-U	3047	0.8	W20TT	IW20TT	IW20TT	4

Свечи зажигания и Свечи накаливания



Таблица применения

Таблица применения

	KW				СТАНДАРТНЫЕ			Twin Tip			QTY
											
RENAULT продолжение											
SUPER 5 (84-96) продолжение											
1.4	44/49/52	C1J.7.68/ C1J.7.80; C2J.7.00/ C2J.7.80/ C2J.7.81, C2J.7.88, C2J.7.89, C2J.7.98; C2J.7.82/ C2J.7.89; C2J.7.84		10/84-08/90	W20EPR-U	3047	0.8	W20TT	IW20TT	IW20TT	4
1.4 Cat	43	C3J.7.00/C3J.7.02/ C3J.7.60		10/85-12/96	W20EPR-U	3047	0.8	W20TT	IW20TT	IW20TT	4
1.4 Turbo	88	C1J.7.82/C1J.7.84/ C1J.7.88		04/85-08/90	IW24	5316	0.7	-	-		4
1.6 D	40	F8M 720; F8M 730	Double Coil(LPH)	10/84-12/96	DG-001		11V				4
1.7	54	F3N 716; F3N 717		10/86-08/90	W20EPR-U	3047	0.8	W20TT	IW20TT	IW20TT	4
1.7	64/66	F2N.7.40/F2N.7.42		06/87-09/90	W24EPR-U	4136	0.8	-	-		4
1.7 i	69	F3N.7.02		10/86-08/91	W24EPR-U	4136	0.8	-	-		4
TALISMAN (15-)											
1.6 dCi 130	96	R9M 409	Vehicle with cylinder pressure sensor, OE: 110650819R, Cylinder r 2,3,4; marking = Yellow	11/15-	DG-631		4.5V				3
1.6 dCi 130	96	R9M 409	Without cylinder pressure sensor, OE:110650819 R	11/15-	DG-631		4.5V				4
1.6 dCi 160	118	R9M 452; R9M 453	Vehicle with cylinder pressure sensor, OE: 110650819R, Cylinder r 2,3,4; marking = Yellow	06/15-	DG-631		4.5V				3
1.6 dCi 160	118	R9M 452; R9M 453	Without cylinder pressure sensor, OE:110650819 R	06/15-	DG-631		4.5V				4
1.6 TCe 150	110	M5M 450		11/15-	VFXEHC22G	5659	0.8	-	-	VFXEHC22G	4
1.6 TCe 200	147	M5M 450		11/15-	VFXEHC22G	5659	0.8	-	-	VFXEHC22G	4
THALIA I (98-)											
1.2 16V	55	D4F 706; D4F 712; D4F 728		04/02-	XE20HR-U9	3427	0.9	-	IXEH20TT	IXEH20TT	4
1.4	55	K7J 700		08/00-	K20TXR	5063	1.0	K20TT	IK20TT	IK20TT	4
1.4 16V	72	K4J 712		08/00-	K20TXR	5063	1.0	K20TT	IK20TT	IK20TT	4
1.5 dCi	48/50/60	K9K 700; K9K 706; K9K 714; K9K 740	Double Coil(LPH)	06/01-	DG-005		11V				4
1.6	66	K7M 746		03/98-	K20TXR	5063	1.0	K20TT	IK20TT	IK20TT	4
1.6 16V	79	K4M 740		07/00-02/09	K20PR-U	3145	0.8	K20TT	IK20TT	IK20TT	4
1.9 D	48	F8Q.630	Double Coil(LPH)	02/98-05/01	DG-008		11V				4
THALIA II (08-)											
1.2 16V	55	D4F 728		09/08-	XE20HR-U9	3427	0.9	-	IXEH20TT	IXEH20TT	4
1.2 LPG	55	D4F 728		01/10-12/13	IXEH20TT	4711	1.0	-	IXEH20TT		4
1.5 dCi	47/62	K9K 700; K9K 718; K9K 740	Double Coil(LPH)	09/08-	DG-005		11V				4
1.5 dCi	55/66	K9K 612; K9K 834	Instant heating (ISS)	01/09-	DG-609		4.4V				4
1.6 16V	77	K4M 743		09/08-	K20PR-U	3145	0.8	K20TT	IK20TT	IK20TT	4
THALIA III (13-)											
1.5 dCi	66	K9K 612	Instant heating (ISS)	12/13-	DG-609		4.4V				4
TRAFIC (80-89)											
1.4	35	847 700; C1J 700		03/80-04/89	W20EPR-U	3047	0.8	W20TT	IW20TT	IW20TT	4
1.6	48	841 705		03/80-06/86	W16EP-U	3018	0.8	W16TT	IW16TT	IW16TT	4
1.6	48	A1M 707		01/83-06/86	W20EPR-U	3047	0.8	W20TT	IW20TT	IW20TT	4
1.6 4x4	48	A1M 707		03/80-08/86	W20EPR-U	3047	0.8	W20TT	IW20TT	IW20TT	4
1.7	50	F1N 722; F1N 724		06/86-04/89	W24EPR-U	4136	0.8	-	-		4

Свечи зажигания и Свечи накаливания

Таблица применения

	KW				СТАНДАРТНЫЕ			Twin Tip			QTY
RENAULT продолжение											
TRAFIC (80-89) продолжение											
1.7	50	F1N 724		06/86-04/89	W22EP-U	3085	0.8	W22TT	-	VW22	4
2.0	59	J5R 716; J5R 726		03/80-04/89	W20EPR-U	3047	0.8	W20TT	IW20TT	IW20TT	4
2.0 4x4	59	J5R 716; J5R 726		05/85-04/89	W20EPR-U	3047	0.8	W20TT	IW20TT	IW20TT	4
2.1 D	43	852 720; 852 750; J8S 750	Double Coil(LPH)	03/80-04/89	DG-001		11V				4
2.1 D 4x4	43	852 750	Double Coil(LPH)	05/85-04/89	DG-001		11V				4
2.5 D	51	S8U 720;S8U 722	Double Coil(LPH)	03/80-04/89	DG-004		11V				4
2.5 D	51	Sofim-8140.61.240	Double Coil(LPH)	03/80-04/89	DG-001		11V				4
TRAFIC (89-01)											
1.4	35	C1J 700		05/89-06/91	W20EPR-U	3047	0.8	W20TT	IW20TT	IW20TT	4
1.7	50	F1N 720		08/92-08/94	W22EP-U	3085	0.8	W22TT	-	VW22	4
1.7	50	F1N 722; F1N 724; F1N.7.20		03/89-08/94	W24EPR-U	4136	0.8	-	-		4
1.9 D	44	F8Q 606	Double Coil(LPH)	06/97-03/01	DG-008		11V				4
2.0	59	J5R 716; J5R 726		05/89-08/90	W20EPR-U	3047	0.8	W20TT	IW20TT	IW20TT	4
2.0 RWD	59	J5R 726		05/89-10/97	W20EPR-U	3047	0.8	W20TT	IW20TT	IW20TT	4
2.1 D	43/47	852 720; 852 750; J8S 620; J8S 758	Double Coil(LPH)	05/89-04/98	DG-001		11V				4
2.1 D RWD	43/47	852 720; J8S 620; J8S 758	Double Coil(LPH)	05/89-10/97	DG-001		11V				4
2.2	70	J7T 780		05/89-06/94	T20EPR-U	5032	0.8	T20TT	IT20TT	IT20TT	4
2.2	70/74	J7T 600; J7T 780		05/89-04/98	T20EP-U	5031	0.8	T20TT	IT20TT	IT20TT	4
2.2 4x4	70/74	J7T 600; J7T 780		05/89-04/98	T20EP-U	5031	0.8	T20TT	IT20TT	IT20TT	4
2.5 D	51/55	S8U 720; S8U 758	Double Coil(LPH)	05/89-03/01	DG-004		11V				4
2.5 D	55	S8U 750; Sofim- 8140.67.2580	Double Coil(LPH)	03/89-03/01	DG-001		11V				4
2.5 D 4x4	55	S8U 750; S8U 752; Sofim- 8140.67.2500	Double Coil(LPH)	05/89-03/01	DG-001		11V				4
2.5 D 4x4	55	S8U 750;S8U 752	Double Coil(LPH)	08/89-03/01	DG-004		11V				4
TRAFIC II (01-)											
1.9 dCi	59/75	F9Q 760; F9Q 762	Double Coil(LPH)	03/01-	DG-005		11V				4
1.9 dCi 80	60	F9Q 760; F9Q 762	Double Coil(LPH)	03/01-	DG-005		11V				4
1.9 dCi 100	74	F9Q 760	Double Coil(LPH)	03/01-	DG-005		11V				4
2.0	88	F4R 720; F4R 722		03/01-	PK20PR-P8	3245	0.8	-	IK20TT	IK20TT	4
2.0 16V	86	F4R 820		08/06-	PK20PR-P8	3245	0.8	-	IK20TT	IK20TT	4
2.0 16V	86	F4R 820		08/06-	VK22	5610	0.8	-	IK22TT	VK22	4
2.0 dCi 115	84	M9R 630	OE:110655813 R/ 110651749R, Instant He ating (ISS)	01/12-12/14	DG-631		4.5V				4
2.5 dCi	84	G9U 630	Double Coil(LPH)	08/07-	DG-126		11V				4
2.5 dCi 115	84	G9U 630	Double Coil(LPH)	02/08-	DG-126		11V				4
2.5 dCi 135	99	G9U 730	Double Coil(LPH)	03/01-	DG-126		11V				4
2.5 dCi 145	107	G9U 630	Double Coil(LPH)	08/06-	DG-126		11V				4
2.5 DTi	99	G9U 730	Double Coil(LPH)	03/03-07/03	DG-126		11V				4
TRAFIC III (14-)											
1.6 dCi 90 (FGME)	66	R9M 408	Without cyl inder press ure sensor, OE:110650819 R	05/14-	DG-631		4.5V				4
1.6 dCi 90 (JGME)	66	R9M 408	Without cyl inder press ure sensor, OE:110650819 R	05/14-	DG-631		4.5V				4

Свечи зажигания и Свечи накаливания





Таблица применения

Таблица применения

	KW				СТАНДАРТНЫЕ			Twin Tip			QTY
RENAULT продолжение											
TRAFIC III (14-) продолжение											
1.6 dCi 95 (JGMR, JGMJ)	70	R9M 413; R9M 415	Vehicle with cylinder pressure sensor, OE: 110650819R, Cylinder r 2,3,4; marking = Yellow	07/15-	DG-631		4.5V				3
1.6 dCi 95 (JGMR, JGMJ)	70	R9M 413; R9M 415	Without cylinder pressure sensor, OE:110650819R, Cylinder r 2,3,4; marking = Yellow	07/15-	DG-631		4.5V				4
1.6 dCi 115 (FGMD)	85	R9M 408	Without cylinder pressure sensor, OE:110650819R	05/14-	DG-631		4.5V				4
1.6 dCi 115 (JGMD)	85	R9M 408	Without cylinder pressure sensor, OE:110650819R	05/14-	DG-631		4.5V				4
1.6 dCi 120 (FGMB)	88	R9M 450	Vehicle with cylinder pressure sensor, OE: 110650819R, Cylinder r 2,3,4; marking = Yellow	05/14-	DG-631		4.5V				3
1.6 dCi 120 (FGMB)	88	R9M 450	Without cylinder pressure sensor, OE:110650819R, Cylinder r 2,3,4; marking = Yellow	05/14-	DG-631		4.5V				4
1.6 dCi 120 (JGMB)	88	R9M 450	Vehicle with cylinder pressure sensor, OE: 110650819R, Cylinder r 2,3,4; marking = Yellow	05/14-	DG-631		4.5V				3
1.6 dCi 120 (JGMB)	88	R9M 450	Without cylinder pressure sensor, OE:110650819R, Cylinder r 2,3,4; marking = Yellow	05/14-	DG-631		4.5V				4
1.6 dCi 125 (JGMH)	92	R9M 452	Vehicle with cylinder pressure sensor, OE: 110650819R, Cylinder r 2,3,4; marking = Yellow	07/15-	DG-631		4.5V				3
1.6 dCi 125 (JGMH)	92	R9M 452	Without cylinder pressure sensor, OE:110650819R, Cylinder r 2,3,4; marking = Yellow	07/15-	DG-631		4.5V				4
1.6 dCi 140 (FGMA)	103	R9M 450	Vehicle with cylinder pressure sensor, OE: 110650819R, Cylinder r 2,3,4; marking = Yellow	05/14-	DG-631		4.5V				3

Свечи зажигания и Свечи накаливания





Таблица применения

	KW				СТАНДАРТНЫЕ			Twin Tip			QTY
RENAULT продолжение											
TRAFIC III (14-) продолжение											
1.6 dCi 140 (FGMA)	103	R9M 450	Without cylinder pressure sensor, OE:110650819R, Cylinder r 2,3,4; marking = Yellow	05/14-	DG-631		4.5V				4
1.6 dCi 140 (JGMA)	103	R9M 450	Vehicle with cylinder pressure sensor, OE: 110650819R, Cylinder r 2,3,4; marking = Yellow	05/14-	DG-631		4.5V				3
1.6 dCi 140 (JGMA)	103	R9M 450	Without cylinder pressure sensor, OE:110650819R, Cylinder r 2,3,4; marking = Yellow	05/14-	DG-631		4.5V				4
1.6 dCi 145 (JGMG)	107	R9M 452	Vehicle with cylinder pressure sensor, OE: 110650819R, Cylinder r 2,3,4; marking = Yellow	07/15-	DG-631		4.5V				3
1.6 dCi 145 (JGMG)	107	R9M 452	Without cylinder pressure sensor, OE:110650819R, Cylinder r 2,3,4; marking = Yellow	07/15-	DG-631		4.5V				4
TWINGO I (93-07)											
1.2	40	C3G 700; C3G 702		03/93-10/96	W16EP-U	3018	0.8	W16TT	IW16TT	IW16TT	4
1.2	40/43	D7F 700; D7F 701; D7F 702; D7F 703; D7F 704; D7F 706		05/96-06/07	K16TNR-S9	3329	0.9	K16TT	IK16TT	IK16TT	4
1.2 16V	44/55	D4F 702; D4F 708		01/01-06/07	XE20HR-U9	3427	0.9	-	IXEH20TT	IXEH20TT	4
1.2 LPG	44	D7F 702; D7F 708		10/03-05/07	K16TNR-S9	3329	0.9	K16TT	IK16TT	IK16TT	4
TWINGO II (07-)											
1.2	43	D7F 800		03/07-	K20TXR	5063	1.0	K20TT	IK20TT	IK20TT	4
1.2 16V	55	D4F 764; D4F 770; D4F 772		03/07-	XE20HR-U9	3427	0.9	-	IXEH20TT	IXEH20TT	4
1.5 dCi	47/62	K9K 718; K9K 740	Double Coil(LPH)	03/07-	DG-005		11V				4
1.5 dCi 75	55	K9K 820	Instant heating (ISS)	10/10-	DG-609		4.4V				4
1.5 dCi 90	63	K9K 820	Instant heating (ISS)	10/10-	DG-609		4.4V				4
1.6 RS	98	K4M 854		05/08-	PK20PR-P8	3245	0.8	-	IK20TT	IK20TT	4
1.6 RS	98	K4M 854	OEM Optional	05/08-	VK22	5610	0.8	-	IK22TT	VK22	4
TWINGO III (14-)											
1.0 SCe 70	52	H4D 400		09/14-	XE20HR-U9	3427	0.9	-	IXEH20TT	IXEH20TT	3
VEL SATIS (02-)											
2.0 16 V Turbo	125	F4R.7.66		04/04-	PK20PR-P8	3245	0.8	-	IK20TT	IK20TT	4
2.0 16V Turbo	120	F4R.7.62/F4R.7.63/ F4R.7.64, F4R.7.65, F4R.7.67, F4R.7.67(170)		06/02-	PK20PR-P8	3245	0.8	-	IK20TT	IK20TT	4
2.0 Turbo	108	F4R 867		04/05-	VK22	5610	0.8	-	IK22TT	VK22	4
2.2 dCi	83/ 85/ 102/ 110	G9T 600; G9T 606; G9T 607; G9T 700; G9T 702; G9T 703	Double Coil(LPH)	06/02-	DG-126		11V				4
3.0 dCi	130/ 133	P9X 701; P9X 715		06/02-	DG-646		11V				6
3.5	170	V4Y 715		10/04-	IKH16TT	4703	1.0	-	IKH16TT		6
3.5 V6	177	V4Y 701; V4Y 711; V4Y 715		06/02-	IKH16TT	4703	1.0	-	IKH16TT		6

Свечи зажигания и Свечи накаливания

Таблица применения

Таблица применения

	KW				СТАНДАРТНЫЕ			Twin Tip			QTY
RENAULT продолжение											
WIND (10-)											
1.6	98	K4M 854		07/10-	PK20PR-P8	3245	0.8	-	IK20TT	IK20TT	4
1.6	98	K4M 854	OEM Optional	07/10-	VK22	5610	0.8	-	IK22TT	VK22	4
RENAULT TRUCKS											
MASCOTT (99-13)											
90.35	63	8140.63.2585		01/99-12/01	DG-111		11V				4
90	63	8140.63.2585		01/99-12/01	DG-111		11V				4
110.35	78	8140.43.B.3586; 8140.43.B.3588; 8140.43.C.2586	Double Coil(LPH)	01/99-06/04	DG-111		11V				4
110.50	78	8140.43.B.3586; 8140.43.B.3588; 8140.43.C.2586	Double Coil(LPH)	01/99-06/04	DG-111		11V				4
110.55	78	8140.43.B.3586; 8140.43.B.3588; 8140.43.C.2586	Double Coil(LPH)	01/99-06/04	DG-111		11V				4
110	78	8140.43.B.3586; 8140.43.B.3588; 8140.43.C.2586	Double Coil(LPH)	01/99-06/04	DG-111		11V				4
120.35 (A00100003, A01100003)	85	DXi 3; ZD3 A 600		05/04-12/10	DG-605		11V				4
120.35 (A02100003)	85	DXi 3; ZD3 A 600		05/04-10/10	DG-605		11V				4
130.35	92	8140.43.S.2585; 8140.43.S.3585		01/99-06/04	DG-001		11V				4
130.55	92	8140.43.S.2585; 8140.43.S.3585	Double Coil(LPH)	01/99-06/04	DG-111		11V				4
130	92	8140.43.S.2585; 8140.43.S.3585	Double Coil(LPH)	01/99-06/04	DG-111		11V				4
140.35	103	8140.43K	Double Coil(LPH)	01/01-06/04	DG-111		11V				4
140.55	103	8140.43K	Double Coil(LPH)	01/01-06/04	DG-111		11V				4
140	103	8140.43K	Double Coil(LPH)	01/01-06/04	DG-111		11V				4
150.35 (A00300161)	107	8140.43N.3585	Double Coil(LPH)	10/01-06/04	DG-111		11V				4
150.35 (A00300164)	107	8140.43N.3585	Double Coil(LPH)	10/01-06/04	DG-111		11V				4
150.35 (A02300161)	107	8140.43N.3585	Double Coil(LPH)	10/01-06/04	DG-111		11V				4
150.55 (A02300164)	107	8140.43N.3585	Double Coil(LPH)	10/01-06/04	DG-111		11V				4
150.65 (A00300166)	107	8140.43N.3585	Double Coil(LPH)	10/01-06/04	DG-111		11V				4
160.35 (A00100013, A01100013)	115	DXi 3; ZD3 A 604		05/04-12/10	DG-605		11V				4
160.35 (A02100013)	115	DXi 3; ZD3 A 604		05/04-10/10	DG-605		11V				4
RILEY											
ELF III (63-68)											
1.0	28			03/63-10/68	W20EPR-U	3047	0.8	W20TT	IW20TT	IW20TT	4
ROLLS-ROYCE											
CORNICHE II (85-89)											
6.7	164	L 410 I		09/85-12/89	IW16TT	4708	1.0	-	IW16TT		8
CORNICHE IV (93-00)											
6.7	165	L 410 I		01/93-12/00	IW16TT	4708	1.0	-	IW16TT		8
CORNICHE V (00-02)											
6.7 V8 Turbo	242	L 410 M1T		01/00-09/02	IW16TT	4708	1.0	-	IW16TT		8
PARK WARD (00-02)											
5.4	240	M73 B54		10/00-12/02	K20TXR	5063	1.0	K20TT	IK20TT	IK20TT	12
PHANTOM VII (02-)											
6.75	338	N73 B68 A		01/03-07/17	K20TXR	5063	1.0	K20TT	IK20TT	IK20TT	12
6.75 V12	338	N73 B68 A		06/07-07/17	K20TXR	5063	1.0	K20TT	IK20TT	IK20TT	12
SILVER Seraph (98-02)											
5.4	240	M73 B54		03/98-09/02	K20TXR	5063	1.0	K20TT	IK20TT	IK20TT	12
5.4	240	M73 B54		03/98-09/02	KJ14CR-L11	3167	1.1	-	-	VK16	12
SILVER Shadow (77-80)											
6.7	184	L 410 M		01/77-12/80	IW16TT	4708	1.0	-	IW16TT		8
SILVER Spirit II (89-97)											
6.7	160/ 180/ 250	L 410 I		12/90-09/96	IW16TT	4708	1.0	-	IW16TT		8
6.75	224	L 410 I		12/90-09/96	IW16TT	4708	1.0	-	IW16TT		8

Свечи зажигания и Свечи накаливания

Таблица применения



	KW				СТАНДАРТНЫЕ				Twin Tip		QTY
											
ROVER											
25 (99-05)											
1.1 16V	55	11 K4F		01/04-05/05	PK20PR-P8	3245	0.8	-	IK20TT	IK20TT	4
1.4 16V	62/76	14 K4F; 14 K4M		10/99-05/05	PK16PR-L11	3275	1.1	-	IK16TT	IK16TT	4
1.4 16V	76	14 K4F	Flexible fuel	10/99-05/05	PK20PR-L11	3142	1.1	-	IK20TT	IK20TT	4
1.6 16V	80	16 K4F		10/99-05/05	PK16PR-L11	3275	1.1	-	IK16TT	IK16TT	4
1.6 16V	80	16 K4F	Flexible fuel	10/99-05/05	PK20PR-L11	3142	1.1	-	IK20TT	IK20TT	4
1.8 16V	85/107	18 K4F; 18 K4K		10/99-05/05	PK16PR-L11	3275	1.1	-	IK16TT	IK16TT	4
1.8 16V	85/107	18 K4F; 18 K4K	Flexible fuel	10/99-05/05	PK20PR-L11	3142	1.1	-	IK20TT	IK20TT	4
2.0 iDT	74/83	20 T2N	Double Coil(LPH)	10/99-05/05	DG-101		11V				4
45 (00-05)											
1.4	76	14 K4F		02/00-05/05	PK16PR-L11	3275	1.1	-	IK16TT	IK16TT	4
1.4	76	14 K4F	Flexible fuel	02/00-05/05	PK20PR-L11	3142	1.1	-	IK20TT	IK20TT	4
1.6	80	16 K4F		02/00-05/05	PK16PR-L11	3275	1.1	-	IK16TT	IK16TT	4
1.6	80	16 K4F	Flexible fuel	02/00-05/05	PK20PR-L11	3142	1.1	-	IK20TT	IK20TT	4
1.8	86	18 K4F		02/00-05/05	PK16PR-L11	3275	1.1	-	IK16TT	IK16TT	4
1.8	86	18 K4F	Flexible fuel	02/00-05/05	PK20PR-L11	3142	1.1	-	IK20TT	IK20TT	4
2.0 iDT	74/83	20 T2N	Double Coil(LPH)	02/00-05/05	DG-101		11V				4
2.0 V6	110	20K6		03/04-05/05	PK20PR-P8	3245	0.8	-	IK20TT	IK20TT	6
2.0 V6	110	20K6F		02/00-02/04	PK16PR-L11	3275	1.1	-	IK16TT	IK16TT	6
75 (99-05)											
1.8	88	K 1.8		02/99-05/05	PK16PR-L11	3275	1.1	-	IK16TT	IK16TT	4
1.8	88	K 1.8	Flexible fuel	02/99-05/05	PK20PR-L11	3142	1.1	-	IK20TT	IK20TT	4
1.8 Turbo	110	18 K4G		05/03-05/05	PK16PR-L11	3275	1.1	-	IK16TT	IK16TT	4
1.8 Turbo	110	18 K4G	Flexible fuel	05/03-05/05	PK20PR-L11	3142	1.1	-	IK20TT	IK20TT	4
2.0 CDT	85	204D2; M 47 R; M47 D20 (204D1)	Double Coil(LPH)	02/99-05/05	DG-145		11V				4
2.0 CDTi	96	204D2	Double Coil(LPH)	02/03-05/05	DG-145		11V				4
2.0 V6	110	20 K4F		02/99-05/05	PK16PR-L11	3275	1.1	-	IK16TT	IK16TT	6
2.0 V6	110	20 K4F	Flexible fuel	02/99-05/05	PK20PR-L11	3142	1.1	-	IK20TT	IK20TT	6
2.5 V6	130	25 K4F; KV 6		02/99-05/05	PK16PR-L11	3275	1.1	-	IK16TT	IK16TT	6
2.5 V6	130	25 K4F; KV 6	Flexible fuel	02/99-05/05	PK20PR-L11	3142	1.1	-	IK20TT	IK20TT	6
100 / METRO (90-98)											
111	44	11K2D		04/94-10/97	PK20PR-P8	3245	0.8	-	IK20TT	IK20TT	4
111 C/L/S	44	11K2A/11K2B/11K2D		03/90-12/98	PK20PR-P8	3245	0.8	-	IK20TT	IK20TT	4
114	55/75	14K2D; 14K4F4		04/94-10/98	K20PR-U	3145	0.8	K20TT	IK20TT	IK20TT	4
114 D	38	TUD 3		10/92-12/94	DG-004		11V				4
114 GTI 16V	69/76	14K4C; 14K4F4		03/90-01/95	K20PR-U	3145	0.8	K20TT	IK20TT	IK20TT	4
114 GTI/GT 16V Cat	66	14K4D		03/90-12/92	K20PR-U	3145	0.8	K20TT	IK20TT	IK20TT	4
114 S/L/GTA	55	14K2A/14K2B/14K2D		03/90-12/98	K20PR-U	3145	0.8	K20TT	IK20TT	IK20TT	4
115 D	42	TUD 5	Double Coil(LPH)	12/94-12/98	DG-003		11V				4
200 (RF) (95-00)											
211	44	11K2F		01/98-03/00	PK20PR-P8	3245	0.8	-	IK20TT	IK20TT	4
214 i	55	14K2D		11/95-03/96	K20PR-U	3145	0.8	K20TT	IK20TT	IK20TT	4
214 i	55	14K2F		11/95-03/00	PK20PR-P8	3245	0.8	-	IK20TT	IK20TT	4
214 Si	76	14K4F4		11/95-03/96	K20PR-U	3145	0.8	K20TT	IK20TT	IK20TT	4
214 Si	76	14K4F4	OEM Optional	11/95-03/00	PK20PR-P8	3245	0.8	-	IK20TT	IK20TT	4
216 Si	82	16K4F4		11/95-06/99	PK20PR-P8	3245	0.8	-	IK20TT	IK20TT	4
218 K Vi	107	18K16		11/95-03/00	PK20PR-P8	3245	0.8	-	IK20TT	IK20TT	4
220 D/SD	63	20 T2R	Double Coil(LPH)	11/95-03/00	DG-101		11V				4
220 SDi	77	20 T2N	Double Coil(LPH)	11/95-03/00	DG-101		11V				4
200 (XH) (85-89)											
213 S	54	EV		09/85-09/89	W20EPR-U11	3049	1.1	W20TT	IW20TT	IW20TT	4
213 S	54	EV 2		09/85-09/89	W16EKR-S11	3016	1.1	W16TT	IW16TT	IW16TT	4
216	61	H16A/H16B		03/85-09/89	K20PR-U	3145	0.8	K20TT	IK20TT	IK20TT	4
216 Vitesse	75	H16B-EFI		09/84-09/89	K20PR-U	3145	0.8	K20TT	IK20TT	IK20TT	4
200 (XW) (89-99)											
214	55	14K2D		09/93-12/95	K20PR-U	3145	0.8	K20TT	IK20TT	IK20TT	4
214 GSi/Si	70/76	14K4C; 14K4F4		01/90-10/95	K20PR-U	3145	0.8	K20TT	IK20TT	IK20TT	4
214 Si/Gsi	66	14K2D/14K4D		10/89-09/92	K20PR-U	3145	0.8	K20TT	IK20TT	IK20TT	4
216	90	D16A8		10/92-03/96	K20PR-U	3145	0.8	K20TT	IK20TT	IK20TT	4









Таблица применения

R

Свечи зажигания и Свечи накаливания

Таблица применения

Таблица применения

	KW				СТАНДАРТНЫЕ			Twin Tip			QTY
											
ROVER продолжение											
200 (XW) (89-99) продолжение											
216 GSi	82/85	D16A7/D16Z2; D16Z2		10/89-12/95	K20PR-U	3145	0.8	K20TT	IK20TT	IK20TT	4
216 GTi	90/96	D16A8/D16Z2; D16A9		01/90-10/95	K20PR-U	3145	0.8	K20TT	IK20TT	IK20TT	4
218 D	52	XUD9		09/91-10/95	DG-001		11V				4
218 TD	65	XUD 7TE	Double Coil(LPH)	09/91-10/95	DG-001		11V				4
220 GSi	100	20T4H		05/94-03/96	K20PR-U	3145	0.8	K20TT	IK20TT	IK20TT	4
220 GTi	100/ 103	20M4F; 20T4H		09/91-10/95	K20PR-U	3145	0.8	K20TT	IK20TT	IK20TT	4
220 Turbo	147	20T4G		10/92-03/96	K20PR-U	3145	0.8	K20TT	IK20TT	IK20TT	4
400 (90-98)											
1.6 i	82/90	D16Z2		05/94-04/95	K20PR-U	3145	0.8	K20TT	IK20TT	IK20TT	4
1.8 i	107	18K4K		06/96-10/97	PK16PR-L11	3275	1.1	-	IK16TT	IK16TT	4
1.8 i	107	18K4K	Flexible fuel	06/96-10/97	PK20PR-L11	3142	1.1	-	IK20TT	IK20TT	4
1.8 TD	65	XUD 7TE	Double Coil(LPH)	09/93-11/98	DG-001		11V				4
2.0 i	100	20T4H		05/94-04/95	K20PR-U	3145	0.8	K20TT	IK20TT	IK20TT	4
414	70	14K4F4		01/93-04/95	K20PR-U	3145	0.8	K20TT	IK20TT	IK20TT	4
414 GSi/Si	66	14K4C/14K4D		04/90-09/92	K20PR-U	3145	0.8	K20TT	IK20TT	IK20TT	4
414 GSi/Si Cat	76	14K4F4		10/92-04/95	K20PR-U	3145	0.8	K20TT	IK20TT	IK20TT	4
416 GSi	82	D16A7/D16Z2		04/90-04/95	K20PR-U	3145	0.8	K20TT	IK20TT	IK20TT	4
416 GSi/GSE	85	D16A7/D16Z2		04/90-04/95	K20PR-U	3145	0.8	K20TT	IK20TT	IK20TT	4
416 GTi	90	D16A8		04/90-09/92	K20PR-U	3145	0.8	K20TT	IK20TT	IK20TT	4
416 GTi/GTE	96	D16A9		04/90-09/92	K20PR-U	3145	0.8	K20TT	IK20TT	IK20TT	4
418 D	49	XUD9	Double Coil(LPH)	09/91-04/95	DG-001		11V				4
418 TD	65	XUD 7TE	Double Coil(LPH)	09/91-04/95	DG-001		11V				4
420 GSi/SLi/GTi/Vite	100	20T4H		01/93-04/95	K20PR-U	3145	0.8	K20TT	IK20TT	IK20TT	4
420 GTi/GSi/Vitesse	103	20M4F		02/92-09/92	K20PR-U	3145	0.8	K20TT	IK20TT	IK20TT	4
420 Turbo	147	20T4G		01/93-04/95	K20PR-U	3145	0.8	K20TT	IK20TT	IK20TT	4
400 (95-00)											
414 Si	76	14K4F4		05/95-03/00	PK20PR-P8	3245	0.8	-	IK20TT	IK20TT	4
416 Si	82	16K4F4		03/95-03/00	PK20PR-P8	3245	0.8	-	IK20TT	IK20TT	4
416 Si	82	D16Y3E		03/95-03/00	K20PR-U11	3121	1.1	K20TT	IK20TT	IK20TT	4
416 Si	85	D16B2		05/95-03/00	Q20PR-U11	3008	1.1	Q20TT	IQ20TT	IQ20TT	4
420 D	63	20 T2R	Double Coil(LPH)	11/95-03/00	DG-101		11V				4
420 Di	77	20 T2N	Double Coil(LPH)	05/95-03/00	DG-101		11V				4
420 Si Lux	100	20T4H		12/95-03/00	PK20PR-P8	3245	0.8	-	IK20TT	IK20TT	4
600 (93-99)											
618 i/Si	85	F18A3		03/96-02/99	KJ20CR-L11	3169	1.1	K20TT	IK20TT	IK20TT	4
620 i	85	F20Z2		08/93-06/96	KJ20CR-L11	3169	1.1	K20TT	IK20TT	IK20TT	4
620 Sdi	77	20 T2N	Double Coil(LPH)	05/94-06/99	DG-101		11V				4
620 Si	96	F20Z1		08/93-02/99	KJ20CR-L11	3169	1.1	K20TT	IK20TT	IK20TT	4
620 Ti Vitesse	147	20T4G		05/94-08/98	PK20PR-P8	3245	0.8	-	IK20TT	IK20TT	4
623 Si	116	H23A3		08/93-06/99	KJ20CR-L11	3169	1.1	K20TT	IK20TT	IK20TT	4
800 (86-99)											
2.5	129	25KV6F-175		02/96-10/98	K20PR-U	3145	0.8	K20TT	IK20TT	IK20TT	6
2.5 Si	129	25KV6F-175		02/96-10/98	K20PR-U	3145	0.8	K20TT	IK20TT	IK20TT	6
820 16 V I/Si	103	M16I		10/86-10/88	K20PR-U	3145	0.8	K20TT	IK20TT	IK20TT	4
820 16V Turbo	132	20T4G/20T4GG		11/91-02/99	K20PR-U	3145	0.8	K20TT	IK20TT	IK20TT	4
820 I/Si	100/ 103	20T4H; M16E/M16I		10/88-02/99	K20PR-U	3145	0.8	K20TT	IK20TT	IK20TT	4
820 Sport	145	20T4G		04/94-03/96	K20PR-U	3145	0.8	K20TT	IK20TT	IK20TT	4
825 D/SD	87	425 SL1RR; 492 4 SHIRG	Double Coil Standard	01/90-11/91	DG-202		11V				4
825 D/SD	87	425 SL1RR; 492 4 SHIRG	Double Coil(LPH)	12/91-04/95	DG-001		11V				4
825 D/SD	87	425 SL1RR; 492 4 SHIRG	Double Coil(LPH)	05/95-02/99	DG-109		11V				4
825 SD	87	425 SL1RR; 492 4 SHIRG	Double Coil(LPH)	09/93-04/95	DG-001		11V				4
825 SD	87	425 SL1RR; 492 4 SHIRG	Double Coil(LPH)	05/95-02/99	DG-109		11V				4
825 Si	129	25KV6F-175		04/96-02/99	K20PR-U	3145	0.8	K20TT	IK20TT	IK20TT	6
825 Si Lux	129	25KV6F-175		04/96-02/99	K20PR-U	3145	0.8	K20TT	IK20TT	IK20TT	6
825 Si/Sterling	123/ 127	C25A2		10/86-10/88	K20PR-U	3145	0.8	K20TT	IK20TT	IK20TT	6

Свечи зажигания и Свечи накаливания

Таблица применения

















	KW				СТАНДАРТНЫЕ			Twin Tip			QTY
ROVER продолжение											
800 (86-99) продолжение											
825 Si/Sterling Catalytic-Conv	110	C25A2		10/86-02/88	K20PR-U	3145	0.8	K20TT	IK20TT	IK20TT	6
827 Si/Sterling	130	20M4G/C27A2		02/88-12/91	K20PR-U	3145	0.8	K20TT	IK20TT	IK20TT	6
827 Si/Sterling Catalytic-Conv	124	C27A1		02/88-09/91	K20PR-U	3145	0.8	K20TT	IK20TT	IK20TT	6
827 Vitesse Catalytic-Conv	124	C27A1		10/88-12/91	K20PR-U	3145	0.8	K20TT	IK20TT	IK20TT	6
827 Vitesse/SLI	130	20M4G/C27A2		10/88-12/91	K20PR-U	3145	0.8	K20TT	IK20TT	IK20TT	6
2000-3500 (76-86)											
2000	74	20V973		10/82-10/86	T20EPR-U	5032	0.8	T20TT	IT20TT	IT20TT	4
2400 TD	67	HR 492 HT	Double Coil Standard	05/82-10/86	DG-202		11V				4
CABRIOLET (90-99)											
214 1.4	66/70	14K4C; 14K4D		01/92-09/92	K20PR-U	3145	0.8	K20TT	IK20TT	IK20TT	4
214 1.4i 16V	76	14K4F4		01/93-03/96	K20PR-U	3145	0.8	K20TT	IK20TT	IK20TT	4
216 1.6i	90	D16A8		01/92-03/96	K20PR-U	3145	0.8	K20TT	IK20TT	IK20TT	4
216 1.6i 16V	82	16K4F4/D16Z2		01/96-11/99	K20PR-U	3145	0.8	K20TT	IK20TT	IK20TT	4
COUPE (96-99)											
1.6 16 V	82	16K4F4		03/96-11/99	K20PR-U	3145	0.8	K20TT	IK20TT	IK20TT	4
1.8 16 V	107	18K4K		03/96-11/99	PK20PR-P8	3245	0.8	-	IK20TT	IK20TT	4
MAESTRO (90-95)											
1.3	49/51	12HE/12HF		09/90-01/95	W20EP-U	3043	0.8	W20TT	IW20TT	IW20TT	4
1.6	63	16H		09/90-04/92	K20PR-U	3145	0.8	K20TT	IK20TT	IK20TT	4
2.0 D	44		Double Coil(LPH)	09/90-10/92	DG-001		11V				4
2.0 TD	60	BB	Double Coil(LPH)	09/90-01/95	DG-001		11V				4
MINI (91-01)											
1.3 Cooper S	59			11/96-05/01	W20EPR-U	3047	0.8	W20TT	IW20TT	IW20TT	4
1.3 S	46	12 A2L		02/98-05/01	W20EPR-U	3047	0.8	W20TT	IW20TT	IW20TT	4
1000	30	99 H; 99 HD 81		08/90-06/93	W20EPR-U	3047	0.8	W20TT	IW20TT	IW20TT	4
1300	37/ 39/46	12 A2A; 12 A2B; 12 A2D; 12 A2E; 12 A2L		01/91-11/00	W20EPR-U	3047	0.8	W20TT	IW20TT	IW20TT	4
1300 / Cooper	45	12 A2A		06/91-02/94	W20EPR-U	3047	0.8	W20TT	IW20TT	IW20TT	4
MINI-Moke (86-93)											
1.0	34	99H		05/90-08/90	W16EPR-U	3021	0.8	W16TT	IW16TT	IW16TT	4
MONTEGO (84-95)											
2.0 D Turbo	60	BB	Double Coil(LPH)	10/88-10/95	DG-001		11V				4
2.0 GTi	86	20HA/20HB59/ 20HB60; 20HA/ 20HB59		10/88-10/91	W20EPR-U	3047	0.8	W20TT	IW20TT	IW20TT	4
2.0 GTi/LXI	75	20HA30/B43		12/90-12/93	W20EP-U	3043	0.8	W20TT	IW20TT	IW20TT	4
2.0 i Cat	75	20HA30/20HB43		12/90-01/92	W20EP-U	3043	0.8	W20TT	IW20TT	IW20TT	4
2.0 Turbo-D	60	BB	Double Coil(LPH)	01/93-12/93	DG-001		11V				4
STREETWISE (03-05)											
1.4	62/76	14 K4F; 14 K4M	Ch: >471564	08/03-05/05	PK20PR-P8	3245	0.8	-	IK20TT	IK20TT	4
1.4	62/76	14 K4F; 14 K4M	Ch: 471565>	08/03-05/05	PK16PR-L11	3275	1.1	-	IK16TT	IK16TT	4
1.6	80	16 K4F	Ch: >471564	01/04-05/05	PK20PR-P8	3245	0.8	-	IK20TT	IK20TT	4
1.6	80	16 K4F	Ch: 471565>	01/04-05/05	PK16PR-L11	3275	1.1	-	IK16TT	IK16TT	4
1.8	86	18K4	Ch: 471565>	08/03-05/05	KJ20CR-L11	3169	1.1	K20TT	IK20TT	IK20TT	4
1.8	86	18K4	Flexible fuel	08/03-05/05	PK20PR-L11	3142	1.1	-	IK20TT	IK20TT	4
2.0 TD	74	20 T2N	Double Coil(LPH)	08/03-05/05	DG-101		11V				4
SAAB											
9-3 (98-03)											
2.0 i	96	B204I		02/98-12/00	IQ16TT	4706	1.0	-	IQ16TT		4
2.0 SE Turbo	147	B204R		02/98-01/99	Q22PR-U11	3257	1.1	-	-	VQ22	4
2.0 Turbo	110/ 113/ 151	B204E; B205E; B205R-205		03/99-08/03	PQ20R	3117	1.1	Q20TT	IQ20TT	IQ20TT	4
2.0 Turbo	113	B204E	OEM Optional	10/98-01/99	Q22PR-U11	3257	1.1	-	-	VQ22	4
2.0 Turbo	136	B204L		02/98-08/03	Q22PR-U11	3257	1.1	-	-	VQ22	4
2.2 TiD	85	D223L; X 22 DTH	Double Coil(LPH)	02/98-11/00	DG-118		11V				4
2.2 TiD	92	D223L	Double Coil(LPH)	11/00-09/02	DG-142		11V				4
2.3 i	110	B234I(149)		02/98-12/00	IQ20TT	4707	1.0	-	IQ20TT		4
2.3 Turbo	165	B235R(224)		10/98-08/03	Q22PR-U11	3257	1.1	-	-	VQ22	4

Таблица применения

R S

Свечи зажигания и Свечи накаливания

Таблица применения

	KW				СТАНДАРТНЫЕ				Twin Tip			QTY
												
SAAB продолжение												
9-3 (02-15)												
1.8 i	90	Z18XE		03/05-01/09	KJ16CR-L11	3132	1.1	K16TT	IK16TT	IK16TT	4	
1.8t 2.0	110	B207E		03/05-01/06	PK20PR-L11	3142	1.1	-	IK20TT	IK20TT	4	
1.9 TiD	88	Z 19 DT	Ch:>72045139; 75030986; 78007391, Double Coi l(LPH)	09/04-02/15	DG-122		11V				4	
1.9 TiD	88	Z 19 DT	Ch:72045140: 75030987; 78007392>, Double Coi l(LPH)	09/04-02/15	DG-196		11V				4	
1.9 TiD	110	Z 19 DTH	Double Coil(LPH)	09/04-02/15	DG-170		11V				4	
1.9 TTiD	96/ 118/ 132	A 19 DTR; Z 19 DTR		12/07-02/15	DG-608		4.4V				4	
1.8t	110	B207E		09/02-02/15	PK20PR-L11	3142	1.1	-	IK20TT	IK20TT	4	
2.0 t	110/ 129/ 154	B207E; B207L; B207R		09/02-02/15	PK20PR-L11	3142	1.1	-	IK20TT	IK20TT	4	
2.0 t	162	A 20 NFT		01/11-02/15	ITV16TT	4718	1.0	-	ITV16TT		4	
2.0 t Bio Power	162	A 20 NFT		01/11-02/15	ITV16TT	4718	1.0	-	ITV16TT		4	
2.0 t Bio Power XWD	154	B207R		06/08-02/15	PK20PR-L11	3142	1.1	-	IK20TT	IK20TT	4	
2.0 t BioPower	129/ 154	B207L; B207R		09/02-12/07	K22PR-U11	3192	1.1	-	IK22TT	VK22	4	
2.0 t BioPower	129/ 154	B207L; B207R		01/08-02/15	PK20PR-L11	3142	1.1	-	IK20TT	IK20TT	4	
2.0 t BioPower	162	A 20 NFT		01/11-02/15	ITV16TT	4718	1.0	-	ITV16TT		4	
2.0 t BioPower XWD	154	B207R		01/08-02/15	PK20PR-L11	3142	1.1	-	IK20TT	IK20TT	4	
2.0 t BioPower XWD	162	A 20 NFT		01/08-02/15	ITV16TT	4718	1.0	-	ITV16TT		4	
2.0 t XWD	154	B207R		06/08-02/15	PK20PR-L11	3142	1.1	-	IK20TT	IK20TT	4	
2.0 t XWD	162	A 20 NFT		01/08-02/15	ITV16TT	4718	1.0	-	ITV16TT		4	
2.0 Turbo XWD	154	B207R		01/08-02/15	PK20PR-L11	3142	1.1	-	IK20TT	IK20TT	4	
2.2 TiD	92	D223L	Double Coil(LPH)	09/02-02/15	DG-142		11V				4	
2.8 Turbo V6	188	B284L		12/07-08/08	IKH20TT	4704	1.0	-	IKH20TT		6	
9-3X (09-12)												
1.9 TTiD AWD	132	A 19 DTR; Z 19 DTR		02/09-12/12	DG-608		4.4V				4	
2.0 t BioPower XWD	154	B207R		02/09-12/12	PK20PR-L11	3142	1.1	-	IK20TT	IK20TT	4	
2.0 t BioPower XWD	162	A 20 NFT		01/11-12/12	ITV16TT	4718	1.0	-	ITV16TT		4	
2.0 t XWD	154	B207R		02/09-12/12	PK20PR-L11	3142	1.1	-	IK20TT	IK20TT	4	
9-5 (97-09)												
1.9 TiD	110	Z 19 DTH	Double Coil(LPH)	01/06-12/09	DG-170		11V				4	
1.9 TiD	129	Z 19 DTR		01/07-12/09	DG-608		4.4V				4	
2.0 t	110	B205E		09/97-08/01	Q20PR-U11	3008	1.1	Q20TT	IQ20TT	IQ20TT	4	
2.0 t	110	B205E; B205E-D4/B205E- E2		09/01-02/07	PQ20R	3117	1.1	Q20TT	IQ20TT	IQ20TT	4	
2.0 t	136/ 141	B205R	Ch: >X047592	10/98-12/09	Q22PR-U11	3257	1.1	-	-	VQ22	4	
2.0 t	136/ 141	B205R	Ch: X047593>	10/98-12/09	Q20PR-U11	3008	1.1	Q20TT	IQ20TT	IQ20TT	4	
2.0 t BioPower	110/ 132	B205E		01/05-12/09	PQ20R	3117	1.1	Q20TT	IQ20TT	IQ20TT	4	
2.0 Turbo SE	141	B205R	Ch: >X047592	10/98-07/00	Q22PR-U11	3257	1.1	-	-	VQ22	4	
2.0 Turbo SE	141	B205R	Ch: X047593>	10/98-07/00	Q20PR-U11	3008	1.1	Q20TT	IQ20TT	IQ20TT	4	
2.2 TiD	88	D223L	Double Coil(LPH)	03/02-12/09	DG-118		11V				4	
2.3 t	125	B235E	Ch: >X047592	09/97-12/09	Q22PR-U11	3257	1.1	-	-	VQ22	4	
2.3 t	125	B235E	OEM Optiona l,Ch:>X047592	10/98-12/09	Q22PR-U11	3257	1.1	-	-	VQ22	4	
2.3 t	125/ 136	B235E	Ch: X047593>	09/97-08/01	Q20PR-U11	3008	1.1	Q20TT	IQ20TT	IQ20TT	4	
2.3 t	136	B235E		01/01-12/09	PQ20R	3117	1.1	Q20TT	IQ20TT	IQ20TT	4	
2.3 t BioPower	136	B235E		01/07-12/09	PQ20R	3117	1.1	Q20TT	IQ20TT	IQ20TT	4	
2.3 Turbo	162/ 184/ 191	B235L; B235L-D4/B235L- E2; B235R(260); B235R; B235R-D4/B235R-E2		09/01-12/09	PQ20R	3117	1.1	Q20TT	IQ20TT	IQ20TT	4	
2.3 Turbo	169	B235R(230)	Ch: Y086667>	10/99-09/01	PQ20R	3117	1.1	Q20TT	IQ20TT	IQ20TT	4	

Свечи зажигания и Свечи накаливания

Таблица применения









	KW				СТАНДАРТНЫЕ				Twin Tip		QTY
											
SAAB продолжение											
9-5 (97-09) продолжение											
2.3 Turbo	169	B235R(230)	OEM Optiona I,Ch:->Y086666	10/99-09/01	PK22PR-L11S	3284	1.1	-	-	VK22G	4
2.3 Turbo	191	B235R(260)		11/05-07/09	PK22PR-L11S	3284	1.1	-	-	VK22G	4
3.0 TiD	130	D308L		07/01-08/05	DG-646		11V				6
3.0 V6t	147	B308E		01/98-08/03	K22PR-U11	3192	1.1	-	IK22TT	VK22	6
9-5 (10-12)											
1.6 Turbo	132	A16LET		05/10-01/12	IK20L	5358	1.1	-	IK20TT	IK20TT	4
2.0 t BioPower	162	A 20 NFT		05/10-01/12	ITV16TT	4718	1.0	-	ITV16TT		4
2.0 t BioPower XWD	162	A 20 NHT		05/10-01/12	ITV20TT	4719	1.0	-	ITV20TT		4
2.0 TiD	118	A 20 DTH		05/10-01/12	DG-608		4.4V				4
2.0 TTIID	140	A 20 DTR		05/10-01/12	DG-608		4.4V				4
2.0 TTIID XWD	140	A 20 DTR		05/10-01/12	DG-608		4.4V				4
2.0 Turbo	162	A 20 NHT		05/10-01/12	ITV20TT	4719	1.0	-	ITV20TT		4
2.0 Turbo XWD	162	A 20 NHT		05/10-01/12	ITV20TT	4719	1.0	-	ITV20TT		4
9-7X (05-)											
5.3 AWD	220	Vortec 5 300		06/04-05/08	IT16TT	4713	1.0	-	IT16TT		8
5.3 AWD	220	Vortec5300GPL/Vorte c 5 300 Bi	Flexible fuel	06/04-05/08	IT16TT	4713	1.0	-	IT16TT		8
90 (84-87)											
2.0	74	B201C/SAAB02		08/84-08/87	W20EPR-U11	3049	1.1	W20TT	IW20TT	IW20TT	4
99 (68-84)											
2.0 GL	74	B20C/B20T		10/80-01/83	W20EPR-U11	3049	1.1	W20TT	IW20TT	IW20TT	4
900 I (78-94)											
2.0	125	B202XL		10/89-10/93	IQ22	5313	0.8	-	-	VQ22	4
2.0 8V Turbo	114	B201S		01/88-01/89	IW22	5307	0.8	-	-	VW22	4
2.0 -16	93	B202I		01/89-12/93	IQ16TT	4706	1.0	-	IQ16TT		4
2.0 -16	93	B202I		01/90-06/94	Q20P-U	3125	0.8	Q20TT	IQ20TT	IQ20TT	4
2.0 c	74	B 20		09/79-12/88	W20EP-U	3043	0.8	W20TT	IW20TT	IW20TT	4
2.0 EMS	87	BI 20		09/78-12/80	W20EP-U	3043	0.8	W20TT	IW20TT	IW20TT	4
2.0 i	85	BI 20		11/80-08/90	W20EP-U	3043	0.8	W20TT	IW20TT	IW20TT	4
2.0 S Turbo-16	104/ 107	B202S		07/91-06/94	IQ22	5313	0.8	-	-	VQ22	4
2.0 Turbo	103/ 110	B201S		01/86-01/89	IW22	5307	0.8	-	-	VW22	4
2.0 Turbo	107	BSI 20		09/78-07/85	W22EP-U	3085	0.8	W22TT	-	VW22	4
2.0 Turbo-16	118	B202XL		11/85-06/94	IQ22	5313	0.8	-	-	VQ22	4
2.0 Turbo-16 S	129	B202XL		01/84-06/94	IQ22	5313	0.8	-	-	VQ22	4
2.0 Turbo-16 S Cat	125/ 129	B202XL		01/89-12/93	IQ22	5313	0.8	-	-	VQ22	4
900 II (93-98)											
2.0 -16 Turbo	136	B204L		07/93-02/98	Q22PR-U11	3257	1.1	-	-	VQ22	4
2.0 i	96	B204I		12/93-02/98	Q20PR-U11	3008	1.1	Q20TT	IQ20TT	IQ20TT	4
2.0 i	96/98	B204I; B206I		07/93-02/98	IQ16TT	4706	1.0	-	IQ16TT		4
2.3 -16	110	B234I		07/93-02/98	Q20PR-U11	3008	1.1	Q20TT	IQ20TT	IQ20TT	4
2.3 -16	110	B234I(149); B234I		12/93-02/98	IQ20TT	4707	1.0	-	IQ20TT		4
2.5 -24 V6	125	B258I		07/93-02/98	K20TXR	5063	1.0	K20TT	IK20TT	IK20TT	6
9000 (84-98)											
2.0	99	B202I		10/88-08/90	Q20PR-U11	3008	1.1	Q20TT	IQ20TT	IQ20TT	4
2.0 -16	92/94	B202I; B202XI		12/85-01/93	Q20PR-U11	3008	1.1	Q20TT	IQ20TT	IQ20TT	4
2.0 -16 CD	96/ 110	B202I; B202S; B204E; B204I; B204S		09/93-12/98	Q20PR-U11	3008	1.1	Q20TT	IQ20TT	IQ20TT	4
2.0 -16 CS	94/96	B202I; B204I		01/89-12/98	Q20PR-U11	3008	1.1	Q20TT	IQ20TT	IQ20TT	4
2.0 -16 ND Turbo	110	B202S; B204E; B204S		09/93-12/98	Q22PR-U	3010	0.8	-	-	VQ22	4
2.0 -16 Turbo	118/ 120/ 127/ 129	B202L; B202XL		09/84-09/93	Q22PR-U	3010	0.8	-	-	VQ22	4
2.0 -16 Turbo CD	108/ 120/ 136	B202L; B202S; B202XL; B204E		09/88-12/98	Q22PR-U	3010	0.8	-	-	VQ22	4
2.0 -16 Turbo CS	136	B202L		09/88-12/98	Q22PR-U	3010	0.8	-	-	VQ22	4
2.0 16v	143	B202L		09/89-01/90	Q22PR-U	3010	0.8	-	-	VQ22	4
2.0 Carlsson	143	B204L		09/89-08/90	Q22PR-U	3010	0.8	-	-	VQ22	4
2.0 T16	150	B202L		06/89-10/90	Q22PR-U	3010	0.8	-	-	VQ22	4
2.3	110	B234I		10/89-12/93	Q20PR-U11	3008	1.1	Q20TT	IQ20TT	IQ20TT	4
2.3	165	B234R		09/90-10/98	Q22PR-U11	3257	1.1	-	-	VQ22	4
2.3 -16 Aero CS	162/ 165	B234R		02/93-12/98	Q22PR-U11	3257	1.1	-	-	VQ22	4
2.3 -16 CD	107	B234I		08/89-12/98	Q20PR-U11	3008	1.1	Q20TT	IQ20TT	IQ20TT	4

Таблица применения

S

Свечи зажигания и Свечи накаливания











Таблица применения

Таблица применения

KW	KW	KW	NOTE	21	СТАНДАРТНЫЕ				Twin Tip			QTY
					STANDARD	STANDARD	STANDARD	STANDARD	STANDARD	STANDARD	STANDARD	
SAAB продолжение												
9000 (84-98) продолжение												
2.3 -16 CD Turbo	147	B234L		07/90-12/98	Q22PR-U11	3257	1.1	-	-	VQ22	4	
2.3 -16 CDE	108	B234I		09/93-12/98	Q20PR-U11	3008	1.1	Q20TT	IQ20TT	IQ20TT	4	
2.3 -16 CDE Eco-Power	125	B234E		09/93-12/98	Q22PR-U11	3257	1.1	-	-	VQ22	4	
2.3 -16 CS	107	B234I		09/89-12/98	Q20PR-U11	3008	1.1	Q20TT	IQ20TT	IQ20TT	4	
2.3 -16 CSE	108	B234I		09/93-12/98	Q20PR-U11	3008	1.1	Q20TT	IQ20TT	IQ20TT	4	
2.3 -16 CSE Eco Power	125	B234E		09/93-12/98	Q22PR-U11	3257	1.1	-	-	VQ22	4	
2.3 -16 Turbo	143	B234L		09/90-12/98	Q22PR-U11	3257	1.1	-	-	VQ22	4	
2.3 -16 Turbo CSE	147	B234L		09/93-12/98	Q22PR-U11	3257	1.1	-	-	VQ22	4	
3.0 -24 V6 CD/CDE	155	B308I		07/94-12/98	K20TXR	5063	1.0	K20TT	IK20TT	IK20TT	6	
3.0 -24 V6 CS/CSE	155	B308I		07/94-12/98	K20TXR	5063	1.0	K20TT	IK20TT	IK20TT	6	
SANTANA												
LANDROVER 88 / 109 (71-91)												
2.3	52	11H		10/71-10/83	W20ESR-U	3057	0.8	-	-		4	
PS10 / ANIBAL (02-)												
2.8 D 4x4	78/92	8140.43P	Double Coil(LPH)	03/03-	DG-111		11V				4	
2.8 TD	78/92	8140.43C; 8140.43P	Double Coil(LPH)	12/02-	DG-111		11V				4	
2.8 TD AWD	92	8140.43P	Double Coil(LPH)	09/04-12/08	DG-111		11V				4	
SAMURAI (86-95)												
1.0	33	F10A		09/89-12/95	W16EXR-U	3031	0.8	W16TT	IW16TT	IW16TT	4	
1.0	33	F10A		09/89-12/95	W16EX-U	3027	0.8	W16TT	IW16TT	IW16TT	4	
1.3	47			09/86-12/94	W20EPR-U	3047	0.8	W20TT	IW20TT	IW20TT	4	
1.3 4x4	47	G13BA		10/91-12/94	K20PR-U	3145	0.8	K20TT	IK20TT	IK20TT	4	
SEAT												
131 (78-86)												
2.0	85	131 C4.000		06/78-12/85	W22EPR-U	3088	0.8	W22TT	-	VW22	4	
132 (73-82)												
2.0 D	40		Double Coil(LPH)	05/73-12/80	DG-001		11V				4	
2.2 D	44	OM 615.912	Double Coil(LPH)	05/79-12/82	DG-001		11V				4	
ALHAMBRA (7V) (96-10)												
1.8 T 20V	110	AJH		10/97-05/00	K20PBR-S10	5061	1.0	K20TT	IK20TT	IK20TT	4	
1.8 T 20V	110	AWC		06/00-03/10	PK20PR-P8	3245	0.8	-	IK20TT	IK20TT	4	
1.9 TDI	66/81	1Z; AFN; AHU; AVG	Auxiliary Heater	04/96-03/10	DG-628		11V				3	
1.9 TDI	66/81	1Z; AFN; AHU; AVG	Double Coil(LPH)	04/96-03/10	DG-005		11V				4	
1.9 TDI	66/85	ANU; AUY; BVK	Ch:> 7M-2-514 000, Double Coi l(LPH)	04/96-10/01	DG-005		11V				4	
1.9 TDI	66/85	ANU; AUY; BVK	Ch: 7M-2-514 001> ,Double Coi l(LPH)	10/01-03/10	DG-109		11V				4	
1.9 TDI	96/ 110	ASZ; BTB		11/02-11/08	DG-109		11V				4	
1.9 TDI 4motion	85	AUY; BVK	Ch:> 7M-2-514 000, Double Coi l(LPH)	06/00-10/01	DG-005		11V				4	
1.9 TDI 4motion	85	AUY; BVK	Ch: 7M-2-514 001> ,Double Coi l(LPH)	10/01-03/10	DG-109		11V				4	
2.0 i	85	ADY; ATM		04/96-03/10	K20PBR-S10	5061	1.0	K20TT	IK20TT	IK20TT	4	
2.8 V6	150	AUE	50000km Lifet ime, IridiumTou gh	06/00-04/02	IK16TT	4701	1.0	-	IK16TT	IK16TT	6	
2.8 V6	150	AYL		06/00-03/10	PKJ16CR-L11	3246	1.1	-	IK16TT	IK16TT	6	
2.8 V6 4motion	150	AUE	50000km Lifet ime, IridiumTou gh	06/00-04/02	IK16TT	4701	1.0	-	IK16TT	IK16TT	6	
2.8 V6 4motion	150	AYL		06/00-03/10	PKJ16CR-L11	3246	1.1	-	IK16TT	IK16TT	6	
ALHAMBRA (710) (10-)												
1.4 TSI	110	CAVA; CNWB; CTHA		06/10-02/11	PKJ20CR8	3173	0.8	-	IK20TT	IK20TT	4	
1.4 TSI	110	CAVA; CNWB; CTHA		02/11-	SKJ20CR-A8	3371	0.8	-	-	SKJ20CR-A8	4	
1.8 TSI	118	CDAA		11/12-	PK22PR8	3273	0.8	-	IK22TT	VK22	4	

Свечи зажигания и Свечи накаливания

Таблица применения

	KW				СТАНДАРТНЫЕ			Twin Tip			QTY
											
SEAT продолжение											
ALHAMBRA (710) (10-) продолжение											
2.0 TDI	85/ 100/ 103/ 125	CFFA; CFFB; CFFE; CFGB		06/10-	DG-193		4.4V				4
2.0 TDI	85/ 110/ 130/ 135	CFGC; CUVA; CUVC; CUWA; DFLA; DFMA; DLTA; DLUB	Pressure sensor(-)	05/11-	DG-193		4.4V				3
2.0 TDI 4Drive	103	CFFB		05/11-	DG-193		4.4V				4
2.0 TDI 4Drive	110/ 135	CUVC; DFLA; DFMA	Pressure sensor(-)	05/15-	DG-193		4.4V				3
2.0 TSI	147	CCZA		11/10-	PK22PR8	3273	0.8	-	IK22TT	VK22	4
ALTEA (XL) (5P) (04-)											
1.4 16V	63	BXW; CGGB		05/06-	KJ20DR-M11	3374	1.1	-	-	SKJ20DR-M11	4
1.4 TSI	92	CAXC		11/07-	PKJ20CR8	3173	0.8	-	IK20TT	IK20TT	4
1.6	75	BGU; BSE; BSF; CCSA; CMXA		03/04-	K20PBR-S10	5061	1.0	K20TT	IK20TT	IK20TT	4
1.6 LPG	75	CHGA		09/09-	K20PBR-S10	5061	1.0	K20TT	IK20TT	IK20TT	4
1.6 Multifuel	75	CCSA		10/06-	K20PBR-S10	5061	1.0	K20TT	IK20TT	IK20TT	4
1.6 TDI	66/77	CAYB; CAYC		10/09-	DG-193		4.4V				4
1.8 TFSI	118	BYT; BZB; CDAA		01/07-	PK22PR8	3273	0.8	-	IK22TT	VK22	4
1.9 TDI	66/77	BJB; BKC; BLS; BXE; BXF		04/04-	DG-177		5V				4
1.9 TDI 4x4	77	BLS		06/09-12/10	DG-177		5V				4
2.0 FSI	110	BLR/ BVY		05/04-03/09	VKA16	5622	1.1	-	-	VKA16	4
2.0 FSI	110	BLY/ BVZ		05/04-03/09	K20PR-U	3145	0.8	K20TT	IK20TT	IK20TT	4
2.0 TDI	100/ 103	AZV; BKD		03/04-	DG-190		4.4V				4
2.0 TDI	103/ 125	CEGA; CFHC		03/04-	DG-193		4.4V				4
2.0 TDI	125	BMN	OE: N 105 798 03/ N 105 798 05, Ceramic	03/06-	DG-622		7V				4
2.0 TDI 4x4	103/ 125	CEGA; CFHC; CFJA		06/07-	DG-193		4.4V				4
2.0 TDI 4x4	125	BMN	OE: N 105 798 03/ N 105 798 05, Ceramic	06/07-	DG-622		7V				4
2.0 TFSI	147	BWA		04/06-05/09	PK22PR8	3273	0.8	-	IK22TT	VK22	4
2.0 TFSI 4x4	147/ 155	BWA; CCZB		06/07-	PK22PR8	3273	0.8	-	IK22TT	VK22	4
AROSA (6H) (97-04)											
1.0	37	AER		05/97-06/04	W20EPBR-S	5067	0.85	W20TT	IW20TT	IW20TT	4
1.0	37	AHT		10/98-01/01	K20PBR-S10	5061	1.0	K20TT	IK20TT	IK20TT	4
1.4	44	AEX		05/97-06/04	W20EPBR-S	5067	0.85	W20TT	IW20TT	IW20TT	4
1.4 16V	74	AQQ		01/00-06/04	K20PBR-S10	5061	1.0	K20TT	IK20TT	IK20TT	4
1.4 TDI	55	AMF	Ch:> 6H-2-009 700, Double Coi l(LPH)	01/00-11/01	DG-005		11V				3
1.4 TDI	55	AMF	Ch: 6H-2-009 701> ,Double Coi l(LPH)	11/01-06/04	DG-109		11V				3
1.7 SDI	44	AKU	Double Coil(LPH)	08/97-06/04	DG-005		11V				4
ATECA (KH7) (16-)											
1.6 TDI	85	DDYA; DGTE	Euro-4; Euro-5	04/16-	DG-193		4.4V				4
1.6 TDI	85	DDYA; DGTE	Euro-6; Pressures ensor(-)	04/16-	DG-193		4.4V				3
2.0 TDI	110	DFFA	Euro-4; Euro-5	04/16-	DG-193		4.4V				4
2.0 TDI	110	DFFA	Euro-6; Pressures ensor(-)	04/16-	DG-193		4.4V				3
2.0 TDI 4Drive	110/ 140	DFFA; DFHA	Euro-4; Euro-5	04/16-	DG-193		4.4V				4
2.0 TDI 4Drive	110/ 140	DFFA; DFHA	Euro-6; Pressures ensor(-)	04/16-	DG-193		4.4V				3
CORDOBA (6K1) (93-99)											
1.0 i	37	AER; ALD; ANV; AUC		09/96-10/02	W20EPBR-S	5067	0.85	W20TT	IW20TT	IW20TT	4

Свечи зажигания и Свечи накаливания

Таблица применения

Таблица применения

SEAT	KW	KW	NOTE	21	СТАНДАРТНЫЕ			Twin Tip		QTY	
					W20EPBR-S	5067	0.85	W20TT	IW20TT		
SEAT продолжение											
CORDOBA (6K1) (93-99) продолжение											
1.4 i	44	AEX; APQ		06/94-12/02	W20EPBR-S	5067	0.85	W20TT	IW20TT	IW20TT	4
1.4 i 16V	74	AFH; AQQ; AUB		09/96-10/02	K20PBR-S10	5061	1.0	K20TT	IK20TT	IK20TT	4
1.6 i	55	1F; ABU; AEE		02/93-12/02	W20EPBR-S	5067	0.85	W20TT	IW20TT	IW20TT	4
1.6 i	74	AEH; AFT; AKL; APF; AUR		07/96-12/02	K20PBR-S10	5061	1.0	K20TT	IK20TT	IK20TT	4
1.8 i	66	ADZ		02/93-09/02	W20EPBR-S	5067	0.85	W20TT	IW20TT	IW20TT	4
1.8 i 16V	95	ADL		10/93-08/96	K22PBR-S	5062	0.85	-	IKB22TT	VK22	4
1.9 D	47/50	1Y		02/93-08/96	DG-012		11V				4
1.9 SDI	47	AEY	Auxiliary Heater	08/96-06/99	DG-012		11V				3
1.9 SDI	47	AEY	Double Coil(LPH)	08/96-06/99	DG-005		11V				4
1.9 TD	55	AAZ		02/93-08/96	DG-012		11V				4
1.9 TDI	66/81	1Z; AFN; AGR; AHU; ALH; ASK; ASV	Auxiliary Heater	08/96-12/02	DG-628		11V				3
1.9 TDI	66/81	1Z; AFN; AGR; AHU; ALH; ASK; ASV	Double Coil(LPH)	08/96-12/02	DG-005		11V				4
2.0 i	85	2E		02/93-06/99	K22PBR-S	5062	0.85	-	IKB22TT	VK22	4
2.0 i 16V	110	ABF		08/96-06/99	PK22PR8	3273	0.8	-	IK22TT	VK22	4
CORDOBA (6K2) (99-02)											
1.4 16V	55	APE		06/99-12/02	K20PBR-S10	5061	1.0	K20TT	IK20TT	IK20TT	4
1.8 T 20V Cupra	115	AQX		07/00-10/02	PK20PR-P8	3245	0.8	-	IK20TT	IK20TT	4
1.9 SDI	50	AGP; AQM	Auxiliary Heater	06/99-12/02	DG-628		11V				3
1.9 SDI	50	AGP; AQM	Double Coil(LPH)	06/99-12/02	DG-005		11V				4
CORDOBA (6L) (02-09)											
1.2	47	AZQ; BME		10/02-06/06	KJ16CR-L11	3132	1.1	K16TT	IK16TT	IK16TT	3
1.2 12V	51	BXV		05/06-11/09	PK20PR-P8	3245	0.8	-	IK20TT	IK20TT	3
1.4 16V	55	BBY	OEM Optional	09/02-04/04	PKJ16CR-L11	3246	1.1	-	IK16TT	IK16TT	4
1.4 16V	55/74	BBY; BBZ; BKY		09/02-11/09	K20PBR-S10	5061	1.0	K20TT	IK20TT	IK20TT	4
1.4 16V	63	BXW		05/06-11/09	KJ20DR-M11	3374	1.1	-	-	SKJ20DR-M11	4
1.4 TDI	51/55/59	AMF; BNM; BNV	Double Coil(LPH)	10/02-11/09	DG-109		11V				3
1.6 16V	77	BTS		11/06-11/09	KJ20DR-M11	3374	1.1	-	-	SKJ20DR-M11	4
1.9 SDI	47	ASY	Double Coil(LPH)	09/02-11/09	DG-005		11V				4
1.9 TDI	74	ATD	Auxiliary Heater	09/02-11/09	DG-628		11V				3
1.9 TDI	74/96	ASZ; ATD; AXR; BLT		09/02-11/09	DG-109		11V				4
2.0	85	AZL; BBX		09/02-11/09	K20PBR-S10	5061	1.0	K20TT	IK20TT	IK20TT	4
EXEO (3R) (08-)											
1.6	75	ALZ		03/09-09/10	K20PBR-S10	5061	1.0	K20TT	IK20TT	IK20TT	4
1.6	75	ALZ	OEM Optional	03/09-09/10	PK20PR-P8	3245	0.8	-	IK20TT	IK20TT	4
1.8 T	110	CFMA		12/08-05/10	K20PBR-S10	5061	1.0	K20TT	IK20TT	IK20TT	4
1.8 T	110	CFMA	OEM Optional	12/08-05/10	PK20PR-P8	3245	0.8	-	IK20TT	IK20TT	4
1.8 TSI	88/118	CDHA; CDHB		05/10-05/13	PK22PR8	3273	0.8	-	IK22TT	VK22	4
2.0 TDI	88/105/125	CAGA; CAGC; CAHA; CGLB; CJCA; CJCC		12/08-05/13	DG-193		4.4V				4
2.0 TFSI	147/155	BWE; CDND		03/09-05/13	PK22PR8	3273	0.8	-	IK22TT	VK22	4
FURA (82-86)											
0.9	29/31/33	100 GL 7000; HB 90		01/82-12/86	W20EPR-U	3047	0.8	W20TT	IW20TT	IW20TT	4
IBIZA I (84-93)											
0.9	29/32	146 A 000		08/86-05/93	W20EPR-U	3047	0.8	W20TT	IW20TT	IW20TT	4
1.2	44/46	021 A 1000		11/84-12/93	Q22P-U	3255	0.8	-	-	VQ22	4
1.2 i	52	021 C.1000		01/89-05/93	Q22P-U	3255	0.8	-	-	VQ22	4
1.5	63	021 A 2000		11/84-05/93	Q22P-U	3255	0.8	-	-	VQ22	4
1.5 i	65	021 D.2000		10/86-05/93	Q22PR-U	3010	0.8	-	-	VQ22	4
1.5 i	74	021 B.2000		03/88-05/93	Q22P-U	3255	0.8	-	-	VQ22	4
1.5 i Cat	66	021 C.2000		10/86-05/93	Q22P-U	3255	0.8	-	-	VQ22	4
1.7	72	021 A.3000		02/92-05/93	Q22P-U	3255	0.8	-	-	VQ22	4
1.7 D	40/42	022 A.5000	Double Coil(LPH)	06/84-05/93	DG-001		11V				4
IBIZA II (6K1) (93-99)											
1.0	33	AAU		03/93-09/96	W20EPBR-S	5067	0.85	W20TT	IW20TT	IW20TT	4
1.0 i	37	AER; ALD; ANV; AUC		09/96-02/02	W20EPBR-S	5067	0.85	W20TT	IW20TT	IW20TT	4
1.3 i	40	AAV		03/93-08/99	W20EPBR-S	5067	0.85	W20TT	IW20TT	IW20TT	4

Свечи зажигания и Свечи накаливания

Таблица применения

	KW				СТАНДАРТНЫЕ			Twin Tip		QTY	
											
SEAT продолжение											
IBIZA II (6K1) (93-99) продолжение											
1.4 i	44	ABD		09/93-02/02	W20EPBR-S	5067	0.85	W20TT	IW20TT	IW20TT	4
1.4 i 16V	74	AFH; AQQ; AUB		06/97-02/02	K20PBR-S10	5061	1.0	K20TT	IK20TT	IK20TT	4
1.6 i	55	1F; ABU		03/93-02/02	W20EPBR-S	5067	0.85	W20TT	IW20TT	IW20TT	4
1.6 i	74	AEH; AFT; AKL; APF; AUR		04/96-02/02	K20PBR-S10	5061	1.0	K20TT	IK20TT	IK20TT	4
1.7 SDI	44	AKU	Double Coil(LPH)	07/97-08/99	DG-005		11V				4
1.8 i	66	ADZ		03/93-08/99	W20EPBR-S	5067	0.85	W20TT	IW20TT	IW20TT	4
1.8 i 16V	95	ADL		11/93-08/96	K22PBR-S	5062	0.85	-	IKB22TT	VK22	4
1.9 D	47/50	1Y		04/93-08/96	DG-012		11V				4
1.9 SDI	47	AEY	Auxiliary Heater	08/96-08/99	DG-012		11V				3
1.9 SDI	47	AEY	Double Coil(LPH)	08/96-08/99	DG-005		11V				4
1.9 TD	55	AAZ		03/93-08/96	DG-012		11V				4
1.9 TDI	66/81	1Z; AFN; AGR; AHU; ALH; ASK; ASV	Auxiliary Heater	08/96-02/02	DG-628		11V				3
1.9 TDI	66/81	1Z; AFN; AGR; AHU; ALH; ASK; ASV	Double Coil(LPH)	08/96-02/02	DG-005		11V				4
2.0 i	85	AGG		03/93-08/99	W20EPBR-S	5067	0.85	W20TT	IW20TT	IW20TT	4
2.0 i 16V	110	ABF		08/96-08/99	PK22PR8	3273	0.8	-	IK22TT	VK22	4
IBIZA II (6K2) (99-02)											
1.0 16V	51	AST; AVZ		10/99-02/02	W22EPR-U	3088	0.8	W22TT	-	VW22	4
1.4 16V	55	APE; AUA		05/00-02/02	K20PBR-S10	5061	1.0	K20TT	IK20TT	IK20TT	4
1.8 T 20V Cupra	115	AQX; AYP		07/00-02/02	K20PBR-S10	5061	1.0	K20TT	IK20TT	IK20TT	4
1.9 SDI	50	AGP; AQM	Auxiliary Heater	08/99-02/02	DG-628		11V				3
1.9 SDI	50	AGP; AQM	Double Coil(LPH)	08/99-02/02	DG-005		11V				4
IBIZA III (6L) (02-09)											
1.2	44/47	AZQ; BBM; BME		02/02-05/08	KJ16CR-L11	3132	1.1	K16TT	IK16TT	IK16TT	3
1.2 12V	51	BXV		05/06-11/09	KJ16CR-L11	3132	1.1	K16TT	IK16TT	IK16TT	3
1.4 16V	55	BBY; BKY	OEM Optional	02/02-12/07	PKJ16CR-L11	3246	1.1	-	IK16TT	IK16TT	4
1.4 16V	55/74	AUB; BBY; BBZ; BKY		02/02-11/09	K20PBR-S10	5061	1.0	K20TT	IK20TT	IK20TT	4
1.4 16V	63	BXW		05/06-11/09	KJ20DR-M11	3374	1.1	-	-	SKJ20DR-M11	4
1.4 TDI	51/59	BNM; BNV	Double Coil(LPH)	05/05-11/09	DG-109		11V				3
1.4 TDI	55	AMF		05/02-12/05	DG-005		11V				3
1.6 16V	77	BTS		11/06-11/09	KJ20DR-M11	3374	1.1	-	-	SKJ20DR-M11	4
1.8 T Cupra R	132	BBU; BLZ		01/04-02/08	PK20PR-P8	3245	0.8	-	IK20TT	IK20TT	4
1.8 T FR	110	BJX; BKV		12/03-05/08	PK20PR-P8	3245	0.8	-	IK20TT	IK20TT	4
1.9 SDI	47	ASY	Double Coil(LPH)	02/02-12/05	DG-005		11V				4
1.9 TDI	74	ATD	Auxiliary Heater	02/02-11/09	DG-628		11V				3
1.9 TDI	74/96	ASZ; ATD; AXR; BLT		02/02-11/09	DG-109		11V				4
1.9 TDI Cupra R	118	BPX; BUK		03/04-02/08	DG-109		11V				4
2.0	85	AZL; BBX		04/02-06/07	K20PBR-S10	5061	1.0	K20TT	IK20TT	IK20TT	4
IBIZA IV (6J, 6P) (08-)											
1.2	44/51	CGPA; CGPB		03/08-	KJ20DR-M11	3374	1.1	-	-	SKJ20DR-M11	3
1.2	51	BZG		03/08-	KJ16CR-L11	3132	1.1	K16TT	IK16TT	IK16TT	3
1.2 TDI	55	CFWA		04/10-	DG-193		4.4V				3
1.4	63	BXW; CGGB		03/08-	KJ20DR-M11	3374	1.1	-	-	SKJ20DR-M11	4
1.4 TDI	55/ 66/77	CUSA; CUSB; CUTA; CYZA	Pressure sensor(-)	05/15-	DG-193		4.4V				2
1.4 TSI	110	CAVF; CNUB; CTHF; CTJB		06/09-02/11	PKJ20CR8	3173	0.8	-	IK20TT	IK20TT	4
1.4 TSI	110	CAVF; CNUB; CTHF; CTJB		02/11-	SKJ20CR-A8	3371	0.8	-	-	SKJ20CR-A8	4
1.4 TSI Cupra	132	CAVE; CTHE; CTJC		06/09-02/11	PKJ20CR8	3173	0.8	-	IK20TT	IK20TT	4
1.4 TSI Cupra	132	CAVE; CTHE; CTJC		02/11-	SKJ20CR-A8	3371	0.8	-	-	SKJ20CR-A8	4
1.6	77	BTS		05/08-	KJ20DR-M11	3374	1.1	-	-	SKJ20DR-M11	4
1.6 LPG	60	CNKA		05/11-	KJ20DR-M11	3374	1.1	-	-	SKJ20DR-M11	4
1.6 TDI	66/77	CAYB; CAYC; CLNA		05/09-	DG-193		4.4V				4
1.9 TDI	66/77	BLS; BXJ		03/08-06/10	DG-177		5V				4
2.0	85	CEKA		10/08-	K20PBR-S10	5061	1.0	K20TT	IK20TT	IK20TT	4
2.0 TDI	105	CFHD		01/10-	DG-193		4.4V				4
INCA (6K9) (95-03)											
1.4 16V	55	AUA		04/00-06/03	K20PBR-S10	5061	1.0	K20TT	IK20TT	IK20TT	4

Таблица применения

S

Свечи зажигания и Свечи накаливания

Таблица применения

Таблица применения

SEAT	KW	AUD	NOTE	21	СТАНДАРТНЫЕ			Twin Tip		QTY	
					PKJ16CR-L11	3246	1.1	-	IK16TT		IK16TT
SEAT продолжение											
INCA (6K9) (95-03) продолжение											
1.4 i	44	AUD		11/95-06/03	PKJ16CR-L11	3246	1.1	-	IK16TT	IK16TT	4
1.6 i	55	1F; AEE		11/95-09/00	W20EPBR-S	5067	0.85	W20TT	IW20TT	IW20TT	4
1.7 D	42	AHB	Auxiliary Heater	09/96-06/03	DG-012		11V				3
1.7 D	42	AHB	Double Coil(LPH)	09/96-06/03	DG-005		11V				4
1.9 D	47	1Y		11/95-06/03	DG-012		11V				4
1.9 SDI	47	AEY	Auxiliary Heater	11/95-06/03	DG-012		11V				3
1.9 SDI	47	AEY; AYQ	Double Coil(LPH)	11/95-06/03	DG-005		11V				4
1.9 TDI	66	ALH	Auxiliary Heater	09/96-06/03	DG-628		11V				3
1.9 TDI	66	ALH	Double Coil(LPH)	09/96-06/03	DG-005		11V				4
LEON (1M) (99-06)											
1.4 16V	55	AHW - Eu3/ APE/ AXP/ BCA		11/99-06/06	K20PBR-S10	5061	1.0	K20TT	IK20TT	IK20TT	4
1.6	75	AEH/ AKL; BFQ		11/99-06/06	K20PBR-S10	5061	1.0	K20TT	IK20TT	IK20TT	4
1.6 16 V	77	AZD/ BCB		09/00-06/06	PKJ16CR-L11	3246	1.1	-	IK16TT	IK16TT	4
1.6 16 V	77	BCB		09/00-06/06	K20PBR-S10	5061	1.0	K20TT	IK20TT	IK20TT	4
1.8 20V	92	AGN; APG		11/99-06/06	K20PBR-S10	5061	1.0	K20TT	IK20TT	IK20TT	4
1.8 20V T	132	APP		11/99-06/06	K20PBR-S10	5061	1.0	K20TT	IK20TT	IK20TT	4
1.8 20V T	132	APP; AUQ	OEM Optional	11/99-06/06	PK20PR-P8	3245	0.8	-	IK20TT	IK20TT	4
1.8 20V T 4	132	AJQ/ ARY/ AUQ		11/99-04/04	PK20PR-P8	3245	0.8	-	IK20TT	IK20TT	4
1.8 T Cupra R	154/165	AMK; BAM		02/02-06/06	PK20PR-P8	3245	0.8	-	IK20TT	IK20TT	4
1.9 SDI	50	AQM	Auxiliary Heater	11/99-06/06	DG-628		11V				3
1.9 SDI	50	AQM	Double Coil(LPH)	11/99-06/06	DG-005		11V				4
1.9 TDI	66/81	AGR; AHF; ALH; ASV	Double Coil(LPH)	11/99-06/06	DG-005		11V				4
1.9 TDI	66/81/110	AGR; AHF; ALH; ARL; ASV	Auxiliary Heater	11/99-06/06	DG-628		11V				3
1.9 TDI	74/96	ASZ; AXR		05/03-06/06	DG-109		11V				4
1.9 TDI	110	ARL	Ch:> 1M-2-062 000, Double Coi l(LPH)	09/00-12/01	DG-005		11V				4
1.9 TDI	110	ARL	Ch: 1M-2-062 001>, Double Coi l(LPH)	12/01-06/06	DG-109		11V				4
1.9 TDI Syncro	110	ARL	Auxiliary Heater	05/02-06/06	DG-628		11V				3
1.9 TDI Syncro	110	ARL	Double Coil(LPH)	05/02-06/06	DG-109		11V				4
2.8 Cupra 4	150	AUE	50000km Lifet ime, IridiumTou gh	02/01-04/01	IK16TT	4701	1.0	-	IK16TT	IK16TT	6
2.8 Cupra 4	150	BDE		02/01-04/04	PKJ16CR-L11	3246	1.1	-	IK16TT	IK16TT	6
LEON (1P) (05-12)											
1.4 16V	63	BXW; CGGB		06/06-12/12	KJ20DR-M11	3374	1.1	-	-	SKJ20DR-M11	4
1.4 TSI	92	CAXC		11/07-12/12	PKJ20CR8	3173	0.8	-	IK20TT	IK20TT	4
1.6	75	BSE; BSF; CCSA; CMXA		07/05-12/12	K20PBR-S10	5061	1.0	K20TT	IK20TT	IK20TT	4
1.6 LPG	75	CHGA		12/09-12/12	K20PBR-S10	5061	1.0	K20TT	IK20TT	IK20TT	4
1.6 MultiFuel	75	BSE; CMXA		11/10-12/12	K20PBR-S10	5061	1.0	K20TT	IK20TT	IK20TT	4
1.6 TDI	66/77	CAYB; CAYC		02/10-12/12	DG-193		4.4V				4
1.8 TSI	118	BZB; CDAA		06/07-12/12	PK22PR8	3273	0.8	-	IK22TT	VK22	4
1.9 TDI	66/77	BKC; BLS; BXE; BXF		07/05-12/10	DG-177		5V				4
2.0 Cupra R	195	CDLA		09/09-12/12	PK22PR8	3273	0.8	-	IK22TT	VK22	4
2.0 FSI	110	BLR; BLY; BVY; BVZ		07/05-05/10	K20PR-U	3145	0.8	K20TT	IK20TT	IK20TT	4
2.0 FSI	110	BLR; BLY; BVY; BVZ	OEM Optional	07/05-05/10	VKA16	5622	1.1	-	-	VKA16	4
2.0 TDI	100/103	AZV; BKD		07/05-12/12	DG-190		4.4V				4
2.0 TDI	103/125	CEGA; CFHC; CFJA; CLCB		07/05-12/12	DG-193		4.4V				4
2.0 TDI	125	BMN	OE: N 105 798 03/ N 105 798 05, Ceramic	05/06-12/12	DG-622		7V				4
2.0 TDI 8V	103	BMM		10/05-10/10	DG-177		5V				4

Свечи зажигания и Свечи накаливания

Таблица применения





	KW				СТАНДАРТНЫЕ			Twin Tip			QTY
SEAT продолжение											
LEON (1P) (05-12) продолжение											
2.0 TFSI	136/ 147/ 155/ 177	BWA1; BWJ; CCZB; CDLD		05/05-12/12	PK22PR8	3273	0.8	-	IK22TT	VK22	4
LEON (5F) (12-)											
1.6 TDI	66/ 77/81	CLHA; CLHB; CRKB; CXXA; CXXB; DBKA; DDYB	Pressure sensor(-)	11/12-	DG-193		4.4V				3
1.6 TDI 4Drive	77/81	CLHA; CXXB	Pressure sensor(-)	04/14-	DG-193		4.4V				3
2.0 TDI	81/ 105	CRVA; CRVC	Euro-4; Euro-5	05/13-	DG-193		4.4V				4
2.0 TDI	81/ 105	CRVA; CRVC	Euro-6; Pressures ensor(-)	05/13-	DG-193		4.4V				3
2.0 TDI	110/ 135	CKFC; CRBC; CRLB; CRMB; CUNA; CUPA; DFFA; DFGA; DJGA	Pressure sensor(-)	09/12-	DG-193		4.4V				3
2.0 TDI 4Drive	110/ 135	CRBC; CRLB; CRMB; CUNA; DCYA; DFGA; DJGA	Pressure sensor(-)	04/14-	DG-193		4.4V				3
MALAGA (84-93)											
1.2	44	021 A 1000		05/85-12/93	Q22P-U	3255	0.8	-	-	VQ22	4
1.5	63	021 A 2000		05/85-12/93	Q22P-U	3255	0.8	-	-	VQ22	4
1.5 i	74	021A		01/87-12/93	Q22PR-U	3010	0.8	-	-	VQ22	4
1.5 i Cat	66	021 A 2000		10/86-12/93	Q22P-U	3255	0.8	-	-	VQ22	4
1.7 D	40/42	022 A.5000	Double Coil(LPH)	05/85-12/93	DG-001		11V				4
MARBELLA (86-98)											
0.8	25	08 NCA		08/86-12/93	W20EPR-U	3047	0.8	W20TT	IW20TT	IW20TT	4
0.9	29/32	08 NCB; 09 NCA; 100 GL 7000		01/87-10/98	W20EPR-U	3047	0.8	W20TT	IW20TT	IW20TT	4
0.9 Cat	29	08 NCB; 09 NCB; 100 GL 7000		01/87-10/98	W20EPR-U	3047	0.8	W20TT	IW20TT	IW20TT	4
PANDA (80-86)											
0.9	31	100 GL 3000		10/80-12/86	W20EPR-U	3047	0.8	W20TT	IW20TT	IW20TT	4
RITMO (78-83)											
1.7 D	41	022 A.5000	Double Coil(LPH)	10/79-09/83	DG-001		11V				4
RONDA (82-88)											
1.2	44/47	021 A 1000		08/83-12/86	Q22P-U	3255	0.8	-	-	VQ22	4
1.5	63	021 A 2000		09/84-12/86	Q22P-U	3255	0.8	-	-	VQ22	4
1.6	68	138 AR 6000		08/83-09/85	W22EP-U	3085	0.8	W22TT	-	VW22	4
1.7 Diesel	40	022 A.5000	Double Coil(LPH)	06/82-12/86	DG-001		11V				4
TERRA (87-96)											
0.9	29	09 NCA		01/87-12/96	W20EPR-U	3047	0.8	W20TT	IW20TT	IW20TT	4
0.9 Cat	29	09 NCB		01/90-12/95	W20EPR-U	3047	0.8	W20TT	IW20TT	IW20TT	4
1.3 D	33	MN	Double Coil(LPH)	03/90-12/94	DG-012		11V				4
1.4 D	35	1 W	Double Coil(LPH)	10/90-12/95	DG-012		11V				4
TOLEDO I (1L) (91-99)											
1.6 i	52/55	1F		05/91-03/99	W20EPBR-S	5067	0.85	W20TT	IW20TT	IW20TT	4
1.6 i	55/74	AFT; EZ		05/91-03/99	K20PBR-S10	5061	1.0	K20TT	IK20TT	IK20TT	4
1.8 16V	92	PL		05/91-03/99	K20PBR	5060	0.85	K20TT	IK20TT	IK20TT	4
1.8 16V	98	KR		05/91-03/99	K22PB	5069	0.85	-	IKB22TT	VK22	4
1.8 i	65	ADZ		11/93-12/96	W20EPBR-S	5067	0.85	W20TT	IW20TT	IW20TT	4
1.8 i	65	RP		05/91-12/96	W22EPB	5066	0.85	W22TT	-	VW22	4
1.9 D	47/50	1Y		05/91-03/99	DG-012		11V				4
1.9 SDI	47	1Y		12/95-03/99	DG-012		11V				4
1.9 TD	55	AAZ		05/91-03/99	DG-012		11V				4
1.9 TDI	66/81	1Z; AFN; AHU	Auxiliary Heater	08/95-03/99	DG-628		11V				3
1.9 TDI	66/81	1Z; AFN; AHU	Double Coil(LPH)	08/95-03/99	DG-005		11V				4
2.0 i	85	AGG		05/91-03/99	W20EPBR-S	5067	0.85	W20TT	IW20TT	IW20TT	4
2.0 i 16V	110	ABF		11/93-03/99	PK22PR8	3273	0.8	-	IK22TT	VK22	4
TOLEDO II (1M) (99-06)											
1.4 16V	55	AHW - Eu3/ AXP		01/00-05/02	K20PBR-S10	5061	1.0	K20TT	IK20TT	IK20TT	4
1.6	74	AEH/ AKL		10/98-07/04	K20PBR-S10	5061	1.0	K20TT	IK20TT	IK20TT	4
1.6 16V	77	AUS		06/00-04/02	K20PBR-S10	5061	1.0	K20TT	IK20TT	IK20TT	4

Таблица применения

S

Свечи зажигания и Свечи накаливания

Таблица применения

Таблица применения

KW	KW	NOTE	21	СТАНДАРТНЫЕ				Twin Tip		QTY	
				1	2	3	4	1	2		
SEAT продолжение											
TOLEDO II (1M) (99-06) продолжение											
1.6 16V	77	AZD/ BCB		06/00-07/04	PKJ16CR-L11	3246	1.1	-	IK16TT	IK16TT	4
1.8 20V	92	AGN; APG		10/98-07/04	K20PBR-S10	5061	1.0	K20TT	IK20TT	IK20TT	4
1.8 20VT	132	AUQ		09/00-07/04	PK20PR-P8	3245	0.8	-	IK20TT	IK20TT	4
1.9 TDI	66/81	AGR; AHF; ALH; ASV	Double Coil(LPH)	10/98-07/04	DG-005		11V				4
1.9 TDI	66/81/110	AGR; AHF; ALH; ARL; ASV	Auxiliary Heater	10/98-07/04	DG-628		11V				3
1.9 TDI	96	ASZ		05/03-05/06	DG-109		11V				4
1.9 TDI	110	ARL	Ch:> 1M-2-062 000, Double Coi (LPH)	10/00-12/01	DG-005		11V				4
1.9 TDI	110	ARL	Ch: 1M-2-062 001>, Double Coi (LPH)	12/01-07/04	DG-109		11V				4
2.3 V5	110	AGZ		10/98-11/00	K20TXR	5063	1.0	K20TT	IK20TT	IK20TT	5
2.3 V5 20V	125	AQN		09/00-11/03	PKJ16CR-L11	3246	1.1	-	IK16TT	IK16TT	5
TOLEDO III (5P) (04-09)											
1.4 16V	63	BXW		05/06-05/09	KJ20DR-M11	3374	1.1	-	-	SKJ20DR-M11	4
1.6	75	BGU/ BSE/ BSF		10/04-05/09	K20PBR-S10	5061	1.0	K20TT	IK20TT	IK20TT	4
1.8 TFSI	118	BYT; BZB; CDAA		01/07-05/09	PK22PR8	3273	0.8	-	IK22TT	VK22	4
1.9 TDI	77	BJB; BKC; BLS; BXE		10/04-05/09	DG-177		5V				4
2.0 FSI	110	BLR; BLY; BVY; BVZ		10/04-05/09	K20PR-U	3145	0.8	K20TT	IK20TT	IK20TT	4
2.0 FSI	110	BLR; BLY; BVY; BVZ	OEM Optional	10/04-05/09	VKA16	5622	1.1	-	-	VKA16	4
2.0 TDI	100/103	AZV; BKD		04/04-05/09	DG-190		4.4V				4
2.0 TDI	125	BMN	OE: N 105 798 03/ N 105 798 05, Ceramic	01/06-05/09	DG-622		7V				4
2.0 TDI	125	CEGA		01/06-05/09	DG-193		4.4V				4
2.0 TFSI	147	BWA		11/05-05/09	PK22PR8	3273	0.8	-	IK22TT	VK22	4
TOLEDO IV (KG3) (12-)											
1.2	55	CGPC		07/12-06/15	KJ20DR-M11	3374	1.1	-	-	SKJ20DR-M11	3
1.4 TDI	66	CUSB	Pressure sensor(-)	05/15-04/19	DG-193		4.4V				2
1.4 TSI	90	CAXA		07/12-06/15	PKJ20CR8	3173	0.8	-	IK20TT	IK20TT	4
1.6	77	CFNA		07/13-06/15	KJ20DR-M11	3374	1.1	-	-	SKJ20DR-M11	4
1.6 TDI	66/77	CAYB; CAYC; CLNA		07/12-06/15	DG-193		4.4V				4
1.6 TDI	85	CXMA	Pressure sensor(-)	05/15-04/19	DG-193		4.4V				3
SHANGHAI MAPLE											
HAIXUAN (06-)											
1.5	69	MR479QA		11/06-	K16R-U11	3120	1.1	K16TT	IK16TT	IK16TT	4
SHELBY											
SERIES 1 (98-)											
4.0	186			01/98-	ZT20EPR11	5087	1.1	T20TT	IT20TT	IT20TT	8
SKODA											
100 (70-77)											
1.0	29/31	OHV		01/70-12/77	W20FS-U	3073	0.7	WF20TT	-		4
105 / 120 (76-90)											
1.0 105 S,L	34	742,10		08/76-12/90	W20FP-U	3068	0.7	WF20TT	-		4
1.0 105 S,L,GL	33	742,10		08/76-08/83	W20FP-U	3068	0.7	WF20TT	-		4
1.2 120 L	38	742.12 X		08/76-12/90	W20FP-U	3068	0.7	WF20TT	-		4
1.2 120 LS	43	742.12 X		08/76-12/90	W20FP-U	3068	0.7	WF20TT	-		4
105 / 120 (83-90)											
1.0 105 S,L	32	742,10		02/88-12/90	W20FP-U	3068	0.7	WF20TT	-		4
1.0 105 S,L,LS	33	742,10		10/83-12/90	W20FP-U	3068	0.7	WF20TT	-		4
1.2 120 GLS	43	742.12 X		02/83-12/90	W20FP-U	3068	0.7	WF20TT	-		4
1.2 120 L	35/38	742,12		10/83-09/89	W20FPR-U	3070	0.7	WF20TT	-		4
110 (69-82)											
1.1 L	33/35			12/69-03/82	W20FSR-U	6053	0.7	WF20TT	-		4
1.1 LS	38	OHV		07/70-03/82	W20FSR-U	6053	0.7	WF20TT	-		4
1.1 R	38	OHV		07/70-03/82	W20FSR-U	6053	0.7	WF20TT	-		4
130 (85-91)											
1.3 GL (S135)	43	135/8		01/87-10/91	W22FP-U	4021	0.7	-	-		4

Свечи зажигания и Свечи накаливания

Таблица применения











	KW				СТАНДАРТНЫЕ				Twin Tip		QTY
											
SKODA продолжение											
130 (85-91) продолжение											
1.3 L_GL	45	742,13		02/85-10/91	W22FP-U	4021	0.7	-	-		4
1000 (64-70)											
1.0 MB	27/32			09/64-01/70	W16FSR	3033	0.7	-	-		4
1.0 MBX de Luxe	34			01/69-01/70	W16FSR	3033	0.7	-	-		4
1100 (69-70)											
1.1 MB	34			01/69-01/70	W16FSR	3033	0.7	-	-		4
FABIA I (6Y) (99-08)											
1.0	37	AQV; ARV		12/99-08/02	K20PBR-S10	5061	1.0	K20TT	IK20TT	IK20TT	4
1.2	40	AWY	Ch:>3-671 670	07/01-10/02	SKJ16CR-L11	3396	1.1	-	IK16TT	IK16TT	3
1.2	40	AWY	Ch:3-671 671>	07/01-05/04	KJ16CR-L11	3132	1.1	K16TT	IK16TT	IK16TT	3
1.2	40	AWY	Eng:>3-671 670	07/01-10/02	SKJ16CR-L11	3396	1.1	-	IK16TT	IK16TT	3
1.2	40	AWY	Eng:3-671 671>	10/02-12/07	KJ16CR-L11	3132	1.1	K16TT	IK16TT	IK16TT	3
1.2	40	BMD		05/04-07/04	K20PBR-S10	5061	1.0	K20TT	IK20TT	IK20TT	3
1.2	40/47	AZQ; BMD; BME		01/03-12/07	KJ16CR-L11	3132	1.1	K16TT	IK16TT	IK16TT	3
1.4	44/50	AZE/AZF; AZE; AZF		04/00-05/03	K16TNR-S9	3329	0.9	K16TT	IK16TT	IK16TT	4
1.4	50	AME; AQW; ATZ		08/99-05/03	IK16TT	4701	1.0	-	IK16TT	IK16TT	4
1.4 16V	55	BKY		08/04-03/08	KJ16CR-L11	3132	1.1	K16TT	IK16TT	IK16TT	4
1.4 16V	55/74	AUA; AUB/ BBZ/ BBZ-E4; AUB; BBY; BBZ; BKY		10/99-03/08	K20PBR-S10	5061	1.0	K20TT	IK20TT	IK20TT	4
1.4 16V	59	BUD		04/06-12/07	KJ20DR-M11	3374	1.1	-	-	SKJ20DR-M11	4
1.4 TDI	51/55/59	AMF; ANY; BNM; BNV	Double Coil(LPH)	04/03-03/08	DG-109		11V				3
1.9 SDI	47	ASY	Double Coil(LPH)	11/99-03/08	DG-005		11V				4
1.9 TDI	74	ATD	Auxiliary Heater	01/00-03/08	DG-628		11V				3
1.9 TDI	74	ATD; AXR	Ch:>6Y-2-451 087	01/00-12/01	DG-005		11V				4
1.9 TDI	74	ATD; AXR	Ch:6Y-2-451 088>	01/02-03/08	DG-109		11V				4
1.9 TDI RS	96	ASZ; BLT		06/03-03/08	DG-109		11V				4
2.0	85	AZL		12/99-03/08	K20PBR-S10	5061	1.0	K20TT	IK20TT	IK20TT	4
FABIA II (06-14)											
1.2	44	BBM	Ch:5J8 B501 226>	10/07-03/10	KJ16CR-L11	3132	1.1	K16TT	IK16TT	IK16TT	3
1.2	44/51	BBM; BZG		12/06-12/14	KJ16CR-L11	3132	1.1	K16TT	IK16TT	IK16TT	3
1.2	44/51	CGPA; CHFA		12/06-12/14	KJ20DR-M11	3374	1.1	-	-	SKJ20DR-M11	3
1.2	51	BZG	Ch:>5J8 3074 394	10/07-03/10	KJ16CR-L11	3132	1.1	K16TT	IK16TT	IK16TT	3
1.2 12V	44	CGPB		11/11-12/14	KJ20DR-M11	3374	1.1	-	-	SKJ20DR-M11	3
1.2 TDI	55	CFWA		05/10-12/14	DG-193		4.4V				3
1.4	63	BXW; CGGB		01/07-12/14	KJ20DR-M11	3374	1.1	-	-	SKJ20DR-M11	4
1.4 TDI	51/59	BNM; BNV	Double Coil(LPH)	01/07-03/10	DG-109		11V				3
1.4 TSI RS	132	CAVE; CTHE		05/10-02/11	PKJ20CR8	3173	0.8	-	IK20TT	IK20TT	4
1.4 TSI RS	132	CAVE; CTHE		02/11-12/14	SKJ20CR-A8	3371	0.8	-	-	SKJ20CR-A8	4
1.6	77	BTS; CFNA; CLSA		04/07-12/14	KJ20DR-M11	3374	1.1	-	-	SKJ20DR-M11	4
1.6 TDI	55/66/77	CAYA; CAYB; CAYC		03/10-12/14	DG-193		4.4V				4
1.9 TDI	77	BLS		04/07-03/10	DG-177		5V				4
1.9 TDI	77	BSW		04/07-03/10	DG-109		11V				4
FABIA III (NJ) (14-)											
1.4 TDI	55/66/77	CUSA; CUSB; CUTA	Pressure sensor(-)	08/14-	DG-193		4.4V				2
FAVORIT (78) (89-97)											
1.3	40/43	135B; 781.135E		09/91-06/97	Q16PR-U	3137	0.8	Q16TT	IQ16TT	IQ16TT	4
1.3	46	OHC		08/91-08/92	Q20P-U	3125	0.8	Q20TT	IQ20TT	IQ20TT	4
1.3	50	136B		12/92-06/97	K20PR-U	3145	0.8	K20TT	IK20TT	IK20TT	4
1.3 135	43	781.135		10/90-09/94	Q16PR-U	3137	0.8	Q16TT	IQ16TT	IQ16TT	4
1.3 135 X,LX,GLX	40	781.135E		01/90-09/94	Q20PR-U	3007	0.8	Q20TT	IQ20TT	IQ20TT	4
1.3 135L	43	781.135		08/92-09/94	Q16PR-U	3137	0.8	Q16TT	IQ16TT	IQ16TT	4
1.3 136	45	136 L		10/90-08/92	Q20P-U	3125	0.8	Q20TT	IQ20TT	IQ20TT	4
FELICIA Fun (6U) (97-02)											
1.3	40	135M		06/97-04/02	Q16PR-U	3137	0.8	Q16TT	IQ16TT	IQ16TT	4
1.3	50	136M		06/97-03/01	K16PR-U	3191	0.8	K16TT	IK16TT	IK16TT	4
1.6	55	AEE		06/97-04/02	W20EPBR-S	5067	0.85	W20TT	IW20TT	IW20TT	4
1.9 D	47	AEF	Double Coil(LPH)	06/97-04/02	DG-012		11V				4











Таблица применения

S

Свечи зажигания и Свечи накаливания

Таблица применения

Таблица применения

	KW				СТАНДАРТНЫЕ			Twin Tip			QTY
											
SKODA продолжение											
FELICIA I (6U) (94-98)											
1.3	40/43	AMG; AMJ		10/94-03/98	Q16PR-U	3137	0.8	Q16TT	IQ16TT	IQ16TT	4
1.3	50	AMH		10/94-03/98	K20PR-U	3145	0.8	K20TT	IK20TT	IK20TT	4
1.3 LX	40	AMG		08/95-03/98	Q16PR-U	3137	0.8	Q16TT	IQ16TT	IQ16TT	4
1.3 LXI	50	AMH		08/95-03/98	K20PR-U	3145	0.8	K20TT	IK20TT	IK20TT	4
1.6 GLX	55	AEE		08/95-03/98	W20EPBR-S	5067	0.85	W20TT	IW20TT	IW20TT	4
1.6 LX	55	AEE		08/95-03/98	W20EPBR-S	5067	0.85	W20TT	IW20TT	IW20TT	4
1.9 D	47	AEF	Double Coil(LPH)	10/95-03/98	DG-012		11V				4
FELICIA II (6U) (98-01)											
1.3	40/43/50	AMG; AMH		01/98-06/01	K16PR-U	3191	0.8	K16TT	IK16TT	IK16TT	4
1.6	55	AEE		01/98-06/01	W20EPBR-S	5067	0.85	W20TT	IW20TT	IW20TT	4
1.9 D	47	AEF	Double Coil(LPH)	01/98-06/01	DG-012		11V				4
OCTAVIA I (1U) (96-10)											
1.4	44	AMD		04/99-03/01	K20PBR-S10	5061	1.0	K20TT	IK20TT	IK20TT	4
1.4 16V	55	AXP		08/00-12/10	PKJ16CR-L11	3246	1.1	-	IK16TT	IK16TT	4
1.4 16V	55	BCA		08/00-12/10	K20PBR-S10	5061	1.0	K20TT	IK20TT	IK20TT	4
1.6	55	AEE		09/96-09/04	W20EPBR-S	5067	0.85	W20TT	IW20TT	IW20TT	4
1.6	75	AKL; AVU; BFQ		02/97-12/10	K20PBR-S10	5061	1.0	K20TT	IK20TT	IK20TT	4
1.8	92	AGN		09/96-07/00	K20PBR-S10	5061	1.0	K20TT	IK20TT	IK20TT	4
1.8 20V	92	AGN		07/98-07/00	K20PBR-S10	5061	1.0	K20TT	IK20TT	IK20TT	4
1.8 T	110	AGU		08/97-12/10	PK20PR-P8	3245	0.8	-	IK20TT	IK20TT	4
1.8 T 4x4	110	AGU; AUM		05/01-05/06	PK20PR-P8	3245	0.8	-	IK20TT	IK20TT	4
1.8 T RS	132	AUQ		05/01-01/06	PK20PR-P8	3245	0.8	-	IK20TT	IK20TT	4
1.9 SDI	50	AGP; AQM	Auxiliary Heater	06/97-12/03	DG-628		11V				3
1.9 SDI	50	AGP; AQM	Double Coil(LPH)	06/97-12/03	DG-005		11V				4
1.9 TDI	66/81	AGR; AHF; ALH; ASV	Auxiliary Heater	09/96-03/10	DG-628		11V				3
1.9 TDI	66/81	AGR; AHF; ALH; ASV	Double Coil(LPH)	09/96-03/10	DG-005		11V				4
1.9 TDI	74	AXR		08/00-11/01	DG-005		11V				4
1.9 TDI	74/96	ASZ; AXR		12/01-12/10	DG-109		11V				4
1.9 TDI 4x4	66	AGR	Double Coil(LPH)	11/99-02/06	DG-005		11V				4
1.9 TDI 4x4	66/74	AGR; ATD	Auxiliary Heater	11/99-02/06	DG-628		11V				3
1.9 TDI 4x4	74	ATD		09/00-11/01	DG-005		11V				4
1.9 TDI 4x4	74	ATD		12/01-01/06	DG-109		11V				4
2.0	85	AEG/ APK/ AQY/ AZH		04/99-05/07	K20PBR-S10	5061	1.0	K20TT	IK20TT	IK20TT	4
2.0	85	AZJ		04/99-05/07	PKJ16CR-L11	3246	1.1	-	IK16TT	IK16TT	4
2.0 4x4	85	AZH		08/00-09/04	K20PBR-S10	5061	1.0	K20TT	IK20TT	IK20TT	4
2.0 4x4	85/88	ATF; AZJ		01/00-12/10	PKJ16CR-L11	3246	1.1	-	IK16TT	IK16TT	4
OCTAVIA II (1Z) (04-13)											
1.4	55	BCA		05/04-05/06	K20PBR-S10	5061	1.0	K20TT	IK20TT	IK20TT	4
1.4	59	BUD; CGGA		06/04-06/13	KJ20DR-M11	3374	1.1	-	-	SKJ20DR-M11	4
1.4 TSI	90	CAXA		11/08-06/13	PKJ20CR8	3173	0.8	-	IK20TT	IK20TT	4
1.6	75	BGU; BSE; BSF; CCSA; CMXA		06/04-06/13	K20PBR-S10	5061	1.0	K20TT	IK20TT	IK20TT	4
1.6 FSI	85	BLF		02/04-10/08	K20PBR-S10	5061	1.0	K20TT	IK20TT	IK20TT	4
1.6 LPG	75	CHGA		08/09-11/12	K20PBR-S10	5061	1.0	K20TT	IK20TT	IK20TT	4
1.6 MultiFuel	75	CCSA; CMXA		01/08-06/13	K20PBR-S10	5061	1.0	K20TT	IK20TT	IK20TT	4
1.6 TDI	77	CAYC		06/09-04/13	DG-193		4.4V				4
1.6 TDI 4x4	77	CAYC		06/09-02/13	DG-193		4.4V				4
1.8 TSI	112/118	BZB; CDAA; CDAB		06/07-06/13	PK22PR8	3273	0.8	-	IK22TT	VK22	4
1.8 TSI	112/118	BZB; CDAA; CDAB	OEM Optional	06/07-06/13	VK22	5610	0.8	-	IK22TT	VK22	4
1.8 TSI 4x4	112/118	CDAA; CDAB		11/08-02/13	PK22PR8	3273	0.8	-	IK22TT	VK22	4
1.8 TSI 4x4	112/118	CDAA; CDAB	OEM Optional	11/08-02/13	VK22	5610	0.8	-	IK22TT	VK22	4
1.9 TDI	77	BJB; BKC; BLS; BXE		06/04-12/10	DG-177		5V				4
1.9 TDI 4x4	77	BKC; BLS; BXE		11/04-12/10	DG-177		5V				4
2.0 FSI	110	BLR/ BVY; BLR/ BVY		11/04-10/08	VKA16	5622	1.1	-	-	VKA16	4
2.0 FSI	110	BLY/ BVZ		11/04-10/08	K20PR-U	3145	0.8	K20TT	IK20TT	IK20TT	4
2.0 FSI 4x4	110	BLX/ BVX		11/04-10/08	VKA16	5622	1.1	-	-	VKA16	4
2.0 RS	147	BWA; CCZA		10/05-02/13	PK22PR8	3273	0.8	-	IK22TT	VK22	4

Свечи зажигания и Свечи накаливания

Таблица применения











	KW				СТАНДАРТНЫЕ				Twin Tip		QTY
											
SKODA продолжение											
OCTAVIA II (1Z) (04-13) продолжение											
2.0 RS	147	BWA; CCZA	OEM Optional	10/05-02/13	VK22	5610	0.8	-	IK22TT	VK22	4
2.0 TDI	81/ 103	CFHC; CFHF; CLCA; CLCB		02/04-06/13	DG-193		4.4V				4
2.0 TDI	100/ 103	AZV; BKD		02/04-05/13	DG-190		4.4V				4
2.0 TDI 4x4	81/ 103	CFHC; CFHF		05/10-02/13	DG-193		4.4V				4
2.0 TDI 8V 4x4	103	BMM		07/06-05/10	DG-177		5V				4
2.0 TDI RS	125	BMN	OE: N 105 798 03/ N 105 798 05, Ceramic	04/06-02/13	DG-622		7V				4
2.0 TDI RS	125	CEGA		04/06-02/13	DG-193		4.4V				4
OCTAVIA III (5E) (12-)											
1.6 TDI	66/ 77/81	CLHA; CLHB; CRKB; CXXA; CXXB; DBKA; DDYB	Pressure sensor(-)	11/12-	DG-193		4.4V				3
1.6 TDI 4x4	77/81	CLHA; CXXB	Pressure sensor(-)	11/12-	DG-193		4.4V				3
2.0 TDI	105	CKFB; CRVC	Euro-4; Euro-5	11/12-	DG-193		4.4V				4
2.0 TDI	105	CKFB; CRVC	Euro-6; Pressures ensor(-)	11/12-	DG-193		4.4V				3
2.0 TDI	110	CKFC; CRMB; CYKA; DCYA; DFFA	Pressure sensor(-)	11/12-	DG-193		4.4V				3
2.0 TDI / TDI RS 4x4	135	CUNA; CUPA; DJGA	Pressure sensor(-)	09/14-	DG-193		4.4V				3
2.0 TDI 4x4	110	CKFC; CRMB; DCYA; DFFA	Pressure sensor(-)	11/12-	DG-193		4.4V				3
2.0 TDI RS	135	CUNA; CUPA; DJGA	Pressure sensor(-)	05/13-	DG-193		4.4V				3
RAPID (HN) (12-)											
1.2	55	CGPC		07/12-	KJ20DR-M11	3374	1.1	-	-	SKJ20DR-M11	3
1.4 TDI	66	CUSB	Pressure sensor(-)	05/15-	DG-193		4.4V				2
1.4 TSI	90	CAXA		07/12-	PKJ20CR8	3173	0.8	-	IK20TT	IK20TT	4
1.6	77	CFNA		07/12-	KJ20DR-M11	3374	1.1	-	-	SKJ20DR-M11	4
1.6 TDI	66/77	CAYB; CAYC; CLNA		07/12-	DG-193		4.4V				4
1.6 TDI	85	CXMA	Pressure sensor(-)	05/15-	DG-193		4.4V				3
RAPID (83-91)											
1.2	43			02/83-12/90	W20FP-U	3068	0.7	WF20TT	-		4
1.3	39/45	742.13; SKOD10		03/85-10/91	W20FPR-U	3070	0.7	WF20TT	-		4
1.3 S	43	SKOD10		08/87-12/90	W20FPR-U	3070	0.7	WF20TT	-		4
ROOMSTER (5J) (06-15)											
1.2	47/51	BME; BZG		05/06-05/15	KJ16CR-L11	3132	1.1	K16TT	IK16TT	IK16TT	3
1.2	51	CGPA		01/07-05/15	KJ20DR-M11	3374	1.1	-	-	SKJ20DR-M11	3
1.2 TDI	55	CFWA		03/10-05/15	DG-193		4.4V				3
1.4	63	BXW; CGGB		09/06-05/15	KJ20DR-M11	3374	1.1	-	-	SKJ20DR-M11	4
1.4 TDI	51/59	BNM; BNV	Double Coil(LPH)	07/06-03/10	DG-109		11V				3
1.6	77	BTS; CFNA		09/06-05/15	KJ20DR-M11	3374	1.1	-	-	SKJ20DR-M11	4
1.6 TDI	66/77	CAYB; CAYC		03/10-05/15	DG-193		4.4V				4
1.9 TDI	74/77	AXR; BSW		03/06-03/10	DG-109		11V				4
1.9 TDI	77	BLS		09/06-03/10	DG-177		5V				4
SUPERB I (3U) (01-08)											
1.8 T	110	AWT		12/01-03/08	PK20PR-P8	3245	0.8	-	IK20TT	IK20TT	4
1.9 TDI	74/96	AVB; AVF; AWX	Double Coil(LPH)	12/01-03/08	DG-109		11V				4
1.9 TDI	77/85	BPZ; BSV	OE: N 105 916 03	10/05-03/08	DG-177		5V				4
2.0	85	AZM		12/01-03/08	K20PBR-S10	5061	1.0	K20TT	IK20TT	IK20TT	4
2.0 TDI 8V	103	BSS	OE: N 105 916 03	10/05-03/08	DG-177		5V				4
2.5 TDI	114/ 120	AYM; BDG	Double Coil(LPH)	12/01-03/08	DG-144		11V				6
2.8 V6	142	AMX/ BBG		12/01-03/08	K20TXR	5063	1.0	K20TT	IK20TT	IK20TT	6
SUPERB II (3T) (08-15)											
1.4 TSI	92	CAXC		07/08-05/15	PKJ20CR8	3173	0.8	-	IK20TT	IK20TT	4
1.6 TDI	77	CAYC		09/10-05/15	DG-193		4.4V				4
1.8 TSI	112/ 118	BZB; CDAA; CDAB		03/08-05/15	PK22PR8	3273	0.8	-	IK22TT	VK22	4











Таблица применения

S

Свечи зажигания и Свечи накаливания

Таблица применения

Таблица применения

	KW				СТАНДАРТНЫЕ				Twin Tip		QTY
											
SKODA продолжение											
SUPERB II (3T) (08-15) продолжение											
1.8 TSI	112/118	BZB; CDAA; CDAB	OEM Optional	03/08-05/15	VK22	5610	0.8	-	IK22TT	VK22	4
1.8 TSI 4x4	112/118	CDAA; CDAB		11/08-05/15	PK22PR8	3273	0.8	-	IK22TT	VK22	4
1.8 TSI 4x4	112/118	CDAA; CDAB	OEM Optional	11/08-05/15	VK22	5610	0.8	-	IK22TT	VK22	4
1.9 TDI	77	BLS; BXE		03/08-11/10	DG-177		5V				4
2.0 TDI	103	BKD		01/09-05/15	DG-190		4.4V				4
2.0 TDI	103/125	CBBB; CFFB; CFGB; CLJA		07/08-05/15	DG-193		4.4V				4
2.0 TDI 4x4	103/125	CBBB; CFFB; CFGB		09/08-05/15	DG-193		4.4V				4
2.0 TSI	147	CCZA		05/10-05/15	PK22PR8	3273	0.8	-	IK22TT	VK22	4
2.0 TSI	147	CCZA	OEM Optional	05/10-05/15	VK22	5610	0.8	-	IK22TT	VK22	4
SUPERB III (3V) (15-)											
1.6 TDI	88	DCXA; DCZA	Pressure sensor(-)	03/15-	DG-193		4.4V				3
2.0 TDI	110/140	CRLB; DDAA; DFCA; DFEA; DFGA; DFHA; DSRA; DSRB	Pressure sensor(-)	03/15-	DG-193		4.4V				3
2.0 TDI 4x4	110/140	CRLB; DDAA; DFCA; DFEA; DFGA; DFHA	Pressure sensor(-)	03/15-	DG-193		4.4V				3
YETI (5L) (09-)											
1.4 TSI	90	CAXA		06/10-05/15	PKJ20CR8	3173	0.8	-	IK20TT	IK20TT	4
1.6 TDI	77	CAYC		11/10-05/15	DG-193		4.4V				4
1.8 TSI 4x4	112/118	CDAA; CDAB		05/09-12/17	PK22PR8	3273	0.8	-	IK22TT	VK22	4
1.8 TSI 4x4	112/118	CDAA; CDAB	OEM Optional	05/09-12/17	VK22	5610	0.8	-	IK22TT	VK22	4
2.0 TDI	81/103	CFHA; CFHC; CLCA; CUUA; DFSA		11/09-12/17	DG-193		4.4V				4
2.0 TDI	110	CUUB; DFSB	Pressure sensor(-)	05/15-12/17	DG-193		4.4V				3
2.0 TDI 4x4	81/103/125	CBDB; CEGA; CFHC; CFHF; CFJA; CLCB; CUUA; DFSA		05/09-12/17	DG-193		4.4V				4
2.0 TDI 4x4	110	CUUB; DFSB	Pressure sensor(-)	05/15-12/17	DG-193		4.4V				3
SMART											
CABRIO (450) (00-04)											
0.6	40/45/52	M 160 E6AL B03; M 160 E6AL B05; M 160.910	Twin Spark	03/00-01/04	K20TXR	5063	1.0	K20TT	IK20TT	IK20TT	6
0.8 CDI	30	OM 660.940; OM 660 DE 8LA	Double Coil(LPH)	03/01-01/04	DG-184		11.5V				3
CITY-Coupe (450) (98-04)											
0.6	33/40/45/52	M 160 E6AL B03; M 160 E6AL B04; M 160 E6AL B05; M 160.910	Twin Spark	07/98-01/04	K20TXR	5063	1.0	K20TT	IK20TT	IK20TT	6
0.8 CDI	30	OM 660.940; OM 660 DE 8LA	Double Coil(LPH)	11/99-01/04	DG-184		11.5V				3
CROSSBLADE (450) (02-03)											
0.6	52	M 160.910	Twin Spark	06/02-12/03	K20TXR	5063	1.0	K20TT	IK20TT	IK20TT	6
FORFOUR I (454) (04-06)											
1.1	47/55	M 134.910; M 134.911		01/04-06/06	K20HR-U11	3381	1.1	KH20TT	IKH20TT	IKH20TT	3
1.3	70	M 135.930		01/04-06/06	K20HR-U11	3381	1.1	KH20TT	IKH20TT	IKH20TT	4
1.5	80/90	M 135.950		01/04-06/06	K20HR-U11	3381	1.1	KH20TT	IKH20TT	IKH20TT	4
1.5	90	M 135.950		01/04-06/06	IKH20TT	4704	1.0	-	IKH20TT		4
1.5 BRABUS	130	M 122.950		05/05-06/06	XU22HDR9	3445	0.9	XUH22TT	IXUH22TT	VXUH22I	4
1.5 CDI	50/70	OM 639.939		09/04-06/06	DG-606		11.5V				3
FORFOUR II (453) (14-)											
1.0	45/52	H4DA401; M 281.920		07/14-	XE20HR-U9	3427	0.9	-	IXEH20TT	IXEH20TT	3
FORTWO (450) (04-07)											
0.6	45	M 160.910	Twin Spark	01/04-02/07	K20TXR	5063	1.0	K20TT	IK20TT	IK20TT	6
0.6 Brabus	55	M 160.910	Twin Spark	01/04-12/06	K20TXR	5063	1.0	K20TT	IK20TT	IK20TT	6
0.8 CDI	30	OM 660 DE 8LA; OM 660.940	Double Coil(LPH)	01/04-01/07	DG-184		11.5V				3
FORTWO (451) (07-)											
0.8 CDI	33	OM 660.950		01/07-	DG-184		11.5V				3
1.0	45/52	M 132.910		01/07-	XU22HDR9	3445	0.9	XUH22TT	IXUH22TT	VXUH22I	3

Свечи зажигания и Свечи накаливания

Таблица применения











	KW				СТАНДАРТНЫЕ			Twin Tip			QTY
											
SMART продолжение											
FORTWO (451) (07-) продолжение											
1.0 Brabus	72/88	M 132.930		01/08-	XU22HDR9	3445	0.9	XUH22TT	IXUH22TT	VXUH22I	3
1.0 Turbo	62	M 132.930		01/07-	XU22HDR9	3445	0.9	XUH22TT	IXUH22TT	VXUH22I	3
1.0 Turbo Brabus	75	M 132.930		07/10-	XU22HDR9	3445	0.9	XUH22TT	IXUH22TT	VXUH22I	3
FORTWO (453) (14-)											
1.0	45/52	M 281.920		07/14-	XE20HR-U9	3427	0.9	-	IXEH20TT	IXEH20TT	3
SPYKER											
C8 (00-)											
4.2	298	BFM		04/00-	IK22	5310	0.8	-	IK22TT	VK22	8
C8 Aileron (10-)											
4.2	298	BFM		04/10-	IK22	5310	0.8	-	IK22TT	VK22	8
C12 (07-)											
Zagato	368	BHT		12/07-	PKJ20CR-L11	3247	1.1	-	IK20TT	IK20TT	12
SSANGYONG											
ACTYON I (05-)											
2.0 Xdi	100/104	D20DT	Double Coil(LPH)	11/05-	DG-188		11V				4
2.3	110	G23D		11/06-01/11	Q16PR-U11	5016	1.1	Q16TT	IQ16TT	IQ16TT	4
2.3 4x4	110	G23D		11/06-01/11	Q16PR-U11	5016	1.1	Q16TT	IQ16TT	IQ16TT	4
200 Xdi 4WD	100/104	D20DT	Double Coil(LPH)	10/06-	DG-188		11V				4
ACTYON Sports I (07-)											
2.0 Xdi	104	D20DT	Double Coil(LPH)	04/07-	DG-188		11V				4
2.0 Xdi 4WD	104	D20DT	Double Coil(LPH)	04/07-	DG-188		11V				4
CHAIRMAN (97-)											
2.3	110	M 111.970; M 111.974		07/97-	K20PBR-S10	5061	1.0	K20TT	IK20TT	IK20TT	4
2.8	142	M 104.945		08/99-	K16PR-U	3191	0.8	K16TT	IK16TT	IK16TT	6
3.2	162	M 104.992		07/97-	K16PR-U	3191	0.8	K16TT	IK16TT	IK16TT	6
ISTANA (92-03)											
2.9 D	70	OM 602.940	Double Coil(LPH)	10/92-05/95	DG-010		11.5V				5
2.9 D	90	OM 602.980	Double Coil(LPH)	06/95-11/03	DG-001		11V				5
2.9 D	90	OM 602.980	Double Coil(LPH)	06/95-11/03	DG-110		11.5V				5
2.9 TD	70	OM 602.940	Double Coil(LPH)	10/92-05/95	DG-010		11.5V				5
KORANDO (88-96)											
2.2 D	50	DC23	Single Coil	12/88-12/96	DG-124		11V				4
KORANDO (96-06)											
2.0	94	M111E20		05/97-03/99	Q16PR-U11	5016	1.1	Q16TT	IQ16TT	IQ16TT	4
2.3	103/105	M111E23		11/97-09/05	Q16PR-U11	5016	1.1	Q16TT	IQ16TT	IQ16TT	4
2.3	103/110	M 111.970; M 161.970		05/97-06/06	K20PBR-S10	5061	1.0	K20TT	IK20TT	IK20TT	4
2.3 D	58	OM 601.940	Double Coil(LPH)	12/96-06/98	DG-010		11.5V				4
2.3 TDiC 4x4	74		Double Coil(LPH)	07/98-11/06	DG-010		11.5V				4
2.9 D	72	MB-OM 662	Double Coil(LPH)	12/96-10/00	DG-010		11.5V				5
2.9 TD	88	MB-OM 662 LA	Double Coil(LPH)	04/98-11/06	DG-010		11.5V				5
3.2	154/156/162	M 104.992; M 104.995		12/96-11/06	K16PR-U	3191	0.8	K16TT	IK16TT	IK16TT	6
KYRON (05-)											
2.0 Xdi	100/104	D20DT	Double Coil(LPH)	05/05-	DG-188		11V				4
2.0 Xdi 4x4	100/104	D20DT	Double Coil(LPH)	05/05-	DG-188		11V				4
2.3	110	M 161.970		01/10-	K20PBR-S10	5061	1.0	K20TT	IK20TT	IK20TT	4
2.7 Xdi 4x4	121	D27DT		05/05-	DG-188		11V				5
3.2 M320 4x4	162	M104.995		03/08-	Q16PR-U11	5016	1.1	Q16TT	IQ16TT	IQ16TT	6
MUSSO (93-07)											
2.0	93	M111E20		10/96-04/05	Q16PR-U11	5016	1.1	Q16TT	IQ16TT	IQ16TT	4
2.3	103	M 111.970		10/96-11/02	K20PBR-S10	5061	1.0	K20TT	IK20TT	IK20TT	4
2.3	110	M161 E23		04/03-04/05	Q16PR-U11	5016	1.1	Q16TT	IQ16TT	IQ16TT	4

Таблица применения

S

Свечи зажигания и Свечи накаливания

Таблица применения

Таблица применения

KW	KW	KW	KW	KW	СТАНДАРТНЫЕ				Twin Tip			QTY
					1	2	3	4	1	2	3	
SSANGYONG продолжение												
MUSSO (93-07) продолжение												
2.3 D	59	MB-OM 661; OM 601.940; OM 661.940	Double Coil(LPH)	03/93-04/99	DG-010		11.5V				4	
2.3 TDiC AWD	74		Double Coil(LPH)	05/97-10/03	DG-010		11.5V				4	
2.9 D	73	MB-OM 662	Double Coil(LPH)	03/96-11/98	DG-010		11.5V				5	
2.9 TD	88		Double Coil(LPH)	04/98-09/07	DG-010		11.5V				5	
3.2	162	M 104.992		06/96-09/04	K16PR-U	3191	0.8	K16TT	IK16TT	IK16TT	6	
MUSSO Sports (04-)												
2.9 D	88		Double Coil(LPH)	08/04-09/07	DG-010		11.5V				5	
2.9 D 4x4	88		Double Coil(LPH)	08/04-	DG-010		11.5V				5	
REXTON (02-)												
2.3 RX230 4x4	110	G23D		05/02-01/11	Q16PR-U11	5016	1.1	Q16TT	IQ16TT	IQ16TT	4	
2.7 D 4x4	137	D27DTP		06/06-	DG-117		11.5V				5	
2.7 Xdi	120	D27DT		03/05-08/06	DG-188		11V				5	
2.7 Xdi	120	D27DT	Double Coil(LPH)	08/04-	DG-188		11V				5	
2.7 Xdi 4x4	118/ 121	D27DT		05/04-	DG-188		11V				5	
2.7 Xdi Turbo 4x4	132	D27DTP		03/08-	DG-117		11.5V				5	
2.9 TD	88		Double Coil(LPH)	04/02-08/06	DG-010		11.5V				5	
3.2 RX320 4x4	162	M104.995		04/02-	Q16PR-U11	5016	1.1	Q16TT	IQ16TT	IQ16TT	6	
RODIUS I (05-)												
2.7 Xdi	121	D27DT		05/05-	DG-188		11V				5	
2.7 Xdi	121	D27DT	Double Coil(LPH)	05/05-	DG-188		11V				5	
2.7 Xdi 4WD	121	D27DT		05/05-	DG-188		11V				5	
2.7 Xdi 4WD	121	D27DT	Double Coil(LPH)	05/05-	DG-188		11V				5	
3.2	162	M104.995		05/05-	Q16PR-U11	5016	1.1	Q16TT	IQ16TT	IQ16TT	6	
3.2 4WD	162	M104.995		07/07-	Q16PR-U11	5016	1.1	Q16TT	IQ16TT	IQ16TT	6	
STAVIC (05-)												
2.7 270 sXDi	121	D27DT		02/05-	DG-188		11V				5	
2.7 270 sXDi 4x4	121	D27DT		02/05-	DG-188		11V				5	
3.2 4x4	162	M104.995		02/05-	Q16PR-U11	5016	1.1	Q16TT	IQ16TT	IQ16TT	6	
SUBARU												
1800 XT COUPE (84-90)												
1.8 Turbo 4WD	88/ 96/ 100	EA82T		11/84-12/90	W20EXR-U11	3067	1.1	W20TT	IW20TT	IW20TT	4	
BRZ (12-)												
2.0	147	FA20D		06/12-	VXEBH27	5686	0.8	-	-	VXEBH27	4	
FORESTER (97-02)												
2.0 AWD	90/92	EJ202		08/97-09/02	K16PR-U11	3130	1.1	K16TT	IK16TT	IK16TT	4	
2.0 AWD	90/92	EJ202		08/97-09/02	K20PR-U	3145	0.8	K20TT	IK20TT	IK20TT	4	
2.0 AWD	92	EJ202		06/98-09/02	K20PR-U11	3121	1.1	K20TT	IK20TT	IK20TT	4	
2.0 S Turbo AWD	125/ 130	EJ205		06/98-09/02	PK20PR-P8	3245	0.8	-	IK20TT	IK20TT	4	
2.5 AWD	123	EJ25D		07/97-05/02	PK20PR11	3168	1.1	K20TT	IK20TT	IK20TT	4	
FORESTER (02-08)												
2.0 AWD	92	EJ201		06/02-05/05	K16PR-U11	3130	1.1	K16TT	IK16TT	IK16TT	4	
2.0 AWD	92	EJ201		06/02-05/05	PK16PR11	3264	1.1	K16TT	IK16TT	IK16TT	4	
2.0 S Turbo AWD	130	EJ205		02/02-05/05	PK20PR-P8	3245	0.8	-	IK20TT	IK20TT	4	
2.0 X AWD	116	EJ201; EJ204		06/05-05/08	IKH20TT	4704	1.0	-	IKH20TT		4	
2.0 X AWD	116	EJ201; EJ204		06/05-05/08	VKH20Y	5639	0.8	-	-	VKH20Y	4	
2.0 X AWD	116	EJ201; EJ204	LPG / GPL	06/05-05/08	VKH22	5619	0.8	-	-	VKH22	4	
2.5 AWD	121	EJ25D		06/05-05/08	PK20PR11	3168	1.1	K20TT	IK20TT	IK20TT	4	
2.5 AWD	155	EJ25		12/03-05/05	IKH20TT	4704	1.0	-	IKH20TT		4	
2.5 AWD	155	EJ251		12/03-05/05	K16PR-U11	3130	1.1	K16TT	IK16TT	IK16TT	4	
2.5 AWD	155	EJ253		12/03-05/05	PK16PR-L11	3275	1.1	-	IK16TT	IK16TT	4	
2.5 AWD	155/ 171	EJ255		12/03-12/09	VKH20Y	5639	0.8	-	-	VKH20Y	4	
2.5 Prodrive Performance Pack AWD	188	EJ255		05/05-09/05	VKH20Y	5639	0.8	-	-	VKH20Y	4	
2.5 RX Nato AWD	115	EJ251		11/02-12/08	K16PR-U11	3130	1.1	K16TT	IK16TT	IK16TT	4	
2.5 RX Nato AWD	115	EJ253		11/02-12/08	PK16PR-L11	3275	1.1	-	IK16TT	IK16TT	4	

Свечи зажигания и Свечи накаливания

Таблица применения











	KW				СТАНДАРТНЫЕ			Twin Tip			QTY	
												
SUBARU продолжение												
FORESTER (02-08) продолжение												
2.5 RX Nato AWD	115	EJ255		11/02-12/08	VKH20Y	5639	0.8	-	-	VKH20Y	4	
2.5 XT AWD	169	EJ255		06/05-05/08	VKH20Y	5639	0.8	-	-	VKH20Y	4	
FORESTER (08-)												
2.0 AWD	110	EJ204		01/08-09/13	IKH20TT	4704	1.0	-	-	IKH20TT	4	
2.0 AWD	110	EJ204	LPG / GPL	01/08-09/13	VKH22	5619	0.8	-	-	VKH22	4	
2.0 AWD	110	FB20A/ FB20B		01/10-	IXEH22TT	4712	1.0	-	-	IXEH22TT	4	
2.0 D AWD	108	EE20Z	Euro-4,OE: 22439-AA000	09/08-12/10	DG-615		11V				4	
2.5	126	EJ253		01/08-	PK16PR-L11	3275	1.1	-	-	IK16TT	IK16TT	4
2.5 AWD	126	EJ25		01/09-09/13	IKH20TT	4704	1.0	-	-	IKH20TT	4	
2.5 AWD	126	EJ253		01/08-09/13	PK16PR-L11	3275	1.1	-	-	IK16TT	IK16TT	4
2.5 AWD	126	FB25		03/11-09/13	IXEH22TT	4712	1.0	-	-	IXEH22TT	4	
2.5 AWD	126/169	EJ255		06/08-09/13	VKH20Y	5639	0.8	-	-	VKH20Y	4	
FORESTER (13-)												
2.0 i AWD	110	FB20A/ FB20B		03/13-	IXEH22TT	4712	1.0	-	-	IXEH22TT	4	
2.0 XT AWD	177	FB20A/ FB20B		03/13-	IXEH22TT	4712	1.0	-	-	IXEH22TT	4	
IMPREZA (92-00)												
1.6	66	EJ16E; EJ161		01/93-12/00	K20PR-U11	3121	1.1	K20TT	IK20TT	IK20TT	4	
1.6 AWD	66	EJ161		12/96-12/00	K20PR-U11	3121	1.1	K20TT	IK20TT	IK20TT	4	
1.6 i	66/70	EJ16; EJ161		08/92-12/00	K20PR-U11	3121	1.1	K20TT	IK20TT	IK20TT	4	
1.6 i AWD	66/70	EJ16; EJ161		08/92-12/00	K20PR-U11	3121	1.1	K20TT	IK20TT	IK20TT	4	
1.8	76	EJ18		01/93-10/95	K20PR-U11	3121	1.1	K20TT	IK20TT	IK20TT	4	
1.8 i	76	EJ18E		11/95-06/96	K20PR-U11	3121	1.1	K20TT	IK20TT	IK20TT	4	
1.8 i AWD	76	EJ18; EJ18E		08/92-12/00	K20PR-U11	3121	1.1	K20TT	IK20TT	IK20TT	4	
2.0 AWD	85	EJ20	For vehicles with switchable power steering (city mode)	12/95-12/00	K16PR-U11	3130	1.1	K16TT	IK16TT	IK16TT	4	
2.0 AWD	85	EJ20E		12/95-12/00	K20PR-U11	3121	1.1	K20TT	IK20TT	IK20TT	4	
2.0 AWD	85	EJ20E/ EJ201		12/95-12/00	K16PR-U11	3130	1.1	K16TT	IK16TT	IK16TT	4	
2.0 AWD	85/206	EJ20E; EJ201; EJ205P		12/95-12/00	PK20PR-P8	3245	0.8	-	-	IK20TT	IK20TT	4
2.0 i	85	EJ20E		07/96-08/98	K20PR-U11	3121	1.1	K20TT	IK20TT	IK20TT	4	
2.0 i	85/92	EJ20E; EJ201		07/96-09/00	K16PR-U11	3130	1.1	K16TT	IK16TT	IK16TT	4	
2.0 i	92	EJ201		09/98-09/00	PK20PR-P8	3245	0.8	-	-	IK20TT	IK20TT	4
2.0 i 16V AWD	92	EJ20	For vehicles with switchable power steering (city mode)	06/98-12/00	K16PR-U11	3130	1.1	K16TT	IK16TT	IK16TT	4	
2.0 i 16V AWD	92	EJ20E		06/98-12/00	K20PR-U11	3121	1.1	K20TT	IK20TT	IK20TT	4	
2.0 i 16V AWD	92	EJ20E/ EJ201		06/98-12/00	K16PR-U11	3130	1.1	K16TT	IK16TT	IK16TT	4	
2.0 i 16V AWD	92	EJ20E; EJ201		06/98-12/00	PK20PR-P8	3245	0.8	-	-	IK20TT	IK20TT	4
2.0 i AWD	85	EJ20	For vehicles with switchable power steering (city mode)	10/95-12/00	K16PR-U11	3130	1.1	K16TT	IK16TT	IK16TT	4	
2.0 i AWD	85	EJ20E		10/95-12/00	K20PR-U11	3121	1.1	K20TT	IK20TT	IK20TT	4	
2.0 i AWD	85	EJ20E; EJ201		10/95-12/00	PK20PR-P8	3245	0.8	-	-	IK20TT	IK20TT	4
2.0 i AWD	85/92	EJ20E/ EJ201		10/95-12/00	K16PR-U11	3130	1.1	K16TT	IK16TT	IK16TT	4	
2.0 i Turbo AWD	155	EJ20 (Turbo)		03/94-12/00	PK20PR-P8	3245	0.8	-	-	IK20TT	IK20TT	4
2.0 Turbo AWD	155	EJ20G		12/96-12/00	PK20PR-P8	3245	0.8	-	-	IK20TT	IK20TT	4
2.0 Turbo GT AWD	155/160	EJ20 (Turbo); EJ205		03/94-12/00	PK20PR-P8	3245	0.8	-	-	IK20TT	IK20TT	4
2.2 GX AWD	97	EJ22		11/95-08/98	K20PR-U11	3121	1.1	K20TT	IK20TT	IK20TT	4	
IMPREZA (00-)												
1.5	74	EJ15		06/01-09/05	PK16PR11	3264	1.1	K16TT	IK16TT	IK16TT	4	
1.5	74/81	EL15; EL154		06/01-03/07	VKH20Y	5639	0.8	-	-	VKH20Y	4	
1.5	81	EL15		10/05-03/07	FK20HR11	3426	1.1	-	-	IKH20TT	IKH20TT	4
1.5	81	EL15		10/05-03/07	IKH20TT	4704	1.0	-	-	IKH20TT	4	
1.5 AWD	77	EL15		05/06-03/07	FK20HR11	3426	1.1	-	-	IKH20TT	IKH20TT	4
1.5 AWD	77	EL15		05/06-03/07	IKH20TT	4704	1.0	-	-	IKH20TT	4	
1.5 AWD	77	EL15		05/06-03/07	VKH20Y	5639	0.8	-	-	VKH20Y	4	
1.6	70	EJ16; EJ161		06/01-09/06	K20PR-U11	3121	1.1	K20TT	IK20TT	IK20TT	4	
1.6 AWD	70	EJ161		12/00-06/09	K20PR-U11	3121	1.1	K20TT	IK20TT	IK20TT	4	
2.0 AWD	92	EJ251		12/00-12/07	K20PR-U11	3121	1.1	K20TT	IK20TT	IK20TT	4	
2.0 AWD	184	EJ205		10/05-03/07	PK20PR-P8	3245	0.8	-	-	IK20TT	IK20TT	4
2.0 i AWD	92	EJ251		12/00-06/09	K20PR-U11	3121	1.1	K20TT	IK20TT	IK20TT	4	
2.0 i R AWD	118	EJ204		09/05-06/07	VKH20Y	5639	0.8	-	-	VKH20Y	4	
2.0 i R AWD	118	EJ204	LPG / GPL	09/05-06/07	VKH22	5619	0.8	-	-	VKH22	4	
2.0 i WRX AWD	168	EJ205		12/02-09/05	PK20PR-P8	3245	0.8	-	-	IK20TT	IK20TT	4

Таблица применения

S

Свечи зажигания и Свечи накаливания

Таблица применения

Таблица применения

SUBARU	KW	KW	NOTE	21	СТАНДАРТНЫЕ				Twin Tip		QTY
					PK22PR8	PK20PR-P8	PK20PR-U11	VKH20Y	IKH20TT	IKH20TT	
IMPREZA (00-) продолжение											
IMPREZA (00-) продолжение											
2.0 i WRX AWD	168	EJ205		12/02-09/05	PK22PR8	3273	0.8	-	IK22TT	VK22	4
2.0 Turbo AWD	160	EJ205		12/00-12/05	PK20PR-P8	3245	0.8	-	IK20TT	IK20TT	4
2.0 WRX STi AWD	195/ 235	EJ207		11/01-07/05	PK20PR-P8	3245	0.8	-	IK20TT	IK20TT	4
2.0 WRX STi AWD	195/ 235	EJ207	OEM Optional	11/01-07/05	VK22	5610	0.8	-	IK22TT	VK22	4
2.0 WRX Turbo AWD	160/ 165	EJ205		12/00-06/06	PK22PR8	3273	0.8	-	IK22TT	VK22	4
2.0 WRX Turbo AWD	160/ 165	EJ205		12/00-03/07	PK20PR-P8	3245	0.8	-	IK20TT	IK20TT	4
2.5 AWD	130	EJ251		03/01-09/05	K20PR-U11	3121	1.1	K20TT	IK20TT	IK20TT	4
2.5 AWD	221	EJ257		10/05-03/07	VKH20Y	5639	0.8	-	-	VKH20Y	4
2.5 i WRX AWD	169	EJ255		09/05-12/08	VKH20Y	5639	0.8	-	-	VKH20Y	4
2.5 WRX AWD	169	EJ255		09/05-12/08	VKH20Y	5639	0.8	-	-	VKH20Y	4
2.5 WRX STi AWD	206	EJ257		09/05-12/07	VKH20Y	5639	0.8	-	-	VKH20Y	4
IMPREZA (08-)											
1.5	79	EL15		02/08-	FK20HR11	3426	1.1	-	IKH20TT	IKH20TT	4
1.5 AWD	79	EL15		02/08-	FK20HR11	3426	1.1	-	IKH20TT	IKH20TT	4
1.5 F	79	EL15		02/08-03/12	FK20HR11	3426	1.1	-	IKH20TT	IKH20TT	4
2.0 D AWD	110	EE20Z	Euro-4, OE: 22439-AA000	01/09-12/10	DG-615		11V				4
2.0 i AWD	110	EJ204		01/11-	IKH20TT	4704	1.0	-	IKH20TT		4
2.0 i AWD	110	EJ204	LPG / GPL	01/11-	VKH22	5619	0.8	-	-	VKH22	4
2.0 R AWD	110	EJ204		01/08-03/12	IKH20TT	4704	1.0	-	IKH20TT		4
2.0 R AWD	110	EJ204	LPG / GPL	01/08-03/12	VKH22	5619	0.8	-	-	VKH22	4
2.5 AWD	169/ 199	EJ255; EJ257		07/07-	VKH20Y	5639	0.8	-	-	VKH20Y	4
2.5 STi CS400 AWD	294	EJ257		04/10-08/13	VKH20Y	5639	0.8	-	-	VKH20Y	4
2.5 WRX S AWD	188	EJ255		02/09-12/10	VKH20Y	5639	0.8	-	-	VKH20Y	4
2.5 WRX STi 330S AWD	243	EJ257		05/09-12/10	VKH20Y	5639	0.8	-	-	VKH20Y	4
2.5 WRX STi AWD	221	EJ257		01/08-	VKH20Y	5639	0.8	-	-	VKH20Y	4
IMPREZA (11-)											
1.6 AWD	85	FB16		01/15-	IXEH22TT	4712	1.0	-	IXEH22TT		4
1.6 i	84	FB16A; FB16B		06/12-09/16	IXEH22TT	4712	1.0	-	IXEH22TT		4
1.6 i AWD	84	FB16B		06/12-	IXEH22TT	4712	1.0	-	IXEH22TT		4
2.0 AWD	110	FB20		01/12-10/16	IXEH22TT	4712	1.0	-	IXEH22TT		4
2.5 STi AWD	221	EJ257		06/14-	VKH20Y	5639	0.8	-	-	VKH20Y	4
JUSTY I (84-95)											
1000	37/40	EF10		11/84-10/95	W20EPR-U11	3049	1.1	W20TT	IW20TT	IW20TT	3
1000 4WD	37/40	EF10		11/84-11/94	W20EPR-U11	3049	1.1	W20TT	IW20TT	IW20TT	3
1200	49	EF12		05/87-10/95	W20EPR-U11	3049	1.1	W20TT	IW20TT	IW20TT	3
1200 4WD	50/55	EF12; EF12E		10/86-04/96	W20EPR-U11	3049	1.1	W20TT	IW20TT	IW20TT	3
JUSTY II (95-03)											
1.3 4x4	63	G13BB		04/01-11/03	IK20TT	4702	1.0	-	IK20TT	IK20TT	4
1.3 4x4	63	G13BB		04/01-11/03	SVK20RZ11	3449	1.1	-	IK20TT	IK20TT	4
1.3 4x4	63	G13BB		04/01-11/03	W22EPR-U	3088	0.8	W22TT	-	VW22	4
1.3 GX 4x4	50	EF13		10/95-11/03	W20EPR-U11	3049	1.1	W20TT	IW20TT	IW20TT	4
JUSTY III (03-)											
1.3 AWD	69	M13A		09/03-	IK20TT	4702	1.0	-	IK20TT	IK20TT	4
1.3 AWD	69	M13A		09/03-	SK16PR-A11	3356	1.1	-	IK16TT	IK16TT	4
1.3 AWD	69	M13A		09/03-	SVK20RZ11	3449	1.1	-	IK20TT	IK20TT	4
1.5 AWD	73	M15A		09/03-	IK20TT	4702	1.0	-	IK20TT	IK20TT	4
1.5 AWD	73	M15A		09/03-	SK16PR-A11	3356	1.1	-	IK16TT	IK16TT	4
1.5 AWD	73	M15A		09/03-	SVK20RZ11	3449	1.1	-	IK20TT	IK20TT	4
JUSTY IV (07-)											
1.0	51	1KR-FE		01/07-11/16	SK20HR11	3421	1.1	-	IKH20TT	IKH20TT	3
1.0	51	1KR-FE		11/16-	IXEH20TT	4711	1.0	-	IXEH20TT		3
1.3 AWD	67	K3-VE		03/08-	SXU22PR9	3434	0.9	-	IXU22TT	VXU22I	4
LEGACY I (89-94)											
2.0	85	EJ20E		08/91-12/93	K20PR-U11	3121	1.1	K20TT	IK20TT	IK20TT	4
2.0 GL	103	EJ20E		08/91-12/93	K20PR-U11	3121	1.1	K20TT	IK20TT	IK20TT	4
1800	76	EJ18 SPI		01/89-07/94	K20PR-U11	3121	1.1	K20TT	IK20TT	IK20TT	4
1800 4WD	76	EJ18 SPI		01/89-07/94	K20PR-U11	3121	1.1	K20TT	IK20TT	IK20TT	4
2000	85	EJ20 EMPI		09/91-12/93	K20PR-U11	3121	1.1	K20TT	IK20TT	IK20TT	4
2000 4WD	85	EJ20 EMPI		08/91-07/94	K20PR-U11	3121	1.1	K20TT	IK20TT	IK20TT	4
2000 Turbo 4WD	147	EJ20-GN		05/92-07/94	PK20PR-P8	3245	0.8	-	IK20TT	IK20TT	4
2000 Turbo Super 4WD	147	EJ20-GN		05/92-07/94	PK20PR-P8	3245	0.8	-	IK20TT	IK20TT	4
2200 4WD	100	EJ22 EMPI		01/89-07/94	K20PR-U11	3121	1.1	K20TT	IK20TT	IK20TT	4

Свечи зажигания и Свечи накаливания

Таблица применения











	KW				СТАНДАРТНЫЕ			Twin Tip			QTY
											
SUBARU продолжение											
LEGACY I (89-94) продолжение											
2200 Super 4WD	100	EJ22 EMPI		01/89-07/94	K20PR-U11	3121	1.1	K20TT	IK20TT	IK20TT	4
LEGACY II (94-99)											
2.0 i	85	EJ20 EMPI; EJ20E		09/94-03/99	K20PR-U11	3121	1.1	K20TT	IK20TT	IK20TT	4
2.0 i 4WD	85	EJ20		09/94-11/98	PK22PR8	3273	0.8	-	IK22TT	VK22	4
2.0 i 4WD	85	EJ20E; EJ201		09/94-03/99	K20PR-U11	3121	1.1	K20TT	IK20TT	IK20TT	4
2.2	94	EJ22		07/94-11/98	K20PR-U11	3121	1.1	K20TT	IK20TT	IK20TT	4
2.2 i 4WD	94/96	EJ22 EMPI		02/94-03/99	K20PR-U11	3121	1.1	K20TT	IK20TT	IK20TT	4
2.5 i 4WD	110	EJ25D		06/96-03/99	PK20PR11	3168	1.1	K20TT	IK20TT	IK20TT	4
LEGACY III (98-03)											
2.0 AWD	92	EJ201		12/98-08/03	K16PR-U11	3130	1.1	K16TT	IK16TT	IK16TT	4
2.0 AWD	92	EJ201		12/98-08/03	K20PR-U11	3121	1.1	K20TT	IK20TT	IK20TT	4
2.0 AWD	206	EJ208		06/02-08/03	PK20PR-P8	3245	0.8	-	IK20TT	IK20TT	4
2.5 AWD	115	EJ251		10/98-08/03	K16PR-U11	3130	1.1	K16TT	IK16TT	IK16TT	4
3.0 H6 AWD	154	EZ30		08/00-08/03	IKH20TT	4704	1.0	-	IKH20TT		6
LEGACY IV (03-09)											
2.0 2WD	132	EJ20Y/ EJ20X		08/05-03/12	VKH20Y	5639	0.8	-	-	VKH20Y	4
2.0 AWD	101	EJ202		09/03-10/05	K16PR-U11	3130	1.1	K16TT	IK16TT	IK16TT	4
2.0 AWD	101/ 121	EJ20X; EJ202; EJ204		09/03-04/09	IK20TT	4702	1.0	-	IK20TT	IK20TT	4
2.0 AWD	121	EJ20X; EJ204		06/05-06/07	VKH20Y	5639	0.8	-	-	VKH20Y	4
2.0 AWD	121	EJ20X; EJ204		04/07-04/09	IKH20TT	4704	1.0	-	IKH20TT		4
2.0 D AWD	110	EE20Z	Euro-4,OE: 22439-AA000	02/08-12/09	DG-615		11V				4
2.0 R AWD	110	EJ204		09/07-12/09	IKH20TT	4704	1.0	-	IKH20TT		4
2.0 R AWD	110	EJ204	LPG / GPL	09/07-12/09	VKH22	5619	0.8	-	-	VKH22	4
2.5 AWD	121	EJ25		09/03-04/09	IK16TT	4701	1.0	-	IK16TT	IK16TT	4
2.5 AWD	121	EJ253		09/03-04/09	PK16PR-L11	3275	1.1	-	IK16TT	IK16TT	4
2.5 AWD	121	EJ255		09/03-04/09	VKH20Y	5639	0.8	-	-	VKH20Y	4
2.5 i AWD	127	EJ25		09/07-12/09	IK16TT	4701	1.0	-	IK16TT	IK16TT	4
2.5 i AWD	127	EJ253		09/07-12/09	PK16PR-L11	3275	1.1	-	IK16TT	IK16TT	4
2.5 i AWD	127	EJ255		09/07-12/09	VKH20Y	5639	0.8	-	-	VKH20Y	4
3.0 R AWD	180	EZ30		09/03-06/09	VKH20Y	5639	0.8	-	-	VKH20Y	6
LEGACY OUTBACK (96-99)											
2.5	110	EJ25D		01/96-12/99	PK20PR11	3168	1.1	K20TT	IK20TT	IK20TT	4
LEGACY V (09-14)											
2.0 D AWD	110	EE20Z	Euro-4,OE: 22439-AA000	09/09-12/10	DG-615		11V				4
2.0 i AWD	110	EJ204		09/09-12/14	IKH20TT	4704	1.0	-	IKH20TT		4
2.0 i AWD	110	EJ204	LPG / GPL	09/09-12/14	VKH22	5619	0.8	-	-	VKH22	4
2.0 i AWD	110	FB20		06/12-12/14	IXEH22TT	4712	1.0	-	IXEH22TT		4
2.0 i LPG AWD	108	EJ204		09/09-12/11	IKH20TT	4704	1.0	-	IKH20TT		4
2.0 i LPG AWD	108	EJ204	LPG / GPL	09/09-12/11	VKH22	5619	0.8	-	-	VKH22	4
2.5 GT AWD	195	EJ255		07/10-12/14	VKH20Y	5639	0.8	-	-	VKH20Y	4
2.5 i AWD	123	EJ253		09/09-12/14	IK20TT	4702	1.0	-	IK20TT	IK20TT	4
2.5 i AWD	127	FB25		07/12-12/14	IXEH22TT	4712	1.0	-	IXEH22TT		4
LEONE I (78-84)											
1300	45	EA65		03/79-10/84	W20EX-U	3062	0.8	W20TT	IW20TT	IW20TT	4
1600	52/63	VA.EA71		09/78-12/84	W20EP-U	3043	0.8	W20TT	IW20TT	IW20TT	4
1600 4WD	52	EA71		03/79-10/84	W20EX-U	3062	0.8	W20TT	IW20TT	IW20TT	4
1600 4WD	52	VA.EA71		03/79-10/84	W20EP-U	3043	0.8	W20TT	IW20TT	IW20TT	4
1800	60	EA81		05/79-12/84	W20EP-U	3043	0.8	W20TT	IW20TT	IW20TT	4
1800 4WD	59	EA81		09/80-10/84	W20EP-U	3043	0.8	W20TT	IW20TT	IW20TT	4
1800 Super 4WD	60	EA81		09/80-10/84	W20EP-U	3043	0.8	W20TT	IW20TT	IW20TT	4
1800 Turismo 4WD	60	EA81		09/80-10/84	W20EP-U	3043	0.8	W20TT	IW20TT	IW20TT	4
LEONE II (84-94)											
1.6	51/54	S.EA71		03/85-12/92	J16AR-U11	3000	1.1	-	-		4
1.6	51/54	VA.EA71		03/85-12/92	W20EPR-U	3047	0.8	W20TT	IW20TT	IW20TT	4
1.8	66/77	EA82		11/84-12/89	W20EPR-U11	3049	1.1	W20TT	IW20TT	IW20TT	4
1.8 4WD	66/72	EA82		09/85-12/94	W20EPR-U11	3049	1.1	W20TT	IW20TT	IW20TT	4
1.8 4WD	96	EA82T		10/86-03/90	W20EXR-U11	3067	1.1	W20TT	IW20TT	IW20TT	4
1.8 GL	59	EA81		08/86-07/89	W20EPR-U	3047	0.8	W20TT	IW20TT	IW20TT	4
1.8 Turbo 4WD	100	EA82T		06/85-10/89	W20EXR-U11	3067	1.1	W20TT	IW20TT	IW20TT	4
1.8 Turbo AWD	100	EA82T		06/85-07/86	W20EXR-U11	3067	1.1	W20TT	IW20TT	IW20TT	4
1300	48	EA65		11/84-09/91	W20EX-U	3062	0.8	W20TT	IW20TT	IW20TT	4
1600	55	EA71-74		11/84-09/91	W20EPR-U11	3049	1.1	W20TT	IW20TT	IW20TT	4
1600	55	S.EA71		11/84-12/94	J16AR-U11	3000	1.1	-	-		4
1600	55	VA.EA71		11/84-12/94	W20EPR-U	3047	0.8	W20TT	IW20TT	IW20TT	4

Таблица применения

S

Свечи зажигания и Свечи накаливания

Таблица применения

Таблица применения

SUBARU	KW	NOTE	21	СТАНДАРТНЫЕ				Twin Tip		QTY
				16mm	18mm	19mm	20mm	16mm	18mm	
SUBARU продолжение										
LEONE II (84-94) продолжение										
1600 4WD	55	S.EA71		01/87-12/94	J16AR-U11	3000	1.1	-	-	4
1600 4WD	55	VA.EA71		01/87-12/94	W20EPR-U	3047	0.8	W20TT	IW20TT	4
1800	66/72	EA82		11/84-09/94	W20EPR-U11	3049	1.1	W20TT	IW20TT	4
1800 4WD	63	EA81		09/84-12/89	W20EPR-U	3047	0.8	W20TT	IW20TT	4
1800 4WD	66/72	EA82		11/84-07/91	W20EPR-U11	3049	1.1	W20TT	IW20TT	4
1800 4WD	88	EA82T		08/86-12/90	W20EXR-U11	3067	1.1	W20TT	IW20TT	4
1800 Cat 4WD	70	EA82		07/86-09/91	W20EPR-U11	3049	1.1	W20TT	IW20TT	4
1800 Super 4WD	96	EA82T		03/89-12/90	W20EXR-U11	3067	1.1	W20TT	IW20TT	4
1800 Super Catalytic-Conv 4WD	70	EA82		07/86-02/92	W20EPR-U11	3049	1.1	W20TT	IW20TT	4
1800 Super Turbo 4WD	100	EA82T		11/84-12/90	W20EXR-U11	3067	1.1	W20TT	IW20TT	4
1800 Turbo 4WD	96/100	EA82T		11/84-12/90	W20EXR-U11	3067	1.1	W20TT	IW20TT	4
LEVORG (15-)										
1.6 AWD	125	FB16		09/15-	IXEH22TT	4712	1.0	-	IXEH22TT	4
LIBERO (83-00)										
1.0	40	EF10		01/84-07/88	W20EPR-U11	3049	1.1	W20TT	IW20TT	3
1.0 4WD	37/40	EF10		01/83-12/87	W20EPR-U11	3049	1.1	W20TT	IW20TT	3
1.2	38	EF12		08/87-07/94	W20EPR-U11	3049	1.1	W20TT	IW20TT	3
1.2 4WD	38/49	EF12; EF12E		08/86-02/00	W20EPR-U11	3049	1.1	W20TT	IW20TT	3
1.2 i	49	EF12E		08/92-04/94	W20EPR-U11	3049	1.1	W20TT	IW20TT	3
1.2 i 4WD	40	EF12		08/91-02/00	W20EPR-U11	3049	1.1	W20TT	IW20TT	3
LUCRA (10-)										
0.66	38	KF		04/10-	VXUH20I	5650	0.9	-	-	VXUH20I
0.66 AWD	38	KF		04/10-	VXUH20I	5650	0.9	-	-	VXUH20I
MV (78-86)										
1.6	52	VA.EA71		06/78-04/81	W20EPR-U	3047	0.8	W20TT	IW20TT	4
1.8	60/66	EA81		05/81-08/86	W20EPR-U	3047	0.8	W20TT	IW20TT	4
OUTBACK (00-03)										
2.5 AWD	115	EJ251		10/00-08/03	K16PR-U11	3130	1.1	K16TT	IK16TT	4
3.0 H6 AWD	154	EZ30		10/00-08/03	IKH20TT	4704	1.0	-	IKH20TT	6
OUTBACK (03-09)										
2.0 D AWD	110	EE20Z	Euro-4, OE: 22439-AA000	09/08-09/09	DG-615		11V			4
2.5 AWD	121	EJ25D		11/03-09/09	PK20PR11	3168	1.1	K20TT	IK20TT	4
2.5 AWD	127	EJ251		09/08-09/09	IK20TT	4702	1.0	-	IK20TT	4
2.5 AWD	127	EJ251		09/08-09/09	K16PR-U11	3130	1.1	K16TT	IK16TT	4
3.0 AWD	180	EZ30		11/03-09/09	VKH20Y	5639	0.8	-	-	VKH20Y
OUTBACK (09-)										
2.0 D AWD	110	EE20Z	Euro-4, OE: 22439-AA000	09/09-12/10	DG-615		11V			4
2.5 i AWD	123	EJ253		09/09-	IK20TT	4702	1.0	-	IK20TT	4
2.5 i AWD	127	FB25B		01/13-	IXEH22TT	4712	1.0	-	IXEH22TT	4
3.6 AWD	183	EZ36D		06/11-12/14	IKH20TT	4704	1.0	-	IKH20TT	6
3.6 R AWD	191	EZ36D		09/09-	IKH20TT	4704	1.0	-	IKH20TT	6
OUTBACK (15-)										
2.5 AWD	129	FB25		03/15-	IXEH22TT	4712	1.0	-	IXEH22TT	4
PLEO (10-)										
0.66	36	KF		01/12-07/14	VXUH20I	5650	0.9	-	-	VXUH20I
0.66 AWD	36	KF		01/12-07/14	VXUH20I	5650	0.9	-	-	VXUH20I
REX I (72-81)										
550	23	EK23		08/77-08/81	W16EX-U	3027	0.8	W16TT	IW16TT	4
REX II (81-89)										
550	23	EK23		08/81-06/87	W16EPR-U11	3201	1.1	W16TT	IW16TT	4
550	26	EK23 6V		06/87-06/89	Q20P-U11	3136	1.1	Q20TT	IQ20TT	4
550 4WD	23	EK23		08/83-06/87	W16EPR-U11	3201	1.1	W16TT	IW16TT	4
550 4WD	26	EK23 6V		06/87-06/89	Q20P-U11	3136	1.1	Q20TT	IQ20TT	4
550 Kompressor	40	EK23 Super Charger		08/88-06/89	Q20P-U11	3136	1.1	Q20TT	IQ20TT	4
550 Turbo	30			07/84-06/87	W20EPR-U11	3049	1.1	W20TT	IW20TT	4
700	27	EK42		08/82-06/89	W20EPR-U11	3049	1.1	W20TT	IW20TT	2
REX III (89-92)										
0.5	28	EN05		06/89-07/90	K20PR-U11	3121	1.1	K20TT	IK20TT	4
0.5 4WD	28	EN05		06/89-07/90	K20PR-U11	3121	1.1	K20TT	IK20TT	4
0.5 Kompressor	45	EN05		06/89-07/90	K20PR-U	3145	0.8	K20TT	IK20TT	4
0.5 Kompressor	45	EN05		06/89-07/90	K20PR-U11	3121	1.1	K20TT	IK20TT	4
0.7	35	EN07E		07/90-03/92	K20PR-U11	3121	1.1	K20TT	IK20TT	4
0.7	47	EN07Z		07/90-02/92	K20PR-U	3145	0.8	K20TT	IK20TT	4

Свечи зажигания и Свечи накаливания

Таблица применения

KW	KW	KW	KW	KW	СТАНДАРТНЫЕ				Twin Tip		QTY
					STANDARD	STANDARD	STANDARD	STANDARD	TWIN TIP	TWIN TIP	
SUBARU продолжение											
REX III (89-92) продолжение											
0.7 4WD	35	EN07E		07/90-03/92	K20PR-U11	3121	1.1	K20TT	IK20TT	IK20TT	4
0.7 Kompressor 4WD	47	EN07Z		07/90-02/92	K20PR-U	3145	0.8	K20TT	IK20TT	IK20TT	4
SAMBAR (12-)											
0.66	34/ 39/47	KF		04/15-	VXUH20I	5650	0.9	-	-	VXUH20I	3
0.66 AWD	34/ 39/47	KF		04/15-	VXUH20I	5650	0.9	-	-	VXUH20I	3
STELLA (12-)											
0.66	38/47	KF		12/14-	VXUH20I	5650	0.9	-	-	VXUH20I	3
0.66 AWD	38/47	KF		12/14-	VXUH20I	5650	0.9	-	-	VXUH20I	3
SVX (92-97)											
3.3 i 24V 4WD	162/ 169	EG33 DOHC		09/92-12/97	PK20PR11	3168	1.1	K20TT	IK20TT	IK20TT	6
TREZIA (11-)											
1.3	73	1NR-FE		03/11-04/15	SC16HR11	3499	1.1	-	IXEH20TT	IXEH20TT	4
1.3	73	1NR-FKE		04/15-	FC16HR8	3504	0.8	-	IXEH20TT	IXEH20TT	4
1.4 D	66	1ND-TV	Double Coil(LPH)	03/11-	DG-240		11V				4
TRIBECA (05-)											
3.0	180/ 184	EZ30		01/05-	VKH20Y	5639	0.8	-	-	VKH20Y	6
3.6	188/ 190	EZ36D		09/07-	IKH20TT	4704	1.0	-	IKH20TT		6
VIVIO (92-98)											
0.7	32	EN07E		08/92-12/98	K16PR-U11	3130	1.1	K16TT	IK16TT	IK16TT	4
0.7	32	EN07E		08/92-12/98	K20PR-U11	3121	1.1	K20TT	IK20TT	IK20TT	4
660 4WD	32	EN07E		03/92-10/95	K16PR-U11	3130	1.1	K16TT	IK16TT	IK16TT	4
660 4WD	32	EN07E		03/92-10/95	K20PR-U11	3121	1.1	K20TT	IK20TT	IK20TT	4
XV (12-)											
1.6 i AWD	84	FB16A; FB16B		03/12-	IXEH22TT	4712	1.0	-	IXEH22TT		4
2.0 i AWD	110	FB20B		03/12-	IXEH22TT	4712	1.0	-	IXEH22TT		4
SUZUKI											
ALTO I (82-85)											
0.8	29	F8A/ F8B		06/82-08/84	W16EXR-U	3031	0.8	W16TT	IW16TT	IW16TT	3
ALTO II (86-93)											
0.8	29	F8B		01/86-12/88	W16EPR-U	3021	0.8	W16TT	IW16TT	IW16TT	3
ALTO III (93-02)											
1.0	39	G10B		09/94-09/98	W16EXR-U	3031	0.8	W16TT	IW16TT	IW16TT	4
1.0	43	G10B-58		01/00-06/02	K20PR-U	3145	0.8	K20TT	IK20TT	IK20TT	4
ALTO IV (02-08)											
1.1	46	F10D; F10DN		09/04-12/08	XU22EPR-U	3179	0.9	XU22TT	IXU22TT	VXU22	4
ALTO V (09-)											
1.0	50	K10B		01/09-	ZXU20PR11	3452	1.1	-	-	VXU20	3
ALTO VI (14-)											
0.7	36/38	R06A		12/14-	VXUH22	5611	0.9	-	IXUH22TT	VXUH22	3
0.7 4WD	36/38	R06A		12/14-	VXUH22	5611	0.9	-	IXUH22TT	VXUH22	3
0.7 Turbo RS	47	R06A-T		12/14-	VXUH22	5611	0.9	-	IXUH22TT	VXUH22	3
0.7 Turbo RS 4WD	47	R06A-T		12/14-	VXUH22	5611	0.9	-	IXUH22TT	VXUH22	3
BALENO (95-02)											
1.3	52	G13BA		09/96-05/02	K20PR-U	3145	0.8	K20TT	IK20TT	IK20TT	4
1.3 16V	63	G13BB		03/97-05/02	K20PR-U	3145	0.8	K20TT	IK20TT	IK20TT	4
1.3 16V	63	G13BB		03/97-05/02	W22EPR-U	3088	0.8	W22TT	-	VW22	4
1.3 i 16V	63	G13BB		07/95-05/02	K20PR-U	3145	0.8	K20TT	IK20TT	IK20TT	4
1.3 i 16V	63	G13BB		07/95-05/02	W22EPR-U	3088	0.8	W22TT	-	VW22	4
1.6 i 16V	72	G16B		07/95-05/02	K20PR-U	3145	0.8	K20TT	IK20TT	IK20TT	4
1.6 i 16V 4x4	73	G16B		07/95-05/02	K20PR-U	3145	0.8	K20TT	IK20TT	IK20TT	4
1.8 GTX	89	J18A		03/96-05/02	K20PR-U11	3121	1.1	K20TT	IK20TT	IK20TT	4
1.8 i 16V	89	J18A		08/96-05/02	K20PR-U11	3121	1.1	K20TT	IK20TT	IK20TT	4
1.9 TD	55	DHV (XUD9BSD); DHW (XUD9SD)	Double Coil(LPH)	04/98-05/02	DG-001		11V				4
BALENO (16-)											
1.0	82	K10C		02/16-	VXUHC22G	5652	0.8	-	-	VXUHC22G	3
1.2	66	K12C		02/16-	VXUH20I	5650	0.9	-	-	VXUH20I	4
1.2 Hybrid	66	K12C		02/16-	VXUH20I	5650	0.9	-	-	VXUH20I	4
CAPPUCINO (92-98)											
0.7	47	F6A		02/92-08/98	XU22EPR-U	3179	0.9	XU22TT	IXU22TT	VXU22	3
0.7	47	F6A-T/C		02/92-08/98	IXU22	5308	0.9	-	IXU22TT	VXU22	3

Свечи зажигания и Свечи накаливания

Таблица применения

Таблица применения

SUZUKI <small>продолжение</small>	KW				СТАНДАРТНЫЕ			Twin Tip			QTY
CARRY (80-85)											
0.8	27	F8A		11/80-10/85	W16EPR-U	3021	0.8	W16TT	IW16TT	IW16TT	4
CARRY (85-90)											
1.0	33	F10A		07/85-12/90	W16EX-U	3027	0.8	W16TT	IW16TT	IW16TT	4
CARRY (95-99)											
1.0	29/33	F10A		08/92-03/99	W16EXR-U	3031	0.8	W16TT	IW16TT	IW16TT	4
CARRY (99-)											
0.7	35	R06A		03/99-	VXUH22	5611	0.9	-	IXUH22TT	VXUH22	3
1.3	56	G13BB		03/99-12/06	W22EPR-U	3088	0.8	W22TT	-	VW22	4
1.3 4x4	58	G13BB		10/00-07/05	W22EPR-U	3088	0.8	W22TT	-	VW22	4
1.3 16 V	58	G13BB		03/00-	W22EPR-U	3088	0.8	W22TT	-	VW22	4
1.3 16 V	58	G13BB/E6		03/00-01/04	K20PR-U	3145	0.8	K20TT	IK20TT	IK20TT	4
CELERIO (14-)											
1.0	50	K10B		03/14-	ZXU20PR11	3452	1.1	-	-	VXU20	3
EVERY (05-15)											
0.7	36	K6A-T		08/05-05/10	IXU22	5308	0.9	-	IXU22TT	VXU22	3
0.7	36	K6A-T		08/05-01/15	XU22EPR-U	3179	0.9	XU22TT	IXU22TT	VXU22	3
0.7	36	K6A-T		05/10-01/15	IXUH22	5353	0.9	-	IXUH22TT	VXUH22	3
0.7 4WD	36	K6A-T		08/05-05/10	IXU22	5308	0.9	-	IXU22TT	VXU22	3
0.7 4WD	36	K6A-T		08/05-01/15	XU22EPR-U	3179	0.9	XU22TT	IXU22TT	VXU22	3
0.7 4WD	36	K6A-T		05/10-01/15	IXUH22	5353	0.9	-	IXUH22TT	VXUH22	3
Grand VITARA I (98-06)											
1.6 4x4	69/73	G16B		03/98-07/03	PK20PR11	3168	1.1	K20TT	IK20TT	IK20TT	4
2.0 4x4	94/97	J20A		03/98-07/03	IK20TT	4702	1.0	-	IK20TT	IK20TT	4
2.0 4x4	94/97	J20A		03/98-07/03	K20PR-U11	3121	1.1	K20TT	IK20TT	IK20TT	4
2.0 4x4	94/97	J20A		03/98-07/03	SVK20RZ11	3449	1.1	-	IK20TT	IK20TT	4
2.0 HDI 110 4x4	80	RHZ		07/01-09/05	DG-116		11V				4
2.0 HDI 110 16V 4x4	80	RHW	Double Coil(LPH)	07/01-09/05	DG-116		11V				4
2.0 TD 4x4	64	RF; RFM	Double Coil(LPH)	03/98-09/05	DG-146		11V				4
2.5 V6 24V 4x4	106/116	H 25 A		04/98-07/03	K20PR-U11	3121	1.1	K20TT	IK20TT	IK20TT	6
2.7	135	H 27 A		09/03-08/06	IK20TT	4702	1.0	-	IK20TT	IK20TT	6
2.7	135	H 27 A		09/03-08/06	SVK20RZ11	3449	1.1	-	IK20TT	IK20TT	6
2.7 4x4	127/135	H 27 A; H27A-184		09/01-07/03	K20PR-U11	3121	1.1	K20TT	IK20TT	IK20TT	6
Grand VITARA II (05-)											
1.6	78	M16A	Check Thread size	10/05-	IK20TT	4702	1.0	-	IK20TT	IK20TT	4
1.6	78	M16A	Check Thread size	10/05-	IKH20TT	4704	1.0	-	IKH20TT		4
1.6	78	M16A	Check Thread size	10/05-	K20PR-U11	3121	1.1	K20TT	IK20TT	IK20TT	4
1.6	78	M16A	Check Thread size	10/05-	SVK20RZ11	3449	1.1	-	IK20TT	IK20TT	4
1.6 AWD	78	M16A	Check Thread size	04/05-	IK20TT	4702	1.0	-	IK20TT	IK20TT	4
1.6 AWD	78	M16A	Check Thread size	04/05-	IKH20TT	4704	1.0	-	IKH20TT		4
1.6 AWD	78	M16A	Check Thread size	04/05-	K20PR-U11	3121	1.1	K20TT	IK20TT	IK20TT	4
1.6 AWD	78	M16A	Check Thread size	04/05-	SVK20RZ11	3449	1.1	-	IK20TT	IK20TT	4
1.9 DDIS AWD	95	F9QB	Ch:>00610000, OE: 18550-84A51, Double Coil(LPH)	10/05-02/15	DG-005		11V				4
1.9 DDIS AWD	95	F9QB	Ch:00610001>, OE: 18550-80KA0, Instant heating	10/05-02/15	DG-619		4.4V				4
2.0	103	J20A		10/05-02/15	K20PR-U11	3121	1.1	K20TT	IK20TT	IK20TT	4
2.0	103	OEM upgrade (optional)		10/05-02/15	SK16PR-A11	3356	1.1	-	IK16TT	IK16TT	4
2.0 AWD	103	J20A		10/05-02/15	K20PR-U11	3121	1.1	K20TT	IK20TT	IK20TT	4
2.0 AWD	103	OEM upgrade (optional)		10/05-02/15	SK16PR-A11	3356	1.1	-	IK16TT	IK16TT	4
2.4	124	J24B		09/09-	IKH20TT	4704	1.0	-	IKH20TT		4
2.4 AWD	122	J24B		01/09-	K16HPR-U11	6076	1.1	KH16TT	IKH16TT	IKH16TT	4
2.4 AWD	122/124	J24B		01/09-	IKH20TT	4704	1.0	-	IKH20TT		4

Свечи зажигания и Свечи накаливания

Таблица применения











	KW				СТАНДАРТНЫЕ			Twin Tip			QTY
											
SUZUKI продолжение											
Grand VITARA II (05-) продолжение											
3.2 AWD	171	N32A		01/09-02/15	PT16VR13	5068	1.3	TV16TT	ITV16TT	ITV16TT	6
IGNIS (16-)											
1.2	66	K12C		10/16-	VXUH20I	5650	0.9	-	-	VXUH20I	4
1.2 AllGrip	66	K12C		10/16-	VXUH20I	5650	0.9	-	-	VXUH20I	4
1.2 Hybrid	66	K12C		10/16-	VXUH20I	5650	0.9	-	-	VXUH20I	4
1.2 Hybrid AllGrip	66	K12C		10/16-	VXUH20I	5650	0.9	-	-	VXUH20I	4
IGNIS I (00-05)											
1.3	61	M13A		10/00-09/03	K20PR-U11	3121	1.1	K20TT	IK20TT	IK20TT	4
1.3	61	M13A		10/00-09/03	SK16PR-A11	3356	1.1	-	IK16TT	IK16TT	4
1.3	61	M13A	LEAN BURN	10/00-09/03	SK20PR-A11	3418	1.1	-	IK20TT	IK20TT	4
1.3 4WD	61	M13A		10/00-09/03	K20PR-U11	3121	1.1	K20TT	IK20TT	IK20TT	4
1.3 4WD	61	M13A		10/00-09/03	SK16PR-A11	3356	1.1	-	IK16TT	IK16TT	4
1.5 Sport	80	M15A		12/03-12/05	IK20TT	4702	1.0	-	IK20TT	IK20TT	4
1.5 Sport	80	M15A		12/03-12/05	SK16PR-A11	3356	1.1	-	IK16TT	IK16TT	4
1.5 Sport	80	M15A		12/03-12/05	SVK20RZ11	3449	1.1	-	IK20TT	IK20TT	4
IGNIS II (03-)											
1.3	69	M13A		09/03-	IK20TT	4702	1.0	-	IK20TT	IK20TT	4
1.3	69	M13A		09/03-	SK16PR-A11	3356	1.1	-	IK16TT	IK16TT	4
1.3	69	M13A		09/03-	SVK20RZ11	3449	1.1	-	IK20TT	IK20TT	4
1.3 4x4	69	M13A		09/03-	IK20TT	4702	1.0	-	IK20TT	IK20TT	4
1.3 4x4	69	M13A		09/03-	SK16PR-A11	3356	1.1	-	IK16TT	IK16TT	4
1.3 4x4	69	M13A		09/03-	SVK20RZ11	3449	1.1	-	IK20TT	IK20TT	4
1.3 DDiS	51	Z13DT	Euro-4,OE: 18550-84E50; 18550-M86J00, Double Coi (LPH)	09/03-	DG-171		11V				4
1.3 DDiS	51	Z13DT	Euro-5; Euro-6,OE: 18550-68L10	09/03-	DG-621		4.4V				4
1.5	73	M15A		09/03-	IK20TT	4702	1.0	-	IK20TT	IK20TT	4
1.5	73	M15A		09/03-	SK16PR-A11	3356	1.1	-	IK16TT	IK16TT	4
1.5	73	M15A		09/03-	SVK20RZ11	3449	1.1	-	IK20TT	IK20TT	4
1.5 4x4	73	M15A		09/03-	IK20TT	4702	1.0	-	IK20TT	IK20TT	4
1.5 4x4	73	M15A		09/03-	SK16PR-A11	3356	1.1	-	IK16TT	IK16TT	4
1.5 4x4	73	M15A		09/03-	SVK20RZ11	3449	1.1	-	IK20TT	IK20TT	4
JIMNY (88-98)											
1.3	52	G13BA		11/88-03/98	K20PR-U	3145	0.8	K20TT	IK20TT	IK20TT	4
JIMNY (98-)											
1.3	63	M13A		08/04-	SK16PR-A11	3356	1.1	-	IK16TT	IK16TT	4
1.3 4WD	62	M13A		05/14-	SVK20RZ11	3449	1.1	-	IK20TT	IK20TT	4
1.3 4x4	63	G13BB		09/98-08/00	W22EPR-U	3088	0.8	W22TT	-	VW22	4
1.3 16V	60	G13BB		09/98-	W22EPR-U	3088	0.8	W22TT	-	VW22	4
1.3 16V	60	G13BB/E6		09/98-	K20PR-U	3145	0.8	K20TT	IK20TT	IK20TT	4
1.3 16V	60	M13A		02/01-	SK16PR-A11	3356	1.1	-	IK16TT	IK16TT	4
1.3 16V	60	M13A(81)/M13A(85)		04/02-	IK20TT	4702	1.0	-	IK20TT	IK20TT	4
1.3 16V	60	M13A(81)/M13A(85)		04/02-	SVK20RZ11	3449	1.1	-	IK20TT	IK20TT	4
1.3 16V 4WD	60	G13BB		09/98-	W22EPR-U	3088	0.8	W22TT	-	VW22	4
1.3 16V 4WD	60	G13BB/E6		09/98-	K20PR-U	3145	0.8	K20TT	IK20TT	IK20TT	4
1.3 16V 4WD	60	M13A		02/01-	SK16PR-A11	3356	1.1	-	IK16TT	IK16TT	4
1.3 16V 4WD	60	M13A(81)		04/02-	IK20TT	4702	1.0	-	IK20TT	IK20TT	4
1.3 16V 4WD	60	M13A(81)		04/02-	SVK20RZ11	3449	1.1	-	IK20TT	IK20TT	4
1.3 16V 4x4	63	M13A		08/05-	SK16PR-A11	3356	1.1	-	IK16TT	IK16TT	4
1.3 16V 4x4	63	M13A(85)		08/05-	IK20TT	4702	1.0	-	IK20TT	IK20TT	4
1.3 16V 4x4	63	M13A(85)		08/05-	SVK20RZ11	3449	1.1	-	IK20TT	IK20TT	4
1.5 DDiS 4WD	48	K9K 700		12/03-	DG-005		11V				4
1.5 DDiS 4x4	63	K9K 266		08/05-	DG-005		11V				4
KIZASHI (10-)											
2.4	131	J24B		10/10-	IKH20TT	4704	1.0	-	IKH20TT		4
2.4 4x4	131	J24B		10/10-	IKH20TT	4704	1.0	-	IKH20TT		4
LIANA (01-07)											
1.3	66	M13A		07/01-12/07	SK16PR-A11	3356	1.1	-	IK16TT	IK16TT	4
1.3	66	M13A(90)		07/01-01/06	SK20PR-A11	3418	1.1	-	IK20TT	IK20TT	4
1.3	66	M13A(90)		03/02-01/06	IK20TT	4702	1.0	-	IK20TT	IK20TT	4
1.3	66	M13A(90)		03/02-01/06	SVK20RZ11	3449	1.1	-	IK20TT	IK20TT	4
1.4 DDiS	66	8HY		04/04-01/06	DG-113		11V				4
1.6	76	M16A		07/01-01/04	K20PR-U11	3121	1.1	K20TT	IK20TT	IK20TT	4

Таблица применения

S

Свечи зажигания и Свечи накаливания

Таблица применения

Таблица применения

SUZUKI	KW	KW	NOTE	21	СТАНДАРТНЫЕ			Twin Tip		QTY	
					1	2	3	1	2		
SUZUKI продолжение											
LIANA (01-07) продолжение											
1.6	76/79	M16A		02/04-12/07	IK20TT	4702	1.0	-	IK20TT	IK20TT	4
1.6	76/79	M16A		02/04-12/07	SVK20RZ11	3449	1.1	-	IK20TT	IK20TT	4
1.6 4WD	76/78	M16A		07/01-01/04	K20PR-U11	3121	1.1	K20TT	IK20TT	IK20TT	4
1.6 4WD	76/78	M16A		02/04-12/07	IK20TT	4702	1.0	-	IK20TT	IK20TT	4
1.6 4WD	76/78	M16A		02/04-12/07	SVK20RZ11	3449	1.1	-	IK20TT	IK20TT	4
1.6 i	78	M16A		04/02-01/04	K20PR-U11	3121	1.1	K20TT	IK20TT	IK20TT	4
1.6 i	78	M16A		02/04-12/07	IK20TT	4702	1.0	-	IK20TT	IK20TT	4
1.6 i	78	M16A		02/04-12/07	SVK20RZ11	3449	1.1	-	IK20TT	IK20TT	4
LJ 80 (77-84)											
0.8	29	F8A		01/80-01/81	W16EPR-U	3021	0.8	W16TT	IW16TT	IW16TT	4
MR Wagon (01-06)											
0.7	40/44	K6A		04/01-04/02	XU22EPR-U	3179	0.9	XU22TT	IXU22TT	VXU22	3
0.7	40/44/47	K6A; K6A-T		04/01-03/06	IXU22	5308	0.9	-	IXU22TT	VXU22	3
MR Wagon (06-13)											
0.7	44	K6A		04/06-12/13	XU22EPR-U	3179	0.9	XU22TT	IXU22TT	VXU22	3
0.7	44	K6A		06/09-12/13	IXUH22	5353	0.9	-	IXUH22TT	VXUH22	3
0.7	44	K6A; K6A-T		04/06-12/13	IXU22	5308	0.9	-	IXU22TT	VXU22	3
0.7 4WD	44	K6A		04/06-12/13	XU22EPR-U	3179	0.9	XU22TT	IXU22TT	VXU22	3
0.7 4WD	44	K6A		06/09-12/13	IXUH22	5353	0.9	-	IXUH22TT	VXUH22	3
0.7 4WD	44	K6A; K6A-T		04/06-12/13	IXU22	5308	0.9	-	IXU22TT	VXU22	3
SAMURAI (88-04)											
1.0 AWD	33	F10A		11/88-12/04	W16EPR-U	3021	0.8	W16TT	IW16TT	IW16TT	4
1.0 AWD	33	F10A		11/88-12/04	W16EXR-U	3031	0.8	W16TT	IW16TT	IW16TT	4
1.3	49/51	G13BA		11/88-03/98	K20PR-U	3145	0.8	K20TT	IK20TT	IK20TT	4
1.3	51	G13BA		11/88-03/98	W20EXR-U	3066	0.8	W20TT	IW20TT	IW20TT	4
1.3 AWD	44/47	G13A		11/88-12/04	W16EPR-U	3021	0.8	W16TT	IW16TT	IW16TT	4
1.3 AWD	44/47	G13A		11/88-12/04	W16EXR-U	3031	0.8	W16TT	IW16TT	IW16TT	4
1.3 AWD	51/59	G13BA		11/88-12/04	K20PR-U	3145	0.8	K20TT	IK20TT	IK20TT	4
1.3 AWD	51/59	G13BA		11/88-12/04	W20EXR-U	3066	0.8	W20TT	IW20TT	IW20TT	4
1.9 TD AWD	46	XUD9	Double Coil(LPH)	11/98-12/04	DG-001		11V				4
SJ 410 (81-88)											
1.0	33	F10A		09/81-07/91	W16EPR-U	3021	0.8	W16TT	IW16TT	IW16TT	4
1.0	33	F10A		09/81-07/91	W16EX-U	3027	0.8	W16TT	IW16TT	IW16TT	4
SJ 413 (84-90)											
1.3	44/47	G13A		09/84-08/90	W16EPR-U	3021	0.8	W16TT	IW16TT	IW16TT	4
1.3	44/47	G13A		09/84-08/90	W16EXR-U	3031	0.8	W16TT	IW16TT	IW16TT	4
SPLASH (08-)											
1.0	48/50	K10B		01/08-	ZXU20PR11	3452	1.1	-	-	VXU20	3
1.2	63	K12B		01/08-	ZXU20PR11	3452	1.1	-	-	VXU20	4
1.2 VVT	66/69	K12B		09/10-	ZXU20PR11	3452	1.1	-	-	VXU20	4
1.3 CDTI	55	D13A; Z 13 DTJ	Euro-4,OE: 18550-84E50; 18550-M86J00, Double Coi I(LPH)	01/08-	DG-171		11V				4
1.3 CDTI	55	D13A; Z 13 DTJ	Euro-5; Euro-6,OE: 18550-68L10	01/08-	DG-621		4.4V				4
SUPER CARRY (85-99)											
1.0	30	F10A		10/92-03/99	W16EXR-U	3031	0.8	W16TT	IW16TT	IW16TT	4
1.0	30	F10A		09/94-03/99	W16EP-U	3018	0.8	W16TT	IW16TT	IW16TT	4
1.0	30/33	F10A		10/85-03/99	W16EX-U	3027	0.8	W16TT	IW16TT	IW16TT	4
1.0	33	F10A		10/85-03/99	W16EPR-U	3021	0.8	W16TT	IW16TT	IW16TT	4
SWIFT I (83-89)											
1.0	37	G10; G10A		10/83-03/89	IW16	5305	1.1	-	IW16TT	IW16TT	3
1.0 Turbo	52	G10T		02/85-12/89	IW16	5305	1.1	-	IW16TT	IW16TT	3
1.3	47/50	G13DOHC		10/84-01/88	W20EPR-U	3047	0.8	W20TT	IW20TT	IW20TT	4
1.3	47/50/54	G13A		10/84-03/89	W16EXR-U	3031	0.8	W16TT	IW16TT	IW16TT	4
1.3 GT/GXi	74	G13B		08/85-03/89	W22EPR-U	3088	0.8	W22TT	-	VW22	4
SWIFT II (89-05)											
1.0	37	G10A	Check Hex size	03/89-08/96	W16EPR-U11	3201	1.1	W16TT	IW16TT	IW16TT	3
1.0	37	G10A	Check Hex size	03/89-08/96	W20EPR-U	3047	0.8	W20TT	IW20TT	IW20TT	3
1.0	37/39	G10A	Check Hex size	01/94-05/01	K20P-U	3276	0.8	K20TT	IK20TT	IK20TT	3
1.0 i	39	G10A	Check Hex size	03/89-08/96	W20EPR-U	3047	0.8	W20TT	IW20TT	IW20TT	3
1.0 i	39	G10A	Check Hex size	09/96-12/05	K20P-U	3276	0.8	K20TT	IK20TT	IK20TT	3
1.3	50	G13B		03/89-05/01	W20EPR-U	3047	0.8	W20TT	IW20TT	IW20TT	4

Свечи зажигания и Свечи накаливания

Таблица применения











	KW				СТАНДАРТНЫЕ			Twin Tip			QTY
											
SUZUKI продолжение											
SWIFT II (89-05) продолжение											
1.3	50	G13BA		09/96-10/96	K20PR-U	3145	0.8	K20TT	IK20TT	IK20TT	4
1.3	50/52	G13A		03/89-05/01	W16EXR-U	3031	0.8	W16TT	IW16TT	IW16TT	4
1.3	50/ 52/63	G13B; G13BB		03/89-12/03	W22EPR-U	3088	0.8	W22TT	-	VW22	4
1.3	50/63	G13B; G13BB	Hungary	09/96-12/03	W20EPR-U	3047	0.8	W20TT	IW20TT	IW20TT	4
1.3	52	G13BA - EU	Japan	03/89-12/91	W20EPR-U	3047	0.8	W20TT	IW20TT	IW20TT	4
1.3 4WD	50/52	G13A		03/89-05/01	W16EXR-U	3031	0.8	W16TT	IW16TT	IW16TT	4
1.3 4WD	52	G13BAK4WD	Japan	10/89-12/91	W20EPR-U	3047	0.8	W20TT	IW20TT	IW20TT	4
1.3 GTi/GXi	74	G13B		03/89-05/01	W22EPR-U	3088	0.8	W22TT	-	VW22	4
1.3 GTi/GXi	74	G13BDOHC/G13DOHC	Japan	03/89-08/96	W20EPR-U	3047	0.8	W20TT	IW20TT	IW20TT	4
1.3 i	50	G13B		09/91-10/96	W20EPR-U	3047	0.8	W20TT	IW20TT	IW20TT	4
1.3 i	50	G13BA		09/91-10/96	K20PR-U	3145	0.8	K20TT	IK20TT	IK20TT	4
1.6	70	G16B		11/89-12/91	K20P-U	3276	0.8	K20TT	IK20TT	IK20TT	4
1.6 4WD	70	G16B		11/89-12/91	K20P-U	3276	0.8	K20TT	IK20TT	IK20TT	4
1.6 4x4	68	G16B		03/89-10/96	K20P-U	3276	0.8	K20TT	IK20TT	IK20TT	4
1.6 i	68	G16B		01/90-05/01	K20P-U	3276	0.8	K20TT	IK20TT	IK20TT	4
1.6 i 4WD	68	G16B		01/90-05/01	K20P-U	3276	0.8	K20TT	IK20TT	IK20TT	4
SWIFT III (05-)											
1.3	68	M13A		02/05-	SK16PR-A11	3356	1.1	-	IK16TT	IK16TT	4
1.3	68	M13AVVT(93)		02/05-01/11	IK20TT	4702	1.0	-	IK20TT	IK20TT	4
1.3	68	M13AVVT(93)		02/05-01/11	SVK20RZ11	3449	1.1	-	IK20TT	IK20TT	4
1.3 4x4	66	M13A		01/06-	IK20TT	4702	1.0	-	IK20TT	IK20TT	4
1.3 4x4	66	M13A		01/06-	SVK20RZ11	3449	1.1	-	IK20TT	IK20TT	4
1.3 4x4	66/68	M13A		02/05-	SK16PR-A11	3356	1.1	-	IK16TT	IK16TT	4
1.3 4x4	68	M13AVVT(93)	Japan	03/06-01/11	IK20TT	4702	1.0	-	IK20TT	IK20TT	4
1.3 4x4	68	M13AVVT(93)	Japan	03/06-01/11	SVK20RZ11	3449	1.1	-	IK20TT	IK20TT	4
1.3 DDiS	51/55	D13A; Z 13 DTJ; Z13DT	Euro-4,OE: 18550-84E50; 18550-M86J00, Double Coi (LPH)	08/05-	DG-171		11V				4
1.3 DDiS	51/55	D13A; Z 13 DTJ; Z13DT	Euro-5; Euro-6,OE: 18550-68L10	08/05-	DG-621		4.4V				4
1.5	75	M15A		02/05-09/10	SK16PR-A11	3356	1.1	-	IK16TT	IK16TT	4
1.5	75	M15A		09/10-	IK20TT	4702	1.0	-	IK20TT	IK20TT	4
1.5	75	M15A		09/10-	SVK20RZ11	3449	1.1	-	IK20TT	IK20TT	4
1.5 4x4	74	M15A		02/05-09/10	SK16PR-A11	3356	1.1	-	IK16TT	IK16TT	4
1.5 4x4	74	M15A		09/10-	IK20TT	4702	1.0	-	IK20TT	IK20TT	4
1.5 4x4	74	M15A		09/10-	SVK20RZ11	3449	1.1	-	IK20TT	IK20TT	4
1.6	92	M16A		05/06-09/11	IK20TT	4702	1.0	-	IK20TT	IK20TT	4
1.6	92	M16A		05/06-09/11	SVK20RZ11	3449	1.1	-	IK20TT	IK20TT	4
SWIFT IV (10-)											
1.2	66/69	K12B		10/10-07/13	ZXU20PR11	3452	1.1	-	-	VXU20	4
1.2 4WD	67	K12B		08/12-07/13	ZXU20PR11	3452	1.1	-	-	VXU20	4
1.2 4x4	66/69	K12B		10/10-07/13	ZXU20PR11	3452	1.1	-	-	VXU20	4
1.3 DDiS	55	D13A; D13AA	Euro-4,OE: 18550-84E50; 18550-M86J00, Double Coi (LPH)	10/10-	DG-171		11V				4
1.3 DDiS	55	D13A; D13AA	Euro-5; Euro-6,OE: 18550-68L10	10/10-	DG-621		4.4V				4
1.6	100	M16A		01/12-	SK20HR11	3421	1.1	-	IKH20TT	IKH20TT	4
SWIFT V (17-)											
1.0	82	K10C		04/17-	IXUH22I	5356	0.9	-	IXUH22TT	VXUH22I	3
1.0 SHVS	82	K10C		04/17-	IXUH22I	5356	0.9	-	IXUH22TT	VXUH22I	3
SX4 (06-)											
1.5	73	M15A	Check Thread size	06/06-06/09	IKH20TT	4704	1.0	-	IKH20TT		4
1.5	73	M15A	Check Thread size	06/09-07/10	IK20TT	4702	1.0	-	IK20TT	IK20TT	4
1.5	73	M15A	Check Thread size	06/09-07/10	SVK20RZ11	3449	1.1	-	IK20TT	IK20TT	4
1.5 VVT	82	M15A		07/10-	IK20TT	4702	1.0	-	IK20TT	IK20TT	4
1.5 VVT	82	M15A		07/10-	SVK20RZ11	3449	1.1	-	IK20TT	IK20TT	4
1.5 VVT 4x4	82	M15A		07/10-	IK20TT	4702	1.0	-	IK20TT	IK20TT	4
1.5 VVT 4x4	82	M15A		07/10-	SVK20RZ11	3449	1.1	-	IK20TT	IK20TT	4
1.6	79/88	M16A	Check Thread size	10/07-06/09	K16HPR-U11	6076	1.1	KH16TT	IKH16TT	IKH16TT	4











Таблица применения

S

Свечи зажигания и Свечи накаливания

Таблица применения

Таблица применения

	KW				СТАНДАРТНЫЕ				Twin Tip			QTY
												
SUZUKI продолжение												
SX4 (06-) продолжение												
1.6	79/88	M16A	Check Thread size	10/07-	IK20TT	4702	1.0	-	IK20TT	IK20TT	4	
1.6	79/88	M16A	Check Thread size	10/07-	IKH20TT	4704	1.0	-	IKH20TT		4	
1.6	79/88	M16A	Check Thread size	10/07-	SVK20RZ11	3449	1.1	-	IK20TT	IK20TT	4	
1.6 AWD	79	M16A	Check Thread size	10/07-06/09	K16HPR-U11	6076	1.1	KH16TT	IKH16TT	IKH16TT	4	
1.6 AWD	79	M16A	Check Thread size	10/07-12/11	IK20TT	4702	1.0	-	IK20TT	IK20TT	4	
1.6 AWD	79	M16A	Check Thread size	10/07-12/11	IKH20TT	4704	1.0	-	IKH20TT		4	
1.6 AWD	79	M16A	Check Thread size	10/07-12/11	SVK20RZ11	3449	1.1	-	IK20TT	IK20TT	4	
1.6 DDIS	66	9HX		04/07-	DG-113		11V				4	
1.6 VVT	79	M16A	Check Thread size	06/06-06/09	K16HPR-U11	6076	1.1	KH16TT	IKH16TT	IKH16TT	4	
1.6 VVT	79/88	M16A	Check Thread size	06/06-	IK20TT	4702	1.0	-	IK20TT	IK20TT	4	
1.6 VVT	79/88	M16A	Check Thread size	06/06-	IKH20TT	4704	1.0	-	IKH20TT		4	
1.6 VVT	79/88	M16A	Check Thread size	06/06-	SVK20RZ11	3449	1.1	-	IK20TT	IK20TT	4	
1.6 VVT 4x4	79	M16A	Check Thread size	06/06-06/09	K16HPR-U11	6076	1.1	KH16TT	IKH16TT	IKH16TT	4	
1.6 VVT 4x4	79/82/88	M16A	Check Thread size	06/06-	IK20TT	4702	1.0	-	IK20TT	IK20TT	4	
1.6 VVT 4x4	79/82/88	M16A	Check Thread size	06/06-	IKH20TT	4704	1.0	-	IKH20TT		4	
1.6 VVT 4x4	79/82/88	M16A	Check Thread size	06/06-	SVK20RZ11	3449	1.1	-	IK20TT	IK20TT	4	
1.9 DDiS	88	D19AA	Double Coil(LPH)	06/06-	DG-196		11V				4	
1.9 DDiS 4x4	88	D19AA	Double Coil(LPH)	06/06-	DG-196		11V				4	
2.0 DDiS	99	D20AA		07/09-	DG-608		4.4V				4	
2.0 DDiS 4x4	99	D20AA		07/09-	DG-608		4.4V				4	
SX4 S-Cross (13-)												
1.0	82	K10C		08/16-	VXUHC22G	5652	0.8	-	-	VXUHC22G	4	
1.6	86/88	M16A		08/13-	SK20HR11	3421	1.1	-	IKH20TT	IKH20TT	4	
1.6 AWD	86/88	M16A		08/13-	SK20HR11	3421	1.1	-	IKH20TT	IKH20TT	4	
1.6 DDiS	88	D16AA		08/13-	DG-608		4.4V				4	
1.6 DDiS AWD	88	D16AA		08/13-	DG-608		4.4V				4	
VITARA (88-99)												
1.6	55/59	G16A (8V)		07/88-01/95	W16EPR-U	3021	0.8	W16TT	IW16TT	IW16TT	4	
1.6	70	G16B		02/91-03/98	K20PR-U	3145	0.8	K20TT	IK20TT	IK20TT	4	
1.6 AWD	54/59	G16A (8V)		07/88-12/98	W16EPR-U	3021	0.8	W16TT	IW16TT	IW16TT	4	
1.6 i 16V	71	G16B		07/90-03/99	K20PR-U	3145	0.8	K20TT	IK20TT	IK20TT	4	
1.6 i 16V AWD	71	G16B		07/90-03/98	K20PR-U	3145	0.8	K20TT	IK20TT	IK20TT	4	
1.9 D	50/55	XUD9A; XUD9SD	Double Coil(LPH)	01/95-03/99	DG-001		11V				4	
1.9 D AWD	50/55	XUD9A; XUD9SD	Double Coil(LPH)	01/95-03/98	DG-001		11V				4	
2.0 16V	97	J20A		12/96-03/99	K20PR-U	3145	0.8	K20TT	IK20TT	IK20TT	4	
2.0 16V AWD	97	J20A		12/96-03/98	K20PR-U	3145	0.8	K20TT	IK20TT	IK20TT	4	
2.0 TD AWD	52	RF	Double Coil(LPH)	12/94-03/98	DG-116		11V				4	
2.0 TD AWD	52	RF	Double Coil(LPH)	12/94-03/98	DG-146		11V				4	
2.0 TD Intercooler AWD	64	RF	Double Coil(LPH)	12/95-03/98	DG-116		11V				4	
2.0 TD Intercooler AWD	64	RF	Double Coil(LPH)	12/95-03/98	DG-146		11V				4	
2.0 V6 24V AWD	100	H 20 A		12/94-03/98	K20PR-U	3145	0.8	K20TT	IK20TT	IK20TT	6	
2.5 V6 24V AWD	118	H 25 A		12/95-03/98	K20PR-U	3145	0.8	K20TT	IK20TT	IK20TT	6	
VITARA (03-05)												
2.0 HDI	64	RHP	Double Coil(LPH)	12/03-12/05	DG-116		11V				4	
VITARA (15-)												
1.4 T	103	K14C		09/15-	VXUHC22G	5652	0.8	-	-	VXUHC22G	4	
1.4 T AWD	103	K14C		09/15-	VXUHC22G	5652	0.8	-	-	VXUHC22G	4	
1.6	86/88	M16A		02/15-	SK20HR11	3421	1.1	-	IKH20TT	IKH20TT	4	
1.6 AWD	86/88	M16A		02/15-	SK20HR11	3421	1.1	-	IKH20TT	IKH20TT	4	
1.6 DDiS	88	D16AA		02/15-	DG-608		4.4V				4	

Свечи зажигания и Свечи накаливания

Таблица применения





	KW				СТАНДАРТНЫЕ			Twin Tip			QTY
SUZUKI продолжение											
VITARA (15-) продолжение											
1.6 DDiS AWD	88	D16AA		02/15-	DG-608		4.4V				4
WAGON R (97-03)											
0.7	40	K6A		07/97-07/00	XU22EPR-U	3179	0.9	XU22TT	IXU22TT	VXU22	3
0.7	47	K6A-T		07/97-07/98	IXU22	5308	0.9	-	IXU22TT	VXU22	3
WAGON R (03-05)											
1.2	59	Z 12 XEP		06/04-08/05	KJ16CR-L11	3132	1.1	K16TT	IK16TT	IK16TT	4
WAGON R (08-12)											
0.7	40	K6A		09/08-08/12	XU22EPR-U	3179	0.9	XU22TT	IXU22TT	VXU22	3
0.7	40/47	K6A; K6A-T		09/08-08/12	IXUH22	5353	0.9	-	IXUH22TT	VXUH22	3
0.7	47	K6A-T		09/08-08/12	IXU22	5308	0.9	-	IXU22TT	VXU22	3
0.7 4WD	40	K6A		09/08-08/12	XU22EPR-U	3179	0.9	XU22TT	IXU22TT	VXU22	3
0.7 4WD	40/47	K6A; K6A-T		09/08-08/12	IXUH22	5353	0.9	-	IXUH22TT	VXUH22	3
0.7 4WD	47	K6A-T		09/08-08/12	IXU22	5308	0.9	-	IXU22TT	VXU22	3
WAGON R (12-)											
0.7	38/47	R06A; R06A-T		08/15-02/17	VXUH22	5611	0.9	-	IXUH22TT	VXUH22	3
0.7 4WD	38/47	R06A; R06A-T		08/15-02/17	VXUH22	5611	0.9	-	IXUH22TT	VXUH22	3
WAGON R+ (98-00)											
1.0	48	K10A		02/98-05/00	XU22EPR-U	3179	0.9	XU22TT	IXU22TT	VXU22	4
1.2	51	K12A		02/98-05/00	XU22EPR-U	3179	0.9	XU22TT	IXU22TT	VXU22	4
1.2 4WD	51	K12A		02/98-05/00	XU22EPR-U	3179	0.9	XU22TT	IXU22TT	VXU22	4
WAGON R+ (00-)											
1.3	56	G13BB		05/00-12/04	W22EPR-U	3088	0.8	W22TT	-	VW22	4
1.3	56/69	G13BB; M13AVVT(93)		05/00-01/08	K20PR-U11	3121	1.1	K20TT	IK20TT	IK20TT	4
1.3	69	M13A		09/03-	SK16PR-A11	3356	1.1	-	IK16TT	IK16TT	4
1.3 4WD	56	G13BB		10/01-01/08	K20PR-U11	3121	1.1	K20TT	IK20TT	IK20TT	4
1.3 4WD	56	G13BB		10/01-	W22EPR-U	3088	0.8	W22TT	-	VW22	4
1.3 4WD	69	M13A		09/03-	SK16PR-A11	3356	1.1	-	IK16TT	IK16TT	4
1.3 4WD	69	M13AVVT(93)		09/03-01/08	W20EPR-U11	3049	1.1	W20TT	IW20TT	IW20TT	4
1.3 DDiS	51	Z13DT	Euro-4,OE: 18550-84E50; 18550-M86J00, Double Coil (LPH)	09/03-	DG-171		11V				4
1.3 DDiS	51	Z13DT	Euro-5; Euro-6,OE: 18550-68L10	09/03-	DG-621		4.4V				4
X-90 (95-97)											
1.6 i 16V	71	G16B		09/95-12/97	K20PR-U	3145	0.8	K20TT	IK20TT	IK20TT	4
1.6 i 16V 4x4	71	G16B		09/95-12/97	K20PR-U	3145	0.8	K20TT	IK20TT	IK20TT	4
TAGAZ											
VEGA (09-12)											
1.6	91			01/09-12/12	K20PR-U	3145	0.8	K20TT	IK20TT	IK20TT	4
TALBOT											
180 (73-82)											
1.9 D	44		Double Coil Std(LPH)	01/82-12/82	DG-001		11V				4
1307-1510 (75-84)											
1510 1.6	66	J2/J2A		07/81-06/82	W20EPR-U	3047	0.8	W20TT	IW20TT	IW20TT	4
Simca 1307 1.3	40/ 44/50	G1; G1D		07/75-08/81	W20EPR-U	3047	0.8	W20TT	IW20TT	IW20TT	4
Simca 1307 1.3S	60	G1		07/75-12/78	W20EPR-U	3047	0.8	W20TT	IW20TT	IW20TT	4
Simca 1308 1.4	55/63	Y2		11/78-07/79	W20EPR-U	3047	0.8	W20TT	IW20TT	IW20TT	4
Simca 1510 1.4	51/ 55/63	Y1/Y2		01/80-01/82	W20EPR-U	3047	0.8	W20TT	IW20TT	IW20TT	4
Simca 1510 1.6	54/65	J2/J2A		10/78-01/82	W20EPR-U	3047	0.8	W20TT	IW20TT	IW20TT	4
EXPRESS 1000 -1500 (82-94)											
1.9 D	51	XUD9A	Double Coil(LPH)	07/87-10/90	DG-001		11V				4
2.5 D	54	CRD93	Double Coil(LPH)	07/82-10/94	DG-001		11V				4
2.5 D AWD	54	CRD93	Double Coil(LPH)	11/88-10/94	DG-001		11V				4
2.5 TD	70	CRD93LS	Double Coil(LPH)	06/87-10/94	DG-001		11V				4
2.5 TD AWD	70	CRD93LS	Double Coil(LPH)	11/88-10/94	DG-001		11V				4
EXPRESS 1000 -1800 (81-94)											
1.9 D	51	XUD9A	Double Coil(LPH)	07/87-10/90	DG-001		11V				4

Таблица применения

S T

Свечи зажигания и Свечи накаливания

Таблица применения

Таблица применения

KW	KW	KW	KW	KW	СТАНДАРТНЫЕ			Twin Tip		QTY	
					STANDARD	STANDARD	STANDARD	TWIN TIP	TWIN TIP		
TALBOT продолжение											
HORIZON (78-86)											
1.1	40/43	2E1A; E1B		01/79-09/84	W20EPR-U	3047	0.8	W20TT	IW20TT	IW20TT	4
1.3	40/43/47/50	2G1-BTC; G1/BTC		02/78-06/86	W20EPR-U	3047	0.8	W20TT	IW20TT	IW20TT	4
1.4	48/51/61	2Y1; 2Y2; Y1/Y1B/ Y2, Y2S; Y2		07/79-06/86	W20EPR-U	3047	0.8	W20TT	IW20TT	IW20TT	4
1.6	66	J1B/J2A/ J2S		07/82-06/86	W20EPR-U	3047	0.8	W20TT	IW20TT	IW20TT	4
1.9 Diesel	47	XUD9	Double Coil(LPH)	07/82-06/86	DG-001		11V				4
MURENA (80-85)											
1.6	66	J2		08/81-01/83	W20EPR-U	3047	0.8	W20TT	IW20TT	IW20TT	4
2.1	85	N2		01/82-01/83	W20EPR-U	3047	0.8	W20TT	IW20TT	IW20TT	4
RANCHO (77-84)											
1.4	59	Y2		01/77-07/84	W20EPR-U	3047	0.8	W20TT	IW20TT	IW20TT	4
SAMBA (81-86)											
0.9	31	XV5/XV8		01/81-12/85	T20EPR-U	5032	0.8	T20TT	IT20TT	IT20TT	4
1.1	37	XW7		01/81-01/85	T20EPR-U	5032	0.8	T20TT	IT20TT	IT20TT	4
1.2 Rallye	65	XZ7R		01/83-01/85	T20EPR-U	5032	0.8	T20TT	IT20TT	IT20TT	4
1.4	44/53/58	XY6B/XY7/ XY8		01/81-01/85	T20EPR-U	5032	0.8	T20TT	IT20TT	IT20TT	4
1.4 Rallye	58	XY6		01/83-10/86	T20EPR-U	5032	0.8	T20TT	IT20TT	IT20TT	4
SIMCA (1609, 1610) (76-80)											
1610 2.0 D	44		Double Coil(LPH)	09/76-12/80	DG-001		11V				4
SOLARA (80-86)											
1.3	40	G1D		02/80-01/83	W20EPR-U	3047	0.8	W20TT	IW20TT	IW20TT	4
1.6	51/54/66	J1/J1A/ J2A; J2A/J1/ J1A		02/80-01/85	W20EPR-U	3047	0.8	W20TT	IW20TT	IW20TT	4
TAGORA (80-87)											
2.1	85	N2		06/80-12/83	W20EPR-U	3047	0.8	W20TT	IW20TT	IW20TT	4
2.3 Turbo Diesel	59	XD2S	Double Coil(LPH)	08/81-12/83	DG-001		11V				4
2.6	122	9L6		08/81-10/83	T20EPR-U	5032	0.8	T20TT	IT20TT	IT20TT	6
TATA											
INDICA (98-)											
1.4 D	39	475 DL		10/98-02/08	DG-003		11V				4
1.4 i	55	475 Si		10/98-	K20PR-U	3145	0.8	K20TT	IK20TT	IK20TT	4
D 1.4 (V2)	37	475 DL		07/03-02/08	DG-003		11V				4
INDICA Vista (08-)											
1.4	55	199 A7.000		10/10-	XU22EPR-U	3179	0.9	XU22TT	IXU22TT	VXU22	4
INDIGO (03-)											
1.4	66	350 A1.000		08/09-12/14	XU22EPR-U	3179	0.9	XU22TT	IXU22TT	VXU22	4
1.4 D	46	475 DL		01/03-	DG-003		11V				4
LOADBETA (94-06)											
1.9 D	50/66	483 DL 45	Double Coil Std(LPH)	08/94-12/06	DG-001		11V				4
1.9 D AWD	66	483 DL	Double Coil Std(LPH)	11/95-12/06	DG-001		11V				4
SAFARI (98-)											
2.0 D 4x4	66	483 DL	Double Coil Std(LPH)	04/98-	DG-001		11V				4
2.0 TDi 4x4	64	483 DL	Double Coil Std(LPH)	07/03-	DG-001		11V				4
2.2 TDiC	103	DW12DD		07/06-	DG-614		11V				4
2.2 TDiC 4x4	103	DW12DD		07/06-10/12	DG-614		11V				4
SIERRA (95-02)											
1.9 D	46/50	483 DL 45	Double Coil Std(LPH)	08/95-02/00	DG-001		11V				4
1.9 D 4x4	50		Double Coil Std(LPH)	08/95-02/00	DG-001		11V				4
2.0 TD	66/68	483 DL	Double Coil Std(LPH)	06/97-12/02	DG-001		11V				4
2.0 TD 4x4	66	483 DL	Double Coil Std(LPH)	06/97-12/02	DG-001		11V				4
TELCOLINE (99-07)											
1.9 TDiC	64	483 DL	Double Coil Std(LPH)	07/03-12/11	DG-001		11V				4
2.0 TDiC 4x4	64	483 DL		07/03-12/11	DG-012		11V				4
XENON (09-)											
2.2 DiCOR	103	DW12DD		01/09-	DG-614		11V				4

Свечи зажигания и Свечи накаливания

Таблица применения

KW	KW	KW	KW	KW	СТАНДАРТНЫЕ			Twin Tip			QTY
					STANDARD	STANDARD	STANDARD	TWIN TIP	TWIN TIP	TWIN TIP	
TATA продолжение											
XENON (09-) продолжение											
2.2 DiCOR 4x4	103	DW12DD		01/09-	DG-614		11V				4
TOFAS											
DOGAN (76-02)											
1.6	59	159 A3.048		01/76-05/92	W20EPR-U	3047	0.8	W20TT	IW20TT	IW20TT	4
1.6	59	159 A3.048		06/92-12/01	W22EPR-U	3088	0.8	W22TT	-	VW22	4
1.6 i.e	61			01/99-12/02	W22EPR-U	3088	0.8	W22TT	-	VW22	4
1.6 IE	66			01/97-07/02	W22EPR-U	3088	0.8	W22TT	-	VW22	4
KARTAL (85-02)											
1.6	55			06/92-09/96	W22EPR-U	3088	0.8	W22TT	-	VW22	4
1.6	55	131 A1.000		10/85-09/96	W20EPR-U	3047	0.8	W20TT	IW20TT	IW20TT	4
1.6 IE	66			01/97-07/02	W22EPR-U	3088	0.8	W22TT	-	VW22	4
SAHIN (80-03)											
1.4 Mirafiori	51			01/80-12/03	W20EPR-U	3047	0.8	W20TT	IW20TT	IW20TT	4
1.6	55	131 A1.000		10/85-09/96	W20EPR-U	3047	0.8	W20TT	IW20TT	IW20TT	4
1.6 IE	63			01/97-07/02	W22EPR-U	3088	0.8	W22TT	-	VW22	4
1.6 S	59	159 A3.048		01/80-05/92	W20EPR-U	3047	0.8	W20TT	IW20TT	IW20TT	4
1.6 S	59	159 A3.048		06/92-12/03	W22EPR-U	3088	0.8	W22TT	-	VW22	4
TOYOTA											
4 RUNNER (N10) (89-96)											
2.0	65	3Y-C		04/89-12/91	W16EX-U	3027	0.8	W16TT	IW16TT	IW16TT	4
2.4 D	66	2L-T		08/89-11/95	DG-648		11V				4
2.8 D 4WD (KDN170)	61	3L	Single Coil	08/89-10/95	DG-648		11V				4
3.0	105	3VZ-E		01/90-10/95	K16R-U	3119	0.8	K16TT	IK16TT	IK16TT	6
3.0 Turbo-D	92	1KZ-T	Ceramic(LPH)	10/93-03/96	DG-671		11V				4
4 RUNNER (N18) (95-02)											
2.7 (RZN180)	112	3RZ-FE		11/95-07/02	K16R-U	3119	0.8	K16TT	IK16TT	IK16TT	4
2.7 4WD	112	3RZ-FE		11/95-08/02	K16R-U	3119	0.8	K16TT	IK16TT	IK16TT	4
3.0 Turbo-D (KZN185)	92	1KZ-T	Ceramic(LPH)	11/95-11/02	DG-671		11V				4
3.4 4WD	136	5VZ-FE		11/95-11/02	K16TR11	3194	1.1	K16TT	IK16TT	IK16TT	6
4 RUNNER (N21) (02-09)											
4.0	183	1GR-FE		08/02-12/09	K20HR-U11	3381	1.1	KH20TT	IKH20TT	IKH20TT	6
4.0 4WD	183	1GR-FE		01/03-12/09	K20HR-U11	3381	1.1	KH20TT	IKH20TT	IKH20TT	6
4.7	175/ 194	2UZ-FE		08/02-12/09	SK20R11	3297	1.1	-	IK20TT	IK20TT	8
4.7 4WD	175/ 194	2UZ-FE		08/02-12/09	SK20R11	3297	1.1	-	IK20TT	IK20TT	8
4 RUNNER (N5) (87-89)											
2.4 4WD	82	22REC		08/87-07/89	W16EXR-U	3031	0.8	W16TT	IW16TT	IW16TT	4
1000 (69-88)											
1.0	33	2K		04/69-08/88	W20EP-U	3043	0.8	W20TT	IW20TT	IW20TT	4
ALLION I (01-07)											
1.5	80	1NZ-FE		06/01-04/05	K16R-U11	3120	1.1	K16TT	IK16TT	IK16TT	4
2.0	114	1AZ-FSE		06/01-04/05	SK20BGR11	3472	1.1	-	-	VKA20	4
ALLION II (07-)											
1.5	80	1NZ-FE		07/07-09/07	FK20HR11	3426	1.1	-	IKH20TT	IKH20TT	4
1.5	80	1NZ-FE		09/07-	FK16HR11	3450	1.1	-	IKH16TT	IKH16TT	4
1.5	80	1NZ-FE		09/07-	IKH16TT	4703	1.0	-	IKH16TT		4
1.8	106	2ZR-FAE		07/07-02/13	SC16HR11	3499	1.1	-	IXEH20TT	IXEH20TT	4
1.8 4WD	98	2ZR-FAE		07/07-02/13	SC16HR11	3499	1.1	-	IXEH20TT	IXEH20TT	4
2.0	116	3ZR-FAE		07/07-02/13	SC16HR11	3499	1.1	-	IXEH20TT	IXEH20TT	4
ALPHARD I (03-08)											
2.4	117	2AZ-FE		09/03-04/08	K20R-U11	3139	1.1	K20TT	IK20TT	IK20TT	4
2.4 4WD	117	2AZ-FE		09/03-04/08	K20R-U11	3139	1.1	K20TT	IK20TT	IK20TT	4
2.4 Hybrid	117	2AZ-FXE		09/03-04/08	SK20R11	3297	1.1	-	IK20TT	IK20TT	4
2.4 Hybrid 4WD	117	2AZ-FXE		09/03-04/08	SK20R11	3297	1.1	-	IK20TT	IK20TT	4
3.0	162	1MZ-FE		04/03-04/08	SK20R11	3297	1.1	-	IK20TT	IK20TT	6
3.0 4WD	162	1MZ-FE		04/03-04/08	SK20R11	3297	1.1	-	IK20TT	IK20TT	6
ALPHARD II (08-14)											
2.4	123	2AZ-FE		04/08-12/14	K20R-U11	3139	1.1	K20TT	IK20TT	IK20TT	4
2.4	125	2AZ-FE		05/08-06/12	SK20R11	3297	1.1	-	IK20TT	IK20TT	4
2.4	125	2AZ-FE		06/12-12/14	SK16R11	3324	1.1	-	IK16TT	IK16TT	4
2.4 4WD	125	2AZ-FE		05/08-06/12	SK20R11	3297	1.1	-	IK20TT	IK20TT	4
2.4 4WD	125	2AZ-FE		06/12-12/14	SK16R11	3324	1.1	-	IK16TT	IK16TT	4
3.5	202/ 206	2GR-FE		04/08-12/14	FK20HR11	3426	1.1	-	IKH20TT	IKH20TT	6
3.5 4WD	206	2GR-FE		04/08-12/14	FK20HR11	3426	1.1	-	IKH20TT	IKH20TT	6

Свечи зажигания и Свечи накаливания

Таблица применения

Таблица применения

TOYOTA	KW	ENGINE	NOTE	21	СТАНДАРТНЫЕ			Twin Tip		QTY	
					SPARK PLUG	RESISTOR	WIRE	SPARK PLUG	SPARK PLUG		
TOYOTA продолжение											
ALTEZZA (99-05)											
2.0	114	1G-FE		01/99-06/01	K20R-U11	3139	1.1	K20TT	IK20TT	IK20TT	6
2.0	114	1G-GE		01/99-06/01	PQ16R	3005	1.1	Q16TT	IQ16TT	IQ16TT	6
2.0	114	1G-GE		01/99-06/01	PQ20R	3117	1.1	Q20TT	IQ20TT	IQ20TT	6
2.0 4WD	114	1G-GE		01/01-12/05	PQ16R	3005	1.1	Q16TT	IQ16TT	IQ16TT	6
2.0 4WD	114	1G-GE		01/01-12/05	PQ20R	3117	1.1	Q20TT	IQ20TT	IQ20TT	6
2.0 VVTi	118	1G-FE		01/99-05/05	K16R-U11	3120	1.1	K16TT	IK16TT	IK16TT	6
2.0 VVTi	118	1G-FE		01/99-05/05	K20R-U11	3139	1.1	K20TT	IK20TT	IK20TT	6
2.0 VVTi	147	3S-GE		02/99-08/02	PK20R11	3128	1.1	K20TT	IK20TT	IK20TT	4
2.0 VVTi	147	3S-GE		08/02-11/05	SK20R11	3297	1.1	-	IK20TT	IK20TT	4
3.0	157	2JZ-GE		07/01-11/05	PK16TR11	3289	1.1	K16TT	IK16TT	IK16TT	6
ARISTO (90-97)											
3.0	169	2JZ-GE		10/90-08/95	PK16R11	3134	1.1	K16TT	IK16TT	IK16TT	6
3.0	169	2JZ-GE		01/95-07/97	PK16TR11	3289	1.1	K16TT	IK16TT	IK16TT	6
3.0	205	2JZ-GTE		10/90-07/93	PK20R8	3127	0.8	-	IK20TT	IK20TT	6
3.0	205	2JZ-GTE		08/93-09/96	PK20R11	3128	1.1	K20TT	IK20TT	IK20TT	6
4.0 4WD	173	1UZ-FE		10/92-07/97	PK20R11	3128	1.1	K20TT	IK20TT	IK20TT	8
4.0 4WD	173	1UZ-FE		10/92-07/97	SK20R11	3297	1.1	-	IK20TT	IK20TT	6
ARISTO (97-04)											
3.0	170	2JZ-GE		08/97-09/04	PK16TR11	3289	1.1	K16TT	IK16TT	IK16TT	6
3.0	206	2JZ-GTE		08/97-09/04	PK20TR11	3253	1.1	K20TT	IK20TT	IK20TT	6
AURIS (E15) (06-12)											
1.33 Dual-VVTi	74	1NR-FE		05/09-09/12	SC16HR11	3499	1.1	-	IXEH20TT	IXEH20TT	4
1.4	71	4ZZ-FE		03/07-09/12	K16R-U11	3120	1.1	K16TT	IK16TT	IK16TT	4
1.4 D-4D	66	1ND-TV	OE: 19850-0W010, Double Coi l(LPH)	03/07-02/09	DG-240		11V				4
1.4 D-4D	66	1ND-TV	OE:19850-3302 0	10/08-09/12	DG-659		11V				4
1.5	81	1NZ-FE		09/09-09/12	FK16HR11	3450	1.1	-	IKH16TT	IKH16TT	4
1.5	81	1NZ-FE		09/09-09/12	IKH16TT	4703	1.0	-	IKH16TT	IKH16TT	4
1.5 4WD	77	1NZ-FE		09/09-09/12	FK16HR11	3450	1.1	-	IKH16TT	IKH16TT	4
1.5 4WD	77	1NZ-FE		09/09-09/12	IKH16TT	4703	1.0	-	IKH16TT	IKH16TT	4
1.6	91/97	1ZR-FAE; 1ZR-FE		03/07-09/12	SC16HR11	3499	1.1	-	IXEH20TT	IXEH20TT	4
1.8	100/ 106/ 108	2ZR-FAE; 2ZR-FE		10/06-09/12	SC16HR11	3499	1.1	-	IXEH20TT	IXEH20TT	4
1.8 4WD	100	2ZR-FAE		02/09-09/12	SC16HR11	3499	1.1	-	IXEH20TT	IXEH20TT	4
1.8 Hybrid	73	2ZR-FXE		09/10-09/12	SC16HR11	3499	1.1	-	IXEH20TT	IXEH20TT	4
2.0 D-4D	93	1AD-FTV		10/06-09/12	DG-600		11V				4
2.2 D	130	2AD-FHV		11/06-09/12	DG-600		11V				4
AURIS (E18) (12-)											
1.2	85	8NR-FTS		03/15-12/18	VDCH22F	5663	0.9	-	-	VDCH22F	4
1.3	73	1NR-FE		10/12-12/18	SC16HR11	3499	1.1	-	IXEH20TT	IXEH20TT	4
1.4 D-4D	66	1ND-TV	OE:19850-3302 0	10/12-05/15	DG-659		11V				4
1.6	97	1ZR-FAE		10/12-12/18	SC16HR11	3499	1.1	-	IXEH20TT	IXEH20TT	4
1.6 D4-D	82	1WW	OE: 19850-WA020	04/15-12/18	DG-613		7V				4
1.8 Hybrid	73	2ZR-FXE		10/12-12/18	SC16HR11	3499	1.1	-	IXEH20TT	IXEH20TT	4
2.0 D-4D	91	1AD-FTV		10/12-04/15	DG-600		11V				4
AVALON (X1) (95-05)											
3.0	150	1MZ-FE		09/96-10/97	PK20R11	3128	1.1	K20TT	IK20TT	IK20TT	6
3.0	150	1MZ-FE		10/97-12/99	PK20TR11	3253	1.1	K20TT	IK20TT	IK20TT	6
3.0	150	1MZ-FE		10/97-12/99	SK20R11	3297	1.1	-	IK20TT	IK20TT	6
AVALON (X2) (99-05)											
3.0	157	1MZ-FE		09/99-12/04	SK20R11	3297	1.1	-	IK20TT	IK20TT	6
AVALON (X3) (05-12)											
3.5	200/ 206	2GR-FE		01/05-09/12	FK20HR11	3426	1.1	-	IKH20TT	IKH20TT	6
AVALON (X4) (12-)											
2.5 Hybrid	149	2AR-FXE		09/12-	FK16HR-A8	3484	0.8	-	-	FK16HR-A8	4
3.5	200	2GR-FE		09/12-03/18	FK20HR11	3426	1.1	-	IKH20TT	IKH20TT	6
AVANZA (F6) (03-11)											
1.3	65	K3-VE		09/02-12/05	K20R-U11	3139	1.1	K20TT	IK20TT	IK20TT	4
1.3	65	K3-VE		12/05-10/11	SXU22PR9	3434	0.9	-	IXU22TT	VXU22I	4
AVENSIS (97-03)											
1.6	74	4A-FE		09/97-10/00	PK20R13	3226	1.3	K20TT	IK20TT	IK20TT	4

Свечи зажигания и Свечи накаливания

Таблица применения









	KW				СТАНДАРТНЫЕ			Twin Tip		QTY	
											
TOYOTA продолжение											
AVENSIS (97-03) продолжение											
1.6	74/81	3ZZ-FE; 4A-FE		09/97-02/03	K16R-U11	3120	1.1	K16TT	IK16TT	IK16TT	4
1.6	74/81	4A-FE	LEAN BURN	09/97-10/00	PK20R13	3226	1.3	K20TT	IK20TT	IK20TT	4
1.6	74/81	4A-FE	LEAN BURN	09/97-10/00	SK20R-P13	3298	1.3	-	IK20TT	IK20TT	4
1.8	81	7A-FE		09/97-10/00	PK16TR13	3350	1.3	K16TT	IK16TT	IK16TT	4
1.8	95	1ZZ-FE		10/00-02/03	K16R-U11	3120	1.1	K16TT	IK16TT	IK16TT	4
2.0	94	3S-FE		09/97-10/00	K20TR11	3195	1.1	K20TT	IK20TT	IK20TT	4
2.0	94	3S-FE	OEM Optional	09/97-10/00	PK20TR11	3253	1.1	K20TT	IK20TT	IK20TT	4
2.0	110	1AZ-FSE		10/00-02/03	SK20BGR11	3472	1.1	-	-	VKA20	4
2.0 D	61	2C-T	Double Coil(LPH)	10/97-05/98	DG-649		10.5V				4
2.0 D	85	1CD-FTV		09/02-02/03	DG-245		11V				4
2.0 D-4D	81	1CD-FTV	Double Coil(LPH)	10/99-02/03	DG-245		11V				4
2.0 TD	66	2C-TE	Double Coil(LPH)	09/97-02/03	DG-649		10.5V				4
2.0 VWT-i	110	1AZ-FSE		10/00-02/03	SK20BGR11	3472	1.1	-	-	VKA20	4
AVENSIS (03-09)											
1.6 VWT-i	81	3ZZ-FE		04/03-11/08	K16R-U11	3120	1.1	K16TT	IK16TT	IK16TT	4
1.8	95	1ZZ-FE		03/03-11/08	K16R-U11	3120	1.1	K16TT	IK16TT	IK16TT	4
2.0	108	1AZ-FSE		03/03-11/08	SK20BR11	3471	1.1	-	-	VKB20	4
2.0 D-4D	85	1CD-FTV	Double Coil(LPH)	04/03-11/08	DG-245		11V				4
2.0 D-4D	93	1AD-FTV		03/06-11/08	DG-600		11V				4
2.0 VWTi	114	1AZ-FE		04/03-11/08	SK20R11	3297	1.1	-	IK20TT	IK20TT	4
2.2 D-4D	110	2AD-FTV		10/05-11/08	DG-600		11V				4
2.2 D-CAT	130	2AD-FHV		07/05-11/08	DG-600		11V				4
2.4	120/125	2AZ-FSE		09/03-11/08	SK20BR11	3471	1.1	-	-	VKB20	4
AVENSIS (08-)											
1.6	97	1ZR-FAE		11/08-10/18	SC16HR11	3499	1.1	-	IXEH20TT	IXEH20TT	4
1.6 D4-D	82	1WW	OE: 19850-WA020	04/15-10/18	DG-613		7V				4
1.8	108	2ZR-FAE		11/08-10/18	SC16HR11	3499	1.1	-	IXEH20TT	IXEH20TT	4
2.0	112	3ZR-FAE; 3ZR-FE		11/08-10/18	SC16HR11	3499	1.1	-	IXEH20TT	IXEH20TT	4
2.0 D-4D	91/93	1AD-FTV		11/08-10/18	DG-600		11V				4
2.0 D-4D	105	2WW	OE: 19850-WA020	04/15-10/18	DG-613		7V				4
2.2 D-4D	110/130	2AD-FHV; 2AD-FTV		11/08-10/18	DG-600		11V				4
AVENSIS Verso (01-09)											
2.0	110	1AZ-FE		08/01-11/09	SK20R11	3297	1.1	-	IK20TT	IK20TT	4
2.0 D	85	1CD-FTV	Double Coil(LPH)	08/01-08/05	DG-245		11V				4
2.4	115	2AZ-FE		08/01-08/07	SK20R11	3297	1.1	-	IK20TT	IK20TT	4
2.4 4WD	115	2AZ-FE		11/03-08/06	SK20R11	3297	1.1	-	IK20TT	IK20TT	4
AYGO (05-)											
1.0	50	1KR-FE		07/05-05/11	K16HR-U11	3482	1.1	KH16TT	IKH16TT	IKH16TT	3
1.0	50	1KR-FE		05/11-05/14	SK16HR11	3417	1.1	-	IKH16TT	IKH16TT	3
1.0 GPL	50	1KR-FE	LPG / GPL	05/11-05/14	SK16HR11	3417	1.1	-	IKH16TT	IKH16TT	3
1.4 HDi	40	2WZ-TV	Double Coil(LPH)	07/05-08/10	DG-180		11V				4
AYGO (14-)											
1.0	51	1KR-FE		05/14-05/18	SC16HR11	3499	1.1	-	IXEH20TT	IXEH20TT	3
1.2	60	1PP		05/14-	IXUH22I	5356	0.9	-	IXUH22TT	VXUH22I	3
bB I (00-05)											
1.3	57	2NZ-FE		01/00-11/05	K16R-U11	3120	1.1	K16TT	IK16TT	IK16TT	4
1.5	80	1NZ-FE		03/00-12/05	K16R-U11	3120	1.1	K16TT	IK16TT	IK16TT	4
BREVIS (99-07)											
2.5	147	1JZ-FSE		10/99-09/02	SK20BR11	3471	1.1	-	-	VKB20	6
3.0	162	2JZ-FSE		10/99-06/07	SK20BR11	3471	1.1	-	-	VKB20	6
CALDINA (T19) (92-97)											
1.8	79	7A-FE		02/92-09/97	PK20R13	3226	1.3	K20TT	IK20TT	IK20TT	4
1.8	92	4S-FE		11/92-01/96	K20R-U11	3139	1.1	K20TT	IK20TT	IK20TT	4
2.0	89/93	3S-FE		02/92-01/96	K20R-U11	3139	1.1	K20TT	IK20TT	IK20TT	4
2.0	89/93	3S-FE		01/96-10/97	K20TR11	3195	1.1	K20TT	IK20TT	IK20TT	4
2.0	129	3S-GE		07/94-09/97	PK20R8	3127	0.8	-	IK20TT	IK20TT	4
2.0 4WD	94	3S-FE		11/92-01/96	K20R-U11	3139	1.1	K20TT	IK20TT	IK20TT	4
2.0 4WD	94	3S-FE		01/96-07/97	K20TR11	3195	1.1	K20TT	IK20TT	IK20TT	4





Таблица применения

T

Свечи зажигания и Свечи накаливания

Таблица применения

Таблица применения

	KW				СТАНДАРТНЫЕ			Twin Tip			QTY
TOYOTA продолжение											
CALDINA (T21) (97-02)											
1.8	85	7A-FE		10/97-08/02	PK16TR13	3350	1.3	K16TT	IK16TT	IK16TT	4
2.0 4WD	140/ 192	3S-GTE		10/97-09/01	PK20R8	3127	0.8	-	IK20TT	IK20TT	4
CALDINA (T24) (02-07)											
2.0	112	1AZ-FSE		09/02-06/07	SK20BGR11	3472	1.1	-	-	VKA20	4
CAMI (99-05)											
1.3	63/66	K3-VE		06/99-12/05	K20R-U11	3139	1.1	K20TT	IK20TT	IK20TT	4
1.3	66	K3-VT		06/99-12/05	VK20Y	5620	0.8	-	-	VK20Y	4
1.3 4WD	63/66	K3-VE		05/00-12/05	K20R-U11	3139	1.1	K20TT	IK20TT	IK20TT	4
1.3 4WD	103	K3-VT		06/99-12/05	VK20Y	5620	0.8	-	-	VK20Y	4
CAMRY (V1) (83-88)											
1.8	66	1S-L		02/83-10/86	W16EXR-U	3031	0.8	W16TT	IW16TT	IW16TT	4
1.8 Turbo-D	54	1C-TL; 1C-TLC	Single Coil	10/82-10/86	DG-652		7V				4
2.0	73/79	2S-E; 2S-ELC		01/83-12/86	W16EXR-U11	3032	1.1	W16TT	IW16TT	IW16TT	4
2.0 4WD	88	3S-FE		03/83-07/86	Q16R-U11	3006	1.1	Q16TT	IQ16TT	IQ16TT	4
CAMRY (V1) (90-97)											
2.2	100	5S-FE		06/91-07/96	PK20R11	3128	1.1	K20TT	IK20TT	IK20TT	4
3.0	135	1MZ-FE		09/93-07/96	K20TR11	3195	1.1	K20TT	IK20TT	IK20TT	6
3.0	135	1MZ-FE	OEM Optional	09/93-07/96	PK20TR11	3253	1.1	K20TT	IK20TT	IK20TT	6
3.0	135/ 138	3VZ-FE		06/91-08/96	PQ20R	3117	1.1	Q20TT	IQ20TT	IQ20TT	6
CAMRY (V2) (86-91)											
1.8	66	1S		11/86-08/89	W16EXR-U	3031	0.8	W16TT	IW16TT	IW16TT	4
1.8	66	1S-L		10/86-08/88	J16AR-U11	3000	1.1	-	-		4
2.0	89/94	3S-FE		11/86-02/93	Q16R-U11	3006	1.1	Q16TT	IQ16TT	IQ16TT	4
2.0 4WD	88/94	3S-FE		10/87-06/91	Q16R-U11	3006	1.1	Q16TT	IQ16TT	IQ16TT	4
2.0 Turbo-D	63	2C-T	Double Coil(LPH)	10/86-05/91	DG-649		10.5V				4
2.0 Turbo-D	63	2C-T	Single Coil	10/86-05/91	DG-652		7V				4
2.5	118	2VZ-FE		10/86-06/91	PQ20R	3117	1.1	Q20TT	IQ20TT	IQ20TT	6
CAMRY (V2) (96-01)											
2.2	93/96	5S-FE		08/96-09/02	PK20TR11	3253	1.1	K20TT	IK20TT	IK20TT	4
3.0 24V	140	1MZ-FE		08/96-11/01	K20TR11	3195	1.1	K20TT	IK20TT	IK20TT	6
3.0 24V	140	1MZ-FE	OEM Optional	08/96-11/01	PK20TR11	3253	1.1	K20TT	IK20TT	IK20TT	6
3.0 V6	135	1MZ-FE		08/96-11/01	K20TR11	3195	1.1	K20TT	IK20TT	IK20TT	6
3.0 V6	135	1MZ-FE	OEM Optional	08/96-11/01	PK20TR11	3253	1.1	K20TT	IK20TT	IK20TT	6
CAMRY (V3) (01-06)											
2.0 VVTi	110	1AZ-FE		08/01-11/06	SK20R11	3297	1.1	-	IK20TT	IK20TT	4
2.4	112	2AZ-FE		11/01-11/06	SK20R11	3297	1.1	-	IK20TT	IK20TT	4
3.0	137	1MZ-FE		08/01-11/06	SK20R11	3297	1.1	-	IK20TT	IK20TT	6
3.3	165	3MZ-FE		08/02-11/06	SK20R11	3297	1.1	-	IK20TT	IK20TT	6
CAMRY (V4) (06-11)											
2.0 VVT-i	108	1AZ-FE		01/06-09/11	SK16R11	3324	1.1	-	IK16TT	IK16TT	4
2.4	116/ 127	2AZ-FE		01/06-09/11	SK20R11	3297	1.1	-	IK20TT	IK20TT	4
2.4 Hybrid	105	2AZ-FXE		01/06-07/11	SK20R11	3297	1.1	-	IK20TT	IK20TT	4
2.4 VVTi	123	2AZ-FE		01/06-09/11	SK20R11	3297	1.1	-	IK20TT	IK20TT	4
2.5 VVTi	129	2AR-FE		01/10-09/11	SK16HR11	3417	1.1	-	IKH16TT	IKH16TT	4
3.5	204	2GR-FE		09/06-12/14	FK20HR11	3426	1.1	-	IKH20TT	IKH20TT	6
3.5 VVTi XLE	197	2GR-FE		01/06-09/11	FK20HR11	3426	1.1	-	IKH20TT	IKH20TT	6
CAMRY (V5) (11-)											
2.0	109	1AZ-FE		09/11-	SK16R11	3324	1.1	-	IK16TT	IK16TT	4
2.0	109	6AR-FSE		01/15-	FK16HBR-J8	3508	0.8	-	-	FK16HBR-J8	4
2.0 Hybrid	123	6AR-FSE		03/15-	FK16HBR-J8	3508	0.8	-	-	FK16HBR-J8	4
2.5	133	2AR-FE		09/11-	SK16HR11	3417	1.1	-	IKH16TT	IKH16TT	4
2.5	157	2AR-FXE		08/11-	FK16HR-A8	3484	0.8	-	-	FK16HR-A8	4
3.5	183/ 204	2GR-FE		09/11-	FK20HR11	3426	1.1	-	IKH20TT	IKH20TT	6
CAMRY (V7) (17-)											
2.0	110	6ARFSE		10/17-	FK16HBR-J8	3508	0.8	-	-	FK16HBR-J8	4
2.5	131	2AR-FE		12/18-	SK16HR11	3417	1.1	-	IKH16TT	IKH16TT	4
CAMRY Solara (98-03)											
3.0	140	1MZ-FE		06/98-06/01	K20TR11	3195	1.1	K20TT	IK20TT	IK20TT	6
3.0	140	1MZ-FE	OEM Optional	06/98-06/01	PK20TR11	3253	1.1	K20TT	IK20TT	IK20TT	6
CAMRY Solara (03-08)											
2.4	117	2AZ-FE		07/03-11/08	SK20R11	3297	1.1	-	IK20TT	IK20TT	4

Свечи зажигания и Свечи накаливания

Таблица применения











	KW				СТАНДАРТНЫЕ			Twin Tip			QTY
											
TOYOTA продолжение											
CARIBE (84-03)											
1.6	84	4A-FE		09/94-08/03	K16R-U11	3120	1.1	K16TT	IK16TT	IK16TT	4
CARINA (73-83)											
1.6	55/ 58/63	2T; 2TB; 2T-C		12/70-09/83	W16EX-U	3027	0.8	W16TT	IW16TT	IW16TT	4
1.6	58/63	2T; 2TB		12/70-03/78	W16EXR-U	3031	0.8	W16TT	IW16TT	IW16TT	4
1.8	57/63	3T; 3T-C		01/78-09/83	W16EXR-U	3031	0.8	W16TT	IW16TT	IW16TT	4
1.8 D	48	1C	Single Coil	04/82-09/83	DG-652		7V				4
CARINA E (92-97)											
1.6	73/78	4A-FE		12/93-09/97	K20R-U	3122	0.8	K20TT	IK20TT	IK20TT	4
1.6	73/ 78/85	4A-FE		04/92-09/97	K16R-U11	3120	1.1	K16TT	IK16TT	IK16TT	4
1.6	73/ 78/85	4A-FE	LEAN BURN	04/92-09/97	PK20R13	3226	1.3	K20TT	IK20TT	IK20TT	4
1.6	73/85	4A-FE		12/93-09/97	Q16R-U	3129	0.8	Q16TT	IQ16TT	IQ16TT	4
1.6	78	4A-FE		01/93-09/97	PQ20R	3117	1.1	Q20TT	IQ20TT	IQ20TT	4
1.6 16V	78	4A-FE		10/95-09/97	Q16R-U	3129	0.8	Q16TT	IQ16TT	IQ16TT	4
1.6 16V	78/85	4A-FE		12/94-09/97	K16R-U11	3120	1.1	K16TT	IK16TT	IK16TT	4
1.6 16V	78/85	4A-FE	LEAN BURN	12/94-09/97	PK20R13	3226	1.3	K20TT	IK20TT	IK20TT	4
1.6 16V	85	4A-FE		12/94-09/97	K20R-U	3122	0.8	K20TT	IK20TT	IK20TT	4
1.6 GLI	79	4A-FE		04/92-09/97	K16R-U11	3120	1.1	K16TT	IK16TT	IK16TT	4
1.6 GLI	79	4A-FE		04/92-09/97	Q16R-U	3129	0.8	Q16TT	IQ16TT	IQ16TT	4
1.6 GLI	79	4A-FE	LEAN BURN	04/92-09/97	PK20R13	3226	1.3	K20TT	IK20TT	IK20TT	4
1.6 i	73	4A-FE		02/95-09/97	K16R-U11	3120	1.1	K16TT	IK16TT	IK16TT	4
1.6 i	73	4A-FE	LEAN BURN	02/95-09/97	PK20R13	3226	1.3	K20TT	IK20TT	IK20TT	4
1.8	79	7A-FE		01/95-09/97	PK20R13	3226	1.3	K20TT	IK20TT	IK20TT	4
1.8 i	79	7A-FE		02/95-09/97	PK20R13	3226	1.3	K20TT	IK20TT	IK20TT	4
1.8 i 16V	79	7A-FE		01/95-09/97	PK20R13	3226	1.3	K20TT	IK20TT	IK20TT	4
2.0	98	3S-FE		01/93-09/97	K20R-U11	3139	1.1	K20TT	IK20TT	IK20TT	4
2.0 D	54	2C	OE:19850-64020	04/92-01/96	DG-216		11V				4
2.0 D	54	2C	OE:19850-64050	04/92-01/96	DG-649		10.5V				4
2.0 GLI	98	3S-FE		04/92-09/97	K20R-U11	3139	1.1	K20TT	IK20TT	IK20TT	4
2.0 GTi	116	3S-GE		04/92-12/95	PK20R8	3127	0.8	-	IK20TT	IK20TT	4
2.0 GTi 16V	129	3S-GE		03/94-09/97	PK20R8	3127	0.8	-	IK20TT	IK20TT	4
2.0 i	93	3S-FE		12/92-09/97	K20R-U11	3139	1.1	K20TT	IK20TT	IK20TT	4
2.0 TD	61	2C-T	Double Coil(LPH)	01/96-09/97	DG-649		10.5V				4
CARINA II (83-92)											
1.6	55/62	4A-LC		10/83-11/87	W14EXR-U11	3014	1.1	-	IW16TT	IW16TT	4
1.6	55/62	4A-LC		10/83-11/87	W16EXR-U	3031	0.8	W16TT	IW16TT	IW16TT	4
1.6	66/ 72/75	4A-F; 4A-FE		12/87-03/92	Q16R-U	3129	0.8	Q16TT	IQ16TT	IQ16TT	4
1.8 GLI	74	1S-EL; 1S-L		10/83-11/87	W16EXR-U	3031	0.8	W16TT	IW16TT	IW16TT	4
2.0	89/94	3S-FE		12/87-04/92	Q16R-U11	3006	1.1	Q16TT	IQ16TT	IQ16TT	4
2.0 D	50	2C-L		02/84-12/86	DG-232		10.5V				4
2.0 D	50	2C-L	QuickGlowSystem, Single Coil	02/84-05/88	DG-652		7V				4
2.0 D	50/54	2C-L	Double Coil(LPH)	02/84-06/92	DG-649		10.5V				4
2.0 D	54	2C	OE:19850-64020	03/88-06/92	DG-216		11V				4
2.0 D	54	2C-L		12/87-01/92	DG-216		11V				4
2.0 GLI	89/94	3S-FE		12/87-03/92	Q16R-U11	3006	1.1	Q16TT	IQ16TT	IQ16TT	4
CAVALIER (94-00)											
2.4	110	T2		08/94-07/00	PT16EPR-L13	5070	1.3	-	IT16TT	IT16TT	4
CELICA (73-78)											
1.6 GT	79	2T-G		12/74-03/78	W20EXR-U	3066	0.8	W20TT	IW20TT	IW20TT	4
1.6 LT	55	2T		02/76-03/78	W16EX-U	3027	0.8	W16TT	IW16TT	IW16TT	4
1.6 LT	55/58	2T; 2TJ		05/73-03/78	W16EXR-U	3031	0.8	W16TT	IW16TT	IW16TT	4
1.6 ST	63	2TB		05/73-03/78	W16EX-U	3027	0.8	W16TT	IW16TT	IW16TT	4
2.0	63	18R		10/75-07/77	W16EXR-U	3031	0.8	W16TT	IW16TT	IW16TT	4
CELICA (77-81)											
1.6 GT	81	2T-G		04/78-07/81	W20EXR-U	3066	0.8	W20TT	IW20TT	IW20TT	4
1.6 LT	55	2TB		02/79-07/81	W16EXR-U	3031	0.8	W16TT	IW16TT	IW16TT	4
1.6 LT	55	2TB		02/79-07/81	W16EX-U	3027	0.8	W16TT	IW16TT	IW16TT	4
1.6 ST	63	4A-L		08/77-07/81	W14EXR-U11	3014	1.1	-	IW16TT	IW16TT	4
1.6 ST	63/66	2TB		08/77-07/81	W16EXR-U	3031	0.8	W16TT	IW16TT	IW16TT	4

Таблица применения

T

Свечи зажигания и Свечи накаливания

Таблица применения

Таблица применения

TOYOTA	KW	KW	NOTE	21	СТАНДАРТНЫЕ			Twin Tip		QTY	
					1	2	3	1	2		
ТОYOTA продолжение											
CELICA (77-81) продолжение											
1.6 ST	63/66	2TB		08/77-07/81	W16EX-U	3027	0.8	W16TT	IW16TT	IW16TT	4
2.0	86	18R-G		08/77-06/81	W20EXR-U	3066	0.8	W20TT	IW20TT	IW20TT	4
2.0 GT	90	18R-G		08/77-07/81	W20EXR-U	3066	0.8	W20TT	IW20TT	IW20TT	4
2.0 XT	66	18R		02/79-07/81	W16EXR-U	3031	0.8	W16TT	IW16TT	IW16TT	4
CELICA (81-85)											
1.6	91	4A-GE		08/83-12/85	PQ16R	3005	1.1	Q16TT	IQ16TT	IQ16TT	4
2.0	77	21R-U		01/82-12/85	W16EXR-U	3031	0.8	W16TT	IW16TT	IW16TT	4
2.0	77/88	18R-G; 21R-U		01/82-12/85	W20EXR-U	3066	0.8	W20TT	IW20TT	IW20TT	4
2.0 XT	77	21R-C		02/82-08/85	W16EXR-U	3031	0.8	W16TT	IW16TT	IW16TT	4
2.8 Supra	125	5M-GE		08/81-10/83	W16EXR-U11	3032	1.1	W16TT	IW16TT	IW16TT	6
2.8 Supra	125	5M-GE		10/83-12/85	P16R	3004	1.0	W20TT	IW20TT	IW20TT	6
CELICA (85-89)											
1.6	63	4A-L		04/86-08/89	W14EXR-U11	3014	1.1	-	IW16TT	IW16TT	4
1.6	63	4A-L		04/86-08/89	W16EXR-U	3031	0.8	W16TT	IW16TT	IW16TT	4
1.6 GT	85	4A-GELC		08/87-08/89	PQ16R	3005	1.1	Q16TT	IQ16TT	IQ16TT	4
1.6 GT 16V	91	4A-GEL		09/85-08/89	PQ16R	3005	1.1	Q16TT	IQ16TT	IQ16TT	4
1.6 GTi 16V	92	4A-GEL		01/88-12/89	PQ16R	3005	1.1	Q16TT	IQ16TT	IQ16TT	4
2.0	103/ 110	3S-GEL; 3S-GELC		01/86-08/89	PQ16R	3005	1.1	Q16TT	IQ16TT	IQ16TT	4
2.0 GT	103/ 110	3S-GELC		08/85-08/89	PQ16R	3005	1.1	Q16TT	IQ16TT	IQ16TT	4
2.0 Turbo 4WD	136	3S-GTE		03/88-08/89	IQ16TT	4706	1.0	-	IQ16TT		4
CELICA (89-93)											
1.6	77	4A-FE		09/89-12/93	Q16R-U	3129	0.8	Q16TT	IQ16TT	IQ16TT	4
2.0 GTi	115/ 118	3S-GE		09/89-01/94	PK20R8	3127	0.8	-	IK20TT	IK20TT	4
2.0 Turbo 4WD	150/ 153	3S-GTE		10/89-01/94	PK20R8	3127	0.8	-	IK20TT	IK20TT	4
2.2	100	5S-FE		10/89-12/94	PK20R11	3128	1.1	K20TT	IK20TT	IK20TT	4
CELICA (93-99)											
1.8 i 16V	85	7A-FE		11/93-11/99	PK16TR13	3350	1.3	K16TT	IK16TT	IK16TT	4
2.0 GTi	129	3S-GE		08/94-12/97	PK20R8	3127	0.8	-	IK20TT	IK20TT	4
2.0 GTi	129	3S-GE		12/97-08/99	PK20R11	3128	1.1	K20TT	IK20TT	IK20TT	4
2.0 i 16V	125/ 129	3S-GE		11/93-12/97	PK20R8	3127	0.8	-	IK20TT	IK20TT	4
2.0 i 16V	125/ 129	3S-GE		12/97-11/99	PK20R11	3128	1.1	K20TT	IK20TT	IK20TT	4
2.0 i Turbo 4WD	178	3S-GTE		02/94-11/99	PK20R8	3127	0.8	-	IK20TT	IK20TT	4
CELICA (99-05)											
1.8 16V TS	141	2ZZ-GE		08/99-09/05	SK20R11	3297	1.1	-	IK20TT	IK20TT	4
1.8 16V VT-i	105	1ZZ-FE		08/99-07/05	K16R-U11	3120	1.1	K16TT	IK16TT	IK16TT	4
CELSIOR (88-93)											
4.0	180	1UZ-FE		12/88-04/93	PK20R11	3128	1.1	K20TT	IK20TT	IK20TT	8
4.0	180	1UZ-FE		12/88-04/93	SK20R11	3297	1.1	-	IK20TT	IK20TT	8
CELSIOR (93-00)											
4.0 (UCF10, UCF11)	194	1UZ-FE		05/93-09/96	PK20R11	3128	1.1	K20TT	IK20TT	IK20TT	8
4.0 (UCF10, UCF11)	194	1UZ-FE		05/93-09/96	PK20R8	3127	0.8	-	IK20TT	IK20TT	8
CELSIOR (00-06)											
4.3 VVTi	208	3UZ-FE		09/00-08/06	SK20R11	3297	1.1	-	IK20TT	IK20TT	8
CENTURY (82-96)											
4.0	121	5V-EU		10/82-12/96	P16R	3004	1.0	W20TT	IW20TT	IW20TT	8
CENTURY (97-)											
5.0	206	1GZ-FE		04/97-08/10	SK16R-P11	3353	1.1	-	IK16TT	IK16TT	12
CHASER (X7, X8) (84-91)											
1.8	85	4S-FE		08/90-09/92	K16R-U11	3120	1.1	K16TT	IK16TT	IK16TT	4
2.0	110	1G-GE		08/88-10/92	K16R-U11	3120	1.1	K16TT	IK16TT	IK16TT	6
CHASER (X9) (92-96)											
2.0 VVTi	99	1G-FE		10/92-08/96	K16R-U11	3120	1.1	K16TT	IK16TT	IK16TT	6
2.5	132	1JZ-GE		10/92-08/96	PK16R11	3134	1.1	K16TT	IK16TT	IK16TT	6
CHASER (X10) (96-01)											
2.0	99/ 118	1G-FE		09/96-08/98	K16R-U11	3120	1.1	K16TT	IK16TT	IK16TT	6
2.0	99/ 118	1G-FE		08/98-05/01	K20R-U11	3139	1.1	K20TT	IK20TT	IK20TT	6
2.5	147	1JZ-GE		10/96-05/01	PK16TR11	3289	1.1	K16TT	IK16TT	IK16TT	6
2.5	206	1JZ-GTE		10/96-05/01	PK20TR11	3253	1.1	K20TT	IK20TT	IK20TT	6
3.0 VVTi	162	2JZ-FSE		10/96-05/01	SK20BR11	3471	1.1	-	-	VKB20	6

Свечи зажигания и Свечи накаливания

Таблица применения











	KW				СТАНДАРТНЫЕ			Twin Tip			QTY
											
TOYOTA продолжение											
С-HR (16-)											
1.2	85	8NR-FTS		10/16-	VDCH22F	5663	0.9	-	-	VDCH22F	4
1.2 4WD	85	8NR-FTS		10/16-	VDCH22F	5663	0.9	-	-	VDCH22F	4
1.8 Hybrid	72/90	2ZR-FXE		10/16-	FC16HR-CY9	3517	0.9			FC16HR-CY9	4
COASTER (82-93)											
4.2 D	59/92	1H-Z		10/87-01/93	DG-651		23V				6
COASTER (93-)											
4.2 D (H2B50)	96	1H-Z		01/93-10/03	DG-651		23V				6
COROLLA (E7) (79-87)											
1.3	44/48	4K; 4K-C		09/79-08/87	W16EX-U	3027	0.8	W16TT	IW16TT	IW16TT	4
1.3	44/48	4K-J/ 4K-U		09/79-08/87	J16BR-U	3001	0.8	-	-		4
1.6	46/63	2TB; 4A		09/79-07/83	W16EXR-U	3031	0.8	W16TT	IW16TT	IW16TT	4
1.6	55/63	2T; 2TB		09/79-09/83	W16EX-U	3027	0.8	W16TT	IW16TT	IW16TT	4
1.6 GT	81	2T-G		05/80-09/83	W20EXR-U	3066	0.8	W20TT	IW20TT	IW20TT	4
1.8	57/63	3T; 3T-C		09/79-09/83	W16EXR-U	3031	0.8	W16TT	IW16TT	IW16TT	4
1.8 D	44	1C	Single Coil	01/83-08/87	DG-652		7V				4
COROLLA (E8) (83-89)											
1.3	48/51	2A; 2A-L		06/83-05/89	W14EXR-U11	3014	1.1	-	IW16TT	IW16TT	4
1.3	48/51	2A; 2A-L		06/83-05/89	W16EXR-U	3031	0.8	W16TT	IW16TT	IW16TT	4
1.3	55/60	2E-L; 2E-LC		08/83-08/87	W16EXR-U11	3032	1.1	W16TT	IW16TT	IW16TT	4
1.6	54/ 58/63	4A-LC		06/83-05/89	W14EXR-U11	3014	1.1	-	IW16TT	IW16TT	4
1.6	54/ 58/63	4A-LC		06/83-05/89	W16EXR-U	3031	0.8	W16TT	IW16TT	IW16TT	4
1.6 16V	85	4A-GEC		12/85-04/87	PQ16R	3005	1.1	Q16TT	IQ16TT	IQ16TT	4
1.6 GT 16V	91	4A-GE		08/83-07/87	PQ16R	3005	1.1	Q16TT	IQ16TT	IQ16TT	4
1.6 SR (AE86)	57	4A-C		05/83-04/87	W16EXR-U	3031	0.8	W16TT	IW16TT	IW16TT	4
1.8 D	43	1C		06/83-12/83	DG-232		10.5V				4
1.8 D	43	1C	Double Coil(LPH)	05/87-05/88	DG-649		10.5V				4
1.8 D	43/47	1C; 1C-L	Single Coil	06/83-04/87	DG-652		7V				4
COROLLA (E9) (87-93)											
1.3	55/60	2E; 2E-E		05/87-06/92	W16EXR-U11	3032	1.1	W16TT	IW16TT	IW16TT	4
1.3 i	55	2E; 2E-E		08/87-04/92	W16EXR-U11	3032	1.1	W16TT	IW16TT	IW16TT	4
1.5 (AE91)	92	5A-FE		11/89-04/92	Q16R-U	3129	0.8	Q16TT	IQ16TT	IQ16TT	4
1.6	66/ 70/77	4A-F; 4A-FE		05/87-11/92	Q16R-U	3129	0.8	Q16TT	IQ16TT	IQ16TT	4
1.6	86/91	4A-GE		05/87-04/92	PQ16R	3005	1.1	Q16TT	IQ16TT	IQ16TT	4
1.6	91	4A-GE		05/87-04/92	PK20R8	3127	0.8	-	IK20TT	IK20TT	4
1.6 (AE92)	86	4A-GE		05/87-04/94	PK20R11	3128	1.1	K20TT	IK20TT	IK20TT	4
1.6 (AE92)	86	4A-GE		05/87-04/94	PK20R8	3127	0.8	-	IK20TT	IK20TT	4
1.6 (AE92)	86	4A-GE		05/87-04/94	PQ16R	3005	1.1	Q16TT	IQ16TT	IQ16TT	4
1.6 4WD	70/77	4A-F; 4A-FE		02/88-10/95	Q16R-U	3129	0.8	Q16TT	IQ16TT	IQ16TT	4
1.6 EFi	85	4A-GE		05/92-04/97	PK20R11	3128	1.1	K20TT	IK20TT	IK20TT	4
1.6 EFi	85	4A-GE		05/92-04/97	PK20R8	3127	0.8	-	IK20TT	IK20TT	4
1.6 GTi	85/92	4A-GE		07/87-10/94	PK20R8	3127	0.8	-	IK20TT	IK20TT	4
1.6 GTi	85/92	4A-GE		07/87-10/94	PQ16R	3005	1.1	Q16TT	IQ16TT	IQ16TT	4
1.6 i	77	4A-FE		05/87-05/92	Q16R-U	3129	0.8	Q16TT	IQ16TT	IQ16TT	4
1.6 i 4WD	77	4A-FE		10/87-08/90	Q16R-U	3129	0.8	Q16TT	IQ16TT	IQ16TT	4
1.6 XLI	77	4A-FE		11/89-06/92	Q16R-U	3129	0.8	Q16TT	IQ16TT	IQ16TT	4
1.6 XLI 4WD	81	4A-FE		08/89-07/95	Q16R-U	3129	0.8	Q16TT	IQ16TT	IQ16TT	4
1.8 D	47/49	1C		07/87-06/92	DG-216		11V				4
1.8 D	47/49	1C	Double Coil(LPH)	07/87-06/93	DG-649		10.5V				4
COROLLA (E10) (92-99)											
1.3 12V	53	2E		07/92-04/97	W16EXR-U11	3032	1.1	W16TT	IW16TT	IW16TT	4
1.3 XLI	55/65	4E-FE		07/92-04/97	K16R-U11	3120	1.1	K16TT	IK16TT	IK16TT	4
1.3 XLI 16V	65	4E-FE		07/92-09/95	K16R-U11	3120	1.1	K16TT	IK16TT	IK16TT	4
1.6	76/ 78/85	4A-FE		09/91-12/97	K16R-U11	3120	1.1	K16TT	IK16TT	IK16TT	4
1.6	76/ 78/85	4A-FE		05/93-04/97	PK20R11	3128	1.1	K20TT	IK20TT	IK20TT	4
1.6	78	4A-F		09/94-12/97	Q16R-U	3129	0.8	Q16TT	IQ16TT	IQ16TT	4
1.6 GLI	84	4A-FE		07/92-04/97	K16R-U11	3120	1.1	K16TT	IK16TT	IK16TT	4
1.6 GLI	84	4A-FE		05/93-05/96	PK20R11	3128	1.1	K20TT	IK20TT	IK20TT	4
1.6 i	78	4A-FE		09/94-05/96	PK20R11	3128	1.1	K20TT	IK20TT	IK20TT	4
1.6 i	78	4A-FE		05/96-11/99	K16R-U11	3120	1.1	K16TT	IK16TT	IK16TT	4
1.6 Si	84	4A-FE		07/92-04/97	K16R-U11	3120	1.1	K16TT	IK16TT	IK16TT	4
1.6 Si	84	4A-FE		05/93-05/96	PK20R11	3128	1.1	K20TT	IK20TT	IK20TT	4
1.8	81	7A-FE		09/92-04/97	PK20R13	3226	1.3	K20TT	IK20TT	IK20TT	4

Таблица применения

Т

Свечи зажигания и Свечи накаливания

Таблица применения

Таблица применения

TOYOTA	KW	KW	NOTE	21	СТАНДАРТНЫЕ			Twin Tip		QTY	
					1	2	3	1	2		
ТОYOTA продолжение											
COROLLA (E10) (92-99) продолжение											
1.8 16V 4WD	81	7A-FE		09/95-04/97	PK20R13	3226	1.3	K20TT	IK20TT	IK20TT	4
1.8 GT	86	7A-FE		11/92-05/95	PK20R13	3226	1.3	K20TT	IK20TT	IK20TT	4
1.8 GTi 4WD	81	7A-FE		11/92-04/95	PK20R13	3226	1.3	K20TT	IK20TT	IK20TT	4
2.0 D	53	2C	OE:19850-64020	07/92-04/97	DG-216		11V				4
2.0 D	53	2C	OE:19850-64050	07/92-04/97	DG-649		10.5V				4
COROLLA (E11) (97-02)											
1.3 (EE110)	55	2E		05/97-10/01	W16EXR-U11	3032	1.1	W16TT	IW16TT	IW16TT	4
1.4	63	4E-FE		04/97-02/00	K16TR11	3194	1.1	K16TT	IK16TT	IK16TT	4
1.4	71	4ZZ-FE		10/99-01/02	K16R-U11	3120	1.1	K16TT	IK16TT	IK16TT	4
1.4 16V	71	4ZZ-FE		02/00-11/01	K16R-U11	3120	1.1	K16TT	IK16TT	IK16TT	4
1.6	81	3ZZ-FE; 4A-FE		04/97-01/02	K16R-U11	3120	1.1	K16TT	IK16TT	IK16TT	4
1.6 16V	81	3ZZ-FE		10/99-10/01	K16R-U11	3120	1.1	K16TT	IK16TT	IK16TT	4
1.6 Aut.	79	4A-FE		04/97-02/00	K16R-U11	3120	1.1	K16TT	IK16TT	IK16TT	4
1.8	81	7A-FE		10/97-10/01	PK16TR13	3350	1.3	K16TT	IK16TT	IK16TT	4
1.8 4WD	81	7A-FE		04/97-10/01	PK16TR13	3350	1.3	K16TT	IK16TT	IK16TT	4
1.9 D	51	1WZ	Double Coil(LPH)	02/00-01/02	DG-003		11V				4
2.0 D	53	2C-E	Double Coil(LPH)	04/97-02/00	DG-649		10.5V				4
2.0 D-4D	66	1CD-FTV	Double Coil(LPH)	09/00-11/01	DG-245		11V				4
COROLLA (E12) (01-07)											
1.3	65	2NZ-FE		08/00-05/04	K16R-U11	3120	1.1	K16TT	IK16TT	IK16TT	4
1.4 D	66	1ND-TV	OE:19850-0W010, Double Coi l(LPH)	07/04-02/07	DG-240		11V				4
1.4 D-4D	66	1ND-TV	OE:19850-0W010, Double Coi l(LPH)	06/04-10/06	DG-240		11V				4
1.4 D4-D	66	1ND-TV	OE:19850-0W010, Double Coi l(LPH)	06/04-10/07	DG-240		11V				4
1.4 VVT-i	71	4ZZ-FE		10/01-02/07	K16R-U11	3120	1.1	K16TT	IK16TT	IK16TT	4
1.5	81	1NZ-FE		11/01-07/07	K16R-U11	3120	1.1	K16TT	IK16TT	IK16TT	4
1.6 VVT-i	81	3ZZ-FE		10/01-03/08	K16R-U11	3120	1.1	K16TT	IK16TT	IK16TT	4
1.8	100	1ZZ-FE		12/01-12/07	K16R-U11	3120	1.1	K16TT	IK16TT	IK16TT	4
1.8 (ZZE122)	96	1ZZ-FE		03/01-07/05	K16R-U11	3120	1.1	K16TT	IK16TT	IK16TT	4
1.8 4WD	100	1ZZ-FE		01/01-02/07	K16R-U11	3120	1.1	K16TT	IK16TT	IK16TT	4
1.8 VVTL-i TS	141/160/165	2ZZ-GE		01/02-02/07	SK20R11	3297	1.1	-	IK20TT	IK20TT	4
2.0 D-4D	66/81/85	1CD-FTV	Double Coil(LPH)	01/02-02/07	DG-245		11V				4
2.0 D-4D	85	1CD-FTV		06/04-07/07	DG-245		11V				4
COROLLA (E14, E15) (06-)											
1.33	74	1NR-FE		12/08-07/14	SC16HR11	3499	1.1	-	IXEH20TT	IXEH20TT	4
1.4 D-4D	66	1ND-TV	OE:19850-0W010, Double Coi l(LPH)	10/06-02/09	DG-240		11V				4
1.4 D-4D	66	1ND-TV	OE:19850-33020	10/08-07/14	DG-659		11V				4
1.4 VVT-i	71	4ZZ-FE		11/06-11/13	K16R-U11	3120	1.1	K16TT	IK16TT	IK16TT	4
1.6	97	1ZR-FAE; 1ZR-FE		11/06-11/13	SC16HR11	3499	1.1	-	IXEH20TT	IXEH20TT	4
1.6 Dual VVTi	91	1ZR-FE		01/07-07/14	SC16HR11	3499	1.1	-	IXEH20TT	IXEH20TT	4
1.6 VVTi	90	1ZR-FE		07/10-05/14	SC16HR11	3499	1.1	-	IXEH20TT	IXEH20TT	4
1.8	100	2ZR-FE		10/06-07/14	SC16HR11	3499	1.1	-	IXEH20TT	IXEH20TT	4
2.0 D-4D	93	1AD-FTV		11/06-07/14	DG-600		11V				4
COROLLA (E18) (13-)											
1.3	73	1NR-FE		06/13-12/18	SC16HR11	3499	1.1	-	IXEH20TT	IXEH20TT	4
1.4 D-4D	66	1ND-TV	OE:19850-33020	06/13-05/15	DG-659		11V				4
1.6	97	1ZR-FAE		06/13-12/18	SC16HR11	3499	1.1	-	IXEH20TT	IXEH20TT	4
COROLLA (KE) (72-80)											
1.2	40/43	3K; 3K-B; 3K-C; 3K-H		10/72-12/80	W16EXR-U	3031	0.8	W16TT	IW16TT	IW16TT	4
1.3	44	4K-C		11/78-11/81	W16EX-U	3027	0.8	W16TT	IW16TT	IW16TT	4
1.3	44	4K-J/ 4K-U		11/78-11/81	J16BR-U	3001	0.8	-	-		4

Свечи зажигания и Свечи накаливания

Таблица применения











	KW				СТАНДАРТНЫЕ			Twin Tip			QTY
TOYOTA продолжение											
COROLLA (KE) (72-80) продолжение											
1.6	54/ 56/62	2T; 2TB; 2T-C		03/76-01/80	W16EX-U	3027	0.8	W16TT	IW16TT	IW16TT	4
1.6	54/62	2T; 2TB		09/76-01/80	W16EXR-U	3031	0.8	W16TT	IW16TT	IW16TT	4
COROLLA Axio (12-)											
1.5 Hybrid	54	1NZ-FXE		08/13-	FK16BR-AL8	3511	0.8	-	-	FK16BR-AL8	4
COROLLA Fielder (12-)											
1.5 Hybrid	54	1NZ-FXE		10/14-	FK16BR-AL8	3511	0.8	-	-	FK16BR-AL8	4
COROLLA FX (84-88)											
1.3	55/60	2E-L		10/84-08/87	W16EXR-U11	3032	1.1	W16TT	IW16TT	IW16TT	4
1.6	55	4A-C; 4A-LC		08/84-09/87	W16EXR-U	3031	0.8	W16TT	IW16TT	IW16TT	4
1.6	55	4A-LC		01/87-09/87	W14EXR-U11	3014	1.1	-	IW16TT	IW16TT	4
1.6 GT 16V	89	4A-GEL		08/85-08/87	PQ16R	3005	1.1	Q16TT	IQ16TT	IQ16TT	4
1.8 D	43	1C	Double Coil(LPH)	01/85-05/87	DG-649		10.5V				4
1.8 D	43/47	1C; 1C-L	Single Coil	01/85-08/87	DG-652		7V				4
COROLLA Levin (E10) (91-97)											
1.6 GT	85	4A-FE		06/91-08/97	K16R-U11	3120	1.1	K16TT	IK16TT	IK16TT	4
1.6 GT	85	4A-FE		05/93-05/96	PK20R11	3128	1.1	K20TT	IK20TT	IK20TT	4
1.6 GT-Z	125	4A-GZE		06/91-08/97	PQ20R-P8	3113	0.8	-	IQ20TT	IQ20TT	4
COROLLA Verso (01-09)											
1.3 VVTi	64	8A-FE		03/04-03/09	FK16R11	3440	1.1	-	IK16TT	IK16TT	4
1.6	81	3ZZ-FE		08/01-03/09	K16R-U11	3120	1.1	K16TT	IK16TT	IK16TT	4
1.8	95	1ZZ-FE		04/04-03/09	K16R-U11	3120	1.1	K16TT	IK16TT	IK16TT	4
1.8 VVT-i	99	1ZZ-FE		12/01-05/04	K16R-U11	3120	1.1	K16TT	IK16TT	IK16TT	4
2.0 D-4D	66/85	1CD-FTV	Double Coil(LPH)	01/02-03/09	DG-245		11V				4
2.2 D-4D	100/ 130	2AD-FHV; 2AD-FTV		10/05-03/09	DG-600		11V				4
CORONA (T1) (70-87)											
1.8	63	3T		06/79-07/81	W16EXR-U	3031	0.8	W16TT	IW16TT	IW16TT	4
2.0	65	18R		09/75-05/79	W16EXR-U	3031	0.8	W16TT	IW16TT	IW16TT	4
2.0 Mark II	65	18R		12/75-10/77	W16EXR-U	3031	0.8	W16TT	IW16TT	IW16TT	4
CORONA (T14) (70-88)											
2.0 S	96	2S		08/85-08/88	W16EXR-U	3031	0.8	W16TT	IW16TT	IW16TT	4
CORONA (T17) (87-92)											
1.5	85/92	5A-F; 5A-FE		11/87-08/89	Q16R-U	3129	0.8	Q16TT	IQ16TT	IQ16TT	4
2.0 D	54	2C	OE:19850-6402 0	12/87-01/92	DG-216		11V				4
CORONA (T19) (92-97)											
1.8	92	4S-FE		10/91-01/96	K20R-U11	3139	1.1	K20TT	IK20TT	IK20TT	4
2.0	93	3S-FE		02/92-09/97	K20R-U11	3139	1.1	K20TT	IK20TT	IK20TT	4
CORONA (T21) (96-03)											
2.0	92	3S-FE		09/96-06/02	K20TR11	3195	1.1	K20TT	IK20TT	IK20TT	4
CORSA (90-94)											
1.3	65	4E-FE		10/90-10/94	K16R-U11	3120	1.1	K16TT	IK16TT	IK16TT	4
CORSA (94-99)											
1.3	65	4E-FE		11/94-12/97	K16R-U11	3120	1.1	K16TT	IK16TT	IK16TT	4
1.3	65	4E-FE		12/97-09/99	K16TR11	3194	1.1	K16TT	IK16TT	IK16TT	4
1.5	70	5E-FE		11/94-12/97	K16R-U11	3120	1.1	K16TT	IK16TT	IK16TT	4
1.5	70	5E-FE		12/97-09/99	K16TR11	3194	1.1	K16TT	IK16TT	IK16TT	4
CRESSIDA (77-81)											
2.0	66	18R; 18R-C		07/77-07/81	W16EXR-U	3031	0.8	W16TT	IW16TT	IW16TT	4
CRESSIDA (80-93)											
2.0	77	21R; 21R-C		09/80-04/85	W16EXR-U	3031	0.8	W16TT	IW16TT	IW16TT	4
2.0 GLI	80	1G-E		08/82-06/85	J16BR-U	3001	0.8	-	-		6
2.0 GLI	80	1G-E		08/82-06/85	W20EXR-U	3066	0.8	W20TT	IW20TT	IW20TT	6
2.2 D	49	L		09/80-04/85	DG-647		11V				4
2.2 D	49	L	Single Coil	09/80-08/82	DG-648		11V				4
2.2 D	49	L	Single Coil	08/82-04/85	DG-215		7V				4
2.4 TD	63	2L-T		01/85-12/86	DG-213		7V				4
2.4 TD (LX71)	66	2L-T		05/85-08/86	DG-213		7V				4
2.8 (MX73)	106	5M-E		05/85-09/88	W16EXR-U	3031	0.8	W16TT	IW16TT	IW16TT	6
2.8 (MX73)	125	5M-GE		05/85-09/88	P16R	3004	1.0	W20TT	IW20TT	IW20TT	6
CRESTA (84-01)											
2.0	118	1G-GE		10/96-09/01	PQ20R	3117	1.1	Q20TT	IQ20TT	IQ20TT	6
2.0 VTI 24V	118	1G-FE		10/96-08/98	K16R-U11	3120	1.1	K16TT	IK16TT	IK16TT	6
2.0 VTI 24V	118	1G-FE		08/98-09/01	K20R-U11	3139	1.1	K20TT	IK20TT	IK20TT	6

Таблица применения

Т

Свечи зажигания и Свечи накаливания

Таблица применения

	KW				СТАНДАРТНЫЕ			Twin Tip			QTY
TOYOTA продолжение											
CRESTA (84-01) продолжение											
2.5 VVTi	147	1JZ-GE		10/96-09/01	PK16TR11	3289	1.1	K16TT	IK16TT	IK16TT	6
CROWN (80-85)											
2.2 D	53	L		04/80-07/83	DG-647		11V				4
2.2 D	53	L	Single Coil	04/80-07/83	DG-648		11V				4
2.8	107	5M; 5M-E		09/80-09/83	W16EXR-U	3031	0.8	W16TT	IW16TT	IW16TT	6
2.8 i Super Saloon	125	5M-GE		02/84-03/85	P16R	3004	1.0	W20TT	IW20TT	IW20TT	6
2.8 SI	107	5M; 5M-E		04/80-07/83	W16EXR-U	3031	0.8	W16TT	IW16TT	IW16TT	6
CROWN (91-99)											
3.0	162	2JZ-GE		10/91-08/95	PK16R11	3134	1.1	K16TT	IK16TT	IK16TT	6
3.0	162	2JZ-GE		08/95-08/99	PK16TR11	3289	1.1	K16TT	IK16TT	IK16TT	6
CROWN (03-08)											
3.0	170	3GR-FE		09/04-05/05	SK20HR11	3421	1.1	-	IKH20TT	IKH20TT	6
3.0	170	3GR-FE		05/05-02/08	FK20HR11	3426	1.1	-	IKH20TT	IKH20TT	6
3.0 4WD	188	3GR-FSE		09/03-02/08	FK20HBR11	3473	1.1	-	IKBH20TT	IKBH20TT	6
CROWN Comfort (95-08)											
2.0 LPG	58	3Y-PE		12/95-07/08	VW20T	5502	0.8	-	IW20TT	IW20TT	4
CROWN Comfort (08-)											
2.0 LPG	85	1TR-FE		08/08-	IKBH20TT	4705	1.0	-	IKBH20TT		4
2.0 LPG	85	1TR-FPE		08/08-	VKH20Y	5639	0.8	-	-	VKH20Y	4
CURREN (93-98)											
1.8	85	7A-FE		11/93-10/98	PK20R13	3226	1.3	K20TT	IK20TT	IK20TT	4
2.0	129	3S-GE		11/93-10/98	PK20R8	3127	0.8	-	IK20TT	IK20TT	4
DUET (98-04)											
1.0	40	EJ-DE		04/98-05/00	K16PR-U11	3130	1.1	K16TT	IK16TT	IK16TT	3
1.0	40/43	EJ-DE; EJ-VE		09/98-04/04	K16TNR-S9	3329	0.9	K16TT	IK16TT	IK16TT	3
DYNA 100 (85-95)											
1.8	58/61	2Y		08/85-04/95	W16EX-U	3027	0.8	W16TT	IW16TT	IW16TT	4
DYNA 150 (85-88)											
1.8	58	2Y		08/85-08/86	W16EX-U	3027	0.8	W16TT	IW16TT	IW16TT	4
2.0	65/79	3Y		08/85-08/88	W16EX-U	3027	0.8	W16TT	IW16TT	IW16TT	4
2.4 D	54	2L		08/85-08/87	DG-215		7V				4
DYNA 150 (88-95)											
2.8 D	61	3L	Single Coil	08/88-05/95	DG-648		11V				4
3.4 D	66	3B		09/88-06/95	DG-232		10.5V				4
3.4 D	66	3B		09/88-06/95	DG-651		23V				4
DYNA 150 (95-01)											
2.8 D	61	3L	Single Coil	05/95-08/98	DG-648		11V				4
3.0 D	65	5L		09/98-07/01	DG-648		11V				4
DYNA 200 (88-95)											
2.2	69	4Y		10/93-05/95	W16EXR-U	3031	0.8	W16TT	IW16TT	IW16TT	4
2.2	69	4Y		10/93-05/95	W16EX-U	3027	0.8	W16TT	IW16TT	IW16TT	4
3.4 D	66	3B	Single Coil	10/89-05/95	DG-222		14V				4
3.4 D	66	3B	Single Coil	10/89-05/95	DG-234		8.5V				4
DYNA 200 (95-01)											
3.4 D	66	3B	Single Coil	06/95-05/99	DG-222		14V				4
3.4 D	66	3B	Single Coil	06/95-05/99	DG-234		8.5V				4
4.1 Di	92	15B-FNE		06/95-05/99	SK20R5-G	3415	0.5	-	-	SK20R5-G	4
4.1 Di	92	15B-FP		06/95-05/99	PK20R8	3127	0.8	-	IK20TT	IK20TT	4
4.1 TDi	110/ 125	15B-FNE		06/95-07/01	SK20R5-G	3415	0.5	-	-	SK20R5-G	4
4.1 TDi	110/ 125	15B-FP		06/95-07/01	PK20R8	3127	0.8	-	IK20TT	IK20TT	4
DYNA 300 (95-02)											
2.4	103	2RZ-FE		06/98-07/01	K16R-U	3119	0.8	K16TT	IK16TT	IK16TT	4
2.7	92	3RZ-FE		06/95-06/99	K16R-U	3119	0.8	K16TT	IK16TT	IK16TT	4
3.4 D	66	3B	Single Coil	06/95-05/99	DG-222		14V				4
3.4 D	66	3B	Single Coil	06/95-05/99	DG-234		8.5V				4
4.1 D	92	15B-FNE		06/95-06/99	SK20R5-G	3415	0.5	-	-	SK20R5-G	4
4.1 D	92	15B-FP		06/95-06/99	PK20R8	3127	0.8	-	IK20TT	IK20TT	4
DYNA (77-87)											
2.0	72/79	3Y; 5R		08/77-08/87	W16EX-U	3027	0.8	W16TT	IW16TT	IW16TT	4
2.4 D	55	2L		08/77-04/79	DG-215		7V				4
2.4 D	55	2L	11V	08/85-08/87	DG-647		11V				4
4.0D	100			09/84-07/87	DG-241		6V				4
DYNA (87-01)											
2.4 D	61	2L		08/85-05/95	DG-648		11V				4

Свечи зажигания и Свечи накаливания

Таблица применения











	KW				СТАНДАРТНЫЕ				Twin Tip			QTY
												
TOYOTA продолжение												
DYNA (01-)												
2.5 D4d	65/75	2KD-FTV		07/01-	DG-245		11V					4
3.0 D4d	65	5L		08/01-	DG-648		11V					4
3.0 D4d	80/ 100/ 106	1KD-FTV		09/06-	DG-245		11V					4
ECHO (99-05)												
1.3	60	2NZ-FE		04/03-08/05	K16R-U11	3120	1.1	K16TT	IK16TT	IK16TT		4
1.5	81	1NZ-FE		08/99-12/05	K16R-U11	3120	1.1	K16TT	IK16TT	IK16TT		4
1.5 VVTi	78	1NZ-FE		04/99-08/05	K16R-U11	3120	1.1	K16TT	IK16TT	IK16TT		4
FJ CRUISER (07-)												
4.0	178/ 194	1GR-FE		01/06-06/13	K20HR-U11	3381	1.1	KH20TT	IKH20TT	IKH20TT		6
4.0 4WD	191/ 194	1GR-FE		01/10-06/13	K20HR-U11	3381	1.1	KH20TT	IKH20TT	IKH20TT		6
4.0 4WD	191/ 200/ 203	1GR-FE		06/13-01/18	SK16HR11	3417	1.1	-	IKH16TT	IKH16TT		6
4.0 4WD	200/ 203	1GR-FE		06/05-06/13	SK20HR11	3421	1.1	-	IKH20TT	IKH20TT		6
4.0 VVTi 4WD	178	1GR-FE		01/06-01/18	K20HR-U11	3381	1.1	KH20TT	IKH20TT	IKH20TT		6
FORTUNER (04-15)												
2.5 D-4D 4WD	75/ 106	2KD-FTV		01/09-05/15	DG-245		11V					4
2.7 VVTi	118	2TR-FE		06/04-07/12	SK20HR11	3421	1.1	-	IKH20TT	IKH20TT		4
2.7 VVTi	118	2TR-FE		07/12-01/15	SK20HR-A11	3493	1.1	-	IKH20TT	IKH20TT		4
2.7 VVTi	118	2TR-FE		01/15-05/15	FK20HR-A8	3509	0.8	-	IKH20TT	IKH20TT		4
2.7 VVTi 4WD	118	2TR-FE		06/04-07/12	SK20HR11	3421	1.1	-	IKH20TT	IKH20TT		4
2.7 VVTi 4WD	118	2TR-FE		07/12-01/15	SK20HR-A11	3493	1.1	-	IKH20TT	IKH20TT		4
2.7 VVTi 4WD	118	2TR-FE		01/15-05/15	FK20HR-A8	3509	0.8	-	IKH20TT	IKH20TT		4
3.0 D	125	1KD-FTV		08/09-05/15	DG-245		11V					4
FORTUNER (15-)												
2.7	120/ 122	2TR-FE		05/15-	FK20HR-A8	3509	0.8	-	IKH20TT	IKH20TT		4
2.7 4WD	122	2TR-FE		05/15-	FK20HR-A8	3509	0.8	-	IKH20TT	IKH20TT		4
GAIA (98-03)												
2.0 VVTi	112	1AZ-FSE		05/98-10/03	SK20BGR11	3472	1.1	-	-	VKA20		4
2.0 VVTi 4WD	99	3S-FE		05/98-03/01	K20TR11	3195	1.1	K20TT	IK20TT	IK20TT		4
2.0 VVTi 4WD	112	1AZ-FSE		05/98-10/03	SK20BGR11	3472	1.1	-	-	VKA20		4
GRANVIA (95-04)												
3.0 TDi	96	1KZ-TE	Ceramic(LPH)	08/95-12/04	DG-671		11V					4
3.4 4x4	140	5VZ-FE		08/97-12/04	PK16TR11	3289	1.1	K16TT	IK16TT	IK16TT		6
GT 86 (12-)												
2.0	147	4U-GSE; FA20D		03/12-	VXEBH27	5686	0.8	-	-	VXEBH27		4
HARRIER (97-03)												
2.2	103	5S-FE		05/97-02/03	PK20TR11	3253	1.1	K20TT	IK20TT	IK20TT		4
2.2 4WD (SXU15)	103	5S-FE		05/97-01/03	PK20TR11	3253	1.1	K20TT	IK20TT	IK20TT		4
2.4 (ACU10)	118	2AZ-FE		06/00-01/03	K20R-U11	3139	1.1	K20TT	IK20TT	IK20TT		4
2.4 (ACU10)	118	2AZ-FE	LEAN BURN	06/00-01/03	SK20R11	3297	1.1	-	IK20TT	IK20TT		4
2.4 4WD	118	2AZ-FE		06/00-01/03	K20R-U11	3139	1.1	K20TT	IK20TT	IK20TT		4
2.4 4WD	118	2AZ-FE	LEAN BURN	06/00-01/03	SK20R11	3297	1.1	-	IK20TT	IK20TT		4
3.0	148/ 164	1MZ-FE		12/97-01/03	SK20R11	3297	1.1	-	IK20TT	IK20TT		6
3.0 4WD	164	1MZ-FE		03/98-01/03	SK20R11	3297	1.1	-	IK20TT	IK20TT		6
HARRIER (03-08)												
2.4	118	2AZ-FE		02/03-12/13	SK20R11	3297	1.1	-	IK20TT	IK20TT		4
2.4 4WD	118	2AZ-FE		10/03-06/12	SK20R11	3297	1.1	-	IK20TT	IK20TT		4
3.3 Hybrid 4WD	155	3MZ-FE		04/05-09/13	SK20R11	3297	1.1	-	IK20TT	IK20TT		6
3.5	206	2GR-FE		04/05-12/08	FK20HR11	3426	1.1	-	IKH20TT	IKH20TT		6
3.5 4WD	206	2GR-FE		04/05-12/08	FK20HR11	3426	1.1	-	IKH20TT	IKH20TT		6
HARRIER (13-)												
2.0	111	3ZR-FAE		10/13-	SC16HR11	3499	1.1	-	IXEH20TT	IXEH20TT		4
2.0 4WD	111	3ZR-FAE		10/13-	SC16HR11	3499	1.1	-	IXEH20TT	IXEH20TT		4
2.5 Hybrid	114	2AR-FXE		10/13-	FK16HR-A8	3484	0.8	-	-	FK16HR-A8		4
HEAVY DUTY TRUCK (69-01)												
4.0	96	2D	03/1969-04/ 1972	03/69-11/01	DG-231		21.5V					6
4.0	96	2D	OE: 19850-76020, 05/1972-	03/69-11/01	DG-228		19V					6

Таблица применения

Т

Свечи зажигания и Свечи накаливания

Таблица применения

Таблица применения

TOYOTA	KW	KW	NOTE	21	СТАНДАРТНЫЕ			Twin Tip		QTY	
					STANDARD	STANDARD	STANDARD	TWIN TIP	TWIN TIP		
ТОУОТА продолжение											
HIACE I (77-85)											
1.6	49	12R		02/77-03/83	W16EX-U	3027	0.8	W16TT	IW16TT	IW16TT	4
2.0	65	18R		07/77-03/83	W16EXR-U	3031	0.8	W16TT	IW16TT	IW16TT	4
2.0	65	18R		07/77-03/83	W16EX-U	3027	0.8	W16TT	IW16TT	IW16TT	4
2.2 D	46	L	OE: 1985054010	01/79-03/83	DG-648		11V				4
2.2 D	46	L	QuickGlow System.SGS	11/82-03/83	DG-215		7V				4
2.2 D	46/49	L		09/79-11/82	DG-647		11V				4
HIACE II (83-89)											
1.8	58	2Y		12/82-11/89	W16EX-U	3027	0.8	W16TT	IW16TT	IW16TT	4
2.0	65	3Y		12/82-08/89	W16EX-U	3027	0.8	W16TT	IW16TT	IW16TT	4
2.2 4WD	69	4Y		09/87-08/89	W16EXR-U	3031	0.8	W16TT	IW16TT	IW16TT	4
2.2 4WD	69	4Y		09/87-08/89	W16EX-U	3027	0.8	W16TT	IW16TT	IW16TT	4
2.2 D	49	L	Single Coil	12/82-11/89	DG-215		7V				4
2.4 D	55	2L		05/84-08/87	DG-647		11V				4
2.4 D	55	2L	QuickGlow System.SGS, Single Coil	05/84-11/89	DG-215		7V				4
2.4 D	55	2L	Single Coil	05/84-11/89	DG-648		11V				4
2.4 D 4WD	55	2L		04/84-07/87	DG-215		7V				4
2.4 D 4WD	55	2L	QuickGlow System.SGS, Single Coil	01/87-01/88	DG-215		7V				4
2.4 D 4WD	55	2L	Single Coil	01/87-01/88	DG-648		11V				4
HIACE III (87-04)											
2.0	74	1RZ		08/89-08/04	W16EXR-U	3031	0.8	W16TT	IW16TT	IW16TT	4
2.4	85/88	2RZ-E		08/89-12/04	P16R	3004	1.0	W20TT	IW20TT	IW20TT	4
2.4 4WD	88	2RZ-E		08/89-08/95	P16R	3004	1.0	W20TT	IW20TT	IW20TT	4
2.4 D	53/55/57	2L	Single Coil	08/89-12/04	DG-648		11V				4
2.4 D 4WD	55/57	2L	Single Coil	08/87-07/99	DG-648		11V				4
2.8 D	61	3L	Single Coil	08/89-08/00	DG-648		11V				4
3.0 TD	103	1KZ-TE	Ceramic(LPH)	01/97-12/02	DG-671		11V				4
HIACE IV (95-)											
2.4	85	2RZ-E		08/95-11/03	P16R	3004	1.0	W20TT	IW20TT	IW20TT	4
2.4 4WD	85	2RZ-E		08/95-04/98	P16R	3004	1.0	W20TT	IW20TT	IW20TT	4
2.4 D	55/58	2L	Single Coil	08/95-08/06	DG-648		11V				4
2.4 D	55/61	2L		08/95-08/01	DG-648		11V				4
2.4 D	58	2L	OE:19850-54090	08/95-01/99	DG-648		11V				4
2.4 D	58	2L	OE:19850-54120	03/97-08/01	DG-648		11V				4
2.4 i	88	2RZ-E		08/95-08/04	P16R	3004	1.0	W20TT	IW20TT	IW20TT	4
2.4 TD	66	2L-T		08/95-08/01	DG-648		11V				4
2.4 TD 4WD	66	2LT; 2L-T		08/95-08/01	DG-648		11V				4
2.5 D-4D	65/70/75/86	2KD-FTV		11/01-	DG-245		11V				4
2.5 D-4D 4WD	65/75/86	2KD-FTV		08/01-	DG-245		11V				4
2.7	106	3RZ-FE		04/98-08/01	SK16R-P8	3303	0.8	-	IK16TT	IK16TT	4
2.7	106	3RZ-FE		08/01-12/06	SK16R11	3324	1.1	-	IK16TT	IK16TT	4
2.7 4WD	106	3RZ-FE		04/98-05/06	SK16R-P8	3303	0.8	-	IK16TT	IK16TT	4
2.7 4WD	106	3RZ-FE		07/99-	SK16R11	3324	1.1	-	IK16TT	IK16TT	4
HIACE V (05-)											
2.5 D-4D	70/75/86	2KD-FTV		06/04-	DG-245		11V				4
2.5 D-4D 4WD	94	2KD-FTV		08/04-09/07	DG-245		11V				4
HILUX I (72-83)											
1.6	49	12R		08/78-07/83	W16EX-U	3027	0.8	W16TT	IW16TT	IW16TT	4
1.6	49	12R		05/72-07/78	W16EX-U	3027	0.8	W16TT	IW16TT	IW16TT	4
1.6	49	12R		09/73-07/78	W16EXR-U	3031	0.8	W16TT	IW16TT	IW16TT	4
2.0	65	18R		01/79-07/83	W16EXR-U	3031	0.8	W16TT	IW16TT	IW16TT	4
2.0 4WD	65	18R		01/79-07/83	W16EXR-U	3031	0.8	W16TT	IW16TT	IW16TT	4
HILUX II (83-05)											
1.8	58	2Y-C		08/83-03/89	P16R	3004	1.0	W20TT	IW20TT	IW20TT	4
1.8	58/61	2Y		08/83-06/98	W16EX-U	3027	0.8	W16TT	IW16TT	IW16TT	4
2.0	65	3Y		08/83-07/88	W16EX-U	3027	0.8	W16TT	IW16TT	IW16TT	4
2.0 4WD	65	3Y; 3Y-C		01/85-12/88	W16EX-U	3027	0.8	W16TT	IW16TT	IW16TT	4
2.2	69	4Y		08/83-12/89	W16EXR-U	3031	0.8	W16TT	IW16TT	IW16TT	4

Свечи зажигания и Свечи накаливания

Таблица применения

TOYOTA	KW	KW	NOTE	21	СТАНДАРТНЫЕ			Twin Tip			QTY	
					STANDARD	STANDARD	STANDARD	TWIN TIP	TWIN TIP	TWIN TIP		
TOYOTA продолжение												
HILUX II (83-05) продолжение												
2.2 4WD	69	4Y			11/85-12/89	W16EXR-U	3031	0.8	W16TT	IW16TT	IW16TT	4
2.2 4WD	69	4Y			11/85-12/89	W16EX-U	3027	0.8	W16TT	IW16TT	IW16TT	4
2.2 D	49	L			08/83-08/84	DG-647		11V				4
2.2 D 4WD	49	L			11/82-08/84	DG-215		7V				4
2.4	107	2RZ-FE			08/97-07/05	K16R-U	3119	0.8	K16TT	IK16TT	IK16TT	4
2.4 D	55/58	2L	OE:19850-54140		08/97-07/05	DG-648		11V				4
2.4 D	55/58/61	2L	Single Coil		09/88-04/05	DG-648		11V				4
2.4 D	58/61	2L			09/88-08/97	DG-647		11V				4
2.4 D 4WD	55	2L			09/94-07/97	DG-647		11V				4
2.4 D 4WD	55/58/61	2L	Single Coil		08/83-12/97	DG-648		11V				4
2.4 i 4WD	84	22RE			01/89-07/97	W16EXR-U	3031	0.8	W16TT	IW16TT	IW16TT	4
2.4 i 4WD	103	2RZ-FE			08/97-10/05	K16R-U	3119	0.8	K16TT	IK16TT	IK16TT	4
2.4 TD	66	2L-T			08/98-01/02	DG-648		11V				4
2.4 TD	66	2L-T	Single Coil		08/98-01/02	DG-648		11V				4
2.4 TD 4WD	66/92	2L-T			08/88-01/02	DG-648		11V				4
2.4 TD 4WD	66/92	2L-T; 2L-TE	Single Coil		08/88-01/02	DG-648		11V				4
2.5 D-4D	65	2KD-FTV			11/01-07/05	DG-245		11V				4
2.5 D-4D 4WD	75	2KD-FTV			11/01-07/05	DG-245		11V				4
2.7	107	3RZ-FE			08/97-10/02	K16R-U	3119	0.8	K16TT	IK16TT	IK16TT	4
2.7	107	3RZ-FE			10/02-08/05	K16R-U11	3120	1.1	K16TT	IK16TT	IK16TT	4
2.8 D	65	3L	Single Coil		01/92-08/96	DG-648		11V				4
2.8 D 4WD	65	3L	Single Coil		08/97-07/05	DG-648		11V				4
3.4 4WD	131	5VZ-FE			08/00-07/05	K16TR11	3194	1.1	K16TT	IK16TT	IK16TT	6
HILUX III (05-)												
2.5 D 4WD	75	2KD-FTV			03/05-05/15	DG-245		11V				4
2.5 D-4D	75/88	2KD-FTV			03/05-05/15	DG-245		11V				4
2.5 D-4D (KUN15, KUN35)	106	2KD-FTV			01/10-05/15	DG-245		11V				4
2.5 D-4D 4WD	88/94	2KD-FTV			11/04-05/15	DG-245		11V				4
2.5 D-4D 4WD (KUN25, KUN10)	106	2KD-FTV			12/07-05/15	DG-245		11V				4
3.0 D 4WD	120/126	1KD-FTV	OE:19850-30010, Euro-4		02/05-	DG-245		11V				4
3.0 D-4D 4WD	126	1KD-FTV	OE:19850-30010, Euro-4		08/05-05/15	DG-245		11V				4
3.0 D-4D 4WD (KUN26)	145	1KD-FTV	OE:19850-30010, Euro-4		05/08-12/12	DG-245		11V				4
IQ (09-)												
1.0	50	1KR-FE			01/09-12/15	SK16HR11	3417	1.1	-	IKH16TT	IKH16TT	3
1.0	50	1KR-FE			11/13-12/15	SC16HR11	3499	1.1	-	IXEH20TT	IXEH20TT	3
1.33	72	1NR-FE			01/09-12/15	SC16HR11	3499	1.1	-	IXEH20TT	IXEH20TT	4
1.4 D-4D	66	1ND-TV	OE:19850-33020		01/09-12/15	DG-659		11V				4
ISIS (04-)												
1.8 VVTi	97	1ZZ-FE			07/04-08/14	K16R-U11	3120	1.1	K16TT	IK16TT	IK16TT	4
1.8 VVTi	106	2ZR-FAE			04/07-08/14	SC16HR11	3499	1.1	-	IXEH20TT	IXEH20TT	4
2.0 VVTi	114	1AZ-FSE			07/04-08/09	SK20BGR11	3472	1.1	-	-	VKA20	4
2.0 VVTi	116	3ZR-FAE			09/09-08/14	SC16HR11	3499	1.1	-	IXEH20TT	IXEH20TT	4
2.0 VVTi 4WD	114	1AZ-FSE			07/04-08/14	SK20BGR11	3472	1.1	-	-	VKA20	4
IST (04-07)												
1.3 VVTi	63	2NZ-FE			05/04-05/05	K16R-U11	3120	1.1	K16TT	IK16TT	IK16TT	4
1.3 VVTi	63	2NZ-FE			05/05-07/07	SK16R11	3324	1.1	-	IK16TT	IK16TT	4
1.5 VVTi	80	1NZ-FE			05/04-07/07	K16R-U11	3120	1.1	K16TT	IK16TT	IK16TT	4
KLUGER / HIGHLANDER I (00-07)												
3.0 4WD	164	1MZFE			11/00-07/03	SK20R11	3297	1.1	-	IK20TT	IK20TT	4
3.3 Hybrid 4WD	200	3MZ-FE			03/05-12/10	SK20R11	3297	1.1	-	IK20TT	IK20TT	6
KLUGER / HIGHLANDER II (07-)												
2.7	139	1AR-FE			09/08-02/14	SK16HR11	3417	1.1	-	IKH16TT	IKH16TT	4
3.5	201	2GR-FE			05/07-02/14	FK20HR11	3426	1.1	-	IKH20TT	IKH20TT	4
3.5 4WD	201	2GR-FE			06/07-02/14	FK20HR11	3426	1.1	-	IKH20TT	IKH20TT	6
KLUGER / HIGHLANDER III (14-)												
2.7	138	1AR-FE			09/16-	SK16HR11	3417	1.1	-	IKH16TT	IKH16TT	4
2.7 AWD	138	1AR-FE			09/16-	SK16HR11	3417	1.1	-	IKH16TT	IKH16TT	4
3.5 AWD	183	2GR-FE			09/14-	FK20HR11	3426	1.1	-	IKH20TT	IKH20TT	6

Свечи зажигания и Свечи накаливания







Таблица применения

Таблица применения

TOYOTA	KW	KW	NOTE	21	СТАНДАРТНЫЕ			Twin Tip		QTY	
					STANDARD	1mm	⚡	Twin Tip	Twin Tip		
ТОЙОТА продолжение											
LAND CRUISER (J40) (69-86)											
3.0 D 4WD	59	B		03/69-10/74	DG-226		19V			4	
3.0 D 4WD	59	B		03/69-01/75	DG-227		8V			4	
3.0 D 4WD	59	B	Double Coil(LPH)	03/69-10/84	DG-001		11V			4	
3.4 D	66	3B		08/80-10/83	DG-232		10.5V			4	
3.4 D	66	3B		08/80-10/83	DG-233		23V			4	
3.4 D	66	3B		08/80-10/83	DG-235		20.5V			4	
3.4 D	66	3B	Single Coil	08/80-10/84	DG-222		14V			4	
3.4 D	66	3B	Single Coil	08/80-10/84	DG-234		8.5V			4	
3.6 D	66	H		01/75-07/80	DG-224		8V			6	
3.6 D	66	H		01/75-07/80	DG-225		19V			6	
3.9	96	F		03/69-01/75	IW16	5305	1.1	-	IW16TT	IW16TT	4
4.0 D	76	2H	Double Coil(LPH)	08/80-10/84	DG-649		10.5V			6	
4.0 D	76	2H	OE:19850-68020	08/80-10/84	DG-233		23V			6	
4.0 D	76	2H	Single Coil	08/80-10/84	DG-222		14V			6	
4.2	89	2F		01/75-04/86	W14EX-U	3011	0.8	-	IW16TT	IW16TT	6
LAND CRUISER (J60) (81-89)											
3.4 Diesel	66	3B	Single Coil	10/81-08/87	DG-222		14V			4	
3.4 Diesel	66	3B	Single Coil	10/81-08/87	DG-234		8.5V			4	
4.0	101	3F		11/84-08/87	W14EX-U	3011	0.8	-	IW16TT	IW16TT	6
4.0	115	3F-E		08/87-12/92	W16EXR-U11	3032	1.1	W16TT	IW16TT	IW16TT	6
4.0 Diesel	74	2H		01/82-12/85	DG-232		10.5V			6	
4.0 Diesel	74/77	2H	OE:19850-68020	01/82-12/89	DG-233		23V			6	
4.0 Diesel	74/77	2H	Single Coil	10/81-12/89	DG-222		14V			6	
4.0 Diesel	77	2H	Double Coil(LPH)	10/81-12/89	DG-649		10.5V			6	
4.0 Turbo-D	100	12HT		10/85-12/89	DG-651		23V			4	
4.2	88	2F		10/81-01/88	W14EXR-U	3013	0.8	-	IW16TT	IW16TT	6
4.2	88	2F		10/81-01/88	W14EX-U	3011	0.8	-	IW16TT	IW16TT	6
LAND CRUISER (J80) (90-98)											
4.0	115	3F-E		01/90-10/92	W16EXR-U	3031	0.8	W16TT	IW16TT	IW16TT	6
4.2 D	99	1H-Z		01/90-12/97	DG-648		11V			6	
4.2 D	99	1H-Z		01/90-12/97	DG-651		23V			6	
4.2 TD	118/123	1HD-T		01/90-12/97	DG-651		23V			6	
4.2 TD	118/123	1HD-T	19850-64050	01/90-12/97	DG-649		10.5V			6	
4.2 TD 24V	125	1HD-FT		01/95-12/97	DG-651		23V			6	
4.5 4WD	215	1FZ-FE		08/92-01/98	PK16R11	3134	1.1	K16TT	IK16TT	IK16TT	6
4.5 24V	151	1FZ-FE		08/92-12/97	PK16R11	3134	1.1	K16TT	IK16TT	IK16TT	6
LAND CRUISER (J100) (98-08)											
4.2 D	96	1H-Z		03/98-08/07	DG-648		11V			6	
4.2 D	96	1H-Z		03/98-08/07	DG-651		23V			6	
4.2 TD	150	1HD-FTE		01/98-07/07	DG-235		20.5V			6	
4.2 TD	150	1HD-FTE		01/98-07/07	DG-649		10.5V			6	
4.7	173/175	2UZ-FE		01/98-08/07	SK20R11	3297	1.1	-	IK20TT	IK20TT	8
LAND CRUISER (J200) (07-)											
4.5 D V8	210	1VD-FTV		01/08-	DG-600		11V			8	
4.5 D-4D	195	1VD-FTV		09/07-	DG-600		11V			8	
4.5 D4-D	173/200	1VD-FTV		08/07-	DG-600		11V			8	
4.6 V8	234	1UR-FE		01/12-	SK20HR11	3421	1.1	-	IKH20TT	IKH20TT	8
4.7 V8	202/212	2UZ-FE		08/07-	SK20R11	3297	1.1	-	IK20TT	IK20TT	8
LAND CRUISER / PRADO (J70) (84-06)											
2.4	77/81/84	22R; 22RE		11/84-12/96	W16EXR-U	3031	0.8	W16TT	IW16TT	IW16TT	4
2.4 D	53	2L	Single Coil	11/84-10/85	DG-215		7V			4	
2.4 TD	63/66	2L-T	Single Coil	10/85-05/96	DG-648		11V			4	
3.0 TD	92	1KZ-T	Ceramic(LPH)	05/93-05/96	DG-671		11V			4	
3.4 D	70	3B		11/84-08/88	DG-232		10.5V			4	
3.4 D	70	3B		11/84-08/88	DG-233		23V			4	
3.4 D	70	3B		08/88-12/96	DG-651		23V			4	
3.4 D	70	3B	Single Coil	11/84-08/88	DG-222		14V			4	
3.4 TD	91	13BT		10/85-08/86	DG-222		14V			4	
3.5 D 4x4	85	1PZ		01/90-08/92	DG-651		23V			5	











Свечи зажигания и Свечи накаливания

Таблица применения

	KW				СТАНДАРТНЫЕ			Twin Tip			QTY
											
TOYOTA продолжение											
LAND CRUISER / PRADO (J70) (84-06) продолжение											
4.0 4x4	115	3F-E		10/89-12/97	W16EXR-U	3031	0.8	W16TT	IW16TT	IW16TT	6
4.0 4x4	170	1GR-FE		03/07-06/13	K20HR-U11	3381	1.1	KH20TT	IKH20TT	IKH20TT	6
4.2 D	96/ 123	1H-Z		01/90-	DG-648		11V				6
4.2 D	96/ 123	1H-Z		01/90-	DG-651		23V				6
4.2 D 4x4	96/ 123	1H-Z		01/90-02/07	DG-648		11V				6
4.2 D 4x4	96/ 123	1H-Z		01/90-02/07	DG-651		23V				6
4.2 TDi 4x4	150	1HD-FTE		09/01-06/06	DG-235		20.5V				6
4.2 TDi 4x4	150	1HD-FTE		09/01-06/06	DG-649		10.5V				6
4.5 4x4	158	1FZ-FE		08/92-11/99	PK16R11	3134	1.1	K16TT	IK16TT	IK16TT	6
LAND CRUISER / PRADO (J120) (02-10)											
3.0 D (LJ120, LJ125)	70	5L-E		09/02-02/10	DG-648		11V				4
3.0 D-4D	92	1KZ-TE	Ceramic(LPH)	09/02-07/09	DG-671		11V				4
3.0 D-4D	120/ 122/ 127	1KD-FTV		09/02-12/10	DG-245		11V				4
4.0	179/ 183/ 203	1GR-FE		09/02-12/10	K20HR-U11	3381	1.1	KH20TT	IKH20TT	IKH20TT	6
LAND CRUISER / PRADO (J150) (10-)											
3.0 D-4D	127/ 140	1KD-FTV	OE: 19850-30010, Euro-4	08/09-	DG-245		11V				4
4.0 V6 Dual VVTi	205	1GR-FE		08/09-06/13	K20HR-U11	3381	1.1	KH20TT	IKH20TT	IKH20TT	6
4.0 V6 Dual VVTi	205	1GR-FE		06/13-	SK16HR11	3417	1.1	-	IKH16TT	IKH16TT	6
4.0 V6 VVTi	183	1GR-FE		11/12-06/13	K20HR-U11	3381	1.1	KH20TT	IKH20TT	IKH20TT	6
4.0 V6 VVTi	183	1GR-FE		06/13-	SK16HR11	3417	1.1	-	IKH16TT	IKH16TT	6
4.0 V6 VVT-i	207	1GR-FE		08/09-06/13	K20HR-U11	3381	1.1	KH20TT	IKH20TT	IKH20TT	6
4.0 V6 VVT-i	207	1GR-FE		06/13-	SK16HR11	3417	1.1	-	IKH16TT	IKH16TT	6
LAND CRUISER / PRADO / COLORADO (J90) (95-)											
2.7	110	3RZ-FE		06/95-08/02	K16R-U	3119	0.8	K16TT	IK16TT	IK16TT	4
3.0 D-4D 4WD	120	1KD-FTV		08/00-08/02	DG-245		11V				4
3.0 TD	92/ 103	1KZ-TE	Ceramic(LPH)	04/95-12/02	DG-671		11V				4
3.4 i 24V	131	5VZ-FE		03/96-06/99	K16TR11	3194	1.1	K16TT	IK16TT	IK16TT	6
3.4 i 24V	131	5VZ-FE		06/99-08/02	PK16TR11	3289	1.1	K16TT	IK16TT	IK16TT	6
LITEACE (79-86)											
1.3	43	4K; 4K-C		10/79-10/86	W16EX-U	3027	0.8	W16TT	IW16TT	IW16TT	4
1.8 D	41	1C	10,5V	10/82-09/85	DG-232		10.5V				4
1.8 D	41	1C	Single Coil	10/82-09/85	DG-652		7V				4
LITEACE (84-92)											
1.5	51	5K		10/85-01/92	W16EXR-U	3031	0.8	W16TT	IW16TT	IW16TT	4
1.8	61	2Y; 2Y-C		01/84-12/92	W16EX-U	3027	0.8	W16TT	IW16TT	IW16TT	4
1.8 D	47	1C	Single Coil	10/85-08/88	DG-652		7V				4
2.0 D	53	2C	OE:19850-6402 0	08/88-01/92	DG-216		11V				4
2.0 D	53	2C	OE:19850-6405 0	08/88-01/92	DG-649		10.5V				4
LITEACE (92-97)											
1.5	52	5K		01/92-01/95	W16EXR-U	3031	0.8	W16TT	IW16TT	IW16TT	4
2.0 D	53/54	2C	OE:19850-6402 0	01/92-05/94	DG-216		11V				4
2.0 D	53/54	2C	OE:19850-6405 0	01/92-05/94	DG-649		10.5V				4
2.2	72	4Y-EC		01/92-01/95	P16R	3004	1.0	W20TT	IW20TT	IW20TT	4
MARK II (88-96)											
2.5	206	1JZ-GTE		10/92-09/96	PK20R8	3127	0.8	-	IK20TT	IK20TT	6
2.5 4WD	132	1JZ-GE		10/92-09/96	PK16R11	3134	1.1	K16TT	IK16TT	IK16TT	6
MARK II (96-01)											
2.0 VVTi	118	1G-FE		10/96-08/98	K16R-U11	3120	1.1	K16TT	IK16TT	IK16TT	6
2.0 VVTi	118	1G-FE		08/98-09/01	K20R-U11	3139	1.1	K20TT	IK20TT	IK20TT	6
2.5	147	2MZ-FE		08/96-07/01	PK20TR11	3253	1.1	K20TT	IK20TT	IK20TT	6
MARK II (02-07)											
2.0 VVTi	118	1G-FE		01/02-06/07	K20R-U11	3139	1.1	K20TT	IK20TT	IK20TT	6
2.0 VVTi 4WD	118	1G-FE		01/02-06/07	K20R-U11	3139	1.1	K20TT	IK20TT	IK20TT	6
2.5	147	1JZ-FSE		01/02-12/04	SK20BR11	3471	1.1	-	-	VKB20	6
2.5 4WD	147	1JZ-GE		10/02-11/04	SK16R-P11	3353	1.1	-	IK16TT	IK16TT	6

Свечи зажигания и Свечи накаливания

Таблица применения

	KW				СТАНДАРТНЫЕ				Twin Tip			QTY
												
TOYOTA продолжение												
MARK X I (04-09)												
3.0 VVTi	183	3GR-FSE		11/04-09/07	FK20HBR11	3473	1.1	-	IKBH20TT	IKBH20TT		6
3.0 VVTi	183	3GR-FSE		09/07-09/09	FK20HR11	3426	1.1	-	IKH20TT	IKH20TT		6
MARK X II (09-)												
2.5	149	4GR-FSE		10/09-	FK20HBR11	3473	1.1	-	IKBH20TT	IKBH20TT		6
MASTER ACE Surf (85-99)												
1.8	58	2Y		02/85-08/90	W16EX-U	3027	0.8	W16TT	IW16TT	IW16TT		4
2.0	65/70	3Y; 3Y-EU		02/85-08/97	W16EX-U	3027	0.8	W16TT	IW16TT	IW16TT		4
2.0	70	3Y-EU		09/90-08/97	P16R	3004	1.0	W20TT	IW20TT	IW20TT		4
2.0 4WD	70	3Y-EU		09/90-08/97	P16R	3004	1.0	W20TT	IW20TT	IW20TT		4
2.0 4WD	70	3Y-EU		09/90-08/97	W16EX-U	3027	0.8	W16TT	IW16TT	IW16TT		4
2.0 TD	62	2C-T	Double Coil(LPH)	08/88-10/93	DG-649		10.5V					4
2.0 TD	62	2C-T	Single Coil	02/85-07/88	DG-652		7V					4
2.0 TD 4WD	62	2C-T	Double Coil(LPH)	08/88-12/96	DG-649		10.5V					4
2.0 TD 4WD	62	2C-T	Single Coil	02/85-07/88	DG-652		7V					4
MATRIX (01-07)												
1.8	91	1ZZ-FE		01/02-12/07	K16R-U11	3120	1.1	K16TT	IK16TT	IK16TT		4
1.8	122	2ZZ-GE		01/03-12/06	SK20R11	3297	1.1	-	IK20TT	IK20TT		4
1.8 4WD	91	1ZZ-FE		01/02-02/04	K16R-U11	3120	1.1	K16TT	IK16TT	IK16TT		4
1.8 VVTi	96	1ZZ-FE		01/02-02/04	K16R-U11	3120	1.1	K16TT	IK16TT	IK16TT		4
MATRIX (08-)												
1.8	97	2ZR-FE		01/08-05/14	SC16HR11	3499	1.1	-	IXEH20TT	IXEH20TT		4
2.4	117	2AZ-FE		01/08-06/12	SK20R11	3297	1.1	-	IK20TT	IK20TT		4
2.4	117	2AZ-FE		06/12-05/14	SK16R11	3324	1.1	-	IK16TT	IK16TT		4
MODELL F (82-90)												
1.8 4WD	58	2Y		11/82-07/86	W16EX-U	3027	0.8	W16TT	IW16TT	IW16TT		4
1.8 4WD	58	2Y-C		11/82-07/86	P16R	3004	1.0	W20TT	IW20TT	IW20TT		4
1.8 De Luxe	58	2Y		11/82-08/84	W16EX-U	3027	0.8	W16TT	IW16TT	IW16TT		4
1.8 De Luxe	58	2Y-C		11/82-08/84	P16R	3004	1.0	W20TT	IW20TT	IW20TT		4
2.0	66	3Y		08/88-01/90	W16EX-U	3027	0.8	W16TT	IW16TT	IW16TT		4
2.0 D	49	2C	OE: 1985064010	04/85-07/87	DG-652		7V					4
2.0 Super	65	3Y		08/84-08/88	W16EXR-U	3031	0.8	W16TT	IW16TT	IW16TT		4
2.0 Super	65	3Y; 3Y-C		08/84-08/88	W16EX-U	3027	0.8	W16TT	IW16TT	IW16TT		4
2.2	72/75	4Y-EC		08/85-01/90	P16R	3004	1.0	W20TT	IW20TT	IW20TT		4
MR 2 I (84-90)												
1.6 16V	85/91/96	4A-GELC		06/84-06/90	PQ16R	3005	1.1	Q16TT	IQ16TT	IQ16TT		4
MR 2 II (89-00)												
2.0	88	3S-FE		12/89-08/92	Q16R-U11	3006	1.1	Q16TT	IQ16TT	IQ16TT		4
2.0	165	3S-GTE		12/89-07/99	PK20R8	3127	0.8	-	IK20TT	IK20TT		4
2.0 16V	115/125/129	3S-GE		12/89-12/97	PK20R8	3127	0.8	-	IK20TT	IK20TT		4
2.0 16V	115/125/129	3S-GE		12/97-05/00	PK20R11	3128	1.1	K20TT	IK20TT	IK20TT		4
2.0 Turbo	167/180	3S-GTE		12/89-07/99	PK20R8	3127	0.8	-	IK20TT	IK20TT		4
2.2	100	5S-FE		01/92-05/95	PK20R11	3128	1.1	K20TT	IK20TT	IK20TT		4
MR 2 III (99-07)												
1.8 16V VT-i	103	1ZZ-FE		10/99-06/07	K16R-U11	3120	1.1	K16TT	IK16TT	IK16TT		4
NADIA (98-03)												
2.0	100/107	3S-FE; 3S-FSE		04/98-08/03	K20TR11	3195	1.1	K20TT	IK20TT	IK20TT		4
2.0 4WD	107	3S-FE		04/98-08/03	PK20GR8	3326	0.8	-	-	VKA20		4
NOAH / VOXY (01-07)												
2.0	112	1AZ-FSE		11/01-06/07	SK20BGR11	3472	1.1	-	-	VKA20		4
NOAH / VOXY (07-13)												
2.0	103	3ZR-FE		06/07-12/13	SC16HR11	3499	1.1	-	IXEH20TT	IXEH20TT		4
NOAH / VOXY (13-)												
1.8 Hybrid	73	2ZR-FXE		10/13-	SC16HR11	3499	1.1	-	IXEH20TT	IXEH20TT		4
2.0	111	3ZR-FAE		10/13-	SC16HR11	3499	1.1	-	IXEH20TT	IXEH20TT		4
2.0 4WD	111	3ZR-FAE		10/13-	SC16HR11	3499	1.1	-	IXEH20TT	IXEH20TT		4
OPA (00-05)												
1.8	100	1ZZ-FE		04/00-08/03	K16R-U11	3120	1.1	K16TT	IK16TT	IK16TT		4
1.8 4WD	92	1ZZ-FE		04/00-08/03	K16R-U11	3120	1.1	K16TT	IK16TT	IK16TT		4
2.0	112	1AZ-FSE		08/00-04/05	SK20BGR11	3472	1.1	-	-	VKA20		4

Свечи зажигания и Свечи накаливания

Таблица применения











	KW				СТАНДАРТНЫЕ			Twin Tip			QTY
											
TOYOTA продолжение											
PASEO (88-95)											
1.5	85	5E-FE		06/88-07/95	K16R-U11	3120	1.1	K16TT	IK16TT	IK16TT	4
1.5 (EL44)	74	5E-FE		06/90-08/95	K16R-U11	3120	1.1	K16TT	IK16TT	IK16TT	4
PASEO (95-99)											
1.5	66/ 81/85	5E-FE		08/95-12/97	K16R-U11	3120	1.1	K16TT	IK16TT	IK16TT	4
1.5	66/ 81/85	5E-FE		12/97-06/99	K16TR11	3194	1.1	K16TT	IK16TT	IK16TT	4
PICNIC (96-01)											
2.0	90/99	3S-FE		05/96-12/01	K20TR11	3195	1.1	K20TT	IK20TT	IK20TT	4
2.0 16V	94	3S-FE		08/96-09/00	K20TR11	3195	1.1	K20TT	IK20TT	IK20TT	4
2.2 D	66	3C-TE	Ceramic(LPH)	08/97-12/01	DG-671		11V				4
PLATZ (99-05)											
1.0	50	1SZ-FE	Japan	04/99-08/05	K16R-U	3119	0.8	K16TT	IK16TT	IK16TT	4
1.3	63	2NZ-FE		08/99-08/05	K16R-U11	3120	1.1	K16TT	IK16TT	IK16TT	4
1.5	78	1NZ-FE		04/99-08/05	K16R-U11	3120	1.1	K16TT	IK16TT	IK16TT	4
PORTE I (04-12)											
1.3 VVTi	64	2NZ-FE		07/04-07/12	K16R-U11	3120	1.1	K16TT	IK16TT	IK16TT	4
1.5 4WD	77	1NZ-FE		07/04-07/12	K16R-U11	3120	1.1	K16TT	IK16TT	IK16TT	4
1.5 VVTi	81	1NZ-FE		07/04-07/12	K16R-U11	3120	1.1	K16TT	IK16TT	IK16TT	4
PREMIO (01-07)											
1.5	80	1NZ-FE		12/01-05/07	K16R-U11	3120	1.1	K16TT	IK16TT	IK16TT	4
PREMIO (07-)											
1.5	81	1NZ-FE		07/07-11/12	FK16HR11	3450	1.1	-	IKH16TT	IKH16TT	4
1.5	81	1NZ-FE		07/07-11/12	IKH16TT	4703	1.0	-	IKH16TT	IKH16TT	4
1.8 4WD	98	2ZR-FAE		07/07-02/13	SC16HR11	3499	1.1	-	IXEH20TT	IXEH20TT	4
2.0 4WD	116	3ZR-FAE		07/07-	SC16HR11	3499	1.1	-	IXEH20TT	IXEH20TT	4
PREVIA / ESTIMA I (90-00)											
2.2D	76	3C-TE		01/92-12/93	DG-308		11V				4
2.2D	76	3C-TE		01/94-12/99	DG-671		11V				4
2.4	97	2TZ-FE		05/90-08/00	PK16R11	3134	1.1	K16TT	IK16TT	IK16TT	4
2.4	118	2TZ-FZE		09/93-12/97	PK20R11	3128	1.1	K20TT	IK20TT	IK20TT	4
2.4 4WD	97	2TZ-FE		01/90-08/00	PK16R11	3134	1.1	K16TT	IK16TT	IK16TT	4
2.4 4WD	118	2TZ-FZE		09/93-12/97	PK20R11	3128	1.1	K20TT	IK20TT	IK20TT	4
PREVIA / ESTIMA II (00-06)											
2.0 D-4D	85	1CD-FTV	Double Coil(LPH)	03/01-01/06	DG-245		11V				4
2.4	115	2AZ-FE		02/00-02/06	K20R-U11	3139	1.1	K20TT	IK20TT	IK20TT	4
2.4	115	2AZ-FE	LEAN BURN	02/00-02/06	SK20R11	3297	1.1	-	IK20TT	IK20TT	4
3.0	162	1MZ-FE		08/00-12/05	SK20R11	3297	1.1	-	IK20TT	IK20TT	6
3.0 4WD	162	1MZ-FE		02/00-12/05	SK20R11	3297	1.1	-	IK20TT	IK20TT	6
PREVIA / ESTIMA III (05-)											
2.4	125	2AZ-FE		10/05-05/12	SK20R11	3297	1.1	-	IK20TT	IK20TT	4
2.4	125	2AZ-FE		05/12-	SK16R11	3324	1.1	-	IK16TT	IK16TT	4
2.4 4WD	125	2AZ-FE		01/06-05/12	SK20R11	3297	1.1	-	IK20TT	IK20TT	4
2.4 4WD	125	2AZ-FE		05/12-	SK16R11	3324	1.1	-	IK16TT	IK16TT	4
PRIUS (W1) (00-04)											
1.5 Hybrid	53	1NZ-FXE		05/00-01/04	SK16R11	3324	1.1	-	IK16TT	IK16TT	4
PRIUS (W2) (03-09)											
1.5	57	1NZ-FXE		09/03-12/09	SK16R11	3324	1.1	-	IK16TT	IK16TT	4
PRIUS (W3) (09-)											
1.8 Hybrid	73	2ZR-FXE		06/08-	SC16HR11	3499	1.1	-	IXEH20TT	IXEH20TT	4
1.8 PHEV	73	2ZR-FXE		01/12-	SC16HR11	3499	1.1	-	IXEH20TT	IXEH20TT	4
PRIUS (W5) (15-)											
1.8 Hybrid	72	2ZR-FXE		09/15-	FC16HR-CY9	3517	0.9			FC16HR-CY9	4
1.8 PHEV	72	2ZR-FXE		01/16-	FC16HR-CY9	3517	0.9			FC16HR-CY9	4
PRIUS C (P1) (11-)											
1.5 Hybrid	54/74	1NZ-FXE		09/11-	FK16R-A8	3485	0.8	-	-	IK16TT	4
PRIUS Plus (W4) (11-)											
1.8 Hybrid	73	2ZR-FXE		05/11-	SC16HR11	3499	1.1	-	IXEH20TT	IXEH20TT	4
PROACE (13-16)											
1.6 D	66	3WZ-TV		06/13-03/16	DG-603		5V				4
2.0 D	94/ 120	4WZ-FHV; 4WZ-FTW		06/13-03/16	DG-603		5V				4
PROBOX / SUCCEED (02-14)											
1.3 VVTi	64	2NZ-FE		07/02-06/10	K16R-U11	3120	1.1	K16TT	IK16TT	IK16TT	4
1.3 VVTi	64	2NZ-FE		06/10-08/14	SK16R11	3324	1.1	-	IK16TT	IK16TT	4
1.5 VVTi	80	1NZ-FE		07/02-06/10	K16R-U11	3120	1.1	K16TT	IK16TT	IK16TT	4

Таблица применения

T

Свечи зажигания и Свечи накаливания

Таблица применения

Таблица применения

TOYOTA	KW	KW	NOTE	21	СТАНДАРТНЫЕ				Twin Tip		QTY
					1	2	3	4	1	2	
TOYOTA продолжение											
PROBOX / SUCCEED (02-14) продолжение											
1.5 VVTi	80	1NZ-FE		06/10-08/14	SK16R11	3324	1.1	-	IK16TT	IK16TT	4
1.5 VVTi 4WD	77	1NZ-FE		07/02-06/10	K16R-U11	3120	1.1	K16TT	IK16TT	IK16TT	4
1.5 VVTi 4WD	77	1NZ-FE		06/10-08/14	SK16R11	3324	1.1	-	IK16TT	IK16TT	4
PROGRES (97-07)											
2.5	147	1JZ-FSE		10/97-07/07	SK20BR11	3471	1.1	-	-	VKB20	6
3.0	162	2JZ-FSE		10/97-07/07	SK20BR11	3471	1.1	-	-	VKB20	6
RACTIS (05-10)											
1.3	64	2SZ-FE		09/05-08/10	SK16HR11	3417	1.1	-	IKH16TT	IKH16TT	4
1.5 VVTi	80	1NZ-FE		09/05-08/10	FK16HR11	3450	1.1	-	IKH16TT	IKH16TT	4
1.5 VVTi	80	1NZ-FE		09/05-08/10	IKH16TT	4703	1.0	-	IKH16TT		4
1.5 VVTi 4WD	76	1NZ-FE		09/05-08/10	FK16HR11	3450	1.1	-	IKH16TT	IKH16TT	4
1.5 VVTi 4WD	76	1NZ-FE		09/05-08/10	IKH16TT	4703	1.0	-	IKH16TT		4
RACTIS (10-)											
1.33	70/73	1NR-FE		11/10-	SC16HR11	3499	1.1	-	IXEH20TT	IXEH20TT	4
1.33	70/73	1NR-FKE		05/14-	FC16HR8	3504	0.8	-	IXEH20TT	IXEH20TT	4
1.5	80	1NZ-FE		11/10-06/11	FK20HR11	3426	1.1	-	IKH20TT	IKH20TT	4
1.5	80	1NZ-FE		06/11-04/14	FK16HR11	3450	1.1	-	IKH16TT	IKH16TT	4
1.5	80	1NZ-FE		06/11-04/14	IKH16TT	4703	1.0	-	IKH16TT		4
1.5 4WD	76	1NZ-FE		11/10-	K16R-U11	3120	1.1	K16TT	IK16TT	IK16TT	4
RAUM (97-03)											
1.5	69	5E-FE		08/97-04/03	K16TR11	3194	1.1	K16TT	IK16TT	IK16TT	4
1.5 4WD	67	5E-FE		08/97-04/03	K16TR11	3194	1.1	K16TT	IK16TT	IK16TT	4
RAUM (03-)											
1.5	80	1NZ-FE		05/03-	K16R-U11	3120	1.1	K16TT	IK16TT	IK16TT	4
1.5 4WD	77	1NZ-FE		05/03-	K16R-U11	3120	1.1	K16TT	IK16TT	IK16TT	4
RAV 4 I / FUNCROISER (94-00)											
2.0	95	3S-FE		09/97-09/00	K20TR11	3195	1.1	K20TT	IK20TT	IK20TT	4
2.0 4WD	94/99	3S-FE		01/94-06/00	K20TR11	3195	1.1	K20TT	IK20TT	IK20TT	4
2.0 4WD	94/99	3S-FE		09/97-06/00	K20R-U11	3139	1.1	K20TT	IK20TT	IK20TT	4
RAV 4 II (00-05)											
1.8	92	1ZZ-FE		08/00-11/05	K16R-U11	3120	1.1	K16TT	IK16TT	IK16TT	4
2.0 4WD	110	1AZ-FE		05/00-11/05	SK20R11	3297	1.1	-	IK20TT	IK20TT	4
2.0 D 4WD	85	1CD-FTV	Double Coil(LPH)	05/01-11/05	DG-245		11V				4
RAV 4 III (05-)											
2.0	116	3ZR-FAE		12/08-06/13	SC16HR11	3499	1.1	-	IXEH20TT	IXEH20TT	4
2.0 4WD	112	1AZ-FE		02/06-06/13	SK20R11	3297	1.1	-	IK20TT	IK20TT	4
2.0 4WD	116	3ZR-FAE		12/08-06/13	SC16HR11	3499	1.1	-	IXEH20TT	IXEH20TT	4
2.2 D	110	2AD-FHV; 2AD-FTV		12/08-06/13	DG-600		11V				4
2.2 D 4WD	100/110/130	2AD-FHV; 2AD-FTV		02/06-06/13	DG-600		11V				4
2.4	125	2AZ-FE		11/05-12/13	SK20R11	3297	1.1	-	IK20TT	IK20TT	4
3.5 4WD	201	2GR-FE		11/05-12/12	FK20HR11	3426	1.1	-	IKH20TT	IKH20TT	6
RAV 4 IV (12-)											
2.0 4WD	111	3ZR-FAE		12/12-	SC16HR11	3499	1.1	-	IXEH20TT	IXEH20TT	4
2.0 D	91	1AD-FTV		12/12-11/18	DG-600		11V				4
2.0 D	105	2WW	OE: 19850-WA020	10/15-11/18	DG-613		7V				4
2.0 D 4WD	91	1AD-FTV		01/13-11/18	DG-600		11V				4
2.0 VVT-i	107	3ZR-FAE		12/12-	SC16HR11	3499	1.1	-	IXEH20TT	IXEH20TT	4
2.2 D 4WD	110	2AD-FHV; 2AD-FTV		12/12-	DG-600		11V				4
2.5 4WD	132	2AR-FE		12/12-	SK16HR11	3417	1.1	-	IKH16TT	IKH16TT	4
2.5 Hybrid	114	2AR-FXE		10/15-11/18	FK16HR-A8	3484	0.8	-	-	FK16HR-A8	4
2.5 Hybrid 4WD	114	2AR-FXE		10/15-12/18	FK16HR-A8	3484	0.8	-	-	FK16HR-A8	4
RUSH (06-)											
1.5	80	3SZ-VE		03/06-	SXU22PR9	3434	0.9	-	IXU22TT	VXU22I	4
1.5 4WD	80	3SZ-VE		03/06-	SXU22PR9	3434	0.9	-	IXU22TT	VXU22I	4
SEQUOIA (00-07)											
4.7	175	2UZ-FE		09/00-10/07	SK20R11	3297	1.1	-	IK20TT	IK20TT	8
4.7 4WD	175	2UZ-FE		09/00-10/07	SK20R11	3297	1.1	-	IK20TT	IK20TT	8
SEQUOIA (07-)											
4.6	231	1UR-FE		01/10-07/12	SK20HR11	3421	1.1	-	IKH20TT	IKH20TT	8
4.7	206	2UZ-FE		11/07-04/14	SK20R11	3297	1.1	-	IK20TT	IK20TT	8
4.7 4WD	206	2UZ-FE		11/07-04/14	SK20R11	3297	1.1	-	IK20TT	IK20TT	8
5.7	280	3UR-FE		11/07-	SK20HR11	3421	1.1	-	IKH20TT	IKH20TT	8

Свечи зажигания и Свечи накаливания

Таблица применения





	KW				СТАНДАРТНЫЕ			Twin Tip			QTY
TOYOTA продолжение											
SERA (90-95)											
1.5	81	5E-FHE		03/90-11/95	K20R-U11	3139	1.1	K20TT	IK20TT	IK20TT	4
SIENNA (97-03)											
3.0	143/ 154	1MZ-FE		08/97-12/02	K20TR11	3195	1.1	K20TT	IK20TT	IK20TT	6
3.0	143/ 154	1MZ-FE	OEM Optional	08/97-12/02	PK20TR11	3253	1.1	K20TT	IK20TT	IK20TT	6
SIENNA (03-09)											
3.3	169	3MZ-FE		01/03-12/06	SK20R11	3297	1.1	-	IK20TT	IK20TT	6
3.3 4WD	169	3MZ-FE		01/03-11/09	SK20R11	3297	1.1	-	IK20TT	IK20TT	6
SIENNA (10-)											
3.5	198	2GR-FE		01/10-	FK20HR11	3426	1.1	-	IKH20TT	IKH20TT	6
3.5 4WD	198	2GR-FE		01/10-	FK20HR11	3426	1.1	-	IKH20TT	IKH20TT	6
SIENTA (15-)											
1.5	81	2NR-FKE		06/15-	FC16HR8	3504	0.8	-	IXEH20TT	IXEH20TT	4
1.5 4WD	76	1NZ-FE		06/15-	FK16HR11	3450	1.1	-	IKH16TT	IKH16TT	4
1.5 4WD	76	1NZ-FE		06/15-	IKH16TT	4703	1.0	-	IKH16TT		4
1.5 4WD	76	2NR-FKE		06/15-03/17	FC16HR8	3504	0.8	-	IXEH20TT	IXEH20TT	4
1.5 Hybrid	54	1NZ-FXE		06/15-	FK16BR-AL8	3511	0.8	-	-	FK16BR-AL8	4
SOARER (80-86)											
2.0	92/ 122	1G-EU		09/80-08/86	J16BR-U	3001	0.8	-	-		6
2.0 Turbo	118	1G-GEU		08/82-08/85	PQ16R	3005	1.1	Q16TT	IQ16TT	IQ16TT	6
2.0 Turbo	118	1G-GEU		08/82-08/85	PQ20R	3117	1.1	Q20TT	IQ20TT	IQ20TT	6
2.8	125	5M-GEU		09/80-01/84	W16EXR-U11	3032	1.1	W16TT	IW16TT	IW16TT	6
2.8	125	5M-GEU		01/84-08/85	P16R	3004	1.0	W20TT	IW20TT	IW20TT	6
3.0	170	7M-GTEU		09/85-08/86	PQ20R-P8	3113	0.8	-	IQ20TT	IQ20TT	6
SOARER (86-91)											
2.0 Turbo	136	1G-GTEU		09/86-03/91	PQ20R-P8	3113	0.8	-	IQ20TT	IQ20TT	6
3.0 Turbo	170	7M-GTEU		09/86-03/91	PQ20R-P8	3113	0.8	-	IQ20TT	IQ20TT	6
3.0 Turbo 4WD	170	7M-GTEU		09/86-03/91	PQ20R-P8	3113	0.8	-	IQ20TT	IQ20TT	6
SOARER (90-00)											
2.5 Turbo	206	1JZ-GTE		09/90-08/96	PK20R8	3127	0.8	-	IK20TT	IK20TT	6
2.5 Turbo	206	1JZ-GTE		08/96-09/00	PK20TR11	3253	1.1	K20TT	IK20TT	IK20TT	6
3.0	166	2JZ-GE		09/90-08/97	PK16R11	3134	1.1	K16TT	IK16TT	IK16TT	6
3.0	166	2JZ-GE		08/97-09/00	PK16TR11	3289	1.1	K16TT	IK16TT	IK16TT	6
4.0	191	1UZ-FE		05/92-09/97	PK20R11	3128	1.1	K20TT	IK20TT	IK20TT	8
SPADE (12-)											
1.3	73	1NR-FE		08/12-	SC16HR11	3499	1.1	-	IXEH20TT	IXEH20TT	4
SPRINTER (82-02)											
1.5	74	5A-FE		06/91-11/02	K16R-U11	3120	1.1	K16TT	IK16TT	IK16TT	4
1.6	81	4A-FE		06/92-10/01	K16R-U11	3120	1.1	K16TT	IK16TT	IK16TT	4
1.6	81	4A-FE		05/93-05/96	PK20R11	3128	1.1	K20TT	IK20TT	IK20TT	4
1.6 4WD	68	4A-F		11/87-10/89	Q16R-U	3129	0.8	Q16TT	IQ16TT	IQ16TT	4
STARLET (P6) (78-84)											
1.0	33	2K		02/78-09/84	W16EXR-U	3031	0.8	W16TT	IW16TT	IW16TT	4
1.2	39/41	3K-H		02/78-09/82	W16EX-U	3027	0.8	W16TT	IW16TT	IW16TT	4
1.2 S	39	3K-H		10/78-08/82	W16EX-U	3027	0.8	W16TT	IW16TT	IW16TT	4
1.3	41/ 43/46	4K; 4K-C		02/78-12/84	W16EX-U	3027	0.8	W16TT	IW16TT	IW16TT	4
1.3	41/ 43/46	4K-J/ 4K-U		02/78-12/84	J16BR-U	3001	0.8	-	-		4
1.3 S	48	4K		08/82-09/84	W16EX-U	3027	0.8	W16TT	IW16TT	IW16TT	4
1.3 S	48	4K-J/ 4K-U		08/82-09/84	J16BR-U	3001	0.8	-	-		4
STARLET (P7) (84-89)											
1.0	40	1E-L		10/84-12/89	W20EXR-U	3066	0.8	W20TT	IW20TT	IW20TT	4
1.3	55	2E-LC		10/84-12/89	W16EXR-U11	3032	1.1	W16TT	IW16TT	IW16TT	4
1.5 D	40	1N	Single Coil	12/86-12/89	DG-215		7V				4
STARLET (P8) (89-96)											
1.0	40	1E		12/89-12/92	W20EXR-U	3066	0.8	W20TT	IW20TT	IW20TT	4
1.3 12V	55	2E; 2E-E		12/89-12/92	W16EXR-U11	3032	1.1	W16TT	IW16TT	IW16TT	4
1.3 12V Cat	55	2E-E		12/89-03/96	W16EXR-U11	3032	1.1	W16TT	IW16TT	IW16TT	4
1.3 Turbo	99	4E-FTE		12/89-12/95	PK20R11	3128	1.1	K20TT	IK20TT	IK20TT	4
1.3 XL	52	2E		12/89-12/91	W16EXR-U11	3032	1.1	W16TT	IW16TT	IW16TT	4
1.5 D	40	1N	Single Coil	12/89-03/96	DG-648		11V				4
STARLET (P9) (96-99)											
1.3	55	4E-FE		01/96-10/99	K16R-U11	3120	1.1	K16TT	IK16TT	IK16TT	4

Таблица применения

Т

Свечи зажигания и Свечи накаливания











Таблица применения

Таблица применения

TOYOTA продолжение	KW	KW	NOTE	21	СТАНДАРТНЫЕ			Twin Tip			QTY
					W16EXR-U	3031	0.8	W16TT	IW16TT	IW16TT	
STARLET 1000 (74-78)											
1.0	33	2K		11/74-08/78	W16EXR-U	3031	0.8	W16TT	IW16TT	IW16TT	4
SUPRA (86-93)											
2.0 i Bi-Turbo	153	1G-GTEU		08/89-05/93	PQ20R-P8	3113	0.8	-	IQ20TT	IQ20TT	6
3.0	140	7M-GE		01/86-05/93	PQ16R	3005	1.1	Q16TT	IQ16TT	IQ16TT	6
3.0 24V	150	7M-GE		01/86-08/88	PQ16R	3005	1.1	Q16TT	IQ16TT	IQ16TT	6
3.0 Turbo	173/ 175	7M-GTE		09/87-05/93	PQ20R-P8	3113	0.8	-	IQ20TT	IQ20TT	6
SUPRA (93-02)											
3.0	165	2JZ-GE		05/93-09/97	PK16R11	3134	1.1	K16TT	IK16TT	IK16TT	6
3.0	165	2JZ-GE		09/97-10/99	PK16TR11	3289	1.1	K16TT	IK16TT	IK16TT	6
3.0 i	168	2JZ-GE		05/93-09/97	PK16R11	3134	1.1	K16TT	IK16TT	IK16TT	6
3.0 i	168	2JZ-GE		09/97-07/02	PK16TR11	3289	1.1	K16TT	IK16TT	IK16TT	6
3.0 i Bi-Turbo	240/ 243	2JZ-GTE		05/93-08/97	PK20R11	3128	1.1	K20TT	IK20TT	IK20TT	6
3.0 i Bi-Turbo	240/ 243	2JZ-GTE		08/97-07/02	PK20TR11	3253	1.1	K20TT	IK20TT	IK20TT	6
TERCEL (79-88)											
1.3	48	2A		03/79-01/88	W16EXR-U	3031	0.8	W16TT	IW16TT	IW16TT	4
1.3	48/55	2A; 2A-U		03/79-01/88	W14EXR-U11	3014	1.1	-	IW16TT	IW16TT	4
1.5	52/61	3A; 3A-C; 3A-U		08/82-12/88	W14EXR-U11	3014	1.1	-	IW16TT	IW16TT	4
1.5 4WD	50/52	3A-C		09/82-01/88	W14EXR-U11	3014	1.1	-	IW16TT	IW16TT	4
TERCEL (86-94)											
1.3 12V	53	2E		05/86-08/90	W16EXR-U11	3032	1.1	W16TT	IW16TT	IW16TT	4
TOWN ACE (85-91)											
2.0 4WD	70	3Y-EU		08/85-12/91	P16R	3004	1.0	W20TT	IW20TT	IW20TT	4
2.0 TD	62	2C-T	Double Coil(LPH)	08/88-12/91	DG-649		10.5V				4
2.0 TD	62	2C-T	Single Coil	04/85-07/88	DG-652		7V				4
TOWN ACE (92-01)											
2.0	65	3Y-C		05/95-09/01	W16EXR-U	3031	0.8	W16TT	IW16TT	IW16TT	4
2.0	94	3S-FE		10/96-12/99	K20TR11	3195	1.1	K20TT	IK20TT	IK20TT	4
2.0 4WD	96	3S-FE		10/96-10/01	K20TR11	3195	1.1	K20TT	IK20TT	IK20TT	4
2.0 D	51	2C	OE:19850-6402 0	01/92-04/95	DG-216		11V				4
TOYOACE (79-95)											
3.0 D	59	B	Cold spec, OE:19850-5402 0	03/79-07/83	DG-238		23V				4
3.0 D	59	B	OE:19850-5401 0	03/79-07/83	DG-648		11V				4
TOYOACE (11-)											
2.0	98	1TR-FE		06/11-	IKBH20TT	4705	1.0	-	IKBH20TT		4
2.0 LPG	85	1TR-FPE		06/11-	VKH20Y	5639	0.8	-	-	VKH20Y	4
2.0 LPG 4WD	85	1TR-FPE		06/11-	VKH20Y	5639	0.8	-	-	VKH20Y	4
TUNDRA (99-06)											
3.4 4WD	140	5VZ-FE		04/99-07/04	PK16TR11	3289	1.1	K16TT	IK16TT	IK16TT	6
4.7	206	2UZ-FE		02/99-11/06	SK20R11	3297	1.1	-	IK20TT	IK20TT	8
4.7 (UCK30)	206	2UZ-FE		02/99-10/06	SK20R11	3297	1.1	-	IK20TT	IK20TT	8
4.7 4WD	206	2UZ-FE		02/99-11/06	SK20R11	3297	1.1	-	IK20TT	IK20TT	8
4.7 4WD (UCK40)	206	2UZ-FE		02/99-10/06	SK20R11	3297	1.1	-	IK20TT	IK20TT	8
TUNDRA (07-)											
4.0	176	1GR-FE		11/06-	K20HR-U11	3381	1.1	KH20TT	IKH20TT	IKH20TT	6
4.0 4WD	176	1GR-FE		11/06-12/11	K20HR-U11	3381	1.1	KH20TT	IKH20TT	IKH20TT	6
4.7	206	2UZ-FE		11/06-03/09	SK20R11	3297	1.1	-	IK20TT	IK20TT	8
4.7 4WD	206	2UZ-FE		11/06-12/09	SK20R11	3297	1.1	-	IK20TT	IK20TT	8
5.7	284	3UR-FE		11/06-	SK20HR11	3421	1.1	-	IKH20TT	IKH20TT	8
5.7 4WD	284	3UR-FE		11/06-	SK20HR11	3421	1.1	-	IKH20TT	IKH20TT	8
URBAN CRUISER (07-)											
1.33	74	1NR-FE		01/09-03/16	SC16HR11	3499	1.1	-	IXEH20TT	IXEH20TT	4
1.4 D-4D	66	1ND-TV	OE:19850-3302 0	01/09-04/14	DG-659		11V				4
1.4 D-4D 4WD	66	1ND-TV	OE:19850-3302 0	01/09-04/14	DG-659		11V				4
1.5 VVTi	80	1NZ-FE		07/07-11/07	FK20HR11	3426	1.1	-	IKH20TT	IKH20TT	4
1.5 VVTi	80	1NZ-FE		11/07-03/16	FK16HR11	3450	1.1	-	IKH16TT	IKH16TT	4
1.5 VVTi	80	1NZ-FE		11/07-03/16	IKH16TT	4703	1.0	-	IKH16TT		4
1.5 VVTi 4WD	76	1NZ-FE		07/07-11/07	FK20HR11	3426	1.1	-	IKH20TT	IKH20TT	4
1.5 VVTi 4WD	76	1NZ-FE		11/07-03/16	FK16HR11	3450	1.1	-	IKH16TT	IKH16TT	4
1.5 VVTi 4WD	76	1NZ-FE		11/07-03/16	IKH16TT	4703	1.0	-	IKH16TT		4

Свечи зажигания и Свечи накаливания

Таблица применения

	KW				СТАНДАРТНЫЕ				Twin Tip		QTY
											
TOYOTA продолжение											
VENZA (08-)											
3.5 4WD	200	2GR-FE		11/08-11/16	FK20HR11	3426	1.1	-	IKH20TT	IKH20TT	6
VEROSSA (00-03)											
2.0 VVTi	118	1G-FE		10/00-11/03	K20R-U11	3139	1.1	K20TT	IK20TT	IK20TT	6
2.0 VVTi 4WD	118	1G-FE		10/00-11/03	K20R-U11	3139	1.1	K20TT	IK20TT	IK20TT	6
2.5 VVTi	147	1JZ-FSE		10/00-11/03	SK20BR11	3471	1.1	-	-	VKB20	6
2.5 VVTi	206	1JZ-GTE		10/00-11/03	PK20TR11	3253	1.1	K20TT	IK20TT	IK20TT	6
VERSO (09-)											
1.6	97	1ZR-FAE		04/09-08/18	SC16HR11	3499	1.1	-	IXEH20TT	IXEH20TT	4
1.6 D4-D	82	1WW	OE: 19850-WA020	11/13-08/18	DG-613		7V				4
1.8	108	2ZR-FAE		04/09-08/18	SC16HR11	3499	1.1	-	IXEH20TT	IXEH20TT	4
2.0 D-4D	91/93	1AD-FTV		04/09-08/18	DG-600		11V				4
2.2 D-4D	110	2AD-FHV		04/09-08/18	DG-600		11V				4
2.2 D-CAT	130	2AD-FHV		04/09-08/18	DG-600		11V				4
VERSO S (10-16)											
1.33	73	1NR-FE		11/10-10/16	SC16HR11	3499	1.1	-	IXEH20TT	IXEH20TT	4
1.4 D4-D	66	1ND-TV	OE:19850-3302 0	11/10-10/16	DG-659		11V				4
VIOS / YARIS (07-)											
1.0	52	1KR-FE		09/05-02/12	K16HR-U11	3482	1.1	KH16TT	IKH16TT	IKH16TT	3
1.3	64	2NZ-FE		09/05-10/13	K16R-U11	3120	1.1	K16TT	IK16TT	IK16TT	4
1.3	64	2SZ-FE		09/05-10/13	SK16HR11	3417	1.1	-	IKH16TT	IKH16TT	4
1.3 4WD	64	2NZ-FE		08/07-04/13	K16R-U11	3120	1.1	K16TT	IK16TT	IK16TT	4
VIOS (02-08)											
1.5	68	5A-FE		07/02-01/08	K16R-U11	3120	1.1	K16TT	IK16TT	IK16TT	4
VISTA (V3, V4) (90-98)											
2.0	96	3S-FE		01/94-05/96	K20R-U11	3139	1.1	K20TT	IK20TT	IK20TT	4
2.0	96	3S-FE		05/96-05/98	K20TR11	3195	1.1	K20TT	IK20TT	IK20TT	4
2.0 4WD	96	3S-FE		01/94-05/96	K20R-U11	3139	1.1	K20TT	IK20TT	IK20TT	4
2.0 4WD	96	3S-FE		05/96-05/98	K20TR11	3195	1.1	K20TT	IK20TT	IK20TT	4
VISTA (V5) (98-03)											
1.8	96	1ZZ-FE		06/98-04/00	K16TR11	3194	1.1	K16TT	IK16TT	IK16TT	4
1.8	96	1ZZ-FE		04/00-08/03	K16R-U11	3120	1.1	K16TT	IK16TT	IK16TT	4
2.0	107	3S-FSE		06/98-08/03	PK20GR8	3326	0.8	-	-	VKA20	4
2.0	112	1AZ-FE		06/98-08/03	SK20R11	3297	1.1	-	IK20TT	IK20TT	4
2.0	112	1AZ-FSE		06/98-08/03	SK20BGR11	3472	1.1	-	-	VKA20	4
WILL Cypha (01-05)											
1.3 VVTi	62	2NZ-FE		05/01-07/05	K16R-U11	3120	1.1	K16TT	IK16TT	IK16TT	4
1.5 VVTi 4WD	78	1NZ-FE		05/01-07/05	K16R-U11	3120	1.1	K16TT	IK16TT	IK16TT	4
WILL Vi (00-01)											
1.3	64	2NZ-FE		01/00-12/01	K16R-U11	3120	1.1	K16TT	IK16TT	IK16TT	4
WILL VS (01-04)											
1.5 VVTi 4WD	81	1NZ-FE		03/01-04/04	K16R-U11	3120	1.1	K16TT	IK16TT	IK16TT	4
WINDOM (91-96)											
3.0	138	3VZ-FE		07/91-09/96	PQ20R	3117	1.1	Q20TT	IQ20TT	IQ20TT	6
WINDOM (96-01)											
2.5	147	2MZ-FE		10/96-07/01	PK20TR11	3253	1.1	K20TT	IK20TT	IK20TT	6
3.0	155	1MZ-FE		10/96-07/01	K20TR11	3195	1.1	K20TT	IK20TT	IK20TT	6
3.0	155	1MZ-FE	OEM Optional	10/96-07/01	PK20TR11	3253	1.1	K20TT	IK20TT	IK20TT	6
WINDOM (01-06)											
3.0 VVTi G	158	1MZ-FE		08/01-07/04	SK20R11	3297	1.1	-	IK20TT	IK20TT	6
WISH (03-09)											
1.8 Hi	97	1ZZ-FE		04/03-03/09	K16R-U11	3120	1.1	K16TT	IK16TT	IK16TT	4
1.8 Hi 4WD	92	1ZZ-FE		04/03-03/09	K16R-U11	3120	1.1	K16TT	IK16TT	IK16TT	4
YARIS (99-05)											
1.0	48/50	1SZ-FE	France	01/01-09/05	K20R-U11	3139	1.1	K20TT	IK20TT	IK20TT	4
1.0	50	1SZ-FE	Japan	04/99-12/02	K16R-U	3119	0.8	K16TT	IK16TT	IK16TT	4
1.3	64	2NZ-FE		11/99-10/05	K16R-U11	3120	1.1	K16TT	IK16TT	IK16TT	4
1.3	64	2SZ-FE		11/99-10/05	SK16HR11	3417	1.1	-	IKH16TT	IKH16TT	4
1.3	64	2SZ-FE		02/03-09/05	K16R-U	3119	0.8	K16TT	IK16TT	IK16TT	4
1.4 D-4D	55	1ND-TV	OE: 19850-0W010, Double Coi (LPH)	10/01-09/05	DG-240		11V				4
1.5	77/ 110	1NZ-FE		03/00-11/05	K16R-U11	3120	1.1	K16TT	IK16TT	IK16TT	4

Свечи зажигания и Свечи накаливания





Таблица применения

Таблица применения

TOYOTA	KW	KW	NOTE	21	СТАНДАРТНЫЕ			Twin Tip		QTY	
					1	2	3	1	2		
TOYOTA продолжение											
YARIS (05-11)											
1.0 GPL	51	1KR-FE	LPG / GPL	01/06-06/11	SK16HR11	3417	1.1	-	IKH16TT	IKH16TT	3
1.0 VVT-i	51	1KR-FE		08/05-06/11	K16HR-U11	3482	1.1	KH16TT	IKH16TT	IKH16TT	3
1.3 4WD	64	2NZ-FE		08/07-11/10	K16R-U11	3120	1.1	K16TT	IK16TT	IK16TT	4
1.3 4WD	64	2SZ-FE		08/07-11/10	SK16HR11	3417	1.1	-	IKH16TT	IKH16TT	4
1.3 VVT-i	64	2NZ-FE		11/05-12/12	K16R-U11	3120	1.1	K16TT	IK16TT	IK16TT	4
1.3 VVT-i	64	2SZFE		08/05-11/10	K16R-U	3119	0.8	K16TT	IK16TT	IK16TT	3
1.3 VVT-i	64	2SZ-FE		11/05-12/12	SK16HR11	3417	1.1	-	IKH16TT	IKH16TT	4
1.33 VVT-i	74	1NR-FE		07/10-05/11	SC16HR11	3499	1.1	-	IXEH20TT	IXEH20TT	4
1.33 VVT-i	74	1NR-FE	France	11/08-12/11	SC16HR11	3499	1.1	-	IXEH20TT	IXEH20TT	4
1.4 D-4D	66	1ND-TV	OE: 19850-0W010, Double Coi I(LPH)	08/05-11/08	DG-240		11V				4
1.4 D-4D	66	1ND-TV	OE:19850-33020	11/08-12/12	DG-659		11V				4
1.8 VVT-i	98	2ZR-FE		01/07-12/11	SC16HR11	3499	1.1	-	IXEH20TT	IXEH20TT	4
YARIS (10-)											
1.0	51	1KR-FE		12/10-11/13	SK16HR11	3417	1.1	-	IKH16TT	IKH16TT	3
1.0	51	1KR-FE		11/13-05/18	SC16HR11	3499	1.1	-	IXEH20TT	IXEH20TT	3
1.3	73	1NR-FE		09/11-	SC16HR11	3499	1.1	-	IXEH20TT	IXEH20TT	4
1.3	73	1NR-FKE		11/13-	FC16HR8	3504	0.8	-	IXEH20TT	IXEH20TT	4
1.3 4WD	70	1NR-FE		12/10-	SC16HR11	3499	1.1	-	IXEH20TT	IXEH20TT	4
1.3 4WD	70	1NR-FKE		11/13-	FC16HR8	3504	0.8	-	IXEH20TT	IXEH20TT	4
1.4 D	66	1ND-TV	OE:19850-33020	09/11-07/14	DG-659		11V				4
1.5 Hybrid	55	1NZ-FXE		03/12-	FK16R-A8	3485	0.8	-	-	IK16TT	4
1.5 Hybrid	55	1NZ-FXE		01/17-	FK16BR-AL8	3511	0.8	-	-	FK16BR-AL8	4
YARIS VERSO (99-05)											
1.3	62	2NZ-FE		08/99-09/05	K16R-U11	3120	1.1	K16TT	IK16TT	IK16TT	4
1.4 D-4D	55	1ND-TV	OE: 19850-0W010, Double Coi I(LPH)	09/00-09/05	DG-240		11V				4
1.5	77	1NZ-FE		03/00-09/05	K16R-U11	3120	1.1	K16TT	IK16TT	IK16TT	4
1.5 4WD	78	1NZ-FE		03/00-09/05	K16R-U11	3120	1.1	K16TT	IK16TT	IK16TT	4
TOYOTA (FAW)											
LAND CRUISER (J200) (07-)											
4.0 AWD (GRJ200)	179	1GR-FE		12/07-12/12	K20HR-U11	3381	1.1	KH20TT	IKH20TT	IKH20TT	6
4.7 (UZJ200)	202	2UZ		12/07-12/12	SK20R11	3297	1.1	-	IK20TT	IK20TT	8
PRADO (03-10)											
4.0 AWD (GRJ120, GRJ121, GRJ125)	179	1GR-FE		10/03-06/10	K20HR-U11	3381	1.1	KH20TT	IKH20TT	IKH20TT	6
TOYOTA (GAC)											
HIGHLANDER (09-)											
2.7 (ASU40)	140	1AR-FE		05/09-12/12	SK16HR11	3417	1.1	-	IKH16TT	IKH16TT	4
2.7 (ASU40_)	138	1AR-FE		01/11-12/15	SK16HR11	3417	1.1	-	IKH16TT	IKH16TT	4
3.5 4WD (GSU45)	201	2GR-FE		05/09-12/15	FK20HR11	3426	1.1	-	IKH20TT	IKH20TT	6
TRABANT											
1.1 (90-91)											
1.1	30	4VO5/9 / 7/5GRF		05/90-12/91	W20EP-U	3043	0.8	W20TT	IW20TT	IW20TT	4
P 601 (66-90)											
0.6	19	P63/64		01/66-04/90	W22FS-U	4025	0.7	-	-		2
TRIUMPH											
2000 (68-77)											
2.0 TC	68	20TC		04/75-12/77	W16EPR-U	3021	0.8	W16TT	IW16TT	IW16TT	6
2500 (74-77)											
S	79			04/75-12/77	W16EPR-U	3021	0.8	W16TT	IW16TT	IW16TT	6
ACCLAIM (82-85)											
1.3 (XD)	51	EN		01/82-06/84	K20PR-U	3145	0.8	K20TT	IK20TT	IK20TT	4
SPITFIRE (62-80)											
1500	51	FM11		01/75-01/80	W16EPR-U	3021	0.8	W16TT	IW16TT	IW16TT	4
STAG (70-77)											
3.0	107			01/70-12/77	W16EPR-U	3021	0.8	W16TT	IW16TT	IW16TT	8
TVR											
280 (83-86)											
2.8 i	110	PRN		01/83-12/86	W22EPR-U	3088	0.8	W22TT	-	WV22	6
350 (83-89)											
3.5 i	145	37A		01/83-12/89	W20EPR-U	3047	0.8	W20TT	IW20TT	IW20TT	8

Свечи зажигания и Свечи накаливания

Таблица применения

	KW				СТАНДАРТНЫЕ			Twin Tip			QTY
TVR продолжение											
390 (84-89)											
3.9	205			01/84-12/89	W22EPR-U	3088	0.8	W22TT	-	VW22	8
400 (89-93)											
3.9	200/ 202	37A40P		01/89-12/93	W22ESR-U	3098	0.8	-	-		8
420 (85-89)											
4.2	224			01/85-12/89	W22EPR-U	3088	0.8	W22TT	-	VW22	8
450 (89-93)											
4.4	238			01/89-12/93	W22ESR-U	3098	0.8	-	-		8
CERBERA (96-03)											
4.0	268	AJA6		01/99-10/03	XU24EPR-U	3312	0.9	-	-	VXU24	6
4.2	257/ 265/ 268	AJP8		01/96-10/03	K20TXR	5063	1.0	K20TT	IK20TT	IK20TT	8
4.5	313	AJP8-4.5		01/97-10/03	K20TXR	5063	1.0	K20TT	IK20TT	IK20TT	8
4.5 GT	324	AJP8-4.5		01/96-10/03	K20TXR	5063	1.0	K20TT	IK20TT	IK20TT	8
CHIMAERA (92-03)											
3.9	177	39SE		01/93-10/03	W22ESR-U	3098	0.8	-	-		8
4.3	206	40D		01/93-12/93	W22ESR-U	3098	0.8	-	-		8
5.0	217/ 235/ 243/ 250	37A50P; 47A50P; J8T		11/92-03/02	W22ESR-U	3098	0.8	-	-		8
GRIFFITH (90-02)											
4.0	177	37A40P		01/90-12/93	W22ESR-U	3098	0.8	-	-		8
4.3	206	40D		01/90-12/93	W22ESR-U	3098	0.8	-	-		8
5.0	235/ 243/ 250/ 254	37A50P; 47A50P; J8T		10/92-03/02	W22ESR-U	3098	0.8	-	-		8
S (86-96)											
2.9	125			01/88-12/96	T20EPR-U	5032	0.8	T20TT	IT20TT	IT20TT	6
SPEED EIGHT (89-92)											
3.9	168	37A40P		01/89-12/92	W22ESR-U	3098	0.8	-	-		8
4.3	198	40D		01/89-12/91	W22ESR-U	3098	0.8	-	-		8
UAZ											
452 (66-)											
2.4	52	UMZ 451M		08/66-11/11	W14F-U	4012	0.7	-	-		4
2.4 4x4	63	UMZ 4178.10		01/07-	W14FR-U	4017	0.7	-	-		4
2.7 4x4	82	ZMZ- 409210; ZMZ-409.10		05/09-	Q16PR-U	3137	0.8	Q16TT	IQ16TT	IQ16TT	4
2.7 4x4	82/97	ZMZ-409.10		10/96-	W16EPR-U	3021	0.8	W16TT	IW16TT	IW16TT	4
469 B (71-)											
2.4	52	UMZ 451M		12/72-08/84	W14F-U	4012	0.7	-	-		4
2.4	59	ZMZ- 402110		09/84-09/93	W16FPR-U	4192	0.7	-	-		4
2.4	63	UMZ 4178.10		01/07-	W14FR-U	4017	0.7	-	-		4
2.7	82/ 83/97	ZMZ-409210		10/96-	W16EPR-U	3021	0.8	W16TT	IW16TT	IW16TT	4
2.9	62	UMZ-4218.10		04/85-01/01	W14F-U	4012	0.7	-	-		4
2.9	62/82	UMZ-4218		04/85-	W14FR-U	4017	0.7	-	-		4
2.9	62/82	UMZ-4218.10		01/01-	W16FPR-U	4192	0.7	-	-		4
2206 (06-)											
2.7 4x4	82	ZMZ- 409210		05/14-	Q16PR-U	3137	0.8	Q16TT	IQ16TT	IQ16TT	4
2315 Pick-up (96-)											
2.5	75	UMZ-420		01/01-	W16FPR-U	4192	0.7	-	-		4
3160 (94-03)											
2.4 i	76	UMZ 4178.10		01/94-01/01	W14F-U	4012	0.7	-	-		4
2.4 i	76	UMZ 4178.10		01/01-12/03	W14FR-U	4017	0.7	-	-		4
2.7 4x4	97	ZMZ- 409210		02/00-12/03	W16EPR-U	3021	0.8	W16TT	IW16TT	IW16TT	4
2.9	76	UMZ-4218		01/94-12/03	W14FR-U	4017	0.7	-	-		4
2.9	76	UMZ-4218.10		01/94-01/01	W14F-U	4012	0.7	-	-		4
2.9	76	UMZ-4218.10		01/01-12/03	W16FPR-U	4192	0.7	-	-		4
2.9	107	UMZ-249		01/01-12/03	W20EPR-U	3047	0.8	W20TT	IW20TT	IW20TT	4
2.9 i	88	UMZ- 421310		01/94-01/01	W20FP-U	3068	0.7	WF20TT	-		4
2.9 i	88	UMZ- 421310		01/01-12/03	W16FPR-U	4192	0.7	-	-		4
31512 (98-)											
2.1 D	61	XUD11 A	Double Coil(LPH)	01/98-02/02	DG-001		11V				4
4.3 V6	135	UMZ-417811		07/97-02/00	W16FS-U	3034	0.7	-	-		6

Свечи зажигания и Свечи накаливания

Таблица применения

Таблица применения

KW	KW	KW	KW	KW	СТАНДАРТНЫЕ			Twin Tip			QTY
					mm	mm	mm	mm	mm	mm	
UAZ (продолжение)											
BARS (3159) (99-)											
2.7	97	ZMZ-409.10		01/99-12/08	W16EPR-U	3021	0.8	W16TT	IW16TT	IW16TT	4
2.7	97	ZMZ-409.10		01/08-	Q16PR-U	3137	0.8	Q16TT	IQ16TT	IQ16TT	4
2.7 AWD	97	ZMZ-409.10		11/99-12/08	W16EPR-U	3021	0.8	W16TT	IW16TT	IW16TT	4
2.7 AWD	97	ZMZ-409.10		01/08-12/04	Q16PR-U	3137	0.8	Q16TT	IQ16TT	IQ16TT	4
2.9	107	UMZ-249		01/03-	W20EPR-U	3047	0.8	W20TT	IW20TT	IW20TT	4
BUKHANKA (3741) (85-)											
2.5	66	UMZ 4178.10		01/89-01/01	W14F-U	4012	0.7	-	-		4
2.5	66	UMZ 4178.10		01/01-	W14FR-U	4017	0.7	-	-		4
2.5	66/75	UMZ-420; ZMZ-4021.10		12/97-	W16FPR-U	4192	0.7	-	-		4
2.7	105	ZMZ-409.10		01/02-	W16EPR-U	3021	0.8	W16TT	IW16TT	IW16TT	4
2.7	105	ZMZ-409.10		01/08-	Q16PR-U	3137	0.8	Q16TT	IQ16TT	IQ16TT	4
2.9	79	UMZ-4218		01/96-	W14FR-U	4017	0.7	-	-		4
2.9	79	UMZ-4218.10		01/96-01/01	W14F-U	4012	0.7	-	-		4
2.9	79/85	UMZ-4213; UMZ-4218.10		01/01-	W16FPR-U	4192	0.7	-	-		4
2.9	107	UMZ-249		01/03-	W20EPR-U	3047	0.8	W20TT	IW20TT	IW20TT	4
CARGO (2360) (04-)											
2.7	94	ZMZ-409.10		07/04-12/08	W16EPR-U	3021	0.8	W16TT	IW16TT	IW16TT	4
2.7	94	ZMZ-409.10		01/08-09/17	Q16PR-U	3137	0.8	Q16TT	IQ16TT	IQ16TT	4
FARMER (3909) (85-)											
2.5	66	UMZ 4178.10		01/89-01/01	W14F-U	4012	0.7	-	-		4
2.5	66	UMZ 4178.10		01/01-	W14FR-U	4017	0.7	-	-		4
2.5	66/75	UMZ-420; ZMZ-4021.10		12/97-	W16FPR-U	4192	0.7	-	-		4
2.7	105	ZMZ-409.10		01/02-	W16EPR-U	3021	0.8	W16TT	IW16TT	IW16TT	4
2.9	79	UMZ-4218		01/96-	W14FR-U	4017	0.7	-	-		4
2.9	79	UMZ-4218.10		01/96-01/01	W14F-U	4012	0.7	-	-		4
2.9	79/85	UMZ-4213; UMZ-4218.10		01/01-	W16FPR-U	4192	0.7	-	-		4
2.9	107	UMZ-249		01/03-	W20EPR-U	3047	0.8	W20TT	IW20TT	IW20TT	4
GOLOVASTIK (3303) (85-)											
2.5	66	UMZ 4178.10		01/89-01/01	W14F-U	4012	0.7	-	-		4
2.5	66	UMZ 4178.10		01/01-	W14FR-U	4017	0.7	-	-		4
2.5	66/75	UMZ-420; ZMZ-4021.10		12/97-	W16FPR-U	4192	0.7	-	-		4
2.7	105	ZMZ-409.10		01/02-	W16EPR-U	3021	0.8	W16TT	IW16TT	IW16TT	4
2.7	105	ZMZ-409.10		01/08-	Q16PR-U	3137	0.8	Q16TT	IQ16TT	IQ16TT	4
2.9	79	UMZ-4218		01/96-	W14FR-U	4017	0.7	-	-		4
2.9	79	UMZ-4218.10		01/96-01/01	W14F-U	4012	0.7	-	-		4
2.9	79/85	UMZ-4213; UMZ-4218.10		01/01-	W16FPR-U	4192	0.7	-	-		4
2.9	107	UMZ-249		01/03-	W20EPR-U	3047	0.8	W20TT	IW20TT	IW20TT	4
HUNTER (3151) (92-)											
2.4 4x4	72	UMZ 4178.10		01/99-01/01	W14F-U	4012	0.7	-	-		4
2.4 4x4	72	UMZ 4178.10		01/01-	W14FR-U	4017	0.7	-	-		4
2.5	66/75	UMZ-420; ZMZ-4021.10		12/97-	W16FPR-U	4192	0.7	-	-		4
2.7	82/94	ZMZ-409.10; ZMZ-40905		10/92-12/08	W16EPR-U	3021	0.8	W16TT	IW16TT	IW16TT	4
2.7	82/94	ZMZ-409.10; ZMZ-40905		01/08-	Q16PR-U	3137	0.8	Q16TT	IQ16TT	IQ16TT	4
2.9	75/81	UMZ-4213		01/01-	W16FPR-U	4192	0.7	-	-		4
2.9	107	UMZ-249		01/03-	W20EPR-U	3047	0.8	W20TT	IW20TT	IW20TT	4
2.9 4x4 (31514)	62	UMZ-4218		10/92-12/04	W14FR-U	4017	0.7	-	-		4
2.9 4x4 (31514)	62	UMZ-4218.10		10/92-01/01	W14F-U	4012	0.7	-	-		4
2.9 4x4 (31514)	62	UMZ-4218.10		01/01-12/04	W16FPR-U	4192	0.7	-	-		4
PATRIOT (04-)											
2.7	82/94	ZMZ- 409210; ZMZ-409.10		07/04-12/08	W16EPR-U	3021	0.8	W16TT	IW16TT	IW16TT	4
2.7	82/94	ZMZ- 409210; ZMZ-409.10		01/08-	Q16PR-U	3137	0.8	Q16TT	IQ16TT	IQ16TT	4
PICKUP (09-)											
2.7 4x4	99	ZMZ-40906		01/09-	Q16PR-U	3137	0.8	Q16TT	IQ16TT	IQ16TT	4
SIBIR (3162) (97-)											
2.7	105	ZMZ-409.10		01/02-	W16EPR-U	3021	0.8	W16TT	IW16TT	IW16TT	4
2.7 4x4	94	ZMZ- 409210		02/04-12/08	W16EPR-U	3021	0.8	W16TT	IW16TT	IW16TT	4
2.7 4x4	94	ZMZ- 409210		01/08-12/07	Q16PR-U	3137	0.8	Q16TT	IQ16TT	IQ16TT	4
2.9	107	UMZ-249		01/03-	W20EPR-U	3047	0.8	W20TT	IW20TT	IW20TT	4
2.9 i	88	UMZ- 421310		01/97-01/01	W20FP-U	3068	0.7	WF20TT	-		4

Свечи зажигания и Свечи накаливания

Таблица применения









	KW				СТАНДАРТНЫЕ			Twin Tip		QTY	
											
UAZ продолжение											
SIMBIR (3162) (97-) продолжение											
2.9 i	88	UMZ- 421310		01/01-	W16FPR-U	4192	0.7	-	-	4	
TREKOL (39041) (88-)											
2.5	68	UMZ 4178.10		01/88-01/01	W14F-U	4012	0.7	-	-	4	
2.5	68	UMZ 4178.10		01/01-	W14FR-U	4017	0.7	-	-	4	
2.9	79	UMZ-4218		01/98-	W14FR-U	4017	0.7	-	-	4	
2.9	79	UMZ-4218.10		01/98-01/01	W14F-U	4012	0.7	-	-	4	
2.9	79	UMZ-4218.10		01/01-	W16FPR-U	4192	0.7	-	-	4	
VAUXHALL											
ADAM (12-)											
1.2	51	A 12 XEL; B 12 XEL; B 12 XER		10/12-	KJ20CR-L11	3169	1.1	K20TT	IK20TT	IK20TT	4
1.4	64/74	A 14 XEL; A 14 XER; B 14 XER		10/12-	KJ20CR-L11	3169	1.1	K20TT	IK20TT	IK20TT	4
1.4 S	110	B 14 NEH; B 14 NET		11/14-	VK22	5610	0.8	-	IK22TT	VK22	4
AGILA I (A) (00-08)											
1.0 12V	43	Z 10 XE; Z 10 XEP		02/00-11/06	K20TXR	5063	1.0	K20TT	IK20TT	IK20TT	3
1.2 16V	55	Z 12 XE		09/00-03/08	K20TXR	5063	1.0	K20TT	IK20TT	IK20TT	4
1.2 16V Twinport	59	Z 12 XEP		07/04-11/06	KJ16CR-L11	3132	1.1	K16TT	IK16TT	IK16TT	4
AGILA II (B) (08-14)											
1.0 12V	48	K10B		01/08-11/14	ZXU20PR11	3452	1.1	-	-	VXU20	3
1.0 i	50	K10B		08/11-11/14	ZXU20PR11	3452	1.1	-	-	VXU20	3
1.2 i 16V	63/69	K12B		01/08-11/14	ZXU20PR11	3452	1.1	-	-	VXU20	4
1.3 CDTi	55	D13A; Z 13 DTJ	OE:93178047; 93193804; 95508486; Double Coi l(LPH)	01/08-11/14	DG-171		11V				4
ANTARA (06-)											
2.0 CDTi 4x4	110	Z 20 DMH		08/06-04/15	DG-604		4.4V				4
2.2 CDTi 4x4	120/ 135	A 22 DM; A 22 DMH	OE:48 02 239; 25181860; (RP8480); GE127;GLP253 / 0 250 403 019	12/10-	DG-653		4.4V				4
2.2 CDTi FWD	120	A 22 DM	OE:48 02 239; 25181860; (RP8480); GE127;GLP253 / 0 250 403 019	12/10-	DG-653		4.4V				4
2.4	123	A24XE		12/10-04/15	ITL16TT	4717	1.0	-	ITL16TT		4
2.4 4x4	103	Z 24 XED		08/06-04/15	K20TXR	5063	1.0	K20TT	IK20TT	IK20TT	4
2.4 4x4	123	A24XE		12/10-04/15	ITL16TT	4717	1.0	-	ITL16TT		4
ARENA (98-01)											
1.9 D	44	F8Q 600; F8Q 606		03/98-08/01	DG-008		11V				4
2.5 D	55	S8U 758; S8U 780; S8U 782		03/98-08/01	DG-004		11V				4
ASTRA I (79-86)											
1.2 S	44	12S		02/82-08/84	W20FPR-U	3070	0.7	WF20TT	-		4
1.3 S	55	13S		09/79-08/84	W20EPR-U	3047	0.8	W20TT	IW20TT	IW20TT	4
1.6 D	40	16 D	Double Coil Std(LPH)	02/82-08/86	DG-001		11V				4
1.6 S	66	16S/16SH; 16S		09/81-10/84	W20EPR-U	3047	0.8	W20TT	IW20TT	IW20TT	4
1.8 GTE	85	18E		03/83-10/84	W20EPR-U	3047	0.8	W20TT	IW20TT	IW20TT	4
ASTRA II (84-94)											
1.2	44	12S		09/84-12/88	W20FPR-U	3070	0.7	WF20TT	-		4
1.2	44	12ST		09/84-08/91	W20EPR-U	3047	0.8	W20TT	IW20TT	IW20TT	4
1.3	55	13S		09/84-10/89	W20EPR-U	3047	0.8	W20TT	IW20TT	IW20TT	4
1.4 i	44	C14NZ		01/90-12/91	W20EPR-U	3047	0.8	W20TT	IW20TT	IW20TT	4
1.4 S	55	14NV		01/89-08/91	W20EPR-U	3047	0.8	W20TT	IW20TT	IW20TT	4
1.6	60	16SV		09/84-08/86	W20EPR-U	3047	0.8	W20TT	IW20TT	IW20TT	4
1.6 D	40	16 DA	Double Coil Std(LPH)	09/84-08/91	DG-001		11V				4
1.6 i	60	16SV		01/87-12/91	W20EPR-U	3047	0.8	W20TT	IW20TT	IW20TT	4
1.6 S	60/66	16S-OHC; 16SV		09/84-12/91	W20EPR-U	3047	0.8	W20TT	IW20TT	IW20TT	4
1.7 D	42	17 D; 17 DR	Double Coil Std(LPH)	01/89-12/91	DG-001		11V				4
1.8	82	18SE		01/86-12/90	W20EPR-U	3047	0.8	W20TT	IW20TT	IW20TT	4
1.8 GTE	82	18SE		09/84-08/91	W20EPR-U	3047	0.8	W20TT	IW20TT	IW20TT	4

Таблица применения











У

V

Свечи зажигания и Свечи накаливания

Таблица применения

Таблица применения

	KW				СТАНДАРТНЫЕ			Twin Tip			QTY
											
VAUXHALL продолжение											
ASTRA II (84-94) продолжение											
1.8 i	83	18SE		01/90-08/91	W20EPR-U	3047	0.8	W20TT	IW20TT	IW20TT	4
2.0 GTE	95	20SEH		09/86-08/91	W20EPR-U	3047	0.8	W20TT	IW20TT	IW20TT	4
2.0 GTE 16V	115	C20XE		05/88-08/91	K20PR-U	3145	0.8	K20TT	IK20TT	IK20TT	4
ASTRA III (F) (91-01)											
1.4 i	44	C 14 NZ	Ch: >02BF1476	09/91-08/95	W20EPR-U	3047	0.8	W20TT	IW20TT	IW20TT	4
1.4 i	44	C 14 NZ	Ch: 02BF1477>	09/91-08/95	K20TXR	5063	1.0	K20TT	IK20TT	IK20TT	4
1.4 i	44/60	C 14 NZ; C 14 SE		03/91-09/98	K20TXR	5063	1.0	K20TT	IK20TT	IK20TT	4
1.4 i 16V	66	X 14 XE		02/96-09/98	K20TXR	5063	1.0	K20TT	IK20TT	IK20TT	4
1.4 S	55	14 NV		09/91-02/98	K20TXR	5063	1.0	K20TT	IK20TT	IK20TT	4
1.6 i	52/55	C 16 NZ; X 16 SZ	Ch: >02BF1476	10/91-08/98	W20EPR-U	3047	0.8	W20TT	IW20TT	IW20TT	4
1.6 i	52/55	C 16 NZ; X 16 SZ	Ch: 02BF1477>	10/91-08/98	K20TXR	5063	1.0	K20TT	IK20TT	IK20TT	4
1.6 i	52/ 55/74	C 16 NZ; C 16 SE; E 16 NZ; X 16 SZ; X 16 SZR		09/91-03/01	K20TXR	5063	1.0	K20TT	IK20TT	IK20TT	4
1.6 i 16V	74	X 16 XEL		01/94-09/98	K20TXR	5063	1.0	K20TT	IK20TT	IK20TT	4
1.6 Si	74	C 16 SE		03/91-12/94	K20TXR	5063	1.0	K20TT	IK20TT	IK20TT	4
1.7 D	42/44	17 D; 17 DR	Double Coil Std(LPH)	09/91-09/98	DG-001		11V				4
1.7 D	44	17 DR	Double Coil(LPH)	03/91-12/94	DG-001		11V				4
1.7 TD	50	X 17 DTL		08/94-09/98	DG-001		11V				4
1.7 TD	50	X 17 DTL	Double Coil(LPH)	01/94-08/98	DG-001		11V				4
1.7 TD	60	17 DT (TC4EE1)	Eng: >956632	12/91-09/98	DG-104		11V				4
1.7 TD	60	17 DT (TC4EE1)	Eng: 956633>	12/91-09/98	DG-300		11V				4
1.7 TD	60	17 DT (TC4EE1)	Eng: 956633>	12/91-09/98	DG-640		11V				4
1.8	92	C 18 XE		09/94-08/96	K20TXR	5063	1.0	K20TT	IK20TT	IK20TT	4
1.8 16V	85	C 18 XEL; X 18 XE		11/94-03/01	K20TXR	5063	1.0	K20TT	IK20TT	IK20TT	4
1.8 i	66	C 18 NZ		09/91-09/98	K20TXR	5063	1.0	K20TT	IK20TT	IK20TT	4
1.8 i 16V	82/ 85/92	18 SE; C 18 XEL; X 18 XE		06/93-02/98	K20TXR	5063	1.0	K20TT	IK20TT	IK20TT	4
2.0 i	85	C 20 NE		09/91-09/98	K20TXR	5063	1.0	K20TT	IK20TT	IK20TT	4
2.0 i 16V	100/ 110	C 20 XE; X 20 XEV		09/91-09/98	K20TXR	5063	1.0	K20TT	IK20TT	IK20TT	4
ASTRA IV (G) (98-06)											
1.4 16V	66	X 14 XE; Z 14 XE	Ch:>42000000, 45000000, 48000000, 4B000000	02/98-05/05	K20TXR	5063	1.0	K20TT	IK20TT	IK20TT	4
1.4 16V	66	X 14 XE; Z 14 XE	Ch:42000001, 45000001, 46000001, 48000001, 4B000001>	02/98-05/05	KJ16CR-L11	3132	1.1	K16TT	IK16TT	IK16TT	4
1.6	55/62	X 16 SZR; Z 16 SE		02/98-05/05	K20TXR	5063	1.0	K20TT	IK20TT	IK20TT	4
1.6	76	Z 16 XEP	Ch:>42000000, 45000000, 48000000, 4B000000	12/02-05/05	K20TXR	5063	1.0	K20TT	IK20TT	IK20TT	4
1.6	76	Z 16 XEP	Ch:42000001, 45000001, 46000001, 48000001, 4B000001>	12/02-05/05	KJ16CR-L11	3132	1.1	K16TT	IK16TT	IK16TT	4
1.6 16V	74	C 16 SEL; X 16 XEL; Z 16 XE; Z 16 XEP		02/98-05/05	K20TXR	5063	1.0	K20TT	IK20TT	IK20TT	4
1.6 16V	74/76	Z 16 XE; Z 16 XEP	Ch:>42000000, 45000000, 48000000, 4B000000	03/00-10/05	K20TXR	5063	1.0	K20TT	IK20TT	IK20TT	4
1.6 16V	74/76	Z 16 XE; Z 16 XEP	Ch:42000001, 45000001, 46000001, 48000001, 4B000001>	03/00-10/05	KJ16CR-L11	3132	1.1	K16TT	IK16TT	IK16TT	4
1.6 Dualfuel	62	Z 16 SE		03/98-05/05	K20TXR	5063	1.0	K20TT	IK20TT	IK20TT	4
1.6 i	55/62	X 16 SZR; Z 16 SE	Ch:>42000000, 45000000, 48000000, 4B000000	08/98-08/06	K20TXR	5063	1.0	K20TT	IK20TT	IK20TT	4

Свечи зажигания и Свечи накаливания

Таблица применения











	KW				СТАНДАРТНЫЕ			Twin Tip			QTY
											
VAUXHALL продолжение											
ASTRA IV (G) (98-06) продолжение											
1.6 i	55/62	X 16 SZR; Z 16 SE	Ch:42000001, 45000001, 46000001, 48000001, 4B000001>	08/98-08/06	KJ16CR-L11	3132	1.1	K16TT	IK16TT	IK16TT	4
1.7 CDTi	59	Z 17 DTL	Ceramic(LPH)	04/04-08/06	DG-302		11V				4
1.7 CDTi	59	Z 17 DTL	Ceramic(LPH)	04/04-08/06	DG-641		11V				4
1.7 CDTi 16V	59	Z 17 DTL	Ceramic(LPH)	04/03-05/05	DG-302		11V				4
1.7 CDTi 16V	59	Z 17 DTL	Ceramic(LPH)	04/03-05/05	DG-641		11V				4
1.7 DTi 16V	55	Y 17 DT		04/01-08/06	DG-302		11V				4
1.7 DTi 16V	55	Y 17 DT		04/01-08/06	DG-641		11V				4
1.7 DTi 16V	55	Y 17 DT	Ceramic(LPH)	02/00-05/05	DG-302		11V				4
1.7 DTi 16V	55	Y 17 DT	Ceramic(LPH)	02/00-05/05	DG-641		11V				4
1.7 TD	50	X 17 DTL	Double Coil(LPH)	02/98-08/06	DG-001		11V				4
1.8 16V	85/92	X 18 XE1; Z 18 XEL		02/98-10/05	K20TXR	5063	1.0	K20TT	IK20TT	IK20TT	4
1.8 16V Dualfuel	87	Z 18 XE		02/98-08/05	K20TXR	5063	1.0	K20TT	IK20TT	IK20TT	4
2.0	147	Z 20 LER; Z 20 LET		09/02-10/05	K20TXR	5063	1.0	K20TT	IK20TT	IK20TT	4
2.0 16V	100	X 20 XEV		02/98-05/05	K20TXR	5063	1.0	K20TT	IK20TT	IK20TT	4
2.0 16V Turbo	140	Z 20 LET		09/00-08/05	K20TXR	5063	1.0	K20TT	IK20TT	IK20TT	4
2.0 DI	60	X 20 DTL; Y 20 DTL	Double Coil(LPH)	02/98-08/06	DG-118		11V				4
2.0 DTi	74	Y 20 DTH	Double Coil(LPH)	04/04-08/06	DG-118		11V				4
2.0 DTi 16V	74	Y 20 DTH		09/02-05/05	DG-142		11V				4
2.0 DTi 16V	74	Y 20 DTH	Double Coil(LPH)	02/98-08/02	DG-118		11V				4
2.0 SRI Turbo	141	Z 20 LET		11/01-05/05	K20TXR	5063	1.0	K20TT	IK20TT	IK20TT	4
2.0 Turbo	141	Z 20 LET		03/02-10/05	K20TXR	5063	1.0	K20TT	IK20TT	IK20TT	4
2.2 16V	108	Z 22 SE		03/00-10/05	PT16VR13	5068	1.3	TV16TT	ITV16TT	ITV16TT	4
ASTRA V (H) (04-10)											
1.3 CDTi	66	Z 13 DTH	OE:93178047; 95508486, Double Coi l(LPH)	01/04-12/13	DG-171		11V				4
1.4	66	Z 14 XEP		01/04-05/09	KJ16CR-L11	3132	1.1	K16TT	IK16TT	IK16TT	4
1.4 i	66	Z 14 XEP		03/05-12/13	KJ16CR-L11	3132	1.1	K16TT	IK16TT	IK16TT	4
1.4 i 16V	66	Z 14 XEP		03/05-11/10	KJ16CR-L11	3132	1.1	K16TT	IK16TT	IK16TT	4
1.6	77	Z 16 XE1; Z 16 XEP		02/05-12/13	KJ20CR-L11	3169	1.1	K20TT	IK20TT	IK20TT	4
1.6	77	Z 16 XEP	Ch:>42000000, 45000000, 48000000, 4B000000	01/04-05/09	K20TXR	5063	1.0	K20TT	IK20TT	IK20TT	4
1.6	77	Z 16 XEP	Ch:42000001, 45000001, 46000001, 48000001, 4B000001>	01/04-05/09	KJ16CR-L11	3132	1.1	K16TT	IK16TT	IK16TT	4
1.6	85	A 16 XER; Z 16 XER	Ch:>92999999/ 95999999/ 98999999/ 9G999999/ 9B999999	08/04-03/09	KJ16CR-L11	3132	1.1	K16TT	IK16TT	IK16TT	4
1.6	85	A 16 XER; Z 16 XER	Ch:A2000001/ A8000001/ AG000001>	08/04-03/09	KJ20CR-L11	3169	1.1	K20TT	IK20TT	IK20TT	4
1.6	85/ 132	Z 16 XER; Z16LET(180)		01/04-11/10	KJ16CR-L11	3132	1.1	K16TT	IK16TT	IK16TT	4
1.6 i 16V	85	A 16 XER; Z 16 XER	Ch:>92999999/ 95999999/ 98999999/ 9G999999/ 9B999999	10/06-08/11	KJ16CR-L11	3132	1.1	K16TT	IK16TT	IK16TT	4
1.6 i 16V	85	A 16 XER; Z 16 XER	Ch:A2000001/ A8000001/ AG000001>	10/06-08/11	KJ20CR-L11	3169	1.1	K20TT	IK20TT	IK20TT	4
1.7 CDTi	59/74	Z 17 DTH; Z 17 DTL	Ceramic(LPH)	01/04-11/10	DG-302		11V				4
1.7 CDTi	59/74	Z 17 DTH; Z 17 DTL	Ceramic(LPH)	01/04-11/10	DG-641		11V				4
1.7 CDTi	59/ 74/ 81/92	A 17 DTJ; A 17 DTR; Z 17 DTH; Z 17 DTJ; Z 17 DTL; Z 17 DTR		01/04-12/13	DG-302		11V				4

Таблица применения

V

Свечи зажигания и Свечи накаливания

Таблица применения

Таблица применения

VAUXHALL	KW	KW	NOTE	21	СТАНДАРТНЫЕ			Twin Tip			QTY
					STANDARD	PLUG	WIRE	TWIN TIP	TWIN TIP	TWIN TIP	
VAUXHALL продолжение											
ASTRA V (H) (04-10) продолжение											
1.7 CDTi	59/ 74/ 81/92	A 17 DTJ; A 17 DTR; Z 17 DTH; Z 17 DTJ; Z 17 DTL; Z 17 DTR		01/04-12/13	DG-641		11V				4
1.8	92	Z 18 XE		01/04-11/10	KJ16CR-L11	3132	1.1	K16TT	IK16TT	IK16TT	4
1.8	103	A 18 XER; Z 18 XER	Ch:>D2999999/ D5999999/ D8999999/ DG999999/ 9B999999	01/04-11/10	KJ16CR-L11	3132	1.1	K16TT	IK16TT	IK16TT	4
1.8	103	A 18 XER; Z 18 XER	Ch:E2000001/ E8000001/ EG000001>	01/04-11/10	KJ20CR-L11	3169	1.1	K20TT	IK20TT	IK20TT	4
1.8 i 16V	103	A 18 XER; Z 18 XER	Ch:>D2999999/ D5999999/ D8999999/ DG999999/ 9B999999	03/07-11/10	KJ16CR-L11	3132	1.1	K16TT	IK16TT	IK16TT	4
1.8 i 16V	103	A 18 XER; Z 18 XER	Ch:E2000001/ E8000001/ EG000001>	03/07-11/10	KJ20CR-L11	3169	1.1	K20TT	IK20TT	IK20TT	4
1.9 CDTi	74/88	Z 19 DTL	Ch:>72045139; 75030986; 78007391, Double Coi I(LPH)	01/04-11/11	DG-122		11V				4
1.9 CDTi	74/88	Z 19 DTL	Ch:72045140: 75030987; 78007392>, Double Coi I(LPH)	08/04-11/11	DG-196		11V				4
1.9 CDTi	88	Z 19 DT	Ch:72045140: 75030987; 78007392>, Double Coi I(LPH)	01/04-05/09	DG-196		11V				4
1.9 CDTi	110	Z 19 DTH	Double Coil(LPH)	01/04-11/11	DG-170		11V				4
1.9 CDTi 16V	88	Z 19 DTJ	Double Coil(LPH)	01/04-05/09	DG-170		11V				4
2.0	125	Z 20 LEL		02/06-11/10	KJ16CR-L11	3132	1.1	K16TT	IK16TT	IK16TT	4
2.0 Turbo	125/ 147	Z 20 LEL; Z 20 LER		01/04-11/10	KJ16CR-L11	3132	1.1	K16TT	IK16TT	IK16TT	4
2.0 Turbo	177	Z 20 LEH		01/04-05/09	PK20PR-P8	3245	0.8	-	IK20TT	IK20TT	4
2.0 VXR	176	Z 20 LEH		02/09-11/10	PK20PR-P8	3245	0.8	-	IK20TT	IK20TT	4
ASTRA VI (J) (09-)											
1.3 CDTi	70	A 13 DTE	Ch:C*000001-> ,OE:55564219	01/11-	DG-621		4.4V				4
1.3 CDTi	70	A 13 DTE	For cylind r no 2,3,Ch: >-B*999999, OE:55564219, Pressures ensor (-)	12/09-12/11	DG-621		4.4V				2
1.4	64/74	A 14 XEL; A 14 XER; B 14 XER		12/09-	KJ20CR-L11	3169	1.1	K20TT	IK20TT	IK20TT	4
1.4	88/ 103	A 14 NEL; A 14 NET; B 14 NEL; B 14 NET		10/11-	VK22	5610	0.8	-	IK22TT	VK22	4
1.4 Turbo	88/ 103	A 14 NEL; A 14 NET; B 14 NEL; B 14 NET		12/09-	VK22	5610	0.8	-	IK22TT	VK22	4
1.6	85	A 16 XER; B 16 XER		12/09-	KJ20CR-L11	3169	1.1	K20TT	IK20TT	IK20TT	4
1.6 CDTi	81/ 100	B 16 DTH; B 16 DTL	OE: 55570037	11/13-	DG-634		4.4V				4
1.6 Turbo	132	A 16 LET		12/09-	IK20L	5358	1.1	-	IK20TT	IK20TT	4
1.7 CDTi	81/92	A 17 DTJ; A 17 DTR		12/09-	DG-302		11V				4
1.7 CDTi	81/92	A 17 DTJ; A 17 DTR		12/09-	DG-641		11V				4
1.7 CDTi	81/96	A 17 DTC; A 17 DTS		12/09-	DG-625		4.4V				4
2.0 Bi-Turbo CDTi	143	A 20 DTR	Ch: >BG999999	12/12-	DG-608		4.4V				4

Свечи зажигания и Свечи накаливания

Таблица применения









	KW				СТАНДАРТНЫЕ			Twin Tip			QTY
    											
VAUXHALL продолжение											
ASTRA VI (J) (09-) продолжение											
2.0 Bi-Turbo CDTI	143	A 20 DTR	Ch:>BG999999 ; B3999999; B8999999	12/12-	DG-608		4.4V				4
2.0 CDTi	118/ 121	A 20 DTH	Ch:>BG999999 ; B3999999; B8999999	12/09-	DG-608		4.4V				4
2.0 VXR	206	A 20 NFT; B 20 NFT		04/12-	ITV16TT	4718	1.0	-		ITV16TT	4
ASTRA VII (K) (15-)											
1.6 CDTi	70/ 81/ 100/ 118	B 16 DTE; B 16 DTH; B 16 DTR; B 16 DTU	OE: 55570037	07/15-	DG-634		4.4V				4
BRAVA (88-02)											
2.3	69/72	4ZDI		08/91-09/96	W20EPR-U	3047	0.8	W20TT	IW20TT	IW20TT	4
2.3 4x4	69/72	4ZDI		06/90-09/96	W20EPR-U	3047	0.8	W20TT	IW20TT	IW20TT	4
2.5 D	56	4JA1		08/91-06/94	DG-108		11V				4
2.5 D 4x4	56	4JA1-T		06/90-06/94	DG-108		11V				4
2.5 DTI	74	4JA1		08/01-12/02	DG-108		11V				4
2.5 DTI 4x4	74	4JA1		08/01-12/02	DG-108		11V				4
2.5 TD	56	4JA1-T		07/94-12/02	DG-108		11V				4
2.5 TD 4x4	56	4JA1-T		07/94-12/02	DG-108		11V				4
CALIBRA (90-97)											
2.0 i	85	C 20 NE		06/90-06/93	W16EPR-U	3021	0.8	W16TT	IW16TT	IW16TT	4
2.0 i	85	C 20 NE		07/93-07/97	K20TXR	5063	1.0	K20TT	IK20TT	IK20TT	4
2.0 i 4x4	85	C 20 NE		06/90-06/93	W16EPR-U	3021	0.8	W16TT	IW16TT	IW16TT	4
2.0 i 4x4	85	C 20 NE		07/93-07/97	K20TXR	5063	1.0	K20TT	IK20TT	IK20TT	4
2.0 i 16V	100/ 110	C 20 XE; X 20 XEV		06/90-07/97	K20TXR	5063	1.0	K20TT	IK20TT	IK20TT	4
2.0 i 16V 4x4	100/ 110	C 20 XE; X 20 XEV		06/90-07/97	K20TXR	5063	1.0	K20TT	IK20TT	IK20TT	4
2.0 i Turbo 4x4	150	C 20 LET		03/92-07/97	KJ20CR-U11	3451	1.1	K20TT	IK20TT	IK20TT	4
2.5 i V6	125	C 25 XE; X 25 XE		04/93-07/97	K20TXR	5063	1.0	K20TT	IK20TT	IK20TT	6
CARLTON II (77-86)											
1.8 S	66	18S		11/82-08/86	W20EPR-U	3047	0.8	W20TT	IW20TT	IW20TT	4
2.0 i	81	20E		01/83-12/84	W20EPR-U	3047	0.8	W20TT	IW20TT	IW20TT	4
2.0 S	74	20S		10/78-08/86	W20EPR-U	3047	0.8	W20TT	IW20TT	IW20TT	4
2.2 i	85	22E		11/84-08/86	W20EPR-U	3047	0.8	W20TT	IW20TT	IW20TT	4
2.3 D	52	23 D	Double Coil Std(LPH)	05/83-08/86	DG-001		11V				4
CARLTON III (86-94)											
1.8	65	E18NVR		09/87-03/94	W20EPR-U	3047	0.8	W20TT	IW20TT	IW20TT	4
1.8 i	85	18SEH		09/86-08/92	W20EPR-U	3047	0.8	W20TT	IW20TT	IW20TT	4
1.8 S	66	18SV		09/86-09/90	W20EPR-U	3047	0.8	W20TT	IW20TT	IW20TT	4
2.0	73	C20NE(100)		09/90-03/94	W16EPR-U	3021	0.8	W16TT	IW16TT	IW16TT	4
2.0	85	C 20 NE	Ch:R1000001, R5000001, P7000001>	09/86-03/94	K20TXR	5063	1.0	K20TT	IK20TT	IK20TT	4
2.0 i	90	20 SE		09/86-03/94	W20EPR-U	3047	0.8	W20TT	IW20TT	IW20TT	4
2.2 TD	66	23 YDT	Double Coil Coil(LPH)	09/86-08/88	DG-001		11V				4
2.3 D	54	23 YD	Double Coil Std(LPH)	09/86-03/94	DG-001		11V				4
2.3 TD Interc.	74	23 DTR	Double Coil Std(LPH)	08/88-03/94	DG-001		11V				4
2.6 i	110	C26NE		09/90-03/94	W20FPR-U	3070	0.7	WF20TT	-		6
3.0	130	30NE		10/89-09/90	W20FPR-U	3070	0.7	WF20TT	-		6
3.0 24V	147	C30SEJ		09/89-03/94	K20TXR	5063	1.0	K20TT	IK20TT	IK20TT	6
3.0 3000	130	30NE		03/87-09/90	W20FPR-U	3070	0.7	WF20TT	-		6
3.0 3000 24V	150	C30SE		09/89-03/94	K20TXR	5063	1.0	K20TT	IK20TT	IK20TT	6
3000 24V	147	C30SEJ		09/89-03/94	K20TXR	5063	1.0	K20TT	IK20TT	IK20TT	6
3000 Cat	130	C30NE		03/88-03/94	K20TXR	5063	1.0	K20TT	IK20TT	IK20TT	6
CASCADA (13-)											
1.4	103	A 14 NET; B 14 NET		02/13-	VK22	5610	0.8	-	IK22TT	VK22	4
CAVALIER I (75-81)											
1.6 S	55	16SOHV	Ch: 634748>	08/75-08/81	W20FPR-U	3070	0.7	WF20TT	-		4
2.0 S	74	20S	Ch: 436257>	01/78-08/81	W20FPR-U	3070	0.7	WF20TT	-		4
1300	44	13SOHV		08/77-08/81	W20EPR-U	3047	0.8	W20TT	IW20TT	IW20TT	4
1900	66	19 S		10/75-03/78	W20FPR-U	3070	0.7	WF20TT	-		4

Таблица применения

Λ

Свечи зажигания и Свечи накаливания

Таблица применения

VAUXHALL	KW	KW	NOTE	21	СТАНДАРТНЫЕ			Twin Tip		QTY	
					W20EPR-U	3070	0.7	WF20TT	-		
VAUXHALL продолжение											
CAVALIER I (75-81) продолжение											
1900	66	19S	Ch: 1603327>	10/75-03/78	W20FPR-U	3070	0.7	WF20TT	-	4	
CAVALIER II (81-88)											
1.3 S	55	13 S		09/81-08/88	W20EPR-U	3047	0.8	W20TT	IW20TT	IW20TT	4
1.6	66	16 SH		10/83-08/88	W20EPR-U	3047	0.8	W20TT	IW20TT	IW20TT	4
1.6 D	40	16 D; 16 DA	Double Coil Std(LPH)	03/82-08/88	DG-001		11V				4
1.6 S	66	16 SH		09/81-08/88	W20EPR-U	3047	0.8	W20TT	IW20TT	IW20TT	4
1.8 i	82/85	18 E; 18 SE		09/81-08/88	W20EPR-U	3047	0.8	W20TT	IW20TT	IW20TT	4
2.0 i	85	20 NE		09/86-08/88	IW20TT	4709	1.0	-	IW20TT		4
2.0 i Cat	85	C 20 NE		09/86-08/88	W16EPR-U	3021	0.8	W16TT	IW16TT	IW16TT	4
2.0 SRi 130	95	20 SEH		03/87-08/88	W20EPR-U	3047	0.8	W20TT	IW20TT	IW20TT	4
1600D	40	16 D; 16 DA	Double Coil Std(LPH)	03/82-08/88	DG-001		11V				4
1800i	82	18 SE		03/85-10/88	W20EPR-U	3047	0.8	W20TT	IW20TT	IW20TT	4
CAVALIER III (88-95)											
1.4 S	55	14 NV		09/88-11/95	W20EPR-U	3047	0.8	W20TT	IW20TT	IW20TT	4
1.6	60	16 SV		09/88-05/93	W20EPR-U	3047	0.8	W20TT	IW20TT	IW20TT	4
1.6 i	52/55	E 16 NZ; X 16 SZ		09/88-11/95	IW20TT	4709	1.0	-	IW20TT		4
1.7 D	42	17 D	Double Coil Std(LPH)	09/88-09/92	DG-001		11V				4
1.7 D	44	17 DR	Double Coil(LPH)	07/92-11/95	DG-001		11V				4
1.7 TD	60	17 DT (TC4EE1)	Eng: >731417	09/88-11/95	DG-124		11V				4
1.7 TD	60	17 DT (TC4EE1)	Eng: 731418>	09/88-11/95	DG-300		11V				4
1.7 TD	60	17 DT (TC4EE1)	Eng: 731418>	09/88-11/95	DG-640		11V				4
1.8	66	18 SV		09/88-08/95	W20EPR-U	3047	0.8	W20TT	IW20TT	IW20TT	4
1.8 i Cat	66	C 18 NZ		03/90-11/95	W16EPR-U	3021	0.8	W16TT	IW16TT	IW16TT	4
2.0 i	85	20 NE		09/88-10/92	IW20TT	4709	1.0	-	IW20TT		4
2.0 i 4x4	85	20 NE		01/91-10/92	W16EPR-U	3021	0.8	W16TT	IW16TT	IW16TT	4
2.0 i 4x4	85	20 NE		09/91-10/92	K20TXR	5063	1.0	K20TT	IK20TT	IK20TT	4
2.0 i 4x4	95	20 SEH		09/88-08/92	W20EPR-U	3047	0.8	W20TT	IW20TT	IW20TT	4
2.0 i 16V	100/110	C 20 XE; X 20 XEV		09/88-11/95	K20TXR	5063	1.0	K20TT	IK20TT	IK20TT	4
2.0 i 16V 4x4	110	C 20 XE		09/88-11/95	K20TXR	5063	1.0	K20TT	IK20TT	IK20TT	4
2.0 i Cat	85	C 20 NE		09/88-11/95	K20TXR	5063	1.0	K20TT	IK20TT	IK20TT	4
2.0 i Cat	85	C 20 NE		09/90-11/95	IW20TT	4709	1.0	-	IW20TT		4
2.0 i Turbo 4x4	150	C 20 LET		09/92-06/94	K20R-U	3122	0.8	K20TT	IK20TT	IK20TT	4
2.0 SRi	95	20 SEH		09/88-09/92	W20EPR-U	3047	0.8	W20TT	IW20TT	IW20TT	4
2.0 SRi 16V	100	X 20 XEV		09/92-08/95	K20TXR	5063	1.0	K20TT	IK20TT	IK20TT	4
2.5 V6	125	C 25 XE		08/88-06/94	K20TXR	5063	1.0	K20TT	IK20TT	IK20TT	6
CHEVETTE (75-85)											
1300	42	13SOHV		09/76-12/85	W20EPR-U	3047	0.8	W20TT	IW20TT	IW20TT	4
COMBO I (B) (94-01)											
1.4	44	C 14 NZ		07/94-10/01	K20TXR	5063	1.0	K20TT	IK20TT	IK20TT	4
1.7 D	44	17 D (4EE1); X 17 D (4EE1)		07/94-10/01	DG-300		11V				4
1.7 D	44	17 D (4EE1); X 17 D (4EE1)		07/94-10/01	DG-640		11V				4
COMBO II (C) (01-12)											
1.3 CDTi 16V	51/55	Y 13 DT; Z 13 DT; Z 13 DTJ	OE:93178047; 93193804; 95508486, Double Coi I(LPH)	09/04-02/12	DG-171		11V				4
1.4	66	Z 14 XEP		10/04-09/10	KJ16CR-L11	3132	1.1	K16TT	IK16TT	IK16TT	4
1.4 16V	66	Z 14 XE		10/01-05/07	KJ16CR-L11	3132	1.1	K16TT	IK16TT	IK16TT	4
1.4 i 16V	66	Z 14 XEP		01/04-11/11	KJ16CR-L11	3132	1.1	K16TT	IK16TT	IK16TT	4
1.6	62/64	Z 16 SE		09/01-11/11	K20TXR	5063	1.0	K20TT	IK20TT	IK20TT	4
1.6 CNG 16V	69/71	Z 16 YNG	LPG / GPL	04/05-02/12	PK20PR-P8	3245	0.8	-	IK20TT	IK20TT	4
1.7 CDTi 16V	74	Z 17 DTH		12/04-11/11	DG-302		11V				4
1.7 CDTi 16V	74	Z 17 DTH		12/04-11/11	DG-641		11V				4
1.7 DI 16V	48	Y 17 DTL		09/01-11/11	DG-302		11V				4
1.7 DI 16V	48	Y 17 DTL		09/01-11/11	DG-641		11V				4
1.7 DTi 16V	55	Y 17 DT		10/01-02/12	DG-302		11V				4
1.7 DTi 16V	55	Y 17 DT		10/01-02/12	DG-641		11V				4
1.7 DTi 16V	55	Y 17 DT	Ceramic(LPH)	10/01-11/11	DG-302		11V				4
1.7 DTi 16V	55	Y 17 DT	Ceramic(LPH)	10/01-11/11	DG-641		11V				4
COMBO III (D) (11-)											
1.3 CDTi	66/70	A 13 FD	Euro-5,OE: 55210051	11/11-	DG-621		4.4V				4

Свечи зажигания и Свечи накаливания

Таблица применения











	KW				СТАНДАРТНЫЕ			Twin Tip			QTY
											
VAUXHALL продолжение											
COMBO III (D) (11-) продолжение											
1.3 CDTi	66/70	A 13 FD	Euro-6,OE: 12 14 106/ 55238404 (RP 9016)	11/11-	DG-658		5V				4
1.4	70	A 14 FP		11/11-	XU22EPR-U	3179	0.9	XU22TT	IXU22TT	VXU22	4
1.6 CDTi	66/ 74/77	A 16 FDH; A 16 FDL	OE: 93191771	11/11-	DG-608		4.4V				4
2.0 CDTi	99	A 20 FD		11/11-	DG-608		4.4V				4
CORSA I (B) (93-00)											
1.0 i 12V	40	X 10 XE		11/96-09/00	K20TXR	5063	1.0	K20TT	IK20TT	IK20TT	3
1.2 i	33	C 12 NZ; X 12 SZ	Ch:>19334656, 19341717	03/93-09/00	W16EPR-U	3021	0.8	W16TT	IW16TT	IW16TT	4
1.2 i	33	C 12 NZ; X 12 SZ	Ch: 19K87118>	03/93-09/00	K20TXR	5063	1.0	K20TT	IK20TT	IK20TT	4
1.2 i 16V	48	X 12 XE		03/98-09/00	K20TXR	5063	1.0	K20TT	IK20TT	IK20TT	4
1.4 i	44	C 14 NZ; C14NZ		03/93-07/95	W16EPR-U	3021	0.8	W16TT	IW16TT	IW16TT	4
1.4 i	44	C 14 NZ; C14NZ/X14SZ		08/95-09/00	K20TXR	5063	1.0	K20TT	IK20TT	IK20TT	4
1.4 i 16V	66	X 14 XE		09/94-09/00	K20TXR	5063	1.0	K20TT	IK20TT	IK20TT	4
1.5 D	37	15 D	Ceramic(LPH)	12/92-12/96	DG-300		11V				4
1.5 D	37	15 D	Ceramic(LPH)	12/92-12/96	DG-640		11V				4
1.5 TD	49	15 DT (T4EC1); X 15 DT (T4EC1)	Ceramic(LPH)	03/93-10/96	DG-300		11V				4
1.5 TD	49	15 DT (T4EC1); X 15 DT (T4EC1)	Ceramic(LPH)	03/93-10/96	DG-640		11V				4
1.6 i 16V	78	C 16 XE; X 16 XE		09/94-09/00	K20TXR	5063	1.0	K20TT	IK20TT	IK20TT	4
1.7 D	44	17 D (4EE1); X 17 D (4EE1)	Ceramic(LPH)	01/94-09/00	DG-300		11V				4
1.7 D	44	17 D (4EE1); X 17 D (4EE1)	Ceramic(LPH)	01/94-09/00	DG-640		11V				4
CORSA II (C) (00-06)											
1.0 12V	44	Z 10 XE		09/00-10/03	K20TXR	5063	1.0	K20TT	IK20TT	IK20TT	3
1.0 12V	44	Z 10 XEP		11/03-10/06	KJ16CR-L11	3132	1.1	K16TT	IK16TT	IK16TT	3
1.2 16V	55	Z 12 XE		09/00-10/06	K20TXR	5063	1.0	K20TT	IK20TT	IK20TT	4
1.2 16V DualFuel	55	Z 12 XE		08/01-10/06	K20TXR	5063	1.0	K20TT	IK20TT	IK20TT	4
1.2 Twinport	59	Z 12 XEP		07/04-10/06	KJ16CR-L11	3132	1.1	K16TT	IK16TT	IK16TT	4
1.3 CDTi 16V	52	Z 13 DT	OE:93178047; 95508486, Double Coi l(LPH)	08/00-09/06	DG-171		11V				4
1.4	66	Z 14 XEP		11/03-06/06	KJ16CR-L11	3132	1.1	K16TT	IK16TT	IK16TT	4
1.4 16V	66	Z 14 XE		09/00-10/06	K20TXR	5063	1.0	K20TT	IK20TT	IK20TT	4
1.4 Twinport	66	Z 14 XEP		06/03-10/06	KJ16CR-L11	3132	1.1	K16TT	IK16TT	IK16TT	4
1.7 CDTi 16V	74	Z 17 DTH	Ceramic(LPH)	08/00-09/06	DG-302		11V				4
1.7 CDTi 16V	74	Z 17 DTH	Ceramic(LPH)	08/00-09/06	DG-641		11V				4
1.7 DI 16V	48	Y 17 DTL	Ceramic(LPH)	08/00-09/06	DG-302		11V				4
1.7 DI 16V	48	Y 17 DTL	Ceramic(LPH)	08/00-09/06	DG-641		11V				4
1.7 DTi 16V	55	Y 17 DT	Ceramic(LPH)	08/00-09/06	DG-302		11V				4
1.7 DTi 16V	55	Y 17 DT	Ceramic(LPH)	08/00-09/06	DG-641		11V				4
1.8 16V	92	Z 18 XE		08/00-09/06	K20TXR	5063	1.0	K20TT	IK20TT	IK20TT	4
CORSA III (D) (06-)											
1.0	44	A 10 XEP; Z 10 XEP		08/06-08/14	KJ20CR-L11	3169	1.1	K20TT	IK20TT	IK20TT	3
1.0 i 12V	48	A10XEP		01/10-08/14	KJ16CR-L11	3132	1.1	K16TT	IK16TT	IK16TT	3
1.2	51	A 12 XEL		01/10-	KJ20CR-L11	3169	1.1	K20TT	IK20TT	IK20TT	4
1.2	59	Z 12 XEP		08/06-	KJ16CR-L11	3132	1.1	K16TT	IK16TT	IK16TT	4
1.2 i 16V	63	A 12 XER		12/09-08/14	KJ20CR-L11	3169	1.1	K20TT	IK20TT	IK20TT	4
1.2 LPG	59	Z 12 XEP		09/09-08/14	KJ20CR-L11	3169	1.1	K20TT	IK20TT	IK20TT	4
1.2 LPG	63	A 12 XER		08/11-08/14	VK20Y	5620	0.8	-	-	VK20Y	4
1.3 CDTi	55	A 13 DTC	For cylind r no 2,3,OE: 55564219, Pressures ensor (-)	07/06-	DG-621		4.4V				2
1.3 CDTi	55/66	Z 13 DTH; Z 13 DTJ	OE:93178047; 95508486	07/06-	DG-171		11V				4
1.3 CDTi	70	A 13 DTE; A 13 DTR; Z 13 DTE	OE: 55564219	07/06-	DG-171		11V				4
1.3 CDTi	70	B 13 DTR	Euro-6,OE: 12 14 106/ 55238404 (RP 9016)	07/06-	DG-658		5V				4
1.4	66	Z 14 XEP		08/06-08/14	KJ16CR-L11	3132	1.1	K16TT	IK16TT	IK16TT	4
1.4	74	A 14 XER		01/10-08/14	KJ20CR-L11	3169	1.1	K20TT	IK20TT	IK20TT	4

Таблица применения

Свечи зажигания и Свечи накаливания











Таблица применения

Таблица применения

VAUXHALL	KW	KW	NOTE	21	СТАНДАРТНЫЕ			Twin Tip		QTY	
					STANDARD	mm	mm	Twin Tip	Twin Tip		
VAUXHALL продолжение											
CORSA III (D) (06-) продолжение											
1.4	88	A 14 NEL		08/12-08/14	VK22	5610	0.8	-	IK22TT	VK22	4
1.4 LPG	66	Z 14 XEP		07/06-08/14	KJ20CR-L11	3169	1.1	K20TT	IK20TT	IK20TT	4
1.6 SRi	110	A16LEL		05/07-08/14	IK20L	5358	1.1	-	IK20TT	IK20TT	4
1.6 VXR	141	A16LER		11/06-08/14	IK20L	5358	1.1	-	IK20TT	IK20TT	4
1.7 CDTi	92	Z 17 DTR	Ceramic(LPH)	11/06-08/14	DG-302		11V				4
1.7 CDTi	92	Z 17 DTR	Ceramic(LPH)	11/06-08/14	DG-641		11V				4
1.7 CDTi	96	A 17 DTS		03/07-08/14	DG-625		4.4V				4
CORSA IV (E) (14-)											
1.3 CDTi	55/70	B 13 DTC; B 13 DTE; B 13 DTN; B 13 DTR	Euro-6,OE: 12 14 106/ 55238404 (RP 9016)	08/14-	DG-658		5V				4
1.4	74	B 14 NEJ		08/14-	VK22	5610	0.8	-	IK22TT	VK22	4
FRONTERA I (A) (91-98)											
2.0	85	C 20 NE; X 20 SE		04/95-08/98	K20TXR	5063	1.0	K20TT	IK20TT	IK20TT	4
2.0 i	85	C 20 NE; X 20 SE		03/92-10/98	K20TXR	5063	1.0	K20TT	IK20TT	IK20TT	4
2.2 i	100	X 22 XE		03/95-10/98	K20TXR	5063	1.0	K20TT	IK20TT	IK20TT	4
2.3 TD	74	23 DTR	Double Coil Std(LPH)	09/91-06/98	DG-001		11V				4
2.4 i	92	C 24 NE		03/92-10/98	W20FPR-U	3070	0.7	WF20TT	-		4
2.5 TDS	85	25TDS (VM41B)	Double Coil(LPH)	11/91-10/98	DG-109		11V				4
2.8 TD	83	28 TDI (4JB1-T)		01/95-12/96	DG-108		11V				4
FRONTERA II (B) (98-04)											
2.2 DTi	85	X 22 DTH	Ch:>YV699999, Double Coi l(LPH)	10/98-09/04	DG-118		11V				4
2.2 DTi	85	Y 22 DTH	Ch:1V500001>, Double Coi l(LPH)	10/98-09/04	DG-142		11V				4
2.2 i	100	X22SE		10/98-10/04	K16PR-U11	3130	1.1	K16TT	IK16TT	IK16TT	4
2.2 i	100	Y22SE		03/01-10/04	PK16PR-L11	3275	1.1	-	IK16TT	IK16TT	4
3.2 i	151	6VD1/Y32NE		10/98-10/04	PK16PR-L11	3275	1.1	-	IK16TT	IK16TT	6
INSIGNIA I (A) (08-17)											
1.4	103	A 14 NET; B 14 NET		04/11-05/17	VK22	5610	0.8	-	IK22TT	VK22	4
1.4 LPG	103	A 14 NET		07/12-05/17	VK22	5610	0.8	-	IK22TT	VK22	4
1.6 CDTi	100	B 16 DTH	OE: 55570037	07/15-05/17	DG-634		4.4V				4
1.6 Turbo	132	A16LET		01/09-05/17	IK20L	5358	1.1	-	IK20TT	IK20TT	4
1.8	103	A 18 XER; B 18 XER		07/08-05/17	KJ20CR-L11	3169	1.1	K20TT	IK20TT	IK20TT	4
2.0 CDTi	81/ 96/ 118/ 120	A 20 DT; A 20 DTC; A 20 DTH; A 20 DTJ; A 20 DTL	Pressure sensor (-)	07/08-05/17	DG-608		4.4V				2
2.0 CDTi 4x4	118	A 20 DTH	Pressure sensor (-)	07/08-05/17	DG-608		4.4V				2
2.0 Turbo	162/ 184	A 20 NFT		07/08-05/17	ITV16TT	4718	1.0	-	ITV16TT		4
2.0 Turbo	162/ 184	A 20 NHT/ B 20 NHT; A 20 NHT		07/08-05/17	ITV20TT	4719	1.0	-	ITV20TT		4
2.0 Turbo 4x4	162/ 184	A 20 NFT		07/08-05/17	ITV16TT	4718	1.0	-	ITV16TT		4
2.0 Turbo 4x4	162/ 184	A 20 NHT/ B 20 NHT; A 20 NHT		07/08-05/17	ITV20TT	4719	1.0	-	ITV20TT		4
MERIVA I (A) (03-10)											
1.3 CDTi	55	Z 13 DTJ	OE:93178047; 93193804; 95508486, Double Coi l(LPH)	01/03-10/09	DG-171		11V				4
1.4 16V Twinport	66	Z 14 XEP		01/03-06/10	KJ16CR-L11	3132	1.1	K16TT	IK16TT	IK16TT	4
1.6 i	64	Z 16 SE		01/03-06/10	K20TXR	5063	1.0	K20TT	IK20TT	IK20TT	4
1.6 i 16V	74	Z 16 XE		01/03-09/05	K20TXR	5063	1.0	K20TT	IK20TT	IK20TT	4
1.6 i 16V Twinport	77	Z 16 XEP		05/03-06/10	KJ16CR-L11	3132	1.1	K16TT	IK16TT	IK16TT	4
1.6 Turbo	132	Z 16 LET		05/06-06/10	PK20PR-L11	3142	1.1	-	IK20TT	IK20TT	4
1.7 CDTi	74	Z 17 DT; Z 17 DTH	Ceramic(LPH)	09/03-08/05	DG-302		11V				4
1.7 CDTi	74	Z 17 DT; Z 17 DTH	Ceramic(LPH)	09/03-08/05	DG-641		11V				4
1.7 DTi	55	Y 17 DT	Ceramic(LPH)	06/03-06/10	DG-302		11V				4
1.7 DTi	55	Y 17 DT	Ceramic(LPH)	06/03-06/10	DG-641		11V				4
1.8 i 16V	92	Z 18 XE		05/03-06/10	K20TXR	5063	1.0	K20TT	IK20TT	IK20TT	4

Свечи зажигания и Свечи накаливания

Таблица применения

	KW				СТАНДАРТНЫЕ			Twin Tip			QTY
											
VAUXHALL продолжение											
MERIVA II (B) (10-)											
1.3 CDTI	55/70	A 13 DTC; A 13 DTE	For cylinder no 2,3,OE: 55564219, Pressures ensor (-)	06/10-	DG-621		4.4V				2
1.4	74	A 14 XER; B 14 XER		06/10-	KJ20CR-L11	3169	1.1	K20TT	IK20TT	IK20TT	4
1.4	88/ 103	A 14 NEL; A 14 NET; B 14 NEL; B 14 NET		06/10-	VK22	5610	0.8	-	IK22TT	VK22	4
1.4 LPG	88	A 14 NEL; B 14 NEL		06/11-	VK22	5610	0.8	-	IK22TT	VK22	4
1.6 CDTi	70/ 81/ 100	B 16 DTC; B 16 DTE; B 16 DTH; B 16 DTL; B 16 DTN	OE: 55570037	08/13-	DG-634		4.4V				4
1.7 CDTI	74/81	A 17 DT; A 17 DTI		06/10-	DG-302		11V				4
1.7 CDTI	74/81	A 17 DT; A 17 DTI		06/10-	DG-641		11V				4
1.7 CDTi	81/96	A 17 DTC; A 17 DTS		06/10-	DG-625		4.4V				4
MIDI (84-94)											
1.8	55	4ZB1		01/85-12/90	W16EXR-U11	3032	1.1	W16TT	IW16TT	IW16TT	4
1.8 4WD	55	4ZB1		09/88-12/90	W16EXR-U11	3032	1.1	W16TT	IW16TT	IW16TT	4
MIDI I (84-88)											
2.0 TD	50	4FC1	Double Coil(LPH)	09/84-05/88	DG-145		11V				4
MIDI II (88-97)											
2.0	60	4ZC1		06/88-08/97	W16EXR-U11	3032	1.1	W16TT	IW16TT	IW16TT	4
2.0	60	4ZC1		01/93-08/97	W20EPR-U	3047	0.8	W20TT	IW20TT	IW20TT	4
2.0 TD	51	4FC1T		06/88-07/90	DG-159		5V				4
2.2 D	45	4FD1	Single Coil	06/88-12/94	DG-159		5V				4
2.4 TD	56	4FG1T	Single Coil	09/94-08/97	DG-159		5V				4
МОККА (12-)											
1.4	103	A 14 NET; B 14 NET; D 14 NET		04/13-	VK22	5610	0.8	-	IK22TT	VK22	4
1.4 4x4	103	A 14 NET; B 14 NET; D 14 NET		06/12-	VK22	5610	0.8	-	IK22TT	VK22	4
1.6	85	A16XER		06/12-	KJ16CR-L11	3132	1.1	K16TT	IK16TT	IK16TT	4
1.6 CDTi	81/ 100	B 16 DTH; B 16 DTN; B 16 DTU	OE: 55570037	01/15-	DG-634		4.4V				4
1.6 CDTi 4x4	100	B 16 DTH	OE: 55570037	01/15-	DG-634		4.4V				4
1.7 CDTI	96	A 17 DTS	Instant heating (ISS)	06/12-	DG-625		4.4V				4
1.7 CDTI 4x4	96	A 17 DTS	Instant heating (ISS)	06/12-	DG-625		4.4V				4
MONTEREY I (91-98)											
3.1 TD	84	4 JG2TC	Single Coil	09/91-07/98	DG-104		11V				4
3.2	130	6VDI		05/94-07/98	K20PR-U11	3121	1.1	K20TT	IK20TT	IK20TT	6
MONTEREY II (98-99)											
3.0 DTI	117	4 JX1	Double Coil(LPH)	07/98-08/99	DG-186		11V				4
3.5 V6 24V	158	6 VE1		07/98-08/99	PK16PR-L11	3275	1.1	-	IK16TT	IK16TT	6
MOVANO I (A) (98-10)											
1.9 DTI	60	F9Q 774	Double Coil(LPH)	10/01-05/10	DG-005		11V				4
2.2 DTI	66	G9T 720; G9T 722; G9T 750		09/00-05/10	DG-126		11V				4
2.5 CDTI	74/ 88/ 107	G9U 632; G9U 650		10/01-12/10	DG-126		11V				4
2.5 D	59	S8U 770; S8U 772		10/98-08/02	DG-004		11V				4
2.5 DTI	84	G9U 720; G9U 724; G9U 750; G9U 754		01/01-05/10	DG-126		11V				4
NOVA (82-94)											
1.0	33	10 S		09/82-03/93	W20FPR-U	3070	0.7	WF20TT	-		4
1.2	33/38	12NV; C 12 NZ		01/90-03/93	W20EPR-U	3047	0.8	W20TT	IW20TT	IW20TT	4
1.2 N	38	12 NV		01/90-03/93	W20EPR-U	3047	0.8	W20TT	IW20TT	IW20TT	4
1.2 S	40	12 ST		09/82-02/90	W20EPR-U	3047	0.8	W20TT	IW20TT	IW20TT	4
1.3 S	51	13 SB		05/83-10/89	W20EPR-U	3047	0.8	W20TT	IW20TT	IW20TT	4
1.4	44	C 14 NZ		10/90-08/92	W20EPR-U	3047	0.8	W20TT	IW20TT	IW20TT	4

Свечи зажигания и Свечи накаливания

Таблица применения

Таблица применения

KW	KW	KW	NOTE	21	СТАНДАРТНЫЕ			Twin Tip		QTY	
					STANDARD	STANDARD	STANDARD	TWIN TIP	TWIN TIP		
VAUXHALL продолжение											
NOVA (82-94) продолжение											
1.4 i	44	C 14 NZ		01/90-03/93	W20EPR-U	3047	0.8	W20TT	IW20TT	IW20TT	4
1.4 i S	60	C 14 SE		09/91-03/93	W20EPR-U	3047	0.8	W20TT	IW20TT	IW20TT	4
1.4 S	55	14 NV		01/90-03/93	W20EPR-U	3047	0.8	W20TT	IW20TT	IW20TT	4
1.5 D	37	15 D	Eng:>804794, Single Coil	09/87-10/94	DG-143		5V				4
1.5 D	37	15 D	Eng:804795>, Single Coil	09/87-10/94	DG-124		11V				4
1.5 TD	49	15 DT (T4EC1)	Eng:>804794, Single Coil	01/90-03/93	DG-159		5V				4
1.5 TD	49	15 DT (T4EC1)	Eng:804795>, Single Coil	01/90-03/93	DG-104		11V				4
1.6 GSI	74	E 16 SE		05/88-03/92	W20EPR-U	3047	0.8	W20TT	IW20TT	IW20TT	4
1.6 GSI Cat	74	C 16 SE		02/92-03/93	W20EPR-U	3047	0.8	W20TT	IW20TT	IW20TT	4
OMEGA (B) (94-03)											
2.0	85	20 SE; X 20 SE		03/94-09/99	K20TXR	5063	1.0	K20TT	IK20TT	IK20TT	4
2.0 16V	100	X 20 XEV		03/94-07/01	K20TXR	5063	1.0	K20TT	IK20TT	IK20TT	4
2.0 DTI 16V	74	X 20 DTH	Double Coil(LPH)	01/98-09/00	DG-118		11V				4
2.2 16V	106	Y 22 XE; Z 22 XE		01/94-06/03	K20TXR	5063	1.0	K20TT	IK20TT	IK20TT	4
2.2 DTI 16V	88	Y 22 DTH	Double Coil(LPH)	08/00-07/03	DG-142		11V				4
2.5 TD	96	U 25 DT; U 25 TD; X 25 DT; X 25 TD	Double Coil(LPH)	04/94-07/01	DG-001		11V				6
2.5 V6	125	X 25 XE		03/94-09/00	K20TNR	3304	1.0	K20TT	IK20TT	IK20TT	6
2.6 V6	132	Y 26 SE		08/00-07/03	K20TNR	3304	1.0	K20TT	IK20TT	IK20TT	6
3.0 V6	155	X 30 XE		04/94-07/00	K20TNR	3304	1.0	K20TT	IK20TT	IK20TT	6
3.2 V6	160	Y 32 SE		02/01-07/03	K20TNR	3304	1.0	K20TT	IK20TT	IK20TT	6
RASCAL (86-93)											
1.0	34	F10A		07/86-08/93	W16EPR-U	3021	0.8	W16TT	IW16TT	IW16TT	4
SENATOR II (B) (87-93)											
2.5 i	103	25 E		09/87-10/90	W20FPR-U	3070	0.7	WF20TT	-		6
2.6 i	110	C 26 NE		09/90-09/93	W20FPR-U	3070	0.7	WF20TT	-		6
3.0	130	30 NE		01/88-09/90	W20FPR-U	3070	0.7	WF20TT	-		6
3.0 24V	150	C 30 SE		09/89-09/93	K20TXR	5063	1.0	K20TT	IK20TT	IK20TT	6
3.0 i Cat	130	C 30 NE		01/88-08/92	W20FPR-U	3070	0.7	WF20TT	-		6
SIGNUM (02-08)											
1.8	90	Z 18 XE	Ch: >31999999	06/03-07/05	K20TXR	5063	1.0	K20TT	IK20TT	IK20TT	4
1.8	90	Z 18 XE	Ch: 41000001>	06/03-07/05	KJ16CR-L11	3132	1.1	K16TT	IK16TT	IK16TT	4
1.8	103	Z 18 XER		08/05-05/08	KJ16CR-L11	3132	1.1	K16TT	IK16TT	IK16TT	4
1.9 CDTI	88	Z 19 DT	Ch:>71021891, Double Coi l(LPH)	04/04-03/08	DG-122		11V				4
1.9 CDTI	88	Z 19 DT	Ch:71021892>, Double Coi l(LPH)	04/04-03/08	DG-196		11V				4
1.9 CDTI 16V	110	Z 19 DTH	Double Coil(LPH)	04/04-03/08	DG-170		11V				4
2.0 DTI	74	Y 20 DTH	Double Coil(LPH)	05/03-04/04	DG-142		11V				4
2.0 i Turbo	129	Z 20 NET		03/03-10/08	PK20PR-L11	3142	1.1	-	IK20TT	IK20TT	4
2.2 DTI	92	Y 22 DTR	Double Coil(LPH)	05/03-05/08	DG-142		11V				4
2.2 i	114	Z22YH(P35A)		05/03-05/08	K20PBR	5060	0.85	K20TT	IK20TT	IK20TT	4
2.8 V6 Turbo	169/ 184	Z 28 NEL; Z 28 NET		07/05-08/08	IKH20TT	4704	1.0	-	IKH20TT		6
3.0 CDTi	130	Y 30 DT		05/03-05/08	DG-646		11V				6
3.0 V6 CDTI	135	Z 30 DT		07/05-06/08	DG-646		11V				6
3.2 V6	155	Z32SE(211)		05/03-09/05	IK16TT	4701	1.0	-	IK16TT	IK16TT	6
SINTRA (96-99)											
2.2 DTI	85	X 22 DTH	Double Coil(LPH)	07/97-04/99	DG-118		11V				4
2.2 i 16 V	104	X 22 XE		11/96-04/99	K20TXR	5063	1.0	K20TT	IK20TT	IK20TT	4
3.0 i 24V	148	X 30 XE		11/96-04/99	K20TXR	5063	1.0	K20TT	IK20TT	IK20TT	6
SPEEDSTER (VX220) (00-06)											
2.0 i Turbo	147	Z 20 LET		03/01-07/05	K20TXR	5063	1.0	K20TT	IK20TT	IK20TT	4
2.2 i	108	Z 22 SE		09/00-07/05	PT16VR13	5068	1.3	TV16TT	ITV16TT	ITV16TT	4
TIGRA (94-00)											
1.4 16V	66	X 14 XE		07/94-12/00	K20TXR	5063	1.0	K20TT	IK20TT	IK20TT	4
1.6 16V	78	X 16 XE		07/94-12/00	K20TXR	5063	1.0	K20TT	IK20TT	IK20TT	4

Свечи зажигания и Свечи накаливания

Таблица применения

	KW				СТАНДАРТНЫЕ			Twin Tip			QTY
											
VAUXHALL продолжение											
TIGRA TwinTop (04-09)											
1.3 CDTI	51	Z 13 DT	OE:93178047; 93193804; 95508486, Double Coil(LPH)	06/04-08/09	DG-171		11V				4
1.4	66	Z 14 XEP		06/04-08/09	KJ16CR-L11	3132	1.1	K16TT	IK16TT	IK16TT	4
1.8	92	Z 18 XE		06/04-08/09	KJ16CR-L11	3132	1.1	K16TT	IK16TT	IK16TT	4
VECTRA I (B) (95-03)											
1.6 i	55	X 16 SZR		08/95-10/01	K20TXR	5063	1.0	K20TT	IK20TT	IK20TT	4
1.6 i 16V	74	X 16 XEL; Y 16 XE; Z 16 XE		08/95-10/01	K20TXR	5063	1.0	K20TT	IK20TT	IK20TT	4
1.7 TD	60	X 17 DT (TC4EE1)	Ceramic(LPH)	10/95-11/96	DG-300		11V				4
1.7 TD	60	X 17 DT (TC4EE1)	Ceramic(LPH)	10/95-11/96	DG-640		11V				4
1.8 i 16V	85/92	X 18 XE; X 18 XE1; Z 18 XE		10/95-07/03	K20TXR	5063	1.0	K20TT	IK20TT	IK20TT	4
2.0 DI 16V	60	X 20 DTL	Ch:>V1;V5; V7;VL;VP;VS	08/95-10/01	DG-133		11V				4
2.0 DI 16V	60	X 20 DTL	Ch:W1;W5;W7; XL;WP;WS>	08/95-10/01	DG-118		11V				4
2.0 DTi 16V	74	X 20 DTH	Ch:W1;W5;W7; XL;WP;WS>	08/95-10/01	DG-118		11V				4
2.0 DTi 16V	74	Y 20 DTH		08/95-10/01	DG-142		11V				4
2.0 i 16V	100	X 20 XEV		10/95-01/01	K20TXR	5063	1.0	K20TT	IK20TT	IK20TT	4
2.2 DTi 16V	92	Y 22 DTR	Double Coil(LPH)	08/95-10/01	DG-142		11V				4
2.2 i 16V	108	Z 22 SE; Z22SE		09/00-07/03	PT16VR13	5068	1.3	TV16TT	ITV16TT	ITV16TT	4
2.5 i GSi	143	X 25 XE		03/98-07/00	K20TXR	5063	1.0	K20TT	IK20TT	IK20TT	6
2.5 i V6	125	X 25 XE		09/95-08/00	K20TXR	5063	1.0	K20TT	IK20TT	IK20TT	6
2.6 i V6	125	Y 26 SE		09/00-07/03	K20TXR	5063	1.0	K20TT	IK20TT	IK20TT	6
VECTRA II (C) (00-08)											
1.8	103	Z 18 XER	Ch:41000001, 48000001>	01/06-07/08	KJ16CR-L11	3132	1.1	K16TT	IK16TT	IK16TT	4
1.8 16V	90	Z18XE(122)		10/05-07/08	KJ16CR-L11	3132	1.1	K16TT	IK16TT	IK16TT	4
1.8 16V	90	Z18XE(125)		04/02-09/05	IK16TT	4701	1.0	-	IK16TT	IK16TT	4
1.8 16V	90	Z18XE-GPL	Flexible fuel	10/03-08/05	IK16TT	4701	1.0	-	IK16TT	IK16TT	4
1.8 16V Dualfuel	90	Z18XE-GPL	Flexible fuel	04/02-09/05	IK16TT	4701	1.0	-	IK16TT	IK16TT	4
1.9 CDTI	88	Z 19 DT	Ch:>71021891; 48999999	04/02-09/08	DG-122		11V				4
1.9 CDTI	88	Z 19 DT	Ch:71021892; 78>	04/02-09/08	DG-196		11V				4
1.9 CDTI 16V	110	Z 19 DTH	Double Coil(LPH)	04/04-05/09	DG-170		11V				4
2.0 16V Turbo	129	Z 20 NET		01/00-10/08	PK20PR-L11	3142	1.1	-	IK20TT	IK20TT	4
2.0 DTi 16V	74	Y 20 DTH	Double Coil(LPH)	04/02-10/08	DG-142		11V				4
2.2 16V	108	Z 22 SE		01/02-10/08	PT16VR13	5068	1.3	TV16TT	ITV16TT	ITV16TT	4
2.2 direct	114	Z22YH(P35A)		10/03-10/08	K20PBR	5060	0.85	K20TT	IK20TT	IK20TT	4
2.2 DTi 16V	92	Y 22 DTR	Double Coil(LPH)	04/02-10/08	DG-142		11V				4
2.8 V6 Turbo	169/ 184/ 188	Z 28 NEL; Z 28 NET		08/05-05/09	IKH20TT	4704	1.0	-	IKH20TT		6
3.0 CDTi	135	Z 30 DT		08/05-07/08	DG-646		11V				6
3.0 V6 CDTI	130	Y 30 DT		06/03-08/05	DG-646		11V				6
3.2 V6	155	Z32SE(210)		08/02-09/05	IK16TT	4701	1.0	-	IK16TT	IK16TT	6
VIVARO (A) (01-14)											
1.9 DI	59	F9Q 762	Double Coil(LPH)	08/01-07/14	DG-005		11V				4
1.9 DTI	74	F9Q 760	Double Coil(LPH)	08/01-12/06	DG-005		11V				4
2.0 16V	88	F4R 720		08/01-07/14	PK20PR-P8	3245	0.8	-	IK20TT	IK20TT	4
2.0 ECOTEC	86	F4R 820		08/06-07/14	PK20PR-P8	3245	0.8	-	IK20TT	IK20TT	4
2.5 CDTI	99/ 107	G9U 630; G9U 730		04/03-07/14	DG-126		11V				4
2.5 DTI	99	G9U 730		07/03-07/14	DG-126		11V				4
VIVARO (B) (14-)											
1.6 CDTI	66/ 85/ 88/ 103	R9M-MA, R9M-MB, R9M-MC, R9M-MD, R9M-ME	Without cyl inder press ure sensor, OE:95518024/ 44 23 206, Marking = Yellow	05/14-	DG-631		4.5V				4

Свечи зажигания и Свечи накаливания











Таблица применения

Таблица применения

VAUXHALL	KW	KW	NOTE	21	СТАНДАРТНЫЕ			Twin Tip			QTY
					STANDARD	STANDARD	STANDARD	TWIN TIP	TWIN TIP	TWIN TIP	
VAUXHALL продолжение											
VIVARO (B) (14-) продолжение											
1.6 CDTi	88/103	R9M-MG, R9M-MH, R9M-MJ, R9M-MK	Vehicle with cylinder pressure sensor, OE: 95518024/44 23 206, Cylinder r 2,3,4; marking = Yellow	05/14-	DG-631		4.5V				3
ZAFIRA I (A) (98-05)											
1.6 16V	74	X 16 XEL; Z 16 XE		04/99-08/05	K20TXR	5063	1.0	K20TT	IK20TT	IK20TT	4
1.6 CNG	71	Z16YNG	Flexible fuel	07/03-06/05	PK20PR-P8	3245	0.8	-	IK20TT	IK20TT	4
1.8 16V	85/92	X 18 XE1; Z 18 XE		05/99-08/05	K20TXR	5063	1.0	K20TT	IK20TT	IK20TT	4
1.8 Dualfuel	92	Z 18 XE		09/00-08/05	K20TXR	5063	1.0	K20TT	IK20TT	IK20TT	4
2.0	147	Z 20 LET		06/02-06/05	K20TXR	5063	1.0	K20TT	IK20TT	IK20TT	4
2.0 DI 16V	60	X 20 DTL	Double Coil(LPH)	10/99-08/05	DG-118		11V				4
2.0 DTI 16V	74	Y 20 DTH	Ch:>22;25;26; 28;2B;2H;2G, Double Coil(LPH)	04/99-08/05	DG-118		11V				4
2.0 DTI 16V	74	Y 20 DTH	Ch:32;35;36; 38;3B;3H;4G>	04/99-08/05	DG-142		11V				4
2.0 GSI Turbo	141	Z 20 LET		09/01-06/05	K20TXR	5063	1.0	K20TT	IK20TT	IK20TT	4
2.2 16V	108	Z 22 SE		11/98-08/04	PT16VR13	5068	1.3	TV16TT	ITV16TT	ITV16TT	4
ZAFIRA II (B) (05-14)											
1.6	77	Z16XEP		07/05-02/09	KJ16CR-L11	3132	1.1	K16TT	IK16TT	IK16TT	4
1.6	85	A 16 XER; Z 16 XER	Ch:>92999999/ 9G999999	12/07-11/14	KJ16CR-L11	3132	1.1	K16TT	IK16TT	IK16TT	4
1.6	85	A 16 XER; Z 16 XER	Ch:A2000001/ AG000001>	12/07-11/14	KJ20CR-L11	3169	1.1	K20TT	IK20TT	IK20TT	4
1.7 CDTi	81/92	A 17 DTJ; A 17 DTR; Z 17 DTJ		01/08-11/14	DG-302		11V				4
1.7 CDTi	81/92	A 17 DTJ; A 17 DTR; Z 17 DTJ		01/08-11/14	DG-641		11V				4
1.8	103	A 18 XER; Z 18 XER	Ch:>D2999999/ AG999999	04/05-11/14	KJ16CR-L11	3132	1.1	K16TT	IK16TT	IK16TT	4
1.8	103	A 18 XER; Z 18 XER	Ch: E2000001>	04/05-11/14	KJ20CR-L11	3169	1.1	K20TT	IK20TT	IK20TT	4
1.9 CDTi	88	Z 19 DT	Ch:> 629999999; 6G999999, Double Coil(LPH)	07/05-11/14	DG-122		11V				4
1.9 CDTi	88	Z 19 DT	Ch:72000001: 7G000001>, Double Coil(LPH)	07/05-11/14	DG-196		11V				4
1.9 CDTi	110	Z 19 DTH	Double Coil(LPH)	07/05-11/14	DG-170		11V				4
2.0	147	Z 20 LER		07/05-11/14	KJ16CR-L11	3132	1.1	K16TT	IK16TT	IK16TT	4
2.0	176	Z 20 LEH		01/06-11/14	PK20PR-P8	3245	0.8	-	IK20TT	IK20TT	4
2.2	110	Z22YH(150)/Z22YH(P 35A)		07/05-11/14	K20PBR	5060	0.85	K20TT	IK20TT	IK20TT	4
ZAFIRA III (C) (11-)											
1.4	88/103	A 14 NEL; A 14 NET; B 14 NET		10/11-08/18	VK22	5610	0.8	-	IK22TT	VK22	4
1.6 CDTi	100	B 16 DTH	OE:55570037, Pressure sensor (-)	03/13-08/18	DG-634		4.4V				2
1.8	85	A 18 XEL		10/11-08/18	KJ16CR-L11	3132	1.1	K16TT	IK16TT	IK16TT	4
1.8	103	A 18 XER		10/11-08/18	KJ20CR-L11	3169	1.1	K20TT	IK20TT	IK20TT	4
2.0 CDTi	96	A 20 DT	Start stop system (-), Manual Transmission, Pressure sensor (-)	10/11-08/18	DG-608		4.4V				2
2.0 CDTi	121	A 20 DTH	Pressure sensor (-)	01/12-08/18	DG-608		4.4V				2
VOLVO											
66 (75-79)											
1.1 DL	33	B 11		08/75-11/79	W20FP-U	3068	0.7	WF20TT	-		4
1.3 GL	42	B 130		08/75-11/79	W20FP-U	3068	0.7	WF20TT	-		4

Свечи зажигания и Свечи накаливания

Таблица применения

	KW				СТАНДАРТНЫЕ			Twin Tip			QTY
											
VOLVO продолжение											
140 (66-75)											
1.8	55	B 18 A		08/66-07/68	W22FS-U	4025	0.7	-	-		4
1.8 S	55/74	B 18 A; B 18 B		08/66-01/72	W22FS-U	4025	0.7	-	-		4
2.0	60/ 70/91	B 20 A; B 20 D; B 20 E		08/68-04/75	W22FP-U	4021	0.7	-	-		4
2.0 S	60/ 70/ 74/ 85/91	B 20 A; B 20 B; B 20 D; B 20 E; B 20 F		08/68-08/75	W22FP-U	4021	0.7	-	-		4
164 (68-74)											
2.9	118	B 30 E		08/72-07/74	W20FPR-U	3070	0.7	WF20TT	-		6
2.9 E	96	B 30 A		08/68-07/73	W20FPR-U	3070	0.7	WF20TT	-		6
240 (74-93)											
2.0	60	B 20 A		08/74-07/76	W22FP-U	4021	0.7	-	-		4
2.0	66/71	B 19 A; B 19 K		08/76-12/84	W20EP-U	3043	0.8	W20TT	IW20TT	IW20TT	4
2.0	76/ 86/89	B200E; B200K		08/84-07/93	W20EPR-U	3047	0.8	W20TT	IW20TT	IW20TT	4
2.0	86/89	B200E		08/83-06/87	W22EPR-U	3088	0.8	W22TT	-	VW22	4
2.1	71/ 74/79	B 21 A		08/74-08/84	W20EP-U	3043	0.8	W20TT	IW20TT	IW20TT	4
2.1	90	B21E		08/74-02/79	W22EPR-U	3088	0.8	W22TT	-	VW22	4
2.1 Turbo	114	B21ET		08/80-07/85	W22EPR-U	3088	0.8	W22TT	-	VW22	4
2.3	82	B 23 A		08/80-07/84	W20EP-U	3043	0.8	W20TT	IW20TT	IW20TT	4
2.3	82/ 85/98	B 230 A; B 230 K; B230E; B230F(113); B230F(116); B230K		08/84-12/89	W20EPR-U	3047	0.8	W20TT	IW20TT	IW20TT	4
2.3	96/ 98/ 100/ 103	B23E(129); B23E(136); B230E		08/78-06/86	W22EPR-U	3088	0.8	W22TT	-	VW22	4
2.3 i Cat	85	B230F(116)		08/86-07/93	W20EPR-U	3047	0.8	W20TT	IW20TT	IW20TT	4
2.4 Diesel	58/60	D 24	Double Coil(LPH)	08/78-08/93	DG-012		11V				6
260 (74-82)											
2.7	92/ 103	B27A; B27E/B27F; B27E		08/75-07/80	T20EPR-U	5032	0.8	T20TT	IT20TT	IT20TT	6
2.8	95/ 114	B28A/B28F; B28E/B28F; B28E		08/80-07/82	T20EPR-U	5032	0.8	T20TT	IT20TT	IT20TT	6
340-360 (75-91)											
1.4	46/ 50/53	B14.1/B14.2/B14.3/B 14.4		08/75-12/88	W16EPR-U	3021	0.8	W16TT	IW16TT	IW16TT	4
1.4	50	B14.0		08/75-07/83	IWF20	5378	0.8	-	-		4
1.6 Diesel	40	D 16	Double Coil Standard	08/84-07/91	DG-006		11V				4
1.7	59	B172		08/85-07/91	W20EPR-U	3047	0.8	W20TT	IW20TT	IW20TT	4
2.0	66/ 68/ 70/ 75/77	B 19 A; B 200 K		08/80-07/90	W16EPR-U	3021	0.8	W16TT	IW16TT	IW16TT	4
2.0	80/ 83/ 85/87	B 19 E; B 200 E; B 200 EA; B 200 F		08/82-07/89	W20EPR-U	3047	0.8	W20TT	IW20TT	IW20TT	4
440 (88-96)											
1.6	61	B16F		10/91-12/96	J16CR-U	3256	0.8	W16TT	IW16TT	IW16TT	4
1.7	58/ 60/ 64/ 70/ 75/78	B 18 EP; B 18 F; B 18 FP; B 18 K; B 18 KD; B 18 KP		08/88-12/96	W20EPR-U	3047	0.8	W20TT	IW20TT	IW20TT	4
1.7 Turbo	88/90	B 18 FT		08/88-12/96	W22EPR-U	3088	0.8	W22TT	-	VW22	4
1.8	66	B 18 U		08/91-12/96	W20EPR-U	3047	0.8	W20TT	IW20TT	IW20TT	4
1.9 Turbo Diesel	66	D 19 T	Double Coil(LPH)	07/94-12/96	DG-012		11V				4
2.0	80	B20F		08/92-07/96	W22EPR-U	3088	0.8	W22TT	-	VW22	4
460 (88-96)											
1.6	61	B16F		07/92-07/96	J16CR-U	3256	0.8	W16TT	IW16TT	IW16TT	4
1.7	58/ 64/ 66/ 75/80	B 18 EP; B 18 KD; B 18 KP		09/88-07/96	W20EPR-U	3047	0.8	W20TT	IW20TT	IW20TT	4
1.7 Turbo	88/90	B 18 FT		08/89-07/96	W22EPR-U	3088	0.8	W22TT	-	VW22	4
1.8	66	B 18 U		08/91-07/96	W20EPR-U	3047	0.8	W20TT	IW20TT	IW20TT	4
1.9 Turbo Diesel	66	D 19 T	Double Coil(LPH)	07/94-07/96	DG-012		11V				4
2.0	80	B20F		08/92-07/96	W22EPR-U	3088	0.8	W22TT	-	VW22	4

Свечи зажигания и Свечи накаливания

Таблица применения

Таблица применения

KW	KW	KW	NOTE	21	СТАНДАРТНЫЕ			Twin Tip		QTY	
					STANDARD	STANDARD	STANDARD	TWIN TIP	TWIN TIP		
VOLVO продолжение											
480 (86-96)											
1.7	70/75	B18F; B18FP		08/87-07/96	J16CR-U	3256	0.8	W16TT	IW16TT	IW16TT	4
1.7	78	B18E		04/86-07/89	W22EPR-U	3088	0.8	W22TT	-	WV22	4
1.7	80	B18E/B18ED	Check Hex size	08/86-07/88	W22EPR-U	3088	0.8	W22TT	-	WV22	4
1.7	80	B18EP/B18FP	Check Hex size	08/86-07/88	J16CR-U	3256	0.8	W16TT	IW16TT	IW16TT	4
1.7 Turbo	88/90	B18FT/B18FTM		08/87-07/96	W22EPR-U	3088	0.8	W22TT	-	WV22	4
2.0	81	B20F		08/92-09/95	W22EPR-U	3088	0.8	W22TT	-	WV22	4
740 (83-92)											
2.0	76/ 82/ 89/ 118	B 200 ET; B 200 F; B 200 G; B 200 K		08/85-07/92	W20EPR-U	3047	0.8	W20TT	IW20TT	IW20TT	4
2.0	86/ 120	B 200 ET		01/85-08/88	W20EP-U	3043	0.8	W20TT	IW20TT	IW20TT	4
2.0 Turbo	114	B 200 FT		09/90-08/91	W20EPR-U	3047	0.8	W20TT	IW20TT	IW20TT	4
2.3	82/ 85/96	B 230 A; B 230 E; B 230 K		08/84-12/92	W20EP-U	3043	0.8	W20TT	IW20TT	IW20TT	4
2.3	82/ 85/ 96/ 111/ 114/ 117	B 230 A; B 230 F; B 230 FB; B 230 K; B 234 F		08/84-12/92	W20EPR-U	3047	0.8	W20TT	IW20TT	IW20TT	4
2.3 Turbo	115/ 121/ 125/ 140	B 230 FT; B 230 GT		08/86-08/91	W20EPR-U	3047	0.8	W20TT	IW20TT	IW20TT	4
2.3 Turbo	134	B 230 ET		08/85-12/88	W20EP-U	3043	0.8	W20TT	IW20TT	IW20TT	4
2.4 Diesel	60	D 24	Double Coil(LPH)	08/84-07/92	DG-012		11V				6
2.4 TD Interc.	90	D 24 TIC	Double Coil(LPH)	08/86-07/88	DG-012		11V				6
2.4 Turbo Diesel	80	D 24 T	Double Coil(LPH)	09/85-07/92	DG-012		11V				6
760 (81-92)											
2.3	121	B 230 FT		01/88-07/92	W20EPR-U	3047	0.8	W20TT	IW20TT	IW20TT	4
2.3 Turbo	115/ 134	B 230 ET; B 230 FT		08/84-08/90	W20EPR-U	3047	0.8	W20TT	IW20TT	IW20TT	4
2.4 D	60	D 24	Double Coil(LPH)	01/82-07/92	DG-012		11V				6
2.4 TD Interc.	85	D 24 TIC	Double Coil(LPH)	08/87-07/92	DG-012		11V				6
2.4 Turbo Diesel	80/82	D 24 T	Double Coil(LPH)	08/82-07/92	DG-012		11V				6
2.8	105/ 115	B 28 E; B 280 F		08/81-08/91	T20EPR-U	5032	0.8	T20TT	IT20TT	IT20TT	6
780 (86-90)											
2.9	108/ 115	B 280 E; B 280 F		08/86-07/90	T20EPR-U	5032	0.8	T20TT	IT20TT	IT20TT	6
850 (91-97)											
2.0	93	B 5202 S		08/94-12/96	K20PBR-S10	5061	1.0	K20TT	IK20TT	IK20TT	5
2.0	105	B 5204 F		06/91-12/96	K20PR-U	3145	0.8	K20TT	IK20TT	IK20TT	5
2.0 Turbo	132/ 155	B 5204 FT; B 5204 T; B 5204 T2		02/93-10/97	PK20PR-P8	3245	0.8	-	IK20TT	IK20TT	5
2.3 T5	166	B 5234 FT		02/93-12/96	PK20PR-P8	3245	0.8	-	IK20TT	IK20TT	5
2.3 T5 R	176	B 5234 T2		04/96-10/96	PK20PR-P8	3245	0.8	-	IK20TT	IK20TT	5
2.3 T5-R	184	B 5234 T4		08/95-12/96	PK20PR-P8	3245	0.8	-	IK20TT	IK20TT	5
2.3 Turbo R	177/ 179	B 5234 T5		09/94-10/97	PK20PR-P8	3245	0.8	-	IK20TT	IK20TT	5
2.4	103/ 106/ 125	B 5252 FS; B 5252; B 5254 S		06/91-12/96	K20PBR-S10	5061	1.0	K20TT	IK20TT	IK20TT	5
2.4 AWD	142	B 5254 T		04/96-12/96	PK20PR-P8	3245	0.8	-	IK20TT	IK20TT	5
2.4 GLE	142	B 5254 T		09/93-10/97	PK20PR-P8	3245	0.8	-	IK20TT	IK20TT	5
2.5 TDI	103	D 5252 T	Double Coil(LPH)	08/95-12/96	DG-005		11V				5
940 I (90-95)											
2.0	82	B 200 F		01/92-07/94	W20EPR-U	3047	0.8	W20TT	IW20TT	IW20TT	4
2.0 Turbo	114	B 200 FT		08/90-07/95	W20EPR-U	3047	0.8	W20TT	IW20TT	IW20TT	4
2.3	85/ 96/ 114/ 118	B 230 FB; B 230 FD; B 230 FT; B 234 F; B 234 G		08/90-12/94	W20EPR-U	3047	0.8	W20TT	IW20TT	IW20TT	4
2.3 Turbo	121/ 140	B 230 FT; B230FT; B230FT+(190)/ B234F		08/90-07/94	W20EPR-U	3047	0.8	W20TT	IW20TT	IW20TT	4

Свечи зажигания и Свечи накаливания

Таблица применения





	KW				СТАНДАРТНЫЕ			Twin Tip			QTY
VOLVO продолжение											
940 I (90-95) продолжение											
2.4 D	60	D 24	Double Coil(LPH)	08/90-07/95	DG-012		11V				6
2.4 TD Intercooler	90	D 24 TIC	Double Coil(LPH)	08/90-12/94	DG-012		11V				6
2.4 Turbo Diesel	80	D 24 T	Double Coil(LPH)	08/90-12/94	DG-012		11V				6
940 II (94-98)											
2.0 Turbo	114	B 200 FT		04/96-10/98	W20EPR-U	3047	0.8	W20TT	IW20TT	IW20TT	4
2.3	85/96	B 230 FB; B 230 FD		08/94-10/98	W20EPR-U	3047	0.8	W20TT	IW20TT	IW20TT	4
2.3 ti	99	B 230 FK		01/95-10/98	W20EPR-U	3047	0.8	W20TT	IW20TT	IW20TT	4
2.3 Turbo	121/ 126	B 230 FT; B230GT(171)		08/94-12/98	W20EPR-U	3047	0.8	W20TT	IW20TT	IW20TT	4
2.4 TD Interc.	90	D 24 TIC	Double Coil(LPH)	08/94-10/98	DG-012		11V				6
960 I (90-94)											
2.0	140	B 204 FT		08/90-09/93	W20EPR-U	3047	0.8	W20TT	IW20TT	IW20TT	4
2.3 Turbo	121	B 230 FT		09/90-08/93	W20EPR-U	3047	0.8	W20TT	IW20TT	IW20TT	4
2.4 TD Interc.	85	D 24 TIC	Double Coil(LPH)	09/91-07/94	DG-012		11V				6
2.9	150	B 6304 F		08/90-07/94	Q20PR-U	3007	0.8	Q20TT	IQ20TT	IQ20TT	6
2.9	150	B 6304 S		08/90-07/94	K20TXR	5063	1.0	K20TT	IK20TT	IK20TT	6
960 II (94-96)											
2.5	125	B 6254 S		07/94-12/96	Q20PR-U	3007	0.8	Q20TT	IQ20TT	IQ20TT	6
2.9	150	B 6304 S		07/94-12/96	K20TXR	5063	1.0	K20TT	IK20TT	IK20TT	6
C30 (06-12)											
1.6	74	B 4164 S3		10/06-12/12	PT16VR13	5068	1.3	TV16TT	ITV16TT	ITV16TT	4
1.6 D	80	D 4164 T	Eng:>-16125, OE:30711106	10/06-12/12	DG-113		11V				4
1.6 D	80	D 4164 T	Eng:16126->, OE:31216248	10/06-12/12	DG-180		11V				4
1.6 D2	84	D 4162 T		10/10-12/12	DG-603		5V				4
1.8	92	B 4184 S11		10/06-12/12	ZT20EPR11	5087	1.1	T20TT	IT20TT	IT20TT	4
1.8 FlexFuel	92	B 4184 S8		01/07-12/12	ZT20EPR11	5087	1.1	T20TT	IT20TT	IT20TT	4
2.0	107	B 4204 S3		10/06-12/12	ZT20EPR11	5087	1.1	T20TT	IT20TT	IT20TT	4
2.0 D	100	D 4204 T	OE: 30725069	10/06-12/12	DG-181		11V				4
2.0 D3	110	D 5204 T5	OE: 30777311	10/10-12/12	DG-620		7V				5
2.0 D4	130	D 5204 T	OE: 30777311	10/10-12/12	DG-620		7V				5
2.0 FlexFuel	107	B 4204 S4		01/10-12/12	ZT20EPR11	5087	1.1	T20TT	IT20TT	IT20TT	4
2.4 D5	120/ 132	D 5244 T13; D 5244 T8; D 5244 T9	Ch:>-62745, OE:8653880	10/06-12/12	DG-610		4.4V				5
2.4 D5	120/ 132	D 5244 T13; D 5244 T8; D 5244 T9	Ch:62746->, OE:30777311	10/06-12/12	DG-620		7V				5
2.4 i	125	B 5244 S4		10/06-12/12	K20HR-U11	3381	1.1	KH20TT	IKH20TT	IKH20TT	5
2.5 T5	162/ 169	B 5254 T3; B 5254 T7		10/06-12/12	VKH22	5619	0.8	-	-	VKH22	5
C70 I (97-05)											
2.0	132	B5204T2		03/97-09/98	PK20PR-P8	3245	0.8	-	IK20TT	IK20TT	5
2.0 T	120/ 166	B5204T3; B5204T4-E2		03/97-10/05	PK20PR-P8	3245	0.8	-	IK20TT	IK20TT	5
2.3 T5	176/ 180	B5234T3-240; B5234T3- E2/B5234T9		03/98-10/05	PK20PR-P8	3245	0.8	-	IK20TT	IK20TT	5
2.3 T-5	176	B5234T3-240/B5234 T3-E2		03/97-09/02	PK20PR-P8	3245	0.8	-	IK20TT	IK20TT	5
2.4	121/ 125	B 5254 S; B5254S		06/98-10/05	PK20PR-P8	3245	0.8	-	IK20TT	IK20TT	5
2.4	125	B5244S		06/98-09/02	K20PBR-S10	5061	1.0	K20TT	IK20TT	IK20TT	5
2.4 T	142/ 147	B 5244 T; B 5254 T; B5244T- 200/B5244T7		03/97-10/05	PK20PR-P8	3245	0.8	-	IK20TT	IK20TT	5
C70 II (06-13)											
2.0 D	100	D 4204 T	OE: 30725069	01/08-10/09	DG-181		11V				4
2.0 D3	110	D 5204 T5	OE: 30777311	10/10-06/13	DG-620		7V				5
2.0 D4	130	D 5204 T	OE: 30777311	10/10-06/13	DG-620		7V				5
2.4	103	B5244S5		03/06-10/09	K20HR-U11	3381	1.1	KH20TT	IKH20TT	IKH20TT	5
2.4 D	120	D 5244 T9	Ch:>-49640, OE:8653880	03/07-06/13	DG-610		4.4V				5
2.4 D	120	D 5244 T9	Ch:49641->, OE:30777311	03/07-06/13	DG-620		7V				5











Таблица применения

Λ

Свечи зажигания и Свечи накаливания

Таблица применения

Таблица применения

	KW				СТАНДАРТНЫЕ				Twin Tip			QTY
												
VOLVO продолжение												
C70 II (06-13) продолжение												
2.4 D5	132	D 5244 T13; D 5244 T8	Ch:>-49640, OE:8653880	03/06-06/13	DG-610		4.4V					5
2.4 D5	132	D 5244 T13; D 5244 T8	Ch:49641->, OE:30777311	03/06-06/13	DG-620		7V					5
2.4 i	125	B5244S4		03/06-10/09	K20HR-U11	3381	1.1	KH20TT	IKH20TT	IKH20TT		5
2.5 T5	162/ 169	B 5254 T3; B 5254 T7		03/06-10/09	VKH22	5619	0.8	-	-	VKH22		5
DUETT (61-67)												
1.8	55	B 18 A		08/61-07/67	W22FPR-U	4022	0.7	-	-			4
P 121 (59-71)												
1.6	44	B 16 A		05/59-09/66	W22FPR-U	4022	0.7	-	-			4
1.8	50/55	B 18		05/59-05/71	W22FPR-U	4022	0.7	-	-			4
2.0	60	B 20 A		11/68-05/71	W22FPR-U	4022	0.7	-	-			4
P 122 S Amazon (59-71)												
1.6	61	B 16		05/59-09/66	W22FPR-U	4022	0.7	-	-			4
1.8	59/ 63/ 66/76	B 18 D; B 18		05/59-05/71	W22FPR-U	4022	0.7	-	-			4
2.0	74	B 20 B		11/68-05/71	W22FPR-U	4022	0.7	-	-			4
P 544 (61-67)												
1.6	44/61	B 16 A; B 16 B		08/61-07/67	W22FPR-U	4022	0.7	-	-			4
1.8	50/59	B 18 D		08/61-07/67	W22FPR-U	4022	0.7	-	-			4
P 1800 (62-73)												
1.8	66/76			04/62-05/70	W22FPR-U	4022	0.7	-	-			4
1.8 S	71			04/62-05/70	W22FPR-U	4022	0.7	-	-			4
2.0 ES	91	B 20 E		04/72-11/73	W22FPR-U	4022	0.7	-	-			4
P 2200 (64-67)												
1.8	50/ 59/63	B 18 A; B 18 B; B 18 D		09/64-08/67	W22FPR-U	4022	0.7	-	-			4
S40 I (95-03)												
1.6	77/80	B 4164 S; B 4164 S2		09/95-12/03	K20PBR	5060	0.85	K20TT	IK20TT	IK20TT		4
1.8	85/90	B 4184 S; B 4184 S2; B 4184 S3		07/95-12/03	K20PBR	5060	0.85	K20TT	IK20TT	IK20TT		4
1.8 i	90/92	B 4184 SJ; B 4184 SM		03/98-12/03	VKB20	5625	1.1	-	-	VKB20		4
1.9 DI	70	D 4192 T2	Double Coil(LPH)	03/99-07/00	DG-101		11V					4
1.9 DI	75/85	D 4192 T3; D 4192 T4	for vehicles without elctr. auxiliary heater	07/00-12/03	DG-005		11V					4
1.9 T4	147	B 4194 T; B 4194 T2		05/97-07/00	PK20PR-P8	3245	0.8	-	IK20TT	IK20TT		4
1.9 TD	66	D 4192 T	Double Coil(LPH)	07/95-08/99	DG-012		11V					4
2.0	100/ 103	B 4204 S; B 4204 S2		07/95-12/03	K20PBR	5060	0.85	K20TT	IK20TT	IK20TT		4
2.0 T	118/ 120	B 4204 T; B 4204 T2; B 4204 T3		10/97-12/03	PK20PR-P8	3245	0.8	-	IK20TT	IK20TT		4
2.0 T4	147	B 4204 T5		07/00-12/03	PK20PR-P8	3245	0.8	-	IK20TT	IK20TT		4
S40 II (04-12)												
1.6	74	B 4164 S3		01/05-12/12	PT16VR13	5068	1.3	TV16TT	ITV16TT	ITV16TT		4
1.6 D	81	D 4164 T	Eng:>-16125, OE:30711106	01/05-12/12	DG-113		11V					4
1.6 D	81	D 4164 T	Eng:16126->, OE:31216248	01/05-12/12	DG-180		11V					4
1.6 D2	84	D 4162 T		10/10-12/12	DG-603		5V					4
1.8	92	B 4184 S11		04/04-12/10	ZT20EPR11	5087	1.1	T20TT	IT20TT	IT20TT		4
1.8 FlexFuel	92	B4184S8(125)	Flexible fuel	01/06-10/09	IT20TT	4714	1.0	-	IT20TT			4
2.0	107	B 4204 S3		10/06-03/11	ZT20EPR11	5087	1.1	T20TT	IT20TT	IT20TT		4
2.0	107	B 4204 S3		04/11-12/12	IT20TT	4714	1.0	-	IT20TT			4
2.0 CDI	98	D 4204 T2	OE: 30725069	07/05-12/06	DG-181		11V					4
2.0 D	100	D 4204 T	OE: 30725069	01/04-12/10	DG-181		11V					4
2.0 D3	110	D 5204 T5	OE: 30777311	10/10-12/12	DG-620		7V					5
2.0 D4	130	D 5204 T	OE: 30777311	10/10-12/12	DG-620		7V					5
2.4	103/ 125	B 5244 S4; B 5244 S5		01/04-12/12	K20HR-U11	3381	1.1	KH20TT	IKH20TT	IKH20TT		5
2.4 CDI	120	D 5244 T9	Ch:>-380303, OE:8653880	03/07-12/10	DG-610		4.4V					5

Свечи зажигания и Свечи накаливания

Таблица применения











	KW				СТАНДАРТНЫЕ			Twin Tip			QTY
											
VOLVO продолжение											
S40 II (04-12) продолжение											
2.4 CDI	120	D 5244 T9	Ch:380304->, OE:30777311	03/07-12/10	DG-620		7V				5
2.4 D5	132	D 5244 T13; D 5244 T8	Ch:>-380303, OE:8653880	03/06-12/10	DG-610		4.4V				5
2.4 D5	132	D 5244 T13; D 5244 T8	Ch:380304->, OE:30777311	03/06-12/10	DG-620		7V				5
2.5 T5	162/ 169	B 5254 T3; B 5254 T7		01/04-12/12	VKH22	5619	0.8	-	-	VKH22	5
2.5 T5 AWD	162/ 169	B 5254 T3; B 5254 T7		04/04-12/10	VKH22	5619	0.8	-	-	VKH22	5
S60 I (00-10)											
2.0 T	132	B 5204 T5		07/00-12/04	PK20PR-P8	3245	0.8	-	IK20TT	IK20TT	5
2.0 T	132	B 5204 T5		01/05-04/10	VKH20Y	5639	0.8	-	-	VKH20Y	5
2.3 T5	184	B5234T3/B5234T7-E 2		07/00-12/04	PK20PR-P8	3245	0.8	-	IK20TT	IK20TT	5
2.4	103/ 125	B 5244 S2		07/00-04/10	K20PBR-S10	5061	1.0	K20TT	IK20TT	IK20TT	5
2.4	132	B 5244 T4		01/05-10/06	VKH22	5619	0.8	-	-	VKH22	5
2.4 Bifuel (CNG)	103	B 5244 SG		07/01-04/10	PK20PR-P8	3245	0.8	-	IK20TT	IK20TT	5
2.4 Bifuel (LPG)	103	B 5244 SG2		07/01-04/10	K20PBR-S10	5061	1.0	K20TT	IK20TT	IK20TT	5
2.4 CDI	85	D 5244 T3	OE: 8631607	10/03-12/05	DG-140		11V				5
2.4 D	90/ 93/ 120	D 5244 T5; D 5244 T6; D 5244 T7	OE: 8653880	03/05-04/10	DG-610		4.4V				5
2.4 D	96	D 5244 T2	OE: 8631607	05/01-04/10	DG-140		11V				5
2.4 D5	120/ 136	D 5244 T; D 5244 T4	OE: 8631607	01/01-04/10	DG-140		11V				5
2.4 T	147	B 5244 T3		07/00-04/10	PK20PR-P8	3245	0.8	-	IK20TT	IK20TT	5
2.4 T AWD	147	B 5244 T3		06/01-04/10	PK20PR-P8	3245	0.8	-	IK20TT	IK20TT	5
2.4 T5	191	B 5244 T5		04/04-04/10	PK20PR-P8	3245	0.8	-	IK20TT	IK20TT	5
2.4 T5	191	B 5244 T5		04/04-04/10	VKH22	5619	0.8	-	-	VKH22	5
2.5 T	154	B 5254 T2		01/03-04/10	PK20PR-P8	3245	0.8	-	IK20TT	IK20TT	5
2.5 T AWD	154	B 5254 T2		07/02-04/10	PK20PR-P8	3245	0.8	-	IK20TT	IK20TT	5
2.5 T R AWD	221	B 5254 T4		01/03-04/10	VKH22	5619	0.8	-	-	VKH22	5
S60 II (10-)											
1.6 D2 (DRIVE)	84	D 4162 T		01/11-12/15	DG-603		5V				4
1.6 T3	110	B 4164 T3		04/10-12/15	ITV20TT	4719	1.0	-	ITV20TT		4
1.6 T4	132	B 4164 T		04/10-12/15	ITV20TT	4719	1.0	-	ITV20TT		4
1.6 T4F	132	B 4164 T2		04/11-12/15	ITV20TT	4719	1.0	-	ITV20TT		4
2.0 D2	88	D 4204 T20; D 4204 T8	OE: 30777311	03/15-	DG-620		7V				4
2.0 D3 I-4	110	D 4204 T4; D 4204 T9	OE: 30777311	03/15-	DG-620		7V				4
2.0 D3 I-5	100/ 120	D 5204 T2; D 5204 T3; D 5204 T7	OE: 30777311	04/10-12/15	DG-620		7V				5
2.0 D4 I-4	133/ 140	D 4204 T14; D 4204 T5	OE: 30777311	09/13-	DG-620		7V				4
2.0 D4 I-5	120	D 5204 T3	OE: 30777311	04/10-12/14	DG-620		7V				5
2.0 D5	165	D 4204 T11	OE: 30777311	03/15-	DG-620		7V				4
2.0 T	149	B 4204 T6	40000km Lifetime	04/10-12/11	ITV22	5340	0.8	-	-		4
2.0 T5	177	B 4204 T7	40000km Lifetime	04/10-12/14	ITV22	5340	0.8	-	-		4
2.4 D4 AWD	140	D 5244 T21	OE: 30777311	03/15-	DG-620		7V				5
2.4 D5	151/ 158/ 169	D 5244 T10; D 5244 T11; D 5244 T15	OE: 30777311	04/10-12/15	DG-620		7V				5
2.4 D5 AWD	151/ 158/ 169	D 5244 T10; D 5244 T15	OE: 30777311	04/10-12/15	DG-620		7V				5
2.5 T5	186	B 5254 T5		09/11-	VKH22	5619	0.8	-	-	VKH22	5
2.5 T5 AWD	187	B 5254 T5		09/12-	VKH22	5619	0.8	-	-	VKH22	5
3.0 T AWD	258	B 6304 T5		04/14-	FK20HR11	3426	1.1	-	IKH20TT	IKH20TT	6
3.0 T AWD	258	B 6304 T5		04/14-	IKH20TT	4704	1.0	-	IKH20TT		6
3.0 T6 AWD	224/ 242	B 6304 T3; B 6304 T4		04/10-12/15	FK20HR11	3426	1.1	-	IKH20TT	IKH20TT	6
3.0 T6 AWD	224/ 242	B 6304 T3; B 6304 T4		04/10-12/15	IKH20TT	4704	1.0	-	IKH20TT		6
S70 (96-00)											
2.0	93	B5202FS		01/97-04/99	K20PBR-S10	5061	1.0	K20TT	IK20TT	IK20TT	5
2.0	120/ 132	B5204T2; B5204T4		01/97-11/00	PK20PR-P8	3245	0.8	-	IK20TT	IK20TT	5
2.0 Turbo	166	B5204T3		01/97-11/00	PK20PR-P8	3245	0.8	-	IK20TT	IK20TT	5









Таблица применения

Λ

Свечи зажигания и Свечи накаливания

Таблица применения

Таблица применения

	KW				СТАНДАРТНЫЕ				Twin Tip		QTY
											
VOLVO продолжение											
S70 (96-00) продолжение											
2.3 Turbo	184	B5234T3/B5234T4/ B5234T7		01/97-11/00	PK20PR-P8	3245	0.8	-	IK20TT	IK20TT	5
2.4	103/ 106/ 121/ 125	B 5244 S; B 5244 S2; B 5244 SG; B 5254 S; B5252FS; B5254FS/B5254S		01/97-11/00	K20PBR-S10	5061	1.0	K20TT	IK20TT	IK20TT	5
2.4 AWD	103/ 121/ 125	B 5244 S2; B5244S		10/98-09/00	K20PBR-S10	5061	1.0	K20TT	IK20TT	IK20TT	5
2.4 Bifuel	103	B 5244 SG		07/99-11/00	K20PBR-S10	5061	1.0	K20TT	IK20TT	IK20TT	5
2.4 Bifuel	106	GB5252S/GB5252S2	Flexible fuel	10/98-04/99	K20PBR-S10	5061	1.0	K20TT	IK20TT	IK20TT	5
2.4 Blu-Fuel	103	B 5244 S2; B 5244 SG		07/97-09/00	K20PBR-S10	5061	1.0	K20TT	IK20TT	IK20TT	5
2.4 T5 AWD	142	B 5254 T		11/96-04/99	PK20PR-P8	3245	0.8	-	IK20TT	IK20TT	5
2.4 Turbo	142	B 5244 T; B 5254 T		01/97-11/00	PK20PR-P8	3245	0.8	-	IK20TT	IK20TT	5
2.5 TDI	103	D 5252 T	Double Coil(LPH)	01/97-11/00	DG-005		11V				5
S80 I (98-06)											
2.0	120	B5204T4		06/98-12/00	K20PBR-S10	5061	1.0	K20TT	IK20TT	IK20TT	5
2.0	120	B5204T4	OEM Optional	06/98-12/00	PK20PR-P8	3245	0.8	-	IK20TT	IK20TT	5
2.0 T	132	B 5204 T5		12/99-12/04	PK20PR-P8	3245	0.8	-	IK20TT	IK20TT	5
2.0 T	132	B 5204 T5		01/05-07/06	VKH20Y	5639	0.8	-	-	VKH20Y	5
2.0 T	132/ 166	B5204T3; B5204T5		06/98-07/06	K20PBR-S10	5061	1.0	K20TT	IK20TT	IK20TT	5
2.0 T	166	B5204T3	OEM Optional	06/98-12/00	PK20PR-P8	3245	0.8	-	IK20TT	IK20TT	5
2.4	103/ 125	B 5244 S2		01/99-07/06	K20PBR-S10	5061	1.0	K20TT	IK20TT	IK20TT	5
2.4 Bifuel (CNG)	103	B 5244 SG2		09/01-07/06	K20PBR-S10	5061	1.0	K20TT	IK20TT	IK20TT	5
2.4 Bifuel (LPG)	103	B 5244 SG		09/01-07/06	K20PBR-S10	5061	1.0	K20TT	IK20TT	IK20TT	5
2.4 D	96	D 5244 T2	OE: 8631607	10/01-07/06	DG-140		11V				5
2.4 D5	120	D 5244 T	OE: 8631607	08/01-07/06	DG-140		11V				5
2.4 T	147	B5244T3		06/00-12/03	K20PBR-S10	5061	1.0	K20TT	IK20TT	IK20TT	5
2.4 T	147	B5244T3	OEM Optional	06/00-12/03	PK20PR-P8	3245	0.8	-	IK20TT	IK20TT	5
2.5 T	154	B 5254 T2		03/03-07/06	PK20PR-P8	3245	0.8	-	IK20TT	IK20TT	5
2.5 T AWD	154	B 5254 T2		07/03-07/06	PK20PR-P8	3245	0.8	-	IK20TT	IK20TT	5
2.5 TDI	103	D 5252 T	Double Coil(LPH)	01/99-07/06	DG-005		11V				5
2.8 T6	200	B6284T		05/98-12/99	K20PBR-S10	5061	1.0	K20TT	IK20TT	IK20TT	6
2.8 T6	200	B6284T	OEM Optional	05/98-12/99	PK20PR-P8	3245	0.8	-	IK20TT	IK20TT	6
2.9	147/ 150	B6294S; B6304S3		05/98-05/01	K20PBR-S10	5061	1.0	K20TT	IK20TT	IK20TT	6
2.9	150	B6304S3	OEM Optional	05/98-12/99	PK20PR-P8	3245	0.8	-	IK20TT	IK20TT	6
3.0	144	B6294S2		06/01-05/05	K20PBR-S10	5061	1.0	K20TT	IK20TT	IK20TT	6
3.0	144	B6294S2	OEM Optional	06/01-05/05	PK20PR-P8	3245	0.8	-	IK20TT	IK20TT	6
3.0 T6	200	B6294T		06/01-07/06	K20PBR-S10	5061	1.0	K20TT	IK20TT	IK20TT	6
3.0 T6	200	B6294T	OEM Optional	06/01-07/06	PK20PR-P8	3245	0.8	-	IK20TT	IK20TT	6
S80 II (06-)											
1.6 D DRIVE	80	D 4164 T	Eng: >-16125, OE: 30711106	01/10-12/11	DG-113		11V				4
1.6 D DRIVE	80	D 4164 T	Eng: 16126-> OE: 31216248	01/10-12/11	DG-180		11V				4
1.6 D DRIVE	84	D 4162 T		06/11-	DG-603		5V				4
1.6 T4	132	B 4164 T		10/10-	ITV20TT	4719	1.0	-	ITV20TT		4
1.6 T4F	132	B 4164 T2		05/11-	ITV20TT	4719	1.0	-	ITV20TT		4
2.0	107	B 4204 S3		01/08-09/12	ZT20EPR11	5087	1.1	T20TT	IT20TT	IT20TT	4
2.0 D3 / D4 I-5	120	D 5204 T2; D 5204 T3	OE: 30777311	01/10-	DG-620		7V				5
2.0 D3 I-5	100	D 5204 T7	OE: 30777311	05/12-	DG-620		7V				5
2.0 D4 I-4	133	D 4204 T5	OE: 30777311	09/13-	DG-620		7V				4
2.0 FlexFuel	107	B 4204 S4		01/08-12/11	ZT20EPR11	5087	1.1	T20TT	IT20TT	IT20TT	4
2.0 T	149	B4204T6(203)		01/10-09/10	VKH22	5619	0.8	-	-	VKH22	4
2.0 T5	177	B4204T7		10/10-12/16	ITV20TT	4719	1.0	-	ITV20TT		4
2.0 TDi	100	D 4204 T	OE: 30725069	02/08-03/11	DG-181		11V				4
2.4 D	120	D 5244 T	OE: 8631607	03/06-	DG-140		11V				5
2.4 D	120	D 5244 T5	OE: 8653880	03/06-	DG-610		4.4V				5
2.4 D	129	D 5244 T14	OE: 30777311	01/10-03/11	DG-620		7V				5
2.4 D5	136	D 5244 T4	OE: 8631607	03/06-	DG-140		11V				5
2.4 D5	151/ 158	D 5244 T10; D 5244 T11; D 5244 T15	OE: 30777311	01/10-	DG-620		7V				5

Свечи зажигания и Свечи накаливания

Таблица применения











	KW				СТАНДАРТНЫЕ			Twin Tip			QTY
											
VOLVO продолжение											
S80 II (06-) продолжение											
2.4 D5 AWD	136	D 5244 T4	OE: 8631607	01/07-	DG-140		11V				5
2.4 D5 AWD	151/ 158	D 5244 T10; D 5244 T15	OE: 30777311	01/10-	DG-620		7V				5
2.5 T	147/ 170	B 5254 T10; B 5254 T6		03/06-12/12	VKH22	5619	0.8	-	-	VKH22	5
2.5 T AWD	147	B 5254 T6		10/06-04/09	VKH22	5619	0.8	-	-	VKH22	5
2.5 T FlexFuel	147/ 170	B 5254 T11; B 5254 T8		05/08-12/11	VKH20Y	5639	0.8	-	-	VKH20Y	5
3.0 T6 AWD	210/ 224	B 6304 T2; B 6304 T4	Ch: >-134000	01/07-12/16	VKH22	5619	0.8	-	-	VKH22	6
3.0 T6 AWD	210/ 224	B 6304 T2; B 6304 T4	Ch: 134001->	01/07-12/16	FK20HR11	3426	1.1	-	IKH20TT	IKH20TT	6
3.0 T6 AWD	210/ 224	B 6304 T2; B 6304 T4	Ch: 134001->	01/07-12/16	IKH20TT	4704	1.0	-	IKH20TT		6
3.2	175/ 179	B 6324 S; B 6324 S5	Ch: >-134000	03/06-	VKH20Y	5639	0.8	-	-	VKH20Y	6
3.2	175/ 179	B 6324 S; B 6324 S5	Ch: 134001->	03/06-	FK20HR11	3426	1.1	-	IKH20TT	IKH20TT	6
3.2	175/ 179	B 6324 S; B 6324 S5	Ch: 134001->	03/06-	IKH20TT	4704	1.0	-	IKH20TT		6
3.2	175/ 179	B 6324 S; B 6324 S5	Eng: >-134000	03/06-	VKH22	5619	0.8	-	-	VKH22	6
3.2 AWD	175/ 179	B 6324 S; B 6324 S5	Ch: >-134000	01/07-12/12	VKH20Y	5639	0.8	-	-	VKH20Y	6
3.2 AWD	175/ 179	B 6324 S; B 6324 S5	Ch: 134001->	01/07-12/12	FK20HR11	3426	1.1	-	IKH20TT	IKH20TT	6
3.2 AWD	175/ 179	B 6324 S; B 6324 S5	Ch: 134001->	01/07-12/12	IKH20TT	4704	1.0	-	IKH20TT		6
3.2 AWD	175/ 179	B 6324 S; B 6324 S5	Eng: >-134000	01/07-12/12	VKH22	5619	0.8	-	-	VKH22	6
4.4 V8 AWD	232	B8444S(315)		03/06-09/10	SK20PR-A11	3418	1.1	-	IK20TT	IK20TT	8
S90 I (96-98)											
2.9	132/ 150	B6304S1/B6304S2; B6304S2		01/97-05/98	K20PR-U	3145	0.8	K20TT	IK20TT	IK20TT	6
S90 II (16-)											
2.0 D3	110	D 4204 T16; D 4204 T9	OE: 30777311	03/16-	DG-620		7V				4
2.0 D4	140	D 4204 T14	OE: 30777311	03/16-	DG-620		7V				4
2.0 D4 AWD	140	D 4204 T14	OE: 30777311	03/16-	DG-620		7V				4
2.0 D5 AWD	173	D 4204 T23	OE: 30777311	03/16-	DG-620		7V				4
V40 (95-04)											
1.6	77/80	B 4164 S; B 4164 S2		12/95-06/04	K20PBR	5060	0.85	K20TT	IK20TT	IK20TT	4
1.8	85/90	B 4184 S; B 4184 S2; B 4184 S3		07/95-06/04	K20PBR	5060	0.85	K20TT	IK20TT	IK20TT	4
1.8 i	90/92	B 4184 SJ; B 4184 SM		03/98-06/04	VKB20	5625	1.1	-	-	VKB20	4
1.9 DI	70	D 4192 T2	Double Coil(LPH)	03/99-07/00	DG-101		11V				4
1.9 DI	75/85	D 4192 T3; D 4192 T4	for vehicles without elctr. auxiliary heater	07/00-06/04	DG-005		11V				4
1.9 T4	147	B 4194 T; B 4194 T2		05/97-07/00	PK20PR-P8	3245	0.8	-	IK20TT	IK20TT	4
1.9 TD	66	D 4192 T	Double Coil(LPH)	07/95-08/99	DG-012		11V				4
2.0	100/ 103	B 4204 S; B 4204 S2		07/95-06/04	K20PBR	5060	0.85	K20TT	IK20TT	IK20TT	4
2.0 T	118/ 120	B 4204 T; B 4204 T2; B 4204 T3		10/97-06/04	PK20PR-P8	3245	0.8	-	IK20TT	IK20TT	4
2.0 T4	147	B 4204 T5		07/00-06/04	PK20PR-P8	3245	0.8	-	IK20TT	IK20TT	4
V40 (12-)											
1.6 D2 (DRIVE)	84	D 4162 T		03/12-	DG-603		5V				4
1.6 T2 GTDi	88	B 4164 T4		03/13-12/15	ITV20TT	4719	1.0	-	ITV20TT		4
1.6 T3 GTDi	110	B 4164 T3		03/12-	ITV20TT	4719	1.0	-	ITV20TT		4
1.6 T4	147	B 4164 T		04/14-	ITV20TT	4719	1.0	-	ITV20TT		4
1.6 T4 GTDi	132	B 4164 T		03/12-	ITV20TT	4719	1.0	-	ITV20TT		4
2.0 D2	88	D 4204 T13; D 4204 T8	OE: 30777311	02/15-	DG-620		7V				4
2.0 D3 I-4	110	D 4204 T16; D 4204 T9	OE: 30777311	04/15-	DG-620		7V				4
2.0 D3 I-5	110	D 5204 T6	OE: 30777311	03/12-03/15	DG-620		7V				5
2.0 D4 I-4	140	D 4204 T14	OE: 30777311	05/14-	DG-620		7V				4











Таблица применения

Λ

Свечи зажигания и Свечи накаливания

Таблица применения

Таблица применения

	KW				СТАНДАРТНЫЕ			Twin Tip			QTY
											
VOLVO продолжение											
V40 (12-) продолжение											
2.0 D4 I-5	130	D 5204 T4	OE: 30777311	03/12-	DG-620		7V				5
V50 (04-12)											
1.6	74	B 4164 S3		01/05-12/12	PT16VR13	5068	1.3	TV16TT	ITV16TT	ITV16TT	4
1.6 D	80	D 4164 T	Eng:>-16125, OE:30711106	01/05-12/11	DG-113		11V				4
1.6 D	80	D 4164 T	Eng:16126->, OE:31216248	01/05-12/11	DG-180		11V				4
1.6 D2	84	D 4162 T		01/10-12/12	DG-603		5V				4
1.8	92	B 4184 S11		04/04-12/10	ZT20EPR11	5087	1.1	T20TT	IT20TT	IT20TT	4
1.8 FlexFuel	92	B4184S8(125)	Flexible fuel	05/06-10/09	IT20TT	4714	1.0	-	IT20TT		4
2.0	107	B4204S3		10/06-12/12	IKH22	5345	0.8	-	-	VKH22	4
2.0 CDI	98	D 4204 T2	OE: 30725069	12/03-12/06	DG-181		11V				4
2.0 D	100	D 4204 T	OE: 30725069	04/04-12/10	DG-181		11V				4
2.0 D3	110	D 5204 T5	OE: 30777311	10/10-12/12	DG-620		7V				5
2.0 D4 I-5	130	D 5204 T	OE: 30777311	10/10-12/12	DG-620		7V				5
2.0 FlexFuel	107	B4204S4	Flexible fuel	01/10-12/12	VKH22	5619	0.8	-	-	VKH22	4
2.4	103/ 125	B 5244 S4; B 5244 S5		04/04-12/10	K20HR-U11	3381	1.1	KH20TT	IKH20TT	IKH20TT	5
2.4 AWD	125	B 5244 S4		08/06-12/09	K20HR-U11	3381	1.1	KH20TT	IKH20TT	IKH20TT	5
2.4 D5	132	D 5244 T13; D 5244 T8	Ch:>-396178, OE:8653880	03/06-12/10	DG-610		4.4V				5
2.4 D5	132	D 5244 T13; D 5244 T8	Ch:396179->, OE:30777311	03/06-12/10	DG-620		7V				5
2.4 Tdi	120	D 5244 T9	Ch:>-396178, OE:8653880	05/07-12/10	DG-610		4.4V				5
2.4 Tdi	120	D 5244 T9	Ch:396179->, OE:30777311	05/07-12/10	DG-620		7V				5
2.5 T5	162/ 169	B 5254 T3; B 5254 T7		04/04-12/12	VKH22	5619	0.8	-	-	VKH22	5
2.5 T5 AWD	162/ 169	B 5254 T3; B 5254 T7		04/04-12/10	VKH22	5619	0.8	-	-	VKH22	5
V60 I (10-)											
1.6 D DRIVE	84	D 4162 T		02/11-12/15	DG-603		5V				4
1.6 T3	110	B 4164 T3		09/10-12/15	ITV20TT	4719	1.0	-	ITV20TT		4
1.6 T4	132	B 4164 T		09/10-12/15	ITV20TT	4719	1.0	-	ITV20TT		4
1.6 T4F	132	B 4164 T2		04/11-12/15	ITV20TT	4719	1.0	-	ITV20TT		4
2.0 D2	88	D 4204 T20; D 4204 T8	OE: 30777311	03/15-	DG-620		7V				4
2.0 D3 / D4 I-5	120	D 5204 T2; D 5204 T3	OE: 30777311	07/10-12/14	DG-620		7V				5
2.0 D3 I-4	110	D 4204 T4; D 4204 T9	OE: 30777311	03/15-	DG-620		7V				4
2.0 D3 I-5	100	D 5204 T7	OE: 30777311	05/12-12/15	DG-620		7V				5
2.0 D4 I-4	133/ 140	D 4204 T14; D 4204 T5	OE: 30777311	10/13-	DG-620		7V				4
2.0 D5	165	D 4204 T11	OE: 30777311	03/15-	DG-620		7V				4
2.0 T	149	B 4204 T6	40000km Lifetime	07/10-12/12	ITV22	5340	0.8	-	-		4
2.0 T5	177	B 4204 T7	40000km Lifetime	09/10-12/14	ITV22	5340	0.8	-	-		4
2.4 D4 AWD	120/ 133/ 140	D 5244 T12; D 5244 T17; D 5244 T21	OE: 30777311	05/12-	DG-620		7V				5
2.4 D5	151/ 158/ 169	D 5244 T10; D 5244 T11; D 5244 T15; D 5244 T23	OE: 30777311	07/10-12/15	DG-620		7V				5
2.4 D5 AWD	151/ 158/ 169	D 5244 T10; D 5244 T15	OE: 30777311	07/10-12/15	DG-620		7V				5
2.4 D5 Hybrid AWD	120	D87PHEV	OE: 30777311	03/15-	DG-620		7V				5
2.4 D6 Hybrid AWD	162	D97PHEV	OE: 30777311	03/15-	DG-620		7V				5
2.4 Hybrid D6 AWD	158	D82PHEV	OE: 30777311	06/12-12/15	DG-620		7V				5
3.0 T AWD	258	B 6304 T5		04/14-	FK20HR11	3426	1.1	-	IKH20TT	IKH20TT	6
3.0 T AWD	258	B 6304 T5		04/14-	IKH20TT	4704	1.0	-	IKH20TT		6
3.0 T6 AWD	224/ 242	B 6304 T3; B 6304 T4		07/10-12/15	FK20HR11	3426	1.1	-	IKH20TT	IKH20TT	6
3.0 T6 AWD	224/ 242	B 6304 T3; B 6304 T4		07/10-12/15	IKH20TT	4704	1.0	-	IKH20TT		6
V70 I (96-00)											
2.0	93	B 5202 S		12/95-03/00	K20TXR	5063	1.0	K20TT	IK20TT	IK20TT	5
2.0	120/ 132	B 5204 T2; B 5204 T4		11/96-12/00	PK20PR-P8	3245	0.8	-	IK20TT	IK20TT	5
2.0 Turbo	166	B 5204 T3		11/96-12/00	PK20PR-P8	3245	0.8	-	IK20TT	IK20TT	5

Свечи зажигания и Свечи накаливания

Таблица применения









	KW				СТАНДАРТНЫЕ				Twin Tip		QTY
											
VOLVO продолжение											
V70 I (96-00) продолжение											
2.0 Turbo AWD	166	B 5204 T3		11/96-12/00	PK20PR-P8	3245	0.8	-	IK20TT	IK20TT	5
2.3 AWD	177	B 5234 T3		04/97-09/98	PK20PR-P8	3245	0.8	-	IK20TT	IK20TT	5
2.3 T AWD	184	B 5234 FT+		04/97-03/00	PK20PR-P8	3245	0.8	-	IK20TT	IK20TT	5
2.3 T-5	176	B 5234 T3		11/96-12/00	PK20PR-P8	3245	0.8	-	IK20TT	IK20TT	5
2.3 T-5 AWD	176	B 5234 T3		01/97-12/00	PK20PR-P8	3245	0.8	-	IK20TT	IK20TT	5
2.3 Turbo	184	B 5234 FT+		12/95-03/00	PK20PR-P8	3245	0.8	-	IK20TT	IK20TT	5
2.4	103/ 125	B5244SG2	Flexible fuel	12/95-12/00	K20PBR-S10	5061	1.0	K20TT	IK20TT	IK20TT	5
2.4	106/ 121	B 5252 S; B 5254 S		12/95-03/00	K20TXR	5063	1.0	K20TT	IK20TT	IK20TT	5
2.4 AWD	121	B 5254 S		06/98-12/99	K20TXR	5063	1.0	K20TT	IK20TT	IK20TT	5
2.4 Bifuel	103/ 106	B5244SG2; GB5252S	Flexible fuel	05/98-12/00	K20PBR-S10	5061	1.0	K20TT	IK20TT	IK20TT	5
2.4 Turbo	142	B 5244 T; B 5254 T		04/96-12/00	PK20PR-P8	3245	0.8	-	IK20TT	IK20TT	5
2.4 Turbo AWD	142	B 5254 T		04/96-12/00	IK22	5310	0.8	-	IK22TT	VK22	5
2.4 Turbo AWD	142/ 195	B 5244 T; B 5254 T; B5244T2		04/96-12/00	PK20PR-P8	3245	0.8	-	IK20TT	IK20TT	5
2.5 TDI	103	D 5252 T	Double Coil(LPH)	12/95-12/00	DG-005		11V				5
V70 II (00-07)											
2.0 T	132	B 5204 T5	Ch: >-349000	11/99-07/04	PK20PR-P8	3245	0.8	-	IK20TT	IK20TT	5
2.0 T	132	B 5204 T5	Ch: 349001->	08/04-08/07	VKH20Y	5639	0.8	-	-	VKH20Y	5
2.0 T	132	B 5204 T5	Ch: 349001->	08/04-08/07	VKH22	5619	0.8	-	-	VKH22	5
2.3 T5	184	B 5234 T3		11/99-12/04	PK20PR-P8	3245	0.8	-	IK20TT	IK20TT	5
2.4	103/ 125	B 5244 S2		03/00-08/07	K20PBR-S10	5061	1.0	K20TT	IK20TT	IK20TT	5
2.4 Bifuel (CNG)	103	B 5244 SG		09/01-08/07	K20PBR-S10	5061	1.0	K20TT	IK20TT	IK20TT	5
2.4 Bifuel (LPG)	103	B 5244 SG2		09/01-08/07	K20PBR-S10	5061	1.0	K20TT	IK20TT	IK20TT	5
2.4 CDI	90	D 5244 T6	OE: 8653880	07/05-12/08	DG-610		4.4V				5
2.4 D	93	D 5244 T7	OE: 8653880	04/05-12/08	DG-610		4.4V				5
2.4 D	96	D 5244 T2	OE: 8631607	07/01-08/07	DG-140		11V				5
2.4 D5	120	D 5244 T5	OE: 8653880	08/05-07/07	DG-610		4.4V				5
2.4 D5	120/ 136	D 5244 T; D 5244 T4; D 5244 T5	OE: 8631607	01/01-12/08	DG-140		11V				5
2.4 D5 AWD	120	D 5244 T5	OE: 8653880	07/02-08/07	DG-610		4.4V				5
2.4 D5 AWD	120/ 136	D 5244 T; D 5244 T2; D 5244 T4	OE: 8631607	07/02-08/07	DG-140		11V				5
2.4 T	147	B 5244 T3		11/99-08/03	PK20PR-P8	3245	0.8	-	IK20TT	IK20TT	5
2.4 T AWD	147	B 5244 T3		09/01-08/02	PK20PR-P8	3245	0.8	-	IK20TT	IK20TT	5
2.4 T5	191	B 5244 T5		04/04-08/07	PK20PR-P8	3245	0.8	-	IK20TT	IK20TT	5
2.4 T5	191	B 5244 T5		04/04-08/07	VKH22	5619	0.8	-	-	VKH22	5
2.5 AWD	155	B 5254 T2		09/02-12/04	PK20PR-P8	3245	0.8	-	IK20TT	IK20TT	5
2.5 T	154	B 5254 T2		07/01-08/07	PK20PR-P8	3245	0.8	-	IK20TT	IK20TT	5
2.5 T AWD	154	B 5254 T2		07/02-08/07	PK20PR-P8	3245	0.8	-	IK20TT	IK20TT	5
2.5 T R AWD	221	B 5254 T4		03/03-08/07	VKH22	5619	0.8	-	-	VKH22	5
2.5 TDI	103	D 5252 T	Double Coil(LPH)	11/99-08/07	DG-005		11V				5
V70 III (07-)											
1.6 D	80	D 4164 T	Eng:>-16125, OE:30711106	07/09-12/11	DG-113		11V				4
1.6 D	80	D 4164 T	Eng:16126->, OE:31216248	07/09-12/11	DG-180		11V				4
1.6 D2 (DRIVE)	84	D 4162 T		04/11-12/15	DG-603		5V				4
1.6 T4	132	B 4164 T		10/10-12/15	ITV20TT	4719	1.0	-	ITV20TT		4
1.6 T4F	132	B 4164 T2		01/11-12/15	ITV20TT	4719	1.0	-	ITV20TT		4
2.0	107	B 4204 S3		10/07-05/10	ZT20EPR11	5087	1.1	T20TT	IT20TT	IT20TT	4
2.0 D	100	D 4204 T	OE: 30725069	10/07-12/15	DG-181		11V				4
2.0 D2	88	D 4204 T20	OE: 30777311	03/15-	DG-620		7V				4
2.0 D3 / D4 I-5	120	D 5204 T2; D 5204 T3	OE: 30777311	03/10-12/15	DG-620		7V				5
2.0 D3 I-4	110	D 4204 T9	OE: 30777311	03/15-	DG-620		7V				4
2.0 D3 I-5 (DRIVE)	100	D 5204 T7	OE: 30777311	10/07-12/15	DG-620		7V				5
2.0 D4 I-4	133	D 4204 T5	OE: 30777311	10/13-	DG-620		7V				4
2.0 FlexFuel	107	B 4204 S4		01/08-12/11	ZT20EPR11	5087	1.1	T20TT	IT20TT	IT20TT	4
2.0 T	149	B4204T6(203)		09/09-09/10	VKH22	5619	0.8	-	-	VKH22	4
2.0 T5	177	B4204T7		01/10-12/14	ITV20TT	4719	1.0	-	ITV20TT		4
2.4 D	120	D 5244 T19; D 5244 T5	OE: 8653880	04/07-12/10	DG-610		4.4V				5

Таблица применения

V

Свечи зажигания и Свечи накаливания

Таблица применения

Таблица применения

VOLVO продолжение	KW	KW	NOTE	21	СТАНДАРТНЫЕ				Twin Tip		QTY
					4	4	4	4	4	4	
V70 III (07-) продолжение											
2.4 D	129	D 5244 T14	OE: 30777311	04/09-12/10	DG-620		7V				5
2.4 D4 AWD	120/ 133	D 5244 T12; D 5244 T17	OE: 30777311	10/07-	DG-620		7V				5
2.4 D5	136	D 5244 T4	OE: 8631607	04/07-12/09	DG-140		11V				5
2.4 D5	151/ 158	D 5244 T10; D 5244 T11; D 5244 T15	OE: 30777311	10/08-12/15	DG-620		7V				5
2.4 D5 AWD	136	D 5244 T4	OE: 8631607	04/07-12/09	DG-140		11V				5
2.4 D5 AWD	151/ 158	D 5244 T10; D 5244 T15	OE: 30777311	12/09-12/15	DG-620		7V				5
2.5 T	147	B 5254 T6		08/07-12/09	IKH20TT	4704	1.0	-	IKH20TT		5
2.5 T	147/ 170	B 5254 T10; B 5254 T6		08/07-12/12	VKH22	5619	0.8	-	-	VKH22	5
2.5 T FlexiFuel	147/ 170	B 5254 T11; B 5254 T8		05/08-12/11	VKH20Y	5639	0.8	-	-	VKH20Y	5
3.0 T6 AWD	210/ 224	B 6304 T2; B 6304 T4	Ch: >-167000	08/07-12/15	VKH22	5619	0.8	-	-	VKH22	6
3.0 T6 AWD	210/ 224	B 6304 T2; B 6304 T4	Ch: 167001->	08/07-12/15	FK20HR11	3426	1.1	-	IKH20TT	IKH20TT	6
3.0 T6 AWD	210/ 224	B 6304 T2; B 6304 T4	Ch: 167001->	08/07-12/15	IKH20TT	4704	1.0	-	IKH20TT		6
3.2	175/ 179	B 6324 S; B 6324 S5	Ch: >-167000	08/07-12/14	VKH20Y	5639	0.8	-	-	VKH20Y	6
3.2	175/ 179	B 6324 S; B 6324 S5	Ch: >-167000	08/07-12/14	VKH22	5619	0.8	-	-	VKH22	6
3.2	175/ 179	B 6324 S; B 6324 S5	Ch: 167001->	08/07-12/14	FK20HR11	3426	1.1	-	IKH20TT	IKH20TT	6
3.2	175/ 179	B 6324 S; B 6324 S5	Ch: 167001->	08/07-12/14	IKH20TT	4704	1.0	-	IKH20TT		6
3.2 AWD	175/ 179	B 6324 S; B 6324 S5	Ch: >-167000	04/07-12/15	VKH20Y	5639	0.8	-	-	VKH20Y	6
3.2 AWD	175/ 179	B 6324 S; B 6324 S5	Ch: >-167000	04/07-12/15	VKH22	5619	0.8	-	-	VKH22	6
3.2 AWD	175/ 179	B 6324 S; B 6324 S5	Ch: 167001->	04/07-12/15	FK20HR11	3426	1.1	-	IKH20TT	IKH20TT	6
3.2 AWD	175/ 179	B 6324 S; B 6324 S5	Ch: 167001->	04/07-12/15	IKH20TT	4704	1.0	-	IKH20TT		6
V90 I (96-98)											
2.5	125/ 132	B 6244 FS; B 6254 FS		11/96-10/98	K20PBR-S10	5061	1.0	K20TT	IK20TT	IK20TT	6
2.9	132/ 150	B6304S1/B6304S2; B6304S2		01/97-12/98	K20PR-U	3145	0.8	K20TT	IK20TT	IK20TT	6
V90 II (16-)											
2.0 D3	110	D 4204 T16; D 4204 T9	OE: 30777311	03/16-	DG-620		7V				4
2.0 D3 AWD	110	D 4204 T4	OE: 30777311	03/16-	DG-620		7V				4
2.0 D4	140	D 4204 T14	OE: 30777311	03/16-	DG-620		7V				4
2.0 D4 AWD	140	D 4204 T14	OE: 30777311	03/16-	DG-620		7V				4
2.0 D5 AWD	173	D 4204 T23	OE: 30777311	03/16-	DG-620		7V				4
XC60 I (08-)											
2.0 D3 / D4 I-5	120	D 5204 T2; D 5204 T3	OE: 30777311	03/10-12/14	DG-620		7V				5
2.0 D3 I-4	110	D 4204 T4	OE: 30777311	03/15-02/17	DG-620		7V				4
2.0 D3 I-5	100	D 5204 T7	OE: 30777311	04/12-12/15	DG-620		7V				5
2.0 D4 I-4	133/ 140	D 4204 T14; D 4204 T5	OE: 30777311	10/13-02/17	DG-620		7V				4
2.0 T	149	B4204T6		12/09-03/11	ITV20TT	4719	1.0	-	ITV20TT		4
2.0 T5	177	B4204T7		09/10-02/17	ITV20TT	4719	1.0	-	ITV20TT		4
2.4 D	129	D 5244 T14	OE: 30777311	04/09-12/10	DG-620		7V				5
2.4 D / D3 / D4 AWD	120	D 5244 T16; D 5244 T17	OE: 30777311	05/08-02/17	DG-620		7V				5
2.4 D / D3 / D4 AWD	120	D 5244 T5	OE: 8653880	05/08-02/17	DG-610		4.4V				5
2.4 D4 AWD	133/ 140	D 5244 T12; D 5244 T21	OE: 30777311	10/13-02/17	DG-620		7V				5
2.4 D5	158	D 5244 T11; D 5244 T15	OE: 30777311	06/11-02/17	DG-620		7V				5
2.4 D5 AWD	136	D 5244 T4	OE: 8631607	05/08-12/09	DG-140		11V				5
2.4 D5 AWD	151/ 158/ 162/ 169	D 5244 T10; D 5244 T11; D 5244 T15; D 5244 T20; D 5244 T22; D 5244 T23	OE: 30777311	07/09-02/17	DG-620		7V				5
3.0 T6 AWD	210/ 224/ 242	B 6304 T2; B 6304 T3; B 6304 T4	Ch: >-134999	05/08-02/17	VKH22	5619	0.8	-	-	VKH22	6

Свечи зажигания и Свечи накаливания

Таблица применения







	KW				СТАНДАРТНЫЕ				Twin Tip		QTY		
													
VOLVO продолжение													
XC60 I (08-) продолжение													
3.0 T6 AWD	210/ 224/ 242	B 6304 T2; B 6304 T3; B 6304 T4	Ch: 135000->	05/08-02/17	FK20HR11	3426	1.1	-	-	IKH20TT	IKH20TT	6	
3.0 T6 AWD	210/ 224/ 242	B 6304 T2; B 6304 T3; B 6304 T4	Ch: 135000->	05/08-02/17	IKH20TT	4704	1.0	-	-	IKH20TT		6	
3.2 AWD	175/ 179	B 6324 S; B 6324 S5	Ch: >-134999	07/09-12/15	VKH20Y	5639	0.8	-	-		VKH20Y	6	
3.2 AWD	175/ 179	B 6324 S; B 6324 S5	Ch: >-134999	07/09-12/15	VKH22	5619	0.8	-	-		VKH22	6	
3.2 AWD	175/ 179	B 6324 S; B 6324 S5	Ch: 135000->	07/09-12/15	FK20HR11	3426	1.1	-	-	IKH20TT	IKH20TT	6	
3.2 AWD	175/ 179	B 6324 S; B 6324 S5	Ch: 135000->	07/09-12/15	IKH20TT	4704	1.0	-	-	IKH20TT		6	
XC70 I Cross Country (97-07)													
2.4 D5 AWD	136	D 5244 T4	OE: 8631607	12/05-08/07	DG-140		11V					5	
2.4 D5 XC AWD	120	D 5244 T	OE: 8631607	09/02-08/07	DG-140		11V					5	
2.4 T XC AWD	142/ 147	B 5244 T3; B 5254 T		11/97-09/02	PK20PR-P8	3245	0.8	-	-	IK20TT	IK20TT	5	
2.5 T XC AWD	154	B 5254 T2		09/02-08/07	PK20PR-P8	3245	0.8	-	-	IK20TT	IK20TT	5	
XC70 II (07-)													
2.0 D3 I-5	120	D 5204 T2; D 5204 T3	OE: 30777311	04/10-12/15	DG-620		7V					5	
2.0 D4 I-4	133	D 4204 T5	OE: 30777311	10/13-	DG-620		7V					4	
2.4 D	129	D 5244 T14	OE: 30777311	06/09-12/10	DG-620		7V					5	
2.4 D / D4 AWD	120	D 5244 T16; D 5244 T17	OE: 30777311	08/07-	DG-620		7V					5	
2.4 D / D4 AWD	120	D 5244 T5	OE: 8653880	08/07-	DG-610		4.4V					5	
2.4 D4 AWD	133	D 5244 T12	OE: 30777311	10/13-	DG-620		7V					5	
2.4 D5 AWD	136	D 5244 T4	OE: 8631607	04/07-12/09	DG-140		11V					5	
2.4 D5 AWD	151/ 158/ 162	D 5244 T10; D 5244 T11; D 5244 T15; D 5244 T20	OE: 30777311	04/09-	DG-620		7V					5	
3.0 T6 AWD	210/ 224	B 6304 T2; B 6304 T4	Ch: >-94000	01/08-	VKH22	5619	0.8	-	-		VKH22	6	
3.0 T6 AWD	210/ 224	B 6304 T2; B 6304 T4	Ch: 94001->	01/08-	FK20HR11	3426	1.1	-	-	IKH20TT	IKH20TT	6	
3.0 T6 AWD	210/ 224	B 6304 T2; B 6304 T4	Ch: 94001->	01/08-	IKH20TT	4704	1.0	-	-	IKH20TT		6	
3.2 AWD	175/ 179	B 6324 S; B 6324 S5	Ch: >-94000	08/07-	VKH20Y	5639	0.8	-	-		VKH20Y	6	
3.2 AWD	175/ 179	B 6324 S; B 6324 S5	Ch: >-94000	08/07-	VKH22	5619	0.8	-	-		VKH22	6	
3.2 AWD	175/ 179	B 6324 S; B 6324 S5	Ch: 94001->	08/07-	FK20HR11	3426	1.1	-	-	IKH20TT	IKH20TT	6	
3.2 AWD	175/ 179	B 6324 S; B 6324 S5	Ch: 94001->	08/07-	IKH20TT	4704	1.0	-	-	IKH20TT		6	
XC90 I (02-14)													
2.4 D3 / D5	120	D 5244 T5	OE: 8653880	04/09-12/14	DG-610		4.4V					5	
2.4 D5 AWD	120	D 5244 T5	OE: 8653880	10/02-12/10	DG-610		4.4V					5	
2.4 D5 AWD	120/ 136	D 5244 T; D 5244 T4	OE: 8631607	10/02-12/10	DG-140		11V					5	
2.4 D5 AWD	147	D 5244 T18	OE: 30777311	01/11-12/14	DG-620		7V					5	
2.5 T AWD	154	B 5254 T2; B 5254 T9		10/02-09/14	PK20PR-P8	3245	0.8	-	-	IK20TT	IK20TT	5	
2.9 T6 AWD	200	B6294T		10/02-12/06	PK20PR-P8	3245	0.8	-	-	IK20TT	IK20TT	6	
3.2 AWD	175/ 179	B 6324 S; B 6324 S5	Ch: >-568000	03/06-12/12	VKH20Y	5639	0.8	-	-		VKH20Y	6	
3.2 AWD	175/ 179	B 6324 S; B 6324 S5	Ch: >-568000	03/06-12/12	VKH22	5619	0.8	-	-		VKH22	6	
3.2 AWD	175/ 179	B 6324 S; B 6324 S5	Ch: 568001->	03/06-12/12	FK20HR11	3426	1.1	-	-	IKH20TT	IKH20TT	6	
3.2 AWD	175/ 179	B 6324 S; B 6324 S5	Ch: 568001->	03/06-12/12	IKH20TT	4704	1.0	-	-	IKH20TT		6	
4.4 V8 AWD	232	B8444S(315)		01/05-12/10	SK20PR-A11	3418	1.1	-	-	IK20TT	IK20TT	8	
XC90 II (14-)													
2.0 D4 I-4	140	D 4204 T14	OE: 30777311	06/15-12/18	DG-620		7V					4	
2.0 D4 I-4 AWD	140	D 4204 T6	OE: 30777311	10/15-12/18	DG-620		7V					4	
2.0 D5 I-4 AWD	165/ 173	D 4204 T11; D 4204 T23	OE: 30777311	09/14-12/19	DG-620		7V					4	
VORTEX													
VORTEX (09-)													
1.6	87	SQR481F		01/09-07/13	K20PR-U	3145	0.8	-	-	K20TT	IK20TT	IK20TT	4
1.8	97	SQR481FC		01/10-07/13	K20PR-U	3145	0.8	-	-	K20TT	IK20TT	IK20TT	4

Таблица применения

V

Свечи зажигания и Свечи накаливания

Таблица применения

KW	KW	NOTE	21	СТАНДАРТНЫЕ				Twin Tip		QTY
				1	2	3	4	1	2	
VW										
181 (69-79)										
1.5	32	H		09/69-07/70	W16FSR	3033	0.7	-	-	4
1.6	32/35	AG; AL; AM		08/70-02/79	W16FSR	3033	0.7	-	-	4
1500, 1600 (61-73)										
1.5	33	K		04/61-07/73	W16FSR	3033	0.7	-	-	4
1.5 L	33	K		07/68-07/73	W16FSR	3033	0.7	-	-	4
1.5 S	40			08/63-07/65	W20FSR-U	6053	0.7	WF20TT	-	4
1.6	40	T; U		08/65-07/73	W20FSR-U	6053	0.7	WF20TT	-	4
1.6 L	37	P		07/64-07/73	W16FSR	3033	0.7	-	-	4
1.6 L	40	T; U		08/65-07/73	W20FSR-U	6053	0.7	WF20TT	-	4
1.6 TL	40	T; U		08/65-07/73	W20FSR-U	6053	0.7	WF20TT	-	4
AMAROK (2H, S1) (10-)										
2.0 BiTDI	120/132	CDCA; CNEA; CSHA		09/10-	DG-193		4.4V			4
2.0 BiTDI 4motion	120/132	CDCA; CNEA; CSHA		09/10-	DG-193		4.4V			4
2.0 TDI	90/103	CDBA; CNFA; CNFB		09/10-10/16	DG-193		4.4V			4
2.0 TDI 4motion	90/103	CDBA; CNFA; CNFB		09/10-10/16	DG-193		4.4V			4
2.0 TSI	118	CFFA		12/10-10/16	PK22PR8	3273	0.8	-	IK22TT	VK22
BEETLE (5C) (11-)										
1.4 TSI	118	CAVD; CNWA; CTHD; CTKA		10/11-07/16	SKJ20CR-A8	3371	0.8	-	-	SKJ20CR-A8
1.6 TDI	77	CAYC		10/11-07/16	DG-193		4.4V			4
2.0 TDI	81/103/110	CFFB; CUUA; CUUB; CVCA; DELA	Pressure sensor(-)	04/12-09/18	DG-193		4.4V			3
2.0 TDI	103	CFFB		04/11-07/16	DG-193		4.4V			4
2.0 TSI	147/155	CBFA; CCTA; CCZA; CPLA; CPPA		04/11-07/19	PK22PR8	3273	0.8	-	IK22TT	VK22
2.5	125	CBTA; CBUA; CCCA		04/11-07/19	KJ20DR-M11	3374	1.1	-	-	SKJ20DR-M11
BORA (1J) (98-05)										
1.4 16V	55	AHW; AKQ		03/00-05/05	K20PBR-S10	5061	1.0	K20TT	IK20TT	IK20TT
1.6	75	AEH; AKL; BFQ		10/98-05/05	K20PBR-S10	5061	1.0	K20TT	IK20TT	IK20TT
1.6 16V	77	AUS		02/00-05/05	K20PBR-S10	5061	1.0	K20TT	IK20TT	IK20TT
1.6 16V	77	AZD/ BCB		02/00-05/05	PKJ16CR-L11	3246	1.1	-	IK16TT	IK16TT
1.6 FSI	81	BAD		01/02-05/05	K20PBR-S10	5061	1.0	K20TT	IK20TT	IK20TT
1.8	92	AGN; BAF		10/98-05/05	K20PBR-S10	5061	1.0	K20TT	IK20TT	IK20TT
1.8 4motion	92	AGN		02/99-05/05	K20PBR-S10	5061	1.0	K20TT	IK20TT	IK20TT
1.8 T	110/132	AGU; ARX; AUM; AUQ; AWP; BAE		05/00-05/05	PK20PR-P8	3245	0.8	-	IK20TT	IK20TT
1.9 SDI	50	AGP; AQM	Auxiliary Heater	10/98-05/05	DG-628		11V			3
1.9 SDI	50	AGP; AQM	Double Coil(LPH)	10/98-05/05	DG-005		11V			4
1.9 TDI	66/74/81/85/110	AGR; AHF; AJM; ALH; ARL; ASV; ATD	Auxiliary Heater	10/98-05/05	DG-628		11V			3
1.9 TDI	66/81/85	AGR; AHF; AJM; ALH; ASV; AUJ	Double Coil(LPH)	10/98-05/05	DG-005		11V			4
1.9 TDI	74/96	ASZ; ATD; AXR; BEW	Ch:> 1J-2-600 000	09/00-03/02	DG-005		11V			4
1.9 TDI	74/96	ASZ; ATD; AXR; BEW	Ch: 1J-2-600 001>	03/02-05/05	DG-109		11V			4
1.9 TDI	110	ARL	Ch:> 1J-2-600 000, Double Coil(LPH)	05/00-03/02	DG-005		11V			4
1.9 TDI	110	ARL	Ch: 1J-2-600 001>, Double Coil(LPH)	03/02-05/05	DG-109		11V			4
1.9 TDI 4motion	66/74/85/110	AGR; AJM; ARL; ATD	Auxiliary Heater	11/98-05/05	DG-628		11V			3
1.9 TDI 4motion	66/85	AGR; AJM; AUJ	Double Coil(LPH)	11/98-04/02	DG-005		11V			4
1.9 TDI 4motion	74/96	ASZ; ATD	Ch:> 1J-2-600 000	09/00-03/02	DG-005		11V			4
1.9 TDI 4motion	74/96	ASZ; ATD	Ch: 1J-2-600 001>	03/02-05/05	DG-109		11V			4

Свечи зажигания и Свечи накаливания

Таблица применения















	KW				СТАНДАРТНЫЕ				Twin Tip			QTY
												
VW продолжение												
BORA (1J) (98-05) продолжение												
1.9 TDI 4motion	110	ARL	Ch:> 1J-2-600 000, Double Coi (LPH)	05/00-03/02	DG-005		11V					4
1.9 TDI 4motion	110	ARL	Ch: 1J-2-600 001> ,Double Coi (LPH)	03/02-05/05	DG-109		11V					4
2.0	85	APK/ AQY/ AZG/ AZH		10/98-12/13	K20PBR-S10	5061	1.0	K20TT	IK20TT	IK20TT		4
2.0	85	AZJ		10/98-12/13	PKJ16CR-L11	3246	1.1	-	IK16TT	IK16TT		4
2.0 4motion	85	AZH		04/00-05/05	K20PBR-S10	5061	1.0	K20TT	IK20TT	IK20TT		4
2.0 4motion	85/88	ATF; AZJ		12/99-05/05	PKJ16CR-L11	3246	1.1	-	IK16TT	IK16TT		4
2.3 V5	110	AGZ		10/98-10/00	K20TXR	5063	1.0	K20TT	IK20TT	IK20TT		5
2.3 V5	125	AQN		10/00-05/05	PKJ16CR-L11	3246	1.1	-	IK16TT	IK16TT		5
2.3 V5 4motion	110	AGZ		12/98-10/00	K20TXR	5063	1.0	K20TT	IK20TT	IK20TT		5
2.3 V5 4motion	125	AQN		10/00-05/05	PKJ16CR-L11	3246	1.1	-	IK16TT	IK16TT		5
2.8 V6 4motion	150	AQP; AUE; BDE		03/99-05/05	PKJ16CR-L11	3246	1.1	-	IK16TT	IK16TT		6
CADDY I (14) (82-92)												
1.5	51	JB		08/82-07/83	W16EPR-U	3021	0.8	W16TT	IW16TT	IW16TT		4
1.6	55	EM; EW		10/82-06/89	W16EPR-U	3021	0.8	W16TT	IW16TT	IW16TT		4
1.6	55	EW		01/83-07/92	W16EP-U	3018	0.8	W16TT	IW16TT	IW16TT		4
1.6 D	40	JK; ME	Double Coil(LPH)	08/82-07/92	DG-012		11V					4
1.8	70	JH		08/85-07/92	W20EPB	5065	0.85	W20TT	IW20TT	IW20TT		4
CADDY II (9K, 9U) (95-04)												
1.4	44	AUD		11/95-01/04	PKJ16CR-L11	3246	1.1	-	IK16TT	IK16TT		4
1.4	55	AUA		08/00-01/04	K20PBR-S10	5061	1.0	K20TT	IK20TT	IK20TT		4
1.4 16V	55	AUA		08/00-01/04	K20PBR-S10	5061	1.0	K20TT	IK20TT	IK20TT		4
1.4 60	44	AEX		11/95-01/04	W20EPBR-S	5067	0.85	W20TT	IW20TT	IW20TT		4
1.6	55	1F; AEE		11/95-12/00	W20EPBR-S	5067	0.85	W20TT	IW20TT	IW20TT		4
1.6 75	55	1F; AEE		11/95-09/00	W20EPBR-S	5067	0.85	W20TT	IW20TT	IW20TT		4
1.7 SDI	42	AHB	Double Coil(LPH)	07/96-09/00	DG-005		11V					4
1.9 D	47	1Y		11/95-01/04	DG-012		11V					4
1.9 D	47	AEF	Double Coil(LPH)	06/96-12/00	DG-012		11V					4
1.9 SDI	47	AEY	Auxiliary Heater	11/95-01/04	DG-012		11V					3
1.9 SDI	47	AEY; AYQ	Double Coil(LPH)	11/95-01/04	DG-005		11V					4
1.9 TDI	66	1Z; AHU; ALE; ALH	Double Coil(LPH)	09/96-01/04	DG-005		11V					4
1.9 TDI	66	1Z; AHU; ALH	Auxiliary Heater	09/96-01/04	DG-628		11V					3
CADDY III (2K, 2C) (04-15)												
1.4	55	BCA		03/04-05/06	K20PBR-S10	5061	1.0	K20TT	IK20TT	IK20TT		4
1.4	59	BUD		05/06-08/10	KJ20DR-M11	3374	1.1	-	-	SKJ20DR-M11		4
1.6	75	BGU/ BSE; BSE/ BSF		04/04-05/15	K20PBR-S10	5061	1.0	K20TT	IK20TT	IK20TT		4
1.6 BiFuel	75	CHGA		05/11-05/15	K20PBR-S10	5061	1.0	K20TT	IK20TT	IK20TT		4
1.6 TDI	55/75	CAYD; CAYE		08/10-05/15	DG-193		4.4V					4
1.9 TDI	55/77	BJB; BLS; BSU		04/04-08/10	DG-177		5V					4
1.9 TDI 4motion	77	BLS		05/08-08/10	DG-177		5V					4
2.0 EcoFuel	80	BSX	Flexible fuel	04/06-08/10	VK20Y	5620	0.8	-	-	VK20Y		4
2.0 SDI	51	BDJ; BST		03/04-08/10	DG-109		11V					4
2.0 TDI	62/ 81/ 103	CFHC; CFHE; CLCA; CLCB		08/10-05/15	DG-193		4.4V					4
2.0 TDI	125	CFJA	Pressure sensor(-)	05/12-05/15	DG-193		4.4V					3
2.0 TDI 4motion	62/ 81/ 103	CFHC; CFHE; CFHF		08/10-05/15	DG-193		4.4V					4
2.0 TDI 8V	103	BMM		09/07-08/10	DG-177		5V					4
CADDY IV (SA) (15-)												
1.6 TDI	55/75	CAYD; CAYE		05/15-	DG-193		4.4V					4
2.0 TDI	55/ 75/ 110	CUUB; CUUD; CUUF; DFSB; DFSC; DFSD; DFSF	Pressure sensor(-)	05/15-	DG-193		4.4V					3
2.0 TDI	103	CFHC; CLCB		05/15-	DG-193		4.4V					4
2.0 TDI 4motion	55/ 90/ 110	CUUE; DFSB; DFSC; DFSE	Pressure sensor(-)	05/15-	DG-193		4.4V					3
2.0 TDI 4motion	81/ 103	CFHC; CFHF		05/15-	DG-193		4.4V					4

Таблица применения

V

Свечи зажигания и Свечи накаливания

Таблица применения

	KW				СТАНДАРТНЫЕ				Twin Tip			QTY
VW продолжение												
CC (358) (11-)												
1.4 TSI	118	CTHD		11/11-12/16	SKJ20CR-A8	3371	0.8	-	-	SKJ20CR-A8	4	
1.8 TSI	112/ 118	CDAА; CDAB		11/11-12/16	PK22PR8	3273	0.8	-	IK22TT	VK22	4	
2.0 TDI	100/ 103/ 125	CFFA; CFFB; CFGB; CLLA		11/11-12/16	DG-193		4.4V				4	
2.0 TDI	110/ 130/ 135	CFGC; CUVC; CUWA	Pressure sensor(-)	12/12-12/16	DG-193		4.4V				3	
2.0 TDI 4motion	103/ 125	CFFB; CFGB		11/11-12/16	DG-193		4.4V				4	
2.0 TDI 4motion	130	CFGC	Pressure sensor(-)	12/12-12/16	DG-193		4.4V				3	
2.0 TSI	147/ 155	CBFA; CCTA; CCZB		11/11-12/16	PK22PR8	3273	0.8	-	IK22TT	VK22	4	
CORRADO (53I) (88-95)												
1.8 16V	100	KR		04/89-07/92	K20PBR	5060	0.85	K20TT	IK20TT	IK20TT	4	
1.8 G60	118	PG		09/88-09/93	P20PR11	3115	1.1	W20TT	IW20TT	IW20TT	4	
2.0 i	85	ADY		04/93-12/95	W20EPBR-S	5067	0.85	W20TT	IW20TT	IW20TT	4	
2.0 i 16V	100	9A		08/91-12/95	K22PBR-S	5062	0.85	-	IKB22TT	VK22	4	
2.9 VR6	140	ABV		08/91-12/95	K20TXR	5063	1.0	K20TT	IK20TT	IK20TT	6	
CRAFTER 30-50 (2E, 2F) (06-16)												
2.0 TDI	80/ 84/ 100/ 103/ 105/ 120	CKTB; CKTC; CKUB; CKUC; CSLA; CSLB; CSLC; CSNA		05/11-12/16	DG-193		4.4V				4	
2.0 TDI 4motion	120	CKUB; CSNA		11/11-12/16	DG-193		4.4V				4	
2.5 TDI	65/ 80/ 100/ 120	BJJ; BJK; BJL; BJM; CEBA; CEBB; CECA; CECB	OE: N 105 916 03	04/06-05/13	DG-177		5V				5	
CRAFTER (16-)												
2.0 TDI	75/ 103/ 130	DAUA; DAUB; DAVA	Pressure sensor(-)	09/16-	DG-193		4.4V				3	
2.0 TDI 4motion	130	DAVA	Pressure sensor(-)	03/17-	DG-193		4.4V				3	
DERBY (86) (77-81)												
0.9	29	HA		02/77-09/81	W20EP-U	3043	0.8	W20TT	IW20TT	IW20TT	4	
1.1	37	HB		02/77-09/81	W20EP-U	3043	0.8	W20TT	IW20TT	IW20TT	4	
1.3	44	HH; HJ		02/77-09/81	W20EP-U	3043	0.8	W20TT	IW20TT	IW20TT	4	
DERBY (86C, 80) (81-84)												
1.0	29	GL		10/81-12/84	W20EP-U	3043	0.8	W20TT	IW20TT	IW20TT	4	
1.1	37	HB		10/81-07/83	W20EP-U	3043	0.8	W20TT	IW20TT	IW20TT	4	
1.3	40/44	HH; HK		08/81-12/84	W20EP-U	3043	0.8	W20TT	IW20TT	IW20TT	4	
1.3	55	GK		09/82-12/84	W22EPR-U	3088	0.8	W22TT	-	VW22	4	
EOS (1F) (06-15)												
1.4 TSI	90/ 118	CAVD; CAXA; CTHD		11/07-08/15	PKJ20CR8	3173	0.8	-	IK20TT	IK20TT	4	
1.4 TSI	118	CAVD; CTHD		02/11-08/15	SKJ20CR-A8	3371	0.8	-	-	SKJ20CR-A8	4	
1.6 FSI	85	BLF		06/06-05/08	K20PR-U	3145	0.8	K20TT	IK20TT	IK20TT	4	
1.6 FSI	85	BLF	OEM Optional	06/06-05/08	VKA16	5622	1.1	-	-	VKA16	4	
2.0 FSI	110	BVY		03/06-05/08	VKA16	5622	1.1	-	-	VKA16	4	
2.0 FSI	110	BVZ		03/06-05/08	K20PR-U	3145	0.8	K20TT	IK20TT	IK20TT	4	
2.0 TDI	100/ 103	CBAB; CFFA; CFFB		05/08-08/15	DG-193		4.4V				4	
2.0 TDI 8V	103	BMM		06/06-05/08	DG-177		5V				4	
2.0 TFSI	147	BPY; BWA; CAWB; CBFA; CCTA; CCZA		03/06-08/15	PK22PR8	3273	0.8	-	IK22TT	VK22	4	
2.0 TSI	155	CCZB		11/09-08/15	PK22PR8	3273	0.8	-	IK22TT	VK22	4	
3.6 V6	191	CDVA		05/09-11/10	VXUHC22G	5652	0.8	-	-	VXUHC22G	6	
FOX (5Z) (03-)												
1.2	40	BMD		04/05-07/11	KJ16CR-L11	3132	1.1	K16TT	IK16TT	IK16TT	3	
1.2	44	CHFA		09/10-12/11	KJ20DR-M11	3374	1.1	-	-	SKJ20DR-M11	3	
1.4	55	BKR		04/05-12/09	PKJ16CR-L11	3246	1.1	-	IK16TT	IK16TT	4	
1.4 TDI	51	BNM	Double Coil(LPH)	04/05-12/09	DG-109		11V				3	
1.6	74	BAH; BLH; BPA; CCRA		10/05-	KJ20DR-M11	3374	1.1	-	-	SKJ20DR-M11	4	
GOLF I (17, 155) (74-93)												
1.1	38	FA; FJ		04/74-07/83	W20EP-U	3043	0.8	W20TT	IW20TT	IW20TT	4	

Свечи зажигания и Свечи накаливания

Таблица применения

KW	KW	KW	KW	KW	СТАНДАРТНЫЕ			Twin Tip		QTY	
					STANDARD	STANDARD	STANDARD	TWIN TIP	TWIN TIP		
VW продолжение											
GOLF I (17, 155) (74-93) продолжение											
1.3	40/44	GF; GS; HK		08/79-07/86	W20EP-U	3043	0.8	W20TT	IW20TT	IW20TT	4
1.5	51	FH		04/74-12/75	W20EPR-U	3047	0.8	W20TT	IW20TT	IW20TT	4
1.5	51	GH/ JB		01/79-11/83	W16EPR-U	3021	0.8	W16TT	IW16TT	IW16TT	4
1.5	51	JB		08/77-07/83	W16EP-U	3018	0.8	W16TT	IW16TT	IW16TT	4
1.5 D	37	CK	Double Coil(LPH)	08/76-07/80	DG-012		11V				4
1.6	51	FV		08/75-07/77	W20EPR-U	3047	0.8	W20TT	IW20TT	IW20TT	4
1.6	53	RE		04/86-02/90	W20EPBR-S	5067	0.85	W20TT	IW20TT	IW20TT	4
1.6	55	EM		08/75-02/84	W20EP-U	3043	0.8	W20TT	IW20TT	IW20TT	4
1.6	55	EW; HN		01/83-04/92	W16EP-U	3018	0.8	W16TT	IW16TT	IW16TT	4
1.6	55	EZ	Ch:>F-350 000	01/83-02/84	W16EPR-U	3021	0.8	W16TT	IW16TT	IW16TT	4
1.6	81	EG		08/79-07/82	W22EP-U	3085	0.8	W22TT	-	VW22	4
1.6	81	EG		08/81-07/82	W22EPR-U	3088	0.8	W22TT	-	VW22	4
1.6 D	40	CR; JK	Double Coil(LPH)	08/80-07/83	DG-012		11V				4
1.6 GTI	81	EG		08/76-07/82	W22EPR-U	3088	0.8	W22TT	-	VW22	4
1.6 TD	51	CY	Double Coil(LPH)	03/82-07/83	DG-012		11V				4
1.8	66/70/72/82	2H; DX; EX; JH		08/82-04/93	W20EPB	5065	0.85	W20TT	IW20TT	IW20TT	4
1.8	82	DX		08/82-07/88	W16EPR-U	3021	0.8	W16TT	IW16TT	IW16TT	4
1.8 GTI	82	JJ		08/82-12/83	W20EPB	5065	0.85	W20TT	IW20TT	IW20TT	4
GOLF II (19, 1G) (83-92)											
1.0	33	GN		11/83-08/85	W20EPR-U	3047	0.8	W20TT	IW20TT	IW20TT	4
1.0	37	HZ		08/85-10/91	W20EP-U	3043	0.8	W20TT	IW20TT	IW20TT	4
1.3	37	NU		08/85-12/87	W20EPB	5065	0.85	W20TT	IW20TT	IW20TT	4
1.3	40/43	GT; HK		08/83-06/87	W20EP-U	3043	0.8	W20TT	IW20TT	IW20TT	4
1.3 Cat	40	2G		06/86-12/92	W20EPB	5065	0.85	W20TT	IW20TT	IW20TT	4
1.6	51/53/55	ABN; PN; RF		08/83-12/92	W20EPB	5065	0.85	W20TT	IW20TT	IW20TT	4
1.6 D	37/40	CS; JP; ME	Double Coil(LPH)	08/83-10/91	DG-012		11V				4
1.6 TD	44	1V		08/89-10/91	DG-012		11V				4
1.6 TD	51/59	JR; MF; RA; SB	Double Coil(LPH)	08/83-10/91	DG-012		11V				4
1.8	62/66	GU; RH		08/84-10/91	W20EPB	5065	0.85	W20TT	IW20TT	IW20TT	4
1.8 GTI	77/82	HT; PB		08/83-10/91	W20EPB	5065	0.85	W20TT	IW20TT	IW20TT	4
1.8 GTI	79	RD		08/85-10/87	W20EPBR-S	5067	0.85	W20TT	IW20TT	IW20TT	4
1.8 GTI 16V	95/102	KR; PL		02/86-10/91	K22PBR-S	5062	0.85	-	IKB22TT	VK22	4
1.8 GTI Cat	79	PF		01/87-10/91	W20EPB	5065	0.85	W20TT	IW20TT	IW20TT	4
1.8 GTI G60	118	PG		04/90-07/91	P20PR11	3115	1.1	W20TT	IW20TT	IW20TT	4
1.8 GTI G60 Syncro	118	1H; PG		08/88-12/91	IW20TT	4709	1.0	-	IW20TT		4
1.8 i Cat	66	RP		08/87-10/91	W20EPB	5065	0.85	W20TT	IW20TT	IW20TT	4
1.8 i Cat Syncro	66	RP		08/87-10/91	W20EPBR-S	5067	0.85	W20TT	IW20TT	IW20TT	4
1.8 Syncro	66	GU		02/86-07/91	W20EPB	5065	0.85	W20TT	IW20TT	IW20TT	4
1.8 Syncro	72	1P		08/88-07/91	W20EP-U	3043	0.8	W20TT	IW20TT	IW20TT	4
GOLF III (1H, 1E) (91-99)											
1.4	40	ABD; AEX		11/91-08/97	W20EPB	5065	0.85	W20TT	IW20TT	IW20TT	4
1.4	40/44	ABD; AEX; APQ		10/91-04/99	W20EPBR-S	5067	0.85	W20TT	IW20TT	IW20TT	4
1.6	55	ABU; AEA; AEE		09/92-08/97	W20EPBR-S	5067	0.85	W20TT	IW20TT	IW20TT	4
1.6	74	AEK; AFT		07/94-04/99	K20PBR-S10	5061	1.0	K20TT	IK20TT	IK20TT	4
1.8	55	AAM		07/93-04/99	W16ETR-S	3285	1.0	W16TT	IW16TT	IW16TT	4
1.8	55/66	AAM; ADZ		11/91-04/99	W20EPBR-S	5067	0.85	W20TT	IW20TT	IW20TT	4
1.8 Syncro	66	ABS; ADZ		01/93-04/99	W20EPBR-S	5067	0.85	W20TT	IW20TT	IW20TT	4
1.9 D	47	1Y		11/91-04/99	DG-012		11V				4
1.9 SDI	47	AEY	Auxiliary Heater	07/95-04/99	DG-012		11V				3
1.9 SDI	47	AEY	Double Coil(LPH)	07/95-04/99	DG-005		11V				4
1.9 TD	55	AAZ		07/93-04/99	DG-012		11V				4
1.9 TD,GTD	55	AAZ		11/91-08/97	DG-012		11V				4
1.9 TDI	66/81	1Z; AFN; AHU	Auxiliary Heater	08/93-04/99	DG-628		11V				3
1.9 TDI	66/81	1Z; AFN; AHU; ALE	Double Coil(LPH)	08/93-04/99	DG-005		11V				4
1.9 TDI Syncro	66	1Z; AHU	Auxiliary Heater	07/95-04/99	DG-628		11V				3
1.9 TDI Syncro	66	1Z; AHU; ALE	Double Coil(LPH)	07/95-04/99	DG-005		11V				4
2.0	85	AGG		11/91-04/99	W20EPBR-S	5067	0.85	W20TT	IW20TT	IW20TT	4
2.0 GL	79	AEP		08/95-09/97	W20EPBR-S	5067	0.85	W20TT	IW20TT	IW20TT	4





Таблица применения

V

Свечи зажигания и Свечи накаливания

Таблица применения

Таблица применения

	KW				СТАНДАРТНЫЕ			Twin Tip			QTY
VW продолжение											
GOLF III (1H, 1E) (91-99) продолжение											
2.0 GTI 16V	110	ABF		08/92-08/97	PK22PR8	3273	0.8	-	IK22TT	VK22	4
2.0 Syncro	85	AGG		08/95-04/99	W20EPBR-S	5067	0.85	W20TT	IW20TT	IW20TT	4
2.8 VR6	120/ 128	AAA		01/92-09/97	K20TXR	5063	1.0	K20TT	IK20TT	IK20TT	6
2.9 VR6 Syncro	140	ABV		10/94-04/99	K20TXR	5063	1.0	K20TT	IK20TT	IK20TT	6
GOLF IV (1J, 1E) (97-06)											
1.4 16V	55	AKQ; APE		05/99-06/06	K20PBR-S10	5061	1.0	K20TT	IK20TT	IK20TT	4
1.6	75/78	AEH; AFT; AKL; AKS; APF; AVU; AWB; BFQ; BJH		08/97-06/06	K20PBR-S10	5061	1.0	K20TT	IK20TT	IK20TT	4
1.6 16V	77	ATN/ AUS		02/00-06/06	K20PBR-S10	5061	1.0	K20TT	IK20TT	IK20TT	4
1.6 16V	77	AZD/ BCB		02/00-06/06	PKJ16CR-L11	3246	1.1	-	IK16TT	IK16TT	4
1.6 FSI	81	BAD		01/02-06/06	K20PBR-S10	5061	1.0	K20TT	IK20TT	IK20TT	4
1.8	55	AAM		06/98-06/02	W16ETR-S	3285	1.0	W16TT	IW16TT	IW16TT	4
1.8	66	ADZ		06/98-06/02	W20EPBR-S	5067	0.85	W20TT	IW20TT	IW20TT	4
1.8	92	AGN		08/97-06/05	K20PBR-S10	5061	1.0	K20TT	IK20TT	IK20TT	4
1.8 4motion	92	AGN		05/98-06/06	K20PBR-S10	5061	1.0	K20TT	IK20TT	IK20TT	4
1.8 T	110	AGU		08/97-06/06	PK20PR-P8	3245	0.8	-	IK20TT	IK20TT	4
1.8 T GTI	132	AUQ		08/01-06/05	PK20PR-P8	3245	0.8	-	IK20TT	IK20TT	4
1.9 SDI	50	AGP; AQM	Auxiliary Heater	08/97-06/06	DG-628		11V				3
1.9 SDI	50	AGP; AQM	Double Coil(LPH)	08/97-06/06	DG-005		11V				4
1.9 TDI	66/ 74/ 81/ 85/ 110	AFN; AGR; AHF; AHU; AJM; ALH; ARL; ASV; ATD	Auxiliary Heater	08/97-06/06	DG-628		11V				3
1.9 TDI	66/ 81/85	AFN; AGR; AHF; AHU; AJM; ALE; ALH; ASV; AUJ; AVG	Double Coil(LPH)	08/97-05/06	DG-005		11V				4
1.9 TDI	74/96	ASZ; ATD; AXR	Ch:> 1J-2-545 141	09/00-02/02	DG-005		11V				4
1.9 TDI	74/96	ASZ; ATD; AXR	Ch: 1J-2-545 142>	02/02-06/06	DG-109		11V				4
1.9 TDI	110	ARL	Ch:> 1J-2-545 141, Double Coi l(LPH)	05/00-02/02	DG-005		11V				4
1.9 TDI	110	ARL	Ch: 1J-2-545 142> ,Double Coi l(LPH)	02/02-06/06	DG-109		11V				4
1.9 TDI 4motion	66/ 74/ 85/ 110	AGR; AJM; ARL; ATD	Auxiliary Heater	07/98-06/06	DG-628		11V				3
1.9 TDI 4motion	66/85	AGR; AJM; AUJ	Double Coil(LPH)	07/98-04/02	DG-005		11V				4
1.9 TDI 4motion	74/96	ASZ; ATD	Ch:> 1J-2-545 141	09/00-02/02	DG-005		11V				4
1.9 TDI 4motion	74/96	ASZ; ATD	Ch: 1J-2-545 142>	02/02-06/06	DG-109		11V				4
1.9 TDI 4motion	110	ARL	Ch:> 1J-2-545 141, Double Coi l(LPH)	02/00-02/02	DG-005		11V				4
1.9 TDI 4motion	110	ARL	Ch: 1J-2-545 142> ,Double Coi l(LPH)	02/02-06/05	DG-109		11V				4
1.9 TDI 4motion	110	ARL	Double Coil(LPH)	05/02-06/05	DG-109		11V				4
2.0	85	AGG/ AKR		06/98-06/02	W20EPBR-S	5067	0.85	W20TT	IW20TT	IW20TT	4
2.0	85	APK/ AQY		07/98-06/06	K20PBR-S10	5061	1.0	K20TT	IK20TT	IK20TT	4
2.0	85	ATU/ AWF/ AWG		06/98-06/02	PK20PR-P8	3245	0.8	-	IK20TT	IK20TT	4
2.0	85	AZG/ AZJ		07/98-06/06	PKJ16CR-L11	3246	1.1	-	IK16TT	IK16TT	4
2.0 4motion	85	AZH		10/00-06/06	K20PBR-S10	5061	1.0	K20TT	IK20TT	IK20TT	4
2.0 4motion	85/88	ATF; AZJ		12/99-06/06	PKJ16CR-L11	3246	1.1	-	IK16TT	IK16TT	4
2.0 BiFuel	85	BEH	Flexible fuel	02/02-06/06	PKJ16CR-L11	3246	1.1	-	IK16TT	IK16TT	4
2.3 V5	110	AGZ		08/97-06/06	K20TXR	5063	1.0	K20TT	IK20TT	IK20TT	5
2.3 V5	125	AQN		10/00-06/06	PKJ16CR-L11	3246	1.1	-	IK16TT	IK16TT	5
2.3 V5 4motion	110	AGZ		12/98-06/06	K20TXR	5063	1.0	K20TT	IK20TT	IK20TT	5
2.3 V5 4motion	125	AQN		10/00-06/06	PKJ16CR-L11	3246	1.1	-	IK16TT	IK16TT	5
2.8 V6 4motion	150	BDE		05/99-06/06	PKJ16CR-L11	3246	1.1	-	IK16TT	IK16TT	6
2.8 VR6 4motion	150	AQP		03/99-06/05	PKJ16CR-L11	3246	1.1	-	IK16TT	IK16TT	6

Свечи зажигания и Свечи накаливания

Таблица применения





	KW				СТАНДАРТНЫЕ			Twin Tip			QTY
VW продолжение											
GOLF Plus (5M, 521) (05-14)											
1.4 16V	55	BCA		01/05-05/06	K20PBR-S10	5061	1.0	K20TT	IK20TT	IK20TT	4
1.4 16V	59	BUD; CGGA		05/06-12/13	KJ20DR-M11	3374	1.1	-	-	SKJ20DR-M11	4
1.4 FSI	66	BLN		07/05-11/06	K20PBR-S10	5061	1.0	K20TT	IK20TT	IK20TT	4
1.4 TSI	90/ 103/ 118/ 125	BLG; BMY; CAVD; CAXA; CNWA; CTHD		05/06-12/13	PKJ20CR8	3173	0.8	-	IK20TT	IK20TT	4
1.4 TSI	118	CAVD; CNWA; CTHD		02/11-12/13	SKJ20CR-A8	3371	0.8	-	-	SKJ20CR-A8	4
1.6	75	BSE - E5		05/05-12/13	K20PBR-S10	5061	1.0	K20TT	IK20TT	IK20TT	4
1.6 BiFuel	75	CHGA		05/09-12/13	K20PBR-S10	5061	1.0	K20TT	IK20TT	IK20TT	4
1.6 FSI	85	BLF		12/04-05/08	K20PBR-S10	5061	1.0	K20TT	IK20TT	IK20TT	4
1.6 MultiFuel	75	CHGA	Flexible fuel	05/09-12/13	K20PBR-S10	5061	1.0	K20TT	IK20TT	IK20TT	4
1.6 TDI	66/77	CAYB; CAYC		02/09-12/13	DG-193		4.4V				4
1.9 TDI	66/77	BKC; BLS; BRU; BXE; BXF; BXJ		01/05-01/09	DG-177		5V				4
2.0 FSI	110	BLR/ BVY		05/05-06/08	VKA16	5622	1.1	-	-	VKA16	4
2.0 FSI	110	BLY/ BVZ		05/05-06/08	K20PR-U	3145	0.8	K20TT	IK20TT	IK20TT	4
2.0 TDI	81/ 100/ 103	CBDA; CBDDB; CBDC; CFHB; CFHC; CLCA		01/05-12/13	DG-193		4.4V				4
2.0 TDI	96/ 100/ 103	AZV; BEE; BKD		01/05-12/13	DG-190		4.4V				4
2.0 TDI 8V	103	BMM		12/05-05/11	DG-177		5V				4
GOLF Sportsvan (AM1) (14-)											
1.6 TDI	66/81	CRKA; CRKB; CXXA; CXXB; DBKA; DDYB	Pressure sensor(-)	02/14-	DG-193		4.4V				3
2.0 TDI	81	CRLD; CRVA; DCYB	Euro-4; Euro-5	05/14-	DG-193		4.4V				4
2.0 TDI	81	CRLD; CRVA; DCYB	Euro-6; Pressures ensor(-)	05/14-	DG-193		4.4V				3
2.0 TDI	110	CRLB; DCYA; DFGA	Pressure sensor(-)	02/14-	DG-193		4.4V				3
GOLF V (1K) (03-09)											
1.4	59	BUD		06/07-07/09	KJ20DR-M11	3374	1.1	-	-	SKJ20DR-M11	4
1.4 16V	55	BCA		10/03-05/06	K20PBR-S10	5061	1.0	K20TT	IK20TT	IK20TT	4
1.4 16V	59	BUD		05/06-11/08	KJ20DR-M11	3374	1.1	-	-	SKJ20DR-M11	4
1.4 FSI	66	BKG; BLN		10/03-07/06	K20PBR-S10	5061	1.0	K20TT	IK20TT	IK20TT	4
1.4 TSI	90/ 103/ 118/ 125	BLG; BMY; CAVD; CAXA		11/05-07/09	PKJ20CR8	3173	0.8	-	IK20TT	IK20TT	4
1.6	75	BGU; BSE; BSF; CCSA		01/04-07/09	K20PBR-S10	5061	1.0	K20TT	IK20TT	IK20TT	4
1.6 FSI	85	BAG; BLF; BLP		10/03-07/08	K20PBR-S10	5061	1.0	K20TT	IK20TT	IK20TT	4
1.6 MultiFuel	75	CCSA		10/07-07/09	K20PBR-S10	5061	1.0	K20TT	IK20TT	IK20TT	4
1.9 TDI	66/77	BKC; BLS; BRU; BXE; BXF; BXJ		10/03-07/09	DG-177		5V				4
1.9 TDI 4motion	77	BKC; BLS; BXE		08/04-07/09	DG-177		5V				4
2.0	147	BWA; CAWB; CCTA		06/07-07/09	PK22PR8	3273	0.8	-	IK22TT	VK22	4
2.0 FSI	110	AXW; BLR; BLX; BLY; BVX; BVY; BVZ		01/04-11/08	VKA16	5622	1.1	-	-	VKA16	4
2.0 FSI	110	BVZ		01/04-11/08	K20PR-U	3145	0.8	K20TT	IK20TT	IK20TT	4
2.0 FSI 4motion	110	BLX; BVX		08/04-05/07	VKA16	5622	1.1	-	-	VKA16	4
2.0 GTI	147	AXX; BPY; BWA; CAWB; CBFA; CCTA		10/04-02/09	PK22PR8	3273	0.8	-	IK22TT	VK22	4
2.0 GTI	169	BYD		09/06-12/08	K20PR-U	3145	0.8	K20TT	IK20TT	IK20TT	4
2.0 SDI	55	BDK		01/04-11/08	DG-177		5V				4
2.0 TDI	100/ 103	AZV; BKD		10/03-07/09	DG-190		4.4V				4
2.0 TDI	103	CBDB		06/07-07/09	DG-193		4.4V				4
2.0 TDI	125	BMN	OE: N 105 798 03/ N 105 798 05, Ceramic	11/05-11/08	DG-622		7V				4
2.0 TDI 4motion	103	BKD		08/04-11/08	DG-190		4.4V				4
2.0 TDI 8V	103	BMM		12/04-07/09	DG-177		5V				4
2.0 TDI 8V 4motion	103	BMM		08/04-11/08	DG-177		5V				4
GOLF VI (5K, AJ5) (08-14)											
1.4	59	BUD; CGGA		10/08-07/13	KJ20DR-M11	3374	1.1	-	-	SKJ20DR-M11	4
1.4 TSI	90/ 118	CAVD; CAXA; CNWA; CTHD; CTKA		10/08-07/13	PKJ20CR8	3173	0.8	-	IK20TT	IK20TT	4





Таблица применения

V

Свечи зажигания и Свечи накаливания



Таблица применения

Таблица применения

	KW				СТАНДАРТНЫЕ			Twin Tip			QTY
VW продолжение											
GOLF VI (5K, AJ5) (08-14) продолжение											
1.4 TSI	118	CAVD; CNWA; CTHD; CTKA		02/11-07/13	SKJ20CR-A8	3371	0.8	-	-	SKJ20CR-A8	4
1.6	75	BSE - E5; BSE		10/08-07/13	K20PBR-S10	5061	1.0	K20TT	IK20TT	IK20TT	4
1.6 BiFuel	75	CHGA		03/09-11/12	K20PBR-S10	5061	1.0	K20TT	IK20TT	IK20TT	4
1.6 MultiFuel	75	CCSA; CMXA		10/08-07/13	K20PBR-S10	5061	1.0	K20TT	IK20TT	IK20TT	4
1.6 TDI	66	CAYB		02/09-07/13	DG-193		4.4V				4
1.6 TDI (BlueMotion)	77	CAYC		02/09-07/13	DG-193		4.4V				4
1.6 TDI 4motion	77	CAYC		07/09-07/13	DG-193		4.4V				4
1.8 TSI	118	CDAA		06/09-01/11	PK22PR8	3273	0.8	-	IK22TT	VK22	4
2.0 GTi	147/ 155/ 173	CBFA; CCTA; CCZA; CCZB; CDLG		04/09-11/13	PK22PR8	3273	0.8	-	IK22TT	VK22	4
2.0 R 4motion	188/ 195/ 199	CDLA; CDLC; CDLF; CRZA		11/09-11/13	PK22PR8	3273	0.8	-	IK22TT	VK22	4
2.0 TDI	81/ 100/ 103/ 125	CBAA; CBAB; CBBB; CBDA; CBDB; CBDC; CFFA; CFFB; CFGB; CFHB; CFHC; CLCA; CLCB		10/08-07/13	DG-193		4.4V				4
2.0 TDI 4motion	103	CBAB; CFFB		05/09-11/12	DG-193		4.4V				4
2.0 TSI	147	CBFA; CCTA; CCZA		07/09-05/14	PK22PR8	3273	0.8	-	IK22TT	VK22	4
2.5 FSI	125	CBTA; CBUA		08/09-05/14	KJ20DR-M11	3374	1.1	-	-	SKJ20DR-M11	5
GOLF VI Convertible (517) (11-16)											
1.4 TSI	90	CAXA		11/11-05/16	PKJ20CR8	3173	0.8	-	IK20TT	IK20TT	4
1.4 TSI	118	CAVD; CNWA; CTHD; CTKA		03/11-05/16	SKJ20CR-A8	3371	0.8	-	-	SKJ20CR-A8	4
1.6 TDI	77	CAYC		03/11-05/16	DG-193		4.4V				4
2.0 GTI	155	CCZB		05/12-05/16	PK22PR8	3273	0.8	-	IK22TT	VK22	4
2.0 R	195	CDLA		01/13-05/16	PK22PR8	3273	0.8	-	IK22TT	VK22	4
2.0 TDI	81/ 110	CUUA; CUUB	Pressure sensor(-)	11/13-05/16	DG-193		4.4V				3
2.0 TDI	103	CFHC		11/11-05/16	DG-193		4.4V				4
2.0 TSI	162	CULC		11/13-05/16	PK22PR8	3273	0.8	-	IK22TT	VK22	4
GOLF VII (5G, BA5) (12-)											
1.6 TDI (BlueMotion)	66/ 77/81	CLHA; CLHB; CRKA; CRKB; CXXA; CXXB; DBKA; DDYB	Pressure sensor(-)	08/12-	DG-193		4.4V				3
1.6 TDI 4motion	81	CRKB; CXXB	Pressure sensor(-)	01/13-	DG-193		4.4V				3
1.6 TDI 4motion (BlueMotion)	77	CLHA	Pressure sensor(-)	11/12-	DG-193		4.4V				3
2.0 GTD	135	CUNA; DGCA; DJGA	Pressure sensor(-)	04/13-	DG-193		4.4V				3
2.0 TDI	81/ 105	CRBB; CRLD; CRVA; CRVC; CYKB; DCYB; DEJB	Euro-4; Euro-5	08/12-	DG-193		4.4V				4
2.0 TDI	81/ 105	CRBB; CRLD; CRVA; CRVC; CYKB; DCYB; DEJB	Euro-6; Pressures ensor(-)	08/12-	DG-193		4.4V				3
2.0 TDI (BlueMotion)	110	CKFC; CRBC; CRLB; CRMB; CRUA; DCYA; DEJA; DFGA	Pressure sensor(-)	11/12-	DG-193		4.4V				3
2.0 TDI 4motion	135	CUNA; DGCA; DJGA	Pressure sensor(-)	12/14-	DG-193		4.4V				3
2.0 TDI 4motion (BlueMotion)	110	CKFC; CRBC; CRLB; CRMB; DCYA	Pressure sensor(-)	11/12-	DG-193		4.4V				3
ILTIS (183) (79-88)											
1.6 TD	51	1C	Double Coil(LPH)	08/87-12/88	DG-012		11V				4
1.7	55	YX		03/79-12/88	W20EP-U	3043	0.8	W20TT	IW20TT	IW20TT	4
JETTA I (16) (78-84)											
1.1	37	FA		08/79-02/84	W20EP-U	3043	0.8	W20TT	IW20TT	IW20TT	4
1.3	44	GF; GS		08/79-02/84	W20EP-U	3043	0.8	W20TT	IW20TT	IW20TT	4
1.5	51	GH/ JB		08/78-02/84	W16EPR-U	3021	0.8	W16TT	IW16TT	IW16TT	4
1.5	51	JB		08/78-02/84	W16EP-U	3018	0.8	W16TT	IW16TT	IW16TT	4
1.5 D	37	CK	Double Coil(LPH)	08/78-07/80	DG-012		11V				4
1.6	55/63	EM; FR		08/78-02/84	W20EP-U	3043	0.8	W20TT	IW20TT	IW20TT	4
1.6 D	40	CR; JK	Double Coil(LPH)	08/80-02/84	DG-012		11V				4
1.6 GLI	81	EG		08/78-07/82	W22EPR-U	3088	0.8	W22TT	-	VW22	4
1.6 TD	51	CY	Double Coil(LPH)	03/82-02/84	DG-012		11V				4

Свечи зажигания и Свечи накаливания

Таблица применения

	KW				СТАНДАРТНЫЕ			Twin Tip			QTY
VW продолжение											
JETTA I (16) (78-84) продолжение											
1.8	82	DX/ JJ		08/82-02/84	W22EPR-U	3088	0.8	W22TT	-	VW22	4
JETTA II (19, 1G) (84-92)											
1.3	40/43	GT; HK		01/84-06/87	W20EP-U	3043	0.8	W20TT	IW20TT	IW20TT	4
1.3 Cat	40	NZ		06/87-12/91	W20EP-U	3043	0.8	W20TT	IW20TT	IW20TT	4
1.6	51/53/55	ABN; PN; RF		01/84-07/92	W20EPB	5065	0.85	W20TT	IW20TT	IW20TT	4
1.6 D	40	JP; ME	Double Coil(LPH)	01/84-10/91	DG-012		11V				4
1.6 TD	44	1V		01/90-10/91	DG-012		11V				4
1.6 TD	51/59	JR; MF; RA; SB	Double Coil(LPH)	01/84-10/91	DG-012		11V				4
1.8	62/66/82	GU; GZ; RH		01/84-10/91	W20EPB	5065	0.85	W20TT	IW20TT	IW20TT	4
1.8	79	RD		08/85-10/87	W20EPBR-S	5067	0.85	W20TT	IW20TT	IW20TT	4
1.8 16V	95/102	KR; PL		08/86-10/91	K22PBR-S	5062	0.85	-	IKB22TT	VK22	4
1.8 Cat	66/79	PF; RP		01/87-10/91	W20EPB	5065	0.85	W20TT	IW20TT	IW20TT	4
1.8 Syncro	66/72	1P; RP		08/87-07/91	W20EPB	5065	0.85	W20TT	IW20TT	IW20TT	4
JETTA III (1K2) (05-10)											
1.4 TSI	90/103/118/125	BLG; BMY; CAVD; CAXA		07/06-10/10	PKJ20CR8	3173	0.8	-	IK20TT	IK20TT	4
1.6	75	BSE/ BSF		10/05-10/10	K20PBR-S10	5061	1.0	K20TT	IK20TT	IK20TT	4
1.6 FSI	85	BLF		09/05-06/08	K20PBR-S10	5061	1.0	K20TT	IK20TT	IK20TT	4
1.6 MultiFuel	75	CCSA		01/08-10/10	K20PBR-S10	5061	1.0	K20TT	IK20TT	IK20TT	4
1.6 TDI	66/77	CAYB; CAYC		06/09-10/10	DG-193		4.4V				4
1.9 TDI	77	BKC; BLS; BXE		08/05-10/10	DG-177		5V				4
2.0 FSI	110	BLR/ BVY		08/05-10/10	VKA16	5622	1.1	-	-	VKA16	4
2.0 FSI	110	BLY/ BVZ		08/05-10/10	K20PR-U	3145	0.8	K20TT	IK20TT	IK20TT	4
2.0 TDI	100/103	AZV; BKD		08/05-10/10	DG-190		4.4V				4
2.0 TDI	100/103/125	CBDA; CBDB; CBEA; CEGA		08/05-10/10	DG-193		4.4V				4
2.0 TDI	125	BMN	OE: N 105 798 03/ N 105 798 05, Ceramic	10/06-10/10	DG-622		7V				4
2.0 TDI 8V	103	BMM		10/05-10/10	DG-177		5V				4
2.0 TFSI	147	AXX; BPY; BWA; CAWB; CBFA; CCTA; CCZA		10/05-10/10	PK22PR8	3273	0.8	-	IK22TT	VK22	4
2.5	110	BTK		01/06-06/07	SKJ16CR-L11	3396	1.1	-	IK16TT	IK16TT	5
2.5	125	CBTA; CBUA; CCCA		07/08-10/10	KJ20DR-M11	3374	1.1	-	-	SKJ20DR-M11	5
JETTA IV (162) (10-)											
1.4 TSI	90	CAXA; CMSB		05/11-	PKJ20CR8	3173	0.8	-	IK20TT	IK20TT	4
1.4 TSI	110/118	CAVA; CAVD; CTHA; CTHD		04/11-	SKJ20CR-A8	3371	0.8	-	-	SKJ20CR-A8	4
1.6	63/77	CFNA; CFNB; CLRA		12/11-	KJ20DR-M11	3374	1.1	-	-	SKJ20DR-M11	4
1.6 TDI	77	CAYC		04/10-07/14	DG-193		4.4V				4
2.0	85	CBPA		06/10-12/17	KJ20DR-M11	3374	1.1	-	-	SKJ20DR-M11	4
2.0 TDI	81/103	CFFB; CFHC; CLCA; CLCB; CUUA		10/10-	DG-193		4.4V				4
2.0 TDI	110	CUUB; DELA; DGMA	Pressure sensor(-)	08/14-	DG-193		4.4V				3
2.0 TSI	147	CBFA; CCTA; CCZA		12/10-	PK22PR8	3273	0.8	-	IK22TT	VK22	4
2.5	125	CBTA; CBUA; CCCA		04/10-	KJ20DR-M11	3374	1.1	-	-	SKJ20DR-M11	5
K 70 (70-74)											
1.6	55/66	DA; DB		08/70-10/74	W20EP-U	3043	0.8	W20TT	IW20TT	IW20TT	4
1.8	74	DC		08/73-10/74	W20EP-U	3043	0.8	W20TT	IW20TT	IW20TT	4
KAEFER (47-03)											
1.2	22	M51		01/54-07/65	W16FSR	3033	0.7	-	-		4
1.3 Karmann	29	F		07/64-07/70	W16FS-U	3034	0.7	-	-		4
1200 1.2	25	D		01/60-12/85	W16FSR	3033	0.7	-	-		4
1300 1.3	28/32	AB; E; F		01/65-01/73	W16FS-U	3034	0.7	-	-		4
1302 1.2	25	D		08/69-08/72	W16FSR	3033	0.7	-	-		4
1302 1.3	29/32	AB; AC		08/70-07/75	W16FS-U	3034	0.7	-	-		4
1302 1.6	34/37	AD; AE; AF; AH; AK		01/70-07/74	W16FS-U	3034	0.7	-	-		4
1302 1.6	37	AS		08/73-06/79	W16FSR	3033	0.7	-	-		4
1303 1.2	25	D		07/72-12/79	W16FSR	3033	0.7	-	-		4
1303 1.3	32	AB; AR		07/70-03/81	W16FS-U	3034	0.7	-	-		4

Свечи зажигания и Свечи накаливания

Таблица применения

KW	KW	KW	NOTE	21	СТАНДАРТНЫЕ			Twin Tip		QTY
					W16FSR	3033	0.7	W20TT	IW20TT	
VW продолжение										
КАЕФЕР (47-03) продолжение										
1303 1.6	35	AD		08/72-12/79	W16FSR	3033	0.7	-	-	4
1303 1.6	35	AE; AH; AK		08/70-07/74	W16FS-U	3034	0.7	-	-	4
1303 LS,S 1.6	37	AD; AJ; AS		08/72-12/79	W16FSR	3033	0.7	-	-	4
1500 1.5	32	H		01/66-11/73	W16FS-U	3034	0.7	-	-	4
1500 1.6	35/37	AD; B		07/69-01/73	W16FS-U	3034	0.7	-	-	4
1600 (Mex.)	34	AF		05/73-09/92	W16FSR	3033	0.7	-	-	4
1600 i (Mex.)	34	ACD		10/92-07/03	W16FSR	3033	0.7	-	-	4
KARMANN GHIA (55-74)										
1200	25	D		09/57-12/64	W16FSR	3033	0.7	-	-	4
1500	32	H		01/66-12/69	W16FSR	3033	0.7	-	-	4
1500	40			08/61-05/70	W20FSR-U	6053	0.7	WF20TT	-	4
1600	35/37	AD; AL		01/70-07/74	W16FSR	3033	0.7	-	-	4
LT 28-35 I (281-363) (75-96)										
2.0	55	CH		04/75-09/83	W20EP-U	3043	0.8	W20TT	IW20TT	4
2.4	66	DL		12/82-07/92	W20EP-U	3043	0.8	W20TT	IW20TT	6
2.4 D	51	1S; ACT		08/89-06/96	DG-012		11V			6
2.4 D	55	CP; DW	Ch: 28-B-000 001> ,Double Coi l(LPH)	12/78-07/92	DG-012		11V			6
2.4 D	55	DW	Double Coil(LPH)	08/91-07/92	DG-012		11V			6
2.4 D Syncro	51	1S		08/91-07/92	DG-012		11V			6
2.4 D Syncro	55	DW	Double Coil(LPH)	08/91-07/92	DG-012		11V			6
2.4 i	69	1E		08/89-06/96	W20EP-U	3043	0.8	W20TT	IW20TT	6
2.4 i	69	1E		03/94-06/96	W20EPR-U	3047	0.8	W20TT	IW20TT	6
2.4 Syncro	66	DL		08/91-07/92	W20EP-U	3043	0.8	W20TT	IW20TT	6
2.4 TD	68	1G		08/88-08/92	DG-012		11V			6
2.4 TD	70/75	ACL; DV	Double Coil(LPH)	12/82-06/96	DG-012		11V			6
2.4 TD Syncro	70	ACL	Double Coil(LPH)	08/92-04/96	DG-012		11V			6
2.7 D	48	CG	Double Coil(LPH)	11/75-01/80	DG-012		11V			4
LT 28-35 II (2D) (96-06)										
2.5 SDI	55	AGX	Double Coil(LPH)	07/96-07/06	DG-005		11V			5
2.5 TDI	61/ 66/ 70/ 75/80	AHD; ANJ; APA; AVR; BBE; BBF	Double Coil(LPH)	05/96-07/06	DG-005		11V			5
2.8 TDI	92/96	AGK; ATA	Double Coil(LPH)	07/97-05/03	DG-139		11V			4
2.8 TDI	116	AUH; BCQ		05/01-06/06	DG-183		11.5V			4
LT 28-46 II (2D) (96-06)										
2.5 SDI	55	AGX	Double Coil(LPH)	09/96-07/06	DG-005		11V			5
2.5 TDI	61/ 66/ 70/ 75/80	AHD; ANJ; APA; AVR; BBE; BBF	Double Coil(LPH)	05/96-07/06	DG-005		11V			5
2.8 TDI	92	AGK	Double Coil(LPH)	07/97-01/02	DG-139		11V			4
2.8 TDI	96	ATA		01/99-07/06	DG-139		11V			4
2.8 TDI	116	AUH; BCQ		04/02-07/06	DG-183		11.5V			4
LT 28-50 I (281-363) (82-92)										
2.4 D	51/55			08/91-07/92	DG-012		11V			6
2.4 TD	68/75			12/82-07/92	DG-012		11V			6
LT 40-55 I (75-96)										
2.0	55	CH		04/75-09/83	W20EP-U	3043	0.8	W20TT	IW20TT	4
2.4	66	DL		12/82-07/92	W20EP-U	3043	0.8	W20TT	IW20TT	6
2.4 4WD	66	DL		12/82-07/92	W20EP-U	3043	0.8	W20TT	IW20TT	6
2.4 D	51	1S; ACT		07/90-06/96	DG-012		11V			6
2.4 D	55	CP; DW	Ch: 28-B-000 001> ,Double Coi l(LPH)	12/78-07/92	DG-012		11V			6
2.4 D 4WD	55	DW	Double Coil(LPH)	01/79-03/86	DG-012		11V			6
2.4 i	69	1E		01/93-06/96	W20EP-U	3043	0.8	W20TT	IW20TT	6
2.4 Syncro	66	DL		12/82-07/89	W20EP-U	3043	0.8	W20TT	IW20TT	6
2.4 TD	68	1G		08/88-08/92	DG-012		11V			6

Свечи зажигания и Свечи накаливания

Таблица применения











	KW				СТАНДАРТНЫЕ			Twin Tip			QTY
											
VW продолжение											
LT 40-55 I (75-96) продолжение											
2.4 TD	70/75	ACL; DV	Double Coil(LPH)	12/82-06/96	DG-012		11V				6
2.4 TD 4WD	75	DV	Double Coil(LPH)	08/78-07/92	DG-012		11V				6
2.4 TD Syncro	68	1G		08/91-07/92	DG-012		11V				6
2.4 TD Syncro	70/75	ACL; DV	Double Coil(LPH)	08/91-04/96	DG-012		11V				6
LUPO (6X, 6E) (98-05)											
1.0	37	AER/ ALL		09/98-05/00	W20EPBR-S	5067	0.85	W20TT	IW20TT	IW20TT	4
1.0	37	AHT		10/98-05/00	K20PBR-S10	5061	1.0	K20TT	IK20TT	IK20TT	4
1.0	37	ALD/ ANV/ AUC		09/98-05/03	PKJ16CR-L11	3246	1.1	-	IK16TT	IK16TT	4
1.2 TDI 3L	45	ANY		07/99-07/05	DG-109		11V				3
1.2 TDI 3L	45	AYZ	Ch:> 6X-2-005 000	07/99-07/01	DG-005		11V				3
1.2 TDI 3L	45	AYZ	Ch: 6X-2-005 001>	07/01-07/05	DG-109		11V				3
1.4	44	AUD		10/00-05/03	PKJ16CR-L11	3246	1.1	-	IK16TT	IK16TT	4
1.4 16V	55/74	AFK/ AQQ/ AUB; AHW; AKQ; APE; AUA; BBY		09/98-07/05	K20PBR-S10	5061	1.0	K20TT	IK20TT	IK20TT	4
1.4 16V	74	AFK		08/99-10/00	W16EPB10	5064	1.0	W16TT	IW16TT	IW16TT	4
1.4 FSI	77	ARR		02/01-05/03	K20PBR-S10	5061	1.0	K20TT	IK20TT	IK20TT	4
1.4 TDI	55	AMF	Ch:> 6X-2-005 000	01/99-07/01	DG-005		11V				3
1.4 TDI	55	AMF	Ch: 6X-2-005 001>	07/01-07/05	DG-109		11V				3
1.6 GTI	92	AVY		09/00-03/03	K20PBR-S10	5061	1.0	K20TT	IK20TT	IK20TT	4
1.7 SDI	44	AKU	Double Coil(LPH)	09/98-07/05	DG-005		11V				4
MULTIVAN V (7H, 7E) (03-)											
1.9 TDI	63/75	BRR; BRS		01/06-11/09	DG-177		5V				4
1.9 TDI	63/77	AXB; AXC		04/03-11/09	DG-109		11V				4
2.0	85	AXA		11/03-08/15	K20PBR-S10	5061	1.0	K20TT	IK20TT	IK20TT	4
2.0 BiTDI	132	CFCA		09/09-08/15	DG-193		4.4V				4
2.0 BiTDI 4motion	132	CFCA		09/09-08/15	DG-193		4.4V				4
2.0 TDI	62/75/84/100/103	CAAA; CAAB; CAAC; CAAD; CAAE; CCHA; CCHB		09/09-08/15	DG-193		4.4V				4
2.0 TDI 4motion	100/103	CAAC; CAAE; CCHA; CCHB		09/09-08/15	DG-193		4.4V				4
2.0 TSI	110/150	CJKA; CJKB		05/11-08/15	PK22PR8	3273	0.8	-	IK22TT	VK22	4
2.0 TSI 4motion	150	CJKA		07/11-08/15	PK22PR8	3273	0.8	-	IK22TT	VK22	4
2.5 TDI	96	AXD	Double Coil(LPH)	04/03-11/09	DG-109		11V				5
2.5 TDI	120/128	AXE; BLJ		04/03-11/09	DG-109		11V				5
2.5 TDI 4motion	96	AXD	Double Coil(LPH)	07/04-11/09	DG-109		11V				5
2.5 TDI 4motion	128	AXE		07/04-11/09	DG-109		11V				5
MULTIVAN VI (SG) (15-)											
2.0 TDI	62/75/84/110/150	CXEB; CXFA; CXGA; CXGB; CXHA; CXHB	Pressure sensor(-)	04/15-	DG-193		4.4V				3
2.0 TDI	75/103/132	CAAB; CAAC; CFCA		04/15-	DG-193		4.4V				4
2.0 TDI 4motion	103/132	CAAC; CFCA		06/15-	DG-193		4.4V				4
2.0 TDI 4motion	110/150	CXEB; CXFA; CXHA	Pressure sensor(-)	06/15-	DG-193		4.4V				3
NEW BEETLE (9C, 1C, 1Y) (98-10)											
1.4	55	BCA		11/01-09/10	PKJ16CR-L11	3246	1.1	-	IK16TT	IK16TT	4
1.6	75	AWH; AYD; BFS		10/99-09/10	K20PBR-S10	5061	1.0	K20TT	IK20TT	IK20TT	4
1.6	75	AYD		06/00-05/01	PKJ16CR-L11	3246	1.1	-	IK16TT	IK16TT	4
1.8 T	110/132	AGU; APH; AVC; AWP; AWU; AWV; BKF		10/99-09/10	PK20PR-P8	3245	0.8	-	IK20TT	IK20TT	4
1.9 TDI	66	ALH	Double Coil(LPH)	01/98-06/04	DG-005		11V				4
1.9 TDI	66/74	ALH; ATD	Auxiliary Heater	01/98-09/10	DG-628		11V				3

Таблица применения

V

Свечи зажигания и Свечи накаливания

Таблица применения

Таблица применения

KW	KW	KW	NOTE	21	СТАНДАРТНЫЕ				Twin Tip			QTY
					STANDARD	STANDARD	STANDARD	STANDARD	STANDARD	STANDARD	STANDARD	
VW продолжение												
NEW BEETLE (9C, 1C, 1Y) (98-10) продолжение												
1.9 TDI	74	ATD	Ch:> 9C-2-623 845	02/01-10/01	DG-005		11V				4	
1.9 TDI	74	ATD	Ch: 9C-2-623 845>	11/01-09/10	DG-109		11V				4	
1.9 TDI	74/77	AXR; BSW		06/03-09/10	DG-109		11V				4	
2.0	85	AEG/ APK/ AQY/ BEJ/ BER/ BEV/ BHP		01/98-10/10	K20PBR-S10	5061	1.0	K20TT	IK20TT	IK20TT	4	
2.0	85	AZG/ AZJ; AZJ/ BDC/ BGD		01/98-10/10	KJ16CR-L11	3132	1.1	K16TT	IK16TT	IK16TT	4	
2.3 V5	125	AQN		10/00-06/05	PKJ16CR-L11	3246	1.1	-	IK16TT	IK16TT	5	
2.5	110	BPR/ BPS		07/05-09/10	SKJ16CR-L11	3396	1.1	-	IK16TT	IK16TT	5	
3.2 RSI 4motion	165	AXJ		04/00-05/01	PKJ16CR-L11	3246	1.1	-	IK16TT	IK16TT	6	
PASSAT (3A2, 35) (88-97)												
1.6	53	1F		04/88-07/89	W20EPBR-S	5067	0.85	W20TT	IW20TT	IW20TT	4	
1.6	53	EZ		04/88-07/89	K20BR-S10	3330	1.0	K20TT	IK20TT	IK20TT	4	
1.6	53/74	AEK; AFT; EZ		04/88-08/96	K20PBR-S10	5061	1.0	K20TT	IK20TT	IK20TT	4	
1.6	55	1F; EZ		04/88-07/91	W16EPR-U	3021	0.8	W16TT	IW16TT	IW16TT	4	
1.6 TD	59	RA; SB	Double Coil(LPH)	08/88-09/93	DG-012		11V				4	
1.8	55	AAM		08/90-08/96	W16ETR-S	3285	1.0	W16TT	IW16TT	IW16TT	4	
1.8	55/66	AAM; ADZ		02/88-05/97	W20EPBR-S	5067	0.85	W20TT	IW20TT	IW20TT	4	
1.8	66/79/82	PB; PF; RP		02/88-08/96	W20EPB	5065	0.85	W20TT	IW20TT	IW20TT	4	
1.8 16V	100	KR		04/88-12/89	K22PBR-S	5062	0.85	-	IKB22TT	VK22	4	
1.8 G60 Syncro	118	PG		08/88-05/97	P20PR11	3115	1.1	W20TT	IW20TT	IW20TT	4	
1.9 D	50	1Y		05/89-10/93	DG-012		11V				4	
1.9 TD	55	AAZ		03/91-05/97	DG-012		11V				4	
1.9 TDI	66/81	1Z; AFN; AHU	Auxiliary Heater	10/93-05/97	DG-628		11V				3	
1.9 TDI	66/81	1Z; AFN; AHU	Double Coil(LPH)	10/93-05/97	DG-005		11V				4	
2.0	79/85	AEP; AGG		02/90-05/97	W20EPBR-S	5067	0.85	W20TT	IW20TT	IW20TT	4	
2.0 16V	100/110	9A; ABF		08/88-08/96	K22PBR-S	5062	0.85	-	IKB22TT	VK22	4	
2.0 16V	110	ABF		01/94-05/97	IK22	5310	0.8	-	IK22TT	VK22	4	
2.0 16V	110	ABF		01/94-05/97	PK22PR8	3273	0.8	-	IK22TT	VK22	4	
2.0 Syncro	85	AGG		10/90-05/97	W20EPBR-S	5067	0.85	W20TT	IW20TT	IW20TT	4	
2.8 VR6	128	AAA		06/91-05/97	K20TXR	5063	1.0	K20TT	IK20TT	IK20TT	6	
2.9 VR6 Syncro	135	ABV		01/94-05/97	K20TXR	5063	1.0	K20TT	IK20TT	IK20TT	6	
PASSAT (3B2, 3B5) (96-01)												
1.6	74	ADP; AHL; ANA; ARM		10/96-11/00	K20PBR-S10	5061	1.0	K20TT	IK20TT	IK20TT	4	
1.8	92	ADR		10/96-11/00	K20PBR-S10	5061	1.0	K20TT	IK20TT	IK20TT	4	
1.8 Syncro/4motion	92	ADR; APT		10/96-11/00	K20PBR-S10	5061	1.0	K20TT	IK20TT	IK20TT	4	
1.8 T	110	AEB		10/96-11/00	PK20PR-P8	3245	0.8	-	IK20TT	IK20TT	4	
1.9 TDI	66/74/81/85	AFN; AHH; AHU; AJM; ATJ; AVB; AVG	Double Coil(LPH)	10/96-11/00	DG-005		11V				4	
1.9 TDI	66/81/85	AFN; AHU; AJM	Auxiliary Heater	10/96-11/00	DG-628		11V				3	
1.9 TDI 4motion	85	ATJ	Double Coil(LPH)	08/99-11/00	DG-005		11V				4	
1.9 TDI Syncro/4motion	81	AFN	Auxiliary Heater	10/96-11/00	DG-628		11V				3	
1.9 TDI Syncro/4motion	81	AFN; AVG	Double Coil(LPH)	10/96-11/00	DG-005		11V				4	
2.3 VR5	110	AGZ		10/96-11/00	K20TXR	5063	1.0	K20TT	IK20TT	IK20TT	5	
2.3 VR5 Syncro/4motion	110	AGZ		10/97-11/00	K20TXR	5063	1.0	K20TT	IK20TT	IK20TT	5	
2.5 TDI	110	AFB; AKN	Double Coil(LPH)	07/98-11/00	DG-144		11V				6	
2.5 TDI Syncro/4motion	110	AFB; AKN	Double Coil(LPH)	12/98-11/00	DG-144		11V				6	
2.8 V6	132/140/142	AGE; APR; ATX; BBG		08/96-11/00	K20TXR	5063	1.0	K20TT	IK20TT	IK20TT	6	
2.8 V6 Syncro/4motion	142	APR		10/96-11/00	K20TXR	5063	1.0	K20TT	IK20TT	IK20TT	6	
PASSAT (3B3, 3B6) (00-05)												
1.6	75	ALZ		11/00-05/05	K20PBR-S10	5061	1.0	K20TT	IK20TT	IK20TT	4	
1.8 4motion	125	AWM		03/01-05/05	PK20PR-P8	3245	0.8	-	IK20TT	IK20TT	4	
1.8 T	125	AWM		02/01-08/05	PK20PR-P8	3245	0.8	-	IK20TT	IK20TT	4	
1.8 T 4motion	125	AWM		03/01-05/05	PK20PR-P8	3245	0.8	-	IK20TT	IK20TT	4	
1.8 T 20V	110	AWT		11/00-05/05	PK20PR-P8	3245	0.8	-	IK20TT	IK20TT	4	

Свечи зажигания и Свечи накаливания

Таблица применения





	KW				СТАНДАРТНЫЕ			Twin Tip			QTY
VW продолжение											
PASSAT (3B3, 3B6) (00-05) продолжение											
1.9 TDI	74/96	AVB; AVF; AWX	Ch:> 3B-2-350 000, Double Coi (LPH)	11/00-01/02	DG-005		11V				4
1.9 TDI	74/96	AVB; AVF; AWX	Ch: 3B-2-350 001> ,Double Coi (LPH)	01/02-05/05	DG-109		11V				4
1.9 TDI 4motion	96	AVF	Ch:> 3B-2-350 000, Double Coi (LPH)	11/00-01/02	DG-005		11V				4
1.9 TDI 4motion	96	AVF	Ch: 3B-2-350 001> ,Double Coi (LPH)	01/02-05/05	DG-109		11V				4
2.0	85/96	ALT; AZM		11/00-05/05	K20PBR-S10	5061	1.0	K20TT	IK20TT	IK20TT	4
2.0 4motion	85	AZM		11/00-05/05	K20PBR-S10	5061	1.0	K20TT	IK20TT	IK20TT	4
2.3 V5	125	AZX		11/00-05/05	PKJ16CR-L11	3246	1.1	-	IK16TT	IK16TT	5
2.3 V5 4motion	125	AZX		11/00-05/05	PKJ16CR-L11	3246	1.1	-	IK16TT	IK16TT	5
2.3 VR5	125	AZX		11/00-05/05	PKJ16CR-L11	3246	1.1	-	IK16TT	IK16TT	5
2.3 VR5 4motion	125	AZX		11/00-05/05	PKJ16CR-L11	3246	1.1	-	IK16TT	IK16TT	5
2.5 TDI	110/ 120	AFB; AKN; BDG	Double Coil(LPH)	11/00-05/05	DG-144		11V				6
2.5 TDI 4motion	110/ 132	AFB; AKN; BAU; BDH	Double Coil(LPH)	11/00-05/05	DG-144		11V				6
2.8 4motion	142	AMX/ ATQ/ BBG		11/00-05/05	K20TXR	5063	1.0	K20TT	IK20TT	IK20TT	6
4.0 W8 4motion	202	BDN; BDP		09/01-09/04	K20TXR	5063	1.0	K20TT	IK20TT	IK20TT	8
PASSAT (3C) (05-11)											
1.4 TSI	90	CAXA		05/07-11/10	PKJ20CR8	3173	0.8	-	IK20TT	IK20TT	4
1.6	75	BSE; BSF		05/05-05/07	K20PBR-S10	5061	1.0	K20TT	IK20TT	IK20TT	4
1.6 FSI	85	BLF		03/05-05/07	K20PBR-S10	5061	1.0	K20TT	IK20TT	IK20TT	4
1.6 TDI	77	CAYC		08/09-11/10	DG-193		4.4V				4
1.8 TSI	112/ 118	BZB; CDAA; CDAB; CGYA		05/07-10/11	PK22PR8	3273	0.8	-	IK22TT	VK22	4
1.9 TDI	77	BKG; BLS; BXE		03/05-11/10	DG-177		5V				4
2.0 BlueTDI	105	CBAC		01/09-11/10	DG-193		4.4V				4
2.0 FSI	110	BLR/ BVY		03/05-05/07	VKA16	5622	1.1	-	-	VKA16	4
2.0 FSI	110	BLY/ BVZ		03/05-05/07	K20PR-U	3145	0.8	K20TT	IK20TT	IK20TT	4
2.0 FSI	125/ 147	AXX; BPY; BWA; CAWB; CBFA; CCTA; CCTB; CCZA		07/05-11/10	PK22PR8	3273	0.8	-	IK22TT	VK22	4
2.0 FSI 4motion	110	BLX/ BLY		09/05-11/05	K20PR-U	3145	0.8	K20TT	IK20TT	IK20TT	4
2.0 FSI 4motion	110	BVX		09/05-05/07	VKA16	5622	1.1	-	-	VKA16	4
2.0 TDI	81/ 100/ 103/ 125	CBAA; CBAB; CBBB; CBDC		03/05-11/10	DG-193		4.4V				4
2.0 TDI	88/ 90/ 100/ 103/ 120/ 125	BKP; BMA; BMR; BUZ; BVE; BWV	OE: N 105 798 03/ N 105 798 05, Ceramic	08/05-11/10	DG-622		7V				4
2.0 TDI 4motion	103	BKP	OE: N 105 798 03/ N 105 798 05, Ceramic	05/07-11/10	DG-622		7V				4
2.0 TDI 4motion	103/ 125	CBAB; CBBB		03/05-11/10	DG-193		4.4V				4
3.2 FSI	184	AXZ		11/05-12/11	VXUHC22G	5652	0.8	-	-	VXUHC22G	6
3.2 FSI 4motion	184	AXZ		11/05-11/10	VXUHC22G	5652	0.8	-	-	VXUHC22G	6
PASSAT (3G) (14-)											
1.6 TDI	88	DCXA; DCZA	Pressure sensor(-)	08/14-	DG-193		4.4V				3
2.0 TDI	110/ 135/ 140	CRLB; CUPA; DBGA; DDAA; DFCA; DFGA; DFHA; DSRA; DSRB	Pressure sensor(-)	11/14-	DG-193		4.4V				3
2.0 TDI 4motion	110/ 135/ 140/ 176	CRLB; CUAA; CUPA; DDAA; DFCA; DFEA; DFGA; DFHA	Pressure sensor(-)	08/14-	DG-193		4.4V				3
PASSAT (32, 33) (73-80)											
1.3	40/44	FY; FZ; ZA; ZF		05/73-07/80	W20EP-U	3043	0.8	W20TT	IW20TT	IW20TT	4
1.5 D	37	CK	Double Coil(LPH)	02/77-07/80	DG-012		11V				4

Таблица применения

V









Свечи зажигания и Свечи накаливания

Таблица применения

KW	KW	KW	NOTE	21	СТАНДАРТНЫЕ			Twin Tip		QTY
					W20EPR-U	3047	0.8	W20TT	IW20TT	
VW продолжение										
PASSAT (32, 33) (73-80) продолжение										
1.6	53/55/63	FS/WP/ YN; FS/WP/ YY; YP		08/75-07/80	W20EPR-U	3047	0.8	W20TT	IW20TT	4
1.6	55	WY; WZ	Ch:>81923000 00	05/73-07/77	W20EP-U	3043	0.8	W20TT	IW20TT	4
1.6	55	WY; WZ	Ch:81A000001 >	05/73-07/77	W16EP-U	3018	0.8	W16TT	IW16TT	4
1.6	55/61/63	YG; YH; YN; YP		08/75-07/80	W20EP-U	3043	0.8	W20TT	IW20TT	4
1.6 D	40	CR	Double Coil(LPH)	02/79-07/80	DG-012		11V			4
1.6 GLi	81	YS		02/79-07/80	W20EPR-U	3047	0.8	W20TT	IW20TT	4
PASSAT (32B) (80-91)										
1.3	40/44	FY; FZ		08/80-07/83	W20EPR-U	3047	0.8	W20TT	IW20TT	4
1.3	44	EP		01/85-07/86	W16EPB10	5064	1.0	W16TT	IW16TT	4
1.3	44	EP; EU		08/80-07/86	W20EP-U	3043	0.8	W20TT	IW20TT	4
1.6	51/53	DTA; PP		01/85-03/88	W16EPB10	5064	1.0	W16TT	IW16TT	4
1.6	51/55/63	WV/ WY; WV; YN; YP		08/80-03/88	W20EPR-U	3047	0.8	W20TT	IW20TT	4
1.6	55	JU		08/84-03/88	W16EPR-U	3021	0.8	W16TT	IW16TT	4
1.6	55/63	DT; WV; YN; YP		08/80-03/88	W20EP-U	3043	0.8	W20TT	IW20TT	4
1.6 D	40	CR; JK	Double Coil(LPH)	08/80-03/88	DG-012		11V			4
1.6 TD	51/59	CY; RA	Double Coil(LPH)	04/82-03/88	DG-012		11V			4
1.8	64	RM		05/86-03/88	W20EP-U	3043	0.8	W20TT	IW20TT	4
1.8	64/66	DS; JN; JV; RM		01/83-03/88	W20EPB	5065	0.85	W20TT	IW20TT	4
1.8 Syncro	66	JN		01/86-03/88	W20EPB	5065	0.85	W20TT	IW20TT	4
1.9	85	WN		01/81-07/83	W22EPR-U	3088	0.8	W22TT	-	VW22
1.9	85	WN		01/81-07/83	W22EP-U	3085	0.8	W22TT	-	VW22
1.9 D	66	1Z		04/88-07/91	DG-005		11V			4
1.9 D	66	1Z	Auxiliary Heater	04/88-07/91	DG-628		11V			3
2.0	85	JS		08/83-03/88	W20EPB	5065	0.85	W20TT	IW20TT	5
2.0 Syncro	85	JS		05/84-03/88	W20EPB	5065	0.85	W20TT	IW20TT	5
2.1	85	WE		01/81-07/83	W20EPR-U	3047	0.8	W20TT	IW20TT	5
2.2	85/100	KV; KX		01/85-03/88	W20EPB	5065	0.85	W20TT	IW20TT	5
2.2 Syncro	88	JT		08/85-03/88	W20EPB	5065	0.85	W20TT	IW20TT	5
PASSAT (362, 365) (10-14)										
1.4 TSI	118	CTHD		11/12-12/14	SKJ20CR-A8	3371	0.8	-	-	SKJ20CR-A8
1.4 TSI (BlueMotion)	90	CAXA		08/10-12/14	PKJ20CR8	3173	0.8	-	IK20TT	IK20TT
1.6 TDI (BlueMotion)	77	CAYC		08/10-12/14	DG-193		4.4V			4
1.8 TSI	112/118	CDAA; CDAB		08/10-12/14	PK22PR8	3273	0.8	-	IK22TT	VK22
2.0 TDI	100	CFFA		08/10-12/14	DG-193		4.4V			4
2.0 TDI	130	CFGC	Pressure sensor(-)	12/12-12/14	DG-193		4.4V			3
2.0 TDI (BlueMotion)	103/125	CFFB; CFGB; CLLA		08/10-12/14	DG-193		4.4V			4
2.0 TDI 4motion	103/125	CFFB; CFGB		08/10-12/14	DG-193		4.4V			4
2.0 TDI 4motion	125/130	CFGB; CFGC	Pressure sensor(-)	01/12-12/14	DG-193		4.4V			3
2.0 TSI	155	CCZB		11/10-12/15	PK22PR8	3273	0.8	-	IK22TT	VK22
2.0 TSI 4motion	155	CCZB		01/12-12/14	PK22PR8	3273	0.8	-	IK22TT	VK22
PASSAT CC (357) (08-12)										
1.8 TSI	112/118	BZB; CDAA; CDAB; CGYA		06/08-01/12	PK22PR8	3273	0.8	-	IK22TT	VK22
2.0 BlueTDI	105	CBAC		05/09-11/10	DG-193		4.4V			4
2.0 TDI	100/103/120/125	CBAA; CBAB; CBBA; CBBB; CFFA; CFFB; CFGB; CLLA		05/08-01/12	DG-193		4.4V			4
2.0 TDI 4motion	103/125	CBAB; CBBB; CFFB; CFGB		08/09-01/12	DG-193		4.4V			4
2.0 TSI	147/155	CAWB; CBFA; CCTA; CCZA; CCZB		06/08-01/12	PK22PR8	3273	0.8	-	IK22TT	VK22
3.6 FSI 4motion	206	BLV; CNNA		06/08-01/12	VXUHC22G	5652	0.8	-	-	VXUHC22G
PHAETON (3D) (02-16)										
3.0 V6 TDI 4motion	165/171/176/180	BMK; CARA; CARB; CEXA; CEXB		09/04-03/16	DG-193		4.4V			6
3.6 V6 4motion	206	CHNA; CMVA		11/08-03/16	VXUHC22G	5652	0.8	-	-	VXUHC22G

Свечи зажигания и Свечи накаливания





Таблица применения

	KW				СТАНДАРТНЫЕ			Twin Tip			QTY
											
VW продолжение											
PHAEON (3D) (02-16) продолжение											
4.2 V8 4motion	246	BGH; BGJ		05/03-03/16	K20PBR-S10	5061	1.0	K20TT	IK20TT	IK20TT	8
5.0 V10 TDI 4motion	230	AJS	Double Coil(LPH)	11/02-10/06	DG-109		11V				10
6.0 W12 4motion	309/ 331	BAN; BAP; BRN; BTT		04/02-03/16	PKJ20CR-L11	3247	1.1	-	IK20TT	IK20TT	12
POLO (6N1) (94-99)											
1.0	33/37	AER; AEV		10/94-12/99	W20EPBR-S	5067	0.85	W20TT	IW20TT	IW20TT	4
1.3	40	ADX		10/94-07/95	W20EPBR-S	5067	0.85	W20TT	IW20TT	IW20TT	4
1.4	40	AEX		08/95-10/99	K20PBR-S10	5061	1.0	K20TT	IK20TT	IK20TT	4
1.4	44	AKV		07/95-10/99	W20EPBR-S	5067	0.85	W20TT	IW20TT	IW20TT	4
1.4 16V	74	AFH		04/96-10/99	K20PBR-S10	5061	1.0	K20TT	IK20TT	IK20TT	4
1.6	55	AEE		10/94-10/99	W20EPBR-S	5067	0.85	W20TT	IW20TT	IW20TT	4
1.6 16V GTI	88	AJV		09/98-10/99	K20PBR-S10	5061	1.0	K20TT	IK20TT	IK20TT	4
1.7 SDI	42/44	AHG; AKU	Double Coil(LPH)	04/97-10/99	DG-005		11V				4
1.9 D	47	AEF	Double Coil(LPH)	10/94-10/99	DG-012		11V				4
1.9 SDI	47	AGD	Double Coil(LPH)	07/96-10/99	DG-005		11V				4
POLO (6N2) (99-01)											
1.0	37	AUC		10/99-09/01	PKJ16CR-L11	3246	1.1	-	IK16TT	IK16TT	4
1.4	40	AKP		10/99-09/01	K20PBR-S10	5061	1.0	K20TT	IK20TT	IK20TT	4
1.4	44	AUD		10/99-09/01	PKJ16CR-L11	3246	1.1	-	IK16TT	IK16TT	4
1.4 16V	55/74	AHW; AQQ		10/99-09/01	K20PBR-S10	5061	1.0	K20TT	IK20TT	IK20TT	4
1.4 TDI	55	AMF	Double Coil(LPH)	10/99-09/01	DG-005		11V				3
1.6 16V GTI	92	AVY		10/99-09/01	K20PBR-S10	5061	1.0	K20TT	IK20TT	IK20TT	4
1.7 SDI	44	AKU	Double Coil(LPH)	10/99-09/01	DG-005		11V				4
1.9 D	47	AEF	Double Coil(LPH)	10/99-09/01	DG-012		11V				4
1.9 SDI	47	AGD; ASX	Double Coil(LPH)	10/99-09/01	DG-005		11V				4
POLO (6R, 6C) (09-)											
1.2	44	CGPB		06/09-	KJ20DR-M11	3374	1.1	-	-	SKJ20DR-M11	3
1.2 (BlueMotion)	51	CGPA		06/09-	KJ20DR-M11	3374	1.1	-	-	SKJ20DR-M11	3
1.2 TDI (BlueMotion)	55	CFWA		10/09-	DG-193		4.4V				3
1.4	63	CDDA; CGGB; CLPA		03/09-05/14	KJ20DR-M11	3374	1.1	-	-	SKJ20DR-M11	4
1.4 BiFuel	60	CMAA		03/10-01/11	KJ20DR-M11	3374	1.1	-	-	SKJ20DR-M11	4
1.4 GTI	132	CAVE; CTHE		05/10-02/11	PKJ20CR8	3173	0.8	-	IK20TT	IK20TT	4
1.4 GTI	132	CAVE; CTHE		02/11-	SKJ20CR-A8	3371	0.8	-	-	SKJ20CR-A8	4
1.4 TDI	55/ 66/77	CUSA; CUSB; CUTA; CYZA; CYZB	Pressure sensor(-)	02/14-	DG-193		4.4V				2
1.6	63/77	CFNA; CFNB; CLSA		01/10-	KJ20DR-M11	3374	1.1	-	-	SKJ20DR-M11	4
1.6 BiFuel	60	CNKA		01/11-	KJ20DR-M11	3374	1.1	-	-	SKJ20DR-M11	4
1.6 TDI	55/77	CAYA; CAYC; CLNA		06/09-	DG-193		4.4V				4
1.6 TDI (BlueMotion)	66	CAYB		06/09-	DG-193		4.4V				4
2.0 R WRC	162	CDLJ		08/13-	PK22PR8	3273	0.8	-	IK22TT	VK22	4
POLO (9N) (01-09)											
1.2	40	AWY		01/02-07/04	SKJ16CR-L11	3396	1.1	-	IK16TT	IK16TT	3
1.2	40/44	BBM; BMD		01/02-11/09	KJ16CR-L11	3132	1.1	K16TT	IK16TT	IK16TT	3
1.2 12V	47/51	AZQ; BME; BZG		10/01-11/09	KJ16CR-L11	3132	1.1	K16TT	IK16TT	IK16TT	3
1.4 16V	55	BKY		10/01-05/08	KJ16CR-L11	3132	1.1	K16TT	IK16TT	IK16TT	4
1.4 16V	55/74	AUA/BBY; AUB; BBZ		10/01-05/08	K20PBR-S10	5061	1.0	K20TT	IK20TT	IK20TT	4
1.4 16V	59	BUD		05/06-11/09	KJ20DR-M11	3374	1.1	-	-	SKJ20DR-M11	4
1.4 FSI	63	AXU		02/02-07/06	K20PBR-S10	5061	1.0	K20TT	IK20TT	IK20TT	4
1.4 TDI	51/ 55/59	AMF; BAY; BNM; BNV	Double Coil(LPH)	10/01-11/09	DG-109		11V				3
1.6 16V	77	BTS		05/06-11/09	KJ20DR-M11	3374	1.1	-	-	SKJ20DR-M11	4
1.8 GTI	110	BJX		09/05-11/09	PK20PR-P8	3245	0.8	-	IK20TT	IK20TT	4
1.8 GTi Cup Edition	132	BBU		05/06-11/09	PK20PR-P8	3245	0.8	-	IK20TT	IK20TT	4
1.9 SDI	47	ASY	Double Coil(LPH)	10/01-11/09	DG-005		11V				4
1.9 TDI	74	ATD	Auxiliary Heater	10/01-11/09	DG-628		11V				3
1.9 TDI	74/96	ASZ; ATD; AXR; BLT		10/01-11/09	DG-109		11V				4
POLO (86) (75-81)											
0.8	25	HE		09/75-07/78	W20EPR-U	3047	0.8	W20TT	IW20TT	IW20TT	4
0.9	29	HA		09/75-09/81	W20EP-U	3043	0.8	W20TT	IW20TT	IW20TT	4
1.1	37	HB		03/75-09/81	W20EP-U	3043	0.8	W20TT	IW20TT	IW20TT	4

Свечи зажигания и Свечи накаливания

Таблица применения

Таблица применения

	KW				СТАНДАРТНЫЕ			Twin Tip			QTY
VW продолжение											
POLO (86) (75-81) продолжение											
1.3	44	HH		12/76-09/81	W20EP-U	3043	0.8	W20TT	IW20TT	IW20TT	4
POLO (86C, 80) (81-94)											
1.0	29/33	AAU; GL; HZ		10/81-09/94	W20EP-U	3043	0.8	W20TT	IW20TT	IW20TT	4
1.0	33	AAU		08/92-07/94	W20EPBR-S	5067	0.85	W20TT	IW20TT	IW20TT	4
1.0 Cat	33	ACM		08/89-09/94	W20EPB	5065	0.85	W20TT	IW20TT	IW20TT	4
1.0 Cat	33	ACM		08/89-09/94	W20EP-U	3043	0.8	W20TT	IW20TT	IW20TT	4
1.1	37	HB		10/81-09/89	W20EP-U	3043	0.8	W20TT	IW20TT	IW20TT	4
1.3	37/ 40/44	HH; HJ; HK; HW		10/81-07/88	W20EP-U	3043	0.8	W20TT	IW20TT	IW20TT	4
1.3	55	3F		03/91-09/94	W20EPB	5065	0.85	W20TT	IW20TT	IW20TT	4
1.3	55	GK		09/82-07/86	W22EPR-U	3088	0.8	W22TT	-	VW22	4
1.3	55	GK		09/82-09/89	W22EP-U	3085	0.8	W22TT	-	VW22	4
1.3 Cat	40	NZ		07/87-09/94	W20EP-U	3043	0.8	W20TT	IW20TT	IW20TT	4
1.3 Cat	40/55	2G; 3F; AAV; MH; NZ		07/87-09/94	W20EPB	5065	0.85	W20TT	IW20TT	IW20TT	4
1.3 D	33	MN	Double Coil(LPH)	08/86-08/90	DG-012		11V				4
1.3 G40	83	PY		08/90-09/94	W20EPB	5065	0.85	W20TT	IW20TT	IW20TT	4
1.3 G40	85	PY		01/87-08/90	W22EPB	5066	0.85	W22TT	-	VW22	4
1.4 D	35	1W	Double Coil(LPH)	08/90-09/94	DG-012		11V				4
POLO Classic (6KV) (95-02)											
1.4	40/44	AKV; ANX		12/95-09/01	W20EPBR-S	5067	0.85	W20TT	IW20TT	IW20TT	4
1.4 16V	55	AUA		10/99-09/01	K20PBR-S10	5061	1.0	K20TT	IK20TT	IK20TT	4
1.6	55	1F; AEE		11/95-09/01	W20EPBR-S	5067	0.85	W20TT	IW20TT	IW20TT	4
1.6	74	AEH		12/95-09/01	K20PBR-S10	5061	1.0	K20TT	IK20TT	IK20TT	4
1.7 SDI	42	AKW	Double Coil(LPH)	07/97-09/01	DG-005		11V				4
1.8	66	ADD		08/98-09/01	W20EPBR-S	5067	0.85	W20TT	IW20TT	IW20TT	4
1.9 D	47	1Y		01/96-10/96	DG-012		11V				4
1.9 SDI	47	AEY	Auxiliary Heater	12/95-09/01	DG-012		11V				3
1.9 SDI	47/50	AEY; AGP; AQM	Double Coil(LPH)	12/95-01/02	DG-005		11V				4
1.9 SDI	50	AGP; AQM	Auxiliary Heater	08/99-01/02	DG-628		11V				3
1.9 TDI	66/81	AFN; AGR; AHU; ALE; ALH; ASV	Double Coil(LPH)	09/96-01/02	DG-005		11V				4
1.9 TDI	66/81	AFN; AGR; AHU; ALH; ASV	Auxiliary Heater	09/96-01/02	DG-628		11V				3
POLO Saloon (9A4) (02-)											
1.4	55	BBY	OEM Optional	11/02-06/05	PKJ16CR-L11	3246	1.1	-	IK16TT	IK16TT	4
1.4	55/74	BBY; BBZ		11/02-	K20PBR-S10	5061	1.0	K20TT	IK20TT	IK20TT	4
1.9 TDi	74	ATD		09/02-	DG-109		11V				4
1.9 TDi	74	ATD	Auxiliary Heater	09/02-	DG-628		11V				3
POLO Variant (6V5) (97-01)											
1.4	40	AKP		12/98-09/01	K20PBR-S10	5061	1.0	K20TT	IK20TT	IK20TT	4
1.4	44	ANW		05/97-09/01	W20EPBR-S	5067	0.85	W20TT	IW20TT	IW20TT	4
1.4 16V	55	AUA		10/99-09/01	K20PBR-S10	5061	1.0	K20TT	IK20TT	IK20TT	4
1.6	55	AEE		05/97-09/01	W20EPBR-S	5067	0.85	W20TT	IW20TT	IW20TT	4
1.6	74	AKL		05/97-09/01	K20PBR-S10	5061	1.0	K20TT	IK20TT	IK20TT	4
1.7 SDI	42	AKW	Double Coil(LPH)	08/97-09/01	DG-005		11V				4
1.9 SDI	47	AEY	Auxiliary Heater	06/97-09/01	DG-012		11V				3
1.9 SDI	47/50	AEY; AGP; AQM	Double Coil(LPH)	06/97-09/01	DG-005		11V				4
1.9 SDI	50	AGP; AQM	Auxiliary Heater	08/99-09/01	DG-628		11V				3
1.9 TDI	66/81	AFN; AGR; AHU; ALE; ALH; ASV	Double Coil(LPH)	05/97-09/01	DG-005		11V				4
1.9 TDI	66/81	AFN; AGR; AHU; ALH; ASV	Auxiliary Heater	05/97-09/01	DG-628		11V				3
ROUTAN (08-)											
3.6	196/ 208	CJRA		12/10-12/13	ITV20TT	4719	1.0	-	ITV20TT		6
3.8	147	CGUA		09/08-11/10	ITL16TT	4717	1.0	-	ITL16TT		6
SANTANA (81-85)											
1.3	44	EP		08/81-07/83	W16EPB10	5064	1.0	W16TT	IW16TT	IW16TT	4
1.6	55	DT/ JU		08/83-12/84	W16EPB10	5064	1.0	W16TT	IW16TT	IW16TT	4
1.6	55/63	DT; WV; YP		08/81-12/84	W20EP-U	3043	0.8	W20TT	IW20TT	IW20TT	4
1.6	55/63	WV/ WY; YP		08/81-07/83	W20EPR-U	3047	0.8	W20TT	IW20TT	IW20TT	4
1.6 D	40	CR; JK	Double Coil(LPH)	08/81-12/84	DG-012		11V				4

Свечи зажигания и Свечи накаливания

Таблица применения















	KW				СТАНДАРТНЫЕ			Twin Tip			QTY
											
VW продолжение											
SANTANA (81-85) продолжение											
1.6 TD	51	CY	Double Coil(LPH)	12/81-12/84	DG-012		11V				4
1.8	66	DS		01/83-12/84	W20EPB	5065	0.85	W20TT	IW20TT	IW20TT	4
1.9	85	WN		08/81-07/83	W22EP-U	3085	0.8	W22TT	-	VW22	5
2.0	85	HP; JS		08/83-12/84	W20EPR-U	3047	0.8	W20TT	IW20TT	IW20TT	5
2.1	85	WE		08/82-12/83	W20EPR-U	3047	0.8	W20TT	IW20TT	IW20TT	5
SCIROCCO (53) (74-80)											
1.1	37	FA		04/74-07/79	W20EP-U	3043	0.8	W20TT	IW20TT	IW20TT	4
1.3	44	GF		08/79-07/80	W20EP-U	3043	0.8	W20TT	IW20TT	IW20TT	4
1.5	51	JB		08/77-07/80	W16EP-U	3018	0.8	W16TT	IW16TT	IW16TT	4
1.6	51/55	EM; FN; FV		08/75-07/79	W20EPR-U	3047	0.8	W20TT	IW20TT	IW20TT	4
1.6	63	FR		08/75-07/80	W20EP-U	3043	0.8	W20TT	IW20TT	IW20TT	4
1.6	81	EG		06/76-07/80	W22EPR-U	3088	0.8	W22TT	-	VW22	4
SCIROCCO (53B) (80-92)											
1.3	44	GF		08/80-12/83	W20EP-U	3043	0.8	W20TT	IW20TT	IW20TT	4
1.5	51	JB		08/80-12/83	W16EP-U	3018	0.8	W16TT	IW16TT	IW16TT	4
1.6	53	RE		04/86-07/90	W20EPBR-S	5067	0.85	W20TT	IW20TT	IW20TT	4
1.6	55	EW		01/83-12/89	W16EP-U	3018	0.8	W16TT	IW16TT	IW16TT	4
1.6	63	FR		08/80-04/84	W20EP-U	3043	0.8	W20TT	IW20TT	IW20TT	4
1.6	81	EG		08/80-07/82	W22EPR-U	3088	0.8	W22TT	-	VW22	4
1.8	66/ 70/82	EX; JH; PB		08/82-07/92	W20EPB	5065	0.85	W20TT	IW20TT	IW20TT	4
1.8	82	JJ		08/82-07/83	W22EPR-U	3088	0.8	W22TT	-	VW22	4
1.8 16V	95/ 102	KR; PL		10/85-07/92	K22PBR-S	5062	0.85	-	IKB22TT	VK22	4
SCIROCCO (137, 138) (08-17)											
1.4 TSI	90/ 118	CAVD; CAXA; CMSB; CNWA; CTHD; CTKA		05/08-11/17	PKJ20CR8	3173	0.8	-	IK20TT	IK20TT	4
1.4 TSI	118	CAVD; CNWA; CTHD; CTKA		02/11-11/17	SKJ20CR-A8	3371	0.8	-	-	SKJ20CR-A8	4
2.0 R	188/ 195/ 206	CDLA; CDLC; CDLK		11/09-11/17	PK22PR8	3273	0.8	-	IK22TT	VK22	4
2.0 TDI	100/ 103/ 125	CBBB; CBDB; CFGB; CFHB; CFHC		08/08-11/17	DG-193		4.4V				4
2.0 TDI	110/ 130/ 135	CFGC; CUUB; CUWA; CUXA	Pressure sensor(-)	01/13-11/17	DG-193		4.4V				3
2.0 TSI	147/ 155	CAWB; CCZB		05/08-11/17	PK22PR8	3273	0.8	-	IK22TT	VK22	4
SHARAN (7M) (95-10)											
1.8 T 20V	110	AWC		09/97-03/10	PK20PR-P8	3245	0.8	-	IK20TT	IK20TT	4
1.9 TDI	66/81	1Z; AFN; AHU	Auxiliary Heater	09/95-03/10	DG-628		11V				3
1.9 TDI	66/81	1Z; AFN; AHU; AVG	Double Coil(LPH)	09/95-03/10	DG-005		11V				4
1.9 TDI	66/85	ANU; AUY; BVK	Ch:> 7M-2-030 004, Double Coi l(LPH)	09/95-10/01	DG-005		11V				4
1.9 TDI	66/85	ANU; AUY; BVK	Ch: 7M-2-030 005> ,Double Coi l(LPH)	10/01-03/10	DG-109		11V				4
1.9 TDI	96/ 110	ASZ; BTB		11/02-03/10	DG-109		11V				4
1.9 TDI 4motion	85	AUY; BVK	Ch:> 7M-2-030 004, Double Coi l(LPH)	04/00-10/01	DG-005		11V				4
1.9 TDI 4motion	85	AUY; BVK	Ch: 7M-2-030 005> ,Double Coi l(LPH)	10/01-03/10	DG-109		11V				4
2.0	85	ADY		09/95-03/10	W20EPBR-S	5067	0.85	W20TT	IW20TT	IW20TT	4
2.0 LPG	85	ATM	LPG / GPL	05/08-03/10	K20PBR-S10	5061	1.0	K20TT	IK20TT	IK20TT	4
2.8 V6 24V	150	AYL		04/00-03/10	PKJ16CR-L11	3246	1.1	-	IK16TT	IK16TT	6
2.8 V6 24V 4motion	150	AYL		04/00-03/10	PKJ16CR-L11	3246	1.1	-	IK16TT	IK16TT	6
2.8 VR6	128	AAA; AMY		09/95-04/00	K20TXR	5063	1.0	K20TT	IK20TT	IK20TT	6
2.8 VR6 Syncro	128	AAA; AMY		11/96-04/00	K20TXR	5063	1.0	K20TT	IK20TT	IK20TT	6
SHARAN (7N) (10-)											
1.4 TSI	110	CAVA; CNWB; CTHA		05/10-02/11	PKJ20CR8	3173	0.8	-	IK20TT	IK20TT	4
1.4 TSI	110	CAVA; CNWB; CTHA		02/11-	SKJ20CR-A8	3371	0.8	-	-	SKJ20CR-A8	4

Таблица применения

V

Свечи зажигания и Свечи накаливания

Таблица применения

	KW				СТАНДАРТНЫЕ			Twin Tip			QTY
VW продолжение											
SHARAN (7N) (10-) продолжение											
2.0 TDI	85/ 100/ 103/ 125	CFFA; CFFB; CFFE; CFGB		05/10-	DG-193		4.4V				4
2.0 TDI	85/ 110/ 130/ 135	CFGC; CUVA; CUVC; CUWA; DFLA; DFLD; DFMA; DLUB	Pressure sensor(-)	05/11-	DG-193		4.4V				3
2.0 TDI 4motion	103	CFFB		05/11-	DG-193		4.4V				4
2.0 TDI 4motion	110/ 135	CUVC; DFLA; DFMA; DLTA	Pressure sensor(-)	05/15-	DG-193		4.4V				3
2.0 TSI	147	CCZA		12/10-	PK22PR8	3273	0.8	-	IK22TT	VK22	4
TARO (89-97)											
1.8	61	2Y		04/89-09/94	W16EXR-U	3031	0.8	W16TT	IW16TT	IW16TT	4
1.8	61	2Y		04/89-09/94	W16EX-U	3027	0.8	W16TT	IW16TT	IW16TT	4
2.2	69	4Y		06/89-07/94	W16EXR-U	3031	0.8	W16TT	IW16TT	IW16TT	4
2.2 4x4	69	4Y		06/89-07/94	W16EXR-U	3031	0.8	W16TT	IW16TT	IW16TT	4
2.4 D	58/61	2L		06/89-03/97	DG-648		11V				4
2.4 D 4x4	58/61	2L		04/89-03/97	DG-648		11V				4
2.4 i 4x4	84	22R		06/89-03/97	W16EXR-U	3031	0.8	W16TT	IW16TT	IW16TT	4
TIGUAN (5N) (07-)											
1.4 TSI	90/ 110	BWK; CAVA; CAXA; CTHA		05/08-07/18	PKJ20CR8	3173	0.8	-	IK20TT	IK20TT	4
1.4 TSI	110/ 118	BWK; CAVA; CAVD; CTHA; CTHD		02/11-07/18	SKJ20CR-A8	3371	0.8	-	-	SKJ20CR-A8	4
1.4 TSI 4motion	110	BWK; CAVA; CTHA		09/07-02/11	PKJ20CR8	3173	0.8	-	IK20TT	IK20TT	4
1.4 TSI 4motion	110/ 118	BWK; CAVA; CAVD; CTHA; CTHD		02/11-07/18	SKJ20CR-A8	3371	0.8	-	-	SKJ20CR-A8	4
2.0 TDI	81/ 103	CBAB; CFFB; CFFD; CUVE		03/08-07/18	DG-193		4.4V				4
2.0 TDI	110	CUVC	Pressure sensor(-)	05/15-07/18	DG-193		4.4V				3
2.0 TDI 4motion	100/ 103/ 120/ 125	CBAA; CBAB; CBBA; CBBB; CFFA; CFFB; CFGB; CLJA		09/07-07/18	DG-193		4.4V				4
2.0 TDI 4motion	110/ 130/ 135	CFGC; CUVC; CUWA	Pressure sensor(-)	11/12-07/18	DG-193		4.4V				3
2.0 TFSI 4motion	125/ 147	CAWA; CAWB; CCTA; CCZA; CCZC		09/07-07/18	PK22PR8	3273	0.8	-	IK22TT	VK22	4
2.0 TSI 4motion	132/ 155	CCZB; CCZD		05/11-07/18	PK22PR8	3273	0.8	-	IK22TT	VK22	4
TIGUAN (AD) (16-)											
1.6 TDI	85	DGDB	Pressure sensor(-)	05/16-	DG-193		4.4V				3
2.0 TDI	85/ 110	DFGA; DFGC	Pressure sensor(-)	01/16-	DG-193		4.4V				3
2.0 TDI 4motion	110/ 176	CUAA; DBGC; DFGA	Pressure sensor(-)	01/16-	DG-193		4.4V				3
2.0 TDI 4motion	140	DFHA	Euro-4; Euro-5	04/16-	DG-193		4.4V				4
2.0 TDI 4motion	140	DFHA	Euro-6; Pressures ensor(-)	04/16-	DG-193		4.4V				3
TOUAREG (7L) (02-10)											
2.5 R5 TDI	120	BLK		08/03-05/10	DG-109		11V				5
2.5 R5 TDI	128	BAC	Double Coil(LPH)	01/03-05/10	DG-109		11V				5
3.0 TDI	155	BUN; CASB		04/06-05/10	DG-193		4.4V				6
3.0 V6 TDI	165	CATA	Pressure sensor(-)	11/04-05/10	DG-193		4.4V				4
3.0 V6 TDI	165/ 176	BKS; CASA; CASC		11/04-05/10	DG-193		4.4V				6
3.6 V6 FSI	206	BHK; BHL		10/05-05/10	VXUHC22G	5652	0.8	-	-	VXUHC22G	6
4.2 V8	228	AXQ		12/02-11/06	K20PBR-S10	5061	1.0	K20TT	IK20TT	IK20TT	8
4.2 V8 FSI	257	BAR		06/06-05/10	VKB20	5625	1.1	-	-	VKB20	8
5.0 V10 TDI	230	AYH	Double Coil(LPH)	10/02-05/10	DG-109		11V				10
6.0 W12	331	BJN/ CFRA		08/04-05/10	PKJ20CR-L11	3247	1.1	-	IK20TT	IK20TT	12
TOUAREG (7P) (10-18)											
3.0 V6 TDI	150/ 176/ 180/ 193	CASA; CASD; CJGD; CJMA; CRCA; CRCD; CVVA; CVWA		01/10-03/18	DG-193		4.4V				6

Свечи зажигания и Свечи накаливания

Таблица применения









	KW				СТАНДАРТНЫЕ				Twin Tip		QTY	
												
VW продолжение												
TOUAREG (7P) (10-18) продолжение												
3.0 V6 TDI	165	CATA	Pressure sensor(-)	06/10-03/18	DG-193		4.4V				4	
3.0 V6 TSI Hybrid	245	CGEA		04/10-03/18	IK24	5311	0.8	-	-		6	
3.6 V6 FSI	183/206	CGRA; CMTA		04/10-03/18	VXUHC22G	5652	0.8	-	-	VXUHC22G	6	
4.2 V8 FSI	265	CGNA		01/11-03/18	VKB20	5625	1.1	-	-	VKB20	8	
4.2 V8 TDI	250	CKDA		01/10-03/18	DG-193		4.4V				8	
TOURAN (1T1, 1T2) (03-10)												
1.4 FSI	125	BLG; CAVB		11/06-05/10	PKJ20CR8	3173	0.8	-	-	IK20TT	IK20TT	4
1.4 TSI	103	BMY; CAVC		02/06-05/10	PKJ20CR8	3173	0.8	-	-	IK20TT	IK20TT	4
1.6	75	BGU; BSE; BSF		07/03-05/10	K20PBR-S10	5061	1.0	K20TT	IK20TT	IK20TT	4	
1.6 FSI	85	BAG; BLF; BLP		02/03-01/07	K20PBR-S10	5061	1.0	K20TT	IK20TT	IK20TT	4	
1.9 TDI	66/74/77	AVQ; BKC; BLS; BRU; BXE; BXF; BXJ		02/03-05/10	DG-177		5V				4	
2.0 EcoFuel	80	BSX	Flexible fuel	02/06-05/09	VK20Y	5620	0.8	-	-	VK20Y	4	
2.0 FSI	110	AXW/ BLX/ BVY		10/03-01/07	VKA16	5622	1.1	-	-	VKA16	4	
2.0 FSI	110	BLR/ BLY/ BVZ		10/03-01/07	K20PR-U	3145	0.8	K20TT	IK20TT	IK20TT	4	
2.0 TDI	100/103	AZV; BKD		02/03-05/10	DG-190		4.4V				4	
2.0 TDI	125	BMN	OE: N 105 798 03/ N 105 798 05, Ceramic	12/05-05/10	DG-622		7V				4	
2.0 TDI 8V	103	BMM		12/05-05/10	DG-177		5V				4	
TOURAN (1T3) (10-15)												
1.4 TSI	103/125	CAVB; CAVC; CTHB; CTHC		05/10-02/11	PKJ20CR8	3173	0.8	-	-	IK20TT	IK20TT	4
1.4 TSI	103/125	CAVB; CAVC; CTHB; CTHC		02/11-05/15	SKJ20CR-A8	3371	0.8	-	-	SKJ20CR-A8	4	
1.6 TDI	66/77	CAYB; CAYC		05/10-05/15	DG-193		4.4V				4	
2.0 TDI	81/103/125	CFHC; CFHF; CFJA; CLCA		05/10-05/15	DG-193		4.4V				4	
2.0 TDI	130	CFJB	Pressure sensor(-)	01/13-05/15	DG-193		4.4V				3	
TOURAN (5T) (15-)												
1.6 TDI	81/85	CRKB; DGDA	Pressure sensor(-)	05/15-	DG-193		4.4V				3	
2.0 TDI	110	DFEA; DFGA	Pressure sensor(-)	05/15-	DG-193		4.4V				3	
2.0 TDI	140	DFHA	Euro-4; Euro-5	11/15-07/19	DG-193		4.4V				4	
2.0 TDI	140	DFHA	Euro-6; Pressures ensor(-)	11/15-07/19	DG-193		4.4V				3	
TRANSPORTER II (67-79)												
1.6	34/37	AF; AS		08/67-07/79	W20FSR-U	6053	0.7	WF20TT	-		4	
1.7	49	CA; CB		08/71-12/73	W16ESR-U	3110	0.8	-	-		4	
2.0	51	CJ; GD; GE		08/75-07/79	W16ESR-U	3110	0.8	-	-		4	
TRANSPORTER III (79-92)												
1.6	37	CT	Eng: 065011>	05/79-12/82	W20ES-U	3051	0.8	-	-		4	
1.6 D	37	CS	Double Coil(LPH)	01/81-07/87	DG-012		11V				4	
1.6 TD	51	JX	Double Coil(LPH)	08/84-07/92	DG-012		11V				4	
1.6 TD Syncro	51	JX	Double Coil(LPH)	03/86-07/92	DG-012		11V				4	
1.7 D	42	KY	Double Coil(LPH)	08/84-07/92	DG-012		11V				4	
1.9	44/57	DF; DG		08/82-07/92	W20EPB	5065	0.85	W20TT	IW20TT	IW20TT	4	
1.9 Syncro	57	DG		11/84-07/92	W20EPB	5065	0.85	W20TT	IW20TT	IW20TT	4	
2.0	51	CU; CV		05/79-04/86	W16ESR-U	3110	0.8	-	-		4	
2.1	64/70	MV; SR		08/85-07/92	W20ESR-U	3057	0.8	-	-		4	
2.1	82	DJ		08/84-07/92	W20EPR-U	3047	0.8	W20TT	IW20TT	IW20TT	4	
2.1 Cat	70	MV		06/89-07/92	W20ESR-U	3057	0.8	-	-		4	
2.1 i	68	SS		07/89-07/92	W20ESR-U	3057	0.8	-	-		4	
2.1 Syncro	64/70	MV; SR		08/85-07/92	W20ESR-U	3057	0.8	-	-		4	
2.1 Syncro	82	DJ		01/86-07/92	W20EPR-U	3047	0.8	W20TT	IW20TT	IW20TT	4	
TRANSPORTER IV (70X, 7D) (90-03)												
1.8	49	PD		12/90-07/92	W20EPB	5065	0.85	W20TT	IW20TT	IW20TT	4	
1.9 D	44	1X	Double Coil(LPH)	07/90-12/95	DG-012		11V				4	

Таблица применения

Λ

Свечи зажигания и Свечи накаливания

Таблица применения

Таблица применения

KW	KW	KW	NOTE	21	СТАНДАРТНЫЕ			Twin Tip		QTY	
					STANDARD	STANDARD	STANDARD	TWIN TIP	TWIN TIP		
VW продолжение											
TRANSPORTER IV (70X, 7D) (90-03) продолжение											
1.9 TD	50	ABL	Double Coil(LPH)	10/92-04/03	DG-012		11V			4	
2.0	62	AAC		07/90-04/03	W16ETR-S	3285	1.0	W16TT	IW16TT	4	
2.0	62	AAC		07/90-04/03	W20EPBR-S	5067	0.85	W20TT	IW20TT	4	
2.4 D	55	AJA	Double Coil(LPH)	08/97-04/03	DG-012		11V			5	
2.4 D	57	AAB		07/90-04/98	DG-012		11V			5	
2.4 D Syncro	57	AAB		10/92-09/98	DG-012		11V			5	
2.5	81/85	AEN; AET		11/90-06/03	W20EPBR-S	5067	0.85	W20TT	IW20TT	5	
2.5	85	APL/ AVT		08/96-04/03	K16TNR-S9	3329	0.9	K16TT	IK16TT	5	
2.5 Syncro	81	AAF; ACU		10/92-04/03	W20EPB	5065	0.85	W20TT	IW20TT	5	
2.5 Syncro	85	AET		07/96-04/03	W20EPBR-S	5067	0.85	W20TT	IW20TT	5	
2.5 Syncro	85	APL/ AVT		08/96-04/03	K16TNR-S9	3329	0.9	K16TT	IK16TT	5	
2.5 TDI	65/ 111	AJT; AXG; AYY		05/98-04/03	DG-005		11V			5	
2.5 TDI	75/ 111	ACV; AHY; AUF; AXG; AYC	Double Coil(LPH)	09/95-04/03	DG-005		11V			5	
2.5 TDI Syncro	75	ACV; AXL	Double Coil(LPH)	09/95-04/03	DG-005		11V			5	
2.8 VR 6	103	AES		11/95-04/00	K20TXR	5063	1.0	K20TT	IK20TT	6	
2.8 VR6	103	AES		05/96-05/00	K20TXR	5063	1.0	K20TT	IK20TT	6	
2.8 VR6	150	AMV; AXK		04/00-04/03	PKJ16CR-L11	3246	1.1	-	IK16TT	IK16TT	6
TRANSPORTER V (7H, 7E, 7J) (03-15)											
1.9 TDI	63/75	BRR; BRS		01/06-11/09	DG-177		5V			4	
1.9 TDI	63/77	AXB; AXC		04/03-11/09	DG-109		11V			4	
2.0	85	AXA		11/03-08/15	K20PBR-S10	5061	1.0	K20TT	IK20TT	4	
2.0 BiTDI	132	CFCA		09/09-08/15	DG-193		4.4V			4	
2.0 BiTDI 4motion	132	CFCA		09/09-08/15	DG-193		4.4V			4	
2.0 TDI	62/ 75/ 84/ 100/ 103	CAAA; CAAB; CAAC; CAAD; CAAE; CCHA; CCHB		09/09-08/15	DG-193		4.4V			4	
2.0 TDI 4motion	100/ 103	CAAC; CAAE; CCHA; CCHB		09/09-08/15	DG-193		4.4V			4	
2.0 TSI	110/ 150	CJKA; CJKB		05/11-08/15	PK22PR8	3273	0.8	-	IK22TT	VK22	4
2.0 TSI 4motion	150	CJKA		07/11-08/15	PK22PR8	3273	0.8	-	IK22TT	VK22	4
2.5 TDI	96	AXD	Double Coil(LPH)	04/03-11/09	DG-109		11V			5	
2.5 TDi	96/ 120/ 128	AXD; AXE; BLJ		04/03-08/15	DG-109		11V			5	
2.5 TDI 4motion	96	AXD	Double Coil(LPH)	07/04-11/09	DG-109		11V			5	
2.5 TDI 4motion	96/ 128	AXD; AXE		05/03-08/15	DG-109		11V			5	
TRANSPORTER VI (SF, SG) (15-)											
2.0 TDI	62/ 75/ 103/ 132	CAAA; CAAB; CAAC; CFCA		04/15-	DG-193		4.4V			4	
2.0 TDI	62/ 75/ 84/ 103/ 110/ 150	CAAC; CXEB; CXFA; CXGA; CXGB; CXHA; CXHB	Pressure sensor(-)	04/15-	DG-193		4.4V			3	
2.0 TDI 4motion	103/ 110/ 150	CAAC; CXEB; CXFA; CXHA	Pressure sensor(-)	06/15-	DG-193		4.4V			3	
2.0 TDI 4motion	103/ 132	CAAC; CFCA		06/15-	DG-193		4.4V			4	
VENTO (1H2) (91-98)											
1.4	44	ABD		11/91-07/95	W16EPB10	5064	1.0	W16TT	IW16TT	4	
1.4	44	AEX		07/95-09/98	W20EPBR-S	5067	0.85	W20TT	IW20TT	4	
1.6	55	ABU		09/92-09/94	W16EPB10	5064	1.0	W16TT	IW16TT	4	
1.6	55	AEA/ AEE		10/94-09/98	W20EPBR-S	5067	0.85	W20TT	IW20TT	4	
1.6	74	AEK; AFT		10/94-09/98	K20PBR-S10	5061	1.0	K20TT	IK20TT	4	
1.6	74	AEK; AFT		12/95-09/98	K16TNR-S9	3329	0.9	K16TT	IK16TT	4	
1.8	55/66	AAM; ABS; ACC; ADD; ADZ		11/91-09/98	W20EPBR-S	5067	0.85	W20TT	IW20TT	4	
1.9 D	48	1Y		11/91-09/98	DG-012		11V			4	
1.9 SDI	47	AEY	Auxiliary Heater	04/97-09/98	DG-012		11V			3	

Свечи зажигания и Свечи накаливания

Таблица применения















	KW				СТАНДАРТНЫЕ			Twin Tip			QTY
											
VW продолжение											
VENTO (1H2) (91-98) продолжение											
1.9 SDI	47	AEY	Double Coil(LPH)	04/97-09/98	DG-005		11V				4
1.9 TD	55	AAZ		11/91-09/98	DG-012		11V				4
1.9 TDI	66/81	1Z; AFN; AHU	Auxiliary Heater	09/93-09/98	DG-628		11V				3
1.9 TDI	66/81	1Z; AFN; AHU; ALE	Double Coil(LPH)	09/93-09/98	DG-005		11V				4
2.0	85	2E; ADY; AGG; AKR		11/91-09/98	W20EPR-S	5067	0.85	W20TT	IW20TT	IW20TT	4
2.8 VR6	128	AAA		01/92-09/98	K20TXR	5063	1.0	K20TT	IK20TT	IK20TT	6
WARTBURG											
353 (66-91)											
1.0	33/37	353,18		06/66-01/89	W20FPR-U	3070	0.7	WF20TT	-		3
1.0	37	353,18		04/69-02/75	M22	5003	0.7	-	-		3
1.0 (353 W 000)	37	353,18		02/75-08/88	W20FPR-U	3070	0.7	WF20TT	-		3
1.3	43	4VO7/2/7/5GRF		09/88-05/91	W20EP-U	3043	0.8	W20TT	IW20TT	IW20TT	4
WESTFIELD											
130 (97-)											
1.6	77	LJF		01/97-	Q20PR-U11	3008	1.1	Q20TT	IQ20TT	IQ20TT	4
1.8	85	RQB		01/97-	PT16VR10	5093	1.0	TV16TT	ITV16TT	ITV16TT	4
ZE (93-97)											
1.8 i	96	RQB		01/93-12/97	PT16VR10	5093	1.0	TV16TT	ITV16TT	ITV16TT	4
WIESMANN											
GT MF4 (03-)											
4.8	270	N62 B48 B		09/03-	IK20TT	4702	1.0	-	IK20TT	IK20TT	8
MF3 Roadster (96-)											
2.8	142	M52 (286S1)		01/96-08/02	K20TXR	5063	1.0	K20TT	IK20TT	IK20TT	6
3.0	170	M54306S3		07/03-	K20TXR	5063	1.0	K20TT	IK20TT	IK20TT	6
3.2	236	S50/ S52		01/96-08/01	K20TXR	5063	1.0	K20TT	IK20TT	IK20TT	6
3.2	236	S50326S1		01/96-08/01	VXU22	5608	0.9	-	IXU22TT	VXU22	6
3.2	239/ 252	S54326S4		05/01-	IXU24	5309	0.9	-	-	VXU24	6
3.2	252	S54326S4		07/03-	VXU24	5609	0.9	-	-	VXU24	6
MF4 Roadster (09-)											
4.8	270	N62 B48 B		03/09-	IK20TT	4702	1.0	-	IK20TT	IK20TT	8
WOLSELEY											
HORNET (61-70)											
1.0	28	99LFD		01/61-12/70	W20EXR-U	3066	0.8	W20TT	IW20TT	IW20TT	4
YULON											
101 Feeling (89-93)											
1.8	72	CA18S		01/89-12/93	Q16PR-U11	5016	1.1	Q16TT	IQ16TT	IQ16TT	4
YULON (93-98)											
1.8 i	76	CA18S		01/93-12/98	Q16PR-U11	5016	1.1	Q16TT	IQ16TT	IQ16TT	4
ZASTAVA											
10 (05-)											
1.2 60	44	188 A4.000	Eng: >2533528	10/05-	K16PR-U	3191	0.8	K16TT	IK16TT	IK16TT	4
1.2 60	44	188 A4.000	Eng: 2533529>	10/05-	XU22EPR-U	3179	0.9	XU22TT	IXU22TT	VXU22	4
101 (73-93)											
1.1	37/40	128 A.000; 128 A.064		06/73-12/93	W20EP-U	3043	0.8	W20TT	IW20TT	IW20TT	4
1.1 Super	47	128 AC 5000		07/79-09/81	W20EP-U	3043	0.8	W20TT	IW20TT	IW20TT	4
1.3	48	128 AR 000		10/81-12/93	W20EP-U	3043	0.8	W20TT	IW20TT	IW20TT	4
YUGO (80-95)											
0.9	33	9A		04/80-06/92	W16EPR-U	3021	0.8	W16TT	IW16TT	IW16TT	4
60 EFI (145 A)	44	100 GL. 0.64		08/91-06/95	W16EPR-U	3021	0.8	W16TT	IW16TT	IW16TT	4
65 EFI (145 A)	48	13 E 1.064		07/81-06/95	W20EPR-U	3047	0.8	W20TT	IW20TT	IW20TT	4
YUGO Florida (88-08)											
1.3 (103 A)	50	13 E.3.064		03/91-11/08	W20EPR-U	3047	0.8	W20TT	IW20TT	IW20TT	4
ZAZ											
CHANCE (04-)											
1.3	52	MEMZ-310		10/04-	W20EPR-U	3047	0.8	W20TT	IW20TT	IW20TT	4
DANA (1105) (97-)											
1.1	39	MEMZ-245		12/97-	W20EPR-U	3047	0.8	W20TT	IW20TT	IW20TT	4
LANOS (04-)											
1.4	55	A13SM		10/04-	W20EPR-U	3047	0.8	W20TT	IW20TT	IW20TT	4
1.5	63	A15SM		10/04-	W20EPR-U	3047	0.8	W20TT	IW20TT	IW20TT	4
1.6 16V	78	A16DMS		10/04-	K20PR-U11	3121	1.1	K20TT	IK20TT	IK20TT	4

Таблица применения

V
W
Y
Z

Свечи зажигания и Свечи накаливания

Таблица применения

	KW				СТАНДАРТНЫЕ			Twin Tip			QTY
ZAZ продолжение											
SENS (04-)											
1.3	52	MEMZ-310		10/04-	W20EPR-U	3047	0.8	W20TT	IW20TT	IW20TT	4
SLAVUTA (1103) (95-11)											
1.1	38	MEMZ-245		03/95-10/01	W20EPR-U	3047	0.8	W20TT	IW20TT	IW20TT	4
1.2	43	VAZ217		10/01-12/11	W20EPR-U	3047	0.8	W20TT	IW20TT	IW20TT	4
1.3	44	MEMZ-310		10/01-12/11	W20EPR-U	3047	0.8	W20TT	IW20TT	IW20TT	4
TAVRIA (1102) (89-07)											
1.1	37	MEMZ-246		01/89-12/07	W20EPR-U	3047	0.8	W20TT	IW20TT	IW20TT	4
1.2	42	MZ2477		01/98-12/07	W20EPR-U	3047	0.8	W20TT	IW20TT	IW20TT	4
1.3	44/52	MEMZ-310		01/89-12/07	W20EPR-U	3047	0.8	W20TT	IW20TT	IW20TT	4
ZAPOROZHETS (968) (67-94)											
1.2	30	MEMZ-968		01/73-12/87	W22FS-U	4025	0.7	-	-		4
ZHENGZHOU NISSAN											
PALADIN (02-)											
3.3	125	VG33E		06/02-	K16PR-U11	3130	1.1	K16TT	IK16TT	IK16TT	6

DENSO Руководство покупателя



Свечи зажигания и Свечи накаливания

Руководство покупателя

DENSO P/N	TT	MAKE	MODEL	
DG-001	-	ALFA ROMEO	145 / 146 (94-01)	
			155 (92-97)	
			164 (87-98)	
			AR 6 (79-89)	
			AR 8 (78-89)	
		ARO	10 (80-06)	
			240-244 (78-06)	
		BEDFORD	BLITZ (69-87)	
			MIDI (84-92)	
		BERTONE	FREECLIMBER (89-99)	
		BMW	3 (E30) (82-94)	
			3 (E36) (90-00)	
			5 (E28) (81-87)	
			5 (E34) (87-97)	
			5 (E39) (95-04)	
			7 (E38) (94-01)	
		CARBODIES	FX FAIRWAY (87-96)	
			FX4 (59-89)	
			FX4S (86-89)	
		CHEVROLET	C1500 (91-00)	
			C3500 (93-96)	
		CHRYSLER	VOYAGER II (90-95)	
			VOYAGER III (95-01)	
		CITROËN	BERLINGO (MF) (96-11)	
			BX (82-94)	
			C15 (84-05)	
			C25 (81-94)	
			C35 (73-94)	
			CX I (74-85)	
			CX II (85-92)	
			DS (56-75)	
			EVASION (94-02)	
			ID (56-75)	
			JUMPER (94-02)	
			JUMPY (95-06)	
			VISA (78-91)	
			XANTIA (93-03)	
			XM (89-94)	
			XM (94-00)	
			XSARA (97-05)	
			ZX (91-98)	
			DAF	400-Serie (89-97)
			DAIHATSU	HIJET (92-)
		DALLAS	FUN (94-98)	
		DODGE	CARAVAN (95-02)	
		FIAT	127 (71-86)	
			131 (74-84)	
			132 (72-82)	
			147 (76-96)	
			242-SERIE (75-82)	
			ARGENTA (78-86)	
			BRAVA (95-02)	
			BRAVO I (95-01)	
			CAMPAGNOLA (74-89)	
			CROMA (85-96)	
			DUCATO (230) (94-02)	
			DUCATO (280) (82-90)	
			DUCATO (290) (89-94)	
			DUNA (87-91)	
			ELBA (85-97)	
			FIORINO (80-93)	
			FIORINO (88-01)	
			PALIO (96-)	
			PANDA (80-04)	
			PUNTO (93-00)	
			REGATA (83-90)	
			RITMO (78-88)	
			SCUDO (220) (96-06)	
			STRADA (99-)	
			TALENTO (290) (89-94)	
			TEMPRA (90-96)	

DENSO P/N	TT	MAKE	MODEL
DG-001 продолжение			TIPO (160) (87-95)
			ULYSSE (94-02)
			UNO (146) (83-00)
		FORD	GRANADA (72-85)
			SCORPIO I (85-94)
			SIERRA (82-87)
			SIERRA (87-93)
		FSO	POLONEZ II (88-92)
			POLONEZ III (92-02)
		HYUNDAI	LANTRA II (95-00)
		INNOCENTI	ELBA (91-96)
		ISUZU	CAMPO (77-91)
			D-MAX I (02-12)
		IVECO	DAILY II (89-99)
		JEEP	CHEROKEE (XJ) (84-01)
		LADA	NIVA I (2121) (76-)
		LANCIA	DEDRA (89-99)
			DELTA I (79-94)
			PRISMA (83-92)
			THEMA (84-94)
			ZETA (95-02)
		LAND ROVER	88 / 109 (61-86)
			90 / 110 (83-90)
			DEFENDER (90-16)
			RANGE ROVER II (94-02)
		LDV	200 (89-96)
			400 (86-98)
			CONVOY (96-09)
			PILOT (96-05)
		MAHINDRA	CJ 3 (88-92)
			CJ5 (87-16)
		MERCEDES-BENZ	/8 (W115) (68-77)
			100 (631) (88-96)
			190 (W201) (82-93)
			COUPE (C123) (77-85)
			E-CLASS (124) (92-96)
			G-CLASS (W460) (79-93)
			G-CLASS (W463) (89-)
			HENSCHEL 2-t (73-77)
			KOMBI (S123) (77-85)
			KOMBI (S124) (85-93)
			Saloon (W123) (76-85)
			Saloon (W124) (84-93)
			S-CLASS (W140) (91-98)
			SPRINTER 2-t (901, 902) (95-06)
			SPRINTER 3-t (903) (95-06)
			SPRINTER 4-t (904) (96-06)
			T1 (601) (77-96)
			T1 (602) (77-96)
			T1 / TN (611) (81-95)
			T2 / L (309, 310, 328) (68-88)
		T2 / LN1 (86-94)	
		OPEL	ASCONA B (75-81)
			ASCONA C (81-88)
			ASTRA F (91-01)
			ASTRA G (98-09)
			FRONTERA A (92-98)
			KADETT D (79-84)
			KADETT E (84-94)
			OMEGA A (86-94)
			OMEGA B (94-03)
			REKORD E (77-86)
			SENATOR A (78-87)
			VECTRA A (88-95)
		PEUGEOT	205 I (83-94)
			205 II (87-98)
			304 (69-80)
			305 I (77-82)
			305 II (82-90)
			306 (93-02)
			309 I (85-89)

Свечи зажигания и Свечи накаливания

Руководство покупателя

DENSO P/N	TT	MAKE	MODEL
DG-001			309 II (89-93)
продолжение			405 I (87-93)
			405 II (92-99)
			406 (95-04)
			504 (68-89)
			505 (79-95)
			604 (77-87)
			605 (89-99)
			806 (94-02)
			BOXER (94-02)
			EXPERT (96-06)
			J5 (81-90)
			J5 (90-94)
			J7 (68-80)
			J9 (80-87)
			PARTNER / RANCH (96-15)
		PIAGGIO	PORTER (93-)
		PUCH	G-MODELL (W460) (79-92)
			G-MODELL (W463) (89-00)
		RENAULT	9 (81-89)
			11 (83-88)
			18 (78-93)
			19 I (88-92)
			19 II (92-01)
			20 (75-83)
			21 (86-95)
			25 (84-93)
			30 (75-86)
			CLIO I (90-98)
			ESPACE I (84-92)
			ESPACE II (91-96)
			EXPRESS (95-99)
			FUEGO (80-85)
			MASTER I (80-98)
			RAPID (85-98)
			SAFRANE I (92-96)
			SUPER 5 (84-96)
			TRAFIC (80-89)
			TRAFIC (89-01)
		RENAULT TRUCKS	MASCOTT (99-13)
		ROVER	200 (XW) (89-99)
			400 (90-98)
			800 (86-99)
			MAESTRO (90-95)
			MONTEGO (84-95)
		SEAT	132 (73-82)
			IBIZA I (84-93)
			MALAGA (84-93)
			RITMO (78-83)
			RONDA (82-88)
		SSANGYONG	ISTANA (92-03)
		SUZUKI	BALENO (95-02)
			SAMURAI (88-04)
			VITARA (88-99)
		TALBOT	180 (73-82)
			EXPRESS 1000 -1500 (82-94)
			EXPRESS 1000 -1800 (81-94)
			HORIZON (78-86)
			SIMCA (1609, 1610) (76-80)
			TAGORA (80-87)
		TATA	LOADBETA (94-06)
			SAFARI (98-)
			SIERRA (95-02)
			TELCOLINE (99-07)
		TOYOTA	LAND CRUISER (J40) (69-86)
		UAZ	31512 (98-)
		VAUXHALL	ASTRA I (79-86)
			ASTRA II (84-94)
			ASTRA III (F) (91-01)
			ASTRA IV (G) (98-06)
			CARLTON II (77-86)

DENSO P/N	TT	MAKE	MODEL
DG-001			CARLTON III (86-94)
продолжение			CAVALIER II (81-88)
			CAVALIER III (88-95)
			FRONTERA I (A) (91-98)
			OMEGA (B) (94-03)
DG-003	-	CITROËN	AX (86-98)
			BERLINGO (MF) (96-11)
			C15 (84-05)
			JUMPY (95-06)
			SAXO (96-04)
			XSARA (97-05)
		FIAT	DUCATO (230) (94-02)
			SCUDO (220) (96-06)
		NISSAN	MICRA II (K11) (92-03)
		PEUGEOT	106 I (91-96)
			106 II (96-04)
			206 (98-)
			306 (93-02)
			EXPERT (96-06)
			PARTNER / RANCH (96-15)
		ROVER	100 / METRO (90-98)
		TATA	INDICA (98-)
			INDIGO (03-)
		TOYOTA	COROLLA (E11) (97-02)
DG-004	-	CITROËN	AX (86-98)
			ZX (91-98)
		FIAT	DUCATO (230) (94-02)
		FORD	ESCORT IV (85-90)
			ESCORT V (90-95)
			ESCORT VI (95-01)
			FIESTA II (83-95)
			FIESTA III (89-97)
			MONDEO I (93-96)
			ORION II (85-90)
			ORION III (90-93)
			P 100 (87-92)
			SIERRA (87-93)
		OPEL	ARENA (97-01)
			MOVANO A (98-)
		PEUGEOT	106 I (91-96)
		RENAULT	MASTER I (80-98)
			TRAFIC (80-89)
			TRAFIC (89-01)
		ROVER	100 / METRO (90-98)
		VAUXHALL	ARENA (98-01)
			MOVANO I (A) (98-10)
DG-005	-	AUDI	80 (8C, B4) (91-96)
			100 (44, C3) (82-91)
			100 (4A, C4) (90-94)
			A3 (8L) (96-03)
			A4 (8D, B5) (94-01)
			A4 (8E, B6) (00-04)
			A6 (4A, C4) (94-97)
			A6 (4B, C5) (97-05)
			CABRIOLET (867) (91-00)
		DACIA	DUSTER (10-)
			LOGAN I (04-)
			LOGAN MCV I (07-)
			SANDERO I (Stepway) (08-)
		FORD	GALAXY (95-06)
		GAZ	GAZELLE (2705, 3221, 3302) (93-02)
		MITSUBISHI	CARISMA (95-06)
			SPACE STAR (98-04)
		NISSAN	ALMERA II (00-)
			INTERSTAR (02-)
			KUBISTAR (03-)
			MICRA III (K12) (03-10)
			NOTE (E11) (06-12)
			NV200 (10-)
			PRIMASTAR (01-)
			PRIMERA (P12) (02-)

Свечи зажигания и Свечи накаливания

Руководство покупателя

DENSO P/N	TT	MAKE	MODEL
DG-005			QASHQAI I (+2) (07-13)
продолжение			TIIDA (04-12)
			TRADE (93-98)
			TRADE (96-04)
		OPEL	MOVANO A (98-)
			VIVARO A (01-)
		RENAULT	CLIO II (98-)
			CLIO III (05-)
			ESPACE III (96-02)
			ESPACE IV (02-)
			Grand SCÉNIC II (04-)
			KANGOO (97-)
			KANGOO (08-)
			LAGUNA I (93-01)
			LAGUNA II (01-)
			LAGUNA III (07-)
			LOGAN I (04-)
			MASTER II (98-)
			MEGANE I (96-03)
			MEGANE II (02-12)
			MODUS (04-)
			SCÉNIC I (99-03)
			SCÉNIC II (03-)
			THALIA I (98-)
			THALIA II (08-)
			TRAFIC II (01-)
			TWINGO II (07-)
		SEAT	ALHAMBRA (7V) (96-10)
			AROSA (6H) (97-04)
			CORDOBA (6K1) (93-99)
			CORDOBA (6K2) (99-02)
			CORDOBA (6L) (02-09)
			IBIZA II (6K1) (93-99)
			IBIZA II (6K2) (99-02)
			IBIZA III (6L) (02-09)
			INCA (6K9) (95-03)
			LEON (1M) (99-06)
			TOLEDO I (1L) (91-99)
			TOLEDO II (1M) (99-06)
		SKODA	FABIA I (6Y) (99-08)
			OCTAVIA I (1U) (96-10)
		SUZUKI	Grand VITARA II (05-)
			JIMNY (98-)
		VAUXHALL	MOVANO I (A) (98-10)
			VIVARO (A) (01-14)
		VOLVO	850 (91-97)
			S40 I (95-03)
			S70 (96-00)
			S80 I (98-06)
			V40 (95-04)
			V70 I (96-00)
			V70 II (00-07)
		VW	BORA (1J) (98-05)
			CADDY II (9K, 9U) (95-04)
			GOLF III (1H, 1E) (91-99)
			GOLF IV (1J, 1E) (97-06)
			LT 28-35 II (2D) (96-06)
			LT 28-46 II (2D) (96-06)
			LUPO (6X, 6E) (98-05)
			NEW BEETLE (9C, 1C, 1Y) (98-10)
			PASSAT (3A2, 35I) (88-97)
			PASSAT (3B2, 3B5) (96-01)
			PASSAT (3B3, 3B6) (00-05)
			PASSAT (32B) (80-91)
			POLO (6N1) (94-99)
			POLO (6N2) (99-01)
			POLO (9N) (01-09)
			POLO Classic (6KV) (95-02)
			POLO Variant (6V5) (97-01)
			SHARAN (7M) (95-10)
			TRANSPORTER IV (70X, 7D) (90-03)

DENSO P/N	TT	MAKE	MODEL
DG-005			VENTO (1H2) (91-98)
продолжение			
DG-006	-	VOLVO	340-360 (75-91)
DG-007	-	FORD	ESCORT VI (95-01)
			FIESTA IV (95-03)
			MONDEO II (96-00)
		MAZDA	121 III (96-03)
DG-008	-	DACIA	SOLENZA (03-)
		OPEL	ARENA (97-01)
		RENAULT	CLIO II (98-)
			KANGOO (97-)
			MEGANE Scénic (96-99)
			THALIA I (98-)
			TRAFIC (89-01)
		VAUXHALL	ARENA (98-01)
DG-009	-	RENAULT	CLIO I (90-98)
			MEGANE I (96-03)
			MEGANE Scénic (96-99)
DG-010	-	DAEWOO	KORANDO (99-)
			MUSSO (99-)
			REXTON (02-)
		MERCEDES-BENZ	190 (W201) (82-93)
			C-CLASS (202) (93-01)
			E-CLASS (124) (92-96)
			G-CLASS (W460) (79-93)
			G-CLASS (W461) (90-)
			G-CLASS (W463) (89-)
			KOMBI (S124) (85-93)
			Saloon (W124) (84-93)
			SPRINTER 2-t (901, 902) (95-06)
			SPRINTER 3-t (903) (95-06)
			SPRINTER 4-t (904) (96-06)
			T1 (601) (77-96)
			T1 (602) (77-96)
			T1 / TN (611) (81-95)
			T2 / LN1 (86-94)
			V-CLASS (638/2) (96-03)
			VITO (638) (96-03)
		PUCH	G-MODELL (W460) (79-92)
			G-MODELL (W461) (91-00)
		RENAULT	MEGANE I (96-03)
		SSANGYONG	ISTANA (92-03)
			KORANDO (96-06)
			MUSSO (93-07)
			MUSSO Sports (04-)
			REXTON (02-)
DG-012	-	ARO	10 (80-06)
		AUDI	80 (81, 85, B2) (78-86)
			80 (89, 8A, B3) (86-91)
			80 (8C, B4) (91-96)
			90 (81, 85, B2) (84-87)
			90 (89, 8A, B3) (87-91)
			100 (43, C2) (76-83)
			100 (44, C3) (82-91)
			100 (4A, C4) (90-94)
			A4 (8D, B5) (94-01)
		BEDFORD	BLITZ (69-87)
		FORD	TRANSIT (77-86)
		MITSUBISHI	CARISMA (95-06)
		NISSAN	BLUEBIRD (80-86)
			LAUREL (81-85)
			LAUREL (84-89)
		RENAULT	19 I (88-92)
			19 II (92-01)
			MEGANE I (96-03)
			MEGANE Scénic (96-99)
		SEAT	CORDOBA (6K1) (93-99)
			IBIZA II (6K1) (93-99)
			INCA (6K9) (95-03)
			TERRA (87-96)
			TOLEDO I (1L) (91-99)

Свечи зажигания и Свечи накаливания

Руководство покупателя

DENSO P/N	TT	MAKE	MODEL
DG-012		SKODA	FELICIA Fun (6U) (97-02)
продолжение			FELICIA I (6U) (94-98)
			FELICIA II (6U) (98-01)
		TATA	TELCOLINE (99-07)
		VOLVO	240 (74-93)
			440 (88-96)
			460 (88-96)
			740 (83-92)
			760 (81-92)
			940 I (90-95)
			940 II (94-98)
			960 I (90-94)
			S40 I (95-03)
			V40 (95-04)
		VW	CADDY I (14) (82-92)
			CADDY II (9K, 9U) (95-04)
			GOLF I (17, 155) (74-93)
			GOLF II (19, 1G) (83-92)
			GOLF III (1H, 1E) (91-99)
			ILTIS (183) (79-88)
			JETTA I (16) (78-84)
			JETTA II (19, 1G) (84-92)
			LT 28-35 I (281-363) (75-96)
			LT 28-50 I (281-363) (82-92)
			LT 40-55 I (75-96)
			PASSAT (3A2, 35I) (88-97)
			PASSAT (32, 33) (73-80)
			PASSAT (32B) (80-91)
			POLO (6N1) (94-99)
			POLO (6N2) (99-01)
			POLO (86C, 80) (81-94)
			POLO Classic (6KV) (95-02)
			SANTANA (81-85)
			TRANSPORTER III (79-92)
			TRANSPORTER IV (70X, 7D) (90-03)
			VENTO (1H2) (91-98)
DG-101	-	CARBODIES	FX4R (82-85)
		FORD	FOCUS I (98-05)
		HONDA	ACCORD V (93-98)
			ACCORD VI (97-05)
			CIVIC VI (94-01)
		LAND ROVER	FREELANDER I (98-06)
		MG	MG ZR (01-05)
			MG ZS (01-05)
		RENAULT	ESPACE III (96-02)
			LAGUNA I (93-01)
			MEGANE I (96-03)
			MEGANE Scénic (96-99)
			SAFRANE II (96-00)
			SCÉNIC I (99-03)
		ROVER	25 (99-05)
			45 (00-05)
			200 (RF) (95-00)
			400 (95-00)
			600 (93-99)
			STREETWISE (03-05)
		VOLVO	S40 I (95-03)
			V40 (95-04)
DG-102	-	FIAT	BRAVA (95-02)
			BRAVO I (95-01)
			MAREA (96-07)
		LANCIA	DELTA II (93-99)
			KAPPA (94-01)
DG-104	-	ISUZU	GEMINI (84-90)
			MIDI (88-96)
			TROOPER II (91-98)
		OPEL	ASTRA F (91-01)
			CAMPO (87-01)
			CORSA A (82-93)
			KADETT E (84-94)
			MONTEREY A (91-98)

DENSO P/N	TT	MAKE	MODEL
DG-104		VAUXHALL	ASTRA III (F) (91-01)
продолжение			MONTEREY I (91-98)
			NOVA (82-94)
DG-106	-	MERCEDES-BENZ	C-CLASS (202) (93-01)
			E-CLASS (210) (95-03)
			G-CLASS (W463) (89-)
			S-CLASS (W140) (91-98)
		PUCH	G-MODELL (W463) (89-00)
DG-108	-	ISUZU	TROOPER I (83-91)
		OPEL	CAMPO (87-01)
			FRONTERA A (92-98)
		VAUXHALL	BRAVA (88-02)
			FRONTERA I (A) (91-98)
DG-109	-	AUDI	A2 (8Z) (00-05)
			A3 (8L) (96-03)
			A4 (8E, B6) (00-04)
			A6 (4B, C5) (97-05)
		CHRYSLER	VOYAGER III (95-01)
		FORD	GALAXY (95-06)
			SCORPIO II (94-98)
		JEEP	Grand CHEROKEE I (91-99)
			Grand CHEROKEE II (98-05)
		OPEL	FRONTERA A (92-98)
		SEAT	ALHAMBRA (7V) (96-10)
			AROSA (6H) (97-04)
			CORDOBA (6L) (02-09)
			IBIZA III (6L) (02-09)
			LEON (1M) (99-06)
			TOLEDO II (1M) (99-06)
		SKODA	FABIA I (6Y) (99-08)
			FABIA II (06-14)
			OCTAVIA I (1U) (96-10)
			ROOMSTER (5J) (06-15)
			SUPERB I (3U) (01-08)
		VAUXHALL	FRONTERA I (A) (91-98)
		VW	BORA (1J) (98-05)
			CADDY III (2K, 2C) (04-15)
			FOX (5Z) (03-)
			GOLF IV (1J, 1E) (97-06)
			LUPPO (6X, 6E) (98-05)
			MULTIVAN V (7H, 7E) (03-)
			NEW BEETLE (9C, 1C, 1Y) (98-10)
			PASSAT (3B3, 3B6) (00-05)
			PHAETON (3D) (02-16)
			POLO (9N) (01-09)
			POLO Saloon (9A4) (02-)
			SHARAN (7M) (95-10)
			TOUAREG (7L) (02-10)
			TRANSPORTER V (7H, 7E, 7J) (03-15)
DG-110	-	MERCEDES-BENZ	E-CLASS (210) (95-03)
			SPRINTER 2-t (901, 902) (95-06)
			SPRINTER 3-t (903) (95-06)
			SPRINTER 4-t (904) (96-06)
			VARIO (96-)
DG-111	-	CITROËN	JUMPER (94-02)
			JUMPER (02-)
		FIAT	DUCATO (230) (94-02)
			DUCATO (244) (02-)
		IVECO	DAILY I (78-89)
			DAILY II (89-99)
			DAILY III (97-06)
		PEUGEOT	BOXER (94-02)
			BOXER (02-)
		RENAULT	MASTER II (98-)
		RENAULT TRUCKS	MASCOTT (99-13)
		SANTANA	PS10 / ANIBAL (02-)
DG-112	-	RENAULT	CLIO II (98-)
			KANGOO (97-)
			MEGANE I (96-03)
			MEGANE Scénic (96-99)
			SCÉNIC I (99-03)

Свечи зажигания и Свечи накаливания

Руководство покупателя

DENSO P/N	TT	MAKE	MODEL		
DG-113	-	CITROËN	BERLINGO (MF) (96-11)		
			C2 (03-)		
			C3 I (02-)		
			C3 Pluriel (03-)		
			C4 Coupe (04-11)		
			C4 I (LC, LR) (04-11)		
			C5 II (04-)		
			XSARA (97-05)		
			XSARA Picasso (99-11)		
			FORD	FIESTA V (01-08)	
		FOCUS C-MAX (03-07)			
		FOCUS II (04-12)			
		FUSION (02-12)			
		MAZDA	2 (03-07)		
			3 (00-09)		
			3 (09-14)		
		PEUGEOT	107 (05-)		
			206 (98-)		
			206 CC (00-)		
			206+ (09-)		
			207 (06-)		
			307 (00-)		
			407 (04-)		
			1007 (05-)		
			PARTNER / RANCH (96-15)		
			SUZUKI	LIANA (01-07)	
		SX4 (06-)			
		VOLVO	C30 (06-12)		
			S40 II (04-12)		
			S80 II (06-)		
			V50 (04-12)		
			V70 III (07-)		
		DG-114	-	ASIA MOTORS	ROCSTA (89-99)
				FORD	ECONOVAN (85-92)
				MAZDA	626 II (82-87)
					E-SERIE (SD) (83-04)
		DG-115	-	LAND ROVER	DEFENDER (90-16)
DISCOVERY I (89-98)					
DISCOVERY II (98-04)					
DG-116	-	CITROËN	BERLINGO (MF) (96-11)		
			C5 I (01-04)		
			C8 (02-)		
			EVASION (94-02)		
			JUMPER (94-02)		
			JUMPER (02-)		
			JUMPY (95-06)		
			XANTIA (93-03)		
			XSARA (97-05)		
			XSARA Picasso (99-11)		
		FIAT	DUCATO (230) (94-02)		
			DUCATO (244) (02-)		
			SCUDO (220) (96-06)		
			SCUDO (270) (07-)		
			ULYSSE (94-02)		
			ULYSSE (02-11)		
			LANCIA	PHEDRA (02-10)	
		ZETA (95-02)			
		PEUGEOT	206 (98-)		
			306 (93-02)		
			307 (00-)		
			406 (95-04)		
			406 Coupe (97-04)		
			607 (00-)		
			806 (94-02)		
			807 (02-)		
			BOXER (94-02)		
			BOXER (02-)		
			EXPERT (96-06)		
			PARTNER / RANCH (96-15)		
			SUZUKI	Grand VITARA I (98-06)	

DENSO P/N	TT	MAKE	MODEL			
DG-116			VITARA (88-99)			
			продолжение	VITARA (03-05)		
DG-117	-	CHRYSLER	PT CRUISER (00-10)			
			MERCEDES-BENZ	C-CLASS (202) (93-01)		
		C-CLASS (203) (00-07)				
		C-CLASS Coupe (CL203) (01-08)				
		CLC (CL203) (08-11)				
		CLK (209) (02-10)				
		E-CLASS (210) (95-03)				
		E-CLASS (211) (02-09)				
		G-CLASS (W461) (90-)				
		G-CLASS (W463) (89-)				
		M-CLASS (W163) (98-05)				
		S-CLASS (W220) (98-05)				
		SPRINTER 2-t (901, 902) (95-06)				
		SPRINTER 3,5-t (906) (06-)				
		SPRINTER 3-t (903) (95-06)				
		SPRINTER 3-t (906) (06-)				
		SPRINTER 4,6-t (906) (06-)				
		SPRINTER 4-t (904) (96-06)				
		SPRINTER 5-t (905) (01-)				
		SPRINTER 5-t (906) (06-)				
		SPRINTER Classic (909) (13-)				
		V-CLASS (638/2) (96-03)				
		VIANO (W639) (03-)				
		VITO (638) (96-03)				
		VITO / MIXTO (W639) (03-)				
		SSANGYONG	REXTON (02-)			
		DG-118	-	BMW	7 (E38) (94-01)	
					OPEL	ASTRA G (98-09)
				FRONTERA B (98-04)		
				OMEGA B (94-03)		
				SINTRA (96-99)		
				VECTRA B (95-03)		
				ZAFIRA A (99-05)		
				SAAB		9-3 (98-03)
						9-5 (97-09)
				VAUXHALL	ASTRA IV (G) (98-06)	
					FRONTERA II (B) (98-04)	
OMEGA (B) (94-03)						
SINTRA (96-99)						
VECTRA I (B) (95-03)						
ZAFIRA I (A) (98-05)						
DG-119	-				MERCEDES-BENZ	C-CLASS (202) (93-01)
					E-CLASS (124) (92-96)	
DG-121	-	FORD	C-MAX I (07-10)			
			FIESTA IV (95-03)			
			FOCUS C-MAX (03-07)			
			FOCUS I (98-05)			
			FOCUS II (04-12)			
			GALAXY (06-15)			
			MONDEO IV (07-15)			
			S-MAX (06-14)			
			TOURNEO Connect (02-13)			
			TRANSIT Connect (02-13)			
DG-122	-	ALFA ROMEO	145 / 146 (94-01)			
			147 (00-10)			
			156 (97-06)			
			166 (98-07)			
			FIAT	BRAVA (95-02)		
				BRAVO I (95-01)		
		CROMA (05-)				
		DOBLO (01-)				
		Grande PUNTO (05-)				
		IDEA (03-)				
		MAREA (96-07)				
		MULTIPLA (99-10)				
		PUNTO (99-12)				
		STILO (01-08)				
		STRADA (99-)				
		LANCIA	KAPPA (94-01)			

Свечи зажигания и Свечи накаливания

Руководство покупателя

DENSO P/N	TT	MAKE	MODEL		
DG-122 продолжение			LYBRA (99-05)		
			MUSA (04-12)		
			THESIS (02-09)		
		OPEL	ASTRA H (04-14)		
			SIGNUM (03-)		
			VECTRA C (02-08)		
			ZAFIRA B (05-14)		
		SAAB	9-3 (02-15)		
		VAUXHALL	ASTRA V (H) (04-10)		
			SIGNUM (02-08)		
			VECTRA II (C) (00-08)		
			ZAFIRA II (B) (05-14)		
DG-123	-	FORD	ESCORT III (80-86)		
			ESCORT IV (85-90)		
			FIESTA II (83-95)		
			ORION I (83-86)		
			ORION II (85-90)		
DG-124	-	ISUZU	CAMPO (77-91)		
			GEMINI (84-90)		
			TROOPER I (83-91)		
		OPEL	CAMPO (87-01)		
			CORSA A (82-93)		
			VECTRA A (88-95)		
		SSANGYONG	KORANDO (88-96)		
		VAUXHALL	CAVALIER III (88-95)		
			NOVA (82-94)		
		DG-126	-	NISSAN	INTERSTAR (02-)
					PRIMASTAR (01-)
OPEL	MOVANO A (98-)				
	VIVARO A (01-)				
RENAULT	AVANTIME (01-03)				
	ESPACE III (96-02)				
	ESPACE IV (02-)				
	LAGUNA II (01-)				
	MASTER II (98-)				
	TRAFIC II (01-)				
	VEL SATIS (02-)				
VAUXHALL	MOVANO I (A) (98-10)				
	VIVARO (A) (01-14)				
DG-127	-	ALFA ROMEO	156 (97-06)		
			159 (05-11)		
			166 (98-07)		
DG-129	-	FIAT	DOBLO (01-)		
			PALIO (96-)		
			PUNTO (99-12)		
			STRADA (99-)		
DG-130	-	CITROËN	JUMPER (06-)		
		FIAT	DUCATO (250, 290) (06-)		
		FORD	MONDEO III (00-07)		
			TRANSIT (00-06)		
			TRANSIT (06-14)		
			TRANSIT Tourneo (06-14)		
		JAGUAR	X-TYPE (01-09)		
		LAND ROVER	DEFENDER (90-16)		
LTI	TX (97-)				
PEUGEOT	BOXER (06-)				
DG-132	-	FIAT	CROMA (85-96)		
DG-133	-	OPEL	VECTRA B (95-03)		
		VAUXHALL	VECTRA I (B) (95-03)		
DG-137	-	LDV	CUB (98-01)		
		NISSAN	SERENA (92-01)		
			TERRANO I (87-96)		
			TERRANO II (92-07)		
			TRADE (96-04)		
	VANETTE Cargo (C23) (94-02)				
DG-139	-	VW	LT 28-35 II (2D) (96-06)		
			LT 28-46 II (2D) (96-06)		
DG-140	-	CITROËN	C5 III (08-)		
			C6 (05-14)		
		JAGUAR	S-TYPE (99-08)		
			XF (08-15)		

DENSO P/N	TT	MAKE	MODEL	
DG-140 продолжение		LAND ROVER	XJ (03-09)	
			DISCOVERY III (04-09)	
			DISCOVERY IV (09-)	
			RANGE ROVER III (02-12)	
			RANGE ROVER Sport (05-13)	
		PEUGEOT	407 (04-)	
			407 Coupe (05-)	
			607 (00-)	
		VOLVO	S60 I (00-10)	
			S80 I (98-06)	
			S80 II (06-)	
			V70 II (00-07)	
			V70 III (07-)	
XC60 I (08-)				
XC70 I Cross Country (97-07)				
XC70 II (07-)				
XC90 I (02-14)				
DG-142	-	OPEL	ASTRA G (98-09)	
			FRONTERA B (98-04)	
			OMEGA B (94-03)	
			SIGNUM (03-)	
			VECTRA B (95-03)	
			VECTRA C (02-08)	
		ZAFIRA A (99-05)		
		SAAB	9-3 (98-03)	
			9-3 (02-15)	
		VAUXHALL	FRONTERA II (B) (98-04)	
			OMEGA (B) (94-03)	
			SIGNUM (02-08)	
			VECTRA I (B) (95-03)	
VECTRA II (C) (00-08)				
ZAFIRA I (A) (98-05)				
DG-143	-	ISUZU	GEMINI (84-90)	
		OPEL	CORSA A (82-93)	
		VAUXHALL	NOVA (82-94)	
DG-144	-	AUDI	A4 (8D, B5) (94-01)	
			A4 (8E, B6) (00-04)	
			A4 (8E, B7) (04-08)	
			A4 Convertible (8H, B6, B7) (02-09)	
			A6 (4B, C5) (97-05)	
			A8 (4D) (94-02)	
			A8 (4E) (02-10)	
			ALLROAD (4BH) (00-05)	
			SKODA	SUPERB I (3U) (01-08)
			VW	PASSAT (3B2, 3B5) (96-01)
			PASSAT (3B3, 3B6) (00-05)	
DG-145	-	ALPINA	D10 (E39) (00-03)	
		BMW	3 (E46) (98-06)	
			5 (E39) (95-04)	
			7 (E38) (94-01)	
			X5 (E53) (00-06)	
		LAND ROVER	FREELANDER I (98-06)	
			RANGE ROVER III (02-12)	
		MG	MG ZT (01-05)	
		OPEL	OMEGA B (94-03)	
ROVER	75 (99-05)			
VAUXHALL	MIDI I (84-88)			
DG-146	-	FORD	RANGER (99-06)	
		KIA	BESTA (92-03)	
			K2700 (97-09)	
			PREGIO (95-)	
			RETONA (99-)	
			SPORTAGE I (94-04)	
		MAZDA	626 III (87-97)	
			626 IV (91-97)	
			B-SERIE (85-99)	
			B-SERIE (99-06)	
			E-SERIE (SD) (83-04)	
E-SERIE (SR) (83-04)				
MPV I (88-99)				
SUZUKI	Grand VITARA I (98-06)			

Свечи зажигания и Свечи накаливания

Руководство покупателя

DENSO P/N	TT	MAKE	MODEL
DG-155	-	MERCEDES-BENZ	A-CLASS (W168) (97-04) Vaneo (414) (02-05)
DG-157	-	NISSAN	PATROL (79-88) PATROL (84-96) PICK UP (720) (80-86) PICK UP (D21) (85-98)
DG-159	-	BEDFORD	MIDI (84-92)
		OPEL	CORSA A (82-93) KADETT E (84-94)
		VAUXHALL	MIDI II (88-97) NOVA (82-94)
DG-161	-	CITROËN	JUMPER (94-02)
		PEUGEOT	BOXER (94-02)
DG-162	-	MITSUBISHI	GALANT II (80-84) L 200 (80-86) L 300 (80-87) PAJERO I (82-91)
DG-170	-	ALFA ROMEO	147 (00-10) 156 (97-06) 159 (05-11) 166 (98-07) BRERA (06-10) GT (03-10) SPIDER (06-10)
		CADILLAC	BLS (06-)
		FIAT	BRAVO II (06-14) CROMA (05-) STILO (01-08)
		LANCIA	THESIS (02-09)
		OPEL	ASTRA H (04-14) SIGNUM (03-) VECTRA C (02-08) ZAFIRA B (05-14)
		SAAB	9-3 (02-15) 9-5 (97-09)
		VAUXHALL	ASTRA V (H) (04-10) SIGNUM (02-08) VECTRA II (C) (00-08) ZAFIRA II (B) (05-14)
DG-171	-	ALFA ROMEO	MITO (08-)
		FIAT	500 (C) (312) (07-) ALBEA / SIENA (96-11) DOBLO (01-) DOBLO (10-) FIORINO (07-) Grande PUNTO (05-) IDEA (03-) LINEA (07-) PALIO (96-) PANDA (03-) PUNTO (99-12) PUNTO (12-) PUNTO Evo (08-12) QUBO (08-) STRADA (99-) STRADA (10-)
		FORD	KA (08-)
		LANCIA	MUSA (04-12) YPSILON (843) (03-11)
		OPEL	AGILA A (00-07) AGILA B (08-14) ASTRA G CLASSIC (09-) ASTRA H (04-14) COMBO C (01-) CORSA C (00-09) CORSA D (06-14) MERIVA A (03-10) TIGRA TwinTop (04-)
		SUZUKI	IGNIS II (03-) SPLASH (08-) SWIFT III (05-)

DENSO P/N	TT	MAKE	MODEL
DG-171			SWIFT IV (10-) WAGON R+ (00-)
продолжение		VAUXHALL	AGILA II (B) (08-14) ASTRA V (H) (04-10) COMBO II (C) (01-12) CORSA II (C) (00-06) CORSA III (D) (06-) MERIVA I (A) (03-10) TIGRA TwinTop (04-09)
DG-172	-	HYUNDAI	H-1 / STAREX (97-07) H100 (93-04) PORTER (94-04) TERRACAN (01-06)
		KIA	CARNIVAL I (99-01) CARNIVAL II (99-07) K2500 (03-)
DG-173	-	HYUNDAI	ACCENT II (99-06) ELANTRA (00-06) GETZ (02-09) GRANDEUR (05-11) HIGHWAY VAN (00-04) i30 (07-12) MATRIX (01-10) SANTA FÉ I (00-06) SANTA FÉ II (06-12) SONATA V (05-10) TRAJECT (00-08) TUCSON (04-10)
		KIA	CARENS II (02-) CARENS III (06-) CEED (06-12) CERATO (04-) MAGENTIS (05-) PRO CEED (08-13) SPORTAGE II (04-)
DG-174	-	HYUNDAI	GALLOPER (91-98) GALLOPER (98-03) H-1 / STAREX (97-07)
		KIA	CARNIVAL I (99-01) CARNIVAL II (99-07) PREGIO (95-)
		MITSUBISHI	GALANT V (92-96) GALANT VI (96-04) L 200 (86-96) L 200 (96-07) L 300 (80-87) L 300 (86-06) L 400 / SPACE GEAR (95-05) LANCER IV (88-94) LANCER V (91-03) LANCER VI (95-03) PAJERO Classic (02-) PAJERO I (82-91) PAJERO II (90-00) PAJERO III (00-07) PAJERO Sport I (97-) SPACE RUNNER (91-99) SPACE WAGON (91-98)
DG-175	-	CHEVROLET	C2500 (96-01) TAHOE (94-96)
		HUMMER	HUMMER H1 (92-06)
DG-176	-	CHRYSLER	VOYAGER IV (00-08)
		JEEP	CHEROKEE / LIBERTY (KJ) (01-08)
		LDV	MAXUS (05-09)
		LTI	TX (97-)
DG-177	-	AUDI	A2 (8Z) (00-05) A3 (8P) (03-13) A3 Convertible (8P7) (08-13) A4 (8E, B6) (00-04) A4 (8E, B7) (04-08)
		SEAT	ALTEA (XL) (5P) (04-)

Свечи зажигания и Свечи накаливания

Руководство покупателя

DENSO P/N	TT	MAKE	MODEL		
DG-177 продолжение			IBIZA IV (6J, 6P) (08-)		
			LEON (1P) (05-12)		
			TOLEDO III (5P) (04-09)		
		SKODA	FABIA II (06-14)		
			OCTAVIA II (1Z) (04-13)		
			ROOMSTER (5J) (06-15)		
			SUPERB I (3U) (01-08)		
			SUPERB II (3T) (08-15)		
			VW	CADDY III (2K, 2C) (04-15)	
				CRAFTER 30-50 (2E, 2F) (06-16)	
				EOS (1F) (06-15)	
		GOLF Plus (5M, 521) (05-14)			
		GOLF V (1K) (03-09)			
		JETTA III (1K2) (05-10)			
		MULTIVAN V (7H, 7E) (03-)			
		PASSAT (3C) (05-11)			
		TOURAN (1T1, 1T2) (03-10)			
		TRANSPORTER V (7H, 7E, 7J) (03-15)			
		DG-178	-	ALPINA	D3 (E90) (05-11)
					D3 (E91) (05-12)
BMW	1 (E81, E87) (03-12)				
	3 (E46) (98-06)				
	3 (E90, E91) (05-12)				
	3 Coupe/Convertible (E92, E93) (06-13)				
	5 (E60, E61) (03-10)				
	6 (E63, E64) (04-10)				
	7 (E65, E66) (01-08)				
	X3 (E83) (04-11)				
	X5 (E53) (00-06)				
	X5 (E70) (07-13)				
	X6 (E71, E72) (08-14)				
	DG-180		-	CITROËN	BERLINGO (B9) (08-)
					BERLINGO (MF) (96-11)
					C1 I (05-14)
C2 (03-)					
C3 I (02-)					
C3 II (09-)					
C3 Picasso (09-)					
C4 (Grand) Picasso I (06-13)					
C4 Coupe (04-11)					
C4 I (LC, LR) (04-11)					
C5 II (04-)					
C5 III (08-)					
JUMPY (07-)					
NEMO (08-)					
XSARA Picasso (99-11)					
FIAT		SCUDO (270) (07-)			
FORD		C-MAX I (07-10)			
		FIESTA V (01-08)			
		FIESTA VI (08-)			
		FOCUS II (04-12)			
MAZDA	FUSION (02-12)				
	2 (07-15)				
MINI	3 (09-14)				
	MINI (R56) (06-13)				
PEUGEOT	MINI Clubman (R55) (07-14)				
	206 (98-)				
	206 CC (00-)				
	207 (06-)				
	307 (00-)				
	308 I (07-)				
	407 (04-)				
	1007 (05-)				
	3008 (09-)				
	5008 I (09-)				
	BIPPER (08-)				
	EXPERT (07-)				
	PARTNER / RANCH (96-15)				
	PARTNER / RANCH (08-)				
TOYOTA	AYGO (05-)				
VOLVO	C30 (06-12)				

DENSO P/N	TT	MAKE	MODEL	
DG-180 продолжение			S40 II (04-12)	
			S80 II (06-)	
			V50 (04-12)	
			V70 III (07-)	
DG-181	-	CITROËN	C4 (Grand) Picasso I (06-13)	
			C4 Coupe (04-11)	
			C4 I (LC, LR) (04-11)	
			C5 I (01-04)	
			C5 II (04-)	
			C5 III (08-)	
			C8 (02-)	
			JUMPER (02-)	
			JUMPY (95-06)	
			JUMPY (07-)	
			XSARA (97-05)	
			FIAT	SCUDO (270) (07-)
				ULYSSE (02-11)
			FORD	C-MAX I (07-10)
		FOCUS C-MAX (03-07)		
		FOCUS II (04-12)		
		GALAXY (06-15)		
		KUGA I (08-12)		
		MONDEO IV (07-15)		
		S-MAX (06-14)		
		LANCIA	PHEDRA (02-10)	
		PEUGEOT	307 (00-)	
			308 CC (07-)	
			308 I (07-)	
			406 (95-04)	
			406 Coupe (97-04)	
			407 (04-)	
			407 Coupe (05-)	
			508 I (10-)	
			607 (00-)	
			807 (02-)	
			BOXER (02-)	
			EXPERT (96-06)	
			EXPERT (07-)	
			VOLVO	C30 (06-12)
C70 II (06-13)				
S40 II (04-12)				
S80 II (06-)				
V50 (04-12)				
V70 III (07-)				
DG-182	-	LAND ROVER	DEFENDER (90-16)	
			DISCOVERY II (98-04)	
DG-183	-	VW	LT 28-35 II (2D) (96-06)	
			LT 28-46 II (2D) (96-06)	
DG-184	-	SMART	CABRIO (450) (00-04)	
			CITY-Coupe (450) (98-04)	
			FORTWO (450) (04-07)	
			FORTWO (451) (07-)	
DG-186	-	ISUZU	TROOPER III (98-04)	
		OPEL	MONTEREY B (98-99)	
		VAUXHALL	MONTEREY II (98-99)	
DG-187	-	MITSUBISHI	PAJERO III (00-07)	
DG-188	-	SSANGYONG	ACTYON I (05-)	
			ACTYON Sports I (07-)	
			KYRON (05-)	
			REXTON (02-)	
			RODIUS I (05-)	
			STAVIC (05-)	
DG-189	-	HYUNDAI	H-1 / STAREX (97-07)	
			H-1 (08-)	
			PORTER (94-04)	
		KIA	SORENTO I (02-)	
DG-190	-	AUDI	A3 (8P) (03-13)	
			A4 (8E, B7) (04-08)	
			A6 (4F, C6) (04-11)	
		CHRYSLER	SEBRING (07-10)	
		DODGE	AVENGER (07-14)	

Свечи зажигания и Свечи накаливания

Руководство покупателя

DENSO P/N	TT	MAKE	MODEL		
DG-190 продолжение		JEEP	CALIBER (06-)		
			JOURNEY (08-)		
			MITSUBISHI	CHEROKEE (KL) (13-)	
				COMPASS (06-)	
		PATRIOT (07-)			
		SEAT	GRANDIS (04-11)		
			LANCER VIII (07-)		
			OUTLANDER II (06-12)		
		SKODA	ALTEA (XL) (5P) (04-)		
			LEON (1P) (05-12)		
			TOLEDO III (5P) (04-09)		
		VW	OCTAVIA II (1Z) (04-13)		
			SUPERB II (3T) (08-15)		
			GOLF Plus (5M, 521) (05-14)		
			GOLF V (1K) (03-09)		
			JETTA III (1K2) (05-10)		
			TOURAN (1T1, 1T2) (03-10)		
			7 (E65, E66) (01-08)		
		DG-191	-	BMW	C-CLASS (203) (00-07)
		DG-192	-	MERCEDES-BENZ	C-CLASS Coupe (CL203) (01-08)
DG-193	-	AUDI	A1 (8X) (10-18)		
			A3 (8P) (03-13)		
			A3 (8V) (12-)		
			A3 Convertible (8P7) (08-13)		
			A3 Convertible (8V7) (13-)		
			A4 (8E, B7) (04-08)		
			A4 (8K, B8) (07-15)		
			A4 (8W, B9) (15-)		
			A4 Allroad (8KH) (09-16)		
			A4 Allroad (8WH) (16-)		
			A4 Convertible (8H, B6, B7) (02-09)		
			A5 (8T, 8F) (07-17)		
			A5 (F5) (16-)		
			A6 (4F, C6) (04-11)		
			A6 (4G, C7) (10-18)		
			A6 Allroad (4FH) (06-11)		
			A6 Allroad (4GH) (12-18)		
			A7 (4GA) (10-18)		
			A8 (4E) (02-10)		
			A8 (4H) (09-18)		
			Q3 (8U) (11-18)		
			Q5 (8R) (08-)		
			Q7 (4L) (06-15)		
			Q7 (4M) (15-)		
			TT (8J) (06-14)		
			TT (FV) (14-)		
			MAN	TGE (16-)	
			PORSCHE	CAYENNE (92A) (10-)	
				CAYENNE (955) (02-10)	
				MACAN (14-)	
			SEAT	PANAMERA (970) (09-)	
				ALHAMBRA (710) (10-)	
				ALTEA (XL) (5P) (04-)	
		ATECA (KH7) (16-)			
		EXEO (3R) (08-)			
		IBIZA IV (6J, 6P) (08-)			
		LEON (1P) (05-12)			
		LEON (5F) (12-)			
		TOLEDO III (5P) (04-09)			
		TOLEDO IV (KG3) (12-)			
		SKODA	FABIA II (06-14)		
			FABIA III (NJ) (14-)		
			OCTAVIA II (1Z) (04-13)		
			OCTAVIA III (5E) (12-)		
			RAPID (HN) (12-)		
			ROOMSTER (5J) (06-15)		
			SUPERB II (3T) (08-15)		
			SUPERB III (3V) (15-)		
			YETI (5L) (09-)		
			VW	AMAROK (2H, S1) (10-)	
		BEETLE (5C) (11-)			

DENSO P/N	TT	MAKE	MODEL		
DG-193 продолжение			CADDY III (2K, 2C) (04-15)		
			CADDY IV (SA) (15-)		
			CC (358) (11-)		
			CRAFTER 30-50 (2E, 2F) (06-16)		
			CRAFTER (16-)		
			EOS (1F) (06-15)		
			GOLF Plus (5M, 521) (05-14)		
			GOLF Sportsvan (AM1) (14-)		
			GOLF V (1K) (03-09)		
			GOLF VI (5K, AJ5) (08-14)		
			GOLF VI Convertible (517) (11-16)		
			GOLF VII (5G, BA5) (12-)		
			JETTA III (1K2) (05-10)		
			JETTA IV (162) (10-)		
			MULTIVAN V (7H, 7E) (03-)		
			MULTIVAN VI (SG) (15-)		
			PASSAT (3C) (05-11)		
			PASSAT (3G) (14-)		
			PASSAT (362, 365) (10-14)		
			PASSAT CC (357) (08-12)		
DG-194	-	CHRYSLER	PHAETON (3D) (02-16)		
			POLO (6R, 6C) (09-)		
			SCIROCCO (137, 138) (08-17)		
			SHARAN (7N) (10-)		
			TIGUAN (5N) (07-)		
			TIGUAN (AD) (16-)		
			TOUAREG (7L) (02-10)		
			TOUAREG (7P) (10-18)		
			TOURAN (1T3) (10-15)		
			TOURAN (5T) (15-)		
		TRANSPORTER V (7H, 7E, 7J) (03-15)			
		TRANSPORTER VI (SF, SG) (15-)			
		JEEP	300 C (04-12)		
			COMMANDER (05-10)		
			Grand CHEROKEE II (98-05)		
			Grand CHEROKEE III (05-10)		
			MERCEDES-BENZ	A-CLASS (W169) (04-12)	
				B-CLASS (W245) (05-11)	
				C-CLASS (203) (00-07)	
				C-CLASS (204) (07-14)	
CLK (209) (02-10)					
CLS (C219) (04-10)					
E-CLASS (211) (02-09)					
E-CLASS (212) (09-)					
G-CLASS (W461) (90-)					
GL-CLASS (X164) (06-)					
GLK (X204) (08-15)					
M-CLASS (W164) (05-11)					
R-CLASS (251) (06-)					
S-CLASS (W221) (05-13)					
SPRINTER 3,5-t (906) (06-)					
SPRINTER 3-t (906) (06-)					
SPRINTER 4,6-t (906) (06-)					
SPRINTER 5-t (906) (06-)					
VIANO (W639) (03-)					
VITO / MIXTO (W639) (03-)					
DG-195	-	CITROËN	JUMPER (06-)		
			FIAT	DUCATO (244) (02-)	
		IVECO	DUCATO (250, 290) (06-)		
			DAILY III (97-06)		
			DAILY IV (06-11)		
			DAILY V (11-14)		
			MASSIF (08-11)		
			PEUGEOT	BOXER (06-)	
		DG-196	-	ALFA ROMEO	147 (00-10)
					FIAT
OPEL	CROMA (05-)				
	DOBLO (01-)				
	SEDICI (06-14)				
	STILO (01-08)				
ASTRA H (04-14)					

Свечи зажигания и Свечи накаливания

Руководство покупателя

DENSO P/N	TT	MAKE	MODEL	
DG-196			SIGNUM (03-)	
продолжение			VECTRA C (02-08)	
			ZAFIRA B (05-14)	
		SAAB	9-3 (02-15)	
		SUZUKI	SX4 (06-)	
		VAUXHALL	ASTRA V (H) (04-10)	
			SIGNUM (02-08)	
			VECTRA II (C) (00-08)	
			ZAFIRA II (B) (05-14)	
DG-197	-	NISSAN	ALMERA II (00-)	
			ALMERA TINO (00-)	
			CABSTAR (F24) (06-13)	
			NAVARA (D22) (97-)	
			NAVARA (D40) (05-)	
			PATHFINDER III (05-)	
			PICK UP (D22) (97-05)	
			PRIMERA (P12) (02-)	
			SERENA (99-05)	
			X-TRAIL (T30) (01-13)	
DG-198	-		ALFA ROMEO	GIULIETTA (77-85)
			LTI	TX (97-)
		MITSUBISHI	COLT II (84-88)	
			COLT III (88-92)	
			GALANT III (84-90)	
			GALANT IV (87-92)	
			L 400 / SPACE GEAR (95-05)	
			LANCER III (83-92)	
			LANCER IV (88-94)	
			SPACE WAGON (83-92)	
			SPACE WAGON (91-98)	
			NISSAN	PATHFINDER II (97-04)
				PATROL GR I (87-98)
				PICK UP (D21) (85-98)
		PICK UP (D22) (97-05)		
			URVAN (81-98)	
DG-202	-	ALFA ROMEO	33 (83-93)	
			33 (90-94)	
			75 (85-92)	
			90 (84-87)	
			164 (87-98)	
			ALFETTA (74-84)	
			AR 6 (79-89)	
		LAND ROVER	RANGE ROVER I (70-95)	
		ROVER	2000-3500 (76-86)	
DG-213	-	TOYOTA	CRESSIDA (80-93)	
DG-215	-	TOYOTA	CRESSIDA (80-93)	
			DYNA 150 (85-88)	
			DYNA (77-87)	
			HIACE I (77-85)	
			HIACE II (83-89)	
			HILUX II (83-05)	
			LAND CRUISER / PRADO (J70) (84-06)	
			STARLET (P7) (84-89)	
DG-216	-	DAIHATSU	CHARADE III (87-93)	
		TOYOTA	CARINA E (92-97)	
			CARINA II (83-92)	
			COROLLA (E9) (87-93)	
			COROLLA (E10) (92-99)	
			CORONA (T17) (87-92)	
			LITEACE (84-92)	
			LITEACE (92-97)	
			TOWN ACE (92-01)	
DG-222	-	DAIHATSU	DELTA (84-87)	
			DELTA Wide (84-99)	
		TOYOTA	DYNA 200 (88-95)	
			DYNA 200 (95-01)	
			DYNA 300 (95-02)	
			LAND CRUISER (J40) (69-86)	
			LAND CRUISER (J60) (81-89)	
			LAND CRUISER / PRADO (J70) (84-06)	
DG-224	-	TOYOTA	LAND CRUISER (J40) (69-86)	

DENSO P/N	TT	MAKE	MODEL	
DG-228	-	TOYOTA	HEAVY DUTY TRUCK (69-01)	
DG-231	-	TOYOTA	HEAVY DUTY TRUCK (69-01)	
DG-232	-	TOYOTA	CARINA II (83-92)	
			COROLLA (E8) (83-89)	
			DYNA 150 (88-95)	
			LITEACE (79-86)	
DG-233	-	TOYOTA	LAND CRUISER (J40) (69-86)	
			LAND CRUISER (J60) (81-89)	
DG-234	-	DAIHATSU	TAFT (76-85)	
DG-235	-	TOYOTA	LAND CRUISER (J100) (98-08)	
			LAND CRUISER / PRADO (J70) (84-06)	
DG-238	-	TOYOTA	TOYOACE (79-95)	
DG-240	-	MINI	MINI (R50, R53) (01-06)	
		SUBARU	TREZIA (11-)	
		TOYOTA	AURIS (E15) (06-12)	
			COROLLA (E12) (01-07)	
			COROLLA (E14, E15) (06-)	
			YARIS (99-05)	
			YARIS (05-11)	
			YARIS VERSO (99-05)	
DG-241	-	TOYOTA	DYNA (77-87)	
DG-245	-	TOYOTA	AVENSIS (97-03)	
			AVENSIS (03-09)	
			AVENSIS Verso (01-09)	
			COROLLA (E11) (97-02)	
			COROLLA (E12) (01-07)	
			COROLLA Verso (01-09)	
			DYNA (01-)	
			FORTUNER (04-15)	
			HIACE IV (95-)	
			HIACE V (05-)	
			HILUX II (83-05)	
			HILUX III (05-)	
			LAND CRUISER / PRADO (J120) (02-10)	
			LAND CRUISER / PRADO (J150) (10-)	
			LAND CRUISER / PRADO / COLORADO (J90) (95-)	
			PREVIA / ESTIMA II (00-06)	
		RAV 4 II (00-05)		
DG-300	-	OPEL	ASTRA F (91-01)	
			COMBO B (94-01)	
			CORSA B (93-02)	
			VECTRA A (88-95)	
			VECTRA B (95-03)	
		VAUXHALL	ASTRA III (F) (91-01)	
			CAVALIER III (88-95)	
			COMBO I (B) (94-01)	
			CORSA I (B) (93-00)	
			VECTRA I (B) (95-03)	
DG-301	-	HYUNDAI	TERRACAN (01-06)	
		KIA	PREGIO (95-)	
		MITSUBISHI	GALLOPER (98-03)	
		PROTON	PERSONA 400 (94-03)	
DG-302	-	HONDA	CIVIC VII (00-05)	
		OPEL	ASTRA G (98-09)	
			ASTRA H (04-14)	
			ASTRA J (09-)	
			COMBO C (01-)	
			CORSA C (00-09)	
			CORSA D (06-14)	
			MERIVA A (03-10)	
			MERIVA B (10-)	
			ZAFIRA B (05-14)	
			VAUXHALL	ASTRA IV (G) (98-06)
				ASTRA V (H) (04-10)
				ASTRA VI (J) (09-)
				COMBO II (C) (01-12)
				CORSA II (C) (00-06)
				CORSA III (D) (06-)
		MERIVA I (A) (03-10)		
		MERIVA II (B) (10-)		
		ZAFIRA II (B) (05-14)		

Свечи зажигания и Свечи накаливания

Руководство покупателя

DENSO P/N	TT	MAKE	MODEL
DG-308	-	TOYOTA	PREVIA / ESTIMA I (90-00)
DG-502	-	MAZDA	5 (05-10)
			6 (02-07)
			323 F VI (98-04)
			323 P V (96-98)
			323 S V (94-98)
			323 S VI (98-04)
			626 V (97-02)
			MPV II (99-06)
			PREMACY (99-05)
DG-600	-	LEXUS	IS II (05-13)
		TOYOTA	AURIS (E15) (06-12)
			AURIS (E18) (12-)
			AVENSIS (03-09)
			AVENSIS (08-)
			COROLLA (E14, E15) (06-)
			COROLLA Verso (01-09)
			LAND CRUISER (J200) (07-)
			RAV 4 III (05-)
			RAV 4 IV (12-)
			VERSO (09-)
DG-601	-	HONDA	ACCORD VII (03-08)
			ACCORD VIII (08-)
			CIVIC IX (12-)
			CIVIC VIII Hatchback (05-)
			CR-V II (01-06)
			CR-V III (06-)
			CR-V IV (12-)
			FR-V (04-)
			HR-V (15-)
DG-602	-	HYUNDAI	ACCENT III (05-10)
			ELANTRA (05-11)
			ELANTRA (11-)
			GETZ (02-09)
			i10 (07-13)
			i20 (08-15)
			i30 (07-12)
			i30 (11-)
			i30 Coupe (13-)
			ix20 (10-)
			MATRIX (01-10)
		KIA	CARENS III (06-)
			CEED (06-12)
			CEED (12-)
			CERATO (04-)
			PICANTO (04-)
			PRO CEED (08-13)
			PRO CEED (13-)
			RIO II (05-)
			RIO III (11-)
			SOUL I (09-)
			SOUL II (14-)
			VENGA (10-)
DG-603	-	CITROËN	BERLINGO (B9) (08-)
			C3 II (09-)
			C3 Picasso (09-)
			C4 (Grand Picasso I) (06-13)
			C4 (Grand Picasso II) (13-)
			C4 Aircross (12-)
			C4 Cactus (14-)
			C4 II (B7, NC) (09-)
			C5 III (08-)
			C8 (02-)
			C-ELYSEE (12-)
			DS3 (09-15)
			DS4 (11-15)
			DS5 (11-15)
			JUMPER (06-)
			JUMPY (07-)
			JUMPY (16-)
			SPACETOURER (16-)

DENSO P/N	TT	MAKE	MODEL
DG-603		DS	DS3 (15-)
продолжение			DS4 (Crossback) (15-)
			DS5 (15-)
		FIAT	SCUDO (270) (07-)
		FORD	B-MAX (12-)
			C-MAX II (10-)
			ECOSPORT (12-)
			FIESTA VI (08-)
			FOCUS III (10-)
			GALAXY (06-15)
			GALAXY (15-)
			Grand C-MAX (10-)
			KUGA II (12-)
			MONDEO IV (07-15)
			MONDEO V (14-)
			S-MAX (06-14)
			TOURNEO Connect (13-)
			TOURNEO Courier (14-)
			TRANSIT Connect (13-)
			TRANSIT Courier (14-)
		MAZDA	2 (07-15)
			5 (10-)
		MITSUBISHI	ASX (10-)
		PEUGEOT	207 (06-)
			208 I (12-)
			301 (12-)
			308 CC (07-)
			308 I (07-)
			308 II (13-)
			407 (04-)
			407 Coupe (05-)
			508 I (10-)
			807 (02-)
			2008 (13-)
			3008 (09-)
			3008 SUV (16-)
			4008 (12-)
			5008 I (09-)
			BOXER (06-)
			EXPERT (96-06)
			EXPERT (07-)
			EXPERT (16-)
			PARTNER / RANCH (08-)
			RCZ (10-)
			TRAVELLER (16-)
		TOYOTA	PROACE (13-16)
		VOLVO	C30 (06-12)
			S40 II (04-12)
			S60 II (10-)
			S80 II (06-)
			V40 (12-)
			V50 (04-12)
			V60 I (10-)
			V70 III (07-)
DG-604	-	CHEVROLET	CAPTIVA (06-)
			CRUZE (09-)
			EPICA (05-)
			LACETTI (05-)
			NUBIRA (05-11)
		OPEL	ANTARA (06-)
		VAUXHALL	ANTARA (06-)
DG-605	-	NISSAN	PATROL GR II (97-)
			TERRANO II (92-07)
		OPEL	MOVANO A (98-)
		RENAULT	MASTER II (98-)
		RENAULT TRUCKS	MASCOTT (99-13)
DG-606	-	MITSUBISHI	COLT VI (04-12)
		SMART	FORFOUR I (454) (04-06)
DG-607	-	MINI	MINI (R56) (06-13)
			MINI Clubman (R55) (07-14)
			MINI Convertible (R57) (07-15)

Свечи зажигания и Свечи накаливания

Руководство покупателя

DENSO P/N	TT	MAKE	MODEL
DG-607			MINI Countryman (R60) (10-16)
продолжение			MINI Coupe (R58) (10-15)
			MINI Paceman (R61) (12-16)
			MINI Roadster (R59) (11-15)
DG-608	-	ALFA ROMEO	159 (05-11)
			BRERA (06-10)
			GIULIETTA (10-)
			MITO (08-)
			SPIDER (06-10)
		CADILLAC	BLS (06-)
		CHRYSLER	DELTA (11-)
		FIAT	500L (12-)
			500X (14-)
			BRAVO II (06-14)
			DOBLO (10-)
			DUCATO (250, 290) (06-)
			FREEMONT (11-)
			Grande PUNTO (05-)
			IDEA (03-)
			LINEA (07-)
			PUNTO Evo (08-12)
			SEDICI (06-14)
			TIPO (356) (15-)
		JEEP	RENEGADE (14-)
		LANCIA	DELTA III (08-14)
			MUSA (04-12)
		OPEL	ASTRA J (09-)
			COMBO D (12-)
			INSIGNIA (A) (08-17)
			ZAFIRA Tourer C (11-)
		SAAB	9-3 (02-15)
			9-3X (09-12)
			9-5 (97-09)
			9-5 (10-12)
		SUZUKI	SX4 (06-)
			SX4 S-Cross (13-)
			VITARA (15-)
		VAUXHALL	ASTRA VI (J) (09-)
			COMBO III (D) (11-)
			INSIGNIA I (A) (08-17)
			ZAFIRA III (C) (11-)
DG-609	-	DACIA	DOKKER (12-)
			DUSTER (10-)
			LOGGY (12-)
			LOGAN I (04-)
			LOGAN II (12-)
			LOGAN MCV I (07-)
			LOGAN MCV II (13-)
			SANDERO I (Stepway) (08-)
			SANDERO II (Stepway) (12-)
		INFINITI	Q30 (15-)
		MERCEDES-BENZ	A-CLASS (W176) (12-)
			B-CLASS (W242, W246) (11-)
			CITAN (415) (12-)
			CLA Coupe (C117) (13-)
			CLA Shooting Brake (X117) (15-)
			GLA (X156) (13-)
		NISSAN	CUBE (10-)
			JUKE (10-)
			NOTE (E11) (06-12)
			NOTE (E12) (13-)
			NV200 (10-)
			PULSAR (C13) (12-)
			QASHQAI I (+2) (07-13)
			QASHQAI II (13-)
		RENAULT	CAPTUR (13-)
			CLIO III (05-)
			CLIO IV (12-)
			FLUENCE (10-)
			Grand SCÉNIC III (09-)
			KADJAR (15-)

DENSO P/N	TT	MAKE	MODEL
DG-609			KANGOO (08-)
продолжение			LAGUNA III (07-)
			LATITUDE (10-)
			MEGANE CC (10-)
			MEGANE III (08-)
			MODUS (04-)
			SCÉNIC III (09-)
			THALIA II (08-)
			THALIA III (13-)
			TWINGO II (07-)
DG-610	-	VOLVO	C30 (06-12)
			C70 II (06-13)
			S40 II (04-12)
			S60 I (00-10)
			S80 II (06-)
			V50 (04-12)
			V70 II (00-07)
			V70 III (07-)
			XC60 I (08-)
			XC70 II (07-)
			XC90 I (02-14)
DG-611	-	CITROËN	JUMPER (06-)
		FORD	RANGER (11-)
			TOURNEO Custom (12-)
			TRANSIT (06-14)
			TRANSIT (13-)
			TRANSIT Custom (12-)
		LAND ROVER	DEFENDER (90-16)
		PEUGEOT	BOXER (06-)
DG-613	-	ALPINA	D3 (E90) (05-11)
			D3 (E91) (05-12)
			D3 (E92) (10-14)
			D3 (F30) (14-)
			D3 (F31) (14-19)
			D4 (F32, F33) (14-)
			D5 (F10, F11) (11-16)
			XD3 (F25) (13-18)
		BMW	1 (E81, E87) (03-12)
			1 (F20, F21) (10-)
			1 Coupe/Convertible (E82, E88) (07-13)
			2 Active Tourer (F45) (14-)
			2 Coupe/Convertible (F22, F23) (13-)
			2 Gran Tourer (F46) (15-)
			3 (E90, E91) (05-12)
			3 (F30, F31) (11-19)
			3 Coupe/Convertible (E92, E93) (06-13)
			3 Gran Turismo (F34) (13-)
			4 Coupe/Convertible (F32, F33) (13-)
			4 Gran Coupe (F36) (14-)
			5 (E60, E61) (03-10)
			5 (F10, F11) (10-16)
			5 (G30, G31) (16-)
			5 Gran Turismo (F07) (09-17)
			6 Coupe/Convertible (F12, F13) (10-18)
			6 Gran Coupe (F06) (11-18)
			7 (F01, F02, F03, F04) (08-15)
			7 (G11, G12) (15-)
			X1 (E84) (09-15)
			X1 (F48) (15-)
			X3 (E83) (04-11)
			X3 (F25) (10-17)
			X4 (F26) (14-18)
			X5 (E70) (07-13)
			X5 (F15) (12-18)
			X6 (E71, E72) (08-14)
			X6 (F16) (14-19)
		MINI	MINI (F55, F56) (13-)
			MINI Clubman (F54) (14-)
			MINI Convertible (F57) (14-)
			MINI Countryman (F60) (16-)
		TOYOTA	AURIS (E18) (12-)

Свечи зажигания и Свечи накаливания

Руководство покупателя

DENSO P/N	TT	MAKE	MODEL
DG-613			AVENSIS (08-)
продолжение			RAV 4 IV (12-)
			VERSO (09-)
DG-614	-	CITROËN	C5 II (04-)
			C5 III (08-)
			C6 (05-14)
			C8 (02-)
			C-CROSSER (07-)
		FORD	GALAXY (06-15)
			MONDEO IV (07-15)
			S-MAX (06-14)
		LANCIA	PHEDRA (02-10)
		LAND ROVER	FREELANDER II (06-14)
		MITSUBISHI	OUTLANDER II (06-12)
		PEUGEOT	407 (04-)
			607 (00-)
			807 (02-)
			4007 (07-)
		TATA	SAFARI (98-)
			XENON (09-)
DG-615	-	SUBARU	FORESTER (08-)
			IMPREZA (08-)
			LEGACY IV (03-09)
			LEGACY V (09-14)
			OUTBACK (03-09)
			OUTBACK (09-)
DG-616	-	MERCEDES-BENZ	C-CLASS (204) (07-14)
			E-CLASS (211) (02-09)
DG-617	-	MERCEDES-BENZ	A-CLASS (W176) (12-)
			B-CLASS (W242, W246) (11-)
			C-CLASS (204) (07-14)
			C-CLASS (205) (13-)
			C-CLASS Coupe (C204) (11-)
			C-CLASS Coupe / Convertible (205) (16-)
			CLA Coupe (C117) (13-)
			CLS (218) (11-)
			E-CLASS (212) (09-)
			E-CLASS Coupe / Convertible (207) (09-)
			G-CLASS (W461) (90-)
			G-CLASS (W463) (89-)
			GLC (X253) (15-)
			GLC Coupe (C253) (16-)
			GL-CLASS (X164) (06-)
			GLE (W166) (15-)
			GLK (X204) (08-15)
			M-CLASS (W164) (05-11)
			M-CLASS (W166) (11-15)
			R-CLASS (251) (06-)
			S-CLASS (222) (13-)
			S-CLASS (W221) (05-13)
			SLC (R172) (16-)
			SLK (R172) (11-)
			SPRINTER 3,5-t (906) (06-)
			SPRINTER 3-t (906) (06-)
			SPRINTER 4,6-t (906) (06-)
			SPRINTER 5-t (906) (06-)
			V-CLASS (14-)
			VIANO (W639) (03-)
			VITO (W447) (14-)
			VITO / MIXTO (W639) (03-)
DG-619	-	RENAULT	Grand SCÉNIC III (09-)
			MEGANE CC (10-)
			MEGANE III (08-)
			SCÉNIC III (09-)
		SUZUKI	Grand VITARA II (05-)
DG-620	-	CHRYSLER	300 C (11-)
		JEEP	Grand CHEROKEE IV (10-)
		LANCIA	THEMA (11-)
		RAM	1500 (DS) (10-)
		VOLVO	C30 (06-12)
			C70 II (06-13)

DENSO P/N	TT	MAKE	MODEL
DG-620			S40 II (04-12)
продолжение			S60 II (10-)
			S80 II (06-)
			S90 II (16-)
			V40 (12-)
			V50 (04-12)
			V60 I (10-)
			V70 III (07-)
			V90 II (16-)
			XC60 I (08-)
			XC70 II (07-)
			XC90 I (02-14)
			XC90 II (14-)
DG-621	-	ALFA ROMEO	MITO (08-)
		CHEVROLET	AVEO (T300) (11-)
		CHRYSLER	YPSILON (846) (11-)
		CITROËN	NEMO (08-)
		FIAT	500 (C) (312) (07-)
			500L (12-)
			DOBLO (10-)
			FIORINO (07-)
			Grande PUNTO (05-)
			IDEA (03-)
			PANDA (12-)
			PUNTO (12-)
			PUNTO Evo (08-12)
			QUBO (08-)
			STRADA (99-)
			STRADA (10-)
		FORD	KA (08-)
		LANCIA	MUSA (04-12)
			YPSILON (312/846) (11-)
			YPSILON (843) (03-11)
		OPEL	ASTRA J (09-)
			COMBO D (12-)
			CORSA D (06-14)
			MERIVA B (10-)
		PEUGEOT	BIPPER (08-)
		SUZUKI	IGNIS II (03-)
			SPLASH (08-)
			SWIFT III (05-)
			SWIFT IV (10-)
			WAGON R+ (00-)
		VAUXHALL	ASTRA VI (J) (09-)
			COMBO III (D) (11-)
			CORSA III (D) (06-)
			MERIVA II (B) (10-)
DG-622	-	AUDI	A3 (8P) (03-13)
			A4 (8E, B7) (04-08)
			A6 (4F, C6) (04-11)
		MITSUBISHI	GRANDIS (04-11)
		SEAT	ALTEA (XL) (5P) (04-)
			LEON (1P) (05-12)
			TOLEDO III (5P) (04-09)
		SKODA	OCTAVIA II (1Z) (04-13)
		VW	GOLF V (1K) (03-09)
			JETTA III (1K2) (05-10)
			PASSAT (3C) (05-11)
			TOURAN (1T1, 1T2) (03-10)
DG-624	-	HYUNDAI	ix35 (09-)
			SANTA FÉ II (06-12)
		KIA	SORENTO II (09-)
			SPORTAGE III (10-)
DG-625	-	CHEVROLET	CRUZE (09-)
			TRAX (12-)
		OPEL	ASTRA J (09-)
			MERIVA B (10-)
			MOKKA (12-)
		VAUXHALL	ASTRA VI (J) (09-)
			CORSA III (D) (06-)
			MERIVA II (B) (10-)

Свечи зажигания и Свечи накаливания

Руководство покупателя

DENSO P/N	TT	MAKE	MODEL
DG-625			MOKKA (12-)
продолжение			
DG-626	-	ASIA MOTORS	HI-TOPIC (93-99)
		FORD	MAVERICK (93-98)
		NISSAN	CABSTAR (F22) (82-93)
			CABSTAR (F23) (92-00)
			PICK UP (D22) (97-05)
			TERRANO II (92-07)
DG-627	-	MAZDA	3 (00-09)
			3 (09-14)
			6 (07-13)
			CX-7 (07-14)
DG-628	-	SEAT	CORDOBA (6L) (02-09)
			IBIZA III (6L) (02-09)
			LEON (1M) (99-06)
			TOLEDO II (1M) (99-06)
		SKODA	FABIA I (6Y) (99-08)
		VW	BORA (1J) (98-05)
			CADDY II (9K, 9U) (95-04)
			GOLF III (1H, 1E) (91-99)
			GOLF IV (1J, 1E) (97-06)
			NEW BEETLE (9C, 1C, 1Y) (98-10)
			PASSAT (3B2, 3B5) (96-01)
			POLO (9N) (01-09)
			POLO Classic (6KV) (95-02)
			POLO Variant (6V5) (97-01)
			SHARAN (7M) (95-10)
			VENTO (1H2) (91-98)
DG-629	-	ALFA ROMEO	147 (00-10)
			159 (05-11)
			BRERA (06-10)
DG-630	-	FORD	RANGER (06-12)
		MAZDA	BT-50 (06-)
DG-631	-	MERCEDES-BENZ	C-CLASS (205) (13-)
			VITO (W447) (14-)
		NISSAN	CABSTAR (F24) (06-13)
			MURANO II (07-14)
			NAVARA (D40) (05-)
			NT400 Cabstar (14-)
			PATHFINDER III (05-)
			QASHQAI I (+2) (07-13)
			QASHQAI II (13-)
			X-TRAIL (T32) (13-)
		OPEL	VIVARO A (01-)
			VIVARO B (14-)
		RENAULT	ESPACE V (15-)
			FLUENCE (10-)
			Grand SCÉNIC III (09-)
			KADJAR (15-)
			MASTER III (10-)
			MEGANE CC (10-)
			MEGANE III (08-)
			MEGANE IV (15-)
			SCÉNIC III (09-)
			TALISMAN (15-)
			TRAFIC II (01-)
			TRAFIC III (14-)
		VAUXHALL	VIVARO (B) (14-)
DG-632	-	CITROËN	C5 III (08-)
		JAGUAR	XF (08-15)
		LAND ROVER	DISCOVERY Sport (14-)
			FREELANDER II (06-14)
			RANGE ROVER Evoque (11-)
		PEUGEOT	508 I (10-)
DG-633	-	CHRYSLER	Grand VOYAGER V (07-)
			VOYAGER IV (00-08)
		DODGE	NITRO (06-12)
		JEEP	CHEROKEE / LIBERTY (KJ) (01-08)
			CHEROKEE / LIBERTY (KK) (08-)
			WRANGLER III (07-)
DG-634	-	OPEL	ASTRA J (09-)

DENSO P/N	TT	MAKE	MODEL
DG-634			ASTRA K (15-)
продолжение			COMBO D (12-)
			INSIGNIA (A) (08-17)
			MERIVA B (10-)
			MOKKA (12-)
			ZAFIRA Tourer C (11-)
		VAUXHALL	ASTRA VI (J) (09-)
			ASTRA VII (K) (15-)
			INSIGNIA I (A) (08-17)
			MERIVA II (B) (10-)
			MOKKA (12-)
			ZAFIRA III (C) (11-)
DG-635	-	ISUZU	D-MAX I (02-12)
			KB (02-)
DG-642	-	NISSAN	ALMERA I (95-00)
			AVENIR (86-97)
			PRIMERA (P10) (90-98)
			PRIMERA (P11) (96-02)
			SUNNY III (90-00)
DG-643	-	MITSUBISHI	GALANT V (96-04)
			L 200 (96-07)
			PAJERO II (90-00)
			PAJERO Sport I (97-)
		NISSAN	PATROL GR II (97-)
DG-644	-	NISSAN	BLUEBIRD (85-92)
			LAUREL (84-89)
			SERENA (92-01)
			SUNNY II (86-91)
			SUNNY III (90-00)
			TRADE (93-98)
			VANETTE (C22) (86-95)
			VANETTE Cargo (C23) (94-02)
DG-645	-	MAZDA	323 C IV (89-00)
			323 III (85-95)
			323 S IV (89-94)
			323 S V (94-98)
DG-646	-	OPEL	SIGNUM (03-)
			VECTRA C (02-08)
		RENAULT	ESPACE IV (02-)
			VEL SATIS (02-)
		SAAB	9-5 (97-09)
		VAUXHALL	SIGNUM (02-08)
			VECTRA II (C) (00-08)
DG-647	-	TOYOTA	CROWN (80-85)
			HIACE I (77-85)
			HIACE II (83-89)
			HILUX II (83-05)
DG-648	-	TOYOTA	4 RUNNER (N10) (89-96)
			DYNA 150 (88-95)
			DYNA 150 (95-01)
			DYNA (87-01)
			DYNA (01-)
			HIACE I (77-85)
			HIACE III (87-04)
			HIACE IV (95-)
			HILUX II (83-05)
			LAND CRUISER (J80) (90-98)
			LAND CRUISER (J100) (98-08)
			LAND CRUISER / PRADO (J70) (84-06)
			LAND CRUISER / PRADO (J120) (02-10)
			STARLET (P8) (89-96)
			TOYOACE (79-95)
		VW	TARO (89-97)
DG-649	-	TOYOTA	AVENSIS (97-03)
			CAMRY (V2) (86-91)
			CARINA E (92-97)
			COROLLA (E10) (92-99)
			COROLLA (E11) (97-02)
			COROLLA FX (84-88)
			LAND CRUISER (J80) (90-98)
			LITEACE (84-92)

Свечи зажигания и Свечи накаливания

Руководство покупателя

DENSO P/N	TT	MAKE	MODEL
DG-649			LITEACE (92-97)
продолжение			MASTER ACE Surf (85-99)
			TOWN ACE (85-91)
DG-651	-	TOYOTA	COASTER (82-93)
			COASTER (93-)
			LAND CRUISER (J60) (81-89)
			LAND CRUISER (J80) (90-98)
			LAND CRUISER / PRADO (J70) (84-06)
DG-652	-	DAIHATSU	CHARADE II (83-87)
			DELTA Wide (84-99)
			ROCKY (85-98)
			RUGGER (84-93)
			TAFT (76-85)
			WILDCAT / ROCKY (85-87)
		TOYOTA	CAMRY (V1) (83-88)
			CARINA (73-83)
			CARINA II (83-92)
			COROLLA (E7) (79-87)
			COROLLA (E8) (83-89)
			COROLLA FX (84-88)
			LITEACE (84-92)
			MODELL F (82-90)
DG-653	-	CHEVROLET	CAPTIVA (06-)
			CRUZE (09-)
			ORLANDO (11-)
		OPEL	ANTARA (06-)
		VAUXHALL	ANTARA (06-)
DG-655	-	MITSUBISHI	L 200 / TRITON (05-15)
			PAJERO Classic (02-)
			PAJERO IV (06-)
			PAJERO Sport II (08-)
DG-656	-	CITROËN	C4 Aircross (12-)
		FIAT	FULLBACK (16-)
		MITSUBISHI	ASX (10-)
			L 200 / TRITON (14-)
			LANCER VIII (07-)
			OUTLANDER II (06-12)
			OUTLANDER III (12-)
			PAJERO Sport III (15-)
		PEUGEOT	4008 (12-)
DG-657	-	HYUNDAI	ACCENT IV / SOLARIS (10-)
			H-1 (08-)
			H350 (15-)
			i20 (08-15)
			i30 (07-12)
			i30 (11-)
			i30 Coupe (13-)
			i40 (11-)
			ix35 (09-)
			PORTER (04-)
			TUCSON (15-)
		KIA	BONGO (03-)
			CARENS IV (13-)
			CEED (12-)
			K2500 (03-)
			OPTIMA (10-)
			OPTIMA (15-)
			PRO CEED (13-)
			SOUL I (09-)
			SPORTAGE III (10-)
			SPORTAGE IV (15-)
DG-658	-	ALFA ROMEO	MITO (08-)
		CITROËN	NEMO (08-)
		FIAT	500 (C) (312) (07-)
			500L (12-)
			500X (14-)
			FIORINO (07-)
			Grande PUNTO (05-)
			PANDA (12-)
			PUNTO (12-)
			PUNTO Evo (08-12)

DENSO P/N	TT	MAKE	MODEL
DG-658			QUBO (08-)
продолжение			STRADA (99-)
			STRADA (10-)
			TIPO (356) (15-)
		LANCIA	YPSILON (312/846) (11-)
		OPEL	COMBO D (12-)
			CORSA E (14-)
		PEUGEOT	BIPPER (08-)
		VAUXHALL	COMBO III (D) (11-)
			CORSA III (D) (06-)
			CORSA IV (E) (14-)
DG-659	-	TOYOTA	AURIS (E15) (06-12)
			AURIS (E18) (12-)
			COROLLA (E14, E15) (06-)
			COROLLA (E18) (13-)
			IQ (09-)
			URBAN CRUISER (07-)
			VERSO S (10-16)
			YARIS (05-11)
			YARIS (10-)
DG-660	-	CHRYSLER	VOYAGER IV (00-08)
		DODGE	NITRO (06-12)
		JEEP	CHEROKEE / LIBERTY (KJ) (01-08)
DG-661	-	KIA	BONGO (03-)
			CARNIVAL III (06-)
			K2900 (08-)
DG-662	-	MITSUBISHI	L 200 / TRITON (05-15)
			PAJERO Sport II (08-)
DG-665	-	MERCEDES-BENZ	A-CLASS (W176) (12-)
			B-CLASS (W242, W246) (11-)
			C-CLASS (204) (07-14)
			C-CLASS (205) (13-)
			C-CLASS Coupe / Convertible (205) (16-)
			CLA Coupe (C117) (13-)
			CLA Shooting Brake (X117) (15-)
			CLS (218) (11-)
			E-CLASS (212) (09-)
			E-CLASS (213) (16-)
			E-CLASS Coupe / Convertible (207) (09-)
			G-CLASS (W463) (89-)
			GLA (X156) (13-)
			GLC (X253) (15-)
			GLC Coupe (C253) (16-)
			GL-CLASS (X164) (06-)
			GL-CLASS (X166) (12-)
			GLE (W166) (15-)
			GLE Coupe (C292) (15-)
			GLK (X204) (08-15)
			GLS (X166) (15-)
			M-CLASS (W166) (11-15)
			R-CLASS (251) (06-)
			S-CLASS (222) (13-)
			S-CLASS (W221) (05-13)
			SLC (R172) (16-)
			SLK (R172) (11-)
DG-667	-	MAZDA	3 (13-)
			6 (12-)
			CX-5 (11-17)
DG-669	-	HYUNDAI	ix35 (09-)
			SANTA FÉ II (06-12)
			SANTA FÉ III (12-)
		KIA	CARNIVAL III (06-)
			SORENTO II (09-)
			SPORTAGE III (10-)
DG-671	-	DAIHATSU	DELTA Wide (84-99)
		TOYOTA	4 RUNNER (N10) (89-96)
			4 RUNNER (N18) (95-02)
			GRANVIA (95-04)
			HIACE III (87-04)
			LAND CRUISER / PRADO (J70) (84-06)
			LAND CRUISER / PRADO (J120) (02-10)

Свечи зажигания и Свечи накаливания

Руководство покупателя

DENSO P/N	TT	MAKE	MODEL
DG-671			LAND CRUISER / PRADO / COLORADO (J90) (95-)
продолжение			PICNIC (96-01)
DG-702	-	NISSAN	PATROL GR II (97-)
DK20PR-D13	-	HONDA	CITY (08-)
			CIVIC VIII Hatchback (05-)
			CR-Z (10-)
			JAZZ III (08-)
DXE22HQR-D11S	-	HONDA	ODYSSEY (RC) (13-)
DXU22HCR-D11S	-	DONGFENG HONDA	JADE (15-)
			XR-V (14-)
		HONDA	CIVIC IX (12-)
			CIVIC X (16-)
		HONDA (GAC)	VEZEL (13-)
FC16HR8	IXEH20TT	SUBARU	TREZIA (11-)
		TOYOTA	RACTIS (10-)
			SIENTA (15-)
			YARIS (10-)
FC16HR-CY9	-	TOYOTA	C-HR (16-)
			PRIUS (W5) (15-)
FK16BR-AL8	-	TOYOTA	COROLLA Axio (12-)
			COROLLA Fielder (12-)
			SIENTA (15-)
			YARIS (10-)
FK16HBR-J8	-	LEXUS	ES (12-)
		TOYOTA	CAMRY (V5) (11-)
			CAMRY (V7) (17-)
FK16HR11	IKH16TT	TOYOTA	ALLION II (07-)
			AURIS (E15) (06-12)
			PREMIO (07-)
			RACTIS (05-10)
			RACTIS (10-)
			SIENTA (15-)
			URBAN CRUISER (07-)
FK16HR-A8	-	LEXUS	ES (12-)
			NX (14-)
		TOYOTA	AVALON (X4) (12-)
			CAMRY (V5) (11-)
			HARRIER (13-)
			RAV 4 IV (12-)
FK16R11	IK16TT	TOYOTA	COROLLA Verso (01-09)
FK16R-A8	IK16TT	TOYOTA	PRIUS C (P1) (11-)
			YARIS (10-)
FK20HBR11	IKBH20TT	LEXUS	GS (05-11)
			GS (12-)
			GX (01-09)
			IS C (09-)
			IS II (05-13)
			IS III (13-)
			LS (06-)
			RC (14-)
		TOYOTA	CROWN (03-08)
			MARK X I (04-09)
			MARK X II (09-)
FK20HBR-J8	IKBH20TT	LEXUS	GS (12-)
			LC (16-)
			RC (14-)
FK20HR11	IKH20TT	HONDA	INSIGHT (09-)
			JAZZ III (08-)
		HYUNDAI	GENESIS (08-)
		LEXUS	ES (06-12)
			ES (12-)
			GS (05-11)
			RX (03-08)
			RX (08-15)
		LOTUS	EVORA (09-)
			EXIGE (12-)
		MITSUBISHI	SPACE STAR / MIRAGE (12-)
		SUBARU	IMPREZA (00-)
			IMPREZA (08-)
		TOYOTA	ALLION II (07-)
			ALPHARD II (08-14)

DENSO P/N	TT	MAKE	MODEL
FK20HR11			AVALON (X3) (05-12)
продолжение			AVALON (X4) (12-)
			CAMRY (V4) (06-11)
			CAMRY (V5) (11-)
			CROWN (03-08)
			HARRIER (03-08)
			KLUGER / HIGHLANDER II (07-)
			KLUGER / HIGHLANDER III (14-)
			MARK X I (04-09)
			RACTIS (10-)
			RAV 4 III (05-)
			SIENNA (10-)
			URBAN CRUISER (07-)
			VENZA (08-)
		TOYOTA (GAC)	HIGHLANDER (09-)
		VOLVO	S60 II (10-)
			S80 II (06-)
			V60 I (10-)
			V70 III (07-)
			XC60 I (08-)
			XC70 II (07-)
			XC90 I (02-14)
FK20HR-A8	IKH20TT	TOYOTA	FORTUNER (04-15)
			FORTUNER (15-)
FXE16HE11	-	NISSAN	TIIDA (04-12)
FXE20HE11	IXEH20ETT	NISSAN	CUBE (03-05)
			JUKE (10-)
			QASHQAI I (+2) (07-13)
			ROGUE (T32) (13-)
			SENTRA VII (12-)
			TEANA III (13-)
			TIIDA (04-12)
			TIIDA (11-)
			X-TRAIL (T32) (13-)
		NISSAN (DFAC)	TIIDA (11-)
FXE20HR11	IXEH20TT	NISSAN	CUBE (10-)
			MICRA C+C (05-)
			MICRA III (K12) (03-10)
			MICRA IV (K13) (10-)
			NOTE (E11) (06-12)
			NOTE (E12) (13-)
			NV200 (10-)
			QASHQAI I (+2) (07-13)
			ROGUE (T31) (07-13)
			SENTRA V (00-06)
			SENTRA VII (12-)
			TEANA II (08-13)
			TIIDA (04-12)
			X-TRAIL (T30) (01-13)
			X-TRAIL (T31) (07-13)
		NISSAN (DFAC)	TEANA (J31) (06-08)
			TEANA (J32) (10-)
			TIIDA QIDA (05-)
			TIIDA YIDA (05-)
		RENAULT	CLIO III (05-)
			FLUENCE (10-)
			Grand SCÉNIC III (09-)
			KOLEOS I (08-)
			LAGUNA III (07-)
			LATITUDE (10-)
			MEGANE CC (10-)
			MEGANE III (08-)
			SCÉNIC III (09-)
FXE22HR11	IXEH22TT	INFINITI	EX (07-)
			FX (08-)
			G (07-)
			JX (12-)
			M (10-)
			M35 (05-)
			Q50 (13-)
			Q70 (Y51) (13-)

Свечи зажигания и Свечи накаливания

Руководство покупателя

DENSO P/N	TT	MAKE	MODEL	
FXE22HR11 продолжение		NISSAN	QX60 (12-)	
			QX70 (13-)	
			350 Z (02-)	
			ALTIMA (12-)	
			MURANO II (07-14)	
			MURANO III (14-)	
		NISSAN (DFAC)	TEANA (J32) (10-)	
			INFINITI	EX (07-)
				FX (08-)
				G (07-)
M (10-)				
M37 (10-)				
Q60 (13-)				
Q70 (Y51) (13-)				
QX50 (13-)				
QX70 (13-)				
370 Z (09-)				
FXU16HR11	-	HYUNDAI	GRANDEUR (11-)	
			SANTA FÉ III (12-)	
		KIA	OPTIMA (10-)	
			SORENTO II (09-)	
			SORENTO III (15-)	
GX8-1	-	MITSUBISHI	LANCER Evo X (07-15)	
			LANCER VIII (07-)	
IK16	IK16TT	MAZDA	E-SERIE (SG) (95-06)	
IK16L IK16TT	IK16TT	DODGE	NITRO (06-12)	
			ACURA	NSX (90-05)
	-	ALFA ROMEO		NSX Targa (95-97)
			RL (95-04)	
	-	ALFA ROMEO	159 (05-11)	
			BRERA (06-10)	
	-	ALPINA	SPIDER (06-10)	
			B12 (E31) (90-96)	
	-	ALPINA	B12 (E32) (88-94)	
			B12 (E38) (95-01)	
	-	AUDI	A4 (8E, B6) (00-04)	
			A4 (8E, B7) (04-08)	
	-	AUDI	A4 Convertible (8H, B6, B7) (02-09)	
			A8 (4D) (94-02)	
	-	BAW	LANDKING (LUBA) (02-07)	
			CONTINENTAL (91-02)	
	IK16TT	BENTLEY	TURBO R (88-98)	
				-
	-	BMW		
				-
	-	CADILLAC		
				-
	-	CHERY		
				-
	-	CHEVROLET		
				-
	-	CHEVROLET		
				-
	-	CHRYSLER		
				-
	-	CHRYSLER		
				-
	IK16TT	CITROËN		
				-
	-	CITROËN		
				-
	-	DAEWOO		
				-
	-	DAIHATSU		
				-
	-	DAIHATSU		
				-
	-	DAIHATSU		
				-

DENSO P/N	TT	MAKE	MODEL
IK16TT		DODGE	AVENGER (07-14)
			продолжение
	-	DODGE	
	IK16TT	-	
	-	EMGRAND	
	-	FIAT	
	-	FIAT	
	-	FIAT	
	-	FIAT	
	-	FIAT	
	-	FIAT	
	-	FIAT	
	-	FORD	
	-	GEELY	
	-	GEELY	
	-	GEELY	
	-	GEELY	
	-	GREAT WALL	
	IK16TT	HOLDEN	
	-	HONDA	
	-	HONDA	
	-	HONDA	
	-	HONDA	
	-	HONDA	
	-	HONDA	
	-	HONDA	
	-	HONDA	
	-	HONDA	
	-	HONDA	
	-	HONDA	
	-	HONDA	
	-	HONDA	
	-	HONDA	
	-	HYUNDAI	
	-	HYUNDAI	
	-	HYUNDAI	
	-	HYUNDAI	

Свечи зажигания и Свечи накаливания

Руководство покупателя

DENSO P/N	TT	MAKE	MODEL
IK16TT продолжение			ELANTRA (05-11)
			EQUUS / CENTENNIAL (99-09)
			GENESIS (08-)
			GETZ (02-09)
			GRANDEUR / XG (98-05)
			GRANDEUR (05-11)
			HIGHWAY VAN (00-04)
			i10 (07-13)
			i20 (08-15)
			i30 (07-12)
			LANTRA II (95-00)
			MATRIX (01-10)
			S COUPE (90-96)
			SANTA FÉ I (00-06)
			SONATA IV (98-05)
			SONATA V (05-10)
			TERRACAN (01-06)
			TIBURON (06-)
			TRAJECT (00-08)
			TUCSON (04-10)
		INFINITI	G20 (90-97)
			Q45 I (89-97)
			Q45 II (97-01)
			QX4 (97-)
	IK16TT	ISUZU	TFR / TFS (88-02)
			TROOPER II (91-98)
			TROOPER III (98-04)
			VEHICROSS (97-00)
			WIZARD (98-02)
		JAGUAR	S-TYPE (99-08)
			XF (08-15)
			XJ (97-03)
			XJ (03-09)
			XJ (09-)
			XK 8 (96-05)
			XK (06-14)
			JEEP
		CJ5 - CJ8 (66-87)	
		COMANCHE (86-96)	
		COMMANDER (05-10)	
		COMPASS (06-)	
		Grand CHEROKEE II (98-05)	
		Grand CHEROKEE III (05-10)	
		PATRIOT (07-)	
		WRANGLER I (86-96)	
		WRANGLER II (96-08)	
		KIA	CARENS II (02-)
			CARENS III (06-)
			CARNIVAL II (99-07)
			CARNIVAL III (06-)
			CEED (06-12)
			CERATO (04-)
			CLARUS (96-)
			MAGENTIS (01-)
			MAGENTIS (05-)
			OPIRUS (03-)
			PICANTO (04-)
			PRO CEED (08-13)
			RIO II (05-)
			SEPHIA (93-97)
			SHUMA I (96-01)
			SHUMA II (01-04)
			SORENTO I (02-)
			SORENTO III (15-)
			SPORTAGE I (94-04)
			SPORTAGE II (04-)
		LANCIA	DEDRA (89-99)
			LYBRA (99-05)
			Y (95-03)
			Y10 (85-95)
			YPSILON (843) (03-11)

DENSO P/N	TT	MAKE	MODEL	
IK16TT продолжение	IK16TT	LAND ROVER	DISCOVERY II (98-04)	
			DISCOVERY III (04-09)	
RANGE ROVER II (94-02)				
RANGE ROVER III (02-12)				
RANGE ROVER Sport (05-13)				
		LEXUS	GS (93-97)	
			GS (97-05)	
			IS I (99-05)	
			LX (95-97)	
			SC (91-00)	
		LOTUS	EUROPA S (06-)	
		MAZDA	2 (03-07)	
	IK16TT		2 (07-15)	
			3 (00-09)	
			3 (09-14)	
			121 II (90-97)	
			323 C IV (89-00)	
			323 C V (94-98)	
			323 F IV (87-94)	
			323 F V (94-98)	
			323 F VI (98-04)	
			323 I (77-86)	
			323 II (80-89)	
			323 S IV (89-94)	
			323 S V (94-98)	
			323 S VI (98-04)	
			626 III (87-97)	
			626 IV (91-97)	
			929 III (87-91)	
			929 IV (90-96)	
			B-SERIE (85-99)	
			DEMIO (98-03)	
			E-SERIE (SG) (95-06)	
			LUCE (89-92)	
			MPV I (88-99)	
			MPV II (99-06)	
			MX-3 (91-98)	
			MX-5 II (98-05)	
			MX-6 (92-97)	
			PREMACY (99-05)	
			XEDOS 6 (92-99)	
			XEDOS 9 (93-02)	
			MERCEDES-BENZ	CABRIOLET (A124) (92-93)
				C-CLASS (202) (93-01)
				C-CLASS (203) (00-07)
				C-CLASS Coupe (CL203) (01-08)
				CLK (208) (97-02)
				CLK (209) (02-10)
				CLS (C219) (04-10)
				COUPE (C124) (87-93)
				E-CLASS (124) (92-96)
		E-CLASS (210) (95-03)		
		E-CLASS (211) (02-09)		
		E-CLASS Coupe / Convertible (124) (93-98)		
		G-CLASS (W463) (89-)		
		KOMBI (S124) (85-93)		
		M-CLASS (W163) (98-05)		
		M-CLASS (W164) (05-11)		
		R-CLASS (251) (06-)		
		Saloon (W124) (84-93)		
		S-CLASS (W140) (91-98)		
		S-CLASS (W220) (98-05)		
		S-CLASS Coupe (C140) (92-99)		
		S-CLASS Coupe (C215) (99-06)		
		SL (R129) (89-01)		
		SL (R230) (01-12)		
		SLK (R170) (96-04)		
		SLK (R171) (04-11)		
		VIANO (W639) (03-)		
		VITO / MIXTO (W639) (03-)		
		MG	MG TF (02-09)	

Свечи зажигания и Свечи накаливания

Руководство покупателя

DENSO P/N	TT	MAKE	MODEL
IK16TT продолжение			MG ZR (01-05)
			MG ZS (01-05)
			MG ZT (01-05)
		MITSUBISHI	COLT IV (92-96)
			COLT V (95-03)
			GALANT V (92-96)
			L 200 (96-07)
			L 300 (86-06)
			L 400 / SPACE GEAR (95-05)
			LANCER V (91-03)
			LANCER VI (95-03)
			LANCER VIII (07-)
	IK16TT		MAGNA (96-05)
	-		OUTLANDER II (06-12)
	IK16TT		OUTLANDER III (12-)
	-		PAJERO II (90-00)
			PAJERO Pinin (99-07)
			PAJERO Sport I (97-)
			SAPPORO III (87-90)
			SPACE RUNNER (99-02)
		SPACE STAR (98-04)	
		SPACE WAGON (98-04)	
		NISSAN	100 NX (90-94)
			200 SX (93-99)
			240 SX (93-97)
			ALMERA I (95-00)
			ALMERA II (00-)
			ALMERA TINO (00-)
			ALTIMA (93-01)
			AVENIR (97-05)
	IK16TT		CEDRIC (91-99)
	-		CIMA (91-96)
	IK16TT		CIMA (96-01)
	-		ELGRAND (95-02)
	IK16TT		INFINITY Q45 (93-97)
	-		MAXIMA III (88-94)
	IK16TT		MAXIMA IV (95-00)
			MAXIMA V (99-03)
	-		MICRA II (K11) (92-03)
			NAVARA (D22) (97-)
			PATHFINDER II (97-04)
			PICK UP (D22) (97-05)
			PRAIRIE (M10) (83-88)
			PRIMERA (P10) (90-98)
			PRIMERA (P11) (96-02)
		SENTRA V (00-06)	
		SERENA (92-01)	
		SERENA (99-05)	
		SILVIA (S15) (99-03)	
	IK16TT	SKYLINE (R33) (93-00)	
		SKYLINE (R34) (98-08)	
	-	SUNNY II (86-91)	
		SUNNY III (90-00)	
		TERRANO II (92-07)	
		OPEL	AGILA A (00-07)
			ASTRA G (98-09)
			ASTRA H (04-14)
			COMBO C (01-)
			CORSA C (00-09)
			CORSA D (06-14)
			FRONTERA B (98-04)
			INSIGNIA (A) (08-17)
			MERIVA A (03-10)
			MOKKA (12-)
			MONTEREY B (98-99)
			SIGNUM (03-)
			TIGRA TwinTop (04-)
			VECTRA C (02-08)
			ZAFIRA A (99-05)
			ZAFIRA B (05-14)
			ZAFIRA Tourer C (11-)

DENSO P/N	TT	MAKE	MODEL
IK16TT продолжение		PERODUA	KELISA (02-)
			KENARI (00-)
			MYVI (06-11)
			VIVA (07-)
		PEUGEOT	106 I (91-96)
			106 II (96-04)
	IK16TT		205 II (87-98)
	-		206 (98-)
	IK16TT		4007 (07-)
	-	PLYMOUTH	BREEZE (95-01)
		PUCH	G-MODELL (W463) (89-00)
		RENAULT	TWINGO I (93-07)
		ROVER	25 (99-05)
			45 (00-05)
			75 (99-05)
			400 (90-98)
			STREETWISE (03-05)
		SAAB	9-3 (02-15)
	IK16TT	SEAT	ALHAMBRA (7V) (96-10)
	-		CORDOBA (6L) (02-09)
			IBIZA III (6L) (02-09)
			IBIZA IV (6J, 6P) (08-)
	IK16TT		INCA (6K9) (95-03)
	-	LEON (1M) (99-06)	
			TOLEDO II (1M) (99-06)
	IK16TT	SHANGHAI MAPLE	HAIXUAN (06-)
	-	SKODA	FABIA I (6Y) (99-08)
			FABIA II (06-14)
			FELICIA Fun (6U) (97-02)
			FELICIA II (6U) (98-01)
			OCTAVIA I (1U) (96-10)
			ROOMSTER (5J) (06-15)
		SSANGYONG	CHAIRMAN (97-)
			KORANDO (96-06)
			MUSSO (93-07)
		SUBARU	FORESTER (97-02)
			FORESTER (02-08)
			FORESTER (08-)
			IMPREZA (92-00)
			IMPREZA (00-)
			JUSTY III (03-)
			LEGACY III (98-03)
	IK16TT		LEGACY IV (03-09)
	-	OUTBACK (00-03)	
		OUTBACK (03-09)	
		VIVIO (92-98)	
		SUZUKI	Grand VITARA II (05-)
			IGNIS I (00-05)
			IGNIS II (03-)
			JIMNY (98-)
			LIANA (01-07)
			SWIFT III (05-)
			WAGON R (03-05)
		WAGON R+ (00-)	
		TOYOTA	4 RUNNER (N10) (89-96)
			4 RUNNER (N18) (95-02)
			ALLION I (01-07)
			ALPHARD II (08-14)
			ALTEZZA (99-05)
			ARISTO (90-97)
			ARISTO (97-04)
			AURIS (E15) (06-12)
			AVENSIS (97-03)
			AVENSIS (03-09)
			bB I (00-05)
			CALDINA (T21) (97-02)
			CAMRY (V4) (06-11)
		CAMRY (V5) (11-)	
		CARIBE (84-03)	
		CARINA E (92-97)	
		CELICA (93-99)	

Свечи зажигания и Свечи накаливания

Руководство покупателя

DENSO P/N	TT	MAKE	MODEL
IK16TT			CELICA (99-05)
продолжение			CENTURY (97-)
			CHASER (X7, X8) (84-91)
			CHASER (X9) (92-96)
			CHASER (X10) (96-01)
			COROLLA (E10) (92-99)
			COROLLA (E11) (97-02)
			COROLLA (E12) (01-07)
			COROLLA (E14, E15) (06-)
			COROLLA Levin (E10) (91-97)
			COROLLA Verso (01-09)
			CORSA (90-94)
			CORSA (94-99)
			CRESTA (84-01)
			CROWN (91-99)
			DUET (98-04)
			DYNA 300 (95-02)
			ECHO (99-05)
			GRANVIA (95-04)
			HIACE IV (95-)
			HILUX II (83-05)
			ISIS (04-)
			IST (04-07)
			LAND CRUISER (J80) (90-98)
			LAND CRUISER / PRADO (J70) (84-06)
			LAND CRUISER / PRADO / COLORADO (J90) (95-)
			MARK II (88-96)
			MARK II (96-01)
			MARK II (02-07)
			MATRIX (01-07)
			MATRIX (08-)
			MR 2 III (99-07)
			OPA (00-05)
			PASEO (88-95)
			PASEO (95-99)
			PLATZ (99-05)
			PORTE I (04-12)
			PREMIO (01-07)
			PREVIA / ESTIMA I (90-00)
			PREVIA / ESTIMA III (05-)
			PRIUS (W1) (00-04)
			PRIUS (W2) (03-09)
			PRIUS C (P1) (11-)
			PROBOX / SUCCEED (02-14)
			RACTIS (10-)
			RAUM (97-03)
			RAUM (03-)
			RAV 4 II (00-05)
			SOARER (90-00)
			SPRINTER (82-02)
			STARLET (P9) (96-99)
			SUPRA (93-02)
			TUNDRA (99-06)
			VIOS / YARIS (07-)
			VIOS (02-08)
			VISTA (V5) (98-03)
			WILL Cypha (01-05)
			WILL Vi (00-01)
			WILL VS (01-04)
			WISH (03-09)
			YARIS (99-05)
			YARIS (05-11)
			YARIS (10-)
			YARIS VERSO (99-05)
		VAUXHALL	AGILA I (A) (00-08)
			ASTRA IV (G) (98-06)
			ASTRA V (H) (04-10)
			COMBO II (C) (01-12)
			CORSA II (C) (00-06)
			CORSA III (D) (06-)
			FRONTERA II (B) (98-04)

DENSO P/N	TT	MAKE	MODEL
IK16TT			MERIVA I (A) (03-10)
продолжение			MOKKA (12-)
			MONTEREY II (98-99)
	IK16TT		SIGNUM (02-08)
	-		TIGRA TwinTop (04-09)
	IK16TT		VECTRA II (C) (00-08)
	-		ZAFIRA II (B) (05-14)
			ZAFIRA III (C) (11-)
		WW	BORA (1J) (98-05)
			CADDY II (9K, 9U) (95-04)
			FOX (5Z) (03-)
			GOLF IV (1J, 1E) (97-06)
			JETTA III (1K2) (05-10)
			LUPO (6X, 6E) (98-05)
			NEW BEETLE (9C, 1C, 1Y) (98-10)
			PASSAT (3B3, 3B6) (00-05)
			POLO (6N2) (99-01)
			POLO (9N) (01-09)
			POLO Saloon (9A4) (02-)
			SHARAN (7M) (95-10)
			TRANSPORTER IV (70X, 7D) (90-03)
			VENTO (1H2) (91-98)
		ZASTAVA	10 (05-)
		ZHENGZHOU NISSAN	PALADIN (02-)
IK20G	-	HONDA	LIFE (03-)
IK20L	IK20TT	DODGE	CALIBER (06-)
		HONDA	ACCORD VI (97-05)
		OPEL	ASTRA G (98-09)
			ASTRA H (04-14)
			ASTRA J (09-)
			CORSA D (06-14)
			INSIGNIA (A) (08-17)
		SAAB	9-5 (10-12)
		VAUXHALL	ASTRA VI (J) (09-)
			CORSA III (D) (06-)
			INSIGNIA I (A) (08-17)
IK20TT	-	ACURA	LEGEND II (91-96)
			NSX (90-05)
			TL (98-03)
			VIGOR (91-94)
		ALFA ROMEO	33 (90-94)
			75 (85-92)
			145 / 146 (94-01)
			147 (00-10)
			155 (92-97)
			156 (97-06)
			164 (87-98)
			166 (98-07)
			GT (03-10)
			GTV (95-05)
			SPIDER (94-05)
		ALPINA	B3 (E36) (93-99)
			B3 (E46) (99-06)
			B5 (E60, E61) (05-10)
			B6 (E63, E64) (06-10)
			B7 (E65) (03-08)
			B8 (E36) (95-98)
			B10 (E34) (88-96)
			B10 (E39) (96-04)
			B11 (E32) (87-94)
			B12 (E31) (90-96)
			B12 (E38) (95-01)
			ROADSTER (Z8) (02-03)
			ROADSTER S (Z4) (03-05)
		AUDI	80 (89, 8A, B3) (86-91)
			80 (8C, B4) (91-96)
			90 (89, 8A, B3) (87-91)
			100 (4A, C4) (90-94)
			A1 (8X) (10-18)
			A2 (8Z) (00-05)
			A3 (8L) (96-03)

Свечи зажигания и Свечи накаливания

Руководство покупателя

DENSO P/N	TT	MAKE	MODEL				
IK20TT продолжение			A3 (8P) (03-13)				
			A3 Convertible (8P7) (08-13)				
			A4 (8D, B5) (94-01)				
			A4 (8E, B6) (00-04)				
			A4 (8E, B7) (04-08)				
			A4 (8K, B8) (07-15)				
			A4 Convertible (8H, B6, B7) (02-09)				
			A5 (8T, 8F) (07-17)				
			A6 (4A, C4) (94-97)				
			A6 (4B, C5) (97-05)				
	IK20TT -			A6 (4F, C6) (04-11)			
				A6 (4G, C7) (10-18)			
				A7 (4GA) (10-18)			
				A8 (4D) (94-02)			
				A8 (4E) (02-10)			
				ALLROAD (4BH) (00-05)			
				CABRIOLET (8G7) (91-00)			
				COUPE (89, 8B) (88-96)			
				Q5 (8R) (08-)			
				TT (8N) (98-06)			
	IK20TT -	AUSTIN		MAESTRO (83-92)			
				MONTEGO (84-92)			
				AUTOBIANCHI	Y10 (85-95)		
					BEDFORD		
				MIDI (84-92)			
				RASCAL (86-90)			
				BENTLEY	ARNAGE I (98-09)		
					CONTINENTAL (91-02)		
				IK20TT -			CONTINENTAL (03-)
							CONTINENTAL Flying Spur (05-)
IK20TT	BMW		1 (E81, E87) (03-12)				
			1 Coupe/Convertible (E82, E88) (07-13)				
			3 (E30) (82-94)				
			3 (E36) (90-00)				
			3 (E46) (98-06)				
			3 (E90, E91) (05-12)				
			3 Coupe/Convertible (E92, E93) (06-13)				
			5 (E28) (81-87)				
			5 (E34) (87-97)				
			5 (E39) (95-04)				
IK20TT -			5 (E60, E61) (03-10)				
			6 (E63, E64) (04-10)				
			7 (E32) (86-94)				
			7 (E38) (94-01)				
			7 (E65, E66) (01-08)				
			8 (E31) (90-99)				
			X1 (E84) (09-15)				
			X3 (E83) (04-11)				
			X5 (E53) (00-06)				
			X5 (E70) (07-13)				
IK20TT -			Z3 (E36) (95-03)				
			Z4 (E85, E86) (03-09)				
			Z8 (E52) (00-03)				
			F3 (05-13)				
			F3R (07-)				
			CADILLAC	BLS (06-)			
				CTS (02-07)			
			CATERHAM	21 (94-02)			
				SUPER SEVEN (80-)			
			CHANGAN (CHANA)	GAZELLE (99-04)			
CHERY			A3 (08-14)				
			A5 (06-)				
			A11 (00-)				
			ARRIZO 7 (13-)				
			BEAT (10-)				
			EASTAR CROSS (07-)				
			FULWIN (06-)				
			INDIS (10-)				
			QIYUN (03-10)				
			QIYUN (10-15)				
			TAXIM MPV (07-)				
			TIGGO 5 (13-)				

DENSO P/N	TT	MAKE	MODEL				
IK20TT продолжение			TIGGO (05-09)				
			TIGGO (10-)				
			TIGGO FL (13-)				
			X1 (10-)				
			XCROSS (10-)				
			CHEVROLET			AVEO (T300) (11-)	
						AVEO / KALOS (T200) (03-08)	
						AVEO / KALOS (T250, T255) (05-)	
						CAPTIVA (06-)	
						CRUZE (09-)	
	EPICA (05-)						
	EVANDA (05-)						
	LACETTI (05-)						
	LANOS (05-)						
	NUBIRA (05-11)						
	IK20TT -			OPTRA (03-08)			
				ORLANDO (11-)			
				REZZO (05-)			
				TRACKER (98-08)			
				TRAX (12-)			
				IK20TT -	CHRYSLER		CIRRUS (94-00)
							CROSSFIRE (03-07)
							NEON I (94-00)
							NEON II (99-06)
							PT CRUISER (00-10)
	STRATUS (95-01)						
	VOYAGER III (95-01)						
	IK20TT -	CITROËN					AX (86-98)
							BERLINGO (MF) (96-11)
							BX (82-94)
C2 (03-)							
C3 I (02-)							
C3 II (09-)							
C3 Pluriel (03-)							
C4 Aircross (12-)							
C15 (84-05)							
EVASION (94-02)							
IK20TT -			JUMPER (94-02)				
			JUMPER (02-)				
			NEMO (08-)				
			SAXO (96-04)				
			XANTIA (93-03)				
			XM (89-94)				
			XM (94-00)				
			XSARA (97-05)				
			ZX (91-98)				
			IK20TT -	DACIA		DOKKER (12-)	
DUSTER (10-)							
LODGY (12-)							
LOGAN I (04-)							
LOGAN II (12-)							
LOGAN MCV I (07-)							
LOGAN MCV II (13-)							
SANDERO I (Stepway) (08-)							
SANDERO II (Stepway) (12-)							
SOLENZA (03-)							
IK20TT -	DAEWOO		SUPERNOVA (00-03)				
			ESPERO (91-99)				
			EVANDA (02-)				
			KALOS (02-)				
			KORANDO (99-)				
			LACETTI (04-)				
			LANOS (97-)				
			LEGANZA (97-04)				
			MUSSO (99-)				
			NEXIA (95-08)				
NEXIA (08-)							
NUBIRA (97-)							
NUBIRA (03-)							
REXTON (02-)							
TACUMA / REZZO (00-)							

Свечи зажигания и Свечи накаливания

Руководство покупателя

DENSO P/N	TT	MAKE	MODEL
IK20TT продолжение		DAIHATSU	APPLAUSE I (89-97)
			APPLAUSE II (97-00)
ATRIA WAGON (92-99)			
CHARADE III (87-93)			
CHARADE IV (93-00)			
COPEN (03-12)			
EXTOL (00-)			
FEROZA (88-99)			
GRAN MOVE (96-02)			
HIJET (92-)			
HIJET (98-)			
MOVE (02-07)			
NAKED (99-05)			
ROCKY (85-98)			
SIRION (98-05)			
SIRION (05-)			
TERIOS (97-05)			
TERIOS (05-)			
YRV (01-)			
DODGE			CALIBER (06-)
	CARAVAN (95-02)		
	NEON I (94-99)		
	NEON II (99-06)		
	NITRO (06-12)		
	RAM (01-09)		
	STRATUS (95-01)		
	DR	DR 1 (10-14)	
		DR 2 (10-14)	
		DR 5 (11-)	
EMGRAND	EC7 (09-)		
FAW	V2 (13-)		
FAW-AUDI	A6L (C6) (05-11)		
FIAT	ALBEA / SIENA (96-11)		
	BARCETTA (95-05)		
	BRAVA (95-02)		
	BRAVO I (95-01)		
	CINQUECENTO (91-99)		
	COUPE (93-00)		
	DOBLO (01-)		
	DUCATO (230) (94-02)		
	DUCATO (244) (02-)		
	ELBA (85-97)		
	FIORINO (88-01)		
	FIORINO (07-)		
	MAREA (96-07)		
	MULTIPLA (99-10)		
	IK20TT -	PALIO (96-)	
PANDA (80-04)			
PUNTO (93-00)			
PUNTO (99-12)			
QUBO (08-)			
SEDICI (06-14)			
SEICENTO (98-10)			
STILO (01-08)			
STRADA (99-)			
ULYSSE (94-02)			
FORD	ESCORT II (73-81)		
	ESCORT IV (85-90)		
	ESCORT V (90-95)		
	ESCORT VI (95-01)		
	FIESTA II (83-95)		
	FIESTA III (89-97)		
	GALAXY (95-06)		
	ORION II (85-90)		
	ORION III (90-93)		
	SCORPIO I (85-94)		
SCORPIO II (94-98)			
IK20TT -	TRANSIT (94-00)		
	TRANSIT (00-06)		
IK20TT -	TRANSIT Tourneo (94-00)		
FORD USA	PROBE II (93-98)		

DENSO P/N	TT	MAKE	MODEL
IK20TT продолжение		FSO	LANOS (04-08)
			POLONEZ III (92-02)
GEELY		BL (05-)	
		CK (05-)	
		HISOON (04-)	
		MR (05-)	
		PANDA (08-)	
		PU (05-)	
		URBAN NANNY (04-)	
		VISION (06-)	
GEO		METRO (88-98)	
		STORM (89-93)	
		TRACKER (88-98)	
GREAT WALL		HOVER H5 (10-)	
HONDA		ACCORD IV (90-94)	
		ACCORD V (93-98)	
		ACCORD VI (97-05)	
		ASCOT (90-97)	
		BEAT (91-96)	
		CITY (01-08)	
	CIVIC IV (87-95)		
	CIVIC V (91-97)		
	CIVIC VI (94-01)		
	CIVIC VII (00-05)		
	CIVIC VIII Hatchback (05-)		
	CR-V I (95-02)		
	CRX II (87-92)		
	CRX III (92-98)		
	FR-V (04-)		
	INSPIRE (91-98)		
	INSPIRE (98-03)		
	JAZZ II (02-08)		
	JAZZ Saloon (03-08)		
	LEGEND II (91-96)		
	LEGEND III (96-06)		
	LIFE (97-01)		
	LIFE (01-03)		
	NSX (90-05)		
	PRELUDE IV (92-96)		
	PRELUDE V (96-00)		
	SHUTTLE (94-04)		
	SMX (96-02)		
	STEPWAGON (96-00)		
	STREAM (01-)		
HYUNDAI	ACCENT I (94-00)		
	ACCENT II (99-06)		
	ACCENT III (05-10)		
	LANTRA II (95-00)		
	S COUPE (90-96)		
INFINITI	G20 (90-97)		
	I30 (97-)		
IK20TT -	Q45 I (89-97)		
INNOCENTI	ELBA (91-96)		
	ISUZU		
ISUZU	GEMINI (84-90)		
	GEMINI (90-93)		
	IMPULSE (90-93)		
	TROOPER II (91-98)		
	JAGUAR		
JAGUAR	XJ (86-94)		
	XJ (94-97)		
	XJ (97-03)		
	XJ Coupe (73-96)		
	XK 8 (96-05)		
JEEP	CHEROKEE (XJ) (84-01)		
	CHEROKEE / LIBERTY (KJ) (01-08)		
	CHEROKEE / LIBERTY (KK) (08-)		
	COMMANDER (05-10)		
	Grand CHEROKEE I (91-99)		
	Grand CHEROKEE II (98-05)		
	Grand CHEROKEE III (05-10)		
IK20TT -	CARENS I (00-02)		
	CARENS II (02-)		

Свечи зажигания и Свечи накаливания

Руководство покупателя

DENSO P/N	TT	MAKE	MODEL			
IK20TT продолжение			CARNIVAL I (99-01)			
			CARNIVAL II (99-07)			
			CERATO (01-04)			
			CLARUS (96-)			
			ELAN (96-99)			
			RETONA (99-)			
			RIO I (00-05)			
			ROADSTER (99-)			
			SHUMA I (96-01)			
			SHUMA II (01-04)			
LADA			SPORTAGE I (94-04)			
			110 (2110) (95-12)			
			GRANTA (2190, 2191, 2349) (11-)			
			KALINA (2192, 2194) (13-)			
			LARGUS (12-)			
			VESTA (15-)			
			X-RAY (16-)			
			XRAY (16-)			
			LANCIA			DEDRA (89-99)
						DELTA II (93-99)
KAPPA (94-01)						
LYBRA (99-05)						
THESIS (02-09)						
Y (95-03)						
Y10 (85-95)						
ZETA (95-02)						
LAND ROVER						DISCOVERY I (89-98)
						DISCOVERY IV (09-)
			FREELANDER I (98-06)			
			RANGE ROVER III (02-12)			
LDV			SHERPA (74-89)			
LEXUS			ES (96-08)			
			GS (93-97)			
			GS (97-05)			
			GS (05-11)			
			GX (01-09)			
			IS I (99-05)			
			LS (89-94)			
			LS (94-00)			
			LS (00-06)			
			LX (98-08)			
			RX (98-03)			
			RX (03-08)			
			SC (91-00)			
			SC (01-10)			
			LOTUS			2 ELEVEN (07-11)
						ELAN (89-95)
ELISE 340R (00-01)						
ELISE (95-01)						
ELISE (00-)						
ESPRIT S4 (89-03)						
EUROPA S (06-)						
EXIGE (00-12)						
IK20TT		MAYBACH	57 (02-12)			
		MAZDA	2 (07-15)			
-			323 C IV (89-00)			
			323 F IV (87-94)			
			323 F V (94-98)			
			323 F VI (98-04)			
			323 P V (96-98)			
			IK20TT	323 S IV (89-94)		
			-			323 S VI (98-04)
						626 III (87-97)
						626 IV (91-97)
						626 V (97-02)
929 II (82-87)						
IK20TT			929 III (87-91)			
			MX-5 I (90-98)			
			MX-5 II (98-05)			
			XEDOS 6 (92-99)			
			XEDOS 9 (93-02)			

DENSO P/N	TT	MAKE	MODEL			
IK20TT продолжение	IK20TT	MERCEDES-BENZ	A-CLASS (W168) (97-04)			
			A-CLASS (W169) (04-12)			
			B-CLASS (W245) (05-11)			
			C-CLASS (202) (93-01)			
			C-CLASS (203) (00-07)			
			C-CLASS Coupe (CL203) (01-08)			
			CLK (208) (97-02)			
			E-CLASS (124) (92-96)			
			E-CLASS (210) (95-03)			
			M-CLASS (W163) (98-05)			
-			Saloon (W124) (84-93)			
			S-CLASS (W140) (91-98)			
			S-CLASS (W220) (98-05)			
			S-CLASS Coupe (C140) (92-99)			
			S-CLASS Coupe (C215) (99-06)			
			SL (R129) (89-01)			
			SLK (R170) (96-04)			
			SPRINTER 2-t (901, 902) (95-06)			
			SPRINTER 3-t (903) (95-06)			
			SPRINTER 4-t (904) (96-06)			
-			VANEO (414) (02-05)			
			V-CLASS (638/2) (96-03)			
			VITO (638) (96-03)			
			MG			MG 6 (10-)
						MG TF (02-09)
						MG X-POWER (03-08)
						MG ZR (01-05)
						MG ZS (01-05)
						MG ZT (01-05)
			-			MGF (95-02)
MINI						MINI (R50, R53) (01-06)
						MINI Convertible (R52) (04-07)
MITSUBISHI						3000 GT (89-99)
						ASX (10-)
						CARISMA (95-06)
						COLT IV (92-96)
						COLT V (95-03)
						GALANT V (92-96)
						GALANT VI (96-04)
			LANCER III (83-92)			
			LANCER IV (88-94)			
			LANCER V (91-03)			
			LANCER VI (95-03)			
			LANCER VII (03-)			
			LANCER VIII (07-)			
			OUTLANDER II (06-12)			
			OUTLANDER III (12-)			
			PAJERO I (82-91)			
PAJERO IV (06-)						
SIGMA (90-96)						
SPACE RUNNER (91-99)						
SPACE STAR (98-04)						
SPACE WAGON (91-98)						
SPACE WAGON (98-04)						
IK20TT		MITSUOKA	OROCHI (06-)			
			MORGAN			AERO 8 (00-)
AERO (12-)						
AERO Supersports (10-)						
-			AEROMAX (07-09)			
			PLUS EIGHT (68-)			
IK20TT		NISSAN	100 NX (90-94)			
			200 SX (93-99)			
			ALMERA I (95-00)			
			ALMERA TINO (00-)			
			AVENIR (97-05)			
			BLUEBIRD Sylphy (12-)			
			CEDRIC (91-99)			
			CEDRIC (96-04)			
			CEFIRO II (94-99)			
			CEFIRO III (00-04)			
-			KUBISTAR (03-)			

Свечи зажигания и Свечи накаливания

Руководство покупателя

DENSO P/N	TT	MAKE	MODEL
IK20TT продолжение			MAXIMA III (88-94)
			MAXIMA IV (95-00)
			MAXIMA V (99-03)
			NT100 Clipper (03-13)
			PATHFINDER I (86-95)
			PRIMASTAR (01-)
			PRIMERA (P10) (90-98)
			PRIMERA (P11) (96-02)
			QUEST (92-98)
			SERENA (92-01)
			SILVIA (S15) (99-03)
			SUNNY II (86-91)
			SUNNY III (90-00)
			TERRANO I (87-96)
			VANETTE Cargo (C23) (94-02)
		OPEL	ADAM (12-)
			AGILA A (00-07)
			ANTARA (06-)
			ASCONA C (81-88)
			ASTRA F (91-01)
			ASTRA F CLASSIC (98-05)
			ASTRA G (98-09)
			ASTRA H (04-14)
			ASTRA J (09-)
			CALIBRA (90-97)
			COMBO B (94-01)
			COMBO C (01-)
			COMBO E (18-)
			CORSA A (82-93)
			CORSA B (93-02)
			CORSA C (00-09)
			CORSA D (06-14)
			FRONTERA A (92-98)
			INSIGNIA (A) (08-17)
			KADETT E (84-94)
			MERIVA A (03-10)
			MERIVA B (10-)
			MOKKA (12-)
			OMEGA A (86-94)
			OMEGA B (94-03)
			SENATOR B (87-93)
			SIGNUM (03-)
			SINTRA (96-99)
			SPEEDSTER (00-)
			TIGRA (94-00)
			VECTRA A (88-95)
			VECTRA B (95-03)
			VECTRA C (02-08)
			VIVARO A (01-)
			ZAFIRA A (99-05)
			ZAFIRA B (05-14)
			ZAFIRA Tourer C (11-)
		PANTHER	KALLISTA (82-93)
		PERODUA	KANCIL (94-)
			MYVI (06-11)
			VIVA (07-)
	IK20TT		
		PEUGEOT	106 I (91-96)
			106 II (96-04)
			205 I (83-94)
			205 II (87-98)
	IK20TT		206 (98-)
			206+ (09-)
			207 (06-)
			306 (93-02)
			307 (00-)
			309 I (85-89)
			309 II (89-93)
			405 I (87-93)
			405 II (92-99)
			406 (95-04)
			406 Coupe (97-04)

DENSO P/N	TT	MAKE	MODEL
IK20TT продолжение			604 (77-87)
			605 (89-99)
			806 (94-02)
			1007 (05-)
			4008 (12-)
			BIPPER (08-)
			BOXER (94-02)
			BOXER (02-)
			PARTNER / RANCH (96-15)
		PIAGGIO	PORTER (93-)
		PLYMOUTH	BREEZE (95-01)
			NEON I (94-99)
			NEON II (99-06)
		PORSCHE	911 (996) (97-05)
			911 (997) (04-12)
			BOXSTER (986) (96-04)
			CAYENNE (955) (02-10)
		PROTON	IMPIAN (01-)
			PERSONA 300 (96-04)
			PERSONA 400 (94-03)
			WIRA (00-)
		RENAULT	19 I (88-92)
			19 II (92-01)
			21 (86-95)
			25 (84-93)
			AVANTIME (01-03)
			CLIO I (90-98)
			CLIO II (98-)
			CLIO III (05-)
			DUSTER (09-)
			ESPACE III (96-02)
			ESPACE IV (02-)
			FLUENCE (10-)
			Grand SCÉNIC II (04-)
			Grand SCÉNIC III (09-)
			KANGOO (97-)
			KANGOO (08-)
			LAGUNA I (93-01)
			LAGUNA II (01-)
			LAGUNA III (07-)
			LOGAN I (04-)
			LOGAN II (13-)
			MEGANE CC (10-)
			MEGANE I (96-03)
			MEGANE II (02-12)
			MEGANE III (08-)
			MEGANE IV (15-)
			MEGANE Scénic (96-99)
			MODUS (04-)
			RAPID (85-98)
			SAFRANE I (92-96)
			SAFRANE II (96-00)
			SANDERO I (Stepway) (07-)
			SANDERO II (Stepway) (13-)
			SCÉNIC I (99-03)
			SCÉNIC II (03-)
			SCÉNIC III (09-)
			SPORT Spider (95-99)
			THALIA I (98-)
			THALIA II (08-)
			TRAFIC II (01-)
			TWINGO II (07-)
			VEL SATIS (02-)
			WIND (10-)
		ROLLS-ROYCE	PARK WARD (00-02)
			PHANTOM VII (02-)
			SILVER Seraph (98-02)
		ROVER	25 (99-05)
			45 (00-05)
			75 (99-05)
			100 / METRO (90-98)

Свечи зажигания и Свечи накаливания

Руководство покупателя

DENSO P/N	TT	MAKE	MODEL			
IK20TT продолжение			200 (RF) (95-00)			
			200 (XH) (85-89)			
			200 (XW) (89-99)			
			400 (90-98)			
			400 (95-00)			
			600 (93-99)			
			800 (86-99)			
			CABRIOLET (90-99)			
			COUPE (96-99)			
			MAESTRO (90-95)			
STREETWISE (03-05)						
SAAB			9-3 (02-15)			
			9-3X (09-12)			
			9-5 (10-12)			
			900 II (93-98)			
			9000 (84-98)			
SANTANA			SAMURAI (86-95)			
SEAT			ALHAMBRA (7V) (96-10)			
			ALHAMBRA (710) (10-)			
			ALTEA (XL) (5P) (04-)			
			AROSA (6H) (97-04)			
			CORDOBA (6K1) (93-99)			
			CORDOBA (6K2) (99-02)			
			CORDOBA (6L) (02-09)			
			EXEO (3R) (08-)			
			IBIZA II (6K1) (93-99)			
			IBIZA II (6K2) (99-02)			
			IBIZA III (6L) (02-09)			
			IBIZA IV (6J, 6P) (08-)			
			INCA (6K9) (95-03)			
			LEON (1M) (99-06)			
			LEON (1P) (05-12)			
			TOLEDO I (1L) (91-99)			
			TOLEDO II (1M) (99-06)			
			TOLEDO III (5P) (04-09)			
			TOLEDO IV (KG3) (12-)			
			SKODA			FABIA I (6Y) (99-08)
FABIA II (06-14)						
FAVORIT (78) (89-97)						
FELICIA I (6U) (94-98)						
OCTAVIA I (1U) (96-10)						
OCTAVIA II (1Z) (04-13)						
RAPID (HN) (12-)						
SUPERB I (3U) (01-08)						
SUPERB II (3T) (08-15)						
YETI (5L) (09-)						
SMART						CABRIO (450) (00-04)
						CITY-Coupe (450) (98-04)
						CROSSBLADE (450) (02-03)
			FORTWO (450) (04-07)			
SPYKER			C12 (07-)			
SSANGYONG			CHAIRMAN (97-)			
			KORANDO (96-06)			
			KYRON (05-)			
			MUSSO (93-07)			
SUBARU			FORESTER (97-02)			
			FORESTER (02-08)			
			IMPREZA (92-00)			
			IMPREZA (00-)			
			JUSTY II (95-03)			
			JUSTY III (03-)			
			LEGACY I (89-94)			
			LEGACY II (94-99)			
			LEGACY III (98-03)			
			LEGACY IV (03-09)			
			LEGACY OUTBACK (96-99)			
			LEGACY V (09-14)			
			OUTBACK (03-09)			
OUTBACK (09-)						
REX III (89-92)						
SVX (92-97)						
IK20TT						
-						
IK20TT						
-						
IK20TT						
-						

DENSO P/N	TT	MAKE	MODEL			
IK20TT продолжение		SUZUKI	VIVIO (92-98)			
			ALTO III (93-02)			
			BALENO (95-02)			
			CARRY (99-)			
			Grand VITARA I (98-06)			
			Grand VITARA II (05-)			
			IGNIS I (00-05)			
			IGNIS II (03-)			
			JIMNY (88-98)			
			JIMNY (98-)			
IK20TT			LIANA (01-07)			
			SAMURAI (88-04)			
IK20TT			SWIFT II (89-05)			
			SWIFT III (05-)			
IK20TT			SX4 (06-)			
			VITARA (88-99)			
			WAGON R+ (00-)			
			X-90 (95-97)			
			TAGAZ		VEGA (09-12)	
			TATA		INDICA (98-)	
			TOYOTA			4 RUNNER (N21) (02-09)
						ALPHARD I (03-08)
						ALPHARD II (08-14)
						ALTEZZA (99-05)
ARISTO (90-97)						
ARISTO (97-04)						
AVALON (X1) (95-05)						
AVALON (X2) (99-05)						
AVANZA (F6) (03-11)						
AVENSIS (97-03)						
AVENSIS (03-09)						
AVENSIS Verso (01-09)						
CALDINA (T19) (92-97)						
CALDINA (T21) (97-02)						
CAMI (99-05)						
CAMRY (V1) (90-97)						
CAMRY (V2) (96-01)						
CAMRY (V3) (01-06)						
CAMRY (V4) (06-11)						
CAMRY Solara (98-03)						
CAMRY Solara (03-08)						
CARINA E (92-97)						
CELICA (89-93)						
CELICA (93-99)						
CELICA (99-05)						
CELSIOR (88-93)						
CELSIOR (93-00)						
CELSIOR (00-06)						
CHASER (X10) (96-01)						
COROLLA (E9) (87-93)						
COROLLA (E10) (92-99)						
COROLLA (E12) (01-07)						
COROLLA Levin (E10) (91-97)						
CORONA (T19) (92-97)						
CORONA (T21) (96-03)						
CRESTA (84-01)						
CURREN (93-98)						
DYNA 200 (95-01)						
DYNA 300 (95-02)						
GAIA (98-03)						
HARRIER (97-03)						
HARRIER (03-08)						
KLUGER / HIGHLANDER I (00-07)						
LAND CRUISER (J100) (98-08)						
LAND CRUISER (J200) (07-)						
MARK II (88-96)						
MARK II (96-01)						
MARK II (02-07)						
MATRIX (01-07)						
MATRIX (08-)						
MR 2 II (89-00)						

Свечи зажигания и Свечи накаливания

Руководство покупателя

DENSO P/N	TT	MAKE	MODEL
IK20TT			NADIA (98-03)
продолжение			PICNIC (96-01)
			PREVIA / ESTIMA I (90-00)
			PREVIA / ESTIMA II (00-06)
			PREVIA / ESTIMA III (05-)
			RAV 4 I / FUNCRAISER (94-00)
			RAV 4 II (00-05)
			RAV 4 III (05-)
			SEQUOIA (00-07)
			SEQUOIA (07-)
			SERA (90-95)
			SIENNA (97-03)
			SIENNA (03-09)
			SOARER (90-00)
			SPRINTER (82-02)
			STARLET (P8) (89-96)
			SUPRA (93-02)
			TOWN ACE (92-01)
			TUNDRA (99-06)
			TUNDRA (07-)
			VEROSSA (00-03)
			VISTA (V3, V4) (90-98)
			VISTA (V5) (98-03)
			WINDOM (96-01)
			WINDOM (01-06)
			YARIS (99-05)
		TOYOTA (FAW)	LAND CRUISER (J200) (07-)
		TRIUMPH	ACCLAIM (82-85)
		TVR	CERBERA (96-03)
		VAUXHALL	ADAM (12-)
			AGILA I (A) (00-08)
			ANTARA (06-)
			ASTRA II (84-94)
			ASTRA III (F) (91-01)
			ASTRA IV (G) (98-06)
			ASTRA V (H) (04-10)
			ASTRA VI (J) (09-)
			CALIBRA (90-97)
			CARLTON III (86-94)
			CAVALIER III (88-95)
			COMBO I (B) (94-01)
			COMBO II (C) (01-12)
			CORSA I (B) (93-00)
			CORSA II (C) (00-06)
			CORSA III (D) (06-)
			FRONTERA I (A) (91-98)
			INSIGNIA I (A) (08-17)
			MERIVA I (A) (03-10)
			MERIVA II (B) (10-)
			MONTEREY I (91-98)
			OMEGA (B) (94-03)
			SENATOR II (B) (87-93)
			SIGNUM (02-08)
			SINTRA (96-99)
			SPEEDSTER (VX220) (00-06)
			TIGRA (94-00)
			VECTRA I (B) (95-03)
			VECTRA II (C) (00-08)
			VIVARO (A) (01-14)
			ZAFIRA I (A) (98-05)
			ZAFIRA II (B) (05-14)
			ZAFIRA III (C) (11-)
		VOLVO	850 (91-97)
			960 I (90-94)
			960 II (94-96)
			C70 I (97-05)
			S40 I (95-03)
			S60 I (00-10)
			S70 (96-00)
			S80 I (98-06)
			S80 II (06-)

DENSO P/N	TT	MAKE	MODEL
IK20TT			S90 I (96-98)
продолжение			V40 (95-04)
			V70 I (96-00)
			V70 II (00-07)
			V90 I (96-98)
			XC70 I Cross Country (97-07)
			XC90 I (02-14)
		VORTEX	VORTEX (09-)
		VW	BORA (1J) (98-05)
			CADDY II (9K, 9U) (95-04)
			CADDY III (2K, 2C) (04-15)
			CORRADO (53I) (88-95)
			EOS (1F) (06-15)
			GOLF III (1H, 1E) (91-99)
			GOLF IV (1J, 1E) (97-06)
			GOLF Plus (5M, 521) (05-14)
			GOLF V (1K) (03-09)
			GOLF VI (5K, AJ5) (08-14)
			GOLF VI Convertible (517) (11-16)
			JETTA III (1K2) (05-10)
			JETTA IV (162) (10-)
			LUPO (6X, 6E) (98-05)
			MULTIVAN V (7H, 7E) (03-)
			NEW BEETLE (9C, 1C, 1Y) (98-10)
			PASSAT (3A2, 35I) (88-97)
			PASSAT (3B2, 3B5) (96-01)
			PASSAT (3B3, 3B6) (00-05)
			PASSAT (3C) (05-11)
			PASSAT (362, 365) (10-14)
			PHAETON (3D) (02-16)
			POLO (6N1) (94-99)
			POLO (6N2) (99-01)
			POLO (6R, 6C) (09-)
			POLO (9N) (01-09)
			POLO Classic (6KV) (95-02)
			POLO Saloon (9A4) (02-)
			POLO Variant (6V5) (97-01)
			SCIROCCO (137, 138) (08-17)
			SHARAN (7M) (95-10)
			SHARAN (7N) (10-)
			TIGUAN (5N) (07-)
			TOUAREG (7L) (02-10)
			TOURAN (1T1, 1T2) (03-10)
			TOURAN (1T3) (10-15)
			TRANSPORTER IV (70X, 7D) (90-03)
			TRANSPORTER V (7H, 7E, 7J) (03-15)
			VENTO (1H2) (91-98)
	IK20TT	WIESMANN	GT MF4 (03-)
	-		MF3 Roadster (96-)
	IK20TT		MF4 Roadster (09-)
	-	ZAZ	LANOS (04-)
IK22	IK22FTT	AUDI	80 (8C, B4) (91-96)
			A4 (8E, B7) (04-08)
			A4 Convertible (8H, B6, B7) (02-09)
			A6 (4F, C6) (04-11)
			A6 Allroad (4FH) (06-11)
			A8 (4E) (02-10)
			COUPE (89, 8B) (88-96)
		CATERHAM	SUPER SEVEN (80-)
		MINI	MINI (R50, R53) (01-06)
			MINI Convertible (R52) (04-07)
		PEUGEOT	106 I (91-96)
			205 I (83-94)
		PORSCHE	911 (996) (97-05)
			911 (997) (04-12)
			BOXSTER (987) (04-11)
			CAYMAN (987) (05-12)
		SPYKER	C8 (00-)
			C8 Aileron (10-)
		VOLVO	V70 I (96-00)
		VW	PASSAT (3A2, 35I) (88-97)

Свечи зажигания и Свечи накаливания

Руководство покупателя

DENSO P/N	TT	MAKE	MODEL
IK22TT	-	ALPINA	B5 (E60, E61) (05-10)
			B7 (E65) (03-08)
		AUDI	80 (8C, B4) (91-96)
			100 (4A, C4) (90-94)
			200 (44) (83-91)
			A1 (8X) (10-18)
			A3 (8P) (03-13)
			A3 Convertible (8P7) (08-13)
			A4 (8D, B5) (94-01)
			A4 (8E, B7) (04-08)
			A4 (8K, B8) (07-15)
			A4 Allroad (8KH) (09-16)
			A4 Convertible (8H, B6, B7) (02-09)
			A5 (8T, 8F) (07-17)
			A6 (4A, C4) (94-97)
			A6 (4B, C5) (97-05)
			A6 (4F, C6) (04-11)
			A6 (4G, C7) (10-18)
			A6 Allroad (4FH) (06-11)
			A8 (4E) (02-10)
			A8 (4H) (09-18)
			COUPE (89, 8B) (88-96)
			Q3 (8U) (11-18)
			Q5 (8R) (08-)
			Q7 (4L) (06-15)
		QUATTRO (85) (80-91)	
		R8 (42) (07-15)	
		R8 (4S) (15-)	
		TT (8J) (06-14)	
		TT (FV) (14-)	
		CATERHAM	SUPER SEVEN (80-)
		CHEVROLET	AVEO (T300) (11-)
			CRUZE (09-)
			ORLANDO (11-)
			TRAX (12-)
		FIAT	ELBA (85-97)
			FIORINO (88-01)
		FORD	ESCORT V (90-95)
			ESCORT VI (95-01)
		GREAT WALL	HOVER H6 (11-)
		HONDA	CIVIC V (91-97)
			CIVIC VI (94-01)
			CRX III (92-98)
		INNOCENTI	ELBA (91-96)
		JAGUAR	XJ (94-97)
		KTM	X-BOW (08-)
		LAMBORGHINI	GALLARDO (03-)
		LOTUS	2 ELEVEN (07-11)
			ELISE (00-)
			EXIGE (00-12)
		MINI	MINI (R50, R53) (01-06)
			MINI Convertible (R52) (04-07)
		NISSAN	200 SX (93-99)
OPEL	ADAM (12-)		
	ASTRA J (09-)		
	CASCADA (13-)		
	CORSA D (06-14)		
	CORSA E (14-)		
	INSIGNIA (A) (08-17)		
	MERIVA B (10-)		
	MOKKA (12-)		
	ZAFIRA Tourer C (11-)		
	PEUGEOT	106 I (91-96)	
205 I (83-94)			
PORSCHE	911 (996) (97-05)		
	911 (997) (04-12)		
	BOXSTER (987) (04-11)		
	CAYENNE (92A) (10-)		
	CAYENNE (955) (02-10)		
	CAYMAN (987) (05-12)		
	PANAMERA (970) (09-)		

DENSO P/N	TT	MAKE	MODEL	
IK22TT продолжение		RENAULT	CLIO III (05-)	
			ESPACE IV (02-)	
			LAGUNA II (01-)	
			LAGUNA III (07-)	
			MEGANE CC (10-)	
			MEGANE II (02-12)	
			MEGANE III (08-)	
			TRAFIC II (01-)	
			TWINGO II (07-)	
			VEL SATIS (02-)	
			WIND (10-)	
			SAAB	9-3 (02-15)
				9-5 (97-09)
			SEAT	ALHAMBRA (710) (10-)
				ALTEA (XL) (5P) (04-)
				CORDOBA (6K1) (93-99)
				EXEO (3R) (08-)
				IBIZA II (6K1) (93-99)
				LEON (1P) (05-12)
				TOLEDO I (1L) (91-99)
				TOLEDO III (5P) (04-09)
		SKODA		OCTAVIA II (1Z) (04-13)
				SUPERB II (3T) (08-15)
			YETI (5L) (09-)	
		SPYKER	C8 (00-)	
			C8 Aileron (10-)	
		SUBARU	IMPREZA (00-)	
			LEGACY II (94-99)	
		VAUXHALL	ADAM (12-)	
			ASTRA VI (J) (09-)	
			CASCADA (13-)	
			CORSA III (D) (06-)	
			CORSA IV (E) (14-)	
			INSIGNIA I (A) (08-17)	
			MERIVA II (B) (10-)	
			MOKKA (12-)	
			ZAFIRA III (C) (11-)	
			VOLVO	V70 I (96-00)
		VW	AMAROK (2H, S1) (10-)	
			BEETLE (5C) (11-)	
			CC (358) (11-)	
			EOS (1F) (06-15)	
			GOLF III (1H, 1E) (91-99)	
			GOLF V (1K) (03-09)	
			GOLF VI (5K, AJ5) (08-14)	
			GOLF VI Convertible (517) (11-16)	
			JETTA III (1K2) (05-10)	
			JETTA IV (162) (10-)	
			MULTIVAN V (7H, 7E) (03-)	
			PASSAT (3A2, 35I) (88-97)	
			PASSAT (3C) (05-11)	
			PASSAT (362, 365) (10-14)	
			PASSAT CC (357) (08-12)	
POLO (6R, 6C) (09-)				
SCIROCCO (137, 138) (08-17)				
SHARAN (7N) (10-)				
TIGUAN (5N) (07-)				
TRANSPORTER V (7H, 7E, 7J) (03-15)				
IK24	-	AUDI	A4 (8K, B8) (07-15)	
			A5 (8T, 8F) (07-17)	
			A6 (4F, C6) (04-11)	
			A6 (4G, C7) (10-18)	
			A6 Allroad (4FH) (06-11)	
			A7 (4GA) (10-18)	
			A8 (4H) (09-18)	
		Q7 (4L) (06-15)		
		LAND ROVER	DISCOVERY IV (09-)	
		PORSCHE	CARRERA GT (03-06)	
VW	TOUAREG (7P) (10-18)			
IK27	-	LAMBORGHINI	GALLARDO (03-)	
IKB22TT	-	ALPINE	A610 (91-95)	

Свечи зажигания и Свечи накаливания

Руководство покупателя

DENSO P/N	TT	MAKE	MODEL					
IKB22TT продолжение		AUDI	80 (89, 8A, B3) (86-91)					
			80 (8C, B4) (91-96)					
			90 (89, 8A, B3) (87-91)					
			100 (4A, C4) (90-94)					
			A6 (4A, C4) (94-97)					
			CABRIOLET (8G7) (91-00)					
		CITROËN	AX (86-98)					
			BX (82-94)					
			XM (89-94)					
		FIAT	DUCATO (250, 290) (06-)					
			PUNTO (93-00)					
			UNO (146) (83-00)					
		LANCIA	DEDRA (89-99)					
			DELTA II (93-99)					
			THEMA (84-94)					
		PEUGEOT	106 I (91-96)					
			205 II (87-98)					
			309 II (89-93)					
			405 I (87-93)					
		PORSCHE	911 (964) (88-94)					
			911 (993) (93-97)					
		RENAULT	SAFRANE I (92-96)					
		SEAT	CORDOBA (6K1) (93-99)					
			IBIZA II (6K1) (93-99)					
			TOLEDO I (1L) (91-99)					
		VW	CORRADO (53I) (88-95)					
			GOLF II (19, 1G) (83-92)					
			JETTA II (19, 1G) (84-92)					
			PASSAT (3A2, 35I) (88-97)					
			SCIROCCO (53B) (80-92)					
		IKBH20TT	-	LEXUS	GS (05-11)			
					GS (12-)			
					GX (01-09)			
					IS C (09-)			
					IS II (05-13)			
					IS III (13-)			
					LC (16-)			
					LS (06-)			
					RC (14-)			
					IKBH20TT		TOYOTA	CROWN (03-08)
								CROWN Comfort (08-)
					-			MARK X I (04-09)
			MARK X II (09-)					
IKBH20TT				TOYOACE (11-)				
IKH16TT	-		CHRYSLER	300 C (04-12)				
				ASPEN (06-)				
				CITROËN	BERLINGO (B9) (08-)			
					BERLINGO (MF) (96-11)			
		C1 I (05-14)						
		C2 (03-)						
		C3 I (02-)						
		C3 Pluriel (03-)						
		C4 (Grand Picasso I) (06-13)						
		C4 Aircross (12-)						
		C4 Coupe (04-11)						
		C4 I (LC, LR) (04-11)						
		C5 I (01-04)						
		C5 II (04-)						
		C5 III (08-)						
		C6 (05-14)						
		C8 (02-)						
		C-ELYSEE (12-)						
		EVASION (94-02)						
		JUMPY (95-06)						
		JUMPY (07-)						
		XSARA (97-05)						
		XSARA Picasso (99-11)						
		IKH16TT		DF CITROEN	C-TRIOMPHE (09-)			
	CHALLENGER (07-)							
	-		DODGE	CHARGER (11-)				

DENSO P/N	TT	MAKE	MODEL			
IKH16TT продолжение			DURANGO (11-)			
			RAM (08-)			
			RAM 4000 (05-)			
		IKH16TT	FIAT	ULYSSE (02-11)		
				HYUNDAI	EQUUS / CENTENNIAL (09-)	
					GRANDEUR (05-11)	
					GRANDEUR (11-)	
					H-1 (08-)	
					ix35 (09-)	
					SANTA FÉ I (00-06)	
				-		SANTA FÉ II (06-12)
						SANTA FÉ III (12-)
						SONATA V (05-10)
						SONATA VI (09-15)
		IKH16TT	INFINITI	FX (02-08)		
				G (02-07)		
				I35 (95-04)		
				Q45 III (01-)		
				-	JEEP	Grand CHEROKEE III (05-10)
						Grand CHEROKEE IV (10-)
				IKH16TT	KIA	CERATO (09-)
						MAGENTIS (05-)
						OPTIMA (10-)
						SORENTO II (09-)
						SORENTO III (15-)
		SPORTAGE III (10-)				
		IKH16TT	LANCIA			PHEDRA (02-10)
						LEXUS
		IKH16TT	MITSUBISHI			ASX (10-)
				COLT VI (04-12)		
				LANCER VIII (07-)		
				-	NISSAN	350 Z (02-)
						ALMERA Classic (06-)
						ALMERA II (00-)
				IKH16TT		ALMERA TINO (00-)
						ALTIMA (01-06)
						ALTIMA (06-13)
						AVENIR (97-05)
						CUBE (03-05)
		ELGRAND (95-02)				
		ELGRAND (02-10)				
		JUKE (10-)				
MAXIMA V (99-03)						
MICRA C+C (05-)						
-		MICRA III (K12) (03-10)				
		MURANO I (03-08)				
		NOTE (E11) (06-12)				
		NV2500 (11-)				
		PATHFINDER II (97-04)				
		PRIMERA (P11) (96-02)				
		PRIMERA (P12) (02-)				
		QUEST (03-)				
		SENTRA V (00-06)				
		SKYLINE (V35) (03-07)				
		TEANA I (03-08)				
TITAN (03-)						
IKH16TT	NISSAN (DFAC)	X-TRAIL (T30) (01-13)				
		X-TRAIL (T31) (07-13)				
		TEANA (J31) (06-08)				
		-	PEUGEOT	107 (05-)		
				206 (98-)		
				206 CC (00-)		
				207 (06-)		
				307 (00-)		
				308 CC (07-)		
				308 I (07-)		
				406 (95-04)		
406 Coupe (97-04)						
407 (04-)						
407 Coupe (05-)						

Свечи зажигания и Свечи накаливания

Руководство покупателя

DENSO P/N	TT	MAKE	MODEL
IKH16TT продолжение	-		607 (00-)
	IKH16TT		806 (94-02)
-	807 (02-)		
-	1007 (05-)		
-	EXPERT (96-06)		
-	EXPERT (07-)		
-	PARTNER / RANCH (96-15)		
-	PARTNER / RANCH (08-)		
-	RAM		1500 (DS) (10-)
-	2500 (DJ) (10-)		
IKH16TT	RENAULT	AVANTIME (01-03)	
-		CLIO II (98-)	
IKH16TT		ESPACE IV (02-)	
-		LAGUNA II (01-)	
-		MEGANE I (96-03)	
IKH16TT		VEL SATIS (02-)	
-	SUZUKI	Grand VITARA II (05-)	
-		SX4 (06-)	
IKH16TT	TOYOTA	ALLION II (07-)	
-		AURIS (E15) (06-12)	
-		AYGO (05-)	
-		CAMRY (V4) (06-11)	
-		CAMRY (V5) (11-)	
-		CAMRY (V7) (17-)	
-		FJ CRUISER (07-)	
-		IQ (09-)	
-		KLUGER / HIGHLANDER II (07-)	
-		KLUGER / HIGHLANDER III (14-)	
-		LAND CRUISER / PRADO (J150) (10-)	
IKH16TT		PREMIO (07-)	
-		RACTIS (05-10)	
-		RACTIS (10-)	
-		RAV 4 IV (12-)	
IKH16TT		SIENTA (15-)	
-		URBAN CRUISER (07-)	
-		VIOS / YARIS (07-)	
-		YARIS (99-05)	
-		YARIS (05-11)	
-		YARIS (10-)	
-	TOYOTA (GAC)	HIGHLANDER (09-)	
IKH20TT	IKH20TT	BMW	1 (E81, E87) (03-12)
-			1 Coupe/Convertible (E82, E88) (07-13)
-			3 (E90, E91) (05-12)
-			3 Coupe/Convertible (E92, E93) (06-13)
-			5 (E60, E61) (03-10)
-			5 (F10, F11) (10-16)
-			6 (E63, E64) (04-10)
-			7 (E65, E66) (01-08)
-			7 (F01, F02, F03, F04) (08-15)
-			X1 (E84) (09-15)
-			X3 (E83) (04-11)
-			X5 (E70) (07-13)
-			Z4 (E85, E86) (03-09)
-			Z4 (E89) (09-16)
-		BMW (BRILLIANCE)	3 (E90) (05-12)
-		CADILLAC	BLS (06-)
-			CTS (02-07)
-			SRX (04-08)
-			STS (04-12)
-		CITROËN	C4 Coupe (04-11)
-			C4 I (LC, LR) (04-11)
-			C5 III (08-)
-			C8 (02-)
-			JUMPY (07-)
-		DAIHATSU	CUORE VII (06-)
-			SIRION (05-)
-		ENGLON	SC7 (10-17)
-		FIAT	SCUDO (220) (96-06)
IKH20TT			SEDICI (06-14)
-			ULYSSE (94-02)
-			ULYSSE (02-11)

DENSO P/N	TT	MAKE	MODEL
IKH20TT продолжение	IKH20TT	FORD	KUGA I (08-12)
	-		S-MAX (06-14)
-		HONDA	CIVIC VIII Saloon (05-)
-			FREED I (08-16)
-			INSIGHT (00-06)
-			INSIGHT (09-)
-			JAZZ III (08-)
-		HYUNDAI	GENESIS (08-)
IKH20TT	INFINITI		FX (02-08)
-			G (02-07)
-			I35 (95-04)
-		LANCIA	PHEDRA (02-10)
-			ZETA (95-02)
IKH20TT	LAND ROVER		FREELANDER II (06-14)
-		LEXUS	ES (06-12)
-			ES (12-)
-			GS (05-11)
-			GX (09-)
-			LS (06-)
-			LX (07-)
-			RX (03-08)
-			RX (08-15)
-		LOTUS	EVORA (09-)
-			EXIGE (12-)
IKH20TT	LTI		TX (97-)
-		MITSUBISHI	COLT CZC (06-09)
-			COLT VI (04-12)
-			ECLIPSE IV (05-12)
-			GALANT VII (03-)
-			GRANDIS (04-11)
-			LANCER VIII (07-)
-			OUTLANDER I (03-06)
-			SPACE STAR / MIRAGE (12-)
-		NISSAN	350 Z (02-)
-			ALTIMA (01-06)
-			ALTIMA (06-13)
-			ELGRAND (95-02)
-			ELGRAND (02-10)
-			MAXIMA V (99-03)
-			MURANO I (03-08)
-			PATHFINDER II (97-04)
-			PATHFINDER III (05-)
-			PATROL GR II (97-)
-			PRIMERA (P12) (02-)
-			QUEST (03-)
-			TEANA I (03-08)
-			X-TRAIL (T30) (01-13)
IKH20TT	NISSAN (DFAC)		TEANA (J31) (06-08)
-		OPEL	SIGNUM (03-)
-			VECTRA C (02-08)
-		PEUGEOT	206 (98-)
-			307 (00-)
-			308 CC (07-)
-			308 I (07-)
IKH20TT	RENAULT		CLIO II (98-)
-			LAGUNA II (01-)
-		SAAB	9-3 (02-15)
-		SMART	FORFOUR I (454) (04-06)
-		SUBARU	FORESTER (02-08)
-			FORESTER (08-)
-			IMPREZA (00-)
-			IMPREZA (08-)
-			JUSTY IV (07-)
IKH20TT			LEGACY III (98-03)
-			LEGACY IV (03-09)
-			LEGACY V (09-14)
-			OUTBACK (00-03)
-			OUTBACK (09-)
-			TRIBECA (05-)
-		SUZUKI	Grand VITARA II (05-)
-			KIZASHI (10-)

Свечи зажигания и Свечи накаливания

Руководство покупателя

DENSO P/N	TT	MAKE	MODEL
IKH20TT	-		SWIFT IV (10-)
продолжение	IKH20TT		SX4 (06-)
			SX4 S-Cross (13-)
			VITARA (15-)
		TOYOTA	4 RUNNER (N21) (02-09)
			ALLION II (07-)
			ALPHARD II (08-14)
			AVALON (X3) (05-12)
			AVALON (X4) (12-)
			CAMRY (V4) (06-11)
			CAMRY (V5) (11-)
			CROWN (03-08)
			FJ CRUISER (07-)
			FORTUNER (04-15)
			FORTUNER (15-)
			HARRIER (03-08)
			KLUGER / HIGHLANDER II (07-)
			KLUGER / HIGHLANDER III (14-)
			LAND CRUISER (J200) (07-)
			LAND CRUISER / PRADO (J70) (84-06)
			LAND CRUISER / PRADO (J120) (02-10)
			LAND CRUISER / PRADO (J150) (10-)
			MARK X I (04-09)
			RACTIS (10-)
			RAV 4 III (05-)
			SEQUOIA (07-)
			SIENNA (10-)
			TUNDRA (07-)
			URBAN CRUISER (07-)
			VENZA (08-)
		TOYOTA (FAW)	LAND CRUISER (J200) (07-)
			PRADO (03-10)
		TOYOTA (GAC)	HIGHLANDER (09-)
	IKH20TT	VAUXHALL	SIGNUM (02-08)
			VECTRA II (C) (00-08)
	-	VOLVO	C30 (06-12)
			C70 II (06-13)
			S40 II (04-12)
	IKH20TT		S60 II (10-)
			S80 II (06-)
	-		V50 (04-12)
	IKH20TT		V60 I (10-)
			V70 III (07-)
			XC60 I (08-)
			XC70 II (07-)
			XC90 I (02-14)
IKH22	-	FORD	FOCUS II (04-12)
			MONDEO IV (07-15)
		PORSCHE	BOXSTER (981) (12-)
			BOXSTER (987) (04-11)
			CAYENNE (92A) (10-)
			CAYENNE (955) (02-10)
			CAYMAN (981) (13-)
			CAYMAN (987) (05-12)
			PANAMERA (970) (09-)
		VOLVO	V50 (04-12)
IKH24	-	AUDI	A6 (4G, C7) (10-18)
			A7 (4GA) (10-18)
		FORD	FOCUS II (04-12)
IQ16TT	IQ16TT	CHEVROLET	MATIZ (05-)
	-	CITROËN	AX (86-98)
			BX (82-94)
		GAZ	GAZELLE (03-13)
			SOBOL (2217, 2310, 2752) (97-)
			VOLGA (3110, 3111) (93-10)
		HONDA	CIVIC III (83-87)
			CIVIC IV (87-95)
			PRELUDE III (86-92)
		INFINITI	M30 (89-93)
		JEEP	CJ5 - CJ8 (66-87)
		NISSAN	300 ZX (84-90)

DENSO P/N	TT	MAKE	MODEL
IQ16TT	IQ16TT		300 ZX (90-95)
продолжение	-		BLUEBIRD (85-92)
			CEDRIC (83-87)
			CEDRIC (87-97)
			CEDRIC (91-99)
			PRIMERA (P10) (90-98)
			STANZA (81-85)
			SUNNY II (86-91)
			SUNNY III (90-00)
		PEUGEOT	106 I (91-96)
			205 I (83-94)
			205 II (87-98)
			306 (93-02)
			405 II (92-99)
		RENAULT	19 II (92-01)
			CLIO I (90-98)
			MEGANE I (96-03)
			MEGANE Scénic (96-99)
			RAPID (85-98)
	IQ16TT	SAAB	9-3 (98-03)
			900 I (78-94)
			900 II (93-98)
	-	SKODA	FAVORIT (78) (89-97)
			FELICIA Fun (6U) (97-02)
			FELICIA I (6U) (94-98)
		SSANGYONG	ACTYON I (05-)
			KORANDO (96-06)
			KYRON (05-)
			MUSSO (93-07)
			REXTON (02-)
			RODIUS I (05-)
			STAVIC (05-)
		TOYOTA	ALTEZZA (99-05)
			CAMRY (V1) (83-88)
			CAMRY (V2) (86-91)
			CARINA E (92-97)
			CARINA II (83-92)
			CELICA (81-85)
	IQ16TT		CELICA (85-89)
	-		CELICA (89-93)
			COROLLA (E8) (83-89)
			COROLLA (E9) (87-93)
			COROLLA (E10) (92-99)
			COROLLA FX (84-88)
			CORONA (T17) (87-92)
			MR 2 I (84-90)
			MR 2 II (89-00)
			SOARER (80-86)
			SPRINTER (82-02)
			SUPRA (86-93)
		UAZ	452 (66-)
			2206 (06-)
			BARS (3159) (99-)
			BUKHANKA (3741) (85-)
			CARGO (2360) (04-)
			GOLOVASTIK (3303) (85-)
			HUNTER (3151) (92-)
			PATRIOT (04-)
			PICKUP (09-)
			SIMBIR (3162) (97-)
			101 Feeling (89-93)
		YULON	YULON (93-98)
IQ20TT	-	ACURA	INTEGRA (85-90)
			LEGEND I (86-91)
		ASTON MARTIN	VIRAGE (87-92)
			VIRAGE (90-00)
		AUSTIN	1000-Series (70-74)
		CHERY	A1 (06-14)
			QQ6 (06-13)
		CITROËN	AX (86-98)
			BX (82-94)

Свечи зажигания и Свечи накаливания

Руководство покупателя

DENSO P/N	TT	MAKE	MODEL
IQ20TT продолжение			C15 (84-05)
			EVASION (94-02)
			JUMPER (94-02)
			JUMPY (95-06)
			XM (89-94)
			ZX (91-98)
		FIAT	PANDA (80-04)
			PUNTO (93-00)
			TIPO (160) (87-95)
			UNO (146) (83-00)
FORD	ESCORT III (80-86)		
	ESCORT IV (85-90)		
	ESCORT V (90-95)		
	ESCORT VI (95-01)		
	FIESTA II (83-95)		
	FIESTA III (89-97)		
	ORION I (83-86)		
	ORION II (85-90)		
	ORION III (90-93)		
	SCORPIO I (85-94)		
	SCORPIO II (94-98)		
	SIERRA (87-93)		
	TRANSIT (91-94)		
	FORD USA	PROBE II (93-98)	
HONDA	ACCORD III (85-89)		
	CIVIC IV (87-95)		
	CIVIC V (91-97)		
	CIVIC VI (94-01)		
	CONCERTO (89-96)		
	CRX I (83-87)		
	CRX II (87-92)		
	INTEGRA (85-93)		
	LEGEND I (86-90)		
	PRELUDE III (86-92)		
	IQ20TT	INFINITI	J30 (92-97)
	-	JAGUAR	XJ (86-94)
			XJ (94-97)
			XJ Coupe (73-96)
LADA	110 (2110) (95-12)		
	111 (2111) (95-13)		
	112 (2112) (95-13)		
	GRANTA (2190, 2191, 2349) (11-)		
	KALINA (1117, 1118, 1119) (04-)		
	KALINA (2192, 2194) (13-)		
	OKA (1111) (88-08)		
	PICKUP (2345) (97-04)		
	PRIORA (2170, 2171, 2172) (08-)		
	SAMARA (2108, 2109, 2113, 2114, 2115) (86-13)		
	LANCIA	Y (95-03)	
		Y10 (85-95)	
	LEXUS	ES (89-97)	
	MAZDA	323 III (85-95)	
626 II (82-87)			
626 III (87-97)			
929 III (87-91)			
E-SERIE (SR) (83-04)			
MERCEDES-BENZ	SL (R129) (89-01)		
MORGAN	FOUR FOUR (68-)		
	PLUS FOUR (85-)		
MORRIS	ITAL (80-84)		
NISSAN	200 SX (88-94)		
	300 ZX (84-90)		
	BLUEBIRD (83-90)		
	BLUEBIRD (85-92)		
	CEDRIC (83-87)		
	CEDRIC (91-99)		
	PATHFINDER II (97-04)		
	PRAIRIE (M10) (83-88)		
	PRAIRIE Pro (M11) (88-94)		
	SILVIA (S12) (84-88)		
	SKYLINE (R32) (89-93)		

DENSO P/N	TT	MAKE	MODEL			
IQ20TT продолжение	IQ20TT		SKYLINE (R33) (93-00)			
			SKYLINE (R34) (98-08)			
	-	OPEL	STANZA (81-85)			
			SUNNY II (86-91)			
			MONTEREY A (91-98)			
			VECTRA A (88-95)			
			PEUGEOT	205 I (83-94)		
				205 II (87-98)		
		305 II (82-90)				
		306 (93-02)				
					309 I (85-89)	
					309 II (89-93)	
405 I (87-93)						
405 II (92-99)						
504 (68-89)						
505 (79-95)						
605 (89-99)						
BOXER (94-02)						
J5 (81-90)						
J5 (90-94)						
PARTNER / RANCH (96-15)						
PONTIAC	TRANS SPORT (89-97)					
RELIANT	SCIMITAR (68-90)					
	SCIMITAR Sabre (92-95)					
RENAULT	19 I (88-92)					
	19 II (92-01)					
			ROVER			
			400 (95-00)			
			IQ20TT	SAAB	9-3 (98-03)	
					9-5 (97-09)	
					900 I (78-94)	
					900 II (93-98)	
						9000 (84-98)
						SKODA
						FAVORIT (78) (89-97)
						SUBARU
TOYOTA	ALTEZZA (99-05)					
	CAMRY (V1) (90-97)					
	CAMRY (V2) (86-91)					
	CARINA E (92-97)					
	COROLLA Levin (E10) (91-97)					
	CRESTA (84-01)					
	SOARER (80-86)					
	SOARER (86-91)					
	SUPRA (86-93)					
	WINDOM (91-96)					
VOLVO	960 I (90-94)					
	960 II (94-96)					
			WESTFIELD			
			130 (97-)			
IQ22	-		CITROËN			
			BX (82-94)			
			SAAB			
			900 I (78-94)			
IQ24	-	ASTON MARTIN	VIRAGE (90-00)			
			FORD	ESCORT III (80-86)		
				FIESTA III (89-97)		
			SIERRA (87-93)			
			SIERRA (87-93)			
IRE01-27	-	MAZDA	RX 7 II (85-91)			
			RX 7 III (92-02)			
IRL01-27	-	MAZDA	RX 8 (03-12)			
			RX 8 (03-12)			
IRT01-31	-		MAZDA			
			RX 8 (03-12)			
			IT16TT	-	ASTON MARTIN	DB7 (94-03)
						BUICK
			PARK AVENUE (90-96)			
			RENDEZVOUZ (00-06)			
			SKYLARK (89-99)			
			ALLANTE (85-93)			
			CTS (02-07)			
						DEVILLE (89-93)
						DEVILLE (93-99)
DEVILLE (99-04)						
ELDORADO (85-91)						
ELDORADO (91-02)						
ESCALADE (98-06)						
IT16TT	-					DEVILLE (89-93)
						DEVILLE (93-99)

Свечи зажигания и Свечи накаливания

Руководство покупателя

DENSO P/N	TT	MAKE	MODEL	
IT16TT продолжение			FLEETWOOD (93-97)	
			SEVILLE II (K) (79-93)	
			SEVILLE III (6K) (92-97)	
			SEVILLE IV (97-04)	
			SRX (04-08)	
			STS (04-12)	
			XLR (04-09)	
			CHEVROLET	ALERO (99-04)
				BLAZER (S10) (94-05)
				CAPRICE (90-96)
		CAVALIER (89-03)		
		IMPALA (99-05)		
		LUMINA APV (89-96)		
		MALIBU (96-03)		
		S10 Pick Up (93-05)		
		SILVERADO (99-07)		
		TAHOE (99-06)		
		TRANS SPORT (96-05)		
		FORD		COUGAR (98-01)
				FIESTA IV (95-03)
			KA (96-08)	
			MONDEO I (93-96)	
			MONDEO II (96-00)	
			MONDEO III (00-07)	
			SCORPIO I (85-94)	
			SIERRA (87-93)	
			FORD USA	AEROSTAR (85-97)
				BRONCO II (85-90)
				EXPLORER (94-01)
		F150 (96-03)		
		MUSTANG (93-04)		
		MUSTANG (04-)		
		TAURUS (85-92)		
		TAURUS (91-95)		
		TAURUS (95-07)		
		THUNDERBIRD (93-97)		
		WINDSTAR (95-04)		
		GMC	JIMMY (94-02)	
			SIERRA (97-07)	
		HUMMER	HUMMER H2 (02-)	
			HUMMER H3 (05-)	
		MAZDA	3 (00-09)	
			5 (05-10)	
			5 (10-)	
			6 (02-07)	
			6 (07-13)	
			121 III (96-03)	
			MPV II (99-06)	
		- IT16TT	MX-5 III (05-14)	
			TRIBUTE (00-08)	
			PONTIAC	BONNEVILLE (86-99)
		MONTANA (98-05)		
		TRANS SPORT (97-99)		
IT16TT	SAAB	9-7X (05-)		
-	TOYOTA	CAVALIER (94-00)		
IT20TT	-	ALPINE	A310 (71-84)	
		ASTON MARTIN	DB9 (04-16)	
		VANQUISH (01-07)		
	AUDI	100 (4A, C4) (90-94)		
		A6 (4A, C4) (94-97)		
		A8 (4D) (94-02)		
		V8 (44, 4C) (88-94)		
	AUSTIN	AMBASSADOR (82-84)		
	CITROËN	BX (82-94)		
		C15 (84-05)		
		CX I (74-85)		
		CX II (85-92)		
		GS (70-86)		
		LNA (76-86)		
		VISA (78-91)		
	IT20TT	DE LOREAN	DMC-12 (81-83)	

DENSO P/N	TT	MAKE	MODEL	
IT20TT продолжение		FORD	C-MAX I (07-10)	
			ESCORT III (80-86)	
			ESCORT IV (85-90)	
			ESCORT V (90-95)	
			ESCORT VI (95-01)	
			FIESTA I (76-86)	
			FIESTA II (83-95)	
			FIESTA III (89-97)	
			FIESTA IV (95-03)	
			FIESTA V (01-08)	
			FOCUS C-MAX (03-07)	
			FOCUS I (98-05)	
			FOCUS II (04-12)	
		GALAXY (06-15)		
		GT (03-06)		
		MAVERICK (01-)		
		MONDEO III (00-07)		
		MONDEO IV (07-15)		
		ORION II (85-90)		
		ORION III (90-93)		
		SCORPIO I (85-94)		
		S-MAX (06-14)		
		TRANSIT (06-14)		
		- IT20TT	FORD USA	EXCURSION (99-05)
				WINDSTAR (95-04)
			JAGUAR	S-TYPE (99-08)
				XF (08-15)
				XJ (94-97)
				XJ (03-09)
				XJ Coupe (73-96)
				XJSC (85-96)
				XK 8 (96-05)
			X-TYPE (01-09)	
			LANCIA	THEMA (84-94)
		LDV	SHERPA (74-89)	
		MAZDA	3 (00-09)	
			5 (05-10)	
			6 (02-07)	
			MPV II (99-06)	
			TRIBUTE (00-08)	
		- IT20TT	MERCEDES-BENZ	190 (W201) (82-93)
				COUPE (C123) (77-85)
				COUPE (C124) (87-93)
				E-CLASS (124) (92-96)
				G-CLASS (W460) (79-93)
				G-CLASS (W461) (90-)
				G-CLASS (W463) (89-)
				KOMBI (S123) (77-85)
				KOMBI (S124) (85-93)
				Saloon (W123) (76-85)
				Saloon (W124) (84-93)
				S-CLASS (W126) (79-91)
				SL (R107) (71-89)
SL (R129) (89-01)				
T1 (601) (77-96)				
T1 (602) (77-96)				
T1 / TN (611) (81-95)				
T2 / L (309, 310, 328) (68-88)				
T2 / LN1 (86-94)				
MORGAN	ROADSTER (04-)			
MORRIS	ITAL (80-84)			
PEUGEOT	104 (72-88)			
	205 I (83-94)			
	205 II (87-98)			
	305 I (77-82)			
	305 II (82-90)			
	309 I (85-89)			
	504 (68-89)			
505 (79-95)				
604 (77-87)				
PROTON	GEN 2 (04-)			

Свечи зажигания и Свечи накаливания

Руководство покупателя

DENSO P/N	TT	MAKE	MODEL	
IT20TT продолжение		PUCH	G-MODELL (W460) (79-92)	
			G-MODELL (W463) (89-00)	
		RENAULT	5 (72-85)	
			14 (76-83)	
			18 (78-93)	
			20 (75-83)	
			21 (86-95)	
			25 (84-93)	
			30 (75-86)	
			ESPACE I (84-92)	
			ESPACE II (91-96)	
			FUEGO (80-85)	
			MASTER I (80-98)	
			SAFRANE I (92-96)	
			TRAFIC (89-01)	
		ROVER	2000-3500 (76-86)	
		SHELBY	SERIES 1 (98-)	
		TALBOT	SAMBA (81-86)	
			TAGORA (80-87)	
		TVR	S (86-96)	
		VOLVO	260 (74-82)	
	760 (81-92)			
	780 (86-90)			
	C30 (06-12)			
	S40 II (04-12)			
	-	S80 II (06-)		
	IT20TT		V50 (04-12)	
	-		V70 III (07-)	
	IT22	-	ALPINE	V6 (85-90)
		-	RENAULT	21 (86-95)
	IT27	-	RENAULT	5 (72-85)
	ITF16TT	-	AC	ACE (95-98)
				ACE (98-)
ACECA (93-01)				
COBRA IV (90-)				
CHEVROLET			ASTRO (84-94)	
			BLAZER (S10) (82-94)	
			BLAZER (S10) (94-05)	
			C1500 (91-00)	
			C2500 (91-96)	
			CAMARO (70-81)	
			CAMARO (81-92)	
			MALIBU (77-83)	
S10 Pick Up (82-94)				
S10 Pick Up (93-05)				
FORD USA		ECONOLINE (76-92)		
GMC		G SERIE (75-84)		
PONTIAC		FIREBIRD (81-92)		
		TRANS SPORT (89-97)		
ITF20TT		-	CADILLAC	FLEETWOOD (84-93)
				CHEVROLET
			CAMARO (92-02)	
			C-K SERIE (94-00)	
		SUBURBAN (91-00)		
		TAHOE (94-96)		
		GMC	YUKON (91-00)	
	PONTIAC	FIREBIRD (92-02)		
ITL16TT	ITL16TT	CHEVROLET	CAPTIVA (06-)	
			HHR (06-11)	
		CHRYSLER	300 C (04-12)	
			ASPEN (06-)	
			CONCORDE (97-03)	
			Grand VOYAGER V (07-)	
			PT CRUISER (00-10)	
			SEBRING (01-07)	
			SEBRING (07-10)	
			VOYAGER IV (00-08)	
			DODGE	AVENGER (07-14)
				CARAVAN (00-07)
		CHARGER (05-10)		
		DURANGO (03-10)		

DENSO P/N	TT	MAKE	MODEL	
ITL16TT продолжение			DURANGO (11-)	
			RAM (01-09)	
			RAM 4000 (05-)	
		JEEP	CHEROKEE / LIBERTY (KJ) (01-08)	
			COMMANDER (05-10)	
			Grand CHEROKEE III (05-10)	
			Grand CHEROKEE IV (10-)	
			WRANGLER II (96-08)	
		OPEL	ANTARA (06-)	
		VAUXHALL	ANTARA (06-)	
VW	ROUTAN (08-)			
ITL20	-	CHRYSLER	300 C (04-12)	
			300 C (11-)	
			300 M (98-04)	
			CONCORDE (97-03)	
			SEBRING (01-07)	
		DODGE	AVENGER (07-14)	
			CHALLENGER (07-)	
			CHARGER (05-10)	
			CHARGER (11-)	
			JOURNEY (08-)	
		JEEP	Grand CHEROKEE III (05-10)	
			Grand CHEROKEE IV (10-)	
			WRANGLER III (07-)	
			ALFA ROMEO	159 (05-11)
				BRERA (06-10)
SPIDER (06-10)				
CADILLAC	CTS (02-07)			
	CTS (08-)			
	SRX (04-08)			
CHEVROLET	STS (04-12)			
	CAPTIVA (06-)			
	TRAILBLAZER (01-08)			
FIAT	CROMA (05-)			
FORD	B-MAX (12-)			
	C-MAX I (07-10)			
	C-MAX II (10-)			
	COUGAR (98-01)			
	ESCORT V (90-95)			
	ESCORT VI (95-01)			
	FIESTA III (89-97)			
	FIESTA IV (95-03)			
	FIESTA V (01-08)			
	FIESTA VI (08-)			
	FOCUS C-MAX (03-07)			
	FOCUS I (98-05)			
	FOCUS II (04-12)			
	FOCUS III (10-)			
	FUSION (02-12)			
	GALAXY (06-15)			
	Grand C-MAX (10-)			
	KA (96-08)			
	KUGA II (12-)			
	MAVERICK (01-)			
MONDEO I (93-96)				
MONDEO II (96-00)				
MONDEO IV (07-15)				
ORION III (90-93)				
P 100 (87-92)				
PUMA (97-02)				
S-MAX (06-14)				
TOURNEO Connect (02-13)				
TRANSIT Connect (02-13)				
FORD USA	ESCAPE (01-07)			
HUMMER	HUMMER H3 (05-)			
MAZDA	2 (03-07)			
	3 (00-09)			
	3 (09-14)			
	5 (05-10)			
	5 (10-)			
ITV16TT		6 (02-07)		

Свечи зажигания и Свечи накаливания

Руководство покупателя

DENSO P/N	TT	MAKE	MODEL
ITV16TT			6 (07-13)
продолжение	-		121 III (96-03)
	ITV16TT		CX-7 (07-14)
			CX-9 (07-)
	-		TRIBUTE (00-08)
		MORGAN	FOUR FOUR (68-)
			PLUS FOUR (85-)
		OPEL	ANTARA (06-)
			ASTRA G (98-09)
	ITV16TT		ASTRA J (09-)
			INSIGNIA (A) (08-17)
	-		SPEEDSTER (00-)
			VECTRA B (95-03)
			VECTRA C (02-08)
			ZAFIRA A (99-05)
		RENAULT	19 I (88-92)
	ITV16TT	SAAB	9-3 (02-15)
			9-3X (09-12)
			9-5 (10-12)
	-	SUZUKI	Grand VITARA II (05-)
		VAUXHALL	ASTRA IV (G) (98-06)
	ITV16TT		ASTRA VI (J) (09-)
			INSIGNIA I (A) (08-17)
	-		SPEEDSTER (VX220) (00-06)
			VECTRA I (B) (95-03)
			VECTRA II (C) (00-08)
			ZAFIRA I (A) (98-05)
		VOLVO	C30 (06-12)
			S40 II (04-12)
			V50 (04-12)
		WESTFIELD	130 (97-)
			ZE (93-97)
ITV20TT	ITV20TT	CHEVROLET	CAPTIVA (06-)
		CHRYSLER	300 C (11-)
			Grand VOYAGER V (07-)
		DODGE	AVENGER (07-14)
			CHALLENGER (07-)
			CHARGER (11-)
			DURANGO (11-)
		FIAT	FREEMONT (11-)
		FORD	B-MAX (12-)
			C-MAX II (10-)
			FIESTA VI (08-)
			FOCUS I (98-05)
			FOCUS III (10-)
			FUSION (02-12)
			GALAXY (06-15)
			Grand C-MAX (10-)
			GT (16-)
			KA (96-08)
			KUGA II (12-)
			MONDEO IV (07-15)
			S-MAX (06-14)
			STREET KA (03-05)
			TOURNEO Connect (13-)
			TRANSIT Connect (13-)
		JEEP	Grand CHEROKEE IV (10-)
			WRANGLER III (07-)
		LANCIA	THEMA (11-)
			VOYAGER (11-14)
		MAZDA	3 (00-09)
			5 (05-10)
			5 (10-)
			6 (07-13)
			MX-5 III (05-14)
		MITSUOKA	HIMIKO (08-)
		OPEL	GT (07-)
			INSIGNIA (A) (08-17)
		RAM	1500 (DS) (10-)
		SAAB	9-5 (10-12)
		VAUXHALL	INSIGNIA I (A) (08-17)

DENSO P/N	TT	MAKE	MODEL
ITV20TT		VOLVO	S60 II (10-)
продолжение			S80 II (06-)
			V40 (12-)
			V60 I (10-)
			V70 III (07-)
			XC60 I (08-)
		WW	ROUTAN (08-)
ITV22	-	FORD	C-MAX II (10-)
			FIESTA VI (08-)
			FOCUS I (98-05)
			FOCUS II (04-12)
			FOCUS III (10-)
			GALAXY (06-15)
			GALAXY (15-)
			MONDEO IV (07-15)
			MONDEO V (14-)
			S-MAX (06-14)
			S-MAX (15-)
		FORD USA	MUSTANG (14-)
		JAGUAR	XF (08-15)
			XJ (09-)
		LAND ROVER	FREELANDER II (06-14)
			RANGE ROVER Evoque (11-)
		MAZDA	3 (00-09)
			3 (09-14)
			6 (02-07)
			CX-7 (07-14)
			CX-9 (07-)
		VOLVO	S60 II (10-)
			V60 I (10-)
IU22	-	ALFA ROMEO	145 / 146 (94-01)
			147 (00-10)
			155 (92-97)
			156 (97-06)
			166 (98-07)
			GT (03-10)
			GTV (95-05)
			SPIDER (94-05)
		FERRARI	F50 (95-97)
			F355 (94-00)
IU24	-	ALFA ROMEO	8C (07-10)
		FERRARI	360 Modena (99-05)
			599 GTB / GTO (06-)
			ENZO (02-03)
			F430 (Spider) (05-09)
		MASERATI	4200 GT (01-)
			GRANCABRIO (10-)
			GRANSPORT (03-)
			GRANTURISMO (08-)
			MC 12 (04-)
			QUATTROPORTE V (04-)
IU27	-	MASERATI	3200 GT (98-02)
			QUATTROPORTE IV (94-01)
IW16	IW16TT	SUZUKI	SWIFT I (83-89)
		TOYOTA	LAND CRUISER (J40) (69-86)
IW16TT	-	ALPINA	B3 (E30) (87-92)
			B6 (E21) (78-83)
			B6 (E30) (83-90)
			B6 (E36) (92-93)
			B7 (E12) (78-82)
			B7 (E24) (78-88)
			B7 (E28) (84-87)
			B9 (E24) (82-85)
			B9 (E28) (81-85)
			B10 (E34) (88-96)
			B11 (E32) (87-94)
			C1 (E30) (83-88)
			C2 (E30) (85-88)
			RLE (Z1) (90-91)
		ARO	10 (80-06)
			SPARTANA (99-06)

Свечи зажигания и Свечи накаливания

Руководство покупателя

DENSO P/N	TT	MAKE	MODEL
IW16TT		ASIA MOTORS	ROCSTA (89-99)
продолжение	IW16TT	AUDI	80 (81, 85, B2) (78-86)
	-		80 (89, 8A, B3) (86-91)
			80 (8C, B4) (91-96)
			90 (89, 8A, B3) (87-91)
			100 (4A, C3) (82-91)
			100 (4A, C4) (90-94)
			A6 (4A, C4) (94-97)
			CABRIOLET (8G7) (91-00)
			COUPE (81, 85) (80-88)
			COUPE (89, 8B) (88-96)
		AUSTIN	METRO (80-90)
		BEDFORD	KB (72-88)
			MIDI (84-92)
	IW16TT	BENTLEY	BROOKLANDS (92-97)
	-		CONTINENTAL (84-95)
			CONTINENTAL (91-02)
	IW16TT		EIGHT (84-92)
			MULSANNE (80-92)
			TURBO R (88-98)
		BERTONE	FREECLIMBER (89-99)
		BMW	02 (E6, E10) (67-77)
			3 (E21) (75-84)
			3 (E30) (82-94)
			5 (E12) (72-81)
			5 (E28) (81-87)
			5 (E34) (87-97)
			6 (E24) (76-90)
			7 (E23) (77-86)
			7 (E32) (86-94)
			1500-2000 (62-72)
			1600 GT (67-69)
			2000 (E9) (65-76)
			2500 (E3) (68-77)
			Z1 (88-91)
		CHEVROLET	AVEO / KALOS (T250, T255) (05-)
			SPARK (00-04)
			SPARK (05-)
		CHRYSLER	LE BARON (86-96)
			SARATOGA (89-95)
			VOYAGER I (87-90)
			VOYAGER II (90-95)
			VOYAGER III (95-01)
			VOYAGER IV (00-08)
		DACIA	NOVA (96-03)
		DAEWOO	KALOS (02-)
			MATIZ (98-04)
			TICO (95-00)
		DAIHATSU	1000 (86-97)
			CHARADE I (77-83)
			CHARADE II (83-87)
			CHARADE III (87-93)
			CHARADE IV (93-00)
			CHARMANT (81-87)
			CUORE IV (94-99)
			DELTA (89-01)
			HIJET (86-90)
			HIJET (92-)
			MIDGET (93-02)
			MOVE (94-02)
			ROCKY (85-98)
			RUGGER (84-93)
			SPARCAR (83-86)
			TAFT (84-93)
		DAIMLER	2.8 - 5.3 (69-93)
			COUPE (73-77)
			LANDAULETTE (74-91)
			LIMOUSINE (68-91)
		DODGE	CARAVAN (95-02)
			CARAVAN (00-07)
		FIAT	DUCATO (280) (82-90)

DENSO P/N	TT	MAKE	MODEL
IW16TT		DUCATO (290) (89-94)	
продолжение		GAZ	GAZELLE (2705, 3221, 3302) (93-02)
			GAZELLE (03-13)
			SOBOL (2217, 2310, 2752) (97-)
			VOLGA (3102) (72-09)
			VOLGA (3110, 3111) (93-10)
		GEO	TRACKER (88-98)
		HONDA	ACCORD I (78-83)
			ACCORD II (83-85)
			ACCORD III (85-89)
			CIVIC III (83-87)
			CRX I (83-87)
			JAZZ I (83-86)
			PRELUDE I (78-82)
			QUINTET (80-84)
		HYUNDAI	GALLOPER (91-98)
			GALLOPER (98-03)
			H-1 / STAREX (97-07)
			SANTA FÉ I (00-06)
			SANTAMO (98-02)
			SONATA II (88-93)
			SONATA III (93-98)
			SONATA IV (98-05)
		INNOCENTI	MINI (74-95)
		ISUZU	117 (72-76)
			CAMPO (77-91)
			FARGO (82-88)
			FLORIAN (67-83)
			GEMINI (74-85)
			GEMINI (90-93)
			KB (80-90)
			MIDI (88-96)
			MU (89-02)
			PICK UP (87-96)
			TROOPER I (83-91)
		JAGUAR	E-TYPE 2+2 (66-75)
			E-TYPE (61-75)
			Mk X (61-70)
			XJ (68-93)
		JEEP	CHEROKEE (80-86)
		KIA	AVELLA (95-01)
			PRIDE (90-)
			RIO I (00-05)
			SEPHIA (93-97)
			SORENTO I (02-)
		LAND ROVER	88 / 109 (61-86)
			90 / 110 (83-90)
			DEFENDER (90-16)
			RANGE ROVER I (70-95)
			RANGE ROVER II (94-02)
		LDV	SHERPA (74-89)
		MARUTI	800 (83-06)
		MAZDA	121 I (87-90)
			121 II (90-97)
			323 C IV (89-00)
			323 F IV (87-94)
			323 I (77-86)
			323 II (80-89)
			323 III (85-95)
			323 S IV (89-94)
			616 (73-78)
			626 I (78-82)
			626 II (82-87)
			626 III (87-97)
			929 III (87-91)
			B-SERIE (77-82)
			B-SERIE (81-85)
			B-SERIE (85-99)
			E-SERIE (SD) (83-04)
			E-SERIE (SR) (83-04)
			E-SERIE (80-84)
	IW16TT		
	-		

Свечи зажигания и Свечи накаливания

Руководство покупателя

DENSO P/N	TT	MAKE	MODEL	
IW16TT продолжение		MERCEDES-BENZ	PULLMANN (64-79)	
			S-CLASS (W108, W109) (66-72)	
S-CLASS (W116) (72-80)				
		MG	MIDGET (64-79)	
		MITSUBISHI	COLT I (78-84)	
			COLT III (88-92)	
			COLT IV (92-96)	
			COLT V (95-03)	
			GALANT II (80-84)	
			GALANT III (84-90)	
			L 300 (80-87)	
			L 300 (86-06)	
			LANCER I (79-83)	
			LANCER II (83-84)	
			LANCER III (83-92)	
			LANCER IV (88-94)	
			LANCER V (91-03)	
			LANCER VI (95-03)	
			MIRAGE (91-03)	
			PAJERO I (82-91)	
			PAJERO II (90-00)	
			NISSAN	BLUEBIRD (85-92)
				CABSTAR (F22) (82-93)
				CABSTAR (F23) (92-00)
				CHERRY I (E10) (70-78)
		CHERRY II (N10) (78-83)		
		CHERRY III (N12) (82-86)		
		DATSUN 100 A (74-80)		
		DATSUN 120 (74-80)		
		DATSUN 120 Y (62-80)		
		LAUREL (77-83)		
		LAUREL (81-85)		
		LAUREL (84-89)		
		MICRA I (K10) (82-92)		
		NAVARA (D21) (86-08)		
		PATROL (84-96)		
		PATROL GR I (87-98)		
		PICK UP (720) (80-86)		
		PICK UP (D21) (85-98)		
		SUNNY (70-82)		
		SUNNY I (82-90)		
		SUNNY II (86-91)		
		TERRANO I (87-96)		
		URVAN (81-98)		
		VANETTE (C12) (81-87)		
		VANETTE (C22) (86-95)		
		OPEL		ASCONA C (81-88)
				CALIBRA (90-97)
				COMBO E (18-)
				COMMODORE C (78-82)
			CORSA A (82-93)	
			CORSA B (93-02)	
			OMEGA A (86-94)	
			VECTRA A (88-95)	
	IW16TT			
	-		PERODUA	KANCIL (94-)
		PLYMOUTH	SUNDANCE (86-94)	
			VOYAGER (89-95)	
			VOYAGER (95-01)	
		PORSCHE	928 (77-95)	
	IW16TT	PROTON	AEROBACK (88-96)	
	-		JUMBUCK (02-)	
			PERSONA 400 (94-03)	
			SATRIA (96-06)	
			WIRA (00-)	
			RELIANT	KITTEN (75-83)
			RENAULT	11 (83-88)
		16 (65-80)		
		19 I (88-92)		
		19 II (92-01)		
		CLIO I (90-98)		
			ESPACE III (96-02)	

DENSO P/N	TT	MAKE	MODEL	
IW16TT продолжение			FUEGO (80-85)	
			MEGANE I (96-03)	
RAPID (85-98)				
SUPER 5 (84-96)				
TRAFIC (80-89)				
TWINGO I (93-07)				
	IW16TT		ROLLS-ROYCE	CORNICHE II (85-89)
				CORNICHE IV (93-00)
				CORNICHE V (00-02)
				SILVER Shadow (77-80)
		SILVER Spirit II (89-97)		
		ROVER	200 (XH) (85-89)	
			MINI-Moke (86-93)	
		SANTANA	SAMURAI (86-95)	
		SUBARU	REX I (72-81)	
			REX II (81-89)	
		SUZUKI	ALTO I (82-85)	
			ALTO II (86-93)	
			ALTO III (93-02)	
			CARRY (80-85)	
			CARRY (85-90)	
			CARRY (95-99)	
			LJ 80 (77-84)	
			SAMURAI (88-04)	
			SJ 410 (81-88)	
			SJ 413 (84-90)	
			SUPER CARRY (85-99)	
		SWIFT I (83-89)		
		SWIFT II (89-05)		
		VITARA (88-99)		
		TOYOTA	4 RUNNER (N10) (89-96)	
			4 RUNNER (N5) (87-89)	
			CAMRY (V1) (83-88)	
			CAMRY (V2) (86-91)	
			CARINA (73-83)	
			CARINA II (83-92)	
			CELICA (73-78)	
			CELICA (77-81)	
			CELICA (81-85)	
			CELICA (85-89)	
			COROLLA (E7) (79-87)	
			COROLLA (E8) (83-89)	
			COROLLA (E9) (87-93)	
			COROLLA (E10) (92-99)	
			COROLLA (E11) (97-02)	
			COROLLA (KE) (72-80)	
			COROLLA FX (84-88)	
			CORONA (T1) (70-87)	
			CORONA (T14) (70-88)	
			CRESSIDA (77-81)	
			CRESSIDA (80-93)	
			CROWN (80-85)	
			DYNA 100 (85-95)	
			DYNA 150 (85-88)	
			DYNA 200 (88-95)	
			DYNA (77-87)	
			HIACE I (77-85)	
		HIACE II (83-89)		
		HIACE III (87-04)		
		HILUX I (72-83)		
		HILUX II (83-05)		
		LAND CRUISER (J40) (69-86)		
		LAND CRUISER (J60) (81-89)		
		LAND CRUISER (J80) (90-98)		
		LAND CRUISER / PRADO (J70) (84-06)		
		LITEACE (79-86)		
		LITEACE (84-92)		
		LITEACE (92-97)		
		MASTER ACE Surf (85-99)		
		MODELL F (82-90)		
		SOARER (80-86)		

Свечи зажигания и Свечи накаливания

Руководство покупателя

DENSO P/N	TT	MAKE	MODEL		
IW16TT продолжение			STARLET (P6) (78-84)		
			STARLET (P7) (84-89)		
			STARLET (P8) (89-96)		
			STARLET 1000 (74-78)		
			TERCEL (79-88)		
			TERCEL (86-94)		
			TOWN ACE (92-01)		
		TRIUMPH	2000 (68-77)		
			2500 (74-77)		
			SPITFIRE (62-80)		
			STAG (70-77)		
		UAZ	452 (66-)		
			469 B (71-)		
			3160 (94-03)		
			BARS (3159) (99-)		
			BUKHANKA (3741) (85-)		
			CARGO (2360) (04-)		
			FARMER (3909) (85-)		
			GOLOVASTIK (3303) (85-)		
			HUNTER (3151) (92-)		
			PATRIOT (04-)		
			SIMBIR (3162) (97-)		
			VAUXHALL	CALIBRA (90-97)	
				CARLTON III (86-94)	
		CAVALIER II (81-88)			
		CAVALIER III (88-95)			
		CORSA I (B) (93-00)			
		MIDI (84-94)			
		MIDI II (88-97)			
		RASCAL (86-93)			
		VOLVO	340-360 (75-91)		
			440 (88-96)		
			460 (88-96)		
			480 (86-96)		
		VW	CADDY I (14) (82-92)		
			GOLF I (17, 155) (74-93)		
			GOLF III (1H, 1E) (91-99)		
			GOLF IV (1J, 1E) (97-06)		
			JETTA I (16) (78-84)		
			LUPO (6X, 6E) (98-05)		
			PASSAT (3A2, 35I) (88-97)		
			PASSAT (32, 33) (73-80)		
			PASSAT (32B) (80-91)		
			SANTANA (81-85)		
			SCIROCCO (53) (74-80)		
			SCIROCCO (53B) (80-92)		
			TARO (89-97)		
			TRANSPORTER IV (70X, 7D) (90-03)		
			VENTO (1H2) (91-98)		
		ZASTAVA	YUGO (80-95)		
		IW20TT		AC	ME (79-86)
				ACURA	INTEGRA (85-90)
				ALFA ROMEO	75 (85-92)
					155 (92-97)
					164 (87-98)
					1750-2000 (68-75)
					GIULIA (62-79)
					GT (63-77)
					RZ (92-94)
					SPIDER (94-05)
				SZ (88-94)	
				ALPINA	B9 (E24) (82-85)
					B9 (E28) (81-85)
B10 (E34) (88-96)					
ASTON MARTIN	DB6 (64-70)				
	DBS (66-72)				
	LAGONDA (76-97)				
AUDI	50 (86) (74-78)				
	80 (80, 82, B1) (72-78)				
	80 (81, 85, B2) (78-86)				
	80 (89, 8A, B3) (86-91)				

DENSO P/N	TT	MAKE	MODEL		
IW20TT продолжение			80 (8C, B4) (91-96)		
			90 (81, 85, B2) (84-87)		
			90 (89, 8A, B3) (87-91)		
			100 (43, C2) (76-83)		
			100 (44, C3) (82-91)		
			100 (4A, C4) (90-94)		
			100 (C1) (68-76)		
			200 (43) (79-82)		
			200 (44) (83-91)		
			A6 (4A, C4) (94-97)		
			CABRIOLET (8G7) (91-00)		
			COUPE (81, 85) (80-88)		
			COUPE (89, 8B) (88-96)		
			QUATTRO (85) (80-91)		
			AUSTIN	1000-Series (70-74)	
				ALLEGRO (73-84)	
				MAESTRO (83-92)	
				MAXI (69-82)	
				METRO (80-90)	
				MINI (60-93)	
		MONTEGO (84-92)			
		PRINCESS (76-82)			
		AUSTIN-HEALEY		3000 III (64-68)	
				SPRITE III (64-66)	
				SPRITE IV (66-71)	
		AUTOBIANCHI		A 112 (69-85)	
				Y10 (85-95)	
		BEDFORD	MIDI (84-92)		
		BENTLEY	CONTINENTAL (91-02)		
			TURBO R (88-98)		
		BMW	02 (E6, E10) (67-77)		
			3 (E21) (75-84)		
			3 (E30) (82-94)		
			5 (E12) (72-81)		
			5 (E34) (87-97)		
			1500-2000 (62-72)		
		2000 (E9) (65-76)			
		BOGDAN	2110 (10-14)		
			2111 (10-14)		
			2310 (10-14)		
		CHEVROLET	AVEO / KALOS (T200) (03-08)		
			AVEO / KALOS (T250, T255) (05-)		
			LANOS (05-)		
			NIVA (2123) (02-)		
		CHRYSLER	VOYAGER III (95-01)		
		IW20TT	CITROËN	C25 (81-94)	
				GS (70-86)	
		-		DACIA	NOVA (96-03)
				DAEWOO	CIELO (94-98)
				ESPERO (91-99)	
				KALOS (02-)	
				LANOS (97-)	
				NEXIA (95-08)	
				NEXIA (08-)	
				RACER (95-97)	
				TACUMA / REZZO (00-)	
				DAIHATSU	CHARADE II (83-87)
					CHARADE III (87-93)
					CUORE I (80-85)
					CUORE II (85-90)
		CUORE III (90-94)			
		CUORE IV (94-99)			
			DELTA (89-01)		
DATSUN	MI-DO (14-)				
	ON-DO (14-)				
DODGE	CARAVAN (95-02)				
FIAT	126 (72-00)				
	127 (71-86)				
	128 (69-84)				
	131 (74-84)				
	132 (72-82)				
IW20TT	-		127 (71-86)		
			128 (69-84)		
			131 (74-84)		
IW20TT	-		132 (72-82)		

Свечи зажигания и Свечи накаливания

Руководство покупателя

DENSO P/N	TT	MAKE	MODEL		
IW20TT	-		900 T/E Panorama (78-86)		
продолжение			900 T/E Pulmino (78-86)		
			ARGENTA (78-86)		
			CINQUECENTO (91-99)		
			COUPE (93-00)		
			CROMA (85-96)		
			DUCATO (280) (82-90)		
			DUNA (87-91)		
			DUNA (91-96)		
			ELBA (85-97)		
			IW20TT	FIORINO (77-87)	
				FIORINO (80-93)	
				FIORINO (88-01)	
				PANDA (80-04)	
				PENNY (86-90)	
				REGATA (83-90)	
				RITMO (78-88)	
				RITMO Bertone (79-89)	
				SEICENTO (98-10)	
				TALENTO (290) (89-94)	
				TEMPRA (90-96)	
			IW20TT	TIPO (160) (87-95)	
				UNO (146) (83-00)	
				X 1/9 (73-89)	
				FORD	CAPRI (68-74)
					CAPRI (78-87)
					GRANADA (72-85)
					SIERRA (82-87)
					TAUNUS (75-79)
				FSO	125P (67-92)
					126P (72-00)
					127P (69-76)
					LANOS (04-08)
					POLONEZ I (77-91)
					POLONEZ II (88-92)
				GREAT WALL	SAIFU (00-03)
		HONDA	ACCORD II (83-85)		
			ACCORD III (85-89)		
			ACTY (78-87)		
			CIVIC I (72-84)		
			CIVIC II (79-83)		
			CIVIC III (83-87)		
			CRX I (83-87)		
			INTEGRA (85-93)		
			JAZZ I (83-86)		
			PRELUDE II (83-87)		
		HYUNDAI	COUPE (96-02)		
			H-1 / STAREX (97-07)		
			H100 (93-04)		
			LANTRA I (90-95)		
			PONY / EXCEL (89-95)		
			PONY (74-82)		
			PONY (85-89)		
			PORTER (94-04)		
			S COUPE (90-96)		
			SANTA FÉ I (00-06)		
			SANTAMO (98-02)		
			SONATA II (88-93)		
			SONATA III (93-98)		
			SONATA IV (98-05)		
			STELLAR (83-91)		
			TRAJECT (00-08)		
		INNOCENTI	ELBA (91-96)		
			KORAL (90-92)		
			MINI (74-95)		
		ISH	Oda (2717) (97-)		
			ORBITA (2126) (87-)		
		ISUZU	CAMPO (77-91)		
			GEMINI (84-90)		
			MIDI (88-96)		
	IW20TT		PIAZZA (81-90)		

DENSO P/N	TT	MAKE	MODEL		
IW20TT	-		PICK UP (87-96)		
продолжение			TROOPER I (83-91)		
			KIA	JOICE (00-)	
				MAGENTIS (01-)	
			LADA	110 (2110) (95-12)	
				111 (2111) (95-13)	
				112 (2112) (95-13)	
				GRANTA (2190, 2191, 2349) (11-)	
				KALINA (1117, 1118, 1119) (04-)	
				LARGUS (12-)	
				NADESCHDA (2120) (97-06)	
				NIVA I (2121) (76-)	
				NIVA II (2123) (02-)	
				NOVA (2104, 2105) (81-12)	
				OKA (1111) (88-08)	
				PICKUP (2329) (98-)	
				PICKUP (2345) (97-04)	
				PRIORA (2170, 2171, 2172) (08-)	
				SAMARA (2108, 2109, 2113, 2114, 2115) (86-13)	
				SAMARA Forma (21099) (87-12)	
				TOSCANA (2107) (82-12)	
				ZHIGULI (70-93)	
				LANCIA	BETA (73-86)
					BETA Monte Carlo (75-81)
					DEDRA (89-99)
					DELTA I (79-94)
					DELTA II (93-99)
					THEMA (84-94)
					TREVI (80-87)
					Y10 (85-95)
				LAND ROVER	DEFENDER (90-16)
					DISCOVERY I (89-98)
					RANGE ROVER I (70-95)
				LOTUS	ECLAT (75-86)
					ELITE (74-82)
					ESPRIT S2 (75-88)
					ESPRIT S3 (80-88)
					ESPRIT S4 (89-03)
					EXCEL (83-91)
					IW20TT
				MASERATI	BORA (71-80)
					GHIPLI I (67-73)
					INDY (69-74)
					MEXICO (67-72)
					QUATTROPORTE III (79-90)
					-
				MAZDA	323 C IV (89-00)
					323 I (77-86)
					323 III (85-95)
					323 S IV (89-94)
					626 I (78-82)
					626 II (82-87)
					626 III (87-97)
					818 (72-78)
			929 I (78-88)		
			929 II (82-87)		
			1300 (75-77)		
			B-SERIE (99-06)		
			E-SERIE (SR) (83-04)		
		MERCEDES-BENZ	/8 (W114) (68-77)		
			/8 (W115) (68-77)		
			CABRIOLET (W111) (69-71)		
			COUPE (C123) (77-85)		
			COUPE (W111) (61-71)		
			G-CLASS (W460) (79-93)		
			G-CLASS (W463) (89-)		
			HECKFLOSSE (W110) (61-68)		
			KOMBI (S123) (77-85)		
			PAGODE (W113) (63-71)		
			PONTON (W121) (59-61)		
			Saloon (W123) (76-85)		
			S-CLASS (W108, W109) (66-72)		
			S-CLASS (W116) (72-80)		

Свечи зажигания и Свечи накаливания

Руководство покупателя

DENSO P/N	TT	MAKE	MODEL
IW20TT			S-CLASS (W126) (79-91)
продолжение			S-CLASS Coupe (C126) (80-91)
			SL (R107) (71-89)
			SL (W121) (55-63)
			SLC (C107) (72-84)
			T1 (601) (77-96)
			T2 / L (309, 310, 328) (68-88)
		MG	MAESTRO (83-90)
			METRO (82-90)
			MGB (66-80)
			MGC (67-69)
			MONTEGO (84-90)
		MITSUBISHI	COLT I (78-84)
			COLT II (84-88)
			COLT III (88-92)
			CORDIA (82-89)
			ECLIPSE I (89-95)
			ECLIPSE II (94-99)
			GALANT I (77-80)
			GALANT II (80-84)
			GALANT III (84-90)
			GALANT IV (87-92)
			GALANT V (92-96)
			L 200 (80-86)
			L 200 (86-96)
			L 200 (96-07)
			L 300 (80-87)
			L 300 (86-06)
			L 400 / SPACE GEAR (95-05)
			LANCER I (79-83)
			LANCER III (83-92)
			LANCER IV (88-94)
			LANCER VII (03-)
			MIRAGE (88-91)
			OUTLANDER I (03-06)
			SANTAMO (99-04)
			SAPPORO I (78-80)
			SAPPORO II (80-84)
			SIGMA (90-96)
			SPACE WAGON (83-92)
			SPACE WAGON (91-98)
			STARION (82-90)
		MORGAN	PLUS EIGHT (68-)
		MORRIS	MARINA (71-80)
			MINI (60-81)
		MOSKVICHI	2141 (89-01)
			2335 (95-01)
			2901 (98-01)
		NISSAN	200 SX Coupe (79-81)
			BLUEBIRD (80-86)
			BLUEBIRD (83-90)
			BLUEBIRD (85-92)
			CABSTAR (F22) (82-93)
			CHERRY II (N10) (78-83)
			CHERRY III (N12) (82-86)
			DATSUN 180 B (77-81)
			FIGARO (91-92)
			LAUREL (77-83)
			LAUREL (81-85)
			NAVARA (D21) (86-08)
			PATHFINDER I (86-95)
			PATROL (79-88)
			PICK UP (720) (80-86)
			PICK UP (D21) (85-98)
			PRAIRIE (M10) (83-88)
			SILVIA (S12) (84-88)
			STANZA (81-85)
			SUNNY (70-82)
			SUNNY I (82-90)
			SUNNY II (86-91)
			URVAN (81-98)
	IW20TT		
	-		
	IW20TT		
	-		

DENSO P/N	TT	MAKE	MODEL
IW20TT			VANETTE (C12) (81-87)
продолжение			VANETTE (C22) (86-95)
		OPEL	ASCONA B (75-81)
			ASCONA C (81-88)
			ASTRA F (91-01)
			CAMPO (87-01)
			CORSA A (82-93)
			KADETT D (79-84)
			KADETT E (84-94)
			MANTA A (70-75)
			MANTA B (75-88)
			OMEGA A (86-94)
			REKORD E (77-86)
			VECTRA A (88-95)
		PEUGEOT	504 (68-89)
			505 (79-95)
			J5 (81-90)
			J5 (90-94)
			J7 (68-80)
			J9 (80-87)
		PIAGGIO	PORTER (93-)
		PININFARINA	SPIDEREUROPA (82-85)
		PLYMOUTH	VOYAGER (95-01)
		PORSCHE	911 (930) (75-90)
			924 (75-89)
			928 (77-95)
			944 (81-91)
			968 (91-95)
		PROTON	AEROBACK (88-96)
			PERSONA 300 (96-04)
			PERSONA 400 (94-03)
			SALOON (91-96)
			G-MODELL (W460) (79-92)
		PUCH	
		RELIANT	SCIMITAR (68-90)
		RENAULT	4 (62-93)
			5 (72-85)
			6 (69-87)
			8 (62-72)
			9 (81-89)
			10 (66-72)
			11 (83-88)
			12 (69-84)
			12 (83-95)
			12 Toros (89-00)
			16 (65-80)
			18 (78-93)
			19 I (88-92)
			19 II (92-01)
			20 (75-83)
			21 (86-95)
			CLIO I (90-98)
			ESTAFETTE (62-81)
			FUEGO (80-85)
			LAGUNA I (93-01)
			MASTER I (80-98)
			MEGANE I (96-03)
			MEGANE Scénic (96-99)
			RAPID (85-98)
			RODEO 6 (70-81)
			SUPER 5 (84-96)
			TRAFIC (80-89)
			TRAFIC (89-01)
		RILEY	ELF III (63-68)
		ROVER	200 (XH) (85-89)
			MAESTRO (90-95)
			MINI (91-01)
			MONTEGO (84-95)
		SAAB	90 (84-87)
			99 (68-84)
			900 I (78-94)
		SANTANA	SAMURAI (86-95)
	IW20TT		
	-		
	IW20TT		
	-		

Свечи зажигания и Свечи накаливания

Руководство покупателя

DENSO P/N	TT	MAKE	MODEL	
IW20TT продолжение		SEAT	AROSA (6H) (97-04)	
			CORDOBA (6K1) (93-99)	
			FURA (82-86)	
			IBIZA I (84-93)	
			IBIZA II (6K1) (93-99)	
			INCA (6K9) (95-03)	
			MARBELLA (86-98)	
			PANDA (80-86)	
			TERRA (87-96)	
			TOLEDO I (1L) (91-99)	
		SKODA	FELICIA Fun (6U) (97-02)	
			FELICIA I (6U) (94-98)	
			FELICIA II (6U) (98-01)	
			OCTAVIA I (1U) (96-10)	
		SUBARU	1800 XT COUPE (84-90)	
			JUSTY I (84-95)	
			JUSTY II (95-03)	
			LEONE I (78-84)	
			LEONE II (84-94)	
			LIBERO (83-00)	
			MV (78-86)	
			REX II (81-89)	
			SUZUKI	SAMURAI (88-04)
				SWIFT I (83-89)
		SWIFT II (89-05)		
		WAGON R+ (00-)		
			TALBOT	
			1307-1510 (75-84)	
			HORIZON (78-86)	
			MURENA (80-85)	
		TOFAS	RANCHO (77-84)	
			SOLARA (80-86)	
			TAGORA (80-87)	
			DOGAN (76-02)	
			KARTAL (85-02)	
		TOYOTA	SAHIN (80-03)	
			1000 (69-88)	
			CELICA (73-78)	
			CELICA (77-81)	
			CELICA (81-85)	
			CENTURY (82-96)	
			COROLLA (E7) (79-87)	
			CRESSIDA (80-93)	
			CROWN (80-85)	
			CROWN Comfort (95-08)	
			HIACE III (87-04)	
			HIACE IV (95-)	
			HILUX II (83-05)	
			LITEACE (92-97)	
			MASTER ACE Surf (85-99)	
		MODELL F (82-90)		
		SOARER (80-86)		
		STARLET (P7) (84-89)		
		STARLET (P8) (89-96)		
		TOWN ACE (85-91)		
		TRABANT	1.1 (90-91)	
		TVR	350 (83-89)	
		UAZ	3160 (94-03)	
			BARS (3159) (99-)	
			BUKHANKA (3741) (85-)	
			FARMER (3909) (85-)	
			GOLOVASTIK (3303) (85-)	
			HUNTER (3151) (92-)	
			SIMBIR (3162) (97-)	
			VAUXHALL	ASTRA I (79-86)
				ASTRA II (84-94)
				ASTRA III (F) (91-01)
				BRAVA (88-02)
				CARLTON II (77-86)
				CARLTON III (86-94)
				CAVALIER I (75-81)
				CAVALIER II (81-88)
		IW20TT		

DENSO P/N	TT	MAKE	MODEL	
IW20TT продолжение		CAVALIER III (88-95)		
			CHEVETTE (75-85)	
			MIDI II (88-97)	
			NOVA (82-94)	
			VOLVO	240 (74-93)
				340-360 (75-91)
				440 (88-96)
				460 (88-96)
				740 (83-92)
				760 (81-92)
		940 I (90-95)		
		940 II (94-98)		
		960 I (90-94)		
		VW		CADDY I (14) (82-92)
			CADDY II (9K, 9U) (95-04)	
			CORRADO (53I) (88-95)	
			DERBY (86) (77-81)	
			DERBY (86C, 80) (81-84)	
			GOLF I (17, 155) (74-93)	
			GOLF II (19, 1G) (83-92)	
			GOLF III (1H, 1E) (91-99)	
			GOLF IV (1J, 1E) (97-06)	
			ILTIS (183) (79-88)	
			JETTA I (16) (78-84)	
			JETTA II (19, 1G) (84-92)	
			K 70 (70-74)	
			LT 28-35 I (281-363) (75-96)	
			LT 40-55 I (75-96)	
			LUPO (6X, 6E) (98-05)	
			PASSAT (3A2, 35I) (88-97)	
			PASSAT (32, 33) (73-80)	
			PASSAT (32B) (80-91)	
			POLO (6N1) (94-99)	
		POLO (86) (75-81)		
		POLO (86C, 80) (81-94)		
		POLO Classic (6KV) (95-02)		
		POLO Variant (6V5) (97-01)		
		SANTANA (81-85)		
		SCIROCCO (53) (74-80)		
		SCIROCCO (53B) (80-92)		
		SHARAN (7M) (95-10)		
		TRANSPORTER III (79-92)		
		TRANSPORTER IV (70X, 7D) (90-03)		
		VENTO (1H2) (91-98)		
		WARTBURG	353 (66-91)	
		WOLSELEY	HORNET (61-70)	
		ZASTAVA	101 (73-93)	
			YUGO (80-95)	
			YUGO Florida (88-08)	
		ZAZ	CHANCE (04-)	
			DANA (1105) (97-)	
			LANOS (04-)	
			SENS (04-)	
			SLAVUTA (1103) (95-11)	
			TAVRIA (1102) (89-07)	
			IW22	ASTON MARTIN
				V8 (69-93)
		AUDI		
		200 (43) (79-82)		
		HONDA		CIVIC III (83-87)
				CIVIC IV (87-95)
				CRX I (83-87)
		LOTUS		ESPRIT S2 (75-88)
		MASERATI		420 / 430 (85-94)
				BITURBO (81-94)
		PORSCHE	911 (901, 911) (63-79)	
			900 I (78-94)	
		IW24	SAAB	FERRARI
				208 / 308 (75-89)
				412 i (85-88)
			MONDIAL (80-93)	
			FORD	CAPRI (78-87)
				COUNTACH (74-91)
			LAMBORGHINI	COUNTACH (74-91)
				ESPADIA (68-81)

Свечи зажигания и Свечи накаливания

Руководство покупателя

DENSO P/N	TT	MAKE	MODEL		
IW24 продолжение		MASERATI	BITURBO (81-94)		
		PORSCHE	911 (901, 911) (63-79)		
			911 (964) (88-94)		
			924 (75-89)		
		RENAULT	9 (81-89)		
			11 (83-88)		
			18 (78-93)		
			FUEGO (80-85)		
			SUPER 5 (84-96)		
		IW27	-	ALPINE	1600 (69-75)
LAMBORGHINI	MIURA (69-72)				
PORSCHE	911 (901, 911) (63-79)				
	911 (930) (75-90)				
IW29	-	FERRARI	208 / 308 (75-89)		
IWF20	-	VOLVO	340-360 (75-91)		
IX22B	-	BMW	5 (E28) (81-87)		
IX24	-	BMW	M1 (79-83)		
			FERRARI	328 GTB (85-89)	
		328 GTS (85-89)			
		348 Spider (93-95)			
		348 TB / GTB (90-94)			
		348 TS / GTS (90-95)			
		MONDIAL (80-93)			
		TESTAROSSA (84-91)			
		LAMBORGHINI	COUNTACH (74-91)		
			LM-002 (83-92)		
		IXEH20ETT	-	NISSAN	ALTIMA (12-)
					CUBE (03-05)
					JUKE (10-)
					QASHQAI I (+2) (07-13)
ROGUE (T32) (13-)					
SENTRA VII (12-)					
TEANA III (13-)					
TIIDA (04-12)					
TIIDA (11-)					
X-TRAIL (T32) (13-)					
NISSAN (DFAC)	TIIDA (11-)				
IXEH20TT	-			ASTON MARTIN	CYGNET (11-13)
				CITROËN	C1 II (14-)
					C2 (03-)
					C3 I (02-)
					C4 Coupe (04-11)
					C4 I (LC, LR) (04-11)
		DACIA	LOGAN I (04-)		
			LOGAN II (12-)		
			LOGAN MCV II (13-)		
			SANDERO I (Stepway) (08-)		
			SANDERO II (Stepway) (12-)		
		DAIHATSU	CHARADE VI (11-)		
		LEXUS	CT (10-)		
			NX (14-)		
		LOTUS	ELISE (00-)		
		NISSAN	CUBE (10-)		
			KUBISTAR (03-)		
MICRA C+C (05-)					
MICRA III (K12) (03-10)					
MICRA IV (K13) (10-)					
NOTE (E11) (06-12)					
NOTE (E12) (13-)					
NV200 (10-)					
QASHQAI I (+2) (07-13)					
ROGUE (T31) (07-13)					
SENTRA V (00-06)					
SENTRA VII (12-)					
TEANA II (08-13)					
TIIDA (04-12)					
X-TRAIL (T30) (01-13)					
X-TRAIL (T31) (07-13)					
NISSAN (DFAC)	TEANA (J31) (06-08)				
	TEANA (J32) (10-)				
	TIIDA QIDA (05-)				

DENSO P/N	TT	MAKE	MODEL
IXEH20TT продолжение		PEUGEOT	TIIDA YIDA (05-)
			108 (14-)
			206 (98-)
			207 (06-)
			307 (00-)
		1007 (05-)	
		RENAULT	CLIO II (98-)
			CLIO III (05-)
			CLIO IV (12-)
			FLUENCE (10-)
Grand SCÉNIC III (09-)			
KANGOO (97-)			
KOLEOS I (08-)			
LAGUNA III (07-)			
LATITUDE (10-)			
LOGAN II (13-)			
IXEH20TT	-	SMART	MEGANE CC (10-)
			MEGANE III (08-)
			MODUS (04-)
			SCÉNIC III (09-)
			THALIA I (98-)
			THALIA II (08-)
			TWINGO I (93-07)
			TWINGO II (07-)
			TWINGO III (14-)
			FORFOUR II (453) (14-)
IXEH20TT	-	SUBARU	FORTWO (453) (14-)
			JUSTY IV (07-)
		TOYOTA	TREZIA (11-)
			ALLION II (07-)
			AURIS (E15) (06-12)
			AURIS (E18) (12-)
			AVENSIS (08-)
			AYGO (14-)
			COROLLA (E14, E15) (06-)
			COROLLA (E18) (13-)
HARRIER (13-)			
IXEH22TT	IXEH22TT	HONDA	IQ (09-)
			ISIS (04-)
			MATRIX (08-)
			NOAH / VOXY (07-13)
			NOAH / VOXY (13-)
			PREMIO (07-)
			PRIUS (W3) (09-)
			PRIUS Plus (W4) (11-)
			RACTIS (10-)
			RAV 4 III (05-)
INFINITI		MAZDA	RAV 4 IV (12-)
			SIENTA (15-)
			SPADE (12-)
			URBAN CRUISER (07-)
			VERSO (09-)
			VERSO S (10-16)
			YARIS (05-11)
			YARIS (10-)
			ACCORD IX (12-)
			EX (07-)
FX (08-)			
G (07-)			
JX (12-)			
M (10-)			
M35 (05-)			
Q50 (13-)			
Q70 (Y51) (13-)			
QX56 (10-)			
QX60 (12-)			
QX70 (13-)			
QX80 (13-)			
2 (14-)			
3 (09-14)			
3 (13-)			

Свечи зажигания и Свечи накаливания

Руководство покупателя

DENSO P/N	TT	MAKE	MODEL			
IXEH22TT продолжение		MERCEDES-BENZ	6 (12-)			
			CX-3 (15-)			
			CX-5 (11-17)			
			MX-5 IV (15-)			
			C-CLASS (204) (07-14)			
			C-CLASS Coupe (C204) (11-)			
			CLK (209) (02-10)			
			CLS (C219) (04-10)			
			E-CLASS (211) (02-09)			
			E-CLASS (212) (09-)			
			M-CLASS (W164) (05-11)			
			R-CLASS (251) (06-)			
			S-CLASS (W221) (05-13)			
			S-CLASS Coupe (C216) (06-13)			
			SL (R230) (01-12)			
		NISSAN	350 Z (02-)			
			ALTIMA (12-)			
			MURANO II (07-14)			
			MURANO III (14-)			
			PATROL III (10-)			
			TEANA II (08-13)			
			TEANA (J32) (10-)			
		SUBARU	FORESTER (08-)			
			FORESTER (13-)			
			IMPREZA (11-)			
			LEGACY V (09-14)			
			LEVORG (15-)			
			OUTBACK (09-)			
			OUTBACK (15-)			
			XV (12-)			
			MAZDA	AZOFFROAD (98-)		
				CAROL (04-10)		
				SCRUM (05-15)		
				NISSAN	MOCO I (02-06)	
					MOCO II (06-10)	
				SUZUKI	CAPPUCINO (92-98)	
					EVERY (05-15)	
		MR Wagon (01-06)				
		MR Wagon (06-13)				
		WAGON R (97-03)				
		WAGON R (08-12)				
		IXU22			IXU22TT	ALFA ROMEO
				BMW		
5 (E34) (87-97)						
Z3 (E36) (95-03)						
CHANGHE	BEIDOUXING (04-)					
	WAGON R (99-04)					
CHEVROLET	AVEO / KALOS (T250, T255) (05-)					
	SPARK (10-)					
CHRYSLER	YPSILON (846) (11-)					
DAEWOO	GENTRA (13-)					
DAIHATSU	BEGO (05-)					
	COPEN (03-12)					
	EXTOL (00-)					
	MATERIA (06-)					
	SIRION (05-)					
	TERIOS (05-)					
	YRV (01-)					
	FAW	V5 (12-)				
	FIAT	500 (C) (312) (07-)				
		500L (12-)				
		ALBEA / SIENA (96-11)				
BRAVO II (06-14)						
DOBLO (01-)						
DOBLO (10-)						
FIORINO (07-)						
Grande PUNTO (05-)						
IDEA (03-)						
LINEA (07-)						
PALIO (96-)						
PANDA (03-)						

DENSO P/N	TT	MAKE	MODEL	
IXU22TT продолжение			PANDA (12-)	
			PUNTO (99-12)	
			PUNTO (12-)	
			PUNTO Evo (08-12)	
			QUBO (08-)	
			SEICENTO (98-10)	
			STILO (01-08)	
			STRADA (99-)	
			TIPO (356) (15-)	
			FORD	KA (08-)
			LANCIA	MUSA (04-12)
				YPSILON (312/846) (11-)
			MAZDA	YPSILON (843) (03-11)
				AZOFFROAD (98-)
				CAROL (89-98)
		CAROL (98-04)		
		CAROL (04-10)		
		CAROL (10-)		
		SCRUM (05-15)		
		TOWN BOX (98-)		
		MITSUBISHI	PAJERO Junior (95-98)	
			PAJERO Mini (94-12)	
		NISSAN	MOCO I (02-06)	
			MOCO II (06-10)	
		OPEL	COMBO D (12-)	
		PERODUA	ALZA (09-)	
			MYVI (06-11)	
		PORSCHE	911 (996) (97-05)	
			911 (997) (04-12)	
		SUBARU	JUSTY IV (07-)	
		SUZUKI	ALTO IV (02-08)	
			CAPPUCINO (92-98)	
			EVERY (05-15)	
			MR Wagon (01-06)	
			MR Wagon (06-13)	
			WAGON R (97-03)	
			WAGON R (08-12)	
			WAGON R+ (98-00)	
			TATA	INDICA Vista (08-)
			INDIGO (03-)	
			TOYOTA	AVANZA (F6) (03-11)
				RUSH (06-)
			VAUXHALL	COMBO III (D) (11-)
WIESMANN	MF3 Roadster (96-)			
ZASTAVA	10 (05-)			
IXU24	-	ALPINA	ROADSTER S (Z4) (03-05)	
		BMW	3 (E46) (98-06)	
			Z3 (E36) (95-03)	
Z4 (E85, E86) (03-09)				
WIESMANN	MF3 Roadster (96-)			
IXU27	-	ABARTH	124 Spider (348) (16-)	
			500 / 595 (C) (312) (07-)	
			Grande PUNTO (05-12)	
			PUNTO Evo (08-12)	
		ALFA ROMEO	GIULIETTA (10-)	
			MITO (08-)	
		CHRYSLER	DELTA (11-)	
		DODGE	DART (12-)	
		FERRARI	456 GT / GTA (93-04)	
			550 BARCETTA (00-05)	
			550 Maranello (96-02)	
			575 Maranello (02-06)	
			612 SCAGLIETTI (04-11)	
			124 Spider (348) (16-)	
		FIAT	500L (12-)	
500X (14-)				
BRAVO II (06-14)				
DOBLO (10-)				
Grande PUNTO (05-)				
LINEA (07-)				
PUNTO (12-)				

Свечи зажигания и Свечи накаливания

Руководство покупателя

DENSO P/N	TT	MAKE	MODEL	
IXU27 продолжение			PUNTO Evo (08-12)	
			TIPO (356) (15-)	
			JEEP	RENEGADE (14-)
			LAMBORGHINI	DIABLO (90-03)
			LANCIA	DELTA III (08-14)
IXUH20I	-	HYUNDAI	COMBO D (12-)	
			i10 (07-13)	
			i10 (13-)	
			i20 (08-15)	
			i20 (14-)	
		i20 Coupe (15-)		
		KIA	PICANTO (11-)	
			RIO III (11-)	
		MITSUBISHI	LANCER VIII (07-)	
			OUTLANDER III (12-)	
IXUH22	IXUH22TT	CATERHAM	SUPER SEVEN (80-)	
			FIAT	500 (C) (312) (07-)
			PANDA (12-)	
		MAZDA	AZOFFROAD (98-)	
			CAROL (10-)	
			SCRUM (05-15)	
		NISSAN	MOCO II (06-10)	
		SUZUKI	EVERY (05-15)	
			MR Wagon (06-13)	
			WAGON R (08-12)	
IXUH22I	IXUH22TT	CITROËN	C1 II (14-)	
			C3 Aircross (17-)	
			C3 II (09-)	
			C3 III (16-)	
			C4 Cactus (14-)	
			C-ELYSEE (12-)	
			DS3 (09-15)	
			DS3 (15-)	
		PEUGEOT	108 (14-)	
			208 I (12-)	
			301 (12-)	
			308 II (13-)	
			2008 (13-)	
		SUZUKI	SWIFT V (17-)	
		TOYOTA	AYGO (14-)	
		IXUH22TT	-	AUDI
BMW	1 (F20, F21) (10-)			
	3 (F30, F31) (11-19)			
CATERHAM	SUPER SEVEN (80-)			
CITROËN	BERLINGO (B9) (08-)			
	C1 II (14-)			
	C3 Aircross (17-)			
	C3 II (09-)			
	C3 III (16-)			
	C3 Picasso (09-)			
	C4 (Grand) Picasso I (06-13)			
	C4 (Grand) Picasso II (13-)			
	C4 Cactus (14-)			
	C4 Coupe (04-11)			
	C4 I (LC, LR) (04-11)			
	C4 II (B7, NC) (09-)			
	C5 III (08-)			
	C-ELYSEE (12-)			
	DS3 (09-15)			
	DS4 (11-15)			
DS5 (11-15)				
DODGE	JOURNEY (08-)			
DS	DS3 (15-)			
FIAT	500 (C) (312) (07-)			
	PANDA (12-)			
HYUNDAI	ACCENT IV / SOLARIS (10-)			
	CRETA (16-)			
	ELANTRA (05-11)			
	ELANTRA (11-)			
	ELANTRA (15-)			
	EQUUS / CENTENNIAL (09-)			

DENSO P/N	TT	MAKE	MODEL	
IXUH22TT продолжение			GENESIS (08-)	
			GENESIS (14-)	
			i20 (08-15)	
			i30 (07-12)	
			i30 (11-)	
			i30 Coupe (13-)	
			i40 (11-)	
			ix20 (10-)	
			ix35 (09-)	
			ix55 (06-)	
			SANTA FÉ III (12-)	
			SONATA VI (09-15)	
			SONATA VII (14-)	
			TUCSON (15-)	
			VELOSTER (11-)	
			KIA	CARENS III (06-)
				CARENS IV (13-)
				CEED (06-12)
				CEED (12-)
				CERATO (18-)
				CERATO (04-)
				CERATO (09-)
				OPIRUS (03-)
				OPTIMA (10-)
				OPTIMA (15-)
PRO CEED (08-13)				
PRO CEED (13-)				
RIO III (11-)				
SORENTO II (09-)				
SORENTO III (15-)				
SOUL I (09-)				
SOUL II (14-)				
SOUL III (19-)				
SPORTAGE III (10-)				
SPORTAGE IV (15-)				
VENGA (10-)				
MAZDA	AZOFFROAD (98-)			
	CAROL (10-)			
	CAROL (15-)			
	SCRUM (05-15)			
MERCEDES-BENZ	C-CLASS (203) (00-07)			
	C-CLASS (204) (07-14)			
	C-CLASS Coupe (C204) (11-)			
	C-CLASS Coupe (CL203) (01-08)			
	CLC (CL203) (08-11)			
	CLK (209) (02-10)			
	CLS (C219) (04-10)			
	E-CLASS (211) (02-09)			
	E-CLASS (212) (09-)			
	E-CLASS Coupe / Convertible (207) (09-)			
	G-CLASS (W463) (89-)			
	GL-CLASS (X164) (06-)			
	GLK (X204) (08-15)			
	M-CLASS (W164) (05-11)			
	R-CLASS (251) (06-)			
	S-CLASS (W221) (05-13)			
	S-CLASS Coupe (C216) (06-13)			
	SL (R230) (01-12)			
	SLK (R171) (04-11)			
	SLK (R172) (11-)			
SPRINTER 3,5-t (906) (06-)				
SPRINTER 3-t (906) (06-)				
SPRINTER 4,6-t (906) (06-)				
SPRINTER 5-t (906) (06-)				
VIANO (W639) (03-)				
VITO / MIXTO (W639) (03-)				
MINI	MINI (R56) (06-13)			
	MINI Clubman (R55) (07-14)			
	MINI Convertible (R57) (07-15)			
	MINI Countryman (R60) (10-16)			
	MINI Coupe (R58) (10-15)			

Свечи зажигания и Свечи накаливания

Руководство покупателя

DENSO P/N	TT	MAKE	MODEL		
IXUH22TT продолжение			MINI Paceman (R61) (12-16)		
			MINI Roadster (R59) (11-15)		
			MITSUBISHI		
			i-MiEV (06-)		
		OUTLANDER II (06-12)			
		PAJERO Sport II (08-)			
		NISSAN	MOCO II (06-10)		
		PEUGEOT	108 (14-)		
			207 (06-)		
			208 I (12-)		
			301 (12-)		
			308 CC (07-)		
			308 I (07-)		
			308 II (13-)		
			508 I (10-)		
			2008 (13-)		
			3008 (09-)		
			5008 I (09-)		
			PARTNER / RANCH (08-)		
			RCZ (10-)		
			PGO	CEVENNES (06-)	
				HAMERA (08-)	
				SPEEDSTER (10-)	
			SMART	FORFOUR I (454) (04-06)	
				FORTWO (451) (07-)	
			SUZUKI	ALTO VI (14-)	
				CARRY (99-)	
		EVERY (05-15)			
		MR Wagon (06-13)			
		SWIFT V (17-)			
		WAGON R (08-12)			
		WAGON R (12-)			
		AYGO (14-)			
		J16AR-U11	-	SUBARU	LEONE II (84-94)
		J16BR-U	-	TOYOTA	CAMRY (V2) (86-91)
					COROLLA (E7) (79-87)
					COROLLA (KE) (72-80)
					CRESSIDA (80-93)
					SOARER (80-86)
					STARLET (P6) (78-84)
		J16CR-U	W16TT	ALPINA	B3 (E30) (87-92)
					B6 (E36) (92-93)
					B10 (E34) (88-96)
					B11 (E32) (87-94)
					C1 (E30) (83-88)
C2 (E30) (85-88)					
RLE (Z1) (90-91)					
BERTONE	FREECLIMBER (89-99)				
BMW	3 (E30) (82-94)				
	5 (E12) (72-81)				
	5 (E28) (81-87)				
	5 (E34) (87-97)				
	6 (E24) (76-90)				
	7 (E32) (86-94)				
	Z1 (88-91)				
VOLVO	440 (88-96)				
	460 (88-96)				
	480 (86-96)				
K16GPR-U11	-			FORD	MAVERICK (93-98)
					NISSAN
				PICK UP (D21) (85-98)	
				PICK UP (D22) (97-05)	
				PRAIRIE Pro (M11) (88-94)	
		STANZA (89-92)			
TERRANO II (92-07)					
K16HPR-U11	KH16TT	CHRYSLER	300 C (04-12)		
			ASPEN (06-)		
			CITROËN	BERLINGO (B9) (08-)	
				BERLINGO (MF) (96-11)	
				C2 (03-)	
				C3 I (02-)	
		C3 Pluriel (03-)			
		C4 (Grand) Picasso I (06-13)			

DENSO P/N	TT	MAKE	MODEL			
K16HPR-U11 продолжение			C4 Coupe (04-11)			
			C4 I (LC, LR) (04-11)			
			C5 I (01-04)			
			C5 II (04-)			
			C5 III (08-)			
			C8 (02-)			
			C-ELYSEE (12-)			
			EVASION (94-02)			
			JUMPY (95-06)			
			JUMPY (07-)			
			XSARA (97-05)			
			XSARA Picasso (99-11)			
			DF CITROEN	C-TRIOMPHE (09-)		
			DODGE	CHALLENGER (07-)		
				CHARGER (11-)		
				DURANGO (11-)		
				RAM (08-)		
				RAM 4000 (05-)		
			HYUNDAI	GRANDEUR (05-11)		
				GRANDEUR (11-)		
				ix35 (09-)		
				SANTA FÉ II (06-12)		
				SONATA V (05-10)		
				SONATA VI (09-15)		
			JEEP	Grand CHEROKEE III (05-10)		
				Grand CHEROKEE IV (10-)		
			KIA	CERATO (09-)		
				MAGENTIS (05-)		
				OPTIMA (10-)		
				SORENTO II (09-)		
				SORENTO III (15-)		
				SPORTAGE III (10-)		
				NISSAN	ALMERA Classic (06-)	
				ALMERA II (00-)		
			ALMERA TINO (00-)			
			ALTIMA (01-06)			
			AVENIR (97-05)			
			CUBE (03-05)			
			PRIMERA (P11) (96-02)			
			PRIMERA (P12) (02-)			
			SENTRA V (00-06)			
			TEANA I (03-08)			
			X-TRAIL (T30) (01-13)			
			X-TRAIL (T31) (07-13)			
			PEUGEOT	206 (98-)		
				206 CC (00-)		
				207 (06-)		
				307 (00-)		
				308 CC (07-)		
				308 I (07-)		
				406 (95-04)		
				406 Coupe (97-04)		
				407 (04-)		
				407 Coupe (05-)		
				607 (00-)		
				806 (94-02)		
				807 (02-)		
				1007 (05-)		
				EXPERT (96-06)		
				EXPERT (07-)		
				PARTNER / RANCH (96-15)		
				PARTNER / RANCH (08-)		
				RAM	1500 (DS) (10-)	
				2500 (DJ) (10-)		
				RENAULT	LAGUNA II (01-)	
				MEGANE I (96-03)		
			SUZUKI	Grand VITARA II (05-)		
			SX4 (06-)			
			K16HR-U11	KH16TT	CITROËN	C1 I (05-14)
					NISSAN	MICRA III (K12) (03-10)
					PEUGEOT	107 (05-)

Свечи зажигания и Свечи накаливания

Руководство покупателя

DENSO P/N	TT	MAKE	MODEL	
K16HR-U11 продолжение		TOYOTA	AYGO (05-)	
			VIOS / YARIS (07-)	
			YARIS (05-11)	
K16PR-U	K16TT	AUDI	A8 (4D) (94-02)	
		BMW	3 (E30) (82-94)	
		CHERY	QQ3 (03-14)	
		CITROËN	XSARA (97-05)	
			XSARA Picasso (99-11)	
		DAEWOO	KORANDO (99-)	
			MUSSO (99-)	
		EMGRAND	EC7 (09-)	
		FIAT	ALBEA / SIENA (96-11)	
			BRAVO I (95-01)	
			DOBLO (01-)	
			MAREA (96-07)	
			MULTIPLA (99-10)	
			PALJO (96-)	
			PANDA (80-04)	
			PANDA (03-)	
			PUNTO (99-12)	
			SEICENTO (98-10)	
			STILO (01-08)	
			STRADA (99-)	
			HYUNDAI	i10 (07-13)
			KIA	CLARUS (96-)
		SEPHIA (93-97)		
		SHUMA I (96-01)		
		SPORTAGE I (94-04)		
		LANCIA	DEDRA (89-99)	
			LYBRA (99-05)	
			Y (95-03)	
			Y10 (85-95)	
		YPSILON (843) (03-11)		
		MAZDA	323 C IV (89-00)	
			323 F IV (87-94)	
			323 II (80-89)	
		MERCEDES-BENZ	CABRIOLET (A124) (92-93)	
			C-CLASS (202) (93-01)	
			CLK (208) (97-02)	
			COUPE (C124) (87-93)	
			E-CLASS (124) (92-96)	
			E-CLASS (210) (95-03)	
			E-CLASS Coupe / Convertible (124) (93-98)	
			G-CLASS (W463) (89-)	
			KOMBI (S124) (85-93)	
			Saloon (W124) (84-93)	
			S-CLASS (W140) (91-98)	
			SL (R129) (89-01)	
			SLK (R170) (96-04)	
			MITSUBISHI	SPACE RUNNER (99-02)
		SPACE WAGON (98-04)		
		NISSAN	100 NX (90-94)	
			ALMERA I (95-00)	
			SUNNY III (90-00)	
		PEUGEOT	106 I (91-96)	
106 II (96-04)				
206 (98-)				
PUCH	G-MODELL (W463) (89-00)			
SKODA	FELICIA Fun (6U) (97-02)			
	FELICIA II (6U) (98-01)			
SSANGYONG	CHAIRMAN (97-)			
	KORANDO (96-06)			
	MUSSO (93-07)			
ZASTAVA	10 (05-)			
K16PR-U11	K16TT	CHERY	TIGGO (05-09)	
		CHEVROLET	CAPRICE (90-96)	
		DAIHATSU	CUORE V (89-03)	
			MOVE (94-02)	
		SIRION (98-05)		
		EMGRAND	EC7 (09-)	
GREAT WALL	COOLBEAR (08-13)			

DENSO P/N	TT	MAKE	MODEL
K16PR-U11 продолжение			HOVER M4 (12-)
			TENGYI (10-)
		HONDA	ORTHIA (95-02)
		HYUNDAI	ACCENT I (94-00)
			ACCENT II (99-06)
			ACCENT III (05-10)
			ATOS (98-14)
			COUPE (96-02)
			COUPE (01-09)
			ELANTRA (00-06)
			ELANTRA (05-11)
			GETZ (02-09)
			GRANDEUR (05-11)
			HIGHWAY VAN (00-04)
			i10 (07-13)
			LANTRA II (95-00)
			MATRIX (01-10)
			S COUPE (90-96)
		SANTA FÉ I (00-06)	
		SONATA V (05-10)	
		TERRACAN (01-06)	
		TRAJECT (00-08)	
		TUCSON (04-10)	
		INFINITI	QX4 (97-)
		KIA	CARENS II (02-)
			CARENS III (06-)
			CERATO (04-)
			MAGENTIS (05-)
			PICANTO (04-)
			RIO II (05-)
			SHUMA I (96-01)
			SHUMA II (01-04)
			SPORTAGE II (04-)
		MAZDA	3 (00-09)
			3 (09-14)
			121 II (90-97)
323 C IV (89-00)			
323 C V (94-98)			
323 F V (94-98)			
323 F VI (98-04)			
323 I (77-86)			
323 S IV (89-94)			
323 S V (94-98)			
323 S VI (98-04)			
626 IV (91-97)			
DEMIO (98-03)			
MPV I (88-99)			
MX-3 (91-98)			
MX-5 II (98-05)			
MX-6 (92-97)			
PREMACY (99-05)			
XEDOS 6 (92-99)			
XEDOS 9 (93-02)			
MERCEDES-BENZ	S-CLASS (W140) (91-98)		
	S-CLASS Coupe (C140) (92-99)		
	SL (R129) (89-01)		
MITSUBISHI	COLT IV (92-96)		
	COLT V (95-03)		
	GALANT V (92-96)		
	L 200 (96-07)		
	L 300 (86-06)		
	L 400 / SPACE GEAR (95-05)		
	LANCER V (91-03)		
	LANCER VI (95-03)		
	PAJERO II (90-00)		
	PAJERO Pinin (99-07)		
SAPPORO III (87-90)			
SPACE STAR (98-04)			
NISSAN	100 NX (90-94)		
	240 SX (93-97)		
	ALMERA II (00-)		

Свечи зажигания и Свечи накаливания

Руководство покупателя

DENSO P/N	TT	MAKE	MODEL		
K16PR-U11 продолжение			ALMERA TINO (00-)		
			ALTIMA (93-01)		
			AVENIR (97-05)		
			ELGRAND (95-02)		
			MICRA II (K11) (92-03)		
			NAVARA (D22) (97-)		
			PATHFINDER II (97-04)		
			PICK UP (D22) (97-05)		
			PRAIRIE (M10) (83-88)		
			PRIMERA (P10) (90-98)		
			PRIMERA (P11) (96-02)		
			SENTRA V (00-06)		
			SUNNY II (86-91)		
			SUNNY III (90-00)		
			TERRANO II (92-07)		
			OPEL	FRONTERA B (98-04)	
			SUBARU	FORESTER (97-02)	
				FORESTER (02-08)	
				IMPREZA (92-00)	
				LEGACY III (98-03)	
				LEGACY IV (03-09)	
				OUTBACK (00-03)	
				OUTBACK (03-09)	
				VIVIO (92-98)	
		TOYOTA	DUET (98-04)		
		VAUXHALL	FRONTERA II (B) (98-04)		
		ZHENGZHOU NISSAN	PALADIN (02-)		
		K16PSR-B8	IK16TT	CITROËN	C-CROSSER (07-)
				MITSUBISHI	OUTLANDER II (06-12)
					OUTLANDER III (12-)
		PEUGEOT	4007 (07-)		
		K16R-U	K16TT	BAW	LANDKING (LUBA) (02-07)
					BMW
				NISSAN	100 NX (90-94)
					PRIMERA (P10) (90-98)
					TOYOTA
				4 RUNNER (N18) (95-02)	
				DYNA 300 (95-02)	
HILUX II (83-05)					
LAND CRUISER / PRADO / COLORADO (J90) (95-)					
PLATZ (99-05)					
YARIS (99-05)					
	YARIS (05-11)				
K16R-U11	K16TT	CHRYSLER	CIRRUS (94-00)		
			STRATUS (95-01)		
			VOYAGER III (95-01)		
		DODGE	CARAVAN (95-02)		
			STRATUS (95-01)		
		FENGSHEN	SUNNY (03-)		
		GEELY	BL (05-)		
			CK (05-)		
			HISOON (04-)		
			MARINDO (05-)		
			MK (05-13)		
			MK (12-)		
			MR (05-)		
			VISION (06-)		
			INFINITI	G20 (90-97)	
			NISSAN	100 NX (90-94)	
		200 SX (93-99)			
		ALMERA I (95-00)			
		ALMERA TINO (00-)			
		AVENIR (97-05)			
		PRIMERA (P10) (90-98)			
		PRIMERA (P11) (96-02)			
		SENTRA V (00-06)			
		SERENA (92-01)			
		SERENA (99-05)			
		SILVIA (S15) (99-03)			
		SUNNY III (90-00)			

DENSO P/N	TT	MAKE	MODEL
K16R-U11 продолжение		PLYMOUTH	BREEZE (95-01)
			SHANGHAI MAPLE
		TOYOTA	ALLION I (01-07)
			ALTEZZA (99-05)
			AURIS (E15) (06-12)
			AVENSIS (97-03)
			AVENSIS (03-09)
			bB I (00-05)
			CARIBE (84-03)
			CARINA E (92-97)
			CELICA (99-05)
			CHASER (X7, X8) (84-91)
			CHASER (X9) (92-96)
			CHASER (X10) (96-01)
			COROLLA (E10) (92-99)
			COROLLA (E11) (97-02)
			COROLLA (E12) (01-07)
			COROLLA (E14, E15) (06-)
			COROLLA Levin (E10) (91-97)
			COROLLA Verso (01-09)
			CORSA (90-94)
			CORSA (94-99)
			CRESTA (84-01)
			ECHO (99-05)
			HILUX II (83-05)
			ISIS (04-)
			IST (04-07)
			MARK II (96-01)
			MATRIX (01-07)
			MR 2 III (99-07)
			OPA (00-05)
			PASEO (88-95)
			PASEO (95-99)
			PLATZ (99-05)
			PORTE I (04-12)
			PREMIO (01-07)
			PROBOX / SUCCEED (02-14)
			RACTIS (10-)
			RAUM (03-)
			RAV 4 II (00-05)
			SPRINTER (82-02)
		STARLET (P9) (96-99)	
		VIOS / YARIS (07-)	
		VIOS (02-08)	
		VISTA (V5) (98-03)	
		WILL Cypha (01-05)	
		WILL Vi (00-01)	
WILL VS (01-04)			
WISH (03-09)			
YARIS (99-05)			
YARIS (05-11)			
YARIS VERSO (99-05)			
K16TNR-S9	K16TT	AUDI	A4 (8E, B6) (00-04)
			A4 (8E, B7) (04-08)
			A4 Convertible (8H, B6, B7) (02-09)
		DAIHATSU	CUORE V (89-03)
			CUORE VI (03-)
			MOVE (94-02)
			SIRION (98-05)
			TREVIS (06-)
			YRV (01-)
		FIAT	ALBEA / SIENA (96-11)
			PALIO (96-)
		PERODUA	KELISA (02-)
			KENARI (00-)
			MYVI (06-11)
			VIVA (07-)
		RENAULT	TWINGO I (93-07)
		SKODA	FABIA I (6Y) (99-08)
		TOYOTA	DUET (98-04)
		VW	TRANSPORTER IV (70X, 7D) (90-03)

Свечи зажигания и Свечи накаливания

Руководство покупателя

DENSO P/N	TT	MAKE	MODEL
K16TNR-S9			VENTO (1H2) (91-98)
продолжение			
K16TR11	K16TT	TOYOTA	4 RUNNER (N18) (95-02) COROLLA (E11) (97-02) CORSA (94-99) HILUX II (83-05) LAND CRUISER / PRADO / COLORADO (J90) (95-) PASEO (95-99) RAUM (97-03) VISTA (V5) (98-03)
K16TT	K16TT	ALFA ROMEO	159 (05-11) BRERA (06-10) SPIDER (06-10)
	-	ALPINA	B12 (E31) (90-96) B12 (E32) (88-94) B12 (E38) (95-01)
		AUDI	A4 (8E, B6) (00-04) A4 (8E, B7) (04-08) A4 Convertible (8H, B6, B7) (02-09) A8 (4D) (94-02)
		BAW	LANDKING (LUBA) (02-07)
		BMW	3 (E30) (82-94) 7 (E32) (86-94) 8 (E31) (90-99)
		CADILLAC	BLS (06-)
		CHERY	QQ3 (03-14) TIGGO (05-09)
		CHEVROLET	CAPRICE (90-96) CRUZE (09-)
		CHRYSLER	CIRRUS (94-00) SEBRING (07-10) STRATUS (95-01) VOYAGER III (95-01)
		CITROËN	XSARA (97-05) XSARA Picasso (99-11)
		DAEWOO	KORANDO (99-) MUSSO (99-)
		DAIHATSU	CUORE V (89-03) CUORE VI (03-) MOVE (94-02) SIRION (98-05) TREVIS (06-) YRV (01-)
		DODGE	AVENGER (07-14) CALIBER (06-) CARAVAN (95-02) JOURNEY (08-) STRATUS (95-01)
		EMGRAND	EC7 (09-)
		FENGSHEN	SUNNY (03-)
		FIAT	ALBEA / SIENA (96-11) BRAVO I (95-01) CROMA (05-) DOBLO (01-) FREEMONT (11-) MAREA (96-07) MULTIPLA (99-10) PALIO (96-) PANDA (80-04) PANDA (03-) PUNTO (99-12) SEICENTO (98-10) STILO (01-08) STRADA (99-)
		GEELY	BL (05-) CK (05-) HISOON (04-) MARINDO (05-) MK (05-13) MK (12-) MR (05-)

DENSO P/N	TT	MAKE	MODEL
K16TT			VISION (06-)
продолжение		GREAT WALL	COOLBEAR (08-13) HOVER M4 (12-) TENGYI (10-)
	K16TT	HOLDEN	FRONTERA (B) (98-04)
	-	HONDA	ACCORD IV (90-94) ACCORD V (93-98) ACCORD VI (97-05) AVANCIER (99-03) CAPA (98-02) CIVIC V (91-97) CIVIC VI (94-01) CIVIC VII (00-05) CR-V I (95-02) CRX III (92-98) DOMANI (88-00) HR-V (99-) INTEGRA (93-01) LAGREAT (98-02) LOGO (99-02) ODYSSEY (RA) (95-00) ODYSSEY (RL1) (02-) ORTHIA (95-02) SHUTTLE (94-04) SMX (96-02) STEPWAGON (96-00) ODYSSEY (02-09)
		HONDA (GAC)	ODYSSEY (02-09)
		HYUNDAI	ACCENT I (94-00) ACCENT II (99-06) ACCENT III (05-10) ATOS (98-14) COUPE (96-02) COUPE (01-09) ELANTRA (00-06) ELANTRA (05-11) GETZ (02-09) GRANDEUR (05-11) HIGHWAY VAN (00-04) i10 (07-13) i20 (08-15) i30 (07-12) LANTRA II (95-00) MATRIX (01-10) S COUPE (90-96) SANTA FÉ I (00-06) SONATA V (05-10) TERRACAN (01-06) TRAJECT (00-08) TUCSON (04-10)
		INFINITI	G20 (90-97) QX4 (97-)
	K16TT	ISUZU	TFR / TFS (88-02) TROOPER II (91-98) TROOPER III (98-04) VEHICROSS (97-00) WIZARD (98-02)
	-	JEEP	CHEROKEE (XJ) (84-01) CJ5 - CJ8 (66-87) COMANCHE (86-96) COMMANDER (05-10) COMPASS (06-) Grand CHEROKEE II (98-05) Grand CHEROKEE III (05-10) PATRIOT (07-) WRANGLER I (86-96) WRANGLER II (96-08)
		KIA	CARENS II (02-) CARENS III (06-) CEED (06-12) CERATO (04-) CLARUS (96-)

Свечи зажигания и Свечи накаливания

Руководство покупателя

DENSO P/N	TT	MAKE	MODEL
K16TT			MAGENTIS (05-)
продолжение			PICANTO (04-)
			PRO CEED (08-13)
			RIO II (05-)
			SEPHIA (93-97)
			SHUMA I (96-01)
			SHUMA II (01-04)
			SPORTAGE I (94-04)
			SPORTAGE II (04-)
		LANCIA	DEDRA (89-99)
			LYBRA (99-05)
			Y (95-03)
			Y10 (85-95)
			YPSILON (843) (03-11)
		LEXUS	GS (93-97)
			GS (97-05)
			IS I (99-05)
			LX (95-97)
			SC (91-00)
		LOTUS	EUROPA S (06-)
		MAZDA	3 (00-09)
			3 (09-14)
			121 II (90-97)
			323 C IV (89-00)
			323 C V (94-98)
			323 F IV (87-94)
			323 F V (94-98)
			323 F VI (98-04)
			323 I (77-86)
			323 II (80-89)
			323 S IV (89-94)
			323 S V (94-98)
			323 S VI (98-04)
			626 III (87-97)
			626 IV (91-97)
			929 III (87-91)
			929 IV (90-96)
			B-SERIE (85-99)
			DEMIO (98-03)
			MPV I (88-99)
			MPV II (99-06)
			MX-3 (91-98)
			MX-5 II (98-05)
			MX-6 (92-97)
			PREMACY (99-05)
			XEDOS 6 (92-99)
			XEDOS 9 (93-02)
		MERCEDES-BENZ	CABRIOLET (A124) (92-93)
			C-CLASS (202) (93-01)
			CLK (208) (97-02)
			COUPE (C124) (87-93)
			E-CLASS (124) (92-96)
			E-CLASS (210) (95-03)
			E-CLASS Coupe / Convertible (124) (93-98)
			G-CLASS (W463) (89-)
			KOMBI (S124) (85-93)
			Saloon (W124) (84-93)
			S-CLASS (W140) (91-98)
			S-CLASS Coupe (C140) (92-99)
			SL (R129) (89-01)
			SLK (R170) (96-04)
		MITSUBISHI	COLT IV (92-96)
			COLT V (95-03)
			GALANT V (92-96)
			L 200 (96-07)
			L 300 (86-06)
			L 400 / SPACE GEAR (95-05)
			LANCER V (91-03)
			LANCER VI (95-03)
			MAGNA (96-05)
			PAJERO II (90-00)

DENSO P/N	TT	MAKE	MODEL
K16TT			PAJERO Pinin (99-07)
продолжение			PAJERO Sport I (97-)
			SAPPORO III (87-90)
			SPACE RUNNER (99-02)
			SPACE STAR (98-04)
			SPACE WAGON (98-04)
		NISSAN	100 NX (90-94)
			200 SX (93-99)
			240 SX (93-97)
			ALMERA I (95-00)
			ALMERA II (00-)
			ALMERA TINO (00-)
			ALTIMA (93-01)
			AVENIR (97-05)
			ELGRAND (95-02)
			MICRA II (K11) (92-03)
			NAVARA (D22) (97-)
			PATHFINDER II (97-04)
			PICK UP (D22) (97-05)
			PRAIRIE (M10) (83-88)
			PRIMERA (P10) (90-98)
			PRIMERA (P11) (96-02)
			SENTRA V (00-06)
			SERENA (92-01)
			SERENA (99-05)
			SILVIA (S15) (99-03)
			SUNNY II (86-91)
			SUNNY III (90-00)
			TERRANO II (92-07)
		OPEL	AGILA A (00-07)
			ASTRA G (98-09)
			ASTRA H (04-14)
			COMBO C (01-)
			CORSA C (00-09)
			CORSA D (06-14)
			FRONTERA B (98-04)
			INSIGNIA (A) (08-17)
			MERIVA A (03-10)
			MOKKA (12-)
			SIGNUM (03-)
			TIGRA TwinTop (04-)
			VECTRA C (02-08)
			ZAFIRA A (99-05)
			ZAFIRA B (05-14)
			ZAFIRA Tourer C (11-)
		PERODUA	KELISA (02-)
			KENARI (00-)
			MYVI (06-11)
			VIVA (07-)
		PEUGEOT	106 I (91-96)
			106 II (96-04)
			206 (98-)
		PLYMOUTH	BREEZE (95-01)
		PUCH	G-MODELL (W463) (89-00)
		RENAULT	TWINGO I (93-07)
		SAAB	9-3 (02-15)
		SEAT	CORDOBA (6L) (02-09)
			IBIZA III (6L) (02-09)
			IBIZA IV (6J, 6P) (08-)
		SHANGHAI MAPLE	HAIXUAN (06-)
		SKODA	FABIA I (6Y) (99-08)
			FABIA II (06-14)
			FELICIA Fun (6U) (97-02)
			FELICIA II (6U) (98-01)
			ROOMSTER (5J) (06-15)
		SSANGYONG	CHAIRMAN (97-)
			KORANDO (96-06)
			MUSSO (93-07)
		SUBARU	FORESTER (97-02)
			FORESTER (02-08)
			IMPREZA (92-00)

Свечи зажигания и Свечи накаливания

Руководство покупателя

DENSO P/N	TT	MAKE	MODEL
K16TT продолжение			IMPREZA (00-)
			LEGACY III (98-03)
			LEGACY IV (03-09)
			OUTBACK (00-03)
			OUTBACK (03-09)
			VIVIO (92-98)
			WAGON R (03-05)
			SUZUKI
			TOYOTA
			4 RUNNER (N10) (89-96)
4 RUNNER (N18) (95-02)			
ALLION I (01-07)			
ALTEZZA (99-05)			
ARISTO (90-97)			
ARISTO (97-04)			
AURIS (E15) (06-12)			
AVENSIS (97-03)			
AVENSIS (03-09)			
bB I (00-05)			
CALDINA (T21) (97-02)			
CARIBE (84-03)			
CARINA E (92-97)			
CELICA (93-99)			
CELICA (99-05)			
CHASER (X7, X8) (84-91)			
CHASER (X9) (92-96)			
CHASER (X10) (96-01)			
COROLLA (E10) (92-99)			
COROLLA (E11) (97-02)			
COROLLA (E12) (01-07)			
COROLLA (E14, E15) (06-)			
COROLLA Levin (E10) (91-97)			
COROLLA Verso (01-09)			
CORSA (90-94)			
CORSA (94-99)			
CRESTA (84-01)			
CROWN (91-99)			
DUET (98-04)			
DYNA 300 (95-02)			
ECHO (99-05)			
GRANVIA (95-04)			
HILUX II (83-05)			
ISIS (04-)			
IST (04-07)			
LAND CRUISER (J80) (90-98)			
LAND CRUISER / PRADO (J70) (84-06)			
LAND CRUISER / PRADO / COLORADO (J90) (95-)			
MARK II (88-96)			
MARK II (96-01)			
MATRIX (01-07)			
MR 2 III (99-07)			
OPA (00-05)			
PASEO (88-95)			
PASEO (95-99)			
PLATZ (99-05)			
PORTE I (04-12)			
PREMIO (01-07)			
PREVIA / ESTIMA I (90-00)			
PROBOX / SUCCEED (02-14)			
RACTIS (10-)			
RAUM (97-03)			
RAUM (03-)			
RAV 4 II (00-05)			
SOARER (90-00)			
SPRINTER (82-02)			
STARLET (P9) (96-99)			
SUPRA (93-02)			
TUNDRA (99-06)			
VIOS / YARIS (07-)			
VIOS (02-08)			
VISTA (V5) (98-03)			
WILL Cypha (01-05)			
WILL Vi (00-01)			

DENSO P/N	TT	MAKE	MODEL
K16TT продолжение			WILL VS (01-04)
			WISH (03-09)
			YARIS (99-05)
			YARIS (05-11)
			YARIS VERSO (99-05)
			VAUXHALL
			AGILA I (A) (00-08)
			ASTRA IV (G) (98-06)
			ASTRA V (H) (04-10)
			COMBO II (C) (01-12)
CORSA II (C) (00-06)			
CORSA III (D) (06-)			
FRONTERA II (B) (98-04)			
MERIVA I (A) (03-10)			
MOKKA (12-)			
SIGNUM (02-08)			
TIGRA TwinTop (04-09)			
VECTRA II (C) (00-08)			
ZAFIRA II (B) (05-14)			
ZAFIRA III (C) (11-)			
VW			
FOX (5Z) (03-)			
NEW BEETLE (9C, 1C, 1Y) (98-10)			
POLO (9N) (01-09)			
TRANSPORTER IV (70X, 7D) (90-03)			
VENTO (1H2) (91-98)			
ZASTAVA			
10 (05-)			
ZHENGZHOU NISSAN			
PALADIN (02-)			
K20BR-S10	K20TT	DAIHATSU	SIRION (98-05)
			YRV (01-)
		RENAULT	CLIO I (90-98)
		VW	PASSAT (3A2, 35I) (88-97)
K20HR-U11	KH20TT	CITROËN	C4 Coupe (04-11)
			C4 I (LC, LR) (04-11)
			C5 III (08-)
			C8 (02-)
			JUMPY (07-)
		FIAT	SCUDO (220) (96-06)
			ULYSSE (94-02)
			ULYSSE (02-11)
		LANCIA	PHEDRA (02-10)
			ZETA (95-02)
		MITSUBISHI	COLT CZC (06-09)
			COLT VI (04-12)
		NISSAN	PRIMERA (P12) (02-)
			TEANA I (03-08)
			X-TRAIL (T30) (01-13)
		PEUGEOT	206 (98-)
			307 (00-)
			308 CC (07-)
			308 I (07-)
		SMART	FORFOUR I (454) (04-06)
		TOYOTA	4 RUNNER (N21) (02-09)
			FJ CRUISER (07-)
			LAND CRUISER / PRADO (J70) (84-06)
			LAND CRUISER / PRADO (J120) (02-10)
			LAND CRUISER / PRADO (J150) (10-)
			TUNDRA (07-)
		TOYOTA (FAW)	LAND CRUISER (J200) (07-)
			PRADO (03-10)
		VOLVO	C30 (06-12)
			C70 II (06-13)
			S40 II (04-12)
			V50 (04-12)
K20PBR	K20TT	ALFA ROMEO	33 (90-94)
			75 (85-92)
			164 (87-98)
		CITROËN	XM (89-94)
			XM (94-00)
			XSARA (97-05)
			ZX (91-98)
		FIAT	PUNTO (93-00)
		LANCIA	DELTA II (93-99)

Свечи зажигания и Свечи накаливания

Руководство покупателя

DENSO P/N	TT	MAKE	MODEL	
K20PBR продолжение		OPEL	SIGNUM (03-)	
			VECTRA C (02-08)	
			ZAFIRA B (05-14)	
		PEUGEOT	306 (93-02)	
			405 II (92-99)	
			605 (89-99)	
		RENAULT	19 II (92-01)	
			21 (86-95)	
			25 (84-93)	
			LAGUNA I (93-01)	
			MEGANE I (96-03)	
			SAFRANE I (92-96)	
			SAFRANE II (96-00)	
			SPORT Spider (95-99)	
			SEAT	TOLEDO I (1L) (91-99)
			VAUXHALL	SIGNUM (02-08)
		VECTRA II (C) (00-08)		
		ZAFIRA II (B) (05-14)		
		VOLVO	S40 I (95-03)	
			V40 (95-04)	
VW	CORRADO (53I) (88-95)			
K20PBR-S10	K20TT	ALFA ROMEO	147 (00-10)	
			AUDI	80 (89, 8A, B3) (86-91)
		80 (8C, B4) (91-96)		
		90 (89, 8A, B3) (87-91)		
		100 (4A, C4) (90-94)		
		A2 (8Z) (00-05)		
		A3 (8L) (96-03)		
		A3 (8P) (03-13)		
		A3 Convertible (8P7) (08-13)		
		A4 (8D, B5) (94-01)		
		A4 (8E, B6) (00-04)		
		A4 (8E, B7) (04-08)		
		A4 Convertible (8H, B6, B7) (02-09)		
		A6 (4A, C4) (94-97)		
		A6 (4B, C5) (97-05)		
		A6 (4F, C6) (04-11)		
		A8 (4D) (94-02)		
		A8 (4E) (02-10)		
		ALLROAD (4BH) (00-05)		
		CABRIOLET (8G7) (91-00)		
		COUPE (89, 8B) (88-96)		
		TT (8N) (98-06)		
		CADILLAC	CTS (02-07)	
		CHEVROLET	EPICA (05-)	
			LACETTI (05-)	
		DAEWOO	KORANDO (99-)	
			MUSSO (99-)	
			REXTON (02-)	
		DAIHATSU	SIRION (98-05)	
			TERIOS (97-05)	
			TERIOS (05-)	
			YRV (01-)	
		FAW-AUDI	A6L (C6) (05-11)	
		FIAT	COUPE (93-00)	
		LANCIA	KAPPA (94-01)	
			THESIS (02-09)	
		MERCEDES-BENZ	A-CLASS (W168) (97-04)	
			C-CLASS (202) (93-01)	
			CLK (208) (97-02)	
			E-CLASS (210) (95-03)	
			M-CLASS (W163) (98-05)	
			SLK (R170) (96-04)	
			SPRINTER 2-t (901, 902) (95-06)	
			SPRINTER 3-t (903) (95-06)	
			SPRINTER 4-t (904) (96-06)	
			VANEO (414) (02-05)	
			V-CLASS (638/2) (96-03)	
		VITO (638) (96-03)		
		PORSCHE	911 (996) (97-05)	
			BOXSTER (986) (96-04)	

DENSO P/N	TT	MAKE	MODEL
K20PBR-S10 продолжение		CAYENNE (955) (02-10)	
			RENAULT
		19 II (92-01)	
		CLIO I (90-98)	
		LAGUNA I (93-01)	
		SAFRANE I (92-96)	
		SAFRANE II (96-00)	
		SEAT	ALHAMBRA (7V) (96-10)
			ALTEA (XL) (5P) (04-)
			AROSA (6H) (97-04)
			CORDOBA (6K1) (93-99)
			CORDOBA (6K2) (99-02)
			CORDOBA (6L) (02-09)
			EXEO (3R) (08-)
			IBIZA II (6K1) (93-99)
			IBIZA II (6K2) (99-02)
			IBIZA III (6L) (02-09)
			IBIZA IV (6J, 6P) (08-)
			INCA (6K9) (95-03)
			LEON (1M) (99-06)
			LEON (1P) (05-12)
			TOLEDO I (1L) (91-99)
			TOLEDO II (1M) (99-06)
			TOLEDO III (5P) (04-09)
		SKODA	FABIA I (6Y) (99-08)
			OCTAVIA I (1U) (96-10)
			OCTAVIA II (1Z) (04-13)
			SUPERB I (3U) (01-08)
		SSANGYONG	CHAIRMAN (97-)
			KORANDO (96-06)
			KYRON (05-)
		MUSSO (93-07)	
		VOLVO	850 (91-97)
			C70 I (97-05)
			S60 I (00-10)
			S70 (96-00)
			S80 I (98-06)
			V70 I (96-00)
			V70 II (00-07)
			V90 I (96-98)
			VW
		CADDY II (9K, 9U) (95-04)	
		CADDY III (2K, 2C) (04-15)	
		GOLF III (1H, 1E) (91-99)	
		GOLF IV (1J, 1E) (97-06)	
		GOLF Plus (5M, 521) (05-14)	
		GOLF V (1K) (03-09)	
		GOLF VI (5K, AJ5) (08-14)	
		JETTA III (1K2) (05-10)	
		LUPO (6X, 6E) (98-05)	
MULTIVAN V (7H, 7E) (03-)			
NEW BEETLE (9C, 1C, 1Y) (98-10)			
PASSAT (3A2, 35I) (88-97)			
PASSAT (3B2, 3B5) (96-01)			
PASSAT (3B3, 3B6) (00-05)			
PASSAT (3C) (05-11)			
PHAETON (3D) (02-16)			
POLO (6N1) (94-99)			
POLO (6N2) (99-01)			
POLO (9N) (01-09)			
POLO Classic (6KV) (95-02)			
POLO Saloon (9A4) (02-)			
POLO Variant (6V5) (97-01)			
SHARAN (7M) (95-10)			
TOUAREG (7L) (02-10)			
TOURAN (1T1, 1T2) (03-10)			
TRANSPORTER V (7H, 7E, 7J) (03-15)			
VENTO (1H2) (91-98)			
K20PR-L11	K20TT	ACURA	VIGOR (91-94)
		HONDA	ASCOT (90-97)
			CIVIC IV (87-95)

Свечи зажигания и Свечи накаливания

Руководство покупателя

DENSO P/N	TT	MAKE	MODEL	
K20PR-L11 продолжение			CIVIC V (91-97)	
			CIVIC VI (94-01)	
			CRX II (87-92)	
			CRX III (92-98)	
			INSPIRE (91-98)	
K20PR-U	K20TT	LDV	SHERPA (74-89)	
		AUDI	A3 (8P) (03-13)	
		AUSTIN	MAESTRO (83-92)	
			MONTEGO (84-92)	
		AUTOBIANCHI	Y10 (85-95)	
		CATERHAM	21 (94-02)	
			SUPER SEVEN (80-)	
		CHANGAN (CHANA)	GAZELLE (99-04)	
		CHERY		A3 (08-14)
				A5 (06-)
A11 (00-)				
ARRIZO 7 (13-)				
BEAT (10-)				
EASTAR CROSS (07-)				
INDIS (10-)				
QIYUN (03-10)				
QIYUN (10-15)				
TIGGO 5 (13-)				
TIGGO (05-09)				
TIGGO (10-)				
TIGGO FL (13-)				
X1 (10-)				
XCROSS (10-)				
CHRYSLER		CIRRUS (94-00)		
		NEON I (94-00)		
		NEON II (99-06)		
		STRATUS (95-01)		
		VOYAGER III (95-01)		
CITROËN		AX (86-98)		
		BERLINGO (MF) (96-11)		
		BX (82-94)		
		C2 (03-)		
		C3 I (02-)		
		C3 II (09-)		
		C3 Pluriel (03-)		
		C15 (84-05)		
		EVASION (94-02)		
		JUMPER (94-02)		
		JUMPER (02-)		
		NEMO (08-)		
		SAXO (96-04)		
		XANTIA (93-03)		
		XM (94-00)		
		XSARA (97-05)		
		ZX (91-98)		
DACIA		DUSTER (10-)		
		LOGGY (12-)		
		LOGAN I (04-)		
		LOGAN II (12-)		
		LOGAN MCV I (07-)		
		SANDERO I (Stepway) (08-)		
		SOLENZA (03-)		
		SUPERNOVA (00-03)		
DODGE		CARAVAN (95-02)		
		NEON I (94-99)		
		NEON II (99-06)		
		STRATUS (95-01)		
DR		DR 1 (10-14)		
		DR 2 (10-14)		
		DR 5 (11-)		
EMGRAND		EC7 (09-)		
FIAT		ALBEA / SIENA (96-11)		
		BARCETTA (95-05)		
		BRAVA (95-02)		
		BRAVO I (95-01)		
		CINQUECENTO (91-99)		

DENSO P/N	TT	MAKE	MODEL
K20PR-U продолжение			DUCATO (230) (94-02)
			DUCATO (244) (02-)
			ELBA (85-97)
			FIORINO (88-01)
			FIORINO (07-)
			MAREA (96-07)
			MULTIPLA (99-10)
			PALIO (96-)
			PANDA (80-04)
			PUNTO (93-00)
			PUNTO (99-12)
			QUBO (08-)
			SEICENTO (98-10)
			ULYSSE (94-02)
FORD			ESCORT II (73-81)
			ESCORT IV (85-90)
			FIESTA II (83-95)
			FIESTA III (89-97)
			ORION III (90-93)
			SCORPIO I (85-94)
			TRANSIT (94-00)
			TRANSIT Tourneo (94-00)
FSO		POLONEZ III (92-02)	
GEELY			BL (05-)
			CK (05-)
			HISOON (04-)
			MR (05-)
			PANDA (08-)
			PU (05-)
		URBAN NANNY (04-)	
		VISION (06-)	
GEO		METRO (88-98)	
		TRACKER (88-98)	
HYUNDAI			ACCENT II (99-06)
			ACCENT III (05-10)
			S COUPE (90-96)
INNOCENTI		ELBA (91-96)	
ISUZU		GEMINI (90-93)	
		IMPULSE (90-93)	
JAGUAR			XJ (86-94)
			XJ (94-97)
			XJ Coupe (73-96)
JEEP		CHEROKEE (XJ) (84-01)	
KIA			CARENS I (00-02)
			CARENS II (02-)
			CERATO (01-04)
			ELAN (96-99)
			RIO I (00-05)
			ROADSTER (99-)
			SHUMA I (96-01)
SHUMA II (01-04)			
LADA			110 (2110) (95-12)
			GRANTA (2190, 2191, 2349) (11-)
			KALINA (2192, 2194) (13-)
			LARGUS (12-)
			VESTA (15-)
			X-RAY (16-)
			XRAY (16-)
LANCIA			DEDRA (89-99)
			DELTA II (93-99)
			LYBRA (99-05)
			Y (95-03)
			Y10 (85-95)
LAND ROVER		DISCOVERY I (89-98)	
LOTUS		ELAN (89-95)	
MAZDA			323 C IV (89-00)
			323 F IV (87-94)
			626 III (87-97)
			929 II (82-87)
MERCEDES-BENZ		SL (R129) (89-01)	
MITSUBISHI		SPACE RUNNER (91-99)	

Свечи зажигания и Свечи накаливания

Руководство покупателя

DENSO P/N	TT	MAKE	MODEL
K20PR-U			SPACE WAGON (91-98)
продолжение		NISSAN	100 NX (90-94)
			ALMERA I (95-00)
			BLUEBIRD Sylphy (12-)
			KUBISTAR (03-)
			PRIMERA (P10) (90-98)
			PRIMERA (P11) (96-02)
			SERENA (92-01)
			SUNNY II (86-91)
			SUNNY III (90-00)
			VANETTE Cargo (C23) (94-02)
		OPEL	KADETT E (84-94)
		PANTHER	KALLISTA (82-93)
		PEUGEOT	106 I (91-96)
			205 I (83-94)
			205 II (87-98)
			206 (98-)
			206+ (09-)
			207 (06-)
			306 (93-02)
			307 (00-)
			309 I (85-89)
			309 II (89-93)
			405 I (87-93)
			405 II (92-99)
			406 (95-04)
			406 Coupe (97-04)
			604 (77-87)
			806 (94-02)
			1007 (05-)
			BIPPER (08-)
			BOXER (94-02)
			BOXER (02-)
			PARTNER / RANCH (96-15)
		PLYMOUTH	BREEZE (95-01)
			NEON I (94-99)
			NEON II (99-06)
		RENAULT	19 II (92-01)
			CLIO I (90-98)
			CLIO II (98-)
			CLIO III (05-)
			DUSTER (09-)
			ESPACE III (96-02)
			ESPACE IV (02-)
			FLUENCE (10-)
			Grand SCÉNIC II (04-)
			Grand SCÉNIC III (09-)
			KANGOO (97-)
			KANGOO (08-)
			LAGUNA I (93-01)
			LAGUNA II (01-)
			LAGUNA III (07-)
			LOGAN I (04-)
			LOGAN II (13-)
			MEGANE CC (10-)
			MEGANE I (96-03)
			MEGANE II (02-12)
			MEGANE III (08-)
			MEGANE IV (15-)
			MEGANE Scénic (96-99)
			MODUS (04-)
			RAPID (85-98)
			SAFRANE II (96-00)
			SANDERO I (Stepway) (07-)
			SANDERO II (Stepway) (13-)
			SCÉNIC I (99-03)
			SCÉNIC II (03-)
			SCÉNIC III (09-)
			THALIA I (98-)
			THALIA II (08-)
		ROVER	100 / METRO (90-98)

DENSO P/N	TT	MAKE	MODEL
K20PR-U			200 (RF) (95-00)
продолжение			200 (XH) (85-89)
			200 (XW) (89-99)
			400 (90-98)
			800 (86-99)
			CABRIOLET (90-99)
			COUPE (96-99)
			MAESTRO (90-95)
		SANTANA	SAMURAI (86-95)
		SEAT	ALTEA (XL) (5P) (04-)
			LEON (1P) (05-12)
			TOLEDO III (5P) (04-09)
		SKODA	FAVORIT (78) (89-97)
			FELICIA I (6U) (94-98)
			OCTAVIA II (1Z) (04-13)
		SUBARU	FORESTER (97-02)
			REX III (89-92)
		SUZUKI	ALTO III (93-02)
			BALENO (95-02)
			CARRY (99-)
			JIMNY (88-98)
			JIMNY (98-)
			SAMURAI (88-04)
			SWIFT II (89-05)
			VITARA (88-99)
			X-90 (95-97)
		TAGAZ	VEGA (09-12)
		TATA	INDICA (98-)
		TRIUMPH	ACCLAIM (82-85)
		VAUXHALL	ASTRA II (84-94)
		VOLVO	850 (91-97)
			S90 I (96-98)
			V90 I (96-98)
		VORTEX	VORTEX (09-)
		VW	EOS (1F) (06-15)
			GOLF Plus (5M, 521) (05-14)
			GOLF V (1K) (03-09)
			JETTA III (1K2) (05-10)
			PASSAT (3C) (05-11)
			TOURAN (1T1, 1T2) (03-10)
K20PR-U11	K20TT	BYD	F3 (05-13)
			F3R (07-)
		CHEVROLET	AVEO / KALOS (T200) (03-08)
			AVEO / KALOS (T250, T255) (05-)
			CRUZE (09-)
			LACETTI (05-)
			LANOS (05-)
			NUBIRA (05-11)
			OPTRA (03-08)
			REZZO (05-)
			TRACKER (98-08)
		DAEWOO	ESPERO (91-99)
			KALOS (02-)
			LACETTI (04-)
			LANOS (97-)
			NEXIA (95-08)
			NEXIA (08-)
			NUBIRA (97-)
			NUBIRA (03-)
			TACUMA / REZZO (00-)
		DAIHATSU	APPLAUSE I (89-97)
			CHARADE III (87-93)
			CHARADE IV (93-00)
			FEROZA (88-99)
			GRAN MOVE (96-02)
			HIJET (98-)
			ROCKY (85-98)
		FORD	ESCORT VI (95-01)
		FSO	LANOS (04-08)
		GEO	STORM (89-93)
		GREAT WALL	HOVER H5 (10-)

Свечи зажигания и Свечи накаливания

Руководство покупателя

DENSO P/N	TT	MAKE	MODEL
K20PR-U11 продолжение		HONDA	BEAT (91-96)
			CITY (01-08)
			CIVIC IV (87-95)
			CIVIC V (91-97)
			CIVIC VI (94-01)
			CIVIC VIII Hatchback (05-)
			JAZZ II (02-08)
			JAZZ Saloon (03-08)
			LIFE (97-01)
			LIFE (01-03)
HYUNDAI	ACCENT I (94-00)		
	LANTRA II (95-00)		
ISUZU	GEMINI (84-90)		
	GEMINI (90-93)		
	IMPULSE (90-93)		
	TROOPER II (91-98)		
KIA	CARENS II (02-)		
	CLARUS (96-)		
	RETONA (99-)		
	SPORTAGE I (94-04)		
LOTUS	ELAN (89-95)		
MAZDA	323 C IV (89-00)		
	323 F IV (87-94)		
	323 F V (94-98)		
	323 P V (96-98)		
	323 S IV (89-94)		
	626 III (87-97)		
	626 IV (91-97)		
	MX-5 I (90-98)		
	MX-5 II (98-05)		
	XEDOS 6 (92-99)		
	MERCEDES-BENZ	A-CLASS (W169) (04-12)	
		B-CLASS (W245) (05-11)	
		E-CLASS (124) (92-96)	
E-CLASS (210) (95-03)			
Saloon (W124) (84-93)			
S-CLASS (W140) (91-98)			
S-CLASS Coupe (C140) (92-99)			
SL (R129) (89-01)			
MITSUBISHI		CARISMA (95-06)	
		COLT IV (92-96)	
	COLT V (95-03)		
	GALANT V (92-96)		
	GALANT VI (96-04)		
	LANCER III (83-92)		
	LANCER IV (88-94)		
	LANCER V (91-03)		
	LANCER VI (95-03)		
	LANCER VII (03-)		
	SPACE RUNNER (91-99)		
	SPACE STAR (98-04)		
	SPACE WAGON (91-98)		
	SPACE WAGON (98-04)		
	NISSAN	MAXIMA III (88-94)	
		PATHFINDER I (86-95)	
		QUEST (92-98)	
	PERODUA	KANCIL (94-)	
	PROTON	IMPIAN (01-)	
PERSONA 300 (96-04)			
PERSONA 400 (94-03)			
ROVER	WIRA (00-)		
	400 (95-00)		
SUBARU	FORESTER (97-02)		
	IMPREZA (92-00)		
	IMPREZA (00-)		
	LEGACY I (89-94)		
	LEGACY II (94-99)		
	LEGACY III (98-03)		
	REX III (89-92)		
	VIVIO (92-98)		
	SUZUKI	BALENO (95-02)	

DENSO P/N	TT	MAKE	MODEL			
K20PR-U11 продолжение			Grand VITARA I (98-06)			
			Grand VITARA II (05-)			
			IGNIS I (00-05)			
			LIANA (01-07)			
			WAGON R+ (00-)			
			VAUXHALL	MONTEREY I (91-98)		
				LANOS (04-)		
			K20PSR-B8	IK20TT	MITSUBISHI	LANCER VIII (07-)
			K20P-U	K20TT	SUZUKI	OUTLANDER III (12-)
						SWIFT II (89-05)
K20R-U	K20TT	ALPINA	B12 (E31) (90-96)			
			CHERY	FULWIN (06-)		
				QIYUN (10-15)		
		TAXIM MPV (07-)				
		XCROSS (10-)				
		CHRYSLER	PT CRUISER (00-10)			
			INFINITI	G20 (90-97)		
		NISSAN		200 SX (93-99)		
			PRIMASTAR (01-)			
			PRIMERA (P10) (90-98)			
			PRIMERA (P11) (96-02)			
			SERENA (92-01)			
			TERRANO I (87-96)			
		OPEL	VECTRA A (88-95)			
			TOYOTA	CARINA E (92-97)		
		VAUXHALL		CAVALIER III (88-95)		
		K20R-U11	K20TT	DAIHATSU	COPEN (03-12)	
					EXTOL (00-)	
					SIRION (98-05)	
SIRION (05-)						
TERIOS (97-05)						
YRV (01-)						
FAW	V2 (13-)					
LEXUS	IS I (99-05)					
LOTUS	ELISE (00-)					
NISSAN	ALMERA I (95-00)					
	AVENIR (97-05)					
	PRIMERA (P11) (96-02)					
PERODUA	MYVI (06-11)					
TOYOTA	ALPHARD I (03-08)					
	ALPHARD II (08-14)					
	ALTEZZA (99-05)					
	AVANZA (F6) (03-11)					
	CALDINA (T19) (92-97)					
	CAMI (99-05)					
	CARINA E (92-97)					
	CHASER (X10) (96-01)					
	CORONA (T19) (92-97)					
	CRESTA (84-01)					
	HARRIER (97-03)					
	MARK II (96-01)					
	MARK II (02-07)					
	PREVIA / ESTIMA II (00-06)					
	RAV 4 I / FUNCRIUSER (94-00)					
	SERA (90-95)					
VEROSSA (00-03)						
VISTA (V3, V4) (90-98)						
YARIS (99-05)						
K20TNR	K20TT	CITROËN	SAXO (96-04)			
			FIAT	ALBEA / SIENA (96-11)		
		BARCETTA (95-05)				
		BRAVA (95-02)				
		BRAVO I (95-01)				
		CINQUECENTO (91-99)				
		COUPE (93-00)				
		MAREA (96-07)				
		PALIO (96-)				
		PUNTO (99-12)				
		STILO (01-08)				
		STRADA (99-)				
		LANCIA	DEDRA (89-99)			

Свечи зажигания и Свечи накаливания

Руководство покупателя

DENSO P/N	TT	MAKE	MODEL			
K20TNR продолжение			DELTA II (93-99)			
			KAPPA (94-01)			
			LYBRA (99-05)			
			THESIS (02-09)			
			Y (95-03)			
		OPEL	OMEGA B (94-03)			
		PORSCHE	BOXSTER (986) (96-04)			
		VAUXHALL	OMEGA (B) (94-03)			
		K20TNR-S	K20TT	DAIHATSU	APPLAUSE I (89-97)	
					APPLAUSE II (97-00)	
CHARADE III (87-93)						
CHARADE IV (93-00)						
HIJET (92-)						
TERIOS (97-05)						
PEUGEOT	106 I (91-96)					
106 II (96-04)						
PIAGGIO	PORTER (93-)					
K20TNR-S9	K20TT			CITROËN	SAXO (96-04)	
		DAIHATSU	APPLAUSE II (97-00)			
			ATRIA WAGON (92-99)			
			MOVE (02-07)			
			NAKED (99-05)			
			TERIOS (97-05)			
			LOTUS	ESPRIT S4 (89-03)		
		K20TR11	K20TT	TOYOTA	AVENSIS (97-03)	
					CALDINA (T19) (92-97)	
					CAMRY (V1) (90-97)	
CAMRY (V2) (96-01)						
CAMRY Solara (98-03)						
CORONA (T21) (96-03)						
GAIA (98-03)						
NADIA (98-03)						
PICNIC (96-01)						
RAV 4 I / FUNCRAISER (94-00)						
SIENNA (97-03)						
TOWN ACE (92-01)						
VISTA (V3, V4) (90-98)						
WINDOM (96-01)						
K20TT	-				ACURA	VIGOR (91-94)
						ALFA ROMEO
						75 (85-92)
						145 / 146 (94-01)
			147 (00-10)			
			155 (92-97)			
			156 (97-06)			
			164 (87-98)			
			166 (98-07)			
			GT (03-10)			
			GTV (95-05)			
			SPIDER (94-05)			
			ALPINA	B3 (E36) (93-99)		
				B3 (E46) (99-06)		
				B5 (E60, E61) (05-10)		
				B6 (E63, E64) (06-10)		
				B7 (E65) (03-08)		
				B8 (E36) (95-98)		
				B10 (E34) (88-96)		
				B10 (E39) (96-04)		
				B11 (E32) (87-94)		
				B12 (E31) (90-96)		
				B12 (E38) (95-01)		
				ROADSTER (Z8) (02-03)		
				ROADSTER S (Z4) (03-05)		
			AUDI	80 (89, 8A, B3) (86-91)		
				80 (8C, B4) (91-96)		
				90 (89, 8A, B3) (87-91)		
				100 (4A, C4) (90-94)		
				A2 (8Z) (00-05)		
				A3 (8L) (96-03)		
				A3 (8P) (03-13)		
				A3 Convertible (8P7) (08-13)		

DENSO P/N	TT	MAKE	MODEL	
K20TT продолжение			A4 (8D, B5) (94-01)	
			A4 (8E, B6) (00-04)	
			A4 (8E, B7) (04-08)	
			A4 Convertible (8H, B6, B7) (02-09)	
			A6 (4A, C4) (94-97)	
			A6 (4B, C5) (97-05)	
			A6 (4F, C6) (04-11)	
			A8 (4D) (94-02)	
			A8 (4E) (02-10)	
			ALLROAD (4BH) (00-05)	
			CABRIOLET (8G7) (91-00)	
			COUPE (89, 8B) (88-96)	
			TT (8N) (98-06)	
			AUSTIN	MAESTRO (83-92)
				MONTEGO (84-92)
			AUTOBIANCHI	Y10 (85-95)
			BEDFORD	MIDI (84-92)
				RASCAL (86-90)
			BENTLEY	ARNAGE I (98-09)
			BMW	
				3 (E30) (82-94)
				3 (E36) (90-00)
				3 (E46) (98-06)
				3 (E90, E91) (05-12)
				5 (E28) (81-87)
				5 (E34) (87-97)
				5 (E39) (95-04)
				5 (E60, E61) (03-10)
				6 (E63, E64) (04-10)
				7 (E32) (86-94)
				7 (E38) (94-01)
				7 (E65, E66) (01-08)
				8 (E31) (90-99)
				X3 (E83) (04-11)
				X5 (E53) (00-06)
				Z3 (E36) (95-03)
				Z4 (E85, E86) (03-09)
			Z8 (E52) (00-03)	
		BYD	F3 (05-13)	
			F3R (07-)	
		CADILLAC	CTS (02-07)	
		CATERHAM	21 (94-02)	
			SUPER SEVEN (80-)	
		CHANGAN (CHANA)	GAZELLE (99-04)	
		CHERY		A3 (08-14)
				A5 (06-)
				A11 (00-)
				ARRIZO 7 (13-)
				BEAT (10-)
				EASTAR CROSS (07-)
	FULWIN (06-)			
	INDIS (10-)			
	QIYUN (03-10)			
	QIYUN (10-15)			
	TAXIM MPV (07-)			
	TIGGO 5 (13-)			
	TIGGO (05-09)			
	TIGGO (10-)			
	TIGGO FL (13-)			
	X1 (10-)			
	XCROSS (10-)			
CHEVROLET			AVEO (T300) (11-)	
		AVEO / KALOS (T200) (03-08)		
		AVEO / KALOS (T250, T255) (05-)		
		CAPTIVA (06-)		
		CRUZE (09-)		
		EPICA (05-)		
		EVANDA (05-)		
		LACETTI (05-)		
		LANOS (05-)		
		NUBIRA (05-11)		
		K20TT		
		-		

Свечи зажигания и Свечи накаливания

Руководство покупателя

DENSO P/N	TT	MAKE	MODEL			
K20TT продолжение			OPTRA (03-08)			
			ORLANDO (11-)			
			REZZO (05-)			
			TRACKER (98-08)			
			TRAX (12-)			
CHRYSLER			CIRRUS (94-00)			
			NEON I (94-00)			
			NEON II (99-06)			
			PT CRUISER (00-10)			
			STRATUS (95-01)			
			VOYAGER III (95-01)			
			CITROËN			AX (86-98)
						BERLINGO (MF) (96-11)
						BX (82-94)
						C2 (03-)
C3 I (02-)						
C3 II (09-)						
C3 Pluriel (03-)						
C15 (84-05)						
EVASION (94-02)						
JUMPER (94-02)						
JUMPER (02-)						
NEMO (08-)						
SAXO (96-04)						
XANTIA (93-03)						
XM (89-94)						
XM (94-00)						
XSARA (97-05)						
ZX (91-98)						
DACIA			DOKKER (12-)			
			DUSTER (10-)			
			LODGY (12-)			
			LOGAN I (04-)			
			LOGAN II (12-)			
			LOGAN MCV I (07-)			
			LOGAN MCV II (13-)			
			SANDERO I (Stepway) (08-)			
			SANDERO II (Stepway) (12-)			
			SOLENZA (03-)			
			SUPERNOVA (00-03)			
			DAEWOO			ESPERO (91-99)
						EVANDA (02-)
KALOS (02-)						
KORANDO (99-)						
LACETTI (04-)						
LANOS (97-)						
LEGANZA (97-04)						
MUSSO (99-)						
NEXIA (95-08)						
NEXIA (08-)						
NUBIRA (97-)						
NUBIRA (03-)						
REXTON (02-)						
TACUMA / REZZO (00-)						
DAIHATSU						APPLAUSE I (89-97)
						APPLAUSE II (97-00)
			ATRIA WAGON (92-99)			
			CHARADE III (87-93)			
			CHARADE IV (93-00)			
			COPEN (03-12)			
			EXTOL (00-)			
			FEROZA (88-99)			
			GRAN MOVE (96-02)			
			HIJET (92-)			
			HIJET (98-)			
			MOVE (02-07)			
			NAKED (99-05)			
			ROCKY (85-98)			
			SIRION (98-05)			
			SIRION (05-)			
			TERIOS (97-05)			

DENSO P/N	TT	MAKE	MODEL			
K20TT продолжение			TERIOS (05-)			
			YRV (01-)			
			DODGE			CARAVAN (95-02)
						NEON I (94-99)
						NEON II (99-06)
NITRO (06-12)						
RAM (01-09)						
DR			STRATUS (95-01)			
			DR 1 (10-14)			
			DR 2 (10-14)			
EMGRAND			DR 5 (11-)			
			EC7 (09-)			
			V2 (13-)			
FAW-AUDI			A6L (C6) (05-11)			
			ALBEA / SIENA (96-11)			
FIAT			BARCETTA (95-05)			
			BRAVA (95-02)			
			BRAVO I (95-01)			
			CINQUECENTO (91-99)			
			COUPE (93-00)			
			DUCATO (230) (94-02)			
			DUCATO (244) (02-)			
			ELBA (85-97)			
			FIORINO (88-01)			
			FIORINO (07-)			
			MAREA (96-07)			
			MULTIPLA (99-10)			
			PALIO (96-)			
			PANDA (80-04)			
			PUNTO (93-00)			
			PUNTO (99-12)			
			QUBO (08-)			
			SEICENTO (98-10)			
			STILO (01-08)			
			STRADA (99-)			
ULYSSE (94-02)						
FORD			ESCORT II (73-81)			
			ESCORT IV (85-90)			
			ESCORT VI (95-01)			
			FIESTA II (83-95)			
			FIESTA III (89-97)			
			GALAXY (95-06)			
			ORION III (90-93)			
			SCORPIO I (85-94)			
			SCORPIO II (94-98)			
			TRANSIT (94-00)			
FORD USA			TRANSIT (00-06)			
			TRANSIT Tourneo (94-00)			
FSO			PROBE II (93-98)			
			LANOS (04-08)			
GEELY			POLONEZ III (92-02)			
			BL (05-)			
			CK (05-)			
			HISoon (04-)			
			MR (05-)			
			PANDA (08-)			
GEO			PU (05-)			
			URBAN NANNY (04-)			
			VISION (06-)			
GEO			METRO (88-98)			
			STORM (89-93)			
			TRACKER (88-98)			
GREAT WALL			HOVER H5 (10-)			
			ACCORD IV (90-94)			
HONDA			ACCORD V (93-98)			
			ACCORD VI (97-05)			
			ASCOT (90-97)			
			BEAT (91-96)			
			CITY (01-08)			
			CIVIC IV (87-95)			
			CIVIC V (91-97)			

Свечи зажигания и Свечи накаливания

Руководство покупателя

DENSO P/N	TT	MAKE	MODEL
K20TT продолжение			CIVIC VI (94-01)
			CIVIC VII (00-05)
			CIVIC VIII Hatchback (05-)
			CR-V I (95-02)
			CRX II (87-92)
			CRX III (92-98)
			FR-V (04-)
			INSPIRE (91-98)
			JAZZ II (02-08)
			JAZZ Saloon (03-08)
			LIFE (97-01)
			LIFE (01-03)
			NSX (90-05)
			PRELUDE IV (92-96)
			PRELUDE V (96-00)
			SHUTTLE (94-04)
			SMX (96-02)
			STEPWAGON (96-00)
			STREAM (01-)
		HYUNDAI	ACCENT I (94-00)
			ACCENT II (99-06)
			ACCENT III (05-10)
			LANTRA II (95-00)
			S COUPE (90-96)
		INFINITI	G20 (90-97)
			I30 (97-)
		INNOCENTI	ELBA (91-96)
		ISUZU	GEMINI (84-90)
			GEMINI (90-93)
			IMPULSE (90-93)
			TROOPER II (91-98)
		JAGUAR	XJ (86-94)
			XJ (94-97)
			XJ Coupe (73-96)
		JEEP	CHEROKEE (XJ) (84-01)
			CHEROKEE / LIBERTY (KJ) (01-08)
			CHEROKEE / LIBERTY (KK) (08-)
			COMMANDER (05-10)
			Grand CHEROKEE I (91-99)
			Grand CHEROKEE III (05-10)
		KIA	CARENS I (00-02)
			CARENS II (02-)
			CERATO (01-04)
			CLARUS (96-)
			ELAN (96-99)
			RETONA (99-)
			RIO I (00-05)
			ROADSTER (99-)
			SHUMA I (96-01)
			SHUMA II (01-04)
			SPORTAGE I (94-04)
			110 (2110) (95-12)
			GRANTA (2190, 2191, 2349) (11-)
			KALINA (2192, 2194) (13-)
		LARGUS (12-)	
		VESTA (15-)	
		X-RAY (16-)	
		XRAY (16-)	
		LANCIA	DEDRA (89-99)
			DELTA II (93-99)
			KAPPA (94-01)
			LYBRA (99-05)
			THESIS (02-09)
			Y (95-03)
			Y10 (85-95)
			ZETA (95-02)
			DISCOVERY I (89-98)
			RANGE ROVER III (02-12)
		LAND ROVER	SHERPA (74-89)
			LDV
		LEXUS	GS (93-97)
			GS (97-05)

DENSO P/N	TT	MAKE	MODEL	
K20TT продолжение			IS I (99-05)	
			LS (89-94)	
			LS (94-00)	
			SC (91-00)	
		LOTUS	ELAN (89-95)	
			ELISE (00-)	
			ESPRIT S4 (89-03)	
			EUROPA S (06-)	
			MAZDA	323 C IV (89-00)
		323 F IV (87-94)		
		323 F V (94-98)		
		323 F VI (98-04)		
		323 P V (96-98)		
		323 S IV (89-94)		
		323 S VI (98-04)		
		626 III (87-97)		
		626 IV (91-97)		
		929 II (82-87)		
		929 III (87-91)		
		MX-5 I (90-98)		
		MX-5 II (98-05)		
		XEDOS 6 (92-99)		
		XEDOS 9 (93-02)		
		MERCEDES-BENZ	A-CLASS (W168) (97-04)	
			A-CLASS (W169) (04-12)	
			B-CLASS (W245) (05-11)	
			C-CLASS (202) (93-01)	
			C-CLASS (203) (00-07)	
			C-CLASS Coupe (CL203) (01-08)	
			CLK (208) (97-02)	
			E-CLASS (124) (92-96)	
			E-CLASS (210) (95-03)	
			M-CLASS (W163) (98-05)	
			Saloon (W124) (84-93)	
			S-CLASS (W140) (91-98)	
			S-CLASS Coupe (C140) (92-99)	
			SL (R129) (89-01)	
			SLK (R170) (96-04)	
			SPRINTER 2-t (901, 902) (95-06)	
			SPRINTER 3-t (903) (95-06)	
			SPRINTER 4-t (904) (96-06)	
			VANEO (414) (02-05)	
			V-CLASS (638/2) (96-03)	
			VITO (638) (96-03)	
			MINI	
			MINI (R50, R53) (01-06)	
			MINI Convertible (R52) (04-07)	
			MITSUBISHI	3000 GT (89-99)
				CARISMA (95-06)
				COLT IV (92-96)
				COLT V (95-03)
				GALANT V (92-96)
				GALANT VI (96-04)
				LANCER III (83-92)
				LANCER IV (88-94)
				LANCER V (91-03)
		LANCER VI (95-03)		
		LANCER VII (03-)		
		PAJERO I (82-91)		
		SIGMA (90-96)		
		SPACE RUNNER (91-99)		
		SPACE STAR (98-04)		
		SPACE WAGON (91-98)		
		SPACE WAGON (98-04)		
		MORGAN		
		AERO 8 (00-)		
		AEROMAX (07-09)		
		NISSAN	100 NX (90-94)	
			200 SX (93-99)	
			ALMERA I (95-00)	
			AVENIR (97-05)	
			BLUEBIRD Sylphy (12-)	
			CEDRIC (91-99)	

Свечи зажигания и Свечи накаливания

Руководство покупателя

DENSO P/N	TT	MAKE	MODEL
K20TT продолжение			CEFIRO II (94-99)
			CEFIRO III (00-04)
			KUBISTAR (03-)
			MAXIMA III (88-94)
			MAXIMA IV (95-00)
			MAXIMA V (99-03)
			NT100 Clipper (03-13)
			PATHFINDER I (86-95)
			PRIMASTAR (01-)
			PRIMERA (P10) (90-98)
			PRIMERA (P11) (96-02)
			QUEST (92-98)
			SERENA (92-01)
			SUNNY II (86-91)
			SUNNY III (90-00)
			TERRANO I (87-96)
			VANETTE Cargo (C23) (94-02)
		OPEL	ADAM (12-)
			AGILA A (00-07)
			ANTARA (06-)
			ASCONA C (81-88)
			ASTRA F (91-01)
			ASTRA F CLASSIC (98-05)
			ASTRA G (98-09)
			ASTRA H (04-14)
			ASTRA J (09-)
			CALIBRA (90-97)
			COMBO B (94-01)
			COMBO C (01-)
			COMBO E (18-)
			CORSA A (82-93)
			CORSA B (93-02)
			CORSA C (00-09)
			CORSA D (06-14)
			FRONTERA A (92-98)
			INSIGNIA (A) (08-17)
			KADETT E (84-94)
			MERIVA A (03-10)
			MERIVA B (10-)
			MOKKA (12-)
			OMEGA A (86-94)
			OMEGA B (94-03)
			SENATOR B (87-93)
			SIGNUM (03-)
			SINTRA (96-99)
			SPEEDSTER (00-)
			TIGRA (94-00)
			VECTRA A (88-95)
			VECTRA B (95-03)
			VECTRA C (02-08)
			VIVARO A (01-)
			ZAFIRA A (99-05)
			ZAFIRA B (05-14)
			ZAFIRA Tourer C (11-)
		PANTHER	KALLISTA (82-93)
		PERODUA	KANCIL (94-)
			MYVI (06-11)
		PEUGEOT	106 I (91-96)
			106 II (96-04)
			205 I (83-94)
			205 II (87-98)
			206 (98-)
			206+ (09-)
			207 (06-)
			306 (93-02)
			307 (00-)
			309 I (85-89)
			309 II (89-93)
			405 I (87-93)
			405 II (92-99)
			406 (95-04)

DENSO P/N	TT	MAKE	MODEL
K20TT продолжение			406 Coupe (97-04)
			604 (77-87)
			605 (89-99)
			806 (94-02)
			1007 (05-)
			BIPPER (08-)
			BOXER (94-02)
			BOXER (02-)
			PARTNER / RANCH (96-15)
		PIAGGIO	PORTER (93-)
		PLYMOUTH	BREEZE (95-01)
			NEON I (94-99)
			NEON II (99-06)
		PORSCHE	911 (996) (97-05)
			911 (997) (04-12)
			BOXSTER (986) (96-04)
			CAYENNE (955) (02-10)
		PROTON	IMPIAN (01-)
			PERSONA 300 (96-04)
			PERSONA 400 (94-03)
			WIRA (00-)
		RENAULT	19 I (88-92)
			19 II (92-01)
			21 (86-95)
			25 (84-93)
			CLIO I (90-98)
			CLIO II (98-)
			CLIO III (05-)
			DUSTER (09-)
			ESPACE III (96-02)
			ESPACE IV (02-)
			FLUENCE (10-)
			Grand SCÉNIC II (04-)
			Grand SCÉNIC III (09-)
			KANGOO (97-)
			KANGOO (08-)
			LAGUNA I (93-01)
			LAGUNA II (01-)
			LAGUNA III (07-)
			LOGAN I (04-)
			LOGAN II (13-)
			MEGANE CC (10-)
			MEGANE I (96-03)
			MEGANE II (02-12)
			MEGANE III (08-)
			MEGANE IV (15-)
			MEGANE Scénic (96-99)
			MODUS (04-)
			RAPID (85-98)
			SAFRANE I (92-96)
			SAFRANE II (96-00)
		SANDERO I (Stepway) (07-)	
		SANDERO II (Stepway) (13-)	
		SCÉNIC I (99-03)	
		SCÉNIC II (03-)	
		SCÉNIC III (09-)	
		SPORT Spider (95-99)	
		THALIA I (98-)	
		THALIA II (08-)	
		TWINGO II (07-)	
		ROLLS-ROYCE	PARK WARD (00-02)
			PHANTOM VII (02-)
			SILVER Seraph (98-02)
		ROVER	100 / METRO (90-98)
			200 (RF) (95-00)
			200 (XH) (85-89)
			200 (XW) (89-99)
			400 (90-98)
			400 (95-00)
			600 (93-99)
			800 (86-99)

Свечи зажигания и Свечи накаливания

Руководство покупателя

DENSO P/N	TT	MAKE	MODEL
K20TT			CABRIOLET (90-99)
продолжение			COUPE (96-99)
			MAESTRO (90-95)
			STREETWISE (03-05)
		SAAB	900 II (93-98)
			9000 (84-98)
		SANTANA	SAMURAI (86-95)
		SEAT	ALHAMBRA (7V) (96-10)
			ALTEA (XL) (5P) (04-)
			AROSA (6H) (97-04)
			CORDOBA (6K1) (93-99)
			CORDOBA (6K2) (99-02)
			CORDOBA (6L) (02-09)
			EXEO (3R) (08-)
			IBIZA II (6K1) (93-99)
			IBIZA II (6K2) (99-02)
			IBIZA III (6L) (02-09)
			IBIZA IV (6J, 6P) (08-)
			INCA (6K9) (95-03)
			LEON (1M) (99-06)
			LEON (1P) (05-12)
			TOLEDO I (1L) (91-99)
			TOLEDO II (1M) (99-06)
			TOLEDO III (5P) (04-09)
		SKODA	FABIA I (6Y) (99-08)
			FAVORIT (78) (89-97)
			FELICIA I (6U) (94-98)
			OCTAVIA I (1U) (96-10)
			OCTAVIA II (1Z) (04-13)
			SUPERB I (3U) (01-08)
		SMART	CABRIO (450) (00-04)
			CITY-Coupe (450) (98-04)
			CROSSBLADE (450) (02-03)
			FORTWO (450) (04-07)
		SSANGYONG	CHAIRMAN (97-)
			KORANDO (96-06)
			KYRON (05-)
			MUSSO (93-07)
		SUBARU	FORESTER (97-02)
			FORESTER (02-08)
			IMPREZA (92-00)
			IMPREZA (00-)
			LEGACY I (89-94)
			LEGACY II (94-99)
			LEGACY III (98-03)
			LEGACY OUTBACK (96-99)
			OUTBACK (03-09)
			REX III (89-92)
			SVX (92-97)
			VIVIO (92-98)
		SUZUKI	ALTO III (93-02)
			BALENO (95-02)
			CARRY (99-)
			Grand VITARA I (98-06)
			Grand VITARA II (05-)
			IGNIS I (00-05)
			JIMNY (88-98)
			JIMNY (98-)
			LIANA (01-07)
			SAMURAI (88-04)
			SWIFT II (89-05)
			VITARA (88-99)
			WAGON R+ (00-)
			X-90 (95-97)
		TAGAZ	VEGA (09-12)
		TATA	INDICA (98-)
		TOYOTA	ALPHARD I (03-08)
			ALPHARD II (08-14)
			ALTEZZA (99-05)
			ARISTO (90-97)
			ARISTO (97-04)

DENSO P/N	TT	MAKE	MODEL
K20TT			AVALON (X1) (95-05)
продолжение			AVANZA (F6) (03-11)
			AVENSIS (97-03)
			CALDINA (T19) (92-97)
			CAMI (99-05)
			CAMRY (V1) (90-97)
			CAMRY (V2) (96-01)
			CAMRY Solara (98-03)
			CARINA E (92-97)
			CELICA (89-93)
			CELICA (93-99)
			CELSIOR (88-93)
			CELSIOR (93-00)
			CHASER (X10) (96-01)
			COROLLA (E9) (87-93)
			COROLLA (E10) (92-99)
			COROLLA Levin (E10) (91-97)
			CORONA (T19) (92-97)
			CORONA (T21) (96-03)
			CRESTA (84-01)
			CURREN (93-98)
			GAIA (98-03)
			HARRIER (97-03)
			MARK II (96-01)
			MARK II (02-07)
			MR 2 II (89-00)
			NADIA (98-03)
			PICNIC (96-01)
			PREVIA / ESTIMA I (90-00)
			PREVIA / ESTIMA II (00-06)
			RAV 4 I / FUNCRUISER (94-00)
			SERA (90-95)
			SIENNA (97-03)
			SOARER (90-00)
			SPRINTER (82-02)
			STARLET (P8) (89-96)
			SUPRA (93-02)
			TOWN ACE (92-01)
			VEROSSA (00-03)
			VISTA (V3, V4) (90-98)
			WINDOM (96-01)
			YARIS (99-05)
		TRIUMPH	ACCLAIM (82-85)
		TVR	CERBERA (96-03)
		VAUXHALL	ADAM (12-)
			AGILA I (A) (00-08)
			ANTARA (06-)
			ASTRA II (84-94)
			ASTRA III (F) (91-01)
			ASTRA IV (G) (98-06)
			ASTRA V (H) (04-10)
			ASTRA VI (J) (09-)
			CALIBRA (90-97)
			CARLTON III (86-94)
			CAVALIER III (88-95)
			COMBO I (B) (94-01)
			COMBO II (C) (01-12)
			CORSA I (B) (93-00)
			CORSA II (C) (00-06)
			CORSA III (D) (06-)
			FRONTERA I (A) (91-98)
			INSIGNIA I (A) (08-17)
			MERIVA I (A) (03-10)
			MERIVA II (B) (10-)
			MONTEREY I (91-98)
			OMEGA (B) (94-03)
			SENATOR II (B) (87-93)
			SIGNUM (02-08)
			SINTRA (96-99)
			SPEEDSTER (VX220) (00-06)
			TIGRA (94-00)

Свечи зажигания и Свечи накаливания

Руководство покупателя

DENSO P/N	TT	MAKE	MODEL			
K20TT продолжение			VECTRA I (B) (95-03)			
			VECTRA II (C) (00-08)			
			ZAFIRA I (A) (98-05)			
			ZAFIRA II (B) (05-14)			
			ZAFIRA III (C) (11-)			
		VOLVO	850 (91-97)			
			960 I (90-94)			
			960 II (94-96)			
			C70 I (97-05)			
			S40 I (95-03)			
			S60 I (00-10)			
			S70 (96-00)			
			S80 I (98-06)			
			S90 I (96-98)			
			V40 (95-04)			
			V70 I (96-00)			
			V70 II (00-07)			
			V90 I (96-98)			
			VORTEX	VORTEX (09-)		
			VW	BORA (1J) (98-05)		
		CADDY II (9K, 9U) (95-04)				
		CADDY III (2K, 2C) (04-15)				
		CORRADO (53I) (88-95)				
		EOS (1F) (06-15)				
		GOLF III (1H, 1E) (91-99)				
		GOLF IV (1J, 1E) (97-06)				
		GOLF Plus (5M, 521) (05-14)				
		GOLF V (1K) (03-09)				
		GOLF VI (5K, AJ5) (08-14)				
		JETTA III (1K2) (05-10)				
		LUPO (6X, 6E) (98-05)				
		MULTIVAN V (7H, 7E) (03-)				
		NEW BEETLE (9C, 1C, 1Y) (98-10)				
		PASSAT (3A2, 35I) (88-97)				
		PASSAT (3B2, 3B5) (96-01)				
		PASSAT (3B3, 3B6) (00-05)				
		PASSAT (3C) (05-11)				
		PHAETON (3D) (02-16)				
		POLO (6N1) (94-99)				
		POLO (6N2) (99-01)				
		POLO (9N) (01-09)				
		POLO Classic (6KV) (95-02)				
		POLO Saloon (9A4) (02-)				
		POLO Variant (6V5) (97-01)				
		SHARAN (7M) (95-10)				
		TOUAREG (7L) (02-10)				
		TOURAN (1T1, 1T2) (03-10)				
		TRANSPORTER IV (70X, 7D) (90-03)				
		TRANSPORTER V (7H, 7E, 7J) (03-15)				
		VENTO (1H2) (91-98)				
		WIESMANN		MF3 Roadster (96-)		
		ZAZ		LANOS (04-)		
		K20TXR	K20TT	ALPINA	B3 (E36) (93-99)	
					B3 (E46) (99-06)	
					B5 (E60, E61) (05-10)	
					B6 (E63, E64) (06-10)	
					B7 (E65) (03-08)	
					B8 (E36) (95-98)	
					B10 (E34) (88-96)	
					B10 (E39) (96-04)	
					B11 (E32) (87-94)	
					B12 (E38) (95-01)	
					ROADSTER (Z8) (02-03)	
					ROADSTER S (Z4) (03-05)	
					AUDI	A4 (8D, B5) (94-01)
						A4 (8E, B6) (00-04)
						A4 (8E, B7) (04-08)
				A4 Convertible (8H, B6, B7) (02-09)		
				A6 (4A, C4) (94-97)		
				A6 (4B, C5) (97-05)		
A6 (4F, C6) (04-11)						

DENSO P/N	TT	MAKE	MODEL	
K20TXR продолжение			A8 (4D) (94-02)	
			A8 (4E) (02-10)	
			ALLROAD (4BH) (00-05)	
			BEDFORD	MIDI (84-92)
			RASCAL (86-90)	
		BENTLEY	ARNAGE I (98-09)	
		BMW	1 (E81, E87) (03-12)	
			3 (E30) (82-94)	
			3 (E36) (90-00)	
			3 (E46) (98-06)	
			3 (E90, E91) (05-12)	
			5 (E28) (81-87)	
			5 (E34) (87-97)	
			5 (E39) (95-04)	
			5 (E60, E61) (03-10)	
			6 (E63, E64) (04-10)	
			7 (E32) (86-94)	
			7 (E38) (94-01)	
			7 (E65, E66) (01-08)	
			8 (E31) (90-99)	
			X3 (E83) (04-11)	
			X5 (E53) (00-06)	
			Z3 (E36) (95-03)	
			Z4 (E85, E86) (03-09)	
			Z8 (E52) (00-03)	
			CHEVROLET	CAPTIVA (06-)
		EVANDA (05-)		
		LACETTI (05-)		
		NUBIRA (05-11)		
		OPTRA (03-08)		
		REZZO (05-)		
		CITROËN		AX (86-98)
			BERLINGO (MF) (96-11)	
			BX (82-94)	
			C15 (84-05)	
			EVASION (94-02)	
			JUMPER (94-02)	
			SAXO (96-04)	
			XANTIA (93-03)	
			XM (94-00)	
			XSARA (97-05)	
			ZX (91-98)	
			DACIA	DOKKER (12-)
				LODGY (12-)
		LOGAN I (04-)		
		LOGAN MCV I (07-)		
		LOGAN MCV II (13-)		
		SANDERO I (Stepway) (08-)		
		SANDERO II (Stepway) (12-)		
		DAEWOO	EVANDA (02-)	
			LACETTI (04-)	
			LEGANZA (97-04)	
			NUBIRA (97-)	
			NUBIRA (03-)	
		TACUMA / REZZO (00-)		
		FAW-AUDI	A6L (C6) (05-11)	
		FIAT	DUCATO (230) (94-02)	
		ULYSSE (94-02)		
		FORD	GALAXY (95-06)	
		LADA	LARGUS (12-)	
		LANCIA	ZETA (95-02)	
		LAND ROVER	RANGE ROVER III (02-12)	
		MERCEDES-BENZ	V-CLASS (638/2) (96-03)	
		MINI	MINI (R50, R53) (01-06)	
			MINI Convertible (R52) (04-07)	
		MORGAN	AERO 8 (00-)	
			AEROMAX (07-09)	
		OPEL	AGILA A (00-07)	
			ANTARA (06-)	
			ASCONA C (81-88)	
ASTRA F (91-01)				

Свечи зажигания и Свечи накаливания

Руководство покупателя

DENSO P/N	TT	MAKE	MODEL
K20TXR			ASTRA F CLASSIC (98-05)
продолжение			ASTRA G (98-09)
			CALIBRA (90-97)
			COMBO B (94-01)
			COMBO C (01-)
			COMBO E (18-)
			CORSA A (82-93)
			CORSA B (93-02)
			CORSA C (00-09)
			FRONTERA A (92-98)
			MERIVA A (03-10)
			OMEGA A (86-94)
			OMEGA B (94-03)
			SENATOR B (87-93)
			SIGNUM (03-)
			SINTRA (96-99)
			SPEEDSTER (00-)
			TIGRA (94-00)
			VECTRA A (88-95)
			VECTRA B (95-03)
			VECTRA C (02-08)
			VIVARO A (01-)
			ZAFIRA A (99-05)
		PEUGEOT	106 I (91-96)
			106 II (96-04)
			205 II (87-98)
			306 (93-02)
			405 II (92-99)
			406 (95-04)
			406 Coupe (97-04)
			605 (89-99)
			806 (94-02)
			BOXER (94-02)
			PARTNER / RANCH (96-15)
		RENAULT	CLIO II (98-)
			ESPACE III (96-02)
			KANGOO (97-)
			KANGOO (08-)
			LAGUNA I (93-01)
			LOGAN I (04-)
			LOGAN II (13-)
			MEGANE I (96-03)
			MEGANE Scénic (96-99)
			SANDERO I (Stepway) (07-)
			SANDERO II (Stepway) (13-)
			SCÉNIC I (99-03)
			THALIA I (98-)
			TWINGO II (07-)
		ROLLS-ROYCE	PARK WARD (00-02)
			PHANTOM VII (02-)
			SILVER Seraph (98-02)
		SAAB	900 II (93-98)
			9000 (84-98)
		SEAT	TOLEDO II (1M) (99-06)
		SKODA	SUPERB I (3U) (01-08)
		SMART	CABRIO (450) (00-04)
			CITY-Coupe (450) (98-04)
			CROSSBLADE (450) (02-03)
			FORTWO (450) (04-07)
		TVR	CERBERA (96-03)
		VAUXHALL	AGILA I (A) (00-08)
			ANTARA (06-)
			ASTRA III (F) (91-01)
			ASTRA IV (G) (98-06)
			ASTRA V (H) (04-10)
			CALIBRA (90-97)
			CARLTON III (86-94)
			CAVALIER III (88-95)
			COMBO I (B) (94-01)
			COMBO II (C) (01-12)
			CORSA I (B) (93-00)

DENSO P/N	TT	MAKE	MODEL
K20TXR			CORSA II (C) (00-06)
продолжение			FRONTERA I (A) (91-98)
			MERIVA I (A) (03-10)
			OMEGA (B) (94-03)
			SENATOR II (B) (87-93)
			SIGNUM (02-08)
			SINTRA (96-99)
			SPEEDSTER (VX220) (00-06)
			TIGRA (94-00)
			VECTRA I (B) (95-03)
			ZAFIRA I (A) (98-05)
		VOLVO	960 I (90-94)
			960 II (94-96)
			V70 I (96-00)
		VW	BORA (1J) (98-05)
			CORRADO (53I) (88-95)
			GOLF III (1H, 1E) (91-99)
			GOLF IV (1J, 1E) (97-06)
			PASSAT (3A2, 35I) (88-97)
			PASSAT (3B2, 3B5) (96-01)
			PASSAT (3B3, 3B6) (00-05)
			SHARAN (7M) (95-10)
			TRANSPORTER IV (70X, 7D) (90-03)
			VENTO (1H2) (91-98)
		WIESMANN	MF3 Roadster (96-)
K22PB	IKB22TT	ALPINE	A610 (91-95)
		AUDI	90 (89, 8A, B3) (87-91)
			COUPE (89, 8B) (88-96)
		SEAT	TOLEDO I (1L) (91-99)
K22PBR-S	IKB22TT	AUDI	80 (89, 8A, B3) (86-91)
			80 (8C, B4) (91-96)
			90 (89, 8A, B3) (87-91)
			100 (4A, C4) (90-94)
			A6 (4A, C4) (94-97)
			CABRIOLET (8G7) (91-00)
			COUPE (89, 8B) (88-96)
		CITROËN	AX (86-98)
			BX (82-94)
			XM (89-94)
		FIAT	DUCATO (250, 290) (06-)
			PUNTO (93-00)
			UNO (146) (83-00)
		LANCIA	DEDRA (89-99)
			DELTA II (93-99)
			THEMA (84-94)
		PEUGEOT	106 I (91-96)
			205 II (87-98)
			309 II (89-93)
			405 I (87-93)
		PORSCHE	911 (964) (88-94)
			911 (993) (93-97)
		RENAULT	SAFRANE I (92-96)
		SEAT	CORDOBA (6K1) (93-99)
			IBIZA II (6K1) (93-99)
		VW	CORRADO (53I) (88-95)
			GOLF II (19, 1G) (83-92)
			JETTA II (19, 1G) (84-92)
			PASSAT (3A2, 35I) (88-97)
			SCIROCCO (53B) (80-92)
K22PR-L11	IK22FTT	HONDA	CIVIC V (91-97)
			CIVIC VI (94-01)
			CRX III (92-98)
K22PR-U	IK22FTT	FIAT	ELBA (85-97)
			FIORINO (88-01)
		GREAT WALL	HOVER H6 (11-)
		INNOCENTI	ELBA (91-96)
		JAGUAR	XJ (94-97)
K22PR-U11	IK22FTT	SAAB	9-3 (02-15)
			9-5 (97-09)
K22TNR-S	-	DAIHATSU	OPTI (92-98)
		PORSCHE	911 (964) (88-94)

Свечи зажигания и Свечи накаливания

Руководство покупателя

DENSO P/N	TT	MAKE	MODEL	
K22TNR-S продолжение			911 (993) (93-97)	
			911 (996) (97-05)	
KH16TT	-	CHRYSLER	300 C (04-12)	
			ASPEN (06-)	
		CITROËN	BERLINGO (B9) (08-)	
			BERLINGO (MF) (96-11)	
			C1 I (05-14)	
			C2 (03-)	
			C3 I (02-)	
			C3 Pluriel (03-)	
			C4 (Grand) Picasso I (06-13)	
			C4 Coupe (04-11)	
			C4 I (LC, LR) (04-11)	
			C5 I (01-04)	
			C5 II (04-)	
			C5 III (08-)	
			C8 (02-)	
			C-ELYSEE (12-)	
			EVASION (94-02)	
			JUMPY (95-06)	
			JUMPY (07-)	
		XSARA (97-05)		
		XSARA Picasso (99-11)		
		DF CITROEN	C-TRIOMPHE (09-)	
		DODGE	CHALLENGER (07-)	
			CHARGER (11-)	
			DURANGO (11-)	
			RAM (08-)	
				RAM 4000 (05-)
		HYUNDAI	GRANDEUR (05-11)	
			GRANDEUR (11-)	
			ix35 (09-)	
			SANTA FÉ II (06-12)	
			SONATA V (05-10)	
				SONATA VI (09-15)
		JEEP	Grand CHEROKEE III (05-10)	
			Grand CHEROKEE IV (10-)	
		KIA	CERATO (09-)	
			MAGENTIS (05-)	
			OPTIMA (10-)	
			SORENTO II (09-)	
			SORENTO III (15-)	
				SPORTAGE III (10-)
		NISSAN	ALMERA Classic (06-)	
			ALMERA II (00-)	
			ALMERA TINO (00-)	
			ALTIMA (01-06)	
			AVENIR (97-05)	
			CUBE (03-05)	
			MICRA C+C (05-)	
			MICRA III (K12) (03-10)	
			NOTE (E11) (06-12)	
			PRIMERA (P11) (96-02)	
		PRIMERA (P12) (02-)		
		SENTRA V (00-06)		
TEANA I (03-08)				
X-TRAIL (T30) (01-13)				
X-TRAIL (T31) (07-13)				
PEUGEOT	107 (05-)			
	206 (98-)			
	206 CC (00-)			
	207 (06-)			
	307 (00-)			
	308 CC (07-)			
	308 I (07-)			
	406 (95-04)			
	406 Coupe (97-04)			
	407 (04-)			
	407 Coupe (05-)			
	607 (00-)			
	806 (94-02)			

DENSO P/N	TT	MAKE	MODEL		
KH16TT продолжение			807 (02-)		
			1007 (05-)		
			EXPERT (96-06)		
			EXPERT (07-)		
			PARTNER / RANCH (96-15)		
			PARTNER / RANCH (08-)		
			RAM	1500 (DS) (10-)	
				2500 (DJ) (10-)	
			KH16TT	RENAULT	CLIO II (98-)
			-		LAGUNA II (01-)
					MEGANE I (96-03)
				SUZUKI	Grand VITARA II (05-)
					SX4 (06-)
		TOYOTA	AYGO (05-)		
			VIOS / YARIS (07-)		
			YARIS (05-11)		
KH20TT	KH20TT	CADILLAC	SRX (04-08)		
			STS (04-12)		
		-	CITROËN	C4 Coupe (04-11)	
				C4 I (LC, LR) (04-11)	
				C5 III (08-)	
				C8 (02-)	
				JUMPY (07-)	
		KH20TT	ENGLON	SC7 (10-17)	
		-	FIAT	SCUDO (220) (96-06)	
				ULYSSE (94-02)	
				ULYSSE (02-11)	
			LANCIA	PHEDRA (02-10)	
				ZETA (95-02)	
			MITSUBISHI	COLT CZC (06-09)	
				COLT VI (04-12)	
			NISSAN	PRIMERA (P12) (02-)	
				TEANA I (03-08)	
				X-TRAIL (T30) (01-13)	
			PEUGEOT	206 (98-)	
				307 (00-)	
				308 CC (07-)	
				308 I (07-)	
			SMART	FORFOUR I (454) (04-06)	
			TOYOTA	4 RUNNER (N21) (02-09)	
				FJ CRUISER (07-)	
				LAND CRUISER / PRADO (J70) (84-06)	
				LAND CRUISER / PRADO (J120) (02-10)	
				LAND CRUISER / PRADO (J150) (10-)	
				TUNDRA (07-)	
			TOYOTA (FAW)	LAND CRUISER (J200) (07-)	
				PRADO (03-10)	
			VOLVO	C30 (06-12)	
				C70 II (06-13)	
			S40 II (04-12)		
			V50 (04-12)		
KJ14CR-L11	-	BMW	7 (E38) (94-01)		
			8 (E31) (90-99)		
		ROLLS-ROYCE	SILVER Seraph (98-02)		
KJ16CR-L11	K16TT	ALFA ROMEO	159 (05-11)		
			ALPINA	B12 (E31) (90-96)	
				B12 (E32) (88-94)	
		B12 (E38) (95-01)			
		BMW	7 (E32) (86-94)		
			8 (E31) (90-99)		
		CADILLAC	BLS (06-)		
			CHEVROLET	CRUZE (09-)	
		FIAT	CROMA (05-)		
			STILO (01-08)		
		HONDA	ACCORD IV (90-94)		
			ACCORD V (93-98)		
			ACCORD VI (97-05)		
			AVANCIER (99-03)		
			CAPA (98-02)		
CIVIC V (91-97)					
CIVIC VI (94-01)					

Свечи зажигания и Свечи накаливания

Руководство покупателя

DENSO P/N	TT	MAKE	MODEL					
KJ16CR-L11 продолжение			CIVIC VII (00-05)					
			CR-V I (95-02)					
			CRX III (92-98)					
			DOMANI (88-00)					
			HR-V (99-)					
			INTEGRA (93-01)					
			LAGREAT (98-02)					
			LOGO (99-02)					
			ODYSSEY (RA) (95-00)					
			ODYSSEY (RL1) (02-)					
			SHUTTLE (94-04)					
			SMX (96-02)					
			STEPWAGON (96-00)					
			HONDA (GAC) ODYSSEY (02-09)					
			ISUZU TFR / TFS (88-02)					
			JEEP	CHEROKEE (XJ) (84-01)				
				CJ5 - CJ8 (66-87)				
				COMANCHE (86-96)				
				COMMANDER (05-10)				
				Grand CHEROKEE II (98-05)				
				Grand CHEROKEE III (05-10)				
				WRANGLER I (86-96)				
				WRANGLER II (96-08)				
				LOTUS EUROPA S (06-)				
				MAZDA	929 III (87-91)			
			929 IV (90-96)					
			MPV I (88-99)					
			OPEL	AGILA A (00-07)				
				ASTRA G (98-09)				
				ASTRA H (04-14)				
				COMBO C (01-)				
				CORSA C (00-09)				
				CORSA D (06-14)				
				INSIGNIA (A) (08-17)				
				MERIVA A (03-10)				
				MOKKA (12-)				
				SIGNUM (03-)				
				TIGRA TwinTop (04-)				
				VECTRA C (02-08)				
				ZAFIRA A (99-05)				
				ZAFIRA B (05-14)				
				ZAFIRA Tourer C (11-)				
				SAAB 9-3 (02-15)				
				SEAT	CORDOBA (6L) (02-09)			
					IBIZA III (6L) (02-09)			
			IBIZA IV (6J, 6P) (08-)					
			SKODA	FABIA I (6Y) (99-08)				
				FABIA II (06-14)				
				ROOMSTER (5J) (06-15)				
			SUZUKI WAGON R (03-05)					
			VAUXHALL	AGILA I (A) (00-08)				
				ASTRA IV (G) (98-06)				
				ASTRA V (H) (04-10)				
				COMBO II (C) (01-12)				
				CORSA II (C) (00-06)				
				CORSA III (D) (06-)				
				MERIVA I (A) (03-10)				
				MOKKA (12-)				
				SIGNUM (02-08)				
				TIGRA TwinTop (04-09)				
				VECTRA II (C) (00-08)				
				ZAFIRA II (B) (05-14)				
				ZAFIRA III (C) (11-)				
				VW	FOX (5Z) (03-)			
				NEW BEETLE (9C, 1C, 1Y) (98-10)				
				POLO (9N) (01-09)				
				KJ16CR-U11	K16TT	CHRYSLER	SEBRING (07-10)	
							DODGE	AVENGER (07-14)
								CALIBER (06-)
								JOURNEY (08-)
			FIAT FREEMONT (11-)					

DENSO P/N	TT	MAKE	MODEL			
KJ16CR-U11 продолжение		HONDA	ACCORD VI (97-05)			
			HYUNDAI	ELANTRA (05-11)		
				i20 (08-15)		
		i30 (07-12)				
		JEEP	COMPASS (06-)			
			PATRIOT (07-)			
		KIA	CEED (06-12)			
			CERATO (04-)			
			PRO CEED (08-13)			
		MAZDA	323 F VI (98-04)			
			626 III (87-97)			
			626 IV (91-97)			
			929 III (87-91)			
			929 IV (90-96)			
			B-SERIE (85-99)			
			MPV I (88-99)			
			MPV II (99-06)			
			MX-6 (92-97)			
			PREMACY (99-05)			
			XEDOS 9 (93-02)			
			KJ20CR-L11	K20TT	CHEVROLET	AVEO (T300) (11-)
						AVEO / KALOS (T250, T255) (05-)
						CRUZE (09-)
		DODGE	NITRO (06-12)			
			RAM (01-09)			
		HONDA	ACCORD IV (90-94)			
			ACCORD V (93-98)			
			ACCORD VI (97-05)			
			CIVIC V (91-97)			
			CIVIC VII (00-05)			
CIVIC VIII Hatchback (05-)						
CR-V I (95-02)						
CRX III (92-98)						
FR-V (04-)						
PRELUDE IV (92-96)						
PRELUDE V (96-00)						
SHUTTLE (94-04)						
SMX (96-02)						
STEPWAGON (96-00)						
STREAM (01-)						
JEEP	CHEROKEE / LIBERTY (KJ) (01-08)					
	CHEROKEE / LIBERTY (KK) (08-)					
	COMMANDER (05-10)					
	Grand CHEROKEE I (91-99)					
	Grand CHEROKEE III (05-10)					
LOTUS EUROPA S (06-)						
OPEL	ADAM (12-)					
	ASTRA H (04-14)					
	ASTRA J (09-)					
	CORSA D (06-14)					
	INSIGNIA (A) (08-17)					
	MERIVA A (03-10)					
	MERIVA B (10-)					
	MOKKA (12-)					
	ZAFIRA A (99-05)					
	ZAFIRA B (05-14)					
	ZAFIRA Tourer C (11-)					
	ROVER 600 (93-99)					
STREETWISE (03-05)						
VAUXHALL	ADAM (12-)					
	ASTRA V (H) (04-10)					
	ASTRA VI (J) (09-)					
	CORSA III (D) (06-)					
	INSIGNIA I (A) (08-17)					
	MERIVA II (B) (10-)					
	ZAFIRA II (B) (05-14)					
ZAFIRA III (C) (11-)						
KJ20CR-U11	K20TT	CHEVROLET	AVEO (T300) (11-)			
			AVEO / KALOS (T250, T255) (05-)			
			CRUZE (09-)			
			ORLANDO (11-)			

Свечи зажигания и Свечи накаливания

Руководство покупателя

DENSO P/N	TT	MAKE	MODEL					
KJ20CR-U11 продолжение			TRAX (12-)					
		FORD USA	PROBE II (93-98)					
		HONDA	ACCORD V (93-98) CR-V I (95-02)					
		MAZDA	323 F VI (98-04)					
			323 S VI (98-04)					
			929 III (87-91)					
			XEDOS 9 (93-02)					
		NISSAN	NT100 Clipper (03-13)					
		OPEL	CALIBRA (90-97)					
		VAUXHALL	CALIBRA (90-97)					
		KJ20DR-M11	-	ACURA	RSX (01-06)			
TSX (09-)								
DONGFENG HONDA	CR-V IV (07-)							
HONDA	ACCORD VII (03-08)							
	CIVIC VII (00-05)							
	CR-V II (01-06)							
	CR-V III (06-)							
	ELEMENT (02-11)							
	ELYSION (04-)							
	FR-V (04-)							
	INTEGRA (02-)							
	STEPWAGON (00-05)							
	STREAM (01-)							
	HONDA (GAC)			ODYSSEY (09-14)				
	SEAT			ALTEA (XL) (5P) (04-)				
				CORDOBA (6L) (02-09)				
IBIZA III (6L) (02-09)								
IBIZA IV (6J, 6P) (08-)								
LEON (1P) (05-12)								
TOLEDO III (5P) (04-09)								
TOLEDO IV (KG3) (12-)								
SKODA	FABIA I (6Y) (99-08)							
	FABIA II (06-14)							
	OCTAVIA II (1Z) (04-13)							
	RAPID (HN) (12-)							
	ROOMSTER (5J) (06-15)							
VW	BEETLE (5C) (11-)							
	CADDY III (2K, 2C) (04-15)							
	FOX (5Z) (03-)							
	GOLF Plus (5M, 521) (05-14)							
	GOLF V (1K) (03-09)							
	GOLF VI (5K, AJ5) (08-14)							
	JETTA III (1K2) (05-10)							
	JETTA IV (162) (10-)							
	POLO (6R, 6C) (09-)							
	POLO (9N) (01-09)							
	KJ22CR-L11			-	HONDA	SHUTTLE (94-04)		
	M22			-	WARTBURG	353 (66-91)		
	MA16PR-U			-	FORD	TRANSIT (77-86)		
MA20PR-U	-			FORD	GRANADA (72-85)			
					SCORPIO I (85-94)			
					SIERRA (82-87)			
					SIERRA (87-93)			
					TAUNUS (79-82)			
					TRANSIT (77-86)			
					TRANSIT (85-92)			
					TRANSIT (91-94)			
					FORD OTOSAN	TAUNUS (89-94)		
					MA20P-U	-	FORD	CAPRI (68-74)
								CAPRI (74-77)
				CAPRI (78-87)				
							ESCORT II (73-81)	
							SCORPIO I (85-94)	
			SIERRA (82-87)					
			SIERRA (87-93)					
			TAUNUS (70-76)					
			TAUNUS (75-79)					
			TAUNUS (79-82)					
			TRANSIT (77-86)					
			TRANSIT (85-92)					

DENSO P/N	TT	MAKE	MODEL			
MW17	-	AUTO UNION	AU 1000 (58-65)			
			DKW F11 (59-66)			
P16PR11	W16TT	HYUNDAI	H-1 / STAREX (97-07)			
			SANTA FÉ I (00-06)			
			SONATA II (88-93)			
			SONATA III (93-98)			
			SONATA IV (98-05)			
		KIA	SORENTO I (02-)			
P16R	W20TT	DAIHATSU	DELTA (89-01)			
			GREAT WALL	SAIFU (00-03)		
		TOYOTA	CELICA (81-85)			
			CENTURY (82-96)			
			CRESSIDA (80-93)			
			CROWN (80-85)			
			HIACE III (87-04)			
			HIACE IV (95-)			
			HILUX II (83-05)			
			LITEACE (92-97)			
			MASTER ACE Surf (85-99)			
MODELL F (82-90)						
SOARER (80-86)						
TOWN ACE (85-91)						
P16R13	W20TT	CHRYSLER	VOYAGER III (95-01)			
		DODGE	CARAVAN (95-02)			
		PLYMOUTH	VOYAGER (95-01)			
P20PR11	W20TT	VW	CORRADO (53I) (88-95)			
			GOLF II (19, 1G) (83-92)			
			PASSAT (3A2, 35I) (88-97)			
P22PR8	IK22FTT	MITSUBISHI	CARISMA (95-06)			
			L 300 (86-06)			
			LANCER Evo IV (96-97)			
			LANCER Evo V (98)			
			LANCER Evo VI (99-01)			
			LANCER Evo VIII (03-05)			
PK16PR11	K16TT	HOLDEN	FRONTERA (B) (98-04)			
			ISUZU	TFR / TFS (88-02)		
					TROOPER II (91-98)	
					TROOPER III (98-04)	
					VEHICROSS (97-00)	
					WIZARD (98-02)	
					SUBARU	FORESTER (02-08)
					IMPREZA (00-)	
		PK16PR-L11	IK16TT	ACURA	NSX (90-05)	
					NSX Targa (95-97)	
RL (95-04)						
CHEVROLET	CAPTIVA (06-)					
CHRYSLER	STRATUS (95-01)					
DAEWOO	REXTON (02-)					
HONDA	INSPIRE (91-98)					
	LEGEND III (96-06)					
	LEGEND IV (06-12)					
	NSX (90-05)					
	HYUNDAI			COUPE (01-09)		
	EQUUS / CENTENNIAL (99-09)					
	GRANDEUR / XG (98-05)					
HIGHWAY VAN (00-04)						
SANTA FÉ I (00-06)						
SONATA IV (98-05)						
TERRACAN (01-06)						
TRAJECT (00-08)						
TUCSON (04-10)						
ISUZU	TROOPER III (98-04)					
JAGUAR			S-TYPE (99-08)			
			XJ (97-03)			
			XK 8 (96-05)			
KIA			CARNIVAL II (99-07)			
			MAGENTIS (01-)			
			MAGENTIS (05-)			
			OPIRUS (03-)			
			SORENTO I (02-)			
			SPORTAGE II (04-)			

Свечи зажигания и Свечи накаливания

Руководство покупателя

DENSO P/N	TT	MAKE	MODEL			
PK16PR-L11 продолжение		LAND ROVER	DISCOVERY II (98-04)			
			RANGE ROVER II (94-02)			
		MERCEDES-BENZ	C-CLASS (202) (93-01)			
			C-CLASS (203) (00-07)			
			C-CLASS Coupe (CL203) (01-08)			
			CLK (208) (97-02)			
			CLK (209) (02-10)			
			CLS (C219) (04-10)			
			E-CLASS (210) (95-03)			
			E-CLASS (211) (02-09)			
			G-CLASS (W463) (89-)			
			M-CLASS (W163) (98-05)			
			M-CLASS (W164) (05-11)			
			R-CLASS (251) (06-)			
			S-CLASS (W220) (98-05)			
			S-CLASS Coupe (C215) (99-06)			
			SL (R129) (89-01)			
			SL (R230) (01-12)			
			SLK (R170) (96-04)			
			SLK (R171) (04-11)			
			VIANO (W639) (03-)			
			VITO / MIXTO (W639) (03-)			
		MG	MG TF (02-09)			
			MG ZR (01-05)			
			MG ZS (01-05)			
			MG ZT (01-05)			
		NISSAN	MAXIMA III (88-94)			
			MAXIMA V (99-03)			
			SKYLINE (R33) (93-00)			
		OPEL	FRONTERA B (98-04)			
			MONTEREY B (98-99)			
		PUCH	G-MODELL (W463) (89-00)			
		ROVER	25 (99-05)			
			45 (00-05)			
			75 (99-05)			
			400 (90-98)			
			STREETWISE (03-05)			
		SUBARU	FORESTER (02-08)			
			FORESTER (08-)			
			LEGACY IV (03-09)			
		VAUXHALL	FRONTERA II (B) (98-04)			
			MONTEREY II (98-99)			
		PK16PR-P11	K16TT	MITSUBISHI	MAGNA (96-05)	
					PAJERO II (90-00)	
					PAJERO Sport I (97-)	
		PK16R11	K16TT	LEXUS	GS (93-97)	
					LX (95-97)	
SC (91-00)						
TOYOTA	ARISTO (90-97)					
	CHASER (X9) (92-96)					
	CROWN (91-99)					
	LAND CRUISER (J80) (90-98)					
	LAND CRUISER / PRADO (J70) (84-06)					
	MARK II (88-96)					
	PREVIA / ESTIMA I (90-00)					
	SOARER (90-00)					
	SUPRA (93-02)					
	PK16TR11			K16TT	LEXUS	GS (93-97)
						GS (97-05)
						IS I (99-05)
	TOYOTA			ALTEZZA (99-05)		
				ARISTO (90-97)		
ARISTO (97-04)						
CHASER (X10) (96-01)						
CRESTA (84-01)						
CROWN (91-99)						
GRANVIA (95-04)						
LAND CRUISER / PRADO / COLORADO (J90) (95-)						
SOARER (90-00)						
SUPRA (93-02)						

DENSO P/N	TT	MAKE	MODEL		
PK16TR11			TUNDRA (99-06)		
продолжение					
PK16TR13	IK16TT	TOYOTA	AVENSIS (97-03)		
			CALDINA (T21) (97-02)		
			CELICA (93-99)		
			COROLLA (E11) (97-02)		
PK20GR8	-	TOYOTA	NADIA (98-03)		
			VISTA (V5) (98-03)		
PK20PR11	K20TT	FORD	SCORPIO I (85-94)		
			SCORPIO II (94-98)		
			TRANSIT (00-06)		
		HONDA	NSX (90-05)		
		INFINITI	I30 (97-)		
		MERCEDES-BENZ	C-CLASS (202) (93-01)		
			C-CLASS (203) (00-07)		
			C-CLASS Coupe (CL203) (01-08)		
		MITSUBISHI	GALANT VI (96-04)		
		NISSAN	CEDRIC (91-99)		
			CEFIRO II (94-99)		
			CEFIRO III (00-04)		
			MAXIMA IV (95-00)		
			MAXIMA V (99-03)		
		RENAULT	CLIO II (98-)		
			ESPACE III (96-02)		
			SAFRANE II (96-00)		
			LEGACY (97-02)		
		SUBARU	FORESTER (02-08)		
			LEGACY II (94-99)		
			LEGACY OUTBACK (96-99)		
			OUTBACK (03-09)		
			SVX (92-97)		
			Grand VITARA I (98-06)		
		SUZUKI	Legend II (91-96)		
		PK20PR-L11	IK20TT	ACURA	LEGEND II (91-96)
					NSX (90-05)
AUDI	A4 (8E, B6) (00-04)				
	A4 (8K, B8) (07-15)				
	A5 (8T, 8F) (07-17)				
	A6 (4F, C6) (04-11)				
	A8 (4E) (02-10)				
Q5 (8R) (08-)					
CADILLAC	BLS (06-)				
CHEVROLET	EPICA (05-)				
HONDA	LEGEND II (91-96)				
	LEGEND III (96-06)				
	NSX (90-05)				
KIA	CARNIVAL I (99-01)				
	CARNIVAL II (99-07)				
LAND ROVER	DISCOVERY IV (09-)				
	FREELANDER I (98-06)				
LOTUS	ELISE 340R (00-01)				
	ELISE (95-01)				
MG	MG 6 (10-)				
	MG TF (02-09)				
	MG ZR (01-05)				
	MG ZS (01-05)				
	MG ZT (01-05)				
MGF (95-02)					
NISSAN	ALMERA TINO (00-)				
	SUNNY III (90-00)				
OPEL	CORSA D (06-14)				
	MERIVA A (03-10)				
	SIGNUM (03-)				
	VECTRA C (02-08)				
RENAULT	AVANTIME (01-03)				
ROVER	25 (99-05)				
	45 (00-05)				
	75 (99-05)				
	400 (90-98)				
	STREETWISE (03-05)				
SAAB	9-3 (02-15)				
	9-3X (09-12)				

Свечи зажигания и Свечи накаливания

Руководство покупателя

DENSO P/N	TT	MAKE	MODEL	
PK20PR-L11 продолжение		VAUXHALL	MERIVA I (A) (03-10)	
			SIGNUM (02-08)	
			VECTRA II (C) (00-08)	
PK20PR-L13	IK20TT	JAGUAR	XJ (97-03) XK 8 (96-05)	
PK20PR-P11	K20TT	MITSUBISHI	3000 GT (89-99)	
			GALANT V (92-96)	
			PAJERO I (82-91)	
			SIGMA (90-96)	
PK20PR-P8	IK20TT	ALFA ROMEO	145 / 146 (94-01)	
			147 (00-10)	
			156 (97-06)	
			164 (87-98)	
			166 (98-07)	
			GT (03-10)	
			GTV (95-05)	
			SPIDER (94-05)	
			AUDI	A3 (8L) (96-03)
				A4 (8D, B5) (94-01)
				A4 (8E, B6) (00-04)
				A4 (8E, B7) (04-08)
		A4 Convertible (8H, B6, B7) (02-09)		
		A6 (4B, C5) (97-05)		
		A6 (4F, C6) (04-11)		
		ALLROAD (4BH) (00-05)		
		TT (8N) (98-06)		
		BENTLEY		CONTINENTAL (03-)
			CONTINENTAL Flying Spur (05-)	
		FORD	ESCORT V (90-95)	
		LANCIA	KAPPA (94-01)	
			THESIS (02-09)	
		MG	MG X-POWER (03-08)	
			MG ZR (01-05)	
			MGF (95-02)	
		NISSAN	200 SX (93-99)	
			AVENIR (97-05)	
			PRIMASTAR (01-)	
			SILVIA (S15) (99-03)	
			SUNNY III (90-00)	
			ASTRA H (04-14)	
		OPEL	COMBO C (01-)	
			VIVARO A (01-)	
			ZAFIRA A (99-05)	
			ZAFIRA B (05-14)	
			RENAULT	AVANTIME (01-03)
		ESPACE IV (02-)		
		Grand SCÉNIC II (04-)		
		LAGUNA I (93-01)		
		LAGUNA II (01-)		
		LAGUNA III (07-)		
		MEGANE CC (10-)		
		MEGANE II (02-12)		
		MEGANE III (08-)		
		TRAFIC II (01-)		
		TWINGO II (07-)		
		VEL SATIS (02-)		
		WIND (10-)		
		ROVER		25 (99-05)
				45 (00-05)
			100 / METRO (90-98)	
			200 (RF) (95-00)	
400 (95-00)				
600 (93-99)				
COUPE (96-99)				
STREETWISE (03-05)				
SEAT	ALHAMBRA (7V) (96-10)			
	CORDOBA (6K2) (99-02)			
	CORDOBA (6L) (02-09)			
	EXEO (3R) (08-)			
	IBIZA III (6L) (02-09)			
	LEON (1M) (99-06)			

DENSO P/N	TT	MAKE	MODEL			
PK20PR-P8 продолжение		SKODA	TOLEDO II (1M) (99-06)			
			OCTAVIA I (1U) (96-10)			
			SUPERB I (3U) (01-08)			
		SUBARU	FORESTER (97-02)			
			FORESTER (02-08)			
			IMPREZA (92-00)			
			IMPREZA (00-)			
			LEGACY I (89-94)			
			LEGACY III (98-03)			
			VAUXHALL	ASTRA V (H) (04-10)		
		COMBO II (C) (01-12)				
		VIVARO (A) (01-14)				
		ZAFIRA I (A) (98-05)				
		ZAFIRA II (B) (05-14)				
		VOLVO		850 (91-97)		
				C70 I (97-05)		
			S40 I (95-03)			
			S60 I (00-10)			
			S70 (96-00)			
			S80 I (98-06)			
			V40 (95-04)			
			V70 I (96-00)			
			V70 II (00-07)			
			XC70 I Cross Country (97-07)			
			XC90 I (02-14)			
			VW	BORA (1J) (98-05)		
				GOLF IV (1J, 1E) (97-06)		
				NEW BEETLE (9C, 1C, 1Y) (98-10)		
				PASSAT (3B2, 3B5) (96-01)		
		PASSAT (3B3, 3B6) (00-05)				
		POLO (9N) (01-09)				
		SHARAN (7M) (95-10)				
		PK20PTR-S9		K20TT	AUDI	A6 (4B, C5) (97-05)
						A8 (4D) (94-02)
		PK20R11		K20TT	LEXUS	GS (93-97)
			LS (89-94)			
		LS (94-00)				
		PK20R13	K20TT	PORSCHE	911 (997) (04-12)	
					TOYOTA	ALTEZZA (99-05)
				ARISTO (90-97)		
				AVALON (X1) (95-05)		
				CAMRY (V1) (90-97)		
CELICA (89-93)						
CELICA (93-99)						
CELSIOR (88-93)						
CELSIOR (93-00)						
COROLLA (E9) (87-93)						
COROLLA (E10) (92-99)						
COROLLA Levin (E10) (91-97)						
MR 2 II (89-00)						
PREVIA / ESTIMA I (90-00)						
SOARER (90-00)						
SPRINTER (82-02)						
STARLET (P8) (89-96)						
SUPRA (93-02)						
PK20R8	IK20TT	TOYOTA	AVENSIS (97-03)			
			CALDINA (T19) (92-97)			
			CARINA E (92-97)			
			COROLLA (E10) (92-99)			
			CURREN (93-98)			
PK20R8	IK20TT	TOYOTA	ARISTO (90-97)			
			CALDINA (T19) (92-97)			
			CALDINA (T21) (97-02)			
			CARINA E (92-97)			
			CELICA (89-93)			
			CELICA (93-99)			
			CELSIOR (93-00)			
			COROLLA (E9) (87-93)			
			CURREN (93-98)			
			DYNA 200 (95-01)			

Свечи зажигания и Свечи накаливания

Руководство покупателя

DENSO P/N	TT	MAKE	MODEL	
PK20R8 продолжение			DYNA 300 (95-02)	
			MARK II (88-96)	
			MR 2 II (89-00)	
			SOARER (90-00)	
PK20TR11	K20TT	ALFA ROMEO	145 / 146 (94-01)	
			147 (00-10)	
			155 (92-97)	
			156 (97-06)	
			166 (98-07)	
			GT (03-10)	
			GTV (95-05)	
			SPIDER (94-05)	
			LEXUS	GS (97-05)
			TOYOTA	ARISTO (97-04)
				AVALON (X1) (95-05)
				AVENSIS (97-03)
		CAMRY (V1) (90-97)		
		CAMRY (V2) (96-01)		
		CAMRY Solara (98-03)		
		CHASER (X10) (96-01)		
		HARRIER (97-03)		
		MARK II (96-01)		
		SIENNA (97-03)		
		SOARER (90-00)		
		SUPRA (93-02)		
		VEROSSA (00-03)		
		WINDOM (96-01)		
PK22PR11	IK22FTT	FORD	ESCORT V (90-95)	
			ESCORT VI (95-01)	
PK22PR8	IK22TT	ALPINA	B5 (E60, E61) (05-10)	
			B7 (E65) (03-08)	
		AUDI	80 (8C, B4) (91-96)	
			100 (4A, C4) (90-94)	
			200 (44) (83-91)	
			A1 (8X) (10-18)	
			A3 (8P) (03-13)	
			A3 Convertible (8P7) (08-13)	
			A4 (8D, B5) (94-01)	
			A4 (8E, B7) (04-08)	
			A4 (8K, B8) (07-15)	
			A4 Allroad (8KH) (09-16)	
			A4 Convertible (8H, B6, B7) (02-09)	
			A5 (8T, 8F) (07-17)	
			A6 (4A, C4) (94-97)	
			A6 (4B, C5) (97-05)	
			A6 (4F, C6) (04-11)	
			A6 (4G, C7) (10-18)	
			A8 (4H) (09-18)	
			COUPE (89, 8B) (88-96)	
			Q3 (8U) (11-18)	
			Q5 (8R) (08-)	
			QUATTRO (85) (80-91)	
			R8 (42) (07-15)	
			R8 (4S) (15-)	
			TT (8J) (06-14)	
			TT (FV) (14-)	
			KTM	X-BOW (08-)
			LAMBORGHINI	GALLARDO (03-)
		LOTUS	2 ELEVEN (07-11)	
			ELISE (00-)	
			EXIGE (00-12)	
		NISSAN	200 SX (93-99)	
		RENAULT	MEGANE II (02-12)	
		SEAT	ALHAMBRA (710) (10-)	
			ALTEA (XL) (5P) (04-)	
			CORDOBA (6K1) (93-99)	
			EXEO (3R) (08-)	
			IBIZA II (6K1) (93-99)	
			LEON (1P) (05-12)	
			TOLEDO I (1L) (91-99)	
			TOLEDO III (5P) (04-09)	

DENSO P/N	TT	MAKE	MODEL		
PK22PR8 продолжение		SKODA	OCTAVIA II (1Z) (04-13)		
			SUPERB II (3T) (08-15)		
			YETI (5L) (09-)		
		SUBARU	IMPREZA (00-)		
			LEGACY II (94-99)		
		VW	AMAROK (2H, S1) (10-)		
			BETTER (5C) (11-)		
			CC (358) (11-)		
			EOS (1F) (06-15)		
			GOLF III (1H, 1E) (91-99)		
			GOLF V (1K) (03-09)		
			GOLF VI (5K, AJ5) (08-14)		
			GOLF VI Convertible (517) (11-16)		
			JETTA III (1K2) (05-10)		
			JETTA IV (162) (10-)		
			MULTIVAN V (7H, 7E) (03-)		
			PASSAT (3A2, 35I) (88-97)		
			PASSAT (3C) (05-11)		
			PASSAT (362, 365) (10-14)		
			PASSAT CC (357) (08-12)		
			POLO (6R, 6C) (09-)		
			SCIROCCO (137, 138) (08-17)		
			SHARAN (7N) (10-)		
TIGUAN (5N) (07-)					
TRANSPORTER V (7H, 7E, 7J) (03-15)					
PK22PR-L11S	-	FORD	GALAXY (95-06)		
			TRANSIT (94-00)		
			TRANSIT Tourneo (94-00)		
		HONDA	CIVIC VI (94-01)		
			INTEGRA (93-01)		
			S2000 (99-)		
		SAAB	9-5 (97-09)		
PKJ16CR8	-	CHRYSLER	SEBRING (07-10)		
			AVENGER (07-14)		
		DODGE	JOURNEY (08-)		
			FREEMONT (11-)		
		LANCIA	FLAVIA (12-14)		
MAZDA	626 V (97-02)				
		XEDOS 9 (93-02)			
PKJ16CR-L11	IK16TT	CHRYSLER	300 M (98-04)		
			GALAXY (95-06)		
		FORD	ACCORD VI (97-05)		
			HONDA	ALHAMBRA (7V) (96-10)	
		SEAT	CORDOBA (6L) (02-09)		
			IBIZA III (6L) (02-09)		
			INCA (6K9) (95-03)		
			LEON (1M) (99-06)		
			TOLEDO II (1M) (99-06)		
			SKODA	OCTAVIA I (1U) (96-10)	
			VW	BORA (1J) (98-05)	
				CADDY II (9K, 9U) (95-04)	
		FOX (5Z) (03-)			
		GOLF IV (1J, 1E) (97-06)			
		LUPO (6X, 6E) (98-05)			
		NEW BEETLE (9C, 1C, 1Y) (98-10)			
		PASSAT (3B3, 3B6) (00-05)			
		POLO (6N2) (99-01)			
		POLO Saloon (9A4) (02-)			
		SHARAN (7M) (95-10)			
		TRANSPORTER IV (70X, 7D) (90-03)			
		PKJ20CR8	IK20TT	AUDI	A1 (8X) (10-18)
					A3 (8P) (03-13)
A3 Convertible (8P7) (08-13)					
		MAZDA	626 V (97-02)		
			CARISMA (95-06)		
		MITSUBISHI	ALHAMBRA (710) (10-)		
			ALTEA (XL) (5P) (04-)		
		SEAT	IBIZA IV (6J, 6P) (08-)		
			LEON (1P) (05-12)		
			TOLEDO IV (KG3) (12-)		
		SKODA	FABIA II (06-14)		

Свечи зажигания и Свечи накаливания

Руководство покупателя

DENSO P/N	TT	MAKE	MODEL	
PKJ20CR8 продолжение			OCTAVIA II (1Z) (04-13)	
			RAPID (HN) (12-)	
			SUPERB II (3T) (08-15)	
			YETI (5L) (09-)	
			VW	EOS (1F) (06-15)
				GOLF Plus (5M, 521) (05-14)
				GOLF V (1K) (03-09)
				GOLF VI (5K, AJ5) (08-14)
				GOLF VI Convertible (517) (11-16)
				JETTA III (1K2) (05-10)
		JETTA IV (162) (10-)		
		PASSAT (3C) (05-11)		
		PASSAT (362, 365) (10-14)		
		POLO (6R, 6C) (09-)		
		SCIROCCO (137, 138) (08-17)		
		SHARAN (7N) (10-)		
		TIGUAN (5N) (07-)		
		TOURAN (1T1, 1T2) (03-10)		
		TOURAN (1T3) (10-15)		
		PKJ20CR-L11	IK20TT	AUDI
A8 (4E) (02-10)				
HONDA	ACCORD V (93-98)			
	ACCORD VI (97-05)			
	INSPIRE (98-03)			
	PRELUDE IV (92-96)			
	PRELUDE V (96-00)			
SPYKER	C12 (07-)			
VW	PHAETON (3D) (02-16)			
TOUAREG (7L) (02-10)				
PKJ20CR-M11	IK20TT	ACURA	TL (98-03)	
		HONDA	INSPIRE (98-03)	
PQ16R	Q16TT	TOYOTA	ALTEZZA (99-05)	
			CELICA (81-85)	
			CELICA (85-89)	
			COROLLA (E8) (83-89)	
			COROLLA (E9) (87-93)	
			COROLLA FX (84-88)	
			MR 2 I (84-90)	
			SOARER (80-86)	
			SUPRA (86-93)	
			PQ20R	Q20TT
NISSAN	200 SX (88-94)			
	BLUEBIRD (85-92)			
	SKYLINE (R32) (89-93)			
	SKYLINE (R33) (93-00)			
	SUNNY II (86-91)			
SAAB	9-3 (98-03)			
	9-5 (97-09)			
	TOYOTA	ALTEZZA (99-05)		
CAMRY (V1) (90-97)				
CAMRY (V2) (86-91)				
CARINA E (92-97)				
CRESTA (84-01)				
SOARER (80-86)				
WINDOM (91-96)				
PQ20R-P8	IQ20TT	TOYOTA	COROLLA Levin (E10) (91-97)	
			SOARER (80-86)	
			SOARER (86-91)	
			SUPRA (86-93)	
PT16EPR-L13	IT16TT	ASTON MARTIN	DB7 (94-03)	
			CADILLAC	ALLANTE (85-93)
		DEVILLE (93-99)		
		DEVILLE (99-04)		
		ELDORADO (91-02)		
		ESCALADE (98-06)		
		FLEETWOOD (93-97)		
		SEVILLE III (6K) (92-97)		
		SEVILLE IV (97-04)		
		SRX (04-08)		
		STS (04-12)		
		XLR (04-09)		

DENSO P/N	TT	MAKE	MODEL		
PT16EPR-L13 продолжение		CHEVROLET	CAPRICE (90-96)		
			FORD	COUGAR (98-01)	
				FIESTA IV (95-03)	
				MONDEO I (93-96)	
				MONDEO II (96-00)	
				MONDEO III (00-07)	
				AEROSTAR (85-97)	
				EXPLORER (94-01)	
			F150 (96-03)		
			MUSTANG (93-04)		
		MUSTANG (04-)			
		TAURUS (95-07)			
		WINDSTAR (95-04)			
		MAZDA	121 III (96-03)		
			MPV II (99-06)		
			PONTIAC	TRANS SPORT (97-99)	
		TOYOTA	CAVALIER (94-00)		
		PT16VR10	TV16TT	FORD	ESCORT V (90-95)
					ESCORT VI (95-01)
					FIESTA III (89-97)
FIESTA IV (95-03)					
MONDEO I (93-96)					
MONDEO II (96-00)					
ORION III (90-93)					
MAZDA	121 III (96-03)				
MORGAN	FOUR FOUR (68-)				
PLUS FOUR (85-)					
WESTFIELD	130 (97-)				
	ZE (93-97)				
PT16VR13	TV16TT	ALFA ROMEO	159 (05-11)		
			BRERA (06-10)		
			SPIDER (06-10)		
		CADILLAC	CTS (02-07)		
			CTS (08-)		
			SRX (04-08)		
		CHEVROLET	STS (04-12)		
			CAPTIVA (06-)		
		TRAILBLAZER (01-08)			
		FIAT	CROMA (05-)		
FORD	MAVERICK (01-)				
	MONDEO I (93-96)				
	PUMA (97-02)				
FORD USA	ESCAPE (01-07)				
	HUMMER	HUMMER H3 (05-)			
MAZDA	2 (03-07)				
	TRIBUTE (00-08)				
	OPEL	ANTARA (06-)			
ASTRA G (98-09)					
SPEEDSTER (00-)					
VECTRA B (95-03)					
VECTRA C (02-08)					
ZAFIRA A (99-05)					
RENAULT	19 I (88-92)				
	SUZUKI	Grand VITARA II (05-)			
VAUXHALL	ASTRA IV (G) (98-06)				
	SPEEDSTER (VX220) (00-06)				
	VECTRA I (B) (95-03)				
	VECTRA II (C) (00-08)				
	ZAFIRA I (A) (98-05)				
VOLVO	C30 (06-12)				
	S40 II (04-12)				
	V50 (04-12)				
PTJ16R15	IT16TT	CHEVROLET	SILVERADO (99-07)		
			TAHOE (99-06)		
		GMC	SIERRA (97-07)		
HUMMER	HUMMER H2 (02-)				
	Q14R-U11	IQ16TT	NISSAN	SUNNY II (86-91)	
Q16PR-U			Q16TT	CITROËN	AX (86-98)
	BX (82-94)				
	GAZ	GAZELLE (03-13)			
SOBOL (2217, 2310, 2752) (97-)					

Свечи зажигания и Свечи накаливания

Руководство покупателя

DENSO P/N	TT	MAKE	MODEL		
Q16PR-U продолжение		PEUGEOT	VOLGA (3110, 3111) (93-10)		
			106 I (91-96)		
			205 I (83-94)		
			306 (93-02)		
		RENAULT	405 II (92-99)		
			CLIO I (90-98)		
			MEGANE I (96-03)		
		SKODA	MEGANE Scénic (96-99)		
			FAVORIT (78) (89-97)		
			FELICIA Fun (6U) (97-02)		
		UAZ	FELICIA I (6U) (94-98)		
			452 (66-)		
			2206 (06-)		
			BARS (3159) (99-)		
			BUKHANKA (3741) (85-)		
			CARGO (2360) (04-)		
			GOLOVASTIK (3303) (85-)		
			HUNTER (3151) (92-)		
			PATRIOT (04-)		
			PICKUP (09-)		
		SIMBIR (3162) (97-)			
		Q16PR-U11	Q16TT	HONDA	CIVIC III (83-87)
					CIVIC IV (87-95)
PRELUDE III (86-92)					
INFINITI	M30 (89-93)				
NISSAN	300 ZX (84-90)				
	BLUEBIRD (85-92)				
	CEDRIC (83-87)				
	CEDRIC (87-97)				
	CEDRIC (91-99)				
	PRIMERA (P10) (90-98)				
	STANZA (81-85)				
	SUNNY III (90-00)				
	SSANGYONG			ACTYON I (05-)	
				KORANDO (96-06)	
KYRON (05-)					
MUSSO (93-07)					
REXTON (02-)					
RODIUS I (05-)					
STAVIC (05-)					
YULON	101 Feeling (89-93)				
	YULON (93-98)				
Q16P-U11	Q16TT			PEUGEOT	205 I (83-94)
					205 II (87-98)
		RENAULT	19 II (92-01)		
Q16R-U	Q16TT	RAPID (85-98)			
		RENAULT	CLIO I (90-98)		
Q16R-U	Q16TT	TOYOTA	CARINA E (92-97)		
			CARINA II (83-92)		
			CELICA (89-93)		
			COROLLA (E9) (87-93)		
			COROLLA (E10) (92-99)		
			CORONA (T17) (87-92)		
			SPRINTER (82-02)		
Q16R-U11	Q16TT	CHEVROLET	MATIZ (05-)		
			NISSAN	300 ZX (84-90)	
		TOYOTA	CEDRIC (91-99)		
			CAMRY (V1) (83-88)		
			CAMRY (V2) (86-91)		
Q16TT		CARINA II (83-92)			
		MR 2 II (89-00)			
Q16TT		CHEVROLET	MATIZ (05-)		
			CITROËN	AX (86-98)	
		GAZ	BX (82-94)		
			GAZELLE (03-13)		
			SOBOL (2217, 2310, 2752) (97-)		
		HONDA	VOLGA (3110, 3111) (93-10)		
			CIVIC III (83-87)		
			CIVIC IV (87-95)		
			PRELUDE III (86-92)		
			INFINITI	M30 (89-93)	

DENSO P/N	TT	MAKE	MODEL	
Q16TT продолжение		JEEP	CJ5 - CJ8 (66-87)	
		NISSAN	300 ZX (84-90)	
			BLUEBIRD (85-92)	
			CEDRIC (83-87)	
			CEDRIC (87-97)	
			CEDRIC (91-99)	
			PRIMERA (P10) (90-98)	
			STANZA (81-85)	
			SUNNY III (90-00)	
			PEUGEOT	106 I (91-96)
				205 I (83-94)
		205 II (87-98)		
		306 (93-02)		
		RENAULT	405 II (92-99)	
			19 II (92-01)	
			CLIO I (90-98)	
			MEGANE I (96-03)	
			MEGANE Scénic (96-99)	
		SKODA	RAPID (85-98)	
			FAVORIT (78) (89-97)	
			FELICIA Fun (6U) (97-02)	
		SSANGYONG	FELICIA I (6U) (94-98)	
			ACTYON I (05-)	
			KORANDO (96-06)	
			KYRON (05-)	
			MUSSO (93-07)	
			REXTON (02-)	
		TOYOTA	RODIUS I (05-)	
			STAVIC (05-)	
			ALTEZZA (99-05)	
			CAMRY (V1) (83-88)	
			CAMRY (V2) (86-91)	
			CARINA E (92-97)	
			CARINA II (83-92)	
			CELICA (81-85)	
			CELICA (85-89)	
			CELICA (89-93)	
			COROLLA (E8) (83-89)	
			COROLLA (E9) (87-93)	
			COROLLA (E10) (92-99)	
			COROLLA FX (84-88)	
			CORONA (T17) (87-92)	
			MR 2 I (84-90)	
MR 2 II (89-00)				
SOARER (80-86)				
SPRINTER (82-02)				
SUPRA (86-93)				
UAZ	452 (66-)			
	2206 (06-)			
	BARS (3159) (99-)			
	BUKHANKA (3741) (85-)			
	CARGO (2360) (04-)			
	GOLOVASTIK (3303) (85-)			
	HUNTER (3151) (92-)			
	PATRIOT (04-)			
	PICKUP (09-)			
	SIMBIR (3162) (97-)			
YULON	101 Feeling (89-93)			
	YULON (93-98)			
Q20PR-U	Q20TT	ASTON MARTIN	VIRAGE (87-92)	
			VIRAGE (90-00)	
Q16TT		AUSTIN	1000-Series (70-74)	
		CITROËN	AX (86-98)	
			BX (82-94)	
			C15 (84-05)	
			EVASION (94-02)	
			JUMPER (94-02)	
			JUMPY (95-06)	
			XM (89-94)	
			ZX (91-98)	
		FIAT	PANDA (80-04)	

Свечи зажигания и Свечи накаливания

Руководство покупателя

DENSO P/N	TT	MAKE	MODEL		
Q20PR-U продолжение			PUNTO (93-00)		
			TIPO (160) (87-95)		
			UNO (146) (83-00)		
		FORD	ESCORT III (80-86)		
			ESCORT IV (85-90)		
			ESCORT V (90-95)		
			FIESTA II (83-95)		
			FIESTA III (89-97)		
			ORION I (83-86)		
			ORION II (85-90)		
			ORION III (90-93)		
			SCORPIO I (85-94)		
			SIERRA (87-93)		
			JAGUAR	XJ (86-94)	
				XJ (94-97)	
				XJ Coupe (73-96)	
		LANCIA	Y (95-03)		
			Y10 (85-95)		
		MAZDA	323 III (85-95)		
			626 II (82-87)		
			626 III (87-97)		
			929 III (87-91)		
			E-SERIE (SR) (83-04)		
		MORGAN	FOUR FOUR (68-)		
			PLUS FOUR (85-)		
		MORRIS	ITAL (80-84)		
		NISSAN	BLUEBIRD (85-92)		
			PRAIRIE (M10) (83-88)		
			STANZA (81-85)		
			SUNNY II (86-91)		
		OPEL	MONTEREY A (91-98)		
			VECTRA A (88-95)		
		PEUGEOT	205 I (83-94)		
			205 II (87-98)		
			305 II (82-90)		
			306 (93-02)		
			309 I (85-89)		
			309 II (89-93)		
			405 I (87-93)		
			405 II (92-99)		
			504 (68-89)		
			505 (79-95)		
			605 (89-99)		
			BOXER (94-02)		
			J5 (81-90)		
			J5 (90-94)		
			PARTNER / RANCH (96-15)		
			PONTIAC	TRANS SPORT (89-97)	
			RELIANT	SCIMITAR (68-90)	
		SKODA	FAVORIT (78) (89-97)		
		VOLVO	960 I (90-94)		
			960 II (94-96)		
		Q20PR-U11	Q20TT	ACURA	INTEGRA (85-90)
					LEGEND I (86-91)
				FORD	ESCORT IV (85-90)
					ESCORT V (90-95)
					ESCORT VI (95-01)
					FIESTA II (83-95)
					FIESTA III (89-97)
					ORION II (85-90)
					ORION III (90-93)
					SCORPIO II (94-98)
					SIERRA (87-93)
					TRANSIT (91-94)
					FORD USA
				HONDA	ACCORD III (85-89)
					CIVIC IV (87-95)
					CIVIC V (91-97)
					CIVIC VI (94-01)
					CONCERTO (89-96)
					CRX I (83-87)

DENSO P/N	TT	MAKE	MODEL		
Q20PR-U11 продолжение			CRX II (87-92)		
			INTEGRA (85-93)		
			LEGEND I (86-90)		
			PRELUDE III (86-92)		
			LADA	110 (2110) (95-12)	
				111 (2111) (95-13)	
				112 (2112) (95-13)	
				GRANTA (2190, 2191, 2349) (11-)	
				KALINA (1117, 1118, 1119) (04-)	
				KALINA (2192, 2194) (13-)	
				PICKUP (2345) (97-04)	
				PRIORA (2170, 2171, 2172) (08-)	
				SAMARA (2108, 2109, 2113, 2114, 2115) (86-13)	
		MAZDA		626 III (87-97)	
		NISSAN	300 ZX (84-90)		
			BLUEBIRD (83-90)		
			BLUEBIRD (85-92)		
			CEDRIC (83-87)		
			CEDRIC (91-99)		
			PATHFINDER II (97-04)		
			PRAIRIE Pro (M11) (88-94)		
			SILVIA (S12) (84-88)		
			SUNNY II (86-91)		
			RELIANT	SCIMITAR (68-90)	
			SCIMITAR Sabre (92-95)		
		ROVER	400 (95-00)		
		SAAB	9-5 (97-09)		
			900 II (93-98)		
			9000 (84-98)		
		WESTFIELD	130 (97-)		
		Q20P-U	Q20TT	CITROËN	AX (86-98)
					BX (82-94)
					C15 (84-05)
					ZX (91-98)
				MERCEDES-BENZ	SL (R129) (89-01)
					PEUGEOT
					205 II (87-98)
					309 I (85-89)
					309 II (89-93)
					405 I (87-93)
				RENAULT	19 I (88-92)
					19 II (92-01)
					SAAB
SKODA	FAVORIT (78) (89-97)				
Q20P-U11	Q20TT			LADA	KALINA (1117, 1118, 1119) (04-)
				NISSAN	CEDRIC (83-87)
				SUBARU	REX II (81-89)
Q20R-U	Q20TT			CHERY	A1 (06-14)
					QQ6 (06-13)
					LADA
	PEUGEOT	309 II (89-93)			
Q20R-U11	Q20TT	HONDA	INTEGRA (85-93)		
			LEGEND I (86-90)		
			PRELUDE III (86-92)		
Q20TT	-	ACURA	INTEGRA (85-90)		
			LEGEND I (86-91)		
		ASTON MARTIN	VIRAGE (87-92)		
			VIRAGE (90-00)		
		AUSTIN	1000-Series (70-74)		
		CHERY	A1 (06-14)		
			QQ6 (06-13)		
		CITROËN	AX (86-98)		
			BX (82-94)		
			C15 (84-05)		
			EVASION (94-02)		
			JUMPER (94-02)		
			JUMPY (95-06)		
			XM (89-94)		
		ZX (91-98)			
		FIAT	PANDA (80-04)		
			PUNTO (93-00)		

Свечи зажигания и Свечи накаливания

Руководство покупателя

DENSO P/N	TT	MAKE	MODEL
Q20TT			TIPO (160) (87-95)
продолжение			UNO (146) (83-00)
		FORD	ESCORT III (80-86)
			ESCORT IV (85-90)
			ESCORT V (90-95)
			ESCORT VI (95-01)
			FIESTA II (83-95)
			FIESTA III (89-97)
			ORION I (83-86)
			ORION II (85-90)
			ORION III (90-93)
			SCORPIO I (85-94)
			SCORPIO II (94-98)
			SIERRA (87-93)
			TRANSIT (91-94)
		FORD USA	PROBE II (93-98)
		HONDA	ACCORD III (85-89)
			CIVIC IV (87-95)
			CIVIC V (91-97)
			CIVIC VI (94-01)
			CONCERTO (89-96)
			CRX I (83-87)
			CRX II (87-92)
			INTEGRA (85-93)
			LEGEND I (86-90)
			PRELUDE III (86-92)
		JAGUAR	XJ (86-94)
			XJ (94-97)
			XJ Coupe (73-96)
		LADA	110 (2110) (95-12)
			111 (2111) (95-13)
			112 (2112) (95-13)
			GRANTA (2190, 2191, 2349) (11-)
Q20TT			KALINA (1117, 1118, 1119) (04-)
-			KALINA (2192, 2194) (13-)
			OKA (1111) (88-08)
			PICKUP (2345) (97-04)
Q20TT			PRIORA (2170, 2171, 2172) (08-)
-			SAMARA (2108, 2109, 2113, 2114, 2115) (86-13)
		LANCIA	Y (95-03)
			Y10 (85-95)
		LEXUS	ES (89-97)
		MAZDA	323 III (85-95)
			626 II (82-87)
			626 III (87-97)
			929 III (87-91)
			E-SERIE (SR) (83-04)
		MERCEDES-BENZ	SL (R129) (89-01)
		MORGAN	FOUR FOUR (68-)
			PLUS FOUR (85-)
		MORRIS	ITAL (80-84)
		NISSAN	200 SX (88-94)
			300 ZX (84-90)
			BLUEBIRD (83-90)
			BLUEBIRD (85-92)
			CEDRIC (83-87)
			CEDRIC (91-99)
			PATHFINDER II (97-04)
			PRAIRIE (M10) (83-88)
			PRAIRIE Pro (M11) (88-94)
			SILVIA (S12) (84-88)
			SKYLINE (R32) (89-93)
			SKYLINE (R33) (93-00)
			STANZA (81-85)
			SUNNY II (86-91)
		OPEL	MONTEREY A (91-98)
			VECTRA A (88-95)
		PEUGEOT	205 I (83-94)
			205 II (87-98)
			305 II (82-90)
			306 (93-02)

DENSO P/N	TT	MAKE	MODEL
Q20TT			309 I (85-89)
продолжение			309 II (89-93)
			405 I (87-93)
			405 II (92-99)
			504 (68-89)
			505 (79-95)
			605 (89-99)
			BOXER (94-02)
			J5 (81-90)
			J5 (90-94)
			PARTNER / RANCH (96-15)
		PONTIAC	TRANS SPORT (89-97)
		RELIANT	SCIMITAR (68-90)
			SCIMITAR Sabre (92-95)
		RENAULT	19 I (88-92)
			19 II (92-01)
		ROVER	400 (95-00)
		SAAB	9-3 (98-03)
			9-5 (97-09)
			900 I (78-94)
			900 II (93-98)
			9000 (84-98)
		SKODA	FAVORIT (78) (89-97)
		SUBARU	REX II (81-89)
		TOYOTA	ALTEZZA (99-05)
			CAMRY (V1) (90-97)
			CAMRY (V2) (86-91)
			CARINA E (92-97)
			CRESTA (84-01)
			SOARER (80-86)
			WINDOM (91-96)
		VOLVO	960 I (90-94)
			960 II (94-96)
		WESTFIELD	130 (97-)
Q22PR-U	-	ALFA ROMEO	155 (92-97)
		ASTON MARTIN	DB7 (94-03)
		CATERHAM	21 (94-02)
		CITROËN	AX (86-98)
			BX (82-94)
			XM (89-94)
			ZX (91-98)
		FIAT	ELBA (85-97)
			PUNTO (93-00)
			SCUDO (220) (96-06)
			TEMPRA (90-96)
			TIPO (160) (87-95)
		FORD	ESCORT III (80-86)
			ESCORT IV (85-90)
			FIESTA I (76-86)
			ORION I (83-86)
			ORION II (85-90)
		LANCIA	DEDRA (89-99)
		PEUGEOT	306 (93-02)
			605 (89-99)
			EXPERT (96-06)
		SAAB	9000 (84-98)
		SEAT	IBIZA I (84-93)
			MALAGA (84-93)
Q22PR-U11	-	NISSAN	300 ZX (84-90)
		SAAB	9-3 (98-03)
			9-5 (97-09)
			900 II (93-98)
			9000 (84-98)
Q22P-U	-	CITROËN	BX (82-94)
			VISA (78-91)
		FORD	ESCORT III (80-86)
			ESCORT IV (85-90)
			ORION I (83-86)
		PEUGEOT	205 II (87-98)
			309 I (85-89)
		SEAT	IBIZA I (84-93)

Свечи зажигания и Свечи накаливания

Руководство покупателя

DENSO P/N	TT	MAKE	MODEL
Q22P-U продолжение			MALAGA (84-93) RONDA (82-88)
QJ16AR-U	-	DODGE JEEP	VIPER (02-10) WRANGLER I (86-96)
QJ16CR11	Q16TT	JEEP	CJ5 - CJ8 (66-87)
QJ16HR-U	-	CHRYSLER JEEP	NEW YORKER (92-98) VISION (93-97) CHEROKEE (80-86) Grand CHEROKEE I (91-99)
QJ20CR11	Q20TT	MAZDA	626 III (87-97) 929 III (87-91)
S-31A	-	MAZDA	RX 7 II (85-91)
SC16HR11	IXEH20TT	ASTON MARTIN CITROËN DAIHATSU LEXUS LOTUS PEUGEOT SUBARU TOYOTA	CYGNET (11-13) C1 II (14-) CHARADE VI (11-) CT (10-) NX (14-) ELISE (00-) 108 (14-) TREZIA (11-) ALLION II (07-) AURIS (E15) (06-12) AURIS (E18) (12-) AVENSIS (08-) AYGO (14-) COROLLA (E14, E15) (06-) COROLLA (E18) (13-) HARRIER (13-) IQ (09-) ISIS (04-) MATRIX (08-) NOAH / VOXY (07-13) NOAH / VOXY (13-) PREMIO (07-) PRIUS (W3) (09-) PRIUS Plus (W4) (11-) RACTIS (10-) RAV 4 III (05-) RAV 4 IV (12-) SPADE (12-) URBAN CRUISER (07-) VERSO (09-) VERSO S (10-16) YARIS (05-11) YARIS (10-)
SK16HR11	IKH16TT	DODGE LEXUS TOYOTA	CHARGER (11-) ES (12-) GX (09-) AYGO (05-) CAMRY (V4) (06-11) CAMRY (V5) (11-) CAMRY (V7) (17-) FJ CRUISER (07-) IQ (09-) KLUGER / HIGHLANDER II (07-) KLUGER / HIGHLANDER III (14-) LAND CRUISER / PRADO (J150) (10-) RACTIS (05-10) RAV 4 IV (12-) VIOS / YARIS (07-) YARIS (99-05) YARIS (05-11) YARIS (10-)
SK16PR-A11	IK16TT	TOYOTA (GAC) CHEVROLET JAGUAR	HIGHLANDER (09-) MW (00-10) XF (08-15) XJ (97-03) XJ (03-09) XJ (09-) XK 8 (96-05) XK (06-14)

DENSO P/N	TT	MAKE	MODEL
SK16PR-A11 продолжение		SUBARU SUZUKI	JUSTY III (03-) Grand VITARA II (05-) IGNIS I (00-05) IGNIS II (03-) JIMNY (98-) LIANA (01-07) SWIFT III (05-) WAGON R+ (00-)
SK16PR-E11	IK16TT	MAZDA	2 (03-07) 2 (07-15) 3 (00-09) 3 (09-14)
SK16PR-L11	IK16TT	HONDA HYUNDAI KIA	CIVIC VII (00-05) COUPE (01-09) ELANTRA (05-11) GENESIS (08-) GETZ (02-09) GRANDEUR (05-11) i30 (07-12) MATRIX (01-10) SANTA FÉ I (00-06) SONATA V (05-10) TIBURON (06-) TRAJECT (00-08) TUCSON (04-10) CARENS II (02-) CARNIVAL III (06-) CEED (06-12) PRO CEED (08-13) SORENTO I (02-) SORENTO III (15-) SPORTAGE II (04-)
SK16R11	IK16TT	LAND ROVER TOYOTA	RANGE ROVER III (02-12) RANGE ROVER Sport (05-13) ALPHARD II (08-14) CAMRY (V4) (06-11) CAMRY (V5) (11-) HIACE IV (95-) IST (04-07) MATRIX (08-) PREVIA / ESTIMA III (05-) PRIUS (W1) (00-04) PRIUS (W2) (03-09) PROBOX / SUCCEED (02-14)
SK16R-P11	IK16TT	TOYOTA	CENTURY (97-) MARK II (02-07)
SK16R-P8	IK16TT	TOYOTA	HIACE IV (95-)
SK20BGR11	-	TOYOTA	ALLION I (01-07) AVENSIS (97-03) CALDINA (T24) (02-07) GAIA (98-03) ISIS (04-) NOAH / VOXY (01-07) OPA (00-05) VISTA (V5) (98-03)
SK20BR11	-	TOYOTA	AVENSIS (03-09) BREVIS (99-07) CHASER (X10) (96-01) MARK II (02-07) PROGRES (97-07) VEROSSA (00-03)
SK20HR11	IKH20TT	DAIHATSU LEXUS SUBARU SUZUKI	CUORE VII (06-) SIRION (05-) GS (05-11) GX (09-) LS (06-) LX (07-) JUSTY IV (07-) SWIFT IV (10-) SX4 S-Cross (13-) VITARA (15-)

Свечи зажигания и Свечи накаливания

Руководство покупателя

DENSO P/N	TT	MAKE	MODEL	
SK20HR11 продолжение		TOYOTA	CROWN (03-08)	
			FJ CRUISER (07-)	
			FORTUNER (04-15)	
			LAND CRUISER (J200) (07-)	
			SEQUOIA (07-)	
			TUNDRA (07-)	
SK20HR-A11	IKH20TT	TOYOTA	FORTUNER (04-15)	
SK20PR-A11	IK20TT	SUZUKI	IGNIS I (00-05)	
			LIANA (01-07)	
		VOLVO	S80 II (06-)	
			XC90 I (02-14)	
SK20PR-A8	IK20TT	DAIHATSU	COPEN (03-12)	
			MOVE (02-07)	
		MITSUBISHI	ASX (10-)	
			PAJERO IV (06-)	
SK20PR-L9	IK20TT	CHRYSLER	CROSSFIRE (03-07)	
			HONDA	LIFE (01-03)
		MERCEDES-BENZ	C-CLASS (202) (93-01)	
			C-CLASS (203) (00-07)	
			C-CLASS Coupe (CL203) (01-08)	
			CLK (208) (97-02)	
			E-CLASS (210) (95-03)	
			S-CLASS (W220) (98-05)	
			S-CLASS Coupe (C215) (99-06)	
			SLK (R170) (96-04)	
			SPRINTER 2-t (901, 902) (95-06)	
			SPRINTER 3-t (903) (95-06)	
			SPRINTER 4-t (904) (96-06)	
SK20R11	IK20TT	LEXUS	ES (96-08)	
			GS (97-05)	
			GS (05-11)	
			GX (01-09)	
			IS I (99-05)	
			LS (94-00)	
			LS (00-06)	
			LX (98-08)	
			RX (98-03)	
			RX (03-08)	
			SC (91-00)	
			SC (01-10)	
			LOTUS	2 ELEVEN (07-11)
				ELISE (00-)
				EXIGE (00-12)
			MITSUBOKA	OROCHI (06-)
			TOYOTA	4 RUNNER (N21) (02-09)
		ALPHARD I (03-08)		
		ALPHARD II (08-14)		
		ALTEZZA (99-05)		
		ARISTO (90-97)		
		AVALON (X1) (95-05)		
		AVALON (X2) (99-05)		
		AVENSIS (03-09)		
		AVENSIS Verso (01-09)		
		CAMRY (V3) (01-06)		
		CAMRY (V4) (06-11)		
		CAMRY Solara (03-08)		
		CELICA (99-05)		
		CELSIOR (88-93)		
		CELSIOR (00-06)		
		COROLLA (E12) (01-07)		
		HARRIER (97-03)		
		HARRIER (03-08)		
		KLUGER / HIGHLANDER I (00-07)		
LAND CRUISER (J100) (98-08)				
LAND CRUISER (J200) (07-)				
MATRIX (01-07)				
MATRIX (08-)				
PREVIA / ESTIMA II (00-06)				
PREVIA / ESTIMA III (05-)				
RAV 4 II (00-05)				
RAV 4 III (05-)				

DENSO P/N	TT	MAKE	MODEL	
SK20R11 продолжение			SEQUOIA (00-07)	
			SEQUOIA (07-)	
			SIENNA (03-09)	
			TUNDRA (99-06)	
			TUNDRA (07-)	
			VISTA (V5) (98-03)	
			WINDOM (01-06)	
			LAND CRUISER (J200) (07-)	
			TOYOTA (FAW)	DYNA 200 (95-01)
SK20R5-G	-	TOYOTA		
SK20R-P11	IK20TT	LEXUS	GS (97-05)	
			IS I (99-05)	
SK20R-P13	IK20TT	TOYOTA	AVENSIS (97-03)	
SK22PR-M11S	-	HONDA	CIVIC VII (00-05)	
			CIVIC VIII Hatchback (05-)	
			INTEGRA (02-)	
SKJ16CR-A8	-	MAZDA	323 F VI (98-04)	
SKJ16CR-L11	IK16TT	HONDA	ACCORD IV (90-94)	
			INSPIRE (98-03)	
			PRELUDE IV (92-96)	
			PRELUDE V (96-00)	
			SKODA	FABIA I (6Y) (99-08)
		VW	JETTA III (1K2) (05-10)	
			NEW BEETLE (9C, 1C, 1Y) (98-10)	
			POLO (9N) (01-09)	
			ACURA	MDX (00-05)
			HONDA	LEGEND IV (06-12)
SKJ16DR-M11	-		ODYSSEY (RL1) (02-)	
			RIDGELINE (05-14)	
			AUDI	A1 (8X) (10-18)
			MAZDA	323 F VI (98-04)
SKJ20CR-A8	-	SEAT	323 S VI (98-04)	
			ALHAMBRA (710) (10-)	
			IBIZA IV (6J, 6P) (08-)	
		SKODA	FABIA II (06-14)	
			VW	BEETLE (5C) (11-)
		CC (358) (11-)		
		EOS (1F) (06-15)		
		GOLF Plus (5M, 521) (05-14)		
		GOLF VI (5K, AJ5) (08-14)		
		GOLF VI Convertible (517) (11-16)		
		JETTA IV (162) (10-)		
		PASSAT (362, 365) (10-14)		
		POLO (6R, 6C) (09-)		
		SCIROCCO (137, 138) (08-17)		
		SHARAN (7N) (10-)		
TIGUAN (5N) (07-)				
TOURAN (1T3) (10-15)				
SKJ20DR-M11	-	ACURA	RSX (01-06)	
			TSX (09-)	
		DONGFENG HONDA	CR-V IV (07-)	
			HONDA	ACCORD VII (03-08)
		CITY (99-04)		
		CIVIC IX (12-)		
		CIVIC VII (00-05)		
		CIVIC VIII Hatchback (05-)		
		CIVIC VIII Saloon (05-)		
		CR-V II (01-06)		
		CR-V III (06-)		
		CR-Z (10-)		
		ELEMENT (02-11)		
ELYSION (04-)				
FIT IV (13-)				
FREED I (08-16)				
FR-V (04-)				
INTEGRA (02-)				
JAZZ III (08-)				
JAZZ IV (13-)				
JAZZ Saloon (03-08)				
JAZZ Shuttle (11-14)				
LAGREAT (98-02)				

Свечи зажигания и Свечи накаливания

Руководство покупателя

DENSO P/N	TT	MAKE	MODEL			
SKJ20DR-M11 продолжение			LEGEND IV (06-12)			
			ODYSSEY (RL1) (02-)			
			RIDGELINE (05-14)			
			STEPWAGON (00-05)			
			STREAM (01-)			
			VEZEL (13-)			
		HONDA (GAC)	FIT IV (13-)			
			ODYSSEY (02-09)			
			ODYSSEY (09-14)			
		SEAT	ALTEA (XL) (5P) (04-)			
			CORDOBA (6L) (02-09)			
			IBIZA III (6L) (02-09)			
			IBIZA IV (6J, 6P) (08-)			
			LEON (1P) (05-12)			
			TOLEDO III (5P) (04-09)			
			TOLEDO IV (KG3) (12-)			
			TOLEDO IV (KG3) (12-)			
		SKODA	FABIA I (6V) (99-08)			
			FABIA II (06-14)			
			OCTAVIA II (1Z) (04-13)			
			RAPID (HN) (12-)			
			ROOMSTER (5J) (06-15)			
			ROOMSTER (5J) (06-15)			
		VW	BEETLE (5C) (11-)			
			CADDY III (2K, 2C) (04-15)			
			FOX (5Z) (03-)			
			GOLF Plus (5M, 521) (05-14)			
			GOLF V (1K) (03-09)			
			GOLF VI (5K, AJ5) (08-14)			
			JETTA III (1K2) (05-10)			
			JETTA IV (162) (10-)			
			POLO (6R, 6C) (09-)			
			POLO (6R, 6C) (09-)			
			POLO (9N) (01-09)			
			POLO (9N) (01-09)			
			POLO (9N) (01-09)			
		SKJ20DR-M11S	-	HONDA	ACCORD IX (12-)	
					ACCORD VIII (08-)	
					CIVIC VIII Hatchback (05-)	
					CIVIC VIII Saloon (05-)	
					CR-V III (06-)	
FR-V (04-)						
FR-V (04-)						
SKJ20DR-M13	-	HONDA	CITY (99-04)			
			CIVIC IX (12-)			
			CIVIC VIII Hatchback (05-)			
			CR-Z (10-)			
			FIT IV (13-)			
			FREED I (08-16)			
			JAZZ III (08-)			
			JAZZ IV (13-)			
			JAZZ Saloon (03-08)			
			JAZZ Shuttle (11-14)			
			VEZEL (13-)			
			VEZEL (13-)			
			HONDA (GAC)	FIT IV (13-)		
			SVK20RZ11	IK20TT	DAIHATSU	EXTOL (00-)
						SIRION (05-)
FIAT	SEDCI (06-14)					
FORD	GALAXY (95-06)					
	SCORPIO II (94-98)					
SUBARU	JUSTY II (95-03)					
	JUSTY III (03-)					
SUZUKI	Grand VITARA I (98-06)					
	Grand VITARA II (05-)					
	IGNIS I (00-05)					
	IGNIS II (03-)					
	JIMNY (98-)					
	LIANA (01-07)					
	SWIFT III (05-)					
	SX4 (06-)					
SXU22HCR11S	-	ACURA	MDX (06-)			
			TL (09-)			
			ZDX (10-)			
		CHRYSLER	300 C (11-)			
			Grand VOYAGER V (07-)			
		DODGE	AVENGER (07-14)			
			CHALLENGER (07-)			

DENSO P/N	TT	MAKE	MODEL	
SXU22HCR11S продолжение			CHARGER (11-)	
			DURANGO (11-)	
			JOURNEY (08-)	
			FIAT	FREEMONT (11-)
			HONDA	ACCORD IX (12-)
				ACCORD VIII (08-)
				CROSSTOUR (09-)
				CR-V IV (12-)
				LEGEND IV (06-12)
				PILOT (08-)
			JEEP	Grand CHEROKEE IV (10-)
				WRANGLER III (07-)
			LANCIA	THEMA (11-)
				VOYAGER (11-14)
			RAM	1500 (DS) (10-)
SXU22HDR8	IXUH22TT	MERCEDES-BENZ	C-CLASS (203) (00-07)	
			C-CLASS (204) (07-14)	
			C-CLASS Coupe (CL203) (01-08)	
			CLC (CL203) (08-11)	
			CLK (209) (02-10)	
			CLS (C219) (04-10)	
			E-CLASS (211) (02-09)	
			E-CLASS (212) (09-)	
			E-CLASS Coupe / Convertible (207) (09-)	
			G-CLASS (W463) (89-)	
			GL-CLASS (X164) (06-)	
			GLK (X204) (08-15)	
			M-CLASS (W164) (05-11)	
			R-CLASS (251) (06-)	
			S-CLASS (W221) (05-13)	
			S-CLASS Coupe (C216) (06-13)	
			SL (R230) (01-12)	
			SLK (R171) (04-11)	
			SPRINTER 3,5-t (906) (06-)	
			SPRINTER 3-t (906) (06-)	
			SPRINTER 4,6-t (906) (06-)	
			SPRINTER 5-t (906) (06-)	
			VIANO (W639) (03-)	
			VITO / MIXTO (W639) (03-)	
			MITSUBISHI	i-MIEV (06-)
OUTLANDER II (06-12)				
PAJERO Sport II (08-)				
SXU22PR9	IXU22TT	DAIHATSU	BEGO (05-)	
			COPEN (03-12)	
			EXTOL (00-)	
			MATERIA (06-)	
			SIRION (05-)	
			TERIOS (05-)	
			YRV (01-)	
			PERODUA	ALZA (09-)
				MYVI (06-11)
				JUSTY IV (07-)
SUBARU	JUSTY IV (07-)			
	TOYOTA	AVANZA (F6) (03-11)		
			RUSH (06-)	
T16EPR-U	T16TT	FORD	KA (96-08)	
			SCORPIO I (85-94)	
			SIERRA (87-93)	
		FORD USA	BRONCO II (85-90)	
			TAURUS (91-95)	
			TAURUS (91-95)	
PONTIAC	BONNEVILLE (86-99)			
	BONNEVILLE (86-99)			
T16EPR-U15	T16TT	BUICK	LE SABRE (91-95)	
			PARK AVENUE (90-96)	
			RENDEZVOUZ (00-06)	
			SKYLARK (89-99)	
			SKYLARK (89-99)	
		CADILLAC	ALLANTE (85-93)	
			DEVILLE (89-93)	
			DEVILLE (93-99)	
		CHEVROLET	ELDORADO (85-91)	
			SEVILLE II (K) (79-93)	
			ALERO (99-04)	
			BLAZER (S10) (94-05)	

Свечи зажигания и Свечи накаливания

Руководство покупателя

DENSO P/N	TT	MAKE	MODEL			
T16EPR-U15 продолжение		FORD USA	CAVALIER (89-03)			
			IMPALA (99-05)			
			LUMINA APV (89-96)			
			MALIBU (96-03)			
			S10 Pick Up (93-05)			
			TRANS SPORT (96-05)			
		GMC	JIMMY (94-02)			
		MAZDA	6 (02-07)			
			6 (07-13)			
		PONTIAC	MONTANA (98-05)			
T16NR-U11	IT16TT	FORD USA	TAURUS (85-92)			
			THUNDERBIRD (93-97)			
T16PR-U	ITF16TT	PONTIAC	FIREBIRD (81-92)			
T16PR-U11	ITF16TT	AC	ACE (95-98)			
			ACE (98-)			
			ACECA (93-01)			
			COBRA IV (90-)			
		CHEVROLET	ASTRO (84-94)			
			BLAZER (S10) (82-94)			
			BLAZER (S10) (94-05)			
			C1500 (91-00)			
			C2500 (91-96)			
			CAMARO (70-81)			
			CAMARO (81-92)			
			MALIBU (77-83)			
			S10 Pick Up (82-94)			
			S10 Pick Up (93-05)			
		FORD USA	ECONOLINE (76-92)			
		GMC	G SERIE (75-84)			
		PONTIAC	FIREBIRD (81-92)			
			TRANS SPORT (89-97)			
T16TT	-	BUICK	LE SABRE (91-95)			
			PARK AVENUE (90-96)			
			RENDEZVOUZ (00-06)			
			SKYLARK (89-99)			
		CADILLAC	ALLANTE (85-93)			
			DEVILLE (89-93)			
			DEVILLE (93-99)			
			ELDORADO (85-91)			
			SEVILLE II (K) (79-93)			
		CHEVROLET	ALERO (99-04)			
			BLAZER (S10) (94-05)			
			CAVALIER (89-03)			
			IMPALA (99-05)			
			LUMINA APV (89-96)			
			MALIBU (96-03)			
			S10 Pick Up (93-05)			
			TRANS SPORT (96-05)			
		FORD	KA (96-08)			
			SCORPIO I (85-94)			
			SIERRA (87-93)			
		FORD USA	BRONCO II (85-90)			
			TAURUS (91-95)			
		GMC	JIMMY (94-02)			
		MAZDA	6 (02-07)			
			6 (07-13)			
		PONTIAC	BONNEVILLE (86-99)			
			MONTANA (98-05)			
		T16VR-U10	TV16TT	FORD	B-MAX (12-)	
					C-MAX I (07-10)	
					C-MAX II (10-)	
					COUGAR (98-01)	
					FIESTA V (01-08)	
					FIESTA VI (08-)	
					FOCUS C-MAX (03-07)	
					FOCUS I (98-05)	
					FOCUS II (04-12)	
					FOCUS III (10-)	
					FUSION (02-12)	
					Grand C-MAX (10-)	
						KA (96-08)

DENSO P/N	TT	MAKE	MODEL	
T16VR-U10 продолжение			P 100 (87-92)	
			PUMA (97-02)	
			TOURNEO Connect (02-13)	
			TRANSIT Connect (02-13)	
		MAZDA	2 (03-07)	
			6 (02-07)	
			6 (07-13)	
T20EPR-U	T20TT	ALPINE	A310 (71-84)	
		AUDI	100 (4A, C4) (90-94)	
			A6 (4A, C4) (94-97)	
			A8 (4D) (94-02)	
			V8 (44, 4C) (88-94)	
		AUSTIN	AMBASSADOR (82-84)	
		CITROËN	BX (82-94)	
			GS (70-86)	
			LNA (76-86)	
		FORD	ESCORT IV (85-90)	
			ESCORT V (90-95)	
			ESCORT VI (95-01)	
			FIESTA I (76-86)	
			FIESTA II (83-95)	
			FIESTA III (89-97)	
			FIESTA IV (95-03)	
			ORION II (85-90)	
			ORION III (90-93)	
			SCORPIO I (85-94)	
		FORD USA	EXCURSION (99-05)	
			WINDSTAR (95-04)	
		JAGUAR	XJ (94-97)	
			XJ Coupe (73-96)	
			XJSC (85-96)	
		LANCIA	THEMA (84-94)	
		LDV	SHERPA (74-89)	
		MORRIS	ITAL (80-84)	
		PEUGEOT	104 (72-88)	
			205 I (83-94)	
			205 II (87-98)	
			305 I (77-82)	
			305 II (82-90)	
			505 (79-95)	
			604 (77-87)	
		PROTON	GEN 2 (04-)	
		RENAULT	5 (72-85)	
			14 (76-83)	
			18 (78-93)	
			20 (75-83)	
			25 (84-93)	
			30 (75-86)	
			FUEGO (80-85)	
			MASTER I (80-98)	
			SAFRANE I (92-96)	
			TRAFIC (89-01)	
			ROVER	2000-3500 (76-86)
			TALBOT	SAMBA (81-86)
	TAGORA (80-87)			
TVR	S (86-96)			
VOLVO	260 (74-82)			
	760 (81-92)			
	780 (86-90)			
T20EPR-U15	-	CHEVROLET	AVALANCHE (00-06)	
			LUMINA (89-94)	
			SILVERADO (99-07)	
		FORD USA	TAHOE (99-06)	
			EXPLORER (90-94)	
			PROBE I (88-93)	
		GMC	SIERRA (97-07)	
		MAZDA	6 (02-07)	
		MERCURY	Grand MARQUIS (91-97)	
		PONTIAC	TRANS SPORT (89-97)	
T20EP-U	T20TT	CITROËN	BX (82-94)	
			C15 (84-05)	

Свечи зажигания и Свечи накаливания

Руководство покупателя

DENSO P/N	TT	MAKE	MODEL		
T20EP-U продолжение			CX I (74-85)		
			CX II (85-92)		
			LNA (76-86)		
			VISA (78-91)		
		FORD	ESCORT III (80-86)		
		MERCEDES-BENZ	190 (W201) (82-93)		
			COUPE (C123) (77-85)		
			COUPE (C124) (87-93)		
			E-CLASS (124) (92-96)		
			G-CLASS (W460) (79-93)		
			G-CLASS (W461) (90-)		
			G-CLASS (W463) (89-)		
			KOMBI (S123) (77-85)		
			KOMBI (S124) (85-93)		
			Saloon (W123) (76-85)		
			Saloon (W124) (84-93)		
			S-CLASS (W126) (79-91)		
			SL (R107) (71-89)		
			SL (R129) (89-01)		
			T1 (601) (77-96)		
			T1 (602) (77-96)		
			T1 / TN (611) (81-95)		
			T2 / L (309, 310, 328) (68-88)		
			T2 / LN1 (86-94)		
			PEUGEOT	104 (72-88)	
		205 I (83-94)			
		205 II (87-98)			
		305 I (77-82)			
		305 II (82-90)			
		309 I (85-89)			
		504 (68-89)			
		PUCH	G-MODELL (W460) (79-92)		
			G-MODELL (W463) (89-00)		
		RENAULT	21 (86-95)		
			ESPACE I (84-92)		
			ESPACE II (91-96)		
			TRAFIC (89-01)		
		T20PR-U	ITF20TT	CADILLAC	FLEETWOOD (84-93)
				CHEVROLET	C2500 (96-01)
					CAMARO (92-02)
					C-K SERIE (94-00)
					SUBURBAN (91-00)
				TAHOE (94-96)	
		GMC	YUKON (91-00)		
		PONTIAC	FIREBIRD (92-02)		
		T20TT	-	ALPINE	A310 (71-84)
				ASTON MARTIN	DB9 (04-16)
VANQUISH (01-07)					
AUDI	100 (4A, C4) (90-94)				
	A6 (4A, C4) (94-97)				
	A8 (4D) (94-02)				
	V8 (44, 4C) (88-94)				
AUSTIN	AMBASSADOR (82-84)				
CITROËN	BX (82-94)				
	C15 (84-05)				
	CX I (74-85)				
	CX II (85-92)				
	GS (70-86)				
	LNA (76-86)				
	VISA (78-91)				
FORD	C-MAX I (07-10)				
	ESCORT III (80-86)				
	ESCORT IV (85-90)				
	ESCORT V (90-95)				
	ESCORT VI (95-01)				
	FIESTA I (76-86)				
	FIESTA II (83-95)				
	FIESTA III (89-97)				
	FIESTA IV (95-03)				
	FOCUS C-MAX (03-07)				
	FOCUS II (04-12)				

DENSO P/N	TT	MAKE	MODEL		
T20TT продолжение			GALAXY (06-15)		
			MAVERICK (01-)		
			MONDEO III (00-07)		
			MONDEO IV (07-15)		
			ORION II (85-90)		
			ORION III (90-93)		
			SCORPIO I (85-94)		
			S-MAX (06-14)		
			FORD USA	EXCURSION (99-05)	
				WINDSTAR (95-04)	
			T20TT	JAGUAR	S-TYPE (99-08)
			-		XF (08-15)
			T20TT		XJ (94-97)
			-		XJ (03-09)
				XJ Coupe (73-96)	
				XJSC (85-96)	
				XK 8 (96-05)	
		T20TT		X-TYPE (01-09)	
		-	LANCIA	THEMA (84-94)	
			LDV	SHERPA (74-89)	
			MAZDA	3 (00-09)	
				5 (05-10)	
				6 (02-07)	
				MPV II (99-06)	
				TRIBUTE (00-08)	
			MERCEDES-BENZ	190 (W201) (82-93)	
				COUPE (C123) (77-85)	
				COUPE (C124) (87-93)	
				E-CLASS (124) (92-96)	
				G-CLASS (W460) (79-93)	
				G-CLASS (W461) (90-)	
				G-CLASS (W463) (89-)	
				KOMBI (S123) (77-85)	
				KOMBI (S124) (85-93)	
				Saloon (W123) (76-85)	
				Saloon (W124) (84-93)	
				S-CLASS (W126) (79-91)	
			SL (R107) (71-89)		
			SL (R129) (89-01)		
			T1 (601) (77-96)		
			T1 (602) (77-96)		
			T1 / TN (611) (81-95)		
			T2 / L (309, 310, 328) (68-88)		
			T2 / LN1 (86-94)		
			MORGAN	ROADSTER (04-)	
			MORRIS	ITAL (80-84)	
			PEUGEOT	104 (72-88)	
	205 I (83-94)				
	205 II (87-98)				
	305 I (77-82)				
	305 II (82-90)				
	309 I (85-89)				
	504 (68-89)				
	505 (79-95)				
	604 (77-87)				
	PROTON	GEN 2 (04-)			
	PUCH	G-MODELL (W460) (79-92)			
		G-MODELL (W463) (89-00)			
	RENAULT	5 (72-85)			
		14 (76-83)			
		18 (78-93)			
		20 (75-83)			
		21 (86-95)			
		25 (84-93)			
		30 (75-86)			
		ESPACE I (84-92)			
		ESPACE II (91-96)			
		FUEGO (80-85)			
		MASTER I (80-98)			
	SAFRANE I (92-96)				
	TRAFIC (89-01)				

Свечи зажигания и Свечи накаливания

Руководство покупателя

DENSO P/N	TT	MAKE	MODEL	
T20TT		ROVER	2000-3500 (76-86)	
продолжение		SHELBY	SERIES 1 (98-)	
		TALBOT	SAMBA (81-86) TAGORA (80-87)	
		TVR	S (86-96)	
		VOLVO	260 (74-82)	
			760 (81-92)	
			780 (86-90)	
			C30 (06-12)	
			S40 II (04-12)	
			S80 II (06-)	
			V50 (04-12) V70 III (07-)	
	T22EP-U	-	ALPINE	V6 (85-90)
				CITROËN
			BX (82-94)	
			CX I (74-85)	
			CX II (85-92)	
VISA (78-91)				
DAIMLER			2.8 - 5.3 (69-93)	
			DAIMLER XJ (94-03)	
JAGUAR			XJ (68-93)	
			XJ Coupe (73-96)	
			XJSC (85-96)	
PEUGEOT			104 (72-88)	
			205 I (83-94)	
			205 II (87-98)	
			305 II (82-90)	
		309 I (85-89)		
		505 (79-95)		
RENAULT		21 (86-95)		
		25 (84-93)		
		ESPACE I (84-92)		
		ESPACE II (91-96)		
TV16TT		-	ALFA ROMEO	159 (05-11)
				BRERA (06-10)
				SPIDER (06-10)
		CADILLAC	CTS (02-07)	
			CTS (08-)	
			SRX (04-08)	
	STS (04-12)			
	CHEVROLET	CAPTIVA (06-)		
		TRAILBLAZER (01-08)		
	FIAT	CROMA (05-)		
	FORD	B-MAX (12-)		
		C-MAX I (07-10)		
C-MAX II (10-)				
COUGAR (98-01)				
ESCORT V (90-95)				
ESCORT VI (95-01)				
FIESTA III (89-97)				
FIESTA IV (95-03)				
FIESTA V (01-08)				
FIESTA VI (08-)				
FOCUS C-MAX (03-07)				
FOCUS I (98-05)				
FOCUS II (04-12)				
FOCUS III (10-)				
FUSION (02-12)				
Grand C-MAX (10-)				
KA (96-08)				
MAVERICK (01-)				
MONDEO I (93-96)				
MONDEO II (96-00)				
ORION III (90-93)				
P 100 (87-92)				
PUMA (97-02)				
TOURNEO Connect (02-13)				
TRANSIT Connect (02-13)				
FORD USA	ESCAPE (01-07)			
HUMMER	HUMMER H3 (05-)			

DENSO P/N	TT	MAKE	MODEL
TV16TT		MAZDA	2 (03-07)
продолжение			6 (02-07)
			6 (07-13)
			121 III (96-03)
			TRIBUTE (00-08)
		MORGAN	FOUR FOUR (68-)
			PLUS FOUR (85-)
		OPEL	ANTARA (06-)
			ASTRA G (98-09)
			SPEEDSTER (00-)
			VECTRA B (95-03)
			VECTRA C (02-08)
			ZAFIRA A (99-05)
		RENAULT	19 I (88-92)
		SUZUKI	Grand VITARA II (05-)
		VAUXHALL	ASTRA IV (G) (98-06)
	SPEEDSTER (VX220) (00-06)		
	VECTRA I (B) (95-03)		
	VECTRA II (C) (00-08)		
	ZAFIRA I (A) (98-05)		
	VOLVO	C30 (06-12)	
		S40 II (04-12)	
		V50 (04-12)	
	WESTFIELD	130 (97-)	
		ZE (93-97)	
U22ETR	-	ALFA ROMEO	147 (00-10)
U24ES-N	-	FERRARI	F40 (88-92)
VDCH22F	-	NISSAN	GT-R (09-)
		TOYOTA	AURIS (E18) (12-) C-HR (16-)
VDKH22F	-	LEXUS	GS (12-)
			IS III (13-)
			NX (14-)
			RC (14-)
			RX (15-)
VFK20F	IK20TT	CITROËN	C4 Aircross (12-)
			HONDA
	CIVIC VIII Hatchback (05-)		
	CR-Z (10-)		
	IK20TT	MITSUBISHI	OUTLANDER II (06-12)
PEUGEOT			4008 (12-)
VFXEH20E	IXEH20ETT	NISSAN	ALTIMA (12-) ROGUE (T32) (13-)
VFXEHC22G	-	DONGFENG HONDA	GIENIA (16-)
			GREIZ (15-)
			XR-V (14-)
		HONDA	ACCORD IX (12-)
			FIT IV (13-)
			FREED II (16-)
			GRACE (14-)
			JADE (15-)
			JAZZ IV (13-)
			N-BOX + (12-)
			N-ONE (12-)
	N-WGN (13-)		
	ODYSSEY (RC) (13-)		
	SHUTTLE (15-)		
	VEZEL (13-)		
	HONDA (GAC)	CITY (15-)	
		FIT IV (13-) VEZEL (13-)	
	NISSAN	JUKE (10-)	
		PULSAR (C13) (12-)	
		QASHQAI II (13-)	
		X-TRAIL (T32) (13-)	
	NISSAN (DFAC)	TIIDA (11-)	
	RENAULT	ESPACE V (15-)	
KADJAR (15-)			
MEGANE IV (15-)			
		TALISMAN (15-)	

Свечи зажигания и Свечи накаливания

Руководство покупателя

DENSO P/N	TT	MAKE	MODEL			
VFUHC22FG	-	DONGFENG HONDA	JADE (15-)			
			XR-V (14-)			
		HONDA	CIVIC IX (12-)			
			CIVIC X (16-)			
LEGEND V (14-)						
		HONDA (GAC)	VEZEL (13-)			
VK16	-	BMW	7 (E38) (94-01)			
			8 (E31) (90-99)			
		ROLLS-ROYCE	SILVER Seraph (98-02)			
VK20G	-	HONDA	LIFE (03-)			
VK20Y	-	CHEVROLET	AVEO (T300) (11-)			
			CAPTIVA (06-)			
			EVANDA (05-)			
			REZZO (05-)			
		DAIHATSU	COPEN (03-12)			
			MOVE (02-07)			
			TERIOS (97-05)			
			YRV (01-)			
		MERCEDES-BENZ	G-CLASS (W463) (89-)			
			S-CLASS (222) (13-)			
			S-CLASS (W220) (98-05)			
			S-CLASS (W221) (05-13)			
			S-CLASS Coupe (C215) (99-06)			
			S-CLASS Coupe (C216) (06-13)			
			S-CLASS Coupe / Convertible (217) (14-)			
			SL (R230) (01-12)			
			SL (R231) (12-)			
			OPEL	ADAM (12-)		
			CORSA D (06-14)			
		TOYOTA	CAMI (99-05)			
		VAUXHALL	CORSA III (D) (06-)			
		VW	CADDY III (2K, 2C) (04-15)			
			TOURAN (1T1, 1T2) (03-10)			
		VK22	-	ALPINA	B5 (E60, E61) (05-10)	
					B7 (E65) (03-08)	
				ALPINE	A610 (91-95)	
				AUDI	80 (89, 8A, B3) (86-91)	
					80 (8C, B4) (91-96)	
					90 (89, 8A, B3) (87-91)	
					100 (4A, C4) (90-94)	
					200 (44) (83-91)	
					A1 (8X) (10-18)	
					A3 (8P) (03-13)	
					A3 Convertible (8P7) (08-13)	
					A4 (8D, B5) (94-01)	
					A4 (8E, B7) (04-08)	
					A4 (8K, B8) (07-15)	
					A4 Allroad (8KH) (09-16)	
					A4 Convertible (8H, B6, B7) (02-09)	
					IK22FTT	A5 (8T, 8F) (07-17)
					-	A6 (4A, C4) (94-97)
					IK22FTT	A6 (4B, C5) (97-05)
					-	A6 (4F, C6) (04-11)
					IK22FTT	A6 (4G, C7) (10-18)
					-	A6 Allroad (4FH) (06-11)
						A8 (4E) (02-10)
						A8 (4H) (09-18)
	CABRIOLET (8G7) (91-00)					
	COUPE (89, 8B) (88-96)					
	Q3 (8U) (11-18)					
	Q5 (8R) (08-)					
IK22FTT	Q7 (4L) (06-15)					
-	QUATTRO (85) (80-91)					
IK22FTT	R8 (42) (07-15)					
-	R8 (4S) (15-)					
	TT (8J) (06-14)					
	TT (FV) (14-)					
	CATERHAM					
IK22FTT	CHEVROLET					
	AVEO (T300) (11-)					
	CRUZE (09-)					
	ORLANDO (11-)					

DENSO P/N	TT	MAKE	MODEL		
VK22			TRAX (12-)		
продолжение	-	CITROËN	AX (86-98)		
			BX (82-94)		
			XM (89-94)		
			DAIHATSU	OPTI (92-98)	
			FIAT	DUCATO (250, 290) (06-)	
				ELBA (85-97)	
				FIORINO (88-01)	
				PUNTO (93-00)	
				UNO (146) (83-00)	
			FORD	ESCORT V (90-95)	
				ESCORT VI (95-01)	
			GREAT WALL	HOVER H6 (11-)	
			HONDA	CIVIC V (91-97)	
				CIVIC VI (94-01)	
				CRX III (92-98)	
				SHUTTLE (94-04)	
			INNOCENTI	ELBA (91-96)	
			JAGUAR	XJ (94-97)	
			KTM	X-BOW (08-)	
			LAMBORGHINI	GALLARDO (03-)	
			LANCIA	DEDRA (89-99)	
				DELTA II (93-99)	
				THEMA (84-94)	
			LOTUS	2 ELEVEN (07-11)	
				ELISE (00-)	
				EXIGE (00-12)	
			MINI	MINI (R50, R53) (01-06)	
				MINI Convertible (R52) (04-07)	
			NISSAN	200 SX (93-99)	
			IK22FTT	OPEL	ADAM (12-)
					ASTRA J (09-)
					CASCADA (13-)
					CORSA D (06-14)
					CORSA E (14-)
					INSIGNIA (A) (08-17)
					MERIVA B (10-)
					MOKKA (12-)
					ZAFIRA Tourer C (11-)
			-	PEUGEOT	106 I (91-96)
					205 I (83-94)
					205 II (87-98)
					309 II (89-93)
					405 I (87-93)
		PORSCHE	911 (964) (88-94)		
			911 (993) (93-97)		
			911 (996) (97-05)		
			911 (997) (04-12)		
			BOXSTER (987) (04-11)		
	IK22FTT		CAYENNE (92A) (10-)		
			CAYENNE (955) (02-10)		
	-		CAYMAN (987) (05-12)		
	IK22FTT	RENAULT	PANAMERA (970) (09-)		
			CLIO III (05-)		
			ESPACE IV (02-)		
			LAGUNA II (01-)		
			LAGUNA III (07-)		
			MEGANE CC (10-)		
			MEGANE II (02-12)		
			MEGANE III (08-)		
			SAFRANE I (92-96)		
	-		TRAFIC II (01-)		
	IK22FTT		TWINGO II (07-)		
			VEL SATIS (02-)		
			WIND (10-)		
	-	SAAB	9-3 (02-15)		
			9-5 (97-09)		
		SEAT	ALHAMBRA (710) (10-)		
			ALTEA (XL) (5P) (04-)		
			CORDOBA (6K1) (93-99)		
			EXEO (3R) (08-)		

Свечи зажигания и Свечи накаливания

Руководство покупателя

DENSO P/N	TT	MAKE	MODEL
VK22			IBIZA II (6K1) (93-99)
продолжение			LEON (1P) (05-12)
			TOLEDO I (1L) (91-99)
			TOLEDO III (5P) (04-09)
	IK22FTT	SKODA	OCTAVIA II (1Z) (04-13)
			SUPERB II (3T) (08-15)
			YETI (5L) (09-)
	-	SPYKER	C8 (00-)
			C8 Aileron (10-)
	IK22FTT	SUBARU	IMPREZA (00-)
	-		LEGACY II (94-99)
	IK22FTT	VAUXHALL	ADAM (12-)
			ASTRA VI (J) (09-)
			CASCADA (13-)
			CORSA III (D) (06-)
			CORSA IV (E) (14-)
			INSIGNIA I (A) (08-17)
			MERIVA II (B) (10-)
			MOKKA (12-)
			ZAFIRA III (C) (11-)
	-	VOLVO	V70 I (96-00)
		VW	AMAROK (2H, S1) (10-)
			BEETLE (5C) (11-)
			CC (358) (11-)
			CORRADO (53I) (88-95)
			EOS (1F) (06-15)
			GOLF II (19, 1G) (83-92)
			GOLF III (1H, 1E) (91-99)
			GOLF V (1K) (03-09)
			GOLF VI (5K, AJ5) (08-14)
			GOLF VI Convertible (517) (11-16)
			JETTA II (19, 1G) (84-92)
			JETTA III (1K2) (05-10)
			JETTA IV (162) (10-)
			MULTIVAN V (7H, 7E) (03-)
			PASSAT (3A2, 35I) (88-97)
			PASSAT (3C) (05-11)
			PASSAT (362, 365) (10-14)
			PASSAT CC (357) (08-12)
			POLO (6R, 6C) (09-)
			SCIROCCO (53B) (80-92)
			SCIROCCO (137, 138) (08-17)
			SHARAN (7N) (10-)
			TIGUAN (5N) (07-)
			TRANSPORTER V (7H, 7E, 7J) (03-15)
VK22G	-	FORD	GALAXY (95-06)
			TRANSIT (94-00)
			TRANSIT Tourneo (94-00)
		HONDA	CIVIC VI (94-01)
			CIVIC VII (00-05)
			CIVIC VIII Hatchback (05-)
			INTEGRA (93-01)
			INTEGRA (02-)
			S2000 (99-)
		SAAB	9-5 (97-09)
VKA16	-	AUDI	A3 (8P) (03-13)
			A4 (8E, B6) (00-04)
		MITSUBISHI	DIAMANTE (99-05)
		SEAT	ALTEA (XL) (5P) (04-)
			LEON (1P) (05-12)
			TOLEDO III (5P) (04-09)
		SKODA	OCTAVIA II (1Z) (04-13)
		VW	EOS (1F) (06-15)
			GOLF Plus (5M, 521) (05-14)
			GOLF V (1K) (03-09)
			JETTA III (1K2) (05-10)
			PASSAT (3C) (05-11)
			TOURAN (1T1, 1T2) (03-10)
VKA20	-	BENTLEY	CONTINENTAL (03-)
		TOYOTA	ALLION I (01-07)
			AVENSIS (97-03)

DENSO P/N	TT	MAKE	MODEL
VKA20			CALDINA (T24) (02-07)
продолжение			GAIA (98-03)
			ISIS (04-)
			NADIA (98-03)
			NOAH / VOXY (01-07)
			OPA (00-05)
			VISTA (V5) (98-03)
VKB16	-	MITSUBISHI	GALANT VI (96-04)
			PAJERO III (00-07)
			PAJERO Pinin (99-07)
			SPACE RUNNER (99-02)
			SPACE WAGON (98-04)
VKB20	-	AUDI	A4 (8E, B7) (04-08)
			A4 Convertible (8H, B6, B7) (02-09)
			A5 (8T, 8F) (07-17)
			A6 (4F, C6) (04-11)
			A6 Allroad (4FH) (06-11)
			A8 (4E) (02-10)
			A8 (4H) (09-18)
			Q7 (4L) (06-15)
			R8 (42) (07-15)
		FAW-AUDI	A6L (C6) (05-11)
		MITSUBISHI	CARISMA (95-06)
			PAJERO Pinin (99-07)
			SPACE STAR (98-04)
		TOYOTA	AVENSIS (03-09)
			BREVIS (99-07)
			CHASER (X10) (96-01)
			MARK II (02-07)
			PROGRES (97-07)
			VEROSSA (00-03)
		VOLVO	S40 I (95-03)
			V40 (95-04)
		VW	TOUAREG (7L) (02-10)
			TOUAREG (7P) (10-18)
VKH20Y	-	FORD	MONDEO IV (07-15)
		LAND ROVER	FREELANDER II (06-14)
		MERCEDES-BENZ	C-CLASS (203) (00-07)
			C-CLASS (204) (07-14)
			C-CLASS Coupe (CL203) (01-08)
			CLK (209) (02-10)
			CLS (C219) (04-10)
			E-CLASS (211) (02-09)
			G-CLASS (W463) (89-)
			S-CLASS (W220) (98-05)
			S-CLASS Coupe (C215) (99-06)
			SL (R230) (01-12)
			SLK (R171) (04-11)
			SLR (R199) (04-)
		MITSUBISHI	COLT CZC (06-09)
			COLT VI (04-12)
		SUBARU	FORESTER (02-08)
			FORESTER (08-)
			IMPREZA (00-)
			IMPREZA (08-)
			IMPREZA (11-)
			LEGACY IV (03-09)
			LEGACY V (09-14)
			OUTBACK (03-09)
			TRIBECA (05-)
		TOYOTA	CROWN Comfort (08-)
			TOYOACE (11-)
		VOLVO	S60 I (00-10)
			S80 I (98-06)
			S80 II (06-)
			V70 II (00-07)
			V70 III (07-)
			XC60 I (08-)
			XC70 II (07-)
			XC90 I (02-14)
VKH22	-	AUDI	A3 (8P) (03-13)

Свечи зажигания и Свечи накаливания

Руководство покупателя

DENSO P/N	TT	MAKE	MODEL		
VKH22 продолжение		FORD	TT (8J) (06-14)		
			FOCUS II (04-12)		
			KUGA I (08-12)		
			MONDEO IV (07-15)		
		LOTUS	EVORA (09-)		
			EXIGE (12-)		
		MITSUBISHI	LANCER Evo IX (05-07)		
		PORSCHE	911 (991) (11-)		
			911 (997) (04-12)		
			BOXSTER (981) (12-)		
			BOXSTER (987) (04-11)		
			CAYENNE (92A) (10-)		
			CAYENNE (955) (02-10)		
			CAYMAN (981) (13-)		
			CAYMAN (987) (05-12)		
			MACAN (14-)		
			PANAMERA (970) (09-)		
			SUBARU	FORESTER (02-08)	
		FORESTER (08-)			
		IMPREZA (00-)			
		IMPREZA (08-)			
		LEGACY IV (03-09)			
		VOLVO	LEGACY V (09-14)		
			C30 (06-12)		
			C70 II (06-13)		
			S40 II (04-12)		
			S60 I (00-10)		
			S60 II (10-)		
			S80 II (06-)		
			V50 (04-12)		
			V70 II (00-07)		
			V70 III (07-)		
			XC60 I (08-)		
		XC70 II (07-)			
		XC90 I (02-14)			
		VQ22	-	ALFA ROMEO	155 (92-97)
				ASTON MARTIN	DB7 (94-03)
				CATERHAM	21 (94-02)
				CITROËN	AX (86-98)
					BX (82-94)
					VISA (78-91)
					XM (89-94)
					ZX (91-98)
				FIAT	ELBA (85-97)
					PUNTO (93-00)
					SCUDO (220) (96-06)
					TEMPRA (90-96)
TIPO (160) (87-95)					
FORD	ESCORT III (80-86)				
	ESCORT IV (85-90)				
	FIESTA I (76-86)				
	ORION I (83-86)				
LANCIA	ORION II (85-90)				
	DEDRA (89-99)				
NISSAN	300 ZX (84-90)				
PEUGEOT	205 II (87-98)				
	306 (93-02)				
	309 I (85-89)				
	605 (89-99)				
	EXPERT (96-06)				
SAAB	9-3 (98-03)				
	9-5 (97-09)				
	900 I (78-94)				
	900 II (93-98)				
	9000 (84-98)				
SEAT	IBIZA I (84-93)				
	MALAGA (84-93)				
	RONDA (82-88)				
VW20	IW20TT	MITSUBISHI	LANCER VII (03-)		
VW20T	IW20TT	TOYOTA	CROWN Comfort (95-08)		

DENSO P/N	TT	MAKE	MODEL
VW22	-	ABARTH	RITMO (78-88)
		ALFA ROMEO	33 (83-93)
			33 (90-94)
			75 (85-92)
			90 (84-87)
			145 / 146 (94-01)
			155 (92-97)
			164 (87-98)
			166 (98-07)
			1750-2000 (68-75)
			ALFASUD (72-89)
			ALFETTA (74-84)
			ALFETTA GT (74-86)
			AR 6 (79-89)
			ARNA (83-86)
			GIULIA (62-79)
		GIULIETTA (77-85)	
		GT (63-77)	
		GTV (78-87)	
		GTV (95-05)	
		RZ (92-94)	
		SPIDER (66-77)	
		SPIDER (71-93)	
		SPIDER (94-05)	
		SZ (88-94)	
		ASTON MARTIN	V8 (69-93)
			ZAGATO (86-89)
		AUDI	80 (81, 85, B2) (78-86)
			100 (43, C2) (76-83)
			200 (43) (79-82)
			COUPE (81, 85) (80-88)
		QUATTRO (85) (80-91)	
		AUTOBIANCHI	A 112 (69-85)
		BEDFORD	ASTRA VAN (82-91)
		FERRARI	400 i (79-85)
			DINO GT4 (74-80)
		FIAT	124 (66-85)
			125 (67-74)
			126 (72-00)
			COUPE (93-00)
			CROMA (85-96)
			ELBA (85-97)
			FIORINO (88-01)
			REGATA (83-90)
			RITMO (78-88)
			RITMO Bertone (79-89)
			TEMPRA (90-96)
TIPO (160) (87-95)			
UNO (146) (83-00)			
FORD	CAPRI (68-74)		
	CAPRI (74-77)		
	CAPRI (78-87)		
	ESCORT II (73-81)		
	GRANADA (72-85)		
	SCORPIO I (85-94)		
	SIERRA (82-87)		
	SIERRA (87-93)		
	FSO	POLONEZ I (77-91)	
POLONEZ II (88-92)			
POLONEZ III (92-02)			
GEO	METRO (88-98)		
HONDA	CIVIC III (83-87)		
	CIVIC IV (87-95)		
	CRX I (83-87)		
INNOCENTI	ELBA (91-96)		
	KORAL (90-92)		
LADA	110 (2110) (95-12)		
	SAMARA (2108, 2109, 2113, 2114, 2115) (86-13)		
	DELTA I (79-94)		
LANCIA	DEDRA (89-99)		
	DELTA II (93-99)		

Свечи зажигания и Свечи накаливания

Руководство покупателя

DENSO P/N	TT	MAKE	MODEL	
VXU22 продолжение	IXU22TT		PAJERO Mini (94-12)	
	-	NISSAN	MOCO I (02-06) MOCO II (06-10)	
	IXU22TT	OPEL	COMBO D (12-)	
	-	PORSCHE	911 (996) (97-05)	
			911 (997) (04-12)	
			SUZUKI	ALTO IV (02-08)
				CAPPUCINO (92-98)
				EVERY (05-15)
				MR Wagon (01-06)
				MR Wagon (06-13)
				WAGON R (97-03)
				WAGON R (08-12)
				WAGON R+ (98-00)
	TATA	INDICA Vista (08-)		
		INDIGO (03-)		
	VAUXHALL	COMBO III (D) (11-)		
	IXU22TT	WIESMANN	MF3 Roadster (96-)	
	VXU22I	-	ZASTAVA	10 (05-)
		-	DAIHATSU	BEGO (05-)
COPEN (03-12)				
EXTOL (00-)				
MATERIA (06-)				
SIRION (05-)				
TERIOS (05-)				
YRV (01-)				
PERODUA				ALZA (09-)
		MYVI (06-11)		
SUBARU		JUSTY IV (07-)		
TOYOTA		AVANZA (F6) (03-11)		
		RUSH (06-)		
VXU24		-	ALPINA	ROADSTER S (Z4) (03-05)
	BMW		3 (E46) (98-06)	
			Z3 (E36) (95-03)	
			Z4 (E85, E86) (03-09)	
	FIAT	ALBEA / SIENA (96-11)		
		BRAVA (95-02)		
		BRAVO I (95-01)		
		IDEA (03-)		
		MAREA (96-07)		
		PALIO (96-)		
		PUNTO (93-00)		
		PUNTO (99-12)		
		STILO (01-08)		
		LANCIA	Y (95-03)	
			YPSILON (843) (03-11)	
	MASERATI	BITURBO (81-94)		
		SHAMAL (89-95)		
	NANJING FIAT	PALIO (03-05)		
	TVR	CERBERA (96-03)		
	WIESMANN	MF3 Roadster (96-)		
	VXUH20I	-	DAIHATSU	CAST (15-)
				HIJET (15-)
				MIRA VII (06-)
				MOVE (08-10)
				MOVE (10-14)
				MOVE (14-)
				MOVE Conte (08-)
				TANTO (07-13)
TANTO (13-)				
WAKE (14-)				
HYUNDAI				ACCENT IV / SOLARIS (10-)
				EQUUS / CENTENNIAL (09-)
				GENESIS (08-)
				i10 (07-13)
				i10 (13-)
				i20 (08-15)
		i20 (14-)		
		i20 Coupe (15-)		
		i30 (11-)		
		i30 (16-)		

DENSO P/N	TT	MAKE	MODEL	
VXUH20I продолжение			i30 Coupe (13-)	
			i40 (11-)	
			ix35 (09-)	
			ix55 (06-)	
			TUCSON (15-)	
			VELOSTER (11-)	
		KIA	CARENS IV (13-)	
			CEED (12-)	
			OPIRUS (03-)	
			OPTIMA (10-)	
			PICANTO (11-)	
			PRO CEED (13-)	
			RIO III (11-)	
			RIO IV (17-)	
			SOUL I (09-)	
			SOUL II (14-)	
		SPORTAGE III (10-)	SPORTAGE IV (15-)	
			LANCER VIII (07-)	
		OUTLANDER III (12-)		
		OPEL	AMPERA (11-)	
		SUBARU	LUCRA (10-)	
			PLEO (10-)	
			SAMBAR (12-)	
			STELLA (12-)	
		SUZUKI	BALENO (16-)	
			IGNIS (16-)	
	VXUH22	-	CATERHAM	SUPER SEVEN (80-)
			FIAT	500 (C) (312) (07-)
				PANDA (12-)
				MAZDA
				CAROL (10-)
IXUH22TT				CAROL (15-)
-			SCRUM (05-15)	
		IXUH22TT	MERCEDES-BENZ	C-CLASS (203) (00-07)
				C-CLASS (204) (07-14)
				C-CLASS Coupe (C204) (11-)
				C-CLASS Coupe (CL203) (01-08)
				CLC (CL203) (08-11)
				CLK (209) (02-10)
				CLS (C219) (04-10)
				E-CLASS (211) (02-09)
				E-CLASS (212) (09-)
				E-CLASS Coupe / Convertible (207) (09-)
		G-CLASS (W463) (89-)		
		GL-CLASS (X164) (06-)		
		GLK (X204) (08-15)		
		M-CLASS (W164) (05-11)		
		R-CLASS (251) (06-)		
		S-CLASS (W221) (05-13)		
		S-CLASS Coupe (C216) (06-13)		
		SL (R230) (01-12)		
		SLK (R171) (04-11)		
		SLK (R172) (11-)		
		SPRINTER 3,5-t (906) (06-)		
		SPRINTER 3-t (906) (06-)		
		SPRINTER 4,6-t (906) (06-)		
		SPRINTER 5-t (906) (06-)		
		VIANO (W639) (03-)		
		VITO / MIXTO (W639) (03-)		
	-	NISSAN	MOCO II (06-10)	
	IXUH22TT	SUZUKI	ALTO VI (14-)	
			CARRY (99-)	
			EVERY (05-15)	
			MR Wagon (06-13)	
			WAGON R (08-12)	
		WAGON R (12-)		
VXUH22I	IXUH22TT	AUDI	A8 (4H) (09-18)	
		BMW	1 (F20, F21) (10-)	
			3 (F30, F31) (11-19)	
		CITROËN	BERLINGO (B9) (08-)	

Свечи зажигания и Свечи накаливания

Руководство покупателя

DENSO P/N	TT	MAKE	MODEL
VXUH22I	-		C1 II (14-)
продолжение			C3 Aircross (17-)
	IXUH22TT		C3 II (09-)
	-		C3 III (16-)
	IXUH22TT		C3 Picasso (09-)
			C4 (Grand) Picasso I (06-13)
			C4 (Grand) Picasso II (13-)
	-		C4 Cactus (14-)
	IXUH22TT		C4 Coupe (04-11)
			C4 I (LC, LR) (04-11)
			C4 II (B7, NC) (09-)
			C5 III (08-)
			C-ELYSEE (12-)
	IXUH22TT		DS3 (09-15)
			DS4 (11-15)
			DS5 (11-15)
		DODGE	JOURNEY (08-)
	-	DS	DS3 (15-)
		HYUNDAI	ACCENT IV / SOLARIS (10-)
	IXUH22TT		CRETA (16-)
	-		ELANTRA (05-11)
	IXUH22TT		ELANTRA (11-)
			ELANTRA (15-)
			EQUUS / CENTENNIAL (09-)
			GENESIS (08-)
			GENESIS (14-)
	-		i20 (08-15)
			i30 (07-12)
			i30 (11-)
			i30 Coupe (13-)
	IXUH22TT		i40 (11-)
	-		ix20 (10-)
	IXUH22TT		ix35 (09-)
			ix55 (06-)
			SANTA FÉ III (12-)
			SONATA VI (09-15)
			SONATA VII (14-)
			TUCSON (15-)
			VELOSTER (11-)
	-	KIA	CARENS III (06-)
	IXUH22TT		CARENS IV (13-)
	-		CEED (06-12)
			CEED (12-)
	IXUH22TT		CERATO (18-)
	-		CERATO (04-)
	IXUH22TT		CERATO (09-)
			OPIRUS (03-)
			OPTIMA (10-)
			OPTIMA (15-)
	-		PRO CEED (08-13)
			PRO CEED (13-)
			RIO III (11-)
	IXUH22TT		SORENTO II (09-)
			SORENTO III (15-)
	-		SOUL I (09-)
	IXUH22TT		SOUL II (14-)
			SOUL III (19-)
			SPORTAGE III (10-)
			SPORTAGE IV (15-)
	-		VENGA (10-)
		MERCEDES-BENZ	C-CLASS (203) (00-07)
	IXUH22TT		C-CLASS (204) (07-14)
	-		C-CLASS Coupe (CL203) (01-08)
			CLC (CL203) (08-11)
			CLK (209) (02-10)
	IXUH22TT		CLS (C219) (04-10)
			E-CLASS (211) (02-09)
	-		E-CLASS (212) (09-)
	IXUH22TT		E-CLASS Coupe / Convertible (207) (09-)
	-		G-CLASS (W463) (89-)
			GL-CLASS (X164) (06-)

DENSO P/N	TT	MAKE	MODEL
VXUH22I			GLK (X204) (08-15)
продолжение			M-CLASS (W164) (05-11)
			R-CLASS (251) (06-)
			S-CLASS (W221) (05-13)
			S-CLASS Coupe (C216) (06-13)
			SL (R230) (01-12)
			SLK (R171) (04-11)
			SPRINTER 3,5-t (906) (06-)
			SPRINTER 3-t (906) (06-)
			SPRINTER 4,6-t (906) (06-)
			SPRINTER 5-t (906) (06-)
			VIANO (W639) (03-)
			VITO / MIXTO (W639) (03-)
	IXUH22TT	MINI	MINI (R56) (06-13)
			MINI Clubman (R55) (07-14)
			MINI Convertible (R57) (07-15)
			MINI Countryman (R60) (10-16)
			MINI Coupe (R58) (10-15)
			MINI Paceman (R61) (12-16)
			MINI Roadster (R59) (11-15)
	-	MITSUBISHI	i-MiEV (06-)
			OUTLANDER II (06-12)
			PAJERO Sport II (08-)
		PEUGEOT	108 (14-)
	IXUH22TT		207 (06-)
			208 I (12-)
	-		301 (12-)
			308 CC (07-)
	IXUH22TT		308 I (07-)
			308 II (13-)
			508 I (10-)
			2008 (13-)
			3008 (09-)
			5008 I (09-)
			PARTNER / RANCH (08-)
			RCZ (10-)
		PGO	CEVENNES (06-)
			HAMERA (08-)
			SPEEDSTER (10-)
	-	SMART	FORFOUR I (454) (04-06)
			FORTWO (451) (07-)
		SUZUKI	SWIFT V (17-)
		TOYOTA	AYGO (14-)
VXUHC22G	-	ACURA	MDX (06-)
			TL (09-)
			ZDX (10-)
		AUDI	Q7 (4L) (06-15)
		CHRYSLER	300 C (11-)
			Grand VOYAGER V (07-)
		DODGE	AVENGER (07-14)
			CHALLENGER (07-)
			CHARGER (11-)
			DURANGO (11-)
			JOURNEY (08-)
		FIAT	FREEMONT (11-)
		HONDA	ACCORD IX (12-)
			ACCORD VIII (08-)
			CROSSTOUR (09-)
			CR-V IV (12-)
			LEGEND IV (06-12)
			PILOT (08-)
		JEEP	Grand CHEROKEE IV (10-)
			WRANGLER III (07-)
		LANCIA	THEMA (11-)
			VOYAGER (11-14)
		PORSCHE	CAYENNE (955) (02-10)
		RAM	1500 (DS) (10-)
		SUZUKI	BALENO (16-)
			SX4 S-Cross (13-)
			VITARA (15-)
		VW	EOS (1F) (06-15)

Свечи зажигания и Свечи накаливания

Руководство покупателя

DENSO P/N	TT	MAKE	MODEL			
VXUHC22G продолжение			PASSAT (3C) (05-11)			
			PASSAT CC (357) (08-12)			
			PHAETON (3D) (02-16)			
			TOUAREG (7L) (02-10)			
			TOUAREG (7P) (10-18)			
W14EPR-U	IW16TT	NISSAN	CHERRY I (E10) (70-78)			
			CHERRY II (N10) (78-83)			
			DATSUN 100 A (74-80)			
			DATSUN 120 (74-80)			
			DATSUN 120 Y (62-80)			
			SUNNY (70-82)			
		RENAULT	19 II (92-01)			
			CLIO I (90-98)			
			FUEGO (80-85)			
			RAPID (85-98)			
			SUPER 5 (84-96)			
			W14EXR-U	IW16TT	TOYOTA	LAND CRUISER (J60) (81-89)
						W14EXR-U11
TOYOTA	CARINA II (83-92)					
	CELICA (77-81)					
	CELICA (85-89)					
	COROLLA (E8) (83-89)					
	COROLLA FX (84-88)					
	TERCEL (79-88)					
W14EX-U	IW16TT	TOYOTA	LAND CRUISER (J40) (69-86)			
W14FR-U	-	UAZ	452 (66-)			
			469 B (71-)			
			3160 (94-03)			
			BUKHANKA (3741) (85-)			
			FARMER (3909) (85-)			
			GOLOVASTIK (3303) (85-)			
			HUNTER (3151) (92-)			
			TREKOL (39041) (88-)			
			W14F-U	-	GAZ	66 (64-98)
						VOLGA (21) (56-70)
						VOLGA (24) (67-92)
UAZ	452 (66-)					
	469 B (71-)					
	3160 (94-03)					
	BUKHANKA (3741) (85-)					
	FARMER (3909) (85-)					
	GOLOVASTIK (3303) (85-)					
	HUNTER (3151) (92-)					
TREKOL (39041) (88-)						
W16EKR-S11	W16TT	HONDA	CIVIC III (83-87)			
			CRX I (83-87)			
ROVER	200 (XH) (85-89)					
	W16EPB10	W16TT	AUDI	80 (81, 85, B2) (78-86)		
80 (89, 8A, B3) (86-91)						
100 (44, C3) (82-91)						
VW	LUPU (6X, 6E) (98-05)					
	PASSAT (32B) (80-91)					
	SANTANA (81-85)					
	VENTO (1H2) (91-98)					
	W16EPR-U	W16TT	ALPINA	B6 (E21) (78-83)		
B6 (E30) (83-90)						
B7 (E12) (78-82)						
B7 (E24) (78-88)						
B7 (E28) (84-87)						
B9 (E24) (82-85)						
B9 (E28) (81-85)						
ARO				10 (80-06)		
				SPARTANA (99-06)		
ASIA MOTORS			ROCSTA (89-99)			
AUSTIN			METRO (80-90)			
BENTLEY			CONTINENTAL (84-95)			
			CONTINENTAL (91-02)			
			TURBO R (88-98)			
BMW			02 (E6, E10) (67-77)			
			3 (E21) (75-84)			

DENSO P/N	TT	MAKE	MODEL
W16EPR-U продолжение			3 (E30) (82-94)
			5 (E12) (72-81)
			5 (E28) (81-87)
			6 (E24) (76-90)
			7 (E23) (77-86)
			1500-2000 (62-72)
			1600 GT (67-69)
			2000 (E9) (65-76)
			2500 (E3) (68-77)
			CHRYSLER
VOYAGER II (90-95)			
VOYAGER III (95-01)			
DACIA	NOVA (96-03)		
DAEWOO	KALOS (02-)		
	MATIZ (98-04)		
TICO (95-00)			
DAIMLER	2.8 - 5.3 (69-93)		
	COUPE (73-77)		
	LANDAULETTE (74-91)		
LIMOUSINE (68-91)			
DODGE	CARAVAN (95-02)		
FIAT	DUCATO (280) (82-90)		
	DUCATO (290) (89-94)		
GAZ	GAZELLE (2705, 3221, 3302) (93-02)		
	GAZELLE (03-13)		
	SOBOL (2217, 2310, 2752) (97-)		
	VOLGA (3102) (72-09)		
	VOLGA (3110, 3111) (93-10)		
GEO	TRACKER (88-98)		
HONDA	PRELUDE I (78-82)		
	QUINTET (80-84)		
INNOCENTI	MINI (74-95)		
JAGUAR	E-TYPE 2+2 (66-75)		
	E-TYPE (61-75)		
	Mk X (61-70)		
XJ (68-93)			
JEEP	CHEROKEE (80-86)		
LAND ROVER	88 / 109 (61-86)		
	90 / 110 (83-90)		
	DEFENDER (90-16)		
	RANGE ROVER I (70-95)		
LDV	SHERPA (74-89)		
MARUTI	800 (83-06)		
MAZDA	121 I (87-90)		
	121 II (90-97)		
	323 C IV (89-00)		
	323 I (77-86)		
	323 II (80-89)		
	323 S IV (89-94)		
	616 (73-78)		
	626 I (78-82)		
	626 II (82-87)		
	626 III (87-97)		
B-SERIE (77-82)			
B-SERIE (85-99)			
E-SERIE (80-84)			
MERCEDES-BENZ	PULLMANN (64-79)		
	S-CLASS (W108, W109) (66-72)		
	S-CLASS (W116) (72-80)		
MG	MIDGET (64-79)		
MITSUBISHI	COLT I (78-84)		
	COLT V (95-03)		
	GALANT II (80-84)		
	GALANT III (84-90)		
	L 300 (80-87)		
	L 300 (86-06)		
	LANCER I (79-83)		
	LANCER II (83-84)		
	LANCER III (83-92)		
	PAJERO I (82-91)		
	NISSAN	CABSTAR (F23) (92-00)	

Свечи зажигания и Свечи накаливания

Руководство покупателя

DENSO P/N	TT	MAKE	MODEL
W16EPR-U			CHERRY II (N10) (78-83)
продолжение			CHERRY III (N12) (82-86)
			LAUREL (77-83)
			LAUREL (81-85)
			LAUREL (84-89)
			MICRA I (K10) (82-92)
			PATROL (84-96)
			PATROL GR I (87-98)
			PICK UP (720) (80-86)
			PICK UP (D21) (85-98)
			SUNNY I (82-90)
			SUNNY II (86-91)
			TERRANO I (87-96)
			URVAN (81-98)
			VANETTE (C12) (81-87)
			VANETTE (C22) (86-95)
		OPEL	ASCONA C (81-88)
			CALIBRA (90-97)
			COMBO E (18-)
			COMMODORE C (78-82)
			CORSA A (82-93)
			CORSA B (93-02)
			OMEGA A (86-94)
			VECTRA A (88-95)
		PLYMOUTH	SUNDANCE (86-94)
			VOYAGER (95-01)
		PROTON	JUMBUCK (02-)
			SATRIA (96-06)
			WIRA (00-)
		RELIANT	KITTEN (75-83)
		RENAULT	11 (83-88)
			16 (65-80)
			19 I (88-92)
			19 II (92-01)
			CLIO I (90-98)
			ESPACE III (96-02)
			MEGANE I (96-03)
			RAPID (85-98)
		ROVER	MINI-Moke (86-93)
		SUZUKI	ALTO II (86-93)
			CARRY (80-85)
			LJ 80 (77-84)
			SAMURAI (88-04)
			SJ 410 (81-88)
			SJ 413 (84-90)
			SUPER CARRY (85-99)
			VITARA (88-99)
		TRIUMPH	2000 (68-77)
			2500 (74-77)
			SPITFIRE (62-80)
			STAG (70-77)
		UAZ	452 (66-)
			469 B (71-)
			3160 (94-03)
			BARS (3159) (99-)
			BUKHANKA (3741) (85-)
			CARGO (2360) (04-)
			FARMER (3909) (85-)
			GOLOVASTIK (3303) (85-)
			HUNTER (3151) (92-)
			PATRIOT (04-)
			SIMBIR (3162) (97-)
		VAUXHALL	CALIBRA (90-97)
			CARLTON III (86-94)
			CAVALIER II (81-88)
			CAVALIER III (88-95)
			CORSA I (B) (93-00)
			RASCAL (86-93)
		VOLVO	340-360 (75-91)
		VW	CADDY I (14) (82-92)
			GOLF I (17, 155) (74-93)

DENSO P/N	TT	MAKE	MODEL
W16EPR-U			JETTA I (16) (78-84)
продолжение			PASSAT (3A2, 35I) (88-97)
			PASSAT (32B) (80-91)
		ZASTAVA	YUGO (80-95)
W16EPR-U11	W16TT	CHEVROLET	AVEO / KALOS (T250, T255) (05-)
			SPARK (00-04)
			SPARK (05-)
		DAEWOO	TICO (95-00)
		KIA	AVELLA (95-01)
			PRIDE (90-)
			SEPHIA (93-97)
		MAZDA	121 I (87-90)
			323 S IV (89-94)
			929 III (87-91)
		MITSUBISHI	COLT III (88-92)
			COLT IV (92-96)
			COLT V (95-03)
			LANCER III (83-92)
			LANCER IV (88-94)
			LANCER V (91-03)
			LANCER VI (95-03)
			MIRAGE (91-03)
			PAJERO I (82-91)
			PAJERO II (90-00)
		NISSAN	BLUEBIRD (85-92)
			CHERRY II (N10) (78-83)
			SUNNY II (86-91)
		PROTON	PERSONA 400 (94-03)
		SUBARU	REX II (81-89)
		SUZUKI	SWIFT II (89-05)
W16EP-U	W16TT	BMW	02 (E6, E10) (67-77)
			3 (E21) (75-84)
			3 (E30) (82-94)
			5 (E12) (72-81)
			5 (E28) (81-87)
			6 (E24) (76-90)
			1500-2000 (62-72)
			1600 GT (67-69)
			2000 (E9) (65-76)
		MITSUBISHI	COLT III (88-92)
		NISSAN	PICK UP (D21) (85-98)
		PORSCHE	928 (77-95)
		RENAULT	19 I (88-92)
			19 II (92-01)
			TRAFIC (80-89)
			TWINGO I (93-07)
		SUZUKI	SUPER CARRY (85-99)
		VW	CADDY I (14) (82-92)
			GOLF I (17, 155) (74-93)
			JETTA I (16) (78-84)
			PASSAT (32, 33) (73-80)
			SCIROCCO (53) (74-80)
			SCIROCCO (53B) (80-92)
W16ESR-U	-	LAND ROVER	90 / 110 (83-90)
		VW	TRANSPORTER II (67-79)
			TRANSPORTER III (79-92)
W16ETR-S	W16TT	AUDI	80 (8C, B4) (91-96)
			90 (89, 8A, B3) (87-91)
			100 (4A, C3) (82-91)
			100 (4A, C4) (90-94)
			A6 (4A, C4) (94-97)
			CABRIOLET (867) (91-00)
			COUPE (81, 85) (80-88)
			COUPE (89, 8B) (88-96)
		VW	GOLF III (1H, 1E) (91-99)
			GOLF IV (1J, 1E) (97-06)
			PASSAT (3A2, 35I) (88-97)
			TRANSPORTER IV (70X, 7D) (90-03)
W16EXR-U	W16TT	DAIHATSU	1000 (86-97)
			CHARADE I (77-83)
			CHARADE II (83-87)

Свечи зажигания и Свечи накаливания

Руководство покупателя

DENSO P/N	TT	MAKE	MODEL		
W16EXR-U продолжение			CHARADE III (87-93)		
			CHARADE IV (93-00)		
			CHARMANT (81-87)		
			DELTA (89-01)		
			HIJET (86-90)		
			HIJET (92-)		
			MIDGET (93-02)		
			ROCKY (85-98)		
			RUGGER (84-93)		
			SPARCAR (83-86)		
			HONDA	ACCORD I (78-83)	
			ACCORD II (83-85)		
			INNOCENTI	MINI (74-95)	
			LAND ROVER	DEFENDER (90-16)	
				RANGE ROVER I (70-95)	
				RANGE ROVER II (94-02)	
			MAZDA	323 F IV (87-94)	
				323 I (77-86)	
				323 III (85-95)	
				626 II (82-87)	
				626 III (87-97)	
				E-SERIE (SD) (83-04)	
				E-SERIE (SR) (83-04)	
				NISSAN	CABSTAR (F22) (82-93)
			CABSTAR (F23) (92-00)		
			NAVARA (D21) (86-08)		
			URVAN (81-98)		
			VANETTE (C22) (86-95)		
			PERODUA	KANCIL (94-)	
			RENAULT	RAPID (85-98)	
			SANTANA	SAMURAI (86-95)	
			SUZUKI	ALTO I (82-85)	
				ALTO III (93-02)	
				CARRY (95-99)	
				SAMURAI (88-04)	
				SJ 413 (84-90)	
				SUPER CARRY (85-99)	
				SWIFT I (83-89)	
				SWIFT II (89-05)	
				TOYOTA	4 RUNNER (N5) (87-89)
					CAMRY (V1) (83-88)
					CAMRY (V2) (86-91)
					CARINA (73-83)
					CARINA II (83-92)
					CELICA (73-78)
			CELICA (77-81)		
			CELICA (81-85)		
			CELICA (85-89)		
			COROLLA (E7) (79-87)		
			COROLLA (E8) (83-89)		
			COROLLA (KE) (72-80)		
			COROLLA FX (84-88)		
			CORONA (T1) (70-87)		
			CORONA (T14) (70-88)		
			CRESSIDA (77-81)		
			CRESSIDA (80-93)		
			CROWN (80-85)		
			DYNA 200 (88-95)		
			HIACE I (77-85)		
			HIACE II (83-89)		
			HIACE III (87-04)		
			HILUX I (72-83)		
			HILUX II (83-05)		
			LAND CRUISER (J80) (90-98)		
			LAND CRUISER / PRADO (J70) (84-06)		
			LITEACE (84-92)		
			LITEACE (92-97)		
			MODELL F (82-90)		
			STARLET (P6) (78-84)		
			STARLET 1000 (74-78)		
			TERCEL (79-88)		

DENSO P/N	TT	MAKE	MODEL
W16EXR-U продолжение			TOWN ACE (92-01)
		VW	TARO (89-97)
W16EXR-U11	W16TT	BEDFORD	KB (72-88)
			MIDI (84-92)
		CHRYSLER	VOYAGER I (87-90)
			VOYAGER III (95-01)
			VOYAGER IV (00-08)
		DAEWOO	MATIZ (98-04)
		DAIHATSU	CHARADE III (87-93)
			CUORE IV (94-99)
			HIJET (92-)
		MOVE (94-02)	
		DODGE	CARAVAN (95-02)
		CARAVAN (00-07)	
		HONDA	ACCORD III (85-89)
		JAZZ I (83-86)	
		HYUNDAI	GALLOPER (91-98)
			GALLOPER (98-03)
			SANTAMO (98-02)
		ISUZU	CAMPO (77-91)
			FARGO (82-88)
			FLORIAN (67-83)
			GEMINI (90-93)
			KB (80-90)
			MIDI (88-96)
			MU (89-02)
			PICK UP (87-96)
			TROOPER I (83-91)
			KIA
		NISSAN	CHERRY II (N10) (78-83)
			CHERRY III (N12) (82-86)
			SUNNY I (82-90)
			SUNNY II (86-91)
			VOYAGER (95-01)
		TOYOTA	CAMRY (V1) (83-88)
			CELICA (81-85)
			COROLLA (E8) (83-89)
			COROLLA (E9) (87-93)
			COROLLA (E10) (92-99)
			COROLLA (E11) (97-02)
			COROLLA FX (84-88)
			LAND CRUISER (J60) (81-89)
SOARER (80-86)			
STARLET (P7) (84-89)			
STARLET (P8) (89-96)			
TERCEL (86-94)			
VAUXHALL	MIDI (84-94)		
MIDI II (88-97)			
W16EXR-U13	W16TT	CHRYSLER	SARATOGA (89-95)
			VOYAGER I (87-90)
			VOYAGER II (90-95)
		VOYAGER III (95-01)	
		DODGE	CARAVAN (95-02)
		MAZDA	626 II (82-87)
			626 III (87-97)
			B-SERIE (85-99)
PLYMOUTH	VOYAGER (89-95)		
W16EX-U	W16TT	DAIHATSU	CHARMANT (81-87)
			DELTA (89-01)
			ROCKY (85-98)
			RUGGER (84-93)
			TAFT (84-93)
		ISUZU	117 (72-76)
		GEMINI (74-85)	
		NISSAN	CABSTAR (F22) (82-93)
			NAVARA (D21) (86-08)
			PICK UP (D21) (85-98)
			URVAN (81-98)
			VANETTE (C12) (81-87)
			VANETTE (C22) (86-95)
			SANTANA

Свечи зажигания и Свечи накаливания

Руководство покупателя

DENSO P/N	TT	MAKE	MODEL			
W16EX-U продолжение		SUBARU	REX I (72-81)			
			SUZUKI	CARRY (85-90)		
				SJ 410 (81-88)		
		SUPER CARRY (85-99)				
		TOYOTA	4 RUNNER (N10) (89-96)			
			CARINA (73-83)			
			CELICA (73-78)			
			CELICA (77-81)			
			COROLLA (E7) (79-87)			
			COROLLA (KE) (72-80)			
			DYNA 100 (85-95)			
			DYNA 150 (85-88)			
			DYNA 200 (88-95)			
			DYNA (77-87)			
			HIACE I (77-85)			
			HIACE II (83-89)			
			HILUX I (72-83)			
			HILUX II (83-05)			
			LITEACE (79-86)			
			LITEACE (84-92)			
			MASTER ACE Surf (85-99)			
			MODELL F (82-90)			
			STARLET (P6) (78-84)			
			VW	TARO (89-97)		
		W16FPR-U	-	DACIA	1310 (81-04)	
					55 (67-72)	
				DAF	66 (72-75)	
					GAZ	GAZELLE (2705, 3221, 3302) (93-02)
						GAZELLE (03-13)
						SOBOL (2217, 2310, 2752) (97-)
						VOLGA (3102) (72-09)
					VOLGA (3110, 3111) (93-10)	
				LAND ROVER	RANGE ROVER I (70-95)	
				MG	MGB (66-80)	
				UAZ	469 B (71-)	
2315 Pick-up (96-)						
3160 (94-03)						
BUKHANKA (3741) (85-)						
FARMER (3909) (85-)						
GOLOVASTIK (3303) (85-)						
HUNTER (3151) (92-)						
SIMBIR (3162) (97-)						
TREKOL (39041) (88-)						
W16FP-U	-			GAZ	GAZELLE (2705, 3221, 3302) (93-02)	
		VOLGA (24) (67-92)				
		VOLGA (3102) (72-09)				
		VOLGA (3110, 3111) (93-10)				
		RENAULT	4 (62-93)			
			RODEO 5 (81-87)			
W16FSR	-	SKODA	1000 (64-70)			
			1100 (69-70)			
		VW	181 (69-79)			
			1500, 1600 (61-73)			
			KAEFER (47-03)			
			KARMANN GHIA (55-74)			
W16FS-U	-	UAZ	31512 (98-)			
		VW	KAEFER (47-03)			
W16TT	-	ALPINA	B3 (E30) (87-92)			
			B6 (E21) (78-83)			
			B6 (E30) (83-90)			
			B6 (E36) (92-93)			
			B7 (E12) (78-82)			
			B7 (E24) (78-88)			
			B7 (E28) (84-87)			
			B9 (E24) (82-85)			
			B9 (E28) (81-85)			
			B10 (E34) (88-96)			
			B11 (E32) (87-94)			
			C1 (E30) (83-88)			
			C2 (E30) (85-88)			
			RLE (Z1) (90-91)			

DENSO P/N	TT	MAKE	MODEL
W16TT продолжение		ARO	10 (80-06)
			SPARTANA (99-06)
		ASIA MOTORS	ROCSTA (89-99)
		AUDI	80 (81, 85, B2) (78-86)
			80 (89, 8A, B3) (86-91)
			80 (8C, B4) (91-96)
			90 (89, 8A, B3) (87-91)
			100 (44, C3) (82-91)
			100 (4A, C4) (90-94)
			A6 (4A, C4) (94-97)
			CABRIOLET (8G7) (91-00)
			COUPE (81, 85) (80-88)
			COUPE (89, 8B) (88-96)
		AUSTIN	METRO (80-90)
		BEDFORD	KB (72-88)
			MIDI (84-92)
		BENTLEY	CONTINENTAL (84-95)
			CONTINENTAL (91-02)
			TURBO R (88-98)
		BERTONE	FREELIMBER (89-99)
		BMW	02 (E6, E10) (67-77)
			3 (E21) (75-84)
			3 (E30) (82-94)
			5 (E12) (72-81)
			5 (E28) (81-87)
			5 (E34) (87-97)
			6 (E24) (76-90)
			7 (E23) (77-86)
			7 (E32) (86-94)
			1500-2000 (62-72)
		1600 GT (67-69)	
		2000 (E9) (65-76)	
		2500 (E3) (68-77)	
		Z1 (88-91)	
		CHEVROLET	AVEO / KALOS (T250, T255) (05-)
			SPARK (00-04)
			SPARK (05-)
		CHRYSLER	LE BARON (86-96)
			SARATOGA (89-95)
			VOYAGER I (87-90)
			VOYAGER II (90-95)
			VOYAGER III (95-01)
		VOYAGER IV (00-08)	
		DACIA	NOVA (96-03)
		DAEWOO	KALOS (02-)
			MATIZ (98-04)
			TICO (95-00)
		DAIHATSU	1000 (86-97)
			CHARADE I (77-83)
			CHARADE II (83-87)
			CHARADE III (87-93)
			CHARADE IV (93-00)
CHARMANT (81-87)			
CUORE IV (94-99)			
DELTA (89-01)			
HIJET (86-90)			
HIJET (92-)			
MIDGET (93-02)			
MOVE (94-02)			
ROCKY (85-98)			
RUGGER (84-93)			
SPARCAR (83-86)			
TAFT (84-93)			
DAIMLER	2.8 - 5.3 (69-93)		
	COUPE (73-77)		
	LANDAULETTE (74-91)		
LIMOUSINE (68-91)			
DODGE	CARAVAN (95-02)		
	CARAVAN (00-07)		
FIAT	DUCATO (280) (82-90)		
	DUCATO (290) (89-94)		

Свечи зажигания и Свечи накаливания

Руководство покупателя

DENSO P/N	TT	MAKE	MODEL
W16TT		GAZ	GAZELLE (2705, 3221, 3302) (93-02)
продолжение			GAZELLE (03-13)
			SOBOL (2217, 2310, 2752) (97-)
			VOLGA (3102) (72-09)
			VOLGA (3110, 3111) (93-10)
		GEO	TRACKER (88-98)
		HONDA	ACCORD I (78-83)
			ACCORD II (83-85)
			ACCORD III (85-89)
			CIVIC III (83-87)
			CRX I (83-87)
			JAZZ I (83-86)
			PRELUDE I (78-82)
			QUINTET (80-84)
		HYUNDAI	GALLOPER (91-98)
			GALLOPER (98-03)
			H-1 / STAREX (97-07)
			SANTA FÉ I (00-06)
			SANTAMO (98-02)
			SONATA II (88-93)
			SONATA III (93-98)
			SONATA IV (98-05)
		INNOCENTI	MINI (74-95)
		ISUZU	117 (72-76)
			CAMPO (77-91)
			FARGO (82-88)
			FLORIAN (67-83)
			GEMINI (74-85)
			GEMINI (90-93)
			KB (80-90)
			MIDI (88-96)
			MU (89-02)
			PICK UP (87-96)
			TROOPER I (83-91)
		JAGUAR	E-TYPE 2+2 (66-75)
			E-TYPE (61-75)
			Mk X (61-70)
			XJ (68-93)
		JEEP	CHEROKEE (80-86)
		KIA	AVELLA (95-01)
			PRIDE (90-)
			RIO I (00-05)
			SEPHIA (93-97)
			SORENTO I (02-)
		LAND ROVER	88 / 109 (61-86)
			90 / 110 (83-90)
			DEFENDER (90-16)
			RANGE ROVER I (70-95)
			RANGE ROVER II (94-02)
		LDV	SHERPA (74-89)
		MARUTI	800 (83-06)
		MAZDA	121 I (87-90)
			121 II (90-97)
			323 C IV (89-00)
			323 F IV (87-94)
			323 I (77-86)
			323 II (80-89)
			323 III (85-95)
			323 S IV (89-94)
			616 (73-78)
			626 I (78-82)
			626 II (82-87)
			626 III (87-97)
			929 III (87-91)
			B-SERIE (77-82)
			B-SERIE (85-99)
			E-SERIE (SD) (83-04)
			E-SERIE (SR) (83-04)
			E-SERIE (80-84)
		MERCEDES-BENZ	PULLMANN (64-79)
			S-CLASS (W108, W109) (66-72)

DENSO P/N	TT	MAKE	MODEL
W16TT			S-CLASS (W116) (72-80)
продолжение		MG	MIDGET (64-79)
		MITSUBISHI	COLT I (78-84)
			COLT III (88-92)
			COLT IV (92-96)
			COLT V (95-03)
			GALANT II (80-84)
			GALANT III (84-90)
			L 300 (80-87)
			L 300 (86-06)
			LANCER I (79-83)
			LANCER II (83-84)
			LANCER III (83-92)
			LANCER IV (88-94)
			LANCER V (91-03)
			LANCER VI (95-03)
			MIRAGE (91-03)
			PAJERO I (82-91)
			PAJERO II (90-00)
		NISSAN	BLUEBIRD (85-92)
			CABSTAR (F22) (82-93)
			CABSTAR (F23) (92-00)
			CHERRY II (N10) (78-83)
			CHERRY III (N12) (82-86)
			LAUREL (77-83)
			LAUREL (81-85)
			LAUREL (84-89)
			MICRA I (K10) (82-92)
			NAVARA (D21) (86-08)
			PATROL (84-96)
			PATROL GR I (87-98)
			PICK UP (720) (80-86)
			PICK UP (D21) (85-98)
			SUNNY I (82-90)
			SUNNY II (86-91)
			TERRANO I (87-96)
			URVAN (81-98)
			VANETTE (C12) (81-87)
			VANETTE (C22) (86-95)
		OPEL	ASCONA C (81-88)
			CALIBRA (90-97)
			COMBO E (18-)
			COMMODORE C (78-82)
			CORSA A (82-93)
			CORSA B (93-02)
			OMEGA A (86-94)
			VECTRA A (88-95)
		PERODUA	KANCIL (94-)
		PLYMOUTH	SUNDANCE (86-94)
			VOYAGER (89-95)
			VOYAGER (95-01)
		PORSCHE	928 (77-95)
		PROTON	JUMBUCK (02-)
			PERSONA 400 (94-03)
			SATRIA (96-06)
			WIRA (00-)
		RELIANT	KITTEN (75-83)
		RENAULT	11 (83-88)
			16 (65-80)
			19 I (88-92)
			19 II (92-01)
			CLIO I (90-98)
			ESPACE III (96-02)
			MEGANE I (96-03)
			RAPID (85-98)
			TRAFIC (80-89)
			TWINGO I (93-07)
		ROVER	200 (XH) (85-89)
			MINI-Moke (86-93)
		SANTANA	SAMURAI (86-95)
		SUBARU	REX I (72-81)

Свечи зажигания и Свечи накаливания

Руководство покупателя

DENSO P/N	TT	MAKE	MODEL
W16TT			REX II (81-89)
продолжение		SUZUKI	ALTO I (82-85)
			ALTO II (86-93)
			ALTO III (93-02)
			CARRY (80-85)
			CARRY (85-90)
			CARRY (95-99)
			LJ 80 (77-84)
			SAMURAI (88-04)
			SJ 410 (81-88)
			SJ 413 (84-90)
			SUPER CARRY (85-99)
			SWIFT I (83-89)
			SWIFT II (89-05)
			VITARA (88-99)
		TOYOTA	4 RUNNER (N10) (89-96)
			4 RUNNER (N5) (87-89)
			CAMRY (V1) (83-88)
			CAMRY (V2) (86-91)
			CARINA (73-83)
			CARINA II (83-92)
			CELICA (73-78)
			CELICA (77-81)
			CELICA (81-85)
			CELICA (85-89)
			COROLLA (E7) (79-87)
			COROLLA (E8) (83-89)
			COROLLA (E9) (87-93)
			COROLLA (E10) (92-99)
			COROLLA (E11) (97-02)
			COROLLA (KE) (72-80)
			COROLLA FX (84-88)
			CORONA (T1) (70-87)
			CORONA (T14) (70-88)
			CRESSIDA (77-81)
			CRESSIDA (80-93)
			CROWN (80-85)
			DYNA 100 (85-95)
			DYNA 150 (85-88)
			DYNA 200 (88-95)
			DYNA (77-87)
			HIACE I (77-85)
			HIACE II (83-89)
			HIACE III (87-04)
			HILUX I (72-83)
			HILUX II (83-05)
			LAND CRUISER (J60) (81-89)
			LAND CRUISER (J80) (90-98)
			LAND CRUISER / PRADO (J70) (84-06)
			LITEACE (79-86)
			LITEACE (84-92)
			LITEACE (92-97)
			MASTER ACE Surf (85-99)
			MODELL F (82-90)
			SOARER (80-86)
			STARLET (P6) (78-84)
			STARLET (P7) (84-89)
			STARLET (P8) (89-96)
			STARLET 1000 (74-78)
			TERCEL (79-88)
			TERCEL (86-94)
			TOWN ACE (92-01)
		TRIUMPH	2000 (68-77)
			2500 (74-77)
			SPITFIRE (62-80)
			STAG (70-77)
		UAZ	452 (66-)
			469 B (71-)
			3160 (94-03)
			BARS (3159) (99-)
			BUKHANKA (3741) (85-)

DENSO P/N	TT	MAKE	MODEL
W16TT			CARGO (2360) (04-)
продолжение			FARMER (3909) (85-)
			GOLOVASTIK (3303) (85-)
			HUNTER (3151) (92-)
			PATRIOT (04-)
			SIMBIR (3162) (97-)
		VAUXHALL	CALIBRA (90-97)
			CARLTON III (86-94)
			CAVALIER II (81-88)
			CAVALIER III (88-95)
			CORSA I (B) (93-00)
			MIDI (84-94)
			MIDI II (88-97)
			RASCAL (86-93)
		VOLVO	340-360 (75-91)
			440 (88-96)
			460 (88-96)
			480 (86-96)
		VW	CADDY I (14) (82-92)
			GOLF I (17, 155) (74-93)
			GOLF III (1H, 1E) (91-99)
			GOLF IV (1J, 1E) (97-06)
			JETTA I (16) (78-84)
			LUPO (6X, 6E) (98-05)
			PASSAT (3A2, 35I) (88-97)
			PASSAT (32, 33) (73-80)
			PASSAT (32B) (80-91)
			SANTANA (81-85)
			SCIROCCO (53) (74-80)
			SCIROCCO (53B) (80-92)
			TARO (89-97)
			TRANSPORTER IV (70X, 7D) (90-03)
			VENTO (1H2) (91-98)
		ZASTAVA	YUGO (80-95)
W20EKR-S11	IW20TT	HONDA	JAZZ I (83-86)
W20EPB	W20TT	ALFA ROMEO	155 (92-97)
			164 (87-98)
		AUDI	80 (80, 82, B1) (72-78)
			80 (81, 85, B2) (78-86)
			80 (89, 8A, B3) (86-91)
			90 (81, 85, B2) (84-87)
			90 (89, 8A, B3) (87-91)
			100 (43, C2) (76-83)
			100 (44, C3) (82-91)
			100 (4A, C4) (90-94)
			200 (43) (79-82)
			200 (44) (83-91)
			COUPE (81, 85) (80-88)
			COUPE (89, 8B) (88-96)
			QUATTRO (85) (80-91)
		FIAT	COUPE (93-00)
		LANCIA	DEDRA (89-99)
			DELTA I (79-94)
			THEMA (84-94)
		PEUGEOT	505 (79-95)
		VW	CADDY I (14) (82-92)
			GOLF I (17, 155) (74-93)
			GOLF II (19, 1G) (83-92)
			GOLF III (1H, 1E) (91-99)
			JETTA II (19, 1G) (84-92)
			PASSAT (3A2, 35I) (88-97)
			PASSAT (32B) (80-91)
			POLO (86C, 80) (81-94)
			SANTANA (81-85)
			SCIROCCO (53B) (80-92)
			TRANSPORTER III (79-92)
			TRANSPORTER IV (70X, 7D) (90-03)
W20EPBR-S	W20TT	AUDI	80 (81, 85, B2) (78-86)
			80 (89, 8A, B3) (86-91)
			80 (8C, B4) (91-96)
			90 (89, 8A, B3) (87-91)

Свечи зажигания и Свечи накаливания

Руководство покупателя

DENSO P/N	TT	MAKE	MODEL		
W20EPBR-S продолжение			100 (4A, C3) (82-91)		
			100 (4A, C4) (90-94)		
			A6 (4A, C4) (94-97)		
			CABRIOLET (8G7) (91-00)		
			COUPE (81, 85) (80-88)		
			COUPE (89, 8B) (88-96)		
		FIAT	CROMA (85-96)		
			TIPO (160) (87-95)		
		LANCIA	DELTA I (79-94)		
		PORSCHE	968 (91-95)		
		SEAT	AROSA (6H) (97-04)		
			CORDOBA (6K1) (93-99)		
			IBIZA II (6K1) (93-99)		
			INCA (6K9) (95-03)		
			TOLEDO I (1L) (91-99)		
			SKODA	FELICIA Fun (6U) (97-02)	
			FELICIA I (6U) (94-98)		
			FELICIA II (6U) (98-01)		
			OCTAVIA I (1U) (96-10)		
		VW	CADDY II (9K, 9U) (95-04)		
			CORRADO (53I) (88-95)		
			GOLF I (17, 155) (74-93)		
			GOLF II (19, 1G) (83-92)		
			GOLF III (1H, 1E) (91-99)		
			GOLF IV (1J, 1E) (97-06)		
			JETTA II (19, 1G) (84-92)		
			LUPU (6X, 6E) (98-05)		
			PASSAT (3A2, 35I) (88-97)		
			POLO (6N1) (94-99)		
			POLO (86C, 80) (81-94)		
			POLO Classic (6KV) (95-02)		
			POLO Variant (6V5) (97-01)		
			SCIROCCO (53B) (80-92)		
			SHARAN (7M) (95-10)		
		TRANSPORTER IV (70X, 7D) (90-03)			
		VENTO (1H2) (91-98)			
		W20EPR-S11	W20TT	KIA	JOICE (00-)
		W20EPR-U	W20TT	AC	ME (79-86)
				ALFA ROMEO	75 (85-92)
					164 (87-98)
					1750-2000 (68-75)
					GIULIA (62-79)
					GT (63-77)
					RZ (92-94)
					SPIDER (94-05)
					SZ (88-94)
					ASTON MARTIN
					DBS (66-72)
				AUDI	80 (80, 82, B1) (72-78)
					80 (81, 85, B2) (78-86)
					100 (4A, C3) (82-91)
100 (C1) (68-76)					
COUPE (81, 85) (80-88)					
AUSTIN	ALLEGRO (73-84)				
	MAESTRO (83-92)				
	MAXI (69-82)				
	MINI (60-93)				
	MONTEGO (84-92)				
	PRINCESS (76-82)				
AUTOBIANCHI	A 112 (69-85)				
	Y10 (85-95)				
BEDFORD	MIDI (84-92)				
BENTLEY	CONTINENTAL (91-02)				
	TURBO R (88-98)				
BMW	3 (E21) (75-84)				
	3 (E30) (82-94)				
	5 (E34) (87-97)				
BOGDAN	2110 (10-14)				
	2111 (10-14)				
	2310 (10-14)				
CHEVROLET	AVEO / KALOS (T200) (03-08)				

DENSO P/N	TT	MAKE	MODEL
W20EPR-U продолжение			AVEO / KALOS (T250, T255) (05-)
			LANOS (05-)
			NIVA (2123) (02-)
		CITROËN	GS (70-86)
		DACIA	NOVA (96-03)
		DAEWOO	CIELO (94-98)
			ESPERO (91-99)
			KALOS (02-)
			LANOS (97-)
			NEXIA (95-08)
			NEXIA (08-)
			RACER (95-97)
			TACUMA / REZZO (00-)
			126 (72-00)
			127 (71-86)
			128 (69-84)
			131 (74-84)
			132 (72-82)
		900 T/E Panorama (78-86)	
		900 T/E Pulmino (78-86)	
		ARGENTA (78-86)	
		CINQUECENTO (91-99)	
		DUCATO (280) (82-90)	
		DUNA (87-91)	
		DUNA (91-96)	
		ELBA (85-97)	
		FIORINO (77-87)	
		FIORINO (80-93)	
		FIORINO (88-01)	
		PANDA (80-04)	
		PENNY (86-90)	
		REGATA (83-90)	
		RITMO (78-88)	
		RITMO Bertone (79-89)	
		SEICENTO (98-10)	
		TEMPRA (90-96)	
		TIPO (160) (87-95)	
		UNO (146) (83-00)	
		X 1/9 (73-89)	
		FORD	CAPRI (78-87)
			GRANADA (72-85)
		FSO	126P (72-00)
			127P (69-76)
			LANOS (04-08)
		HONDA	CIVIC I (72-84)
			CIVIC II (79-83)
		HYUNDAI	H-1 / STAREX (97-07)
			H100 (93-04)
			PONY (74-82)
			PONY (85-89)
			PORTER (94-04)
SONATA II (88-93)			
STELLAR (83-91)			
INNOCENTI	ELBA (91-96)		
	KORAL (90-92)		
ISH	Oda (2717) (97-)		
	ORBITA (2126) (87-)		
ISUZU	CAMPO (77-91)		
	MIDI (88-96)		
	PICK UP (87-96)		
	TROOPER I (83-91)		
LADA	110 (2110) (95-12)		
	111 (2111) (95-13)		
	112 (2112) (95-13)		
	KALINA (1117, 1118, 1119) (04-)		
	NADESCHDA (2120) (97-06)		
	NIVA I (2121) (76-)		
	NIVA II (2123) (02-)		
	NOVA (2104, 2105) (81-12)		
	OKA (1111) (88-08)		
	PICKUP (2329) (98-)		

Свечи зажигания и Свечи накаливания

Руководство покупателя

DENSO P/N	TT	MAKE	MODEL
W20EPR-U			PICKUP (2345) (97-04)
продолжение			SAMARA (2108, 2109, 2113, 2114, 2115) (86-13)
			SAMARA Forma (21099) (87-12)
			TOSCANA (2107) (82-12)
			ZHIGULI (70-93)
		LANCIA	BETA (73-86)
			BETA Monte Carlo (75-81)
			DEDRA (89-99)
			DELTA I (79-94)
			DELTA II (93-99)
			THEMA (84-94)
		TREVI (80-87)	
		Y10 (85-95)	
	LAND ROVER	DISCOVERY I (89-98)	
		RANGE ROVER I (70-95)	
	LOTUS	ECLAT (75-86)	
		ELITE (74-82)	
		ESPRIT S2 (75-88)	
		ESPRIT S3 (80-88)	
		EXCEL (83-91)	
	MAZDA	323 III (85-95)	
		626 I (78-82)	
		818 (72-78)	
		929 I (78-88)	
		929 II (82-87)	
		1300 (75-77)	
	MG	MAESTRO (83-90)	
		METRO (82-90)	
		MGB (66-80)	
		MGC (67-69)	
		MONTEGO (84-90)	
	MITSUBISHI	COLT I (78-84)	
		COLT II (84-88)	
		COLT III (88-92)	
		CORDIA (82-89)	
		ECLIPSE I (89-95)	
		ECLIPSE II (94-99)	
		GALANT II (80-84)	
		GALANT III (84-90)	
		GALANT IV (87-92)	
		GALANT V (92-96)	
		L 200 (86-96)	
		L 300 (86-06)	
		L 400 / SPACE GEAR (95-05)	
		LANCER I (79-83)	
		LANCER III (83-92)	
		LANCER IV (88-94)	
		MIRAGE (88-91)	
		SPACE WAGON (83-92)	
		SPACE WAGON (91-98)	
	MORGAN	PLUS EIGHT (68-)	
	MORRIS	MINI (60-81)	
	MOSKVICH	2141 (89-01)	
		2335 (95-01)	
		2901 (98-01)	
	NISSAN	BLUEBIRD (80-86)	
		BLUEBIRD (83-90)	
		CHERRY II (N10) (78-83)	
		CHERRY III (N12) (82-86)	
		DATSUN 180 B (77-81)	
		LAUREL (77-83)	
		LAUREL (81-85)	
		PATHFINDER I (86-95)	
		PATROL (79-88)	
		PRAIRIE (M10) (83-88)	
		STANZA (81-85)	
		SUNNY (70-82)	
		SUNNY I (82-90)	
		SUNNY II (86-91)	
		URVAN (81-98)	
		VANETTE (C12) (81-87)	

DENSO P/N	TT	MAKE	MODEL
W20EPR-U			VANETTE (C22) (86-95)
продолжение		OPEL	ASCONA B (75-81)
			ASCONA C (81-88)
			ASTRA F (91-01)
			CORSA A (82-93)
			KADETT D (79-84)
			KADETT E (84-94)
			MANTA A (70-75)
			MANTA B (75-88)
			OMEGA A (86-94)
			REKORD E (77-86)
		VECTRA A (88-95)	
	PEUGEOT	504 (68-89)	
		J5 (81-90)	
		J7 (68-80)	
	PIAGGIO	PORTER (93-)	
	PININFARINA	SPIDEREUROPA (82-85)	
	PORSCHE	911 (930) (75-90)	
		924 (75-89)	
		928 (77-95)	
		944 (81-91)	
	PROTON	AEROBACK (88-96)	
		PERSONA 300 (96-04)	
		SALOON (91-96)	
	RENAULT	4 (62-93)	
		5 (72-85)	
		6 (69-87)	
		8 (62-72)	
		9 (81-89)	
		10 (66-72)	
		11 (83-88)	
		12 (69-84)	
		16 (65-80)	
		18 (78-93)	
		19 I (88-92)	
		19 II (92-01)	
		20 (75-83)	
		21 (86-95)	
		CLIO I (90-98)	
		ESTAFETTE (62-81)	
		LAGUNA I (93-01)	
		MASTER I (80-98)	
		MEGANE I (96-03)	
		RAPID (85-98)	
		RODEO 6 (70-81)	
		SUPER 5 (84-96)	
		TRAFIC (80-89)	
		TRAFIC (89-01)	
	RILEY	ELF III (63-68)	
	ROVER	MINI (91-01)	
		MONTEGO (84-95)	
	SANTANA	SAMURAI (86-95)	
	SEAT	FURA (82-86)	
		IBIZA I (84-93)	
		MARBELLA (86-98)	
		PANDA (80-86)	
		TERRA (87-96)	
	SUBARU	LEONE II (84-94)	
		MV (78-86)	
	SUZUKI	SWIFT I (83-89)	
		SWIFT II (89-05)	
	TALBOT	1307-1510 (75-84)	
		HORIZON (78-86)	
		MURENA (80-85)	
		RANCHO (77-84)	
		SOLARA (80-86)	
		TAGORA (80-87)	
	TOFAS	DOGAN (76-02)	
		KARTAL (85-02)	
		SAHIN (80-03)	
	TVR	350 (83-89)	

Свечи зажигания и Свечи накаливания

Руководство покупателя

DENSO P/N	TT	MAKE	MODEL		
W20EPR-U продолжение		UAZ	3160 (94-03)		
			BARS (3159) (99-)		
			BUKHANKA (3741) (85-)		
			FARMER (3909) (85-)		
			GOLOVASTIK (3303) (85-)		
			HUNTER (3151) (92-)		
			SIMBIR (3162) (97-)		
		VAUXHALL	ASTRA I (79-86)		
			ASTRA II (84-94)		
			ASTRA III (F) (91-01)		
			BRAVA (88-02)		
			CARLTON II (77-86)		
			CARLTON III (86-94)		
			CAVALIER I (75-81)		
			CAVALIER II (81-88)		
			CAVALIER III (88-95)		
			CHEVETTE (75-85)		
			MIDI II (88-97)		
			NOVA (82-94)		
			VOLVO	240 (74-93)	
				340-360 (75-91)	
				440 (88-96)	
				460 (88-96)	
				740 (83-92)	
				760 (81-92)	
				940 I (90-95)	
		940 II (94-98)			
		960 I (90-94)			
		VW	GOLF I (17, 155) (74-93)		
			GOLF II (19, 1G) (83-92)		
			LT 28-35 I (281-363) (75-96)		
			PASSAT (32, 33) (73-80)		
			PASSAT (32B) (80-91)		
			POLO (86) (75-81)		
			SANTANA (81-85)		
			SCIROCCO (53) (74-80)		
		TRANSPORTER III (79-92)			
		ZASTAVA	YUGO (80-95)		
			YUGO Florida (88-08)		
		ZAZ	CHANCE (04-)		
			DANA (1105) (97-)		
			LANOS (04-)		
			SENS (04-)		
			SLAVUTA (1103) (95-11)		
			TAVRIA (1102) (89-07)		
		W20EPR-U11	W20TT	CHEVROLET	AVEO / KALOS (T250, T255) (05-)
				DATSUN	MI-DO (14-)
					ON-DO (14-)
				HYUNDAI	COUPE (96-02)
					LANTRA I (90-95)
					PONY / EXCEL (89-95)
					PONY (85-89)
					S COUPE (90-96)
SANTA FÉ I (00-06)					
SANTAMO (98-02)					
SONATA II (88-93)					
SONATA III (93-98)					
SONATA IV (98-05)					
TRAJECT (00-08)					
ISUZU	CAMPO (77-91)				
	PICK UP (87-96)				
	TROOPER I (83-91)				
KIA	MAGENTIS (01-)				
LADA	111 (2111) (95-13)				
	GRANTA (2190, 2191, 2349) (11-)				
	LARGUS (12-)				
	NADESCHDA (2120) (97-06)				
	NIVA I (2121) (76-)				
	NIVA II (2123) (02-)				
	PICKUP (2329) (98-)				
PICKUP (2345) (97-04)					

DENSO P/N	TT	MAKE	MODEL		
W20EPR-U11 продолжение			PRIORA (2170, 2171, 2172) (08-)		
			SAMARA (2108, 2109, 2113, 2114, 2115) (86-13)		
			SAMARA Forma (21099) (87-12)		
			TOSCANA (2107) (82-12)		
			MAZDA	323 C IV (89-00)	
				323 S IV (89-94)	
				B-SERIE (99-06)	
			MITSUBISHI	COLT II (84-88)	
				COLT III (88-92)	
				ECLIPSE I (89-95)	
				ECLIPSE II (94-99)	
				GALANT III (84-90)	
				GALANT IV (87-92)	
		L 200 (86-96)			
		L 200 (96-07)			
		L 300 (86-06)			
		LANCER III (83-92)			
		LANCER IV (88-94)			
		SANTAMO (99-04)			
		SIGMA (90-96)			
		SPACE WAGON (83-92)			
		STARION (82-90)			
		NISSAN	BLUEBIRD (80-86)		
			BLUEBIRD (83-90)		
			BLUEBIRD (85-92)		
			SILVIA (S12) (84-88)		
		OPEL	CAMPO (87-01)		
		PORSCHE	928 (77-95)		
			968 (91-95)		
		PROTON	PERSONA 400 (94-03)		
		ROVER	200 (XH) (85-89)		
		SAAB	90 (84-87)		
			99 (68-84)		
		SUBARU	JUSTY I (84-95)		
			JUSTY II (95-03)		
			LEONE II (84-94)		
			LIBERO (83-00)		
			REX II (81-89)		
		SUZUKI	WAGON R+ (00-)		
		W20EPR-U	W20TT	ALPINA	B9 (E24) (82-85)
					B9 (E28) (81-85)
					B10 (E34) (88-96)
				AUDI	50 (86) (74-78)
					80 (80, 82, B1) (72-78)
					80 (81, 85, B2) (78-86)
					100 (43, C2) (76-83)
					100 (44, C3) (82-91)
					COUPE (81, 85) (80-88)
				AUSTIN	1000-Series (70-74)
					MAESTRO (83-92)
					METRO (80-90)
				AUSTIN-HEALEY	3000 III (64-68)
					SPRITE III (64-66)
BMW	02 (E6, E10) (67-77)				
	5 (E12) (72-81)				
	1500-2000 (62-72)				
	2000 (E9) (65-76)				
CITROËN	C25 (81-94)				
DAIHATSU	CUORE I (80-85)				
FIAT	DUCATO (280) (82-90)				
	PANDA (80-04)				
	TALENTO (290) (89-94)				
	TIPO (160) (87-95)				
FORD	CAPRI (68-74)				
FSO	125P (67-92)				
	POLONEZ I (77-91)				
	POLONEZ II (88-92)				
LADA	NIVA I (2121) (76-)				
	NOVA (2104, 2105) (81-12)				
	TOSCANA (2107) (82-12)				
	ZHIGULI (70-93)				

Свечи зажигания и Свечи накаливания

Руководство покупателя

DENSO P/N	TT	MAKE	MODEL
W20EP-U		MAZDA	323 I (77-86)
продолжение		MERCEDES-BENZ	/8 (W114) (68-77)
			/8 (W115) (68-77)
			CABRIOLET (W111) (69-71)
			COUPE (C123) (77-85)
			COUPE (W111) (61-71)
			G-CLASS (W460) (79-93)
			G-CLASS (W463) (89-)
			HECKFLOSSE (W110) (61-68)
			KOMBI (S123) (77-85)
			PAGODE (W113) (63-71)
			PONTON (W121) (59-61)
			Saloon (W123) (76-85)
			S-CLASS (W108, W109) (66-72)
			S-CLASS (W116) (72-80)
			S-CLASS (W126) (79-91)
			S-CLASS Coupe (C126) (80-91)
			SL (R107) (71-89)
			SL (W121) (55-63)
			SLC (C107) (72-84)
			T1 (601) (77-96)
			T2 / L (309, 310, 328) (68-88)
		MITSUBISHI	CORDIA (82-89)
			GALANT I (77-80)
			L 200 (80-86)
			L 300 (80-87)
			SAPPORO I (78-80)
			SAPPORO II (80-84)
		MORRIS	MARINA (71-80)
		NISSAN	BLUEBIRD (80-86)
			CABSTAR (F22) (82-93)
			PICK UP (720) (80-86)
		PEUGEOT	504 (68-89)
			505 (79-95)
J5 (81-90)			
J5 (90-94)			
J7 (68-80)			
J9 (80-87)			
PUCH	G-MODELL (W460) (79-92)		
RENAULT	5 (72-85)		
	12 (69-84)		
	12 (83-95)		
	12 Toros (89-00)		
	18 (78-93)		
	19 II (92-01)		
	CLIO I (90-98)		
	FUEGO (80-85)		
	LAGUNA I (93-01)		
	MEGANE I (96-03)		
MEGANE Scénic (96-99)			
ROVER	MAESTRO (90-95)		
	MONTEGO (84-95)		
SAAB	900 I (78-94)		
SUBARU	LEONE I (78-84)		
TOYOTA	1000 (69-88)		
TRABANT	1.1 (90-91)		
VOLVO	240 (74-93)		
	740 (83-92)		
VW	DERBY (86) (77-81)		
	DERBY (86C, 80) (81-84)		
	GOLF I (17, 155) (74-93)		
	GOLF II (19, 1G) (83-92)		
	ILTIS (183) (79-88)		
	JETTA I (16) (78-84)		
	JETTA II (19, 1G) (84-92)		
	K 70 (70-74)		
	LT 28-35 I (281-363) (75-96)		
	LT 40-55 I (75-96)		
	PASSAT (32, 33) (73-80)		
	PASSAT (32B) (80-91)		
	POLO (86) (75-81)		

DENSO P/N	TT	MAKE	MODEL
W20EP-U			POLO (86C, 80) (81-94)
продолжение			SANTANA (81-85)
			SCIROCCO (53) (74-80)
			SCIROCCO (53B) (80-92)
			WARTBURG
			353 (66-91)
			ZASTAVA
			101 (73-93)
W20ESR-U	-	LAND ROVER	88 / 109 (61-86)
		MG	MGA (55-62)
		MORRIS	MINI (60-81)
			MINOR (55-71)
			OXFORD (59-70)
		SANTANA	LANDROVER 88 / 109 (71-91)
		VW	TRANSPORTER III (79-92)
W20ES-U	-	PORSCHE	914 (69-76)
		VW	TRANSPORTER III (79-92)
W20ETR-L	IW20TT	DAIHATSU	CHARADE II (83-87)
			CHARADE III (87-93)
		LOTUS	ESPRIT S4 (89-03)
			EXCEL (83-91)
W20EXR-U	W20TT	ACURA	INTEGRA (85-90)
		ASTON MARTIN	LAGONDA (76-97)
		DAIHATSU	CHARADE II (83-87)
			CHARADE III (87-93)
			CUORE I (80-85)
			CUORE II (85-90)
			CUORE III (90-94)
			CUORE IV (94-99)
		FORD	SIERRA (82-87)
			TAUNUS (75-79)
		HONDA	ACTY (78-87)
			INTEGRA (85-93)
			PRELUDE II (83-87)
		MAZDA	626 II (82-87)
			626 III (87-97)
			E-SERIE (SR) (83-04)
		SUZUKI	SAMURAI (88-04)
		TOYOTA	CELICA (73-78)
			CELICA (77-81)
			CELICA (81-85)
			COROLLA (E7) (79-87)
			CRESSIDA (80-93)
			STARLET (P7) (84-89)
			STARLET (P8) (89-96)
			WOLSELEY
W20EXR-U11	W20TT	HONDA	ACCORD II (83-85)
			ACCORD III (85-89)
			CIVIC III (83-87)
			CRX I (83-87)
			ISUZU
			PIAZZA (81-90)
		NISSAN	FIGARO (91-92)
		SUBARU	1800 XT COUPE (84-90)
			LEONE II (84-94)
W20EX-U	W20TT	AUSTIN	METRO (80-90)
		AUSTIN-HEALEY	SPRITE IV (66-71)
		INNOCENTI	MINI (74-95)
		ISUZU	TROOPER I (83-91)
		LAND ROVER	DEFENDER (90-16)
			RANGE ROVER I (70-95)
		MG	METRO (82-90)
		NISSAN	200 SX Coupe (79-81)
			BLUEBIRD (80-86)
			CABSTAR (F22) (82-93)
			NAVARA (D21) (86-08)
			PICK UP (D21) (85-98)
			URVAN (81-98)
			VANETTE (C12) (81-87)
			SUBARU
			LEONE II (84-94)
W20FPR-U	WF20TT	CITROËN	2 CV (63-90)
			CX I (74-85)

Свечи зажигания и Свечи накаливания

Руководство покупателя

DENSO P/N	TT	MAKE	MODEL
W20FPR-U продолжение			CX II (85-92)
			DYANE (67-84)
			HY (69-77)
		DACIA	1210 (83-94)
			1300 (72-83)
1304 (83-04)			
1307 (84-94)			
1309 (90-01)			
1310 (81-04)			
1410 (85-98)			
PICK UP (89-08)			
DAF	66 (72-75)		
FIAT	PANDA (80-04)		
OPEL	ASCONA A (70-75)		
	ASCONA B (75-81)		
	CORSA A (82-93)		
	FRONTERA A (92-98)		
	GT (68-73)		
	KADETT B (65-73)		
	KADETT D (79-84)		
	MANTA A (70-75)		
	MANTA B (75-88)		
	MONZA A (78-86)		
	OLYMPIA A (67-71)		
	OMEGA A (86-94)		
	REKORD B (65-67)		
	REKORD C (66-71)		
	REKORD D (72-77)		
REKORD E (77-86)			
SENATOR A (78-87)			
SENATOR B (87-93)			
RANGER	REKORD (72-78)		
SKODA	105 / 120 (83-90)		
	RAPID (83-91)		
VAUXHALL	ASTRA I (79-86)		
	ASTRA II (84-94)		
	CARLTON III (86-94)		
	CAVALIER I (75-81)		
	FRONTERA I (A) (91-98)		
	NOVA (82-94)		
SENATOR II (B) (87-93)			
VOLVO	164 (68-74)		
WARTBURG	353 (66-91)		
W20FP-U	WF20TT	CITROËN	C35 (73-94)
			CX I (74-85)
			CX II (85-92)
		FIAT	126 (72-00)
		GAZ	VOLGA (24) (67-92)
		OPEL	ASCONA B (75-81)
			ASCONA C (81-88)
			CORSA A (82-93)
			KADETT C (73-79)
			OMEGA A (86-94)
			REKORD E (77-86)
			SENATOR A (78-87)
			SENATOR B (87-93)
		RENAULT	12 (69-84)
			RODEO 4 (71-81)
		SKODA	105 / 120 (76-90)
			105 / 120 (83-90)
RAPID (83-91)			
UAZ	3160 (94-03)		
	SIMBIR (3162) (97-)		
VOLVO	66 (75-79)		
W20FSR-U	WF20TT	CITROËN	2 CV (63-90)
			ACADIANE (78-88)
			AMI (63-77)
			DYANE (67-84)
			MEHARI (68-87)
		FIAT	500 (57-76)
		SKODA	110 (69-82)

DENSO P/N	TT	MAKE	MODEL
W20FSR-U продолжение		VW	1500, 1600 (61-73)
			KARMANN GHIA (55-74)
			TRANSPORTER II (67-79)
W20FS-U	WF20TT	CITROËN	LNA (76-86)
		SKODA	100 (70-77)
W20PR-U	-	OPEL	KADETT E (84-94)
W20TT	-	AC	ME (79-86)
		ACURA	INTEGRA (85-90)
		ALFA ROMEO	75 (85-92)
			155 (92-97)
			164 (87-98)
			1750-2000 (68-75)
			GIULIA (62-79)
			GT (63-77)
		RZ (92-94)	
		SPIDER (94-05)	
		SZ (88-94)	
		ALPINA	B9 (E24) (82-85)
			B9 (E28) (81-85)
			B10 (E34) (88-96)
		ASTON MARTIN	DB6 (64-70)
			DBS (66-72)
			LAGONDA (76-97)
		AUDI	50 (86) (74-78)
			80 (80, 82, B1) (72-78)
			80 (81, 85, B2) (78-86)
80 (89, 8A, B3) (86-91)			
80 (8C, B4) (91-96)			
90 (81, 85, B2) (84-87)			
90 (89, 8A, B3) (87-91)			
100 (43, C2) (76-83)			
100 (44, C3) (82-91)			
100 (4A, C4) (90-94)			
100 (C1) (68-76)			
200 (43) (79-82)			
200 (44) (83-91)			
A6 (4A, C4) (94-97)			
CABRIOLET (8G7) (91-00)			
COUPE (81, 85) (80-88)			
COUPE (89, 8B) (88-96)			
QUATTRO (85) (80-91)			
AUSTIN	1000-Series (70-74)		
	ALLEGRO (73-84)		
	MAESTRO (83-92)		
	MAXI (69-82)		
	METRO (80-90)		
	MINI (60-93)		
	MONTEGO (84-92)		
	PRINCESS (76-82)		
	AUSTIN-HEALEY	3000 III (64-68)	
		SPRITE III (64-66)	
SPRITE IV (66-71)			
AUTOBIANCHI	A 112 (69-85)		
Y10 (85-95)			
BEDFORD	MIDI (84-92)		
BENTLEY	CONTINENTAL (91-02)		
	TURBO R (88-98)		
BMW	02 (E6, E10) (67-77)		
	3 (E21) (75-84)		
	3 (E30) (82-94)		
	5 (E12) (72-81)		
	5 (E34) (87-97)		
	1500-2000 (62-72)		
2000 (E9) (65-76)			
BOGDAN	2110 (10-14)		
	2111 (10-14)		
	2310 (10-14)		
CHEVROLET	AVEO / KALOS (T200) (03-08)		
	AVEO / KALOS (T250, T255) (05-)		
	LANOS (05-)		
	NIVA (2123) (02-)		

Свечи зажигания и Свечи накаливания

Руководство покупателя

DENSO P/N	TT	MAKE	MODEL
W20TT		CHRYSLER	VOYAGER III (95-01)
продолжение		CITROËN	C25 (81-94)
			GS (70-86)
		DAZIA	NOVA (96-03)
		DAEWOO	CIELO (94-98)
ESPERO (91-99)			
KALOS (02-)			
LANOS (97-)			
NEXIA (95-08)			
NEXIA (08-)			
RACER (95-97)			
TACUMA / REZZO (00-)			
DAIHATSU	CHARADE II (83-87)		
	CHARADE III (87-93)		
	CUORE I (80-85)		
	CUORE II (85-90)		
	CUORE III (90-94)		
	CUORE IV (94-99)		
	DELTA (89-01)		
	DATSUN	MI-DO (14-)	
ON-DO (14-)			
DODGE	CARAVAN (95-02)		
FIAT	126 (72-00)		
	127 (71-86)		
	128 (69-84)		
	131 (74-84)		
	132 (72-82)		
	900 T/E Panorama (78-86)		
	900 T/E Pulmino (78-86)		
	ARGENTA (78-86)		
	CINQUECENTO (91-99)		
	COUPE (93-00)		
	CROMA (85-96)		
	DUCATO (280) (82-90)		
	DUNA (87-91)		
	DUNA (91-96)		
	ELBA (85-97)		
	FIORINO (77-87)		
	FIORINO (80-93)		
	FIORINO (88-01)		
	PANDA (80-04)		
	PENNY (86-90)		
	REGATA (83-90)		
	RITMO (78-88)		
	RITMO Bertone (79-89)		
	SEICENTO (98-10)		
	TALENTO (290) (89-94)		
	TEMPRA (90-96)		
	TIPO (160) (87-95)		
	UNO (146) (83-00)		
	X 1/9 (73-89)		
	FORD	CAPRI (68-74)	
		CAPRI (78-87)	
		GRANADA (72-85)	
		SIERRA (82-87)	
TAUNUS (75-79)			
FSO	125P (67-92)		
	126P (72-00)		
	127P (69-76)		
	LANOS (04-08)		
	POLONEZ I (77-91)		
POLONEZ II (88-92)			
GREAT WALL	SAIFU (00-03)		
HONDA	ACCORD II (83-85)		
	ACCORD III (85-89)		
	ACTY (78-87)		
	CIVIC I (72-84)		
	CIVIC II (79-83)		
	CIVIC III (83-87)		
	CRX I (83-87)		
	INTEGRA (85-93)		

DENSO P/N	TT	MAKE	MODEL
W20TT			PRELUDE II (83-87)
продолжение		HYUNDAI	COUPE (96-02)
			H-1 / STAREX (97-07)
H100 (93-04)			
LANTRA I (90-95)			
PONY / EXCEL (89-95)			
PONY (74-82)			
PONY (85-89)			
PORTER (94-04)			
S COUPE (90-96)			
SANTA FÉ I (00-06)			
SANTAMO (98-02)			
SONATA II (88-93)			
SONATA III (93-98)			
SONATA IV (98-05)			
STELLAR (83-91)			
TRAJECT (00-08)			
		INNOCENTI	ELBA (91-96)
			KORAL (90-92)
		ISH	Oda (2717) (97-)
			ORBITA (2126) (87-)
		ISUZU	CAMPO (77-91)
			GEMINI (84-90)
			MIDI (88-96)
			PIAZZA (81-90)
			PICK UP (87-96)
			TROOPER I (83-91)
			KIA
		MAGENTIS (01-)	
	W20TT	LADA	110 (2110) (95-12)
	-		111 (2111) (95-13)
	-		112 (2112) (95-13)
	-		GRANTA (2190, 2191, 2349) (11-)
	-		KALINA (1117, 1118, 1119) (04-)
	-		LARGUS (12-)
	-		NADESCHDA (2120) (97-06)
	-		NIVA I (2121) (76-)
	W20TT		NIVA II (2123) (02-)
	-		NOVA (2104, 2105) (81-12)
	-		OKA (1111) (88-08)
	-		PICKUP (2329) (98-)
	-		PICKUP (2345) (97-04)
	-		PRIORA (2170, 2171, 2172) (08-)
	-	SAMARA (2108, 2109, 2113, 2114, 2115) (86-13)	
	-	SAMARA Forma (21099) (87-12)	
	-	TOSCANA (2107) (82-12)	
	-	ZHIGULI (70-93)	
		LANCIA	BETA (73-86)
			BETA Monte Carlo (75-81)
			DEDRA (89-99)
			DELTA I (79-94)
			DELTA II (93-99)
			THEMA (84-94)
		TREVI (80-87)	
		Y10 (85-95)	
		LAND ROVER	DEFENDER (90-16)
			DISCOVERY I (89-98)
			RANGE ROVER I (70-95)
		LOTUS	ECLAT (75-86)
			ELITE (74-82)
			ESPRIT S2 (75-88)
			ESPRIT S3 (80-88)
		MAZDA	EXCEL (83-91)
			323 C IV (89-00)
			323 I (77-86)
			323 III (85-95)
			323 S IV (89-94)
			626 I (78-82)
			626 II (82-87)
		626 III (87-97)	

Свечи зажигания и Свечи накаливания

Руководство покупателя

DENSO P/N	TT	MAKE	MODEL
W20TT			818 (72-78)
продолжение			929 I (78-88)
			929 II (82-87)
			1300 (75-77)
			B-SERIE (99-06)
			E-SERIE (SR) (83-04)
		MERCEDES-BENZ	/8 (W114) (68-77)
			/8 (W115) (68-77)
			CABRIOLET (W111) (69-71)
			COUPE (C123) (77-85)
			COUPE (W111) (61-71)
			G-CLASS (W460) (79-93)
			G-CLASS (W463) (89-)
			HECKFLOSSE (W110) (61-68)
			KOMBI (S123) (77-85)
			PAGODE (W113) (63-71)
			PONTON (W121) (59-61)
			Saloon (W123) (76-85)
			S-CLASS (W108, W109) (66-72)
			S-CLASS (W116) (72-80)
			S-CLASS (W126) (79-91)
			S-CLASS Coupe (C126) (80-91)
			SL (R107) (71-89)
			SL (W121) (55-63)
			SLC (C107) (72-84)
			T1 (601) (77-96)
			T2 / L (309, 310, 328) (68-88)
		MG	MAESTRO (83-90)
			METRO (82-90)
			MGB (66-80)
			MGC (67-69)
			MONTEGO (84-90)
		MITSUBISHI	COLT I (78-84)
			COLT II (84-88)
			COLT III (88-92)
			CORDIA (82-89)
			ECLIPSE I (89-95)
			ECLIPSE II (94-99)
			GALANT I (77-80)
			GALANT II (80-84)
			GALANT III (84-90)
			GALANT IV (87-92)
			GALANT V (92-96)
			L 200 (80-86)
			L 200 (86-96)
			L 200 (96-07)
			L 300 (80-87)
			L 300 (86-06)
			L 400 / SPACE GEAR (95-05)
			LANCER I (79-83)
			LANCER III (83-92)
			LANCER IV (88-94)
			MIRAGE (88-91)
			SANTAMO (99-04)
			SAPPORO I (78-80)
			SAPPORO II (80-84)
			SIGMA (90-96)
			SPACE WAGON (83-92)
			SPACE WAGON (91-98)
			STARION (82-90)
		MORGAN	PLUS EIGHT (68-)
		MORRIS	MARINA (71-80)
			MINI (60-81)
		MOSKVICHI	2141 (89-01)
			2335 (95-01)
			2901 (98-01)
		NISSAN	200 SX Coupe (79-81)
			BLUEBIRD (80-86)
			BLUEBIRD (83-90)
			BLUEBIRD (85-92)
			CABSTAR (F22) (82-93)

DENSO P/N	TT	MAKE	MODEL
W20TT			CHERRY II (N10) (78-83)
продолжение			CHERRY III (N12) (82-86)
			DATSUN 180 B (77-81)
			FIGARO (91-92)
			LAUREL (77-83)
			LAUREL (81-85)
			NAVARA (D21) (86-08)
			PATHFINDER I (86-95)
			PATROL (79-88)
			PICK UP (720) (80-86)
			PICK UP (D21) (85-98)
			PRAIRIE (M10) (83-88)
			SILVIA (S12) (84-88)
			STANZA (81-85)
			SUNNY (70-82)
			SUNNY I (82-90)
			SUNNY II (86-91)
			URVAN (81-98)
			VANETTE (C12) (81-87)
			VANETTE (C22) (86-95)
		OPEL	ASCONA B (75-81)
			ASCONA C (81-88)
			ASTRA F (91-01)
			CAMPO (87-01)
			CORSA A (82-93)
			KADETT D (79-84)
			KADETT E (84-94)
			MANTA A (70-75)
			MANTA B (75-88)
			OMEGA A (86-94)
			REKORD E (77-86)
			VECTRA A (88-95)
		PEUGEOT	504 (68-89)
			505 (79-95)
			J5 (81-90)
			J5 (90-94)
			J7 (68-80)
			J9 (80-87)
		PIAGGIO	PORTER (93-)
		PININFARINA	SPIDEREUROPA (82-85)
		PLYMOUTH	VOYAGER (95-01)
		PORSCHE	911 (930) (75-90)
			924 (75-89)
			928 (77-95)
			944 (81-91)
			968 (91-95)
		PROTON	AEROBACK (88-96)
			PERSONA 300 (96-04)
			PERSONA 400 (94-03)
			SALOON (91-96)
		PUCH	G-MODELL (W460) (79-92)
		RENAULT	4 (62-93)
			5 (72-85)
			6 (69-87)
			8 (62-72)
			9 (81-89)
			10 (66-72)
			11 (83-88)
			12 (69-84)
			12 (83-95)
			12 Toros (89-00)
			16 (65-80)
			18 (78-93)
			19 I (88-92)
			19 II (92-01)
			20 (75-83)
			21 (86-95)
			CLIO I (90-98)
			ESTAFETTE (62-81)
			FUEGO (80-85)
			LAGUNA I (93-01)

Свечи зажигания и Свечи накаливания

Руководство покупателя

DENSO P/N	TT	MAKE	MODEL
W20TT			MASTER I (80-98)
продолжение			MEGANE I (96-03)
			MEGANE Scénic (96-99)
			RAPID (85-98)
			RODEO 6 (70-81)
			SUPER 5 (84-96)
			TRAFIC (80-89)
			TRAFIC (89-01)
		RILEY	ELF III (63-68)
		ROVER	200 (XH) (85-89)
			MAESTRO (90-95)
			MINI (91-01)
			MONTEGO (84-95)
		SAAB	90 (84-87)
			99 (68-84)
			900 I (78-94)
		SANTANA	SAMURAI (86-95)
		SEAT	AROSA (6H) (97-04)
			CORDOBA (6K1) (93-99)
			FURA (82-86)
			IBIZA I (84-93)
			IBIZA II (6K1) (93-99)
			INCA (6K9) (95-03)
			MARBELLA (86-98)
			PANDA (80-86)
			TERRA (87-96)
			TOLEDO I (1L) (91-99)
		SKODA	FELICIA Fun (6U) (97-02)
			FELICIA I (6U) (94-98)
			FELICIA II (6U) (98-01)
			OCTAVIA I (1U) (96-10)
		SUBARU	1800 XT COUPE (84-90)
			JUSTY I (84-95)
			JUSTY II (95-03)
			LEONE I (78-84)
			LEONE II (84-94)
			LIBERO (83-00)
			MV (78-86)
			REX II (81-89)
		SUZUKI	SAMURAI (88-04)
			SWIFT I (83-89)
			SWIFT II (89-05)
			WAGON R+ (00-)
		TALBOT	1307-1510 (75-84)
			HORIZON (78-86)
			MURENA (80-85)
			RANCHO (77-84)
			SOLARA (80-86)
			TAGORA (80-87)
		TOFAS	DOGAN (76-02)
			KARTAL (85-02)
			SAHIN (80-03)
		TOYOTA	1000 (69-88)
			CELICA (73-78)
			CELICA (77-81)
			CELICA (81-85)
			CENTURY (82-96)
			COROLLA (E7) (79-87)
			CRESSIDA (80-93)
			CROWN (80-85)
			HIACE III (87-04)
			HIACE IV (95-)
			HILUX II (83-05)
			LITEACE (92-97)
			MASTER ACE Surf (85-99)
			MODELL F (82-90)
			SOARER (80-86)
			STARLET (P7) (84-89)
			STARLET (P8) (89-96)
			TOWN ACE (85-91)
		TRABANT	1.1 (90-91)

DENSO P/N	TT	MAKE	MODEL
W20TT		TVR	350 (83-89)
продолжение		UAZ	3160 (94-03)
			BARS (3159) (99-)
			BUKHANKA (3741) (85-)
			FARMER (3909) (85-)
			GOLOVASTIK (3303) (85-)
			HUNTER (3151) (92-)
			SIMBIR (3162) (97-)
		VAUXHALL	ASTRA I (79-86)
			ASTRA II (84-94)
			ASTRA III (F) (91-01)
			BRAVA (88-02)
			CARLTON II (77-86)
			CARLTON III (86-94)
			CAVALIER I (75-81)
			CAVALIER II (81-88)
			CAVALIER III (88-95)
			CHEVETTE (75-85)
			MIDI II (88-97)
			NOVA (82-94)
		VOLVO	240 (74-93)
			340-360 (75-91)
			440 (88-96)
			460 (88-96)
			740 (83-92)
			760 (81-92)
			940 I (90-95)
			940 II (94-98)
			960 I (90-94)
		VW	CADDY I (14) (82-92)
			CADDY II (9K, 9U) (95-04)
			CORRADO (53I) (88-95)
			DERBY (86) (77-81)
			DERBY (86C, 80) (81-84)
			GOLF I (17, 155) (74-93)
			GOLF II (19, 1G) (83-92)
			GOLF III (1H, 1E) (91-99)
			GOLF IV (1J, 1E) (97-06)
			ILTIS (183) (79-88)
			JETTA I (16) (78-84)
			JETTA II (19, 1G) (84-92)
			K 70 (70-74)
			LT 28-35 I (281-363) (75-96)
			LT 40-55 I (75-96)
			LUPO (6X, 6E) (98-05)
			PASSAT (3A2, 35I) (88-97)
			PASSAT (32, 33) (73-80)
			PASSAT (32B) (80-91)
			POLO (6N1) (94-99)
			POLO (86) (75-81)
			POLO (86C, 80) (81-94)
			POLO Classic (6KV) (95-02)
			POLO Variant (6V5) (97-01)
			SANTANA (81-85)
			SCIROCCO (53) (74-80)
			SCIROCCO (53B) (80-92)
			SHARAN (7M) (95-10)
			TRANSPORTER III (79-92)
			TRANSPORTER IV (70X, 7D) (90-03)
			VENTO (1H2) (91-98)
		WARTBURG	353 (66-91)
		WOLSELEY	HORNET (61-70)
		ZASTAVA	101 (73-93)
			YUGO (80-95)
			YUGO Florida (88-08)
		ZAZ	CHANCE (04-)
			DANA (1105) (97-)
			LANOS (04-)
			SENS (04-)
			SLAVUTA (1103) (95-11)
			TAVRIA (1102) (89-07)

Свечи зажигания и Свечи накаливания

Руководство покупателя

DENSO P/N	TT	MAKE	MODEL
W22EBR	-	MAZDA	RX 5 (75-81) RX 7 I (79-86)
W22EPB	W22TT	AUDI	COUPE (81, 85) (80-88)
		FIAT	COUPE (93-00)
		LANCIA	DELTA I (79-94) DELTA II (93-99)
		SEAT	TOLEDO I (1L) (91-99)
		VW	POLO (86C, 80) (81-94)
W22EPR-U	W22TT	ABARTH	RITMO (78-88)
		ALFA ROMEO	33 (83-93) 33 (90-94) 75 (85-92) 90 (84-87) 145 / 146 (94-01) 155 (92-97) 164 (87-98) 166 (98-07) 1750-2000 (68-75) ALFASUD (72-89) ALFETTA (74-84) ALFETTA GT (74-86) AR 6 (79-89) ARNA (83-86) GIULIA (62-79) GIULIETTA (77-85) GT (63-77) GTV (78-87) GTV (95-05) RZ (92-94) SPIDER (66-77) SPIDER (71-93) SPIDER (94-05) SZ (88-94)
		ASTON MARTIN	ZAGATO (86-89)
		AUDI	QUATTRO (85) (80-91)
		AUTOBIANCHI	A 112 (69-85)
		BEDFORD	ASTRA VAN (82-91)
		FERRARI	400 i (79-85) DINO GT4 (74-80)
		FIAT	124 (66-85) 125 (67-74) COUPE (93-00) CROMA (85-96) ELBA (85-97) FIORINO (88-01) REGATA (83-90) RITMO (78-88) RITMO Bertone (79-89) TEMPRA (90-96) TIPO (160) (87-95) UNO (146) (83-00)
		FORD	CAPRI (68-74) CAPRI (74-77) CAPRI (78-87) GRANADA (72-85) SCORPIO I (85-94) SIERRA (82-87) SIERRA (87-93)
		FSO	POLONEZ I (77-91) POLONEZ II (88-92) POLONEZ III (92-02)
		GEO	METRO (88-98)
		INNOCENTI	ELBA (91-96) KORAL (90-92)
		LANCIA	DEDRA (89-99) DELTA I (79-94) DELTA II (93-99) GAMMA (81-84) PRISMA (83-92) THEMA (84-94)
		LOTUS	ECLAT (75-86)

DENSO P/N	TT	MAKE	MODEL
W22EPR-U			ELITE (74-82)
продолжение		MERCEDES-BENZ	COUPE (W111) (61-71) S-CLASS (W108, W109) (66-72)
		MITSUBISHI	COLT II (84-88) ECLIPSE II (94-99) LANCER Evo I (92-93) LANCER Evo II (94-95)
		MOSKVICHI	407 (58-69) 2137 (76-01) 2140 (76-88) 2141 (89-01)
		PORSCHE	924 (75-89) 944 (81-91)
		RENAULT	19 I (88-92) 19 II (92-01) CLIO I (90-98)
		SEAT	131 (78-86) IBIZA II (6K2) (99-02)
		SUBARU	JUSTY II (95-03)
		SUZUKI	BALENO (95-02) CARRY (99-) JIMNY (98-) SWIFT I (83-89) SWIFT II (89-05) WAGON R+ (00-)
		TOFAS	DOGAN (76-02) KARTAL (85-02) SAHIN (80-03)
		TVR	280 (83-86) 390 (84-89) 420 (85-89)
		VOLVO	240 (74-93) 440 (88-96) 460 (88-96) 480 (86-96)
		VW	DERBY (86C, 80) (81-84) GOLF I (17, 155) (74-93) JETTA I (16) (78-84) PASSAT (32B) (80-91) POLO (86C, 80) (81-94) SCIROCCO (53) (74-80) SCIROCCO (53B) (80-92)
W22EP-U	W22TT	AUDI	80 (81, 85, B2) (78-86) 100 (43, C2) (76-83)
		FIAT	126 (72-00)
		FORD	ESCORT II (73-81)
		MERCEDES-BENZ	HECKFLOSSE (W110) (61-68) HECKFLOSSE (W111, W112) (59-68)
		PEUGEOT	505 (79-95)
		PORSCHE	911 (901, 911) (63-79) 914 (69-76)
		RENAULT	9 (81-89) 11 (83-88) 19 II (92-01) 21 (86-95) CLIO I (90-98) TRAFIC (80-89) TRAFIC (89-01)
		SAAB	900 I (78-94)
		SEAT	RONDA (82-88)
		VW	GOLF I (17, 155) (74-93) PASSAT (32B) (80-91) POLO (86C, 80) (81-94) SANTANA (81-85)
W22ESR-U	-	ALFA ROMEO	GIULIETTA (77-85)
		ISH	Oda (2717) (97-) ORBITA (2126) (87-)
		MG	MGA (55-62)
		MITSUBISHI	CORDIA (82-89) GALANT II (80-84) GALANT III (84-90)

Свечи зажигания и Свечи накаливания

Руководство покупателя

DENSO P/N	TT	MAKE	MODEL	
W22ESR-U продолжение		STARION	(82-90)	
		MOSKVICH	2901 (98-01)	
		NSU	TT (65-71)	
			TTS (70-71)	
		TVR	400 (89-93)	
			450 (89-93)	
			CHIMAERA (92-03)	
			GRIFFITH (90-02)	
			SPEED EIGHT (89-92)	
		W22ES-U	-	ISH
2715 (72-01)				
Oda (2717) (97-)				
ORBITA (2126) (87-)				
MOSKVICH	412 (71-88)			
	427 (69-79)			
	2141 (89-01)			
W22ETR-L	W22TT	LADA	110 (2110) (95-12)	
			SAMARA (2108, 2109, 2113, 2114, 2115) (86-13)	
		MITSUBISHI	LANCER Evo III (95-96)	
W22FPR-U	-	ARO	240-244 (78-06)	
		CITROËN	CX I (74-85)	
			CX II (85-92)	
		FIAT	126 (72-00)	
		FSO	126P (72-00)	
			VOLVO	DUETT (61-67)
				P 121 (59-71)
				P 122 S Amazon (59-71)
			P 544 (61-67)	
			P 1800 (62-73)	
P 2200 (64-67)				
W22FP-U	-	PORSCHE	356 (50-68)	
		SKODA	130 (85-91)	
		VOLVO	140 (66-75)	
240 (74-93)				
W22FS-U	-	LUAZ	969 (75-96)	
		PORSCHE	356 (50-68)	
			912 (65-70)	
		TRABANT	P 601 (66-90)	
		VOLVO	140 (66-75)	
		ZAZ	ZAPOROZHETS (968) (67-94)	
W22TT	-	ABARTH	RITMO (78-88)	
		ALFA ROMEO	33 (83-93)	
			33 (90-94)	
			75 (85-92)	
			90 (84-87)	
			145 / 146 (94-01)	
			155 (92-97)	
			164 (87-98)	
			166 (98-07)	
			1750-2000 (68-75)	
			ALFASUD (72-89)	
			ALFETTA (74-84)	
			ALFETTA GT (74-86)	
			AR 6 (79-89)	
			ARNA (83-86)	
			GIULIA (62-79)	
			GIULIETTA (77-85)	
			GT (63-77)	
			GTV (78-87)	
			GTV (95-05)	
			RZ (92-94)	
			SPIDER (66-77)	
			SPIDER (71-93)	
			SPIDER (94-05)	
		SZ (88-94)		
		ASTON MARTIN	ZAGATO (86-89)	
		AUDI	80 (81, 85, B2) (78-86)	
			100 (43, C2) (76-83)	
			COUPE (81, 85) (80-88)	
			QUATTRO (85) (80-91)	
		AUTOBIANCHI	A 112 (69-85)	

DENSO P/N	TT	MAKE	MODEL	
W22TT продолжение		BEDFORD	ASTRA VAN (82-91)	
		FERRARI	400 i (79-85)	
			DINO GT4 (74-80)	
		FIAT	124 (66-85)	
			125 (67-74)	
			126 (72-00)	
			COUPE (93-00)	
			CROMA (85-96)	
			ELBA (85-97)	
			FIORINO (88-01)	
			REGATA (83-90)	
			RITMO (78-88)	
			RITMO Bertone (79-89)	
			TEMPRA (90-96)	
			TIPO (160) (87-95)	
			UNO (146) (83-00)	
		FORD	CAPRI (68-74)	
			CAPRI (74-77)	
			CAPRI (78-87)	
			ESCORT II (73-81)	
			GRANADA (72-85)	
			SCORPIO I (85-94)	
			SIERRA (82-87)	
			SIERRA (87-93)	
			FSO	POLONEZ I (77-91)
				POLONEZ II (88-92)
		POLONEZ III (92-02)		
		GEO	METRO (88-98)	
		INNOCENTI	ELBA (91-96)	
			KORAL (90-92)	
		LADA	110 (2110) (95-12)	
		LANCIA	SAMARA (2108, 2109, 2113, 2114, 2115) (86-13)	
			DEDRA (89-99)	
			DELTA I (79-94)	
			DELTA II (93-99)	
			GAMMA (81-84)	
		PRISMA (83-92)	THEMA (84-94)	
			LOTUS	ECLAT (75-86)
				ELITE (74-82)
		MERCEDES-BENZ	COUPE (W111) (61-71)	
			HECKFLOSSE (W110) (61-68)	
			HECKFLOSSE (W111, W112) (59-68)	
			S-CLASS (W108, W109) (66-72)	
			MITSUBISHI	COLT II (84-88)
		ECLIPSE II (94-99)		
		LANCER Evo I (92-93)		
		LANCER Evo II (94-95)		
		LANCER Evo III (95-96)		
		MOSKVICH	407 (58-69)	
			2137 (76-01)	
2140 (76-88)				
2141 (89-01)				
PEUGEOT	505 (79-95)			
PORSCHE	911 (901, 911) (63-79)			
	914 (69-76)			
	924 (75-89)			
	944 (81-91)			
RENAULT	9 (81-89)			
	11 (83-88)			
	19 I (88-92)			
	19 II (92-01)			
	21 (86-95)			
	CLIO I (90-98)			
	TRAFIC (80-89)			
	TRAFIC (89-01)			
	SAAB	900 I (78-94)		
	SEAT	131 (78-86)		
IBIZA II (6K2) (99-02)				
RONDA (82-88)				
TOLEDO I (1L) (91-99)				

Свечи зажигания и Свечи накаливания

Руководство покупателя

DENSO P/N	TT	MAKE	MODEL		
W22TT продолжение		SUBARU	JUSTY II (95-03)		
			SUZUKI	BALENO (95-02)	
				CARRY (99-)	
				JIMNY (98-)	
				SWIFT I (83-89)	
				SWIFT II (89-05)	
				WAGON R+ (00-)	
			TOFAS	DOGAN (76-02)	
				KARTAL (85-02)	
		SAHIN (80-03)			
		TVR	280 (83-86)		
			390 (84-89)		
			420 (85-89)		
		VOLVO	240 (74-93)		
			440 (88-96)		
			460 (88-96)		
			480 (86-96)		
		VW	DERBY (86C, 80) (81-84)		
			GOLF I (17, 155) (74-93)		
			JETTA I (16) (78-84)		
			PASSAT (32B) (80-91)		
			POLO (86C, 80) (81-94)		
			SANTANA (81-85)		
			SCIROCCO (53) (74-80)		
			SCIROCCO (53B) (80-92)		
			W24EPR-U	FORD	CAPRI (68-74)
					SIERRA (82-87)
		MASERATI		228 (86-93)	
				420 / 430 (85-94)	
				BITURBO (81-94)	
		RENAULT		9 (81-89)	
				17 (72-80)	
				19 I (88-92)	
21 (86-95)					
FUEGO (80-85)					
SUPER 5 (84-96)					
TRAFIC (80-89)					
TRAFIC (89-01)					
W24EP-U	PORSCHE		911 (901, 911) (63-79)		
			W24ESR-U	AUTOBIANCHI	Y10 (85-95)
CATERHAM	SUPER SEVEN (80-)				
HONDA	N (68-74)				
PORSCHE	911 (930) (75-90)				
W24ES-U	PORSCHE	356 (50-68)			
W27EBR	MAZDA	RX 7 I (79-86)			
W27ES-U	PORSCHE	911 (901, 911) (63-79)			
		911 (930) (75-90)			
W27ES-V	RENAULT	12 (69-84)			
W29EBR	MAZDA	RX 7 II (85-91)			
WF20TT		CITROËN	2 CV (63-90)		
			ACADIANE (78-88)		
			AMI (63-77)		
			C35 (73-94)		
			CX I (74-85)		
			CX II (85-92)		
			DYANE (67-84)		
			HY (69-77)		
			LNA (76-86)		
			MEHARI (68-87)		
			DACIA	1210 (83-94)	
				1300 (72-83)	
				1304 (83-04)	
				1307 (84-94)	
				1309 (90-01)	
				1310 (81-04)	
				1410 (85-98)	
		PICK UP (89-08)			
		DAF	66 (72-75)		
		FIAT	126 (72-00)		
			500 (57-76)		
			PANDA (80-04)		

DENSO P/N	TT	MAKE	MODEL	
WF20TT продолжение		GAZ	VOLGA (24) (67-92)	
			OPEL	ASCONA A (70-75)
				ASCONA B (75-81)
				ASCONA C (81-88)
				CORSA A (82-93)
				FRONTERA A (92-98)
				GT (68-73)
				KADETT B (65-73)
				KADETT C (73-79)
				KADETT D (79-84)
				MANTA A (70-75)
			MANTA B (75-88)	
			MONZA A (78-86)	
			OLYMPIA A (67-71)	
			OMEGA A (86-94)	
			REKORD B (65-67)	
			REKORD C (66-71)	
		REKORD D (72-77)		
		REKORD E (77-86)		
		SENATOR A (78-87)		
		SENATOR B (87-93)		
		RANGER	REKORD (72-78)	
		RENAULT	12 (69-84)	
			RODEO 4 (71-81)	
		SKODA	100 (70-77)	
			105 / 120 (76-90)	
			105 / 120 (83-90)	
			110 (69-82)	
			RAPID (83-91)	
			3160 (94-03)	
		UAZ	SIMBIR (3162) (97-)	
			VAUXHALL	ASTRA I (79-86)
				ASTRA II (84-94)
CARLTON III (86-94)				
CAVALIER I (75-81)				
FRONTERA I (A) (91-98)				
NOVA (82-94)				
SENATOR II (B) (87-93)				
VOLVO	66 (75-79)			
	164 (68-74)			
VW	1500, 1600 (61-73)			
	KARMANN GHIA (55-74)			
TRANSPORTER II (67-79)				
WARTBURG	353 (66-91)			
X22EPR-U9		BMW	5 (E28) (81-87)	
			5 (E34) (87-97)	
			6 (E24) (76-90)	
			M1 (79-83)	
X22ESR-U		BMW	3 (E30) (82-94)	
			X24EP-U9	BMW
X24ESR-U		LANCIA	THEMA (84-94)	
XE20HR-U9		IXEH20TT	PORSCHE	959 (86-91)
	CITROËN			C2 (03-)
			C3 I (02-)	
			C4 Coupe (04-11)	
			C4 I (LC, LR) (04-11)	
	DACIA		LOGAN I (04-)	
			LOGAN II (12-)	
			LOGAN MCV II (13-)	
			SANDERO I (Stepway) (08-)	
			SANDERO II (Stepway) (12-)	
NISSAN	KUBISTAR (03-)			
PEUGEOT	206 (98-)			
	207 (06-)			
	307 (00-)			
	1007 (05-)			
	RENAULT	CLIO II (98-)		
CLIO III (05-)				
CLIO IV (12-)				
KANGOO (97-)				
LOGAN II (13-)				

Свечи зажигания и Свечи накаливания

Руководство покупателя

DENSO P/N	TT	MAKE	MODEL			
XE20HR-U9 продолжение			MODUS (04-)			
			THALIA I (98-)			
			THALIA II (08-)			
			TWINGO I (93-07)			
			TWINGO II (07-)			
			TWINGO III (14-)			
			SMART			
			FORFOUR II (453) (14-)			
			FORTWO (453) (14-)			
			XU20EPR-U	-	BMW	5 (E34) (87-97)
XU20HR9	XUH20TTi	DAIHATSU	CAST (15-)			
			HIJET (15-)			
			MIRA VII (06-)			
			MOVE (08-10)			
			MOVE (10-14)			
			MOVE (14-)			
			MOVE Conte (08-)			
			TANTO (07-13)			
			TANTO (13-)			
			WAKE (14-)			
			XU22EPR-U	XU22TT	ALFA ROMEO	MITO (08-)
			BMW		3 (E36) (90-00)	
					5 (E34) (87-97)	
			CHANGHE		BEIDOUXING (04-)	
CHEVROLET	WAGON R (99-04)					
	AVEO / KALOS (T250, T255) (05-)					
CHRYSLER	YPSILON (846) (11-)					
DAEWOO	GENTRA (13-)					
FAW	V5 (12-)					
FIAT	500 (C) (312) (07-)					
	500L (12-)					
	ALBEA / SIENA (96-11)					
	BRAVO II (06-14)					
	DOBLO (01-)					
	DOBLO (10-)					
	FIORINO (07-)					
	Grande PUNTO (05-)					
	IDEA (03-)					
	LINEA (07-)					
	PALIO (96-)					
	PANDA (03-)					
	PANDA (12-)					
	PUNTO (99-12)					
	PUNTO (12-)					
	PUNTO Evo (08-12)					
	QUBO (08-)					
	SEICENTO (98-10)					
	STILO (01-08)					
	STRADA (99-)					
	TIPO (356) (15-)					
	FORD	KA (08-)				
	LANCIA	MUSA (04-12)				
YPSILON (312/846) (11-)						
YPSILON (843) (03-11)						
MAZDA	CAROL (89-98)					
	CAROL (98-04)					
	CAROL (04-10)					
	CAROL (10-)					
	SCRUM (05-15)					
	TOWN BOX (98-)					
MITSUBISHI	PAJERO Junior (95-98)					
	PAJERO Mini (94-12)					
NISSAN	MOCO I (02-06)					
	MOCO II (06-10)					
OPEL	COMBO D (12-)					
PORSCHE	911 (996) (97-05)					
	911 (997) (04-12)					
SUZUKI	ALTO IV (02-08)					
	CAPPUCINO (92-98)					
	EVERY (05-15)					
	MR Wagon (01-06)					

DENSO P/N	TT	MAKE	MODEL			
XU22EPR-U продолжение			MR Wagon (06-13)			
			WAGON R (97-03)			
			WAGON R (08-12)			
			WAGON R+ (98-00)			
			TATA			
			INDICA Vista (08-)			
			INDIGO (03-)			
			VAUXHALL			
			COMBO III (D) (11-)			
			ZASTAVA			
10 (05-)						
XU22HDR9	XUH22TT	HYUNDAI	ACCENT IV / SOLARIS (10-)			
			ELANTRA (05-11)			
			ELANTRA (11-)			
			ELANTRA (15-)			
			i20 (08-15)			
			i30 (07-12)			
			i30 (11-)			
			i30 Coupe (13-)			
			ix20 (10-)			
			VELOSTER (11-)			
			KIA	CARENS III (06-)		
				CEED (06-12)		
				CEED (12-)		
				CERATO (04-)		
				CERATO (09-)		
				PRO CEED (08-13)		
				PRO CEED (13-)		
				RIO III (11-)		
		SOUL I (09-)				
		SOUL II (14-)				
		VENGA (10-)				
		MITSUBISHI		i-MiEV (06-)		
		SMART	FORFOUR I (454) (04-06)			
			FORTWO (451) (07-)			
		XU22PR9	XU22TT	DAIHATSU	SIRION (05-)	
		XU22TT	-	ALFA ROMEO	MITO (08-)	
					BMW	3 (E36) (90-00)
						5 (E34) (87-97)
				CHANGHE	BEIDOUXING (04-)	
				CHEVROLET	WAGON R (99-04)	
					AVEO / KALOS (T250, T255) (05-)	
				SPARK (10-)	CHRYSLER	YPSILON (846) (11-)
					DAEWOO	GENTRA (13-)
				DAIHATSU	SIRION (05-)	
				FAW	V5 (12-)	
					FIAT	500 (C) (312) (07-)
				500L (12-)		
				ALBEA / SIENA (96-11)		
				BRAVO II (06-14)		
				DOBLO (01-)		
DOBLO (10-)						
FIORINO (07-)						
Grande PUNTO (05-)						
IDEA (03-)						
LINEA (07-)						
PALIO (96-)						
PANDA (03-)						
PANDA (12-)						
PUNTO (99-12)						
PUNTO (12-)						
PUNTO Evo (08-12)						
QUBO (08-)						
SEICENTO (98-10)						
STILO (01-08)						
STRADA (99-)						
TIPO (356) (15-)						
FORD	KA (08-)					
LANCIA	MUSA (04-12)					
	YPSILON (312/846) (11-)					
	YPSILON (843) (03-11)					
MAZDA	CAROL (89-98)					
	CAROL (98-04)					
	CAROL (04-10)					
	CAROL (10-)					

Свечи зажигания и Свечи накаливания

Руководство покупателя

DENSO P/N	TT	MAKE	MODEL		
XU22TT продолжение			CAROL (04-10)		
			CAROL (10-)		
			SCRUM (05-15)		
			TOWN BOX (98-)		
		MITSUBISHI	PAJERO Junior (95-98)		
			PAJERO Mini (94-12)		
		NISSAN	MOCO I (02-06)		
			MOCO II (06-10)		
		OPEL	COMBO D (12-)		
		PORSCHE	911 (996) (97-05)		
			911 (997) (04-12)		
		SUZUKI	ALTO IV (02-08)		
			CAPPUCINO (92-98)		
			EVERY (05-15)		
			MR Wagon (01-06)		
			MR Wagon (06-13)		
			WAGON R (97-03)		
			WAGON R (08-12)		
			WAGON R+ (98-00)		
			TATA	INDICA Vista (08-)	
				INDIGO (03-)	
		VAUXHALL	COMBO III (D) (11-)		
		ZASTAVA	10 (05-)		
		XU24EPR-U	-	FIAT	ALBEA / SIENA (96-11)
					BRAVA (95-02)
					BRAVO I (95-01)
					IDEA (03-)
					MAREA (96-07)
					PALIO (96-)
					PUNTO (93-00)
					PUNTO (99-12)
					STILO (01-08)
					LANCIA
YPSILON (843) (03-11)					
MASERATI	BITURBO (81-94)				
	SHAMAL (89-95)				
NANJING FIAT	PALIO (03-05)				
TVR	CERBERA (96-03)				
XU27EPR-U	-			LANCIA	THEMA (84-94)
					MASERATI
					GHIBLI II (92-97)
					QUATTROPORTE IV (94-01)
XUH20TTI	XUH20TTI	HYUNDAI	ACCENT IV / SOLARIS (10-)		
			i10 (07-13)		
			i10 (13-)		
			i20 (08-15)		
			i20 (14-)		
			i20 Coupe (15-)		
			i30 (11-)		
			i30 Coupe (13-)		
			KIA	CEED (12-)	
				PICANTO (11-)	
		PRO CEED (13-)			
		RIO III (11-)			
		XUH22TT	-	HYUNDAI	ACCENT IV / SOLARIS (10-)
					ELANTRA (05-11)
ELANTRA (11-)					
ELANTRA (15-)					
i20 (08-15)					
i30 (07-12)					
i30 (11-)					
i30 Coupe (13-)					
ix20 (10-)					
VELOSTER (11-)					
KIA	CARENS III (06-)				
	CEED (06-12)				
	CEED (12-)				
	CERATO (04-)				
	CERATO (09-)				
	PRO CEED (08-13)				
	PRO CEED (13-)				

DENSO P/N	TT	MAKE	MODEL		
XUH22TT продолжение			RIO III (11-)		
			SOUL I (09-)		
			SOUL II (14-)		
			VENGA (10-)		
		MITSUBISHI	i-MIEV (06-)		
			SMART	FORFOUR I (454) (04-06)	
				FORTWO (451) (07-)	
		ZT20EPR11	IT20TT	ASTON MARTIN	DB9 (04-16)
					VANQUISH (01-07)
FORD	C-MAX I (07-10)				
	FOCUS C-MAX (03-07)				
	FOCUS II (04-12)				
	GALAXY (06-15)				
	MAVERICK (01-)				
	MONDEO III (00-07)				
	MONDEO IV (07-15)				
	S-MAX (06-14)				
	JAGUAR			S-TYPE (99-08)	
				XK 8 (96-05)	
MAZDA	3 (00-09)				
	5 (05-10)				
	6 (02-07)				
	MPV II (99-06)				
	TRIBUTE (00-08)				
	MORGAN			ROADSTER (04-)	
				SHELBY SERIES 1 (98-)	
	VOLVO			C30 (06-12)	
S40 II (04-12)					
S80 II (06-)					
V50 (04-12)					
V70 III (07-)					
ZXU20HCR8	-	HYUNDAI	SONATA VI (09-15)		
ZXU20PR11	-	CHANGHE	BEIDOUXING (04-)		
		MARUTI SUZUKI	ALTO (12-)		
			PIXO (09-)		
		OPEL	AGILA B (08-14)		
		SUZUKI	ALTO V (09-)		
			CELERIO (14-)		
SPLASH (08-)					
		SWIFT IV (10-)			
		VAUXHALL	AGILA II (B) (08-14)		

DENSO Таблица взаимозаменяемости



Свечи зажигания и Свечи накаливания

Таблица взаимозаменяемости - OE

Внимание!

Пользоваться настоящей таблицей необходимо только в случае, если ваш автомобиль НЕ внесен в Таблицу рменяемости настоящего каталога.

AC	DENSO	TT
28G	DG-012	-
30G	DG-001	-
41XL	W27ESR-U	-
44F	W16FSR	-
60G	DG-175	-
C42CXLS	W20EPR-U	W20TT
C42XLS	W20EPR-U	W20TT
CR43CTS	T20PR-U	ITF20TT
S41XL	W27ESR-U	-

ALFA ROMEO	DENSO	TT
116610535800	DG-202	-
116760535801	DG-202	-
4249164	W20EPR-U	W20TT
4345041	W20EPR-U	W20TT
4393814	DG-001	-
4474413	DG-001	-
46447610	DG-102	-
46449690	PK20TR11	K20TT
46451951	DG-127	-
46480307	K20TNR	K20TT
46484273	XU24EPR-U	-
46521529	PK20TR11	K20TT
46521530	IU22	-
46550991	K20PBR-S10	K20TT
46550992	U22ETR	-
46751764	DG-129	-
46754154	DG-122	-
46759688	W20EPR-U	W20TT
46792355	DG-170	-
46792359	DG-170	-
4714294	DG-001	-
4729585	DG-001	-
4738576	DG-001	-
4752281	DG-001	-
4754011	DG-001	-
4774412	DG-001	-
4774413	DG-001	-
4781356	DG-001	-
4832279	DG-111	-
4849466	DG-001	-
55208177	DG-629	-
55210051	DG-621	-
60512848	K20PBR	K20TT
60569086	P20PR11	W20TT
60569957	PK20PR-P8	IK20TT
60571785	K20PR-U	K20TT
60571786	Q22PR-U	-
60593139	K20PBR	K20TT
60599495	IU22	-
60734155	W22ESR-U	-
60816139	DG-127	-
71741208	PT16VR13	TV16TT

APRILIA	DENSO	TT
0297542	X24ESR-U	-
0297830	IW31	-
0297921	U24ESR-N	-
0297942	XU27EPR-U	-
0297945	RU01-31	-
0897055	W24ESR-U	-
2BEN000088	W24FPR	-
2BEN000181	N24EXRB	-
2BEN000276	N24EXRB	-
8122586	X22ESR-U	-
8206870	W22FSR	-
8206871	W24FSR	-
8550352	U22ESR-N	-
COEO6060	RU01-34	-

ASTON MARTIN	DENSO	TT
723116	Q20PR-U	Q20TT
770920	IQ24	-
785723	IT20TT	IT20TT

AUDI	DENSO	TT
N01781123	W22EPR-U	W22TT
N01781239	W22EPR-U	W22TT
N10302101	DG-628	-
N10302102	DG-628	-

AUTOBIANCHI	DENSO	TT
4401550	W20EPR-U	W20TT
7565476	W24ESR-U	-

BENTLEY	DENSO	TT
101905600C	VKA20	-

BMW	DENSO	TT
0 022 902	VXU24	-
0 030 548	K20TXR	K20TT
0 031 708	IK22	IK22FTT
0 032 136	K20TXR	K20TT
0 034 097	VXUH22I	IXUH22TT
0 034 098	VXUH22I	IXUH22TT
0 034 677	VXUH22I	IXUH22TT
0 035 531	VXUH22I	IXUH22TT
0 035 933	VXUH22I	IXUH22TT
0 035 934	DG-613	-
0 037 607	K20TXR	K20TT
0 141 871	K20TXR	K20TT
0 148 593	K20TXR	K20TT
1 262 360	W16EPR-U	W16TT
1 265 595	W20EPR-U	W20TT
1 267 485	W20EPR-U	W20TT
1 276 283	W16EPR-U	W16TT
1 279 526	W16EPR-U	W16TT
1 288 234	W16EPR-U	W16TT
1 288 245	DG-001	-
1 312 569	XU20EPR-U	-
1 338 142	W20EP-U	W20TT
1 338 145	W20EPR-U	W20TT
1 338 145	W20EP-U	W20TT
1 340 961	K22TNR-S	-
1 341 422	K22TNR-S	-
1 341 492	K22TNR-S	-
1 342 125	K22TNR-S	-
1 342 422	K22TNR-S	-
1 342 836	K22TNR-S	-
1 344 520	K20TXR	K20TT
1 435 956	K20TXR	K20TT
1 465 104	X22EPR-U9	-
1 705 914	K20TXR	K20TT
1 710 731	J16CR-U	W16TT
1 711 296	W20EPR-U	W20TT
1 714 751	J16CR-U	W16TT
1 715 539	K20TXR	K20TT
1 721 895	J16CR-U	W16TT
12 12 0 022 902	VXU24	-
12 12 0 030 548	K20TXR	K20TT
12 12 0 031 708	IK22	IK22FTT
12 12 0 032 136	K20TXR	K20TT
12 12 0 034 097	VXUH22I	IXUH22TT
12 12 0 034 098	VXUH22I	IXUH22TT
12 12 0 034 677	VXUH22I	IXUH22TT
12 12 0 035 531	VXUH22I	IXUH22TT
12 12 0 035 933	VXUH22I	IXUH22TT
12 12 0 037 607	K20TXR	K20TT
12 12 0 141 871	K20TXR	K20TT
12 12 0 148 593	K20TXR	K20TT
12 12 1 262 360	W16EPR-U	W16TT
12 12 1 265 595	W20EPR-U	W20TT

BMW	DENSO	TT
12 12 1 267 485	W20EPR-U	W20TT
12 12 1 276 283	W16EPR-U	W16TT
12 12 1 279 526	W16EPR-U	W16TT
12 12 1 288 234	W16EPR-U	W16TT
12 12 1 312 569	XU20EPR-U	-
12 12 1 338 142	W20EP-U	W20TT
12 12 1 338 145	W20EPR-U	W20TT
12 12 1 338 145	W20EP-U	W20TT
12 12 1 340 961	K22TNR-S	-
12 12 1 341 422	K22TNR-S	-
12 12 1 341 492	K22TNR-S	-
12 12 1 342 125	K22TNR-S	-
12 12 1 342 422	K22TNR-S	-
12 12 1 342 836	K22TNR-S	-
12 12 1 344 520	K20TXR	K20TT
12 12 1 435 956	K20TXR	K20TT
12 12 1 465 104	X22EPR-U9	-
12 12 1 705 914	K20TXR	K20TT
12 12 1 710 731	J16CR-U	W16TT
12 12 1 711 296	W20EPR-U	W20TT
12 12 1 714 751	J16CR-U	W16TT
12 12 1 715 539	K20TXR	K20TT
12 12 1 721 895	J16CR-U	W16TT
12 12 2 158 165	VXUH22I	IXUH22TT
12 12 2 163 332	VXUH22I	IXUH22TT
12 12 2 293 697	VXUH22I	IXUH22TT
12 12 2 343 144	X24ESR-U	-
12 12 7 556 979	IK22	IK22FTT
12 12 7 570 106	VXUH22I	IXUH22TT
12 12 7 653 439	U24ESR-NB	-
12 12 7 653 771	K22TNR-S	-
12 12 7 664 404	X24ESR-U	-
12 12 7 671 302	XU22EPR-U	XU22TT
12 12 7 677 560	XU24EPR-U	-
12 12 7 681 415	XU22EPR-U	XU22TT
12 12 7 690 603	XU24EPR-U	-
12 12 7 699 116	IXU27	-
12 12 7 710 636	IU27A	-
12 12 7 728 634	XU24EPR-U	-
12 12 7 728 635	IXU27	-
12 12 9 056 446	W16EPR-U	W16TT
12 12 9 056 447	W16EPR-U	W16TT
12 12 9 059 794	K20TXR	K20TT
12 12 9 061 382	K20TXR	K20TT
12 12 9 061 383	J16CR-U	W16TT
12 12 9 061 444	IW16	IW16TT
12 12 9 061 445	J16CR-U	W16TT
12 12 9 061 867	XU20EPR-U	-
12 12 9 061 868	X22ESR-U	-
12 12 9 061 869	J16CR-U	W16TT
12 12 9 061 870	K20TXR	K20TT
12 12 9 061 871	W20EPR-U	W20TT
12 12 9 061 882	X22EPR-U9	-
12 12 9 063 428	K20TXR	K20TT
12 12 9 064 617	K20TXR	K20TT
12 12 9 064 619	K20TXR	K20TT
12 12 9 064 656	K20TXR	K20TT
12 12 9 065 004	XU22EPR-U	XU22TT
12 12 9 065 062	K20TXR	K20TT
12 12 9 065 366	K20TXR	K20TT
12 12 9 068 016	KJ14CR-L11	-
12 12 9 069 048	VXU22	IXU22TT
12 12 9 070 999	KJ14CR-L11	-
12 12 9 071 003	K20TXR	K20TT
12 23 0 035 934	DG-613	-
12 23 1 288 245	DG-001	-
12 23 2 240 255	DG-001	-
12 23 2 241 387	DG-001	-
12 23 2 241 389	DG-001	-
12 23 2 248 059	DG-145	-
12 23 2 248 422	DG-118	-

Свечи зажигания и Свечи накаливания

Таблица взаимозаменяемости - OE

BMW	DENSO	TT
12 23 7 786 869	DG-178	-
12 23 7 788 957	DG-191	-
12 23 7 791 101	DG-240	-
12 23 7 798 001	DG-607	-
12 23 7 798 001	DG-623	-
12 23 7 803 368	DG-613	-
12 23 7 806 041	DG-180	-
12 23 9 061 353	DG-001	-
12 23 9 061 354	DG-001	-
2 158 165	VXUH22I	IXUH22TT
2 163 332	VXUH22I	IXUH22TT
2 240 255	DG-001	-
2 241 387	DG-001	-
2 241 389	DG-001	-
2 248 059	DG-145	-
2 248 422	DG-118	-
2 293 697	VXUH22I	IXUH22TT
2 343 144	X24ESR-U	-
7 556 979	IK22	IK22FTT
7 570 106	VXUH22I	IXUH22TT
7 653 439	U24ESR-NB	-
7 653 771	K22TNR-S	-
7 664 404	X24ESR-U	-
7 671 302	XU22EPR-U	XU22TT
7 677 560	XU24EPR-U	-
7 681 415	XU22EPR-U	XU22TT
7 690 603	XU24EPR-U	-
7 699 116	IXU27	-
7 710 636	IU27A	-
7 728 634	XU24EPR-U	-
7 728 635	IXU27	-
7 786 869	DG-178	-
7 788 957	DG-191	-
7 791 101	DG-240	-
7 798 001	DG-607	-
7 798 001	DG-623	-
7 803 368	DG-613	-
7 806 041	DG-180	-
9 056 446	W16EPR-U	W16TT
9 056 447	W16EPR-U	W16TT
9 059 794	K20TXR	K20TT
9 061 353	DG-001	-
9 061 354	DG-001	-
9 061 382	K20TXR	K20TT
9 061 383	J16CR-U	W16TT
9 061 444	IW16	IW16TT
9 061 445	J16CR-U	W16TT
9 061 867	XU20EPR-U	-
9 061 868	X22ESR-U	-
9 061 869	J16CR-U	W16TT
9 061 870	K20TXR	K20TT
9 061 871	W20EPR-U	W20TT
9 061 882	X22EPR-U9	-
9 063 428	K20TXR	K20TT
9 064 617	K20TXR	K20TT
9 064 619	K20TXR	K20TT
9 064 656	K20TXR	K20TT
9 065 004	XU22EPR-U	XU22TT
9 065 062	K20TXR	K20TT
9 065 366	K20TXR	K20TT
9 068 016	KJ14CR-L11	-
9 069 048	VXU22	IXU22TT
9 070 999	KJ14CR-L11	-
9 071 003	K20TXR	K20TT

BRIGGS & STRATTON	DENSO	TT
BS19LM	W9LM-US	-
BS19LMR	W9LMR-US	-

CADILLAC	DENSO	TT
24425327	K20PBR-S10	K20TT

CATERPILLAR	DENSO	TT
2A3643	L14-U	-
2W9486	W20EPR-U	W20TT
3B6583	W16LS	-
8F6347	W20M-US	-
9B0444	W20S-U	-
9M4141	W16PR-U	-
9M4142	W16PR-U	-

CHERY	DENSO	TT
A11-3707110CA	K20PR-U	K20TT

CHEVROLET	DENSO	TT
55664219	DG-621	-
94535748	W16EPR-U11	W16TT
94837756	W20EPR-U	W20TT
96110493	W20EPR-U	W20TT
96307562	PK20PR-L11	IK20TT
96307729	K20PBR-S10	K20TT
96353255	W16EXR-U11	W16TT
96376288	XU22EPR-U	XU22TT
96417176	K20PBR-S10	K20TT
96440144	DG-604	-
96464000	XU22EPR-U	XU22TT
96990231	XU22EPR-U	XU22TT
EC229566	K20TXR	K20TT
EC229626	K20TXR	K20TT

CHRYSLER	DENSO	TT
05058011AD	DG-117	-
05066840AA	DG-176	-
05080046AA	DG-117	-
05080047AB	DG-117	-
05175756AA	DG-194	-
4318131	W16EPR-U11	W16TT
4606402AB	ITL16TT	ITL16TT
4606402AC	ITL16TT	ITL16TT
4606402AD	ITL16TT	ITL16TT
4606823AB	KJ16CR-U11	K16TT
4609076	KJ14CR-L11	-
4609079	K16R-U11	K16TT
4622162	DG-176	-
4671057	K20PR-U	K20TT
4686083	W16EXR-U13	W16TT
4727114	P16R13	W20TT
4796779	PK16PR-L11	IK16TT
4863826	DG-109	-
5066840AA	DG-176	-
5098168AA	SK20PR-L9	IK20TT
5149002AA	ITL16TT	ITL16TT
5149003AA	ITL16TT	ITL16TT
5175756AA	DG-194	-
5213693	W16EPR-U	W16TT
5235010	W16EXR-U13	W16TT
5269556	IK20	IK20TT
5269897	K20PR-U	K20TT
56006240	IK16	IK16TT
56027108	KJ20CR-L11	K20TT
56028179	KJ20CR-L11	K20TT
56028886AA	K16R-U11	K16TT
56041402AB	KJ16CR-L11	K16TT
68000913AA	DG-190	-
68029497AA	DG-633	-
68055948AA	DG-617	-
68096212AA	DG-190	-
MS851552	IW16	IW16TT
MS851555	W20EPR-U	W20TT
MS851571	IK20	IK20TT
MS851622	IK20	IK20TT
S2RE14MCC5	ITL16TT	ITL16TT
S3RE14PLP5	ITL16TT	ITL16TT
SP00RC9MCC	K20R-U	K20TT

CHRYSLER	DENSO	TT
SPOORN12YC	W16EPR-U	W16TT
SP149125AD	VXUH22I	IXUH22TT
SPLZTR4A11	ITL16TT	ITL16TT
SPOORN12YC	ITL16TT	ITL16TT
SPORC12YC5	K16R-U11	K16TT
SPRC12PEC5	PKJ16CR-L11	IK16TT
SPRE10PMC5	ITL20	-
SPRE14MCC4	ITL16TT	ITL16TT
SPRE14MCC5	ITL16TT	ITL16TT
SPRE14PLP5	ITL16TT	ITL16TT
SPRE14PMC5	ITL16TT	ITL16TT

CITROEN/PEUGEOT	DENSO	TT
16 072 718 80	DG-614	-
16 104 191 80	DG-116	-
16 104 289 80	DG-001	-
16 104 290 80	DG-003	-
16 104 292 80	DG-113	-
16 104 293 80	DG-180	-
16 104 294 80	DG-181	-
16 104 296 80	DG-161	-
16 104 297 80	DG-130	-
16 104 298 80	DG-614	-
16 104 299 80	DG-111	-
16 104 300 80	DG-195	-
16 104 339 80	DG-140	-
16 115 481 80	SC16HR11	IXEH20TT
16 127 366 80	DG-603	-
16 134 015 80	VXUH22I	IXUH22TT
16 160 600 80	DG-111	-
16 163 173 80	DG-658	-
5403277	W20FPR-U	WF20TT
5418536	W20FSR-U	WF20TT
5493205	DG-001	-
5952 5G	K20PR-U	K20TT
5960 04	Q20PR-U	Q20TT
5960 07	W20EPR-U	W20TT
5960 08	W20EX-U	W20TT
5960 12	DG-113	-
5960 15	K20PR-U	K20TT
5960 17	K20HR-U11	KH20TT
5960 18	K20TXR	K20TT
5960 19	DG-113	-
5960 34	DG-010	-
5960 35	DG-106	-
5960 40	DG-649	-
5960 53	K16HPR-U11	KH16TT
5960 54	K16HPR-U11	KH16TT
5960 55	XE20HR-U9	IXEH20TT
5960 56	XE20HR-U9	IXEH20TT
5960 57	K16HPR-U11	KH16TT
5960 58	K16HPR-U11	KH16TT
5960 59	K20HR-U11	KH20TT
5960 62	K20HR-U11	KH20TT
5960 64	DG-181	-
5960 65	DG-181	-
5960 66	DG-116	-
5960 67	DG-116	-
5960 68	DG-003	-
5960 69	DG-003	-
5960 71	DG-111	-
5960 72	DG-111	-
5960 73	K20HR-U11	KH20TT
5960 75	K20HR-U11	KH20TT
5960 76	DG-140	-
5960 77	DG-140	-
5960 78	DG-180	-
5960 79	DG-180	-
5960 83	XE20HR-U9	IXEH20TT
5960 84	XE20HR-U9	IXEH20TT
5960 85	K20HR-U11	KH20TT

CITROEN/PEUGEOT	DENSO	TT
5960 87	K20HR-U11	KH20TT
5960 88	DG-130	-
5960 89	DG-130	-
5960 90	K20HR-U11	KH20TT
5960 91	K16HPR-U11	KH16TT
5960 92	VXUH22I	IXUH22TT
5960 93	VXUH22I	IXUH22TT
5960 96	K20PR-U	K20TT
5960 97	K16HR-U11	KH16TT
5960 98	K20HR-U11	KH20TT
5960 99	DG-614	-
5960 A0	DG-614	-
5960 A3	DG-195	-
5960 A4	DG-195	-
5960 A5	VXUH22I	IXUH22TT
5960 C1	K20PR-U	K20TT
5960 C2	K16PSR-B8	IK16TT
5960 C3	K16PSR-B8	IK16TT
5960 C4	K16PSR-B8	IK16TT
5960 C5	K16PSR-B8	IK16TT
5960 E1	VXUH22I	IXUH22TT
5960 E2	VXUH22I	IXUH22TT
5960 E3	K16HPR-U11	KH16TT
5960 E4	K20HR-U11	KH20TT
5960 E6	DG-603	-
5960 E9	DG-113	-
5960 F0	K20PR-U	K20TT
5960 F1	K20TXR	K20TT
5960 F2	K16HPR-U11	KH16TT
5960 F3	K16HPR-U11	KH16TT
5960 F4	DG-181	-
5960 F5	DG-116	-
5960 F6	DG-003	-
5960 F7	K16HPR-U11	KH16TT
5960 F8	DG-140	-
5960 F9	DG-180	-
5960 G1	XE20HR-U9	IXEH20TT
5960 G2	DG-130	-
5960 G3	K20HR-U11	KH20TT
5960 G4	VXUH22I	IXUH22TT
5960 G5	K20PR-U	K20TT
5960 G6	DG-614	-
5960 G7	DG-001	-
5960 G8	T20EPR-U	T20TT
5960 H6	DG-161	-
5960 H7	K20HR-U11	KH20TT
5960 H9	VXUH22I	IXUH22TT
5960 J0	W20EPR-U	W20TT
5960 J2	K20PR-U	K20TT
5960 J3	K20PR-U	K20TT
5960 J4	T20EPR-U	T20TT
5960 J5	K20PR-U	K20TT
5960 J6	K20PR-U	K20TT
5960 J7	K20TNR-S	K20TT
5960 J8	K20PBR	K20TT
5960 J9	K20PR-U	K20TT
5960 K0	DG-004	-
5960 K1	K20PBR	K20TT
5960 K3	K20HR-U11	KH20TT
5960 K4	DG-195	-
5960 K5	DG-111	-
5960 K6	DG-603	-
5960 K9	VXUH22I	IXUH22TT
5960 L0	VXUH22I	IXUH22TT
5960 L1	DG-632	-
5960 L2	K16HR-U11	KH16TT
5960 L3	VXUH22I	IXUH22TT
5960 L4	DG-621	-
5960 L5	VXUH22I	IXUH22TT
5960 L0	VXUH22I	IXUH22TT
5961 20	W22EPR-U	W22TT

Свечи зажигания и Свечи накаливания

Таблица взаимозаменяемости - OE

CITROEN/PEUGEOT	DENSO	TT
5961 39	DG-001	-
5961 40	DG-001	-
5961 53	DG-001	-
5961 57	DG-001	-
5961 5L	K16HPR-U11	KH16TT
5961 99	T20EPR-U	T20TT
5962 03	DG-001	-
5962 05	T20EPR-U	T20TT
5962 08	DG-001	-
5962 09	T20EPR-U	T20TT
5962 0G	Q20PR-U	Q20TT
5962 0J	Q16PR-U	Q16TT
5962 0P	Q20PR-U	Q20TT
5962 0V	K20PR-U	K20TT
5962 0W	K20PR-U	K20TT
5962 13	W20EPR-U	W20TT
5962 14	T20EPR-U	T20TT
5962 15	T20EPR-U	T20TT
5962 16	W20EPR-U	W20TT
5962 1K	K20PR-U	K20TT
5962 1N	K20TXR	K20TT
5962 1P	DG-161	-
5962 1Q	DG-161	-
5962 1R	DG-001	-
5962 1S	DG-123	-
5962 1T	DG-001	-
5962 1V	DG-001	-
5962 1W	DG-004	-
5962 1X	DG-012	-
5962 1Y	DG-006	-
5962 1Z	DG-012	-
5962 21	W20EPB	W20TT
5962 22	IW20	IW20TT
5962 2A	W20EPR-U	W20TT
5962 2J	K20TXR	K20TT
5962 2K	K20TXR	K20TT
5962 2W	K20PR-U	K20TT
5962 2Y	DG-003	-
5962 2Z	DG-003	-
5962 35	DG-001	-
5962 3C	DG-116	-
5962 3E	DG-116	-
5962 3H	DG-001	-
5962 3J	DG-001	-
5962 3L	W20EPR-U	W20TT
5962 3N	W20FPR-U	WF20TT
5962 3P	W20FPR-U	WF20TT
5962 3R	W20EPR-U	W20TT
5962 3T	W22EPR-U	W22TT
5962 3W	W22EPR-U	W22TT
5962 3X	W22EPR-U	W22TT
5962 4A	K20TXR	K20TT
5962 4E	W20EPR-U	W20TT
5962 4W	K20PR-U	K20TT
5962 5A	DG-111	-
5962 5C	K16HPR-U11	KH16TT
5962 5G	K20PR-U	K20TT
5962 5M	K20HR-U11	KH20TT
5962 5V	W20FSR-U	WF20TT
5962 5W	T20EPR-U	T20TT
5962 5Y	W20EPR-U	W20TT
5962 61	T20EPR-U	T20TT
5962 65	W20EPR-U	W20TT
5962 6G	Q20PR-U	Q20TT
5962 6K	K20PR-U	K20TT
5962 6L	K20PR-U	K20TT
5962 6V	K20PR-U	K20TT
5962 6X	W22EPR-U	W22TT
5962 71	K20PR-U	K20TT
5962 72	T20EPR-U	T20TT
5962 74	DG-001	-

CITROEN/PEUGEOT	DENSO	TT
5962 7F	DG-116	-
5962 7Q	K20PR-U	K20TT
5962 7S	K20PR-U	K20TT
5962 7W	K20HR-U11	KH20TT
5962 7X	K20HR-U11	KH20TT
5962 81	T20EPR-U	T20TT
5962 87	T20EPR-U	T20TT
5962 88	W22EPR-U	W22TT
5962 98	W22EPR-U	W22TT
5962 99	W20EPR-U	W20TT
5962 A2	Q20PR-U	Q20TT
5962 A5	VXUH22I	IXUH22TT
5962 A7	T20EPR-U	T20TT
5962 A8	W20EPR-U	W20TT
5962 C0	T16EPR-U	T16TT
5962 C2	T20EPR-U	T20TT
5962 C5	K20PR-U	K20TT
5962 C6	K20PR-U	K20TT
5962 C8	K22PB	IKB22TT
5962 E2	K20PR-U	K20TT
5962 E3	K20PR-U	K20TT
5962 E9	W20EPR-U	W20TT
5962 F7	Q20R-U	Q20TT
5962 F8	Q20R-U	Q20TT
5962 G2	Q22PR-U	-
5962 H1	T22EP-U	-
5962 H2	K20PR-U	K20TT
5962 H7	K20PBR	K20TT
5962 H8	K16PR-U	K16TT
5962 H9	Q20PR-U	Q20TT
5962 J0	Q20R-U	Q20TT
5962 J1	K16PR-U	K16TT
5962 J2	DG-006	-
5962 J3	DG-004	-
5962 J4	DG-001	-
5962 J5	DG-001	-
5962 J6	DG-001	-
5962 J7	DG-012	-
5962 J9	K20PR-U	K20TT
5962 K0	Q20PR-U	Q20TT
5962 K1	K20PR-U	K20TT
5962 K2	K20PR-U	K20TT
5962 K3	K22PB	IKB22TT
5962 K4	K20PR-U	K20TT
5962 K5	DG-001	-
5962 K6	K20PR-U	K20TT
5962 K7	K20PBR	K20TT
5962 L0	Q22PR-U	-
5962 OE	PK20PR11	K20TT
5962 Q9	K20TXR	K20TT
5962 R0	K20PBR	K20TT
5962 R4	Q20PR-U	Q20TT
5962 R5	K20PBR	K20TT
5962 R8	DG-001	-
5962 R9	K20PR-U	K20TT
5962 S1	T20EPR-U	T20TT
5962 S3	K20PR-U	K20TT
5962 S8	DG-001	-
5962 S9	Q20PR-U	Q20TT
5962 T0	Q20PR-U	Q20TT
5962 T1	DG-006	-
5962 T2	DG-012	-
5962 T7	DG-004	-
5962 T9	K20PR-U	K20TT
5962 U8	DG-001	-
5962 V2	K20PR-U	K20TT
5962 V8	Q22PR-U	-
5962 W1	Q20PR-U	Q20TT
5962 W2	DG-003	-
5962 W3	DG-003	-
5962 W4	K20PBR	K20TT

CITROEN/PEUGEOT	DENSO	TT
5962 W6	Q22PR-U	-
5962 W7	Q22PR-U	-
5962 W8	DG-001	-
5962 W9	K20TXR	K20TT
5962 X0	K20TXR	K20TT
5962 X5	Q20R-U	Q20TT
5962 X8	Q20R-U	Q20TT
5962 X9	K20PR-U	K20TT
5962 Y1	K16TNR-S9	K16TT
5962 Y2	K20TXR	K20TT
5962 Y8	K20TXR	K20TT
5962 Y9	K20TR11	K20TT
5962 Z1	PK20PR11	K20TT
5962 Z2	K20PR-U	K20TT
5962 Z3	K20TNR-S	K20TT
5967 A7	T20EPR-U	T20TT
5990 94	K20HR-U11	KH20TT
7664 20	U22ETR	-
78 260 993 00	W20EX-U	W20TT
79 325 677 18	DG-001	-
91 508 602 80	DG-012	-
91 508 610 80	DG-012	-
91 521 849 80	DG-001	-
91 536 646 80	DG-001	-
91517001	W20EX-U	W20TT
91517007	T20EPR-U	T20TT
91517013	T22EP-U	-
95534788	DG-001	-
95598466	W22FPR-U	-
95618377	W20FSR-U	WF20TT
95619038	W22FSR	-
95619039	W22FPR-U	-
95619040	W20FPR-U	WF20TT
95619041	T22EP-U	-
96 165 724 80	DG-001	-
96 374 699 80	DG-113	-
96 525 482 80	DG-614	-
96 756 809 80	DG-611	-
96 762 881 80	IXUH22I	IXUH22TT
96 831 952 80	DG-603	-
96 865 043 80	DG-603	-
96 879 578 80	DG-632	-
96009087	Q20R-U	Q20TT
96009090	K20P-U	K20TT
96024607	Q20PR-U	Q20TT
96024614	K20PR-U	K20TT
96037952	K20TXR	K20TT
96064890	Q16PR-U	Q16TT
96070659	K20TXR	K20TT
96070663	K20PR-U	K20TT
96076258	DG-004	-
96088669	Q20PR-U	Q20TT
96089220	K20PR-U	K20TT
96096685	K22PBR-S	IKB22TT
96141678	DG-001	-
96145071	K20PBR	K20TT
97533994	T20EPR-U	T20TT
98 028 401 80	VXUH22I	IXUH22TT
AM212207A	W20FSR-U	WF20TT
AYB2127	W20FSR-U	WF20TT
E160023	K16HPR-U11	KH16TT
E161003	DG-001	-
E161004	DG-003	-
E161016	DG-161	-
E161024	DG-116	-
E161036	DG-113	-
E161040	DG-140	-
E161042	DG-181	-
E161043	DG-180	-
E161114	DG-130	-
MKP00071	DG-012	-

CITROEN/PEUGEOT	DENSO	TT
MYC000006N	W24EPR-U	-
MYC000006R	Q22PR-U	-
MYC000007R	Q22PR-U	-
MYC000279N	W22EPR-U	W22TT
ZB9000060U	W22EPR-U	W22TT
ZB9000061U	T20EPR-U	T20TT
ZB9000062U	T20EPR-U	T20TT
ZB9000063U	Q22PR-U	-
ZB9000064U	Q20PR-U	Q20TT
ZB9000065U	W22FS-U	-
ZB9862093U	W20EPR-U	W20TT
ZB9862094U	T22EP-U	-
ZB9862095U	T20EPR-U	T20TT

DACIA	DENSO	TT
110655687R	DG-609	-
22401-8760R	XE20HR-U9	IXEH20TT
6001544293	K20PR-U	K20TT
6001544609	K20PR-U	K20TT
6001544751	W20FPR-U	WF20TT
6001545515	DG-112	-
8671016890	XE20HR-U9	IXEH20TT

DAEWOO	DENSO	TT
242229606	K20TXR	K20TT
242229611	K20TXR	K20TT
3490274	W20EPR-U	W20TT
88900741	DG-010	-
90359815	W16EPR-U	W16TT
96503394	Q16R-U11	Q16TT
96990231	XU22EPR-U	XU22TT
ZWR8DC	W16EPR-U	W16TT

DAF	DENSO	TT
0192618	DG-001	-
494164	DG-001	-

DAIHATSU	DENSO	TT
19850-68030-000	DG-234	-
19850-87309-000	DG-234	-
19850-87701-000	DG-652	-
19850-87703-000	DG-652	-
90048-51005	W20EPR-U	W20TT
90048-51006	IW24	-
90048-51008	W22ESR-U	-
90048-51014	W24ESR-U	-
90048-51015	W20ESR-U	-
90048-51018	W22ESR-U	-
90048-51021	W20FSR-U	WF20TT
90048-51033	W16ESR-U	-
90048-51034	W20EPR-U	W20TT
90048-51035	W20EX-U	W20TT
90048-51036	W16EXR-U	W16TT
90048-51036	W16EX-U	W16TT
90048-51037	W16ESR-U	-
90048-51037	W16ES-U	-
90048-51038	W20ESR-U	-
90048-51039	W20ETR-L	IW20TT
90048-51040	IW20	IW20TT
90048-51041	W20EXR-U	W20TT
90048-51043	W20EPR-U	W20TT
90048-51044	W16EXR-U	W16TT
90048-51047	W16EXR-U	W16TT
90048-51048	W16EXR-U	W16TT
90048-51049	W14EXR-U11	IW16TT
90048-51053	W16EXR-U	W16TT
90048-51054	W16EXR-U	W16TT
90048-51055	W20EP-U	W20TT
90048-51056	W20EP-U	W20TT
90048-51058	J16AR-U11	-
90048-51059	W20EPR-U	W20TT

Свечи зажигания и Свечи накаливания

Таблица взаимозаменяемости - OE

DAIHATSU	DENSO	TT
90048-51069	W20EX-U	W20TT
90048-51072	W16EPR-U	W16TT
90048-51073	IW20	IW20TT
90048-51074	IW20	IW20TT
90048-51076	W20ETR-L	IW20TT
90048-51077	W20ETR-L	IW20TT
90048-51079	K22PR-U11	IK22FTT
90048-51080	K20P-U	K20TT
90048-51081	IW16	IW16TT
90048-51082	W16ETR-S	W16TT
90048-51083	W22ETR-L	W22TT
90048-51083	W22TT	W22TT
90048-51084	W22ETR-L	W22TT
90048-51086	IW20	IW20TT
90048-51087	IW20	IW20TT
90048-51088	Q20P-U11	Q20TT
90048-51091	W16EXR-U11	W16TT
90048-51092	W20EXR-U11	W20TT
90048-51093	W16EXR-U11	W16TT
90048-51095	W20EPR-U	W20TT
90048-51096	W20EPR-U	W20TT
90048-51099	K20PR-U11	K20TT
90048-51100	K20PR-U11	K20TT
90048-51102	W20ETR-L	IW20TT
90048-51104	W20ETR-L	IW20TT
90048-51106	K20PR-U11	K20TT
90048-51114	W16EPR-U	W16TT
90048-51117	PK20PR11	K20TT
90048-51123	K20R-U11	K20TT
90048-51132	W14EXR-U	IW16TT
90048-51135	W20EPR-U	W20TT
90048-51136	K20TNR-S	K20TT
90048-51136-A	K20TNR-S	K20TT
90048-51137	K20TNR-S	K20TT
90048-51138	K20PR-U11	K20TT
90048-51143	K22TNR-S	-
90048-51143-C	K22TNR-S	-
90048-51144	K22TNR-S	-
90048-51147-000	IK27	-
90048-51151	K20PR-U	K20TT
90048-51152	K20PR-U	K20TT
90048-51154	K20TNR	K20TT
90048-51154A	IK20	IK20TT
90048-51154-A	K20TNR	K20TT
90048-51155	K20TNR	K20TT
90048-51157	K16PR-U11	K16TT
90048-51158	K16PR-U11	K16TT
90048-51159	K20TNR-S9	K20TT
90048-51160	K20TNR-S9	K20TT
90048-51162	VK22	IK22FTT
90048-51163	K20R-U11	K20TT
90048-51163-A	K20R-U11	K20TT
90048-51164	K16TNR-S9	K16TT
90048-51164A	IK16	IK16TT
90048-51164-A	K16TNR-S9	K16TT
90048-51165	K16TNR-S9	K16TT
90048-51166	PK20PR-P8	IK20TT
90048-51167	VK20Y	-
90048-51168	K20PBR-S10	K20TT
90048-51169	K20BR-S10	K20TT
90048-51169-A	K20BR-S10	K20TT
90048-51170	IK20	IK20TT
90048-51172	SVK20RZ11	IK20TT
90048-51172-000	IK20TT	IK20TT
90048-51174-000	PK20PTR-S9	K20TT
90048-51175-000	PK20PTR-S9	K20TT
90048-51182	SK20PR-A8	IK20TT
90048-51183	IK20	IK20TT
90048-51184	IK20	IK20TT
90048-51185-000	SK20HR11	IKH20TT
90048-51186	SK20R11	IK20TT

DAIHATSU	DENSO	TT
90048-51187	SXU22PR9	IXU22TT
90048-51189	IXUH22I	IXUH22TT
90048-51190	VXUH22I	IXUH22TT
90048-51190-000	VXUH22I	IXUH22TT
90048-51192	XU22HDR9	XUH22TT
90048-51194	VXU22	IXU22TT
90048-51195	VXUH22I	IXUH22TT
90048-51196	XU22PR9	XU22TT
90048-51197	XU22PR9	XU22TT
90048-51198	VXUH22I	IXUH22TT
90048-51198-000	VXUH22I	IXUH22TT
90048-51199	VXUH22I	IXUH22TT
90048-51199-000	VXUH22I	IXUH22TT
90048-51200	SXU22PR9	IXU22TT
90048-51208	VXUH20I	-
90048-51208-000	VXUH20I	-
90048-51210	VXUH22I	IXUH22TT
90048-51212-000	XU20HR9	XUH20TTi
90048-61169	IK20	IK20TT
90048-61169A	K20BR-S10	K20TT
90048-61170	IK20	IK20TT
90919-01056	W14EX-U	IW16TT
90919-01059	W16EX-U	W16TT
90919-01059-000	W16EX-U	W16TT
90919-01060	W14EX-U	IW16TT
90919-01062	W20ETR-L	IW20TT
90919-01064	W16EXR-U	W16TT
90919-01064-000	W16EXR-U	W16TT
90919-01065	W14EXR-U	IW16TT
90919-01065-000	W14EXR-U	IW16TT
90919-01086	W14EXR-U11	IW16TT
90919-01089	IW20	IW20TT
90919-01106	W14EXR-U11	IW16TT
90919-01110-000	P16R	W20TT
90919-01115	P16R	W20TT
90919-01115-000	P16R	W20TT
90919-01191	SK20HR11	IKH20TT
90919-01191-000	SK20HR11	IKH20TT
90919-01253	SC16HR11	IXEH20TT
90919-01259	FK16HR-A8	-
90919-01275	SC16HR11	IXEH20TT
90919-51072	W16EPR-U	W16TT
94448-51155	K20TNR	K20TT
98079-60000	W20EPR-U	W20TT
99113-39236200	MW17	-
99113-39236-200	MW17	-
99147-10236	W14E	-
99226-11236	W22EPR-U	W22TT
99254-90200-120	W9-U	-
99520-01236	W20EP-U	W20TT
99906-850P9001	IW20	IW20TT
99906-850P9002	W14FR-U	-
99906-850P9003	W20FSR-U	WF20TT
99906-850P9005	W16FPR-U	-
99906-850P9006	W20FPR-U	WF20TT
99906-850P9007	W16ESR-U	-
99906-850P9008	W20ESR-U	-
99906-850P9009	W22ESR-U	-
99906-850P9010	IW24	-
99906-850P9011	W16EPR-U11	W16TT
99906-850P9-012	W20EPR-U11	W20TT
99906-850P9013	W16EXR-U13	W16TT
99906-850P9014	W20ETR-L	IW20TT
99906-850P9015	W16ETR-S	W16TT
99906-850P9-015	W16ETR-S	W16TT
99906-850P9017	J16AR-U11	-
99906-850P9-017	J16AR-U11	-
99906-850P9018	J16BR-U	-
99906-910P9013	W16ETR-S	W16TT
99906-910P9015	W14EXR-U11	IW16TT
99906-910X9001	IW16	IW16TT

DAIHATSU	DENSO	TT
99906-910X9002	IW20	IW20TT
99906-910X9003	IW22	-
99906-910X9004	IQ16TT	IQ16TT
99906-910X9005	IQ20TT	IQ20TT
99906-910X9006	IK16	IK16TT
99906-910X9007	IK20	IK20TT
99906-910X9008	IWF20	-
99906-910X9009	IWF22	-
99906-910X9010	IWF22	-
99906-910X9011	IWF22	-
99906-910X9012	IW24	-
99906-910X9013	IW27	-
99906-910X9014	IX24	-
99906-910X9015	IX27	-
99906-910X9016	IX24B	-
99906-910X9017	IX27B	-
99906-910X9018	IXU22	IXU22TT
99906-910X9019	IK16L	IK16TT
99906-910X9021	IUH24	-
99906-910X9022	IUH27	-
99906-910X9023	IU24	-
99906-910X9024	IU27	-
99906-910X9026	IW16	IW16TT
99906-910X9027	IW20	IW20TT
99906-910X9028	IK16	IK16TT
99906-910X9030	IK22	IK22FTT
99934-03685-100	IW24	-
99934-07685-100	W16EXR-U11	W16TT
99934-08685-100	W20EXR-U11	W20TT
99934-09685-100	W20FPR-U	WF20TT
99934-10685-100	W9EP	-
99934-11685-000	W16EXR-U11	W16TT
99934-12685-100	W16FPR-U	-
99934-12685-100	W16FP-U	-
99934-13685-100	W20EPR-U11	W20TT
99934-14685-100	W16EXR-U13	W16TT
99934-15685	W20EXR-U11	W20TT
99934-16685	W20ESR-U	-
NDIK16	IK16	IK16TT
NDIK16A	IK16	IK16TT
NDIK20	IK20	IK20TT
NDIK20A	IK20	IK20TT
NDIK22	IK22	IK22FTT
NDIK22A	IK22	IK22FTT
NDIK24A	IK24	-
NDIK27A	IK27	-
NDIQ16	IQ16TT	IQ16TT
NDIQ16A	IQ16TT	IQ16TT
NDIQ20	IQ20TT	IQ20TT
NDIQ20A	IQ20TT	IQ20TT
NDIQ22A	IQ22	-
NDIQ22A	IQ22	-
NDIQ24A	IQ24	-
NDIQ27A	IQ27	-
NDIW16	IW16	IW16TT
NDIW16A	IW16	IW16TT
NDIW20	IW20	IW20TT
NDIW20A	IW20	IW20TT
NDIW22	IW22	-
NDIW22A	IW22	-
NDIXU22	IXU22	IXU22TT
NDIXU22A	IXU22	IXU22TT
NDIXU24	IXU24	-
NDIXU24A	IXU24	-
NDIXUH22IA	IXUH22I	IXUH22TT
NDVK20Y	VK20Y	-
NDVK20YA	VK20Y	-
NDVK22	VK22	IK22FTT
NDVK22A	VK22	IK22FTT
NDVQ16	IQ16TT	IQ16TT
NDVQ16A	IQ16TT	IQ16TT

DAIHATSU	DENSO	TT
NDVQ20	IQ20TT	IQ20TT
NDVQ20A	IQ20TT	IQ20TT
NDVQ22	VQ22	-
NDVQ22A	VQ22	-
NDVW16	IW16TT	IW16TT
NDVW16A	IW16TT	IW16TT
NDVW20	VW20	IW20TT
NDVW20A	VW20	IW20TT
NDVW22	VW22	-
NDVW22A	VW22	-
NDVXU22	VXU22	IXU22TT
NDVXU22A	VXU22	IXU22TT
NDVXU24	VXU24	-
NDVXU24A	VXU24	-
NDVXUH22IA	VXUH22I	IXUH22TT

DODGE	DENSO	TT
5149177AB	KJ16CR-L11	K16TT
68029497AA	DG-633	IK
SP002FR5AP	IK16	IK16TT
SP149125AE	VXUH22I	IXUH22TT
SPTE10PMC5	ITL20	-

DUCATI	DENSO	TT
670.4.006.1	XU22EPR-U	XU22TT
670.4.007.1A	XU24EPR-U	-
670.4.012.1A	IX27	-
670.4.016.1B	U27ESR-N	-
670.4.023.1A	IU27	-
670.9.012.1A	IXU27	-
670.9.030.1A	RU01-31	-

FERRARI	DENSO	TT
155743	IXU27	-
167098	IU24	-
168325	IU24	-
169483	IU22	-
174954	IXU27	-
192637	IU24	-
2192637	IU24	-
FERRB0005	IX24	-

FIAT	DENSO	TT
4233922	W22EPR-U	W22TT
4401547	W22FPR-U	-
4401549	W20EPR-U	W20TT
4401551	W20EPR-U	W20TT
4401552	W20EPR-U	W20TT
46093110	IW20	IW20TT
46144731	XU24EPR-U	-
46229251	W20EPR-U	W20TT
46413386	K20TNR	K20TT
46417010	K20PR-U	K20TT
46451923	K16TNR-S9	K16TT
46454145	K16PR-U	K16TT
46461873	XU24EPR-U	-
46463801	K20TNR	K20TT
46471078	K20PBR-S10	K20TT
46472021	K20TNR	K20TT
46475164	IK20	IK20TT
46480309	K16TNR-S9	K16TT
46480362	K20PR-U	K20TT
46481378	W22EPR-U	W22TT
46531917	XU24EPR-U	-
46531918	K16PR-U	K16TT
46531919	XU24EPR-U	-
46531935	K16PR-U	K16TT
46548478	K20PR-U	K20TT
46551918	K16PR-U	K16TT
46551935	K16PR-U	K16TT
46750545	XU24EPR-U	-

Свечи зажигания и Свечи накаливания

Таблица взаимозаменяемости - OE

FIAT	DENSO	TT
46796050	DG-171	-
46799927	K16PR-U	K16TT
46821457	K20PR-U	K20TT
46823299	XU22EPR-U	XU22TT
500316493	DG-111	-
500351992	DG-195	-
5493206	DG-001	-
55182623	IK16	IK16TT
55187863	DG-170	-
55188857	XU22EPR-U	XU22TT
55190788	XU22EPR-U	XU22TT
55198201	XU22EPR-U	XU22TT
55200755	DG-608	-
55200817	DG-196	-
55210051	DG-621	-
55210685	IXU27	-
55226083	XU22EPR-U	XU22TT
55232360	VXU22	IXU22TT
55240046	IXUH22	IXUH22TT
55249868	IXU27	-
5894585	W22EPR-U	W22TT
5894586	K20PR-U	K20TT
5894587	W20EPR-U	W20TT
5894588	Q22PR-U	-
5896177	K20TNR	K20TT
5896824	K20TNR	K20TT
5950464	DG-001	-
5951861	DG-001	-
5951879	DG-001	-
5951881	DG-001	-
5951882	DG-001	-
5973752	DG-001	-
5973753	DG-001	-
5984035	W22EPR-U	W22TT
5984036	W20EPR-U	W20TT
6000100138	XU22EPR-U	XU22TT
60504563	IW20	IW20TT
60507123	DG-202	-
60512929	W22EPR-U	W22TT
60579903	PK20PR-P8	IK20TT
60596245	DG-001	-
60597490	Q22PR-U	-
60617002	DG-109	-
60800325	W22EPR-U	W22TT
60806024	W20EPB	W20TT
60810689	PK20PR-P8	IK20TT
60812292	DG-001	-
60814613	DG-127	-
7029585	DG-001	-
71711638	IK20	IK20TT
71711639	W20EPR-U	W20TT
71711640	W20EPR-U	W20TT
71711806	W20EPR-U	W20TT
71711807	K20PR-U	K20TT
71711808	K20PR-U	K20TT
71719015	DG-001	-
71719244	K16PR-U	K16TT
71734087	DG-127	-
71735458	DG-122	-
71735459	DG-102	-
71735461	DG-001	-
71735463	DG-132	-
71735464	DG-129	-
71736277	K16PR-U	K16TT
71736278	W20EPR-U	W20TT
71736279	W20EPR-U	W20TT
71737139	XU22EPR-U	XU22TT
71739210	PT16VR13	TV16TT
71769195	VXU22	IXU22TT
7546518	Q20PR-U	Q20TT
7546519	K20PR-U	K20TT

FIAT	DENSO	TT
7554432	W20EPR-U	W20TT
7554434	IW22	-
7554436	W22EPR-U	W22TT
7554437	W20EPR-U	W20TT
7554440	W22EPR-U	W22TT
7554444	W20EPR-U	W20TT
7554445	IWF20	-
7565853	IK20	IK20TT
7571541	K20PR-U	K20TT
7571564	IK22	IK22FTT
7571575	W22EPR-U	W22TT
7571576	K20PR-U	K20TT
7571577	W20EPR-U	W20TT
7571579	IK22	IK22FTT
762266740	DG-001	-
7632587	DG-132	-
7648199	DG-001	-
7651745	IW22	-
7658628	DG-132	-
7668669	W20EPR-U	W20TT
7683358	IK20	IK20TT
7686643	W20EPB	W20TT
7698212	Q20PR-U	Q20TT
7702960	DG-001	-
7735920	DG-001	-
7754445	W22FPR-U	-
7760381	IW22	-
7760382	W20EPR-U	W20TT
7760383	IK20	IK20TT
7760384	Q22PR-U	-
7769243	K20TNR	K20TT
77719244	XU22EPR-U	XU22TT
7772453	K20PR-U	K20TT
7772456	W20EPR-U	W20TT
7772515	W22EPR-U	W22TT
7774321	Q22PR-U	-
7774341	W22EPR-U	W22TT
7777837	DG-004	-
7782067	K22PBR-S	IKB22TT
91 517 001 80	W16EPR-U	W16TT
94 059 600 78	W16EPR-U	W16TT
96 147 386 80	K20TXR	K20TT
96 184 945 80	K20TXR	K20TT
96 185 718 80	K20TXR	K20TT
96 196 245 80	K20TXR	K20TT
96 265 754 80	K20TXR	K20TT
96 280 002 80	K20PR-U	K20TT
96 363 934 80	K20HR-U11	KH20TT
96 364 192 80	K20PR-U	K20TT
96 381 057 80	K20PR-U	K20TT
96 398 143 80	K20PR-U	K20TT
96 494 640 80	K20HR-U11	KH20TT
96 494 641 80	K20HR-U11	KH20TT
9616472480	DG-001	-
9623638380	DG-116	-
9631658980	DG-003	-
9633214380	DG-001	-
9638985980	DG-116	-
9650100080	DG-180	-
9651029780	DG-116	-
9651029880	DG-003	-
9651583680	DG-181	-
9659279280	DG-130	-
98462490	DG-001	-
98498630	DG-004	-
F2VB	DG-001	-
FU2A	DG-001	-
FU4A	DG-001	-
KSP149125AD	VXUH22I	IXUH22TT

FIAT GROUP	DENSO	TT
55238404	DG-658	-

FORD	DENSO	TT
1 000 996	PK20PR11	K20TT
1 011 256	PK16PR11	K16TT
1 012 639	PT16EPR-L13	IT16TT
1 023 706	IK20TT	IK20TT
1 032 705	K20TXR	K20TT
1 077 002	PT16VR13	TV16TT
1 085 952	T16EPR-U	T16TT
1 086 019	PK22PR-L11S	-
1 086 020	PK20PR11	K20TT
1 087 278	T20EPR-U	T20TT
1 088 847	PT16VR10	TV16TT
1 090 749	PT16VR13	TV16TT
1 110 500	K20PR-U	K20TT
1 120 170	PKJ16CR-L11	IK16TT
1 120 817	IQ24	-
1 120 818	MA20P-U	-
1 120 820	MA20P-U	-
1 120 821	Q22PR-U	-
1 120 822	MA20P-U	-
1 120 824	T20EPR-U	T20TT
1 120 825	T20EPR-U	T20TT
1 120 827	Q22PR-U	-
1 120 828	Q20PR-U11	Q20TT
1 120 829	Q20PR-U11	Q20TT
1 120 830	Q20PR-U11	Q20TT
1 120 831	Q20PR-U11	Q20TT
1 120 833	IQ24	-
1 120 834	IQ24	-
1 120 835	W22EPR-U	W22TT
1 120 836	W20EXR-U	W20TT
1 125 332	PK20PR11	K20TT
1 128 053	ZT20EPR11	IT20TT
1 151 999	ITV24	-
1 202 935	ITV20TT	ITV20TT
1 204 572	ZT20EPR11	IT20TT
1 216 460	T20EPR-U	T20TT
1 220 057	PK20PR11	K20TT
1 222 858	IT20TT	IT20TT
1 229 477	IT20TT	IT20TT
1 233 897	T16VR-U10	TV16TT
1 255 464	T16VR-U10	TV16TT
1 307 093	ZT20EPR11	IT20TT
1 315 691	IT20TT	IT20TT
1 324 211	ZT20EPR11	IT20TT
1 362 012	T16VR-U10	TV16TT
1 369 704	ZT20EPR11	IT20TT
1 371 606	IKH22	-
1 379 739	ITV16TT	ITV16TT
1 430 393	IKH20	IKH20TT
1 439 595	T16VR-U10	TV16TT
1 468 761	PK20PR11	K20TT
1 493 001	T16VR-U10	TV16TT
1 493 602	PT16VR13	TV16TT
1 505 812	IKH20TT	IKH20TT
1 518 878	W22EPR-U	W22TT
1 542 499	XU22EPR-U	XU22TT
1 583 231	IKH20	IKH20TT
1 680 032	ITV22	-
1 685 720	ITV20TT	ITV20TT
1 698 597	ITV22	-
1 787 829	T16VR-U10	TV16TT
1 903 144	T16VR-U10	TV16TT
1001049	DG-007	-
1008792	DG-007	-
1037204	DG-005	-
1056857	DG-007	-
1079401	DG-121	-
1096527	DG-130	-

FORD	DENSO	TT
1148105	DG-113	-
1207068	DG-109	-
1207069	DG-109	-
1309471	DG-130	-
1313809	DG-181	-
1369590	DG-180	-
1427905	DG-614	-
1441267	DG-645	-
1447128	DG-180	-
1449686	DG-630	-
1473356	DG-181	-
1525910	DG-113	-
1536023	DG-146	-
1542845	DG-171	-
1587444	DG-001	-
1669977	DG-005	-
1682276	DG-603	-
1690048	DG-109	-
1703269	DG-603	-
1717631	DG-611	-
1724842	DG-621	-
1824690	DG-603	-
186466	DG-611	-
1952464	DG-137	-
1961149	DG-626	-
1M50-12405-CA	ITV20TT	ITV20TT
1R23-12405-AA	IW16TT	IW16TT
1S7G-12405-DA	ZT20EPR11	IT20TT
1S7J-12405-DA	ZT20EPR11	IT20TT
1S7J-12405-EB	ZT20EPR11	IT20TT
2 000 077	PK22PR-U8	IK22TT
2 050 957	T16VR-U10	TV16TT
2M5V-12405-CA	ITV24	-
2M5V-12405-CB	ITV24	-
2S6QM090AA	DG-113	-
2S6QM090BB	DG-180	-
2S7E-12405-AB	ZT20EPR11	IT20TT
2S7E-12405-AC	ZT20EPR11	IT20TT
2S7J-12405-AC	ZT20EPR11	IT20TT
2U7J-12405-AA	T16VR-U10	TV16TT
3 333 704	PT16EPR-L13	IT16TT
3 539 125	PT16EPR-L13	IT16TT
3 588 254	KJ16CR-L11	K16TT
3 899 252	K20PR-U11	K20TT
3 936 373	ZT20EPR11	IT20TT
3 966 269	PT16VR13	TV16TT
3252725	DG-114	-
3R23-12405-AA	IK16TT	IK16TT
3R23-12405-BA	IK20TT	IK20TT
3R23-12405-CA	IK20TT	IK20TT
3S4G-12405-AB	IT20TT	IT20TT
3S4G-12405-BA	IT20TT	IT20TT
3S4J-12405-AB	IT20TT	IT20TT
4 331 810	PT16EPR-L13	IT16TT
4 333 361	IT20TT	IT20TT
4 454 955	ZT20EPR11	IT20TT
4 496 578	PT16VR13	TV16TT
4 716 193	IT20TT	IT20TT
4 988 520	PT16VR13	TV16TT
4025139	DG-146	-
4434918	DG-645	-
4612191	DG-130	-
4M5G-12405-AA	T16VR-U10	TV16TT
4M5G-12405-BA	T16VR-U10	TV16TT
4M5G-12405-XC	T16VR-U10	TV16TT
4M5G-12405-XD	T16VR-U10	TV16TT
4M5G-12405-XE	T16VR-U10	TV16TT
4M5J-12405-AA	T16VR-U10	TV16TT
5 029 052	W20EP-U	W20TT
5 029 053	W16EP-U	W16TT
5 081 089	ZT20EPR11	IT20TT

Свечи зажигания и Свечи накаливания

Таблица взаимозаменяемости - OE

FORD	DENSO	TT
5 086 351	ITV24	-
5 099 342	T20EPR-U	T20TT
5 099 721	T20EPR-U	T20TT
5 099 722	IQ24	-
5 099 723	T20EPR-U	T20TT
5 099 725	IQ24	-
5 099 726	IQ24	-
5 099 727	K20PR-U	K20TT
5 099 728	K20PR-U	K20TT
5 099 729	K20TT	K20TT
5 099 731	MA20PR-U	-
5 099 732	MA20PR-U	-
5 099 735	MA20PR-U	-
5 099 739	T20EPR-U	T20TT
5 099 741	T20EPR-U	T20TT
5 099 742	W22EPR-U	W22TT
5 099 743	W24EPR-U	-
5 099 744	W20FPR-U	WF20TT
5 099 747	W22FPR-U	-
5 099 748	W20FSR-U	WF20TT
5 099 750	T22EP-U	-
5 099 751	W16EPR-U	W16TT
5 099 752	W24EP-U	-
5 099 756	Q22P-U	-
5 099 762	MA20P-U	-
5 099 766	T20EPR-U	T20TT
5 099 767	W20EPR-U	W20TT
5 099 768	W22EPR-U	W22TT
5 099 769	W24EPR-U	-
5 099 770	IQ24	-
5 099 775	K20PR-U	K20TT
5 099 777	K20PR-U	K20TT
5 099 778	K22PR-U	IK22FTT
5 099 779	Q20P-U	Q20TT
5 099 780	Q22P-U	-
5 099 781	T20EPR-U	T20TT
5 099 782	W20EP-U	W20TT
5 099 783	W22EP-U	W22TT
5 099 784	W20FPR-U	WF20TT
5 099 827	IQ24	-
5 099 828	K20PR-U	K20TT
5 099 831	K22PR-U	IK22FTT
5 099 833	K20PR-U	K20TT
5 099 848	MA20PR-U	-
5 099 933	W20FSR-U	WF20TT
5 099 946	IT22	-
5 099 947	T22EP-U	-
5 099 949	W24EP-U	-
5 099 950	W24EPR-U	-
5 100 429	ITV22	-
5 158 132	ITV16TT	ITV16TT
5 190 932	PT16EPR-L13	IT16TT
5 190 933	PT16EPR-L13	IT16TT
5 191 259	PT16VR13	TV16TT
5 215 216	ITV22	-
5 249 907	ZT20EPR11	IT20TT
5007956	DG-645	-
5023372	DG-001	-
5031006	DG-001	-
5G5E-12405-AA	PT16VR13	TV16TT
5M5G-12405-AA	ZT20EPR11	IT20TT
5M5G-12405-BC	PT16VR13	TV16TT
5R29-12405-AA	SK20R11	IK20TT
5R29-12405-BA	VK20Y	-
5R29-12405-CA	VK20Y	-
5U2J-12405-AA	IT20TT	IT20TT
6 173 150	T20EPR-U	T20TT
6 190 831	K20PR-U11	K20TT
6 726 180	PT16VR13	TV16TT
6 762 458	PK22PR11	IK22FTT
6075812	DG-012	-

FORD	DENSO	TT
6110609	DG-001	-
6132244	DG-123	-
6132246	DG-123	-
6154593	DG-001	-
6163811	DG-004	-
6G9N-18344-CA	IKH20	IKH20TT
6G9QM090AA	DG-614	-
6M34-12A342-AA	DG-630	-
6M5G-12405-AA	IKH22	-
6M5J-12405-AA	IKH20TT	IKH20TT
6M8G-12405-BB	ITV16TT	ITV16TT
7 099 023	PK20PR11	K20TT
7 335 128	PK22PR11	IK22FTT
7072673	DG-001	-
7088988	DG-004	-
73205072	DG-611	-
795F6M090AA	DG-012	-
795F6M090CA	DG-012	-
7G9N-12405-AA	IKH20	IKH20TT
7T4E-12405-AA	PT16VR13	TV16TT
800F-12405-DA	W24EPR-U	-
800F-12405-EA	W24EP-U	-
800F-12405-JA	T22EP-U	-
800F-12405-KA	IT22	-
810F-12405-LA	W20FSR-U	WF20TT
830F-12405-JB	MA20PR-U	-
83BB6M090A1A	DG-001	-
83BB6M090A2A	DG-001	-
830F-12405-JD	MA20PR-U	-
830F-12405-JE	MA20P-U	-
84BB6M090AA	DG-001	-
84FF6M090B1A	DG-123	-
84FF6M090B2A	DG-123	-
840F-12405-JD	MA20PR-U	-
840F-12405-JE	MA20P-U	-
86SF-12405-BC	Q22PR-U	-
87YF-12405-AC	T20EPR-U	T20TT
87YF-12405-AD	T20EPR-U	T20TT
87YF-12405-AE	T20EPR-U	T20TT
880F-12405-CA	IQ24	-
88HF-12405-AD	MA20P-U	-
880F-12405-CB	IQ24	-
88SF-12405-CB	K20PR-U11	K20TT
88SF-12405-EC	K20PR-U	K20TT
890F-12405-AA	K20PR-U	K20TT
890F-12405-CA	K22PR-U	IK22FTT
890F-12405-FA	K20PR-U	K20TT
89BF-12405-AA	T20EPR-U	T20TT
89BF-12405-AB	T20EPR-U	T20TT
89BF-12405-AC	T20EPR-U	T20TT
89FF6M090AA	DG-004	-
8R29-12405-AA	IK20	IK20TT
8R29-12405-BA	SK20R11	IK20TT
9 059 238	IK24	-
9 059 238 4	IK24	-
9 059 409	IK24	-
9 059 409 4	IK24	-
910X6M090AA	DG-006	-
910X6M090BA	DG-001	-
910F-12405-BB	K20TT	K20TT
920F-12405-BVA	MA20PR-U	-
920F-12405-EB	Q20PR-U11	Q20TT
920F-12405-TB	W20EXR-U	W20TT
928F-12405-AE	PT16VR13	TV16TT
928F-12405-AF	PT16VR13	TV16TT
920F-12405-AA	Q22P-U	-
920F-12405-AAA	W16EPR-U	W16TT
920F-12405-AFA	MA20P-U	-
920F-12405-AGA	T22EP-U	-
920F-12405-AHA	T20EPR-U	T20TT
920F-12405-AJA	T20EPR-U	T20TT

FORD	DENSO	TT
920F-12405-AJB	T20EPR-U	T20TT
920F-12405-AMA	W20FSR-U	WF20TT
920F-12405-ANA	W22FPR-U	-
920F-12405-ASA	W20FPR-U	WF20TT
920F-12405-BA	K22PR-U	IK22FTT
920F-12405-BB	Q22PR-U	-
920F-12405-BHA	W20FPR-U	WF20TT
920F-12405-BJA	W24EPR-U	-
920F-12405-BKA	W22EPR-U	W22TT
920F-12405-BLA	T20EPR-U	T20TT
920F-12405-BNA	T20EPR-U	T20TT
920F-12405-CAA	K20PR-U	K20TT
920F-12405-CAB	Q20PR-U11	Q20TT
920F-12405-CBA	K20PR-U	K20TT
920F-12405-CBB	Q20PR-U11	Q20TT
920F-12405-DA	Q20P-U	Q20TT
920F-12405-EA	K20PR-U	K20TT
920F-12405-EB	Q20PR-U11	Q20TT
920F-12405-FA	K20PR-U	K20TT
920F-12405-FB	Q20PR-U11	Q20TT
920F-12405-GA	IQ24	-
920F-12405-JA	Q22P-U	-
920F-12405-KA	IQ24	-
920F-12405-KB	IQ24	-
920F-12405-MB	IQ24	-
920F-12405-PA	W24EP-U	-
920F-12405-RA	W24EPR-U	-
920F-12405-RB	W22EPR-U	W22TT
920F-12405-SA	W22EP-U	W22TT
920F-12405-TA	W22EPR-U	W22TT
920F-12405-TB	W20EXR-U	W20TT
920F-12405-YA	W20EP-U	W20TT
920F-12405-ZA	W20EPR-U	W20TT
930X-12405-AA	W20EP-U	W20TT
930X-12405-BA	W16EP-U	W16TT
93FF6M090AA	DG-004	-
93TF-12405-AA	PT16EPR-L13	IT16TT
959F-12405-AA	PK20PR11	K20TT
95VW-12405-CA	PK16PR11	K16TT
95VW-12405-DA	K20TXR	K20TT
95WF-12405-AB	PK20PR11	K20TT
95WF-12405-BA	PK22PR11	IK22FTT
95WF-12405-BB	PK22PR-L11S	-
95WF-12405-CA	PK20PR11	K20TT
95WF-12405-DA	PK20PR11	K20TT
96BF-12405-AA	PT16EPR-L13	IT16TT
96FF6M090AA	DG-007	-
96FF6M090AB	DG-007	-
96FF6M090BA	DG-007	-
96FF6M090BB	DG-007	-
96XF-12405-BA	IK20TT	IK20TT
96XF-12405-BB	PK20PR11	K20TT
978F-12405-DC	PT16VR13	TV16TT
97BF-12405-AA	T16EPR-U	T16TT
99FF6M090AA	DG-007	-
9A6G-12405-AA	ITV22	-
9A6G-12405-BA	ITV22	-
9A6G-12405-CA	ITV22	-
9S51-12405-AA	XU22EPR-U	XU22TT
9S516M090AA	DG-171	-
AV2Q-6M090-BA	DG-603	-
AV6Q-6M090-BA	DG-603	-
BK3Q6M090AB	DG-611	-
BM5G-12405-CA	ITV20TT	ITV20TT
BS516M090AA	DG-621	-
CB5E-12405-AA	ITV22	-
CV6E-12405-AA	ITV16TT	ITV16TT
D2PF-12405-BA	W22EPR-U	W22TT
F43E-12405-EA	PT16EPR-L13	IT16TT
F43E-12405-EB	PT16EPR-L13	IT16TT
F43E-12405-EC	PT16EPR-L13	IT16TT

FORD	DENSO	TT
F75E-12405-CA	ZT20EPR11	IT20TT
F75E-12405-CD	PT16EPR-L13	IT16TT
F7PE-12405-AA	PT16VR13	TV16TT
H82SM-12405-AA	IK24	-
H82SM-12405-BA	IK24	-
V90SF-12405-AC	IQ24	-
V92HF-12405-AA	PK22PR11	IK22FTT
V92HF-12405-BA	PK22PR8	IK22TT
V94DX6M090AA	DG-001	-
V90SF-12405-AB	IQ24	-
XM34-12A342-BA	DG-146	-
XM34-12A342-BB	DG-146	-
XS2E-12405-AB	IT20TT	IT20TT
XS4F-12405-DA	PT16VR13	TV16TT
XS4U6M090AB	DG-121	-
XS6F-12405-BA	PT16VR10	TV16TT
XS7U-6M090-BB	DG-130	-
YM21-12405-AA	PKJ16CR-L11	IK16TT
YN2J-12405-AA	T16VR-U10	TV16TT

FSO	DENSO	TT
055124	DG-001	-
4238208	W20EP-U	W20TT
4559422	W22FPR-U	-

GM	DENSO	TT
03490184	W20FPR-U	WF20TT
05505819	W20FPR-U	WF20TT
12561466	IT16TT	IT16TT
12561466	PT16EPR-L13	IT16TT
12563554	DG-175	-
12563703	PTJ16R15	IT16TT
12563707	PTJ16R15	IT16TT
12565753	IT16TT	IT16TT
12565996	KH20TT	KH20TT
12571165	IT20TT	IT20TT
12571533	PT16EPR-L13	IT16TT
12571535	PT16EPR-L13	IT16TT
12597464	PT16VR13	TV16TT
12598004	ITL16TT	ITL16TT
12607234	PT16EPR-L13	IT16TT
12625058	ITL16TT	ITL16TT
12625507	DG-633	-
12640384	DG-610	-
12788884	IKH20TT	IKH20TT
22472368	DG-653	-
24504873	PT16EPR-L13	IT16TT
25108074	Q20PR-U	Q20TT
25109002	W20EPR-U	W20TT
25161442	PT16EPR-L13	IT16TT
25161444	PT16EPR-L13	IT16TT
25161677	PT16EPR-L13	IT16TT
25161678	PT16EPR-L13	IT16TT
25162555	PT16EPR-L13	IT16TT
25163148	PT16EPR-L13	IT16TT
25164048	PT16EPR-L13	IT16TT
25165715	PT16EPR-L13	IT16TT
25166821	PT16EPR-L13	IT16TT
25168651	DG-175	-
25173406	PT16EPR-L13	IT16TT
25181860	DG-653	-
25186682	KJ20CR-L11	K20TT
25312442	PT16EPR-L13	IT16TT
25315018	PT16EPR-L13	IT16TT
25324618	PT16VR13	TV16TT
3490184	W20FPR-U	WF20TT
3490185	W20TT	W20TT
3490229	W20FPR-U	WF20TT
3490258	W20FPR-U	WF20TT
3490275	K20TXR	K20TT
3496291	W20EPR-U11	W20TT

Свечи зажигания и Свечи накаливания

Таблица взаимозаменяемости - OE

GM	DENSO	TT
3496307	W20EPR-U	W20TT
415129484	PK22PR8	IK22TT
5505819	W20FPR-U	WF20TT
5505836	W20TT	W20TT
55210051	DG-621	-
55238404	DG-658	-
55562534	KJ16CR-L11	K16TT
55565219	KJ20CR-L11	K20TT
5613100	W20EPR-U	W20TT
5614288	T20PR-U	ITF20TT
5614289	PT16EPR-L13	IT16TT
88900721	DG-145	-
90239568	W20EPR-U	W20TT
90239569	W20FPR-U	WF20TT
90297143	W20FPR-U	WF20TT
90338179	K20PBR	K20TT
90350018	W20EPR-U	W20TT
90355136	W20EPR-U	W20TT
90357582	K20PR-U	K20TT
90369815	K20TXR	K20TT
90397451	K20R-U	K20TT
90414815	W24FSR	-
90423215	K20PR-U	K20TT
90442210	K20PR-U	K20TT
90442650	K20TNR	K20TT
90444723	K20TXR	K20TT
90485247	W20EPR-U	W20TT
90487588	Q20PR-U	Q20TT
90509739	K20TXR	K20TT
90510924	DG-001	-
90512986	K20TXR	K20TT
90512989	W16EPR-U	W16TT
90541059	K20TXR	K20TT
9110724	DG-005	-
9110945	DG-008	-
91132006	K20TXR	K20TT
91132099	PT16VR13	TV16TT
91143774	W20EPR-U	W20TT
91149455	K20PR-U11	K20TT
91149685	W16EPR-U	W16TT
91149686	K20TXR	K20TT
91153992	K20TXR	K20TT
91158431	PT16VR13	TV16TT
9146367	K20TXR	K20TT
9195109	K20TXR	K20TT
9196669	DG-142	-
9199038	PT16VR13	TV16TT
9201698	DG-126	-
92063308	K16PR-U11	K16TT
92067204	PT16VR13	TV16TT
92108895	PTJ16R15	IT16TT
92141875	T20EPR-U15	-
92143446	T20EPR-U	T20TT
9270293	PK20PR-P8	IK20TT
93160201	PK20PR-P8	IK20TT
93161199	PK20PR-P8	IK20TT
93161342	DG-126	-
93161489	DG-126	-
93171875	DG-145	-
93171875	W20FSR-U	WF20TT
93175880	K20PBR	K20TT
93175935	K20PBR	K20TT
93175994	PK20PR-P8	IK20TT
93176467	PK20PR-L11	IK20TT
93176801	KJ16CR-L11	K16TT
93176802	KJ16CR-L11	K16TT
93178047	DG-171	-
93178225	DG-142	-
93178411	DG-170	-
93180295	DG-122	-
93180485	KJ16CR-L11	K16TT

GM	DENSO	TT
93183738	DG-104	-
93183738	DG-300	-
93183738	DG-640	-
93183739	DG-300	-
93183739	DG-640	-
93188550	K20TXR	K20TT
93189648	DG-005	-
93190433	DG-196	-
93190953	PK20PR-L11	IK20TT
93193723	ZXU20PR11	-
93193804	DG-171	-
93196922	DG-005	-
93742296	W16EPR-U	W16TT
94217232	W20FPR-U11	W20TT
94319700	DG-124	-
94402303	DG-159	-
94481972	DG-104	-
94481972	DG-300	-
94481972	DG-640	-
94856823	IK20	IK20TT
95508486	DG-171	-
95508508	DG-300	-
95508508	DG-640	-
95519058	KJ16CR-L11	K16TT
96068562	K20PR-U	K20TT
96068563	K20PR-U	K20TT
96130723	K20PR-U11	K20TT
97044037	DG-104	-
97080554	DG-300	-
97080554	DG-640	-
97125969	PK16PR-L11	IK16TT
97143674	DG-186	-
97357290	DG-646	-

HARLEY-DAVIDSON	DENSO	TT
10R12A	IXU24	-
10R12A	XU24EPR-U	-
10R12X	XU24EPR-U	-
2767101K	XU24EPR-U	-
3	W16LS	-
3230160	W16PR-U	-
3230180	IWF20	-
3231077	W16EXR-U	W16TT
3231183	W16EXR-U11	W16TT
3231278A	J16BR-U	-
3231786	XU22EPR-U	XU22TT
3231786A	XU22EPR-U	XU22TT
3232191	IXU22	IXU22TT
3232691	W16EXR-U	W16TT
3232791	IW16	IW16TT
3262978	W16LS	-
34	W16PR-U	-
4	W16LS	-
45	W22FPR-U	-
4R	W16LS	-
4R5	W22FP-U10	-
4R5G	IWF22	-
5	W20S-U	-
5A6	W16EXR-U	W16TT
5A6A	W14EXR-U11	IW16TT
5R6	W16EXR-U	W16TT
5R6A	W16EXR-U11	W16TT
5R6AG	IW16	IW16TT
5R6APP	P16R	W20TT
5RL	J16CR-U	W16TT
6	W22ESR-U	-
6R12	XU22EPR-U	XU22TT
6R12G	IXU22	IXU22TT
6R12PP	IXU22	IXU22TT
6R7	W22EPR-U	W22TT
7	W24ESR-U	-

HARLEY-DAVIDSON	DENSO	TT
8	IW31	-
EVS13P	IW16	IW16TT
EVS13S	IW16	IW16TT
EX12P	IXU22	IXU22TT
EX12S	XU22EPR-U	XU22TT

HINO	DENSO	TT
0 676 0046 70	W16EX-U	W16TT
19110-1040	DG-236	-
19110-1040A	DG-236	-
19110-1180	DG-241	-
19110-1180C	DG-241	-
1985A-68030	DG-234	-
1985A-68040	DG-235	-
28550-1100	DG-236	-
6 301 3300 10	DG-236	-
6 301 3300 11	DG-236	-
S1911-01040	DG-236	-

HITACHI	DENSO	TT
42W	W27S-U	-
43W	W24S-U	-
44W	W22S-U	-
45PW	W20PR-U	-
45W	W20S-U	-
46PW	W16PR-U	-
46W	W16S-U	-
47PW	W14PR-U	-
47W	W14PR-U	-
48W	W9-U	-
83W	M24S	-
84VPW	MA20P-U	-
84W	M22	-
85W	M17	-
86VPW	MA16PR-U	-
86VW	MA16PR-U	-
C45VW	T22M-U	-
C45W	W22M-U	-
C46VW	T20M-U	-
C46W	W20M-US	-
L12W	U24FSR-U	-
L13W	U22FSR-U	-
L14W	U20FSR-U	-
L23W	X24ESR-U	-
L24W	X22ESR-U	-
L41W	W31ESR-U	-
L42W	W27ESR-U	-
L43PW	W24EPR-U	-
L43W	W24ESR-U	-
L44PW	W22EPR-U	W22TT
L44VPW	T20EPR-U	T20TT
L44W	W22ESR-U	-
L45PW	W20EP-U	W20TT
L45PW11	W20EPR-U11	W20TT
L45VPW	T16EPR-U	T16TT
L45W	W20ESR-U	-
L46PW	W16EPR-U	W16TT
L46PW11	W16EPR-U11	W16TT
L46W	W16ESR-U	-
L47PW	W14EPR-U	IW16TT
L47W	W14E	-
M23W	X24FS-U	-
M25W	X20FSR-U	-
M42W	W27FSR	-
M43PW	W24FP-U	-
M43W	W24FSR	-
M44PW	W22FPR-U	-
M44W	W22FS-U	-
M45PW	W20FPR-U	WF20TT
M45VPW	T20PR-U	ITF20TT
M45W	W20FSR-U	WF20TT

HITACHI	DENSO	TT
M46PW	W16FPR-U	-
M46VPW	T16PR-U	ITF16TT
M46W	W16FSR	-
M47VPW	T14PR-U	ITF16TT
M47W	W14F-U	-

HONDA	DENSO	TT
12209-PLE0040	SKJ16CR-L11	IK16TT
12290-59B-003	VXEHC24G	-
12290-5A2-A01	DXE22HQR-D11S	-
12290-5A2-A02	DXE22HQR-D11S	-
12290-5B0-Y01	IXEH22TT	IXEH22TT
12290-5B0-Y02	DXE22HQR-D11S	-
12290-5K0-A01	VFXEHC22G	-
12290-5R0-003	VFXEHC22G	-
12290-5R0-004	VFXEHC22G	-
12290-5Z2-003	VXEHC24G	-
12290-5Z2-004	VXEHC24G	-
12290-PCX-000	PK22PR-L11S	-
12290-PCX0001	PK22PR-L11S	-
12290-PFD0000	SK20PR-L9	IK20TT
12290-PGE-A01	PKJ20CR-M11	IK20TT
12290-PGEA010	PKJ20CR-M11	IK20TT
12290-PGE-A02	PKJ20CR-L11	IK20TT
12290-PLE0040	SKJ16CR-L11	IK16TT
12290-PNE-003	KJ20DR-M11	-
12290-PNE-004	KJ20DR-M11	-
12290-PNL-E01	KJ20DR-M11	-
12290-PRB-A01	SK22PR-M11S	-
12290-R1A-A01	DXU22HCR-D11S	-
12290-R1A-A010M2	DXU22HCR-D11S	-
12290-R1A-H01	SXU22HCR11S	-
12290-R40-A01	SXU22HCR11S	-
12290-R40-A02	SXU22HCR11S	-
12290-R41-L01	DXU22HCR-D11S	-
12290-R60-002	SKJ20DR-M11S	-
12290-R60-U01	SKJ20DR-M11S	-
12290-R60-U02	SKJ20DR-M11S	-
12290-R70-A01	VXUH22I	IXUH22TT
12290-R71-A01	VXUH22I	IXUH22TT
12290-R71-L01	DXU22HCR-D11S	-
12290-R9P-A01	VFXUH22FG	-
12290-RB0-J01	DK20PR-D13	-
12290-RB0-JB11	DK20PR-D13	-
12290-RB1-003	SKJ20DR-M13	-
12290-RB1-004	SKJ20DR-M13	-
12290-RBJ-003	FK20HR11	IKH20TT
12290-RGB-A004	VK20G	-
12290-RL6-G01	SXU22HCR11S	-
12290-RMX-004	IKH20TT	IKH20TT
12290-RMX-014	IKH20TT	IKH20TT
12290-RMXA0040	IKH20TT	IKH20TT
12290-RSH-003	SK20PR-L11	IK20TT
12290-RSH-004	SK20PR-L11	IK20TT
12290-RTW-004	DK20PR-D13	-
12290-RW0-003	FK20HR11	IKH20TT
12291-P5T-G00	DG-101	-
12291-P5T-G02	DG-101	-
12291-PLZ-D00	DG-302	-
12291-PLZ-D00	DG-641	-
12291-RBD-E01	DG-601	-
12291-RL0-G01	DG-601	-
31901-NF4-J6511	IW01-32	-
31911-KRN-731	IU01-24	-
31911-KSK-731	W27ESR-V	-
31911-MBT-F21	IX24B	-
31911-MBW-E11	VUH24D	-
31911-MCW-003	VNH24Z	-
31911-MEE-J01	VUH24ES	-
31912-HW1-671	VNH27Z	-
31912-KRN-731	IU01-27	-

Свечи зажигания и Свечи накаливания

Таблица взаимозаменяемости - OE

HONDA	DENSO	TT
31912-MBW-E11	VUH27D	-
31912-MCW-003	VNH27Z	-
31912-MEE-J01	VUH24ES	-
31912-MEL-003	VUH27ES	-
31912-MFL-003	VUH27ES	-
31912-MGH-641	VUH24ES	-
31916-KPH-901	U20EPR9	-
31916-KPH-9012	U20EPR9	-
31916-KPH-9012-M1	U20EPR9	-
31916-KRM-841	U24EPR9	-
31916-KRM-8413	U24EPR9	-
31916-KRM-8413-M1	U24EPR9	-
31916-KSP-8610M1	U20EPR9	-
31916-KWB-601	U20EPR9	-
31916-KYT-9010	U24EPR9	-
31916-KYT-9010-M1	U24EPR9	-
31916-MEH-003	IU24	-
31916-MEH-0030	IU24	-
31916-ZY3-003	VKJ20RZ-M11	-
31916-ZY3-004	VKJ20RZ-M11	-
31918-MEB-671	VK24PRZ11	-
31918-MEB-672	VK24PRZ11	-
31918-MEB6720M2	VK24PRZ11	-
31919-MEB-671	VK27PRZ11	-
31919-MEB-672	VK27PRZ11	-
31919-MEB6720M2	VK27PRZ11	-
31921-MBW-E12	VUH24D	-
31921-MBWE121M2	VUH24D	-
31921-MCWA0040	VNH24Z	-
31921-MFF-D000	U24EPR9	-
31921-MOW-004	VNH24Z	-
31922-MBW-E12	VUH27D	-
31922-MBWE121M2	VUH27D	-
31922-MCW-004	VNH27Z	-
31922-MCWA0040	VNH27Z	-
31922-MEL-003	VUH27ES	-
31922-MFL-003	VUH27ES	-
31922-MOW-004	VNH27Z	-
31926-KPH-901	U20EPR9	-
31926-KPH-9010	U20EPR9	-
31926-KPH-9010-M1	U20EPR9	-
31926-KPH-9010-M2	U20EPR9	-
31926-KPH-9011	U20EPR9	-
31926-KPH-9011-M1	U20EPR9	-
31927-KPH-9010	U22EPR9	-
31927-KPH-9010-M1	U22EPR9	-
31927-KPH-9011	U22EPR9	-
31927-KPH-9011-M1	U22EPR9	-
31928-MFF-D01	U24EPR9	-
31940-NX5-7520-M1	IA01-32	-
31940-NX5-9410	IA01-32	-
31940-NX5-A0030	IAE01-32	-
31988-GEV-761	Y24FER-C	-
31989-GEV-761	Y27FER-C	-
80765-772600	IQ27	-
98049-58716	Y24FER-C	-
98049-587-26	Y24FER-C	-
98049-587-2601	Y24FER-C	-
98049-587-2R	Y24FER-C	-
98049-587-2R00	Y24FER-C	-
98049-59716	Y27FER-C	-
98049-597-26	IY27	-
98049-597-2601	IY27	-
98049-597-2R	Y27FER-C	-
98049-597-2R00	Y27FER-C	-
98049-60716	Y31FER-C	-
98049-607-26	Y31FER-C	-
98049-607-2601	Y31FER-C	-
98049-607-2R	Y31FER-C	-
98049-607-2R00	Y31FER-C	-
98056-547-26	U14FSR-UB	-

HONDA	DENSO	TT
98056-547-2601	U14FSR-UB	-
98056-54750	U14FSR-UB	-
98056-54757	U14FSR-UB	-
98056-547-57	U14FSR-UB	-
98056-547-5701	U14FSR-UB	-
98056-5475U	IUF14-UB	-
98056-547-5U	IUF14-UB	-
98056-55713	U16FSR-U	-
98056-55717	U16FSR-U	-
98056-55718	U16FSR-U	-
98056-55723	U16FSR-U	-
98056-557-23	U16FS-U	-
98056-557-2303	U16FS-U	-
98056-557-231H	U16FS-U	-
98056-55726	U16FSR-U	-
98056-557-26	U16FSR-U	-
98056-557-2601	U16FSR-U	-
98056-55750	U16FS-UB	-
98056-557-50	U16FS-UB	-
98056-557-5000	U16FS-UB	-
98056-55757	U16FSR-UB	-
98056-557-57	U16FSR-UB	-
98056-557-5700	U16FSR-UB	-
98056-557-5701	U16FSR-UB	-
98056-55770	U16FS-UB	-
98056-55777	U16FSR-UB	-
98056-56713	U20FSR-U	-
98056-56716	U20FSR-U	-
98056-56717	U20FSR-U	-
98056-56718	U20FSR-U	-
98056-56718HE	IUF22	-
98056-56723	U20FS-U	-
98056-567-23	U20FS-U	-
98056-567-2303	U20FS-U	-
98056-567-231H	U20FS-U	-
98056-56723-1H	U20FS-U	-
98056-567-233N	U20FS-U	-
98056-56726	U20FSR-U	-
98056-567-26	Q16R-U11	Q16TT
98056-567-2601	Q16R-U11	Q16TT
98056-567-2604	U20FSR-U	-
98056-57713	U22FSR-U	-
98056-57716	U22FSR-U	-
98056-57717	U22FSR-U	-
98056-57718	U22FSR-U	-
98056-57723	U22FS-U	-
98056-577-23	U22FS-U	-
98056-577-2303	U22FS-U	-
98056-577-231H	U22FS-U	-
98056-577-233N	U22FS-U	-
98056-57726	U22FSR-U	-
98056-577-26	U22FSR-U	-
98056-577-2603	U22FSR-U	-
98056-58713	U24FSR-U	-
98056-58716	U24FSR-U	-
98056-58718	U24FSR-U	-
98056-587-23	U24FS-U	-
98056-587-2301	U24FS-U	-
98056-58726	U22FSR-U	-
98056-587-26	U24FSR-U	-
98056-587-2603	U24FSR-U	-
98059-55916	U16FER9	-
98059-55926	U16FER9	-
98059-57916	U22FER9	-
98059-57926	U22FER9	-
98059-579-26	U22FER9	-
98059-579-2601	U22FER9	-
98059-5792U	IUH24D	-
98059-58910	U24FE9	-
98059-58916	U24FER9	-
98059-58916HE	IUH24	-

HONDA	DENSO	TT
98059-5891F	IUH24	-
98059-58920	U24FE9	-
98059-589-20	U24FE9	-
98059-589-2001	U24FE9	-
98059-58926	U24FER9	-
98059-589-26	U24FER9	-
98059-589-2601	U24FER9	-
98059-5892D	IUH24D	-
98059-589-2U	IUH24D	-
98059-5892UP	IUH24	-
98059-589J6	IUH24	-
98059-589K6	IUH24	-
98059-59910	U27FER9	-
98059-59916	U27FER9	-
98059-59916HE	IUH27	-
98059-5991F	IUH27	-
98059-5991U	IUH27D	-
98059-59926	U27FER9	-
98059-599-26	U27FER9	-
98059-599-2601	U27FER9	-
98059-59926-01	U27FER9	-
98059-5992U	IUH27D	-
98059-599-2U	IUH27D	-
98059-5992UP	IUH27	-
98059-599J6	IUH27	-
98059-60916	U31ESR-N	-
98061-58611	X24GPR-U	-
98061-58616	X24GPR-U	-
98061-58626	X24GPR-U	-
98061-586-26	X24GPR-U	-
98061-586-2603	X24GPR-U	-
98061-586-2604	X24GPR-U	-
98061-59616	X27GPR-U	-
98061-59626	X27GPR-U	-
98061-596-26	X27GPR-U	-
98061-596-2603	X27GPR-U	-
98066-54716	X16FSR-U	-
98066-55710	X16FSR-U	-
98066-55716	X16FSR-U	-
98066-55726	X16FSR-U	-
98066-557-26	X16FSR-U	-
98066-557-2602	X16FSR-U	-
98066-55740	X16FSR-U	-
98066-56710	X20FSR-U	-
98066-56716	X20FSR-U	-
98066-56717	X20FSR-U	-
98066-56726	X20FSR-U	-
98066-567-26	X20FSR-U	-
98066-567-2602	X20FSR-U	-
98066-567-27	X20FS-U	-
98066-567-2703	X20FS-U	-
98066-58716	X24FS-U	-
98066-58717	X24FS-U	-
98066-587-27	X24FS-U	-
98069-38716	X24ESR-U	-
98069-38719	X24ESR-U	-
98069-55916	X16EPR-U9	-
98069-559-26	X16EPR-U9	-
98069-559-2601	X16EPR-U9	-
98069-56717	X20ESR-U	-
98069-567-27	X20ES-U	-
98069-567-2702	X20ES-U	-
98069-56911	X20EPR-U9	-
98069-56916	X20EPR-U9	-
98069-56926	X20EPR-U9	-
98069-569-26	X20EPR-U9	-
98069-569-2602	X20EPR-U9	-
98069-569-5Q	XU20EPR-U	-
98069-5697Q	XU20EPR-U	-
98069-5697QHE	IXU22	IXU22TT
98069-57717	X22ESR-U	-

HONDA	DENSO	TT
98069-57719	X22ESR-U	-
98069-5771P	X22ESR-U	-
98069-577-23	W20EPB	W20TT
98069-57726	X22ESR-U	-
98069-577-26	X22ESR-U	-
98069-577-2603	X22ESR-U	-
98069-577-27	X22ES-U	-
98069-577-2703	X22ES-U	-
98069-577-271H	X22ES-U	-
98069-577-28	X22EPR-U9	-
98069-577-282N	X22EPR-U9	-
98069-57756	IX22	-
98069-5777P	X22ESR-U	-
98069-57911	X22EPR-U9	-
98069-57916	X22EPR-U9	-
98069-57916HE	IX22B	-
98069-5791U	VX22BC	-
98069-57926	X22EPR-U9	-
98069-579-26	X22EPR-U9	-
98069-579-2603	X22EPR-U9	-
98069-5792U	VX22BC	-
98069-579-2U	VX22BC	-
98069-579-2U01	VX22BC	-
98069-57956	X22EPR-U9	-
98069-579-5Q	XU22EPR-U	XU22TT
98069-58717	X24ESR-U	-
98069-58719	X27ESR-U	-
98069-58726	X24ESR-U	-
98069-587-2603	X24ESR-U	-
98069-58727	X24ES-U	-
98069-587-27	X24ES-U	-
98069-587-2703	X24ES-U	-
98069-587-271H	X24ES-U	-
98069-587-28	X24EPR-U9	-
98069-587-2801	X24EPR-U9	-
98069-587-282N	X24EPR-U9	-
98069-58911	X24EPR-U9	-
98069-58916	X24EPR-U9	-
98069-58916HE	IX24B	-
98069-5891F	IX24B	-
98069-58921	X24EP-U9	-
98069-589-21	X24EP-U9	-
98069-589-210N	X24EP-U9	-
98069-589-211N	X24EP-U9	-
98069-58926	X24EPR-U9	-
98069-589-26	X24EPR-U9	-
98069-589-2603	X24EPR-U9	-
98069-59717	X27ESR-U	-
98069-59726	X27ESR-U	-
98069-597-26	X27ESR-U	-
98069-597-2603	X27ESR-U	-
98069-597-27	X27ES-U	-
98069-597-2703	X27ES-U	-
98069-597-28	X27EP-U9	-
98069-59916	X27EPR-U9	-
98069-59916HE	IX27B	-
98069-5991F	IX27B	-
98069-599-21	X27EP-U9	-
98069-599-2103	X27EP-U9	-
98069-599-210N	X27EP-U9	-
98069-59926	X27EPR-U9	-
98069-599-26	X27EPR-U9	-
98069-599-2603	X27EPR-U9	-
98069-607-26	X31ESR-U	-
98073-54710	W14PR-U	-
98073-54740	W14MR-U	-
98073-54740	W14M-U	-
98073-54744	W14MR-U	-

Свечи зажигания и Свечи накаливания

Таблица взаимозаменяемости - OE

HONDA	DENSO	TT
98073-54750	W14MR-U	-
98073-547-50	W14M-U	-
98073-547-5002	W14M-U	-
98073-54754	W14MR-U	-
98073-547-54	W14MR-U	-
98073-547-5402	W14MR-U	-
98073-54771	W14MP-U10	-
98073-54776	W14MPR-U10	-
98073-54941	W14MP-U10	-
98073-54944	W14MPR-U10	-
98073-54951	W14MP-U10	-
98073-549-51	W14MP-U10	-
98073-549-5102	W14MP-U10	-
98073-549-54	W14MPR-U10	-
98073-549-5402	W14MPR-U10	-
98073-56740	W20MR-U	-
98073-56741	W20MP-U	-
98073-56744	W20MR-U	-
98073-56750	W20MR-U	-
98073-567-51	W20MP-U	-
98073-567-5101	W20MP-U	-
98073-567-54	W20MR-U	-
98073-567-5402	W20MR-U	-
98073-56941	W20MPR-U10	-
98073-56944	W20MPR-U10	-
98073-569-54	W20MPR-U10	-
98073-569-5402	W20MPR-U10	-
98073-57944	W22MPR-U	-
98076-52717	W9FP-UL	-
98076-54710	W14F-U	-
98076-54711	W14FPR-UL	-
98076-54715	W14FPR-UL	-
98076-54719	W14FPR-UL	-
98076-5471G	W14FR-L	-
98076-547-20	W14F-U	-
98076-547-2002	W14F-U	-
98076-547-26	W14FR-U	-
98076-547-28	W14FR-U	-
98076-547-2800	W14FR-U	-
98076-547-2801	W14FR-U	-
98076-547-2G	W14FR-L	-
98076-547-2G01	W14FR-L	-
98076-54746	W14FR-U	-
98076-54747	W14FPR-UL	-
98076-54757	W14FR-L	-
98076-547-57	W14FR-U	-
98076-547-5700	W14FR-U	-
98076-547-5701	W14FR-U	-
98076-547-58	W14FPR-UL	-
98076-547-5800	W14FPR-UL	-
98076-54780	W14F-U	-
98076-547-801H	W14F-U	-
98076-54911	W14FPR-UL10	-
98076-54914	W14FPR-UL10	-
98076-54919	W14FPR-UL	-
98076-5491G	W14FR-L	-
98076-54921	W14FPR-UL	-
98076-54921	W14FPR-UL10	-
98076-549-21	W14FPR-UL	-
98076-549-2102	W14FPR-UL	-
98076-549-24	W14FPR-UL10	-
98076-549-2400	W14FPR-UL10	-
98076-549-2402	W14FPR-UL10	-
98076-54947	W14FPR-UL	-
98076-549-54	W14FPR-UL10	-
98076-549-5400	W14FPR-UL10	-
98076-549-5401	W14FPR-UL10	-
98076-549-5402	W14FPR-UL10	-
98076-55711	W16FPR-U	-
98076-55719	W16FPR-U	-

HONDA	DENSO	TT
98076-557-27	W16FSR	-
98076-557-2701	W16FSR	-
98076-55747	W16FPR-U	-
98076-56713	W20FR-L	WF20TT
98076-56715	W20FR-L	WF20TT
98076-56716	W20FSR-U	WF20TT
98076-56717	W20FPR-U	WF20TT
98076-56719	W20FPR-U	WF20TT
98076-5671G	W20FR-L	WF20TT
98076-56721	W20FPR-U	WF20TT
98076-567-23	W20FP-L	WF20TT
98076-567-2301	W20FP-L	WF20TT
98076-56724	W20FS-U	WF20TT
98076-567-2402	W20FS-U	WF20TT
98076-56725	W20FR-L	WF20TT
98076-567-28	W20FSR-U	WF20TT
98076-567-2802	W20FSR-U	WF20TT
98076-56729	W20FPR-U	WF20TT
98076-567-2900	W20FPR-U	WF20TT
98076-5672G	W20FR-L	WF20TT
98076-567-2G	W20FR-L	WF20TT
98076-567-2G01	W20FR-L	WF20TT
98076-56740	W20FSR-U	WF20TT
98076-56747	W20FPR-U	WF20TT
98076-56756	W20FPR-U	WF20TT
98076-56917	W20FPR-U10	WF20TT
98076-5691G	W20FR-L	WF20TT
98076-56921	W20FP-U	WF20TT
98076-569-21	W20FP-U	WF20TT
98076-569-2102	W20FP-U	WF20TT
98076-56927	W20FPR-U10	WF20TT
98076-569-27	W20FPR-U10	WF20TT
98076-569-2702	W20FPR-U10	WF20TT
98076-5692G	W20FR-L	WF20TT
98076-57716	W22FSR	-
98076-57717	W22FPR-U	-
98076-57719	W22FPR-U	-
98076-577-20	W22FS-U	-
98076-577-2002	W22FS-U	-
98076-577-26	W22FSR	-
98076-577-2600	W22FSR	-
98076-577-2602	W22FSR	-
98076-57740	W22FS-U	-
98076-58710	W24FSR	-
98076-58715	W24FR-L	-
98076-58716	W24FSR	-
98076-58717	W24FPR	-
98076-58719	W24FP-U	-
98076-5871G	W24FR-L	-
98076-587-26	W24FSR	-
98076-587-2600	W24FSR	-
98076-587-2602	W24FSR	-
98076-587-27	W24FPR	-
98076-587-2701	W24FPR	-
98076-5872G	W24FR-L	-
98076-587-2G	W24FR-L	-
98076-587-2G01	W24FR-L	-
98076-5891G	W24FR-L	-
98076-59716	W27FSR	-
98076-597-26	W27FSR	-
98076-597-2600	W27FSR	-
98076-597-2602	W27FSR	-
98076-59740	W27FSR	-
98078-5614G	KJ20CR-U11	K20TT
98079-52876	W9EXR-UCU	-
98079-541-5G	KJ14CR-L11	-
98079-541-5G00	KJ14CR-L11	-
98079-54841	W14EPR-U	IW16TT
98079-54846	W14EXR-U	IW16TT

HONDA	DENSO	TT
98079-54855	W14EPR-U	IW16TT
98079-548-55	W14EPR-U	IW16TT
98079-548-5501	W14EPR-U	IW16TT
98079-5485V	J16CR-U	W16TT
98079-5487V	J16CR-U	W16TT
98079-55132	W16EXR-U11	W16TT
98079-551-32	W16EXR-U11	W16TT
98079-551-3201	W16EXR-U11	W16TT
98079-55141	W16EXR-U11	W16TT
98079-55145	W16EXR-U11	W16TT
98079-55146	W16EXR-U11	W16TT
98079-55148	Q16PR-U11	Q16TT
98079-55149	Q16R-U11	Q16TT
98079-5514A	Q16R-U11	Q16TT
98079-5514E	K16PR-U11	K16TT
98079-5514EHE	K16PR-U11	K16TT
98079-5514G	KJ16CR-U11	K16TT
98079-5514H	PK16PR-L11	IK16TT
98079-5514J	K16PR-U	K16TT
98079-5514N	SKJ16CR-L11	IK16TT
98079-5514P	KJ16CR-L11	K16TT
98079-551-50	Q16P-U11	Q16TT
98079-551-5001	Q16P-U11	Q16TT
98079-55155	W16EPR-U11	W16TT
98079-551-55	W16EPR-U11	W16TT
98079-551-5501	W16EPR-U11	W16TT
98079-55158	Q16PR-U11	Q16TT
98079-551-58	Q16PR-U11	Q16TT
98079-551-5801	Q16PR-U11	Q16TT
98079-5515E	K16PR-U11	K16TT
98079-551-5E	K16PR-U11	K16TT
98079-551-5E01	K16PR-U11	K16TT
98079-5515G	KJ16CR-L11	K16TT
98079-551-5G	KJ16CR-L11	K16TT
98079-551-5G01	KJ16CR-L11	K16TT
98079-5515H	PK16PR-L11	IK16TT
98079-551-5H	PK16PR-L11	IK16TT
98079-551-5H01	PK16PR-L11	IK16TT
98079-551-5H02	PK16PR-L11	IK16TT
98079-5515J	K16PR-L11	K16TT
98079-551-5J	K16PR-L11	K16TT
98079-551-5J01	K16PR-L11	K16TT
98079-551-5K	Q16PR-U11	Q16TT
98079-551-5K01	Q16PR-U11	Q16TT
98079-5515N	PKJ16CR-L11	IK16TT
98079-551-5N	PKJ16CR-L11	IK16TT
98079-551-5N01	PKJ16CR-L11	IK16TT
98079-5515U	VK16PRZ11	IK16TT
98079-551-5U	VK16PRZ11	IK16TT
98079-551-5U02	VK16PRZ11	IK16TT
98079-5515V	SK16PR-L11	IK16TT
98079-551-5V	SK16PR-L11	IK16TT
98079-551-5V00	SK16PR-L11	IK16TT
98079-5515W	SKJ16CR-L11	IK16TT
98079-55173	W16EKR-S11	W16TT
98079-5517U	VK16PRZ11	IK16TT
98079-5517V	SK16PR-L11	IK16TT
98079-5517W	SKJ16CR-L11	IK16TT
98079-55183	W16EKR-S11	W16TT
98079-551-83	W16EKR-S11	W16TT
98079-551-8302	W16EKR-S11	W16TT
98079-551-88	W16ESR-U	-
98079-551-8801	W16ESR-U	-
98079-55816	W16ESR-U	-
98079-55817	W16EPR-U	W16TT
98079-558-20	W16ES-U	-
98079-558-21	W16EP-U	W16TT
98079-558-211H	W16EP-U	W16TT
98079-558-26	W16ESR-U	-
98079-558-2601	W16ESR-U	-
98079-55827	W16EPR-U	W16TT

HONDA	DENSO	TT
98079-558-27	W16EPR-U	W16TT
98079-558-2701	W16EPR-U	W16TT
98079-558-2702	W16EPR-U	W16TT
98079-558-31	W16EX-U	W16TT
98079-558-3101	W16EX-U	W16TT
98079-558-3102	W16EX-U	W16TT
98079-55832	W16EXR-U	W16TT
98079-558-32	W16EXR-U	W16TT
98079-558320	W16EXR-U	W16TT
98079-558-3201	W16EXR-U	W16TT
98079-558-3203	W16EXR-U	W16TT
98079-55840	W16ESR-U	-
98079-55841	W16EPR-U	W16TT
98079-55846	W16EPR-U	W16TT
98079-55847	W16ESR-U	-
98079-558-54	W16EP-U	W16TT
98079-558-5401	W16EP-U	W16TT
98079-55855	W16EPR-U	W16TT
98079-558-55	W16EPR-U	W16TT
98079-558-5501	W16EPR-U	W16TT
98079-558-5502	W16EPR-U	W16TT
98079-558-5503	W16EPR-U	W16TT
98079-558-58	W16ESR-U	-
98079-558-5804	W16ESR-U	-
98079-5585C	IK16	IK16TT
98079-5585V	J16CR-U	W16TT
98079-558-5V	J16CR-U	W16TT
98079-5587V	J16CR-U	W16TT
98079-55941	W16EXR-U	W16TT
98079-55946	W16EXR-U	W16TT
98079-55A4N	PQ16R	Q16TT
98079-55A5N	PKJ16CR-L11	IK16TT
98079-55A-5N	PKJ16CR-L11	IK16TT
98079-56132	W20EXR-U11	W20TT
98079-561-32	W20EXR-U11	W20TT
98079-561-3200	W20EXR-U11	W20TT
98079-561-3202	W20EXR-U11	W20TT
98079-5613K	W20EXR-U11	W20TT
98079-561-3K	W20EXR-U11	W20TT
98079-561-3K01	W20EXR-U11	W20TT
98079-56144	W20EPR-U11	W20TT
98079-56145	W20EPR-U11	W20TT
98079-56146	W20EXR-U11	W20TT
98079-56148	Q20PR-U11	Q20TT
98079-56149	Q20R-U11	Q20TT
98079-5614A	Q20PR-U11	Q20TT
98079-5614E	K20PR-U11	K20TT
98079-5614EHE	K20PR-U11	K20TT
98079-5614F	IQ20TT	IQ20TT
98079-5614G	KJ20CR-U11	K20TT
98079-5614H	PK20PR11	K20TT
98079-5614J	K20PR-L11	K20TT
98079-5614N	PKJ20CR-L11	IK20TT
98079-5614P	KJ20CR-L11	K20TT
98079-561-50	Q20P-U11	Q20TT
98079-561-5001	Q20P-U11	Q20TT
98079-56155	W20EPR-U11	W20TT
98079-561-55	W20EPR-U11	W20TT
98079-561-5501	W20EPR-U11	W20TT
98079-56158	Q20PR-U11	Q20TT
98079-561-58	Q20PR-U11	Q20TT
98079-561-5801	Q20PR-U11	Q20TT
98079-56159	Q20PR-U11	Q20TT
98079-5615E	K20PR-U11	K20TT
98079-561-5E	K20PR-U11	K20TT
98079-561-5E01	K20PR-U11	K20TT
98079-561-5F	IQ20TT	IQ20TT
98079-561-5F01	IQ20TT	IQ20TT
98079-5615G	KJ20CR-L11	K20TT
98079-561-5G01	KJ20CR-L11	K20TT

Свечи зажигания и Свечи накаливания

Таблица взаимозаменяемости - OE

HONDA	DENSO	TT
98079-5615H	PK20PR-L11	IK20TT
98079-561-5H	PK20PR-L11	IK20TT
98079-561-5H01	PK20PR-L11	IK20TT
98079-561-5H02	PK20PR-L11	IK20TT
98079-5615J	K20PR-L11	K20TT
98079-561-5J	K20PR-L11	K20TT
98079-561-5J01	K20PR-L11	K20TT
98079-5615N	PKJ20CR-L11	IK20TT
98079-561-5N	PKJ20CR-L11	IK20TT
98079-561-5N01	PKJ20CR-L11	IK20TT
98079-561-5N02	PKJ20CR-L11	IK20TT
98079-5615U	VK20PRZ11	-
98079-561-5U	VK20PRZ11	-
98079-561-5U01	VK20PRZ11	-
98079-5615V	SK20PR-L11	IK20TT
98079-561-5V	SK20PR-L11	IK20TT
98079-56173	W20EKR-S11	IW20TT
98079-5617S	PK20PR11	K20TT
98079-5617U	VK20PRZ11	-
98079-56183	W20EKR-S11	IW20TT
98079-561-83	W20EKR-S11	IW20TT
98079-561-8302	W20EKR-S11	IW20TT
98079-561-87	W20EKR-S11	IW20TT
98079-561-8700	W20EKR-S11	IW20TT
98079-56811	W20EPR-U	W20TT
98079-56817	W20ESR-U	-
98079-568-20	W20ES-U	-
98079-568-21	W20EP-U	W20TT
98079-568-211H	W20EP-U	W20TT
98079-568-26	W20ESR-U	-
98079-568-2600	W20ESR-U	-
98079-568-2601	W20ESR-U	-
98079-568-31	W20EX-U	W20TT
98079-568-3101	W20EX-U	W20TT
98079-568-3102	W20EX-U	W20TT
98079-56832	W20EXR-U	W20TT
98079-568-32	W20EXR-U	W20TT
98079-568-3201	W20EXR-U	W20TT
98079-568-3203	W20EXR-U	W20TT
98079-56840	W20ESR-U	-
98079-56841	W20EPR-U	W20TT
98079-56844	IW20	IW20TT
98079-56846	W20EPR-U	W20TT
98079-56847	W20ESR-U	-
98079-568-50	W20ES-U	-
98079-56851	W20EPR-U	W20TT
98079-56854	W20EPR-U	W20TT
98079-568-54	W20EP-U	W20TT
98079-568-5400	W20EP-U	W20TT
98079-56855	W20EPR-U	W20TT
98079-568-55	W20EPR-U	W20TT
98079-568-5500	W20EPR-U	W20TT
98079-568-5502	W20EPR-U	W20TT
98079-568-5504	W20EPR-U	W20TT
98079-5685C	IK20	IK20TT
98079-56941	W20EXR-U	W20TT
98079-56946	W20EXR-U	W20TT
98079-5695U	SK20PR-L9	IK20TT
98079-569-5U	SK20PR-L9	IK20TT
98079-5697U	SK20PR-L9	IK20TT
98079-569BE	IK20G	-
98079-569BU	VK20G	-
98079-569CE	IK20G	-
98079-569CU	VK20G	-
98079-56A-5H	PK20PR-L13	IK20TT
98079-56A-5H00	PK20PR-L13	IK20TT
98079-56A-5H01	PK20PR-L13	IK20TT
98079-56A7W	SKJ20DR-M13	-
98079-57145	W22EPR-U11	W22TT
98079-57148	Q22PR-U	-
98079-57149	Q22PR-U	-

HONDA	DENSO	TT
98079-5714A	Q22PR-U	-
98079-5714E	VK22	IK22FTT
98079-5714G	KJ22CR-L11	-
98079-5714H	PK22PR-L11S	-
98079-5714P	KJ22CR-L11	-
98079-571-50	Q22P-U	-
98079-571-5001	Q22P-U	-
98079-57155	W22EPR-U11	W22TT
98079-571-55	W22EPR-U11	W22TT
98079-571-5501	W22EPR-U11	W22TT
98079-57158	Q22PR-U11	-
98079-571-58	Q22PR-U11	-
98079-571-5801	Q22PR-U11	-
98079-5715E	K22PR-U11	IK22FTT
98079-571-5E	K22PR-U11	IK22FTT
98079-571-5E01	K22PR-U11	IK22FTT
98079-5715G	KJ22CR-L11	-
98079-571-5G	KJ22CR-L11	-
98079-571-5G01	KJ22CR-L11	-
98079-5715H	PK22PR-L11S	-
98079-5715J	K22PR-L11	IK22FTT
98079-571-5J	K22PR-L11	IK22FTT
98079-571-5J01	K22PR-L11	IK22FTT
98079-5715U	VK22PRZ11	IK22FTT
98079-5715V	SK22PR-M11	IK22FTT
98079-571-5V	SK22PR-M11	IK22FTT
98079-571-5V00	SK22PR-M11	IK22FTT
98079-57171	W22EPR-U11	W22TT
98079-57173	IW22	-
98079-57175	W20EKR-S11	IW20TT
98079-5717U	VK22PRZ11	IK22FTT
98079-5717V	SK22PR-M11S	-
98079-57181	W22EPR-U11	W22TT
98079-57183	IW22	-
98079-57185	W22EPR-U11	W22TT
98079-571-88	IW22	-
98079-571-8802	IW22	-
98079-571BH	PK22PR-L11S	-
98079-571BV	SK22PR-M11S	-
98079-571CH	PK22PR-L11S	-
98079-571-CH	PK22PR-L11S	-
98079-571-CH00	PK22PR-L11S	-
98079-571CV	SK22PR-M11S	-
98079-571-CV00	SK22PR-M11S	-
98079-57816	W22ESR-U	-
98079-578-21	W22EP-U	W22TT
98079-578-211H	W22EP-U	W22TT
98079-578-25	W22ES-U	-
98079-578-2501	W22ES-U	-
98079-578-2701	W22ESR-U	-
98079-57840	W22ESR-U	-
98079-57841	W22EPR-U	W22TT
98079-57846	W22EPR-U	W22TT
98079-578-54	W22EP-U	W22TT
98079-578-5400	W22EP-U	W22TT
98079-57855	W22EPR-U	W22TT
98079-578-55	W22EPR-U	W22TT
98079-578-58	IW22	-
98079-578-5802	IW22	-
98079-5785C	IK22	IK22FTT
98079-5785G	KJ22CR-L8	-
98079-578-5G	KJ22CR-L8	-
98079-578-5G00	KJ22CR-L8	-
98079-57877	W22ESR-U	-
98079-5787G	KJ22CR-L8	-
98079-5787T	PK22PR8	IK22TT
98079-5814E	K24PR-U11	-
98079-5815E	K24PR-U11	-
98079-581-5E	K24PR-U11	-
98079-5815U	IK24C11	-

HONDA	DENSO	TT
98079-5817U	IK24C11	-
98079-58644	IW24	-
98079-58646	IW24	-
98079-586-58	W24ES-V	-
98079-586-5802	W24ES-V	-
98079-58659	W24ESR-V	-
98079-586-59	W24ESR-V	-
98079-586-5902	W24ESR-V	-
98079-58678	W24ES-V	-
98079-58679	W24ESR-V	-
98079-58816	W24ESR-U	-
98079-588-17	W24ESR-U	-
98079-588-1700	W24ESR-U	-
98079-58819	W24ESR-U	-
98079-588-21	W24EP-U	-
98079-588-211H	W24EP-U	-
98079-588-24	W24ES-U	-
98079-588-2401	W24ES-U	-
98079-588-27	W24ESR-U	-
98079-588-2701	W24ESR-U	-
98079-58840	W24ESR-U	-
98079-58842	W24ESR-U	-
98079-58846	W24ESR-U	-
98079-58847	W24EPR-U	-
98079-588-53	W24ES-U	-
98079-588-5301	W24ES-U	-
98079-588-56	W24ESR	-
98079-58857	W24ESR-U	-
98079-588-57	W24ESR-U	-
98079-588-5701	W24ESR-U	-
98079-5915U	IK27C11	-
98079-591-5U	IK27C11	-
98079-5917U	IK27C11	-
98079-59644	IW27	-
98079-596-58	W27ES-V	-
98079-596-5802	W27ES-V	-
98079-59659	W27ESR-V	-
98079-596-59	W27ESR-V	-
98079-596-5902	W27ESR-V	-
98079-59678	W27ES-V	-
98079-59679	W27ESR-V	-
98079-59811	W27ESR-U	-
98079-59816	W27ESR-U	-
98079-59819	W27ESR-V	-
98079-598-25	W27ES-U	-
98079-598-2501	W27ES-U	-
98079-598-26	W27ESR	-
98079-598-2600	W27ESR	-
98079-59827	W27ESR-U	-
98079-598-27	W27ESR-U	-
98079-598-2700	W27ESR-U	-
98079-598-2701	W27ESR-U	-
98079-59840	W27ESR-U	-
98079-59847	W27ESR-U	-
98079-598-53	W27ES-U	-
98079-598-5301	W27ES-U	-
98079-598-57	W27ESR-U	-
98079-598-5701	W27ESR-U	-
98079-59872	W27ES-V	-
98079-59876	W27ESR-U	-
98079-600000	W22EPR-U11	W22TT
98079-60679	IW31	-
98079-60817	W31ESR-U	-
98079-608-27	W31ESR-U	-
98079-608-2701	K16PR-L11	K16TT
98079-60875	IWM31	-
9807B-5515W	SKJ16DR-M11	-
9807B-551-5W	SKJ16DR-M11	-
9807B-551-5W00	SKJ16DR-M11	-
9807B-5615P	KJ20DR-M11	-
9807B-561-5P	KJ20DR-M11	-

HONDA	DENSO	TT
9807B-5615W	SKJ20DR-M11	-
9807B-561-5W	SKJ20DR-M11	-
9807B-5617C	SKJ20DR-M11	-
9807B-5617P	KJ20DR-M11	-
9807B-5617W	SKJ20DR-M11	-
9807B-561BP00	SKJ20DR-M11S	-
9807B-561BW	SKJ20DR-M11	-
9807B-561CP	SKJ20DR-M11S	-
9807B-561CW	SKJ20DR-M11S	-
9807B-561-CW	SKJ20DR-M11S	-
9807B-56A5W	SKJ20DR-M13	-
9807B-56A-5W	SKJ20DR-M13	-
9807B-56A7W	SKJ20DR-M13	-
H98515-517J	IK16	IK16TT
H98515-517K	IK16	IK16TT
H98515-617J	IK20	IK20TT
H98515-617K	IK20	IK20TT
H98515-617Q	IQ20TT	IQ20TT
H98535-617L	IK20	IK20TT
H98795-518K	IK16TT	IK16TT
H98795-518Q	IQ16TT	IQ16TT
H98795-618K	IK20TT	IK20TT
H98795-618Q	IQ20TT	IQ20TT
H98795-618Q	IQ20TT	IQ20TT
H98795-718K	VK22	IK22FTT
H98805-518K	IK16TT	IK16TT
H98805-518Q	IQ16TT	IQ16TT
H98805-618K	IK20TT	IK20TT
H98805-618Q	IQ20TT	IQ20TT
H98805-718K	VK22	IK22FTT
H98815-515K	IK16TT	IK16TT
H98815-615K	IK20TT	IK20TT
H98885-618K	IK20TT	IK20TT
ZH98000-1000	W20EPR-U	W20TT
ZH98000-2000	U27ESR-N	-
ZH98000-3000	X24ESR-U	-
ZH98000-4000	U24ESR-N	-
ZH98000-5000	X27ESR-U	-
ZJ98000-2000	U27ETR	-
ZJ98000-3000	X27ETR	-
ZJ98000-4000	U24ETR	-
ZK98000-1000	U22ESR-N	-

HUSQVARNA	DENSO	TT
611 39 093 000	IXU24	-
800057446	W27ESR-V	-
800077478	U24ES-N	-
8A0057446	W27ESR-V	-
8B0057446	U22ESR-N	-

HYUNDAI	DENSO	TT
08914-18110	W16EXR-U	W16TT
099PM-18000	PK16PR11	K16TT
099PM-18010	P16PR11	W16TT
18811-08061	W20EPR-U11	W20TT
18811-11051	W16EXR-U11	W16TT
18811-11060	W20EPR-U11	W20TT
18811-11061	W20EPR-U11	W20TT
18812-11061	W20EPR-S11	W20TT
18813-11051	P16PR11	W16TT
18814-08051	K16PR-U11	K16TT
18814-08061	K20PR-U	K20TT
18814-08062	K20PR-U	K20TT
18814-11041	K16PR-U11	K16TT
18814-11051	K16PR-U11	K16TT
18814-11061	K20PR-U11	K20TT
18814-25000	SK16PR-A11	IK16TT
18817-11051	PK16PR-L11	IK16TT
18818-11051	P16PR11	W16TT
18822-08091	W20EPR-U11	W20TT
18822-11090	W20EPR-U11	W20TT
18822-11091	W20EPR-U11	W20TT

Свечи зажигания и Свечи накаливания

Таблица взаимозаменяемости - OE

HYUNDAI	DENSO	TT
18823-08061	K20PR-U	K20TT
18823-08071	K22PR-U	IK22FTT
18823-08091	K20PR-U	K20TT
18823-08101	K16PR-U11	K16TT
18823-11091	K20PR-U11	K20TT
18823-11101	K16PR-U11	K16TT
18823-11102	K16PR-U	K16TT
18825-11101	P16PR11	W16TT
18826-11101	PK16PR-L11	IK16TT
18827-09080	SXU22HDR8	IXUH22TT
18829-11050	KJ16CR-U11	K16TT
18835-11161	P16PR11	W16TT
18837-08051	K16PR-U11	K16TT
18840-11051	IKH16TT	IKH16TT
18841-11051	K16HPR-U11	KH16TT
18843-08062	XUH20TTi	XUH20TTi
18843-10062	XUH20TTi	XUH20TTi
18845-08200	FK20HR11	IKH20TT
18845-11160	IKH16TT	IKH16TT
18846-08070	VXUH22i	IXUH22TT
18846-10060	VXUH20i	-
18846-10070	VXUH22i	IXUH22TT
18846-11060	VXUH20i	-
18846-11070	VXUH22i	IXUH22TT
18847-08200	ZXU20HCR8	-
18847-11160	FXU16HR11	-
18850-11050	IKH16TT	IKH16TT
18851-11060	VXUH20i	-
18851-11070	VXUH22i	IXUH22TT
18854-09080	XU22HDR9	XUH22TT
18854-10080	XU22HDR9	XUH22TT
18855-10060	XU22HDR9	XUH22TT
18855-10060	XUH20TTi	XUH20TTi
18855-10061	VXUH22i	IXUH22TT
27400-18110	K20PR-U	K20TT
27410-23700	SK16PR-L11	IK16TT
27410-37100	PK16PR-L11	IK16TT
27410-3C000	SK16PR-L11	IK16TT
36710-27000	DG-173	-
36710-27010	DG-173	-
36710-29000	DG-001	-
36710-29001	DG-001	-
36710-2A100	DG-602	-
36710-2A200	DG-602	-
36710-2A700	DG-657	-
36710-2A710	DG-657	-
36710-2F000	DG-669	-
36710-2F001	DG-669	-
36710-2F100	DG-624	-
36710-2F101	DG-669	-
36710-42000	DG-172	-
36710-42010	DG-172	-
36710-42020	DG-172	-
36710-42021	DG-198	-
36710-42050	DG-301	-
36710-42500	DG-174	-
36710-42510	DG-172	-
36710-42550	DG-198	-
36710-4A000	DG-189	-
36710-4A100	DG-189	-
36710-4X900	DG-661	-
S36710-2F100	DG-624	-
Y18823-11101	K16PR-U11	K16TT

INFINITI	DENSO	TT
22401-1LA1C	IXEH22TT	IXEH22TT
22401-EW61C	FXE22HR11	IXEH22TT

INNOCENTI	DENSO	TT
6553206604	W20EPR-U	W20TT
6563208605	W20EPR-U	W20TT

INNOCENTI	DENSO	TT
7510960	W20EPR-U	W20TT

ISUZU	DENSO	TT
0-9820-0051-0	DG-635	-
5-81380001-0	W16EPR-U	W16TT
5-81380005-0	W16EPR-U	W16TT
5-81380006-0	W20EP-U	W20TT
5-81380007-0	W16EXR-U	W16TT
5-81380007-0	W16EX-U	W16TT
5-81380008-0	W20EX-U	W20TT
5-81380012-0	W16EXR-U11	W16TT
5-81380013-0	W20EXR-U11	W20TT
5-86003122-0	KJ16CR-U11	K16TT
5-86003124-0	KJ20CR-U11	K20TT
5-86007635-0	K16PR-U11	K16TT
5-86007636-0	KJ16CR-L11	K16TT
5-86007639-0	KJ20CR-L11	K20TT
5-86013957-0	PKJ16CR-L11	IK16TT
5-8610-1642-0	DG-626	-
5-86103386-0	PK20PR11	K20TT
5-86103389-0	P16PR11	W16TT
5-86121749-0	K16PR-U11	K16TT
8-94120560-0	W16EXR-U11	W16TT
8-94120561-0	W16EXR-U11	W16TT
8-94120562-0	W20EXR-U11	W20TT
8-9413-3759-1	DG-108	-
8-9413-3759-6	DG-108	-
8-9413-3759-8	DG-108	-
8-9413-3759-9	DG-108	-
8-9414-0115-6	DG-108	-
8-94160627-0	W20EXR-U	W20TT
8-9417-5158-1	DG-108	-
8-94217232-0	W20EPR-U11	W20TT
8-94219943-0	W20EPR-U	W20TT
8-9422-1719-3	DG-143	-
8-94235966-0	W16EPR-U11	W16TT
8-94237203-0	W16EXR-U11	W16TT
8-94241059-0	W20EPR-U11	W20TT
8-9424-1449-0	DG-143	-
8-9424-1449-1	DG-143	-
8-9424-9692-1	DG-143	-
8-94252270-0	W20EXR-U11	W20TT
8-9425-5588-0	DG-143	-
8-9431-9700-1	DG-124	-
8-9431-9700-2	DG-124	-
8-94328372-0	K20PR-U11	K20TT
8-94328374-0	K20PR-U11	K20TT
8-94328375-0	K22PR-U11	IK22FTT
8-9440-2303-1	DG-159	-
8-9443-9218-0	DG-143	-
8-9448-1972-0	DG-104	-
8-97012928-0	K20PR-U	K20TT
8-97012930-0	K20PR-U	K20TT
8-97012931-0	K22PR-U	IK22FTT
8-97111376-0	PK16PR11	K16TT
8-97111376-1	IK16TT	IK16TT
8-9714-3674-1	DG-186	-
8-97170268-0	IK16	IK16TT
8-97170268-0	IK16TT	IK16TT
8-9721-0818-2	DG-302	-
8-9721-0818-2	DG-641	-
8-9732-6046-0	DG-635	-
8-97380046-0	GX8-1	-
8-9738-9905-0	DG-302	-
8-9738-9905-0	DG-641	-
8-9801-3392-0	DG-635	-
8-98119290-0	GX8-1	-
8-9817-4898-0	DG-635	-
9-82513103-0	W20EPR-U	W20TT
9-82513106-0	W16EPR-U	W16TT
9-89119290-0	GX8-1	-

IVECO	DENSO	TT
27600323	DG-195	-
4783047	DG-001	-
4841294	DG-001	-
4849406	DG-001	-
504082651	IK22	IK22FTT
88032415	IK22	IK22FTT

JAGUAR	DENSO	TT
02JD61604	DG-140	-
2JD61604	DG-140	-
4U3Q6M090AA	DG-140	-
7R83-12405-AA	T20TT	T20TT
AJ812146	IXEH20TT	IXEH20TT
AJ84575	SK16PR-A11	IK16TT
C2A1535	SK16PR-A11	IK16TT
C2S40053	DG-130	-
C2S46895	T20TT	T20TT
EAC008554	T22EP-U	-
EAC008584	T22EP-U	-
EAC8554	T22EP-U	-
EAC8584	T22EP-U	-
EAC8917	W16EPR-U	W16TT
EBC004021	T22EP-U	-
EBC11480	K20PR-U	K20TT
EBC4021	T22EP-U	-
EBC8143	K16PR-U	K16TT
JD61164	DG-130	-
JDE13601	DG-632	-
JDE3926	DG-140	-
NAB3850DA	T20EPR-U	T20TT
NCA3850DA2	IK20	IK20TT
NCA3850FA1	IK16	IK16TT
NCA3850HA2	PK20PR-L13	IK20TT
XR811790	IT20TT	IT20TT
XR815349	T20TT	T20TT
XR815350	PK16PR-L11	IK16TT
XR819660	ZT20EPR11	IT20TT
XR82810	IK20	IK20TT
XR842795	ZT20EPR11	IT20TT

JEEP	DENSO	TT
33003862	K20PR-U	K20TT
56027275	KJ16CR-L11	K16TT
56028236AA	KJ16CR-L11	K16TT
68029497AA	DG-633	-
68090 434AA	DG-660	-
68211 173AA	DG-620	-
LCTR5A13A	ITL16TT	ITL16TT
S2RE14PLP5	ITL16TT	ITL16TT
SP000ZFR5N	KJ16CR-L11	K16TT
SPORC12ECC	KJ16CR-L11	K16TT
SP0ZFR5F11	KJ16CR-U11	K16TT
SPLZFR5C11	K16HPR-U11	KH16TT
SPLZTR5A13	ITL20	-
SPRC12MCC4	KJ16CR-L11	K16TT
SPRC7PYCB4	IK20	IK20TT
SPRE14MCCS	ITL16TT	ITL16TT
SPZFR6F11G	KJ20CR-L11	K20TT

KAWASAKI	DENSO	TT
92070-036	W27FSR	-
92070-045-2	W24ESR-U	-
92070-1003	W22ESR-U	-
92070-1003	W22ES-U	-
92070-1007	W20ESR-U	-
92070-1007	W20ES-U	-
92070-1009	W24ESR-U	-
92070-1009	W24ES-U	-
92070-1010	X24ESR-U	-
92070-1012	X22ESR-U	-
92070-1012	X22ES-U	-

KAWASAKI	DENSO	TT
92070-1016	W24ESR-U	-
92070-1020	X24ESR-U	-
92070-1020	X24ES-U	-
92070-1028	W20EPR-U	W20TT
92070-1028	W20EP-U	W20TT
92070-1029	W20EPR-U	W20TT
92070-1030	W22EPR-U	W22TT
92070-1030	W22EP-U	W22TT
92070-1031	W22EPR-U	W22TT
92070-1033	W24ESR-U	-
92070-1036	W22ESR-U	-
92070-1038	W24EPR-U	-
92070-1038	W24EP-U	-
92070-1041	W20ESR-U	-
92070-1045	W16ESR-U	-
92070-1047	W27ESR-U	-
92070-1048	W16EPR-U	W16TT
92070-1049	W24EPR-U	-
92070-1050	W16ESR-U	-
92070-1050	W16ES-U	-
92070-1051	W27ESR-U	-
92070-1051	W27ES-U	-
92070-1052	W16EPR-U	W16TT
92070-1052	W16EP-U	W16TT
92070-1102	X24EPR-U9	-
92070-1103	X24EPR-U9	-
92070-1103	X24EP-U9	-
92070-1104	X27EPR-U9	-
92070-1105	X27EPR-U9	-
92070-1105	X27EP-U9	-
92070-1110	X27ESR-U	-
92070-1110	X27ES-U	-
92070-1112	X27ESR-U	-
92070-1117	X22ESR-U	-
92070-1120	X22EPR-U9	-
92070-1121	X22EPR-U9	-
92070-1127	U16FSR-U	-
92070-1127	U16FS-U	-
92070-1128	U20FSR-U	-
92070-1128	U20FS-U	-
92070-1129	U22FSR-U	-
92070-1129	U22FS-U	-
92070-1135	U24FSR-U	-
92070-1135	U24FS-U	-
92070-1137	X20EPR-U9	-
92070-1139	X20EPR-U9	-
92070-1143	U27ESR-N	-
92070-1144	U27ES-N	-
92070-1145	U27ETR	-
92070-1147	X20ESR-U	-
92070-1147	X20ES-U	-
92070-1148	U27ESR-N	-
92070-1150	U27ES-N	-
92070-1151	U27ESR-N	-
92070-1156	W22FPR-U	-
92070-1156	W22FP-U	-
92070-1158	U24ETR	-
92070-1159	U27ETR	-
92070-1160	U24ETR	-
92070-1162	X20ESR-U	-
92070-1169	U24ESR-N	-
92070-1170	U24ES-N	-
92070-1171	U24ESR-N	-
92070-1183	U22FSR-U	-
92070-1184	U24FSR-U	-
92070-1187	IW31	-
92070-1188	IW31	-
92070-1203	W22FPR-U	-
92070-1209	U22ESR-N	-
92070-1236	IW01-27	-
92070-1251	X16EPR-U9	-

Свечи зажигания и Свечи накаливания

Таблица взаимозаменяемости - OE

KAWASAKI	DENSO	TT
92070-1270	IW24	-
92070-1272	IW31	-
92070-1275	IW01-24	-
92070-3704	IW01-27	-
92070-4120	X22ES-U	-
E920701034	X27ESR-U	-
E920701155	U24FSR-U	-
J4520IU0124	IU01-24	-
J4520IU0127	IU01-27	-
J4520IU0131	IU01-31	-
J4520IU0134	IU01-34	-
J4520IU22	IU22	-
J4520IU24	IU24	-
J4520IU24A	IU24A	-
J4520IU27	IU27	-
J4520IU27A	IU27A	-
J4520IU31	IU31	-
J4520IU31A	IU31A	-
J4520IUF22	IUF22	-
J4520IUF24	IUF24	-
J4520IUH24	IUH24	-
J4520IUH27	IUH27	-
J4520IW0124	IW01-24	-
J4520IW0127	IW01-27	-
J4520IW0129	IW01-29	-
J4520IW0131	IW01-31	-
J4520IW0132	IW01-32	-
J4520IW0134	IW01-34	-
J4520IW16	IW16	IW16TT
J4520IW20	IW20	IW20TT
J4520IW22	IW22	-
J4520IW24	IW24	-
J4520IW27	IW27	-
J4520IW29	IW29	-
J4520IW31	IW31	-
J4520IW34	IW34	-
J4520IWF22	IWF22	-
J4520IWF24	IWF24	-
J4520IWF27	IWF27	-
J4520IX22	IX22	-
J4520IX22B	IX22B	-
J4520IX24	IX24	-
J4520IX24B	IX24B	-
J4520IX27	IX27	-
J4520IX27B	IX27B	-
J4520IXU0127	IXU01-27	-
J4520IXU0131	IXU01-31	-
J4520IXU0134	IXU01-34	-
J4520IXU22	IXU22	IXU22TT
J4520IXU24	IXU24	-
J4520U20FSRU	U20FSR-U	-
J4520U22ESRN	U22ESR-N	-
J4520U22FSRU	U22FSR-U	-
J4520U24ESRN	U24ESR-N	-
J4520U27ESRN	U27ESR-N	-
J4520U27ETR	U27ETR	-
J4520W20EPRU	W20EPR-U	W20TT
J4520W20EPU	W20EP-U	W20TT
J4520W20FPRU	W20FPR-U	WF20TT
J4520W22FPRU	W22FPR-U	-
J4520W24ESRU	W24ESR-U	-
J4520W24FSU10	W24FSR-U10	-
J4520W27ESRU	W27ESR-U	-
J4520W27ESU	W27ESR-U	-
J4520W31ESRU	W31ESR-U	-
J4520X20EPRU9	X20EPR-U9	-
J4520X20FSU	X20FSR-U	-
J4520X22EPRU9	X22EPR-U9	-
J4520X24EPRU9	X24EPR-U9	-
J4520X24EPU9	X24EPR-U9	-
J4520X24ESRU	X24ESR-U	-

KAWASAKI	DENSO	TT
J4520X24ESU	X24ESR-U	-
J4520-X24GP-U	X24GPR-U	-
J4520X27EPRU9	X27EPR-U9	-

KIA	DENSO	TT
0K0111-8110	K16PR-U	K16TT
0K0131 8110	K20PR-U11	K20TT
0K01A1-8110	K16PR-U	K16TT
0K01C1 8100	K20PR-U11	K20TT
0K01C1 8110	K20PR-U11	K20TT
0K05418140	DG-146	-
0K1DC1 8110	K16PR-U11	K16TT
0K20W18110	W16EPR-U11	W16TT
0K2A11 8110	W16EXR-U11	W16TT
0K2AA1 8100	K20PR-U	K20TT
0K2AA1 8110	K20PR-U11	K20TT
0K71018140	DG-146	-
0K71018140A	DG-146	-
0K75A18140	DG-146	-
0K75B18140	DG-146	-
0K9A71 8110	K20PR-U	K20TT
18844-10060	VXUH20I	-
18846-10060	VXUH20I	-
18855-10060	XUH20TTI	XUH20TTI
36710-2A700	DG-657	-
36710-2A710	DG-657	-
36710-2F000	DG-669	-
36710-2F001	DG-669	-
36710-2F100	DG-624	-
36710-2F101	DG-669	-
36710-42050	DG-301	-
36710-4X900	DG-661	-
AA13A18110	P16PR11	W16TT
K05418140	DG-146	-
K066018110	W16EXR-U	W16TT
K20W18110	W16EPR-U11	W16TT
K55818110	PK20PR-L11	IK20TT
K71018140	DG-146	-
K71018140A	DG-146	-
K75A18140	DG-146	-
K75B18140	DG-146	-
KB60118110	W16EPR-U11	W16TT
KK15018110	W16EPR-U11	W16TT
KKY0118110	W16EPR-U11	W16TT
S36710-2F100	DG-624	-

KOMATSU	DENSO	TT
22401-58000	W14EX-U	IW16TT
22401-58001	W16ES-U	-
60081-51340	DG-226	-
60081-513404	DG-226	-
60081-51350	DG-234	-
TJ9009809125	W9EP	-
TJ9091901055	W9EP	-
V9110-6037	W20FP-U	WF20TT

KUBOTA	DENSO	TT
0790923150	W20MR-U	-
0790923160	W22M-U	-
07909-23160	W22M-U	-
1020267711	MW17	-
10202-67711	MW17	-
12366-67711	W14FR-U	-
1264767710	W20FPR-U	WF20TT
1268167740	W16ESR-U	-
12866-67711	W16EP-U	W16TT
12992-67711	W16EPR-U	W16TT
1307867710	W20EP-U	W20TT
1310167711	W16S-U	-
13101-67711	W16S-U	-
13156-67712	W14M-U	-

KUBOTA	DENSO	TT
1315767710	W14MR-U	-
1315767710	W14M-U	-
1317367711	W14F-U	-
1321167711	W14PR-U	-
1328167711	W14F-U	-
13281-67711	W14F-U	-
1330267710	W9-U	-
13302-67710	W9-U	-
13373-67741	W14MR-U	-
1337567740	W14FPR-UL10	-
13375-67741	W14FPR-UL10	-
13378-67741	W14FPR-UL	-
1340367711	W20S-U	-
13403-67711	W20S-U	-
1341267710	W22S-U	-
1345167712	W20FSR-U	WF20TT
13451-67712	W20FS-U	WF20TT
1358167710	W22FS-U	-
13641-67711	W14F-U	-
1371167711	W14PR-U	-
1374267711	W14FPR-UL10	-
13871-67711	W14FPR-UL	-
1390167712	W20FPR-U	WF20TT
1390267711	W20FPR-U	WF20TT
13902-67711	W20FP-U	WF20TT
15694-65512	DG-157	-
15694-65513	DG-157	-

LADA	DENSO	TT
2101037070	W20EPR-U	W20TT
210137000	W20EPR-U	W20TT
21013707	W20EPR-U	W20TT
2101-3707000-02	W20EPR-U	W20TT
2101-3707000-60	W20EP-U	W20TT
21013707001	W20EPR-U	W20TT
210837000	W20EPR-U	W20TT
2108370701	W20EPR-U	W20TT
21083707010	W20EPR-U	W20TT
2108-3707010-10	W20EPR-U	W20TT
2108-3707010-12	W20EPR-U	W20TT
211137000	Q20PR-U11	Q20TT
2111370701	W20EPR-U	W20TT
21113707010	W20EPR-U	W20TT
2111-3707010-01	W20EPR-U	W20TT
211237000	Q20PR-U11	Q20TT
2112370701	W20EPR-U	W20TT
2112-3707010-01	W20EPR-U	W20TT
212153740010	DG-001	-

LANCIA	DENSO	TT
4079729	IW20	IW20TT
46481273	XU24EPR-U	-
46796050	DG-171	-
4896406	DG-001	-
55210051	DG-621	-
7554442	W20EPR-U	W20TT
79 102 472 04	T20EPR-U	T20TT
91 519 892 80	T20EPR-U	T20TT
96 147 386 80	K20TXR	K20TT
96 265 754 80	K20TXR	K20TT
96 381 057 80	K20PR-U	K20TT

LAND ROVER	DENSO	TT
1354289	DG-140	-
4550157	SK16PR-A11	IK16TT
ERC8450	DG-001	-
ERC8648	DG-202	-
ERR3799	W16EXR-U	W16TT
ERR6066	DG-182	-
ETC8847	DG-115	-
LR001302	DG-614	-

LAND ROVER	DENSO	TT
LR002535	PK20PR-L11	IK20TT
LR004377	DG-130	-
LR004377G	DG-130	-
LR005253	SK16PR-A11	IK16TT
LR005483	VKH20Y	-
LR019484	IXEH20TT	IXEH20TT
LR021006	K20TXR	K20TT
LR022300	DG-632	-
LR025605	ITV22	-
LR029960	DG-611	-
NCC100050L	DG-101	-
NCC100120L	DG-145	-
NLP000020L	PK20PR-L11	IK20TT
NLP000130L	PK20PR-L11	IK20TT
NLP10003	K20PR-U	K20TT
NLP100190	K20PR-U11	K20TT
NLP100290L	PK20PR-L11	IK20TT
NLP100320	PK16PR-L11	IK16TT
NPL000030	K20TXR	K20TT
RTC3569	W20ESR-U	-
RTC3570	W16EPR-U	W16TT
RTC3812	W20EP-U	W20TT
STC2223	DG-001	-
STC3103	DG-001	-

LDV	DENSO	TT
5961 58	DG-001	-

LEXUS	DENSO	TT
90919-01191	SK20HR11	IKH20TT
90919-01191-79	SK20HR11	IKH20TT
90919-01240	SK16R11	IK16TT
90919-01240-79	SK16R11	IK16TT
90919-01249	FK20HBR11	IKBH20TT
90919-01249-79	FK20HBR11	IKBH20TT
90919-01259	FK16HR-A8	-
90919-01259-79	FK16HR-A8	-
90919-01279	FK20HBR-J8	IKBH20TT
90919-01279-79	FK20HBR-J8	IKBH20TT

LOTUS	DENSO	TT
A100E6277S	K20PR-U	K20TT
A910E7009F	W20ETR-L	IW20TT
A918E6039F	K20TNR	K20TT
AE100E6277S	IK20	IK20TT
LOTUB0001	W20ETR-L	IW20TT
PS304017621AF	K20P-U	K20TT

MASERATI	DENSO	TT
192637	IU24	-
194503	IU24	-
239242	IU24	-
CND96596	W24EPR-U	-
CND96875	XU24EPR-U	-
CND97219	XU27EPR-U	-

MASSEY-FERGUSON	DENSO	TT
834225MI	W14PR-U	-
834230MI	W14PR-U	-
834232MI	W9-U	-
834234MI	IWF16	-
834236MI	W16EPR-U	W16TT
834237MI	MA16PR-U	-
834241MI	MA16PR-U	-
834245MI	L14-U	-
834247MI	IWF16	-
834248MI	MA20PR-U	-

MAZDA	DENSO	TT
00001010GV	IW31	-
00001011GV	IW34	-

Свечи зажигания и Свечи накаливания

Таблица взаимозаменяемости - OE

MAZDA	DENSO	TT
0000108GV	IW24	-
0000109GV	IW27	-
000010BKR7	K22PR-U11	IK22FTT
000010R105	IRE01-32	-
000010R11	IRE01-34	-
000010R54008	IK24	-
000010R54009	IK01-27	-
0222 18 110	W20EX-U	W20TT
0222 18 110 94	W20EX-U	W20TT
0304 18 110	W20EPR-U	W20TT
0418 18 110A	W22ESR-U	-
0418 18 110A	W22ES-U	-
0418 18 110A94	W22ES-U	-
0513 18 110	W20ES-U	-
0744 18 110	W22EP-U	W22TT
0745 24 210	W20EPR-U	W20TT
0802 18 600	W22EBR	-
100277550	W16EXR-U	W16TT
100377550	W20EX-U	W20TT
1409 18 110	W16EXR-U13	W16TT
1410 18 110	W16EXR-U13	W16TT
1482 18 600A	IRE01-27	-
1483 18 600	IRE01-27	-
1534 18 110	W16EXR-U	W16TT
1534 18 110	W16EX-U	W16TT
1534 18 110 94	W16EX-U	W16TT
1690 18 110	W20EPR-U	W20TT
18BP01	K16PR-U11	K16TT
18BP03	K20PR-U11	K20TT
1A01 18 110	P16PR11	W16TT
1A02 18 110	IXU22	IXU22TT
1A03 18 110	VXU22	IXU22TT
1A10 18 110	IW16	IW16TT
1A11 18 110	IXU22	IXU22TT
1A12 18 110	SXU22HDR8	IXUH22TT
1A13 18 110	IXUH22	IXUH22TT
1A15 18 110	VXUH22	IXUH22TT
1A16 18 110	VXUH22	IXUH22TT
1A61 18 110	IXU22	IXU22TT
1E03 18 110	PT16EPR-L13	IT16TT
1E04 18 110	PT16EPR-L13	IT16TT
1E05 18 110	PT16VR10	TV16TT
1E06 18 110	PT16VR10	TV16TT
1E07-18-601	DG-007	-
1E07-18-601B	DG-007	-
1N04 18 110	K16R-U11	K16TT
1N08 18 110	PK16PR-L11	IK16TT
1N14 18 110	FXE16HE11	-
1N19 18 110	FXE20HR11	IXEH20TT
1N24 18 110	FXE20HE11	IXEH20ETT
1N25 18 110	FXE20HE11	IXEH20ETT
1UD0 18 110	IW16	IW16TT
1UD1 18 110	IW20	IW20TT
1UD2 18 110	IW22	-
1UD3 18 110	IK16	IK16TT
1UD4 18 110	IK20	IK20TT
1UD6 18 110	IQ16TT	IQ16TT
1UD7 18 110	IQ20TT	IQ20TT
1UD9 18 110	IXU22	IXU22TT
1UN0 18 110	IW16	IW16TT
1UN1 18 110	IW20	IW20TT
1UN2 18 110	IW22	-
1UN3 18 110	IW16	IW16TT
1UN4 18 110	IW20	IW20TT
1UN6 18 110	IK16	IK16TT
1UN7 18 110	IK20	IK20TT
1UN9 18 110	IK16	IK16TT
1UNA 18 110	IK20	IK20TT
1UNC 18 110	IQ16TT	IQ16TT
1UND 18 110	IQ20TT	IQ20TT
1UNF 18 110	IXU22	IXU22TT

MAZDA	DENSO	TT
1UNG 18 110	IK16L	IK16TT
1UTO 18 110	IW16TT	IW16TT
1UT1 18 110	VW20	IW20TT
1UT2 18 110	VW22	-
1UT6 18 110	IQ16TT	IQ16TT
1UT7 18 110	IQ20TT	IQ20TT
1UT9 18 110	VXU22	IXU22TT
1UX0 18 110	IW16TT	IW16TT
1UX1 18 110	VW20	IW20TT
1UX3 18 110	IW16TT	IW16TT
1UX4 18 110	VW20	IW20TT
1UXC 18 110	PQ16R	Q16TT
1UXD 18 110	PQ20R	Q20TT
1UXF 18 110	VXU22	IXU22TT
1UXG 18 110	PKJ16CR-L11	IK16TT
1UXH 18 110	IK20L	IK20TT
1WT1 18 110	W16TT	W16TT
1WT3 18 110	K20TT	K20TT
1WT4 18 110	XU22TT	XU22TT
1WT5 18 110	XUH22TT	XUH22TT
22218110	W20EXR-U	W20TT
304-18-110	W20EPR-U	W20TT
3648 18 600	W22EBR	-
3649 18 600	W27EBR	-
3710 18 110	W20EXR-U11	W20TT
3953 18 110	W16EXR-U	W16TT
3954 18 110	W20EPR-U	W20TT
4075 18 110	W14EPR-U	IW16TT
4095 18 110	W14EX-U	IW16TT
4095 18 110 94	W14EX-U	IW16TT
4096 18 110A	W14EXR-U11	IW16TT
41918110	W22ESR-U	-
42018110	W24ESR-U	-
4882 18 110	W9EP	-
4884 18 110	W9EXR-UCU	-
66018110	W16EPR-U	W16TT
745-24-210	W20EPR-U	W20TT
8042 18 110	W20EXR-U11	W20TT
8344 18 600	W27EBR	-
8345 18 600	W27EBR	-
86618600	W22EBR	-
9814 18 110	W16EXR-U	W16TT
A502 18 110	W20EP-U	W20TT
AJ03 18 110	T16EPR-U15	T16TT
AJ09 18 110	T16EPR-U15	T16TT
AJ09 18 110B	T16EPR-U15	T16TT
AZ08 18 110	W16EPR-U	W16TT
AZ09 18 110	W16EPR-U	W16TT
AZ28 18 110	IXU22	IXU22TT
AZ29 18 110	IXU22	IXU22TT
B305 18 110	W16EXR-U	W16TT
B601 18 110	W16EXR-U11	W16TT
B602 18 110	W16EXR-U11	W16TT
B608 18 110	W16EXR-U11	W16TT
B619 18 110	W20EXR-U	W20TT
B64N 18 110	J16AR-U11	-
B64P 18 110	J16AR-U11	-
B660 18 110	Q20P-U11	Q20TT
B667 18 110	Q20P-U11	Q20TT
B673 18 110	W16EXR-U	W16TT
B674 18 110	W16EXR-U	W16TT
B695 18 110	Q20PR-U	Q20TT
B696 18 110	Q20PR-U	Q20TT
B6B3 18 110	Q16PR-U11	Q16TT
B6B4 18 110	Q16PR-U11	Q16TT
B6V7 18 110	K20PR-U11	K20TT
BP01 18 110	K16PR-U11	K16TT
BP02 18 110	K16PR-U11	K16TT
BP03 18 110	K20PR-U11	K20TT
BP04 18 110	K20PR-U11	K20TT
BP05 18 110	K22PR-U11	IK22FTT

MAZDA	DENSO	TT
BP06 18 110	K22PR-U11	IK22FTT
BP08 18 110	K20PR-U11	K20TT
BP11 18 110	K16PR-U11	K16TT
BP12 18 110	K16PR-U11	K16TT
BP13 18 110	K16PR-U11	K16TT
BP13 18 110A	K16PR-U11	K16TT
BP14 18 110	K20PR-U11	K20TT
BP47 18 110	K16PR-U	K16TT
BP48 18 110	K16PR-U	K16TT
BP49 18 110	K20PR-U	K20TT
BP50 18 110	K20PR-U	K20TT
BP52 18 110	K22PR-U	IK22FTT
BP8J 18 110	IK20TT	IK20TT
BPY1 18 110	K16PR-U11	K16TT
BPY2 18 110	K16PR-U11	K16TT
BPY4 18 110	K20PR-U11	K20TT
C201 18 110	PT16VR13	TV16TT
CY01 18 110	ITV22	-
E356 18 110	J16AR-U11	-
E357 18 110	J16AR-U11	-
E552 18 110	W16EXR-U	W16TT
E552 18 110	W16EX-U	W16TT
F201 18 110	QJ20CR11	Q20TT
F202 18 110A	QJ20CR11	Q20TT
F203 18 110	KJ16CR-L11	K16TT
F204 18 110	KJ16CR11	Q16TT
F205 18 110	KJ22CR-L11	-
F210 18 110	Q16PR-U	Q16TT
F211 18 110	Q16PR-U	Q16TT
F220 18 110	Q20PR-U11	Q20TT
F221 18 110	Q20PR-U11	Q20TT
F262 18 110	QJ20CR11	Q20TT
F285 18 110	KJ20CR-U11	K20TT
F286 18 110	KJ20CR-U11	K20TT
F287 18 110	KJ16CR-U11	K16TT
F288 18 110	KJ16CR-L11	K16TT
F290 18 110	KJ22CR-L11	-
F293 18 110	KJ16CR-U11	K16TT
F2SK 18 110	W9EXR-UCU	-
F2Y2 18 110	KJ16CR-L11	K16TT
F8L8 18 110	W14EXR-U11	IW16TT
F8L9 18 110	W14EXR-U11	IW16TT
FE3P 18 110	Q22P-U	-
FE6F 18 110	Q22PR-U11	-
FE79 18 110	W20EPR-U11	W20TT
FE82 18 110	W20EXR-U11	W20TT
FEDK 18 110	W16EXR-U13	W16TT
FEDM 18 110	W16EXR-U13	W16TT
FEEG 18 110	W20EXR-U11	W20TT
FEEH 18 110	W20EXR-U11	W20TT
H288 18 110	KJ16CR-L11	K16TT
IA11 18 110	IXU22	IXU22TT
IA50 18 110	K20PR-U	K20TT
JE03 18 110	Q22PR-U	-
JE04 18 110	Q22PR-U	-
JE26 18 110	IK20	IK20TT
JE28 18 110	IQ16TT	IQ16TT
JE41 18 110	IK16	IK16TT
JE42 18 110	IK16	IK16TT
JE43 18 110	IK20	IK20TT
JF03 18 110	Q16PR-U11	Q16TT
JF04 18 110	Q16PR-U11	Q16TT
JF04 18 110	Q16P-U11	Q16TT
KJ11 18 110	PKJ20CR8	IK20TT
KJ12 18 110	PKJ20CR8	IK20TT
KJ13 18 110	PKJ16CR8	-
KJ14 18 110	PKJ16CR8	-
KJ17 18 110	PKJ16CR8	-
KJ18 18 110	PKJ20CR8	IK20TT
L341 18 110	ZT20EPR11	IT20TT
L3BD 18 110	ITV22	-

MAZDA	DENSO	TT
L3K9 18 110	ITV22	-
L3K9 18 110A	ITV22	-
L3Y3 18 110	ITV22	-
L3Y4 18 110	ZT20EPR11	IT20TT
L3YD 18 110	ITV22	-
L813 18 110	ZT20EPR11	IT20TT
L814 18 110	T20EPR-U15	-
LFJD 18 110	ITV16TT	ITV16TT
LFY1 18 110	T16VR-U10	TV16TT
LFY3 18 110	T16EPR-U15	T16TT
N201 18 600	IRE01-27	-
N202 18 600	IRE01-27	-
N229 18 600	IRE01-27	-
N245 18 600	IRE01-31	-
N246 18 600	IRE01-27	-
N253 18 600	IRE01-27	-
N318 18 110	S-31A	-
N319 18 110	IRE01-31	-
N319 18 110	S-31A	-
N323 18 110	W29EBR	-
N328 18 100	IRE01-27	-
N331 18 110	IRE01-27	-
N333 18 110	S-31A	-
N338 18 110	S-31A	-
N342 18 110	IRE01-27	-
N343 18 110	IRE01-27	-
N3A1 18 110	IRE01-27	-
N3A2 18 110	IRE01-27	-
N3A3 18 110	IRE01-27	-
N3H8 18 110A	IRT01-31	-
N3Y1 18 110	IRT01-31	-
N3Y1 18 110A	IRT01-31	-
N3Y4 18 110A	IRT01-31	-
N3Z1 18 110A	IRL01-27	-
N3Z2 18 110A	IRL01-27	-
N3Z5 18 110	IRL01-27	-
P51R 18 110	IXEH22TT	IXEH22TT
PE01 18 110	IXEH22TT	IXEH22TT
PE01 18 110A	IXEH22TT	IXEH22TT
PE02 18 110	IXEH22TT	IXEH22TT
PE55 18 110	IXEH22TT	IXEH22TT
PE5R 18 110	IXEH22TT	IXEH22TT
PE5S 18 110	IXEH22TT	IXEH22TT
PN11-18-601	DG-645	-
R2AA-18-601	DG-627	-
R2L2-18-601	DG-104	-
RF1M-18-601	DG-146	-
RF2A-18-601	DG-502	-
RF61-18-601	DG-146	-
RFJ5-18-601	DG-146	-
RFN1-18-601	DG-146	-
RFN1-18-601	DG-501	-
S201-18-140	DG-114	-
S210-18-140	DG-146	-
S501-18-140A	DG-114	-
SH01-18-601A	DG-667	-
VS01-18-601	DG-104	-
WE01-18-601	DG-630	-
WL03-18-601	DG-146	-
WL81-18-601	DG-146	-
WLE7-18-601	DG-645	-
Y401-18-601	DG-113	-
Y401-18-601A	DG-113	-
Y404-18-601	DG-180	-
Y404-18-601A	DG-180	-
Y650-18-601	DG-603	-
YF10 18 110	PT16VR13	TV16TT
Z601 18 110	SK16PR-E11	IK16TT
Z6B7 18 110	IK16	IK16TT
ZJ46 18 110	SK16PR-E11	IK16TT
ZJY6 18 110	SK16PR-E11	IK16TT

Свечи зажигания и Свечи накаливания

Таблица взаимозаменяемости - OE

MAZDA	DENSO	TT
ZM01 18 110	SKJ16CR-A8	-
ZM02 18 110	SKJ20CR-A8	-
ZY51 18 110	IK16TT	IK16TT
ZYY1 18 110	IK16TT	IK16TT
ZZ33 18 110	J16CR-U	W16TT
ZZC2 18 110	PT16EPR-L13	IT16TT
ZZC2 18 110A	PT16EPR-L13	IT16TT
ZZJ1 18 110	ITV22	-
ZZS1 18 110	XU22EPR-U	XU22TT
ZZS2 18 110	XU22EPR-U	XU22TT
ZZS4 18 110	J16CR-U	W16TT

MERCEDES-BENZ	DENSO	TT
0 159 00 03	W20EPR-U	W20TT
000 159 00 03	W20EPR-U	W20TT
001 159 08 03	W22EPR-U	W22TT
001 159 13 03	W22EPR-U	W22TT
001 159 15 03	W22EPR-U	W22TT
001 159 16 03	W22EPR-U	W22TT
001 159 56 01	DG-616	-
001 159 57 01	DG-617	-
001 159 58 01	DG-616	-
001 159 66 01	DG-617	-
001 159 68 01	DG-616	-
001 159 87 03	W22EPR-U	W22TT
001 159 93 03	W22EPR-U	W22TT
002 159 00 03	T20EPR-U	T20TT
002 159 01 03	T20EPR-U	T20TT
002 159 18 03	W22EPR-U	W22TT
002 159 22 03	W16EPR-U	W16TT
002 159 24 03	W20EPR-U	W20TT
002 159 27 03	W22EPR-U	W22TT
002 159 28 03	W20EPR-U	W20TT
002 159 29 03	W16EPR-U	W16TT
002 159 31 03	W16EPR-U	W16TT
002 159 41 03	W20EPR-U	W20TT
002 159 42 03	W20EPR-U	W20TT
002 159 48 03	W16EPR-U	W16TT
002 159 49 03	T20EPR-U	T20TT
002 159 56 03	T20EPR-U	T20TT
002 159 57 03	T16EPR-U	T16TT
002 159 58 03	T16EPR-U	T16TT
002 159 62 03	W22EPR-U	W22TT
002 159 64 03	T22EP-U	-
002 159 65 03	T22EP-U	-
002 159 66 03	T20EPR-U	T20TT
002 159 67 03	T22EP-U	-
002 159 68 03	T20EPR-U	T20TT
002 159 69 03	T20EPR-U	T20TT
002 159 76 03	T20EPR-U	T20TT
002 159 77 03	Q16R-U	Q16TT
002 159 78 03	T16EPR-U	T16TT
003 159 00 03	W22EPR-U	W22TT
003 159 04 03	PK16PR-L11	IK16TT
003 159 05 03	T16EPR-U	T16TT
003 159 06 03	T20EPR-U	T20TT
003 159 07 03	T20EPR-U	T20TT
003 159 08 03	T22EP-U	-
003 159 10 03	W16EPR-U	W16TT
003 159 11 03	W16EPR-U	W16TT
003 159 12 03	W20EPR-U	W20TT
003 159 13 03	W20EPR-U	W20TT
003 159 14 03	W22EPR-U	W22TT
003 159 16 03	Q20R-U	Q20TT
003 159 23 03	T20EPR-U	T20TT
003 159 24 03	T16EPR-U	T16TT
003 159 25 03	T22EP-U	-
003 159 26 03	W20EPR-U	W20TT
003 159 27 03	W16EPR-U	W16TT
003 159 28 03	T16EPR-U	T16TT
003 159 29 03	W16EPR-U	W16TT

MERCEDES-BENZ	DENSO	TT
003 159 30 03	K16PR-U11	K16TT
003 159 31 03	K20PR-U11	K20TT
003 159 32 03	W22EPR-U	W22TT
003 159 33 03	T22EP-U	-
003 159 34 03	T20EPR-U	T20TT
003 159 35 03	T20EPR-U	T20TT
003 159 36 03	T16EPR-U	T16TT
003 159 37 03	Q16R-U	Q16TT
003 159 40 03	K20PR-U	K20TT
003 159 41 03	K16PR-U11	K16TT
003 159 42 03	K16PR-U11	K16TT
003 159 45 03	W20EPR-U	W20TT
003 159 46 03	W20PR-U	-
003 159 47 03	W16EPR-U	W16TT
003 159 53 03	K16PR-U	K16TT
003 159 54 03	K16PR-U11	K16TT
003 159 56 03	W22EPR-U	W22TT
003 159 57 03	W20EPR-U	W20TT
003 159 58 03	W22EPR-U	W22TT
003 159 59 03	T22EP-U	-
003 159 60 03	K20P-U	K20TT
003 159 65 03	K20PBR-S10	K20TT
003 159 66 03	PK16PR-L11	IK16TT
003 159 67 03	K16PR-U11	K16TT
003 159 68 03	K16PR-U11	K16TT
003 159 71 03	K16PR-U	K16TT
003 159 72 03	K20PBR-S10	K20TT
003 159 73 03	K20PBR-S10	K20TT
003 159 75 03	K20PBR-S10	K20TT
003 159 75 03 26	K20PBR-S10	K20TT
003 159 76 03	K20PBR-S10	K20TT
003 159 78 03	K20PBR-S10	K20TT
003 159 80 03	SK20PR-L9	IK20TT
003 159 81 03	PK16PR-L11	IK16TT
003 159 86 03	PK16PR-L11	IK16TT
003 159 90 03	K20PBR-S10	K20TT
003 159 91 03	K20TXR	K20TT
003 159 92 03	K20TXR	K20TT
003 159 94 03	PK16PR-L11	IK16TT
003 159 96 03	SK16PR-A11	IK16TT
003 159 96 03 26	SK16PR-A11	IK16TT
003 159 97 03	SK20PR-L9	IK20TT
003 159 97 03 26	SK20PR-L9	IK20TT
004 159 02 03	SK20PR-L9	IK20TT
004 159 07 03	SK20PR-L9	IK20TT
004 159 09 03	PK16PR-L11	IK16TT
004 159 13 03	VKH20Y	-
004 159 18 03	VXUH22	IXUH22TT
004 159 18 03 26	VXUH22	IXUH22TT
004 159 19 03	PK16PR-L11	IK16TT
004 159 20 03	PK20PR11	K20TT
004 159 20 03 26	PK20PR11	K20TT
004 159 23 03	VKH20Y	-
004 159 25 03	VXUH22I	IXUH22TT
004 159 26 03	K20PR-U	K20TT
004 159 30 03	K20PR-U11	K20TT
004 159 34 03	SXU22HDR8	IXUH22TT
004 159 36 03	K20PR-U11	K20TT
004 159 39 03	IXEH22TT	IXEH22TT
004 159 44 03	VXUH22	IXUH22TT
004 159 44 03 26	VXUH22	IXUH22TT
004 159 45 03	VKH20Y	-
004 159 49 03	SXU22HDR8	IXUH22TT
004 159 50 03	PK16PR-L11	IK16TT
004 159 58 03	VXUH22	IXUH22TT
005 918 03 26	VXUH22	IXUH22TT
005 920 03 26	PK20PR11	K20TT
005 944 03 26	VXUH22	IXUH22TT
005 975 03 26	K20PBR-S10	K20TT
005 996 03 26	SK16PR-A11	IK16TT
005 997 03 26	SK20PR-L9	IK20TT

MERCEDES-BENZ	DENSO	TT
006 159 00 03	W20EPR-U	W20TT
006 159 01 03	W20EPR-U	W20TT
1 159 08 03	W22EPR-U	W22TT
1 159 13 03	W22EPR-U	W22TT
1 159 15 03	W22EPR-U	W22TT
1 159 16 03	W22EPR-U	W22TT
1 159 56 01	DG-616	-
1 159 57 01	DG-617	-
1 159 58 01	DG-616	-
1 159 66 01	DG-617	-
1 159 68 01	DG-616	-
1 159 73 01	DG-665	-
1 159 80 01	DG-665	-
1 159 87 03	W22EPR-U	W22TT
1 159 93 03	W22EPR-U	W22TT
102 159 00 03	T20EPR-U	T20TT
102 159 01 03	T20EPR-U	T20TT
103 159 00 03	T20EPR-U	T20TT
110 159 00 03	W20EPR-U	W20TT
11590001	DG-001	-
11590201	DG-001	-
11591501	DG-119	-
11591601	DG-119	-
11591701	DG-001	-
11592001	DG-106	-
11592101	DG-106	-
11592201	DG-001	-
11592601	DG-110	-
11592701	DG-155	-
11592801	DG-117	-
11593601	DG-001	-
11593701	DG-117	-
11593801	DG-117	-
11594201	DG-117	-
11594610	DG-606	-
11594801	DG-117	-
11594901	DG-117	-
11595001	DG-194	-
11595101	DG-192	-
11595201	DG-192	-
11597101	DG-194	-
116 159 00 03	W20EPR-U	W20TT
116 159 01 03	W20EPR-U	W20TT
123 159 00 03	W22EPR-U	W22TT
1500281	DG-010	-
1594901	DG-117	-
1597501	DG-001	-
1597701	DG-001	-
1598101	DG-001	-
1598201	DG-001	-
1598301	DG-001	-
1599601	DG-001	-
1599901	DG-001	-
2 159 00 03	T20EPR-U	T20TT
2 159 01 03	T20EPR-U	T20TT
2 159 18 03	W22EPR-U	W22TT
2 159 22 03	W16EPR-U	W16TT
2 159 24 03	W20EPR-U	W20TT
2 159 27 03	W22EPR-U	W22TT
2 159 28 03	W20EPR-U	W20TT
2 159 29 03	W16EPR-U	W16TT
2 159 31 03	W16EPR-U	W16TT
2 159 41 03	W20EPR-U	W20TT
2 159 42 03	W20EPR-U	W20TT
2 159 48 03	W16EPR-U	W16TT
2 159 49 03	T20EPR-U	T20TT
2 159 56 03	T20EPR-U	T20TT
2 159 57 03	T16EPR-U	T16TT
2 159 58 03	T16EPR-U	T16TT
2 159 62 03	W22EPR-U	W22TT
2 159 64 03	T22EP-U	-

MERCEDES-BENZ	DENSO	TT
2 159 65 03	T22EP-U	-
2 159 66 03	T20EPR-U	T20TT
2 159 67 03	T22EP-U	-
2 159 68 03	T20EPR-U	T20TT
2 159 69 03	T20EPR-U	T20TT
2 159 76 03	T20EPR-U	T20TT
2 159 77 03	Q16R-U	Q16TT
2 159 78 03	T16EPR-U	T16TT
3 159 00 03	W22EPR-U	W22TT
3 159 04 03	PK16PR-L11	IK16TT
3 159 05 03	T16EPR-U	T16TT
3 159 06 03	T20EPR-U	T20TT
3 159 07 03	T20EPR-U	T20TT
3 159 08 03	T22EP-U	-
3 159 10 03	W16EPR-U	W16TT
3 159 11 03	W16EPR-U	W16TT
3 159 12 03	W20EPR-U	W20TT
3 159 13 03	W20EPR-U	W20TT
3 159 14 03	W22EPR-U	W22TT
3 159 16 03	Q20R-U	Q20TT
3 159 23 03	T20EPR-U	T20TT
3 159 24 03	T16EPR-U	T16TT
3 159 25 03	T22EP-U	-
3 159 26 03	W20EPR-U	W20TT
3 159 27 03	W16EPR-U	W16TT
3 159 28 03	T16EPR-U	T16TT
3 159 29 03	W16EPR-U	W16TT
3 159 30 03	K16PR-U11	K16TT
3 159 31 03	K20PR-U11	K20TT
3 159 32 03	W22EPR-U	W22TT
3 159 33 03	T22EP-U	-
3 159 34 03	T20EPR-U	T20TT
3 159 35 03	T20EPR-U	T20TT
3 159 36 03	T16EPR-U	T16TT
3 159 37 03	Q16R-U	Q16TT
3 159 40 03	K20PR-U	K20TT
3 159 41 03	K16PR-U11	K16TT
3 159 42 03	K16PR-U11	K16TT
3 159 45 03	W20EPR-U	W20TT
3 159 46 03	W20PR-U	-
3 159 47 03	W16EPR-U	W16TT
3 159 53 03	K16PR-U	K16TT
3 159 54 03	K16PR-U11	K16TT
3 159 56 03	W22EPR-U	W22TT
3 159 57 03	W20EPR-U	W20TT
3 159 58 03	W22EPR-U	W22TT
3 159 59 03	T22EP-U	-
3 159 60 03	K20P-U	K20TT
3 159 65 03	K20PBR-S10	K20TT
3 159 66 03	PK16PR-L11	IK16TT
3 159 67 03	K16PR-U11	K16TT
3 159 68 03	K16PR-U11	K16TT
3 159 71 03	K16PR-U	K16TT
3 159 72 03	K20PBR-S10	K20TT
3 159 73 03	K20PBR-S10	K20TT
3 159 75 03	K20PBR-S10	K20TT
3 159 75 03 26	K20PBR-S10	K20TT
3 159 76 03	K20PBR-S10	K20TT
3 159 78 03	K20PBR-S10	K20TT
3 159 80 03	SK20PR-L9	IK20TT
3 159 81 03	PK16PR-L11	IK16TT
3 159 86 03	PK16PR-L11	IK16TT
3 159 90 03	K20PBR-S10	K20TT
3 159 91 03	K20TXR	K20TT
3 159 92 03	K20TXR	K20TT
3 159 94 03	PK16PR-L11	IK16TT
3 159 96 03	SK16PR-A11	IK16TT
3 159 96 03 26	SK16PR-A11	IK16TT
3 159 97 03	SK20PR-L9	IK20TT
3 159 97 03 26	SK20PR-L9	IK20TT
4 159 02 03	SK20PR-L9	IK20TT

Свечи зажигания и Свечи накаливания

Таблица взаимозаменяемости - OE

MERCEDES-BENZ	DENSO	TT
4 159 07 03	SK20PR-L9	IK20TT
4 159 09 03	PK16PR-L11	IK16TT
4 159 13 03	VKH20Y	-
4 159 18 03	VXUH22	IXUH22TT
4 159 18 03 26	VXUH22	IXUH22TT
4 159 19 03	PK16PR-L11	IK16TT
4 159 20 03	PK20PR11	K20TT
4 159 20 03 26	PK20PR11	K20TT
4 159 23 03	VKH20Y	-
4 159 25 03	VXUH22I	IXUH22TT
4 159 26 03	K20PR-U	K20TT
4 159 30 03	K20PR-U11	K20TT
4 159 34 03	SXU22HDR8	IXUH22TT
4 159 36 03	K20PR-U11	K20TT
4 159 39 03	IXEH22TT	IXEH22TT
4 159 44 03	VXUH22	IXUH22TT
4 159 44 03 26	VXUH22	IXUH22TT
4 159 45 03	VKH20Y	-
4 159 49 03	SXU22HDR8	IXUH22TT
4 159 50 03	PK16PR-L11	IK16TT
4 159 58 03	VXUH22	IXUH22TT
4151590001	DG-609	-
5 918 03 26	VXUH22	IXUH22TT
5 920 03 26	PK20PR11	K20TT
5 944 03 26	VXUH22	IXUH22TT
5 975 03 26	K20PBR-S10	K20TT
5 996 03 26	SK16PR-A11	IK16TT
5 997 03 26	SK20PR-L9	IK20TT
6 159 00 03	W20EPR-U	W20TT
6 159 01 03	W20EPR-U	W20TT
6221590001	DG-631	-
6601590001	DG-184	-
A 000 159 00 03	W20EPR-U	W20TT
A 001 159 08 03	W22EPR-U	W22TT
A 001 159 13 03	W22EPR-U	W22TT
A 001 159 15 03	W22EPR-U	W22TT
A 001 159 16 03	W22EPR-U	W22TT
A 001 159 56 01	DG-616	-
A 001 159 57 01	DG-617	-
A 001 159 58 01	DG-616	-
A 001 159 66 01	DG-617	-
A 001 159 68 01	DG-616	-
A 001 159 73 01	DG-665	-
A 001 159 80 01	DG-665	-
A 001 159 87 03	W22EPR-U	W22TT
A 001 159 93 03	W22EPR-U	W22TT
A 002 159 00 03	T20EPR-U	T20TT
A 002 159 01 03	T20EPR-U	T20TT
A 002 159 18 03	W22EPR-U	W22TT
A 002 159 22 03	W16EPR-U	W16TT
A 002 159 24 03	W20EPR-U	W20TT
A 002 159 27 03	W22EPR-U	W22TT
A 002 159 28 03	W20EPR-U	W20TT
A 002 159 29 03	W16EPR-U	W16TT
A 002 159 31 03	W16EPR-U	W16TT
A 002 159 41 03	W20EPR-U	W20TT
A 002 159 42 03	W20EPR-U	W20TT
A 002 159 48 03	W16EPR-U	W16TT
A 002 159 49 03	T20EPR-U	T20TT
A 002 159 56 03	T20EPR-U	T20TT
A 002 159 57 03	T16EPR-U	T16TT
A 002 159 58 03	T16EPR-U	T16TT
A 002 159 62 03	W22EPR-U	W22TT
A 002 159 64 03	T22EP-U	-
A 002 159 65 03	T22EP-U	-
A 002 159 66 03	T20EPR-U	T20TT
A 002 159 67 03	T22EP-U	-
A 002 159 68 03	T20EPR-U	T20TT
A 002 159 69 03	T20EPR-U	T20TT
A 002 159 76 03	T20EPR-U	T20TT
A 002 159 77 03	Q16R-U	Q16TT

MERCEDES-BENZ	DENSO	TT
A 002 159 78 03	T16EPR-U	T16TT
A 003 159 00 03	W22EPR-U	W22TT
A 003 159 04 03	PK16PR-L11	IK16TT
A 003 159 05 03	T16EPR-U	T16TT
A 003 159 06 03	T20EPR-U	T20TT
A 003 159 07 03	T20EPR-U	T20TT
A 003 159 08 03	T22EP-U	-
A 003 159 10 03	W16EPR-U	W16TT
A 003 159 11 03	W16EPR-U	W16TT
A 003 159 12 03	W20EPR-U	W20TT
A 003 159 13 03	W20EPR-U	W20TT
A 003 159 14 03	W22EPR-U	W22TT
A 003 159 16 03	Q20R-U	Q20TT
A 003 159 23 03	T20EPR-U	T20TT
A 003 159 24 03	T16EPR-U	T16TT
A 003 159 25 03	T22EP-U	-
A 003 159 26 03	W20EPR-U	W20TT
A 003 159 27 03	W16EPR-U	W16TT
A 003 159 28 03	T16EPR-U	T16TT
A 003 159 29 03	W16EPR-U	W16TT
A 003 159 30 03	K16PR-U11	K16TT
A 003 159 31 03	K20PR-U11	K20TT
A 003 159 32 03	W22EPR-U	W22TT
A 003 159 33 03	T22EP-U	-
A 003 159 34 03	T20EPR-U	T20TT
A 003 159 35 03	T20EPR-U	T20TT
A 003 159 36 03	T16EPR-U	T16TT
A 003 159 37 03	Q16R-U	Q16TT
A 003 159 40 03	K20PR-U	K20TT
A 003 159 41 03	K16PR-U11	K16TT
A 003 159 42 03	K16PR-U11	K16TT
A 003 159 45 03	W20EPR-U	W20TT
A 003 159 46 03	W20PR-U	-
A 003 159 47 03	W16EPR-U	W16TT
A 003 159 53 03	K16PR-U	K16TT
A 003 159 54 03	K16PR-U11	K16TT
A 003 159 56 03	W22EPR-U	W22TT
A 003 159 57 03	W20EPR-U	W20TT
A 003 159 58 03	W22EPR-U	W22TT
A 003 159 59 03	T22EP-U	-
A 003 159 60 03	K20P-U	K20TT
A 003 159 65 03	K20PBR-S10	K20TT
A 003 159 66 03	PK16PR-L11	IK16TT
A 003 159 67 03	K16PR-U11	K16TT
A 003 159 68 03	K16PR-U11	K16TT
A 003 159 71 03	K16PR-U	K16TT
A 003 159 72 03	K20PBR-S10	K20TT
A 003 159 73 03	K20PBR-S10	K20TT
A 003 159 75 03	K20PBR-S10	K20TT
A 003 159 75 03 26	K20PBR-S10	K20TT
A 003 159 76 03	K20PBR-S10	K20TT
A 003 159 78 03	K20PBR-S10	K20TT
A 003 159 80 03	SK20PR-L9	IK20TT
A 003 159 81 03	PK16PR-L11	IK16TT
A 003 159 86 03	PK16PR-L11	IK16TT
A 003 159 90 03	K20PBR-S10	K20TT
A 003 159 91 03	K20TXR	K20TT
A 003 159 92 03	K20TXR	K20TT
A 003 159 94 03	PK16PR-L11	IK16TT
A 003 159 96 03	SK16PR-A11	IK16TT
A 003 159 96 03 26	SK16PR-A11	IK16TT
A 003 159 97 03	SK20PR-L9	IK20TT
A 003 159 97 03 26	SK20PR-L9	IK20TT
A 004 159 02 03	SK20PR-L9	IK20TT
A 004 159 07 03	SK20PR-L9	IK20TT
A 004 159 09 03	PK16PR-L11	IK16TT
A 004 159 13 03	VKH20Y	-
A 004 159 18 03	VXUH22	IXUH22TT
A 004 159 18 03 26	VXUH22	IXUH22TT
A 004 159 19 03	PK16PR-L11	IK16TT
A 004 159 20 03	PK20PR11	K20TT

MERCEDES-BENZ	DENSO	TT
A 004 159 20 03 26	PK20PR11	K20TT
A 004 159 23 03	VKH20Y	-
A 004 159 25 03	VXUH22I	IXUH22TT
A 004 159 26 03	K20PR-U	K20TT
A 004 159 30 03	K20PR-U11	K20TT
A 004 159 34 03	SXU22HDR8	IXUH22TT
A 004 159 36 03	K20PR-U11	K20TT
A 004 159 39 03	IXEH22TT	IXEH22TT
A 004 159 44 03	VXUH22	IXUH22TT
A 004 159 44 03 26	VXUH22	IXUH22TT
A 004 159 45 03	VKH20Y	-
A 004 159 49 03	SXU22HDR8	IXUH22TT
A 004 159 50 03	PK16PR-L11	IK16TT
A 004 159 58 03	VXUH22	IXUH22TT
A 005 918 03 26	VXUH22	IXUH22TT
A 005 920 03 26	PK20PR11	K20TT
A 005 944 03 26	VXUH22	IXUH22TT
A 005 975 03 26	K20PBR-S10	K20TT
A 005 996 03 26	SK16PR-A11	IK16TT
A 005 997 03 26	SK20PR-L9	IK20TT
A 006 159 00 03	W20EPR-U	W20TT
A 006 159 01 03	W20EPR-U	W20TT
A 102 159 00 03	T20EPR-U	T20TT
A 102 159 01 03	T20EPR-U	T20TT
A 103 159 00 03	T20EPR-U	T20TT
A 110 159 00 03	W20EPR-U	W20TT
A 116 159 00 03	W20EPR-U	W20TT
A 116 159 01 03	W20EPR-U	W20TT
A 123 159 00 03	W22EPR-U	W22TT
A0001500281	DG-010	-
A0001594901	DG-117	-
A0001597501	DG-001	-
A0001597701	DG-001	-
A0001598101	DG-001	-
A0001598201	DG-001	-
A0001598301	DG-001	-
A0001599601	DG-001	-
A0001599901	DG-001	-
A0011590001	DG-001	-
A0011590201	DG-001	-
A0011591501	DG-119	-
A0011591601	DG-119	-
A0011591701	DG-001	-
A0011592001	DG-106	-
A0011592101	DG-106	-
A0011592201	DG-001	-
A0011592601	DG-110	-
A0011592701	DG-155	-
A0011592801	DG-117	-
A0011593601	DG-001	-
A0011593701	DG-117	-
A0011593801	DG-117	-
A0011594201	DG-117	-
A0011594610	DG-606	-
A0011594801	DG-117	-
A0011594901	DG-117	-
A0011595001	DG-194	-
A0011595101	DG-192	-
A0011595201	DG-192	-
A0011597101	DG-194	-
A4151590001	DG-609	-
A6221590001	DG-631	-
A6601590001	DG-184	-

MERCURUISER	DENSO	TT
3337405	W20ESR-U	-
333854400	T20R-U	-
3354527	W20ESR-U	-
3359571	T20R-U	-
3360056	W20ESR-U	-
338134711	W20ESR-U	-

MERCURUISER	DENSO	TT
33816336	W20EPR-U	W20TT
33979826	T20R-U	-

MG	DENSO	TT
GSP9662	PK20PR-L11	IK20TT
NLP000090	PK20PR-L11	IK20TT
NLP000130	PK20PR-L11	IK20TT

MINI	DENSO	TT
0 034 097	VXUH22I	IXUH22TT
0 034 098	VXUH22I	IXUH22TT
0 034 677	VXUH22I	IXUH22TT
0 035 531	VXUH22I	IXUH22TT
0 035 933	VXUH22I	IXUH22TT
12 12 0 034 097	VXUH22I	IXUH22TT
12 12 0 034 098	VXUH22I	IXUH22TT
12 12 0 034 677	VXUH22I	IXUH22TT
12 12 0 035 531	VXUH22I	IXUH22TT
12 12 0 035 933	VXUH22I	IXUH22TT
12 12 2 158 165	VXUH22I	IXUH22TT
12 12 2 163 332	VXUH22I	IXUH22TT
12 12 2 293 697	VXUH22I	IXUH22TT
12 12 7 570 106	VXUH22I	IXUH22TT
2 158 165	VXUH22I	IXUH22TT
2 163 332	VXUH22I	IXUH22TT
2 293 697	VXUH22I	IXUH22TT
7 570 106	VXUH22I	IXUH22TT

MITSUBISHI	DENSO	TT
08010-08	W20ES-U	-
08010-08A	W20ES-U	-
08010-08K	W20ES-U	-
08010-33	W22FS-U	-
08010-33A	W22FS-U	-
08010-33K	W22FS-U	-
1820A006	DG-662	-
1820A009	DG-655	-
1820A019	DG-656	-
1820A020	DG-662	-
1822-A002	VKH20Y	-
1822A009	XU22HDR9	XUH22TT
1822-A009	XU22HDR9	XUH22TT
1822-A010	SXU22HDR8	IXUH22TT
1822-A011	SXU22HDR8	IXUH22TT
1822-A021	GX8-1	-
1822-A022	VKH22	-
1822-A030	K16PSR-B8	IK16TT
1822-A036	XU22HDR9	XUH22TT
1822-A061	FXU22HR11	IXUH22TT
1822-A064	FXU22HR8	IXUH22TT
1822-A068	IK16TT	IK16TT
1822-A069	VFK20F	IK20TT
1822-A071	FK20HR11	IKH20TT
1822-A085	IKH16TT	IKH16TT
1822-A086	IKH16TT	IKH16TT
1822-A088	IXUH20I	-
1822-A154	IK16TT	IK16TT
22401-EW61C	FXE22HR11	IXEH22TT
22401-EW61D	IXEH22TT	IXEH22TT
22401-JK01D	FXE24HR11	-
30695-22935	W20ES-U	-
CLP37201	K16TT	K16TT
CLP37202	K20TT	K20TT
CLP37203	XU22TT	XU22TT
CLP37204	XUH22TT	XUH22TT
CLP37205	W16TT	W16TT
FR31722	W9-U	-
M04671057	IK20	IK20TT
M05269897	W20EPR-U	W20TT
M05269899	W20EXR-U11	W20TT
M816732	DG-012	-

Свечи зажигания и Свечи накаливания

Таблица взаимозаменяемости - OE

MITSUBISHI	DENSO	TT
M883828	DG-005	-
MA848593	KH20TT	KH20TT
MD014997	DG-162	-
MD050212	DG-198	-
MD077167	DG-301	-
MD082832	DG-301	-
MD197511	DG-174	-
MD301950	DG-174	-
MD310294	K20PR-U11	K20TT
MD313443	PK20PR11	K20TT
MD314766	IK22	IK22FTT
MD319586	IK22	IK22FTT
MD320543	IK22	IK22FTT
MD321150	K20TNR	K20TT
MD322771	PK20PR11	K20TT
MD336367	PKJ20CR8	IK20TT
MD338991	P22PR8	IK22FTT
MD343244	P22PR8	IK22FTT
MD343277	P20PR11	W20TT
MD344180	K16PR-U11	K16TT
MD344460	DG-174	-
MD344469	DG-174	-
MD348296	VKB16	-
MD350291	K20PR-U11	K20TT
MD351467	VKA16	-
MD354500	DG-174	-
MD355067	VKA20	-
MD357531	IK20TT	IK20TT
MD357531	VW20	IW20TT
MD358200	KJ20CR-U11	K20TT
MD358202	KJ20CR-U11	K20TT
MD358203	KJ20CR-U11	K20TT
MD360019	VKB20	-
MD360383	VKB16	-
MD361067	SK16PR-A11	IK16TT
MD362097	KJ16CR-U11	K16TT
MD362098	KJ16CR-U11	K16TT
MD362902	VKA16	-
MD363621	KJ16CR-U11	K16TT
MD366819	VKA16	-
MD371434	S22PR-A7	-
MD371435	S22PR-A7	-
MD372421	VKA16	-
MD372422	VKA20	-
MD372553	SK16PR-A11	IK16TT
MD372588	SK20PR-A11	IK20TT
MD373645	SK20PR-A11	IK20TT
MD374841	S22PR-A7	-
MD375642	VKA16	-
MD376962	PK16PR11	K16TT
MD378086	S22PR-A7	-
MD851023	W20EP-U	W20TT
MD851332	PK20PR11	K20TT
ME200970	DG-643	-
ME201632	DG-643	-
ME201638	DG-643	-
ME202785	DG-643	-
ME203539	DG-187	-
ME203583	DG-643	-
ME203754	DG-643	-
ME205539	DG-187	-
ME220826	VK22	IK22FTT
ME222165	VK22	IK22FTT
ME300970	DG-643	-
MN119487	SK20PR-A8	IK20TT
MN119489	VW20T	IW20TT
MN119500	VW20	IW20TT
MN119942	K20PBR-S10	K20TT
MN122257	VK20Y	-
MN122493	VXU22	IXU22TT
MN122494	VXU22	IXU22TT

MITSUBISHI	DENSO	TT
MN128362	K20HR-U11	KH20TT
MN128363	KH20TT	KH20TT
MN158596	IKH20	IKH20TT
MN158956	IKH20	IKH20TT
MN163235	K16PSR-B8	IK16TT
MN163236	SK20PR-A8	IK20TT
MN163807	K20PSR-B8	IK20TT
MN176628	IKH20	IKH20TT
MN960270	DG-606	-
MN960296	DG-606	-
MN980234	DG-190	-
MN980406	DG-622	-
MN982294	DG-614	-
MQ500368	ZXU20PR11	-
MQ504109	IXUH22	IXUH22TT
MR577131	DG-174	-
MR984646	VK20Y	-
MR984943	SK20PR-A8	IK20TT
MS343277	P20PR11	W20TT
MS851013	W20ES-U	-
MS851021	W14EPR-U	IW16TT
MS851022	W16EPR-U	W16TT
MS851023	W20EP-U	W20TT
MS851024	W22EPR-U	W22TT
MS851025	W24EPR-U	-
MS851026	W14EPR-U	IW16TT
MS851027	W16EPR-U11	W16TT
MS851028	W20EPR-U11	W20TT
MS851029	W22EPR-U11	W22TT
MS851097	W16EXR-U	W16TT
MS851097	W16EX-U	W16TT
MS851098	W20EX-U	W20TT
MS851101	W14EX-U	IW16TT
MS851101A	W14EX-U	IW16TT
MS851101K	W14EX-U	IW16TT
MS851102	W16EXR-U	W16TT
MS851102	W16EX-U	W16TT
MS851102A	W16EX-U	W16TT
MS851102E	W16EX-U	W16TT
MS851102K	W16EX-U	W16TT
MS851104	W20EX-U	W20TT
MS851104A	W20EX-U	W20TT
MS851104K	W20EX-U	W20TT
MS851106	W14EXR-U11	IW16TT
MS851107	W16EXR-U11	W16TT
MS851108	W20EXR-U11	W20TT
MS851126	W20EPR-U	W20TT
MS851174	W22ESR-U	-
MS851181	W14EPR-U	IW16TT
MS851182	W16EPR-U	W16TT
MS851183	W20EPR-U	W20TT
MS851184	W22EPR-U	W22TT
MS851187	W16EPR-U11	W16TT
MS851188	W20EPR-U11	W20TT
MS851189	W22EPR-U11	W22TT
MS851232	W16EPR-U	W16TT
MS851233	W20EPR-U	W20TT
MS851234	W22EPR-U	W22TT
MS851235	W16EPR-U	W16TT
MS851236	W20EPR-U	W20TT
MS851237	W16EXR-U11	W16TT
MS851238	W20EPR-U11	W20TT
MS851239	W22EPR-U11	W22TT
MS851243	W16EXR-U	W16TT
MS851253	W20EPR-S11	W20TT
MS851254	IW22	-
MS851272	W16EPR-U11	W16TT
MS851273	W20EPR-S11	W20TT
MS851274	IW22	-
MS851283	W20EP-U	W20TT
MS851292	P20PR11	W20TT

MITSUBISHI	DENSO	TT
MS851302	P20PR11	W20TT
MS851316	XU20EPR-U	-
MS851317	XU22EPR-U	XU22TT
MS851328	IXU24	-
MS851332	PK20PR11	K20TT
MS851335	PK16PR-P11	K16TT
MS851336	PK20PR-P11	K20TT
MS851346	PK20PR-P8	IK20TT
MS851347	PK22PR8	IK22TT
MS851351	K16PR-U	K16TT
MS851352	K20P-U	K20TT
MS851357	K16PR-U11	K16TT
MS851358	K20PR-U11	K20TT
MS851359	K22PR-U11	IK22FTT
MS851361	K16PR-U11	K16TT
MS851362	K20PR-U11	K20TT
MS851363	K22PR-U11	IK22FTT
MS851367	K16PR-U	K16TT
MS851368	K20PR-U	K20TT
MS851377	K16PR-U11	K16TT
MS851378	IK20	IK20TT
MS851379	K22PR-U11	IK22FTT
MS851402	W16EPR-U	W16TT
MS851403	W20EPR-U	W20TT
MS851407	W16EXR-U	W16TT
MS851408	W20EPR-U11	W20TT
MS851409	W22EPR-U11	W22TT
MS851411	W14EPR-U	IW16TT
MS851412	W16EPR-U	W16TT
MS851413	W20EPR-U	W20TT
MS851414	W22EPR-U	W22TT
MS851417	W16EPR-U11	W16TT
MS851418	W20EPR-U11	W20TT
MS851419	W22EPR-U11	W22TT
MS851428	W20EPR-S11	W20TT
MS851428	W20EP-S11	IW20TT
MS851428A	W20EP-S11	IW20TT
MS851429	IW22	-
MS851432	W16EPR-U11	W16TT
MS851432	W16EP-U	W16TT
MS851433	W20EPR-U11	W20TT
MS851433	W20EP-U	W20TT
MS851434	W22EPR-U11	W22TT
MS851435	IW16	IW16TT
MS851437	W16EPR-U	W16TT
MS851437	W16EP-U	W16TT
MS851438	W20EP-U	W20TT
MS851438A	W20EP-U	W20TT
MS851438E	W20EP-U	W20TT
MS851438K	W20EP-U	W20TT
MS851439	W22EPR-U	W22TT
MS851439	W22EP-U	W22TT
MS851447	W20EPR-S11	W20TT
MS851448	W16EPR-U11	W16TT
MS851449	W20EPR-U11	W20TT
MS851454	W20EPR-U11	W20TT
MS851454	W22ESR-U	-
MS851463	P20PR11	W20TT
MS851472	P16PR11	W16TT
MS851473	P20PR11	W20TT
MS851486	XU20EPR-U	-
MS851487	XU22EPR-U	XU22TT
MS851488	XU24EPR-U	-
MS851497	IXU22	IXU22TT
MS851498	IXU24	-
MS851501	PK16PR-P11	K16TT
MS851502	PK20PR-P11	K20TT
MS851506	PK20PR-P8	IK20TT
MS851534	W20EPR-U11	W20TT
MS851540	W20EPR-U11	W20TT

MITSUBISHI	DENSO	TT
MS851544	IW22	-
MS851550	W22EPR-U11	W22TT
MS851554	IW22	-
MS851572	K16PR-U11	K16TT
MS851623	W20EPR-U11	W20TT
MS851710	W14EPR-U	IW16TT
MS851718	W20EPR-U11	W20TT
MS851720	K16PR-U	K16TT
MS851721	K16PR-U	K16TT
MS851722	K20P-U	K20TT
MS851723	K20P-U	K20TT
MS851727	K16PR-U11	K16TT
MS851728	K20PR-U11	K20TT
MS851729	K22PR-U11	IK22FTT
MS851731	K16PR-U11	K16TT
MS851732	K20PR-U11	K20TT
MS851733	W20EPR-U11	W20TT
MS851737	K16PR-U	K16TT
MS851738	K20PR-U	K20TT
MS851739	K22PR-U	IK22FTT
MS851767	XU22EPR-U	XU22TT
MS851783	IK22	IK22FTT
MS851792	W20ETR-L	IW20TT
MS851793	IW22	-
MS851861	PK20PR-P8	IK20TT
MS851872	IK22	IK22FTT
MS851881	W20ETR-L	IW20TT
MS851882	W22ETR-L	W22TT
MW30756065	DG-005	-
MY018551	W20EPR-U11	W20TT
MZ602020	IK16	IK16TT
MZ602021	IK20	IK20TT
MZ602022	IK22	IK22FTT
MZ602023	IK24	-
MZ602024	IK27	-
MZ602025	IK31	-
MZ602026	IQ16TT	IQ16TT
MZ602027	IQ20TT	IQ20TT
MZ602028	IQ22	-
MZ602029	IQ24	-
MZ602030	IQ27	-
MZ602031	IQ31	-
MZ602032	IW16	IW16TT
MZ602033	IW20	IW20TT
MZ602034	IW22	-
MZ602035	IW24	-
MZ602036	IW27	-
MZ602037	IXU22	IXU22TT
MZ602038	IXU24	-
MZ602039	IXU27	-
MZ602042	VK22	IK22FTT
MZ602043	IQ16TT	IQ16TT
MZ602044	IQ20TT	IQ20TT
MZ602045	VQ22	-
MZ602046	IW16TT	IW16TT
MZ602047	VW20	IW20TT
MZ602048	VW22	-
MZ602049	VXU22	IXU22TT
MZ602050	VXU24	-
MZ602060	IW16	IW16TT
MZ602061	IW20	IW20TT
MZ602062	IW22	-
MZ602063	IQ16TT	IQ16TT
MZ602064	IQ20TT	IQ20TT
MZ602065	IK16	IK16TT
MZ602066	IK20	IK20TT
MZ602067	IXU22	IXU22TT
MZ602068	IK16L	IK16TT
MZ602070	IW16	IW16TT
MZ602071	IW20	IW20TT
MZ602072	IK16	IK16TT

Свечи зажигания и Свечи накаливания

Таблица взаимозаменяемости - OE

MITSUBISHI	DENSO	TT
MZ602073	IK20	IK20TT
MZ602074	VW20T	IW20TT
MZ602078	PQ16R	Q16TT
MZ602079	PQ20R	Q20TT
MZ602080	VXU22	IXU22TT
MZ602081	IK22	IK22FTT
MZ602084	PKJ16CR-L11	IK16TT
MZ602085	IK20L	IK20TT
RAY66001	IW22	-
RAY66002	IW24	-

MV AGUSTA	DENSO	TT
80099561	IJ27A	-

NISMO	DENSO	TT
22401-RN0106	IK20	IK20TT
22401-RN0108	IK24	-
22401-RN02006	IKH20	IKH20TT
22401-RN02007	VKH22	-
22401-RN0206	IKH20	IKH20TT
22401-RN0207	IKH22	-
22401-RS1128	IK24	-
22401-RS1189	IK27	-
22401-RS2329	IQ27	-
22401-RS34508	IKH01-24	-
22401-RS34509	IKH01-27	-
22401-RS34510	IKH01-31	-
22401-RS3458	IKH01-24	-
22401-RS3459	IKH01-27	-

NISSAN	DENSO	TT
11065-10G00	DG-157	-
11065-00Q00	DG-005	-
11065-00Q0A	DG-126	-
11065-00Q0E	DG-609	-
11065-00Q0H	DG-631	-
11065-00Q0L	DG-631	-
11065-00QAA	DG-005	-
11065-00QAB	DG-126	-
11065-00QAE	DG-126	-
11065-00QAF	DG-005	-
11065-00QAG	DG-005	-
11065-0W801	DG-626	-
11065-10G00	DG-157	-
11065-29W00	DG-157	-
11065-2W202	DG-605	-
11065-2W204	DG-605	-
11065-2W211	DG-605	-
11065-31N00	DG-137	-
11065-37506	DG-157	-
11065-37507	DG-157	-
11065-43G01	DG-198	-
11065-4P400	DG-643	-
11065-57J00	DG-642	-
11065-5C900	DG-642	-
11065-63G00	DG-198	-
11065-65N00	DG-626	-
11065-65N01	DG-626	-
11065-6F900	DG-003	-
11065-7C000	DG-137	-
11065-7F400	DG-626	-
11065-9C600	DG-137	-
11065-AD200	DG-197	-
11065-AD201	DG-197	-
11065-AD20A	DG-197	-
11065-AD210	DG-197	-
11065-AD220	DG-197	-
11065-BN701	DG-005	-
11065-C8600	DG-702	-
11065-D9702	DG-644	-
11065-G2400	DG-137	-

NISSAN	DENSO	TT
11065-G2460	DG-137	-
11065-G5501	DG-644	-
11065-T8200	DG-157	-
11065-T8202	DG-157	-
11065-V0700	DG-012	-
11065-V0710	DG-012	-
22401-00Q0A	PK20PR-P8	IK20TT
22401-00QAA	PK20PR-P8	IK20TT
22401-01B14	W14EXR-U11	IW16TT
22401-01M14	W14EXR-U11	IW16TT
22401-01P14	Q14R-U11	IQ16TT
22401-01P15	Q16PR-U11	Q16TT
22401-01P16	Q20PR-U11	Q20TT
22401-01P17	K22PR-U	IK22FTT
22401-02P15	Q16PR-U11	Q16TT
22401-02P16	Q20R-U	Q20TT
22401-02P17	Q22PR-U11	-
22401-03300	W14PR-U	-
22401-08U15	PQ16R	Q16TT
22401-08U16	PQ20R	Q20TT
22401-08015	K16R-U	K16TT
22401-0P615	PQ16R	Q16TT
22401-0P616	PQ20R	Q20TT
22401-10F14	Q14R-U11	IQ16TT
22401-10F15	Q16R-U	Q16TT
22401-10F16	Q20R-U	Q20TT
22401-10F17	Q22PR-U	-
22401-10P15	Q16PR-U11	Q16TT
22401-10P16	K20PR-U11	K20TT
22401-10P17	Q22PR-U11	-
22401-11200	W20ESR-U	-
22401-12E15	Q16PR-U	Q16TT
22401-12E16	Q20PR-U	Q20TT
22401-12E23	K22PR-U	IK22FTT
22401-18V16	P20PR11	W20TT
22401-19V15	Q16R-U	Q16TT
22401-19V16	Q20R-U	Q20TT
22401-19V66	Q20PR-U	Q20TT
22401-1F700	K20PR-U11	K20TT
22401-1F720	K16PR-U11	K16TT
22401-1HC1B	FXE20HR11	IXEH20TT
22401-1KT1B	FXE20HE11	IXEH20ETT
22401-1N516	K20PR-U	K20TT
22401-1P115	PK16PR-L11	IK16TT
22401-1P116	PK20PR11	K20TT
22401-1P117	PK22PR-L11S	-
22401-1P175	PK16PR-L11	IK16TT
22401-1TT1C	VFXHC22G	-
22401-20J05	K16PR-U	K16TT
22401-20J06	K20PR-U	K20TT
22401-20J07	K16PR-U	K16TT
22401-21B15	W16EPR-U	W16TT
22401-21B16	W20EPR-U	W20TT
22401-2331R	FXE20HR11	IXEH20TT
22401-27N65	PK16PR-L11	IK16TT
22401-27N66	PK20PR11	K20TT
22401-27T65	P16PR11	W16TT
22401-2F200	KJ20CR-L11	K20TT
22401-2J200	K16R-U11	K16TT
22401-2J204	IK16	IK16TT
22401-30R14	K16PR-U11	K16TT
22401-30R15	K16GPR-U11	-
22401-30R75	K16GPR-U11	-
22401-3682R	K20TXR	K20TT
22401-37P15	PK16R11	K16TT
22401-40P65	PK16R11	K16TT
22401-40V05	Q16PR-U11	Q16TT
22401-40V06	Q20PR-U	Q20TT
22401-40V07	Q22PR-U	-
22401-50V16	VW20T	IW20TT
22401-50Y04	K16PR-U11	K16TT

NISSAN	DENSO	TT
22401-50Y05	K16PR-U11	K16TT
22401-50Y06	K20PR-U11	K20TT
22401-53J04	K20R-U	K20TT
22401-53J05	K16R-U	K16TT
22401-53J06	K20R-U	K20TT
22401-53J07	K22PR-U	IK22FTT
22401-53J13	PK20PR-P8	IK20TT
22401-53J66	PK20PR-P8	IK20TT
22401-53J67	PK22PR8	IK22TT
22401-53V16	PK20PR-P8	IK20TT
22401-53V17	PK22PR8	IK22TT
22401-55V16	PK20R8	IK20TT
22401-58S15	PQ16R	Q16TT
22401-58S16	PQ20R	Q20TT
22401-70J10	IK20	IK20TT
22401-70J11	IK20	IK20TT
22401-70J13	IK16	IK16TT
22401-70J19	K20PR-U	K20TT
22401-74B00	K16PR-U11	K16TT
22401-74B11	K16PR-U11	K16TT
22401-75507	W20EPR-U	W20TT
22401-85E15	K16PR-U11	K16TT
22401-85E16	K20PR-U11	K20TT
224018651R	SK20PR-A8	IK20TT
22401-8651R	K20PR-U	K20TT
22401-8H314	KH16TT	KH16TT
22401-8H315	KH16TT	KH16TT
22401-8H316	KH20TT	KH20TT
22401-8H514	K20HR-U11	KH20TT
22401-8H515	K16HPR-U11	KH16TT
22401-8H516	K20HR-U11	KH20TT
22401-8P315	PK16PR11	K16TT
22401-97E65	PK16R11	K16TT
22401-99B07	K22PR-U11	IK22FTT
22401-99B09	K20PR-U11	K20TT
22401-99B12	IK16	IK16TT
22401-99B17	K22PR-U11	IK22FTT
22401-99B19	K20PR-U11	K20TT
22401-99B22	Q16PR-U11	Q16TT
22401-A4704	W14EPR-U	IW16TT
22401-A4705	W20EPR-U	W20TT
22401-A4706	W16EPR-U	W16TT
22401-AG215	PK16PR-L11	IK16TT
22401-AH415	IK16	IK16TT
22401-AL515	KH16TT	KH16TT
22401-AR015	IKH16TT	IKH16TT
22401-AU015	K16HPR-U11	KH16TT
22401-AX015	K16HPR-U11	KH16TT
22401-BC01B	K16HR-U11	KH16TT
22401-CK81B	FXE20HR11	IXEH20TT
22401-CP51B	FXE20HR11	IXEH20TT
22401-EA014	FXE20HR11	IXEH20TT
22401-EA016	IXEH22TT	IXEH22TT
22401ED715	FXE20HE11	IXEH20ETT
22401-ED715	FXE20HE11	IXEH20ETT
22401ED71A	FXE16HE11	-
22401-ED71A	FXE16HE11	-
22401-ED71B	FXE20HE11	IXEH20ETT
22401ED775	FXE20HE11	IXEH20ETT
22401-ED815	FXE20HR11	IXEH20TT
22401-ED816	IXEH22TT	IXEH22TT
22401-EN215	IXEH20TT	IXEH20TT
22401EN275	IXEH20TT	IXEH20TT
22401-EN275	IXEH20TT	IXEH20TT
22401-EW61C	FXE22HR11	IXEH22TT
22401-EW61C	IXEH22TT	IXEH22TT
22401EW67B	FXE20HR11	IXEH20TT
22401-F2000	W14EPR-U	IW16TT
22401-F6515	IQ16TT	IQ16TT
22401-F6516	PQ20R	Q20TT
22401-HC000	W16EXR-U13	W16TT

NISSAN	DENSO	TT
22401-JA01B	FXE20HR11	IXEH20TT
22401-JD01B	FXE20HR11	IXEH20TT
22401-JD07B	FXE20HR11	IXEH20TT
22401-JF01D	VDC22F	-
22401-JK01D	FXE24HR11	-
22401-M7714	W14E	-
22401-M7715	W16ESR-U	-
22401-M7716	W20ESR-U	-
22401-M7717	W22ESR-U	-
22401-M7915	W16ESR-U	-
22401-N8714	W14EXR-U11	IW16TT
22401-N8715	W16EPR-U11	W16TT
22401-N8716	W20EPR-U11	W20TT
22401-OP615	IQ16TT	IQ16TT
22401-OP616	IQ20TT	IQ20TT
22401-P8314	W14EXR-U11	IW16TT
22401-P8315	W16EXR-U11	W16TT
22401-P8316	W20EPR-U11	W20TT
22401-P8817	W22ESR-U	-
22401-Q9104	Q22PR-U11	-
22401-S2000	W16EPR-U	W16TT
22401-S2100	W20EPR-U	W20TT
22401-S6015	W16EXR-U13	W16TT
22401-S6500	W14EXR-U	IW16TT
22401-V0516	W20EPR-U	W20TT
22401-V1414	W14EXR-U	IW16TT
22401-V1415	W16EPR-U	W16TT
22401-V1416	W20EPR-U	W20TT
22401-V1491	W20EPR-U	W20TT
22401-V5015	Q16R-U11	Q16TT
22401-V5016	Q20P-U11	Q20TT
22401-V5017	Q22PR-U11	-
22401-VB000	W16EPR-U11	W16TT
22401-VR306	VW20T	IW20TT
22401-W8914	W14EPR-U	IW16TT
22401-W8915	W16EPR-U	W16TT
22401-W8916	W20EPR-U	W20TT
22401-W8917	W20EPR-U	W20TT
22401-WA066	PK20PR-P8	IK20TT
22401-WD517	IK22	IK22FTT
22401-Y9015	K20PBR	K20TT
22401-Y9066	K20PBR	K20TT
22401-Y9067	K22PB	IKB22TT
22401-ZJ51B	IKH16TT	IKH16TT
997261	DG-202	-
B2401-00QAA	K20PR-U	K20TT
B2401-4A00A	ZXU20PR11	-
B2401-4A00B	IXUH22	IXUH22TT
B2401-4A0A0	XU22EPR-U	XU22TT
B2401-4A0A2	IXU22	IXU22TT
B2401-6A00G	IXUH22	IXUH22TT
B2401-89904	W16EXR-U	W16TT
B2401-89905	W20EX-U	W20TT
B2401-95FOA	K16HPR-U11	KH16TT
BY480-BKR5E	IK16	IK16TT
BY480-BKR6E	IK20	IK20TT
BY480-BPR5E	IW16	IW16TT
BY480-BPR6E	IW20	IW20TT
BY480-BPR7E	IW22	-
BY480-BPR8E	IW24	-
BY480-BPR9E	IW27	-
BY480-DCPR7E	IXU22	IXU22TT
BY481-BCPR5	IQ16TT	IQ16TT
BY481-BCPR6	IQ20TT	IQ20TT
BY481-BKR5E	IK16	IK16TT
BY481-BKR6E	IK20	IK20TT
BY481-BKR7E	IK22	IK22FTT
BY481-BPR5E	IW16	IW16TT
BY481-BPR6E	IW20	IW20TT
BY481-LFR5A	IKH16	IKH16TT
BY481-LFR5A	IKH16TT	IKH16TT

Свечи зажигания и Свечи накаливания

Таблица взаимозаменяемости - OE

NISSAN	DENSO	TT
BY481-LFR6A	IKH20	IKH20TT
BY481-ZFR5F	IK16L	IK16TT
BY482-BPR6E	VW20T	IW20TT
BY483-BCPR5	PQ16R	Q16TT
BY483-BCPR6	PQ20R	Q20TT
BY483-ZFR5F	PKJ16CR-L11	IK16TT
BY484-BKR7E	VK22	IK22FTT
BY484-DCPR7	VXU22	IXU22TT
BY484-LFR6A	VKH20Y	-
BY484-LFR7A	VKH22	-

OPEL	DENSO	TT
12 14 000	K20TXR	K20TT
12 14 002	W16EPR-U	W16TT
12 14 003	K20TNR	K20TT
12 14 004	K20R-U	K20TT
12 14 005	K20TXR	K20TT
12 14 007	W20EPR-U	W20TT
12 14 008	W20EPR-U11	W20TT
12 14 009	Q20PR-U	Q20TT
12 14 011	K20TXR	K20TT
12 14 012	PT16VR13	TV16TT
12 14 013	PT16VR13	TV16TT
12 14 015	K20TXR	K20TT
12 14 016	KJ20CR-L11	K20TT
12 14 018	W20FSR-U	WF20TT
12 14 019	W20FPR-U	WF20TT
12 14 026	PK20PR-P8	IK20TT
12 14 027	K20PBR	K20TT
12 14 029	PK20PR-P8	IK20TT
12 14 030	PK20PR-L11	IK20TT
12 14 031	KJ16CR-L11	K16TT
12 14 041	KJ16CR-L11	K16TT
12 14 042	DG-300	-
12 14 042	DG-640	-
12 14 043	DG-300	-
12 14 043	DG-640	-
12 14 046	PK20PR-P8	IK20TT
12 14 060	PK20PR-L11	IK20TT
12 14 085	DG-300	-
12 14 085	DG-640	-
12 14 112	KJ20CR-L11	K20TT
12 14 120	KJ16CR-L11	K16TT
12 14 134	W20FPR-U	WF20TT
12 14 138	W20FPR-U	WF20TT
12 14 139	W20EPR-U	W20TT
12 14 141	K20TXR	K20TT
12 14 144	K20PR-U	K20TT
12 14 148	Q20PR-U	Q20TT
12 14 149	W16EPR-U	W16TT
12 14 310	DG-300	-
12 14 310	DG-640	-
12 14 316	DG-300	-
12 14 316	DG-640	-
12 14 455	K20TXR	K20TT
12 14 458	K16PR-U11	K16TT
12 14 462	PK16PR-L11	IK16TT
12 14 527	IKH20TT	IKH20TT
12 14 528	IK20L	IK20TT
12 14 700	W20FPR-U	WF20TT
12 14 801	W20FPR-U	WF20TT
12 14 802	W20EPR-U	W20TT
12 14 803	W20EPR-U11	W20TT
12 14 805	W20FPR-U	WF20TT
12 14 807	W20EPR-U	W20TT
1214018	DG-145	-
1214020	DG-005	-
1214028	DG-646	-
1214032	DG-171	-
1214033	DG-142	-
1214034	DG-170	-

OPEL	DENSO	TT
1214035	DG-302	-
1214035	DG-641	-
1214036	DG-646	-
1214040	DG-122	-
1214042	DG-104	-
1214045	DG-133	-
1214056	DG-142	-
1214062	DG-302	-
1214062	DG-641	-
1214063	DG-302	-
1214063	DG-641	-
1214064	DG-196	-
1214067	DG-625	-
1214070	DG-171	-
1214071	DG-170	-
1214073	DG-122	-
1214079	DG-646	-
1214080	DG-126	-
1214082	DG-005	-
1214090	DG-621	-
1214094	DG-608	-
1214096	DG-302	-
1214096	DG-641	-
1214098	DG-634	-
1214301	DG-302	-
1214301	DG-641	-
1214304	DG-001	-
1214305	DG-142	-
1214306	DG-001	-
1214307	DG-001	-
1214308	DG-143	-
1214309	DG-159	-
1214310	DG-104	-
1214311	DG-124	-
1214312	DG-124	-
1214315	DG-104	-
1214317	DG-001	-
1214319	DG-001	-
1214320	DG-104	-
1214321	DG-108	-
1214322	DG-133	-
1214323	DG-108	-
1214324	DG-001	-
1214334	DG-608	-
1214427	DG-109	-
1214456	DG-118	-
1214457	DG-118	-
1214459	DG-186	-
1826357	DG-621	-
25193473	KJ20CR-L11	K20TT
43 00 010	W20EPR-U	W20TT
43 17 021	W20EPR-U	W20TT
4300425	DG-108	-
44 10 220	PK20PR-P8	IK20TT
44 13 288	PK20PR-P8	IK20TT
44 32 200	PK20PR-P8	IK20TT
4402724	DG-005	-
4402945	DG-008	-
4403145	DG-004	-
4406338	DG-631	-
4415128	DG-605	-
4416912	DG-005	-
4423206	DG-631	-
4430069	DG-126	-
4430920	DG-126	-
4506155	DG-126	-
47 08 892	ZXU20PR11	-
4708970	DG-171	-
48 02 903	ITL16TT	ITL16TT
48 05 484	PT16VR13	TV16TT
48 11 581	ITV16TT	ITV16TT

OPEL	DENSO	TT
4805511	DG-604	-
5614216	DG-012	-
5614218	DG-001	-
5614219	DG-012	-
5614221	DG-143	-
88900715	DG-117	-
88900716	DG-109	-
88900717	DG-144	-
88900718	DG-155	-
88900719	DG-184	-
88900720	DG-007	-
88900722	DG-005	-
88900723	DG-012	-
88900724	DG-119	-
88900725	DG-001	-
88900726	DG-003	-
88900727	DG-106	-
88900728	DG-001	-
88900729	DG-102	-
88900731	DG-001	-
88900732	DG-123	-
88900733	DG-001	-
88900734	DG-001	-
88900736	DG-001	-
88900737	DG-004	-
88900738	DG-001	-
88900739	DG-143	-
88900740	DG-006	-
88900743	DG-124	-
90040991	DG-123	-
90051950	DG-001	-
90093867	DG-001	-
90093897	DG-001	-
90166155	DG-001	-
90210824	DG-001	-
90487858	DG-001	-
90540864	DG-001	-
90569338	DG-118	-
91153919	DG-109	-
94439218	DG-143	-
97127646	DG-646	-

OPEL-VAUXHALL	DENSO	TT
12 14 091	XU22EPR-U	XU22TT
12 14 092	XU22EPR-U	XU22TT
12 14 093	IXU27	-
12 14 100	ITV20TT	ITV20TT
12 14 102	IXU27	-
12 14 106	DG-658	-
12647827	ITV20TT	ITV20TT
48 02 239	DG-653	-
55188857	XU22EPR-U	XU22TT
55198201	XU22EPR-U	XU22TT
55210685	IXU27	-
55249868	IXU27	-
55500619	ITV20TT	ITV20TT

PEUGEOT-CITROËN AUTOMOBILE	DENSO	TT
16 078 499 80	DG-656	-
E161043	DG-180	-

PIAGGIO	DENSO	TT
493061	DG-001	-
641387	Y27FER-C	-
P2M	W27ESR-U	-
P4M	W22ESR-U	-
P82M	IWF22	-
P86M	W16FSR	-

POLARIS	DENSO	TT
3070189	IT22	-

PORSCHE	DENSO	TT
92809460203	W20EPR-U	W20TT
955 170 220 90	VXUHC22G	-
95517032090	DG-193	-
999 170 014 90	W27ESR-U	-
999 170 017 90	IW24	-
999 170 044 90	W27ESR-U	-
999 170 220 90	VXUHC22G	-
999 170 228 90	VKH22	-
99902080210	W20FSR-U	WF20TT
99917000290	W22FPR-U	-
99917000890	IW24	-
99917000891	IW24	-
99917001090	IW24	-
99917001091	IW24	-
99917002291	IW24	-
99917005090	W22EPR-U	W22TT
99917005190	W22EPR-U	W22TT
99917005290	W22EPR-U	W22TT
99917005590	W22EPR-U	W22TT
99917005690	W22EPR-U	W22TT
99917010390	PK20R11	K20TT
99917010790	W24EPR-U	-
99917011090	IW24	-
99917011190	W22EPR-U	W22TT
99917011990	W20EPR-U	W20TT
99917012690	W20EPR-U	W20TT
99917012890	IW24	-
99917012990	XU22EPR-U	XU22TT
99917013290	W16EPR-U	W16TT
99917013390	W16EPR-U	W16TT
99917013590	W22EPR-U	W22TT
99917013690	W16EPR-U	W16TT
99917013890	W20EPR-U	W20TT
99917013990	W20EPR-U	W20TT
99917014190	W20FPR-U	WF20TT
99917014290	W20FPR-U	WF20TT
99917014690	W20EPR-U	W20TT
99917014890	W20EPR-U	W20TT
99917016590	W22EPR-U	W22TT
99917016790	W20FPR-U	WF20TT
99917016890	W20EPR-U	W20TT
99917017090	W16EPR-U	W16TT
99917017690	X24ESR-U	-
99917018290	K22PBR-S	IKB22TT
99917018390	K20PBR-S	IKB22TT
99917018690	IW24	-
99917019590	K22TNR-S	-
99917020190	K20TNR	K20TT
99917020490	K20PBR-S10	K20TT
99917020491	K20PBR-S10	K20TT
99917020791	K20PBR-S10	K20TT
99917021890	K20PBR-S10	K20TT
99917021990	K20PBR-S10	K20TT
99917022190	VK22	IK22FTT
99917022300	K22PBR-S	IKB22TT
99917022390	IK22	IK22FTT
99917022790	IK24	-
99917022990	IKH22	-
N1781119	W20ESR-U	-
N1781113	W22EPR-U	W22TT
N1781118	W20EPR-U	W20TT
N1781216	W20ESR-U	-
N178128	W20EPR-U	W20TT
N1781399	W20EPR-U	W20TT

POWER LAWN PARTS	DENSO	TT
PLP14JC	W14MR-U	-
PLP6JD	T22M-U	-
PLP7JD	T20M-U	-
PLP8J	W14PR-U	-
PLP8JC	W20M-US	-

Свечи зажигания и Свечи накаливания

Таблица взаимозаменяемости - OE

POWER LAWN PARTS	DENSO	TT
PLP8JD	T20M-U	-

PROTON	DENSO	TT
LAP6FS	MA20P-U	-
LAPR6FS	MA20PR-U	-
LBCP6ES	Q20PR-U	Q20TT
LBCPR6ES	Q20PR-U	Q20TT
LBP5ES	W16EPR-U	W16TT
LBP6EFS	T20EPR-U	T20TT
LBP6ES	W20EPR-U	W20TT
LBPR6EFS	T20EPR-U	T20TT
MS851232E	W16EPR-U	W16TT
MS851233E	W20EPR-U	W20TT
MS851358E	K20PR-U11	K20TT

RENAULT	DENSO	TT
11065-0819R	DG-631	-
11065-1492R	DG-631	-
11065-1749R	DG-631	-
22401-1TT1C	VFXEHC22G	-
22401-8760R	XE20HR-U9	IXEH20TT
5001001587	DG-001	-
6001004972	IT27	-
6001040356	K20PBR-S10	K20TT
6001040357	K20PBR-S10	K20TT
6001040543	T16EPR-U	T16TT
7439146775	K20PBR-S10	K20TT
7700100558	DG-008	-
7700100586	DG-101	-
7700100635	DG-112	-
7700101401	Q16PR-U	Q16TT
7700103502	W16EPR-U	W16TT
7700103503	W16EPR-U	W16TT
7700103533	K20TXR	K20TT
7700103674	DG-126	-
7700105290	DG-009	-
7700107916	K20TXR	K20TT
7700111323	DG-005	-
7700111940	DG-112	-
7700115827	K20TXR	K20TT
7700260637	K20TXR	K20TT
7700267140	T20EPR-U	T20TT
7700267805	IT22	-
7700273462	K20PR-U	K20TT
7700273698	PK20PR-P8	IK20TT
7700274004	K20PR-U	K20TT
7700274154	K20PR-U	K20TT
7700274155	K20PR-U	K20TT
7700500000	W20EPR-U	W20TT
7700500012	W16EPR-U	W16TT
7700500024	W24EPR-U	-
7700500036	IW24	-
7700500048	W16EPR-U	W16TT
7700500072	T20EPR-U	T20TT
7700500084	T20EPR-U	T20TT
7700500096	K20TXR	K20TT
7700500108	T22EP-U	-
7700500120	IW22	-
7700500132	K20PBR	K20TT
7700500144	K20PBR	K20TT
7700500155	K20PR-U	K20TT
7700500155	SK20PR-A8	IK20TT
7700500168	K20TXR	K20TT
7700500180	K20PR-U	K20TT
7700500192	K16HPR-U11	KH16TT
7700500204	T16EPR-U	T16TT
7700500216	IK22	IK22FTT
7700500228	IT27	-
7700500240	PK20PR-L11	IK20TT
7700529980	W20FPR-U	WF20TT
7700558395	W16FPR-U	-

RENAULT	DENSO	TT
7700565155	IW27	-
7700587168	W20FPR-U	WF20TT
7700692428	W16EPR-U	W16TT
7700701130	DG-001	-
7700704185	DG-001	-
7700714540	IK20	IK20TT
7700715768	DG-001	-
7700722095	T20EPR-U	T20TT
7700722395	T20EPR-U	T20TT
7700724821	W16EPR-U	W16TT
7700725302	W16EPR-U	W16TT
7700726503	T22EP-U	-
7700727383	IT20TT	IT20TT
7700731583	T22EP-U	-
7700732626	W24EPR-U	-
7700733076	DG-001	-
7700733422	W20EPR-U	W20TT
7700734955	DG-006	-
7700735455	IW22	-
7700736149	T22EP-U	-
7700736150	T22EP-U	-
7700737457	W20EPR-U	W20TT
7700737458	T20EPR-U	T20TT
7700737459	W24EPR-U	-
7700737612	Q16R-U	Q16TT
7700741144	DG-001	-
7700742094	W22EPR-U	W22TT
7700743137	Q16R-U	Q16TT
7700749163	Q16R-U	Q16TT
7700824821	W16EPR-U	W16TT
7700852543	IT22	-
7700854538	DG-012	-
7700855463	K20PBR	K20TT
7700855865	DG-001	-
7700855918	IT20TT	IT20TT
7700856238	DG-001	-
7700856292	DG-012	-
7700856342	K20PBR	K20TT
7700856908	Q16R-U	Q16TT
7700856909	Q16PR-U	Q16TT
7700856910	Q20PR-U	Q20TT
7700858208	DG-101	-
7700858444	K20PBR-S10	K20TT
7700859910	Q16R-U	Q16TT
7700859967	W16EXR-U	W16TT
7700860235	W16EXR-U	W16TT
7700860796	DG-101	-
7700861471	W24EPR-U	-
7700861906	DG-101	-
7700862054	IW22	-
7700867002	DG-009	-
7700867617	DG-012	-
7700868864	W16EPR-U	W16TT
7700869200	K16PR-U	K16TT
7700871617	K20PBR	K20TT
7700874336	DG-009	-
7701021767	T20EPR-U	T20TT
7701023080	W20EPR-U	W20TT
7701029762	DG-001	-
7701032921	T22EP-U	-
7701033403	DG-001	-
7701035956	DG-001	-
7701039387	DG-001	-
7701040208	DG-004	-
7701041214	W16EPR-U	W16TT
7701041215	T20EPR-U	T20TT
7701043624	K20PBR	K20TT
7701052949	DG-646	-
7701057806	DG-646	-
7701058142	DG-605	-
7701065085	FXE20HR11	IXEH20TT

RENAULT	DENSO	TT
7701069730	DG-005	-
7701069731	DG-001	-
7701349475	DG-001	-
7701349943	DG-001	-
7701349949	DG-012	-
7701366084	IW24	-
7701366085	IW24	-
7701366086	W20EPR-U	W20TT
7701366087	W24EPR-U	-
7701366137	T20EPR-U	T20TT
7701366138	W20EPR-U	W20TT
7701366267	W20EPR-U	W20TT
7701366268	W22EPR-U	W22TT
7701366269	W16EPR-U	W16TT
7701366270	T20EPR-U	T20TT
7701366513	IW22	-
7701366514	T20EPR-U	T20TT
7701366515	W16FPR-U	-
7701366516	IWF20	-
7701366533	IW20	IW20TT
7701366539	W16EPR-U	W16TT
7701366903	IWF16	-
7701414021	W16EPR-U	W16TT
7701414022	IWF20	-
7701414023	W16FPR-U	-
7701414024	IW20	IW20TT
7701414025	IW22	-
7701414026	IW20	IW20TT
7701414027	IT22	-
7701414028	IT22	-
7701414029	T22EP-U	-
7701414030	IT20TT	IT20TT
7701414031	IT20TT	IT20TT
7701414032	W16EPR-U	W16TT
7701414036	W16EPR-U	W16TT
7701414037	IWF22	-
7701414038	IWF22	-
7701414039	IT20TT	IT20TT
7701414040	IK20	IK20TT
7701414056	IK22	IK22FTT
7701414065	IT20TT	IT20TT
7701414066	IK22	IK22FTT
7701414072	DG-001	-
7701414076	DG-001	-
7701414077	DG-012	-
7701414078	DG-123	-
7701414080	DG-001	-
7701414081	DG-004	-
7701414084	DG-202	-
7701414086	DG-001	-
7701414088	DG-012	-
7701414107	DG-010	-
7701414108	DG-001	-
7701414123	DG-001	-
7701414157	DG-010	-
7701742094	IT27	-
8200012099	DG-126	-
8200020791	K20PR-U	K20TT
8200020796	K20PR-U	K20TT
8200021856	K20PR-U	K20TT
8200030765	XE20HR-U9	IXEH20TT
8200033622	K20PR-U	K20TT
8200034236	K16HPR-U11	KH16TT
8200046337	PK20PR-P8	IK20TT
8200090817	DG-001	-
8200120796	IKH20TT	IKH20TT
8200239321	PK20PR-L11	IK20TT
8200314928	VK22	IK22FTT
8200322273	XE20HR-U9	IXEH20TT
8200332273	XE20HR-U9	IXEH20TT
8200363384	PK20PR-P8	IK20TT

RENAULT	DENSO	TT
8200421091	DG-005	-
8200423227	DG-112	-
8200434855	DG-005	-
8200445627	DG-126	-
8200464077	DG-005	-
8200490950	DG-005	-
8200492426	VK22	IK22FTT
8200592215	XE20HR-U9	IXEH20TT
8200656784	K20PR-U	K20TT
8200662185	XE20HR-U9	IXEH20TT
8200682592	DG-609	-
8200787721	DG-112	-
8200794920	DG-619	-
8304504277	KJ16CR-L11	K16TT
8660001621	DG-609	-
8671004070	K20TXR	K20TT
8671004086	K20PR-U	K20TT
8671004086	SK20PR-A8	IK20TT
8671004853	DG-005	-
8933003862	K20PR-U	K20TT
9632182880	PK20PR11	K20TT
9636415880	IKH16TT	IKH16TT
UE0073007	IK20	IK20TT

ROLLS-ROYCE	DENSO	TT
12120037608	K20TXR	K20TT
12120148591	K20TXR	K20TT
RH12050	IW16	IW16TT
RH13439	IK16	IK16TT
RH13998	IK16	IK16TT
UEM78911	IK22	IK22FTT

ROTAX	DENSO	TT
278000609	W24ESR-U	-
278001574	KJ14CR-L11	-
297940	XU24EPR-U	-
414961100	W27ESR-U	-
897255	XU22EPR-U	XU22TT
897257	X27EPR-U9	-

ROVER	DENSO	TT
ADU9830	DG-001	-
DBP9184	W20EPR-U11	W20TT
ERR743	W20EX-U	W20TT
ETC7244	W16EPR-U	W16TT
FDU2522	Q20PR-U11	Q20TT
FDU2522EVA	Q20PR-U11	Q20TT
GSP161	W20EPR-U	W20TT
GSP163	W20EPR-U	W20TT
GSP181	W20EPR-U	W20TT
GSP2001	PK20PR-P8	IK20TT
GSP264	W20EPR-U	W20TT
GSP281	W22EPR-U	W22TT
GSP361	T20EPR-U	T20TT
GSP4362	W20EP-U	W20TT
GSP4382	W16EPR-U	W16TT
GSP4452	W20EPR-U	W20TT
GSP4462	W20EX-U	W20TT
GSP4482	W16EPR-U	W16TT
GSP4552	Q20PR-U	Q20TT
GSP4562	Q20PR-U	Q20TT
GSP4652	K22PR-U	IK22FTT
GSP4662	K20PR-U	K20TT
GSP5658	K20PR-U11	K20TT
GSP665	PK20PR-P8	IK20TT
GSP6652	K20PR-U	K20TT
GSP66527	PK16PR-L11	IK16TT
GSP6662	K20PR-U	K20TT
GSP7662	K20PR-U	K20TT
GSP7663	KJ20CR-L11	K20TT
GSP7664	KJ20CR-L11	K20TT

Свечи зажигания и Свечи накаливания

Таблица взаимозаменяемости - OE

ROVER	DENSO	TT
GSP7669	W20EPR-U	W20TT
GSP9652	PK20PR-P8	IK20TT
NCC10001	DG-001	-
NCC10002	DG-004	-
NCC100050	DG-101	-
NCC100120	DG-145	-
NLP000030	K20PBR-S10	K20TT
NLP000040	PK20PR-P8	IK20TT
NLP000050	KJ20CR-L11	K20TT
NLP000120	IT20TT	IT20TT
NLP007664EVA	KJ20CR-L11	K20TT
NLP007666EVA	KJ16CR-L11	K16TT
NLP1000320	PK16PR11	K16TT
NLP10010	W20EP-U	W20TT
NLP100130	KJ20CR-L11	K20TT
NLP100240	K20PR-U11	K20TT
NLP100260	W20EPR-U	W20TT
NLP100290	PK16PR-L11	IK16TT
RTC3571	W20EX-U	W20TT
RTC3573	W16FPR-U	-
XHM279	K20PR-U	K20TT
XHM281	K20PR-U	K20TT

SAAB	DENSO	TT
12787099	PK20PR-L11	IK20TT
32000118	K20PBR-S10	K20TT
4444741	K20TXR	K20TT
4501029	K20TXR	K20TT
4772471	DG-142	-
4811581	ITV16TT	ITV16TT
5344502	DG-142	-
55564162	DG-608	-
55564763	IK20L	IK20TT
5954839	DG-646	-
7504442	K22PR-U	IK22FTT
8350076	W20EPR-U11	W20TT
8814402	W20EPR-U11	W20TT
8819302	IQ22	-
8819310	IW22	-
8819328	IW22	-
8819336	W20EPR-U11	W20TT
885004	IW20	IW20TT
885087	M22	-
885095	IQ20TT	IQ20TT
8851297	PQ20R	Q20TT
885186	IQ22	-
885210	IQ20TT	IQ20TT
885244	Q22PR-U11	-
885285	IW20	IW20TT
885293	IW22	-
885308	IW22	-
885511	IWF22	-
885632	IQ22	-
885756	IQ16TT	IQ16TT
885855	IQ20TT	IQ20TT
885999	Q22PR-U	-
9112541	Q22PR-U11	-
9116385	Q16R-U	Q16TT
9117565	Q20PR-U11	Q20TT
9136276	IQ16TT	IQ16TT
9139643	IQ20TT	IQ20TT
9171307	K22PR-U11	IK22FTT
9188681	PK22PR-L11S	-
9399866	PQ20R	Q20TT

SEAT	DENSO	TT
030 905 999 16	W22EPR-U	W22TT
048 905 999 4	W22EPR-U	W22TT
N10302101	DG-628	-
N10302102	DG-628	-
SE021919000A	Q22PR-U	-

SEAT	DENSO	TT
SE021919000B	Q22PR-U	-
SE127919000A	W20EPR-U	W20TT
SE127919000B	W20EPR-U	W20TT
SE127919000C	W20EPR-U	W20TT
SE138919000A	DG-001	-
X03965520	DG-001	-

SKODA	DENSO	TT
06H905601A	PK22PR8	IK22TT
JZW905603A	PKJ16CR-L11	IK16TT
N10302101	DG-628	-
N10302102	DG-628	-

SMART	DENSO	TT
0004562V003000000	DG-184	-
003085V005000000	K20TXR	K20TT
11594601	DG-606	-
1221590003	XU22HDR9	XUH22TT
1321590003	XU22HDR9	XUH22TT
1321590103	XU22HDR9	XUH22TT
1351500018	K20HR-U11	KH20TT
1351500118	KH20TT	KH20TT
3085V005000000	K20TXR	K20TT
4562V003	DG-184	-
6601590201	DG-184	-
A0011594601	DG-606	-
A1321590003	XU22HDR9	XUH22TT
A1321590103	XU22HDR9	XUH22TT
A1351500018	K20HR-U11	KH20TT
A6601590201	DG-184	-
Q0003085V005000000	K20TXR	K20TT

SSANGYONG	DENSO	TT
1621593046	Q20PR-U	Q20TT
1621593103	K20TXR	K20TT
1721590003	VXUH22I	IXUH22TT
6641590001	DG-188	-
6641590101	DG-188	-
6641590201	DG-188	-
6651590001	DG-188	-
6651590101	DG-188	-
A6641590001	DG-188	-
A6641590101	DG-188	-
A6641590201	DG-188	-
A6651590001	DG-188	-
A6651590101	DG-188	-
P96307562	PK20PR-L11	IK20TT

STI	DENSO	TT
ST224014S000	IK20	IK20TT
ST224014S010	IK22	IK22FTT
ST224014S020	IK24	-

SUBARU	DENSO	TT
09019-01211	PK20PR-P8	IK20TT
09482-00299	W20EPR-U	W20TT
09482-00506	W16EPR-U	W16TT
22401-AA000	W16EPR-U11	W16TT
22401-AA010	W20EPR-U11	W20TT
22401-AA020	W20EPR-U	W20TT
22401-AA060	IW16	IW16TT
22401-AA080	W20EXR-U11	W20TT
22401-AA090	W22EPR-U	W22TT
22401-AA100	J16AR-U11	-
22401-AA110	J16AR-U11	-
22401-AA120	W20EPR-U11	W20TT
22401AA130	W20EPR-U11	W20TT
22401-AA130	W20EPR-U11	W20TT
22401-AA130	W20EPR-U11	W20TT
22401-AA130	W20EPR-U11	W20TT
22401-AA160	W22EP-U	W22TT
22401-AA200	W20EPR-U	W20TT

SUBARU	DENSO	TT
22401AA210	W22EPR-U	W22TT
22401-AA210	W22EPR-U	W22TT
22401-AA220	W20EPR-U	W20TT
22401-AA310	K20PR-U11	K20TT
22401AA320	K20PR-U11	K20TT
22401-AA320	K20PR-U11	K20TT
22401-AA370	PK20PR11	K20TT
22401-AA371	PK16PR-L11	IK16TT
22401AA390	J16AR-U11	-
22401-AA390	J16AR-U11	-
22401-AA400	PK20PR-P8	IK20TT
22401AA460	W16EXR-U11	W16TT
22401-AA460	W16EXR-U11	W16TT
22401AA470	W20EXR-U11	W20TT
22401-AA470	W20EXR-U11	W20TT
22401-AA480	W16EXR-U11	W16TT
22401AA490	PK20PR11	K20TT
22401-AA500	IK20	IK20TT
22401-AA510	IK20	IK20TT
22401-AA520	PK20PR11	K20TT
22401-AA530	PK20PR-P8	IK20TT
22401-AA531	PK20PR-P8	IK20TT
22401-AA540	K20PR-U11	K20TT
22401-AA550	K16PR-U11	K16TT
22401-AA570	PK16PR-L11	IK16TT
22401-AA580	IKH20TT	IKH20TT
22401-AA600	PK22PR8	IK22TT
22401-AA610	IK20L	IK20TT
22401-AA630	VKH20Y	-
22401-AA650	PK16PR11	K16TT
22401-AA65A	PK16PR11	K16TT
22401-AA660	VKH22	-
22401-AA670	VKH20Y	-
22401-AA700	FK20HR11	IKH20TT
22401-AA720	IKH20TT	IKH20TT
22401-AA730	IK20TT	IK20TT
22401-AA740	VKH20Y	-
22401-AA750	IKH20TT	IKH20TT
22401-AA751	IKH20TT	IKH20TT
22401-AA760	VKH20Y	-
22401-AA761	VKH20Y	-
22401-AA780	IXEH22TT	IXEH22TT
22401-AA781	IXEH22TT	IXEH22TT
22401-AA800	VXEBH27	-
22401-AA801	VXEBH27	-
22401-EA015	FXE20HR11	IXEH20TT
22401-KA000	W20EPR-S11	W20TT
22401-KA010	Q20P-U11	Q20TT
22401KA030	Q20P-U11	Q20TT
22401-KA030	Q20P-U11	Q20TT
22401-KA050	W20EPR-S11	W20TT
22401KA060	W20EPR-S11	W20TT
22401-KA060	W20EPR-S11	W20TT
22401-KA080	K20PR-U11	K20TT
22401KA090	Q20PR-U	Q20TT
22401-KA090	Q20PR-U	Q20TT
22401-KA100	Q20PR-U	Q20TT
22401KA130	W20EPR-U	W20TT
22401-KA130	W20EPR-U	W20TT
22401KA150	K20PR-U	K20TT
22401-KA150	K20PR-U	K20TT
22401KA190	W16EPR-U11	W16TT
22401-KA190	W16EPR-U11	W16TT
22401KA200	K16PR-U11	K16TT
22401-KA200	K16PR-U11	K16TT
22401-KA210	K16PR-U11	K16TT
22401-KA240	XU22EPR-U	XU22TT
22401KA260	XU22EPR-U	XU22TT
22401-KA260	XU22EPR-U	XU22TT
22401-KA290	IK16	IK16TT
22401-KA310	XU24EPR-U	-

SUBARU	DENSO	TT
22401-KA320	IXU24	-
22401-KA330	IK20	IK20TT
22401-KA340	IXU24	-
22401-KA430	PK20TR11	K20TT
22401-KA440	K16PR-U	K16TT
22401-KA450	IXUH22	IXUH22TT
22401-KA460	SK20PR-A8	IK20TT
22439-AA000	DG-615	-
380280102	W20EX-U	W20TT
380280802	W16ESR-U	-
380280802	W16ES-U	-
380281102	W22ESR-U	-
380281102	W22ES-U	-
420543200	W16EPR-U	W16TT
420545402	W16EPR-U	W16TT
420545502	W20EP-U	W20TT
420545702	W20EPR-U11	W20TT
420545800	J16BR-U	-
420545802	J16BR-U	-
420547102	W16EX-U	W16TT
420547302	W16EXR-U11	W16TT
420547602	W20EPR-U11	W20TT
420547702	W20EPR-U11	W20TT
480281302	W20ESR-U	-
480281302	W20ES-U	-
480287002	W14EX-U	IW16TT
480287100	W14EXR-U11	IW16TT
482415700	W16EPR-U	W16TT
490010033	W16EPR-U	W16TT
490010043	W16EXR-U	W16TT
490010053	W20EX-U	W20TT
490010072	W14EXR-U	IW16TT
490010082	W16EXR-U	W16TT
490010092	W20EXR-U	W20TT
820541812	W20FSR-U	WF20TT
820546012	W24FSR	-
820548600	W20ESR-U	-
820549312	W22FS-U	-
880287802	W16FSR	-
880287802	W16FS-U	-
90048-51188	SXU22PR9	IXU22TT
90048-51188-000	SXU22PR9	IXU22TT
90048-51189	XU22HDR9	XUH22TT
90048-51192	XU20HR9	XUH20TT
90048-51198	VXUH22I	IXUH22TT
90048-51207	VXUH20I	-
90048-51208	VXUH20I	-
90048-51210	VXUH22I	IXUH22TT
90048-51215	VXUH20I	-
90048-51216	IXEH20TT	IXEH20TT
90919-01243	FK16HR11	IKH16TT
90919-01253	SC16HR11	IXEH20TT
90919-01280	FC16HR8	IXEH20TT
SAB330DE0710	PK16PR-L11	IK16TT
SAB330DE0720	IK20TT	IK20TT
SAB330DE0730	VK22	IK22FTT
SAB330DE0800	VXU22	IXU22TT
SAB330DE0810	VXU24	-
SAB330DE2340	K20PR-U	K20TT
SAB330DE2640	IKH20	IKH20TT
SAB330DE2650	IKH22	-
SAB330DE2670	VKH20Y	-
SAB330DE2680	VKH22	-
SAB330DE2800	VK20Y	-
SAB330DE3360	IK16	IK16TT
SAB330DE3370	IK20	IK20TT
SAB330DE3430	IXU22	IXU22TT
SAB330DE3440	IXU24	-
SAB330DE3450	IK22	IK22FTT
SAB330DE3715	ITV20TT	ITV20TT
SAB330DE3730	VK22	IK22FTT

Свечи зажигания и Свечи накаливания

Таблица взаимозаменяемости - OE

SUBARU	DENSO	TT
SAB330DE3800	VXU22	IXU22TT
SAB330DE3810	VXU24	-
SAB330DE3950	VK20Y	-
SAB330DE4540	IKH20TT	IKH20TT
SAB330DE4540	VKH20Y	-
SAB330DE5140	IKH20	IKH20TT
SAB330DE5170	IKH22	-
SAB330DE5260	VKH20Y	-
SAB330DE5270	VKH22	-
SAB330DE8430	IK22	IK22FTT
SAB330DE8640	SK16PR-A11	IK16TT
SAB330DE8680	IK16	IK16TT
SAB330DE8690	IK20	IK20TT
SAB330DE8720	IXU22	IXU22TT
SAB330DE8730	IXU24	-
SAB330DE8740	IXUH22	IXUH22TT
SAB330DE8750	VXUH22	IXUH22TT
SAB330DE8760	IXUH22I	IXUH22TT
SAB330DE8770	VXUH22I	IXUH22TT
SAB330NG0508	IK16	IK16TT
SAB330NG0511	IK16	IK16TT
SAB330NG0608	IK20	IK20TT
SAB330NG0611	IK20	IK20TT
SAB330NG1708	IXU22	IXU22TT
SAB330NG4611	IKH20	IKH20TT
SAB330NG8708	VK22	IK22FTT
SAB330NG9708	VXU22	IXU22TT
SAB33NG5708	IK22	IK22FTT
SAB33NG6808	IXU24	-
SOA528000	W20EPR-U11	W20TT

SUZUKI	DENSO	TT
09482-00004	IQ16TT	IQ16TT
09482-00036	W14FPR-U	-
09482-00041	W14FPR-U	-
09482-00052	W22FS-U	-
09482-00054	W20ESR-U	-
09482-00057	W24FSR	-
09482-00058	W20FSR-U	WF20TT
09482-00061	IWF24	-
09482-00062	W20FPR-U	WF20TT
09482-00066	W27ESR-U	-
09482-00068	IW01-24	-
09482-00068	W20ES-U	-
09482-00071	W20ESR-U	-
09482-00082	W22FS-U	-
09482-00083	IWF22	-
09482-00083	W22FS-U	-
09482-00084	W20FPR-U	WF20TT
09482-00085	W22FS-U	-
09482-00089	W22ESR-U	-
09482-00090	W20FPR-U	WF20TT
09482-00091	W24ESR-U	-
09482-00092	W22ESR-U	-
09482-00094	W24ESR-U	-
09482-00095	W20FSR-U	WF20TT
09482-00105	W22FPR-U	-
09482-00106	IW01-24	-
09482-00118	W20EPR-U	W20TT
09482-00119-7	W27ESR-U	-
09482-00120	W16FPR-U	-
09482-00121	W24ESR-U	-
09482-00123	W16EXR-U	W16TT
09482-00123	W16EX-U	W16TT
09482-00124	W16FPR-U	-
09482-00128	W20ESR-U	-
09482-00128	W20ES-U	-
09482-00129	W14EX-U	IW16TT
09482-00130	W14EX-U	IW16TT
09482-00131	W16EPR-U	W16TT
09482-00132	W22FPR-U	-

SUZUKI	DENSO	TT
09482-00136	W14FPR-UL	-
09482-00138	W16EPR-U	W16TT
09482-00139	W22EPR-U	W22TT
09482-00140	W14FPR-U	-
09482-00141	W20FPR-U	WF20TT
09482-00142	W14F-U	-
09482-00144	X24ESR-U	-
09482-00145	X24ESR-U	-
09482-00145	X24ES-U	-
09482-00147	W16FPR-U	-
09482-00149	X24ESR-U	-
09482-00154	W22EPR-U	W22TT
09482-00155	W16EPR-U	W16TT
09482-00159	W14EXR-U	IW16TT
09482-00160	W20EPR-U	W20TT
09482-00162	IW27	-
09482-00163	W16FPR-U	-
09482-00167	W16EXR-U	W16TT
09482-00170	W14FPR-UL	-
09482-00171	W14FPR-UL	-
09482-00173	W14FPR-UL	-
09482-00173	W9FP-UL	-
09482-00175	W24EPR-U	-
09482-00176	W9FP-UL	-
09482-00178	W24EPR-U	-
09482-00180	IW31	-
09482-00182	X22ESR-U	-
09482-00183	X22ESR-U	-
09482-00183	X22ES-U	-
09482-00184	X27ESR-U	-
09482-00185	X27ESR-U	-
09482-00186	W14FPR-U	-
09482-00186	W14FP-U	-
09482-00187	IWF24	-
09482-00187	W16FP-U	-
09482-00188	W20FPR-U	WF20TT
09482-00188	W20FP-U	WF20TT
09482-00189	W22FPR-U	-
09482-00189	W22FP-U	-
09482-00190	W20FSR-U	WF20TT
09482-00191	W22FS-U	-
09482-00192	W24FSR	-
09482-00192	W24FS-U	-
09482-00193	W20EP-U	W20TT
09482-00194	W16FPR-U	-
09482-00194	W22EP-U	W22TT
09482-00195	W22ESR-U	-
09482-00195	W22ES-U	-
09482-00196	W24ESR-U	-
09482-00196	W24ES-U	-
09482-00197	W22EPR-U	W22TT
09482-00197	W27ES-U	-
09482-00205	W14FPR-UL	-
09482-00206	W14FPR-UL	-
09482-00208	IW24	-
09482-00209	IW27	-
09482-00210	IW31	-
09482-00216	W14EXR-U11	IW16TT
09482-00217	W16EXR-U11	W16TT
09482-00218	W14EXR-U11	IW16TT
09482-00222	X22ESR-U	-
09482-00223	X24ESR-U	-
09482-00224	X27ESR-U	-
09482-00231	W27ESR-U	-
09482-00233	W27ESR	-
09482-00233	W27ESR-U	-
09482-00233-111	W27ESR	-
09482-00233-111	W27ESR-U	-
09482-00239	W24EPR-U	-
09482-00240	W24EPR-U	-

SUZUKI	DENSO	TT
09482-00240-111	W24EPR-U	-
09482-00241	IW27	-
09482-00241	W24FSR	-
09482-00241-111	IW27	-
09482-00241-111	W24FSR	-
09482-00242	W24FSR	-
09482-00242-111	W24FSR	-
09482-00243	W14FPR-U	-
09482-00243-111	W14FPR-U	-
09482-00244	W22FPR-U	-
09482-00244-111	W22FPR-U	-
09482-00245	W22ESR-U	-
09482-00245-000	W22ESR-U	-
09482-00245-111	W20FPR-U	WF20TT
09482-00246	W27ESR	-
09482-00247	W24ESR	-
09482-00247-111	W24ESR	-
09482-00249	W22FSR	-
09482-00249-111	W22FSR	-
09482-00250	W24FSR	-
09482-00251	W24ESR	-
09482-00252	W24ESR-U	-
09482-00253	W22EPR-U	W22TT
09482-00253-000	W22EPR-U	W22TT
09482-00255	W22FPR-U	-
09482-00258	W20MPR-U10	-
09482-00261	W14MPR-U10	-
09482-00262	W16FPR-U	-
09482-00263	W16FPR-U	-
09482-00264	W20FPR-U10	WF20TT
09482-00265	W20FPR-U10	WF20TT
09482-00265-111	W20FP-U	WF20TT
09482-00269	W22FS-U	-
09482-00273	W22ESR-U	-
09482-00273-111	W22ESR-U	-
09482-00274	W24FP-U	-
09482-00274-111	W24FP-U	-
09482-00278	W24FSR-U10	-
09482-00280	W24FSR-U10	-
09482-00284	W20EXR-U11	W20TT
09482-00285	W20EPR-U11	W20TT
09482-00286	W20EXR-U11	W20TT
09482-00287	W16EPR-U11	W16TT
09482-00294	U20FSR-U	-
09482-00295	W24FP-U	-
09482-00298	W16FPR-U	-
09482-00298-111	W16FPR-U	-
09482-00299	W20EPR-U	W20TT
09482-00300	W20EXR-U	W20TT
09482-00302	W20FPR-U	WF20TT
09482-00302-111	W20FPR-U	WF20TT
09482-00303	W20EX-U	W20TT
09482-00312	W16EXR-U11	W16TT
09482-00314	U22FSR-U	-
09482-00314-000	U22FSR-U	-
09482-00316	W16FPR-U	-
09482-00317	U24FSR-U	-
09482-00318	U24FS-U	-
09482-00318	W20EXR-U	W20TT
09482-00318-111	W20EXR-U	W20TT
09482-00320	U24FSR-U	-
09482-00320-111	U24FSR-U	-
09482-00322	IW16	IW16TT
09482-00329	U24FSR-U	-
09482-00329-111	U24FSR-U	-
09482-00330	X27EPR-U9	-
09482-00331	X27EPR-U9	-
09482-00331-111	X27EPR-U9	-
09482-00332	X24EPR-U9	-
09482-00333	X24EPR-U9	-

SUZUKI	DENSO	TT
09482-00333	X24EP-U9	-
09482-00333-111	X24EPR-U9	-
09482-00334	X24EPR-U9	-
09482-00335	X24EPR-U9	-
09482-00335-111	X24EPR-U9	-
09482-00338	W20FSR-U	WF20TT
09482-00340	U20FSR-U	-
09482-00349	W27ESR-U	-
09482-00353	X27EPR-U9	-
09482-00353-111	X27EPR-U9	-
09482-00354	X22EPR-U9	-
09482-00355	X22EPR-U9	-
09482-00355-111	X22EPR-U9	-
09482-00359	W16FPR-U	-
09482-00361	X22EPR-U9	-
09482-00362	J16CR-U	W16TT
09482-00373	U24FSR-U	-
09482-00374	U24FSR-U	-
09482-00374-111	U24FSR-U	-
09482-00375	W24FSR-U10	-
09482-00378	XU24EPR-U	-
09482-00379	XU24EPR-U	-
09482-00383	U24FSR-U	-
09482-00384	IXU24	-
09482-00385	W22EPR-U	W22TT
09482-00386	IXU22	IXU22TT
09482-00387	IXU24	-
09482-00392	W20EP-U	W20TT
09482-00393	XU20EPR-U	-
09482-00395	J16CR-U	W16TT
09482-00396	IXU22	IXU22TT
09482-00396-111	IXU22	IXU22TT
09482-00397	X27ETR	-
09482-00399	X24ESR-U	-
09482-00400	X27ESR-U	-
09482-00404	U24FSR-U	-
09482-00405	IW27	-
09482-00406	U20FSR-U	-
09482-00407	U20FSR-U	-
09482-00407-000	U20FSR-U	-
09482-00409	W20EPR-U	W20TT
09482-00409	W20EXR-U	W20TT
09482-00410	U27ETR	-
09482-00411	U27ETR	-
09482-00411-000	U27ETR	-
09482-00412	U24ETR	-
09482-00413	U24ETR	-
09482-00415	U22ETR	-
09482-00415-000	U22ETR	-
09482-00416	W16FPR-U	-
09482-00416-111	W16FPR-U	-
09482-00420	W14FPR-U	-
09482-00420-111	W14FPR-U	-
09482-00421	W20EPR-U11	W20TT
09482-00422	IWM01-29	-
09482-00426	K20P-U	K20TT
09482-00427	K20PR-U	K20TT
09482-00428	K20P-U	K20TT
09482-00429	K20PR-U	K20TT
09482-00432	W16EPR-U	W16TT
09482-00433	W16EXR-U11	W16TT
09482-00434	W22EPR-U	W22TT
09482-00434	W22EP-U	W22TT
09482-00443	W24ESR	-
09482-00444	W27ESR	-
09482-00446	XU20EPR-U	-
09482-00447	XU20EPR-U	-
09482-00448	XU22EPR-U	XU22TT
09482-00449	XU22EPR-U	XU22TT
09482-00449-000	XU22EPR-U	XU22TT
09482-00450	XU24EPR-U	-

Свечи зажигания и Свечи накаливания

Таблица взаимозаменяемости - OE

SUZUKI	DENSO	TT
09482-00451	K20P-U	K20TT
09482-00451	XU24EPR-U	-
09482-00453	XU24EPR-U	-
09482-00454	J16CR-U	W16TT
09482-00455	J16CR-U	W16TT
09482-00456	U24ESR-N	-
09482-00457	U24ESR-N	-
09482-00457-000	U24ESR-N	-
09482-00458	U27ESR-N	-
09482-00459	U27ESR-N	-
09482-00459-000	U27ESR-N	-
09482-00461	U31ESR-N	-
09482-00461-000	U31ESR-N	-
09482-00462	U31ETR	-
09482-00463	U31ETR	-
09482-00468	W16EPR-U	W16TT
09482-00469	W14EPR-U	W16TT
09482-00471	J16CR-U	W16TT
09482-00476	K16PR-U	K16TT
09482-00477	K16PR-U	K16TT
09482-00478	W31ESR-U	-
09482-00479	IXU22	IXU22TT
09482-00481	IXU24	-
09482-00482	IWM31	-
09482-00484	IXU22	IXU22TT
09482-00487	W20EPR-U	W20TT
09482-00493	W16EPR-U11	W16TT
09482-00494	K20PR-U11	K20TT
09482-00495	W22EPR-U	W22TT
09482-00496	W16EPR-U11	W16TT
09482-00497	K16PR-U11	K16TT
09482-00498	W22EPR-U	W22TT
09482-00499	IW24	-
09482-00500	IW27	-
09482-00503	IXU24	-
09482-00504	W16EXR-U	W16TT
09482-00505	K20PR-U	K20TT
09482-00506	W16EPR-U	W16TT
09482-00508	K20PR-U11	K20TT
09482-00509	IW01-24	-
09482-00510	K20PR-U11	K20TT
09482-00512	W22ESR-U	-
09482-00515	U22ESR-N	-
09482-00515-000	U22ESR-N	-
09482-00516	U22ESR-N	-
09482-00520	IXU22	IXU22TT
09482-00521	P16PR11	W16TT
09482-00522	W22FPR-U	-
09482-00525	VXU22	IXU22TT
09482-00527	IXU22	IXU22TT
09482-00529	U20ESR-N	-
09482-00529-000	U20ESR-N	-
09482-00530	W20FPR-U	WF20TT
09482-00532	W22FS-U	-
09482-00534	W20FSR-U	WF20TT
09482-00537	IXU27	-
09482-00546	IW16	IW16TT
09482-00547	SK16PR-A11	IK16TT
09482-00548	SK20PR-A11	IK20TT
09482-00549	SK16PR-A11	IK16TT
09482-00554	IU22	-
09482-00555	IU24D	-
09482-00555-000	IU24D	-
09482-00557	IU27D	-
09482-00557-000	IU27D	-
09482-00559	IU31	-
09482-00562	SK16PR-A11	IK16TT
09482-00563	IXU22	IXU22TT
09482-00584	IU24	-
09482-00600	IU24	-
09482-00602	ZXU20PR11	-

SUZUKI	DENSO	TT
09482-00603	ZXU20PR11	-
09482-00605	K16HPR-U11	KH16TT
09482-00607	IXUH22	IXUH22TT
09482-00608	IXUH22	IXUH22TT
09482-00610	VXU22	IXU22TT
09482-00618	ZXU20PR11	-
09482-00633	VXUH22	IXUH22TT
09482-00634	VXUH22	IXUH22TT
09482-00642	VXUHC22G	-
09482-00647	VXUH20I	-
09482-00647-000	VXUH20I	-
09482-00649	XU20HR9	XUH20TTi
09482-79856	P16PR11	W16TT
09482-79856	W14EXR-U11	IW16TT
09482-A00155	W20EPR-U	W20TT
09482-M00611	ZXU20PR11	-
09482-M00651	VXUH20I	-
09482-M40132	W16EPR-U	W16TT
1119284E00	KJ16CR-L11	K16TT
11192-84E00	KJ16CR-L11	K16TT
1119A-78J00	PT16VR13	TV16TT
13170-79J81	DG-608	-
15320-86CA0	DG-001	-
18550-50KA0	DG-619	-
18550-66G00	DG-001	-
18550-67G00	DG-116	-
18550-67G10	DG-116	-
18550-67G11	DG-116	-
18550-67JG0	DG-005	-
18550-68L10	DG-621	-
18550-73J00	DG-113	-
18550-78E00	DG-146	-
18550-79J50	DG-196	-
18550-79J80	DG-608	-
18550-79J81	DG-608	-
18550-80KA0	DG-619	-
18550-80KA0-000	DG-619	-
18550-84A00	DG-005	-
18550-84A50	DG-005	-
18550-84A51	DG-005	-
18550-84E50	DG-171	-
18550-M68L10	DG-621	-
18550-M86J00	DG-171	-
271175	IK22	IK22FTT
271180	IU24	-
271185	IK24	-
271190	IXU27	-
4DA36-M07	IK22	IK22FTT
4DA36-M08	IK24	-
4DA36-M09	IK27	-
4DA36-M10	IK31	-
4GA36-M08	IXU24	-
4GA36-M09	IXU27	-
9048200448	IXU22	IXU22TT
99000-69835-B6R	IWF22	-
99000-69835-B7R	IWF22	-
99000-69835-B8R	IWF24	-
99000-69835-BP6	IWF20	-
99000-69835-BP7	IWF22	-
99000-69835-BR1	IW31	-
99000-69835-BR8	IW24	-
99000-69835-BR9	IW27	-
99000-69835-C6R	IUF22	-
99000-69835-C7R	IUF22	-
99000-69835-C8R	IUF24	-
99000-69835-CR7	IU22	-
99000-69835-CR8	IU24	-
99000-69835-CR9	IU27	-
99000-69835-DC8	IXU24	-
99000-69835-DR8	IX24	-
99000-69835-DR9	IX27	-

SUZUKI	DENSO	TT
99000-69835-PR7	IX22B	-
99000-69835-PR8	IX24B	-
99000-69835-PR9	IX27B	-
99000-79372	W14EXR-U11	IW16TT
99000-79372	W20EX-U	W20TT
99000-79374	IW24	-
99000-79384	W14FP-U	-
99000-79384	W20EX-U	W20TT
99000-79385	W14FPR-U	-
99000-79385	W16FP-U	-
99000-79386	W20FP-U	WF20TT
99000-79387	W16ES-U	-
99000-79387	W16FPR-U	-
99000-79388	W16ESR-U	-
99000-79388	W22ES-U	-
99000-79389	W22ESR-U	-
99000-79682	W20FSR-U	WF20TT
99000-79682	W20FS-U	WF20TT
99000-79683	W20FSR-U	WF20TT
99000-79683	W22FS-U	-
99000-79684	W22FS-U	-
99000-79684	W24FS-U	-
99000-79A37	IUF24	-
99000-79A37-16E	IW16	IW16TT
99000-79A37-20F	IWF20	-
99000-79A37-22E	IW24	-
99000-79A37-22F	IWF22	-
99000-79A37-24E	IW24	-
99000-79A37-24F	IWF24	-
99000-79A37-24R	IW24	-
99000-79A37-27E	IW27	-
99000-79A37-27R	IW27	-
99000-79A37-29E	IW29	-
99000-79A37-31E	IW31	-
99000-79A37-K0P	IK20	IK20TT
99000-79A37-K6P	IK16	IK16TT
99000-79A37-U2F	IUF22	-
99000-79A37-U4E	IU24	-
99000-79A37-U4F	IUF24	-
99000-79A37-U4R	IUF24	-
99000-79A37-U7E	IU27	-
99000-79A37-U7F	IUF27A	-
99000-79A37-W0P	IW20	IW20TT
99000-79A37-W1M	IWM31	-
99000-79A37-W2P	IW22	-
99000-79A37-W4X	IW16	IW16TT
99000-79A37-W6X	IW16	IW16TT
99000-79A37-W7M	IWM27	-
99000-79A37-X2E	IX22	-
99000-79A37-X4E	IX24	-
99000-79A37-X4P	IX24B	-
99000-79A37-X7E	IX27	-
99000-79A37-X7P	IX27B	-
99000-79A37-XU2	IXU22	IXU22TT
99000-79A37-XU4	IXU24	-
99000-79B56	W14EXR-U11	IW16TT
99000-79J80-K16	IK16	IK16TT
99000-79J80-K20	IK20	IK20TT
99000-79J80-U22	IXU22	IXU22TT
99000-79J80-U24	IXU24	-
99000-79J80-UH2	IXUH22	IXUH22TT
99000-79J80-W16	IW16	IW16TT
99000-79J80-W20	IW20	IW20TT
99000-79J80-W22	IW22	-
99000-79K24-22B	IX22B	-
99000-79K24-24A	IU24A	-
99000-79K24-24B	IX24B	-
99000-79K24-27A	IU27A	-
99000-79K24-27B	IX27B	-
99000-79K24-31A	IU31A	-
99000-79K24-F22	IUF22	-

SUZUKI	DENSO	TT
99000-79K24-F24	IUF24	-
99000-79K24-H24	IUH24	-
99000-79K24-H27	IUH27	-
99000-79K24-IW4	IW24	-
99000-79K24-IW7	IW27	-
99000-79K24-U22	IU22	-
99000-79K24-U24	IU24	-
99000-79K24-U27	IU27	-
99000-79K24-U31	IU31	-
99000-79K24-W22	IWF22	-
99000-79K24-W24	IWF24	-
99000-79K24-W27	IWF27	-
99000-79K24-W31	IW31	-
99000-79K24-X22	IX22	-
99000-79K24-X24	IX24	-
99000-79K24-X27	IX27	-
99000-79K60-BP6	IW20	IW20TT
99000-79K60-DC7	IXU22	IXU22TT
99000-79K60-K5R	IK16	IK16TT
99000-79K60-K6R	IK20	IK20TT
99000-79K60-KR6	IK20	IK20TT
99000-79K60-P5R	IW16	IW16TT
99000-79K60-P6R	IW20	IW20TT
99000-79K60-P7R	IW22	-
99000-79K60-PR5	IW16	IW16TT
99000-79K73-U22	IXU22	IXU22TT
99000-79K73-U24	VXU24	-
99000-79K73-UH2	VXUH22	IXUH22TT
99000-79K73-W16	IW16TT	IW16TT
99000-79K73-W20	VW20	IW20TT
99000-79K73-W22	VW22	-
99000-79L65	VK20Y	-
99000-79L65-004	VXU22	IXU22TT
99000-79L65-006	VK22	IK22FTT
99000-79L65-008	IW16TT	IW16TT
99000-79L65-009	VW20	IW20TT
99000-79L65-010	VW20	IW20TT
99000-79X12-K16	K16TT	K16TT
99000-79X12-K20	K20TT	K20TT
99000-79X12-W16	W16TT	W16TT
99000-79X12-XU2	XU22TT	XU22TT
99000-79X12-XUH	XUH22TT	XUH22TT

TACTI	DENSO	TT
067600-1810	IW06-27	-
067600-1820	IW06-31	-
067600-1830	IW06-34	-
267700-1010	IU01-24	-
267700-1020	IU01-27	-
267700-1030	IU01-31	-
267700-1040	IU01-34	-
267700-1060	IXU01-24	-
267700-1070	IXU01-27	-
267700-1080	IXU01-31	-
267700-1090	IXU01-34	-
267700-1110	IW01-24	-
267700-1120	IW01-27	-
267700-1130	IW01-29	-
267700-1140	IW01-31	-
267700-1150	IW01-32	-
267700-1160	IW01-34	-
267700-1210	IWM01-29	-
267700-1220	IWM01-31	-
267700-1230	IWM01-32	-
267700-1240	IWM01-34	-
267700-1260	IA01-31	-
267700-1270	IA01-32	-
267700-1280	IA01-34	-
267700-1310	IK01-24	-
267700-1320	IK01-27	-
267700-1330	IK01-31	-

Свечи зажигания и Свечи накаливания

Таблица взаимозаменяемости - OE

ТАСТI	DENSO	TT
267700-1340	IK01-34	-
267700-1360	IK02-24	-
267700-1370	IK02-27	-
267700-1380	IK02-31	-
267700-1410	IQ01-24	-
267700-1420	IQ01-27	-
267700-1430	IQ01-31	-
267700-1440	IQ01-34	-
267700-1460	IQ02-24	-
267700-1470	IQ02-27	-
267700-1480	IQ02-31	-
267700-1570	RU01-27	-
267700-1580	RU01-31	-
267700-1590	RU01-34	-
267700-2940	IAE01-32	-
267700-2950	IAE01-34	-
267700-4450	IKH01-24	-
267700-4460	IKH01-27	-
267700-4470	IKH01-31	-
V9110-2001	W16EXR-U11	W16TT
V9110-2002	W16EXR-U	W16TT
V9110-2003	K16R-U11	K16TT
V9110-2004	Q16R-U	Q16TT
V9110-2005	J16BR-U	-
V9110-2007	W20EXR-U	W20TT
V9110-2008	Q16R-U11	Q16TT
V9110-2010	K20R-U11	K20TT
V9110-2011	XU22EPR-U	XU22TT
V9110-2012	Q20R-U11	Q20TT
V9110-2013	IW20	IW20TT
V9110-2019	K20PR-L11	K20TT
V9110-2023	KJ20CR-L11	K20TT
V9110-2025	K20R-U	K20TT
V9110-2026	K16R-U	K16TT
V9110-2028	KJ16CR-L11	K16TT
V9110-2031	KJ16CR-L11	K16TT
V9110-2039	K22TNR-S	-
V9110-2040	K16TR11	K16TT
V9110-2041	K20TR11	K20TT
V9110-2042	K16PR-U11	K16TT
V9110-2043	K20PR-U11	K20TT
V9110-2044	W16EPR-U	W16TT
V9110-2045	Q20PR-U11	Q20TT
V9110-2046	Q16PR-U11	Q16TT
V9110-2047	K20PR-U	K20TT
V9110-2048	KJ16CR-U11	K16TT
V9110-2049	K20TNR-S9	K20TT
V9110-2110	PKJ16CR-L11	IK16TT
V9110-2111	PKJ20CR-L11	IK20TT
V9110-2301	IQ16TT	IQ16TT
V9110-2302	IQ20TT	IQ20TT
V9110-2303	IK16	IK16TT
V9110-2304	IK20	IK20TT
V9110-2305	IW16	IW16TT
V9110-2306	IW20	IW20TT
V9110-2307	IW22	-
V9110-2308	IXU22	IXU22TT
V9110-2309	IXU24	-
V9110-2601	IQ16TT	IQ16TT
V9110-2602	IQ20TT	IQ20TT
V9110-2605	IW16TT	IW16TT
V9110-2606	VW20	IW20TT
V9110-2607	VW22	-
V9110-2608	VXU22	IXU22TT
V9110-2609	VXU24	-
V9110-3000	J16AR-U11	-
V9110-3001	J16BR-U	-
V9110-3002	J16BR-U	-
V9110-3006	Q16R-U11	Q16TT
V9110-3007	Q20PR-U	Q20TT
V9110-3009	Q20R-U11	Q20TT

ТАСТI	DENSO	TT
V9110-3012	W14EXR-U11	IW16TT
V9110-3013	W14EXR-U	IW16TT
V9110-3014	W14EXR-U11	IW16TT
V9110-3016	W16EKR-S11	W16TT
V9110-3018	W16EPR-U	W16TT
V9110-3021	W16EPR-U	W16TT
V9110-3025	W16ESR-U	-
V9110-3029	W16EXR-U13	W16TT
V9110-3032	W16EXR-U11	W16TT
V9110-3033	W16FSR	-
V9110-3034	W16FSR	-
V9110-3035	W16LS	-
V9110-3037	W16PR-U	-
V9110-3041	W20EKR-S11	IW20TT
V9110-3043	W20EP-U	W20TT
V9110-3046	W20EPR-S11	W20TT
V9110-3047	W20EPR-U	W20TT
V9110-3049	W20EPR-U11	W20TT
V9110-3051	W20ESR-U	-
V9110-3057	W20ESR-U	-
V9110-3059	IW20	IW20TT
V9110-3060	IW20	IW20TT
V9110-3064	W20EXR-U11	W20TT
V9110-3068	W20FPR-U	WF20TT
V9110-3072	W20FSR-U	WF20TT
V9110-3073	W20FSR-U	WF20TT
V9110-3075	W20S-U	-
V9110-3076	W20S-U	-
V9110-3085	W22EPR-U	W22TT
V9110-3088	W22EPR-U	W22TT
V9110-3093	W22ESR-U	-
V9110-3098	W22ESR-U	-
V9110-3105	IRE01-27	-
V9110-3110	W16ESR-U	-
V9110-3112	QJ20CR11	Q20TT
V9110-3114	P16PR11	W16TT
V9110-3119	K16R-U	K16TT
V9110-3120	K16R-U11	K16TT
V9110-3121	K20PR-U11	K20TT
V9110-3122	K20R-U	K20TT
V9110-3129	Q16R-U	Q16TT
V9110-3130	K16PR-U11	K16TT
V9110-3131	KJ16CR-L11	K16TT
V9110-3132	KJ16CR-L11	K16TT
V9110-3133	KJ20CR-U11	K20TT
V9110-3135	K16GPR-U11	-
V9110-3137	Q16PR-U	Q16TT
V9110-3139	K20R-U11	K20TT
V9110-3140	Q20R-U	Q20TT
V9110-3141	PK20PR-P11	K20TT
V9110-3142	PK20PR-L11	IK20TT
V9110-3143	K16PR-L11	K16TT
V9110-3144	K20PR-L11	K20TT
V9110-3145	K20PR-U	K20TT
V9110-3167	KJ14CR-L11	-
V9110-3168	PK20PR11	K20TT
V9110-3169	KJ20CR-L11	K20TT
V9110-3170	IW22	-
V9110-3174	PK16PR-P11	K16TT
V9110-3175	PKJ16CR8	-
V9110-3178	XU20EPR-U	-
V9110-3179	XU22EPR-U	XU22TT
V9110-3180	XU24EPR-U	-
V9110-3181	Q16R-U11	Q16TT
V9110-3182	Q20R-U11	Q20TT
V9110-3183	Q14R-U11	IQ16TT
V9110-3184	Q16PR-U11	Q16TT
V9110-3185	Q20P-U11	Q20TT
V9110-3186	Q16PR-U11	Q16TT
V9110-3187	Q20PR-U11	Q20TT
V9110-3191	K16PR-U	K16TT

ТАСТI	DENSO	TT
V9110-3192	K22PR-U11	IK22FTT
V9110-3194	K16TR11	K16TT
V9110-3195	K20TR11	K20TT
V9110-3196	K20TNR-S	K20TT
V9110-3197	K22TNR-S	-
V9110-3199	W16EPR-U11	W16TT
V9110-3200	W22EPR-U11	W22TT
V9110-3201	W16EPR-U11	W16TT
V9110-3202	W14EX-U	IW16TT
V9110-3203	W16EXR-U	W16TT
V9110-3204	W20EX-U	W20TT
V9110-3205	W16EXR-U11	W16TT
V9110-3206	W20EXR-U11	W20TT
V9110-3208	VW20T	IW20TT
V9110-3210	W16EXR-U	W16TT
V9110-3211	W20EXR-U	W20TT
V9110-3212	W20EXR-U11	W20TT
V9110-3213	W16EXR-U13	W16TT
V9110-3214	VW20T	IW20TT
V9110-3215	W16ETR-S	W16TT
V9110-3216	W16ETR-S	W16TT
V9110-3220	J16AR-U11	-
V9110-3221	J16BR-U	-
V9110-3232	W16FPR-U	-
V9110-3235	QJ16AR-U	-
V9110-3236	QJ16CR11	Q16TT
V9110-3245	PK20PR-P8	IK20TT
V9110-3247	PKJ20CR-L11	IK20TT
V9110-3249	IK22	IK22FTT
V9110-3250	W20EPR-S11	W20TT
V9110-3251	IW22	-
V9110-3252	IRE01-31	-
V9110-3258	W16EKR-S11	W16TT
V9110-3263	IK22	IK22FTT
V9110-3264	PK16PR11	K16TT
V9110-3266	IQ16TT	IQ16TT
V9110-3268	W20FPR-U10	WF20TT
V9110-3293	IK16	IK16TT
V9110-3304	K20TNR	K20TT
V9110-3305	K20TNR-S9	K20TT
V9110-3311	KJ16CR-U11	K16TT
V9110-3329	K16TNR-S9	K16TT
V9110-3374	KJ20DR-M11	-
V9110-3381	XU2HR-U11	KH20TT
V9110-3445	KJ20HDR9	XUH22TT
V9110-3451	KJ20CR-U11	K20TT
V9110-3455	SKJ20DR-M11S	-
V9110-3456	IK20	IK20TT
V9110-3470	IK20G	-
V9110-4000	U16FSR-U	-
V9110-4002	U20FSR-U	-
V9110-4004	U20FSR-U	-
V9110-4006	U22FSR-U	-
V9110-4008	U22FSR-U	-
V9110-4012	W14F-U	-
V9110-4013	W14FPR-U	-
V9110-4014	W14FPR-UL	-
V9110-4019	W16FPR-U	-
V9110-4021	W22FPR-U	-
V9110-4024	W22FSR	-
V9110-4025	W22FS-U	-
V9110-4027	W22S-U	-
V9110-4028	W24EPR-U	-
V9110-4030	W24ESR-U	-
V9110-4033	W24ESR-U	-
V9110-4034	W24ES-V	-
V9110-4037	W24FSR	-
V9110-4038	W24FSR	-
V9110-4045	W27ESR-U	-
V9110-4046	W27ESR-U	-
V9110-4047	W27ES-V	-

ТАСТI	DENSO	TT
V9110-4052	W27FSR	-
V9110-4054	W27FSR	-
V9110-4062	W31ESR-U	-
V9110-4075	X16FSR-U	-
V9110-4076	X20ESR-U	-
V9110-4078	X20FSR-U	-
V9110-4080	X20FSR-U	-
V9110-4086	X22EPR-U9	-
V9110-4090	X22ESR-U	-
V9110-4091	X22ESR-U	-
V9110-4096	X24EPR-U9	-
V9110-4099	X24ESR-U	-
V9110-4101	X24ESR-U	-
V9110-4103	X24FS-U	-
V9110-4111	X27EPR-U9	-
V9110-4114	X27ESR-U	-
V9110-4116	X27ESR-U	-
V9110-4148	W16FPR-U	-
V9110-4149	W20FR-L	WF20TT
V9110-4150	X24GPR-U	-
V9110-4152	W9FP-UL	-
V9110-4157	X20ESR-U	-
V9110-4160	IWM31	-
V9110-5000	L14-U	-
V9110-5008	MA16PR-U	-
V9110-5013	MA20PR-U	-
V9110-5020	T14PR-U	ITF16TT
V9110-5022	T16EPR-U	T16TT
V9110-5023	T16EPR-U15	T16TT
V9110-5026	T16PR-U11	ITF16TT
V9110-5032	T20EPR-U	T20TT
V9110-5033	T20EPR-U15	-
V9110-5036	T20PR-U11	ITF20TT
V9110-5040	T22EP-U	-
V9110-5044	W16S-U	-
V9110-5046	W20PR-U	-
V9110-5047	T16NR-U11	IT16TT
V9110-5048	T20NR-U11	IT20TT
V9110-5060	K20PBR	K20TT
V9110-5061	K20PBR-S10	K20TT
V9110-5062	K22PBR-S	IKB22TT
V9110-5063	K20TXR	K20TT
V9110-5064	W16EPB10	W16TT
V9110-5065	W20EPB	W20TT
V9110-5066	W22EPB	W22TT
V9110-5070	PT16EPR-L13	IT16TT
V9110-5301	IQ16TT	IQ16TT
V9110-5302	IQ20TT	IQ20TT
V9110-5303	IK16	IK16TT
V9110-5304	IK20	IK20TT
V9110-5305	IW16	IW16TT
V9110-5306	IW20	IW20TT
V9110-5307	IW22	-
V9110-5308	IXU22	IXU22TT
V9110-5309	IXU24	-
V9110-5310	IK22	IK22FTT
V9110-5311	IK24	-
V9110-5312	IK27	-
V9110-5313	IQ22	-
V9110-5314	IQ24	-
V9110-5315	IQ27	-
V9110-5316	IW24	-
V9110-5317	IW27	-
V9110-5318	IW29	-
V9110-5319	IW31	-
V9110-5320	IW34	-
V9110-5321	IK31	-
V9110-5322	IK34	-
V9110-5323	IQ31	-
V9110-5324	IQ34	-
V9110-5326	IT20TT	IT20TT

Свечи зажигания и Свечи накаливания

Таблица взаимозаменяемости - OE

ТАCTI	DENSO	TT
V9110-5327	IT22	-
V9110-5328	IT24	-
V9110-5329	IT27	-
V9110-5331	ITF20TT	ITF20TT
V9110-5332	ITF22	-
V9110-5333	ITF24	-
V9110-5334	ITF27	-
V9110-5337	IXU27	-
V9110-5340	ITV22	-
V9110-5341	ITV24	-
V9110-5342	ITV27	-
V9110-5343	IKH16	IKH16TT
V9110-5344	IKH20	IKH20TT
V9110-5345	IKH22	-
V9110-5346	IKH24	-
V9110-5347	IKH27	-
V9110-5348	IK22G	IK22FTT
V9110-5349	ITL16TT	ITL16TT
V9110-5350	ITL20	-
V9110-5351	IK16G	-
V9110-5352	IK20G	-
V9110-5353	IXUH22	IXUH22TT
V9110-5356	IXUH22I	IXUH22TT
V9110-5359	IWF16	-
V9110-5360	IU20	-
V9110-5361	IU22	-
V9110-5362	IU24	-
V9110-5363	IU27	-
V9110-5364	IU31	-
V9110-5365	IU24A	-
V9110-5366	IU27A	-
V9110-5367	IU31A	-
V9110-5368	IUH24	-
V9110-5369	IUH27	-
V9110-5371	IX22	-
V9110-5372	IX24	-
V9110-5373	IX27	-
V9110-5375	IX22B	-
V9110-5376	IX24B	-
V9110-5377	IX27B	-
V9110-5378	IWF20	-
V9110-5379	IWF22	-
V9110-5380	IWF24	-
V9110-5381	IWF27	-
V9110-5383	IUF22	-
V9110-5384	IUF24	-
V9110-5391	IWM24	-
V9110-5392	IWM27	-
V9110-5393	IWM31	-
V9110-5394	IXG24	-
V9110-5395	IXG27	-
V9110-5502	VW20T	IW20TT
V9110-5601	IQ16TT	IQ16TT
V9110-5602	IQ20TT	IQ20TT
V9110-5605	IW16TT	IW16TT
V9110-5606	VW20	IW20TT
V9110-5607	VW22	-
V9110-5608	VXU22	IXU22TT
V9110-5609	VXU24	-
V9110-5610	VK22	IK22FTT
V9110-5611	VXUH22	IXUH22TT
V9110-5613	VQ22	-
V9110-5618	IKH20TT	IKH20TT
V9110-5619	VKH22	-
V9110-5620	VK20Y	-
V9110-5622	VKA16	-
V9110-5623	VKA20	-
V9110-5624	VKB16	-
V9110-5625	VKB20	-
V9110-5636	VK22G	-
V9110-5638	IT20TT	IT20TT

ТАCTI	DENSO	TT
V9110-5639	VKH20Y	-
V9110-5640	VK16G	IK16TT
V9110-5641	VK20G	-
V9110-5645	IXEH20TT	IXEH20TT
V9110-5646	IXEH22TT	IXEH22TT
V9110-5654	IKH16TT	IKH16TT
V9110-5655	FK20HR11	IKH20TT
V9110-5656	VXUH22I	IXUH22TT
V9110-5719	IRE01-27	-
V9110-5720	IRE01-31	-
V9110-5721	IRE01-32	-
V9110-5722	IRE01-34	-
V9110-5752	IRT01-31	-
V9110-5753	IRT01-34	-
V9110-5754	IRL01-27	-
V9110-5755	IRL01-31	-
V9110-6004	W9-U	-
V9110-6008	W14PR-U	-
V9110-6009	W14E	-
V9110-6010	W14EPR-U	IW16TT
V9110-6011	W14EPR-U	IW16TT
V9110-6021	W14PR-U	-
V9110-6022	W20MR-U	-
V9110-6023	W20MP-U	-
V9110-6026	W22M-U	-
V9110-6027	W22MPR-U	-
V9110-6028	W27FSR	-
V9110-6037	W20FPR-U10	WF20TT
V9110-6039	T20M-U	-
V9110-6041	T22M-U	-
V9110-6044	W9EXR-UCU	-
V9110-6045	W9EP	-
V9110-6046	W9EXR-UCU	-
V9110-6047	W24FSR-U10	-
V9110-6076	K16HPR-U11	KH16TT
V9110-7001	K16TT	K16TT
V9110-7002	K20TT	K20TT
V9110-7003	W16TT	W16TT
V9110-7004	XU22TT	XU22TT
V9110-7005	XUH22TT	XUH22TT
V9110-7006	XUH20TTi	XUH20TTi

TOYOTA	DENSO	TT
04195-34020	W20EP-U	W20TT
08922-01016	W16EXR-U	W16TT
08922-01016-83	W16EXR-U	W16TT
08922-01017	W20EXR-U11	W20TT
08922-01017-83	W20EXR-U11	W20TT
08922-01018	W16EX-U	W16TT
08922-01018-83	W16EX-U	W16TT
08922-01019	W16EXR-U11	W16TT
08922-01019-83	W16EXR-U11	W16TT
08922-01020	PQ16R	Q16TT
08922-01020-83	PQ16R	Q16TT
19111-U2120	T14PR-U	ITF16TT
19111-U2120-71	T14PR-U	ITF16TT
19850-05010	DG-212	-
19850-05010	DG-648	-
19850-0L010	DG-245	-
19850-0R010	DG-600	-
19850-0R020	DG-600	-
19850-0R022	DG-600	-
19850-0W010	DG-240	-
19850-17020	DG-648	-
19850-26010	DG-600	-
19850-26020	DG-600	-
19850-26021	DG-600	-
19850-26022	DG-600	-
19850-27010	DG-245	-
19850-30010	DG-245	-
19850-46021	DG-224	-

TOYOTA	DENSO	TT
19850-46030	DG-225	-
19850-46031	DG-225	-
19850-54010	DG-648	-
19850-54020	DG-238	-
19850-54030	DG-647	-
19850-54031	DG-647	-
19850-54050	DG-215	-
19850-54060	DG-239	-
19850-54070	DG-213	-
19850-54071	DG-213	-
19850-54090	DG-648	-
19850-54110	DG-310	-
19850-54120	DG-212	-
19850-54120	DG-648	-
19850-54130	DG-310	-
19850-54130-D	DG-310	-
19850-54140	DG-242	-
19850-54140	DG-648	-
19850-54150	DG-218	-
19850-54150	DG-648	-
19850-56010	DG-226	-
19850-56011	DG-226	-
19850-56012	DG-226	-
19850-56020	DG-227	-
19850-56021	DG-234	-
19850-56022	DG-234	-
19850-58010	DG-651	-
19850-64010	DG-652	-
19850-64020	DG-216	-
19850-64020	DG-650	-
19850-64030	DG-649	-
19850-64040	DG-308	-
19850-64050	DG-649	-
19850-64060	DG-309	-
19850-64061	DG-309	-
19850-67020	DG-671	-
19850-67030	DG-671	-
19850-68010	DG-232	-
19850-68020	DG-233	-
19850-68030	DG-234	-
19850-68040	DG-235	-
19850-68060	DG-222	-
19850-76001	DG-226	-
19850-76004	DG-232	-
19850-76005	DG-234	-
19850-76008	DG-231	-
19850-76010	DG-224	-
19850-76010-71	DG-224	-
19850-76011	DG-225	-
19850-76012	DG-233	-
19850-76013	DG-228	-
19850-76020	DG-228	-
19850-77010	DG-231	-
19850-77011	DG-231	-
19850-78020	DG-241	-
19850-WA020	DG-613	-
80098-76005	W16S-U	-
80919-76008	W20EX-U	W20TT
80919-76011	W9EP	-
80919-76012	K16R-U	K16TT
87343-20010	DG-648	-
90048-51185	SK20HR11	IKH20TT
90048-51195	VXUH22I	IXUH22TT
90048-51208	VXUH20I	-
90048-51216	IXEH20TT	IXEH20TT
9004A-91011	K20R-U	K20TT
9004A-91031	XU22PR9	XU22TT
9004A-91032	XU22PR9	XU22TT
9004A-91039	XU22PR9	XU22TT
90080-91032	Q16R-U11	Q16TT
90080-91048	K20R-U	K20TT

TOYOTA	DENSO	TT
90080-91065	PK20R13	K20TT
90080-91066	K20R-U	K20TT
90080-91108	K20R-U	K20TT
90080-91116	PK20TR11	K20TT
90080-91145	K16TR11	K16TT
90080-91159	SK20R-P13	IK20TT
90080-91161	K16R-U11	K16TT
90080-91161-A	K16R-U11	K16TT
90080-91180	SK20R11	IK20TT
90080-91180-B	SK20R11	IK20TT
90080-91184	SK16R11	IK16TT
90080-91193	K16R-U11	K16TT
90080-91193-B	K16R-U11	K16TT
90080-91194	K16R-U11	K16TT
90080-91200	K16R-U11	K16TT
90080-91204	K20R-U11	K20TT
90080-91217	K16R-U11	K16TT
90080-91229	K16R-U	K16TT
90080-91229-B	K16R-U	K16TT
90080-91234	W16EXR-U	W16TT
90080-91235	W16EXR-U11	W16TT
9008091236	W16EXR-U11	W16TT
90080-91236-A	W16EXR-U11	W16TT
90080-91237	W16EXR-U	W16TT
90080-91237-A	W16EXR-U	W16TT
90080-91243	K20R-U	K20TT
90098-09125	W9EP	-
90098-14125	W14EX-U	IW16TT
90098-14395	W14EX-U	IW16TT
90098-14595	W14EX-U	IW16TT
90098-14715	W14PR-U	-
90098-14785	T14PR-U	ITF16TT
90098-16395	W16EX-U	W16TT
90098-16505	W16ES-U	-
90098-16595	W16EX-U	W16TT
90098-20276	W16S-U	-
90098-20395	W20EX-U	W20TT
90098-20785	T20PR-U	ITF20TT
90098-64015	L14-U	-
90916-01176	K16R-U	K16TT
90919-01020	W16EXR-U	W16TT
90919-01026	W14EX-U	IW16TT
90919-01027	W16EXR-U	W16TT
90919-01041	W16EX-U	W16TT
90919-01045	W20EXR-U	W20TT
90919-01046	W20EX-U	W20TT
90919-01050	W14EX-U	IW16TT
90919-01051	W16EPR-U	W16TT
90919-01053	W14EPR-U	IW16TT
90919-01055	W9EP	-
90919-01056	W14EX-U	IW16TT
90919-01057	W20EPR-U	W20TT
90919-01059	W16EXR-U	W16TT
90919-01064	W16EXR-U	W16TT
90919-01065	W14EXR-U	IW16TT
90919-01083	W20EX-U	W20TT
90919-01084	W20EXR-U	W20TT
90919-01085	W14EXR-U11	IW16TT
90919-01087	W16ETR-S	W16TT
90919-01088	IW20	IW20TT
90919-01089	IW20	IW20TT
90919-01090	W16ETR-S	W16TT
90919-01091	W16EXR-U11	W16TT
90919-01092	IW20	IW20TT
90919-01094	W16EXR-U11	W16TT
90919-01095	W16ETR-S	W16TT
90919-01096	W16ETR-S	W16TT
90919-01097	IW20	IW20TT
90919-01098	W20EXR-U	W20TT
90919-01100	T16EPR-U	T16TT
90919-01102	W16EXR-U	W16TT

Свечи зажигания и Свечи накаливания

Таблица взаимозаменяемости - OE

TOYOTA	DENSO	TT
90919-01103	W14EXR-U	IW16TT
90919-01104	W16EXR-U11	W16TT
90919-01108	W14EXR-U11	IW16TT
90919-01109	W14EXR-U11	IW16TT
90919-01113	J16AR-U11	-
90919-01114	J16AR-U11	-
90919-01115	P16R	W20TT
90919-01116	P16R	W20TT
90919-01117	J16BR-U	-
90919-01118	J16BR-U	-
90919-01119	J16BR-U	-
90919-01120	J16AR-U11	-
90919-01121	PQ16R	Q16TT
90919-01122	PQ16R	Q16TT
90919-01123	J16BR-U	-
90919-01125	W20EXR-U11	W20TT
90919-01126	W20EXR-U11	W20TT
90919-01127	PQ20R	Q20TT
90919-01128	PQ20R	Q20TT
90919-01129	Q16R-U11	Q16TT
90919-01131	Q20R-U11	Q20TT
90919-01133	P16R13	W20TT
90919-01134	P16R13	W20TT
90919-01135	IQ20TT	IQ20TT
90919-01136	IQ20TT	IQ20TT
90919-01139	W20EXR-U11	W20TT
90919-01141	IQ16TT	IQ16TT
90919-01143	P16R	W20TT
90919-01144	P16R	W20TT
90919-01145	PQ20R-P8	IQ20TT
90919-01146	PQ20R-P8	IQ20TT
90919-01149	Q20R-U	Q20TT
90919-01153	Q16R-U	Q16TT
90919-01155	QJ16AR-U	-
90919-01157	IQ16TT	IQ16TT
90919-01158	IQ16TT	IQ16TT
90919-01159	Q16R-U11	Q16TT
90919-01161	PQ20R	Q20TT
90919-01162	PQ20R	Q20TT
90919-01164	K16R-U11	K16TT
90919-01165	K16R-U11	K16TT
90919-01166	K20R-U	K20TT
90919-01168	PK16R11	K16TT
90919-01169	PK16R11	K16TT
90919-01170	Q14R-U11	IQ16TT
90919-01172	IK20TT	IK20TT
90919-01173	IK20TT	IK20TT
90919-01176	K16R-U	K16TT
90919-01177	K16R-U	K16TT
90919-01178	PK20R11	K20TT
90919-01179	PK20R11	K20TT
90919-01180	PK20R8	IK20TT
90919-01181	PK20R8	IK20TT
90919-01182	PQ20R	Q20TT
90919-01184	K20R-U11	K20TT
90919-01185	K20R-U11	K20TT
90919-01187	PK20R13	K20TT
90919-01188	PK20R13	K20TT
90919-01191	SK20HR11	IKH20TT
90919-01192	K16TR11	K16TT
90919-01193	K16TR11	K16TT
90919-01194	PK20TR11	K20TT
90919-01195	PK20TR11	K20TT
90919-01196	PK16TR11	K16TT
90919-01197	PK16TR11	K16TT
90919-01198	K20TR11	K20TT
90919-01200	PK16TR13	IK16TT
90919-01201	PK16TR13	IK16TT
90919-01202	K20TR11	K20TT
90919-01205	PK16PR11	K16TT
90919-01206	PK16PR11	K16TT

TOYOTA	DENSO	TT
90919-01207	SK20R-P11	IK20TT
90919-01208	PK20GR8	-
90919-01209	SK16R-P11	IK16TT
90919-01210	SK20R11	IK20TT
90919-01211	SK20R11	IK20TT
90919-01212	SK20R-P13	IK20TT
90919-01213	PK20GR8	-
90919-01214	SK16R-P8	IK16TT
90919-01215	SK16R-P8	IK16TT
90919-01217	SK16R11	IK16TT
90919-01218	SK16R11	IK16TT
90919-01219	SK16R-P11	IK16TT
90919-01220	PK20R11	K20TT
90919-01221	SK20BGR11	-
90919-01223	IW16	IW16TT
90919-01224	IW16	IW16TT
90919-01225	SK20R-P11	IK20TT
90919-01226	SK20BR11	-
90919-01229	SK20R5-G	-
90919-01230	SK20BR11	-
90919-01231	VK20Y	-
90919-01233	SK16HR11	IKH16TT
90919-01235	K20HR-U11	KH20TT
90919-01236	K20HR-U11	KH20TT
90919-01237	SK20R11	IK20TT
90919-01238	SK20R11	IK20TT
90919-01240	SK16R11	IK16TT
90919-01241	SK16R11	IK16TT
90919-01242	K16R-U11	K16TT
90919-01243	FK16HR11	IKH16TT
90919-01243	IKH16TT	IKH16TT
90919-01244	K16R-U	K16TT
90919-01245	K16R-U	K16TT
90919-01247	FK20HR11	IKH20TT
90919-01248	FK20HR11	IKH20TT
90919-01249	FK20HR11	IKH20TT
90919-01250	VW20T	IW20TT
90919-01252	FK16R11	IK16TT
90919-01253	SC16HR11	IXEH20TT
90919-01258	K16HR-U11	KH16TT
90919-01259	FK16HR-A8	-
90919-01265	FK16R-A8	IK16TT
90919-01266	SK20HR-A11	IKH20TT
90919-01275	SC16HR11	IXEH20TT
90919-01281	FC16HR-CY9	-
90919-01286	FK16HBR-J8	-
90919-01287	FK20HR-A8	IKH20TT
90919-01288	IKBH20TT	IKBH20TT
90919-01950	W9EP	-
90919-01954	W9EXR-UCU	-
90919-22357	W16EXR-U	W16TT
90919-91048	PK20R13	K20TT
90919-91066	PK20R13	K20TT
90919-A1002	SK20HR11	IKH20TT
90919-A1003	SK16HR11	IKH16TT
90919-C1002	SK16R11	IK16TT
90919-C1006	FK16HBR-J8	-
90919-T1002	K16R-U	K16TT
90919-T1002-A	K16R-U	K16TT
90919-T1003	K16R-U11	K16TT
90919-T1004-A	K20HR-U11	KH20TT
90919-T1005	K20HR-U11	KH20TT
90919-T1006	SK20HR11	IKH20TT
90919-T1007	SK20R11	IK20TT
90919-T1007-A	SK20R11	IK20TT
90919-T1009	SC16HR11	IXEH20TT
90919-T1012	SK16R11	IK16TT
90919-W1001	K16HR-U11	KH16TT
90919-W1002	SK20HR11	IKH20TT
90919-W1003	SK16HR11	IKH16TT
90919-W1006	SC16HR11	IXEH20TT

TOYOTA	DENSO	TT
90919-W1007	SC16HR11	IXEH20TT
90919-YZZAA	Q16R-U	Q16TT
90919-YZZAB	Q20R-U	Q20TT
90919-YZZAC	Q20R-U11	Q20TT
90919-YZZAD	K16R-U	K16TT
90919-YZZAE	K16R-U11	K16TT
90919-YZZAF	K20R-U	K20TT
90919-YZZAG	K20R-U11	K20TT
90999-09001	W20EP-U	W20TT
90999-09002	T20R-U	-
90999-09006	W16EXR-U	W16TT
90999-09007	W20EX-U	W20TT
SU00100351	DG-003	-
SU00100671	DG-113	-
SU00100850	DG-180	-
SU00100894	DG-180	-
SU001-01126	IXUH22I	IXUH22TT
SU001A1261	DG-603	-
SU003-00416	VXEBH27	-
SU003-04931	VXEBH27	-

TOYOTA/LEXUS	DENSO	TT
08479-00801	IW16TT	IW16TT
08479-00802	VW20	IW20TT
08479-00803	IQ16TT	IQ16TT
08479-00804	IQ20TT	IQ20TT
08479-00808	VW20	IW20TT
19850-0W020	DG-659	-
19850-33020	DG-659	-
19850-64060	DG-671	-
19850-64061	DG-671	-
90098-00845	SF-50	-
90098-00855	SF-51	-
90098-09035	W9-U	-
90098-09036	W9-U	-
90098-09125	W9EP	-
90098-09146	MA9P-U	-
90098-09395	W9EX-U	-
90098-09685	W9FP-UL	-
90098-09815	W9PR-U	-
90098-14015	M14	-
90098-14055	W14E	-
90098-14425	W14EXR-U	IW16TT
90098-14515	W14FP-U	-
90098-14595	W14EX-U	IW16TT
90098-14645	W14F-U	-
90098-14665	W14EXR-U11	IW16TT
90098-14685	W14FPR-UL	-
90098-14785	T14PR-U	ITF16TT
90098-14815	W14PR-U	-
90098-16185	W16ES-U	-
90098-16215	W16EX-U	W16TT
90098-16225	W16FS-U	-
90098-16275	W16S-U	-
90098-16395	W16EX-U	W16TT
90098-16395-70	W16EX-U	W16TT
90098-16425	W16EXR-U	W16TT
90098-16455	W16ESR-U	-
90098-16505	W16ES-U	-
90098-16515	W16FP-U	-
90098-16595	W16EX-U	W16TT
90098-16645	W16FS-U	-
90098-16655	W16ESR-U	-
90098-16675	W16EXR-U	W16TT
90098-16695	W16EP-U	W16TT
90098-16725	W16S-U	-
90098-16735	MA16PR-U	-
90098-16745	W16EPR-U	W16TT
90098-16805	T16R-U	T16TT
90098-16815	W16PR-U	-
90098-16865	T16R-U	T16TT

TOYOTA/LEXUS	DENSO	TT
90098-16895	T16EPR-U	T16TT
90098-17015	M17	-
90098-17025	MW17	-
90098-20145	MA20P-U	-
90098-20185	W20ES-U	-
90098-20275	W20S-U	-
90098-20276	W20S-U	-
90098-20335	W20ESR-U	-
90098-20405	K16GPR-U11	-
90098-20425	W20EXR-U	W20TT
90098-20465	X20ES-U	-
90098-20475	X20ESR-U	-
90098-20485	X20FS-U	-
90098-20495	X20FSR-U	-
90098-20505	W20ES-U	-
90098-20515	W20FP-U	WF20TT
90098-20595	W20EX-U	W20TT
90098-20645	W20FS-U	WF20TT
90098-20675	W20EXR-U	W20TT
90098-20695	W20EP-U	W20TT
90098-20705	T20PR-U	ITF20TT
90098-20705	T20PR-U11	ITF20TT
90098-20735	MA20PR-U	-
90098-20755	W20EP-S11	IW20TT
90098-20765	U20FS-U	-
90098-20785	T20PR-U	ITF20TT
90098-20795	T20PR-U11	ITF20TT
90098-20805	T20PR-U	ITF20TT
90098-20865	T20R-U	-
90098-20885	T20EP-U	T20TT
90098-20895	T20EPR-U	T20TT
90098-20935	W20ESR-U	-
90098-22015	M22	-
90098-22225	W22FS-U	-
90098-22275	W22S-U	-
90098-22276	W22S-U	-
90098-22355	W22M-U	-
90098-22455	IW22	-
90098-22465	X22ES-U	-
90098-22475	X22ESR-U	-
90098-22505	W22ES-U	-
90098-22515	W22FP-U	-
90098-22645	W22FS-U	-
90098-22655	IW22	-
90098-22695	W22EP-U	W22TT
90098-22765	U22FS-U	-
90098-22885	T22EP-U	-
90098-22935	W22ESR-U	-
90098-24157	W22EPB	W22TT
90098-24276	W24S-U	-
90098-24335	W24ESR	-
90098-24465	X24ES-U	-
90098-24475	X24ESR-U	-
90098-24485	X24FS-U	-
90098-24505	W24ES-U	-
90098-24645	W24FS-U	-
90098-24935	W24ESR-U	-
90098-27276	W27S-U	-
90098-27465	X27ES-U	-
90098-27475	X27ESR-U	-
90098-27505	W27ES-U	-
90098-27645	W27FS-U	-
90098-27935	W27ESR-U	-
90098-31156	K22PB	IKB22TT
90098-31185	W31ESR-U	-
90098-31225	W31FS	-
90098-31465	X31ES-U	-
90098-31505	W31ESR-U	-
90098-64066	KJ14CR-L11	-
90098-66004	W16EPR-U11	W16TT
90098-66011	X16FSR-U	-

Свечи зажигания и Свечи накаливания

Таблица взаимозаменяемости - OE

TOYOTA/LEXUS	DENSO	TT
90098-66031	W16EXR-U11	W16TT
90098-66055	T16EPR-U15	T16TT
90098-66059	K16PR-L11	K16TT
90098-66064	PK16PR-P11	K16TT
90098-66070	PK16PR11	K16TT
90098-66075	K16GPR-U11	-
90098-66080	PKJ16CR-L11	IK16TT
90098-66081	PKJ16CR8	-
90098-66082	Q16PR-U	Q16TT
90098-66083	T16NR-U11	IT16TT
90098-66108	P16PR11	W16TT
90098-66113	PT16EPR-L13	IT16TT
90098-70023	U20FSR-U	-
90098-70051	XU20EPR-U	-
90098-70055	T20EPR-U15	-
90098-70061	T20M-U	-
90098-70062	T20MP-U	-
90098-70064	PK20PR-P11	K20TT
90098-70071	W27ESR-U	-
90098-70080	PKJ20CR-L11	IK20TT
90098-70081	PKJ20CR8	IK20TT
90098-70082	Q20PR-U	Q20TT
90098-70083	T20NR-U11	IT20TT
90098-70085	W20EPB	W20TT
90098-70086	PK20PR-P8	IK20TT
90098-70105	W20ETR-L	IW20TT
90098-70106	W20FPR-U10	WF20TT
90098-70108	P20PR11	W20TT
90098-72021	X22EPR-U9	-
90098-72023	U22FSR-U	-
90098-72047	K22PR-U11	IK22FTT
90098-72051	XU22EPR-U	XU22TT
90098-72061	T22M-U	-
90098-72062	T22MP-U	-
90098-72070	PK22PR11	IK22FTT
90098-74021	X24EPR-U9	-
90098-74051	XU24EPR-U	-
90098-77021	X27EPR-U9	-
90179-04019	DG-648	-
90919-01011	W14F-U	-
90919-01045	W20EXR-U	W20TT
90919-01050	W14EX-U	W16TT
90919-01055	W9EP	-
90919-01059	W16EX-U	W16TT
90919-01059-3	W16EX-U	W16TT
90919-01059-70	W16EX-U	W16TT
90919-01059-99	W16EX-U	W16TT
90919-01064	W16EXR-U	W16TT
90919-01064-01	W16EXR-U	W16TT
90919-01064-02	W16EXR-U	W16TT
90919-01064-03	W16EXR-U	W16TT
90919-01064-3	W16EXR-U	W16TT
90919-01064-4	W16EXR-U	W16TT
90919-01064-99	W16EXR-U	W16TT
90919-01065	W14EXR-U	W16TT
90919-01065-99	W14EXR-U	W16TT
90919-01073	W16ESR-U	-
90919-01078	W14FP-U	-
90919-01083	W20EX-U	W20TT
90919-01084	W20EXR-U	W20TT
90919-01084-3	W20EXR-U	W20TT
90919-01091	W20ESR-U	-
90919-01091-02	W16EXR-U11	W16TT
90919-01095	W16ETR-S	W16TT
90919-01108	W14EXR-U11	W16TT
90919-01113	J16AR-U11	-
90919-01115	P16R	W20TT
90919-01119	J16BR-U	-
90919-01121	P16R	W20TT
90919-01125	W20EXR-U11	W20TT
90919-01125-1	W20EXR-U11	W20TT

TOYOTA/LEXUS	DENSO	TT
90919-01127	PQ20R	Q20TT
90919-01129	Q16R-U11	Q16TT
90919-01129-1	Q16R-U11	Q16TT
90919-01131	Q20R-U11	Q20TT
90919-01133	P16R13	W20TT
90919-01133-1	P16R13	W20TT
90919-01135	IQ20TT	IQ20TT
90919-01143	P16R	W20TT
90919-01145	PQ20R-P8	IQ20TT
90919-01149	Q20R-U	Q20TT
90919-01153	Q16R-U	Q16TT
90919-01153-1	Q16R-U	Q16TT
90919-01155	QJ16AR-U	-
90919-01155-1	QJ16AR-U	-
90919-01155-2	QJ16AR-U	-
90919-01157	IQ16TT	IQ16TT
90919-01164	K16R-U11	K16TT
90919-01164-1	K16R-U11	K16TT
90919-01166	K20R-U	K20TT
90919-01168	W16EX-U	W16TT
90919-01170	Q14R-U11	IQ16TT
90919-01170-1	Q14R-U11	IQ16TT
90919-01172	IK20TT	IK20TT
90919-01176	K16R-U	K16TT
90919-01178	PK20R11	K20TT
90919-01180	PK20R8	IK20TT
90919-01184	K20R-U11	K20TT
90919-01187	PK20R13	K20TT
90919-01191	SK20HR11	IKH20TT
90919-01192	K16TR11	K16TT
90919-01194	PK20TR11	K20TT
90919-01196	PK16TR11	K16TT
90919-01198	K20TR11	K20TT
90919-01200	PK16TR13	IK16TT
90919-01205	PK16PR11	K16TT
90919-01207	SK20R-P11	IK20TT
90919-01208	PK20GR8	-
90919-01209	SK16R-P11	IK16TT
90919-01210	SK20R11	IK20TT
90919-01212	SK20R-P13	IK20TT
90919-01214	SK16R-P8	IK16TT
90919-01217	SK16R11	IK16TT
90919-01221	SK20BGR11	-
90919-01223	IW16TT	IW16TT
90919-01225	SK20R-P11	IK20TT
90919-01229	SK20R5-G	-
90919-01230	SK20BR11	-
90919-01233	SK16HR11	IKH16TT
90919-01235	K20HR-U11	IKH20TT
90919-01237	SK20R11	IK20TT
90919-01239	VK20Y	-
90919-01240	SK16R11	IK16TT
90919-01243	FK16HR11	IKH16TT
90919-01244	K16R-U	K16TT
90919-01247	FK20HR11	IKH20TT
90919-01249	FK20HBR11	IKBH20TT
90919-01252	FK16R11	IK16TT
90919-01258	K16HR-U11	KH16TT
90919-01259	FK16HR-A8	-
90919-01259-A	FK16HR-A8	-
90919-01265	FK16R-A8	IK16TT
90919-01266	SK20HR-A11	IKH20TT
90919-01272	FK16BR-AL8	-
90919-01275	SC16HR11	IXEH20TT
90919-01276	VDKH22F	-
90919-01279	FK20HBR-J8	IKBH20TT
90919-01280	FC16HR8	IXEH20TT
90919-01281	FC16HR-CY9	-
90919-01284	FK16BR-AL8	-
90919-01285	VDC22F	-
90919-01286	FK16HBR-J8	-

TOYOTA/LEXUS	DENSO	TT
90919-01287	FK20HR-A8	IKH20TT
90919-01298	FC16HR-CY9	-
90919-C1006	FK16HBR-J8	-
90999-09006	W16EX-U	W16TT
90999-09007	W20EX-U	W20TT
91919-01091	W16EXR-U11	W16TT
DEL44-11008	W9EP	-
DEL73-00845	W20EXR-U11	W20TT

TRD	DENSO	TT
10901SP00324	IW24	-
10901SP04127	IK01-27	-
10901SP04129	IK01-31	-
10901SP04131	IK01-31	-
19059SP00422	IK22	IK22FTT
19059SP00424	IK24	-
19059SP00427	IK27	-
TRDIK16X	IK16	IK16TT
TRDIK20X	IK20	IK20TT
TRDIK22	IK22	IK22FTT
TRDIK24	IK24	-
TRDIK27	IK27	-
TRDK31AZ	IK31	-

VAG	DENSO	TT
101 905 601B	KJ20DR-M11	-
04L 963 319 B	DG-193	-
059 963 319 S	DG-193	-
101 905 601C	KJ20DR-M11	-
101 905 601F	KJ20DR-M11	-
101 905 617C	KJ20DR-M11	-
101 905 623	KJ22CR-L11	-
101 905 625	K22PR-U	IK22FTT
101 905 632	KJ22CR-L11	-
101905601B	KJ16CR-L11	K16TT
N 105 798 03	DG-622	-
N 105 798 05	DG-622	-

VAUXHALL	DENSO	TT
25193473	KJ20CR-L11	K20TT
55200755	DG-608	-
55210051	DG-621	-
55564219	DG-621	-
55567737	DG-625	-
55570037	DG-634	-
55571391	PK20PR-L11	IK20TT
55588475	DG-302	-
55588475	DG-641	-
90464737	DG-133	-
90509368	DG-001	-
9111145	DG-004	-
91143773	W20FPR-U	WF20TT
9118201	DG-118	-
93178047	DG-171	-
93183990	DG-133	-
93187927	DG-302	-
93187927	DG-641	-
93191771	DG-608	-
93193804	DG-171	-
94133759	DG-108	-
94140115	DG-108	-
94175158	DG-108	-
95508486	DG-171	-
95508492	DG-646	-
95514173	DG-631	-
95516186	DG-631	-
95518024	DG-631	-
97210818	DG-302	-
97210818	DG-641	-
97358626	DG-302	-
97358626	DG-641	-

VAUXHALL	DENSO	TT
97389905	DG-302	-
97389905	DG-641	-

VM	DENSO	TT
46 07 2012F	DG-660	-
46072010F	DG-633	-
6072020F	DG-620	-
D6070054A	DG-620	-

VOLKSWAGEN	DENSO	TT
004081161A	K20PR-U	K20TT
03C905601A	PKJ20CR8	IK20TT
03C905601B	SKJ20CR-A8	-
03L963319	DG-193	-
03L963319A	DG-193	-
03L963319C	DG-193	-
059 963 319 T	DG-193	-
059963319	DG-144	-
059963319A	DG-144	-
059963319C	DG-193	-
059963319E	DG-193	-
059963319F	DG-193	-
059963319H	DG-144	-
059963319J	DG-193	-
059963319M	DG-193	-
05998319	DG-193	-
061905061	DG-012	-
062905061	DG-139	-
062905061A	DG-183	-
068905061	DG-012	-
06H905601A	PK22PR8	IK22TT
06H905604	VK22	IK22FTT
06H905611	PK22PR8	IK22TT
06H905621	PK22PR8	IK22TT
079905626B	VKH22	-
079905626E	VKH22	-
101 905 622	VXUHC22G	-
101000000AA	W22EPR-U	W22TT
101000000AB	W20EPR-U	W20TT
101000000AC	W16EPR-U	W16TT
101000001AA	W22EPB	W22TT
101000001AB	W20EPB	W20TT
101000001AC	W20EPB	W20TT
101000001AD	W16EPB10	W16TT
101000001AE	W16EPB10	W16TT
101000002AA	W16EPR-U	W16TT
101000002AB	W20EPR-U	W20TT
101000002AC	W20EPR-U	W20TT
101000002AD	W22EPR-U	W22TT
101000002AE	IW20	IW20TT
101000003AA	K22PB	IKB22TT
101000004AA	K22PB	IKB22TT
101000004AB	K20PBR-S10	K20TT
101000005AA	W20EPB	W20TT
101000005AB	W20EPB	W20TT
101000005AC	W22EPB	W22TT
101000005AD	W16EPB10	W16TT
101000005AE	W16EPB10	W16TT
101000005AF	W16EPB10	W16TT
101000006AA	W22EPR-U	W22TT
101000006AB	W20EPR-U	W20TT
101000006AC	W20EPR-U	W20TT
101000006AD	W16EPR-U	W16TT
101000006AF	IW20	IW20TT
101000007AA	W20EPB	W20TT
101000007AB	W20EPB	W20TT
101000007AC	W16EPB10	W16TT
101000007AD	W20EPB	W20TT
101000009AA	W20ESR-U	-
101000010AB	T20EPR-U	T20TT
101000012AA	W20ESR-U	-

Свечи зажигания и Свечи накаливания

Таблица взаимозаменяемости - OE

VOLKSWAGEN	DENSO	TT
101000013AA	IK20	IK20TT
101000014AA	K22PBR-S	IKB22TT
101000014AB	K20PBR-S10	K20TT
101000015AA	T20EPR-U	T20TT
101000016AA	PK22PR8	IK22TT
101000016AB	PK20PR-P8	IK20TT
101000017AA	K22PB	IKB22TT
101000017AB	K20PBR-S10	K20TT
101000018AA	W16EPR-U	W16TT
101000019AA	W16EPR-U	W16TT
101000020AA	W16EPR-U	W16TT
101000021AA	W20EPB	W20TT
101000025AA	K20TXR	K20TT
101000026AA	W20EPBR-S	W20TT
101000026AB	W20EPBR-S	W20TT
101000027AA	W20EPB	W20TT
101000027AB	W16EPB10	W16TT
101000027AC	W16EPB10	W16TT
101000028AA	K22PB	IKB22TT
101000029AA	T20EPR-U	T20TT
101000029AB	T20EPR-U	T20TT
101000031AA	K20TXR	K20TT
101000031AB	IK22	IK22FTT
101000033AA	K20PBR-S10	K20TT
101000033AB	K22PBR-S	IKB22TT
101000033AC	K16TNR-S9	K16TT
101000033AF	K20PBR-S10	K20TT
101000033AG	K16TNR-S9	K16TT
101000034AA	W20EPR-U	W20TT
101000035AA	K20TXR	K20TT
101000035AB	K20TXR	K20TT
101000035AE	IK22	IK22FTT
101000035AH	K20TXR	K20TT
101000035HJ	K20TXR	K20TT
101000036AA	W20EPBR-S	W20TT
101000036AB	W20EPBR-S	W20TT
101000036AC	W20EPBR-S	W20TT
101000038AA	W16ETR-S	W16TT
101000038AB	W16ETR-S	W16TT
101000039AA	W16ETR-S	W16TT
101000039AB	W16ETR-S	W16TT
101000040AC	W20EPBR-S	W20TT
101000040AD	W20EPBR-S	W20TT
101000040AE	W20EPBR-S	W20TT
101000041AC	K20PBR-S10	K20TT
101000041AD	K20PBR-S10	K20TT
101000041AE	K22PBR-S	IKB22TT
101000044AA	IK16	IK16TT
101000045AA	IK22	IK22FTT
101000047AA	W16EPR-U	W16TT
101000047AB	P20PR11	W20TT
101000049AC	IK16	IK16TT
101000049AD	IK20	IK20TT
101000049AE	K16PR-U	K16TT
101000049AF	K16PR-U	K16TT
101000050AA	W20EPBR-S	W20TT
101000050AB	W20EPBR-S	W20TT
101000050AC	W20EPBR-S	W20TT
101000051AA	K20PBR-S10	K20TT
101000051AB	K22PBR-S	IKB22TT
101000052AA	T20EPR-U	T20TT
101000052AB	T20EPR-U	T20TT
101000053AA	PK16PR11	K16TT
101000054AC	K20PBR-S10	K20TT
101000054AD	K20PBR-S10	K20TT
101000055AA	K20TXR	K20TT
101000060AA	K16TNR-S9	K16TT
101000062AA	VKA20	-
101000062AB	PKJ16CR-L11	IK16TT
101000063AA	PK20PR-P8	IK20TT
101000063AC	PK22PR8	IK22TT

VOLKSWAGEN	DENSO	TT
101000065AA	K20PBR	K20TT
101000067AA	K20TXR	K20TT
101000068AA	K20PBR-S10	K20TT
101000068AA	K20PBR-S10	K20TT
101905115	PKJ20CR8	IK20TT
101905600	SKJ16CR-L11	IK16TT
101905600A	PKJ20CR-L11	IK20TT
101905600C	VKA16	-
101905601	PKJ16CR-L11	IK16TT
101905603B	KJ16CR-L11	K16TT
101905607	K20TXR	K20TT
101905608AA	K20PBR-S10	K20TT
101905610A	K20PR-U	K20TT
101905610B	IK20	IK20TT
101905611	PK20PR-L11	IK20TT
101905611A	PK20PR-L11	IK20TT
101905611B	PK22PR8	IK22TT
101905611G	IK24	-
101905615A	K20PBR-S10	K20TT
101905616	K20PBR-S10	K20TT
101905617	KJ16CR-L11	K16TT
101905617A	KJ16CR-L11	K16TT
101905618	KJ16CR-L11	K16TT
101905618A	KJ16CR-L11	K16TT
101905620	VKA16	-
101905621A	VKB20	-
101905621B	VKB20	-
101905626	PKJ20CR8	IK20TT
101905626B	PKJ20CR8	IK20TT
101905631	VK22	IK22FTT
101905631A	PK20PR-L11	IK20TT
101905631B	PK22PR8	IK22TT
101905631C	PK20PR-P8	IK20TT
101905631E	PK20PR-L11	IK20TT
101905631G	VK22	IK22FTT
101905631H	PK22PR8	IK22TT
101905640	IK22	IK22FTT
101905640A	VKB20	-
101905640D	VKB20	-
101905641	VKH22	-
101935631G	VK22	IK22FTT
101955631B	PK22PR8	IK22TT
10213002	DG-012	-
10591602	DG-177	-
10591603	DG-177	-
191905450	W20EPB	W20TT
191905450A	W20EPB	W20TT
191905450J	K22PB	IKB22TT
191905451J	K22PB	IKB22TT
194917764	K16PR-U	K16TT
194917864	Q22PR-U	-
197917764	K16PR-U	K16TT
199917764	K16PR-U	K16TT
199917766	K20PR-U	K20TT
3090599916	W22EPR-U	W22TT
3L963319	DG-193	-
3L963319A	DG-193	-
410905619	IXU24	-
59 963 319 T	DG-193	-
59963319A	DG-144	-
59963319C	DG-193	-
59963319E	DG-193	-
59963319F	DG-193	-
59963319H	DG-144	-
59963319J	DG-193	-
59963319M	DG-193	-
62905061A	DG-183	-
6U0000156	K16PR-U	K16TT
J1985054090	DG-648	-
J9091901064	W16EXR-U	W16TT
JZW905603A	PKJ16CR-L11	IK16TT

VOLKSWAGEN	DENSO	TT
JZW905603D	K20PBR-S10	K20TT
N0178011	W16FSR	-
N01780113	W20FSR-U	WF20TT
N01781124	W16ESR-U	-
N01781130	W22ESR-U	-
N01781139	W20EPR-U	W20TT
N01781144	IW22	-
N01781155	W20EPR-U	W20TT
N01781159	W22EPR-U	W22TT
N01781171	W22EPR-U	W22TT
N01781175	W20EPR-U	W20TT
N01781213	W20EPR-U	W20TT
N01781216	W22ESR-U	-
N01781234	W16EPR-U	W16TT
N01781236	W20EPR-U	W20TT
N01781240	W20EPR-U	W20TT
N01781241	W16EPR-U	W16TT
N01781244	W22EPR-U	W22TT
N01781249	W20EPB	W20TT
N01781253	W20EPR-U	W20TT
N01781333	W20EPR-U	W20TT
N0190811	DG-012	-
N0190812	DG-012	-
N0190814	DG-012	-
N0190971	DG-012	-
N01910005	DG-012	-
N0191001	DG-012	-
N0191002	DG-012	-
N0191005	DG-012	-
N0191006	DG-012	-
N10140101	DG-005	-
N10140102	DG-005	-
N10140103	DG-005	-
N10140104	DG-005	-
N10140105	DG-005	-
N10213001	DG-012	-
N10213002	DG-012	-
N10302101	DG-628	-
N10302102	DG-628	-
N10579201	DG-109	-
N10579202	DG-109	-
N10579802	DG-190	-
N10579804	DG-190	-
N10591602	DG-177	-
N10591603	DG-177	-

VOLVO	DENSO	TT
109X9146775	K20PBR-S10	K20TT
1257141	DG-012	-
1257889	DG-012	-
1269915	T20EPR-U	T20TT
1275580	DG-628	-
1306604	W22EPR-U	W22TT
13066048	W20EPR-U	W20TT
1306605	W20EPR-U	W20TT
1346541	W20EPR-U	W20TT
13465414	W20EPR-U	W20TT
1357826	IWF22	-
1357827	IWF22	-
1357828	W20FPR-U	WF20TT
135827	W20FPR-U	WF20TT
1367015	W22EPR-U	W22TT
1367526	W20EX-U	W20TT
1367527	W22EPR-U	W22TT
1367528	W20EPR-U	W20TT
1367528-5	W20EPR-U11	W20TT
1367529	W20EPR-U	W20TT
1367529.3	W20EPR-U	W20TT
1389896	T22EP-U	-
1542319	DG-202	-
1667529	W20EPR-U	W20TT

VOLVO	DENSO	TT
207X9146775	K20PBR-S10	K20TT
241402	W20FPR-U	WF20TT
270746-1	W20EPR-U	W20TT
2707479	W22EPR-U	W22TT
271239	VKB20	-
271239-6	VKB20	-
271409-5	W20EPR-U	W20TT
2714152	W22EPR-U	W22TT
2714277	K20PR-U	K20TT
271603	K20PR-U	K20TT
2716033	K22PR-U	IK22FTT
2716363	K20PR-U	K20TT
271727	K20PR-U	K20TT
2717270	K20PBR-S10	K20TT
271758	IK22	IK22FTT
2717668	IK22	IK22FTT
272207	K20PBR	K20TT
2722072	IT20TT	IT20TT
2723138	IK22	IK22FTT
272344	PK20PR-P8	IK20TT
272344-3	VK22	IK22FTT
272372	K20PBR-S10	K20TT
272767	PK20PR-P8	IK20TT
2735967	W22EPR-U	W22TT
2735975	W20EPR-U	W20TT
2735991	T20EPR-U	T20TT
304X9146775	K20PBR-S10	K20TT
30637308	IK22	IK22FTT
30637385	IKH22	-
30650379	IKH22	-
30650843	K20HR-U11	KH20TT
30711106	DG-113	-
30713859	IKH22	-
30725069	DG-181	-
30725678	DG-603	-
30731383	SK20PR-A11	IK20TT
30731425	PT16VR13	TV16TT
30751468	VKH22	-
30751805	VKH22	-
30751806	VKH20Y	-
30758131	ITV22	-
30777311	DG-620	-
30777349	ZT20EPR11	IT20TT
30862690	DG-101	-
30883828	DG-005	-
31216183	VKH20Y	-
31216184	VKH20Y	-
31216248	DG-180	-
31216525	ZT20EPR11	IT20TT
31216674	VKH20Y	-
31251481	PT16VR13	TV16TT
31272399	VKH20Y	-
31272427	PT16VR13	TV16TT
31286359	FK20HR11	IKH20TT
31293000	FK20HR11	IKH20TT
31312691	FK20HR11	IKH20TT
31330212	DG-603	-
31330450	ITV20TT	ITV20TT
32017060	DG-628	-
32133274	W22EPR-U	W22TT
32705069	J16CR-U	W16TT
33443151	W16EPR-U	W16TT
33444720	J16CR-U	W16TT
33444738	J16CR-U	W16TT
33448986	W22EPR-U	W22TT
33448994	W22EPR-U	W22TT
3517629	K22PR-U	IK22FTT
3517980	K20PR-U	K20TT
402X9146775	K20PBR-S10	K20TT
6470058	IK20	IK20TT
8631607	DG-140	-

Свечи зажигания и Свечи накаливания

Таблица взаимозаменяемости - OE

VOLVO	DENSO	TT
8642660	K20PBR-S10	K20TT
8642661	K20PBR-S10	K20TT
8653104	IK20	IK20TT
8653698	DG-181	-
8653880	DG-610	-
8658474	IKH22	-
8670057	PK20PR-P8	IK20TT
8670058	IK22	IK22FTT
8670059	IK22	IK22FTT
8692070	PK20PR-P8	IK20TT
8692071	PK20PR-P8	IK20TT
8692072	PK20PR-P8	IK20TT
8694749	IT20TT	IT20TT
9135871	IK22	IK22FTT
9146775	K20PBR-S10	K20TT
917910	PK20PR-P8	IK20TT

YAMAHA	DENSO	TT
90793-20018	IW31	-
90793-20029	IW29	-
90793-20030	IW01-32	-
90793-20032	IW31	-
90793-20033	U24ES-N	-
90793-20034	U27ES-N	-
90793-20150	IU24	-
90793-20151	IU27	-
90793-20152	IX24	-
90793-20153	IX27	-
90793-20154	IX24B	-
90793-20155	IX27B	-
90793-20156	IWF20	-
90793-20157	IWF22	-
90793-20158	IWF22	-
90793-20159	IWF22	-
90793-20160	IW24	-
90793-20161	IW27	-
90793-20162	IUH24	-
90793-20163	IUH27	-
90793-20164	IWF24	-
90793-20165	IW31	-
90793-20166	IWF24	-
90793-20167	IW16	IW16TT
90793-20168	IW20	IW20TT
90793-20170	IUF22	-
90793-20171	IUF22	-
90793-20172	IU22	-
90793-20173	IX22B	-
90793-20174	IUF24	-
90793-20175	IW22	-
907-93220-08	W16ES-U	-
90793-22008	W16ESR-U	-
90793-22010	W27ESR-U	-
907-93220-13	W14EX-U	IW16TT
907-93220-14	W16EX-U	W16TT
907-93220-15	W20EX-U	W20TT
907-93220-23	W27FS-U	-
90793-22035	W20ESR-U	-
90793-22036	W22ESR-U	-
90793-22037	W27ESR-U	-
90793-22039	W24FSR	-
907-93220-40	W14EXR-U	IW16TT
907-93220-41	W16EXR-U	W16TT
907-93220-42	W20EXR-U	W20TT
907-93220-43	W14EXR-U11	IW16TT
907-93220-44	W16EXR-U11	W16TT
907-93220-45	W20EXR-U11	W20TT
90793-22045	W20EXR-U11	W20TT
907-93220-46	X20EPR-U9	-
907-93220-47	X22EPR-U9	-
90793-22047	X22EPR-U9	-
907-93220-49	X27EPR-U9	-

YAMAHA	DENSO	TT
907-93220-69	W14FPR-UL	-
907-93220-72	W16S-U	-
907-93220-73	W20S-U	-
907-93220-74	W22S-U	-
907-93220-75	W14MP-U10	-
907-93220-77	W14FPR-UL	-
907-93220-78	W14FPR-UL10	-
907-93220-79	W14MPR-U10	-
907-93220-80	W20MPR-U10	-
907-93220-81	W14MR-U	-
907-93220-82	W20MR-U	-
90793-22088	IW24	-
90793-22089	IW27	-
90793-22090	IW29	-
90793-22091	IW31	-
90793-22092	IW34	-
90793-22093	IU22	-
90793-22094	IU24	-
90793-22095	IU27	-
90793-22096	IUH24	-
90793-22097	IUH27	-
90793-22098	IX22B	-
90793-22099	IX24B	-
90793-22100	IX27B	-
90793-22101	IW22	-
90793-22102	IU31	-
90793-22103	IU24A	-
90793-22104	IU27A	-
90793-22105	IU31A	-
90793-22106	IX22	-
90793-22107	IX24	-
90793-22108	IX27	-
90793-22109	IWF22	-
90793-22110	IWF24	-
90793-22111	IWF27	-
90793-22112	IW16	IW16TT
90793-22114	IUF22	-
90793-22115	IUF24	-
907-93780-13	W22M-U	-
9079E-ND001	W16FSR	-
9079E-ND002	W20FSR-U	WF20TT
9079E-ND004	W22FS-U	-
9079E-ND006	W24FSR	-
9079E-ND007	W24FSR-U10	-
9079E-ND008	W27FSR	-
9079E-ND009	W27FSR	-
9079E-ND010	W16FSR	-
9079E-ND011	W20FSR-U	WF20TT
9079E-ND012	W22FSR	-
9079E-ND013	W24FSR	-
9079E-ND014	W24FSR-U10	-
9079E-ND015	W27FSR	-
9079E-ND016	W27FSR	-
9079E-ND017	U20FSR-U	-
9079E-ND019	U22FSR-U	-
9079E-ND020	W14FPR-UL	-
9079E-ND021	W16ESR-U	-
9079E-ND022	W20EP-U	W20TT
9079E-ND023	W20FPR-U	WF20TT
9079E-ND024	W20FPR-U	WF20TT
9079E-ND026	W22EPR-U	W22TT
9079E-ND027	W22EPR-U	W22TT
9079E-ND028	W22FPR-U	-
9079E-ND030	W24ESR-U	-
9079E-ND031	W24ESR-U	-
9079E-ND032	W24EPR-U	-
9079E-ND033	W24FP-U	-
9079E-ND035	W27ESR-U	-
9079E-ND036	W27ESR-U	-
9079E-ND037	X22EPR-U9	-
9079E-ND038	X24EPR-U9	-

YAMAHA	DENSO	TT
9079E-ND039	X24ESR-U	-
9079E-ND040	W22FPR-U	-
9079E-ND041	U20FSR-U	-
9079E-ND042	W22ESR-U	-
9079E-ND043	X22ESR-U	-
9079E-ND044	X24ESR-U	-
9079E-ND045	U27ES-N	-
9079E-ND046	W20FPR-U10	WF20TT
9079E-ND049	X20FSR-U	-
9079E-ND050	X24FS-U	-
9079E-ND051	U16FSR-U	-
9079E-ND052	W22FP-U10	-
9079E-ND053	W22EPR-U11	W22TT
9079E-ND055	W16FPR-U	-
9079E-ND056	X27GPR-U	-
9079E-ND057	U22FSR-U	-
9079E-ND058	U24ESR-N	-
9079E-ND059	U27ESR-N	-
9079E-ND060	X20EPR-U9	-
9079E-ND067	IWF20	-
9079E-ND069	X27EPR-U9	-
9079E-ND070	X22EPR-U9	-
9079E-ND071	W20EPR-U	W20TT
9079E-ND072	W16EPR-U	W16TT
9079E-ND073	X24EPR-U9	-
9079E-ND075	W16EPR-U	W16TT
9079E-ND077	W9EXR-UCU	-
9079E-ND078	X22ESR-U	-
9079E-ND079	X27ESR-U	-
9079E-ND081	K16HPR-U11	KH16TT
9079E-ND084	IWF20	-
9079E-ND085	W20MR-U	-
9079Q-30501	U27ESR-N	-
90890-78079	IW20	IW20TT
90890-78082	IW31	-
908-90780-85	W22FP-U10	-
90890-78086	W24ESR-U	-
908-90780-91	X27EP-U9	-
90890-78094	W20FSR-U	WF20TT
90890-78097	W14FPR-UL	-
90890-78102	W20MR-U	-
90890-78110	IW27	-
90890-78111	IW29	-
90890-78112	IW31	-
90893-22113	IW20	IW20TT
909-19010-45	W20EXR-U	W20TT
909-19010-64	W16EXR-U	W16TT
909-19010-84	W20EXR-U	W20TT
909-19010-91	W16EXR-U11	W16TT
909-19011-13	J16AR-U11	-
909-19011-21	PQ16R	Q16TT
909-19011-25	W20EXR-U11	W20TT
909-19011-27	PQ20R	Q20TT
90919-01237	SK20R11	IK20TT
947-00001-76	W20ES-U	-
94700-00181	X24ES-U	-
947-00001-84	X27ES-U	-
947-00002-01	W20EP-U	W20TT
947-00002-02	W22EP-U	W22TT
947-00002-09	W24EP-U	-
947-00002-10	W24EPR-U	-
947-00002-20	W22EPR-U	W22TT
94700-00220	W22EPR-U	W22TT
94700-00222	X24ESR-U	-
947-00002-23	W20FP-U	WF20TT
947-00002-25	W20ES-U	-
947-00002-28	W20EPR-U	W20TT
947-00002-30	W20FP-U	WF20TT
947-00002-35	W20FPR-U	WF20TT
947-00002-36	W20ESR-U	-
94700-00242	X24EPR-U9	-

YAMAHA	DENSO	TT
94700-00248	W22FSR	-
947-00002-55	U22FS-U	-
947-00002-57	U20FS-U	-
94700-00257	U20FS-U	-
947-00002-65	U22FSR-U	-
94700-00265	U22FSR-U	-
94700-00283	U20FSR-U	-
947-00002-86	X24EP-U9	-
947-00003-05	U22ES-N	-
947-00003-06	U24ES-N	-
947-00003-07	U27ES-N	-
947-00003-19	U27ESR-N	-
94700-00319	U27ESR-N	-
947-00003-27	W22FPR-U	-
947-00003-29	U24ESR-N	-
94700-00329	U24ESR-N	-
947-00003-41	X27ESR-U	-
947-00003-52	U22ESR-N	-
947-00003-55	W22FSR	-
94700-00379	X22EPR-U9	-
94700-00407	IU27D	-
94700-00834	U22FSR-U	-
94700-00870	U24EPR9	-
94700-00873	U24ESR-N	-
94700-00881	U22ESR-N	-
94700-00886	U22FSR-U	-
94700-00895	U20FSR-U	-
94700-00898	U22ESR-N	-
94701-00039	W20FSR-U	WF20TT
94701-00040	W22FS-U	-
94701-00042	W24FSR	-
94701-00043	W20ESR-U	-
94701-00044	W22ESR-U	-
94701-00045	W24ESR-U	-
94701-00046	W27ESR-U	-
94701-00048	IWF24	-
94701-00050	W22FPR-U	-
94701-00061	IW24	-
94701-00063	IW27	-
94701-00069	W16FSR	-
94701-00078	W16ESR-U	-
94701-00108	W20FPR-U	WF20TT
94701-00110	W22FSR	-
94701-00111	W20ESR-U	-
94701-00112	W22ESR-U	-
94701-00113	IW24	-
94701-00116	W20EPR-U	W20TT
94701-00117	W22EPR-U	W22TT
94701-00118	W24EPR-U	-
94701-00148	IWF24	-
94701-00157	X24ESR-U	-
94701-00159	W14FPR-UL	-
94701-00160	W24FSR-U10	-
94701-00168	W16FPR-U	-
947-01001-78	X22ES-U	-
947-01001-81	X24ES-U	-
9470100188	W27ESR-U	-
94701-00188-00	W27ESR-U	-
94701-00189	X22ESR-U	-
94701-00190	W16FPR-U	-
94701-00193	IW27	-
94701-00194	W16FPR-U	-
94701-00195	W24FSR	-
94701-00198	W20FPR-U	WF20TT
947-01002-02	W22EP-U	W22TT
94701-00203	X24ESR-U	-
94701-00204	W24ESR-U	-
94701-00208	X22ESR-U	-
947-01002-10	W24EPR-U	-
94701-00218	W22EPR-U	W22TT

Свечи зажигания и Свечи накаливания

Таблица взаимозаменяемости - OE

YAMAHA	DENSO	TT
94701-00219	W24EPR-U	-
947-01002-20	W22EPR-U	W22TT
94701-00220	W22FPR-U	-
947-01002-22	X24ESR-U	-
94701-00222	X24ESR-U	-
94701-00227	W22FPR-U	-
947-01002-28	W20EPR-U	W20TT
947-01002-30	W20FP-U	WF20TT
94701-00232	W20FPR-U	WF20TT
94701-00234	W20EPR-U	W20TT
947-01002-35	W20FPR-U	WF20TT
947-01002-36	W20ESR-U	-
9470100237	W24FPR-U10	-
94701-00241	X24EPR-U9	-
947-01002-42	X24EPR-U9	-
94701-00248	W20FSR-U	WF20TT
94701-00250	U22FSR-U	-
94701-00251	W27FSR	-
94701-00254	U22FSR-U	-
94701-00256	U20FSR-U	-
94701-00258	W14FPR-UL	-
94701-00262	X22EPR-U9	-
94701-00263	X22EPR-U9	-
94701-00264	W22FP-U10	-
94701-00265	U22FSR-U	-
94701-00266	X27ESR-U	-
94701-00267	W24EPR-U	-
94701-00268	W24FP-U	-
94701-00273	W20FSR-U	WF20TT
94701-00274	W20FSR-U	WF20TT
94701-00275	X24EPR-U9	-
94701-00280	W24FPR	-
94701-00282	U20FSR-U	-
94701-00283	U20FSR-U	-
94701-00284	IW20	IW20TT
94701-00285	IW20	IW20TT
94701-00287	X27ESR-U	-
94701-00292	W20FPR-U10	WF20TT
94701-00300	U16FSR-U	-
94701-00301	IW20	IW20TT
94701-00311	W16ESR-U	-
94701-00318	U27ESR-N	-
947-01003-21	W22FP-U	-
94701-00328	W16EPR-U	W16TT
94701-00329	U24ESR-N	-
94701-00330	U24ESR-N	-
94701-00332	IWM01-32	-
94701-00333	X24ESR-U	-
94701-00340	X27ESR-U	-
94701-00345	X22ESR-U	-
94701-00353	U22ESR-N	-
94701-00354	U14FSR-UB	-
94701-00361	X27EPR-U9	-
94701-00365	T20R-U	-
94701-00366	U22FSR-U	-
94701-00372	U20FSR-U	-
94701-00375	X20EPR-U9	-
94701-00381	U20ESR-N	-
94701-00386	U31ETR	-
94701-00394	IU01-31	-
94701-00395	U27ETR	-
9470100403	U27ETR	-
94701-00403-00	U27ETR	-
94701-00407	IU27D	-
94701-00408	IU27D	-
94701-00410	U27ESR-N	-
94701-00411	U24ESR-N	-
94701-00840	U22ESR-N	-
94702-00044	W22ESR-U	-
94702-00045	W24ESR-U	-
94702-00046	W27ESR-U	-

YAMAHA	DENSO	TT
94702-00149	W22FS-U	-
94702-00188	W27ESR-U	-
94702-00193	IW27	-
94702-00195	W24FSR	-
94702-00204	W24ESR-U	-
94702-00211	W20MPR-U10	-
9470200234	W20EPR-U	W20TT
94702-00247	W24FSR-U10	-
94702-00249	W16FSR	-
94702-00271	W22FSR	-
94702-00272	W22FSR	-
94702-00274	W20FSR-U	WF20TT
94702-00309	W27FSR	-
94702-00317	W27FSR	-
94702-00323	W24ES-V	-
94702-00324	W27ESR-V	-
94702-00325	W27ES-V	-
94702-00326	W24ESR-V	-
94702-00331	W14EPR-U	IW16TT
94702-00343	W14E	-
94702-00348	W9EXR-UCU	-
94702-00349	W22ESR-U	-
94702-00367	IW31	-
94702-00368	IW31	-
94702-00372	U20FSR-U	-
94702-00373	IW31	-
94702-00374	IWM01-32	-
94702-00391	K16HPR-U11	KH16TT
94702-00427	K20HR-U11	KH20TT
94702-00429	XU22HDR9	XUH22TT
94702-00801	X24ESR-U	-
94702-00N01	W16FPR-U	-
94703-00001	W14F-U	-
94703-00039	W20FSR-U	WF20TT
94703-00040	W22FS-U	-
94703-00041	W24FSR	-
94703-00043	W20ESR-U	-
94703-00044	W22ESR-U	-
94703-00045	W24ESR-U	-
94703-00046	W27ESR-U	-
94703-00050	W22FPR-U	-
94703-00069	W16FSR	-
94703-00078	W16ESR-U	-
94703-00108	W20FPR-U	WF20TT
94703-00110	W22FSR	-
94703-00112	W22ESR-U	-
94703-00114	IW27	-
94703-00116	W20EPR-U	W20TT
94703-00117	W22EPR-U	W22TT
94703-00133	W16EPR-U	W16TT
947-03001-54	W22FS-U	-
94703-00157	X24ESR-U	-
94703-00159	W14FPR-UL	-
94703-00160	W24FSR-U10	-
94703-00168	W16FPR-U	-
947-03001-73	W16FS-U	-
947-03001-76	W20ES-U	-
947-03001-81	X24ES-U	-
94703-00181	X24ESR-U	-
94703-00188	W27ESR-U	-
94703-00189	X22ESR-U	-
94703-00194	W16FPR-U	-
94703-00198	W20FPR-U	WF20TT
947-03002-01	W20EP-U	W20TT
94703-00203	X24ESR-U	-
94703-00204	W24ESR-U	-
94703-00207	W14E	-
947-03002-09	W24EP-U	-
94703-00213	U20FSR-U	-
94703-00215	U22FSR-U	-
94703-00217	W22FS-U	-

YAMAHA	DENSO	TT
94703-00218	W22EPR-U	W22TT
94703-00220	W22EPR-U	W22TT
947-03002-22	X24ESR-U	-
94703-00222	X24ESR-U	-
947-03002-23	W20FP-U	WF20TT
94703-00223	W20FPR-U	WF20TT
947-03002-24	W16FP-U	-
947-03002-25	W20ES-U	-
94703-00227	W22FPR-U	-
947-03002-28	W20EPR-U	W20TT
94703-00232	W20FPR-U10	WF20TT
94703-00234	W20EPR-U	W20TT
94703-00235	W20FPR-U	WF20TT
947-03002-36	W20ESR-U	-
94703-00241	X24EPR-U9	-
94703-00254	U22FSR-U	-
94703-00256	U20FSR-U	-
94703-00258	W14FPR-UL	-
94703-00262	X22EPR-U9	-
94703-00263	X22EPR-U9	-
94703-00264	W22FP-U10	-
94703-00267	W24EPR-U	-
94703-00275	X24EPR-U9	-
94703-00277	IW27	-
947-03002-83	U20FSR-U	-
94703-00283	U20FSR-U	-
94703-00307	U27ES-N	-
94703-00314	U24ES-N	-
94703-00315	U27ES-N	-
94703-00318	U27ESR-N	-
94703-00319	U27ESR-N	-
94703-00320	W22EPR-U11	W22TT
947-03003-21	W22FP-U	-
94703-00323	W24ES-V	-
94703-00325	W27ES-V	-
94703-00327	W22FPR-U	-
94703-00329	U24ESR-N	-
94703-00330	U24ESR-N	-
94703-00332	IWM01-32	-
94703-00333	X24ESR-U	-
94703-00345	X22ESR-U	-
94703-00352	U22ESR-N	-
94703-00353	U22ESR-N	-
94703-00355	W22FSR	-
94703-00366	U22FSR-U	-
94703-00367	IW31	-
94703-00372	U20FSR-U	-
947-03022-22	X24ESR-U	-
94709-00195	W24FSR	-
94709-00247	W24FSR-U10	-
94709-00324	W27ESR-V	-
94709-00372	U20FSR-U	-
94709-00383	W27ESR-V	-
94709-00384	W31ESR-U	-
94709-00391	K16HPR-U11	KH16TT
94709-00400	K20HR-U11	KH20TT
94709-00N01	W16FPR-U	-
IQG-10862-20	XU22EPR-U	XU22TT
LKR-6E000-00-00	XU20HR9	XUH20TTI
NGKBR10EG000	IW31	-
Q1Q-DNS-021-000	IXU22	IXU22TT
Q1Q-DNS-022-000	IXU24	-
Q1Q-DNS-026-000	IQ22	-

YANASE	DENSO	TT
51050T20	IT20TT	IT20TT
51050T22	IT22	-
51050W16	IW16	IW16TT
51050W20	IW20	IW20TT
51050W22	IW22	-
5105TF20	ITF20TT	ITF20TT
5105VK22	VK22	IK22FTT
5105VQ16	IQ16TT	IQ16TT
5105VQ20	IQ20TT	IQ20TT
5105VQ22	VQ22	-
5105VW16	IW16TT	IW16TT
5105VW20	VW20	IW20TT
5105VW22	VW22	-
5105VXU220	VXU22	IXU22TT
5105WF22	IWF22	-
5105XU22	IXU22	IXU22TT

YANMAR	DENSO	TT
129155-77800	DG-157	-
160610-78010	W14FPR-UL	-

YANASE	DENSO	TT
51050K16	IK16	IK16TT
51050K20	IK20	IK20TT
51050K22	IK22	IK22FTT
51050Q16	IQ16TT	IQ16TT
51050Q20	IQ20TT	IQ20TT
51050Q22	IQ22	-

Свечи зажигания и Свечи накаливания

Таблица взаимозаменяемости – Другие производители

ACCEL	DENSO	TT
111	IW27	-
112	W24EPR-U	-
113	W22EPR-U	W22TT
114	W20EX-U	W20TT
115	W20EP-U	W20TT
116	W16EXR-U	W16TT
117	W14EX-U	IW16TT
123	W22S-U	-
124	W20S-U	-
134	W20PR-U	-
137	W16PR-U	-
138	W9PR-U	-
141	W27ESR-U	-
142	W24ESR-U	-
143	W22ESR-U	-
146	W16ESR-U	-
166	W16LS	-
168	W14L	-
198	W9PR-U	-
2401P	W9PR-U	-
2403P	W16EXR-U	W16TT
2407P	W24ESR-U	-
2412P	W22EPR-U	W22TT
2413P	W22FPR-U	-
2417P	J16BR-U	-
262	ITF27	-
263	ITF24	-
272	IT27	-
274	T20PR-U	ITF20TT
276	T16PR-U	ITF16TT
276S	T20MP-U	-
286	T16PR-U11	ITF16TT
375	MA20P-U	-
378	MA16PR-U	-
416	Q16PR-U	Q16TT
437	W16PR-U	-
437S	W16PR-U	-
453	W22FPR-U	-
494	W20EXR-U	W20TT
496	W16EXR-U	W16TT
498	W9PR-U	-
504	T20NR-U11	IT20TT
506	T16NR-U11	IT16TT
514	T20EPR-U	T20TT
516	T16EPR-U	T16TT
524	T20EPR-U15	-
526	T16EPR-U15	T16TT
566	T16R-U	T16TT
574	T20PR-U	ITF20TT
576	T16PR-U	ITF16TT
577	T14PR-U	ITF16TT
586	T16PR-U11	ITF16TT
596	T16PR-U11	ITF16TT
675	MA20PR-U	-
736	KJ16CR-U11	K16TT
761	IK31	-
762	IK27	-
763	K24PR-U11	-
765	K22PR-U	IK22FTT
784	K20PR-U	K20TT
786	K16PR-U	K16TT
842	X24ESR-U	-
882	X24EPR-U9	-
997	J16BR-U	-
ACC7ES	W22ESR-U	-
ACC7HS	W22FS-U	-
ACC8ES	W24ESR-U	-
ACC8HS	W24FSR	-
ACC9ES	W27ESR-U	-
ACCR7ES	W22ESR-U	-
ACCR8ES	W24ESR-U	-

ACCEL	DENSO	TT
ACCR8HS	W24FSR	-
ACCR9ES	W27ESR-U	-
P411	IW27	-
P437	W16PR-U	-
P496	W16EXR-U	W16TT
P524S	IT20TT	IT20TT
P526S	PT16EPR-L13	IT16TT
P562	IT27	-
P563	IT24	-
P566	T16R-U	T16TT
P574	T20PR-U	ITF20TT
P576	T16PR-U	ITF16TT
P678	MA16PR-U	-
P962	IT27	-

ACDelco	DENSO	TT
101G	DG-117	-
110G	DG-005	-
114G	DG-119	-
118G	DG-106	-
11G	DG-175	-
121XLS	X24EPR-U9	-
148G	DG-001	-
241G	DG-001	-
28G	DG-012	-
30G	DG-001	-
31G	DG-012	-
33G	DG-143	-
40TS	ITF22	-
41	W27S-U	-
41103	ITL16TT	ITL16TT
41104	IT20TT	IT20TT
41105	ITL16TT	ITL16TT
41-125	ITV20TT	ITV20TT
41600	T16EPR-U15	T16TT
41601	T16EPR-U15	T16TT
41602	K20PR-U	K20TT
41603	K16PR-U	K16TT
41606	T16EPR-U15	T16TT
41608	K16PR-U11	K16TT
41610	K16PR-U	K16TT
41611	K16PR-U11	K16TT
41627	K16PR-U11	K16TT
41628	K16PR-U	K16TT
41629	K16PR-U	K16TT
41801	K20PR-U11	K20TT
41806	KJ16CR-L11	K16TT
41810	T20EPR-U	T20TT
41814	PT16VR13	TV16TT
41900	PT16EPR-L13	IT16TT
41902	PT16EPR-L13	IT16TT
41904	PT16EPR-L13	IT16TT
41906	PT16EPR-L13	IT16TT
41907	PT16EPR-L13	IT16TT
41908	PT16EPR-L13	IT16TT
41910	PT16EPR-L13	IT16TT
41913	PT16EPR-L13	IT16TT
41919	PT16EPR-L13	IT16TT
41921	PT16EPR-L13	IT16TT
41928	PT16EPR-L13	IT16TT
41929	PT16EPR-L13	IT16TT
41931	PT16EPR-L13	IT16TT
41932	PT16EPR-L13	IT16TT
41933	PT16EPR-L13	IT16TT
41936	PT16EPR-L13	IT16TT
41937	PT16EPR-L13	IT16TT
41940	PT16EPR-L13	IT16TT
41942	PT16EPR-L13	IT16TT
41943	PT16EPR-L13	IT16TT
41947	PT16EPR-L13	IT16TT
41948	PT16EPR-L13	IT16TT

ACDelco	DENSO	TT
41950	PT16EPR-L13	IT16TT
41952	PT16EPR-L13	IT16TT
41963	PT16EPR-L13	IT16TT
41974	PTJ16R15	IT16TT
41975	PT16EPR-L13	IT16TT
41986	PT16EPR-L13	IT16TT
41987	PT16EPR-L13	IT16TT
41990	PT16VR13	TV16TT
41993	PT16EPR-L13	IT16TT
41F	W27FSR	-
41TS	ITF22	-
41XL	W27ESR-U	-
41XLS	W24EPR-U	-
426FS	W22FPR-U	-
42F	W22FS-U	-
42FS	W22FPR-U	-
42LTS	T20EPR-U	T20TT
42S	W20PR-U	-
42TS	T20PR-U	ITF20TT
42XL	W22ESR-U	-
42XLS	W22EPR-U	W22TT
43	W20S-U	-
438XLS	W24EPR-U	-
43F	W20FSR-U	WF20TT
43FS	W20FPR-U	WF20TT
43LS	W16LS	-
43N	W20ESR-U	-
43S	W20PR-U	-
43TS	T20PR-U	ITF20TT
43XL	W20ESR-U	-
43XLS	W20EPR-U	W20TT
44	W16S-U	-
44F	W16FSR	-
44FFS	W16FPR-U	-
44FS	W16FPR-U	-
44N	W20ESR-U	-
44NS	W16EPR-U	W16TT
44S	W16PR-U	-
44TS	T16PR-U	ITF16TT
44XL	W20ESR-U	-
44XLS	W16EPR-U	W16TT
45	W14PR-U	-
45F	W16FSR	-
45FFS	W14FPR-U	-
45L	W14L	-
45LS	W14L	-
45NS	W14EX-U	IW16TT
45S	W14PR-U	-
45TS	T16PR-U	ITF16TT
45XL	W16ESR-U	-
45XLS	W14EX-U	IW16TT
46	W9-U	-
46F	W14F-U	-
46N	W16ESR-U	-
46S	W9PR-U	-
46TS	T14PR-U	ITF16TT
46XL	W16ESR-U	-
46XLS	W9EP	-
47XL	W14E	-
500GG	DG-012	-
503GG	DG-001	-
507GG	DG-001	-
508GG	DG-012	-
509GG	DG-202	-
510GG	DG-123	-
511GG	DG-001	-
512GG	DG-001	-
517GG	DG-143	-
519GG	DG-234	-
521GG	DG-648	-
523GG	DG-114	-

ACDelco	DENSO	TT
525GG	DG-001	-
527GG	DG-123	-
83CTS	MA20P-U	-
83TS	MA20P-U	-
84T	MA16PR-U	-
84TS	MA16PR-U	-
85T	MA16PR-U	-
85TS	MA16PR-U	-
86TS	MA9P-U	-
9G	DG-175	-
B43	W20S-U	-
C41CLTS	T22EP-U	-
C41CXLS	W22EPR-U	W22TT
C421	W24S-U	-
C42CFS	W22FPR-U	-
C42CLTS	T20EPR-U	T20TT
C42CXLS	W20EP-U	W20TT
C42N	W22ESR-U	-
C42XLS	W20EP-U	W20TT
C43	W20S-U	-
C43CXLS	W16EPR-U	W16TT
C43L	W16LS	-
C43N	W20ESR-U	-
C44	W16S-U	-
C44N	W20ESR-U	-
C44NS	W16EXR-U	W16TT
C44S	W16PR-U	-
C45	W14PR-U	-
C45L	W14L	-
C47W	W9-U	-
C49	W9-U	-
C81	M22	-
C82	M22	-
C82T	MA20P-U	-
C83	M17	-
C83T	MA20PR-U	-
C84T	MA16PR-U	-
C84TS	MA16PR-U	-
C85	L14-U	-
C85S	L14-U	-
C85T	MA16PR-U	-
C85TS	MA16PR-U	-
C86	L14-U	-
C86S	L14-U	-
C87	L14-U	-
C88	L14-U	-
C88L	L14-U	-
CFR1CLS	K22PR-U	IK22FTT
CFR2CLS	K20PR-U	K20TT
CFR3CLS	K16PR-U	K16TT
CR41CXLS	W22EPR-U	W22TT
CR425FS	W20FPR-U	WF20TT
CR425XLS	W16EPR-U	W16TT
CR42CLTS	T20EPR-U	T20TT
CR42CTS	T20PR-U	ITF20TT
CR42N	W22ESR-U	-
CR42TS	T20PR-U	ITF20TT
CR42XLS	W20EPR-U	W20TT
CR42XLSX	W20EPR-U11	W20TT
CR43	W20S-U	-
CR43CXLS	W16EPR-U	W16TT
CR43N	W20ESR-U	-
CR43S	W20PR-U	-
CR43TS	T20PR-U	ITF20TT
CR43TSM	T20PR-U	ITF20TT
CR44N	W20ESR-U	-
CR44NS	W16EPR-U	W16TT
CR44TS	T16PR-U	ITF16TT
CR45L	W14L	-
CR45TS	T16PR-U	ITF16TT
CS41	W22M-U	-

Свечи зажигания и Свечи накаливания

Таблица взаимозаменяемости – Другие производители

ACDelco	DENSO	TT
CS42	W22M-U	-
CS42S	W22MPR-U	-
CS42T	T22M-U	-
CS45	W20MR-U	-
CS45T	T20M-U	-
CSR45	W20PR-U	-
FR1LS	K20PR-U11	K20TT
FR2LS	K20PR-U11	K20TT
FR3CLS	K16PR-U11	K16TT
FR3LS	K16R-U11	K16TT
FR3LS6	K16PR-U11	K16TT
FR3LSK	K16PR-U11	K16TT
FR5LS	K16PR-U11	K16TT
LM46	W14LM-U	-
LM49	W14LM-U	-
M40FFX	W27FSR	-
M41FF	W24FSR	-
M41FFG	IWF27	-
M41K	W22S-U	-
M42FF	W22FS-U	-
M43FF	W20FSR-U	WF20TT
M43S	W20PR-U	-
M44C	W16S-U	-
M44L	W14L	-
M45	W14PR-U	-
M45FF	W16FSR	-
M47	W9-U	-
MR41T	ITF22	-
MR42LTS	T20EPR-U	T20TT
MR43LTS	T20EPR-U	T20TT
MR43T	T20R-U	-
MR441	T16R-U	T16TT
MR44C	W20S-U	-
MR44T	T16R-U	T16TT
R121CXLS	X24EPR-U9	-
R121XLS	X24EPR-U9	-
R41CF	W24FSR	-
R41CXL	W27ESR-U	-
R41F	W24FSR	-
R41XL	W27ESR-U	-
R42CF	W22FSR	-
R42CFS	W22FPR-U	-
R42CLTS	T20EPR-U	T20TT
R42CLTS6	T20EPR-U15	-
R42CT	T20R-U	-
R42CTS	T20PR-U	ITF20TT
R42CXL	W22ESR-U	-
R42CXLS	W22EPR-U	W22TT
R42F	W22FSR	-
R42FS	W22FPR-U	-
R42LTS	T20EPR-U	T20TT
R42LTS6	T20EPR-U15	-
R42LTSM	T20EPR-U	T20TT
R42NS	W22EPR-U	W22TT
R42S	W20PR-U	-
R42T	T20R-U	-
R42TS	T20PR-U	ITF20TT
R42TSM	T20PR-U	ITF20TT
R42TX	T20R-U	-
R42XL	W22ESR-U	-
R42XLS	W22EPR-U	W22TT
R42XLS6	W22EPR-U11	W22TT
R42XLSM	W22EPR-U	W22TT
R43	W20S-U	-
R43C	W20S-U	-
R43CFS	W20FPR-U	WF20TT
R43CS	W20PR-U	-
R43CT6	T20R-U	-
R43CTS	T20PR-U	ITF20TT
R43CTS6	T20PR-U	ITF20TT
R43CXL	W20ESR-U	-

ACDelco	DENSO	TT
R43CXLS	W20EXR-U	W20TT
R43FS	W20FPR-U	WF20TT
R43LTS	T20EPR-U	T20TT
R43LTS6	T20EPR-U15	-
R43LTSSE	T20EPR-U	T20TT
R43LTSX	T20EPR-U15	-
R43N	W20ESR-U	-
R43NS	W20EPR-U	W20TT
R43NTS6	T20EPR-U15	-
R43NTSE	T20NR-U11	IT20TT
R43S	W20PR-U	-
R43T	T20R-U	-
R43TS	T20PR-U	ITF20TT
R43TS6	T20PR-U	ITF20TT
R43TSK	T20PR-U	ITF20TT
R43TSX	T20PR-U	ITF20TT
R43TX	T20R-U	-
R43XL	W20ESR-U	-
R43XLS	W20EXR-U	W20TT
R44CF	W16FSR	-
R44CXL	W20ESR-U	-
R44CXLS	W16EPR-U	W16TT
R44F	W16FSR	-
R44LT	W16EPR-U	W16TT
R44LTS	T16EPR-U	T16TT
R44LTS6	T16EPR-U15	T16TT
R44LTS6K	T16EPR-U15	T16TT
R44LTSM	T16EPR-U	T16TT
R44LTSM6	T16EPR-U15	T16TT
R44LTSMA	T16EPR-U	T16TT
R44N	W16ESR-U	-
R44NS	W16EXR-U	W16TT
R44NSX	W16EPR-U11	W16TT
R44NTSE	T16NR-U11	IT16TT
R44S	W16PR-U	-
R44SX	W16PR-U	-
R44T	T16R-U	T16TT
R44TS	T16PR-U	ITF16TT
R44TS8	T16PR-U11	ITF16TT
R44TSX	T16PR-U11	ITF16TT
R44TX	T16R-U	T16TT
R44XL	W20ESR-U	-
R44XLS	W16EPR-U	W16TT
R44XLS6	W16EXR-U11	W16TT
R44XLSE	KJ16CR-L11	K16TT
R44XLSM	J16BR-U	-
R45NS	W14EXR-U	IW16TT
R45NSX	W14EXR-U11	IW16TT
R45NTSE	T16NR-U11	IT16TT
R45S	W14PR-U	-
R45SX	W14PR-U	-
R45T	T16R-U	T16TT
R45TS	T16PR-U	ITF16TT
R45TS8	T16PR-U11	ITF16TT
R45TSX	T16PR-U11	ITF16TT
R45XL	W16ESR-U	-
R45XLS	W14EXR-U	IW16TT
R45XLS6	W14EXR-U11	IW16TT
R46LTS	T16EPR-U	T16TT
R46S	W9PR-U	-
R46SX	W9PR-U	-
R46SZ	W9PR-U	-
R46T	T16R-U	T16TT
R46TS	T14PR-U	ITF16TT
R46TSX	T14PR-U	ITF16TT
R46TX	T16R-U	T16TT
R47S	W9PR-U	-
R47SX	W9PR-U	-
R83CTS	MA20PR-U	-
R83TS	MA20PR-U	-
R84TS	MA16PR-U	-

ACDelco	DENSO	TT
R84TSX	MA16PR-U	-
R85T	MA16PR-U	-
R85TS	MA16PR-U	-
R86T	MA16PR-U	-
R86TS5	MA16PR-U	-
RF#1	T20PR-U	ITF20TT
RF#2	T16PR-U	ITF16TT
RF#4	W20EXR-U	W20TT
RF#5	Q16PR-U11	Q16TT
S102F	U22FSR-U	-
S104F	U20FSR-U	-
S121XL	X24ESR-U	-
S122F	X24FS-U	-
S123XL	X22ESR-U	-
S124FS	X20FSR-U	-
S404XLG	IW01-27	-
S40F	W27FSR	-
S40FR	W27FSR	-
S40XL	W27ESR-U	-
S40XLG	IW31	-
S40XLR	W27ESR-U	-
S412FR	W24FSR	-
S41F	W24FSR	-
S41FG	IWF27	-
S41FR	W24FSR	-
S41SLG	IW01-27	-
S41XL	W27ESR-U	-
S41XLR	W27ESR-U	-
S42	W24S-U	-
S42F	W22FS-U	-
S42FR	W22FSR	-
S42XL	W22ESR-U	-
S42XLR	W22ESR-U	-
S43XL	W20ESR-U	-
S43XLR	W20ESR-U	-
S44	W16S-U	-
S44F	W16FSR	-
S44XL	W20ESR-U	-
S45F	W16FSR	-
S46	W9-U	-
S81F	M22	-
S82F	M22	-
S83F	M17	-
S85F	L14-U	-
SV4XL	SF-50	-
V40FFK	SF-51	-
V40FFM	SF-50	-
V40FFS	SF-50	-
VB40FFK	SF-50	-
VR40FFM	SF-50	-

APEX	DENSO	TT
06	IQ20TT	IQ20TT
06STD	IK20	IK20TT
07	IQ22	-
07STD	IK22	IK22FTT
08	IQ24	-
08STD	IK24	-
09	IQ27	-
09STD	IK27	-

BERU	DENSO	TT
0 100 226 575	DG-659	-
0 100 226 577	DG-635	-
0 100 226 638	DG-659	-
0 106 671 802	DG-622	-
0001245702	X22EPR-U9	-
0001325701	W14EPR-U	IW16TT
0001325704	W14EPR-U	IW16TT
0001325705	K16PR-U11	K16TT
0001325710	W16EPB10	W16TT

BERU	DENSO	TT
0001330104	W20EPBR-S	W20TT
0001330112	W20EPBR-S	W20TT
0001330113	W20EPBR-S	W20TT
0001330116	K20PBR-S10	K20TT
0001330117	K20PBR-S10	K20TT
0001330501	K20TXR	K20TT
0001330702	W16EPR-U	W16TT
0001330707	K16PR-U11	K16TT
0001330709	W16EPB10	W16TT
0001330713	W16EPR-U	W16TT
0001330717	KJ16CR-L11	K16TT
0001330718	J16CR-U	W16TT
0001330725	K16PR-U11	K16TT
0001330726	W16EPR-U	W16TT
0001330731	K16PR-U11	K16TT
0001330780	K20PR-U	K20TT
0001330904	PK16PR-L11	IK16TT
0001330905	SK16PR-L11	IK16TT
0001335107	K20PBR-S10	K20TT
0001335108	W20EPBR-S	W20TT
0001335110	K20PBR-S10	K20TT
0001335702	W20EPR-U	W20TT
0001335707	W20ESR-U	-
0001335709	W20EPB	W20TT
0001335714	W20EP-U	W20TT
0001335721	K20P-U	K20TT
0001335725	K20P-U	K20TT
0001335729	K20P-U	K20TT
0001335732	K20TXR	K20TT
0001335737	W20EP-U	W20TT
0001335742	KJ16CR-L11	K16TT
0001335905	SK20PR-L9	IK20TT
0001335910	PK20PR-P8	IK20TT
0001335911	PKJ16CR-L11	IK16TT
0001335914	PK20PR-P8	IK20TT
0001340103	K20PBR-S10	K20TT
0001340702	W20EPR-U	W20TT
0001340704	W20EPB	W20TT
0001340706	K20PBR	K20TT
0001340707	W20EPR-U	W20TT
0001340716	K20P-U	K20TT
0001340717	K20PBR	K20TT
0001340723	K20P-U	K20TT
0001340806	IK20	IK20TT
0001340903	IW20	IW20TT
0001340908	VK22	IK22FTT
0001340915	VKB20	-
0001345702	W22EPR-U	W22TT
0001345704	W22EPB	W22TT
0001345711	W22EPR-U	W22TT
0001345720	K22PR-U	IK22FTT
0001345906	IKH22	-
0001345914	PK22PR8	IK22TT
0001350903	IW24	-
0001350910	VKH22	-
0001355700	W27ESR-U	-
0001400701	W20FSR-U	WF20TT
0001430700	W16FPR-U	-
0001430701	W16FSR	-
0001435700	W20FPR-U	WF20TT
0001435705	W20FSR-U	WF20TT
0001440700	W20FPR-U	WF20TT
0001445700	W22FPR-U	-
0001445702	W22FS-U	-
0001450702	W24FSR	-
0001529302	W16S-U	-
0001625700	T16EPR-U	T16TT
0001625702	T16EPR-U	T16TT
0001630700	T16EPR-U	T16TT
0001630704	T16EPR-U	T16TT
0001635700	T20EPR-U	T20TT

Свечи зажигания и Свечи накаливания

Таблица взаимозаменяемости – Другие производители

BERU	DENSO	TT
0001635709	T20EPR-U	T20TT
0001640700	T20EPR-U	T20TT
0001640705	T20EPR-U	T20TT
0001645700	T22EP-U	-
0001735700	MA20P-U	-
0001835700	M17	-
0002140900	IU22	-
0002230300	XE20HR-U9	IXEH20TT
0002230901	VXUH22I	IXUH22TT
0002235700	XU22PR9	XU22TT
0002235901	VXUH22I	IXUH22TT
0002235905	FXE20HR11	IXEH20TT
0002240701	XU22EPR-U	XU22TT
0002240702	XU22EPR-U	XU22TT
0002240703	XU22HDR9	XUH22TT
0002240902	VXUH22I	IXUH22TT
0002240907	VXUH22I	IXUH22TT
0002240909	VXUH22I	IXUH22TT
0002240911	IXUH22	IXUH22TT
0002245704	XU24EPR-U	-
0002325700	W16EPR-U	W16TT
0002325723	KJ16CR-L11	K16TT
0002325900	P16R13	W20TT
0002330102	K20TXR	K20TT
0002330104	K20PBR	K20TT
0002330203	QJ16AR-U	-
0002330204	K16R-U11	K16TT
0002330206	K16PR-U	K16TT
0002330215	KJ16CR-L11	K16TT
0002330701	W16EPR-U	W16TT
0002330702	W16EPR-U11	W16TT
0002330703	K16PR-U	K16TT
0002330704	K16PR-U11	K16TT
0002330706	W20EPBR-S	W20TT
0002330709	W16EPR-U	W16TT
0002330710	K20TXR	K20TT
0002330712	KJ16CR-L11	K16TT
0002330713	K16R-U	K16TT
0002330714	K16R-U	K16TT
0002330716	K16HPR-U11	KH16TT
0002330794	KJ16CR-L11	K16TT
0002330795	K16TR11	K16TT
0002330918	VKB16	-
0002330930	PK16PR-L11	IK16TT
0002335100	K20PBR-S10	K20TT
0002335104	K20PBR-S10	K20TT
0002335128	K20TXR	K20TT
0002335131	K20PBR-S10	K20TT
0002335137	K20PBR-S10	K20TT
0002335138	K16TNR-S9	K16TT
0002335139	K20BR-S10	K20TT
0002335500	K20TNR	K20TT
0002335503	K20TXR	K20TT
0002335701	W20EPR-U	W20TT
0002335706	W20EPR-U11	W20TT
0002335707	K20PR-U	K20TT
0002335708	K20PR-U11	K20TT
0002335709	K20TXR	K20TT
0002335712	K20R-U	K20TT
0002335713	K20R-U	K20TT
0002335714	K20R-U11	K20TT
0002335715	KJ20CR-L11	K20TT
0002335717	K20PR-U	K20TT
0002335719	K20HR-U11	KH20TT
0002335802	KJ20DR-M11	-
0002335901	IK20	IK20TT
0002335902	PK20R11	K20TT
0002335903	PQ20R	Q20TT
0002335904	PK20R8	IK20TT
0002335908	PK20PR-P8	IK20TT
0002335911	K20TXR	K20TT

BERU	DENSO	TT
0002335912	K20TXR	K20TT
0002335914	PK20PR-L11	IK20TT
0002335925	VKB20	-
0002335926	SK20R11	IK20TT
0002335937	SK16PR-E11	IK16TT
0002335939	IKH22	-
0002335940	PK20PR-P8	IK20TT
0002335946	PK20PR-P8	IK20TT
0002335947	IK20L	IK20TT
0002336715	KJ20CR-L11	K20TT
0002336724	K20PR-U	K20TT
0002336738	K20HR-U11	KH20TT
0002340101	K20PBR-S10	K20TT
0002340102	K20TXR	K20TT
0002340117	K20PBR-S10	K20TT
0002340123	K20PBR-S10	K20TT
0002340500	K22TNR-S	-
0002340501	K22TNR-S	-
0002340701	W20EPR-U	W20TT
0002340702	K20PR-U	K20TT
0002340703	W20EPR-U11	W20TT
0002340704	Q20PR-U11	Q20TT
0002340903	IK20TT	IK20TT
0002340905	PK20PR-L11	IK20TT
0002340908	PK20PR-L11	IK20TT
0002340910	PK20PR-P8	IK20TT
0002340915	VW20	IW20TT
0002345118	IKH22	-
0002345501	K20TXR	K20TT
0002345701	W22EPR-U	W22TT
0002345702	K22PR-U	IK22FTT
0002345704	K22PBR-S	IKB22TT
0002345906	SKJ20DR-M11	-
0002435701	W20FPR-U	WF20TT
0002620708	ITL16TT	ITL16TT
0002625700	T16EPR-U	T16TT
0002630701	PT16VR13	TV16TT
0002630715	PT16VR13	TV16TT
0002630900	PT16EPR-L13	IT16TT
0002635100	T20EPR-U	T20TT
0002635700	T20EPR-U	T20TT
0002635701	T20EPR-U	T20TT
0002635902	ZT20EPR11	IT20TT
0002635903	PT16VR13	TV16TT
0002635904	ITV16TT	ITV16TT
0002640100	T20EPR-U	T20TT
0002640700	T20EPR-U	T20TT
0002640701	T20PR-U	ITF20TT
0002640900	PT16VR10	TV16TT
0002640904	ZT20EPR11	IT20TT
0002640910	ITV24	-
0004535300	W20MR-U	-
0004545401	W22MPR-U	-
0100220103	DG-012	-
0100220118	DG-157	-
0100221102	DG-001	-
0100221103	DG-001	-
0100221105	DG-012	-
0100221106	DG-001	-
0100221107	DG-001	-
0100221108	DG-012	-
0100221132	DG-123	-
0100221133	DG-001	-
0100221135	DG-001	-
0100221141	DG-202	-
0100221144	DG-004	-
0100221145	DG-001	-
0100221146	DG-004	-
0100221147	DG-198	-
0100221148	DG-234	-
0100221151	DG-647	-

BERU	DENSO	TT
0100221152	DG-012	-
0100221153	DG-001	-
0100221154	DG-114	-
0100221163	DG-001	-
0100221164	DG-001	-
0100221167	DG-001	-
0100221170	DG-132	-
0100221186	DG-143	-
0100222101	DG-215	-
0100222102	DG-159	-
0100222102	DG-239	-
0100222105	DG-213	-
0100222106	DG-189	-
0100226128	DG-001	-
0100226129	DG-115	-
0100226163	DG-006	-
0100226164	DG-012	-
0100226170	DG-137	-
0100226171	DG-137	-
0100226173	DG-012	-
0100226180	DG-652	-
0100226182	DG-232	-
0100226183	DG-162	-
0100226184	DG-101	-
0100226185	DG-001	-
0100226186	DG-001	-
0100226188	DG-003	-
0100226189	DG-001	-
0100226194	DG-198	-
0100226198	DG-004	-
0100226199	DG-628	-
0100226203	DG-130	-
0100226206	DG-133	-
0100226207	DG-124	-
0100226208	DG-104	-
0100226209	DG-159	-
0100226227	DG-005	-
0100226229	DG-001	-
0100226233	DG-172	-
0100226234	DG-010	-
0100226235	DG-106	-
0100226237	DG-012	-
0100226238	DG-101	-
0100226242	DG-216	-
0100226242	DG-650	-
0100226243	DG-648	-
0100226245	DG-008	-
0100226246	DG-161	-
0100226248	DG-007	-
0100226249	DG-102	-
0100226250	DG-110	-
0100226255	DG-182	-
0100226258	DG-119	-
0100226284	DG-139	-
0100226299	DG-009	-
0100226300	DG-118	-
0100226301	DG-121	-
0100226302	DG-626	-
0100226312	DG-186	-
0100226336	DG-146	-
0100226338	DG-144	-
0100226343	DG-109	-
0100226344	DG-116	-
0100226351	DG-126	-
0100226352	DG-137	-
0100226353	DG-155	-
0100226354	DG-111	-
0100226362	DG-145	-
0100226365	DG-155	-
0100226366	DG-001	-
0100226368	DG-184	-

BERU	DENSO	TT
0100226370	DG-118	-
0100226371	DG-003	-
0100226372	DG-127	-
0100226373	DG-005	-
0100226375	DG-112	-
0100226379	DG-117	-
0100226381	DG-007	-
0100226383	DG-172	-
0100226384	DG-121	-
0100226385	DG-130	-
0100226391	DG-129	-
0100226392	DG-184	-
0100226417	DG-142	-
0100226422	DG-173	-
0100226435	DG-183	-
0100226436	DG-122	-
0100226462	DG-184	-
0100226473	DG-117	-
0100226475	DG-216	-
0100226475	DG-650	-
0100226480	DG-240	-
0100226482	DG-109	-
0100226492	DG-181	-
0100226493	DG-188	-
0100226494	DG-176	-
0100226495	DG-300	-
0100226495	DG-640	-
0100226496	DG-188	-
0100226497	DG-302	-
0100226497	DG-641	-
0100226511	DG-174	-
0100226513	DG-642	-
0100226514	DG-644	-
0100226517	DG-188	-
0100226520	DG-108	-
0100226522	DG-602	-
0100226525	DG-646	-
0100226526	DG-502	-
0100226527	DG-245	-
0100226538	DG-600	-
0100226568	DG-671	-
0100226569	DG-643	-
0100226570	DG-245	-
0100226639	DG-196	-
0100230107	DG-702	-
0100231107	DG-222	-
0100231114	DG-233	-
0100266001	DG-177	-
0100266002	DG-178	-
0100266003	DG-191	-
0100266005	DG-192	-
0100266007	DG-194	-
0100266008	DG-177	-
0100266009	DG-190	-
0100266010	DG-192	-
0100266011	DG-194	-
0100266014	DG-193	-
0100266016	DG-193	-
0100266020	DG-193	-
0100266024	DG-608	-
0100266030	DG-653	-
0100266031	DG-621	-
0100266032	DG-609	-
0100266033	DG-619	-
0100266034	DG-608	-
0100266037	DG-607	-
0100266037	DG-623	-
0100266040	DG-193	-
0100266045	DG-194	-
0100266050	DG-625	-
0100266053	DG-619	-

Свечи зажигания и Свечи накаливания

Таблица взаимозаменяемости – Другие производители

BERU	DENSO	TT
0100266056	DG-631	-
0100266068	DG-603	-
0100266071	DG-611	-
0100266072	DG-610	-
0100266075	DG-631	-
0100266076	DG-604	-
0100266077	DG-634	-
0100266079	DG-653	-
0100271106	DG-175	-
0100276003	DG-195	-
0100276004	DG-113	-
0100276005	DG-140	-
0100276007	DG-171	-
0100276008	DG-171	-
0100276009	DG-606	-
0100276012	DG-180	-
0100276014	DG-606	-
0100276015	DG-170	-
0100276024	DG-614	-
0100276031	DG-629	-
0100800031	DG-197	-
0100800033	DG-187	-
0100800035	DG-605	-
0100800036	DG-601	-
0900102024	DG-001	-
0900102025	DG-123	-
0900102026	DG-001	-
0900102028	DG-001	-
0900102029	DG-012	-
0900102038	DG-001	-
0900102054	DG-004	-
10 FR-6 CPU03	IJ22	-
105 MN	DG-001	-
12 FR 6 DU	XU22EPR-U	XU22TT
12 FR 7 DU	XU22PR9	XU22TT
12 FR-6 LUX	XU22EPR-U	XU22TT
12 FR-6 MUW	XU22HR9	XUH22TT
12 VR-8 SE	XE20HR-U9	IXEH20TT
12 ZR-6 SP02	VXUH22I	IXUH22TT
12 ZR-6 SP03	VXUH22I	IXUH22TT
12 ZR-6 SP2	VXUH22I	IXUH22TT
12 ZR-6 SPP2	VXUH22I	IXUH22TT
12 ZR-7 SP03	VXUH22I	IXUH22TT
12-5 DU	X22EPR-U	-
12FR2CDU	X27ETR	-
12FR4CDU	IK24	-
12FR5DU	XU24EPR-U	-
12R5DU	X22EPR-U9	-
12VR7SPUX	FXE20HR11	IXEH20TT
12ZR6SPP21	IXUH22	IXUH22TT
12ZR-8 STP	VXUH22I	IXUH22TT
14 7 CU	W20ESR-U	-
14 F-4 NBPR	VKH22	-
14 F-5 DPURS2	PK22PR8	IK22TT
14 F-6 DPUR021	VK22	IK22FTT
14 F-6 DTPR02	VKB20	-
14 F-6 DTU	K20PBR	K20TT
14 F-6 DU0	K20P-U	K20TT
14 F-6 KPURW2	IK20TT	IK20TT
14 F-7 DU0	K20P-U	K20TT
14 F-7 HUR2	KJ16CR-L11	K16TT
14 F-7 HURU02	KJ20DR-M11	-
14 F-7DU	K20P-U	K20TT
14 F-8 DU0	K16PR-U11	K16TT
14 F-8 DUR	K20PR-U	K20TT
14 F-8 LUR	KJ16CR-L11	K16TT
14 F-9 DU0	K16PR-U11	K16TT
14 FGH-7 DTURX0	K20PBR-S10	K20TT
14 FGH-8 DTUR	K20PBR-S10	K20TT
14 FGH-8 DTURX0	K20PBR-S10	K20TT
14 FGH-7 DTUT	K20PBR-S10	K20TT

BERU	DENSO	TT
14 FGH-7 DTUU	K20BR-S10	K20TT
14 FGH-7 LDUW	K16TNR-S9	K16TT
14 FGR-5 NTE	IKH22	-
14 FGR-6 DDU	K20TXR	K20TT
14 FGR-6 HQU	K20PBR-S10	K20TT
14 FGR-6 KQU	K20PBR-S10	K20TT
14 FGR-7 CTU	K20PBR-S10	K20TT
14 FGR-7 KDU6	K20TXR	K20TT
14 FGR-7 KQE	K20PBR-S10	K20TT
14 FGR-7 KQU	K20PBR-S10	K20TT
14 FGR-8 CTU	K20PBR-S10	K20TT
14 FGR-8 MQPU	IKH16TT	IKH16TT
14 FR 8 DU	K16PR-U	K16TT
14 FR-5 LPU0X	SKJ20DR-M11	-
14 FR-6 DPOX	PK20PR-L11	IK20TT
14 FR-6 DPU02S	VW20	IW20TT
14 FR-6 DPUW2	PK20PR-P8	IK20TT
14 FR-7 DPPUS2	PK20PR-P8	IK20TT
14 FR-7 DPPUW2	PK20PR-P8	IK20TT
14 FR-7 DPUV02	SK16PR-E11	IK16TT
14 FR-7 DU2	K20PR-U	K20TT
14 FR-7 HUX	KJ20CR-L11	K20TT
14 FR-7 KPUV	PQ20R	Q20TT
14 FR-7 KPUX02	SK20R11	IK20TT
14 FR-7 KU0	K20R-U	K20TT
14 FR-7 LDU	K20TNR	K20TT
14 FR-7 LPU02	VKB20	-
14 FR-7 LPUT02	IK20L	IK20TT
14 FR-7 LPUX02	IK20TT	IK20TT
14 FR-7 LUX	KJ20CR-L11	K20TT
14 FR-7 LUX0	KJ20DR-M11	-
14 FR-7 MPUS	IKH22	-
14 FR-7 NUX2	K20HR-U11	KH20TT
14 FR-7 SPUX03	KH20TT	KH20TT
14 FR-8 DPPUX	PK16PR-L11	IK16TT
14 FR-8 DUW	K16PR-U	K16TT
14 FR-8 HU	KJ16CR-L11	K16TT
14 FR-8 HUT	QJ16AR-U	-
14 FR-8 KU0	K16R-U	K16TT
14 FR-8 LDU3	K16TR11	K16TT
14 FR-8 LPU02	VKB16	-
14 FR-8 LU2T	KJ16CR-L11	K16TT
14 FR-8 MPUX2	IKH16TT	IKH16TT
14 FR-8 MUI2	K16HPR-U11	KH16TT
14 GH-8 DTUR	W20EPBR-S	W20TT
14 K-5 DU	T22EP-U	-
14 K-6 DU	T20EPR-U	T20TT
14 K-6 DU0	T20EPR-U	T20TT
14 K-7 DU0	T20EPR-U	T20TT
14 K-8 DU	T16EPR-U	T16TT
14 K-8 DU0	T16EPR-U	T16TT
14 K-9 DU0	T16EPR-U	T16TT
14 KGR-6 KQU	T20EPR-U	T20TT
14 KGR-7 KQU	T20EPR-U	T20TT
14 KR-6 DU	T20EPR-U	T20TT
14 KR-6 KPUV02	ZT20EPR11	IT20TT
14 KR-6 MPV	ITV24	-
14 KR-7 DPUV	ZT20EPR11	IT20TT
14 KR-7 DUX	T20EPR-U	T20TT
14 KR-7 MPUV2	ITV16TT	ITV16TT
14 KR-7 MPUX2	PT16VR13	TV16TT
14 KR-8 MPUV2	ITV20TT	ITV20TT
14 KR-8 STUX	PT16VR13	TV16TT
14 R-6 DU	W20EPR-U	W20TT
14 R-6 DUX	W20EPR-U11	W20TT
14 R-7 BU	W20FPR-U	WF20TT
14 R-9 KPUV2	P16R13	W20TT
14 S-7 E	W20MR-U	-
14 X-AU	W20FSR-U	WF20TT
14 Z-4 AU	W24FSR	-
1404AS	IW31	-

BERU	DENSO	TT
14095AS	IW31	-
1410A	W14F-U	-
1410B	W14FPR-UL	-
1410C	W14E	-
1410D	W14EPR-U	IW16TT
1410DU	W14EPR-U	IW16TT
1410E	W14PR-U	-
142AS1	W27FSR	-
143A1	W24FSR	-
143AS1	IWF24	-
143AU	W24FSR	-
143CS	IW24	-
143CU	W24ESR-U	-
143DP2	IW24	-
14-4 DPO	IW24	-
144A	W22FS-U	-
144A1	W24FSR	-
144A2	W22FS-U	-
144AS1	IWF24	-
144AU	W22FS-U	-
144B2	W22FPR-U	-
144C1	W24ESR-U	-
144C2	W22ESR-U	-
144CS1	IW24	-
14-5 AU	W22FS-U	-
14-5 BU	W22FPR-U	-
14-5 DTU	W22EPB	W22TT
14-5 DU	W22EPR-U	W22TT
14-5 DU0	W22EPR-U	W22TT
145A	W22FS-U	-
145B	W22FPR-U	-
145C	W22ESR-U	-
145D	W22EPR-U	W22TT
145D1	W22EPR-U	W22TT
145DP1	W22EPR-U	W22TT
145E	W22S-U	-
145F	W20PR-U	-
14-6 B	W20FPR-U	WF20TT
14-6 BU	W20FPR-U	WF20TT
14-6 D	W20EP-U	W20TT
14-6 D1	W20EPR-U	W20TT
14-6 DTU	W20EPB	W20TT
14-6 DU	W20EPR-U	W20TT
14-6 DU0	W20EPR-U	W20TT
146C	W20ESR-U	-
146DP0	IW20	IW20TT
14-7 A	W20FSR-U	WF20TT
147 AU	W20FSR-U	WF20TT
14-7 B	W20FPR-U	WF20TT
14-7 BU	W20FPR-U	WF20TT
14-7 D	W20EP-U	W20TT
14-7 DU0	W20EP-U	W20TT
147C	W20ESR-U	-
147DTU	W20EPB	W20TT
147DU	W20EPR-U	W20TT
147E	W20S-U	-
147F	W20PR-U	-
14-8 AU	W16FSR	-
14-8 DU0	W16EPR-U	W16TT
14-8 E	W16S-U	-
14-8 LUR	J16CR-U	W16TT
148A	W16FSR	-
148B	W16FPR-U	-
148BU	W16FPR-U	-
148C	W16ESR-U	-
148C1	W20ESR-U	-
148D	W16EPR-U	W16TT
148DC	W16EPR-U	W16TT
148DTU	W16EPB10	W16TT
148DU	W16EPR-U	W16TT
148F	W16PR-U	-

BERU	DENSO	TT
14-9 C	W16ESR-U	-
14-9 DTU	W16EPB10	W16TT
149DU	W14EPR-U	IW16TT
149DU0	W14EPR-U	IW16TT
149EU0	W14LM-U	-
14F03DAR	K22PBR-S	IKB22TT
14F5DU	K22PR-U	IK22FTT
14F5MPUR02	VKH22	-
14F5MPUR03	IKH22	-
14F6DPUR02	PK20PR-P8	IK20TT
14F6DSR	IK20	IK20TT
14F6DU0R	K20P-U	K20TT
14F7 LDUR	K20TXR	K20TT
14F7DPUR02	PK20PR-P8	IK20TT
14F7DPURX2	PK20PR-P8	IK20TT
14F7DU0R	K20P-U	K20TT
14F7HPURX2	PKJ16CR-L11	IK16TT
14F7LDUR4	K20TXR	K20TT
14F8DPURX02	SK16PR-L11	IK16TT
14F8DU	K16PR-U11	K16TT
14F8DU4	K16PR-U11	K16TT
14F8DUX	Q16PR-U11	Q16TT
14F8LDUSR	K20TXR	K20TT
14FDH8DPURX2	PK16PR-L11	IK16TT
14FG8DTU	K20PBR-S10	K20TT
14FGH6DTUR	K20PBR-S10	K20TT
14FGH7DPURX2	SK20PR-L9	IK20TT
14FGH7DTURX	K20PBR-S10	K20TT
14FGH8DPURX2	PK16PR-L11	IK16TT
14FGR8DPURX2	PK16PR-L11	IK16TT
14FGR8DQU7	K20PBR	K20TT
14FGR8KQU	K20TXR	K20TT
14FLR8LDUX	K20TXR	K20TT
14-FR5 DTU	K22PBR-S	IKB22TT
14FR5DPUX	IK20	IK20TT
14FR5DU	K22PR-U	IK22FTT
14FR5LDU	K20TXR	K20TT
14FR6DPUX	IK20TT	IK20TT
14FR6DPUX02	PK20PR-L11	IK20TT
14FR6DU	K20PR-U	K20TT
14FR6DUX	Q20PR-U11	Q20TT
14FR6LDU	K22TNR-S	-
14FR6LDU0	K22TNR-S	-
14FR6LDU3	K22TNR-S	-
14FR6MPU2	IKH20TT	IKH20TT
14FR7DPU2	PK20PR-P8	IK20TT
14FR7DPU3	K20TXR	K20TT
14FR7DPUX	IK20	IK20TT
14FR7DPUX02	PK20PR-L11	IK20TT
14FR7DQUP7	K20TXR	K20TT
14FR7DU	K20PR-U	K20TT
14FR7DUW	K20PR-U	K20TT
14FR7DUX	K20PR-U11	K20TT
14FR7KDU	K20TXR	K20TT
14FR7KPU	PK20R8	IK20TT
14FR7KPUX	PK20R11	K20TT
14FR7KU	K20R-U	K20TT
14FR7KUOX	K20R-U11	K20TT
14FR7LDUW	K20TXR	K20TT
14FR7MU2	K20HR-U11	KH20TT
14FR8 LDU	K20TXR	K20TT
14FR8DPUX	IK16	IK16TT
14FR8DUX	K16PR-U11	K16TT
14FR8KU	K16R-U	K16TT
14FR8KU0U	K16R-U11	K16TT
14FR8LDU4	K20TXR	K20TT
14FR8LDUOX4	K20TXR	K20TT
14FR8LU2	KJ16CR-L11	K16TT
14FR8NQU213	K20HR-U11	KH20TT
14FR9KUX2	KJ16CR-L11	K16TT
14FSH7DSUR	K20TXR	K20TT

Свечи зажигания и Свечи накаливания

Таблица взаимозаменяемости – Другие производители

BERU	DENSO	TT
14G8DTU	W20EPBR-S	W20TT
14GH7DTUR	W20EPBR-S	W20TT
14GH8DTURX	W20EPBR-S	W20TT
14GR8DTU	W20EPBR-S	W20TT
14K5DUO	T22EP-U	-
14K6D	T20EPR-U	T20TT
14K7D	T20EPR-U	T20TT
14K7DU	T20EPR-U	T20TT
14K9DU	T16EPR-U	T16TT
14KR10SUV2	ITL16TT	ITL16TT
14-KR6 BU	T20PR-U	ITF20TT
14KR6DPUV02	ZT20EPR11	IT20TT
14KR6MPX	PT16VR10	TV16TT
14KR6ZPPV	PT16VR13	TV16TT
14KR7 DU	T20EPR-U	T20TT
14KR8DPUV0V	PT16EPR-L13	IT16TT
14KR8DPUV0V	PT16EPR-L13	IT16TT
14KR8MUV	PT16VR13	TV16TT
14KR9 DUX	T16EPR-U	T16TT
14R11F	W14PR-U	-
14-R5 DU	W22EPR-U	W22TT
14R5BPU	IWF22	-
14R5DPU	IW22	-
14R6B	W20FPR-U	WF20TT
14R6BU	W20FPR-U	WF20TT
14R6D	W20EPR-U	W20TT
14R7B	W20FPR-U	WF20TT
14R7CU	W20ESR-U	-
14R7D	W20EPR-U	W20TT
14R7DU	W20EPR-U	W20TT
14R7DUX	W20EPR-U11	W20TT
14R8DU	W16EPR-U	W16TT
14R8DU4	W16EPR-U	W16TT
14R8DUX	W16EPR-U11	W16TT
14R9DU	W16EPR-U	W16TT
14R9EUO	W14LM-U	-
14S5F	W22MPR-U	-
14S7F	W20MP-U	-
14SR6F	W22MPR-U	-
14Z3AU	W24FSR	-
14Z3CU	W27ESR-U	-
14Z4CU	W24ESR-U	-
14Z6A2	W20FSR-U	WF20TT
14Z7AU	W22FS-U	-
151 MJ	DG-001	-
162 MJ	DG-012	-
162MJ	DG-012	-
18 K-7 BU	MA20P-U	-
1810AU	L14-U	-
185AU	M22	-
187AU	M17	-
18K6BU	MA20P-U	-
18K8BU	MA16PR-U	-
2 510 029 124	DG-661	-
2 510 029 129	DG-655	-
226 569	DG-643	-
226 570	DG-245	-
2330902	IKH16TT	IKH16TT
2335915	KH20TT	KH20TT
266 031	DG-621	-
266 038	DG-611	-
266 053	DG-619	-
266020	DG-193	-
266053	DG-619	-
601 MJ	DG-012	-
601MJ	DG-012	-
603 MJ	DG-001	-
604 MJ	DG-012	-
631 MJ	DG-123	-
636 MJ	DG-001	-
642 MJ	DG-001	-

BERU	DENSO	TT
657 MJ	DG-202	-
661 MJ	DG-004	-
663 MJ	DG-001	-
666 MJ	DG-004	-
673 MJ	DG-198	-
689 MJ	DG-012	-
691 MJ	DG-001	-
705 MJ	DG-114	-
719 MJ	DG-001	-
724 MJ	DG-001	-
727 MJ	DG-001	-
730 MJ	DG-132	-
749 MJ	DG-143	-
783 MJ	DG-115	-
798 MJ	DG-001	-
844 MJ	DG-012	-
852 MJ	DG-006	-
853 MJ	DG-137	-
854 MJ	DG-137	-
855 MJ	DG-005	-
857 MJ	DG-012	-
858 MJ	DG-010	-
896 MJ	DG-159	-
898 MJ	DG-162	-
905 MJ	DG-101	-
908 MJ	DG-001	-
909 MJ	DG-001	-
912 MJ	DG-003	-
917 MJ	DG-001	-
920 MJ	DG-157	-
921 MJ	DG-198	-
927 MJ	DG-004	-
944 MJ	DG-133	-
945 MJ	DG-159	-
946 MJ	DG-124	-
947 MJ	DG-104	-
948 MJ	DG-106	-
955 MJ	DG-172	-
964 MJ	DG-161	-
966MJ	DG-007	-
970 MJ	DG-102	-
999 MJ	DG-101	-
CGP003	DG-622	-
CS1K	T16PR-U	ITF16TT
CS2K	T20PR-U	ITF20TT
G 1 SB	DG-012	-
G 10 SB	DG-004	-
G 2 SB	DG-001	-
G 3 SB	DG-001	-
G 4 SB	DG-123	-
G 6 SB	DG-001	-
G 7 SB	DG-001	-
G10SB	DG-004	-
G1SB	DG-012	-
G4SB	DG-123	-
GE 100	DG-177	-
GE 101	DG-190	-
GE 102	DG-178	-
GE 103	DG-191	-
GE 104	DG-192	-
GE 105	DG-194	-
GE 110	DG-609	-
GE 111	DG-619	-
GE 114	DG-608	-
GE 118	DG-607	-
GE 118	DG-623	-
GE 121 A	DG-603	-
GE 123	DG-610	-
GE 127	DG-653	-
GE100	DG-177	-
GE101	DG-190	-

BERU	DENSO	TT
GE102	DG-178	-
GE103	DG-191	-
GE104	DG-192	-
GE105	DG-194	-
GE108	DG-193	-
GE110	DG-609	-
GE111	DG-619	-
GE112	DG-621	-
GE114	DG-608	-
GE115	DG-193	-
GE117	DG-625	-
GE118	DG-607	-
GE118	DG-623	-
GE121A	DG-603	-
GE122	DG-611	-
GE123	DG-610	-
GE124	DG-631	-
GE125	DG-604	-
GE126	DG-634	-
GE133	DG-193	-
GN 003	DG-117	-
GN 005	DG-146	-
GN 007	DG-109	-
GN 008	DG-144	-
GN 010	DG-155	-
GN 012	DG-111	-
GN 013	DG-001	-
GN 015	DG-184	-
GN 016	DG-003	-
GN 017	DG-127	-
GN 018	DG-005	-
GN 019	DG-112	-
GN 022	DG-007	-
GN 024	DG-145	-
GN 025	DG-118	-
GN 026	DG-126	-
GN 027	DG-116	-
GN 030	DG-129	-
GN 033	DG-142	-
GN 035	DG-173	-
GN 037	DG-195	-
GN 039	DG-137	-
GN 041	DG-122	-
GN 042	DG-240	-
GN 043	DG-216	-
GN 043	DG-650	-
GN 044	DG-702	-
GN 045	DG-140	-
GN 046	DG-109	-
GN 050	DG-183	-
GN 053	DG-171	-
GN 054	DG-181	-
GN 055	DG-176	-
GN 056	DG-180	-
GN 057	DG-189	-
GN 058	DG-606	-
GN 059	DG-170	-
GN 060	DG-188	-
GN 061	DG-108	-
GN 062	DG-602	-
GN 063	DG-614	-
GN 065	DG-245	-
GN 068	DG-245	-
GN 070	DG-187	-
GN 072	DG-605	-
GN 073	DG-601	-
GN 095	DG-635	-
GN 097	DG-196	-
GN 101	DG-644	-
GN 102	DG-642	-
GN 103	DG-300	-

BERU	DENSO	TT
GN 103	DG-640	-
GN 104	DG-302	-
GN 104	DG-641	-
GN 107	DG-174	-
GN 108	DG-600	-
GN 109	DG-197	-
GN 116	DG-615	-
GN 117	DG-661	-
GN 853	DG-137	-
GN 854	DG-137	-
GN 855	DG-005	-
GN 857	DG-012	-
GN 860	DG-119	-
GN 905	DG-101	-
GN 908	DG-001	-
GN 909	DG-001	-
GN 912	DG-003	-
GN 917	DG-001	-
GN 927	DG-004	-
GN 939	DG-130	-
GN 944	DG-133	-
GN 948	DG-106	-
GN 954	DG-001	-
GN 955	DG-172	-
GN 959	DG-012	-
GN 961	DG-110	-
GN 963	DG-008	-
GN 964	DG-161	-
GN 970	DG-102	-
GN 985	DG-182	-
GN 989	DG-139	-
GN 991	DG-009	-
GN 992	DG-118	-
GN 993	DG-121	-
GN 997	DG-186	-
GN 999	DG-101	-
GN003	DG-117	-
GN005	DG-146	-
GN007	DG-109	-
GN008	DG-144	-
GN010	DG-155	-
GN012	DG-111	-
GN015	DG-184	-
GN016	DG-003	-
GN017	DG-127	-
GN018	DG-005	-
GN019	DG-112	-
GN022	DG-007	-
GN024	DG-145	-
GN026	DG-126	-
GN027	DG-116	-
GN030	DG-129	-
GN033	DG-142	-
GN035	DG-173	-
GN037	DG-195	-
GN039	DG-137	-
GN041	DG-122	-
GN042	DG-240	-
GN043	DG-216	-
GN043	DG-650	-
GN044	DG-702	-
GN045	DG-140	-
GN046	DG-109	-
GN047	DG-113	-
GN050	DG-183	-
GN053	DG-171	-
GN054	DG-181	-
GN055	DG-176	-
GN056	DG-180	-
GN057	DG-189	-
GN058	DG-606	-

Свечи зажигания и Свечи накаливания

Таблица взаимозаменяемости – Другие производители

BERU	DENSO	TT
GN059	DG-170	-
GN060	DG-188	-
GN061	DG-108	-
GN062	DG-602	-
GN063	DG-614	-
GN064	DG-502	-
GN065	DG-245	-
GN067	DG-643	-
GN068	DG-245	-
GN069	DG-629	-
GN070	DG-187	-
GN072	DG-605	-
GN073	DG-601	-
GN097	DG-196	-
GN101	DG-644	-
GN102	DG-642	-
GN103	DG-300	-
GN103	DG-640	-
GN104	DG-302	-
GN104	DG-641	-
GN106	DG-646	-
GN107	DG-174	-
GN109	DG-197	-
GN110	DG-671	-
GN121	DG-655	-
GN123	DG-656	-
GN853	DG-137	-
GN854	DG-137	-
GN855	DG-005	-
GN857	DG-012	-
GN858	DG-010	-
GN860	DG-119	-
GN905	DG-101	-
GN912	DG-003	-
GN927	DG-004	-
GN928	DG-628	-
GN939	DG-130	-
GN944	DG-133	-
GN948	DG-106	-
GN955	DG-172	-
GN959	DG-012	-
GN961	DG-110	-
GN963	DG-008	-
GN964	DG-161	-
GN970	DG-102	-
GN985	DG-182	-
GN989	DG-139	-
GN991	DG-009	-
GN992	DG-118	-
GN993	DG-121	-
GN994	DG-626	-
GN997	DG-186	-
GN999	DG-101	-
GV 001	DG-213	-
GV 004	DG-175	-
GV 105	DG-001	-
GV 602	DG-001	-
GV 603	DG-001	-
GV 604	DG-012	-
GV 631	DG-123	-
GV 636	DG-001	-
GV 642	DG-001	-
GV 657	DG-202	-
GV 661	DG-004	-
GV 663	DG-001	-
GV 666	DG-004	-
GV 673	DG-198	-
GV 678	DG-234	-
GV 688	DG-647	-
GV 689	DG-012	-
GV 691	DG-001	-

BERU	DENSO	TT
GV 705	DG-114	-
GV 719	DG-001	-
GV 724	DG-001	-
GV 727	DG-001	-
GV 730	DG-132	-
GV 749	DG-143	-
GV 783	DG-115	-
GV 798	DG-001	-
GV 844	DG-012	-
GV 852	DG-006	-
GV 886	DG-652	-
GV 894	DG-215	-
GV 895	DG-222	-
GV 896	DG-239	-
GV 897	DG-232	-
GV 898	DG-162	-
GV 920	DG-157	-
GV 921	DG-198	-
GV 945	DG-159	-
GV 946	DG-124	-
GV 947	DG-104	-
GV 967	DG-216	-
GV 967	DG-650	-
GV 968	DG-648	-
GV 969	DG-233	-
GV001	DG-213	-
GV004	DG-175	-
GV604	DG-012	-
GV631	DG-123	-
GV657	DG-202	-
GV661	DG-004	-
GV666	DG-004	-
GV673	DG-198	-
GV678	DG-234	-
GV688	DG-647	-
GV689	DG-012	-
GV705	DG-114	-
GV730	DG-132	-
GV749	DG-143	-
GV783	DG-115	-
GV844	DG-012	-
GV852	DG-006	-
GV886	DG-652	-
GV894	DG-215	-
GV895	DG-222	-
GV896	DG-239	-
GV897	DG-232	-
GV898	DG-162	-
GV920	DG-157	-
GV921	DG-198	-
GV945	DG-159	-
GV946	DG-124	-
GV947	DG-104	-
GV967	DG-216	-
GV967	DG-650	-
GV969	DG-233	-
RS16	IWF20	-
RS18	IWF22	-
RS35	IW20	IW20TT
RS37	IW20	IW20TT
RS39	IW22	-
S1K	T20EPR-U	T20TT
S2K	IT22	-
S3F	IK20	IK20TT
S5	IW20	IW20TT
S6	IWF22	-
S7	IW20	IW20TT
S9	IW22	-
UXF79P	K20TXR	K20TT
Z 213	K20TXR	K20TT
Z1	W16EPR-U	W16TT

BERU	DENSO	TT
Z10	W20FPR-U	WF20TT
Z100	K16PR-U11	K16TT
Z101	K20TXR	K20TT
Z103	IW24	-
Z104	IW20	IW20TT
Z105	IK20	IK20TT
Z11	W20EPR-U	W20TT
Z112	W16S-U	-
Z116	K22TNR-S	-
Z117	T16EPR-U	T16TT
Z118	W16FPR-U	-
Z119	W16EPR-U	W16TT
Z12	W20EPB	W20TT
Z120	K20PBR-S10	K20TT
Z121	K20PBR-S10	K20TT
Z122	PK16PR-L11	IK16TT
Z123	K20TXR	K20TT
Z126	K20PBR-S10	K20TT
Z127	T20EPR-U	T20TT
Z129	K20PBR-S10	K20TT
Z13	K20P-U	K20TT
Z130	IK20	IK20TT
Z14	K20TXR	K20TT
Z144	T20EPR-U	T20TT
Z145	K20TXR	K20TT
Z148	PT16EPR-L13	IT16TT
Z149	PK20R11	K20TT
Z15	K20PR-U	K20TT
Z150	PQ20R	Q20TT
Z151	PK20R8	IK20TT
Z152	KJ16CR-L11	K16TT
Z153	K16R-U	K16TT
Z154	K16R-U	K16TT
Z155	K20R-U	K20TT
Z156	K20R-U	K20TT
Z157	K20R-U11	K20TT
Z158	KJ20CR-L11	K20TT
Z159	IK20TT	IK20TT
Z16	K20PR-U11	K20TT
Z17	T20EPR-U	T20TT
Z171	PK20PR-P8	IK20TT
Z172	K20PBR-S10	K20TT
Z173	K20TXR	K20TT
Z176	PKJ16CR-L11	IK16TT
Z177	PT16VR13	TV16TT
Z18	T20EPR-U	T20TT
Z183	K16HPR-U11	KH16TT
Z184	K20HR-U11	KH20TT
Z185	VK22	IK22FTT
Z188	PK20PR-P8	IK20TT
Z19	W20FPR-U	WF20TT
Z190	K20PBR	K20TT
Z192	K20TXR	K20TT
Z193	K20PR-U	K20TT
Z194	K22TNR-S	-
Z2	W16EPB10	W16TT
Z20	W20EPR-U	W20TT
Z200	KJ16CR-L11	K16TT
Z203	KJ16CR-L11	K16TT
Z204	K20PBR-S10	K20TT
Z206	PK20PR-P8	IK20TT
Z208	K16TR11	K16TT
Z209	ZT20EPR11	IT20TT
Z21	W20EPR-U11	W20TT
Z210	IU22	-
Z211	IKH16TT	IKH16TT
Z213	K20TXR	K20TT
Z216	ITL16TT	ITL16TT
Z22	W20EPR-U	W20TT
Z220	KJ16CR-L11	K16TT
Z221	PK20PR-L11	IK20TT

BERU	DENSO	TT
Z222	PT16VR13	TV16TT
Z224	K20TXR	K20TT
Z225	KJ20CR-L11	K20TT
Z226	IKH20TT	IKH20TT
Z227	K20PR-U	K20TT
Z228	PK20PR-L11	IK20TT
Z23	K20P-U	K20TT
Z230	ZT20EPR11	IT20TT
Z233	VXUH22I	IXUH22TT
Z234	XUJ22PR9	XUJ22TT
Z235	KH20TT	KH20TT
Z237	K20TXR	K20TT
Z239	K20PBR-S10	K20TT
Z24	K20PR-U	K20TT
Z240	SK16PR-L11	IK16TT
Z243	XE20HR-U9	IXEH20TT
Z247	K20PR-U	K20TT
Z248	QJ16AR-U	-
Z249	K16R-U11	K16TT
Z25	T20EPR-U	T20TT
Z255	K16PR-U	K16TT
Z257	K20TXR	K20TT
Z26	T20EPR-U	T20TT
Z265	W22MPR-U	-
Z266	W20MR-U	-
Z27	W20EPR-U	W20TT
Z272	KJ20DR-M11	-
Z273	K20HR-U11	KH20TT
Z277	IKH22	-
Z278	VKB16	-
Z279	VKB20	-
Z28	W20EPR-U11	W20TT
Z280	SK20R11	IK20TT
Z282	SK20PR-L9	IK20TT
Z284	PK20PR-L11	IK20TT
Z285	P16R13	W20TT
Z287	KJ16CR-L11	K16TT
Z288	VXUH22I	IXUH22TT
Z29	K22PR-U	IK22FTT
Z291	XUJ24EPR-U	-
Z292	XUJ22EPR-U	XUJ22TT
Z293	XUJ22EPR-U	XUJ22TT
Z294	IKH22	-
Z295	VKB20	-
Z296	ZT20EPR11	IT20TT
Z299	KJ20DR-M11	-
Z3	J16CR-U	W16TT
Z30	K22PR-U	IK22FTT
Z300	K20PBR-S10	K20TT
Z301	IK20TT	IK20TT
Z302	IKH16TT	IKH16TT
Z304	K20PBR-S10	K20TT
Z307	SK16PR-E11	IK16TT
Z308	XUJ22HDR9	XUH22TT
Z31	T22EP-U	-
Z310	ITV20TT	ITV20TT
Z314	PK20PR-P8	IK20TT
Z315	ITV24	-
Z318	VXUH22I	IXUH22TT
Z32	MA20P-U	-
Z320	VXUH22I	IXUH22TT
Z322	IK20TT	IK20TT
Z324	K16TNR-S9	K16TT
Z325	FXE20HR11	IXEH20TT
Z326	IKH22	-
Z332	IXUH22	IXUH22TT
Z336	VXUH22I	IXUH22TT
Z337	PK20PR-P8	IK20TT
Z339	VKH22	-
Z340	VW20	IW20TT
Z342	ITV16TT	ITV16TT

Свечи зажигания и Свечи накаливания

Таблица взаимозаменяемости – Другие производители

BERU	DENSO	TT
Z343	PK16PR-L11	IK16TT
Z346	IK20L	IK20TT
Z347	PK22PR8	IK22TT
Z354	SKJ20DR-M11	-
Z356	PT16VR13	TV16TT
Z36	X22EPR-U9	-
Z360	K20BR-S10	K20TT
Z38	W27ESR-U	-
Z39	W24FSR	-
Z4	KJ16CR-L11	K16TT
Z40	W22FS-U	-
Z41	W22FPR-U	-
Z42	W22EPR-U	W22TT
Z43	W22EPR-U	W22TT
Z44	W22EPB	W22TT
Z45	K22PBR-S	IKB22TT
Z47	W22EPR-U	W22TT
Z48	W20FPR-U	WF20TT
Z49	T20PR-U	ITF20TT
Z5	K16PR-U11	K16TT
Z50	W20EPR-U	W20TT
Z51	W20EPB	W20TT
Z52	K20PBR	K20TT
Z53	K20PBR	K20TT
Z54	K20P-U	K20TT
Z56	T20EPR-U	T20TT
Z57	W20FSR-U	WF20TT
Z58	W20ESR-U	-
Z6	T16EPR-U	T16TT
Z60	K20PBR-S10	K20TT
Z61	W20EP-U	W20TT
Z62	W20EP-U	W20TT
Z63	K20P-U	K20TT
Z64	K20P-U	K20TT
Z67	T20EPR-U	T20TT
Z68	W16FSR	-
Z69	W16EPR-U	W16TT
Z7	T16EPR-U	T16TT
Z70	W16EPR-U	W16TT
Z71	K16PR-U11	K16TT
Z72	K16PR-U	K16TT
Z73	K16PR-U11	K16TT
Z74	K20TXR	K20TT
Z75	W20EPBR-S	W20TT
Z76	W14EPR-U	IW16TT
Z77	W14EPR-U	IW16TT
Z78	W16EPB10	W16TT
Z79	K16PR-U11	K16TT
Z8	W16EPR-U	W16TT
Z80	T16EPR-U	T16TT
Z81	T16EPR-U	T16TT
Z82	W16EPR-U	W16TT
Z85	W20FSR-U	WF20TT
Z87	M17	-
Z89	K20PBR-S10	K20TT
Z9	W16EPR-U11	W16TT
Z90	K20PBR-S10	K20TT
Z91	W20EPBR-S	W20TT
Z92	W20EPBR-S	W20TT
Z93	W20EPBR-S	W20TT
Z94	W20EPBR-S	W20TT
Z95	T20EPR-U	T20TT
Z97	PT16VR10	TV16TT
Z98	K20TNR	K20TT
Z99	Q20PR-U11	Q20TT

BLITZ	DENSO	TT
R610510	IQ31	-
R61057	IQ22	-
R61058	IQ24	-
R61059	IQ27	-

BLITZ	DENSO	TT
R6187105	IRE01-32	-
R618711	IRE01-34	-
T7340B6	IK20	IK20TT
T7340B7	IK22	IK22FTT
T7340B8	IK24	-
T7341B6	IQ20TT	IQ20TT
T7341B7	IQ22	-
T7341B8	IQ24	-

BLUE PRINT	DENSO	TT
ADH21803	DG-601	-
ADN11831	DG-631	-
ADS71801	DG-615	-

BOSCH	DENSO	TT
+1	W20EPR-U	W20TT
+10	W20FPR-U	WF20TT
+11	K20PR-U11	K20TT
+12	W20EPR-U	W20TT
+13	K20PR-U	K20TT
+14	T20EPR-U	T20TT
+15	W22EPR-U	W22TT
+16	W16EPR-U	W16TT
+17	PT16VR13	TV16TT
+18	T20EPR-U	T20TT
+19	K16PR-U11	K16TT
+2	W20EPBR-S	W20TT
+20	W16FPR-U	-
+21	W20EPR-U11	W20TT
+22	W16EPR-U11	W16TT
+23	K20PBR-S10	K20TT
+24	PK20PR-P8	IK20TT
+3	W16EPR-U	W16TT
+31	K20R-U11	K20TT
+32	KJ20CR-U11	K20TT
+36	K16TR11	K16TT
+38	IK20TT	IK20TT
+39	T16VR-U10	TV16TT
+4	W20EPBR-S	W20TT
+40	XE20HR-U9	IXEH20TT
+41	XU22EPR-U	XU22TT
+42	K16HPR-U11	KH16TT
+43	K16R-U	K16TT
+44	K20PBR-S10	K20TT
+45	PK16PR-L11	IK16TT
+46	T20EPR-U	T20TT
+47	K20R-U	K20TT
+48	K20TXR	K20TT
+49	ZT20EPR11	IT20TT
+5	T20EPR-U	T20TT
+50	PK20PR-P8	IK20TT
+51	KJ16CR-L11	K16TT
+51	KJ20DR-M11	-
+52	PKJ20CR-L11	IK20TT
+53	K20TNR-S	K20TT
+55	PQ20R-P8	IQ20TT
+6	K16PR-U	K16TT
+7	K20TR11	K20TT
+7	K20TXR	K20TT
+8	K20PR-U	K20TT
+9	K20TXR	K20TT
0 241 040 501	U20FSR-U	-
0 241 045 001	U20FSR-U	-
0 241 045 502	U20FSR-U	-
0 241 050 002	U22FSR-U	-
0 241 056 501	U22ESR-N	-
0 241 140 500	XU20EPR-U	-
0 241 145 500	X22EPR-U9	-
0 241 145 501	X22ESR-U	-
0 241 145 505	XU22EPR-U	XU22TT
0 241 145 510	XU22EPR-U	XU22TT

BOSCH	DENSO	TT
0 241 150 503	X27EPR-U9	-
0 241 150 504	X24ESR-U	-
0 241 200 500	SF-50	-
0 241 219 540	W14F-U	-
0 241 219 541	W14E	-
0 241 219 543	W14F-U	-
0 241 219 554	W14PR-U	-
0 241 219 555	W9EP	-
0 241 225 547	W14E	-
0 241 225 548	W14PR-U	-
0 241 225 549	W14F-U	-
0 241 225 551	W14LM-U	-
0 241 225 573	T16EPR-U	T16TT
0 241 225 581	W16ETR-S	W16TT
0 241 225 590	W14LM-U	-
0 241 225 593	W14EPR-U	IW16TT
0 241 225 824	W14LM-U	-
0 241 225 825	W14MR-U	-
0 241 229 541	T20M-U	-
0 241 229 560	W20MR-U	-
0 241 229 561	W20MP-U	-
0 241 229 579	W16ESR-U	-
0 241 229 580	W16S-U	-
0 241 229 604	W16FSR	-
0 241 229 612	W16FSR	-
0 241 229 617	T16EPR-U	T16TT
0 241 229 676	K20PBR-S10	K20TT
0 241 229 712	K16PR-U11	K16TT
0 241 229 713	K16PR-U11	K16TT
0 241 229 714	W16FPR-U	-
0 241 229 715	W16EPR-U	W16TT
0 241 229 716	W20EPB	W20TT
0 241 229 724	W16EPR-U	W16TT
0 241 229 725	W16FSR	-
0 241 229 887	W16FSR	-
0 241 229 970	T20M-U	-
0 241 229 971	W16S-U	-
0 241 235 089	W20ESR-U	-
0 241 235 566	W20MR-U	-
0 241 235 594	W20S-U	-
0 241 235 607	W20FSR-U	WF20TT
0 241 235 610	W20EPR-U11	W20TT
0 241 235 619	W20FSR-U	WF20TT
0 241 235 623	W20PR-U	-
0 241 235 689	W20EPB	W20TT
0 241 235 703	K20PBR-S10	K20TT
0 241 235 706	K20PBR-S10	K20TT
0 241 235 713	T20M-U	-
0 241 235 729	T20MP-U	-
0 241 235 730	KJ20DR-M11	-
0 241 235 735	KJ20DR-M11	-
0 241 235 750	K20P-U	K20TT
0 241 235 751	K20TXR	K20TT
0 241 235 752	K20PBR-S10	K20TT
0 241 235 753	T20EPR-U	T20TT
0 241 235 754	W20FPR-U	WF20TT
0 241 235 755	W20EPR-U	W20TT
0 241 235 756	W20EPB	W20TT
0 241 235 757	W20EPBR-S	W20TT
0 241 235 776	T20EPR-U	T20TT
0 241 235 888	KJ20DR-M11	-
0 241 240 552	T20EPR-U	T20TT
0 241 240 585	IK20	IK20TT
0 241 240 597	IK20	IK20TT
0 241 240 600	W20MR-U	-
0 241 240 601	W20MP-U	-
0 241 240 602	T22M-U	-
0 241 240 603	W20FSR-U	WF20TT
0 241 240 604	W22ESR-U	-
0 241 240 608	K20P-U	K20TT
0 241 240 609	K20PBR	K20TT

BOSCH	DENSO	TT
0 241 240 610	T20EPR-U	T20TT
0 241 240 611	W20EP-U	W20TT
0 241 242 502	T22EP-U	-
0 241 245 044	W22EPR-U	W22TT
0 241 245 539	T22M-U	-
0 241 245 544	W22M-U	-
0 241 245 555	W22MPR-U	-
0 241 245 574	IWF22	-
0 241 245 580	W22FS-U	-
0 241 245 581	W22ESR-U	-
0 241 245 602	W22FS-U	-
0 241 245 641	IK22	IK22FTT
0 241 245 655	K22PR-U	IK22FTT
0 241 247 500	IW24	-
0 241 248 531	W24FSR	-
0 241 248 538	W24ESR-U	-
0 241 250 512	IW24	-
0 241 250 514	IT24	-
0 241 250 526	IK24	-
0 241 252 521	IWF24	-
0 241 252 522	IW24	-
0 241 255 505	IT24	-
0 241 255 507	IK27	-
0 241 256 512	W24FSR	-
0 241 256 515	IW24	-
0 241 256 517	IW24	-
0 241 256 519	W24FSR	-
0 241 256 522	W24ESR-U	-
0 241 260 507	W27FSR	-
0 241 260 508	W27ESR-U	-
0 241 260 510	IT27	-
0 241 260 512	IK27	-
0 241 262 505	IWF27	-
0 241 262 506	IW31	-
0 241 265 501	IK31	-
0 241 268 505	IWF27	-
0 241 268 506	IW31	-
0 241 268 508	IK31	-
0 241 274 504	W31FS	-
0 241 274 505	IW34	-
0 241 280 503	IW34	-
0 241 309 501	L14-U	-
0 241 319 513	L14-U	-
0 241 329 522	MA16PR-U	-
0 241 329 526	L14-U	-
0 241 335 526	M17	-
0 241 335 528	MA20P-U	-
0 241 340 501	MA20P-U	-
0 241 345 512	M22	-
0 241 350 505	M24S	-
0 242 040 500	U20FSR-U	-
0 242 040 502	IU22	-
0 242 050 501	U22FSR-U	-
0 242 055 501	U22FSR-U	-
0 242 055 502	U22ESR-N	-
0 242 055 505	U22FSR-U	-
0 242 060 501	U24ESR-N	-
0 242 129 502	X20EPR-U9	-
0 242 129 506	XE20HR-U9	IXEH20TT
0 242 129 508	XE20HR-U9	IXEH20TT
0 242 129 510	XE20HR-U9	IXEH20TT
0 242 129 512	VXUH22I	IXUH22TT
0 242 129 514	FXE20HR11	IXEH20TT
0 242 129 524	VXUH20I	-
0 242 129 529	SC16HR11	IXEH20TT
0 242 129 801	XE20HR-U9	IXEH20TT
0 242 135 500	X22EPR-U9	-
0 242 135 502	XU22EPR-U	XU22TT
0 242 135 507	X22EPR-U9	-
0 242 135 509	VXUH22	IXUH22TT
0 242 135 510	VXUH22	IXUH22TT

Свечи зажигания и Свечи накаливания

Таблица взаимозаменяемости – Другие производители

BOSCH	DENSO	TT
0 242 135 515	XU22EPR-U	XU22TT
0 242 135 518	VXUH22	IXUH22TT
0 242 135 524	FXE20HE11	IXEH20ETT
0 242 135 527	XU22HDR9	XUH22TT
0 242 135 529	IXEH22TT	IXEH22TT
0 242 135 531	FXE20HE11	IXEH20ETT
0 242 135 533	IXUH22	IXUH22TT
0 242 135 556	ZXU20HCR8	-
0 242 135 564	VXUH20I	-
0 242 135 802	XU22EPR-U	XU22TT
0 242 140 500	X24ESR-U	-
0 242 140 504	XU22EPR-U	XU22TT
0 242 140 512	VXUH22	IXUH22TT
0 242 140 515	SXU22HDR8	IXUH22TT
0 242 140 519	XU22PR9	XU22TT
0 242 140 530	XE20HR-U9	IXEH20TT
0 242 140 536	VFXEHC22G	-
0 242 145 500	X22EPR-U9	-
0 242 145 503	XU24EPR-U	-
0 242 145 504	XU24EPR-U	-
0 242 145 510	SXU22HDR8	IXUH22TT
0 242 150 501	X24ESR-U	-
0 242 160 501	IX24	-
0 242 209 500	W9LMR-US	-
0 242 215 500	W9PR-U	-
0 242 215 502	W9LMR-US	-
0 242 215 801	W9LMR-US	-
0 242 219 004	W14FR-U	-
0 242 219 512	W14PR-U	-
0 242 219 513	W14PR-U	-
0 242 219 515	T14PR-U	ITF16TT
0 242 219 517	T14PR-U	ITF16TT
0 242 219 522	T14PR-U	ITF16TT
0 242 219 525	W14EPR-U	IW16TT
0 242 219 527	T16EPR-U	T16TT
0 242 219 530	J16CR-U	W16TT
0 242 219 532	K16PR-U	K16TT
0 242 219 535	W14EXR-U11	IW16TT
0 242 219 537	K16PR-U11	K16TT
0 242 219 539	T14PR-U	ITF16TT
0 242 219 541	T14PR-U	ITF16TT
0 242 219 544	T16EPR-U	T16TT
0 242 219 547	W14PR-U	-
0 242 219 548	J16CR-U	W16TT
0 242 219 549	J16CR-U	W16TT
0 242 222 501	IW16TT	IW16TT
0 242 222 502	IW16TT	IW16TT
0 242 222 503	K16TNR-S9	K16TT
0 242 222 507	T16PR-U	ITF16TT
0 242 225 528	J16AR-U11	-
0 242 225 533	T16EPR-U	T16TT
0 242 225 534	T16EPR-U15	T16TT
0 242 225 537	QJ16HR-U	-
0 242 225 538	W14EPR-U	IW16TT
0 242 225 539	J16CR-U	W16TT
0 242 225 549	Q14R-U11	IQ16TT
0 242 225 552	T20NR-U11	IT20TT
0 242 225 553	W14EPR-U	IW16TT
0 242 225 554	W14EXR-U11	IW16TT
0 242 225 580	KJ16CR-L11	K16TT
0 242 225 582	Q14R-U11	IQ16TT
0 242 225 596	K16TNR-S9	K16TT
0 242 225 599	W16EPR-U	W16TT
0 242 225 610	J16CR-U	W16TT
0 242 225 611	PTJ16R15	IT16TT
0 242 225 622	T16PR-U	ITF16TT
0 242 225 623	T16EPR-U15	T16TT
0 242 225 624	W14EXR-U11	IW16TT
0 242 225 625	J16CR-U	W16TT
0 242 225 626	J16CR-U	W16TT
0 242 225 641	T16PR-U11	ITF16TT

BOSCH	DENSO	TT
0 242 225 642	T16EPR-U	T16TT
0 242 225 643	T16EPR-U15	T16TT
0 242 225 645	T20NR-U11	IT20TT
0 242 225 668	ITL16TT	ITL16TT
0 242 225 859	W16EPR-U	W16TT
0 242 229 525	W16PR-U	-
0 242 229 526	T20R-U	-
0 242 229 528	T16PR-U	ITF16TT
0 242 229 529	T16PR-U11	ITF16TT
0 242 229 533	W16ESR-U	-
0 242 229 534	W16FSR	-
0 242 229 537	W16EPR-U	W16TT
0 242 229 543	IK16	IK16TT
0 242 229 544	QJ16HR-U	-
0 242 229 555	IW16	IW16TT
0 242 229 556	W16ESR-U	-
0 242 229 557	IW16	IW16TT
0 242 229 576	KJ16CR-L11	K16TT
0 242 229 579	PKJ16CR-L11	IK16TT
0 242 229 586	W16FPR-U	-
0 242 229 590	QJ16HR-U	-
0 242 229 598	IK16	IK16TT
0 242 229 604	T16EPR-U15	T16TT
0 242 229 613	K20PBR-S10	K20TT
0 242 229 628	K16TR11	K16TT
0 242 229 630	K16HPR-U11	KH16TT
0 242 229 635	K16R-U11	K16TT
0 242 229 641	PT16EPR-L13	IT16TT
0 242 229 643	W14MR-U	-
0 242 229 648	K20PBR-S10	K20TT
0 242 229 650	T16VR-U10	TV16TT
0 242 229 652	PT16EPR-L13	IT16TT
0 242 229 654	K20TXR	K20TT
0 242 229 655	T20EPR-U	T20TT
0 242 229 656	W16EPR-U	W16TT
0 242 229 657	W16FPR-U	-
0 242 229 658	W20EPBR-S	W20TT
0 242 229 659	K16PR-U	K16TT
0 242 229 660	K16PR-U11	K16TT
0 242 229 661	PT16VR13	TV16TT
0 242 229 676	W16FSR	-
0 242 229 680	IW16	IW16TT
0 242 229 687	W16EPR-U11	W16TT
0 242 229 692	W16EPR-U	W16TT
0 242 229 699	KJ16CR-L11	K16TT
0 242 229 702	K16HPR-U11	KH16TT
0 242 229 708	IKH16TT	IKH16TT
0 242 229 712	K20TXR	K20TT
0 242 229 715	KJ16CR-L11	K16TT
0 242 229 719	IK16	IK16TT
0 242 229 722	KH16TT	KH16TT
0 242 229 737	T16EPR-U	T16TT
0 242 229 739	PT16VR13	TV16TT
0 242 229 752	ITV16TT	ITV16TT
0 242 229 773	T20R-U	-
0 242 229 775	T16EPR-U	T16TT
0 242 229 779	J16CR-U	W16TT
0 242 229 782	K16TR11	K16TT
0 242 229 785	T16VR-U10	TV16TT
0 242 229 796	PT16VR13	TV16TT
0 242 229 797	K16HPR-U11	KH16TT
0 242 229 798	K16R-U	K16TT
0 242 229 799	K20PBR-S10	K20TT
0 242 229 878	K20TXR	K20TT
0 242 229 879	T20EPR-U	T20TT
0 242 229 880	W16EPR-U	W16TT
0 242 229 881	W16FPR-U	-
0 242 229 882	W20EPBR-S	W20TT
0 242 229 883	K16PR-U	K16TT
0 242 229 884	K16PR-U11	K16TT
0 242 229 885	W16EPR-U11	W16TT

BOSCH	DENSO	TT
0 242 229 902	T16VR-U10	TV16TT
0 242 229 923	K16HPR-U11	KH16TT
0 242 229 924	K20PBR-S10	K20TT
0 242 229 925	PK16PR-L11	IK16TT
0 242 229 986	T16VR-U10	TV16TT
0 242 230 500	PK16PR-L11	IK16TT
0 242 230 505	K16PSR-B8	IK16TT
0 242 230 508	ITL16TT	ITL16TT
0 242 230 519	SK16PR-E11	IK16TT
0 242 230 533	SK16HR11	IKH16TT
0 242 230 554	IKH16TT	IKH16TT
0 242 232 504	W20EPBR-S	W20TT
0 242 232 505	W20EPBR-S	W20TT
0 242 232 506	IWF20	-
0 242 232 507	IT20TT	IT20TT
0 242 232 508	IT20TT	IT20TT
0 242 232 804	W20EPBR-S	W20TT
0 242 235 525	IW20	IW20TT
0 242 235 532	W20ESR-U	-
0 242 235 533	W20FSR-U	WF20TT
0 242 235 535	IWF22	-
0 242 235 540	IW20	IW20TT
0 242 235 541	IW20	IW20TT
0 242 235 546	W20ESR-U	-
0 242 235 547	IK20	IK20TT
0 242 235 554	W20S-U	-
0 242 235 556	IK20	IK20TT
0 242 235 571	W20EPBR-S	W20TT
0 242 235 588	KJ20CR-U11	K20TT
0 242 235 604	PT16VR13	TV16TT
0 242 235 607	T20EPR-U	T20TT
0 242 235 610	K20R-U	K20TT
0 242 235 640	K20PR-U	K20TT
0 242 235 650	J16CR-U	W16TT
0 242 235 651	W20MPR-U10	-
0 242 235 656	K20PBR-S10	K20TT
0 242 235 661	T20EPR-U	T20TT
0 242 235 663	W20EPR-U	W20TT
0 242 235 664	W20EPBR-S	W20TT
0 242 235 665	W20FPR-U	WF20TT
0 242 235 666	K20PR-U	K20TT
0 242 235 667	K20PR-U11	K20TT
0 242 235 668	K20TR11	K20TT
0 242 235 668	K20TXR	K20TT
0 242 235 690	PK20PR11	K20TT
0 242 235 692	K16GPR-U11	-
0 242 235 696	IKH20TT	IKH20TT
0 242 235 700	IT20TT	IT20TT
0 242 235 703	IWF22	-
0 242 235 707	W20EPR-U11	W20TT
0 242 235 715	K20PBR-S10	K20TT
0 242 235 740	PK20PR-P8	IK20TT
0 242 235 743	IKH20TT	IKH20TT
0 242 235 748	K20PBR-S10	K20TT
0 242 235 749	PK20PR-P8	IK20TT
0 242 235 751	W20EPR-U11	W20TT
0 242 235 756	IKH20TT	IKH20TT
0 242 235 758	K20HR-U11	KH20TT
0 242 235 766	K20PBR-S10	K20TT
0 242 235 767	PT16VR13	TV16TT
0 242 235 769	IKH20TT	IKH20TT
0 242 235 791	K20HR-U11	KH20TT
0 242 235 797	K20PR-U	K20TT
0 242 235 909	W20EPR-U	W20TT
0 242 235 910	W20EPBR-S	W20TT
0 242 235 911	W20FPR-U	WF20TT
0 242 235 912	K20PR-U	K20TT
0 242 235 913	K20PR-U11	K20TT
0 242 235 914	K20TR11	K20TT
0 242 235 914	K20TXR	K20TT
0 242 235 915	W20EPR-U11	W20TT

BOSCH	DENSO	TT
0 242 235 916	PT16VR13	TV16TT
0 242 235 917	K20PBR-S10	K20TT
0 242 235 918	PK20PR-P8	IK20TT
0 242 235 979	T20EPR-U	T20TT
0 242 235 980	K20R-U	K20TT
0 242 235 981	K20TXR	K20TT
0 242 235 982	PK20PR-P8	IK20TT
0 242 235 983	KJ20DR-M11	-
0 242 235 984	PKJ20CR-L11	IK20TT
0 242 235 985	K20R-U11	K20TT
0 242 235 986	KJ20CR-U11	K20TT
0 242 235 987	IK20TT	IK20TT
0 242 236 510	IKH20TT	IKH20TT
0 242 236 528	IKH20TT	IKH20TT
0 242 236 541	K20R-U11	K20TT
0 242 236 543	T20EPR-U15	-
0 242 236 556	IK20	IK20TT
0 242 236 557	IK20	IK20TT
0 242 236 558	IK20	IK20TT
0 242 236 559	IT20TT	IT20TT
0 242 236 560	T20EPR-U	T20TT
0 242 236 561	K20R-U	K20TT
0 242 236 562	K20TXR	K20TT
0 242 236 563	ZT20EPR11	IT20TT
0 242 236 564	PK20PR-P8	IK20TT
0 242 236 565	KJ20DR-M11	-
0 242 236 566	PKJ20CR-L11	IK20TT
0 242 236 571	VK22	IK22FTT
0 242 236 572	VKB20	-
0 242 236 576	IW20	IW20TT
0 242 236 577	VKH20Y	-
0 242 236 578	IXUH22	IXUH22TT
0 242 236 580	W20ESR-U	-
0 242 236 604	IKH20TT	IKH20TT
0 242 236 610	DK20PR-D13	-
0 242 236 633	T16VR-U10	TV16TT
0 242 236 668	IK20TT	IK20TT
0 242 240 004	IW20	IW20TT
0 242 240 506	W22MPR-U	-
0 242 240 516	IW20	IW20TT
0 242 240 519	T20EPR-U	T20TT
0 242 240 520	T20PR-U	ITF20TT
0 242 240 521	IW20	IW20TT
0 242 240 522	T20EPR-U	T20TT
0 242 240 528	K20PBR	K20TT
0 242 240 530	IK20	IK20TT
0 242 240 531	W20EPR-U11	W20TT
0 242 240 533	IK20	IK20TT
0 242 240 539	K20PR-U11	K20TT
0 242 240 555	IW20	IW20TT
0 242 240 558	IK20	IK20TT
0 242 240 561	W20FPR-U	WF20TT
0 242 240 562	K20TNR-S	K20TT
0 242 240 564	K22TNR-S	-
0 242 240 566	K20TXR	K20TT
0 242 240 569	T20EPR-U	T20TT
0 242 240 572	K20PBR	K20TT
0 242 240 576	W22MPR-U	-
0 242 240 577	K20PR-U	K20TT
0 242 240 582	W20MR-U	-
0 242 240 584	K20TXR	K20TT
0 242 240 585	W22FSR	-
0 242 240 586	W22ESR-U	-
0 242 240 587	K20PBR-S10	K20TT
0 242 240 590	K20PBR-S10	K20TT
0 242 240 591	T20EPR-U	T20TT
0 242 240 592	W20EPR-U	W20TT
0 242 240 593	K20PR-U	K20TT
0 242 240 615	PK20PR11	K20TT
0 242 240 618	K20PBR	K20TT
0 242 240 619	VKH20Y	-

Свечи зажигания и Свечи накаливания

Таблица взаимозаменяемости – Другие производители

BOSCH	DENSO	TT
0 242 240 620	ZT20EPR11	IT20TT
0 242 240 621	PK20PR11	K20TT
0 242 240 625	PQ20R-P8	IQ20TT
0 242 240 628	PK20PR-P8	IK20TT
0 242 240 635	K20HR-U11	KH20TT
0 242 240 637	VKH22	-
0 242 240 638	K20PR-U11	K20TT
0 242 240 648	K20TNR-S	K20TT
0 242 240 649	PK20PR-L11	IK20TT
0 242 240 650	PQ20R-P8	IQ20TT
0 242 240 653	SK20PR-A8	IK20TT
0 242 240 655	VKH20Y	-
0 242 240 846	W22MPR-U	-
0 242 240 848	T20EPR-U	T20TT
0 242 240 849	W20EPR-U	W20TT
0 242 240 850	K20PR-U	K20TT
0 242 240 860	PK20PR-L11	IK20TT
0 242 242 501	IK22	IK22FTT
0 242 242 505	VW22	-
0 242 245 018	K22PBR-S	IKB22TT
0 242 245 514	IW22	-
0 242 245 517	W22FSR	-
0 242 245 519	IW22	-
0 242 245 520	IK22	IK22FTT
0 242 245 521	W22ESR-U	-
0 242 245 527	T22EP-U	-
0 242 245 533	W22MPR-U	-
0 242 245 536	K22PR-U	IK22FTT
0 242 245 539	K22PBR-S	IKB22TT
0 242 245 550	K22PR-U11	IK22FTT
0 242 245 552	W22EPR-U	W22TT
0 242 245 556	IWF22	-
0 242 245 558	PK22PR-L11S	-
0 242 245 559	IK22	IK22FTT
0 242 245 572	VKH22	-
0 242 245 576	VK22	IK22FTT
0 242 245 812	W22EPR-U	W22TT
0 242 250 503	W24ESR-U	-
0 242 250 506	W24FSR	-
0 242 250 512	IW24	-
0 242 250 803	W24FSR	-
0 242 255 501	IRE01-27	-
0 242 255 502	W27ESR-U	-
0 242 255 504	IW27	-
0 242 255 506	IW27	-
0 242 260 001	W31ESR-U	-
0 242 319 501	MA16PR-U	-
0 242 325 501	MA16PR-U	-
0 242 329 503	MA16PR-U	-
0 242 329 505	MA16PR-U	-
0 242 335 504	MA20PR-U	-
0 242 340 501	MA20PR-U	-
0 250 200 049	DG-202	-
0 250 200 053	DG-202	-
0 250 200 054	DG-001	-
0 250 200 057	DG-001	-
0 250 200 058	DG-001	-
0 250 200 059	DG-001	-
0 250 200 060	DG-001	-
0 250 200 063	DG-012	-
0 250 200 064	DG-001	-
0 250 200 065	DG-001	-
0 250 200 066	DG-001	-
0 250 200 068	DG-001	-
0 250 200 069	DG-001	-
0 250 200 469	DG-001	-
0 250 201 001	DG-001	-
0 250 201 004	DG-012	-
0 250 201 005	DG-001	-
0 250 201 006	DG-001	-
0 250 201 008	DG-001	-

BOSCH	DENSO	TT
0 250 201 009	DG-001	-
0 250 201 011	DG-012	-
0 250 201 012	DG-202	-
0 250 201 014	DG-202	-
0 250 201 015	DG-012	-
0 250 201 017	DG-123	-
0 250 201 019	DG-001	-
0 250 201 021	DG-012	-
0 250 201 026	DG-010	-
0 250 201 027	DG-001	-
0 250 201 030	DG-001	-
0 250 201 031	DG-012	-
0 250 201 032	DG-012	-
0 250 201 033	DG-001	-
0 250 201 034	DG-202	-
0 250 201 035	DG-119	-
0 250 201 036	DG-628	-
0 250 201 037	DG-001	-
0 250 201 038	DG-106	-
0 250 201 039	DG-001	-
0 250 201 041	DG-010	-
0 250 201 042	DG-001	-
0 250 201 043	DG-006	-
0 250 201 046	DG-012	-
0 250 201 047	DG-010	-
0 250 201 048	DG-106	-
0 250 201 049	DG-007	-
0 250 201 050	DG-012	-
0 250 201 053	DG-129	-
0 250 201 054	DG-106	-
0 250 201 055	DG-010	-
0 250 201 405	DG-001	-
0 250 201 415	DG-012	-
0 250 201 469	DG-001	-
0 250 201 930	DG-012	-
0 250 201 933	DG-012	-
0 250 201 935	DG-006	-
0 250 201 937	DG-001	-
0 250 201 939	DG-001	-
0 250 201 946	DG-010	-
0 250 201 950	DG-001	-
0 250 201 951	DG-123	-
0 250 201 952	DG-001	-
0 250 201 954	DG-010	-
0 250 202 001	DG-004	-
0 250 202 002	DG-111	-
0 250 202 003	DG-198	-
0 250 202 004	DG-234	-
0 250 202 006	DG-648	-
0 250 202 007	DG-114	-
0 250 202 008	DG-143	-
0 250 202 009	DG-005	-
0 250 202 012	DG-226	-
0 250 202 015	DG-157	-
0 250 202 018	DG-004	-
0 250 202 019	DG-001	-
0 250 202 020	DG-003	-
0 250 202 022	DG-005	-
0 250 202 023	DG-109	-
0 250 202 024	DG-009	-
0 250 202 025	DG-101	-
0 250 202 026	DG-110	-
0 250 202 027	DG-133	-
0 250 202 028	DG-127	-
0 250 202 029	DG-117	-
0 250 202 032	DG-116	-
0 250 202 033	DG-127	-
0 250 202 034	DG-102	-
0 250 202 035	DG-008	-
0 250 202 036	DG-122	-
0 250 202 038	DG-176	-

BOSCH	DENSO	TT
0 250 202 040	DG-115	-
0 250 202 041	DG-155	-
0 250 202 042	DG-118	-
0 250 202 043	DG-142	-
0 250 202 045	DG-117	-
0 250 202 046	DG-109	-
0 250 202 048	DG-181	-
0 250 202 051	DG-652	-
0 250 202 052	DG-216	-
0 250 202 052	DG-650	-
0 250 202 053	DG-648	-
0 250 202 054	DG-215	-
0 250 202 056	DG-114	-
0 250 202 058	DG-232	-
0 250 202 060	DG-198	-
0 250 202 064	DG-157	-
0 250 202 065	DG-108	-
0 250 202 070	DG-239	-
0 250 202 073	DG-213	-
0 250 202 076	DG-222	-
0 250 202 077	DG-157	-
0 250 202 079	DG-649	-
0 250 202 085	DG-124	-
0 250 202 086	DG-159	-
0 250 202 087	DG-104	-
0 250 202 089	DG-146	-
0 250 202 092	DG-174	-
0 250 202 093	DG-137	-
0 250 202 094	DG-198	-
0 250 202 095	DG-649	-
0 250 202 096	DG-648	-
0 250 202 097	DG-651	-
0 250 202 102	DG-144	-
0 250 202 103	DG-145	-
0 250 202 119	DG-235	-
0 250 202 121	DG-643	-
0 250 202 124	DG-187	-
0 250 202 125	DG-245	-
0 250 202 126	DG-175	-
0 250 202 128	DG-126	-
0 250 202 129	DG-112	-
0 250 202 130	DG-130	-
0 250 202 131	DG-121	-
0 250 202 132	DG-196	-
0 250 202 135	DG-181	-
0 250 202 137	DG-302	-
0 250 202 137	DG-641	-
0 250 202 140	DG-110	-
0 250 202 141	DG-117	-
0 250 202 142	DG-117	-
0 250 202 143	DG-182	-
0 250 202 146	DG-197	-
0 250 202 710	DG-132	-
0 250 202 901	DG-004	-
0 250 203 001	DG-170	-
0 250 203 002	DG-171	-
0 250 203 004	DG-140	-
0 250 203 009	DG-195	-
0 250 203 012	DG-614	-
0 250 203 018	DG-611	-
0 250 204 001	DG-113	-
0 250 204 002	DG-180	-
0 250 212 006	DG-173	-
0 250 212 009	DG-005	-
0 250 212 010	DG-648	-
0 250 212 011	DG-602	-
0 250 212 013	DG-145	-
0 250 312 001	DG-626	-
0 250 312 002	DG-642	-
0 250 312 003	DG-300	-
0 250 312 003	DG-640	-

BOSCH	DENSO	TT
0 250 312 007	DG-301	-
0 250 402 001	DG-177	-
0 250 402 002	DG-178	-
0 250 402 003	DG-660	-
0 250 402 005	DG-177	-
0 250 403 001	DG-610	-
0 250 403 002	DG-190	-
0 250 403 003	DG-604	-
0 250 403 004	DG-633	-
0 250 403 005	DG-608	-
0 250 403 006	DG-194	-
0 250 403 008	DG-194	-
0 250 403 009	DG-193	-
0 250 403 010	DG-604	-
0 250 403 011	DG-608	-
0 250 403 012	DG-609	-
0 250 403 013	DG-619	-
0 250 403 014	DG-621	-
0 250 403 019	DG-653	-
0 250 403 021	DG-631	-
0 250 404 001	DG-603	-
0 250 404 002	DG-632	-
0 250 503 003	DG-601	-
0 250 523 002	DG-662	-
0 250 523 004	DG-655	-
0 250 603 006	DG-613	-
0 250 603 008	DG-620	-
0250212018	DG-144	-
1	DG-001	-
10	DG-004	-
103	DG-108	-
109	DG-176	-
111	DG-181	-
115	DG-140	-
117	DG-114	-
119	DG-010	-
12	DG-007	-
142	DG-232	-
144	DG-610	-
149	DG-001	-
16	DG-171	-
173	DG-613	-
2	DG-012	-
205	DG-195	-
209	DG-171	-
212	DG-600	-
22	DG-117	-
221	DG-609	-
224	DG-005	-
226	DG-621	-
233	DG-611	-
235	DG-197	-
236	DG-632	-
237	DG-631	-
25	DG-119	-
3	DG-005	-
30	DG-142	-
34	DG-198	-
38	DG-146	-
4	DG-003	-
41	DG-111	-
43	DG-170	-
44	DG-175	-
51	DG-130	-
54	DG-174	-
55	DG-181	-
59	DG-113	-
6	DG-010	-
66	DG-196	-
7402	K20TR11	K20TT
8	DG-117	-

Свечи зажигания и Свечи накаливания

Таблица взаимозаменяемости – Другие производители

BOSCH	DENSO	TT
89	DG-001	-
9 240 033 535	W20FPR-U	WF20TT
9 443 612 053	DG-645	-
D 6 BC	MA20P-U	-
D 7 BC	MA20P-U	-
D 8 AC	MA16PR-U	-
D10B	MA16PR-U	-
D10BC	MA16PR-U	-
DR 6 BC	MA20PR-U	-
DR 7 BC	MA20PR-U	-
DR 8 BC	MA16PR-U	-
DR 8 BPX+	MA16PR-U	-
DR 9 BC	MA16PR-U	-
DR10BC	MA16PR-U	-
F 002 G50 031	DG-171	-
F 002 G50 048	DG-195	-
F 01G 000 00P	DG-600	-
F 01G 004 02U	DG-645	-
F 01G 004 02X	DG-601	-
F 01G 004 031	DG-656	-
F 08 CS	IK31	-
F 09 CS	IK31	-
F 2 CS	IK27	-
F 3 CS	IK27	-
F 4 CS	IK24	-
F 5 DC	K22PR-U	IK22FTT
F 5 DP 0 R	IK22	IK22FTT
F 6 DC	K20P-U	K20TT
F 6 DP 0 R	IK20	IK20TT
F 6 DSR	IK20	IK20TT
F 6 DTC	K20PBR	K20TT
F 6 HER 2	KJ20DR-M11	-
F 6 NPP 332	VKH20Y	-
F 7 DC	K20P-U	K20TT
F 7 KTCR	K20PBR-S10	K20TT
F 7 LDCR	K20TXR	K20TT
F 7 LTGR	K20PBR-S10	K20TT
F 8 DC	K16PR-U11	K16TT
F 8 DC 4	K16PR-U11	K16TT
F01G00402Z	DG-600	-
F8KTCR	K20PBR-S10	K20TT
FGR 5 KQE0	IK22	IK22FTT
FGR 6 HQE 0	K20PBR-S10	K20TT
FGR 6 KQE	K20PBR-S10	K20TT
FGR 6 NQE0	K20HR-U11	KH20TT
FGR 7 DQ+	K20PBR-S10	K20TT
FGR 7 DQP+	K20TXR	K20TT
FGR 7 KQE	K20PBR-S10	K20TT
FGR 7 KQE 0	K20PBR-S10	K20TT
FGR 7 MQPE	IKH20TT	IKH20TT
FGR 8 KQE	K20PBR-S10	K20TT
FGR 8 KQE 0	K20PBR-S10	K20TT
FLR 8 LDCU+	K20TXR	K20TT
FLR 9 LTE	K16TNR-S9	K16TT
FQ 5 LER 2	KJ22CR-L11	-
FQR 7 ME	K20HR-U11	KH20TT
FQR 8 LE 2	KJ16CR-L11	K16TT
FQR 8 LEU 2	KJ16CR-L11	K16TT
FR 10 DC	K16PR-U	K16TT
FR 10 DCX+	K16PR-U11	K16TT
FR 5 DC	K22PR-U	IK22FTT
FR 5 DCX	K22PR-U11	IK22FTT
FR 5 DP+	IK22	IK22FTT
FR 5 DPP 222	PK22PR-L11S	-
FR 5 DTC	K22PBR-S	IKB22TT
FR 5 KPP 332S	VK22	IK22FTT
FR 5 LDC	K22PBR-S	IKB22TT
FR 5 NI 332 S	VKH22	-
FR 56	IK22	IK22FTT
FR 6 DC 2	K20PR-U	K20TT
FR 6 DC+	K20PR-U	K20TT

BOSCH	DENSO	TT
FR 6 DCX	K20PR-U11	K20TT
FR 6 DCX+	K20PR-U11	K20TT
FR 6 DDC	K22TNR-S	-
FR 6 DP+	IK20	IK20TT
FR 6 DPP 22	PQ20R-P8	IQ20TT
FR 6 DPP 22 U	PK20PR11	K20TT
FR 6 DPP 33 X	PK20PR11	K20TT
FR 6 DPP 332 S	PK20PR-P8	IK20TT
FR 6 DPX+	IK20	IK20TT
FR 6 DS	IK20	IK20TT
FR 6 KDC	K20TNR-S	K20TT
FR 6 KDC+	K20TNR-S	K20TT
FR 6 KDE 0	K20TXR	K20TT
FR 6 KI 332 S	SK20PR-A8	IK20TT
FR 6 KPP 33 X+	PK20PR-L11	IK20TT
FR 6 KPP 33+	PQ20R-P8	IQ20TT
FR 6 KPP 332 S	IK20TT	IK20TT
FR 6 KPP 332 U	IK20TT	IK20TT
FR 6 KTC	K20PBR	K20TT
FR 6 LDC	K20TR11	K20TT
FR 6 LTC	K20PBR	K20TT
FR 6 MPP 332	VKH20Y	-
FR 6 NI 332 S	VKH20Y	-
FR 7 DC+	K20PR-U	K20TT
FR 7 DCX+	K20PR-U11	K20TT
FR 7 DE 2	K20PR-U	K20TT
FR 7 DII 35 V	DK20PR-D13	-
FR 7 DP+	IK20	IK20TT
FR 7 DPP 22 U	PK20PR11	K20TT
FR 7 DPP 33	PK20PR-P8	IK20TT
FR 7 DPP 332	IK20TT	IK20TT
FR 7 DPP+	PK20PR-P8	IK20TT
FR 7 DPX+	IK20	IK20TT
FR 7 HC 0 X	K16GPR-U11	-
FR 7 HC+	KJ20DR-M11	-
FR 7 HPP 33+	PKJ20CR-L11	IK20TT
FR 7 HPP 332 W	IK20TT	IK20TT
FR 7 KC+	K20R-U	K20TT
FR 7 KCW	K20R-U	K20TT
FR 7 KCX+	K20R-U11	K20TT
FR 7 KI 332 S	VK22	IK22FTT
FR 7 KII 33 X	IK20TT	IK20TT
FR 7 KII 332 S	IK20TT	IK20TT
FR 7 KP	IK20	IK20TT
FR 7 KPP 33 U+	IK20TT	IK20TT
FR 7 KPP 33+	PK20PR-P8	IK20TT
FR 7 KPP 332	IK20TT	IK20TT
FR 7 KPP 332U	IK20TT	IK20TT
FR 7 KPX	IK20	IK20TT
FR 7 KTC	K20PBR-S10	K20TT
FR 7 LC 2	KJ20CR-U11	K20TT
FR 7 LCX+	KJ20CR-U11	K20TT
FR 7 LD+	K20TR11	K20TT
FR 7 LD+	K20TXR	K20TT
FR 7 LDC	K20TXR	K20TT
FR 7 LDC+	K20TR11	K20TT
FR 7 LI 332 S	VKB20	-
FR 7 LPX	IK20	IK20TT
FR 7 MPP 10	IKH20TT	IKH20TT
FR 7 NES	IXUH22	IXUH22TT
FR 7 NI 33	IKH20TT	IKH20TT
FR 7 NI 332 S	VKH20Y	-
FR 7 NII 33 X	IKH20TT	IKH20TT
FR 7 NII 35 S	IKH20TT	IKH20TT
FR 7 NII 35 U	IKH20TT	IKH20TT
FR 7 NPP 33	IKH20TT	IKH20TT
FR 7 NPP 332	IKH20TT	IKH20TT
FR 7 SE	K20HR-U11	KH20TT
FR 7 SI 30	IKH20TT	IKH20TT
FR 78 X	IK20TT	IK20TT
FR 78	IK20TT	IK20TT

BOSCH	DENSO	TT
FR 8 D+	K16PR-U	K16TT
FR 8 DCX+	K16PR-U11	K16TT
FR 8 DP	IK16	IK16TT
FR 8 DPP 33+	PK16PR-L11	IK16TT
FR 8 DPX +	IK16	IK16TT
FR 8 DS	IK16	IK16TT
FR 8 HC	QJ16HR-U	-
FR 8 HDC+	K16TR11	K16TT
FR 8 HP+	QJ16HR-U	-
FR 8 KC+	K16R-U	K16TT
FR 8 KCU	K16R-U11	K16TT
FR 8 KDC	K16TR11	K16TT
FR 8 KI 33 V	SK16PR-E11	IK16TT
FR 8 KI 332 S	K16PSR-B8	IK16TT
FR 8 KTC+	K20PBR-S10	K20TT
FR 8 LC	K20TXR	K20TT
FR 8 LCX	KJ16CR-L11	K16TT
FR 8 LPX+	PKJ16CR-L11	IK16TT
FR 8 ME	K16HPR-U11	KH16TT
FR 8 MII 33 X	SK16HR11	IKH16TT
FR 8 NII 35 U	IKH16TT	IKH16TT
FR 8 NP	KH16TT	KH16TT
FR 8 SC+	K16HPR-U11	KH16TT
FR 8 SE 0	K16HPR-U11	KH16TT
FR 8 SPP 332	IKH16TT	IKH16TT
FR 9 DC	Q14R-U11	IQ16TT
FR 9 DCX	Q14R-U11	IQ16TT
FR 9 HC+	QJ16HR-U	-
FR 9 LCX	KJ16CR-L11	K16TT
FR 91	K16TNR-S9	K16TT
FR6 NPP	VKH22	-
FR6 NPP 332	VKH22	-
FR6DTC	K20PBR	K20TT
FR6LDC	K20TXR	K20TT
FR7DE	K20PR-U	K20TT
GLP 228	DG-145	-
GLP001	DG-001	-
GLP002	DG-012	-
GLP003	DG-005	-
GLP004	DG-003	-
GLP006	DG-010	-
GLP008	DG-117	-
GLP010	DG-004	-
GLP012	DG-007	-
GLP016	DG-171	-
GLP019	DG-118	-
GLP021	DG-110	-
GLP022	DG-117	-
GLP023	DG-109	-
GLP025	DG-119	-
GLP030	DG-142	-
GLP031	DG-144	-
GLP033	DG-109	-
GLP034	DG-198	-
GLP035	DG-300	-
GLP035	DG-640	-
GLP038	DG-146	-
GLP040	DG-145	-
GLP041	DG-111	-
GLP042	DG-648	-
GLP043	DG-170	-
GLP044	DG-175	-
GLP048	DG-115	-
GLP050	DG-177	-
GLP051	DG-130	-
GLP054	DG-174	-
GLP055	DG-181	-
GLP057	DG-126	-
GLP059	DG-113	-
GLP066	DG-196	-
GLP070	DG-178	-

BOSCH	DENSO	TT
GLP073	DG-628	-
GLP074	DG-649	-
GLP078	DG-133	-
GLP089	DG-001	-
GLP092	DG-302	-
GLP092	DG-641	-
GLP093	DG-190	-
GLP094	DG-180	-
GLP099	DG-643	-
GLP103	DG-108	-
GLP109	DG-176	-
GLP111	DG-181	-
GLP115	DG-140	-
GLP117	DG-114	-
GLP119	DG-010	-
GLP120	DG-159	-
GLP125	DG-157	-
GLP132	DG-651	-
GLP137	DG-187	-
GLP142	DG-232	-
GLP144	DG-610	-
GLP147	DG-601	-
GLP149	DG-001	-
GLP158	DG-010	-
GLP173	DG-613	-
GLP179	DG-604	-
GLP194	DG-193	-
GLP195	DG-660	-
GLP196	DG-608	-
GLP197	DG-194	-
GLP199	DG-620	-
GLP2	DG-660	-
GLP201	DG-633	-
GLP202	DG-194	-
GLP203	DG-173	-
GLP205	DG-195	-
GLP209	DG-171	-
GLP210	DG-614	-
GLP212	DG-600	-
GLP221	DG-609	-
GLP222	DG-619	-
GLP223	DG-648	-
GLP224	DG-005	-
GLP225	DG-182	-
GLP226	DG-621	-
GLP233	DG-611	-
GLP235	DG-197	-
GLP-236	DG-632	-
GLP237	DG-631	-
GLP2-4	DG-614	-
GLP242	DG-662	-
GLP2-5	DG-145	-
GLP2-5	DG-182	-
GLP2-5/4.5	DG-648	-
GLP251	DG-656	-
GLP252	DG-655	-
GLP253	DG-653	-
GLP2-HS	DG-190	-
GLP2-HS	DG-193	-
GLP2-HS	DG-610	-
GLP2-HS	DG-619	-
GLP2-HS	DG-633	-
GLP31	DG-144	-
GLP4	DG-662	-
GLP5	DG-620	-
GSK2	DG-178	-
H 2 CS	IT27	-
H 3 CS	IT24	-
H 4 CS	IT24	-
H 56	T22EP-U	-
H 6 DC	T20EPR-U	T20TT

Свечи зажигания и Свечи накаливания

Таблица взаимозаменяемости – Другие производители

BOSCH	DENSO	TT
H 7 DC	T20EPR-U	T20TT
H 8 DC	T16EPR-U	T16TT
H 9 DC 0	T16EPR-U	T16TT
H6DP	T20EPR-U	T20TT
HGR 6 KQC	T20EPR-U	T20TT
HGR 7 KQC	T20EPR-U	T20TT
HGR 8 MQI	ITV16TT	ITV16TT
HLR 8 STEX	PT16VR13	TV16TT
HR 10 ACY	T14PR-U	ITF16TT
HR 10 BC+	T14PR-U	ITF16TT
HR 10 BCX	T14PR-U	ITF16TT
HR 10 BCY+	T14PR-U	ITF16TT
HR 10 BCZ	T14PR-U	ITF16TT
HR 10 HC 0	T16EPR-U	T16TT
HR 10 HC+	T16EPR-U	T16TT
HR 5 DC	T22EP-U	-
HR 6 BC	T20PR-U	ITF20TT
HR 6 D+	T20EPR-U	T20TT
HR 6 DP+	T20EPR-U	T20TT
HR 6 DPP 33 V	ZT20EPR11	IT20TT
HR 6 DS	T20EPR-U	T20TT
HR 7 D+	T20EPR-U	T20TT
HR 7 DCX+	T20EPR-U	T20TT
HR 7 DCY+	T20EPR-U15	-
HR 7 DP+	IT20TT	IT20TT
HR 7 DPX	IT20TT	IT20TT
HR 7 KPP 33+	ZT20EPR11	IT20TT
HR 7 MEV	T16VR-U10	TV16TT
HR 7 MPP 302	PT16VR13	TV16TT
HR 7 MPP+V	PT16VR13	TV16TT
HR 7 NI 332 W	ITV20TT	ITV20TT
HR 78 X	IT20TT	IT20TT
HR 78	IT20TT	IT20TT
HR 8 AC	T20R-U	-
HR 8 BC	T16PR-U	ITF16TT
HR 8 BCY	T16PR-U11	ITF16TT
HR 8 D+	T20EPR-U	T20TT
HR 8 DCV+	T16EPR-U	T16TT
HR 8 DCX+	T16EPR-U	T16TT
HR 8 DCY	T16EPR-U15	T16TT
HR 8 DP	T16TT	T16TT
HR 8 DP V	T16TT	T16TT
HR 8 DP X+	T16TT	T16TT
HR 8 DPP 15 V	PT16EPR-L13	IT16TT
HR 8 DPP 22 U	PT16EPR-L13	IT16TT
HR 8 MCV+	T16VR-U10	TV16TT
HR 8 MEV	T16VR-U10	TV16TT
HR 8 MPV	PT16VR13	TV16TT
HR 8 NI 332 W	ITL16TT	ITL16TT
HR 8 NPP 302	PT16VR13	TV16TT
HR 9 BC+	T16PR-U	ITF16TT
HR 9 BCY+	T16PR-U11	ITF16TT
HR 9 DC	T16EPR-U	T16TT
HR 9 DC+	T16EPR-U	T16TT
HR 9 DCX	T16EPR-U15	T16TT
HR 9 DCX+	T16EPR-U15	T16TT
HR 9 DCY+	T16EPR-U15	T16TT
HR 9 HC+	T20NR-U11	IT20TT
HR 9 HCO	T20NR-U11	IT20TT
HR 9 KI 33 Y	IT16TT	IT16TT
HR 9 LPP 22 Y	PTJ16R15	IT16TT
HR 9 SEOX	ITL16TT	ITL16TT
HR 91 GX	T16PR-U	ITF16TT
HR7MPP	PT16VR13	TV16TT
HS 5 E	T22M-U	-
HS 6 E	T22M-U	-
HS 7 E	T20M-U	-
HS 7 F	T20MP-U	-
HS 8 E	T20M-U	-
M 10 AC	L14-U	-
M 12 B	L14-U	-

BOSCH	DENSO	TT
M 4 AC	M24S	-
M 5 AC	M22	-
M 7 AC	M17	-
M 8 AC	L14-U	-
U 3 CC	U22ESR-N	-
U 4 AC	U22FSR-U	-
U 5 AC	U20FSR-U	-
U 6 AC	U20FSR-U	-
UR 2 CC	U24ESR-N	-
UR 3 AC	U22FSR-U	-
UR 3 CC	U22ESR-N	-
UR 4 AC	U22FSR-U	-
UR 6 AC	U20FSR-U	-
UR 6 DE	IU22	-
VR 6 NE	XE20HR-U9	IXEH20TT
VR 6 NII 35 T	VFXEHC22G	-
VR 7 NII 33 X	IXEH22TT	IXEH22TT
VR 7 SPP 33	FXE20HE11	IXEH20ETT
VR 7 TII 35 U	FXE20HE11	IXEH20ETT
VR 8 NII 35 U	FXE20HR11	IXEH20TT
VR 8 SC+	XE20HR-U9	IXEH20TT
VR 8 SE 0	XE20HR-U9	IXEH20TT
VR 8 SEW	XE20HR-U9	IXEH20TT
VR 8 SII 33 X	SC16HR11	IXEH20TT
W 06 CS	IW34	-
W 07 AS	W31FS	-
W 07 CS	IW34	-
W 08 AS	IWF27	-
W 08 CS	IW31	-
W 10 AC	W14F-U	-
W 10 CC	W14E	-
W 10 DC	W9EP	-
W 10 EC	W14PR-U	-
W 2 AC	W27FSR	-
W 2 AS	IWF27	-
W 2 CC	W27ESR-U	-
W 2 CS	IW31	-
W 3 AC	W24FSR	-
W 3 CC	W24ESR-U	-
W 3 CS	IW24	-
W 3 DP 0	IW24	-
W 4 AC	W24FSR	-
W 4 AS	IWF24	-
W 4 CC	W24ESR-U	-
W 4 CS	IW24	-
W 4 DP 0	IW24	-
W 5 AC	W22FS-U	-
W 5 AS	IWF22	-
W 5 CC	W22ESR-U	-
W 5 DP 0	IW24	-
W 6 AC	W20FSR-U	WF20TT
W 6 CC	W22ESR-U	-
W 6 DC	W20EP-U	W20TT
W 7 AC	W20FSR-U	WF20TT
W 7 BC	W20FPR-U	WF20TT
W 7 CC	W20ESR-U	-
W 7 DC	W20EPR-U	W20TT
W 7 DCX	W20EPR-U11	W20TT
W 7 DSR	W20EPB	W20TT
W 7 DTC	W20EPB	W20TT
W 7 EC	W20S-U	-
W 7 FC	W20PR-U	-
W 7 LTCR	W20EPBR-S	W20TT
W 8 AC	W16FSR	-
W 8 BC	W16FPR-U	-
W 8 CC	W16ESR-U	-
W 8 DC	W16EPR-U	W16TT
W 8 DTC	W20EPB	W20TT
W 8 EC	W16S-U	-
W 9 AC	W14F-U	-
W 9 CC	W14E	-

BOSCH	DENSO	TT
W 9 DC	W14EPR-U	IW16TT
W 9 EC	W14PR-U	-
W 9 EC 0	W14LM-U	-
W 9 LDCR	W16ETR-S	W16TT
W5DC	W22EPR-U	W22TT
WEA	SF-50	-
WR 10 AC	W14FR-U	-
WR 10 DC	W14EPR-U	IW16TT
WR 10 DCX	W14EXR-U11	IW16TT
WR 10 FC	W14PR-U	-
WR 10 FCY	W14PR-U	-
WR 10 FCZ+	W14PR-U	-
WR 10 LC+	J16CR-U	W16TT
WR 10 LCV	J16CR-U	W16TT
WR 10 LCV+	J16CR-U	W16TT
WR 11 E 0	W9LMR-US	-
WR 11 F	W9PR-U	-
WR 12 EC	W9LMR-US	-
WR 2 CC	W31ESR-U	-
WR 3 CC	W27ESR-U	-
WR 3 CP+	IW27	-
WR 3 CS	IW27	-
WR 3 CTC	IRE01-27	-
WR 4 AC	W24FSR	-
WR 4 CC	W24ESR-U	-
WR 4 DP 0	IW24	-
WR 5 AC	W22FSR	-
WR 5 AP+	IWF22	-
WR 5 CC	W22ESR-U	-
WR 5 D+	W22EPR-U	W22TT
WR 5 DP+	IW22	-
WR 5 DS	IW22	-
WR 56	VW22	-
WR 6 AC	W22FSR	-
WR 6 BC	W20FPR-U	WF20TT
WR 6 CC	W22ESR-U	-
WR 6 D+	W20EPR-U	W20TT
WR 6 DCX	W20EPR-U11	W20TT
WR 6 DP 0	IW20	IW20TT
WR 6 DP+	IW20	IW20TT
WR 6 DS	IW20	IW20TT
WR 7 AC	W20FSR-U	WF20TT
WR 7 AP+	IWF22	-
WR 7 B+	W20FPR-U	WF20TT
WR 7 BP+	IWF22	-
WR 7 CC	W20ESR-U	-
WR 7 CE	W20ESR-U	-
WR 7 CP+	W20ESR-U	-
WR 7 D+	W20EPR-U	W20TT
WR 7 DCX+	W20EPR-U11	W20TT
WR 7 DP+	IW20	IW20TT
WR 7 DPX+	IW20	IW20TT
WR 7 DS	IW20	IW20TT
WR 7 DTC	W20EPBR-S	W20TT
WR 7 EC	W20S-U	-
WR 7 KI 33 S	IW20	IW20TT
WR 7 LC	J16CR-U	W16TT
WR 7 LTC+	W20EPBR-S	W20TT
WR 78 G	IWF20	-
WR 78 X	W20EPBR-S	W20TT
WR 78	W20EPBR-S	W20TT
WR 8 AC	W16FSR	-
WR 8 AP+	W16FSR	-
WR 8 B+	W16FPR-U	-
WR 8 BC+	W16FPR-U	-
WR 8 CC	W16ESR-U	-
WR 8 CP+	W16ESR-U	-
WR 8 D+	W16EPR-U	W16TT
WR 8 D+X	W16EPR-U11	W16TT
WR 8 DC+	W16EPR-U	W16TT
WR 8 DP+	IW16	IW16TT

BOSCH	DENSO	TT
WR 8 DPX+	IW16	IW16TT
WR 8 DS	W16EPR-U	W16TT
WR 8 FC	W16PR-U	-
WR 8 LC+	J16CR-U	W16TT
WR 8 LP+	IW16	IW16TT
WR 8 LT+	W20EPBR-S	W20TT
WR 9 D+	W16EPR-U	W16TT
WR 9 DCX+	W14EXR-U11	IW16TT
WR 9 DP+	W14EPR-U	IW16TT
WR 9 DPX+	W14EXR-U11	IW16TT
WR 9 DS	W14EPR-U	IW16TT
WR 9 FP	W16PR-U	-
WR 9 HC	J16AR-U11	-
WR 9 LCX+	J16CR-U	W16TT
WR 9 LE	J16CR-U	W16TT
WR 9 LEV+	J16CR-U	W16TT
WR 9 LS	J16CR-U	W16TT
WR 91 X	IW16TT	IW16TT
WR 91	IW16TT	IW16TT
WR9D+X	W20EPR-U11	W20TT
WS 12 E	W14MR-U	-
WS 5 E	W22M-U	-
WS 5 F	W22MPR-U	-
WS 6 E	W20MR-U	-
WS 6 F	W20MP-U	-
WS 7 E	W20MR-U	-
WS 8 E	W20MR-U	-
WS 8 F	W20MP-U	-
WS 9 EC	W14MR-U	-
WSR 5 F	W22MPR-U	-
WSR 6 E	W20MR-U	-
WSR 6 F	W22MPR-U	-
WSR 7 F	W20MPR-U10	-
WSR 8 E	W14MR-U	-
X 4 CC	X24ESR-U	-
X 4 DC	X27EPR-U9	-
X 5 DC	X22EPR-U9	-
X 5 DTC	X22ESR-U	-
XR 2 CS	IX24	-
XR 4 CS	X24ESR-U	-
XR 5 DC	X22EPR-U9	-
XR 6 CC	X24ESR-U	-
XR 7 DC	X22EPR-U9	-
XR 7 LDC	X22EPR-U9	-
XR 8 DC	X20EPR-U9	-
Y 5 DDC	XU22EPR-U	XU22TT
Y 6 DC	XU20EPR-U	-
YR 5 DDE	XU24EPR-U	-
YR 5 LDE	XU24EPR-U	-
YR 5 NI 332 S	SXU22HDR8	IXUH22TT
YR 6 DES	XU22PR9	XU22TT
YR 6 LDE	XU22EPR-U	XU22TT
YR 6 NI 332 S	SXU22HDR8	IXUH22TT
YR 6 NPP 332	VXUH22	IXUH22TT
YR 7 DC+	XU22EPR-U	XU22TT
YR 7 DE	XU22EPR-U	XU22TT
YR 7 LPP 332 W	VXU22	IXU22TT
YR 7 MPP 33	VXUH22	IXUH22TT
YR 7 NE	XU22HDR9	XUH22TT
YR 7 NII 33 S	IXUH22	IXUH22TT
YR 7 SII 33	VXUH20I	-
YR 8 SEU	XU22HDR9	XUH22TT
YR 8 SII 33 U	VXUH20I	-
ZOR 8 SI 302	VXUH22I	IXUH22TT
ZR 7 SI 332 S	VXUH22	IXUH22TT

BRISKPAL	DENSO	TT
B12YC	X27EPR-U9	-
B14YC	X24EPR-U9	-
B15YC	X22EPR-U9	-
D12Y	IK24	-

Свечи зажигания и Свечи накаливания

Таблица взаимозаменяемости – Другие производители

BRISKPAL	DENSO	TT
D12YC	IK24	-
D14Y	Q22PR-U	-
D14YC	Q22PR-U	-
D15YC	Q20PR-U	Q20TT
D17Y	Q16PR-U	Q16TT
D17YC	Q16PR-U	Q16TT
DOR08LGS	IK31	-
DOR08TS	IK31	-
DOR10LGS	IK27	-
DOR10TS	IK27	-
DOR11LGS	IK27	-
DOR12LGS	IK24	-
DOR12TS	IK24	-
DOX15LE1	KJ16CR-L11	K16TT
DR12YC	Q22PR-U	-
DR12ZC	IK22	IK22FTT
DR14TC	K22PBR-S	IKB22TT
DR14TC1	K22PBR-S	IKB22TT
DR14YC	Q22PR-U	-
DR14YPP1	IK22	IK22FTT
DR14YS	IK22	IK22FTT
DR14ZC	IK20	IK20TT
DR14ZC1	IK20	IK20TT
DR15LTC1	K20PBR-S10	K20TT
DR15TC	K20PBR	K20TT
DR15TCY1	K20PBR-S10	K20TT
DR15YC	Q20PR-U	Q20TT
DR15YC1	Q20PR-U11	Q20TT
DR15YPP1	IK20	IK20TT
DR15ZC	IK20	IK20TT
DR15ZC1	IK20	IK20TT
DR17TC	K20PBR-S10	K20TT
DR17TCY	K16TNR-S9	K16TT
DR17YC	Q16PR-U	Q16TT
DR17YPP1	IK16	IK16TT
DR17YS	IK16	IK16TT
DX14LTC1	K22PBR-S	IKB22TT
DX14TC	K22PB	IKB22TT
DX15LTC1	K20PBR-S10	K20TT
DX15TC	K20PBR	K20TT
DX17LTC1	K20PBR-S10	K20TT
DX17TC	K20PBR-S10	K20TT
F15YC	MA20P-U	-
FR15YC	MA20PR-U	-
G12YC	T22EP-U	-
G14Y	T22EP-U	-
G14YC	T22EP-U	-
G15Y	T20EPR-U	T20TT
G15YC	T20EPR-U	T20TT
G17Y	T16EPR-U	T16TT
G17YC	T16EPR-U	T16TT
GR12YC	T22EP-U	-
GR12ZC	T22EP-U	-
GR14YC	T22EP-U	-
GR14ZC	T20EPR-U	T20TT
GR14ZC1	T20EPR-U15	-
GR15YC	T20EPR-U	T20TT
GR15ZC	T16EPR-U	T16TT
GR15ZC1	T16EPR-U15	T16TT
GR17YC	T16EPR-U	T16TT
J19	W9LM-US	-
JR17	W14LM-U	-
JR19	W9LMR-US	-
K15YC	W20PR-U	-
K17C	W16S-U	-
K17Y	W16PR-U	-
K19	W14PR-U	-
L08JW	IW34	-
L08S	IW34	-
L08W	IW01-34	-
L10JW	IW29	-

BRISKPAL	DENSO	TT
L12W	IW27	-
L12Y	W24EPR-U	-
L12YC	W24EPR-U	-
L14C	W22ESR-U	-
L14U	W22ESR-U	-
L14Y	W22EPR-U	W22TT
L14YC	W22EPR-U	W22TT
L15	W20ESR-U	-
L15C	W20ESR-U	-
L15W	IW24	-
L15Y	W20EP-U	W20TT
L15YC	W20EP-U	W20TT
L17	W16ESR-U	-
L17C	W16ESR-U	-
L17W	IW20	IW20TT
L17Y	W16EPR-U	W16TT
L17YC	W16EPR-U	W16TT
L19	W14E	-
LOR08LGS	IW31	-
LOR08TS	IW31	-
LOR10LGS	IW27	-
LOR10TS	IW27	-
LOR12LGS	IW24	-
LOR12TS	IW24	-
LR12S	IW24	-
LR12YC	W24EPR-U	-
LR12ZC	IW22	-
LR14YC	W22EPR-U	W22TT
LR14YPP	IW22	-
LR14YS	IW22	-
LR14ZC	IW20	IW20TT
LR14ZC1	IW20	IW20TT
LR15TC	W20EPBR-S	W20TT
LR15YC	W20EPR-U	W20TT
LR15YC1	W20EPR-U11	W20TT
LR15YS	IW20	IW20TT
LR15ZC	IW20	IW20TT
LR15ZC1	IW20	IW20TT
LR17TC	W20EPBR-S	W20TT
LR17TC1	W20EPBR-S	W20TT
LR17YC	W16EPR-U	W16TT
LR17YPY	IW16	IW16TT
LR17YS	IW16	IW16TT
LX14TC	W22EPB	W22TT
LX15LTC1	W20EPBR-S	W20TT
LX15TC	W20EPB	W20TT
LX15TC1	W20EPB	W20TT
LX17LTC1	W20EPBR-S	W20TT
LX17TC	W16EPB10	W16TT
LX17TC1	W16EPB10	W16TT
N12W	IWF27	-
N14	W22FS-U	-
N14C	W22FS-U	-
N14Y	W22FPR-U	-
N14YC	W22FPR-U	-
N15	W20FSR-U	WF20TT
N15C	W20FSR-U	WF20TT
N15W	IWF22	-
N15Y	W20FPR-U	WF20TT
N15YC	W20FPR-U	WF20TT
N17	W16FSR	-
N17C	W16FSR	-
N17W	IWF22	-
N17YC	W16FPR-U	-
N19	W14F-U	-
N19C	W16FSR	-
NR12S	W27FSR	-
NR12YC	W24FPR	-
NR14	W22FSR	-
NR14YC	W22FPR-U	-
NR15	W20FSR-U	WF20TT

BRISKPAL	DENSO	TT
NR15YC	W20FPR-U	WF20TT
NR17	W16FSR	-
NR17C	W16FSR	-
NR17YC	W16FPR-U	-
NR19	W14FR-U	-
P15	W22M-U	-
P15Y	W22MPR-U	-
P17	W20M-US	-
P17Y	W20MP-U	-
PR15Y	W22MPR-U	-
PR17Y	W20MPR-U10	-
U15	T22M-U	-
U17	T20M-U	-
UR15	T22M-U	-
UR17	T20M-U	-

CHAMPION	DENSO	TT
10R12A	IXU24	-
1L45JR	IW22	-
1L4J	W20EPR-U	W20TT
1L4JR	W20EPR-U	W20TT
206	IK20	IK20TT
207	IK22	IK22FTT
208	IK24	-
248814	IW22	-
3013	T16EPR-U15	T16TT
3015	T16EPR-U	T16TT
3018	T16PR-U11	ITF16TT
3031	W16EXR-U13	W16TT
3034	IK16	IK16TT
307	IW22	-
3071	Q16PR-U	Q16TT
3401	T16EPR-U	T16TT
3405	W16EXR-U	W16TT
3407	T16EPR-U15	T16TT
3415	W20EPR-U	W20TT
470	ITL20	-
4VLSR	W20EPR-U	W20TT
5834	W14MR-U	-
5846	T20M-U	-
7015	IT16TT	IT16TT
7032	PT16VR13	TV16TT
7034	J16AR-U11	-
7440	ITL20	-
7712	VKA20	-
7953	VKA20	-
7FY5	IW22	-
7FY5R	IW22	-
7FY5SR	IW22	-
7GBMSR	K22PBR-S	IKB22TT
7GBYSR4	K22PBR-S	IKB22TT
7GYSSR	Q22PR-U	-
82CYS	W22FPR-U	-
860	MA20PR-U	-
870	MA16PR-U	-
9006	IKH20TT	IKH20TT
9204	IT20TT	IT20TT
9402	IT20TT	IT20TT
9407	VXUH22I	IXUH22TT
9407/T04	VXUH22I	IXUH22TT
942M	PKJ16CR-L11	IK16TT
952M	PKJ16CR-L11	IK16TT
955	XU24EPR-U	-
9701	VXU22	IXU22TT
9801	VK20Y	-
9804	VW20	IW20TT
9805	SK20PR-L9	IK20TT
9806	SK20R11	IK20TT
9808	IT20TT	IT20TT
9901	ITV16TT	ITV16TT
9FY5	W20EPR-U	W20TT

CHAMPION	DENSO	TT
9FY5R	W20EPR-U	W20TT
9FY5SR	W20EPR-U	W20TT
9GY5R	IK20	IK20TT
9GY5SR	K20PR-U	K20TT
A10	X20ESR-U	-
A2HC	X27ESR-U	-
A49GC	IXU27	-
A4HC	XU27EPR-U	-
A504R	IXU01-34	-
A506R	IXU01-34	-
A51R	IXU01-34	-
A52R	IXU01-34	-
A53C	IXU01-34	-
A53R	IXU01-34	-
A53V	IXU01-34	-
A54R	IXU01-31	-
A55C	IXU01-34	-
A55G	IXU01-34	-
A55R	IXU01-31	-
A57C	X31ESR-U	-
A57C-TT/003	X31ESR-U	-
A57G	IXU01-31	-
A57R	IXU01-31	-
A59C	X27ESR-U	-
A59G	IXU27	-
A59GC	IXU27	-
A5HC	X24ESR-U	-
A5YC	X27EPR-U9	-
A6	X24ESR-U	-
A61	X27ESR-U	-
A61G	IX27	-
A6G	IX24	-
A6GC	IX24	-
A6GHC	IX24B	-
A6HC	X24EPR-U9	-
A6Y	X24EPR-U9	-
A6YC	X24ESR-U	-
A7HC	X22ESR-U	-
A8	X22ESR-U	-
A85Y	X24EPR-U9	-
A8HC	X22EPR-U9	-
A8Y	X24ESR-U	-
A8YC	X22EPR-U9	-
BL11Y	T20PR-U	ITF20TT
BL13Y	T16PR-U	ITF16TT
BL15Y	T16PR-U	ITF16TT
BL6	ITF24	-
BL60	ITF27	-
BL60Y	ITF27	-
BL8	T20R-U	-
BL9Y	T20PR-U	ITF20TT
BN12Y	T16EPR-U	T16TT
BN14Y	T16EPR-U	T16TT
BN2	IT27	-
BN3	IT27	-
BN5	T22EP-U	-
BN59	IT27	-
BN60	IT27	-
BN60Y	IT27	-
BN63Y	IT24	-
BN6Y	T22EP-U	-
BN7Y	T22EP-U	-
BN89Y	T20EPR-U	T20TT
BN9Y	T20EPR-U	T20TT
C10YCC	K20P-U	K20TT
C10YCX	K20P-U	K20TT
C11YCC	K16PR-U	K16TT
C12YCC	K16PR-U11	K16TT
C279C	K22PR-U	IK22FTT
C281YC	K20P-U	K20TT
C501R	IK02-31	-

Свечи зажигания и Свечи накаливания

Таблица взаимозаменяемости – Другие производители

CHAMPION	DENSO	TT
CH709/002	DG-194	-
CH716	DG-625	-
CH724	DG-634	-
CH725	DG-611	-
CH79	DG-123	-
CH79/002	DG-123	-
CH800	DG-608	-
CH800/002	DG-608	-
CH802	DG-604	-
CH802/002	DG-604	-
CH803	DG-603	-
CH803/002	DG-603	-
CH806	DG-602	-
CH806/002	DG-602	-
CH809	DG-601	-
CH809/002	DG-601	-
CH810	DG-600	-
CH810/002	DG-600	-
CH813	DG-607	-
CH813	DG-623	-
CH813/002	DG-607	-
CH813/002	DG-623	-
CH814	DG-605	-
CH814/002	DG-605	-
CH819	DG-606	-
CH819/002	DG-606	-
CH87	DG-001	-
CH87/002	DG-001	-
CH90	DG-132	-
CH90/002	DG-132	-
CH94	DG-198	-
CH94/002	DG-198	-
CH97	DG-114	-
CH97/002	DG-114	-
CJ3	W22M-U	-
CJ4	W22M-U	-
CJ6	W22M-U	-
CJ6Y	W22MPR-U	-
CJ7Y	W22MPR-U	-
CJ8	W20MR-U	-
CJ8Y	W20MP-U	-
D10	M17	-
D14/013	L14-U	-
D14N	L14-U	-
D15Y	L14-U	-
D16	L14-U	-
D16J	L14-U	-
D18Y	L14-U	-
D21	L14-U	-
D23	L14-U	-
D6	M24S	-
D78Y	M24S	-
D9/013	M22	-
D9J	M22	-
DJ6J	T22M-U	-
DJ6Y	T22MP-U	-
DJ7J	T20M-U	-
DJ7Y	T20MP-U	-
DJ8J	T20M-U	-
E54R	IW31	-
E57R	IW27	-
EON3/286	T20EPR-U	T20TT
EON3/287	T20EPR-U	T20TT
EON4/286	PT16VR13	TV16TT
EON4/287	PT16VR13	TV16TT
EON5/286	W20EPR-U	W20TT
EON5/287	W20EPR-U	W20TT
F10	MA20PR-U	-
F10C	MA20PR-U	-
F11Y	MA16PR-U	-
F11YC	MA16PR-U	-

CHAMPION	DENSO	TT
F14Y	MA9P-U	-
F14YC	MA9P-U	-
F7Y	MA20P-U	-
F7YC	MA20P-U	-
F7YCC	MA20P-U	-
F9Y	MA20P-U	-
F9YC	MA20P-U	-
FN14LY	KJ16CR-L11	K16TT
FN507Y	Q22PR-U	-
G2	U24ESR-N	-
G508R	IU01-34	-
G509	IU01-34	-
G52V	RU01-34	-
G53C	IU01-34	-
G53R	IU01-34	-
G54R	IU01-31	-
G54V	RU01-31	-
G55	U31ESR-N	-
G55C	U31ESR-N	-
G55R	IU01-31	-
G56R	IU01-31	-
G57C	U31ESR-N	-
G57R	IU01-31	-
G58	U27ES-N	-
G59C	U27ES-N	-
G59C-ST/003	U27ES-N	-
G59R	IU01-27	-
G61	U27ES-N	-
G63	U24ESR-N	-
G7C	U22ESR-N	-
GI	U27ES-N	-
H10	W16LS	-
H10C	W16LS	-
H10J	W14L	-
H11	W14L	-
H12	W14L	-
H18Y	W16LS	-
H8	W16LS	-
H8C	W16LS	-
H8J	W16LS	-
H9	W16LS	-
J10	W20S-U	-
J10Y	W20PR-U	-
J11	W9-U	-
J11C	W9-U	-
J11J	W9-U	-
J11Y	W16PR-U	-
J12C	W9-U	-
J12J	W9-U	-
J12Y	W16PR-U	-
J12YC	W16PR-U	-
J13Y	W14PR-U	-
J14J	W9-U	-
J14Y	W14PR-U	-
J14YC	W14PR-U	-
J17LM	W14LM-U	-
J18Y	W9PR-U	-
J18YC	W9PR-U	-
J19LM	W9LM-US	-
J2	W27S-U	-
J2J	W27S-U	-
J4	W24S-U	-
J4C	W24S-U	-
J4J	W24S-U	-
J5	W22S-U	-
J6	W20S-U	-
J6C/T04	W20S-U	-
J6J	W20S-U	-
J7	W16S-U	-
J7J	W16S-U	-
J8	W14PR-U	-

CHAMPION	DENSO	TT
J8C	W14PR-U	-
J8J	W14PR-U	-
K13	L14-U	-
K15J	L14-U	-
K8	M22	-
K9	M22	-
KC10PYPB4	PK16PR-L11	IK16TT
KC11PYP	PK16PR-L11	IK16TT
KC8WYPB4	SK20PR-L9	IK20TT
KC8ZMCC	K20PBR-S10	K20TT
KC8ZPYPB4	PKJ16CR-L11	IK16TT
L10	W16FSR	-
L10S	W22FS-U	-
L11YC	W16FPR-U	-
L12Y	W16FPR-U	-
L14U	W14F-U	-
L20V	SF-50	-
L288	W16FSR	-
L2G	IWF27	-
L3G	IWF24	-
L4G	IWF22	-
L4J	W27FSR	-
L5	W22FS-U	-
L55C	W31FS	-
L55G	W31FS	-
L57R	IWF27	-
L58R	IWF27	-
L5YC	W24FP-U	-
L60R	IWF24	-
L61Y	W24FP-U	-
L62R	IWF24	-
L64Y	W22FPR-U	-
L66Y	W20FPR-U	WF20TT
L6G	IWF22	-
L6VC	IWF22	-
L70V	SF-50	-
L76V	SF-50	-
L77J	W27FSR	-
L77J4	W27FSR	-
L77JC	W27FSR	-
L77JC4	W27FSR	-
L78	W24FSR	-
L78C	W24FSR	-
L78V	SF-51	-
L78Y	W24FP-U	-
L78YC	W24FP-U	-
L78YC6	W24FPR-U10	-
L7J	W22FS-U	-
L7YC	W22FPR-U	-
L7YC4	W22FP-U	-
L81Y	W22FPR-U	-
L82C	W22FS-U	-
L82C/T10	W22FS-U	-
L82CC	W22FS-U	-
L82Y	W22FPR-U	-
L82YC	W22FPR-U	-
L82YCC	W22FPR-U	-
L85	W20FSR-U	WF20TT
L85C	W20FSR-U	WF20TT
L86	W16FSR	-
L86C	W16FSR	-
L87R	IWF27	-
L87Y	W20FPR-U	WF20TT
L87YC	W20FPR-U	WF20TT
L87YCC	W20FPR-U	WF20TT
L88A	W16FSR	-
L89CM	W16FSR	-
L90	W16FSR	-
L90C	W16FSR	-
L92Y	W16FPR-U	-

CHAMPION	DENSO	TT
L92YC	W16FPR-U	-
L9G	IWF22	-
L9J	W20FSR-U	WF20TT
L9YC	W20FPR-U	WF20TT
N1	W31ESR-U	-
N10PY	IW20	IW20TT
N10Y	W20EX-U	W20TT
N10Y4	W20EPR-U11	W20TT
N11Y	W16EPR-U	W16TT
N11YC	W16EPR-U	W16TT
N11YC4	W16EPR-U11	W16TT
N11YCC	W16EPR-U	W16TT
N12Y	W16EPR-U	W16TT
N12YC	W16EPR-U	W16TT
N12YCC	W16EPR-U	W16TT
N13L	J16BR-U	-
N13Y	W16EPR-U	W16TT
N14Y	J16AR-U11	-
N14Y	W16EPR-U	W16TT
N16Y	W14EPR-U	IW16TT
N16YC	W14EPR-U	IW16TT
N178B	IRE01-27	-
N179BC	IRE01-27	-
N180B	IRE01-27	-
N1C	W27ESR-U	-
N2	W27ESR-U	-
N21	W14E	-
N279Y	W22EPR-U	W22TT
N279YC	W22EPR-U	W22TT
N281YC	W20EP-U	W20TT
N288	W20ESR-U	-
N2C	W27ESR-U	-
N2G	IW27	-
N3	W24ESR-U	-
N3C	W24ESR-U	-
N3CX	W24ESR-U	-
N3G	IW24	-
N4	W22ESR-U	-
N4C	W22ESR-U	-
N4G	W22ESR-U	-
N4YC	W22EPR-U	W22TT
N5	W20ESR-U	-
N54R	IW01-34	-
N55G	IW34	-
N57	W31ESR-U	-
N57G	IW31	-
N57R	IW01-31	-
N59G	IW29	-
N5C	W20ESR-U	-
N5G	IW20	IW20TT
N5YC	W24EPR-U	-
N6	W16ESR-U	-
N60	W27ESR-U	-
N60R	IW01-29	-
N60Y	IW27	-
N61YD	IW27	-
N62R	IW01-27	-
N63Y	IW27	-
N63YD	W24EPR-U	-
N64Y	W24EPR-U	-
N65Y	W22EPR-U	W22TT
N66Y	W20EP-U	W20TT
N6BYC	W22EPB	W22TT
N6GY	IW24	-
N6Y	W24EPR-U	-
N6YC	W24EPR-U	-
N6YCC	W24EPR-U	-
N6YCX	W24EPR-U	-
N7	W16ESR-U	-
N74C	W22ESR-U	-
N79Y	W22EPR-U	W22TT

Свечи зажигания и Свечи накаливания

Таблица взаимозаменяемости – Другие производители

CHAMPION	DENSO	TT
N7BMC	W20ETR-L	IW20TT
N7BYC	W22EPB	W22TT
N7C	W22ESR-U	-
N7GY	IW22	-
N7LCC	W22EPR-U	W22TT
N7Y	W22EPR-U	W22TT
N7YC	W22EPR-U	W22TT
N7YC4	W22EPR-U11	W22TT
N7YCC	W22EPR-U	W22TT
N7YCE	W22EPR-U	W22TT
N7YCX	W22EPR-U	W22TT
N8	W20ESR-U	-
N80	IW01-34	-
N80G	IW34	-
N82	IW29	-
N82G	IW31	-
N82S	IW31	-
N84	W27ES-V	-
N84G	IW29	-
N86	W24ES-V	-
N86G	IW27	-
N87	W24ESR-U	-
N87G	IW24	-
N88	W16ESR-U	-
N8GY	IW20	IW20TT
N8L	J16BR-U	-
N8Y	W20EP-U	W20TT
N9BMC	W20ETR-L	IW20TT
N9BYC	W20EPB	W20TT
N9BYC4	W20EPB	W20TT
N9Y	W20EP-U	W20TT
N9YC	W20EX-U	W20TT
N9YC4	W20EXR-U11	W20TT
N9YCC	W20EP-U	W20TT
N9YCX	W20EP-U	W20TT
NA12	IW29	-
NA14	IW31	-
NR2C	W27ESR-U	-
OBLY9	T20PR-U	ITF20TT
OE001	W20EP-U	W20TT
OE001/R04	W20EP-U	W20TT
OE001/T10	W20EP-U	W20TT
OE002	K20PR-U	K20TT
OE002/R04	K20PR-U	K20TT
OE002/T10	K20PR-U	K20TT
OE003	Q20PR-U	Q20TT
OE003/T10	Q20PR-U	Q20TT
OE004	W20EPR-U	W20TT
OE004/R04	W20EPR-U	W20TT
OE004/T10	W20EPR-U	W20TT
OE005	Q20PR-U	Q20TT
OE005/T10	Q20PR-U	Q20TT
OE006	W20EPR-U	W20TT
OE006/R04	W20EPR-U	W20TT
OE006/T10	W20EPR-U	W20TT
OE007	W20FPR-U	WF20TT
OE007/R04	W20FPR-U	WF20TT
OE007/T10	W20FPR-U	WF20TT
OE008	W22EPR-U	W22TT
OE008/R04	W22EPR-U	W22TT
OE008/T10	W22EPR-U	W22TT
OE009	T20EPR-U	T20TT
OE009/T10	T20EPR-U	T20TT
OE010	W22EPR-U	W22TT
OE010/R04	W22EPR-U	W22TT
OE010/T10	W22EPR-U	W22TT
OE011	T20EPR-U	T20TT
OE011/R04	T20EPR-U	T20TT
OE011/T10	T20EPR-U	T20TT
OE012	W22EPB	W22TT
OE012/R04	W22EPB	W22TT

CHAMPION	DENSO	TT
OE012/T10	W22EPB	W22TT
OE013	Q16PR-U	Q16TT
OE013/R04	Q16PR-U	Q16TT
OE013/T10	Q16PR-U	Q16TT
OE014	K22PR-U	IK22FTT
OE014/T10	K22PR-U	IK22FTT
OE015	W16EPR-U	W16TT
OE015/R04	W16EPR-U	W16TT
OE015/T10	W16EPR-U	W16TT
OE016	K16PR-U	K16TT
OE016/R04	K16PR-U	K16TT
OE016/T10	K16PR-U	K16TT
OE017	Q22PR-U	-
OE017/T10	Q22PR-U	-
OE018	W22EPR-U	W22TT
OE018/R04	W22EPR-U	W22TT
OE018/T10	W22EPR-U	W22TT
OE019	K16TNR-S9	K16TT
OE019/R04	K16TNR-S9	K16TT
OE019/T10	K16TNR-S9	K16TT
OE020	T20EPR-U	T20TT
OE020/T10	T20EPR-U	T20TT
OE021	K22TNR-S	-
OE021/T10	K22TNR-S	-
OE022	W20EP-U	W20TT
OE022/T10	W20EP-U	W20TT
OE023	Q20PR-U	Q20TT
OE023/T10	Q20PR-U	Q20TT
OE024	Q20PR-U11	Q20TT
OE024/T10	Q20PR-U11	Q20TT
OE025	W20EPBR-S	W20TT
OE025/R04	W20EPBR-S	W20TT
OE025/T10	W20EPBR-S	W20TT
OE026	K20TXR	K20TT
OE026/T10	K20TXR	K20TT
OE027	W20EPBR-S	W20TT
OE027/R04	W20EPBR-S	W20TT
OE027/T10	W20EPBR-S	W20TT
OE028	W16EPB10	W16TT
OE028/R04	W16EPB10	W16TT
OE028/T10	W16EPB10	W16TT
OE029	PT16VR13	TV16TT
OE029/R04	PT16VR13	TV16TT
OE029/T10	PT16VR13	TV16TT
OE030	K20TNR	K20TT
OE030/T10	K20TNR	K20TT
OE031	PT16VR13	TV16TT
OE031/R04	PT16VR13	TV16TT
OE031/T10	PT16VR13	TV16TT
OE032	K20PBR-S10	K20TT
OE032/R04	K20PBR-S10	K20TT
OE032/T10	K20PBR-S10	K20TT
OE033	K20PR-U	K20TT
OE033/R04	K20PR-U	K20TT
OE033/T10	K20PR-U	K20TT
OE034	K20PR-U	K20TT
OE034/R04	K20PR-U	K20TT
OE034/T10	K16PR-U11	K16TT
OE034/T10	K20PR-U	K20TT
OE035	K20HR-U11	KH20TT
OE035/T10	K20HR-U11	KH20TT
OE036	T20EPR-U	T20TT
OE036/T10	T20EPR-U	T20TT
OE037	W16FSR	-
OE037/T10	W16FSR	-
OE038	W22FPR-U	-
OE038/T10	W22FPR-U	-
OE039	Q20PR-U11	Q20TT
OE039/R04	Q20PR-U11	Q20TT
OE039/T10	Q20PR-U11	Q20TT
OE040	W27ESR-U	-

CHAMPION	DENSO	TT
OE040/T10	W27ESR-U	-
OE041	KJ16CR-L11	K16TT
OE041/T10	KJ16CR-L11	K16TT
OE042	W16EPR-U	W16TT
OE042/R04	W16EPR-U	W16TT
OE042/T10	W16EPR-U	W16TT
OE043	Q22PR-U	-
OE043/T10	Q22PR-U	-
OE044	W20EPB	W20TT
OE044/T10	W20EPB	W20TT
OE045	W16EPR-U	W16TT
OE045/T10	W16EPR-U	W16TT
OE046	W22EPR-U	W22TT
OE046/T10	W22EPR-U	W22TT
OE047	W20EPR-U11	W20TT
OE047/T10	W20EPR-U11	W20TT
OE048	Q22PR-U	-
OE048/R04	Q22PR-U	-
OE048/T10	Q22PR-U	-
OE049	W16EPR-U11	W16TT
OE049/T10	W16EPR-U11	W16TT
OE050	T22EP-U	-
OE050/R04	T22EP-U	-
OE050/T10	T22EP-U	-
OE051	W16EPR-U	W16TT
OE051/R04	W16EPR-U	W16TT
OE051/T10	W16EPR-U	W16TT
OE052	XU24EPR-U	-
OE052/T10	XU24EPR-U	-
OE053	MA20PR-U	-
OE053/T10	MA20PR-U	-
OE054	MA20PR-U	-
OE054/R04	MA20PR-U	-
OE054/T10	MA20PR-U	-
OE055	W16EPR-U	W16TT
OE055/T10	W16EPR-U	W16TT
OE056	Q22PR-U11	-
OE056/T10	Q22PR-U11	-
OE057	K16PR-U	K16TT
OE057/R04	K16PR-U	K16TT
OE057/T10	K16PR-U	K16TT
OE058	Q22PR-U	-
OE058/R04	Q22PR-U	-
OE058/T10	Q22PR-U	-
OE059	W16FPR-U	-
OE059/R04	W16FPR-U	-
OE059/T10	W16FPR-U	-
OE060	J16CR-U	W16TT
OE060/T10	J16CR-U	W16TT
OE061	MA20P-U	-
OE061/T10	MA20P-U	-
OE062	K16PR-U11	K16TT
OE062/T10	K16PR-U11	K16TT
OE063	K16PR-U11	K16TT
OE063/T10	K16PR-U11	K16TT
OE064	W22FPR-U	-
OE064/T10	W22FPR-U	-
OE065	W16EPR-U	W16TT
OE065/T10	W16EPR-U	W16TT
OE066	K20R-U	K20TT
OE066/R04	K20R-U	K20TT
OE066/T10	K20R-U	K20TT
OE067	T22EP-U	-
OE067/T10	T22EP-U	-
OE068	W24ESR-U	-
OE068/T10	W24ESR-U	-
OE070	W20FPR-U	WF20TT
OE070/T10	W20FPR-U	WF20TT
OE071	W22FPR-U	-
OE071/T10	W22FPR-U	-
OE072	T20EPR-U	T20TT

CHAMPION	DENSO	TT
OE072/T10	T20EPR-U	T20TT
OE073	XU24EPR-U	-
OE073/T10	XU24EPR-U	-
OE074	W20ESR-U	-
OE074/T10	W20ESR-U	-
OE075	Q22PR-U	-
OE075/T10	Q22PR-U	-
OE076	K22PB	IKB22TT
OE076/T10	K22PB	IKB22TT
OE077	K22PBR-S	IKB22TT
OE077/T10	K22PBR-S	IKB22TT
OE078	IW24	-
OE078/T10	IW24	-
OE079	W22ESR-U	-
OE079/T10	W22ESR-U	-
OE080	Q22PR-U11	-
OE080/T10	Q22PR-U11	-
OE081	K20PR-U11	K20TT
OE081/T10	K20PR-U11	K20TT
OE082	T22EP-U	-
OE082/T10	T22EP-U	-
OE083	XU24EPR-U	-
OE083/T10	XU24EPR-U	-
OE084	W24EPR-U	-
OE084/R04	W24EPR-U	-
OE084/T10	W24EPR-U	-
OE085	K20TXR	K20TT
OE085/T10	K20TXR	K20TT
OE086	W22FSR	-
OE086/T10	W22FSR	-
OE087	W24EPR-U	-
OE087/R04	W24EPR-U	-
OE087/T10	W24EPR-U	-
OE088	Q16PR-U	Q16TT
OE088/T10	Q16PR-U	Q16TT
OE089	KJ20CR-L11	K20TT
OE089/R04	KJ20CR-L11	K20TT
OE089/T10	KJ20CR-L11	K20TT
OE090	T22EP-U	-
OE090/T10	T22EP-U	-
OE091	W27ESR-U	-
OE091/T10	W27ESR-U	-
OE092	U27ESR-N	-
OE092/T10	U27ESR-N	-
OE093	K16PR-U	K16TT
OE093/R04	K16PR-U	K16TT
OE093/T10	K16PR-U	K16TT
OE094	Q22PR-U	-
OE094/T10	Q22PR-U	-
OE095	W22ETR-L	W22TT
OE095/T10	W22ETR-L	W22TT
OE096	W16FSR	-
OE096/T10	W16FSR	-
OE097	W22EPR-U	W22TT
OE097/T10	W22EPR-U	W22TT
OE098	W22ESR-U	-
OE098/T10	W22ESR-U	-
OE099	T16EPR-U	T16TT
OE099/T10	T16EPR-U	T16TT
OE100	W20ETR-L	IW20TT
OE100/T10	W20ETR-L	IW20TT
OE101	W16EPR-U11	W16TT
OE101/T10	W16EPR-U11	W16TT
OE102	K20PR-U	K20TT
OE102/T10	K20PR-U	K20TT
OE103	IXU27	-
OE103/T10	IXU27	-
OE104	W22FPR-U	-
OE104/T10	W22FPR-U	-
OE105	P16R13	W20TT
OE105/T10	P16R13	W20TT

Свечи зажигания и Свечи накаливания

Таблица взаимозаменяемости – Другие производители

CHAMPION	DENSO	TT
OE106	W16EPR-U	W16TT
OE106/T10	W16EPR-U	W16TT
OE107	W22EPR-U11	W22TT
OE107/T10	W22EPR-U11	W22TT
OE108	W24ESR-U	-
OE108/T10	W24ESR-U	-
OE109	W22EPB	W22TT
OE109/T10	W22EPB	W22TT
OE110	Q22PR-U	-
OE110/T10	Q22PR-U	-
OE111	W20EPR-U	W20TT
OE111/T10	W20EPR-U	W20TT
OE112	IX24	-
OE112/T10	IX24	-
OE113	W20EPR-U11	W20TT
OE113/R04	W20EPR-U11	W20TT
OE113/T10	W20EPR-U11	W20TT
OE115	QJ16AR-U	-
OE115/T10	QJ16AR-U	-
OE116	W24EPR-U	-
OE116/T10	W24EPR-U	-
OE117	W22EPR-U11	W22TT
OE117/T10	W22EPR-U11	W22TT
OE118	K22PBR-S	IKB22TT
OE118/T10	K22PBR-S	IKB22TT
OE119	K20PR-U	K20TT
OE119/T10	K20PR-U	K20TT
OE120	K20PBR-S10	K20TT
OE120/R04	K20PBR-S10	K20TT
OE120/T10	K20PBR-S10	K20TT
OE121	Q16PR-U	Q16TT
OE121/T10	Q16PR-U	Q16TT
OE122	IU22	-
OE122/T10	IU22	-
OE123	K20PBR-S10	K20TT
OE123/T10	K20PBR-S10	K20TT
OE124	PK16PR11	K16TT
OE124/T10	PK16PR11	K16TT
OE125	IW27	-
OE125/T10	IW27	-
OE126	PK22PR8	IK22TT
OE126/T10	PK22PR8	IK22TT
OE127	K20PR-U	K20TT
OE127/T10	K20PR-U	K20TT
OE129	IK22	IK22FTT
OE129/T10	IK22	IK22FTT
OE130	XE20HR-U9	IXEH20TT
OE130/R04	XE20HR-U9	IXEH20TT
OE130/T10	XE20HR-U9	IXEH20TT
OE131	PT16EPR-L13	IT16TT
OE131/R04	PT16EPR-L13	IT16TT
OE131/T10	PT16EPR-L13	IT16TT
OE132	XU24EPR-U	-
OE132/T10	XU24EPR-U	-
OE133	T22EP-U	-
OE133/T10	T22EP-U	-
OE134	PK16PR11	K16TT
OE134/T10	PK16PR11	K16TT
OE135	K16HPR-U11	KH16TT
OE135/T10	K16HPR-U11	KH16TT
OE136	PK20PR-P8	IK20TT
OE136/R04	PK20PR-P8	IK20TT
OE136/T10	PK20PR-P8	IK20TT
OE137	Q16PR-U	Q16TT
OE137/T10	Q16PR-U	Q16TT
OE138	PK16PR-L11	IK16TT
OE138/T10	PK16PR-L11	IK16TT
OE140	KJ20CR-L11	K20TT
OE140/T10	KJ20CR-L11	K20TT
OE141	IK16	IK16TT
OE141/T10	IK16	IK16TT

CHAMPION	DENSO	TT
OE142	IXU27	-
OE142/T10	IXU27	-
OE143	PK20PR-P8	IK20TT
OE143/T10	PK20PR-P8	IK20TT
OE144	PK20PR-P8	IK20TT
OE144/R04	PK20PR-P8	IK20TT
OE144/T10	PK20PR-P8	IK20TT
OE145	IK16	IK16TT
OE145/R04	IK16	IK16TT
OE145/T10	IK16	IK16TT
OE146	PK20PR11	K20TT
OE146/R04	PK20PR11	K20TT
OE146/T10	PK20PR11	K20TT
OE147	KJ20CR-L11	K20TT
OE147/T10	KJ20CR-L11	K20TT
OE148	K16HPR-U11	KH16TT
OE148/T10	K16HPR-U11	KH16TT
OE149	PK16PR-L11	IK16TT
OE149/T10	PK16PR-L11	IK16TT
OE150	IU24	-
OE150/T10	IU24	-
OE151	T16EPR-U	T16TT
OE151/T10	T16EPR-U	T16TT
OE152	K20PR-U11	K20TT
OE152/T10	K20PR-U11	K20TT
OE153	K16PR-U	K16TT
OE153/T10	K16PR-U	K16TT
OE154	KJ16CR-L11	K16TT
OE154/T10	KJ16CR-L11	K16TT
OE155	MA20PR-U	-
OE155/T10	MA20PR-U	-
OE156	J16BR-U	-
OE156/T10	J16BR-U	-
OE157	IK27	-
OE157/T10	IK27	-
OE158	IK31	-
OE158/T10	IK31	-
OE160	J16BR-U	-
OE160/T10	J16BR-U	-
OE161	W16EPR-U	W16TT
OE161/T10	W16EPR-U	W16TT
OE162	W20ESR-U	-
OE162/T10	W20ESR-U	-
OE163	ITL16TT	ITL16TT
OE163/T10	ITL16TT	ITL16TT
OE164	IK27	-
OE164/T10	IK27	-
OE165	IK31	-
OE165/T10	IK31	-
OE166	U24ES-N	-
OE166/T10	U24ES-N	-
OE167	ITL16TT	ITL16TT
OE167/T10	ITL16TT	ITL16TT
OE168	PT16EPR-L13	IT16TT
OE168/T10	PT16EPR-L13	IT16TT
OE169	IT27	-
OE169/T10	IT27	-
OE170	W16EPR-U	W16TT
OE170/T10	W16EPR-U	W16TT
OE171	T20PR-U	ITF20TT
OE171/T10	T20PR-U	ITF20TT
OE172	W27ES-V	-
OE172/T10	W27ES-V	-
OE173	X31ESR-U	-
OE174	ITL20	-
OE174/T10	ITL20	-
OE175	KH16TT	KH16TT
OE175/R04	KH16TT	KH16TT
OE175/T10	KH16TT	KH16TT
OE176	PKJ16CR-L11	IK16TT
OE176/T10	PKJ16CR-L11	IK16TT

CHAMPION	DENSO	TT
OE177	KJ16CR-L11	K16TT
OE177/T10	KJ16CR-L11	K16TT
OE178	K20HR-U11	KH20TT
OE178/R04	K20HR-U11	KH20TT
OE178/T10	K20HR-U11	KH20TT
OE180	SK16PR-A11	IK16TT
OE180/R04	SK16PR-A11	IK16TT
OE180/T10	SK16PR-A11	IK16TT
OE181	SK20PR-L9	IK20TT
OE181/R04	SK20PR-L9	IK20TT
OE181/T10	SK20PR-L9	IK20TT
OE182	SK20R11	IK20TT
OE182/R04	SK20R11	IK20TT
OE182/T10	SK20R11	IK20TT
OE183	IT20TT	IT20TT
OE183/R04	IT20TT	IT20TT
OE183/T10	IT20TT	IT20TT
OE185	VKB20	-
OE185/T10	VKB20	-
OE186	XU22EPR-U	XU22TT
OE186/T10	XU22EPR-U	XU22TT
OE189	ITV16TT	ITV16TT
OE189/R04	ITV16TT	ITV16TT
OE189/T10	ITV16TT	ITV16TT
OE190	IKH20TT	IKH20TT
OE190/R04	IKH20TT	IKH20TT
OE190/T10	IKH20TT	IKH20TT
OE191	PK16PR-L11	IK16TT
OE191/R04	PK16PR-L11	IK16TT
OE191/T10	PK16PR-L11	IK16TT
OE198	KJ20CR-L11	K20TT
OE198/T10	KJ20CR-L11	K20TT
OE199	XU22EPR-U	XU22TT
OE199/T10	XU22EPR-U	XU22TT
OE201	XU22HDR9	XUH22TT
OE201/T10	XU22HDR9	XUH22TT
OE240	FXE20HR11	IXEH20TT
OJ11Y	W16PR-U	-
OJ12Y	W16PR-U	-
OJ13Y	W16PR-U	-
ON11Y	W16EPR-U	W16TT
ON12Y	W16EPR-U	W16TT
P10Y	X20FSR-U	-
P7	X24FS-U	-
P7Y	X20FSR-U	-
P82M	W22FS-U	-
P86M	W16FSR	-
P8Y	X20FSR-U	-
PA5HC	X22ESR-U	-
PA7HC	X22ESR-U	-
PG7C	U22ESR-N	-
PL11YC	W16FPR-U	-
PL5YC	W24FP-U	-
PL7YC	IWF22	-
PL7YC4	W20FPR-U10	WF20TT
PL9YC	W20FPR-U	WF20TT
PN5C	W24ESR-U	-
PN5YC	IW24	-
PN7C	IW24	-
PRA7HC	X22EPR-U9	-
PRL9SC	W20FR-L	WF20TT
PRL9SC	W14FR-L	-
PRZ9HC	U20FSR-U	-
PZ7HC	U22FSR-U	-
PZ9HC	U20FSR-U	-
QC10WEP	VKJ20RZ-M11	-
QC12PEP	VKA20	-
QC12PEPB	VKA20	-
QC12YC	Q16PR-U	Q16TT
QC501V	IK02-31	-
QC57	IK31	-

CHAMPION	DENSO	TT
QC57C	IK31	-
QC59	IK31	-
QC59C-ST/003	IK27	-
QC59YC	IK27	-
QC61YC	IK27	-
QC9MC4	KJ20CR-L11	K20TT
QJ19LM	W9LMR-US	-
QL16V	W24FSR	-
QL55	W31FS	-
QL57	IWF27	-
QL76V	SF-50	-
QL77CC	W27FSR	-
QL77J	W27FSR	-
QL77J4	W27FSR	-
QL77JC	W27FSR	-
QL77JC4	W27FSR	-
QL78C	W24FSR	-
QL78V	SF-51	-
QL78YC	W24FPR	-
QL78YC6	W24FPR-U10	-
QL7J	W22FSR	-
QL81Y	W22FPR-U	-
QL82C	W22FSR	-
QL82YC	W22FPR-U	-
QL86	W20FSR-U	WF20TT
QL86C	W20FSR-U	WF20TT
QL87C	W20FSR-U	WF20TT
QL87YC	W20FPR-U	WF20TT
QN1	W31ESR-U	-
QN14MC	J16CR-U	W16TT
QN2	W27ESR-U	-
QN2C	W27ESR-U	-
QN2G	IW27	-
QN3	W24ESR-U	-
QN3C	W24ESR-U	-
QN3G	IW24	-
QN508V	IW01-32	-
QN53VS	IW01-32	-
QN84	W27ESR-V	-
QN86/012	W24ESR-V	-
QN86C	W24ESR-V	-
R10	X20ESR-U	-
R6	X24ESR-U	-
R6G	IX24	-
R8	X22ESR-U	-
RA2HC	X27ESR-U	-
RA4GHC	XU27EPR-U	-
RA4HC	XU24EPR-U	-
RA4HCX	XU24EPR-U	-
RA4YC	XU27EPR-U	-
RA59GC	IXU27	-
RA59PP	IXU27	-
RA5YC	XU27EPR-U	-
RA6	XU24EPR-U	-
RA6HC	XU24EPR-U	-
RA6Y	XU24EPR-U	-
RA6YC	XU24EPR-U	-
RA7YC	XU22EPR-U	XU22TT
RA8GHC	IXU22	IXU22TT
RA8HC	XU22EPR-U	XU22TT
RA8Y	X22EPR-U9	-
RA8YC	XU22EPR-U	XU22TT
RA8YCX4	XU22EPR-U	XU22TT
RAX92C	X27ESR-U	-
RAX92DC	X27ETR	-
RAX92YC	X27EPR-U9	-
RAX94C	X24ESR-U	-
RAX94YC	X24EPR-U9	-
RAX96C	X22ESR-U	-
RAX96YC	X22EPR-U9	-

Свечи зажигания и Свечи накаливания

Таблица взаимозаменяемости – Другие производители

CHAMPION	DENSO	TT
RBL11Y	T20PR-U	ITF20TT
RBL11Y4	T20PR-U11	ITF20TT
RBL11Y6	T20PR-U	ITF20TT
RBL12	T16R-U	T16TT
RBL126	T16R-U	T16TT
RBL13Y	T16PR-U	ITF16TT
RBL13Y6	T16PR-U11	ITF16TT
RBL15Y	T16PR-U	ITF16TT
RBL15Y4	T16PR-U11	ITF16TT
RBL15Y6	T16PR-U11	ITF16TT
RBL15Y8	T16PR-U11	ITF16TT
RBL16Y	T14PR-U	ITF16TT
RBL17Y	T14PR-U	ITF16TT
RBL17Y6	T14PR-U	ITF16TT
RBL8	T20R-U	-
RBL86	T20R-U	-
RBL9Y	T20PR-U	ITF20TT
RBN12Y	T16EPR-U	T16TT
RBN13Y	T16EPR-U	T16TT
RBN14Y	T16EPR-U	T16TT
RBN7Y	IT22	-
RBN9GY	IT20TT	IT20TT
RBN9Y	T20EPR-U	T20TT
RC10DMC	K20TXR	K20TT
RC10ECC	KJ20CR-U11	K20TT
RC10MC4	K16R-U11	K16TT
RC10MCC	KJ20CR-L11	K20TT
RC10PMPA	PKJ16CR8	-
RC10PYC	IK16	IK16TT
RC10PYP4	PK16PR-L11	IK16TT
RC10PYPB4	PK16PR-L11	IK16TT
RC10VTYC4	K20PBR-S10	K20TT
RC10WYPB4	SK16PR-A11	IK16TT
RC10YC	K16PR-U	K16TT
RC10YC4	K16PR-U11	K16TT
RC10YCC	K20PR-U	K20TT
RC10YCC4	K16PR-U11	K16TT
RC10YCL	K16PR-U	K16TT
RC10YCX	K16PR-U	K16TT
RC10YP4	IK20	IK20TT
RC11LCC4	KJ16CR-L11	K16TT
RC11PYPB4	PK16PR-L11	IK16TT
RC11ZYC4	K16GPR-U11	-
RC12ECC	KJ16CR-L11	K16TT
RC12LC4	KJ16CR-L11	K16TT
RC12LYC	KJ16CR-L11	K16TT
RC12MC4	KJ16CR-L11	K16TT
RC12MCC	KJ16CR-U11	K16TT
RC12MCC4	KJ16CR-L11	K16TT
RC12PEC5/013	PKJ16CR-L11	IK16TT
RC12PMC5	PKJ16CR-L11	IK16TT
RC12YC	K16PR-U	K16TT
RC12YC4	K16PR-U11	K16TT
RC12YC5	K16R-U11	K16TT
RC12YCC	Q16PR-U	Q16TT
RC12YCC4	Q16PR-U11	Q16TT
RC12YCE	Q16PR-U	Q16TT
RC279YC	K22PR-U	IK22FTT
RC281YC	K20PR-U	K20TT
RC57C	IK31	-
RC59C	IK27	-
RC59YC	IK27	-
RC61YC	IK27	-
RC6BMC	K22PBR-S	IKB22TT
RC6PYP	PK22PR8	IK22TT
RC6VYCC	IK22	IK22FTT
RC6YC	K22PR-U	IK22FTT
RC6YCC	K22PR-U	IK22FTT
RC7BMC	K22PBR-S	IKB22TT
RC7BYC	K22PBR-S	IKB22TT
RC7BYC4	K22PBR-S	IKB22TT

CHAMPION	DENSO	TT
RC7GYC	IK22	IK22FTT
RC7MCC	KJ22CR-L8	-
RC7PYCB	IK22	IK22FTT
RC7PYCB4	IK20	IK20TT
RC7Y	Q22PR-U	-
RC7YC	K22PR-U	IK22FTT
RC7YC4	K22PR-U11	IK22FTT
RC7YCC	K22PR-U	IK22FTT
RC7YCC4	K22PR-U11	IK22FTT
RC7YCX	K22PR-U	IK22FTT
RC87PYC	K20PSR-B8	IK20TT
RC87YC	K20PR-U	K20TT
RC87YCC	K20PR-U	K20TT
RC87YCL	K20PR-U	K20TT
RC89PYC	IK16	IK16TT
RC89TMC	K20PBR-S10	K20TT
RC89WYPB4	SK20R11	IK20TT
RC89YCC	K16PR-U	K16TT
RC89YCL	K16PR-U	K16TT
RC8BYC	K20PBR	K20TT
RC8DMC	K20TXR	K20TT
RC8J	W20MR-U	-
RC8MCC	KJ20CR-L11	K20TT
RC8MCC4	KJ20CR-L11	K20TT
RC8PMPA	PKJ20CR8	IK20TT
RC8PYCB	PK20PR-P8	IK20TT
RC8PYP	PK20PR-P8	IK20TT
RC8PYP4	PK20PR11	K20TT
RC8PYPB4	PK20PR11	K20TT
RC8TYC	K20PBR-S10	K20TT
RC8VTYC	K20PBR-S10	K20TT
RC8VTYC4	K20PBR-S10	K20TT
RC8WYPB4	PK20PR-L11	IK20TT
RC8YC	K20PR-U	K20TT
RC8YC4	K20PR-U11	K20TT
RC8YCC	K20PR-U	K20TT
RC8YCC4	K20PR-U11	K20TT
RC8YCL	K16PR-U11	K16TT
RC8YCL	K20PR-U	K20TT
RC8YLC	K20PR-U	K20TT
RC9BMC	K20TXR	K20TT
RC9BYC	K20PBR	K20TT
RC9MC4	KJ20CR-L11	K20TT
RC9MCC	K20R-U	K20TT
RC9MCC4	KJ20CR-L11	K20TT
RC9Y	Q20PR-U	Q20TT
RC9YC	K20PR-U	K20TT
RC9YC4	K20PR-U11	K20TT
RC9YCC	K20PR-U	K20TT
RC9YCC4	K20PR-U11	K20TT
RC9YCE	Q20PR-U	Q20TT
RC9YCN4	K20PR-U11	K20TT
RCJ4	W22M-U	-
RCJ6	W22M-U	-
RCJ6Y	W22MPR-U	-
RCJ7Y	W22MPR-U	-
RCJ8	W20MR-U	-
RCJ8Y	W20MPR-U10	-
RD14	L14-U	-
RD15Y	L14-U	-
RD16	L14-U	-
RD16J	L14-U	-
RD18Y	L14-U	-
RDJ6J	T22M-U	-
RDJ7J	T20M-U	-
RDJ7Y	T20MP-U	-
RDJ8J	T20M-U	-
RE10LC	T20NR-U11	IT20TT
RE10PM5	ITL20	-
RE10PMC5	ITL20	-
RE12PEC5	ITL16TT	ITL16TT

CHAMPION	DENSO	TT
RE12PMC5	ITL16TT	ITL16TT
RE14MCC4	ITL16TT	ITL16TT
RE14MCC5	ITL16TT	ITL16TT
RE14PLP5	ITL16TT	ITL16TT
RE14PMC5	ITL16TT	ITL16TT
RE16MC	ITL16TT	ITL16TT
RE7PYP6	PT16VR13	TV16TT
RE7YCC	T16VR-U10	TV16TT
REA12WMB4	FXE20HR11	IXEH20TT
REA8MCL	XE20HR-U9	IXEH20TT
REA8MX	XE20HR-U9	IXEH20TT
REC10PYC4	KH16TT	KH16TT
REC10WYPB4	IKH20TT	IKH20TT
REC10YC4	K16HPR-U11	KH16TT
REC14MCC5	ITL16TT	ITL16TT
REC14PYC	K16HPR-U11	KH16TT
REC9MCLX	K20HR-U11	KH20TT
REC9YCL	K20HR-U11	KH20TT
RE8MC	XU22HDR9	XUH22TT
RE8YCC	IXUH22	IXUH22TT
RE8ZYCCB4	VXUH22I	IXUH22TT
RES9PYP4	PT16VR13	TV16TT
RES9WYPB5	ITV16TT	ITV16TT
RES9YCC4	T16VR-U10	TV16TT
RF10	MA20PR-U	-
RF10C	MA20PR-U	-
RF11LC	MA20PR-U	-
RF11Y	MA16PR-U	-
RF11YC	MA16PR-U	-
RF12	MA16PR-U	-
RF125	MA16PR-U	-
RF14LC	MA16PR-U	-
RF14Y	MA9P-U	-
RF14Y4	MA16PR-U	-
RF14YC	MA16PR-U	-
RF18YC	MA9P-U	-
RF7YC	MA20PR-U	-
RF7YCC	MA20PR-U	-
RF9Y	MA20PR-U	-
RF9YC	MA20PR-U	-
RFC58LZP	IK16	IK16TT
RFN14LY/013	QJ16AR-U	-
RG2PHP	IU24	-
RG4HC	U27ESR-N	-
RG4PHP	IU27	-
RG519HC	U27ESR-N	-
RG59V	RU01-31	-
RG6PP	IU24	-
RG6YC	U24ESR-N	-
RG6YCA	U24ESR-N	-
RG6YCH	N24EXRB	-
RG92C	U27ESR-N	-
RG92DC	U27ETR	-
RG94C	U24ESR-N	-
RG96C	U22ESR-N	-
RGU92C	U27FER9	-
RGU94C	U24FER9	-
RH10C	W16LS	-
RH12	W16LS	-
RH8C	W16LS	-
RJ10Y	W20PR-U	-
RJ11	W20S-U	-
RJ11Y	W16PR-U	-
RJ12C	W14PR-U	-
RJ12Y	W16PR-U	-
RJ12Y6	W16PR-U	-
RJ12YC	W16PR-U	-
RJ12YC6	W16PR-U	-
RJ13Y	W14PR-U	-
RJ14J	W14PR-U	-
RJ14Y	W14PR-U	-

CHAMPION	DENSO	TT
RJ14YC	W14PR-U	-
RJ17LM	W14LM-U	-
RJ18Y	W9PR-U	-
RJ18Y6	W9PR-U	-
RJ18Y8	W9PR-U	-
RJ18YC	W9PR-U	-
RJ18YC6	W9PR-U	-
RJ18YC8	W9PR-U	-
RJ19LM	W9LMR-US	-
RJ6	W20S-U	-
RJ6C	W20S-U	-
RJ6J	W20S-U	-
RJ7	W20S-U	-
RJ8	W20S-U	-
RJ8C	W20S-U	-
RJ8J	W20S-U	-
RL12Y	W16FPR-U	-
RL19	W16FSR	-
RL4J	W24FSR	-
RL5SC	W24FR-L	-
RL77J	W27FSR	-
RL77JC4	W27FSR	-
RL78	W24FSR	-
RL78C	W24FSR	-
RL7J	W22FSR	-
RL82C	W22FSR	-
RL82Y	W22FPR-U	-
RL82YC	W22FPR-U	-
RL82YCC	W22FPR-U	-
RL86	W20FSR-U	WF20TT
RL86C	W20FSR-U	WF20TT
RL87Y	W20FPR-U	WF20TT
RL87YC	W20FPR-U	WF20TT
RL87YCC	W20FPR-U	WF20TT
RL90	W16FSR	-
RL92YC	W16FPR-U	-
RL95YC	W14FPR-U	-
RL9SC	W20FR-L	WF20TT
RN10GY	IW20	IW20TT
RN10PYP4	VW20	IW20TT
RN10VTYC4	W20EPBR-S	W20TT
RN10Y	W20EPR-U	W20TT
RN10Y4	W20EPR-U11	W20TT
RN10YC	W20EPR-U	W20TT
RN10YC4	W20EPR-U11	W20TT
RN10YCC4	W20EPR-U11	W20TT
RN11Y	W16EPR-U	W16TT
RN11Y4	W16EPR-U11	W16TT
RN11YC	W16EXR-U	W16TT
RN11YC4	W16EPR-U11	W16TT
RN11YCC	W16EPR-U11	W16TT
RN11YCC4	W16EPR-U11	W16TT
RN12GY	IW16	IW16TT
RN12MC4	W16EXR-U11	W16TT
RN12Y4	W16EPR-U11	W16TT
RN12YC	W16EPR-U	W16TT
RN12YC4	W16EXR-U11	W16TT
RN12YC6	W16EPR-U11	W16TT
RN12YCC	W16EPR-U	W16TT
RN13L	J16BR-U	-
RN13LYC	J16BR-U	-
RN13LYC5	J16BR-U	-
RN14LY	J16BR-U	-
RN14MC5	W16EXR-U13	W16TT
RN14PMP5	P16R13	W20TT
RN14Y	W14EPR-U	IW16TT
RN14Y6	W14EXR-U11	IW16TT
RN14YC	W14EXR-U	IW16TT
RN16Y	W14EPR-U	IW16TT
RN16YC	W14EPR-U	IW16TT
RN16YC5	W14EXR-U11	IW16TT

Свечи зажигания и Свечи накаливания

Таблица взаимозаменяемости – Другие производители

CHAMPION	DENSO	TT
RN179BC	IRE01-27	-
RN180B	W22EBR	-
RN1C	W27ESR-U	-
RN2	W27ESR-U	-
RN279YC	W22EPR-U	W22TT
RN281YC	W20EPR-U	W20TT
RN2C	W27ESR-U	-
RN2G	IW27	-
RN3	W24ESR-U	-
RN3C	W24ESR-U	-
RN3G	IW24	-
RN4	W22ESR-U	-
RN4C	W22ESR-U	-
RN4HC	W24ESR-U	-
RN4YC	W24EPR-U	-
RN5	W20ESR-U	-
RN57YC	IW29	-
RN57YCC	IW29	-
RN5C/013	W20ESR-U	-
RN6	W20ESR-U	-
RN6Y	W24EPR-U	-
RN6YC	W24EPR-U	-
RN6YCX	W24EPR-U	-
RN74C	W22ESR-U	-
RN7BYC	W22EPB	W22TT
RN7GY	IW22	-
RN7LCC	W22EPR-U	W22TT
RN7Y	W22EPR-U	W22TT
RN7YC	W22EPR-U	W22TT
RN7YC4	W22EPR-U11	W22TT
RN7YCC	W22EPR-U	W22TT
RN7YCC4	W22EPR-U11	W22TT
RN7YCX	W22EPR-U	W22TT
RN8	W20ESR-U	-
RN83C	W20ESR-U	-
RN8L	J16BR-U	-
RN8VTC	W20EPBR-S	W20TT
RN8VTC4	W20EPBR-S	W20TT
RN8YC	W20EPR-U	W20TT
RN8YC4	W20EPR-U11	W20TT
RN9GY	IW20	IW20TT
RN9LCC	J16CR-U	W16TT
RN9Y	W20EPR-U	W20TT
RN9YC	W20EPR-U	W20TT
RN9YC4	W20EPR-U11	W20TT
RN9YCC	W20EPR-U	W20TT
RN9YCC4	W20EPR-U11	W20TT
RN9YCE	W20EPR-U	W20TT
RN9YCX	W20EPR-U	W20TT
RP7	X24FS-U	-
RS10LC	T20EPR-U	T20TT
RS12PYP	PT16EPR-L13	IT16TT
RS12YC	T16EPR-U	T16TT
RS12YC6	T16EPR-U15	T16TT
RS13LYC	T16NR-U11	IT16TT
RS14LC/012	T16NR-U11	IT16TT
RS14YC/013	T16EPR-U	T16TT
RS14YC6/T04	T16EPR-U15	T16TT
RS15LYC/013	T16NR-U11	IT16TT
RS16YC	T16EPR-U	T16TT
RS17YX	T16EPR-U	T16TT
RS279YC	T22EP-U	-
RS281YC	T20EPR-U	T20TT
RS5C	T22EP-U	-
RS6YC	T22EP-U	-
RS6YCC	T22EP-U	-
RS7YC	T22EP-U	-
RS8WYPB5	IT20TT	IT20TT
RS9PYP4	ZT20EPR11	IT20TT
RS9Y	T20EPR-U	T20TT
RS9YC	T20EPR-U	T20TT

CHAMPION	DENSO	TT
RS9YCC	T20EPR-U	T20TT
RS9YCX	T20EPR-U	T20TT
RV12C	T16R-U	T16TT
RV12C6	T16R-U	T16TT
RV12YC	T20PR-U	ITF20TT
RV12YC6	T20PR-U11	ITF20TT
RV15YC	T16PR-U	ITF16TT
RV15YC4	T16PR-U11	ITF16TT
RV15YC6	T16PR-U11	ITF16TT
RV15YC8	T16PR-U11	ITF16TT
RV17YC/T04	T14PR-U	ITF16TT
RV17YC6/T04	T14PR-U	ITF16TT
RV19YC/T04	T14PR-U	ITF16TT
RV19YC6	T14PR-U	ITF16TT
RV8C	T20R-U	-
RV8C6	T20R-U	-
RV91MC	T16PR-U	ITF16TT
RV9YC/012	T20PR-U	ITF20TT
RZ8	U22FSR-U	-
RZ94C	U24FSR-U	-
RZ96C	U22FSR-U	-
RZ98C	U20FSR-U	-
S10YCC	T20EPR-U	T20TT
S12YC	T16EPR-U	T16TT
S12YCC	T16EPR-U	T16TT
S14YC	T16EPR-U	T16TT
S279YC	T20EPR-U	T20TT
S281YC	T20EPR-U	T20TT
S379YC	T22EP-U	-
S57YC	IT27	-
S59C	IT27	-
S59YC	IT27	-
S6YC	T22EP-U	-
S6YCC	T22EP-U	-
S7YC	T22EP-U	-
S7YCC	T22EP-U	-
S9YC	T20EPR-U	T20TT
S9YCC	T20EPR-U	T20TT
S9YCX	T20EPR-U	T20TT
TJ8J	W20M-US	-
UD16	L14-U	-
UJ11G	W16S-U	-
UJ12	W9-U	-
UJ12C	W14PR-U	-
UJ12Y	W16PR-U	-
UJ2J	W24S-U	-
UJ4J	W24S-U	-
UJ6	W20S-U	-
UJ8	W20S-U	-
UJ81C	W22S-U	-
UJ81J	W22S-U	-
UK10	M17	-
UL17V	SF-50	-
UL18V	SF-50	-
UL19V	SF-50	-
UL4J	W22FS-U	-
UL77V	SF-50	-
UL81C	W24FSR	-
UL81J	W24FSR	-
UN79Y	W22EPR-U	W22TT
V12YC	T16PR-U	ITF16TT
V15YC	T16PR-U	ITF16TT
V45LSR	IW22	-
V4C	ITF24	-
V4LSR	W20EPR-U	W20TT
V59C	ITF27	-
V59YC	ITF27	-
V61	ITF24	-
V63C	ITF24	-
V63Y	ITF24	-
V9YC	T20PR-U	ITF20TT

CHAMPION	DENSO	TT
XC12PEP	PKJ16CR-L11	IK16TT
XC12PEPB	PKJ16CR-L11	IK16TT
XC12YC	K16PR-U	K16TT
XC92YC	K16PR-U	K16TT
XJ10Y	W20PR-U	-
XJ4J	W24S-U	-
Z10G	IUF22	-
Z7G	IUF22	-
Z7HC	U22FSR-U	-
Z9HC	U20FSR-U	-
Z9Y	U22FSR-U	-
Z9YC	W14PR-U	-

DAYTONA MAXFIRE	DENSO	TT
61479	IW24	-
61480	IW27	-
61481	IU24	-
61482	IU27	-
61483	IUH24	-
61484	IUH27	-
61485	IUF22	-
61486	IUF22	-
61487	IUF24	-
61488	IX24	-
61489	IX27	-
61490	IWF20	-
61491	IWF22	-
61492	IWF24	-
61493	IX22B	-
61494	IX24B	-

DELPHI	DENSO	TT
HDS 241	DG-114	-
HDS 400	DG-108	-
HDS216	DG-001	-
HDS217	DG-012	-
HDS218	DG-001	-
HDS221	DG-001	-
HDS222	DG-004	-
HDS225	DG-001	-
HDS231	DG-012	-
HDS237	DG-233	-
HDS239	DG-157	-
HDS245	DG-234	-
HDS247	DG-143	-
HDS248	DG-157	-
HDS254	DG-012	-
HDS255	DG-001	-
HDS257	DG-001	-
HDS267	DG-202	-
HDS268	DG-232	-
HDS270	DG-198	-
HDS271	DG-123	-
HDS272	DG-114	-
HDS273	DG-004	-
HDS274	DG-001	-
HDS276	DG-198	-
HDS280	DG-157	-
HDS283	DG-157	-
HDS295	DG-001	-
HDS296	DG-001	-
HDS303	DG-115	-
HDS337	DG-001	-
HDS338	DG-159	-
HDS339	DG-004	-
HDS340	DG-157	-
HDS341	DG-012	-
HDS342	DG-005	-
HDS343	DG-012	-
HDS345	DG-124	-
HDS346	DG-104	-

DELPHI	DENSO	TT
HDS347	DG-006	-
HDS348	DG-001	-
HDS349	DG-001	-
HDS350	DG-003	-
HDS351	DG-001	-
HDS352	DG-010	-
HDS353	DG-001	-
HDS354	DG-106	-
HDS355	DG-101	-
HDS356	DG-102	-
HDS357	DG-132	-
HDS358	DG-137	-
HDS359	DG-137	-
HDS360	DG-118	-
HDS361	DG-109	-
HDS362	DG-007	-
HDS363	DG-119	-
HDS364	DG-127	-
HDS365	DG-161	-
HDS366	DG-009	-
HDS368	DG-005	-
HDS371	DG-001	-
HDS374	DG-144	-
HDS375	DG-111	-
HDS376	DG-008	-
HDS377	DG-117	-
HDS378	DG-155	-
HDS379	DG-121	-
HDS380	DG-129	-
HDS383	DG-130	-
HDS384	DG-142	-
HDS385	DG-112	-
HDS386	DG-133	-
HDS387	DG-184	-
HDS390	DG-186	-
HDS391	DG-174	-
HDS392	DG-187	-
HDS393	DG-245	-
HDS394	DG-146	-
HDS397	DG-173	-
HDS406	DG-181	-
HDS407	DG-182	-
HDS408	DG-176	-
HDS410	DG-240	-
HDS411	DG-643	-
HDS412	DG-644	-
HDS413	DG-177	-
HDS414	DG-190	-
HDS415	DG-178	-
HDS416	DG-180	-
HDS418	DG-196	-
HDS421	DG-188	-
HDS440	DG-183	-

DENSO	DENSO	TT
067100-1042	DG-224	-
067100-1053	DG-225	-
067100-1070	DG-236	-
067100-1071	DG-236	-
067100-1120	DG-226	-
067100-1130	DG-227	-
067100-1140	DG-228	-
067100-1220	DG-238	-
067100-1250	DG-231	-
067100-1330	DG-232	-
067100-1340	DG-233	-
067100-1350	DG-234	-
067100-1360	DG-235	-
067100-1370	DG-215	-
067100-1380	DG-239	-
067100-1430	DG-652	-

Свечи зажигания и Свечи накаливания

Таблица взаимозаменяемости – Другие производители

DENSO	DENSO	TT
067100-1460	DG-222	-
067100-1500	DG-213	-
067100-1621	DG-241	-
067100-1630	DG-647	-
067100-1690	DG-216	-
067100-1690	DG-650	-
067100-1700	DG-651	-
067100-1840	DG-212	-
067100-1850	DG-501	-
067100-1860	DG-649	-
067100-1862	DG-649	-
067100-1900	DG-502	-
067100-1901	DG-502	-
067100-1910	DG-218	-
067100-1920	DG-217	-
067100-1940	DG-648	-
067100-1950	DG-212	-
067100-1960	DG-242	-
067100-1980	DG-217	-
067600-0310	M14	-
067600-0320	M17	-
067600-0330	M22	-
067600-0340	M24S	-
067600-0390	K20P-U	K20TT
067600-0420	MW17	-
067600-0871	W9EP	-
067600-0881	W14E	-
067600-1810	IW06-27	-
067600-1820	IW06-31	-
067600-1830	IW06-34	-
067600-2210	W16EX-U	W16TT
067600-2571	W31FS	-
067600-2740	W20EPB	W20TT
067600-2750	W22EPB	W22TT
067600-2770	K22PB	IKB22TT
067600-2940	W22TT	W22TT
067600-3323	W16ESR-U	-
067600-3341	W14L	-
067600-3351	W16LS	-
067600-3401	IW22	-
067600-4641	W9EX-U	-
067600-4663	W14EX-U	IW16TT
067600-4681	W20EX-U	W20TT
067600-5691	IW22	-
067600-5780	W27S-U	-
067600-5781	W27S-U	-
067600-6031	W16ES-U	-
067600-6041	W20ES-U	-
067600-6051	W22ES-U	-
067600-6061	W24ES-U	-
067600-6071	W27ES-U	-
067600-6081	W31ESR-U	-
067600-6121	W14FP-U	-
067600-6131	W16FP-U	-
067600-6141	W20FP-U	WF20TT
067600-6151	W22FP-U	-
067600-6191	W27FS-U10	-
067600-6201	W20FP-U	WF20TT
067600-6281	W24FP-U	-
067600-6372	W14EX-U	IW16TT
067600-6381	W16EX-U	W16TT
067600-6391	W20EX-U	W20TT
067600-6591	W14FPR-UL	-
067600-6601	W9FP-UL	-
067600-6611	W14FPR-UL	-
067600-6671	W24FS-U10	-
067600-6681	W14F-U	-
067600-6701	W20EP-S11	IW20TT
067600-6711	W14LM-U	-
067600-6791	W16S-U	-
067600-6801	W20S-U	-

DENSO	DENSO	TT
067600-6821	W14F-U	-
067600-6831	W16FS-U	-
067600-6841	W20FS-U	WF20TT
067600-6851	W22FS-U	-
067600-6861	W24FS-U	-
067600-6871	W27FS-U	-
067600-6881	W24S-U	-
067600-6890	W22S-U	-
067600-6891	W22S-U	-
067600-6900	W9-U	-
067600-6901	W9-U	-
067600-7131	W24ES-V	-
067600-7141	W27ES-V	-
067600-7200	Q16P-U11	Q16TT
067600-7231	W16EP-U	W16TT
067600-7241	W20EP-U	W20TT
067600-7251	W22EP-U	W22TT
067600-7261	W24EP-U	-
067600-7300	Q20P-U11	Q20TT
067600-7380	T20EP-U	T20TT
067600-7390	T22EP-U	-
067600-7421	W14M-U	-
067600-7451	W22M-U	-
067600-7460	W14MP-U10	-
067600-7461	W14MP-U10	-
067600-7481	W20MP-U	-
067600-7491	W22MP-U	-
067600-7511	MA9P-U	-
067600-7550	MA20P-U	-
067600-7553	MA20P-U	-
067600-7570	L14-U	-
067600-7680	Q20P-U	Q20TT
067600-7690	Q22P-U	-
067600-7810	Q20P-U11	Q20TT
067600-7850	W16EPB10	W16TT
067600-7880	IQ16TT	IQ16TT
067600-8450	T20M-U	-
067600-8460	T22M-U	-
067600-8470	T20MP-U	-
067600-8480	T22MP-U	-
067600-8590	W20M-US	-
067600-8600	W14LM-U	-
067600-8790	W9LM-US	-
067600-8890	W20FP-U	WF20TT
067600-8900	W22FP-U10	-
067600-8960	W20FP-L	WF20TT
067600-9270	TR22-10	-
067600-9700	T16PR-U	ITF16TT
067600-9711	T20PR-U	ITF20TT
067600-9711	T20PR-U11	ITF20TT
067700-0020	PK20PR-P8	IK20TT
067700-0300	PK20PR11	K20TT
067700-0540	K16GPR-U11	-
067700-0570	KJ20CR-U11	K20TT
067700-0750	W22EBR	-
067700-0770	W27EBR	-
067700-0780	W29EBR	-
067700-0831	W16FSR	-
067700-0851	W22FSR	-
067700-0860	W24FSR	-
067700-0861	W24FSR	-
067700-0871	W27FSR	-
067700-0891	W27FSR	-
067700-1380	T20R-U	-
067700-1511	W9EXR-U	-
067700-1521	W14EXR-U	IW16TT
067700-1522	W14EXR-U	IW16TT
067700-1531	W16EXR-U	W16TT
067700-1541	W20EXR-U	W20TT
067700-1571	W16EXR-U	W16TT
067700-1581	W20EXR-U	W20TT

DENSO	DENSO	TT
067700-1871	W14FPR-UL10	-
067700-1881	W14FPR-UL	-
067700-1920	W24ESR-V	-
067700-1921	W24ESR-V	-
067700-1931	W27ESR-V	-
067700-2110	W16EKR-S11	W16TT
067700-2150	W22ETR-L	W22TT
067700-2160	W20ETR-L	IW20TT
067700-2171	W16ETR-S	W16TT
067700-2200	W20EKR-S11	IW20TT
067700-2330	W16ESR-U	-
067700-2341	W20ESR-U	-
067700-2351	W22ESR-U	-
067700-2361	W24ESR-U	-
067700-2371	W27ESR-U	-
067700-2421	W14EXR-U11	IW16TT
067700-2431	W16EXR-U11	W16TT
067700-2441	W20EXR-U11	W20TT
067700-2481	W20EXR-U11	W20TT
067700-2591	W20EPR-S11	W20TT
067700-2651	W14EPR-U	IW16TT
067700-2661	W16EPR-U	W16TT
067700-2671	W20EPR-U	W20TT
067700-2681	W22EPR-U	W22TT
067700-2691	W24EPR-U	-
067700-2701	W20EPR-U11	W20TT
067700-2710	W16EPR-U11	W16TT
067700-2720	W22EPR-U11	W22TT
067700-2911	W9PR-U	-
067700-2912	W9PR-U	-
067700-2921	W16PR-U	-
067700-2931	W14PR-U	-
067700-2951	W20PR-U	-
067700-3020	K16HPR-U11	KH16TT
067700-3041	W20S-U	-
067700-3081	W20FPR-U10	WF20TT
067700-3130	T16EPR-U	T16TT
067700-3140	T20EPR-U	T20TT
067700-3150	SK20R-P11	IK20TT
067700-3190	T16EPR-U15	T16TT
067700-3201	W14MR-U	-
067700-3210	T20EPR-U15	-
067700-3221	W20MR-U	-
067700-3280	W14MPR-U10	-
067700-3281	W14MPR-U10	-
067700-3301	W20MPR-U10	-
067700-3330	W14FR-U	-
067700-3341	W20FSR-U	WF20TT
067700-3350	W22MPR-U	-
067700-3390	P16PR11	W16TT
067700-3400	P20PR11	W20TT
067700-3472	J16BR-U	-
067700-3520	SK20R5-G	-
067700-3531	J16AR-U11	-
067700-3560	SK20BR11	-
067700-3630	MA16PR-U	-
067700-3660	MA20PR-U	-
067700-3663	MA20PR-U	-
067700-3831	W20FPR-U	WF20TT
067700-3841	W22FPR-U	-
067700-3992	IQ20TT	IQ20TT
067700-4000	W24FPR	-
067700-4082	IQ20TT	IQ20TT
067700-4102	PQ20R-P8	IQ20TT
067700-4110	P16R13	W20TT
067700-4120	P16R	W20TT
067700-4130	P16R	W20TT
067700-4171	PQ16R	Q16TT
067700-4191	PQ20R	Q20TT
067700-4210	IQ16TT	IQ16TT
067700-4380	IQ16TT	IQ16TT

DENSO	DENSO	TT
067700-4390	IQ20TT	IQ20TT
067700-4410	Q16R-U	Q16TT
067700-4421	Q20R-U	Q20TT
067700-4431	Q16R-U11	Q16TT
067700-4441	Q20R-U11	Q20TT
067700-4450	Q16PR-U	Q16TT
067700-4460	Q20PR-U	Q20TT
067700-4470	Q22PR-U	-
067700-4510	Q16PR-U11	Q16TT
067700-4520	Q20PR-U11	Q20TT
067700-4530	Q22PR-U11	-
067700-4670	Q14R-U11	IQ16TT
067700-4700	W16FPR-U	-
067700-4760	W14FPR-U	-
067700-4830	S-31A	-
067700-5010	X16FSR-U	-
067700-5020	X20FSR-U	-
067700-5030	X27ETR	-
067700-5060	X20ESR-U	-
067700-5070	X22ESR-U	-
067700-5080	X24ESR-U	-
067700-5090	X27ESR-U	-
067700-5110	X31ESR-U	-
067700-5140	X31ETR	-
067700-5180	W24ESR	-
067700-5190	W27ESR	-
067700-5240	XU22EPR-U	XU22TT
067700-5250	XU24EPR-U	-
067700-5270	X16EPR-U9	-
067700-5280	X20EPR-U9	-
067700-5290	X22EPR-U9	-
067700-5300	X24EPR-U9	-
067700-5310	X27EPR-U9	-
067700-5320	U22ESR-N	-
067700-5380	U24ESR-N	-
067700-5390	U27ESR-N	-
067700-5450	U24ETR	-
067700-5460	U27ETR	-
067700-5540	X24GPR-U	-
067700-5550	X27GPR-U	-
067700-5560	U22ETR	-
067700-5580	U16FSR-U	-
067700-5590	U20FSR-U	-
067700-5600	U22FSR-U	-
067700-5610	U24FSR-U	-
067700-5630	U31ETR	-
067700-5640	U31ESR-N	-
067700-5650	T16R-U	T16TT
067700-5700	T14PR-U	ITF16TT
067700-5750	T16PR-U	ITF16TT
067700-5760	T16PR-U11	ITF16TT
067700-5770	T16PR-U11	ITF16TT
067700-5780	T16PR-U11	ITF16TT
067700-5800	XU20EPR-U	-
067700-5810	U22FER9	-
067700-5820	U24FER9	-
067700-5830	U27FER9	-
067700-5851	T20PR-U	ITF20TT
067700-5861	T20PR-U11	ITF20TT
067700-5871	T20PR-U	ITF20TT
067700-5910	QJ16HR-U	-
067700-5920	QJ16AR-U	-
067700-5950	T20R-U	-
067700-5990	U16FSR-UB	-
067700-6100	QJ20CR11	Q20TT
067700-6130	T16NR-U11	IT16TT
067700-6140	T20NR-U11	IT20TT
067700-6230	QJ16CR11	Q16TT
067700-6270	K16PR-U11	K16TT
067700-6280	K20PR-U11	K20TT
067700-6290	K22PR-U11	IK22FTT

Свечи зажигания и Свечи накаливания

Таблица взаимозаменяемости – Другие производители

DENSO	DENSO	TT
067700-6300	K16PR-U	K16TT
067700-6310	K20PR-U	K20TT
067700-6340	IY27	-
067700-6400	K16R-U	K16TT
067700-6410	K20R-U	K20TT
067700-6420	K16R-U11	K16TT
067700-6430	K20R-U11	K20TT
067700-6440	IK20TT	IK20TT
067700-6450	W16EXR-U13	W16TT
067700-6460	PK20PR-P11	K20TT
067700-6500	W31ESR-U	-
067700-6530	IQ20TT	IQ20TT
067700-6550	K16PR-L11	K16TT
067700-6560	K20PR-L11	K20TT
067700-6570	K22PR-L11	IK22FTT
067700-6640	IQ16TT	IQ16TT
067700-6660	PK16PR11	K16TT
067700-6661	PK16PR11	K16TT
067700-6670	PK20R8	IK20TT
067700-6680	PK16R11	K16TT
067700-6690	PK20R11	K20TT
067700-6710	PK20R13	K20TT
067700-6740	PK16PR-L11	IK16TT
067700-6742	PK16PR-L11	IK16TT
067700-6750	PK20PR-L11	IK20TT
067700-6800	W14FR-L	-
067700-6810	W20FR-L	WF20TT
067700-6820	W24FR-L	-
067700-6870	PK16PR-P11	K16TT
067700-6940	KJ16CR-L11	K16TT
067700-6950	KJ20CR-L11	K20TT
067700-6960	KJ22CR-L11	-
067700-6990	J16CR-U	W16TT
067700-7030	IQ16TT	IQ16TT
067700-7040	IQ20TT	IQ20TT
067700-7130	PKJ16CR-L11	IK16TT
067700-7140	PKJ20CR-L11	IK20TT
067700-7240	W9EXR-UCU	-
067700-7250	P22PR8	IK22FTT
067700-7370	PK16PR11	K16TT
067700-7380	PK20PR11	K20TT
067700-7390	PK22PR11	IK22FTT
067700-7450	KJ14CR-L11	-
067700-7480	PK20PR-L13	IK20TT
067700-7520	K22PR-U	IK22FTT
067700-7550	Y24FER-C	-
067700-7560	Y27FER-C	-
067700-7570	Y31FER-C	-
067700-7690	PK22PR8	IK22TT
067700-7760	W20EKR-S11	IW20TT
067700-7780	KJ20CR-U11	K20TT
067700-7800	PKJ16CR8	-
067700-7810	PKJ20CR8	IK20TT
067700-7850	W9LMR-US	-
067700-7860	W14LM-U	-
067700-7900	K16TR11	K16TT
067700-7910	K22TNR-S	-
067700-7930	PK20TR11	K20TT
067700-7940	PT16VR13	TV16TT
067700-7990	PK16TR11	K16TT
067700-8000	K20TNR-S	K20TT
067700-8040	W20EPBR-S	W20TT
067700-8050	K20PBR	K20TT
067700-8060	K20PBR-S10	K20TT
067700-8070	K22PBR-S	IKB22TT
067700-8080	K20TXR	K20TT
067700-8090	XU27EPR-U	-
067700-8110	K20TR11	K20TT
067700-8120	PK16TR13	IK16TT
067700-8140	PT16EPR-L13	IT16TT
067700-8150	XU24EPR-U	-

DENSO	DENSO	TT
067700-8170	W24FSR-U10	-
067700-8180	W16ETR-S	W16TT
067700-8190	J16CR-U	W16TT
067700-8211	PK20GR8	-
067700-8240	KJ22CR-L8	-
067700-8250	IK16TT	IK16TT
067700-8270	IW20TT	IW20TT
067700-8280	SK16R-P11	IK16TT
067700-8290	U14FSR-UB	-
067700-8300	PKJ16CR-L11	IK16TT
067700-8340	SK20R11	IK20TT
067700-8350	SK16R-P8	IK16TT
067700-8360	SK20R-P13	IK20TT
067700-8420	IW20TT	IW20TT
067700-8430	IK22	IK22FTT
067700-8460	IK24	-
067700-8470	IK27	-
067700-8471	IK27	-
067700-8480	IQ22	-
067700-8490	IQ24	-
067700-8500	IQ27	-
067700-8501	IQ27	-
067700-8600	IXU27	-
067700-8620	SVK20RZ11	IK20TT
067700-8630	SK20PR-L9	IK20TT
067700-8650	IW16	IW16TT
067700-8660	IW20	IW20TT
067700-8670	IW22	-
067700-8680	IK16	IK16TT
067700-8690	IK20	IK20TT
067700-8700	IQ16TT	IQ16TT
067700-8710	IQ20TT	IQ20TT
067700-8720	IXU22	IXU22TT
067700-8730	IXU24	-
067700-8740	K24PR-U11	-
067700-8770	K20TNR	K20TT
067700-8800	K20TNR-S9	K20TT
067700-8810	KJ16CR-U11	K16TT
067700-8820	W24FPR-U10	-
067700-8840	SK16R11	IK16TT
067700-8850	U20ESR-N	-
067700-8860	SK16R-P11	IK16TT
067700-8870	XU22EPR-U	XU22TT
067700-8880	PK20R11	K20TT
067700-8890	IW24	-
067700-8900	IW27	-
067700-8910	IW29	-
067700-8920	IW31	-
067700-8930	IW34	-
067700-8960	IW16TT	IW16TT
067700-9220	IK31	-
067700-9230	IQ31	-
067700-9240	VW20T	IW20TT
067700-9260	IU22	-
067700-9261	IU22	-
067700-9270	IU24	-
067700-9271	IU24	-
067700-9280	IU27	-
067700-9281	IU27	-
067700-9290	IU31	-
067700-9291	IU31	-
067700-9300	IU24A	-
067700-9301	IU24A	-
067700-9310	IU27A	-
067700-9311	IU27A	-
067700-9320	IU31A	-
067700-9330	IUH24	-
067700-9340	IUH27	-
067700-9350	IX22	-
067700-9360	IX24	-
067700-9370	IX27	-

DENSO	DENSO	TT
067700-9380	IX22B	-
067700-9390	IX24B	-
067700-9400	IX27B	-
067700-9410	IWF22	-
067700-9420	IWF24	-
067700-9430	IWF27	-
067700-9460	PKJ20CR-M11	IK20TT
067700-9480	IUF22	-
067700-9490	IUF24	-
067700-9520	IK27C11	-
067700-9550	IK24C11	-
067700-9560	IUH24D	-
067700-9570	IUH27D	-
067700-9590	IK34	-
067700-9600	IQ34	-
067700-9670	S22PR-A7	-
067700-9680	SKJ16CR-L11	IK16TT
067700-9700	IUF27A	-
067700-9710	IUF31A	-
067700-9720	VX22BC	-
067700-9730	SK20BGR11	-
067700-9750	K20BR-S10	K20TT
067700-9770	K16TNR-S9	K16TT
067800-0031	SF-50	-
067800-0041	SF-51	-
067800-0280	SF-24	-
067800-4020	X20FS-U	-
067800-4040	X24FS-U	-
067800-4070	X20FSR-U	-
067800-4110	X20ES-U	-
067800-4120	X22ES-U	-
067800-4130	X24ES-U	-
067800-4140	X27ES-U	-
067800-4160	X31ES-U	-
067800-4290	X22EPR-U9	-
067800-4300	X24EPR-U9	-
067800-4360	X24EP-U9	-
067800-4370	X27EP-U9	-
067800-4590	U16FS-U	-
067800-4600	U20FS-U	-
067800-4610	U22FS-U	-
067800-4620	U24FS-U	-
067800-4690	U16FS-UB	-
067800-4820	U24FE9	-
067800-4850	U22ES-N	-
067800-4860	U24ES-N	-
067800-4870	U27ES-N	-
067800-6370	IT16TT	IT16TT
067800-7270	IT16TT	IT16TT
067800-7280	PTJ16R15	IT16TT
067800-7320	IT16TT	IT16TT
067800-7340	ZT20EPR11	IQ20TT
067800-8180	IT16TT	IT16TT
067800-8290	XU22PR9	XU22TT
067800-9390	IT16TT	IT16TT
142000-0031	DG-308	-
142000-0060	DG-310	-
142000-0200	DG-671	-
142000-0210	DG-309	-
142000-0300	DG-310	-
142000-1890	DG-627	-
267700-0520	I16FER9	-
267700-0540	IUF14-UB	-
267700-0550	KJ20DR-M11	-
267700-0560	SKJ20DR-M13	-
267700-0570	SK20PR-A11	IK20TT
267700-0620	IT20TT	IT20TT
267700-0630	IT22	-
267700-0640	IT24	-
267700-0650	IT27	-
267700-0670	ITF20TT	ITF20TT

DENSO	DENSO	TT
267700-0680	ITF22	-
267700-0690	ITF24	-
267700-0700	ITF27	-
267700-0730	VK22	IK22FTT
267700-0740	IQ16TT	IQ16TT
267700-0750	IQ20TT	IQ20TT
267700-0760	VQ22	-
267700-0770	IW16TT	IW16TT
267700-0780	VW20	IW20TT
267700-0790	VW22	-
267700-0800	VXU22	IXU22TT
267700-0810	VXU24	-
267700-0840	IU24D	-
267700-0850	IU27D	-
267700-0870	SK16PR-A11	IK16TT
267700-0890	SKJ16CR-A8	-
267700-0910	SKJ20DR-M11	-
267700-0930	SK22PR-M11	IK22FTT
267700-0980	PK22PR-L11S	-
267700-1010	IU01-24	-
267700-1020	IU01-27	-
267700-1030	IU01-31	-
267700-1040	IU01-34	-
267700-1060	IXU01-24	-
267700-1070	IXU01-27	-
267700-1080	IXU01-31	-
267700-1090	IXU01-34	-
267700-1110	IW01-24	-
267700-1120	IW01-27	-
267700-1130	IW01-29	-
267700-1140	IW01-31	-
267700-1150	IW01-32	-
267700-1160	IW01-34	-
267700-1210	IWM01-29	-
267700-1220	IWM01-31	-
267700-1230	IWM01-32	-
267700-1240	IWM01-34	-
267700-1260	IA01-31	-
267700-1270	IA01-32	-
267700-1280	IA01-34	-
267700-1310	IK01-24	-
267700-1320	IK01-27	-
267700-1330	IK01-31	-
267700-1340	IK01-34	-
267700-1360	IK02-24	-
267700-1370	IK02-27	-
267700-1380	IK02-31	-
267700-1410	IQ01-24	-
267700-1420	IQ01-27	-
267700-1430	IQ01-31	-
267700-1440	IQ01-34	-
267700-1460	IQ02-24	-
267700-1470	IQ02-27	-
267700-1480	IQ02-31	-
267700-1520	IRE01-27	-
267700-1530	IRE01-31	-
267700-1540	IRE01-32	-
267700-1550	IRE01-34	-
267700-1570	RU01-27	-
267700-1580	RU01-31	-
267700-1590	RU01-34	-
267700-1640	IW16TT	IW16TT
267700-1760	SKJ20CR-A8	-
267700-1840	VK16PRZ11	IK16TT
267700-1850	VK20PRZ11	-
267700-1860	VK22PRZ11	IK22FTT
267700-1870	VK24PRZ11	-
267700-1930	VUH27D	-
267700-1931	VUH27D	-
267700-1970	VKJ20RZ-M11	-
267700-2010	VUH24D	-

Свечи зажигания и Свечи накаливания

Таблица взаимозаменяемости – Другие производители

DENSO	DENSO	TT
267700-2011	VUH24D	-
267700-2050	VK27PRZ11	-
267700-2060	VNH24Z	-
267700-2070	VNH27Z	-
267700-2200	SK16PR-L11	IK16TT
267700-2280	U27ESR-NB	-
267700-2290	N24EXRB	-
267700-2300	U24ESR-NB	-
267700-2320	PK20PTR-S9	K20TT
267700-2340	SK20PR-A8	IK20TT
267700-2500	ITV22	-
267700-2510	ITV24	-
267700-2520	ITV27	-
267700-2610	SKJ16DR-M11	-
267700-2640	IKH20	IKH20TT
267700-2650	IKH22	-
267700-2680	VKH22	-
267700-2730	U22ESR-NB	-
267700-2740	SK16PR-E11	IK16TT
267700-2790	VKB20	-
267700-2880	K20HR-U11	KH20TT
267700-2890	IWM24	-
267700-2900	IWM27	-
267700-2910	IWM31	-
267700-2920	IXG24	-
267700-2930	IXG27	-
267700-2940	IAE01-32	-
267700-2950	IAE01-34	-
267700-3000	SK16HR11	IKH16TT
267700-3130	VK20Y	-
267700-3660	IKH16	IKH16TT
267700-3670	IKH20	IKH20TT
267700-3720	VK20Y	-
267700-3800	VK22G	-
267700-4120	SK20HR11	IKH20TT
267700-4160	PK22PR-L11S	-
267700-4170	SK22PR-M11S	-
267700-4200	FK20HBR11	IKBH20TT
267700-4230	FK20HR11	IKH20TT
267700-4280	IKH24	-
267700-4290	IKH27	-
267700-4320	IXEH20TT	IXEH20TT
267700-4340	IK16TT	IK16TT
267700-4360	IK20TT	IK20TT
267700-4380	K20PSR-B8	IK20TT
267700-4450	IKH01-24	-
267700-4460	IKH01-27	-
267700-4470	IKH01-31	-
267700-4480	IT20TT	IT20TT
267700-4490	IY24	-
267700-4500	IY27	-
267700-4510	IY31	-
267700-4520	XU22HDR9	XUH22TT
267700-4530	SXU22HDR8	IXUH22TT
267700-4540	VKH20Y	-
267700-4570	W16EPR-U	W16TT
267700-4580	U20EPR9	-
267700-4770	VUH27ES	-
267700-4810	T16VR-U10	TV16TT
267700-4820	IRL01-27	-
267700-4830	IRL01-31	-
267700-4840	IRT01-31	-
267700-4850	IRT01-34	-
267700-4880	FXE20HR11	IXEH20TT
267700-4900	GX8-1	-
267700-4930	SKJ20DR-M11S	-
267700-4950	FXE16HE11	-
267700-4980	ITL16TT	ITL16TT
267700-4990	ITL20	-
267700-5000	IWF16	-
267700-5010	IWF20	-

DENSO	DENSO	TT
267700-5020	IU20	-
267700-5030	VKA16	-
267700-5040	VKA20	-
267700-5050	VKB16	-
267700-5060	VKB20	-
267700-5120	IK16L	IK16TT
267700-5130	IK20L	IK20TT
267700-5290	FK16R11	IK16TT
267700-5480	FXE20HE11	IXEH20ETT
267700-5490	XU22PR9	XU22TT
267700-5500	IKH20TT	IKH20TT
267700-5530	SXU22HCR11S	-
267700-5590	GX8-1	-
267700-5600	SK20PR-L11	IK20TT
267700-5610	IK16G	-
267700-5620	IK20G	-
267700-5630	VK16G	IK16TT
267700-5640	VK20G	-
267700-5660	IK22G	IK22FTT
267700-5670	VK22G	-
267700-5810	XE20HR-U9	IXEH20TT
267700-5830	FXE22HR11	IXEH22TT
267700-5860	K16PSR-B8	IK16TT
267700-5900	SXU22PR9	IXU22TT
267700-6120	PT16VR10	TV16TT
267700-6130	VUH24ES	-
267700-6160	SK22PR-M11S	-
267700-6280	K16HR-U11	KH16TT
267700-6301	W16TT	W16TT
267700-6310	W20TT	W20TT
267700-6311	W20TT	W20TT
267700-6450	IXUH22	IXUH22TT
267700-6460	VXUH22	IXUH22TT
267700-6480	U22EPR9	-
267700-6490	U24EPR9	-
267700-6970	FXE24HR11	-
267700-7020	ZXU20PR11	-
267700-7080	XU22TT	XU22TT
267700-7090	XUH22TT	XUH22TT
267700-7140	FK16HR11	IKH16TT
267700-7170	IXUH22	IXUH22TT
267700-7260	FXU16HR11	-
267700-7370	IXUH22I	IXUH22TT
267700-7380	VXUH22I	IXUH22TT
267700-7390	DK20PR-D13	-
267700-7420	VFKH20	IKH20TT
267700-7430	K16TT	K16TT
267700-7431	K16TT	K16TT
267700-7441	K20TT	K20TT
267700-7450	KH16TT	KH16TT
267700-7451	KH16TT	KH16TT
267700-7460	KH20TT	KH20TT
267700-7470	Q16TT	Q16TT
267700-7471	Q16TT	Q16TT
267700-7480	Q20TT	Q20TT
267700-7481	Q20TT	Q20TT
267700-7490	TV16TT	TV16TT
267700-7500	WF20TT	WF20TT
267700-7510	W22TT	W22TT
267700-7520	FXU22HR11	IXUH22TT
267700-7550	ZXU20HCR8	-
267700-7560	FXU22HR8	IXUH22TT
267700-7580	DXU22HCR-D11S	-
267700-7590	VXUH22I	IXUH22TT
267700-7630	VFXEH20E	IXEH20ETT
267700-7660	VFKBH20	IKBH20TT
267700-7700	FK16HR-A8	-
267700-7730	VFXEH20E	IXEH20ETT
267700-7750	VKH20Y	-
267700-7780	FK16R-A8	IK16TT
267700-7800	DXE22HQR-D11S	-

DENSO	DENSO	TT
267700-7810	DXE22HQR-D11S	-
267700-7820	T16TT	T16TT
267700-7830	T20TT	T20TT
267700-7850	SK20HR-A11	IKH20TT
267700-7940	IXEH22TT	IXEH22TT
267700-8130	VXUH20I	-
267700-8140	XU20HR9	XUH20TTI
267700-8160	VXUH20I	-
267700-8170	IXUH20I	-
267700-8180	FC16HR8	IXEH20TT
267700-8190	IQ16TT	IQ16TT
267700-8200	IQ20TT	IQ20TT
267700-8210	IW16TT	IW16TT
267700-8220	IW20TT	IW20TT
267700-8230	IT16TT	IT16TT
267700-8240	ITV16TT	ITV16TT
267700-8250	ITV20TT	ITV20TT
267700-8260	ITF16TT	ITF16TT
267700-8270	ITF20TT	ITF20TT
267700-8280	ITL16TT	ITL16TT
267700-8290	XUH20TTI	XUH20TTI
267700-8300	SC16HR11	IXEH20TT
267700-8390	VXEHC24G	-
267700-8430	IXU22I	IXU22TT
267700-8440	VXU22I	IXU22TT
267700-8450	IK16TT	IK16TT
267700-8460	IKH16TT	IKH16TT
267700-8470	IKH20TT	IKH20TT
267700-8480	IKBH20TT	IKBH20TT
267700-8490	IXEH20ETT	IXEH20ETT
267700-8500	IXEH20TT	IXEH20TT
267700-8510	IXEH22TT	IXEH22TT
267700-8520	IT20TT	IT20TT
267700-8530	IK20TT	IK20TT
267700-8560	FK16BR-AL8	-
267700-8570	FK20HBR-J8	IKBH20TT
267700-8590	FK16HBR-J8	-
267700-8600	FK20HR-A8	IKH20TT
267700-8620	FC16HR-CY9	-
267700-8670	VXUHC22G	-
267700-8680	VFXUHC22FG	-
267700-8750	VDKH22F	-
267700-9140	VXU20	-
267700-9160	VFK20F	IK20TT
267700-9170	VXEBH27	-
267700-9220	VFXEHC22G	-
267700-9230	VXEHC24G	-
267700-9290	VDCH22F	-
267700-9430	IXU22I	IXU22TT
AN067800-8180	IT16TT	IT16TT
DE260270-0010	DG-648	-
DE260270-0020	DG-245	-
DE260270-0040	DG-650	-
DE260270-0050	DG-649	-
DE260270-0060	DG-235	-
DE260270-0070	DG-502	-
DG-214	DG-649	-
DG-305	DG-671	-
DK20PR-D13	VFK20F	IK20TT
DXE22HCR11S	VFXEHC22G	-
DXU22HCR-D11S	VFXUHC22FG	-
FC16HR8	IXEH20TT	IXEH20TT
FC16HR-C9	FC16HR-CY9	-
FC16HR-C9	IXEH20TT	IXEH20TT
FC20HPR8	IXEH22TT	IXEH22TT
FK16HQR11	IKH16TT	IKH16TT
FK16HR11	IKH16TT	IKH16TT
FK16PR11	IK16TT	IK16TT
FK16R11	IK16TT	IK16TT
FK16R-A8	IK16TT	IK16TT
FK16R-AL8	IK16TT	IK16TT

DENSO	DENSO	TT
FK20HBR11	IKBH20TT	IKBH20TT
FK20HBR11-T	IKBH20TT	IKBH20TT
FK20HBR8	IKBH20TT	IKBH20TT
FK20HBR-J8	IKBH20TT	IKBH20TT
FK20HBR-TJ8	IKBH20TT	IKBH20TT
FK20HQR10	IKH20TT	IKH20TT
FK20HQR8	IKH20TT	IKH20TT
FK20HR11	IKH20TT	IKH20TT
FK20HR11-G	IKH20TT	IKH20TT
FK20HR-A8	IKH20TT	IKH20TT
FXE20HE11	IXEH20ETT	IXEH20ETT
FXE20HE11C	IXEH20ETT	IXEH20ETT
FXE20HE11C	VFXEH20E	IXEH20ETT
FXE20HR11	IXEH20TT	IXEH20TT
FXE22HR11	IXEH22TT	IXEH22TT
H1 453	DG-624	-
H5 122	DG-622	-
H5 123	DG-669	-
H5 124	DG-617	-
H5 128	DG-667	-
H5 209	DG-616	-
H5 210	DG-613	-
H5 213	DG-620	-
H5 221	DG-665	-
IK16	IK16TT	IK16TT
IK16F	IK16TT	IK16TT
IK16FJ	IK16TT	IK16TT
IK16G	VK16G	IK16TT
IK16L	IK16TT	IK16TT
IK20	IK20TT	IK20TT
IK20C11	IK20	IK20TT
IK20C11	IK20TT	IK20TT
IK20F	IK20TT	IK20TT
IK20FJ	IK20TT	IK20TT
IK20G	VK20G	-
IK20L	IK20TT	IK20TT
IK22	VK22	IK22FTT
IK22G	VK22G	-
IK24C11	IK24	-
IK27C11	IK27	-
IKH16	IKH16TT	IKH16TT
IKH20	IKH20TT	IKH20TT
IKH22	VKH22	-
IQ16	IQ16TT	IQ16TT
IQ20	IQ20TT	IQ20TT
IQ22	VQ22	-
IT16	IT16TT	IT16TT
IT20	IT20TT	IT20TT
ITF16	ITF16TT	ITF16TT
ITF20	ITF20TT	ITF20TT
ITL16	ITL16TT	ITL16TT
ITV16	ITV16TT	ITV16TT
ITV20	ITV20TT	ITV20TT
IU22D	IU22	-
IU27D	IU27	-
IU31D	IU31	-
IUH22D	VUH24D	-
IUH24	VUH24D	-
IUH24D	IUH24	-
IUH24D	VUH24D	-
IUH27	VUH27D	-
IUH27D	IUH27	-
IUH27D	VUH27D	-
IW16	IW16TT	IW16TT
IW20	IW20TT	IW20TT
IW22	VW22	-
IXU22	VXU22	IXU22TT
IXU22C	IXU22	IXU22TT
IXU22C	VXU22	IXU22TT
IXU22HPR	IXUH22	IXUH22TT
IXU22HPR	VXUH22	IXUH22TT

Свечи зажигания и Свечи накаливания

Таблица взаимозаменяемости – Другие производители

DENSO	DENSO	TT
IXU22I	IXU22	IXU22TT
IXU22I	VXU22I	IXU22TT
IXU24	VXU24	-
IXUH20I	VXUH20I	-
IXUH22	VXUH22	IXUH22TT
IXUH22I	VXUH22I	IXUH22TT
J14CR-U	IW16	IW16TT
J14CR-U	IW16TT	IW16TT
J14C-U	IW16	IW16TT
J14C-U	IW16TT	IW16TT
J16CR-U	IW16	IW16TT
J16CR-U	IW16TT	IW16TT
J16CR-U	W16TT	W16TT
J16C-U	IW16	IW16TT
J16C-U	IW16TT	IW16TT
J16C-U	W16TT	W16TT
K16HPR-U11	IKH16	IKH16TT
K16HPR-U11	IKH16TT	IKH16TT
K16HPR-U11	KH16TT	KH16TT
K16HR-U11	IKH16	IKH16TT
K16HR-U11	IKH16TT	IKH16TT
K16HR-U11	KH16TT	KH16TT
K16PR-L11	IK16	IK16TT
K16PR-L11	IK16TT	IK16TT
K16PR-L11	K16TT	K16TT
K16PR-P11	IK16	IK16TT
K16PR-P11	IK16TT	IK16TT
K16PR-P11	K16TT	K16TT
K16PR-TP11	IK16	IK16TT
K16PR-TP11	IK16TT	IK16TT
K16PR-TP11	K16TT	K16TT
K16PR-U	IK16	IK16TT
K16PR-U	IK16TT	IK16TT
K16PR-U	K16TT	K16TT
K16PR-U11	IK16	IK16TT
K16PR-U11	IK16TT	IK16TT
K16PR-U11	K16TT	K16TT
K16PR-UR	IK16	IK16TT
K16PR-UR	IK16TT	IK16TT
K16PR-ZU11	IK16	IK16TT
K16PSR-B8	IK16	IK16TT
K16PSR-B8	IK16TT	IK16TT
K16P-U	IK16	IK16TT
K16P-U	IK16TT	IK16TT
K16P-U	K16TT	K16TT
K16P-U11	IK16	IK16TT
K16P-U11	IK16TT	IK16TT
K16P-U11	K16TT	K16TT
K16PZR13	IK16TT	IK16TT
K16R-U	IK16	IK16TT
K16R-U	IK16TT	IK16TT
K16R-U	K16TT	K16TT
K16R-U11	IK16	IK16TT
K16R-U11	IK16TT	IK16TT
K16R-U11	K16TT	K16TT
K16R-U11	K16TT	K16TT
K16R-ZU11	IK16	IK16TT
K16SR14	IK16	IK16TT
K16SR14	IK16TT	IK16TT
K16TNR-S9	IK16	IK16TT
K16TNR-S9	IK16TT	IK16TT
K16TNR-S9	K16TT	K16TT
K16TR11	IK16	IK16TT
K16TR11	IK16TT	IK16TT
K16TR11	K16TT	K16TT
K16TT	IK16	IK16TT
K16TT	IK16TT	IK16TT
K16-U	IK16	IK16TT
K16-U	IK16TT	IK16TT
K16-U11	IK16	IK16TT
K16-U11	IK16TT	IK16TT
K20BR-S10	IK20	IK20TT

DENSO	DENSO	TT
K20BR-S10	IK20TT	IK20TT
K20BR-S10	K20TT	K20TT
K20HR-U11	IKH20	IKH20TT
K20HR-U11	IKH20TT	IKH20TT
K20HR-U11	KH20TT	KH20TT
K20PBR	IK20	IK20TT
K20PBR	IK20TT	IK20TT
K20PBR	K20TT	K20TT
K20PBR-S10	IK20	IK20TT
K20PBR-S10	IK20TT	IK20TT
K20PBR-S10	K20TT	K20TT
K20PR-L11	IK20	IK20TT
K20PR-L11	IK20TT	IK20TT
K20PR-L11	K20TT	K20TT
K20PR-SU9	IK20	IK20TT
K20PR-SU9	IK20TT	IK20TT
K20PR-TP11	IK20	IK20TT
K20PR-TP11	IK20TT	IK20TT
K20PR-TP11	K20TT	K20TT
K20PR-U	IK20	IK20TT
K20PR-U	IK20TT	IK20TT
K20PR-U	K20TT	K20TT
K20PR-U11	IK20	IK20TT
K20PR-U11	IK20TT	IK20TT
K20PR-U11	K20TT	K20TT
K20PR-U8S	IK20G	-
K20PR-U8S	IK20TT	IK20TT
K20PR-U9S	IK20G	-
K20PR-U9S	VK20G	-
K20PR-UR	IK20	IK20TT
K20PR-UR	IK20TT	IK20TT
K20PR-ZU11	IK20	IK20TT
K20PSR-B8	IK20	IK20TT
K20PSR-B8	IK20TT	IK20TT
K20PTR-S	IK20	IK20TT
K20PTR-S	IK20TT	IK20TT
K20PTR-S	K20TT	K20TT
K20P-U	IK20	IK20TT
K20P-U	IK20TT	IK20TT
K20P-U	K20TT	K20TT
K20P-U11	IK20	IK20TT
K20P-U11	IK20TT	IK20TT
K20P-U11	K20TT	K20TT
K20R-U	IK20	IK20TT
K20R-U	IK20TT	IK20TT
K20R-U	K20TT	K20TT
K20R-U11	IK20	IK20TT
K20R-U11	IK20TT	IK20TT
K20R-U11	K20TT	K20TT
K20R-ZU11	IK20	IK20TT
K20SR11	IK20	IK20TT
K20SR11	IK20TT	IK20TT
K20SR13	IK20	IK20TT
K20SR13	IK20TT	IK20TT
K20SR14	IK20	IK20TT
K20SR14	IK20TT	IK20TT
K20TNR	IK20	IK20TT
K20TNR	IK20TT	IK20TT
K20TNR	K20TT	K20TT
K20TNR-S	IK20	IK20TT
K20TNR-S	IK20TT	IK20TT
K20TNR-S	K20TT	K20TT
K20TNR-S9	IK20	IK20TT
K20TNR-S9	IK20TT	IK20TT
K20TNR-S9	K20TT	K20TT
K20TR11	IK20	IK20TT
K20TR11	IK20TT	IK20TT
K20TR11	K20TT	K20TT
K20TT	IK20	IK20TT
K20TT	IK20TT	IK20TT
K20TXR	IK20	IK20TT

DENSO	DENSO	TT
K20TXR	IK20TT	IK20TT
K20TXR	K20TT	K20TT
K20-U	IK20	IK20TT
K20-U	IK20TT	IK20TT
K20-U11	IK20	IK20TT
K20-U11	IK20TT	IK20TT
K22P11	IK22	IK22FTT
K22P11	VK22	IK22FTT
K22PB	IK22	IK22FTT
K22PB	VK22	IK22FTT
K22PBR-S	IK22	IK22FTT
K22PBR-S	VK22	IK22FTT
K22PR-L11	IK22	IK22FTT
K22PR-L11	VK22	IK22FTT
K22PR-U	IK22	IK22FTT
K22PR-U	VK22	IK22FTT
K22PR-U11	IK22	IK22FTT
K22PR-U11	VK22	IK22FTT
K22PR-UR	IK22	IK22FTT
K22PR-UR	VK22	IK22FTT
K22PR-ZU	IK22	IK22FTT
K22TM11	IK22	IK22FTT
K22TM11	VK22	IK22FTT
K22TMR11	IK22	IK22FTT
K22TMR11	VK22	IK22FTT
K22TNR-S	IK22	IK22FTT
K22TNR-S	VK22	IK22FTT
K24PR-U11	IK24	-
K24PR-ZU	IK24	-
K27A-Z	IK27	-
K27PR-ZU	IK27	-
K29A-Z	IK31	-
K31A-Z	IK31	-
KH16TT	IKH16	IKH16TT
KH16TT	IKH16TT	IKH16TT
KH20TT	IKH20	IKH20TT
KH20TT	IKH20TT	IKH20TT
KJ14CR11	IK16L	IK16TT
KJ14CR11	IK16TT	IK16TT
KJ14CR-L11	IK16L	IK16TT
KJ14CR-L11	IK16TT	IK16TT
KJ16CR	IK16L	IK16TT
KJ16CR	IK16TT	IK16TT
KJ16CR	K16TT	K16TT
KJ16CR11	IK16L	IK16TT
KJ16CR11	IK16TT	IK16TT
KJ16CR11	K16TT	K16TT
KJ16CR-L11	IK16L	IK16TT
KJ16CR-L11	IK16TT	IK16TT
KJ16CR-L11	K16TT	K16TT
KJ16CR-U11	IK16L	IK16TT
KJ16CR-U11	IK16TT	IK16TT
KJ16CR-U11	K16TT	K16TT
KJ20CR11	IK20L	IK20TT
KJ20CR11	IK20TT	IK20TT
KJ20CR11	K20TT	K20TT
KJ20CR-L11	IK20L	IK20TT
KJ20CR-L11	IK20TT	IK20TT
KJ20CR-L11	K20TT	K20TT
KJ20CR-U11	IK20L	IK20TT
KJ20CR-U11	IK20TT	IK20TT
KJ20CR-U11	K20TT	K20TT
KJ20DR-M11	IK20L	IK20TT
KJ20DR-M11S	IK20G	-
KJ20DR-M11S	VK20G	-
KJ20SR11	IK20L	IK20TT
KJ20SR11	IK20TT	IK20TT
KJ22CR11	IK22	IK22FTT
KJ22CR11	VK22	IK22FTT
KJ22CR-L11	IK22	IK22FTT
KJ22CR-L11	VK22	IK22FTT

DENSO	DENSO	TT
KJ22CR-L8	IK22	IK22FTT
KJ22CR-L8	VK22	IK22FTT
LP20R-U	IW20	IW20TT
LP20R-U	IW20TT	IW20TT
LP20-U	IW20	IW20TT
LP20-U	IW20TT	IW20TT
N24EXRB	IU24	-
P16PR11	IW16	IW16TT
P16PR11	IW16TT	IW16TT
P16PR11	W16TT	W16TT
P16PR8	IW16	IW16TT
P16PR8	IW16TT	IW16TT
P16R	IW20	IW20TT
P16R	IW20TT	IW20TT
P16R	W20TT	W20TT
P16R13	IW20	IW20TT
P16R13	IW20TT	IW20TT
P16R13	W20TT	W20TT
P16R8	IW16	IW16TT
P16R8	IW16TT	IW16TT
P20PR11	IW20	IW20TT
P20PR11	IW20TT	IW20TT
P20PR11	W20TT	W20TT
P20PR8	IW20	IW20TT
P20PR8	IW20TT	IW20TT
P20PR8	IW20TT	IW20TT
P20PR-P8	IW20	IW20TT
P20PR-P8	IW20TT	IW20TT
P20PR-S11	IW20	IW20TT
P20PR-S11	IW20TT	IW20TT
P20R11	IW20	IW20TT
P20R11	IW20TT	IW20TT
P20R8	IW20	IW20TT
P20R8	IW20TT	IW20TT
P22PR8	IW22	-
P22PR8	VW22	-
PK16PR11	IK16	IK16TT
PK16PR11	IK16TT	IK16TT
PK16PR11	K16TT	K16TT
PK16PR-L11	IK16	IK16TT
PK16PR-L11	IK16TT	IK16TT
PK16PR-P11	IK16	IK16TT
PK16PR-P11	IK16TT	IK16TT
PK16PR-P11	K16TT	K16TT
PK16R11	IK16	IK16TT
PK16R11	IK16TT	IK16TT
PK16R11	K16TT	K16TT
PK16R8	IK16	IK16TT
PK16R8	IK16TT	IK16TT
PK16R8	PK16PR11	K16TT
PK16R-P8	IK16	IK16TT
PK16R-P8	IK16TT	IK16TT
PK16TR11	IK16	IK16TT
PK16TR11	IK16TT	IK16TT
PK16TR11	K16TT	K16TT
PK16TR13	IK16	IK16TT
PK16TR13	IK16TT	IK16TT
PK20GR8	IK20L	IK20TT
PK20GR8	VKA20	-
PK20PR11	IK20	IK20TT
PK20PR11	IK20TT	IK20TT
PK20PR11	K20TT	K20TT
PK20PR-L11	IK20	IK20TT
PK20PR-L11	IK20TT	IK20TT
PK20PR-L13	IK20	IK20TT
PK20PR-L13	IK20TT	IK20TT
PK20PR-P11	IK20	IK20TT
PK20PR-P11	IK20TT	IK20TT
PK20PR-P11	K20TT	K20TT
PK20PR-P8	IK20	IK20TT
PK20PR-P8	IK20TT	IK20TT

Свечи зажигания и Свечи накаливания

Таблица взаимозаменяемости – Другие производители

DENSO	DENSO	TT
PK20PTR-S9	IK20	IK20TT
PK20PTR-S9	IK20TT	IK20TT
PK20PTR-S9	K20TT	K20TT
PK20R11	IK20	IK20TT
PK20R11	IK20TT	IK20TT
PK20R11	K20TT	K20TT
PK20R13	IK20	IK20TT
PK20R13	IK20TT	IK20TT
PK20R13	K20TT	K20TT
PK20R8	IK20	IK20TT
PK20R8	IK20TT	IK20TT
PK20R-P8	IK20	IK20TT
PK20R-P8	IK20TT	IK20TT
PK20TR11	IK20	IK20TT
PK20TR11	IK20TT	IK20TT
PK20TR11	K20TT	K20TT
PK20TR11-G	IK20	IK20TT
PK20TR11-G	IK20TT	IK20TT
PK20TR8-G	IK20	IK20TT
PK20TR8-G	IK20TT	IK20TT
PK22PR11	IK22	IK22FTT
PK22PR11	VK22	IK22FTT
PK22PR8	IK22	IK22FTT
PK22PR8	VK22	IK22FTT
PK22PR-L11	IK22G	IK22FTT
PK22PR-L11	VK22G	-
PK22PR-L11S	IK22G	IK22FTT
PK22PR-L11S	VK22G	-
PKJ16CR8	IK16L	IK16TT
PKJ16CR-L11	IK16L	IK16TT
PKJ16CR-L11	IK16TT	IK16TT
PKJ16CR-L13	IK16L	IK16TT
PKJ16CR-L13	IK16TT	IK16TT
PKJ16CR-L13	PKJ16CR-L11	IK16TT
PKJ20CR8	IK20L	IK20TT
PKJ20CR-L11	IK20L	IK20TT
PKJ20CR-L11	IK20TT	IK20TT
PKJ20CR-L13	IK20L	IK20TT
PKJ20CR-L13	IK20TT	IK20TT
PKJ20CR-M11	IK20L	IK20TT
PKJ20CR-M11	IK20TT	IK20TT
PQ16R	IQ16TT	IQ16TT
PQ16R	Q16TT	Q16TT
PQ16R13	IQ16TT	IQ16TT
PQ16R8	IQ16TT	IQ16TT
PQ16R8	Q16TT	Q16TT
PQ16R-P11	IQ16TT	IQ16TT
PQ16R-P11	Q16TT	Q16TT
PQ20R	IQ20TT	IQ20TT
PQ20R	Q20TT	Q20TT
PQ20R13	IQ20TT	IQ20TT
PQ20R13	Q20TT	Q20TT
PQ20R8	IQ20TT	IQ20TT
PQ20R8	Q20TT	Q20TT
PQ20R-P11	IQ20TT	IQ20TT
PQ20R-P8	IQ20TT	IQ20TT
PT16EPR10	IT16TT	IT16TT
PT16EPR13	IT16TT	IT16TT
PT16EPR-C13	IT16TT	IT16TT
PT16EPR-L13	IT16TT	IT16TT
PT16VR10	ITV16TT	ITV16TT
PT16VR10	TV16TT	TV16TT
PT16VR13	ITV16TT	ITV16TT
PT16VR13	TV16TT	TV16TT
PTJ14R15	IT16TT	IT16TT
PTJ16R15	IT16TT	IT16TT
Q14R-U11	IQ16TT	IQ16TT
Q16PR-TP11	IQ16TT	IQ16TT
Q16PR-U	IQ16TT	IQ16TT
Q16PR-U	Q16TT	Q16TT
Q16PR-U11	IQ16TT	IQ16TT

DENSO	DENSO	TT
Q16PR-U11	Q16TT	Q16TT
Q16PR-U15	IQ16TT	IQ16TT
Q16PR-U15	Q16TT	Q16TT
Q16PR-ZU11	IQ16TT	IQ16TT
Q16P-U11	IQ16TT	IQ16TT
Q16P-U11	Q16TT	Q16TT
Q16R-U	IQ16TT	IQ16TT
Q16R-U	Q16TT	Q16TT
Q16R-U11	IQ16TT	IQ16TT
Q16R-U11	Q16TT	Q16TT
Q16R-ZU11	IQ16TT	IQ16TT
Q16TT	IQ16TT	IQ16TT
Q16-U	IQ16TT	IQ16TT
Q16-U	Q16TT	Q16TT
Q16-U11	IQ16TT	IQ16TT
Q16-U11	Q16TT	Q16TT
Q16-ZU11	IQ16TT	IQ16TT
Q20PR-P11	IQ20TT	IQ20TT
Q20PR-U	IQ20TT	IQ20TT
Q20PR-U	Q20TT	Q20TT
Q20PR-U11	IQ20TT	IQ20TT
Q20PR-U11	Q20TT	Q20TT
Q20PR-ZU11	IQ20TT	IQ20TT
Q20P-U	IQ20TT	IQ20TT
Q20P-U	Q20TT	Q20TT
Q20P-U11	IQ20TT	IQ20TT
Q20P-U11	Q20TT	Q20TT
Q20R-U	IQ20TT	IQ20TT
Q20R-U	Q20TT	Q20TT
Q20R-U11	IQ20TT	IQ20TT
Q20R-U11	Q20TT	Q20TT
Q20R-ZU11	IQ20TT	IQ20TT
Q20TT	IQ20TT	IQ20TT
Q20-U	IQ20TT	IQ20TT
Q20-U	Q20TT	Q20TT
Q20-U11	IQ20TT	IQ20TT
Q20-U11	Q20TT	Q20TT
Q20-ZU11	IQ20TT	IQ20TT
Q22PR-P11	IQ22	-
Q22PR-P11	VQ22	-
Q22PR-U	IQ22	-
Q22PR-U	VQ22	-
Q22PR-U11	IQ22	-
Q22PR-U11	VQ22	-
Q22PR-ZU	IQ22	-
Q22PR-ZU11	IQ22	-
Q22P-U	IQ22	-
Q22P-U	VQ22	-
Q24PR-ZU	IQ24	-
Q27PR-ZU	IQ27	-
Q29A-Z	IQ31	-
Q31A-Z	IQ31	-
QJ14C11	IQ16TT	IQ16TT
QJ14C11	Q16TT	Q16TT
QJ16C11	IQ16TT	IQ16TT
QJ16C11	Q16TT	Q16TT
QJ16CR11	IQ16TT	IQ16TT
QJ16CR11	Q16TT	Q16TT
QJ20C11	IQ20TT	IQ20TT
QJ20C11	Q20TT	Q20TT
QJ20CR11	IQ20TT	IQ20TT
QJ20CR11	Q20TT	Q20TT
S20R8-G	IW20	IW20TT
S20R8-G	IW20TT	IW20TT
S22PR-A7	IW22	-
S22PR-A7	VW22	-
SC16HR11	IXEH20TT	IXEH20TT
SC20HR11	IXEH22TT	IXEH22TT
SK16HR11	IKH16	IKH16TT
SK16HR11	IKH16TT	IKH16TT
SK16HR-G11	IKH16	IKH16TT

DENSO	DENSO	TT
SK16HR-G11	IKH16TT	IKH16TT
SK16PR-A11	IK16	IK16TT
SK16PR-A11	IK16TT	IK16TT
SK16PR-E11	IK16	IK16TT
SK16PR-E11	IK16TT	IK16TT
SK16PR-E13	IK16TT	IK16TT
SK16PR-F8	IK16	IK16TT
SK16PR-F8	IK16TT	IK16TT
SK16PR-L11	IK16	IK16TT
SK16PR-L11	IK16TT	IK16TT
SK16R11	IK16	IK16TT
SK16R11	IK16TT	IK16TT
SK16R8-PG	IK16L	IK16TT
SK16R8-PG	VK20Y	-
SK16R-P11	IK16	IK16TT
SK16R-P11	IK16TT	IK16TT
SK16R-P8	IK16	IK16TT
SK16R-P8	IK16TT	IK16TT
SK20BGR11	VKA20	-
SK20BR11	VKB20	-
SK20HPR-L11	IKH20	IKH20TT
SK20HPR-L11	IKH20TT	IKH20TT
SK20HR11	IKH20	IKH20TT
SK20HR11	IKH20TT	IKH20TT
SK20HR8-T	IKH20TT	IKH20TT
SK20HR-A11	IKH20TT	IKH20TT
SK20HR-GT8	IKH20TT	IKH20TT
SK20PR-A11	IK20	IK20TT
SK20PR-A11	IK20TT	IK20TT
SK20PR-A8	IK20	IK20TT
SK20PR-A8	IK20TT	IK20TT
SK20PR-B8	IK20	IK20TT
SK20PR-B8	IK20TT	IK20TT
SK20PR-F8	IK20	IK20TT
SK20PR-F8	IK20TT	IK20TT
SK20PR-L11	IK20	IK20TT
SK20PR-L11	IK20TT	IK20TT
SK20PR-L9	IK20	IK20TT
SK20PR-L9	IK20TT	IK20TT
SK20PR-L9S	IK20G	-
SK20PR-L9S	IK20TT	IK20TT
SK20PR-N9	IK20	IK20TT
SK20PR-N9	IK20TT	IK20TT
SK20PR-N9S	IK20G	-
SK20PR-N9S	IK20TT	IK20TT
SK20R11	IK20	IK20TT
SK20R11	IK20TT	IK20TT
SK20R8	IK20TT	IK20TT
SK20R8-G	IK20TT	IK20TT
SK20R-P11	IK20	IK20TT
SK20R-P11	IK20TT	IK20TT
SK20R-P13	IK20	IK20TT
SK20R-P13	IK20TT	IK20TT
SK22PR-M11	IK22	IK22FTT
SK22PR-M11	VK22	IK22FTT
SK22PR-M11S	IK22G	IK22FTT
SK22PR-M11S	VK22G	-
SKJ16CR-A8	IK16L	IK16TT
SKJ16CR-L11	IK16L	IK16TT
SKJ16CR-L11	IK16TT	IK16TT
SKJ16DR-M11	IK16L	IK16TT
SKJ20CR-A8	IK20L	IK20TT
SKJ20DR-M11	IK20L	IK20TT
SKJ20DR-M11	IK20TT	IK20TT
SKJ20DR-M11S	IK20G	-
SKJ20DR-M13	IK20L	IK20TT
SKJ20DR-M13	IK20TT	IK20TT
SVK20RZ11	IK20	IK20TT
SVK20RZ11	IK20TT	IK20TT
SVK20RZ8	IK20TT	IK20TT
SVK20RZ8	IK22	IK22FTT

DENSO	DENSO	TT
SXE22HQR11S	DXE22HOR-D11S	-
SXE24HCR8S	VXEHC24G	-
SXU20HPR11	IXUH20I	-
SXU20HPR11	VXUH20I	-
SXU22HCR11	VXUHC22G	-
SXU22HCR11S	VXUHC22G	-
SXU22HCR8S	VXUHC22G	-
SXU22HDR8	IXUH22I	IXUH22TT
SXU22HDR8	VXUH22I	IXUH22TT
SXU22HPR11	IXUH22I	IXUH22TT
SXU22HPR11	VXUH22I	IXUH22TT
SXU22HPR8	IXUH22I	IXUH22TT
SXU22HPR9	VXUH22I	IXUH22TT
SXU22HR9	IXUH22I	IXUH22TT
SXU22HR9	VXUH22I	IXUH22TT
SXU22PR9	IXU22I	IXU22TT
SXU22PR9	VXU22I	IXU22TT
SXU22PR-A9	IU22	IU22TT
SXU22PR-A9	VXU22	IU22TT
T14PR-U	ITF16TT	ITF16TT
T14PR-U15	ITF16TT	ITF16TT
T16EPR-U	IT16TT	IT16TT
T16EPR-U	T16TT	T16TT
T16EPR-U15	IT16TT	IT16TT
T16EPR-U15	T16TT	T16TT
T16EX-U	IT16TT	IT16TT
T16EX-U	T16TT	T16TT
T16NR-U11	IT16TT	IT16TT
T16PR-U	ITF16TT	ITF16TT
T16PR-U11	ITF16TT	ITF16TT
T16PR-U15	ITF16TT	ITF16TT
T16PR-U15	T16PR-U11	ITF16TT
T16PR-U20	ITF16TT	ITF16TT
T16PR-U20	T16PR-U11	ITF16TT
T16P-U	ITF16TT	ITF16TT
T16R-U	IT16TT	IT16TT
T16R-U15	IT16TT	IT16TT
T16TT	IT16TT	IT16TT
T16-U15	IT16TT	IT16TT
T16VR-U10	ITV16TT	ITV16TT
T16VR-U10	TV16TT	TV16TT
T20EPR-U	IT20TT	IT20TT
T20EPR-U	T20TT	T20TT
T20EPR-U15	IT20TT	IT20TT
T20EP-U	IT20TT	IT20TT
T20EP-U	T20TT	T20TT
T20EP-U15	IT20TT	IT20TT
T20NR-U11	IT20TT	IT20TT
T20PR-U	ITF20TT	ITF20TT
T20PR-U11	ITF20TT	ITF20TT
T20PR-U15	ITF20TT	ITF20TT
T20PR-U15	T20PR-U	ITF20TT
T20P-U	ITF20TT	ITF20TT
T20P-U	T20PR-U	ITF20TT
T20P-U	T20PR-U11	ITF20TT
T20TT	IT20TT	IT20TT
T22EP-U	IT22	-
TJ16R15	IT16TT	IT16TT
TR20	IWF20	-
TR20	WF20TT	WF20TT
TR22	IWF22	-
TR22-10	IWF22	-
TR24	IWF24	-
TR24-10	IWF24	-
TV16TT	ITV16TT	ITV16TT
U14FSR-UB	IUF14-UB	-
U14FS-UB	IUF14-UB	-
U20EPR9	IU20	-
U20EPR9S	IU22	-
U20ESR-N	IU20	-

Свечи зажигания и Свечи накаливания

Таблица взаимозаменяемости – Другие производители

DENSO	DENSO	TT
U20FSR-U	IUF22	-
U20FS-U	IUF22	-
U20FS-ZU	IUF22	-
U22EPR9	IU22	-
U22ES-N	IU22	-
U22ESR-N	IU22	-
U22ESR-NB	IU22	-
U22ETR	IU22	-
U22FER9	IUH24	-
U22FSR-U	IUF22	-
U22FS-U	IUF22	-
U22FS-ZU	IUF22	-
U24EPR9	IU24A	-
U24ES-N	IU24	-
U24ESR-N	IU24	-
U24ESR-NB	IU24	-
U24ESR-NZU	IU24	-
U24ETR	IU24A	-
U24FE9	IUH24	-
U24FER9	IUH24	-
U24FER9S	IUH24	-
U24FER-ZU9	IUH24	-
U24FE-ZU9	IUH24	-
U24FSR-C	IUF24	-
U24FSR-U	IUF24	-
U24FS-U	IUF24	-
U27EPR9	IU27D	-
U27EPR-N9	IU27D	-
U27ES-N	IU27	-
U27ESR-N	IU27	-
U27ESR-NB	IU27	-
U27ESR-NZU	IU27	-
U27ETR	IU27A	-
U27FE9	IUH27	-
U27FER9	IUH27	-
U27FER-ZU9	IUH27	-
U31ESR-N	IU31	-
U31ESR-NZU	IU31	-
U31ETR	IU31A	-
U31FER9	IU31	-
U31FER-ZU9	IU31	-
VCH16	IXEH20TT	IXEH20TT
VCH20	IXEH22TT	IXEH22TT
VCH16	IXEH20TT	IXEH20TT
VFK16	IK16TT	IK16TT
VFK20F	IK20TT	IK20TT
VFKBH20	IKBH20TT	IKBH20TT
VFKH16	IKH16TT	IKH16TT
VFKH20	IKH20TT	IKH20TT
VFXEH20	IXEH20TT	IXEH20TT
VFXEH20E	IXEH20ETT	IXEH20ETT
VFXEH22	IXEH22TT	IXEH22TT
VK16	IK16	IK16TT
VK16	IK16TT	IK16TT
VK16G	IK16G	-
VK16G	IK16TT	IK16TT
VK16PRZ11	IK16	IK16TT
VK16PRZ11	IK16TT	IK16TT
VK20	IK20	IK20TT
VK20	IK20TT	IK20TT
VK20G	IK20G	-
VK20PRZ11	IK20	IK20TT
VK20PRZ11	VK20Y	-
VK20T	IK20TT	IK20TT
VK22	IK22	IK22FTT
VK22G	IK22G	IK22FTT
VK22PRZ11	IK22	IK22FTT
VK22PRZ11	VK22	IK22FTT
VK24PRZ11	IK24	-
VK27PRZ11	IK27	-
VKH16	IKH16	IKH16TT

DENSO	DENSO	TT
VKH16	IKH16TT	IKH16TT
VKH20	IKH20	IKH20TT
VKH20	IKH20TT	IKH20TT
VKH20T	IKH20TT	IKH20TT
VKH22	IKH22	-
VQ16	IQ16TT	IQ16TT
VQ20	IQ20TT	IQ20TT
VQ22	IQ22	-
VT16	IT16TT	IT16TT
VT20	IT20TT	IT20TT
VUH24D	IUH24	-
VUH27D	IUH27	-
VW16	IW16	IW16TT
VW16	IW16TT	IW16TT
VW16R-A13	IW16TT	IW16TT
VW20	IW20	IW20TT
VW20	IW20TT	IW20TT
VW20T	IW20TT	IW20TT
VW22	IW22	-
VXU22	IXU22	IXU22TT
VXU22I	IXU22I	IXU22TT
VXU24	IXU24	-
VXUH20I	IXUH20I	-
VXUH22	IXUH22	IXUH22TT
VXUH22I	IXUH22I	IXUH22TT
W14EPR-U	IW16	IW16TT
W14EPR-U	IW16TT	IW16TT
W14EP-U	IW16	IW16TT
W14EP-U	IW16TT	IW16TT
W14EXR-U	IW16	IW16TT
W14EXR-U	IW16TT	IW16TT
W14EXR-U11	IW16	IW16TT
W14EXR-U11	IW16TT	IW16TT
W14EXR-U13	IW16	IW16TT
W14EXR-U13	IW16TT	IW16TT
W14EXR-U15	IW16	IW16TT
W14EXR-U15	IW16TT	IW16TT
W14EXR-ZU	IW16	IW16TT
W14EX-U	IW16	IW16TT
W14EX-U	IW16TT	IW16TT
W14EX-U11	IW16	IW16TT
W14EX-U11	IW16TT	IW16TT
W14EX-U13	IW16	IW16TT
W14EX-U13	IW16TT	IW16TT
W14FP	IWF16	-
W14FP-L	IWF16	-
W14FPR	IWF16	-
W14FPR-U	IWF16	-
W14FPR-UL	IWF16	-
W14FPR-UL10	IWF16	-
W14FP-U	IWF16	-
W14FP-UL	IWF16	-
W14FP-UL10	IWF16	-
W14FR-L	IWF16	-
W14LMR-US	W14LM-U	-
W16EKR-S11	IW16	IW16TT
W16EKR-S11	IW16TT	IW16TT
W16EKR-S11	W16TT	W16TT
W16EK-S11	IW16TT	IW16TT
W16EP	IW16	IW16TT
W16EP	IW16TT	IW16TT
W16EP11	IW16	IW16TT
W16EP11	IW16TT	IW16TT
W16EP11	W16TT	W16TT
W16EPB10	IW16	IW16TT
W16EPB10	IW16TT	IW16TT
W16EPB10	W16TT	W16TT
W16EPR	IW16	IW16TT
W16EPR	IW16TT	IW16TT
W16EPR11	IW16	IW16TT
W16EPR11	IW16TT	IW16TT

DENSO	DENSO	TT
W16EPR-S11	IW16	IW16TT
W16EPR-S11	IW16TT	IW16TT
W16EPR-S11	W16TT	W16TT
W16EPR-U	IW16	IW16TT
W16EPR-U	IW16TT	IW16TT
W16EPR-U	W16TT	W16TT
W16EPR-U10	IW16	IW16TT
W16EPR-U10	IW16TT	IW16TT
W16EPR-U10	W16TT	W16TT
W16EPR-U11	IW16	IW16TT
W16EPR-U11	IW16TT	IW16TT
W16EPR-U11	W16TT	W16TT
W16EP-U	IW16	IW16TT
W16EP-U	IW16TT	IW16TT
W16EP-U	W16TT	W16TT
W16EP-U11	IW16	IW16TT
W16EP-U11	IW16TT	IW16TT
W16EP-U11	W16TT	W16TT
W16EP-ZU	IW16	IW16TT
W16ES-L	W16ESR-U	-
W16ET-L	IW16	IW16TT
W16ET-L	IW16TT	IW16TT
W16ETR-S	IW16	IW16TT
W16ETR-S	IW16TT	IW16TT
W16ETR-S	W16TT	W16TT
W16ET-S	IW16	IW16TT
W16ET-S	IW16TT	IW16TT
W16EX-GU	IW16	IW16TT
W16EX-GU	IW16TT	IW16TT
W16EXR-U	IW16	IW16TT
W16EXR-U	IW16TT	IW16TT
W16EXR-U11	IW16	IW16TT
W16EXR-U11	IW16TT	IW16TT
W16EXR-U11	W16TT	W16TT
W16EXR-U13	IW16	IW16TT
W16EXR-U13	IW16TT	IW16TT
W16EXR-U13	W16TT	W16TT
W16EXR-U13	IW16	IW16TT
W16EXR-U13	IW16TT	IW16TT
W16EXR-U13	W16TT	W16TT
W16EX-U	IW16	IW16TT
W16EX-U	IW16TT	IW16TT
W16EX-U	W16TT	W16TT
W16EX-U11	IW16	IW16TT
W16EX-U11	IW16TT	IW16TT
W16EX-U11	W16TT	W16TT
W16EX-U13	IW16	IW16TT
W16EX-U13	IW16TT	IW16TT
W16EX-U13	W16TT	W16TT
W16EXUA	W16EX-U	W16TT
W16EX-ZU	IW16	IW16TT
W16FP	IWF16	-
W16FPR	IWF16	-
W16FPR-U	IWF16	-
W16FP-U	IWF16	-
W16FP-U10	IWF16	-
W16FSR	IWF16	-
W16TT	IW16	IW16TT
W16TT	IW16TT	IW16TT
W20EKR-S11	IW20	IW20TT
W20EKR-S11	IW20TT	IW20TT
W20EKR-S11	W20TT	W20TT
W20EK-S11	IW20TT	IW20TT
W20EP	IW20	IW20TT
W20EP	IW20TT	IW20TT
W20EP11	IW20	IW20TT
W20EP11	IW20TT	IW20TT
W20EP11	W20TT	W20TT
W20EPB	IW20	IW20TT
W20EPB	IW20TT	IW20TT
W20EPB	W20TT	W20TT
W20EPBR-S	IW20	IW20TT
W20EPBR-S	IW20TT	IW20TT
W20EPBR-S	W20TT	W20TT

DENSO	DENSO	TT
W20EPR	IW20	IW20TT
W20EPR	IW20TT	IW20TT
W20EPR11	IW20	IW20TT
W20EPR11	IW20TT	IW20TT
W20EPR-S11	IW20	IW20TT
W20EPR-S11	IW20TT	IW20TT
W20EPR-U	IW20	IW20TT
W20EPR-U	IW20TT	IW20TT
W20EPR-U	W20TT	W20TT
W20EPR-U10	IW20	IW20TT
W20EPR-U10	IW20TT	IW20TT
W20EPR-U10	W20TT	W20TT
W20EPR-U11	IW20	IW20TT
W20EPR-U11	IW20TT	IW20TT
W20EPR-U11	W20TT	W20TT
W20EPR-ZU	IW20	IW20TT
W20EPR-ZU11	IW20	IW20TT
W20EP-S11	IW20	IW20TT
W20EP-S11	IW20TT	IW20TT
W20EP-U	IW20	IW20TT
W20EP-U	IW20TT	IW20TT
W20EP-U	W20TT	W20TT
W20EP-U11	IW20	IW20TT
W20EP-U11	IW20TT	IW20TT
W20EP-U11	W20TT	W20TT
W20EP-ZU	IW20	IW20TT
W20ES-L	IW20	IW20TT
W20ES-L	IW20TT	IW20TT
W20ES-L11	IW20	IW20TT
W20ES-L11	IW20TT	IW20TT
W20ESR-L	IW20	IW20TT
W20ESR-L	IW20TT	IW20TT
W20ESR-L11	IW20	IW20TT
W20ESR-L11	IW20TT	IW20TT
W20ET-L	IW20	IW20TT
W20ET-L	IW20TT	IW20TT
W20ETR	IW20	IW20TT
W20ETR	IW20TT	IW20TT
W20ETR-L	IW20	IW20TT
W20ETR-L	IW20TT	IW20TT
W20ETR-L8	IW20	IW20TT
W20ETR-L8	IW20TT	IW20TT
W20ETR-S	IW20	IW20TT
W20ETR-S	IW20TT	IW20TT
W20ETR-S	W20TT	W20TT
W20ET-S	IW20	IW20TT
W20ET-S	IW20TT	IW20TT
W20ET-S	W20TT	W20TT
W20EVR-ZU	IW20	IW20TT
W20EXR-U	IW20	IW20TT
W20EXR-U	IW20TT	IW20TT
W20EXR-U11	IW20	IW20TT
W20EXR-U11	IW20TT	IW20TT
W20EXR-U11	W20TT	W20TT
W20EXR-U13	IW20	IW20TT
W20EXR-U13	IW20TT	IW20TT
W20EX-U	IW20	IW20TT
W20EX-U	IW20TT	IW20TT
W20EX-U	W20TT	W20TT
W20EX-U11	IW20	IW20TT
W20EX-U11	IW20TT	IW20TT
W20EX-U11	W20TT	W20TT
W20EX-U13	IW20	IW20TT
W20EX-U13	IW20TT	IW20TT
W20EX-U13	W20TT	W20TT
W20EX-ZU	IW20	IW20TT
W20FP	IWF20	-
W20FP	WF20TT	WF20TT

Свечи зажигания и Свечи накаливания

Таблица взаимозаменяемости – Другие производители

DENSO	DENSO	TT
W20FP-L	IWF20	-
W20FF-L	WF20TT	WF20TT
W20FPR	IWF20	-
W20FPR	WF20TT	WF20TT
W20FPR-L	IWF20	-
W20FPR-L	WF20TT	WF20TT
W20FPR-U	IWF20	-
W20FPR-U	WF20TT	WF20TT
W20FPR-U10	IWF20	-
W20FPR-U10	WF20TT	WF20TT
W20FPR-ZU	IWF20	-
W20FP-U	IWF20	-
W20FP-U	WF20TT	WF20TT
W20FP-U10	IWF20	-
W20FP-U10	WF20TT	WF20TT
W20FR-L	IWF20	-
W20FR-L	WF20TT	WF20TT
W20FR-L9	IWF20	-
W20FR-L9	WF20TT	WF20TT
W20FS	IWF20	-
W20FS	WF20TT	WF20TT
W20FSR	IWF20	-
W20FSR	WF20TT	WF20TT
W20FSR-U	IWF22	-
W20FSR-U	WF20TT	WF20TT
W20FS-U	IWF20	-
W20FS-U	WF20TT	WF20TT
W20FS-U10	IWF22	-
W20FS-U10	WF20TT	WF20TT
W20FS-ZU	IWF22	-
W20SR-U	W20S-U	-
W20TT	IW20	IW20TT
W20TT	IW20TT	IW20TT
W21ES-L11	IW20	IW20TT
W21ES-L11	IW20TT	IW20TT
W21ESR-L11	IW20	IW20TT
W21ESR-L11	IW20TT	IW20TT
W22EKR-S11	IW22	-
W22EKR-S11	VW22	-
W22EP	IW22	-
W22EP	VW22	-
W22EP	W22TT	W22TT
W22EP11	IW22	-
W22EP11	VW22	-
W22EP11	W22TT	W22TT
W22EPB	IW22	-
W22EPB	VW22	-
W22EPB	W22TT	W22TT
W22EPR	IW22	-
W22EPR	VW22	-
W22EPR	W22TT	W22TT
W22EPR11	IW22	-
W22EPR11	VW22	-
W22EPR11	W22TT	W22TT
W22EPR-U	IW22	-
W22EPR-U	VW22	-
W22EPR-U	W22TT	W22TT
W22EPR-U11	IW22	-
W22EPR-U11	VW22	-
W22EPR-U11	W22TT	W22TT
W22EPR-ZU	IW22	-
W22EPR-ZU11	IW22	-
W22EP-S11	IW22	-
W22EP-S11	VW22	-
W22EP-U	IW22	-
W22EP-U	VW22	-
W22EP-U	W22TT	W22TT
W22EP-U11	IW22	-
W22EP-U11	VW22	-
W22EP-U11	W22TT	W22TT

DENSO	DENSO	TT
W22EP-ZU	IW22	-
W22ES-L	IW22	-
W22ES-L11	IW22	-
W22ES-ZU	IW24	-
W22ET-L	VW22	-
W22ET-L	W22TT	W22TT
W22ETR-L	IW22	-
W22ETR-L	VW22	-
W22ETR-L	W22TT	W22TT
W22ETR-L8	IW22	-
W22ETR-L8	VW22	-
W22EX-U	IW22	-
W22EX-U	VW22	-
W22EX-U	W22TT	W22TT
W22FP	IWF22	-
W22FPR	IWF22	-
W22FPR-U	IWF22	-
W22FPR-ZU	IWF22	-
W22FP-U	IWF22	-
W22FP-U10	IWF22	-
W22FSR	IWF22	-
W22FS-U	IWF22	-
W22FS-U10	IWF22	-
W22FS-ZU	IWF22	-
W22TT	IW22	-
W22TT	VW22	-
W24EMR-C	IWM24	-
W24EP	IW24	-
W24EPR	IW24	-
W24EPR-U	IW24	-
W24EPR-ZU	IW24	-
W24EP-U	IW24	-
W24ESR	IW24	-
W24ESR-U	IW24	-
W24ESR-V	IW24	-
W24ESR-ZU	IW24	-
W24ES-U	IW24	-
W24ES-V	IW24	-
W24ES-ZU	IW24	-
W24FP	IWF24	-
W24FPR	IWF24	-
W24FPR-L	IWF24	-
W24FPR-U10	IWF24	-
W24FP-U	IWF24	-
W24FR-L	IWF24	-
W24FSR	IWF24	-
W24FSR-U10	IWF24	-
W24FS-U	IWF24	-
W24FS-U10	IWF24	-
W24FS-ZU	IWF24	-
W25FN	IWF24	-
W27A-Z	IW27	-
W27EMR-C	IWM27	-
W27EMR-ZU	IWM27	-
W27ES-C	IW27	-
W27ESR	IW27	-
W27ESR-U	IW27	-
W27ESR-V	IW27	-
W27ESR-ZU	IW27	-
W27ES-U	IW27	-
W27ES-V	IW27	-
W27ES-ZU	IW27	-
W27FN	IWF27	-
W27FSR	IWF27	-
W27FSR-U10	IWF27	-
W27FSR-U10	W27FSR	-
W27FS-U	IWF27	-
W27FS-U10	IWF27	-
W27FS-ZU	IWF27	-
W29A-Z	IW29	-
W29ESR-V	IW29	-

DENSO	DENSO	TT
W29ES-V	IW29	-
W29ES-ZU	IW29	-
W31A-Z	IW31	-
W31EMR-C	IWM31	-
W31EMR-ZU	IWM31	-
W31ESR-U	IW31	-
W31ESR-ZU	IW31	-
W31ES-U	IW31	-
W31ES-U	W31ESR-U	-
W31ES-ZU	IW31	-
W9EXR-U+CU	W9EXR-UCU	-
WF20TT	IWF20	-
X20EPR-U9	IX22B	-
X20FS-ZU	X20FSR-U	-
X22EPR-GL	IX22B	-
X22EPR-U9	IX22B	-
X22EPR-ZU9	IX22B	-
X22EP-U	X22EPR-U9	-
X22EP-U9	IX22B	-
X22ESR-U	IX22	-
X22ESR-UB	IX22	-
X22ES-U	IX22	-
X22ES-ZU	IX22	-
X22GPR-U	IXG24	-
X22GP-U	IXG24	-
X24EPR-GL	IX24B	-
X24EPR-U9	IX24B	-
X24EPR-ZU9	IX24B	-
X24EP-U	X24EPR-U9	-
X24EP-U9	IX24B	-
X24ESR-U	IX24	-
X24ESR-ZU	IX24	-
X24ES-U	IX24	-
X24ES-ZU	IX24	-
X24GPR-U	IXG24	-
X24GP-U	IXG24	-
X27EPR-U9	IX27B	-
X27EPR-ZU9	IX27B	-
X27EP-U9	IX27B	-
X27ESR-U	IX27	-
X27ESR-ZU	IX27	-
X27ES-U	IX27	-
X27ES-ZU	IX27	-
X27ETR	IX27	-
X27GPR-U	IXG27	-
X27GP-U	IXG27	-
XE20HR-U9	IXEH20TT	IXEH20TT
XU20EPR-U	IXU22	IXU22TT
XU20EPR-U	VXU22	IXU22TT
XU20EPR-ZU	IXU22	IXU22TT
XU20EP-U	IXU22	IXU22TT
XU20EP-U	VXU22	IXU22TT
XU20EP-ZU	IXU22	IXU22TT
XU20HR9	IXUH20I	-
XU22EP-P	IXU22	IXU22TT
XU22EP-P	VXU22	IXU22TT
XU22EP-P	XU22TT	XU22TT
XU22EPR-U	IXU22	IXU22TT
XU22EPR-U	VXU22	IXU22TT
XU22EPR-U	XU22TT	XU22TT
XU22EPR-ZU	IXU22	IXU22TT
XU22EP-U	IXU22	IXU22TT
XU22EP-U	VXU22	IXU22TT
XU22EP-U	XU22TT	XU22TT
XU22EP-ZU	IXU22	IXU22TT
XU22HDR9	IXUH22I	IXUH22TT
XU22HDR9	VXUH22I	IXUH22TT
XU22HDR9	XUH22TT	XUH22TT
XU22HR9	IXUH22I	IXUH22TT
XU22HR9	VXUH22I	IXUH22TT
XU22HR9	XUH22TT	XUH22TT

DENSO	DENSO	TT
XU22PR9	IXU22I	IXU22TT
XU22PR9	VXU22I	IXU22TT
XU22PR9	XU22TT	XU22TT
XU22TT	IXU22	IXU22TT
XU22TT	VXU22	IXU22TT
XU24EPR-U	IXU24	-
XU24EPR-U	VXU24	-
XU24EPR-ZU	IXU24	-
XU24EP-U	IXU24	-
XU24EP-U	VXU24	-
XU24EP-ZU	IXU24	-
XU27EPR-U	IXU27	-
XU27EPR-ZU	IXU27	-
XUH20TTi	IXUH20I	-
XUH20TTi	VXUH20I	-
XUH22TT	IXUH22	IXUH22TT
XUH22TT	VXUH22	IXUH22TT
Y24FER-C	IY24	-
Y27FER	IY27	-
Y27FER-C	IY27	-
Y31FER-C	IY31	-
ZC20HPR11	IXEH22TT	IXEH22TT
ZK20HQR8	VKH20Y	-
ZK20R11	IK20TT	IK20TT
ZK20R13	IK20	IK20TT
ZK20R13	IK20TT	IK20TT
ZK20R7	VK20Y	-
ZK20R9	VK20Y	-
ZT16EPR11	IT16TT	IT16TT
ZT20EPR11	IT20TT	IT20TT
ZTJ16R10	IT16TT	IT16TT
ZTJ16VR10	IT16TT	IT16TT
ZXE20HR13	IXEH20TT	IXEH20TT
ZXE27HBR8	VXEBH27	-
ZXU20HPR11	IXUH20I	-
ZXU20HPR11	VXUH20I	-
ZXU20PR11	VXU20	-
ZXU22HCR8	VXUHC22G	-
ZXU22HPR8	IXUH22I	IXUH22TT
ZXU22HPR8	VXUH22	IXUH22TT
ZXU22PR11	IXU22	IXU22TT
ZXU22PR11	VXU22	IXU22TT

EYQUEM	DENSO	TT
1000	W24FSR	-
1000C	W24S-U	-
1000CM	W22S-U	-
1000L	W24ESR-U	-
100M	W24FSR	-
1100	W27FSR	-
1100L	W24ESR-U	-
1150	W27FSR	-
1150L	W27ESR-U	-
200	W14F-U	-
202CT	W9LM-US	-
300A	W14L	-
30AM	W14L	-
406	W16FSR	-
450L	W14E	-
480CS	W14PR-U	-
500	W16FSR	-
5002	W16FSR	-
500A	W16LS	-
500C	W20S-U	-
500CJT	T20M-U	-
500CM	W20S-U	-
500CS	W16PR-U	-
500CT	W20MR-U	-
500JS	T16PR-U	ITF16TT
500M	W16FSR	-
502	W16FSR	-

Свечи зажигания и Свечи накаливания

Таблица взаимозаменяемости – Другие производители

EYQUEM	DENSO	TT
505JS	T16PR-U	ITF16TT
50AM	W16LS	-
50M	W16FSR	-
520CS	W16PR-U	-
550CS	W16PR-U	-
550JS	T16PR-U	ITF16TT
550LS	W14EX-U	IW16TT
550S	W14FPR-U	-
580LS	W14EX-U	IW16TT
580S	W16FPR-U	-
600CS	W20PR-U	-
600JS	T20PR-U	ITF20TT
600L	W20ESR-U	-
600LS	W16EPR-U	W16TT
600S	W16FPR-U	-
700	W20FSR-U	WF20TT
700C	W20S-U	-
700CM	W20S-U	-
700CTS	W20MP-U	-
705L	W16ESR-U	-
705S	W20FPR-U	WF20TT
707LS	W16EPR-U	W16TT
70M	W20FSR-U	WF20TT
750	W20FSR-U	WF20TT
750L	W20ESR-U	-
750LS	W20EP-U	W20TT
753LJS	T20EPR-U	T20TT
755	W22FS-U	-
755C	W22S-U	-
755CJT	T22M-U	-
755CM	W20S-U	-
755CT	W22M-U	-
755L	W20ESR-U	-
755LJS	T20EPR-U	T20TT
755LJSP	IT20TT	IT20TT
755LS	W20EP-U	W20TT
755M	W20FSR-U	WF20TT
755S	W22FPR-U	-
755SX	W22FPR-U	-
755X	W22FS-U	-
75LM	W20ESR-U	-
75M	W20FSR-U	WF20TT
775SX	W20FPR-U	WF20TT
775X	W20FSR-U	WF20TT
800LJS	T20EPR-U	T20TT
800LS	W22EPR-U	W22TT
803LJS	T22EP-U	-
803LJSP	IT22	-
805L	W22ESR-U	-
805LJS	T22EP-U	-
805LJSP	IT24	-
805LP	IW24	-
850	W22FS-U	-
850LS	W22EPR-U	W22TT
883LJ	IT27	-
883LJP	IT27	-
A-CL588S	DG-198	-
C30LS	W14EPR-U	IW16TT
C32	W16FSR	-
C32LS	W16EPR-U	W16TT
C32S	W16FPR-U	-
C42LJS3	T16EPR-U	T16TT
C42S	W20FPR-U	WF20TT
C52LJS	T20EPR-U	T20TT
C52LS	W16EPR-U	W16TT
C52LS3	W16EPB10	W16TT
C52LS3X	W16EPB10	W16TT
C62	W22FS-U	-
C62LJS	T20EPR-U	T20TT
C62LS	W20EP-U	W20TT
C62LS3X	W20EPB	W20TT

EYQUEM	DENSO	TT
C62S	W22FPR-U	-
C72LJS	T22EP-U	-
C72LS	W22EPR-U	W22TT
C72LS3X	W22EPB	W22TT
C82LJS	T22EP-U	-
C82LS	W22EPR-U	W22TT
C82LS3X	W22EPB	W22TT
C83LJS	T22EP-U	-
C92LS	W24EPR-U	-
CD566R	DG-004	-
CD659R	DG-012	-
CD660R	DG-012	-
CD661R	DG-012	-
CD666R	DG-123	-
CD670T	DG-001	-
CD674V	DG-202	-
CL564P	DG-157	-
CL580P	DG-104	-
CL581S	DG-114	-
CL586T	DG-124	-
CL588S	DG-198	-
CT580T	DG-132	-
D1000	X24FS-U	-
D1000L	X27ESR-U	-
D1050L	X27ESR-U	-
D755	X20FSR-U	-
D775	X16FSR-U	-
D800L	X22ESR-U	-
D900L	X24ESR-U	-
DD6120V	DG-106	-
DD659R	DG-012	-
DD665T	DG-006	-
DD668S	DG-010	-
DD670T	DG-001	-
DD671T	DG-001	-
DD678S	DG-001	-
DT584T	DG-101	-
DT589V	DG-003	-
DT592T	DG-005	-
F100	W24FSR	-
F20	W14F-U	-
F220	W27FSR	-
F260	IWF27	-
F280	IWF27	-
F50	W16FSR	-
F55P	W16FPR-U	-
F65P	W20FPR-U	WF20TT
F70	W16FSR	-
F75	W20FSR-U	WF20TT
F75H	W20FSR-U	WF20TT
F80	W22FS-U	-
F85P	W20FPR-U	WF20TT
F86	IK22	IK22FTT
F95P	W22FPR-U	-
FA50	W14L	-
FA70	W16LS	-
FC42LS	K16PR-U11	K16TT
FC42LS2E	K20TXR	K20TT
FC52LS	K20P-U	K20TT
FC58LS	K20P-U	K20TT
FC58LS2E	K20TXR	K20TT
FC58LS3	K20PBR	K20TT
FC62LS	K20P-U	K20TT
FC62LS3	K20PBR	K20TT
FC62LS3X	K20PBR	K20TT
FC72LS	K22PR-U	IK22FTT
FC82LS	K22PR-U	IK22FTT
FC82LS2	IK22	IK22FTT
FC82LS3	K22PB	IKB22TT
FE100	W24ESR-U	-
FE125P	W20EP-U	W20TT

EYQUEM	DENSO	TT
FE135P	W22EPR-U	W22TT
FE145P	W24EPR-U	-
FE155P	W24EPR-U	-
FE220	IW24	-
FE260	IW27	-
FE280	IW29	-
FE285	IW31	-
FE310	IW01-32	-
FE320	IW34	-
FE35P	W14EPR-U	IW16TT
FE395	IW01-32	-
FE45P	W16EPR-U	W16TT
FE55P	W20EP-U	W20TT
FE65CPR	W20EPR-U	W20TT
FE65P	W20EP-U	W20TT
FE70	W20ESR-U	-
FE75	W22ESR-U	-
FE80	W22ESR-U	-
FE85P	W20EP-U	W20TT
FE95P	W22EPR-U	W22TT
FET65P	T20EPR-U	T20TT
FET75P	T22EP-U	-
FN52LS	W20EPR-U	W20TT
FS100	W24S-U	-
FS100H	W27S-U	-
FS20	W9-U	-
FS30	W14PR-U	-
FS35P	W14PR-U	-
FS45P	W16PR-U	-
FS50	W20S-U	-
FS55P	W20PR-U	-
FS70	W20S-U	-
FS75	W22S-U	-
FS75H	W22S-U	-
FSC50	W20M-US	-
FSC50P	W20MP-U	-
FSC70P	W20MP-U	-
FSC75P	W22MPR-U	-
FT55P	T16PR-U	ITF16TT
FT65P	T16PR-U	ITF16TT
FT85P	T20PR-U	ITF20TT
GT4S	W16PR-U	-
GT4T	MA16PR-U	-
GT5	W16FPR-U	-
GT5L	W16EPR-U	W16TT
GT6	W20FPR-U	WF20TT
GT6L	W20EP-U	W20TT
GT6T	MA20P-U	-
GT7	W22FPR-U	-
GT7L	W22EPR-U	W22TT
GT8L	W24EPR-U	-
J65	IT20TT	IT20TT
J87	IT22	-
K200M	L14-U	-
K300JS	MA16PR-U	-
K300M	M17	-
K450JS	MA16PR-U	-
K500M	M17	-
K550JS	MA20P-U	-
K600M	M22	-
K750M	M17	-
KC52JS	MA20P-U	-
KC62JS	MA20P-U	-
L3	IW16	IW16TT
L65	IW20	IW20TT
L87	IW22	-
M50	M17	-
M60	M17	-
M75	M22	-
M80	M24S	-
MT45P	MA16PR-U	-

EYQUEM	DENSO	TT
MT55P	MA16PR-U	-
MT65P	MA20P-U	-
MT75P	MA20P-U	-
MT85P	MA20P-U	-
N43	IWF22	-
R1000	W24FSR	-
R1000L	W24ESR-U	-
R850	W22FSR	-
RC30LS	W14EPR-U	IW16TT
RC32LS	W16EPR-U	W16TT
RC32LS5	W16EPR-U11	W16TT
RC42S	W20FPR-U	WF20TT
RC52LJS	T20EPR-U	T20TT
RC52LJS5	T20EPR-U	T20TT
RC52LS	W20EPR-U	W20TT
RC52LS5	W20EPR-U11	W20TT
RC52LZ3EX	W20EPBR-S	W20TT
RC52LZE	J16CR-U	W16TT
RC58LZ3EX	W20EPBR-S	W20TT
RC62HJSDP	PT16VR13	T16TT
RC62LJS	T20EPR-U	T20TT
RC62LJS5	T20EPR-U	T20TT
RC62LS	W20EPR-U	W20TT
RC62S	W22FPR-U	-
RC72LJS	T22EP-U	-
RC72LJS2	T22EP-U	-
RC72LJS3	T22EP-U	-
RC72LJS5	T22EP-U	-
RC72LS	W22EPR-U	W22TT
RC72LS5	W22EPR-U11	W22TT
RC82LS	W22EPR-U	W22TT
RC82LS5	W22EPR-U11	W22TT
RFC32LZ5	K16R-U11	K16TT
RFC42LS	K16PR-U	K16TT
RFC42LS2E	K20TXR	K20TT
RFC42LS5	K16PR-U11	K16TT
RFC42LZ2E	K20TXR	K20TT
RFC42LZ2E	K20TXR	K20TT
RFC52LS	K20PR-U	K20TT
RFC52LS2E	K20TXR	K20TT
RFC52LS3	K20PBR	K20TT
RFC52LS5	K20PR-U11	K20TT
RFC52LSP	PK20PR11	K20TT
RFC52LZ3EX	K20PBR-S10	K20TT
RFC52LZDP6	PK20R13	K20TT
RFC52LZE	K16R-U	K16TT
RFC57LS3	K20PBR	K20TT
RFC58LS	K20PR-U	K20TT
RFC58LS2E	K20TXR	K20TT
RFC58LS3	K20PBR	K20TT
RFC58LS5	K20PR-U11	K20TT
RFC58LSP	PK20PR11	K20TT
RFC58LZ	Q20PR-U	Q20TT
RFC58LZ2	K20TNR	K20TT
RFC58LZ2E	K20TXR	K20TT
RFC58LZ3EX	K20PBR-S10	K20TT
RFC58LZ5	K20R-U11	K20TT
RFC58LZDP	PK20PR-P8	IK20TT
RFC58LZE5	KJ20CR-L11	K20TT
RFC58LZK	K20PR-U	K20TT
RFC62LS	K22PR-U	IK22FTT
RFC62LS3	K22PBR-S	IKB22TT
RFC62LS3X	K22PBR-S	IKB22TT
RFC62LS5	K22PR-U11	IK22FTT
RFC62LZ3EX	K22PBR-S	IKB22TT
RFC82LS	K22PR-U	IK22FTT
RFC82LS3	K22PBR-S	IKB22TT
RFC82LS5	K22PR-U11	IK22FTT
RFN42LZG5	QJ16AR-U	-
RFN52HZ	K16HPR-U11	KH16TT
RFN52HZ3A	K16HPR-U11	KH16TT

Свечи зажигания и Свечи накаливания

Таблица взаимозаменяемости – Другие производители

EYQUEM	DENSO	TT
RFN52LZ	K16PR-U	K16TT
RFN52LZDPF5	PKJ16CR-L11	IK16TT
RFN58HZ	K20HR-U11	KH20TT
RFN58LZ	K20PR-U	K20TT
RFN62LZ	K22PR-U	IK22FTT
RKC52JS	MA20PR-U	-
RKC62JS	MA20PR-U	-
T30	U20FSR-U	-
T70	U22FSR-U	-
T850	U22FSR-U	-
T90	U24FSR-U	-
TW270	X20FSR-U	-
TW275	X20FSR-U	-
TW280	X24FS-U	-
TWE270	X24ESR-U	-
TWE275	X27ESR-U	-
XC30LS	W14EPR-U	IW16TT
XC32LS	W16EPR-U	W16TT
XC42S	W20FPR-U	WF20TT
XC52LS	W16EPR-U	W16TT
XC62LJS	T20EPR-U	T20TT
XC62LS	W20EPR-U	W20TT
XC62S	W22FPR-U	-
XC72LJS	T22EP-U	-
XC72LS	W22EPR-U	W22TT
XFC62LS	K22PR-U	IK22FTT
XFC82LS	K22PR-U	IK22FTT
XKC52JS	MA20PR-U	-
XKC62JS	MA20PR-U	-

HERTH+BUSS ELPARTS	DENSO	TT
J5710506	DG-669	-
J5710901	DG-662	-
J5713014	DG-627	-

HKS	DENSO	TT
M35	IQ22	-
M35G	IW22	-
M35i	IK22	IK22FTT
M35iL	IKH22	-
M35LF	ITV22	-
M40	IQ24	-
M40G	IW24	-
M40i	IK24	-
M40iL	IKH24	-
M40LF	ITV24	-
M40X	IXU24	-
M45	IQ27	-
M45G	IW27	-
M45i	IK27	-
M45iL	IKH27	-
M45RE	IRE01-27	-
M45REL	IRL01-27	-
M45X	IXU27	-
M50RE	IRE01-31	-
M50RET	IRT01-31	-
M525RE	IRE01-32	-
M55RE	IRE01-34	-
R45	IQ01-27	-
R45i	IK01-27	-
R45RE	IRE01-27	-
R50	IQ01-31	-
R50i	IK01-31	-
R50RE	IRE01-31	-
R525RE	IRE01-32	-
R55	IQ01-34	-
R55i	IK01-34	-
R55RE	IRE01-34	-
S30	IQ20TT	IQ20TT
S30i	IK20	IK20TT
S35	IQ22	-

HKS	DENSO	TT
S35G	IW22	-
S35i	IK22	IK22FTT
S35iL	IKH22	-
S40	IQ24	-
S40G	IW24	-
S40i	IK24	-
S40iL	IKH24	-
S40X	IXU24	-
S45	IQ27	-
S45G	IW27	-
S45i	IK27	-
S45iL	IKH27	-
S45X	IXU27	-
S50	IQ31	-
S50i	IK31	-
S55	IQ34	-
S55i	IK34	-

ISKRA	DENSO	TT
F100	W24FSR	-
F100RS	W24FSR	-
F100S	W24FSR	-
F20	W14F-U	-
F45P	W14FPR-U	-
F50	W16FSR	-
F55P	W16FPR-U	-
F55PRS	W16FPR-U	-
F55PS	W16FPR-U	-
F65CP	W20FPR-U	WF20TT
F65CPR	W20FPR-U	WF20TT
F65P	W20FPR-U	WF20TT
F65PR	W20FPR-U	WF20TT
F65PRS	W20FPR-U	WF20TT
F65PS	W20FPR-U	WF20TT
F70	W20FSR-U	WF20TT
F75	W20FSR-U	WF20TT
F75RS	W20FSR-U	WF20TT
F75S	W20FSR-U	WF20TT
F80	W22FS-U	-
F80C	W22FS-U	-
F80S	W22FS-U	-
F85CP	W20FPR-U	WF20TT
F85P	W20FPR-U	WF20TT
F85PS	W20FPR-U	WF20TT
F95P	W22FPR-U	-
F95PS	W22FPR-U	-
FE100	W27ESR-U	-
FE100RS	W27ESR-U	-
FE100S	W27ESR-U	-
FE125P	W20EP-U	W20TT
FE135P	W22EPR-U	W22TT
FE145P	W24EPR-U	-
FE155P	W24EPR-U	-
FE220	W27ESR-U	-
FE35P	W14EPR-U	IW16TT
FE45P	W16EPR-U	W16TT
FE50	W16ESR-U	-
FE55P	W16EPR-U	W16TT
FE55PRS	W16EPR-U	W16TT
FE55PS	W16EPR-U	W16TT
FE55PTRS	W16ETR-S	W16TT
FE55PTS	W16EPB10	W16TT
FE65CP	W20EP-U	W20TT
FE65CPD	W20EPB	W20TT
FE65CPR	W20EPR-U	W20TT
FE65PR	W20EPR-U	W20TT
FE65PRS	W20EPR-U	W20TT
FE65PS	W20EP-U	W20TT
FE65PTRS	W20EPBR-S	W20TT
FE65PTS	W20EPB	W20TT
FE70	W20ESR-U	-

ISKRA	DENSO	TT
FE75	W22ESR-U	-
FE75RS	W22ESR-U	-
FE75S	W22ESR-U	-
FE80	W24ESR-U	-
FE80RS	W24ESR-U	-
FE80S	W24ESR-U	-
FE85CP	W22EPR-U	W22TT
FE85CPR	W22EPR-U	W22TT
FE85CPR11	W22EPR-U11	W22TT
FE85P	W22EPR-U	W22TT
FE85PR	W22EPR-U	W22TT
FE85PR11	W22EPR-U11	W22TT
FE85PRS	W22EPR-U	W22TT
FE85PS	W22EPR-U	W22TT
FE85PTRS	W22EPB	W22TT
FE85PTS	W22EPB	W22TT
FE95CP	W24EPR-U	-
FE95CPR	W24EPR-U	-
FE95P	W22EPR-U	W22TT
FE95PR	W22EPR-U	W22TT
FET55PRS	T16EPR-U	T16TT
FET55PS	T16EPR-U	T16TT
FET65P	T20EPR-U	T20TT
FET65PRS	T20EPR-U	T20TT
FET65PS	T20EPR-U	T20TT
FET75CP	T22EP-U	-
FET75CPR	T22EP-U	-
FET75P	T22EP-U	-
FET75PRS	T22EP-U	-
FS100	W24S-U	-
FS100H	W27S-U	-
FS20	W9-U	-
FS30	W14PR-U	-
FS30LMR	W14LM-U	-
FS35P	W14PR-U	-
FS45P	W16PR-U	-
FS50	W16S-U	-
FS50C	W20M-US	-
FS55P	W20PR-U	-
FS70	W20S-U	-
FS70C	W20MP-U	-
FS75	W22S-U	-
FS75C	W22MPR-U	-
FS75H	W22S-U	-
FSC50	W20M-US	-
FSC50P	W20MP-U	-
FSC50R	W20MR-U	-
FSC70P	W20MP-U	-
FSC75CP	W22MPR-U	-
FSC75CPR	W22MPR-U	-
FSC75P	W22MPR-U	-
FT55P	T16PR-U	ITF16TT
FT65P	T20PR-U	ITF20TT
FT65PR	T20PR-U	ITF20TT
FT65PS	T20PR-U	ITF20TT
FT85P	T20PR-U	ITF20TT
GT4S	W16PR-U	-
GT4T	MA16PR-U	-
GT5	W16FPR-U	-
GT5L	W16EPR-U	W16TT
GT6	W20FPR-U	WF20TT
GT6L	W20EP-U	W20TT
GT6T	MA20P-U	-
GT7	W22FPR-U	-
GT7L	W22EPR-U	W22TT
GT8L	W24EPR-U	-
M50	M14	-
M60	M17	-
M75	M22	-
M80	M24S	-

ISKRA	DENSO	TT
MT45P	MA16PR-U	-
MT55P	MA16PR-U	-
MT65CP	MA20P-U	-
MT65P	MA20P-U	-
MT65PRS	MA20PR-U	-
MT65PS	MA20P-U	-
MT75P	MA20P-U	-
MT85P	MA20P-U	-
SFE55LDRS	K20TXR	K20TT
SFE55LRS	KJ16CR-L11	K16TT
SFE55LS	KJ16CR-L11	K16TT
SFE55PRS	Q16PR-U	Q16TT
SFE55PS	Q16PR-U11	Q16TT
SFE55PTRS	K20PBR-S10	K20TT
SFE55PTS	K20PBR	K20TT
SFE65CPR	Q20PR-U	Q20TT
SFE65LDRS	K20TXR	K20TT
SFE65LDS	K20TXR	K20TT
SFE65LRS	KJ20CR-L11	K20TT
SFE65LTS	K20PBR	K20TT
SFE65PRS	Q20PR-U	Q20TT
SFE65PS	Q20PR-U	Q20TT
SFE65PTRS	K20PBR	K20TT
SFE65PTS	K20PBR	K20TT
SFE85CPR	Q22PR-U	-
SFE85LDRS	K20TNR	K20TT
SFE85LTS	K22PB	IKB22TT
SFE85PRS	Q22PR-U	-
SFE85PS	Q22PR-U	-
SFE85PTRS	K22PBR-S	IKB22TT
SFE85PTS	K22PB	IKB22TT
T30	U20FSR-U	-
T70	U22FSR-U	-
T90	U24FSR-U	-
TW270	X20FSR-U	-
TW275	X20FSR-U	-
TW280	X24FS-U	-
TWE270	X24ESR-U	-
TWE275	X27ESR-U	-

JAPANPARTS	DENSO	TT
CP-74	DG-659	-

KAVO	DENSO	TT
IGP1002	DG-174	-
IGP3003	DG-172	-
IGP3503	DG-126	-
IGP4002	DG-186	-
IGP4005	DG-189	-
IGP5501	DG-173	-
IGP5502	DG-005	-
IGP6501	DG-643	-
IGP6509	DG-001	-
IGP6511	DG-671	-
IGP6512	DG-187	-

KITAHARA	DENSO	TT
B-032	DG-123	-
B-040	DG-001	-
CP-02	DG-642	-
CP-07	DG-301	-
CP-50	DG-300	-
CP-50	DG-640	-
CP-51	DG-302	-
CP-51	DG-641	-
CP72	DG-197	-
PI-46	DG-143	-
PI-49	DG-108	-
PI-57	DG-104	-
PI-58	DG-124	-
PM-161	DG-162	-

Свечи зажигания и Свечи накаливания

Таблица взаимозаменяемости – Другие производители

КИТАНАРА	DENSO	TT
PM167	DG-174	-
PM168	DG-187	-
PM-75	DG-198	-
PN-132	DG-157	-
PN-138	DG-137	-
PN-81	DG-127	-
PN-89	DG-012	-
PZ-33	DG-114	-
PZ704	DG-502	-

LODGE	DENSO	TT
25HL	W22EPR-U	W22TT
25HLD	Q22PR-U	-
2HL	W22EPR-U	W22TT
2HLD	Q22PR-U	-
2HLDR	K22PBR-S	IKB22TT
2HLN	W22ESR-U	-
3HLN	W24ESR-U	-
B4Y	T22EP-U	-
B6Y	T20EPR-U	T20TT
B6YR	T20EPR-U	T20TT
CNY	W16FPR-U	-
HBANC	W20M-US	-
HBANCY	W20MPR-U10	-
HBLT	T20EPR-U	T20TT
HL	W20EP-U	W20TT
HLD	Q20PR-U	Q20TT
HLT	T22EP-U	-
L4Y	W22EPR-U	W22TT
L4YR	W22EPR-U	W22TT
L5	W22ESR-U	-
L6Y	W20EP-U	W20TT
L6YR	W20EPR-U	W20TT
M5Y	Q22PR-U	-
M5YR	Q22PR-U	-
M6Y	Q20PR-U	Q20TT
M6YR	Q20PR-U	Q20TT
R49	IWF24	-
R50	IWF24	-
R51	IWF27	-
RL47	IW24	-
RL49	IW27	-
RL51	IW31	-
RL52	IW34	-
S3	W24FSR	-
S5	W22FS-U	-
S6	W20FSR-U	WF20TT
S6Y	W20FPR-U	WF20TT
S6YR	W20FPR-U	WF20TT

LPM	DENSO	TT
0001521000	W16S-U	-
0001521001	W14PR-U	-
0001521002	W9-U	-
0001521003	W14L	-
0001521012	W16ES-U	-
0001521014	W14EX-U	IW16TT
0001521015	M17	-
0001521019	L14-U	-
0001521033	W16EXR-U	W16TT
0001522036	W20EX-U	W20TT
0001522158	T20PR-U	ITF20TT
0001523029	W9EP	-
0001523030	W16EX-U	W16TT
0001523032	T16PR-U	ITF16TT
0001523033	T14PR-U	ITF16TT
0001523034	W14EPR-U	IW16TT
0001523036	T20R-U	-
0001523037	W9EXR-UCU	-
0001523038	T16NR-U11	IT16TT
0001523039	T16R-U	T16TT

LPM	DENSO	TT
0001523040	T16PR-U11	ITF16TT
0001523041	MA20PR-U	-
0001523042	W22EPR-U	W22TT
0001523043	W14EXR-U	IW16TT
0001523044	PT16EPR-L13	IT16TT
0001523045	K16PR-U	K16TT
0001523046	K16R-U	K16TT
0001523047	MA16PR-U	-
0001523048	W24EP-U	-
0001523049	W20EXR-U	W20TT
0001525022	T16EPR-U	T16TT
0001526046	W9EX-U	-

LUCAS ELECTRICAL	DENSO	TT
LP022	DG-012	-
LP027	DG-005	-
LP033	DG-001	-
LP037	DG-003	-
LP043	DG-109	-
LP051	DG-116	-
LP055	DG-117	-
LP062	DG-121	-
LP067	DG-174	-
LP072	DG-122	-
LP074	DG-130	-
LP076	DG-302	-
LP076	DG-641	-
LP077	DG-142	-
LP087	DG-177	-
LP098	DG-171	-
LP101	DG-170	-

MAGNETI MARELLI	DENSO	TT
06090060606	DG-613	-
060900610606	DG-616	-
062900086304	DG-669	-
062900108304	DG-632	-
062900109304	DG-613	-
062900110304	DG-620	-
062900112304	DG-617	-
062900114304	DG-622	-
062900120304	DG-659	-
062900122304	DG-616	-
062900123304	DG-665	-
600000179540	DG-669	-
75LMCR	K20TNR	K20TT
7LC	Q20PR-U	Q20TT
7LC1R	Q20PR-U11	Q20TT
7LCR	Q20PR-U	Q20TT
7LPR	Q20PR-U	Q20TT
8LC	Q22PR-U	-
8LCR	Q22PR-U	-
8LDCR	PT16VR13	TV16TT
8LPR	Q22PR-U	-
9LC	Q22PR-U	-
AW56C	W20M-US	-
AW5C	W20M-US	-
CM3N	M14	-
CM4N	M17	-
CM5N	M17	-
CM6N	M22	-
CU7N	U20FSR-U	-
CW101L	W27ESR-U	-
CW10L	W27ESR-U	-
CW10N	W27FSR	-
CW11L	W27ESR-U	-
CW12L	IW31	-
CW12N	W31FS	-
CW12NV	SF-50	-
CW13L	W31ESR-U	-
CW14L	W31ESR-U	-

MAGNETI MARELLI	DENSO	TT
CW15L	IW34	-
CW2C	W9-U	-
CW2CJ	W9-U	-
CW2L	W9EP	-
CW3C	W9-U	-
CW3CJ	W9-U	-
CW3L	W9EP	-
CW4C	W14PR-U	-
CW4CJ	W14PR-U	-
CW4CP	W14PR-U	-
CW4L	W14E	-
CW4LP	W14EPR-U	IW16TT
CW4N	W14F-U	-
CW55N	W16FSR	-
CW5C	W16S-U	-
CW5CP	W16PR-U	-
CW5L	W16ESR-U	-
CW5LP	W16EPR-U	W16TT
CW5LS	W16ESR-U	-
CW5LSZ	W16ESR-U	-
CW5N	W16FSR	-
CW5NJ	W16FSR	-
CW5NP	W16FPR-U	-
CW5NR	W16FSR	-
CW5NS	W16FSR	-
CW67L	W20ESR-U	-
CW67LP	W20EP-U	W20TT
CW67N	W20FSR-U	WF20TT
CW67NR	W20FSR-U	WF20TT
CW67P	W20EP-U	W20TT
CW6C	W16S-U	-
CW6CE	W20M-US	-
CW6CJ	W16S-U	-
CW6L	W16ESR-U	-
CW6LP	W16EPR-U	W16TT
CW6LR	W16ESR-U	-
CW6LS	W16ESR-U	-
CW6LSZ	W16ESR-U	-
CW6N	W20FSR-U	WF20TT
CW6NE	W20M-US	-
CW6NJ	W20M-US	-
CW6NP	W20FPR-U	WF20TT
CW6NPR	W20FPR-U	WF20TT
CW6NR	W20FSR-U	WF20TT
CW75LP	W20EP-U	W20TT
CW78L	W20ESR-U	-
CW78LP	W20EP-U	W20TT
CW78LPR	W20EPR-U	W20TT
CW78LPS	W20EPR-S11	W20TT
CW7C	W20S-U	-
CW7L	W20ESR-U	-
CW7LCR	Q20PR-U	Q20TT
CW7LJ	W20ESR-U	-
CW7LP	W20EP-U	W20TT
CW7LPH	W20EP-U	W20TT
CW7LPR	W20EPR-U	W20TT
CW7LR	W20ESR-U	-
CW7N	W20FSR-U	WF20TT
CW7NJ	W20FSR-U	WF20TT
CW7NP	W20FPR-U	WF20TT
CW7NPR	W20FPR-U	WF20TT
CW7NR	W20FSR-U	WF20TT
CW89LP	W22EPR-U	W22TT
CW8CJ	W22S-U	-
CW8L	W22ESR-U	-
CW8LCR	Q22PR-U	-
CW8LJ	W22ESR-U	-
CW8LP	W22EPR-U	W22TT
CW8LPR	W22EPR-U	W22TT
CW8LPS	W22EPR-U	W22TT
CW8N	W22FS-U	-

MAGNETI MARELLI	DENSO	TT
CW8NP	W22FPR-U	-
CW8NR	W22FSR	-
CW9L	W24ESR-U	-
CW9LP	W24EPR-U	-
CW9N	W24FSR	-
CW9NJ	W24FSR	-
CWC12NJ	W31FS	-
CWC67NJ	W20FSR-U	WF20TT
CWC6NJ	W16FSR	-
CWC7NJ	W20FSR-U	WF20TT
CWC9NJ	W24FSR	-
CWF11L	IW27	-
CWP10L	IW27	-
CWP10N	IWF27	-
CWP11L	IW31	-
CWP7L	IW20	IW20TT
CWP7N	IWF22	-
CWP8L	IW24	-
CWP8N	IWF22	-
CWP9L	IW24	-
CWP9N	IWF24	-
CX6N	X20FSR-U	-
CX8L	X22ESR-U	-
DW4CJR	W14LM-U	-
F45LCR	W16EPR-U	W16TT
F45LDCR	W16EPR-U	W16TT
F4LC	W16EPR-U	W16TT
F4LCR	W16EPR-U	W16TT
F6LMC1R	W20EPBR-S	W20TT
F6NC	W16FPR-U	-
F6NCR	W16FPR-U	-
F75LMC1R	W20EPBR-S	W20TT
F7CN	W20FSR-U	WF20TT
F7LC	W20EP-U	W20TT
F7NC	W20FPR-U	WF20TT
F7NCR	W20FPR-U	WF20TT
F8LC	W22EPR-U	W22TT
FC6N	W16FSR	-
FC7N	W20FSR-U	WF20TT
FC8L	W22EPR-U	W22TT
FC9L	W24EPR-U	-
FL7LCR	W20EPR-U	W20TT
FL7MCR	W20EPBR-S	W20TT
FL8LCR	W22EPR-U	W22TT
FL8LNCR	W20EXR-U	W20TT
L10BPCPR	IU22	-
L10CR	XU24EPR-U	-
L10DCR	XU24EPR-U	-
L7LCD1R	Q20PR-U11	Q20TT
L7LCR	Q20PR-U	Q20TT
L7LDCR	K20PR-U	K20TT
L7MCR	K20PBR	K20TT
L8LCR	Q22PR-U	-
L9LPCPR	PK22PR8	IK22TT
SW5C	T20M-U	-
T7LC	T20EPR-U	T20TT
T7LCR	T20EPR-U	T20TT
T8LC	T22EP-U	-
T8LCR	T22EP-U	-
T8LDC	T22EP-U	-
TIX1A	DG-012	-
TIX2A	DG-001	-
TIX7A	DG-202	-
TM2NP	MA16PR-U	-
TM3NP	MA16PR-U	-
TM4NP	MA20P-U	-
TW4LP	T16EPR-U	T16TT
TW5NP	T16PR-U	ITF16TT
TW6NP	T16PR-U	ITF16TT
TW78LP	T20EPR-U	T20TT
TW78LPR	T20EPR-U	T20TT

Свечи зажигания и Свечи накаливания

Таблица взаимозаменяемости – Другие производители

MAGNETI MARELLI	DENSO	TT
TW78NPR	T20PR-U	ITF20TT
TW7LP	T20EPR-U	T20TT
TW7LPR	T20EPR-U	T20TT
TW7NP	T20PR-U	ITF20TT
UC10A	DG-124	-
UC11A	DG-127	-
UC12A	DG-116	-
UC13A	DG-101	-
UC14A	DG-109	-
UC15A	DG-003	-
UC16A	DG-118	-
UC17A	DG-117	-
UC18A	DG-155	-
UC21A	DG-008	-
UC2A	DG-132	-
UC3A	DG-005	-
UC4A	DG-102	-
UC7A	DG-003	-
UC8A	DG-101	-
UC9A	DG-104	-
UX11A	DG-004	-
UX12A	DG-123	-
UX14A	DG-006	-
UX15A	DG-001	-
UX16A	DG-119	-
UX17A	DG-106	-
UX18A	DG-012	-
UX19A	DG-007	-
UX20A	DG-001	-
UX21A	DG-129	-
UX2A	DG-001	-
UX4A	DG-001	-
UX7A	DG-202	-
UX8A	DG-012	-
UX9A	DG-001	-
UY15A	DG-669	-
UY31A	DG-632	-
UY32A	DG-613	-
UY33A	DG-620	-
UY35A	DG-617	-
UY37A	DG-622	-
UY43A	DG-659	-
UY45A	DG-616	-
UY46A	DG-665	-

MOTORCRAFT	DENSO	TT
1 493 602	PT16VR13	TV16TT
1Y0018110	W16EPR-U	W16TT
1Y0118110	W20EPR-U	W20TT
1Y0318110	W16EPR-U11	W16TT
1Y0618110	K16PR-U	K16TT
1Y0718110	K20PR-U	K20TT
1Y0918110	K16PR-U11	K16TT
1Y0A18110	K20PR-U11	K20TT
1Y0B18110	K22PR-U11	IK22FTT
1Y0F18110	XU22EPR-U	XU22TT
1Y0G18110	KJ16CR-L11	K16TT
1Y0H18110	KJ20CR-L11	K20TT
1Y0K18110	W16EXR-U13	W16TT
1Y0L18110	J16AR-U11	-
1YR118110	VW20	IW20TT
1YRF18110	VXU22	IXU22TT
A11	W9-U	-
A11LM	W14LM-U	-
A11X	W9-U	-
A21X	W24S-U	-
A22	W20PR-U	-
A22NX	W22MPR-U	-
A2C	W24S-U	-
A2NX	W22M-U	-
A32	W20PR-U	-

MOTORCRAFT	DENSO	TT
A3NX	W22M-U	-
A3X	W20S-U	-
A42	W16PR-U	-
A42C	W16PR-U	-
A42N	W16S-U	-
A5	W16S-U	-
A52	W14PR-U	-
A5X	W16S-U	-
A7	W14PR-U	-
A7C	W14PR-U	-
A7CLM	W14LM-U	-
A7CX	W14PR-U	-
A7LM	W14LM-U	-
A7NX	W20MR-U	-
A7X	W14PR-U	-
A82	W9PR-U	-
A9	W9-U	-
A901	W27S-U	-
A9X	W9-U	-
AE091	IWF27	-
AE1C	W22FS-U	-
AE1X	W22FS-U	-
AE22	W22FPR-U	-
AE22C	W22FPR-U	-
AE23	IWF24	-
AE2C	W22FS-U	-
AE2X	W22FS-U	-
AE3	W20FSR-U	WF20TT
AE32	W20FPR-U	WF20TT
AE32C	W20FPR-U	WF20TT
AE3C	W20FSR-U	WF20TT
AE3X	W20FSR-U	WF20TT
AE4	W16FSR	-
AE42	W16FPR-U	-
AE42C	W16FPR-U	-
AE4X	W16FSR	-
AE6	W14F-U	-
AE901	W24FSR	-
AE901X	W24FSR	-
AE903	IWF27	-
AER22C	W22FPR-U	-
AER2X	W22FSR	-
AER32	W20FPR-U	WF20TT
AER4	W16FSR	-
AER4X	W16FSR	-
AER6	W14FR-U	-
AES4C	W16FSR	-
AF22	T20PR-U	ITF20TT
AF32	T20PR-U	ITF20TT
AF3NX	T22M-U	-
AF42	T16PR-U	ITF16TT
AF42C	T16PR-U	ITF16TT
AF52	T16PR-U	ITF16TT
AF52C	T16PR-U	ITF16TT
AF5NX	T20M-U	-
AF701	ITF27	-
AF901	ITF24	-
AG040	IW31	-
AG051	W31ESR-U	-
AG071	W27ESR-U	-
AG091	W24ESR-U	-
AG092C	W24ESR-U	-
AG1	W24ESR-U	-
AG12	W24EPR-U	-
AG12C	W24EPR-U	-
AG1C	W24ESR-U	-
AG1CX	W24ESR-U	-
AG1X	W22ESR-U	-
AG2	W22ESR-U	-
AG200	IW34	-
AG203	IW34	-

MOTORCRAFT	DENSO	TT
AG22	W22EPR-U	W22TT
AG22C	W22EPR-U	W22TT
AG22CT	W20EPB	W20TT
AG23	IW24	-
AG2C	W22ESR-U	-
AG2CX	W22ESR-U	-
AG2X	W22ESR-U	-
AG3	W20ESR-U	-
AG303	IW34	-
AG32	W20EP-U	W20TT
AG32A	W20EP-U	W20TT
AG32C	W20EX-U	W20TT
AG32CT	W20EPB	W20TT
AG32CT1	W20EPB	W20TT
AG34	W20EX-U	W20TT
AG3C	W20ESR-U	-
AG3CX	W20ESR-U	-
AG3X	W20ESR-U	-
AG4	W16ESR-U	-
AG400	IW31	-
AG403	IW31	-
AG42C	W16EPR-U	W16TT
AG44	KJ16CR-L11	K16TT
AG44CU	W16EXR-U	W16TT
AG5	W16ESR-U	-
AG501	W31ESR-U	-
AG501X	W31ESR-U	-
AG52	W14EPR-U	IW16TT
AG52C	W14EX-U	IW16TT
AG54	KJ16CR-L11	K16TT
AG600	IW01-27	-
AG603	W27ESR-U	-
AG7	W14E	-
AG701	W27ESR-U	-
AG701C	W27ESR-U	-
AG701X	W27ESR-U	-
AG82	W9EP	-
AG9	W14E	-
AG901	W24ESR-U	-
AG901C	W24ESR-U	-
AG901CU	W24ESR-U	-
AG901X	W24ESR-U	-
AG902	W24EPR-U	-
AG903	IW24	-
AGF12C	T22EP-U	-
AGF22	T20EPR-U	T20TT
AGF22C	T20EPR-U	T20TT
AGFS22C	T20EPR-U	T20TT
AGFS22C1	T20EPR-U	T20TT
AGFS22CM1	T20EPR-U	T20TT
AGFS22FE1	ZT20EPR11	IT20TT
AGFS22FE13J	T20EPR-U	T20TT
AGFS22IPJ	IT20TT	IT20TT
AGFS32C1	T20EPR-U	T20TT
AGN42	W16EXR-U	W16TT
AGP12C	K22PR-U	IK22FTT
AGP22C	K20P-U	K20TT
AGP22CD	Q20PR-U	Q20TT
AGP901C	Q22P-U	-
AGPR12C	K22PR-U	IK22FTT
AGPR12CD	K22PR-U	IK22FTT
AGPR12P	IK20	IK20TT
AGPR12P1	IK20	IK20TT
AGPR12PP	PK20PR-P11	K20TT
AGPR12PP11	PK20PR-P11	K20TT
AGPR12PP8	PK20PR-P8	IK20TT
AGPR22C	K20PR-U	K20TT
AGPR22C1	K20PR-U11	K20TT
AGPR22CD	Q20PR-U	Q20TT
AGPR22CD1	Q20PR-U11	Q20TT
AGPR22P	IK20	IK20TT

MOTORCRAFT	DENSO	TT
AGPR22P1	IK20	IK20TT
AGPR22PP	PK20PR11	K20TT
AGPR22PP8	PK20PR-P8	IK20TT
AGPR22PPJ	PK20PR11	K20TT
AGPR32C	K20PR-U	K20TT
AGPR32C1	K20PR-U11	K20TT
AGPR32CD	Q20PR-U	Q20TT
AGPR32CD1	Q20PR-U11	Q20TT
AGPR32PD	PK16PR-P11	K16TT
AGPR601P	IK31	-
AGPR701C	IK27	-
AGPR702C	IK27	-
AGPR901C	IQ24	-
AGPR901C1	IK24	-
AGPR902C	IQ27	-
AGPR902C1	K24PR-U11	-
AGPR902P	IQ27	-
AGPS071C	IQ24	-
AGPS091C	IQ24	-
AGPS091C1	Q22PR-U	-
AGPS092C1	IQ24	-
AGPS12C	Q22PR-U	-
AGPS12P1	PK22PR-L11S	-
AGPS22C	Q20PR-U11	Q20TT
AGPS22C1	Q20PR-U11	Q20TT
AGPS22PP1	PK20PR11	K20TT
AGPS32C	Q20PR-U11	Q20TT
AGPS32C1	Q20PR-U11	Q20TT
AGPS44F11	PKJ16CR-L11	IK16TT
AGR12	W24EPR-U	-
AGR12C	W24EPR-U	-
AGR16C	W27EPR-U	-
AGR1C	W22ESR-U	-
AGR1X	W22ESR-U	-
AGR21	W22ESR-U	-
AGR22	W22EPR-U	W22TT
AGR22C	W22EPR-U	W22TT
AGR2C	W22ESR-U	-
AGR2X	W22ESR-U	-
AGR31	W20ESR-U	-
AGR32	W20EPR-U	W20TT
AGR32C	W20EXR-U	W20TT
AGR34CU	W20EXR-U	W20TT
AGR34CU11	W20EXR-U11	W20TT
AGR3X	W20ESR-U	-
AGR41	W16ESR-U	-
AGR42	W16EPR-U	W16TT
AGR42C	W16EXR-U	W16TT
AGR44	J16BR-U	-
AGR44C1	W16EXR-U11	W16TT
AGR44CU	W16EXR-U	W16TT
AGR47CU11	J16AR-U11	-
AGR51	W16ESR-U	-
AGR52	W14EXR-U	IW16TT
AGR526	W14EXR-U11	IW16TT
AGR52A	W14EPR-U	IW16TT
AGR52C6	W14EXR-U11	IW16TT
AGR54	J16BR-U	-
AGR701X	W27ESR-U	-
AGR803C	W27ESR-U	-
AGR82	W14EXR-U	IW16TT
AGR901X	W24ESR-U	-
AGRF12C	T20EPR-U	T20TT
AGRF2	T20EPR-U	T20TT
AGRF22	T20EPR-U	T20TT
AGRF226	T20EPR-U15	-
AGRF22C	T20EPR-U	T20TT
AGRF22C1	T20EPR-U	T20TT
AGRF22CD	T20EPR-U	T20TT
AGRF22PP	T20EPR-U	T20TT
AGRF22PP1	PT16EPR-L13	IT16TT

Свечи зажигания и Свечи накаливания

Таблица взаимозаменяемости – Другие производители

MOTORCRAFT	DENSO	TT
AGRF32	T20EPR-U	T20TT
AGRF326	T20EPR-U15	-
AGRF32C1	T20EPR-U	T20TT
AGRF42	T16EPR-U	T16TT
AGRF42C1	T16EPR-U	T16TT
AGRF42C6	T16EPR-U15	T16TT
AGRF52	T16EPR-U	T16TT
AGRP44	T20EPR-U	T20TT
AGS081C	W27ESR-U	-
AGS12C	W22EPR-U	W22TT
AGS1C	W22ESR-U	-
AGS22C	W22EPR-U	W22TT
AGS2C	W22ESR-U	-
AGS32C	W16EXR-U11	W16TT
AGS32C1	W16EXR-U11	W16TT
AGS3C	W20ESR-U	-
AGS42C	W16EXR-U	W16TT
AGS44	J16BR-U	-
AGS4C	W16ESR-U	-
AGS52C	W14EXR-U	W16TT
AGS52C6	W14EXR-U11	W16TT
AGSF2	T22EP-U	-
AGSF22C	T20EPR-U	T20TT
AGSF22FCM	PT16EPR-L13	IT16TT
AGSF22FM1	PT16EPR-L13	IT16TT
AGSF22FSM	IT20TT	IT20TT
AGSF22IPJ	IT20TT	IT20TT
AGSF22PP	PT16EPR-L13	IT16TT
AGSF22PPJ	IT20TT	IT20TT
AGSF22PPM	IT20TT	IT20TT
AGSF22WM	IT20TT	IT20TT
AGSF24C	T20EPR-U	T20TT
AGSF24FM	IT20TT	IT20TT
AGSF24FN	IT20TT	IT20TT
AGSF24PGM	IT20TT	IT20TT
AGSF24PN	IT20TT	IT20TT
AGSF32C	T20EPR-U	T20TT
AGSF32FM	ZT20EPR11	IT20TT
AGSF32M	T16EPR-U15	T16TT
AGSF32P	IT20TT	IT20TT
AGSF32PM	IT20TT	IT20TT
AGSF32W	T16EPR-U15	T16TT
AGSF32WM	T16EPR-U15	T16TT
AGSF33C	T20EPR-U	T20TT
AGSF34C	T20EPR-U	T20TT
AGSF34FM	T20EPR-U	T20TT
AGSF34FP	PT16EPR-L13	IT16TT
AGSF42	T16EPR-U	T16TT
AGSF42C6	T16EPR-U15	T16TT
AGSF42EEM	PT16EPR-L13	IT16TT
AGSF52C	T16EPR-U	T16TT
AGSP22YE07	VK20Y	-
AGSP22YE09	VK20Y	-
AGSP22Z11	IK20	IK20TT
AGSP32C	K16PR-U11	K16TT
AGSP32P	PQ16R	Q16TT
AGSP32PP	PQ16R	Q16TT
AGSP32Z	IK16	IK16TT
AGSP33C	KJ20CR-U11	K20TT
AGSP52C	K16PR-U11	K16TT
AGSP54	KJ16CR-L11	K16TT
AL11	W14L	-
AL5	W16LS	-
AL5X	W16LS	-
AL7	W14L	-
AL7C	W14L	-
AL7X	W14L	-
AL82	W14L	-
AL9	W14L	-
AL9X	W14L	-
AR31	W20S-U	-

MOTORCRAFT	DENSO	TT
AR32	W20PR-U	-
AR41	W20S-U	-
AR42	W16PR-U	-
AR426	W16PR-U	-
AR52	W14PR-U	-
AR526	W14PR-U	-
AR5S	W20S-U	-
AR82	W9PR-U	-
AR826	W9PR-U	-
AR828	W9PR-U	-
AR82S	W9PR-U	-
AR86	T16R-U	T16TT
ARF2	T20R-U	-
ARF22	T20PR-U	ITF20TT
ARF22C	T20PR-U	ITF20TT
ARF26	T20R-U	-
ARF3	T20R-U	-
ARF32	T20PR-U	ITF20TT
ARF326	T20PR-U	ITF20TT
ARF32C6	T20PR-U	ITF20TT
ARF32M	T20PR-U	ITF20TT
ARF36	T20R-U	-
ARF3C	T20R-U	-
ARF4	T20R-U	-
ARF42	T16PR-U	ITF16TT
ARF426	T16PR-U11	ITF16TT
ARF428	T16PR-U11	ITF16TT
ARF42C6	T16PR-U11	ITF16TT
ARF46	T20R-U	-
ARF52	T16PR-U	ITF16TT
ARF526	T16PR-U11	ITF16TT
ARF528	T16PR-U11	ITF16TT
ARF6	T16R-U	T16TT
ARF62	T14PR-U	ITF16TT
ARF626	T14PR-U	ITF16TT
ARF8	T16R-U	T16TT
ARF86	T16R-U	T16TT
ARL5	W16LS	-
ARL8	W14L	-
ARL82	W14L	-
AS42C	W20PR-U	-
AS4C	W20S-U	-
AS52C	W16PR-U	-
AS827	W14PR-U	-
ASF32	T20PR-U	ITF20TT
ASF32C	T20PR-U	ITF20TT
ASF32C6	T20PR-U	ITF20TT
ASF32CM	T20PR-U	ITF20TT
ASF32M	T20PR-U	ITF20TT
ASF32P	T20PR-U11	ITF20TT
ASF3C	T20PR-U	ITF20TT
ASF3C6	T20PR-U	ITF20TT
ASF42	T16PR-U	ITF16TT
ASF42C	T16PR-U	ITF16TT
ASF42C6	T16PR-U11	ITF16TT
ASF42C7	T16PR-U	ITF16TT
ASF42P	T16PR-U	ITF16TT
ASF44P	T16PR-U11	ITF16TT
ASF4C	T16PR-U	ITF16TT
ASF4C6	T16PR-U11	ITF16TT
ASF52	T16PR-U	ITF16TT
ASF526	T16PR-U11	ITF16TT
ASF52C	T16PR-U	ITF16TT
ASF52C7	T16PR-U11	ITF16TT
ASF8	T16R-U	T16TT
ASF86	T16R-U	T16TT
AT1	W27S-U	-
AT10	W9-U	-
AT2	W24S-U	-
AT3	W20S-U	-
AT4	W16S-U	-

MOTORCRAFT	DENSO	TT
AT42	W16PR-U	-
AT6	W14PR-U	-
AT8	W14PR-U	-
ATL3	W16LS	-
ATL4	W16LS	-
ATL8	W14L	-
AV091X4	W27FSR	-
AV1X	W22FS-U	-
AV23	IWF24	-
AV2X	W20FSR-U	WF20TT
AV4	W16FSR	-
AV6	W14F-U	-
AV603	IWF27	-
AV701CU10	W27FSR	-
AV901X	W27FSR	-
AV901X4	W27FSR	-
AV903	IWF24	-
AVK0	SF-50	-
AVKOD	SF-51	-
AVZK0	SF-50	-
AWRF32	T20EPR-U	T20TT
AWRF325	T20EPR-U15	-
AWRF42	T16EPR-U	T16TT
AWS42EE	PT16EPR-L13	IT16TT
AWS44EE	PT16EPR-L13	IT16TT
AWSF22C	T20EPR-U	T20TT
AWSF22E	T20EPR-U	T20TT
AWSF22F	PT16EPR-L13	IT16TT
AWSF22FM	PT16EPR-L13	IT16TT
AWSF22FS	PT16EPR-L13	IT16TT
AWSF24	T20NR-U11	IT20TT
AWSF24C	T20NR-U11	IT20TT
AWSF32	T20EPR-U	T20TT
AWSF32C	T20EPR-U	T20TT
AWSF32E	PT16EPR-L13	IT16TT
AWSF32EE	PT16EPR-L13	IT16TT
AWSF32EG	PT16EPR-L13	IT16TT
AWSF32F	PT16EPR-L13	IT16TT
AWSF32FM	PT16EPR-L13	IT16TT
AWSF32P	PT16EPR-L13	IT16TT
AWSF32PF	PT16EPR-L13	IT16TT
AWSF32PM	PT16EPR-L13	IT16TT
AWSF32PP	PT16EPR-L13	IT16TT
AWSF34	T20NR-U11	IT20TT
AWSF34C	T20NR-U11	IT20TT
AWSF34P	T20NR-U11	IT20TT
AWSF34PP	T20NR-U11	IT20TT
AWSF3PP	PT16EPR-L13	IT16TT
AWSF42	T16EPR-U	T16TT
AWSF42C	T16EPR-U	T16TT
AWSF42C6	T16EPR-U15	T16TT
AWSF42EE	PT16EPR-L13	IT16TT
AWSF42P	T16EPR-U	T16TT
AWSF42PP	PT16EPR-L13	IT16TT
AWSF44	T16NR-U11	IT16TT
AWSF44C	T16NR-U11	IT16TT
AWSF44EE	PT16EPR-L13	IT16TT
AWSF44PP	PT16EPR-L13	IT16TT
AWSF52	T16EPR-U	T16TT
AWSF52C	T16EPR-U	T16TT
AWSF54	T16NR-U11	IT16TT
AWSF54C	T16NR-U11	IT16TT
AWSF62	T16EPR-U	T16TT
AWSFA32C	T20EPR-U	T20TT
AYFS092FEC	ITV24	-
AYFS22C	ITV22	-
AYFS22CB	T16VR-U10	TV16TT
AYFS22F1	T16VR-U10	TV16TT
AYFS22FB	PT16VR13	TV16TT
AYFS22FE1J	ITV22	-
AYFS22FM	ITV22	-

MOTORCRAFT	DENSO	TT
AYFS22FPM	PT16VR13	TV16TT
AYFS22PP	ITV22	-
AYFS22PP1	PT16VR13	TV16TT
AYFS32CJ	T16VR-U10	TV16TT
AYRF22P	PT16VR13	TV16TT
AYRF22PG1	PT16VR13	TV16TT
AYRF22PP	PT16VR13	TV16TT
AZ2	W24S-U	-
AZ3	W20S-U	-
AZ7	W9-U	-
AZ9	W9-U	-
AZFS22C	T16VR-U10	TV16TT
AZFS22FE	PT16VR13	TV16TT
AZFS22PP	PT16VR13	TV16TT
AZFS32F	PT16VR13	TV16TT
AZFS32FE	PT16VR13	TV16TT
B2W	M24S	-
B3W	M22	-
B3X	M22	-
B4X	M22	-
B6W	M17	-
B82	L14-U	-
B8X	L14-U	-
BF22	MA20P-U	-
BF22C	MA20P-U	-
BF22CX	MA20P-U	-
BF22X	MA20P-U	-
BF32	MA20P-U	-
BF32C	MA20P-U	-
BF32X	MA20P-U	-
BF42	MA16PR-U	-
BF42C	MA16PR-U	-
BF82	MA16PR-U	-
BF82C	MA16PR-U	-
BF8Z	L14-U	-
BF92	MA9P-U	-
BFS22C	MA20P-U	-
BFS32C	MA20P-U	-
BFS32C1	MA20P-U	-
BR8	L14-U	-
BRF22	MA20PR-U	-
BRF22C	MA20PR-U	-
BRF22CX	MA20PR-U	-
BRF22X	MA20PR-U	-
BRF31	MA20PR-U	-
BRF314	MA20PR-U	-
BRF32	MA20PR-U	-
BRF32C	MA20PR-U	-
BRF32C1	MA20PR-U	-
BRF32X	MA20PR-U	-
BRF3M	MA20PR-U	-
BRF42	MA16PR-U	-
BRF6	MA16PR-U	-
BRF82	MA16PR-U	-
BSF3	MA20PR-U	-
BSF31	MA20PR-U	-
BSF314	MA20PR-U	-
BSF42	MA16PR-U	-
BSF42C	MA16PR-U	-
BSF44C	MA20PR-U	-
BSF44P	MA20PR-U	-
BSF6	MA16PR-U	-
BSF82	MA16PR-U	-
BSF82C	MA16PR-U	-
BSF92	MA9P-U	-
BT10	L14-U	-
BT15	L14-U	-
BT2	M24S	-
BT3	M22	-
BT4	M22	-
BT6	M17	-

Свечи зажигания и Свечи накаливания

Таблица взаимозаменяемости – Другие производители

MOTORCRAFT	DENSO	TT
BT8	L14-U	-
BT9	L14-U	-
BTF3	MA20PR-U	-
BTF31	MA20PR-U	-
BTF42	MA16PR-U	-
BTF6	MA16PR-U	-
BTRF42	MA16PR-U	-
BTS8	L14-U	-
BZ8	L14-U	-
CYFS12F3	ITV22	-
CYFS12Y2	ITV22	-
CYFS12YEC	ITV22	-
CYFS12YECB	ITV22	-
CYFS12YP	ITV22	-
CYFS12YPC	ITV22	-
CYFS12YPC5	ITV22	-
CYFS-12YT4	ITV20TT	ITV20TT
CYFS13YRC	ITV20TT	ITV20TT
EZD.10	DG-012	-
EZD.11	DG-001	-
EZD.12	DG-001	-
EZD.13	DG-202	-
EZD.14	DG-001	-
EZD.15	DG-001	-
EZD.16	DG-001	-
EZD.18	DG-198	-
EZD.2	DG-001	-
EZD.22	DG-114	-
EZD.23	DG-143	-
EZD.4	DG-001	-
EZD.5	DG-001	-
EZD.6	DG-123	-
EZD.7	DG-114	-
EZD.8	DG-004	-
EZD.A	DG-012	-
EZD.B	DG-001	-
EZD.C	DG-001	-
EZD.D	DG-202	-
EZD.E	DG-001	-
EZD.F	DG-001	-
EZD.G	DG-001	-
EZD.U	DG-198	-
EZD.Y	DG-114	-
EZD.Z	DG-143	-
EZD10	DG-012	-
EZD11	DG-001	-
EZD12	DG-001	-
EZD13	DG-202	-
EZD14	DG-001	-
EZD15	DG-001	-
EZD16	DG-001	-
EZD18	DG-198	-
EZD2	DG-001	-
EZD22	DG-114	-
EZD23	DG-143	-
EZD4	DG-001	-
EZD5	DG-001	-
EZD6	DG-123	-
EZD7	DG-114	-
EZD8	DG-004	-
EZDA	DG-012	-
EZDB	DG-001	-
EZDC	DG-001	-
EZDD	DG-202	-
EZDE	DG-001	-
EZDF	DG-001	-
EZDG	DG-001	-
EZDU	DG-198	-
EZDY	DG-114	-
EZDZ	DG-143	-
HG2	X24ESR-U	-

MOTORCRAFT	DENSO	TT
HG22	X24EPR-U9	-
HG22C	X24EPR-U9	-
HG2C	X24ESR-U	-
HGS22C	X24EPR-U9	-
HV2	X24FS-U	-
HV22	X20FSR-U	-
HV2C	X24FS-U	-
HV3	X20FSR-U	-
PV1	U24FSR-U	-
PV2	U22FSR-U	-
PV3	U20FSR-U	-

NGK	DENSO	TT
0127	IK20TT	IK20TT
1005	IKH20TT	IKH20TT
1009	DG-003	-
1010	M17	-
1011	IW22	-
1013	VKA20	-
1015	W24ES-U	-
1017	PKJ16CR-L11	IK16TT
1019	DG-005	-
1024	MA20PR-U	-
1028	W14EX-U	IW16TT
1029	W20MPR-U10	-
1030	IX24B	-
1032	DG-157	-
1034	W22EP-U	W22TT
1041	QJ20CR11	Q20TT
1043	IW24	-
1044	W14FPR-UL	-
1046	W20FR-L	WF20TT
1047	W24FPR	-
1048	T20EPR-U15	-
1049	IT24	-
1052	W20FP-U	WF20TT
1059	IXU01-31	-
1063	IW01-32	-
1065	DG-157	-
1068	X20EPR-U9	-
1071	MA20PR-U	-
1072	IXU01-34	-
1081	IQ20TT	IQ20TT
1084	PQ20R	Q20TT
1085	IT27	-
1086	Q14R-U11	IQ16TT
1087	W22EP-U	W22TT
1088	Q16R-U11	Q16TT
1089	Q22PR-U11	-
1090	W20FSR-U	WF20TT
1092	W22FPR-U	-
1093	W22FPR-U	-
1094	T22EP-U	-
1095	Q22PR-U11	-
1096	W14EXR-U11	IW16TT
1097	W14E	-
1098	W22FSR	-
1099	Q16PR-U11	Q16TT
1101	DG-113	-
1108	IKH16TT	IKH16TT
1110	M22	-
1111	W22ES-U	-
1117	X24ESR-U	-
1124	MA16PR-U	-
1125	IW22	-
1127	T14PR-U	ITF16TT
1128	W20ETR-L	IW20TT
1134	W24FSR-U10	-
1142	W22EPR-U	W22TT
1143	W14EXR-U11	IW16TT
1144	W22EPR-U	W22TT

NGK	DENSO	TT
1145	Q16PR-U	Q16TT
1146	Q20R-U	Q20TT
1147	W9LM-US	-
1148	Q16R-U11	Q16TT
1149	W22EPR-U11	W22TT
1152	IQ27	-
1155	IW01-32	-
1157	W24FSR-U10	-
1175	VK22G	-
1179	XU22TT	XU22TT
1180	W16EPR-U11	W16TT
1183	T20EPR-U	T20TT
1188	K16TT	K16TT
1199	S-31A	-
1208	IKH20TT	IKH20TT
1210	M24S	-
1219	IK16TT	IK16TT
1228	W14LM-U	-
1229	DG-114	-
1230	IX27B	-
1239	DG-012	-
1243	PQ16R	Q16TT
1249	DG-157	-
1250	DG-001	-
1252	IRE01-27	-
1257	PQ20R	Q20TT
1262	IW24	-
1263	W20EPB	W20TT
1265	IW27	-
1266	Q16R-U	Q16TT
1267	Q22PR-U11	-
1268	T22MP-U	-
1269	Q20PR-U	Q20TT
1270	T20MP-U	-
1271	Q22PR-U11	-
1272	Q22PR-U	-
1273	Q16PR-U11	Q16TT
1275	U24ESR-N	-
1277	ITF20TT	ITF20TT
1281	PK20PR11	K20TT
1283	K22PR-U11	IK22FTT
1284	IAE01-34	-
1295	W14E	-
1297	Q20PR-U	Q20TT
1299	X31ETR	-
1305	FXE24HR11	-
1311	IK16TT	IK16TT
1312	VFK20F	IK20TT
1313	K16PSR-B8	IK16TT
1314	SK20PR-L11	IK20TT
1317	IXEH22TT	IXEH22TT
1406	IXEH22TT	IXEH22TT
1422	GX8-1	-
1436	DG-112	-
1441	DG-116	-
1462	U22ETR	-
1464	SXU22PR9	IXU22TT
1483	KH20TT	KH20TT
1497	VW20T	IW20TT
1498	IQ20TT	IQ20TT
1501	FK20HBR11	IKH20TT
1502	IXEH20TT	IXEH20TT
1511	ITV16TT	ITV16TT
1516	IT20TT	IT20TT
1534	IK16TT	IK16TT
1566	DG-146	-
1578	XU22HDR9	XUH22TT
1582	U20EPR9	-
1632	PK20PR-L11	IK20TT
1637	IKH16TT	IKH16TT
1640	IKH20TT	IKH20TT

NGK	DENSO	TT
1643	XU22HDR9	XUH22TT
1654	IXEH22TT	IXEH22TT
1662	K16PR-U11	K16TT
1663	DG-300	-
1663	DG-640	-
1664	PKJ16CR-L11	IK16TT
1667	K16PR-U	K16TT
1669	K16HR-U11	KH16TT
1673	Y27FER-C	-
1675	PK22PR8	IK22TT
1682	XU22TT	XU22TT
1684	DG-113	-
1691	XU22EPR-U	XU22TT
1748	IK20L	IK20TT
1749	DG-110	-
1959	IKH20TT	IKH20TT
1961	VXUHC22G	-
1983	DG-302	-
1983	DG-641	-
1989	SXU22HDR8	IXUH22TT
2000	IA01-31	-
2001	IA01-34	-
2002	IAE01-32	-
2003	IAE01-34	-
2004	IAE01-32	-
2015	W9EXR-UCU	-
2023	W22EPR-U	W22TT
2024	MA16PR-U	-
2027	W20MR-U	-
2033	W22EBR	-
2042	T20EP-U	T20TT
2046	IW01-24	-
2055	IW34	-
2056	Q22PR-U	-
2058	P20PR11	W20TT
2059	Q22PR-U11	-
2065	W14EXR-U11	IW16TT
2072	P20PR11	W20TT
2074	QJ16AR-U	-
2075	K20PBR	K20TT
2077	IW01-32	-
2078	K22PB	IKB22TT
2086	U24FSR-U	-
2087	K16R-U	K16TT
2091	PK16PR-L11	IK16TT
2093	PK20PR-P8	IK20TT
2096	T16PR-U11	ITF16TT
2097	PQ16R	Q16TT
21079	W16EXR-U13	W16TT
2108	W27ES-U	-
2110	MA16PR-U	-
2113	PK16PR-P11	K16TT
2114	IWM01-34	-
2115	IW16	IW16TT
2120	X24ES-U	-
2128	W14EXR-U	IW16TT
2129	W22FS-U	-
2130	IX22B	-
2139	T20PR-U	ITF20TT
2140	W16EP-U	W16TT
2141	Q22PR-U11	-
2142	U27FER9	-
2144	T20M-U	-
2145	IW29	-
2147	SF-50	-
2150	IW01-24	-
2152	IXU01-27	-
2153	IW01-27	-
2158	IW27	-
2159	IQ24	-
2161	DG-162	-

Свечи зажигания и Свечи накаливания

Таблица взаимозаменяемости – Другие производители

NGK	DENSO	TT
2162	DG-239	-
2164	K22PBR-S	IKB22TT
2168	U24FS-U	-
2170	X27ETR	-
2171	IW01-32	-
2173	SF-51	-
2176	IW27	-
2177	IW22	-
2179	IW24	-
2184	IW31	-
2185	IQ27	-
2187	DG-215	-
2188	DG-222	-
2189	DG-198	-
2190	DG-233	-
2191	IW01-34	-
2193	U22FER9	-
2194	IX22B	-
2197	K20PBR	K20TT
2199	W31ESR-U	-
2202	IX24B	-
2203	DG-115	-
2204	X27ESR-U	-
2210	MA20PR-U	-
2212	W20EXR-U11	W20TT
2213	K20TNR-S	K20TT
2215	PK20R8	IK20TT
2223	T16EPR-U	T16TT
2224	T16R-U	T16TT
2230	T14PR-U	ITF16TT
2237	DG-001	-
2238	T20EPR-U	T20TT
2242	IX27	-
2247	X31ETR	-
2248	T20PR-U	ITF20TT
2249	K20R-U	K20TT
2251	IQ20TT	IQ20TT
2254	IWF27	-
2256	XU20EPR-U	-
2262	KJ16CR-U11	K16TT
2264	W9EXR-UCU	-
2265	IXU24	-
2268	W20EPR-U	W20TT
2270	K22PR-U	IK22FTT
2271	PK16R11	K16TT
2273	DG-101	-
2284	K20TNR	K20TT
2285	W16EP-U	W16TT
2287	W16EPB10	W16TT
2288	K20TXR	K20TT
2298	W16PR-U	-
2300	PK16PR-L11	IK16TT
2302	FXE20HE11	IXE20ETT
2305	IU27A	-
2306	U24EPR9	-
2308	U27ESR-N	-
2309	IKH22	-
2311	W22ESR-U	-
2314	ITL20	-
2316	IXU27	-
2319	W20S-U	-
2321	T20NR-U11	IT20TT
2325	IUF22	-
2327	T20EPR-U15	-
2329	IRE01-27	-
2330	Q20PR-U	Q20TT
2340	PK22PR8	IK22TT
2341	PK20PR-L13	IK20TT
2347	VW20T	IW20TT
2351	Q14R-U11	IQ16TT
2353	PK20R11	K20TT

NGK	DENSO	TT
2355	K16R-U11	K16TT
23559	IU24	-
2357	W22EPR-U	W22TT
2359	T16EPR-U15	T16TT
2360	U31ETR	-
2363	XU22EPR-U	XU22TT
2364	W16EP-U	W16TT
2365	PQ16R	Q16TT
2372	Q16TT	Q16TT
2374	ITF24	-
2378	Q14R-U11	IQ16TT
2380	PK22PR-L11S	-
2382	K16PR-U11	K16TT
2385	IQ16TT	IQ16TT
2386	XU22TT	XU22TT
2387	K22PR-U11	IK22FTT
2391	K16PR-L11	K16TT
2392	PK16PR11	K16TT
2396	IW01-32	-
2397	K20PBR-S10	K20TT
2399	W31FS	-
2400	P22PR8	IK22FTT
2401	IW27	-
2402	T20EPR-U15	-
2405	ITF20TT	ITF20TT
2408	DG-005	-
2409	U14FSR-UB	-
2411	W24ESR-U	-
2412	W22EPR-U	W22TT
2417	W20FP-U	WF20TT
2419	DG-008	-
2420	X27ES-U	-
2421	W22FS-U	-
2422	SF-50	-
2423	T16PR-U	ITF16TT
2434	IWM27	-
2438	MA20PR-U	-
2440	Q14R-U11	IQ16TT
2443	J16CR-U	W16TT
2445	PQ16R	Q16TT
2446	IQ20TT	IQ20TT
2449	PK20PR-L13	IK20TT
2451	T16PR-U11	ITF16TT
2457	IWM31	-
2460	K16PR-U	K16TT
2466	T20TT	T20TT
2467	PT16VR13	TV16TT
2470	W20EPBR-S	W20TT
2477	IK16L	IK16TT
2484	IW01-32	-
2485	PK20PR-P11	K20TT
2495	IU01-27	-
2500	DG-197	-
2501	IK16TT	IK16TT
2513	PK20TR11	K20TT
2522	SF-50	-
2526	K16R-U11	K16TT
2527	T14PR-U	ITF16TT
2528	W22ESR-U	-
2531	DG-157	-
2535	W22ETR-L	W22TT
2546	K16TT	K16TT
2547	T20EPR-U	T20TT
2550	PK20R13	K20TT
2551	IK22	IK22FTT
2556	X24ESR-U	-
2563	K20TT	K20TT
2574	IK20TT	IK20TT
2591	IAE01-32	-
2610	MA16PR-U	-
2611	W27ESR-U	-

NGK	DENSO	TT
2621	W24FS-U	-
2622	SF-50	-
2623	T20PR-U	ITF20TT
2630	W24FP-U	-
2633	W20FPR-U10	WF20TT
2634	IWF24	-
2635	W14EXR-U	IW16TT
2637	W16PR-U	-
2641	XU27EPR-U	-
2642	W14EXR-U11	IW16TT
2643	DG-001	-
2645	PK20PR-P8	IK20TT
2647	PK16PR-L11	IK16TT
2659	IW31	-
2660	IK24	-
2667	IK22	IK22FTT
2668	IK24	-
2669	IK27	-
2671	IW24	-
2672	IUF24	-
2680	W20M-US	-
2683	T16EPR-U15	T16TT
2684	PK20PR11	K20TT
2686	DG-172	-
2687	K20PSR-B8	IK20TT
2689	W27ESR-V	-
2690	VK22	IK22FTT
2691	DG-145	-
2696	DG-644	-
2697	IWM01-32	-
2702	IQ01-24	-
2707	IWM27	-
2710	MA20P-U	-
2712	W22EPR-U11	W22TT
2720	X31ESR-U	-
2721	IWF27	-
2727	T14PR-U	ITF16TT
2734	IX22	-
2737	QJ20CR11	Q20TT
2738	W16TT	W16TT
2740	IWF22	-
2741	IW01-32	-
2743	PK20PR-P11	K20TT
2746	W20PR-U	-
2751	W14FR-L	-
2756	K20PR-U11	K20TT
2761	PK16PR-L11	IK16TT
2771	T20PR-U	ITF20TT
2772	K20TXR	K20TT
2773	IW01-34	-
2776	VK22	IK22FTT
2777	IW22	-
2781	IK24	-
2782	IK24	-
2785	DG-010	-
2788	IAE01-32	-
2789	K16TNR-S9	K16TT
2790	IA01-34	-
2792	W22FS-U	-
2809	IRT01-31	-
2813	IW01-32	-
2817	ITF22	-
2821	W24ES-U	-
2822	W14EXR-U11	IW16TT
2825	IX22	-
2828	W16EXR-U	W16TT
2830	T20EPR-U15	-
2834	IX27	-
2838	PK16R11	K16TT
2840	PK20PR-P8	IK20TT
2841	ITF16TT	ITF16TT

NGK	DENSO	TT
2842	IX22B	-
2846	IK01-27	-
2848	K20TNR	K20TT
2850	IX24	-
2851	W16EXR-U	W16TT
2862	Y31FER-C	-
2867	PK16R11	K16TT
2871	X27ESR-U	-
2872	IX24B	-
2874	U16FSR-U	-
2876	W20EPBR-S	W20TT
2877	W22ESR-U	-
2880	IW01-24	-
2881	IRE01-27	-
2885	T20TT	T20TT
2887	X16EPR-U9	-
2890	K20TXR	K20TT
2891	W22S-U	-
2895	VK22	IK22FTT
2900	VKH22	-
2910	MW17	-
2911	W14PR-U	-
2912	W24EP-U	-
2922	MA20PR-U	-
2923	X24ESR-U	-
2924	T16PR-U11	ITF16TT
2927	T20R-U	-
2933	IX24B	-
2938	IWF22	-
2940	W31FS	-
2941	J16CR-U	W16TT
2948	W20EPR-U	W20TT
2950	IQ16TT	IQ16TT
2951	DG-647	-
2952	IQ01-27	-
2954	IW01-27	-
2963	W20MP-U	-
2975	KJ22CR-L11	-
2978	PK20R11	K20TT
2979	DG-245	-
2983	U20FSR-U	-
2984	IQ24	-
2985	IQ16TT	IQ16TT
2989	MA20P-U	-
2990	W16PR-U	-
3000	PK16PR-L11	IK16TT
3001	IW01-24	-
3006	IWM31	-
3010	M22	-
3011	W16PR-U	-
3014	W24FS-U	-
3017	DG-642	-
3025	IX24	-
3028	W16EXR-U11	W16TT
3030	DG-235	-
3035	IWM24	-
3040	DG-187	-
3044	IK27	-
3045	K20PBR-S10	K20TT
3061	IU24	-
3064	IK20L	IK20TT
3078	DG-155	-
3089	IW27	-
3099	VK20Y	-
3100	PK20PR-P8	IK20TT
3106	S22PR-A7	-
3107	SK16PR-L11	IK16TT
3108	IX22B	-
3110	W9-U	-
3111	W20PR-U	-
3112	W14L	-

Свечи зажигания и Свечи накаливания

Таблица взаимозаменяемости – Другие производители

NGK	DENSO	TT
3116	VKB20	-
3121	W22EBR	-
3122	MA16PR-U	-
3123	X22ESR-U	-
3124	T16PR-U11	ITF16TT
3129	IRE01-27	-
3130	W24ESR-V	-
3132	Q20PR-U11	Q20TT
3133	W24FPR-U10	-
3136	J16CR-U	W16TT
3141	PK20PR-L13	IK20TT
3146	X22EPR-U9	-
3153	W16EXR-U	W16TT
3154	W16EXR-U13	W16TT
3161	IU24	-
3165	IU01-34	-
3169	IK24	-
3171	XU24EPR-U	-
3172	W20EPBR-S	W20TT
3173	W16TT	W16TT
3174	IU01-27	-
3177	T20EPR-U	T20TT
3179	IK01-31	-
3181	X16EPR-U9	-
3187	IW22	-
3188	X27ETR	-
3194	W27ESR-U	-
3197	IUF27A	-
3199	K20TXR	K20TT
3200	P22PR8	IK22FTT
3201	W22MPR-U	-
3210	W14PR-U	-
3212	W16LS	-
3215	PQ16R	Q16TT
3219	DG-001	-
3221	IRE01-27	-
3228	U20FS-U	-
3230	W27ESR-V	-
3232	W16EKR-S11	W16TT
3236	IW24	-
3239	W16EPR-U	W16TT
3240	PK20R11	K20TT
3245	IW27	-
3249	ITF24	-
3252	IWM27	-
3253	IQ01-31	-
3256	IU27A	-
3261	IW01-32	-
3268	PK16R11	K16TT
3271	PKJ20CR-L11	IK20TT
3272	IA01-32	-
3275	IK31	-
3280	IU01-31	-
3306	IQ16TT	IQ16TT
3311	W14FP-U	-
3312	W20ESR-U	-
3319	DG-126	-
3321	W22EBR	-
3322	W14FR-U	-
3323	MA20PR-U	-
3324	T20PR-U	ITF20TT
3326	X16FSR-U	-
3328	IRE01-27	-
3330	Q22PR-U	-
3331	IX27B	-
3332	W20PR-U	-
3334	IWM01-32	-
3335	IW24	-
3336	IQ22	-
3340	IXU01-27	-
3342	IRE01-31	-

NGK	DENSO	TT
3344	IT22	-
3346	T22EP-U	-
3349	T16EPR-U15	T16TT
3350	PQ20R	Q20TT
3354	W24S-U	-
3355	W22EPR-U	W22TT
3360	IUH27	-
3366	RU01-27	-
3376	ITF20TT	ITF20TT
3377	W20EPBR-S	W20TT
3380	DG-001	-
3381	ITL16TT	ITL16TT
3382	IK34	-
3384	K20TXR	K20TT
3388	IU01-27	-
3395	IK31	-
3406	IK22	IK22FTT
3410	W14LM-U	-
3412	T16PR-U	ITF16TT
3413	DG-122	-
3419	IWF22	-
3430	W24ES-V	-
3436	W16TT	W16TT
3437	X27ESR-U	-
3440	PK16R11	K16TT
3442	ITF27	-
3452	PK20TR11	K20TT
3456	IA01-31	-
3466	P16R13	W20TT
3467	W9EP	-
3468	W16EXR-U	W16TT
3470	PK16R11	K16TT
3472	IXU01-31	-
3473	DG-001	-
3475	T20R-U	-
3478	U24ETR	-
3479	PK20PR-P8	IK20TT
3481	XU20EPR-U	-
3483	X24EPR-U9	-
3486	U22FER9	-
3488	T20EP-U	T20TT
3500	PK20PR-P8	IK20TT
3506	IW31	-
3508	SK16R-P8	IK16TT
3510	W20S-U	-
3511	W14FPR-UL	-
3512	T20PR-U	ITF20TT
3512	T20PR-U11	ITF20TT
3520	IWM24	-
3521	IU27	-
3522	W20S-U	-
3524	Q16PR-U11	Q16TT
3525	IW31	-
3526	T22EP-U	-
3527	W22ESR-U	-
3529	W16EKR-S11	W16TT
3530	W27ES-V	-
3535	ITF22	-
3536	K20P-U	K20TT
3539	K20TT	K20TT
3540	K20TT	K20TT
3546	PK20PR-L11	IK20TT
3549	IAE01-34	-
3557	ITF27	-
3559	IRE01-27	-
3566	IK16TT	IK16TT
3568	W14MR-U	-
3570	W27ESR-V	-
3571	IQ27	-
3573	P16PR11	W16TT
3577	W20EXR-U11	W20TT

NGK	DENSO	TT
3579	W22FSR	-
3583	K20TR11	K20TT
3584	K20TXR	K20TT
3586	PKJ20CR-L11	IK20TT
3587	ITV20TT	ITV20TT
3588	IKH20TT	IKH20TT
3602	IWF16	-
3605	IXU22	IXU22TT
3606	IXU24	-
3611	W14FPR-UL	-
3612	ITF22	-
3617	DG-004	-
3618	IWM01-34	-
3623	T20EPR-U	T20TT
3624	T20R-U	-
3625	IW24	-
3626	W27FS-U10	-
3628	W16ETR-S	W16TT
3630	IW31	-
3635	IT22	-
3639	W24ESR-U	-
3641	VXU22	IXU22TT
3645	DG-001	-
3650	IK24	-
3653	VUH24D	-
3654	VKA20	-
3656	IKH20	IKH20TT
3657	SKJ16DR-M11	-
3672	K20HR-U11	KH20TT
3678	VK20PRZ11	-
3679	PKJ16CR-L11	IK16TT
3680	IY24	-
3683	W24ESR-U	-
3684	W22EPB	W22TT
3686	K16PR-U11	K16TT
3687	DG-104	-
3688	PK20PR11	K20TT
3689	IT20TT	IT20TT
3690	IT22	-
3691	IT24	-
3696	K20R-U	K20TT
3698	IWM01-34	-
3703	DG-142	-
3704	DG-012	-
3709	DG-189	-
3710	W22S-U	-
3712	T16EPR-U	T16TT
3717	X27EPR-U9	-
3720	Q20R-U11	Q20TT
3722	W16FSR	-
3724	W16ESR-U	-
3725	W24FPR	-
3733	IQ22	-
3738	P20PR11	W20TT
3741	PKJ16CR8	-
3753	Q20TT	Q20TT
3754	T16EPR-U	T16TT
3764	IK20	IK20TT
3781	W16EPR-U	W16TT
3782	DG-216	-
3782	DG-650	-
3783	K20PR-U	K20TT
3784	PT16EPR-L13	IT16TT
3786	DG-144	-
3787	ITV22	-
3788	IW31	-
3789	ITV20TT	ITV20TT
3790	VKH20Y	-
3795	IRL01-27	-
3797	IUH24	-
3809	IQ01-27	-

NGK	DENSO	TT
3810	W24S-U	-
3811	ITV16TT	ITV16TT
3812	T20EP-U	T20TT
3818	DG-005	-
3821	W22EBR	-
3823	W24FPR-U10	-
3824	W20ESR-U	-
3825	IW27	-
3826	W20EKR-S11	IW20TT
3829	DG-012	-
3830	IW31	-
3836	IW01-31	-
3837	PQ20R	Q20TT
3841	W9LMR-US	-
3850	W20MR-U	-
3852	DG-111	-
3854	IX27B	-
3856	ITF27	-
3857	IRE01-32	-
3861	DG-643	-
3869	KJ20CR-L11	K20TT
3872	IUH27	-
3873	DG-004	-
3874	IW29	-
3901	U22EPR9	-
3903	IW20	IW20TT
3905	IU01-31	-
3909	IW01-32	-
3913	W27S-U	-
3914	IWF27	-
3922	W20FSR-U	WF20TT
3923	W24EPR-U	-
3927	IW27	-
3928	W14EXR-U11	IW16TT
3930	P16R	W20TT
3932	XU22EPR-U	XU22TT
3933	PQ20R	Q20TT
3935	IW01-27	-
3943	IU24	-
3949	IW01-32	-
3951	T20EPR-U15	-
3961	W24ESR	-
3964	K20TXR	K20TT
3965	DG-006	-
3967	K16TR11	K16TT
3969	ITF16TT	ITF16TT
3971	P16R	W20TT
3972	W24ESR-U	-
3974	IK27	-
3975	W20FP-U	WF20TT
3978	PK22PR-L11S	-
3979	IQ02-27	-
3981	IW27	-
3987	P16PR11	W16TT
3988	W27ESR-U	-
3992	W24ESR-V	-
3993	IW31	-
3997	W24ES-V	-
3998	W27ES-V	-
3999	ITF20TT	ITF20TT
4000	W14MR-U	-
4002	W20MR-U	-
4003	W22M-U	-
4004	W14MR-U	-
4006	W16EPR-U	W16TT
4008	W20EPR-U	W20TT
4010	W14F-U	-
4011	Y24FER-C	-
4012	W16EXR-U13	W16TT
4013	W9LMR-US	-
4014	PK20PR11	K20TT

Свечи зажигания и Свечи накаливания

Таблица взаимозаменяемости – Другие производители

NGK	DENSO	TT
4015	W27ESR-V	-
4016	IWF27	-
4024	W22ESR-U	-
4027	W24ESR-U	-
4028	W16EXR-U11	W16TT
4042	U20FSR-U	-
4043	KJ14CR-L11	-
4045	PQ20R	Q20TT
4046	Q20PR-U	Q20TT
4055	IW22	-
4073	K20R-U11	K20TT
4074	IW01-27	-
4075	IQ02-24	-
4076	IW01-32	-
4079	T20PR-U	ITF20TT
4080	VKB16	-
4085	IWF20	-
4090	DG-130	-
4091	IK22	IK22FTT
4095	VKJ20RZ-M11	-
4110	W14F-U	-
4111	W16FP-U	-
4114	W20MPR-U10	-
4115	PK20PR-L13	IK20TT
4118	DG-007	-
4119	DG-115	-
4120	Q16R-U11	Q16TT
4121	W22EBR	-
4122	W22FSR	-
4123	T16R-U	T16TT
4128	W20EXR-U11	W20TT
4129	W14E	-
4133	W14LM-U	-
4140	ITF24	-
4144	IK31	-
4150	IU01-31	-
4156	IUF27A	-
4174	PQ20R	Q20TT
4175	IT24	-
4177	T20EPR-U	T20TT
4179	XU24EPR-U	-
4180	PK22PR8	IK22TT
4182	DG-012	-
4187	DG-144	-
4193	IAE01-32	-
4200	W20FSR-U	WF20TT
4210	W16FS-U	-
4215	DG-012	-
4216	RU01-31	-
4218	IU24	-
4221	W27EBR	-
4224	W14EXR-U11	IW16TT
4226	W22M-U	-
4228	W20EXR-U11	W20TT
4233	W20TT	W20TT
4234	IWM31	-
4249	W16EXR-U13	W16TT
4254	IU01-31	-
4256	ITF20TT	ITF20TT
4259	IU22	-
4266	IK02-27	-
4268	W14EXR-U11	IW16TT
4275	DG-119	-
4279	DG-003	-
4282	IRL01-31	-
4286	IU24	-
4288	SXU22HDR8	IXUH22TT
4290	DG-004	-
4291	KJ20CR-L11	K20TT
4291	KJ20CR-U11	K20TT
4292	PK16PR-L11	IK16TT

NGK	DENSO	TT
4293	K20PR-U11	K20TT
4296	W20FR-L	WF20TT
4297	X27ETR	-
4300	KH16TT	KH16TT
4302	PK16TR11	K16TT
4305	DG-300	-
4305	DG-640	-
4309	DG-182	-
4311	IRE01-34	-
4315	DG-300	-
4315	DG-640	-
4318	IW27	-
4321	IRE01-27	-
4322	W24FSR	-
4323	T20R-U	-
4337	IW27	-
4339	XU24EPR-U	-
4341	PK16PR-L11	IK16TT
4342	IKH20TT	IKH20TT
4344	ITV16TT	ITV16TT
4345	W22MPR-U	-
4347	IXU24	-
4356	DG-001	-
4359	DG-116	-
4363	SKJ16CR-L11	IK16TT
4364	PK22PR8	IK22TT
4367	ITF22	-
4368	K20R-U11	K20TT
4370	IQ02-27	-
4371	PK22PR8	IK22TT
4374	IU24A	-
4377	PK20PR-P8	IK20TT
4379	IKH24	-
4386	T16PR-U11	ITF16TT
4388	K20TXR	K20TT
4389	DG-102	-
4392	T16EPR-U	T16TT
4409	DG-008	-
4415	XU22EPR-U	XU22TT
4421	IK16	IK16TT
4424	W16EPR-U11	W16TT
4425	IWF24	-
4429	U16FS-U	-
4430	X24GPR-U	-
4433	PK20TR11	K20TT
4435	K16GPR-U11	-
4450	IUH24	-
4452	W9LMR-US	-
4455	IU22	-
4457	IW01-31	-
4458	IKH20TT	IKH20TT
4461	W20FR-L	WF20TT
4467	DG-124	-
4469	IKH16	IKH16TT
4477	ZT20EPR11	IT20TT
4479	DG-123	-
4483	K20TXR	K20TT
4485	IQ22	-
4488	ITF20TT	ITF20TT
4492	IW01-24	-
4495	W24FPR-U10	-
4497	IQ20TT	IQ20TT
4499	IKH27	-
4509	U22ESR-N	-
4510	W20FSR-U	WF20TT
4511	W20FP-U	WF20TT
4517	IK02-31	-
4520	DG-121	-
4521	IRE01-27	-
4522	W27FSR	-
4525	IW24	-

NGK	DENSO	TT
4528	W27EBR	-
4533	IUF22	-
4536	W16PR-U	-
4542	VW20T	IW20TT
4546	IUH24	-
4547	IU31A	-
4548	U27ETR	-
4549	U22FS-U	-
4551	W27FSR	-
4553	W20FPR-U	WF20TT
4555	IWF20	-
4559	T16VR-U10	TV16TT
4562	W20MP-U	-
4563	K20PBR	K20TT
4577	W22S-U	-
4578	U22ESR-N	-
4579	VQ22	-
4581	ITF20TT	ITF20TT
4582	IRE01-27	-
4585	DG-001	-
4588	PQ16R	Q16TT
4589	SK20R11	IK20TT
4590	IQ02-31	-
4600	DG-145	-
4602	DG-202	-
4612	ITL20	-
4613	VXU22	IXU22TT
4614	IA01-32	-
4615	IK27	-
4617	DG-302	-
4617	DG-641	-
4618	W9LMR-US	-
4619	K20PR-U	K20TT
4620	PKJ16CR-L11	IK16TT
4623	X16FSR-U	-
4624	W16EPR-U11	W16TT
4626	W22MPR-U	-
4629	U22FS-U	-
4630	X27GPR-U	-
4632	W20FR-L	WF20TT
4635	WF20TT	WF20TT
4636	K16PR-U11	K16TT
4637	IQ02-31	-
4638	IW34	-
4639	PK20PR11	K20TT
4642	PK16PR-P11	K16TT
4645	DG-004	-
4651	PK20R11	K20TT
4652	MA9P-U	-
4654	IKH27	-
4656	IKH01-27	-
4657	IKH01-31	-
4658	IK01-27	-
4660	IK27	-
4663	IU22	-
4663	U22ESR-NB	-
4664	DG-502	-
4665	T20EPR-U	T20TT
4669	W16EPR-U	W16TT
4673	IKH20TT	IKH20TT
4675	IU27	-
4677	W27ESR-V	-
4684	W31ESR-U	-
4685	IK22	IK22FTT
4689	P22PR8	IK22FTT
4691	W16EX-U	W16TT
4694	DG-127	-
4695	U14FSR-UB	-
4696	IK16TT	IK16TT
4699	IK02-24	-
4704	K20HR-U11	KH20TT

NGK	DENSO	TT
4705	DG-117	-
4707	IK27C11	-
4708	IU24	-
4709	IK27C11	-
4712	U20FS-U	-
4717	IU27	-
4722	W16ESR-U	-
4725	IW27	-
4728	IW16	IW16TT
4730	X24GPR-U	-
4735	IXU01-27	-
4737	W22FSR	-
4741	IW01-27	-
4742	IXU24	-
4751	DG-004	-
4754	IA01-34	-
4759	SXU22PR9	IXU22TT
4762	T16PR-U	ITF16TT
4764	IRE01-27	-
4772	IX27	-
4775	KH16TT	KH16TT
4778	IUF31A	-
4783	Q16P-U11	Q16TT
4789	IK24	-
4791	DG-004	-
4793	PK20PR-P8	IK20TT
4795	XU22EPR-U	XU22TT
4818	DG-101	-
4823	X20FSR-U	-
4824	W20EPR-U11	W20TT
4830	X27GPR-U	-
4832	W31ESR-U	-
4836	IW24	-
4838	W24FPR-U10	-
4839	W24FPR-U10	-
4840	IK02-27	-
4842	DG-155	-
4848	IU24D	-
4853	PK22PR8	IK22TT
4854	U24ESR-N	-
4855	X24ESR-U	-
4856	K20PR-U	K20TT
4867	VK20Y	-
4870	K16TT	K16TT
4871	T20EPR-U15	-
4873	IX24B	-
4875	W16TT	W16TT
4876	K20PR-U	K20TT
4877	PK22PR8	IK22TT
4885	IK20TT	IK20TT
4888	VNH27Z	-
4889	IK24	-
4891	IK31	-
4892	IK01-24	-
4894	IK01-31	-
4895	IQ24	-
4896	IQ27	-
4897	IQ31	-
4898	IQ01-24	-
4899	IQ01-27	-
4900	IQ01-31	-
4901	IKH24	-
4902	DG-008	-
4904	SK20HR11	IKH20TT
4905	IKH01-24	-
4912	IXEH22TT	IXEH22TT
4915	W24FSR	-
4916	DG-009	-
4919	IQ20TT	IQ20TT
4921	W22MP-U	-
4922	W20ESR-U	-

Свечи зажигания и Свечи накаливания

Таблица взаимозаменяемости – Другие производители

NGK	DENSO	TT
4929	X24EPR-U9	-
4930	Q20R-U	Q20TT
4936	K16GPR-U11	-
4937	DG-198	-
4940	IU01-31	-
4948	IU24	-
4950	DG-001	-
4951	DG-127	-
4956	DG-012	-
4965	SK22PR-M11	IK22FTT
4966	DG-614	-
4968	T20TT	T20TT
4973	ITF20TT	ITF20TT
4975	Q16PR-U11	Q16TT
4983	XU22EPR-U	XU22TT
4984	P20PR11	W20TT
4985	IA01-32	-
4988	IQ31	-
4989	W27ESR-U	-
4994	DG-301	-
4996	SK16R11	IK16TT
4998	ITL16TT	ITL16TT
4999	IQ02-27	-
5	T16VR-U10	TV16TT
5000	DG-118	-
5005	DG-003	-
5006	U27ESR-N	-
5009	IRT01-31	-
5011	W14FPR-UL	-
5013	DG-173	-
5017	ITL16TT	ITL16TT
5018	KH16TT	KH16TT
5019	TV16TT	TV16TT
5024	W14FPR-UL	-
5030	Q22P-U	-
5039	W20EP-U	W20TT
5044	IW24	-
5045	DG-106	-
5055	PT16VR10	TV16TT
5058	IK27	-
5059	DG-129	-
5065	DG-109	-
5066	IU24	-
5068	VK24PRZ11	-
5084	QJ16CR11	Q16TT
5089	P20PR11	W20TT
5096	U22ES-N	-
5098	W14FPR-UL	-
5099	IRE01-27	-
5104	DG-101	-
5109	IK02-31	-
5110	W22FS-U	-
5111	W22FP-U	-
5116	DG-146	-
5118	FXE20HR11	IXEH20TT
5122	W22ESR-U	-
5123	X24FS-U	-
5126	W24FS-U10	-
5127	IW31	-
5129	X22EPR-U9	-
5135	K20PBR	K20TT
5136	W20TT	W20TT
5139	IX24	-
5141	T20TT	T20TT
5146	PT16EPR-L13	IT16TT
5148	DG-007	-
5149	IXUH22	IXUH22TT
5152	IU01-34	-
5153	IW01-27	-
5155	K16PR-U	K16TT
5156	W16EPB10	W16TT

NGK	DENSO	TT
5165	KJ16CR-L11	K16TT
5167	IQ02-31	-
5170	W24EPR-U	-
5171	DG-009	-
5175	VXU22	IXU22TT
5182	K16TT	K16TT
5186	IQ24	-
5188	K16PR-U11	K16TT
5196	IW01-27	-
5200	PKJ20CR8	IK20TT
5201	K22TNR-S	-
5207	DG-180	-
5216	K16TNR-S9	K16TT
5219	U24FER9	-
5221	W16EPR-U11	W16TT
5224	IW01-31	-
5238	IK27	-
5245	VKH22	-
5255	IRE01-27	-
5256	W20MPR-U10	-
5264	DG-104	-
5265	IK27	-
5266	SKJ20DR-M11S	-
5267	DG-001	-
5269	T16EPR-U	T16TT
5273	T20TT	T20TT
5275	PQ20R-P8	IQ20TT
5281	IXU01-31	-
5282	Q20PR-U11	Q20TT
5285	DG-171	-
5287	DG-301	-
5312	IQ22	-
5317	DG-006	-
5318	IXUH22	IXUH22TT
5327	IW22	-
5328	W20EKR-S11	IW20TT
5329	X27EPR-U9	-
5334	T20R-U	-
5339	W20EPR-U11	W20TT
5341	PK16PR11	K16TT
5343	W20FPR-U	WF20TT
5344	SK20PR-L9	IK20TT
5360	IQ01-24	-
5368	SK20PR-A11	IK20TT
5372	P22PR8	IK22FTT
5373	T16EPR-U	T16TT
5375	K20PR-U	K20TT
5376	DG-648	-
5377	PK16PR-L11	IK16TT
5389	IW01-31	-
5390	DG-161	-
5411	W9EX-U	-
5413	DG-006	-
5422	W24ESR-U	-
5423	X27ESR-U	-
5424	IK16	IK16TT
5428	W20EPR-S11	W20TT
5430	IQ24	-
5441	IQ24	-
5442	IW01-24	-
5444	ITL16TT	ITL16TT
5452	W24ESR-U	-
5454	U27FER9	-
5459	PK16PR11	K16TT
5461	K20PBR-S10	K20TT
5463	PK16PR11	K16TT
5464	IK16	IK16TT
5467	DG-245	-
5468	IKH20TT	IKH20TT
5469	X22ESR-U	-
5470	W16TT	W16TT

NGK	DENSO	TT
5472	VKH20Y	-
5476	ITV16TT	ITV16TT
5477	IXU24	-
5483	IRE01-27	-
5486	DG-626	-
5487	IQ27	-
5492	IXU27	-
5495	IRT01-34	-
5497	IU01-24	-
5501	IRE01-31	-
5508	IW16	IW16TT
5510	W24FSR	-
5513	DG-240	-
5516	IQ27	-
5521	W20ETR-L	IW20TT
5531	X20EPR-U9	-
5539	W24FR-L	-
5540	DG-122	-
5541	W22FPR-U	-
5542	PK20PR-L11	IK20TT
5545	IX27B	-
5547	VKB20	-
5548	VKA16	-
5553	K20PR-U11	K20TT
5554	IK27	-
5555	PK20PR-L11	IK20TT
5558	IQ31	-
5564	W16EXR-U13	W16TT
5565	IW22	-
5566	IU01-34	-
55664219	DG-621	-
5568	DG-119	-
5573	IW24	-
5576	IW27	-
5583	IW01-27	-
5584	KJ16CR-L11	K16TT
5585	KJ20CR-L11	K20TT
5586	KJ22CR-L11	-
5587	W22ESR-U	-
5588	IKH20TT	IKH20TT
5598	ZT20EPR11	IT20TT
5599	IT16TT	IT16TT
5600	U27ETR	-
5602	IU01-34	-
5605	DG-005	-
5606	Y24FER-C	-
5611	W14EXR-U11	IW16TT
5613	KH16TT	KH16TT
5618	DG-184	-
5623	W14EXR-U	IW16TT
5624	IWF22	-
5626	SF-51	-
5627	IW24	-
5631	IX27B	-
5637	W20EP-U	W20TT
5638	W16EPR-U11	W16TT
5639	W20FR-L	WF20TT
5642	DG-104	-
5643	K16PR-U11	K16TT
5647	IQ31	-
5648	VK20Y	-
5649	K20TXR	K20TT
5661	DG-190	-
5664	Q16TT	Q16TT
5665	DG-240	-
5666	U24FER9	-
5667	PK22PR11	IK22FTT
5673	IW24	-
5675	K16PR-U	K16TT
5685	W16ETR-S	W16TT
5687	IWF27	-

NGK	DENSO	TT
5688	IQ16TT	IQ16TT
5689	IQ20TT	IQ20TT
5690	IQ22	-
5691	IQ22	-
5692	XU24EPR-U	-
5693	IK16	IK16TT
5700	DG-102	-
5703	VKA20	-
5705	VKB20	-
5718	DG-003	-
5722	W27ESR-U	-
5724	K20PR-L11	K20TT
5728	W14MR-U	-
5730	W20EKR-S11	IW20TT
5738	IQ24	-
5740	DG-106	-
5742	K20PBR-S10	K20TT
5743	VW20	IW20TT
5744	IRL01-27	-
5751	W27EBR	-
5756	IXU27	-
5757	PK20PR-L11	IK20TT
5758	PKJ20CR8	IK20TT
5759	IK22	IK22FTT
5760	P16PR11	W16TT
5766	VUH27ES	-
5768	VK22	IK22FTT
5772	IK22	IK22FTT
5773	PK20PR-P8	IK20TT
5776	K16R-U11	K16TT
5784	W20EXR-U11	W20TT
5785	IW01-24	-
5787	SXU22HCR11S	-
5788	K20HR-U11	KH20TT
5789	T16TT	T16TT
5793	W27S-U	-
5798	W9LMR-US	-
5801	IU01-34	-
5809	ZT20EPR11	IT20TT
5810	W27FS-U	-
5811	W14EX-U	IW16TT
5813	IK02-31	-
5816	IQ34	-
5820	IK31	-
5823	W16EXR-U	W16TT
5824	IWF22	-
5827	IW27	-
5829	X24EP-U9	-
5831	IW34	-
5832	W20TT	W20TT
5835	IAE01-32	-
5836	KJ22CR-L11	-
5837	DG-159	-
5838	PK16PR-L11	IK16TT
5839	J16CR-U	W16TT
5843	VXUH22I	IXUH22TT
5847	XU22HDR9	XUH22TT
5849	DG-193	-
5851	IU24	-
5855	IQ22	-
5858	W16PR-U	-
5860	Q20PR-U	Q20TT
5861	RU01-27	-
5869	Y27FER-C	-
5874	PK20PR-L11	IK20TT
5879	IW01-34	-
5880	W31ESR-U	-
5881	K22TNR-S	-
5882	IU01-27	-
5885	T20TT	T20TT
5897	IU01-31	-

Свечи зажигания и Свечи накаливания

Таблица взаимозаменяемости – Другие производители

NGK	DENSO	TT
5901	IQ27	-
5906	DG-010	-
5909	DG-005	-
5913	KJ22CR-L8	-
5915	DG-004	-
5921	W20MR-U	-
5924	IWF24	-
5927	IW31	-
5928	W14MP-U10	-
5929	J16BR-U	-
5930	J16AR-U11	-
5932	W20EPBR-S	W20TT
5941	DG-122	-
5942	XE20HR-U9	IXEH20TT
5943	IU27	-
5944	IWF22	-
5947	IAE01-34	-
5948	ITV20TT	ITV20TT
5950	T20MP-U	-
5953	W20PR-U	-
5957	RU01-34	-
5958	IU20	-
5960	KJ20DR-M11	-
5961	W24S-U	-
5962	IW01-31	-
5965	VKA20	-
5968	DG-178	-
5974	IQ24	-
5979	DG-129	-
5981	W16PR-U	-
5982	IAE01-34	-
5986	DG-121	-
5987	IKH20TT	IKH20TT
5989	FXE20HR11	IXEH20TT
5990	VUH24ES	-
5992	VXUH22I	IXUH22TT
5996	DG-009	-
5998	IXU01-34	-
5999	DG-124	-
6001	DG-005	-
6002	K20TXR	K20TT
6003	DG-110	-
6010	W31FS	-
6012	IX22B	-
6026	W20MPR-U10	-
6028	W14MPR-U10	-
6029	J16AR-U11	-
6042	DG-116	-
6043	IXEH22TT	IXEH22TT
6044	IT16TT	IT16TT
6046	IXU22	IXU22TT
6074	DG-193	-
6078	T20EPR-U	T20TT
6092	DG-170	-
6097	K22PR-U	IK22FTT
6124	IWF27	-
6127	W22ESR-U	-
6129	Q20PR-U	Q20TT
6130	Q16PR-U	Q16TT
6140	DG-137	-
6148	VW20T	IW20TT
6154	W20FSR-U	WF20TT
6158	DG-101	-
6160	DG-300	-
6160	DG-640	-
6176	FK20HR11	IKH20TT
6193	X27ETR	-
6195	W16ETR-S	W16TT
6199	U24FSR-U	-
6207	IKH16TT	IKH16TT
6208	IUF24	-

NGK	DENSO	TT
6210	W16ES-U	-
6211	W16EXR-U	W16TT
6212	X16FSR-U	-
6214	DG-006	-
6216	IUH27	-
6217	IWF24	-
6221	T20M-U	-
6222	W16FPR-U	-
6223	W16EXR-U11	W16TT
6226	W24ES-U	-
6228	W14MP-U10	-
6229	J16AR-U11	-
6234	K16PR-U11	K16TT
6236	IK22	IK22FTT
6237	Q20P-U	Q20TT
6239	W31ESR-U	-
6240	IKH16TT	IKH16TT
6241	IWF22	-
6244	DG-143	-
6246	DG-116	-
6248	P20PR11	W20TT
6253	IRE01-27	-
6256	K22PR-L11	IK22FTT
6262	Q20R-U11	Q20TT
6263	U27ESR-N	-
6264	U31ESR-N	-
6265	IWF24	-
6267	IQ31	-
6281	DG-003	-
6283	IXEH22TT	IXEH22TT
6285	DG-012	-
6286	DG-194	-
6287	DG-194	-
6289	IU27D	-
6290	PQ20R	Q20TT
6298	DG-142	-
6305	DG-001	-
6313	K22PR-U11	IK22FTT
6314	PK20PR-P8	IK20TT
6321	W22M-U	-
6323	Q20TT	Q20TT
6324	IW16	IW16TT
6326	W20FP-U	WF20TT
6328	W14MPR-U10	-
6334	J16CR-U	W16TT
6338	Q22P-U	-
6341	IK16	IK16TT
6342	K16TNR-S9	K16TT
6343	K20TXR	K20TT
6344	PT16EPR-L13	IT16TT
6345	Q16PR-U	Q16TT
6346	DG-117	-
6350	W22FSR	-
6351	IW27	-
6354	IX24	-
6361	IX27	-
6368	IK16	IK16TT
6371	PK16PR11	K16TT
6372	W16PR-U	-
6376	K16HPR-U11	KH16TT
6378	IU24	-
6382	DG-142	-
6410	W16ES-U	-
6411	W16EXR-U11	W16TT
6416	DG-112	-
6418	IK20	IK20TT
6419	IUH27	-
6421	T22M-U	-
6422	W22FPR-U	-
6424	IW20	IW20TT
6426	DG-227	-

NGK	DENSO	TT
6427	W20EXR-U	W20TT
6429	J16BR-U	-
6431	SF-24	-
6434	IT27	-
6436	IXU27	-
6437	K20PBR-S10	K20TT
6441	IK20L	IK20TT
6448	IRE01-27	-
6449	K20PBR-S10	K20TT
6452	U16FS-UB	-
6457	RU01-34	-
6458	PK20PR-P8	IK20TT
6461	DG-117	-
6464	W20EPR-U	W20TT
6465	K20PR-U11	K20TT
6466	T20EP-U	T20TT
6481	VKH20Y	-
6482	IU31	-
6485	PK20GR8	-
6487	IU24	-
6488	T20EPR-U	T20TT
6500	U20FSR-U	-
6502	VK16PRZ11	IK16TT
6503	VKA16	-
6504	PK22PR8	IK22TT
6506	IKH16TT	IKH16TT
6507	VK20Y	-
6508	IU27	-
6509	ITV20TT	ITV20TT
6510	ITV22	-
6511	W16EPR-U	W16TT
6512	X20FS-U	-
6521	W22M-U	-
6523	W16ESR-U	-
6524	SK20PR-L9	IK20TT
6526	W9EXR-UCU	-
6535	U16FSR-UB	-
6537	VKA16	-
6546	IXU24	-
6548	U31ESR-N	-
6549	IW01-24	-
6557	DG-009	-
6564	IK24	-
6573	DG-005	-
6578	W14EXR-U	IW16TT
6584	VKB16	-
6585	T16VR-U10	TV16TT
6586	DG-137	-
6587	K24PR-U11	-
6588	VK27PRZ11	-
6592	DG-174	-
6597	IW16	IW16TT
6599	DG-012	-
6600	DG-184	-
6607	IU24	-
6615	W22ESR-U	-
6619	IKH20	IKH20TT
6629	X27EP-U9	-
6630	T16PR-U	ITF16TT
6634	IWF27	-
6635	K20TXR	K20TT
6637	IW20	IW20TT
6639	DG-132	-
6643	FXE20HR11	IXEH20TT
6644	PT16EPR-L13	IT16TT
6645	IKH20TT	IKH20TT
6649	DG-118	-
6650	IXU27	-
6651	XU22PR9	XU22TT
6659	W20PR-U	-
6664	IW22	-

NGK	DENSO	TT
6668	K20HR-U11	KH20TT
6669	W27ESR-V	-
6670	DG-178	-
6674	T16EPR-U15	T16TT
6677	K20HR-U11	KH20TT
6679	DG-112	-
6681	IX24	-
6684	IW24	-
6687	S22PR-A7	-
6689	U16FER9	-
6696	Q16PR-U11	Q16TT
6698	IW01-31	-
6703	W22MPR-U	-
6704	DG-101	-
6707	DG-130	-
6711	KJ20DR-M11	-
6714	K16PR-U	K16TT
6715	W24FSR	-
6717	K20PR-U	K20TT
6723	W20ESR-U	-
6724	W22ES-U	-
6726	W20MPR-U10	-
6727	W16ETR-S	W16TT
6737	VKA16	-
6741	SK20PR-A11	IK20TT
6742	IWF24	-
6748	SKJ20DR-M11	-
6764	W20TT	W20TT
6774	SKJ20DR-M13	-
6777	VUH27D	-
6792	DG-007	-
6799	XE20HR-U9	IXEH20TT
6801	IW31	-
6803	IK20G	-
6806	VXU22	IXU22TT
6810	W16ES-U	-
6814	IQ27	-
6821	U24FS-U	-
6824	IW24	-
6832	IW22	-
6836	DG-605	-
6837	T20EPR-U	T20TT
6838	K20TT	K20TT
6844	IQ24	-
6848	DG-106	-
6850	DG-101	-
6853	IW27	-
6868	IY27	-
6872	K20TXR	K20TT
6874	PK16TR13	IK16TT
6887	IW01-24	-
6891	IT20TT	IT20TT
6892	DG-005	-
6893	KJ16CR-U11	K16TT
6895	K20TNR	K20TT
6897	DG-145	-
6899	U20EPR9	-
6900	DG-104	-
6903	SK16PR-E11	IK16TT
6914	IU22	-
6928	W14EPR-U	IW16TT
6931	W20EKR-S11	IW20TT
6934	W22ES-U	-
6935	IW20	IW20TT
6943	DG-109	-
6945	T16PR-U11	ITF16TT
6950	T16PR-U11	ITF16TT
6951	IRE01-34	-
6953	K16PR-U11	K16TT
6955	U27ESR-NB	-
6962	K20PR-U	K20TT

Свечи зажигания и Свечи накаливания

Таблица взаимозаменяемости – Другие производители

NGK	DENSO	TT
6963	IK24C11	-
6965	U20ESR-N	-
6966	IUH27D	-
6968	IK24C11	-
6985	IU24A	-
6988	IK22	IK22FTT
6989	ZT20EPR11	IT20TT
6992	K20PBR-S10	K20TT
6993	K20TXR	K20TT
6994	SKJ20DR-M11	-
7001	IWF24	-
7003	IW16	IW16TT
7004	U22ETR	-
7021	W20MP-U	-
7022	W20FPR-U	WF20TT
7023	U20FSR-U	-
7026	IW20	IW20TT
7028	W20EKR-S11	IW20TT
7030	W20EKR-S11	IW20TT
7031	IW22	-
7035	IW27	-
7038	W14EXR-U	IW16TT
7043	RU01-34	-
7049	PK16PR11	K16TT
7050	IW01-34	-
7051	IW24	-
7052	T20R-U	-
7055	W16PR-U	-
7058	W27ES-V	-
7060	T20EPR-U	T20TT
7067	IWF22	-
7075	W16EPR-U	W16TT
7082	W16TT	W16TT
7084	W20TT	W20TT
7086	Q16TT	Q16TT
7088	Q20TT	Q20TT
7090	K16TT	K16TT
7092	K20TT	K20TT
7094	IQ20TT	IQ20TT
7098	IK16L	IK16TT
7100	IK20L	IK20TT
7102	IW16	IW16TT
7112	X24FS-U	-
7113	K16HPR-U11	KH16TT
7121	Q20PR-U11	Q20TT
7124	IW27	-
7148	W27ESR-U	-
7149	IW16	IW16TT
7162	X24ESR-U	-
7164	IT20TT	IT20TT
7168	XU24EPR-U	-
7177	ITF20TT	ITF20TT
7204	W24FSR-U10	-
7210	Q20P-U11	Q20TT
7214	IW16	IW16TT
7221	W22MP-U	-
7222	W14EPR-U	IW16TT
7223	U22FS-U	-
7226	W22EPR-U11	W22TT
7227	DG-234	-
7236	IUF24	-
7237	IX24	-
7239	W27EBR	-
7240	T20R-U	-
7243	IT20TT	IT20TT
7250	W22TT	W22TT
7252	KJ20CR-L11	K20TT
7254	IW27	-
7264	W20EPBR-S	W20TT
7265	W22EPR-U	W22TT
7270	W22TT	W22TT

NGK	DENSO	TT
7272	ITF20TT	ITF20TT
7273	VKA16	-
7274	IUF22	-
7280	T20EPR-U15	-
7281	W16EPR-U	W16TT
7300	IT16TT	IT16TT
7310	W20ES-U	-
7311	W16EPR-U11	W16TT
7316	IT16TT	IT16TT
7321	W22MP-U	-
7324	IW31	-
7327	W16EX-U	W16TT
7331	W20FP-U	WF20TT
7334	W20EPR-U11	W20TT
7335	IW31	-
7340	K20PR-U11	K20TT
7341	K22PR-U11	IK22FTT
7348	ITF20TT	ITF20TT
7352	W20TT	W20TT
7354	K22TNR-S	-
7359	IQ02-24	-
7361	IQ20TT	IQ20TT
7373	K20PR-U	K20TT
7378	PKJ16CR8	-
7382	IQ27	-
7383	IWF24	-
7385	IU22	-
7386	TR22-10	-
7390	K16R-U	K16TT
7397	IT20TT	IT20TT
7400	RU01-31	-
7401	ITF16TT	ITF16TT
7411	N24EXRB	-
7415	VXU24	-
7418	SK16PR-A11	IK16TT
7421	W20MR-U	-
7422	W16EPR-U	W16TT
7423	U24FSR-U	-
7426	W16FP-U	-
7429	W16FP-U	-
7434	W20EKR-S11	IW20TT
7435	IWF22	-
7437	IX24B	-
7443	W20MP-U	-
7444	X31ETR	-
7445	IQ16TT	IQ16TT
7447	SF-24	-
7449	W27EBR	-
7450	IW01-29	-
7451	IW01-24	-
7452	IXU01-31	-
7453	IW31	-
7455	IW01-27	-
7457	IWM01-31	-
7460	IW24	-
7461	IQ31	-
7464	DG-146	-
7466	IW24	-
7468	IWF22	-
7469	T16EPR-U15	T16TT
7471	U24ES-N	-
7472	W22MPR-U	-
7473	U24FE9	-
7474	W16FPR-U	-
7477	PK16R11	K16TT
7479	X27ETR	-
7480	W29EBR	-
7481	IXU01-34	-
7482	IW01-34	-
7483	IW01-29	-
7484	IX27	-

NGK	DENSO	TT
7485	IWM01-29	-
7487	IW22	-
7490	IW27	-
7492	DG-652	-
7493	DG-232	-
7496	Q16R-U	Q16TT
7497	W22M-U	-
7498	IW27	-
7499	U27ES-N	-
7502	U27FER9	-
7503	DG-007	-
7505	IKH20TT	IKH20TT
7509	S22PR-A7	-
7512	X20ES-U	-
7516	ITF20TT	ITF20TT
7524	IW16	IW16TT
7526	W27ES-U	-
7528	W14EXR-U11	IW16TT
7529	W20EP-U	W20TT
7532	W16EXR-U11	W16TT
7537	W16EXR-U	W16TT
7541	P16PR11	W16TT
7542	IW01-27	-
7544	IUF22	-
7545	DG-004	-
7546	U22ETR	-
7548	W27ESR	-
7549	T16TT	T16TT
7550	PKJ20CR8	IK20TT
7553	K16TNR-S9	K16TT
7556	VUH27ES	-
7559	ITF16TT	ITF16TT
7560	DG-177	-
7569	ZT20EPR11	IT20TT
7586	PT16VR13	TV16TT
7588	ITF20TT	ITF20TT
7598	IW27	-
7611	W20EX-U	W20TT
7612	W16LS	-
7613	W31ESR-U	-
7623	W14FPR-UL	-
7625	DG-236	-
7626	W9FP-UL	-
7632	W16EXR-U	W16TT
7634	W16EXR-U11	W16TT
7637	W24FSR-U10	-
7639	W20EP-U	W20TT
7641	IU01-31	-
7642	K16PR-U	K16TT
7648	DG-008	-
7654	IKH20TT	IKH20TT
7659	K20TNR-S9	K20TT
7669	IUF24	-
7677	W9LMR-US	-
7680	IW31	-
7681	IQ22	-
7682	IX22B	-
7684	IU24A	-
7697	W24FSR	-
7717	DG-109	-
7718	VXUH22I	IXUH22TT
7727	W20EX-U	W20TT
7732	W16EPR-U11	W16TT
7736	IQ01-31	-
7738	W22ETR-L	W22TT
7740	PT16EPR-L13	IT16TT
7742	VKA16	-
7743	SKJ16CR-L11	IK16TT
7746	SK22PR-M11S	-
7748	VKA16	-
7750	IUH24	-

NGK	DENSO	TT
7755	IK16	IK16TT
7756	IRE01-34	-
7763	IW01-27	-
7768	DG-190	-
7771	DG-702	-
7772	PK22PR-L11S	-
7773	ITF20TT	ITF20TT
7782	DG-649	-
7784	U24ESR-NB	-
7785	IU27A	-
7788	W27ESR	-
7789	IXU22	IXU22TT
7790	PKJ20CR-L11	IK20TT
7791	IU01-24	-
7792	IU01-27	-
7794	DG-140	-
7795	IXU27	-
7803	IX22B	-
7810	Q16R-U11	Q16TT
7811	W20EP-U	W20TT
7822	W20EPR-U	W20TT
7823	W14FPR-UL	-
7824	IW20	IW20TT
7825	DG-226	-
7829	W22FP-U	-
7834	W16EX-U	W16TT
7836	IWF22	-
7837	T20EPR-U	T20TT
7839	X22ESR-U	-
7840	U16FSR-U	-
7841	PK20PR11	K20TT
7852	W22FSR	-
7854	SK16PR-L11	IK16TT
7862	PT16EPR-L13	IT16TT
7865	DG-617	-
7866	SK16PR-A11	IK16TT
7870	IXU24	-
7873	K22PBR-S	IKB22TT
7880	DG-124	-
7892	K20TXR	K20TT
7901	VX22BC	-
7906	DG-001	-
7909	M24S	-
7910	W20ES-U	-
7912	X22ES-U	-
7913	VKH20Y	-
7917	KJ16CR-L11	K16TT
7925	DG-130	-
7926	W9FP-UL	-
7928	W31ESR-U	-
7937	W24FR-L	-
7938	K16PR-U	K16TT
7947	DG-012	-
7956	K20TXR	K20TT
7957	DG-181	-
7960	SXU22HCR11S	-
7963	PK22PR8	IK22TT
7967	IU20	-
7968	PKJ16CR-L11	IK16TT
7980	ZXU20PR11	-
7986	W24ESR-U	-
7992	DG-155	-
7994	SK16PR-A11	IK16TT
7995	DG-108	-
7998	K20PBR	K20TT
8013	IWF24	-
8027	IXU27	-
8196	IXU22	IXU22TT
8201	IY24	-
8643	DG-606	-
8659	VKH20Y	-

Свечи зажигания и Свечи накаливания

Таблица взаимозаменяемости – Другие производители

NGK	DENSO	TT
8838	DG-300	-
8838	DG-640	-
8851	DG-603	-
8888	DG-193	-
8894	KJ20CR-L11	K20TT
8902	DG-187	-
8904	DG-603	-
8926	DG-193	-
8939	DG-181	-
8944	DG-174	-
90002	DG-196	-
90007	DG-669	-
90066	DG-643	-
90083	ITV16TT	ITV16TT
90137	VFXEHC22G	-
90223	VXUH22I	IXUH22TT
9029	FXE20HR11	IXEH20TT
90448	T22EP-U	-
90779	IXUH22	IXUH22TT
90784	DG-171	-
90813	IT16TT	IT16TT
90828	DG-196	-
90852	K20TXR	K20TT
90860	DG-621	-
90888	K20PR-U11	K20TT
91015	KJ16CR-U11	K16TT
91064	IU24	-
91083	K20TXR	K20TT
91215	VFXEHC22G	-
91238	DG-655	-
91322	DG-180	-
9138	DG-118	-
91406	W20EPR-U	W20TT
91416	DG-661	-
91440	DG-610	-
91578	DXE22HOR-D11S	-
91584	DG-665	-
91597	K16PR-U11	K16TT
91617	DG-188	-
91648	DG-607	-
91648	DG-623	-
91691	FXE20HE11	IXEH20ETT
91722	K20PBR-S10	K20TT
91763	KJ16CR-U11	K16TT
91766	DG-126	-
91843	DG-602	-
9198	IU24D	-
92010	W20FPR-U	WF20TT
92083	DG-600	-
92283	DG-624	-
92340	DG-665	-
92402	VXU22	IXU22TT
92406	T20EPR-U	T20TT
92483	XU20HR9	XUH20TTi
92491	FK20HR11	IKH20TT
92610	K20TXR	K20TT
92703	DG-667	-
92734	K20HR-U11	KH20TT
92924	DXU22HCR-D11S	-
93026	VDCH22F	-
93030	XE20HR-U9	IXEH20TT
93034	DG-635	-
93053	IXUH22	IXUH22TT
93283	DG-630	-
9329	SKJ20DR-M11S	-
93293	DG-197	-
93298	IKH16TT	IKH16TT
93311	IXU27	-
93322	PK22PR8	IK22TT
93482	IXEH22TT	IXEH22TT
93707	DG-621	-

NGK	DENSO	TT
93759	IKH16TT	IKH16TT
93815	VXUH20I	-
93911	IXUH22	IXUH22TT
94001	KJ20DR-M11	-
94024	W20EPBR-S	W20TT
94037	XU22EPR-U	XU22TT
94040	VKH20Y	-
94067	K20PR-U	K20TT
94103	DG-609	-
94167	DK20PR-D13	-
94251	DG-608	-
94288	DG-671	-
94313	W20FPR-U	WF20TT
94460	IK24	-
94470	DG-671	-
94542	DG-186	-
9456	DG-121	-
94629	DG-195	-
94658	IT20TT	IT20TT
94716	VXUH22	IXUH22TT
94811	W20EPR-U	W20TT
94832	DG-130	-
95061	DG-188	-
95112	VXEHC24G	-
95173	DG-605	-
95232	DG-657	-
95264	IXUH20I	-
95369	ITV22	-
95397	VUH24ES	-
95420	T20TT	T20TT
95437	T16EPR-U	T16TT
95626	T20EPR-U	T20TT
95710	DXU22HCR-D11S	-
95737	W16EPR-U	W16TT
95770	VXUH22I	IXUH22TT
95820	VK22	IK22FTT
95836	DG-608	-
95843	IXEH20TT	IXEH20TT
95970	DG-176	-
96037	DG-130	-
96062	DG-619	-
96178	Q20PR-U	Q20TT
96187	DG-602	-
96209	SKJ20CR-A8	-
96289	DG-176	-
96404	W16EPR-U	W16TT
96463	T16VR-U10	TV16TT
96478	DG-604	-
96498	SKJ20CR-A8	-
96509	VFXEHC22G	-
96523	KJ16CR-U11	K16TT
96543	DG-667	-
96569	XUH20TTi	XUH20TTi
96614	DG-609	-
96621	ITV22	-
96628	K16PR-U	K16TT
96652	IY27	-
96723	K20PBR-S10	K20TT
96779	SK16HR11	IKH16TT
96853	DG-195	-
96870	ITV22	-
96987	ZXU20HCR8	-
97009	DG-626	-
97177	ITV20TT	ITV20TT
97195	Q16PR-U	Q16TT
97199	DG-610	-
9723	VXUH22I	IXUH22TT
97237	KJ20DR-M11	-
97256	DG-171	-
97374	K16HPR-U11	KH16TT
97387	PK20PR-P8	IK20TT

NGK	DENSO	TT
97416	W22EPR-U	W22TT
97472	XU22EPR-U	XU22TT
97719	DG-621	-
97725	W20EPBR-S	W20TT
97750	VXEHC24G	-
9776	DG-177	-
97786	PKJ16CR-L11	IK16TT
97930	DG-600	-
97999	IXUH22I	IXUH22TT
9835	DG-622	-
9864	DG-622	-
9883	DG-616	-
99404	SK20PR-A8	IK20TT
9957	DG-616	-
9970	DG-617	-
9974	DG-172	-
A5FS	MA16PR-U	-
A-6	M17	-
A6FS	MA20PR-U	-
A7	M22	-
A8	M24S	-
AB-6	MW17	-
AB-7	M22	-
AB-8	M24S	-
AP4FS	MA9P-U	-
AP5FS	MA16PR-U	-
AP6F	MA20P-U	-
AP6FS	MA20P-U	-
AP6FVG	MA20P-U	-
APR5FS	MA16PR-U	-
APR5FS11	MA16PR-U	-
APR5FS15	MA16PR-U	-
APR6F	MA20PR-U	-
APR6FS	MA20PR-U	-
AR5FS	MA16PR-U	-
AR6	L14-U	-
AR6FS	MA20PR-U	-
AR6FS11	MA20PR-U	-
B105EGP	IW01-32	-
B105EGV	IW01-32	-
B105EP	IW01-32	-
B10ECS	W31ESR-U	-
B10EG	IW31	-
B10EGP	IW01-31	-
B10EGV	IW31	-
B10EN	IW31	-
B10EP	IW31	-
B10ES	W31ESR-U	-
B10EV	IW31	-
B10EVX	IW31	-
B10H	W31FS	-
B10HS	W31FS	-
B10HVX	W31FS	-
B11EG	IW34	-
B11EGP	IW01-34	-
B11EGV	IW34	-
B11EN	IW34	-
B11EP	IW34	-
B2	W9-U	-
B210	W9-U	-
B2LM	W9LM-US	-
B2LMY	W9LM-US	-
B4	W14PR-U	-
B410	W14PR-U	-
B4ES	W14E	-
B4H	W14F-U	-
B4H10	W14F-U	-
B4HS	W14F-U	-
B4L	W14L	-
B4LM	W14LM-U	-
B4LMY	W14LM-U	-

NGK	DENSO	TT
B5EB	W16ES-U	-
B5EB11	W16EKR-S11	W16TT
B5ES	W16ES-U	-
B5ES11	W16ES-U	-
B5EV	IW16	IW16TT
B5HS	W16FS-U	-
B5HS15	W16FSR	-
B5S	W16S-U	-
B6EB	W20EKR-S11	IW20TT
B6EB11	W20EKR-S11	IW20TT
B6EBL11	W20EKR-S11	IW20TT
B6ECS	W20ESR-U	-
B6EFS	T20EP-U	T20TT
B6ES	W20ES-U	-
B6ES11	W20ES-U	-
B6EV	IW20	IW20TT
B6EVX	W20TT	W20TT
B6FS	T20R-U	-
B6HS	W20FP-U	WF20TT
B6HS-10	W20FP-U	WF20TT
B6HS-5	W20FSR-U	WF20TT
B6HSA	W20FR-L	WF20TT
B6HV	IWF22	-
B6HVX	IWF22	-
B6L	W16LS	-
B6LY	W16LS	-
B6S	W20S-U	-
B6Y	W20S-U	-
B77HC	W24FSR	-
B7EB	IW22	-
B7EB11	IW22	-
B7ECS	W22ESR-U	-
B7EG	IW24	-
B7EM	W22EBR	-
B7ES	W22ES-U	-
B7ES11	W22ESR-U	-
B7ET	W22EBR	-
B7EV	W22ES-U	-
B7EVX	W22ES-U	-
B7HCS	W22FS-U	-
B7HS	W22FS-U	-
B7HS10	W22FS-U	-
B7HV	IWF22	-
B7HVX	IWF22	-
B7S	W22S-U	-
B85EGP	IW01-24	-
B85EGV	IW27	-
B8ECS	W24ES-U	-
B8EFS	IT24	-
B8EG	W24ES-V	-
B8EGP	IW01-24	-
B8EGV	IW24	-
B8EM	IRE01-27	-
B8EMV	W27EBR	-
B8EN	IW24	-
B8EP	IW24	-
B8ES	W24ES-U	-
B8ES11	W24ES-U	-
B8ET	IRE01-27	-
B8EV	IW24	-
B8EVX	IW24	-
B8HCS	W24FS-U	-
B8HCS10	IWF24	-
B8HS	W24FS-U	-
B8HS10	W24FS-U10	-
B8HSA	W24FR-L	-
B8HV	IWF24	-
B8HVX	IWF24	-
B8S	W24S-U	-
B8X	L14-U	-
B95EG	IW29	-

Свечи зажигания и Свечи накаливания

Таблица взаимозаменяемости – Другие производители

NGK	DENSO	TT
BM7A	W22M-U	-
BM7F	T22M-U	-
BMR2A	W9LMR-US	-
BMR2A10	W9LMR-US	-
BMR4A	W14MR-U	-
BMR6A	W20MR-U	-
BMR6F	T20M-U	-
BMR7A	W22M-U	-
BP10EV	IW31	-
BP10EVX	IW31	-
BP2E	W9EX-U	-
BP2ES	W9EP	-
BP2HA	W9FP-UL	-
BP2HS	W9FP-UL	-
BP4	W14PR-U	-
BP4E	W14EX-U	IW16TT
BP4EA11	W14EXR-U11	IW16TT
BP4EFS	T16EPR-U	T16TT
BP4ES	W14EPR-U	IW16TT
BP4ES11	W14EXR-U11	IW16TT
BP4ES13	W14EXR-U11	IW16TT
BP4ESL11	W14EXR-U11	IW16TT
BP4EY	W14EX-U	IW16TT
BP4EY11	W14EXR-U11	IW16TT
BP4FS	T14PR-U	ITF16TT
BP4H	W14FP-U	-
BP4HA	W14FPR-UL	-
BP4HS	W14FPR-UL	-
BP4HS10	W14FPR-UL	-
BP4HSA	W14FPR-UL	-
BP5E	W16EP-U	W16TT
BP5EA	W14EX-U	IW16TT
BP5EA11	W14EXR-U11	IW16TT
BP5EA13	W14EXR-U11	IW16TT
BP5EAL	W16EX-U	W16TT
BP5EAL11	W16EXR-U11	W16TT
BP5EFS	T16EPR-U	T16TT
BP5EFS13	T16EPR-U15	T16TT
BP5EKA	W16ETR-S	W16TT
BP5EKN	W16ETR-S	W16TT
BP5EQ13	W16EPR-U11	W16TT
BP5ES	W16EP-U	W16TT
BP5ES11	W16EPR-U11	W16TT
BP5ES13	W16EXR-U13	W16TT
BP5ESA	W16EP-U	W16TT
BP5ESL	W16EP-U	W16TT
BP5ESZ	W16EX-U	W16TT
BP5ET	W16EPB10	W16TT
BP5ET10	W16EPB10	W16TT
BP5EV	IW16	IW16TT
BP5EVX	W16TT	W16TT
BP5EVX-11	W16TT	W16TT
BP5EY	W16EX-U	W16TT
BP5EY11	W16EXR-U11	W16TT
BP5EZ	W16EP-U	W16TT
BP5FS	T16PR-U	ITF16TT
BP5HA	W16FP-U	-
BP5HM	W16FPR-U	-
BP5HS	W16FP-U	-
BP5HS10	W16FP-U	-
BP5S	W16PR-U	-
BP6E	W20EP-U	W20TT
BP6EA	W20EX-U	W20TT
BP6EA11	W20EXR-U11	W20TT
BP6EF	T20EP-U	T20TT
BP6EF-13	T20EPR-U15	-
BP6EFS	T20EP-U	T20TT
BP6EFS13	T20EPR-U15	-
BP6EKA	IW20	IW20TT
BP6EQ13	W20EPR-U11	W20TT
BP6ES	W20EP-U	W20TT

NGK	DENSO	TT
BP6ES11	W20EPR-U11	W20TT
BP6ES13	W20EXR-U11	W20TT
BP6ESA	W20EP-U	W20TT
BP6ESZ	W20EP-U	W20TT
BP6ET	W20EPB	W20TT
BP6EV	IW20	IW20TT
BP6EVX	W20TT	W20TT
BP6EVX-11	W20TT	W20TT
BP6EY	W20EX-U	W20TT
BP6EY11	W20EXR-U11	W20TT
BP6EZ	W20EP-U	W20TT
BP6F	T20PR-U	ITF20TT
BP6F	T20PR-U11	ITF20TT
BP6FS	T20PR-U	ITF20TT
BP6FS	T20PR-U11	ITF20TT
BP6H	W20FP-U	WF20TT
BP6HK	W20FR-L	WF20TT
BP6HS	W20FP-U	WF20TT
BP6HS10	W20FP-U	WF20TT
BP6HSA	W20FR-L	WF20TT
BP6HV	IWF20	-
BP6HV-G	IWF20	-
BP6HVX	WF20TT	WF20TT
BP6S	W20PR-U	-
BP7E	W22EP-U	W22TT
BP7EFS	T22EP-U	-
BP7EVX	IT22	-
BP7EKN	W22ETR-L	W22TT
BP7EQ13	W22EPR-U11	W22TT
BP7ES	W22EP-U	W22TT
BP7ES11	W22EPR-U11	W22TT
BP7ET	W22EPB	W22TT
BP7EV	IW22	-
BP7EVX	W22TT	W22TT
BP7EVX11	W22TT	W22TT
BP7EY	W22EP-U	W22TT
BP7EY11	W22EPR-U11	W22TT
BP7FS	ITF22	-
BP7HS	W22FP-U	-
BP7HS10	W22FP-U	-
BP7HV	IWF22	-
BP7HVX	IWF22	-
BP8ES	W24EP-U	-
BP8ES11	W24EP-U	-
BP8EV	IW24	-
BP8EVX	IW24	-
BP8FS	ITF24	-
BP8HN10	W24FPR-U10	-
BP8HS	W24FP-U	-
BP8HS10	W24FPR-U10	-
BP8HSA	W24FR-L	-
BP8HSN10	W24FP-U	-
BP9ES	W27ES-U	-
BP9EV	IW27	-
BP9EVX	IW27	-
BP9HS	W27FS-U	-
BP9HVX	IWF27	-
BPM4A	W14MP-U10	-
BPM4A10	W14MP-U10	-
BPM6A	W20MP-U	-
BPM6A10	W20MPR-U10	-
BPM6F	T20MP-U	-
BPM6Y	W20MP-U	-
BPM7	W22MP-U	-
BPM7A	W22MP-U	-
BPM7F	T22MP-U	-
BPM7Y	W22MP-U	-
BPMR4A	W14MPR-U10	-
BPMR4A10	W14MPR-U10	-
BPMR6A	W20MPR-U10	-
BPMR6A10	W20MPR-U10	-

NGK	DENSO	TT
BPMR6F	T20MP-U	-
BPMR6Y	W20MPR-U10	-
BPMR7A	W22MPR-U	-
BPR10EV	IW31	-
BPR10EVX	IW31	-
BPR2E	W9EXR-UJU	-
BPR2ES	W9EXR-UJU	-
BPR2HS	W9FP-UL	-
BPR4E	W14EPR-U	IW16TT
BPR4ES	W14EPR-U	IW16TT
BPR4ES	W14EXR-U	IW16TT
BPR4ES11	W14EXR-U11	IW16TT
BPR4ES13	W14EXR-U11	IW16TT
BPR4ESL11	W14EXR-U11	IW16TT
BPR4EVX	W16TT	W16TT
BPR4EY	W14EXR-U	IW16TT
BPR4EY11	W14EXR-U11	IW16TT
BPR4EY13	W14EXR-U11	IW16TT
BPR4FS	T14PR-U	ITF16TT
BPR4FS11	T14PR-U	ITF16TT
BPR4FS15	T14PR-U	ITF16TT
BPR4FS20	T14PR-U	ITF16TT
BPR4H	W14FPR-UL	-
BPR4HS	W14FPR-UL	-
BPR4HS10	W14FPR-UL	-
BPR4HSA	W14FPR-UL	-
BPR4S	W14PR-U	-
BPR4S15	W14PR-U	-
BPR4S20	W14PR-U	-
BPR5E	W16EPR-U	W16TT
BPR5E11	W16EPR-U11	W16TT
BPR5EA	W14EXR-U	IW16TT
BPR5EA11	W14EXR-U11	IW16TT
BPR5EAL	W16EXR-U	W16TT
BPR5EAL11	W16EXR-U11	W16TT
BPR5EF	T16EPR-U	T16TT
BPR5EF-13	T16EPR-U15	T16TT
BPR5EFS	T16EPR-U	T16TT
BPR5EFS13	T16EPR-U15	T16TT
BPR5EFVX	T16TT	T16TT
BPR5EGP	W16TT	W16TT
BPR5EIX	IW16	IW16TT
BPR5EIX11	IW16	IW16TT
BPR5EIX11P	IW16TT	IW16TT
BPR5EIXP	IW16TT	IW16TT
BPR5EKA	W16ETR-S	W16TT
BPR5EKN	W16ETR-S	W16TT
BPR5EKU	W16ETR-S	W16TT
BPR5EP11	P16R	W20TT
BPR5EP-13	P16R13	W20TT
BPR5ES	W16EPR-U	W16TT
BPR5ES11	W16EXR-U11	W16TT
BPR5ES13	W16EXR-U13	W16TT
BPR5ES15	W16EPR-U11	W16TT
BPR5ESA	W16EXR-U	W16TT
BPR5ESL	W16EPR-U	W16TT
BPR5EV	IW16	IW16TT
BPR5EVX	W16TT	W16TT
BPR5EVX11	W16TT	W16TT
BPR5EY	W16EXR-U	W16TT
BPR5EY11	W16EXR-U11	W16TT
BPR5FS11	T16PR-U11	ITF16TT
BPR5FS15	T16PR-U11	ITF16TT
BPR5HM	W16FPR-U	-
BPR5HS	W16FPR-U	-
BPR5S	W16PR-U	-
BPR5S15	W16PR-U	-
BPR6E	W20EPR-U	W20TT
BPR6E11	W20EPR-U	W20TT
BPR6EF	T20EPR-U	T20TT

NGK	DENSO	TT
BPR6EF11	T20TT	T20TT
BPR6EF13	T20EPR-U15	-
BPR6EFIX-10	IT20TT	IT20TT
BPR6EFIX13P	IT20TT	IT20TT
BPR6EFIX15	IT20TT	IT20TT
BPR6EFS	T20EPR-U	T20TT
BPR6EFS13	T20EPR-U15	-
BPR6EFS15	T20EPR-U15	-
BPR6EGP	W20TT	W20TT
BPR6EIX	IW20	IW20TT
BPR6EIX11	IW20	IW20TT
BPR6EIX11P	VW20	IW20TT
BPR6EIX-LPG	IW20TT	IW20TT
BPR6EIXP	VW20	IW20TT
BPR6EKA	IW20	IW20TT
BPR6EKN	W20ETR-L	IW20TT
BPR6EP11	VW20	IW20TT
BPR6EP8	VW20T	IW20TT
BPR6ES	W20EPR-U	W20TT
BPR6ES11	W20EPR-U11	W20TT
BPR6ES13	W20EXR-U11	W20TT
BPR6ESN11	W20EPR-U11	W20TT
BPR6EV	IW20	IW20TT
BPR6EVX	W20TT	W20TT
BPR6EVX11	W20TT	W20TT
BPR6EY	W20EXR-U	W20TT
BPR6EY-11	W20EXR-U11	W20TT
BPR6EYZ	W20EXR-U	W20TT
BPR6EZ	W20EPR-U	W20TT
BPR6FS	T20PR-U	ITF20TT
BPR6FS11	T20PR-U11	ITF20TT
BPR6FS15	T20PR-U	ITF20TT
BPR6H	W20FPR-U	WF20TT
BPR6HGP	IWF16	-
BPR6HIX	IWF20	-
BPR6HS	W20FPR-U	WF20TT
BPR6HS10	W20FPR-U10	WF20TT
BPR6HSA	W20FR-L	WF20TT
BPR6HVX	WF20TT	WF20TT
BPR6S	W20PR-U	-
BPR7E	W22EPR-U	W22TT
BPR7EFS	IT22	-
BPR7EFS15	IT22	-
BPR7EIX	IW22	-
BPR7EKN	W22ETR-L	W22TT
BPR7ES	W22EPR-U	W22TT
BPR7ES11	W22EPR-U11	W22TT
BPR7EV	IW22	-
BPR7EVX	W22TT	W22TT
BPR7EVX11	W22TT	W22TT
BPR7EY	W22EPR-U	W22TT
BPR7EY11	W22EPR-U11	W22TT
BPR7HIX	IWF22	-
BPR7HS	W22FPR-U	-
BPR7HS10	W22FPR-U	-
BPR7HSA	W22FPR-U	-
BPR7HVX	IWF22	-
BPR8EIX	IW24	-
BPR8ES	W24EPR-U	-
BPR8EV	IW24	-
BPR8EVX	IW24	-
BPR8HIX	IWF24	-
BPR8HS	W24FPR	-
BPR8HS10	W24FPR-U10	-
BPR8HSA	W24FR-L	-
BPR9EIX	IW27	-
BPR9ES	W27ESR	-
BPR9EV	IW27	-
BPR9EVX	IW27	-
BPRGAS	VW20T	IW20TT
BPZ7HS10	W22FPR-U	-

Свечи зажигания и Свечи накаливания

Таблица взаимозаменяемости – Другие производители

NGK	DENSO	TT
BP28HN10	W24FPR-U10	-
BP28HS10	W24FPR-U10	-
BR10ECM	IWM31	-
BR10ECMIX	IWM31	-
BR10ECMVX	IWM31	-
BR10ECS	W31ESR-U	-
BR10EG	IW31	-
BR10EGV	IW31	-
BR10EIX	IW31	-
BR10ES	W31ESR-U	-
BR10ET	W29EBR	-
BR10EV	IW31	-
BR10EVX	IW31	-
BR10EYA	W31ESR-U	-
BR2LM	W9LMR-US	-
BR4ES	W14E	-
BR4HS	W14FR-U	-
BR4HSA	W14FR-L	-
BR4LM	W14LM-U	-
BR5EB	W16ESR-U	-
BR5EB11	W16ESR-U	-
BR5EF	T16EPR-U	T16TT
BR5ES	W16ESR-U	-
BR5ES11	W16ESR-U	-
BR5FS	T16R-U	T16TT
BR5FS15	T16R-U	T16TT
BR5HS	W16FSR	-
BR6EB	W20ESR-U	-
BR6EB11	W20EKR-S11	IW20TT
BR6EBL	W20EKR-S11	IW20TT
BR6EBL11	W20EKR-S11	IW20TT
BR6EF	T20EPR-U	T20TT
BR6EFS	T20EPR-U	T20TT
BR6ES	W20ESR-U	-
BR6ES11	W20ESR-U	-
BR6FS	T20R-U	-
BR6FS15	T20R-U	-
BR6HIX	IWF22	-
BR6HS	W20FSR-U	WF20TT
BR6HS10	W20FSR-U	WF20TT
BR6HSA	W20FR-L	WF20TT
BR6S	W20S-U	-
BR7EB	W22ESR-U	-
BR7EB11	W22ESR-U	-
BR7EF	T22EP-U	-
BR7EFS	T22EP-U	-
BR7EG	W22ESR-U	-
BR7EM	W22EBR	-
BR7ES	W22ESR-U	-
BR7ES11	W22ESR-U	-
BR7ET	W22EBR	-
BR7HIX	IWF22	-
BR7HS	W22FSR	-
BR7HS-10	W22FSR	-
BR8E1X	IW24	-
BR8ECM	IWM24	-
BR8ECMIX	IWM24	-
BR8ECS	W24ESR-U	-
BR8ECSIX	IW01-24	-
BR8EG	W24ESR-V	-
BR8EIX	IW24	-
BR8EM	W27EBR	-
BR8EQ	IRE01-27	-
BR8EQ14	IRE01-27	-
BR8ES	W24ESR	-
BR8ES11	W24ESR-U	-
BR8ET	W27EBR	-
BR8EV	IW24	-
BR8EVX	IW24	-
BR8HCS10	W24FSR-U10	-
BR8HIX	IWF24	-

NGK	DENSO	TT
BR8HS	W24FSR	-
BR8HS10	W24FSR-U10	-
BR8HSA	W24FR-L	-
BR8HV	IWF24	-
BR8HVX	IWF24	-
BR9E1X	IW27	-
BR9ECM	IWM27	-
BR9ECMIX	IWM27	-
BR9ECMVX	IWM27	-
BR9ECS	W27ESR-V	-
BR9ECS-5	W27ESR-V	-
BR9ECSIX	IW01-27	-
BR9ECSIX5	IW01-27	-
BR9EG	W27ESR-V	-
BR9EGN8	W27ESR-V	-
BR9EGV	IW27	-
BR9EIX	IW27	-
BR9EQ14	IRE01-27	-
BR9ES	W27ESR-U	-
BR9ET	W27EBR	-
BR9EV	IW27	-
BR9EVX	IW27	-
BR9EYA	W27ESR	-
BR9HIX	IWF27	-
BR9HS	W27FSR	-
BR9HS10	W27FSR	-
BR9HVX	IWF27	-
BRE527Y11	J16AR-U11	-
BRE529Y	J16AR-U11	-
BRE529Y11	J16BR-U	-
BU5EB11	W16EKR-S11	W16TT
BU6EA11	W20EPR-S11	W20TT
BU6EB11	W20EKR-S11	IW20TT
BU6EFSZ	T20EP-U	T20TT
BU7EA11	IW22	-
BU7EB11	IW22	-
BU8H	SF-24	-
BUH	SF-50	-
BUHW	SF-50	-
BUHW2	SF-51	-
BUHX	SF-50	-
BUR5EA11	W16EPR-U11	W16TT
BUR5EB11	W16EKR-S11	W16TT
BUR5ET	W20EPBR-S	W20TT
BUR5ET-10	W20EPBR-S	W20TT
BUR5ETB10	W20EPBR-S	W20TT
BUR6EA11	W20EPR-S11	W20TT
BUR6EB11	W20EKR-S11	IW20TT
BUR6EBVX11	W20TT	W20TT
BUR6EFSZ	T20EPR-U	T20TT
BUR6ET	W20EPBR-S	W20TT
BUR7EA11	IW22	-
BUR7EB11	IW22	-
BUR7EQ	IRE01-27	-
BUR7EQP	IRE01-27	-
BUR8EQ	IRE01-27	-
BUR8EQP	IRE01-27	-
BUR9EQ	IRE01-27	-
BUR9EQP	IRE01-27	-
BUZ8H	SF-24	-
BUZHW	SF-50	-
BUZHW2	SF-51	-
BZ7HS10	W22FSR	-
BZ8ES	W24ESR-U	-
BZ9EV	IW27	-
C10EH9	U31ESR-N	-
C10H	IUF31A	-
C4H	U14FSR-UB	-
C4HA	U14FSR-UB	-
C4HSA	U14FSR-UB	-
C4HSB	U14FSR-UB	-

NGK	DENSO	TT
C5HA	U16FS-U	-
C5HSA	U16FS-U	-
C5HSB	U16FS-UB	-
C6H	U20FS-U	-
C6HA	U20FS-U	-
C6HSA	U20FS-U	-
C7E	U22ES-N	-
C7EH9	U22FER9	-
C7HA	U22FS-U	-
C7HS	U22FS-U	-
C7HSA	U22FS-U	-
C7HV	IUF22	-
C7HVX	IUF22	-
C8E	U24ES-N	-
C8EH9	U24FE9	-
C8EHVX9	IUH24	-
C8EVX	IU24	-
C8HA	U24FS-U	-
C8HSA	U24FS-U	-
C8HV	IUF24	-
C8HVX	IUF24	-
C9E	U27ES-N	-
C9EH9	U27FER9	-
C9EHVX9	IUH27	-
C9EVX	IU27	-
C9H	IUF27A	-
CPR6EA9	U20EPR9	-
CPR6EA-9S	U20EPR9	-
CPR6EB9	IU20	-
CPR7EA-9	U22EPR9	-
CPR7EAIX-9	IU24D	-
CPR8E	N24EXRB	-
CPR8EA9	U24EPR9	-
CPR8EB9	IU24	-
CPR9EA9	U27ESR-N	-
CPR9EB9	IU27	-
CR10E	U31ESR-N	-
CR10EH9	U31ESR-N	-
CR10EIA9	IU31	-
CR10EIX	IU31	-
CR10EK	U31ETR	-
CR4HSB	U14FSR-UB	-
CR5EH9	U16FER9	-
CR5HS	U16FSR-U	-
CR5HSA	U16FSR-U	-
CR5HSB	U16FSR-UB	-
CR5HSB9	U16FSR-UB	-
CR6E	U20ESR-N	-
CR6EB	U20ESR-N	-
CR6EIA9	IU20	-
CR6HIX	IUF22	-
CR6HS	U20FSR-U	-
CR6HSA	U20FSR-U	-
CR6HSB	U20FSR-U	-
CR7E	U22ESR-N	-
CR7EB	IU22	-
CR7EB	U22ESR-NB	-
CR7EH9	U22FER9	-
CR7EIA9	IU22	-
CR7EIX	IU22	-
CR7EK	U22ETR	-
CR7EKA	U22ETR	-
CR7EKB	IU22	-
CR7EKC	U22ETR	-
CR7HIX	IUF22	-
CR7HS	U22FSR-U	-
CR7HSA	U22FSR-U	-
CR7HSA9	U22FSR-U	-
CR7HVX	IUF22	-
CR7RK	U22ETR	-
CR8E	U24ESR-N	-

NGK	DENSO	TT
CR8EB	U24ESR-NB	-
CR8EH9	U24FER9	-
CR8EH9S	IUH24	-
CR8EHIX9	IUH24	-
CR8EHV	IUH24	-
CR8EHVX9	IUH24	-
CR8EIA	IU24	-
CR8EIA10	IU24	-
CR8EIA-9	IU24	-
CR8EIB	IU24	-
CR8EIB10	IU24	-
CR8EIX	IU24	-
CR8EK	IU24ETR	-
CR8EKB	IU24A	-
CR8EKPA	IU24A	-
CR8EVX	IU24	-
CR8HIX	IUF24	-
CR8HS	U24FSR-U	-
CR8HSA	U24FSR-U	-
CR8HVX	IUF24	-
CR8RK	U24ETR	-
CR9E	U27ESR-N	-
CR9E9	U27ESR-N	-
CR9EB	U27ESR-NB	-
CR9EH9	U27FER9	-
CR9EH9S	IUH27	-
CR9EH9	IUH27	-
CR9EHIX9	IUH27	-
CR9EHV	IUH27	-
CR9EHVX9	IUH27	-
CR9EIA9	IU27D	-
CR9EIX	IU27	-
CR9EIX9	IU27	-
CR9EK	U27ETR	-
CR9EKB	IU27A	-
CR9EKPA	IU27A	-
CR9EVX	IU27	-
CR9HIX	IUF27A	-
CS1	W9LM-US	-
CS2	W20MR-U	-
CS3	W20S-U	-
CS4	W14LM-U	-
CY03	DG-300	-
CY03	DG-640	-
CY51	DG-644	-
CY52	DG-642	-
CY55	DG-643	-
CY57	DG-301	-
CY58	DG-626	-
CZ105	DG-669	-
CZ106	DG-616	-
CZ113	DG-667	-
CZ163	DG-667	-
CZ201	DG-655	-
CZ203	DG-657	-
CZ251	DG-655	-
CZ256	DG-643	-
CZ258	DG-605	-
CZ261	DG-626	-
CZ303	DG-617	-
CZ304	DG-622	-
CZ501	DG-665	-
CZ551	DG-665	-
CZ71	DG-605	-
D10E	X31ES-U	-
D10EA	X31ESR-U	-
D10EV	IU01-31	-
D5HS	X16FSR-U	-
D6EA	X20ES-U	-
D6ES	X20ESR-U	-
D6HA	X20FS-U	-

Свечи зажигания и Свечи накаливания

Таблица взаимозаменяемости – Другие производители

NGK	DENSO	TT
D6HS	X20FSR-U	-
D7EA	X22ES-U	-
D7EV	IX22	-
D7EVX	IX22	-
D8EA	X24ES-U	-
D8ES	X27ESR-U	-
D8ESL	X24ESR-U	-
D8EV	IX24	-
D8EVX	IX24	-
D8HA	X24FS-U	-
D8HS	X24FS-U	-
D9EA	X27ES-U	-
D9ES	X27ESR-U	-
D9EV	IX27	-
D9EVX	IX27	-
DCP6E	XU20EPR-U	-
DCP7E	XU22EPR-U	XU22TT
DCP7EVX	XU22TT	XU22TT
DCP8E	XU24EPR-U	-
DCP8EVX	IXU24	-
DCPR6E	XU20EPR-U	-
DCPR6EIX	IXU22	IXU22TT
DCPR6ES	XU20EPR-U	-
DCPR7E	XU22EPR-U	XU22TT
DCPR7EA9	XU22PR9	XU22TT
DCPR7EGP	XU22TT	XU22TT
DCPR7EIX	IXU22	IXU22TT
DCPR7EIXP	VXU22	IXU22TT
DCPR7EN	XU22EPR-U	XU22TT
DCPR7E-N-10	XU22EPR-U	XU22TT
DCPR7ES	XU22EPR-U	XU22TT
DCPR7EVX	XU22TT	XU22TT
DCPR8E	XU24EPR-U	-
DCPR8EA9	XU24EPR-U	-
DCPR8EIX	IXU24	-
DCPR8EKC	XU24EPR-U	-
DCPR8EKP	VXU24	-
DCPR8EN	XU24EPR-U	-
DCPR8EVX	IXU24	-
DCPR9E	XU27EPR-U	-
DCPR9EIX	IXU27	-
DCPR9EVX	IXU27	-
DCR7EIX	IXU22	IXU22TT
DCR8EIX	IXU24	-
DCR9EIX	IXU27	-
DF5A11A	IK16TT	IK16TT
DF6H11A	FXE20HE11	IXEH20ETT
DF6H-11B	FXE20HR11	IXEH20TT
DF7H-11B	IXEH22TT	IXEH22TT
DF8H-11B	FXE24HR11	-
DFH6B-11A	FK20HBR11	IKBH20TT
DIFR5C11	IK16TT	IK16TT
DIFR6A13G	DK20PR-D13	-
DIFR6C11	VFK20F	IK20TT
DIFR6D13	DK20PR-D13	-
DILFR5A11	IKH16TT	IKH16TT
DILFR5A11D	IKH16TT	IKH16TT
DILFR5E-11	IKH16TT	IKH16TT
DILFR6A11	FK20HR11	IKH20TT
DILFR6D11	FK20HR11	IKH20TT
DILFR6F11G	FK20HR11	IKH20TT
DILFR6J11	FK20HR11	IKH20TT
DILFR7K9G	VDKH22F	-
DILKAR6A11	FXE20HR11	IXEH20TT
DILKAR7B11	IXEH22TT	IXEH22TT
DILKAR7C9H	VFXEHC22G	-
DILKAR7E9HS	VFXEHC22G	-
DILKAR7F8	IXEH22TT	IXEH22TT
DILKAR7G11GS	DXE22HOR-D11S	-
DILKAR8A8	VDCH22F	-
DILKAR8J9G	VDCH22F	-

NGK	DENSO	TT
DILKR6D11G	IXUH20I	-
DILZKAR6A11	FXE20HE11	IXEH20ETT
DILZKAR7C11S	VFXEHC22G	-
DILZKR7A11G	DXU22HCR-D11S	-
DILZKR7A11GS	DXU22HCR-D11S	-
DILZKR7B11	VFXUHC22FG	-
DILZKR7B11G	VFXUHC22FG	-
DILZKR7B11GS	DXU22HCR-D11S	-
DIMR8A10	IU24	-
DP 68	DG-657	-
DP1	DG-001	-
DP10	DG-003	-
DP11	DG-117	-
DP12	DG-112	-
DP13	DG-174	-
DP14	DG-118	-
DP15	DG-006	-
DP16	DG-106	-
DP17	DG-101	-
DP18	DG-005	-
DP19	DG-009	-
DP2	DG-012	-
DP20	DG-109	-
DP21	DG-301	-
DP22	DG-101	-
DP23	DG-004	-
DP24	DG-116	-
DP25	DG-012	-
DP26	DG-127	-
DP27	DG-121	-
DP28	DG-124	-
DP29	DG-102	-
DP3	DG-004	-
DP30	DG-119	-
DP31	DG-144	-
DP32	DG-145	-
DP33	DG-004	-
DP34	DG-115	-
DP35	DG-130	-
DP36	DG-122	-
DP37	DG-142	-
DP38	DG-155	-
DP39	DG-146	-
DP4	DG-005	-
DP40	DG-113	-
DP41	DG-110	-
DP42	DG-302	-
DP42	DG-641	-
DP43	DG-129	-
DP44	DG-245	-
DP45	DG-240	-
DP46	DG-184	-
DP47	DG-178	-
DP48	DG-190	-
DP49	DG-193	-
DP5	DG-007	-
DP50	DG-177	-
DP51	DG-194	-
DP53	DG-616	-
DP54	DG-617	-
DP55	DG-622	-
DP56	DG-181	-
DP57	DG-193	-
DP59	DG-187	-
DP5EA9	X16EPR-U9	-
DP6	DG-010	-
DP60	DG-300	-
DP60	DG-640	-
DP61	DG-197	-
DP62	DG-171	-
DP63	DG-671	-

NGK	DENSO	TT
DP64	DG-195	-
DP65	DG-600	-
DP66	DG-126	-
DP6EA9	X20EPR-U9	-
DP7	DG-008	-
DP70	DG-196	-
DP71	DG-176	-
DP72	DG-621	-
DP73	DG-180	-
DP74	DG-610	-
DP76	DG-655	-
DP77	DG-609	-
DP7EV9	IX22B	-
DP8	DG-300	-
DP8	DG-640	-
DP81	DG-188	-
DP82	DG-667	-
DP85	DG-665	-
DP8EA9	X24EP-U9	-
DP8EV9	IX24B	-
DP8EVX9	IX24B	-
DP8Z	X24GPR-U	-
DP9	DG-003	-
DP9EA9	X27EP-U9	-
DP9EV9	IX27B	-
DP9EVX9	IX27B	-
DP9Z	X27GPR-U	-
D-Power 1	DG-001	-
D-Power 9	DG-003	-
D-Power 10	DG-003	-
D-Power 11	DG-117	-
D-Power 12	DG-112	-
D-Power 13	DG-174	-
D-Power 14	DG-118	-
D-Power 15	DG-006	-
D-Power 16	DG-106	-
D-Power 17	DG-101	-
D-Power 18	DG-005	-
D-Power 19	DG-009	-
D-Power 2	DG-012	-
D-Power 20	DG-109	-
D-Power 21	DG-301	-
D-Power 22	DG-101	-
D-Power 23	DG-004	-
D-Power 24	DG-116	-
D-Power 25	DG-012	-
D-Power 26	DG-127	-
D-Power 27	DG-121	-
D-Power 28	DG-124	-
D-Power 29	DG-102	-
D-Power 3	DG-004	-
D-Power 30	DG-119	-
D-Power 31	DG-144	-
D-Power 32	DG-145	-
D-Power 33	DG-004	-
D-Power 34	DG-115	-
D-Power 35	DG-130	-
D-Power 36	DG-122	-
D-Power 37	DG-142	-
D-Power 38	DG-155	-
D-Power 39	DG-146	-
D-Power 4	DG-005	-
D-Power 40	DG-113	-
D-Power 41	DG-110	-
D-Power 42	DG-302	-
D-Power 42	DG-641	-
D-Power 43	DG-129	-
D-Power 44	DG-245	-
D-Power 45	DG-240	-
D-Power 46	DG-184	-
D-Power 47	DG-178	-

NGK	DENSO	TT
D-Power 48	DG-190	-
D-Power 49	DG-193	-
D-Power 5	DG-007	-
D-Power 50	DG-177	-
D-Power 51	DG-194	-
D-Power 53	DG-616	-
D-Power 54	DG-617	-
D-Power 55	DG-622	-
D-Power 56	DG-181	-
D-Power 57	DG-193	-
D-Power 59	DG-187	-
D-Power 6	DG-010	-
D-Power 60	DG-300	-
D-Power 60	DG-640	-
D-Power 61	DG-197	-
D-Power 62	DG-171	-
D-Power 63	DG-671	-
D-Power 64	DG-195	-
D-Power 65	DG-600	-
D-Power 66	DG-126	-
D-Power 68	DG-657	-
D-Power 69	DG-630	-
D-Power 7	DG-008	-
D-Power 70	DG-196	-
D-Power 71	DG-176	-
D-Power 72	DG-621	-
D-Power 73	DG-180	-
D-Power 74	DG-610	-
D-Power 76	DG-655	-
D-Power 77	DG-609	-
D-Power 8	DG-300	-
D-Power 8	DG-640	-
D-Power 81	DG-188	-
D-Power 82	DG-667	-
D-Power 85	DG-665	-
DPR5EA9	X16EPR-U9	-
DPR6EA9	X20EPR-U9	-
DPR6EB9	IX22B	-
DPR7EA9	X22EPR-U9	-
DPR7EIX9	IX22B	-
DPR7EV9	IX22B	-
DPR7EVX9	IX22B	-
DPR8EA-9	X24EPR-U9	-
DPR8EIX-9	IX24B	-
DPR8EV9	IX24B	-
DPR8EVX9	IX24B	-
DPR8Z	X24GPR-U	-
DPR8ZIX	IXG24	-
DPR9EA9	X27EPR-U9	-
DPR9EIX9	IX27B	-
DPR9EV9	IX27B	-
DPR9EVX9	IX27B	-
DPR9Z	X27GPR-U	-
DR4HS	X16FSR-U	-
DR5HS	X16FSR-U	-
DR6EA	X20ESR-U	-
DR6HS	X20FSR-U	-
DR7EA	X22ESR-U	-
DR7EB	X22ESR-U	-
DR7ES	X22ESR-U	-
DR8EA	X24ESR-U	-
DR8EB	X24ESR-U	-
DR8EIX	IX24	-
DR8ES	X27ESR-U	-
DR8ESL	X24ESR-U	-
DR8EVX	IX24	-
DR8HS	X24FS-U	-
DR9EA	X27ESR-U	-
DR9EIX	IX27	-
DR9ES	X27ESR-U	-
DR9EVX	IX27	-

Свечи зажигания и Свечи накаливания

Таблица взаимозаменяемости – Другие производители

NGK	DENSO	TT
ER10EH	Y31FER-C	-
ER8EH	Y24FER-C	-
ER8EHIХ	IY24	-
ER8EHN	Y24FER-C	-
ER9EH	Y27FER-C	-
ER9EH-6N	Y27FER-C	-
ER9EHIХ	IY27	-
FR4	K16PR-U	K16TT
FR45	K16PR-U11	K16TT
FR4BP11	IK16	IK16TT
FR5	K20PR-U	K20TT
FR51	KJ20CR-L11	K20TT
FR5-1	KJ20CR-L11	K20TT
FR5AP-10	PK16PR11	K16TT
FR5AP-11	PK16PR11	K16TT
FR5BP11	IK16	IK16TT
FR5CP	IK16	IK16TT
FR5EI	K16PSR-B8	IK16TT
FR5FI	K16PSR-B8	IK16TT
FR6BP11	IK20	IK20TT
FR6EI	K20PSR-B8	IK20TT
FR7AID	IK22	IK22FTT
FR7AP10	IK22	IK22FTT
FR7B11	IK22	IK22FTT
FR8B11	IK24C11	-
FR9B11	IK27C11	-
GR4	W14EXR-U	IW16TT
GR45	W14EXR-U11	IW16TT
GR4IX	IW16	IW16TT
GR5	W16EXR-U	W16TT
GR55	W16EXR-U13	W16TT
GR5A10	IW16	IW16TT
GR5IX	IW16	IW16TT
GR5VX	W16TT	W16TT
GR6A10	IW20	IW20TT
GR8DI-8	IW24	-
GR9DI-8	IW27	-
HAMPFR5C11G	IK16	IK16TT
HAMPFR6C11G	IK20	IK20TT
HAMPFR6DI11G	IQ20TT	IQ20TT
HAMPZFR5F11G	IK16	IK16TT
HAMPZFR6F11G	IK20	IK20TT
HAMPZFR6K11G	IK20	IK20TT
HB6AIX-11P	VKA20	-
HB6BIX-11P	VKB20	-
IFR5A11	SK16R11	IK16TT
IFR5A8N	SK16R-P8	IK16TT
IFR5D10	IK16TT	IK16TT
IFR5E11	SK16PR-A11	IK16TT
IFR5E13	SK16PR-E11	IK16TT
IFR5G11	SK16PR-L11	IK16TT
IFR5G11K	SK16PR-L11	IK16TT
IFR5J11	SK16PR-A11	IK16TT
IFR5L11	VK16PRZ11	IK16TT
IFR5N10	SK16PR-A11	IK16TT
IFR5T11	SK16R11	IK16TT
IFR5T8N	SK16R-P8	IK16TT
IFR6A11	SK20R11	IK20TT
IFR6A11T	SK20BR11	-
IFR6B	VK20Y	-
IFR6B11	SK20PR-A11	IK20TT
IFR6BK	VK20Y	-
IFR6C	SK20PR-L9	IK20TT
IFR6CS	VK20G	-
IFR6D10	SK20PR-L9	IK20TT
IFR6E11	SK20PR-A11	IK20TT
IFR6G11K	SK20PR-L11	IK20TT
IFR6J11	IK20TT	IK20TT
IFR6L11	VK20PRZ11	-
IFR6Q-G	VK20Y	-
IFR6QS	VK20G	-

NGK	DENSO	TT
IFR6S	SK20PR-A8	IK20TT
IFR6T11	SK20R11	IK20TT
IFR6W-7G	VK20Y	-
IFR6Z7G	VK20Y	-
IFR7F6D	IK22	IK22FTT
IFR7F8D	VK22	IK22FTT
IFR7F8J	VK22	IK22FTT
IFR7FD	VK22	IK22FTT
IFR7FJ8	IK22	IK22FTT
IFR7G-11K	SK22PR-M11	IK22FTT
IFR7G-11KS	SK22PR-M11S	-
IFR7L11	VK22PRZ11	IK22FTT
IFR7U	VK22	IK22FTT
IFR7X8G	VK22	IK22FTT
IFR8H11	VK24PRZ11	-
IFR8L11	VK24PRZ11	-
IFR9H11	VK27PRZ11	-
IFR9L11	VK27PRZ11	-
IGR5B10D	IW16TT	IW16TT
IGR6A	VW20T	IW20TT
IGR6A-11	VW20	IW20TT
IGR6B-10D	VW20T	IW20TT
IGR7A	S22PR-A7	-
IGR7A-G	S22PR-A7	-
IGR7B-10D	S22PR-A7	-
IJR7A	VX22BC	-
IJR7A9	VX22BC	-
IJR8B9	IX24B	-
IKR6G11	ZXU20PR11	-
IKR7A	VXU22	IXU22TT
IKR7B	VXU22	IXU22TT
IKR7C	SXU22PR9	IXU22TT
IKR7D	SXU22PR9	IXU22TT
IKR7E9	VXU22	IXU22TT
IKR9F8	IXU27	-
IKR9J8	IXU27	-
ILFR5B11	IKH16TT	IKH16TT
ILFR5C11	SK16HR11	IKH16TT
ILFR5-T11	SK16HR11	IKH16TT
ILFR6A	IKH20TT	IKH20TT
ILFR6B	VKH20Y	-
ILFR6C11	SK20HR11	IKH20TT
ILFR6D11	FK20HR11	IKH20TT
ILFR6G	IKH20TT	IKH20TT
ILFR6J-11K	IKH20TT	IKH20TT
ILFR6K-8	VKH20Y	-
ILFR6T-11	SK20HR11	IKH20TT
ILFR7B-8	VKH22	-
ILFR7FD	VKH22	-
ILFR7H	VKH22	-
ILKAR6C-10	IXEH20TT	IXEH20TT
ILKAR6F11	VXUH20I	-
ILKAR7B11	IXEH22TT	IXEH22TT
ILKAR7K11S	DXE22HQR-D11S	-
ILKAR7L11	IXEH22TT	IXEH22TT
ILKR6F11	VXUH20I	-
ILKR7B-8	SXU22HDR8	IXUH22TT
ILKR7C-9	VXUH22I	IXUH22TT
ILKR7D-9	VXUH22I	IXUH22TT
ILKR7E-6	IXUH22	IXUH22TT
ILKR7K8	IXUH22	IXUH22TT
ILKR8E6	GX8-1	-
ILTR5A-13G	ITV16TT	ITV16TT
ILTR5B11	ITL16TT	ITL16TT
ILTR5C11	ITL16TT	ITL16TT
ILTR5D	ITV16TT	ITV16TT
ILTR5E11	ITV16TT	ITV16TT
ILTR6A-13G	ITV20TT	ITV20TT
ILTR6A-8G	ITV22	-
ILTR6B11	ITL20	-
ILTR6G8G	ITV22	-

NGK	DENSO	TT
ILTR6H8G	ITV22	-
ILZFR5B	IKH16TT	IKH16TT
ILZFR6C-11K	IKH20TT	IKH20TT
ILZFR6CK	IKH20TT	IKH20TT
ILZFR6D11	IKH20TT	IKH20TT
ILZKAR7A	IXEH22TT	IXEH22TT
ILZKAR7A10	IXEH22TT	IXEH22TT
ILZKAR7B11	IXEH22TT	IXEH22TT
ILZKAR7E11S	VFXEHC22G	-
ILZKAR8F8S	VXEHC24G	-
ILZKAR8H8S	VXEHC24G	-
ILZKBR7A8G	VXUH22I	IXUH22TT
ILZKBR7B8DG	VXUH22I	IXUH22TT
ILZKR6F11	VXUH20I	-
ILZKR7A	VXUHC22G	-
ILZKR7B11	VXUH22I	IXUH22TT
ILZKR7B11GS	SXU22HCR11S	-
ILZKR7B-11S	SXU22HCR11S	-
ILZKR7D8	VXUHC22G	-
IMR8A-9H	IUH24D	-
IMR8B-9H	VNH24Z	-
IMR8C-9H	VUH24D	-
IMR8C-9HES	VUH24ES	-
IMR8E-9HES	VUH24ES	-
IMR9A-9H	IUH27D	-
IMR9B-9H	VNH27Z	-
IMR9C-9H	VUH27D	-
IMR9C-9HE	VUH27D	-
IMR9C-9HES	VUH27ES	-
IMR9E-9HES	VUH27ES	-
IRIMAC8	IXU24	-
IRIMAC9	IXU27	-
IRITOP 7	IQ22	-
IRITOP 8	IQ24	-
IRITOP 9	IQ27	-
IRIWAY 7	IK22	IK22FTT
IRIWAY 8	IK24	-
IRIWAY 9	IK27	-
ITR4A15	IT16TT	IT16TT
ITR5F13	IT16TT	IT16TT
ITR6F13	ZT20EPR11	IT20TT
IZFR5B	VKB16	-
IZFR5C	VKA16	-
IZFR5F11	SKJ16CR-L11	IK16TT
IZFR5K11	SKJ16DR-M11	-
IZFR5L11	SKJ16CR-L11	IK16TT
IZFR6B	VKB20	-
IZFR6F11	VKJ20RZ-M11	-
IZFR6H11	IK20TT	IK20TT
IZFR6K11	SKJ20DR-M11	-
IZFR6K11E	SKJ20DR-M11	-
IZFR6K11NS	SKJ20DR-M11S	-
IZFR6K-11S	SKJ20DR-M11S	-
IZFR6K13	SKJ20DR-M13	-
IZKR6B-10E	IXU22	IXU22TT
IZKR7A	IXU22	IXU22TT
J10A	X31ETR	-
J10B	X31ETR	-
J9A	X27ETR	-
J9B	X27ETR	-
JR10A	X31ETR	-
JR10B	X31ETR	-
JR10C	X31ETR	-
JR8B	IX24	-
JR8C	IX24	-
JR9A	X27ETR	-
JR9B	X27ETR	-
JR9C	X27ETR	-
KR6A10	XU20EPR-U	-
KR7AI	IXU22	IXU22TT
KR8AI	IXU24	-

NGK	DENSO	TT
KR8BI	IXU24	-
KR8DI	IXU24	-
KR9CI	IXU27	-
L8A	U24FSR-U	-
LFR4AP-11	KH16TT	KH16TT
LFR5A-11	K16HPR-U11	KH16TT
LFR5AGP	KH16TT	KH16TT
LFR5AIX-11	IKH16	IKH16TT
LFR5AIX-11P	IKH16TT	IKH16TT
LFR5AP-11	KH16TT	KH16TT
LFR5AQP	IKH16TT	IKH16TT
LFR5B	K16HPR-U11	KH16TT
LFR5BP-11	KH16TT	KH16TT
LFR5E-11	K16HR-U11	KH16TT
LFR5P11	KH16TT	KH16TT
LFR6A	K20HR-U11	KH20TT
LFR6A11	K20HR-U11	KH20TT
LFR6AIX11	IKH20	IKH20TT
LFR6AIX11P	IKH20TT	IKH20TT
LFR6AIXLPG	IKH20TT	IKH20TT
LFR6AIXP	VKH20Y	-
LFR6AP-11	KH20TT	KH20TT
LFR6AP-9	KH20TT	KH20TT
LFR6AQP	IKH20TT	IKH20TT
LFR6B	K20HR-U11	KH20TT
LFR6BP-11	KH20TT	KH20TT
LFR6C	K20HR-U11	KH20TT
LFR6C-11	K20HR-U11	KH20TT
LFR6CGP	KH20TT	KH20TT
LFR6D	K20HR-U11	KH20TT
LFR7AIX	IKH22	-
LFR7AIXP	VKH22	-
LKAR6AIX13P	IXEH20TT	IXEH20TT
LKR6C	XU20HR9	XUH20TTi
LKR6D-10E	XUH20TTi	XUH20TTi
LKR6D-E	XUH20TTi	XUH20TTi
LKR6E	XU20HR9	XUH20TTi
LKR7AI	IXUH22	IXUH22TT
LKR7AIX	IXUH22	IXUH22TT
LKR7AIXP	VXUH22I	IXUH22TT
LKR7B	XU22HDR9	XUH22TT
LKR7B-9	XU22HDR9	XUH22TT
LKR7BI8	IXUH22	IXUH22TT
LKR7BIXP	VXUH22	IXUH22TT
LKR7DI-12	IXUH22	IXUH22TT
LKR7E	XU22HDR9	XUH22TT
LL1	IK20TT	IK20TT
LL2	IW20TT	IW20TT
LL3	IQ20TT	IQ20TT
LL4	ITV16TT	ITV16TT
LL5	IT20TT	IT20TT
LL6	IK20TT	IK20TT
LL7	IKH20TT	IKH20TT
LL8	VXU22	IXU22TT
LPG Laser Line 1	IK20TT	IK20TT
LPG Laser Line 2	IW20TT	IW20TT
LPG Laser Line 3	IQ20TT	IQ20TT
LPG Laser Line 4	ITV16TT	ITV16TT
LPG Laser Line 5	IT20TT	IT20TT
LPG Laser Line 6	IK20TT	IK20TT
LPG Laser Line 7	IKH20TT	IKH20TT
LPG Laser Line 8	VXU22	IXU22TT
LPG1	IK20TT	IK20TT
LPG2	IW20TT	IW20TT
LPG3	IQ20TT	IQ20TT
LPG4	ITV16TT	ITV16TT
LPG5	IT20TT	IT20TT
LPG6	IK20TT	IK20TT
LPG7	IKH20TT	IKH20TT
LPG8	VXU22	IXU22TT
LR8A	U24FSR-U	-

Свечи зажигания и Свечи накаливания

Таблица взаимозаменяемости – Другие производители

NGK	DENSO	TT
LR8B	IUF24	-
LTR5BI-13	ITV16TT	ITV16TT
LTR5GP	TV16TT	TV16TT
LTR5IX11	ITV16TT	ITV16TT
LTR6B-10T	ITV20TT	ITV20TT
LTR6CI-8	ITV20TT	ITV20TT
LTR6IX11	ITV20TT	ITV20TT
LTR7IX11	ITV22	-
LZFR5BI-11	IKH16TT	IKH16TT
LZFR5C11	K16HPR-U11	KH16TT
LZFR5C11G	K16HPR-U11	KH16TT
LZFR6AI	IKH20	IKH20TT
LZFR6B10E	KH20TT	KH20TT
LZKAR6AP11	FXE20HR11	IXEH20TT
LZKAR7A	XE20HR-U9	IXEH20TT
LZKAR7B	XE20HR-U9	IXEH20TT
LZKR6AI-10G	IXUH22I	IXUH22TT
LZKR6B-10E	XU22HDR9	XUH22TT
LZKR6B-10E	XUH20TTi	XUH20TTi
LZKR6BE	IXUH22I	IXUH22TT
LZTR4A11	ITL16TT	ITL16TT
LZTR4AGP	ITL16TT	ITL16TT
LZTR4AIX13	ITL16TT	ITL16TT
LZTR5A11	ITL16TT	ITL16TT
LZTR5A13	ITL20	-
LZTR5AGP	ITL16TT	ITL16TT
LZTR5AIX13	ITL20	-
LZTR6A11	ITL20	-
LZTR6AIX13	ITL20	-
PFR5A-11	PQ16R	Q16TT
PFR5B	PK16PR11	K16TT
PFR5B-11	PK16PR-L11	IK16TT
PFR5B-11B	PK16R11	K16TT
PFR5B-11C	PK16R11	K16TT
PFR5B9	PK16PR11	K16TT
PFR5BD	PK16PR11	K16TT
PFR5C-11	PK16R11	K16TT
PFR5F-11	PQ16R	Q16TT
PFR5F-11A	PQ16R	Q16TT
PFR5G-11	PK16PR-L11	IK16TT
PFR5G-11E	PK16PR-L11	IK16TT
PFR5G-13E	PK16PR-L11	IK16TT
PFR5J11	PK16PR-P11	K16TT
PFR5K11	PQ16R	Q16TT
PFR5L11	PK16PR-L11	IK16TT
PFR5N11	PK16PR-L11	IK16TT
PFR5P	PK16PR11	K16TT
PFR5P11	PK16PR-L11	IK16TT
PFR5R11	PK16PR-L11	IK16TT
PFR6A-11	PQ20R	Q20TT
PFR6A-11A	PQ20R	Q20TT
PFR6B	PK20PR-P8	IK20TT
PFR6B-11	PK20PR11	K20TT
PFR6B-11B	PK20R11	K20TT
PFR6B-11C	PK20PR11	K20TT
PFR6B-9	PK20PR-P8	IK20TT
PFR6BD	PK20R8	IK20TT
PFR6C-11	PK20R11	K20TT
PFR6D10G	PK20PR-L11	IK20TT
PFR6E	PK20PR-P8	IK20TT
PFR6E10	PK20PR11	K20TT
PFR6E-10	PK20PR11	K20TT
PFR6F-11A	IQ20TT	IQ20TT
PFR6G	PK20PR-P8	IK20TT
PFR6G-11	PK20PR-L11	IK20TT
PFR6G-11E	PK20PR-L11	IK20TT
PFR6G-13	PK20PR-L13	IK20TT
PFR6G-13E	PK20PR-L13	IK20TT
PFR6G-9	PK20PR-P8	IK20TT
PFR6H-10	PQ20R	Q20TT
PFR6J	PK20PR-P8	IK20TT

NGK	DENSO	TT
PFR6J-11	PK20PR-P11	K20TT
PFR6J-13	PK20PR-L13	IK20TT
PFR6K-11	PQ20R	Q20TT
PFR6L-11	PK20PR11	K20TT
PFR6L-13	PK20PR-L13	IK20TT
PFR6M	PK20PR-P8	IK20TT
PFR6N	SK20PR-L9	IK20TT
PFR6N-11	PK20PR-L11	IK20TT
PFR6P	PK20R8	IK20TT
PFR6P-11	PK20PR-L11	IK20TT
PFR6Q	PK20PR-P8	IK20TT
PFR6R-11	PK20PR-L11	IK20TT
PFR6T-10	PK20PR-L11	IK20TT
PFR6T-10G	PK20PR-L11	IK20TT
PFR6TG	PK20PR-P8	IK20TT
PFR6U-11G	PK20PR-L11	IK20TT
PFR6WT	VKB20	-
PFR6WTG	VKB20	-
PFR6X-11	PK20PR-L11	IK20TT
PFR7A-11	VQ22	-
PFR7AB	PK22PR8	IK22TT
PFR7B	PK22PR8	IK22TT
PFR7B-11	PK22PR11	IK22FTT
PFR7B-9	PK22PR8	IK22TT
PFR7BD	VK22	IK22FTT
PFR7G	PK22PR8	IK22TT
PFR7G-11	PK22PR-L11S	-
PFR7G-11S	PK22PR-L11S	-
PFR7G-9	PK22PR8	IK22TT
PFR7H-10	PK22PR-L11S	-
PFR7M	PK22PR8	IK22TT
PFR7ND	PK22PR8	IK22TT
PFR7Q	PK22PR8	IK22TT
PFR7S8EG	PK22PR8	IK22TT
PFR7ZTG	VK22	IK22FTT
PFR8B	IK24	-
PFR8B-9	IK24	-
PFR8S8EG	IK24	-
PGR5A	P16PR11	W16TT
PGR5A-11	P16PR11	W16TT
PGR5C-11	P16PR11	W16TT
PGR6A	P20PR11	W20TT
PGR6A-11	P20PR11	W20TT
PGR6AD	VW20T	IW20TT
PGR6B	P20PR11	W20TT
PGR6D	P20PR11	W20TT
PGR7A	P22PR8	IK22FTT
PGR7A-11	P22PR8	IK22FTT
PJ7A	IX22B	-
PJR7A	IX22B	-
PJR8A	IX24B	-
PKR7A	VXU22	IXU22TT
PKR9B	IXU27	-
PKUR6EKPA	PK20PTR-S9	K20TT
PLFR5A-11	IKH16TT	IKH16TT
PLFR6A	VKH20Y	-
PLFR6A-11	IKH20TT	IKH20TT
PLFR6A-9	IKH20TT	IKH20TT
PLFR6C-10G	IKH20TT	IKH20TT
PLFR7A-11	VKH22	-
PLFR7A-9	VKH22	-
PLKR6A	IXUH22	IXUH22TT
PLKR7A	SXU22HDR8	IXUH22TT
PLKR7B8E	VXUH22	IXUH22TT
PLTR6A10G	ITV20TT	ITV20TT
PLZFR6A-11S	IKH20TT	IKH20TT
PLZKAR6A-11	FXE20HR11	IXEH20TT
PLZKAR6A-11D	FXE20HR11	IXEH20TT
PLZKAR6AP-11	FXE20HR11	IXEH20TT
PLZKBR7A-G	VXUH22I	IXUH22TT
PLZKBR7B8DG	VXUH22I	IXUH22TT

NGK	DENSO	TT
PLZTR5A13	ITL16TT	ITL16TT
PMR7A	IU22	-
PMR8A	IU24	-
PMR8B	IU24	-
PMR9B	IU27	-
PTR4B-15	PT16EPR-L13	IT16TT
PTR4G-15	PT16EPR-L13	IT16TT
PTR5A-10	PT16VR10	TV16TT
PTR5A-13	PT16VR13	TV16TT
PTR5C-13	PT16EPR-L13	IT16TT
PTR5D-10	PT16EPR-L13	IT16TT
PTR5D-13	PT16EPR-L13	IT16TT
PTR6D-13	ZT20EPR11	IT20TT
PTR6D-13G	ZT20EPR11	IT20TT
PTR6E-13	IT20TT	IT20TT
PTR6F-13	ZT20EPR11	IT20TT
PZFR5B	VKB16	-
PZFR5C	VKA16	-
PZFR5D-11	PKJ16CR-L11	IK16TT
PZFR5E-11	SKJ16CR-L11	IK16TT
PZFR5F	PKJ16CR8	-
PZFR5F-11	SKJ16CR-L11	IK16TT
PZFR5F-13	PKJ16CR-L11	IK16TT
PZFR5J-11	SKJ16CR-L11	IK16TT
PZFR5N-11T	VKA16	-
PZFR5N-11TG	VKA16	-
PZFR5Q-11	VKA16	-
PZFR6B	PKJ20CR8	IK20TT
PZFR6D-11	VKA20	-
PZFR6E-11	PKJ20CR-L11	IK20TT
PZFR6F	PKJ20CR8	IK20TT
PZFR6F-11	PKJ20CR-L11	IK20TT
PZFR6F-8	PKJ20CR-L11	IK20TT
PZFR6J-11	PKJ20CR-L11	IK20TT
PZFR6N-11TG	SK20BGR11	-
PZFR6Q-11	VKA20	-
PZFR6R	PKJ20CR8	IK20TT
PZFR6R8EG	SKJ20CR-A8	-
PZTR5A15	PT16EPR-L13	IT16TT
R0045J-10	RU01-31	-
R0045J-11	RU01-34	-
R0045J-9	RU01-27	-
R0045Q-10	RU01-31	-
R0045Q-11	RU01-34	-
R015-10	IU31	-
R015-8	IU27	-
R015-9	IU31	-
R016-10	IU01-31	-
R016-11	IU01-34	-
R0161-10	IUF31A	-
R0161-9	IUF27A	-
R016-8	IU01-24	-
R016-8.5	IU01-27	-
R016-9	IU01-27	-
R017-10	IU31A	-
R017-11	IU01-34	-
R017-7	U22ETR	-
R017-8	IU24A	-
R017-8.5	IU27	-
R017-9	IU27A	-
R017-S11	IU01-34	-
R018G-8	IU24	-
R0200G-10	RU01-31	-
R0200G-11	RU01-34	-
R0256B-10	IU01-31	-
R0256B-11	IU01-34	-
R0256R-10	IU01-31	-
R0256R-11	IU01-34	-
R0256R-9	IU01-27	-
R0310B-10	RU01-31	-
R0310B-11	RU01-34	-

NGK	DENSO	TT
R0373A-10	IU01-31	-
R0373A-11	IU01-34	-
R0373A-9	IU01-27	-
R0375A-10	IU01-31	-
R0379A-10	IU01-31	-
R0406A-8	IU01-24	-
R0406A-9	IU01-27	-
R0409B-10	IU01-31	-
R0409B-8	IU01-24	-
R0409B-9	IU01-27	-
R216-10	IXU01-31	-
R216-11	IXU01-34	-
R216-8	IXU01-24	-
R216-9	IXU01-27	-
R217-10	IXU01-31	-
R217-11	IXU01-34	-
R217-9	IX27	-
R218-10	IXU01-31	-
R218-9	IX27B	-
R2198-10P	IXU01-31	-
R2198-11P	IXU01-34	-
R2525-10	IXU01-31	-
R2525-11	IXU01-34	-
R2525-9	IXU01-27	-
R4118S-10	IW31	-
R4118S-10.5	IW01-32	-
R4118S-11	IW34	-
R4118S-7	IW22	-
R4118S-7.5	IW24	-
R4118S-8	IW24	-
R4118S-8.5	IW27	-
R4118S-9	IW27	-
R4118S-9.5	IW29	-
R4304A-10	IW31	-
R4304A-7	IW22	-
R4304A-8	IW24	-
R4304A-9	IW27	-
R4339-10	IW31	-
R4339-8	IW24	-
R4339-9	IW27	-
R4452D-10	IW31	-
R4452D-10.5	IW01-32	-
R4452D-11	IW34	-
R4452D-7	IW22	-
R4452D-7.5	IW24	-
R4452D-8	IW24	-
R4452D-8.5	IW24	-
R4452D-9	IW27	-
R4452D-9.5	IW29	-
R4468A-10.5	IRE01-32	-
R4468A-11	IRE01-34	-
R4630A-10	IW01-31	-
R4630A-10.5	IW01-32	-
R4630A-11	IW01-34	-
R4630A-8	IW01-24	-
R4630A-8.5	IW01-27	-
R4630A-9	IW01-27	-
R4630A-9.5	IW01-29	-
R4652-10	IW31	-
R4652-10.5	IW34	-
R4652-8	IW24	-
R4652-8.5	IW27	-
R4652-9	IW27	-
R4652-9.5	IW29	-
R5184-10	IWM01-31	-
R5184-10.5	IWM01-32	-
R5184-11	IWM01-34	-
R5184-9.5	IWM01-29	-
R5400.10	IQ31	-
R5400.7	IQ22	-
R5400-8	IQ24	-

Свечи зажигания и Свечи накаливания

Таблица взаимозаменяемости – Другие производители

NGK	DENSO	TT
R5400-9	IQ27	-
R5525-7	IWF22	-
R5525-8	IWF24	-
R5525-9	IWF27	-
R5530-8	IWF24	-
R5530-9	IWF27	-
R5540-10	IWM01-31	-
R5540F-11	IWM01-34	-
R5670-5	W16PR-U	-
R5670-6	W20PR-U	-
R5670-7	W22S-U	-
R5670-8	W24S-U	-
R5670-9	W27S-U	-
R5671-10	W31ESR-U	-
R5671-7	W22ESR-U	-
R5671-8	W24ESR-U	-
R5671-9	W27ESR-U	-
R5671A-10	IK31	-
R5671A-11	IK34	-
R5671A-7	IK22	IK22FTT
R5671A-8	IK24	-
R5671A-9	IK27	-
R5672-8	IW24	-
R5672-9	IW27	-
R5672A-10	IK31	-
R5672A-8	IK24	-
R5672A-9	IK27	-
R5673-6	ITF20TT	ITF20TT
R5673-7	ITF22	-
R5673-8	ITF24	-
R5673-9	ITF27	-
R5674-6	ITF20TT	ITF20TT
R5674-7	ITF22	-
R5674-8	ITF24	-
R5674-9	ITF27	-
R5686-10	IQ31	-
R5686-11	IQ34	-
R5686-8	IQ24	-
R5686-9	IQ27	-
R5687-10	IQ02-31	-
R5687-8	IQ02-24	-
R5687-9	IQ02-27	-
R5724-8	IT24	-
R5724-9	IT27	-
R5796-10	IQ01-31	-
R5796-8	IQ01-24	-
R5796-9	IQ01-27	-
R5830-10	IQ01-31	-
R5830-11	IQ01-34	-
R5830-8	IQ01-24	-
R5830-9	IQ01-27	-
R6021E-10	IW31	-
R6021E-105	IW01-32	-
R6021E-11	IW34	-
R6021E-7	IW22	-
R6021E-8	IW24	-
R6021E-8.5	IW27	-
R6021E-9	IW27	-
R6021E-9.5	IW29	-
R6061-10	IW01-31	-
R6061-11	IW01-34	-
R6061-9	IW01-27	-
R6120-10	IA01-31	-
R6120-10.5	IAE01-32	-
R6120-11	IAE01-34	-
R6120A-10	IA01-31	-
R6120A-10.5	IA01-32	-
R6120A-11	IA01-34	-
R6120M-10	IA01-31	-
R6120M-10.5	IAE01-32	-
R6179A-10.5P	IWM01-32	-

NGK	DENSO	TT
R6179A-10P	IWM01-31	-
R6179A-11P	IWM01-34	-
R6179C-10.5P	IA01-32	-
R6198C-9	IW01-27	-
R6205-10	IK31	-
R6206-10	IK02-31	-
R6206-8	IK02-24	-
R6206-9	IK02-27	-
R6241-10	IK31	-
R6241-8	IK01-24	-
R6241-9	IK01-27	-
R6242-10	IK02-31	-
R6242-8	IK02-24	-
R6242-9	IK02-27	-
R6252E-10	IW01-31	-
R6252E-10.5	IW01-32	-
R6252E-9	IW01-27	-
R6252E-9.5	IW01-29	-
R6252K-10.5	IW01-32	-
R6254E-10.5	IW01-32	-
R6254E-8	IW01-24	-
R6254E-9	IW01-27	-
R6254K-10.5	IW01-32	-
R6255-10	IK31	-
R6255-7	IK22	IK22FTT
R6255-8	IK24	-
R6255-9	IK27	-
R6255F-10	IK31	-
R6255F-7	IK22	IK22FTT
R6255F-8	IK24	-
R6255F-9	IK27	-
R6326-10	IK31	-
R6326-7	IK22	IK22FTT
R6326-8	IK24	-
R6326-9	IK27	-
R6337-10	IQ31	-
R6337-7	IQ22	-
R6337-8	IQ24	-
R6337-9	IQ27	-
R6385-105P	IW01-32	-
R6385-10P	IW01-31	-
R6385-11P	IW01-34	-
R6385-7.5P	IW01-24	-
R6385-8P	IW01-24	-
R6385-9.5P	IW01-29	-
R6385-9P	IW01-27	-
R6385A-10.5P	IW01-32	-
R6427-10	IK31	-
R6427-7	IK22	IK22FTT
R6427-8	IK24	-
R6427-9	IK27	-
R6701-7	IQ22	-
R6701-8	IQ24	-
R6702-10	IQ01-31	-
R6702-9	IQ01-27	-
R6725-10	IRE01-31	-
R6725-10.5	IRE01-32	-
R6725-11	IRE01-34	-
R6725-9	IRE01-27	-
R6758-7	IK22	IK22FTT
R6758-8	IK24	-
R6759-10	IK01-31	-
R6759-9	IK01-27	-
R6794-10	IRE01-31	-
R6794-11	IRE01-34	-
R6794-9	IRE01-27	-
R6809-9	IK27	-
R6850-8	IW01-24	-
R6850-9	IW01-27	-
R6888A-10	IK01-31	-
R6888A-8	W27EBR	-

NGK	DENSO	TT
R6888A-9	W27EBR	-
R6918B-10	IW01-31	-
R6918B-11	IW01-34	-
R6918B-8	IW01-24	-
R6918B-9	IW01-27	-
R6918C-9	IW01-27	-
R7112-10	IK31	-
R7112-11	IK34	-
R7112-7	IK22	IK22FTT
R7112-8	IK24	-
R7112-9	IK27	-
R7113-10	IK31	-
R7113-7	IK22	IK22FTT
R7113-8	IK24	-
R7113-9	IK27	-
R7114-10	IK31	-
R7114-8	IK24	-
R7114-9	IK27	-
R7115-10	IK31	-
R7115-8	IK24	-
R7115-9	IK27	-
R7116-10	IK01-31	-
R7116-8	IK01-24	-
R7116-9	IK01-27	-
R7117-10	IK01-31	-
R7117-11	IK01-34	-
R7117-8	IK01-24	-
R7117-9	IK01-27	-
R7118-10	IK02-31	-
R7118-8	IK02-24	-
R7118-9	IK02-27	-
R7119-10	IK02-31	-
R7119-8	IK02-24	-
R7119-9	IK02-27	-
R7232-10	IQ31	-
R7232-11	IQ34	-
R7232-7	IQ22	-
R7232-8	IQ24	-
R7232-9	IQ27	-
R7233-10	IQ31	-
R7233-7	IQ22	-
R7233-8	IQ24	-
R7233-9	IQ27	-
R7234-10	IQ31	-
R7234-11	IQ34	-
R7234-8	IQ24	-
R7234-9	IQ27	-
R7235-10	IQ31	-
R7235-8	IQ24	-
R7235-9	IQ27	-
R7236-10	IQ01-31	-
R7236-11	IQ01-34	-
R7236-8	IQ01-24	-
R7236-9	IQ01-27	-
R7237-10	IQ01-31	-
R7237-8	IQ01-24	-
R7237-9	IQ01-27	-
R7238-10	IQ02-31	-
R7238-8	IQ02-24	-
R7238-9	IQ02-27	-
R7239-10	IQ02-31	-
R7239-8	IQ02-24	-
R7239-9	IQ02-27	-
R7279-10	IK02-31	-
R7282-10	IA01-31	-
R7282-10.5	IA01-32	-
R7282-11	IA01-34	-
R7282A-10	IA01-31	-
R7282A-10.5	IA01-32	-
R7282A-11	IA01-34	-
R7282C-10.5	IAE01-32	-

NGK	DENSO	TT
R7282C-11	IAE01-34	-
R7345-8	IKH24	-
R7345-9	IKH27	-
R7346-10	IQ01-31	-
R7346-8	IQ01-24	-
R7346-9	IQ01-27	-
R7376-10	IW01-31	-
R7376-8	IW01-24	-
R7376-9	IW01-27	-
R7420-10	IRE01-31	-
R7420-10.5	IRE01-32	-
R7420-11	IRE01-34	-
R7420-9	IRE01-27	-
R7420T-10	IRE01-31	-
R7420T-11	IRE01-34	-
R7420T-9	IRE01-27	-
R7433-10	IK31	-
R7433-8	IK24	-
R7433-9	IK27	-
R7434-10	IK01-31	-
R7434-8	IK01-24	-
R7434-9	IK01-27	-
R7435-10	IQ31	-
R7435-8	IQ24	-
R7435-9	IQ27	-
R7436-10	IQ01-31	-
R7436-8	IQ01-24	-
R7436-9	IQ01-27	-
R7437-8	IKH24	-
R7437-9	IKH27	-
R7438-10	IKH01-31	-
R7438-8	IKH01-24	-
R7438-9	IKH01-27	-
R7440A-10L	IRL01-31	-
R7440A-9L	IRL01-27	-
R7440B-10T	IRT01-31	-
R7440B-11T	IRT01-34	-
RE7AL	IRL01-27	-
RE7CL	IRL01-27	-
RE8AL	IRL01-27	-
RE9BT	IRT01-31	-
SD10	IRE01-31	-
SD10A	IRE01-27	-
SD11A	S-31A	-
SD11A-T	S-31A	-
SD9	IRE01-27	-
SD9A	IRE01-27	-
SIFR6A11	IK20TT	IK20TT
SILFR6A	VKH20Y	-
SILFR6A11	IKH20TT	IKH20TT
SILFR6A6	VKH20Y	-
SILFR6B8	VKH20Y	-
SILFR6C11	IKH20TT	IKH20TT
SILKAR6G11G	IXEH20TT	IXEH20TT
SILKR6C10E	VXUH20I	-
SILKR6D10G	VXUH20I	-
SILTR6A7G	ITV22	-
SILZKR7B11	IXEH22TT	IXEH22TT
SILZKR6B10E	VXUH20I	-
SILZKR6B-11	VXUH20I	-
SILZKR6D8	ZXU20HCR8	-
SILZKR7AS	VXUH22I	IXUH22TT
SILZKR7B11	VXUH22I	IXUH22TT
SILZKR7C11S	SXU22HCR11S	-
SILZKR7E11	VXUH22I	IXUH22TT
SIMR8A9	IU24	-
SIZFR6B8EG	SKJ20CR-A8	-
SR5	T20NR-U11	IT20TT
T7340T6	IK20	IK20TT
T7340T7	IK22	IK22FTT
T7340T8	IK24	-

Свечи зажигания и Свечи накаливания

Таблица взаимозаменяемости – Другие производители

NGK	DENSO	TT
T7340T9	IK27	-
T7341T6	IQ20TT	IQ20TT
T7341T7	IQ22	-
T7341T8	IQ24	-
T7341T9	IQ27	-
T7418T10	IK01-31	-
T7418T8	IK01-24	-
T7418T9	IK01-27	-
T7419T10	IQ01-31	-
T7419T8	IQ01-24	-
T7419T9	IQ01-27	-
TR4	T16EPR-U	T16TT
TR42	T16EPR-U	T16TT
TR4IX	IT16TT	IT16TT
TR4VX	T16TT	T16TT
TR5	T20EPR-U	T20TT
TR51	T20EPR-U	T20TT
TR51X	IT20TT	IT20TT
TR51VX	T20TT	T20TT
TR55	T20EPR-U15	-
TR551	T16EPR-U15	T16TT
TR551X	IT16TT	IT16TT
TR551VX	T20TT	T20TT
TR55IX	IT20TT	IT20TT
TR55VX	T20TT	T20TT
TR5A-10	T16VR-U10	TV16TT
TR5A13	T16VR-U10	TV16TT
TR5A1-13	IT16TT	IT16TT
TR5B13	T16VR-U10	TV16TT
TR5B-13	T16VR-U10	TV16TT
TR5BP12	T16TT	T16TT
TR5IX	IT20TT	IT20TT
TR5VX	T20TT	T20TT
TR6	T20EPR-U	T20TT
TR6AP13	ZT20EPR11	IT20TT
TR6AP-13E	T20TT	T20TT
TR6GP	T20TT	T20TT
TR6IX	IT20TT	IT20TT
TR7IX	IT22	-
TR8IX	IT24	-
UR4	T16PR-U	ITF16TT
UR40	T16PR-U11	ITF16TT
UR45	T16PR-U11	ITF16TT
UR45IX	ITF16TT	ITF16TT
UR45VX	ITF16TT	ITF16TT
UR4IX	ITF16TT	ITF16TT
UR4VX	ITF16TT	ITF16TT
UR5	T20PR-U	ITF20TT
UR55	T20PR-U	ITF20TT
UR55IX	ITF20TT	ITF20TT
UR55VX	ITF20TT	ITF20TT
UR5IX	ITF20TT	ITF20TT
UR5VX	ITF20TT	ITF20TT
UR6	ITF20TT	ITF20TT
UR6IX	ITF20TT	ITF20TT
UR6VX	ITF20TT	ITF20TT
VL1	W20EPBR-S	W20TT
VL10	W20EXR-U11	W20TT
VL11	Q20PR-U11	Q20TT
VL12	Q20PR-U	Q20TT
VL13	W20EPR-U11	W20TT
VL14	K20PR-U11	K20TT
VL15	J16CR-U	W16TT
VL16	Q16P-U11	Q16TT
VL17	Q20P-U	Q20TT
VL18	W20FP-U	WF20TT
VL19	W22EPR-U	W22TT
VL2	W20EPR-U	W20TT
VL20	K20TXR	K20TT
VL21	W20EPBR-S	W20TT
VL22	W20EPBR-S	W20TT

NGK	DENSO	TT
VL23	K20TXR	K20TT
VL24	K20PBR-S10	K20TT
VL25	PT16VR13	TV16TT
VL26	K20TNR	K20TT
VL27	K20PBR-S10	K20TT
VL28	K20PR-U	K20TT
VL29	K16TNR-S9	K16TT
VL3	W20FPR-U	WF20TT
VL30	K20TXR	K20TT
VL31	PT16EPR-L13	IT16TT
VL32	Q16PR-U	Q16TT
VL33	K16PR-U11	K16TT
VL34	PKJ16CR-L11	IK16TT
VL35	K16PR-U	K16TT
VL36	K16PR-U	K16TT
VL37	PK20PR-P8	IK20TT
VL38	K20PR-U	K20TT
VL39	K16R-U11	K16TT
VL4	W20EP-U	W20TT
VL40	KJ16CR-U11	K16TT
VL41	KJ16CR-U11	K16TT
VL42	XU22EPR-U	XU22TT
VL43	XU22EPR-U	XU22TT
VL44	KJ20DR-M11	-
VL45	T16VR-U10	TV16TT
VL5	T20EP-U	T20TT
VL6	W16EPR-U	W16TT
VL7	T20EPR-U	T20TT
VL8	W16EP-U	W16TT
VL9	W16EXR-U	W16TT
V-Line 1	W20EPBR-S	W20TT
V-Line 10	W20EXR-U11	W20TT
V-Line 11	Q20PR-U11	Q20TT
V-Line 12	Q20PR-U	Q20TT
V-Line 13	W20EPR-U11	W20TT
V-Line 14	K20PR-U11	K20TT
V-Line 15	J16CR-U	W16TT
V-Line 16	Q16P-U11	Q16TT
V-Line 17	Q20PR-U	Q20TT
V-Line 18	W20FP-U	WF20TT
V-Line 19	W22EPR-U	W22TT
V-line 2	W20EPR-U	W20TT
V-Line 20	K20TXR	K20TT
V-Line 21	W20EPBR-S	W20TT
V-Line 22	W20EPBR-S	W20TT
V-Line 23	K20TXR	K20TT
V-Line 24	K20PBR-S10	K20TT
V-Line 25	PT16VR13	TV16TT
V-Line 26	K20TNR	K20TT
V-Line 27	K20PBR-S10	K20TT
V-Line 28	K20PR-U	K20TT
V-Line 29	K16TNR-S9	K16TT
V-line 3	W20FPR-U	WF20TT
V-Line 30	K20TXR	K20TT
V-Line 31	PT16EPR-L13	IT16TT
V-Line 32	Q16PR-U	Q16TT
V-Line 33	K16PR-U11	K16TT
V-Line 34	PKJ16CR-L11	IK16TT
V-Line 35	K16PR-U	K16TT
V-Line 36	K16PR-U	K16TT
V-Line 37	PK20PR-P8	IK20TT
V-Line 38	K20PR-U	K20TT
V-Line 39	K16R-U11	K16TT
V-line 4	W20EP-U	W20TT
V-Line 40	KJ16CR-U11	K16TT
V-Line 41	KJ16CR-U11	K16TT
V-Line 42	XU22EPR-U	XU22TT
V-Line 43	XU22EPR-U	XU22TT
V-Line 44	KJ20DR-M11	-
V-Line 45	T16VR-U10	TV16TT
V-line 5	T20EP-U	T20TT

NGK	DENSO	TT
V-Line 6	W16EPR-U	W16TT
V-Line 7	T20EPR-U	T20TT
V-Line 8	W16EP-U	W16TT
V-Line 9	W16EXR-U	W16TT
WR41	MA9P-U	-
WR5	MA20PR-U	-
XR4	W16PR-U	-
XR40	W16PR-U	-
XR45	W16PR-U	-
XR5	W20PR-U	-
Y1001J1	DG-635	-
Y1002AS	DG-193	-
Y1003AS	DG-624	-
Y1005J	DG-181	-
Y1007J	DG-187	-
Y1012J	DG-600	-
Y1013J	DG-671	-
Y1030J	DG-196	-
Y1031J	DG-176	-
Y1035AS	DG-609	-
Y1036AS	DG-619	-
Y1038J	DG-186	-
Y107R	DG-114	-
Y112M1	DG-157	-
Y112R1	DG-157	-
Y115R1	DG-162	-
Y115T1	DG-198	-
Y118R	DG-215	-
Y118T1	DG-647	-
Y128	DG-227	-
Y128T	DG-234	-
Y146R	DG-652	-
Y147T	DG-232	-
Y168R	DG-239	-
Y176	DG-236	-
Y178	DG-226	-
Y178T	DG-235	-
Y197R	DG-222	-
Y197T	DG-233	-
Y204TS1	DG-012	-
Y207T	DG-012	-
Y208T	DG-001	-
Y306R	DG-143	-
Y307R	DG-159	-
Y501U	DG-144	-
Y502R	DG-111	-
Y503J	DG-003	-
Y503R	DG-003	-
Y504J	DG-116	-
Y504R	DG-116	-
Y506J	DG-008	-
Y506R	DG-008	-
Y507J	DG-145	-
Y507R	DG-145	-
Y508J	DG-189	-
Y515J	DG-005	-
Y516J	DG-112	-
Y517J	DG-126	-
Y519J	DG-197	-
Y523J	DG-142	-
Y524J	DG-121	-
Y525J	DG-130	-
Y526J1	DG-630	-
Y527J	DG-602	-
Y529J	DG-502	-
Y530J	DG-137	-
Y531J	DG-245	-
Y532J	DG-649	-
Y534J	DG-122	-
Y535J	DG-661	-
Y536J	DG-188	-

NGK	DENSO	TT
Y541J	DG-302	-
Y541J	DG-641	-
Y542J	DG-240	-
Y543J	DG-184	-
Y547AS	DG-178	-
Y548J	DG-130	-
Y603J	DG-300	-
Y603J	DG-640	-
Y605J	DG-182	-
Y607AS	DG-177	-
Y609AS	DG-193	-
Y701J	DG-146	-
Y702R	DG-157	-
Y703R	DG-216	-
Y703R	DG-650	-
Y705RS	DG-157	-
Y707RS	DG-198	-
Y710J	DG-124	-
Y711J	DG-124	-
Y712RS	DG-137	-
Y715R	DG-648	-
Y719RS1	DG-104	-
Y721RS	DG-104	-
Y722J	DG-172	-
Y722JS	DG-172	-
Y723U	DG-005	-
Y729U	DG-115	-
Y730U	DG-101	-
Y731U	DG-003	-
Y732J	DG-005	-
Y732U	DG-005	-
Y733J	DG-174	-
Y738U	DG-161	-
Y739R	DG-132	-
Y740U	DG-101	-
Y741U	DG-109	-
Y742U	DG-124	-
Y743U	DG-104	-
Y745U	DG-117	-
Y746J	DG-155	-
Y746R	DG-155	-
Y747U	DG-127	-
Y748U	DG-118	-
Y749J	DG-173	-
Y755RS	DG-702	-
Y8001AS	DG-603	-
Y8002AS	DG-194	-
Y8003J	DG-171	-
Y8005J	DG-195	-
Y8008AS	DG-610	-
Y8009AS	DG-604	-
Y9001AS	DG-621	-
Y9003AS	DG-608	-
Y9004AS	DG-621	-
Y902R	DG-001	-
Y904M1	DG-108	-
Y907R	DG-123	-
Y908R	DG-001	-
Y909R	DG-202	-
Y910J	DG-004	-
Y910R	DG-004	-
Y911J	DG-004	-
Y913J	DG-006	-
Y913M	DG-006	-
Y914U	DG-001	-
Y916J	DG-010	-
Y916R	DG-010	-
Y917U	DG-001	-
Y918J	DG-012	-
Y918R	DG-012	-
Y920R	DG-001	-

Свечи зажигания и Свечи накаливания

Таблица взаимозаменяемости – Другие производители

NGK	DENSO	TT
Y922R	DG-001	-
Y923U	DG-001	-
Y924J	DG-001	-
Y925J	DG-106	-
Y925R	DG-106	-
Y927J	DG-009	-
Y927R	DG-009	-
Y928U	DG-102	-
Y929U	DG-110	-
Y930U	DG-119	-
Y932R	DG-012	-
Y933J	DG-012	-
Y935U	DG-004	-
Y937J	DG-007	-
Y937R	DG-007	-
Y938R	DG-001	-
Y939J	DG-129	-
YE04	DG-113	-
YE05	DG-180	-
YE06	DG-171	-
YE07	DG-170	-
YE08	DG-614	-
YE12	DG-140	-
YE13	DG-606	-
YE14	DG-190	-
YR5	T20R-U	-
YR55	T20R-U	-
YR55IX	ITF20TT	ITF20TT
YR55VX	ITF20TT	ITF20TT
YR5IX	ITF20TT	ITF20TT
YR5VX	ITF20TT	ITF20TT
ZF5A11	QJ16CR11	Q16TT
ZF5A-11	QJ16CR11	Q16TT
ZF5F11	KJ16CR-L11	K16TT
ZF6A11	QJ20CR11	Q20TT
ZFR4F11	KJ14CR-L11	-
ZFR5A11	QJ16CR11	Q16TT
ZFR5A-11	QJ16CR11	Q16TT
ZFR5AP	IK16	IK16TT
ZFR5C11G	KJ16CR-L11	K16TT
ZFR5D11	K16GPR-U11	-
ZFR5E11	K16GPR-U11	-
ZFR5F	KJ16CR-L11	K16TT
ZFR5F-11	KJ16CR-U11	K16TT
ZFR5FGP	IK16L	IK16TT
ZFR5FIX11	IK16L	IK16TT
ZFR5FIX11P	PKJ16CR-L11	IK16TT
ZFR5FIX55	IK20	IK20TT
ZFR5J11	KJ16CR-L11	K16TT
ZFR5LP13G	IK16L	IK16TT
ZFR5N	KJ16CR-L11	K16TT
ZFR5N11	KJ16CR-L11	K16TT
ZFR5P-G	KJ16CR-U11	K16TT
ZFR6A11	QJ20CR11	Q20TT
ZFR6AGP	IQ20TT	IQ20TT
ZFR6BP-G	IK20L	IK20TT
ZFR6F-11	KJ20CR-U11	K20TT
ZFR6F11G	KJ20CR-L11	K20TT
ZFR6FGP	IK20L	IK20TT
ZFR6FIX11	IK20L	IK20TT
ZFR6FIX11P	IK20L	IK20TT
ZFR6FIX55	IK20	IK20TT
ZFR6J11	KJ20CR-L11	K20TT
ZFR6K11	KJ20DR-M11	-
ZFR6K-11E	KJ20DR-M11	-
ZFR6K11S	SKJ20DR-M11S	-
ZFR6K13	KJ20DR-M11	-
ZFR6K1X11PS	VK20G	-
ZFR6S-Q	K20PBR-S10	K20TT
ZFR6T-11G	KJ20DR-M11	-
ZFR6U11	KJ20CR-L11	K20TT

NGK	DENSO	TT
ZFR6V-G	KJ20CR-L11	K20TT
ZFR7A-11	KJ22CR-L11	-
ZFR7F	KJ22CR-L8	-
ZFR7F11	KJ22CR-L11	-
ZFR7F-11	KJ22CR-L11	-
ZFR7J11	KJ22CR-L11	-
ZFR7RG	KJ22CR-L11	-
ZG4A	J16CR-U	W16TT
ZG5A	J16CR-U	W16TT
ZG5E	J16CR-U	W16TT
ZGR4A	J16CR-U	W16TT
ZGR5A	J16CR-U	W16TT
ZGR5AGP	IW16	IW16TT
ZGR5C	J16CR-U	W16TT
ZGR5E	J16CR-U	W16TT
ZKR7A	XU22EPR-U	XU22TT
ZKR7A-10	XU22EPR-U	XU22TT
ZKR7AI8	VXU22	IXU22TT
ZMR7AP	IU22	-

NHSP	DENSO	TT
A7RTC	U20FSR-U	-
A7T	U22FSR-U	-
A7TC	U22FSR-U	-
B8RC	U24ESR-N	-
D6TC	X20FSR-U	-
D7	X22ESR-U	-
D8RTC	X24ESR-U	-
D8T	X24ESR-U	-
D8TC	X24ESR-U	-
DF7RECZ	XU22EPR-U	XU22TT
E5C	W14F-U	-
E5T	W14FPR-U	-
E6C	W20FSR-U	WF20TT
E6T	W14FPR-UL	-
E6TC	W20FPR-U	WF20TT
E7C	W20FSR-U	WF20TT
E7RTC	W20FPR-U	WF20TT
E7TC	W22FPR-U	-
E8C	W22FS-U	-
E8TC	W22FPR-U	-
F5C	W14E	-
F5T	W14EX-U	IW16TT
F5TC	W16EPR-U	W16TT
F6RTC	W16EXR-U11	W16TT
F6TC	W20EX-U	W20TT
F7RTC	W20EXR-U	W20TT
F7TC	W22EPR-U	W22TT
F7TJC	W20EPB	W20TT
F8C	W22ESR-U	-
F8TC	W22EPR-U	W22TT
G3F	W14PR-U	-
G3TC	W14PR-U	-
G5RC	W20S-U	-
G6	W20S-U	-
H5	W20S-U	-
K5RHCW	KJ16CR-L11	K16TT
K6RTC	K16PR-U11	K16TT
K6RTDC	K20TXR	K20TT
K6RTJC	K20PBR	K20TT
K6TC	Q16R-U	Q16TT
K6TJC	K20PBR	K20TT
K7RTC	K20PR-U11	K20TT
K7RTJC	K20PBR	K20TT
K7TC	Q20R-U	Q20TT
K7TJC	K20PBR	K20TT
L5T	W14MP-U10	-
L6T	W20MP-U	-
L7	W20M-US	-
L7T	W20MP-U	-
L7Y	W22M-U	-

NHSP	DENSO	TT
L8RT	W22MPR-U	-
L9	W22M-U	-
L9T	W22MPR-U	-
N6	T20M-U	-
N9	T22M-U	-
Q7TC	T16EPR-U	T16TT
R4C	MW17	-
T5RTC	MA20PR-U	-

QUINTON HAZELL	DENSO	TT
QGP105	DG-012	-
QGP106	DG-202	-
QGP107	DG-001	-
QGP110	DG-001	-
QGP112	DG-012	-
QGP113	DG-202	-
QGP114	DG-123	-
QGP115	DG-001	-
QGP117	DG-198	-
QGP120	DG-114	-
QGP131	DG-012	-
QGP147	DG-004	-
QGP148	DG-010	-
QGP151	DG-001	-
QGP155	DG-005	-
QGP163	DG-124	-
QGP168	DG-198	-
QGP169	DG-104	-
QGP170	DG-157	-
QGP174	DG-115	-
QGP175	DG-003	-
QGP178	DG-007	-
QGP179	DG-101	-
QGP180	DG-133	-
QGP181	DG-012	-

RALLIART	DENSO	TT
RAY66001	VW22	-
RAY66002	IW24	-

RPOWER	DENSO	TT
RP4410	DG-202	-
RP4422	DG-012	-
RP4432	DG-123	-
RP4444	DG-001	-
RP4446	DG-132	-
RP4458	DG-006	-
RP4486	DG-004	-
RP4490	DG-010	-
RP6434	DG-224	-
RP6438	DG-227	-
RP6444	DG-236	-
RP6588	DG-235	-
RP6590	DG-226	-
RP6592	DG-234	-
RP6690	DG-225	-
RP6692	DG-648	-
RP6804	DG-215	-
RP6816	DG-175	-
RP6824	DG-143	-
RP6840	DG-652	-
RP6912	DG-114	-
RP6914	DG-222	-
RP6914	DG-238	-
RP6916	DG-233	-
RP8106	DG-108	-
RP8126	DG-231	-
RP8134	DG-159	-
RP8168	DG-157	-
RP8174	DG-198	-
RP8184	DG-239	-

RPOWER	DENSO	TT
RP8186	DG-647	-
RP8188	DG-232	-
RP8188	DG-649	-
RP8192	DG-213	-
RP8208	DG-216	-
RP8208	DG-650	-
RP8272	DG-005	-
RP8320	DG-119	-
RP8322	DG-124	-
RP8324	DG-104	-
RP8332	DG-648	-
RP8342	DG-110	-
RP8344	DG-102	-
RP8346	DG-115	-
RP8348	DG-137	-
RP8352	DG-003	-
RP8354	DG-009	-
RP8358	DG-106	-
RP8364	DG-146	-
RP8368	DG-133	-
RP8370	DG-109	-
RP8372	DG-127	-
RP8374	DG-117	-
RP8378	DG-651	-
RP8386	DG-645	-
RP8388	DG-007	-
RP8390	DG-101	-
RP8396	DG-008	-
RP8398	DG-161	-
RP8400	DG-118	-
RP8404	DG-144	-
RP8406	DG-155	-
RP8408	DG-111	-
RP8410	DG-116	-
RP8412	DG-126	-
RP8414	DG-172	-
RP8416	DG-604	-
RP8426	DG-605	-
RP8428	DG-602	-
RP8434	DG-502	-
RP8436	DG-180	-
RP8440	DG-606	-
RP8444	DG-608	-
RP8454	DG-609	-
RP8470	DG-610	-
RP8472	DG-603	-
RP8474	DG-607	-
RP8474	DG-623	-
RP8480	DG-653	-
RP8486	DG-655	-
RP8488	DG-656	-
RP8490	DG-657	-
RP8494	DG-635	-
RP8496	DG-634	-
RP8500	DG-659	-
RP8502	DG-660	-
RP8504	DG-615	-
RP8506	DG-661	-
RP8508	DG-633	-
RP8510	DG-623	-
RP8518	DG-662	-
RP8600	DG-644	-
RP8602	DG-642	-
RP8610	DG-671	-
RP8612	DG-643	-
RP8616	DG-121	-
RP8618	DG-130	-
RP8620	DG-112	-
RP8622	DG-122	-
RP8622/30	DG-196	-
RP8626	DG-145	-

Свечи зажигания и Свечи накаливания

Таблица взаимозаменяемости – Другие производители

RPOWER	DENSO	TT
RP8628	DG-129	-
RP8630	DG-139	-
RP8634	DG-184	-
RP8638	DG-142	-
RP8640	DG-173	-
RP8644	DG-240	-
RP8646	DG-649	-
RP8650	DG-140	-
RP8652	DG-113	-
RP8654	DG-182	-
RP8658	DG-186	-
RP8668	DG-118	-
RP8670	DG-302	-
RP8670	DG-641	-
RP8672	DG-195	-
RP8676	DG-183	-
RP8678	DG-171	-
RP8680	DG-300	-
RP8680	DG-640	-
RP8896	DG-174	-
RP8904	DG-187	-
RP8906	DG-245	-
RP8908	DG-188	-
RP8914	DG-170	-
RP8922	DG-601	-
RP8924	DG-194	-
RP8928	DG-193	-
RP8930	DG-181	-
RP8932	DG-176	-
RP8936	DG-197	-
RP8938	DG-189	-
RP8942	DG-632	-
RP9000	DG-177	-
RP9002	DG-190	-
RP9004	DG-178	-
RP9006	DG-191	-
RP9008	DG-192	-
RP9016	DG-658	-
RP9700	DG-616	-
RP9702	DG-613	-
RP9704	DG-620	-
RP9708	DG-617	-
RP9712	DG-622	-
RP9718	DG-665	-
RP9722	DG-667	-
RP9726	DG-669	-

SARD	DENSO	TT
SR20ISO	IK20	IK20TT
SR20JIS	IQ20TT	IQ20TT
SR22ISO	IK22	IK22FTT
SR22JIS	IQ22	-
SR24ISO	IK24	-
SR24JIS	IQ24	-
SR27ISO	IK27	-
SR27JIS	IQ27	-
SR31ISO	IK31	-

SPLITFIRE	DENSO	TT
SF10B	T22EP-U	-
SF10C	T22EP-U	-
SF10D	T20EPR-U	T20TT
SF10D6	T20EPR-U	T20TT
SF10E6	T16EPR-U	T16TT
SF13C	ITF24	-
SF14E	T16PR-U	ITF16TT
SF254F	T16EPR-U	T16TT
SF259D	W24ESR-U	-
SF25E	W20MR-U	-
SF263D	W27FSR	-
SF265F	W16FSR	-

SPLITFIRE	DENSO	TT
SF295F	T20M-U	-
SF29E	W14PR-U	-
SF2C	T20PR-U	ITF20TT
SF2D6	T20PR-U	ITF20TT
SF2E	T16PR-U	ITF16TT
SF30C	W20S-U	-
SF392A	K24PR-U11	-
SF392B	K22PR-U	IK22FTT
SF392C	K20PR-U	K20TT
SF392D	K16PR-U	K16TT
SF392D6	K16PR-U	K16TT
SF405A	W31ESR-U	-
SF405B	IW27	-
SF405C	IW24	-
SF405D	W24ESR-U	-
SF405F	W22ESR-U	-
SF406A	IW31	-
SF406B	W27ESR-U	-
SF406C	W24ESR-U	-
SF409B	W24FSR	-
SF409C	W22FS-U	-
SF40D	W20ESR-U	-
SF412C	W20FPR-U	WF20TT
SF413B	X27ESR-U	-
SF415B	X27EPR-U9	-
SF415C	X24EPR-U9	-
SF416B	X27EPR-U9	-
SF416C	X24EPR-U9	-
SF416D	X22EPR-U9	-
SF419D	U20FSR-U	-
SF426C	W20EXR-U	W20TT
SF426E	W16EXR-U	W16TT
SF430B	U27ESR-N	-
SF430C	U24ESR-N	-
SF45F	W14LM-U	-
SF4E	MA16PR-U	-
SF512E	MA20PR-U	-
SF514D	T20EPR-U	T20TT
SF516D	T20EPR-U	T20TT
SF524E	T16EPR-U	T16TT
SF550C	K20PR-U11	K20TT
SF6A	W24EPR-U	-
SF6C	W20EPR-U	W20TT
SF6D	W20EPR-U	W20TT
SF6E	W16EPR-U	W16TT
SF6F6	W14EXR-U11	IW16TT
SF8E	W16PR-U	-
SF98E	KJ20CR-L11	K20TT
TP10C	IT20TT	IT20TT
TP2C	ITF22	-
TP2D	ITF20TT	ITF20TT
TP392A	IK22	IK22FTT
TP392B	IK22	IK22FTT
TP392C	IK20	IK20TT
TP392D	IK16	IK16TT
TP405A	IW31	-
TP406B	IW27	-
TP406C	IW24	-
TP409B	IWF24	-
TP416B	IX27B	-
TP416C	IX24B	-
TP430B	U27ESR-N	-
TP6A	IW24	-
TP6B	IW22	-
TP6C	IW20	IW20TT
TP6D	IW16	IW16TT

TOM'S	DENSO	TT
10901TSP0106	IK20	IK20TT
10901TSP0107	IK22	IK22FTT

TORCH	DENSO	TT
2197	X22ESR-U	-
2197C	X22ESR-U	-
4104JC	W14PR-U	-
4106JC	W20S-U	-
4135J	W14F-U	-
4136J	W16FSR	-
4195J	W16ESR-U	-
4197J	W22ESR-U	-
4198J	W24ESR-U	-
5580	W20EPB	W20TT
8012	IW20	IW20TT
A4106C	W20M-US	-
A6RC	U20FSR-U	-
A6RTC	U20FSR-U	-
A6TC	U20FSR-U	-
A7RC	U22FSR-U	-
A7RTC	U22FSR-U	-
A7TC	U22FSR-U	-
A8RTC	U24FSR-U	-
A8TC	U24FSR-U	-
B7R	U22ESR-N	-
B8R	U24ESR-N	-
B8RD	U24ETR	-
B9R	U27ESR-N	-
C6RTC	X20FSR-U	-
C6TC	X20FSR-U	-
C7ER	U20ESR-N	-
CPR6E	U20EPR9	-
D6RTC9	X20EPR-U9	-
D7CA	X22ESR-U	-
D7RC	X22ESR-U	-
D7RTC	X22EPR-U9	-
D7RTC9	X22EPR-U9	-
D7TC	X22EPR-U9	-
D8C	X24ESR-U	-
D8RC	X24ESR-U	-
D8RTC	X24ESR-U	-
D8RTC9	X24EPR-U9	-
D8TC	X24ESR-U	-
DK7RTC	XU22EPR-U	XU22TT
DK7RTC9	XU22PR9	XU22TT
DK7RTPP	IXU22	IXU22TT
E4RTC	W14FPR-UL	-
E4TC	W14FPR-UL	-
E5RTC	W16FPR-U	-
E5TC	W16FPR-U	-
E6C	W20FSR-U	WF20TT
E6RC	W20FSR-U	WF20TT
E6RCA	W20FR-L	WF20TT
E6RTC	W20FPR-U	WF20TT
E6TC	W20FPR-U	WF20TT
E7RC	W22FSR	-
E7RTC	W22FPR-U	-
E7TC	W22FPR-U	-
E8C	W24FSR	-
E8RC	W24FSR	-
E8RCA	W24FR-L	-
E8RTC	W24FPR	-
E8TC	W24FP-U	-
F5RF	W16EXR-U	W16TT
F5RTC	W16EXR-U	W16TT
F5TC	W16EPR-U	W16TT
F6C	W20ESR-U	-
F6RF	W20EXR-U	W20TT
F6RTC	W20EXR-U	W20TT
F6TC	W20EX-U	W20TT
F7C	W22ESR-U	-
F7RC	W22ESR-U	-
F7RTC	W22EPR-U	W22TT
F7RTJC	W20EPB	W20TT

TORCH	DENSO	TT
F7TC	W22EPR-U	W22TT
F7TJC	W20EPB	W20TT
F8C	W24ESR-U	-
F8RC	W24ESR-U	-
F8RTC	W24EPR-U	-
F8TC	W24EPR-U	-
F9C	W27ESR-U	-
G4C	W14PR-U	-
G4RC	W14PR-U	-
G6C	W20S-U	-
G6RC	W20S-U	-
GL4	W14LM-U	-
GL4RC	W14LM-U	-
K4RTC3	KJ16CR-L11	K16TT
K5RF11	K16PR-U11	K16TT
K5RTC	Q16PR-U	Q16TT
K5RTC11	K16PR-U11	K16TT
K5TC	K16PR-U11	K16TT
K6RF	K20PR-U11	K20TT
K6RF11	K20PR-U11	K20TT
K6RTC	K16PR-U11	K16TT
K6RTC11	K20PR-U11	K20TT
K6RTC9	K20PR-U	K20TT
K6RTC-9	K20PR-U	K20TT
K6RTJC	K20PBR-S10	K20TT
K6TC	Q16R-U	Q16TT
K6TJC	K20PBR	K20TT
K7RF	K22PR-U	IK22FTT
K7RTC	Q22PR-U	-
K7TC	Q20R-U	Q20TT
KR8TPP	IK24	-
L6	W20M-US	-
L6C	W20MR-U	-
L6RC	W20MR-U	-
L6RTC	W20MPR-U10	-
L6T	W20MP-U	-
L6TC	W20MP-U	-
L7	W20M-US	-
L7RTC	W22MPR-U	-
L7T	W20MP-U	-
L7TC	W22MPR-U	-
L9	W22M-U	-
L9T	W22MPR-U	-
N6C	T20M-U	-
N6RC	T20M-U	-
N6RTC	T20MP-U	-
N6TC	T20MP-U	-
N7C	T22M-U	-
N7RC	T22M-U	-
P5RTC	T16PR-U	ITF16TT
P5TC	T16PR-U	ITF16TT
P6RTC	T20PR-U	ITF20TT
P6TC	T20PR-U	ITF20TT
P7RTC	ITF22	-
P7TC	ITF22	-
PRA7HC	U22ESR-N	-
Q5RTC	T16EPR-U	T16TT
Q5TC	T16EPR-U	T16TT
Q6RTC	T20EPR-U	T20TT
Q6TC	T20EPR-U	T20TT
T1136	U20FSR-U	-
T1137	U22FSR-U	-
T1137C	U22FSR-U	-
T2138	X20FSR-U	-
T4135JC	W16FPR-U	-
T4136JC	W20FPR-U	WF20TT
T4137JC	W22FPR-U	-
T4195J	W14EPR-U	IW16TT
T4196JC	W20EP-U	W20TT
T4197JC	W22EPR-U	W22TT
T5RTC	MA20PR-U	-

Свечи зажигания и Свечи накаливания

Таблица взаимозаменяемости – Другие производители

TORCH	DENSO	TT
T5TC	MA16PR-U	-
T6RTC	MA20PR-U	-
T6TC	MA20P-U	-
T8RTC	MA20PR-U	-
T8TC	MA20P-U	-

TRUST	DENSO	TT
07	IQ22	-
07ISO	IK22	IK22FTT
08	IQ24	-
08ISO	IK24	-
09	IQ01-27	-
09ISO	IK01-27	-
10	IQ01-31	-
10ISO	IK01-31	-
IT06ISO	IK20	IK20TT
IT06JIS	IQ20TT	IQ20TT
IT07ISO	IK22	IK22FTT
IT07JIS	IQ22	-
IT07L	IKH22	-
IT08ISO	IK24	-
IT08JIS	IQ24	-
IT08L	IKH24	-
IT09ISO	IK27	-
IT09JIS	IQ27	-
RE09	IRE01-27	-
RE10	IRE01-31	-
RE11	IRE01-34	-
RE9	IRE01-27	-
RP08	IQ01-24	-
RP08ISO	IK01-24	-
RP09	IQ01-27	-
RP09ISO	IK01-27	-
RP10	IQ01-31	-
RP10ISO	IK01-31	-

UNIPART	DENSO	TT
ERR3799	W16EXR-U	W16TT
FDU2522	Q20PR-U11	Q20TT
FDU2522EVA	Q20PR-U11	Q20TT
GGP1	DG-001	-
GGP13	DG-143	-
GGP15	DG-124	-
GGP16	DG-104	-
GGP17	DG-012	-
GGP18	DG-001	-
GGP2	DG-001	-
GGP20	DG-198	-
GGP22	DG-001	-
GGP23	DG-003	-
GGP24	DG-101	-
GGP25	DG-005	-
GGP26	DG-102	-
GGP27	DG-119	-
GGP28	DG-006	-
GGP29	DG-001	-
GGP30	DG-106	-
GGP31	DG-115	-
GGP32	DG-012	-
GGP4	DG-012	-
GGP5	DG-123	-
GGP7	DG-001	-
GGP8	DG-004	-
GSP130	W16ESR-U	-
GSP131	W16EPR-U	W16TT
GSP141	W16EPR-U	W16TT
GSP151	W20EP-U	W20TT
GSP160	W20ESR-U	-
GSP163	W20EP-U	W20TT
GSP171	W20EP-U	W20TT
GSP181	W20EPR-U	W20TT

UNIPART	DENSO	TT
GSP191	W24EPR-U	-
GSP2001	K20PR-U	K20TT
GSP2002	W20EPR-U	W20TT
GSP2003	Q20PR-U	Q20TT
GSP2004	KJ20CR-L11	K20TT
GSP2005	K20PR-U11	K20TT
GSP2006	T20EPR-U	T20TT
GSP2007	K20PR-U	K20TT
GSP2008	W16EPR-U	W16TT
GSP2009	W20EPR-U	W20TT
GSP2010	W20EPB	W20TT
GSP2011	PT16VR13	TV16TT
GSP2012	T20EPR-U	T20TT
GSP2013	J16CR-U	W16TT
GSP2014	K20R-U	K20TT
GSP2015	K20R-U	K20TT
GSP2016	IK20	IK20TT
GSP2017	K20TXR	K20TT
GSP2018	K20TXR	K20TT
GSP2019	W20EPR-U11	W20TT
GSP2020	W16EPR-U	W16TT
GSP2021	MA20P-U	-
GSP2022	Q16PR-U	Q16TT
GSP2023	Q22PR-U	-
GSP2024	W20EPBR-S	W20TT
GSP2025	K16R-U	K16TT
GSP2026	MA20PR-U	-
GSP2027	T20EPR-U	T20TT
GSP2028	K20TXR	K20TT
GSP2029	W20FPR-U	WF20TT
GSP2030	W20EPBR-S	W20TT
GSP2031	W20EPB	W20TT
GSP2032	W16FSR	-
GSP2033	MA16PR-U	-
GSP2034	W16EPR-U	W16TT
GSP2035	Q16PR-U	Q16TT
GSP2036	W22EPR-U	W22TT
GSP2037	K20PR-U11	K20TT
GSP2038	W20EPBR-S	W20TT
GSP2039	W16EPR-U11	W16TT
GSP2040	T16EPR-U	T16TT
GSP2042	K20R-U11	K20TT
GSP2043	QJ16AR-U	-
GSP2044	IK22	IK22FTT
GSP2045	Q16PR-U11	Q16TT
GSP2046	W20ESR-U	-
GSP2047	W20EPBR-S	W20TT
GSP2048	K20PBR	K20TT
GSP2049	W20FSR-U	WF20TT
GSP2050	W22FS-U	-
GSP2051	W24ESR-U	-
GSP2052	IK20	IK20TT
GSP2053	K20TNR-S	K20TT
GSP2054	T16EPR-U	T16TT
GSP2055	IK20	IK20TT
GSP2056	W20FPR-U	WF20TT
GSP2059	K20TXR	K20TT
GSP2060	K20PBR-S10	K20TT
GSP2061	IW20	IW20TT
GSP2062	IK22	IK22FTT
GSP2063	X24EPR-U9	-
GSP2064	K20PBR	K20TT
GSP2098	W20EP-U	W20TT
GSP2099	W16EPR-U	W16TT
GSP2100	Q20PR-U	Q20TT
GSP2101	T20EPR-U	T20TT
GSP2102	T20EPR-U	T20TT
GSP2103	Q20PR-U	Q20TT
GSP2111	W20EPR-U	W20TT
GSP244	W16EPR-U	W16TT
GSP263	W20EPR-U	W20TT

UNIPART	DENSO	TT
GSP264	W16EPR-U	W16TT
GSP281	W22EPR-U	W22TT
GSP30	W20S-U	-
GSP331	T16EPR-U	T16TT
GSP351	T16EPR-U	T16TT
GSP361	T20EPR-U	T20TT
GSP381	T22EP-U	-
GSP4154	MA20P-U	-
GSP4154X	MA20P-U	-
GSP4256	W22FS-U	-
GSP4266	W16FSR	-
GSP4342	W24EPR-U	-
GSP4347	W22EPB	W22TT
GSP4352	W22EPR-U	W22TT
GSP4352X	W22EPR-U	W22TT
GSP4356	W22FPR-U	-
GSP4357	W22EPB	W22TT
GSP4362	W20EP-U	W20TT
GSP4362X	W20EP-U	W20TT
GSP4366	W20FPR-U	WF20TT
GSP4367	W20EPB	W20TT
GSP4372	W16EPR-U	W16TT
GSP4376	W16FPR-U	-
GSP4382	W16EPR-U	W16TT
GSP4382X	W16EPR-U	W16TT
GSP4452	W22EPR-U	W22TT
GSP44523	W20EPBR-S	W20TT
GSP4456	W22FPR-U	-
GSP4456X	W22FPR-U	-
GSP4462	W20EXR-U	W20TT
GSP44623	W20EPBR-S	W20TT
GSP4462X	W20EPR-U	W20TT
GSP4472	W16EPR-U	W16TT
GSP4482	W16EPR-U	W16TT
GSP4543	T22EP-U	-
GSP4547	K22PB	IKB22TT
GSP4552	Q22PR-U	-
GSP4552X	Q22PR-U	-
GSP4553	T22EP-U	-
GSP4562	Q20PR-U	Q20TT
GSP4562X	Q20PR-U	Q20TT
GSP4563	T20EPR-U	T20TT
GSP4563X	T20EPR-U	T20TT
GSP4573	T16EPR-U	T16TT
GSP4642	Q22PR-U	-
GSP46515	PT16VR13	TV16TT
GSP46522	K20TXR	K20TT
GSP46523	K20PBR-S10	K20TT
GSP4652X	Q22PR-U	-
GSP4657	K22PBR-S	IKB22TT
GSP4662	K20PR-U	K20TT
GSP46622	K20TXR	K20TT
GSP46623	K20PBR-S10	K20TT
GSP4663	T20EPR-U	T20TT
GSP4663X	T20EPR-U	T20TT
GSP4664	T20PR-U	ITF20TT
GSP4763	T22EP-U	-
GSP4854	MA20PR-U	-
GSP531	W16FPR-U	-
GSP540	W20FSR-U	WF20TT
GSP541	W20FPR-U	WF20TT
GSP550	W20FSR-U	WF20TT
GSP560	W22FS-U	-
GSP5658	K20PR-U11	K20TT
GSP571	W22FPR-U	-
GSP6154	MA20P-U	-
GSP634	Q16PR-U	Q16TT
GSP6352	W22EPR-U	W22TT
GSP6356	W22FPR-U	-
GSP6362	W20EP-U	W20TT
GSP6366	W20FPR-U	WF20TT

UNIPART	DENSO	TT
GSP6382	W16EPR-U	W16TT
GSP6452	W22EPR-U	W22TT
GSP6452X	W22EPR-U	W22TT
GSP6458	W22EPR-U11	W22TT
GSP6462	W20EPR-U	W20TT
GSP6462X	W20EPR-U	W20TT
GSP6468	W20EPR-U11	W20TT
GSP6472	W16EPR-U	W16TT
GSP6478	W16EPR-U11	W16TT
GSP6552	Q22PR-U	-
GSP6553	T22EP-U	-
GSP6562	Q20PR-U	Q20TT
GSP6563	T20EPR-U	T20TT
GSP65721	Q16PR-U11	Q16TT
GSP6573	T16EPR-U	T16TT
GSP665	Q20PR-U	Q20TT
GSP6651	PT16VR13	TV16TT
GSP66514	PT16VR13	TV16TT
GSP6652	Q22PR-U	-
GSP66527	PK20PR11	K20TT
GSP6652X	Q22PR-U	-
GSP6658	Q22PR-U11	-
GSP6662	K20PR-U	K20TT
GSP6662X	K20PR-U	K20TT
GSP6663	T20EPR-U	T20TT
GSP6663X	T20EPR-U	T20TT
GSP684	Q22PR-U	-
GSP6854	MA20P-U	-
GSP6962	KJ20CR-L11	K20TT
GSP761	T20PR-U	ITF20TT
GSP7662	Q20PR-U11	Q20TT
GSP7664	KJ20CR-L11	K20TT
GSP7666	KJ16CR-L11	K16TT
GSP7669	W20EPR-U	W20TT
GSP881	T20PR-U	ITF20TT
GSP9652	PK20PR-P8	IK20TT
GSP981	MA20P-U	-
NLP007664EVA	KJ20CR-L11	K20TT
NLP007666EVA	KJ16CR-L11	K16TT
NLP100130	KJ20CR-L11	K20TT
XMH279	K20PR-U11	K20TT

VALEO	DENSO	TT
17C	M22	-
19C	M22	-
19L	M22	-
20C	M17	-
20E	M17	-
20L	M17	-
213	M24S	-
21C	M17	-
21E	M17	-
21L	M17	-
22L	M14	-
22LM	M14	-
232	W24FSR	-
232H	W24ESR-U	-
233	W24FSR	-
233H	W22ESR-U	-
345249	DG-616	-
345250	DG-613	-
345251	DG-620	-
345255	DG-622	-
345258	DG-665	-
345260	DG-667	-
345262	DG-669	-
345HS	W20EP-U	W20TT
34C	W22S-U	-
34CM	W22S-U	-
34HS	W22ESR-U	-
34HSM	W22ESR-U	-

Свечи зажигания и Свечи накаливания

Таблица взаимозаменяемости – Другие производители

VALEO	DENSO	TT
34S	W22FS-U	-
35	W20FSR-U	WF20TT
351	W20FPR-U	WF20TT
351B	W20FPR-U	WF20TT
351D	W20FPR-U	WF20TT
3536D	W20FPR-U	WF20TT
3536P	W20FPR-U	WF20TT
3536R	W20FPR-U	WF20TT
35B	W20FSR-U	WF20TT
35C	W20S-U	-
35CM	W20S-U	-
35HA	W20EP-U	W20TT
35HS	W20ESR-U	-
35M	W20FSR-U	WF20TT
35P	IWF22	-
35S	W22FS-U	-
36	W20FSR-U	WF20TT
36B	W16FSR	-
36C	W14PR-U	-
36CM	W16S-U	-
36D	W16FSR	-
36HS	W16ESR-U	-
36M	W16FSR	-
36P	IWF16	-
37S	W16FSR	-
3H	W27ESR-U	-
4N	W22FS-U	-
5H	W22EPR-U	W22TT
5N	W20FSR-U	WF20TT
64H	W22EPR-U	W22TT
64H3E	W22EPB	W22TT
67HP	IW24	-
6H	W20EP-U	W20TT
6N	W20FSR-U	WF20TT
70H	W22EPR-U	W22TT
70H3E	W22EPB	W22TT
76H	W20EP-U	W20TT
76H3E	W20EPB	W20TT
7H	W20EP-U	W20TT
84H	W16EPR-U	W16TT
84H3E	W20EPB	W20TT
88N	W20FPR-U	WF20TT
8H	W20EP-U	W20TT
90H	W16EPR-U	W16TT
90N	W16FPR-U	-
9H	W16EPR-U	W16TT
AC422Z	W20FSR-U	WF20TT
C55HP	IT27	-
C60H	T22EP-U	-
C62HP	IT22	-
C64H	T22EP-U	-
C64HP	IT22	-
C68H	T20EPR-U	T20TT
C72H	T20EPR-U	T20TT
C7H	T22EP-U	-
C8H	T20EPR-U	T20TT
F64H	Q22PR-U	-
F68H3	K22PB	IKB22TT
F70H	Q22PR-U	-
F72H	Q22PR-U	-
F72H3	K22PB	IKB22TT
F72H3E	K22PB	IKB22TT
F74H	Q20PR-U	Q20TT
F74H3	K20PBR	K20TT
F80H	Q20PR-U	Q20TT
GC68N	MA20P-U	-
GC72N	MA20P-U	-
GT34	W22FPR-U	-
GT342H	W20EP-U	W20TT
GT345	W20FPR-U	WF20TT
GT345D	W20FPR-U	WF20TT

VALEO	DENSO	TT
GT345H	W20EP-U	W20TT
GT345HA	W20EP-U	W20TT
GT345HD	W20EP-U	W20TT
GT34D	W22FPR-U	-
GT34H	W22EPR-U	W22TT
GT34HD	W20EP-U	W20TT
GT35	W20FSR-U	WF20TT
GT35D	W16FPR-U	-
GT35H	W16EPR-U	W16TT
GT35HD	W16EPR-U	W16TT
H32RG	IW27	-
H33RG	IW24	-
H34F	W24ESR-U	-
HA322	W24ESR-U	-
HA32RS	IW27	-
HF33R	IW27	-
HF34	W22ESR-U	-
HF34F	W24ESR-U	-
M101	T20EPR-U	T20TT
M103	W20FPR-U	WF20TT
M104	T22EP-U	-
M123	Q20PR-U	Q20TT
M127	W20EPR-U	W20TT
M132	K20TNR-S	K20TT
M4T	W24S-U	-
M5T	W22S-U	-
M6T	W20S-U	-
R64H	W22EPR-U	W22TT
R64H11	W22EPR-U11	W22TT
R70H	W22EPR-U	W22TT
R70H11	W22EPR-U11	W22TT
R70H3E	W22EPB	W22TT
R76H	W20EPR-U	W20TT
R76H11	W20EPR-U11	W20TT
R84H	W16EPR-U	W16TT
R84H11	W16EPR-U11	W16TT
R84HZ3YE	W20EPBR-S	W20TT
R84HZY	J16CR-U	W16TT
R88N	W20FPR-U	WF20TT
R90H	W16EPR-U	W16TT
R90H11	W16EPR-U11	W16TT
R92H	W14EXR-U	IW16TT
RC64H	IT22	-
RC68H	T20EPR-U	T20TT
RC68LPP	PT16VR13	TV16TT
RC72H	T20EPR-U	T20TT
RC72H11	T20EPR-U	T20TT
RF64H	Q22PR-U	-
RF64H11	Q22PR-U11	-
RF72H	Q22PR-U	-
RF72H11	Q22PR-U11	-
RF72H3E	K22PBR-S	IKB22TT
RF72HZ3YE	K22PBR-S	IKB22TT
RF72HZDC	Q22PR-U	-
RF74H	Q20PR-U	Q20TT
RF74H11	Q20PR-U11	Q20TT
RF74H3	K20PBR	K20TT
RF74HZ	K20R-U	K20TT
RF74HZ11	K20R-U11	K20TT
RF74HZ2	K20TNR	K20TT
RF74HZ2Y	K20TXR	K20TT
RF74HZ3YE	K20PBR-S10	K20TT
RF74HZDC	K20PR-U	K20TT
RF74HZY11	KJ20CR-L11	K20TT
RF74LZDC	KH20TT	KH20TT
RF80H	Q16PR-U	Q16TT
RF80H11	Q16PR-U	Q16TT
RF80H3	K20PBR-S10	K20TT
RF80HZ2Y	K20TXR	K20TT
RF80HZY	K16R-U	K16TT
RF80LZDC	K16HPR-U11	KH16TT

VALEO	DENSO	TT
RF82H	Q16PR-U	Q16TT
RF82H11	Q16PR-U11	Q16TT
RF82H2Y	K16TNR-S9	K16TT
RGC68N	MA20PR-U	-
RR31HS	IW31	-
RR32HS	IW27	-
RR33HSS	IW31	-
S5N	M22	-
S6N	M17	-
SCGT345H	T22EP-U	-
SCGT35H	T20EPR-U	T20TT
T6	W22M-U	-
T7	W20MP-U	-
T8	W20M-US	-
TC6	T22M-U	-
TC8	T20M-U	-
V36A	W16FSR	-
V6N	W16FSR	-

WLD	DENSO	TT
A7TC	U22FSR-U	-
D7	X22ESR-U	-
D8EA	X24ESR-U	-
D8RTC	X24ESR-U	-
D8TC	X24ESR-U	-
E6C	W20FSR-U	WF20TT
E6TC	W20FPR-U	WF20TT
E7C	W22FS-U	-
E7TC	W22FPR-U	-
F5TC	W16EPR-U	W16TT
F6TC	W20EX-U	W20TT
F7TC	W22EPR-U	W22TT
F7TJC	W20EPB	W20TT
K6TC	Q16R-U	Q16TT
K6TJC	K20PBR	K20TT
K7TC	Q20R-U	Q20TT
K7TJC	K22PB	IKB22TT
L7	W20M-US	-
L7T	W20MP-U	-
L9	W22M-U	-
L9T	W22MPR-U	-
T4T	MA16PR-U	-
T5RTC	MA20PR-U	-

DENSO Фотогид свечей накаливания



DG-001



DG-006



DG-003



DG-007



DG-004



DG-008



DG-005



DG-009



DG-010

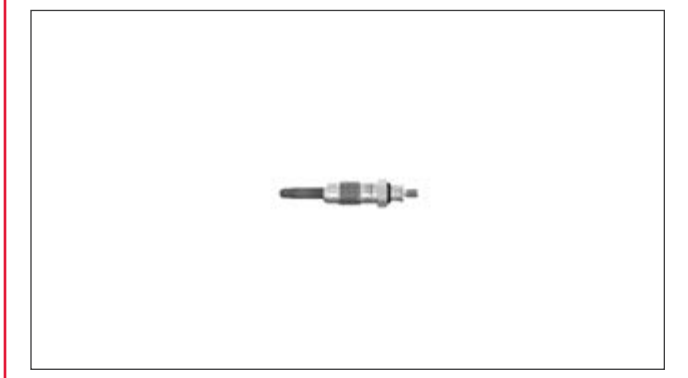

DG-104

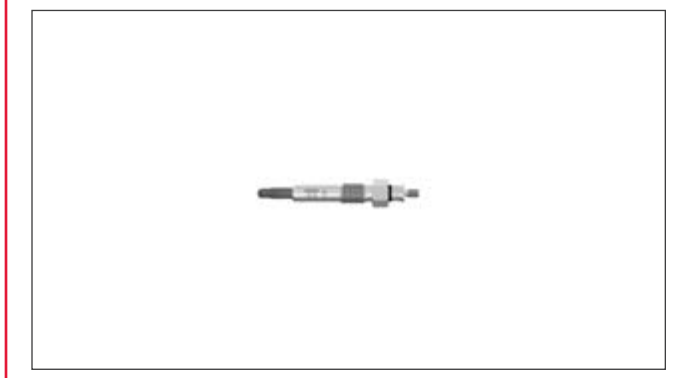

DG-012

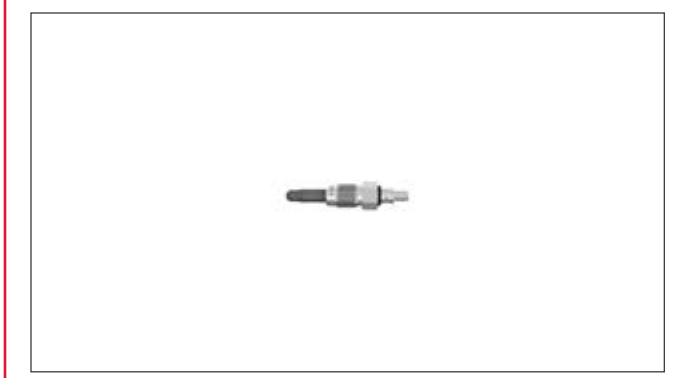

DG-106



DG-101



DG-108



DG-102

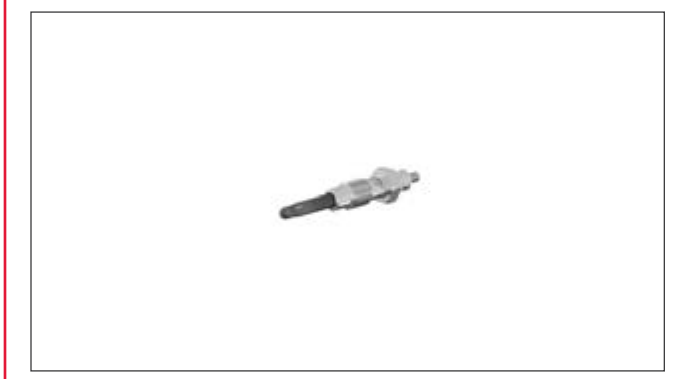

DG-109



DG-110



DG-114



DG-111



DG-115



DG-112



DG-116



DG-113



DG-117



DG-118



DG-123



DG-119



DG-124



DG-121



DG-126



DG-122



DG-127



DG-129



DG-137



DG-130



DG-139



DG-132



DG-140



DG-133



DG-142



DG-143



DG-155



DG-144



DG-157



DG-145



DG-159



DG-146



DG-161



DG-162



DG-173



DG-170



DG-174



DG-171



DG-175



DG-172



DG-176



DG-177



DG-182



DG-178



DG-183



DG-180



DG-184



DG-181



DG-186



DG-187



DG-191



DG-188



DG-192



DG-189



DG-193



DG-190



DG-194



DG-195



DG-202



DG-196



DG-213



DG-197



DG-215



DG-198



DG-216



DG-222



DG-232



DG-224



DG-233



DG-228



DG-234



DG-231



DG-235



DG-238



DG-300

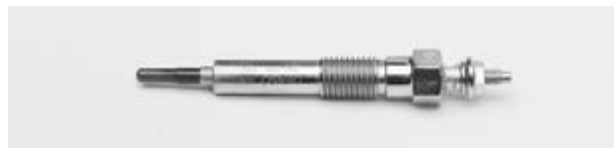

DG-240



DG-301

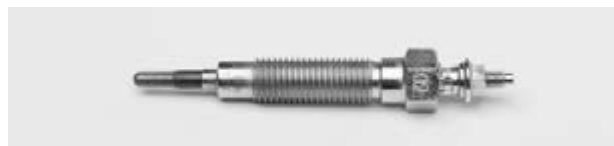

DG-241



DG-302



DG-245



DG-308



DG-502



DG-603



DG-600



DG-604



DG-601



DG-605



DG-602



DG-606



DG-607



DG-611



DG-608



DG-613



DG-609



DG-614



DG-610



DG-615



DG-616



DG-621



DG-617



DG-622



DG-619



DG-624



DG-620



DG-625



DG-626

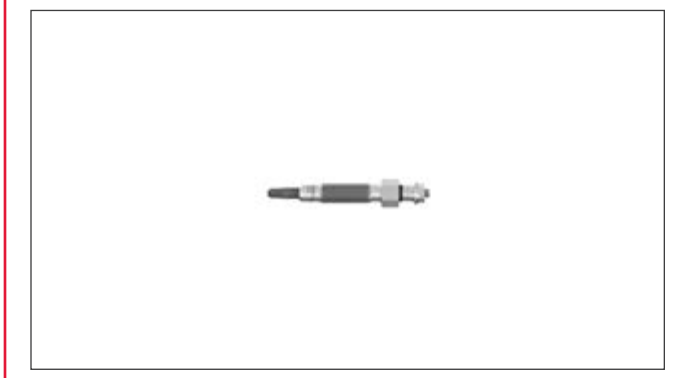

DG-630



DG-627



DG-631

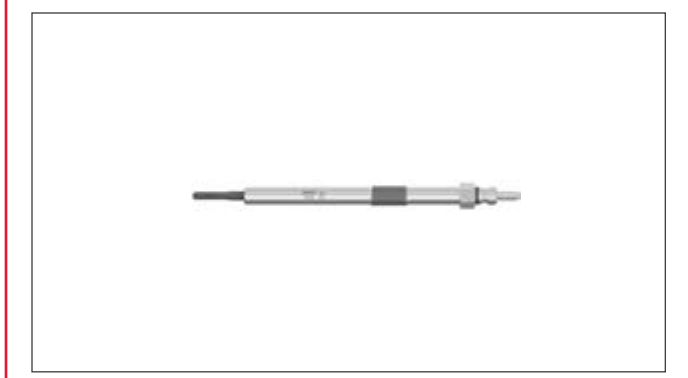

DG-628



DG-632



DG-629



DG-633



DG-634



DG-644



DG-635



DG-645



DG-642



DG-646



DG-643



DG-647



DG-648



DG-653



DG-649



DG-655



DG-651



DG-656



DG-652



DG-657



DG-658



DG-662



DG-659



DG-665



DG-660



DG-667



DG-661



DG-669



DG-671























DG-702













DENSO Технические сведения



										
	V	mm	mm	mm	mm	mm	mm	mm	mm	mm
DG-001	11	M12x1.25	72	24.3	6.1 Probe	12	15-20	Thread	3-4	
DG-003	11	M10x1.0	89	29.6	5 Probe	10	10-12	Thread	1-1.5	
DG-004	11	M12x1.25	70	20.3	5 Probe	12	15-20	Thread	1-1.5	
DG-005	11	M10x1.0	92	24.6	5 Probe	10	10-12	Pin	-	
DG-006	11	M12x1.25	67	24.3	6.1 Probe	12	15-20	Thread	3-4	
DG-007	11.5	M12x1.25	63	17.3	6.1 Probe	12	15-20	Thread	3-4	
DG-008	11	M10x1.0	93	24.6	5 Probe	10	10-12	Thread	1-1.5	
DG-009	11	M12x1.25	70	25.3	5 Probe	12	15-20	Thread	1-1.5	
DG-010	11.5	M12x1.25	70	22.3	6.1 Probe	12	15-20	Thread	3-4	
DG-012	11	M12x1.25	62.2	20.3	6.1 Probe	12	15-20	M5x0.8	3-4	
DG-101	11	M10x1.0	84	24.5	5 Probe	10	10-12	Thread	1-1.5	
DG-102	11	M12x1.25	71.5	24.3	5 Probe	12	15-20	Thread	1-1.5	
DG-104	11	M10x1.25	80	16.9	5 Probe	12	10-12	Thread	1-1.5	
DG-106	11.5	M12x1.25	114	27.3	6.1 Probe	12	15-20	Pin	-	
DG-108	11	M12x1.25	135	23.85	5 Probe	12	15-20	Thread	1-1.5	
DG-109	11	M10x1.0	97	29.6	5 Probe	10	10-12	Pin	-	
DG-110	11.5	M12x1.25	87	27.3	5 Probe	12	15-20	Pin	-	
DG-111	11	M10x1.0	76	24.6	5 Probe	10	10-12	Thread	1-1.5	
DG-112	11	M10x1.0	99	24.6	5 Probe	10	10-12	Pin	-	
DG-113	11	M8x1.0	118.5	27.7	5 Probe	8	8-10	Thread	1-1.5	
DG-114	11	M10x1.25	82,9	22	5 Probe	12	10-12	M4x0.7	1-1.5	
DG-115	11.5	M10x1.0	125	26	5 Probe	10	10-12	Thread	1-1.5	
DG-116	11	M10x1.0	107.5	27.6	5 Probe	10	10-12	Thread	1-1.5	
DG-117	11.5	M10x1.0	130	26.6	5 Probe	10	10-12	Pin	-	
DG-118	11	M10x1.0	133	28.6	5 Probe	10	10-12	Pin	-	
DG-119	11.5	M12x1.25	120	27.3	6.1 Probe	12	15-20	Pin	-	
DG-121	10	M10x1.0	95	24.6	5 Probe	10	10-12	Thread	1-1.5	
DG-122	11	M10x1.0	102.4	23.9	5 Probe	10	10-12	Pin	-	
DG-123	11	M12x1.25	67	19.3	6.1 Probe	12	15-20	Thread	3-4	
DG-124	11	M10x1.25	87	23.9	5 Probe	12	10-12	Thread	1-1.5	
DG-126	11	M10x1.0	150.5	24	5 Probe	10	10-12	Pin	-	
DG-127	11	M10x1.0	95	24.4	5 Probe	10	10-12	Thread	1-1.5	
DG-129	11	M12x1.25	75.2	20.3	6.1 Probe	12	15-20	Pin	-	
DG-130	11.5	M10x1.0	146,1	35	5 Probe	10	10-12	Thread	1-1.5	
DG-132	11	M10x1.0	82	24.6	5 Probe	10	10-12	Thread	1-1.5	
DG-133	11	M10x1.0	126	28.6	5 Probe	10	10-12	Thread	1-1.5	
DG-137	11	M10x1.25	85	19.1	5 Probe	12	10-12	M4x0.7	1-1.5	
DG-139	11	M10x1.0	149.5	26	5 Probe	8	10-12	Pin	-	
DG-140	11	M8x1.0	126	24.5	4 Probe	8	8-10	Pin	-	
DG-142	11	M10x1.0	135	30.6	5 Probe	10	10-12	Pin	-	
DG-143	5	M10x1.25	90	23.5	5 Probe	12	10-12	Thread	1-1.5	
DG-144	11	M10x1.0	125	33.6	5 Probe	10	10-12	Pin	-	
DG-145	11	M10x1.0	105	31.6	5 Probe	10	10-12	Pin	-	
DG-146	11	M10x1.25	83	21.9	5 Probe	12	10-12	Thread	1-1.5	
DG-155	11.5	M10x1.0	128	29.6	5 Probe	10	10-12	Thread	1-1.5	
DG-157	11	M10x1.25	68	16.9	5 Probe	12	10-12	Thread	1-1.5	
DG-159	5	M10x1.25	83	18	5 Probe	12	10-12	Thread	1-1.5	
DG-161	11	M10x1.0	117	33.6	5 Probe	10	10-12	Thread	1-1.5	
DG-162	6	M10x1.25	95	22	5 Probe	12	10-12	M4x0.7	1-1.5	
DG-170	11	M9x1.0	151	29.6	4 Probe	9	10-12	Pin	-	
DG-171	11	M8x1.0	119	27.6	4 Probe	8	8-10	Pin	-	
DG-172	11	M10x1.25	97	21.85	5 Probe	12	10-12	Thread	1-1.5	
DG-173	11	M10x1.0	111.5	29.6	5 Probe	10	10-12	Thread	1-1.5	
DG-174	11	M10x1.25	82	18.9	5 Probe	12	10-12	Thread	1-1.5	
DG-175	10.5	M10x1.0	78.4	28.3	5 Probe	3/8"	10-12	Faston	-	
DG-176	11.5	M10x1.0	130	25.5	5 Probe	10	10-12	Pin	-	
DG-177	5	M10x1.0	96	29.1	5 Probe	10	10-12	Pin	-	
DG-178	5	M10x1.0	105	31.6	5 Probe	10	10-12	Pin	-	
DG-180	11	M8x1.0	124,1	27.7	3.5 Probe	8	8-10	Pin	-	
DG-181	11	M10x1.0	117,4	26.8	5 Probe	12	10-12	M4x0.7	1-1.5	
DG-182	11	M10x1.0	106	23.5	5 Probe	10	10-12	Pin	-	
DG-183	11.5	M10x1.0	130	25.5	5 Probe	10	10-12	Pin	-	
DG-184	11.5	M10x1.0	121	39.6	5 Probe	10	10-12	Pin	-	
DG-186	11	M10x1.25	144	24.35	5 Probe	12	10-12	Thread	1-1.5	
DG-187	11	M10x1.25	170	35	5 Probe	12	10-12	Thread	1-1.5	
DG-188	11	M10x1.0	150	23.8	4 Probe	10	10-12	Pin	-	
DG-189	11	M10x1.25	150	31	3.6 Probe	10	10-12	Pin	-	
DG-190	4.4	M8x1.0	117.6	29.6	4 Probe	8	8-10	Pin	-	
DG-191	5	M10x1.0	133	28.6	5 Probe	10	10-12	Pin	-	
DG-192	5	M10x1.0	133	30	5 Probe	10	10-12	Pin	-	





										
	V	mm	mm	mm	mm	mm	mm	mm	mm	mm
DG-193	4.4	M10x1.0	126.3	24	4 Probe	10	10-12	Pin	-	
DG-194	4.4	M8x1.0	147.9	26.6	4 Probe	8	8-10	Pin	-	
DG-195	11	M8x1.0	151	39.6	5 Probe	8	8-10	Pin	-	
DG-196	11	M10x1.0	109.5	30.2	5 Probe	10	10-12	Pin	-	
DG-197	11	M10x1.25	177.8	21	4.4 Probe	12	10-12	M4x0.7	1-1.5	
DG-198	11	M10x1.25	89.9	21.85	5 Probe	12	10-12	Thread	1-1.5	
DG-202	11	M12x1.25	77	29.3	6.1 Probe	12	15-20	Thread	3-4	
DG-213	7	M10x1.25	95.5	32	3.6 Probe	12	10-12	M4x0.7	1-1.5	
DG-215	7	M10x1.25	95.5	32	4.3 Probe	12	10-12	M4x0.7	1-1.5	
DG-216	11	M10x1.25	101.5	28	5 Probe	12	10-12	M4x0.7	1-1.5	
DG-222	14	M10x1.25	100.5	28	5 Probe	12	10-12	M4x0.7	1-1.5	
DG-224	8	M10x1.25	89	28	5 Probe	17	10-12	M5x0.8	3-4	
DG-228	19	M18x1.5	78	21	5 Probe	26	30-40	M5x0.8	3-4	
DG-231	21.5	M10x1.25	94.5	22	5 Probe	12	10-12	M5x0.8	3-4	
DG-232	10.5	M10x1.25	101.5	28	5 Probe	12	10-12	M4x0.7	1-1.5	
DG-233	23	M10x1.25	101.5	28	5 Probe	12	10-12	M4x0.7	1-1.5	
DG-234	8.5	M10x1.25	101.5	28	5 Probe	12	10-12	M4x0.7	1-1.5	
DG-235	20.5	M10x1.25	100.5	28	5 Probe	12	10-12	M4x0.7	1-1.5	
DG-238	23	M10x1.25	91.5	32	5 Probe	12	10-12	M5x0.8	3-4	
DG-240	11	M10x1.25	160	36	5 Probe	10	10-12	M4x0.7	1-1.5	
DG-241	6	M12x1.25	141	24	5 Probe	12	15-20	M4x0.7	1-1.5	
DG-245	11	M10x1.25	170	36.6	3.5 Probe	12	10-12	Thread	1-1.5	
DG-300	11	M10x1.25	87.5	18	4.5 Probe	12	10-12	Thread	1-1.5	
DG-301	11	M10x1.25	81.5	18	4.5 Probe	12	10-12	Thread	1-1.5	
DG-302	11	M10x1.25	144.4	24	4.5 Probe	12	10-12	Pin	-	
DG-308	11	M10x1.25	100.8	25	3.5 Probe	12	10-12	M4x0.7	1-1.5	
DG-502	11	M10x1.25	121.5	30	3.5 Probe	12	10-12	M4x0.7	1-1.5	
DG-600	11	M10x1.25	160	28.5	3.5 Probe	10	10-12	M4x0.7	1-1.5	
DG-601	11	M10x1.25	160.9	31	4 Probe	12	10-12	Pin	-	
DG-602	11	M10x1.25	134.5	30	5 Probe	12	10-12	M4x0.7	1-1.5	
DG-603	5	M8x1.0	113.9	27.5	4 Probe	8	8-10	Pin	-	
DG-604	4.4	M8x1.0	93.9	29	4 Probe	8	8-10	Pin	-	
DG-605	11	M10x1.25	213	23	4.3 Probe	12	10-12	M4x0.7	1-1.5	
DG-606	11.5	M8x1.0	147.9	26.5	4 Probe	8	8-10	Pin	-	
DG-607	4.4	M10x1.0	133.5	28	4 Probe	10	10-12	Pin	-	
DG-608	4.4	M9x1.0	156.4	35	4 Probe	9	10-12	Pin	-	
DG-609	4.4	M10x1.0	96.4	24.0	4 Probe	10	10-12	Pin	-	
DG-610	4.4	M8x1.0	135.0	27.5	4 Probe	8	8-10	Pin	-	
DG-611	4.4	M10x1.0	148.5	35	4 Probe	10	10-12	M4x0.7	1-1.5	
DG-613	7	M10x1.0	134	28	4 Probe	10	10-12	Pin	-	
DG-614	11	M8x1.0	98.4	27.5	4 Probe	8	8-10	Pin	-	
DG-615	11	M10x1.0	155	27.7	5 Probe	10	10-12	Pin	-	
DG-616	7	M10x1.0	131	27	4 Probe	10	10-12	Pin	-	
DG-617	7	M8x1.0	147.4	26	4 Probe	8	8-10	Pin	-	
DG-619	4.4	M10x1.0	90.5	24.0	4 Probe	10	10-12	Pin	-	
DG-620	7	M8x1.0	135	27.5	4 Probe	8	8-10	Pin	-	
DG-621	4.4	M9x1.0	119	27.5	3.3 Probe	9	10-12	Pin	-	
DG-622	7	M8x1.0	116	29.5	4 Probe	8	8-10	Pin	-	
DG-624	4.4	M10x1.25	139	28.5	4.4 Probe	10	10-12	M4x0.7	1-1.5	
DG-625	4.4	M10x1.25	138	24	4 Probe	10	10-12	Pin	-	
DG-626	11	M10x1.25	81	16	5 Probe	12	10-12	M4x0.7	1-1.5	
DG-627	11	M10x1.25	138.5	30	4 Probe	12	10-12	M4x0.7	1-1.5	
DG-628	11	M12x1.25	75.5	20	6 Probe	12	15-20	Pin	-	
DG-629	11	M9x1.0	160	34.5	4 Probe	9	10-12	Pin	-	
DG-630	11	M10x1.25	156	30	4 Probe	12	10-12	M4x0.7	1-1.5	
DG-631	4.5	M10x1.0	163	26	5 Probe	10	10-12	Pin	-	
DG-632	5	M8x1.0	100.4	30.5	4 Probe	10	8-10	Pin	-	
DG-633	4.4	M8x1.0	129	25.5	4 Probe	8	8-10	Pin	-	
DG-634	4.4	M10x1.0	145	31	4 Probe	10	10-12	Pin	-	
DG-635	11	M10x1.25	151	36	3.5 Probe	12	10-12	M4x0.7	1-1.5	
DG-642	11	M10x1.25	96.9	19	5 Probe	12	10-12	Thread	1-1.5	
DG-643	11	M10x1.25	88.8	21	5 Probe	12	10-12	M4x0.7	1-1.5	
DG-644	11	M10x1.25	83.9	18.5	5 Probe	12	10-12	Thread	1-1.5	
DG-645	11	M10x1.25	82.9	22	5 Probe	12	10-12	Thread	1-1.5	
DG-646	11	M10x1.25	132	24	4.3 Probe	12	10-12	M4x0.7	1-1.5	
DG-647	11	M10x1.25	90.4	32	5 Probe	12	10-12	M4x0.7	1-1.5	
DG-648	11	M10x1.25	97.3	32	5 Probe	12	10-12	Thread	1-1.5	
DG-649	10.5	M10x1.25	102.7	28	5 Probe	12	10-12	M4x0.7	1-1.5	
DG-651	23	M10x1.25	95.9	27.5	5 Probe	12	10-12	M4x0.7	1-1.5	
DG-652	7	M10x1.25	95.9	27.5	5 Probe	12	10-12	M4x0.7	1-1.5	

										
		V	mm	mm	mm	mm	mm	mm	mm	mm
DG-653		4.4	M8x1.0	144	31	3.3 Probe	8	8-10	Pin	-
DG-655		11	M10x1.25	167	30	3.3 Probe	12	10-12	M4x0.7	1-1.5
DG-656		11	M10x1.25	159	28	3.3 Probe	10	10-12	Pin	-
DG-657		11	M10x1.25	129	29	3.3 Probe	12	10-12	M4x0.7	1-1.5
DG-658		5	M9x1.0	119	28	3.3 Probe	9	10-12	Pin	-
DG-659		11	M10x1.25	156	28	3.3 Probe	10	10-12	M4x0.7	1-1.5
DG-660		5	M10x1.0	131	26	3.5 Probe	10	10-12	Pin	-
DG-661		11	M10x1.25	164	36	3.5 Probe	10	10-12	M4x0.7	1-1.5
DG-662		11	M10x1.25	171	31	3.3 Probe	10	10-12	Pin	-
DG-665		7	M10x1.0	157	26	4 Probe	8	10-12	Pin	-
DG-667		7	M10x1.25	158	29	4 Probe	12	10-12	Pin	-
DG-669		7	M10x1.25	135	27.5	4 Probe	10	10-12	Pin	-
DG-671		11	M10x1.25	100.3	25	4.3 Probe	12	15-20	Thread	1-1.5
DG-702		24	M10x1.25	70	19	5 Probe	12	10-12	M4x0.7	1-1.5

Свечи зажигания и Свечи накаливания

Сокращения

	Автомобиль: марка, модель, объем двигателя
KW	Мощность двигателя
	Код двигателя
	Дополнительная информация
	Год (с - по)
	Свеча зажигания
	Код
4 РАСК	Упаковка по 4шт.
	Искровой зазор
	Iridium Power
	Iridium Tough
	Свеча зажигания ТТ
Cat.	Катализатор выхлопных газов
cc	Кубический сантиметр
CDI	Конденсаторная (тиристорная) система зажигания
cu.in	Кубический дюйм
EFI,i,INJ,i.e.	Впрыск топлива с электронным управлением
EGR	Рециркуляция выхлопных газов
Alternate	Вариант замены
FI	впрыск топлива
FSI	последний впрыск топлива (прямой впрыск топлива)
HC	высокая степень сжатия
UPP, JPP, FRP	Сделано в Великобритании, Сделано в Японии, Сделано во Франции
LC	низкая степень сжатия
LPG	сжиженный газ

L, Ltr.	литр
Mpi	многоточечный впрыск
Org. Nr.	серийный номер (нумерация продукции фирм Ситроен/Пежо)
Spi	одноточечный впрыск
VV	регулируемая операция
VVT	регулирование открытия клапанов
2V	двухкамерный карбюратор
W/O	без
Ch No	Номер шасси
Eng No	Номер двигателя
	Каталожный номер свечи накаливания (сокращенный код)
	Напряжение
	Диаметр резьбы
	Общая длина
	Длина наконечника
	Диаметр наконечника
	Размер под ключ
	Момент затяжки свечи накаливания
	Тип клеммы контактного стержня
	Момент затяжки клеммы

БЦ "Водный"
Головинское шоссе 5 корп. 1
125212 Москва, Россия

Тел: +7 (495) 970 57 57
amsales@denso.ru

www.denso-am.ru



Russian Federation
DECATSPGP20