

CATALOGUE 2017

BALZER 
Quality since 1949.



REELS

Let your passion
run free

Let your passion run free

The equipment is packed, the weather conditions stable. And as you at the water arrive, is even your best place free. Those are the days, for which hours of full conscientious preparation is worthwhile itself. Here outside you can rely completely on your experience, each handle must sit to control the catch. Owing to your know-how and a material that in each situation supports you.

MATERIALS

The MK Adventure Hybrid and Masterpiece reels have frames made from CNC mill-cut duraluminium. Even under the greatest strain the entirely torsion-proof aluminium frame prevents pressure from being exerted on the reel gear. This protects the mechanics to a very large extent and the reel continues to run smoothly throughout, even under heavy loads.

For several years already we have been using for most of our reels state-of-the-art, robust, durable materials for reel construction. Many parts are made of metal: housing, rotor, drag buttons and so on are made from torsion-proof, lightweight aluminium; the ball bearings and even the bail are made from the best quality stainless steel, which means that the reels are highly recommended for the very toughest use in saltwater.

LINE LAY AND GEAR

Most of our other reels are equipped with the superior S-stroke system that guarantees optimal line lay even when using braided lines. Apart from the outstanding materials, special attention was paid by some reels to a perfect, crosswise line lay. The flag ships of the Masterpiece family or the Tactics Feeder reels are equipped with wormshaft gears for perfect crosswise line lay, even with the very thinnest braided lines!

DRAGS

A drag that functions well is prerequisite for relaxed, successful fishing. The reel drag should therefore work without jerking to ensure that the fish do not break out during play and that no lines or rods are caused to break.

The two most important reel drags are the front and rear drags.

The front drags work particularly smoothly and gently thanks to the direct force displacement from the drag-regulating screw which has a direct impact on the spool. Besides, it is possible to build-in larger drag discs to raise the drag performance. The main advantage of rear drag reels is that they are fast and easy to operate because it is very easy to grip the reel from behind and adjust the drag effect during play.

The ADRENALIN Multiplier reels

The extra-narrow form of the housing and spool facilitates very even line lay, even if the line is brought in fast; and it also prevents the line from knotting. Nevertheless the reels have sufficient line capacity!

The new needle bearing (infinite return stop) ensures that the reels are absolutely free from backlash, ideal for jig fishing.

MK Adventure Hybrid 8000



MK Adventure Hybrid 8000

Matze's top model reel is attractive because of its spectacular design and technical treats.

Matze wanted a reel with an extremely torsion-free housing but which was also light. No easy task in view of the fact that torsion-free materials are relatively heavy (aluminium). One has to be aware that a torsion-free housing with zero tolerance is vital for a smooth-running gear. But then, who likes fishing with a heavy reel?

So we developed a "hybrid": The foot of the reel, which is exposed to the greatest stress is made from anodised aluminium. The housing and the stylish rotor are fashioned by a lightweight carbon/nylon composite, whereby the enhancement of the nylon by means of approximately 25% carbon provides additional stiffness.

Matze also gave high priority to perfect line winding, even in the case of thin braided lines. We have developed an S-lifting gear with a slow lift for this purpose. The result is really something to be proud of: with perfect cross-wise winding which does not dig-in and runs of the reel excellently.

Also when it comes to the drag, Matze is uncompromising: It starts smoothly, finely dosed, yet it is also really tough!

- Hybrid reel construction: Aluminium and Carbon-/Nylon-Composite
- 7 precision ball bearings plus 1 needle bearing
- Main axle made of stainless steel
- Slow S stroke system for optimal line lay for casting
- Bail Fix System: no unwanted turn back of the bail when casting
- Total Tolerance Control System (T.T.C.): any conceivable tolerances of the crank, gear and drags are reduced to a minimum
- Strong Bail Concept: the bail is made from extra-strong, lightweight aluminium
- Quick-Stop-System (Q.S.S.) to stop the rotor instantaneously
- Anti Swing-System (A.S.S.), prevents undesirable vibrations
- Strong front drag (S.D.S) with large carbon brake discs
- Anti-Twist line roller with ball bearing
- CNC-cut aluminium power crank
- Aluminium spool
- Optional left or right manual operation



Perfect line winding



Anti-Twist line rollers

MK ADVENTURE HYBRID 8000

Item-No.	Order-No.	Line capacity m Ø mm	weight g	gear ratio	spare spool Aluminium
100950	/820	140 0.20	275	5.8 : 1	190950/820
	/830	135 0.25	290	5.8 : 1	190950/830
	/835	140 0.28	400	5.8 : 1	190950/835
	/840	185 0.30	435	5.8 : 1	190950/840

MK Adventure 6000 BR



Matze Koch's long distance free-running reel

Lots of anglers have been waiting for this: A free-running reel from Matze Koch, developed by him and thoroughly tested in practical use.

The 60 size is ideal for fishing for carp and predators. The extremely finely-adjustable free running is a genuine highlight. The fleeing fish feels hardly any resistance.

The specific combination of the extra-large drag discs ensures extremely finely-dosed drag power. The S-stroke gear guarantees precision crosswise line winding.

- 5 precision ball bearings plus 1 needle bearing
- Finely adjustable free-running system
- S stroke system for optimal line lay for casting
- Bail Fix System: no unwanted turn back of the bail when casting
- Quick Stop (Q.S.S.) for stopping the rotor immediately
- Strong Bail Concept: Bail made from strong, lightweight aluminium
- Finely adjustable front drag (S.D.S.)
- Anti-Swing System (A.S.S.) for optimal smooth running
- Anti-twist line roller
- CNC-cut aluminium power crank
- Aluminium long-distance casting spool
- Spare spool made from aluminium
- Impact-resistant housing
- Optional left or right manual operation

MK ADVENTURE 6000 BR

Item-No.	Order-No.	Line capacity m Ø mm	weight g	gear ratio	spare spool Aluminium
100920	/560	210 0.40	505	4.6 : 1	190920/560



READER TEST FISCH & FANG
09/2015: SCORE 1,3

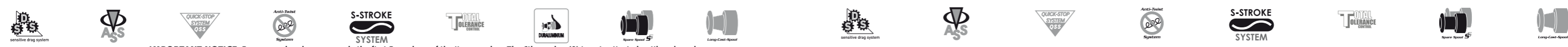

IMPORTANT NOTICE: For your order please use only the first 5 numbers of the item number. The 6th number (0) is not activated until we launch our new ERP Software in the course of our new fiscal year. The Order-No. remains as a 3 digit number.

MK Adventure Spin 6000 FD and RD



MK Adventure 6000...Matze Kochs spinning reels

Many Matze Koch fans have been waiting for this first spin-reel series. Matze was involved in the development process right beginning to end; this enabled him to contribute all his wishes and requirements to it.

Matze deemed it important that, first and foremost, the reels should be designed entirely for practical use by the water and not be equipped with any unnecessary nick-nacks. The reels therefore manage with only 6 exceptionally high quality bearings which enable the reels run as smooth as silk. No "ball-bearing mania"!

Further important points in Matze's view are: excellent line lay as well as an extremely precise, smooth drag and its low tare weight.

It goes without saying that it should also look good, exactly matching Matze's rods as well as his new bag series.

- 5 precision ball bearings plus 1 needle bearing
- S stroke system for optimal line lay for casting
- Bail Fix System: no unwanted turn back of the bail when casting
- Total Tolerance Control System (T.T.C.): any conceivable tolerances of the crank, gear and drags are reduced to a minimum
- Strong Bail Concept: the bail is made from extra-strong, lightweight aluminium
- Quick-Stop-System (Q.S.S.) to stop the rotor instantaneously
- Anti Swing-System (A.S.S.), prevents undesirable vibrations
- Finely adjustable drag (S.D.S) with large brake discs
- Anti-Twist line rollers with titanium alloy
- Aluminium spool
- Nylon/ABS spare spool
- CNC-cut aluminium power crank
- Optional left or right manual operation



MK ADVENTURE SPIN 6000 FD

Item-No.	Order-No.	Line capacity m Ø mm	weight g	gear ratio		spare spool Aluminium
	/620	140 0.20	275	5.3 : 1		190930/620
	/630	135 0.25	305	5.3 : 1		190930/630
100930	/635	175 0.25	400	5.3 : 1		190930/635
	/640	185 0.30	435	5.1 : 1		190930/640

MK Adventure 6000 with rear drag

Matzes popular spin reel as rear-drag version.

The technology corresponds to that of the front drag reels. The "Micro Drag" drag system can be dosed very delicately and brings a shine to the eyes of rear-drag fans.

MK ADVENTURE SPIN 6000 RD

Item-No.	Order-No.	Line capacity m Ø mm	weight g	gear ratio		spare spool Aluminium
	/625	135 0.25	275	5.1 : 1		190940/625
100940	/630	100 0.30	285	5.1 : 1		190940/630
	/640	135 0.35	310	5.1 : 1		190940/640

MK Adventure 6000 BR



MK Adventure 6000

Matze Kochs new BR reels

Matze's successful series has been extended by 4 free-running models in accordance with many requests.

The reels have an amazingly soft, precision-controlled free run and a fantastic price/performance ratio!

The 4 sizes cover more or less all types of use.

- 5 precision ball bearings plus 1 needle bearing
- Finely adjustable free-running
- S stroke system for optimal line lay for casting
- Bail Fix System: no unwanted turn back of the bail when casting
- Quick Stop (Q.S.S.) for stopping the rotor immediately
- Strong Bail Concept: Bail made from strong, lightweight aluminium
- Finely adjustable front drag (S.D.S.)
- Anti-Swing System (A.S.S.) for optimal smooth running
- Anti-twist line roller
- CNC-cut aluminium power crank
- Aluminium long-distance casting spool
- Spare spool made from Nylon-/ABS
- Impact-resistant housing
- Optional left or right manual operation

MK ADVENTURE 6000 BR

Item-No.	Order-No.	Line capacity m Ø mm	weight g	gear ratio		spare spool Aluminium
	/625	140 0.20	330	5.3 : 1		190910/625
	/630	135 0.25	345	5.3 : 1		190910/630
100910	/640	175 0.25	445	5.3 : 1		190910/640
	/650	185 0.30	455	5.1 : 1		190910/650



Tactics Supra 4000 / Alegra Mini

TACTICS ⁴⁰⁰⁰ Supra

Tactics Supra 4000...black, slim, strong and really affordable

The design of this new reel series captivates one immediately. One is immediately captivated by the extremely slim housing and the "skeleton" lightweight construction, whereby the weight of the housing, spool, crank and rotor was reduced. Spin fishing fans will especially appreciate this advantage.

The S-lifting gear ensures very tidy line lay; the fast-folding crank is also practical.

- 3 precision ball bearings plus 1 needle bearing
- Skeleton lightweight construction
- Quick-Stop-System (Q.S.S.) for stopping rotor instantaneously
- Total Tolerance Control System (T.T.C.): all tolerances in the crank, gear and drag are reduced to a minimum
- S stroke system for optimal line lay for casting
- Anti-Swing System (A.S.S.), prevents inadvertent vibrations
- Finely adjustable drag (S.D.S) with extra-large brake discs
- Fast folding crank
- Aluminium spool plus nylon/ABS spare spool

TACTICS SUPRA 4000 FD

Item-No.	Order-No.	Line capacity m Ø mm	weight g	gear ratio		spare spool Aluminium
	/425	115 0.25	265	5.1 : 1		191800/425
	/430	120 0.30	310	5.1 : 1		191800/430
101800	/435	125 0.33	350	5.1 : 1		191800/435
	/445	185 0.40	410	4.9 : 1		191800/445



ALEGRA Mini 515

Our little turbocharger

This dwarf is a genuine wolf in sheep's clothing. Our smallest Alegra will win you over because of its great design, state-of-the-art technology and excellent running properties. Ideal for ultra light spin fishing, light float fishing and for ice fishing.

- 4 precision ball bearings plus 1 needle bearing
- Quick-Stop-System (Q.S.S.) for stopping rotor instantaneously
- Total Tolerance Control System (T.T.C.): all tolerances in the crank, gear and drag are reduced to a minimum
- Anti-Swing System (A.S.S.), prevents inadvertent vibrations
- Finely adjustable front drag (S.D.S) with extra large brake discs
- CNC mill-cut aluminium power crank
- Anti-twist line rollers
- Aluminium spool, plus aluminium spare spool.
- Optional left or right-handed operation

ALEGRA MINI 515

Item-No.	Order-No.	Line capacity m Ø mm	weight g	gear ratio		spare spool Aluminium
101200	/515	100 0.15	175	5.1 : 1		191200/515

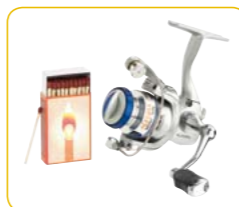

Tactics Ela 5000 BR

TACTICS Ela 5000

Tactics Ela 5000 BR

The Tactics Elas free-running reels have very slender, compact housings and large winding cores. This specific construction enables fast line winding and efficiently counteracts undesirable slack line.

The free-running can be adjusted so finely that the fish does not become wary when snapping the bait.

The S-lifting gear ensures a line lay which optimises casting.

The free run reel is available in 3 sizes: The smallest reel is for fine bottom fishing and smaller predator fishes. The 35er is perfect for medium distances and medium sized fishes like pike-perch and eel. The 45 size is recommended for long distance fishing and large predators and carps.

- 4 precision ball bearings plus 1 needle bearing
- FREE FLOW gear for silky smooth running
- Finely adjustable drag
- Total-Tolerance Control System (T.T.C.): all tolerances in the crank, gear and drag are reduced to a minimum
- Quick-Stop-System (Q.S.S.): Infinite return stop for stopping the rotor instantaneously
- S stroke system for optimal line lay for casting
- Anti-Swing System (A.S.S.), prevents inadvertent vibrations
- Aluminium long-distance casting spool plus nylon/ABS spare spool
- Anti-Twist line roller with titanium alloy



Line Guard System

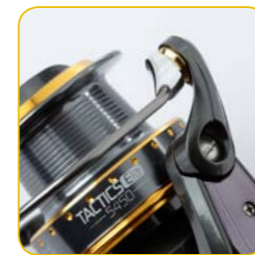

Anti-Twist line rollers

TACTICS ELA 5000 BR

Item-No.	Order-No.	Line capacity m Ø mm	weight g	gear ratio		spare spool Aluminium
	/525	130 0.25	350	5.1 : 1		192220/525
102220	/535	130 0.35	370	5.1 : 1		192220/535
	/545	150 0.45	435	4.8 : 1		192220/545



TACTICS GOLD

PERMANENT LOW PRICE



Tactics Gold 4000...our new gold nuggets!

A superb reel series with a wonderful price/performance ratio.

Not only do the reels look very attractive, they also have a lot to offer. The characteristics of these treasures are their smooth run, controlled drag systems and astonishingly subtle free run in the BR version.

- 3 precision ball bearings plus 1 needle bearing
- S stroke system for optimal line lay for casting
- Bail Fix System: no unwanted turn back of the bail when casting
- Total Tolerance Control System (T.T.C.): any conceivable tolerances of the crank, gear and drags are reduced to a minimum
- Strong Bail Concept: the bail is made from extra-strong, lightweight aluminium
- Quick-Stop-System (Q.S.S.) to stop the rotor instantaneously
- Anti Swing-System (A.S.S.), prevents undesirable vibrations
- Finely adjustable drag (S.D.S) with large brake discs
- Aluminium spool
- Nylon/ABS spare spool
- Optional left or right manual operation

TACTICS GOLD 4000 RD							
Item-No.	Order-No.	Line capacity m Ø mm	weight g	gear ratio			spare spool Aluminium
100310	/420	220 0.20	195	5.4 : 1			190310/420
	/425	185 0.25	220	5.4 : 1			190310/425
	/430	150 0.30	275	5.2 : 1			190310/430

TACTICS GOLD 4000 FD							
Item-No.	Order-No.	Line capacity m Ø mm	weight g	gear ratio			spare spool Aluminium
100300	/420	220 0.20	195	5.4 : 1			190300/420
	/425	185 0.25	205	5.4 : 1			190300/425
	/430	150 0.30	260	5.2 : 1			190300/430
	/440	140 0.35	265	5.2 : 1			190300/440
	/455	175 0.40	340	4.4 : 1			190300/455



TACTICS GOLD

- 3 precision ball bearings plus 1 needle bearing
- Finely adjustable free run system
- S stroke system for optimal line lay for casting
- Bail Fix System: no unwanted turn back of the bail when casting
- Total Tolerance Control System (T.T.C.): any conceivable tolerances of the crank, gear and drags are reduced to a minimum
- Strong Bail Concept: the bail is made from extra-strong, lightweight aluminium
- Quick-Stop-System (Q.S.S.) to stop the rotor instantaneously
- Anti Swing-System (A.S.S.), prevents undesirable vibrations
- Finely adjustable drag (S.D.S) with large brake discs
- Aluminium spool
- Nylon/ABS spare spool
- Optional left or right manual operation

TACTICS GOLD 4000 BR							
Item-No.	Order-No.	Line capacity m Ø mm	weight g	gear ratio			spare spool Aluminium
100320	/425	170 0.30	220	5.2 : 1			190320/425
	/430	200 0.30	270	5.2 : 1			190320/430
	/440	190 0.40	280	5.2 : 1			190320/440
	/450	250 0.40	355	5.2 : 1			190320/450

ALEGRA NEO 6000

Alegra NEO 6000-top reels for a broad spectrum!

Great front drag reels with silky-smooth motion and precision drags which cover more or less all facets of angling.

Size 20 is a genuine 20, i.e. it has a very small body and rotor and is excellent for fine fishing.

The 55 is a strong reel, ideal for heavy-duty freshwater fishing or for boat fishing in the North and Baltic seas.

The finely graduated sizes in between enable you to practice most types of angling successfully.

- 5 precision ball bearings plus 1 needle bearing
- S stroke system for optimal line lay for casting
- Bail Fix System: no unwanted turn back of the bail when casting
- Total Tolerance Control System (T.T.C.): any conceivable tolerances of the crank, gear and drags are reduced to a minimum
- Strong Bail Concept: the bail is made from extra-strong, lightweight aluminium
- Quick-Stop-System (Q.S.S.) to stop the rotor instantaneously
- Anti Swing-System (A.S.S.), prevents undesirable vibrations
- Finely adjustable drag (S.D.S) with large brake discs
- Aluminium spool
- Nylon/ABS spare spool
- CNC-cut aluminium power crank
- Optional left or right manual operation

ALEGRA NEO 6000 FD							
Item-No.	Order-No.	Line capacity m Ø mm	weight g	gear ratio			spare spool Aluminium
102000	/620	180 0.20	200	5.8 : 1			192000/620
	/625	150 0.25	210	5.8 : 1			192000/625
	/630	110 0.30	260	5.8 : 1			192000/630
	/640	115 0.35	270	5.7 : 1			192000/640
	/655	140 0.40	350	5.7 : 1			192000/655



SHIKA 1000

Modul Shika 1000...brings colour to fishing

Fishing tackles does not always have to be just black or green. The colourful Shika reels bring a good mood and some pep to the water. They are already loaded with a monofilament quality line.

Besides the Shika reels there are also the matching Module Shika rods (p. 87) which match technically and from the point of view of colours. Together they are the ideal combination for kids and beginners!

- 1 precision ball bearing
- Multi-Stop-System (Q.S.S.) stops rotor quickly
- Finely adjustable drag (S.D.S)
- Anti-Swing-System (A.S.S.) for optimum smooth running
- S stroke system for optimal line lay for casting
- Anti-twist line rollers
- Nylon/ABS long-distance casting spool
- Optional left or right-handed operation



Besides the Shika reels there are also the matching Module Shika rods which match technically and from the point of view of colours.

MODUL SHIKA 1000						
Item-No.	Order-Nr.	Colour	Loaded with m Ø mm	weight g	gear ratio	
100960	/130	Green	100 0.30	225	4.8 : 1	
100970	/130	Orange	100 0.30	225	4.8 : 1	
100980	/130	Pink	100 0.30	220	4.8 : 1	
100990	/130	Blue	100 0.30	220	4.8 : 1	



GREEN/ORANGE WITH REAR DRAG
BLUE/PINK WITH FRONT DRAG

MATCHING RODS AND COMBOS CAN BE FOUND ON PAGE 87

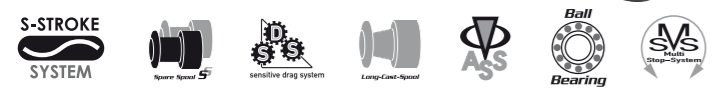

SPEZI



Respectable reels for little money

The Spezi reels presents itself in a top modern design and with the proven technology. Each reel is already fitted with the appropriate target fish line, which in each case is geared exactly to the relevant target fish in terms of colour and diameter.

- 1 precision ball bearing
- S stroke system for optimal line lay for casting
- Finely adjustable micro disc drag system (S.D.S)
- Anti-swing system for excellent smooth running (A.S.S.)
- Long distance casting spool made from lightweight nylon/ABS
- Knock-resistant nylon /ABS housing with two-component varnish coating
- Optional left or right-handed operation
- Rust-free brass pinion
- All reels carry a monofilament line



SPEZI 100						
Item-No.	Order-No.	Type	Carried with Ø mm	weight g	gear ratio	
102600	/125	Trout	0.23mm	220	4.8 : 1	
	/135	Carp	0.30mm	240	4.8 : 1	
	/140	Pike	0.32mm	260	4.8 : 1	
	/120	Coarsefish	0.20mm	210	4.8 : 1	
	/136	Eel	0.37mm	260	4.8 : 1	
102610	/130	Spin	0.25mm	210	4.8 : 1	
	/140	Spin	0.30mm	250	4.8 : 1	



Spezi 100 BR...Free-running for everyone

These inexpensive free-running reels in a top modern design, with an astonishingly sensitive free-running function and tidy line-winding are usually impossible to find in this price category. Ideal for beginners and young anglers.

The reels are already loaded with a monofilament quality line.

- Size 25: 0,25mm
- Size 30: 0,30mm
- Size 40: 0,35mm
- Size 50: 0,40mm

- 1 precision ball bearing
- Multi-Stop-System (Q.S.S.) stops rotor quickly
- Finely adjustable drag (S.D.S)
- Anti-Swing-System (A.S.S.) for optimum smooth running
- S stroke system for optimal line lay for casting
- Anti-twist line rollers
- Rust-free brass pinion
- Nylon/ABS long-distance casting spool
- Optional left or right-handed operation



40er and 50er size with T-handle

SPEZI 100 BR					
Item-No.	Order-Nr.	Line capacity m Ø mm	weight g	gear ratio	
102620	/125	240 0.25	340	5.2 : 1	
	/130	200 0.30	345	5.2 : 1	
	/140	190 0.40	460	5.2 : 1	
	/150	250 0.40	470	5.2 : 1	

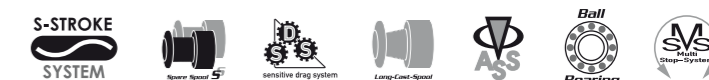

Masterpiece 8550

Masterpiece 8550 F

Masterpiece 8550: Michael Zammataro's masterpiece!

In the brand-new Masterpiece 8550 together with Michael Zammataro we are following the trend towards slimmer and smaller feeder reels. The Masterpiece is now significantly more filigree than the predecessor model, the Zammataro 9600.

The principal item is the new worm-shaft gear with a retarded stroke. This means that the rotor turns significantly more slowly than a normal worm-shaft and this results in an outstanding, cross-wise line lay. Even wet, very thin braided lines don't cut in.

The **Lazy Rotor system** automatically fixes the rotor in place as soon as the bail folds down, so that it does not inadvertently turn during the cast. However it is not completely blocked, so that fine adjustments are still possible before the cast.

The **Bail Fix System** enables the bail to click in when it is turning over, thus preventing it from inadvertently folding down during the cast, which inevitably causes the line or even the rod to break.

The **Safety LINE Clip PLUS** is a further development of the Safety Line Clip - even smoother and with better suspension. The new Safety LINE Clip PLUS guarantees top safety for the line in terms of casting limitation. This guarantees that the line is protected even when the feeder basket is decelerated very hard.

The conical shape of the long-distance casting spool adds a few extra metres to the cast.

We offer a further spool with a greater line capacity.

- 8 precision stainless steel ball bearings plus 1 needle bearing (extra large)
- Chrome-plated brass worm shaft gear for a super long strike and crosswise line lay: ideal for braided line
- Lazy Rotor System: fixes the rotor when the bail folds
- Rotor Controller System: prevents the line from getting caught in the rotor
- Rubber-buffered and spring-loaded Safety Line Clip
- Total-Tolerance Control System (T.T.C.): all tolerances in the crank, gear and drag are reduced to a minimum
- Quick-Stop-System (Q.S.S.) for stopping rotor instantaneously
- Strong-Bail-Concept, bail made of strong, lightweight aluminium
- Bail-Fix-System, no unwanted bail backlash during casting
- Extra strong stainless steel main axle
- Anti-Swing System (A.S.S.), prevents inadvertent vibrations
- Finely adjustable front drag (S.D.S) with extra large brake discs
- CNC mill-cut aluminium power crank
- Anti-twist line rollers with double ball bearings
- 10 line stoppers included to fix the line on the spool



LINE WINDING: 0.9 M PER HANDLE ROTATION

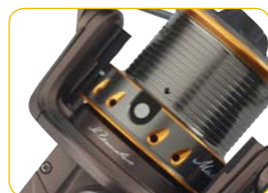

Rubber-buffered and spring-loaded Safety Line Clip PLUS and spool with hole to fix the line reliably with line stoppers



Lazy Rotor System: fixes the rotor when the bail is folded, preventing it from twisting before or during casting



Extra slim body.

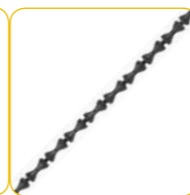

10 line stoppers included

MASTERPIECE FEEDER 8550					
Item-No.	Order-No.	Line capacity Ø mm	weight g	gear ratio	
103250	/855	200 0.10	570	4.8 :1	

ALUMINIUM SPARE SPOOL					
Item-No.	Order-No.	Line capacity m Ø mm	Spare spool for:		
193250	/855	200 0.10	flat spool for braided line		
	/856	300 0.25	lower spool for monofilament line		



Masterpiece Light Feeder 8400

Masterpiece 8400 LF

Masterpiece 8400 LF... a true masterpiece!

Based on our flagship, Matze Koch's MK Adventure Hybrid 8000, we have further developed this masterpiece for light feeder fishing and method feeder fishing in cooperation with Michael Zammataro.

Like the Hybrid the Masterpiece also has a hybrid body, i.e. a combination of aluminium, carbon and nylon/ABS.

The reel base, which – especially when feeder fishing - naturally bears the greatest load, is made from torsion-free aluminium. The body of the reel is made from lightweight Nylon/ABS, reinforced by approx. 25% carbon fibre which makes the body extremely hard and resilient.

The shape of the rotor was designed according to Michael's requirements and it makes it possible to grasp the handle and the line clip without any hindrance.

The **Safety LINE Clip PLUS** is a further development of the Safety Line Clip - even smoother and with better suspension. The new Safety LINE Clip PLUS guarantees top safety for the line in terms of casting limitation. This guarantees that the line is protected even when the feeder basket is decelerated very hard.

With a transmission of 5.2:1 the Masterpiece pulls in the assembly briskly. However, it is still low enough, in order to also bring in baskets out of the current.

We are particularly proud of the design of the extremely smooth-running gear: The decelerated S-stroke ensures perfect line winding; even wet, extremely thin braided lines don't cut in!

For those for whom the line capacity is insufficient, we also offer an e-spool with a considerably higher line capacity.

This reel is a genuine masterpiece!

- Hybrid reel construction: Aluminium and Carbon-/Nylon-Composite
- 7 precision ball bearings plus 1 needle bearing
- Main axle made of stainless steel
- Slow S stroke system for optimal line lay for casting
- Bail Fix System: no unwanted turn back of the bail when casting
- Total Tolerance Control System (T.T.C.): any conceivable tolerances of the crank, gear and drags are reduced to a minimum
- Strong Bail Concept: the bail is made from extra-strong, lightweight aluminium
- Quick-Stop-System (Q.S.S.) to stop the rotor instantaneously
- Anti Swing-System (A.S.S.), prevents undesirable vibrations
- Strong front drag (S.D.S) with large brake discs
- Anti-Twist line roller with ball bearing
- CNC-cut aluminium power crank
- Aluminium spool
- Optimised safety line clip
- Easy Fix line fixing system
- Optional left or right manual operation

LINE WINDING: 0.8 M PER HANDLE ROTATION

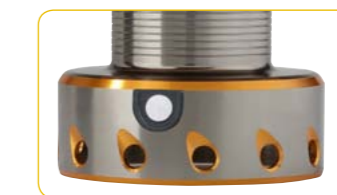

Rubber-buffered Safety Line Clip and spool with hole to fix the line reliably with special line stoppers



10 line stoppers included

MASTERPIECE LIGHT FEEDER 8400					
Item-No.	Order-No.	Line capacity m Ø mm	weight g	gear ratio	
103250	/840	210 0.10	330	5.2:1	

ALUMINIUM SPARE SPOOL					
Item-No.	Order-No.	Line capacity m Ø mm	Spare spool for:		
193250	/840	200 0.10	flat spool for braided line		
	/841	200 0.25	lower spool for monofilament line		



Tactics Feeder 7600

TACTICS Feeder 7600

Tactics Feeder 7600...Michael Zammataro's new feeder reel

The excellent price/performance ratio and its great features make Michael's latest feeder reel an attractive proposition.

The smooth-running worm shaft gear guarantees perfect crosswise line lay. The rubber-buffered safety line clip prevents the line from being damaged by the long-distance casting limitation.

The two casting-optimised aluminium spools have different line capacities. One spool is designed for thin braided lines; the other for monofilament lines.

- 6 precision ball bearings plus 1 needle bearing
- Quick-Stop-System (Q.S.S.) for stopping rotor instantaneously
- Strong Bail Concept Bail made from strong, lightweight aluminium
- Worm shaft gear for perfect cross-wise winding and spool contour
- Strong front drag (S.D.S) with extra large brake discs
- Line guide system
- Anti-Swing-System (A.S.S.) for optimum smooth running
- Total Tolerance Control, reduces tolerances to a minimum
- Ball-bearing anti-twist line rollers with titanium alloy
- Knock-resistant housing with two-component varnish coating
- Aluminium power crank
- Rubber-buffered Safety Line Clip
- 2 cast-optimised conical aluminium spools in 2 sizes:
Spool 1: 200x0,10mm
Spool 2: 200x0,25mm
- 10 line stoppers included to fix the line on the spool



LINE WINDING: 1 M PER HANDLE ROTATION

WITH 2 DIFFERENT ALUMINIUM SPOOLS



Michael Zammataro



Line Guard System



Rubber-buffered Safety Line Clip and spool with hole to fix the line reliably with special line stoppers



10 line stoppers included

TACTICS FEEDER 7600					
Item-No.	Order-No.	Line capacity m Ø mm	weight g	gear ratio	
103210	/760	200 0.10/200 0.25	585	4.9 : 1	

ALUMINIUM SPARE SPOOL				
Item-No.	Order-No.	Line capacity m Ø mm	Spare spool for:	
193210	/760	200 0.10	braided line	
	/761	200 0.25	monofilament line	



Tactics Feeder 7600 BR

TACTICS Feeder 7600 BR

Tactics Feeder 7600 BR...also available in a free-running version

It goes without saying that Michael's feeder reel is also available with free-running. The rest of the technical equipment corresponds exactly to the Tactics Feeder 7600.

Free run facilitates perfect timing and handling of both basket and fish. A further advantage: in view of the fact that the reel has two spools with different line capacities, they can also be used for carp fishing!

- 6 precision ball bearings plus 1 needle bearing
- Super-sensitive free run
- Quick-Stop-System (Q.S.S.) for stopping rotor instantaneously
- Strong Bail Concept Bail made from strong, lightweight aluminium
- Worm shaft gear for perfect cross-wise winding and spool contour
- Strong front drag (S.D.S) with extra large brake discs
- Line guide system
- Anti-Swing-System (A.S.S.) for optimum smooth running
- Total Tolerance Control, reduces tolerances to a minimum
- Ball-bearing anti-twist line rollers with titanium alloy
- Knock-resistant housing with two-component varnish coating
- Aluminium power crank
- Rubber-buffered Safety Line Clip
- 2 cast-optimised conical aluminium spools in 2 sizes:
Spool 1: 200 x 0,10mm
Spool 2: 200 x 0,25mm
- 10 line stoppers included to fix the line on the spool



LINE WINDING: 1 M PER HANDLE ROTATION

WITH 2 DIFFERENT ALUMINIUM SPOOLS

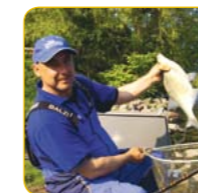

Michael Zammataro



Line Guard System

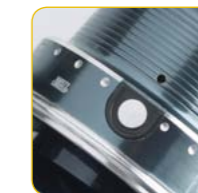

Rubber-buffered Safety Line Clip and spool with hole to fix the line reliably with special line stoppers

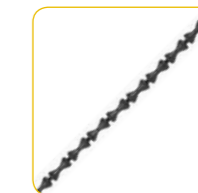

10 line stoppers included

TACTICS FEEDER 7600 BR					
Item-No.	Order-No.	Line capacity m Ø mm	weight g	gear ratio	
103220	/760	200 0.10/200 0.25	620	4.9 : 1	

ALUMINIUM SPARE SPOOL				
Item-No.	Order-No.	Line capacity m Ø mm	Spare spool for:	
193220	/760	200 0.10	braided line	
	/761	200 0.25	monofilament line	



Tactics Light Feeder and Ultra Light Feeder

TACTICS Light Feeder/ Ultra Light Feeder

Tactics Light Feeder 7400...ideal for light feeder-fishing and method feeder-fishing

Both light and method feeder-fishing are becoming increasingly popular. We have already done justice to this trend in the form of the new Masterpiece rods and the new Magna Pro Feeder series. We have also developed the matching reel in collaboration with Michael Zammataro. The Tactics light feeder is a filigree rod with a high line-winding capacity?

The conical shape of the spools prevents the line from curling during casting. The two aluminium spools have different line capacities. This makes it possible to choose between a braided or a monofilament line, or the reel can be used variably for other areas.

Furthermore, the light feeder is equipped with a rubber-cushioned line clip which protects the line optimally from damage while slowing down the cast.

Tactics Ultra Light Feeder

In addition to the proven Tactics Light Feeder we integrated now a smaller one: the Tactics Ultralight Feeder! Technically it corresponds to the Ultra Light Feeder, but is still significantly smaller, lighter and more delicate. Also for trout and match fishing ideal!

- 6 precision ball bearings plus 1 needle bearing
- Quick-Stop-System (Q.S.S.) for stopping rotor instantaneously
- Line Guard System
- Strong Bail Concept Bail made from strong, lightweight aluminium
- S stroke system for optimal line lay for casting
- Strong front drag (S.D.S) with extra large brake discs
- Anti-Swing-System (A.S.S.) for optimum smooth running
- Total Tolerance Control, reduces tolerances to a minimum
- Ball-bearing anti-twist line rollers with titanium alloy
- Knock-resistant housing with two-component varnish coating
- Aluminium power crank
- Rubber-buffered Safety Line Clip
- 2 conical long cast spools with 2 different line capacities
- 10 line stoppers included to fix the line on the spool

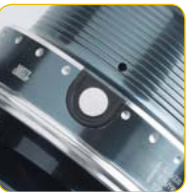

Rubber-buffered Safety Line Clip and spool with hole to fix the line



10 line stoppers included



Line Guard System

TACTICS LIGHT FEEDER 7400

Item-No.	Order-No.	Line capacity m Ø mm	weight g	gear ratio
103210	/735	150 0.10/160 0.20	400	4.9:1
	/740	200 0.10/200 0.25	405	4.9:1

ALUMINIUM SPARE SPOOL FOR LIGHT FEEDER 7400

Item-No.	Order-No.	Line capacity m Ø mm	Spare spools for 103210/740
193210	/740	200 0.10	braided line
	/741	200 0.25	monofilament line

LINE WINDING: 0.8 M PER HANDLE ROTATION
WITH 2 DIFFERENT ALUMINIUM SPOOLS

Tactics Light Feeder 7400 BR

TACTICS Light Feeder BR

Tactics Light Feeder 7400 BR...also with free-running

Of course the Tactics Light Feeder is also available with a free-running function.

The reel is excellent to use for light to medium bottom fishing for trout, pike-perch, carp etc.

- 6 precision ball bearings plus 1 needle bearing
- Super-sensitive free run
- Quick-Stop-System (Q.S.S.) for stopping rotor instantaneously
- Strong Bail Concept Bail made from strong, lightweight aluminium
- S stroke system for optimal line lay for casting
- Strong front drag (S.D.S) with extra large brake discs
- Line guide system
- Anti-Swing-System (A.S.S.) for optimum smooth running
- Total Tolerance Control, reduces tolerances to a minimum
- Ball-bearing anti-twist line rollers with titanium alloy
- Knock-resistant housing with two-component varnish coating
- Aluminium power crank
- Rubber-buffered Safety Line Clip
- 2 conical long cast spools with 2 different line capacities
- 10 line stoppers included to fix the line on the spool



Rubber-buffered Safety Line Clip and spool with hole to fix the line reliably with special line stoppers



10 line stoppers included



Line Guard System

LINE WINDING: 0.8 M PER HANDLE ROTATION
WITH 2 DIFFERENT ALUMINIUM SPOOLS

TACTICS LIGHT FEEDER 7400 BR

Item-No.	Order-No.	Line capacity m Ø mm	weight g	gear ratio
103220	/740	200 0.10/200 0.25	450	4.9:1

ALUMINIUM SPARE SPOOL

Item-No.	Order-No.	Line capacity m Ø mm	Spare spool for:
193220	/740	200 0.10	braided line
	/741	200 0.25	monofilament line



Tactics Pilk and Surf

TACTICS Surf and Pilk

Tactics Pilk 7500...for cod and coalfish

It is a powerful, yet easy-to-handle, reel for pilking and fishing with rubber fish off a cutter or a small boat. Both the ball bearings and the main axle are made from stainless steel, thereby providing maximum protection from aggressive saltwater.

The S-lifting gear guarantees correct line lay. At 0.8m per crank rotation, this filigree reel brings in the line astonishingly fast.

- 6 precision ball bearings plus 1 needle bearing
- S stroke system for optimal line lay for casting
- Quick-Stop-System (Q.S.S.) for stopping rotor instantaneously
- Strong Bail Concept Bail made from strong, lightweight aluminium
- Strong front drag (S.D.S) with extra large brake discs
- Line guide system
- Anti-Swing-System (A.S.S.) for optimum smooth running
- Total Tolerance Control, reduces tolerances to a minimum
- Ball-bearing anti-twist line rollers with titanium alloy
- Knock-resistant housing with two-component varnish coating
- Aluminium power crank with extra large Duplon handle
- Aluminium long cast spool plus nylon/ABS spare spool

TACTICS PILK 7500

Item-No.	Order-No.	Line capacity m Ø mm	weight g	gear ratio		spare spool Aluminium
100760	/750	200 0.40	390	4.8:1		190760/750



Line Guard

**BALL BEARINGS AND AXLE
MADE OF STAINLESS STEEL**

Tactics Surf 7650...for long-distance casts in surf

A reel for surf fishing with a top price/performance ratio.

Both the ball bearings and the main axle are made from stainless steel, thereby providing maximum protection from aggressive saltwater.

The powerful worm-shaft gear facilitates fast line-winding at 1m per crank rotation. In the process the line is wound extremely tidily cross-wise; it doesn't dig in and runs off the spool optimally during casting.

The conical shape of the aluminium spool prevents the line from curling during casting. The non-slip Duplon handle is positioned securely and pleasantly in your hand even when it is wet and cold out.

- 6 precision ball bearings plus 1 needle bearing
- Worm shaft gear for perfect cross-wise winding and spool contour
- Quick-Stop-System (Q.S.S.) for stopping rotor instantaneously
- Strong Bail Concept Bail made from strong, lightweight aluminium
- Strong front drag (S.D.S) with extra large brake discs
- Line guide system
- Anti-Swing-System (A.S.S.) for optimum smooth running
- Total Tolerance Control, reduces tolerances to a minimum
- Ball-bearing anti-twist line rollers with titanium alloy
- Knock-resistant housing with two-component varnish coating
- Aluminium power crank with extra large Duplon handle
- Aluminium long cast spool plus nylon/ABS spare spool

TACTICS SURF 7650

Item-No.	Order-No.	Line capacity m Ø mm	weight g	gear ratio		spare spool Aluminium
100770	/765	300 0.35	550	4.9:1		190770/765



Line Guard



Tactics Strong II / Alegra Fight

TACTICS Strong 3650 II

An indestructible demon for work

Our indestructible demon for work now in the new design and with an even stronger drag effect.

The reel is suitable for using both in the sea (pilking, surf) and for big fish in fresh water.

The strong axle can even deal with catfish and big cod.

- 3 precision ball bearings
- Multi-Stop-System (M.S.S.)
- Finely adjustable front drag (S.D.S) with extra large brake discs
- S stroke system for optimal line lay for casting
- Strong-Bail-Concept, bail made of strong, lightweight aluminium
- Anti-Swing-System (A.S.S.) for optimum smooth running
- Anti-Twist line rollers
- Aluminium long distance casting spool
- Nylon/ABS spare spool
- Knock-proof housing with two-component varnish coating
- Optional left or right-handed operation
- Power crank

TACTICS STRONG 3650 II

Item-No.	Order-No.	Line capacity m Ø mm	weight g	gear ratio		spare-spool aluminium
102260	/365	335 0.40	665	4.1:1		192260/365

ALEGRA Fight 4000

Alegra Fight 4000...our proven battleship in a new design!

Our reliable, popular battleship in a new design and with improved gear. Ideal for spin and bottom fishing for larger fish such as pike, carp etc. Size 55 is of course also a perfect a pilking reel.

4 precision bearings ensure smooth running; the S-stroke gear guarantees crosswise line lay.

- 3 precision ball bearings plus 1 needle bearing
- Quick-Stop-System (Q.S.S.) for stopping rotor instantaneously
- Finely adjustable front drag (S.D.S) with extra large brake discs
- S stroke system for optimal line lay for casting
- Anti-Swing-System (A.S.S.) for optimum smooth running
- Anti-Twist line rollers
- Aluminium long distance casting spool
- Nylon/ABS spare spool
- Optional left or right-handed operation
- Power crank

ALEGRA FIGHT 4000

Item-No.	Order-No.	Line capacity m Ø mm	weight g	gear ratio		spare-spool aluminium
102270	/445	190 0.40	315	5.2:1		192270/445
	/455	155 0.50	430	5.2:1		192270/455

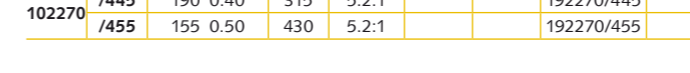

Adrenalin multiplier reels

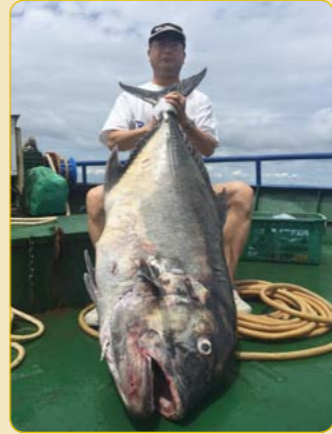

ADRENALIN® - Superlative multiple reels!



Place in the top 3 sea fishing reels in the nomination for the "Golden Fishing Hook" of the Jahr Top Special Publisher 2012.

Carbon drag washers
Made in USA

Perfect for fishing in Norway.

Monster GT: caught during test fishing in Malaysia in 2015.

The newest generation of our Adrenalin reels boast new – even more powerful gears and power crank handles made from aluminium. The silver housing not only looks great, it also goes excellently with our Edition 71°North and Adrenalin rods!

Like the previous series, these reels will also continue to be produced in Taiwan not in China in order to guarantee the high quality standard. All components of these reels comes exclusively from Japan, the US or Taiwan; and the precision CNC mill-cutting machines were exported from Japan! And the very popular size 12 is now also available as a 2-speed reel. Size 14 (2-speed) is also new and its perfect handling, light weight and high line capacity account for the fact that they are most captivating!

FEATURES:

HOUSING

The one-part housings are made from a block of 6061-T6 aluminium. This type of aluminium is also used in aircraft construction; it is distinguished by an extremely low weight yet is extremely resilient.

FORM

The extra-narrow form of the housing and spool facilitates very even line lay, even if the line is brought in fast; and it also prevents the line from knotting. Nevertheless the reels have sufficient line capacity! The narrow shape was developed for us by the Taiwanese speed-jig champion, Ken Wu.

SURFACE TREATMENT

The entire housing is anodised and provides excellent protection against aggressive saltwater.

GEAR

The whole gear is made from non-corrosive stainless steel. This also applies to every single screw or spring.

LEVER-SHIFT DRAG

This infinitely adjustable carbon/stainless steel drag system, which works brilliantly, is impressive owing to a jerk-free, even drag action – both at 40 degrees on the Ebro and at minus temperatures on the Lofoten.

The drag disks made from hardened carbon are manufactured in the United States and are unbeatable with regard to the drag action and service life.

A locking device secures the free-run mechanism and the drag to prevent inadvertent activation of the former or blocking of the latter.

BALL BEARINGS

All reels are equipped with 7 Japanese, double-sealed ball bearings and one needle bearing, also made in Japan. The needle bearing (infinite return stop) ensures that the reels are absolutely free from backlash.

CRANKS

The cranks are now made of special aircraft aluminium and the handle is extra long to guarantee even more convenient line winding.

FREE-RUN

There are arguably only a few reels with such a sensationally smooth free-run function.

RIGHT / LEFT-HAND

Some Adrenalin models are available both in a right and a left-hand version.

All reels are supplied with tool kit, supplies and a small bottle of oil.

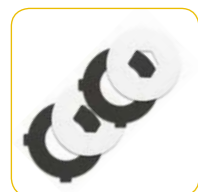

Carbon drag washers



Lever-shift drag



Power gear made of stainless steel



Ball bearing mounted power handle made of aluminium



Pin for easy and safe line fixing



Tool kit, supplies and reel oil

Adrenalin multiplier reels



Adrenalin AN 10 LH

Small, but oh boy! Don't be misled by the delicate size. All of 22 LBS drag capacity can make even very strong opponents look old. They are used with light to medium-weight artificial bait and natural bait fish for cod, saithe, pollock etc. However, it is also very good for trawling in both fresh water and saltwater. Fast line retraction thanks to the 5.2:1 transmission.

ADRENALIN AN 10 LH							
Item-No.	Order-No.	Model	Line capacity m Ø mm	Drag power	weight g	gear ratio	
107100	/010	LH	460 0.20	22lbs/10 kg	430	5.2:1	



Adrenalin AN 12 LH / AN 12 RH

A real allrounder for Norway! With this reel you are excellently equipped for any situation. The strong 26.5 lbs drag performance outfights even the biggest fish. The high 5.8:1 transmission facilitates fast line winding.

ADRENALIN AN 12 LH / AN 12 RH							
Item-No.	Order-No.	Model	Line capacity m Ø mm	Drag power	weight g	gear ratio	
107120	/012	LH	480 0.25	26lbs/12 kg	600	5.8:1	
	/112	RH	480 0.25	26lbs/12 kg	600	5.8:1	



* for the predecessor reel



THE PREDECESSOR REEL WAS TESTED IN BLINKER 04/2010

Features:



Practical test:

Price:



The Blinker quality seal is only awarded to high quality tackle that is achieved at least 13 (of 15 possible) points on the test scale.

Adrenalin multiplier reels



Adrenalin TS-12 LH / TS-12 RH

Size 12 is now available with an energy-saving 2-speed gear. The high gear has a high-speed transmission of 6.2:1 and permits extremely fast line winding. The lower, 3.9:1 gear is switched on for playing big fish or bringing in heavy assemblies with hooked fish and saves your strength.



Adrenalin-TS 12 with powerful 2-speed gear to save strength

ADRENALIN TS-12 LH / TS 12 RH

Item-No.	Order-No.	Model	Line capacity m Ø mm	Drag power	weight g	gear ratio
107120	/212	LH	480 0.25	26lbs/12kg	610	6.2:1/3.9:1
	/312	RH	480 0.25	26lbs/12kg	610	6.2:1/3.9:1

Adrenalin TS-14 LH

Our strongest Adrenalin, also with a 2-speed gear.

Size 14 is ideal for fishing with natural bait at great depths for ling, ocean perch etc. where a greater line capacity is needed, and for hunting for the really big ones! The reel weighs only 710g and thus provides wonderful handling. With its gigantic 30-pound drag capacity this reel can stand up to even the biggest flounders and lings.

Ultra fast line winding in 1st gear thanks to the 6.2:1 high speed transmission and strength-saving 3.9:1 in 2nd gear.

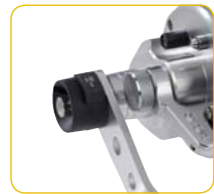

Adrenalin-TS 14 with powerful 2-speed gear to save strength

ADRENALIN TS-14 LH

Item-No.	Order-No.	Model	Line capacity m Ø mm	Drag power	weight g	gear ratio
107140	/014	LH	650 0.30	33lbs/15kg	710	6.2:1/3.9:1



Alegra BC 6000 / Hitra 6400 LCL

ALEGRA BC 6000

The spinfishing with baitcast reels is enjoying ever-increasing popularity. In this case the free-run is simply activated by means of thumb pressure enabling single-handed casting and significantly raising the casting frequency. The magnetic drag system can be adjusted with extreme precision and it prevents the spool from overrotating during casting (no tangling).

With 5 ball bearings and 1 needle bearing.

ALEGRA BC 6000

Item-No.	Order-No.	Line capacity m Ø mm	w. g	gear ratio	spare spool aluminium
104280	/600	250 0.20	220	6.2:1	194280/600



HITRA

Hitra 4000 LCL... let's go Norge!

Extremely durable left-hander multiple reel with a metric counter. In addition to 3 ball bearings the reel also boasts needle bearings (infinite reverse stop), which prevents any kickback. The line guide lays the line evenly on the spool, thus sparing you the unpleasant task of distributing the line evenly when reeling in.

The ergonomic star drag can be dosed very well and it has great drag efficiency.

It goes without saying that it has a free-run function for lowering the bait and a spike in the reel core for fastening the main line.

The ideal reel for all travellers to Norway seeking a reliable, affordable multiple reel!

- 4 precision ball bearings
- Quick-Stop-System (infinite return stop)
- Line counter up to 999 metres
- Line guide for a perfect line lay
- Star drag with great drag performance
- Free-run function
- Spike on the spool for safe, slip-proof line fastening

HITRA 6400 LCL

Item-No.	Order-No.	Line capacity m Ø mm	weight g	gear ratio
104200	/640	350 0.40	540	4.6:1



Line Guide System:
The line guide lays the line evenly on the spool, thus sparing you the unpleasant task of distributing the line evenly when reeling in.



Tactics Fly / Tactics AX

TACTICS FLY

Big core, small price

Our new fly reel with the large core is convincing because of its top quality at a super price! The reel is made from high quality duraluminium and - besides 2 stainless steel ball bearings - a high quality needle bearing. The drag can be adjusted with extreme precision and also forestalls the flight of big fish masterfully. The large spool core facilitates very fast line retraction.

- 2 precision ball bearings
- Housing made of Duraluminium
- Super-sensitive drag-system

TACTICS FLY

Item-No.	Order-No.	Type	weight g.	AFTMA-class		
107950	/006	Fly 4/5/6	165	4/5/6		
	/008	Fly 7/8	180	7/8/9		



TACTICS AX

Extra lightweight Nottingham reel made of Aluminium for fishing for lavarets or perch.

- 2 japanese ball bearings
- Spool made of aluminium
- Weight 120g
- Lockable drag (releases during fight)

TACTICS AX

Item-No.	Order-No.	Line capacity m Ø mm	w. g	gear ratio		
107970	/000	-	120	-		



Fly fishing combos consisting of rod, reel and line can be found on page 88. Accessories and lines can be found on page 206-207.

Schöner kann
angeln nicht sein

Schenken Sie sich
oder anderen ein Jahr
lang pure Angelfreude!

Druckfrisch und frei Haus.

Tel.: 030/41909-335
E-Mail: abo@ruteundrolle.de
www.ruteundrolle.de

Tolle Prämienangebote
finden Sie unter
www.ruteundrolle.de!

12x im Jahr
zum Vorteilspreis
von nur 45,- €





RODS

When man and tool
become one



When man and tool become one

The rod is the extended arm of the angler. Not only a stick with a line to it, but a precision instrument most developed. It is the link which lets a perfect interaction of the angler with its equipment become reality.

Rods made of best carbon fibre

EDITION IM-12

For a long time our Edition rods are convincing in design and technology. Our designer team has succeeded in producing a genuine hit in terms of appearance. The symbiosis between the ruby-red, shimmering carbon surface and the gold-coloured elements has a superb, noble effect.

MK ADVENTURE IM 12 NANO RODS / IM 8 RODS

Matze Kochs target was to enable the angler to react as flexibly as possible.

We have succeeded in performing this tightrope walk-type feat in the form of the high class IM-12 and the affordable IM-8 rods. A sensitive rod for catching both perch and medium-sized pike? It exists! A rod which is short and easy to handle and at the same time capable of making it easier to embark on vertical fishing. A rod suitable for medium spin fishing and light jerking? This too was made possible in the MK series.

Casting weight specifications ranging from 6 to 60 grams are by no means utopian. And it is so delicate that it can present ultra light bait perfectly and nevertheless go ahead and perform a full swipe with a 50-gram jerk.

MASTERPIECE SNAKE SKIN / MAGNA PRO FEEDER

Michael Zammataro and his team here also invested a great deal of time in the further development of the IM-8 feeder rods. Not only were the existing models further optimised, new rod types - such as the Method Feeder - were furnished with sensible extras.

DIABOLO NEO

Our all-time most successful rod series is in the 9th generation! And that's quite something: The new rods are lighter, more dynamic and faster. These well-balanced blanks are made from the best IM-7 carbon fibre and enhanced good looks. The precision tongue-and-groove joints, the slender titanium SIC guides and the ergonomic cork handles guarantee unadulterated fishing pleasure.

ADRENALIN ARCTIC RODS

Our best sea rods now in a new outfit! Visually and technically they match the new generation of our Adrenalin reels. The rods not only look fantastic, they are made from the best Japanese IM-12+ carbon fibre and are equipped with the very finest components. We use FUJI Alconite guides only.

EDITION IM-12 71° NORTH NANO

How can you improve a perfect product? Volker Dapoz and our technicians pursued precisely this question in connection with our legendary 71° North rod series. The result is real high tech rods based on carbon fibre fortified by nanoparticles.

Carbon mats made from carbon nanotubes (CNT) are combined with IM-12 carbon mats for the special blank construction. An extremely high fracture resistance is thereby obtained, which provides for slender blanks and a low weight.

Edition IM-12 put over

Edition IM-12

Edition IM-12...fast, slender, good-looking

The most recent Edition IM-12 generation scores well thanks to the slender, well-made, lightweight blanks with actions as fast as arrows.

Japanese, highly compressed IM-12 carbon-fibre blanks form the basis for these first-class rods. The spin rods impress with sturdy, taut fast taper actions.

The innovative FUJI reel seat of the put-in rods is open on both sides to enable one's fingers to lay on the blanks while one is fishing. There is no other more sensitive bait detection and bait guidance to be had!

It goes without saying that the reel seats on the telescopic rods also come from FUJI.

The special Vector Angle ring frames on the put-in rods not only look 'hip', they prevent the line from tangling. Of course all the rods are equipped with the very best SIC guides and natural Portuguese cork handles (except for Bolognese = Roughgrip).

FEATURES:

- Japanese IM-12 carbon fibre
- Precision FUJI reel seat
- Super-slim Titanium SIC Vector Angle guides, ideal also for braided lines
- Precision-ground tongue and groove joints
- Handles made from Portuguese natural cork or Roughgrip
- Guide connections sealed with epoxy varnish
- Delivered in soft case



SPIN 15

Ultra light rod for fishing with extra small artificial bait in small streams or from the boat.

Item-No.	Order-No.	Length m	Sec.	Transp.-Length m	weight g	Casting weight g	Handle		
112700	/185	1.85	2	0,95	95	3-15	natural cork		



SPIN 25

Wonderfully filigree rod for light spin fishing with small artificial bait. The extremely fast action casts even the tiniest bait over amazing distances with outstanding precision. It is most pleasurable to play a big trout with this rod.

Item-No.	Order-No.	Length m	Sec.	Transp.-Length m	weight g	Casting weight g	Handle		
112710	/195	1.95	2	1.05	120	5-25	natural cork		
	/225	2.25	2	1.18	135	5-25	natural cork		
	/255	2.55	2	1.32	150	5-25	natural cork		



SPIN 45

A real general purpose rod, sensitive enough to fish for trout and perch, yet on the other hand strong enough to be able to deal with a pike. The ideal use for it is spin fishing for big trout and perch, pike-perch or medium-sized pike.

Item-No.	Order-No.	Length m	Sec.	Transp.-Length m	weight g	Casting weight g	Handle		
112720	/215	2,15	2	1,13	125	15-45	natural cork		
	/245	2,45	2	1,28	150	15-45	natural cork		
	/275	2,75	2	1,42	170	15-45	natural cork		



SPIN 75

The Ideal spin fishing rod for pike and pike-perch with. All kinds of artificial baits can be used.

Item-No.	Order-No.	Length m	Sec.	Transp.-Length m	weight g	Casting weight g	Handle		
112730	/235	2.35	2	1.23	160	25-75	natural cork		
	/265	2.65	2	1.37	195	25-75	natural cork		
	/295	2.95	2	1.55	225	25-75	natural cork		



Special FUJI reel seat for direct contact to the blank



Precision FUJI reel seat also by the tele rods



2 leg Titanium SIC Vector Angle guides



Portuguese natural cork



Titanium SIC guides by the tele rods



1 leg Titanium SIC Vector Angle guides



SPIN 105

Ideal for spin fishing with large artificial baits for pike and other large predators. Also excellent for fishing in the baltic sea or light tackle fishing in norway.

Item-No.	Order-No.	Length m	Sec.	Transp.-Length m	weight g	Casting weight g	Handle		
112740	/285	2,85	2	1,47	215	40-105	natural cork		



CATFISH SPIN

Targeted spin fishing for catfish is becoming increasingly popular. Unfortunately, there are only a few really good rods. No wonder, for they are very demanding: a strong backbone to stand up to big fish, but a relative sensitive tip so that a catfish can suck in the bait. In the shape of the new IM-12 we have succeeded in producing a truly masterly rod!

Item-No.	Order-No.	Length m	Sec.	Transp.-Length m	weight g	Casting weight g	Handle		
112750	/285	2.85	2	1.47	325	80-225	natural cork		



SEATROUT

Lots of anglers have been waiting for this: A sea trout rod developed especially for fishing with braided lines. The bottom and top guides are always subjected to special strain when using hard braided lines. This prompted us to select highly resilient Low Rider guides for the starting guide. All the guides in between are special single-foot guides that save a good deal of weight.

Item-No.	Order-No.	Length m	Sec.	Transp.-Length m	weight g	Casting weight g	Handle		
112770	/305	3.05	2	1.58	185	7-34	natural cork		
	/335	3.35	2	1.73	205	7-34	natural cork		



SEATROUT HEAVY

This rod has the same characteristics as the "Seatrout", but in terms of the blank and action it is designed for heavy artificial bait. Also a real windbreaker!

Item-No.	Order-No.	Length m	Sec.	Transp.-Length m	weight g	Casting weight g	Handle		
112780	/325	3.25	2	1.68	228	14-58	natural cork		

Edition IM-12 put over and telescopic rods

EXTRA LARGE GUIDES



HUCHEN / DANUBE SALMON WINTER SPIN

This is a special rod for spin fishing in winter for Huchen. The extra-large guides prevent the guides from freezing over at temperatures below zero.

With the powerful blank it is possible to guide even larger artificial types of bait well in a strong current and to play big fish securely.

Item-No.	Order-No.	Length m	Sec.	Transp.-Length m	weight g	Casting weight g	Handle		
112760	/270	2.70	2	1.42	240	40-85	natural cork		



LAVARET

Wonderfully filigree lavaret rod made of IM-12 carbon fibre developed by Swiss lavaret specialist Ruedi Bleuer. The extremely parabolic blank reduces the proportion of escapers to a minimum, yet it is powerful enough to play several fish safely. Supplied with 2 exchangeable tips.

Item-No.	Order-No.	Length m	Sec.	Transp.-Length m	weight g	Casting weight g	Handle		
112790	/180	1.80	2	0.93	65	-	natural cork		
	/210	2.10	2	1.10	75	-	natural cork		
	/240	2.40	2	1.25	85	-	natural cork		
	/000	Spare tip soft							
	/001	Spare tip medium							

Edition IM-12

The telescopic rods have an entirely new kind of blank design with woven carbon design. It makes them very light and slender. As far as dynamics are concerned, they are by no means inferior to put-in rods!

Also the telescopic rods are equipped with Fuji reel seats.



Original Fuji reel seat

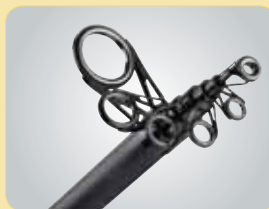

Super-slim titanium SIC guides, also ideal for braided lines



Portuguese natural cork except Distance with Duplon handle and Bolognese with Roughgrip



MINI SPIN

Anyone travelling with little baggage who does not want to do without his top grade »favourite« must choose these mini spin rods because, despite the short, convenient sections, you still get the perfect action you need for long, precise casts.

Item-No.	Order-No.	Length m	Sec.	Transp.-Length m	weight g	Casting weight g	Handle		
116600	/180	1.80	6	0.44	100	15-50	natural cork		
	/210	2.10	7	0.44	110	15-50	natural cork		
	/240	2.40	8	0.45	145	15-50	natural cork		
	/270	2.70	9	0.45	170	15-50	natural cork		



TELE ALLROUND 75

Well-balanced and with a strong backbone for light and medium spin, float and ground fishing for perch, trout and pike-perch.

Item-No.	Order-No.	Length m	Sec.	Transp.-Length m	weight g	Casting weight g	Handle		
116650	/285	2.85	7	0,75	210	20-75	natural cork		

**DISTANCE**

This is the ideal long distance casting rod for telescopic-rod fans. It is ideal for carp fishing as well as for fishing with dead baitfish. The rod charges itself progressively when casting – similar to a carp rod – and facilitates such astonishing casting distances!

Item-No.	Order-No.	Length m	Sec.	Transp.-Length m	weight g	Cast. w. g	Handle		
116610	/360	3.60	7	0.87	240	40-90	natural cork		

**TELE CARP**

Wonderful all-rounder for carp fans. The harmonious interaction between the sensitive tip and the powerful backbone make fishing with float and bottom assemblies a real experience.

Item-No.	Order-No.	Length m	Sec.	Transp.-Length m	weight g	Casting weight g	Handle		
116620	/365	3.65	7	0.87	245	20-65	natural cork		

**TELE PIKE**

Top grade pike rod with which you can cast and guide big bait accurately. The fantastic dynamism of the blank will even play out capital pike reliably. Also ideal for baitfish assemblies.

Item-No.	Order-No.	Length m	Sec.	Transp.-Length m	weight g	Casting weight g	Handle		
116630	/355	3.55	7	0.87	220	30-85	natural cork		

**TELE TROUT**

Wonderfully sensitive trout rod for bottom and float fishing: The super sensitive solid carbon tip shows every single tug and can reliably cushion even the most sudden flights of a big rainbow trout. This makes it possible to fish for big trout even with fine lines.

Item-No.	Order-No.	Length m	Sec.	Transp.-Length m	weight g	Casting weight g	Handle		
116640	/360	3.60	8	0.84	210	4-25	natural cork		

ONLY 270 GRAM

**BOLOGNESE**

Wonderfully sensitive, slim and lightweight bolognese rods. Even heavier bolognese floats can be casted easily and also bigger fish can be fought out safely.

Item-No.	Order-No.	Length m	Sec.	Transp.-Length m	weight g	Casting weight g	Handle		
116660	/600	6.00	7	1.35	270	7-25	Roughgrip		
	/700	7.00	8	1.36	320	7-25	Roughgrip		

Matze Koch MK ADVENTURE NANO WHIPS

MK Adventure

by
Matze
Koch

NANO PEIT'SCHE



Matze Koch's pike-perch, pike and perch whips have become a standard term and meet with amazing reactions. Nevertheless, Matze is convinced that improvement is always possible. Artificial bait rods must be fast and light; they must also react rigidly to the strike. The secret behind the new "whips" is carbon nano-tubes (CNT). Those are microscopically small, tubular carbon formations. These give the blanks fantastic actions, making them extremely strong, even faster and feather-light. The carbon-tape coils not only look great; they also reinforce the blank.

The Vector angular guides with the filigree inserts made of 6 times hardened stainless steel are ideal for braided lines. Splitting inserts is finally a thing of the past! They can ALSO no longer fall out and they reduce the weight more. Correspondingly, the rod's action is less impaired. Splintered guide inserts after a rough encounter with the stone packing are history.

However, the Nano-whip series is not limited to spin rods. In the telescopic field unforeseen opportunities also present themselves because we have been able to construct one of the longest bait-fish rods ever to have been available on the German market: the MK XXL Pike Stand measuring - believing or not - 9 m in length.

Features:

- IM-12 CNT (Carbon Nano Tube)
- Carbon Tape spiral wrapping
- FUJI Skeleton reel seat
- Precisely grounded spigot joints
- Vector Angle guides with 6 times hardened stainless steel guide inserts



MK TROUT / MK FORELLE

There is hardly any species of fish that requires as much sensitivity and such small baits paired with extremely sensitive bait guidance as a trout. Irrespective of whether you are by a stream or a trout pond, you will be extremely enthusiastic about these, the lightest and most sensitive little rod from the MK series.

Item-No.	Order-No.	Length m	Sec.	Transp.-Length m	weight g	Casting weight g	Handle		
112800	/180	1.80	2	0.96	100	2-12	Duplon		



MK PERCH LIGHT / MK BARSCH SENSO

In the rubber sector this ultrasensitive perch rod is used only for the very smallest rubber baits. Their main sector is the Mini wobbler and the spinner. Bait which doesn't require excessive elasticity in the blank and which is so soft that no perch will opt out any more. The rod continues to spring very gently, but - thanks to the fast IM 12 carbon fibre - it still never "wobbles" and is very accommodating to the sensitive, porous mouths of perch. Of course it is also super trout rod.

Item-No.	Order-No.	Length m	Sec.	Transp.-Length m	weight g	Casting weight g	Handle		
112810	/185	1.85	2	0.99	110	3-18	Duplon		
	/215	2.15	2	1.14	120	3-18	Duplon		
	/245	2.45	2	1.28	135	3-18	Duplon		



MK PERCH / MK BARSCH

"Perch beyond 40 cm are more difficult to catch than metre-long pike" Matze is in the habit of saying. Therefore one must tackle them with perfectly adapted gear, in order to be able to present small bait enticingly. At the same time an extremely sensitive action is needed, because pike-perch anglers know only too well that hooked perch tend to flee shortly before they are landed. This rod with its wonderfully soft upper section takes this circumstance into account. This certainly doesn't mean it is a lamb's tail; if a pike-perch or pike happens to pick up the hook the progressive action ensures that the lower section of the rod takes over the work, while the upper section springs at lightning speed. The brand new filigree guides make the lightweight rod even nicer to handle and the angler can fish for big shy perch for hours.

Item-No.	Order-No.	Length m	Sec.	Transp.-Length m	weight g	Casting weight g	Handle		
112820	/190	1.90	2	1.04	115	8-23	Duplon		
	/220	2.20	2	1.17	135	8-23	Duplon		
	/250	2.50	2	1.32	155	8-23	Duplon		

IM-12 CARBON

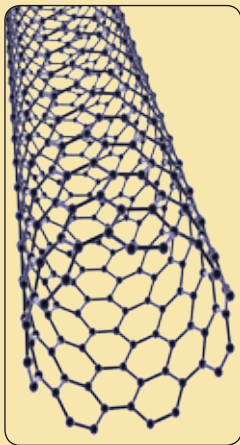

Carbon Nanotube

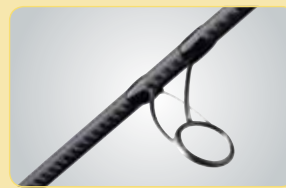
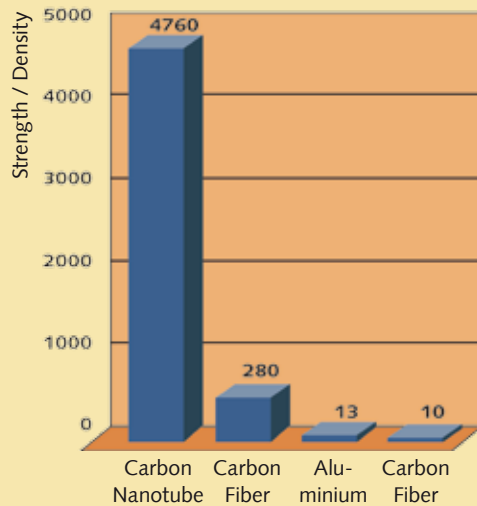

Titanium SIC guides



Original Fuji reel seat



Japanese IM-12 carbon fibre



Original Fuji reel seat also by the rods with cork handle



MK PIKE-PERCH / MK ZANDER

Delicate jerks to the rubber bait or subtle guidance of a small, deep-running wobbler are the guarantees for success with the shy "glass eyes". The pike-perch whip is therefore extremely sensitive in its action, uncompromising in the strike and even faster in the nanophase. In this price class the new pike-perch nano-whip is unparalleled in the German market. If the big pike happen to join in, don't worry, the pike-perch whip can deal with any esox. Even light bait can be cast and presented accurately. The 1.95 m version is also excellent for vertical fishing. It has a somewhat tauter action than the "vertical tracer" and is therefore suitable for greater depths with heavier lead heads weighing up to 30 g.

Item-No.	Order-No.	Length m	Sec.	Transp.-Length m	weight g	Casting weight g	Handle		
112830	/225	2.25	2	1.18	145	14-35	Duplon		
	/250	2.50	2	1.32	160	14-35	Duplon		
	/275	2.75	2	1.45	180	14-35	Duplon		



MK PIKE / MK HECHT

Like all the models in the Nano series, this exceptionally fast spin rod is light in weight and you can fish for many hours with it without tiring, despite the enormous power in the backbone. Medium wobblers up to 20 cm are no problem for the jagged action, and even light jerks can be presented appealingly. When fishing with rubber bait the pike whip demonstrates its full strength. Short, sensitive lobs from the rod blank suit it just as well as the classic lazy-bones method. At the same time it is also sensitive enough to present lighter pike-perch bait successfully.

Item-No.	Order-No.	Length m	Sec.	Transp.-Length m	weight g	Casting weight g	Handle		
112840	/235	2.35	2	1.25	165	19-56	Duplon		
	/265	2.65	2	1.37	180	19-56	Duplon		
	/295	2.95	2	1.54	200	19-56	Duplon		



MK GIANT PIKE / MK GROSSHECHT

You want to shoot out bait beyond the 50 gram mark as powerfully as you can? And expedite those baits powerfully away from the bottom; and cope easily with pike measuring more than a metre? Then this is the right rod. It displays its strength with a pleasant ease wherever big baits are to be offered; and it carries the necessary hard strike into even the hardest pike mouth. The ultra-large guides make it possible to cast with almost no friction resistance. Matze even tested the rod successfully on catfish. With fish measuring around a meter it clearly indicates that the backbone of this monster rod still has plenty of leeway for bigger fish. No matter whether it is guiding a big wobbler aggressively, heavy spoon-bait, wound in a giant twister or twitched jerkbait, the big pike cudgel copes with everything.

Item-No.	Order-No.	Length m	Sec.	Transp.-Length m	weight g	Casting weight g	Handle		
112850	/275	2.75	2	1.44	220	28-74	Duplon		

Matze Koch MK ADVENTURE NANO WHIPS



MK DROP SHOT STICK

With the dropshot method one can offer the bait extremely sensitively and slowly in particularly promising places. Specialists even leave the lead at the bottom and hit the line gently with the soft tip of the rod. Thus the bait bobs and tumbles seductively on the spot. In order to use this bait guidance perfectly, the rod must have a particularly sensitive and soft tip in order to be able to set the aforementioned gentle tugs and be sure to recognise the bites. At the same time it needs a hard strike and good buffering action, so that the hook is not torn out. This rod fulfils precisely those requirements.

Item-No.	Order-No.	Length m	Sec.	Transp.-Length m	weight g	Casting weight g	Handle		
112860	/235	2.35	2	1.24	120	3-28	Duplon		
	/265	2.65	2	1.39	135	3-28	Duplon		



MK DROP SHOT HAMMER

Anyone who binds the dropshot assembly with steel to secure it against pike is well served with this harder rod. Big rubber baits can be presented just as sensitively as when fishing for perch. Natural baits can also be presented perfectly bobbing on the spot to make pikes', and of course perch-pikes' mouths water.

Item-No.	Order-No.	Length m	Sec.	Transp.-Length m	weight g	Casting weight g	Handle		
112870	/240	2.40	2	1.29	130	9-38	Duplon		
	/270	2.70	2	1.44	155	9-38	Duplon		



MK JERK

After having concentrated on the big pike whip for many months, in order to cast his big wobbler models he now goes one better with an ultra-stable, strong jerk rod which is also capable of shooting even fat jerks into the horizon. Matze calls the model his "nearly one-piece rod", because the division of the short pike tamer is located very close to the handle so that the action is quasi continuous, and is in no way affected negatively by the division. Strong jerks and sensitive twitches are equally possible with the light gear, while during play it turns into a monster tamer.

Item-No.	Order-No.	Length m	Sec.	Transp.-Length m	weight g	Casting weight g	Handle		
112880	/195	1.95	2	1.45	140	20-60	Duplon		



MK VERTICAL / TRIGGER

An ultrasensitive little rod for scanning the bottom sensitively. With this short rod the bait can be guided from the wrist, irrespective of whether you want to move the bait gently or twitch it toughly. The extremely delicate blank passes on even the tiniest twitches straight into the angler's arm. With Trigger real seat for bait cast reels.

Item-No.	Order-No.	Length m	Sec.	Transp.-Length m	weight g	Casting weight g	Handle		
112910	/190	1.90	2	0.99	125	8-28	Duplon		



MK SPIN / MK FRIESEN SPIN

This rod is now even lighter, but similar to the soft action of nostalgic rods, it has a full cork handle and is not as fast and taut as a jig rod. Anyone who wants to offer nothing but spinners, spoons or wobblers but seeks plenty of grip on the handle, and also backs elastic action, is very well served with the Frisian Spin.

Item-No.	Order-No.	Length m	Sec.	Transp.-Length m	weight g	Casting weight g	Handle		
112890	/270	2.70	2	1.43	185	25-75	Cork		



MK STALKER

Rather than sitting out a carp, creeping up on it and catching it with surface baits, is one of the greatest thrills an angler can ever experience. The rod must be parabolic for the play that takes place nearby to have a good buffering effect. Nevertheless, there must also be a backbone in order to succeed in keeping carps away from water lilies, weeds and deadwood. The short length measuring just 10 ft. also contributes to this. In order for the pressure to be transferred as evenly to the blank as possible despite the short length, Matze decided to use no less than ten guides, because the casting range is not relevant on the surface.

Item-No.	Order-No.	Length m	Sec.	Transp.-Length m	weight g	Casting weight lbs	Handle		
112940	/305	3.05	2	1.55	230	3.00	Cork		



MK CARP OLD SCHOOL

Carp anglers have a modern approach and favour slender, filigree and feather-light rods. However, in order to inspire the old-school carp anglers, together with Matze we are delighted to be able to offer a rod with the classic cork handle which not only reminds one of past successes, but also conjures the warm "handle feeling", which many spin anglers appreciate also when fishing traditionally for carp. Cork alone gives one this pleasant grasping feeling. In view of the fact that old-school anglers prefer the sensitive play feeling of the casting distance, we only offer this dream of a rod in the 2.75 lb test curve.

Item-No.	Order-No.	Length m	Sec.	Transp.-Length m	weight g	Casting weight lbs	Handle		
112930	/360	3.60	2	1.87	255	2.75	Cork		



MK CARP

Advanced carp anglers swear by the rod's springiness and a fine, thin blank for a perfect feeling during play. Matze carries this to extremes in the Nano series of carp rods. During play, or when the direction is suddenly changed, it bounces back to the initial position as fast as lightning without bobbing up and down, thus reducing the risk of a dangerously entangled line. The big guides with the fine stainless-steel inserts appear delicate and facilitate great casting distances: perfect both for braided and monofilament lines. Matze refuses to be party to minimal equipment with only five guides; the smooth power transmission to the blank during play is more important to him. Therefore the 3-pound rod has six guides and the 2.5 lb one even has seven. The blanks are extremely slender, yet one can still pull even heavier assemblies through with ease.

Item-No.	Order-No.	Length m	Sec.	Transp.-Length m	weight g	Casting wt. lbs	Handle		
112920	/360	3.60	2	1.87	265	2.50	Duplon		
	/361	3,60	2	1,87	295	3,00	Duplon		



MK NATURAL BAIT PIKE STAND XXL / MK HECHTSTÄNDER XXL

Here it is: The longest baitfish rod in the republic! At the amazing length of 9 m we have dared to make a rod which is longer than any other before. The ultra-lightweight nanoparticles also make this possible. Furthermore, wide stone packings and impassable weed banks are hereby easily bridged. Baitfish rods are used everywhere that baitfish are to be presented statically, but in open waters. If its stone packing or the weed field is to be bridged should be several metres wide, 6.5 m can be too little. At the incredible length of 9 m length they offer the bait from the very distant bank. The expansive rod which is feather-light thanks to its new design as is an absolute top model for specialists.

Item-No.	Order-No.	Length m	Sec.	Transp.-Length m	weight g	Casting weight g	Handle		
112900	/900	9.00	7	1.53	775	40-150	Roughgrip		

Matze Koch MK ADVENTURE IM-8 RODS



by
Matze
Koch

IM-8 CARBON

Our two MK Adventure rod series, for which Matze Koch placed his knowledge at our disposal, have been a permanent feature in our range of products. In the new MK Adventure IM-8 series Matze has developed artificial-bait rods with very fast actions, similar to those in the IM-12 series. This springiness is clearly tangible, enable even beginners to get used to the snappy blank quickly, which is so indispensable for fishing with rubber fish. Indeed all other types of artificial bait can be cast better and more accurately the less a rod continues to bob.

What's more, they are also look really good: The novel wooven look of the blanks is really super!

We offer you an inexpensive alternative with excellent rods in the form of the MK IM-8 series.

Features:

- IM-8 carbon fibre
- Top modern woven carbon look
- Fast actions
- Slender Titanium SIC guides
- Precision Nylon-/Stainless Steel reel seats
- Ergonomic Duplon handles



TROUT PICKER / "MK FORELLEN PIEKER"

To date an ultra-lightweight rod for trout and perch was missing in Matze's range of rods. Here it is now, made from fast IM8 carbon fibre. Super lightweight, size-one spinners or mini-wobblers like the fidget or perch-tickler in the 3-cm version are ideal for this rod. In combination with a size 620 MK spin reel with a 0.10 braided line there is nothing more to prevent fun playing with the smaller predator fish, and light bait can be served with precision and fire it out far enough.

Item-No.	Order-No.	Length m	Sec.	Transp.-Length m	weight g	Casting weight g	Handle		
111000	/180	1.80	2	0.95	110	2-7	Duplon		



MK PERCH FIDDLER / "MK BARSCH FIEDLER"

Many beginners have been waiting for the perch rod – comparable to the perch brush – and built with the affordable IM 8 carbon fibre. This price/performance ratio must be difficult to top, and beginners are also able to get a taste of the professional league.

Item-No.	Order-No.	Length m	Sec.	Transp.-Length m	weight g	Casting weight g	Handle		
111010	/210	2.10	2	1.10	115	3-15	Duplon		
	/240	2.40	2	1.25	130	3-15	Duplon		



MK PERCH SPORTSTER / "MK BARSCH FLITZER"

This lightweight series of perch rods is rounded off by this stiffer model which can be compared with the Perch Whip in the IM-12 series with regard to its action. Small wobblers and rubbers can be cast with this rod without tangling because the springiness of the IM-8 carbon fibre prevents further bobbing.

Item-No.	Order-No.	Length m	Sec.	Transp.-Length m	weight g	Casting weight g	Handle		
111020	/210	2.10	2	1.10	120	5-20	Duplon		
	/240	2.40	2	1.25	145	5-20	Duplon		
	/270	2.70	2	1.40	165	5-20	Duplon		

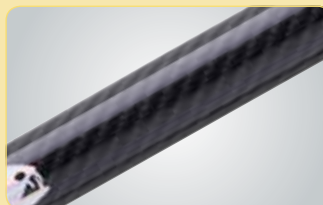

Novel woven look



Precision reel seat made of Nylon/ Stainless steel



Slim Titanium SIC guides



MK PIKE-PERCH SHOCK / "MK ZANDER SCHRECK"

Fast action is important when fishing with rubber fish; this frequently involves high prices because the requisite high proportion of high quality carbon-fibre rods is extremely expensive. This rod, which is similar to the pike-perch whip in terms of its action, is fast enough to give beginners the opportunity to guide rubbers in a variety of ways.

Item-No.	Order-No.	Length m	Sec.	Transp.-Length m	weight g	Casting weight g	Handle		
111030	/210	2.10	2	1.10	150	10-30	Duplon		
	/240	2.40	2	1.25	170	10-30	Duplon		
	/270	2.70	2	1.42	185	10-30	Duplon		



MK PIKE CUTTER / "MK HECHT FRÄSE"

Big wobblers like the 16-cm pike can be served exactly where the pike are waiting, no matter whether it is by a polder dyke or by a big river, this rod can be used everywhere. The stable rod is also the top choice for large spinners. With its backbone it can serve rebellious bait accurately without any problems.

Item-No.	Order-No.	Length m	Sec.	Transp.-Length m	weight g	Casting weight g	Handle		
111040	/240	2.40	2	1.25	180	10-42	Duplon		
	/270	2.70	2	1.42	200	10-42	Duplon		



MK PIKE PUMP / "MK HECHT PUMPE"

An extremely robust pike rod with which you can shoot even heavy bait into the horizon is needed if you intend to fish in large waters using fat rubbers in excess of 30 grams to catch really fat pike. Jigging the bait works equally perfectly without any delay, as does trolling big wobblers.

Item-No.	Order-No.	Length m	Sec.	Transp.-Length m	weight g	Casting weight g	Handle		
111050	/270	2.70	2	1.42	210	12-56	Duplon		

Matze Koch MK ADVENTURE IM-8 RODS



by
Matze
Koch

IM-8 CARBON



MK DOUBLE STRIKE SPIN / MK "EIN FALL FÜR ZWEI"

The two tips make it easy to do justice to Matze's most important recipe for success: "remain flexible". This rod with its two tips covers everything from perch to pike-perch and on to pike. The two exchangeable tips which differ in hardness make it possible to fish both with rubber fish using the taut tip and guide a spinner or small wobblers sensitively with the finer tip.

Item-No.	Order-No.	Length m	Sec.	Transp.-Length m	weight g	Casting weight g	Handle		
111070	/240	2.40	2+1	1.28	190 195	10-45 20-75	Duplon		
	/270	2.70	2+1	1.44	215 220	10-45 20-75	Duplon		



MK NATURAL BAIT / MK "NATUR PUR"

As one of the best-known all-rounders Matze swears by natural bait rods which can be used for several species of fish at the same time. That is why his carp rods are also put to use in winter when fishing traditionally for pike. This all-round rod is extremely suitable for eel, tench, bream, orfe, carp, pike-perch and pike. The three-part division ensures that the taut action can be felt all the way into the handle. A super-strong rod for all-round fishing.

Item-No.	Order-No.	Length m	Sec.	Transp.-Length m	weight g	Casting weight g	Handle		
111080	/360	3.60	3	1.28	280	30-110	Cork		



MK CARP

Despite their favourable price the rods have high-quality shrink-rubber handles as well as a high proportion of carbon fibre. You notice it immediately when you hold the rod in your hand for the first time: amazingly light and slender! Anyone who still has doubts will be convinced after the first cast at the very latest. Wonderful, how the blanks become charged during casting. The softer 2.5 lb rod is marvellous for smaller waters and for surface fishing. The 3 lbs. in 12" is the absolute all-rounder, and the 13" in 3.5 lbs. developed by Matze is a genuine long-distance casting machine.

Item-No.	Order-No.	Length m	Sec.	Transp.-Length m	weight g	Casting weight g	Handle		
111090	/360	3,60	2	1,87	250	2,50	Duplon		
	/361	3,60	2	1,87	255	3,00	Duplon		
	/390	3,90	2	2,00	270	3,50	Duplon		

LENGTH: 8M !!!



MK NATURAL BAIT / MK STELLFISCH MONSTER

Baitfish rods are not necessarily there just for pike. Pike-perch like natural bait offered vertically on fine float assemblies. Matze's new IM-8 baitfish rod has simply been extended by 1.50 m by comparison with the previous model from the IM-7 series. The bait fish can now be offered even in the face of water-lily patches or extreme stone packings, which have remained hidden from the anglers with shorter models to date. Despite its amazingly low price the rod is slim and very firm.

MK NATURAL BAIT									
Item-No.	Order-No.	Length m	Sec.	Transp.-Length m	weight g	Casting weight g	Handle		
111060	/800	8.00	7	1.44	755	40-150	Roughgrip		

Jörg Strehlow



- » Professioneller Angelguide
- » Buchautor & Fachautor
- » Produktentwickler & Berater
- » Handel mit Angelgeräten
- » Coaching für Eltern & Kinder
- » Coaching für Führungskräfte
- » Coaching zur Teambildung

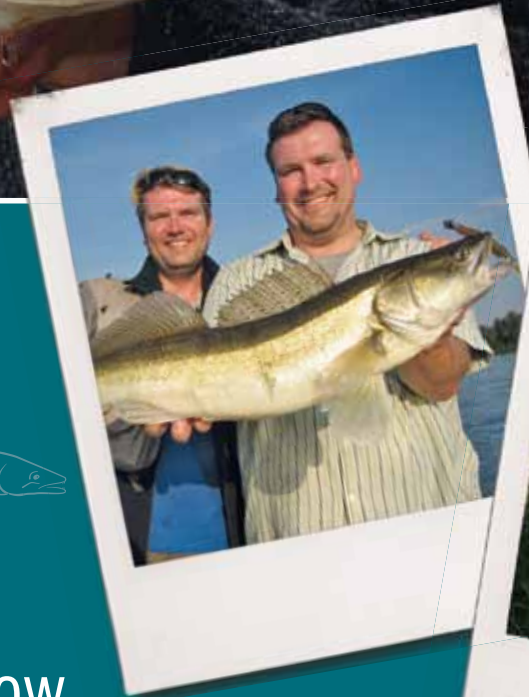

Jörg Strehlow

KONTAKT

Elbstraße 11 • D-21354 Bleckede
Tel./SMS: +49(0)170 - 90 36 028

Mail: joergstrehlow@t-online.de
Website: www.der-angler.de

Jörg Strehlow Signature rods

JS Signature by Jörg Strehlow

Fishing with artificial bait using an ideal rod is a bit like being with a dear and loyal companion: He's always there when he's needed, having supported us discreetly and giving us a pleasant sense of security. This invaluable characteristic is the essential thing about a TOP rod for spin fishing: At the very moment the bite takes place it has to drive the hook into the hard, bony mouth of the pike-perch within fractions of a second. Prior to this, it must be nothing more, nor less, than a reliable extension to our arm. It must not be top-heavy, although it is designed for many



hundreds of casts per day, without causing pain in our wrist and shoulder by the end of it. When it comes to how a perfect, practical rod for fishing for pike-perch with rubber bait should be, all the approaches merge in the work of the leading pike-perch expert, Jörg Strehlow. All four models were developed with great care in the course of innumerable days spent fishing by the water. The rods are a perfect symbiosis between lightness, equilibrium, speed, hardness of strike and flexibility during play and could only be resolved by means of superb, progressive rod blanks.



JS LAZYBONES BOAT

At last we now have the right boat rod for all depths and all types of water: it offers great casting capacity and is fast enough to be sure to place the hook even a long way from the boat. Yet it is also taut enough for great vertical fishing in deep waters!

Item-No.	Order-No.	Length m	Sec.	Transp.-Length m	weight g	Casting weight g	Handle		
111760	/240	2.40	2	1.25	200	21-58	Cork		



JS LAZYBONES CLASSIC

With this rod you are excellently equipped for flowing or still waters which you preferably fish from the bank. Are you amazed at how fast the wolf can bite during the strike, yet is then quick to be tamed and to cushion the head-butting of the pike-perch right through to the handle! A rod like the developer himself: A soul full of passion with no superfluous bric-à-brac and visual gimmicks.

Item-No.	Order-No.	Length m	Sec.	Transp.-Length m	weight g	Casting weight g	Handle		
111760	/270	2.70	2	1.40	220	24-62	Cork		



JS LAZYBONES DISTANCE

One of the few rods which was really missing on the market: Using the "Lazybones-Distance" you will be able to reach the press water of the next groyne at a casting distance of over 80 to 90 metres! Or the underwater edge at the lake which you could only reach with heavy bottom rods and bait fish until now. Nevertheless, this dream rod does not lose its speed and tautness.

Item-No.	Order-No.	Length m	Sec.	Transp.-Length m	weight g	Casting weight g	Handle		
111760	/310	3.10	2	1.60	295	27-68	Cork		



JS PIKE-PERCH WOBBLER

Unlike his perfect rubber-fish rods, Jörg Strehlow has put a softer tip onto this innovative wobbler rod. This makes it easy to observe the filigree play of the bait on the one hand, and – on the other – to vary it perfectly. Experienced wobbler anglers know that when a pike-perch bites bait play frequently ceases immediately before the attack, or the pressure of the wobbler on the rod decreases. If you, too, wish to genuinely perceive such details, instead of just imagining them, Jörg Strehlow will come up with exactly the right weapon to match your hand!

Item-No.	Order-No.	Length m	Sec.	Transp.-Length m	weight g	Casting weight g	Handle		
111770	/255	2.55	2	1.35	225	11-36	Cork		
	/285	2.85	2	1.48	260	11-36	Cork		



FEATURES:

- Blanks made of light-weight high modulus IM-12 carbon
- Precision FUJI reel seat from
- Super slim Titanium SIC guides, ideal for braided lines
- Perfect joints sealed with epoxy laquer
- Rod grip made of Portuguese natural cork

What you don't all maybe know: Jörg Strehlow is also one of the most experienced sea trout guides in Germany! His tours have been a household name to all friends of the "fast silver", and each year numerous anglers take part in them. It goes without saying that the insights of such experienced professionals are worth a mint when it comes to constructing the perfect sea trout rod! Unlike a pike-perch rod, spin rods for the coast must be absolute casting catapults. Such a catapult must be capable of a successful cast over a distance of 100 metres carrying baits weighing maximally 25 grams. They then develop plenty of heart and soul during play:

For sea trout have soft mouths and slip out if the rod is too hard! Nevertheless, the ideal rod must provide sufficient reserve for a fat cod or the "Big Mama" as sea trout anglers endearingly call capital fish beyond the five-kilo mark, with a sparkle in their eyes. All these characteristics come together in the 3.20-metre long "Sea Trout Classic" recently developed for us by Jörg. For those who prefer to fish with lighter bait weights - which is often done successfully in German firths, Danish Fjords or essentially on flatter beaches - the perfect partner is available in the shape of the "Sea Trout Senso".



JS SEATROUT CLASSIC

A spin rod for wade fishing on the coast of the Baltic Sea or the North Sea is an absolutely high-tech device: It must offer extreme lightness and perfect balance with the mounted reel. At the same time it must achieve casting distances measuring hundreds of metres and, far out there, it must also drive the hook into the mouth of a biting cod, a sea trout or sea bass. It must unite all this with a silky-soft play curve which gives one a good, secure feeling during the entire fight. The SEA-TROUT CLASSIC comes from the workshop of Jörg Strehlow, the longest-serving sea-trout guide in Germany. By the way, this rod is also eminently suitable for fishing for saithe, pollack and other sea predators from the shore: a magnificent play experience!

Item-No.	Order-No.	Length m	Sec.	Transp.-Length m	weight g	Casting weight g	Handle		
111780	/320	3.20	2	1.66	200	11-32	Cork		

ONLY 200 GRAM



JS SEATROUT SENSO

There are two fundamental differences when spin fishing on the coast: For one thing one can have luck with sea predators over a great distance while being rather stationary: the CLASSIC is ideal for this. The SEA TROUT SENSO is the ideal companion for covering larger sections of a beach, but above all for fishing with lighter baits in shallower bays or overgrown parts of beaches. It is a real experience to be able to shoot even very light bait with the catapult-like rod blank over incredible casting distances. Yet you have the permanent feeling that you are holding no weight in your hand! The silky-soft action brings every fish safely into the landing net. Nevertheless in most cases there is sufficient reserve to be able to restrain even the fish of your life. It is also a great pleasure to fish for garpike using small, slim spoons and the SENSO: you can hardly get any more action when you are spin fishing!

Item-No.	Order-No.	Length m	Sec.	Transp.-Length m	weight g	Casting weight g	Handle		
111780	/300	3.00	2	1.55	180	4-19	Cork		

ONLY 180 GRAM

Magna Triple Ruten

MAGNA *Triple*

Magna Triple...short transportation lengths, consistent actions

Short transportation lengths, yet with consistent actions? You don't think it's possible? Then you should test out the new Magna Triple rods some-time!

3 parts provide the rods with very handy transportation lengths and, at the same time, perfect actions.

The bottom guide is on the handle on all the rods, making transportation even more convenient.

The IM-6 Carbon ensures fast actions which are intentionally designed to be a little firmer. It makes the rods ideal for all facets of modern artificial-bait fishing.

The high-class titanium SIC guides are ideal when using braided lines.



LURE 15

This is ideal for fine fishing for smaller predators such as perch and trout with artificial bait.

Item-No.	Order-No.	Length m	Sec.	Transp.-Length m	weight g	Casting weight g	Handle		
117800	/245	2.45	3	0.87	140	3-15	Cork		



LURE 20

Considering its light weight, this rod has an extraordinarily rigid backbone and at the same time fine tip action. Smaller rubber bait and wobblers can therefore be presented excellently.

Item-No.	Order-No.	Length m	Sec.	Transp.-Length m	weight g	Casting weight g	Handle		
117810	/255	2.55	3	0.90	155	5-20	Cork		



LURE 30

The Spin 30 is ideal for fishing for pike-perch and large perch. It has very sensitive actions, also when striking, but with enough power to outplay a big pike-perch. With this rod rubber baits and deep-running wobblers can be presented equally well.

Item-No.	Order-No.	Length m	Sec.	Transp.-Length m	weight g	Casting weight g	Handle		
117820	/265	2.65	3	0.93	165	10-30	Cork		



LURE 42

Fast spin rod, perfectly designed for artificial bait fishing for pike. Thanks to the taut action large spoons, wobblers and rubber bait can be cast a long distance and stand up to large pike during play.

Item-No.	Order-No.	Length m	Sec.	Transp.-Length m	weight g	Casting weight g	Handle		
117830	/275	2.75	3	0.97	180	10-42	Cork		

FEATURES:

- IM-6 carbon fibre blanks
- All rods divided into three parts, hence convenient transportation lengths
- Continuous actions
- Titanium SIC guides
- Cork handles
- Hook holder
- Reel seat made from Nylon/ABS and stainless steel



Titanium SIC guides



Precision reel seat made of Nylon-ABS and stainless steel



Marker points for a perfect and straight connection of the joints



PIKE SPIN 55

Dynamic yet lightweight pike rod; ideal for fishing with medium heavy artificial baits.

Item-No.	Order-No.	Length m	Sec.	Transp.-Length m	weight g	Casting weight g	Handle		
117860	/270	2.70	3	0.93	175	25-55	Cork		



SEATROUT 32

It is a great long-distance casting rod with a proper spine for decent distance casts and more reliable strikes, also over a long distance.

Item-No.	Order-No.	Length m	Sec.	Transp.-Length m	weight g	Casting weight g	Handle		
117840	/315	3.15	3	1.10	180	8-32	Cork		



PILK 180

This progressive pilking rod has a hard backbone and tip action. The backbone guarantees long distance casts and good controllability during play and the tip action makes for good bait guidance.

Item-No.	Order-No.	Length m	Sec.	Transp.-Length m	weight g	Casting weight g	Handle		
117850	/240	2.40	3	0.85	180	55-170	Cork		
	/270	2.70	3	0.96	190	55-170	Cork		

Edition fly rods

Edition

Edition IM-12 - Gorgeous fly rods at top prices

Light in weight, slender, well-balanced and with outstanding actions. That is why the new Edition IM-12 fly rods can be described in very few words.

Why pay more for a big name in the fly-fishing field? Compare our rods with those of relevant brands. You'll see that our rods are by no means inferior, but a lot cheaper! No wonder, after all, we had reputable fly fishing experts to support us during the entire development phase, and they were totally uncompromising.

One immediately becomes aware of this unique symbiosis between elegance and dynamics, right from the very first cast.

All of the rods are supplied in a Cordura transport tube.

Equipment:

- High Modulus IM-12 carbon
- TITANIUM SIC starter guide
- Portuguese natural cork handles
- Real seat made from fine wood and stainless steel
- Cordura transport tube



160 AX / 180 AX

Perfect all-rounder rods for small, overgrown streams. Due to its length of just 1.60m/1,80m the rods allow a perfect handling.
Line class: AFTMA 4/5.

Item-No.	Order-No.	Length cm	Sec.	Transp.-Length m	weight g	AFTMA	Handle		
114710	/160	1.60	2	0.87	78	4/5	natural cork		
	/180	1.80	2	0.95	85	4/5	natural cork		



210 AX

Tailor-made for precision casting in small spaces by smaller waters. Ideal for small dry flies and nymphs.
Line class: AFTMA 4/5.

Item-No.	Order-No.	Length cm	Sec.	Transp.-Length m	weight g	AFTMA	Handle		
114710	/210	2.10	2	1.10	88	4/5	natural cork		



235 FX / 255 FX / 275 FX

The multipurpose rods for almost all situations by or on the water. Precision casts, even if the loops of the line are small, are a strong point of these rods!
Line class: AFTMA 5/6

Item-No.	Order-No.	Length cm	Sec.	Transp.-Length m	weight g	AFTMA	Handle		
114720	/235	2.35	2	1.25	95	5/6	natural cork		
	/255	2.55	2	1.35	100	5/6	natural cork		
	/275	2.75	2	1.42	115	5/6	natural cork		



285 LX

Magnificent streamer rod, powerful and with accurate casting even in gusty winds. Ideal when fishing for sea trout, pike, steelheads and grilses. Line class: AFTMA 7/8.

Item-No.	Order-No.	Length cm	Sec.	Transp.-Length m	weight g	AFTMA	Handle		
114730	/285	2,85	2	1,48	125	7/8	natural cork		

Edition IM-12 Travel – always with you, no matter where

You don't have to do without your fly rods even when you are travelling. The 4-section giant rods are also popular because of their outstanding actions and lightness.

With markings on the put-in connections.



All Jewel rods are supplied with in hard-shell case.



Noble design, with woven carbon



Reel seat made of stainless steel and woven carbon



210TX

The ideal multipurpose rod; versatile and in a convenient transport length. Line class: AFTMA 4/5

Item-No.	Order-No.	Length cm	Sec.	Transp.-Length m	weight g	AFTMA	Handle		
114740	/210	2.10	4	0.65	95	4/5	natural cork		



255TX

The ideal multipurpose rod; versatile and in a convenient transport length. Line class: AFTMA 5/6

Item-No.	Order-No.	Length cm	Sec.	Transp.-Length m	weight g	AFTMA	Handle		
114750	/255	2.55	4	0.65	110	5/6	natural cork		



285TX

Excellent, short-sectioned rod that easily deal with a gusty wind and large flies. Ideal for sea trout, smaller salmon and pike, but also for bonefish and smaller tarpons. Line class: AFTMA 7/8

Item-No.	Order-No.	Length cm	Sec.	Transp.-Length m	weight g	AFTMA	Handle		
114760	/285	2.85	4	0.73	130	7/8	natural cork		

Edition IM-12



The corresponding casting weight class are easy to recognize according to the numbers (1-4) and different colour codes.

Edition IM-12 Trout Tremarella Ruten

Tremarella fishing originates from Italy. What is therefore more obvious than to have the rods developed there?

Our Italian trout professionals, Claudio Valentino and Daniele Scaioli have perfected this series down to the last small detail.

The result is incredibly filigree blanks with complex actions which guarantee the right "bobbing" during fishing. The right bobbing is extremely important for the chain assemblies to make the right movements in the water and thus play a major part in determining on success or failure!

Edition IM-12 Trout Sbirolino Ruten

The well-known trout expert, Willi Frosch is „father“ to these fantastic Sbirolino rods: wonderfully filigree, lightweight and slender for modern trout fishing.

The highly compacted IM-12 carbon fibre facilitates perfect actions for long, accurate casts and lively play.

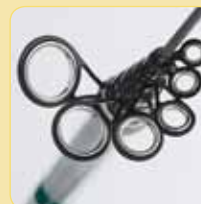
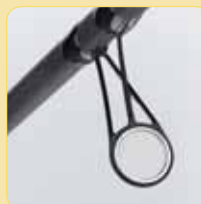

Filigree, super light-weight Diamond guides

FEATURES:

- Highly compacted IM-12 carbon fibre
- Ultra-light blank technology
- FUJI precision reel seat
- Filigree Diamond guides
- Portuguese natural cork on the put-in rods

**FROM 74 GRAM
ROD WEIGHT**



TREMARELLA 1

Our most sensitive Tremarella rod for all kind of ultra-light trout fishing.

Item No.	Order No.	Length m	Sec.	Transp.-Length m	W. g	Casting weight g	Handle		
116740	/335	3.35	8	1.11	74	1-5	Rough Grip		
	/375	3.75	8	1.12	90	1-5	Rough Grip		



TREMARELLA 2

Like Tremarella 1 but with higher casting weight.

Item No.	Order No.	Length m	Sec.	Transp.-Length m	W. g	Casting weight g	Handle		
116750	/345	3.45	8	1.11	79	2-8	Rough Grip		
	/385	3.85	8	1.13	95	2-8	Rough Grip		



TREMARELLA 3

Like Tremarella 1 and 2 but with higher casting weight.

Item No.	Order No.	Length m	Sec.	Transp.-Length m	W. g	Casting weight g	Handle		
116760	/355	3.55	8	1.11	85	4-12	Rough Grip		
	/395	3.95	8	1.12	99	4-12	Rough Grip		



TREMARELLA 4

The "power packs" among the Tremarella rods with sufficient strength to reach even more remote standing places with heavier assemblies.

Item No.	Order No.	Length m	Sec.	Transp.-Length m	W. g	Casting weight g	Handle		
116770	/365	3.65	6	1.12	98	6-16	Rough Grip		
	/405	4.05	7	1.14	113	6-16	Rough Grip		



SBIRO 25

Sensitive, lightweight Sbirolino rod for all fans of put-in rods. Its lightness makes it easy to handle the rod and have fun to fish in a trout lake for hours on end.

Item No.	Order No.	Length m	Sec.	Transp.-Length m	W. g	Casting weight g	Handle		
116700	/330	3.30	3	1,16	175	3-25	nat. cork		
	/360	3.60	3	1,26	193	3-25	nat. cork		
	/390	3.90	3	1,36	210	3-25	nat. cork		



SBIRO 55

Powerful Sbirolino rod with a sensitive tip, ideal for sea trout, large rainbow trouts, pike and pike-perch. With extra-large long distance casting guides!

Item No.	Order No.	Length m	Sec.	Transp.-Length m	W. g	Casting weight g	Handle		
116710	/360	3.60	3	1,26	215	15-55	nat. cork		
	/390	3.90	3	1,36	235	15-55	nat. cork		
	/420	4.20	3	1,46	250	15-55	nat. cork		



If you have the right rods you'll catch more

Fishing in trout lakes is becoming increasingly popular and has a high guaranteed fun factor. However, anyone who believes that trout bite anything that moves, is completely mistaken. Anyone who wants to catch them on a regular basis requires special tackle.

The Trota Italia series includes all kinds of rods for successful traditional angling by trout lakes.

The low weight of the IM-7 carbon fibre makes it possible to fish for hours without tiring, and to cast accurately and play sensitively.

FEATURES:

- IM-7 carbon fibre
- Titanium SIC guides
- Fine cork or rough grip handles
- Precision reel seat



TELE TROUT PICKER

Constructed like a very fine feeder rod, it is used to fish with bottom and buoyant assemblies. Good catching e.g. using a coffin weight or feeder basket and pop-up assemblies (e.g. trout paste or maggots with pop-up balls). With 2 varyingly hard replacement tips in 0.75 and 1.25 oz.

Item No.	Order No.	Length m	Sec.	Transp.-Length m	W. g	Casting weight g	Handle		
113060	/315	3.15	3+2	1.10	220	5-32	Cork		



TELE TROUT

Very sensitive rod with fine action for float and bottom fishing for trout and perch. The extra-long cork handle and the precision reel seat facilitate long, accurate casts. An ideal travelling rod thanks to the short transport length.

Item No.	Order No.	Length m	Sec.	Transp.-Length m	W. g	Casting weight g	Handle		
113050	/300	3.00	7	0.72	205	3-28	Cork		
	/330	3.30	8	0.74	230	3-28	Cork		
	/360	3.60	8	0.76	250	3-28	Cork		

Trota Italia Trout rods



SBIRO 25

Fantastic light, balanced rods for sbirolino fishing. The blank enables wide, very accurate casts.

Item No.	Order No.	Length m	Sec.	Transp.-Length m	W. g	Casting weight g	Handle		
113020	/330	3.30	3	1,17	190	3-25	Cork		
	/360	3.60	3	1,27	225	3-25	Cork		
	/390	3.90	3	1,37	250	3-25	Cork		



SBIRO 55

The stronger version of the Sbiro rods offers very low weight and real power! Ideal for fishing for sea trout or large rainbow trouts. With extra large guides!

Item No.	Order No.	Length m	Sec.	Transp.-Length m	W. g	Casting weight g	Handle		
113030	/360	3.60	3	1,27	230	15-55	Cork		
	/390	3.90	3	1,38	265	15-55	Cork		
	/420	4.20	3	1,48	295	15-55	Cork		



TROUT STICK

These super lightweight rods are for ultra-fine trout fishing with a built-in fun factor. Originally developed for Tremarella fishing, it can also be fished with floats or small artificial baits.

Item No.	Order No.	Length m	Sec.	Transp.-Length m	W. g	Casting weight g	Handle		
113000	/180	1.80	2	0,95	85	2-16	Cork		
	/210	2.10	2	1,10	95	2-16	Cork		
	/240	2.40	2	1,25	105	2-16	Cork		
	/270	2.70	2	1,40	115	2-16	Cork		
	/300	3.00	2	1,55	120	2-16	Cork		

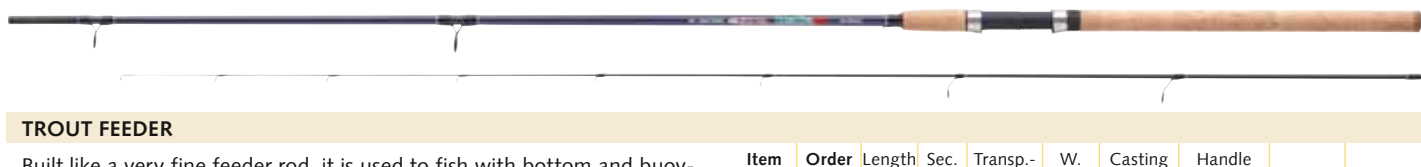

TROUT FEEDER

Built like a very fine feeder rod, it is used to fish with bottom and buoyant assemblies. Good catching e.g. using a coffin weight or feeder basket and pop-up assemblies (e.g. trout paste or maggots with pop-ups).

Item No.	Order No.	Length m	Sec.	Transp.-Length m	W. g	Casting weight g	Handle		
113010	/315	3.15	2	1,62	135	5-32	Cork		



Trota Italia Tremarella rods

Just like our new Edition IM-12 Tremarella rods, the Tremarella rods in the Trota Italia series were developed by our Italian trout professionals, Claudio Valentino and Daniele Scaioli.

The result is featherweight rods with sensitive actions and which guarantee the right "bobbing" when fishing. The right bobbing is extremely important for the chain assemblies to make the right movements in the water and thus play a major part in determining on success or failure!



Number codes indicate the different casting weights.



TREMARELLA 1

Our most sensitive Tremarella rod for all form of ultra-light trout fishing.

Item No.	Order No.	Length m	Sec.	Transp.-Length m	W. g	Casting weight g	Handle		
113070	/345	3.45	6	1.10	85	1-6	Rough Grip		
	/375	3.75	6	1.13	100	1-6	Rough Grip		



TREMARELLA 2

Like Tremarella 1 but with higher casting weight.

Item No.	Order No.	Length m	Sec.	Transp.-Length m	W. g	Casting weight g	Handle		
113080	/350	3.50	6	1.10	90	3-9	Rough Grip		
	/380	3.80	6	1.13	100	3-9	Rough Grip		



TREMARELLA 3

Like Tremarella 1 and but casting weight up to 12g.

Item No.	Order No.	Length m	Sec.	Transp.-Length m	W. g	Casting weight g	Handle		
113090	/355	3.55	6	1.10	95	5-12	Rough Grip		
	/385	3.85	6	1.12	110	5-12	Rough Grip		



TREMARELLA 4

Like above but casting weight up to 16g.

Item No.	Order No.	Length m	Sec.	Transp.-Length m	W. g	Casting weight g	Handle		
113100	/360	3.60	6	1.10	100	7-16	Rough Grip		
	/390	3.90	6	1.13	115	7-16	Rough Grip		



TREMARELLA 5

The »power pack« in the Tremarella rod series.

Item No.	Order No.	Length m	Sec.	Transp.-Length m	W. g	Casting weight g	Handle		
113110	/365	3.65	6	1.11	105	9-20	Rough Grip		
	/395	3.95	6	1.12	120	9-20	Rough Grip		



SBIRO TREMA

Our legendary SbiroTrema rod comes in a new design and additional length. For those who do not yet know this filigree little stick: Thanks to two replacement tips of different hardness the rod can be fished both bobbing with Tremarella assemblies and with sbirolinos or trawling floats. Simply great!

Item No.	Order No.	Length m	Sec.	Transp.-Length m	W. g	Casting weight g	Handle		
113120	/330	3.30	4+2	1.02	185	9-20	Rough Grip		
	/360	3.60	4+2	1.06	200	9-20	Rough Grip		
	/000					Spare tip soft			
	/001					Spare tip hard			

Michael Zammataro Edition IM-12 Masterpiece Snake Skin

Masterpiece Snake Skin

Masterpiece Snake Skin...the best ever of Michael Zammataro's rods with Snakeskin technology

Michael Zammataro has developed an entirely new rod concept in the new Masterpiece Snake Skin series.

The own weight of the rods is considerably less than the previous models and the actions are significantly more finely tuned. The incredible filigree actions make the Ultra Light, Light Feeder and Method Feeder models highly attractive.

In the case of the models in the previous series the legendary stability of the rods was achieved by way of the excessively long mortise and tenon joints, and that increases the dead weight.

Thanks to the sensational Snake Skin blank construction it is possible to achieve the same stability at a significantly lower weight!

The Snake Skin blank technology functions like this: The blank is manufactured from highly-compressed Japanese IM-12 carbon fibre, guaranteeing very lightweight rods and perfect actions.

The blanks are hardly sanded at all to retain maximum strength. It is noticeable from the slightly rough surface.

Thereafter the blanks are fused with our innovative Snake Skin sheathing. This net-type sheath – consisting of spiral-shaped high performance strands and a net-type surface – gives the rods enormous tensile forces

and stability! The rod surface is reminiscent of snakeskin!

This results in very lightweight, well-balanced rods with fantastic actions and great tensile forces!

The front 2/3 of the handles are made from Portuguese natural cork, the rear third from Shrink Rubber Cork which is extremely good to clean of residual feed while at the same time providing maximum grip, even with wet hands!

Masterpiece Snake Skin, simply in a class of its own!

FEATURES:

- Japanese IM-12 carbon fibre
- Snake Skin blank construction
- FUJI precision reel seat
- handles made from Portuguese natural cork with shrink-rubber cork
- Titanium SIC guides
- Supersoft transport bag



ULTRA LIGHT FEEDER 30

The Ultra-Light Feeder 30 is the finest and most sensitive rod in our new series. The two-part ultra-sensitive rod guarantees 100 per cent bite indication all the way through into the handle. The very thin plug-in tips with an insertion depth of 2.2 mm work as a unit together with the upper section of the rod and they do not even offer very small fish any resistance whatsoever when taking the bait. The Ultra-Light 30 is used for fishing for small roach and bleaks etc. and also guarantees to help you land capital bream on the very finest leaders.

Item-No.	Order-No.	Length m	Sec.	Transp.-Length m	weight g	Casting weight g	Handle		
112100	/315	3.15	2+3	1.31	215	40	natural cork		
	/345	3.45	2+3	1.48	230	40	natural cork		

3 carbon tips with 2,2mm spigot diameter: 0,5oz/0,75oz/1oz: each in 65cm



LIGHT FEEDER 60

These are extremely versatile rods with brilliant casting properties. Here, too, we use a split blank which is equipped with 2.2-mm tip inserts at the top end. Two slogans which describe this dream of a rod: Accurate, forceful casting characteristics paired with fantastic bite transmission.

Item-No.	Order-No.	Length m	Sec.	Transp.-Length m	weight g	Casting weight g	Handle		
112110	/330	3.30	3+3	1.38	224	60	natural cork		
	/360	3.60	3+3	1.58	255	60	natural cork		

3 carbon tips with 2,2mm spigot diameter: Lenght 65cm, 0.75oz/1 oz/1.25 oz



Pro Staff Team Zammataro - for years at the top of the feeder scene!



Even the young talents swear by the Snake Skin:
Marc Zammataro and Luis Saddeler



Original Fuji reel seat

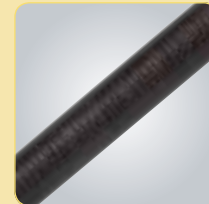

The „Snake Skin“



Blank diameter of the Heavy Feeder (above) compared with a rod of one competitor



Natural cork with shrink-rubber cork

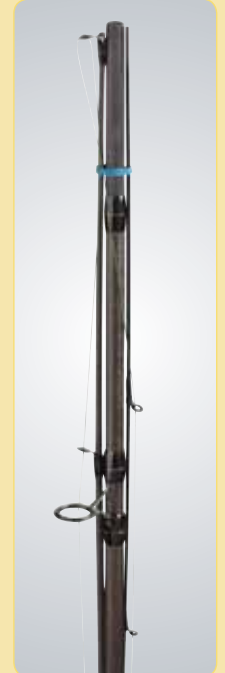

We recommend for a safe transport to detach the feeder tip and let them slide down the cord.

There is a big selection of **spare tips** to choose from. The diameter of the inserts on the feeder tips is **2.2 mm** for the Ultra-Light and Light Feeder rods. On all other rods it is 3.6 mm as usual! The **3.6mm** tips fit all our Masterpiece I and II, Magna Pro Feeder, Magna Feederace rods as well as most feeder rods available on the market.

BLINKER TEST 2016/7

15 stars from max. 15 reached



MEDIUM FEEDER 100

The Medium Feeder 100 is used by lakes and rivers for fishing over distances between 60 and 80 metres. Thanks to its low deadweight, paired with parabolic action, you can fish for many hours with this rod without tiring. A high bite yield and secure play guarantee unadulterated feeder fun with this gem of a rod.

Item-No.	Order-No.	Length m	Sec.	Transp.-Length m	weight g	Casting weight g	Handle		
112120	/360	3.60	2+3	1.58	295	100	natural cork		
	/390	3.90	3+3	1.19	305	100	natural cork		

3 carbon tips with 3,6mm spigot diameter: Lenght 65cm, 1oz/1,5oz/2oz



MEDIUM HEAVY FEEDER 125

Here it is, the multipurpose rod for a gentle current and all types of still waters if you intend to fish over distances ranging from 60 to 90 metres. Our team uses this feeder rod very frequently because it casts a very long distance and with great precision. The even curve in the top area of the rod permits one to land big fish fast and securely.

Item-No.	Order-No.	Length m	Sec.	Transp.-Length m	weight g	Casting weight g	Handle		
112130	/400	4.00	3+3	1.19	370	125	natural cork		

3 carbon tips with 3,6mm spigot diameter: Lenght 65cm, 1oz/1,5oz/2oz

Thanks to its 4-m length the Medium Heavy Feeder lies comfortably in your hand and makes it easier to carry strong fish over dangerous edges. Speed-baskets are used by preference. The maximum weight of the basket should not exceed 100 g plus feed.

Michael Zammataro's Edition IM-12 Masterpiece



HEAVY FEEDER 150

When it comes to extremely long distance casting or pure stream fishing you are bound to hear the name Masterpiece Heavy Feeder. Casting distances of more than 100 m can very easily be achieved with this power-pack. Furthermore, there is hardly any alternative to enable you to fish professionally in a strong current. A perfectly coordinated action gives us the perfect combination of dynamism, power transmission and reliability when landing big fish.

Item-No.	Order-No.	Length m	Sec.	Transp.-Length m	weight g	Casting weight g	Handle		
112140	/390	3.90	3+3	1.15	385	150	natural cork		
	/420	4.20	3+3	1.30	435	150	natural cork		

3 carbon tips with 3,6mm spigot diameter: Length 65 cm, 2oz, 3oz, 4oz



ULTRA HEAVY FEEDER 250

Extreme conditions such as strong currents or big powerful fish make tremendous demands on our gear. This rod is popular for fishing for barbel in strong currents. It can be used for carrying feeder baskets weighing more than 200 g and for long-distance casts from inside river dams all the way to the flow edge. If you are looking for a rod on which you can rely without any compromises, here it is.

Item-No.	Order-No.	Length m	Sec.	Transp.-Length m	weight g	Casting weight g	Handle		
112150	/450	4.50	3+3	1.34	435	250	natural cork		

3 carbon tips with 3,6mm spigot diameter: Length 65 cm, 4oz, 5oz, 6oz



METHOD FEEDER 65

Owing to the assembly in conjunction with extremely short leaders, when you engage in method feeder-fishing you will experience self-hooking bites with an extreme initial acceleration. In this situation carp and big breams flee directly after taking up the bait, thus putting an enormous strain on our tackle. In order to do justice to this situation we have developed special blanks which bend all the way into the handle under pressure. Absolute parabola is the top priority here. Hardly a single fish is lost when you use this rod during critical play phases.

Item-No.	Order-No.	Length m	Sec.	Transp.-Length m	weight g	Casting weight g	Handle		
112160	/325	3.25	2+3	1.33	224	max 65	natural cork		
	/365	3.65	2+3	1.55	270	max 65	natural cork		

3 glass tips with 3,6mm spigot diameter: Length 65 cm: 0.75 oz/1oz/1.25oz



SPARE TIPS: CONTENT: 1 TIP

Item-No.	Order-No.	Material	Length cm	action /oz	Insert tip Ø mm				
114180	/850	Carbon	65	0.50	2.20				
	/875	Carbon	65	0.75	2.20				
	/810	Carbon	65	1.00	2.20				
	/825	Carbon	65	1.25	2.20				
	/050	Fiberglass	65	0.50	3.60				
	/065	Carbon	65	1.50	3.60				
	/075	Carbon	75	1.50	3.60				
	/165	Carbon	65	0.50	3.60				
	/175	Fiberglass	75	1.00	3.60				
	/176	Carbon	75	1.00	3.60				
	/265	Carbon	65	2.00	3.60				
	/275	Carbon	75	2.00	3.60				
114180	/350	Carbon	50	4.00	3.60				
	/365	Carbon	65	3.00	3.60				
	/375	Fiberglass	75	0.50	3.60				
	/450	Carbon	50	5.00	3.60				
	/465	Carbon	65	4.00	3.60				
	/475	Fiberglass	75	0.75	3.60				
	/550	Carbon	50	6.00	3.60				
	/565	Carbon	65	0.75	3.60				
	/575	Fiberglass	65	0.75	3.60				
	/650	Fiberglass	65	1.00	3.60				
	/651	Carbon	65	1.00	3.60				
	/750	Carbon	75	0.75	3.60				

MAGNA PRO FEEDER

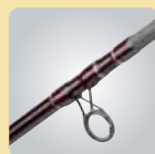

IM-8 Carbon and Power-Fibre Concept



Stainless steel / nylon reel seat



Handles made from cork and Duplon

We also come up trumps in the 2nd league

With the Magna Pro Feeder Michael Zammataro has proved impressively that – besides his top models in the Masterpiece series – he is also absolutely capable of developing top rods such as the IM-8 Carbon Level.

It goes without saying that Michael's new rod concept – lighter blanks and more refined actions – also influences this series.

This fantastic sensitivity can be felt immediately especially in the Light and Method Feeder rods.

This great series is based on highly-compressed IM-8 carbon fibre which ensures progressive actions and well-balanced blanks. Thanks to the pro-

gressive blanks, the baskets can be cast a long distance and very well-controlled.

The handles are made from cork and the rear third from non-slip Duplon for good handling even with wet hands.

The Ultra Light Feeder, Light Feeder and Heavy Feeder are having interchangeable tips made of carbon, all others are having fibreglass tips.



ULTRA LIGHT FEEDER 30

This ultra-light rod are used in small to medium waters (lakes and slow flowing water). It plays its strength in casting distances up to approximately 40m. When fishing for small to medium sized fish, you are absolutely right with the Ultra Light Feeder. Due to their low weight you can fish for hours without tiring.

Item-No.	Order-No.	Length m	Sec.	Transp.-Length m	weight g	Casting weight g	Handle
113600	/345	3.45	3+3	1.20	260	max 30	Cork/Dupl.

3 carbon tips with 2.2mm spigot diameter: Lenght 65cm: 0,75oz/1oz/1,25oz



LIGHT FEEDER 60

Developed for feeder fishing in smaller waters and where trees do not permit the use of long rods. Although the rod is beautifully sensitive it nevertheless easily carries feeder baskets weighing up to 60g a long distance. Also excellent for fishing by trout lakes and for »eel-picking«.

Item-No.	Order-No.	Length m	Sec.	Transp.-Length m	weight g	Casting weight g	Handle
113610	/365	3.65	3+3	1.27	310	max 60	Cork/Dupl.

3 carbon tips with 2.2mm spigot diameter: Lenght 65cm, 0,75oz/1oz/1,25oz



MEDIUM FEEDER 100

Extremely dynamic rods with extra-large long distance casting guides. The slender, lightweight IM-8 rod blanks have astonishing power reserves, making distances up to 80m no difficulty. Despite their power, these rods are very well balanced in the upper section and thus minimise the number of fish lost during play.

Item-No.	Order-No.	Length m	Sec.	Transp.-Length m	weight g	Casting weight g	Handle
113620	/375	3.75	3+3	1.32	333	max 100	Cork/Dupl.

3 glass tips with 3,6mm spigot diameter: Lenght 65cm, 2oz/3oz/4oz

Magna Pro Feeder IM-8



MEDIUM HEAVY FEEDER 125

A perfect allround rod for many water types, flowing conditions and fish species. The balanced bending curve in the upper rod section allows also the safe landing of large fish.

Item-No.	Order-No.	Length m	Sec.	Transp.-Length m	weight g	Casting weight g	Handle		
113630	/385	3.85	3+3	1.34	337	max 125	Cork/Dupl.		

3 glass tips with 3,6mm spigot diameter: Length 65cm, 2oz/3oz/4oz



HEAVY FEEDER 150

Developed for heavy feeder fishing. This rod brings heavy feeder baskets effortlessly to width. Also strong barbels and large breams can be handled easily also in the flow.

Item-No.	Order-No.	Length m	Sec.	Transp.-Length m	weight g	Casting weight g	Handle		
113640	/395	3.95	3+3	1.36	381	max 150	Cork/Dupl.		

3 carbon tips with 3,6mm spigot diameter: Length 65 cm, 2oz, 3oz, 4oz



METHOD FEEDER 65

In Method fishing you use self-hooking assemblies. Immediately after the fish have picked up the bait they flee with incredible power. Our engineers have taken this into account and have designed this extremely lightweight, slender rod according to the bungee principle. The fish is intercepted every time it flees. The tip zone has been marked in signal colours and it clearly signalises each and every movement.

Item-No.	Order-No.	Length m	Sec.	Transp.-Length m	weight g	Casting weight g	Handle		
113650	/355	3.55	3+3	1.25	262	max 65	Cork/Dupl.		

3 glass tips with 3,6mm spigot diameter: Length 65 cm: 2oz/3oz/4oz

Jetzt erst

Hecht!



Immer faszinierend, lebendig und praxisnah.
Unsere Angelmagazine mit DVD.

Ein Abo lohnt sich.

www.abo.raubfisch.de

www.abo.fischundfang.de



Adrenalin Arctic Jigger - the new superlative boat rods!

The new Adrenalin series was developed together with Norway professional and BALZER team angler, Steffen Dietze. No matter whether you prefer to fish with the spin reel or you are a multiple-reel fan, or if you are looking for a travel rod, the new Adrenalin covers all areas excellently.

Owing to its relatively short length – only 1.97 m – the rods can be handled excellently on the boat and at the same time, due to the short lever, they guarantee many hours of tireless fishing as well as optimal power transmission during play.

In addition to the 2-part rods each model is also available in a 3-section version which - measuring just 75 cm for transportation - fits into any larger suitcase. This is an advantage which should not be underestimated in times when airlines raise the price enormously for additional luggage.

The mainstay of these rods is their strong, yet slim and lightweight blanks made from Japanese IM-12 carbon fibre. High-quality reel seats from FUJI, under-wound titanium SIC guides and shrink-rubber handles leave nothing to be desired.

For the sake of easier identification of the individual casting weights we have come up with something fine: in accordance with the number of decorative guides on the aluminium parts and on the guide coils, the casting weights reveal themselves in ascending order: 1 guide = 14 lb, 4 guides = 40 lb.



FEATURES:

- Japanese IM-12 carbon fibre
- Fuji reel seat
- Underwound titanium SIC guides
- Non-slip shrink-rubber handles
- Precision put-in connections
- Travelling rods with short 70 cm transport length
- High quality padded bag



Reel seat from Fuji on the spinning rods



Reel seat from Fuji on the Cast rods



Cross-butt section made of aluminium by the 30 and 40 lbs rods



Titanium SIC guides



Wonderful action

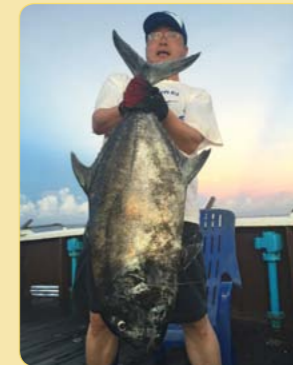

Adrenalin Arctic Jigger, 14 lbs Spin and Cast

A dream of a rod for those who want to stalk pollack and coalfish easily. This rod gives you an optimal feel for the bait and still has reserves for the really fat ones. Here you can fish with weights and rubber fish weighing 40 to 150 g without any problems. In combination with the smallest Adrenalin AN-10 the cast rod is a superlative. No cross butt.

Adrenalin Arctic Jigger, 20 lb Spin and Cast

A genuine masterpiece when it comes to fishing for cod and coalfish. The ideal weights range from 100 to 350 g. Thanks to the tip action the bait can be guided with great precision, also in deeper waters. The perfect reel for the Cast Version is our Adrenalin AN-12. No cross butt.

Adrenalin Arctic Jigger, 30 lb Spin and Cast

The all-rounder with which you can use perks, rubber fish or natural bait weighing up to 500 g without any problems. This rod can even deal easily with big halibut. It is suitable both for use in Norway and in tropical waters. With a cross-butt permitting the use of belly belts. Here again the Adrenalin AN-12 is the first choice of reel!

Adrenalin Arctic Jigger, 40 lb Cast

These rods are real power rods. Ideal for stalking ling, halibut and ocean perch in the depths of fjords with assemblies weighing over 1000 g. During our tests in warm waters this rod got the better of even aggressive predators such as tuna, Amber Jack and GT. Ideal in combination with the two-speed Multi-Adrenalin TS-14. With a cross-butt permitting the use of belly belts.

ARCTIC JIGGER 14/SPIN, 20/SPIN AND 30/SPIN

Item No.	Order No.	Length m	Sec.	Transp.-Length m	Wg. g	Cast. wg. lbs	Handle
110040	/110	1.97	2	1.30	340	8-14	Shrink Rubber
	/120	1.97	2	1.30	365	10-20	Shrink Rubber
	/130	1.97	2	1.30	440	20-30	Shrink Rubber

ARCTIC JIGGER 14/CAST, 20/CAST, 30/CAST AND 40/CAST

Item No.	Order No.	Length m	Sec.	Transp.-Length m	Wg. g	Cast. wg. lbs	Handle
110040	/010	1.97	2	1.30	370	8-14	Shrink Rubber
	/020	1.97	2	1.30	385	10-20	Shrink Rubber
	/030	1.97	2	1.30	460	20-30	Shrink Rubber
	/040	1.97	2	1.30	465	30-40	Shrink Rubber



Equipment as for Adrenalin Arctic Jigger Spin, but as a 3-section travel rod.

ARCTIC JIGGER TRAVEL 14/SPIN, 20/SPIN AND 30/SPIN

Item No.	Order No.	Length m	Sec.	Transp.-Length m	Wg. g	Cast. wg. lbs	Handle
110050	/110	1.97	3	0.75	380	8-14	Shrink Rubber
	/120	1.97	3	0.75	390	10-20	Shrink Rubber
	/130	1.97	3	0.75	400	20-30	Shrink Rubber

Equipment as for Adrenalin Arctic Jigger Cast, but as a 3-section travel rod.

ARCTIC JIGGER TRAVEL 14/CAST, 20/CAST, 30/CAST AND 40/CAST

Item No.	Order No.	Length m	Sec.	Transp.-Length m	Wg. g	Cast. wg. lbs	Handle
110050	/010	1.97	3	0.75	430	8-14	Shrink Rubber
	/020	1.97	3	0.75	370	10-20	Shrink Rubber
	/030	1.97	3	0.75	450	20-30	Shrink Rubber
	/040	1.97	3	0.75	460	30-40	Shrink Rubber



Volker Dapoz's "Best of" with nanotechnology

How can you improve a perfect product? Volker Dapoz and our technicians pursued precisely this question in connection with our legendary 71° North rod series. The result is real high tech rods based on carbon fibre fortified by nanoparticles.

Carbon mats made from carbon nanotubes (CNT) are combined with IM-12 carbon mats for the special blank construction.

An extremely high fracture resistance is thereby obtained, which provides for slender blanks and a low weight.

The guides are resistant to salt water and underwound to ease the burden on the blanks when the line exerts a lot of pressure.

Besides the established models, some more interesting rods have been added, for example halibut trolling rods and a special pollack rod. All the rods are supplied in a padded case.



FLEXPILK 200

Wonderfully lightweight pilk rods, ideal for perks weighing up to 200g and depths of up to approx. 100m. The length 2.45m and 2.75m have halved, easy-to-transport sections, the 2.15m rod is sectioned above the handle.

Item No.	Order No.	Length m	Sec.	Transp.-Length m	W. g	Casting weight g	Handle
112480	/215	2.15	2	1.60	295	50-200	Shrink Rubber
	/245	2.45	2	1.27	305	50-200	Shrink Rubber
	/275	2.75	2	1.42	340	50-200	Shrink Rubber



BALTIC SEA 125

The featherweight rod blanks made from IM-12 carbon are dead fast and carry perks or rubber fish extremely long distances. However, at the same time the tip is flexible enough to facilitate excellent bait guidance and to minimise the number of fish that are lost. The ingenious combination of low rider and single-foot guides combine lightness with maximum stability.

Item No.	Order No.	Length m	Sec.	Transp.-Length m	W. g	Casting weight g	Handle
112490	/240	2.40	2	1.25	225	30-125	Shrink Rubber
	/280	2.80	2	1.46	250	30-125	Shrink Rubber
	/320	3.20	2	1.65	295	30-125	Shrink Rubber



BALTIC SEA HEAVY 185

Many of those who fish from boats have been waiting for it: our Baltic Sea rod which already enjoys a cult status is now available in a stronger version! With this rod perks and rubber baits in excess of 120g can be casted and guided. In spite of the stronger blank construction, the "Big Brother" is a genuine featherweight with which you can fish for hours without tiring.

Item No.	Order No.	Length m	Sec.	Transp.-Length m	W. g	Casting weight g	Handle
112490	/275	2.75	2	1.43	265	60-185	Shrink Rubber



POWER PILK 275

If you do not wish to fish without your spinning reel in Norway and you are looking for a perfectly tuned rod, you have just the right thing in the Power Pilk. Handle, reel seat and guides are all designed to be used with spinning reels.

Item No.	Order No.	Length m	Sec.	Transp.-Length m	W. g	Casting weight g	Handle
112530	/240	2.40	2	1.25	300	100-275	Shrink Rubber
	/280	2.80	2	1.46	355	100-275	Shrink Rubber



BALTIC JIG 180

Long-distance casting rods par excellence! These two rods carry rubber bait and perks to extreme distances. The blank and guides are wonderfully light and they permit many hours of untiring fishing. The rods are suitable for fishing with rubber bait and light to medium perks, especially when long distances are important. The rods are nice and rigid and make it possible to guide the bait optimally. Even shy touches are felt immediately and they give rise to a strike. The 3.35 m version is the very weapon to have on any cutter!

Item No.	Order No.	Length m	Sec.	Transp.-Length m	W. g	Casting weight g	Handle
112600	/285	2.85	2	1.46	270	80-180	Shrink Rubber
	/335	3.35	2	1.72	300	80-180	Shrink Rubber



BOAT 20

The ideal boat rod for fishing with perks weighing between 100g and 400g. The ingenious tip action facilitates extremely precise bait guidance and minimises the risk of the hook being torn out during play. With a cross-butt for using belly belts.

Item No.	Order No.	Length m	Sec.	Transp.-Length m	W. g	Cast. wg. g/lbs	Handle
112400	/220	2.20	2	1.53	445	100-400/15-20	Duplon

BOAT 30

A great all round rod for pilking in fjords and the Atlantic with baits up to approx. 650g. The ideal bait weighs between 200 and 400g. With a cross-butt for using belly belts.

Item No.	Order No.	Length m	Sec.	Transp.-Length m	W. g	Cast. wg. g/lbs	Handle
112410	/220	2.20	2	1.53	465	300-650/25-30	Duplon

BOAT 40

When we held the rod in our hands for the first time, we were totally crazy about how light it is and how fantastically it handles. With a cross-butt for using belly belts.

Item No.	Order No.	Length m	Sec.	Transp.-Length m	W. g	Cast. wg. g/lbs	Handle
112420	/220	2.20	2	1.53	505	350-1100/30-40	Duplon



All inliner rods were delivered with screw-off top guide an wire lining aid.

The threading of the line with the threading wire can be a little tricky. We recommend you to watch our video on our YouTube channel: <https://www.youtube.com/user/Fishingalarm/videos>.



BOAT 20 INLINER

The ideal boat rod for fishing with perks weighing between 100g and 400g. The ingenious tip action facilitates extremely precise bait guidance and minimises the risk of the hook being torn out during play. With a cross-butt for using belly belts. Delivered with wire as lining aid.

Item No.	Order No.	Length m	Sec.	Transp.-Length m	W. g	Cast. wg. g/lbs	Handle
112430	/215	2.15	2	1.48	425	100-400/15-20	Duplon

BOAT 30 INLINER

A great all round rod for pilking in fjords and the Atlantic with baits up to approx. 650g. The ideal bait weighs between 200 and 400g. For the Boat 30 great importance was attached to a balanced tip action. With a cross-butt for using belly belts. Delivered with wire as lining aid.

Item No.	Order No.	Length m	Sec.	Transp.-Length m	W. g	Cast. wg. g/lbs	Handle
112440	/215	2.15	2	1.48	440	300-650/25-30	Duplon

BOAT 40 INLINER

The strong brother to the Boat 30 Inliner. When it is necessary to go down to great depths with heavy lures for ocean perch, ling etc. or you are engaged in targeting capital predatory fish, you have just the right things in this rod. Delivered with wire as lining aid.

Item No.	Order No.	Length m	Sec.	Transp.-Length m	W. g	Cast. wg. g/lbs	Handle
112450	/215	2.15	2	1.48	465	350-1100/30-40	Duplon



THE NATURAL BAIT ROD 40

A super rod, specially designed for natural bait fishing for ling, lumpfish and halibut. By contrast with the IM-12 boat rods, the action of the natural bait rods is almost parabolic. This makes it possible to fish in a very controlled manner even at great depths and when using heavy leads. Of course it possesses a cross-butt for using belly belts.

Item No.	Order No.	Length m	Sec.	Transp.-Length m	W. g	Casting w. g/lbs	Handle
112510	/215	2.15	2	1.46	495	350-1100/25-40	Duplon



COALFISH JERK 120 SPIN

Ideal for speed jigging in Norway. The guides are designed for fishing with a fixed reel. The 2.50m length and halved, easy-to-transport sections. The 2.10m rod is sectioned above the handle.

Item No.	Order No.	Length m	Sec.	Transp.-Length m	W. g	Casting weight g	Handle
112500	/210	2.10	2	1.60	265	30-120	Shrink Rubber
	/250	2.50	2	1.30	290	30-120	Shrink Rubber
	/290	2.90	2	1.50	345	30-120	Shrink Rubber

The 2.10m rod is sectioned above the handle.



BALTIC SEA INLINER

Our successful pilking rod now also in an inliner version. The short version is ideal for small boats and the longer version for cutters. It is a genuine pleasure to fish with these rods! Delivered with wire as lining aid.

Item No.	Order No.	Length m	Sec.	Transp.-Length m	W. g	Cast. wg. g	Handle
112460	/240	2.40	2	1.25	275	45-165 g	Shrink Rubber
	/280	2.80	2	1.44	340	45-165 g	Shrink Rubber



POLLACK SPECIAL

Developed for fishing with small jigs and rubber bait for strong pollacks. The rods permits great casting distances, making it possible to fish larger areas in front of cliff coasts dry. The dynamic blank is constructed such that it charges up during casting and can also intercept sudden flights by big pollacks. For fishing with a fixed spool reel.

Item No.	Order No.	Length m	Sec.	Transp.-Length m	W. g	Casting weight g	Handle
112580	/255	2.55	2	1.32	200	15-85	Shrink Rubber
112560	/305	3.05	2	1.58	250	15-85	Shrink Rubber



FLATFISH SPECIAL

Thanks to the strong backbone, you can fish with heavy sinkers without any difficulty. The extremely sensitive, signal-red tip reliably registers the gentle bites of the flat fish. The long model is intended for fishing off a cutter, the shorter rod for fishing from a small boat. It is suitable both for multiplying and fixed spool reels. All guides are underground!

Item No.	Order No.	Length m	Sec.	Transp.-Length m	W. g	Casting weight g	Handle
112520	/245	2.45	2	1.28	270	35-230	Duplon
	/305	3.05	2	1.58	350	35-230	Duplon



BOAT 30/S

Like Boat 30, page 57, but designed for large fixed spool reels.

Item No.	Order No.	Length m	Sec.	Transp.-Length m	W. g	Casting w. g/lbs	Handle
112550	/245	2.45	2	1.28	455	300-650/25-30	Duplon



HALIBUT WOBBLER

In view of the fact that flatfish are frequently to be found submerged on sandy ground at depths between 10 to 20 m, it is possible to fish large areas dry. This rod was developed precisely for this type of angling: It has a strong blank, many close-fitting guides as well as semi-sensitive tip to signalise bites. With a cross-butt. Can also be used as boat rod for fishing with artificial and natural bait.

Item No.	Order No.	Length m	Sec.	Transp.-Length m	W. g	Casting w. g/lbs	Handle
112540	/225	2.25	2	1.58	470	25 lbs, Wobbler up to 50 cm	Duplon



DOWNRIGGER

Lovely rod for trolling for salmon or seatrout in Scandinavia and the Baltic Sea. It is also excellent for downrigger fishing for pike and lake trout.

Item No.	Order No.	Length m	Sec.	Transp.-Length m	W. g	Casting weight g	Handle
112470	/241	2.40	2	1.25	320	0.3-0.4 mm	Shrink Rubber



SOCK FOR BOAT RODS

After fishing simply pull the sock over the rod and the blank is protected from damage. Fits all commercial boat rods.

Item No.	Order No.	length m	width cm	packing unit.
110000	/999	1.70	3	5

Edition 71° NORTH IM-12 **nano** 71° North Travel 



BALTIC SEA TRAVEL 125

Like Baltic Sea, but as a 5-sectioned travelling rod.

* The printing on the rod was changed from 165g to 125g. The rod action is unchanged.

Item No.	Order No.	Length m	Sec.	Transp.-Length m	W. g	Casting weight g	Handle
112490	/281	2.80	5	0.63	275	30-125	Duplon



HALIBUT WOBBLER TRAVEL

Like the "Halibut Wobbler" rod above, but as 4-section travelling rod.

Item No.	Order No.	Length m	Sec.	Transp.-Length m	W. g	Casting w. g/lbs	Handle
112540	/226	2,25	4	0.65	460	25 lbs, Wobbler up to 50 cm	Duplon



BOAT 30/S TRAVEL

Like the "Boat 30/S", but as 4-section travelling rod.

Item No.	Order No.	Length m	Sec.	Transp.-Length m	W. g	Casting w. g/lbs	Handle
112410	/211	2.10	4	0.68	455	300-650/25-30	Duplon

71° North NANO



TRAVEL BOAT 30

Like the Boat 30 but in a 5-section travel version.

Item-No.	Order-No.	Length m	Sec.	Transp.-Length m	W. g	Casting weight lbs	Handle
112410	/210	2.10	5	0.43	540	25-30	Duplon



THE NATURAL BAIT ROD 40/TRAVEL

Like the Natural Bait 40 rod but in a 5-section travel version.

Item-No.	Order-No.	Length m	Sec.	Transp.-Length m	W. g	Casting weight lbs	Handle
112510	/216	2.15	5	0.51	545	30-40	Duplon



BOAT INLINER 30 TRAVEL

Like Boat Inliner 30, but with 3 sections and shorter.

Item-No.	Order-No.	Length m	Sec.	Transp.-Length m	W. g	Casting weight lbs	Handle
112440	/190	1.90	3	0.69	405	25-30	Duplon



POWER PILK TRAVEL

Like Power Pilk 275 but in a 5-section travel version.

Item-No.	Order-No.	Length m	Sec.	Transp.-Length m	W. g	Casting weight g	Handle
112530	/281	2.80	5	0.62	350	100-275	Shrink Rubber



COALFISH JERK 120 TRAVEL

Like Coalfish Jerk but in a 5-section travel version.

Item-No.	Order-No.	Length m	Sec.	Transp.-Length m	W. g	Casting weight g	Handle
112500	/211	2.10	5	0.47	230	30-120	Shrink Rubber



SOFT BAIT TRAVEL

5-section rod for fishing with shads for cod, pollack and coalfish.

Item-No.	Order-No.	Length m	Sec.	Transp.-Length m	W. g	Casting weight g	Handle
112570	/280	2.80	5	0.61	270	15-75	Shrink Rubber

Magna Nordic



MAGNA NORDIC

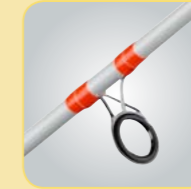

Titanium SIC guides



Extra strong Low Ryder guides by the boat rods



Reel seat made from stainless steel/nylon ABS

Magna Nordic...modern sea rods with perfect design, action and equipment!

They are certainly great to look at, our new sea rods. And they have a lot more to offer: Manufactured from high-quality IM-7 carbon fibre and equipped with modern components. Each rod was developed individually for its designated purpose. That can be seen immediately from the fact that the rods each have different guide types. The actions have been coordinated with the state of the art in modern sea fishing. Each rod has up-to-date divided Duplon handles which not only lend it a modern look, they also guarantee stress-free handling.

FEATURES:

- High Modulus IM-7 Carbon
- Slender titanium SIC guides, ideal for braided lines
- Divided Duplon handles
- Robust reel seat made from stainless steel/nylon ABS
- Precision put-in connections



BOAT 25

A genuine allrounder for artificial and natural bait fishing for bait weighing up to 600g. With a cross-butt for using belly belts. Ultra strong reel seat

Item No.	Order No.	Length m	Sec.	Transp.-Length m	W. g	Cast. wg. g/lbs	Handle
117110	/210	2.10	2	1.15	290	400-600/20-25	Duplon

The threading of the line with the threading wire can be a little tricky. We recommend you to watch our video on our YouTube channel: <https://www.youtube.com/user/Fishingalarm/videos>.



INLINER BOAT 25

Inline rods are enjoying increasing popularity. The advantages are obvious: no risk of damage to guides, continuous action and less weight. The rod is a genuine allrounder for artificial and natural bait fishing for bait weighing up to approximately 600g. With a cross-butt for using belly belts. Ultra strong reel seat! Delivered with threading wire.

Item No.	Order No.	Length m	Sec.	Transp.-Length m	W. g	Cast. wg. g/lbs	Handle
117120	/210	2.10	2	1.13	285	400-600/20-25	Duplon



HEAVY PILK 265

Extra strong pilking rod for fishing with fixed-spool reels.

Item-No.	Order-No.	Length m	Sec.	Transp.-Length m	weight g	Casting weight g	Handle
117130	/210	2.10	2	1.15	220	80-265	Duplon
	/240	2.40	2	1.29	250	80-265	Duplon



FLEXPILK 220

Lovely lightweight pilking rod for water depths up to approx. 100 m and bait weights up to around 200 g. With special Low Ryder guides.

Item-No.	Order-No.	Length m	Sec.	Transp.-Length m	weight g	Casting weight g	Handle
117140	/215	2.15	2	1.17	210	55-220	Duplon
	/245	2.45	2	1.30	240	55-220	Duplon



BALTIC JIGGER 160

This rod was developed specifically for fishing for saithe. When fishing for these lively fish the perk is wound upwards rapidly; the brutal bite usually takes place in mean-flow conditions.

Item-No.	Order-No.	Length m	Sec.	Transp.-Length m	weight g	Casting weight g	Handle
117190	/285	2.85	2	1.48	250	60-160	Duplon



FLATFISH

Lovely lightweight boat rod for bottom fishing. The rod has a sensitive tip and a nice action for a precise bait guidance. The special guides permit both multiplying reels and fixed spool reels to be used.

Item-No.	Order-No.	Length m	Sec.	Transp.-Length m	weight g	Casting weight g	Handle
117160	/240	2.40	2	1.25	260	35-220	Duplon



BALTIC PILK 115

Wonderfully filigree long distance casting pilking rod for fishing with light tackle in Norway, yet also ideal for our native Baltic Sea. The blank charges up during casting and hence facilitates extreme casting distances. The tip action permits very controlled bait guidance and bite identification. The specific combination of different guide types unites lightness and stability.

Item-No.	Order-No.	Length m	Sec.	Transp.-Length m	weight g	Casting weight g	Handle
117150	/240	2.40	2	1.30	190	30-115	Duplon
	/280	2.80	2	1.45	215	30-115	Duplon



SEATROUT

Lots of anglers have been waiting for this: A sea trout rod developed especially for fishing with braided lines. The bottom and top guides are always subjected to special strain when using hard braided lines. This prompted us to select highly resilient Low Rider guides for the starting guide. All the guides in between are special single-foot guides that save a good deal of weight.

Item-No.	Order-No.	Length m	Sec.	Transp.-Length m	weight g	Casting weight g	Handle
117180	/310	3.10	2	1.57	240	15-45	Duplon



SURF

Ultramodern surf rods with Vector angular guides; ideal also for braided lines. With ergonomic, high-quality shrink-rubber handles for maximum grip. The put-in joints are rough, so that the sections can also be pulled out when they are wet without any trouble.

Item-No.	Order-No.	Length m	Sec.	Transp.-Length m	weight g	Casting weight g	Handle
117170	/391	3.90	3	1.38	610	80-240	Shrink Rubber
	/420	4.20	3	1.48	660	80-240	Shrink Rubber

MAGNA NORDIC



Magna Nordic Travel

It is in line with the present trend to fly off conveniently to have a fishing holiday. No wonder, with air travel constantly becoming cheaper. However, in some cases the airlines charge a lot for transporting the long rod tubes. That is why we now have the Magna Nordic rods in a 3-section travel version which fits easily into your case.

When it comes to action and balance the 2-section rods are by no means inferior.



BOAT 25 TRAVEL

Characteristics and equipment as for the Magna Nordic Boat 25, but the rod has 3 sections and is a bit shorter.

Item No.	Order No.	Length m	Sec.	Transp.-Length m	W. g	Cast. wg. g / lbs	Handle
117110	/195	1.95	3	0.70	250	400-600/20-25	Duplon



BOAT 25 INLINER TRAVEL

Equipment as for the Magna Nordic Inliner Boat 25, but the rod has 3 sections and is a bit shorter.

Item No.	Order No.	Length m	Sec.	Transp.-Length m	W. g	Cast. wg. g / lbs	Handle
117120	/195	1.95	3	0.69	250	400-600/20-25	Duplon



HEAVY PILK 265 TRAVEL

Characteristics and equipment as for the Magna Nordic Heavy Pilk, but the rod has 3 sections and is a bit shorter.

Item No.	Order No.	Length m	Sec.	Transp.-Length m	W. g	Cast. wg. g	Handle
117130	/195	1.95	3	0.68	170	80-265	Duplon



BALTIC JIGGER 160 TRAVEL

Characteristics and equipment as for the Magna Nordic Arctic Baltic Jigger, but the rod has 3 sections and is a bit shorter.

Item No.	Order No.	Length m	Sec.	Transp.-Length m	W. g	Cast. wg. g	Handle
117190	/195	1.95	3	0.69	165	60-160	Duplon

DIABOLO NEO



Diabolo NEO...with 30% more carbon fibre than the predecessor series!

The rods of the Diabolo NEO family have been completely re-engineered and brought up to date. Furthermore, the series has been extended to include numerous new models.

The blanks have an approximately **30% higher proportion of carbon fibre** than the previous series. This makes the rods considerably lighter, more slender and above all they display significantly faster and better structured actions, especially the spin rods! With these blanks it is possible to practice all modern methods of fishing for predators in the best possible way. We have designed a new concept for the handles of the telescopic rods.

Most telescopic rods have divided cork handles. Hence the rods are perfect to handle and they also remain extremely delicate in the handle. The blanks of the telescopic rods were also completely reengineered and they too are now slimmer and lighter than their predecessors.

FEATURES:

- IM-7 high-density carbon fibre
- Considerably more smooth and compact actions than before
- Slender Titanium SIC guides
- Cork handles* (*except for Carp, Baitfish and Bolognese)
- Divided handles on most telescopic rods
- Precision put-in connections
- Reel seat made from stainless steel/nylon ABS



Comparison of blank diameter of old (above) and new (below) Diabolo Spin 40



Reel seat made of Steel/Nylon-ABS



Precision ground faucet joints



Slender titanium SIC guides



Nice butt cap



SPIN 10

Extremely sensitive short spin rod for ultra-light fishing for trout and perch. Ideal for small overgrown stretches of water.

Item No.	Order No.	Length m	Sec.	Transp.-Length m	Wt. g	Casting weight g	Handle
110300	/150	1.50	2	0.81	100	2-10	Cork
	/180	1.80	2	0.96	115	2-10	Cork

SPIN 20

Fantastically lightweight spin rod, ideal for fine spin fishing for trout, perch and chub.

Item No.	Order No.	Length m	Sec.	Transp.-Length m	Wt. g	Casting weight g	Handle
110310	/190	1.90	2	1.00	120	5-20	Cork
	/210	2.10	2	1.10	130	5-20	Cork
	/240	2.40	2	1.27	150	5-20	Cork
	/270	2.70	2	1.43	175	5-20	Cork



SPIN 40

Delicate but powerful rods for fine to medium spin and bottom fishing for non-predatory and predatory fish.

Item No.	Order No.	Length m	Sec.	Transp.-Length m	Wt. g	Casting weight g	Handle
110320	/210	2.10	2	1.10	135	10-40	Cork
	/240	2.40	2	1.25	155	10-40	Cork
	/270	2.70	2	1.42	190	10-40	Cork
	/300	3.00	2	1.60	220	10-40	Cork

SPIN 70

Powerful, dynamic all-round rods with sensitive tips for carp, pike and pike-perch fishing.

Item No.	Order No.	Length m	Sec.	Transp.-Length m	Wt. g	Casting weight g	Handle
110330	/240	2.40	2	1.27	165	25-70	Cork
	/270	2.70	2	1.43	190	25-70	Cork
	/300	3.00	2	1.59	255	25-70	Cork



SPIN 100

The power packs in this spin rod series. These rods easily stand up to a catfish or large pike. These rods are also ideal for pilking in the Baltic Sea.

Item No.	Order No.	Length m	Sec.	Transp.-Length m	Wt. g	Casting weight g	Handle
110340	/285	2.85	2	1.50	275	40-100	Cork



SHORTY SPIN

The best hot spots for predator fish are to be found where a dense population of trees and undergrowth makes fishing virtually impossible. The ultra short Shorty Spin rod is developed precisely for this purpose.

Item No.	Order No.	Length m	Sec.	Transp.-Length m	Wt. g	Casting weight g	Handle
110380	/155	1.55	2	0.81	105	10-45	Cork



PIKE

Dynamic yet lightweight pike rod; ideal for fishing with artificial bait and baitfish.

Item No.	Order No.	Length m	Sec.	Transp.-Length m	Wt. g	Casting weight g	Handle
110350	/245	2.45	2	1.28	170	35-80	Cork
	/275	2.75	2	1.43	195	35-80	Cork



TWITCH SPECIAL MEDIUM AND HEAVY

2 great rods for fishing with wobblers for small to medium-sized predators such as perch, pike-perch and also pike. The stiff action permits very accurate bait guidance and they cope ideally with jerking, popping and twitching.

Item No.	Order No.	Length m	Sec.	Transp.-Length m	Wt. g	Casting weight g	Handle
110370	/195	1.95	2	1.02	130	6-24	Cork
	/196	1.95	2	1.02	140	14-34	Cork



VERTICAL

Developed specially for vertical fishing with rubber baits or zockers. With jigs the ideal weights range between 10 and 40g for jigs. The short handle facilitates unproblematic, single-handed use while fishing.

Item No.	Order No.	Length m	Sec.	Transp.-Length m	Wt. g	Casting weight g	Handle
110480	/185	1.85	2	0.99	160	10-40	Cork



DROP SHOT

Very light Drop shot rods for fishing. The special construction of the blank guarantees extremely sensitive bait guidance and very finely tuned bite recognition.

Item No.	Order No.	Length m	Sec.	Transp.-Length m	Wt. g	Casting weight g	Handle
110360	/240	2,40	2	1,30	155	3-24	Cork
	/270	2,70	2	1,43	175	3-24	Cork



LAVARET

Special rod for lavaret and perch fishing. Ultra light version but strong enough to lift 3 or more lavarets at one time. With 1 tip (soft) which can be converted, if required, with separately available interchangeable tips.

Item No.	Order No.	Length m	Sec.	Transp.-Length m	Wt. g	Casting weight g	Handle	
110400	/180	1.80	2	0.97	100	-	Cork	
	/210	2.10	2	1.11	102	-	Cork	
	/240	2.40	2	1.28	122	-	Cork	
	/000	Spare tip soft						
	/001	Spare tip medium						



PIKE-PERCH

Great three-part rod for fishing for pike-perch with natural bait. On the one hand the rod has great power for casting the baitfish assembly into a good position; on the other hand it is also sensitive, enabling you to play the pike-perch sensitively to the full. With an especially large number of guides for a perfect action during play.

Item No.	Order No.	Length m	Sec.	Transp.-Length m	Wt. g	Casting weight g	Handle
110410	/360	3.60	3	1.27	330	15-50	Cork



ALLROUND 75

A multipurpose rod for medium spin, bottom and float fishing. With a casting weight up to 75 you are perfectly equipped for fishing for carp, pike-perch and pike.

Item No.	Order No.	Length m	Sec.	Transp.-Length m	Wt. g	Casting weight g	Handle
110420	/350	3.50	3	1.28	355	25-75	Cork

ALLROUND 105

Powerful rod to cast heavy baitfish or even big spoons and wobblers much better and further with this rod with strong backbone.

Item No.	Order No.	Length m	Sec.	Transp.-Length m	Wt. g	Casting weight g	Handle
110420	/351	3.50	3	1.28	425	50-105	Cork



CLASSIC FLOAT

The action is considerably more rigid than with a match rod, likewise the guides are larger so that line stoppers go through with no trouble. These rods cover all areas of float fishing for non-predatory fish and are even suitable for lighter fishing for trout, perch, pike-perch and eel with natural bait. **Tip:** Anglers in Switzerland and Austria use these rods for float fishing for grayling and trout.

Item No.	Order No.	Length m	Sec.	Transp.-Length m	Wt. g	Casting weight g	Handle
110520	/360	3,60	3	1,26	250	5-25	Cork
	/390	3,90	3	1,36	260	5-25	Cork
	/420	4,20	3	1,46	280	5-25	Cork



CATFISH SPIN

Wonderful rod specifically for spin fishing for catfish. This rod is no "truncheon", but it has a great, powerful action, on the other hand, it is still fine enough to transfer the play of the artificial bait to the blank.

Item No.	Order No.	Length m	Sec.	Transp.-Length m	Wt. g	Casting weight g	Handle
110450	/275	2.75	2	1.43	315	100-300	Cork



JERKBAIT SPIN

Top grade jerkbait rod for spinning reels. In spite of its hard backbone, still agreeably light in weight. With this rod you can bring the bait to life perfectly and lure the really big ones to the surface.

Item No.	Order No.	Length m	Sec.	Transp.-Length m	Wt. g	Casting weight g	Handle
110460	/191	1.90	2	1.04	140	40-120	Cork



JERKBAIT CAST

Top grade jerkbait rod for baitvasting reels. In spite of its hard backbone, still agreeably light in weight. With this rod you can bring the bait to life perfectly and lure the really big ones to the surface.

Item No.	Order No.	Length m	Sec.	Transp.-Length m	Wt. g	Casting weight g	Handle
110460	/190	1.90	2	1.04	140	40-120	Cork



EEL PICKER

Strong Eel Picker with powerful blank for long casts and hard fights to prevent the eel to reach roots or plants on the bottom. With 2 interchangeable tips, which are each equipped with a special guide for chemical lights.

Item No.	Order No.	Length m	Sec.	Transp.-Length m	Wt. g	Casting weight g	Handle
110510	/275	2.75	2+2	1.43	235	30-80	Cork



EEL PICKER HEAVY

Design as for the Eel picker, but with significantly tauter action. Ideal for big rivers or waters with a lot of obstacles, where an eel on a hook has to be played uncompromisingly. Supplied with 2 exchangeable tips (medium and heavy).

Item No.	Order No.	Length m	Sec.	Transp.-Length m	Wt. g	Casting weight g	Handle
110510	/305	3.05	2+2	1.58	285	70-150	Cork



FLY 5/6

Great general purpose fly rod, excellently suited to both sensitive dry fly fishing and to fishing with nymphs and small streamers. With SIC bottom and top guides as well as a cigar handle.

Item No.	Order No.	Length m	Sec.	Transp.-Length m	Wt. g	AFTMA-Class	Handle
110500	/255	2.55	2	1.35	105	5/6	Cork

Diabolo put-in rods



WINKLEPICKER HEAVY

For anyone for whom a traditional winkle-picker rod is too light, and a feeder rod too heavy, will find the perfect rod here. It can be used to cast both somewhat heavier assemblies and for fishing in a current. Equipped with three tips: 55cm, 1, 1.5 and 2oz. Tip slot diameter 3.6 mm, exactly matching to our Feeder Tips on page 56.

Item No.	Order No.	Length m	Sec.	Transp.-Length m	Wt. g	Casting weight g	Handle
110430	/275	2.75	2+3	1.43	205	10-55	Cork
	/305	3.05	2+3	1.57	210	10-55	Cork



MATCH FEEDER

Very practical 2-section feeder rod for use in smaller waters; also ideal for trout lakes and feeder fishing under trees that makes the use of long feeder rods impossible. Equipped with 2 tips: 55cm, 1 and 2oz. Tip slot diameter 3.6 mm, exactly matching to our Feeder Tips on page 56.

Item No.	Order No.	Length m	Sec.	Transp.-Length m	Wt. g	Casting weight g	Handle
110530	/315	3.15	2+2	1.62	270	to 90	Cork



HEAVY MATCH FEEDER

Designed like the Match Feeder but with a significantly tauter blank. Ideal for feeder fishing in smallish rivers with strong currents. Equipped with 2 tips: 55cm, 3 and 4oz.

Item No.	Order No.	Length m	Sec.	Transp.-Length m	Wt. g	Casting weight g	Handle
110540	/315	3.15	2+2	1.62	275	to 150	Cork



CARP

Light, slender carp rods with great price/performance ratio. The blanks charge themselves progressively during casting, thus enabling such long-distance casts. Anti-skid, high-quality shrink rubber is used for the handles, making the rods very slender.

Item No.	Order No.	Length m	Sec.	Transp.-Length m	Wt. g	Casting weight lbs	Handle
110550	/360	3.60	2	1.85	265	3.00	Duplon
	/390	3.90	2	2.00	325	3.50	Duplon



STALKER

Special rod for still fishing for carp. At a length of just 10' the rod is very handy and can be transported through rough terrain (reeds, undergrowth etc.). The action is parabolic especially in order to be able to play out hooked carp reliably over a short distance.

Item No.	Order No.	Length m	Sec.	Transp.-Length m	Wt. g	Casting weight lbs	Handle
110560	/305	3.05	2	1.60	270	3.00	Cork



CARP MATCH

The action of this rod can be compared with a robust match or Sbirolino rod. Fishing for carp with this little stick with float is not just a load of fun, it is also extremely successful. With extra-large guides through which line stoppers slide without any problems.

Item No.	Order No.	Length m	Sec.	Transp.-Length m	Wt. g	Casting weight lbs	Handle
110570	/360	3.60	3	1.28	225	2.00	Cork

Diabolo put-in rods



CARP OLDSCHOOL

If you don't want to do without a cork handle when fishing for carp, but still want an extremely modern blank, you are well-advised to use this rod. Also, this rod loads up progressively during casting and has a parabolic action.

Item No.	Order No.	Length m	Sec.	Transp.-Length m	Wt. g	Casting weight lbs	Handle
110580	/360	3.60	3	1.26	385	3.00	Cork



SEATROUT

Great long distance casting rod that lies perfectly balanced in your hand. Even at long distances your strike will be certain. The long distance casting handle gives you the crucial extra metres.

Item No.	Order No.	Length m	Sec.	Transp.-Length m	Wt. g	Casting weight g	Handle
110440	/310	3.10	2	1.60	225	10-45	Cork



MUSCLE STICK

This little power pack is ideal for pilking from small boats. However, it can also be used for heavy duty bottom fishing in small to medium-sized rivers and as a jerkbait rod.

Item No.	Order No.	Length m	Sec.	Transp.-Length m	Wt. g	Casting weight g	Handle
110470	/215	2.15	2	1.14	195	50-175	Cork



SEA JIGGER

A great rod, developed especially for fishing with rubber baits for cod, coalfish and pollack. The filigree rod becomes well charged during casting. The taut, but nevertheless sensitive, tip guarantees excellent bait guidance and bite detection.

Item No.	Order No.	Length m	Sec.	Transp.-Length m	Wt. g	Casting weight g	Handle
110490	/280	2.80	2	1.48	270	50-120	Duplon



VARIO SURF

Ultramodern surf rod with Low Ryder guides, ergonomic shrink-rubber handles and as well as 2 exchangeable tips. By comparison with the predecessor model the tip actions have clearly become firmer. The put-in connections are roughened which means that the parts can still be pulled out easily even when they are wet. First tip: casting weight 80-180g, second tip: casting weight 140-220g.

Item No.	Order No.	Length m	Sec.	Transp.-Length m	W. g	Casting weight g	Handle
110390	/420	4.20	3+1	1.48	655	see left	Shr. rubber

DIABOLO NEO



Diabolo Tele

Our Diabolo telescopic rods are almost equal to the put-in rods with regard to their action and dynamics. With extra-short sections for especially convenient transportation and splitted handles.



With splitted handle



Reel seat made of Steel/ Nylon-ABS



Slender titanium SIC guides



MINI SPIN 45

Thanks to their extremely short transport length, these telescopic rods are ideal for small baggage. All of the rods have sensitive solid carbon tips which make catching trout and perch great fun. The powerful backbone is also stands up well to pike and pike-perch.

Item No.	Order No.	Length m	Sec.	Transp. Length m	W. g	Casting weight g	Handle
110710	/210	2.10	7	0.48	145	5-45	Cork
	/240	2.40	7	0.49	165	5-45	Cork
	/270	2.70	8	0.54	230	5-45	Cork



TELE 40

Well-balanced and with a strong backbone for light and medium spin, float and bottom fishing for perch, trout and pike-perch.

Item No.	Order No.	Length m	Sec.	Transp. Length m	W. g	Casting weight g	Handle
110720	/210	2.10	5	0.61	135	10-40	Cork
	/240	2.40	5	0.65	145	10-40	Cork
	/270	2.70	6	0.68	180	10-40	Cork
	/300	3.00	6	0.76	195	10-40	Cork



TELE 70

Medium-heavy bottom rod for carp, pike, pike-perch and eel. The lengths of 3 metres and over are excellent for medium-heavy float fishing.

Item No.	Order No.	Length m	Sec.	Transp. Length m	W. g	Casting weight g	Handle
110730	/240	2.40	5	0.68	150	20-70	Cork
	/270	2.70	6	0.67	195	20-70	Cork
	/300	3.00	6	0.76	200	20-70	Cork
	/330	3.30	6	0.83	220	20-70	Cork

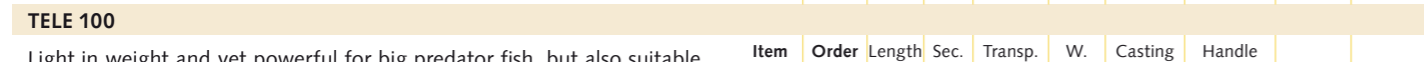

TELE 100

Light in weight and yet powerful for big predator fish, but also suitable for light perks and twister assemblies.

Item No.	Order No.	Length m	Sec.	Transp. Length m	W. g	Casting weight g	Handle
110740	/300	3.00	6	0.78	215	40-100	Cork



TELE ALLROUND 55 / 85 / 105

Powerful carp rods, which are suitable both for floats and bottom assemblies. The strong blanks facilitate long casts and will surely conquer even a capital mossback.

Item No.	Order No.	Length m	Sec.	Transp. Length m	W. g	Casting weight g	Handle
110750	/350	3.50	5	1.12	260	20-55	Cork
	/351	3.50	5	1.12	265	30-85	Cork
	/352	3.50	5	1.12	275	40-105	Cork



TROUT

Very sensitive rod with fine action for float and bottom fishing for trout and perch.

Item No.	Order No.	Length m	Sec.	Transp. Length m	W. g	Casting weight g	Handle
110800	/300	3.00	7	0.73	205	5-30	Cork



BOLOGNESE

Classic Bolognese rods for fishing for white fish with Bolo floats in rivers and canals.

Item No.	Order No.	Length m	Sec.	Transp. Length m	W. g	Casting weight g	Handle
110760	/600	6.00	6	1.26	390	5-28	Rough Grip



TELE WINKLEPICKER

For all telescopic rod fans there is now a telescopic winklepicker rod. It goes without saying that it is wonderfully convenient for transportation, and it always cuts a fine figure when fishing. Due to the blank construction somewhat heavier assemblies can be cast precisely. Supplied with 2 tips.

Item No.	Order No.	Length m	Sec.	Transp. Length m	W. g	Casting weight g	Handle
110770	/285	2.85	3 + 2	1.04	180	8-55	Cork



TELE EEL PICKER

Anyone wishing to fish successfully for eels needs a sensitive bite indicator, but at the same time also a rod with sufficient strength. The times are over when you needed rigid staves and little bells. Capital fish in particular often bite very cautiously; the fine picker tips indicate every single bite and the powerful backbone counters even fat predatory eels. The special tip guide makes it possible to install a mini chemical light.

Item No.	Order No.	Length m	Sec.	Transp. Length m	W. g	Casting weight g	Handle
110780	/305	3.05	3 + 2	1.04	190	30-80	Cork



TELE CARP

Anyone looking for a modern carp rod, but will not do without cork handle, is well served by the Tele Carp. Whether used for float or bottom fishing this rod is an ideal all-rounder.

Item No.	Order No.	Length m	Sec.	Transp. Length m	W. g	Casting w. lbs	Handle
110820	/360	3.60	7	0.85	265	3	Cork



DISTANCE CARP

The ideal travelling rod for all carp fans who don't want to forego the popular split Duplon handle. Whether used with a float or a ground assembly, this carp rod is an ideal allrounder. The "English" action as well as the perfect blank connections are convincing enough even for real put-in rod fans.

Item No.	Order No.	Length m	Sec.	Transp. Length m	W. g	Casting w. lbs	Handle
110810	/360	3.60	7	0.87	265	3	Duplon
	/390	3.90	8	0.87	290	3	Duplon

NOW IN 7,5M



BAITFISH

This baitfish rod has been redesigned and is now half a metre longer than its predecessor. It now proudly measures 7.5m, but it is still sturdy and is amazingly light in weight.

Item No.	Order No.	Length m	Sec.	Transp. Length m	W. g	Casting weight g	Handle
110790	/750	7.50	7	1.35	715	40-150	Rough Grip

Magna® MX-3 Gorilla



Rods with Anti-Crack technology

Our very popular MX-3 Gorilla rods with a cork handle by popular request. The power tip and the special composite material make the rods virtually indestructible.

FEATURES:

- Titanium SIC guides
- Ergonomic handles made of Duplon/Cork
- Real seats made of Stainless Steel and Nylon ABS



SPIN 50

Powerful rods for medium spin and bottom fishing with sensitive tips hence they facilitate the use of small spinners and wobblers.

Item-No.	Order-No.	Length m	Sec.	Transp.-Length m	W. g	Casting weight g	Handle		
114630	/210	2.10	2	1.10	190	15-50	Cork/Dupl.		
	/240	2.40	2	1.25	220	15-50	Cork/Dupl.		
	/270	2.70	2	1.40	270	15-50	Cork/Dupl.		



SPIN 80

Spin rods with powerful backbone, ideal for pike, pike-perch and big salmonide species.

Item-No.	Order-No.	Length m	Sec.	Transp.-Length m	W. g	Casting weight g	Handle		
114640	/210	2.10	2	1.15	220	25-80	Cork/Dupl.		
	/240	2.40	2	1.25	250	25-80	Cork/Dupl.		
	/270	2.70	2	1.40	270	25-80	Cork/Dupl.		
	/300	3.00	2	1.55	290	25-80	Cork/Dupl.		



SPIN 120

Extremely strong spin and bottom rods. Also ideal for trolling and pilking.

Item-No.	Order-No.	Length m	Sec.	Transp.-Length m	W. g	Casting weight g	Handle		
114650	/270	2.70	2	1.40	335	45-120	Cork/Dupl.		
	/300	3.00	2	1.55	360	45-120	Cork/Dupl.		



JERK CAST

Super jerk rod with a Trigger handle for fishing with baitcast reels. The powerful action lends each jerkbait realistic play.

Item-No.	Order-No.	Length m	Sec.	Transp.-Length m	W. g	Casting weight g	Handle		
114690	/185	1.85	2	1.00	175	30-95	Cork/Dupl.		

STRUCTURE OF THE MX-3 RODS

Power-tip tip

100% sheathed in power tip fibres

Magna® composite material



Titanium-SIC guides



Fine duplon/cork handles



Stainless steel/Nylon-ABS reel seat



EEL

This rod possesses a powerful backbone and fine tip for a very sensitive bite indication, yet it also has sufficient power to play out big eels really fast. The special top guide allows for the attachment of chemical lights and nightlights.

Item-No.	Order-No.	Length m	Sec.	Transp.-Length m	W. g	Casting weight g	Handle		
114660	/285	2.85	2	1.50	335	30-75	Cork/Dupl.		



PILK

Extremely fast »Light« pilking rod with hard backbone for long-distance casts. The fantastically sensitive tips facilitate optimal bait guidance and precise bite indication.

Item-No.	Order-No.	Length m	Sec.	Transp.-Length m	W. g	Casting weight g	Handle		
114680	/250	2.50	2	1.28	295	40-185	Cork/Dupl.		
	/280	2.80	2	1.45	385	40-185	Cork/Dupl.		



BIG FISH

Great rod for fresh water and salt water. In fresh water it is a perfect catfish rod, and in salt water it can really show its strong points for pilking and when using paternosters to catch mackerel.

Item-No.	Order-No.	Length m	Sec.	Transp.-Length m	W. g	Casting weight g	Handle		
114670	/245	2.45	2	1.25	470	100-350	Cork/Dupl.		
	/275	2.75	2	1.45	510	100-350	Cork/Dupl.		

Black Jack rods

BLACK JACK



Black Jack...now made from IM-6 carbon fibre!

Like the Diabolo NEO rods, the follow-up series of Euphoria rods has also been completely refurbished.

The blanks are now no longer made from mixed carbon, but from IM-6 carbon fibre, making them perceptibly lighter and the actions distinctly firmer.

In addition to the classic spin and telescopic rods, this series has been enlarged to include feeder, carp and baitfish rods...all at sensational prices!

FEATURES:

- High Modulus IM-6 Carbon
- Titanium SIC guides throughout
- Cork handles (except for carp and baitfish)
- Reel seat made from stainless steel/nylon ABS
- Precision put-in connections
- Hook holder on all put-in rods



TROUT/PERCH LIGHT

Very filigree rods for fine spin fishing, e.g. with micro-jigs, small wobblers etc.

Item-No.	Order-No.	Length m	Sec.	Transp.-Length m	W. g	Casting weight g	Handle		
116210	/180	1.80	2	0.97	110	3-15	Cork		



TROUT/PERCH

Optimal rods for fishing with artificial bait for perch and trout etc.: the rigid blank with the fine tip enables extremely well-controlled bait guidance and a fast strike.

Item-No.	Order-No.	Length m	Sec.	Transp.-Length m	W. g	Casting weight g	Handle		
116220	/210	2.10	2	1.10	150	5-25	Cork		
	/240	2.40	2	1.27	185	5-25	Cork		
	/270	2.70	2	1.42	215	5-25	Cork		



PIKE/PIKE-PERCH

A real all-rounder for pike and pike-perch. The taut action is ideal for fishing with rubber fish. Top bait guidance and fast strikes!

Item-No.	Order-No.	Length m	Sec.	Transp.-Length m	W. g	Casting weight g	Handle		
116230	/240	2.40	2	1.27	200	20-50	Cork		
	/270	2.70	2	1.45	225	20-50	Cork		
	/300	3.00	2	1.56	250	20-50	Cork		



PERCH TWITCH

Wonderful rods for medium spin fishing for predators.

Item-No.	Order-No.	Length m	Sec.	Transp.-Length m	W. g	Casting weight g	Handle		
116250	/190	1.90	2	1.00	115	8-28	Cork		



Titanium SIC guides

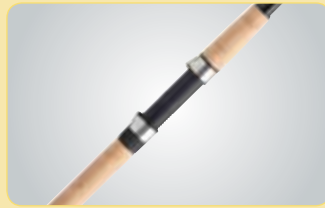

Fine Duplon /cork handles



Stainless steel/nylon ABS reel seat



Titanium-SIC guides also by our tele rods



HEAVY PIKE

As the name indicates, this rod was developed for catching pike. It takes large wobblers and rubbers to long distances without any problems and also shows pike ladies who the boss is.

Item-No.	Order-No.	Length m	Sec.	Transp.-Length m	W. g	Casting weight g	Handle		
116240	/245	2.45	2	1.27	250	30-75	Cork		
	/275	2.75	2	1.40	270	30-75	Cork		



CARP

Modern carp rod with an unostentatious design and with high-quality shrink-rubber handles. The blank loads up progressively and the action is naturally parabolic – typical for carp. This rod has an unbeatable price/performance ratio!

Item-No.	Order-No.	Length m	Sec.	Transp.-Length m	W. g	Casting wg. lbs	Handle		
116270	/360	3.60	2	1.89	360	3.00	Duplon		



LIGHT FEEDER

Developed for feeder fishing in smaller waters and where trees do not permit the use of long rods. Although the rod is beautifully sensitive it nevertheless easily carries feeder baskets weighing up to 60g a long distance. Also excellent for fishing by trout lakes and for »eel-picking«.

Item-No.	Order-No.	Length m	Sec.	Transp.-Length m	W. g	Casting weight g	Handle		
116260	/330	3.30	3+3	1.17	220	to 60	Cork		

1 glasfiber tip (60cm, 0.75oz), 2 carbon fiber tips, 60cm: 1 / 1.25oz
The 2.2mm spare tips from page 56 are fitting too.

Black Jack rods



MEDIUM FEEDER

Extremely dynamic rods with extra-large long distance casting guides. The slender, lightweight IM-6 rod blanks have astonishing power reserves, making distances up to 80m no difficulty. Despite their power, these rods are very well balanced in the upper section and thus minimise the number of fish lost during play.

Item-No.	Order-No.	Length m	Sec.	Transp.-Length m	W. g	Casting weight g	Handle		
116260	/360	3.60	3+3	1.27	290	to 100	Cork		

1 glasfiber tip (60cm, 1oz), 2 carbon fiber tips, 60cm: 1.5 / 2oz
The 3.6mm spare tips from page 56 are fitting too.



HEAVY FEEDER

A perfect allround rod for many water types, flowing conditions and fish species. The balanced bending curve in the upper rod section allows also the safe landing of large fish.

Item-No.	Order-No.	Length m	Sec.	Transp.-Length m	W. g	Casting weight g	Handle		
116260	/390	3.90	3+3	1.37	350	to 150	Cork		

1 glasfiber tip (65cm, 2oz), 2 carbon fiber tips, 65cm: 3 / 4oz
The 3.6mm spare tips from page 56 are fitting too.



ULTRA HEAVY FEEDER

Developed for heavy feeder fishing. This rod brings heavy feeder baskets effortlessly to width. Also strong barbels and large breams can be handled easily also in the flow.

Item-No.	Order-No.	Length m	Sec.	Transp.-Length m	W. g	Casting weight g	Handle		
116260	/420	4.20	3+3	1.47	425	to 220	Cork		

1 glasfiber tip (65cm, 4oz), 2 carbon fiber tips, 65cm: 5 / 6oz
The 3.6mm spare tips from page 56 are fitting too.



TELE POLE

Light float fishing rod for beginners. Fast action and an unusually light weight for glass rods make it possible to fish for hours without tiring.

Item-No.	Order-No.	Length m	Sec.	Transp.-Length m	W. g	Casting weight g	Handle		
112350	/500	5,00	5	1,25	210	-	Rough Grip		
	/600	6,00	6	1,25	320	-	Rough Grip		
	/700	7,00	7	1,25	435	-	Rough Grip		



TELE 45

Sensitive spin rod for fishing with artificial bait for perch, trout and pike-perch. The long rods are also ideal for medium-heavy float and bottom fishing.

Item-No.	Order-No.	Length m	Sec.	Transp.-Length m	W. g	Casting weight g	Handle		
112300	/240	2.40	7	0.58	190	10-45	Cork		
	/270	2.70	7	0.67	210	10-45	Cork		
	/300	3.00	7	0.78	260	10-45	Cork		
	/330	3.30	7	0.88	265	10-45	Cork		



TELE 75

Heavy spin rod for fishing for pike, large salmonide species and carp. Also for fishing in stronger currents.

Item-No.	Order-No.	Length m	Sec.	Transp.-Length m	W. g	Casting weight g	Handle		
112310	/240	2.40	7	0.58	345	25-75	Cork		
	/270	2.70	7	0.67	255	25-75	Cork		
	/300	3.00	7	0.78	280	25-75	Cork		
	/330	3.30	7	0.87	320	25-75	Cork		



TELE 135

For heavy bottom and spin fishing, but also extremely suitable as a pilking rod.

Item-No.	Order-No.	Length m	Sec.	Transp.-Length m	W. g	Casting weight g	Handle		
112320	/300	3.00	6	0.81	320	50-135	Cork		
	/330	3.30	7	0.83	340	50-135	Cork		
	/360	3.60	7	0.88	360	50-135	Cork		



BAITFISH

Ideal for overriding waterlilies or packed rocks when you are after pike or pike-perch.

Item-No.	Order-No.	Length m	Sec.	Transp.-Length m	W. g	Casting weight g	Handle		
112330	/695	6.95	6	1.40	720	45-140	Rough Grip		



TELE FEEDER

Universal Feeder rod for the light and medium range with 2 interchangeable tips (1 and 2oz).

Item-No.	Order-No.	Length m	Sec.	Transp.-Length m	W. g	Casting weight g	Handle		
112340	/330	3.30	4+2	1.05	205	max 100	Cork		

Modul Rosso

MODUL ROSSO

Glass rods with excellent features

These visual delicacies offer far more than conventional glass rods! Besides the chic design and the astonishingly good actions for glass rods, they are equipped with high quality **Titanium SIC guides** which are much lighter in weight and of a better quality than the ceramic guides which are normally used on glass rods. The fine Duplon handles rest pleasantly in your hand. The precision reel seat is made from stainless steel and Nylon/ABS.



Reel seat made from Nylon/ABS and stainless steel

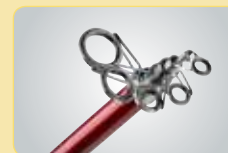

Titanium SIC guides

FEATURES:

- Highly compressed glass fibre
- Titanium SIC guides
- Reel seat made from Nylon/ABS and stainless steel
- Fine Duplon handles (except Tele Trout/Perch and Pole = Roughrip)



SPIN 40

Fantastic series of put-in rods, ideal for light and medium spin and bottom fishing. The rods are very well-balanced and lie well in one's hand. All rods have a light tip action for successful long-distance, accurate casting.

Item-No.	Order-No.	Length m	Sec.	Transp.-Length m	W. g	Casting weight g	Handle		
114100	/180	1.80	2	0.96	145	10-40	Duplon		
	/210	2.10	2	1.11	175	10-40	Duplon		
	/240	2.40	2	1.27	205	10-40	Duplon		
	/270	2.70	2	1.41	265	10-40	Duplon		



SPIN 70

Fantastic series of put-in rods, ideal for light and medium spin and bottom fishing. The rods are very well-balanced and lie well in one's hand. All rods have a light tip action for successful long-distance, accurate casting.

Item-No.	Order-No.	Length m	Sec.	Transp.-Length m	W. g	Casting weight g	Handle		
114110	/210	2.10	2	1.11	150	20-70	Duplon		
	/240	2.40	2	1.27	200	20-70	Duplon		
	/270	2.70	2	1.41	260	20-70	Duplon		
	/300	3.00	2	1.41	260	20-70	Duplon		



FEEDER 150

Inexpensive feeder rod for medium-sized feeder basket fishing with sufficient strength for long-distance casts and 3 interchangeable tips for sensitive bite indication.

Item-No.	Order-No.	Length m	Sec.	Transp.-Length m	W. g	Casting weight g	Handle		
114120	/360	3.60	3+3	1.25	375	50-150	Duplon		



WINKELPICKER

Lightweight picker rod with interchangeable tips. The interchangeable tips are equipped throughout with SIC guides for better line protection.

Item-No.	Order-No.	Length m	Sec.	Transp.-Length m	W. g	Casting weight g	Handle		
114140	/275	2.75	2+2	1.40	225	10-40	Duplon		



EEL PICKER

Big eels often bite cautiously, so one needs a sensitive bite indicator. The two exchangeable tips which differ in hardness indicate even cautious bites. A mini chemical light can be attached to the special top guide. The interchangeable tips are equipped throughout with SIC guides for better line protection.

Item-No.	Order-No.	Length m	Sec.	Transp.-Length m	W. g	Casting weight g	Handle		
114150	/285	2,85	2+2	1,48	285	20-65	Rough Grip		



BIG FISH

Extra-strong, robust rods up to dealing with all species of big fish in fresh and saltwater as well as in strong currents.

Item-No.	Order-No.	Length m	Sec.	Transp.-Length m	W. g	Casting weight g	Handle		
114130	/240	2.40	2	1.28	315	80-250	Duplon		
	/270	2.70	2	1.43	370	80-250	Duplon		



TELE 40

Extra short-sectioned rods for light spin fishing.

Item-No.	Order-No.	Length m	Sec.	Transp.-Length m	W. g	Casting weight g	Handle		
114010	/150	1.50	4	0.50	135	10-40	Duplon		
	/180	1.80	5	0.46	160	10-40	Duplon		
	/210	2.10	6	0.48	195	10-40	Duplon		
	/240	2.40	6	0.57	225	10-40	Duplon		
	/270	2.70	6	0.62	260	10-40	Duplon		



TELE 70

Universal rod for spin and bottom fishing.

Item-No.	Order-No.	Length m	Sec.	Transp.-Length m	W. g	Casting weight g	Handle		
114020	/210	2.10	6	0.48	200	20-70	Duplon		
	/240	2.40	6	0.57	220	20-70	Duplon		
	/270	2.70	6	0.62	270	20-70	Duplon		
	/300	3.00	7	0.64	300	20-70	Duplon		



TELE EEL

A great bottom rod with a strong backbone for the classic way to catch eels. During the day the red tip indicates the bites. At night a chemical light can be attached to the special top guide.

Item-No.	Order-No.	Length m	Sec.	Transp.-Length m	W. g	Casting weight g	Handle		
114030	/260	2.60	5	0.62	275	25-75	Duplon		

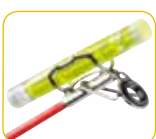

TELE EEL PICKER

Big eels often bite cautiously, so one needs a sensitive bite indicator. The two exchangeable tips which differ in hardness indicate even cautious bites. A mini chemical light can be attached to the special top guide.

Item-No.	Order-No.	Length m	Sec.	Transp.-Length m	W. g	Casting weight g	Handle		
114040	/285	2.85	4+2	0.64	245	20-65	Duplon		

Modul Rosso / Modul Rosso Combos



TELE POLE

Light float fishing rod for beginners. Fast action and an unusually light weight for glass rods make it possible to fish for hours without tiring.

Item-No.	Order-No.	Length m	Sec.	Transp.-Length m	W. g	Casting weight g	Handle		
114000	/300	3.00	3	1.15	170	-	RoughGrip		
	/400	4.00	4	1.15	250	-	RoughGrip		
	/500	5.00	5	1.15	350	-	RoughGrip		
	/600	6.00	6	1.15	480	-	RoughGrip		



TELE TROUT / PERCH

Sensible rod for fishing for perch and trout.

Item-No.	Order-No.	Length m	Sec.	Transp.-Length m	W. g	Casting weight g	Handle		
114060	/240	2.40	4	0.88	165	5-25	Blank		
	/300	3.00	4	0.90	185	5-25	Blank		
	/340	3.40	4	0.90	205	5-25	Blank		



TELE PILK

Extra strong rod for heavy fresh water fishing and pilking.

Item-No.	Order-No.	Length m	Sec.	Transp.-Length m	W. g	Casting weight g	Handle		
114050	/210	2.10	4	0.80	170	50-185	Duplon		
	/240	2.40	5	0.81	250	50-185	Duplon		

MODUL ROSSO Combos



The perfect combination of rod and reel at a fantastic price! All combos are fitted with the single ball bearing reel from the new Spezi series. Each reel is already fitted with the appropriate target fish line.

EQUIPPED WITH THE NEW SPEZI REELS



TROUT/PERCH WITH SPEZI SPIN 30 AND 0.25MM LINE

Item-No.	Order-No.	Length m	Sec.	Transp.-Length m	W. g	Casting weight g	Handle		
116990	/170	2.40	4	0.56	225	5-25	Roughgrip		

PIKE TELE SPIN 70 WITH SPEZI SPIN 40 AND 0.30MM LINE

Item-No.	Order-No.	Length m	Sec.	Transp.-Length m	W. g	Casting weight g	Handle		
116990	/171	2.70	6	0.62	270	20-70	Duplon		



EELPICKER WITH SPEZI EEL AND 0.37MM LINE

Item-No.	Order-No.	Length m	Sec.	Transp.-Length m	W. g	Casting weight g	Handle		
116990	/172	2.85	2+2	1.46	285	20-65	Duplon		

TELE EEL WITH SPEZI EEL AND 0.37MM LINE

Item-No.	Order-No.	Length m	Sec.	Transp.-Length m	W. g	Casting weight g	Handle		
116990	/173	2.60	5	0.62	275	25-75	Duplon		



WINKLEPICKER WITH SPEZI ROACH AND 0.20MM LINE

Item-No.	Order-No.	Length m	Sec.	Transp.-Length m	W. g	Casting weight g	Handle		
116990	/174	2.75	2+2	1.40	225	10-40	Duplon		

FEEDER WITH SPEZI CARP AND 0.30MM LINE

Item-No.	Order-No.	Length m	Sec.	Transp.-Length m	W. g	Casting weight g	Handle		
116990	/175	3,60	3+3	1.27	375	150	Duplon		

MODUL SHIKA

MODUL SHIKA

Modern glass rods in 4 chic colours!
 Either individually or as a combination with the respective colour-coordinated Shika reel which are even loaded with the matching line!
 All rods have titanium SIC guides throughout and precision stainless steel/nylon ABS reel seats.



Ready made combos are also for special prices available!

MATCHING REELS CAN BE FOUND ON PAGE 14



MODUL SHIKA TELE 45

Extra short-sectioned rods for light spin fishing.

Item-No.	Order-No.	Color	Length	Sec.	Transp. Length m	weight g	casting wt. g	Handle
110960	/180	Green	1.80	4	0.55	180	10-45	Duplon
	/210	Green	2.10	5	0.55	200	10-45	Duplon
	/240	Green	2.40	6	0.55	225	10-45	Duplon

SHIKA TELE 45 COMBO

Item-No.	Order-No.	Reel Rod
116990	/180	1 00960/130 1 10960/180
	/181	1 00960/130 1 10960/210
	/182	1 00960/130 1 10960/240



MODUL SHIKA TELE 75

Universal rod for light and medium spin and bottom fishing.

Item-No.	Order-No.	Color	Length	Sec.	Transp. Length m	weight g	casting wt. g	Handle
110970	/240	Orange	2.40	6	0.56	220	20-75	Duplon
	/270	Orange	2.70	7	0.56	240	20-75	Duplon

SHIKA TELE 75 COMBO

Item-No.	Order-No.	Reel Rod
116990	/183	1 00970/130 1 10970/240
	/184	1 00970/130 1 10970/270



MODUL SHIKA SPIN 45

Put-in rods, ideal for light spin and bottom fishing. All rods have a light tip action for successful long-distance, accurate casting.

Item-No.	Order-No.	Color	Length	Sec.	Transp. Length m	weight g	casting wt. g	Handle
110980	/240	Pink	2.40	2	1.25	195	10-45	Duplon
	/270	Pink	2.70	2	1.40	215	10-45	Duplon

SHIKA SPIN 45 COMBO

Item-No.	Order-No.	Reel Rod
116990	/185	1 00980/130 1 10980/240
	/186	1 00980/130 1 10980/270



MODUL SHIKA SPIN 75

Fantastic series of put-in rods, ideal for medium spin and bottom fishing.

Item-No.	Order-No.	Color	Length	Sec.	Transp. Length m	weight g	casting wt. g	Handle
110990	/240	Blue	2.40	2	1.25	215	20-75	Duplon
	/270	Blue	2.70	2	1.40	235	20-75	Duplon

SHIKA SPIN 75 COMBO

Item-No.	Order-No.	Reel Rod
116990	/187	1 00990/130 1 10990/240
	/188	1 00990/130 1 10990/270

Rod combos



ATLANTIC SURF COMBO

The set includes:

A surf reel with 2 ball bearings, with extra strong aluminium crank, multi-stop system, S-stroke system and finely adjustable front drag. Already filled with yellow-fluorescent 0.35mm line.

The rod:

Powerful 3 piece surf rod with dynamic blank construction.

Item-No.	Order-No.	Length m	Sec.	Transp.-Length m	W. g	Casting weight g	Handle		
116990	/315	4.20	3	1.45		100-200	Duplon		



ATLANTIC PILK COMBO

Strong front drag reel with 2 ball bearings (rest as above), ideal for sea and pike fishing. Filled with yellow-fluorescent 0.40mm line.

Solid Pilk rod made of highly compressed fiber glass, with beautiful parabolic action and amazingly low weight.

Item-No.	Order-No.	Length m	Sec.	Transp.-Length m	W. g	Casting weight g	Handle		
116990	/316	2.40	2	1.25		60-180	Duplon		

COMBO MAGNA SPECIAL FLY

Practical fly-rod package which fulfil even more exacting demands. Carbon fibre rod, class 5/6 with natural cork grip, the main and top guides with an SIC inlay. Aluminium fly reel with disc brake system and salt-water resistant anticorrosion coating. Reel can vary. Rod bag and fly line class 5-6 included.

Item-No.	Order-No.	Length	Sec.	Transp. length m	wt. g	AFTMA		
116990	/240	2.40	2	1.25	100	5/6		



COMBO MODUL FLY

The perfect combination for beginners and advanced fishermen: rod, reel and original English fly line, class 5/6. Reel can vary.



Item-No.	Order-No.	Length	Sec.	Transp. length m	wt. g	AFTMA		
116980	/240	2.40	2	1.25	115	5/6		



BEGINNER ASSORTMENT

Consisting of telescopic rod, reel, line and accessories.

Item-No.	Order-No.		
117030	/165		



SIC GUIDES



SIC TIP-GUIDE ASSORTMENT

280 pieces in 28 sizes, separated into ring and tube diameters (an informative sticker on the box shows ring and tube diameters).

Item-No.	Order-No.
118580	/280



STRONG SIC TIP GUIDE ASSORTMENT

100 pieces of guides with extra thick SIC inlay which prevents lines from damage under hard conditions and if the line gets in touch with the guide frame. Content: 100 guides in 7 different sizes/diameters.

Item-No.	Order-No.
118580	/101



SIC GUIDES ARE ALSO SEPARATELY AVAILABLE



SIC TIP-GUIDE ASSORTMENT

100 pieces in the 8 most common sizes (an informative sticker on the box shows ring and tube diameters).

Item-No.	Order-No.
118580	/100



ASSORTMENT OF 3-LEG SIC-GUIDES

100 pieces of 3-leg SIC-guides (2 tying legs) in 9 different sizes.

Item-No.	Order-No.
118590	/100



ASSORTMENT OF 2-LEG SIC-GUIDES

100 pieces of 2-leg SIC-guides (1 tying leg) in 9 different sizes.

Item-No.	Order-No.
118600	/100

REPLACEMENT TIPS

Suitable as spare-tips or for self made rods. Colour shining black.



A COAL FIBRE TIPS

Item-No.	Order-No.	Length cm	Top Ø mm	End Ø mm
118320	/060	60	0.5	2.0
	/061	60	0.8	2.0

D SOLID GLASS FIBRE ROD TIPS, BLACK

Item-No.	Order-No.	Length cm	Top Ø mm	End Ø mm
118280	/080	80	0.8	5.5
	/081	80	1.0	6.0
	/082	80	2.0	7.0

B HOLLOW GLASS FIBRE ROD TIPS

Item-No.	Order-No.	Length cm	Top Ø mm	End Ø mm	Casting weight
118000	/020	80	1.6	4.0	10-20
	/030	80	1.6	4.0	10-30
	/040	80	1.8	5.0	20-40
	/060	80	1.8	5.2	30-60
	/080	60	2.0	5.3	40-80
	/100	60	2.0	5.4	50-100
	/150	60	2.3	5.8	80-150
	/200	60	2.7	7.3	100-200

C CARBON-TIPS

Item-No.	Order-No.	Length cm	Top Ø mm	End Ø mm	Casting weight
118050	/015	70	1.2	3.4	2-15
	/020	70	1.2	3.5	5-20
	/030	70	1.2	3.6	10-30
	/040	70	1.4	4.3	20-40
	/060	70	1.4	4.3	30-60
	/080	60	1.5	4.3	40-80
	/100	60	1.5	4.5	50-100
	/150	60	1.7	5.3	80-150
	/200	60	2.0	6.2	100-200

Bite indicators



GALAXY AX		
Item-No.	Order-No.	
119680	/001	

- Sound and volume separately adjustable
- Infinitely variable sensitivity levels
- Night LED
- Rubberised, non-slip surface
- Extra bright leds for bite indication and afterglow
- Protected from splashes and rainwater
- Bite indicated by a magnetic sensor
- Low power consumption
- Operated with 9 Volt batterie (not included in the scope of supply)

GALAXY XP		
Item-No.	Order-No.	
119660	/000	

- Wide volume settings
- Separate sound settings
- Bite indicated by a magnetic sensor
- Standardized connection for a sounder box
- Standardized thread for common banksticks
- Low power consumption
- Operated with 3xAAA batterie ((not included in the scope of supply)

FLASH TIP-LIGHT



NEW: NOW ALSO WITH GREEN LIGHT



With 2 adapters

The Flash Tip Light is as easy as pie to mount on the tip of a rod. A bite causes the Tip Light to flash in a bright red or green. If the fish ceases to bite urgently, the light continues to shine in blue for a few seconds. This makes it much easier to orientate oneself when using more than one rod. If the fish snaps up the bait again, the Flash Tip Light starts to flash again. It is supplied with 2 adapters and is therefore equally suitable for fine and strong tips. Supplied with battery (CR 1225 3V).





/003: green flashing /002: red flashing Continues shining

Picture left and middle:
When a fish bites the LED is flashing green or red

Picture right:
Blue lightning when a fish has biten with a 10-second afterglow

Item-No.	Order-No.	Colour	
119750	/002	Red	
	/003	Green	

SMALL BUT FINE: SENSOTEC BABY



Small electronic bite indicator with sound and signal. Easy to fix on every rod blank. The wheel indicates even the smoothest bites. Batteries included.

Item-No.	Order-No.	
119670	/100	

DEPTH METER



- Indicates from 0 to 999 metres
- Can be fixed on rod easily and safely
- Housing protected against spray
- Reset button

Item-No.	Order-No.	
119790	/000	

Chemical light, rod bells



CH. L. HOLD. DOUBLE BELL

Chemical-light holder with integrated double bell of fluorescent synthetic material for BALZER standard chemical-light.

Item-No.	Order-No.	For rod tips Ø
119780	/011	2.6-3.0 mm
	/012	3.1-3.6 mm
	/013	3.7-4.2 mm



CHEMICAL LIGHT HOLDER

Screwable an chemical light holders. For rod tips up to Ø 5.5mm. For BALZER standard chem.-light. 39x4,5mm.

Item-No.	Order-No.	For rod tips Ø
119780	/001	2.6-3.0 mm
	/002	3.1-3.6 mm
	/003	3.7-4.2 mm
	/004	4.5-5.5 mm



ROD BELL FLUORSCENT

Made of fluorescent synthetic mat.

Item-No.	Order-No.	For rod tips Ø
119780	/031	2.6-3.0 mm
	/032	3.1-3.6 mm
	/033	3.7-4.2 mm



CHEMICAL LIGHT HOLDER RUBBER

Length 2.5 cm.

Item-No.	Order-No.	For rod tips Ø
119820	/100	-



MINI CHEMICAL LIGHT

Ø 2,9mm, Length 23 mm.

Item-No.	Order-No.
119790	/100



CHEMICAL LIGHT BOX

50 pieces, Ø 4.5 mm, Length 39mm with 25 adapters.

Item-No.	Order-No.
119790	/051



CHEMICAL LIGHT DISPLAY

Ø 4,5 mm, Length 39 mm.

Item-No.	Order-No.
119790	/052

Content: 50 packages, each 2 pieces.

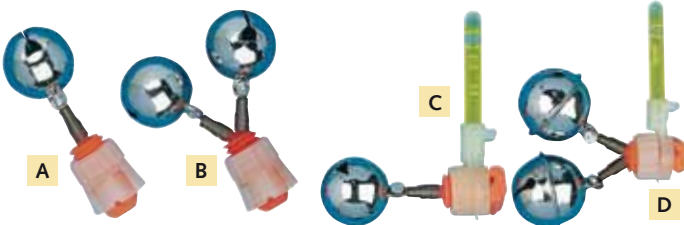

ROD BELL

Loose, with integrated adapter. Type C and D with additional adapter to fastening chemical light, length 4.5 cm.

Item-No.	Order-No.	
119850	/001	A
	/002	B
119830	/001	C
	/002	D

ROD CLIP BITE INDICATOR

This practical rod clip is simply clamped onto the rod. You fish with the bail open and the line fixed behind the ball.

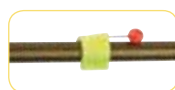

Item-No.	Order-No.	Colour	Rod Ø mm
164110	/007	black	10-16
	/008	black	17-25
	/010	neonyellow	10-16
	/011	neonyellow	17-25



ROD BELL, SILVER

With flat clamp, Length 8 cm.

Item-No.	Order-No.
119800	/004



ROD BELL, SILVER

With pointed clamp, length 7 cm.

Item-No.	Order-No.
119800	/001



With pointed clamp, length 9 cm. /003 with double bell.

Item-No.	Order-No.
119800	/002
	/003

Bite indicators / spare parts for rods / Belly belts



BITE INDICATOR

Can be equipped with ch. lights.

Item-No.	Order-No.	Ø mm
119810	/038	38
	/048	48



TRANSP. BITE INDICATOR

Can be equipped with ch. lights.

Item-No.	Order-No.
119810	/010



BITE INDICATOR

Can be equipped with ch. lights.

Item-No.	Order-No.
119810	/000



BITE INDICATOR

Can be equipped with ch. lights.

Item-No.	Order-No.	Diameter mm
119810	/030	30
	/035	35
	/042	42

FLOURESCENT

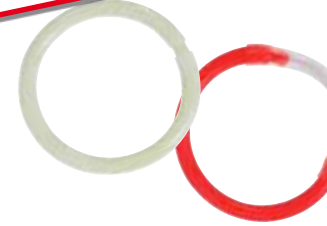

BITE INDICATOR RING

Easy to use, only hang in line. Good visibility.

Item-No.	Order-No.	Col.
119810	/001	lum.
	/002	red



A REEL GREASE 15 G

Gear-grease, salt waterproof, therefore also suitable for bait-cast reels.

Item-No.	Order-No.	Content
109300	/000	10 pieces

B COVER VARNISH 20 ML

Quick-drying varnish for rod connections. Brush included in the cover.

Item-No.	Order-No.	Content
118880	/010	5 pieces

C NYLON YARN, SORTED, 25 METER SPOOLS

Ideal for own rod building and repairing. 10x black, 10x25 m spools.

Item-No.	Order-No.	Content
118890	/000	1 Set = 10 x black

D REEL OIL 20 ML

Item-No.	Order-No.	Content
109200	/000	10 pieces

E SUPER ADHESIVE

For all purposes. Top holding power.

Item-No.	Order-No.
1 87800	/000

BELLY BELTS



STANDARD BELLY BELT

Multipurpose belly belt with large holding surface and adjustable belt.

Item-No.	Order-No.
119590	/010



BELLY BELT FOR CROSS BUTT RODS

Can swivel in all directions. For rods with cross-butt.

Item-No.	Order-No.
119590	/000

SPOT MARKER, 45M



SPOT MARKER, 45M

Simply throw the Spot Marker into the water, the lead unwinds automatically down to the bottom.

Item-No.	Order-No.	Length m
159980	/000	45

BALZER

Qualität seit 1949.



- **BALZER - Teamangler**
- **Autor in Fachmagazinen**
- **Referent auf Angelmessen**
- **Angelmedienhersteller**



MICHAEL KOMUCZKI -

einer von uns - einer von BALZER!



Die DVD von Anglern für Angler!

Vertrieb in Österreich:

michael.komuczki@gmail.com

www.michael-komuczki.com

Vertrieb in Deutschland:

www.media-fishingstore.de

A sunset over a body of water with a green geometric overlay on the left side. The sun is low on the horizon, creating a bright orange and yellow glow that reflects on the water. The sky transitions from a deep blue at the top to a lighter orange near the horizon. The water is calm, with some reeds or sticks visible in the foreground. A large green shape, resembling a stylized arrow or a large 'L' rotated 90 degrees, is overlaid on the left side of the image, pointing towards the right.

LINE

**And suddenly it's
your move**



And suddenly it's your move

Everything is centred on this one crucial moment. And then the time is ripe. Without any forewarning and very suddenly you have to react like lightning while remaining calm. This is a skill only anglers possess.

Then, with every movement, you get the catch more and more under control. So it is good if you refrain from making any compromises when it comes to your gear.

THE ADVANTAGES OF MONOFILAMENT LINES:

Greater stretching power for absorbing the flights of fish and to keep the fish on the hook

High resistance to abrasion

High knot strength

Depending on the colouring, difficult to see in the water

Reasonably priced

Apart from the monofilament lines, there are also the multifilament or braided lines, which consist of several interwoven Spectra fibres where the chief distinction made is that between round and »square« braided lines. Round braided lines such as the Iron Line are relatively new and have the great advantage that the water resistance is significantly lower with the same load bearing capacity as with square braided lines. This is an advantage which should not be underestimated when fishing at great depths and/or over long distances.

Many single Spectra fibres are interwoven in circular form and then stretched at great heat so that the weave becomes even closer and stretch is reduced to less than 1%. In addition, the fibres are then bonded and sealed inside and out with waterproof silicon. The final result are our topclass high-tech lines such as our **Iron Line 8-folded** braided lines.

THE ADVANTAGES OF BRAIDED LINES:

Almost no stretch and hence direct contact with bait and fish

Very high load-bearing capacity

Very little water absorption and therefore enduring, constant load bearing capacities

Long service life thanks to minimal abrasion

Long service life thanks to a high degree of UV resistance

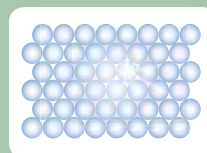

Highly densified nylon molecules for maximum breaking strength

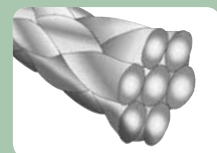

Very high breaking strength and no stretch

Platinum Royal / Platinum Carp

PLATINUM ROYAL

By using state-of-the-art polymers the Platinum has significant great resistance to abrasion, yet it remains just as supple as ever. The Anti-Twist system developed by Balzer reduces line-twisting to a minimum. The special anti-reflex coating ensures inconspicuous bait presentation even on bright days or in clear water.

- Highly compressed molecules ensure maximum load-bearing capacities
- UV protective coating
- Extremely high resistance to abrasion
- Incredibly little elongation
- Extremely supple owing to special surface sealing; for maximum casting distances and natural bait presentation
- Anti-Twist system reduces twisted lines to a minimum



30M CONNECTED SPOOLS			
Item-No.	Order-No.	Line Ø mm	Strength kg
123000	/010	0.10	1.25
	/012	0.12	1.88
	/014	0.14	2.50
	/016	0.16	3.30
	/018	0.18	4.40
	/020	0.20	4.80
	/022	0.22	6.10
	/025	0.25	7.00

150M SPOOLS			
Item-No.	Order-No.	Line Ø mm	Strength kg
123010	/012	0.12	1.88
	/014	0.14	2.50
	/016	0.16	3.30
	/018	0.18	4.40
	/020	0.20	4.80
	/022	0.22	6.10
	/025	0.25	7.00
	/028	0.28	7.90
	/030	0.30	9.10
	/035	0.35	13.50
/040	0.40	17.00	

300M SPOOLS			
Item-No.	Order-No.	Line Ø mm	Strength kg
123020	/016	0.16	3.30
	/018	0.18	4.40
	/020	0.20	4.80
	/022	0.22	6.10
	/025	0.25	7.00
	/028	0.28	7.90
	/030	0.30	9.10
	/035	0.35	13.50
	/040	0.40	17.00

2500M SPOOLS			
Item-No.	Order-No.	Line Ø mm	Strength kg
123030	/016	0.16	3.30
	/018	0.18	4.40
	/020	0.20	4.80
	/022	0.22	6.10
	/025	0.25	7.00
	/028	0.28	7.90
	/030	0.30	9.10
	/035	0.35	13.50
	/040	0.40	17.00

PLATINUM ROYAL MATCH / FEEDER - LENGTH 200M

This sinking platinum was developed specifically for match and feeder anglers. Owing to its sinking characteristics, it prevents the line from forming arcs and guarantees precise fishing even in a wind.

- Sinking
- Highly compressed molecules ensure maximum load-bearing capacities
- UV protective coating
- Extremely high resistance to abrasion
- Incredibly little elongation
- Extremely supple owing to special surface sealing; for maximum casting distances and natural bait presentation
- Anti-Twist system reduces twisted lines to a minimum
- The line is wounded parallel on the spool



Item-No.	Order-No.	Line Ø mm	Strength kg
120970	/014	0.14	2.00
	/016	0.16	2.50
	/018	0.18	3.10
	/020	0.20	3.80
	/022	0.22	4.60
	/025	0.25	5.20
	/028	0.28	6.90

PLATINUM CARP 600M SPOOLS

PLATINUM CARP

High-tech Carp line

Especially high quality polyamides and a surface treated with TF Pro Teflon ensure outstanding properties: Minimal friction losses permit extremely long-distance casts at the same time affording very high resistance to abrasion: an absolute must for water with many hindrances.

- Great suppleness and an extremely smooth surface owing to the TF Pro coating for maximum casting distances
- Optimised load-bearing capacity and knot strength molecules
- UV-protective coating
- Extremely resistant to abrasion
- Very little stretching
- Anti-Twist system for minimum line-twisting



PLATINUM CARP					
Item-No.	Order-No.	Line Ø mm	Length m	Strength kg	
120850	/030	0.30	600	8.3	
	/035	0.35	600	12.1	
	/040	0.40	600	15.7	

CAMTEC®

catching more! with system

The colour, elongation and suppleness are adjusted optimally to the biting behaviour of the resp. target fish of course, in the best possible quality.



PIKE						
Item-No.	Order-No.	Line Ø mm	Length m	Strength kg	Colour	
121610	/030	0.30	400	7.9	grey	
	/035	0.35	400	10.8	grey	
	/040	0.40	400	13.0	grey	



MATCH						
Item-No.	Order-No.	Line Ø mm	Length m	Strength kg	Colour	
121640	/016	0.16	500	2.5	grey	
	/018	0.18	500	2.9	grey	
	/020	0.20	500	3.7	grey	
	/022	0.22	500	4.1	grey	



SBIRO						
Item-No.	Order-No.	Line Ø mm	Length m	Strength kg	Colour	
121710	/018	0.18	500	2.9	fluo-yellow	
	/020	0.20	500	3.8	fluo-yellow	
	/022	0.22	500	4.3	fluo-yellow	
	/025	0.25	500	5.7	fluo-yellow	



BOAT						
Item-No.	Order-No.	Line Ø mm	Length m	Strength kg	Colour	
121690	/035	0.35	400	10.6	fluo-orange	
	/040	0.40	400	12.9	fluo-orange	
	/045	0.45	250	15.2	fluo-orange	
	/050	0.50	250	18.6	fluo-orange	



CARP						
Item-No.	Order-No.	Line Ø mm	Length m	Strength kg	Colour	
121620	/025	0.25	500	5.8	brown	
	/028	0.28	500	6.7	brown	
	/030	0.30	400	7.9	brown	
	/035	0.35	400	10.8	brown	
	/040	0.40	400	13.0	brown	



CATFISH						
Item-No.	Order-No.	Line Ø mm	Length m	Strength kg	Colour	
121660	/055	0.55	200	24.6	brown	
	/065	0.65	200	28.5	brown	



TROUT						
Item-No.	Order-No.	Line Ø mm	Length m	Strength kg	Colour	
121600	/018	0.18	500	2.9	transparent	
	/020	0.20	500	3.8	transparent	
	/022	0.22	500	4.3	transparent	
	/025	0.25	500	5.7	transparent	



EEL						
Item-No.	Order-No.	Line Ø mm	Length m	Strength kg	Colour	
121650	/030	0.30	400	7.9	brown	
	/035	0.35	400	10.8	brown	
	/040	0.40	400	13.0	brown	



PIKE-PERCH						
Item-No.	Order-No.	Line Ø mm	Length m	Strength kg	Colour	
121630	/025	0.25	500	5.7	sand	
	/028	0.28	400	6.6	sand	
	/030	0.30	400	7.8	sand	

Iron Line 8

Iron Line 8



TOP PRICE

Ironline® 8: our new high performance line with 8-fold braiding and a sensational price/performance ratio!

For many years the Ironline® name has stood for extremely high-quality braided lines. Balzer's new Ironline 8 boasts an eightfold braided high-performance line with an excellent load-bearing capacity. The line is impressive thanks to a soft, yet abrasion-resistant surface that enables the line to slide silently through the guides and which facilitates enormous casting distances.

Thanks to the fact that it hardly stretches at all, you have direct contact to both bait and fish. In the Ironline 8 series you can find the right line for all types of fishing; what's more at fantastic prices!

Features

- 8-fold braiding
- Round braiding
- 100% PE fibre
- High load-bearing capacities
- Very soft surface
- High abrasion resistance
- Extremely little stretching
- UV protected

Iron Line Spin yellow

Thanks to its very clear visibility it is an ideal spin line.

RECOMMENDED BY MATZE KOCH



150m spools in attractive self-service package

IRON LINE YELLOW 150 M

Item No.	Order No.	Length m	Line Ø mm	Strength kg	
	/008	150	0.08	7.2	
	/010	150	0.10	8.1	
	/012	150	0.12	9.8	
	/014	150	0.14	10.7	
	/016	150	0.16	11.6	
126610	/018	150	0.18	12.7	
	/021	150	0.21	15.4	
	/024	150	0.24	19.5	
	/027	150	0.27	27.5	
	/030	150	0.30	34.8	

IRON LINE YELLOW 1500 M

Item No.	Order No.	Length m	Line Ø mm	Strength kg	
	/008	1500	0.08	7.2	
	/010	1500	0.10	8.1	
	/012	1500	0.12	9.8	
	/014	1500	0.14	10.7	
	/016	1500	0.16	11.6	
126600	/018	1500	0.18	12.7	
	/021	1500	0.21	15.4	
	/024	1500	0.24	19.5	
	/027	1500	0.27	27.5	
	/030	1500	0.30	34.8	

Iron Line 8

Iron Line green

Thanks to the dark-green colouring the cord is ideal wherever inconspicuous colours are needed to avoid a shooping effect.

**RECOMMENDED BY
MATZE KOCH**



IRON LINE GREEN 150 M					
Item No.	Order No.	Length m	Line Ø mm	Strength kg	
126630	/008	150	0.08	7.2	
	/010	150	0.10	8.1	
	/012	150	0.12	9.8	
	/014	150	0.14	10.7	
	/016	150	0.16	11.6	
	/018	150	0.18	12.7	
	/021	150	0.21	15.4	
	/024	150	0.24	19.5	
	/027	150	0.27	27.5	
	/030	150	0.30	34.8	

IRON LINE GREEN 1500 M					
Item No.	Order No.	Length m	Line Ø mm	Strength kg	
126620	/008	1500	0.08	7.2	
	/010	1500	0.10	8.1	
	/012	1500	0.12	9.8	
	/014	1500	0.14	10.7	
	/016	1500	0.16	11.6	
	/018	1500	0.18	12.7	
	/021	1500	0.21	15.4	
	/024	1500	0.24	19.5	
	/027	1500	0.27	27.5	
	/030	1500	0.30	34.8	

150m spools in attractive self-service package

Iron Line Multicolour

The ideal line for all sea anglers and the thin diameters are great for freshwater fishing. The line changes colour every 5 m with black marks on the transitions making them very much easier to see.

**COLOUR CHANGES
EVERY 5M**



IRON LINE MULTICOLOUR 1500 M					
Item No.	Order No.	Length m	Line Ø mm	Strength kg	
126640	/010	1500	0.10	8.1	
	/015	1500	0.15	10.7	
	/020	1500	0.20	15.1	
	/025	1500	0.25	20.3	
	/030	1500	0.30	34.8	

Iron Line 8

Iron Line Catfish green

Enormous load-bearing capacities and inconspicuous colouring distinguish this line. Ideal for spin fishing for fat catfish, but also for fishing with natural bait, of course.



IRON LINE CATFISH 1500 M / GREEN

Item No.	Order No.	Length m	Line Ø mm	Strength kg	
	/040	1500	0.40	40.8	
126650	/050	1500	0.50	51.3	
	/060	1500	0.60	75.5	

Iron Line Catfish white

The enormous load-bearing capacity and excellent visibility of this line is convincing, especially for fishing with buoys at night.



IRON LINE CATFISH/W 1500 M / WHITE

Item No.	Order No.	Length m	Line Ø mm	Strength kg	
	/050	1500	0.50	51.3	
126660	/060	1500	0.60	75.5	



Shirasu Fluorocarbon line

Made from fluorocarbon throughout. This gives you the guarantee that even after long-term use, the Shirasu line still retains its characteristic of refracting light, thus becoming quasi invisible in the water. Length: 25m.

SHIRASU FLUOROCARBON LINE

Item-No.	Order No.	line Ø mm	tensile strength kg
120920	/012	0.12	1.20
	/014	0.14	1.85
	/016	0.16	2.40
	/018	0.18	2.90
	/020	0.20	3.90
	/022	0.22	4.60
	/025	0.25	5.10
	/028	0.28	5.80
	/030	0.30	6.60
	/035	0.35	8.20
	/040	0.40	10.80
/050	0.50	14.20	



Saltwater leader line

The optimal line for self-constructed strike lines, spacers, pilk leaders, paternosters or surf leaders. Running length 50m.

SALTWATER LEADER LINE

Item-No.	Order-No.	line Ø mm	length m	tensile str. kg/lbs	color
125910	/040	0,40	50	12.5/27,5	transparent
	/050	0.50	50	15/33	transparent
	/060	0.60	50	20/44	transparent
	/070	0.70	50	25/55	transparent
	/080	0.80	50	35/77	transparent
	/090	0.90	50	40/88	transparent
	/100	1.00	50	47/103	transparent
	/120	1.20	50	60/132	transparent



LINE GREASE FOR BRAIDED LINES

Minimising fraying and colour loss. At the same time it forms a long-lasting, super-smooth surface for long-distance casts and little abrasion.

Item-No.	Order-No.	Content gr.
129000	/100	15

Saltwater leader lien / Feeder lien / Feeder taper tips



Feeder leader line

Developed by Michael Zammataro especially for feeder fishing. 150m.

FEEDER LEADER LINE				
Item-No.	Order-No.	line Ø mm	tensile strength kg	
120950	/025	0.25	6.8 kg	
	/028	0.28	7.6 kg	
	/031	0.31	8.8 kg	



Lightfeeder-/Method Feeder line

Developed by Michael Zammataro especially for light and method feeder fishing. Highly condensed polymers, high resistance to abrasion, high knot strength, UV protection, little elongation. Run length: 200 m.

LIGHT FEEDER-/METHOD FEEDER LINE				
Item-No.	Order No.	line Ø mm	tensile strength kg	
120960	/022	0.22	6.30	
	/025	0.25	7.20	
	/028	0.28	8.00	



Feedermaster® Taper Tips

Strike line tapered from 0.32mm to 0.20mm, especially for feeder fishing. Contents: 5x15m.

FEEDERMASTER® TAPER TIPS			
Item-No.	Order-No.	tapered from to mm	
125920	/020	0.32 to 0.20mm	



Taperline

Knotless special line for surffishing.

TAPERLINE		
Item-No.	Order-No.	Characteristic
125900	/028	Total length 220 m, 200 m of 0.28 mm and 20 m running conically from 0.28 mm to 0.58 mm.
	/030	Total length 220 m, 200 m of 0.30 mm and 20 m running conically from 0.30 mm to 0.58 mm.
	/033	Total length 220 m, 200 m of 0.33 mm and 20 m running conically from 0.33 mm to 0.58 mm.
	/035	Total length 220 m, 200 m of 0.35 mm and 20 m running conically from 0.35 mm to 0.58 mm.

Taper Tips

Tapered leader line for surf fishing, 5 x 15 m.

TAPER TIPS		
Item-No.	Order-No.	Characteristic
125920	/028	Tapertips 0.28 mm – 0.58mm
	/030	Tapertips 0.30mm – 0.58mm
	/033	Tapertips 0.33 mm – 0.58mm
	/035	Tapertips 0.35 mm – 0.58mm

Camtec Fly

Floating fly line, tapered at both ends, it can fish for twice as long as a long-distance casting line. If one end is worn, simply respool and use the other end. Available in AFTMA class 5/6. Length 25m.

CAMTEC FLY, DT, FLOATING				
Item-No.	Order-No.	AFTMA. class	colour	
128350	/056	5/6	peach	

Colonel fly line

Fly leaders must be soft and supple, allowing the fly to drift and play naturally. Length: 3 yards = 2.75 m.

COLONEL-DRY FLY-LINE LEADER					
Item-No.	Order-No.	Strength	Top mm Ø	Loop mm Ø	
145220	/000	0x	0.28	0.64	
	/001	1x	0.25	0.58	
	/002	2x	0.23	0.56	
	/003	3x	0.20	0.53	
	/004	4x	0.18	0.53	
	/005	5x	0.15	0.50	
	/006	6x	0.13	0.43	
	/007	7x	0.10	0.43	

FLY LINE CONNECTOR

For a knotless, absolutely secure connection between fly line and leader.

Item-No.	Order-No.	
145210	/015	



ARTIFICIAL BAIT

Benefit from the nature



Benefit from the diversity of nature

There are as many artificial baits these days as there are grains of sand on the beach – you can get the most wonderful models in all shapes, colours and sizes. But if you want to fish successfully these days you need a supplier who knows his business and who can offer the angler the best bait for the particular fish he wants to catch, the waters he is fishing in, the time of year etc.

With our artificial baits you can always rely on the workmanship, the materials, hook quality, running properties, etc; we still can't guarantee that you will catch your fish but by keeping to simple basic rules many things are easier and more successful:

WHAT COLOUR SHOULD I CHOOSE?

The brighter the light, the less reflective colour of the artificial bait should be: This means that we use »silver« when there is not much light or when the water is murky and »gold« when the light is brighter or the water is fairly clear.

»Copper« or simply »black« baits hardly reflect at all in the water and are ideal for very bright light or crystal clear water. The general situation of the fish in the particular waters is also important, i.e. we use silver or light blue colours if the predatory fish have a large food supply of bleak and roach.

Darker baits are more suitable when the food supply tends to consist of insects and larvae. The colour of the water also plays a part in making the choice. Another factor is how active the fish are. In the winter when the fish are very lethargic, a very bright, noticeable type of bait can provoke a predator to bite.

Colonel Classic Spinner / Duo Spinner

Original
Colonel[®]



Original Colonel[®] Classic: Trust is good, but it's nothing on decades of experience is better

For decades Colonel[®] has been the epitome of high class spinners that have outwitted innumerable predator fish all over the world. The Colonel[®] Classic spinners combine the shapes that have proven their worth a thousand times over with the most recent findings of research and practice. For example, we have developed a completely new rotating bail that makes the spinner rotate at the lightest tug.

All the spinners are equipped with our needle-sharp, stainless tiger steel carbon hooks that have proven themselves so well in our Norway range. The body and rotors are made of top grade brass: no rusting, no bending. Put your trust in the experience of several decades!

COLONEL CLASSIC STANDARD

These spinners equip you excellently for everything from trout to pike. The aerodynamic shape guarantees long-distance, precisely targeted casts.



UNI GOLD

Item-No.	Order-No.	Weight g	
130350	/003	3	
	/005	5	
	/007	7	
	/010	10	
	/014	14	



UNI SILVER

Item-No.	Order-No.	Weight g	
130360	/003	3	
	/005	5	
	/007	7	
	/010	10	
	/014	14	



UNI COPPER

Item-No.	Order-No.	Weight g	
130370	/003	3	
	/005	5	
	/007	7	
	/010	10	
	/014	14	



SILVER-GLITTER

Item-No.	Order-No.	Weight g	
130380	/003	3	
	/005	5	
	/007	7	
	/010	10	
	/014	14	



RED STRIPE

Item-No.	Order-No.	Weight g	
130390	/003	3	
	/005	5	
	/007	7	
	/010	10	
	/014	14	



SILVER WITH RED FOIL

Item-No.	Order-No.	Weight g	
130340	/003	3	
	/005	5	
	/007	7	
	/010	10	
	/014	14	



COPPER - BLACK WITH RED SPOTS

Item-No.	Order-No.	Weight g	
130330	/003	3	
	/005	5	
	/007	7	
	/010	10	
	/014	14	



SILVER WITH RED SPOTS

Item-No.	Order-No.	Weight g	
130320	/003	3	
	/005	5	
	/007	7	
	/010	10	
	/014	14	

COLONEL CLASSIC FLUO

Original
Colonel[®]

The brilliant colours are suitable for all waters and predatory fish. Fish can perceive the version with the three-coloured spinner blade at any depth.



BLACK WITH YELLOW-RED SPOTS

Item-No.	Order-No.	Weight g
130670	/003	3
	/005	5
	/007	7
	/010	10
	/014	14



YELLOW

Item-No.	Order-No.	Weight g
130600	/003	3
	/005	5
	/007	7
	/010	10
	/014	14



RED-WHITE

Item-No.	Order-No.	Weight g
130660	/003	3
	/005	5
	/007	7
	/010	10
	/014	14



PINK-BLUE

Item-No.	Order-No.	Weight g
130650	/003	3
	/005	5
	/007	7
	/010	10
	/014	14



RED

Item-No.	Order-No.	Weight g
130610	/003	3
	/005	5
	/007	7
	/010	10
	/014	14



RED-YELLOW-GREEN

Item-No.	Order-No.	Weight g
130620	/003	3
	/005	5
	/007	7
	/010	10
	/014	14



WHITE-MOTHER OF PEARL

Item-No.	Order-No.	Weight g
130630	/003	3
	/005	5
	/007	7
	/010	10
	/014	14



BLACK

Item-No.	Order-No.	Weight g
130640	/003	3
	/005	5
	/007	7
	/010	10
	/014	14

COLONEL CLASSIC SPIN-FLIES

Your grandfather is bound to have caught trout and pike with spin flies. A genuine classic, the catching properties of which are completely underestimated in times of shiny 3-D foils.

Item-No.	Order-No.	weight g
130410	/004	A 4
	/006	B 6
	/010	C 10

A



B



C



Colonel Classic DUO / Colonel Fuzzy

COLONEL CLASSIC DUO

When nothing else can help, with the Duo you can usually manage something. The 2 spinner rotors generate extremely high pressure waves and signalise a small, injured fish even at a long distance.

NEW WEIGHTS



DUO GOLD

Item-No.	Order-No.	Weight g
130420 NEW NEW NEW NEW	/207	9
	/310	13
	/217	17
	/221	21
	/225	25

DUO SILVER

Item-No.	Order-No.	Weight g
130430 NEW NEW NEW NEW	/207	9
	/310	13
	/217	17
	/221	21
	/225	25

DUO RED STRIPE

Item-No.	Order-No.	Weight g
130440 NEW NEW NEW NEW	/207	9
	/310	13
	/217	17
	/221	21
	/225	25

3D



SILVER WITH RED FOIL

Item-No.	Order-No.	Weight g
130450	/007	9
	/010	13
	/017	17
	/021	21
	/025	25

RAINBOW

Item-No.	Order-No.	Weight g
130450	/107	9
	/110	13
	/117	17
	/121	21
	/125	25

COPPER WITH BLACK FOIL AND RED SPOTS

Item-No.	Order-No.	Weight g
130450	/407	9
	/410	13
	/417	17
	/421	21
	/425	25

COLONEL FUZZY

Top spinner for pike-perch, trout and chub. With needle-sharp Mustad hooks. The treble hook can be changed easily thanks to the split ring.



Mustad Hooks



PINK LADY

Item-No.	Order-No.	Weight g
1 32050	/003	3
	/005	5
	/007	7

HONEY BEE

Item-No.	Order-No.	Weight g
1 32060	/003	3
	/005	5
	/007	7

ORANGE TIGER

Item-No.	Order-No.	Weight g
1 32070	/003	3
	/005	5
	/007	7



Colour under black light (UV light)

BLACK DEVIL

Item-No.	Order-No.	Weight g
1 32080	/003	3
	/005	5
	/007	7

BLOODY SNOW

Item-No.	Order-No.	Weight g
1 32090	/003	3
	/005	5
	/007	7

TOXIC (UV)

Item-No.	Order-No.	Weight g
1 32100	/003	3
	/005	5
	/007	7

Original[®] Colonel Z

FALL IN PRICES

Runs fantastically well.
Catches incredibly well.
Costs little.

Original Colonel Z

Great spinner for catching; comes in a million well tested decors with excellent running properties and at incredible prices. Also with sealed, realistic 3-D foils available.

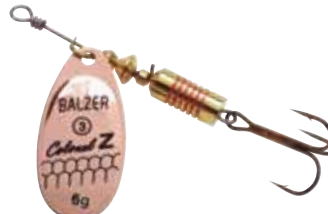
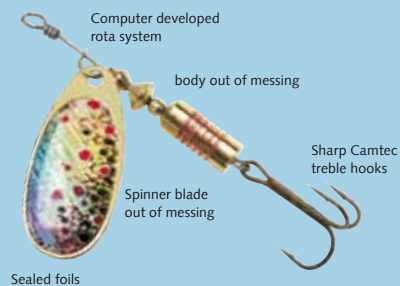

SILVER

Item-No.	Order-No.	Weight g
132700	/003	3
	/004	4
	/006	6
	/010	10
	/012	12

GOLD

Item-No.	Order-No.	Weight g
132720	/003	3
	/004	4
	/006	6
	/010	10
	/012	12

COPPER

Item-No.	Order-No.	Weight g
132730	/003	3
	/004	4
	/006	6
	/010	10
	/012	12

SILVER FLEX

Item-No.	Order-No.	Weight g
132750	/003	3
	/004	4
	/006	6
	/010	10
	/012	12

3D



BLACK BEAUTY

Item-No.	Order-No.	Weight g
132760	/003	3
	/004	4
	/006	6
	/010	10
	/012	12

RED STRIPE

Item-No.	Order-No.	Weight g
132770	/003	3
	/004	4
	/006	6
	/010	10
	/012	12

BROWN TROUT

Item-No.	Order-No.	Weight g
132780	/003	3
	/004	4
	/006	6
	/010	10
	/012	12

RAINBOW TROUT

Item-No.	Order-No.	Weight g
132790	/003	3
	/004	4
	/006	6
	/010	10
	/012	12

3D

3D

3D

3D



ROACH

Item-No.	Order-No.	Weight g
132800	/003	3
	/004	4
	/006	6
	/010	10
	/012	12

REDFEDER

Item-No.	Order-No.	Weight g
132810	/003	3
	/004	4
	/006	6
	/010	10
	/012	12

PERCH

Item-No.	Order-No.	Weight g
132820	/003	3
	/004	4
	/006	6
	/010	10
	/012	12

SILVER RED SPOTS

Item-No.	Order-No.	Weight g
132740	/003	3
	/004	4
	/006	6
	/010	10
	/012	12

3D

3D

3D

3D

Colonel Z Spinner / Single hook spinner

COLONEL Z SPINNER



SILVER BLUE SPOTS

Item-No.	Order-No.	Weight g
132670	/003	3
	/004	4
	/006	6
	/010	10
	/012	12



ORANGE BLACK SPOTS

Item-No.	Order-No.	Weight g
132680	/003	3
	/004	4
	/006	6
	/010	10
	/012	12



FIRE

Item-No.	Order-No.	Weight g
132690	/003	3
	/004	4
	/006	6
	/010	10
	/012	12



COPPER ORANGE SPOTS

Item-No.	Order-No.	Weight g
132660	/003	3
	/004	4
	/006	6
	/010	10
	/012	12

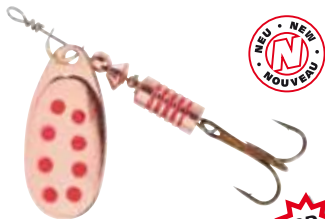

COPPER RED SPOTS

Item-No.	Order-No.	Weight g
132620	/003	3
	/004	4
	/006	6
	/010	10
	/012	12



SILBER RED SPOTS

Item-No.	Order-No.	Weight g
132630	/003	3
	/004	4
	/006	6
	/010	10
	/012	12



GOLD RED SPOTS

Item-No.	Order-No.	Weight g
132640	/003	3
	/004	4
	/006	6
	/010	10
	/012	12

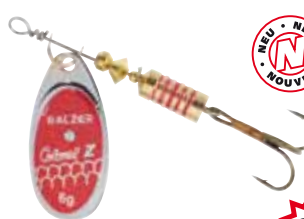

SILVER RED FOIL

Item-No.	Order-No.	Weight g
132650	/003	3
	/004	4
	/006	6
	/010	10
	/012	12

COLONEL Z SPINNER WITH SINGLE HOOK

Our catchy Colonel Z spinners with single hook and hook changing system.

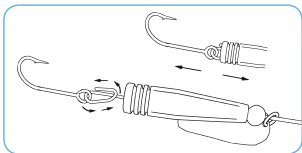

With a hook-changing system!



SILVER

Item-No.	Order-No.	Weight g
130900	/003	3
	/004	4
	/006	6



GOLD

Item-No.	Order-No.	Weight g
130910	/003	3
	/004	4
	/006	6



COPPER

Item-No.	Order-No.	Weight g
130920	/003	3
	/004	4
	/006	6



BLACK BEAUTY

Item-No.	Order-No.	Weight g
130930	/003	3
	/004	4
	/006	6

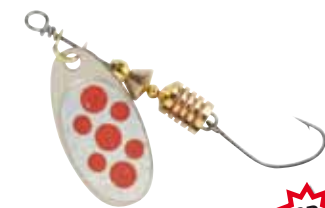

RED SPOT

Item-No.	Order-No.	Weight g
130940	/003	3
	/004	4
	/006	6

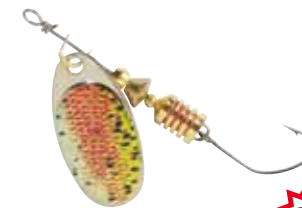

RAINBOW TROUT

Item-No.	Order-No.	Weight g
130950	/003	3
	/004	4
	/006	6



BROWN TROUT

Item-No.	Order-No.	Weight g
130960	/003	3
	/004	4
	/006	6

Colonel Lead Head Spinner / Shallow water spinners

COLONEL REALITY 3D LEAD HEAD SPINNER

Great lead-head spinner with extremely realistic 3D décors and excellent running properties. The small sizes are dead certs for deep-lying perch and trout.



SILVER			
Item-No.	Order-No.	Length cm	
130000	/004	4	
	/007	7	
	/010	10	
	/014	14	



GOLD			
Item-No.	Order-No.	Length cm	
130010	/004	4	
	/007	7	
	/010	10	
	/014	14	



COPPER			
Item-No.	Order-No.	Length cm	
130020	/004	4	
	/007	7	
	/010	10	
	/014	14	



WHITE SNOW			
Item-No.	Order-No.	Length cm	
130030	/004	4	
	/007	7	
	/010	10	
	/014	14	



ORANGE TIGER			
Item-No.	Order-No.	Length cm	
130040	/004	4	
	/007	7	
	/010	10	
	/014	14	



PERCH			
Item-No.	Order-No.	Length cm	
130060	/004	4	
	/007	7	
	/010	10	
	/014	14	



FIRESHARK			
Item-No.	Order-No.	Length cm	
130100	/004	4	
	/007	7	
	/010	10	
	/014	14	



ROACH-BLUE			
Item-No.	Order-No.	Length cm	
130090	/004	4	
	/007	7	
	/010	10	
	/014	14	

COLONEL SHALLOW-WATER SPINNER

Top spinner for shallow waters for perch, trout, chub and pike.



SILVER			
Item-No.	Order-No.	Weight g	Length cm
1 30700	/003	3g / 6cm	
	/005	5g / 8cm	
	/007	7g / 10cm	



GOLD			
Item-No.	Order-No.	Weight g	Length cm
1 30710	/003	3g / 6cm	
	/005	5g / 8cm	
	/007	7g / 10cm	



COPPER			
Item-No.	Order-No.	Weight g	Length cm
1 30720	/003	3g / 6cm	
	/005	5g / 8cm	
	/007	7g / 10cm	

COLONEL DUO LIGHT SPINNER

Top double blade spinner for shallow waters for perch, trout, pike-perch and pike.



SILVER			
Item-No.	Order-No.	Weight g	Length cm
1 30750	/207	7g / 10cm	
	/210	10g / 13cm	



GOLD			
Item-No.	Order-No.	Weight g	Length cm
1 30760	/207	7g / 10cm	
	/210	10g / 13cm	



COPPER			
Item-No.	Order-No.	Weight g	Length cm
1 30770	/207	7g / 10cm	
	/210	10g / 13cm	

Colonel Classic spoons

COLONEL CLASSIC HB SPOONS

Original
Colonel[®]

Colonel Classic HB Spoon:

It's back! The legendary HB spoon which the company's founder, Hanns Balzer, included in the Balzer product range all of 60 years ago and which has outwitted innumerable predator fish over the years.

Beautiful finish and great décors.

Corpus made from non-rusting brass!



Permanent changing colours by means of an electronically-anodised surface!



RAINBOW

Item-No.	Order-No.	Weight g	Length mm
131190	/006	6	33
	/016	16	46
	/022	22	56
	/030	30	66
	/045	45	81



ANODISED

Item-No.	Order-No.	Weight g	Length mm
131280	/006	6	33
	/016	16	46
	/022	22	56
	/030	30	66
	/045	45	81

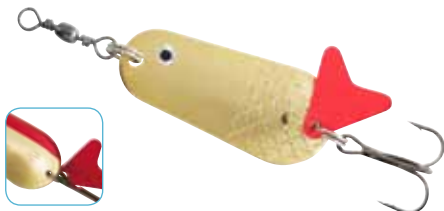

GOLD

Item-No.	Order-No.	Weight g	Length mm
131160	/006	6	33
	/016	16	46
	/022	22	56
	/030	30	66
	/045	45	81



RED SPOT

Item-No.	Order-No.	Weight g	Length mm
131180	/006	6	33
	/016	16	46
	/022	22	56
	/030	30	66
	/045	45	81



SILVER

Item-No.	Order-No.	Weight g	Length mm
131150	/006	6	33
	/016	16	46
	/022	22	56
	/030	30	66
	/045	45	81



COPPER

Item-No.	Order-No.	Weight g	Length mm
131170	/006	6	33
	/016	16	46
	/022	22	56
	/030	30	66
	/045	45	81



SILVER WITH SILVER REFLECTING FOIL

Item-No.	Order-No.	Weight g	Length mm
131260	/006	6	33
	/016	16	46
	/022	22	56
	/030	30	66
	/045	45	81



ORANGE TIGER

Item-No.	Order-No.	Weight g	Length mm
131200	/006	6	33
	/016	16	46
	/022	22	56
	/030	30	66
	/045	45	81

Colonel Classic spoons

COLONEL CLASSIC HB SPOONS



BLOODY SNOW

Item-No.	Order-No.	Weight g	Length mm
131210	/006	6	33
	/016	16	46
	/022	22	56
	/030	30	66
	/045	45	81



PERCH

Item-No.	Order-No.	Weight g	Length mm
131220	/006	6	33
	/016	16	46
	/022	22	56
	/030	30	66
	/045	45	81



SILVER WITH RED REFLECTING FOIL

Item-No.	Order-No.	Weight g	Length mm
131270	/006	6	33
	/016	16	46
	/022	22	56
	/030	30	66
	/045	45	81



ROACH

Item-No.	Order-No.	Weight g	Length mm
131250	/006	6	33
	/016	16	46
	/022	22	56
	/030	30	66
	/045	45	81

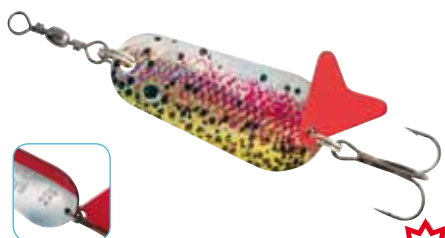

RAINBOW TROUT

Item-No.	Order-No.	Weight g	Length mm
131240	/006	6	33
	/016	16	46
	/022	22	56
	/030	30	66
	/045	45	81

COLONEL Z WEED SPOON

You can fish successfully even in weedy waters.



SILVER

Item-No.	Order-No.	Weight g	Length mm
131290	/006	6	33
	/016	16	46
	/022	22	56
	/030	30	66
	/045	45	81

SHIRASU VERTICAL KILLER

Excellent vertical bait for fishing from a boat, sheet piles and of course for ice fishing.

Thanks to the special fin the bait glides through the water perfectly.

Extremely good for catching perch and pikeperch. But other predators are also not averse to it!

The three-hook system of the MUSTAD reduces the missed bite rate to a minimum.



TROUT

Item-No.	Order-No.	Weight g	Length mm
139540	/106	6	45
	/112	12	50
	/118	18	65



FIRESHARK

Item-No.	Order-No.	Weight g	Length mm
139540	/206	6	45
	/212	12	50
	/218	18	65



PERCH

Item-No.	Order-No.	Weight g	Length mm
139540	/306	6	45
	/312	12	50
	/318	18	65



MONSTER PERCH

Item-No.	Order-No.	Weight g	Length mm
139540	/406	6	45
	/412	12	50
	/418	18	65

Colonel Star Dust spoons

COLONEL CLASSIC HB SPOON STAR DUST

Original
Colonel
STAR DUST



Extremely enticing from the application of STAR DUST glitter particles and subsequent sealing with UV lacquer.
Delivered in self-service blister package.



SILVER

Item-No.	Order-No.	Weight g	Length mm
131410	/006	6	33
	/016	16	46
	/022	22	56
	/030	30	66



GOLD

Item-No.	Order-No.	Weight g	Length mm
131400	/006	6	33
	/016	16	46
	/022	22	56
	/030	30	66



COPPER

Item-No.	Order-No.	Weight g	Length mm
131420	/006	6	33
	/016	16	46
	/022	22	56
	/030	30	66



TURQOISE

Item-No.	Order-No.	Weight g	Length mm
131430	/006	6	33
	/016	16	46
	/022	22	56
	/030	30	66



SILVER-RED

Item-No.	Order-No.	Weight g	Length mm
131440	/006	6	33
	/016	16	46
	/022	22	56
	/030	30	66



FLUO-ORANGE

Item-No.	Order-No.	Weight g	Length mm
131450	/006	6	33
	/016	16	46
	/022	22	56
	/030	30	66



FLUO-YELLOW

Item-No.	Order-No.	Weight g	Length mm
131460	/006	6	33
	/016	16	46
	/022	22	56
	/030	30	66



RED

Item-No.	Order-No.	Weight g	Length mm
131470	/006	6	33
	/016	16	46
	/022	22	56
	/030	30	66

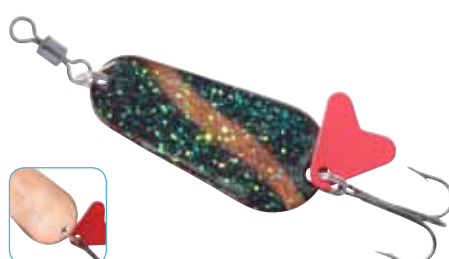

BLACK

Item-No.	Order-No.	Weight g	Length mm
131480	/006	6	33
	/016	16	46
	/022	22	56
	/030	30	66



BLUE

Item-No.	Order-No.	Weight g	Length mm
131490	/006	6	33
	/016	16	46
	/022	22	56
	/030	30	66



With original MUSTAD hooks

Colonel Spinner Baits / Colonel Z Minnow

COLONEL SPINNER BAITS

This bait is very popular in the US and a real killer for pike. The interplay between the outstanding motions of the 3D spinner blades and the rubber fronds is irresistible to pike. Highly recommended in shallow and overgrown waters. With ball bearing swivel for perfect rotation.

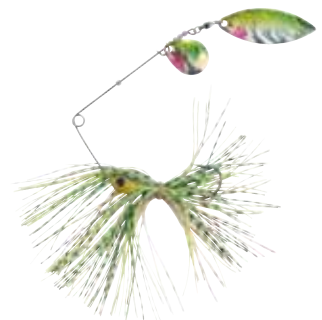

SILVER-BLACK

Item-No.	Order-No.	Weight g
133350	/000	24
	/010	12

FIRESHARK

Item-No.	Order-No.	Weight g
133350	/001	24
	/011	12

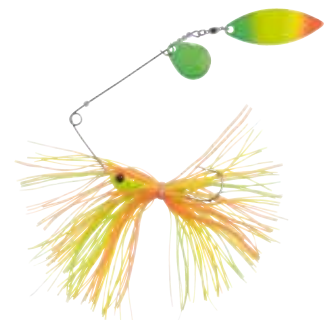
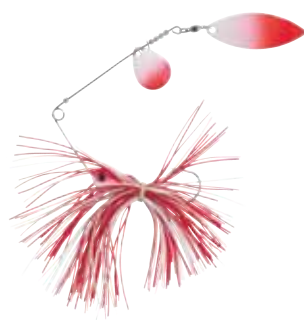

RED-YELLOW

Item-No.	Order-No.	Weight g
133350	/002	24
	/012	12

RED-WHITE

Item-No.	Order-No.	Weight g
133350	/003	24
	/013	12

FLUO-YELLOW

Item-No.	Order-No.	Weight g
133350	/004	24
	/014	12

COLONEL Z MINNOW

The 3-D spinner bodies, combined with the realistic little fish with the 3-D eyes, make this bait so good for catching fish. The catchy Colonel Z «Minnow» with great decoration and 3-D spinner wings.



COARSEFISH

Item-No.	Order-No.	Wt. g	Length mm
132870	/004	4	9
	/006	6	12
	/010	10	15
	/012	12	17

PERCH

Item-No.	Order-No.	Wt. g	Length mm
132900	/004	4	9
	/006	6	12
	/010	10	15
	/012	12	17

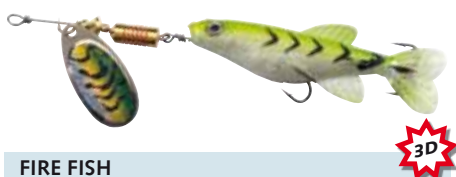

FIRE FISH

Item-No.	Order-No.	Wt. g	Length mm
132910	/004	4	9
	/006	6	12
	/010	10	15
	/012	12	17

RED STRIPE

Item-No.	Order-No.	Wt. g	Length mm
132880	/004	4	9
	/006	6	12
	/010	10	15
	/012	12	17

TROUT

Item-No.	Order-No.	Wt. g	Length mm
132890	/004	4	9
	/006	6	12
	/010	10	15
	/012	12	17

Colonel Z Seatrout

COLONEL Z SEATROUT



Tried and tested sea trout spoons with bodies made from rustproof brass, stainless steel split rings and saltwater-resistant treble hooks.

**PERMANENT
COLOUR CHANGE**



Permanently changing colours by means of an electronically anodised surface!

ANODISED, PAINTED ON BOTH SIDES

Item-No.	Order-No.	Weight g	Length mm
131130	/018	18	80
	/022	22	80
	/026	26	80



RED-BLACK

Item-No.	Order-No.	Weight g	Length mm
131030	/018	18	80
	/022	22	80
	/026	26	80



SILVER

Item-No.	Order-No.	Weight g	Length mm
131000	/018	18	80
	/022	22	80
	/026	26	80

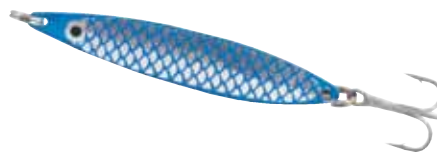

BLUE-SILVER

Item-No.	Order-No.	Weight g	Length mm
131020	/018	18	80
	/022	22	80
	/026	26	80



COPPER-RED

Item-No.	Order-No.	Weight g	Length mm
131080	/018	18	80
	/022	22	80
	/026	26	80



COPPER

Item-No.	Order-No.	Weight g	Length mm
131010	/018	18	80
	/022	22	80
	/026	26	80



COPPER-BLACK

Item-No.	Order-No.	Weight g	Length mm
131070	/018	18	80
	/022	22	80
	/026	26	80



**PAINTED ON
BOTH SIDES**

BLACK, RED SPOTS

Item-No.	Order-No.	Weight g	Length mm
131100	/018	18	80
	/022	22	80
	/026	26	80



GREEN-YELLOW

Item-No.	Order-No.	Weight g	Length mm
131040	/018	18	80
	/022	22	80
	/026	26	80



PINK-WHITE, BLACK SPOTS

Item-No.	Order-No.	Weight g	Length mm
131090	/018	18	80
	/022	22	80
	/026	26	80



SAND EEL

Item-No.	Order-No.	Weight g	Length mm
131110	/018	18	80
	/022	22	80
	/026	26	80



ORANGE-YELLOW, BLACK SPOTS

Item-No.	Order-No.	Weight g	Length mm
131060	/018	18	80
	/022	22	80
	/026	26	80



**PAINTED ON
BOTH SIDES**

RED-WHITE

Item-No.	Order-No.	Weight g	Length mm
131050	/018	18	80
	/022	22	80
	/026	26	80



YELLOW GREEN

Item-No.	Order-No.	Weight g	Length mm
131120	/018	18	80
	/022	22	80
	/026	26	80

SEATROUT RIGS AND SEATROUT FLY ASSORTMENT

For spin fishing for seatrout. In front use a spoon or a hard bait, but often the bite comes on the springer fly. During the fight the leader line pulls down with the hooked fish and thus prevents the hook to get fixed on the base.

Main line 0,28m and sidearm 0,33mm made of Fluorocarbon. Length 85cm, hook size. 6.

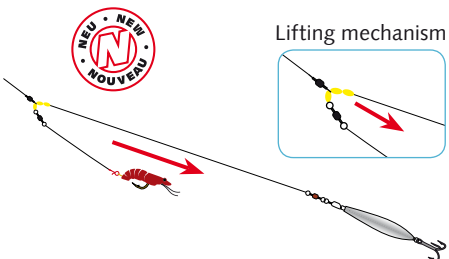

SEATRIBUT RIG POLAR MAGNUS

Item-No.	Order-No.	
147850	/001	



SEATRIBUT RIG JULETRUE GLITTER

Item-No.	Order-No.	
147850	/002	



SEATRIBUT RIG SHRIMP

Item-No.	Order-No.	
147850	/003	



SEATRIBUT RIG SHRIMP WHITE

Item-No.	Order-No.	
147850	/004	



SEATRIBUT FLY ASSORTMENT

Item-No.	Order-No.	
168000	/008	

COLONEL TROLLING

Original Colonel®

Very catchy trolling spoons for trolling with downriggers.

The spoon was developed both for fishing for salmon, sea trout and cod and for trolling for fresh-water predators.



SILVER

Item-No.	Order-No.	Weight g	Length mm
131700	/008	7	80
	/010	10	100
	/012	16	120

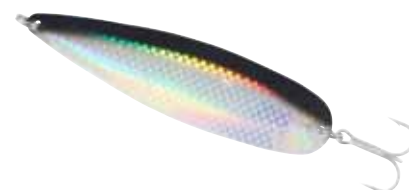

BLACK-SILVER

Item-No.	Order-No.	Weight g	Length mm
131710	/008	7	80
	/010	10	100
	/012	16	120



YELLOW-RED-WHITE

Item-No.	Order-No.	Weight g	Length mm
131720	/008	7	80
	/010	10	100
	/012	16	120



PINK-BLUE-WHITE

Item-No.	Order-No.	Weight g	Length mm
131730	/008	7	80
	/010	10	100
	/012	16	120

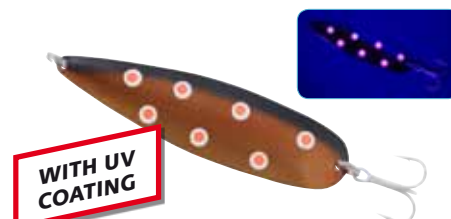

WITH UV COATING

UV COATING

Item-No.	Order-No.	Weight g	Length mm
131740	/008	7	80
	/010	10	100
	/012	16	120

Zocker / Disc Blinker

ZOCKER



PERCH			
Item-No.	Order-No.	Weight g	
139530	/007	7	
	/014	14	
	/025	25	
	/040	40	
	/060	60	

ROACH			
Item-No.	Order-No.	Weight g	
139520	/007	7	
	/014	14	
	/025	25	
	/040	40	
	/060	60	

BROWN TROUT			
Item-No.	Order-No.	Weight g	
139500	/007	7	
	/014	14	
	/025	25	
	/040	40	
	/060	60	

RAINBOW TROUT			
Item-No.	Order-No.	Weight g	
139510	/007	7	
	/014	14	
	/025	25	
	/040	40	
	/060	60	

KILLER ZOCKER



SILVER			
Item-No.	Order-No.	Weight g	
139660	/010	10	
	/015	15	
	/020	20	
	/025	25	
	/035	35	

FLASH ZOCKER



SILVER			
Item-No.	Order-No.	Weight g	
139600	/007	7	
	/012	12	
	/018	18	
	/028	28	

ZOCKER-ASSORTMENT

The set contains each 4 zocker in the most wanted colours. Ideal for perch fishing and ultra-light pilking in the Baltic Sea and Norway.



ZOCKER ASSORTMENT

Item-No.	Order-No.	Weight g	
139650	/018	Set 1: 4 x 18g	
	/025	Set 2: 4 x 25g	
	/035	Set 3: 4 x 35g	

COLONEL Z DISC SPOONS

Extra heavy, tumbling spoon with chrome-plated surface and tiger steel treble hooks.



DISC SILVER			
Item-No.	Order-No.	Weight g	
131870	/005	5	
	/010	10	
	/015	15	
	/020	20	
	/030	30	
	/040	40	

DISC SILVER-GLITTER			
Item-No.	Order-No.	Weight g	
131880	/005	5	
	/010	10	
	/015	15	
	/020	20	
	/030	30	
	/040	40	

DISC GREEN-GLITTER			
Item-No.	Order-No.	Weight g	
131860	/005	5	
	/010	10	
	/015	15	
	/020	20	
	/030	30	
	/040	40	

DISC RED-GLITTER			
Item-No.	Order-No.	Weight g	
131890	/005	5	
	/010	10	
	/015	15	
	/020	20	
	/030	30	
	/040	40	

COLONEL LAZER EYE SHADS

4 attractive soft lure with inner lead and 3D eyes. The shads have a very realistic movement in the water.



Item-No.	Order-No.	Type	Weight g	Length cm
136600	/008	Bream	11	8
	/010	Bream	18	10
	/012	Bream	30	12
	/015	Bream	50	15
	/108	Roach	11	8
	/110	Roach	18	10
	/112	Roach	30	12
	/115	Roach	50	15
	/208	Perch	11	8
	/210	Perch	18	10
	/212	Perch	30	12
	/215	Perch	50	15
	/308	Rudd	11	8
	/310	Rudd	18	10
	/312	Rudd	30	12
/315	Rudd	50	15	

COLONEL SOFTBAIT ASSORTMENTS



Perch/Trout (pic. left): Contents: 10 Jigheads, 30xSingle tails in 3, 5 and 7 cm, 10 Shads in 6 cm.



Pike-Perch/Pike (pic right): Contents: 10 Jigheads, 10xsingle tails 8cm, 10xdouble tails in 8cm, 5xShads in 10cm and 5xShads in 13cm.

Item-No.	Order-No.	Target Fish
137330	/000	Perch/Trout
137330	/005	Pike-Perch/Pike



KILLER GOBY

In many rivers the goby has meanwhile become the no. 1 forage fish for perch and pike-perch. A perfect imitation!

Item-No.	Order-No.	Weight g	Length cm
136030	/007	16	7
	/009	22	9
	/011	40	11

KILLER FROG

Very realistic imitation of a small frog. Swimming. With weed protection hook.

NEW COLOURS

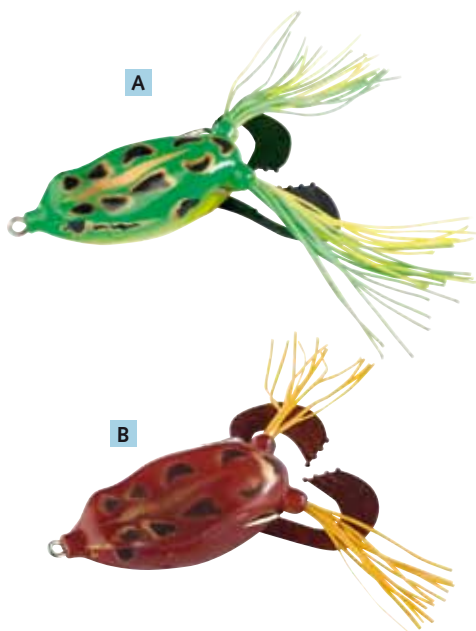

D



F



Item-No.	Order-No.	Color	Weight g	Length cm
136500	/001	A green	15	12
	/002	B brown	15	12
	/003	C Leopard	15	12
	/004	D Sand Tiger	15	12
	/005	E Army green	15	12
	/006	F Bright green	15	12
	/007	G Black	15	12

SHIRASU

DESIGNED IN JAPAN

浅き夢見し酔ひもせず

Our Shirasu Premium Soft Baits are among the most successful predator baits worldwide. They are the result of many years of experience of our Predator Professionals from Japan and Europe.

Perfect rubber mixtures, catchy colors, refined running properties and not least fair price distinguish this super bait.

In order to enable our dealers the widest possible, individual presentation opportunity we offer different types of packaging:

1. SB packs:

The baits are separately packed in resealable bags with euro hole.



SHIRASU EURO-HANGERS

Thanks to the special slits in the bottom, the Shirasu sales box can be drawn onto our exactly matching euro-hangers and can thus hang on any wall with euro-standard holes!

Item-No.	Order-No.	Length cm
136990	/010	12

SHIRASU FLOOR DISPLAY

The perfect sales aid for primary or secondary placement of our single Shirasu rubber baits. With the help of these exactly matching euro-hangers, the sales boxes can be fixed onto the display and presented in a clear, orderly manner! Supplied with 50 euro-hangers!

Item-No.	Order-No.	Size cm
136990	/000	180 x 52 x 25cm

2. Test packs

The soft lures are color mixed in resealable bags with euro hole. Thus, the customer can seek his favorite colors while fishing.

3. Loose soft lures in the Shirasu multifunctional box

The innovative Shirasu Box enables sales-boosting presentation, individually tailored to suit your business!

Thanks to the special slits in the bottom, the box can be drawn onto our exactly matching euro-hangers and can thus hang on any wall with Euro-standard holes!

Furthermore, we offer you our perfectly coordinated, low-price Shirasu floor display stand as an option. You can load it liberally with the boxes as the primary or secondary placement.

SHIRASU, LOOSE IN BOX



AKIRI WORM 7 CM, 49 PCS.

Item-No.	Order-No.	Lgth. cm	Color
	/001	7	A Akira
	/002	7	B Hiroko
	/003	7	C Kaito
	/004	7	D Kenzo
	/005	7	E Naoki
	/006	7	F Saburo
	/007	7	G Yoshi
136300	/008	7	H Hiroto
	/009	7	I Funiko
	/010	7	J Masaru
	/011	7	K Osamu
	/012	7	L Reika
	/013	7	M Beniko
	/014	7	N Teiko
	/015	7	O Yumi

AKIRI WORM 9.5 CM, 20 PCS.

Item-No.	Order-No.	Lgth. cm	Color
	/101	9.5	A Akira
	/102	9.5	B Hiroko
	/103	9.5	C Kaito
	/104	9.5	D Kenzo
	/105	9.5	E Naoki
	/106	9.5	F Saburo
	/107	9.5	G Yoshi
136300	/108	9.5	H Hiroto
	/109	9.5	I Funiko
	/110	9.5	J Masaru
	/111	9.5	K Osamu
	/112	9.5	L Reika
	/113	9.5	M Beniko
	/114	9.5	N Teiko
	/115	9.5	O Yumi

AKIRI WORM 12.5 CM, 16 PCS.

Item-No.	Order-No.	Lgth. cm	Color
	/201	12.5	A Akira
	/202	12.5	B Hiroko
	/203	12.5	C Kaito
	/204	12.5	D Kenzo
	/205	12.5	E Naoki
	/206	12.5	F Saburo
	/207	12.5	G Yoshi
136300	/208	12.5	H Hiroto
	/209	12.5	I Funiko
	/210	12.5	J Masaru
	/211	12.5	K Osamu
	/212	12.5	L Reika
	/213	12.5	M Beniko
	/214	12.5	N Teiko
	/215	12.5	O Yumi

AKIRI WORM 15 CM, 9 PCS.

Item-No.	Order-No.	Lgth. cm	Color
	/301	15	A Akira
	/302	15	B Hiroko
	/303	15	C Kaito
	/304	15	D Kenzo
	/305	15	E Naoki
	/306	15	F Saburo
	/307	15	G Yoshi
136300	/308	15	H Hiroto
	/309	15	I Funiko
	/310	15	J Masaru
	/311	15	K Osamu
	/312	15	L Reika
	/313	15	M Beniko
	/314	15	N Teiko
	/315	15	O Yumi

AKIRI WORM SETS, ASSORTED COLOURS



Item-No.	Order-No.	Length cm	Content Colour
137850	/101	7	A/C/I/J/N
	/102	7	A/D/E/K/O
	/103	7	F/G/H/L/M
	/104	7	A/D/E/G/N

Item-No.	Order-No.	Length cm	Content Colour
137860	/101	9.5	C/D/H/L/M
	/102	9.5	A/B/E/F/K
	/103	9.5	A/G/I/J/N

Item-No.	Order-No.	Length cm	Content Colour
137870	/201	12.5	A/C/I/J/N
	/202	12.5	A/D/E/K/O
	/203	12.5	F/G/H/L/M

Item-No.	Order-No.	Length cm	Content Colour
137870	/301	15	A/G/O
	/302	15	C/K/I
	/303	15	B/J/N

AKIRI WORM

One of the best rubber baits for catching fish. The paddle lures predators over a great distance and the narrow ribs send out very fine vibrations when they get close.

WITH FISH OIL

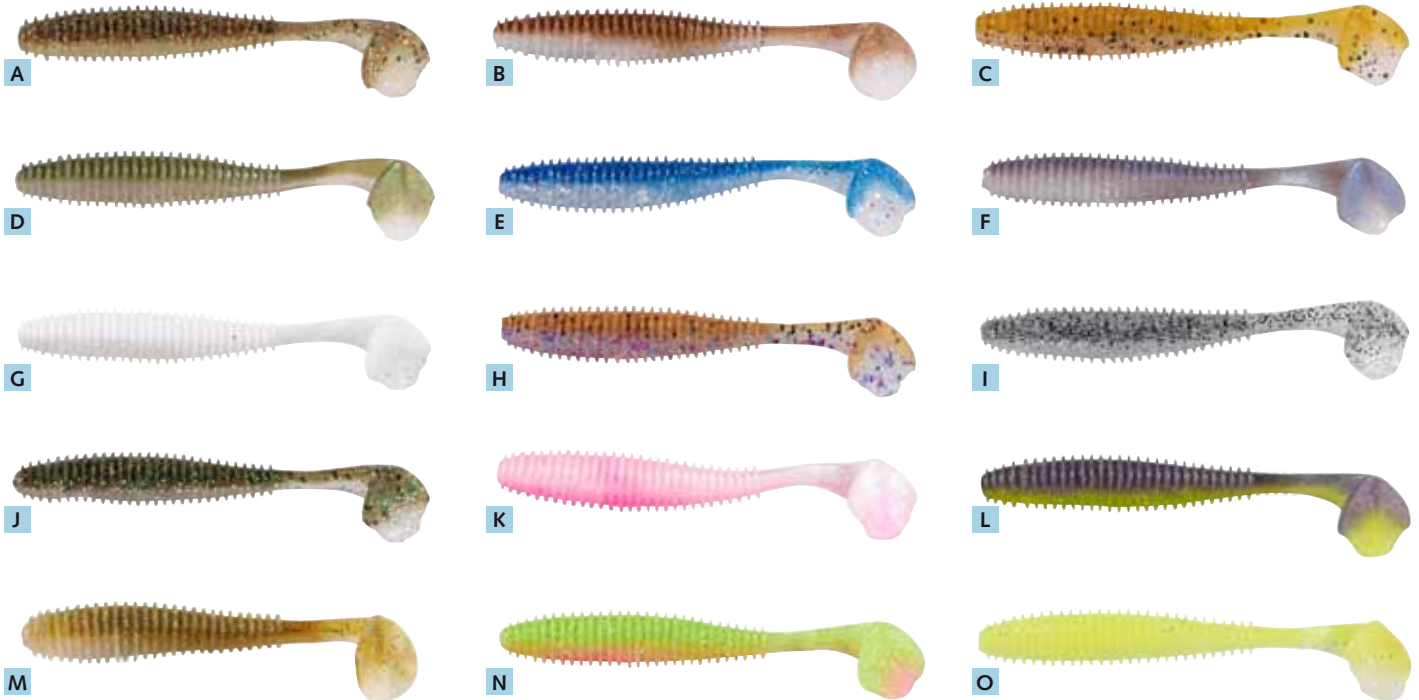

AKIRI WORM 7 CM

Item-No.	Order-No.	Lgth. cm	Color
137850	/001	7	A Akira
	/002	7	B Hiroko
	/003	7	C Kaito
	/004	7	D Kenzo
	/005	7	E Naoki
	/006	7	F Saburo
	/007	7	G Yoshi
	/008	7	H Hiroto
	/009	7	I Funiko
	/010	7	J Masaru
	/011	7	K Osamu
	/012	7	L Reika
	/013	7	M Beniko
	/014	7	N Teiko
	/015	7	O Yumi

AKIRI WORM 9.5 CM

Item-No.	Order-No.	Lgth. cm	Color
137860	/001	9.5	A Akira
	/002	9.5	B Hiroko
	/003	9.5	C Kaito
	/004	9.5	D Kenzo
	/005	9.5	E Naoki
	/006	9.5	F Saburo
	/007	9.5	G Yoshi
	/008	9.5	H Hiroto
	/009	9.5	I Funiko
	/010	9.5	J Masaru
	/011	9.5	K Osamu
	/012	9.5	L Reika
	/013	9.5	M Beniko
	/014	9.5	N Teiko
	/015	9.5	O Yumi

AKIRI WORM 12.5 CM

Item-No.	Order-No.	Lgth. cm	Color
137870	/001	12.5	A Akira
	/002	12.5	B Hiroko
	/003	12.5	C Kaito
	/004	12.5	D Kenzo
	/005	12.5	E Naoki
	/006	12.5	F Saburo
	/007	12.5	G Yoshi
	/008	12.5	H Hiroto
	/009	12.5	I Funiko
	/010	12.5	J Masaru
	/011	12.5	K Osamu
	/012	12.5	L Reika
	/013	12.5	M Beniko
	/014	12.5	N Teiko
	/015	12.5	O Yumi

AKIRI WORM 15 CM

Item-No.	Order-No.	Lgth. cm	Color
137870	/101	15	A Akira
	/102	15	B Hiroko
	/103	15	C Kaito
	/104	15	D Kenzo
	/105	15	E Naoki
	/106	15	F Saburo
	/107	15	G Yoshi
	/108	15	H Hiroto
	/109	15	I Funiko
	/110	15	J Masaru
	/111	15	K Osamu
	/112	15	L Reika
	/113	15	M Beniko
	/114	15	N Teiko
	/115	15	O Yumi

SHIRASU Soft Lures

SHIRASU

浅き夢見し酔ひもせず



SUKI SWIMMER

The «kink» in the middle facilitates this inimitable run. Can be used to fish with a jighead or offset hook.

WITH FISH OIL



SUKI SWIMMER

SUKI SWIMMER 7,5 CM

Item-No.	Order-No.	Lgth. cm	Color
	/001	7.5	A Akira
	/002	7.5	B Hiroko
	/003	7.5	C Kaito
	/004	7.5	D Kenzo
	/005	7.5	F Saburo
	/006	7.5	G Yoshi
	/007	7.5	H Hiroto
	/008	7.5	I Funiko
	/009	7.5	J Masaru
	/010	7.5	K Osamu
	/011	7.5	L Reika
	/012	7.5	M Beniko
	/013	7.5	N Teiko
	/014	7.5	O Yumi

SUKI SWIMMER 10 CM

Item-No.	Order-No.	Lgth. cm	Color
	/001	10	A Akira
	/002	10	B Hiroko
	/003	10	C Kaito
	/004	10	D Kenzo
	/005	10	F Saburo
	/006	10	G Yoshi
	/007	10	H Hiroto
	/008	10	I Funiko
	/009	10	J Masaru
	/010	10	K Osamu
	/011	10	L Reika
	/012	10	M Beniko
	/013	10	N Teiko
	/014	10	O Yumi

SUKI SWIMMER 12,5 CM

Item-No.	Order-No.	Lgth. cm	Color
	/101	12.5	A Akira
	/102	12.5	B Hiroko
	/103	12.5	C Kaito
	/104	12.5	D Kenzo
	/105	12.5	F Saburo
	/106	12.5	G Yoshi
	/107	12.5	H Hiroto
	/108	12.5	I Funiko
	/109	12.5	J Masaru
	/110	12.5	K Osamu
	/111	12.5	L Reika
	/112	12.5	M Beniko
	/113	12.5	N Teiko
	/114	12.5	O Yumi

SUKI SWIMMER 15 CM

Item-No.	Order-No.	Lgth. cm	Color
	/201	15	A Akira
	/202	15	B Hiroko
	/203	15	C Kaito
	/204	15	D Kenzo
	/205	15	F Saburo
	/206	15	G Yoshi
	/207	15	H Hiroto
	/208	15	I Funiko
	/209	15	J Masaru
	/210	15	K Osamu
	/211	15	L Reika
	/212	15	M Beniko
	/213	15	N Teiko
	/214	15	O Yumi



SUKI SWIMMER SETS, ASSORTED COLORS



Item-No.	Order-No.	Length cm	Content	Colour
137880	/101	7.5	C/D/I/M/N	
	/102	7.5	A/B/F/G/L	
	/103	7.5	A/C/J/K/O	
	/104	7.5	C/F/G/J/N	

Item-No.	Order-No.	Length cm	Content	Colour
137890	/301	10	C/D/M/N/I	
	/302	10	A/B/F/G/L	
	/303	10	A/H/J/K/O	

Item-No.	Order-No.	Length cm	Content	Colour
137890	/401	12.5	A/F/G/O	
	/402	12.5	D/I/K/L	
	/403	12.5	H/J/M/N	

Item-No.	Order-No.	Length cm	Content	Colour
137890	/501	15	A/G/O	
	/502	15	D/I/K	
	/503	15	J/M/N	

SUKI SWIMMER, LOOSE IN BOX

The Suki Swimmer is in all colours and sizes available in practical sales box for the display wall or any walls with euro-standard holes!

Of course the sales box can also be placed as second or third placement on the counter space.



SUKI SWIMMER 7,5 CM

Item-No.	Order-No.	Lgth. cm	Color
136310	/001	7.5	A Akira
	/002	7.5	B Hiroko
	/003	7.5	C Kaito
	/004	7.5	D Kenzo
	/006	7.5	F Saburo
	/007	7.5	G Yoshi
	/008	7.5	H Hiroto
	/009	7.5	I Funiko
	/010	7.5	J Masaru
	/011	7.5	K Osamu
	/012	7.5	L Reika
	/013	7.5	M Beniko
	/014	7.5	N Teiko
	/015	7.5	O Yumi

SUKI SWIMMER 10 CM

Item-No.	Order-No.	Lgth. cm	Color
136310	/101	10	A Akira
	/102	10	B Hiroko
	/103	10	C Kaito
	/104	10	D Kenzo
	/106	10	F Saburo
	/107	10	G Yoshi
	/108	10	H Hiroto
	/109	10	I Funiko
	/110	10	J Masaru
	/111	10	K Osamu
	/112	10	L Reika
	/113	10	M Beniko
	/114	10	N Teiko
	/115	10	O Yumi

SUKI SWIMMER 12,5 CM

Item-No.	Order-No.	Lgth. cm	Color
136310	/201	12.5	A Akira
	/202	12.5	B Hiroko
	/203	12.5	C Kaito
	/204	12.5	D Kenzo
	/206	12.5	F Saburo
	/207	12.5	G Yoshi
	/208	12.5	H Hiroto
	/209	12.5	I Funiko
	/210	12.5	J Masaru
	/211	12.5	K Osamu
	/212	12.5	L Reika
	/213	12.5	M Beniko
	/214	12.5	N Teiko
	/215	12.5	O Yumi

SUKI SWIMMER 15 CM

Item-No.	Order-No.	Lgth. cm	Color
136310	/301	15	A Akira
	/302	15	B Hiroko
	/303	15	C Kaito
	/304	15	D Kenzo
	/306	15	F Saburo
	/307	15	G Yoshi
	/308	15	H Hiroto
	/309	15	I Funiko
	/310	15	J Masaru
	/311	15	K Osamu
	/312	15	L Reika
	/313	15	M Beniko
	/314	15	N Teiko
	/315	15	O Yumi

SHIRASU Soft Lures

WAGGLE SHAD

The slender shape, paired with the supersized paddle tail enable the waggle to be flanked permanently when it is being hauled in, similar to a wobbler. This run is immensely attractive to all predators, making them incredibly susceptible to being caught.

Now available in the practical sales box and in 14 attractive colours and 5 sizes.

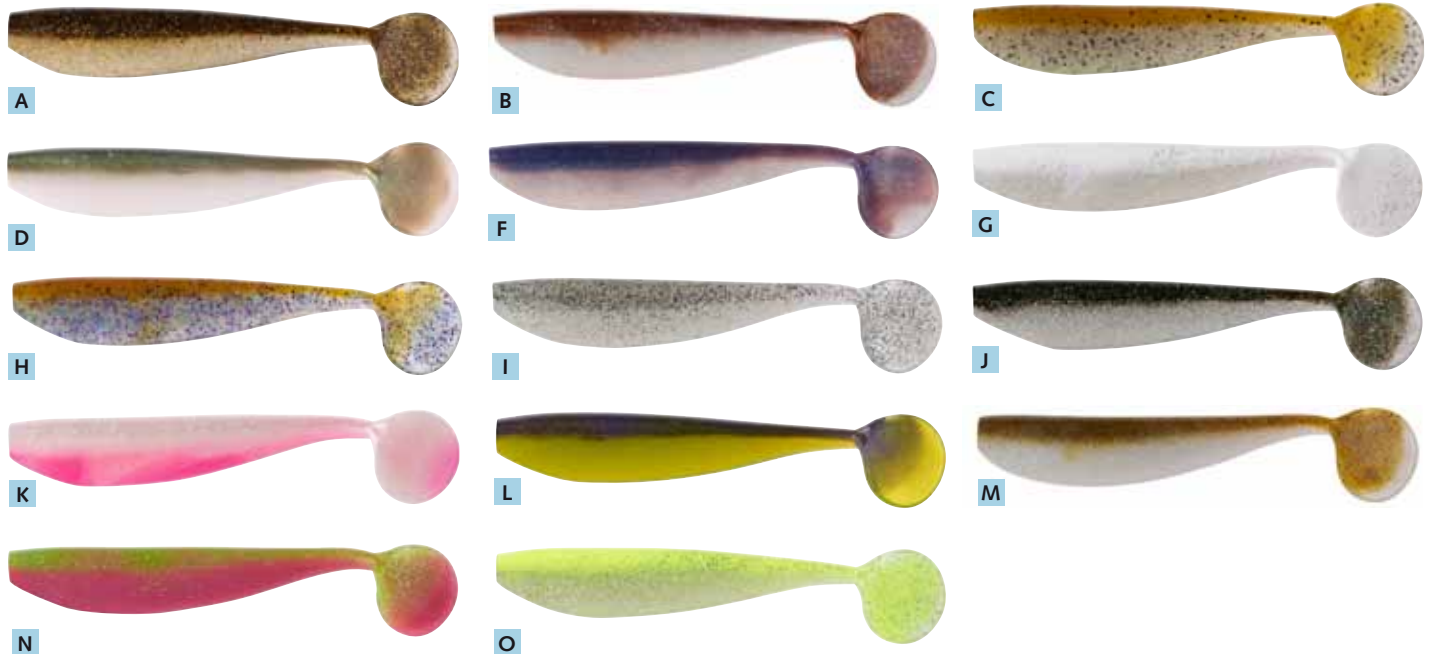

WAGGLE SHAD 5 CM

Item-No.	Order-No.	Lgth. cm	Color	
136360	/001	5	A Akira	
	/002	5	B Hiroko	
	/003	5	C Kaito	
	/004	5	D Kenzo	
	/006	5	F Saburo	
	/007	5	G Yoshi	
	/008	5	H Hiroto	
	/009	5	I Funiko	
	/010	5	J Masaru	
	/011	5	K Osamu	
	/012	5	L Reika	
	/013	5	M Beniko	
	/014	5	N Teiko	
	/015	5	O Yumi	

WAGGLE SHAD 7.5 CM

Item-No.	Order-No.	Lgth. cm	Color	
136360	/101	7.5	A Akira	
	/102	7.5	B Hiroko	
	/103	7.5	C Kaito	
	/104	7.5	D Kenzo	
	/106	7.5	F Saburo	
	/107	7.5	G Yoshi	
	/108	7.5	H Hiroto	
	/109	7.5	I Funiko	
	/110	7.5	J Masaru	
	/111	7.5	K Osamu	
	/112	7.5	L Reika	
	/113	7.5	M Beniko	
	/114	7.5	N Teiko	
	/115	7.5	O Yumi	

WAGGLE SHAD 10 CM

Item-No.	Order-No.	Lgth. cm	Color	
136360	/201	10	A Akira	
	/202	10	B Hiroko	
	/203	10	C Kaito	
	/204	10	D Kenzo	
	/206	10	F Saburo	
	/207	10	G Yoshi	
	/208	10	H Hiroto	
	/209	10	I Funiko	
	/210	10	J Masaru	
	/211	10	K Osamu	
	/212	10	L Reika	
	/213	10	M Beniko	
	/214	10	N Teiko	
	/215	10	O Yumi	

WAGGLE SHAD 12.5 CM

Item-No.	Order-No.	Lgth. cm	Color	
136360	/301	12.5	A Akira	
	/302	12.5	B Hiroko	
	/303	12.5	C Kaito	
	/304	12.5	D Kenzo	
	/306	12.5	F Saburo	
	/307	12.5	G Yoshi	
	/308	12.5	H Hiroto	
	/309	12.5	I Funiko	
	/310	12.5	J Masaru	
	/311	12.5	K Osamu	
	/312	12.5	L Reika	
	/313	12.5	M Beniko	
	/314	12.5	N Teiko	
	/315	12.5	O Yumi	

WAGGLE SHAD 15 CM

Item-No.	Order-No.	Lgth. cm	Color	
136360	/401	15	A Akira	
	/402	15	B Hiroko	
	/403	15	C Kaito	
	/404	15	D Kenzo	
	/406	15	F Saburo	
	/407	15	G Yoshi	
	/408	15	H Hiroto	
	/409	15	I Funiko	
	/410	15	J Masaru	
	/411	15	K Osamu	
	/412	15	L Reika	
	/413	15	M Beniko	
	/414	15	N Teiko	
	/415	15	O Yumi	



HOLO YOKO SHAD

The incorporated hologram foil flashes seductively in water. Can be used to fish with jig or offset hooks or as drop shot.

WITH FISH OIL



A



B



C



D



E



F

HOLO YOKO SHAD 7,5 CM

Item-No.	Order-No.	Lgth. cm	Color
137940	/001	7.5	A Yellow-tiger
	/002	7.5	B Perch
	/003	7.5	C Minnow
	/004	7.5	D Pink Lady
	/005	7.5	E Blue Artic
	/006	7.5	F Red Crispy

HOLO YOKO SHAD 11,5 CM

Item-No.	Order-No.	Lgth. cm	Color
137930	/001	11.5	A Yellow-tiger
	/002	11.5	B Perch
	/003	11.5	C Minnow
	/004	11.5	D Pink Lady
	/005	11.5	E Blue Artic
	/006	11.5	F Red Crispy

HOLO YOKO SHAD 15 CM

Item-No.	Order-No.	Lgth. cm	Color
137970	/001	15	A Yellow-tiger
	/002	15	B Perch
	/003	15	C Minnow
	/004	15	D Pink Lady
	/005	15	E Blue Artic
	/006	15	F Red Crispy

HOLO YOKO SHAD, LOOSE IN BOX



HOLO YOKO SHAD 7,5 CM

Item-No.	Order-No.	Lgth. cm	Color
136320	/020	7.5	A Yellow-tiger
	/021	7.5	B Perch
	/022	7.5	C Minnow
	/023	7.5	D Pink Lady
	/024	7.5	E Blue Artic
	/025	7.5	F Red Crispy

HOLO YOKO SHAD 11,5 CM

Item-No.	Order-No.	Lgth. cm	Color
136320	/120	11.5	A Yellow-tiger
	/121	11.5	B Perch
	/122	11.5	C Minnow
	/123	11.5	D Pink Lady
	/124	11.5	E Blue Artic
	/125	11.5	F Red Crispy

HOLO YOKO SHAD 15 CM

Item-No.	Order-No.	Lgth. cm	Color
136320	/220	15	A Yellow-tiger
	/221	15	B Perch
	/222	15	C Minnow
	/223	15	D Pink Lady
	/224	15	E Blue Artic
	/225	15	F Red Crispy

HOLO YOKO SHAD SETS



Item-No.	Order-No.	Length cm	Content/Colour
137940	/100	7.5	1 37940: /001, /002, /003, /004 /005
137930	/100	11.5	1 37930: /001, /002, /003, /004 /005
137970	/100	15	1 37970: /002, /003, /005

SHIRASU Soft Lures

HIROSHI CRAB 6 AND 10 CM

This floating imitation crayfish will pick up any perch and pike-perch around. It is fished with a lead head, but with the lead at the back (!) This makes the pincers stand upright in the water which is an imitation of its natural defensive attitude. Is wound in twitching! Can also be fished with drop shot rig.

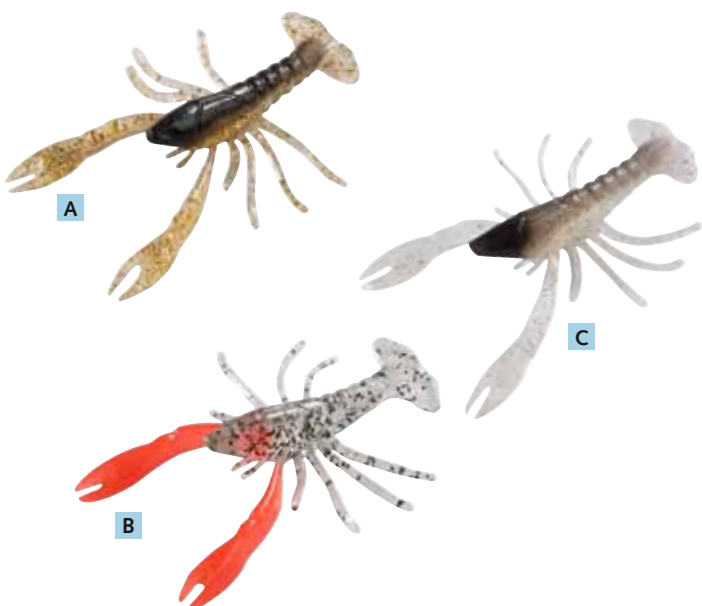

FLOATING
WITH FISH OIL



Item-No.	Order-No.	Lgth. cm	Color
137960	/001	6	A Gold-Pepper
	/002	6	B Red Claw
	/003	6	C Black Jack

Item-No.	Order-No.	Lgth. cm	Color
137960	/101	10	A Gold-Pepper
	/102	10	B Red Claw
	/103	10	C Black Jack

HIROSHI CRAB 6 AND 10 CM, LOOSE IN BOX



The Hiroshi Crab is also in all colors and sizes available in practical sales box for the display wall or any walls with euro-standard holes!.

Of course the sales box can also be placed as second or third placement on the counter space.

Item-No.	Order-No.	Lgth. cm	Color
136330	/020	6	A Gold-Pepper
	/021	6	B Red Claw
	/022	6	C Black Jack
	/120	10	A Gold-Pepper
	/121	10	B Red Claw
	/122	10	C Black Jack

HIROSHI CRAB SET, ASSORTED COLORS - 6 CM



Item-No.	Order-No.	Length cm	Content/Colour
137960	/100	6	1 37960: /001, /002, /003

SHIRASU GOBIES

Nowadays, in many rivers gobies are the most frequent prey of perch and pike-perch. We have copied nature astoundingly realistically in the Shirasu Gobi rubber fish; not only in appearance, but also in its movements. You can choose between 8 catchy colours and 2 sizes (8 and 12 cm)!

Even the Shirasu Gobies are now in all colors and sizes available in practical sales box for the display wall or any walls with euro-standard holes!

Of course the sales box can also be placed as second or third placement on the counter space.



SHIRASU GOBY 8 / 10CM

Item-No.	Order-No.	Length cm	Color
136370	/020	8	A Brown Stripe
	/021	8	B Zebra
	/022	8	C Spot
	/023	8	D Blacky
	/024	8	E Gold Nugget
	/025	8	F White Pearl
	/026	8	G Orange Pepper
	/027	8	H Pumpkin
	/120	12	A Brown Stripe
	/121	12	B Zebra
	/122	12	C Spot
	/123	12	D Blacky
	/124	12	E Gold Nugget
	/125	12	F White Pearl
	/126	12	G Orange Pepper
	/127	12	H Pumpkin

MINI UV-LAMP WITH WHISTLE

With this tool you can find every lure which responds to UV light. Batteries included. 30 pieces in box.

Item-No.	Order-No.
184410	/030



SHIRASU Soft Lures

HARUTO SNAKE

Twister with an innovative, extra long «corkscrew» tail for a perfect run, even if guided slowly.

WITH FISH OIL



HARUTO SNAKE 6 CM

Item-No.	Order-No.	Lgth.cm		Color
137900	/001	6	A	Yumi
	/002	6	B	Akira
	/003	6	C	Funiko
	/004	6	D	Masaru
	/005	6	E	Osamu
	/006	6	F	Yoshi
	/007	6	G	Hiroto
	/008	6	H	Reika
	/009	6	I	Beniko
	/010	6	J	Teiko
	/011	6	K	Naoki
	/012	6	L	Kaito

HARUTO SNAKE 8 CM

Item-No.	Order-No.	Lgth.cm		Color
137910	/001	8	A	Yumi
	/002	8	B	Akira
	/003	8	C	Funiko
	/004	8	D	Masaru
	/005	8	E	Osamu
	/006	8	F	Yoshi
	/007	8	G	Hiroto
	/008	8	H	Reika
	/009	8	I	Beniko
	/010	8	J	Teiko
	/011	8	K	Naoki
	/012	8	L	Kaito

HARUTO SNAKE 10 CM

Item-No.	Order-No.	Lgth.cm		Color
137920	/001	10	A	Yumi
	/002	10	B	Akira
	/003	10	C	Funiko
	/004	10	D	Masaru
	/005	10	E	Osamu
	/006	10	F	Yoshi
	/007	10	G	Hiroto
	/008	10	H	Reika
	/009	10	I	Beniko
	/010	10	J	Teiko
	/011	10	K	Naoki
	/012	10	L	Kaito

HARUTO SNAKE, LOOSE

Even the Haruto Snake is in all colors and sizes available in practical sales box for the display wall or any walls with euro-standard holes!

Of course the sales box can also be placed as second or third placement on the counter space.



HARUTO SNAKE 6 CM

Item-No.	Order-No.	Lgth.cm		Color
136340	/001	6	B	Akira
	/003	6	L	Kaito
	/005	6	K	Naoki
	/007	6	F	Yoshi
	/008	6	G	Hiroto
	/009	6	C	Funiko
	/010	6	D	Masaru
	/011	6	E	Osamu
	/012	6	H	Reika
	/013	6	I	Beniko
	/014	6	J	Teiko
	/015	6	A	Yumi

HARUTO SNAKE 8 CM

Item-No.	Order-No.	Lgth.cm		Color
136340	/101	8	B	Akira
	/103	8	L	Kaito
	/105	8	K	Naoki
	/107	8	F	Yoshi
	/108	8	G	Hiroto
	/109	8	C	Funiko
	/110	8	D	Masaru
	/111	8	E	Osamu
	/112	8	H	Reika
	/113	8	I	Beniko
	/114	8	J	Teiko
	/115	8	A	Yumi

HARUTO SNAKE 10 CM

Item-No.	Order-No.	Lgth.cm		Color
136340	/201	10	B	Akira
	/203	10	L	Kaito
	/205	10	K	Naoki
	/207	10	F	Yoshi
	/208	10	G	Hiroto
	/209	10	C	Funiko
	/210	10	D	Masaru
	/211	10	E	Osamu
	/212	10	H	Reika
	/213	10	I	Beniko
	/214	10	J	Teiko
	/215	10	A	Yumi

GIANT SHAD

Classic shad shape with a big paddle. Ideal for large predators in fresh or saltwater.



A



B



C



D



E

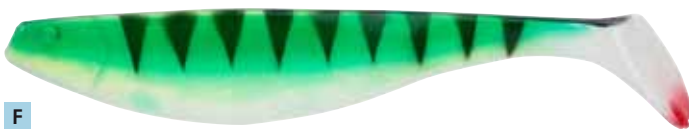

F



G

Colour		Blue-Silver A	Black-Silver B	Orange-Yellow C	Mackerel D	White-Red E	Perch F	Luminous G	
Item-No.	Length cm	Order-No.	Order-No.	Order-No.	Order-No.	Order-No.	Order-No.	Order-No.	
137100	16	/016	/116	/216	/316	/416	/516	/616	
	20	/020	/120	/220	/320	/420	/520	/620	
	24	/024	/124	/224	/324	/424	/524	/624	

MINI TWISTER

The incorporated hologram foil flashes seductively in water. Can be used to fish with jig or offset hooks or as drop shot.



TWISTER, WHITE

Item-No.	Order-No.	Lgth. cm	Color	
137060	/003	3	white	



TWISTER, YELLOW

Item-No.	Order-No.	Lgth. cm	Color	
137060	/103	3	gelb	



TWISTER, RED

Item-No.	Order-No.	Lgth. cm	Color	
137060	/203	3	red	



TWISTER, BLACK

Item-No.	Order-No.	Lgth. cm	Color	
137060	/303	3	white	



TWISTER, CHARTREUSE

Item-No.	Order-No.	Lgth. cm	Color	
137060	/403	3	chartreuse	



TWISTER, BROWN

Item-No.	Order-No.	Lgth. cm	Color	
137060	/503	3	brown glitter	



TWISTER, PINK

Item-No.	Order-No.	Lgth. cm	Color	
137060	/603	3	pink	

SHIRASU accessories / Jig heads

SHIRASU JIG HEADS

SHIRASU

High quality jig heads with lazer sharp **MUSTAD** hooks to match most varieties of Shirasu rubber baits. The special mount holds the bait gently and securely.



All jigheads are in self-service blister packs.

SHIRASU JIG HEADS, ROUND

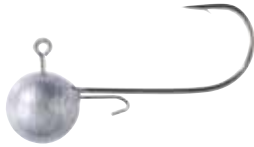

Item-No.	Order-No.	Size	weight in g	Content
137550	/003	1	3	5
	/005	1	5	5
	/007	1	7,5	5
	/010	1	10	5
137560	/005	1/0	5	5
	/010	1/0	10	4
137570	/015	1/0	15	3
	/010	3/0	10	5
	/015	3/0	15	4
	/020	3/0	20	3
	/025	3/0	25	3

SHIRASU JIG HEADS, ROUND

Item-No.	Order-No.	Size	weight in g	Content
137580	/010	5/0	10	5
	/015	5/0	15	4
	/020	5/0	20	3
	/025	5/0	25	3
	/030	5/0	30	3
	/035	5/0	35	3
137590	/040	5/0	40	3
	/020	7/0	20	3
	/030	7/0	30	3
	/040	7/0	40	3
	/050	7/0	50	3
137600	/060	7/0	60	2
	/050	9/0	50	3
	/070	9/0	70	2
	/090	9/0	90	2

SHIRASU JIG HEADS, STAND-UP



Item-No.	Order-No.	Size	weight in g	Content
137570	/110	3/0	10	5
	/115	3/0	15	4
	/120	3/0	20	3
137580	/110	5/0	10	5
	/120	5/0	20	3
	/125	5/0	25	3

JIG HEADS

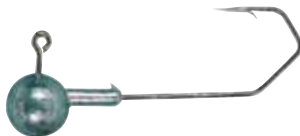

TRIANGLE JIG HEAD, SILVER

Item-No.	Order-No.	Weight g	Con.	Hook size
137670	/007	7	25	2/0
	/010	10	25	2/0
	/015	15	25	2/0
137680	/007	7	25	4/0
	/010	10	25	4/0
	/015	15	25	4/0
	/020	20	25	4/0
137690	/010	10	25	6/0
	/015	15	25	6/0
	/020	20	25	6/0
	/025	25	25	6/0



JIG HEADS

Item-No.	Order-No.	Color	Hook size	Weight g
137720	/002	silver	2	2
	/003	silver	2	3
	/102	silver	1	2
	/004	silver	1	4
	/005	silver	1	5
	/105	silver	1/0	5
	/007	silver	1/0	7
	/010	silver	1/0	10
	/110	silver	2/0	10
	/015	silver	2/0	15
	/020	silver	2/0	20

NEW WEIGHTS



HOT BALLS RED/SILVER

Item-No.	Order-No.	Weight g	Colour
138480	/010	10	red
	/015	15	red
	/020	20	red
	/025	25	red
	/035	35	red
NEW NEW	/045	45	red
	/010	10	silver
138490	/015	15	silver
	/020	20	silver
	/025	25	silver
	/035	35	silver
	/045	45	silver



EXCHANGE LEADHEADS

Leadheads which can be exchanged in seconds. Optionally a second treble hook can be hung from the eye.

Item-No.	Order-No.	Con.	Weight g
136930	/010	3	10
	/020	3	20
	/030	3	30
	/040	2	40
	/050	2	50



JIGHEAD WITH SPIRAL

NEW WEIGHTS

With spiral for simply twisting into the shad or twister. A panic hook with a treble hook is inserted into the rear eyelet.

Item-No.	Order-No.	Con.	Weight g
166330 NEW NEW NEW NEW	/010	10	10
	/015	10	15
	/020	10	20
	/025	10	25
	/030	10	30
	/040	10	40
	/050	10	50
	/060	10	60



SWIMMING JIG HEADS

Item-No.	Order-No.	Color	Size	Con.
137630	/000	yellow	S	5
	/005	yellow	M	5
	/010	yellow	L	5
137640	/000	red	S	5
	/005	red	M	5
	/010	red	L	5

COLONEL BONITO

Original
Colonel[®]

Colonel Bonito

The big epoxy eyes, the lively play and attractive colours make the Bonitos excellent for catching.



RED HEAD

Item-No.	Order-No.	Weight g	Length cm
137830	/508	12	8
	/510	20	10
	/511	15	10
	/512	20	12
	/514	40	14
	/515	30	14



TROUT

Item-No.	Order-No.	Weight g	Length cm
137830	/008	12	8
	/010	20	10
	/011	15	10
	/012	20	12
	/014	40	14
	/015	30	14



PERCH

Item-No.	Order-No.	Weight g	Length cm
137830	/108	12	8
	/110	20	10
	/111	15	10
	/112	20	12
	/114	40	14
	/115	30	14



COARSEFISH

Item-No.	Order-No.	Weight g	Length cm
137830	/208	12	8
	/210	20	10
	/211	15	10
	/212	20	12
	/214	40	14
	/215	30	14



GUDGEON

Item-No.	Order-No.	Weight g	Length cm
137830	/308	12	8
	/310	20	10
	/311	15	10
	/312	20	12
	/314	40	14
	/315	30	14



FIRESHARK

Item-No.	Order-No.	Weight g	Length cm
137830	/408	12	8
	/410	20	10
	/411	15	10
	/412	20	12
	/414	40	14
	/415	30	14



MOTOROIL

Item-No.	Order-No.	Weight g	Length cm
137830	/608	12	8
	/610	20	10
	/611	15	10
	/612	20	12
	/614	40	14
	/615	30	14



YELLOW-GLITTER

Item-No.	Order-No.	Weight g	Length cm
137830	/708	12	8
	/710	20	10
	/711	15	10
	/712	20	12
	/714	40	14
	/715	30	14



PINKY

Item-No.	Order-No.	Weight g	Length cm
137830	/808	12	8
	/810	20	10
	/811	15	10
	/812	20	12
	/814	40	14
	/815	30	14

SHIRASU

浅き夢見し酔ひもせず

Kunstköder der Superlative

Unsere Shirasu Wobbler gehören sicherlich zu den erfolgreichsten und fängigsten Wobblern am Markt.

Aber in einer Zeit, in der es stetig Innovationen und Verbesserungen gibt, müssen auch etablierte Kunstköderserien von Zeit zu Zeit „überholt“ werden. Deshalb stehen wir permanent mit unseren japanischen und europäischen Raubfischexperten in Kontakt, die uns genau sagen, was einen fängigen Wobbler auszeichnet und so den Unterschied macht. So wird bei der neuen Generation der Shirasu Wobbler eine spezielle

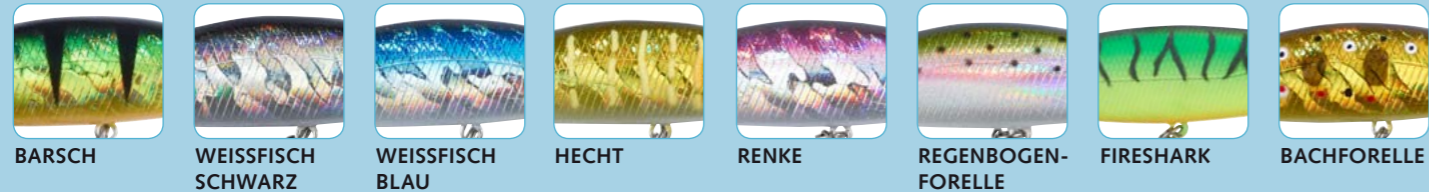

BARSCH WEISSFISCH SCHWARZ WEISSFISCH BLAU HECHT RENKE REGENBOGEN-FORELLE FIRESHARK BACHFORELLE

Mustad Hooks



Reflexfolie eingesetzt, die das Glitzern von Schuppen verblüffend imitiert.

Auch die Farbpalette wurde komplett überarbeitet. Neu ist die **Shirasu Holo Serie**, deren Wobbler innenliegende Hologrammfolien haben, die äußerst intensive, fängige Lichtreflexe verursachen.

Alle Wobbler sind mit nadscharfen Mustad- oder VMC-Haken sowie innenliegenden Stahlkugeln ausgestattet (Ausnahme Baby Minnow).

9 CM: SINKEND
14/19 CM: SUSPENDING



STALKER SU

Der Stalker ist ein Suspender und schwebt perfekt im Wasser. Zwar kann er auch ganz normal geführt werden, aber seine wahren Killerqualitäten zeigt er beim »Twitchen«. Dabei bricht der Stalker seitlich aus und macht wahre Purzelbäume, ganz wie ein verletzter, in Panik verfallener Beutefisch. Anschließend lassen sie ihn kurz bewegungslos schweben, oftmals kommt jetzt die Attacke. Diese Technik ist besonders dann erfolgreich, wenn es beim normalen Wobbeln Nachläufer gibt.

Typ: Suspender (schwebend), Tauchtiefe: 5cm: 0,7m; 7cm: 1,0m.

Art.-Nr.	Best.-Nr.	Länge cm	Gewicht g	Dekor	Hdl.-EK netto €
135220	/005	5	3	Barsch	3,65
	/105	5	3	Weißfisch schwarz	3,65
	/205	5	3	Weißfisch blau	3,65
	/305	5	3	Hecht	3,65
	/405	5	3	Renke	3,65
	/505	5	3	Forelle	3,65
	/705	5	3	Bachforelle	3,65
135220	/007	7	8	Barsch	3,95
	/107	7	8	Weißfisch schwarz	3,95
	/207	7	8	Weißfisch blau	3,95
	/307	7	8	Hecht	3,95
	/407	7	8	Renke	3,95
	/507	7	8	Forelle	3,95
	/707	7	8	Bachforelle	3,95

STALKER SU-DR

Wenn die Räuber mal tiefer stehen, kommt dieser Wobbler zum Einsatz. Er verfügt über die gleichen Eigenschaften wie der Stalker 70 SU, aber aufgrund seiner langen Tauchschaufel arbeitet er in tieferen Regionen. Er lässt sich normal führen oder zum Twitchen verwenden.

Typ: tieflaufender Suspender, Tauchtiefe: 9cm: 2,50 m.

Art.-Nr.	Best.-Nr.	Länge cm	Gewicht g	Dekor	Hdl.-EK netto €
135230	/009	9	10	Barsch	5,05
	/109	9	10	Weißfisch schwarz	5,05
	/209	9	10	Weißfisch blau	5,05
	/309	9	10	Hecht	5,05
	/409	9	10	Renke	5,05
	/509	9	10	Forelle	5,05
	/709	9	10	Bachforelle	5,05

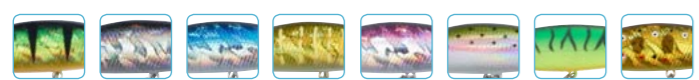

Längenangabe = Länge des Körpers ohne Tauchschaufel und Haken.

VPE: 1 Stück, Preis pro Stück.

KILL BILL 90 SI / 140 SU / 190 SU

Ein sehr beweglicher 3-teiliger Wobbler. Beim normalen Einholen zeigt er ein gleichmäßiges Laufverhalten, beim Jerken bricht er hektisch seitlich aus und imitiert einen verletzten Fisch. Da er suspending ist lassen Sie ihn nach jedem Twitch kurz schweben - absolut tödlich!

Tauchtiefe: 9cm: 1m, 14cm: 1,3m, 19cm: 1,5m.

Modell 9cm: sinkend, Modelle 14 und 19cm: suspending.

Art.-Nr.	Best.-Nr.	Länge cm	Gewicht g	Dekor	Hdl.-EK netto €
135210	/009	9	10	Barsch	4,95
	/109	9	10	Weißfisch schwarz	4,95
	/209	9	10	Weißfisch blau	4,95
	/309	9	10	Hecht	4,95
	/409	9	10	Renke	4,95
	/509	9	10	Forelle	4,95
	/609	9	10	Fireshark	4,95
135210	/709	9	10	Bachforelle	4,95
	/014	14	23	Barsch	6,20
	/114	14	23	Weißfisch schwarz	6,20
	/214	14	23	Weißfisch blau	6,20
	/314	14	23	Hecht	6,20
	/414	14	23	Renke	6,20
	/514	14	23	Forelle	6,20
135210	/614	14	23	Fireshark	6,20
	/714	14	23	Bachforelle	6,20
	/019	19	52	Barsch	6,85
	/119	19	52	Weißfisch schwarz	6,85
	/219	19	52	Weißfisch blau	6,85
	/319	19	52	Hecht	6,85
	/419	19	52	Renke	6,85
135210	/519	19	52	Forelle	6,85
	/619	19	52	Fireshark	6,85
	/719	19	52	Bachforelle	6,85

CREATURE 140 SI

Das Geheimnis seiner überragenden Fängigkeit liegt an dem Verbindungssystem der einzelnen Glieder. Sie sind nicht durch Metallstreben verbunden sondern durch ein flexibles ABS Material, wodurch der Wobbler einen unglaublich realistischen Lauf erhält. **Geheimtipp auf große Hechte!** Typ: sinkend.

Art.-Nr.	Best.-Nr.	Länge cm	Gewicht g	Dekor	Hdl.-EK netto €
135180	/014	14	40	Barsch	5,55
	/114	14	40	Weißfisch schwarz	5,55
	/214	14	40	Weißfisch blau	5,55
	/314	14	40	Hecht	5,55
	/414	14	40	Renke	5,55
	/514	14	40	Forelle	5,55
	/614	14	40	Fireshark	5,55
/714	14	40	Bachforelle	5,55	



HYDRO POP 50 SF/70 FL

Einfach unbeschreiblich, wie der Hydro Pop bei kleinen Schlägen mit der Rute laute Splashes und wahre Wasserfontänen verursacht und dabei auch noch seitlich ausbricht. Dieser Provokation können sich auch misstrauische Räuber nur schwer entziehen. Typ: Oberflächenköder.

Art.-Nr.	Best.-Nr.	Länge cm	Gewicht g	Dekor	Hdl.-EK netto €
135250	/005	5	4	Barsch	3,70
	/105	5	4	Weißfisch schwarz	3,70
	/205	5	4	Fireshark	3,70
135250	/007	7	5	Barsch	3,80
	/107	7	5	Weißfisch schwarz	3,80
	/207	7	5	Fireshark	3,80



Längenangabe = Länge des Körpers ohne Tauchschaufel und Haken.

VPE: 1 Stück, Preis pro Stück.

Shirasu Wobbler



Längenangabe = Länge des Körpers ohne Tauchschaufel und Haken.

BABY MINNOW 50 SU

Ein vorzüglicher Köder für Forelle, Barsch und Döbel. Das Baby ist suspending (schwerelos) und lässt sich twitchen, jerken oder ganz normal führen. Seine Stärken spielt er ganz klar beim Twitchen aus. Toll, wie er ausbricht und seine Flanken zeigt. **Typ: Suspender (schwebend), Tauchtiefe: bis 0,5 m.**

Art.-Nr.	Best.-Nr.	Länge cm	Gewicht g	Dekor	Hdl.-EK netto €
135240	/005	5	2,5	Barsch	3,95
	/105	5	2,5	Weißfisch schwarz	3,95
	/205	5	2,5	Weißfisch blau	3,95
	/305	5	2,5	Hecht	3,95
	/405	5	2,5	Renke	3,95
	/505	5	2,5	Forelle	3,95
	/605	5	2,5	Fireshark	3,95
	/705	5	2,5	Bachforelle	3,95

SUDDEN DEATH 100 SU

Der Sudden Death ist ein echter Provokateur und reizt auch nicht aktive Raubfische zu einer Attacke... vorausgesetzt man hat die richtige Technik drauf! Dieser Suspender sollte getwitched werden, dann ein kurzer Einholstopp und weiter getwitched werden. **Typ: Suspender (schwebend), Tauchtiefe: 1,3 m.**

Art.-Nr.	Best.-Nr.	Länge cm	Gewicht g	Dekor	Hdl.-EK netto €
135260	/010	10	17	Barsch	5,05
	/110	10	17	Weißfisch schwarz	5,05
	/210	10	17	Weißfisch blau	5,05
	/310	10	17	Hecht	5,05
	/410	10	17	Renke	5,05
	/510	10	17	Forelle	5,05
	/610	10	17	Fireshark	5,05
	/710	10	17	Bachforelle	5,05



JOHNNY DEEP 120 DR

Klassischer Deep Runner mit einer Tauchtiefe bis zu 9 Metern. Die speziellen 5 Farben haben sich bei Tieftauchern als DIE Farben schlechthin rausgestellt. Ideal zum Schleppen in größeren Seen und Talsperren, aber auch extrem fängig auf Dorsch und Köhler. Mit salzwasserfesten Drillingen von VMC!

Typ: Tiefläufer, schwimmend, Tauchtiefe: bis 9m.

Art.-Nr.	Best.-Nr.	Länge cm	Gewicht g	Dekor	Hdl.-EK netto €
135270	/012	12	30	A Blau	5,80
	/112	12	30	B Fireshark	5,80
	/212	12	30	C Barsch rot	5,80
	/312	12	30	D Orange-Gelb	5,80
	/412	12	30	E Grün-Gelb	5,80



VPE: 1 Stück, Preis pro Stück.

Shirasu Wobbler



Längenangabe = Länge des Körpers ohne Tauchschaufel und Haken.



CRAZY CRAWLER 50 SI

Ihr Gewässer ist überfischt? Die Raubfische kennen alle Wobbler schon mit Artikelnummer? Dann testen Sie mal den Crazy Crawler! Diesen kleinen Flusskrebis haben besonders feiste Barsche und Zander zum Fressen gern. Aber auch große Forellen wissen ihn zu schätzen. Beim Einziehen wobbelt er und spielt dabei verführerisch mit seinen Scheren. Er lässt sich sowohl gleichmäßig einholen als auch twitchen! Klasse Video unter www.balzer.de. **Typ: sinkend.**

Art.-Nr.	Best.-Nr.	Länge cm	Gewicht g	Dekor	Hdl.-EK netto €
135740	/005	5	8,5	A Rot	3,95
	/105	5	8,5	B Natur	3,95
	/205	5	8,5	C UV-schwarz-gelb	3,95
	/305	5	8,5	D Gelb	3,95

CRAZY CRAWLER MAGIC ARMS 50 / 70 SI

Die Weiterentwicklung unseres legendären Crazy Crawlers. Der Clou sind die Scheren aus auftreibendem Material!

Bei Einholstopps stehen die Scheren aufrecht und kopieren in absolut realistischer Weise das Abwehrverhalten eines Flusskrebises. Da der Wobbler sinkend ist, steht er bei Stopps am Grund und die Scheren taumeln verführerisch in der Luft. Wir empfehlen den Wobbler zu twitchen mit Einholstopps. Gerade während der Stopps kommen oftmals sehr aggressive Attacken.

Erhältlich in 2 Größen!

Typ: sinkend.

Art.-Nr.	Best.-Nr.	Länge cm	Gewicht g	Dekor	Hdl.-EK netto €
135740	/405	5	8,5	E Rot	4,35
	/505	5	8,5	F Natur	4,35
	/605	5	8,5	G UV-schwarz-gelb	4,35
	/705	5	8,5	H Gelb	4,35

Art.-Nr.	Best.-Nr.	Länge cm	Gewicht g	Dekor	Hdl.-EK netto €
135740	/407	7	12	E Rot	4,60
	/507	7	12	F Natur	4,60
	/607	7	12	G UV-schwarz-gelb	4,60
	/707	7	12	H Gelb	4,60

POP FROG 70 FL

In den flacheren Uferzonen von Gewässern mit Froschpopulation fängt dieser Popper ganz hervorragend. Die extrem konkave Wölbung lässt den Pop Frog so richtig ploppen und spritzen. Die Gummibeine erzeugen beim »poppern« die für den Frosch so typischen Schwimmbewegungen. Wird mit Ersatzbeinen geliefert.

Typ: Oberflächenköder.

Art.-Nr.	Best.-Nr.	Länge cm	Gewicht g	Hdl.-EK netto €
135200	/007	7	A 12	4,75
	/107	7	B 12	4,75
	/207	7	C 12	4,75

VPE: 1 Stück, Preis pro Stück.

Shirasu Holo Wobbler



BLOODY FROG 60 FL

Tolles Frosch-Imitat, in Lauf und Optik! Der Bloody Frog läuft knapp unter der Oberfläche. Nach der Laichzeit, wenn die Hechte noch im Flachen stehen, ist er eine echte Bank! Ebenso ganzjährig überall dort wo Frösche auf dem Speiseplan stehen.

Typ: schwimmend, Tauchtiefe: 0,4 m

Art.-Nr.	Best.-Nr.	Länge cm	Gewicht g	Dekor	Hdl.-EK netto €
135190	/106	6	10	A Schwarz	4,35
	/206	6	10	B Grün-Gelb	4,35
	/306	6	10	C Braun-Gelb	4,35
	/406	6	10	D Natur	4,35

SHIRASU HOLO

Die neuen Shirasu Holo Wobbler besitzen eine innenliegende Reflexfolie, die das Glitzern eines Schuppenkleides sehr genau imitiert und gerade an überfischten Gewässern oder kniffligen Tagen seine Stärke ausspielt.

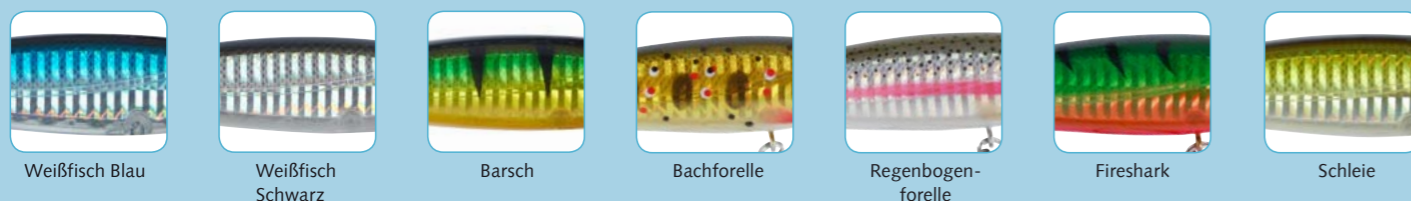

HOLO CRANK 70 DR

Ein reinrassiger Tiefläufer, der unter Wasser so richtig Radau macht! Er macht starke hektische Bewegungen, wodurch die Hologrammfolie einen flankenden Fisch imitiert. Die Stahlrasseln sorgen zusätzlich für starken akustischen Reiz. Topp auf tiefstehende Hechte und Zander. Auch ideal zum Schleppen! Typ: Tiefläufer. Tauchtiefe: 3,5-6m.

Art.-Nr.	Best.-Nr.	Länge cm	Gewicht g	Dekor	Hdl.-EK netto €
135410	/007	7	20	Weißfisch blau	5,70
	/107	7	20	Weißfisch schwarz	5,70
	/207	7	20	Barsch	5,70
	/307	7	20	Bachforelle	5,70
	/407	7	20	Regenbogenforelle	5,70
	/507	7	20	Fireshark	5,70
	/607	7	20	Schleie	5,70



Längenangabe = Länge des Körpers ohne Tauchschaufel und Haken.

VPE: 1 Stück, Preis pro Stück.

HOLO MINNOW 70 / 100 / 130 FL

Sehr fängiger schwimmender Wobbler, dessen ruhiger, natürlicher Lauf eine magische Wirkung auf alle Räuber hat. Der 7cm Minnow hat sich topp auf Barsch bewährt, die beiden anderen Größen sind echte Abräumer auf Zander und Hecht. Er kann sowohl gleichmäßig eingeholt, als auch getwitched werden.

Typ: schwimmend. Tauchtiefe: 7cm: 0,5m; 10cm: 1,3m; 12cm, 1,4m.

Art.-Nr.	Best.-Nr.	Länge cm	Gewicht g	Dekor	Hdl.-EK netto €
135420	/007	7	5	Weißfisch blau	4,20
	/107	7	5	Weißfisch schwarz	4,20
	/207	7	5	Barsch	4,20
	/307	7	5	Bachforelle	4,20
	/407	7	5	Regenbogenforelle	4,20
	/507	7	5	Fireshark	4,20
	/607	7	5	Schleie	4,20
135420	/010	10	14	Weißfisch blau	4,50
	/110	10	14	Weißfisch schwarz	4,50
	/210	10	14	Barsch	4,50
	/310	10	14	Bachforelle	4,50
	/410	10	14	Regenbogenforelle	4,50
	/510	10	14	Fireshark	4,50
	/610	10	14	Schleie	4,50
135420	/012	12	29	Weißfisch blau	4,80
	/112	12	29	Weißfisch schwarz	4,80
	/212	12	29	Barsch	4,80
	/312	12	29	Bachforelle	4,80
	/412	12	29	Regenbogenforelle	4,80
	/512	12	29	Fireshark	4,80
/612	12	29	Schleie	4,80	



HOLO POPPER FL

An der Oberfläche spielt die Holgrammfolie ihre Stärke natürlich besonders gut aus, bedingt durch den direkten Lichteinfall. Wenn er mit kleinen Schlägen gejerkt wird bricht er seitlich aus, macht kleine Wassersplashes sowie ploppende Geräusche und imitiert so beeindruckend einen panisch fliehenden Kleinfisch. Typ: Oberflächenköder.

Art.-Nr.	Best.-Nr.	Länge cm	Gewicht g	Dekor	Hdl.-EK netto €
135430	/007	7	10	Weißfisch blau	5,20
	/507	7	10	Fireshark	5,20
	/607	7	10	Schleie	5,20



Längenangabe = Länge des Körpers ohne Tauchschaufel und Haken.

VPE: 1 Stück, Preis pro Stück.



by Matze Koch



nen Hunger haben, indem er nämlich das Revierverhalten der Hechte anspricht, ein Schlüsselreiz der oft unterschätzt wird. Matze ist jedoch Allrounder und so wurde in einem Atemzug aus dem einzelnen Wobblerwunsch eine ganze Serie, die Barsche, Zander und Hechte gleichermaßen anspricht. Selbst für Rapfen und Döbel sind passende Modelle dabei und auch Forellenangler kommen nicht zu kurz. Nach vielen Tests am Wasser hat Matze die fängigsten Modelle und Dekore für Sie zusammengestellt. Alle Wobbler sind mit nadelscharfen VMC Haken ausgestattet, die Streamerhaken sind von Mustad.

Matze Koch's Erfolgswobbler exklusiv bei Balzer

Eigentlich hatte Matze Koch nur vor, einen langersehnten Lieblingswobbler nach eigenen Vorstellungen zu entwerfen. Ein absoluter Großhechtfänger, wie er ihn schon in vielen seiner Filme erfolgreich eingesetzt hat. Ein Wobbler, der auch dann fängt, wenn die Fische gar kei-



EIN WORT ZUR TAUCHTIEFE:

Bitte beachten Sie, dass sich die Tauchtiefe niemals exakt angeben lässt, da sie von vielen Faktoren wie Einholtempo, Schnurstärke und der Entfernung des Köders abhängt. Der twitchende Angler zum Beispiel lässt den Köder immer wieder auf-treiben und kann daher etwas tiefer laufende Modelle wählen. Dünne Schnüre dagegen lassen den Köder tiefer abtauchen. Je weiter der Köder ausgeworfen und je schneller er geführt wird, desto tiefer läuft er. Ihr Ziel sollte es beim Zielfisch Hecht sein, über den Köpfen der Räuber zu fischen. Beim Zander muss der Köder weiter runter und darf hin und wie-der gerne den Grund touchieren. Nach diesen Kriterien und Matze's Motto "Flexibel sein ist alles!" sollten Sie ihre Wahl treffen.

MK "RÄUBERHAPPEN"

Der stark ausschlagende Allroundköder spricht die Großen unter den Räubern an. Starke Barsche, Zander, die in der Dämmerung in Flachzonen auf Raubzug gehen und natürlich Hechte, die hochrückigere Beute gerne attackieren, gehen an die Drillinge dieses Modells. Erhältlich in vierfacher Ausführung, alle am Naturdesign Barsch und Weißfisch orientiert. Je eines für klare Gewässer in der natürlichen Ausführung, und je ein etwas grellereres Naturmuster für die trübe Umgebung und dunkles Wetter. Auch bei den Räuberhappen bringt der Streamerschwanz den entscheidenden Zusatzreiz!
Typ: schwimmend.
Lauftiefen:
7cm Modell: 1 - 1,5m
9cm Modell: 1,5 - 2m
11cm Modell: 2 - 2,5m



BARSCH NATUR				
Art.-Nr.	Best.-Nr.	Länge cm	Gewicht g	Hdl.-EK netto €
134020	/007	7	5	6,05
	/009	9	14	6,55
	/011	11	18	7,50

ROTAUGE				
Art.-Nr.	Best.-Nr.	Länge cm	Gewicht g	Hdl.-EK netto €
134020	/107	7	5	6,05
	/109	9	14	6,55
	/111	11	18	7,50



BARSCH, SIGNAL				
Art.-Nr.	Best.-Nr.	Länge cm	Gewicht g	Hdl.-EK netto €
134020	/207	7	5	6,05
	/209	9	14	6,55
	/211	11	18	7,50

BRASSE				
Art.-Nr.	Best.-Nr.	Länge cm	Gewicht g	Hdl.-EK netto €
134020	/307	7	5	6,05
	/309	9	14	6,55
	/311	11	18	7,50

Längenangabe = Länge des Körpers ohne Tauchschaufel und Haken.

VPE: 1 Stück, Preis pro Stück.

MK ADVENTURE HECHT



Hier ist der langersehnte Hecht mit Streamerschwanz endlich komplett erhältlich. In weit ausholenden, schlangenartigen Bewegungen hebt er sich von allem anderen ab, was durch ihre Gewässer gekurbelt wird. Allzu hektische Bewegungen schrecken Großhechte ab, sie haben schon zu viel gesehen. Die ungewöhnlich kurvenartige Präsentation treibt jeden Hecht in den Wahnsinn.

Mit dem völlig neuen Hecht-Design und der prallen Form lässt das Modell keinen Esox mehr zweifeln: "Hier will ein Konkurrent in mein Revier eindringen!" Die logische Folge ist eine brachiale Attacke. Und wenn es dann doch mal zackiger sein soll, genügt es den Streamerschwanz gegen einen Drilling zu tauschen, und schon sind die Ausschläge hart und flankend.

Typ: schwimmend.
7cm Modell: Lauftiefe: 1,00 - 1,20m
10cm Modell: Lauftiefe: 1,40 - 1,60m
13-16cm Modell: Lauftiefe: 1,50 - 2,00m.



MK "GROSSHECHT-SCHLANGE" - TIEFLÄUFER

Wie die Großhechtschlange, aber als Tiefläufer.

Typ: schwimmend, Lauftiefe 10 und 13cm: 1-3m; 16cm: 2,5-4m.

Art.-Nr.	Best.-Nr.	Länge cm	Gewicht g	Hdl.-EK netto €
134000	/110	10	15	6,25
	/113	13	27	6,60
	/116	16	47	6,90



MK "HECHTALARM", 2-TEILIG

Wo keine Riesenwurfabstände erforderlich sind, hat er sein Einsatzgebiet, sowohl an Flüssen als auch Seen. Die Bewegung ist im hinteren Wobblerteil besonders agil. Das versetzt die Rasselkugeln in ein besonders aggressives Rappeln. Der Hecht wird vom Wirbel des Hinterteils gereizt und kann das ruhige Kopfteil umso gezielter attackieren. Gleichmäßiges

MK "HECHTALARM", 2-TEILIG

Art.-Nr.	Best.-Nr.	Länge cm	Gewicht g	Hdl.-EK netto €
134010	/010	10	10	6,85
	/013	13	21	7,40
	/016	16	45	8,25

Längenangabe = Länge des Körpers ohne Tauchschaufel und Haken.



MK "GROSSHECHT-SCHLANGE" NATUR

Art.-Nr.	Best.-Nr.	Farbe	Länge cm	Gewicht g	Hdl.-EK netto €
134000	/007	Hecht natur	7	6	5,25
	/010	Hecht natur	10	13	5,55
	/013	Hecht natur	13	26	5,90
	/016	Hecht natur	16	50	6,60

MK "GROSSHECHT-SCHLANGE" HECHTLEUCHTE

Art.-Nr.	Best.-Nr.	Farbe	Länge cm	Gewicht g	Hdl.-EK netto €
134000	/307	Hechtleuchte	7	6	5,25
	/310	Hechtleuchte	10	13	5,55
	/313	Hechtleuchte	13	26	5,90
	/316	Hechtleuchte	16	50	6,60

VPE: 1 Stück, Preis pro Stück.



MK "GROSSHECHT-SCHLANGE" HECHTLEUCHTE - TIEFLÄUFER

Wie die Großhechtschlange, aber als Tiefläufer.

Typ: schwimmend, Lauftiefe 10 und 13cm: 1-3m; 16cm: 2,5-4m.

Art.-Nr.	Best.-Nr.	Länge cm	Gewicht g	Hdl.-EK netto €
134000	/210	10	15	6,25
	/213	13	27	6,60
	/216	16	47	6,90

VPE: 1 Stück, Preis pro Stück.



MK "GROSSHECHT-SCHLANGE" HECHTLEUCHTE, 2-TEILIG

Art.-Nr.	Best.-Nr.	Länge cm	Gewicht g	Hdl.-EK netto €
134010	/110	10	10	6,85
	/213	13	21	7,40
	/216	16	45	8,25

VPE: 1 Stück, Preis pro Stück.

MK Adventure Wobbler

MK "KLEINKRAMS" TIEFLÄUFER

Die zierlichen Körper dieser Wobbler sprechen Barsche und Forelle besonders an. Sie lassen sich twitchen und einkurbeln, starke Beschleunigungsphasen lassen ihn verführerisch aufflanken.

Tauchtiefen:

3 cm: 0,5 - 1,00m

5 cm: 1,50 - 2,00m

Typ: Tiefläufer / schwimmend



FORELLE

Art.-Nr.	Best.-Nr.	Länge cm	Gewicht g	Hdl.-EK netto €
134170	/003	3	2,5	5,10
	/005	5	5	5,80



BLAUER BLITZ

Art.-Nr.	Best.-Nr.	Länge cm	Gewicht g	Hdl.-EK netto €
134170	/103	3	2,5	5,10
	/105	5	5	5,80



ROTE GEFAHR

Art.-Nr.	Best.-Nr.	Länge cm	Gewicht g	Hdl.-EK netto €
134170	/303	3	2,5	5,10
	/305	5	5	5,80



FIRE PIKE

Art.-Nr.	Best.-Nr.	Länge cm	Gewicht g	Hdl.-EK netto €
134170	/403	3	2,5	5,10
	/405	5	5	5,80

VPE: 1 Stück, Preis pro Stück.

KARAUSCHE

Art.-Nr.	Best.-Nr.	Länge cm	Gewicht g	Hdl.-EK netto €
134170	/203	3	2,5	5,10
	/205	5	5	5,80

MK "TIEFKLOPPER"

Ein extremer Tiefläufer für Seen und zum Schleppfischen, der es bis über 6 Meter Tiefe bringt. Fast senkrecht, wie ein Fisch auf der Futtersuche, tickt die Schaufel auf den Grund. Ab 3 Metern Tiefe berührt sie den Grund auch bei moderatem Tempo. Besonders Zander, vom Boot aus geschleppt, werden sich an diesem Modell vergreifen.

Aber auch beim Schleppen in der Ostsee ist er sehr erfolgreich auf Dorsch.

Typ: Tiefläufer, schwimmend

Lauftiefe: 2,50 - 4,00m.



VAMPIR

Art.-Nr.	Best.-Nr.	Länge cm	Gewicht g	Hdl.-EK netto €
134030	/407	7	15	6,05



BARSCH NATUR

Art.-Nr.	Best.-Nr.	Länge cm	Gewicht g	Hdl.-EK netto €
134030	/007	7	15	6,05

VPE: 1 Stück, Preis pro Stück.



WEISSFISCH

Art.-Nr.	Best.-Nr.	Länge cm	Gewicht g	Hdl.-EK netto €
134030	/107	7	15	6,05



STREICHHOLZ

Art.-Nr.	Best.-Nr.	Länge cm	Gewicht g	Hdl.-EK netto €
134030	/207	7	15	6,05

MK "FLATTERMANN"

Bei diesem Allroundköder dreht sich das Spinnerlatt um einen spitz zulaufenden Wobblerkörper. So wird dem Räuber nicht nur die Druckwelle des Blattes präsentiert, sondern auch ein farblich perfekt abgestimmter Körper. Perfekt für flache Gewässer, an denen man leichte Köder weiter raus befördern will. Typ: sinkend.



BARSCH NATUR

Art.-Nr.	Best.-Nr.	Länge cm	Gewicht g	Hdl.-EK netto €
134070	/004	4	8	3,70
	/504	4	12	4,05



BARSCH SIGNAL

Art.-Nr.	Best.-Nr.	Länge cm	Gewicht g	Hdl.-EK netto €
134070	/104	4	8	3,70
	/604	4	12	4,05



WEISSFISCH

Art.-Nr.	Best.-Nr.	Länge cm	Gewicht g	Hdl.-EK netto €
134070	/204	4	8	3,70
	/704	4	12	4,05

VPE: 1 Stück, Preis pro Stück.

Längenangabe = Länge des Körpers ohne Tauchschaufel und Haken.

MK Adventure Wobbler



MK ADVENTURE "FLACHKLOPPER"

Die kugelige Bauchform gibt es jetzt auch für's Flachwasser. Die vielen kleinen Rasseln machen viel Radau ohne dabei zu aggressiv zu werden - ein weiches, sanftes Rasseln, das sich von den meisten anderen Rasselmodellen deutlich abhebt. Die bauchige Form verstärkt mir ihrer starken Wasserverdrängung das Gefühl für den Hecht, es mit einer großen Beute zu tun zu haben.

Geheimtipp: Wenn die Zander ins Flachwasser kommen, nehmen sie diesen Rasselton besonders gerne.

Typ: schwimmend

Tauchtiefen: 7 cm: 0,6m, 9cm: bis 1m



BARSCH NATUR

Art.-Nr.	Best.-Nr.	Länge cm	Gewicht g	Hdl.-EK netto €
134110	/007	7	13	5,30
	/009	9	20	5,75



BARSCH SIGNAL

Art.-Nr.	Best.-Nr.	Länge cm	Gewicht g	Hdl.-EK netto €
134110	/107	7	13	5,30
	/109	9	20	5,75



VAMPIR

Art.-Nr.	Best.-Nr.	Länge cm	Gewicht g	Hdl.-EK netto €
134110	/407	7	13	5,30
	/409	9	20	5,75



WEISSFISCH

Art.-Nr.	Best.-Nr.	Länge cm	Gewicht g	Hdl.-EK netto €
134110	/207	7	13	5,30
	/209	9	20	5,75



STREICHHOLZ

Art.-Nr.	Best.-Nr.	Länge cm	Gewicht g	Hdl.-EK netto €
134110	/307	7	13	5,30
	/309	9	20	5,75

VPE: 1 Stück, Preis pro Stück.

MATZE'S "MONSTERBARSCH"

Diesen seit vielen Jahren überaus erfolgreichen Balzerköder hat Matze mit neuen Farbcodes und seinem Streamer versehen, was ihn zur ultimativen Waffe bei allen Raubfischen macht. Wie bei allen MK Wobblern mit Streamer kauft man zwei Laufeigenschaften zu einem Preis. Der Streamer nämlich verleiht dem Köder einen seidenweichen und schlängelnden Lauf. Tauscht man den Streamer gegen einen gewöhnlichen Drilling aus, verändert sich der Lauf komplett und der Wobbler läuft zackig und aggressiv wie ein marschierender Soldat.

Tauchtiefe: schwimmend:

3-5 cm: 0,5-1 m

7-11 cm: 1-3 m

>14 cm: 2,5-4 m

Tiefläufer

5cm: 1,5-2,5 m

9cm: 2,5-5 m

14cm: 5-10 m



MONSTERBARSCH ORIGINAL

Schwimmend.

Art.-Nr.	Best.-Nr.	Länge cm	Gewicht g	Hdl.-EK netto €
134100	/003	3	2	4,55
	/004	4	4	4,95
	/005	5	7	5,25
	/007	7	10	5,70
	/009	9	20	6,15
	/011	11	37	7,05
	/014	14	60	7,90
	/018	18	115	9,90



MONSTERBARSCH SIGNAL

Schwimmend.

Art.-Nr.	Best.-Nr.	Länge cm	Gewicht g	Hdl.-EK netto €
134100	/103	3	2	4,55
	/104	4	4	4,90
	/105	5	7	5,30
	/107	7	10	5,70
	/109	9	20	6,15
	/111	11	37	7,05
	/114	14	60	7,90
	/118	18	115	9,90



MONSTERBARSCH NATUR

Schwimmend.

Art.-Nr.	Best.-Nr.	Länge cm	Gewicht g	Hdl.-EK netto €
134100	/203	3	2	4,55
	/204	4	4	4,90
	/205	5	7	5,30
	/207	7	10	5,70
	/209	9	20	6,15
	/211	11	37	7,05
	/214	14	60	7,90
	/218	18	115	10,90



MONSTERBARSCH ORIGINAL TIEFLÄUFER

Art.-Nr.	Best.-Nr.	Länge cm	Gewicht g	Hdl.-EK netto €
134090	/005	5	8	6,15
	/009	9	23	7,05
	/014	14	56	8,95



MONSTERBARSCH SIGNAL - TIEFLÄUFER

Art.-Nr.	Best.-Nr.	Länge cm	Gewicht g	Hdl.-EK netto €
134090	/105	5	8	6,15
	/109	9	23	7,05
	/114	14	56	8,95



MONSTERBARSCH NATUR - TIEFLÄUFER

Art.-Nr.	Best.-Nr.	Länge cm	Gewicht g	Hdl.-EK netto €
134090	/205	5	8	6,15
	/209	9	23	7,05
	/214	14	56	8,95

Längenangabe = Länge des Körpers ohne Tauchschaufel und Haken.

VPE: 1 Stück, Preis pro Stück.

MK Adventure Wobbler

MK "KLEINKRAMS"

Die zierlichen Körper dieser Wobbler sprechen Barsche und Forelle besonders an. Sie lassen sich twitchen und einkurbeln, starke Beschleunigungsphasen lassen ihn verführerisch auf-flanken.

Tauchtiefen:

3 cm: 0,5 m

5 cm: 0,5-0,75 m.

Typ: schwimmend



FORELLE				
Art.-Nr.	Best.-Nr.	Länge cm	Gewicht g	Hdl.-EK netto €
134140	/003	3	2	3,85
	/005	5	3	4,05



REGENBOGENFORELLE				
Art.-Nr.	Best.-Nr.	Länge cm	Gewicht g	Hdl.-EK netto €
134140	/103	3	2	3,85
	/105	5	3	4,05



WEISSFISCH				
Art.-Nr.	Best.-Nr.	Länge cm	Gewicht g	Hdl.-EK netto €
134140	/203	3	2	3,85
	/205	5	3	4,05



FIRE TIGER				
Art.-Nr.	Best.-Nr.	Länge cm	Gewicht g	Hdl.-EK netto €
134140	/303	3	2	3,85
	/305	5	3	4,05



BARSCH NATUR				
Art.-Nr.	Best.-Nr.	Länge cm	Gewicht g	Hdl.-EK netto €
134140	/403	3	2	3,85
	/405	5	3	4,05



BARSCH SIGNAL				
Art.-Nr.	Best.-Nr.	Länge cm	Gewicht g	Hdl.-EK netto €
134140	/503	3	2	3,85
	/505	5	3	4,05



SAIBLING				
Art.-Nr.	Best.-Nr.	Länge cm	Gewicht g	Hdl.-EK netto €
134140	/603	3	2	3,85
	/605	5	3	4,05

VPE: 1 Stück, Preis pro Stück.

MK "ZAPPELPHILLIPP"

Dieser schlanke und besonders wilde Wobbler läuft extrem aggressiv. Die unverhältnismäßig großen Augen geben den Räubern einen klaren Zielpunkt an, weshalb der vordere Drilling weit vorn am Kopf montiert ist. Die 4cm Variante ist eine echte Bank auf Barsch, Forelle und Döbel.

Nachdem der Zappelphillip bei Barsch- und Forellenglern eingeschlagen hat wie eine Bombe, war es naheliegend, dass Matze über ein Jahr lang mit einem großen Modell experimentierte. Hier ist er nun, genauso wild laufend bringt Phillip in 6+8cm auch die Zander und Hechte um den Verstand.

Besonderer Tipp: Diesen Köder mal twitchen!

Typ: schwimmend

Lauftiefe:

4cm: 0,5m

6cm: 0,5-0,75m

8cm: 0,5-1m



HECHT				
Art.-Nr.	Best.-Nr.	Länge cm	Gewicht g	Hdl.-EK netto €
134060	/004	4	3	3,80
	/006	6	7	4,40
	/008	8	11	5,10



FORELLE				
Art.-Nr.	Best.-Nr.	Länge cm	Gewicht g	Hdl.-EK netto €
134060	/104	4	3	3,80
	/106	6	7	4,40
	/108	8	11	5,10



WEISSFISCH				
Art.-Nr.	Best.-Nr.	Länge cm	Gewicht g	Hdl.-EK netto €
134060	/204	4	3	3,80
	/206	6	7	4,40
	/208	8	11	5,10



FIRE TIGER				
Art.-Nr.	Best.-Nr.	Länge cm	Gewicht g	Hdl.-EK netto €
134060	/304	4	3	3,80
	/306	6	7	4,40
	/308	8	11	5,10



STREICHHOLZ				
Art.-Nr.	Best.-Nr.	Länge cm	Gewicht g	Hdl.-EK netto €
134060	/404	4	3	3,80
	/406	6	7	4,40
	/408	8	11	5,10



BARSCH				
Art.-Nr.	Best.-Nr.	Länge cm	Gewicht g	Hdl.-EK netto €
134060	/504	4	3	3,80
	/506	6	7	4,40
	/508	8	11	5,10

Längenangabe = Länge des Körpers ohne Tauchschaufel und Haken.

VPE: 1 Stück, Preis pro Stück.

MK Adventure Wobbler



MK "FRIESEN JERK"

Der erste Jerkbait in Matzes Wobblerreihe. An der kurzen Hechtpeitsche mit Triggergriff lässt er sich perfekt führen, bei unwegsameren Ufern greift man zu längeren Ruten. Auch mit einer harten Spinnrute lässt er sich bestens servieren und präsentieren. Der Jerk sinkt im Schneckentempo ab (abhängig vom verwendeten Stahlvorfach mit Karabiner) und flankt heftig auf, wenn man ihn gefühlvoll antwicht.

Typ: langsam sinkend



VAMPIR				
Art.-Nr.	Best.-Nr.	Länge cm	Gewicht g	Hdl.-EK netto €
134130	/008	8	22	5,95
	/010	10	38	6,70
	/012	12	60	7,40



BARSCH NATUR				
Art.-Nr.	Best.-Nr.	Länge cm	Gewicht g	Hdl.-EK netto €
134130	/108	8	22	5,95
	/110	10	38	6,70
	/112	12	60	7,40



HECHT				
Art.-Nr.	Best.-Nr.	Länge cm	Gewicht g	Hdl.-EK netto €
134130	/208	8	22	5,95
	/210	10	38	6,70
	/212	12	60	7,40



WEISSFISCH				
Art.-Nr.	Best.-Nr.	Länge cm	Gewicht g	Hdl.-EK netto €
134130	/308	8	22	5,95
	/310	10	38	6,70
	/312	12	60	7,40

VPE: 1 Stück, Preis pro Stück.

MK "RAPFENSCHRECK"

Die blitzschnellen Rapfen fängt man am besten, wenn man sie rauben sieht und gezielt anwirft. Dafür muss ein Köder zwei Kriterien erfüllen: Erstens muss er kompakt sein und sich weit werfen lassen, denn selten rauben die Silberbarren direkt vor den Füßen des Anglers. Zweitens muss er auch dann noch stabil laufen, wenn man ihn mit höchster Geschwindigkeit einholt. Diese Kriterien erfüllt der Rapfenschreck.

Typ: sinkend.



WEISSFISCH BLAU				
Art.-Nr.	Best.-Nr.	Länge cm	Gewicht g	Hdl.-EK netto €
134160	/007	7	15	5,95



WEISSFISCH SCHWARZ				
Art.-Nr.	Best.-Nr.	Länge cm	Gewicht g	Hdl.-EK netto €
134160	/107	7	15	5,95

VPE: 1 Stück, Preis pro Stück.

MK "POPPFANT"

Matze fischt sie gerne im Sommer. Dieser hier hat eine schön ausgeprägte konkave Wölbung, die es auch dem Einsteiger erleichtert, das gewünschte "Plopp" zu erzeugen. Rutenvorschlag für den 5cm-Version: MK Barschpeitsche 7 cm und 9cm: Zanderpeitsche, jeweils in kurzer Ausführung.

Typ: Oberflächenköder



BARSCH NATUR				
Art.-Nr.	Best.-Nr.	Länge cm	Gewicht g	Hdl.-EK netto €
134120	/005	5	8	4,40
	/007	7	10	4,75
	/009	9	16	5,10



WEISSFISCH				
Art.-Nr.	Best.-Nr.	Länge cm	Gewicht g	Hdl.-EK netto €
134120	/105	5	8	4,40
	/107	7	10	4,75
	/109	9	16	5,10

VPE: 1 Stück, Preis pro Stück.

Längenangabe = Länge des Körpers ohne Tauchschaufel und Haken.

MK Adventure Wobbler

MK "KUGELBLITZ"

Und noch ein neuer Köder für die kleineren Räuber wie Forelle, Barsch und Döbel. Die stark gedrungene Form lässt den Kugelblitz auch in stärkster Strömung sauber laufen, wo andere Wobbler längst kapitulieren müssen.

Typ: schwimmend
Tauchtiefe: 0,2-0,5 m

SPEZIELL FÜR STARKE STRÖMUNG



KARPFEN				
Art.-Nr.	Best.-Nr.	Länge cm	Gewicht g	Hdl.-EK netto €
134150	/003	3	3	4,25
	/004	5	5	4,55



WEISSFISCH				
Art.-Nr.	Best.-Nr.	Länge cm	Gewicht g	Hdl.-EK netto €
134150	/103	3	3	4,25
	/104	5	5	4,55



FIRE TIGER				
Art.-Nr.	Best.-Nr.	Länge cm	Gewicht g	Hdl.-EK netto €
134150	/303	3	3	4,25
	/304	5	5	4,55



STREICHHOLZ				
Art.-Nr.	Best.-Nr.	Länge cm	Gewicht g	Hdl.-EK netto €
134150	/403	3	3	4,25
	/404	5	5	4,55

VPE: 1 Stück, Preis pro Stück.

BARSCHE

Art.-Nr.	Best.-Nr.	Länge cm	Gewicht g	Hdl.-EK netto €
134150	/203	3	3	4,25
	/204	5	5	4,55

MK "FORELLEN-/BARSCHEITZLER"

Für den Barschpinsel, die neue Rute für kleine Spinner und Miniwobbler, ist dieser Köder eine seltene Spitze. An der weichen Rute lassen sich die leichten Köder dank ihrer kompakten Form weit rausfeuern und verführen die Barschtruppe reihenweise. Aufgrund seiner zierlichen Bauweise eignet sich der "Mops" auch großartig für Forellen, Döbel und Rapfen. Eingestreute Twitches bewirken auch mit dem Miniköder der Serie Wunder.

Typ: schwimmend.
3cm Modell: 0,3 - 0,6m Lauftiefe
5cm Modell: 0,8 - 1,2m Lauftiefe



FORELLE				
Art.-Nr.	Best.-Nr.	Länge cm	Gewicht g	Hdl.-EK netto €
134080	/003	3	2	4,10
	/005	5	5,5	4,60



BLAUER BLITZ				
Art.-Nr.	Best.-Nr.	Länge cm	Gewicht g	Hdl.-EK netto €
134080	/103	3	2	4,10
	/105	5	5,5	4,60



KARAUSCHE				
Art.-Nr.	Best.-Nr.	Länge cm	Gewicht g	Hdl.-EK netto €
134080	/203	3	2	4,10
	/205	5	5,5	4,60



ROTE GEFAHR				
Art.-Nr.	Best.-Nr.	Länge cm	Gewicht g	Hdl.-EK netto €
134080	/303	3	2	4,10
	/305	5	5,5	4,60



FIRE PIKE				
Art.-Nr.	Best.-Nr.	Länge cm	Gewicht g	Hdl.-EK netto €
134080	/403	3	2	4,10
	/405	5	5,5	4,60

VPE: 1 Stück, Preis pro Stück.

MK SCHLÜSSELANHÄNGER

Für alle Fans von Matze Koch und alle Angel-Enthusiasten.



SCHLÜSSELANHÄNGER

Art.-Nr.	Best.-Nr.	Modell	Hdl.-EK netto €
134280	/000	Hecht	2,00
	/001	Bachforelle	2,00
	/002	Barsch	2,00

Netto-/Netto-Preis

VPE: 10 Stück, Preis pro Stück.

Längenangabe = Länge des Körpers ohne Tauchschaufel und Haken.

MK Adventure Wobbler

MK "TROTZKOPF"

Wer nicht gezielt auf Großfisch angeln möchte und auch die Barschspeitsche gerne schwingt, ist mit dieser Serie gut beraten. Barsch, Zander, Hecht, alle Räuber werden diesem Modell folgen. Die kleinen Ausführungen haben sich aber auch am Forellenteich bewährt. Hektisch flanken die länglichen Beuteimitate von links nach rechts, ohne dabei in Beschleunigungsphasen auszubrechen.

Typ: schwimmend
5cm Modell: 0,7 - 1,0m Lauftiefe
7cm Modell: 1,2 - 1,6m Lauftiefe



WEISSFISCH				
Art.-Nr.	Best.-Nr.	Länge cm	Gewicht g	Hdl.-EK netto €
134040	/005	5	3	4,00
	/007	7	7	4,50



FORELLE				
Art.-Nr.	Best.-Nr.	Länge cm	Gewicht g	Hdl.-EK netto €
134040	/305	5	3	4,00
	/307	7	7	4,50



SAIBLING				
Art.-Nr.	Best.-Nr.	Länge cm	Gewicht g	Hdl.-EK netto €
134040	/705	5	3	4,00
	/707	7	7	4,50



GRÜNDLING				
Art.-Nr.	Best.-Nr.	Länge cm	Gewicht g	Hdl.-EK netto €
134040	/105	5	3	4,00
	/107	7	7	4,50



BARSCHE NATUR				
Art.-Nr.	Best.-Nr.	Länge cm	Gewicht g	Hdl.-EK netto €
134040	/405	5	3	4,00
	/407	7	7	4,50



VAMPIR				
Art.-Nr.	Best.-Nr.	Länge cm	Gewicht g	Hdl.-EK netto €
134040	/605	5	3	4,00
	/607	7	7	4,50



FIRE TIGER				
Art.-Nr.	Best.-Nr.	Länge cm	Gewicht g	Hdl.-EK netto €
134040	/205	5	3	4,00
	/207	7	7	4,50



ROTE ELRITZE				
Art.-Nr.	Best.-Nr.	Länge cm	Gewicht g	Hdl.-EK netto €
134040	/505	5	3	4,00
	/507	7	7	4,50

VPE: 1 Stück, Preis pro Stück.

MK "POLDERQUIRL"

Dieser Wobbler ist genau für die flachen Polder-Gewässer konzipiert. Wenn das Kraut auch noch so weit an die Oberfläche reicht, der Polderquirl läuft noch darüber und ist dennoch ständig im Blickfeld der Hechte, deren Augen nach oben gerichtet sind. Die kleinen Radaumacher mit ihren dezenten Rasselkugeln lassen keinen Hecht kalt. Der Köder ist nicht rund, wie man vermuten könnte, sondern seitlich etwas zusammengedrückt, was ein verführerisches Flanken zur Folge hat.

Typ: schwimmend
7 - 9cm Modell: bis 0,5m Lauftiefe



VAMPIR				
Art.-Nr.	Best.-Nr.	Länge cm	Gewicht g	Hdl.-EK netto €
134050	/407	7	10	5,70
	/409	9	21	6,25



FIRE TIGER				
Art.-Nr.	Best.-Nr.	Länge cm	Gewicht g	Hdl.-EK netto €
134050	/007	7	10	5,70
	/009	9	21	6,25



KARAUSCHE				
Art.-Nr.	Best.-Nr.	Länge cm	Gewicht g	Hdl.-EK netto €
134050	/107	7	10	5,70
	/109	9	21	6,25



BUNTER SPECHT				
Art.-Nr.	Best.-Nr.	Länge cm	Gewicht g	Hdl.-EK netto €
134050	/207	7	10	5,70
	/209	9	21	6,25



ROTFEDER				
Art.-Nr.	Best.-Nr.	Länge cm	Gewicht g	Hdl.-EK netto €
134050	/307	7	10	5,70
	/309	9	21	6,25

VPE: 1 Stück, Preis pro Stück.

Längenangabe = Länge des Körpers ohne Tauchschaufel und Haken.



Colonel Z Wobbler – fängige Wobbler zu günstigen Preisen!

Colonel Z Wobbler stehen seit vielen Jahren für tadellos laufende Wobbler für kleines Geld! Die neueste Generation kommt jetzt mit neuen fängigen Dekoren und Formen. Alle Wobbler sind mit scharfen Camtec Drillingen sowie mit Stahlkugeln im Körper ausgestattet.

Erhältliche Dekore

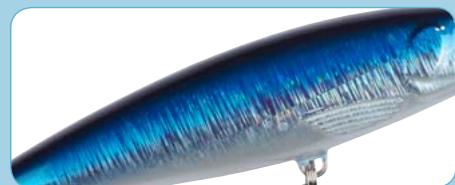

WEISSFISCH BLAU



FIRESHARK

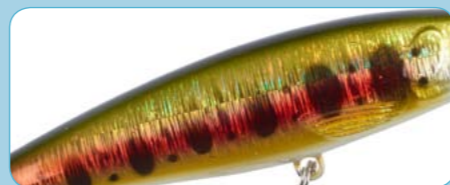

FORELLE

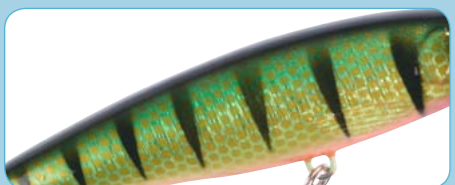

BARSCH



GHOSTFISH



WEISSFISCH OLIV

MIKE MINNOW 7CM / 9CM / 11CM

Klassische Wobblerform, aus keiner Wobblerbox wegzudenken. Ein echter Allrounder!

Typ: schwimmend, Tauchtiefe: 7 cm: 0,5 m / 9 cm: 0,7 m / 11 cm: 1,10 m.



Art.-Nr.	Best.-Nr.	Farbe	Länge/Gew.	Hdl.-EK netto €
134900	/007	Weißfisch blau	7/5	1,65
	/107	Firehark	7/5	1,65
	/207	Forelle	7/5	1,65
	/307	Barsch	7/5	1,65
	/407	Ghostfish	7/5	1,65
	/507	Weißfisch oliv	7/5	1,65
	/009	Weißfisch blau	9/8	1,90
	/109	Firehark	9/8	1,90
	/209	Forelle	9/8	1,90
	/309	Barsch	9/8	1,90
	/409	Ghostfish	9/8	1,90
	/509	Weißfisch oliv	9/8	1,90
	/011	Weißfisch blau	11/14	2,10
	/111	Firehark	11/14	2,10
	/211	Forelle	11/14	2,10
	/311	Barsch	11/14	2,10
/411	Ghostfish	11/14	2,10	
/511	Weißfisch oliv	11/14	2,10	

J.J. JUNIOR 3CM

Ein echter Abräumer, speziell auf Forelle. Aber auch auf Barsch und Döbel top! Die Kombination aus hektischem Lauf und dem Zusatzreiz durch die Federn machen ihn so fängig.

Typ: schwimmend, Tauchtiefe: 0,2 m.

Art.-Nr.	Best.-Nr.	Farbe	Länge/Gew.	Hdl.-EK netto €
134980	/003	Weißfisch blau	3/2	1,50
	/103	Firehark	3/2	1,50
	/203	Forelle	3/2	1,50
	/303	Barsch	3/2	1,50
	/403	Ghostfish	3/2	1,50
	/503	Weißfisch oliv	3/2	1,50

Längenangabe = Länge des Körpers ohne Tauchschaufel und Haken.

PETER PIKE 9 CM / 11 CM / 13 CM

Klasse Kopie eines kleinen Hechtes. Hechte reagieren oftmals sehr aggressiv wenn ein Konkurrent in ihr Revier eindringt und attackieren ihn sofort. Deshalb fangen Hechtimitate auch bei Beißflauten noch.

Typ: schwimmend, Tauchtiefe: 9 cm: 0,4 m / 11 cm: 0,9 m / 13cm: 1,3m.

Art.-Nr.	Best.-Nr.	Farbe	Länge/Gew.	Hdl.-EK netto €
134970	/009	Hecht	9/8	1,90
	/011	Hecht	11/14	2,10
	/013	Hecht	13/18	2,50

VPE: 5 Stück, Preis pro Stück.

COLONEL Z WOBBLER



JIM SHALLOW 4,5 CM

Ein echter Flachläufer, der ganz knapp unter dem Oberflächenfilm läuft. Daher ideal für verkrautete Gewässer oder über hochstehenden Krautfahren. Die Federn sorgen für zusätzlichen Reiz.

Tipp: Nach der Schonzeit stehen viele Hechte noch im Kraut. Da ist dieser Wobbler eine echte Bank!

Typ: schwimmend, Tauchtiefe: 0,1 m.

Art.-Nr.	Best.-Nr.	Farbe	Länge/Gew.	Hdl.-EK netto €
134910	/005	Weißfisch blau	4,5/5	1,90
	/105	Firehark	4,5/5	1,90
	/205	Forelle	4,5/5	1,90
	/305	Barsch	4,5/5	1,90
	/405	Ghostfish	4,5/5	1,90
	/505	Weißfisch oliv	4,5/5	1,90



PAUL POPP 5 CM

Der konkave Kopf wurde bewusst größer gestaltet als der Rest des Körpers. So erzeugt der Wobbler irre Ploppgeräusche und Wasserfontänen. Topp auf raubende Barsche und Rapfen!

Typ: schwimmender Oberflächen-Wobbler, Tauchtiefe: 0 m.

Art.-Nr.	Best.-Nr.	Farbe	Länge/Gew.	Hdl.-EK netto €
134930	/005	Weißfisch blau	5/10	2,00
	/105	Firehark	5/10	2,00
	/205	Forelle	5/10	2,00
	/305	Barsch	5/10	2,00
	/405	Ghostfish	5/10	2,00
	/505	Weißfisch oliv	5/10	2,00



FREDDY FAT DR 6 CM

Wenn die Raubfische tiefer stehen kommt die Tiefläufervariante von Freddy Fat zum Einsatz.

Typ: schwimmender Deeprunner, Tauchtiefe: 3,5 m.

Art.-Nr.	Best.-Nr.	Farbe	Länge/Gew.	Hdl.-EK netto €
134950	/006	Weißfisch blau	6/15	2,40
	/106	Firehark	6/15	2,40
	/206	Forelle	6/15	2,40
	/306	Barsch	6/15	2,40
	/406	Ghostfish	6/15	2,40
	/506	Weißfisch oliv	6/15	2,40

Längenangabe = Länge des Körpers ohne Tauchschaufel und Haken.



GERRY GNOM 5 CM

Ein topp Wobbler auf Barsch, Forelle und Döbel. Seine spezielle Form verleiht ihm einen sehr aufreizenden Lauf. Durch die etwas längere Schaufel taucht er bis zu 0,6m und ist so ideal für tiefere Gumpen.

Typ: schwimmend, Tauchtiefe: 0,6 m.

Art.-Nr.	Best.-Nr.	Farbe	Länge/Gew.	Hdl.-EK netto €
134920	/005	Weißfisch blau	5/5	1,90
	/105	Firehark	5/5	1,90
	/205	Forelle	5/5	1,90
	/305	Barsch	5/5	1,90
	/405	Ghostfish	5/5	1,90
	/505	Weißfisch oliv	5/5	1,90



BILLY BREEM 7 CM

Dieser Wobbler imitiert perfekt hochrückige Beutefische wie Rotaugen oder Barsch. Ein guter Allrounder auf Hecht und speziell große Barsche.

Typ: schwimmend, Tauchtiefe: 0,7 m.

Art.-Nr.	Best.-Nr.	Farbe	Länge/Gew.	Hdl.-EK netto €
134940	/007	Weißfisch blau	7/10	2,10
	/107	Firehark	7/10	2,10
	/207	Forelle	7/10	2,10
	/307	Barsch	7/10	2,10
	/407	Ghostfish	7/10	2,10
	/507	Weißfisch oliv	7/10	2,10



FREDDY FAT SR 6 CM

Hektisch laufender Flachläufer mit bulligem Körper. Ein echter Abräumer auf Barsch, aber auch auf Hecht und große Forellen sehr fängig!

Typ: schwimmend, Tauchtiefe: 0,4 m.

Art.-Nr.	Best.-Nr.	Farbe	Länge/Gew.	Hdl.-EK netto €
134960	/006	Weißfisch blau	6/10	2,25
	/106	Firehark	6/10	2,25
	/206	Forelle	6/10	2,25
	/306	Barsch	6/10	2,25
	/406	Ghostfish	6/10	2,25
	/506	Weißfisch oliv	6/10	2,25

VPE: 5 Stück, Preis pro Stück.

1x7 Niroflex

1X7 NIROFLEX



1X7 NIROFLEX DISPLAYKARTE

Display mit 72 Vorfächern. Je 24 Stück in den Längen 15, 22 und 31 cm. Tragkraft 12 kg.

Art.-Nr.	Best.-Nr.	Hdl.-EK netto €
146110	/072	15,90

VPE: 1 Display, Preis pro Display.

ERSATZVORFÄCHER FÜR DISPLAYKARTE

Art.-Nr.	Best.-Nr.	Länge cm	Hdl.-EK netto €
146110	/022	22	4,90
	/031	31	5,90

VPE: Preis pro 24 Stück.



1X7 NIROFLEX

10m Spule, mit Klemmhülsen.

Art.-Nr.	Best.-Nr.	Tragkraft kg	Länge m	Hdl.-EK netto €
146100	/006	6	10	1,40
	/009	9	10	1,50
	/012	12	10	1,60
	/015	15	10	1,70

VPE: 10 Spulen, Preis pro Spule.



1X7 NIROFLEX

Mit Wirbel und Schlaufe. Inhalt 2 Stück.

Art.-Nr.	Best.-Nr.	Tragkraft kg	Länge cm	Hdl.-EK netto €
146050	/006	6	20	0,75
	/009	9	20	0,75
	/012	12	20	0,75
	/015	15	20	0,75
146060	/006	6	40	0,80
	/009	9	40	0,80
	/012	12	40	0,80

PREISSTURZ



1X7 NIROFLEX

Mit Drilling. Länge 50cm. Inhalt 1 Stück.

Art.-Nr.	Best.-Nr.	Tragkraft kg	Haken-größe	Hdl.-EK netto €
146000	/001	12	1	0,65
	/002	9	2	0,65
	/004	9	4	0,65
	/100	12	1/0	0,65
	/200	15	2/0	0,65



1X7 NIROFLEX

Mit Einzelhaken Länge 50cm. Inhalt 1 Stück.

Art.-Nr.	Best.-Nr.	Tragkraft kg	Haken-größe	Hdl.-EK netto €
146020	/001	9	1	0,60
	/002	9	2	0,60
	/100	12	1/0	0,60
	/200	15	2/0	0,60



1X7 NIROFLEX

Mit 2 Schlaufen. Inhalt 2 Stück.

Art.-Nr.	Best.-Nr.	Tragkraft kg	Länge cm	Hdl.-EK netto €
146070	/006	6	50	0,55
	/009	9	50	0,55
	/012	12	50	0,55
	/015	15	50	0,55
	/106	6	70	1,00
	/109	9	70	0,70
	/112	12	70	0,70
	/115	15	70	0,70



1X7 NIROFLEX

Mit Ryderhaken. Länge 50cm. Inhalt 1 Stück.

Art.-Nr.	Best.-Nr.	Tragkraft kg	Haken-größe	Hdl.-EK netto €
146010	/001	9	1	0,60
	/002	9	2	0,60
	/100	12	1/0	0,60



1X7 NIROFLEX

Mit Karabiner und Wirbel. Inhalt 2 Stück.

Art.-Nr.	Best.-Nr.	Tragkraft kg	Länge cm	Hdl.-EK netto €
NEU	/006	6	25	0,90
	/009	9	25	0,90
	/012	12	25	0,90
	/015	15	25	0,90
NEU	/006	6	50	0,90
	/009	9	50	0,90
	/012	12	50	0,90
	/015	15	50	0,90



1X7 NIROFLEX

Mit Dreifachwirbel. Inhalt 2 Stück.

Art.-Nr.	Best.-Nr.	Tragkraft kg	Länge cm	Hdl.-EK netto €
146080	/006	6	25	1,20
	/009	9	25	1,20
	/012	12	25	1,20
	/015	15	25	1,20
146090	/006	6	40	1,25
	/009	9	40	1,25
	/012	12	40	1,25
	/015	15	40	1,25

VPE: 10 SB-Packungen, Preis pro SB-Packung.

7x7 Niroflex-Edelstahlvorfach

7X7 NIROFLEX

PREISSTURZ

7x7 NIROFLEX Edelstahlvorfach

Die 7x7 Raubfischvorfächer sind aus rostfreiem Niroflex Edelstahl und bestehen aus 49 Einzellitzen. Durch den Verzicht auf die Kunststoffummantelung wird ein Maximum an Geschmeidigkeit erreicht. Auf die neuen Super-Safe Wirbel können Sie sich verlassen. Durch den raffinierten Snap kann sich der Wirbel während des Angelns nicht mehr öffnen.



EDELSTAHLVORFACH 7X7

Vorfach, 1 Super-Safe Wirbel, 1 Schlaufe.

Art.-Nr.	Best.-Nr.	Tragkraft kg	Länge cm	Hdl.-EK netto €
145660	/006	6	40	1,80
	/009	9	40	1,60
	/013	13	40	1,40

VPE: 5 SB-Packungen, 2 Stück, Preis pro SB-Packungen.



EDELSTAHLVORFACH 7X7

Doppelschlaufensystem.

Art.-Nr.	Best.-Nr.	Tragkraft kg	Länge cm	Hdl.-EK netto €
145730	/006	6	50	1,80
	/009	9	50	1,60
	/013	13	50	1,40
	/106	6	70	1,90
	/109	9	70	1,70
	/113	13	70	1,80

VPE: 5 SB-Packungen à 2 Stück, Preis pro SB-Packung.



EDELSTAHLVORFACH 7X7

Mit Einzelhaken und Schlaufe.

Art.-Nr.	Best.-Nr.	Tragkraft kg	Länge cm	Haken-größe	Hdl.-EK netto €
145710	/006	6	50	1	1,10
	/009	9	50	1/0	1,00
	/013	13	50	2/0	0,90

VPE: 5 Stück, Inhalt 1 Stück, Preis pro Stück.



EDELSTAHLVORFACH 7X7

Anti-Drall Vorfach, 1 Dreifachwirbel, 1 Super-Safe Wirbel.

Art.-Nr.	Best.-Nr.	Tragkraft kg	Länge cm	Hdl.-EK netto €
145670	/006	6	25	1,60
	/009	9	25	1,40
	/013	13	25	1,20
	/106	6	35	1,80
	/109	9	35	1,60
	/113	13	35	1,40
	/206	6	45	1,90
	/209	9	45	1,70
	/213	13	45	1,50

VPE: 5 SB-Packungen, 2 Stück, Preis pro SB-Packungen.

EDELSTAHLVORFACH 7X7



EDELSTAHLVORFACH 7X7

Vorfach, 1 Super-Safe Wirbel, 1 Drilling.

Art.-Nr.	Best.-Nr.	Tragkraft kg	Länge cm	Haken-größe	Hdl.-EK netto €
145680	/006	6	50	1	1,50
	/009	9	50	1/0	1,30
	/013	13	50	2/0	1,10

VPE: 5 Stück, Inhalt 1 Stück, Preis pro Stück.



EDELSTAHLVORFACH 7X7

Ideal für Spinnangler. Mit 1 Super-Safe Wirbel und 1 Tonnenwirbel.

Art.-Nr.	Best.-Nr.	Tragkraft kg	Länge cm	Hdl.-EK netto €
145650	/006	6	25	1,60
	/009	9	25	1,40
	/013	13	25	1,20
	/106	6	35	1,70
	/109	9	35	1,50
	/113	13	35	1,30
	/206	6	45	1,90
	/209	9	45	1,70
	/213	13	45	1,50

VPE: 5 SB-Packungen, 2 Stück, Preis pro SB-Packungen.

Display mit 72 Vorfächern.

Art.-Nr.	Best.-Nr.	Tragkraft kg	Hdl.-EK netto €
145750	/100	9	27,90

VPE: 1 Display, Preis pro Display.



ERSATZVORFÄCHER FÜR DISPLAY

Art.-Nr.	Best.-Nr.	Länge cm	Hdl.-EK netto €
145750	/022	22	9,90
	/031	31	12,90

VPE: Preis pro 24 Stück.

SHIRASU ZUBEHÖR

SHIRASU

浅き夢見し酔ひもせず

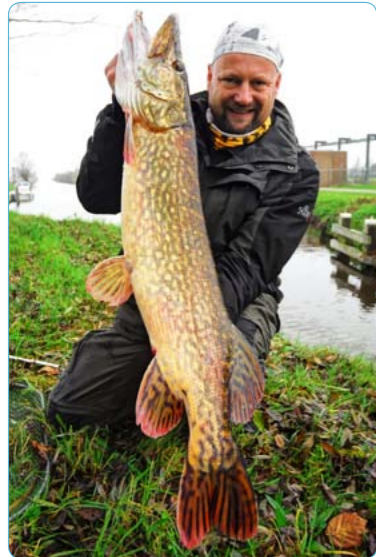

PREISSTURZ

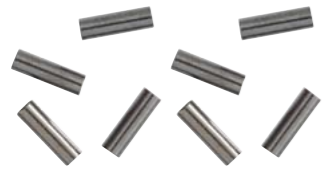

QUETSCHHÜLSEN

Präzisionsquetschhülsen für sicheren Halt.

Art.-Nr.	Best.-Nr.	Ø mm	Hdl.-EK netto €
144550	/060	0,60	0,60
	/080	0,80	0,65
	/100	1,00	0,70
	/140	1,40	0,75
	/160	1,60	0,90
	/200	2,00	1,10
	/260	2,60	1,20

VPE: 10 SB-Packungen, Inhalt 20 Stück, Preis pro SB-Packung.

ERSATZVORFÄCHER FÜR KARTE, 24 STÜCK

24 Kunstködervorfächer aus Titanium. Völlig knitter- und verwindungsfrei. Die Wicklungen sind mit Epoxy-Lack versiegelt. Inhalt: je 24 Stück.

Art.-Nr.	Best.-Nr.	Tragkraft kg	Länge cm	Hdl.-EK netto €
145800	/020	6	20	25,90
	/030	9	30	21,90
	/040	13	40	26,90

VPE: 1 Pack à 24 Stück, Preis pro Pack.

TITANIUM VORFÄCHER

72 Kunstködervorfächer aus Titanium mit einer Tragkraft von 9kg. Völlig knitter- und verwindungsfrei. Die Wicklungen sind mit Epoxy-Lack versiegelt. Inhalt: je 24 Stück in 20cm, 30cm und 40cm. Tragkraft: alle 9kg.

Art.-Nr.	Best.-Nr.	Hdl.-EK netto €
145800	/072	64,90

VPE: 1 Display, Preis pro Display.

SPINNSTANGE

Spinnstange zwischen Kunstköder und Hauptschnur schalten. Dies verhindert ein Überschlagen – ideal für Jerk Baits.

Art.-Nr.	Best.-Nr.	Größe	Hdl.-EK netto €
158920	/000	S	0,80
	/005	L	0,90

VPE: 10 SB-Packungen à 2 Stück, Preis pro Packung.



100 % Fluorocarbon
100 % Hardmono
100 % Unsichtbar
100 % sicher gegen scharfe Raubfischzähne

PREISSTURZ



100 % FLUOROCARBON HARDMONO

Mit Einzelhaken, Länge 50cm.

Art.-Nr.	Best.-Nr.	Ø mm	Haken-größe	Tragkraft kg	Hdl.-EK netto €
146150	/001	0,60	1	16	1,05
	/002	0,50	2	11	0,95
	/100	0,70	1/0	20	1,15

VPE: 10 SB-Packungen, Inhalt 1 Stück, Preis pro SB-Packung.



HARDMONO SPULE

10m Spule mit Quetschhülsen.

Art.-Nr.	Best.-Nr.	Ø mm	Tragkraft kg	Hdl.-EK netto €
146230	/011	0,50	11	6,90
	/016	0,60	16	9,90
	/020	0,70	20	12,90

VPE: 5 Spulen, Preis pro Spule.



100 % FLUOROCARBON HARDMONO

Mit 1 Sicherheitswirbel und 1 Schlaufe.

Art.-Nr.	Best.-Nr.	Ø mm	Länge cm	Tragkraft kg	Hdl.-EK netto €
146180	/011	0,50	20	11	1,00
	/016	0,60	20	16	1,20
	/020	0,70	20	20	1,40
146190	/011	0,50	40	11	1,50
	/016	0,60	40	16	1,60
	/020	0,70	40	20	1,70

VPE: 10 SB-Packungen, Inhalt 2 Stück, Preis pro SB-Packung.



100 % FLUOROCARBON HARDMONO

Mit 1 Sicherheitswirbel und 1 Dreifachwirbel.

Art.-Nr.	Best.-Nr.	Ø mm	Länge cm	Tragkraft kg	Hdl.-EK netto €
146200	/011	0,50	25	11	1,50
	/016	0,60	25	16	1,70
	/020	0,70	25	20	1,90
146210	/011	0,50	40	11	1,80
	/016	0,60	40	16	2,00
	/020	0,70	40	20	2,20

VPE: 10 SB-Packungen, Inhalt 2 Stück, Preis pro SB-Packung.



100 % FLUOROCARBON HARDMONO

Mit 1 Sicherheitswirbel und 1 Tonnenwirbel.

Art.-Nr.	Best.-Nr.	Ø mm	Länge cm	Tragkraft kg	Hdl.-EK netto €
146160	/011	0,50	25	11	1,20
	/016	0,60	25	16	1,40
	/020	0,70	25	20	1,60
146170	/011	0,50	50	11	1,50
	/016	0,60	50	16	1,70
	/020	0,70	50	20	1,90

VPE: 10 SB-Packungen, Inhalt 2 Stück, Preis pro SB-Packung.



100 % FLUOROCARBON HARDMONO

Mit Ryderhaken, Länge 50cm.

Art.-Nr.	Best.-Nr.	Ø mm	Haken-größe	Tragkraft kg	Hdl.-EK netto €
146140	/001	0,60	1	16	1,10
	/002	0,50	2	11	1,00
	/100	0,70	1/0	20	1,20

VPE: 10 SB-Packungen, Inhalt 1 Stück, Preis pro SB-Packung.



HARDMONO DISPLAYKARTE

72 Vorfächer, je 24 in den Längen 15, 22 und 31 cm.

Art.-Nr.	Best.-Nr.	Ø mm	Tragkraft kg	Hdl.-EK netto €
146220	/072	0,60	16	34,90

VPE: 1 Display, Preis pro Display.

ERSATZVORFÄCHER FÜR DISPLAY

Art.-Nr.	Best.-Nr.	Länge cm	Hdl.-EK netto €
146220	/022	22	10,90
	/031	31	12,90

VPE: Preis pro 24 Stück.

Dead Bait leaders

When it comes to catching predatory fish, artificial bait is predominant in the angling magazines. But we all know that baitfish represent an equivalent, frequently better, alternative. And when fishing at night for pike-perch and big eels, you can't do without baitfish!

As we all know, fishing with live baitfish is forbidden, so – together with experienced predatory fish experts – we have developed ingenious, innovative systems and accessories, both for bottom and float fishing and for spin fishing and trawling.

Each pack bears exact portrayals and explanations of how to fish successfully with the respective system!

All the systems are equipped with 2 treble hooks and 7x7 stainless steel leader (except size 1: with mono).

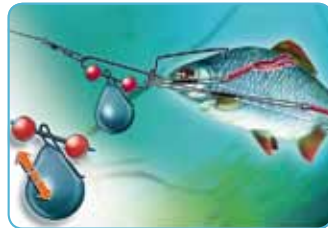

VARIO SPIN SYSTEM

The highlight of this system is that the special lead can be replaced by another weight in seconds without having to remove the baitfish. This means you can react to new situations in the water (current, depth etc.) at all times. The system for fastening baitfish is simple to handle and holds very securely.

Equipped with 2 treble hooks and 7x7 stainless steel leader.

Item-No.	Order-No.	Hook size	Lead w. kg	Rec. bait size cm	Target fish
143500	/005	12	5	3-6 cm	Trout, Perch, Chub
	/008	4	8	5-8 cm	Trout, Perch, Pike-Perch
	/010	2	10	7-12 cm	P.-Perch, Pike, Seatrout
	/015	1	15	11-17 cm	P.-Perch, Pike, Seatrout
	/020	1/0	20	16-22 cm	Pike, Catfish

CHANGEABLE LEADS

The changeable lead fit on all VARIO systems. It can be expedient, for example to fish system size 1 using 15 g if there are deep basins or strong currents to deal with.

Item-No.	Order-No.	Lead weight kg	Cont.
143510	/005	5	4
	/008	8	4
	/010	10	3
	/015	15	3
	/020	20	2
	/100	5, 8, 10, 15, 20	5 (1 per weight)

TREBLE HOOK SYSTEM WITH SECOND MOVABLE TREBLE HOOK

For bottom fishing for all predatory fish. Since it can be moved, the system can be adjusted individually to the size of the baitfish. Length: 70cm, 7x7 stainless steel.

Item-No.	Order-No.	Hook size	Strength kg
143570	/001	1	13
	/002	2	9
	/004	4	9
	/006	6	9
	/100	1/0	13



TREBLE HOOK SYSTEM WITH A MOVABLE SINGLE HOOK

For bottom fishing for all predatory fish. The single hook serves for lip-baiting. Since it can be moved, the system can be adjusted individually to the size of the baitfish.

Length: 70cm, 7x7 stainless steel.

Item-No.	Order-No.	Hook size	Strength kg
143550	/001	1+1/0	13
	/002	2+1	9
	/004	4+2	9
	/006	6+4	9
	/100	1/0+2/0	13



BUOYANCY SYSTEM

The baitfish is pushed onto the wooden rod and secured with the copper wire. Thanks to the buoyancy of the wooden rod, the baitfish floats, suspended above the bottom and can thus be better localized by the predators. The upstream pearl with the oversized eyes generates an additional stimulus. It is indispensable wherever the bottom is muddy or overgrown.

Length: 70cm, 7x7 stainless steel.

Item-No.	Order-No.	Hook size	Rec. bait size cm	Target fish
143520	/000	8	4-7 cm	Eel, Pike-Perch, Perch, Trout
	/001	4	7-12 cm	Pike-Perch, Pike
	/002	2	12-18 cm	Pike, Catfish



TRAWLING SYSTEM

Special system for trawling for pike, catfish and lake trout. The individual hook is for lip-baiting, the two treble hooks go into the body of the baitfish.

Length: 70cm, 7x7 stainless steel.

Item-No.	Order-No.	Hook size	Strength kg
143530	/001	1+1/0	9
	/100	1/0+2/0	13



LONG DISTANCE CASTING SYSTEM

For all those fishing for predatory fish who do not have a boat or are forbidden to fish from a boat, or when a sailing float does not function because the wind is in the wrong direction.

The baitfish remains perfectly attached to the system and withstands even the most aggressive casting. During powerful strikes the hooks reliably penetrate the fish's mouth because there are treble hooks placed – offset – on both sides of the baitfish.

Expert tip: Put a piece of polystyrene sprinkled with luring oils into the baitfish and sprinkle. Length: 70cm, 7x7 stainless steel.

Item-No.	Order-No.	Hook size	Strength kg
143560	/001	1+1/0	13
	/002	2+1	9
	/004	4+2	9



FLOAT SYSTEM

We developed this ingenious loop system specifically for float fishing. The baitfish can be presented in an absolutely natural, horizontal swimming position. It is simply pushed into the loop. The two special treble hooks are inserted into the sides of the baitfish and the single hook into the back. This secures and balances the baitfish perfectly! Since one arch of the treble hook is stretched it is perfectly situated in the flanks of the baitfish and minimises the missed bite rate.

Length: 70cm, 7x7 stainless steel.

Item-No.	Order-No.	Hook size	Rec. bait size cm	Strength kg
143600	/006	6+4	small	9
	/001	1+1/0	medium	13
	/100	1/0+2/0	large	13

Dead Bait Accessories



BUOYANCY STICKS

For building your own buoyancy systems.

Item-No.	Order-No.	Length cm	
143520	/100	4	
	/101	7	
	/102	10	



CIGAR FLOAT

These pre-weighted balsawood floats enable extremely sensitive bite indication. The leader with the bait fish lies on the bottom. If a predatory fish has taken the artificial bait, the float takes off without the fish noticing any resistance. The floats can be used as slider floats or fixed floats.

Item-No.	Order-No.	Length cm	Tensile strength g
143610	/015	15	10+3
	/018	18	15+4



TRAWLING FLOAT

Owing to the curvature the line is clamped firmly and this prevents a change to angling depth during trawling; hence the bait is always guided at the desired depth.

Ideally this float is used for trawling from a boat.

Made from foam. Can be used as a slider or fixed float.

Item-No.	Order-No.	Tensile strength g
143620	/020	20
	/030	30
	/040	40
	/050	50

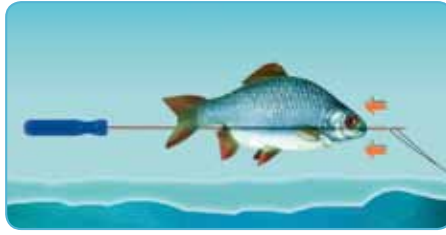

DE LUXE BAIT NEEDLE

With these two perfect bait needles it is possible to thread even big baitfish securely and without any difficulty.

Item-No.	Order-No.	Length cm
143630	/027	27
	/037	37



LEADER STORAGE

The systems can be kept secure and fixed in place in these two boxes.

Sizes: small: 8 cm with 12 pins; large: 12 cm with 20 pins.

Item-No.	Order-No.	Size
143000	/039	small
	/040	large



COPPER WIRE

10 m of fine copper wire for additionally fastening baitfish to the systems

Item-No.	Order-No.	Length m	Colour
143640	/010	10	copper

SPINNING SYSTEM FOR DEAD BAITFISH

Item-No.	Order-No.	Recommended bait size cm
147310	/006	4-6
	/009	5-9
	/013	9-13
	/018	12-18



SPEAR TREBLE HOOK

The straight tip is stuck into the bait; the two other hooks thus remain absolutely straight and bring considerably fewer missed bites.

Item-No.	Order-No.	Hook Size cm	Cont.
143650	/001	1	5
	/002	2	5
	/004	4	5
	/006	6	5
	/008	8	5
	/100	1/0	5
	/200	2/0	5



BAITFISH ROD HOLDER

Extremely strong earth rod holder made from galvanised steel which was conceived specifically for the use of baitfish rods.

Item-No.	Order-No.
119510	/060



with lead

PILKER COD MAGNET

First class perks to an incredible price in enticing 3D designs with needle sharp saltwater-resistant Tiger steel treble hooks. Whirls seductively.



	Black-Silver	Blue-Silver	Red-Silver	Green-Silver	Orange
	Item-No. 139000	Item-No. 139010	Item-No. 139020	Item-No. 139030	Item-No. 139040
Wgt. g	Order-No.	Order-No.	Order-No.	Order-No.	Order-No.
50	/050	/050	/050	/050	/050
75	/075	/075	/075	/075	/075
100	/100	/100	/100	/100	/100
125	/125	/125	/125	/125	/125
150	/150	/150	/150	/150	/150
200	/200	/200	/200	/200	/200
250	/250	/250	/250	/250	/250
300	/300	/300	/300	/300	/300

PILKER RÜGEN

Affordable, luring pilks which come in different colours and with silver glitter. The point of gravity at the front makes the pilks go down deep fast. Their special shape makes them whirl seductively. With tiger steel treble hooks!



	Pink-Silver	Red-Silver	Blue-Silver	Black-Silver	Green-Silver	Orange-Silver
	Item-No. 139400	Item-No. 139410	Item-No. 139420	Item-No. 139430	Item-No. 139440	Item-No. 139450
Wgt.g	Order-No.	Order-No.	Order-No.	Order-No.	Order-No.	Order-No.
	A	B	C	D	E	F
50	/050	/050	/050	/050	/050	/050
75	/075	/075	/075	/075	/075	/075
100	/100	/100	/100	/100	/100	/100
125	/125	/125	/125	/125	/125	/125
150	/150	/150	/150	/150	/150	/150

LOFOTEN PILKER SILVER

Classic Norway perks with Tiger steel treble hooks and fluorescent octopus. This perk shape has in the past placed innumerable big cod on the planks. The treble hooks on the models til 150g have no fluorescent octopus fringes.



Item-No.	Order-No.	Colour	Weight g
139140	/040	silver	40
	/060		60
	/080		80
	/100		100
	/125		125
	/150		150
	/200		200
	/300		300
	/400		400
	/500		500
	/600		600

SHIRASU SOFT LURE SET, 12 + 15CM

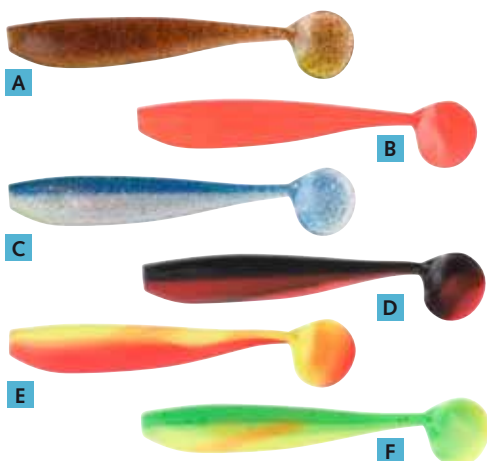

We have combined the mega catchy Shirasu Waggle Shad with matching Jigheads in the right weight for fishing for cod, coalfish and pollack in the Baltic and North Sea but also in Norway. Available in 6 colours.

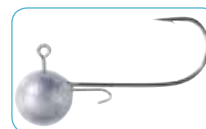

With sharp Camtec hooks and special wire on the jighead to attach the shad fish safely.

Item-No.	Order-No.	Colour	Weight g	Length cm
147910	/001	A Motoroil	60+80g Jighead	12+15
	/002	B Orange	60+80g Jighead	12+15
	/003	C Blue-Glitter	60+80g Jighead	12+15
	/004	D Black-Orange	60+80g Jighead	12+15
	/005	E Yellow-Orange	60+80g Jighead	12+15
	/006	F Green-Yellow	60+80g Jighead	12+15

71° NORTH



Our norway range for specialists

All the experience of professional fishing guides has been incorporated in our Norway range; and you will notice it immediately.

No off-the-rack rigs; instead: truly innovative products of outstanding quality that do one thing above all else: they catch fish! On each self-service card we explain in detail how to fish with the respective rig.

See also our 71 ° North NANO Norway rods.



Copyright: Fotolia.com



COD AND COALFISH SYSTEM

Very good pilking system for catching cod, coalfish and pollack



Item-No.	Order-No.	Color	Hooks	Length cm	Line Ø mm
148260	/000	blue	4/0	150	0.90
	/001	luminous	4/0	150	0.90
	/002	black	4/0	150	0.90
	/003	red	4/0	150	0.90

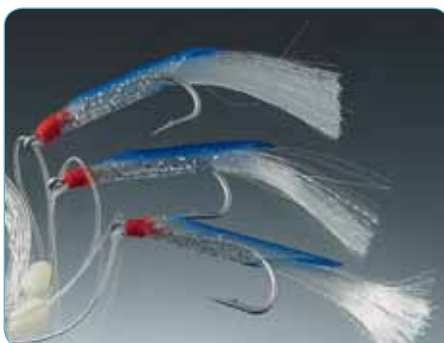

COD AND COALFISH SYSTEM

Top system for cod, saithe and pollack

Item-No.	Order-No.	Color	Hooks	Length cm	Line Ø mm
148260	/100	green	7/0	150	0.90
	/101	pink	7/0	150	0.90
	/102	yellow	7/0	150	0.90



TUBE RIG

An extraordinarily innovative system originating from the Big Game field. The tubular bait has an irresistible effect on almost all predators in Norway. Unbeatable when it comes to saithe and cod.

Item-No.	Order-No.	Color	Hooks	Length cm	Line Ø mm
148160	/200	pink	4/0	130	0.80
	/201	green	4/0	130	0.80
	/202	blue	4/0	130	0.80



71° North

COD AND COALFISH SYSTEM

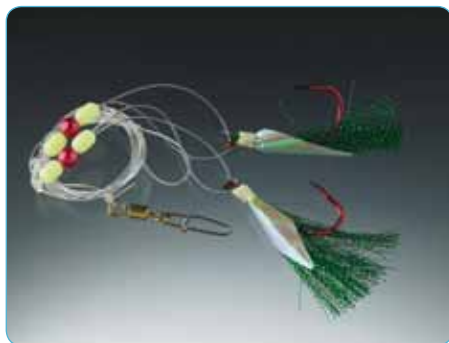

Top system for cod, saithe and pollack



Item-No.	Order-No.	Color	Hooks	Length cm	Line Ø mm
148260	/200	red	5/0	110	0.90
	/201	green	5/0	110	0.90
	/202	yellow	5/0	110	0.90



SCANDI RIG

In a small size this system is a classic for catching mackerel. The larger version we developed is ideal for pollack, saithe and haddock and also for big mackerel in the summer.

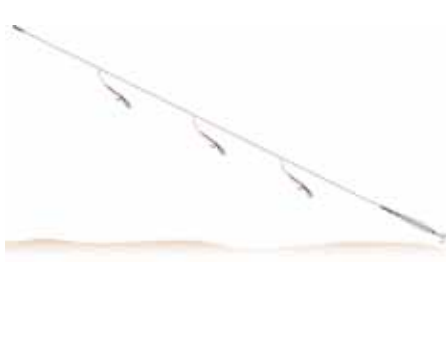

Item-No.	Order-No.	Color	Hooks	Length cm	Line Ø mm
148160	/100	pink	8/0	135	0.90
	/101	luminous	8/0	135	0.90
	/102	black	8/0	135	0.90



71° North

OCEAN PERCH RIG

The ingenious double-hook system has 2 advantages: Firstly, the fish scraps can be spiked on as bait better than with a single hook and secondly the proportion of escapers is significantly lower. With a tube to accommodate a chemical light.

Item-No.	Order-No.	Hooks	Length cm	Line Ø mm
148260	/600	2	310	0.90



FLATFISH SYSTEM WITH WHITE BEADS

Besides cod and coalfish in Norway it is always worth trying to catch the plaice and flounder which are to be found in impressive sizes there. We have developed these two catchy systems for precisely these flat guys.

Item-No.	Order-No.	Hooks	Length cm	Line Ø mm
148260	/900	3 x 2/0	200	0.80



COD AND COALFISH SYSTEM WITH MAKK

The combination of a cod spoon and Japanese-red rubber Makk has put many cod and coalfish on the planks.

Item-No.	Order-No.	Hooks	Length cm	Line Ø mm
148160	/300	3/0	160	0.80
148260	/300	5/0	160	1.00

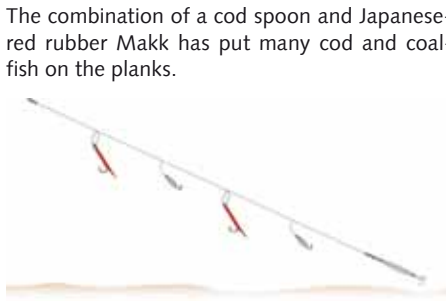

FLUO OCTOPUS

For do-it-yourself sea leaders.

Item-No.	Order-No.	Color	Hooks	Length cm	Line Ø mm
148270	/065	red		6.5	
	/066	green		6.5	
	/067	blue		6.5	
	/115	red		11.5	
	/116	green		11.5	
	/117	blue		11.5	



71° North

SHRIMP RIG



On some days the fish have obviously set their sights on small shrimps and it is clearly pointless using perks and other rigs. Happy he who owns a rig of this type.



Item-No.	Order-No.	Hooks	Length cm	Line Ø mm
148250	/006	4/0	110	0.80



SHRIMPS LOSE



Lose shrimps, ideal for assembling side arm rigs.



Item-No.	Order-No.	Hooks	Length cm	Line Ø mm
148250	/007	4/0	-	-



UNIVERSAL RIG

Universal rig für cod and coalfish.

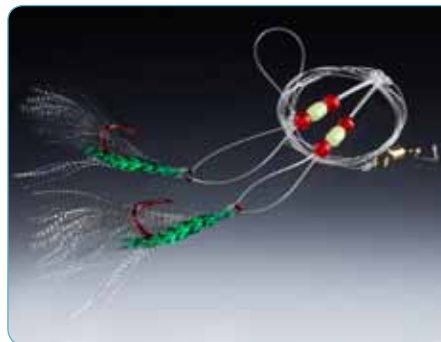
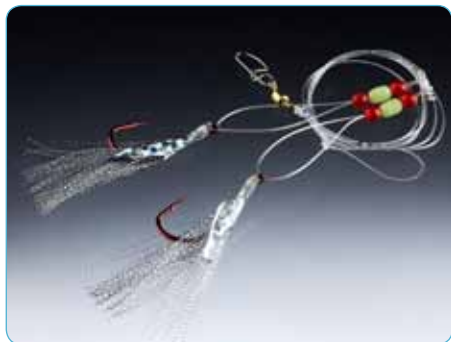

Item-No.	Order-No.	Color	Hooks	Length cm	Line Ø mm
148160	/001	silver	7/0	105	0.90
	/002	blue	7/0	105	0.90
	/003	green	7/0	105	0.90
	/004	red	7/0	105	0.90

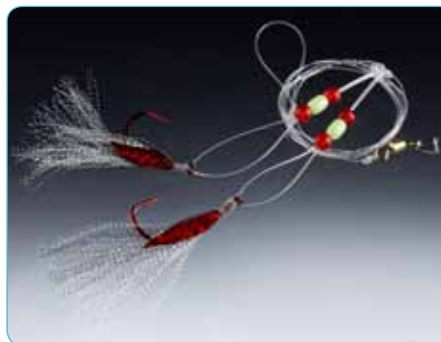

GLITTER RIG

This rig is ideal for target fishing for large coalfish and cod. With extra strong hooks.



Item-No.	Order-No.	Color	Hooks	Length cm	Line Ø mm
148160	/600	pink	6/0	105	0.80
	/601	blue	6/0	105	0.80



COALFISH RIG

Especially developed for fishing for coalfish in south and middle of Norway.



Item-No.	Order-No.	Color	Hooks	Length cm	Line Ø mm
148160	/700	pink	3/0	155	0.70
	/701	blue	3/0	155	0.70



FLASH RIG

Very successful system for catching cod and coalfish. The special flashing foil, combined with the glittery threads make this leader so luring.



Item-No.	Order-No.	Hooks	Length cm	Line Ø mm
148160	/500	6/0	155	0.90

PILK RIG EXTRA STRONG

Extra-strong pilking rig for Norway and the Yellow Reef.

Line diameter: 1.00 mm, side arms made of steel.

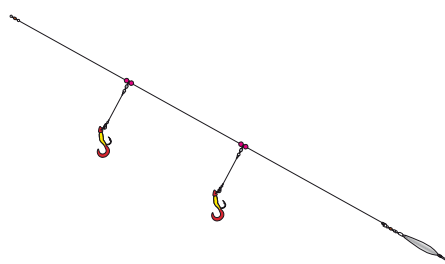

Item-No.	Order-No.	Arms	Length cm	Line Ø mm
148250	/019	1	80	1.00
	/020	2	80	1.00

71° North

BIG COD RIG



This system is designed entirely for catching capital cod. Biggest cod during the test phase: 48 lbs!



Item-No.	Order-No.	Hooks	Length cm	Line Ø mm
148260	/500	9/0	140	1.00



COD AND COALFISH SYSTEM WITH GENUINE FISH SKIN



Quasi the XXL version of the classic herring leader. Has proved super for catching cod, coalfish and pollack.



Item-No.	Order-No.	Hooks	Length cm	Line Ø mm
148260	/450	5/0	140	0.7/0.6
	/470	7/0	140	0.9/0.8

SPECIAL NATURAL BAIT RIG FOR OCEAN PERCH



The hooks are baited with small bits of coalfish or herring. A heavy lead is hung onto the end. The entire assembly is then lowered to the bottom and can be gradually brought up in sections, since the ocean perch are often to be found at a medium depth and not at the bottom. If you sense a bite, leave the leader at the depth where the ocean perch is lurking, because that is where the rest of the swarm is to be found.

Tip: With the aid of the swivels you can combine two rigs, to double the chances of success.

Item-No.	Order-No.	Hooks	Length cm	Line Ø mm
148220	/000	6/0	300	0.80



SIEGMAR MEISELE RIG



Very efficient cod leader, though all other salt-water fish like to take this bait. It is important when fishing with this leader to fish actively.



Item-No.	Order-No.	Hooks	Length cm	Line Ø mm
148220	/102	4/0	160	0.80

BIG COD RIG

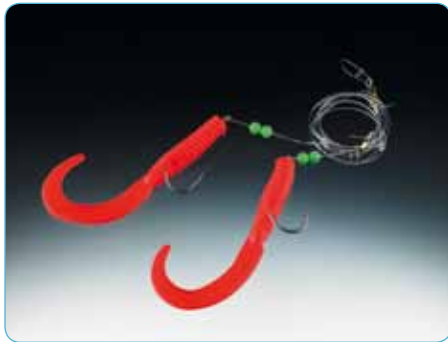

Very good catching rig for large cod. And large saithe can also be outwitted.



Item-No.	Order-No.	Hooks	Color	Length cm	Line Ø mm
148250	/010	4/0	red	140	0.90
	/011	4/0	red/black	140	0.90



TWIRLY TAIL RIG

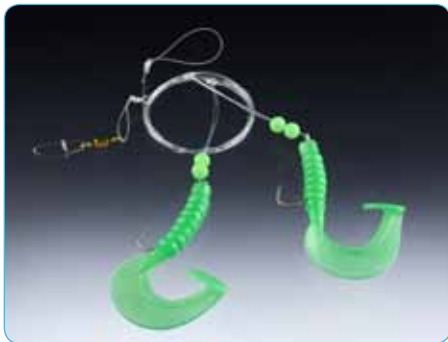

The tail is a mixture of a twister and a shad fish. It plays fantastic in the water and is a bank in difficult situations for cod, coalfish and haddock.

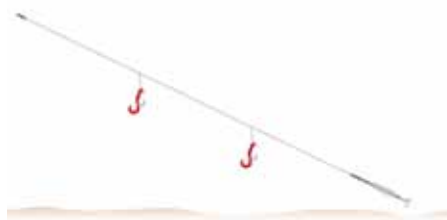

Item-No.	Order-No.	Hooks	Color	Length cm	Line Ø mm
148160	/010	5/0	luminous	130	0.80
	/011	5/0	japanred	130	0.80



71° North

COD SPOON RIG



Most Norway travellers are familiar with this rig. And innumerable cod have fallen prey to it. A real classic that should not be missing from any tackle box.



Item-No.	Order-No.	Hooks	Length cm	Line Ø mm
148250	/000	4/0	210	0.80

COD SPOON



Item-No.	Order-No.	Hooks	Length cm	Line Ø mm
148250	/001	4/0	-	-



MULTIPURPOSE PATERNOSTER



Whether for mackerel, whiting or coalfish, this rig is a real all-rounder and should be taken along on all Norway trips.



Item-No.	Order-No.	Hooks	Length cm	Line Ø mm
148250	/004	4/0	120	0.80

MACKEREL AND WHITING RIG



I can't tell you how many mackerel, whiting and even coalfish I have already caught with this rig. It is my number 1 choice if I need a couple of »baitfish« or a few fish for the frying pan in a hurry.



Item-No.	Order-No.	Hooks	Length cm	Line Ø mm
148250	/005	4/0	170	0.80

COALFISH/BIG MACKEREL RIG



This rig has especially proved its worth in the summer fishing for big mackerel and coalfish. Here too, you must start to fish actively until the swarm is detected.



Item-No.	Order-No.	Hooks	Length cm	Line Ø mm	
148250	/003	4/0	170	0.80	

COALFISH, BIG MACKEREL SYSTEM WITH CIRCLE HOOK



The same system as 148250/003 but with circle hooks. Never strike with circle hooks, simply exercise a light pull – the hook rotates itself into the fish mouth and remains securely fixed.



Item-No.	Order-No.	Hooks	Length cm	Line Ø mm	
147920	/088	4/0	170	0.80	

SPECIAL COALFISH RIG



This rig is the top favourite for Norwegian anglers if they are targeting coalfish.



Item-No.	Order-No.	Hooks	Length cm	Line Ø mm	
148250	/002	4/0	180	0.80	

OKTOPUS RIG

The 5 octopuses with additional glittering pink threads is very good for catching cod, pollack and haddock. In summer it is also excellent for fat mackerel.



Item-No.	Order-No.	Hooks	Length cm	Line Ø mm	
148160	/400	3/0	155	0.80	



ANTI-CRASH SOFT PEARL

There is nothing worse than when you are slightly inattentive when winding up and your swivel lands in the top guide, thus damaging the guide inlay. This is why you always should install an extremely soft pearl upstream from the swivel.

Item-No.	Order-No.	Farbe	Ø mm
148270	/005	black	8
	/006	black	10
	/105	red	8
	/106	red	10

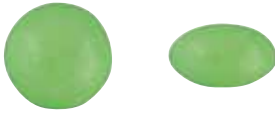

FLUO PEARLS

Luminous pearls with an extra large hole suitable for lines thicker than 1.00 mm.

Item-No.	Order-No.	Form
148270	/010	round
	/011	oval



ANTI TANGLE BOOM

Anti-tangle boom made from brass for building your own rigs.

Item-No.	Order-No.	Size
148270	/008	Small
	/108	Large

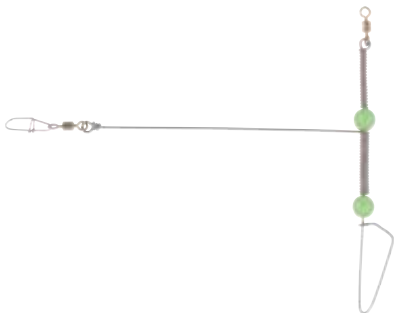

SPECIAL ANTI-TANGLE BOOM, EXTRA-STRONG

Super-strong anti-tangle boom made from rustproof steel for building your own rigs.

Item-No.	Order-No.
148270	/007



RUST-PROOF ULTRA-STRONG SPLIT RINGS

Rust-proof split rings with gigantic load-bearing capacities. A must for to catch the real capital fish. Contents: 10 pieces.

Item-No.	Order-No.	Ø mm	Bearing cap. kg
148310	/000	13	145
	/001	17	175



SPECIAL NATURAL BAIT HOOKS

Super-sharp natural bait hook made from saltwater-resistant Tiger steel.

Item-No.	Order-No.	Hooks
148280	/000	6/0
	/001	8/0
	/002	10/0



SPECIAL CIRCLE HOOK

The new circle shape makes it penetrate the fish mouth better than any conventional circle hook.

Item-No.	Order-No.	Hooks
148290	/000	6/0
	/001	8/0
	/002	10/0



HOOK PROTECTOR FOR TREBLE HOOKS

Item-No.	Order-No.	Size
174800	/000	Large
	/005	extra-large



Length: 100 cm

FLUORESCENT TUBE

Item-No.	Order-No.	Size
148270	/009	4 mm
	/109	2 mm

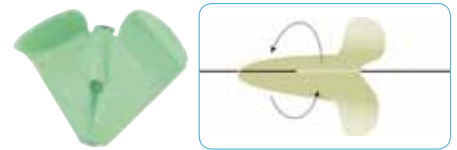

HELICOPTER XXL, LUMINOUS

The helicopter made from rustproof brass. Scope of supply includes U-joints and rotating pearls.

Item-No.	Order-No.
148270	/013

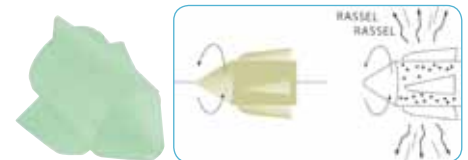

FLUO SPIN'N RATTLE

This self-illuminating rattle is drawn onto the line like a sliding float. The rotors are picked up by the current and makes the rattle turn. The steel balls create a »hell of a noise«, stimulating the side stripes of the predator fish.

Item-No.	Order-No.	Hooks	Length cm	Line Ø mm
148270	/014	-	-	-

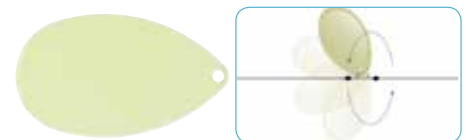

SPINNER FIN XXL

Luminous spinner blade made from rustproof brass. Scope of supply includes U-joints and rotating pearls.

Item-No.	Order-No.
148270	/012

FLUORESCENT RISING EGG-SHAPED FLOAT



For building your own natural bait rigs. Indispensable where the bottom is overhung by rocks and such like, or if little sharks or lumpfish are stationary at the bottom, because the rising tendency holds the bait above the bottom. The high tech material ensures that the egg remains undamaged even at a depth of 300 m.

Item-No.	Order-No.	Hooks	Length cm	Line Ø mm
148270	/000	-	-	-

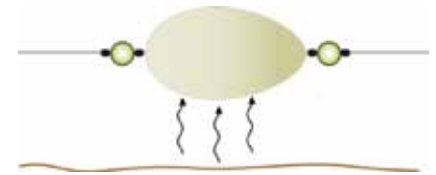

FLASHLIGHT I AND II



A



B

Light = catch! Nowhere does this rule apply more than in the depths of the sea. Below approximately 100m it is completely dark and the predators react to the tiniest source of light. The flashlight can be threaded on the line like a sliding lead and immediately emanates automatic light flashes when it comes into contact with water. The special prismatic glass increases the intensity to 30m under water! **Flash lasts up to 200 hours.**

Item-No.	Order-No.	Colour	Length cm	
148270	/001	fluo yellow	7	A
	/016	fluo yellow	4	B

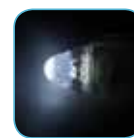

CHEMICAL LIGHT HOLDER



I have seen the most outrageous attempt by customers to fasten a chemical light to the leader. Without doubt a chemical light enhances the prospects of a catch. I have developed a chemical light holder with Balzer that can be mounted absolutely firmly on the line without damaging it. Just great!

Item-No.	Order-No.	Hooks	Length cm	Line Ø mm
148270	/002	-	-	-

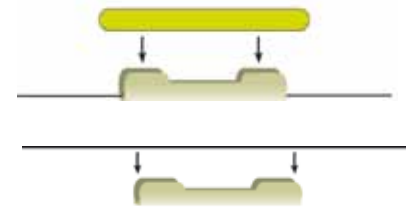

FEEDER BAG



Fill the feeder bag with fish innards and/or chopped pieces of fish and hook it into the swivel together with the lead. During test fishing the rod with the feeder bag almost always brought in more fish than the one without.

Item-No.	Order-No.	Hooks	Length cm	Line Ø mm
148270	/003	-	-	-

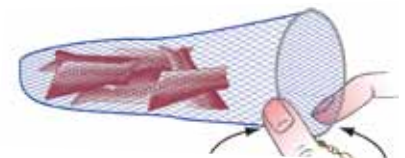

REUSABLE NATURAL BAIT TIES



Many ready-made natural bait systems possess a wire for fixing on the bait fillet but these wire breaks after being used a few times. Simple cable tie for fixing the bait has the disadvantage that it is too thick and, above all, it can only be used once. Our fine, reusable bait tie that can be used over and over again and holds the bait securely on the hook.

Item-No.	Order-No.	Hooks	Length cm	Line Ø mm
148270	/004	-	-	-



Edition 71 Grad Nord SPEZI

Edition 71° NORTH SPEZI



Targeted fishing brings more success!

SPEZI natural bait rigs are precisely tailored to the respective target fish and anglers who tunes their equipment accurately formed for target fish also have more success!

Benefit from years of experience of Balzer Norway team anglers, such as Steffen Dietze. All their experience and tricks stuck in these rigs.

Only high-quality components such as Japanese high performance line, safety swivels and hooks are used.

OCEAN PERCH RIG 10+1



This 17m(!) long system with 10+1(!) hooks really picks up all the ocean perch. Ocean perch do not hover directly at the bottom, but at up to 20 m above it. To make sure that you don't fish at the wrong depth, you need a leader which is long enough. The hooks are garnished with bits of fish. The bottom hook is extra large and is fished with a large piece of fish because ling and lumpfish are often not far away. Supplied with a winder.

Item-No.	Order-No.	Hooks	Length m	Line Ø mm
148000	/000	10x6/0 1x10/0	17	1.20



OCEAN PERCH RIG 5+1



The shorter version in 9m with 5+1 hooks. Ocean perch do not hover directly at the bottom, but at up to 20 m above it. To make sure that you don't fish at the wrong depth, you need a leader which is long enough. The hooks are garnished with bits of fish. The bottom hook is extra large and is fished with a large piece of fish because ling and lumpfish are often not far away. Supplied with a winder.

Item-No.	Order-No.	Hooks	Length m	Line Ø mm
148000	/100	5x6/0 1x10/0	10	1.20

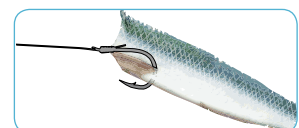

HALIBUT RIG



TIPP

Special drift rig for fishing with dead baitfish on Halibut. Connect the single hook in the mouth of the dead bait fish and the treble hook in the back. The lead is placed near the bottom, now it can drift with the boat. The shape of the front of the lead is formed like a diving lip of a hard bait. This lead is maintained even with heavy flow on the base and does not drift into the middle water as conventional sinkers.

Item-No.	Order-No.	Hooks	Length cm	Line Ø mm	Weight g
148000	/300	1x8/0 1x8/0	140	1.20	
	/400	1x8/0 1x8/0	140	1.20	

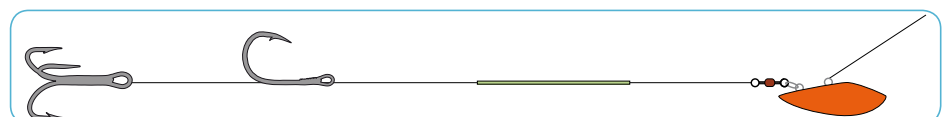



COD AND HADDOCK RIG



The allrounder which every angler should have in his tackle. This assembly enables you to fish successful easily for almost all species of fish in Norway.

Item-No.	Order-No.	Hooks	Length cm	Line Ø mm
148000	/003	2x8/0	200	1.00

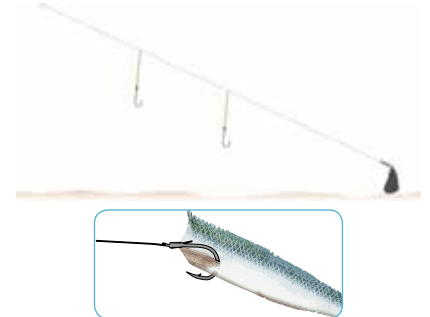

WOLF FISH RIG



Developed especially for fishing for wolf fish. Equipped with extremely sharp hooks to make sure the hook holds securely in the hard fish mouth. The silicone sheaths protect the lines against the teeth.

Item-No.	Order-No.	Hooks	Length cm	Line Ø mm
148000	/004	2x6/0	150	0.90

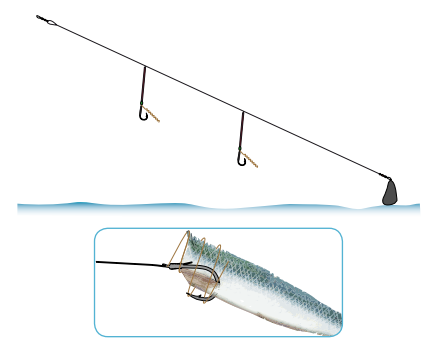

RIG FOR LING AND LUMB



Ling and lumb are usually not far apart. So you should make this circumstance to your advantage. At the upper hook comes a half fish, which is intended for Lumbs. Since it is not directly on the ground the bait will be discovered soon by small lumbs. At the lower double hook system comes a whole baitfish for the bigger Lings.

Item-No.	Order-No.	Size	Hooks	Length cm	Line Ø mm
148000	/005	medium	8/0	190	1.00

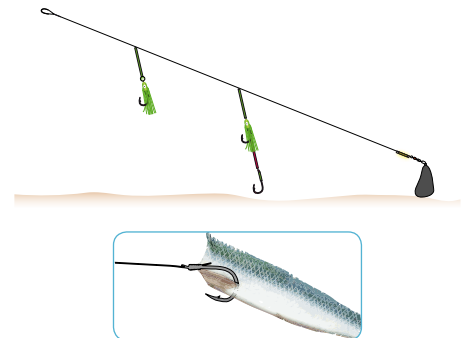

HAKE RIG

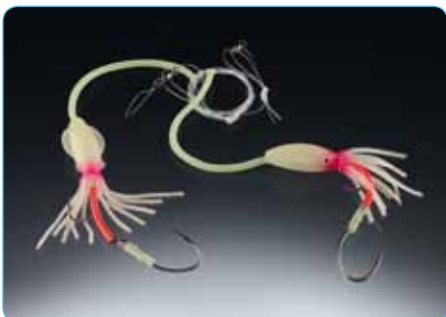

Special rig for fishing for capricious hake. In view of the fact that hake often bite cautiously, a double-hook system is imperative. The hook is baited with small bits of fish.

Item-No.	Order-No.	Hooks	Length cm	Line Ø mm
148000	/002	2x6/0 2x2/0	165	0.90

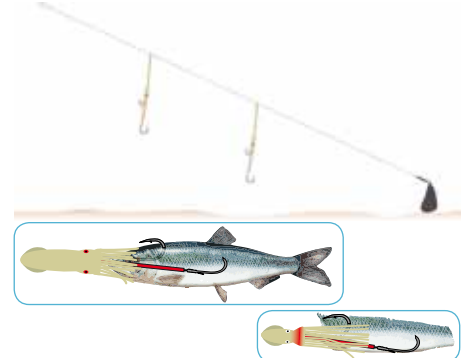

EDITION SEA HERRING

Wide variety of herring systems so that you are perfectly equipped for all kinds of situations. The Micro Herrings rigs are extremely good catching qualities in cold water. With genuine fish skin.



HOOK SIZE 14
REAL FISH SKIN

MICRO HERRINGS RIG I					
Item-No.	Order-No.	Hooks	Length cm	Line Ø mm	
147920	/100	5	135	0.30/0.20	
	/101	2	75	0.30/0.20	



HOOK SIZE 14
REAL FISH SKIN

MICRO HERRINGS RIG II					
Item-No.	Order-No.	Hooks	Length cm	Line Ø mm	
147920	/102	2	150	0.30/0.20	
	/103	5	150	0.30/0.20	



HOOK SIZE 14

MICRO HERRINGS RIG III FLUO					
Item-No.	Order-No.	Hooks	Length cm	Line Ø mm	
147920	/104	2	75	0.30/0.20	
	/105	5	135	0.30/0.20	



MINI SHRIMP RIG					
Item-No.	Order-No.	Hooks	Length cm	Line Ø mm	
147920	/051	5x3	130	0.45/0.45	



MINI SHRIMP RIG					
Item-No.	Order-No.	Hooks	Length cm	Line Ø mm	
147920	/050	5x3	130	0.45/0.45	



REAL FISH SKIN

HERRINGS RIG					
Item-No.	Order-No.	Hooks	Length cm	Line Ø mm	
147920	/090	2	80	0.40/0.30	
	/091	5	150	0.40/0.30	



REAL FISH SKIN
VERY STRONG

PILK-/HERRINGS RIG					
Item-No.	Order-No.	Hooks	Length cm	Line Ø mm	
147920	/092	5	120	0.60/0.45	

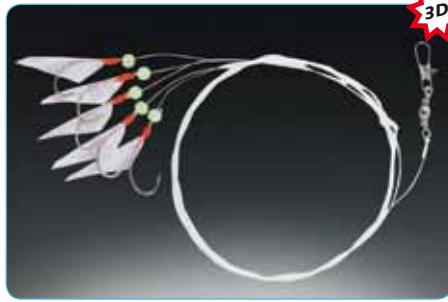

3D

3D-HERRINGS RIG					
Item-No.	Order-No.	Hooks	Length cm	Line Ø mm	
147920	/093	5	125	0.40/0.30	
	/094	2	70	0.40/0.30	



REAL FISH SKIN

FLUO HERRINGS RIG					
Item-No.	Order-No.	Hooks	Length cm	Line Ø mm	
147920	/096	2	80	0.40/0.30	
	/095	5	150	0.40/0.30	



REAL FISH SKIN

HERRINGS RIG SPECIAL					
Item-No.	Order-No.	Hooks	Length cm	Line Ø mm	
147920	/099	5	135	0.40/0.30	



WITH CIRCLE HOOKS

HERRINGS RIG WITH CIRCLE HOOK					
Item-No.	Order-No.	Hooks	Length cm	Line Ø mm	
147920	/097	2	80	0.40/0.30	
	/098	5	150	0.40/0.30	

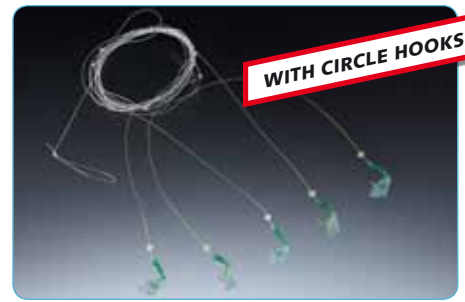

WITH CIRCLE HOOKS

FLUO HERRINGS RIG WITH CIRCLE HOOKS					
Item-No.	Order-No.	Hooks	Length cm	Line Ø mm	
147920	/106	2	75	0.40/0.30	
	/107	5	135	0.40/0.30	

EDITION SEA MACKEREL

Very good systems for catching mackerel. All leaders are equipped with swivels, onto which you can hang perks or lead.



MACKEREL PATERNOSTER

Item-No.	Order-No.	Hooks	Length cm	Line Ø mm
147920	/089	5	145	0.55/0.40



MACKEREL PATERNOSTER

Item-No.	Order-No.	Hooks	Length cm	Line Ø mm
147550	/000	5	180	0.60/0.40
	/001	5	180	0.60/0.40



147550/001 = pink
147550/002 = green
147550/003 = yellow
147550/000 = white



MACKEREL PATERNOSTER

Item-No.	Order-No.	Hooks	Length cm	Line Ø mm
147410	/005	5	145	0.55/0.40



3D MACKEREL PATERNOSTER

Item-No.	Order-No.	Hooks	Length cm	Line Ø mm
147410	/006	5	145	0.55/0.40



MACKEREL PATERNOSTER

Item-No.	Order-No.	Hooks	Length cm	Line Ø mm
147410	/007	5	145	0.55/0.40

EDITION SEA PILK

Pilking systems developed according to the most recent fishing techniques. For example, we use fast-exchange beads, sliding paternoster swivels etc.



PILK RIG

Item-No.	Order-No.	Hooks	Length cm	Line Ø mm
147920	/061	1	95	0.70/0.60
	/062	2	125	0.70/0.60



PILK RIG

Item-No.	Order-No.	Hooks	Length cm	Line Ø mm
147320	/007	1	45	0.60
	/008	2	75	0.60



PILK RIG

Item-No.	Order-No.	Hooks	Length cm	Tensile strength kg
147920	/082	1	80	25
	/083	2	120	25

Edition Sea Pilk

EDITION SEA PILK



OCTOPUS MULTICOLOR, LOOSE

Item-No.	Order-No.	Size cm
137510	/004	4
	/009	9
	/012	12



OCTOPUS BLUE/PINK, LOOSE

Item-No.	Order-No.	Size cm
137510	/104	4
	/109	9
	/112	12



OCTOPUS LUMINOUS, LOOSE

Item-No.	Order-No.	Size cm
137510	/204	4
	/209	9
	/212	12



OCTOPUS JAPANRED, LOOSE

Item-No.	Order-No.	Size cm
137510	/304	4
	/309	9
	/312	12

EDITION SEA PILK

Pilk rigs with 1 or 2 arms in attractive colors.

Twister size: 8cm, Hook size: 2/0

Jighead weight: 4g



PILK RIG 1 x /2 x BLACK-JAPANRED

Item-No.	Order-No.	Hooks	Length cm	Line Ø mm
147920	/056	1	90	0.60/0.45
	/156	2	100	0.60/0.45



PILK RIG 1 x /2 x PINK

Item-No.	Order-No.	Hooks	Length cm	Line Ø mm
147920	/059	1	90	0.60/0.45
	/159	2	100	0.60/0.45



PILK RIG 1 x JAPAN RED /2 x JAPAN RED

Item-No.	Order-No.	Hooks	Length cm	Line Ø mm
147920	/052	1	90	0.60/0.45
	/053	2	100	0.60/0.45



PILK RIG 1 x /2 x BLUE-JAPANRED

Item-No.	Order-No.	Hooks	Length cm	Line Ø mm
147920	/057	1	90	0.60/0.45
	/157	2	100	0.60/0.45



PILK RIG 1 x JAPAN RED 1 x BLACK

Item-No.	Order-No.	Hooks	Length cm	Line Ø mm
147920	/055	2	100	0.60/0.45



PILK RIG 1 x /2 x BROWN-GLITTER

Item-No.	Order-No.	Hooks	Length cm	Line Ø mm
147920	/058	1	90	0.60/0.45
	/158	2	100	0.60/0.45

WONDERTAIL – COD TWISTER

The tail with four sits. The slightly harder rubber mixture also stands up to frequent attacks by cod. The body has a special channel to make it easy to draw onto the hook.



WONDERTAIL – COD TWISTER

Item-No.	Order-No.	Length cm	Color
147320	/060	8	japan red
	/061	8	black
	/063	8	japan red/black

WONDERTAIL – COD TWISTER WITH JIGHEAD

With Jighead in 4g, hook size: 2/0



WONDERTAIL – COD TWISTER WITH JIGHEAD

Item-No.	Order-No.	Length cm weight g	Color
147320	/070	8cm / 4g	japan red
	/071	8cm / 4g	black
	/073	8cm / 4g	japan red/black

50 JAPANRED TWISTER, 7 CM, LOOSE



50 JAPANRED TWISTER, 7 CM, LOOSE

Item-No.	Order-No.
147320	/050

COD ROCKET

Very catchy combination of moving lead-head and wondertail twister. The Oval shaped form is ideal for casting.



COD ROCKET, OLIVE-SHAPED

Item-No.	Order-No.	weight g Length cm	Color
138710	/050	50/7	japan red
	/075	75/7	japan red
	/100	100/7	japan red
	/051	50/7	japan red/black
	/076	75/7	japan red/black
	/101	100/7	japan red/black

DORSCH TWISTER WONDERTAIL PILKSYSTEM

Our wondertails now also as pilk-system with 1 or 2 arms.

Twister size: 8 cm

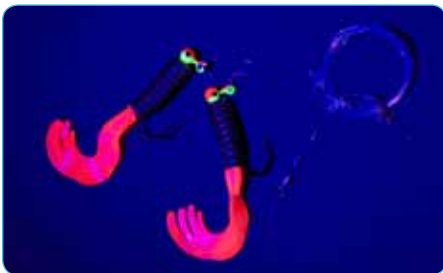

High visibility unter UV-light



JAPANRED				
Item-No.	Order-No.	Length cm	Line ø mm	
147320	/080	90	0.60/0.45	

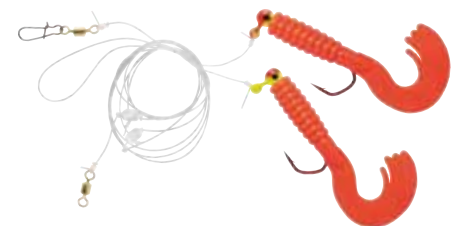

JAPANRED				
Item-No.	Order-No.	Length cm	Line ø mm	
147320	/090	100	0.60/0.45	



JAPANRED-BLACK				
Item-No.	Order-No.	Length cm	Line ø mm	
147320	/082	90	0.60/0.45	

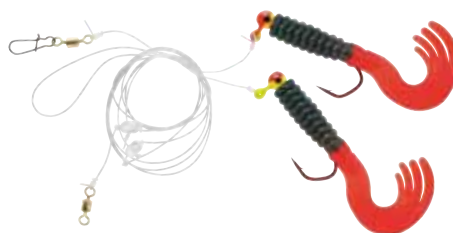

JAPANRED-BLACK				
Item-No.	Order-No.	Length cm	Line ø mm	
147320	/092	100	0.60/0.45	

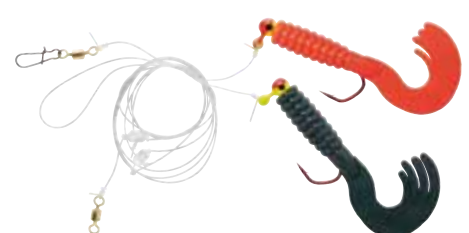

JAPANRED-BLACK				
Item-No.	Order-No.	Length cm	Line ø mm	
147320	/093	100	0.60/0.45	

Edition Sea

FLATFISH SPOON

Is used for fishing in combination with a leader with natural bait (e.g. lugworm). In this case the flatfish spoon is tugged over the bottom like a rubber fish and soon arouses flatfishes.



ORANGE

Item-No.	Order-No.	weight g
147320	/401	40
	/601	60
	/801	80



YELLOW

Item-No.	Order-No.	weight g
147320	/402	40
	/602	60
	/802	80



ORANGE-YELLOW

Item-No.	Order-No.	weight g
147320	/403	40
	/603	60
	/803	80



WHITE

Item-No.	Order-No.	weight g
147320	/404	40
	/604	60
	/804	80



WHITE WITH RED SPOTS

Item-No.	Order-No.	weight g
147320	/405	40
	/605	60
	/805	80

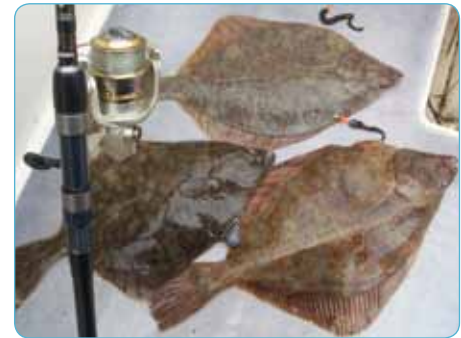

FLATFISH SPOON STARTER SET

Starter Set with 60 g flatfish spoon and 2 rigs on practical rewinder.



FLATFISH SPOON STARTER SET - 60G

Item-No.	Order-No.	Hooks	Length cm	Ø mm
147320	/000	1 x 1	35	0.40



FLATFISH SPOON RIGS

Perfect fitting rigs for fishing with our flatfish spoons.



FLATFISH SPOON RIG, YELLOW

Item-No.	Order-No.	Hooks	Length cm	Ø mm
147330	/000	1 x 1	35	0.40



FLATFISH SPOON RIG, ORANGE

Item-No.	Order-No.	Hooks	Length cm	Ø mm
147330	/001	1 x 1	35	0.40



FLATFISH SPOON RIG, WHITE

Item-No.	Order-No.	Hooks	Length cm	Ø mm
147330	/002	1 x 1	35	0.40

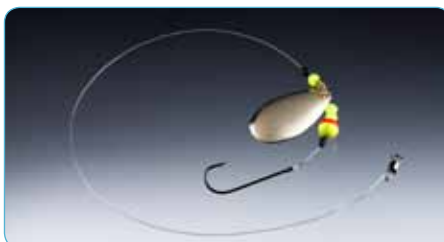

FLATFISH SPOON BLADE RIG

Item-No.	Order-No.	Hooks	Length cm	Ø mm
147330	/100	1 x 1	35	0.40



FLATFISH SPOON RIG, MOTHER OF PEARL

Item-No.	Order-No.	Hooks	Length cm	Ø mm
147330	/003	1 x 1	35	0.40



FLATFISH SPOON RIG, FLUO

Item-No.	Order-No.	Hooks	Length cm	Ø mm
147330	/004	1 x 1	35	0.40

EDITION SEA SURF RIGS

First-class rigs for fishing with natural baits from the shore or small boat.
The program includes rigs for surf fishing, fishing from piers and harbors and for boat fishing.

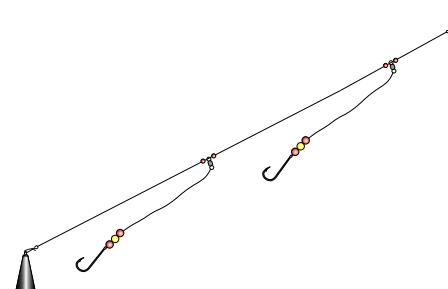
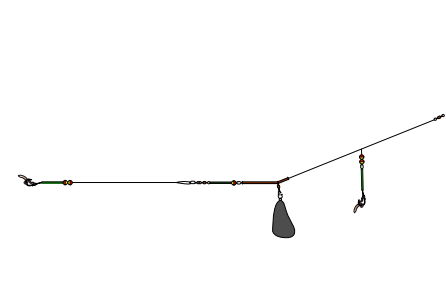
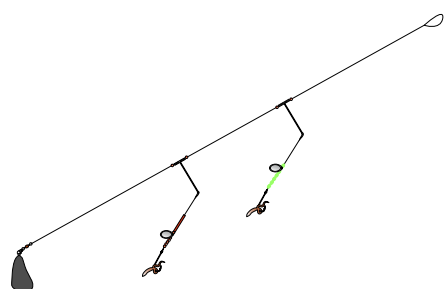
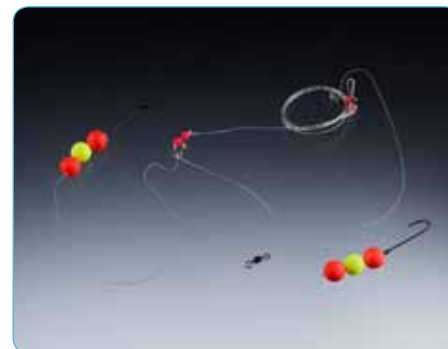
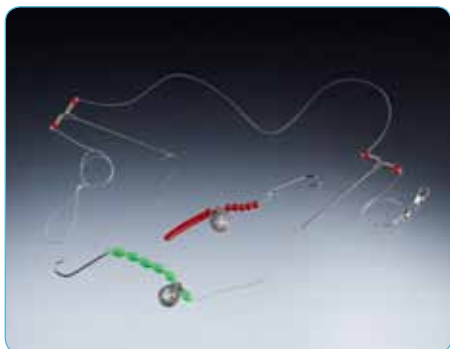

NATURAL BAIT RIG

Item-No.	Order-No.	Hooks	Length cm	Line Ø mm	
147990	/000	2 x 1	85	0.60/0.40	

NATURAL BAIT RIG

Item-No.	Order-No.	Hooks	Length cm	Line Ø mm	
147990	/001	2 x 1	95	0.60/0.40	

SURFCASTING RIG

Item-No.	Order-No.	Hooks	Length cm	Line Ø mm	
147990	/002	2 x 1	80	0.60/0.40	

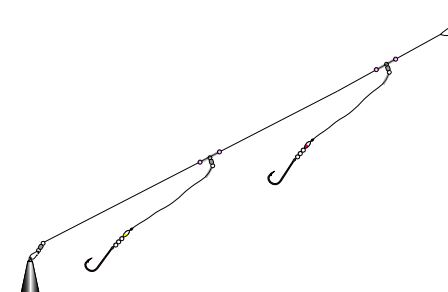
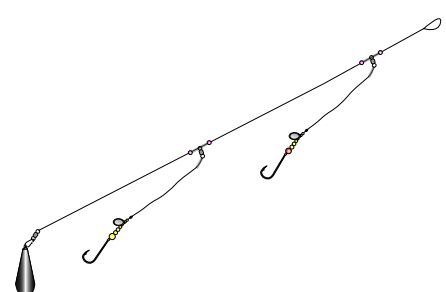
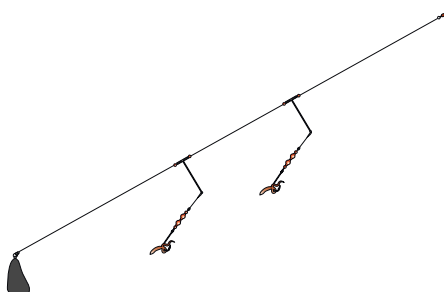
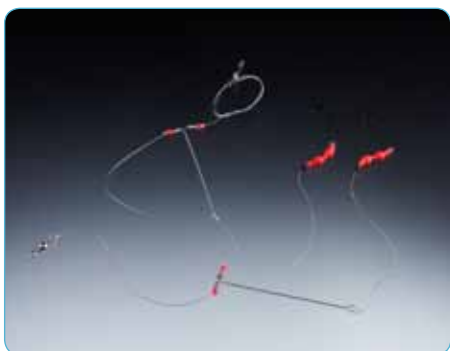

NATURAL BAIT RIG

Item-No.	Order-No.	Hooks	Length cm	Line Ø mm	
147990	/003	2 x 1	60	0.60/0.40	

SURFCASTING RIG

Item-No.	Order-No.	Hooks	Length cm	Line Ø mm	
147990	/004	2 x 1	120	0.60/0.35	

SURFCASTING RIG

Item-No.	Order-No.	Hooks	Length cm	Line Ø mm	
147990	/005	2 x 1	160	0.60/0.35	

Edition Sea Surf

EDITION SEA LEADERS

Excellent surfcasting rigs, snelled on japanese hightech monofilament.

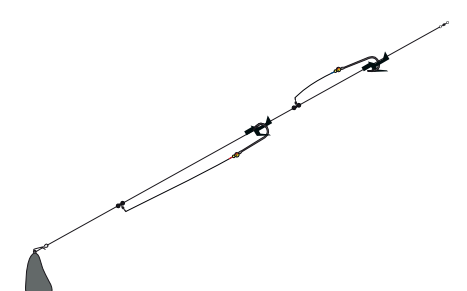
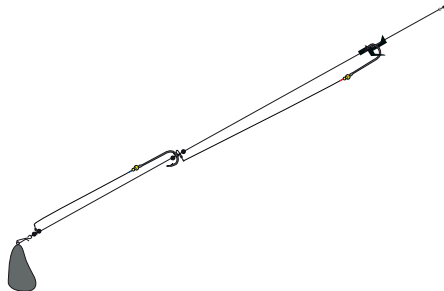
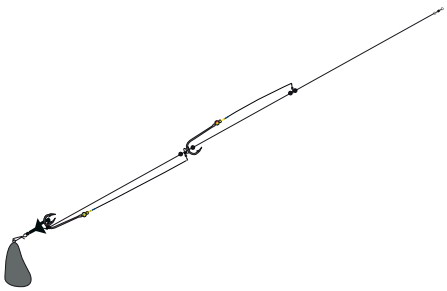
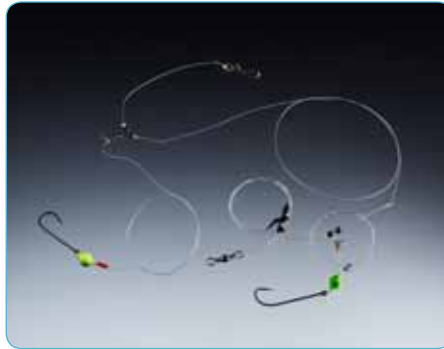

NATURAL BAIT RIG

Item-No.	Order-No.	Hooks	Length cm	Line Ø mm
147990	/006	2 x 1	100	0.60/0.40

NATURAL BAIT RIG

Item-No.	Order-No.	Hooks	Length cm	Line Ø mm
147990	/008	2 x 1	120	0.60/0.40

NATURAL BAIT RIG

Item-No.	Order-No.	Hooks	Length cm	Line Ø mm
147990	/009	2 x 1	120	0.70/0.40

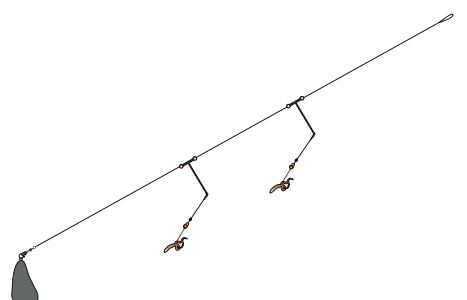
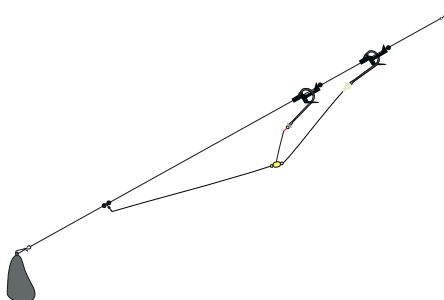
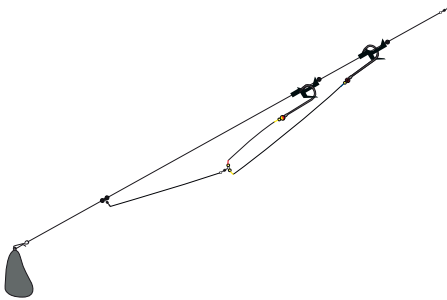

NATURAL BAIT RIG

Item-No.	Order-No.	Hooks	Length cm	Line Ø mm
147990	/010	2 x 1	90	0.60/0.40

NATURAL BAIT RIG

Item-No.	Order-No.	Hooks	Length cm	Line Ø mm
147990	/011	2 x 1	100	0.70/0.40

NATURAL BAIT RIG

Item-No.	Order-No.	Hooks	Length cm	Line Ø mm
147990	/012	2 x 1	125	0.60/0.40

EDITION SEA LEADERS

Excellent surfcasting rigs, snelled on japanese hightech monofilament.

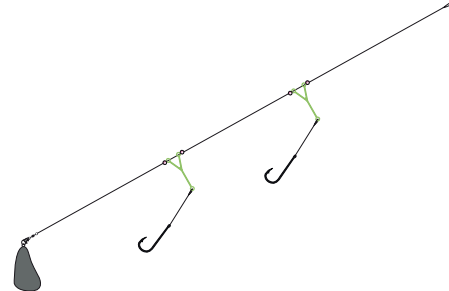
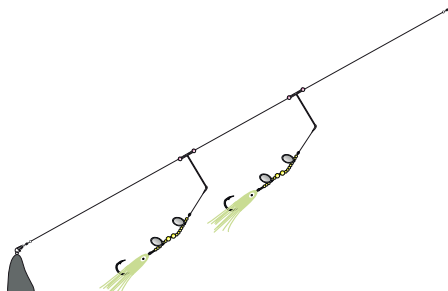
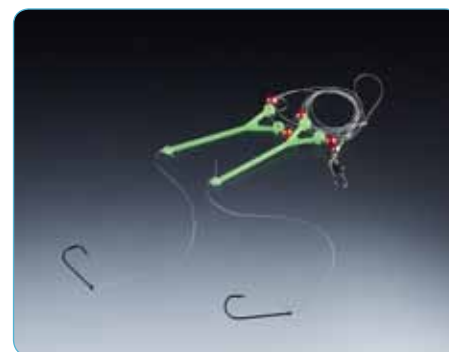

NATURAL BAIT RIG

Item-No.	Order-No.	Hooks	Length cm	Line Ø mm
147990	/013	2 x 1	115	0.60/0.40

NATURAL BAIT RIG

Item-No.	Order-No.	Hooks	Length cm	Line Ø mm
147990	/014	2 x 1	100	0.60/0.50

NATURAL BAIT RIG

Item-No.	Order-No.	Hooks	Length cm	Line Ø mm
147990	/015	2 x 1	95	0.50/0.50

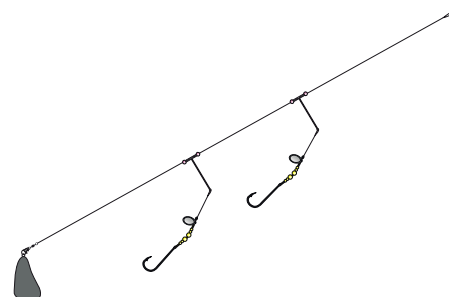
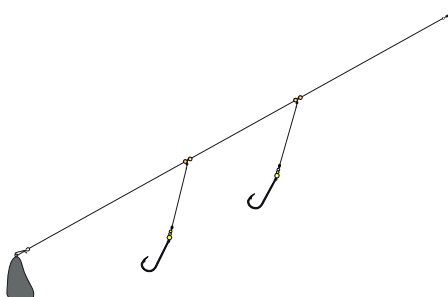
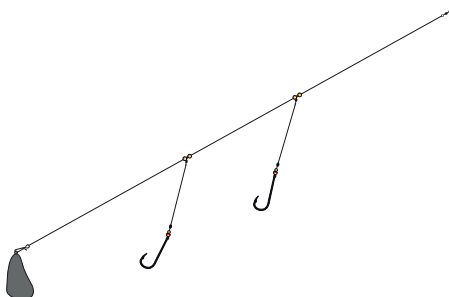

NATURAL BAIT RIG

Item-No.	Order-No.	Hooks	Length cm	Line Ø mm
147990	/016	2 x 1	90	0.60/0.40

NATURAL BAIT RIG

Item-No.	Order-No.	Hooks	Length cm	Line Ø mm
147990	/017	2 x 1	90	0.60/0.40

NATURAL BAIT RIG

Item-No.	Order-No.	Hooks	Length cm	Line Ø mm
147990	/018	2 x 1	125	0.60/0.40

Edition Sea

EDITION SEA: SEA TACKLE

Useful accessories for all anglers, who want to construct their own systems or in order to refine existing leaders individually.



FLATFISH BLADES WITH EYE

Item-No.	Order-No.	Cont.	Length cm	Colour
147320	/022	5	2.2	silver
	/023	5	2.2	gold
	/042	5	2.2	fluo-yellow
	/043	5	2.2	fluo-orange
	/122	5	3.2	silver
	/123	5	3.2	gold
	/142	5	3.2	fluo-yellow
	/143	5	3.2	fluo-orange

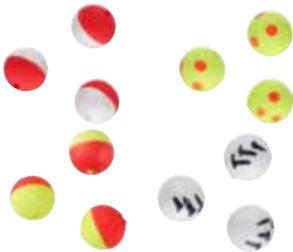

BEADS

Item-No.	Order-No.	Cont.	Color	Line Ø mm
147320	/044	10	White/red	10
	/045	10	Yellow/red spots	10
	/046	10	Yellow/red	10
	/047	10	White/black	10



BEADS

Item-No.	Order-No.	Cont.	Color	Line Ø mm
147320	/037	10	Fluo/yellow	10
	/038	10	Fluo/red	10
	/039	10	Fluo/orange	10

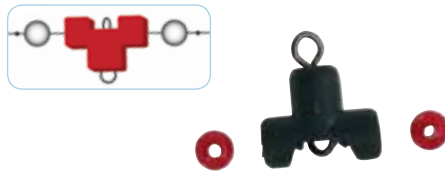

PATERNOSTER SWIVEL

Item-No.	Order-No.	Content
147320	/024	5 swivel + 10 pearls



RUBBER HOSE

Item-No.	Order-No.	Cont.	Length cm	color	Line Ø mm
147320	/032	1	100	fluo	5
	/040	1	100	red	5

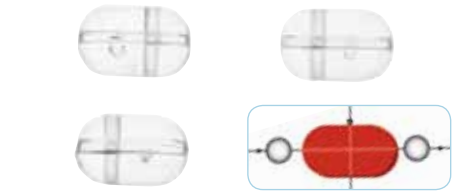

QUICK BEADS

Item-No.	Order-No.	Cont.	Size mm	Line Ø mm
147320	/025	5	5 x 8	-
	/026	5	7 x 10	-



LONG CAST CLIPS

Item-No.	Order-No.	Cont.	Length cm	Line Ø mm
147320	/034	5	-	-

BEADS, OVAL, FLUORESCENT

Item-No.	Order-No.	Cont.	Size	Line Ø mm
147320	/030	10	S A	-
	/031	10	L B	-



WIRE ARMS WITH BEADS

Item-No.	Order-No.	Cont.	Length cm	Line Ø mm
147320	/006	5 arms + 10 beads	6	0.60
	/035		8	0.80
	/036		12	1.20



LONG CAST SHIELDS

Item-No.	Order-No.	Cont.	Length cm	Line Ø mm
147320	/033	5	-	-

REFLECTING FOILS

Self-adhesive reflecting foil with extremely strong reflectivity. Size approx. 75 x 145 mm, 2 per packet.

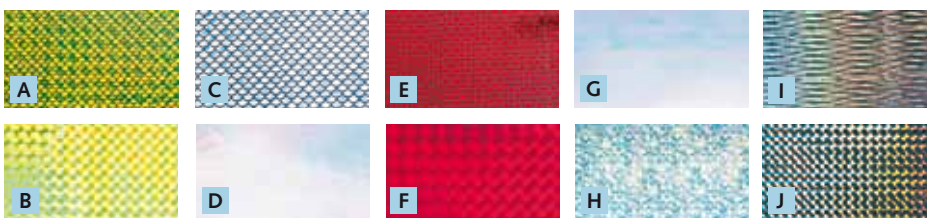

J FOIL »EYES«

Self-adhesive reflecting eyes. Approx. 200 pieces per packet.

TOP SELF-ADHESIVE REFLECTING FOILS

Item-No.	Order-No.	Colour
159400	/000	A yellow/shed
	/001	B yellow/waves
	/002	C silver/shed
	/003	D silver effect
	/004	E red/shed
	/005	F red/waves
	/006	G mother of pearl
	/007	H prism-effect
	/008	I silver Lines
	/009	J eyes



Blinker-ABONNIEREN:

**3 HEFTE FÜR
NUR 9,60€**

- ✓ Gratis ein Geschenk
- ✓ Sie sparen 35%
- ✓ Lieferung pünktlich & bequem nach Hause
- ✓ Kein Risiko: nach Laufzeit monatlich kündbar

GRATIS

Filettermesser

Extra scharf mit elastisch geschliffener 19 cm Klinge. Das Messer liegt Dank des rutschfesten Softgrip besonders gut in der Hand. Inkl. Kunststoffscheide

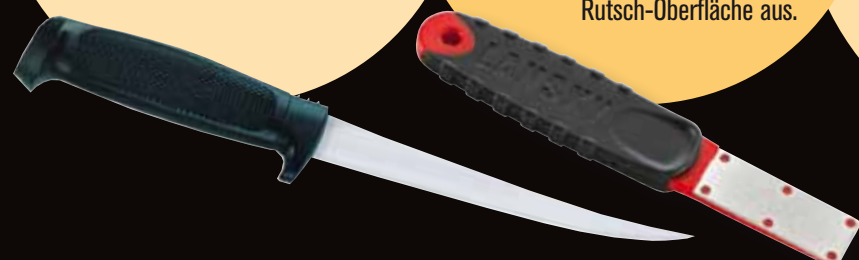

GRATIS

Messerschärfer

Dieser handliche Diamant-Schleifblock von Lansky stellt eine Schleiffläche von 2 x 5 cm mit grober (rot) Körnung bereit. Der Handgriff zeichnet sich durch eine mit Gummi beschichtete Anti-Rutsch-Oberfläche aus.

GRATIS

Blinker-Cap

Dieses schwarze Basecap aus 100% Baumwolle ist frontseitig mit dem Schriftzug „Team Blinker“ und rückseitig mit www.blinker.de bestickt.



BEQUEM TELEFONISCH ODER ONLINE BESTELLEN:

040-38 906 880* www.blinker.de/balzer

* Bitte die Aktions-Nr. 1368906 angeben

A photograph of a salmon swimming in a river. The water is clear and shows some ripples. A large, light blue, semi-transparent shape is overlaid on the left side of the image, containing the text. The salmon is positioned in the middle-right part of the frame, facing left.

FISHING METHODS

For the specialist



Specialists get the whole programme

On the following pages we are presenting to you the all-inclusive product ranges for selected angling methods that have been put together with care and expertise by our BALZER Expert Teams. They have been developed as the result of all the past and most recent experience of our specialists for the sole purpose of enabling you to pursue your passion with even greater success.

THE METHOD FEEDER RANGE BY MICHAEL ZAMMATARO!

Just as boilie fishing revolutionised carp fishing many years ago, for some time now Method Feeder fishing with mini boilies and pellets has been causing plenty of ripples in feeder fishing.

In collaboration with Willy Frosch Michael Zammatato has developed an innovative complete programme for successful Method Feeder fishing. Whether it be a rod, reel, accessories or feed, here you will find everything you need for successful Method Feeder fishing.

FOR MODERN TROUT FISHING – THE TROUT ATTACK SERIES

Under the name of TROUT ATTACK® the experienced trout professionals Willy Frosch and Tim Paasch have developed a top series for modern trout lake/lake trout fishing. Of course, it is impossible to reinvent the wheel and sbirolino and trawling floats are still among the successful methods. However, combined with our new innovative baits these techniques are far more successful! Also a small range of tremarella products complete the trout range.

JÖRG STREHLOW'S EDITION PIKE-PERCH

Jörg Strehlow, one of the famous pike-perch specialists in Germany, has developed a unique programme exclusively for us and we have completed it with his fantastic KAULI.

Excellent baits for jig, drop shot and vertical fishing are just waiting to put lots of predators on the planks for you. Special systems for fishing with a Carolina rig are also just waiting to be used.

EDITION CARP

We have developed a small range of accessories for modern carp fishing in close cooperation with our carp-fishing team.

EDITION LAVARET AND PERCH

A professional program with high quality standard and love of detail was developed in collaboration with Swiss experts.

Also in Germany fishing for lavaret becomes more and more popular especially in large dams.

Jörg Strehlow's Edition Pike-Perch



The original KAULI

The Kauli has a very filigree play. And secondly, the rubber is treated with fish oil, making it even more irresistible! This Kauli floats and they are suitable for both Lazybones fishing and for jigging; furthermore, they can also be used for angling according to American methods, for example for dropshot fishing or on a Texas and Carolina rig.



- Motor oil glitter:** For cloudy weather and cloudy waters.
- Blue-silver glitter:** For water with strong incident light, i.e. midday hours.
- Pearl - silver:** Especially in clear waters with a large population of orfes.
- White-blue-red:** It is a great choice for all situations and types of waters.
- Transparent silver-red:** Imitate a wounded fish perfectly.
- Transparent silver-pink:** a universal weapon for all situations.
- Yellow-silver:** For fishing in rivers, natural lakes and barrages.
- Blue-silver-red:** one of his most iconic Kaulis which is a classic.
- Mushroom:** Imitates perfectly an injured fish.
- Törtel:** With this color Jörg has caught more than a half of his pike-perches.

- Blau-Pinky:** A Kauli for clear and turbid waters
- Amber:** This color combination should be in every tackle box - unbeatable in large rivers and dams.
- Black-Red-Glitter:** Especially for fishing in the night.
- Orange:** For rising, muddy water, for dark places, or in the shadow
- Perch:** Perch belong to the bait fish that walleye, pike and even the own kind like to eat.
- Trout:** The decor of the rainbow trout attracts predators magically, maybe perhaps they are always on the move.



ORIGINAL KAULI 12 CM

Item No.	Order No.	Colour	Length cm
	/012	A Motoroil-Glitter	12
	/112	B Blue-Silver-Glitter	12
	/212	C Pearl-Silver	12
	/312	D White-Blue-Red	12
	/412	E Transp.-Silver-Red	12
	/512	F Transp.-Silver-Pink	12
	/612	G Yellow-Silver	12
	/712	H Blue-Silver-Red	12
	/812	I Mushroom	12
	/912	J Törtel	12
166030	/913	K Blue-Pinky	12
	/914	L Amber	12
	/921	M Black-Red-Glitter	12
	/924	N Perch	12
	/928	O Orange	12
	/932	P Trout	12

ORIGINAL KAULI 15 CM

Item No.	Order No.	Colour	Length cm
	/015	A Motoroil-Glitter	15
	/115	B Blue-Silver-Glitter	15
	/215	C Pearl-Silver	15
	/315	D White-Blue-Red	15
	/415	E Transp.-Silver-Red	15
	/515	F Transp.-Silver-Pink	15
	/615	G Yellow-Silver	15
	/715	H Blue-Silver-Red	15
	/815	I Mushroom	15
	/915	J Törtel	15
	/916	K Blue-Pinky	15
	/917	L Amber	15
	/918	M Black-Red-Glitter	15
	/925	N Perch	15
	/929	O Orange	15
	/933	P Trout	15

ORIGINAL KAULI 6 CM

Item No.	Order No.	Colour	Length cm
	/006	A Motoroil-Glitter	6
	/106	B Blue-Silver-Glitter	6
	/206	C Pearl-Silver	6
	/306	D White-Blue-Red	6
	/406	E Transp.-Silver-Red	6
	/506	F Transp.-Silver-Pink	6
	/606	G Yellow-Silver	6
	/706	H Blue-Silver-Red	6
	/806	I Mushroom	6
	/906	J Törtel	6
	/907	K Blue-Pinky	6
	/908	L Amber	6
	/919	M Black-Red-Glitter	6
	/922	N Perch	6
	/926	O Orange	6
	/930	P Trout	6

ORIGINAL KAULI 9 CM

Item No.	Order No.	Colour	Length cm
	/009	A Motoroil-Glitter	9
	/109	B Blue-Silver-Glitter	9
	/209	C Pearl-Silver	9
	/309	D White-Blue-Red	9
	/409	E Transp.-Silver-Red	9
	/509	F Transp.-Silver-Pink	9
	/609	G Yellow-Silver	9
	/709	H Blue-Silver-Red	9
	/809	I Mushroom	9
	/909	J Törtel	9
	/910	K Blue-Pinky	9
	/911	L Amber	9
	/920	M Black-Red-Glitter	9
	/923	N Perch	9
	/927	O Orange	9
	/931	P Trout	9

ORIGINAL KAULI COLORED ASSORTMENTS - 6, 9, 12 AND 15 CM

Assorted set of the most common Kaulis in 6, 9, 12 and 15 cm.
The bait in the self-service packs are all mixed differently.
So you are always well prepared for all situations.



WITH NATURAL FISHOIL

Item-No.	Order-No.	Length cm	Content/Colour
166030	/061	6	1 66030: /006, /106, /406, /806, /906
	/062	6	1 66030: /206, /306, /606, /907, /919
	/063	6	1 66030: /006, /206, /506, /706, /908
	/091	9	1 66030: /009, /109, /409, /809, /909
	/092	9	1 66030: /209, /309, /609, /910, /920
	/093	9	1 66030: /009, /209, /509, /709, /911
	/121	12	1 66030: /012, /112, /412, /812, /912
	/122	12	1 66030: /212, /312, /612, /913, /921
	/123	12	1 66030: /012, /212, /512, /712, /914
	/151	15	1 66030: /015, /115, /415
	/152	15	1 66030: /215, /315, /615
	/153	15	1 66030: /015, /215, /515

The KAULI perfectly camouflaged: hard luck for predators

Put it to the test and place a genuine little fish on your hand: you will be amazed at the reflections you see there! Depending on the direction in which you rotate the little fish, the play of colours of its scales will change. Nature is so perfect that it almost takes your breath away.

Anyone who has spent one of those days by the water when, due to major changes to the air pressure or a massive drop in the temperature of

the water, there was simply no chance of catching a pike-perch (or even a single pike), is bound to have wished to have a real baitfish on the rod.

But that's not necessary! With the KAULI HOLO in the six new mineral-effect colours they are so damned close to nature that the illusion is perfect. The different décors provide the perfect alternative for all light conditions on days spent fishing when until recently we went home with empty hands.

KAULI HOLO 12 CM

SINKING

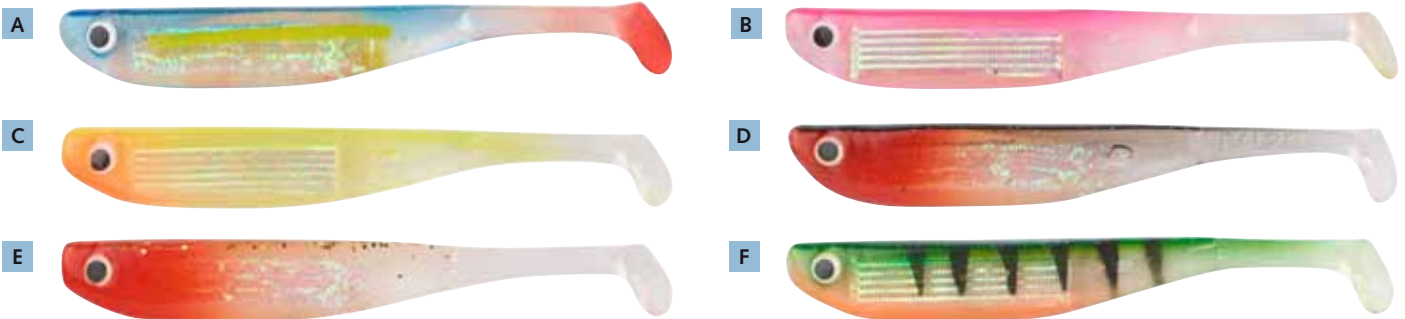

Item No.	Order No.	Color	Length cm
166050	/012	A Blue-Transparent	12
	/112	B Pink-Transparent	12
	/212	C Yellow-Transparent	12
	/312	D Roach	12
	/412	E Transparent-Ret	12
	/512	F Perch	12

KAULI HOLO COLORED ASSORTMENT - 12 CM

The Kauli Holo in 12cm in the self-service packs and mixed colors.
So you are always well prepared for all situations.

Item-No.	Order-No.	Length cm	Content/Colour
166050	/120	12	1 66050: /012, /112, /212, /312, /512



Edition Pike-Perch

My Kauli has done it: within barely 15 years it has become THE standard bait for pike-perch anglers.

However, despite the trust I place in the universal characteristics of this cult bait, there are situations by the water where one is better advised to use bait which develops more "self-initiative". That is why the Kauli has a somewhat less tame brother: the KAULI ACTIVE!

The KAULI ACTIVE is a special type of bait: in spite of its broad tail stock and the comparatively large tail plate, it can be catapulted over very long casting distances without any rollovers and without fluttering in the air. This is a huge advantage when casting against a gusty wind! The compact design clearly reveals that it is member of the KAULI family and ensures excellent bait control underwater because – contrary to other active rubber baits – it glides like an arrow through the current because it can also be guided excellently against the current. Furthermore, it offers the water so little resistance that the KAULI ACTIVE can be conducted around perfectly with the current. Experts know that when the bait reaches its "tipping point" one often gets the most heaviest pike-perch onto the hook. As soon as the KAULI ACTIVE begins to sink it starts its tantalising dance which comes from the ribbed, flat tail stock and the

specially constructed tail plate. Even when fishing with the current and stopping on the spot the new Kauli starts to run and drives pike, pike-perch and perch crazy! Catfish and asp also reacted to the new piece of rubber in a very irritated way during the test phase.

For the KAULI ACTIVE I again attached great importance to a durable rubber mixture which needs only a little softener. The gratifying result is greater durability and greater environmental compatibility. And YES, the rubber mixture is compatible with all other baits from my Kauli series, and with almost all other baits on the market without any problems. The greatest advantage compared to most mixtures in the products of our competitors in the market: The Kauli and the KAULI ACTIVE are absolutely secure on the jighead without us having to apply even a single drop of super-glye to fix anything!

We are starting directly with the complete range of 16 colours which we also started offering this year for my original. Only with regard to size we are counting on the especially popular 12-centimetre version (for the moment).

Your best bet is to combine the KAULI ACTIVE with a size 5/0 OWNER needlepoint. Pack the new one in your box.

SINKING

KAULI ACTIVE 12 CM



KAULI ACTIVE 12 CM

Item No.	Order No.	Colour	Length cm
166040	/012 A	Motoroil-Glitter	12
	/112 B	Blue-Silver-Glitter	12
	/212 C	Pearl-Silver	12
	/312 D	White-Blue-Red	12
	/412 E	Transp.-Silver-Red	12
	/512 F	Transp.-Silver-Pink	12
	/612 G	Yellow-Silver	12
	/712 H	Blue-Silver-Red	12
	/812 I	Mushroom	12
	/912 J	Törtel	12
	/913 K	Blue-Pinky	12
	/914 L	Amber	12
	/921 M	Black-Red-Glitter	12
	/924 N	Perch	12
	/928 O	Orange	12
	/932 P	Trout	12

KAULI ACTIVE 12 CM ASSORTMENTS

The most common Kauli Actives by Jörg in 12 cm. The bait in the self-service packs are all mixed differently. So you are always well prepared for all situations.



Item No.	Order No.	Colour
166040	/121	Colours A, B, E, I, J
	/122	Colours C, D, G, K, M
	/123	Colours A, C, F, H, L

STRINGER HOOK LEADER

There are days on which the predator fish bite extremely cautiously and the missed bite rate is high. On such days an stringer hook leader with an additional treble hook should be used! This is hooked into the hook eye very easily using Jörg's special clip and the treble hook pierces the rubber fish at the side.



FALL IN PRICES



STRINGER HOOK LEADER 7x7

Item No.	Order No.	Length cm	Hook size	For bait size
166140	/004	7.5	4	to 15 cm
	/006	5.5	6	to 10 cm
	/008	3.5	8	to 6 cm



STRINGER HOOK LEADER FLUOROCARBON

Item No.	Order No.	Length cm	Hook size	For bait size
166150	/004	7.5	4	to 15 cm
	/006	5.5	6	to 10 cm
	/008	3.5	8	to 6 cm

SPECIAL STRINGER RIG

The straight tip is stuck into the baitfish or rubber fish. The two other hooks thus remain absolutely straight and give rise to significantly fewer missed bites.



SPECIAL 7X7 STAINLESS STEEL RIG

Item No.	Order No.	Length cm	Hook size	For bait size
166140	/104	7.5	4	to 15 cm
	/106	5.5	6	to 10 cm
	/108	3.5	8	to 6 cm



SPECIAL FLUOROCARBON HARDMONO RIG

Item No.	Order No.	Length cm	Hook size	For bait size
166150	/104	7.5	4	to 15 cm
	/106	5.5	6	to 10 cm
	/108	3.5	8	to 6 cm

DOUBLE STINGER RIG

Sophisticated panic-hook system with 2 treble hooks for the optimal yield from bites.

Made optionally from 7 x 7 stainless steel with 9 kg bearing capacity or fluorocarbon hard mono with 11 kg bearing capacity.



DOUBLE STINGER RIG 7x7 STAINLESS STEEL

Item No.	Order No.	Length cm	Hook size	For bait size
166140	/204	7.5	4	to 15 cm
	/206	5.5	6	to 10 cm
	/208	3.5	8	to 6 cm



DOUBLE STINGER RIG FLUOROCARBON

Item No.	Order No.	Length cm	Hook size	For bait size
166150	/204	7.5	4	to 15 cm
	/206	5.5	6	to 10 cm
	/208	3.5	8	to 6 cm

»PIKE KILLER« DROP SHOT SYSTEM

Drop shot system made from 7x7 stainless steel and a stinger rig for drop shot fishing for pike

Item-No.	Order-No.	Size	Tensile Strength kg
166200	/606	1/0	6
	/609	2/0	9

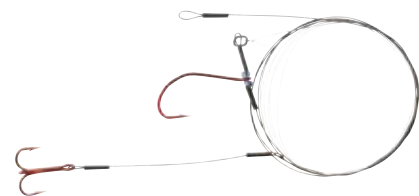

JIGHEADS



NEW SIZES



JIGHEAD WITH SPIRAL

The spiral is simply twisted into the shad or twister, preventing any damage. A panic hook with a treble hook can be inserted into the rear eyelet.

Item-No.	Order-No.	Con.	Weight g
166330	/010	10	10
	/015	10	15
	/020	10	20
	/025	10	25
	/030	10	30
	/040	10	40
NEW	/050	10	50
NEW	/060	10	60

HOT BALLS RED/SILVER

Item-No.	Order-No.	Weight g	Colour
138480	/010	10	red
	/015	15	red
	/020	20	red
	/025	25	red
	/035	35	red
138490	/045	45	red
	/010	10	silver
	/015	15	silver
	/020	20	silver
	/025	25	silver
NEW	/035	35	silver
NEW	/045	45	silver

Drop shot rigs



Drop Shot

Fantastic video can be found at www.balzer.de or in our Youtube channel. More detailed information can be found in Jörg's pike-perch manual.

DROP SHOT SHAD



A



B



C



D



E



F



G



H



I



J

PIKE-PERCH MAGNET

Especially for pike-perch. But even pikes like this shads. The permanent vibrations are very attractive for all predatory fishes!

PERCH KILLER

A real killer for perch and also trouts. The tail causes permanent vibrations. Shape like pike-perch magnet but 6 cm.

PIKE-PERCH MAGNET

Item No.	Ord.-No.	Colour	Lgth. cm	
166260	/100	Black-red-glitter	10	A
	/101	Black-silver-glitter	10	B
	/102	Pink-glitter	10	C
	/103	Brown-black-glitter	10	D
	/104	Green-Silver-glitter	10	E
	/105	Brown-green-mother of p.	10	F
	/106	Clear-silver-glitter	10	G
	/107	Clear-blue-goldglitter	10	H
	/108	Black-mother of pearl	10	I
	/109	Blue-mother of pearl	10	J

PERCH KILLER

Item No.	Ord.-No.	Colour	Lgth. cm	
166260	/060	Black-red-glitter	6	A
	/061	Black-silver-glitter	6	B
	/062	Pink-glitter	6	C
	/063	Brown-black-glitter	6	D
	/064	Green-Silver-glitter	6	E
	/065	Brown-green-mother of p.	6	F
	/066	Clear-silver-glitter	6	G
	/067	Clear-blue-goldglitter	6	H
	/068	Black-mother of pearl	6	I
	/069	Blue-mother of pearl	6	J

READY-MADE DROP SHOT SYSTEMS

Fully-assembled drop shot systems tied to fluorocarbon! Length: 1.50m; diameter: 0.35 mm.

System A: Ideal for vertical fishing from boats or steel pile walls.

System B: The hook is tied to a five-centimetre long side arm. Ideal for bank fishing in still water and in light current.

System C: Hook is tied to a 15 cm long side arm. Ideal for medium current or when bait is to be fished with intensive movements.

READY-MADE DROP SHOT SYSTEMS

Item No.	Order No.	Hooks size	Side arm length cm	
166200	/000	1	A without	
	/005	2	B 5	
	/015	4	C 15	

CLASSIC

An allrounder for cold days and when the fishes are not active.

Item-No.	Order-No.	Hooks size	Line Ø	
166200	/101	1	0.30	
	/102	2	0.28	
	/104	4	0.25	
	/106	6	0.25	

ACTIVE

With 5 cm long side arm for attractive action. With red bead.

Item-No.	Order-No.	Hooks size	Line Ø	
166200	/201	1	0.30	
	/202	2	0.28	
	/204	4	0.25	
	/206	6	0.25	

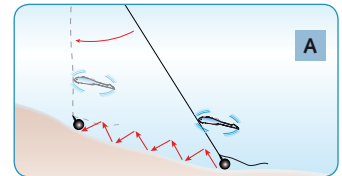
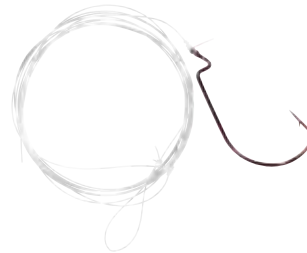

A

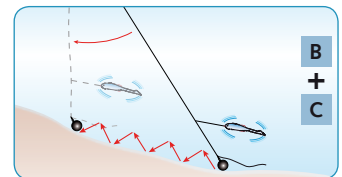

B + C

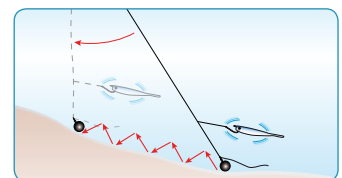
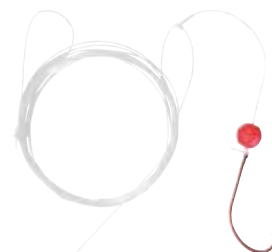
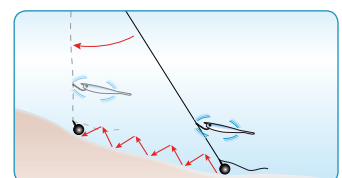

DROP SHOT LEAD

Drop shot lead is equipped with a special line clip which grips the line like a limpet and does not loosen even in the case of long distance casts and when it gets caught up. The clip is very easy to remove. This means that the distance between bait and bottom can be varied at any time!

FALL IN PRICES

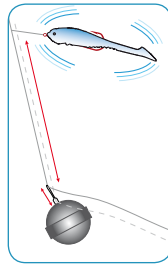

DROP SHOT LEAD »ROUND«

This is used when the bottom is hard and/or the current gentle because after it is twitched it still rolls over the bottom, breathing addition life into the bait.

Item-No.	Order-No.	Weight g	Content
166180	/005	5	5
	/010	10	5
	/015	15	4
	/020	20	4
	/025	25	3

DROP SHOT LEAD »LONG«

Owing to its long shape the lead descends fast. While it is being twitched the lead keeps tipping from the vertical to the horizontal position; thus the bait is constantly moving gently. A real all-rounder!

Item-No.	Order-No.	Weight g	Content
166190	/005	5	5
	/010	10	5
	/015	15	4
	/020	20	4
	/025	25	3

DROP SHOT HOOKS

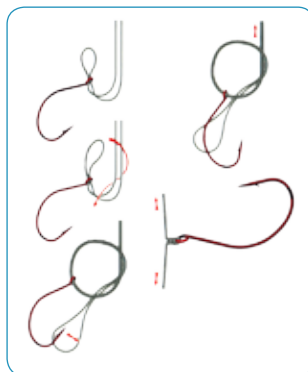
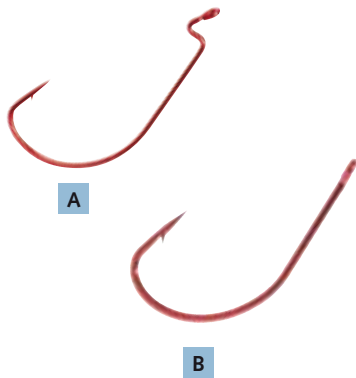

The PALOMAR knot.

Item-No.	Order-No.	Item	Hooks-size
166210	/001	A Drop Shot hook, red	1
	/002	A Drop Shot hook, red	2
	/004	A Drop Shot hook, red	4
	/006	A Drop Shot hook	6
	/100	A Drop Shot hook	1/0
166210	/101	B Drop Shot hook	1
	/102	B Drop Shot hook	2
	/104	B Drop Shot hook special	4
	/106	B Drop Shot hook special	6

DROP SHOT ASSORTMENT

All for the successful start for drop shotting for perche and pike-perch, assembled by our specialist Jörg Strehlow.

DROP SHOT ASSORTMENT

Item No.	Order No.
166360	/001

Content:

- 2 Dropshot lead round in 10 and 15g
- 2 Dropshot lead oval in 10 and 15g
- 2 Dropshot-Rigs Classic, hook size 2 and 4
- 2 Zander Dropshot Shads 1 66260 103
- 2 Zander Dropshot Shads 1 66260 108
- 2 Perch Dropshot Shads 1 66260 063
- 2 Perch Dropshot Shads 1 66260 068



CAROLINA SYSTEMS



CAROLINA BULLET-TYPE WEIGHT

Bullet-type weights plus bead for self-made Carolina rigs.

Item-No.	Order-No.	Wg. g	Content
166170	/005	5	5
	/010	10	5
	/015	15	4
	/020	20	4
	/025	25	3

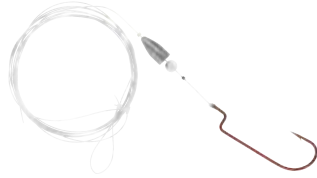

CAROLINA DROP SHOT SYSTEM

System tied to fluorocarbon for drop shot fishing by the Carolina method. 15 g.

Item-No.	Order-No.	Line Ø	Size
166200	/502	0.25	2
	/510	0.30	1/0
	/530	0.35	3/0



CAROLINA HOOK

Item-No.	Order-No.	Size
166210	/302	2
	/310	1/0
	/330	3/0



BORED GLASS BEADS

For making Carolina rigs.

Item-No.	Order-No.	Colour	Ø mm
166170	/100	transp.	8
	/101	red	8

JÖRG STREHLOW ACCESSORIES



PIKE-PERCH RATTLE

Rattle with metal balls, that strike one another at the very smallest bait movement. Even lazy predators notice them. Rattles simply plug into the rubber fish! 5 pieces.

Item No.	Order No.
166170	/000



CARABINER

This special carabiner may make the difference between success and failure! The special, generous shape of the hook permits extremely natural bait play; it is convenient to open even with cold hands!

Item No.	Order No.	Size
166160	/002	S / 8kg
	/006	M / 17kg
	/010	L / 26kg



GLASS RATTLES

The glass rattle is filled with steel balls and in the water it produces seductive sounds. It is simply inserted into the shad.

Item No.	Order No.	Size mm
166170	/200	5 x 25.5
	/300	5 x 16.5



SCENTED PEARLS

Absorbs liquid luring substances very well and ensures a longlasting odour trail. Diam. 7mm.

Item No.	Order No.
166250	/000



JÖRG STREHLOW'S POWER GEL

With Jörg's Power Gel you can tweak any shad properly: The gel is smeared onto the rubber bait, and with its specific odour it increases the catching capacity many times over! The allure is increased even more by the glittering silver particles thanks to the glitter gel. **Very good adherence!** Content: 25.

JÖRG STREHLOW'S POWER GEL

Item No.	Order No.	Aroma
166240	/100	Pike
	/101	Perch/Pike-Perch
	/102	Jörg's Secret
	/103	Jörg's Secret Silver-Glitter



PIKE-PERCH MAGNET

Simply spray onto the artificial or natural bait. Content 50ml.

Item No.	Order No.	Aroma
166240	/000	Smelt
	/001	Blood/Fish

JÖRG STREHLOW'S SPECIAL WOBBLERS FOR PIKE-PERCH

Even as a young fisherman I noticed that the pike-perches on warm summer evenings react much better near the bank to a floating lure as presented baits near the bottom. These were valuable insights for Balzer for developing wobblers for all weather and water conditions.

A special Pike-Perch wobbler must have different characteristics than classic hardbaits. So my wobblers are all elongated and slender and have a nearly round cross section.

So you have enough volume to attract a Pike-Perch also in the turbulent waters of a great river. And yet they do not offer as much resistance in the water and can therefore be perfect for fishing against the tide!

A special detail is the attachment of a triple hook in the middle because Pike-Perches attack their prey fish mostly on the head.

To avoid hangers let the floating bait over obstacles easily raise short.

You can also let the lure perfectly drift with the current into catchy areas - for example near a current edge or to impact water an opposite groin.

Wobblers are also successful artificial baits for night spin fishing for Pike-Perch. Therefore you will find in my series two special night wobblers.

All wobblers are available as deep- and shallow runners. The maximum diving depths of the shallow runners are 1-3m, the deeprunner goes down to 5m.



Deeprunner



Deeprunner



Deeprunner



Floating



Floating



Floating

DAY PIKE-PERCH WOBBLER BLUE ARTIC

Perfect colour for clear and slightly to medium cloudy waters. Catches best in bright weather and in changing light situations.

Item-No.	Order No.	type	Weight g	Length cm
134570	/211	Shallow runner, floating, 1-3m	11	11
	/311	Deeprunner, floating, 2.5-5m	11	11

DAY PIKE-PERCH WOBBLER HONEY BEE

Yellow and black are colour combination with high contrast. Therefore it tempts pike-perch especially in cloudy weather and in the evening.

Item-No.	Order No.	type	Weight g	Length cm
134570	/411	Shallow runner, floating, 1-3m	11	11
	/511	Deeprunner, floating, 2.5-5m	11	11

DAY PIKE-PERCH WOBBLER FUNNY VIOLA

Perfect synthesis of natural colour and shock colour! Sensational catching results at night in clear waters!

Item-No.	Order No.	type	Weight g	Length cm
134570	/611	Shallow runner, floating, 1-3m	11	11
	/711	Deeprunner, floating, 2.5-5m	11	11



Deeprunner



Floating

DAY PIKE-PERCH WOBBLER SUNNY SIN

What an outstanding colour at very low water temperatures or in very cloudy water! Also ideal for very aggressive pike-perch (and pike) in the early summer.

Item-No.	Order No.	type	Weight g	Length cm
134570	/811	Shallow runner, floating, 1-3m	11	11
	/911	Deeprunner, floating, 2.5-5m	11	11

NIGHT WOBBLER PIKE-PERCH

Pike-Perches attack their bait at dusk or even at night in the near bank area and on the surface - so we needed a black floating lure! And the wobbler should be slim and has to work diligently and rattle. For slightly deeper waters, however, is a reflective wob-

bler the first choice for spin fishing in the darkness (best in Colour pearl). Two brilliant ideas that Jörg Strehlow could realize in developing its exclusive wobblers.



NIGHT WOBBLER PIKE-PERCH BLACK KNIGHT

Developed for pike-perch hunting in shallow water close to the bank. The black colour provides an ideal contrast to the sky.

Item-No.	Order No.	type	Weight g	Length cm
134570	/011	shallow runner, floating, 1-3m	18	11



NIGHT WOBBLER PIKE-PERCH WHITE PEARL

This mother-of-pearl deep runner is a guarantee for success on dark nights and at greater depths.

Item-No.	Order No.	type	Weight g	Length cm
134570	/111	Deeprunner, floating, 2.5-5m	18	11

Edition Lavaret/Perch

Edition FELCHEN

Edition BARSCH

Professional rigs developed in collaboration with our Swiss expert, Ruedi Bleuer.

Right from the first glimpse one recognises the high quality standard and love of detail. These chemically sharpened hooks and the high performance line come from Japan and the precision swivel from Korea. Everything about these lavaret rigs is as it should be, beginning with the high quality nymphs, continuing with the correct length of the lateral arms and through to the well conceived winding board.

So it is little wonder that these rigs are frequently better for catching by far than many others.



Secure fixing and clear recognition of the nymphs. A sticker on the winding board indicates the right sequence!

LAVARET RIGS



JURA LAVARET RIG

Item-No.	Order-No.	Hook-size	Length cm	Line Ø mm
147880	/012	12	195	0.20
	/014	14	195	0.18



CANDY LAVARET RIG

Item-No.	Order-No.	Hook-size	Length cm	Line Ø mm
147880	/212	12	195	0.20
	/214	14	195	0.18



LAKE THUN LAVARET RIG

Item-No.	Order-No.	Hook-size	Length cm	Line Ø mm
147880	/612	12	195	0.20
	/614	14	195	0.18



PUPPA LAVARET RIG

Item-No.	Order-No.	Hook-size	Length cm	Line Ø mm
147880	/312	12	195	0.20
	/314	14	195	0.18



CANTON LAVARET RIG

Item-No.	Order-No.	Hook-size	Length cm	Line Ø mm
147880	/412	12	195	0.20
	/414	14	195	0.18

PERCH RIGS

BOUND TO FLUOROCARBON



PERCH RIG EGLI CLASSIC

Item-No.	Order-No.	Hook-size	Length cm	Line Ø mm
147890	/006	5 x 6	195	0.25



PERCH RIG LAMETTA

Item-No.	Order-No.	Hook-size	Length cm	Line Ø mm
147890	/106	5 x 6	195	0.25

PERCH RIGS

Excellent perch rigs top finish and extremely good catchers. With 5 cm shads.

Each system packed for self-service with foam winders.

Item-No.	Order-No.	Hook-size	Length m	Line Ø mm	
147820	/001	A	6	1.65	0.28
	/002	B	6	1.65	0.28
	/003	C	6	1.65	0.28



PERCH HEGENES

Very catchy perch hegenes, realistic-looking little rubber fish with 3D eyes.

Item-No.	Order-No.	Hook-size	Length m	Line Ø mm	
147840	/000	A	6	1.65	0.25
	/005	B	6	1.65	0.25
	/010	C	6	1.65	0.25

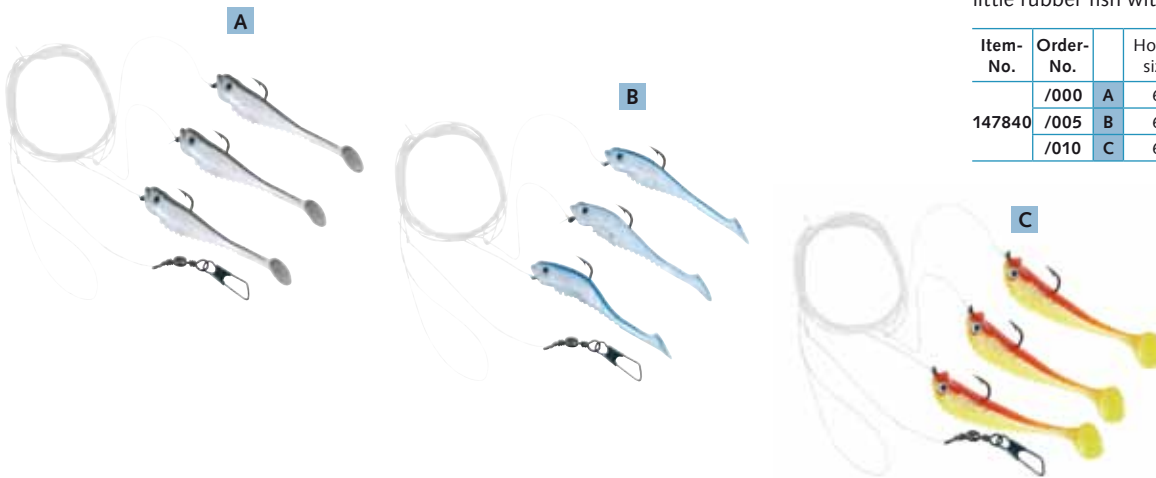

3D PERCH RIG

Perch rigs with very flexible hologram shads for excellent catching.

Item-No.	Order-No.	Hook-size	Length m	Line Ø mm	
147840	/100	A	6	1.65	0.25
	/105	B	6	1.65	0.25
	/110	C	6	1.65	0.25





The complete program for maximum success at trout lakes

Under the name of TROUT ATTACK® the experienced trout professionals Willy Frosch and Tim Paasch have developed a top series for modern trout-lake fishing.

Of course, there is no way we can reinvent the wheel and Sbirolino and trolling floats are still among the successful methods. However, combined with our new innovative baits these techniques are far more successful!

These days specialists are target fishing for trout with the Drop Shot method. With the right technique and our TROUT ATTACK® Drop Shot program it is still possible to achieve massive catches, while your neighbours are simply shaking their heads in resignation.

We have deliberately designed our packaging units for artificial bait to be »angler-friendly«. For example, all our baits in a pack are in assorted colours. This means that you don't have to buy 10 twisters in a single colour; a single blister pack contains twisters in different colours. This saves money and gives plenty of latitude for experimenting.

You can read about how to angle successfully at trout lakes in the free TROUT ATTACK® guide. It is available at your specialist dealer.

Or you can watch it on the TROUT ATTACK® DVD on which Willy Frosch and Tim Paasch divulge their tips and tricks (page 206).



POWER SBIRO

... der Schnellwechsel-Sbirolino für maximalen Erfolg!



POWER SBIROS

The Power Sbiros can be exchanged in a matter of seconds without cutting the line. This enables you to vary greatly in reaction to changing situations and you are guaranteed to catch more than your neighbour!

The principle corresponds to that of a Catharinen lead. The little tube remains on the line; the slit body can be changed as desired.

The attractively packed sets contain 2 little tubes and 3 Power Sbiros each (10g, 15g and 20g). All the Sbiros can be combined with one another.



SET POWER SBIRO FLOATING

Item No.	Order No.	Weight g*	
160000	/000	10 (6g), 15 (10g), 20 (14g)	



SET POWER SBIRO, SLOW-SINKING

Item No.	Order No.	Weight g	
160000	/100	10, 15, 20	

TROUT ATTACK TROUT EGG

Developed for surface fishing for trouts. Guarantees long casts and even at long distance a good visibility. Available from 10 to 25g. On each package is a self assembly manual.

NOW ALSO IN 30 + 40 GRAMS



Item No.	Order No.	Weight g	
160490	/007	7	
	/010	10	
	/015	15	
	/020	20	
	/025	25	
	NEW	/030	30
NEW	/040	40	



SBIROLINO FLOATING BLISTER PACKED

Transparent, nearly invisible sbirolino for fishing on the surface.

Item No.	Order No.	Weight g	
151100	/110	10	
	/115	15	
	/120	20	
	/125	25	
	/130	30	
	/140	40	



SBIROLINO HALF-SINKING, BLISTER PACKED

Nearly invisible, for surface and middle water fishing. Because of the specific weight, it has under water only 1/5 of the casting weight (e. g. casting weight 10 g = 2 g under water/sinking speed).

Item No.	Order No.	Weight g	
150100	/110	10	
	/115	15	
	/120	20	
	/125	25	
	/130	30	
	/140	40	

SILENT HUNTER

Newly developed Sbirolino with a slender, aerodynamic corpus. Contrary to conventionally-shaped ones, this sbiro has outstanding casting characteristics and dives almost silently into the water without shooping any fish away. All sbiros are packed for self service.

***Please note:**

The **volume** of the floating sbiros is roughly equivalent to those of the slow sinking sbiros, but the **weights** are in reality much lower.



SILENT HUNTER FLOATING

Item No.	Order No.	Weight g	
150200	/010	7.5	
	/012	10	
	/015	12	
	/020	15	
	/025	20	
	/030	22	
	/040	30	



SILENT HUNTER HALF-SINKING

Item No.	Order No.	Weight g	
150220	/010	10	
	/012	12	
	/015	15	
	/020	20	
	/025	25	
	/030	30	
	/040	40	



SILENT HUNTER SUPER SLOW SINKING

Item No.	Order No.	Weight g	
150210	/010	10	
	/012	12	
	/015	15	
	/020	20	
	/025	25	
	/030	30	
	/040	40	

Trout Attack®



BOTTOM BOUNCER I ASSORTMENT

It couldn't be faster: the weights can be exchanged while you are fishing within seconds by means of a thread. This makes you incredibly flexible!
Weights: 8, 10, 12 and 15 g.

Item No.	Order No.	weight g
160030	/400	8, 10, 12, 15



BOTTOM BOUNCER I

By the bottom bouncer the lead ball lies on the bottom and the wooden stock stands upright and lets the line run smoothly through the eye. Ideal for fishing with pop-up bottom rigs.

Item No.	Order No.	weight g
160030	/005	5
	/008	8
	/010	10
	/012	12
	/015	15
	/020	20
	/025	25
	/030	30



BOTTOM BOUNCER II

Its aerodynamic form enables our new bottom gauge to be cast very well. On the bottom it stands up and lets the line glide smoothly through the eyelet. Ideal for pop-up bottom rigs.

Item No.	Order No.	weight g
160030	/105	5
	/108	8
	/110	10
	/112	12
	/115	15
	/120	20
	/125	25
	/130	30



RATTLING EGG

Is used like a floating sbirolino when fishing. The egg contains small balls which are guaranteed to attract the attention of the trout while the line is being wound in.

Item No.	Order No.	Weight g
160070	/100	7
	/101	11
	/102	15

BOMBARDO, FLOATING

Floating Bombardo made of Rohacell from Germany. Ideal for surface fishing.

Item No.	Order No.	Weight g
160480	/008	8
	/010	10
	/012	12
	/015	15
	/020	20



LINE-THREADING AID

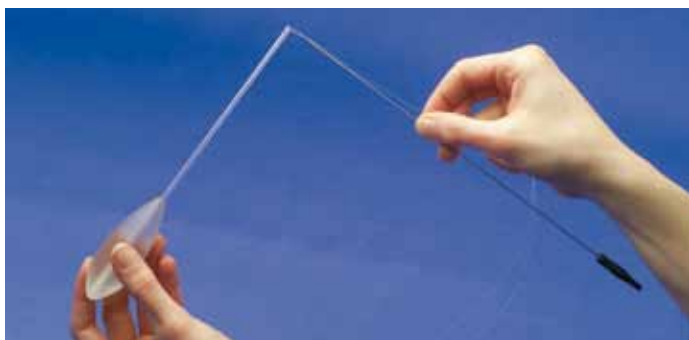

For threading the line through the Sbirolinos.

Item No.	Order No.
160350	/002



TROLLING FLOATS / BOTTOM BOUNCER

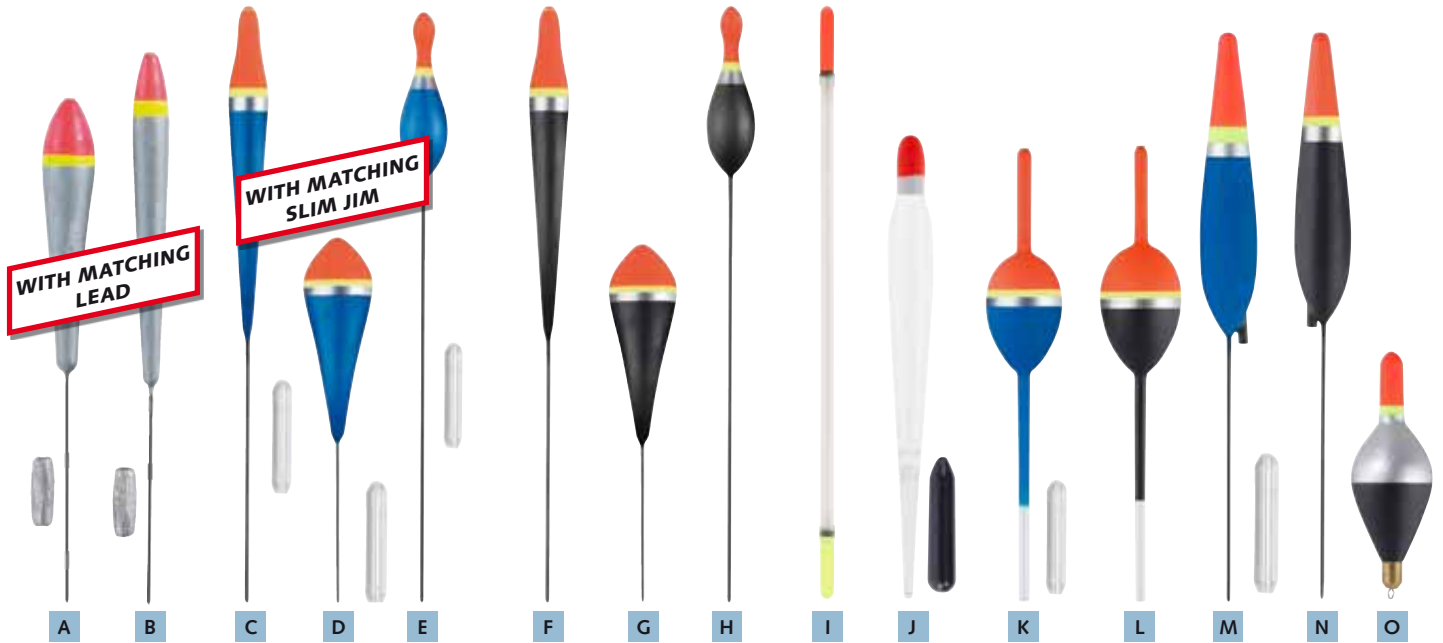

A »TROUT ATTACK« TROLLING FLOAT

Float for long distance casts. Including matching trolling lead!

Item No.	Order No.	Tensile str.	g
160020	/002	2	
	/004	4	
	/006	6	
	/008	8	

B »TROUT ATTACK« TROLLING FLOAT

Float for trolling and traditional angling. Matching trolling lead included.

Item No.	Order No.	Tensile str.	g
160010	/002	2	
	/004	4	
	/006	6	
	/008	8	

C TROUT ATTACK WITH SLIM JIM FLOAT 1

Slender inline float for trolling and traditional angling. Supplied in a self-service packet incl. a matching glass weight.

Item No.	Order No.	Tensile str.	g
160440	/003	3	
	/004	4	
	/005	5	

D TROUT ATTACK DROP WITH SLIM JIM 2

Float corpus for longer casts. For trolling and traditional angling. Supplied in a self-service packet including a matching glass weight.

Item No.	Order No.	Tensile str.	g
160420	/003	3	
	/004	4	
	/005	5	

E TROUT ATTACK WITH SLIM JIM FLOAT 3

For trolling and traditional angling. Supplied including a matching glass weight.

Item No.	Order No.	Tensile str.	g
160430	/003	3	
	/004	4	
	/005	5	

F TROUT ATTACK ALLROUND FLOAT I

Item No.	Order No.	Tensile str.	g
160440	/103	3	
	/104	4	
	/105	5	

G TROUT ATTACK DROP III

Item No.	Order No.	Tensile str.	g
160420	/103	3	
	/104	4	
	/105	5	

H TROUT ATTACK ALLROUND FLOAT II

Item No.	Order No.	Tensile str.	g
160430	/103	3	
	/104	4	
	/105	5	

I TWIN TIP TROLLING FLOAT

Depending on visibility conditions you can fish with a red or yellow tip.

Item No.	Order No.	Tensile str.	g
160520	/001	1	
	/002	2	
	/003	3	
	/004	4	
	/005	5	

J CHYSTAL FLOAT WITH SILICONE LEAD

Invisible trawling float with matching silicone lead. Also as fixed or sliding float useable. Self-service package.

Item No.	Order No.	Tensile str.	g
160010	/102	2	
	/103	3	
	/104	4	
	/105	5	
	/106	6	

K TROUT ATTACK FLOAT WITH SLIM JIM

Item No.	Order No.	Tensile str.	g
160470	/003	3	
	/004	4	
	/005	5	

L TROUT ATTACK FLOAT

Item No.	Order No.	Tensile str.	g
160470	/103	3	
	/104	4	
	/105	5	

M TROUT ATTACK FLOAT WITH SLIM JIM

Item No.	Order No.	Tensile str.	g
160540	/003	3	
	/004	4	
	/005	5	

N TROUT ATTACK FLOAT

Item No.	Order No.	Tensile str.	g
160540	/103	3	
	/104	4	
	/105	5	

O LONG CAST DROP FLOAT LEADEN

Item No.	Order No.	Tensile str.	g
160550	/202	2+2	
	/402	4+2	
	/602	6+2	



P

P RUNNING LEAD WITH SILICONE COVER

Protects line extremely well. Ideal to leaden all kinds of float and trolling assemblies.

Item No.	Order No.	Weight g
160590	/002	2
	/003	3
	/004	4
	/005	5
	/006	6

Soft salmon roe / Power Larvae / Trout Paste



SOFT SALMON ROE

Buoyant soft rubber salmon roe. They are fished together with natural bait on pop-up rigs, e.g. with our ground sensor. Unique for catching!

Item-No.	Order-No.	
160390	/000	

BEE MAGGOT OIL

A 100% natural product which serves primarily to release the dough well from the dough shaper. Simply brush the cheeks of the dough shaper with the oil.

Item-No.	Order-No.	
160070	/000	

DOUGH SHAPER

Turns a ball of dough into an irresistible, rotating »spinner blade« in seconds and then catches more fish! Instructions for use enclosed.

Item-No.	Order-No.	Size	
160380	/000	small-med.	
	/001	large	



TROUT ATTACK POWER LARVAE

The latest development from our Trout Attack creators: bee larvae, which retain their entirely natural consistency thanks to an innovative oxygen pressure procedure which makes them just as luring as living bee larvae. So forget about hard, mummified larvae and trust in the unique Power Larvae.

- Supplied in a vacuum-sealed jar (contents approximately 30-35 larvae)
- Keep for at least 2 years, if opened for approx. 6-8 weeks (refrigerated)

Item-No.	Order-No.	Color	
160080	/100	Nature	
	/101	Red	
	/102	Green	

TROUT ATTACK AROMASPRAY

These 100% naturally pure aromas made in Germany significantly improve the catching capacity of all kinds of bait. With a practical sprayer! Content 10ml.

Item-No.	Order-No.	Aroma	
160080	/000	Bee Grubs	
	/001	Liver/Blood	
	/002	Gammarus	
	/003	Salmon Egg	
	/004	Trout	
	/005	Garlic	

AROMASPRAY-DISPLAY

Item-No.	Order-No.	
160080	/025	

WITH GARLIC AROMA

TROUT ATTAC GARLIC TROUT PASTE

The perfect consistency of our new types of floating trout paste will convince you. The dough is slightly tough making it excellent to shape and it remains on the hook for a long time.

Amino acids to which trout are particularly partial are mixed into the dough. All types have glitter particles mixed in and they have a very strong garlic aroma which has long since been discovered to be especially good for catching. Supplied in a 50-g jar.



Item-No.	Order-No.	Packing unit 50g	
185450	/100	Garlic-White	
	/101	Garlic-Red	
	/102	Garlic-Black	
	/103	Garlic-Chartreuse	
	/104	Garlic-Yellow	
	/105	Garlic-Rainbow	

Sbirolino fishing – Trout Attack

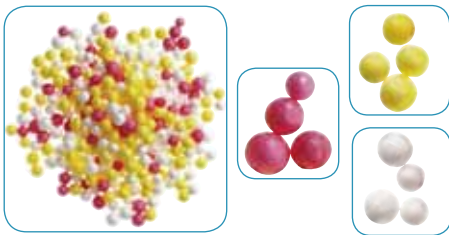

POP-UP BALLS

Pop-up polystyrene balls sizes 5-7 mm. Ideal for pop-up bottom rigs. Contents: approx. 150 balls.

Item-No.	Order-No.	Content
160370	/000	appr. 150 pcs. mixed
160530	/000	appr. 150 pcs., red
	/001	appr. 150 pcs., white
	/002	appr. 150 pcs., yellow



TROUT ATTACK DISGORGER

Probably the best digorger on the market. Releases the hook fast and safely without the tip getting stuck in the gullet.

Item-No.	Order-No.	Length cm
160350	/000	15
	/001	18



SOFT RUBBER BEADS

To protect the swivelknot, it cushions the Sbirolino excellently.

Item-No.	Order-No.	Ø mm
160360	/004	4
	/006	6
	/008	8



PILOT BALLS, ROUND

Still clearly visible in diffuse lighting conditions.

Item-No.	Order-No.	Ø mm
158820	/112	12
	/115	15
	/120	20



PILOT BALLS, OVALE

Still clearly visible in diffuse lighting conditions.

Item-No.	Order-No.	Ø mm
158830	/112	12
	/115	15
	/120	20



PILOT BALLS WILLI FROSCH

Willi's favourite pilot balls is drawn onto the line like a float and locked in place with a stick.

The balls can be changed without the cutting the line! So you can react quickly to changing light conditions.

Item-No.	Order-No.	Ø mm	Colour
160600	/012	12	yellow
	/015	15	yellow
	/020	20	yellow
	/112	12	orange
	/115	15	orange
	/120	20	orange
	/212	12	white
	/215	15	white
	/220	20	white
	/312	12	black
	/315	15	black
	/320	20	black

3 IN 1 WONDER TOOL

Many anglers have been waiting for this for a long time: a professional hook remover, fish bat and a knife blade to kill the fish. That's what the new wonder tool has to offer! The hook remover and blade can be stowed away in the tool for convenient transportation.



SPARE HOOK REMOVER XL FOR WONDER TOOL

Fits to our wonder tool. Extra large.

Item No.	Order No.
184570	/031



SBIROLINO LINE STOPPER XL

Ensures that the knots between the sbirolino and the swivel are protected.

Item No.	Order No.
160580	/000

Trout spinners / spoons

STAR DUST TROUT SPOON: 3.5 AND 6.5 GRAM

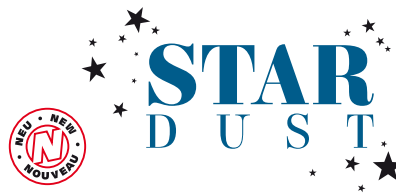
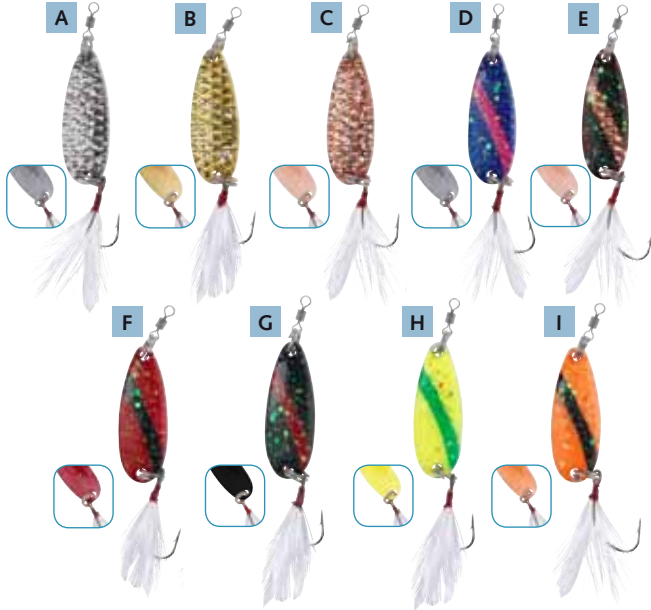

High quality trout spoons with brass body. With glossy glitter and epoxy lacquer sealing.

Item-No.	Order-No.	Weight 3.5g Color	Wg. g	Item-No.	Order-No.	Weight 6.5g Color	Wg. g
160560	/035	A Silver	3.5	160560	/065	A Silver	6.5
	/135	B Gold	3.5		/165	B Gold	6.5
	/235	C Copper	3.5		/265	C Copper	6.5
	/335	D Blue	3.5		/365	D Blue	6.5
	/435	E Black-Copper	3.5		/465	E Black-Copper	6.5
	/535	F Red	3.5		/565	F Red	6.5
	/635	G Black-Red	3.5		/665	G Black-Red	6.5
	/735	H Fluo-Yellow	3.5		/765	H Fluo-Yellow	6.5
	/835	I Fluo-Orange	3.5		/865	I Fluo-Orange	6.5

TROUT SPOON

Excellent running characteristics, very good for catching. Used for fishing with a sbiro, or solo on an ultra light spin rod. Weight: 2g.



Item-No.	Order-No.	Color
160450	/001	Silver
	/002	Gold
	/003	Copper
	/004	Red
	/005	Yellow
	/006	Blue-Black
	/101	Silver with scales
	/102	Gold with scales
	/103	Copper with scales

TROUT TWISTER-SPINNER

Very catchy combination of spinner and twister. Used for fishing with a sbiro or solo on an ultra light spin rod. Length 7 cm, weight 2g.



Item-No.	Order-No.	Color
160460	/001	Silver
	/002	Gold
	/003	Copper
	/004	Red
	/005	Yellow
	/006	Blue-Black



PROP & SPIN SPINNERS

Besides the rotating spinner blade, at the top a propeller blade also rotates. It can be used to fish with sbirolinos or on ultra-light spin rods. Extremely seductive! Weight: 2.5g.

Item-No.	Order-No.	Color
160460	/101	Silver
	/102	Gold
	/103	Black
	/104	White
	/105	Rainbow
	/106	Pink-White



TURBO PROPS HELI ASSORTMENT

Double lure = more fish!
Thanks to the wings the turbo-prop twister twists permanently around its own axis when being wound in. The propeller attached at the front also provides plenty of action. No trout can resist that!

Item-No.	Order-No.	Colour
160460	/300	3 pieces assorted



"KING WILLI" TROUT WOBBLER FLY

Willi Frosch's favourite for fat trout! It is a mixture of wobbler and fly which can be fished both with a sbirolino and a lightweight spin rod. The wobbling makes the rubber arms vibrate permanently, exerting an enormous stimulus. Also for perch and chub.
Type: Floating. Immersion depth: 0.5m.

Item-No.	Order-No.	Length/Weight cm/g	Colour
160510	/004	2.5cm / 1.5g	A red-white
	/104	2.5cm / 1.5g	B red-black
	/204	2.5cm / 1.5g	C blue-white
	/304	2.5cm / 1.5g	D green-white
	/404	2.5cm / 1.5g	E green-black
	/504	2.5cm / 1.5g	F green-yellow
	/604	2.5cm / 1.5g	G pink



TROUT POPPER

It is twitched on the surface on a fine rod, making plopping sounds and creating little plumes of water. Very good in the summer months and fishing with them is tremendous fun! Also good for perch.

Item-No.	Order-No.	Color	Length cm	Weight g
160500	/003	A Whitefish	3	2
	/103	B Trout	3	2
	/203	C Perch	3	2
	/303	D Fireshark	3	2



SPINNER SET, TREBLE HOOK

Ultra lightweight spinners. They are fished with a long leader and sbirolino. Weight 1.5g.

Item-No.	Order-No.
160330	/000



SPINNER SET SINGLE HOOK

Spinner with single hooks for natural baits like maggots or worms! Weight 1.5g.

Item-No.	Order-No.
160330	/001



»TROUT CRANK« WOBBLER

Hectic Crank Wobbler with rattles. Sinking. **Important: For perfect play of the wobbler we recommend the use of loop knot.**

Item-No.	Order-No.	Color	Length cm	Weight g
160240	/000	A Perch	3	2
	/100	A Perch	2	1
	/001	B Whitefish	3	2
	/101	B Whitefish	2	1
	/002	C Yellow/Red	3	2
	/102	C Yellow/Red	2	1
	/003	D Fireshark	3	2
	/103	D Fireshark	2	1
	/004	E Red Head	3	2
	/104	E Red Head	2	1
	/005	F Monster Perch	3	2
	/105	F Monster Perch	2	1
	/006	G Trout	3	2
	/106	G Trout	2	1



SPINNING MAGGOT

This imitation of a bee maggot can be fished with a spinning or sbirolino rod. The maggot rotates around its own axis during line retrieving. Very catchy for big trouts! Available in 4 colours. Sinking.

Item-No.	Order-No.	Length/Weight cm/g	Colour
160150	/100	4cm / 2.5g	white
	/101	4cm / 2.5g	yellow-green (UV)
	/102	4cm / 2.5g	yellow-black (UV)
	/103	4cm / 2.5g	red-black



TROUT SPOONS

Minute spoon with optimal running properties. Length 3 cm, 1.5 g.

Item-No.	Order-No.	Color
160230	/000	Silver
	/001	Copper
	/002	Gold



ARTIFICIAL BAIT, SINGLE HOOK

Special single hook for changing artificial baits.

Item No.	Order No.	Hook-size
160450	/202	2
	/206	6

Drop Shot Assortments / Trout Attack rubber baits



DROP SHOT ASSORTMENT »TROUT KILLER«

Floating drop-shot shads, positively lethal for big trout! But also excellent for perch! 10 shads of assorted colours in a self-service blister pack.

Item-No.	Order-No.	Length cm
160190	/000	4
160200	/000	2.5



DROP SHOT ASSORTMENT »BLOODY TROUT«

The constant, fine vibrations of the V-forked tail entices even lethargic rainbow trout to chance a bite. Also the tops for perch! 5 colours each 2 pieces.

Item-No.	Order-No.	Length cm
160330	/300	3



3D SHADS

The secret behind the success of this shad: Very natural play combined with unique light reflections. Contents: 5 colours, 2 of each.

Item-No.	Order-No.	Length cm
160130	/000	6

TROUT ATTACK SUPER SOFT LURES

SUPER SOFT

FLOATING

Our popular and successful assortments of rubber baits in ultra-soft rubber mixture. Tests have shown that trout merely attack harder rubber bait, whilst they inhale extremely soft rubber bait.

Like the previous models, the Ultra-Soft Lures float, thus enabling the bait to be guided much more variedly with a sibirolino.

The artificial bee maggots, which are even more realistic than the previous ones and almost indistinguishable from real ones, are new.



TROUT TWISTER

Extra broad tail shape for dynamic play. Contents: 5 colours and 2 units in each.

Item-No.	Order-No.	Length cm
160100	/100	3
160110	/100	4



TWISTER SHAD

The combination of a shad and a twister has convincing, outstanding running properties. Contents: 5 colours, 2 units of each.

Item-No.	Order-No.	Length cm
160120	/100	3



SPAGHETTI

Cut off a short section and stick it onto the hook in an L-shape Go ahead and combine colours!

Item-No.	Order-No.	Length cm
160160	/100	8



POWER BEE MAGGOTS

Trout love them! Can be angled with alone or in combination with genuine bee maggots. Always attach the bait in an L-shape for optimal rotation. **Tip:** Spray with the »Bee Maggot« power aroma and combine it with other colours from time to time.

Item-No.	Order-No.	Length cm
160140	/002	2.0
160150	/002	2.5



SUPER SOFT BEE MAGGOTS

The new Super Soft Lure bee maggots are floating and are now even more realistic as they are almost indistinguishable from real ones.

Item-No.	Order-No.	Length cm
160140	/102	2.0
160140	/202	2.5



TROUT-SICHEL

The Trout Sichel is used for fishing in combination with a natural bait (e.g. bee maggot or trout dough). The natural bait is put on the hook first, then the sichel. Very seductive play! Floating. 5 colours, 2 of each.

Item-No.	Order-No.	Color
160740	/200	5 colors assorted

Soft bait assortments



TROUT WORM

Push the trout worm onto the hook. When fishing with sbirolinos it twists seductively around its own axis. Floating. 5 colours, 2 of each.

Item-No.	Order-No.	Color
160740	/100	5 colors assorted



TURBO PROPS

Extremely luring trout trawling bait. Thanks to their spiral shape the Turbo Props revolve around their own axis as they are drawn in. Since the Turbo Props float they can be guided to display a multitude of facets.

Item-No.	Order-No.	Color
160390	/012	assorted



TWISTING TAIL

Extremely luring Sbirolino bait. The bait is simply pulled onto the hook.

Item-No.	Order-No.	Color
147810	/000	White
	/001	Black
	/002	Chartreuse
	/003	Red
	/004	Yellow
	/005	Brown

PROP & TWIST TWISTER

Our Prop & Twist twisters are sensationally luring and vastly superior to other baits in numerous tests! The crucial element is the propeller in the front section. While being hauled in the tail works like a normal twister. However, at the same time the twister permanently rotates around its own axis forming an L shape just the way we know bee maggots or trawling dough do. This parallel sequence of movements is enormously attractive to trout. We have carried out tests at popular fishing waters, whereby conventional baits were used for fishing parallel to the Prop & Twist rubber bait. While little or nothing happened to the standard rubber baits, there were permanently bites being made on the Prop & Twist rubber baits. Also perfect to perch. The twisters float!

Item-No.	Order-No.	Color	Length cm
1 60400	/103	White	3.5
	/203	Red	3.5
	/303	Black	3.5
	/403	Chartreuse	3.5
	/503	Brown-Glitter	3.5
	/603	Pink	3.5
	/703	Yellow	3.5

UTILITY MODEL PROTECTION



Assortm. 3.5cm: 5 colors (except yellow and black)

1 60400	/100	5 colors	3.5
---------	------	----------	-----

Item-No.	Order-No.	Color	Length cm
1 60400	/105	White	5
	/205	Red	5
	/305	Black	5
	/405	Chartreuse	5
	/505	Brown-Glitter	5
	/605	Pink	5
	/705	Yellow	5

Assortm. 5cm: 5 colors (except yellow and black)

1 60400	/101	5 colors	5
---------	------	----------	---

TROUT ATTACK KILLER TADPOLE

In late spring trout lakes are often populated with many tadpoles. The trout, especially the capitals, then targeted hunting of these easy to catch and tasty prey. Blessed is the who has our killer tadpoles in his bait box! They are fished with a Sbirolino or a jig head. Of course swimming and made of super soft material! Contents: 12 pcs.



Item-No.	Order-No.	Length cm	Colour
160750	/012	2 cm	mixed assortm.
	/112	2 cm	Black
	/212	2 cm	Black-Glitter

TACKLE MATE MULTIFUNCTION BOX

The multifunctional box can be used as an accessory box or trout bait glasses depot. With 3 foam boards an compartment separators.

Item-No.	Order-No.	Size cm L x W x H
183260	/004	34x22x9



Simply put the foam trays in the box and put the glasses without compartment separators into the box.



Variable compartments, perfect for larger accessories



With seals against moisture.

TREMARELLA STARTER SET



Content: 4 rigs including instructions at a super price!

Item-No.	Order-No.
160340	/400

TREMARELLA SYSTEME

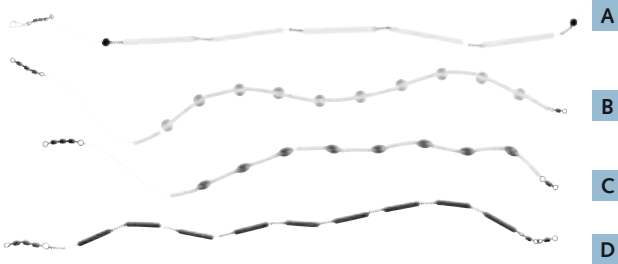

A
B
C
D

A Very slow to sink (for the surface). 2g, 26cm.

B Slow to sink = when trout are active in the top third. 4g, 24cm.

C Medium-fast to sink (for the middle depth or deeper). 6g, 24cm.

D Fast to sink = when the fish are close to the bottom. 8g, 24cm.

Item-No.	Order-No.	Type
160340	/100	A very slow sinking
	/101	B slow sinking
	/102	C medium-fast sinking
	/103	D fast sinking

BEE-MAGGOT HAIR RIGS AND ACCESSORIES

There is a silicone ring on the hair. Use the spreader forceps to open the ring and stick the bee maggot into the ring. The maggots don't escape, they play temptingly.

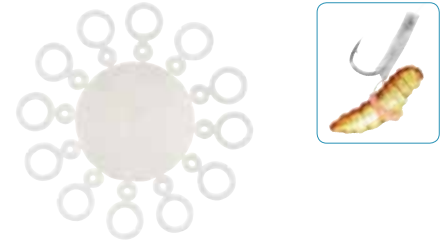

BEE-MAGGOT HAIR RIGS, 60 CM

Item No.	Order No.	Hook size / line diameter	Leader length cm
160710	/006	6 / 0,22 mm	60
	/008	8 / 0,20 mm	60
	/010	10 / 0,18 mm	60

BEE-MAGGOT HAIR RIGS, 140 CM

Item No.	Order No.	Hook size / line diameter	Leader length cm
160700	/006	6 / 0,22 mm	140
	/008	8 / 0,20 mm	140
	/010	10 / 0,18 mm	140

PLIER FOR BEE MAGGOTS

Indispensable tool for fixing the hook bait like bee maggots in the pellet tape. Simply stick the pliers into the pellet tape; as you press them the jaws open and the maggot can be inserted into the tape.

Item No.	Order No.
160730	/000

BEE MAGGOT QUICKIES

The quickies turn any hook into a hair rig in a matter of seconds! Draw the quickie onto the hook, stick the bee maggot into the silicone ring using the spreader forceps and you're ready to go!

Item No.	Order No.
160720	/000

Fischers Fritz braucht keine Drogen.



Wer schon in jungen Jahren lernt, sich in der Natur zurechtzufinden, der wird sich auch im Leben zurechtfinden. Geben Sie Ihrem Kind ein Ziel, einen Wert, eine Angelrute und dem Dealer keine Chance.

Für Interessenten steht die Balzer-Hotline (Tel. 06641-88 0 oder Fax 06641-88 77) zur Verfügung.
Wir informieren Sie gerne über die Aktion oder vermitteln Sie an zuständige Stellen.

Trout flies / Trout streamer

STREAMER ASSORTMENTS

Top trout streamer assortments in the most catching colours! They are brought in slowly in small tugs with Sbirolino, Ghost or the Cray Rattle. No matter if they float or sink slowly or fast, you are perfectly equipped for all kinds of situations.



»FAST-SINKING« STREAMER ASSORTMENT

The interaction of the elastic rubber feet with the marabou feathers is unique. The eyes bring the streamer down to the right depth fast. Contents: 4 streamers.

Item-No.	Order-No.	
160260	/000	



»SLOW-SINKING« STREAMER ASSORTMENT

Extremely appealing play of the rubber feet and marabou feathers Sinks slowly
Contents: 4 streamers.

Item-No.	Order-No.	
160270	/000	



SALMON ROE STREAMERS

Amazingly realistic imitation of salmon roe with milk (sperm). Super-catchy, especially on difficult days. It is slowly wound in, twitching, on a sbirolino.

Item-No.	Order-No.	
160330	/200	



»SUPER SLOW-SINKING« STREAMER ASSORT.

This streamer can literally hover in the water and should be fished with halts while being brought in.
Contents: 4 streamers.

Item-No.	Order-No.	
160280	/000	



»FLOATING« STREAMER ASSORTMENT

If the trout are hovering at the surface, this streamer is a sure bet!
Contents: 4 streamers.

Item-No.	Order-No.	
160290	/000	



GOLDEN-HEADED NYMPH ASSORTMENT

The golden-headed nymph is considered one of the best trout baits among fly fishers. This assortment is geared to lake trout in terms of size and colour composition. Contents: 4 streamers.

Item-No.	Order-No.	
160300	/000	



MICRO JIGHEAD ASSORTMENT

The Micro Jigs with marabou tails can even be used for fishing with an ultra light jig rod. If brought in with slow plucks, it is incredibly good for catching! Contents: 3 streamers.

Item-No.	Order-No.	
160310	/000	



HELICOPTER-FLY ASSORTMENT

As it is wound in the propeller rotates and the marabou feathers play seductively. Very good for catching.

Item-No.	Order-No.	
160320	/100	



ASSORTED »BIG EYE« STREAMERS

They are fantastically luring in domestic trout lakes. Since the eyes lend the streamer buoyancy, lead shot should be fixed onto the leader. Then twitch it at short intervals while winding in!

Item-No.	Order-No.	
160330	/100	

Trout trolling systems

BOUND TO FLUOROCARBON

TROLLING SYSTEMS

Very catchy systems for trolling. They can be used to fish with natural or artificial bait. All systems are tied to Japanese fluorocarbon lines and are therefore virtually invisible to the trout. Length of all systems: 2 m.



HELICOPTER SYSTEM

Even at a slight tug the silver helicopter starts to rotate, attracting the attention of the fish.

Item-No.	Order-No.	Hook-size	Line Ø mm
160320	/000	6	0.25



SPINNER BLADE SYSTEM

The chromium plated spinner blade rotates when pulled and lures the trout. The anti-tangle sheath prevents tangling.

Item-No.	Order-No.	Hook-size	Line Ø mm
160320	/308	6	0.25



HOOK SPINNER BLADE SYSTEM

With this system the spinner blade is attached directly to the hook shank with the help of a micro swivel and tumbles seductively to and fro.

Item-No.	Order-No.	Hook-size	Line Ø mm
160320	/208	6	0.25



TANDEM SPINNER SYSTEM

As above, but with 2 spinner blades rotating one behind the other for double attractiveness

Item-No.	Order-No.	Hook-size	Line Ø mm
160320	/408	6	0.25



PILOT BALL FLOAT SYSTEM

2 systems with pilot ball floats of different sizes. For trolling and longlining. Contents: 2 systems

Item-No.	Order-No.	Hook-size	Line Ø mm
160320	/108	6/8	0.25/0.22

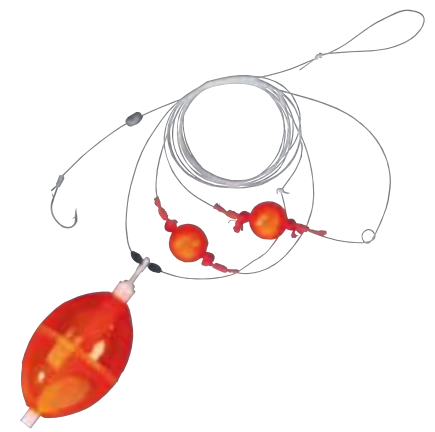

SBIRO-/TROUT SYSTEM

Ready assembled trout rig with buoyancy ball and pilot floats. Length: 1.90m, Ø 0,25mm, hook size 6.

Item-No.	Order-No.
147820	/005



MICRO SPINNER BLADE ASSORTMENT

12 micro spinner blades (6 colours, 2 of each), including 12 baits.

Item-No.	Order-No.	Colour
160320	/610	Silver



MICRO SPINNER BLADES

10 micro spinner blades plus bail for self-made systems.

Item-No.	Order-No.	Colour
160320	/510	Silver



HELICOPTER WITH BRASS BALLS

5 helicopters plus brass balls for self-made systems.

Item-No.	Order-No.
160320	/001

Fly Fishing

Fly fishing

Useful tackle and accessories for the fly fisherman.

Affordable rods and reels for beginners can be found on page 28 and 85.

Rods for the serious fly fisherman on page 48-49.



EDITION FLY FLY ASSORTMENTS

The most popular and best flies for catching, put together by leading fly fishing experts for a wide variety of uses.

The names of the respective fly is on each blister pack as a guide for beginners.



DRY FLY ASSORTMENT

Item-No.	Order-No.	
168000	/001	



WET FLY AND NYMPHS ASSORTMENT

Item-No.	Order-No.	
168000	/002	



GOLD HEAD NYMPHS ASSORTMENT

Item-No.	Order-No.	
168000	/003	



TROUT STREAMER ASSORTMENT

Item-No.	Order-No.	
168000	/004	



RAINBOW TROUT ASSORTMENT

Item-No.	Order-No.	
168000	/005	



SEATROUT ASSORTMENT WINTER/SPRING

Item-No.	Order-No.	
168000	/006	



SEATROUT ASSORTM. SUMMER/AUTUMN

The most popular sea trout flies select by leading fly fishing experts. Content: 4 pieces.

Item-No.	Order-No.	
168000	/007	



DVD TROUT FISHING

A video from Balzer, delivered in jewel case. Length 70 min.

Item-No.	Order-No.	
199270	/363	

FLY COMBOS



COMBO MAGNA SPECIAL FLY

Practical fly-rod package which fulfil even more exacting demands. Rod bag and fly line class 6DT included.

ROD

Carbon fibre rod, class 5/6 with natural cork grip, the main and top guides with an SIC inlay, snake guides and an aluminium reel seat.

REEL

Aluminium fly reel with disc brake system and salt-water resistant anticorrosion coating. Reel can vary.

Item-No.	Order-No.	Length	Sec.	Transp. Length m	weight g	AFTMA-class	Handle
116990	/240	2.40	2	1.25	100	5/6	Cork



SILICONE FLIES AND LINE GREASE

Also for leaders or fly-lines which will no longer float. Grease the fly only once for several successive catches. Melt between two fingers and spread on very thinly. Contents 20g.

Item-No.	Order-No.
169100	/000

LINE GREASE

Acknowledged top-grade. Suitable also for fly-lines prepared with oil or covered with synthetic materials covered. Long-lasting preparation due to high silicon content. Contents 20g

Item-No.	Order-No.
129000	/000

COLONEL-DRY FLY-LINE LEADER

Fly leaders must be soft and supple, allowing the fly to drift and play naturally. Length: 3 yards = 2.75 m.

Item-No.	Order-No.	Strength	Top mm Ø	Loop mm Ø
145220	/000	0x	0.28	0.64
	/001	1x	0.25	0.58
	/002	2x	0.23	0.56
	/003	3x	0.20	0.53
	/004	4x	0.18	0.53
	/005	5x	0.15	0.50
	/006	6x	0.13	0.43
	/007	7x	0.10	0.43



CAMTEC FLY

Double tapered line. AFTMA class 5-6.

Item-No.	Order-No.	Model	Characteristic	Color
128350	/056	DT 5 FL	FL=floating	peach

FLY LINE CONNECTOR

For a knotless, absolutely secure connection between fly line and leader.

Item-No.	Order-No.
145210	/015

ROLLER CLIP

Practical roller clip, ideal for fixing accessories like hook disgorger, pliers and so on.

Item-No.	Order-No.
169200	/000

Edition Carp



BITE INDICATOR WITH CHAIN

Could be adjusted to all situation by adding weights to the hangers. For monofilament and braided lines and for each diameter.

- Chemical lights can be used
- Corrosion-resistant chain
- Removable holder (Quick Change System)
- Additional weights available

Item No.	Order No.	
164210	/000	



BITE INDICATOR WITH REMOV. WEIGHT

- Adjustable metal trigger clip
- Chemical lights can be used
- Corrosion-resistant arm
- Removable holder (Quick Change System)
- sliding weight

Item No.	Order No.	
164210	/002	

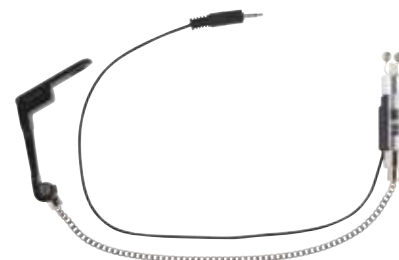

BITE INDICATOR WITH CHAIN AND LED

Same features as beside.

Additional features:

Additionally equipped with cable to connect your line controller with the sounder box of your bite indicator. If the LED in your bait indicator indicates a bite, your line controller reacts immediately.

Item No.	Order No.	
164210	/001	

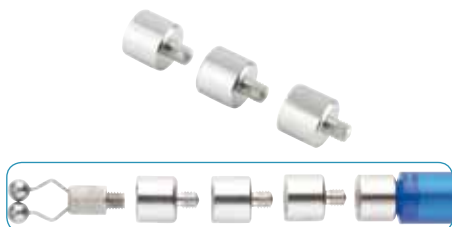

ADDITIONAL WEIGHTS FOR BITE INDICATOR

Additional weights for line controller

Extra weights for all our line controllers. Simply to screw. Weight: 10g.

Item No.	Order No.	
164210	/003	



METAL CASTING SCOOP

Very sturdy metal casting scoop which is most helpful when feeding with particles, boilies or other bait.

Item No.	Order No.	
164110	/000	



THROWING STICK

For our casting scoop and for feeding with particles and boilies in short distances. Length 25cm.

Item No.	Order No.	
164110	/100	



SOFT ROD REST WITH BRASS THREAD

Prevents scratches on the blank and stops the rod from slipping off.

Item No.	Order No.	
164110	/001	



SOFT ROD REST WITH BRASS THREAD

Prevents scratches on the blank and stops the rod from slipping off.

Item No.	Order No.	
164110	/005	



STAINLESS STEEL QUICK-RELEASE ADAPTER

Very robust stainless-steel quick-release adapter for bite indicator on the bank stick or the buzzer bar.

Item No.	Order No.	
164110	/004	



PVA BAGS IN DISPENSER BOX

PVA bags in tear-off dispenser pack for boilies, particle or stick mixes. Dissolves completely. Easy to process. 20 pieces.

Item No.	Order No.	Size mm
164310	/000	80x105



PVA LINE

PVA line for building stringers with boilies or for knotting PVA bags. Dissolves completely. Easy to process.

Item No.	Order No.	Length m
164310	/001	20



PVA BAGS

PVA bags for offering boilies, particle or stick mixes directly next to the hook bait. Dissolves completely. Easy to process.

Item No.	Order No.	Size mm
164310	/002	85x175
	/003	60x220
	/004	85x120



SILICONE TUBE

Very helpful tool for fixing the hair onto the hook shank and for protecting knots ; also for building unusual assemblies.

Item No.	Order No.	Color	Length m
164170	/000	clear brown	1



PVC TUBE

Prevents the assembly from tangling during casting and protects the fish against injuries during play. Very abrasion-resistant surface. Easy line threading.

Item No.	Order No.	Color	Length m
164150	/000	clear brown	1



KNOTPULLER

For tightening knots easily and securely, especially thick and braided lines .

Item-No.	Order-No.	Size
148270	/015	large



SAFETY CLIPS

Safety clip with included the tail rubber. Can be relied on to release the lead if there is a tangle.

Item No.	Order No.	Color
164180	/000	clear brown



SHRINK TUBE

For building rigs and assemblies. Protects knots; possesses very good shrinking properties.

Item No.	Order No.	Color	Length cm
164160	/000	clear brown	5



ANTI TANGLE SLEEVES

Anti-tangle sleeves guarantee a secure leader connection. Furthermore, it prevents the assembly from getting tangled when cast.

Item No.	Order No.	Color
164190	/000	clear brown

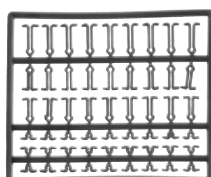

BOILIESTOPPER V SHAPE

Stopper board with 3 different stopper lengths.

Item No.	Order No.
164000	/005



BOILIESTOPPER

Boilie stopper in black. Standard shape.

Item No.	Order No.	Color
164000	/002	black

Edition Carp



STAINLESS STEEL BOILIE DRILL

Robust stainless steel boilie drill; drill length 45 mm.

Item No.	Order No.	
164120	/000	



STAINLESS STEEL BOILIE NEEDLE WITH HOOK

Robust boilie needle made from stainless steel with hook for attaching boilies and other baits.

Item No.	Order No.	
164120	/001	



STAINLESS STEEL BOILIE NEEDLE W. FOLDING EYE

Robust boilie needle made from stainless steel with folding eye for attaching boilies and bait.

Item No.	Order No.	
164120	/002	



STAINLESS STEEL STRINGER NEEDLE

Robust stringer needle for attaching boilie stringers or little PVA bags. Made from stainless steel.

Item No.	Order No.	
164120	/003	



FLUO BOILIE DRILL

Fluo boilie drill (almost impossible to lose) with a 45 mm long drill.

Item No.	Order No.	
164130	/000	



FLUO BOILIE NEEDLE WITH A HOOK

Boilie needle with a hook for attaching boilies and other baits.

Item No.	Order No.	
164130	/001	



FLUO BOILIE NEEDLE WITH FOLDING EYE

Boilie needle with a folding eye for attaching boilies and other baits.

Item No.	Order No.	
164130	/002	



FLUO STRINGER NEEDLE

Stringer needle for attaching boilie stringers or little PVA bags.

Item No.	Order No.	
164130	/003	

Edition Carp

Quality rigs with japanese hooks at affordable prices. All rigs are blister-packed. Content: 2 rigs.



STANDARD / LINE-ALIGNER RIG

Can be used if the bottom is firm or muddy. A rubber stopper on the hair fixes the bait, preventing particles or multiple boilies from slip. Thanks to the very long hair even Big Balls can be used.

Item-No.	Order-No.	hook size	strength lbs	Length cm	
164350	/002	2	25	20	
	/004	4	25	20	
	/006	6	25	20	



ANTI BLOW OUT RIG

Can be used if the bottom is firm. When the fish attempts to blow the bait out together with the hook, the sliding ring on the shank to which the hair is attached is pushed towards the eye of the hook. Thus the bait exits the carp's mouth and the hook is drawn into the lower lip.

Item-No.	Order-No.	hook size	strength lbs	Length cm	
164360	/002	2	25	20	
	/004	4	25	20	
	/006	6	25	20	

ROD POD TACTICS CARP



ROD POD TACTICS CARP

The extremely flexible construction of the Rod Pod makes for a particularly broad range of settings and uses.

The Pod can be used both in a very compactly and as a large or high pod (by using the two enclosed extensions).

Useful dimensions: length 80-120cm, height 50-100cm (with extension parts as a High Pod on one side up to 120cm).

Characteristics:

- Particularly light but strong aluminium construction
- Fast setup and conversion
- Precision quick-release fasteners
- Height of rod rests can be adjusted individually
- Supplied incl. 3x V- and 3x U-rod rests
- High quality nylon transport bag

Item No.	Order No.	Length adjustable	Height adjustable	
1 19490	/050	0.80–1.20 m	0.50–1.00 m	



Quick-release devices to adjust the height of the legs.



Quick-release devices to adjust the height of the banksticks.



Quick-release devices to adjust the length of the rod pod.



Compact transport bag.

ROD POD HOLIDAY

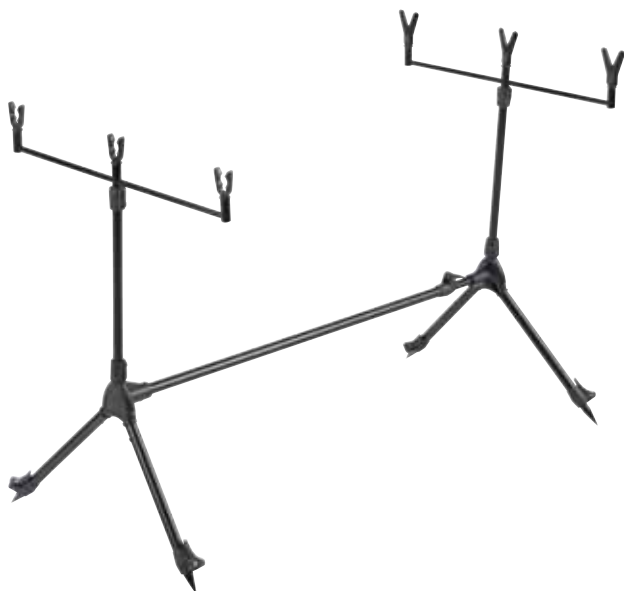

ROD POD HOLIDAY

Height and length-adjustable rod pod made from aluminium. It has a quick-release device and rod rests for up to 3 rods. Ideal for beginners and occasional anglers.

Item No.	Order No.	Length adjustable	Height adjustable	
1 19480	/200	0.70–1.20 m	0.54–0.64 m	



Quick-release devices to adjust length and height.

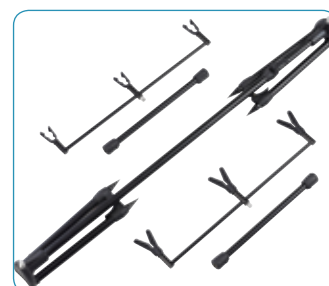

Compact packing and transport dimensions.

Metallica Pod

Metallica Pod. The only combinable tripod, rod pod and high pod in the world

**TEST CARP MIRROR
2-2010: SCORE 1.6**

The unique design of the BALZER Metallica Pod makes the impossible possible: You can use this Combi Pod as an individual tripod, rod pod or high pod as you require ... fast and easy!

Only very high quality parts and materials are used. For example, each of the 3 legs has 2 locking points. Therefore the angle of inclination of each leg can be adjusted individually. This provides a large number of possible settings – from very steep to quite flat. The legs are sheathed in non-slip Duplon and can be adjusted dead easily even in the cold or wet.

By working a quick-snap mechanism the tripod can be removed in seconds, then the 4 telescopic feet on the double tubes only have to be folded out and you already have a first class height and length adjustable rod pod.

FEATURES:

- Duraluminium, lightweight and torsion-proof
- Conversion from tripod to 4-legged rod pod in seconds
- Precision quick-snap mechanisms
- Buzzer bars with separate height adjustment
- Infinitely rotatable 360° locks firmly
- Angle of inclination adjustable between 0° and 70°degrees
- Fast set-up thanks to quick-snap locks
- Hook for additional weight
- Scope of supply includes 3×V- and 3×U-rod rests
- High quality nylon transport bag

METALLICA POD GOLD



Conversion from tripod to rod pod in seconds



Conversion from tripod to rod pod in seconds

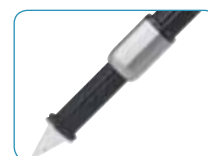

Pointed feet for safe standing (Gold Pod)

ROD ATTACHMENT FOR HIGH PODS



The ideal supplement to the Metallica pods if it is set up as a high pod and hence the rods can be secured towards the rear.

Item No.	Order No.	diameter cm
164110	/003	5 cm
	/103	3 cm

METALLICA POD GOLD

Item No.	Order No.	Length adjustable	Height adjustable
119490	/200	1.00–1.60 m	0.60–1.00 m

APPRAISAL IN BLINKER, 06/2008 ISSUE

Features:



Practical test:



Price::



The Blinker quality seal is only awarded to high quality tackle that has achieved at least 13 (of 15 possible) points on the test scale.



METALLICA POD SILVER

The Metallica Silver Pod is constructed similarly and equipped like the Metallica Gold Pod.

The main differences are:

- Smaller dimensions
- Other feet on the Tripod
- Other quick-release fasteners on the telescopic legs of the tripod and the Rod Pod
- Other mechanism for the conversion from Tripod to Rod Pod



The Silver Pod can be converted from tripod to rod pod also in seconds



Fast setup thanks to quick-snap locks for the telescopic legs of the Silver Pod



Pressure locks of the Silver Pod for adjusting the angle of the legs

METALLICA POD SILVER

Item No.	Order No.	Length adjustable	Height adjustable	
119490	/100	0.90–1.40 m	0.50–0.90 m	

Feedermaster - Method Feeder Fishing

METHOD FEEDER
by Michael Zammataro



Team Zammataro
German Feeder champion 2013 and 2012

Michael Zammataro's complete Method Feeder programme

Just as boilie fishing revolutionised carp fishing many years ago, for some time now Method Feeder fishing with mini boilies and pellets has been causing plenty of ripples in feeder fishing. This method of fishing has meanwhile become so successful for whiting, carp stock and tench that in some waters it has already been prohibited.

In collaboration with Michael Diener and Willy Frosch Michael Zammataro has developed an innovative complete programme for successful Method Feeder fishing.

ELASTIC METHOD FEEDER BASKET



Michael's newest Method Feeder basket with shock absorber and feed table for boilies and/or pellets. The plate always guarantees perfect bait presentation and prevents the hook from getting caught on the bars.

Including Quick-Change swivel and bead.

Item-No.	Order-No.	weight g	
141150	/010	10	
	/020	20	
	/030	30	
	/040	40	
	/050	50	



Shock absorber

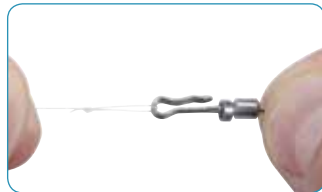

Quick-change swivel



Place leader with hook and bait in the feeder form and put feed inside.

Press feeder basket onto egg, then squeeze out the basket from the other flexible rubber side. The result is a perfect presentation of the bait on the feeder bomb.

METHOD FEEDER BASKET «INLINER»



Michael's new Method Feeder basket is also available as an In-liner version which is drawn onto the line like a running lead. Including Quick-Change swivel and bead.

Item-No.	Order-No.	weight g	
141150	/110	10	
	/120	20	
	/130	30	
	/140	40	
	/150	50	

METHOD FEEDER FORM



The feeder egg is the counterpart to the basket and fits all weights! The hook pellet or boilie is placed in the recess on the bottom, then the feed is put into the egg, the feeder basket pressed onto the egg and the feed is pressed out of the egg! The result is a feeder bomb with the bait lying directly on the bait support of the basket, thanks to the recess. Thanks to the flexible material of the egg, the feed can be pressed out cleanly. **Fits both feeder baskets.**

Item-No.	Order-No.	
141150	/000	



QUICK CHANGE SWIVEL

Simply push the ring down onto the clip; then hook in the leader and push the ring upwards again. To protect the swivel knot stick the bead with the large aperture onto the barrel completely.

Item-No.	Order-No.	
141110	/100	

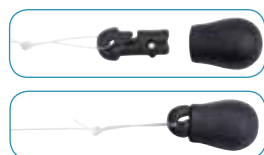

QUICK CHANGE BEAD

Open the Quick-Change Bead, then hook the leader into the Quick-Change Clip and then lock it again with the clip.

Item-No.	Order-No.	
141110	/110	

METHOD FEEDER HAIR RIGS AND HOOKS

HAIR RIG FOR PELLETS

On the hair is a pellet tape made from silicone. Open the tape with the pellet pliers, insert the pellet and you're ready to go! For 6 and 10 mm pellets. Leader length: 12 cm.



Item No.	Order No.	Hook size / line diameter mm	Bait Ø mm
141030	/010	10 / 0.22 mm	6 + 10
	/012	12 / 0.20 mm	6 + 10
	/014	14 / 0.18 mm	6 + 10
	/016	16 / 0.18 mm	6 + 10

HAIR RIG WITH SPEAR

There is a small spear with barbs on the hair onto which a boilie or pellet is simply speared - the bait stays on very well even during long-distance casts. The little spear is 8 mm long, making it ideal for boilies and pellets up to 15 mm. The longer one is for double boilies or pellets, maggots or combined baits. Leader length: 12cm.

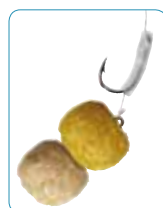

Item No.	Order No.	Hook size / line diameter mm	Spear length
141020	/008	8 / 0.22 mm	15mm
	/010	10 / 0.22 mm	15mm
	/012	12 / 0.20 mm	15mm
	/014	14 / 0.18 mm	15mm
141020	/110	10 / 0.22 mm	8mm
	/112	12 / 0.20 mm	8mm
	/114	14 / 0.18 mm	8mm
	/116	16 / 0.18 mm	8mm

METHOD FEEDER HOOK

Special hook with eye for assembling your own feeder rigs.



Item No.	Order No.	Hook size
141040	/010	10
	/012	12
	/014	14
	/016	16

QUICKIES

The ingenious quickies turn any hook into a hair rig in a matter of seconds! Simply draw the quickie onto the hook and that's it! There are 3 versions, 1x with pellet tape and the spear version in 2 lengths!



Item No.	Order No.	
141080	/000	

Item No.	Order No.	Length mm
141090	/000	8
	/010	15



PELLET PLIER

Simply stick the pliers into the pellet tape; as you press them the jaws open and the pellet can be inserted into the tape.

Item No.	Order No.	
141070	/000	

Feedermaster - Method Feeder Fishing

QUICK STOP RIGS

Pre-bound Quick Stop leader, 10 cm in length. The Quick-Stop is put on the needle, then inserted through the pre-drilled Boilie. You just draw out the needle and that's it!



Item No.	Order No.	Hook size / line diameter mm
141100	/008	8 / 0.,25 mm
	/010	10 / 0.22 mm
	/012	12 / 0.20 mm
	/014	14 / 0.18 mm



Srew a hole into the Boilie with our Boilie drill

Fix the Quick-Stop with our Boilie needle



Push the Quick-Stop through the hole

Fix the mounting - ready



BOILIE DRILL

Indispensable tool for preparing Boilies for Quick-Stop leaders.

Item No.	Order No.
141110	/020



QUICK STOP NEEDLE

Indispensable tool for fixing boilies on the hair for DIY Quick-Stop leaders.

Item No.	Order No.
141110	/010

QUICK STOPS

For DIY Quick-Stop leaders.

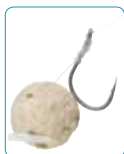

Item No.	Order No.
141110	/000

MICRO PREMIUM HALIBUT PELLETS, 2 AND 3 MM



High-quality halibut pellets measuring 2 mm and 3 mm with a high proportion of fishmeal and proteins. Soak the pellets for about 2 to 3 minutes in water and allow them to continue to absorb for a while. Then mix them with the moist Method Feeder feed and put them into the Method Feeder basket. Contents: 1000g.

HALIBUT PELLETS

Item No.	Order No.	Pellet Diameter mm
184840	/002	2 mm
	/003	3 mm

DIPS

The dips are of a tough, very sticky consistency like honey and they coat the dipped-in pellet or boilie like a second skin. Plenty stays on and it is so firm that nothing is lost even when casts are made over long distances. In the water the dip slowly disintegrates and releases the ingredients for stimulating feeding evenly into the water over a long period of time. When it bites, the taste receptors of the fish are stimulated intensively, causing it to take the whole bait. In our 5 aromas, of course!

Item No.	Order No.	Flavour Content 100 ml
185310	/075	Strawberry-red
	/175	Scopex-yellow
	/275	Mussel/Fish-green
	/375	Blood/Liver-black
	/475	Cocos/Crocant-white



HOOK PELLETS 6 AND 10 MM

Contrary to conventional pellets/boilies, our hook pellets and mini boilies are not boiled; they are gently steamed! By this method all the ingredients which stimulate feeding, such as amino acids, fishmeal and silkworms remain intact and are not cooked to rags. At the same time the pellets and boilies become slightly rubbery and supple and even when cast over long distances they do not come off the pellet tape. After just a very short time in the water they disperse their intensely luring ingredients and catch fish like the devil!



MINI BOILIES 8 AND 10 MM



HOOK PELLET POP UPS 10 MM / MINI BOILIES POP UPS 10 MM

Hook pellets, pop-ups and mini pop-ups are produced according to the same formula and, just like their sinking counterparts, they are gently steamed. Popups, especially in garish colours, have proved their worth excellently in many tests, especially for Method Feeder fishing. A tiny lead shot clamped onto the line just above the floating bait turns the hook bait into a balance that floats into the fish mouth without any resistance.



METHOD FEEDER DUMBBELLS 6 MM

By the mid inwardly curved shape the dumbbells pellets hold significantly safer in a wpellet ring than conventional pellets. Also our Dumbbells are gently steamed!



HOOK PELLETS 6 MM

Item No.	Order No.	Flavour Content 120 g
185270	/006	Strawberry-red
	/106	Scopex-yellow
	/206	Mussel/Fish-green
	/306	Blood/Liver-black
	/406	Cocos/Crocant-white

HOOK PELLETS 10 MM

Item No.	Order No.	Flavour Content 120 g
185280	/010	Strawberry-red
	/110	Scopex-yellow
	/210	Mussel/Fish-green
	/310	Blood/Liver-black
	/410	Cocos/Crocant-white

MINI BOILIES 8 MM

Item No.	Order No.	Flavour Content 120 g
185260	/008	Strawberry-red
	/108	Scopex-yellow
	/208	Mussel/Fish-green
	/308	Blood/Liver-black
	/408	Cocos/Crocant-white

MINI BOILIES 10 MM

Item No.	Order No.	Flavour Content 120 g
185260	/010	Strawberry-red
	/110	Scopex-yellow
	/210	Mussel/Fish-green
	/310	Blood/Liver-black
	/410	Cocos/Crocant-white

HOOK PELLETS POP UPS 10 MM

Item No.	Order No.	Flavour Content 100g
185290	/010	Scopex-yellow
	/110	Strawberry-red
	/210	Cocos/Crocant-white

MINI BOILIES POP UP 10 MM

Item No.	Order No.	Flavour Content 75 g
185270	/010	Scopex-yellow
	/110	Strawberry-red
	/210	Cocos/Crocant-white

Item No.	Order No.	Flavour Content 120 g
185300	/000	Strawberry-neon red
	/001	Scopex-neon yellow
	/002	Mussel/Fish-neon green
	/003	Blood/Liver-pink
	/004	Cocos/Crocant-white



Feedermaster accessories

FEEDERMASTER READY MADE RIGS

FEEDERMASTER®
by Michael Zammataro

Michael's successful assemblies are pre-tied for immediate use by the water. All the rigs are suitable for use both in flowing and still water.

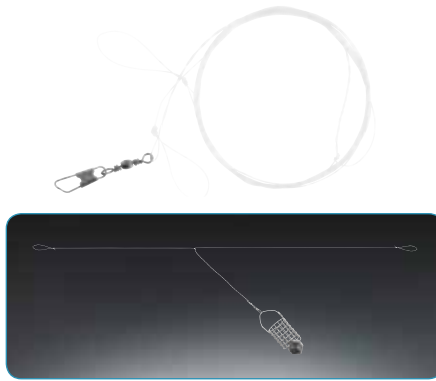

MONOFILAMENT SIDE ARM FEEDER RIG

Item-No.	Order-No.	Length cm
141060	/000	110 / 12

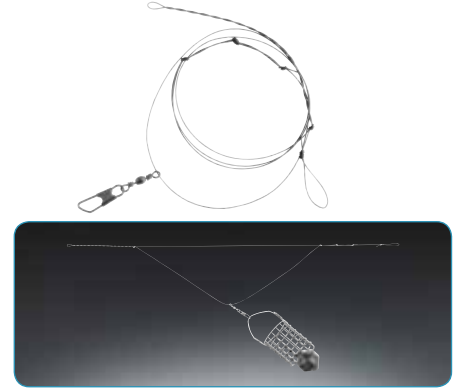

FEEDER RIG WITH LOOP

Item-No.	Order-No.	Length cm
141060	/001	30

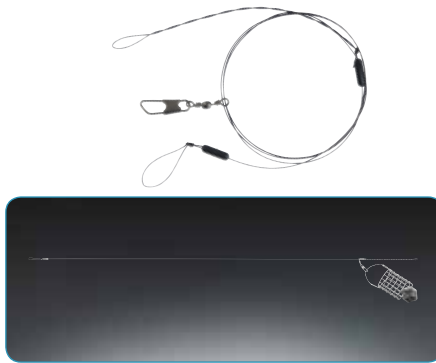

FREE RUN FEEDER RIG

Item-No.	Order-No.	Length cm
141060	/002	50

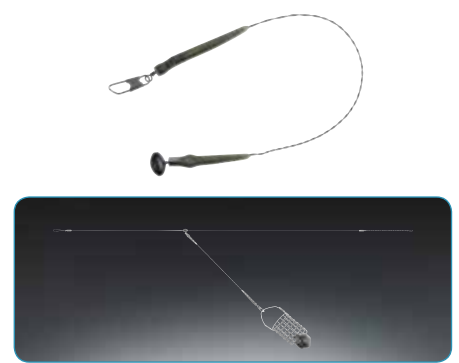

QUICK CHANGE RIG WITH BEAD

Item-No.	Order-No.	Length cm
141060	/003	17



FEEDER DOUBLE CLIP

The feed basket is hooked into one side of the clip and the line on the other side. Weighs virtually nothing; has no edges and makes the basket fly excellently. Cont. 10 pcs.

Item-No.	Order-No.
142010	/100



MICRO SWIVEL WITH SIC GUIDE INLAY

Guide the main line through the mounted ring and fasten the feeder double snap onto the eye opposite to it. Now hang the basket onto the other side of the double snap and it is ready to use! The adapter is so small that it can pass through the guides and can therefore remain on the line after fishing is over. Cont. 5 pieces.



Tip for assembling

Item-No.	Order-No.	Size
142060	/100	S
	/105	M



MICRO SWIVEL

For a secure, non-twisting connection between the leader and the main line. Cont. 10 pieces.

Item-No.	Order-No.	Size
142010	/105	20



FEEDERMASTER FREE RUNNING SIDE ARM

Arm is simply threaded onto the main line and –owing to its specified length (10 cm) – it permits the fish to take off without any resistance whatsoever when it picks up the bait. The line slides through a hole drilled in the guide sleeve. The feeder basket is simply hooked onto the carabiner swivel at the end of the adapter. This product is absolutely tangle-free.

Item-No.	Order-No.
125920	/001

CAMOUFLAGE CAP FEEDER BASKETS

Our waters are becoming cleaner than ever, and thus also clearer. Therefore feeder anglers are increasingly confronted with the problem of the shoing effect of normal wire baskets, in particular in waters where fishing is under high pressure. Some companies have coated their baskets in black gloss varnish to counteract this. However, tests run by Michael and his team revealed that this gloss varnish reflects the light, especially on sunny days, and scares off the fish.

When matt varnish was used the fish no longer displayed any distrust. After numerous failures we finally found the ultimate varnish: matt and impact-resistant on the baskets!

Michael finally selected a dark army green. Videos taken with underwater cams showed that the fish clearly regard baskets with this varnish as a part of their natural environment. In tests comparing these camouflage caps with unvarnished and/or painted with glossy varnish, the camouflage caps were clearly in front. The clearer the water, or the sunnier the weather is, the greater is their superiority.

You will be astonished at:

<https://www.youtube.com/watch?v=UC8nUime9Zs>



A comparison: In the back our Feeder baskets and in front a standard feeder basket: the shiny material reflects the light, especially on sunny days, and scares off the fish.



FEEDERMASTER INLINER FEEDER BASKETS

Classic shape Inliner Feeder Basket. Can be cast well and releases the feed quickly. The lead on the cage baskets is clenched.



SPEED FEEDER BASKET

If needed for long distance casts, this basket is a must because it has outstanding casting characteristics.

Item-No.	Order-No.	Weight g	Size cm WxH
SPEED FEEDER BASKET, SMALL			
189620	/020	20	24x25
	/030	30	24x25
	/040	40	24x25
	/050	50	24x25
SPEED FEEDER BASKET, LARGE			
189630	/030	30	32x38
	/040	40	32x38
	/050	50	32x38
	/060	60	32x38
	/070	70	32x38
	/080	80	32x38

9 pieces per display.

CAGE FEEDER BASKET

Classic shape; can be cast well and releases the feed quickly.

Item-No.	Order-No.	Weight g	Size cm WxH
CAGE FEEDER BASKET, SMALL			
189600	/020	20	28x35
	/030	30	28x35
	/040	40	28x35
	/050	50	28x35
	/060	60	28x35
	/080	80	28x35
CAGE FEEDER BASKET, LARGE			
189610	/030	30	28x45
	/040	40	28x45
	/060	60	28x45
	/080	80	28x45
	/100	100	28x45
	/120	120	28x45

9 pieces per display.

INLINER FEEDER BASKETS

Item-No.	Order-No.	Weight g	Size cm WxH
189600	/120	20	28x35
	/130	30	28x35
	/140	40	28x35
	/150	50	28x35
	/160	60	28x35
	/180	80	28x35

9 pieces per display.

FEEDMASTER FEEDER BASKETS WITH LEAD EDGE

The lead ring is poured around the basket and is open downward. The basket has excellent flight characteristics: it flies far and accurately, almost like a speed Feeder.



FEEDER BASKETS WITH LEAD EDGE

Item-No.	Order-No.	Weight g	Size cm WxH
189650	/060	60	32x38
	/070	70	32x38
	/080	80	32x38
	/100	100	32x38
	/120	120	32x38

9 pieces per display.

FEEDMASTER FEEDER BASKET WITH CLAWS

Special feeder basket with claws for river anglers. By the claws the feeder remains well anchored to the ground, also when fishing with lighter baskets. The basket can be released easily by a short, powerful pull. The claws are extra long and stable.

How to use:

The claws are gently bent about 90 degrees to the back.



DELIVERED IN DISPLAY

FEEDER BASKET WITH CLAWS

Item-No.	Order-No.	Weight g	Size cm WxH
189660	/075	75	32x38
	/100	100	32x38
	/125	125	32x38
	/150	150	32x38

9 pieces per display.

FEEDMASTER PLASTIC FEEDER BASKETS

Michael's latest plastic feeder baskets. In certain situations plastic baskets have clear advantages over wire baskets:

1. Muddy bottom:

When fishing where the bottom is muddy or has many obstacles, due to their low weight the baskets do not sink into the mud.

2. Bottom with many obstacles:

The baskets rise to the top much faster than wire baskets, thus significantly reducing the risk of getting entangled.

3. Smaller apertures:

Thanks to the smaller apertures "sandwiches" can be chummed. This means that live baits is

put into the centre of the basket (e.g. Pinkies) which are then sealed with feed on both sides.

As with the stainless steel baskets, the suspension brackets are made from nylon with ferrules.

Supplied in displays.

DELIVERED IN DISPLAY



CAGE FEEDER BASKET

Item-No.	Order-No.	Weight g	Size cm WxH
----------	-----------	----------	-------------

CAGE FEEDER BASKET, SMALL

189700	/020	20	26x38
	/030	30	26x38
	/040	40	26x38

CAGE FEEDER BASKET LARGE

189710	/020	20	30x44
	/030	30	30x44
	/040	40	30x44
	/050	50	30x44
	/060	60	30x44

10 pieces per display.

SPEED FEEDER BASKET

Item-No.	Order-No.	Weight g	Size cm WxH
----------	-----------	----------	-------------

SPEED FEEDER BASKET, SMALL

189720	/020	20	27x27
	/030	30	27x27
	/040	40	27x27

SPEED FEEDER BASKET LARGE

189730	/020	20	27x33
	/030	30	27x33
	/040	40	27x33
	/050	50	27x33
	/060	60	27x33

10 pieces per display.



Feedermaster - the feed developed by feeder-fishing champ Michael Zammataro

Readymade feed mixture especially for feeder fishing in flowing and still waters.

The aromas and colours are perfectly adapted to the respective target fish. The recipes come from feeder champion Michael Zammataro and have a tremendous luring effect.

The feed is quick to break out of the basket and keeps the fish in that place for a long time.



FEEDERMASTER FOOD

Please note the following when preparing your food:

Mix the food well in a bucket.

Then gradually fill in some water and mix well. You may repeat this process several times.

Now put the wet food on a sieve and press it through the sieve. You can repeat this process till the result meets your wishes.

Michael Zammataro recommends the following combinations:

- Blackjack and Roach
- If a sticky food like the variety of Bream is to loosen it can be mixed with less sticky food like the varieties of Roach or Black Jack
- If different kinds of fishes are expected you can combine a packet of Roach and a bag of Bream.

NOTE: The Method Feeder food has an extra high proportion of fish meal. In waters where regularly is fished and fed with boilies this food attracts almost large bream and carp and is unbeatable!

Item-No.	Order-No.	Packing unit 1000g	
184810	/001	Bream	
	/002	Bream yellow	
	/003	Carp/Tench	
	/004	Roach	
	/005	Black Jack	
	/006	Barbel	
	/007	MF Mussel-Fish	
	/008	MF Strawberry	
	/009	MF Scopex	
	/010	MF Cokos/Crokant	
	/011	MF Blood/Liver	

MF = Method Feeder



BLACK JACK

BREAM

BARBEL

METHOD FEEDER
MUSSEL-FISH

METHOD FEEDER
STRAWBERRY

METHOD FEEDER
SCOPEX

ROACH

BREAM
YELLOW

CARP/
TENCH

METHOD FEEDER
COKOS-CROKANT

METHOD FEEDER
BLOOD LIVER

Feedermaster accessories

Feedermaster Softbaits

Michael Zammataro's latest creation: Imitation larvae, casters and corn made from buoyant soft rubber.

The bait is combined with natural bait on the hook. Thanks to their **buoyancy** they neutralise the dead weight of the hook and hence afford the genuine baits much more natural presentation.



FLOATING

SOFT PINKIES / MAGGOTS

The bright-coloured maggots arouse the attention of the fish in cloudy waters. Very natural shape, 2 sizes, colours: yellow, orange, Japanese red and white. Content: 40 pieces

Item-No.	Order-No.	Length mm	
138750	/000	10 (Pinkies)	
	/100	15 (Maggots)	

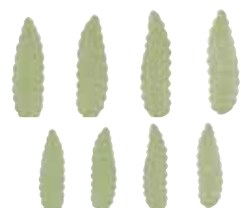

SOFT PINKIES / MAGGOTS FLUO

Perfect for fishing in muddy water. Not floating. Content: 40 pieces.

Item-No.	Order-No.	Length mm	
138750	/400	10 (Pinkies)	
	/700	15 (Maggots)	



FLOATING

SOFT CORNS

Here the bright colours arouse the attention of the fish. The corn is also available in its natural colouring for clear waters. 3 sizes, colours: Maize natural, orange, Japanese red and white. Content: 40 pieces

Item-No.	Order-No.	Length mm	
138760	/000	6	
	/100	8	
	/200	10	



SOFT CORNS FLUO

Perfect for fishing in muddy water. Not floating. Content: 40 pieces.

Item-No.	Order-No.	Length mm	
138760	/300	6	
	/400	8	
	/500	10	

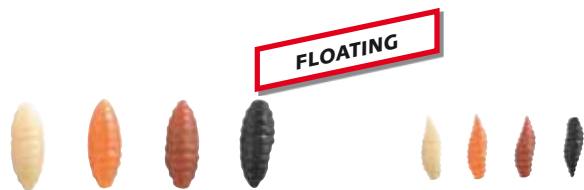

FLOATING

SOFT CASTERS / MAGGOTS AND PINKIES

Incredibly natural imitation of larvae/maggots in 4 different stages; In the form of a larva / maggot and caster in 3 different stages of pupation. Michael likes to use these casters especially over long distances because real casters often tend to fly off the hook unnoticed during casting. Size: 11mm, Content: 40 pieces

Item-No.	Order-No.	Length mm	
138750	/800	6	
	/200	11	

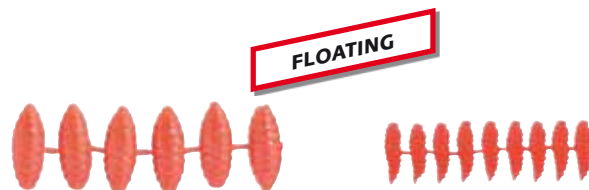

FLOATING

SOFT MAGGOTS AND PINKIES JAPANESE RED

The colour japanese red is also very catchy in fresh water. Content: 40 pieces.

Item-No.	Order-No.	Length mm	
138750	/900	6	
	/300	11	

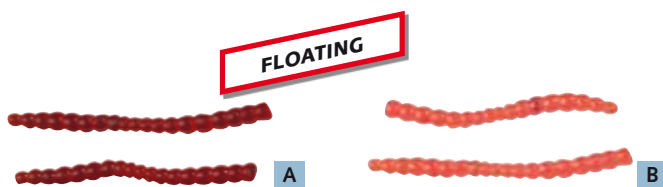

FLOATING

SOFT MOSQUITO LARVAE

Very natural imitation mosquito larvae Extra-soft and floating! Also very catchy in trout lakes. Contents: 40 units

Item-No.	Order-No.		Color	
138750	/500	A	nature	
	/600	B	japanred	



UNIQUE MODULAR CONCEPT



Feeder Master System: Michael Zammataro's new bag range with system!

The new Feedermaster bag and bait-box range draws features a unique modular concept and a number of well-conceived details.

The individual bags and boxes can be combined, fitting together perfectly and saving space!

Michael has set great store by using only the

very highest quality materials. Thus most bags are made from 840D nylon!

Experience the program in use:
<https://www.youtube.com/watch?v=MOVfwXzROkI>



ROD CASE 3 + 1

Padded rod backpack made from high-quality 840D Oxford nylon. Capacity for 3 assembled rods and one unassembled rod and/or. Larger accessories such as an umbrella, landing-net handle etc. Another external pocket for smaller tackle or our Feeder tube or the Feeder Case. Waterproof PVC material is sewn over the underside; it can be cleaned easy. The padded, adjustable back straps guarantee comfortable transportation. Pretty much all established feeder rods measuring 1.35 and 1.65 m fit in to it.

ROD CASE FOR 4 RODS

Item-No.	Order-No.	Size cm LxWxH
119060	/135	135x40x12
	/165	165x40x12



Waterproof PVC material is sewn over the underside

COOL BAGS



Compartment for cool battery

COOL BAG LARGE

Indispensable for transporting bait, drinks and food. The ISO material insulates extremely well and ensures prolonged cooling. The dimensions of the bag are exactly coordinated with our new bait and pellet boxes, which can also be stacked. Thanks to the removable partition food and bait boxes can be separated hygienically.

Additionally, the bottom has waterproof, easy-to-clean PVC material sewn on. Padded carrying belts and handles.

Material: 840D Oxford nylon with PVC coating.

Delivered without content.

Item-No.	Order-No.	Size cm LxWxH
119080	/000	50x26x18

COOL BAG SMALL

Small handy cooling bag, which can accommodate exactly 4 large or 8 small bait/pellet boxes. Of course, it is also ideal for storing food and drinks. A separate compartment for the ice pack. The ISO material insulates extremely well and ensures prolonged cooling. Exactly right for the Concept Bag.

Material: 840D Oxford nylon with PVC coating.

Delivered without content.

Item-No.	Order-No.	Size cm LxWxH
119080	/005	30x18x18

All bags are delivered without content.

Feedermaster bags

TRANSPORT BAG CONCEPT



Feeder basket box included



Stabilising partition

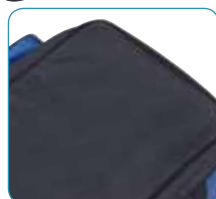

Waterproofed PVC bottom



With padded carrying straps

You have certainly never seen such a well thought-out carryall before. The 4 hard shells supplied with the bag are inserted into the side pockets on the inside, thus making the bag dimensionally stable. Inside the bag is a feeder-basket box in which up to 24 baskets can be stowed.

Optionally one can also insert the partition contained in the scope of supply and thus separate the storage space. With the help of the flexible belt bulky things such as a jacket, tripod etc. can be stowed away well on top of the bag.

Thanks to the modular concept the two containers and the small cooler bag fit exactly into the Concept bag and can be stacked so that each centimetre of the interior is optimally used.

The bag is made from 1200D Oxford nylon. Additionally, the bottom has waterproof PVC material sewn on, which is easy to clean.

With padded carrying straps and handles.

Delivered without content.

Nice Video under: <https://www.youtube.com/watch?v=M0VFwXzROkI>

Item-No.	Order-No.	Size cm LxWxH
119070	/000	60x35x30

ROLL-UP SHEATH FOR FEEDER TIPS: "TIP CASE"



Provides space for up to 20 feeder tips. Using a water-resistant marker you can write the casting weight of every individual tip on the white PVC strips. The tips are easily fixed by means of Velcro® tape. Matches the 3+1 rod case exactly. Material: 840D Oxford nylon with PVC coating. Delivered without content.

Item-No.	Order-No.	Length cm
119090	/020	80cm

TRANSPORT BAG „WATER STOP BAG“



Spacious transport bag made from watertight PVC and with a firm, indestructible plastic bottom. Thanks to the special watertight zippers the contents remain dry even during continuous and torrential rain. The two containers S and L fit into this bag exactly and can be stacked. With fixable handles as well as an adjustable shoulder strap.

Material: PVC. Delivered without content.

Item-No.	Order-No.	Size cm LxWxH
119100	/000	45x27x27

TRANSPARENT BAGS «CONTAINER S AND L»



Any amount of accessories can be stowed away neatly in these two containers made from waterproof PVC. The top feature is the transparent topsides: It means that you can see the contents already from the outside and no longer need to open them. They fit in exactly and can be stacked for the water stop bag as well as the "Concept" transportation bag. Material: PVC. Delivered without content.

Item-No.	Order-No.	Size cm LxWxH
119100	/012	15x12.5x6 (S)
	/025	15x25x6 (L)



FEEDER TIP HARDCASE «TIP TUBE»

For the safe transportation of feeder tips. Matches the 3+1 rod case exactly. Material: 840D Oxford nylon with PVC coating.

Item-No.	Order-No.	Size cm LxWxH
119090	/010	80x6x6

All bags are delivered without content.

NET BAG

Very spacious landing net bag made of water- and odor-proof PVC material and special watertight zippers for storing keep nets and net heads. Reliable protection against moisture and odors. Material: PVC. Delivered without content.

Item-No.	Order-No.	Size cm LxWxH
119100	/058	54x52x17



Watertight zippers

Keep nets and net heads can be stored easily

FOLDABLE WATER BUCKET WITH LINE

Indispensable for fetching water on sheet-pile walls or embankments. Length of the cord 9.50m.

Item-No.	Order-No.	Size cm LxWxH
183020	/002	18.5x20



FEEDERMASTER® SYSTEM BAIT BOXES

The brand-new bait-box range goes well with Michael's new bags. Thanks to the adapters on the lids and the matching counterparts on the underside of the tins, these can be stacked securely. The lids close very precisely. All boxes are exactly co-ordinated with our two cooler bags.

See our Youtube-Video under: <https://www.youtube.com/watch?v=UC8nUime9Zs>



MAGGOT BOXES

Extra-small vents, therefore also suitable for pinkies.

Item-No.	Order-No.	Content l	Size cm LxWxH
183500	/003	0.3	15x10x3
	/006	0.6	15x10x6



PELLET-/MICROBOILIE BOXES

The lids do not have holes in order to preserve the aroma of pellets and boilies.

Item-No.	Order-No.	Content l	Size cm LxWxH
183500	/103	0.3	15x10x3
	/106	0.6	15x10x6



FEEDER BASKET BOX

The extra expansive compartments offer sufficient room to store feeder baskets. If the baskets are extremely long (e.g. claw basket) the separators can be removed to enlarge the compartment. Provides space for up to 24 baskets. Delivered without content.

Item-No.	Order-No.	Size cm LxWxH
183250	/040	36x22x4.5



SPECIAL SIEVE FOR CASTERS

Fill the maggot box with water and casters; take out an appropriate quantity of casters and lay them on the sieve. The water drips off through the sieve. The tin can be locked for transportation, also with lid. Delivered without box and content.

Item-No.	Order-No.	Size cm LxW
183500	/300	14.5x9.5



MAGGOT ESCAPE PROTECTION

Is there anybody who doesn't know it? As soon as the maggot tin is a bit damp, maggots and pinkies start crawling up the sides. We've put an end to that now! The escape protection is simply clicked onto the tin. Delivered without box and content.

Item-No.	Order-No.	Size cm LxW
183500	/200	15.5x10.5

All bags are delivered without content.

Feedermaster accessories / Feeder accessories

FEEDERMASTER DISTANCE FINDER

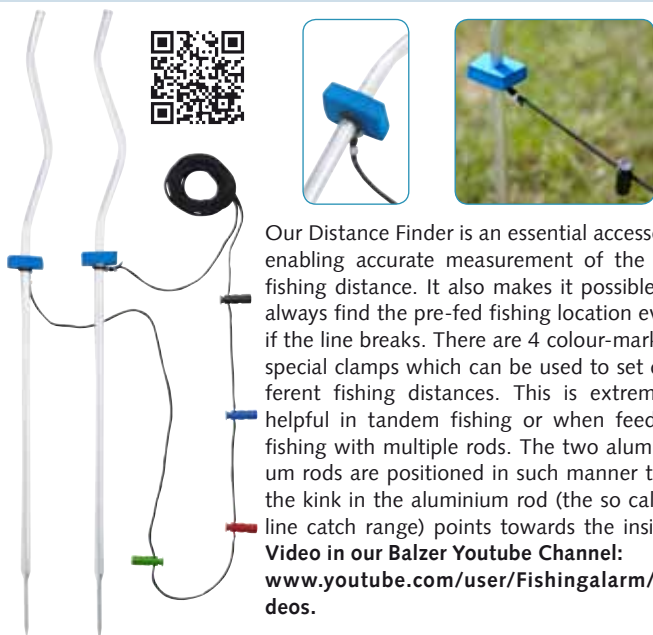

Our Distance Finder is an essential accessory enabling accurate measurement of the set fishing distance. It also makes it possible to always find the pre-fed fishing location even if the line breaks. There are 4 colour-marked special clamps which can be used to set different fishing distances. This is extremely helpful in tandem fishing or when feeder-fishing with multiple rods. The two aluminium rods are positioned in such manner that the kink in the aluminium rod (the so called line catch range) points towards the inside. **Video in our Balzer Youtube Channel: www.youtube.com/user/Fishingalarm/videos.**

Item No.	Order No.	
1 19550	/000	

FEEDERMASTER LANDING NET HEAD AND LANDING NET POLES



ZAMMATARO FEEDERMASTER LANDING NET HEAD

Nylon odour-free landing-net head with an ergonomic shape.

Item-No.	Order-No.	Size cm L x W	mesh size mm	
180900	/000	45x40	8	



FEED BUCKET, 25 LITRES

Professional feed bucket with removable tray and an overlapping cover which prevents moisture from entering the bucket.

Item-No.	Order-No.	Content l	
183470	/025	25	



FEEDERMASTER METHOD FEEDER ROD REST

Professional rod rest made from soft moss rubber and with a left-hand thread. In view of the fact that with Method feeders the fish often hook themselves and take off at full speed, the special shape preventing the rod from being pulled off the rest.

Ideal in combination with our tripod 1 65020/200.

Item No.	Order No.	
1 65030	/100	



FEEDERMASTER EVA FEEDER ROD REST

Professional rod rest made from soft moss rubber and with a left-hand thread. Ideal in combination with our tripod 1 65020/200.

Item No.	Order No.	
1 65030	/200	



ZAMMATARO CARBON LANDING NET POLE

3-sectionend put over landing net pole made of lightweight carbon. Fits exactly to Michael's land net head. The connection parts are strengthened, the thread fixed by rivet is made of brass. Weight: 270 gr.

Item-No.	Order-No.	Sections	Length m	
180900	/330	3	3.30	



ZAMMATARO CARBON LANDING NET POLE EXTENSION

With the put over extension part made of carbon the landing net pole can be lengthen up to 4.40m.

Item-No.	Order-No.	Sections	Length m	
180900	/120	1	1.10	

FEED SIEVE



Fits perfectly onto our feed bucket. The chief attraction of this sieve: it can be placed exactly(!)in and not on the bucket. Hence the sieve can be transported in the bucket, including the tray, with the lid completely closed. Conventional sieves have to be transported separately.

Item-No.	Order-No.	Sieve ø cm	Mesh width mm	
183470	/125	38 cm	3.5 mm	

EDITION FEEDER ROD RESTS



SPECI FEEDER REST

Feeder rod rest with many resting points to meet your individual needs. With a folding joint for adjusting the angle of the rest.

Item No.	Order No.	
1 19640	/000	



FEEDER ROD REST

Rubberised Feeder rest with infinitely adjustable rubber rings for the resting points to meet your individual needs. With a clever folding joint for adjusting the angle of the rest.

Item No.	Order No.	
1 65030	/000	



SPECI FEEDER TRIPOD

Great telescopic feeder tripod made of aluminium with Quick-Close locks. The rubber rings on the rubber rod rest are for infinite sliding, enabling you to set the resting points of the rods to your personal requirements. The middle of rest contains a line guidance slot for fishing with a free-run reel.

Hooks available for additional weights.

Height: 75-125 cm.

Item No.	Order No.	
1 65020	/000	



TRIPOD WITH ROD REST

Telescopic aluminium tripod and foldable rod rests.

Height: 50-90 cm.

Item No.	Order No.	
1 65020	/100	



UNIVERSAL TRIPOD WITH THREAD

Telescopic aluminium tripod with a left-hand thread for fixing on bite indicators and rod forks etc. Ideal together with our multifunctional table. Adjustable height: 50-105 cm.

Item No.	Order No.	
1 65020	/200	



Delivered without Tripod.

MULTIFUNCTIONAL TABLE REST

This extendable table is an ideal aid for all seated anglers. It takes up no extra space during transportation and it can be pulled out on both sides on the bank. Underneath there is a thread enabling you to screw it onto any bank stick or, even better, onto our tripod.

The table has different compartments for storing away bait, accessories, food etc. in an organised manner. Size unfolded: 49 x 18cm.

Item No.	Order No.	
1 65020	/201	



LEAD/SWIVEL

**With a feeling for
subtleties**



With a feeling for subtleties

Lead is lead and swivels are swivels; that's what many anglers think. And to a large extent they are right. However we should never forget just how important these essential utensils are for the angler's daily needs. You must be able to rely on them 100% to stop that dream fish from getting away at the wrong moment.

Swivels provide the connection between line, spacers, hooks, leaders etc and should prevent the line from twisting when reeling in as well as allowing a quick change of system. Apart from these features, what makes BALZER's swivels perfect is above all the enormous and reliable load capacity (load capacity guarantee) which means the angler can be sure never to lose a fish. However, along with this, what is very important is that the knots are correctly and cleanly tied. This can often be a weak point in the assembly.

Do yourself a favour and put your trust in BALZER's reliable, tried and tested products, which put you in control at all times and let you enjoy the peace and relaxation that angling can bestow!

Best quality by OWNER: Swivels, Snaps and snap rings

We can offer you the perfect quality from Owner. Check out the Japan Quality at once, you will find that every penny is worth more safety and reliability - see page 250.

Lead



DRILLED LEAD BULLETS

With detailed weight information on package.

Item-No.	Order-No.	Sorted mm	
140370	/000	0.7/1.2/1.8/2/2.5g (120g)	



DRILLED LEAD BULLETS

Item-No.	Order-No.	Cont.	Weight g
140010	/007	20	0.7
	/018	15	1.8
	/040	12	4.0
	/075	8	7.5
	/125	7	12.5
	/190	5	19
	/280	3	28
	/400	3	40



SWIVEL LEAD

Item-No.	Order-No.	Cont.	Weight g
140180	/003	10	3
	/005	10	5
	/007	5	7
	/010	5	10
	/015	4	15
	/020	2	20
	/030	2	30
	/040	2	40
	/050	2	50
	/060	2	60
	/080	1	80

In blister-pack.



DRILLED COFFIN WEIGHTS

Item-No.	Order-No.	Cont.	Weight g	
140060	/015	3	15	
	/020	3	20	
	/025	3	25	
	/030	3	30	
	/035	3	35	
	/045	2	45	
	/060	2	60	
	/080	1	80	
		/100	1	100



PRACTICAL SORTING

SHOT-LEAD SPLIT

With detailed weight information on package.

Item-No.	Order-No.	Sorted mm	
140340	/000	2/3/4/5/6 (70g)	
	/070	2/3/4/5/6 (120g)	
	/080	5/6/7/8 (120g)	
140350	/120	0.06g to 0.8g (120g)	



TROLLING-LEAD

Reliable trolling weight form, ideal for the natural bait fishing.

Item No.	Order No.	Cont.	Wt. g
140890	/010	3	10
	/014	2	14
	/021	2	21
	/028	2	28



SWIVEL LEAD

Item-No.	Order-No.	Weight g
140170	/003	3
	/005	5
	/007	7
	/010	10
	/015	15
	/020	20
	/025	25
	/030	30
	/040	40
	/050	50
	/060	60
	/080	80
	/100	100

50 pieces in bag.



HERRING-LEAD

Item-No.	Order-No.	Weight g
140880	/050	50



DRILLED OLIVE LEADS

Item-No.	Order-No.	Cont.	Weight g
140110	/030	8	3
	/060	5	6
	/095	4	9.5
	/120	4	12
	/150	4	15
	/210	3	21
	/310	3	31
	/400	2	40

Lead



TIROLER HÖLZL

Item-No.	Order-No.	Weight g
140310	/015	15
	/020	20
	/025	25
	/030	30
	/040	40
	/050	50
	/060	60



ANTI TANGLE STAND UP LEAD

Even if the bottom is muddy it guarantees that the line can run out freely.

Item-No.	Order-No.	Weight g
140920	/010	10
	/015	15
	/020	20
	/025	25
	/030	30
	/040	40

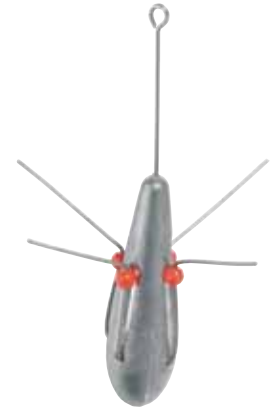

SURFCASTING-LEAD

Item-No.	Order-No.	Weight g
140960	/080	80
	/100	100
	/125	125
	/150	150
	/175	175
	/200	200

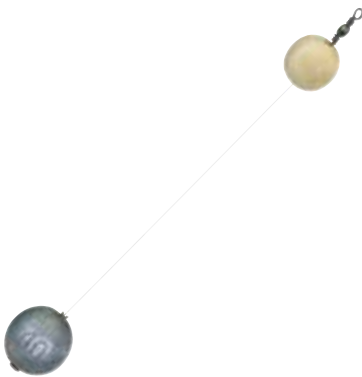

STAND-UP LEAD

Item-No.	Order-No.	Weight g
140910	/010	10
	/015	15
	/020	20
	/025	25
	/030	30



STAND-UP-LEAD

Always remains upright and lets the line slide through unhindered.

Item-No.	Order-No.	Weight g
189670	/010	10
	/020	20
	/030	30
	/040	40
	/050	50

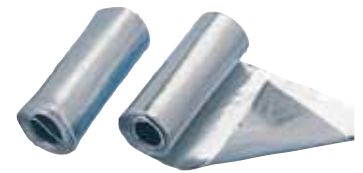

WRAPPING LEAD

Item No.	Order No.	Length mm
140210	/023	0.33



BOTTOM FINDER

Item No.	Order No.	Weight g
140950	/005	5
	/010	10
	/015	15
	/020	20

10 pieces in bag.



BOTTOM FINDER

Item No.	Order No.	Weight g
140950	/105	5
	/110	10
	/115	15
	/120	20

10 blister, 1 per blister.



BOTTOM FINDER SET: 5, 10, 15, 20 GR.

Item No.	Order No.	Weight g
140950	/400	5, 10, 15, 20

5 blister, 4 per blister.

Swivels

In our newly launched Swivel program we changed packing contents like that that for all sizes of a type only one price is sufficient - we think that this is a huge relief when labeling prices.

Besides many proven models, the program has been extended to some new types.



SWIVEL WITH SNAP-LINK

Item-No.	Order-No.	Cap. kg	Cont.	Size
142140	/002	12	5	2
	/004	10	6	4
	/006	9	9	6
	/008	8.5	10	8
	/010	7.5	10	10
	/012	6.5	10	12
	/014	6	10	14
	/016	4	10	16
	/018	3	10	18
	/020	2	10	20



DOUBLE SWIVEL

Item-No.	Order-No.	Cap. kg	Cont.	Size
142150	/006	9	9	6
	/008	8.5	10	8
	/010	7.5	10	10
	/012	6.5	10	12
	/014	6	10	14



TRIPLE SWIVEL

Item-No.	Order-No.	Cap. kg	Cont.	Size
142030	/010	9	5	10
	/012	8	5	12
	/014	6	5	14
	/016	4	5	16
	/018	2.5	5	18



SCANDI SWIVEL

Item-No.	Order-No.	Cap. kg	Cont.	Size
142130	/300	55	3	3/0
	/200	50	3	2/0
	/100	45	3	1/0
	/001	40	4	1
	/002	35	4	2
	/004	30	5	4
	/006	25	6	6
	/008	20	6	8
	/010	17	6	10
	/012	14	7	12



SEA-FISHING SWIVEL

Item-No.	Order-No.	Cap. kg	Cont.	Size
142120	/500	75	2	5/0
	/400	65	2	4/0
	/300	55	2	3/0
	/200	45	2	2/0
	/001	40	5	1
	/002	35	5	2
	/003	30	5	3
	/004	25	5	4
	/005	20	5	5



SECURITY SWIVEL

Item-No.	Order-No.	Cap. kg	Cont.	Size
142050	/010	14	5	10
	/012	12	5	12
	/014	10	5	14
	/016	8.5	5	16
	/018	7.5	5	18
	/020	6.5	5	20



THREE-WAY SWIVEL

Item-No.	Order-No.	Cap. kg	Cont.	Size
142000	/002	25	6	2
	/004	20	7	4
	/006	18	8	6
	/008	15	9	8
	/010	12	10	10
	/012	10	10	12



BARREL SWIVEL

Item-No.	Order-No.	Cap. kg	Cont.	Size
142040	/002	38	5	2
	/004	32	5	4
	/006	28	10	6
	/008	24	10	8
	/010	18	10	10
	/012	14	10	12



SPECIAL SAFETY SWIVEL

Item-No.	Order-No.	Cap. kg	Cont.	Size
142110	/004	38	5	4
	/006	30	5	6
	/008	25	5	8
	/010	20	5	10
	/012	16	5	12
/014	12	5	14	



SPECIAL SWIVEL WITH SNAP

Item-No.	Order-No.	Cap. kg	Cont.	Size
142100	/001	45	5	1
	/002	40	5	2
	/004	32	5	4
	/006	28	5	6
	/008	24	5	8
	/010	20	5	10
	/012	16	5	12
	/014	12	5	14



SECURITY SWIVEL

Item-No.	Order-No.	Cap. kg	Cont.	Size
142090	/001	40	5	1
	/002	36	5	2
	/004	32	5	4
	/006	30	5	6
	/008	27	5	8
	/010	22	5	10



LINE-CONNECTOR

Item-No.	Order-No.	Cap. kg	Cont.	Size
142010	/000	8	20	S
	/005	10	18	L
	/010	15	16	XL
	/015	20	14	XXL
	/020	25	12	XXXL



CARABINER

Item No.	Order No.	Size	Capac. kg
166160	/002	S	8kg
	/006	M	17kg
	/010	L	26kg



HOOKED SNAP

Item-No.	Order-No.	Cap. kg	Cont.	Size
142200	/000	10	5	S
	/001	15	5	M
	/003	20	5	L

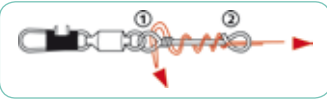

NO KNOT BEARING SWIVEL

With ball bearings and movable line connector. Stays absolutely safe! Cont. 5 pieces.

Item No.	Order No.	Size	Capac. kg
142160	/004	18	
	/006	12	
	/008	8	



MICRO SWIVEL

For a secure, non-twisting connection between leader and main line. Cont. 10 pieces.

Item-No.	Order-No.	Size
142010	/105	20



HOOKED SNAP

Item-No.	Order-No.	Cap. kg	Cont.	Size
142190	/004	15	10	S
	/006	20	10	L



FEEDER DOUBLE CLIP

The feed basket is hooked into one side of the clip and the line on the other side. Weighs virtually nothing; has no edges and makes the basket fly excellently. Cont. 10 pcs.

Item-No.	Order-No.
142010	/100



SWIVEL

Item-No.	Order-No.	Cap. kg	Cont.	Size
142180	/004	32	8	4
	/006	28	10	6
	/008	25	10	8
	/010	20	10	10
	/012	16	10	12



SWIVEL WITH SNAP-LINK

Item-No.	Order-No.	Cap. kg	Cont.	Size
142070	/001	45	7	1
	/002	40	8	2
	/003	35	9	3
	/004	30	9	4
	/005	25	10	5
	/006	20	10	6
	/007	17	10	7
	/008	15	10	8



MICRO SWIVEL

Guide the main line through the mounted ring and fasten the feeder double snap onto the eye opposite to it. Now hang the basket onto the other side of the double snap and it is ready to use! The adapter is so small that it can pass through the guides and can therefore remain on the line after fishing is over. Cont. 5 pieces.

Item-No.	Order-No.	Size
142060	/100	S
	/105	M



Tip for assembling



NICKEL SPLIT RING

Item-No.	Order-No.	Cap. kg	Cont.	Ø mm
144510	/106	4	-	6
	/108	8	-	8
	/109	10	-	9
	/111	15	-	11
	/113	28	-	13
	/115	32	-	15



STAINLESS STEEL SPLIT RING

High-grade.

Item-No.	Order-No.	Cap. kg	Cont.	Ø mm
142400	/006	5	10	6
	/008	8	9	8
	/009	10	8	9
	/011	15	7	11
	/013	25	6	13
	/015	32	5	15



SWIVELS WITH SNAP-LINKS ASSORTMENTS

25 brown swivels with snap-links in the 5 most common sizes in distributor box.

Item-No.	Order-No.
142300	/025



SPECIAL SWIVEL

Item-No.	Order-No.	Cap. kg	Cont.	Size
142080	/100	24	4	1/0
	/001	20	4	1
	/002	18	5	2
	/004	16	5	4
	/006	14	5	6
	/008	12	5	8
	/010	10	5	10
	/012	9	5	12



NICKEL SPLIT RING

Item-No.	Order-No.	Cap. kg	Ø mm
144530	/006	4	6
	/008	8	8
	/009	10	9
	/011	15	11
	/013	28	13
	/015	32	15

Content 20 pieces.



FLOATS

Controlled relaxation



Controlled relaxation

Have you ever experienced this? You watch the float spellbound. Your thoughts circle around a single question: When will it move at last, gradually slide way and then disappear from the surface of the water like greased lightning? That is the moment that finally puts us out of our misery: a bite! Professionals can tell what species has bitten by the way the float behaves. Bream lift, tench gently tug, carp take off, zander takes simply ages and pike grab the line uncompromisingly.

Float fishing is a fascinating story that never repeats itself. Floats are also known as antennas, probably because anglers often wish they could command the float to at last get moving by means of telepathy.

Furthermore: To be able to select the right float, as an angler one really needs a sixth sense to identify a float and its quality, whereby there are huge differences between them. In collaboration with the BALZER Experts Team a selection of floats has been developed in the BALZER float programme to meet all requirements.

Balsawood floats with an excellent finish, which are particularly visible owing to the use of iridescent varnishes. With bodies that do not lose their shape under pressure. Eyes that hold. Antenna that don't break right off.

Our Balsawood floats are MADE IN EU, our Rohacell floats are MADE IN GERMANY!

Float assortments

Our float assortments are made from the best materials and high quality finish, ideally suited to the different areas of fishing.

Whether Trout floats, chemical light floats or all-purpose-round floats: here you find whatever you need.

Everyset is perfectly assorted for optimal in-store presentation at sensational prices.



CRYSTAL FLOATS ASSORTMENT

100 crystal floats assorted. 10 x 10 types.

Content from left to right:

- 15g
- 12, 20g
- 11, 15g
- 2, 4, 6g
- 5, 10g

Item-No.	Order-No.	
153030	/100	



CHEMICAL LIGHT FLOATS ASSORTMENT

100 chemical light floats assorted. 20x5 types

Content from left to right:

- 15, 25g
- 5, 7, 9g
- 4, 6, 8, 10g
- 5, 7, 9g
- 6, 8, 10g
- 8+1, 10+2g
- 15, 20, 30g

Item-No.	Order-No.	
153030	/101	



TROUT FLOATS ASSORTMENT

100 trout floats, assorted. 10x10 types,

Content from left to right:

- 2+2, 4+2g
- 4, 6g
- 4, 6g
- 4, 6g
- 5g
- 10g

Item-No.	Order-No.	
153030	/102	



TARGET FISH FLOATS ASSORTMENT

100 target fish floats assorted. 20x5 types.

Content from left to right:

- 20, 25, 30, 35g
- 4, 6, 8, 10g
- 6, 8, 10g
- 6, 8, 10g
- 5, 7, 9g
- 1,5, 2, 4g

Item-No.	Order-No.	
153030	/103	



BUBBLE FLOATS ASSORTMENT

100 bubble floats assorted. 10x10 types.

Content from left to right:

- 28, 35mm
- 28, 35mm
- 28, 35mm
- 28, 35mm
- 23, 32mm

Item-No.	Order-No.	
153030	/104	

Float assortments

Premium floats **MADE IN EU**, made of balsa wood or most quality rohacell foam!
With these float assortments we combine best materials with high quality workmanship floats for professional fishermen.



ROHACELL FLOATS ASSORTMENT

100 floats made of Rohacell assorted. 20x5 types.

Content from left to right:

- 10, 15, 20g
- 4, 6, 8g
- 20, 25, 30g
- 4, 6g
- 5, 7, 9g
- 6, 8, 10g
- 5, 7, 9g

Item-No.	Order-No.	
153030	/105	



CHEMICAL LIGHT FLOATS ASSORTMENT

100 chemical light floats made of Balsa wood, assorted. 10x10 types.

Content from left to right:

- 4, 6, 8g
- 20, 30g
- 6, 8g
- 3, 5g
- 10+2g



Item-No.	Order-No.	
153030	/106	



ALLROUND FLOATS ASSORTMENT

100 trout floats made of Balsa wood, assorted. 20x5 types.

Content from left to right:

- 15, 25g
- 4, 6, 8g
- 6, 8g
- 6, 8, 10g
- 3, 5g
- 5, 7g
- 6, 8g
- 4, 6g
- 4, 6g



Item-No.	Order-No.	
153030	/107	



FLOAT SETS

The float sets contain an assortment of select target fish floats as well as the transparent Clear Line floats suitable for both beginners and experienced anglers – at top prices! All the sets are packed for self-service.

A FLOAT ASSORTMENT CLEAR LINE

Item-No.	Order-No.
154800	/030

Content: 2 g, 1,5 g, 3 g

B FLOAT ASSORTMENT TROUT

Item-No.	Order-No.
154800	/130

Content: 3+2 g, 4 g, 4 g

C FLOAT ASSORTMENT EEL

Item-No.	Order-No.
154800	/230

Content: 6 g, 8 g, 9 g

D FLOAT ASSORTMENT CARP

Item-No.	Order-No.
154800	/330

Content: 6 g, 7 g, 8 g

E FLOAT ASSORTMENT MATCH

Item-No.	Order-No.
154800	/430

Content: 3 g, 2+2 g, 4 g

F CRYSTAL FLOAT ASSORTMENT LIGHT

Item-No.	Order-No.
154800	/530

Content: 2 g, 4 g, 5 g

G CRYSTAL FLOAT ASSORTMENT PIKE

Item-No.	Order-No.
154800	/630

Content: 12 g, 20 g, 15 g

READY MADE RIGS

All ready made rigs had a perfect setup and are ideal for beginners who want to have an easy and fast rig. The length of the main line is 7 m. All the sets are packed for self-service.

A READY MADE RIG

Item-No.	Order-No.
153020	/001

Ready Made Rig with 7m line in 0,18mm. Buoyancy 1g. Hook size 12.

B READY MADE RIG

Item-No.	Order-No.
153020	/002

Ready Made Rig with 7m line in 0,18mm. Buoyancy 0,5g. Hook size 12.

C READY MADE RIG

Item-No.	Order-No.
153020	/003

Ready Made Rig with 7m line in 0,18mm. Buoyancy 1g. Hook size 12.

D READY MADE RIG

Item-No.	Order-No.
153020	/004

Ready Made Rig with 7m line in 0,18mm. Buoyancy 1g. Hook size 12.

E READY MADE RIG

Item-No.	Order-No.
153020	/005

Ready Made Rig with 7m line in 0,18mm. Buoyancy 1g. Hook size 12.

F READY MADE RIG

Item-No.	Order-No.
153020	/007

Ready Made Rig with 7m line in 0,18mm. Buoyancy 3.5g. Hook size 8.

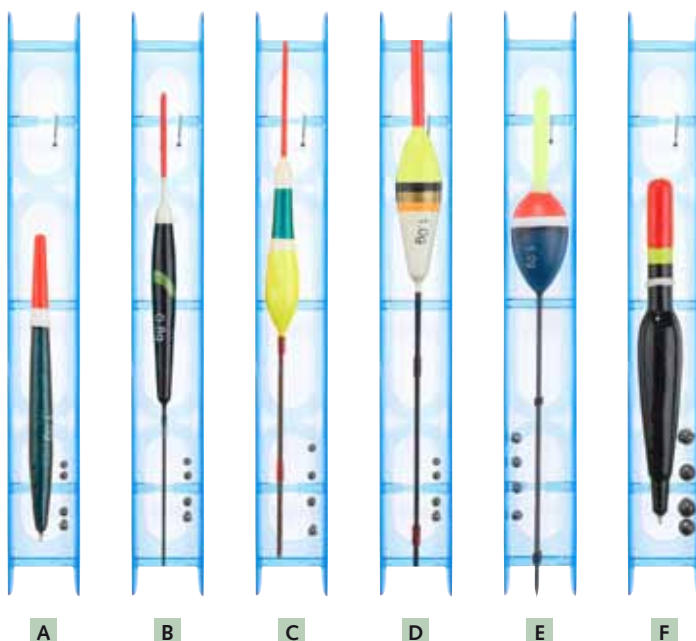

Electro floats

ELECTRO-FLOATS E-POWER

Our of battery-driven floats for nighttime fishing. The advantage over chemical-light floats is obvious: You switch on the battery when you start fishing and then off again thereafter, but a chemical light is normally disposed of after fishing, even though it is still giving off light.

The bodies of the float are made from wood, the antennas and float feet from unbreakable glass fibre composite (except 1 52540/).

The multicolour antennas shine very brightly and can be seen well even at great distances. Another advantage: the antennas are very slender. When they bite, the fish feel virtually no resistance.

Operated with 1 CR 425 / 3V tubular battery, (not included in scope of supply, but available from Balzer). Battery has a service life of around 45 hours!

Supplied in a self-service blister pack.

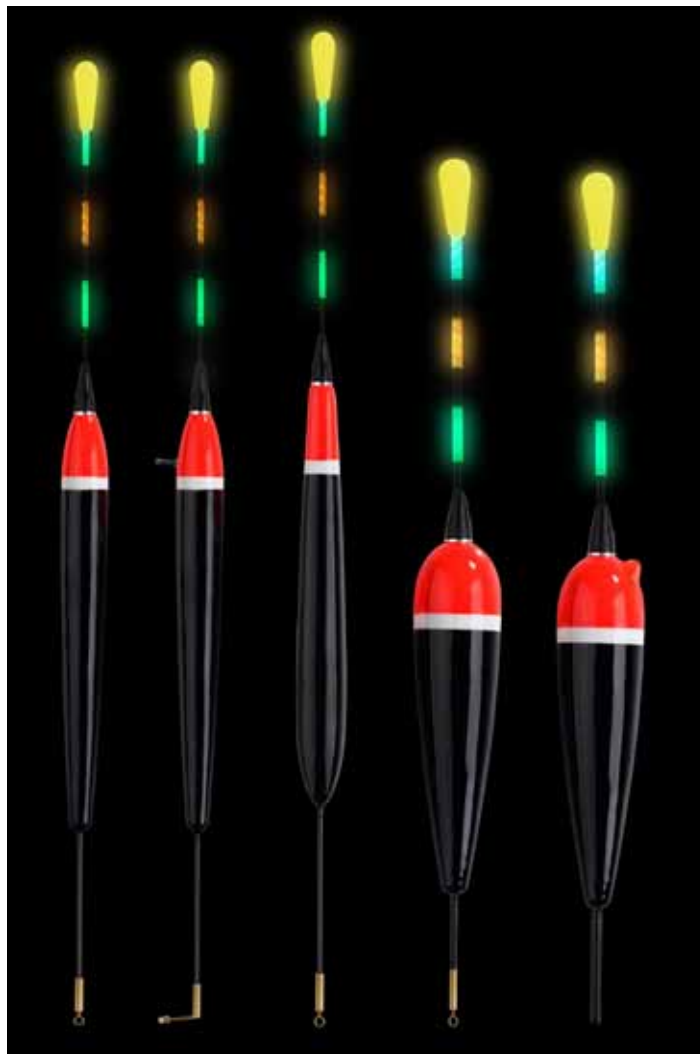

A CARP AND PIKE-PERCH FLOAT

Item-No.	Order-No.	Length cm	Tensile strenght g
152500	/003	23	3
	/005	26	5
	/007	27	7
	/009	28.5	9

B CARP / PIKE-PERCH FLOAT WITH SLIDER

Item-No.	Order-No.	Length cm	Tensile strenght g
152510	/004	24.5	4
	/006	26	6
	/008	28	8

C STILL WATER FLOAT

Item-No.	Order-No.	Length cm	Tensile strenght g
152520	/002	22	2
	/004	24	4
	/006	26	6

D EEL FLOAT

Item-No.	Order-No.	Length cm	Tensile strenght g
152530	/004	22.5	4
	/006	24	6
	/008	25.5	8
	/010	27.5	10

E EEL FLOAT WITH INNER SLIDER

Item-No.	Order-No.	Length cm	Tensile strenght g
152540	/004	22	4
	/006	22.5	6
	/008	23	8
	/010	25.5	10

F BATTERY CR 425 / 3V

Special lithium battery for use in our E-Power floats. Nice and light as well as very durable. Service life around 45 hours.

Item-No.	Order-No.	Volt
152600	/000	3

CORK FLOATS

These extremely robust floats are very popular among anglers. Note: Cork is a pure natural product, therefore buoyancy can differ up to 15 % of the given data.



A CORK FLOAT LONG

Item-No.	Order-No.	Tensile strength g	Float length mm
150780	/030	1.0	30
	/040	2.0	40
	/050	4.0	50
	/060	6.0	60
	/070	10.0	70

B CORK FLOAT

Item-No.	Order-No.	Tensile strength g	Float length mm
150740	/018	1.0	18
	/020	1.5	20
	/025	2.0	25
	/030	3.0	30
	/035	5.0	35
	/040	8.0	40
	/045	10.0	45
	/050	12.0	50
	/060	15.0	60

C CORK FLOAT WITH A CUT

Item-No.	Order-No.	Tensile strength g	Float length mm
151740	/030	2.0	30
	/035	4.0	35
	/040	6.0	40
	/045	8.0	45
	/050	10.0	50

BUBBLE FLOATS, LAVARET FLOATS, SPECIAL FLOATS



D BUBBLE FLOAT, TRANSPARENT

Item-No.	Order-No.	Ø mm
158800	/023	23
	/032	32
	/040	40

E OVAL, INNER-SLIDING / TRANSPARENT

Item-No.	Order-No.	Ø mm
158800	/423	23
	/428	28
	/435	35

F OVAL, INNER-SLIDING, TRANSP.-ORANGE

Item-No.	Order-No.	Ø mm
158800	/123	23
	/128	28
	/135	35

G PILOT FLOAT DELUXE

Item-No.	Order-No.	Tensile strength g	Float length mm
156420	/005	6	35



SPARE PLUGS FOR BUBBLE FLOATS

Spare rubber plugs for ovale bubble floats. Content: 10 pieces.

Item-No.	Order-No.
153030	/204

FLOAT CONTAINER

Individually adjustable in the length.

Item-No.	Order-No.	length cm	Ø cm
183270	/000	40-60	7.0
	/001	32-50	3.5
	/002	36-55	5.0



H LAVARET FLOAT

This float is unbeatable if there is no or only a slack wind when fishing from a boat. It is specifically tared to start »dancing« on the surface at the tiniest bite.

Item-No.	Order-No.	Tensile strength g
150050	/015	15
	/025	25
	/035	35

I HORNED PIKE SLIDING FLOAT, LEADEN

Item-No.	Order-No.	Length cm	Tensile strength g
151700	/030	33	30
	/040	35	40

J HORNED PIKE SLIDING FLOAT, NOT LEADEN

Item-No.	Order-No.	Length cm	Tensile strength g
151700	/130	33	30
	/140	35	40

Pilot floats / float accessories



PILOT FLOATS FOR FIXING

Are drawn onto the line and fixed like a stopper.

PILOTBALLS – ROUND

Item-No.	Order-No.	length/width	
158820	/000	9 mm	
	/005	12 mm	
	/010	15 mm	
	/015	20 mm	
	/020	23 mm	
	/025	27 mm	

PILOTBALLS – OVAL

Item-No.	Order-No.	length/width	
158830	/000	15x7mm	
	/005	18x9mm	
	/010	20x10mm	
	/015	25x11mm	
	/020	30x12mm	
	/025	35x13mm	

BUOYANCY BALLS

12 buoyancy balls with diameter of 18mm, red, orange, yellow and fluorescent, each colour 3 times. Ideal as pilot-float for trout-fishing. Packed in practical box 13x6cm.

Item-No.	Order-No.	
157990	/018	

SPACERS



SPACERS, BRASS

Brass tube with swivel.

Item-No.	Order-No.	Content	Size cm	
158940	/038	5	4.5	
	/070	5	7.5	
	/100	3	10	
	/150	3	14.5	
	/250	3	22.5	

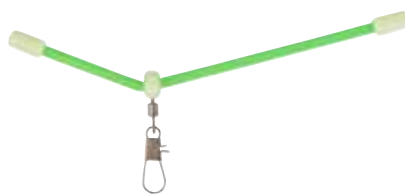

FLUORESCENT SPACER, PLASTIC

With swivel and fluorescent ending-caps.

Item-No.	Order-No.	Content	Size cm	
158960	/006	3	7.5	
	/009	3	10.5	
	/011	3	14.5	
	/015	3	17	



SPACER, BLACK

Item-No.	Order-No.	Content	Size cm	
158950	/110	3	10	
	/115	3	15	
	/120	3	20	



TRANSPARENT-FLUORESCENT SPACER

With swivel, transparent-fluorescent.

Item-No.	Order-No.	Content	Size cm	
158950	/010	3	10	
	/015	3	15	
	/020	3	20	



FLOAT SWIVEL DE LUXE

Item-No.	Order-No.	Size	Recomm. line Ø mm	
144220	/000	S	0.20-0.30	
	/001	M	0.30-0.40	
	/002	L	0.40-0.50	



FLOAT SWIVEL DE LUXE

Item-No.	Order-No.	Size	Recomm. line Ø mm	
142060	/000	S	0.20-0.30	
	/005	M	0.30-0.40	

LEADER HOOK WINDER



J

K

L

J LEADER HOOK WINDER WITH KORK

Item-No.	Order-No.	Length cm	
159850	/005	10	

K LEADER HOOK WINDER WITH FOAM

Item-No.	Order-No.	Length cm	
159900	/010	20	

L FOAM LEADER HOOK WINDER

Item-No.	Order-No.	Length cm	
159860	/000	15	
	/005	30	
	/010	40	

/000 and /005: Packing unit: 10 pieces.
/010: Packing unit: 5 pieces.

Line stopper

Absolute top, because we use the thread of the threads

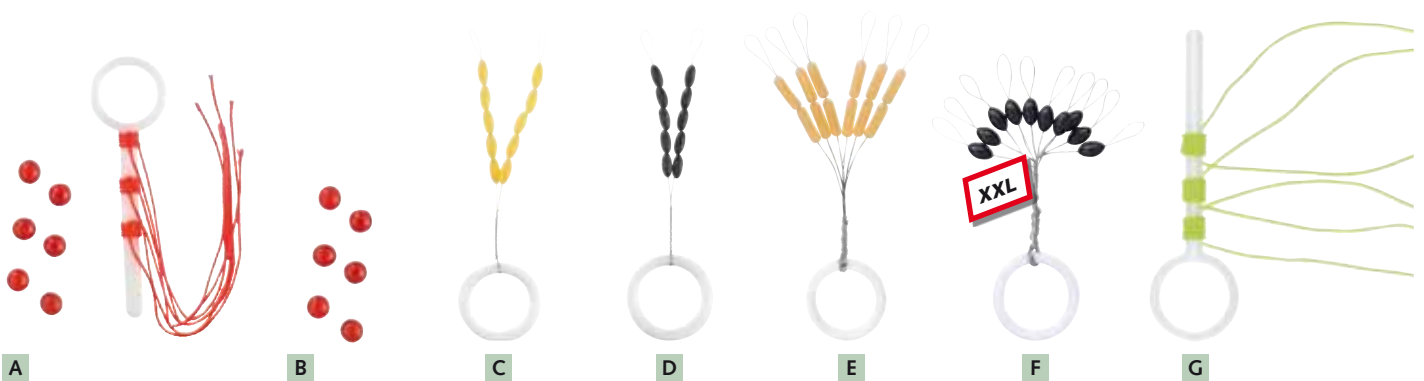

A LINE STOPPER

- Thermal treated high performance thread
 - No rubbing, with blunt coating
 - No sliding on the line
 - High visible fluorescent color
 - Knot contracts very cleanly
- Including 6 glasspearls in each self packages

Item-No.	Order-No.	Size	Recomm. line Ø mm
159220	/001	S	0.10-0.20
	/002	M	0.20-0.30
	/003	L	0.30-0.40
	/004	XL	0.40-0.60

B STOPPER PEARLS

Item-No.	Order-No.	Size
159280	/000	M
	/001	L



FLOAT RING ASSORTMENT

Suitable for all floats with chemical lights with tubes.

Item-No.	Order-No.	Size
158980	/090	small



C SILICON STOPPER DE LUXE

Item-No.	Order-No.	Size	Recomm. line Ø mm
159240	/001	S	0.10-0.20
	/002	M	0.15-0.30
	/003	L	0.25-0.40
	/004	XL	0.35-0.50
	/005	XXL	0.40-0.60

D RUBBER STOPPER DE LUXE

Item-No.	Order-No.	Size	Recomm. line Ø mm
159260	/001	S	0.10-0.20
	/002	M	0.15-0.30
	/003	L	0.25-0.40
	/004	XL	0.35-0.50
	/005	XXL	0.40-0.60



FLOAT RING ASSORTMENT

Suitable for all floats with chemical lights with tubes.

Item-No.	Order-No.	Size
158980	/080	large

FLOAT PAINT, ORANGE

Float paint, 20 ml, in practical bottle with integrated brushes.

Item-No.	Order-No.
159990	/001

E LINE STOPPER ELONGATED

Item-No.	Order-No.	Size	Recomm. line Ø mm
159270	/001	S	0.10-0.20
	/002	M	0.15-0.30
	/003	L	0.25-0.40
	/004	XL	0.35-0.50

F XXL LINE STOPPER

Item-No.	Order-No.	Size	Recomm. line Ø mm
159220	/005	XXL	0.15-0.30

G LATEX LINE STOPPER – NON-SLIP

Item-No.	Order-No.	Size	Recomm. line Ø mm
159250	/000	S	0.12-0.25
	/005	M	0.25-0.35
	/010	L	0.35-0.50



SILICON FLOAT RING ASSORTMENTS

/025: Set of clear silicon float rings, fits to all diameters of chemical light floats, app. 6mm.
/005-/010: for all float tubes in the mentioned diameter.

Item-No.	Order-No.	tube size Ø mm	Content
158980	/000	0.50 - 3.00	75
	/005	1.50 - 5.00	75
	/010	3.00 - 7.00	75
	/025	app. 6.5mm	20

HOOKS

Immerse and lay back





Immerse and lay back

Our hooks are sharpened and pointed in chemical processes which make them free of grooves and uneven spots and the shock-tempered steel gives them enormous resilience as well as quality of the highest standard. The steel is enhanced with high-carbon to make the hooks even sharper, more resistant and extremely light, reducing the sinking speed and giving the bait a more natural and deceptively realistic behaviour.

For leader material we use our high-tech line, Platinum Royal, for maximum security when playing the fish. We guarantee that all the joints are tied by hand and checked.

Our programme of loose and tied hooks will fulfil your every wish, with even more unmistakable optical characteristics to meet your requirements and the exact details about the specific purpose of each hook.



Balzer takes over the exclusive distribution of OWNER hooks, which are among the absolute world leaders!

Owner is one of the very first hook manufacturers and has significantly marked their entire development. Over 75 years' experience in the art of forging and crafting as well as professional angling experience (in Japan there is something like a professional league similar to the United States) have made OWNER into what it is today: maybe the best hook manufacturer in the world.

We can provide you with a fantastic series of excellent tied and loose hooks made from the best carbon steel.

A precision-guided laser cut ensures that the tip on every single hook is very fine and sharp. Contrary to conventional methods, all OWNER ® hooks are not hardened just by heating and quenching them. OWNER ® hooks are additionally treated in chemical baths and thereby achieve a degree of strength, combined with flexibility, which reliably prevents them from breaking off or bending open.

You can find out more about the special features of the OWNER hooks on the following pages.



OWNER, a class of its own

Exclusively at Balzer

The Japanese manufacturer, OWNER, stands primarily for superlative hooks. Over 75 years' experience in both the art of metalworking and in the professional angling field – both Japan and the USA have a professional league – have made OWNER a brand which stands for top quality products.

Products

Besides the extensive assortment of loose and tied hooks, in our OWNER range you will also find rubber baits and high class accessories such as swivels and split rings. In collaboration with the Japanese engineers from OWNER and our specialists we always endeavour to develop products which are exactly in line with the indigenous angling methods and fish.

Quality

Hence OWNER operates a very comprehensive, unparalleled quality management. Only thoroughly tested quality leaves the factory.

Future projects

OWNER and BALZER invest a lot in the development of new products. Our common objective is to present anglers with innovative new products every year to give them successful hours by the water.



Owner Soft Lures

Normally rubber bait and hooks are produced by different manufacturers and consequently coordination problems arise. OWNER has attended to this problem and has developed first class soft lures which are 100% in line with the OWNER hooks, even for different angling techniques.

In terms of quality and catching capacity the soft lures are by no means inferior to the hooks. In Japan and the USA OWNER stages numerous predator tournaments and has reputable specialists under contract world-wide who were the mentors of this development.

Quite simply in a class of their own!

You will find the right hook for each of the different angling techniques in our catalogue and on the packaging.

Available in super colours!

YUKI BU

The Yuki bug is one of the so-called hybrid creatures. The Yuki bug's tail contains an air chamber which allows the tail to rise up over the body of the bait similar to a scorpion's tail. It can be twitched and can fish on the Drop Shot, Carolina or Texas rig or simply on the worm hook in flat areas of water. The large paddle emits outstanding vibrations with the feet and arms constantly in motion. **See our video:** <http://www.ownerhooks.com/yukibug.htm>.



YUKI BUG 8.5 CM

Item-No.	Order-No.	Lgth. cm		Color
136480	/009	8.5	A	Cinnamon-blue
	/109	8.5	B	Chart-yellow

YUKI BUG 11 CM

Item-No.	Order-No.	Lgth. cm		Color
136480	/011	11	A	Cinnamon-blue
	/111	11	B	Chart-yellow

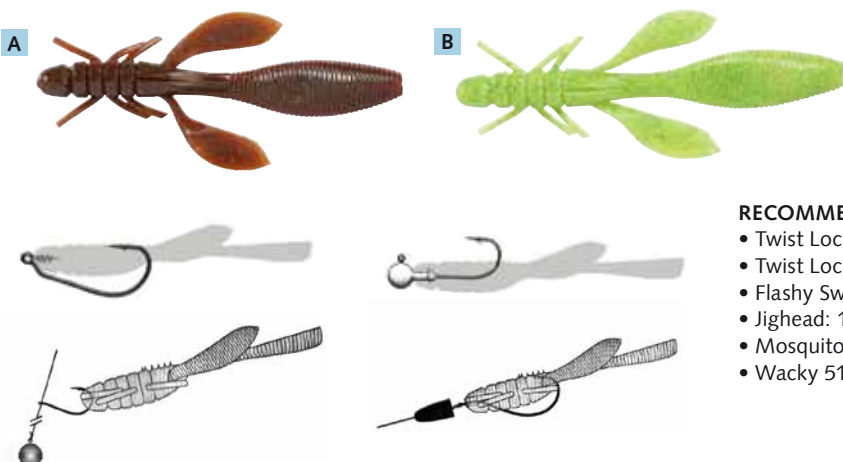

RECOMMENDED HOOKS:

- Twist Lock 5132: 1/0
- Twist Lock 5167: 1/0
- Flashy Swimmer: 1/0
- Jighead: 1/0, 2/0
- Mosquito: 1, 2
- Wacky 5172/P: 1, 2

RECOMMENDED HOOKS:

- Twist Lock 5167: 3/0, 4/0
- Twist Lock 5167/W: 4/0
- Twist Lock 5132: 3/0, 4/0
- Twist Lock 5132/W: 4/0
- Jighead: 4/0
- Wide Gap 3/0, 5/0
- Mosquito: 1/0
- Wacky 5172/P: 1/0

JUSTER SHAD™ 10,5 CM

The Juster shad is an ideal twitch bait. It flanks/crosses and has an active paddle. A top bait for pike-perch.
See our video: <http://www.youtube.com/user/Fishingalarm/videos>.



RECOMMENDED HOOKS:

- Twist Lock 5167: 3/0, 4/0
- Twist Lock 5167/W: 4/0
- Twist Lock 5132: 3/0
- Twist Lock 5132/W: 4/0, 5/0
- Twist Lock 5132/W: 4/0
- Flashy Swimmer: 3/0
- Jighead: 2/0, 4/0
- Mosquito: 1; 1/0
- Wacky 5172/P: 1, 1/0

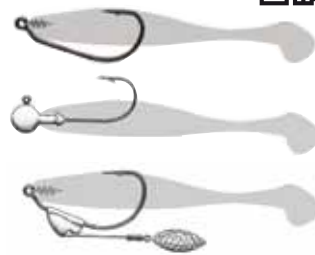

A



B



D



E



G



H

Item-No.	Order-No.	Lgth. cm	Color
136460	/010	10.5	A Green pumpkin-black
	/110	10.5	B Pro Blue
	/210	10.5	C Blue Gill
	/310	10.5	D Purple Weenie-silv.
	/410	10.5	E Ghost-silver flake
	/510	10.5	F Smokey Shad
	/610	10.5	G Ayu
	/710	10.5	H Flash Bass
	/810	10.5	I Pro Blue-silver flake



C



F



I

NERVOUS REX™ 15 CM

A perfect bait for jerking and twitching and with stupendous action. In the water it breaks away from one side to the other and its big glittering tail flashes realistically. Combined with the OWNER Flashy Swimmer hook it is an outstanding "Searching Bait" which also lures predators from further away.
See our video: <http://www.ownerhooks.com/nervousrex.htm>.



RECOMMENDED HOOKS:

- Twist Lock 5167: 4/0, 5/0
- Twist Lock 5167/W: 4/0, 5/0
- Twist Lock 5132: 5/0
- Twist Lock 5132/W: 5/0
- Jighead: 4/0
- Flashy Swimmer: 5/0



A



B



D



E



G



H

Item-No.	Order-No.	Lgth. cm	Color
136430	/015	15	A Green pumpkin-black
	/115	15	B Pro Blue
	/215	15	C Blue Gill
	/315	15	D Purple Weenie-silv.
	/415	15	E Ghost-silver flake
	/515	15	F Smokey Shad
	/615	15	G Ayu
	/715	15	H Flash Bass
	/815	15	I Pro Blue-silver flake



C



F



I

JUSTER CRAWLER™ 14.5 CM

If you see this creature in action, hopping over the bottom of a stretch of water, you will understand why it is so lethal. Its action is truly unique and imitates fish, shrimps or crabs equally well.
See our video: <http://www.youtube.com/user/Fishingalarm/videos>.



A



B



C

RECOMMENDED HOOKS:

- Twist Lock 5167: 3/0
- Twist Lock 5167/W: 4/0
- Twist Lock 5132: 3/0
- Twist Lock 5132/W: 4/0
- Jighead: 1/0, 2/0
- Wacky 5172/P: 1, 2

Item-No.	Order-No.	Lgth. cm	Color
136470	/014	14.5	A Watermelon-black
	/114	14.5	B Cinnamon-blue
	/214	14.5	C Ebi Miso



Owner® Soft Lures

JR MINNOW™

This bait plays incredibly seductively in the water. It can be used for fishing with a variety of techniques, e.g. as a Carolina Rig, Bottom Bouncing or Twitching. In the case of Bottom Bouncing it looks like a fish feeding from the bottom; when twitched it floats from one side to the other and on the Carolina Rig it tips from the right to the left and the glittering sides flash realistically. See our video: <http://www.ownerhooks.com/jrminnow.htm>

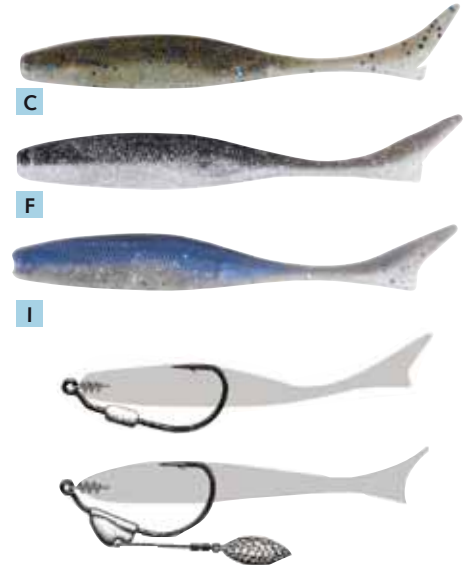
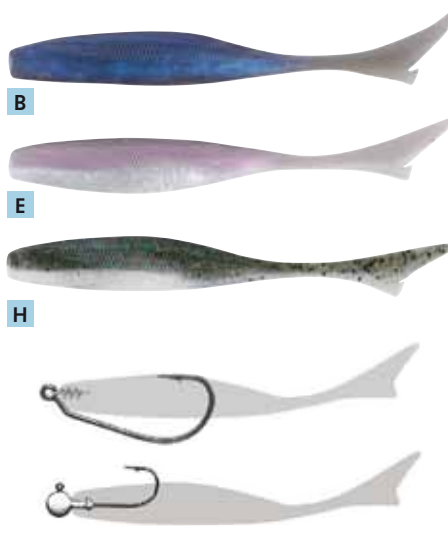
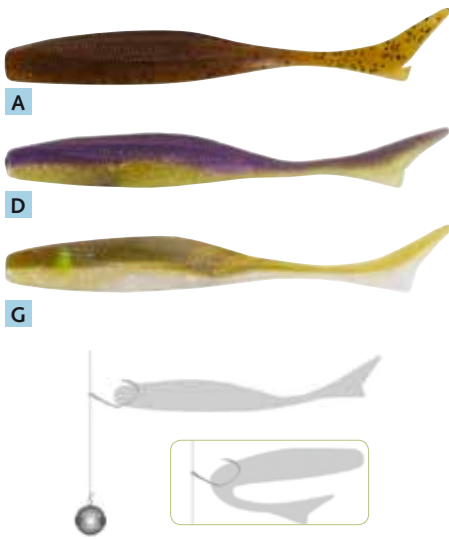

Rigging recommendations:

RECOMMENDED HOOKS MINNOW 9 CM

- Twist Lock 5167: 1/0
- Flashy Swimmer: 1/0
- Jighead: 1/0, 2/0
- Mosquito: 2
- Wacky 5172/P: 2

RECOMMENDED HOOKS MINNOW 11.5 CM

- Twist Lock 5167: 3/0
- Twist Lock 5167/W: 4/0
- Twist Lock 5132: 3/0
- Twist Lock 5132/W: 4/0
- Flashy Swimmer: 3/0
- Jighead: 2/0, 4/0
- Mosquito: 1; 1/0
- Wacky 5172/P: 1, 1/0

RECOMMENDED HOOKS MINNOW 14 CM

- Twist Lock 5167: 4/0, 5/0
- Twist Lock 5167/W: 4/0, 5/0
- Twist Lock 5132: 4/0, 5/0
- Twist Lock 5132/W: 4/0, 5/0
- Flashy Swimmer: 5/0
- Jighead: 4/0
- Mosquito: 1/0
- Wacky 5172/P: 1/0

JR MINNOW™ 9 CM

Item-No.	Order-No.	Lgth. cm		Color
136400	/009	9	A	Green pumpkin-black
	/109	9	B	Pro Blue
	/209	9	C	Blue Gill
	/309	9	D	Purple Weenie-silv.
	/409	9	E	Ghost-silver flake
	/509	9	F	Smokey Shad
	/609	9	G	Ayu
	/709	9	H	Flash Bass
	/809	9	I	Pro Blue-silver flake

JR MINNOW™ 11.5 CM

Item-No.	Order-No.	Lgth. cm		Color
136410	/011	11.5	A	Green pumpkin-black
	/111	11.5	B	Pro Blue
	/211	11.5	C	Blue Gill
	/311	11.5	D	Purple Weenie-silv.
	/411	11.5	E	Ghost-silver flake
	/511	11.5	F	Smokey Shad
	/611	11.5	G	Ayu
	/711	11.5	H	Flash Bass
	/811	11.5	I	Pro Blue-silver flake

JR MINNOW™ 14 CM

Item-No.	Order-No.	Lgth. cm		Color
136420	/014	14	A	Green pumpkin-black
	/114	14	B	Pro Blue
	/214	14	C	Blue Gill
	/314	14	D	Purple Weenie-silv.
	/414	14	E	Ghost-silver flake
	/514	14	F	Smokey Shad
	/614	14	G	Ayu
	/714	14	H	Flash Bass
	/814	14	I	Pro Blue-silver flake

OWNER SPECIAL HOOKS



OWNER TWIST LOCK 5132

With Twistlock™ CPS (patent pending) attached to the hook eye. Baits can be permanently secured by inserting the pin in the center of the nose of a soft plastic and onto the TwistLOCK™ coil spring so that any bait will rig perfectly. Thick wire.

Item-No.	Order-No.	hook size	weight in g	Content
171600	/300	3/0		4
	/500	5/0		4



OWNER TWIST LOCK 5132/W

Like 5132 Twistlock™, but also features a non-movable weight attached to the shank. The hook's added weight helps to sink or "swim" the bait into the strike zone. Thick wire.

Item-No.	Order-No.	hook size	weight in g	Content
171610	/300	3/0	1,8	3
	/500	5/0	3,5	3



OWNER TWIST LOCK 5167/W

Like the 5167 but with a non-movable weight attached helps to sink or swim a rigged bait down into the strike zone. Light-weighted.

Item-No.	Order-No.	hook size	weight in g	Content
171630	/400	4/0	2.65	3
	/500	5/0	2.65	3

Owner® hooks



OWNER TWIST LOCK 5167

A lighter version than the 5132. With CPS attached to the hook eye, baits can be „permanently“ secured by inserting the pin in the center of the nose of a soft plastic. Thin wire.

Item-No.	Order-No.	hook size	weight in g	Content
171620	/100	1/0		5
	/300	3/0		5
	/500	5/0		5



OWNER FLASHY SWIMMER 5164

The Flashy Swimmer with Twist LOCK is a unique setup for rigging soft swimbaits. The added weight helps sink or „swim“ the rigged bait down into the strike zone, while the blade adds a fish-attracting flash.

Item-No.	Order-No.	hook size	weight in g	Content
171640	/100	1/0	3.5	2
	/300	3/0	5.3	2
	/500	5/0	7.1	2



OWNER JIG RIG TWIST LOCK, 5199

The hook is „free-floating“ from the weight to allow max. bait movement. With the weight leading the way, the rig allows long and accurate casts.

Item-No.	Order-No.	hook size	weight in g	Content
171670	/200	2/0	3.5	2
	/300	3/0	5.3	2
	/400	4/0	7	2
	/500	5/0	10	2

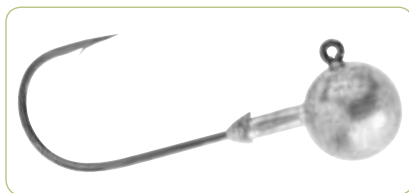

ROUND JIGHEAD

Perfect relation between the tip of the hook and the eye plus the slender spur.

Item-No.	Order-No.	hook size	weight in g	Content
138100	/003	1	3	5
	/005	1	5	5
	/010	1	10	5
	/015	1	15	3
138110	/003	1/0	3	5
	/005	1/0	5	5
	/010	1/0	10	5
	/015	1/0	15	3
	/005	2/0	5	3
138120	/010	2/0	10	3
	/015	2/0	15	3
	/020	2/0	20	3
	/025	2/0	25	3
	/030	2/0	30	2
138130	/010	4/0	10	3
	/015	4/0	15	3
	/020	4/0	20	3
	/025	4/0	25	3
	/030	4/0	30	2

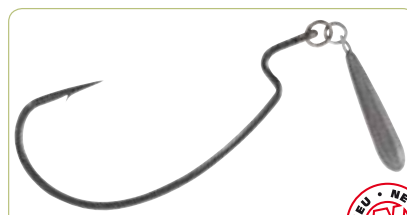

OWNER BC JIG RIG, 5122

Perfect for Texas Rig'n. The light wire hook (attached to a solid ring) features an extra wide gap, Z-Lock shoulder bend, super needle point. Black chrome finish.

Item-No.	Order-No.	hook size	weight in g	Content
171700	/100	1/0	5.3	2
	/300	3/0	5.3	2
	/500	5/0	7	2
	/001	1	5.3	2



OWNER BC BEAST TWISTLOCK 5130

Wide Gap hook with Z-lock bent and Twist LOCK.

Item-No.	Order-No.	hook size	weight in g	Content
171690	/400	4/0		3
	/600	6/0		3
	/800	8/0		3
	/110	10/0		2



OWNER WACKY HOOK 5172 P

Perfect hook for down-and drop-shotting natural baits and soft plastics. The hooks large bend is ideal for rigging worms and little bait fishes.

Item-No.	Order-No.	hook size	weight in g	Content
171660	/100	1/0		8
	/001	1		9
	/002	2		9
	/004	4		9



OWNER SPINNERBAIT 5131

With wide gap, round bend, oversized eye, and a heavy-duty, forged short shank. Ideal for rigging as a trailer on spinnerbaits and jigs, or as a replacement hook for spoons. Skinned eye keeps rigged hook from slipping off.

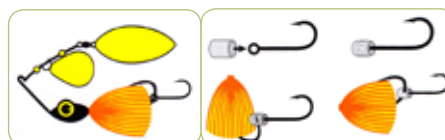

Item-No.	Order-No.	hook size	weight in g	Content
171710	/200	2/0		7
	/300	3/0		6
	/400	4/0		5



OWNER MOSQUITO

Ideal for drop shot fishing or rigging soft plastics, and for wacky worm.

Item-No.	Order-No.	hook size	weight in g	Content
171650	/200	2/0		6
	/100	1/0		7
	/001	1		8
	/002	2		9
	/004	4		10
	/006	6		10
	/008	8		11
	/010	10		12

Owner® swivles and split rings

OWNER ACCESSORIES



Innumerable capital fish have been lost because the quality of the swivels or split rings was poor. Play safe and use OWNER swivels, snaps and split rings. **All of the articles are made exclusively in Japan from the very best stainless steel!**

ANTI TWIST SAFETY SWIVEL

Double crane anti twist swivel with interlock snap. Ideal for quick rig or lure change.



Item-No.	Order-No.	Cap. kg	Cont.	Size
144700	/006	25	5	6
	/008	23.2	6	8
	/010	20	8	10
	/012	15.4	9	12
	/014	14.4	10	14
	/016	10.5	10	16
	/018	9.5	10	18

POWER SWIVEL

Owner high quality stainless Cross Lock Snaps in black chrome finish made in Japan.



Item-No.	Order-No.	Cap. kg	Cont.	Size
144720	/400	58	3	4/0
	/200	43	4	2/0
	/001	43	5	1
	/003	28	6	3
	/004	28	7	4
	/006	15	9	6
	/008	14	10	8
	/010	14	10	10
	/012	6	10	12
	/014	6	10	14
	/016	6	10	16
	/018	6	10	18

SPECIAL SWIVEL

Strong snap swivel with barrel. Easy bait replacements.



Item-No.	Order-No.	Cap. kg	Cont.	Size
144730	/004	36	7	4
	/006	30	8	6
	/008	21	9	8
	/010	21	9	10
	/012	20	9	12

LURE SWIVEL

Stainless, bright finish, pocket packs. Ideal for all general lure work where a strong wide action connection is required.



Item-No.	Order-No.	Cap. kg	Cont.	Size
144740	/000	12	6	0
	/001	18	6	1.5
	/002	21	6	2

MINI SWIVEL FOR SMALL LURES

A micro swivel and snap clip for running small crankbaits, spinners etc for fresh and light tackle saltwater lure work.



Item-No.	Order-No.	Cap. kg	Cont.	Size
144750	/000	9	4	0
	/001	7	4	1

QUICK-ANTI TWIST CONNECTOR

Phantastic strong snap swivel with double barrel. Easy bait replacements.

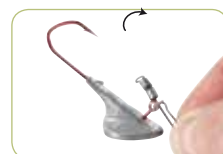

POWER SPLIT RINGS



Super heavy duty split rings, made from the highest quality stainless steel. Quick "spring-back" after opening. Available in black chrome.



Item-No.	Order-No.	Cap. kg	Cont.	Size
144770	/100	4.5	24	00
	/000	7.0	24	0
	/001	8.6	24	1
	/002	17.0	22	2
	/003	19.2	20	3
	/004	19.8	18	4

POWER SPLIT RINGS



Super heavy duty split rings. Made from the highest quality stainless steel.



Item-No.	Order-No.	Cap. kg	Cont.	Size
144760	/005	27	9	5
	/006	31	8	6
	/007	36	7	7
	/008	54	7	8
	/009	77	6	9
	/010	99	6	10
	/011	113	5	11



Item-No.	Order-No.	Cap. kg	Cont.	Size
144710	/012	26	7	12
	/014	16	8	14
	/016	12.4	8	16
	/018	10.3	8	18



To catch a fish you need a fishing hook. The hook plays a crucial role as to whether a fish is caught or lost. It was a long development path on the way to the current state-of-the-art in fishing hooks. OWNER® underwent and participated in the entire development.

Over 75 years' experience, forging and craft and endless years of experience in fishing have made OWNER® into what it is today: maybe the best hook manufacturer in the world.

The top grade hooks from the OWNER® range are made from the very best carbon steel. A precision-guided laser cut ensures the fineness and sharpness of the point on every single hook.

Contrary to conventional methods, all OWNER® hooks are not hardened only by heating and quenching them. OWNER® hooks are additionally treated in chemical baths and thereby achieve a degree of strength, combined with flexibility, which reliably prevents them from breaking off or bending open.

A special feature of the OWNER® hooks is how the points are shaped.

The **Cutting Point** developed by OWNER® is unique in the history of fishing hooks. The Cutting Point is far superior to the points of normal, conventional hooks.

The Cutting Point, with its needle-sharp point and the three cut-throat razor blades with specially angled friction surfaces, effortlessly overcomes any resistance to penetration.

Since all OWNER® hook points are not just cut but also forged, they are already optimally sharpened when supplied and used.

Caution: This is why you should never regrind OWNER® hooks. This seriously impairs the quality of its sharpness. OWNER® hooks are ground so sharp that any further sharpening is superfluous. You can have complete confidence in this incredible sharpness directly out of the self-service packet of OWNER® – hook after hook, packet after packet.

We are proud to be licensed to distribute the hooks of probably the most renowned and best hook manufacturer in the world.

The Owner hooks are available exclusively only in Germany and Austria.



The top view of the Cutting Point reveals the needle-sharp point with the three even razor blade cuts on all edges.



Bird's eye perspective of the Cutting Point showing the needle-sharp point and the smooth, flat sliding area tapering inwards with the two cut-throat razor blades on both sides.



The lateral view of the Cutting Point shows the flat inner surface, the sliding area with the needlepoint barbed hook and the rearward razor blade cut with additional back reinforcement of the needle point.

PRE-TIED HOOKS



OWNER TROUT BEE MAGGOT, SILVER (50172), 150CM

Developed especially for fishing with bee maggots. The barbed hook on the shank holds the maggot securely; the generous curvature guarantees an extremely high bite yield.

Item-No.	Order-No.	Size	Line-Ø	Content
170950	/006	6	0.25	8
	/008	8	0.22	9
	/010	10	0.20	9
	/012	12	0.18	9

leader length: 150cm

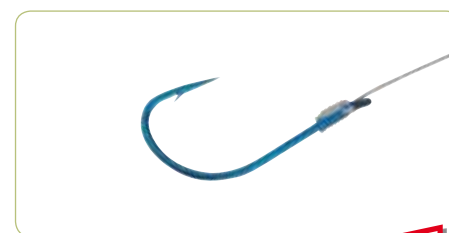

OWNER TROUT, BLUE (RL-175), 60CM

60 CM

The high quality fine steel wire was multi hardened. The super needle-pointed hook with wide curve guarantees certain strike and hold, even when catching a big fish. Naturally it is blue, non-reflective so that the prey is not scared off.

Item-No.	Order-No.	Size	Line-Ø	Content
171050	/006	6	0.25	10
	/008	8	0.22	10
	/010	10	0.20	10
	/012	12	0.18	10

leader length: 60cm

Owner® Hooks

PRE-TIED HOOKS

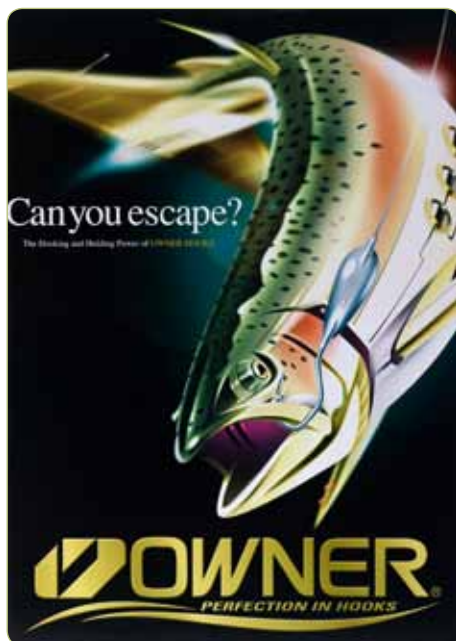

OWNER TROUT, BLUE (RL-175), 150CM

150 CM

The high quality fine steel wire was multi hardened. The super needle-pointed hook with wide curve guarantees certain strike and hold, even when catching a big fish. Naturally it is blue, non-reflective so that the prey is not scared off.

Item-No.	Order-No.	Size	Line-Ø	Content
171060	/006	6	0.25	8
	/008	8	0.22	9
	/010	10	0.20	9
	/012	12	0.18	9

leader length: 150cm



OWNER TROUT, BLUE (RL-175), 200CM

200 CM

The high quality fine steel wire was multi hardened. The super needle-pointed hook with wide curve guarantees certain strike and hold, even when catching a big fish. Naturally it is blue, non-reflective so that the prey is not scared off.

Item-No.	Order-No.	Size	Line-Ø	Content
171070	/006	6	0.25	8
	/008	8	0.22	9
	/010	10	0.20	9
	/012	12	0.18	9

leader length: 200cm



OWNER TROUT LIGHT, BLUE (RL-175), 250CM

250 CM

The high quality fine steel wire was multi hardened. The super needle-pointed hook with wide curve guarantees certain strike and hold, even when catching a big fish. Naturally it is blue, non-reflective. With extra thin leader for cautious trouts.

Item-No.	Order-No.	Size	Line-Ø	Content
171070	/106	6	0.20	8
	/108	8	0.18	9
	/110	10	0.16	9
	/112	12	0.14	9

leader length: 250cm



OWNER TROUT FLUOROCARBON, BLUE (50175), 60CM

The fluorocarbon – made in Japan – makes the leader virtually invisible in the water. Indispensable for cautious trout.

Item-No.	Order-No.	Size	Line-Ø	Content
170960	/006	5	0.28	7
	/008	6	0.25	7
	/010	7	0.22	7
	/012	8	0.20	7

leader length: 60cm



OWNER TROUT FLUOROCARBON, BLUE (50175), 150CM

The fluorocarbon – made in Japan – makes the leader virtually invisible in the water. Indispensable for cautious trout.

Item-No.	Order-No.	Size	Line-Ø	Content
170960	/106	5	0.28	6
	/108	6	0.25	6
	/110	7	0.22	6
	/112	8	0.20	6

leader length: 150cm

PRE-TIED HOOKS



BARBELESS HOOK, SILVER (RL-238)

These hooks have the perfect angle between the length of the shank and the hook curve and point. The fine wire steel is multi hardened and also enables bigger fish to be caught.

Item-No.	Order-No.	Size	Line-Ø	Content
170990	/002	2	0.25	9
	/003	3	0.22	10
	/004	4	0.20	10
	/005	5	0.18	10

leader length: 70cm



OWNER CARP HOOKS, GOLD (RL-330)

Perfect carp hooks: Multi hardened, forged steel, set point and a needle point drawn inwards guarantee reliable strikes and play. The gold hooks are particularly suitable for baits such as dough, bread, corn etc.

Item-No.	Order-No.	Size	Line-Ø	Content
171010	/001	1	0.35	6
	/002	2	0.30	7
	/004	4	0.30	8
	/006	6	0.28	9
	/008	8	0.25	9
	/010	10	0.20	10

leader length: 70cm



OWNER CARP HOOKS, BLACK (RL-044)

Perfect carp hooks: Multi hardened, forged steel, set point and a needle point drawn inwards guarantee reliable strikes and play. The non-reflecting black hooks are ideal combined with natural baits and boilies.

Item-No.	Order-No.	Size	Line-Ø	Content
171020	/001	1	0.35	9
	/002	2	0.30	10
	/004	4	0.30	10
	/006	6	0.28	10
	/008	8	0.25	10
	/010	10	0.20	10

leader length: 70cm



OWNER MULTIPURPOSE HOOKS, GOLD (RL-046)

Fine wired – but strong wide curve – but short leverage and the proverbial needle-fine point make this type of hook so popular.

Item-No.	Order-No.	Size	Line-Ø	Content
171030	/004	4	0.30	8
	/006	6	0.25	9
	/008	8	0.22	10
	/010	10	0.20	10
	/012	12	0.18	10
	/014	14	0.14	10

leader length: 70cm



OWNER BREM, GUNSMOKE (RL-340), LEADER 70 CM

Catching large bream is an art. The OWNER® hooks are non-reflective gunsmoke, especially fine wired and incredibly strong. The needlepoint with barb enters without resistance and guarantees a secure hold.

Item-No.	Order-No.	Size	Line-Ø	Content
171040	/004	4	0.25	10
	/006	6	0.22	10
	/008	8	0.20	10
	/010	10	0.18	10
	/012	12	0.16	10
	/014	14	0.14	10
	/016	16	0.12	10
	/018	18	0.12	10



OWNER LIGHT-FLOAT / ROACH HOOKS, SILVER (RL-560)

The especially long shank and the distinctive limerick shape with the extra-fine needle point guarantee success with this method of fishing. The fine-wire material is hardened, it is also possible to catch large fish.

Item-No.	Order-No.	Size	Line-Ø	Content
171090	/010	10	0.14	10
	/012	12	0.14	10
	/014	14	0.12	10
	/016	16	0.12	10
	/018	18	0.10	10
	/020	20	0.08	10

leader length: 70cm

Owner® Hooks



DEVELOPED BY
MICHAEL ZAMMATARO

UNIVERSAL FEEDER, SILVER (FRL-354)

A true multipurpose hook for feeder fishing and which Michael likes to use for roach and small to medium-sized bream. The thin-wired hook is multi-hardened and can get the better even of larger fish.

Item-No.	Order-No.	Size	Line-Ø	Content
170820	/010	10	0.16	10
	/110	10	0.18	10
	/012	12	0.14	10
	/112	12	0.16	10
	/014	14	0.12	10
	/114	14	0.14	10
	/214	14	0.16	10
	/016	16	0.10	10
	/116	16	0.12	10
	/018	18	0.10	10
/118	18	0.12	10	

leader length: 80cm



DEVELOPED BY
MICHAEL ZAMMATARO

BREAM SPECIAL FEEDER, BROWN (FRL-319)

Michael uses this hook specifically when fishing for bream and big roach. Light in weight but nevertheless extremely sturdy.

Item-No.	Order-No.	Size	Line-Ø	Content
170810	/008	8	0.20	9
	/108	8	0.22	9
	/010	10	0.16	10
	/110	10	0.20	10
	/012	12	0.12	10
	/112	12	0.14	10
	/014	14	0.12	10
	/114	14	0.14	10
	/214	14	0.16	10
	/016	16	0.12	10
/116	16	0.14	10	

leader length: 80cm



DEVELOPED BY
MICHAEL ZAMMATARO

BARBEL SPECIAL, BROWN (FRL-044)

The multi-hardened forged steel and the point of the needle drawn inwards guarantee that this hook will reliably hook string barbels even in a really tough current.

Item-No.	Order-No.	Size	Line-Ø	Content
170800	/008	8	0.25	9
	/010	10	0.22	10
	/110	10	0.25	9
	/012	12	0.20	10
	/112	12	0.22	10
	/014	14	0.20	10

leader length: 100cm



OWNER PIKE-PERCH/ZANDER, SILVER (50607)

This hook was developed especially for fishing with baitfish. The extra wide curvature exposes the tip and thus prevents baits from being missed.

Item-No.	Order-No.	Size	Line-Ø	Content
170970	/001	1	0.28	8
	/002	2	0.25	9
	/004	4	0.22	9

leader length: 80cm

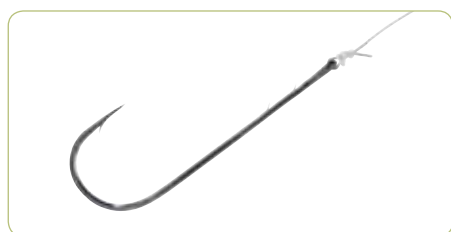

OWNER FLATFISH HOOK, GUNSMOKE (RL-5100)

The especially long shank and the distinctive limerick shape with the extra-fine needle point guarantee success with this method of fishing. Thanks to the special way in which the fine-wire material is hardened, it is also possible to catch large fish.

Item-No.	Order-No.	Size	Line-Ø	Content
171100	/001	1	0.30	4
	/002	2	0.30	4

leader length: 70cm



OWNER COD HOOKS, SILVER (RL-172)

The special steel is hardened and forged in a certain way. The set needle point which is curved towards the inside permits the strike to be made confidently.

Item-No.	Order-No.	Size	Line-Ø	Content
171110	/300	3/0	0.47	5
	/100	1/0	0.40	6
	/002	2	0.30	8

leader length: 70cm



OWNER EEL HOOKS, RED (RL-9330)

2 barbs on the shank prevent the worm from slipping off; an angle of traction exactly in alignment with the point guarantees a reliable strike.

Item-No.	Order-No.	Size	Line-Ø	Content
171000	/002	2	0.35	7
	/004	4	0.30	8
	/006	6	0.30	9
	/008	8	0.25	10
	/010	10	0.25	10
	/012	12	0.25	10

leader length: 70cm



OWNER WORM HOOK (RL-5123)

The brown worm hook made of high performance steel is specially forged and hardened. The two barbs positioned up high on the shank guarantee optimal bait holding.

Item-No.	Order-No.	Size	Line-Ø	Content
170980	/001	1	0.40	5
	/002	2	0.35	6
	/004	4	0.30	6
	/006	6	0.28	7
	/008	8	0.25	7

leader length: 65 cm



OWNER MATCH/TENCH HOOKS, BROWN (RL-1414)

22 CM

These hooks have the perfect angle between the length of the shank and the hook curve and point. The fine wire steel is multi hardened and also enables bigger fish to be caught. The barb guarantees a secure hold and correct removal from the hook.

Item-No.	Order-No.	Size	Line-Ø	Content
170830	/010	10	0.12	11
	/012	12	0.12	11
	/014	14	0.10	11
	/016	16	0.10	11
	/018	18	0.08	11
	/020	20	0.08	11

leader length: 22cm



OWNER MATCH/TENCH HOOKS, BROWN (RL-1414)

36 CM

These hooks have the perfect angle between the length of the shank and the hook curve and point. The fine wire steel is multi hardened and also enables bigger fish to be caught. The barb guarantees a secure hold and correct removal from the hook.

Item-No.	Order-No.	Size	Line-Ø	Content
170840	/010	10	0.12	11
	/012	12	0.12	11
	/014	14	0.10	11
	/016	16	0.10	11
	/018	18	0.08	11
	/020	20	0.08	11

leader length: 36cm



OWNER MATCH/TENCH HOOKS, BROWN (RL-282)

70 CM

These hooks have the perfect angle between the length of the shank and the hook curve and point. The fine wire steel is multi hardened and also enables bigger fish to be caught. The barb guarantees a secure hold and correct removal from the hook.

Item-No.	Order-No.	Size	Line-Ø	Content
171080	/008	8	0.22	10
	/010	10	0.20	10
	/012	12	0.18	10
	/014	14	0.16	10
	/016	16	0.14	10
	/018	18	0.12	10

leader length: 70cm

Owner® Hooks

LOOSE HOOKS

Laser-cut and forged hot and cold until it reaches its ultimate strength and stability. The sharpness achieved in the forging process is perfected by a diamond polish. Chemical hardening makes the Carp C series hooks indestructible. All hooks with eye.



OWNER BC CARP C3 (53270)

Item-No.	Order-No.	Size	Cont.
171250	/202	2	5
	/204	4	6
	/206	6	7
	/208	8	8



OWNER CARP C3 (50923)

Item-No.	Order-No.	Size	Cont.
171250	/001	1	5
	/002	2	5



OWNER CARP C1 (53261)

Item-No.	Order-No.	Size	Cont.
171240	/001	1	4
	/002	2	4



OWNER CARP C4 (50924)

Item-No.	Order-No.	Size	Cont.
171260	/001	1	5
	/002	2	6



CARP C6 BARBELESS HOOK

Extra strong barbeless hook, black.

Item-No.	Order-No.	Size	Cont.
171470	/001	1	7
	/002	2	8
	/004	4	10
	/006	6	11
	/008	8	12



OWNER EYE FLYLINER, GUNSMOKE (5106)

The multi hardening and forging of the material are the reasons for the great popularity of hooks of this shape.

Item-No.	Order-No.	Size	Content
171210	/100	1/0	7
	/001	1	7
	/002	2	8
	/004	4	8
	/006	6	9
	/008	8	9



OWNER CARP C5 (53265)

Item-No.	Order-No.	Size	Cont.
171270	/001	1	7
	/002	2	8
	/004	4	10
	/006	6	11
	/008	8	12
	/010	10	14
	/012	12	15

OWNER CARP TAFF CT1/CT3/CT4/CT5

The Taff series is the latest generation of carp hooks. The hooks are entirely coated with Teflon, making them sensationally strong and sharp!

Contrary to most other eyed hooks the eye is completely closed, making it impossible for it to bend open or slip out.

It goes without saying that all hooks have the Owner cutting point!

All hooks with eye, colour: Teflon black-chrome.



OWNER CARP CT 1

Item-No.	Order-No.	Size	Cont.
171240	/102	2	5
	/104	4	6
	/106	6	6
	/108	8	6



OWNER CARP CT 4

Item-No.	Order-No.	Size	Cont.
171260	/102	2	7
	/104	4	8
	/106	6	9
	/108	8	9



OWNER CARP CT 3

Item-No.	Order-No.	Size	Cont.
171250	/102	2	6
	/104	4	7
	/106	6	8
	/108	8	9



OWNER CARP CT 5

Item-No.	Order-No.	Size	Cont.
171270	/102	2	7
	/104	4	8
	/106	6	9
	/108	8	9

LOOSE HOOKS



OWNER MATCH / FLAT-EYE TENCH HOOKS, BROWN

These hooks have the perfect angle between the length of the shank and the hook curve and point. The fine wire steel is multi hardened and also enables bigger fish to be caught.

Item-No.	Order-No.	Size	Content
171120	/008	8	14
	/010	10	14
	/012	12	14
	/014	14	15
	/016	16	15
	/018	18	15
	/020	20	15



OWNER FLAT-EYE TROUT HOOKS, BLUE (50175)

The high quality, fine wire steel is multi hardened and also enables capital fish to be caught. The wide curve and super-sharp point guarantee reliable strikes and secure hold in the mouths of big fish.

Item-No.	Order-No.	Size	Content
171150	/004	4	13
	/006	6	14
	/008	8	15
	/010	10	15
	/012	12	15
/014	14	15	



OWNER UNICUT HOOKS WITH EYE, GUNSMOKE (53853)

The Unicut hook is the allrounder hook with eye and needle sharp point. Unique bending angle, ultra strong material and extra sharp forged hook point.

Item-No.	Order-No.	Size	Content
171200	/001	1	8
	/002	2	9
	/004	4	10
	/006	6	11
	/008	8	12
	/010	10	13



OWNER LIGHT-FLOAT / ROACH FLAT-EYE HOOKS

The especially long shank and the distinctive limerick shape with the extra-fine needle point guarantee success with this method of fishing.

Item-No.	Order-No.	Size	Content
171130	/010	10	17
	/012	12	17
	/014	14	17
	/016	16	17
	/018	18	17
	/020	20	17



OWNER BARBELESS HOOK (50238), SILVER

Item-No.	Order-No.	Size	Content
171460	/001	1	9
	/002	2	10
	/003	3	11
	/004	4	12
	/005	5	13
	/006	6	14



OWNER BARBELESS HOOK (50708), GOLD

Item-No.	Order-No.	Size	Content
171480	/003	3	11
	/004	4	12
	/005	5	13



OWNER FLAT-EYE CARP HOOKS, BLACK (50044)

The multi hardened, forged steel, set point and the needle point drawn inwards guarantee reliable strikes and play and landing.

Item-No.	Order-No.	Size	Content
171170	/100	1/0	10
	/001	1	11
	/002	2	11
	/004	4	13
	/006	6	14
	/008	8	14



OWNER FLAT-EYE BREAM HOOKS, GUNSMOKE (50340)

All non-predator anglers know the problem with catching bream. It is only possible to catch bream on a regular basis with a hook that is produced especially for the purpose.

Item-No.	Order-No.	Size	Content
171140	/004	4	15
	/006	6	16
	/008	8	16
	/010	10	17
	/012	12	17
	/014	14	17
	/016	16	17
	/018	18	17



OWNER CHIKA 50354

Thin competition hook with long leg and round arch especially for fishing with maggots, pinkies and worms. Ideal to get a lot of bait on the hook.

Item-No.	Order-No.	Size	Content
170850	/010	10	14
	/012	12	14
	/013	13	14
	/014	14	14
	/015	15	14
	/016	16	14
	/017	17	14
	/018	18	14



OWNER FLAT-EYE CARP HOOKS, GOLD (50330)

Many carp anglers fish for their favourite prey with dough, bread, corn or such like. The gold OWNER carp hook is especially good for this purpose.

Item-No.	Order-No.	Size	Content
171180	/200	2/0	8
	/100	1/0	9
	/001	1	8
	/002	2	9
	/004	4	10
	/006	6	11

Owner® Hooks

LOOSE HOOKS



OWNER SEATROUT WITH SPECIAL EYE (S75M)

When trebles or doubles are too much, retro fit your small crankbaits, spinners and wobblers with these single wide gape in line eye hooks. Suit all small lures. Also fish friendly hook.

Item-No.	Order-No.	Size	Content
171680	/200	2/0	3
	/100	1/0	4
	/001	1	5
	/002	2	6
	/004	4	7
	/006	6	8



CUTTING POINT

OWNER RIG 'N HOOK, BLACK-CHROME (5137)

Thanks to the special curve of the short shank the point of the hook, slightly curved inwardly, is located in the perfect position just above the eye of the hook so that it can be concealed very well in the bait. When bitten on the Cutting Point immediately emerges from the bait and penetrates the fish's mouth very fast. Perfect for perch and pike-perch.

Item-No.	Order-No.	Size	Content
171360	/500	5/0	5
	/300	3/0	5
	/100	1/0	6
	/001	1	6
	/002	2	6



OWNER FLAT-EYE WORM EEL HOOKS, RED (59330)

With two additional barbs on the shank and a small angle between the hook shaft and hook point.

Item-No.	Order-No.	Size	Content
171160	/001	1	5
	/002	2	6
	/004	4	8
	/006	6	9
	/008	8	11
	/010	10	12



OWNER SEATROUT, BLACK-CHROME

Equipped with a large eye for easy assembling of the hook to lures with snap rings

Item-No.	Order-No.	Size	Content
171500	/300	3/0	7
	/100	1/0	9
	/002	2	9



CUTTING POINT

OWNER DOWN SHOT OFFS., BLACK-CHROME (5133)

With a long shank, an angular hook curve, with the eye facing slightly upwards, and ultra-sharp Cutting Point it is the perfect hook for all slender drop shot bait.

Item-No.	Order-No.	Size	Content
171370	/300	3/0	6
	/100	1/0	7
	/001	1	7
	/002	2	7
	/004	4	7

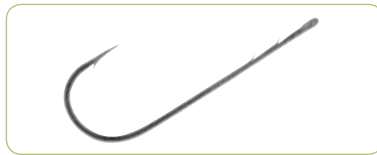

OWNER EYE WORM CUTTING POINT, GUNSMOKE

With Cutting Point and a gunsmoke finish for professional use. The high performance steel is specially forged and hardened. The two barbs positioned up high on the shank guarantee optimal bait holding.

Item-No.	Order-No.	Size	Content
171290	/100	1/0	6
	/001	1	6
	/002	2	6



OWNER DOUGH / TROUT HOOKS WITH EYES, SILVER

Dough bait can be presented especially enticingly and cast over long distances with this hook.

Item-No.	Order-No.	Size	Content
171340	/002	2	5
	/004	4	5
	/006	6	5
	/008	8	5
	/010	10	6
	/012	12	6



NEU • NEW • NOUVEAU

OWNER SEATROUT/SPECIAL EYE (S-59)

The OWNER seatrout hook with extra-sharp needle point penetrates also in attacks over great distances safely. Equipped with a large eye for easy assembling of the hook to lures with snap rings

Item-No.	Order-No.	Size	Content
171680	/102	2	6
	/104	4	7
	/106	6	8
	/108	8	9



CUTTING POINT

OWNER WIDE GAP WITH EYE, BLACK-CHROME (5139)

With special rounded, wide hook curve. Perfect for the inconspicuous hook mount in the bait. The super sharp cutting point immediately penetrates the fish's mouth and guarantees optimal catches.

Item-No.	Order-No.	Size	Content
171380	/100	1/0	6
	/300	3/0	5
	/500	5/0	5



CUTTING POINT

OWNER Z-NECK OFFSET WITH EYE, BLACK-CHROME

The Z-Neck with the narrow hook curve and the long shaft is designed for the best possible presentation of slender drop-shot baits.

Item-No.	Order-No.	Size	Content
171390	/100	1/0	5
	/300	3/0	4
	/500	5/0	4



OWNER TROUT HOOKS WITH EYES, BLUE (53117)

Even the most distrusting of fish do not feel the trout hook with an eye and a wire diameter of just 0.35 mm.

Item-No.	Order-No.	Size	Content
171350	/004	4	10
	/006	6	10
	/008	8	11
	/010	10	12
	/012	12	13



OWNER OFFSHORE WITH EYE, SILVER (5129)

Designed as an ocean hook especially for medium-sized bait. Unique bending angle, ultra strong material, extra sharp forged hook point, black chrome finish for permanent corrosion resistance.

Item-No.	Order-No.	Size	Content
171310	/110	10/0	3
	/800	8/0	5
	/600	6/0	7
	/400	4/0	9

OWNER GORILLA, BLACK-CHROME (5105)

The perfect hook for large baits. Ideal also for catfishing.

Item-No.	Order-No.	Size	Content
171490	/800	8/0	2
	/600	6/0	3
	/400	4/0	4
	/200	2/0	5
	/100	1/0	6
	/001	1	7
	/002	2	7
	/004	4	7



OWNER SJ 41 TN (11766)

The Owner SJ-41 is a super strong hook ideal for many popping and jigging situations. Great for assist rigs for use on deepwater jigs. Also the perfect hook for catfish rigs. The hooks are short shank and very light which does not affect lures action too much but at the same time not sacrificing any strength

Item-No.	Order-No.	Size	Content
171510	/300	3/0	5
	/500	5/0	4
	/700	7/0	3
	/900	9/0	3
	/110	11/0	3
	/130	13/0	3

OWNER SSW EYE CUTTING POINT, GUNSMOKE (5111)

The extra large SSW Cutting Points are perfect when fishing for catfish with natural bait rigs. The best way to present bundles of night crawlers and baitfish rigs. Perfect sharpness and maximum strength for big fish.

Item-No.	Order-No.	Size	Content
171230	/110	10/0	3
	/800	8/0	3
	/700	7/0	3
	/600	6/0	4
	/500	5/0	5
	/400	4/0	6
	/300	3/0	7
	/200	2/0	8
	/100	1/0	8
	/001	1	9
	/002	2	10
	/004	4	10
	/006	6	11
	/008	8	12



OWNER NEEDLE POINT, SMOKE, 5115 **OWNER NEEDLE POINT, RED**

Perfect bi game game hook. Multi hardened, forged, with eye and set point it meets any demand. The super needlepoint permits the hook to be set securely. Non-reflecting gunsmoke finish.

Item-No.	Order-No.	Size	Content
171220	/700	7/0	3
	/500	5/0	4
	/300	3/0	5
	/100	1/0	7
	/001	1	8
	/002	2	8
	/004	4	9
	/006	6	10
/008	8	10	

Item-No.	Order-No.	Size	Content
171520	/700	7/0	3
	/500	5/0	4
	/300	3/0	5
	/100	1/0	7
	/001	1	8
	/002	2	8
	/004	4	9
	/006	6	10
/008	8	10	



OWNER CIRCLE HOOKS WITH EYE, GUNSMOKE (5114)

This type of hook keeps the promise its name implies. When fish bites it automatically rotates into the fish's mouth.

Item-No.	Order-No.	Size	Content
171320	/300	3/0	5
	/500	5/0	4
	/700	7/0	3

OWNER TREBLE HOOKS



OWNER ST-36, GUNSMOKE

The perfect artificial bait treble hook with extra strong wire, the hook point slightly curved inwards and a 3-fold ultra sharp Cutting Point.

Item-No.	Order-No.	Size	Content
171400	/300	3/0	5
	/200	2/0	5
	/100	1/0	5
	/001	1	6
	/002	2	6
	/004	4	7
	/006	6	8
	/008	8	8
	/010	10	8
	/012	12	8
	/014	14	8
	/016	16	8
/018	18	8	

OWNER ST-36, RED

The perfect artificial bait treble hook with extra strong wire, the hook point slightly curved inwards - now also available in red.



Item-No.	Order-No.	Size	Content
171400	/102	2	6
	/104	4	7
	/106	6	8
	/108	8	8



OWNER ST-31, SILVER

The big brother of the OWNER ST-21, but available with stronger wire and in sizes 1, 2, 4 and 6. The Cutting Point points of this treble hook are fast and reliable.

Item-No.	Order-No.	Size	Content
171440	/001	1	6
	/002	2	7
	/004	4	8
	/006	6	8



OWNER ST-41, BLACK

Forged and sharpened for professional use. There is no better treble hook for your bait. Ideal for improving on catchy artificial baits.

Item-No.	Order-No.	Size	Content
171410	/200	2/0	6
	/100	1/0	6
	/001	1	6
	/002	2	7
	/004	4	8
	/006	6	8



OWNER ST-11, GUNSMOKE

The ideal medium to small treble hook for fishing in fresh water for small and medium-sized predators. Very fine wire!

Item-No.	Order-No.	Size	Content
171420	/008	8	8
	/010	10	8
	/012	12	8
	/014	14	8



OWNER ST-66, SILVER

The OWNER ST-66 was developed for all those who like to fish in seawater. Light in weight so as not to impair bait guidance and strong and sharp to hook and land any predator reliably.

Item-No.	Order-No.	Size	Content
171450	/100	1/0	6
	/200	2/0	5
	/300	3/0	6
	/400	4/0	5
	/500	5/0	5

CAMTEC®

Camtec Platinum - now even sharper

This third generation of the Camtec Platinum target fish hook, which we can now offer you, is a hook which has been manufactured in compliance with the state-of-the-art in production engineering. This entails steel greatly enriched with carbon, shock-hardened and with chemically sharpened tips. All types of hooks can be tied onto our Platinum Royal high performance line. The supple lines enable very natural bait presentation. Each hook tied on is inspected individually before being packaged!



TROUT, 60CM

Leader length 60 cm.

Item-No.	Order-No.	Size	Content	Strength. kg
172010	/004	4	10	15.0
	/006	6	10	13.0
	/008	8	10	11.0
	/010	10	10	9.0
	/012	12	10	



TROUT, 150CM

Leader length 150 cm.

Item-No.	Order-No.	Size	Line Ø	Content
172000	/004	4	0.25	10
	/006	6	0.22	10
	/008	8	0.20	10
	/010	10	0.18	10
	/012	12	0.16	10



ALLROUND

Leader length 60 cm.

Item-No.	Order-No.	Size	Line Ø	Content
172070	/006	6	0.25	10
	/008	8	0.23	10
	/010	10	0.20	10

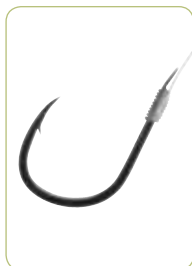

CARP

Leader length 70 cm.

Item-No.	Order-No.	Size	Line Ø	Content
172020	/002	2	0.30	10
	/004	4	0.28	10
	/006	6	0.25	10
	/008	8	0.20	10



CORN GOLD

Leader length 70 cm.

Item-No.	Order-No.	Size	Line Ø	Content
172030	/002	2	0.30	10
	/004	4	0.28	10
	/006	6	0.25	10
	/008	8	0.20	10



ROACH

Leader length 60 cm.

Item-No.	Order-No.	Size	Line Ø	Content
172040	/010	10	0.18	10
	/012	12	0.16	10
	/014	14	0.14	10
	/016	16	0.14	10
	/018	18	0.12	10
	/020	20	0.10	10



EEL

Leader length 60 cm.

Item-No.	Order-No.	Size	Line Ø	Content
172050	/001	1	0.40	7
	/002	2	0.35	8
	/004	4	0.30	9
	/006	6	0.28	9
	/008	8	0.25	10



WORM

Leader length 60 cm.

Item-No.	Order-No.	Size	Line Ø	Content
172060	/001	1	0.40	10
	/002	2	0.35	10
	/004	4	0.30	10
	/006	6	0.28	10
	/008	8	0.25	10
	/010	10	0.23	10
	/012	12	0.20	10

Camtec® Speci Hooks

CAMTEC speci

PRICE CUT

Laser sharp, high-tech hooks, sharpened in a chemical process.
The leader material for tied hooks is japanese quality line.



TROUT/SBIRO

Silver, bent, 1 barbe, medium size leg
leader length: 200cm.

Item-No.	Order-No.	Size	Line-Ø
178100	/004	4	0.25
	/006	6	0.22
	/008	8	0.20
	/010	10	0.18
	/012	12	0.16



TROUT/SBIRO

Red, bent, 1 barbe, medium size leg
leader length: 200cm.

Item-No.	Order-No.	Size	Line-Ø
178100	/104	4	0.25
	/106	6	0.22
	/108	8	0.20
	/110	10	0.18
	/112	12	0.16



TROUT/SBIRO

Silver, bent, 1 barbe, medium size leg
leader length: 140cm.

Item-No.	Order-No.	Size	Line-Ø
178110	/004	4	0.25
	/006	6	0.22
	/008	8	0.20
	/010	10	0.18
	/012	12	0.16

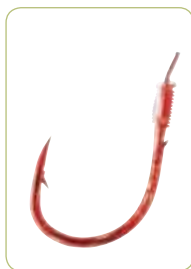

TROUT/SBIRO

Red, bent, 1 barbe, medium size leg
leader length: 140cm.

Item-No.	Order-No.	Size	Line-Ø
178110	/104	4	0.25
	/106	6	0.22
	/108	8	0.20
	/110	10	0.18
	/112	12	0.16



TROUT

Silver, bent, 1 barbe, medium size leg
leader length: 60cm.

Item-No.	Order-No.	Size	Line-Ø
178120	/004	4	0.25
	/006	6	0.22
	/008	8	0.20
	/010	10	0.18
	/012	12	0.16



BOILIE, BLACK

Leader length 50cm.

Item-No.	Order-No.	Size	Strength. kg
177000	/001	1	10.0
	/002	2	10.0
	/004	4	6.0
	/006	6	6.0

CAMTEC SPECI HOOKS



EEL

Red, 2 barbes, straight tip, long leg straight tip, leader length: 60 cm.

Item-No.	Order-No.	Size	Line-Ø
178130	/001	1	0.40
	/002	2	0.35
	/004	4	0.30
	/006	6	0.30
	/008	8	0.25



CARP, ULTRA STRONG, BLACK

Black, straight tip, short leg, leader length: 70 cm.

Item-No.	Order-No.	Size	Line-Ø
178140	/102	2	0.35
	/104	4	0.33
	/106	6	0.30
	/108	8	0.28



TROUT

Red, bent, 1 barbe, medium size leg leader length: 60 cm.

Item-No.	Order-No.	Size	Line-Ø
178120	/104	4	0.25
	/106	6	0.22
	/108	8	0.20
	/110	10	0.18
	/112	12	0.16



WORM

Brown, 2 barbes, long leg, leader length: 60 cm.

Item-No.	Order-No.	Size	Line-Ø
178250	/001	1	0.40
	/002	2	0.35
	/004	4	0.30
	/006	6	0.30
	/008	8	0.25
	/010	10	0.25
	/012	12	0.20

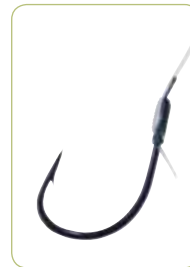

TENCH

Black, short leg, leader length: 60 cm.

Item-No.	Order-No.	Size	Line-Ø
178260	/006	6	0.18
	/008	8	0.16
	/010	10	0.14
	/012	12	0.14
	/014	14	0.12



CARP

Black, straight tip, short leg, leader length: 70 cm.

Item-No.	Order-No.	Size	Line-Ø
178140	/002	2	0.30
	/004	4	0.25
	/006	6	0.25
	/008	8	0.20



MATCH

Red, leader length: 60 cm.

Item-No.	Order-No.	Size	Line-Ø
178280	/010	10	0.18
	/012	12	0.16
	/014	14	0.14
	/016	16	0.14
	/018	18	0.12
	/020	20	0.10



BARBELESS HOOK

Silver, leader length: 60 cm.

Item-No.	Order-No.	Size	Line-Ø
178330	/002	2	0.23
	/004	4	0.20
	/006	6	0.18
	/008	8	0.16
	/010	10	0.14
	/012	12	0.14
	/014	14	0.14
	/016	16	0.12
	/018	18	0.10



MAGGOT

Silver, middle size leg, leader length: 60 cm.

Item-No.	Order-No.	Size	Line-Ø
178270	/006	6	0.22
	/008	8	0.20
	/010	10	0.18
	/012	12	0.16
	/015	14	0.14
	/016	16	0.12
	/019	18	0.10

Camtec® Speci



COARSEFISH

Silver, straight tip, short leg,
leader length: 60cm.

Item-No.	Order-No.	Size	Line-Ø
178150	/010	10	0.18
	/012	12	0.16
	/014	14	0.14
	/016	16	0.14
	/018	18	0.12
	/020	20	0.10



CORN

Gold, short leg,
leader length: 60cm.

Item-No.	Order-No.	Size	Line-Ø
178160	/002	2	0.30
	/004	4	0.25
	/006	6	0.25
	/008	8	0.20



FLADFISH

Red, long leg, 2 barbes
leader length: 30 cm

Item-No.	Order-No.	Size	Line-Ø
178170	/001	1	0.40
	/002	2	0.35
	/004	4	0.30



PERCH

Brown, straight tip, middle size leg,
leader length: 60cm.

Item-No.	Order-No.	Size	Line-Ø
178180	/004	4	0.25
	/006	6	0.22
	/008	8	0.20



PIKE-PERCH

Silver, straight tip, long leg,
leader length: 80cm.

Item-No.	Order-No.	Size	Line-Ø
178190	/001	1	0.28
	/002	2	0.25
	/004	4	0.22



DOUGH

Gold, with spiral, short leg,
leader length: 60 cm.

Item-No.	Order-No.	Size	Line-Ø
178200	/002	2	0.30
	/004	4	0.25
	/006	6	0.25
	/008	8	0.25
	/010	10	0.18

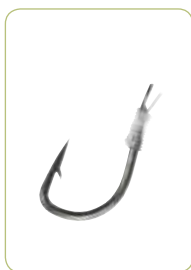

FEEDER

Black, straight tip, middle size leg,
leader length: 85 cm.

Item-No.	Order-No.	Size	Line-Ø
178220	/010	10	0.18
	/012	12	0.16
	/014	14	0.14
	/016	16	0.12



PIKE-PERCH RYDER, BROWN

Brown, long leg, leader length: 70 cm.

Item-No.	Order-No.	Size	Line-Ø
178230	/001	1	0.28
	/002	2	0.25
	/004	4	0.25
	/100	1/0	0.30



ALLROUND

Brown, long leg, straight tip, leader length: 60cm.

Item-No.	Order-No.	Size	Line-Ø
178240	/004	4	0.25
	/006	6	0.22
	/008	8	0.20
	/010	10	0.18
	/012	12	0.16
	/014	14	0.14



TROUT PASTE

Red, leader length: 140cm.

Item-No.	Order-No.	Size	Line-Ø
178310	/004	4	0.25
	/006	6	0.18
	/008	8	0.16
	/010	10	0.14

CAMTEC HAIR

The use of hair rigs is already for a long time the most successful method to catch carps. The advantage is clearly obvious: Since the bait sits on the Hair, it »floats« beside the hook and the fish can aspirate it without distrust, without feeling the hook. With the Camtec Hair program you can use this method beside carps now also successfully to breams, large roaches or tenches. The hair is very thin, a guarantor for a natural bait presentation.

HOOK WITH SPIRAL FOR PASTE



Item-No.	Order-No.	Size	Line Ø
178350	/002	2	0.28
	/004	4	0.25
	/006	6	0.22
	/008	8	0.20
	/010	10	0.18
	/012	12	0.16

Special Hair Rigs for fishing with paste on carps, tench and large white fish. In muddy waters we recommend to under-add to the paste the Camtec Hair lift powder then the paste floats over the ground and can not sink into the mudd.

HOOK WITH SPEAR FOR MAGGOTS & CORN



Item-No.	Order-No.	Size	Line Ø
178360	/002	2	0.28
	/004	4	0.25
	/006	6	0.22
	/008	8	0.20
	/010	10	0.18
	/012	12	0.16

Special hair rigs for fishing with corn, maggot or grain on carps, tench and large roaches. Simply put the bait on the sting. In muddy waters we recommend to put a Camtec Hair Pop Up ball on the point of the needle.

LIFT POWDER



Item-No.	Order-No.	Content
178400	/000	100g

Smell and taste-neutral lift powder for all kinds of paste. Ideally in combination with the Camtec Hair paste hook if you want to fish on muddy water bottom and the bait is to be remarkably presented. Application: Knead the powder into the finished paste. For self production of the paste mix the powder into the dry bait and knead as usual with water. The buoyancy is adjustable depending on the quantity of lift powder. Not for the human consumption. Contents: 100g.

POP UP BALLS

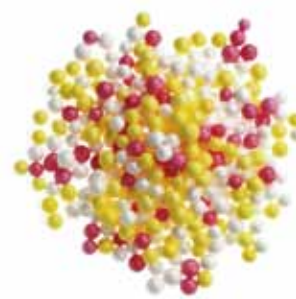

Item-No.	Order-No.	Content
178400	/100	100 pcs.

Application: First put the bait (corn, maggot or grain) on the sting. Attach 1 or 2 pop up balls on the point of the sting. If bait chains are to be used the bait can be pushed also additionally onto the hair. Ideally for muddy bottom or if the bait is to be remarkably presented.

Camtec® Hair / Camtec® Speci Carbon Hooks



EEL-LINE

Ready assembled system for lay-out. With professional tied eel-hook.

Item-No.	Order-No.	
147700	/010	
	/020	

/010: with 10 hooks, /020: with 20 hooks



OPEN DOUBLE HOOK

Item-No.	Order-No.	Size	
178560	/100	1/0	
	/001	1	
	/002	2	
	/004	4	



RYDER HOOK

Brown, long leg, with eye.

Item-No.	Order-No.	Size	
178550	/100	1/0	
	/001	1	
	/002	2	
	/004	4	



TROUT

Red, long leg, straight tip.

Item-No.	Order-No.	Size	
178710	/004	4	
	/006	6	
	/008	8	
	/010	10	



TROUT

Silver, long leg, with barbe.

Item-No.	Order-No.	Size	
178700	/004	4	
	/006	6	
	/008	8	
	/010	10	



CORN

Gold, middle long leg, straight tip.

Item-No.	Order-No.	Size	
178750	/001	1	
	/002	2	
	/004	4	
	/006	6	
	/008	8	



DOUGH

Red, with spirale.

Item-No.	Order-No.	Size	
178800	/004	4	
	/006	6	
	/008	8	
	/010	10	



MATCH RED

Item-No.	Order-No.	Size	
178780	/010	10	
	/012	12	
	/014	14	
	/016	16	



FLADFISH

Black, long leg, with eye.

Item-No.	Order-No.	Size	
178790	/001	1	
	/002	2	
	/004	4	



ABERDEEN

Item-No.	Order-No.	Size	
178810	/100	1/0	
	/001	1	
	/002	2	
	/004	4	



PIKE-PERCH

Long leg, straight tip.

Item-No.	Order-No.	Size	
178760	/001	1	
	/002	2	
	/004	4	



EEL/COD, RED

Item-No.	Order-No.	Size
178720	/100	1/0
	/001	1
	/002	2
	/004	4
	/006	6
	/008	8



ALLROUND

Brown, long leg, straight tip.

Item-No.	Order-No.	Size
178770	/002	2
	/004	4
	/006	6
	/008	8
	/010	10
	/012	12



CARP

Black, long leg, straight tip.

Item-No.	Order-No.	Size
178740	/100	1/0
	/001	1
	/002	2
	/004	4
	/006	6
	/008	8



WORM

Brown, long leg, 2 barbes, straight tip.

Item-No.	Order-No.	Size
178730	/001	1
	/002	2
	/004	4
	/006	6
	/008	8
	/010	10



BAITHOLDER

Nickel, round steel, with eye.

Item-No.	Order-No.	Size
175490	/001	1/0
	/002	2/0
	/003	3/0
	/004	4/0
	/005	5/0
	/006	6/0
	/007	7/0
	/008	8/0
	/009	9/0
	/010	10/0



SPEAR TREBLE HOOK

The straight tip is stuck into baitfish or rubber fish; the two other hooks thus remain absolutely straight and give rise to significantly fewer missed bites.

Item-No.	Order-No.	Size	Content
143650	/200	2/0	5
	/100	1/0	5
	/001	1	5
	/002	2	5
	/004	4	5
	/006	6	5
	/008	8	5



SEA TREBLE HOOK

Silver, round steel, with eye.

Item-No.	Order-No.	Size	Content
178640	/600	6/0	2
	/400	4/0	3
	/200	2/0	4
	/100	1/0	4
	/001	1	5
	/002	2	6
	/004	4	6



SEA TREBLE HOOK

Red, round steel, with eye.

Item-No.	Order-No.	Size	Content
178680	/200	2/0	4
	/100	1/0	4
	/001	1	5
	/002	2	6
	/004	4	6
	/006	6	6
	/008	8	6
	/010	10	6



TREBLE HOOK

Brown, round steel, with eye.

Item-No.	Order-No.	Size
178620	/100	1/0
	/001	1
	/002	2
	/004	4
	/006	6
	/008	8
	/010	10
	/012	12
	/014	14
	/016	16



FOOD

Get a taste



Get a taste

It takes a good deal of expert knowledge and many years of experimentation to achieve the greatest possible effectiveness in such a broad range of applications as our sports fishing. An additional factor is that the amino acids with a scientifically proven luring effect are difficult to obtain and extremely expensive. Used in effective concentrations, they make the final product considerably more expensive. The difference in quality between our top grade products enriched with pure amino acid compared to the standard qualities of many competitors is often not immediately apparent because purchases are frequently based on either the lower price or overstated advertising. Only pure additives from the food and feedstuffs industry are used in production. Our producers function strictly in accordance with the food regulations and the products are inspected regularly.

WILLI FROSCH'S SYSTEM LOCK

Those who fish with a system catch more! Willi adapted the high-quality flours, aromas and colours optimally for the respective target fish.

CHAMPION'S LOCK - DEVELOPED BY WINNERS FOR WINNERS!

Our premium compound feed for the very highest demands. The recipes come from leading German and Italian competitive anglers and have already yielded many championship titles. Only the very best ingredients are used.

FEEDERMASTER: THE FEEDER FOOD OF MICHAEL ZAMMATARO!

Readymade feed mixture especially for feeder fishing in flowing and still waters.

The aromas and colours are perfectly adapted to the respective target fish. The recipes come from feeder champion Michael Zammataro and have a tremendous luring effect.

The feed is quick to break out of the basket and keeps the fish in that place for a long time.

MATZE KOCH SPECIAL EDITION

Matze Koch is without a doubt one of the most popular and successful anglers in Germany. Who do not know his monthly articles appearing in *Fisch&Fang*, his great video podcasts and his product innovations? Now you too can benefit from his wealth of experience and his popular name!

Willi Frosch's Champions Lock

BALZER 

Qualität seit 1949.

MK Adventure  by Matze Koch

FEEDER MASTER
by Michael Zammataro

METHOD FEEDER
by Michael Zammataro

SYSTEM LOCK
by Willi Frosch

CHAMPION'S LOCK 

Beißfix 

The BALZER feeder offensive

We are delighted to present our feeder and attractant range to you; it leaves nothing to be desired.

All the feed and attractants stem exclusively from **German and Italian production**. Only select, high-quality aromas, flours and attractants are used in them.

We have developed the range and the recipes in collaboration with such specialists as Matze Koch, Michael Zammataro and Willi Frosch, to name just a few of them.

The range comprises the following subsections:

Matze Koch MK Adventure: readymade food, boilies, pellets and dips

Michael Zammataro's Feedermaster: readymade feed for feeder fishing

Michael Zammataro's Method Feeder: readymade feed, micro pellets and boilies as well as dips for method feeder fishing

Champion's Lock: High-end, premium quality ready-made feed

Willi Frosch's System Lock: Ready-made feed and hook bait at great prices.

System Lock Boilie: German-produced quality boilies at top prices

Beissfix: liquid attractants and sprays

CHAMPION'S LOCK



Champion's Lock - developed by winners for winners

Our premium compound feed for the very highest demands. The recipes come from leading German and Italian competitive anglers and have already yielded many championship titles. Only the very best ingredients are used. An enormous luring effect even in difficult conditions!



CHAMPIONS LOCK

Item-No.	Order-No.	Packing unit 1000g	
184800	/001	Carp/Tench	
	/002	Bream natural	
	/003	Bream yellow	
	/004	Roach	
	/005	X-Factor red	
	/006	X-Factor black	
	/007	Chub, Barbel	



Roach



Bream yellow



X-Factor red



Chub, Barbel



Carp/
Tench



Bream
nature



X-Factor black

CHAMPIONS LOCK ATTRACTANTS

The new attractant concentrates from Balzer are sophisticated additives composed by specialists. They are micro-encapsulated powder attractants enriched with appetite and flavour enhancers. They are particularly intensive and enrich your feed in terms of odour and flavour. It goes without saying that they correspond ideally to our feed series.

Dosage: We recommend 1 bag for 5 kg of dry feed in autumn/winter. In spring/summer or in water with little pollution max. 150 g for 5 kg of feed.

Tips: For a rapid luring effect you start by putting the first feed balls or feed basket mixtures into a separate vessel and adding some attractant to them without overly flavouring all of the feed. This highly-concentrated mixture guides the fish to where the angling is to take place; thereafter mix the rest of the feed with a slightly lower concentration. If the will to bite abates, repeat the additional seasoning.



Item-No.	Order-No.	Packing unit 250 g
184800	/100	Bream Special
	/101	Carp/Tench Special
	/102	Roach Special
	/103	Brasem
	/104	Vanilla
	/105	Cheese
	/106	Strawberry
	/108	Almond



CHAMPIONS LOCK HEMP

Hemp, untreated: Untreated hemp, ideal for making it swell in water.

Hemp, ground: The ground hemp is rich in oils, has a strong inherent smell, is very nutritious and an ideal and digestive feed component. Before processing it, we recommend steeping it in warm water.

Hemp, roasted: Freshly roasted hemp is slightly oily and has a very intense inherent smell. It is very nutritious, and used as an additive it makes the feed very loose and ensures that the feed disintegrates quickly.

Item-No.	Order-No.	Hemp
184820	/100	Hemp, untreated, 1 kg
	/101	Hemp, ground, 1 kg
	/102	Hemp, roasted, 700g

CHAMPIONS LOCK LIQUID

The new attractant concentrates from Balzer are sophisticated additives composed by specialists. They are micro-encapsulated liquid attractants enriched with appetite and flavour enhancers. They are particularly intensive and enrich your feed in terms of odour and flavour. It goes without saying that they correspond ideally to our feed series.



Item-No.	Order-No.	Packing unit 50 ml
184850	/001	Liver, dark brown
	/002	Fish, light green
	/003	Pineapple, yellow
	/004	Vanilla, beige
	/005	Caramel, brown
	/006	Garlic, clear
	/007	Honey, light brown
	/008	Tutti Frutti, orange



CHAMPIONS LOCK SWEETENER

An intense powdered sweetener for your groundbaits. As it is so concentrated a little goes a long way (1 tea spoon to 1 kg of groundbait). It also enhances the nutritive value of your groundbait. Works well for carps, breams and other big fishes.

Item-No.	Order-No.	Content g
184830	/100	250 g



CHAMPIONS LOCK COPRA MOLASSES

The dark Copra Molasses (rich, sweet and greasy flour) with the chocolate/cocoa odour is absolutely ideal for carp, bream and roach. Adheres and bonds very well and dissolves easily in water. It can be used to darken feed.

Item-No.	Order-No.	Content g
184830	/200	500 g

Willi Frosch's System Lock



Willi Frosch's System Lock....
catch more with a system

Those who fish with a system catch more! Willi adapted the high-quality flours, aromas and colours optimally for the respective target fish. The feed forms clouds and has a great luring effect.



WILLI FROSCH'S SYSTEM LOCK

Item-No.	Order-No.	Packing unit	
184880	/001	Carp/Tench,brown	
	/002	Bream, yellow	
	/003	Bream, red	
	/004	Roach	
	/005	Allround, sand	
	/006	Allround, black	
	/007	Feeder, yellow	



Roach

Bream yellow

Bream red

Allround

Carp/Tench

Feeder

Allround black



WILLI FROSCH'S SYSTEM LOCK SPECIAL

Especially for fishing in rivers and canals with moderate to strong current.
High bonding strength.

Item-No.	Order-No.	Packing unit	
184880	/008	Bream, red	
	/009	Bream, yellow	
	/010	Carp,sand	
	/011	Roach, brown	



Bream red



Roach brown



Carp red



Bream yellow



System Lock Boilies
Top quality at top prices
from German production

Anyone who tracks the quality tests in the food industry will find that frequently low-price products receive a better assessment than other highly-praised brands. That is also true in the carp field when it comes to boilies. If one keeps one's eyes open, and doesn't simply go by expensive promises, can find a high quality product which is quite cheap.

We have done exactly that for you; our System Lock boilies provide high quality and a high catching capacity at low prices. Three decades of experience in the production of fishing bait, best contacts with the food industry and especially favourable purchasing of raw materials by our producer guarantee the top quality and fantastic prices of our boilie series.



SYSTEM LOCK BOILIES - 20 MM

Item-No.	Order-No.	Packing unit 1000g
184770	/000	Butter Vanilla
	/001	Tigernut / Corn
	/002	Mussel / Crab
	/003	Stinky Fish
	/004	Monster Crab
	/005	Tutti Frutti / Cream
	/006	Ripe Strawberry



Butter
Vanilla



Mussel-
Crab



Tutti Frutti-
Cream



Stinky
Fish



Tigernut-
Corn



Monster
Crab



Ripe
Strawberry

WILLI FROSCH'S SYSTEM LOCK PASTE

Very catchy ready-made paste prepared according to proven recipes of Willi Frosch. The dough is enriched with lots of amino acids and intense, natural flavors. Despite its flexibility the dough adheres very well on the hook.

Item-No.	Order-No.	Packing unit 100g
184790	/000	Carp/Tench Vanilla
	/001	Carp/Tench, Fish/Mussel
	/002	Carp/Tench, Tutti Frutti
	/003	Bream red
	/004	Bream yellow
	/005	Roach



Beißfix® Attractant / Bait

BEISSFIX® POWER SPRAY



Highly-concentrated attractant in a spray bottle. Simply spray on feed or the hook bait or feed basket and then sit back and catch the fish.

Item-No.	Order-No.	Packing unit 50 ml
186160	/000	Eel
	/001	Trout
	/002	Carp/Tench
	/003	Whitefish/Bream
	/004	Predatory Special
	/005	Crab
	/006	Vanilla
	/007	Anis
	/008	Cheese
	/009	Garlic
	/010	Liver
	/011	Catfish
/012	Smoked Salmon	



TROUT ATTACK POWER LARVAE

Bee larvae, which retain their entirely natural consistency which makes them just as luring as living bee larvae.

- Supplied in a vacuum-sealed jar (contents approximately 30-35 larvae)
- Available colours: natural, red, green

Item-No.	Order-No.	Color
160080	/100	Nature
	/101	Red
	/102	Green

BEE MAGGOT OIL



A 100 % natural product which serves primarily to release the dough well from the dough shaper. Simply brush the dough shaper with the oil. Content 10ml.

Item-No.	Order-No.
160070	/000

TROUT ATTACK AROMASPRAY

These 100 % naturally pure aromas made in Germany significantly improve the catching capacity of all kinds of bait. Willy and Tim experimented for a long time and have put together the most luring aromas for you. With a practical sprayer! Also available as a sales-boosting counter display. Content 10ml.

Item-No.	Order-No.	Packing unit 10 ml
160080	/000	Bee Grubs
	/001	Liver / Blood
	/002	Gammarus
	/003	Salmon Egg
	/004	Trout
	/005	Garlic

1.000 SPRAY PROCEDURES



PIKE-PERCH MAGNET

Scented spray with excellent luring effect for perch-type fish species. Simply spray onto the artificial or natural bait. Often the key to success when the fish are biting sluggishly! Content 50ml.

Item-No.	Order-No.	Packing unit 50 ml
166240	/000	Smelt
	/001	Blood/Fish

FLOATING BREAD



In water the flake soon expands in water to many times its original size. Remains in place on the hook and can be cast many times over without changing its consistency. If you fish mainly/exclusively with the outer crust, the dough floats; if you only use dough from the middle the bait will sink. Can always be enriched with aromas or colourants.

The bread is made from natural raw materials and nature-identical additives and contains no preservatives.

How to use: Simply cut off a piece of bread using a piece of braided line. Shelf life: Can be kept for a very long time. Content: 50 grams.

FLOATING BREAD

Item-No.	Order-No.
185410	/050



Exclusively by Balzer

Matze Koch is without a doubt one of the most popular and successful anglers in Germany. Who do not know his monthly articles appearing in Fisch&Fang, his great video podcasts at DMAX/Fish&Fun and his product innovations?

He has given the company Top Secret his secret boilie and food receipts to produce them exclusively in best quality for us! Only the finest ingredients are used!

Fantastic video about Matze Koch can be found at www.balzer.de or in our Balzer Youtube channel.



TEST RESULT FISCH & FANG: MARK 1,9

MATZE KOCH SPECIAL EDITION BOILIES

One of the outstanding features of the new bait is its special consistency. A boilie, fresh from the bag, can never be too soft, just too hard. And if problems occur with crabs, coarsefish or crustaceans, the balls can easily harden for several days in air at room temperature just so long harden until the desired hardness is reached. I fish the balls fresh out of the bag in its original condition because carp like it soft. But note to check the balls more often.

Do not use as default boilies with the classic standard diameter of 20mm. Personally I appreciate especially the smaller variety in 16mm for a simple reason: There are much more boilies on the ground. A kilo of 20mm boilies includes approximately 200 balls, a kilo of 16mm already 300! To feed with 16er balls is much more effective.



Boilies in 13, 16 und 20mm in attractive colour combinations.

NEW AROMAS AND DIAMETER (13MM)

MATZE KOCH SPECIAL EDITION BOILIES 16 AND 20MM

Item-No.	Type	Ø mm 16mm	Ø mm 20mm
185980	Monster Crab - Robin Red	/000	/100
	Honey - Vanilla	/001	/101
	Strawberry - Nut	/002	/102
	Scopex - Tigernut	/003	/103
	Banana - Pistachio	/004	/104
	Liver - Mussel	/005	/105
	Tropic - Birdfood	/006	/106
	Maracuja-Ananas, res	/007	/107
	Lobster-Garlic, orange	/008	/108
	Potato-Corn, yellow/brown	/009	/109
	Cokunut-Hemp, white	/010	/110
	Cayenne Pepper/Robin Red	/011	/111
	Crab/Peach	/012	/112
	Liver-Roasted Hemp	/013	/113
Robin Red-Garlic	/014	/114	
NEW	Spekulatius-almond-hemp no artificial colours, natural	/015	/115



Good consistency and high quality particles



MATZE KOCH SPECIAL EDITION BOILIES 13MM

Item-No.	Order-No.	Type	Ø mm
185980	/202	Monster Crab - Robin Red	13
	/201	Liver - Mussel	13
	/200	Spekulatius-almond-hemp	13



Matze Koch Special Edition



MATZE KOCH SPECIAL EDITION DUMBBELLS

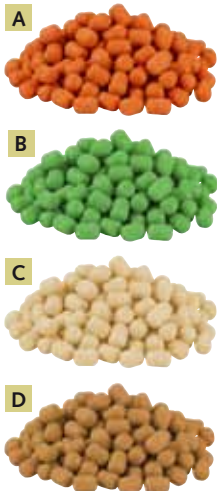

Fishing differently to others is one of Matze Koch's recipes for success. Carp recognise round boilies everywhere, so Matze halves his boilies - or divides them into four - in extremely popular fishing waters. You can save yourself this trouble by fishing with these dumbbells. The shape clearly differs from the classic ball and causes carp and other fish to bite unsuspectingly. Big non-predatory fish such as tench or bream also like the rarely-used shape of the bait.

Length: 16mm, height: 10mm.

MATZE KOCH SPECIAL EDITION DUMBBELLS

Item-No.	Order-No.	Type	
185990	/400	Tutti Frutti, orange	A
	/401	Liver / Mussel, green	B
	/402	Coconut / Hemp, white	C
	/403	Monster Crab / Robin Red, brown	D

MATZE KOCH SPECIAL EDITION CRUNCHY BOILIES



WITH CRACKING MATERIAL



In places where carps especially eat mussels, they crack open both wandering and river mussels with their strong pharyngeal teeth. In my view, anyone who wants their boilie to come as close as possible to the natural food does well to acquire this one. The large proportion of "cracking material" in the boilie seems very familiar to carps. Indeed, the "crispy portion" is easier for it to digest because it is made from many eggshells and not shells as such.

MATZE KOCH SPECIAL EDITION CRUNCHY BOILIES

Item-No.	Order-No.	Type	
185980	/016	Crunchy Mussel 16mm	
	/116	Crunchy Mussel 20mm	

MATZE KOCH SPECIAL EDITION POP UP BOILIES - 75 G

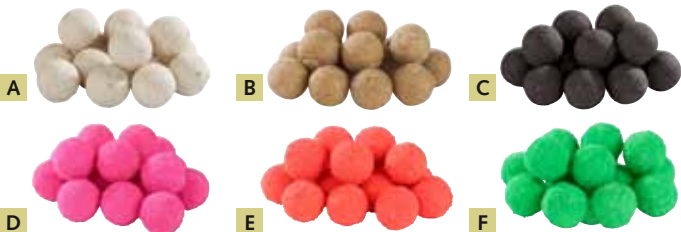

Matze's new pop-ups in the same colours as the sinking boilies, and then again as flamboyant fluo versions, are guaranteed to attract the attention of the moss backs. Let the pop-up float 5-10cm above the ground. For longer rigs you can adjust the height with split shot lead or putty. Try also the snowman sassembly. A Robin Red Monstercrab boilie followed by a pop up gives a super catchy double-bait that strikes heavily. Diameter: 20mm.

MATZE KOCH SPECIAL EDITION POP UP BOILIES - 75 G

Item-No.	Order-No.	Type	
185990	/201	Honey/Vanilla	A
	/202	Liver/Mussel	B
	/203	Monster Crab	C
	/204	FLUO-PINK Monster Crab/Robin Red	D
	/205	FLUO-ORANGE Honey/Vanilla	E
	/206	FLUO-GREEN Liver Mussel	F

MATZE KOCH SPECIAL EDITION LIQUID DIP - 100 ML



Anglers who want to get the carps faster to the bait use Matze's liquid dip with the special flavours and colours. 3 different dips, geared exactly to the corresponding boilies in terms of odour and colour.

MATZE KOCH SPECIAL EDITION LIQUID DIP, 100 ML

Item-No.	Order-No.	Type	
185990	/101	Honey/Vanilla	
	/102	Liver/Mussel	
	/103	Monster Crab/Robin Red	



MATZE KOCH SPECIAL EDITION FOOD - 1000 G

Although carp, bream and roach behave different on a wide variety of foods. But some small differences allows you to fish more selective. Very important is the consistency of the food which can be achieved only by properly mixing. Carp like it solid and pick without problems even bigger balls apart. Especially large particles make it difficult for small fishes and keep them away from the fishing spot. You can improve your mixtures. For carp I recommend corn and its juice in addition. For breams i use a handful of casters, or little red worms. The all-round mixture I improve with some loose maggots. You can use Amino Glue maggot adhesive for longer distances. If you want a significantly stronger adhesive mixture you can use Bisquit flour. If the mixture should be more fluffy you can use flour from corn or rusk (double-toasted bread, zwieback). The food is ready to fish but you can stretch it up to a ratio of 1:3 for example with breadcrumbs, flour from bisquit, rusks or the inexpensive Systemlock food. Only the carp places they should use pure.

MATZE KOCH SPECIAL EDITION FOOD - 1000 G

Item-No.	Order-No.	Type	
185990	/000	Carp	
	/001	Allround	
	/002	Bream	
	/003	Monster Crab-Robin Red	
	/004	Roach/Hemp	
	/005	Big Fish	



MATZE KOCH CORN PELLETS WITH AMINO ACID

When fishing for carp, chumming is extremely important and corn/maize is often used as a basis by the best carp anglers. However, it is elaborate to let the maize soak or to boil it. These feed pellets with amino acid enable one to avoid the problem because the smell of maize spreads seductively under water. The easily dissolved pellets are guaranteed to be eaten completely as extensive tests have shown. The pellets are also excellent for creating Matze's "Feed Pyramid" which he has presented in a variety of films where there is not enough time for prefeeding. The swelling pellets lure roach and bream. This, in turn, makes carps curious. Fishing then takes place on the pellet rug with boilies (e.g. with contrasting colours and flavours, such as: pineapple/maracuya). It goes without saying the pellets are suitable for all species. This feed lends itself even for light float fishing or fishing with feeder basket..

MATZE KOCH CORN PELLETS WITH AMINO ACID

Item-No.	Order-No.	Type	Conteng kg	
185990	/301	Corn pellets	1	
	/302	Corn pellets	2.5	

BEISSFIX® SPECI AROMAS



BEISSFIX® SPECI AROMAS

The aroma »Beißfix«, tried and tested over many years has been composed exactly for target fish or flavours; exclusive from BALZER. The sophisticated recipes are 100 % natural and have a fantastic luring effect.

Item-No.	Order-No.	Packing unit 10 ml Aroma	
185150	/000	Eel	
	/001	Trout	
	/002	Carp-Tench	
	/003	Whiting-Bream	
	/005	Anise	
	/006	Vanilla	
	/007	Crab	
	/008	Caramel	
	/010	Tutti Frutti	
	/011	Wattworm	
	/012	Herring	
	/013	Garlic	
	/014	Cheese	

DISPLAY – CONTENT: 45 BOTTLES

Item-No.	Order-No.	
185150	/999	



ACCESSORIES

A love of detail



A love of detail

For over 60 years BALZER has offered the angler a well-rounded and carefully selected range of goods. In this chapter you can find everything to satisfy the angler's heart and make it beat a little faster – from landing nets and knives to disgorgers, scales, rod rests and so on and so forth.

Along with this we also offer a high-quality range of bags. This not only lets you make an impression on the water but also means you can enjoy the great materials, quality zips and well-thought out and ingenious details.

TECHNICAL INNOVATIONS

Furthermore, with technical innovations you can both refine your very personal method for catching fish and extend your repertoire with more comprehensive tackle. Hence you are always up-to-date and at the same time equipped for all eventualities.

We combine this concentrated innovative power with the experience and tradition of over 60 years of BALZER, enabling us to provide you with the well-rounded and purposefully selected full range to be found in this chapter. It truly comprises all an angler's heart can possibly desire – from landing nets and knives to disgorgers; from scales to rod rests.

MK Adventure Bags



Matze's compact, very sophisticated bag series. Visually, the series matches the rods and reels perfectly and looks simply great! The two rod hard cases have the exact dimensions to accommodate his rods and reels but are

Matze Koch's innovative bag series

of course suitable for other rods too. All of the bags are made of the best 600D Oxford nylon with high quality zippers.

With an embroidered MK Adventure logo.



ROD HARDCASE

This hard case not only looks great, it also protects your rods and reels from breaking. Accommodates 2 assembled rods.

Item-No.	Order-No.	Size cm LxWxH	
119300	/115	115x40x12	
	/155	155x40x12	



MK «WATER STOP BAG»

Spacious transport bag made from watertight PVC and with a firm, indestructible plastic bottom. Thanks to the special watertight zippers the contents remain dry even during continuous and torrential rain. The two containers S and L fit into this bag exactly and can be stacked. With fixable handles as well as an adjustable shoulder strap. Material: PVC. Delivered without content.

Item-No.	Order-No.	Size cm LxBxH	
119340	/000	45x27x27	



TRANSPARENT BAGS «CONTAINER S AND L»

Any amount of accessories can be stowed away neatly in these two containers made from waterproof PVC. The top feature is the transparent topsides: It means that you can see the contents already from the outside and no longer need to open them. They fit in exactly and can be stacked for the water stop bag as well as the "Concept" transportation bag. Material: PVC. Delivered without content.

Item-No.	Order-No.	Size cm LxBxH	
119340	/012	15x12.5x6 (S)	
	/025	15x25x6 (L)	

All bags are delivered without content.



ORGANIZER S

Small, but mighty. 4 tackle boxes, 3 outside pockets and 2 plier-holders make the tremendous chaos in your fishing bag a thing of the past.

Item-No.	Order-No.	Size cm LxBxH	
119320	/000	26x19x15	



ORGANIZER L

This padded organizer puts your tackle in order. 3 large and one smaller box provide plenty of room for the accessories. 3 outside pockets and 2 plier-holders provide further stowage space.

Item-No.	Order-No.	Size cm LxBxH	
119320	/010	38x22x25	



SPIN FISHER BELT BAG

This bag is for mobile spin anglers who want to have a lot of tackle with them without being restricted in their movements. The belt has a dual hanging system for artificial bait without them getting tangled. Further pockets and stowage space for lots of accessories. Plier holders including fastening cords. The belt is well padded and can be worn tirelessly for hours.

Item-No.	Order-No.	Size cm LxWxH	
119310	/000	54x46x17	



SHOULDER BAG

Smart shoulder bag with plenty of stowage space for mobile anglers.

Item-No.	Order-No.	Size cm LxWxH	
119310	/100	26x12x20	



RUCKSACK

Wonderfully lightweight rucksack with plenty of stowage space. Ideal for fishing and hiking.

Item-No.	Order-No.	Size cm LxWxH	
119310	/050	54x46x17	



MK ADVENTURE BAIT BAG

Artificial bait bag made from 600D nylon. Artificial bait can be fastened excellently in the foam. Small accessories such as swivels and snaps etc. can be kept in an orderly manner in the small transparent pocket with zipper. The bag can be attached to the outer ring by means of a clip or karabiner.



Item-No.	Order-No.	Size cm LxWxH	
119330	/000	15 x 13 x 4	
	/005	20 x 15 x 4	

Edition bags

Edition

The modern bag range

Extremely robust bags and rod bags made from the best Oxford nylon. The bags are very ingenious and their many practical details are convincing.



ROD RUCKSACK WITH 2 COMPARTMENTS

The two separate zipper bags offer space for two assembled rods. One outer bag for transportation of umbrellas and rod holders. With the special upholstered shoulder belts the bag can be worn like a rucksack.

Item-No.	Order-No.	Size cm L x W	
119170	/125	125 x 25	
	/145	145 x 25	
	/165	165 x 25	



ROD RUCKSACK WITH 4 COMPARTMENTS

The four separate zipper bags offer space for four assembled rods. One outer bag for transportation of umbrellas and rod holders. With the special upholstered shoulder belts the bag can be worn like a rucksack.

Item-No.	Order-No.	Size cm L x W	
119190	/125	125 x 40	
	/145	145 x 40	
	/165	165 x 40	



ROD RUCKSACK WITH 3 COMPARTMENTS

The three separate zipper bags offer space for three assembled rods. One outer bag for transportation of umbrellas and rod holders. With the special upholstered shoulder belts the bag can be worn like a rucksack.

Item-No.	Order-No.	Size cm L x W	
119180	/125	125 x 35	
	/145	145 x 35	
	/165	165 x 35	



ROD CASE

Form stable rod case with frame out of steel wire, suitable for 3-5 assembled rods. On the other side is a big umbrella bag.

Item-No.	Order-No.	Size cm LxWxH	
119160	/100	100 x 15 x 25	
	/125	125 x 15 x 25	
	/145	145 x 15 x 25	
	/165	165 x 15 x 25	



TELESCOPIC ROD BAG

At a length of 90cm these bags are suitable for all popular telescopic rods. With outer pockets for accessories.

Item-No.	Order-No.	Compartments	Size cm LxWxH	
119200	/092	2	90 x 10 x 25	
	/093	3	90 x 18 x 25	
	/094	4	90 x 28 x 25	

Edition

Edition Soft Line bags

The extra-thickly padded bags provide excellent protection for your rods and reels. The bags are made from the best Oxford nylon and are easy to clean.



Extra padded bags for a safe rod and reel transport



SURF ROD BAG

Offers space for up to 5 surf rods, two of them with mounted reels. On the outside there are fixtures for safely transporting a tripod and a windshield/beach shelter. Two big inside pockets with closures provide generous stowing space for lots of accessories.

Item-No.	Order-No.	Compartments	Size cm LxWxH
119000	/202	2	175x25x12

REEL BAG

Protects your reels well against damage.

Item-No.	Order-No.	Size cm LxWxH
119230	/015	22x19x7



ROD RUCKSACK WITH 2 COMPARTMENTS

The two separate zipper bags offer space for two assembled rods. One outer bag for transportation of umbrellas and rod holders. With the special upholstered shoulder belts the bag can be worn like a rucksack.

Item-No.	Order-No.	Size cm L x W
119170	/126	125x25
	/146	145x25
	/166	165x25

TELESCOPIC ROD BAG

At a length of 90cm these bags are suitable for all popular telescopic rods. With outer pockets for accessories.

Item-No.	Order-No.	Compartments	Size cm LxWxH
119200	/192	2	90x10x25
	/193	3	90x18x25
	/194	4	90x28x25



ROD RUCKSACK WITH 3 COMPARTMENTS

The three separate zipper bags offer space for three assembled rods. One outer bag for transportation of umbrellas and rod holders. With the special upholstered shoulder belts the bag can be worn like a rucksack.

Item-No.	Order-No.	Size cm L x W
119180	/126	125x35
	/146	145x35
	/166	165x35

ROD RUCKSACK WITH 4 COMPARTMENTS

The four separate zipper bags offer space for four assembled rods. One outer bag for transportation of umbrellas and rod holders. With the special upholstered shoulder belts the bag can be worn like a rucksack.

Item-No.	Order-No.	Size cm L x W
119190	/126	125x40
	/146	145x40
	/166	165x40

Edition Bags



SPINFISHING BAG

For the mobile spin fisher. The spacious interior compartments offer plenty of storage space for all accessories. With special fixtures for attaching artificial baits. These outer pockets are removable and can easily be attached to a belt by means of the attached loops.

Item-No.	Order-No.	Size cm LxWxH	
119230	/010	40x22x15	



ISO-RUCKSACK

Spacious angler rucksack, lateral slide-in units and Velcros for the transport of telescopic-rods, landing-nets, rod holders, etc. The cooling division with integrated shoulder belt can be detached from the rucksack by zipper and is usable as fish bag separately. Very practical for spin- and fly-fishing.

Item-No.	Order-No.	Size cm LxWxH	
119250	/000	60x38x15	



RUCKSACK

Very heavy-duty rucksack for angling and hiking.

Item-No.	Order-No.	Size cm LxWxH	
119250	/005	54x46x17	



PROFESSIONAL LEADER BAG

Professional bag for the well organised storage of systems and accessories. With removable, sealable leader pockets.

Item-No.	Order-No.	Size cm LxWxH	
119210	/004	22x19x7	

SHOULDER BAGS

Three reasonable shoulder bags in very good processing.



SHOULDER BAG

Item-No.	Order-No.	Size cm LxWxH	
119210	/001	26x12x20	

SHOULDER BAG

Item-No.	Order-No.	Size cm LxWxH	
119210	/002	31x13x20	

SHOULDER BAG

Item-No.	Order-No.	Size cm LxWxH	
119210	/003	34x10x26	

ROD BELTS



NEOPRENE ROD TAPE SET

Set of neoprene rod tapes (2 pieces), each 15 cm, for a careful transport of put-in rods.

Item-No.	Order-No.	
119240	/026	



NEOPRENE ROD TAPE SET

Set of neoprene rod tapes (2 different length) for a careful transport of put-in rods.

Item-No.	Order-No.	
119240	/025	



ROD TAPES

Item-No.	Order-No.	Size	
119240	/065	S	
	/066	L	

MAGGOT AND BAIT CATAPULTS



ALU MAGGOT AND BAIT CATAPULT

Robust alu catapult with grip-hollows.

Item-No.	Order-No.	Length cm	
189860	/010	17	



MAGGOT AND BAIT CATAPULT

Robust plastic catapult with grip-hollows.

Item-No.	Order-No.	Length cm	
189860	/015	17	



MAGGOT AND BAIT CATAPULT

Maggot catapult with grip-hollows.

Item-No.	Order-No.	Length cm	
189860	/005	17	



CAR ADAPTED AERATOR PUMP

Pic. right: High-grade 12 volt-aerator pump with connecting cable for car cigarette-lighter or battery-poles, also for 1.5 volt battery suitable.

Item-No.	Order-No.	
183440	/005	

AERATOR PUMP

Picture left: Common aerator pump. Operation period: until 30 hours.

Item-No.	Order-No.	
183440	/004	



MAGGOT BOX

The special lid prevents maggots and worms from climbing out.

Item No.	Order No.	Size cm	
183550	/100	16 x 6.5	
	/101	16 x 9.5	



MAGGOT BOX

Item No.	Order No.	Content l	
183550	/000	0.125	



BAITFISH BUCKET

3 baitfish buckets (5, 10, 17 liters) with removable insert and lockable opening for oxygen pump.

Item-No.	Order-No.	Capacity l	
1 83450	/005	5	
	/010	10	
	/017	17	

Tackle Mate Boxes



**ULTRA STRONG
BOX DESIGN**

**100 %
WATERPROOF**

Tackle Mate SPECIMEN boxes

High-quality professional accessory boxes, 100% waterproof and extremely impact-resistant. Well thought-out down to the minutest detail.

Supplied in strong-selling self-service packaging with euro tags.

All the articles shown here are supplied without contents.



ACCESSORY BOX 1

Ideally for small accessories such as swivel, split rings, hooks etc. The compartment lids spring open by pressing a button (Easy Open System).



Item-No.	Order-No.	Size cm LxWxH	
183330	/000	11.5x7.5x3.5	



Easy Open System

ACCESSORY BOX 2

Like Accessory Box 1, but considerably bigger and with the addition of variable compartment arrangements thanks to removable dividers.



Item-No.	Order-No.	Size cm LxWxH	
183330	/001	19.5x11x4.5	



Variable compartments



Easy Open System



Variable compartments
for small accessories

STINGER RIG BOX

The treble hooks of Stinger Rigs (panic-hook leaders) can be attached securely in the wave-shaped Duplon. The leaders are then simply inserted into the pre-cut slits and thus remain smooth and are not damaged.



Item-No.	Order-No.	Size cm L x W x H	
183330	/002	19.5x11x4.5	



Easy Fix System for a fast and safe attachment of the rigs in the pre-cut slots

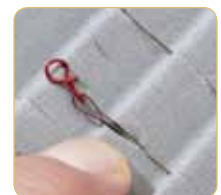

Easy Fix System

STINGER RIG COMBI BOX

On the one hand the treble hooks can be inserted securely in the wave-shaped Duplon; thereafter the leaders are simply inserted into the pre-cut slits, thus remaining so smooth and undamaged. On the other hand, small accessories can be stored in the compartments. With the Easy Open System and variable compartment organisation.



Item-No.	Order-No.	Size cm L x W x H
183330	/003	19.5x11x4.5



Easy Fix System for a fast and safe attachment of the rigs in the pre-cut slots



Variable compartments



Easy Open System



Variable compartments for small accessories

LURE/JIG BOX

Thanks to the special stair shape of the Duplon, artificial bait of all kinds can be hooked in simply and orderly and they no longer fall off during transportation and do not get tangled up.



Item-No.	Order-No.	Size cm L x W x H
183330	/004	19.5x11x4.5



The special waved foam board allows a simple and safe fastening of the lures.

LURE/JIG COMBI BOX

On the one hand artificial bait of all kinds can be attached securely and tidily in the stair-shaped Duplon. On the other hand, small accessories can be stored in the compartments. With the Easy-Open System and variable compartment organisation.



Item-No.	Order-No.	Size cm L x W x H
183330	/005	19.5x11x4.5



The special waved foam board allows a simple fastening of the lures.



Variable compartments



Easy Open System



Variable compartments for small accessories

Tackle Mate Boxes



It is so easy to keep things tidy with our Tackle Mate series

We have developed a high quality, excellently designed range of boxes called Tackle Mate. All the boxes are of course resistant to warping and knocks and have variable compartments.

KEEP THINGS TIDY



»BOY« 2-DRAWER TACKLE BOX

Very sturdy tackle box for all types of accessories.

Item-No.	Order-No.	Size cm LxWxH
183280	/001	34x20x15.5



»BIG BOY« 3-DRAWER TACKLE BOX

The three big drawers offers sufficient space to hold all your accessories in good order. Loops for attaching a carrying strap as well as external hooks for artificial bait, pliers etc.

Item-No.	Order-No.	Size cm LxWxH
183280	/002	44x24x20



»SUPER BIG BOY« 3-DRAWER TACKLE BOX

Like »Big Boy« but even bigger!

Item-No.	Order-No.	Size cm LxWxH
183280	/003	48x25x25



TACKLE BOX

With many varying divisions.

Item-No.	Order-No.	Size cm L x W x H
183250	/050	35 x 23 x 5



TACKLE BOX

Extra-large, deep box for large spoons, pilks and floats. Cover with cm scale.

Item-No.	Order-No.	Size cm L x W x H
183300	/020	32x22x5



TACKLE BOX

Typical all-round box for all kinds of accessories.

Item-No.	Order-No.	Size cm L x W x H
183300	/015	27.5x18.5x5



TACKLE BOX

Extra-long compartments, just right for longer floats and artificial bait.

Item-No.	Order-No.	Size cm L x W x H
183300	/010	23.5x12x3.5



TACKLE BOX

Ideal for swivels, lead, smaller floats and artificial bait.

Item-No.	Order-No.	Size cm L x W x H
183300	/005	20x14.5x4



TACKLE BOX

Very well conceived box for spin fishers. Both sides can be used for small and larger artificial baits. Included: shoulder straps and a fixing clip.

Item-No.	Order-No.	Size cm L x W x H
183300	/035	18x11x4.5

TACKLE MATE SPECIAL BOXES



TACKLE MATE SYSTEM BOX »COLOSSUS«

Excellently designed system boxes which organise and accommodate a huge amount of accessories. Both models have 6 small boxes and adjustable compartments. The »Colossus« box also offers a rig board.

Item-No.	Order-No.	Size cm LxWxH
183290	/003	36x30x6



TACKLE MATE SYSTEM BOX »GNOME«

Like left, with 6 small boxes, adjustable compartments but smaller measures and no rig board included.

Item-No.	Order-No.	Size cm LxWxH
183290	/004	27x20x6



RIG BOARD

Rig board for all kind of rigs. With special pins for attaching the lines.

Item-No.	Order-No.	Size cm L x W x H
183280	/050	32.5x8.5x2.5



TACKLE BOX

Ideal for the mobile angler, with shoulder strap and holding clip.

Item-No.	Order-No.	Size cm L x W x H
183300	/000	12x10.5x3.5



ACCESSORIES BOXES WITH SEALINGS

The new Tackle Mate accessories boxes with variable compartments and sealing rings to protect the contents safe from rain and moisture. Of course twister resistant!

Item-No.	Order-No.	Size cm L x W x H
183260	/001	18 x 12 x 4.5cm
	/002	27 x 17 x 4.5cm
	/003	35 x 22 x 4.5cm



LEADER ROLL UP DEPOT

Perfect for all kind of leaders. Content: 10 roll ups and 10 pins.

Item-No.	Order-No.	Size cm LxWxH
183250	/100	15x10x7



TACKLE FLY BOX

Ideal box with soft foam lining to protect the flies.

Item-No.	Order-No.	Size cm L x W x H
183310	/000	12.5x8.5x2.5

TACKLE MATE ROD TUBE



TACKLE MATE ROD TUBE

There is no better way of protecting your rods for transportation or when traveling. The extra thick, knock-resistant nylon/ABS provides optimal protection. The tube can be adjusted from 1.60m to 2.10m, making it ideal also for long carp and Norway rods with divided lower sections.

Item-No.	Order-No.	Size cm L x W x H
183240	/000	160x13x20

Accessorie Plastic Boxes

TACKLE MATE MULTIFUNCTION BOX

The multifunctional box can be used as an accessory box or trout bait glasses depot. With 3 foam boards an compartment separators.

Item-No.	Order-No.	Size cm L x W x H
183260	/004	34x22x9



Simply put the foam trays in the box and put the glasses without compartments separator into the box. Perfect for trout paste.



Variable compartments, perfect for larger accessories



With seals against moisture.

TRANSPARENT TACKLE MATE ACCESSORIES BOXES



TACKLE BOX

With 5 compartments.

Item-No.	Order-No.	Size cm L x W x H
183250	/080	18x9x3



BAIT BOX S/L

Suitable for storing artificial baits by the loops attached in the box.

Item No.	Order No.	Size cm L x W x H	Size
183250	/094	12x7.5x2.5	S
	/096	16x10x3	L



TACKLE BOX VARIO

With varying divisions.

Item-No.	Order-No.	Size cm L x W x H
183250	/064	20x14x4
	/068	25x18x4



ARTIFICIAL BAIT AND TACKLE BOX

The triangular shape of the compartment enables you to pick up artificial bait easily. The holes in the box allow the moisture to escape and prevent the hooks from corroding.

Item No.	Order No.	Size cm L x W x H
183290	/101	20 x 12.5 x 3.5



ARTIFICIAL BAIT AND TACKLE BOX

Like box on the left but only one compartment and without holes.

Item No.	Order No.	Size cm L x W x H
183290	/100	13 x 6 x 2.5



TACKLE BOX

Item No.	Order No.	Size cm L x W x H
183250	/015	13 x 6 x 2.5

METALLICA **XTRA STRONG**

Metallica Premium "Xtra Strong"

The latest generation of our Metallica landing nets is especially attractive because of its unparalleled strength. The secret is the specific metal of the lock which is also used for armouring in the US Army. It is more or less indestructible: even a raised box of water enlists no reaction from the lock (please don't copy this because the frame of the landing-net head be distorted by such extreme loads).

The rest of the equipment has been designed entirely for strength and convenience. With a rubberised net and adjustable front handle made from Duplon for maximal comfort.

Landing net handle and frame are made from thick-walled aluminium.



Adjustable front handle made from Duplon



Tough hinges



METALLICA LANDING NET

Item-No.	Order-No.	Headsize cm	Total length m	
1 82630	/220	70	2.20	
	/260	70	2.60	

Mesh width: 12 mm, bottom mesh width 6mm



METALLICA LANDING NET

Item-No.	Order-No.	Headsize cm	Total length m	
1 82640	/240	90	2.40	
	/280	90	2.80	

Mesh width: 12 mm, bottom mesh width 6mm



FOLD & CARRY BOAT LANDING NET

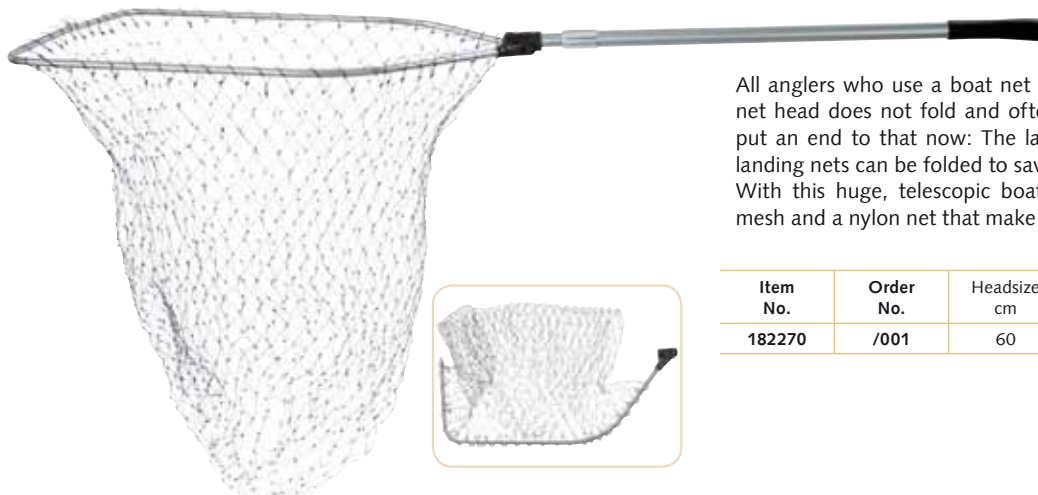

All anglers who use a boat net are aware of the problem: The landing net head does not fold and often pose transport problems. But we've put an end to that now: The landing net heads of the «Fold & Carry» landing nets can be folded to save space.

With this huge, telescopic boat landing net you have an extra-large mesh and a nylon net that make it child's play to remove treble hooks.

Item No.	Order No.	Headsize cm	Trans.-length m	Total length m	
182270	/001	60	0.90	2.40	

Mesh width: 70mm

Never Hook, Never Smell landing net

**NEVER
HOOK
NEVER
SMELL**
DIE KESCHER MIT DEM
GUMMIERTEN NETZ!

Every fisherman is familiar with the problem: Once the fish is lying in the landing net the treble hook gets snarled up in the net and it is often impossible to release the hook, the only solution being to use scissors. Thanks to the rubberized surface of the net, this problem is at last a thing of the past. It is now child's play to release snarled up treble hooks. Another advantage is that the net repels all smells because the fish slime cannot penetrate the net material. The joint is made of the solid, hard chrome-plated aluminium, the frame of the landing net head is made from solid aluminium.



Rubberised net:
Easy to release hooks



Conventional landing net: Scissors are the last resort!



2-SECTIONED ALL-ROUND LANDING NET

Infinite adjustment and detention.

Item-No.	Order-No.	Headsize cm	Trans.-length m	Total length m	
182450	/175	55	0.85	1.75	
	/235	55	1.10	2.35	

Mesh width: 8mm

Item-No.	Order-No.	Headsize cm	Trans.-length m	Total length m	
182470	/255	75	1,15	2.55	

Mesh width: 12mm



BOAT AND PREDATORY LANDING NET FOR

Ideal for capital fishes and boat anglers. Infinite adjustment and detention.

Item-No.	Order-No.	Headsize cm	Trans.-length m	Total length m	
182270	/100	85 x 76	0.98	2.65	

Mesh width: 12mm

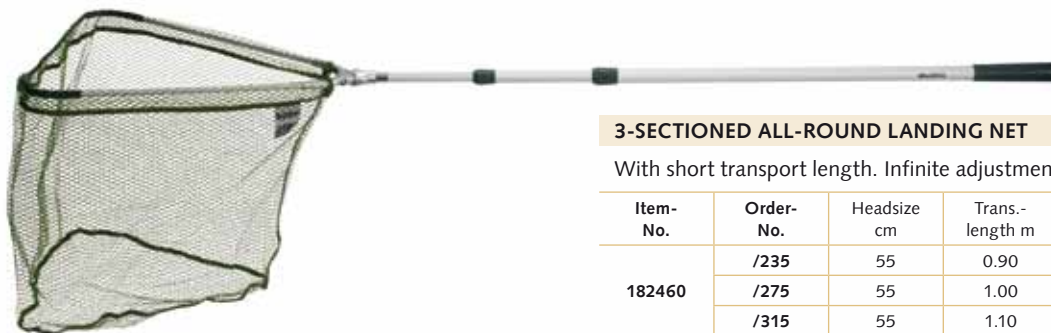

3-SECTIONED ALL-ROUND LANDING NET

With short transport length. Infinite adjustment and detention.

Item-No.	Order-No.	Headsize cm	Trans.-length m	Total length m	
182460	/235	55	0.90	2.35	
	/275	55	1.00	2.75	
	/315	55	1.10	3.15	

Mesh width: 8mm



3-SECTIONED MATCH LANDING NET

Item-No.	Order-No.	Headsize cm	Trans.-length m	Total length m	
182480	/305	50	1.15	3.05	

Mesh width: 3mm



KEEP NET

No unpleasant smell of fish thanks to the rubberized net. With a holder on the bottom of the net for attaching a weight and synthetic frame.

Item-No.	Order-No.	Head size cm (frame material)	Total length m
182950	/080	30 (synthetic)	0.80
	/120	30 (synthetic)	1.20

Mesh width: 6mm



WADING NET

Our new sea trout landing net is also simply great: Extra-deep rubberised net and magnetic clip for convenient transport and easy use. The frame is encased in a buoyant material that makes the landing net float. Mesh width 8mm, 45 x 55cm.

Item-No.	Order-No.
182190	/050

WADING NET

Diameter 30cm. Incl. elastic cord and belt clip. Mesh width: 8mm.

Item-No.	Order-No.
182490	/000



WADING NET WITH MAGNETIC CLIP

Our superlative new wading landing net: the rubberised net prevents snagging and odour formation. Thanks to the magnetic clip the landing net can be transported and used extremely easily. The removable cable lock prevents the landing net from getting caught or lost unnoticed. Mesh width 8mm, 35 x 45cm.

Item-No.	Order-No.
182190	/030



MAGNETIC CLIP

Can be fixed onto any conventional net and makes it much easier to transport and use it.

Item-No.	Order-No.
182190	/999

EASY CATCH TROUT LANDING NET



With a pure rubber net, ideal for trout ponds. The transparent, rubberized mesh has a low displacement effect when landing a fish. Easy to clean and no snarling of hooks.

Item No.	Order No.	Headsize Ø cm	Trans.-length m	Total length m
182030	/000	50	0.98	2.25

Mesh width: 15mm

Alegra II Aluminium landing nets

ALEGRA

ALEGRA II landing net

The centrepiece of this landing net is the strong folding joint made from tough aluminium.



All the landing nets have a carrying clip.



2-SECTION ALLROUND LANDING NET

For multipurpose use. Infinite adjustment and locking.

Item-No.	Order-No.	Headsize cm	Trans.-length m	Total length m	
182650	/140	60	0.70	1.40	
	/180	60	0.85	1.80	
	/220	60	0.90	2.20	

Mesh width: 8mm



2-SECTION LANDING NET

With extra large heads. Just the right thing for capital fish.

Item-No.	Order-No.	Headsize cm	Trans.-length m	Total length m	
182670	/200	70	0.90	2.00	
	/240	70	1.10	2.50	
	/280	70	1.15	2.80	

Mesh width: 12mm



3-SECTION LANDING NET

Strong folding joint made from a tough aluminium and zinc alloy.

Item-No.	Order-No.	Headsize cm	Trans.-length m	Total length m	
182660	/220	60	0.85	2.20	
	/260	60	1.00	2.60	
	/300	60	1.15	3.00	
	/360	60	1.30	3.60	

Mesh width: 8mm

BOAT LANDING NET



Huge boat landing net with special locking mechanism and a nylon net from which removing treble hooks is child's play.

Item-No.	Order-No.	Headsize cm	Trans.-length m	Total length m	
182270	/000	80	0.90	2.40	

Mesh width: 70(!)mm

LAVARET LANDING NET

With monofilament net, preventing the lavaret leaders from tangling up Length telescopically adjustable. Diameter: 45cm, mesh size: 6mm.

Item-No.	Order-No.	Headsize cm	Trans.-length m	Total length m	
182010	/000	45	1.2	2.25	

PERFORMER® II LANDING NET

Affordable landing net with infinitely telescoping landing net rods. The landing net with a 60-cm head has a landing-net head made from aluminium, making it especially stable! All landing nets have a carrying clip.



3-SECTION LANDING NET

3 piece, infinitely adjustable and telescopic landing net.

Item-No.	Order-No.	Headsize cm	Trans.-length m	Total length m
182710	/220	50	0.85	2.20
	/260	50	1.00	2.60
	/300	50	1.15	3.00

Mesh width: 7mm

2-SECTION ALLROUND LANDING NET

Infinitely adjustable and telescopic landing net with extra large net head.

Item-No.	Order-No.	Headsize cm	Trans.-length m	Total length m
182700	/140	50	0.70	1.40
	/180	50	0.85	1.80
	/220	50	0.95	2.20

Mesh width: 8mm



2-SECTION LANDING NET

2 piece, infinitely adjustable and telescopic landing net.

Item-No.	Order-No.	Headsize cm	Trans.-length m	Total length m
182730	/200	60	0.90	2.00
	/240	60	1.10	2.40
	/280	60	1.20	2.80

Mesh width: 12mm

3-SECTION MATCH LANDING NET

Extra long match landing net with continuous 2mm mesh. With the landing net head measuring 50cm, one can safely land even capital bream and medium-sized carp.

Item-No.	Order-No.	Headsize cm	Trans.-length m	Total length m
182740	/300	50	1.25	3.00

Mesh width: 2mm

BOAT AND PREDATOR LANDING NET, 2 SECTIONED



Extra-large and long nylon landing net with 3 sections for boat and bank. The Release Clip into which the net is clamped so that nothing gets caught on it is very clever. When a fish is landed the net comes out of the clip of its own accord.

Item-No.	Order-No.	Headsize cm	Trans.-length m	Total length m
182270	/280	60 x 55	1.25	2.80

Mesh width: 70(!)mm

FISH GRIP



For landing fish safely and carefully. Safety clip included.

Item-No.	Order-No.
184160	/005

Landing nets / keep nets



FISH STRINGER

For safe transportation of fish caught while wading. Absolute security thanks to the locking spring on each hook. With especially large hooks to make it easier to hang up the fish. Including safety karabiner for attaching it to a belt or such like. 2.5m overall length.

Item-No.	Order-No.	Length m	
184160	/250	2.50	



WADING NET

Wading net made of aluminium with knotless net and rubber cord. Mesh width 8mm.

Item-No.	Order-No.	Size cm	
182190	/000	35	



SHEET PILE LANDING NET

This landing net enables fish to be landed in places where it would previously have been almost impossible: on sheet piles, bridges, canals or extremely steep banks. Supplied with rope. Mesh size: 12mm.

Item-No.	Order-No.	Size cm	
182020	/000	90	



KEEP NET

Inexpensive keep net with drawstring. Diam. 30cm, mesh width 8mm.

Item-No.	Order-No.	Length m	Mesh width	
182920	/080	0.80	8mm	
	/120	1.20	8mm	
	/150	1.50	8mm	



BOAT KEEP NET

Floats thanks to the buoyancy element, Can be closed with a cord.

Item-No.	Order-No.	Length m	Mesh width	
182920	/100	80x30	8mm	



SBIRO KEEP NET

Keep net, length 1m, knotless net (smell refusing). With practical handle for easy transport.

Item-No.	Order-No.	Length m	
182920	/200	1.00	



WIRE KEEP NET

Wire keepnet, ideal for eel anglers and for scaling herrings.

Item-No.	Order-No.	Size cm	
182930	/100	50x38	



POND NET

Improved quality.

Item-No.	Order-No.	Size cm	
180840	/100	100	



AQUARIUM-NET

Item-No.	Order-No.	Size cm	Mesh width	
180870	/015	15	-	

Drop nets / baitfish traps



DROP NET WITHOUT FOLDING JOINT

This spike is intentionally designed without a folding joint, making the frame considerably more stable.

Item-No.	Order-No.	Length m	Mesh width mm
181200	/100	1 x 1	8



UMBRELLA DROP NET

The special drop-net with umbrella system is very easy to fold and assemble without removing the net.

Extra strong model also suitable to use in strong currents.

Size 1 x 1 m and 8 mm net diameter.

Extra deep net.

Item-No.	Order-No.	Length m	Mesh width mm
181200	/001	1 x 1	8

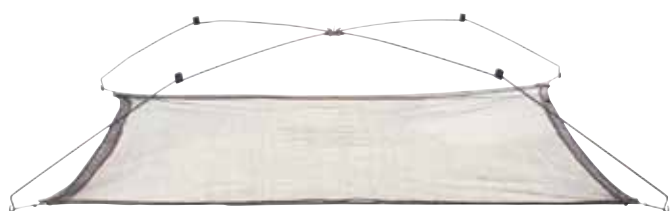

DROP NET WITH FOLDING JOINT

This spike is intentionally designed with a folding joint for fast setup.

Item-No.	Order-No.	Length m	Mesh width mm
181200	/050	1 x 1	8



BAITFISH TRAP XL

Extra large baitfish trap with no-knot honeycomb net.

Mesh width: 5mm.

Item- No.	Order- No.	Size cm
182800	/080	80x50

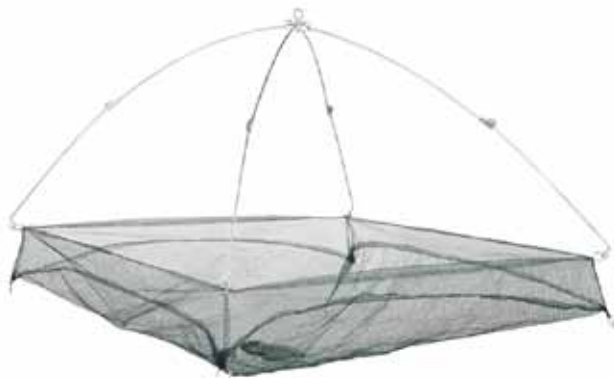

DROP NET WITH ESCAPE PROTECTION

Thanks to the lateral escape protection there is no chance to escape for the baitfish. The extra small mesh size of 3mm allows lowering on small baitfish.

Item-No.	Order-No.	Length m	Mesh width mm
181200	/025	1 x 1	3

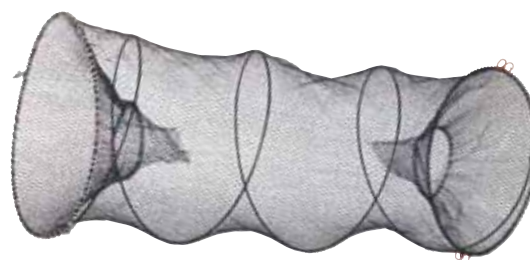

EEL TRAP

Dimensions: 110 x 45cm. Mesh size: 10mm.

Item- No.	Order- No.	Size cm
182800	/110	110x45



SPARE NETS FOR DROPNETS

Item-No.	Order-No.	Size m	Mesh width mm
181200	/099	A 1 x 1	4
181200	/199	B 1 x 1 (extra deep)	8



BAITFISH TRAP

Very practical baitfish traps for catching baitfish. With integrated feedbag and cord. Foldable, excellent for transport purposes.

Item- No.	Order- No.	Size cm
182800	/000	55

Landing nets / Landing net poles / Gaffs



KEEP NETS

Our keep nets comply with the statutory requirements, i.e. minimum length 3.50m and diameter 50cm. Due to differing legislation, the individual national laws in place must be observed. The net material is water and smell repellent. A practical feature is the adjustable incline of the net head as well as the removable rod rest. English screw thread.

Item-No.	Order-No.	Length m	Mesh width mm
182920	/350	3,50	4



TELESCOPIC NET POLE MADE OF FIBREGLASS

Item No.	Order- No.	Sections	Length m
180040	/201	2	2.00
	/301	3	3.00



BAIT-FISH DROP-NET POLE EXTRA STRONG

Brass ending-cap with 6 mm drill hole for the sure fastening of the traction rope.

Item No.	Order- No.	Sections	Length m
180050	/401	4	4.00



TELE-GAFF

Telescopic gaffs made of extruded aluminium, a saltwater-resistant special alloy and with a carrying clip. The gaff hook can be screwed off and thus transported in a safe, space-saving manner.

Item No.	Order- No.	Sections	Length m	Transport length m
182180	/060	2	0.60	0.47
	/120	3	1.20	0.67
	/180	3	1.80	1.03



ZAMMATARO FEEDERMASTER LANDING NET HEAD

Michael's new nylon odour-free landing-net head with an ergonomic shape.

Item-No.	Order-No.	Size cm L x W	mesh size mm
180900	/000	45 x 40	8



ZAMMATARO CARBON LANDING NET POLE

3-sectionend put over landing net pole made of lightweight IM-8 carbon. Fits exactly to Michael Zammataro's land net head. The connection parts are strengthened, the thread fixed by rivet is made of brass. Weight: 270 g.

Item No.	Order- No.	Sections	Length m
180900	/330	3	3.30



ZAMMATARO CARBON LANDING NET POLE EXTENSION

With the put over extension part made of carbon the landing net pole can be lengthen up to 4.40m.

Item No.	Order- No.	Sections	Length m
180900	/120	1	1.10



FOLDABLE WATER BUCKET WITH LINE

Indispensable for fetching water on sheet-pile walls or embankments. Length of the cord 9.50m.

Item-No.	Order-No.	Size cm LxWxH
183020	/002	18.5 x 20



Willi Frosch

Complete program of smoking marinades of Willi Frosch.

His great experience and his expertise as cook and hotelier, were fed into the development of these selected smoking marinades. The content and the flavour matched to the most important fish species.

All ingredients and components are 100% natural, no preservatives and no flavour enhancers. Quick guide on each package.

Content: 400g.



TROUT CLASSIC

Item-No.	Order-No.	Type	
198750	/000	Trout Classic	
	/001	Trout delicious	
	/002	Trout Hungarian	
	/003	Eel Special	
	/004	Mackerel Special	
	/005	Sea Fish Special	
	/006	Herbes de Provence	
	/007	Mediterrané	
	/008	Asia Mix	

SMOKING AGENT / SMOKING GRANULES



INSTANT SMOKING AGENT

After approx. 2 hours your fish are ready for smoking. Contents of the 600g sachet sufficient for approx. 20 trout.

Item-No.	Order-No.	Content g	
198710	/005	150	
	/010	600	



HERBAL SMOKING GRANULES

Beech granules with additional herbs: juniper berries, rosemary, pine needles and cones. 500g.

Item-No.	Order-No.	
198700	/000	



SMOKING HERBS

A harmonious blend of paprika, juniper, carrot, dill, savoury, celery and leek. 250g.

Item-No.	Order-No.	
198720	/000	



BEAR'S GARLIC SPICED WOOD CHIPS

Wood chips with bear's garlic spice mixture. Contents 500g.

Item-No.	Order-No.	
198700	/005	



BEECH SMOKING GRANULES

The popular, classical smoking granules. 500g.

Item-No.	Order-No.	
198700	/010	



SMOKING-HOOK WITH WOODEN GRIP

With 2 hooks for a secure attachment. The wooden handle prevents a burning of the fingers. Length 18cm.

Item-No.	Order-No.	
187000	/003	

Rod rests / rod holder

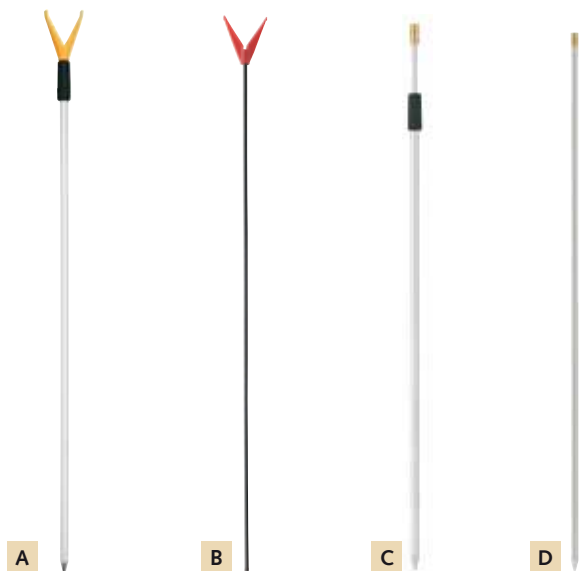

A TELESCOPIC ROD HOLDER

Very sturdy, telescopic rod holder made of beautifully finished aluminium.

Item-No.	Order-No.	Length cm	
	/075	50-75	
119420	/105	60-105	
	/130	75-130	

B ROD HOLDER

Very inexpensive metal rod holder.

Item-No.	Order-No.	Length cm	Cont.
	/060	60	10 pcs.
119410	/075	75	100 pcs.
	/080	80	10 pcs.

C TELESCOPIC ROD HOLDER

Outer tube made of aluminium. With solid tip and telescopic glass internal member.

Item-No.	Order-No.	Length cm	
	/075	50-75	
119600	/130	75-130	

D KEEPNET STICK

Spike from glass with brass thread head, robust tip. English thread BSF 3/8 inch.

Item-No.	Order-No.	Length cm	
119570	/081	80	



ROD REST ASSORTMENT (50 PIECES)

50 rod rests (25 x V-shape and 25 x U-shape) with top-grade brass threads that fit on all standard bank sticks on the market.

Item-No.	Order-No.	
119610	/000	

RUBBER ROD REST

Made of rubber for rod protection.

Item-No.	Order-No.	Type
119530	/000	V-Form
	/001	U-Form



FOLDABLE ROD HOLDER

With screwing, solid spike and brass thread.

Item-No.	Order-No.
119460	/040



BOAT ROD HOLDER

For screwing on at the boat edge.

Item-No.	Order-No.
119450	/070



BOAT ROD HOLDER

Funktional boat rod holder. 360° rotatable, traversable, with rod fixing ring and 3 possibilities to fix. Screws and nuts made of stainless steel. Delivered in self packing unit.

Item-No.	Order-No.
119500	/005



BAITFISH ROD HOLDER

Extremely strong rod holder stake made from galvanised steel specially designed for using long baitfish rods. Now with 7 fixed holes for bullet-proof grip.

Item-No.	Order-No.
119510	/060

Bait needle / disgorgers / accessories



GAG

Strong spring-stoppage, nickel plated. No sharp edges, no injuring.

Item-No.	Order-No.	Length cm
184550	/000	16



GAG

With strong spring and special protective rubber for gentle hook loosening.

Item-No.	Order-No.	Length cm
184500	/014	17



BAITING NEEDLE

Flat steel-needle, no thicken end perfectly smooth.

Item-No.	Order-No.	Length cm
184120	/002	12.5
	/110	12.5



DISGORGER

Made of plastic, on both sides usable.

Item-No.	Order-No.
184030	/000



DISGORGER

Made of plastic.

Item-No.	Order-No.
184020	/000



BAITING NEEDLE SPECIMEN

Round sharpened, with broken eye.

Item-No.	Order-No.	Content
184110	/002	2 pieces

WORM NEEDLE, STAINLESS STEEL

Item-No.	Order-No.	Length cm
184080	/020	20
	/030	30

MINI DISGORGER

On both sides usable with put-in clip.

Item-No.	Order-No.
184010	/000

WORM NEEDLE, EXTRA LONG

Item-No.	Order-No.	Length cm
184140	/030	30
	/040	40



MINI DISGORGER

On both sides usable with put-in clip.

Item-No.	Order-No.
184010	/000

WORM-NEEDLE, BRASS

Item-No.	Order-No.	Length cm
184100	/180	18
	/290	29



DISGORGER

Made of plastic with put-in clip.

Item-No.	Order-No.	Length cm
160350	/000	15
	/001	18

DISGORGER

Latching the hook surely and solving fast with one notching levelled off and slit ending eye.

Item-No.	Order-No.	Length cm
184060	/000	12,8



DISGORGER SET

Of almost unbreakable plastic. With large and small disgorgers.

Item-No.	Order-No.	Length cm
184040	/001	14 / 17.2



DISGORGER

Of almost unbreakable plastic. With large and small disgorgers.

Item-No.	Order-No.	Length cm
184040	/000	17.2



DISGORGER WITH PRIEST

Of almost unbreakable plastic. With large disgorgers. The heavy end can be used as priest.

Item-No.	Order-No.	Length cm
184040	/002	17.2



DISGORGER SET

3 hook disgorgers in three sizes and different removing mechanism.

Item-No.	Order-No.
184040	/003

Knives

CAMTEC®

Camtec knives, ultra sharp!

Only the sharpest are given the name Camtec.

Our series of knives truly deserves this name: all knives are made of hardened, non-rusting steel with the very sharpest of blades.

The knives have ergonomic handles that make it virtually impossible for your hand to lose its grip.



FILLETING KNIFE WITH INTERCHANGEABLE BLADES

This filleting knife is a real hit. It has two blades of different sizes that can be exchanged in a matter of seconds. This way you always have the right sized blade to hand. Handle and blades can be carried in the space-saving transport pouch attached to your belt. The ideal travelling companion!

Item-No.	Order-No.	Overall length cm	Total length cm
184200	/003	19/24	31/36



FILLETING KNIFE

Very sharp filleting knife with extremely safe handle. Supplied with plastic sheath and belt attachment clip.

Item-No.	Order-No.	Overall length cm	Total length cm
184200	/002	17	29



HUNTING AND FISHING KNIFE WITH SMOOTH BLADE

With continuous smooth blade. Supplied with belt sheath.

Item-No.	Order-No.	Overall length cm	Total length cm
184200	/022	10	22



FISHING KNIFE WITH FIXED BLADE

Practical all-round knife with stainless, fixed blade as well as belt sheath. Overall length: 20 cm, blade length: 9.5 cm.

Item No.	Order No.	Overall length cm	Total length cm
184200	/901	9.5	20



FOLDING KNIFE

Folding knife with heavy stainless steel blade and safety lock to prevent the blade from folding back inadvertently.

Item No.	Order No.	Overall length cm	Total length cm
184200	/903	9.5	21



HEAVY HUNTING AND FISHING KNIFE

With an extra-heavy blade. Handle made of fine wood with stainless steel trimmings. The safety lock prevents the blade from folding involuntarily. In addition, this knife has a saw and a bottle opener.

Item-No.	Order-No.	Overall length cm	Total length cm
184200	/004	10	22



HUNTING AND FISHING KNIFE

Extra heavy knife with very sharp, fixed stainless steel blade. Ergonomic rubber handle for safe holding. Supplied with belt sheath with closure.

Item-No.	Order-No.	Overall length cm	Total length cm
184200	/018	12	25



FOLDING KNIFE

Very sharp folding knife with rust-proof blade. Ergonomic grip with safety closure and belt clip.

Item-No.	Order-No.	Overall length cm	Total length cm
184200	/020	8.5	22



UNIVERSAL KNIFE

A great knife with a heavy, stainless steel blade and ergonomic grip. With a carrying clip and safety catch to prevent the blade from snapping back involuntarily.

Item-No.	Order-No.	Overall length cm	Total length cm
184200	/012	10	21



CAMTEC GUTTING KNIFE

The rounded, sharp blade made of stainless steel is ideal for gutting fish. Folding.

Item-No.	Order-No.	Overall length cm	Total length cm
184200	/023	6.5	15.50

Knives

OUTLAW FREAKY FISHING TACKLE



All knives will be delivered with a presentbox.



FILLETING KNIFE

Extremely sharp filleting knife with a flexible blade and rubberised handle for safe use. With a genuine leather belt sheath.
Total length: 29,5m, blade length: 16cm.

Item-No.	Order No.	
184200	/097	



FISHING KNIFE

Great multipurpose fishing knife. A fish scaler is located on the upper side. Rubberised handle. With a genuine leather belt sheath.
Total length: 26cm, blade length: 13cm.

Item-No.	Order No.	
184200	/096	



ARMY KNIFE

Impressive knife with an extra-heavy blade. On the upper side there is a sharp saw which can also be used to saw thicker branches. With a belt sheath made from real leather.
Total length: 30cm, blade length: 17,5cm.

Item-No.	Order No.	
184200	/098	



2-BLADED FOLDING KNIFE

Great folding knife with 2 blades (knife and saw). The blades lock in place and can be folded by pressing a button.
Total length: 21m, blade length: 9cm.

Item-No.	Order No.	
184200	/095	



»BLACK STEEL« OUTLAW FOLDING KNIFE

Very high quality folding knife with a 7CR17 stainless-steel blade and black Cold-Steel alloy for very good corrosion resistance. The grip plates are made from Duraluminium. With belt clip. Supplied in a gift box.
Total length: 20cm, blade length: 9cm.

Item-No.	Order No.	
184200	/099	



FILETING GLOVES

Protects your fingers and hand while filleting. Material: Kevlar with metal threads.

Item-No.	Order-No.	
184220	/000	



SPECIAL CUTTER

Special cutter for braided lines. Cuts through lines without any roving!

Item-No.	Order-No.	Length cm
184190	/005	13



SMALL SPLIT RING PLIER

With smaller pin and therefore ideal for smaller split rings The integrated scissors can cut even braided lines without any difficulty.

Item-No.	Order-No.	Length cm
184190	/025	11



PRECISION PLIER, CURVED

Curved plier with cutter function.

Item-No.	Order-No.	Length cm
184190	/030	16



PRECISION RETAINER RING PLIERS

Precision retainer ring pliers make it very easy to open all types of retainer rings. Incl. cutter function.

Item-No.	Order-No.	Length cm
184190	/000	15



ARTERY-CLAMP WITH , BENT

Item-No.	Order-No.	Length cm	Tip
184370	/014	14	curved
	/020	20	curved
	/025	25	curved
	/120	20	straight

Metallica Pliers

The program of plier

All pliers made high quality steel, perfectly to the different designed for all fishing purposes.

Supplied with sturdy plastic hangers for a good presentation in your store.



CRIMPED SLEEVE PLIER

For save fixing of sleeves and other ferruels.

Item-No.	Order-No.	Length cm	
184210	/001	15	



ALLROUND PLIER, CURVED

With cutter function.

Item-No.	Order-No.	Length cm	
184210	/002	18	



SPECIAL PLIER, CURVED

Long curved plier for different purposes. Perfect for removing triple hooks where a longer distance to the fish or hooks is more safe.

Item-No.	Order-No.	Length cm	
184210	/003	22	



SPECIAL PLIER, CURVED

Long curved plier for different purposes. Perfect for removing triple hooks where a longer distance to the fish or hooks is more safe.

Item-No.	Order-No.	Length cm	
184210	/004	28	



MULTI PURPOSE PLIER, CURVED

Curved plier with cutter and crimp function.

Item-No.	Order-No.	Length cm	
184210	/005	23	



MULTI PURPOSE PLIER, STRAIGHT

Allround plier with cutter function and for rebuilding split rings.

Item-No.	Order-No.	Length cm	
184210	/006	23	

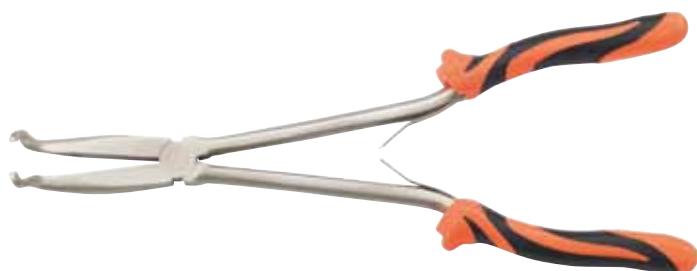

SPECIAL PLIER

Because of the special shape of the jaws large treble hooks ca be removed easily. Ideal for boat anglers in Norway or big game fishermen.

Item-No.	Order-No.	Length cm	
184210	/008	30	

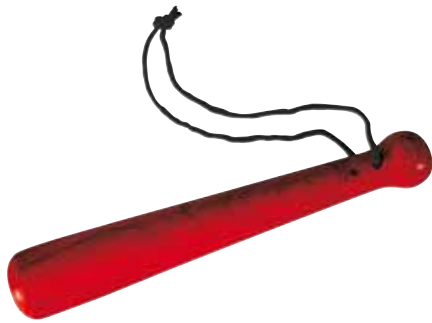

FISH SLAUGHTERER XL

Extra large, heavy wooden fish slaughterer. Ideal for big fish such as cod, pike etc. Incl. carrying strap.

Item-No.	Order-No.	Length cm	
184570	/020	28	



ELECTRIC SCALES UP TO 40 KILOS

Displays weights up to 40 kg / 90 lbs, in 10 g stages, optional kg or lb display, tare function, automatic switch-off function, stable housing, batteries included.

Item-No.	Order-No.		
187280	/140		



PRIEST

Item-No.	Order-No.	Length cm	
184570	/000	14	



DESCALER

In two rows indent, robust model.

Item-No.	Order-No.	Length cm	
184870	/001	19	

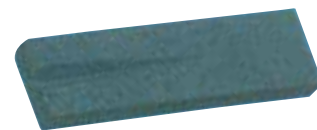

OXIDE-CERAMIC HOOK SHARPENER

Whetstone, with sharp-groove.

Item-No.	Order-No.	Length cm	
184410	/013	8	



DESCALER

With prongs in two rows. With wooden handle.

Item-No.	Order-No.	Length cm	
184870	/002	19	



DIAMOND HOOK SHARPENER

In form of a key, with sharp-groove and long durability.

Item-No.	Order-No.	Length cm	
184410	/014	5.5	



GLUE

For all purposes. Top holding power.

Item-No.	Order-No.	Length cm	
187800	/000	-	



DESCALER

In two rows indent, robust model.

Item-No.	Order-No.	Length cm	
184870	/000	19	



OUTDOOR

At home in the wild



At home in the wild

As a true nature lover one knows only too well: there is no such thing as bad weather, only the wrong clothing. Besides, a passionate fisherman will not allow this experience to be clouded over by bad weather,

Anyone who loves his hobby will not allow it to be spoiled by adverse conditions. One is more likely to take recourse to a full set of equipment that will stand up to the forecast with all the means required. This prepares one excellently for a stay of several days outdoors and means that one doesn't end a fishing excursion before one wants to.

For the specific requirements of recreational and sport fishing we developed fishing wear of highest quality and top function and design.

MK ADVENTURE Clothing



by
Matze
Koch

Matze Koch Fan Collection...
Matze Koch is simply legendary

Together with us, Matze has designed his own fan clothes for his many fans. A smart, classic design exactly to match his rods, reels and bags. With these clothes you look good, and not just by the water.



Back

MK ADVENTURE SOFTSHELL JACKET

Chic, windproof softshell jacket with 2 outer pockets and a pocket in the chest area (each with zippers). Seam with drawstring and adjustable stoppers. Material: 100% polyester.

Item-No.	Order-No.	Size	
186000	/000	S	
	/005	M	
	/010	L	
	/015	XL	
	/020	XXL	



Back

MK ADVENTURE HOODY

The soft cotton material ensures a great comfort. Model with lined hood and kangaroo pocket.

Material: 80% cotton, 20% polyester.

Item-No.	Order-No.	Size	
186010	/000	S	
	/005	M	
	/010	L	
	/015	XL	
	/020	XXL	



Back

MK ADVENTURE POLO SHIRT

Black polo shirt with collar and placket.
Material: 80% cotton, 20% polyester.

Item-No.	Order-No.	Size	
186020	/000	S	
	/005	M	
	/010	L	
	/015	XL	
	/020	XXL	



Back

MK ADVENTURE SHIRT

A classic t-shirt that is a must in any wardrobe. The pleasant cotton quality promises best wearing comfort.

Material: 80% cotton, 20% polyester.

Item-No.	Order-No.	Size	
186030	/000	S	
	/005	M	
	/010	L	
	/015	XL	
	/020	XXL	



MK ADVENTURE HEAD SCARF

Multifunctional headwear provides protection against sun, cold or snow, is easy to clean and looks cool.

Material: 100% cotton.

Item-No.	Order-No.	Size
186040	/000	universal size



MK ADVENTURE CAP

Material: 100% cotton.
Adjustable size.

Item-No.	Order-No.	Size
186040	/005	universal size



MK ADVENTURE WOOL CAP

Keeps you warm.
Material: 100% acrylic.

Item-No.	Order-No.	Size
186040	/010	universal size

TEAM Zammataro[®] powered by BALZER

Team Zammataro Collection

Are you a fan of feeder champ Michael Zammataro? Then wear the smart Zammataro team clothes by the water.



FEEDERMASTER FLEECE JACKET

Nice and light-weight fleece jacket made Micro Fleece. With 2 practical zipped pockets. Seam with drawstring and adjustable stoppers.
Material: 100% polyester.

Item-No.	Order-No.	Size
186170	/005	M
	/010	L
	/015	XL
	/020	XXL



Back



Back

FEEDERMASTER POLOSHIRT

Blue polo shirt with collar and placket.
Material: 80% cotton, 20% polyester.

Item-No.	Order-No.	Size
186180	/005	M
	/010	L
	/015	XL
	/020	XXL

FEEDERMASTER BASECAP

Material: 100% cotton.
Adjustable size.



Item-No.	Order-No.	Size
186190	/000	universal size

Wading pants / Wading shoes

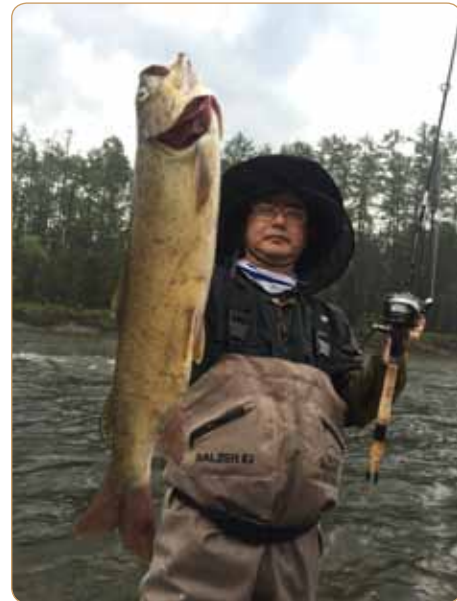
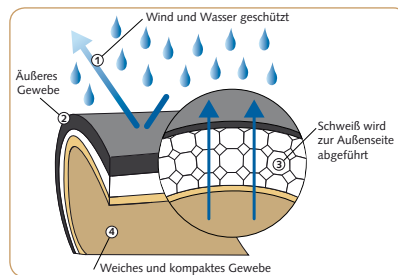

WADING SHOES WITH FELT SOLES



BREATHABLE WADING PANTS

Excellent breathable wading pants made from strong, three- and five layer material. The special Active Breath membrane is extremely breathable at more than 6000 g/m²/24 h, and of course it is 100% watertight. The Active Breath material is thicker (five layer material) on the legs to prevent you from getting too cold in the water. The two breast pockets are equipped with water-repellent zippers. Such accessories as a wading landing net can be fixed onto the wading belt. High quality 3.5-mm neoprene socks with rubber soles for a secure footing and bucket tops with hooks for the wading shoes.

- 5mm neoprene
- 100% watertight
- Active Breath Membran: breathable at more than 6000g/m²/24h
- 3,5mm neoprene socks with non slip rubber sole
- Waterrepellent zippers
- 2 breast pockets
- Wading belt

BREATHABLE WADER

Item-No.	Order-No.	Size	chest meas. cm	leg opening cm	total length cm
186810	/040	40-41	100	79	128
	/042	42-43	110	83	129
	/044	44-45	120	86	131
	/046	46-47	133	94	144

Colour-matched for our breathable wading pants. The surface material is made from durable synthetic leather and meshed fabric. The heel and toe areas are reinforced for maximum protection. The tongue and top part of the shoe are padded and provide the wearer with maximum comfort. The ergonomic cut makes them easy to put on and take off. With openings for water drainage for fast drying. With a non-skid felt sole.

Item-No.	Order-No.	Size
186810	/140	40-41
	/142	42-43
	/144	44-45
	/146	46-47

produced by
aquaz®

AQUA Z NEOPRENE WADER

High-end wading pants made from 5-mm neoprene in absolutely top quality. The pants are produced exactly according to our specifications by the well-known, exclusive manufacturer AquaZ. The result is pants of excellent quality which fit perfectly and with a great design. Instead of PVC, the boots are made from soft rubber, guaranteeing maximum comfort. The infinitely adjustable braces are also made from soft neoprene. The soles are made with non-skid felt.

After completion the pants are tested individually to ensure that they are watertight.

- 5mm neoprene
- Soft rubber boots with non skid felt soles
- Reinforced knee area
- Breast pocket and inside pocket with zipper
- Adjustable braces made of neoprene

AQUA Z NEOPRENE WADER

Item-No.	Order-No.	Size	chest meas. cm	leg opening cm	total length cm
186790	/040	40-41	104	75	131
	/042	42-43	107	78	135
	/044	44-45	113	79	139
	/046	46-47	119	81	141

The boot material above the sole is made of neoprene for best mobility and comfort. With extra-thick felt sole.



Clothing



ANGLING BOOTS

Very robust angling boots made of heavy duty PVC with a high profile sole for extra grip. Sizes 40–46.

Item-No.	Order-No.	Size	
186870	/040	40	
	/041	41	
	/042	42	
	/043	43	
	/044	44	
	/045	45	
	/046	46	



EVA THERMAL BOOTS

Super lightweight thermal boots made of EVA foam. With removable lining. Keep your feet up - 20 degrees warm and cozy. High comfort and low weight (the couple in 44 weighs only 855g).

Item-No.	Order-No.	Size	
186930	/039	39	
	/040	40	
	/041	41	
	/042	42	
	/043	43	
	/044	44	
	/045	45	
	/046	46	
	/047	47	
	/048	48	

REPLACEMENT LINER FOR EVA THERMAL BOOTS

Item-No.	Order-No.	Size	
186930	/139	39	
	/140	40	
	/141	41	
	/142	42	
	/143	43	
	/144	44	
	/145	45	
	/146	46	
	/147	47	
	/148	48	



BALZER T-SHIRT

100% cotton.

Item-No.	Order-No.	Size	
186970	/000	S	
	/005	M	
	/010	L	
	/015	XL	



NEOPRENE FLEECE GLOVES

With open fingers.

Item-No.	Order-No.	Size	
186080	/010	10*	

*only approximate arranging sizes



FINGER PROTECTION

For surf and carp anglers Protects the forefinger from injury during extremely long casts. Suitable for the left- and right-handed alike. Finger cap made of leather, joint band made of polyester.

Item-No.	Order-No.	
186050	/000	



OWNER CAP

100 % cotton.

Item-No.	Order-No.
199500	/002



BALZER CAP

Balzer cap with 3D embroidery. 100 % cotton.

Item-No.	Order-No.
199500	/001



MINI UV-LAMP WITH WHISTLE

With this tool you can find every lure which responds to UV light. Batteries included. 30 pieces in box.

Item-No.	Order-No.
184410	/030



Magnet function for use in tents.



Easy to use in umbrellas



With practical hanger

LED TENT LAMP

With magnet and hanger and therefore very various usable. 3 lighting levels can be selected. Delivered without batteries.

Item-No.	Order-No.
184410	/010

MULTI LED HEAD LAMP



- long life LEDs (100.000 hours)
- adjustable
- adjustable head belt
- low consumption
- working with 3x1,5 V AAA batteries (not included in scope of supply)

Item-No.	Order-No.
184410	/025



HEAD LAMP WITH 5 LEDs

Batteries included.

Item-No.	Order-No.
184410	/101

HEAD LAMP WITH SENSOR



Kutter&Küste reader test 62-2016: Overall rating: perfect (1,56).



- On/Off by simple hand movement in front of the lamp
- Optional white or red light
- Super bright XP-E-Technology
- 90° tilting angle
- Adjustable head belt
- Working with 3 x AAA batteries (included in scope of supply)

Item-No.	Order-No.
184410	/005

Polavision Glasses

POLAVISION



**POLARIZED
GLASSES**

**ALL GLASSES IN
PRACTICAL BOX**

For a clear view during fishing. New models with an improved polarization effect (eliminates light reflection, which makes it so difficult to see into the water). Indispensable for example when fly or spin fishing. Polavision glasses also provide eye protection by filtering out damaging UV radiation (UV400 Protection). Lenses made of knock and scratch-resistant polycarbonate, frame of top-grade metal alloys or nylon ABS. The side pieces can be reshaped and fitted individually, by means of gentle pressure.



POLAVISION METAL CLASSIC

Classic glasses with a filigree metal frame and dark, polarised lenses, (UV 400 Protection).

Item-No.	Order-No.	
187300	/030	



POLAVISION SPORTS CLASSIC

Sporting glasses with a matt, dark red nylon ABS half lens dark, polarised lenses, (UV400 Protection). The sporting glasses which are suitable not only for fishing, but also for jogging or riding a bike.

Item-No.	Order-No.	
187300	/033	



POLAVISION ICELAND

Glasses with light, polarised lenses for a more brilliant view; frame made of matt black nylon ABS UV 400 Protection. Round-the-neck cord for glasses.

Item-No.	Order-No.	
187300	/038	



POLAVISION RIO CLASSIC

Glasses with classic, dark polarised lenses and side protection glass, UV200 protection, frame made of olive green nylon ABS, UV 400 Protection.

Item-No.	Order-No.	
187300	/035	



POLAVISION MADRID

Glasses with dark polarised lenses; frame made of shiny-black nylon ABS UV 400 Protection.

Item-No.	Order-No.	
187300	/036	



POLAVISION VENICE

Glasses with dark polarised lenses; frame made of shiny-black nylon ABS UV 400 Protection.

Item-No.	Order-No.	
187300	/037	



POLAVISION RIO YELLOW

Same equipment like above Rio Classic but with brown glasses.

Item-No.	Order-No.	
187300	/040	



Easy lens change



POLAVISION VARIO

Modern glasses supplied with 2 interchangeable polarizing lenses (1 x yellow, 1 x gray). UV 400 protection. Supplied with hardcase.

Item-No.	Order-No.	
187300	/057	



Will be delivered with a hardcase.



Both glasses will be delivered with a hardcase.



POLAVISION SUPERIOR BLUE

Stylish glasses with a stable metal frame and dark blue, polarised lenses, (UV400 Protection). Supplied with hardcase.

Item-No.	Order-No.
187300	/058



POLAVISION SUPERIOR BLACK

Glasses with a stable metal frame and dark, polarised lenses, (UV400 Protection). Supplied with hardcase.

Item-No.	Order-No.
187300	/059



POLAVISION WIND-/LIGHT PROTECTOR

Glasses with dark, polarised lenses and frame made of matt black nylon ABS. The extra wide strap minimize contact with wind and light. UV400 Protection.

Item-No.	Order-No.
187300	/053



POLAVISION PUT OVER

Ideal for spectacle wearers. Fits over many conventional glasses. With dark, polarized lenses. UV 400 protection.

Item-No.	Order-No.
187300	/054



Delivered with protection bag.



POLAVISION «FOLD»

Foldable glasses with dark, polarized lenses. Can be folded very small for transport. UV 400 protection. Supplied with bag.



Item-No.	Order-No.
187300	/056

OUTLAW GLASSES



OUTLAW ICE MAN GLASSES

Really cool rapper-look glasses.

Item-No.	Order No.
187300	/051



OUTLAW TOP GUN GLASSES

Very modern pilot glasses with metal frames. With these glasses you look good, and not just by the water!

Item-No.	Order No.
187300	/052

Both glasses will be delivered with a hardcase.



HARDCASE FOR GLASSES

Stable hardcase for the safe transport of your glasses.

Item-No.	Order-No.
187300	/055

Glasses / BALZER-Shop



ELASTIC-CORDS

Elasticated glass cords with adjustable silicone loops.

Item-No.	Order-No.
187300	/100



ACRYL COUNTER DISPLAY

Strong-selling acrylic display for 6 glasses (without glasses).

Item-No.	Order-No.
187300	/900



POLAVISION «CLIP»

Flip-up, clip-on glasses to be used with optical glasses.

Item-No.	Order-No.
187300	/001



7-PIECE STAINLESS STEEL HIP

The ideal escort when on the go! Contents: 1 stainless steel hip flask with safety catch. Capacity: 210ml, with (pike) engraving! 4 stainless steel tumblers, filling aid, tumbler pouch.

Item-No.	Order-No.
199150	/000

PINS

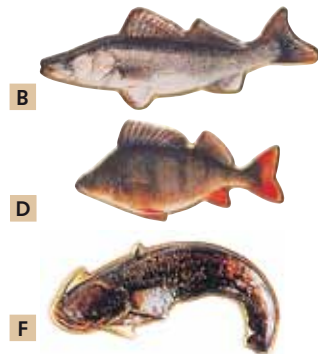
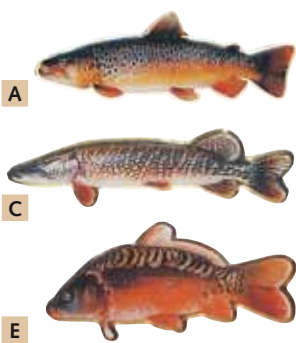

FISH-PINS

in a beautiful, photo realistic representation.

Item-No.	Order-No.	Type
199540	/024	A Brown trout
	/011	B Pike-Perch
	/012	C Pike
	/013	D Perch
	/025	E Carp
	/023	F Catfish

KEY RINGS



BALZER KEY RING

Item-No.	Order No.
199640	/000



»NO LIMITS« KEY RING

Item-No.	Order No.
199640	/100

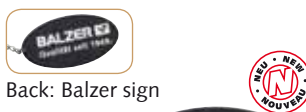

MK ADVENTURE KEY RING

Item-No.	Order No.
199640	/200



MK ADVENTURE STICKER

Item-No.	Order No.
199530	/302



LIGHTER

Item-No.	Order-No.	
199670	/002	A
	/003	B
	/004	C

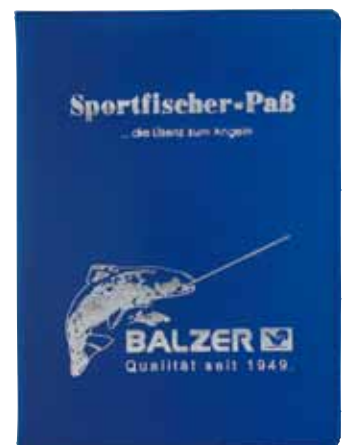

LICENCE PASSPORT COVER

Item-No.	Order No.
199700	/010

UMBRELLA TENT



This umbrella tent made of nylon with telescopic aluminium bottom spike offers perfect protection against rain and wind. The tent can be detached by a zipper and can be used as an umbrella. The linkage has a special surface sealing which is applied with high pressure. Thereby the material is non-scratching and offers an extremely noble optics. Diameter: 230 cm. Material 100 % Polyester.

Item No.	Order No.	
187140	/230	

UMBRELLA



**SPAN:
2.20M**

Umbrella made of nylon with a telescopic ground spike and adjustable tilt. Span: 2.20m.

Item- No.	Order- No.	Span cm	
187130	/220	220cm	

PULL & CAMP BIVY XL

Item No.	Order No.	
187110	/005	

- Assembled in 1 minute
- Size 2.5 x 2.5m, maximum height inside: 1.60 m
- Material: 190 T Polyester with a PU coating
- Watertightness: 4m water column. Sealed seams
- Mosquito protection for entrance areas and side windows
- 2 Entrances/exits
- Removable floor
- Supplied in a high quality transport bag. Incl. 8 tent pegs
- Weight: only 6 kg



**TAKES 2 LARGE CARP
CAMPBEDS**

TWO ENTRANCES

