

LED KING ONE

แอลดีคิงส์วัน

จำหน่ายไฟ LED ทุกชนิด ราคาโรงงาน คุณภาพดี
มาตรฐานระดับสากล จัดส่งทั่วประเทศ

โทร. 02-0700711 มือถือ. 089-712-5206
FAX. 02-0700611

www.ledkingone.com

COMPANY PROFILE

แอลอีดีคิงส์วัน เราดำเนินกิจการมายาวนาน และได้จดทะเบียนเมื่อปี พ.ศ.2560 โดยประกอบธุรกิจ จัดจำหน่าย ผลิตภัณฑ์อุปกรณ์ส่องสว่าง หลอดไฟ โคมไฟ ประเภทแอลอีดี ซึ่งมีประสบการณ์เฉพาะทางมากกว่า 10 ปี ทางเราได้นำเข้า ผลิตภัณฑ์สินค้าและอุปกรณ์ส่องสว่างที่มีประสิทธิภาพ มาตรฐานระดับสากล และทันต่อยุคสมัย โดยคำนึงถึงคุณภาพและราคา รวมไปถึงบริการหลังการขาย ที่มีบุคคลที่มีความรู้เฉพาะทางไว้คอยบริการลูกค้า เราจัดจำหน่ายหลอดไฟ โคมไฟ แอลอีดี (LED) ภายในประเทศไทย ซึ่งมีทั้งขายปลีกและขายส่ง เรายังมีบริการส่งทั่วประเทศด้วย เพื่อความสะดวกสำหรับลูกค้าที่อยู่ต่างจังหวัด สามารถเข้าชมสินค้าของเราและขอใบเสนอราคาได้ที่ www.ledkingone.com

ทั้งนี้ แอลอีดีคิงส์วัน เรามุ่งเน้นที่จะเป็นทางเลือกให้กับผู้บริโภค ในการลดใช้พลังงาน มุ่งมั่นเรื่องประสิทธิภาพในการประหยัดพลังงานและรักษาสิ่งแวดล้อม รวมถึงการบริการให้เป็นไปตามข้อกำหนดของแอลอีดีคิงส์วัน เพื่อให้เกิดความมั่นใจในการใช้ผลิตภัณฑ์ของเรา ตลอดจนความพึงพอใจ แต่ลูกค้าอย่างสูงสุด

แอลอีดีคิงส์วัน(สำนักงานใหญ่)

95/52 หมู่ 17 ตำบลบึงคำสร้อย
อำเภอสำลูกกา จังหวัดปทุมธานี 12150

หมายเลขประจำตัวผู้เสียภาษี 149-07000-23-636

โทร. 02-0700711

มือถือ. 089-712-5206

Fax. 02-0700611

Email: led_2560pro-x@hotmail.com

www.ledkingone.com





LED Track Light PAR30
www.ledkingone.com

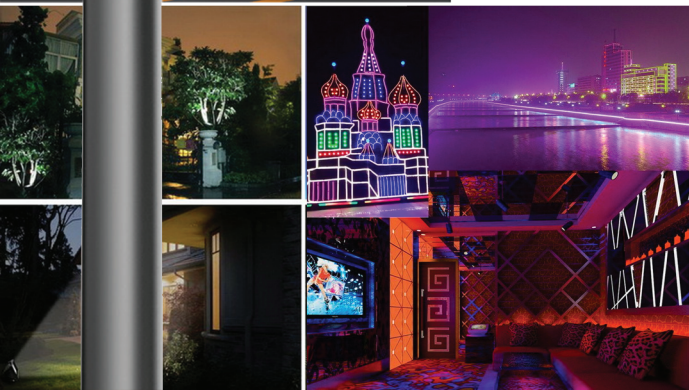

Applications

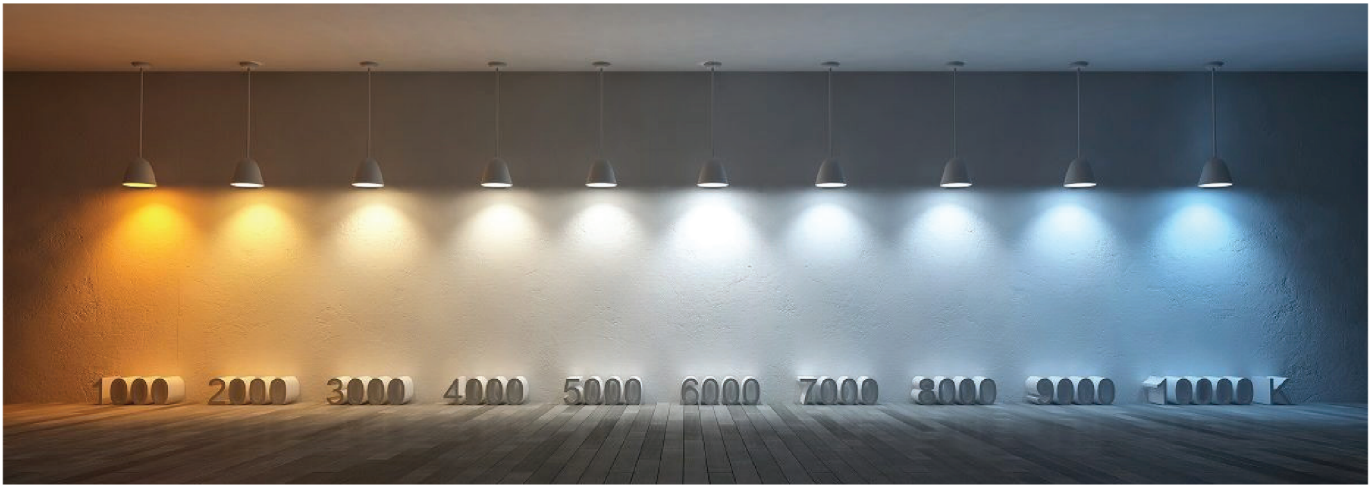

CONTENTS

01	LAMPS - <i>Light Source</i>	P01
02	DOWNLIGHT - <i>Indoor Light</i>	P15
03	TRACKLIGHT - <i>Indoor Light</i>	P48
04	CEILING LIGHT - <i>Indoor Light</i>	P55
05	FIXTURE - <i>Indoor&outdoor Light</i>	P58
06	CANOPY - <i>Indoor Light</i>	P75
07	HIGH BAY - <i>Indoor Light</i>	P76
08	FLOODLIGHT - <i>Outdoor Light</i>	P81
09	STREETLIGHT - <i>Outdoor Light</i>	P91
10	LANDSCAPE - <i>Outdoor Light</i>	P101
11	LINEAR - <i>Indoor&outdoor Light</i>	P175
12	ACCESSORY - <i>Indoor&outdoor Light</i>	P178

DESCRIPTION

หลอดไฟแอลอีดีประหยัดค่าไปได้สูงสุด 60% เพราะลดการใช้พลังงานถึง 80% แต่ความสว่างเท่าเดิม อายุการใช้งานยังยาวนานมากกว่า 15 ปี และยังมีแสงที่นุ่มนวล กระทบสายตา เปิดติดสว่างทันที เปิด-ปิดได้บ่อยครั้ง ไม่มีความร้อนจากหลอด ไม่มีรังสี UV และ IR ใช้งานง่ายสามารถเปลี่ยนแทนหลอดเดิมได้เลย และยังมีสารปรอท แคมยังเป็นมิตรต่อสิ่งแวดล้อม



LED BULB G45 SERIES



SPECIFICATION

Input Voltage	AC100-265V ,50-60 Hz
Material	Aluminum + PC
Lampholder	E27
Luminaire Efficiency (lm/W)	90 lm/W
CRI	>80
Ambient Temp.	-20°C ~ +45°C
Beam angle	180°
Power Factor	0.50
Life time (Hrs.)	30,000 Hrs

Product Model	Power (W)	CCT (K)	Lumen (lm)	Dimension (mm.)		Price (฿)
				ØDia.	H	
BG4501-3(65/30)	3W	6500K , 3000K	270lm	Ø45	82	
BG4501-6(65/30)	6W	6500K , 3000K	540lm	Ø45	82	

LED BULB C38 SERIES



SPECIFICATION

Input Voltage	AC100-265V ,50-60 Hz
Material	Aluminum + PC
Lampholder	E14
Luminaire Efficiency (lm/W)	90 lm/W
CRI	>80
Ambient Temp.	-20°C ~ +45°C
Beam angle	180°
Power Factor	0.50
Life time (Hrs.)	30,000 Hrs

Product Model	Power (W)	CCT (K)	Lumen (lm)	Dimension (mm.)		Price (฿)
				ØDia.	H	
BC38C01-3(65/30)	3W	6500K , 3000K	270lm	Ø38	100	
BC38C01-6(65/30)	6W	6500K , 3000K	540lm	Ø38	100	
BC38T01-3(65/30)	3W	6500K , 3000K	270lm	Ø38	125	
BC38T01-6(65/30)	6W	6500K , 3000K	540lm	Ø38	125	

LED BULB A60 SERIES

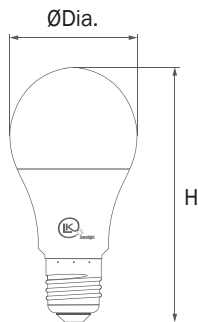

SPECIFICATION

Input Voltage	AC100-265V ,50-60 Hz
Material	Aluminum + PC
Lampholder	E27
Luminaire Efficiency (lm/W)	100 lm/W
CRI	>80
Ambient Temp.	-20°C ~ +45°C
Beam angle	180°
Power Factor	0.90
Life time (Hrs.)	30,000 Hrs

Product Model	Power (W)	CCT (K)	Lumen (lm)	Dimension (mm.)		Price (฿)
				ØDia.	H	
BE2701-5(65/30)	5W	6500K , 3000K	500lm	Ø60	100	
BE2701-7(65/30)	7W	6500K , 3000K	700lm	Ø60	100	
BE2701-9(65/30)	9W	6500K , 3000K	900lm	Ø60	100	
BE2701-12(65/30)	12W	6500K , 3000K	1,200lm	Ø60	110	
BE2701-15(65/30)	15W	6500K , 3000K	1,500lm	Ø60	110	

LED BULB A60 ECO SERIES

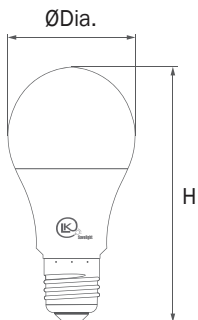

SPECIFICATION

Input Voltage	AC100-240V ,50-60 Hz
Material	Aluminum + PC
Lampholder	E27
Luminaire Efficiency (lm/W)	90 lm/W
CRI	>80
Ambient Temp.	-20°C ~ +45°C
Beam angle	180°
Power Factor	0.50
Life time (Hrs.)	30,000 Hrs

Product Model	Power (W)	CCT (K)	Lumen (lm)	Dimension (mm.)		Price (฿)
				ØDia.	H	
BE2701E-3(65/30)	3W	6500K , 3000K	270lm	Ø47	90	
BE2701E-5(65/30)	5W	6500K , 3000K	450lm	Ø47	90	
BE2701E-7(65/30)	7W	6500K , 3000K	630lm	Ø56	105	
BE2701E-9(65/30)	9W	6500K , 3000K	810lm	Ø56	105	
BE2701E-12(65/30)	12W	6500K , 3000K	1,080lm	Ø67	128	
BE2701E-15(65/30)	15W	6500K , 3000K	1,350lm	Ø75	142	



SPECIFICATION

Input Voltage	AC100-240V ,50-60 Hz
Material	Aluminum + PC
Lampholder	E27
Luminaire Efficacy (lm/W)	90 lm/W
CRI	>80
Ambient Temp.	-20 °C ~ +45 °C
Beam angle	180°
Power Factor	0.50
Life time (Hrs.)	30,000 Hrs

LED BULB DRAGON SERIES



Product Model	Power (W)	CCT (K)	Lumen (lm)	Dimension (mm.)		Price (฿)
				ØDia.	H	
BDG01-6(65/30)	6W	6500K , 3000K	540lm	Ø37	123	
BDG01-9(65/30)	9W	6500K , 3000K	810lm	Ø37	123	
BDG01-12(65/30)	12W	6500K , 3000K	1,080lm	Ø45	142	
BDG01-15(65/30)	15W	6500K , 3000K	1,350lm	Ø45	142	

LED HANDSOME SERIES



Product Model	Power (W)	CCT (K)	Lumen (lm)	Dimension (mm.)		Price (฿)
				ØDia.	H	
BHS01-30(65/30)	30W	6500K , 3000K	2,700lm	Ø101	178	
BHS01-40(65/30)	40W	6500K , 3000K	3,500lm	Ø116	201	
BHS01-50(65/30)	50W	6500K , 3000K	4,300lm	Ø126	223	
BHS01-60(65/30)	60W	6500K , 3000K	5,200lm	Ø143	236	

LED CALA SERIES



Product Model	Power (W)	CCT (K)	Lumen (lm)	Dimension (mm.)		Price (฿)
				ØDia.	H	
BCL01-30(65/30)	30W	6500K , 3000K	2,700lm	Ø94	202	
BCL01-40(65/30)	40W	6500K , 3000K	3,600lm	Ø105	224	
BCL01-50(65/30)	50W	6500K , 3000K	4,500lm	Ø105	244	

LED HIGH POWER SERIES



SPECIFICATION

Input Voltage	AC100-240V,50-60 Hz
Material	Aluminum + PC
Lampholder	E40
Luminaire Efficiency (lm/W)	80 lm/W
CRI	>80
Ambient Temp.	-20°C ~ +45°C
Beam angle	180°
Power Factor	0.70
Life time (Hrs.)	30,000 Hrs

Product Model	Power (W)	CCT (K)	Lumen (lm)	Dimension (mm.)		Price (฿)
				ØDia.	H	
BHP01-80(65/30)	80W	6500K , 3000K	6,400lm	Ø142	296	
BHP01-100(65/30)	100W	6500K , 3000K	8,000lm	Ø142	296	
BHP01-150(65/30)	150W	6500K , 3000K	12,000lm	Ø160	323	
BHP01-200(65/30)	200W	6500K , 3000K	16,000lm	Ø160	323	

LED CORN SERIES



SPECIFICATION

Input Voltage	AC100-240V,50-60 Hz
Material	Aluminum + PC
Lampholder	E27 / E40
Luminaire Efficiency (lm/W)	120 lm/W
CRI	>80
Ambient Temp.	-20°C ~ +45°C
Beam angle	180°
Power Factor	0.70
Life time (Hrs.)	30,000 Hrs

Product Model	Power (W)	Lampholder	CCT (K)	Lumen (lm)	Dimension (mm.)		Price (฿)
					ØDia.	H	
BC01-20(65/30)	20W	E27	6500K , 3000K	2,400lm	Ø65	178	
BC01-27(65/30)	27W	E27	6500K , 3000K	3,240lm	Ø95	194	
BC01-36(65/30)	36W	E27	6500K , 3000K	4,320lm	Ø95	224	
BC01-54(65/30)	54W	E40	6500K , 3000K	6,480lm	Ø95	275	
BC01-80(65/30)	80W	E40	6500K , 3000K	9,600lm	Ø135	300	
BC01-100(65/30)	100W	E40	6500K , 3000K	12,000lm	Ø135	320	
BC01-120(65/30)	120W	E40	6500K , 3000K	14,400lm	Ø135	340	



SPECIFICATION

Input Voltage	AC100-240V ,50-60 Hz
Material	Aluminum + PC
Lampholder	E27
Luminaire Efficacy (lm/W)	80 lm/W
CRI	>80
Ambient Temp.	-20°C ~ +45°C
Beam angle	60°
Power Factor	0.50
Life time (Hrs.)	30,000 Hrs

LED PAR IP20 SERIES



Product Model	Power (W)	CCT (K)	Lumen (lm)	Dimension (mm.)		Price (฿)
				ØDia.	H	
PAR2020-7(65/30)	7W	6500K , 3000K	560lm	Ø63	84	
PAR3020-10(65/30)	10W	6500K , 3000K	800lm	Ø95	80	
PAR3820-15(65/30)	15W	6500K , 3000K	1,200lm	Ø121	121	

LED PAR IP65 SERIES



Product Model	Power (W)	CCT (K)	Lumen (lm)	Dimension (mm.)		Price (฿)
				ØDia.	H	
PAR1665-7(65/30)	7W	6500K , 3000K	560lm	Ø50	82	
PAR2065-7(65/30)	7W	6500K , 3000K	560lm	Ø63	91	
PAR3065-10(65/30)	10W	6500K , 3000K	800lm	Ø95	93	
PAR3865-15(65/30)	15W	6500K , 3000K	1,200lm	Ø121	135	

LED PAR IP65 SERIES

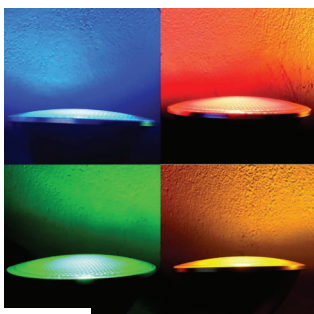

Product Model	Power (W)	CCT (K)	Dimension (mm.)		Price (฿)
			ØDia.	H	
PAR3865-15R	15W	Red	Ø122	133	
PAR3865-15G	15W	Green	Ø122	133	
PAR3865-15B	15W	Blue	Ø122	133	
PAR3865-15Y	15W	Yellow	Ø122	133	

SPECIFICATION

Input Voltage	12VDC/220VAC ,50-60 Hz
Material	Aluminum + PC
Lampholder	GU5.3/GU10
Luminaire Efficiency (lm/W)	80 lm/W
CRI	>80
Ambient Temp.	-20°C ~ +45°C
Beam angle	15° , 45°
Power Factor	0.50
Life time (Hrs.)	30,000 Hrs

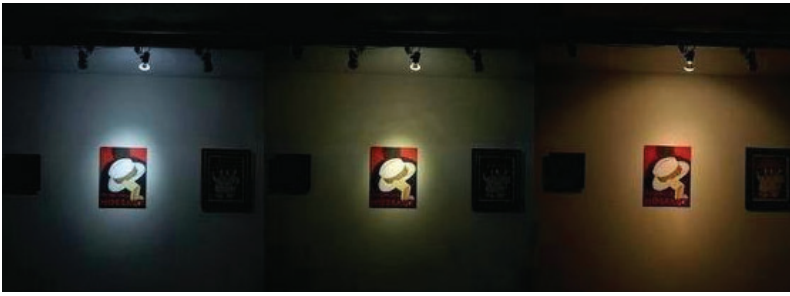
**LED MR16 GU5.3 12V SERIES**

Product Model	Power (W)	CCT (K)	Lumen (lm)	Dimension (mm.)		Price (฿)
				ØDia.	H	
MR165.3-512(65/30)	5W	6500K , 3000K	400lm	Ø49	47	
MR165.3-712(65/30)	7W	6500K , 3000K	560lm	Ø49	47	
MR165.3-912(65/30)	9W	6500K , 3000K	720lm	Ø49	47	

LED MR16 GU5.3 220V SERIES

Product Model	Power (W)	CCT (K)	Lumen (lm)	Dimension (mm.)		Price (฿)
				ØDia.	H	
MR165.3-5220(65/30)	5W	6500K , 3000K	400lm	Ø49	80	
MR165.3-7220(65/30)	7W	6500K , 3000K	560lm	Ø49	80	
MR165.3-9220(65/30)	9W	6500K , 3000K	720lm	Ø49	80	

LED MR16 GU10 220V SERIES

Product Model	Power (W)	CCT (K)	Lumen (lm)	Dimension (mm.)		Price (฿)
				ØDia.	H	
MR1610-7220(65/30)	7W	6500K , 3000K	560lm	Ø50	80	
MR1610-9220(65/30)	9W	6500K , 3000K	720lm	Ø50	80	

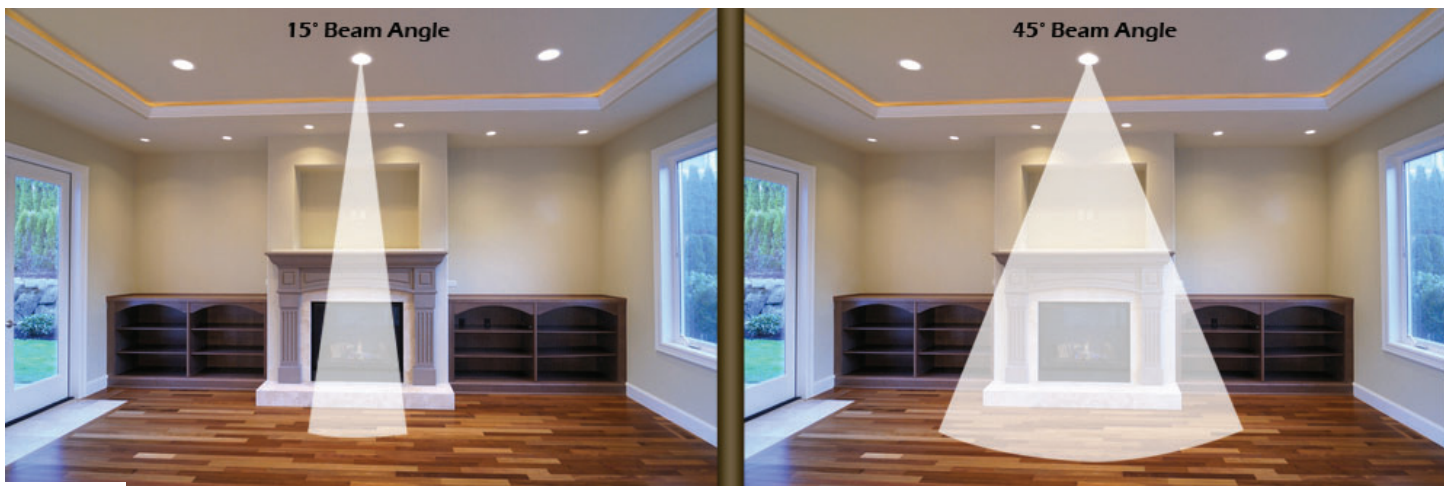

LED GX53 SERIES



SPECIFICATION

Input Voltage	12VDC/220VAC ,50-60 Hz
Material	Aluminum + PC
Lampholder	GX53
Luminaire Efficiency (lm/W)	80 lm/W
CRI	>80
Ambient Temp.	-20°C ~ +45°C
Beam angle	120°
Power Factor	0.50
Life time (Hrs.)	30,000 Hrs

Product Model	Power (W)	CCT (K)	Lumen (lm)	Dimension (mm.)		Price (฿)
				ØDia.	H	
GX5301-7(65/30)	7W	6500K , 3000K	560lm	Ø74	24	
GX5301-9(65/30)	9W	6500K , 3000K	720lm	Ø74	24	

LED AR111 SERIES



SPECIFICATION

Input Voltage	12VDC/220VAC ,50-60 Hz
Material	Aluminum + PC
Lampholder	AR111
Luminaire Efficiency (lm/W)	80 lm/W
CRI	>80
Ambient Temp.	-20°C ~ +45°C
Beam angle	25°
Power Factor	0.50
Life time (Hrs.)	30,000 Hrs

Product Model	Power (W)	CCT (K)	Lumen (lm)	Dimension (mm.)		Price (฿)
				ØDia.	H	
AR11101-12(65/30)	12W	6500K , 3000K	960lm	Ø111	66	
AR11101-15(65/30)	15W	6500K , 3000K	1,200lm	Ø111	66	



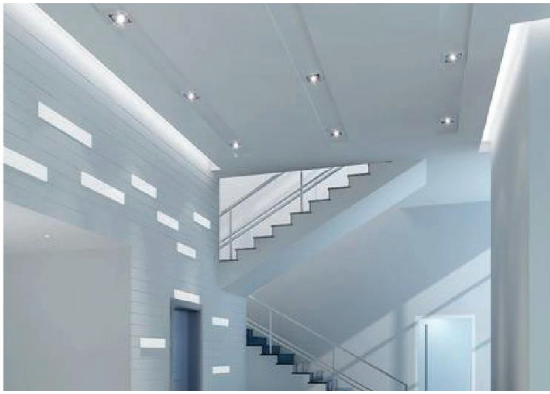

SPECIFICATION

Input Voltage	220-240VAC ,50-60 Hz
Material	Aluminum + PC
Lampholder	G24
Luminaire Efficiency (lm/W)	80 lm/W
CRI	>80
Ambient Temp.	-20°C ~ +45°C
Beam angle	120°
Power Factor	0.90
Life time (Hrs.)	30,000 Hrs

LED PLC ROTA SERIES



Product Model	Power (W)	CCT (K)	Lumen (lm)	Dimension (mm.)		Price (฿)
				W	H	
PLCR01-5(65/30)	5W	6500K , 3000K	400lm	35	127	
PLCR01-7(65/30)	7W	6500K , 3000K	560lm	35	154	
PLCR01-10(65/30)	10W	6500K , 3000K	800lm	35	193	

LED PLC CORN SERIES



Product Model	Power (W)	CCT (K)	Lumen (lm)	Dimension (mm.)		Price (฿)
				W	H	
PLCC01-5(65/30)G24-2	5W	6500K , 3000K	400lm	34	120	
PLCC01-7(65/30)G24-2	7W	6500K , 3000K	560lm	34	144	
PLCC01-12(65/30)G24-2	12W	6500K , 3000K	960lm	34	172	
PLCC01-5(65/30)E27	5W	6500K , 3000K	400lm	34	120	
PLCC01-7(65/30)E27	7W	6500K , 3000K	560lm	34	144	
PLCC01-12(65/30)E27	12W	6500K , 3000K	960lm	34	172	



G24 4pins



G24 2pins



G23 2pins



E27/E26



LED MAGNET LEN SERIES



SPECIFICATION

Input Voltage	AC100-240V,50-60 Hz
Material	Aluminum + PC
LED Type	SMD
Luminaire Efficiency (lm/W)	80 lm/W
CRI	>80
Ambient Temp.	-20°C ~ +45°C
Beam angle	180°
Power Factor	0.70
Life time (Hrs.)	30,000 Hrs

Product Model	Power (W)	CCT (K)	Lumen (lm)	Dimension (mm.)	Price (฿)
				ØDia.	
MNL01-12(65/30)	12W	6500K , 3000K	960lm	Ø130	
MNL01-18(65/30)	18W	6500K , 3000K	1,440lm	Ø150	
MNL01-24(65/30)	24W	6500K , 3000K	1,920lm	Ø170	
MNL01-36(65/30)	36W	6500K , 3000K	2,880lm	Ø235	



LED TUBE T8140 AL+PC SERIES

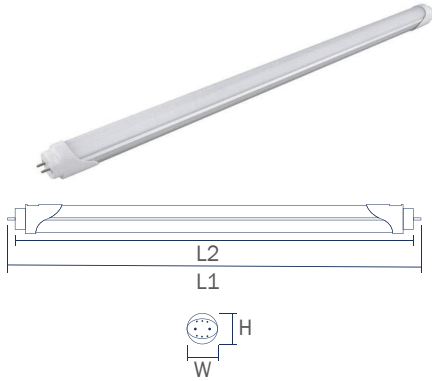

SPECIFICATION

Input Voltage (V)	AC185-250V
Power Frequency (Hz)	50-60Hz
Material	Aluminium + PC
Lampholder	G13
Luminaire Efficiency (lm/W)	140lm/W
CRI	80
Ambient Temp.(°C)	-20°C ~ +45°C
Beam Angle	150°
Power Factor	0.90
Life time (Hrs.)	50,000 Hrs

Product Model	Power (W)	CCT (K)	Lumen (lm)	Dimension (mm.)				Price (฿)
				W	L1	L2	H	
T8140-9(65/30)/AL	9W	6500K , 3000K	1,260 lm	27	608	587	32	
T8140-18(65/30)/AL	18W	6500K , 3000K	2,520 lm	27	1208	1187	32	

LED TUBE T8100 GLASS SERIES

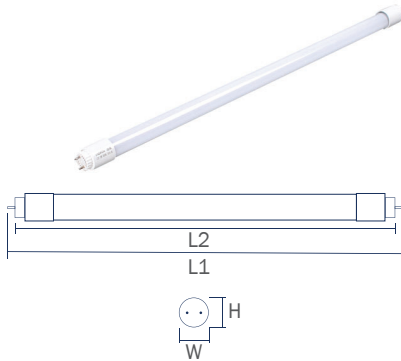

SPECIFICATION

Input Voltage (V)	AC185-250V
Power Frequency (Hz)	50-60Hz
Material	Glass
Lampholder	G13
Luminaire Efficiency (lm/W)	100 lm/W
CRI	80
Ambient Temp.(°C)	-20°C ~ +45°C
Beam Angle	270°
Power Factor	0.90
Life time (Hrs.)	30,000 Hrs

Product Model	Power (W)	CCT (K)	Lumen (lm)	Dimension (mm.)				Price (฿)
				W	L1	L2	H	
T8100-9(65/30)/G	9W	6500K , 3000K	900 lm	27	608	587	27	
T8100-18(65/30)/G	18W	6500K , 3000K	1,800 lm	27	1208	1187	27	

LED TUBE T8100 NANO SERIES

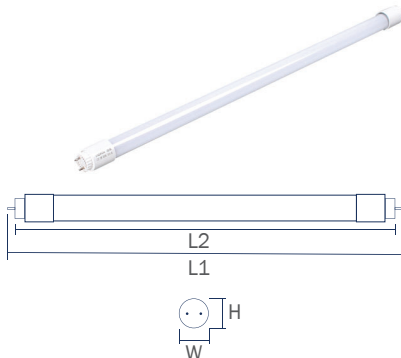

SPECIFICATION

Input Voltage (V)	AC185-250V
Power Frequency (Hz)	50-60Hz
Material	PC
Lampholder	G13
Luminaire Efficiency (lm/W)	100 lm/W
CRI	80
Ambient Temp.(°C)	-20°C ~ +45°C
Beam Angle	270°
Power Factor	0.90
Life time (Hrs.)	30,000 Hrs

Product Model	Power (W)	CCT (K)	Lumen (lm)	Dimension (mm.)				Price (฿)
				W	L1	L2	H	
T8100-9(65/30)/NN	9W	6500K , 3000K	900 lm	27	608	587	27	
T8100-18(65/30)/NN	18W	6500K , 3000K	1,800 lm	27	1208	1187	27	

LED TUBE T5120 AL+PC SERIES

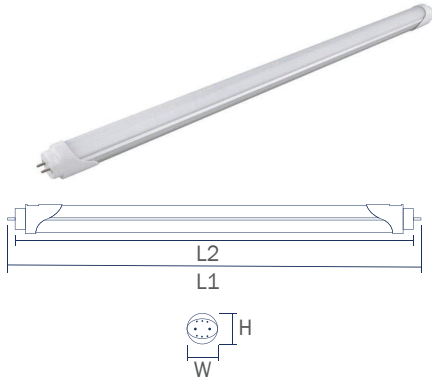

SPECIFICATION

Input Voltage (V)	AC185-250V
Power Frequency (Hz)	50-60Hz
Material	Aluminium + PC
Lampholder	G5
Luminaire Efficiency (lm/W)	120lm/W
CRI	80
Ambient Temp.(°C)	-20°C ~ +45°C
Beam Angle	150°
Power Factor	0.90
Life time (Hrs.)	50,000 Hrs

Product Model	Power (W)	CCT (K)	Lumen (lm)	Dimension (mm.)				Price (฿)
				W	L1	L2	H	
T5120-8(65/30)/AL	8W	6500K , 3000K	960 lm	22	563	549	22	
T5120-16(65/30)/AL	16W	6500K , 3000K	1,920 lm	22	1163	1149	22	

LED TUBE T5100 GLASS SERIES

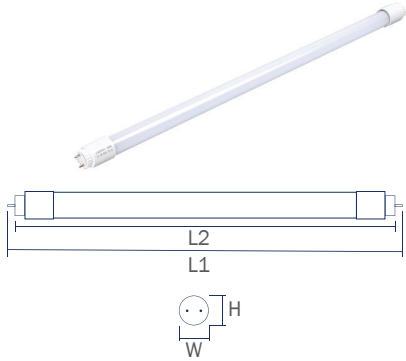

SPECIFICATION

Input Voltage (V)	AC185-250V
Power Frequency (Hz)	50-60Hz
Material	Glass
Lampholder	G5
Luminaire Efficiency (lm/W)	100 lm/W
CRI	80
Ambient Temp.(°C)	-20°C ~ +45°C
Beam Angle	270°
Power Factor	0.90
Life time (Hrs.)	30,000 Hrs

Product Model	Power (W)	CCT (K)	Lumen (lm)	Dimension (mm.)				Price (฿)
				W	L1	L2	H	
T5100-8(65/30)/G	8W	6500K , 3000K	800 lm	22	563	549	22	
T5100-16(65/30)/G	16W	6500K , 3000K	1,600 lm	22	1163	1149	22	

LED SET T8100 G SERIES

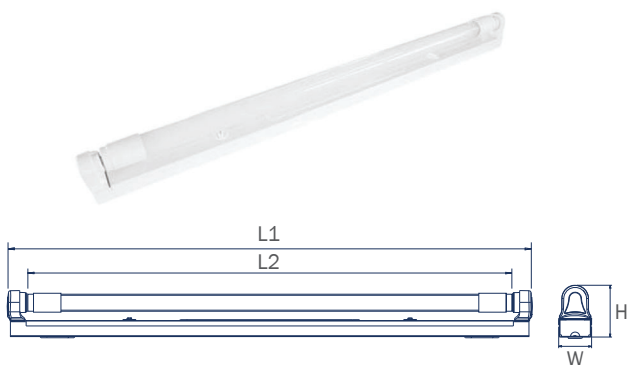

SPECIFICATION

Input Voltage (V)	AC220-250V
Power Frequency (Hz)	50-60Hz
Material	Steel + Glass
Lampholder	G13
Luminaire Efficiency (lm/W)	100lm/W
CRI	80
Ambient Temp.(°C)	-20°C ~ +45°C
Beam Angle	270°
Power Factor	0.9
Life time (Hrs.)	30,000 Hrs

Product Model	Power (W)	CCT (K)	Lumen (lm)	Dimension (mm.)				Price (฿)
				W	L1	L2	H	
T8S100-9(65/30)/G	9W	6500K , 3000K	900 lm	35	630	587	50	
T8S100-18(65/30)/G	18W	6500K , 3000K	1,800 lm	35	1230	1187	50	

LED SET T5100 G SERIES

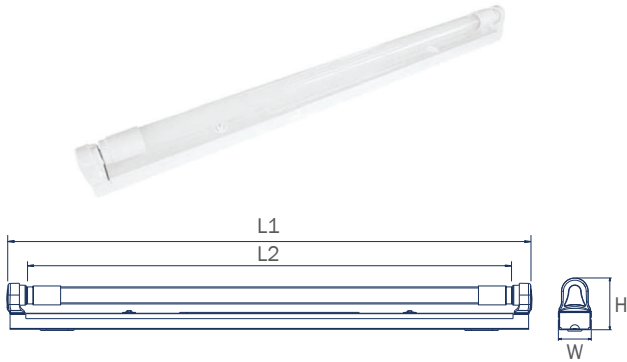

SPECIFICATION

Input Voltage (V)	AC220-250V
Power Frequency (Hz)	50-60Hz
Material	Steel + Glass
Lampholder	G5
Luminaire Efficiency (lm/W)	100lm/W
CRI	80
Ambient Temp.(°C)	-20°C ~ +45°C
Beam Angle	270°
Power Factor	0.9
Life time (Hrs.)	30,000 Hrs

Product Model	Power (W)	CCT (K)	Lumen (lm)	Dimension (mm.)				Price (฿)
				W	L1	L2	H	
T5S100-8(65/30)/G	8W	6500K , 3000K	800 lm	23	572	549	35	
T5S100-16(65/30)/G	16W	6500K , 3000K	1,600 lm	23	1172	1149	35	

LED FULL SET T8100 SERIES

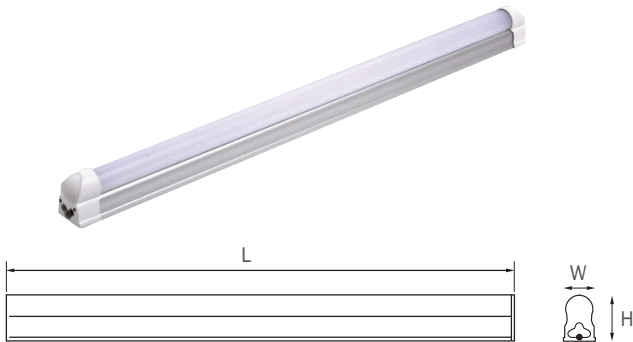

SPECIFICATION

Input Voltage (V)	AC220-240V
Power Frequency (Hz)	50-60Hz
Material	Aluminium + PC
Luminaire Efficiency (lm/W)	100 lm/W
CRI	>75
Ambient Temp.(°C)	-20°C ~ +45°C
Beam Angle	150°
Power Factor	0.6
Life time (Hrs.)	30,000 Hrs

Product Model	Power (W)	CCT (K)	Lumen (lm)	Dimension (mm.)			Price (฿)
				W	L	H	
T8FS100-9(65/30)	9W	6500K , 3000K	900 lm	28	597	35	
T8FS100-18(65/30)	18W	6500K , 3000K	1,800 lm	28	1206	35	

LED FULL SET T5100 SERIES



SPECIFICATION

Input Voltage (V)	AC220-240V
Power Frequency (Hz)	50-60Hz
Material	Aluminium + PC
Luminaire Efficiency (lm/W)	100 lm/W
CRI	>75
Ambient Temp.(°C)	-20°C ~ +45°C
Beam Angle	150°
Power Factor	0.6
Life time (Hrs.)	30,000 Hrs

Product Model	Power (W)	CCT (K)	Lumen (lm)	Dimension (mm.)			Price (฿)
				W	L	H	
T5FS100-8(65/30)	8W	6500K , 3000K	800 lm	22	586	35	
T5FS100-16(65/30)	16W	6500K , 3000K	1,600 lm	22	1166	35	



SPECIFICATION

Input Voltage	AC170-260V ,50-60 Hz
Material	Aluminum + PC
Lampholder	E27
Luminaire Efficiency (lm/W)	70 lm/W
CRI	>70
Ambient Temp.	-20°C ~ +45°C
Beam angle	180°
Power Factor	0.50
Life time (Hrs.)	30,000 Hrs

LED BULB MOSQUITOES-REPELLING SERIES



Product Model	Power (W)	CCT (K)	Lumen (lm)	Dimension (mm.)		Price (฿)
				ØDia.	H	
BMQR01-7W	7W	1700K	490lm	Ø60	113	
BMQR01-9W	9W	1700K	630lm	Ø60	113	
BMQR01-11W	11W	1700K	770lm	Ø60	121	

LED BULB BLUETOOTH SERIES



Product Model	Power (W)	CCT (K)	Lumen (lm)	Dimension (mm.)		Price (฿)
				ØDia.	H	
BBT01-8W	8W	3000K , 6500K	640lm	Ø60	118	

- Bluetooth 4.1 wireless control
- Mobile phone
- Multi function control
- Stepless adjusted
- Color temperature adjustment
- Timing control
- Intelligent linkage

LED BULB BLUETOOTH RGB SERIES



Product Model	Power (W)	CCT (K)	Lumen (lm)	Dimension (mm.)		Price (฿)
				ØDia.	H	
BBT01-7RGB	7W	RGB	550lm	Ø60	110	



Millions of color is adjustable
Experience the visual fast of light

**SPECIFICATION**

Input Voltage	AC170-260V ,50-60 Hz
Material	Aluminum + PC
Lampholder	E27
Luminaire Efficiency (lm/W)	80 lm/W
CRI	>80
Ambient Temp.	-20°C ~ +45°C
Beam angle	180°
Power Factor	0.50
Life time (Hrs.)	30,000 Hrs

LED BULB 3 STEP COLOR SERIES

Product Model	Power (W)	CCT (K)	Lumen (lm)	Dimension (mm.)		Price (฿)
				ØDia.	H	
B3S01-7W	7W	3CCT	630lm	Ø60	112	
B3S01-9W	9W	3CCT	720lm	Ø60	112	
B3S01-12W	12W	3CCT	960lm	Ø60	120	

**6500K 4000K 3000K****LED BULB 3 STEP DIM SERIES**

Product Model	Power (W)	CCT (K)	Lumen (lm)	Dimension (mm.)		Price (฿)
				ØDia.	H	
B3SD01-8W	8W	3000K , 6500K	640lm	Ø60	112	
B3SD01-10W	10W	3000K , 6500K	800lm	Ø60	112	
B3SD01-12W	12W	3000K , 6500K	960lm	Ø60	120	

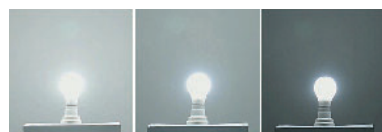
**100% 50% 12%****LED BULB DIM SERIES**

Product Model	Power (W)	CCT (K)	Lumen (lm)	Dimension (mm.)		Price (฿)
				ØDia.	H	
BDM01-7W	7W	3000K , 6500K	560lm	Ø60	108	
BDM01-9W	9W	3000K , 6500K	630lm	Ø60	112	
BDM01-12W	12W	3000K , 6500K	960lm	Ø60	118	
BDM01-15W	15W	3000K , 6500K	1,200lm	Ø65	133	



SPECIFICATION

Input Voltage	AC170-260V ,50-60 Hz
Material	Aluminum + PC
Lampholder	E14 / E27
Luminaire Efficiency (lm/W)	80 - 90 lm/W
CRI	>70
Ambient Temp.	-20°C ~ +45°C
Beam angle	180°
Power Factor	0.50
Life time (Hrs.)	30,000 Hrs

LED BULB C38 DIM SERIES



Cander

Tail

Product Model	Power (W)	CCT (K)	Lumen (lm)	Dimension (mm.)		Price (\$)
				ØDia.	H	
BC38CD01-5W	5W	3000K	560lm	Ø38	100	
BC38TD01-5W	5W	3000K	560lm	Ø38	125	

LED EDISON DIM SERIES



A60

G45



Cander

Tail

Product Model	Power (W)	CCT (K)	Lumen (lm)	Dimension (mm.)		Price (\$)
				ØDia.	H	
EDA60D01-527	5W	2700K	450lm	Ø60	105	
EDA60D01-927	9W	2700K	810lm	Ø60	105	
EDG45D01-427	4W	2700K	360lm	Ø45	78	
EDC38CD01-427	4W	2700K	360lm	Ø35	98	
EDC38TD01-427	4W	2700K	360lm	Ø35	120	



**SPECIFICATION**

Input Voltage	AC220-240V ,50-60 Hz
Material	Aluminum + PC
Lampholder	E27 / GU10
Luminaire Efficiency (lm/W)	60 lm/W
CRI	>80
Ambient Temp.	-20 °C ~ +45 °C
Beam angle	15° , 45°
Power Factor	0.50
Life time (Hrs.)	30,000 Hrs

LED BULB RGB SERIES

Product Model	Power (W)	CCT (K)	Lumen (lm)	Dimension (mm.)		Price (฿)
				ØDia.	H	
BR01-4RGB	4W	RGB	-	Ø60	106	
BR01-8RGB	8W	RGB	-	Ø60	106	
BR01-10RGB	10W	RGB	-	Ø60	106	

LED MR16 RGB SERIES

Product Model	Power (W)	CCT (K)	Lumen (lm)	Dimension (mm.)		Price (฿)
				ØDia.	H	
MR1610R01-4RGB	4W	RGB	-	Ø55	56	
MR1610R01-8RGB	8W	RGB	-	Ø55	56	
MR1610R01-10RGB	10W	RGB	-	Ø55	56	

LED BULB P45 SERIES

Product Model	Power (W)	CCT (K)	Dimension (mm.)		Price (฿)
			ØDia.	H	
BP4501-127	1W	2700K	Ø45	73	
BP4501-140	1W	4000K	Ø45	73	
BP4501-165	1W	6500K	Ø45	73	
BP4501-1B	1W	Blue	Ø45	73	
BP4501-1Y	1W	Yellow	Ø45	73	
BP4501-1G	1W	Green	Ø45	73	
BP4501-1O	1W	Orange	Ø45	73	
BP4501-1R	1W	Red	Ø45	73	
BP4501-1RGB	1W	RGB	Ø45	73	

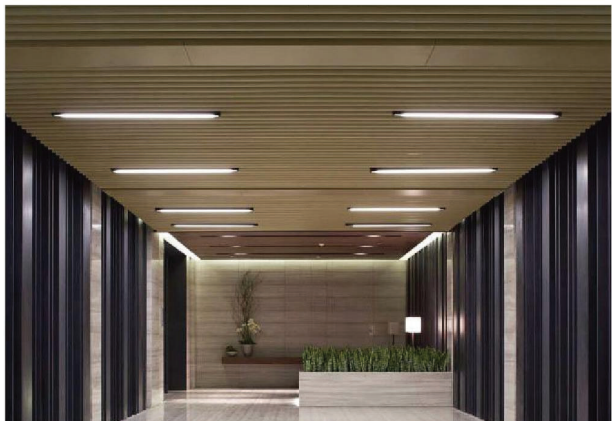

SPECIFICATION

Input Voltage (V)	AC185-250V
Power Frequency (Hz)	50-60Hz
Material	Aluminium + PC
Lampholder	G13
Luminaire Efficiency (lm/W)	120lm/W
CRI	80
Ambient Temp.(°C)	-20°C ~ +45°C
Beam Angle	150°
Power Factor	0.90
Life time (Hrs.)	30,000 Hrs

LED TUBE T8 RADAR SENSOR SERIES

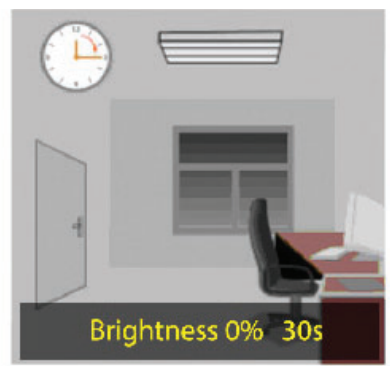
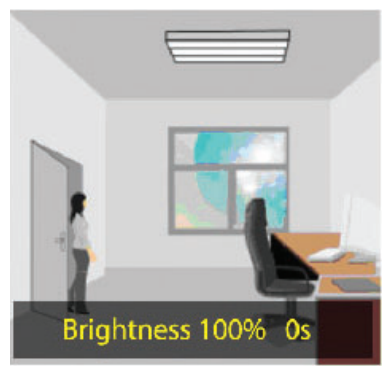
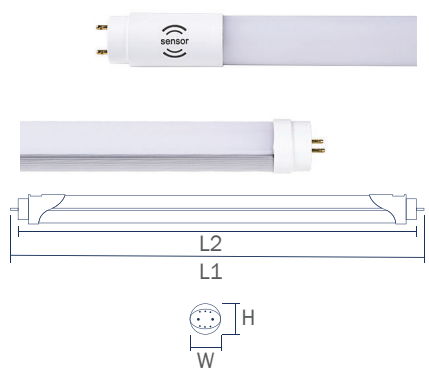

Product Model	Power (W)	CCT (K)	Lumen (lm)	Dimension (mm.)				Price (฿)
				W	L1	L2	H	
T8RS-9(65/30)/AL	9W	6500K , 3000K	1,170 lm	28	608	587	28	
T8RS-18(65/30)/AL	18W	6500K , 3000K	2,160 lm	28	1213	1187	28	

LED TUBE T8 EMERGENCY SERIES

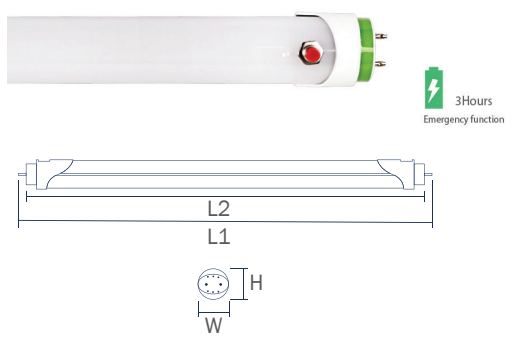

Product Model	Power (W)	CCT (K)	Lumen (lm)	Dimension (mm.)				Price (฿)
				W	L1	L2	H	
T8EM-9(65/30)/AL	9W	6500K , 3000K	900 lm	28	604	587	28	
T8EM -18(65/30)/AL	18W	6500K , 3000K	1,800 lm	28	1213	1187	28	

DESCRIPTION

โคมดาวนไลท์ แอลอีดี ออกแบบมาให้มีขนาดกระทัดรัด บาง สะดวกในการติดตั้งในพื้นที่ที่มีช่องว่าง หลังดวงโคมเพียง 3-10 ซม. โครงสร้างอลูมิเนียมขึ้นรูปด้วยกรรมวิธี High pressure Aluminium - Die Casting ให้ประสิทธิภาพการระบายความร้อนสูง และยังปราศจากสนิม เพื่อการใช้งานในระยะยาว พิสูจน์สำเร็จรูปแผ่นเคลือบด้วยสีฝุ่นทนการกัดกร่อนได้ดี และยังมีวัสดุพลาสติกนำแสงและกระจายแสงแบบใหม่ จึงให้แสงสว่างที่สม่ำเสมอ
การใช้งาน : ติดตั้งง่ายด้วยคลิปสปริง แข็งแรงคงทน

SPECIFICATION

Input Voltage (V)	AC185-250V
Power Frequency (Hz)	50-60Hz
Material	Aluminium + PC
Luminaire Efficiency (lm/W)	80-110 lm/W
CRI	80
Ambient Temp.(°C)	-20°C ~ +45°C
Beam Angle	120°
Power Factor	0.5 - 0.9
Colors Temp. (K)	3,000K or 6,500K
Life time (Hrs.)	30,000 Hrs

LED DOWNLIGHT SLIM A ROUND SERIES

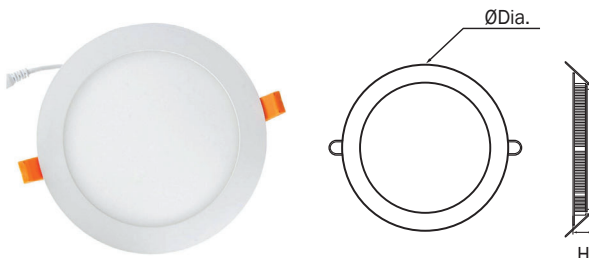

Product Model	Power (W)	Lumen (lm)	Dimension (mm.)		Price (฿)
			ØDia.	H	
DLRA3-6(65/30)	6	540	120	23	
DLRA4-9(65/30)	9	810	145	23	
DLRA5-12(65/30)	12	1,080	170	23	
DLRA7-18(65/30)	18	1,620	225	23	
DLRA9-24(65/30)	24	2,160	300	23	

LED DOWNLIGHT SLIM A SQUARE SERIES

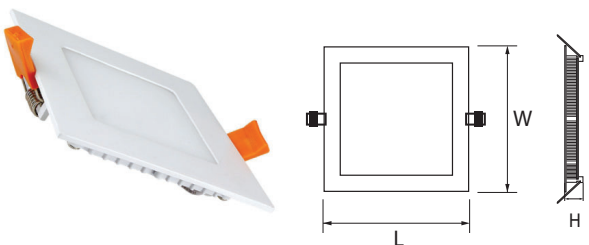

Product Model	Power (W)	Lumen (lm)	Dimension (mm.)			Price (฿)
			W	L	H	
DLSA3-6(65/30)	6	540	120	120	23	
DLSA4-9(65/30)	9	810	145	145	23	
DLSA5-12(65/30)	12	1,080	170	170	23	
DLSA7-18(65/30)	18	1,620	225	225	23	
DLSA9-24(65/30)	24	2,160	300	300	23	

LED DOWNLIGHT SLIM B ROUND SERIES



Product Model	Power (W)	Lumen (lm)	Dimension (mm.)		Price (฿)
			ØDia.	H	
DLRB3-6(65/30)	6	540	90	30	
DLRB5-12(65/30)	12	1,080	125	30	
DLRB7-16(65/30)	16	1,440	170	30	
DLRB9-24(65/30)	24	2,160	225	30	



LED DOWNLIGHT SLIM B SQUARE SERIES



Built-In Driver
 ប្រព័ន្ធបញ្ជាដំឡើង

Product Model	Power (W)	Lumen (lm)	Dimension (mm.)			Price (฿)
			W	L	H	
DLSB3-6(65/30)	6	540	90	90	30	
DLSB5-12(65/30)	12	1,080	125	125	30	
DLSB7-16(65/30)	16	1,440	170	170	30	
DLSB9-24(65/30)	24	2,160	225	225	30	

LED DOWNLIGHT AC ROUND SERIES



Product Model	Power (W)	Lumen (lm)	Dimension (mm.)		Price (฿)
			ØDia.	H	
DLRAC-6(65/30)	6	480	100	20	
DLRAC-8(65/30)	8	640	118	20	
DLRAC-15(65/30)	15	1,200	175	20	
DLRAC-20(65/30)	20	1,600	230	20	

LED DOWNLIGHT AB ROUND Adj. SERIES



Product Model	Power (W)	Lumen (lm)	Dimension (mm.)		Price (฿)
			ØDia.	H	
DLRAB-3(65/30)/ADJ	3	240	75	40	
DLRAB-5(65/30)/ADJ	5	400	91	46	
DLRAB-9(65/30)/ADJ	9	720	112	51	
DLRAB-12(65/30)/ADJ	12	960	133	56	

LED DOWNLIGHT AB SQUARE Adj. SERIES



Product Model	Power (W)	Lumen (lm)	Dimension (mm.)			Price (฿)
			W	L	H	
DLSAB-3(65/30)/ADJ	3	240	75	75	40	
DLSAB-5(65/30)/ADJ	5	400	91	91	46	
DLSAB-9(65/30)/ADJ	9	720	112	112	51	
DLSAB-12(65/30)/ADJ	12	960	133	133	56	

LED DOWNLIGHT AD SERIES



Product Model	Power (W)	Lumen (lm)	Dimension (mm.)		Price (฿)
			ØDia.	H	
DLAD-15(65/30)	15	1,300	166	74	
DLAD-20(65/30)	20	1,600	195	76	
DLAD-30(65/30)	30	2,300	225	78	

LED DOWNLIGHT AE SERIES



Product Model	Power (W)	Lumen (lm)	Dimension (mm.)		Price (฿)
			ØDia.	H	
DLAE-8(65/30)	8	560	90	45	
DLAE-11(65/30)	11	770	120	50	
DLAE-15(65/30)	15	1,050	165	50	
DLAE-30(65/30)	30	2,100	225	60	

LED DOWNLIGHT AF SERIES

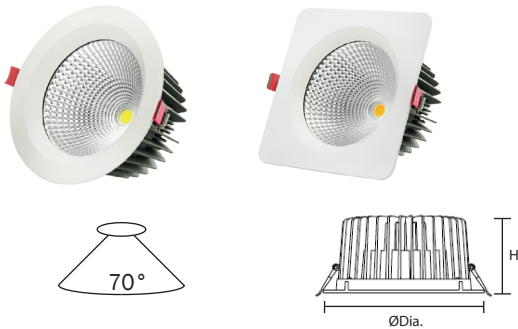

Product Model	Power (W)	Lumen (lm)	Dimension (mm.)		Price (฿)
			ØDia.	H	
DLAFR-60(65/30)	60	4,800	230	110	
DLAFS-60(65/30)	60	4,800	230x230	110	

LED DOWNLIGHT AG SERIES

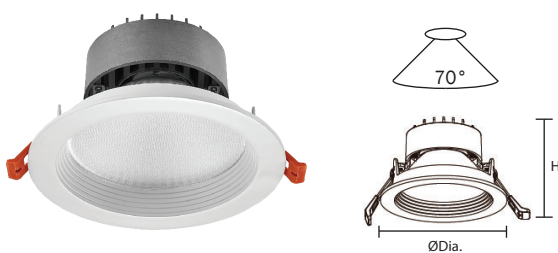

Product Model	Power (W)	Lumen (lm)	Dimension (mm.)		Price (฿)
			ØDia.	H	
DLAG-15(65/30)	10	800	110	68	
DLAG-20(65/30)	15	1,200	140	85	
DLAG-30(65/30)	30	2,400	190	109	

LED DOWNLIGHT AH SERIES



Product Model	Power (W)	Lumen (lm)	Dimension (mm.)		Price (฿)
			ØDia.	H	
DLAH-30(65/30)	30	2,400	145	110	
DLAH-45(65/30)	45	3,600	190	137	

Downlight - Indoor Light

LED DOWNLIGHT AI SERIES

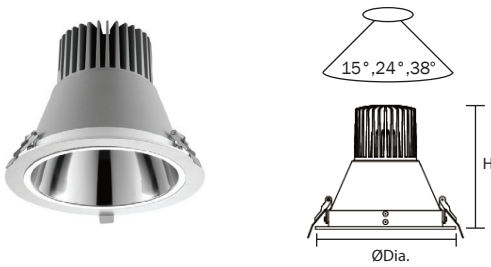

Product Model	Power (W)	Lumen (lm)	Dimension (mm.)		Price (฿)
			ØDia.	H	
DLAI-40(65/30)	40	3,400	190	163	
DLAI-55(65/30)	55	4,680	240	193	

LED DOWNLIGHT AJ SERIES

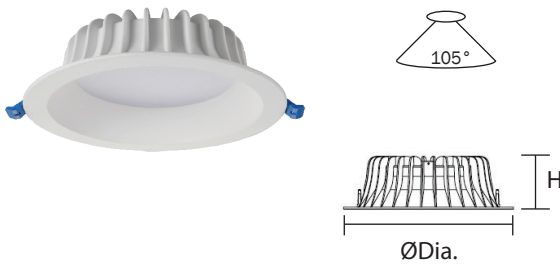

Product Model	Power (W)	Lumen (lm)	Dimension (mm.)		Price (฿)
			ØDia.	H	
DLAJ-7(65/30)	7	480	95	40	
DLAJ-12(65/30)	12	960	115	45	
DLAJ-15(65/30)	15	1,200	140	50	
DLAJ-24(65/30)	24	1,920	190	65	
DLAJ-35(65/30)	35	2,800	225	70	

LED DOWNLIGHT AK SERIES



Product Model	Power (W)	Lumen (lm)	Dimension (mm.)		Price (฿)
			ØDia.	H	
DLAK-6(65/30)	6	480	100	21	
DLAK-10(65/30)	10	800	120	29	
DLAK-14(65/30)	14	1,200	145	30	
DLAK-24(65/30)	24	1,920	180	31	
DLAK-30(65/30)	30	2,400	230	33	

LED DOWNLIGHT AL SERIES



Product Model	Power (W)	Lumen (lm)	Dimension (mm.)		Price (฿)
			ØDia.	H	
DLALR-7(65/30)	7	560	85	62	
DLALR-10(65/30)	10	800	105	65	

Product Model	Power (W)	Lumen (lm)	Dimension (mm.)		Price (฿)
			W+L	H	
DLALS-7(65/30)	7	560	85 x 85	62	
DLALS-10(65/30)	10	800	105 x 105	65	

LED DOWNLIGHT AM SERIES



Product Model	Power (W)	Lumen (lm)	Dimension (mm.)			Price (฿)
			W	L	H	
DLAM-115(65/30)	1x15	1,200	116	116	98	
DLAM-215(65/30)	2x15	2,400	116	214	98	
DLAM-315(65/30)	3x15	3,600	116	307	98	
DLAM-130(65/30)	1x30	2,400	176	176	138	
DLAM-230(65/30)	2x30	4,800	176	325	138	
DLAM-330(65/30)	3x30	7,200	176	474	138	

LED DOWNLIGHT AN SERIES

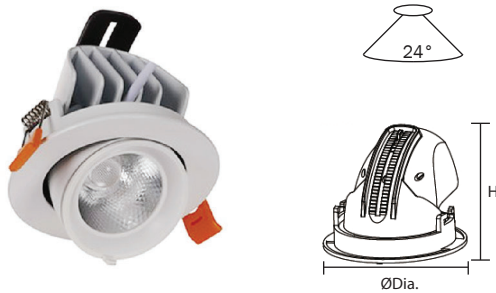

Product Model	Power (W)	Lumen (lm)	Dimension (mm.)		Price (฿)
			ØDia.	H	
DLAN-12(65/30)	12	840	96	75	
DLAN-1865(30)	18	1,260	125	100	
DLAN-30(65/30)	30	2,100	164	131	

LED DOWNLIGHT AO SERIES

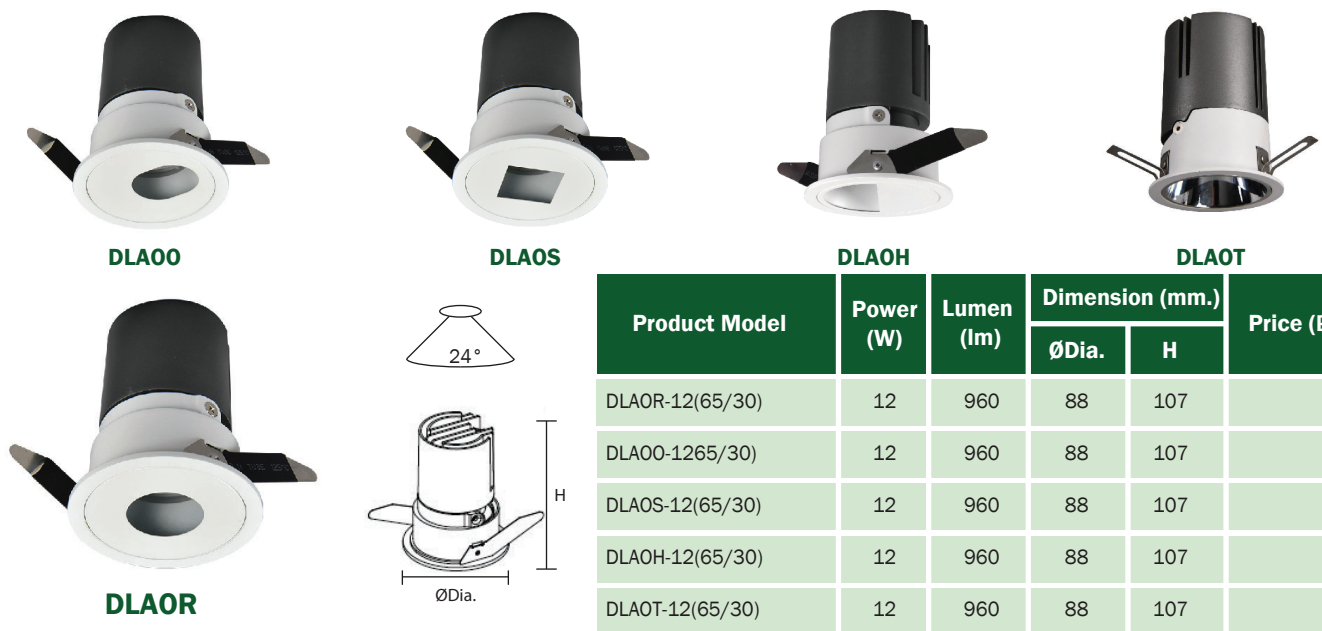

Product Model	Power (W)	Lumen (lm)	Dimension (mm.)		Price (฿)
			ØDia.	H	
DLAOR-12(65/30)	12	960	88	107	
DLA00-1265(30)	12	960	88	107	
DLAOS-12(65/30)	12	960	88	107	
DLA0H-12(65/30)	12	960	88	107	
DLA0T-12(65/30)	12	960	88	107	

Downlight - Indoor Light

LED DOWNLIGHT SLIM A ROUND SURFACE SERIES



Product Model	Power (W)	Lumen (lm)	Dimension (mm.)		Price (฿)
			ØDia.	H	
DLRAS3-6(65/30)	6	540	120	40	
DLRAS4-9(65/30)	9	810	145	40	
DLRAS5-12(65/30)	12	1,080	170	40	
DLRAS7-18(65/30)	18	1,620	225	40	
DLRAS9-24(65/30)	24	2,160	300	40	

LED DOWNLIGHT SLIM A SQUARE SURFACE SERIES

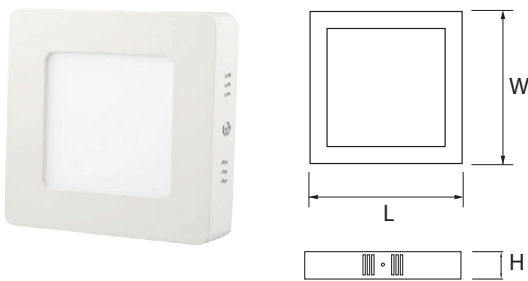

Product Model	Power (W)	Lumen (lm)	Dimension (mm.)			Price (฿)
			W	L	H	
DLSAS3-6(65/30)	6	540	120	120	40	
DLSAS4-9(65/30)	9	810	145	145	40	
DLSAS5-12(65/30)	12	1,080	170	170	40	
DLSAS7-18(65/30)	18	1,620	225	225	40	
DLSAS9-24(65/30)	24	2,160	300	300	40	

LED DOWNLIGHT SLIM B ROUND SURFACE SERIES

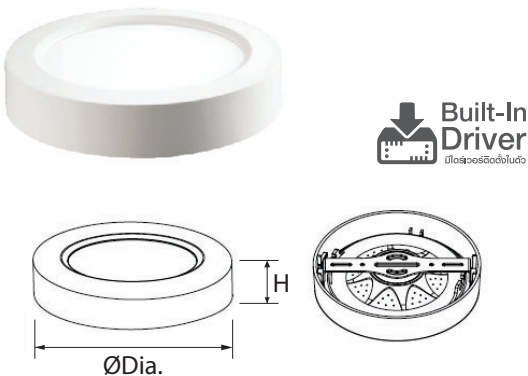

Product Model	Power (W)	Lumen (lm)	Dimension (mm.)		Price (฿)
			ØDia.	H	
DLSRS3-6(65/30)	6	540	120	32	
DLSRS5-12(65/30)	12	1,080	170	32	
DLSRS7-18(65/30)	18	1,620	225	32	

LED DOWNLIGHT SLIM B SQUARE SURFACE SERIES

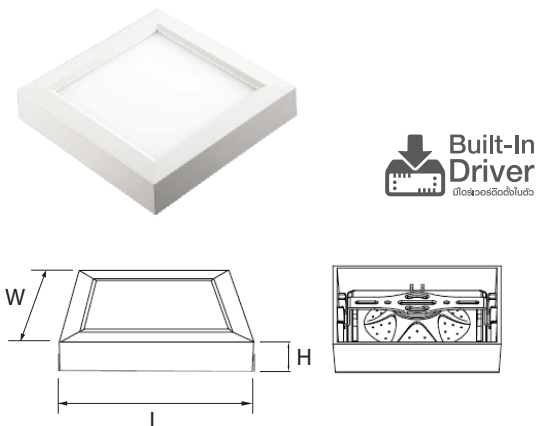

Product Model	Power (W)	Lumen (lm)	Dimension (mm.)			Price (฿)
			W	L	H	
DLSSS3-6(65/30)	6	540	120	120	32	
DLSSS5-12(65/30)	12	1,080	170	170	32	
DLSSS7-18(65/30)	18	1,620	225	225	32	

LED DOWNLIGHT AP ROUND SURFACE SERIES



Product Model	Power (W)	Lumen (lm)	Dimension (mm.)		Price (฿)
			ØDia.	H	
DLAPR3-8(65/30)	8	560	93	56	
DLAPR5-12(65/30)	12	840	124	56	
DLAPR7-20(65/30)	20	1,400	184	55	
DLAPR9-30(65/30)	30	2,100	222	55	
DLAPR12-40(65/30)	40	2,800	302	60	

LED DOWNLIGHT AP SQUARE SURFACE SERIES



Product Model	Power (W)	Lumen (lm)	Dimension (mm.)			Price (฿)
			W	L	H	
DLAPS3-8(65/30)	8	560	93	93	56	
DLAPS5-12(65/30)	12	840	124	124	56	
DLAPS7-20(65/30)	20	1,400	184	184	55	
DLAPS9-30(65/30)	30	2,100	222	222	55	
DLAPS12-40(65/30)	40	2,800	302	302	60	

LED DOWNLIGHT AQ SURFACE SERIES



Product Model	Power (W)	Lumen (lm)	Dimension (mm.)		Price (฿)
			ØDia.	H	
DLAQ-25(65/30)	25	2,000	232	45	
DLAQ-35(65/30)	35	2,800	292	45	

LED DOWNLIGHT AR ROUND SURFACE SERIES



Product Model	Power (W)	Lumen (lm)	Dimension (mm.)		Price (฿)
			ØDia.	H	
DLAR-7(65/30)	7	560	100	103	
DLAR-12(65/30)	12	960	169	149	
DLAR-20(65/30)	20	1,600	180	185	
DLAR-30(65/30)	30	2,400	220	225	

DOWNLIGHT STANDARD E27 SERIES



SPECIFICATION

แรงดันไฟฟ้าที่ใช้งาน (V)
วัสดุ

AC220V ,50-60Hz
หน้าโคมผลิตจากเหล็ก ขึ้นรูป ผ่านกรรมวิธีพ่นสีฝุ่น Powder Coating เพื่อได้งานที่สวยงามและทนทาน อลูมิเนียมชุบด้วยสียูเรทนาฟกาส (ลายเพชร)
ขั้ว E27
ภายใน ใช้สำหรับฝังฝ้า

รีเฟรคเตอร์
ขั้วโคมไฟ
ลักษณะการติดตั้ง

Downlight - Indoor Light

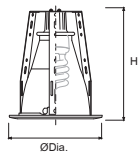

Cut out size (mm.)
4" = 120
5" = 150
6" = 170

Product Model	Lamp Holder	Dimension (mm.)		Price(฿)
		ØDia.	H	
DLR114-E27	1 x E27	143	168	
DLR114S-E27	1 x E27	143	148	
DLR115-E27	1 x E27	177	178	
DLR116-E27	1 x E27	190	178	

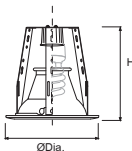

Cut out size (mm.)
4" = 120
5" = 150

Product Model	Lamp Holder	Dimension (mm.)		Price(฿)
		ØDia.	H	
DLR0614-E27	1 x E27	146	135	
DLR0615-E27	1 x E27	177	150	

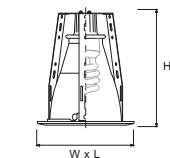

Cut out size (mm.)
4" = 115 x 115
5" = 148 x 148

Product Model	Lamp Holder	Dimension (mm.)		Price(฿)
		WxL	H	
DLSR114-E27	1 x E27	136x136	168	
DLSR115-E27	1 x E27	166x166	178	

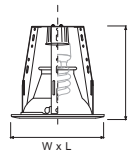

Cut out size (mm.)
4" = 115 x 115

Product Model	Lamp Holder	Dimension (mm.)		Price(฿)
		WxL	H	
DLSR0614-E27	1 x E27	136x136	135	

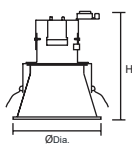

Cut out size (mm.)
4" = 125

Product Model	Lamp Holder	Dimension (mm.)		Price(฿)
		ØDia.	H	
DLR0094-E27	1 x E27	137	160	

DOWNLIGHT STANDARD SQUARE SERIES

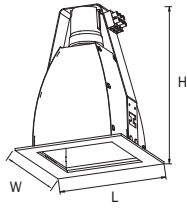

Cut out size (mm.)
 3" = 85 x 85
 4" = 105 x 105
 5" = 128 x 128
 6" = 145 x 145

Product Model	Lamp Holder	Dimension (mm.)			Price(
		W	L	H	
DLS0013-E27	1 x E27	107	107	125	
DLS0014-E27	1 x E27	128	128	162	
DLS0015-E27	1 x E27	145	145	175	
DLS0016-E27	1 x E27	160	160	185	

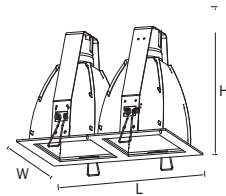

Cut out size (mm.)
 2E27 = 110 x 215
 3E27 = 110 x 215

Product Model	Lamp Holder	Dimension (mm.)			Price(
		W	L	H	
DLS0014-2E27	2 x E27	128	237	160	
DLS0014-3E27	3 x E27	128	346	160	

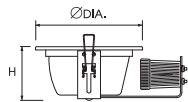
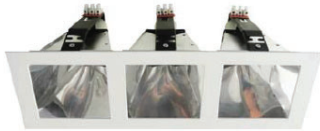

Cut out size (mm.)
 4" = 125
 5" = 155

Product Model	Lamp Holder	Dimension (mm.)		Price(
		ØDia.	H	
DLRH0104-E27	1 x E27	146	135	
DLRH0105-E27	1 x E27	177	150	

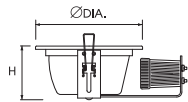

Cut out size (mm.)
 8" = 155

Product Model	Lamp Holder	Dimension (mm.)		Price(
		ØDia.	H	
DLRH0338-2E27	2 x E27	227	100	

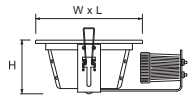
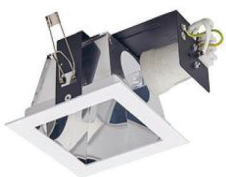

Cut out size (mm.)
 4" = 110 x 110

Product Model	Lamp Holder	Dimension (mm.)		Price(
		WxL	H	
DLSH0584-E27	1 x E27	227	100	

Downlight - Indoor Light

DOWNLIGHT MR16 SERIES

SPECIFICATION

แรงดันไฟฟ้าที่ใช้งาน (V)	AC220V
ความถี่ที่ใช้งาน (Hz)	50-60Hz
วัสดุ	หน้าโคมผลิตจากเหล็ก ขึ้นรูป ผ่านกรรมวิธีพ่นสีฝุ่น Powder Coating เพื่อได้งานที่สวยงามและทนทาน (White or Black)
รีเฟรคเตอร์	อลูมิเนียมชุบด้วยสียูเรทนาฟาก (ลายเพชร)
ขั้วโคมไฟ	ขั้ว GU5.3 หรือ GU10
ลักษณะการติดตั้ง	ภายใน ใช้สำหรับฝังฝ้า



Cut out size
DLR005 = Ø95



Cut out size
DLSR005 = 95 x 95



Cut out size
1 x GU5.3 = 70 x 70
2 x GU5.3 = 70 x 160

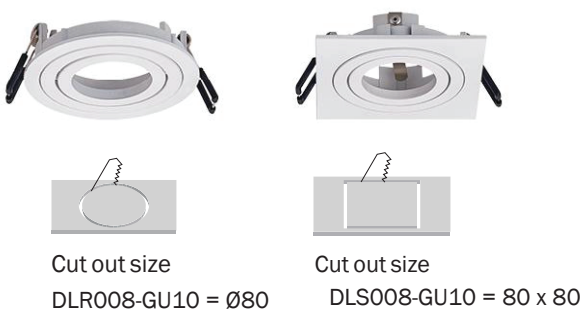

Cut out size
DLR008-GU10 = Ø80

Cut out size
DLS008-GU10 = 80 x 80

Product Model	Lamp Holder	Type	Dimension (mm.)	Price (฿)
DLR05-GU10/WH	1 x GU10	Round	Ø110 x H50	
DLR05-GU10/BK	1 x GU10	Round	Ø110 x H50	

Product Model	Lamp Holder	Type	Dimension (mm.)	Price (฿)
DLSR05-GU10/WH	1 x GU10	Square	W110 x L110 x H50	
DLSR05-GU10/BK	1 x GU10	Square	W110 x L110 x H50	

Product Model	Lamp Holder	Type	Dimension (mm.)	Price (฿)
DLS07-1GU5.3/(WH/BK)	1 x GU5.3	Square	W80 x L170 x H45	
DLS07-2GU5.3/(WH/BK)	2 x GU5.3	Square	W80 x L80 x H45	

Product Model	Lamp Holder	Type	Dimension (mm.)	Price (฿)
DLR08-GU10/WH	1 x GU10	Round	Ø86 x H24	
DLS08-GU10/WH	1 x GU10	Square	88 x 88 x H24	

DOWNLIGHT MR16 SERIES

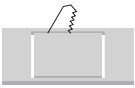

Cut out size
 DLS009 = 100 x 100
 DLS009-2 = 100 x 200

Product Model	Lamp Holder	Type	Dimension (mm.)	Price
DLS009-GU10/BK	1 x GU10	Square	97 x 97 x H140	
DLS009-2GU10/BK	2 x GU10	Square	97 x 198 x H140	

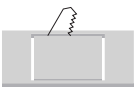

Cut out size
 DLS010 = 95 x 95
 DLS010-2 = 95 x 185

Product Model	Lamp Holder	Type	Dimension (mm.)	Price
DLS010-GU10/BK	1 x GU10	Square	90 x 90 x H100	
DLS010-2GU10/BK	2 x GU10	Square	90 x 190 x H100	

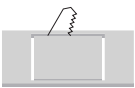

Cut out size
 DLS011 = 95 x 95
 DLS011-2 = 95 x 190

Product Model	Lamp Holder	Type	Dimension (mm.)	Price
DLS011-GU10/WH	1 x GU10	Square	107 x 107 x H46	
DLS011-2GU10/WH	2 x GU10	Square	107 x 205 x H46	

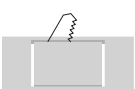

Cut out size
 DLS012 = 100 x 100
 DLS012-2 = 100 x 200
 DLS012-3 = 100 x 285

Product Model	Lamp Holder	Type	Dimension (mm.)	Price
DLS012-GU10/WH	1 x GU10	Square	118 x 118 x H128	
DLS012-2GU10/WH	2 x GU10	Square	118 x 220 x H128	
DLS012-3GU10/WH	3 x GU10	Square	118 x 305 x H128	

Downlight - Indoor Light

DOWNLIGHT AR111 SERIES



Product Model	Lamp Holder	Type	Dimension (mm.)	Price (฿)
DLS013-AR111/WH	1 x AR111	Square	186 x 186 x 37	
DLS013-2AR111/BK	2 x AR111	Square	186 x 335 x 37	
DLS013-3AR111/WH	3 x AR111	Square	186 x 486 x 37	
DLS013-4AR111/BK	4 x AR111	Square	335 x 335 x 37	



Cut out size
 DLS013 = 168 x 168
 DLS013-2 = 168 x 318
 DLS013-3 = 168 x 480
 DLS013-4 = 318 x 318



Product Model	Lamp Holder	Type	Dimension (mm.)	Price (฿)
DLS014-AR111/WH	1 x AR111	Square	195 x 200 x H130	
DLS014-2AR111/WH	2 x AR111	Square	195 x 350 x H130	
DLS014-3AR111/WH	3 x AR111	Square	195 x 495 x H130	

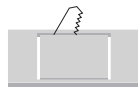

Cut out size
 DLS014 = 95 x 100
 DLS014-2 = 95 x 195
 DLS014-3 = 95 x 290



GX53-(9W/15W)



DLS015-GX53/WH



DLR015-GX53/WH



DLSR015-GX53/WH



DLR015-GX53/CH



DLR015-GX53/SN

Product Model	Lamp Holder	Type	Dimension (mm.)	Cut out (mm.)	Price (฿)
DLS015-GX53/WH	1 x GX53	Square	110 x 110 x H50	85 x 85	
DLR015-GX53/WH	1 x GX53	Round	Ø107 x H40	Ø85	
DLR015-GX53/CH	1 x GX53	Round	Ø107 x H40	Ø85	
DLR015-GX53/SN	1 x GX53	Round	Ø107 x H40	Ø85	
DLSR015-GX53/WH	1 x GX53	Round	Ø107 x H40	-	

DOWNLIGHT SERIES

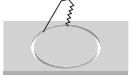

Cut out size
DLR015 = Ø70



Product Model	Lamp Holder	Type	Dimension (mm.)
DLR015-GU10/WH	1 x GU10	Round	Ø83 x H56
DLR015-GU10/BK	1 x GU10	Round	Ø83 x H56



Product Model	Lamp Holder	Type	Dimension (mm.)
DLSS016-GU5.3/WH	1 x GU5.3	Square	186 x 186 x 37
DLSS016-2GU5.3/WH	2 x GU5.3	Square	186 x 335 x 37
DLSS016-3GU5.3/WH	3 x GU5.3	Square	186 x 486 x 37
DLSS016-4GU5.3/BK	4 x GU5.3	Square	335 x 335 x 37



Product Model	Lamp Holder	Type	Dimension (mm.)
DLSS017-GU5.3/WH	1 x GU5.3	Square	100 x 100 x H100
DLSS017-2GU5.3/BK	2 x GU5.3	Square	100 x 200 x H100

Product Model	Lamp Holder	Type	Dimension (mm.)
DLSS018-GU10/WH	1 x GU10	Square	100 x 100 x H100
DLSS018-GU10/BK	1 x GU10	Round	100 x 200 x H100



Product Model	Lamp Holder	Type	Dimension (mm.)
DLSS019-35E27/BK	1 x E27	Square	116 x 116 x H162
DLSS019-40E27/BK	1 x E27	Square	135 x 135 x H192
DLSS019-50E27/BK	1 x E27	Square	168 x 168 x H221
DLSS019-60E27/BK	1 x E27	Square	184 x 184 x H236

Downlight - Indoor Light

DOWNLIGHT SERIES



Product Model	Lamp Holder	Type	Dimension (mm.)	Price (฿)
DLSR0204-E27/WH	1 x E27	Round	Ø140 x H160	
DLSR0204-E27/BK	1 x E27	Round	Ø140 x H160	
DLSR0206-E27/WH	1 x E27	Round	Ø170 x H190	
DLSR0206-E27/BK	1 x E27	Round	Ø170 x H190	



Product Model	Lamp Holder	Type	Dimension (mm.)	Price (฿)
DLSR0204G-E27/WH	1 x E27	Round	Ø140 x H160	
DLSR0204G-E27/BK	1 x E27	Round	Ø140 x H160	
DLSR0206G-E27/WH	1 x E27	Round	Ø170 x H190	
DLSR0206G-E27/BK	1 x E27	Round	Ø170 x H190	



Product Model	Lamp Holder	Type	Dimension (mm.)	Price (฿)
DLSR021-GU10/WH	1 x GU10	Round	Ø100 x H160	
DLSR021-2GU10/WH	2 x GU10	Round	Ø100 x L180 x H160	



Product Model	Lamp Holder	Type	Dimension (mm.)	Price (฿)
DLSR022-E27/WH	1 x E27	Square	W105 x L105 x H160	
DLSR022-2E27/WH	2 x E27	Square	W105 x L190 x H160	



Product Model	Lamp Holder	Type	Dimension (mm.)	Price (฿)
DLSR022-AR111/WH	1 x AR111	Square	W140 x L140 x H170	
DLSR022-2AR111/WH	2 x AR111	Square	W140 x L280 x H170	



Downlight - Indoor Light

DOWNLIGHT SERIES

DDL18421



DLL18420



DDL18421WH



BK



SV



DDL18421-1WH



SM



BK



GM



SV



DLL18420WH



SM



GM



SM



GM



BK



Downlight - Indoor Light

DOWNLIGHT SERIES

Downlight - Indoor Light



DDL18421-1



Model	Light source	Power	Voltage	Lamp holder	Size
DDL18420	MR16	50W	12V	GU5.3/GU10	90x45mm
DDL18421	MR16	50W	12V	GU5.3/GU10	95x50mm
DDL18421-1	MR16	50W	12V	GU5.3/GU10	95x50mm



DOWNLIGHT SERIES

Aluminum, With Movable Ring. Available In Various Colors. Suitable For Cob Light Source.

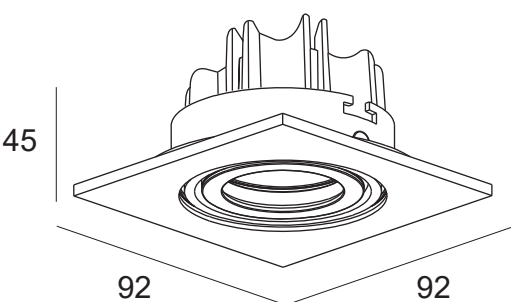

Model	Light source	Power	Voltage	Lamp holder	Size
DDL17431-2	MR16	50W	12V	GU5.3/GU10	172x92x45mm
DDL17431-3	MR16	50W	12V	GU5.3/GU10	260x92x45mm

Model	Light source	Power	Voltage	Color Temp	Luminous flux Lm	CRI	Size
DLL17431	COB	7W	100-240V	2700-6500K	70LM/W	≥80	92x92x45mm

Color: silve / white / black



Downlight - Indoor Light

DOWNLIGHT SERIES

DDL17432GW



DDL17432GG



DDL17432SW



DDL17432GB



DDL17432

DDL17433GW



DDL17433GG



DDL17433SW



DDL17433GB



DDL17433

DDL17434GM



DDL17434G



DDL17434S



DDL17434



+



=



DDL17434G

SWH

DDL17434G/SWH



+



=



DDL17434GM

RBK

DDL17434GM/RBK

Model	Light source	Power	Voltage	Lamp holder	Size
DDL17433G/RBK	MR16	Max 50W	12V/220V	GU5.3/GU10	92x25mm
DDL17433G/SWH	MR16	Max 50W	12V/220V	GU5.3/GU10	92x92x25mm

Color: white+white / gold / silver / black



DOWNLIGHT SERIES

Aluminum, with movable ring.
suitable for GU10, bulbs not included.



DDL17433GB/RWH



DDL17433GB/SWH

Downlight - Indoor Light



DOWNLIGHT SERIES

Aluminum. Available in various colors, suitable for LED bulbs with GU10 or MR16. with COB type, 2 years warranty.

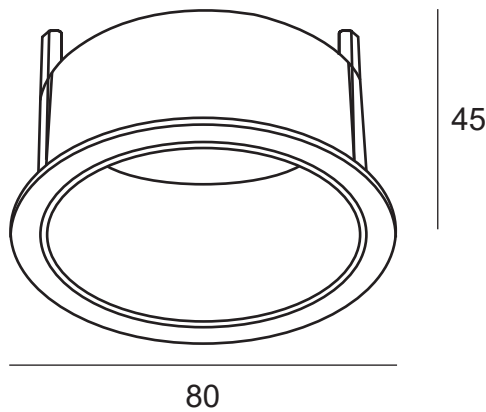
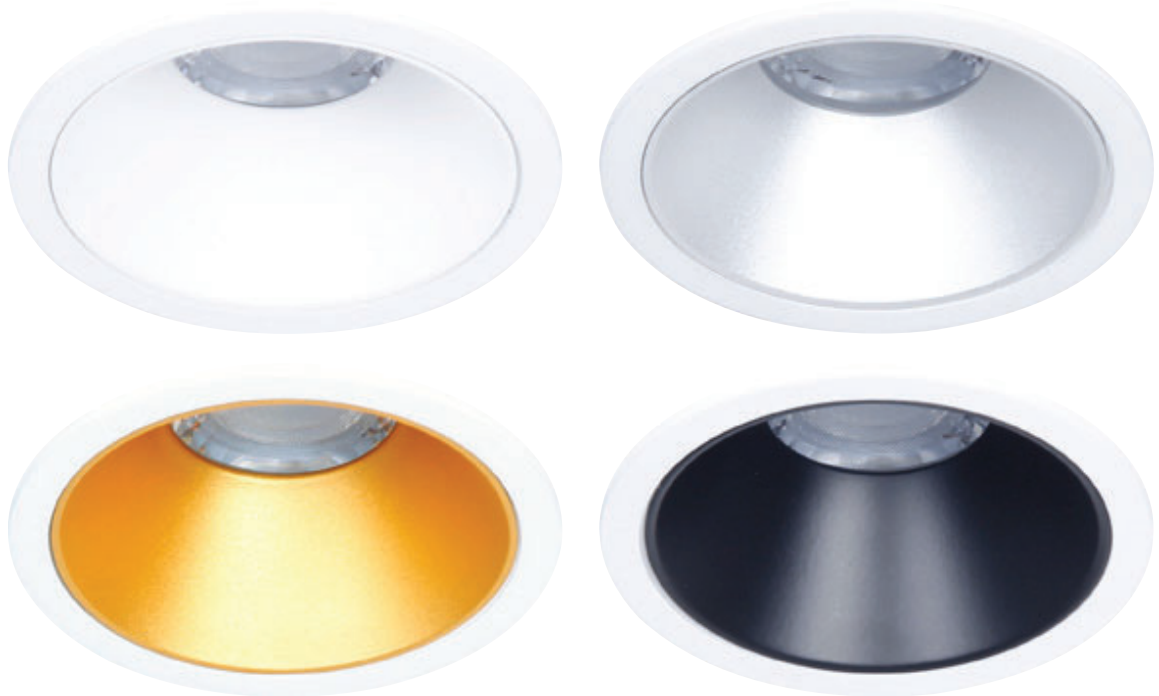

Model	Light source	Power	Voltage	Lamp holder	Size
DDL17530	MR16	50W	12V	GU5.3/GU10	80x45mm

Color: white+white / silver / gold / black



DOWNLIGHT SERIES

Aluminum. Available in various colors, suitable for LED bulbs with GU10 or MR16.



DDL17419DGY

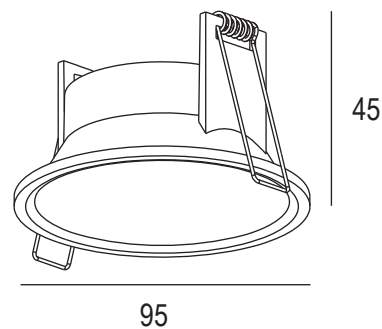

Downlight - Indoor Light



DDL17419SV

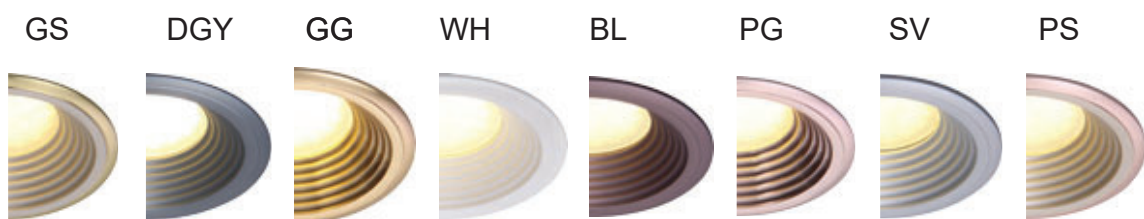
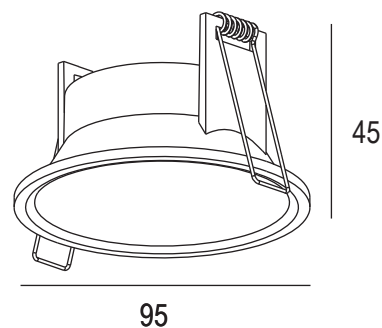

Model	Light source	Power	Voltage	Lamp holder	Size
DDL17419	MR16	50W	12V	GU5.3/GU10	95x45mm



DOWNLIGHT SERIES



DL110WH



DL110BK



DL110SWH



DL110SBK



DL160WH-1



DL160BK-2

Model	Light source	Power	Voltage	Lamp holder	Size
DL110	MR16	7W	220V	GU10	Φ96X30mm
DL110S	MR16	7W	220V	GU10	96X96X30mm
DL160-1	E14	4W	220V	E14	Φ96x125mm
DL160-2	E27	9W	220V	E27	Φ96x125mm



DOWNLIGHT SERIES



DL120WH



DL120BK



DL120SWH



DL120SBK



Downlight - Indoor Light

Model	Light source	Power	Voltage	Lamp holder	Size
DL120	MR16	7W	220V	GU10	Φ60x100mm
DL120S	MR16	7W	220V	GU10	60x60x150mm
DL130	MR16	7W	220V	GU10	Φ60x200mm
DL130S	MR16	7W	220V	GU10	60x60x250mm



DOWNLIGHT SERIES



DL140WH



DL140BK



DL150WH



DL150BK

Model	Light source	Power	Voltage	Lamp holder	Size
DL140	MR16	7W	220V	GU10	Φ96mm
DL150	MR16	7W	220V	GU10	Φ96x125mm



DOWNLIGHT SERIES



DL140SWH



DL140SBK



DL150SWH



DL150SBK

Downlight - Indoor Light

Model	Light source	Power	Voltage	Lamp holder	Size
DL140S	MR16	13W	230V	GU10	96x96x45mm
DL150S	MR16	13W	230V	GU10	96x96x125mm



DOWNLIGHT SERIES

Aluminum, With Movable Ring. Suitable For Gu10, Bulbs Not Included.

Downlight - Indoor Light



DLL17432BKB-25



DLL17432WHS-20



DLL17432BKG-15



DLL17432WHS-10



Model	Light source	Power	Voltage	Lamp holder	Size
DLL17432-10	MR16	7W	220V	GU10	Φ60x100mm
DLL17432-15	MR16	7W	220V	GU10	Φ60x150mm
DLL17432-20	MR16	7W	220V	GU10	Φ60x200mm
DLL17432-25	MR16	7W	220V	GU10	Φ60x250mm



DOWNLIGHT SERIES



SDL17432WW-S



SDL17432GG-M



SDL17432GG



SDL17432BB



SDL17432SW



SDL17432WW



SDL17434GG



SDL17434BB



SDL17434SW



SDL17434WW



SDL17433GG



SDL17433BB



SDL17433SW



SDL17433WW

Downlight - Indoor Light

Model	Light source	Power	Voltage	Lamp holder	Size
SDL17433-S	MR16	7W	220V	GU10	Φ80mm
SDL17433-M	MR16	7W	220V	GU10	Φ80mm



LED DOWNLIGHT AS SERIES



Product Model	Power (W)	Lumen (lm)	Dimension (mm.)		Price (฿)
			ØDia.	H	
DLAS-5(65/30)	5	350	88	33	
DLAS-7(65/30)	7	490	110	38	
DLAS-15(65/30)	15	1,050	136	55	

LED DOWNLIGHT AT SERIES

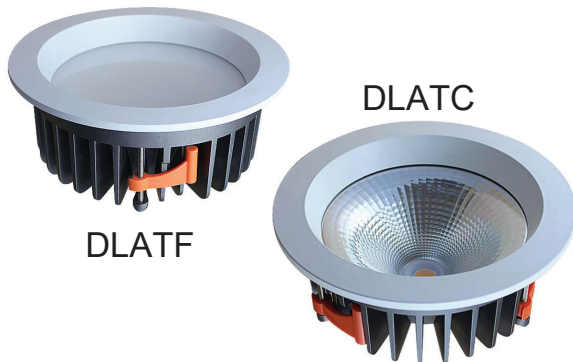

Product Model	Power (W)	Lumen (lm)	Dimension (mm.)		Price (฿)
			ØDia.	H	
DLATF-20(65/30)	20	1,600	190	86	
DLATF-30(65/30)	30	2,400	190	86	
DLATC-20(65/30)	20	1,600	190	86	
DLATC-30(65/30)	30	2,400	190	86	

LED DOWNLIGHT AU SERIES



Product Model	Power (W)	Lumen (lm)	Dimension (mm.)		Price (฿)
			ØDia.	H	
DLAUR-12(65/30)	12	960	90	117	
DLAUS-12(65/30)	12	960	90	117	
DLAUS-212(65/30)	2 x 12	1,920	160	208	

LED DOWNLIGHT AV DIM SERIES



Product Model	Power (W)	Lumen (lm)	Dimension (mm.)		Price (฿)
			ØDia.	H	
DLAV3-3DIM	3	240	70	55	
DLAV3.5-7DIM	7	560	90	65	
DLAV4-10DIM	10	800	110	80	
DLAV5-20DIM	20	1,600	138	100	
DLAV6-30DIM	30	2,400	160	120	



LED DOWNLIGHT SLIM A ROUND 3 STEP COLOR SERIES

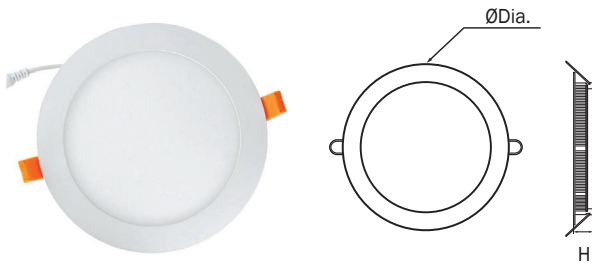

Product Model	Power (W)	Lumen (lm)	Dimension (mm.)		Price (฿)
			ØDia.	H	
DLRA3-63CCT	6	540	120	23	
DLRA4-93CCT	9	810	145	23	
DLRA5-123CCT	12	1,080	170	23	
DLRA7-183CCT	18	1,620	225	23	
DLRA9-243CCT	24	2,160	300	23	

LED DOWNLIGHT SLIM A SQUARE 3 STEP COLOR SERIES

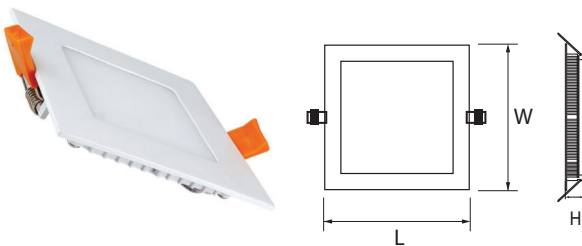

Product Model	Power (W)	Lumen (lm)	Dimension (mm.)			Price (฿)
			W	L	H	
DLSA3-63CCT	6	540	120	120	23	
DLSA4-93CCT	9	810	145	145	23	
DLSA5-123CCT	12	1,080	170	170	23	
DLSA7-183CCT	18	1,620	225	225	23	
DLSA9-243CCT	24	2,160	300	300	23	



LED DOWNLIGHT SLIM B2 ROUND DIM SERIES



Product Model	Power (W)	Lumen (lm)	Dimension (mm.)		Price (฿)
			ØDia.	H	
DLRB24-6DIM	6	300	95	31	
DLRB26-12DIM	12	720	150	32	
DLRB28-18DIM	18	1,440	200	32	

Downlight - Indoor Light

LED DOWNLIGHT SLIM B2 SQUARE DIM SERIES



Product Model	Power (W)	Lumen (lm)	Dimension (mm.)			Price (฿)
			W	L	H	
DLSB4-6(65/30)	6	300	95	95	30	
DLSB6-12(65/30)	12	720	150	150	30	
DLSB8-18(65/30)	18	1,440	200	200	30	

LED DOWNLIGHT MICRO SURFACE 3CCT SERIES



Product Model	Power (W)	Lumen (lm)	Dimension (mm.)		Price (฿)
			ØDia.	H	
DLMR8-183CCT	18	1,440	220	18	
DLMR13-243CCT	24	1,920	330	18	

OPTIONAL



Ordinary



Color Temp adjustable



Microwave sensor



Microwave sensor + Color Temp adjustable

LED DOWNLIGHT TEC SERIES



Product Model	Power (W)	Lumen (lm)	Dimension (mm.)		Price (฿)
			ØDia.	H	
DLTECR-6(65/30)	6	540	116	36	
DLTECR-9(65/30)	9	810	116	36	
DLTECR-12(65/30)	12	1,200	166	36	
DLTECR-15(65/30)	15	1,500	166	36	
DLTECR-18(65/30)	18	1,800	220	36	
DLTECR-22(65/30)	22	2,200	220	36	



SPECIFICATION

Input Voltage (V)	AC185-250V
Power Frequency (Hz)	50-60Hz
Material	Aluminium + PC
Luminaire Efficiency (lm/W)	80-110 lm/W
CRI	80
Ambient Temp.(°C)	-20°C ~ +45°C
Beam Angle	20° - 120°
Power Factor	0.5 - 0.9
Colors Temp. (K)	3,000K or 6,500K
Life time (Hrs.)	30,000 Hrs

TRACKLIGHT AA SERIES



Product Model	Power (W)	Lumen (lm)	Dimension (mm.)		Price (฿)
			ØDia.	H	
TLAA-20(65/30)/WH	20	1,600	70	110	
TLAA-30(65/30)/WH	30	2,400	90	130	

TRACKLIGHT AB SERIES



Product Model	Power (W)	Lumen (lm)	Dimension (mm.)		Price (฿)
			ØDia.	H	
TLAB-18(65/30)/WH	18	1,440	75	95	
TLAB-30(65/30)/WH	30	2,400	95	128	

TRACKLIGHT AC SERIES



Product Model	Power (W)	Lumen (lm)	Dimension (mm.)		Price (฿)
			ØDia.	H	
TLAC-30(65/30)/WH	30	2,400	90	145	
TLAC-50(65/30)/WH	50	4,000	105	146	

TRACKLIGHT AD SERIES



Product Model	Power (W)	Lumen (lm)	Dimension (mm.)		Price (฿)
			ØDia.	H	
TLAD-12(65/30)/WH	12	960	65	110	
TLAD-18(65/30)/WH	18	1,440	75	130	
TLAD-30(65/30)/WH	30	2,400	95	140	

TRACKLIGHT AE SERIES



Product Model	Power (W)	Lumen (lm)	Dimension (mm.)		Price (฿)
			ØDia.	H	
TLAE-12(65/30)/WH	12	960	56	97	
TLAE-18(65/30)/WH	18	1,440	73	130	
TLAE-30(65/30)/WH	30	2,400	90	140	

TRACKLIGHT AF SERIES



Product Model	Power (W)	Lumen (lm)	Dimension (mm.)		Price (฿)
			ØDia.	H	
TLAF-25(65/30)/WH	25	2,250	90	183	
TLAF-25(65/30)/BK	25	2,250	90	183	

TRACKLIGHT AG SERIES



Product Model	Power (W)	Lumen (lm)	Dimension (mm.)		Price (฿)
			ØDia.	H	
TLAG-12(65/30)/WH	12	960	65	110	
TLAG-12(65/30)/BK	12	960	65	110	

TRACKLIGHT AH SERIES



Product Model	Power (W)	Lumen (lm)	Dimension (mm.)		Price (฿)
			ØDia.	H	
TLAH-12(65/30)/WH	12	960	65	140	
TLAH-12(65/30)/BK	12	960	65	140	



TRACKLIGHT AI SERIES



Product Model	Power (W)	Lumen (lm)	Dimension (mm.)		Price (฿)
			ØDia.	H	
TLAI-3(65/30)/WH	3	240	25	300	
TLAI-5(65/30)/WH	5	400	30	300	



TRACKLIGHT AJ SERIES



Product Model	Power (W)	Lumen (lm)	Dimension (mm.)		Price (฿)
			ØDia.	H	
TLAJ-220(65/30)/BK	2 x 20	3,200	73	124	
TLAJ-230(65/30)/BK	2 x 30	4,800	94	148	
TLAJ-240(65/30)/BK	2 x 40	6,400	94	148	



TRACKLIGHT AK SERIES



Product Model	Power (W)	Lumen (lm)	Dimension (mm.)		Price (฿)
			ØDia.	H	
TLAK-30(65/30)/WH	30	2,400	75	110	
TLAK-30(65/30)/BK	30	2,400	75	110	



TRACKLIGHT AL SERIES



Product Model	Lamp Holder	Body Color	Dimension (mm.)		Price (฿)
			ØDia.	H	
TLAL-GU10/WH	GU10	White	60	110	
TLAL-GU10/BK	GU10	Black	60	110	



TRACKLIGHT AM SERIES



Product Model	Lamp Holder	Body Color	Dimension (mm.)		Price (฿)
			ØDia.	H	
TLAM-PAR30/WH	E27	White	114	180	
TLAM-PAR30/BK	E27	Black	114	180	



TRACKLIGHT AO SERIES



Product Model	Lamp Holder	Body Color	Dimension (mm.)		Price (฿)
			ØDia.	H	
TLAO-PAR30/WH	E27	White	120	160	
TLAO-PAR30/BK	E27	Black	120	160	



TRACKLIGHT AP SERIES



Product Model	Lamp Holder	Body Color	Dimension (mm.)		Price (฿)
			ØDia.	H	
TLAP-PAR30/WH	E27	White	100	250	
TLAP-PAR30/BK	E27	Black	100	250	



Spotlight - Indoor Light

SPOTLIGHT AI SERIES



Product Model	Power (W)	Lumen (lm)	Dimension (mm.)		Price (฿)
			ØDia.	H	
SPAI-3(65/30)/WH	3	240	25	300	
SPAI-5(65/30)/WH	5	400	30	300	



SPOTLIGHT AQ SERIES



Product Model	Power (W)	Lumen (lm)	Dimension (mm.)		Price (฿)
			ØDia.	H	
SPAQ-15(65/30)/WH	15	1,050	68	200	
SPAQ-15(65/30)/BK	15	1,050	68	200	



SPOTLIGHT AR SERIES



Product Model	Power (W)	Lumen (lm)	Dimension (mm.)		Price (฿)
			ØDia.	H	
SPAR-5(65/30)/WH	5	350	47	92	
SPAR-5(65/30)/BK	5	350	47	92	
SPAR-5(65/30)/SV	5	350	47	92	



SPOTLIGHT AS SERIES



Product Model	Power (W)	Lumen (lm)	Dimension (mm.)		Price (฿)
			ØDia.	H	
SPAS-12(65/30)/WH	12	840	47	164	
SPAS-12(65/30)/BK	12	840	47	164	



Tracklight - Indoor Light

SPOTLIGHT DDL SERIES

DDL32GW



DDL32GG



DDL32SW



DDL32GB



DDL33GW



DDL33GG



DDL33SW



DDL33GB



DDL34GM



DDL34G



DDL34S



DDL34W



Product Model	Lamp Holder	Body Color	Dimension (mm.)		Price (฿)
			ØDia.	H	
SPDDL33WW-GU10/WH	GU10	White	60	100	
SPDDL33WW-GU10/BK	GU10	Black	60	100	



SPOTLIGHT AT SERIES



Product Model	Power (W)	Lumen (lm)	Dimension (mm.)		Price (฿)
			ØDia.	H	
SPAT-12(65/30)/WH	12	840	100	27	
SPAT-15(65/30)/WH	15	1,050	100	30	
SPAT-20(65/30)/WH	20	1,400	120	37	



SPOTLIGHT AU SERIES



Product Model	Lamp Holder	Body Color	Dimension (mm.)		Price (฿)
			ØDia.	H	
SPAU-AR111/WH	G53	White	120	190	
SPAU-AR111/BK	G53	Black	120	190	



SPOTLIGHT AU SERIES



Product Model	Lamp Holder	Body Color	Dimension (mm.)		Price (฿)
			ØDia.	H	
SPAU-2AR111/WH	G53	White	300	190	
SPAU-3AR111/WH	G53	White	450	190	



SPOTLIGHT AV SERIES



Product Model	Lamp Holder	Body Color	Dimension (mm.)		Price (฿)
			ØDia.	H	
SPAV-GU10/WH	GU10	White	300	190	
SPAV-GU10/BK	GU10	Black	450	190	



Spotlight - Indoor Light





DESCRIPTION

โคมไฟเพดาน เหมาะสำหรับติดตั้งเพดาน ให้แสงสม่ำเสมอ เพื่อความสว่างและความสวยงาม

SPECIFICATION

แรงดันไฟฟ้าที่ใช้งาน (V) 220 Vac
 ความถี่ที่ใช้งาน (Hz) 50-60Hz
 วัสดุ ตัวถังโคมผลิตจากเหล็กขึ้นรูป ผ่านกรรมวิธีพ่น Powder Coating เพื่อได้งานที่สวยงามและทนทาน หน้าปัดจากอะคริลิก ขึ้นรูปภายใน ใช้สำหรับติดตั้ง

CEILING LIGHT AA SERIES



Product Model	Power (W)	Lumen (lm)	Dimension (mm.)		Price (฿)
			ØDia.	H	
CLAA-12(65/30)	12	960	280	60	
CLAA-18(65/30)	18	1,440	350	60	
CLAA-24(65/30)	24	1,920	400	60	
CLAA-36(65/30)	36	2,880	500	70	



Ceiling light - Indoor Light

CEILING LIGHT ABR SERIES



Product Model	Power (W)	Lumen (lm)	Dimension (mm.)		Price (฿)
			ØDia.	H	
CLABR-15(65/30)	15	1,350	220	50	
CLABR-18(65/30)	18	1,530	280	50	
CLABR-24(65/30)	24	2,000	330	50	



CEILING LIGHT ABS SERIES



Product Model	Power (W)	Lumen (lm)	Dimension (mm.)			Price (฿)
			W	L	H	
CLABS-15(65/30)	15	1,350	220	220	50	
CLABS-18(65/30)	18	1,530	280	280	50	
CLABS-24(65/30)	24	2,000	330	330	50	



CEILING LIGHT THIN SERIES

ALLSTAR



IP20
WATER PROOF

Ra ≥ 80



CE2059

Ceiling light - Indoor Light

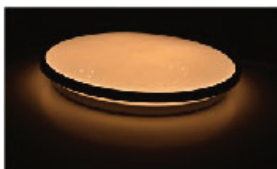

warm white

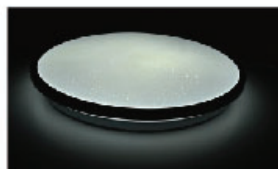

cool white



nature white

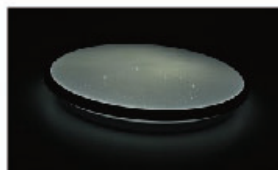

nightlight

Size

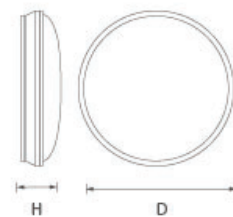

Product Model	Power (W)	CCT (K)	Lumen (lm)	Material	Dimension (mm.)		Price (฿)
					ØDia.	H	
CLTH-243CC	24	6500K , 3000K	1,320 lm	PMMA + Steel	390	60	
CLTH-363CC	36	6500K , 3000K	2,000 lm	PMMA + Stee	490	70	

T-BAR & GYPSUM REFLECTOR CUP T8 SERIES

SPECIFICATION

Housing

Steel sheet thickness of 0.4 - 0.8 mm. And all metal parts are rust - proofed after fabrication to prevent any corrosion (Zinc phosphate) and finished with high-grade epoxy polyester power coating.

Reflector & Louver

99.90% purity anodized aluminium reflector to provide total reflectors machined to TR 87 - 95% mirror - finish, parabolic reflectors machined to provide optimum optical performance for maximum high-output-ratio.

Lamp holder

Rotary lock (G13)

Installation & Application

Suitable for both T-Bar and Plaster ceiling. Ideas for indoor and Office buildings, Stores, Shopping malls, Hospitals, etc.

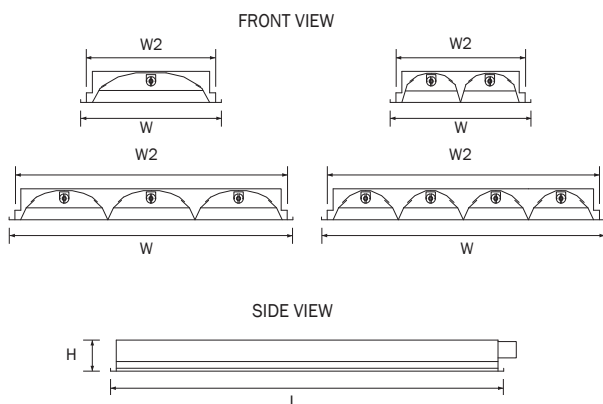
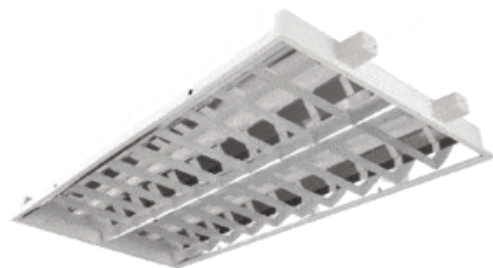

Product Model	Lamp	Dimension (mm.)				Price (฿)
		W	W2	L	H	
TLC1182/T6/87	1x18W	200	180	600	110	
TLC1183/T6/87	1x18W	300	280	600	95	
TLC2183/T6/87	2x18W	300	280	600	95	
TLC2186/T6/87	2x18W	600	580	600	95	
TLC3186/T6/87	3x18W	600	580	600	95	
TLC4186/T6/87	4x18W	600	580	600	95	
TLC1362/T6/87	1x36W	200	180	1200	110	
TLC1363/T6/87	1x36W	300	280	1200	95	
TLC2363/T6/87	2x36W	300	280	1200	95	
TLC2366/T6/87	2x36W	600	580	1200	95	
TLC3366/T6/87	3x36W	600	580	1200	95	
TLC4366/T6/87	4x36W	600	580	1200	95	

ORDERING DATA : TL1182/.../...

- Total of Reflectance (87 = TR87% , 95 = TR95%)
- Standard Thickness Available (T4=0.4mm., T6 = 0.6mm., T8 = 0.8mm.)

Fixture light - Indoor Light

T-BAR & GYPSUM REFLECTOR T8 SERIES

SPECIFICATION

Housing

Steel sheet thickness of 0.4 - 0.8 mm. And all metal parts are rust - proofed after fabrication to prevent any corrosion (Zinc phosphate) and finished with high-grade epoxy polyester power coating.

Reflector & Louver

99.90% purity anodized aluminium reflector to provide total reflectors machined to TR 87 - 95% mirror - finish, parabolic reflectors machined to provide optimum optical performance for maximum high-output-ratio.

Lamp holder

Rotary lock (G13)

Installation & Application

Suitable for both T-Bar and Plaster ceiling. Ideas for indoor and Office buildings, Stores, Shopping malls, Hospitals, etc.

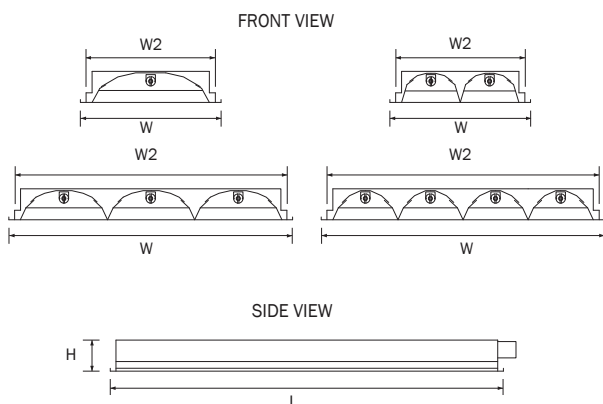

Product Model	Lamp	Dimension (mm.)				Price (฿)
		W	W2	L	H	
TL1182/T6/87	1x18W	200	180	600	110	
TL1183/T6/87	1x18W	300	280	600	95	
TL2183/T6/87	2x18W	300	280	600	95	
TL2186/T6/87	2x18W	600	580	600	95	
TL3186/T6/87	3x18W	600	580	600	95	
TL4186/T6/87	4x18W	600	580	600	95	
TL1362/T6/87	1x36W	200	180	1200	110	
TL1363/T6/87	1x36W	300	280	1200	95	
TL2363/T6/87	2x36W	300	280	1200	95	
TL2366/T6/87	2x36W	600	580	1200	95	
TL3366/T6/87	3x36W	600	580	1200	95	
TL4366/T6/87	4x36W	600	580	1200	95	

ORDERING DATA : TL1182/.../....

- └ Total of Reflectance (87 = TR87% , 95 = TR95%)
- └ Standard Thickness Available (T4=0.4mm., T6 = 0.6mm., T8 = 0.8mm.)

SURFACE MOUNTED REFLECTOR T8 SERIES

SPECIFICATION

Housing

Steel sheet thickness of 0.4 - 0.8 mm. And all metal parts are rust - proofed after fabrication to prevent any corrosion (Zinc phosphate) and finished with high-grade epoxy polyester power coating.

Reflector & Louver

99.90% purity anodized aluminium reflector to provide total reflectors machined to TR 87 - 95% mirror - finish, parabolic reflectors machined to provide optimum optical performance for maximum high-output-ratio.

Lamp holder

Rotary lock (G13)

Installation & Application

Suitable for surface mounted. Ideas for indoor and Office buildings, Stores, Shopping malls, Hospitals, School etc.



FRONT VIEW

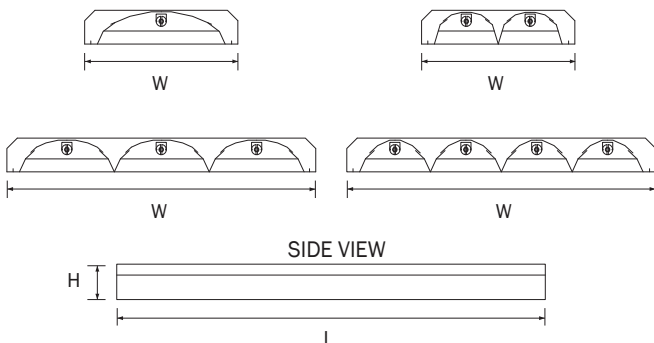

Product Model	Lamp	Dimension (mm.)			Price (฿)
		W	L	H	
SL1182/T6/87	1x18W	200	630	100	
SL1183/T6/87	1x18W	320	630	100	
SL2183/T6/87	2x18W	320	630	100	
SL2186/T6/87	2x18W	620	630	100	
SL3186/T6/87	3x18W	620	630	100	
SL4186/T6/87	4x18W	620	630	100	
SL1362/T6/87	1x36W	200	1225	100	
SL1363/T6/87	1x36W	320	1225	100	
SL2363/T6/87	2x36W	320	1225	100	
SL2366/T6/87	2x36W	620	1225	100	
SL3366/T6/87	3x36W	620	1225	100	
SL4366/T6/87	4x36W	620	1225	100	

ORDERING DATA : SL1182/.../...

- └ Total of Reflectance (87 = TR87% , 95 = TR95%)
- └ Standard Thickness Available (T4=0.4mm., T6 = 0.6mm., T8 = 0.8mm.)

Fixture light - Indoor Light

T-BAR & GYPSUM ACRYLIC DIFFUSER T8 SERIES

SPECIFICATION

Housing

Steel sheet thickness of 0.4 - 0.8 mm. And all metal parts are rust - proofed after fabrication to prevent any corrosion (Zinc phosphate) and finished with high-grade epoxy polyester power coating.

Reflector & Diffuser

99.90% purity anodized aluminium reflector to provide total reflectors machined to TR 87 - 95% mirror - finish, parabolic reflectors machined to provide optimum optical performance for maximum high-output-ratio.

Acrylic diffuser with a choice of Prismatic (P) , Opal (M) , Clear (C) and Strpple (S)

Lamp holder

Rotary lock (G13)

Installation & Application

Suitable for both T-Bar and Plaster ceiling. Ideas for indoor and Office buildings, Stores, Shopping malls, Hospitals, etc.



FRONT VIEW

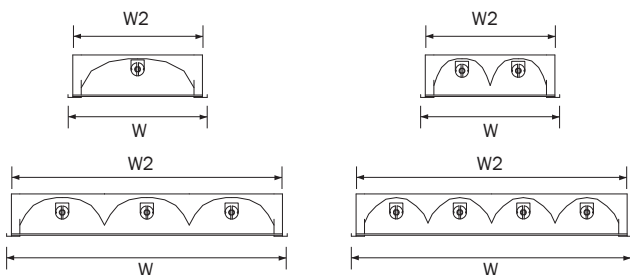

SIDE VIEW

Product Model	Lamp	Dimension (mm.)				Price (฿)
		W	W2	L	H	
TA1182/T6/87	1x18W	200	180	600	110	
TA1183/T6/87	1x18W	300	280	600	95	
TA2183/T6/87	2x18W	300	280	600	95	
TA2186/T6/87	2x18W	600	580	600	95	
TA3186/T6/87	3x18W	600	580	600	95	
TA4186/T6/87	4x18W	600	580	600	95	
TA1362/T6/87	1x36W	200	180	1200	110	
TA1363/T6/87	1x36W	300	280	1200	95	
TL2363/T6/87	2x36W	300	280	1200	95	
TA2366/T6/87	2x36W	600	580	1200	95	
TA3366/T6/87	3x36W	600	580	1200	95	
TA4366/T6/87	4x36W	600	580	1200	95	

ORDERING DATA : TA1182/.../.../...

- Total of Reflectance (87 = TR87%, 95 = TR95%)
- Acrylic diffuser (Prismatic (P), Opal (M) , Clear (C) and Strpple (S))
- Standard Thickness Available (T4 = 0.4mm., T6 = 0.6mm., T8 = 0.8mm.)

SURFACE MOUNTED ACRYLIC DIFFUSER T8 SERIES

SPECIFICATION

Housing

Steel sheet thickness of 0.6 - 0.8 mm. And all metal parts are rust - proofed after fabrication to prevent any corrosion (Zine phosphate) and finished with high-grade epoxy polyester power coating.

Reflector & Diffuser

99.90% purity anodized aluminium reflector to provide total reflectors machined to TR 87 - 95% mirror - finish, parabolic reflectors machined to provide optimum optical performance for maximum high-output-ratio.

Acrylic diffuser with a choice of Prismatic (P) , Opal (M) , Clear (C) and Strpple (S)

Lamp holder

Rotary lock (G13)

Installation & Application

Suitable for both T-Bar and Plaster ceiling. Ideas for indoor and Office buildings, Stores, Shopping malls, Hospitals, etc.

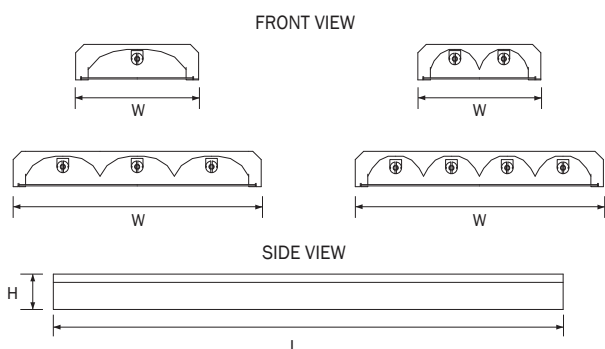

Product Model	Lamp	Dimension (mm.)			Price (฿)
		W	L	H	
SA1182/T6/87	1x18W	200	630	100	
SA1183/T6/87	1x18W	320	630	100	
SA2183/T6/87	2x18W	320	630	100	
SA2186/T6/87	2x18W	620	630	100	
SA3186/T6/87	3x18W	620	630	100	
SA4186/T6/87	4x18W	620	630	100	
SA1362/T6/87	1x36W	200	1225	100	
SA1363/T6/87	1x36W	320	1225	100	
SA2363/T6/87	2x36W	320	1225	100	
SA2366/T6/87	2x36W	620	1225	100	
SA3366/T6/87	3x36W	620	1225	100	
SA4366/T6/87	4x36W	620	1225	100	

ORDERING DATA : SA1182/.../.../....

- Total of Reflectance (87 = TR87%, 95 = TR95%)
- Acrylic diffuser (Prismatic (P), Opal (M) , Clear (C) and Strpple (S))
- Standard Thickness Available (T4 = 0.4mm., T6 = 0.6mm., T8 = 0.8mm.)

CLEAN ROOM ACRYLIC DIFFUSER T8 SERIES

SPECIFICATION

Housing

Steel sheet thickness of 0.6 - 0.8 mm. And all metal parts are rust - proofed after fabrication to prevent any corrosion (Zine phosphate) and finished with high-grade epoxy polyester power coating. IP rating : IP44

Reflector & Diffuser

99.90% purity anodized aluminium reflector to provide total reflectors machined to TR 87 - 95% mirror - finish, parabolic reflectors machined to provide optimum optical performance for maximum high-output-ratio.

Acrylic diffuser with a choice of Prismatic (P) , Opal (M) , Clear (C) and Strpple (S)

Lamp holder

Rotary lock (G13)

Installation & Application

Suitable for Plaster ceiling. Providing high luminance area with lowest of glare. Ideas for Hospitals, Pharmaceutic industrial, Laboratory etc.



FRONT VIEW

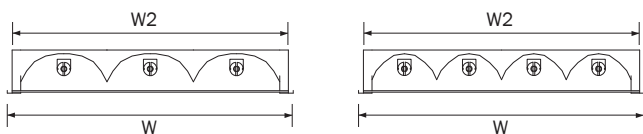
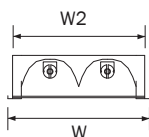

SIDE VIEW

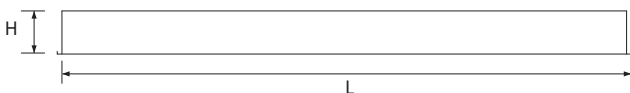

Product Model	Lamp	Dimension (mm.)				Price (฿)
		W	W2	L	H	
CR2183/T6/P/87	2x18W	320	280	665	100	
CR2186/T6/P/87	2x18W	620	580	665	100	
CR3186/T6/P/87	3x18W	620	580	665	100	
CR4186/T6/P/87	4x18W	620	580	665	100	
CR2363/T6/P/87	2x36W	320	280	1265	100	
CR2366/T6/P/87	2x36W	620	580	1265	100	
CR3366/T6/P/87	3x36W	620	580	1265	100	
CR4366/T6/P/87	4x36W	620	580	1265	100	

ORDERING DATA : CR1182/.../.../...

- Total of Reflectance (87 = TR87%, 95 = TR95%)
- Acrylic diffuser (Prismatic (P), Opal (M) , Clear (C) and Strpple (S))
- Standard Thickness Available (T6 = 0.6mm., T8 = 0.8mm.)

Fixture light - Indoor Light

BATTEN TYPE T8 SERIES

SPECIFICATION

Housing

Steel sheet thickness of 0.4 - 0.8 mm. And all metal parts are rust - proofed after fabrication to prevent any corrosion (Zinc phosphate) and finished with high-grade epoxy polyester power coating.



Lamp holder

Rotary lock (G13)

Installation & Application

Suitable for both T-Bar and Plaster ceiling. Ideas for indoor and Office buildings, Stores, Shopping malls, Hospitals, etc.

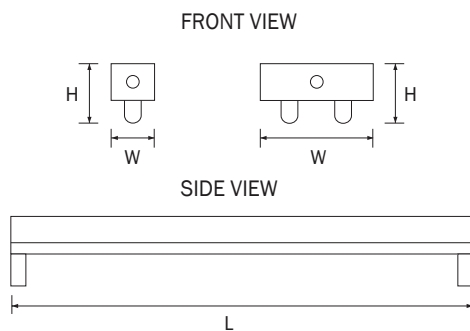

Product Model	Lamp	Dimension (mm.)			Price (฿)
		W	L	H	
BT118/T6	1x18W	52	613	80	
BT218/T6	2x18W	150	613	75	
BT136/T6	1x36W	52	1223	80	
BT236/T6	2x36W	150	1223	75	

ORDERING DATA : TB118/....

Standard Thickness Available
(T4 = 0.4mm., T6 = 0.6mm.,
T8 = 0.8mm.)

BATTEN TYPE T8 SERIES

SPECIFICATION

Housing

Steel sheet thickness of 0.4 mm. And all metal parts are rust - proofed after fabrication to prevent any corrosion (Zinc phosphate) and finished with high - grade epoxy polyester power coating.

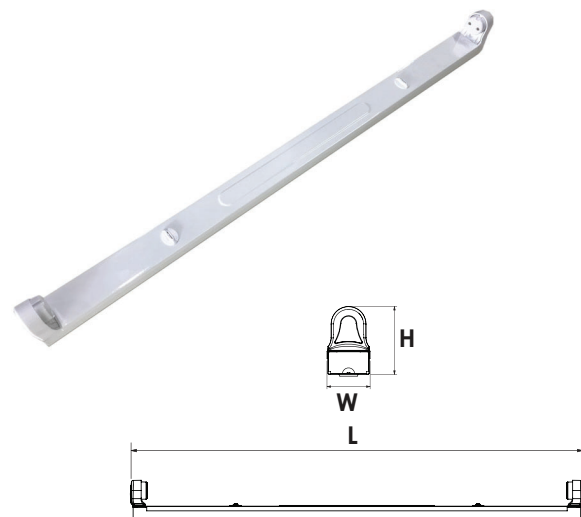

Lamp holder

Rotary lock (G13)

Installation & Application

Suitable for both T-Bar and Plaster ceiling. Ideas for indoor and Office buildings, Stores, Shopping malls, Hospitals, etc.

Product Model	Lamp	Dimension (mm.)			Price (฿)
		W	L	H	
BT109-LED	1x9W	35	630	50	
BT118-LED	1x18W	35	1230	50	

Fixture light - Indoor Light

SPECIFICATION

Housing

Steel sheet thickness of 0.4 - 0.8 mm. And all metal parts are rust - proofed after fabrication to prevent any corrosion (Zine phosphate) and finished with high-grade epoxy polyester power coating.

Lamp holder

Rotary lock (G13)

Installation & Application

Suitable for both T-Bar and Plaster ceiling. Ideas for indoor and Office buildings, Stores, Shopping malls, Hospitals, etc.

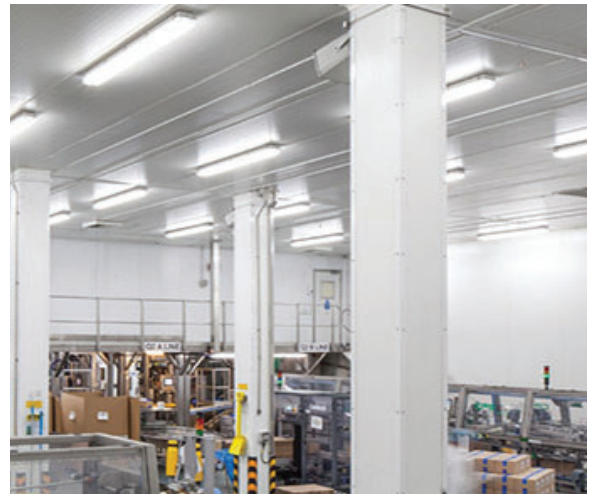

BATTEN TYPE Y SHAPE T8 SERIES

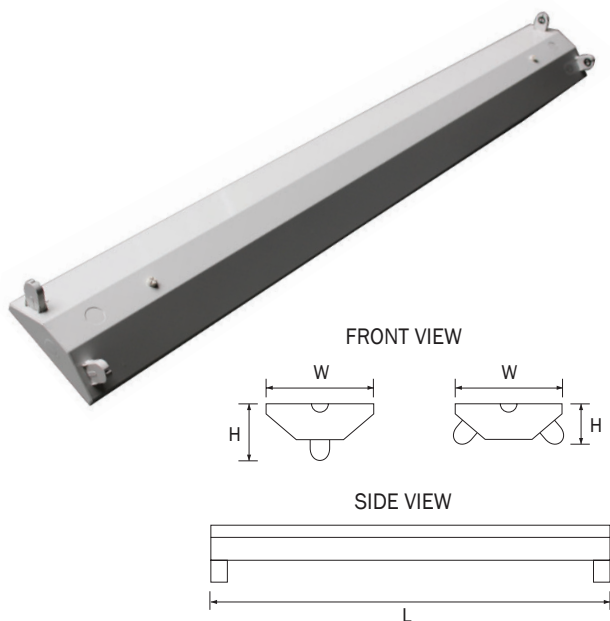

Product Model	Lamp	Dimension (mm.)			Price (฿)
		W	L	H	
BTY118/T6	1x18W	162	620	97	
BTY218/T6	2x18W	162	620	71	
BTY136/T6	1x36W	162	1230	97	
BTY236/T6	2x36W	162	1230	71	

ORDERING DATA : BTY118/....

Standard Thickness Available
(T4 = 0.4mm., T6 = 0.6mm.,
T8 = 0.8mm.)

BATTEN TYPE V SHAPE T8 SERIES

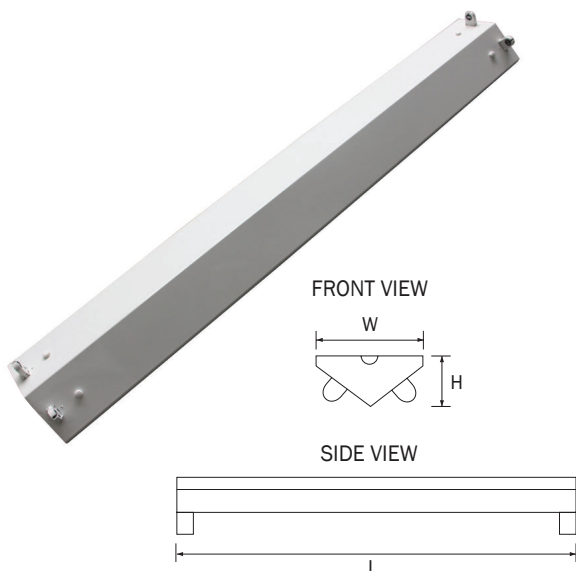

Product Model	Lamp	Dimension (mm.)			Price (฿)
		W	L	H	
BTV218/T6	2x18W	220	620	80	
BTV236/T6	2x36W	220	1230	80	

ORDERING DATA : BTY118/....

Standard Thickness Available
(T4 = 0.4mm., T6 = 0.6mm.,
T8 = 0.8mm.)

INDUSTRIAL BATTEN TYPE T8 SERIES

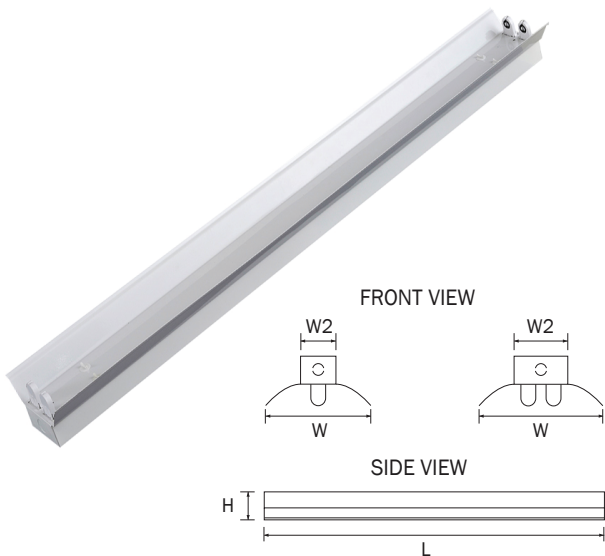

Product Model	Lamp	Dimension (mm.)				Price (฿)
		W	W2	L	H	
IT118/T6/W	1x18W	140	53	613	95	
IT218/T6/W	2x18W	210	115	613	95	
IT136/T6/W	1x36W	140	53	1223	95	
IT236/T6/W	2x36W	210	115	1223	95	

ORDERING DATA : IT118/.../....

- └ Total of Reflectance (87 = TR87% , 95 = TR95% W = White powder coating)
- └ Standard Thickness Available (T4=0.4mm.,T6 = 0.6mm., T8 = 0.8mm.)

ASYMMETRIC BATTEN TYPE T8 SERIES



Product Model	Lamp	Dimension (mm.)			Price (฿)
		W	L	H	
RT118/T6/W	1x18W	80	613	110	
RT136/T6/W	1x36W	80	1223	110	

ORDERING DATA : RT118/.../....

- └ Total of Reflectance (87 = TR87% , 95 = TR95% W = White powder coating)
- └ Standard Thickness Available (T4=0.4mm.,T6 = 0.6mm., T8 = 0.8mm.)

BATTEN TYPE U SHAPE ACRYLIC DIFFUSER T8 SERIES

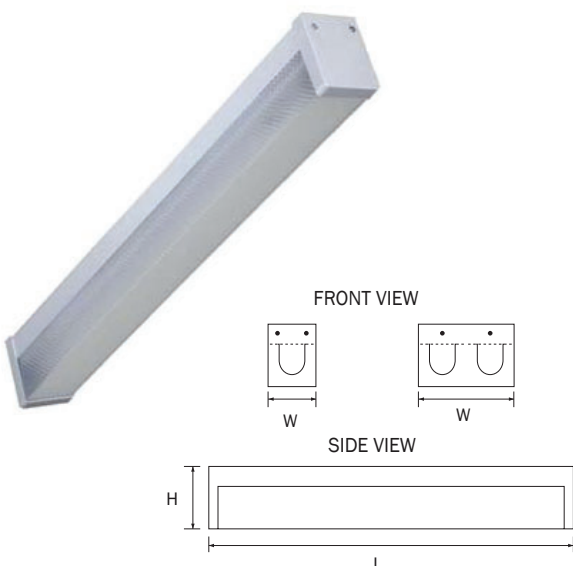

Product Model	Lamp	Dimension (mm.)			Price (฿)
		W	L	H	
UT118/T6/P	1x18W	65	625	95	
UT218/T6/P	2x18W	155	625	100	
UT136/T6/P	1x36W	65	1235	95	
UT236/T6/P	2x36W	155	1235	100	

ORDERING DATA : UT118/.../....

- └ Acrylic diffuser (Prismatic (P), Opal (M) ,Clear (C) and Strpple (S)
- └ Standard Thickness Available (T4=0.4mm.,T6 = 0.6mm., T8 = 0.8mm.)

WIRE GUARD BATTEN TYPE T8 SERIES

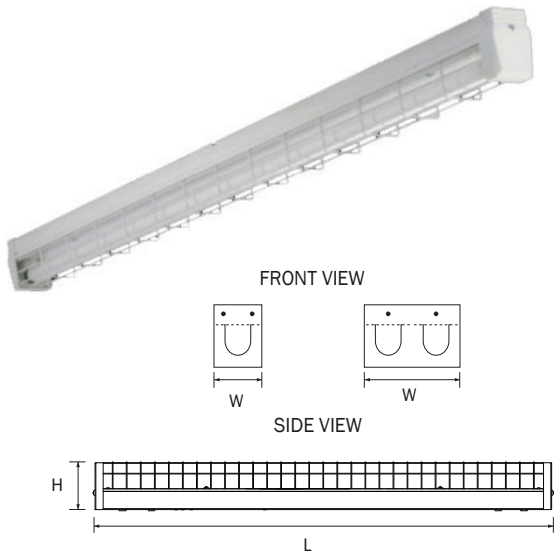

Product Model	Lamp	Dimension (mm.)			Price (฿)
		W	L	H	
WG118/T6	1x18W	65	625	95	
WG218/T6	2x18W	155	625	100	
WG136/T6	1x36W	65	1235	95	
WG236/T6	2x36W	155	1235	100	

ORDERING DATA : WG118/....

Standard Thickness Available
(T4=0.4mm.,T6 = 0.6mm.,
T8 = 0.8mm.)

WIRE GUARD BATTEN TYPE T8 SERIES

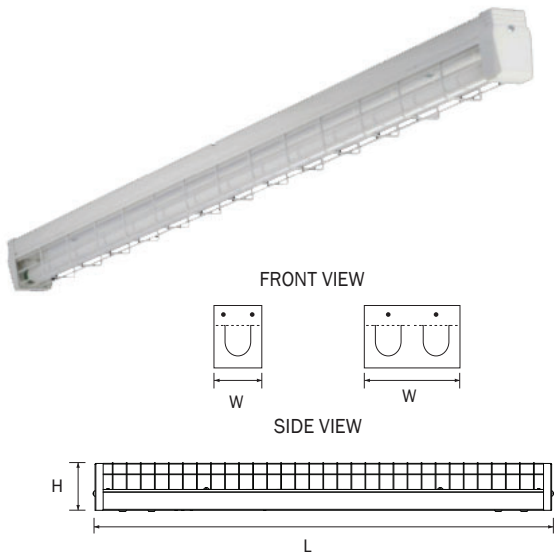

Product Model	Lamp	Dimension (mm.)			Price (฿)
		W	L	H	
WGW118/T6	1x18W	65	625	95	
WGW218/T6	2x18W	155	625	100	
WGW136/T6	1x36W	65	1235	95	
WGW236/T6	2x36W	155	1235	100	

ORDERING DATA : WGW118/....

Standard Thickness Available
(T4=0.4mm.,T6 = 0.6mm.,
T8 = 0.8mm.)

Fixture light - Indoor Light



WATERPROOF T8 SERIES

SPECIFICATION

Material & Characteristic

- Polyester body reinforced with fiber glass.
- Polycarbonate front cover.
- High luminous effect.
- Silicon seal circle in the light fitting with heat-resisting and excellent water-proof performance.
- Water-proof, dust-proof, moisture-proof connection wire by cable glands.
- Gear tray made for stainless steel plate.
- Lamp trays have safty wire for hanging.
- Stainless steel clips lock
- Mounting bracket by stainless steel.
- IP65
- Lampholder : G13

Application

Ideas for outdoor and high humidity area such as Factory, Warehouse, Car park, Cleanroom, Canteens, Corridors, etc.

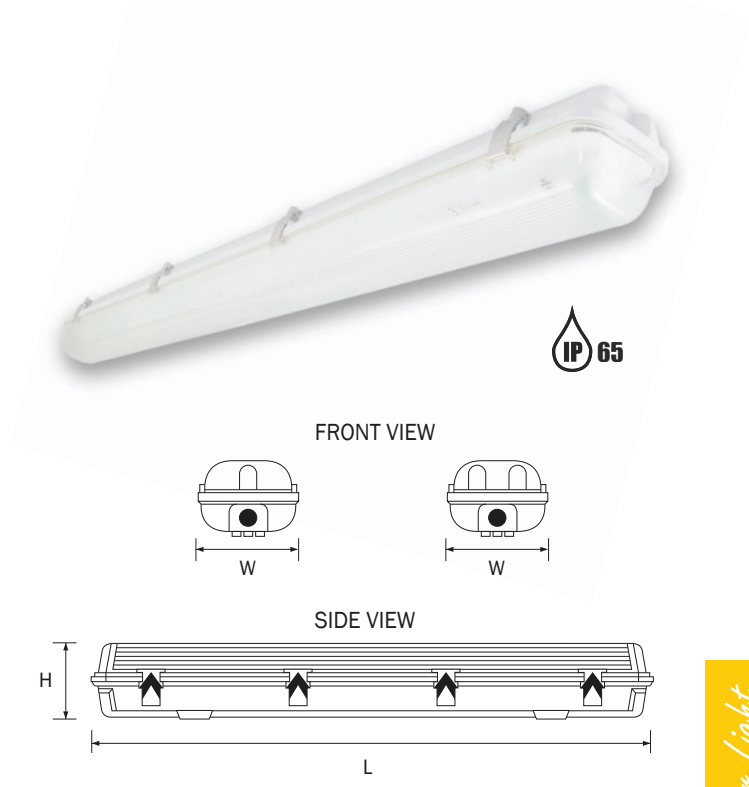

Product Model	Lamp	Chip Lock	IP	Dimension (mm.)			Price (฿)
				W	L	H	
WPS118	1x18W	4 pcs.	IP65	100	670	105	
WPS218	2x18W	4 pcs.	IP65	165	670	105	
WPS136	1x36W	8 pcs.	IP65	100	1270	105	
WPS236	2x36W	8 pcs.	IP65	165	1270	105	

Fixture light - Indoor Light



PENDANT ACRYLIC DIFFUSER SLIM T8 SERIES



Product Model	Lamp	Dimension (mm.)			Price (฿)
		W	L	H	
PDSA-118LED/BK	1x18W	100	1245	100	
PDSA-218LED/BK	2x18W	150	1245	100	

RECESSED ACRYLIC DIFFUSER SLIM T8 SERIES



Product Model	Lamp	Dimension (mm.)			Price (฿)
		W	L	H	
PDRA-118LED/BK	1x18W	100	1245	100	
PDRA-218LED/BK	2x18W	150	1245	100	

PENDANT LOUVER SLIM T8 SERIES

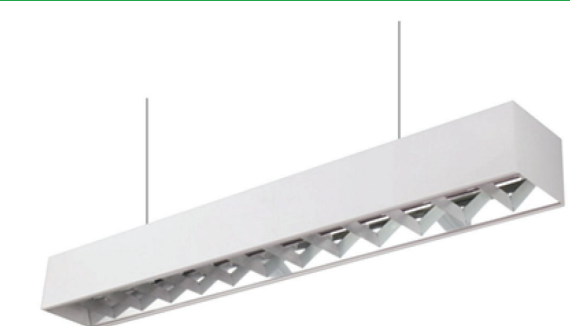

Product Model	Lamp	Dimension (mm.)			Price (฿)
		W	L	H	
PDSL-118LED/BK	1x18W	120	1245	130	
PDSL-218LED/BK	2x18W	150	1245	130	

RECESSED LOUVER SLIM T8 SERIES

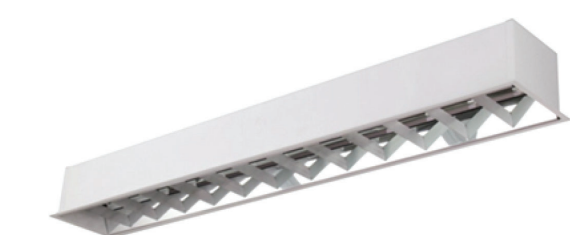

Product Model	Lamp	Dimension (mm.)			Price (฿)
		W	L	H	
PDRL-118LED/BK	1x18W	150	1270	130	
PDRL-218LED/BK	2x18W	180	1270	130	

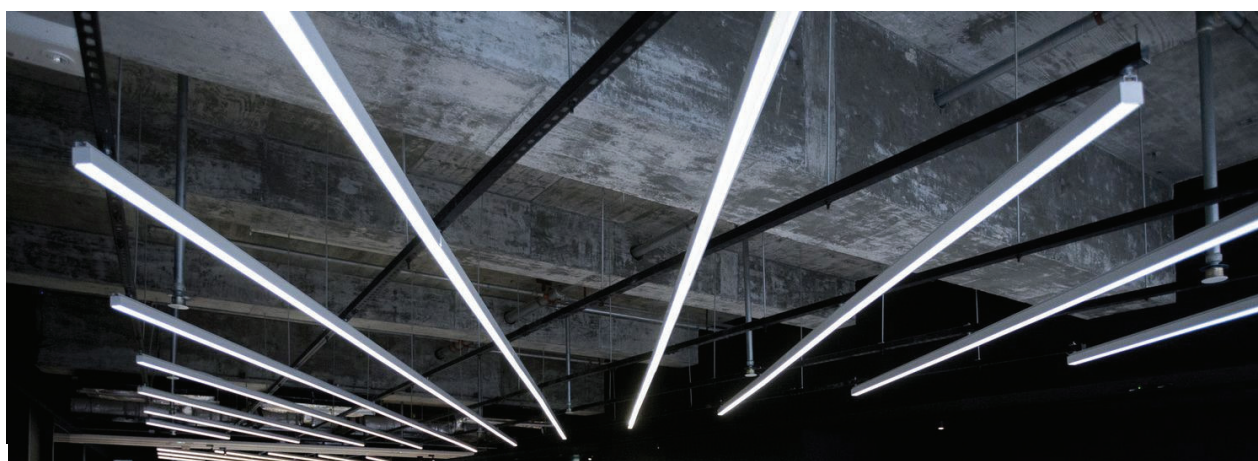

LED PANEL RECESSED SQUARE SERIES

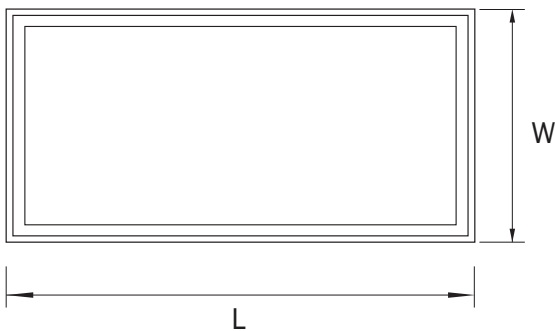

SPECIFICATION

Working Voltage (V)	90-265V
Frequency (Hz)	50-60Hz
Power Factor (PF)	0.6
Luminaire Efficiency (lm/W)	100 lm/W
CRI	>80
Beam angle (°)	120°
Working Temp. (°C)	-20°C to +45°C
Life time (Hrs.)	30,000 Hrs
Protection Rating	IP20

Product Model	Power (W)	Lumen (lm)	Dimension (mm.)			Price (฿)
			W	L	H	
PNR10-83030(65/30)	8	800	300	300	13	
PNR10-123030(65/30)	12	1,200	300	300	13	
PNR10-163060(65/30)	16	1,600	300	600	13	
PNR10-203060(65/30)	20	2,000	300	600	13	
PNR10-3630120(65/30)	36	3,600	300	1200	13	
PNR10-366060(65/30)	36	3,600	600	600	13	
PNR10-486060(65/30)	48	4,800	600	600	13	
PNR10-7260120(65/30)	72	7,200	600	1200	13	

LED Panel - Indoor Light



LED PANEL SURFACE SQUARE SERIES

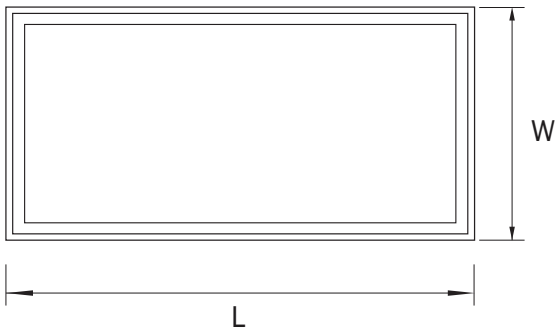

SPECIFICATION

Working Voltage (V)	90-265V
Frequency (Hz)	50-60Hz
Power Factor (PF)	0.6
Luminaire Efficiency (lm/W)	100 lm/W
CRI	>80
Beam angle (°)	120°
Working Temp. (°C)	-20°C to +45°C
Life time (Hrs.)	30,000 Hrs
Protection Rating	IP20

LED Panel - Indoor Light

Product Model	Power (W)	Lumen (lm)	Dimension (mm.)			Price (฿)
			W	L	H	
PNS10-83030(65/30)	8	800	300	300	13	
PNS10-123030(65/30)	12	1,200	300	300	13	
PNS10-163060(65/30)	16	1,600	300	600	13	
PNS10-203060(65/30)	20	2,000	300	600	13	
PNS10-3630120(65/30)	36	3,600	300	1200	13	
PNS10-366060(65/30)	36	3,600	600	600	13	
PNS10-486060(65/30)	48	4,800	600	600	13	
PNS10-7260120(65/30)	72	7,200	600	1200	13	



GOLDEN LINEAR SERIES

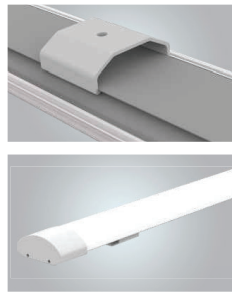

SPECIFICATION

Working Voltage (V)	100-240V
Frequency (Hz)	50-60Hz
Power Factor (PF)	0.95
Luminaire Efficiency (lm/W)	130 lm/W
CRI	>80
Beam angle (°)	120°
Working Temp. (°C)	-20°C to +45°C
Life time (Hrs.)	50,000 Hrs
Protection Rating	IP44



Product Model	Power (W)	Lumen (lm)	Dimension (mm.)			Price (฿)
			W	L	H	
GDL-15(65/30)	15	2,000	72	600	43	
GDL-30(65/30)	30	3,900	72	1200	43	
GDL-40(65/30)	45	5,200	72	1500	43	

SMART LINEAR SERIES

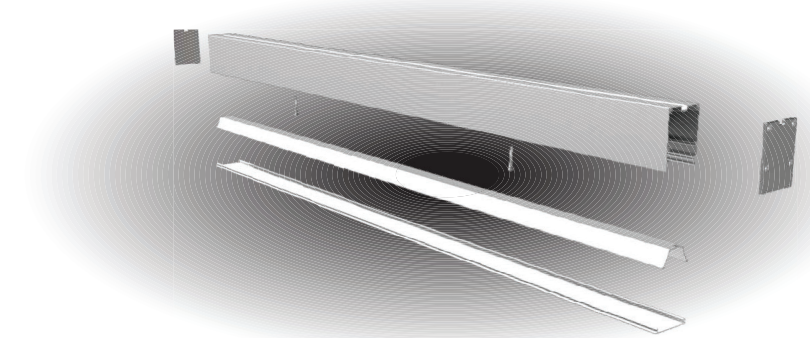
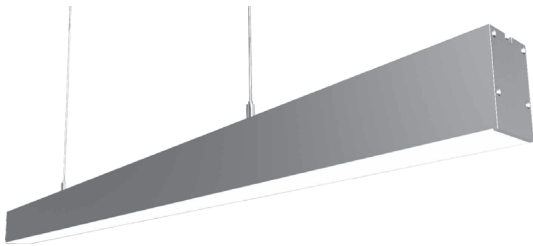

SPECIFICATION

Working Voltage (V)	100-240V
Frequency (Hz)	50-60Hz
Power Factor (PF)	0.95
Luminaire Efficiency (lm/W)	130 lm/W
CRI	>80
Beam angle (°)	120°
Working Temp. (°C)	-20°C to +45°C
Life time (Hrs.)	50,000 Hrs
Protection Rating	IP44



Product Model	Power (W)	Lumen (lm)	Dimension (mm.)			Price (฿)
			W	L	H	
SML-30(65/30)	30	3,000	55	1200	75	
SML-50(65/30)	50	5,000	55	1500	75	

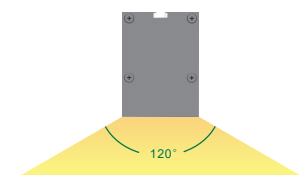
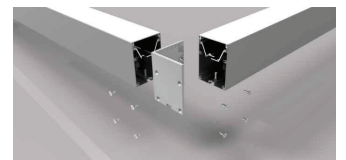
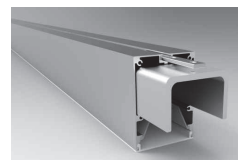
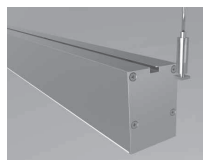
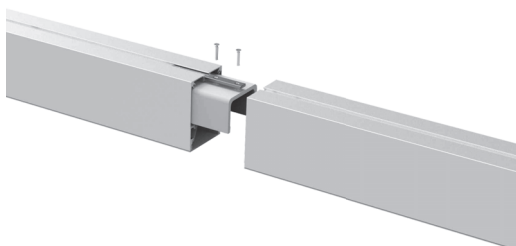

LED Fixture - Indoor Light

LED PURIFY FIXTURE SERIES



SPECIFICATION

Working Voltage (V)	90-265V
Frequency (Hz)	50-60Hz
Power Factor (PF)	0.9
Luminaire Efficiency (lm/W)	80 lm/W
CRI	>80
Beam angle (°)	120°
Working Temp. (°C)	-20°C to +45°C
Life time (Hrs.)	30,000 Hrs
Protection Rating	IP20

Product Model	Power (W)	Lumen (lm)	Dimension (mm.)			Price (฿)
			W	L	H	
FTL01-18(65/30)	18	1,440	73	600	22	
FTL01-28(65/30)	28	2,240	73	900	22	
FTL01-36(65/30)	36	2,880	73	1200	22	
FTL01-45(65/30)	45	3,840	73	1500	22	

LED TRIPROOF TUBE SERIES

SPECIFICATION

Working Voltage (V)	100-240V
Frequency (Hz)	50-60Hz
Power Factor (PF)	0.9
Luminaire Efficiency (lm/W)	80 lm/W
CRI	>80
Beam angle (°)	120°
Working Temp. (°C)	-20°C to +45°C
Life time (Hrs.)	30,000 Hrs
Protection Rating	IP65



Product Model	Power (W)	Lumen (lm)	Dimension (mm.)			Price (฿)
			W	L	H	
TPLA-18(65/30)	18	1,620	57	600	51	
TPLA-24(65/30)	24	2,160	57	900	51	
TPLA-36(65/30)	36	3,240	57	1200	51	
TPLA-48(65/30)	48	4,320	57	1500	51	
TPLA-54(65/30)	54	4,860	57	1800	51	

Product Model	Power (W)	Lumen (lm)	Dimension (mm.)			Price (฿)
			W	L	H	
TPLB-24(65/30)	24	2,160	100	600	57	
TPLB-40(65/30)	40	3,600	100	900	57	
TPLB-54(65/30)	54	4,860	100	1200	57	
TPLB-72(65/30)	72	6,480	100	1500	57	
TPLB-80(65/30)	80	7,200	100	1800	57	

MINI TRI-PROOF SERIES

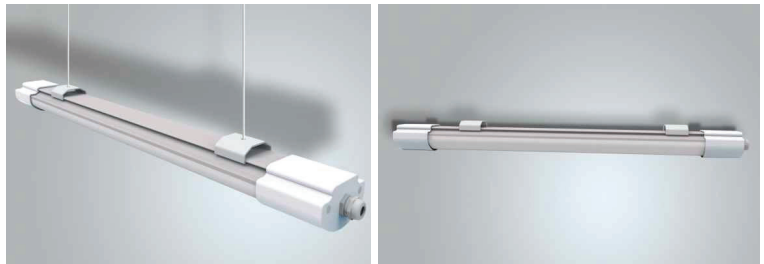

SPECIFICATION

Working Voltage (V)	100-240V
Frequency (Hz)	50-60Hz
Power Factor (PF)	0.95
Luminaire Efficiency (lm/W)	130 lm/W
CRI	>80
Beam angle (°)	120°
Working Temp. (°C)	-20°C to +45°C
Life time (Hrs.)	50,000 Hrs
Protection Rating	IP66

Product Model	Power (W)	Lumen (lm)	Dimension (mm.)			Price (฿)
			W	L	H	
MNTP-15(65/30)	15	2,000	74	600	43	
MNTP-30(65/30)	30	3,900	74	1200	43	
MNTP-40(65/30)	45	5,200	74	1500	43	

GOLDEN LED TRI-PROOF SERIES



SPECIFICATION

Working Voltage (V)	100-240V
Frequency (Hz)	50-60Hz
Power Factor (PF)	0.95
Luminaire Efficiency (lm/W)	100 lm/W
CRI	>80
Beam angle (°)	120°
Working Temp. (°C)	-20°C to +45°C
Life time (Hrs.)	50,000 Hrs
Protection Rating	IP66

Product Model	Power (W)	Lumen (lm)	Dimension (mm.)			Price (฿)
			W	L	H	
GDTP-226(65/30)	22	2,200	87	600	86	
GDTP-3012(65/30)	30	3,000	87	1200	86	
GDTP-20012(65/30)	200	20,000	87	1200	86	
GDTP-5015(65/30)	50	5,000	87	1500	86	
GDTP-6018(65/30)	60	6,000	87	1800	86	
GDTP-8024(65/30)	80	8,000	87	2400	86	
GDTP-20050(65/30)	200	20,000	87	5000	86	

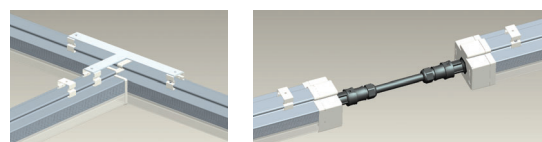

LED Fixture - Indoor Light

DESCRIPTION

โคมไฟปั้มน้ำมัน แอลอีดี ผลิตมาจากแผ่นอลูมิเนียมขนาดใหญ่ เพื่อเพิ่มประสิทธิภาพในการระบายความร้อน และยืดอายุการใช้งาน ของ LED Chip ชุดควบคุมหลอด (LED Driver) อายุการใช้งาน มากถึง 50,000 ชั่วโมง เหมาะสำหรับใช้งานใน โถงสูง ทั้งภายใน และภายนอกอาคาร เช่น ปั้มน้ำมัน, อาคารแสดงสินค้า, คลังสินค้า, สนามบิน, อาคารโรงงาน ฯลฯ

การติดตั้ง : ติดตั้งได้ทั้ง ฝังฝ้า และ ติดลอย



CANOPY SNOO I SERIES

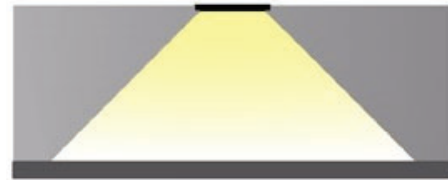

SPECIFICATION

Input Voltage (V)	AC90-295V
Power Frequency (Hz)	50-60Hz
Material	Aluminium
Luminaire Efficiency (lm/W)	110 lm/W
CRI	>75
Ambient Temp.(°C)	-20°C to +50°C
Beam Angle	125° x 65° / 90° x 90°
Power Factor	0.95
Colors Temp. (K)	3,000K or 6,500K
IP Rating	IP65
Life time (Hrs.)	50,000 Hrs

Product Model	Power (W)	Lumen (lm)	Dimension (mm.)			Price (฿)
			W	L	H	
CNSN1-100(65/30)	100	11,000	230	350	75	
CNSN1-150(65/30)	150	16,500	310	350	75	
CNSN1-200(65/30)	200	22,000	394	350	75	
CNSN1-240(65/30)	240	26,400	474	350	75	

AC90-295V	Hz 50-60	PF >0.95	CRI 75	-20°C~50°C	10~90%	50000h	IP65
-----------	----------	----------	--------	------------	--------	--------	------

CANOPY SNOO I SERIES



SPECIFICATION

Input Voltage (V)	AC90-295V
Power Frequency (Hz)	50-60Hz
Material	Aluminium
Luminaire Efficiency (lm/W)	120 lm/W
CRI	>70
Ambient Temp.(°C)	-20°C to +50°C
Beam Angle	120°
Power Factor	0.95
Colors Temp. (K)	3,000K or 6,500K
IP Rating	IP65
Life time (Hrs.)	50,000 Hrs

Product Model	Power (W)	Lumen (lm)	Dimension (mm.)			Price (฿)
			W	L	H	
CNSN2-30(65/30)	30	3,600	320	320	140	
CNSN2-50(65/30)	50	6,000	320	320	140	
CNSN2-80(65/30)	80	9,600	370	370	160	
CNSN2-100(65/30)	100	12,000	370	370	160	

AC90-295V	Hz 50-60	PF >0.95	CRI 70	-20°C~50°C	10~90%	50000h	IP65
-----------	----------	----------	--------	------------	--------	--------	------

DESCRIPTION

โคมไฮเบย์ แอลอีดี พผลิตมาจากแผ่นอลูมิเนียมขนาดใหญ่ เพื่อเพิ่มประสิทธิภาพในการระบายความร้อน และยืดอายุการใช้งานของ LED Chip ชุดควบคุมหลอด (LED Driver) อายุการใช้งานมากถึง 50,000 ชั่วโมง เหมาะสำหรับใช้งานใน โถงสูง ทั้งภายในและภายนอกอาคาร เช่น อาคารแสดงสินค้า, คลังสินค้า, สนามบิน, อาคารโรงงาน ฯลฯ

การติดตั้ง : ติดตั้งได้ 3 ลักษณะ ดังนี้ ขายึด (Bracket), ท่อแขวนแขวน (Pipe pendant), ใช้แขวน (Flexible pendant)

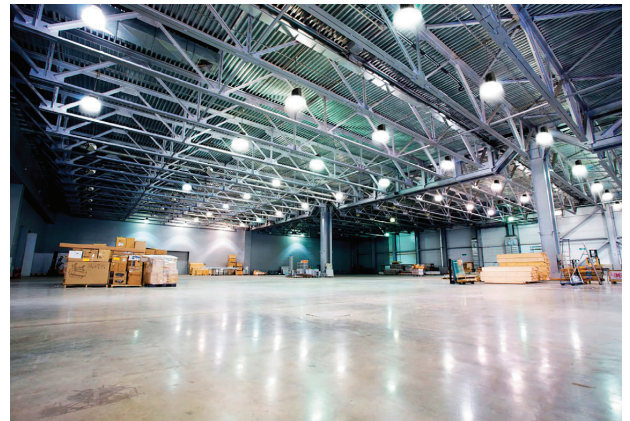

HISTRONG SERIES

SPECIFICATION

Input Voltage (V)	90 - 305 VAC
Power Frequency (Hz)	50-60Hz
Material	Aluminum Die-cast
LED type	SMD
Luminaire efficacy	160 lm/W
Ambient Temp.(°C)	-20°C ~ 45°C
Beam Angle	60°/90°/120°
Power Factor	> 0.95
IP Rating	IP65
IK Rating	IK08
Life time (Hrs.)	50,000 Hrs.



Product Model	Power (W)	Lumen (lm)	Dimension (mm.)		Price (฿)
			ØDia.	H	
HBST-70(65/30)	70	11,200	280	168	
HBST-110(65/30)	110	17,600	340	169	
HBST-150(65/30)	150	24,000	400	182	

HICENGO SERIES

SPECIFICATION

Input Voltage (V)	100 - 277 VAC
Power Frequency (Hz)	50-60Hz
Material	Aluminum Die-cast
LED type	SMD
Luminaire efficacy	130 lm/W
Ambient Temp.(°C)	-20°C ~ 45°C
Beam Angle	60°/90°/120°
Power Factor	> 0.90
IP Rating	IP66
IK Rating	IK08
Life time (Hrs.)	50,000 Hrs.



Product Model	Power (W)	Lumen (lm)	Dimension (mm.)		Price (฿)
			ØDia.	H	
HBCG-100(65/30)	100	13,000	270	142.5	
HBCG-150(65/30)	150	19,500	300	160	
HBCG-200(65/30)	200	26,000	330	166	
HBCG-240(65/30)	240	31,200	330	166	

HILUX SERIES

SPECIFICATION

Input Voltage (V)	90 - 305 VAC
Power Frequency (Hz)	50-60Hz
Material	Aluminum Die-cast
LED type	SMD
Luminaire efficacy	140 lm/W
Ambient Temp.(°C)	-20°C ~ 45°C
Beam Angle	60°/90°/120°
Power Factor	> 0.95
IP Rating	IP66
IK Rating	IK08
Life time (Hrs.)	50,000 Hrs.



Product Model	Power (W)	Lumen (lm)	Dimension (mm.)		Price (฿)
			ØDia.	H	
HBLX-60(65/30)	60	8,400	270	142.5	
HBLX-80(65/30)	80	11,200	270	142.5	
HBLX-100(65/30)	100	14,000	270	142.5	
HBLX-120(65/30)	120	16,800	300	160	
HBLX-150(65/30)	150	21,000	300	160	
HBLX-200(65/30)	200	28,000	330	166	
HBLX-240(65/30)	240	33,600	330	166	

HIFEIE SERIES

SPECIFICATION

Input Voltage (V)	90 - 305 VAC
Power Frequency (Hz)	50-60Hz
Material	Aluminum Die-cast
LED type	SMD
Luminaire efficacy	160 lm/W
Ambient Temp.(°C)	-20°C ~ 45°C
Beam Angle	60°/90°/120°
Power Factor	> 0.95
IP Rating	IP65
IK Rating	IK08
Life time (Hrs.)	50,000 Hrs.



Product Model	Power (W)	Lumen (lm)	Dimension (mm.)		Price (฿)
			ØDia.	H	
HBFE-50(65/30)	50	6,000	360	128	
HBFE-100(65/30)	100	12,000	360	128	
HBFE-120(65/30)	120	14,400	360	128	
HBFE-150(65/30)	150	18,000	360	128	
HBFE-180(65/30)	180	21,600	420	146	
HBFE-200(65/30)	200	24,000	420	146	
HBFE-230(65/30)	230	27,600	420	146	



60° PC Lampshade
only for 50-150W



60°/90° Alu Reflector

HIMASS CLASS SERIES



SPECIFICATION

Input Voltage (V)	100 - 240 VAC
Power Frequency (Hz)	50-60Hz
Material	Aluminum Die-cast
LED type	SMD
Luminaire efficacy	100 lm/W
Ambient Temp.(°C)	-40°C ~ 50°C
Beam Angle	60°/90°/120°
Power Factor	> 0.90
IP Rating	IP65
Life time (Hrs.)	50,000 Hrs.

Product Model	Power (W)	Lumen (lm)	Dimension (mm.)		Price (฿)
			ØDia.	H	
HBMS-80(65/30)	80	8,000	505	382	
HBMS-100(65/30)	100	10,000	505	414	
HBMS-120(65/30)	120	12,000	505	440	
HBMS-150(65/30)	150	15,000	505	440	
HBMS-200(65/30)	200	20,000	505	490	
HBMS-240(65/30)	240	24,000	505	495	
HBMS-300(65/30)	300	30,000	505	495	

HI-BAR II SERIES



SPECIFICATION

Input Voltage (V)	220-240 VAC
Power Frequency (Hz)	50-60Hz
Material	Aluminum
LED type	SMD
Luminaire efficacy	120 lm/W
Ambient Temp.(°C)	-25°C ~ 45°C
Beam Angle	120°
Power Factor	0.9
IP Rating	IP 65
Life time (Hrs.)	50,000 Hrs.

Product Model	Power (W)	Lumen (lm)	Dimension (mm.)			Price (฿)
			W	L	H	
HBBAR02-50	50	6,000	140	625	112	
HBBAR02-100	100	12,000	140	920	112	
HBBAR02-150	150	18,000	140	1215	112	
HBBAR02-200	200	24,000	140	1510	112	

High Bay - Indoor Light

HIPHENAS SERIES



Features

1. Unique heatsink design.
2. Optical PC lens and 60°, 90°, 120° beam angle optional.
3. Stamping cover, with less weight for whole highbay.
4. Dimmable driver for options.
5. Up to 130 lm/W, high efficiency output.
6. 3 sizes available.



Application

Building, Super market, Warehouse, Workshop, Factory



SPECIFICATION

Input Voltage (V)	100 - 240 VAC
Power Frequency (Hz)	50-60Hz
Material	Aluminum Die-cast
LED type	SMD
Luminaire efficacy	110 lm/W
Ambient Temp.(°C)	-40°C ~ 50°C
Beam Angle	60°/90°/120°
Power Factor	> 0.90
IP Rating	IP65
Life time (Hrs.)	50,000 Hrs.

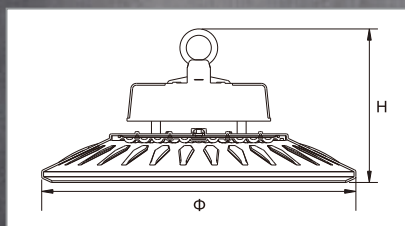

Product Model	Power (W)	Lumen (lm)	Dimension (mm.)		Price (฿)
			ØDia.	H	
HBPN-80(65/30)	80	8,000	300	180	
HBPN-100(65/30)	100	11,000	300	180	
HBPN-120(65/30)	120	13,200	360	190	
HBPN-160(65/30)	160	17,600	360	190	
HBPN-200(65/30)	200	22,000	420	190	
HBPN-240(65/30)	240	26,400	420	190	

HICIA I SERIES

SPECIFICATION

Input Voltage (V)	100-277 VAC
Power Frequency (Hz)	50-60Hz
Material	Aluminum Die-cast
LED type	SMD
Luminaire efficacy	100 lm/W
Ambient Temp.(°C)	-20°C ~ 45°C
Beam Angle	60°/90°/120°
Power Factor	> 0.90
IP Rating	IP65
Life time (Hrs.)	50,000 Hrs.



Product Model	Power (W)	Lumen (lm)	Dimension (mm.)		Price (฿)
			ØDia.	H	
HBCI1-100(65/30)	100	10,000	295	150	
HBCI1-150(65/30)	150	15,000	350	165	
HBCI1-200(65/30)	200	20,000	390	175	

HI-JP PLUS+ SERIES



SPECIFICATION

Input Voltage (V)	100 - 277 VAC
Power Frequency (Hz)	50-60Hz
Material	Aluminum Die-cast
LED type	SMD
Luminaire efficacy	120 lm/W
Ambient Temp.(°C)	-20°C ~ 45°C
Beam Angle	30°/80°/120°
Power Factor	> 0.90
IP Rating	IP20
Life time (Hrs.)	50,000 Hrs.



Product Model	Power (W)	Lumen (lm)	Dimension (mm.)			Price (฿)
			W	L	H	
HBJP60-100(65/30)	100	12,000	283	635	62	
HBJP60-150(65/30)	150	18,000	453	635	62	
HBJP60-200(65/30)	200	24,000	453	635	62	
HBJP80-100(65/30)	100	12,000	283	826	62	
HBJP80-150(65/30)	150	18,000	283	826	62	
HBJP80-210(65/30)	210	25,100	453	826	62	
HBJP80-300(65/30)	300	36,000	453	826	62	
HBJP120-100(65/30)	100	12,000	283	1212	62	
HBJP120-150(65/30)	150	18,000	283	1212	62	
HBJP120-200(65/30)	200	24,000	453	1212	62	
HBJP120-300(65/30)	300	36,000	453	1212	62	
HBJP120-400(65/30)	400	48,000	453	1212	62	

High Bay - Indoor Light

DESCRIPTION

โคมไฟฟลัดไลท์ ผลิตจากอลูมิเนียมฉีดอัดด้วยความดันสูง (High Pressure Aluminium Die-Casting) เพื่อเพิ่มประสิทธิภาพในการระบายความร้อนสูง และยืดอายุการใช้งานของ LED Chip มีความทนทานต่อการกัดกร่อน ไร้สารปรอทเคลือบด้วยสีฟลูออโรโพลีเมอร์ให้ความเงางามคงทน ส่วนประกอบกระจกปิดหน้าแบบ Tempered Glass มีความคงทนสูง สามารถรับแรงกระแทกของวัตถุ เสน่ห์ทำจากโพลีคาร์บอเนต ช่วยให้การกระจายของแสงได้ตามพื้นที่ใช้งาน ตั้งแต่ 30° ~ 120° และยังมียางซิลิโคน และกาวซิลิโคน ความร้อน ทำให้เหมาะสำหรับใช้งานภายนอกได้อย่างมั่นใจ ด้วยระดับป้อง IP65



FLOODGOLD SERIES

SPECIFICATION

Working Voltage (V)	90-265V
Frequency (Hz)	50-60Hz
Material	Aluminium Die-Cast
Power Factor (PF)	0.9
Luminaire Efficiency (lm/W)	120 lm/W
CRI	>75
Beam angle (°)	120°
Working Temp. (°C)	-40°C to +60°C
Life time (Hrs.)	50,000 Hrs
Protection Rating	IP65



Product Model	Power (W)	Lumen (lm)	Dimension (mm.)			Price (฿)
			W	L	H	
FLGD-50(65/30)	50	6,000	291	230	62	
FLGD-100(65/30)	100	12,000	291	277	62	
FLGD-150(65/30)	150	18,000	291	353	62	
FLGD-200(65/30)	200	24,000	291	428	62	

FLOODPHIN SERIES



30W



50W



70-110W



220W

SPECIFICATION







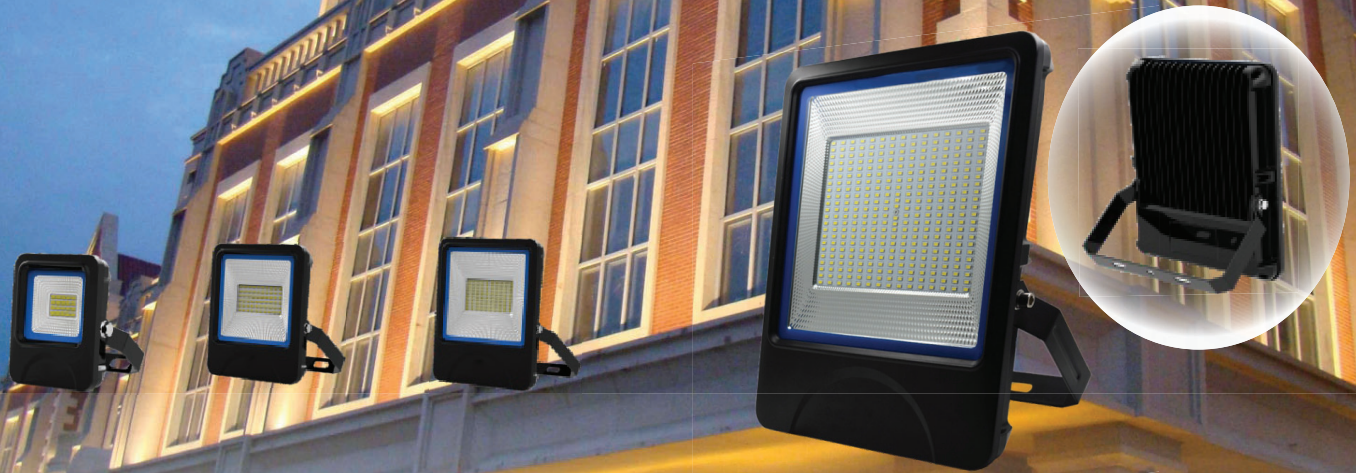

Working Voltage (V)	90-265V
Frequency (Hz)	50-60Hz
Material	Aluminium Die-Cast
Power Factor (PF)	0.9
Luminaire Efficiency (lm/W)	120 lm/W
CRI	>75
Beam angle (°)	120°
Working Temp. (°C)	-40°C to +60°C
Life time (Hrs.)	50,000 Hrs
Protection Rating	IP65

Product Model	Power (W)	Lumen (lm)	Dimension (mm.)			Price (฿)
			W	L	H	
FLPN-30(65/30)	30	3,600	142	193	41	
FLPN-50(65/30)	50	6,000	201	270	41	
FLPN-70(65/30)	70	8,400	234	315.5	41	
FLPN-110(65/30)	110	13,200	234	315.5	41	
FLPN-220(65/30)	220	26,400	500	510	52.6	



FLOODISHIN I SERIES



SPECIFICATION

Working Voltage (V)	85-265Vac
Frequency (Hz)	50-60Hz
Material	Aluminium Die-Cast
Power Factor (PF)	0.9
Luminaire Efficiency (lm/W)	110 lm/W
CRI	>80
Beam angle (°)	120°
Working Temp. (°C)	-40°C to +50°C
Life time (Hrs.)	50,000 Hrs
Protection Rating	IP66

Product Model	Power (W)	Lumen (lm)	Dimension (mm.)			Price (฿)
			W	L	H	
FLIS1-10(65/30)	10	1,100	129	99	44	
FLIS1-20(65/30)	20	2,200	175	135	44	
FLIS1-30(65/30)	30	3,300	215	175	47	
FLIS1-50(65/30)	50	5,500	275	225	48	
FLIS1-100(65/30)	100	11,000	325	275	53	
FLIS1-150(65/30)	150	16,500	385	385	58	

FLOODISHIN II RGB SERIES









SPECIFICATION

Working Voltage (V)	85-265Vac
Frequency (Hz)	50-60Hz
Material	Aluminium Die-Cast
Luminaire Efficiency (lm/W)	80 lm/W
CRI	>80
Beam angle (°)	120°
Working Temp. (°C)	-40°C to +50°C
Life time (Hrs.)	50,000 Hrs
Protection Rating	IP66

Product Model	Power (W)	Lumen (lm)	Dimension (mm.)			Price (฿)
			W	L	H	
FLIS2-10RGB	10	800	129	99	44	
FLIS2-20RGB	20	1,600	175	135	44	
FLIS2-30RGB	30	2,400	215	175	47	
FLIS2-50RGB	50	4,000	275	225	48	
FLIS2-100RGB	100	8,000	325	275	53	

FLOODISHIN III SENSORS SERIES

SPECIFICATION

Working Voltage (V)	85-265 Vac
Frequency (Hz)	50-60Hz
Material	Aluminium Die-Cast
Power Factor (PF)	0.5
Luminaire Efficiency (lm/W)	110 lm/W
CRI	>80
Beam angle (°)	120°
Working Temp. (°C)	-40°C to +50°C
Life time (Hrs.)	50,000 Hrs
Protection Rating	IP66



AC85-265V	Hz 50-60	PF >0.5	CRI 80	-40°C~45°C	10~90%	50000h	IP66
-----------	----------	---------	--------	------------	--------	--------	------

Feature :

- ultra-thin integration design concept
- Thicken the heat sink, Protect the product from leakage
- built-in sensors to save transportation costs
- induction distance 8 - 10m.
- 210° bracket angle adjustable

Product Model	Power (W)	Lumen (lm)	Dimension (mm.)			Price (฿)
			W	L	H	
FLIS3-10S(65/30)	10	1,100	129	99	44	
FLIS3-20S(65/30)	20	2,200	175	135	44	
FLIS3-30S(65/30)	30	3,300	215	175	47	
FLIS3-50S(65/30)	50	5,500	275	225	48	
FLIS3-100S(65/30)	100	11,000	325	275	53	
FLIS3-150S(65/30)	150	16,500	385	385	58	

FLOOD JD-CLASS I SERIES



AC110-277V	Hz 50-60	PF >0.9	<15%	CRI 80	-40°C~45°C	10~90%	50000h	IP66
------------	----------	---------	------	--------	------------	--------	--------	------

SPECIFICATION

Working Voltage (V)	110-277 Vac
Frequency (Hz)	50-60Hz
Material	Aluminium Die-Cast
Power Factor (PF)	0.90
Luminaire Efficiency (lm/W)	80 lm/W
CRI	>80
Beam angle (°)	120°
Working Temp. (°C)	-40°C to +45°C
Life time (Hrs.)	50,000 Hrs
Protection Rating	IP66

Product Model	Power (W)	Lumen (lm)	Dimension (mm.)			Price (฿)
			W	L	H	
FLJDC1-10(65/30)	10	800	199	164	38	
FLJDC1-20(65/30)	20	1,600	199	164	38	
FLJDC1-30(65/30)	30	2,400	335	320	52	
FLJDC1-50(65/30)	50	4,000	335	320	52	
FLJDC1-100(65/30)	100	8,000	460	417	61	
FLJDC1-150(65/30)	150	12,000	460	417	61	

Light - Outdoor Light

FLOOD JD-CLASS II SERIES



SPECIFICATION

AC110-277V	Hz 50-60	PF >0.9	<15%	CRI 80	-40°C~45°C	10~90%	50000h	IP66
------------	----------	---------	------	--------	------------	--------	--------	------

Working Voltage (V)	85-265Vac
Frequency (Hz)	50-60Hz
Material	Aluminium Die-Cast
Power Factor (PF)	0.9
Luminaire Efficiency (lm/W)	110 lm/W
CRI	>80
Beam angle (°)	120°
Working Temp. (°C)	-40°C to +50°C
Life time (Hrs.)	50,000 Hrs
Protection Rating	IP66

Product Model	Power (W)	Lumen (lm)	Dimension (mm.)			Price (฿)
			W	L	H	
FLJDC2-10(65/30)	10	1,100	148	151	34	
FLJDC2-20(65/30)	20	2,200	148	151	34	
FLJDC2-30(65/30)	30	3,300	264	268	52	
FLJDC2-50(65/30)	50	5,500	264	268	52	
FLJDC2-100(65/30)	100	11,000	370	371	71	
FLJDC2-150(65/30)	150	16,500	370	371	71	

FLOODGAO I SERIES

SPECIFICATION

Working Voltage (V)	85-265Vac
Frequency (Hz)	50-60Hz
Material	Aluminium Die-Cast
Power Factor (PF)	0.9
Luminaire Efficiency (lm/W)	80 lm/W
CRI	>80
Beam angle (°)	120°
Working Temp. (°C)	-40°C to +50°C
Life time (Hrs.)	50,000 Hrs
Protection Rating	IP65



AC85-265V	Hz 50-60	PF >0.9	CRI 80	-40°C~45°C	10~90%	50000h	IP65
-----------	----------	---------	--------	------------	--------	--------	------

Product Model	Power (W)	Lumen (lm)	Dimension (mm.)			Price (฿)
			W	L	H	
FLGA1-10(65/30)	10	800	104	125	27	
FLGA1-20(65/30)	20	1,600	125	152	28	
FLGA1-30(65/30)	30	2,400	168	209	27	
FLGA1-50(65/30)	50	4,000	200	237	36	
FLGA1-100(65/30)	100	8,000	277	231	40	
FLGA1-150(65/30)	150	12,000	333	420	51	
FLGA1-200(65/30)	200	16,000	385	470	51	

Feature :

- Ultra-thin design and the shape is unique.
- Plastic housing with Alu heat radiating material and high-tech spraying technology, never rust, never corrosion.
- Using new technology to ensure the integrity of the fixture is good, reliable sealing, waterproof.
- Heat dissipation quickly, long life.

STADIUMISHIN BULE I SERIES

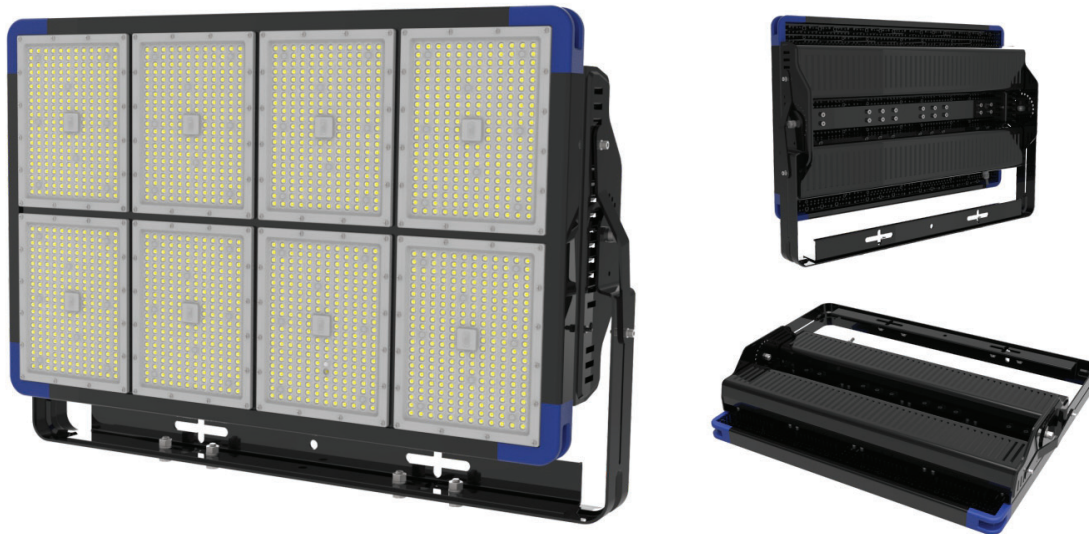

AC95-305V	Hz 50-60	PF >0.95	CRI 80	-40°C-50°C	10-90%	50000h	IP66
-----------	----------	----------	--------	------------	--------	--------	------

SPECIFICATION

Working Voltage (V)	95-305 Vac
Frequency (Hz)	50-60Hz
Material	Aluminium Die-Cast
Power Factor (PF)	0.95
Luminaire Efficiency (lm/W)	140 lm/W
CRI	>80
Beam angle (°)	10°/25°/45°/60°
Working Temp. (°C)	-40°C to +50°C
Life time (Hrs.)	50,000 Hrs
Protection Rating	IP66

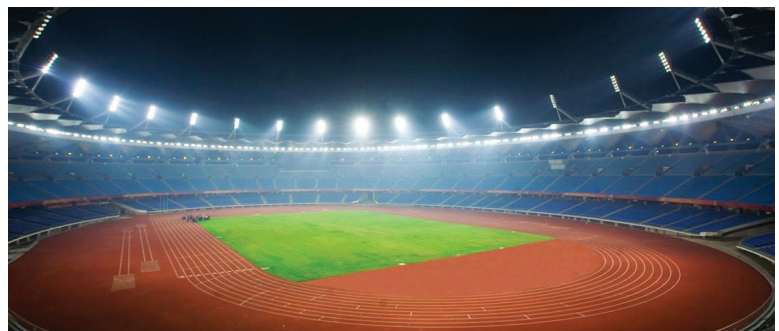

Feature :

- Cold Forging heat dissipation process, 200 - 1500W multi-power optional
- Anodic oxidation, increasing the fitting degree of the lamp plate and radiator, so that the temperature can be exported rapidly
- Optical PC lens material, the transmittance is 94% and the light effect can reach 140 lm/W
- Lengthening bracket for various angles of irradiation

Product Model	Power (W)	Lumen (lm)	Dimension (mm.)			Price (฿)
			W	L	H	
SDIS1-200(65/30)	200	28,000	250	300	120	
SDIS1-360(65/30)	360	50,400	300	460	150	
SDIS1-540(65/30)	540	75,600	300	670	150	
SDIS1-720(65/30)	720	100,800	460	560	150	
SDIS1-1080(65/30)	1080	151,200	560	670	200	
SDIS1-1440(65/30)	1440	201,600	560	880	200	

Light - Outdoor Light

STADIUMISHIN BULE II SERIES



AC110-277V	Hz 50-60	PF >0.9	CRI 80	-25°C~50°C	10~90%	50000h	IP66
------------	----------	---------	--------	------------	--------	--------	------

SPECIFICATION

Working Votage (V)	85-277Vac
Frequency (Hz)	50-60Hz
Material	Aluminium Die-Cast
Power Factor (PF)	0.9
Luminaire Efficacy (lm/W)	140 lm/W
CRI	>80
Beam angle (°)	15°/25°/45°/60°
Working Temp. (°C)	-25°C to +50°C
Life time (Hrs.)	50,000 Hrs
Protaction Rating	IP66



Featule :

- Cold Forging heat dissipation process, 50 - 600W multi-power optional
- Anodic oxidation, increasing the fitting degree of the lamp plate and radiator, so that the temperature can be exported rapidly
- Optical PC lens material, the transmittance is 94% and the light effect can reach 140 lm/W
- Lengthening bracket for various angles of irradiation

Product Model	Power (W)	Lumen (lm)	Dimension (mm.)			Price (฿)
			W	L	H	
SDIS2-50(65/30)	50	8,000	170	310	87	
SDIS2-100(65/30)	100	14,000	228	310	87	
SDIS2-150(65/30)	150	21,000	309	310	87	
SDIS2-200(65/30)	200	28,000	382	310	87	
SDIS2-250(65/30)	250	50,400	459	310	87	
SDIS2-300(65/30)	300	75,600	539	310	87	
SDIS2-400(65/30)	400	100,800	388	571	107	
SDIS2-500(65/30)	500	151,200	461	571	107	
SDIS2-600(65/30)	600	201,600	529	571	107	

STADIUM RHYTHM I SERIES



Feature :



Copper Heatpipe

Maximum Contact Between Heatpipe and Fin for Maximum Heat Dissipation

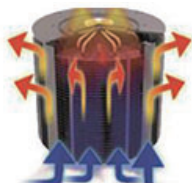

High heat dissipation aluminum

360° Three-Dimensional optimized thermal solution,

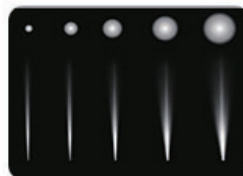

Multiple beam angle choose

15° available



Smart Control System

match 1-10V Dali system



AC95-305V



Hz 50-60



PF >0.9



CRI 80



-40°C~45°C



10-90%



50000h



IP66

SPECIFICATION

Working Voltage (V)	100-277 Vac
Frequency (Hz)	50-60Hz
Material	Aluminium Die-Cast
Power Factor (PF)	0.95
Luminaire Efficiency (lm/W)	100 lm/W
CRI	>80
Beam angle (°)	15°/24°/36°/60°
Working Temp. (°C)	-40°C to +50°C
Life time (Hrs.)	50,000 Hrs
Protection Rating	IP66

Product Model	Power (W)	Lumen (lm)	Dimension (mm.)		Price (฿)
			ØDia.	H	
SDRT1-600(65/30)	600	60,000	450	488	
SDRT1-800(65/30)	800	80,000	450	488	
SDRT1-1000(65/30)	1000	100,000	450	528	
SDRT1-1200(65/30)	1200	120,000	450	528	

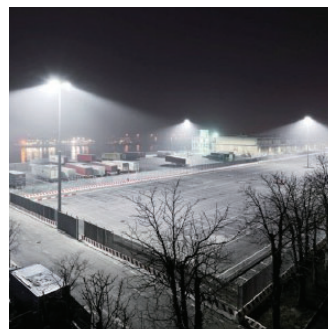
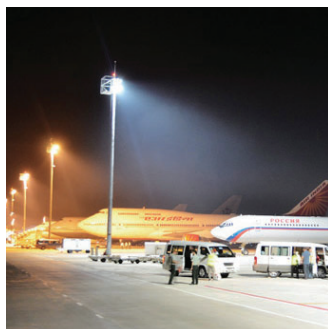
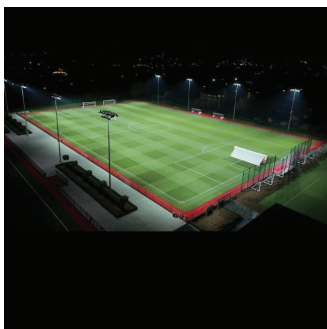

Light - Outdoor Light



STADIUM RHYTHM II SERIES



Feature :



Streamline Design
less wind resistance



Independent electric box
design into a drawer style, smart maintenance and multiple installation solution

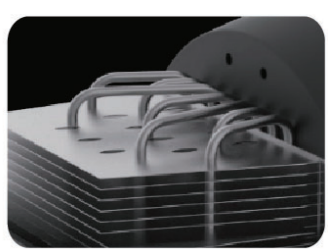

Copper Heatpipe
great heat dissipation by copper pipe and 110 heat conductivity PCB



Unique handle designed
easy carrying and installation

SPECIFICATION

Working Voltage (V) 100-277 Vac
 Frequency (Hz) 50-60Hz
 Material Aluminium Die-Cast
 Power Factor (PF) 0.95
 Luminaire Efficiency (lm/W) 130 lm/W
 CRI >80
 Beam angle (°) 12°/24°/38°/60°
 Working Temp. (°C) -40°C to +50°C
 Life time (Hrs.) 50,000 Hrs
 Protection Rating IP65

AC95-305V	Hz 50-60	PF >0.9	CRI 80	-40°C~45°C	10~90%	50000h	IP65
-----------	----------	---------	--------	------------	--------	--------	------

Product Model	Power (W)	Lumen (lm)	Dimension (mm.)		Price (฿)
			ØDia.	H	
SDRT2-600(65/30)	600	78,000	576	488	
SDRT2-800(65/30)	800	104,000	576	488	
SDRT2-1000(65/30)	1000	130,000	576	528	
SDRT2-1200(65/30)	1200	156,000	576	528	

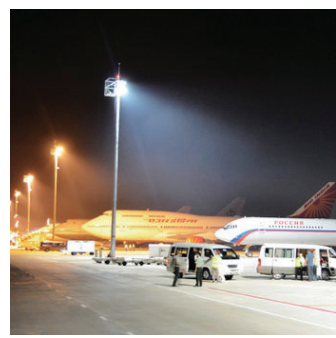
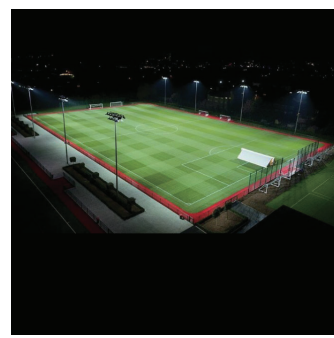



MASTER SERIES

HIGH POWER MODULAR
LED FLOOD LIGHT
80W-960W

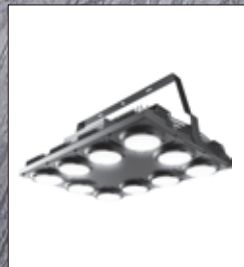

FLOOD MASTER I SERIES

Features

1. Professional optical design, precise light distribution, low light glare
2. 80W/module, 80W-960W available Replace traditional 150W-2000W light fixture
3. 9°, 15°, 30°, 60°, 90°, 120° beam angle available
4. Philips / Meanwell driver, Cree / Osram / Lumileds led, 5 years warranty
5. High Light transmittance tempered glass
6. UV Protection PC lens
7. High purity aluminium&die-casting aluminium
8. Pure aluminium cold forging technology + anodic oxidation (more safety)
9. Low luminous decay LEDs: Zero decay within 3,000 hours and less than 30% after 50,000 hours
10. Compact design, module size: 150mm*150mm, module weight: ≤ 1.5 KG/module.
11. Replaceable modular design.
12. CE, SAA certificate (UL, ETL, VDE under applying)

Application

Stadium, Construction, Highmast, Tennis court, Football court Plaza, airport, Port, highway crossroad, Theater, Airportterminal, Gymnasium, Railway station, Warehouse, Parking lot, Tennis court, Football court, Courtyard etc.

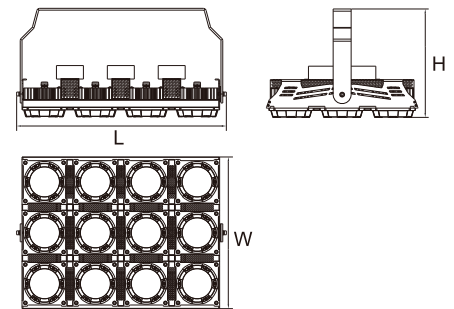
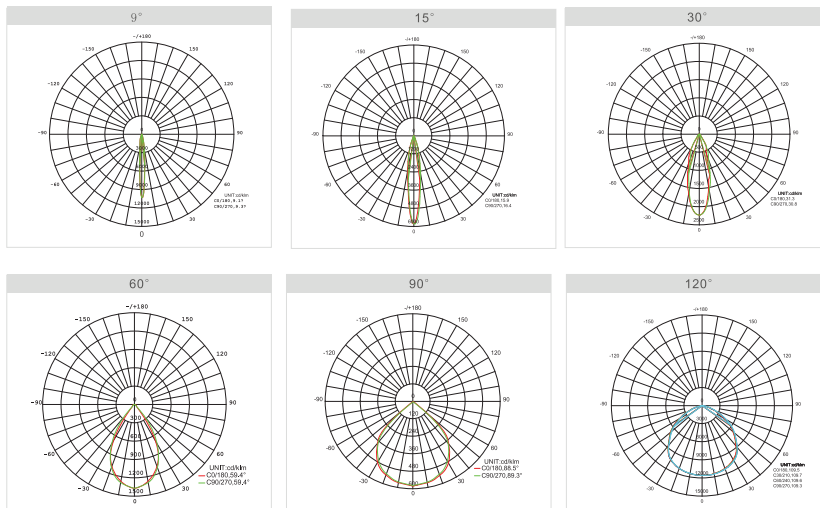
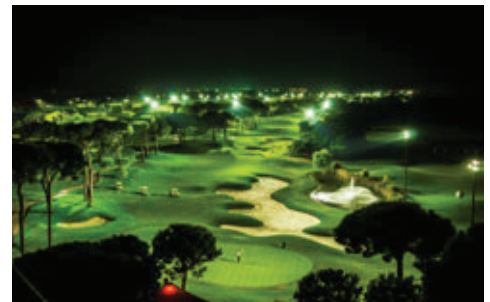

Product Model	Power (W)	Lumen (lm)	Dimension (mm.)			Price (\$)
			W	L	H	
FLMT1-80(65/30)	80	9,600	150	150	239	
FLMT1-160(65/30)	160	19,200	166	354	239	
FLMT1-240(65/30)	240	28,800	166	522	259	
FLMT1-320(65/30)	320	38,400	336	354	270	
FLMT1-480(65/30)	480	57,600	336	527	311	
FLMT1-640(65/30)	640	76,800	506	527	342	
FLMT1-720(65/30)	720	86,400	506	527	342	
FLMT1-800(65/30)	800	96,000	506	699	365	
FLMT1-960(65/30)	960	115,200	506	699	365	

DESCRIPTION

โคมไฟถนน แอลอีดี พลาสติกจากอลูมิเนียมฉีดอัดด้วยความดันสูง (High Pressure Aluminium Die-Casting) ทำให้มีน้ำหนักเบาขนาดมีความเที่ยงตรงสูง ทนทานต่อการกัดกร่อน ไร้สนิม พื้นเคลือบด้วยสีฝุ่น และช่วยระบายความร้อนได้ดีด้วยแผงครีระบายความร้อนขนาดใหญ่ด้านหลัง ยึดอายุการใช้งานของ LED Chip ชุดควบคุมหลอด (LED Driver) อายุการใช้งานมากถึง 50,000 ชั่วโมง



ST1001 SERIES



SPECIFICATION

Input Voltage (V)	AC100-265V
Power Frequency (Hz)	50-60Hz
Material	Aluminium Die-Cast
Luminaire Efficiency (lm/W)	100 lm/W
CRI	>75
Ambient Temp. (°C)	-40 °C to +50 °C
Beam Angle	120°
Power Factor	0.90
Colors Temp. (K)	3,000K or 6,500K
IP Rating	IP65
Life time (Hrs.)	50,000 Hrs

Product Model	Power (W)	Lumen (lm)	Dimension (mm.)			Price (฿)
			W	L	H	
ST1001-50(65/30)	50	5,000	318	422	136	
ST1001-100(65/30)	100	10,000	318	422	136	
ST1001-120(65/30)	120	12,000	318	522	136	
ST1001-150(65/30)	150	15,000	318	522	136	
ST1001-200(65/30)	200	20,000	318	835	136	

AC100-265V	Hz 50-60	PF >0.9	CRI 75	-40°C~50°C	10~90%	50000h	IP65
------------	----------	---------	--------	------------	--------	---------------	-------------

ST1002 SERIES



SPECIFICATION

Input Voltage (V)	AC185-250V
Power Frequency (Hz)	50-60Hz
Material	Aluminium Die-Cast
Luminaire Efficiency (lm/W)	120 lm/W
CRI	>75
Ambient Temp. (°C)	-40 °C to +50 °C
Beam Angle	120°
Power Factor	0.90
Colors Temp. (K)	3,000K or 6,500K
IP Rating	IP65
Life time (Hrs.)	50,000 Hrs

Product Model	Power (W)	Lumen (lm)	Dimension (mm.)			Price (฿)
			W	L	H	
ST1002-60(65/30)	60	7,200	315	580	90	
ST1002-90(65/30)	90	10,800	315	680	90	
ST1002-100(65/30)	100	12,000	315	580	90	
ST1002-120(65/30)	120	14,400	315	780	90	
ST1002-150(65/30)	150	18,000	315	680	90	
ST1002-180(65/30)	180	21,600	315	980	90	
ST1002-250(65/30)	250	30,000	315	880	90	
ST1002-300(65/30)	300	36,000	315	980	90	

AC185-250V	Hz 50-60	PF >0.9	CRI 75	-40°C~60°C	10~90%	50000h	IP65
------------	----------	---------	--------	------------	--------	---------------	-------------

ST1003 SERIES



SPECIFICATION

Input Voltage (V)	AC185-250V
Power Frequency (Hz)	50-60Hz
Material	Aluminium Die-Cast
Luminaire Efficiency (lm/W)	120 lm/W
CRI	>75
Ambient Temp.(°C)	-40°C to +60°C
Beam Angle	120°
Power Factor	0.90
Colors Temp. (K)	3,000K or 6,500K
IP Rating	IP65
Life time (Hrs.)	50,000 Hrs

Product Model	Power (W)	Lumen (lm)	Dimension (mm.)			Price (฿)
			W	L	H	
ST1003-40(65/30)	40	4,800	240	480	100	
ST1003-60(65/30)	60	7,200	240	480	100	
ST1003-80(65/30)	80	9,600	300	650	130	
ST1003-100(65/30)	100	12,000	300	650	130	
ST1003-120(65/30)	120	14,400	375	864	168	
ST1003-150(65/30)	150	18,000	375	864	168	

						50000h	IP65
--	--	--	--	--	--	---------------	-------------

ST1004 SERIES



SPECIFICATION

Input Voltage (V)	AC185-250V
Power Frequency (Hz)	50-60Hz
Material	Aluminium Die-Cast
Luminaire Efficiency (lm/W)	120 lm/W
CRI	>75
Ambient Temp.(°C)	-40°C to +60°C
Beam Angle	120°
Power Factor	0.95
Colors Temp. (K)	2,700K or 6,500K
IP Rating	IP65
Life time (Hrs.)	50,000 Hrs

Product Model	Power (W)	Lumen (lm)	Dimension (mm.)			Price (฿)
			W	L	H	
ST1004-40(65/30)	40	4,800	92	423	98	
ST1004-60(65/30)	60	7,200	292	495	98	
ST1004-90(65/30)	90	10,800	292	587	98	
ST1004-120(65/30)	120	14,400	292	679	98	
ST1004-150(65/30)	150	18,000	292	771	98	
ST1004-180(65/30)	180	21,600	292	863	98	

						50000h	IP65
--	--	--	--	--	--	---------------	-------------

ROAD EVER I SERIES



SPECIFICATION

Input Voltage (V)	AC90-305V
Power Frequency (Hz)	50-60Hz
Material	Aluminium Die-Cast
Luminaire Efficiency (lm/W)	120 lm/W
CRI	>75
Ambient Temp.(°C)	-30°C to +45°C
Beam Angle	120°
Power Factor	0.95
Colors Temp. (K)	2,700K or 6,500K
IP Rating	IP65
Life time (Hrs.)	50,000 Hrs

Product Model	Power (W)	Lumen (lm)	Dimension (mm.)			Price (฿)
			W	L	H	
STEV1-30(65/30)	30	3,600	299	376	79	
STEV1-60(65/30)	60	7,200	299	450	86	
STEV1-90(65/30)	90	10,800	299	450	86	
STEV1-120(65/30)	120	14,400	299	525	90	
STEV1-150(65/30)	150	18,000	299	608	102	
STEV1-200(65/30)	200	24,000	299	608	102	

						50000h	IP65
--	--	--	--	--	--	---------------	-------------

ROAD FALCON SERIES



SPECIFICATION

Input Voltage (V)	AC100-240V
Power Frequency (Hz)	50-60Hz
Material	Aluminium Die-Cast
Luminaire Efficiency (lm/W)	130 lm/W
CRI	>70
Ambient Temp.(°C)	-40 °C to +50 °C
Beam Angle	40°x150°
Power Factor	0.90
Colors Temp. (K)	3,000K or 6,500K
IP Rating	IP66
Life time (Hrs.)	50,000 Hrs

Product Model	Power (W)	Lumen (lm)	Dimension (mm.)			Price (฿)
			W	L	H	
STFC-20(65/30)	20	2,600	166	350	62	
STFC-40(65/30)	40	5,200	199	481	62	
STFC-60(65/30)	60	7,800	239	507	69	
STFC-80(65/30)	80	10,400	239	507	79	
STFC-100(65/30)	100	13,000	239	507	79	

AC100-240V	Hz 50-60	PF >0.9	CRI 70	-40°C-60°C	20-90%	50000h	IP66
------------	----------	---------	--------	------------	--------	---------------	-------------

ROAD G4 SERIES



SPECIFICATION

Input Voltage (V)	AC100-240V
Power Frequency (Hz)	50-60Hz
Material	Aluminium Die-Cast
Luminaire Efficiency (lm/W)	130 lm/W
CRI	>80
Ambient Temp.(°C)	-40 °C to +60 °C
Beam Angle	90°x140°
Power Factor	0.90
Colors Temp. (K)	3,000K or 6,500K
IP Rating	IP66
Life time (Hrs.)	50,000 Hrs

Product Model	Power (W)	Lumen (lm)	Dimension (mm.)			Price (฿)
			W	L	H	
STG4-30(65/30)	30	3,900	308	507	81	
STG4-50(65/30)	50	6,500	308	507	81	
STG4-100(65/30)	100	13,000	375	565	82	
STG4-150(65/30)	150	19,500	375	565	82	
STG4-200(65/30)	200	26,000	376	785	101	
STG4-300(65/30)	300	39,000	376	785	101	

AC100-240V	Hz 50-60	PF >0.9	CRI 80	-40°C-60°C	10-90%	50000h	IP66
------------	----------	---------	--------	------------	--------	---------------	-------------

ROAD JED I SERIES



SPECIFICATION

Input Voltage (V)	AC100-240V
Power Frequency (Hz)	50-60Hz
Material	Aluminium Die-Cast
Luminaire Efficiency (lm/W)	120 lm/W
CRI	>75
Ambient Temp.(°C)	-40 °C to +50 °C
Beam Angle	150°
Power Factor	0.90
Colors Temp. (K)	3,000K or 6,500K
IP Rating	IP66
Life time (Hrs.)	50,000 Hrs

Product Model	Power (W)	Lumen (lm)	Dimension (mm.)			Price (฿)
			W	L	H	
STJED1-30(65/30)	30	3,600	246	580	72	
STJED1-50(65/30)	50	6,000	246	580	72	
STJED1-70(65/30)	70	8,400	290	656	72	
STJED1-100(65/30)	100	12,000	290	656	72	

AC100-240V	Hz 50-60	PF >0.9	CRI 75	-40°C-50°C	10-90%	50000h	IP66
------------	----------	---------	--------	------------	--------	---------------	-------------

ROAD JED II SERIES

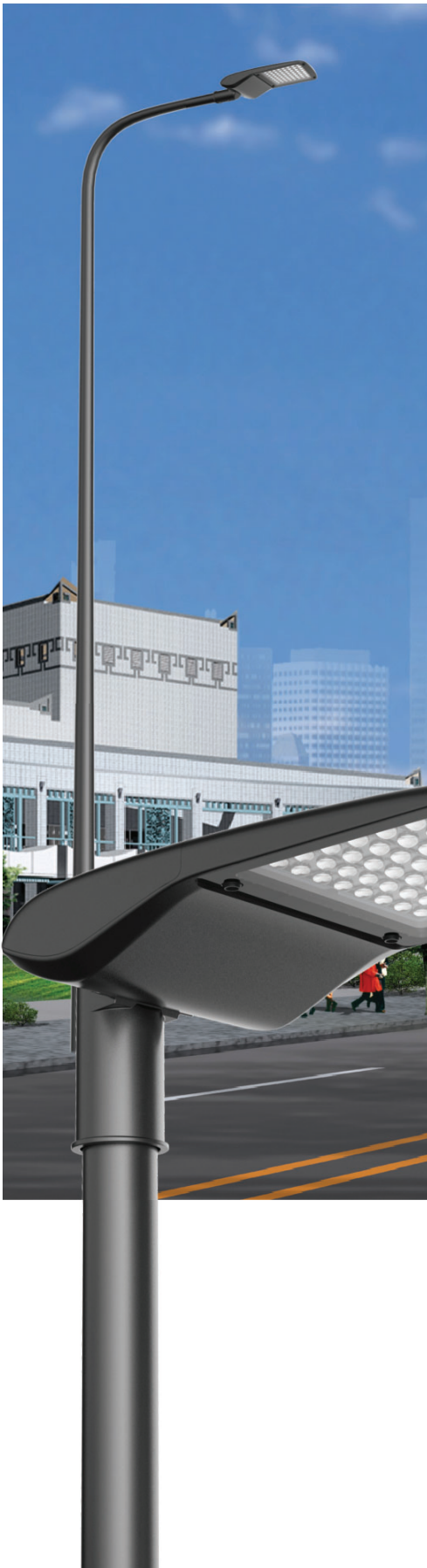

SPECIFICATION

Input Voltage (V)	AC100-240V
Power Frequency (Hz)	50-60Hz
Material	Aluminium Die-Cast
Luminaire Efficiency (lm/W)	120 lm/W
CRI	>75
Ambient Temp.(°C)	-40°C to +60°C
Beam Angle	150°
Power Factor	0.90
Colors Temp. (K)	3,000K or 6,500K
IP Rating	IP66
Life time (Hrs.)	50,000 Hrs

Product Model	Power (W)	Lumen (lm)	Dimension (mm.)			Price (฿)
			W	L	H	
STJED2-30(65/30)	30	3,600	230	525	110	
STJED2-50(65/30)	50	6,000	230	525	110	
STJED2-70(65/30)	70	8,400	263	617	119	
STJED2-100(65/30)	100	12,000	263	617	119	

AC100-240V	Hz 50-60	PF >0.9	CRI 75	-40°C-60°C	10-90%	50000h	IP66
------------	----------	---------	--------	------------	--------	--------	------

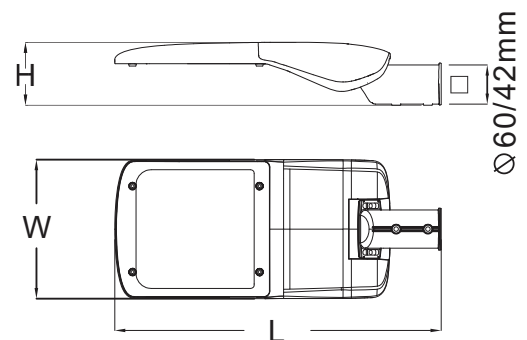

Light Distribution Curve

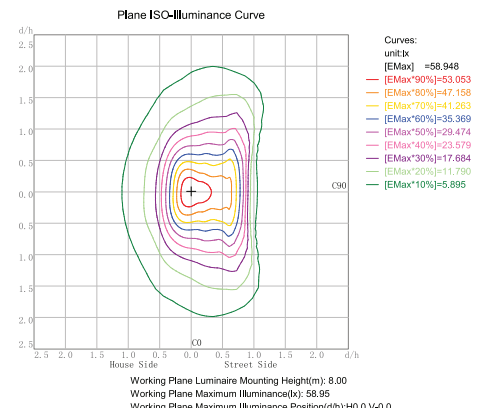
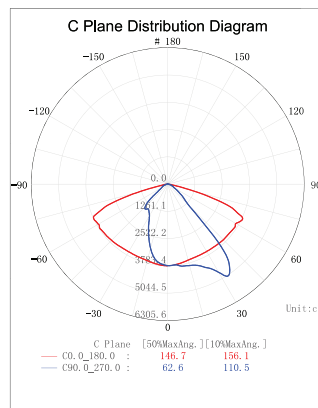

ROAD JED III SERIES

SPECIFICATION

Input Voltage (V)	AC185-250V
Power Frequency (Hz)	50-60Hz
Material	Aluminium Die-Cast
Luminaire Efficiency (lm/W)	120 lm/W
CRI	>75
Ambient Temp.(°C)	-40°C to +50°C
Beam Angle	120°
Power Factor	0.90
Colors Temp. (K)	3,000K or 6,500K
IP Rating	IP66
Life time (Hrs.)	50,000 Hrs



Product Model	Power (W)	Lumen (lm)	Dimension (mm.)			Price (฿)
			W	L	H	
STJED3-30(65/30)	30	3,600	245	573	120	
STJED3-50(65/30)	50	6,000	245	573	120	
STJED3-70(65/30)	70	8,400	320	717	130	
STJED3-100(65/30)	100	12,000	320	717	130	
STJED3-120(65/30)	120	14,400	392	867	159	
STJED3-150(65/30)	150	18,000	392	867	159	
STJED3-200(65/30)	200	24,000	392	867	159	

AC100-240V	Hz 50-60	PF >0.9	CRI 75	-40°C~50°C	10~90%	50000h	IP66
------------	----------	---------	--------	------------	--------	---------------	-------------

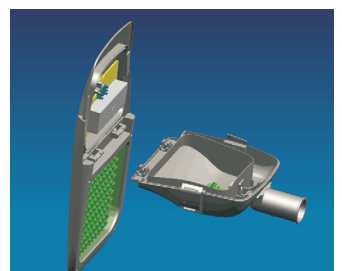
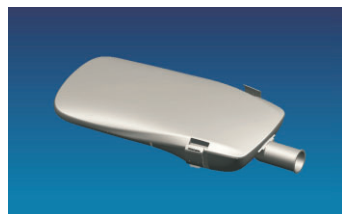
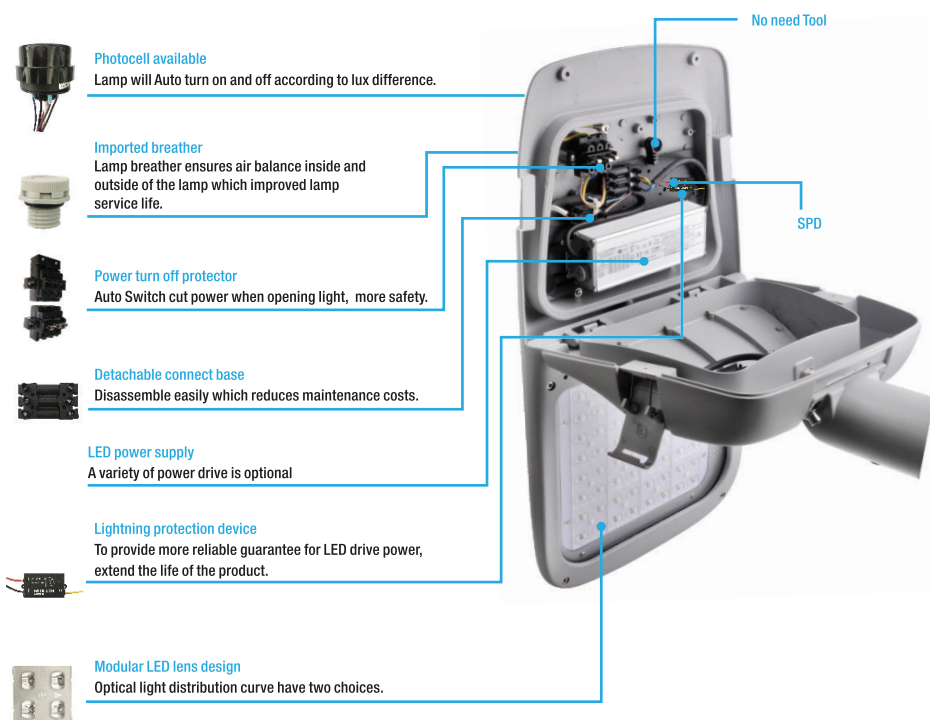

ROAD JED IX SERIES



SPECIFICATION

Input Voltage (V)	AC100-240V
Power Frequency (Hz)	50-60Hz
Material	Aluminium Die-Cast
Luminaire Efficiency (lm/W)	120 lm/W
CRI	>75
Ambient Temp.(°C)	-40 °C to +50 °C
Beam Angle	150°
Power Factor	0.90
Colors Temp. (K)	3,000K or 6,500K
IP Rating	IP66
Life time (Hrs.)	50,000 Hrs

Product Model	Power (W)	Lumen (lm)	Dimension (mm.)			Price (฿)
			ØDia.	L	H	
STJED4-30(65/30)	30	3,000	516	743	122	
STJED4-60(65/30)	60	6,000	516	743	122	
STJED4-100(65/30)	100	10,000	516	743	122	

AC100-240V	Hz 50-60	PF >0.9	CRI 75	-40°C-60°C	10-90%	50000h	IP66
------------	----------	---------	--------	------------	--------	--------	------

ROAD JED X SERIES



SPECIFICATION

Input Voltage (V)	AC100-240V
Power Frequency (Hz)	50-60Hz
Material	Aluminium Die-Cast
Luminaire Efficiency (lm/W)	120 lm/W
CRI	>75
Ambient Temp.(°C)	-40 °C to +50 °C
Beam Angle	150°
Power Factor	0.90
Colors Temp. (K)	3,000K or 6,500K
IP Rating	IP66
Life time (Hrs.)	50,000 Hrs

Product Model	Power (W)	Lumen (lm)	Dimension (mm.)			Price (฿)
			ØDia.	L	H	
STJED5-30(65/30)	30	3,000	516	550	200	
STJED5-60(65/30)	60	6,000	516	550	200	
STJED5-100(65/30)	100	10,000	516	550	200	

AC100-240V	Hz 50-60	PF >0.9	CRI 75	-40°C-60°C	10-90%	50000h	IP66
------------	----------	---------	--------	------------	--------	--------	------

ROAD LUX I SERIES



SPECIFICATION

Input Voltage (V)	AC185-250V
Power Frequency (Hz)	50-60Hz
Material	Aluminium Die-Cast
Luminaire Efficiency (lm/W)	130 lm/W
CRI	>80
Ambient Temp.(°C)	-40°C to +50°C
Beam Angle	120°
Power Factor	0.95
Colors Temp. (K)	3,000K or 6,500K
IP Rating	IP66
Life time (Hrs.)	50,000 Hrs

Product Model	Power (W)	Lumen (lm)	Dimension (mm.)			Price (฿)
			W	L	H	
STLUX1-60(65/30)	60	7,800	272	585	120	
STLUX1-80(65/30)	80	10,400	272	585	120	
STLUX1-100(65/30)	100	13,000	318	688	128	
STLUX1-120(65/30)	120	15,600	318	688	128	
STLUX1-150(65/30)	150	19,500	318	688	128	
STLUX1-180(65/30)	180	23,400	344	764	130	
STLUX1-200(65/30)	200	26,000	344	764	130	

AC100-240V	Hz 50-60	PF >0.95	CRI 80	-40°C~50°C	10~90%	50000h	IP66
------------	----------	----------	--------	------------	--------	---------------	-------------

ROAD LUX II SERIES



SPECIFICATION

Input Voltage (V)	AC185-250V
Power Frequency (Hz)	50-60Hz
Material	Aluminium Die-Cast
Luminaire Efficiency (lm/W)	100 lm/W
CRI	>80
Ambient Temp.(°C)	-40°C to +50°C
Beam Angle	120°
Power Factor	0.90
Colors Temp. (K)	3,000K or 6,500K
IP Rating	IP66
Life time (Hrs.)	50,000 Hrs

Product Model	Power (W)	Lumen (lm)	Dimension (mm.)			Price (฿)
			W	L	H	
STLUX2-30(65/30)	30	3,000	250	525	105	
STLUX2-60(65/30)	60	6,000	250	525	105	
STLUX2-80(65/30)	80	8,000	290	625	105	
STLUX2-100(65/30)	100	10,000	290	625	105	
STLUX2-120(65/30)	120	12,000	320	775	105	
STLUX2-150(65/30)	150	15,000	320	775	105	
STLUX2-180(65/30)	180	18,000	320	775	105	

AC100-240V	Hz 50-60	PF >0.9	CRI 80	-40°C~50°C	10~90%	50000h	IP66
------------	----------	---------	--------	------------	--------	---------------	-------------

ROAD YU I SERIES



AC100-277V

Hz
50-60

PF
>0.9

CRI
75

-40°C~60°C

10~90%

50000h

IP66

SPECIFICATION

Input Voltage (V)	AC100-277V
Power Frequency (Hz)	50-60Hz
Material	Aluminium Die-Cast
Luminaire Efficiency (lm/W)	130 lm/W
CRI	>75
Ambient Temp.(°C)	-40°C to +50°C
Beam Angle	150°
Power Factor	0.90
Colors Temp. (K)	3,000K or 6,500K
IP Rating	IP66
Life time (Hrs.)	50,000 Hrs

Product Model	Power (W)	Lumen (lm)	Dimension (mm.)			Price (฿)
			W	L	H	
STYU1-100(65/30)	100	13,000	351	344	79	
STYU1-150(65/30)	150	19,500	505	344	79	
STYU1-200(65/30)	200	26,000	505	344	79	
STYU1-300(65/30)	300	39,000	659	344	79	



Slip fitter



Adapter



Trunnion



Square pole



Round pole

1.Slip Fitter

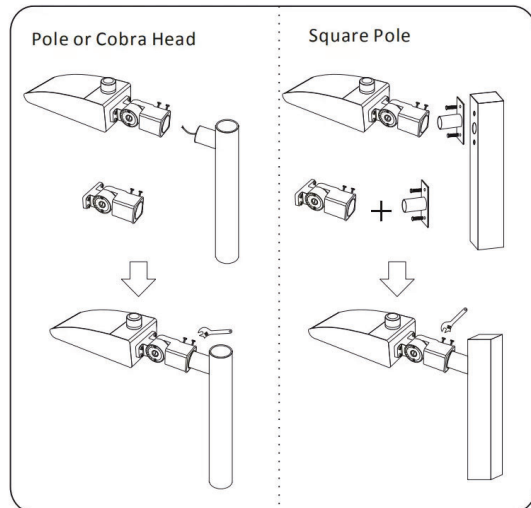

2.Trunnion

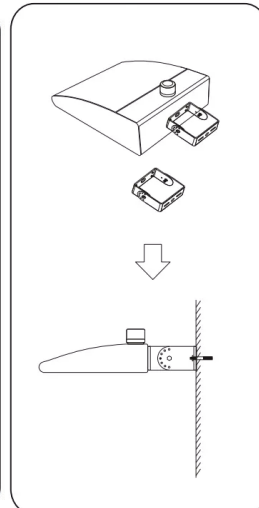

3.Arm

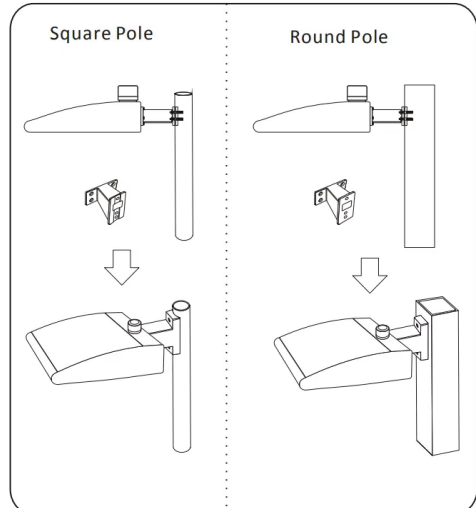

ROAD MASS I SERIES

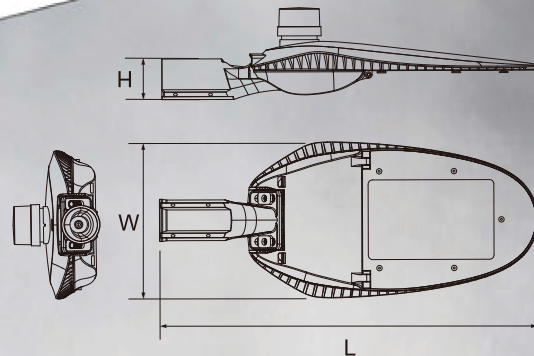

SPECIFICATION

Input Voltage (V)	AC100-240V
Power Frequency (Hz)	50-60Hz
Material	Aluminium Die-Cast
Luminaire Efficiency (lm/W)	130 lm/W
CRI	>70
Ambient Temp.(°C)	-40°C to +50°C
Beam Angle	120°
Power Factor	0.95
Colors Temp. (K)	3,000K or 6,500K
IP Rating	IP66
Life time (Hrs.)	50,000 Hrs

Feature :

- Standard lumen efficiency : 130 lm/W
- High light transmittance tempered glass
- UV protection PC Lens
- Intergarted die-casting heat sink
- Curvy design (Self cleaning system to get rid of any accumulation of dirt on the surface)
- Surge protection (optional 10kV or 20kV)
- Multiple control methods and sensor devices available
- Easy installation



Product Model	Power (W)	Lumen (lm)	Dimension (mm.)			Price (฿)
			W	L	H	
STMS1-20(65/30)	20	2,600	245	522	76	
STMS1-40(65/30)	40	5,200	245	522	76	
STMS1-60(65/30)	60	7,800	245	608	88	
STMS1-80(65/30)	80	10,400	287	699	112	
STMS1-90(65/30)	90	11,700	287	699	112	
STMS1-100(65/30)	100	13,000	287	699	112	
STMS1-110(65/30)	110	14,300	287	699	112	

AC 100-240V	Hz 50-60	PF >0.95	CRI 70	-40°C~50°C	20-95%	50000h	IP66
-------------	----------	----------	--------	------------	--------	--------	------

ROAD MASS II SERIES

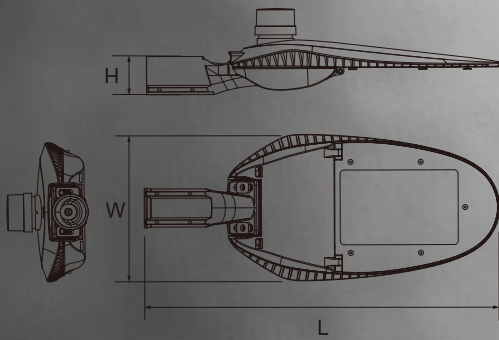
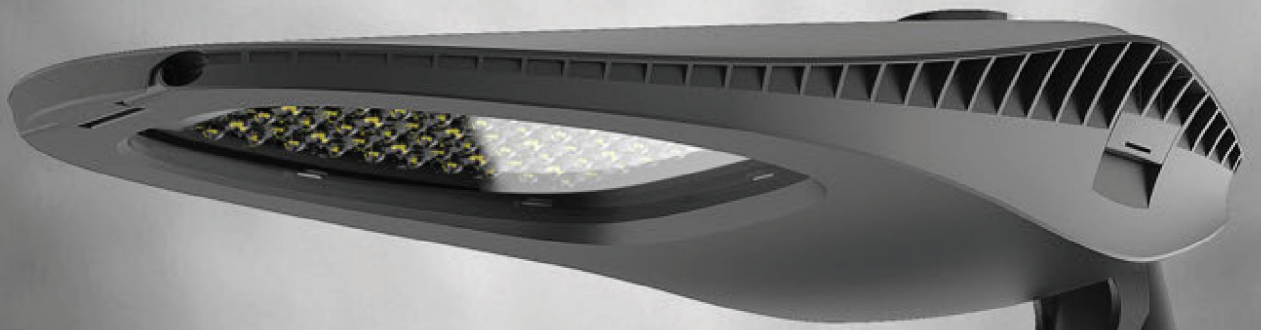

SPECIFICATION

Input Voltage (V)	AC100-277V
Power Frequency (Hz)	50-60Hz
Material	Aluminium Die-Cast
Luminaire Efficiency (lm/W)	130 lm/W
CRI	>70
Ambient Temp.(°C)	-40°C to +50°C
Beam Angle	120°
Power Factor	0.95
Colors Temp. (K)	3,000K or 6,500K
IP Rating	IP66
Life time (Hrs.)	50,000 Hrs

Feature :

- Standard lumen efficiency : 130 lm/W
- High light transmittance tempered glass
- UV protection PC Lens
- Intergarted die-casting heat sink
- Curvy design (Self cleaning system to get rid of any accumulation of dirt on the surface)
- Surge protection (optional 10kV or 20kV)
- Multiple control methods and sensor devices available
- Easy installation



Product Model	Power (W)	Lumen (lm)	Dimension (mm.)			Price (฿)
			W	L	H	
STMS2-100(65/30)	100	13,000	350	818	132	
STMS2-120(65/30)	120	15,600	350	818	132	
STMS2-150(65/30)	150	22,500	350	818	132	



DESCRIPTION

โคมไฟ Landscape ผลิตจากอลูมิเนียมและสแตนเลสคุณภาพสูงเพื่อเพิ่มประสิทธิภาพในการระบายความร้อนสูง ทนทานต่อการกัดกร่อนเงางาม และกระจกปิดหน้ามีความคงทนสูง สามารถรับแรงกระแทกของวัตถุ และยังมียางซิลิโคน กาวซิลิโคน ความร้อน ทำให้เหมาะสำหรับใช้งานภายนอกได้อย่างมั่นใจ ด้วยระดับป้องกัน IP55 และ IP65 และยังมีโคมไฟใต้น้ำที่มี ระดับป้องกัน IP68



WALL LAMP SERIES



SPECIFICATION

Input Voltage (V)	AC220-240V
Power Frequency (Hz)	50-60Hz
Material	Aluminium Die-Cast
Colors Temp. (K)	2,700K or 6,500K
IP Rating	IP54
Life time (Hrs.)	30,000 Hrs
Body Color	BK=Black/DG=Dark Gray /SG=Silver Gray



Product Model	Power (W)	Body Color	Dimension (mm.)			Price (฿)
			W	L	H	
WL1001-16(65/30)/SG	1x6	Silver Gray	90	135	150	
WL1001-26(65/30)/SG	2x6	Silver Gray	90	135	200	
WL1001-1GU10/SG	1xGU10	Silver Gray	90	135	150	
WL1001-2GU10/SG	2xGU10	Silver Gray	90	135	200	



Product Model	Power (W)	Body Color	Dimension (mm.)			Price (฿)
			W	L	H	
WL1002-18(65/30)/SG	1x8	Silver Gray	90	135	150	
WL1002-28(65/30)/SG	2x8	Silver Gray	90	135	200	
WL1002-1GU10/SG	1xGU10	Silver Gray	90	135	150	
WL1002-2GU10/SG	2xGU10	Silver Gray	90	135	200	



Product Model	Power (W)	Body Color	Dimension (mm.)			Price (฿)
			W	L	H	
WL1003-18(65/30)/SG	1x6	Silver Gray	120	90	150	
WL1003-28(65/30)/SG	2x6	Silver Gray	120	90	200	

WALL LAMP SERIES



SPECIFICATION

Input Voltage (V) AC220-240V
 Power Frequency (Hz) 50-60Hz
 Material Aluminium Die-Cast
 Colors Temp. (K) 2,700K or 6,500K
 IP Rating IP54
 Life time (Hrs.) 30,000 Hrs
 Body Color BK=Black/DG=Dark Gray /SG=Sliver Gray



Product Model	Power (W)	Body Color	Dimension (mm.)			Price (฿)
			W	L	H	
WL1004-9(65/30)/SG	9	Silver Gray	100	170	260	



Product Model	Power (W)	Body Color	Dimension (mm.)			Price (฿)
			W	L	H	
WL1005-9(65/30)/BK	9	Black	130	200	250	



Product Model	Power (W)	Body Color	Dimension (mm.)			Price (฿)
			W	L	H	
WL1006-10(65/30)/BK	10	Black	50	100	250	



Product Model	Power (W)	Body Color	Dimension (mm.)			Price (฿)
			W	L	H	
WL1007-13(65/30)/DG	1x3	Black	65	90	80	
WL1007-23(65/30)/DG	2x3	Black	65	90	150	
WL1007-1GU10/DG	1xGU10	Black	65	90	80	
WL1007-2GU10/DG	2xGU10	Black	65	90	150	



Product Model	Power (W)	Body Color	Dimension (mm.)			Price (฿)
			W	L	H	
WL1008-13(65/30)/DG	1x3	Black	65	90	80	
WL1008-23(65/30)/DG	2x3	Black	65	90	150	
WL1008-1GU10/DG	1xGU10	Black	65	90	80	
WL1008-2GU10/DG	2xGU10	Black	65	90	150	

Landscape - Outdoor Light

WALL LAMP SERIES



SPECIFICATION

Input Voltage (V)	AC220-240V
Power Frequency (Hz)	50-60Hz
Material	Aluminium Die-Cast
Colors Temp. (K)	2,700K or 6,500K
IP Rating	IP54
Life time (Hrs.)	30,000 Hrs
Body Color	BK=Black/DG=Dark Gray /SG=Sliver Gray



Product Model	Power (W)	Body Color	Dimension (mm.)			Price (฿)
			W	L	H	
WL1009-23(65/30)/DG	2x3	Dark Gray	90	66	160	



Product Model	Power (W)	Body Color	Dimension (mm.)			Price (฿)
			W	L	H	
WL1010-23(65/30)/DG	2x3	Dark Gray	210	136	35	



Product Model	Power (W)	Body Color	Dimension (mm.)			Price (฿)
			W	L	H	
WL1011-23(65/30)/DG	2x3	Dark Gray	90	65	160	

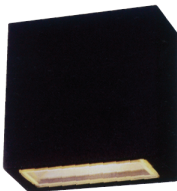

Product Model	Power (W)	Body Color	Dimension (mm.)			Price (฿)
			W	L	H	
WL1012-3(65/30)/BK	3	Black	90	10	90	



Product Model	Power (W)	Body Color	Dimension (mm.)			Price (฿)
			W	L	H	
WL1013-13(65/30)/DG	1x3	Dark Gray	125	90	153	
WL1013-23(65/30)/DG	2x3	Dark Gray	125	90	153	



Product Model	Power (W)	Body Color	Dimension (mm.)			Price (฿)
			W	L	H	
WL1014-22(65/30)/BK	2x2	Black	90	10	90	

WALL LAMP SERIES



SPECIFICATION

Input Voltage (V) AC220-240V
 Power Frequency (Hz) 50-60Hz
 Material Aluminium Die-Cast
 Colors Temp. (K) 2,700K or 6,500K
 IP Rating IP54
 Life time (Hrs.) 30,000 Hrs
 Body Color BK=Black/DG=Dark Gray /SG=Sliver Gray



Product Model	Power (W)	Body Color	Dimension (mm.)			Price (฿)
			W	L	H	
WL1015-23(65/30)/DG	2x3	Dark Gray	140	40	90	

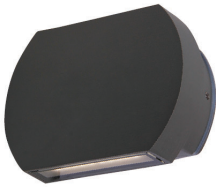

Product Model	Power (W)	Body Color	Dimension (mm.)			Price (฿)
			W	L	H	
WL1016-22(65/30)/DR	2x2	Dark Gray	130	60	100	



Product Model	Power (W)	Body Color	Dimension (mm.)			Price (฿)
			W	L	H	
WL1017-3(65/30)/BK	3	Black	100	40	88	



Product Model	Power (W)	Body Color	Dimension (mm.)			Price (฿)
			W	L	H	
WL1018-8(65/30)/BK	8	Black	215	118	35	



Product Model	Power (W)	Body Color	Dimension (mm.)			Price (฿)
			W	L	H	
WL1019-16(65/30)/BK	16	Black	210	136	35	



Product Model	Power (W)	Body Color	Dimension (mm.)			Price (฿)
			W	L	H	
WL1020-8(65/30)/BK	8	Black	215	113	35	

Landscape - Outdoor Light

WALL LAMP SERIES



SPECIFICATION

Input Voltage (V) AC220-240V
 Power Frequency (Hz) 50-60Hz
 Material Aluminium Die-Cast
 Colors Temp. (K) 2,700K or 6,500K
 IP Rating IP54
 Life time (Hrs.) 30,000 Hrs
 Body Color BK=Black/DG=Dark Gray /SG=Sliver Gray

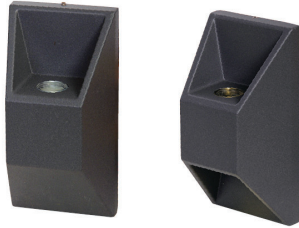

Product Model	Power (W)	Body Color	Dimension (mm.)			Price (฿)
			W	L	H	
WL1021-13(65/30)/DG	1x3	Dark Gray	80	160	63	
WL1021-23(65/30)/DG	2x3	Dark Gray	80	160	63	



Product Model	Power (W)	Body Color	Dimension (mm.)			Price (฿)
			W	L	H	
WL1022-8(65/30)/BK	8	Black	100	170	70	



Product Model	Power (W)	Body Color	Dimension (mm.)			Price (฿)
			W	L	H	
WL1023-8(65/30)/DG	6	Dark Gray	80	142	70	



Product Model	Power (W)	Body Color	Dimension (mm.)			Price (฿)
			W	L	H	
WL1024-8(65/30)/BK	8	Black	100	198	78	



Product Model	Power (W)	Body Color	Dimension (mm.)			Price (฿)
			W	L	H	
WL1025-13(65/30)/DG	1x3	Dark Gray	81	76	63	
WL1025-23(65/30)/DG	2x3	Dark Gray	81	142	63	

Landscape - Outdoor Light

WALL LAMP SERIES



SPECIFICATION

Input Voltage (V) AC220-240V
 Power Frequency (Hz) 50-60Hz
 Material Aluminium Die-Cast
 Colors Temp. (K) 2,700K or 6,500K
 IP Rating IP54
 Life time (Hrs.) 30,000 Hrs
 Body Color BK=Black/DG=Dark Gray /SG=Sliver Gray



Product Model	Power (W)	Body Color	Dimension (mm.)			Price (฿)
			W	L	H	
WL1026-3(65/30)/DG	3	Dark Gray	150	150	65	



Product Model	Power (W)	Body Color	Dimension (mm.)			Price (฿)
			W	L	H	
WL1027-13(65/30)/DG	1x3	Dark Gray	120	180	65	
WL1027-23(65/30)/DG	2x3	Dark Gray	120	180	65	



Product Model	Power (W)	Body Color	Dimension (mm.)			Price (฿)
			W	L	H	
WL1028-23(65/30)/DG	2x3	Dark Gray	160	200	61	



Product Model	Power (W)	Body Color	Dimension (mm.)			Price (฿)
			W	L	H	
WL1029-43(65/30)/DG	4x3	Dark Gray	200	160	61	



Product Model	Power (W)	Body Color	Dimension (mm.)			Price (฿)
			W	L	H	
WL1030-63(65/30)/DG	6x3	Dark Gray	200	160	61	

Landscape - Outdoor Light

WALL LAMP SERIES



SPECIFICATION

Input Voltage (V)	AC220-240V
Power Frequency (Hz)	50-60Hz
Material	Aluminium Die-Cast
Colors Temp. (K)	2,700K or 6,500K
IP Rating	IP54
Life time (Hrs.)	30,000 Hrs
Body Color	BK=Black/DG=Dark Gray /SG=Sliver Gray



Product Model	Power (W)	Body Color	Dimension (mm.)			Price (฿)
			W	L	H	
WL1031-10(65/30)/BK	10	Black	120	200	44	
WL1031-15(65/30)/BK	15	Black	155	260	55	



Product Model	Power (W)	Body Color	Dimension (mm.)			Price (฿)
			W	L	H	
WL1032-10(65/30)/BK	10	Black	200	200	44	
WL1032-15(65/30)/BK	15	Black	260	260	55	



Product Model	Power (W)	Body Color	Dimension (mm.)		Price (฿)
			ØDia.	H	
WL1033-10(65/30)/BK	10	Black	200	44	
WL1033-15(65/30)/BK	15	Black	260	55	



Product Model	Power (W)	Body Color	Dimension (mm.)			Price (฿)
			W	L	H	
WL1034-10(65/30)/BK	10	Black	175	270	149	
WL1034-E27/BK	E27	Black	175	270	149	



Product Model	Power (W)	Body Color	Dimension (mm.)			Price (฿)
			W	L	H	
WL1035-18(65/30)/BK	6x3	Black	150	355	120	

WALL LAMP SERIES



SPECIFICATION

Input Voltage (V)	AC220-240V
Power Frequency (Hz)	50-60Hz
Material	Aluminium Die-Cast
Colors Temp. (K)	2,700K or 6,500K
IP Rating	IP54
Life time (Hrs.)	30,000 Hrs
Body Color	BK=Black/DG=Dark Gray /SG=Sliver Gray



Product Model	Power (W)	Body Color	Dimension (mm.)			Price (\$)
			W	L	H	
WL1036-6(65/30)/DG	6	Dark Gray	84	285	120	



Product Model	Power (W)	Body Color	Dimension (mm.)			Price (\$)
			W	L	H	
WL1037-6(65/30)/BK	6	Black	125	260	50	

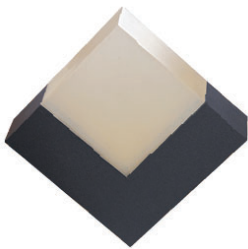

Product Model	Power (W)	Body Color	Dimension (mm.)			Price (\$)
			W	L	H	
WL1038-6(65/30)/DG	6	Dark Gray	150	212	100	



Product Model	Power (W)	Body Color	Dimension (mm.)			Price (\$)
			W	L	H	
WL1039-6(65/30)/DG	6	Dark Gray	150	150	100	



Product Model	Power (W)	Body Color	Dimension (mm.)			Price (\$)
			W	L	H	
WL1040-9(65/30)/BK	9	Black	93	360	88	



Product Model	Power (W)	Body Color	Dimension (mm.)		Price (\$)
			ØDai.	H	
WL1041-5(65/30)/BK	5	Black	190	70	

WALL LAMP SERIES



SPECIFICATION

Input Voltage (V) AC220-240V
 Power Frequency (Hz) 50-60Hz
 Material Aluminium Die-Cast
 Colors Temp. (K) 2,700K or 6,500K
 IP Rating IP54
 Life time (Hrs.) 30,000 Hrs
 Body Color BK=Black/DG=Dark Gray /SG=Sliver Gray

Landscape - Outdoor Light

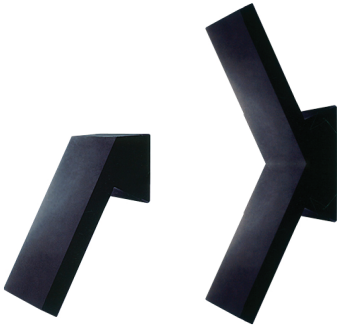

Product Model	Power (W)	Body Color	Dimension (mm.)			Price (\$)
			W	L	H	
WL1042-10(65/30)/BK	10	Black	80	220	125	
WL1042-210(65/30)/BK	2x10	Black	80	440	125	



Product Model	Power (W)	Body Color	Dimension (mm.)		Price (\$)
			ØDai.	H	
WL1043-23(65/30)/DG	2x3	Dark Gray	180	90	



Product Model	Power (W)	Body Color	Dimension (mm.)		Price (\$)
			ØDai.	H	
WL1044-22(65/30)/BK	2x2	Black	130	75	



Product Model	Power (W)	Body Color	Dimension (mm.)		Price (\$)
			ØDai.	H	
WL1045-3(65/30)/DG	3	Dark Gray	70	55	
WL1045-6(65/30)/DG	6	Dark Gray	140	55	



Product Model	Power (W)	Body Color	Dimension (mm.)			Price (\$)
			W	L	H	
WL1046A-33(65/30)/DG	3x3	Dark Gray	138	138	44	
WL1046B-33(65/30)/DG	3x3	Dark Gray	138	138	44	
WL1046C-23(65/30)/DG	2x3	Dark Gray	138	138	44	



WL1046A WL1046B WL1046C

WALL LAMP SERIES



SPECIFICATION

Input Voltage (V)	AC220-240V
Power Frequency (Hz)	50-60Hz
Material	Aluminium Die-Cast
Colors Temp. (K)	2,700K or 6,500K
IP Rating	IP54
Life time (Hrs.)	30,000 Hrs
Body Color	BK=Black/DG=Dark Gray /SG=Sliver Gray



Product Model	Power (W)	Body Color	Dimension (mm.)			Price (฿)
			W	L	H	
WL1047-10(65/30)/DG	10	Dark Gray	135	245	120	

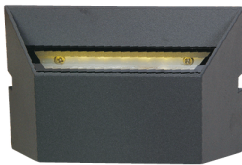

Product Model	Power (W)	Body Color	Dimension (mm.)			Price (฿)
			W	L	H	
WL1048-23(65/30)/DG	2x3	Dark Gray	60	150	130	



Product Model	Power (W)	Body Color	Dimension (mm.)			Price (฿)
			W	L	H	
WL1049-6(65/30)/BK	6	Black	145	120	45	

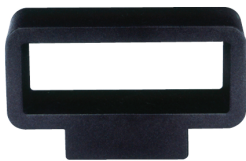

Product Model	Power (W)	Body Color	Dimension (mm.)			Price (฿)
			W	L	H	
WL1050-6(65/30)/BK	6	Black	130	220	55	



Product Model	Power (W)	Body Color	Dimension (mm.)			Price (฿)
			W	L	H	
WL1051-5(65/30)/BK	5	Black	156	160	55	



Product Model	Power (W)	Body Color	Dimension (mm.)			Price (฿)
			W	L	H	
WL1052-26(65/30)/BK	2x6	Black	105	214	160	

WALL LAMP SERIES



SPECIFICATION

Input Voltage (V) AC220-240V
 Power Frequency (Hz) 50-60Hz
 Material Aluminium Die-Cast
 Colors Temp. (K) 2,700K or 6,500K
 IP Rating IP54
 Life time (Hrs.) 30,000 Hrs
 Body Color BK=Black/DG=Dark Gray /SG=Sliver Gray



Product Model	Power (W)	Body Color	Dimension (mm.)			Price (฿)
			W	L	H	
WL1053-26(65/30)/BK	2x6	Black	105	214	160	



Product Model	Power (W)	Body Color	Dimension (mm.)			Price (฿)
			W	L	H	
WL1054-10(65/30)/BK	10	Black	85	350	120	
WL1054-E27/BK	E27	Black	85	350	120	



WL1055S

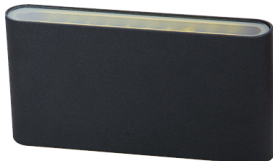

WL1055L

Product Model	Power (W)	Body Color	Dimension (mm.)			Price (฿)
			W	L	H	
WL1055S-8(65/30)/BK	8	Black	28	115	90	
WL1055L-8(65/30)/BK	8	Black	28	175	90	



Product Model	Power (W)	Body Color	Dimension (mm.)			Price (฿)
			W	L	H	
WL1056-5(65/30)/DG	5	Dark Gray	65	120	130	



Product Model	Power (W)	Body Color	Dimension (mm.)			Price (฿)
			W	L	H	
WL1057-20(65/30)/SG	20	Silver Gray	155	150	150	



Product Model	Power (W)	Body Color	Dimension (mm.)			Price (฿)
			W	L	H	
WL1058-25(65/30)/BK	2x5	Black	65	95	220	

WALL LAMP SERIES



SPECIFICATION

Input Voltage (V)	AC220-240V
Power Frequency (Hz)	50-60Hz
Material	Aluminium Die-Cast
Colors Temp. (K)	2,700K or 6,500K
IP Rating	IP54
Life time (Hrs.)	30,000 Hrs
Body Color	BK=Black/DG=Dark Gray /SG=Sliver Gray



Product Model	Power (W)	Body Color	Dimension (mm.)			Price (฿)
			W	L	H	
WL1059-3(65/30)/SG	3	Silver Gray	66	100	100	



Product Model	Power (W)	Body Color	Dimension (mm.)			Price (฿)
			W	L	H	
WL1060-5(65/30)/DG	5	Dark Gray	114	109	58	



Product Model	Power (W)	Body Color	Dimension (mm.)			Price (฿)
			W	L	H	
WL1061-6(65/30)/BK	6	Black	115	140	250	



Product Model	Power (W)	Body Color	Dimension (mm.)			Price (฿)
			W	L	H	
WL1062-12(65/30)/BK	12	Black	230	80	80	



Product Model	Power (W)	Body Color	Dimension (mm.)			Price (฿)
			W	L	H	
WL1063-12(65/30)/BK	12	Black	230	80	80	

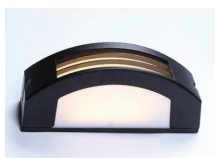

Product Model	Power (W)	Body Color	Dimension (mm.)			Price (฿)
			W	L	H	
WL1064-12(65/30)/BK	12	Black	115	290	125	

WALL LAMP SERIES

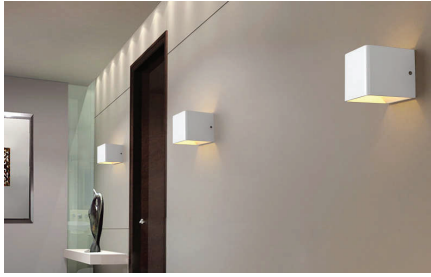

SPECIFICATION

Input Voltage (V)	AC220-240V
Power Frequency (Hz)	50-60Hz
Material	Aluminium Die-Cast
Colors Temp. (K)	2,700K or 6,500K
IP Rating	IP54
Life time (Hrs.)	30,000 Hrs
Body Color	BK=Black/DG=Dark Gray /SG=Sliver Gray



Product Model	Power (W)	Body Color	Dimension (mm.)			Price (\$)
			W	L	H	
WL1065-18(65/30)/BK	18	Black	230	135	80	

Product Model	Power (W)	Body Color	Dimension (mm.)			Price (\$)
			W	L	H	
WL1066-18(65/30)/BK	18	Black	230	135	80	

Product Model	Power (W)	Body Color	Dimension (mm.)			Price (\$)
			W	L	H	
WL1067-12(65/30)/BK	12	Black	125	260	150	



Product Model	Power (W)	Body Color	Dimension (mm.)			Price (\$)
			W	L	H	
WL1068S-12(65/30)/BK	12	Black	150	150	200	
WL1068L-12(65/30)/BK	12	Black	125	260	125	

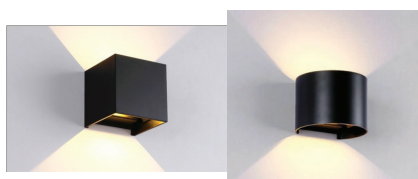

Product Model	Power (W)	Body Color	Dimension (mm.)			Price (\$)
			W	L	H	
WL1069R-23(65/30)/BK	2x3	Black	100	100	100	
WL1069S-23(65/30)/BK	2x3	Black	135	115	100	

WALL LAMP SERIES

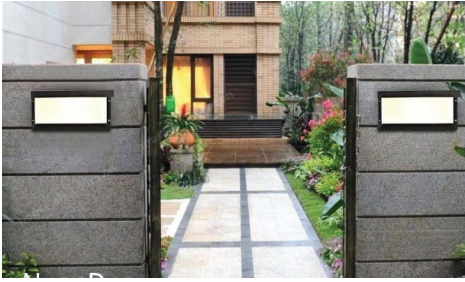

SPECIFICATION

Input Voltage (V)	AC220-240V
Power Frequency (Hz)	50-60Hz
Material	Aluminium Die-Cast
Colors Temp. (K)	2,700K or 6,500K
IP Rating	IP65
Life time (Hrs.)	30,000 Hrs
Body Color	BK=Black/DG=Dark Gray /SG=Sliver Gray



Product Model	Power (W)	Body Color	Dimension (mm.)		Price (฿)
			ØDai.	H	
WL1070S-5(65/30)/SG	6	Silver Gray	145	65	
WL1070M-5(65/30)/SG	12	Silver Gray	220	80	
WL1070L-10(65/30)/SG	18	Silver Gray	275	86	
WL1070XL-15(65/30)/SG	24	Silver Gray	360	155	
WL1070S-GU10/SG	GU10	Silver Gray	145	65	
WL1070M-E27/SG	E27	Silver Gray	220	80	
WL1070L-E27/SG	E27	Silver Gray	275	86	
WL1070XL-E27/SG	E27	Silver Gray	360	155	



Product Model	Power (W)	Body Color	Dimension (mm.)		Price (฿)
			ØDai.	H	
WL1071S-5(65/30)/SG	6	Silver Gray	145	65	
WL1071M-5(65/30)/SG	12	Silver Gray	220	80	
WL1071L-10(65/30)/SG	18	Silver Gray	275	86	
WL1071XL-15(65/30)/SG	24	Silver Gray	360	155	
WL1071S-GU10/SG	GU10	Silver Gray	145	65	
WL1071M-E27/SG	E27	Silver Gray	220	80	
WL1071L-E27/SG	E27	Silver Gray	275	86	
WL1071XL-E27/SG	E27	Silver Gray	360	155	



Product Model	Power (W)	Body Color	Dimension (mm.)		Price (฿)
			ØDai.	H	
WL1072S-5(65/30)/SG	6	Silver Gray	145	65	
WL1072M-5(65/30)/SG	12	Silver Gray	220	80	
WL1072L-10(65/30)/SG	18	Silver Gray	275	86	
WL1072XL-15(65/30)/SG	24	Silver Gray	360	155	
WL1072S-GU10/SG	GU10	Silver Gray	145	65	
WL1072M-E27/SG	E27	Silver Gray	220	80	
WL1072L-E27/SG	E27	Silver Gray	275	86	
WL1072XL-E27/SG	E27	Silver Gray	360	155	

WALL LAMP SERIES



SPECIFICATION

Input Voltage (V)	AC220-240V
Power Frequency (Hz)	50-60Hz
Material	Aluminium Die-Cast
Colors Temp. (K)	2,700K or 6,500K
IP Rating	IP65
Life time (Hrs.)	30,000 Hrs
Body Color	BK=Black/DG=Dark Gray /SG=Silver Gray

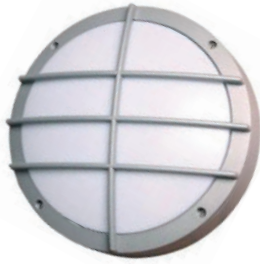

Product Model	Power (W)	Body Color	Dimension (mm.)		Price (\$)
			ØDai.	H	
WL1074S-5(65/30)/SG	6	Silver Gray	145	65	
WL1074M-5(65/30)/SG	12	Silver Gray	220	80	
WL1074L-10(65/30)/SG	18	Silver Gray	275	86	
WL1074XL-15(65/30)/SG	24	Silver Gray	360	155	
WL1074S-GU10/SG	GU10	Silver Gray	145	65	
WL1074M-E27/SG	E27	Silver Gray	220	80	
WL1074L-E27/SG	E27	Silver Gray	275	86	
WL1074XL-E27/SG	E27	Silver Gray	360	155	



Product Model	Power (W)	Body Color	Dimension (mm.)			Price (\$)
			W	L	H	
WL1075-24(65/30)/SG	24	Silver Gray	360	360	105	



Product Model	Power (W)	Body Color	Dimension (mm.)			Price (\$)
			W	L	H	
WL1076-24(65/30)/SG	24	Silver Gray	360	360	105	

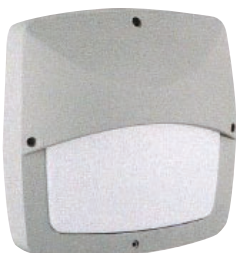

Product Model	Power (W)	Body Color	Dimension (mm.)			Price (\$)
			W	L	H	
WL1077-24(65/30)/SG	24	Silver Gray	360	360	105	

WALL LAMP SERIES

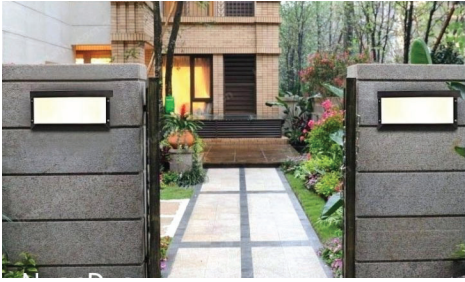

SPECIFICATION

Input Voltage (V)	AC220-240V
Power Frequency (Hz)	50-60Hz
Material	Aluminium Die-Cast
Colors Temp. (K)	2,700K or 6,500K
IP Rating	IP65
Life time (Hrs.)	30,000 Hrs
Body Color	BK=Black/DG=Dark Gray /SG=Sliver Gray



Product Model	Power (W)	Body Color	Dimension (mm.)			Price (฿)
			W	L	H	
WL1078-24(65/30)/SG	24	Silver Gray	300	300	105	



Product Model	Power (W)	Body Color	Dimension (mm.)			Price (฿)
			W	L	H	
WL1079-9(65/30)/SG	9	Silver Gray	135	260	90	
WL1079-E27/SG	E27	Silver Gray	135	260	90	



Product Model	Power (W)	Body Color	Dimension (mm.)			Price (฿)
			W	L	H	
WL1080-9(65/30)/SG	9	Silver Gray	135	260	90	
WL1080-E27/SG	E27	Silver Gray	135	260	90	



Product Model	Power (W)	Body Color	Dimension (mm.)			Price (฿)
			W	L	H	
WL1081-9(65/30)/SG	9	Silver Gray	135	260	90	
WL1081-E27/SG	E27	Silver Gray	135	260	90	



Product Model	Power (W)	Body Color	Dimension (mm.)			Price (฿)
			W	L	H	
WL1082-9(65/30)/SG	9	Silver Gray	135	260	90	
WL1082-E27/SG	E27	Silver Gray	135	260	90	

WALL LAMP SERIES



SPECIFICATION

Input Voltage (V)	AC220-240V
Power Frequency (Hz)	50-60Hz
Material	Aluminium Die-Cast
Colors Temp. (K)	2,700K or 6,500K
IP Rating	IP65
Life time (Hrs.)	30,000 Hrs
Body Color	BK=Black/DG=Dark Gray /SG=Silver Gray



Product Model	Power (W)	Body Color	Dimension (mm.)			Price (฿)
			W	L	H	
WL1083S-6(65/30)/SG	6	Silver Gray	135	220	65	
WL1083L-9(65/30)/SG	9	Silver Gray	185	285	100	
WL1083S-E27/SG	E27	Silver Gray	135	220	65	
WL1083L-E27/SG	E27	Silver Gray	185	285	100	



Product Model	Power (W)	Body Color	Dimension (mm.)			Price (฿)
			W	L	H	
WL1084S-6(65/30)/SG	6	Silver Gray	135	220	65	
WL1084L-9(65/30)/SG	9	Silver Gray	185	285	100	
WL1084S-E27/SG	E27	Silver Gray	135	220	65	
WL1084L-E27/SG	E27	Silver Gray	185	285	100	



Product Model	Power (W)	Body Color	Dimension (mm.)			Price (฿)
			W	L	H	
WL1085S-6(65/30)/SG	6	Silver Gray	135	220	65	
WL1085L-9(65/30)/SG	9	Silver Gray	185	285	100	
WL1085S-E27/SG	E27	Silver Gray	135	220	65	
WL1085L-E27/SG	E27	Silver Gray	185	285	100	

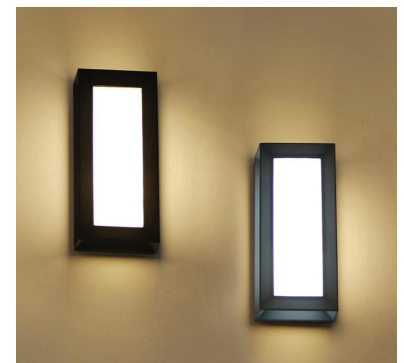

WALL LAMP SERIES



SPECIFICATION

Input Voltage (V)	AC220-240V
Power Frequency (Hz)	50-60Hz
Material	Aluminium Die-Cast
Colors Temp. (K)	2,700K or 6,500K
IP Rating	IP65
Life time (Hrs.)	30,000 Hrs
Body Color	BK=Black/DG=Dark Gray /SG=Sliver Gray



Product Model	Power (W)	Body Color	Dimension (mm.)			Price (฿)
			W	L	H	
WL1086S-6(65/30)/SG	6	Silver Gray	135	220	65	
WL1086L-9(65/30)/SG	9	Silver Gray	185	285	100	
WL1086S-E27/SG	E27	Silver Gray	135	220	65	
WL1086L-E27/SG	E27	Silver Gray	185	285	100	

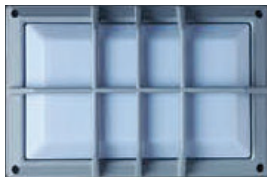

Product Model	Power (W)	Body Color	Dimension (mm.)			Price (฿)
			W	L	H	
WL1087S-6(65/30)/SG	6	Silver Gray	135	220	65	
WL1087L-9(65/30)/SG	9	Silver Gray	185	285	100	
WL1087S-E27/SG	E27	Silver Gray	135	220	65	
WL1087L-E27/SG	E27	Silver Gray	185	285	100	



Product Model	Power (W)	Body Color	Dimension (mm.)			Price (฿)
			W	L	H	
WL1088S-6(65/30)/SG	6	Silver Gray	135	220	65	
WL1088L-9(65/30)/SG	9	Silver Gray	185	285	100	
WL1088S-E27/SG	E27	Silver Gray	135	220	65	
WL1088L-E27/SG	E27	Silver Gray	185	285	100	



Product Model	Power (W)	Body Color	Dimension (mm.)			Price (฿)
			W	L	H	
WL1089S-6(65/30)/SG	6	Silver Gray	135	220	65	
WL1089L-9(65/30)/SG	9	Silver Gray	185	285	100	
WL1089S-E27/SG	E27	Silver Gray	135	220	65	
WL1089L-E27/SG	E27	Silver Gray	185	285	100	

WALL LAMP SERIES



SPECIFICATION

Input Voltage (V) AC220-240V
 Power Frequency (Hz) 50-60Hz
 Material Aluminium Die-Cast
 Colors Temp. (K) 2,700K or 6,500K
 IP Rating IP65
 Life time (Hrs.) 30,000 Hrs
 Body Color BK=Black/DG=Dark Gray /SG=Silver Gray



Product Model	Power (W)	Body Color	Dimension (mm.)			Price (\$)
			W	L	H	
WL1090S-6(65/30)/SG	6	Silver Gray	135	220	65	
WL1090L-9(65/30)/SG	9	Silver Gray	185	285	100	
WL1090S-E27/SG	E27	Silver Gray	135	220	65	
WL1090L-E27/SG	E27	Silver Gray	185	285	100	



Product Model	Power (W)	Body Color	Dimension (mm.)			Price (\$)
			W	L	H	
WL1091S-6(65/30)/SG	6	Silver Gray	135	220	65	
WL1091L-9(65/30)/SG	9	Silver Gray	185	285	100	
WL1091S-E27/SG	E27	Silver Gray	135	220	65	
WL1091L-E27/SG	E27	Silver Gray	185	285	100	



Landscape - Outdoor Light

WALL LAMP SERIES

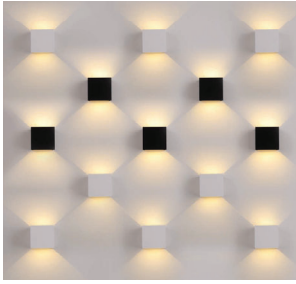

SPECIFICATION

Input Voltage (V) AC220-240V
 Power Frequency (Hz) 50-60Hz
 Material Aluminium Die-Cast
 Colors Temp. (K) 2,700K or 6,500K
 IP Rating IP20
 Life time (Hrs.) 30,000 Hrs
 Body Color BK=Black/DG=Dark Gray /SG=Sliver Gray



Product Model	Power (W)	Body Color	Dimension (mm.)			Price (฿)
			W	L	H	
WL1092S-10(65/30)/SG	10	Silver Gray	150	150	50	
WL1092R-10(65/30)/SG	10	Dark Gray	150	150	50	



Product Model	Power (W)	Body Color	Dimension (mm.)			Price (฿)
			W	L	H	
WL1093-6(65/30)/DG	6	Dark Gray	160	150	30	



Product Model	Power (W)	Body Color	Dimension (mm.)			Price (฿)
			W	L	H	
WL1094-5(65/30)/SG	5	Silver Gray	140	140	65	

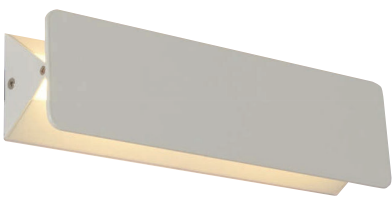

Product Model	Power (W)	Body Color	Dimension (mm.)			Price (฿)
			W	L	H	
WL1095L-5(65/30)/WH	5	White	55	180	80	
WL1095-10(65/30)/WH	10	White	55	350	80	
WL1095-15(65/30)/WH	15	White	55	520	80	



Product Model	Power (W)	Body Color	Dimension (mm.)			Price (฿)
			W	L	H	
WL1096S-5(65/30)/WH	5	White	100	100	80	
WL1096L-5(65/30)/WH	5	White	100	200	80	
WL1096-10(65/30)/WH	10	White	100	370	80	
WL1096-15(65/30)/WH	15	White	100	530	80	

Wall lamp - indoor Light

WALL LAMP SERIES

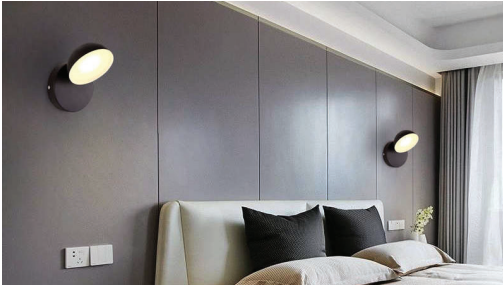

SPECIFICATION

Input Voltage (V)	AC220-240V
Power Frequency (Hz)	50-60Hz
Material	Aluminium Die-Cast
Colors Temp. (K)	2,700K or 6,500K
IP Rating	IP54/IP20
Life time (Hrs.)	30,000 Hrs
Body Color	BK=Black/DG=Dark Gray /SG=Sliver Gray



Product Model	Power (W)	Body Color	Dimension (mm.)			Price (฿)
			W	L	H	
WL1097-6(65/30)/BK	6	Black	300	60	100	



Product Model	Power (W)	Body Color	Dimension (mm.)			Price (฿)
			W	L	H	
WL1098-6(65/30)/BK	6	Black	350	60	70	



Product Model	Power (W)	Body Color	Dimension (mm.)			Price (฿)
			W	L	H	
WL1099-5(65/30)/SG	5	Silver Gray	350	60	70	



Product Model	Power (W)	Body Color	Dimension (mm.)			Price (฿)
			W	L	H	
WL1100-5(65/30)/SG	5	Silver Gray	190	60	110	



Product Model	Power (W)	Body Color	Dimension (mm.)			Price (฿)
			W	L	H	
WL1101-5(65/30)/BK	5	Black	140	140	180	



Product Model	Power (W)	Body Color	Dimension (mm.)			Price (฿)
			W	L	H	
WL1102-5(65/30)/BK	5	Black	100	140	130	

WALL LAMP SERIES



SPECIFICATION

Input Voltage (V)	AC220-240V
Power Frequency (Hz)	50-60Hz
Material	Aluminium Die-Cast
Colors Temp. (K)	2,700K or 6,500K
IP Rating	IP20
Life time (Hrs.)	30,000 Hrs
Body Color	BK=Black/DG=Dark Gray /SG=Sliver Gray



Product Model	Power (W)	Body Color	Dimension (mm.)		Price (฿)
			ØDai.	H	
WL1103-8(65/30)/BK	12	Black	130	120	



Product Model	Power (W)	Body Color	Dimension (mm.)			Price (฿)
			W	L	H	
WL1104-23(65/30)/DG	2x3	Dark Gray	90	130	135	



Product Model	Power (W)	Body Color	Dimension (mm.)			Price (฿)
			W	L	H	
WL1105-23(65/30)/SG	2x3	Silver Gray	35	50	135	

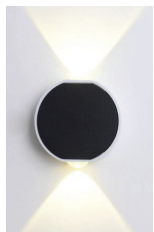

Product Model	Power (W)	Body Color	Dimension (mm.)			Price (฿)
			W	L	H	
WL1106-23(65/30)/WH	2x3	White	35	100	100	



Product Model	Power (W)	Body Color	Dimension (mm.)		Price (฿)
			ØDai.	H	
WL1107-3(65/30)/WH	3	White	90	60	

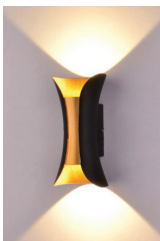

Product Model	Power (W)	Body Color	Dimension (mm.)			Price (฿)
			W	L	H	
WL1108-23(65/30)/SV	2x3	Silver	100	105	200	

WALL LAMP SERIES



SPECIFICATION

Input Voltage (V) AC220-240V
 Power Frequency (Hz) 50-60Hz
 Material Aluminium Die-Cast
 Colors Temp. (K) 2,700K or 6,500K
 IP Rating IP20
 Life time (Hrs.) 30,000 Hrs
 Body Color BK=Black/DG=Dark Gray /SG=Sliver Gray



Product Model	Power (W)	Body Color	Dimension (mm.)			Price (฿)
			W	L	H	
WL1109-23(65/30)/SV	2x3	Silver	290	110	48	

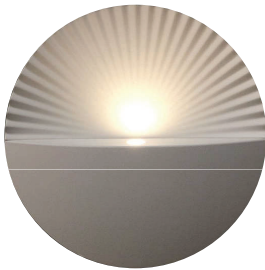

Product Model	Power (W)	Body Color	Dimension (mm.)		Price (฿)
			ØDai.	H	
WL1110-4(65/30)/SG	4	Silver Dark	150	50	



Product Model	Power (W)	Body Color	Dimension (mm.)			Price (฿)
			W	L	H	
WL1111-5(65/30)/WH	5	White	80	100	150	

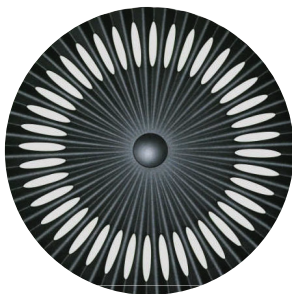

Product Model	Power (W)	Body Color	Dimension (mm.)		Price (฿)
			ØDai.	H	
WL1112S-8(65/30)/BK	8	Black	250	125	
WL1112M-8(65/30)/BK	8	Black	320	125	
WL1112L-8(65/30)/BK	8	Black	400	125	



Product Model	Power (W)	Body Color	Dimension (mm.)		Price (฿)
			ØDai.	H	
WL1113-4(65/30)/SG	4	Silver Dark	150	50	

Wall lamp - indoor Light

WALL LAMP SERIES

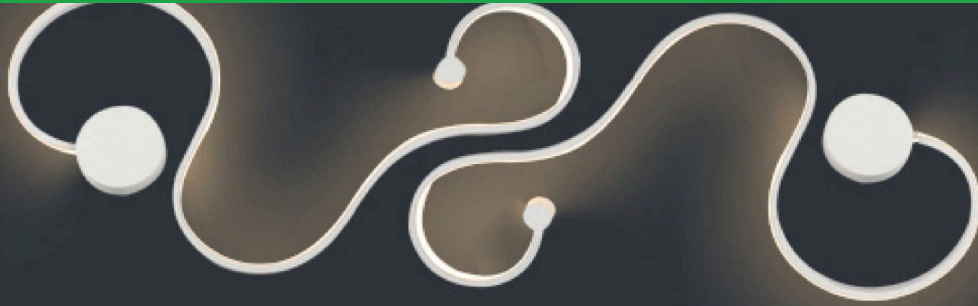

LIGHT ART
LIFE PEACE

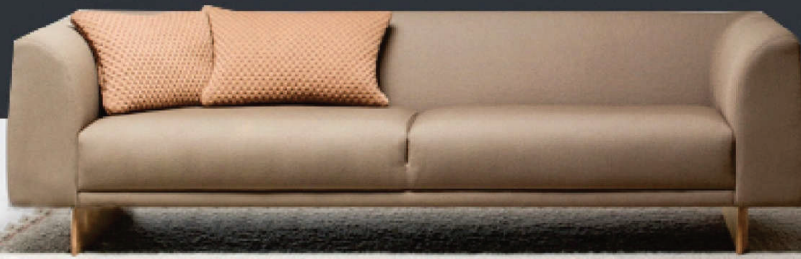

Wall lamp - indoor Light

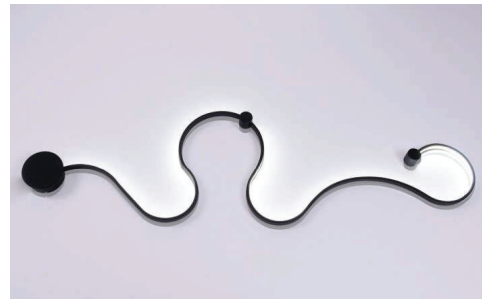
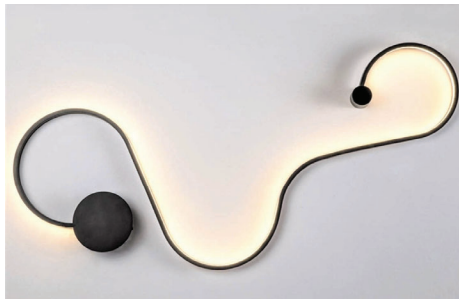

Product Model	Power (W)	Body Color	Dimension (mm.)		Price (\$)
			ØDia.	L	
WL1114S-5(65/30)/WH	23	White	500	520	
WL1114M-5(65/30)/WH	27	White	420	680	
WL1114L-10(65/30)/WH	30	White	430	800	
WL1114XL-15(65/30)/WH	38	White	380	1180	

WALL LAMP SERIES

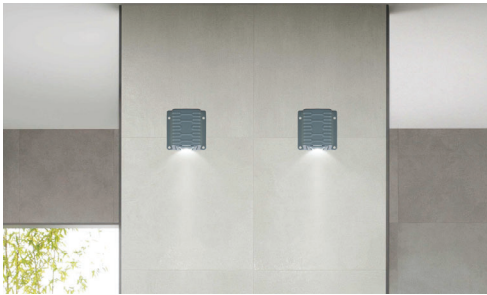

SPECIFICATION

Input Voltage (V) AC220-240V
 Power Frequency (Hz) 50-60Hz
 Material Aluminium Die-Cast
 Colors Temp. (K) 2,700K or 6,500K
 IP Rating IP54
 Life time (Hrs.) 30,000 Hrs
 Body Color BK=Black/DG=Dark Gray /SG=Sliver Gray

Landscape - Outdoor Light

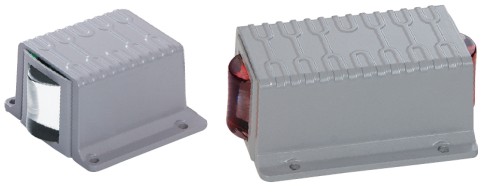

Product Model	Power (W)	Body Color	Dimension (mm.)			Price (฿)
			W	L	H	
WL1115-11(65/30)/SG	1x1	Silver Gray	45	70	40	
WL1115-21(65/30)/SG	2x1	Silver Gray	45	40	105	

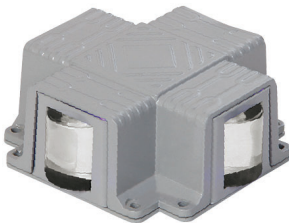

Product Model	Power (W)	Body Color	Dimension (mm.)			Price (฿)
			W	L	H	
WL1116-41(65/30)/SG	4x1	Silver Gray	105	115	45	

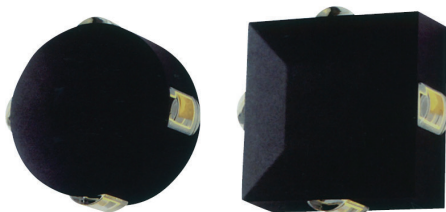

Product Model	Power (W)	Body Color	Dimension (mm.)			Price (฿)
			W	L	H	
WL1117R-41(65/30)/BK	4x1	Black	112	112	63	
WL1117S-41(65/30)/BK	4x1	Black	124	124	63	



Product Model	Power (W)	Body Color	Dimension (mm.)		Price (฿)
			ØDai.	H	
WL1118-3(65/30)/SG	3	Silver Gray	90	95	



Product Model	Power (W)	Body Color	Dimension (mm.)			Price (฿)
			W	L	H	
WL1119-3(65/30)/DG	3	Drak Gray	80	80	70	

WALL LAMP SERIES



SPECIFICATION

Input Voltage (V)	AC220-240V
Power Frequency (Hz)	50-60Hz
Material	Aluminium Die-Cast
Holder lamp	E27
IP Rating	IP65
Body Color	BK=Black/DG=Dark Gray /SG=Sliver Gray



WL1120-E27/BK

1xE27 Ø130xH50

Price (฿)



WL1121-E27/BK

1xE27 Ø130xH50

Price (฿)



WL1122-E27/BK

1xE27 Ø300xH82

Price (฿)



WL1123-E27/BK

1xE27 123x220xH90

Price (฿)



WL1124-E27/BK

1xE27 123x220xH90

Price (฿)



WL1125-E27/BK

1xE27 114x172xH70

Price (฿)



WL1126-E27/BK

1xE27 196x172xH70

Price (฿)



WL1127-E27/BK

1xE27 130x280xH130

Price (฿)



WL1128-E27/BK

1xE27 120x280xH160

Price (฿)



WL1129S-E27/BK

1xE27 Ø90xH160

Price (฿)



WL1129M-E27/BK

1xE27 Ø108xH210

Price (฿)



WL1129L-E27/BK

1xE27 Ø145xH300

Price (฿)



WL1130S-2E27/BK

2xE27 Ø90xH260

Price (฿)



WL1130M-2E27/BK

1xE27 Ø108xH300

Price (฿)



WL1130L-2E27/BK

2xE27 Ø145xH450

Price (฿)



WL1131S-E27/BK

1xE27 Ø90xH210

Price (฿)

Landscape - Outdoor Light

WALL LAMP SERIES



SPECIFICATION

Input Voltage (V)	AC220-240V
Power Frequency (Hz)	50-60Hz
Material	Aluminium Die-Cast
Holder lamp	E27
IP Rating	IP65
Body Color	BK=Black/DG=Dark Gray /SG=Sliver Gray



WL1131M-E27/BK

1xE27 Ø108xH210

Price (฿)



WL1131L-E27/BK

1xE27 Ø145xH300

Price (฿)



WL1132S-2E27/BK

2xE27 Ø90xH320

Price (฿)



WL1132M-2E27/BK

2xE27 Ø108xH320

Price (฿)



WL1132L-2E27/BK

2xE27 Ø145xH450

Price (฿)



WL1133S-E27/BK

1xE27 Ø90xH160

Price (฿)



WL1133M-E27/BK

1xE27 Ø110xH200

Price (฿)



WL1134S-2E27/BK

2xE27 Ø90xH260

Price (฿)



WL1134M-2E27/BK

2xE27 Ø110xH300

Price (฿)



WL1135S-E27/BK

1xE27 90x90xH160

Price (฿)



WL1135M-E27/BK

1xE27 120x120xH200

Price (฿)



WL1135L-E27/BK

1xE27 Ø150x150xH260

Price (฿)



WL1136S-2E27/BK

2xE27 90x90xH260

Price (฿)



WL1136M-2E27/BK

2xE27 120x120xH300

Price (฿)



WL1136L-2E27/BK

2xE27 150x150xH420

Price (฿)



WL1137-2E27/BK

1xE27 90x90xH260

Price (฿)

WALL LAMP SERIES



SPECIFICATION

Input Voltage (V)	AC220-240V
Power Frequency (Hz)	50-60Hz
Material	Aluminium Die-Cast
Holder lamp	E27
IP Rating	IP65
Body Color	BK=Black/DG=Dark Gray /SG=Sliver Gray



WL1138-E27/BK

1xE27 120x120xH350

Price (฿)



WL1139-E27/BK

1xE27 120x200xH350

Price (฿)



WL1140-E27/BK

1xE27 120x200xH350

Price (฿)



WL1141-E27/BK

1xE27 135x200xH350

Price (฿)



WL1142-E27/BK

1xE27 135x200xH350

Price (฿)



WL1143-E27/BK

1xE27 135x200xH350

Price (฿)



WL1144-E27/BK

1xE27 135x200xH350

Price (฿)



WL1145-E27/BK

1xE27 120x249xH132

Price (฿)



WL1146-E27/BK

1xE27 120x249xH132

Price (฿)



WL1147-E27/BK

1xE27 120x249xH132

Price (฿)



WL1148-E27/BK

1xE27 120x249xH132

Price (฿)



WL1149-E27/BK

1xE27 120x249xH132

Price (฿)



WL1150-2E27/BK

2xE27 120x249xH132

Price (฿)



WL1151-2E27/BK

1xE27 120x249xH132

Price (฿)



Landscape - Outdoor Light

STEP LAMP SERIES

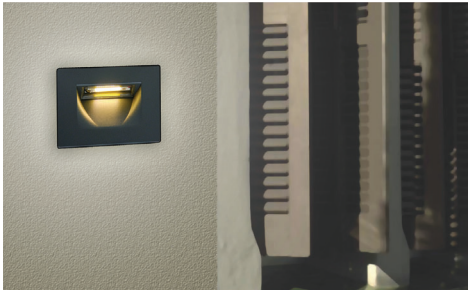

SPECIFICATION

Input Voltage (V) AC220-240V
 Power Frequency (Hz) 50-60Hz
 Material Aluminium Die-Cast
 Colors Temp. (K) 2,700K or 6,500K
 IP Rating IP65
 Life time (Hrs.) 30,000 Hrs
 Body Color BK=Black/DG=Dark Gray /SG=Sliver Gray



Product Model	Power (W)	Body Color	Dimension (mm.)			Price (฿)
			W	L	H	
SP1001-2(65/30)/SG	2	Silver Gray	90	90	90	



Product Model	Power (W)	Body Color	Dimension (mm.)			Price (฿)
			W	L	H	
SP1002-2(65/30)/BK	2	Black	60	105	55	
SP1002-4(65/30)/BK	4	Black	60	210	55	



Product Model	Power (W)	Body Color	Dimension (mm.)			Price (฿)
			W	L	H	
SP1003-2(65/30)/BK	2	Black	105	60	55	
SP1003-2(65/30)/BK	2	Black	210	60	55	



Product Model	Power (W)	Body Color	Dimension (mm.)			Price (฿)
			W	L	H	
SP1004-2(65/30)/DG	2	Dark Gray	70	106	60	

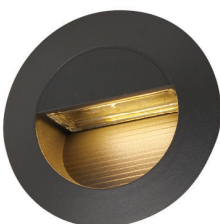

Product Model	Power (W)	Body Color	Dimension (mm.)		Price (฿)
			ØDai.	H	
SP1005-2(65/30)/DG	2	Dark Gray	80	55	

Landscape - Outdoor Light

STEP LAMP SERIES



SPECIFICATION

Input Voltage (V) AC220-240V
 Power Frequency (Hz) 50-60Hz
 Material Aluminium Die-Cast
 Colors Temp. (K) 2,700K or 6,500K
 IP Rating IP54
 Life time (Hrs.) 30,000 Hrs
 Body Color BK=Black/DG=Dark Gray /SG=Sliver Gray

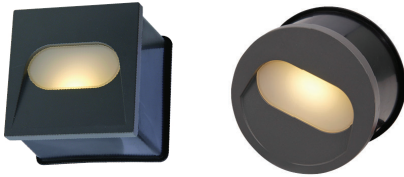

Product Model	Power (W)	Body Color	Dimension (mm.)			Price (฿)
			W	L	H	
SP1006S-9(65/30)/DG	9	Dark Gray	138	138	96	
SP1006R-9(65/30)/DG	9	Dark Gray	126	129	80	



Product Model	Power (W)	Body Color	Dimension (mm.)			Price (฿)
			W	L	H	
SP1007-6(65/30)/DG	6	Dark Gray	180	160	69	
SP1007-9(65/30)/DG	9	Dark Gray	180	160	69	



Product Model	Power (W)	Body Color	Dimension (mm.)			Price (฿)
			W	L	H	
SP1008-2(65/30)/DG	2	Dark Gray	90	120	23	
SP1008-10(65/30)/DG	10	Dark Gray	135	200	33	



SP1009-E27/BK

1xE27 80x233xH101

Price (฿)



SP1010-E27/BK

1xE27 80x233xH101

Price (฿)



SP1011-E27/BK

1xE27 80x233xH101

Price (฿)



SP1012-E27/BK

1xE27 80x233xH101

Price (฿)



SP1013-E27/BK

1xE27 80x225xH125

Price (฿)



SP1014-E27/BK

1xE27 80x225xH125

Price (฿)

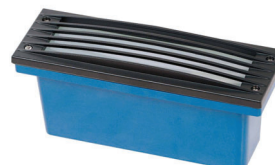

SP1015-E27/BK

1xE27 88x256xH115

Price (฿)



SP1016-E27/BK

1xE27 88x256xH115

Price (฿)

Landscape - Outdoor Light

SPOT LIGHT SERIES

SPECIFICATION

Input Voltage (V) AC220-240V
 Power Frequency (Hz) 50-60Hz
 Material Aluminium Die-Cast
 Colors Temp. (K) 2,700K or 6,500K
 IP Rating IP65
 Life time (Hrs.) 30,000 Hrs
 Body Color BK=Black/DG=Dark Gray /SG=Sliver Gray



Product Model	Power (W)	Body Color	Dimension (mm.)			Price (฿)
			ØDai.	L	H	
SP1001-6(65/30)/SG	6	Silver Gray	90	175	110	
SP1001-9(65/30)/SG	9	Silver Gray	120	225	120	

∠ 5°,15°,25°,
45°,60°



Product Model	Power (W)	Body Color	Dimension (mm.)			Price (฿)
			ØDai.	L	H	
SP1002-7(65/30)/SG	7	Silver Gray	90	155	110	
SP1002-12(65/30)/SG	12	Silver Gray	120	200	120	

∠ 5°,15°,25°,
45°,60°



Product Model	Power (W)	Body Color	Dimension (mm.)			Price (฿)
			ØDai.	L	H	
SP1003-6(65/30)/SG	6	Silver Gray	90	175	310	
SP1003-9(65/30)/SG	9	Silver Gray	120	225	310	

∠ 5°,15°,25°,
45°,60°



Product Model	Power (W)	Body Color	Dimension (mm.)			Price (฿)
			ØDai.	L	H	
SP1004-7(65/30)/SG	7	Silver Gray	90	155	310	
SP1004-12(65/30)/SG	12	Silver Gray	120	200	310	

∠ 5°,15°,25°,
45°,60°

SPOT LIGHT SERIES

SPECIFICATION

Input Voltage (V)	AC220-240V
Power Frequency (Hz)	50-60Hz
Material	Aluminium Die-Cast
Colors Temp. (K)	2,700K or 6,500K
IP Rating	IP65
Life time (Hrs.)	30,000 Hrs
Body Color	BK=Black/DG=Dark Gray /SG=Sliver Gray



∠ 16°,30°

Product Model	Power (W)	Body Color	Dimension (mm.)			Price (฿)
			ØDai.	L	H	
SP1005-10(65/30)/SG	10	Silver Dark	93	110	110	
SP1005-20(65/30)/SG	20	Silver Dark	125	145	145	



∠ 16°,30°

Product Model	Power (W)	Body Color	Dimension (mm.)			Price (฿)
			ØDai.	L	H	
SP1006-10(65/30)/SG	10	Silver Gray	93	110	110	
SP1006-20(65/30)/SG	20	Silver Gray	125	145	145	



∠ 30°,45°

Product Model	Power (W)	Body Color	Dimension (mm.)			Price (฿)
			ØDai.	L	H	
SP1007-3(65/30)/BK	3	Black	42	65	55	
SP1007-5(65/30)/BK	5	Black	60	98	75	



∠ 30°

Product Model	Power (W)	Body Color	Dimension (mm.)			Price (฿)
			ØDai.	L	H	
SP1008-3(65/30)/BK	3	Black	42	65	55	



∠ 25°

Product Model	Power (W)	Body Color	Dimension (mm.)			Price (฿)
			ØDai.	L	H	
SP1009-2(65/30)/BK	2	Black	40	75	60	
SP1009-5(65/30)/BK	5	Black	50	75	60	

Landscape - Outdoor Light

SPOT LIGHT SERIES

SPECIFICATION

Input Voltage (V) AC220-240V
 Power Frequency (Hz) 50-60Hz
 Material Aluminium Die-Cast
 Colors Temp. (K) 2,700K or 6,500K
 IP Rating IP65
 Life time (Hrs.) 30,000 Hrs
 Body Color BK=Black/DG=Dark Gray /SG=Sliver Gray



Product Model	Power (W)	Body Color	Dimension (mm.)			Price (฿)
			W	L	H	
SP1010-6(65/30)/SG	6	Silver Gray	60	80	140	

∠ 5°,15°,25°,
45°,60°



Product Model	Power (W)	Body Color	Dimension (mm.)			Price (฿)
			ØDai.	L	H	
SP1011-7(65/30)/BK	7	Black	95	110	220	

∠ 5°,15°,25°,
45°,60°



Product Model	Power (W)	Body Color	Dimension (mm.)			Price (฿)
			ØDai.	L	H	
SP1012-3(65/30)/SG	3	Silver Gray	55	85	90	

∠ 5°,15°,25°,
45°,60°



Product Model	Power (W)	Body Color	Dimension (mm.)			Price (฿)
			ØDai.	L	H	
SP1013-2(65/30)/SG	2	Silver Gray	50	75	80	
SP1013-2(65/30)/SG	2	Silver Gray	50	100	80	

∠ 5°,15°,25°,
45°,60°



Product Model	Power (W)	Body Color	Dimension (mm.)			Price (฿)
			ØDai.	L	H	
SP1014-2(65/30)/SG	2	Silver Gray	50	68	55	

∠ 5°,15°,25°,
45°,60°

Landscape - Outdoor Light

SPOT LIGHT SERIES

SPECIFICATION

Input Voltage (V) AC220-240V
 Power Frequency (Hz) 50-60Hz
 Material Aluminium Die-Cast
 Colors Temp. (K) 2,700K or 6,500K
 IP Rating IP65
 Life time (Hrs.) 30,000 Hrs
 Body Color BK=Black/DG=Dark Gray /SG=Silver Gray



Product Model	Power (W)	Body Color	Dimension (mm.)			Price (฿)
			ØDai.	L	H	
SP1015-5(65/30)/SG	5	Silver Gray	60	90	50	
SP1015-10(65/30)/SG	10	Silver Gray	80	120	50	
SP1015-15(65/30)/SG	15	Silver Gray	100	155	50	
SP1015-30(65/30)/SG	30	Silver Gray	140	280	50	

∠ 24°



Product Model	Power (W)	Body Color	Dimension (mm.)			Price (฿)
			ØDai.	L	H	
SP1016-5(65/30)/SG	5	Silver Gray	70	90	120	
SP1016-10(65/30)/SG	10	Silver Gray	90	105	100	

∠ 5°, 15°, 25°, 45°, 60°



Product Model	Power (W)	Body Color	Dimension (mm.)			Price (฿)
			ØDai.	L	H	
SP1017-5(65/30)/BK	3	Black	90	30	80	

∠ 5°, 15°, 25°, 45°, 60°



Product Model	Power (W)	Body Color	Dimension (mm.)			Price (฿)
			ØDai.	L	H	
SP1018-5(65/30)/BK	3	Black	90	30	80	

∠ 5°, 15°, 25°, 45°, 60°



Product Model	Power (W)	Body Color	Dimension (mm.)			Price (฿)
			ØDai.	L	H	
SP1019-5(65/30)/BK	3	Black	90	30	80	

∠ 5°, 15°, 25°, 45°, 60°

Landscape - Outdoor Light

SPOT LIGHT SERIES

SPECIFICATION

Input Voltage (V)	AC220-240V
Power Frequency (Hz)	50-60Hz
Material	Aluminium Die-Cast
Colors Temp. (K)	2,700K or 6,500K
IP Rating	IP65
Life time (Hrs.)	30,000 Hrs
Body Color	BK=Black/DG=Dark Gray /SG=Sliver Gray



Product Model	Power (W)	Body Color	Dimension (mm.)			Price (฿)
			ØDai.	L	H	
SP1020-10(65/30)/BK	10	Black	138	170	100	
SP1020-12(65/30)/BK	12	Black	180	210	150	

∠ 5°,15°,25°,
45°,60°



Product Model	Power (W)	Body Color	Dimension (mm.)			Price (฿)
			ØDai.	L	H	
SP1021-9(65/30)/SG	9	Silver Gray	138	170	100	
SP1021-12(65/30)/SG	12	Silver Gray	180	210	150	

∠ 5°,15°,25°,
45°,60°



Product Model	Power (W)	Body Color	Dimension (mm.)			Price (฿)
			ØDai.	L	H	
SP1022-10(65/30)/BK	10	Black	65	135	320	
SP1022-15(65/30)/BK	15	Black	75	135	320	

∠ 24°



Product Model	Power (W)	Body Color	Dimension (mm.)			Price (฿)
			ØDai.	L	H	
SP1023-18(65/30)/WH	18	White	110	200	145	
SP1023-30(65/30)/WH	30	White	145	200	145	
SP1023-36(65/30)/WH	36	White	160	225	145	
SP1023-54(65/30)/WH	54	White	180	240	145	

∠ 5°,15°,25°,
45°,60°

SPOT LIGHT SERIES

SPECIFICATION

Input Voltage (V) AC220-240V
 Power Frequency (Hz) 50-60Hz
 Material Aluminium Die-Cast
 Colors Temp. (K) 2,700K or 6,500K
 IP Rating IP65
 Life time (Hrs.) 30,000 Hrs
 Body Color BK=Black/DG=Dark Gray /SG=Sliver Gray



Product Model	Power (W)	Body Color	Dimension (mm.)			Price (฿)
			ØDai.	L	H	
SP1024-18(65/30)/WH	18	White	110	200	145	
SP1024-30(65/30)/WH	30	White	145	200	145	
SP1024-36(65/30)/WH	36	White	160	225	145	
SP1024-54(65/30)/WH	54	White	180	240	145	

∠ 5°,15°,25°,
45°,60°



Product Model	Power (W)	Body Color	Dimension (mm.)			Price (฿)
			W	L	H	
SP1025-9(65/30)/SG	9	Silver Gray	120	120	120	
SP1025-18(65/30)/SG	18	Silver Gray	120	120	120	
SP1025-25(65/30)/SG	25	Silver Gray	150	150	125	
SP1025-50(65/30)/SG	50	Silver Gray	150	150	125	

∠ 5°,15°,25°,
45°,60°



Product Model	Power (W)	Body Color	Dimension (mm.)			Price (฿)
			ØDai.	L	H	
SP1026-9(65/30)/BK	3	Black	90	135	90	
SP1026-18(65/30)/BK	7	Black	115	180	140	
SP1026-25(65/30)/BK	15	Black	150	210	160	
SP1026-50(65/30)/BK	30	Black	150	210	160	

∠ 5°,15°,25°,
45°,60°



Product Model	Power (W)	Body Color	Dimension (mm.)			Price (฿)
			W	L	H	
SP1027-18(65/30)/BK	18	Black	160	100	135	
SP1027C-18(65/30)/BK	18	Black	160	175	135	

∠ 5°,15°,25°,
45°,60°

Landscape - Outdoor Light

SPOT LIGHT SERIES

SPECIFICATION

Input Voltage (V)	AC220-240V
Power Frequency (Hz)	50-60Hz
Material	Aluminium Die-Cast
Colors Temp. (K)	2,700K or 6,500K
IP Rating	IP65
Life time (Hrs.)	30,000 Hrs
Body Color	BK=Black/DG=Dark Gray /SG=Sliver Gray



Product Model	Power (W)	Body Color	Dimension (mm.)			Price (฿)
			ØDai.	L	H	
SP1028S-3(65/30)/SG	3	Silver Gray	85	95	95	
SP1028S-6(65/30)/SG	6	Silver Gray	85	95	95	
SP1028M-9(65/30)/SG	9	Silver Gray	125	135	125	
SP1028M-18(65/30)/SG	18	Silver Gray	125	135	125	
SP1028L-18(65/30)/SG	18	Silver Gray	165	180	170	
SP1028L-36(65/30)/SG	36	Silver Gray	165	180	170	

△ 5°,15°,25°,
45°,60°



Product Model	Power (W)	Body Color	Dimension (mm.)			Price (฿)
			ØDai.	L	H	
SP1029M-18(65/30)/SG	18	Silver Gray	195	160	200	
SP1029M-36(65/30)/SG	36	Silver Gray	195	160	200	
SP1029L-36(65/30)/SG	36	Silver Gray	230	205	255	
SP1029L-48(65/30)/SG	48	Silver Gray	230	205	255	
SP1029L-72(65/30)/SG	72	Silver Gray	230	205	255	
SP1029L-96(65/30)/SG	96	Silver Gray	230	205	255	

△ 5°,15°,25°,
45°,60°



Product Model	Power (W)	Body Color	Dimension (mm.)			Price (฿)
			ØDai.	L	H	
SP1030M-9(65/30)/SG	9	Silver Gray	125	135	145	
SP1030M-18(65/30)/SG	18	Silver Gray	125	135	145	
SP1030L-18(65/30)/SG	18	Silver Gray	165	180	145	
SP1030L-36(65/30)/SG	36	Silver Gray	165	180	145	

△ 5°,15°,25°,
45°,60°

SPOT LIGHT SERIES

SPECIFICATION

Input Voltage (V)	AC220-240V
Power Frequency (Hz)	50-60Hz
Material	Aluminium Die-Cast
Colors Temp. (K)	2,700K or 6,500K
IP Rating	IP65
Life time (Hrs.)	30,000 Hrs
Body Color	BK=Black/DG=Dark Gray /SG=Sliver Gray



Product Model	Power (W)	Body Color	Dimension (mm.)			Price (฿)
			ØDai.	L	H	
SP1031S-3(65/30)/SG	3	Silver Gray	85	135	220	
SP1031S-6(65/30)/SG	6	Silver Gray	85	135	220	
SP1031M-9(65/30)/SG	9	Silver Gray	125	185	385	
SP1031M-18(65/30)/SG	18	Silver Gray	125	185	385	
SP1031L-18(65/30)/SG	18	Silver Gray	165	245	385	
SP1031L-36(65/30)/SG	36	Silver Gray	165	245	385	

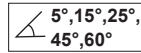

Product Model	Power (W)	Body Color	Dimension (mm.)			Price (฿)
			ØDai.	L	H	
SP1032-5(65/30)/SG	5	Silver Gray	110	98	146	
SP1032-9(65/30)/SG	9	Silver Gray	170	122	215	
SP1032-18(65/30)/SG	18	Silver Gray	170	122	215	
SP1032-36(65/30)/SG	36	Silver Gray	206	145	245	
SP1032-72(65/30)/SG	72	Silver Gray	240	190	380	
SP1032-96(65/30)/SG	96	Silver Gray	280	215	370	

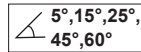

Product Model	Power (W)	Body Color	Dimension (mm.)			Price (฿)
			ØDai.	L	H	
SP1032C-5(65/30)/SG	5	Silver Gray	110	138	146	
SP1032C-9(65/30)/SG	9	Silver Gray	170	162	215	
SP1032C-18(65/30)/SG	18	Silver Gray	170	162	215	
SP1032C-36(65/30)/SG	36	Silver Gray	206	185	245	
SP1032C-72(65/30)/SG	72	Silver Gray	240	230	380	
SP1032C-96(65/30)/SG	96	Silver Gray	280	270	370	

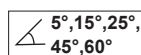

Landscape - Outdoor Light

SPOT LIGHT SERIES

SPECIFICATION

Input Voltage (V)	AC220-240V
Power Frequency (Hz)	50-60Hz
Material	Aluminium Die-Cast
Colors Temp. (K)	2,700K or 6,500K
IP Rating	IP65
Life time (Hrs.)	30,000 Hrs
Body Color	BK=Black/DG=Dark Gray /SG=Sliver Gray



Product Model	Power (W)	Body Color	Dimension (mm.)			Price (฿)
			ØDai.	L	H	
SP1033-3(65/30)/SG	3	Silver Gray	148	85	160	
SP1033-12(65/30)/SG	12	Silver Gray	201	98	218	
SP1033-24(65/30)/SG	24	Silver Gray	280	140	290	
SP1033-36(65/30)/SG	36	Silver Gray	300	100	300	
SP1033-50(65/30)/SG	50	Silver Gray	370	100	300	

∠ 5°,15°,25°,
45°,60°



Product Model	Power (W)	Body Color	Dimension (mm.)			Price (฿)
			ØDai.	L	H	
SP1034-5(65/30)/SG	5	Silver Gray	100	110	140	
SP1034-9(65/30)/SG	9	Silver Gray	130	130	150	
SP1034-18(65/30)/SG	18	Silver Gray	160	160	185	
SP1034-24(65/30)/SG	24	Silver Gray	190	175	205	
SP1034-36(65/30)/SG	36	Silver Gray	230	200	250	
SP1034-54(65/30)/SG	54	Silver Gray	230	200	250	
SP1034-98(65/30)/SG	98	Silver Gray	290	220	250	

∠ 5°,15°,25°,
45°,60°



Product Model	Power (W)	Body Color	Dimension (mm.)			Price (฿)
			ØDai.	L	H	
SP1035A-18(65/30)/SG	18	Silver Gray	160	200	250	
SP1035A-24(65/30)/SG	24	Silver Gray	220	280	340	
SP1035B-18(65/30)/SG	18	Silver Gray	160	184	306	
SP1035B-24(65/30)/SG	24	Silver Gray	220	251	416	

∠ 5°,15°,25°,
45°,60°



SPOT LIGHT SERIES

SPECIFICATION

Input Voltage (V) AC220-240V
 Power Frequency (Hz) 50-60Hz
 Material Aluminium Die-Cast
 Colors Temp. (K) 2,700K or 6,500K
 IP Rating IP65
 Life time (Hrs.) 30,000 Hrs
 Body Color BK=Black/DG=Dark Gray /SG=Sliver Gray



Product Model	Power (W)	Body Color	Dimension (mm.)			Price (฿)
			ØDai.	L	H	
SP1036A-15(65/30)/SG	15	Silver Gray	150	165	145	
SP1036A-30(65/30)/SG	30	Silver Gray	150	165	145	
SP1036B-20(65/30)/SG	20	Silver Gray	150	165	145	
SP1036B-30(65/30)/SG	30	Silver Gray	150	165	145	

∠ 5°,15°,25°,
45°,60°



Product Model	Power (W)	Body Color	Dimension (mm.)			Price (฿)
			ØDai.	L	H	
SP1036AC-15(65/30)/SG	15	Silver Gray	150	245	145	
SP1036AC-30(65/30)/SG	30	Silver Gray	150	245	145	
SP1036BC-20(65/30)/SG	20	Silver Gray	150	245	145	
SP1036BC-30(65/30)/SG	30	Silver Gray	150	245	145	

∠ 5°,15°,25°,
45°,60°



Product Model	Power (W)	Body Color	Dimension (mm.)			Price (฿)
			ØDai.	L	H	
SP10377-50(65/30)/SG	50	Silver Gray	210	235	190	
SP10372-50(65/30)/SG	50	Silver Gray	210	420	190	

∠ 2°,7°



Product Model	Power (W)	Body Color	Dimension (mm.)			Price (฿)
			ØDai.	L	H	
SP1038A-10(65/30)/SG	10	Silver Gray	130	114	140	
SP1038B-10(65/30)/SG	10	Silver Gray	130	114	140	

∠ 3°,25°

Landscape - Outdoor Light

SPOT LIGHT SERIES

SPECIFICATION

Input Voltage (V)	AC220-240V
Power Frequency (Hz)	50-60Hz
Material	Aluminium Die-Cast
Colors Temp. (K)	2,700K or 6,500K
IP Rating	IP65
Life time (Hrs.)	30,000 Hrs
Body Color	BK=Black/DG=Dark Gray /SG=Sliver Gray



Product Model	Power (W)	Body Color	Dimension (mm.)				Price (฿)
			W	W2	L	H	
SP1039S-10(65/30)/SG	10	Silver Gray	100	125	135	100	
SP1039S-15(65/30)/SG	15	Silver Gray	100	125	135	100	
SP1039M-20(65/30)/SG	20	Silver Gray	120	160	165	135	
SP1039M-30(65/30)/SG	30	Silver Gray	120	160	165	135	
SP1039L-50(65/30)/SG	50	Silver Gray	140	190	210	145	
SP1039XL-100(65/30)/SG	100	Silver Gray	190	240	250	160	

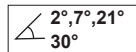

Product Model	Power (W)	Body Color	Dimension (mm.)				Price (฿)
			W	W2	L	H	
SP1040-4(65/30)/SG	4	Silver Gray	90	90	78	78	
SP1040-9(65/30)/SG	9	Silver Gray	112	135	92	90	
SP1040-12(65/30)/SG	12	Silver Gray	112	135	92	90	
SP1040-18(65/30)/SG	18	Silver Gray	155	175	113	100	
SP1040-24(65/30)/SG	24	Silver Gray	155	175	113	100	
SP1040-36(65/30)/SG	36	Silver Gray	228	260	133	120	
SP1040-54(65/30)/SG	54	Silver Gray	228	260	133	120	

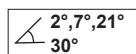

Product Model	Power (W)	Body Color	Dimension (mm.)				Price (฿)
			W	W2	L	H	
SP1041-18(65/30)/SG	18	Silver Gray	160	160	100	135	
SP1041-24(65/30)/SG	24	Silver Gray	190	190	120	155	
SP1041-36(65/30)/SG	36	Silver Gray	190	190	120	155	

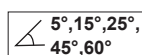

SPOT LIGHT SERIES

SPECIFICATION

Input Voltage (V)	AC220-240V
Power Frequency (Hz)	50-60Hz
Material	Aluminium Die-Cast
Holder lamp	E27/GU10
IP Rating	IP65
Body Color	BK=Black/DG=Dark Gray /SG=Sliver Gray



SP1042-E27/BK

1xE27 Ø160xH360

Price (฿)



SP1043-E27/BK

1xE27 Ø160xH500

Price (฿)



SP1044-E27/BK

1xE27 Ø160xH500

Price (฿)



SP1045-E27/BK

1xE27 Ø160xH500

Price (฿)



SP1046-E27/BK

1xE27 Ø160xH300

Price (฿)



SP1047-E27/BK

1xE27 Ø150xH330

Price (฿)



SP1048-E27/BK

1xE27 Ø140xH330

Price (฿)



SP1049-GU10/BK

1xGU10 Ø105xH280

Price (฿)



SP1050-GU10/BK

1xGU10 Ø105xH470

Price (฿)



SP1051-GU10/BK

1xGU10 Ø105xH480

Price (฿)



SP1052-GU10/BK

1xGU10 Ø80xH220

Price (฿)



SP1053-GU10/BK

1xGU10 Ø100xH260

Price (฿)



SP1054-GU10/BK

1xGU10 Ø100xH400

Price (฿)



SP1055-GU10/BK

1xGU10 Ø100xH250

Price (฿)



SP1056-GU10/BK

1xGU10 Ø140xH380

Price (฿)



SP1057-GU10/BK

1xGU10 Ø100xH270

Price (฿)

Landscape - Outdoor Light

SPOT LIGHT SERIES

SPECIFICATION

Input Voltage (V)	AC220-240V
Power Frequency (Hz)	50-60Hz
Material	Aluminium Die-Cast
Holder lamp	E27/GU10
IP Rating	IP65
Body Color	BK=Black/DG=Dark Gray /SG=Sliver Gray

**SP1058-GU10/BK**

1xGU10 Ø100xH260

Price (฿)**SP1059-GU10/BK**

1xGU10 Ø100xH260

Price (฿)**SP1060-E27/BK**

1xE27 Ø145xH435

Price (฿)**SP1061-E27/BK**

1xE27 Ø145xH435

Price (฿)**SP1062-E27/BK**

1xE27 Ø145xH455

Price (฿)**SP1063-E27/BK**

1xE27 Ø145xH320

Price (฿)**SP1064-E27/BK**

1xE27 Ø145xH320

Price (฿)**SP1065-E27/BK**

1xE27 Ø145xH340

Price (฿)**SP1066-E27/BK**

1xE27 Ø151xH590

Price (฿)**SP1067-E27/BK**

1xE27 Ø151xH520

Price (฿)**SP1068-E27/BK**

1xE27 Ø151xH520

Price (฿)**SP1069-E27/BK**

1xE27 Ø145xH360

Price (฿)**SP1070-E27/BK**

1xE27 Ø151xH400

Price (฿)**SP1071-E27/BK**

1xE27 Ø145xH250

Price (฿)**SP1072-E27/BK**

1xE27 Ø160xH500

Price (฿)**SP1073-E27/BK**

1xE27 Ø160xH480

Price (฿)

SPOT LIGHT SERIES

SPECIFICATION

Input Voltage (V)	AC220-240V
Power Frequency (Hz)	50-60Hz
Material	Aluminium Die-Cast
Holder lamp	E27/GU10
IP Rating	IP65
Body Color	BK=Black/DG=Dark Gray /SG=Sliver Gray



SP1074-E27/BK

1xE27 Ø160xH455

Price (฿)



SP1075-E27/BK

1xE27 Ø140xH440

Price (฿)



SP1076-E27/BK

1xE27 Ø155xH220

Price (฿)



SP1077-E27/BK

1xE27 Ø155xH235

Price (฿)



SP1078-E27/BK

1xE27 Ø160xH460

Price (฿)



SP1079-E27/BK

1xE27 Ø160xH300

Price (฿)



SP1080-E27/BK

1xE27 Ø160xH300

Price (฿)



SP1081-E27/BK

1xE27 Ø160xH390

Price (฿)



SP1082-E27/BK

1xE27 Ø160xH300

Price (฿)



SP1083-E27/BK

1xE27 Ø160xH390

Price (฿)



SP1084-E27/BK

1xE27 Ø133xH274

Price (฿)



SP1085-E27/BK

1xE27 Ø133xH452

Price (฿)



SP1086-E27/BK

1xE27 Ø200xH380

Price (฿)



SP1087-GU10/BK

1xGU10 Ø85xH175

Price (฿)



SP1088-GU10/BK

1xGU10 Ø85xH175

Price (฿)



SP1089-GU10/BK

1xGU10 Ø85xH380

Price (฿)

Landscape - Outdoor Light

SPOT LIGHT SERIES

SPECIFICATION

Input Voltage (V)	AC220-240V
Power Frequency (Hz)	50-60Hz
Material	Aluminium Die-Cast
Holder lamp	E27/GU10
IP Rating	IP65
Body Color	BK=Black/DG=Dark Gray /SG=Sliver Gray



SP1090-GU10/BK

1xGU10 Ø85xH393

Price (฿)



SP1091-GU10/BK

1xGU10 Ø75xH180

Price (฿)



SP1092-GU10/BK

1xGU10 Ø90xH218

Price (฿)



SP1093-GU10/BK

1xGU10 Ø90xH218

Price (฿)



SP1094-GU10/BK

1xGU10 Ø95xH205

Price (฿)



SP1095-GU10/BK

1xGU10 Ø90xH70

Price (฿)



SP1096-GU10/BK

1xGU10 Ø90xH100

Price (฿)

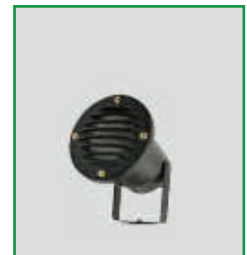

SP1097-GU10/BK

1xGU10 Ø90xH79

Price (฿)



SP1098-GU10/BK

1xGU10 Ø90xH100

Price (฿)



SP1099-GU10/BK

1xGU10 Ø90xH104

Price (฿)



SP1100-GU10/BK

1xGU10 Ø90xH129

Price (฿)



SP1101-E27/BK

1xE27 Ø72xH210

Price (฿)



SP1102-E27/BK

1xE27 Ø75xH179

Price (฿)



SP1103-2E27/BK

2xE27 Ø75xH280

Price (฿)



SP1104-E27/BK

1xE27 Ø75xH430

Price (฿)



SP1105-2E27/BK

2xE27 Ø75xH400

Price (฿)

BOLLARD SERIES



SPECIFICATION

Input Voltage (V) AC220-240V
 Power Frequency (Hz) 50-60Hz
 Material Aluminium Die-Cast
 Colors Temp. (K) 2,700K or 6,500K
 IP Rating IP65
 Life time (Hrs.) 30,000 Hrs
 Body Color BK=Black/DG=Dark Gray /SG=Sliver Gray



Product Model	Power (W)	Body Color	Dimension (mm.)			Price (\$)
			W	L	H	
BL1001M-10(65/30)/BK	10	Black	50	50	600	
BL1001L-10(65/30)/BK	10	Black	50	50	900	



Product Model	Power (W)	Body Color	Dimension (mm.)			Price (\$)
			W	L	H	
BL1002A-10(65/30)/BK	10	Black	110	270	500	
BL1002B-10(65/30)/BK	10	Black	110	270	500	



BL1005A

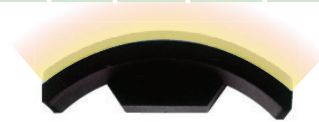

BL1005B



Product Model	Power (W)	Body Color	Dimension (mm.)			Price (\$)
			W	L	H	
BL1003M-9(65/30)/BK	9	Black	150	150	600	
BL1003L-9(65/30)/BK	9	Black	150	150	900	



Product Model	Power (W)	Body Color	Dimension (mm.)			Price (\$)
			W	L	H	
BL1004M-9(65/30)/BK	9	Black	150	150	600	
BL1004L-9(65/30)/BK	9	Black	150	150	900	

Landscape - Outdoor Light

BOLLARD SERIES



SPECIFICATION

Input Voltage (V)	AC220-240V
Power Frequency (Hz)	50-60Hz
Material	Aluminium Die-Cast
Colors Temp. (K)	2,700K or 6,500K
IP Rating	IP65
Life time (Hrs.)	30,000 Hrs
Body Color	BK=Black/DG=Dark Gray /SG=Sliver Gray

Product Model	Power (W)	Body Color	Dimension (mm.)		Price (฿)
			ØDai.	H	
BL1005-7(65/30)/BK	7	Black	108	500	



Product Model	Power (W)	Body Color	Dimension (mm.)			Price (฿)
			W	L	H	
BL1006-7(65/30)/BK	7	Black	80	105	400	



Product Model	Power (W)	Body Color	Dimension (mm.)		Price (฿)
			ØDai.	H	
BL1007M-7(65/30)/BK	7	Black	90	600	
BL1007L-7(65/30)/BK	7	Black	90	900	



Product Model	Power (W)	Body Color	Dimension (mm.)			Price (฿)
			W	L	H	
BL1008M-7(65/30)/BK	7	Black	110	110	600	
BL1009L-7(65/30)/BK	7	Black	110	110	900	



BOLLARD SERIES



SPECIFICATION

Input Voltage (V) AC220-240V
 Power Frequency (Hz) 50-60Hz
 Material Aluminium Die-Cast
 Colors Temp. (K) 2,700K or 6,500K
 IP Rating IP65
 Life time (Hrs.) 30,000 Hrs
 Body Color BK=Black/DG=Dark Gray /SG=Sliver Gray



Product Model	Power (W)	Body Color	Dimension (mm.)		Price (\$)
			ØDai.	H	
BL1009M-10(65/30)/BK	10	Black	118	500	
BL1009L-10(65/30)/BK	10	Black	118	800	
BL1009XL-25(65/30)/BK	25	Black	118	1000	



Product Model	Power (W)	Body Color	Dimension (mm.)			Price (\$)
			W	L	H	
BL1010M-8(65/30)/BK	8	Black	40	60	600	
BL1010L-8(65/30)/BK	8	Black	40	60	800	



Product Model	Power (W)	Body Color	Dimension (mm.)			Price (\$)
			W	L	H	
BL1011-5(65/30)/DG	5	Dark Gray	230	220	800	



Product Model	Power (W)	Body Color	Dimension (mm.)			Price (\$)
			W	L	H	
BL1012-10(65/30)/DG	10	Dark Gray	110	285	800	

Landscape - Outdoor Light

BOLLARD SERIES



SPECIFICATION

Input Voltage (V)	AC220-240V
Power Frequency (Hz)	50-60Hz
Material	Aluminium Die-Cast
Colors Temp. (K)	2,700K or 6,500K
IP Rating	IP65
Life time (Hrs.)	30,000 Hrs
Body Color	BK=Black/DG=Dark Gray /SG=Sliver Gray

Product Model	Power (W)	Body Color	Dimension (mm.)			Price (฿)
			W	L	H	
BL1013M-9(65/30)/DG	9	Dark Gray	125	125	600	
BL1013L-9(65/30)/DG	9	Dark Gray	125	125	900	



Product Model	Power (W)	Body Color	Dimension (mm.)			Price (฿)
			W	L	H	
BL1014M-9(65/30)/DG	9	Dark Gray	125	125	600	
BL1014L-9(65/30)/DG	9	Dark Gray	125	125	900	



Product Model	Power (W)	Body Color	Dimension (mm.)			Price (฿)
			W	L	H	
BL1015S-10(65/30)/DG	10	Dark Gray	60	150	370	
BL1015M-10(65/30)/DG	10	Dark Gray	60	150	600	
BL1015L-10(65/30)/DG	10	Dark Gray	60	150	1000	



Product Model	Power (W)	Body Color	Dimension (mm.)		Price (฿)
			ØDai.	H	
BL1016M-12(65/30)/DG	12	Dark Gray	160	600	
BL1016L-12(65/30)/DG	12	Dark Gray	160	1000	



BOLLARD SERIES



SPECIFICATION

Input Voltage (V) AC220-240V
 Power Frequency (Hz) 50-60Hz
 Material Aluminium Die-Cast
 Colors Temp. (K) 2,700K or 6,500K
 IP Rating IP65
 Life time (Hrs.) 30,000 Hrs
 Body Color BK=Black/DG=Dark Gray /SG=Sliver Gray



Product Model	Power (W)	Body Color	Dimension (mm.)		Price (฿)
			ØDai.	H	
BL1017-12(65/30)/BK	12	Black	120	600	



Product Model	Power (W)	Body Color	Dimension (mm.)		Price (฿)
			ØDai.	H	
BL1018M-10(65/30)/DG	10	Dark Gray	108	600	
BL1018L-10(65/30)/DG	10	Dark Gray	108	900	



Product Model	Power (W)	Body Color	Dimension (mm.)			Price (฿)
			W	L	H	
BL1019M-10(65/30)/BK	10	Black	25	125	600	



Product Model	Power (W)	Body Color	Dimension (mm.)			Price (฿)
			W	L	H	
BL1020M-E27/DG	E27	Dark Gray	125	125	600	
BL1020L-E27/DG	E27	Dark Gray	125	125	900	

Landscape - Outdoor Light

BOLLARD SERIES



SPECIFICATION

Input Voltage (V) AC220-240V
 Power Frequency (Hz) 50-60Hz
 Material Aluminium Die-Cast
 Colors Temp. (K) 2,700K or 6,500K
 IP Rating IP65
 Life time (Hrs.) 30,000 Hrs
 Body Color BK=Black/DG=Dark Gray /SG=Sliver Gray



Product Model	Power (W)	Body Color	Dimension (mm.)			Price (฿)
			W	L	H	
BL1021-16(65/30)/BK	1x6	Black	100	193	600	
BL1021-26(65/30)/BK	2x6	Black	100	280	600	



Product Model	Power (W)	Body Color	Dimension (mm.)			Price (฿)
			W	L	H	
BL1022-16(65/30)/BK	1x6	Black	100	193	600	
BL1023-26(65/30)/BK	2x6	Black	100	280	600	



Product Model	Power (W)	Body Color	Dimension (mm.)		Price (฿)
			ØDai.	H	
BL1024M-6(65/30)/BK	7	Black	83	600	
BL1024L-6(65/30)/BK	7	Black	83	900	



Product Model	Power (W)	Body Color	Dimension (mm.)		Price (฿)
			ØDai.	H	
BL1025-10(65/30)/BK	100	Black	185	900	

Landscape - Outdoor Light

BOLLARD SERIES



SPECIFICATION

Input Voltage (V)	AC220-240V
Power Frequency (Hz)	50-60Hz
Material	Aluminium Die-Cast
Holder lamp	E27/GU10
IP Rating	IP65
Body Color	BK=Black/DG=Dark Gray /SG=Sliver Gray



BL1026-E27/SG
1xE27 Ø165xH600
Price (฿)



BL1027-E27/SG
1xE27 Ø155xH600
Price (฿)



BL1028-E27/BK
1xE27 150x150xH800
Price (฿)



BL1029-GU10/BK
1xGU10 Ø165xH600
Price (฿)



BL1030-E27/SG
1xE27 Ø170xH800
Price (฿)



BL1031-E27/BK
1xE27 Ø170xH800
Price (฿)



BL1032-E27/SG
1xE27 Ø170xH800
Price (฿)



BL1033-E27/BK
1xE27 Ø170xH800
Price (฿)



BL1034-E27/DG
1xE27 Ø170xH800
Price (฿)



BL1035-E27/SG
1xE27 Ø170xH800
Price (฿)



BL1036-E27/DG
1xE27 150x150xH800
Price (฿)



BL1037-E27/BK
1xE27 Ø170xH800
Price (฿)

Landscape - Outdoor Light

BOLLARD SERIES



SPECIFICATION

Input Voltage (V)	AC220-240V
Power Frequency (Hz)	50-60Hz
Material	Aluminium Die-Cast
Holder lamp	E27/GU10
IP Rating	IP65
Body Color	BK=Black/DG=Dark Gray /SG=Sliver Gray



BL1038-E27/DG

1xE27 Ø170xH800

Price (฿)



BL1039-E27/DG

1xE27 Ø170xH800

Price (฿)



BL1040-E27/DG

1xE27 Ø170xH800

Price (฿)



BL1041-E27/SG

1xE27 Ø155xH600

Price (฿)



BL1042-E27/SG

1xE27 Ø20.8xH600

Price (฿)



BL1043-E27/BK

1xE27 Ø155xH600

Price (฿)



BL1044-E27/DG

1xE27 Ø210xH600

Price (฿)



BL1045-E27/BK

1xE27 Ø140xH600

Price (฿)



BL1046-E27/S

1xE27 Ø130xH600

Price (฿)



BL1047-E27/S

1xE27 Ø100xH600

Price (฿)



BL1048-E27/DG

1xE27 150x150xH600

Price (฿)



BL1049-E27/DG

1xE27 150x150xH600

Price (฿)

Landscape - Outdoor Light

BOLLARD SERIES



SPECIFICATION

Input Voltage (V)	AC220-240V
Power Frequency (Hz)	50-60Hz
Material	Aluminium Die-Cast
Holder lamp	E27/GU10
IP Rating	IP65
Body Color	BK=Black/DG=Dark Gray /SG=Sliver Gray



BL1050-E27/BK

1xE27 Ø170xH1000

Price (฿)



BL1051-E27/BK

1xE27 Ø170xH1000

Price (฿)



BL1052-E27/BK

1xE27 90x90xH600
1xE27 90x90xH800

Price (฿)



BL1053-E27/BK

1xE27 Ø90xH600
1xE27 Ø90xH800

Price (฿)



BL1054-E27/BK

1xE27 Ø90xH600
1xE27 Ø90xH800

Price (฿)



BL1055-E27/BK

1xE27 Ø90xH600
1xE27 Ø90xH800

Price (฿)



BL1056-E27/SG

1xE27 Ø170xH600

Price (฿)



BL1057-E27/BK

1xE27 Ø140xH600

Price (฿)



BL1058-E27/DG

1xE27 Ø150xH600

Price (฿)



BL1059-E27/SG

1xE27 Ø150xH600

Price (฿)



BL1060-E27/DG

1xE27 Ø150xH600

Price (฿)



BL1061-E27/BK

1xE27 Ø130xH600

Price (฿)

Landscape - Outdoor Light

POLE LIGHT SERIES



SPECIFICATION

Input Voltage (V)	AC220-240V
Power Frequency (Hz)	50-60Hz
Material	Aluminium Die-Cast
Colors Temp. (K)	2,700K or 6,500K
IP Rating	IP66
Life time (Hrs.)	50,000 Hrs
Body Color	BK=Black/DG=Dark Gray /SG=Sliver Gray



Product Model	Power (W)	Body Color	Dimension (mm.)			Price (฿)
			W	L	H	
PL1001-30(65/30)/BK	30	Black	500	500	665	
PL1001-50(65/30)/BK	50	Black	500	500	665	
PL1001-100(65/30)/BK	100	Black	500	500	665	



Product Model	Power (W)	Body Color	Dimension (mm.)		Price (฿)
			ØDai.	H	
PL1002-30(65/30)/BK	30	Black	516	500	
PL1002-60(65/30)/BK	60	Black	516	500	
PL1002-100(65/30)/BK	100	Black	516	500	



Product Model	Power (W)	Body Color	Dimension (mm.)		Price (฿)
			ØDai.	H	
PL10031-30(65/30)/BK	30	Black	544	305	
PL10032-60(65/30)/BK	60	Black	544	305	
PL10033-60(65/30)/BK	60	Black	544	305	

POLE LIGHT SERIES

SPECIFICATION

Input Voltage (V)	AC220-240V
Power Frequency (Hz)	50-60Hz
Material	Aluminium Die-Cast
Colors Temp. (K)	2,700K or 6,500K
IP Rating	IP66
Life time (Hrs.)	50,000 Hrs
Body Color	BK=Black/DG=Dark Gray /SG=Sliver Gray



Landscape - Outdoor Light

Product Model	Power (W)	Body Color	Dimension (mm.)			Price (\$)
			W	L	H	
PL10041-30(65/30)/BK	30	Black	544	377	305	
PL10042-60(65/30)/BK	60	Black	544	499	305	
PL10043-60(65/30)/BK	60	Black	544	621	305	

POLE LIGHT SERIES

SPECIFICATION

Input Voltage (V)	AC220-240V
Power Frequency (Hz)	50-60Hz
Material	Aluminium Die-Cast
Colors Temp. (K)	2,700K or 6,500K
IP Rating	IP66
Life time (Hrs.)	50,000 Hrs
Body Color	BK=Black/DG=Dark Gray /SG=Sliver Gray



Product Model	Power (W)	Body Color	Dimension (mm.)		Price (฿)
			ØDai.	H	
PL1005-30(65/30)/BK	30	Black	450	570	
PL1005-60(65/30)/BK	60	Black	450	570	
PL1005-100(65/30)/BK	100	Black	450	570	

POLE LIGHT SERIES

SPECIFICATION

Input Voltage (V)	AC220-240V
Power Frequency (Hz)	50-60Hz
Material	Aluminium Die-Cast
Colors Temp. (K)	2,700K or 6,500K
IP Rating	IP66
Life time (Hrs.)	50,000 Hrs
Body Color	BK=Black/DG=Dark Gray /SG=Sliver Gray



Landscape - Outdoor Light

Product Model	Power (W)	Body Color	Dimension (mm.)		Price (\$)
			ØDai.	H	
PL1006-30(65/30)/BK	30	Black	450	318	
PL1006-60(65/30)/BK	60	Black	450	318	
PL1006-100(65/30)/BK	100	Black	450	318	

POLE LIGHT SERIES



SPECIFICATION

Input Voltage (V) AC220-240V
 Power Frequency (Hz) 50-60Hz
 Material Aluminium Die-Cast
 Colors Temp. (K) 2,700K or 6,500K
 IP Rating IP66
 Life time (Hrs.) 50,000 Hrs
 Body Color BK=Black/DG=Dark Gray /SG=Sliver Gray

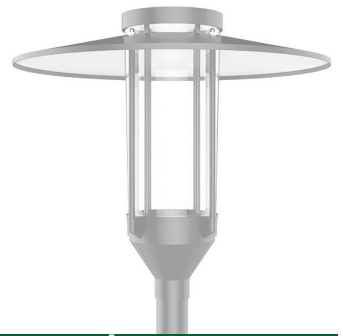

Product Model	Power (W)	Body Color	Dimension (mm.)		Price (฿)
			ØDai.	H	
PL1007-70(65/30)/WH	60	White	585	392	



Product Model	Power (W)	Body Color	Dimension (mm.)		Price (฿)
			ØDai.	H	
PL1008-30(65/30)/BK	30	Black	797	722	
PL1008-60(65/30)/BK	60	Black	797	722	



Product Model	Power (W)	Body Color	Dimension (mm.)		Price (฿)
			ØDai.	H	
PL1009-15(65/30)/BK	15	Black	600	550	
PL1009-30(65/30)/BK	30	Black	600	550	



POLE LIGHT SERIES

SPECIFICATION

Input Voltage (V)	AC220-240V
Power Frequency (Hz)	50-60Hz
Material	Aluminium Die-Cast
Colors Temp. (K)	2,700K or 6,500K
IP Rating	IP66
Life time (Hrs.)	50,000 Hrs
Body Color	BK=Black/DG=Dark Gray /SG=Sliver Gray

Product Model	Power (W)	Body Color	Dimension (mm.)		Pole (m.)	Price (฿)
			ØDai.	H		
PL1010-75(65/30)/BK	75	Black	1000	1090	0	
PL1010-75(65/30)/BK/H3	75	Black	1000	1090	3	
PL1010-75(65/30)/BK/H6	75	Black	1000	1090	6	

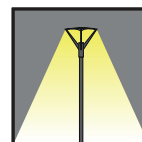
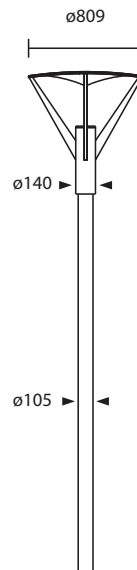
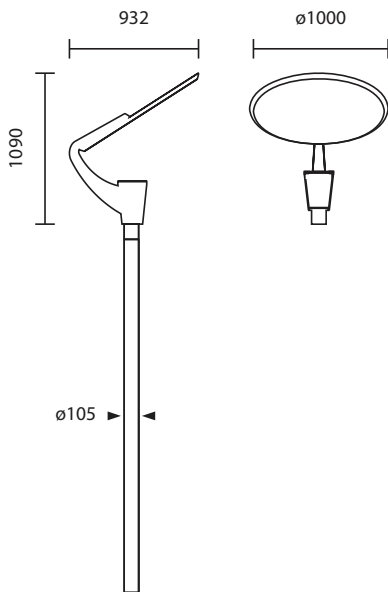
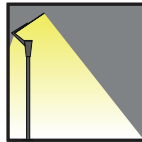
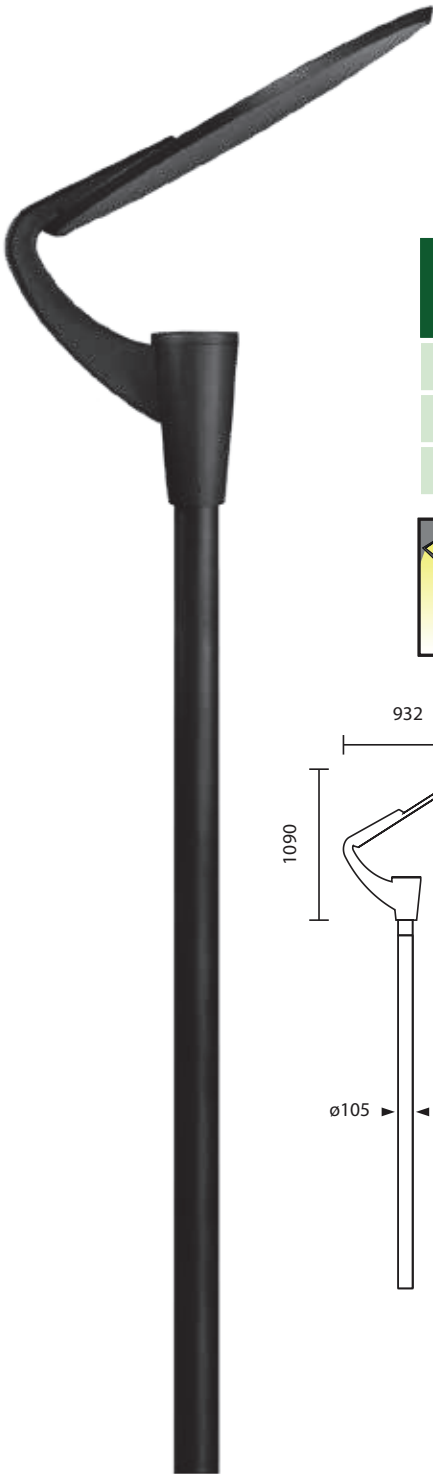

Product Model	Power (W)	Body Color	Dimension (mm.)		Pole (m.)	Price (฿)
			ØDai.	H		
PL1011-75(65/30)/BK	75	Black	809	1090	0	
PL1011-75(65/30)/BK/H3	75	Black	809	1090	3	
PL1011-75(65/30)/BK/H6	75	Black	809	1090	6	

Landscape - Outdoor Light

POLE LIGHT SERIES

SPECIFICATION

Input Voltage (V)	AC220-240V
Power Frequency (Hz)	50-60Hz
Material	Aluminium Die-Cast
Colors Temp. (K)	2,700K or 6,500K
IP Rating	IP66
Life time (Hrs.)	50,000 Hrs
Body Color	BK=Black/DG=Dark Gray /SG=Sliver Gray

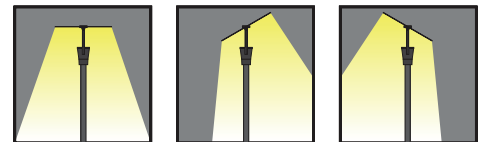
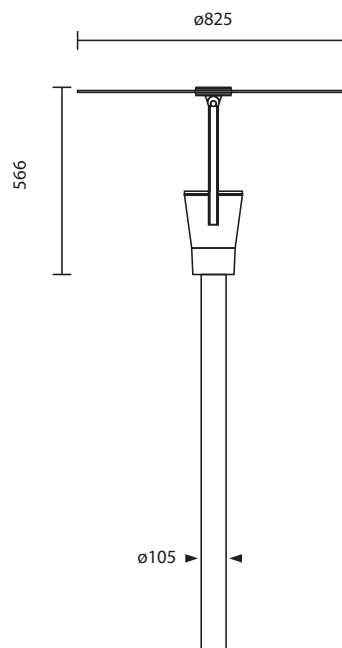
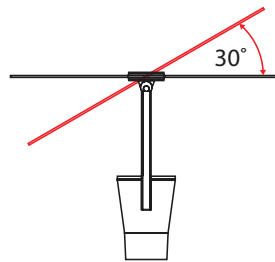

Product Model	Power (W)	Body Color	Dimension (mm.)		Pole (m.)	Price (฿)
			ØDai.	H		
PL1012-75(65/30)/BK	75	Black	825	566	0	
PL1012-75(65/30)/BK/H3	75	Black	825	566	3	
PL1012-75(65/30)/BK/H6	75	Black	825	566	6	

POLE LIGHT SERIES

SPECIFICATION

Input Voltage (V)	AC220-240V
Power Frequency (Hz)	50-60Hz
Material	Aluminium Die-Cast
Colors Temp. (K)	2,700K or 6,500K
IP Rating	IP66
Life time (Hrs.)	50,000 Hrs
Body Color	BK=Black/DG=Dark Gray /SG=Sliver Gray



Product Model	Power (W)	Body Color	Dimension (mm.)		Pole (m.)	Price (฿)
			W	L		
PL1013-418(65/30)/BK/H3	4x18	Black	180	180	3	

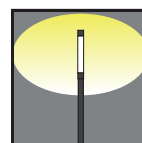
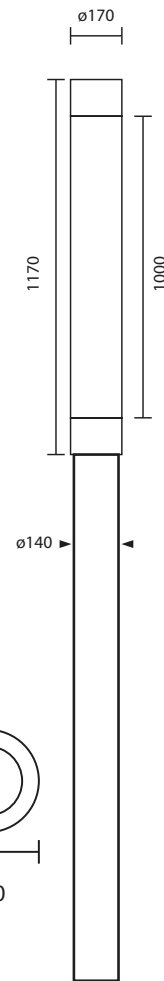
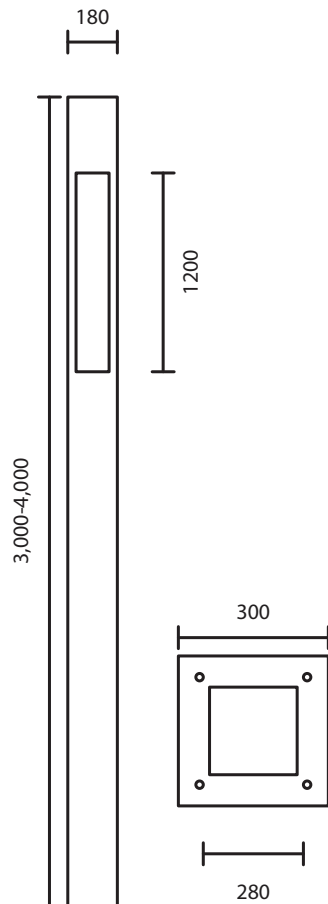
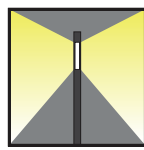

Product Model	Power (W)	Body Color	Dimension (mm.)	Pole (m.)	Price (฿)
			ØDai.		
PL1014-318(65/30)/BK/H3	3x18	Black	180	3	

Landscape - Outdoor Light

POST TOP SERIES



SPECIFICATION

Input Voltage (V) AC220-240V
 Power Frequency (Hz) 50-60Hz
 Material Aluminium Die-Cast
 Colors Temp. (K) 2,700K or 6,500K
 IP Rating IP65
 Life time (Hrs.) 30,000 Hrs
 Body Color BK=Black/DG=Dark Gray /SG=Sliver Gray



Product Model	Power (W)	Body Color	Dimension (mm.)			Price (฿)
			W	L	H	
PT1001-10(65/30)/BK	10	Black	50	50	300	

Product Model	Power (W)	Body Color	Dimension (mm.)			Price (฿)
			W	L	H	
PT1002-7(65/30)/BK	7	Black	110	110	300	

Product Model	Power (W)	Body Color	Dimension (mm.)			Price (฿)
			W	L	H	
PT1003-9(65/30)/BK	9	Black	150	150	300	

Product Model	Power (W)	Body Color	Dimension (mm.)			Price (฿)
			W	L	H	
PT1004-9(65/30)/DG	9	Dark Gray	125	125	300	

Product Model	Power (W)	Body Color	Dimension (mm.)		Price (฿)
			ØDai.	H	
BL1005-7(65/30)/BK	7	Black	90	300	

Landscape - Outdoor Light

POST TOP SERIES



SPECIFICATION

Input Voltage (V) AC220-240V
 Power Frequency (Hz) 50-60Hz
 Material Aluminium Die-Cast
 Colors Temp. (K) 2,700K or 6,500K
 IP Rating IP65
 Life time (Hrs.) 30,000 Hrs
 Body Color BK=Black/DG=Dark Gray /SG=Sliver Gray

Landscape - Outdoor Light



Product Model	Power (W)	Body Color	Dimension (mm.)		Price (฿)
			ØDai.	H	
BL1006-12(65/30)/BK	12	Black	120	300	



Product Model	Power (W)	Body Color	Dimension (mm.)			Price (฿)
			W	L	H	
BL1007-10(65/30)/BK	10	Black	25	125	300	

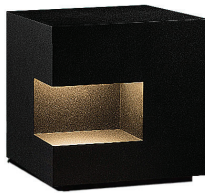

Product Model	Power (W)	Body Color	Dimension (mm.)			Price (฿)
			W	L	H	
BL1008-10(65/30)/BK	10	Black	220	220	250	



Product Model	Power (W)	Body Color	Dimension (mm.)			Price (฿)
			W	L	H	
BL1009-5(65/30)/BK	5	Black	140	50	210	



Product Model	Power (W)	Body Color	Dimension (mm.)		Price (฿)
			ØDai.	H	
BL1010-10(65/30)/BK	10	Black	160	380	
BL1010-E27/BK	E27	Black	160	380	

POST TOP SERIES



SPECIFICATION

Input Voltage (V)	AC220-240V
Power Frequency (Hz)	50-60Hz
Material	Aluminium Die-Cast
Colors Temp. (K)	2,700K or 6,500K
IP Rating	IP65
Life time (Hrs.)	30,000 Hrs
Body Color	BK=Black/DG=Dark Gray /SG=Sliver Gray



PT1011-E27/BK

1xE27 160x160xH190
1xE27 230x230xH270

Price (฿)



BL1012-E27/SG

1xE27 120x120xH273

Price (฿)



BL1013-E27/BK

1xE27 150x150xH275

Price (฿)



BL1014-E27/BK

1xE27 150x150xH600

Price (฿)



PT1011-E27/BK

1xE27 Ø290xH280

Price (฿)



BL1012-E27/SG

1xE27 Ø160xH380

Price (฿)



BL1013-E27/BK

1xE27 125x125xH265

Price (฿)

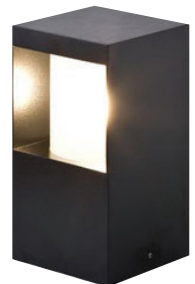

BL1014-E27/BK

1xE27 125x125xH265

Price (฿)



PT1011-E27/BK

1xE27 Ø290xH280

Price (฿)



BL1012-E27/SG

1xE27 Ø160xH380

Price (฿)



BL1013-E27/BK

1xE27 197x197xH400

Price (฿)



BL1014-E27/BK

1xE27 197x197xH400

Price (฿)

Landscape - Outdoor Light

INGROUND SERIES



SPECIFICATION

Input Voltage (V) AC220-240V
 Power Frequency (Hz) 50-60Hz
 Material Aluminium Die-Cast
 Colors Temp. (K) 2,700K or 6,500K
 IP Rating IP66
 Life time (Hrs.) 30,000 Hrs
 Body Color BK=Black/DG=Dark Gray /SG=Sliver Gray



Product Model	Power (W)	Body Color	Dimension (mm.)		Price (฿)
			ØDai.	H	
IN1001-1(65/30)/S	1	Silver	42	70	
IN1001-3(65/30)/S	3	Silver	75	90	

∠ 5°,15°

One Side Two Side Four Side



Product Model	Power (W)	Body Color	Dimension (mm.)		Price (฿)
			ØDai.	H	
IN10020N-45(65/30)/S	4.5	Silver	62	95	
IN1002TW-45(65/30)/S	4.5	Silver	62	95	
IN1002FO-45(65/30)/S	4.5	Silver	62	95	



Product Model	Power (W)	Body Color	Dimension (mm.)			Price (฿)
			W	L	H	
IN1003-1(65/30)/S	1	Silver	45	45	70	
IN1003-2(65/30)/S	2	Silver	65	65	85	

∠ 5°,15°



Product Model	Power (W)	Body Color	Dimension (mm.)		Price (฿)
			ØDai.	H	
IN1004-5(65/30)/S	5	Silver	120	97	
IN1004-7(65/30)/S	7	Silver	120	97	
IN1004-10(65/30)/S	10	Silver	150	116	
IN1004-15(65/30)/S	15	Silver	180	120	

∠ 25°

INGROUND SERIES



SPECIFICATION

Input Voltage (V)	AC220-240V
Power Frequency (Hz)	50-60Hz
Material	Aluminium Die-Cast
Colors Temp. (K)	2,700K or 6,500K
IP Rating	IP66
Life time (Hrs.)	30,000 Hrs
Body Color	BK=Black/DG=Dark Gray /SG=Sliver Gray



Product Model	Power (W)	Body Color	Dimension (mm.)		Price (฿)
			ØDai.	H	
IN1005-5(65/30)/S	5	Silver	120	97	
IN1005-7(65/30)/S	7	Silver	120	97	
IN1005-10(65/30)/S	10	Silver	150	116	
IN1005-15(65/30)/S	15	Silver	180	120	



One Side



Two Side

Product Model	Power (W)	Body Color	Dimension (mm.)		Price (฿)
			ØDai.	H	
IN10060N-7(65/30)/S	7	Silver	150	150	
IN1006TW-7(65/30)/S	7	Silver	150	150	
IN1006TH-7(65/30)/S	7	Silver	150	150	
IN1006FO-7(65/30)/S	7	Silver	150	150	



Three Side



Four Side

Product Model	Power (W)	Body Color	Dimension (mm.)		Price (฿)
			ØDai.	H	
IN1007TWS-7(65/30)/DG	5	Dark Gray	150	142	
IN1007TWM-7(65/30)/DG	5	Dark Gray	150	142	
IN1007TH-7(65/30)/DG	5	Dark Gray	150	142	
IN1007FO-7(65/30)/DG	5	Dark Gray	150	142	
IN1007EIS-7(65/30)/DG	5	Dark Gray	150	142	
IN1007EIM-7(65/30)/DG	5	Dark Gray	150	142	



Landscape - Outdoor Light

INGROUND SERIES



SPECIFICATION

Input Voltage (V)	AC220-240V
Power Frequency (Hz)	50-60Hz
Material	Aluminium Die-Cast
Colors Temp. (K)	2,700K or 6,500K
IP Rating	IP66
Life time (Hrs.)	30,000 Hrs
Body Color	BK=Black/DG=Dark Gray /SG=Sliver Gray



Product Model	Power (W)	Body Color	Dimension (mm.)		Price (฿)
			ØDai.	H	
IN1008-3(65/30)/S	3	Silver	100	100	
IN1008-5(65/30)/S	5	Silver	130	95	
IN1008-9(65/30)/S	9	Silver	160	105	
IN1008-15(65/30)/S	15	Silver	210	120	
IN1008-18(65/30)/S	18	Silver	230	135	
IN1008-24(65/30)/S	24	Silver	260	135	
IN1008-36(65/30)/S	36	Silver	320	105	

∠ 5°, 15°



Product Model	Power (W)	Body Color	Dimension (mm.)		Price (฿)
			ØDai.	H	
IN1009-5(65/30)/S	5	Silver	130	140	
IN1009-7(65/30)/S	7	Silver	130	140	
IN1009-9(65/30)/S	9	Silver	160	160	
IN1009-18(65/30)/S	18	Silver	260	195	
IN1009-36(65/30)/S	36	Silver	260	195	

∠ 5°, 15°



Product Model	Power (W)	Body Color	Dimension (mm.)		Price (฿)
			ØDai.	H	
IN1010-6(65/30)/S	6	Silver	130	140	
IN1010-10(65/30)/S	10	Silver	160	160	
IN1010-20(65/30)/S	20	Silver	260	195	
IN1010-30(65/30)/S	30	Silver	260	195	

∠ 30°, 45°



INGROUND SERIES



SPECIFICATION

Input Voltage (V)	AC220-240V
Power Frequency (Hz)	50-60Hz
Material	Aluminium Die-Cast
Colors Temp. (K)	2,700K or 6,500K
IP Rating	IP66
Life time (Hrs.)	30,000 Hrs
Body Color	BK=Black/DG=Dark Gray /SG=Sliver Gray



∠ 25°

Product Model	Power (W)	Body Color	Dimension (mm.)		Price (฿)
			ØDai.	H	
IN1011-10(65/30)/S	10	Silver	210	110	
IN1005-12(65/30)/S	12	Silver	250	120	
IN1005-15(65/30)/S	15	Silver	250	120	



∠ 30°

Product Model	Power (W)	Body Color	Dimension (mm.)		Price (฿)
			ØDai.	H	
IN1012-7(65/30)/S	7	Silver	100	145	



∠ 5°, 15°

Product Model	Power (W)	Body Color	Dimension (mm.)			Price (฿)
			W	L	H	
IN1013-4(65/30)/S	4	Silver	130	130	130	
IN1013-9(65/30)/S	9	Silver	170	170	130	
IN1013-16(65/30)/S	16	Silver	210	210	130	
IN1013-36(65/30)/S	36	Silver	260	260	130	



Product Model	Power (W)	Body Color	Dimension (mm.)			Price (฿)
			W	L	H	
IN1014-6(65/30)/S	6	Silver	90	300	90	
IN1014-9(65/30)/S	9	Silver	90	500	90	
IN1014-12(65/30)/S	12	Silver	90	600	90	
IN1014-24(65/30)/S	24	Silver	90	1000	90	

Landscape - Outdoor Light

UNDERWATER SERIES



SPECIFICATION

Input Voltage (V)	AC220-240V / DC12V / DC24V
Power Frequency (Hz)	50-60Hz
Material	Aluminium Die-Cast
Colors Temp. (K)	2,700K or 6,500K
IP Rating	IP68
Life time (Hrs.)	30,000 Hrs
Body Color	BK=Black/DG=Dark Gray /SG=Sliver Gray



Product Model	Power (W)	Body Color	Dimension (mm.)		Price (฿)
			ØDai.	H	
UW1001-3(65/30)/S	3	Silver	96	76	
UW1001-6(65/30)/S	6	Silver	115	150	
UW1001-12(65/30)/S	12	Silver	170	196	
UW1001-15(65/30)/S	15	Silver	190	197	

∠ 5°,15°



Product Model	Power (W)	Body Color	Dimension (mm.)		Price (฿)
			ØDai.	H	
UW1002-3(65/30)/S	3	Silver	85	125	
UW1002-6(65/30)/S	6	Silver	135	146	
UW1002-9(65/30)/S	9	Silver	145	155	
UW1002-12(65/30)/S	12	Silver	170	176	
UW1002-15(65/30)/S	15	Silver	190	197	
UW1002-18(65/30)/S	18	Silver	215	229	
UW1002-24(65/30)/S	24	Silver	240	249	
UW1002-36(65/30)/S	36	Silver	300	241	

∠ 5°,15°



Product Model	Power (W)	Body Color	Dimension (mm.)			Price (฿)
			W	L	H	
UW1003-42(65/30)/S	42	Silver	115	630	105	

∠ 5°,15°

UNDERWATER SERIES



SPECIFICATION

Input Voltage (V) AC220-240V
 Power Frequency (Hz) 50-60Hz
 Material Aluminium Die-Cast
 Colors Temp. (K) 2,700K or 6,500K
 IP Rating IP66
 Life time (Hrs.) 30,000 Hrs
 Body Color BK=Black/DG=Dark Gray /SG=Sliver Gray



Product Model	Power (W)	Body Color	Dimension (mm.)		Price (฿)
			ØDai.	H	
UW1004-3(65/30)/S	3	Silver	100	100	
UW1004-6(65/30)/S	6	Silver	130	110	
UW1004-9(65/30)/S	9	Silver	150	105	
UW1004-12(65/30)/S	12	Silver	190	125	
UW1004-15(65/30)/S	15	Silver	210	135	
UW1004-18(65/30)/S	18	Silver	240	145	
UW1004-24(65/30)/S	24	Silver	260	155	
UW1004-36(65/30)/S	36	Silver	300	165	

∠ 5°,15°



Product Model	Power (W)	Body Color	Dimension (mm.)		Price (฿)
			ØDai.	H	
UW1005-12(65/30)/WH	12	White	245	50	
UW1005-15(65/30)/WH	15	White	295	50	
UW1005-18(65/30)/WH	18	White	300	50	



Product Model	Power (W)	Body Color	Dimension (mm.)		Price (฿)
			ØDai.	H	
UW1006-18(65/30)/S	18	Silver	290	165	

Landscape - Outdoor Light

UNDERWATER SERIES



SPECIFICATION

Input Voltage (V)	AC220-240V / DC12V / DC24V
Power Frequency (Hz)	50-60Hz
Material	Aluminium Die-Cast
Colors Temp. (K)	2,700K or 6,500K
IP Rating	IP68
Life time (Hrs.)	30,000 Hrs
Body Color	BK=Black/DG=Dark Gray /SG=Sliver Gray

Landscape - Outdoor Light



Product Model	Power (W)	Body Color	Dimension (mm.)		Price (฿)
			ØDai.	H	
UW1007-6(65/30)/S	6	Silver	170	76	
UW1007-9(65/30)/S	9	Silver	170	76	
UW1007-12(65/30)/S	12	Silver	180	76	
UW1007-15(65/30)/S	15	Silver	210	76	
UW1007-18(65/30)/S	18	Silver	250	76	

∠ 5°, 15°



Product Model	Power (W)	Body Color	Dimension (mm.)		Price (฿)
			ØDai.	H	
UW1007-6(65/30)/S	6	Silver	110	90	
UW1007-9(65/30)/S	9	Silver	160	90	
UW1007-12(65/30)/S	12	Silver	180	90	
UW1007-18(65/30)/S	18	Silver	200	90	



WALL WASHER SERIES

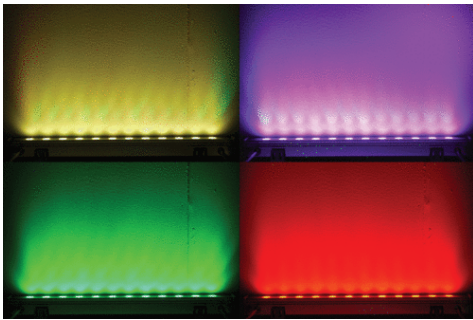

SPECIFICATION

Input Voltage (V) AC220-240V / DC12V/ DC24V
 Power Frequency (Hz) 50-60Hz
 Material Aluminium Die-Cast
 Colors Temp. (K) 2,700K or 6,500K or RGB
 IP Rating IP66
 Life time (Hrs.) 30,000 Hrs
 Body Color BK=Black/DG=Dark Gray /SG=Sliver Gray



∠ 15°, 30°
45°, 60°



∠ 15°, 30°
45°, 60°

Product Model	Power (W)	Body Color	Dimension (mm.)			Price (฿)
			W	L	H	
WW1001-118RGB/S	1X18	Silver	42	500	38	
WW1001-136RGB/S	1X36	Silver	42	1000	38	
WW1001-236RGB/S	2X36	Silver	42	1000	38	

Product Model	Power (W)	Body Color	Dimension (mm.)			Price (฿)
			W	L	H	
WW1001-118(65/30)/S	1X18	Silver	42	500	38	
WW1001-136(65/30)/S	1X36	Silver	42	1000	38	
WW1001-236(65/30)/S	2X36	Silver	42	1000	38	



Landscape - Outdoor Light

DESCRIPTION

LED Strip มีความยืดหยุ่นสูง สามารถ ตัดโค้งงอได้ และ ตัด-ต่อได้ มีทั้งรูปแบบ Indoor และ Outdoor จึงเหมาะสำหรับใช้ในงานตกแต่ง เช่น ร้านค้า ตู้โชว์สินค้า รถยนต์ ป้ายโฆษณา สถานที่เชิง สวนสนุก โรงภาพยนตร์ ฯลฯ



STRIPLIGHT 5050 IP20 SERIES

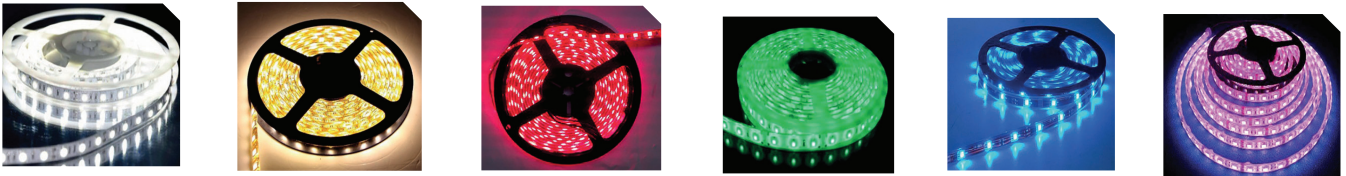

SPECIFICATION

Input Voltage (V)	12 Vdc
Power	14.4 W/m.
Current	1.2 A/m.
LED type	LED SMD5050
LED Quantity	60 leds/m.
Lumen	90 lm/W
Life time (Hrs.)	30,000 Hrs.
IP Rating	IP20
Packing	5m./reel (ความยาว 5เมตร/ม้วน)

สามารถม้วน งอ ทำมุม ลวดลายต่างๆได้ เหมาะสำหรับใช้ตกแต่งได้ภายในบ้าน, ร้านค้า, ตู้โชว์สินค้า, รถยนต์, ป้ายโฆษณา, และอื่นๆ

Product Model	Colors	Price (฿/Roll)
LKSL12-14.4IP20/DL	Daylight	
LKSL12-14.4IP20/WW	Warm white	
LKSL12-14.4IP20/R	Red	
LKSL12-14.4IP20/G	Green	
LKSL12-14.4IP20/B	Blue	
LKSL12-14.4IP20/P	Pink	
LKSL12-14.4IP20/RGB	RGB	

STRIPLIGHT 3528 IP20 SERIES

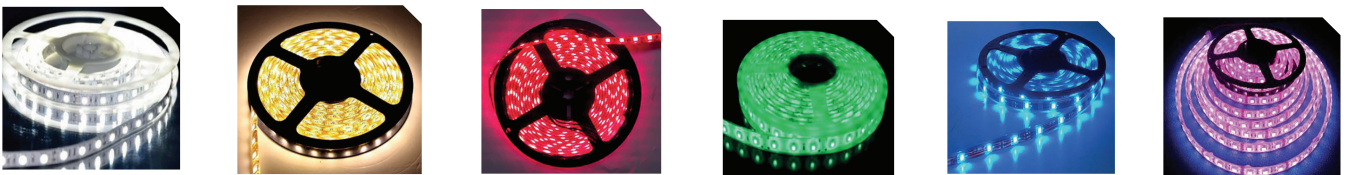

SPECIFICATION

Input Voltage (V)	12 Vdc
Power	4.8 W/m.
Current	0.4 A/m.
LED type	LED SMD3528
LED Quantity	60 leds/m.
Lumen	90 lm/W
Life time (Hrs.)	30,000 Hrs.
IP Rating	IP20
Packing	5m./reel (ความยาว 5เมตร/ม้วน)

สามารถม้วน งอ ทำมุม ลวดลายต่างๆได้ เหมาะสำหรับใช้ตกแต่งได้ภายในบ้าน, ร้านค้า, ตู้โชว์สินค้า, รถยนต์, ป้ายโฆษณา, และอื่นๆ

Product Model	Colors	Price (฿/Roll)
LKSL12-4.8IP20/DL	Daylight	
LKSL12-4.8IP20/WW	Warm white	
LKSL12-4.8IP20/R	Red	
LKSL12-4.8IP20/G	Green	
LKSL12-4.8IP20/B	Blue	
LKSL12-4.8IP20/P	Pink	
LKSL12-4.8IP20/RGB	RGB	

STRIPLIGHT 5050 IP65 SERIES

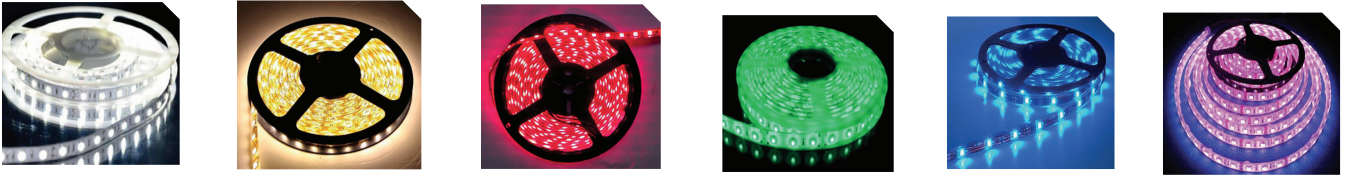

SPECIFICATION

Input Voltage (V)	12 Vdc
Power	14.4 W/m.
Current	1.2 A/m.
LED type	LED SMD5050
LED Quantity	60 leds/m.
Lumen	90 lm/W
Life time (Hrs.)	30,000 Hrs.
IP Rating	IP65
Packing	5m./reel (ความยาว 5เมตร/ม้วน)

สามารถม้วน งอ ทำมุม ลวดลายต่างๆได้ เหมาะสำหรับใช้ตกแต่ง
ติดตั้งภายนอกและภายใน บ้าน, ร้านค้า, ตู้โชว์สินค้า, รถยนต์, ป้ายโฆษณา,
และอื่นๆ

Product Model	Colors	Price (฿/Roll)
LKSL12-14.4IP65/DL	Daylight	
LKSL12-14.4IP65/WW	Warm white	
LKSL12-14.4IP65/R	Red	
LKSL12-14.4IP65/G	Green	
LKSL12-14.4IP65/B	Blue	
LKSL12-14.4IP65/P	Pink	
LKSL12-14.4IP65/RGB	RGB	

STRIPLIGHT 3528 IP65 SERIES

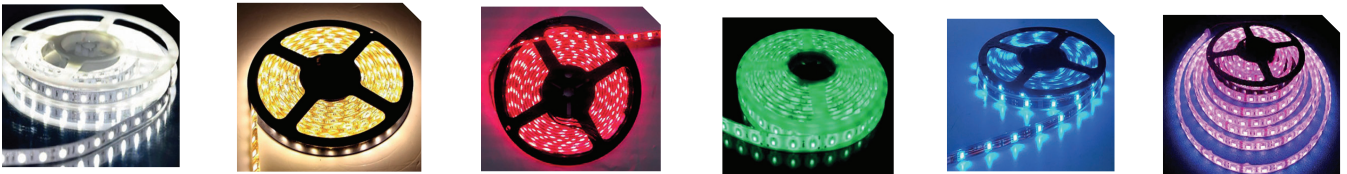

SPECIFICATION

Input Voltage (V)	12 Vdc
Power	4.8 W/m.
Current	0.4 A/m.
LED type	LED SMD3528
LED Quantity	60 leds/m.
Lumen	90 lm/W
Life time (Hrs.)	30,000 Hrs.
IP Rating	IP65
Packing	5m./reel (ความยาว 5เมตร/ม้วน)

สามารถม้วน งอ ทำมุม ลวดลายต่างๆได้ เหมาะสำหรับใช้ตกแต่ง
ติดตั้งภายนอกและภายใน บ้าน, ร้านค้า, ตู้โชว์สินค้า, รถยนต์, ป้ายโฆษณา,
และอื่นๆ

Product Model	Colors	Price (฿/Roll)
LKSL12-4.8IP65/DL	Daylight	
LKSL12-4.8IP65/WW	Warm white	
LKSL12-4.8IP65/R	Red	
LKSL12-4.8IP65/G	Green	
LKSL12-4.8IP65/B	Blue	
LKSL12-4.8IP65/P	Pink	
LKSL12-4.8IP65/RGB	RGB	

LED RIGID BAR SERIES



SPECIFICATION

Input Voltage (V)	12 Vdc
LED Quantity	60 leds/m.
Lumen	90 lm/W
Life time (Hrs.)	30,000 Hrs.
IP Rating	IP20
Packing	1m.

Product Model	Power (W/m.)	Colors	Price (฿)
LKSB5050(DL/WW)	14.4	Daylight , Warm white	
LKSB5630(DL/WW)	18	Daylight , Warm white	

LED ROPE LIGHT SERIES

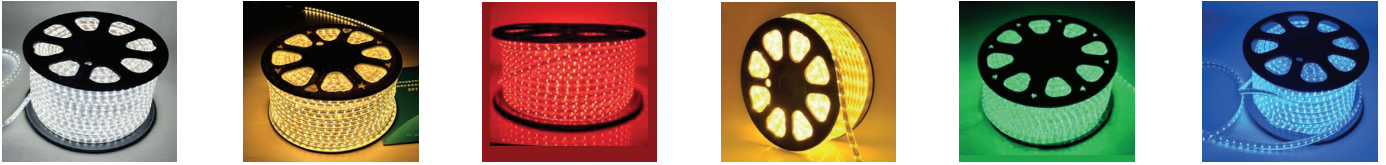

SPECIFICATION

Input Voltage (V) AC220 V
 Power 14.4 W/m.
 Current 1.2 A/m.
 LED type LED SMD5050
 LED Quantity 60 leds/m.
 Lumen 90 lm/W
 Life time (Hrs.) 30,000 Hrs.
 IP Rating IP65
 Packing 100m./reel
 (ความยาว 100เมตร/ม้วน)

ใช้งานง่าย ใช้ร่วมกับปลั๊ก **AC1006-ROPE**



Product Model	Colors	Price (฿/Roll)
LKRL220-14.4IP65/DL	Daylight	
LKRL220-14.4IP65/WW	Warm white	
LKRL220-14.4IP65/R	Red	
LKRL220-14.4IP65/G	Green	
LKRL220-14.4IP65/B	Blue	
LKRL220-14.4IP65/Y	Yellow	

LED NEON FLEX SERIES

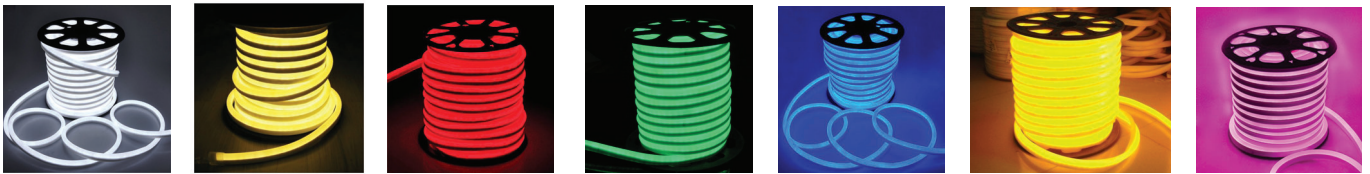

SPECIFICATION

Input Voltage (V) 12 Vdc, AC220V
 Power 7.2 W/m.
 LED type LED SMD3528
 LED Quantity 60 leds/m.
 Lumen 90 lm/W
 Life time (Hrs.) 30,000 Hrs.
 IP Rating IP67
 Packing 50m./reel
 (ความยาว 50เมตร/ม้วน)

สามารถม้วน งอ ทำมุม ลวดลายต่างๆได้ เหมาะสำหรับใช้ตกแต่ง
 ได้ทั้งภายในและภายนอก บ้าน, ร้านค้า, ตู้โชว์สินค้า, รถยนต์, ป้ายโฆษณา,
 และอื่นๆ

Product Model	Colors	Price (฿/Roll)
NEONF3528(12/220)/DL	Daylight	
NEONF3528(12/220)/WW	Warm white	
NEONF3528(12/220)/R	Red	
NEONF3528(12/220)/G	Green	
NEONF3528(12/220)/B	Blue	
NEONF3528(12/220)/P	Pink	
NEONF3528(12/220)/Y	Yellow	

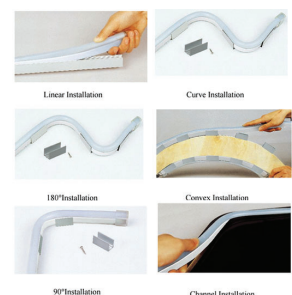
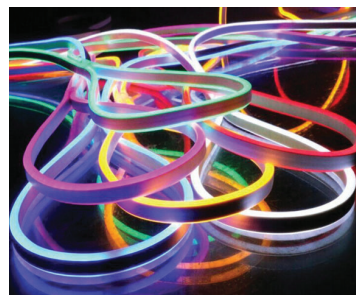
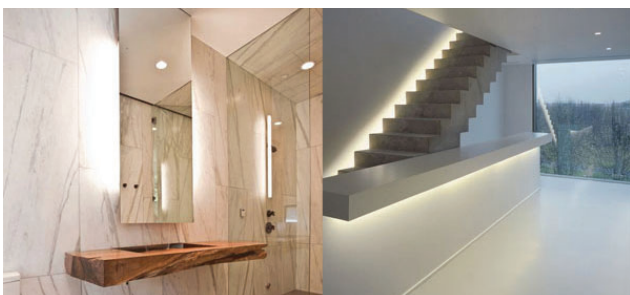

Linear - Indoor & Outdoor Light

SWITCHING IP20 SERIES



Product Model	Voltage (V)	Current (A)	Power (W)	Dimension (mm.)			Price (฿)
				W	L	H	
SW01-12V5A	12	5	60	78	110	35	
SW01-12V10A	12	10	120	90	153	40	
SW01-12V15A	12	15	180	98	215	43	
SW01-12V20A	12	20	240	110	200	50	
SW01-12V30A	12	30	360	115	235	55	
SW01-12V40A	12	40	480	113	215	50	
SW01-24V5A	24	5	100	46	187	46	
SW01-24V7.5A	24	7.5	180	46	187	46	
SW01-24V10A	24	10	240	70	223	70	

SWITCHING MEAN WELL SERIES



Product Model	Voltage (V)	Current (A)	Power (W)	Dimension (mm.)			Price (฿)
				W	L	H	
LRS-35-12	12	3	35	82	99	30	
LRS-75-12	12	6	75	97	99	30	
LRS-100-12	12	8.5	100	97	129	30	
LRS-150-12	12	12.5	150	97	199	38	
LRS-200-12	12	17	200	115	215	30	
LRS-350-12	12	29	350	115	215	50	

SWITCHING 12V IP65 SERIES

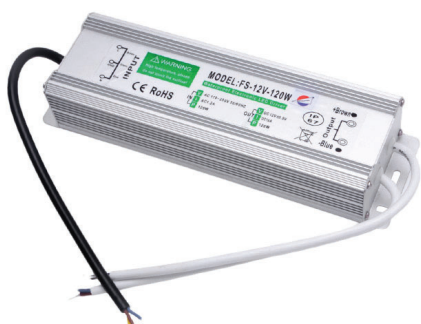

Product Model	Voltage (V)	Current (A)	Power (W)	Dimension (mm.)			Price (฿)
				W	L	H	
SW02-12V2A	12	2	24	78	110	35	
SW02-12V5A	12	5	60	90	153	40	
SW02-12V10A	12	10	120	98	215	43	
SW02-12V16.5A	12	16.5	198	110	200	50	
SW02-12V25A	12	25	300	115	235	55	
SW02-24V10A	24	10	240	113	215	50	
SW02-24V16.7A	24	16.7	400				

Accessory - Indoor & outdoor

ADAPTER IP68 SERIES



Product Model	Voltage (V)	Current (A)	Power (W)	Dimension (mm.)			Price (฿)
				W	L	H	
AD01-12V15	12	1.25	15	43	43	60	
AD01-12V20	12	1.65	20	43	43	60	
AD01-12V30	12	2.5	30	52	52	70	
AD01-12V40	12	3	40	52	52	70	
AD01-12V60	12	5	60	67	67	95	
AD01-12V105	12	8.75	105	47	47	98	

ADAPTER IP68 SERIES



Product Model	Voltage (V)	Current (A)	Power (W)	Dimension (mm.)			Price (฿)
				W	L	H	
AD01-24V15	24	0.625	15	43	43	60	
AD01-24V20	24	0.8	20	43	43	60	
AD01-24V30	24	1.25	30	52	52	70	
AD01-24V40	24	1.65	40	52	52	70	
AD01-24V60	24	2.5	60	67	67	95	
AD01-24V105	24	4.37	105	47	47	98	

Accessory - Indoor & outdoor

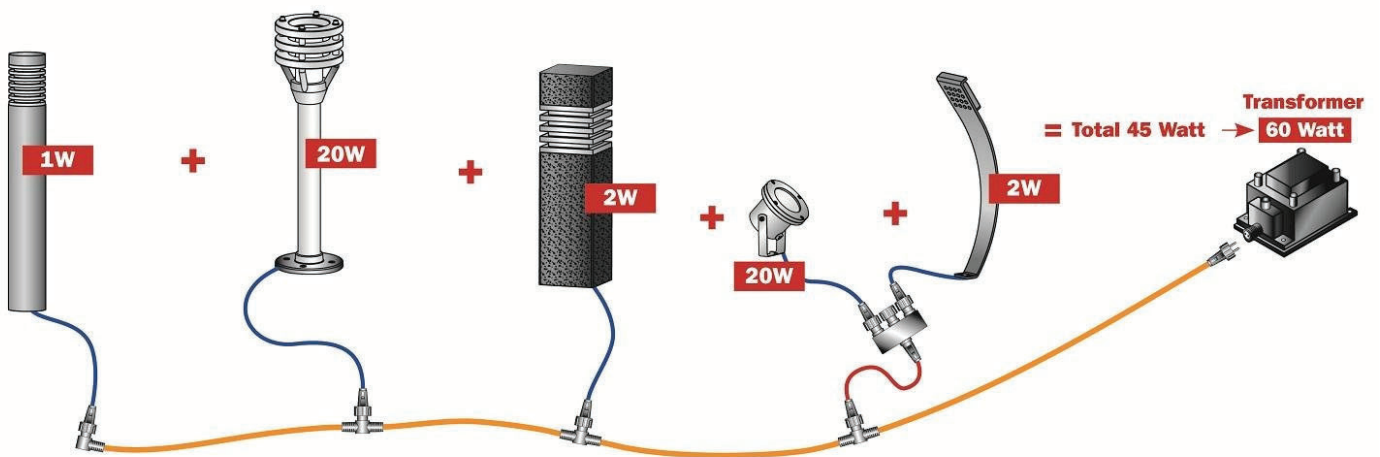

LINEAR STRIP SERIES



Product Model	Body Color	Dimension (mm.)			Price (฿)
		W	L	H	
LN1001-1M	Silver	17	1000	8	



Product Model	Body Color	Dimension (mm.)			Price (฿)
		W	L	H	
LN1002-1M	Silver	17	1000	15	



Product Model	Body Color	Dimension (mm.)			Price (฿)
		W	L	H	
LN1003-1M	Silver	17	1000	8	



Product Model	Body Color	Dimension (mm.)			Price (฿)
		W	L	H	
LN1004-1M	Silver	21	1000	20	



Product Model	Body Color	Dimension (mm.)			Price (฿)
		W	L	H	
LN1005-1M	Silver	23	1000	10	



Product Model	Body Color	Dimension (mm.)			Price (฿)
		W	L	H	
LN1006-1M	Silver	25	1000	15	

Accessory - Indoor & Outdoor

LINEAR STRIP SERIES



Product Model	Body Color	Dimension (mm.)			Price (฿)
		W	L	H	
LN1007-1M	Silver	23	1000	10	



Product Model	Body Color	Dimension (mm.)			Price (฿)
		W	L	H	
LN1008-1M	Silver	30	1000	30	



Product Model	Body Color	Dimension (mm.)			Price (฿)
		W	L	H	
LN1009-1M	Silver	16	1000	16	



Product Model	Body Color	Dimension (mm.)			Price (฿)
		W	L	H	
LN1010-1.2M	Black	65	1200	35	



Product Model	Body Color	Dimension (mm.)			Price (฿)
		W	L	H	
LN1011-1M	Silver	16	1000	16	



ACCESSORY SERIES



AC1001-RGBW

Voltage: DC12-24V
Total Output Current: 24A
Control way: RGB+White

Price (฿)



AC1001-RGB

Voltage: DC12-24V
Total Output Current: 18A
Control way: RGB

Price (฿)



AC1002-RGB

Voltage: DC12-24V
Total Output Current: 12A
Control way: RGB

Price (฿)



AC1003-DIM30A

Voltage: DC12-24V
Total Output Current: 30A
Control way: Dimmable

Price (฿)



AC1004-RGB

Voltage: DC12V
Total Output Current: 6A
Control way: RGB

Price (฿)



AC1005-RGB

Voltage: DC12V
Total Output Current: 6A
Control way: RGB

Price (฿)



AC1006-NEON

Voltage: 220V

Price (฿)



AC1007-ROPE

Voltage: 220V

Price (฿)



AC1008-G1000

Voltage: DC5-40V
Controller protocol: TTL/DMX
Single port control: P1

Price (฿)



AC1009-SW301T

Voltage: AC100-240V
Controller protocol: TTL/DMX

Price (฿)



AC1010-RGB

Voltage: DC12-24V
Total Output Current: 12A
Control way: RGB

Price (฿)



AC1011-DIM

Voltage: DC12-24V
Total Output Current: 16A
Control way: Dimmable

Price (฿)

