

THE DIY STEN GUN

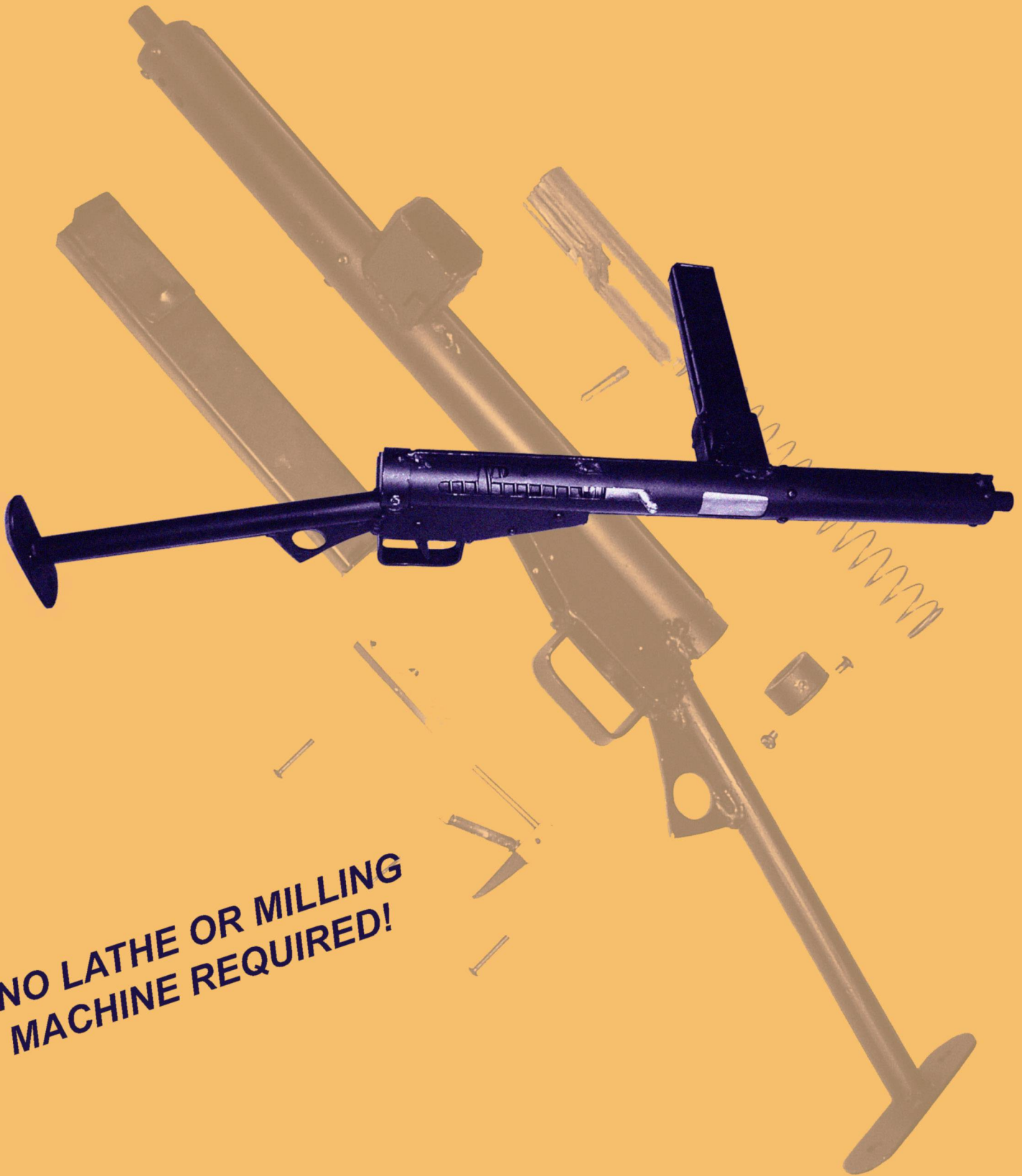

**NO LATHE OR MILLING
MACHINE REQUIRED!**

Practical Scrap Metal Small Arms Vol.3

The DIY STEN Gun



Practical Scrap Metal Small Arms Vol.3

By Professor Parabellum

Plans on pages 11 to 18

Introduction

The DIY STEN Gun is a simplified 1:1 copy of the British STEN MKIII submachine gun. The main differences however include the number of components having been greatly reduced and it's overall construction made even cruder. Using the simple techniques described, the need for a milling machine or lathe is eliminated making it ideal for production in the home environment with very limited tools.

For obvious legal reasons, the demonstration example pictured was built as a non-firing display replica. It's dummy barrel consists of a hardened steel spike welded and pinned in place at the chamber end and a separate solid front portion protruding from the barrel shroud for display. It's bolt is also inert with no firing pin. ***This document is for academic study purposes only.***



(Disassembled: Back plug, recoil spring, bolt, magazine, sear and trigger displayed)



(Non-functioning dummy barrel present on display model)

Tools & construction techniques

A few very basic and inexpensive power tools can be used to simulate machining actions usually reserved for a milling machine. Using a cheap angle grinder the average hobbyist has the ability to perform speedy removal of steel using a variety of cutting and grinding discs. Rather than tediously using a hacksaw to cut steel sheet, an angle grinder fitted with a 1mm slitting disc will accurately cut a straight line through steel of any thickness in mere seconds. Fitted with a 2mm disc it can be used to easily 'sculpt' thick steel into any shape in a fraction of the time it takes to manually use a hand file. It's most useful application for this project is to cut and grind the bolt to it's required profile. This is a relatively quick process and with care can produce a bolt just as good as a factory made original.



Force PT110921 4-1/2-Inch Angle

\$19.99 from 3 stores

7.5 Amp, 11,000 rpm motor designed for fast material removal

Inexpensive arc welders are available for purchase over the Internet:



ONLY \$65



Force 1.1 Amp Rotary Tool Kit

\$13.98



The Force 1.1 Amp Rotary Tool Kit is an essential tool for homeowners and c

A rotary tool or Dremel is highly useful for delicate grinding and cutting operations. Fitted with a 'reinforced cutting disc' it becomes a mini angle grinder, ideal for cutting out and grinding openings in pieces of tube quickly and neatly without having to manually use a hand file. This is particularly effective when used in combination with a 'chain' of drill holes to quickly remove an opening marked on the STEN receiver. Rotary tools can be purchased cheaply online with a large variety of cutting, grinding and sanding bits available for working with metal.

All tools mentioned can be found very cheaply online, or being practically given away at any swap meet.

Useful tools

Angle grinder

Hacksaw + cobalt tipped blades

Cobalt or titanium tipped drill bits

Drill press or hand drill combined with a stand

Welder

Dremel / rotary tool + reinforced cutting discs

Hand files

Materials

Receiver: 1 1/2" (38mm / 1.5mm wall) mild steel tube

Magazine-well: 1" x 2" (50mm x 25mm) steel box section

Trigger housing: 14 gauge (2mm) steel sheet

Stock: 3/4" (19/20mm) steel tube

Barrel collars: 3/4" shaft lock collars (35mm outer diameter)

10mm aluminum plate

35mm mild steel bar stock

Bolt construction

A typical submachine gun bolt copy can be constructed without the use of a lathe or milling machine by using a combination of drilling and slitting using a cheap angle grinder to remove the unneeded material. A 135mm length of 38mm diameter round steel bar stock is required to construct the bolt for the STEN. Many original STEN bolts were casted from soft bronze later on in WW2, so even a fairly soft 'machine-able' or 'leaded' grade of mild steel bar stock is perfectly suitable.



The centre of the bolt is first marked and drilled using a 10mm drill bit until 3mm deep. This is best achieved using a number of smaller drill bits starting at 6mm. If misalignment is experienced, the piece being worked on can be manually tilted by hand and drilled at an angle until the drill bit wanders back to the centre. The resulting hole can then be levelled flat using a second 10mm drill bit modified by removing it's tip using an angle grinder. A slight bevel is made around the hole using a 16mm+ drill bit or rotary tool grinding bit.



Next a series of drill holes are made in order to aid in removing material from the bolt, eventually forming the magazine feeding cuts. The positions of six holes are marked and drilled using a 4mm bit until 45mm deep. Using a cheap drill press and a well oiled bit, each hole only takes 3 minutes or less to bore when working with regular mild steel. Once each hole has been drilled, an angle grinder fitted with a 1mm slitting disc is used to cut through the sides of the holes as close to the edges as possible, enabling the two pieces of excess material to be easily removed. A drill hole can be made at each end to aid in prying each piece out with a screw driver and hammer.



Once the main bulk of material is removed, the remaining lower section is cut off at a marked point leaving 3mm of material remaining to be formed into the feed lips. This area is ground inwards into a slight ramp profile using a dremel fitted with a grinding bit. This section should fit between the lips of a sten magazine without any friction, thus may require additional

grinding until around 8mm in width. Once complete, the ejector channel is cut into the bolt using a 1mm slitting disc then widened using a 2mm disc until entering 1mm into the 10mm center of the bolt. A dremel fitted with a cutting disc can be used to score a straight line before hand in order to aid in accuracy.



The sear contact point is cut into the bolt by using a hacksaw to mark a line, after which material in front of this point is removed using a 2mm or 3mm grinding disc aimed at a 45 degree angle to 'sculpt' out a gorge.

Finally, a spring guide at the rear of the bolt can be made by drilling a 7mm hole in the center and tapping it to accept an m8 bolt and five 1" washers with an 8mm hole. The bolt is finished by aligning it inside the receiver with the magazine and marking the point to drill for the bolt handle.



Trigger group

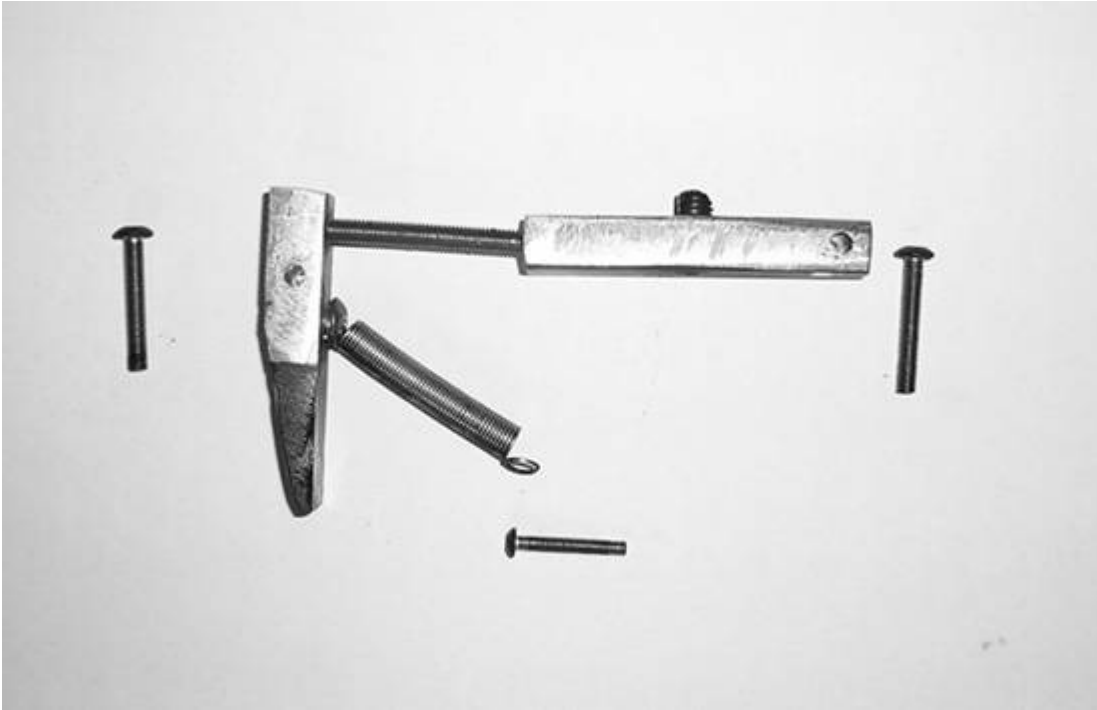

The trigger group has been simplified to two very easily constructed components, each made using a section of 10mm aluminum or steel plate with a few additional modifications. Being typical of an open-bolt design, the trigger acts as a lever, pivoting the sear out of the way of the bolt when pulled, only to be pushed back into engagement when the trigger is released due to continuous spring tension acting upon it. This assembly allows for fully automatic fire only.



Recoil spring



A lever type grease gun almost always contains a near perfect compression spring for an SMG. Depending on manufacturer, you may need to loosen up the spring slightly by repeatedly compressing it rapidly with a firm slamming motion. A large 9 cell flash light is usually a perfect fit inside the grease gun tube to perform this action. The spring will usually be 1" to 30mm in outer diameter and around 7" long.

Design notes

The original STEN design includes a removable stock which also doubles as the back plug of the receiver. The DIY STEN Gun has been simplified by instead having a permanently fixed stock welded in place and a much stronger back plug retained by two bolts. This is vastly easier to construct and will result in a much more secure assembly. The original sights have been substituted for a 17" long steel bar welded in place to simulate the quick target acquisition properties of the original top rib seam. The dust cover present on the original has been left out as it is unneeded. A cartridge extractor is also not essential for function and can be left out, though a template for the original has been included should one be desired. This design uses original unmodified STEN magazines.

Plans

All pages included should be printed out on 8.5 x 11 US letter paper. Each component template is drawn to scale and can be cut out and glued to their respective thickness of material or used as reference for measurements. Make sure the ruler at the bottom left of each sheet is 2 inches in length. Alternatively, take a screen-shot and enlarge the plans using a computer program until the ruler is the correct length, then trace the parts needed onto a sheet of paper taped over your computer's screen.

A receiver template for A4 paper has also been included.

Receiver template

Start template 36mm from back of tube

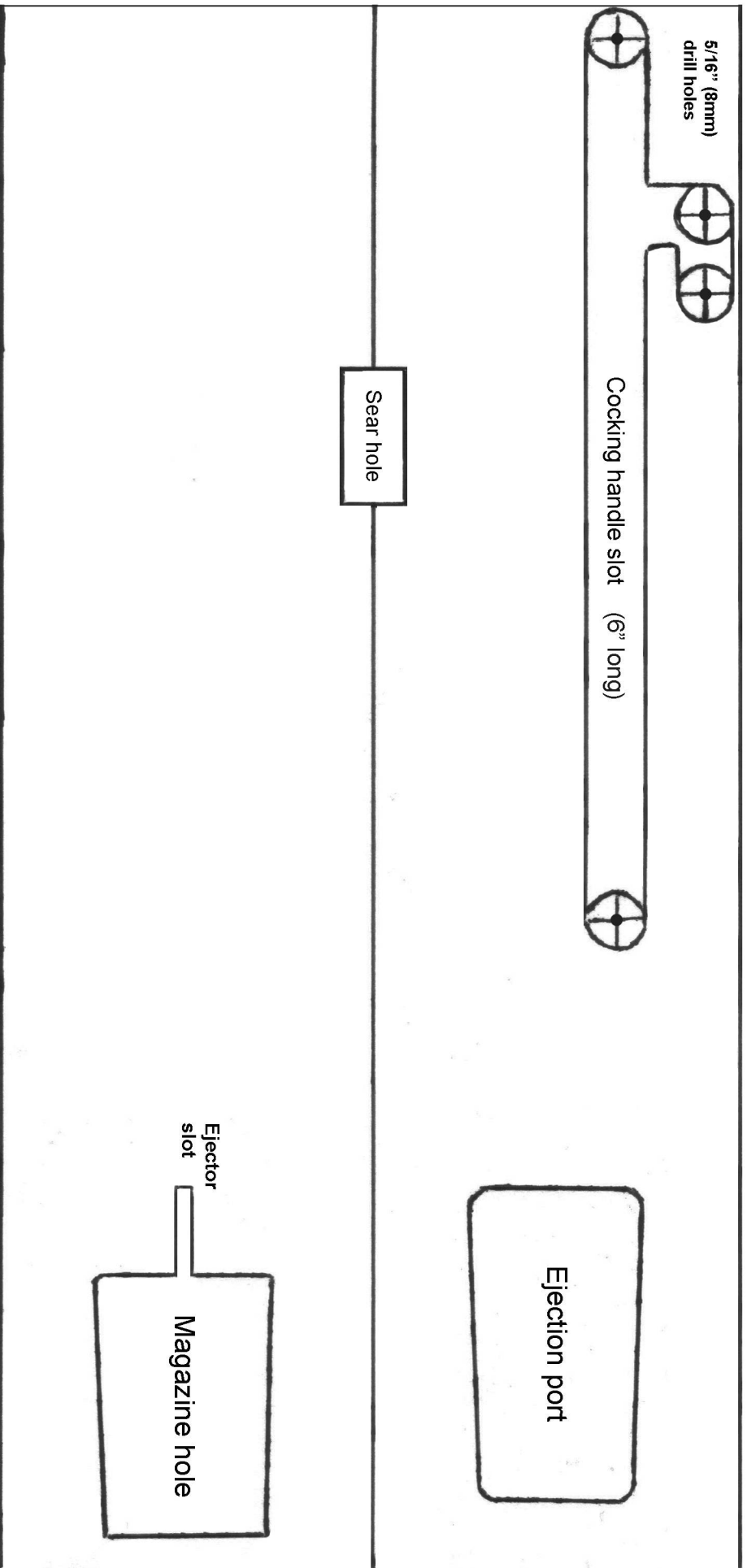

Cut out template and glue around an 18" long section of 1 1/2" 0.062 wall (38mm x 1.5mm) mild steel tube
- Leave 36mm of space behind start of template.

2 inches

Trigger housing

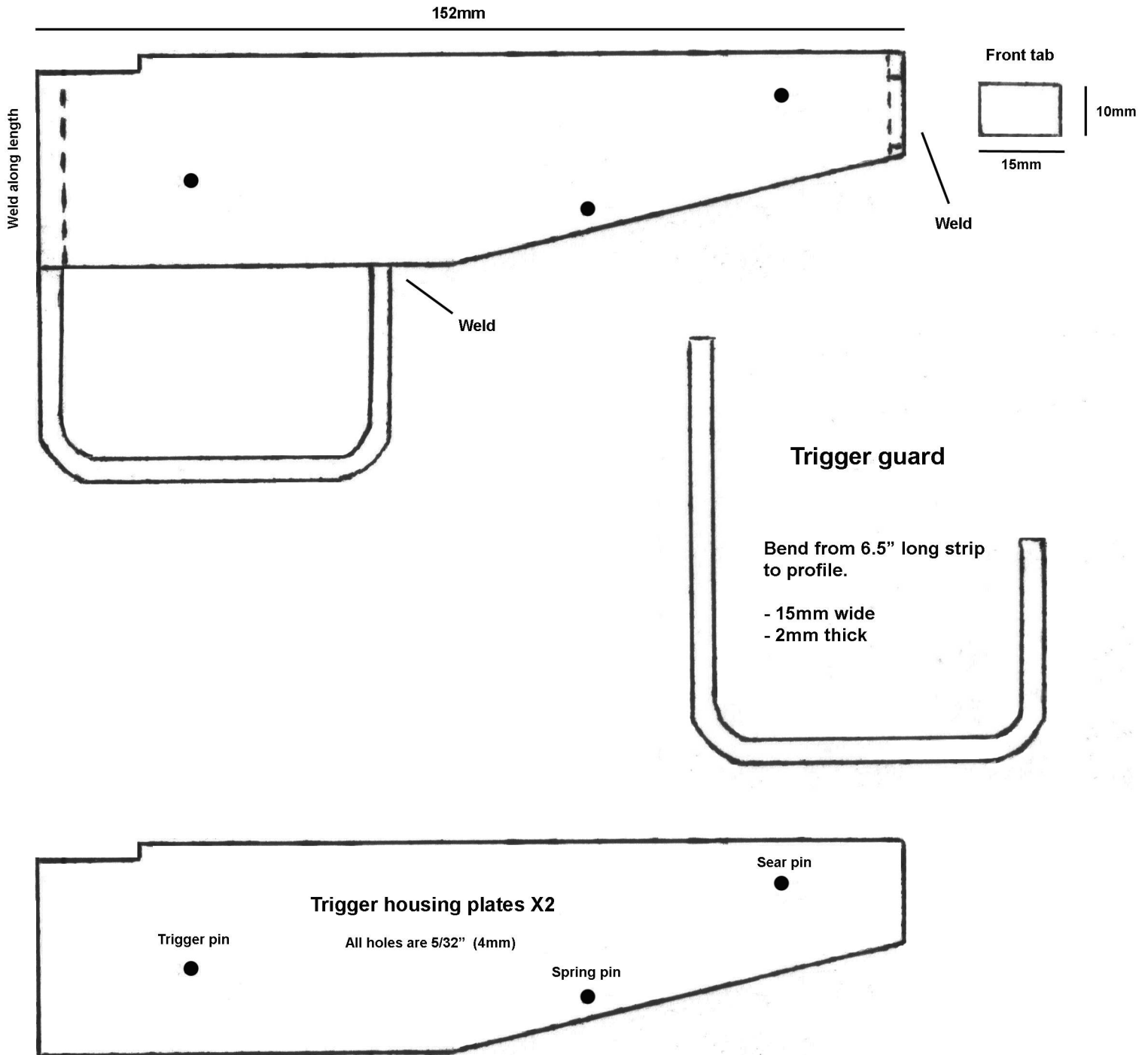

Trigger group

Trigger

Cut from a 14mm wide strip of 10mm aluminum plate (60mm long)

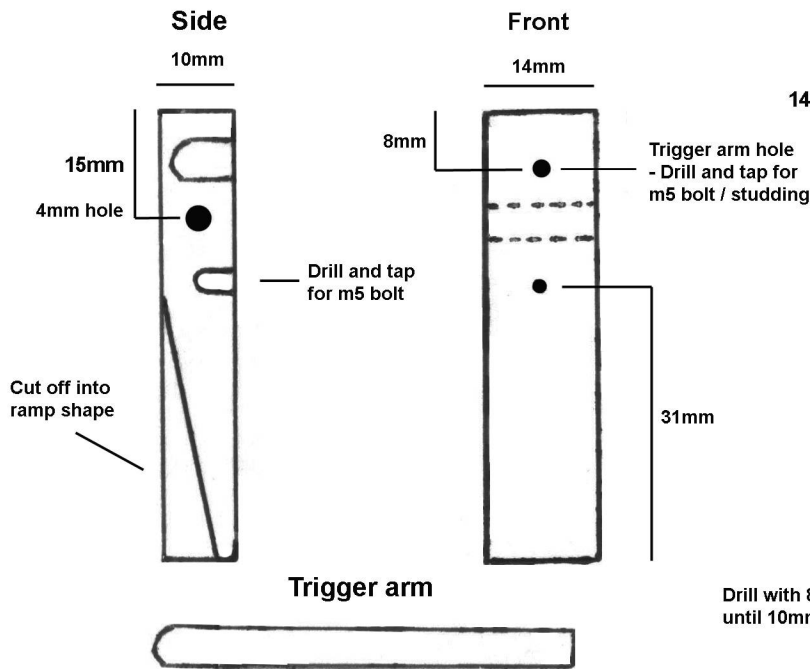

Section of bolt, studding or bar - 5mm wide, 55mm long
- Thread or epoxy in place.

Sear

10mm aluminum plate

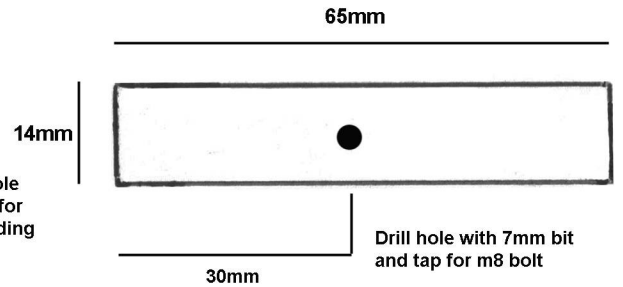

Sear tooth - tap m8 bolt in place and cut to profile

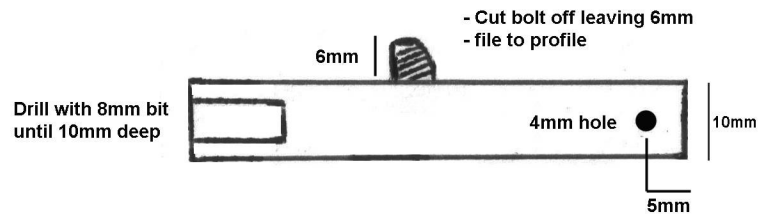

Assembled:

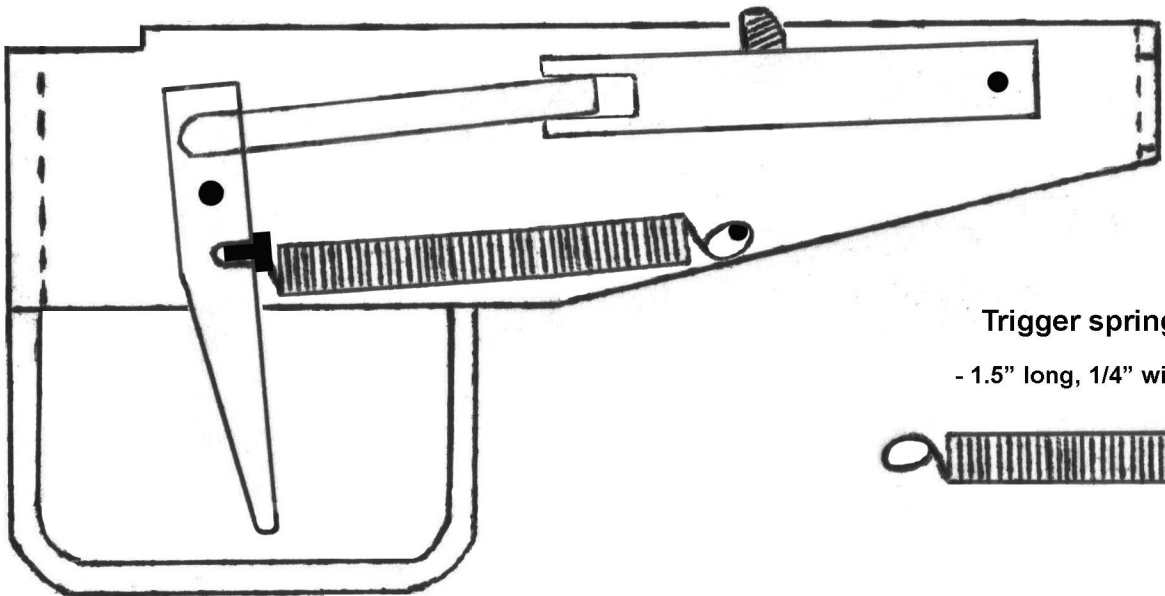

Trigger spring

- 1.5" long, 1/4" wide



2 inches

Magazine-well

The magazine well is created by removing a 1" side from a length of 1" x 2" (25mm x 50mm) steel box section after which the channel is widened out slightly to accept a STEN magazine. The removed portion of wall is then welded back into place to form the correct inner dimension.
 - Use a STEN magazine as a reference throughout this process

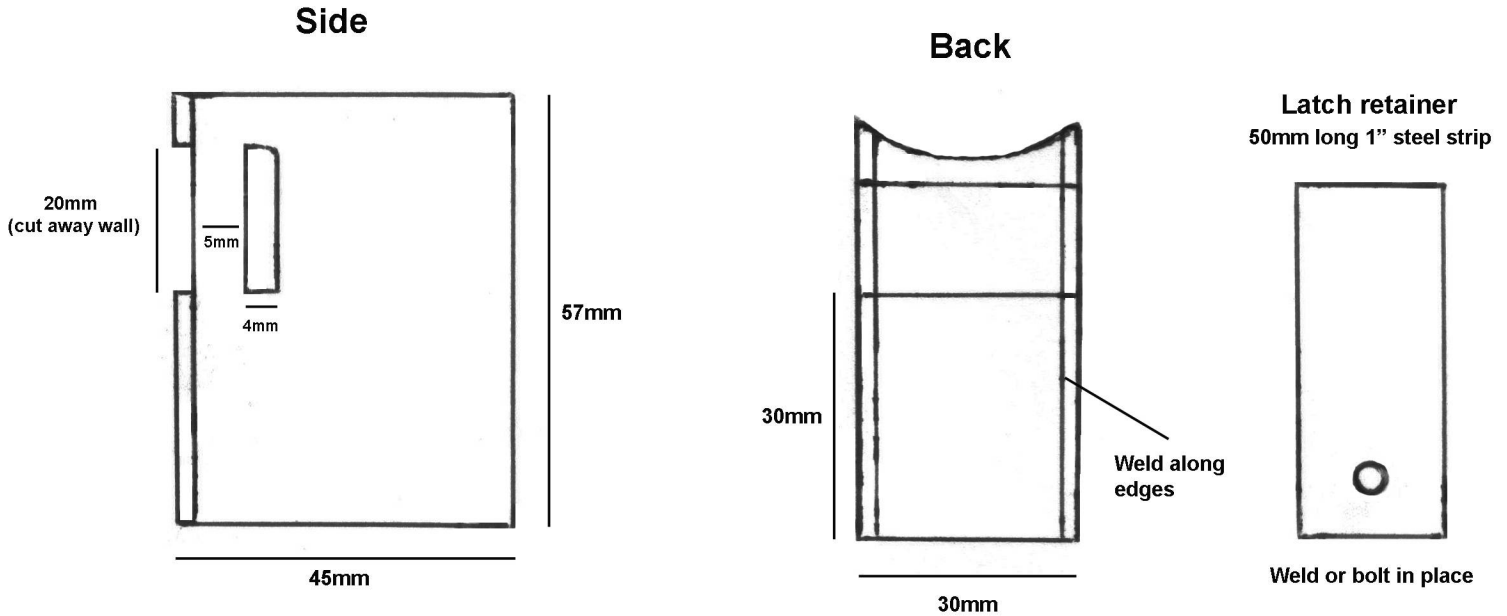

Magzine latch

Bend from a 70mm long, 20mm wide, 2mm thick steel strip to profile below

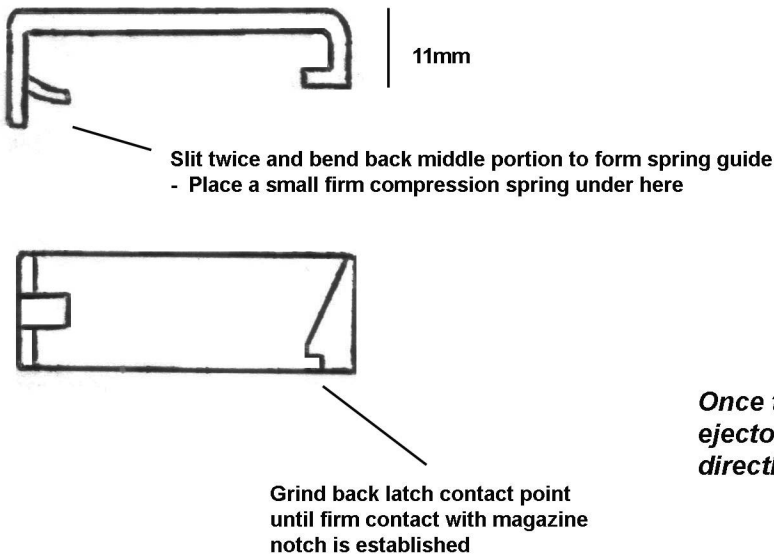

Ejector

Position flush with receiver walls into ejector slot - weld in place



Once the magazine-well has been assembled and ejector welded in place, weld the magazine-well directly over magazine opening on receiver.

2 inches

Bolt

Face

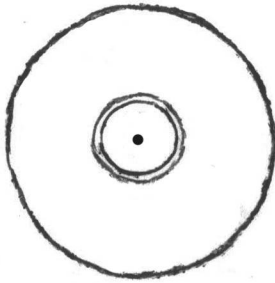

- Drill center with a 10mm drill bit until 3mm deep.
- Flatten using a 10mm drill bit with tip removed using angle grinder.
- Bevel rim using 16mm+ bit or dremel tool

- Drill marked positions with a 4mm (5/32") drill bit for 45mm deep.
- Cut through holes using angle grinder fitted with 1mm slitting disc.

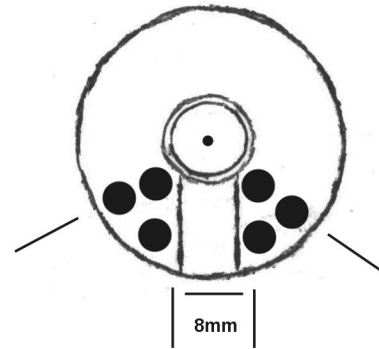

Material removed

Extractor (Optional)

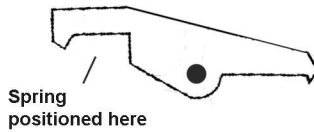
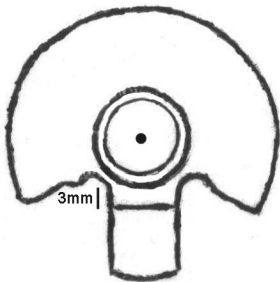

Spring positioned here

Extractor pin hole is drilled 15mm behind front of bolt

Extractor slot parallel with ejector

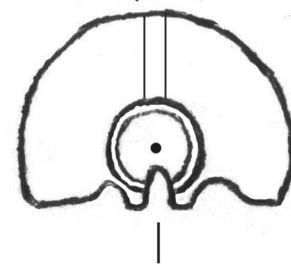

Slit with 1mm slitting disc and widen with 2mm disc until entering 1mm into face

- Mark 3mm below rim (25mm from top to bottom)
- Cut off below marked point

Bottom

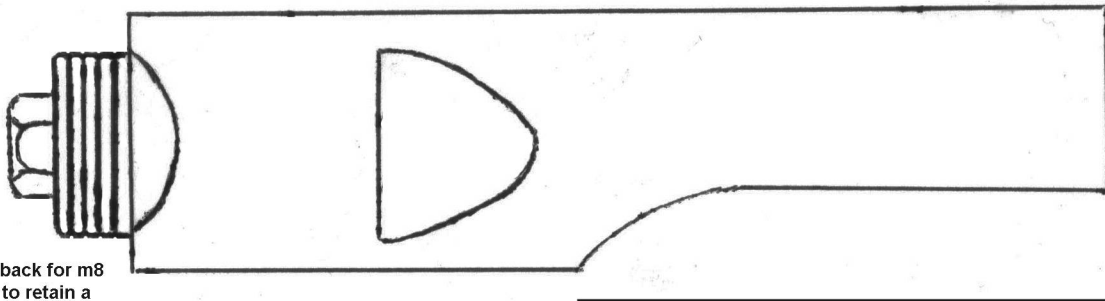

Tap back for m8 bolt to retain a stack five 1" washers

70mm

Cocking handle

Rotate in drill while using a file or bench grinder to turn down dia

27mm

Side

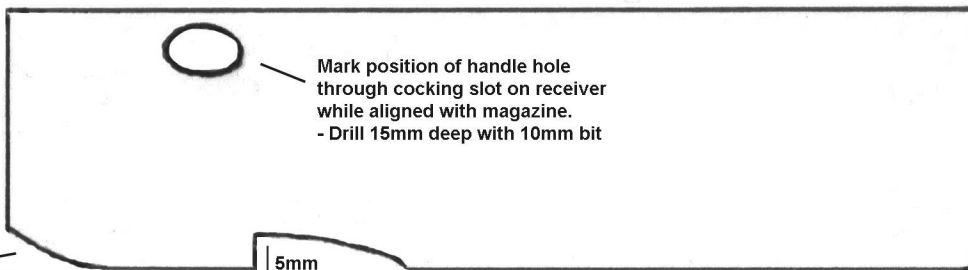

Mark position of handle hole through cocking slot on receiver while aligned with magazine.
- Drill 15mm deep with 10mm bit

8mm

10mm round bar

15mm

Grind curve

33mm

5mm

Grind sear contact point to shape using angle grinder fitted with 2mm grinding disc.

Alternatively drill hole 7mm and tap for a standard M8 bolt

2 inches

Bolt : 35mm dia mild steel round bar stock
Cocking handle : 10mm bar stock or m8 bolt
Extractor : 14 gauge (2mm) steel sheet

Stock

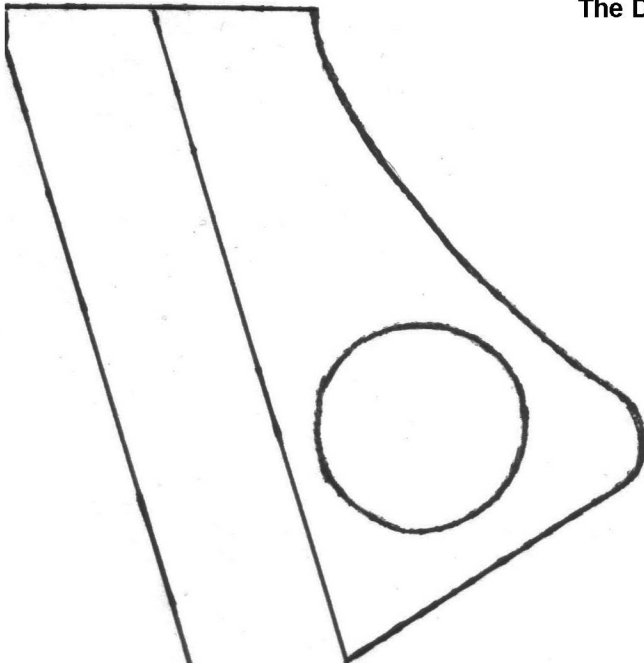

Weld along length

Grip

3mm to 1/4" steel plate

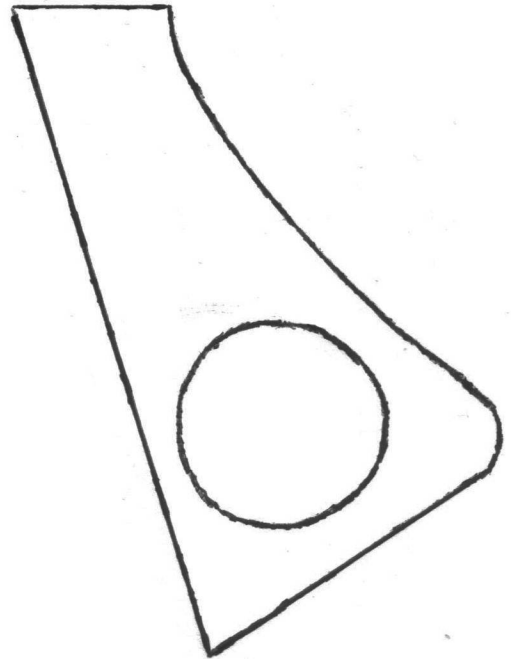

Encircle with weld

Stock pad

2mm to 1/4" steel plate

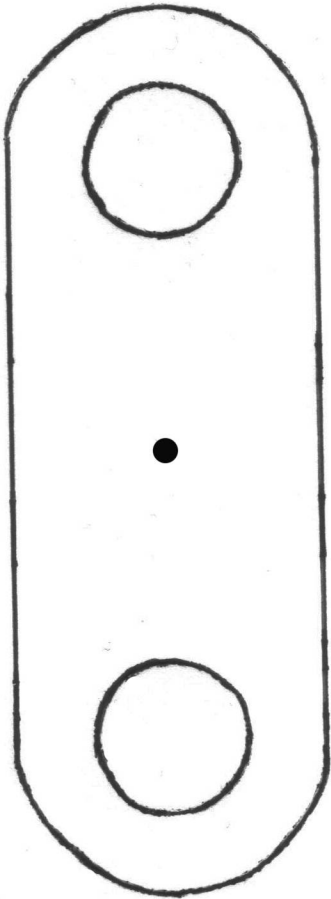

2 inches

10.5" long, 3/4" dia

Barrel

(Non-functioning dummy)

Receiver (continued)

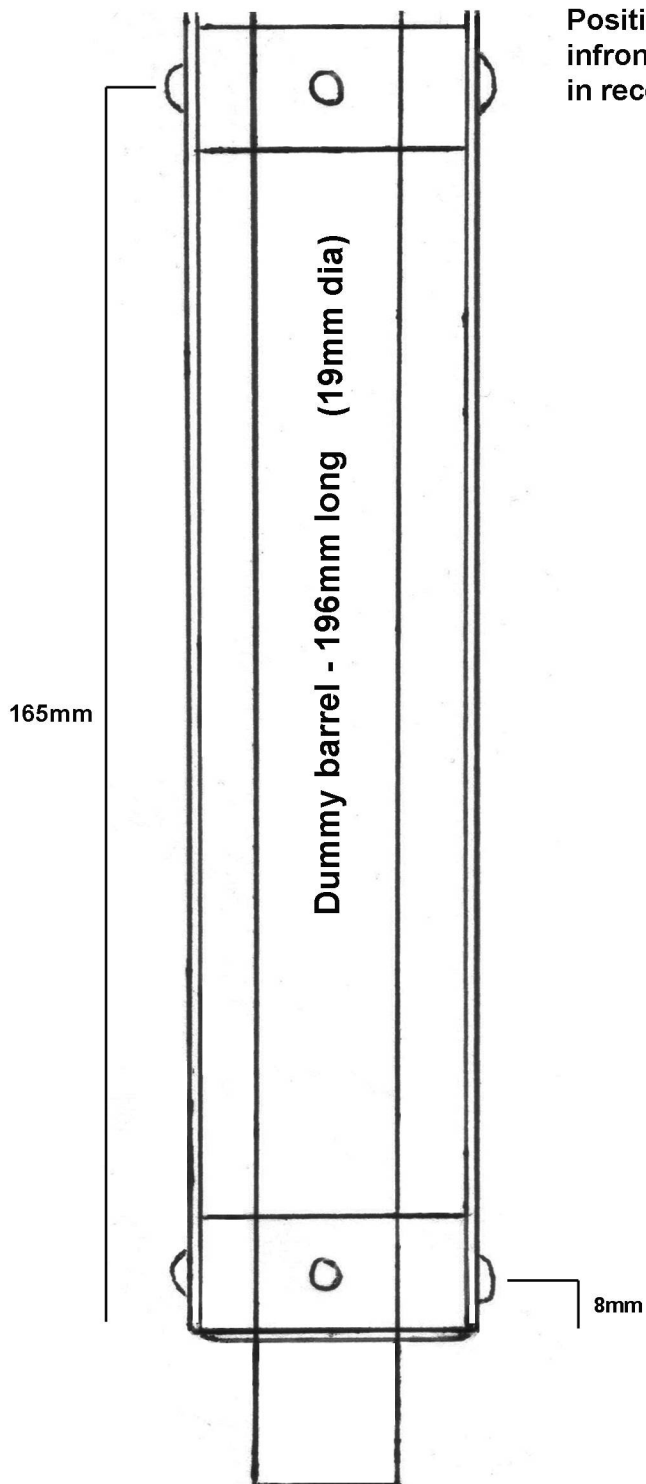

Position first collar 2mm
infront of magazine cut
in receiver

Barrel collars



3/4" Shaft lock collar

- 3/4" (19mm) inner diameter
- 35mm outer diameter
- Can be sleeved down to 16mm using 19mm x 1.5 tubing

Make a shallow pit mark using a 5mm drill bit through collar's screw hole to ensure secure locking when grub screw is tightened.

Secure collars to receiver via four m4 or m5 bolts

Rear assembly

Reinforcing collar

Cut a slot into an 18mm long section of 38mm tube and widen out until able to be placed over the back of the receiver - weld in place

Sight rail - 17" long steel strip, 8mm wide

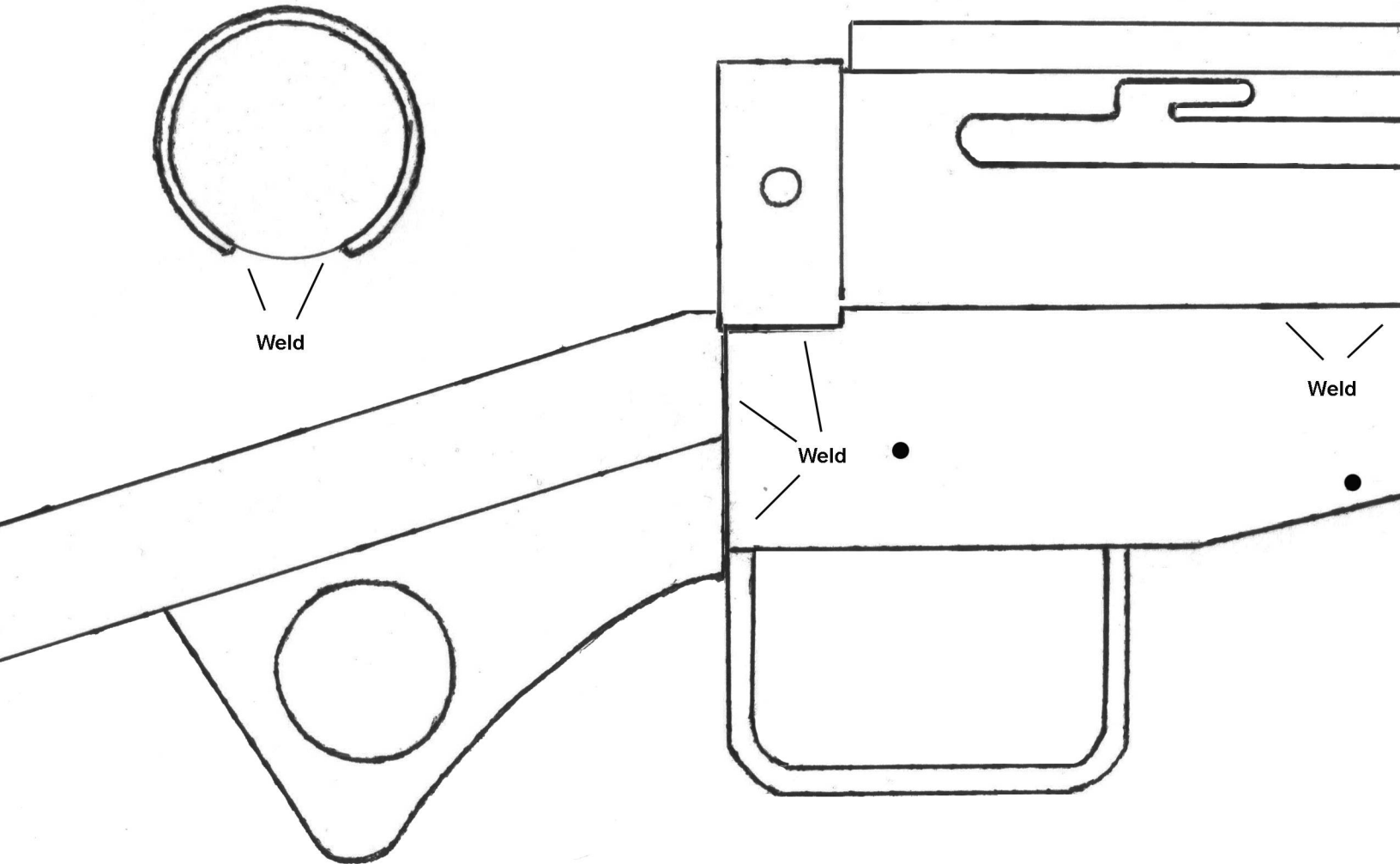

The back retaining plug consists of a 17mm long section of 35mm mild steel bar or a 3/4" lock collar. It is secured in place via two M8 steel bolts tapped in place either side or a single 2" long M8 bolt inserted from above

Recoil spring

A compression spring taken from a lever type grease applicator gun will be suitable in this design.

- Dimensions are usually around 30mm wide, 7" long.

Original sten recoil spring: Wire diameter 0.067 in, Spring OD 1.00 in. Active coils 15, Free length 9.40 in, Initial length 6.80 in. Final length 3.20 in.

2 inches

Reference photos

Original cast bronze STEN bolt:



Top: cast bronze, bottom: machined steel:

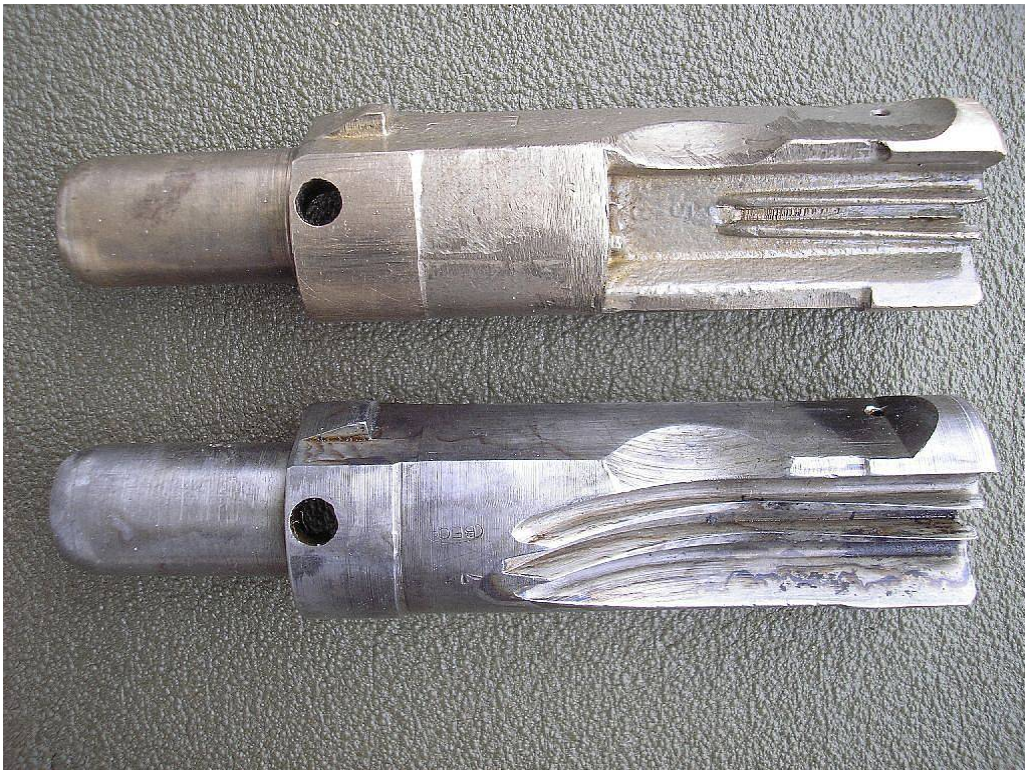

Original STEN bolt face:

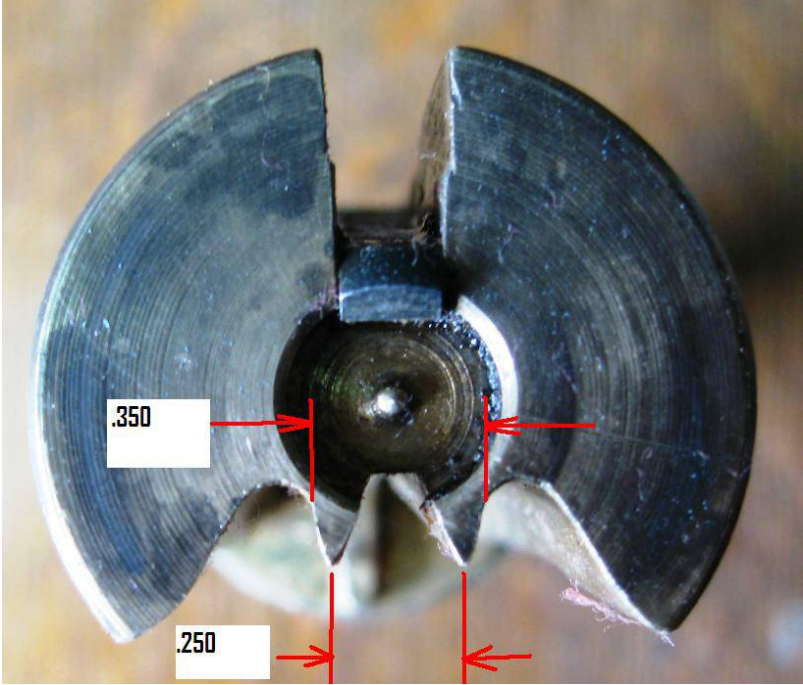

Original STEN chamber feed entrance:



STEN MKIII magazine-well and latch:



Firing sequence illustrated:

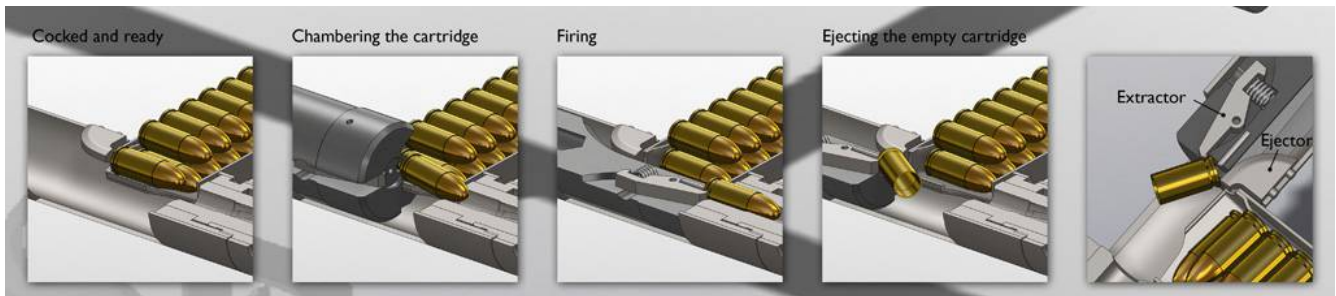

Receiver template

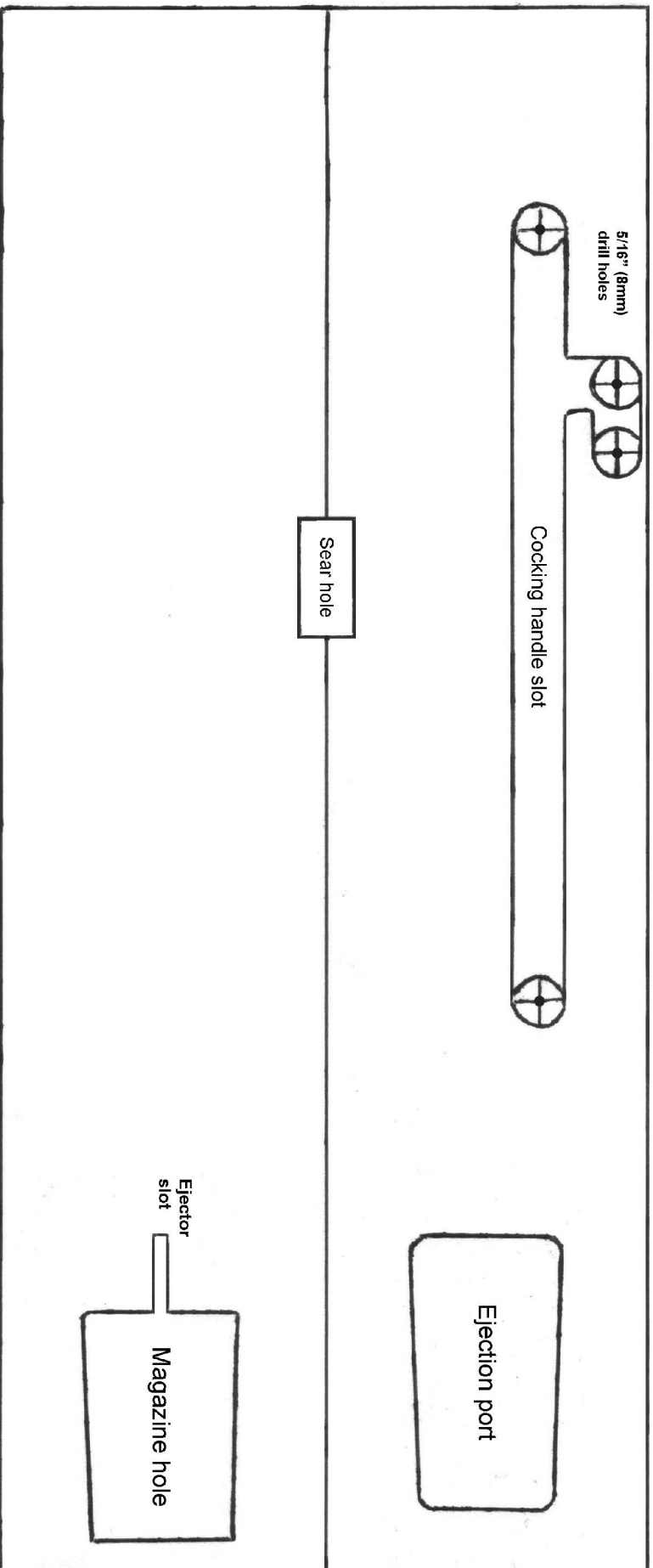

Cut out template and glue around an 18" long section of 1 1/2" 0.062 wall (38mm x 1.5mm) mild steel tube

2 inches

Print on A4 paper

You may also wish to seek out....

