

**LEWIS'S
VERDICT ON
HIS STUNNING
CHINA WIN**

"Seb put up a very
fair and strong fight"



FORMULA 1 • SPORTSCARS • TOURING CARS • NASCAR • INDYCAR • RALLYING • NATIONAL RACING & MORE

AUTOSPORT

McLAREN STUNS RED BULL

APRIL 21 2011 •

£3.30 • WWW.AUTOSPORT.COM

RED-HOT HAMILTON TOPPLES VETTEL

20 pages of amazing
Chinese GP action

PLUS

BUMPER RACE ISSUE

WRC Ogier wins by 0.2s!

IndyCar Brit Conway on top
BTCC Plato's huge crash



haymarket





EUROPEAN RALLYCROSS CHAMPIONSHIP

RALLYCROSS

ROUND 1 GREAT BRITAIN

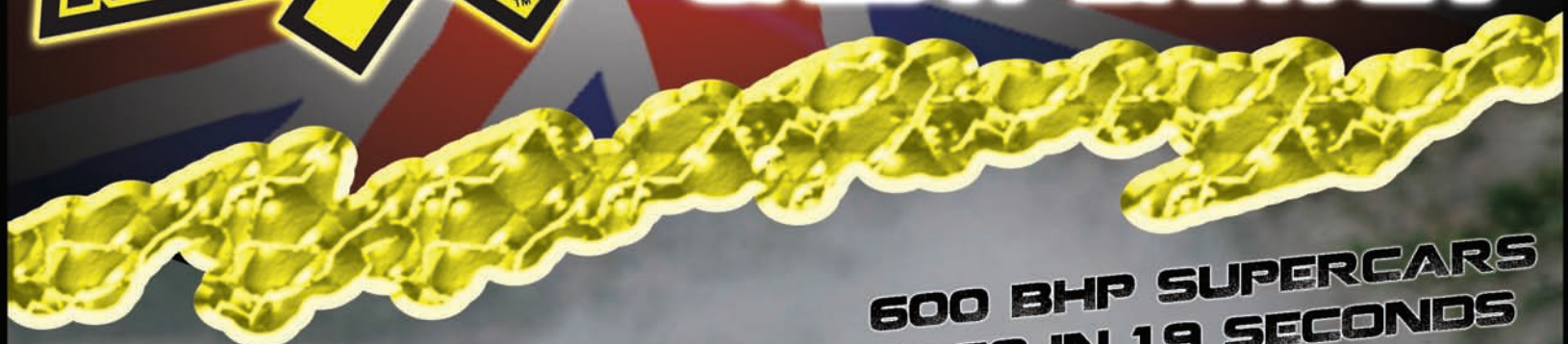

600 BHP SUPERCARS
0-60 IN 1.9 SECONDS



APRIL 24 & 25TH

LYDDEN HILL RACE CIRCUIT, KENT. CT4 6ET

FOR INFO CALL 01304 830557 OR WWW.LYDDENHILL.CO.UK

CONTENTS

April 21 2011 – vol 204 no 3



AUTOSPORT.COM

Up-to-the-minute news and reports from F1, WRC and more. Subscribe for must-read opinion, stats and images

COVER IMAGE:
LIU JIN/AFP/
GETTY IMAGES
INSETS:
DUNBAR, JONES,
EBREY/LAT



“Shame McLaren won in a way, but also we can’t let Seb [Vettel] get too far away. It was a good day for the racing, I think”

MARK WEBBER WASN'T TOO UNHAPPY THAT VETTEL MISSED OUT IN CHINA

63

That's the number of overtaking moves for track position made during the Chinese Grand Prix. The degradation characteristics of the Pirelli tyres brought divergent pit strategies and the DRS wings also played a role. Fabulous!

SUBSCRIBE...

to AUTOSPORT and get a free McLaren cap **P66**

NEWS



26 Red Bull prioritises KERS

Reliability needed after both Vettel and Webber (above) hit difficulties in China

16 Gow to slow turbos

BTCC boss turns down the wick **20 Raikkonen 'not interested'** Kimi: no to full-time NASCAR ride

24 Rally GB route criticised

WRC teams demand new Wales base; Citroen boss hits out at starting order in Jordan

REPORTS



COVER STORY

26 Chinese Grand Prix

Lewis Hamilton (above) chases down and passes Sebastian Vettel to win in Shanghai

40 BTCC Donington

James Nash takes series lead

44 BTCC supports

Tio Ellinas wins FRenault

46 WRC Jordan

Ogier heads closest-ever finish

55 World of Sport

NASCAR; IRC; ALMS; V8s

60 IndyCar Long Beach

Mike Conway's maiden win

62 Formula 2 Silverstone

Bortolotti stages comeback

64 British F3 Monza

Carlin drivers on top again

67 World Series Aragon

Rossi misses out on double

FEATURES

68 STCC preview

Ex-BTCC champions James Thompson and Colin Turkington head north to compete in the Scandinavian Touring Car Championship this year

94 British GT preview

Stunning year is in prospect featuring Audi's R8, the Lotus Evora, Mercedes-Benz SLS and Ferrari 458 Italia as well as all the old favourites.

REGULARS

5 From the editor

6 Snapshot

15 Mark Hughes

66 Subscribe for a free gift

96 Final drive

Letters and Latest Gear

98 On track/on screen

The best action in the next week

101 From the archive

Larry Perkins, Monza F3 1975

102 Rally of my life

Tony Adamowicz, Daytona 1970

SPORTS EXTRA



85 Brands crash investigated

MR2 flies into public area (left)

90 National reports

All the action from Silverstone, Brands Hatch, Snetterton, Rockingham and Oulton Park

UNLIKE MOST PERFORMANCE CARS, THE NEW SPECIAL EDITION WRX STI 320R COMES WITH ADDED POWER AND SAT NAV AT NO ADDED COST.

IT'S FOR PEOPLE WHO KNOW WHERE THEY'RE GOING.

Unlike most performance cars, the new special edition Subaru WRX STI 320R has 20PS more power than a standard WRX STI. It also has a free touch screen Sat Nav fitted. And unlike other exclusive special editions, there's no additional cost compared with a standard WRX STI. There's even the option of a performance hatchback or a performance saloon.

The new WRX STI 320R combines power, precision and performance with everyday practicality. Supreme balance and control comes from permanent Symmetrical All-Wheel Drive combined with our legendary spec.C suspension. The new WRX STI 320R is a vehicle that inspires every time you take hold of the wheel. **Unlike most performance cars.**



BOXER TURBO ENGINE
FOR BALANCE
AND PERFORMANCE



AWD
FOR GRIP



SPEC.C
SUSPENSION
FOR AGILITY



320
PS
HIGH POWER
FOR EXHILARATION



SATELLITE NAVIGATION
FOR STRESS FREE JOURNEYS



Call 08446 626622
subaru.co.uk/as
or text '320R' to 60800

UNCOMMON ENGINEERING
UNCOMMON STABILITY
UNCOMMON ROADHOLDING
UNCOMMON SENSE



SUBARU

WRX STI 320R is a Subaru WRX STI with a performance upgrade added post-registration.
WRX STI range fuel consumption in mpg (L/100km): Urban 20.0 (14.1). Extra urban 33.6 (8.4). Combined 26.9 (10.5).
CO₂ emissions 243 (g/km).

EDITOR
Andrew van de Burgt
andrew.vandeburgt@haymarket.com ext.5974

AUTOSPORT.COM EDITOR
Simon Strang ext.5093
simon.strang@haymarket.com

DEPUTY EDITOR
Charles Bradley
charles.bradley@haymarket.com ext.5889

GROUP F1 EDITOR ext.5810
Jonathan Noble
jonathan.noble@haymarket.com

F1 EDITOR
Edd Straw ext.5887
edd.straw@haymarket.com

DEPUTY F1 EDITOR
Mark Glendenning ext.5801
mark.glendenning@haymarket.com

NEWS EDITOR
Glenn Freeman ext.5309
glenn.freeman@haymarket.com

MANAGING EDITOR
Peter Hodges ext.8617
peter.hodges@haymarket.com

WEB MANAGING EDITOR
Pablo Elizalde

GRAND PRIX EDITOR
Mark Hughes
autosport.editorial@haynet.com

F1 COLUMNIST
David Coulthard

RALLIES EDITOR
David Evans
david.evans@haymarket.com

INTERNATIONAL EDITOR-AT-LARGE
Gary Watkins

ART EDITOR
Aubrey Smith ext.5914
aubrey.smith@haymarket.com

PRESENTER/SUB-EDITOR
Henry Hope-Frost ext.5835
henry.hope-frost@haymarket.com

CHIEF SUB-EDITOR
Marcus Simmons ext.5807
marcus.simmons@haymarket.com

NATIONAL EDITOR
Kevin Turner ext.5432
kevin.turner@haymarket.com

EDITORIAL ASSISTANT
Ben Anderson ext.5425
ben.anderson@haymarket.com

NATIONAL EDITOR-AT-LARGE
Marcus Pye

BTCC EDITOR
Jamie O'Leary ext.5811
jamie.oleary@haymarket.com

SENIOR DESIGNER
Matthew Dungate

DESIGNER
Will Clarke

PICTURE EDITOR
Peter Mills ext.5918
peter.mills@haymarket.com

AUTOSPORT.COM TECHNICAL TEAM LEADER
Geoff Creighton
geoff.creighton@haymarket.com

AUTOSPORT.COM USER INTERFACE DEVELOPER
Pete Holmes
pete.holmes@haymarket.com

AUTOSPORT.COM PICTURE EDITOR
Chris Bird
chris.bird@haymarket.com

SECRETARY
Joanne Grove
joanne.grove@haymarket.com ext.5804

PHOTOGRAPHS
LAT Photographic

SPECIAL CORRESPONDENT
Adam Cooper

TECHNICAL CONSULTANT
Gary Anderson

TECHNICAL EDITOR
Giorgio Piola

NEWS GRAPHICS
Alan Eldridge

CARTOONIST
Jim Bamber

CORRESPONDENTS

ARGENTINA
Tony Watson

AUSTRALIA
Phil Branagan

AUSTRIA
Gerhard Kuntzsch

BELGIUM
Gordon McKay

BRAZIL
Lito Cavalcanti

FINLAND
Esa Illoninen

GERMANY
Rene de Boer

GREECE
Dimitris Papadopoulos

ITALY
Roberto Chinchero

JAPAN
Jiro Takahashi, Len Clarke

NEW ZEALAND
Bernard Carpinter

RUSSIA
Gregory Golshev

SOUTH AFRICA
Richard Asher

SPAIN
Raimon Duran

SWEDEN
Tege Tornvall

USA
Jonathan Ingram, Bruce

Martin, David Phillips, Diego Mejia, Robin Miller, Jeff Olson, Jeremy Shaw.

UK & EIRE
David Addison, Ben Bostock, Dud Candier, Jonathan Crawford, Kerry Dunlop, Leanne Fahy, Paul Jurd, Linda Keen, Paul Lawrence, Marc Oms, Graham Read, Peter Scherer, Ian Sowman, Oliver Timson, Ian Titchmarsh, Matt Upton, Eddie Walker, Tim Whittington, Richard Young

ADVERTISING
Tel: +44 (0) 20 8267 5858
Fax: +44 (0) 20 8267 5850
E-mail: autosport.ads@haymarket.com

SALES MANAGER
Rachel Brock, ext: 5820
rachel.brock@haymarket.com

DISPLAY ADVERTISING
Adam Stimpson, ext: 5244
adam.stimpson@haymarket.com

Katie Gamble, ext: 5961
katie.gamble@haymarket.com

Karen Reilly, ext: 5576
karen.reilly@haymarket.com

CLASSIFIED ADVERTISING
Andrew Barclay, ext: 5027
andrew.barclay@haymarket.com

ADVERTISING DIRECTOR
Matthew Witham

AD PRODUCTION
Tel: +44 (0) 20 8267 5740 Fax: +44 (0) 20 8267 5320

SPECIAL PROJECTS DIRECTOR
Derek Redfern

LICENSING DIRECTOR
Tim Bulley

PRODUCTION MANAGER
Carrie McNally, ext: 5814
carrie.mcnally@haymarket.com

SENIOR DISPLAY PRODUCTION CONTROLLER
Saba Bonser, ext: 5740
saba.bonser@haymarket.com

CLASSIFIED PRODUCTION
Tom Piggott, ext: 5349
tom.piggott@haymarket.com

SUBSCRIPTIONS
UK 08456 777 817
OVERSEAS +44 (0)1795 592 974
EMAIL autosport@servicehelpline.co.uk

US & CANADA 1-866-918-1446
US & CANADA EMAIL haymarket@imsnews.com

AUTOSPORT (USPS 454230) is published weekly by Haymarket Magazines Ltd, c/o Mercury International Ltd of 365 Blair Road, Avenel, New Jersey 07001. For subscription rates please contact.

Tel: 1-866-918-1446, Email: haymarket@imsnews.com
Periodicals paid at Rahway, NJ.
Postmaster please send address correction changes to AUTOSPORT, c/o Mercury International at above address.

MANAGEMENT

PUBLISHING DIRECTOR
Peter Higham

PUBLISHER
Rob Ahrens

PUBLISHING MANAGER
Samantha Jemson

DIGITAL PRODUCT MANAGER
Jim Foster

SPECIAL EVENTS MANAGER
Laura Coppin

SYNDICATION SALES MANAGER
Roshini Sethi, 444 208 267 5396
roshini.sethi@haymarket.com

HAYMARKET CONSUMER MEDIA
Publishing, trade and further subscription details on www.autosport.com While due care is taken to ensure the contents of AUTOSPORT are accurate, the publishers and printers cannot accept liability for errors and omissions. Advertisements are accepted for publication in AUTOSPORT only upon Haymarket Consumer Media's Standard Terms of Acceptance of Advertising, copies of which are available from the Advertising Sales Department of AUTOSPORT.

CIRCULATION TRADE ENQUIRIES
Frontline Ltd, Park House, 117 Park Road Peterborough, Cambs, PE21 2TS. Tel: +44 (0) 1733 555161. Printed in England by Wyndeham Press Ltd. Cover and centre sections printed by CSM Impact, Basingstoke. Colour original on: Colour Systems, 90-92 Pentonville Road, London N1 9PS (editorial and advertising). ISSN 0269-946X. AUTOSPORT, incorporating Autosport, is published weekly by Haymarket Consumer Media, Teddington Studios, Broom Road, Teddington, TW11 9BE, UK.

STRATEGICAL AND PLANNING DIRECTOR
Bob McDowell

MANAGING DIRECTOR
David Prasher

CHIEF EXECUTIVE
Kevin Costello

haymarket
Haymarket is certified by BSI to environmental standard ISO14001

POLE POSITION

Let's have more vintage racing the Chinese way



WHAT A FANTASTIC WEEKEND OF motor racing! Lewis Hamilton's brilliant drive to win a thrilling Chinese GP was the icing on the cake, but across the board there was tremendous action taking place. Transport issues meant the first day of the Jordan Rally was cancelled. But this mattered not as Jari-Matti Latvala and Sebastien Ogier went head-to-head into the concluding Powerstage. Ogier prevailed by 0.2s in the smallest winning margin ever.

It was a similar story in the IRC, where Jan Kopecky and Juho Hanninen staged an equally close fight – Hanninen taking victory on Gran Canaria by just over a second.

The winning gaps were larger, but the action no less intense in the BTCC encounter at Donington, while even British F3 wowed, with some classic slipstreaming battles at Monza.

Over in America, the NASCAR race at Talladega broke the record for the number of lead changes, while in IndyCar, Briton Mike Conway completed his recovery from his horrendous Indy 500 crash last year with a brilliant maiden win at Long Beach.

You can get the full low-down on all of it in this issue.

Andrew van de Burgt, editor

BAMBER'S WEEK

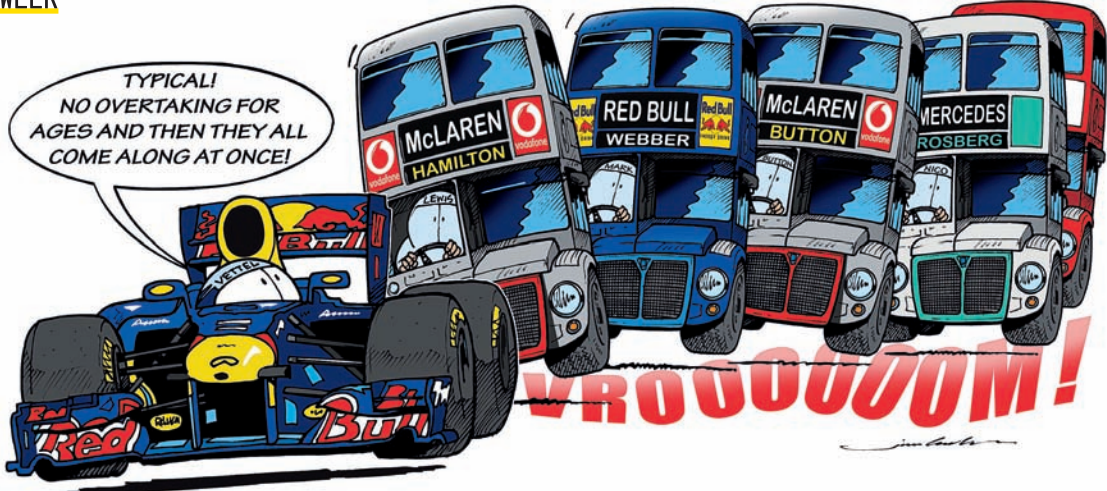



BTCC

You're Cruzing for a bruising, Jason

Reigning BTCC champion Jason Plato had a fraught weekend at Donington Park, suffering a puncture in race one, then this spectacular race-two shunt. Remarkably, the spanner-wielders at RML managed to repair his Chevy Cruze for Sunday's final outing, in which he salvaged a sixth-place finish. Report, p40

Picture: Ebrey/LAT



Red Bull prioritises KERS

Championship-leading team is desperate to get system working to stay ahead of the pack. By EDD STRAW



Red Bull has made solving its KERS problems its top priority after the hybrid system cost the team a potential one-two finish in the Chinese Grand Prix.

Sebastian Vettel's KERS worked in the first half of the race, but was available only intermittently thereafter. As well as the laptime cost, he was hindered when a lock-up damaged his tyres during his first stint because of the way the system recovers energy under braking. Vettel was later powerless to hold back Lewis Hamilton, who used his KERS to take the lead four laps from home.

Vettel's team-mate Mark

Webber started 18th after being unable to use KERS during qualifying as a result of a wiring loom problem that meant the water pump that cools the system was not working. His KERS was available only for 25 laps during the race and, had he had it during the remaining 31, he would have been significantly closer to race winner Hamilton, whom he trailed by just over seven seconds, at the finish.

Team principal Christian Horner downplayed the scale of Red Bull's KERS problems, and said: "I'm confident that we can get on top of it," but AUTOSPORT understands that the team is very concerned about what is proving to be its Achilles heel. Much of the post-race debrief was spent dissecting the problem, with sources indicating that they would be surprised if KERS was functioning reliably despite modifications scheduled for next month's Turkish Grand Prix.

NO FUNDAMENTAL CHANGES

Red Bull only started using its KERS during the final pre-season test at Barcelona and is battling problems both with cooling, caused primarily by chief technical officer Adrian Newey's desire not to compromise

his aerodynamic packaging, and vibrations.

Horner ruled out changing the composition of the RB7's KERS or overhauling the car design, and the team will persevere with making its current installation work.

Red Bull's KERS system is identical to the one used by Renault, except for a more compact battery set-up, with a secondary battery located in the bellhousing of the gearbox. "We are making progress every weekend," Horner told AUTOSPORT. "We have some things in the pipeline."

Red Bull did not use KERS at all during qualifying and the race in Australia, with Webber's system going into a safe mode before the start in Malaysia last week after its water pump failed. Vettel, too, was forced to stop using the 80bhp boost on his way to winning the race, meaning that Red Bull has not managed a clean KERS run so far this season.

THE COST OF NO KERS

The laptime benefit of KERS varies from track to track and Red Bull's first priority is to ensure that its system works reliably during qualifying

and at the start of races.

In China, for example, Webber reckoned KERS to be worth between four and five tenths in qualifying because the driver can deploy his boost on the run to the start/finish before beginning the lap and then have the full 6.7s available again after crossing the line. On a normal lap, it is worth around three-tenths of a second on an average track.

While Hamilton's quicker three-stop strategy, compared to Vettel's two-stopper, was key to his win, there's no question the German would have put up a stronger fight with his KERS fully operational. Although the DRS wing gives a greater increase in speed, KERS is vital in repulsing such an attack. With McLaren stronger in the races than it is in qualifying, Red Bull risks losing wins to its hybrid problems again in the future.

"We want to address it as soon as possible," said Webber when asked by AUTOSPORT how important it is to solve the problems. "It will be a clear focus for us in terms of durability and consistency and understanding. It's not only a performance thing, it's also extremely disrupting in the garage; when you open a car up and put it back together all the time, it's not easy."



Vettel was without KERS in closing laps



KERS could have helped hold Hamilton at bay

60 SECONDS WITH

MARTIN WHITMARSH
MCLAREN TEAM PRINCIPAL



Is your proven KERS a trump card with all of the problems Red Bull is having?

It's difficult to say. We've had some KERS problems this weekend, but Mercedes has done a fantastic job with it. But together, KERS, the tyres and DRS are producing exciting and challenging races. You've got to make the right calls on everything.

What does this win mean for the championship battle?

It's early days, but mentally it's very important to get the first win in any season. There's a long championship ahead and we've got to improve our car quicker than the others. If we can do that, then we can win the championship.

How far away did this first win seem when you were struggling for pace and reliability during testing?

We are in a world where you have to respond quickly. In the last test at Barcelona we were a long way off in terms of reliability and performance and the team has done a fantastic job to turn it around.

Lewis's tyre management has been questioned in the past. Do you think that he managed the tyres well in the race?

I think he did. He saved a set of tyres from qualifying, but it didn't prove to be that beneficial because the mistakes that led into the first stop and our analysis of what was happening in the race meant we changed from a two- to a three-stop, which meant that the fresh options went on and came off quickly.

How difficult is it to react strategically with this year's rules?

Very difficult. It's easy to get it wrong because you are on a knife-edge. It's taken F1 to another level of a sprint between the stops. You've got to be fast and you've got to conserve tyres.



Martin Whitmarsh was talking to AUTOSPORT F1 editor **Edd Straw**

EXPERT VIEW

GARY ANDERSON
TECHNICAL CONSULTANT

Red Bull is fighting hard to overcome KERS reliability issues because it's clear that the extra 80bhp that's available for 6.7s per lap is going to be vitally important as the competition catches up.

For this system (inset) to work correctly and consistently, one of the most important factors is cooling and I have no doubt that most of Red Bull's problems will

come from this area. Adrian Newey is renowned for his uncompromising packaging and the performance of the Red Bull shows how important this is.

Any airflow that's used to cool either brakes, water, oil or in this case KERS is airflow that can't be used to produce downforce and Newey won't give this up lightly.

But sometimes it can be a step too far. It took more or less two

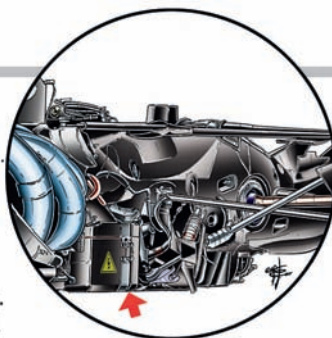

seasons for the team to cope with the packaging and operational detail of its hydraulic system and I am afraid to say that KERS might prove to be a similar challenge.

WHAT IS KERS?

The kinetic energy recovery system was introduced for the 2009 season and returned this year after not being used in 2010 by team agreement.

It uses energy recovered that would otherwise be wasted while the car is braking to charge a battery, with the power being used to deliver an 80bhp boost for a maximum of 6.666s per lap.

The KERS is made up of three

Rubber gloves required when KERS is active



components: the battery or batteries (usually lithium), where the energy is stored, a motor generator unit, which converts the energy for storage

and also converts it back to create the 80bhp boost, and the ECU, which controls the system. The lightest units are believed to weigh around 20kg.



McLaren snatched win from Red Bull

Mercedes form convinces Rosberg

Stronger performance in Chinese Grand Prix leaves German happy that he is in the right team for the future

Nico Rosberg insists that he is fully committed to Mercedes after its race-leading performance in the Chinese Grand Prix.

The 25-year-old led 14 laps in China after an early pitstop allowed him to leapfrog Sebastian Vettel and both McLaren drivers. He eventually finished fifth after having to conserve fuel throughout the race because the team misjudged the consumption levels based on long runs in free practice. Despite this, the weekend was a vast improvement for Mercedes, which had lagged two seconds off the pace in the qualifying for the first two races.

Mercedes is believed to have an option on Rosberg for 2012,

and the German played down speculation that he could leave the team at the end of this year.

"I don't want to comment on my contracts, but what I can say is that I am very happy with where I am at the moment," he told AUTOSPORT. "It's a dream for me to drive a Silver Arrow and to work with the people in this team. I really hope and believe that we can have success."

"We have everything it takes to move forward. We have a strong group of people, the factory, all of the facilities, so there is no reason why we cannot make it happen."

Mercedes made a significant change to the way it approached the weekend in China, focusing on setting up its car to ensure it maximised tyre life. In Malaysia,

Rosberg and team-mate Michael Schumacher showed single-lap pace comparable to Ferrari, but ended up battling with the likes of Force India during the race. This policy was changed following a series of meetings between team principal Ross Brawn and senior engineers between Malaysia and China.

"The approach we had was based very much around the tyres that we had for the last few years," said Brawn. "With these [new] tyres and these cars we needed to rethink how we approached things in terms of set-up."

DRS problems continued to affect Mercedes, with Schumacher missing Q2 after his adjustable wing malfunctioned. A new rear wing is scheduled to be included

in the upgrade package planned for next month's Turkish Grand Prix, which should also address the airflow separation problems that struck in Australia and Malaysia.

Schumacher, who finished eighth in China, believes that the new direction taken by the team has transformed the car.

"It has been a different approach this weekend with how we worked with the car," he said. "With fuel, in race conditions the car handles much better than what I have experienced in the first two races."

Despite improving its race pace, Mercedes appears to have sacrificed little of the one-lap potential that it has showed – in flashes – since the major upgrade was added at the final pre-season test in Barcelona.



Nico pleased with new-found speed

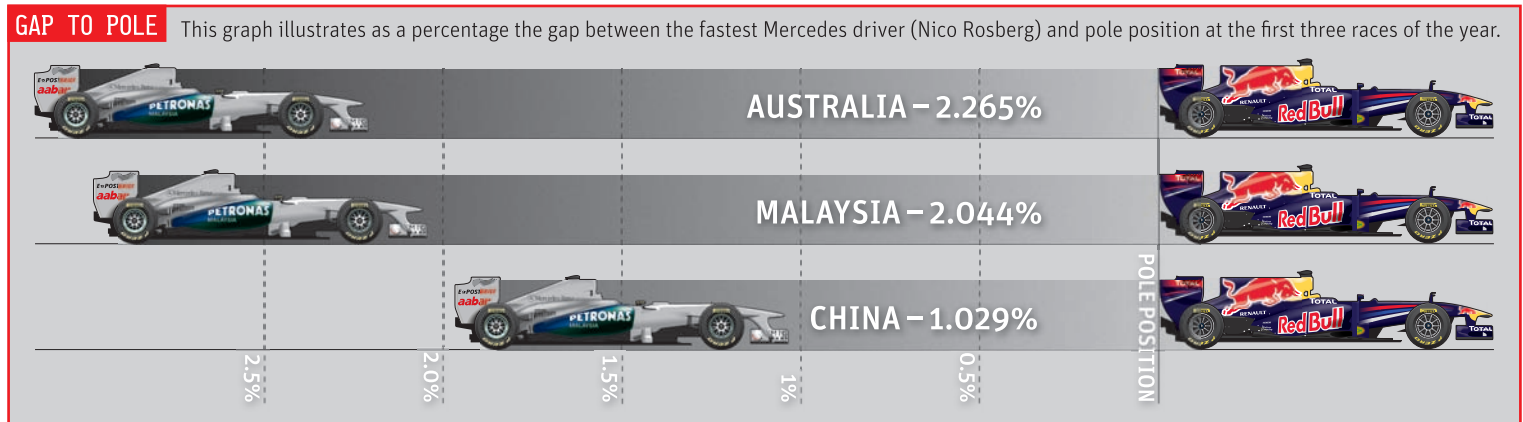

PICS: GILHAM/GETTY; HONE/LAT; FERRARO/LAT; MASON/GETTY



Aero paint was used in practice

Ferrari starting to understand car

FERRARI HAS MADE SIGNIFICANT progress in understanding why its car is not performing as expected.

Fernando Alonso ran a modified front wing and brake ducts carrying FloVIZ aero paint during free practice in China as Ferrari sought to understand why the performance seen in the windtunnel and during the final pre-season test at Barcelona has been absent during the first three races of the year.

While admitting it doesn't have a complete understanding of how to

solve its difficulties, there is a feeling it now knows where the problem lies. It appears to centre on the way the front wing and endplates are interacting with the front wheels as they rotate. It is suspected Pirelli's windtunnel tyres, which offered only a scaled-down approximation of the behaviour of its rubber, may have contributed to the problem, which has left the car with less downforce than anticipated.

Technical director Aldo Costa said: "Some components are not

delivering the performance expected, so we are doing a correlation job between the track and windtunnel. An F1 car is a very complex aerodynamic machine, so there are a lot of vortices that can interfere with one another."

After a disappointing run to seventh in China, Alonso was cautious about the prospects for Turkey. "I don't know how much we will be able to improve. But I will be asking the team to work above all on the aerodynamics."

FIA glitch for Alonso

FERRARI WAS NOT PENALISED for Fernando Alonso's DRS wing opening outside of the designated overtaking zone during the Chinese Grand Prix because it was caused by an FIA electronic glitch.

The DRS zone was on the back straight on the approach to Turn 14, but on lap 23 Alonso's wing opened on the run out of the hairpin. A Ferrari spokesman confirmed this was caused by "a late enabling signal received from the FIA" and that it happened only once.

AUTOSPORT understands the DRS was not armed until Alonso was around 400 metres into the

overtaking zone and as a knock-on effect of that delay was then available on the run out of the corner. As this was neither Alonso's fault – he did not activate the system on the exit of the hairpin – nor a performance benefit, no penalty was issued.

AUTOSPORT understands the teams will discuss with the FIA the problems that have been encountered with the system.

● Felipe Massa also escaped a penalty for briefly crossing the white line as he exited the pitlane after his final stop. This was because he did not cross onto the track proper and moved back into the pit-exit lane.



Ferrari has had some DRS issues

Hamilton: no weaving

LEWIS HAMILTON

has vowed not to weave in future after his penalty for changing line too many times while battling with Fernando Alonso during the Malaysian Grand Prix two weeks ago.

He was given a 20-second penalty 12 months after being warned for the same offence during last year's Malaysian race, relegating him from seventh to eighth in the results. In response to that penalty, Hamilton accepted that he must not do so again.

"I will just try to avoid doing that in the future so no one can complain," he said. "I didn't weave even half as much as I did the previous time and I didn't put anyone in danger, but the rules state you can only move once."

This interpretation of the rule was reiterated in the drivers' briefing in China. One defensive move is allowed before retaking the line into the braking area provided there is space to do so.



AUTOSPORT SAYS...

EDD STRAW
F1 EDITOR

edd.straw
@haymarket.com



It must be a strange feeling, climbing from the upper echelons of karting through Formula BMW, Formula 3 and GP2, winning races every step of the way, only to hit a win drought in F1. Nico Rosberg has started 92 grands prix with just five visits to the podium, a record that is almost entirely down to being in the right team at the wrong time.

Having spent four years at Williams during its 100-plus race win drought, a move to Mercedes seemed to guarantee victories. As Brawn, the Brackley team had won eight races in 2009 and even though a repeat of that haul in 2010 was always going to be a long shot, surely there would be one? But it wasn't to be. In fact, of all the races Rosberg has started, the only sniff of a win he had was for Williams in Singapore in 2009, when he overcooked it coming out of the pits and slid across the white line marking the pit exit.

Privately, Rosberg is frustrated at the lack of recognition he has received for thrashing Michael Schumacher in the same car. He led comfortably in China and looks every bit a racewinner in the right car, but it won't be until Mercedes produces a genuine frontrunner that we will know for sure whether the intelligent Rosberg is, as he appears, a very good driver, or a great one.



Winless streak irks Rosberg

ROLL OF (DIS)HONOUR

Of the 24 drivers currently on the F1 grid, only two have gone longer without winning an international car race than Nico Rosberg

- Nico Rosberg (Bahrain GP2, 2005)
- Jarno Trulli (Monaco GP, 2004)
- Nick Heidfeld (A1-Ring F3000, 1999)



Double win in '05 GP2 finale



Michael (l) has his driver's support

Barrichello backs tech boss

Williams's veteran driver is sure that Sam Michael should stay at the team despite its poor start to 2011

Sam Michael is the right man to turn around Williams's form after a disastrous start to the season, but the team must make changes to give him more support, according to Rubens Barrichello.

Michael, who was appointed Williams technical director in 2004, has admitted that he is willing to walk away if it's in the best interests of the team after chairman Adam Parr confirmed that changes will be made in a bid to turn things around. AUTOSPORT understands that Michael has become frustrated by the problems imposed on him by the

team's structure, which forces him to micro-manage too many aspects of the car's design and development.

"I have worked with Sam since my early days at Jordan and he's a super guy," Barrichello told AUTOSPORT. "He's doing more than he should be doing, to be honest, and there is too much on his back. He is very good and I'm sure that he can do the job."

Parr is evaluating the strengths and weakness of the team and has confirmed that the changes are imminent. The aerodynamic design office in particular is likely to be strengthened. Williams has not

won a race since the 2004 season finale, and during the first half of the last decade, when the team won 10 races, its success has largely been attributed to BMW's powerplants. It is widely regarded to have not evolved to keep pace with the changes in F1 since it last won the world championship in 1997, and that is what Parr is hoping to change.

"There is no question that we are not where we need to be," Parr told AUTOSPORT. "I've been with the team for five years and the methodology that we are taking to car design and the development process is broadly the same. I'm not saying that it hasn't evolved, but we have had a very stable group of people. What we are doing is understanding where we are not strong, where we are good and whether we are in a position to strengthen the team. The answer is that we are. The plan will be agreed upon and implemented imminently."

That process will involve structural and personnel changes. Parr would not confirm Michael's job was safe, but insisted that his contribution is very valuable.

"As technical director, I am responsible for our performance"

SAM MICHAEL

"I've worked with Sam for five years and think he's an absolutely exceptional guy," said Parr. "He's a real racer and lives and dies for F1 and Williams. He works incredibly hard, he's very intelligent, very organised, very disciplined and a very valuable part of this team."

Michael has taken full responsibility for the team's struggles and remains confident that Williams is still able to achieve its goal of improving on last year's sixth in the constructors' championship.

"We are equipped to perform in Formula 1," he told AUTOSPORT. "Although we have had a tough start to the year, our goal is to get ourselves up there. You're always going to question what you've got when you are not competitive and that includes all aspects of the team. But as technical director, I am responsible for our performance."



Williams has been off the pace so far



Racing was frantic in China on Sunday

More exciting races expected this year

THE TYRE PERFORMANCE SEEN during the Chinese Grand Prix is set to continue throughout the season, according to Pirelli and the teams.

During the previous week's Malaysian Grand Prix several drivers, including Red Bull's Mark Webber, were forced to make four pitstops because of the unusually high track temperatures at Sepang. But Shanghai, where track temperature was around the 30C mark throughout the race, is a more representative case study.

The race produced a variety of strategies, with cars opting for either two or three stops and Sebastian Vettel losing the lead only four laps

from home to Lewis Hamilton, who had made one more stop and was on fresher rubber.

Pirelli motorsport director Paul Hembery told AUTOSPORT: "This [race] is towards the middle of the spectrum. The surface is mid-range in terms of abrasiveness so we had less wear and degradation during the race. It was a very fine line between a two and a three-stop strategy. We're going to see a lot of races with 25-30C track temperature and we hope to see more of this. It's looking good for the fans."

One area that Pirelli is aiming to improve is the difference in range of the soft and hard compounds. In

China, the peak laptime difference was just over a second, but the harder prime rubber would ideally have lasted three or four laps longer than it did. A more durable hard tyre could be tried during Friday practice in Turkey with a view to it replacing the current compound.

McLaren team principal Martin Whitmarsh, chairman of FOTA, which has set improving the show as one of its priorities, believes that the rules package has been a success, telling AUTOSPORT that "we have got a great formula at the moment".

 **P26 CHINESE GP**

HRT setting up UK arm



Willis will get to work on F111

HRT IS SETTING UP A DESIGN office to be based in the United Kingdom's 'motorsport valley'.

Technical director Geoff Willis wants to base the office close to the Mercedes team headquarters in Brackley, where it is hoped that Hispania will start windtunnel testing its F111 machine in June. Currently, windtunnel models are being designed and built that will allow the team to get its aerodynamic project running.

"In the short-term, it will probably be within striking distance of the windtunnel programme," Willis told AUTOSPORT. "I need to put the aerodynamicists and the model designers together. We also have a strong software group and performance engineering group, which is mainly Spanish-based, so I need to ensure that we have

sufficient communication between the two."

Despite HRT's disastrous start to the season, failing to qualify in Australia after completing only seven laps during free practice, Vitantonio Liuzzi came within seven tenths of a second of outqualifying both Virgins in China. Willis is confident the F111 can make major steps forward this year, and despite hoping that the whole team can eventually be brought under one roof, is confident that the new design office will have a major benefit.

"You can see it's possible," he said. "Toro Rosso has something like 40 people in Bicester and the main team in Faenza, so it's a model that works. Long-term, the ideal is to have everybody in exactly the same place and sharing the team's culture."

Virgin uses Symonds

FORMER RENAULT DIRECTOR OF engineering Pat Symonds could play a key role in Virgin turning around its season, as he evaluates the way that the team is working.

Virgin has underperformed during the first three races of the season, largely because its car is not achieving the levels of downforce needed to compete. Symonds, who is currently banned from Formula 1 for his part in the 2008 Singapore Grand Prix crash controversy, is allowed to act as a consultant.

Team principal John Booth said: "Pat's main job is to take an overview of where we are and I'm sure he'll have some conclusions or pointers."

A major upgrade will be introduced at next month's Turkish Grand Prix which Booth describes as "pretty close" to a B-spec car.



Symonds is serving ban

THIS WEEK IN F1



RED BULL Team principal Christian Horner believes that Mark Webber's charge from 18th on the grid to third in the Chinese Grand Prix will restore his confidence. "It is great for Mark to get a good result after a great drive," he said.



McLAREN Jenson Button's accidental visit to the Red Bull pit box during the Chinese Grand Prix was caused by him being distracted by operating switches on the steering wheel.



FERRARI Felipe Massa's strong performance during the Chinese Grand Prix, where he outraced Fernando Alonso, was "a positive sign that we need at the moment", according to team principal Stefano Domenicali.



MERCEDES A modified cooling system will be introduced at the Turkish Grand Prix, which the team is hopeful will solve the problems that it has had in that area so far this season.



RENAULT Team principal Eric Boullier has admitted that the team must learn from the strategic mistakes it made during both qualifying and the race in China. "We did not ideally handle the whole weekend," Boullier told AUTOSPORT. "We need to sit down and make sure that this doesn't happen again."



WILLIAMS The team opted to drop its new exhaust blown floor package ahead of qualifying for the Chinese Grand Prix. It is not likely to use the upgrade in Turkey, either, since there is a further evolution of the diffuser package due for the Spanish Grand Prix.



FORCE INDIA Mercedes team principal Norbert Haug has paid tribute to his former DTM driver Paul di Resta, who has made an impressive start to his grand prix career. "His car and his team-mate are tough so the speed is quite impressive," Haug said.



SAUBER Sergio Perez used a new chassis in China after debris from an unknown source pierced the monocoque and lodged in his ECU during the Malaysian Grand Prix. Sauber has asked the FIA to look into cockpit safety in the wake of the incident.



TORO ROSSO Jaime Alguersuari's lack of pace during last week's Malaysian Grand Prix has been traced to a manufacturing fault. Scratches in the front wing caused it to droop, costing him a significant amount of downforce.



LOTUS Team Air Asia GP2 driver Luiz Razia made his F1 weekend debut during Friday's first free practice session in Shanghai. He completed only an installation lap and one eight-lap run, before stopping with a suspension failure.



PIRELLI The Pirelli super soft compound will be used for the first time at the Monaco Grand Prix, where the soft will be used as the prime tyre. The Italian company has also confirmed that soft and hard rubber will be allocated for the Turkish and Spanish races.



LOTUS SPORT ITALY **1ST PLACE**



MOTORSPORT

Lotus Motorsport would like to congratulate Edoardo Piscopo, Leo Mansell and Greg Mansell for their class victory in the inaugural race of the Blancpain GT Endurance Series race at Monza on April 17th in their Lotus Evora GT4.

Congratulations are also extended to Stefan Landmann, Csaba Walter and Florian Aichinger for taking 2nd place in class in their Lotus Driving Academy Evora GT4 entry.

FOR FURTHER INFORMATION ON THE LOTUS EVORA GT4 PLEASE CONTACT...

RUSSELL GIBBONS - RACE SALES MANAGER - MOTORSPORT
LOTUS CARS LIMITED, HETHEL, NORWICH, NORFOLK NR14 8EZ, ENGLAND
T +44 (0)1953 608507 F +44 (0)1953 608685
rgibbons@lotuscars.com

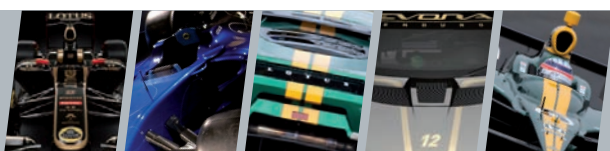

LOTUSCARS.COM/MOTORSPORT
LOTUSDRIVINGACADEMY.COM



MPH Mark Hughes

AUTOSPORT grand prix editor

Driving a grand prix is now more about tyre conservation than flat-out racing. And 'the show' won't always be good enough to disguise that fact

The fast-wearing traits of the Pirelli F1 tyres made for a great Chinese Grand Prix; strategic variation and hugely different performance levels according to compound and usage – enough to create overtaking even without the help of DRS wings and KERS. But there is a price.

The game has changed. Driving a grand prix is now a matter of tyre conservation. The most effective way of minimising your stint time now is not to drive flat-out but to begin it around 3s off the pace and only gradually begin to push harder – at about the same rate the tyre grip is dropping off, the two largely cancelling each other out so the net effect is near enough the same lap time throughout the stint. Hamilton's victory might have looked flat-out, but it wasn't.

PIC: FLAMAND/DPP/PI

Davidson is now "pretty much flat-out" – in endurance racing



"I was just trying to nurse my tyres while trying to pick up pace," he said afterwards.

If you didn't know better, you might think it was endurance racing. Except that in endurance racing they now drive flat-out the whole way – just like they used to in F1!

Anthony Davidson's F1 career didn't take off in the way it might have, but he's still driving flat-out – in endurance racing for Peugeot. Here's his take on it: "We do drive pretty much all-out from the start. Just as in anything, you are driving to the level of the tyre and if the tyre will take it, you cannot afford not to. My quadruple stint at Le Mans last year, which was the quickest ever, was about driving every lap like a qualifying lap. But we can't always do that. At Paul Ricard, for example, it's a very front-tyre-limited track and we're finding we are having to save the tyre early in the stint to give us the fastest overall time. The mentality of F1 driving is now shifting towards that. I wouldn't say it's better or worse, just different. What's better, the 100-metre sprint or the London marathon?"

Some drivers are adapting to it more naturally than others. Pirelli found, for example, that Fernando Alonso was initially very aggressive with the tyres, particularly the fronts, but say that he's now found the sweet spot of technique. It would be fair to say that both Hamilton and Mark Webber are only reluctantly coming to terms with the less-is-more approach. Although in Melbourne Lewis's tyres were holding out better than Sebastian Vettel's, at the more tyre-demanding venue of Sepang,

flat-spotting a set of softs in qualifying eventually cost him dear in the race, forcing him onto a well-used set of hards in his third stint that left him off the pace and eventually led to a late fourth stop. "These tyres are finished," he said, after sliding off. "I'm coming in." The team implored him to stay out, pointing out there were only three laps left, but in he came anyway.

Webber, who tends to keep the lateral load on the car just that little bit longer than Vettel, is proving harder on the rubber than his team-mate and is disdainful of people being able to get in the points by driving at not much more than GP2 pace for big parts of the race. A Moto GP bike, with only two tiny strips of rubber, can lap Sepang within 13s of the times the lower order points scorers were doing in the race there. Teams are now instructing drivers to use coasting techniques into the braking areas, for if they are having to drive off the pace for the sake of tyre life, they may as well save fuel and enable the car to start lighter. In F1! It's somewhat ironic that the sport rejected Michelin's proposal to use an F1 programme to promote fuel economy tyres, yet inadvertently that's exactly what we have now.

Does it matter? If the 'show' is good, what's the problem? The problem is that F1 races have always been contested as close to flat-out as they possibly could be, given the technology of the era. For the first time, we have deliberately introduced technology that enforces endurance driving. In China the excellent show disguised that. But it won't always. ❧

"Lewis Hamilton's win might have looked flat-out, but it wasn't"



BTCC

FLYING START

Jason Plato rolled in the second BTCC race at Donington after contact between Gordon Shedden and Liam Griffin sent Griffin into the double champion's Chevrolet Cruze at the Craner Curves. Plato's RML squad repaired the car in time for him to take sixth in the third event.



P40 BTCC DONINGTON REPORT

BTCC

BTCC set to peg back turbos

Boost changes are expected before next round after turbo dominance at Donington. By KEVIN TURNER



Neal says rivals are "playing the game"

British Touring Car boss Alan Gow says it is "very likely" the turbo-engined cars in the championship will be slowed down in time for the next round at Thruxton at the end of the month.

Turbo-engined machines dominated the second round at Donington Park last weekend. Matt Neal's Honda Civic, which has switched to a two-litre Neil Brown-prepared turbo after running a normally aspirated unit last year, took his second consecutive pole.

He was almost 1.5 seconds faster than the best 2010 Honda

qualifying time and 1.2s faster than Jason Plato's RML-run Chevrolet Cruze, which led the normally aspirated runners. The non-turbo cars were also down through all three speed traps and not one of them registered a podium finish.

Gow has now vowed to look into the issue and is likely to reduce the amount of boost, currently 1.8 bar, the turbos are allowed to run.

"Obviously we will look at the data and it's very likely that there will be an adjustment before Thruxton," he said. "All teams are aware and fully accept that it's our

policy to make tweaks throughout the season, if and when needed, as they continue to refine the characteristics and performance levels of their cars."

Plato, who took a best finish of sixth at Donington, believes the cut needs to be significant for TOCA's stated aim of parity to be reached. "What we have at the moment is not right," he said.

"We certainly are a long, long way from parity at the moment. TOCA has a great opportunity now to prove they will keep to their word."

But Matt Neal pointed out other

factors, such as the increased tyre wear and less agile handling caused by the turbo, to argue that any changes should not be large.

"RML is playing the game at the moment to accentuate the gap," he said. "Alan's been pretty fair with the Chevy so far – that car runs like a clock."

"We are going to have non-finishes [due to tyre wear]. I see Alan's dilemma, but there are a lot more factors to consider than just the clock. If he pegs us back it could gift it to Chevy – they had something in hand last year."

FORMULA 3

Few Brits go for F3 Trophy

THE NEW FIA INTERNATIONAL F3

Trophy will kick off at the Hockenheim Euro Series season opener next weekend with only one British-based team set to take part.

AUTOSPORT understands Euro Series drivers from Signature, Prema and Motopark have all signed up, but only Carlin is likely to join an expected 10-12 registrations for the inaugural series. More British teams are expected to enter individual rounds on an ad hoc basis.

Fortec boss Richard Dutton, whose team is running four cars in British F3 this season, said the need to find extra funding – estimated to be close to £100,000 for the six-race series – was the main factor deterring drivers from taking part.

“We’d love to support it, but it’s all about budget,” he said. “It’s quite a lot extra and the economic climate is that tough.”

Hitech boss Ryan Sharp said the logistics of racing at Hockenheim



Carlin is hoping to run at Hockenheim

only a week after the second round of British F3 at Oulton Park this weekend were also off-putting.

“The first round is only a week after Oulton and rushing back to get to Hockenheim doesn’t make sense,” he said. “Pietro [Fantin] is our only full-time driver at the moment, it’s a learning year and he needs to concentrate on British F3 without complicating the situation by adding in things like tyres and

tracks he doesn’t know.”

Racing Steps Foundation-backed driver Jack Harvey is another who won’t enter the new series. RSF co-ordinator Derek Walters said: “The main objective is for Jack to do well in British F3 and not go off course by driving on Kumho tyres.

“It could be a bit of a lottery. What would be useful from an FIA perspective would be to standardise an F3 tyre globally.”

LE MANS

Oreca lifeline for Premat



Premat: LMP2 for Le Mans

OUSTED AUDI FACTORY DRIVER Alexandre Premat will make his race return with the French ORECA team at the Le Mans 24 Hours in June.

Premat, who was sacked from the German manufacturer’s DTM squad at the end of last season, will drive ORECA’s Nissan-powered LMP2 entry at Le Mans. The Frenchman will share the car with Formula Le Mans graduate Dominik Kraihamer and amateur driver David Hallyday.

Premat, who raced for Audi at Le Mans between 2007 and 2009, said he was “thrilled to be involved with a team like ORECA”.

“It is an important team,” he said. “For me there is Audi, Peugeot and ORECA. They have a very good set-up and it is good to be involved with such a very professional team.”

Premat, who admitted that he had talked to ORECA about driving its first-generation Peugeot 908 HDi at Le Mans this year, said that he had ambitions to move up to LMP1 with the team. He also stated that he is continuing to work on a return to the DTM for 2012.

BTCC

Dynamics solves Shedden glitch

HONDA RACING IS HOPING TO fix the problem that caused Gordon Shedden to be disqualified from the first BTCC race at Donington last weekend.

Shedden’s Civic finished behind team-mate Matt Neal and Andrew Jordan’s Eurotech Racing Vauxhall Vectra on the road but was found to have run above the 1.8 bar permitted for the turbo-engined cars.

Steve Neal, boss of the Team Dynamics team that operates the cars, accepted the exclusion and confirmed the squad had been experiencing problems that could cause overboosting.

“We’ve had a wastegate exhaust issue, which we’re hoping to have sorted for Thruxton,” he said. “We have four engine maps and we don’t run maximum boost – we don’t think it’s necessary as it hurts the tyres. Gordon thought he had a handling problem, so he turned it up to the top map. He shot himself in the foot.”

Neal confirmed that the baseline boost was lowered for the remaining races at Donington so that any wastegate exhaust-induced overboosting would not result in the cars exceeding the limit.



Shedden had wastegate issue

AUTOSPORT SAYS...

GLENN FREEMAN
NEWS EDITOR

glenn.freeman
@haymarket.com



Penske values Helio’s Indy form

Dario Franchitti wouldn’t bite when pressed on the issue of Will Power losing a hatful of points thanks to a punt from Penske team-mate Helio Castroneves at Long Beach last weekend. Yes, it’s only race three, but Power lost 14 points to Franchitti thanks to that shunt, and the Scot only beat him to last year’s title by five. Plus, it means Power goes into a run of four oval races – his weakness throughout last year – already behind in the title race.

Penske’s senior figures have played down the clash (p18), Castroneves has offered a gushing apology, and Power has done well to bite his tongue. But reports in America claim that when Roger Penske told Power “nobody feels worse than Helio”, the quick-witted Australian responded with: “I do.”

But blunders like this are unlikely to push Castroneves close to the exit door at Team Penske. Why? Because the Brazilian so often delivers in the most important month of the year for his iconic team boss – May.

As Castroneves told me before the start of the season, winning at Indy means more to him than a championship. And Penske will not give the boot to someone he knows can deliver for him in the biggest race of them all.

MILESTONES



AUDI BACK IN BTCC

Rob Austin’s BTCC debut at Donington last weekend in his own team’s Audi A4 marked the first time that the German marque has been represented in the series since its factory squad left at the end of 1998

IN BRIEF



INDYCAR QUALIFYING TWEAK

IndyCar has tweaked its qualifying system for road and street courses, scrapping the random draw that previously determined the two qualifying groups for the first round in favour of a system based on Friday practice times. The move, which was introduced at Long Beach (above), is intended to balance the two groups out.

TRACY TARGETS MORE RACES

Paul Tracy is still working on converting his part-time IndyCar drive with Dragon Racing into a full-time deal. The Canadian had a difficult return to the series at Long Beach last week but said that he is still optimistic of adding more races.

BACHETA SET FOR GP3

Luciano Bacheta is expected to be announced as part of Mucke's GP3 line-up for this season. The Briton was second in the Formula Renault Eurocup last year.

LAST-GASP F2 SIGNINGS

Mihai Marinescu sealed a late deal to remain in the Formula 2 Championship for a second year just days before last weekend's Silverstone season-opener. Ramon Pineiro and Mikkel Mac also confirmed their drives last week.

TEST BREAK FOR NGTC

NGTC cars have been given a testing break in the BTCC. The lower-cost newer-generation cars will now be able to run outside of the regular test restrictions provided the teams advise series organiser TOCA in advance.

BAMBOO IN CRUZE MODE

Bamboo Engineering has taken delivery of the Chevrolet Cruzes (below) it will run from the Zolder World Touring Car round onwards. The British squad ran Darryl O'Young and Yukinori Taniguchi in older Lacettis at the Curitiba season-opener.



INDYCAR

No blame game at Penske

Team chiefs refuse to criticise Castroneves for taking out team-mate Power

Team Penske bosses have played down the collision between its drivers Helio Castroneves and Will Power which cost the Australian the IndyCar championship lead at Long Beach last weekend.

Three-time Indianapolis 500 winner Castroneves slid into Power under braking for Turn 1 on a restart with 18 laps to go. Both drivers went from

contending for victory to finishing well down the order, allowing reigning champion Dario Franchitti to leapfrog Power in the title race.

Power was speechless when he saw the incident on TV after the race, while Castroneves apologised immediately and described the clash as "unacceptable". Team boss Roger Penske would not

criticise Castroneves afterwards, but he made note of Franchitti's trouble-free run to third place.

"Helio isn't interested in running into everybody," said Penske. "It looked like he had a run and quite honestly I don't think he knew how deep he was [into the corner] when he got on the brakes. There was no place he could go and he ran into Will. It was not a great day for those two guys, and Franchitti was smart like he always is and hung in there."

Team president Tim Cindric, who looks after race strategy for Castroneves, added: "Both of them hate to see that happen. But we go from the opportunity to win to the opportunity to finish 10th. Nobody likes those kind of days. I thought we had a podium car today – the speed is there but we just have to execute."

Franchitti enjoyed a 14-point swing over Power at Long Beach, giving him a seven point lead in the standings.

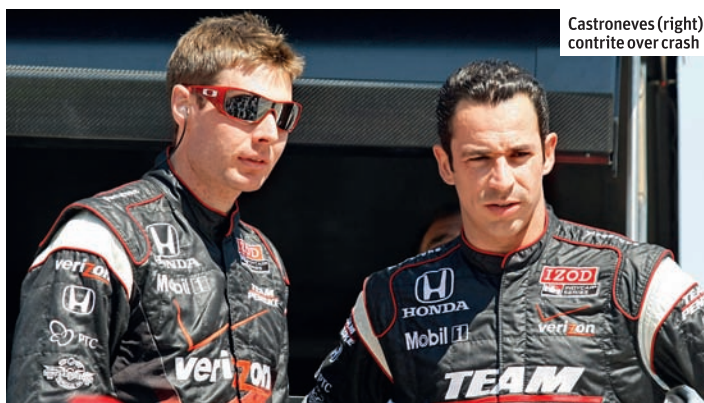

Castroneves (right) contrite over crash



Power (12) punted off by Penske team-mate

Soft tyres too durable

FIRESTONE HAS ADMITTED that it made a miscalculation with the tyres that it took to last weekend's IndyCar race that resulted in the softer tyres lasting longer than expected.

The red-sidewalled tyres are intended to offer more performance at the expense of a dramatically shorter lifespan, but the new compound used at Long Beach held up so well that drivers were able to run them over long stints. Penske's Ryan Briscoe completed 60 of the race's 85 laps on the red tyres on his way to second place.

Firestone's Al Speyer said that such durability was not intentional. "The alternative tyre obviously held up very well, maybe better than we expected or wanted," he said. "We saw Briscoe set his fastest lap three-quarters through his stint, and although they will go away at the end, that's longer than we wanted."

WHELDON'S INDIANAPOLIS 500 WARPAIN IS REVEALED

Somewhere among all the kids in caps is the livery that 2005 Indy 500 winner Dan Wheldon will run on his Bryan Herta Autosport entry at the Brickyard in May



INDYCAR/NASCAR

Hornish eyes comeback

SAM HORNISH HAS TARGETED THE Charlotte Nationwide race in May as his best opportunity to impress in NASCAR and find the backing for a full-time seat in 2012.

The three-time IndyCar champion and 2006 Indy 500 winner endured three disappointing seasons in Sprint Cup with Penske before a lack of budget left him with just a limited Nationwide schedule with the team this season.

Running at Charlotte essentially rules him out of returning to Indy this year as the races are on the same weekend, but Hornish said



Hornish briefly subbed for Gordon at 'Dega

that skipping the Brickyard was a calculated risk.

"Roger [Penske] and I talked about that, and I feel like Charlotte has always been a good track for me," he said. "I'd like to get a good run there and work on how we're going

to run full-time next year."

Hornish has had some seat time in Penske Racing's Cup car during testing this year, and made a brief return to competitive Cup running at Talladega last weekend when he drove Robby Gordon's car during qualifying.



Prize pot fits Indy ethos, says Bernard

INDYCAR

\$5m Vegas prize 'no gimmick'

INDYCAR CEO RANDY BERNARD INSISTS that his offer of a \$5 million bonus to any 'outsider' who can come into the series and win the season finale at Las Vegas is not a gimmick.

The series has attracted a lot of attention since the bonus was announced despite no drivers being confirmed for any of the five entry slots left open for guest drivers. But Bernard insists that the plan is not just a publicity stunt.

"I have a lot of people ask me if this is a gimmick. Absolutely not," he said. "This is

something that was taken from the textbook of what the Indianapolis 500 was always about. It was about bringing the very best to Indianapolis and letting them prove who was the champion on the day. That's all we're doing here.

"If you think you're a great driver, one of the best drivers in the world, and you think you can beat our drivers, then come compete for \$5m. We believe that we can make a big impact with this."

The Las Vegas season finale is scheduled to be held on October 16.



NASCAR

TALLADEGA BITES

Critics of tandem drafting departed Talladega with plenty of ammunition last weekend after a race marred by accidents. This one, involving David Ragan (6), Trevor Bayne (21) and Marcos Ambrose (9) was sparked by Penske team-mates Brad Keselowski and Kurt Busch colliding

➔ **P59** NASCAR SPRINT CUP REPORT

NASCAR

Kimi turns down the money

Multi-million dollar offer not enough to tempt Finn into full-time NASCAR switch

Kimi Raikkonen is set to turn down a multi-million dollar offer to make a full-time switch to NASCAR racing, AUTOSPORT can reveal.

Sources close to the Kyle Busch Motorsports and Joe Gibbs Racing teams in America understand that a huge deal is being put together for the Finn, who will make his oval racing debut in the third tier Truck Series at Charlotte next month.

However, while the 2007 Formula 1 world champion is eager to try his hand at the top tier Sprint Cup, it is understood that he is not keen to make a full-time switch to NASCAR.

Raikkonen, who finished sixth in the Jordan Rally last weekend, told

reporters at the event that he was relaxed about his future.

"I don't have any plans for next year," he said. "I do what I want. I'm not with anybody, so I can choose to stop if I want tomorrow. For me, it's easy right now."

On the appeal of racing in America, he admitted that it was not something that had been at the forefront of his mind in the past.

"I have had a few offers [from America] before," he said. "It's nice to try. It's not something I've always been thinking to do, but why not go and try it? I have only been there once, so I can't say much, but the people have been nice."

"It's a different way how they work there and the sport is quite

different, but so far it's okay."

Raikkonen also played down the significance of his tests at Gresham Motorsports Park and Rockingham Speedway earlier this month, where he was reportedly running at an impressive pace.

"I only did a test so far," he said. "It's going to be different when there are 40 cars around me. But the cars are better than I thought they would be to drive."

The 31-year-old also declared his performance in Jordan last weekend as the best of his short rallying career. He was on course to match his best ever WRC finish of fifth until a penultimate stage puncture dropped him behind Matthew Wilson's Ford.



Raikkonen: "no plans"

EVERY type of insurance that ANY person involved in Motorsport may require

MIS MOTORSPORT
INSURANCE
SERVICES

**ON TRACK - PERSONAL ACCIDENT - MOTORTRADE -
COMMERCIAL - LIABILITY**

www.raceinsurance.co.uk or call 01943 884555

Motorsport Insurance Services Limited is Authorised and Regulated by the Financial Services Authority

LE MANS

Aston is playing the long game

ASTON MARTIN RACING HAS

promised “steady progress” rather than a dramatic improvement from its new AMR-One LMP1 design at the Le Mans Test Day on Sunday.

AMR team principal George Howard-Chappell said he wasn’t expecting the all-new Le Mans 24 Hours challenger to “jump to the top of the petrol-powered P1 times”. The team’s aim is to reduce the deficit from where it was at what Howard-Chappell described as a “effectively a public test” at the Paul Ricard Le Mans Series opener earlier this month.

“We are realistic about how quickly we can improve,” said Howard-Chappell, who confirmed that there will be two AMR-Ones at the test. “We are



Aston Martin “realistic” about AMR-One changes

just starting out in what is a two or three-year programme. We dialed out a few things in testing and there are some new things coming for this weekend, but we have six or seven weeks to the race in June and we are anticipating a major step forward by then.”

Howard-Chappell insisted that not all successful racing cars were quick out of

the box. He listed a number of examples of cars developed by the Prodrive organisation (which includes AMR) that weren’t straight on the pace.

“Two months before the first BTCC race of 2000 with our new Ford Mondeo, we could barely get the thing to run, and that car ended up finishing 1-2-3 in the championship,” he said.



Rossiter to share with Mowlem

LE MANS

Rossiter to make Le Mans debut in Lotus

RISING BRITISH SPORTSCAR STAR

James Rossiter will make his Le Mans 24 Hours debut in one of the new Lotus Evora GTE contenders in June.

Lotus test and development driver Rossiter, a race winner in the ALMS in 2008, and Johnny Mowlem will race the lead Evora entered by the Austrian Jetalliance team in the remainder of the Intercontinental Le Mans Cup, including the 24 Hours. They will share the car with former FIA GT1 World Championship driver Jonathan Hirschi.

Lotus Motorsport boss Claudio Berro said: “We have put James and

Johnny together in the leading entry to help develop the car. We need to work together with Jetalliance to move the car forward.”

Rossiter said: “This is an amazing opportunity. It doesn’t get much better than making your Le Mans debut with a British manufacturer which is going back there after such a long absence.”

The two Jetalliance crews taking part in the 24 Hours will share one Evora GTE at this weekend’s Le Mans Test Day. The second car will be completed in time for the next ILMC round at Spa on May 7.

LE MANS

Tandy lands Porsche seat



Tandy has Porsche experience

NICK TANDY, RUNNER-UP IN THE 2010

Porsche Supercup, is set to make his Le Mans 24 Hours debut with the German manufacturer this year.

The 26-year-old Briton will drive a Porsche 911 GT3-RSR for the factory-backed Felbermayr-Proton squad in this weekend’s Test Day at Le Mans. His appearance at the test is expected to be a precursor to a drive with the team in the 24 Hours in June.

Felbermayr has entered two of the three cars it will run in the race for the test. Tandy will share the #88 Felbermayr-Proton Porsche with US sportscar regulars Spencer Pumpelly and Bryce Miller, plus Porsche Supercup driver Abdulaziz al Faisal, this weekend.

Tandy’s previous long-distance experience includes this year’s Daytona 24 Hours and two VLN long-distance races on the Nurburgring-Nordschleife.

IN BRIEF

RICHARDS APPEAL LAUNCHED

V8 Supercar drivers have launched an auction site to raise money for cancer-stricken colleague Jason Richards. For more details visit bid4jase.com.

RULE TWEAK FOR LMP2

Turbocharged LMP2 engines have been given an air-restrictor break by the Le Mans 24 Hours organisers. The RML team’s simulations suggest the revised restrictor would have halved the three-second deficit to the P2 front-runners its HPD ARX-01d suffered at the Le Mans Series opener at Paul Ricard earlier this month.

SIGNATURE SCALES BACK

Signature has withdrawn the second of the ORECA-Nissan O3s it was due to run in the Le Mans 24 Hours. Soheil Ayari has been confirmed alongside Franck Mailleux and Lucas Ordenez for the rest of the season.

WALTRIP FOR LE MANS

Two-time Daytona 24 Hours winner Michael Waltrip will contest the Le Mans 24 Hours with the AF Corse team. The 48-year-old will share a GTE Pro class Ferrari 458 Italia with Rob Kauffman, his partner in the Michael Waltrip Racing NASCAR team, and Rui Aguas.

ALESHIN TO GERMAN F3

Mikhail Aleshin has been confirmed for this year’s German F3 championship. The reigning Formula Renault 3.5 champion was scheduled to race in GP2 with Carlin before the deal fell through due to lack of budget. He will drive a National class ArtTech-Opel in Germany.

BERTOLINI/BARTELS SPLIT

Reigning FIA GT1 World Champion Andrea Bertolini will not race the lead Ferrari 458 Italia entered by the Vita4One team (formerly Vitaphone Racing) in the new Blancpain Endurance Series. Long-time team-mate Michael Bartels is sharing with Franck Kechele and Nico Verdonck.

BIFFLE TAKES PAY CUT

NASCAR star Greg Biffle has signed a contract extension with Roush Fenway. Biffle (below) admitted that he had been forced to take a pay cut due to the economic climate, and tipped other soon-to-be-free agents including Carl Edwards and Juan Pablo Montoya to have to similarly scale back.



SHIFT the way you move



NISSAN JUKE
FROM £13,295 - £20,595

**ADVANTAGE
NISSAN**

**3 YEARS FREE
SERVICING***

**3 YEARS NISSAN
ROADSIDE
ASSISTANCE**

**3 YEARS LOW
RATE FINANCE**

JUKE 1.6 ACENTA PREMIUM

FROM **£239*** PER
MONTH

WITH ADVANTAGE NISSAN YOU CAN'T LOSE

Buying a new JUKE has never been so easy. Advantage Nissan is an unbeatable package that combines attractive finance rentals with great specification as standard. Right now, you could get the 1.6 JUKE Acenta Premium with 17" alloy wheels, our all-in-one sat nav entertainment system Nissan Connect and reversing camera for just £239 per month. Get onto a winner with Advantage Nissan today.

For more information visit www.nissan.co.uk/offers

*3 years free servicing available when funded through Nissan Finance's Preferences or Lease finance agreements. *Rental stated is for Nissan Lease. Same rentals on Nissan Preferences PCP finance product are also available. If you choose Nissan Lease then you will not own the car. When you have paid the final rental at the end of the contract, you can keep using the car and pay an annual rental amount of £50+VAT. Advance rental £2,061 followed by 36 monthly rentals of £239, final rental £6,705, all figures inclusive of VAT. Guarantees and indemnities may be required. You must be at least 18 and a UK resident (excluding Isle of Man and Channel Islands) to apply. Finance provided by RCI Financial Services Limited, PO Box 149, Watford WD17 1FJ. At participating dealers only. Not available in conjunction with any schemes or other offers, please visit www.nissan.co.uk/offers or your local dealer for information. Breakdown services provided by RAC Motoring Services and/or RAC Insurance Ltd. All prices include first registration fee and road fund licence. Model shown is Juke 1.6 Acenta Premium priced £15,295 on the road plus optional metallic paint at £400 incl. VAT. Information correct at time of going to print. Model shot is for illustration purposes only. Models subject to availability. Nissan Motor (GB) Ltd, The Rivers Office Park, Denham Way, Rickmansworth, Hertfordshire WD3 9YS. 100183/1A

Fuel Consumption figures for JUKE 1.6 MANUAL: CO₂ 147g/km – URBAN 34.9mpg/8.1L/100km – EXTRA URBAN 53.3mpg/5.3L/100km – COMBINED 44.8mpg/6.3L/100km.

PIT BITS

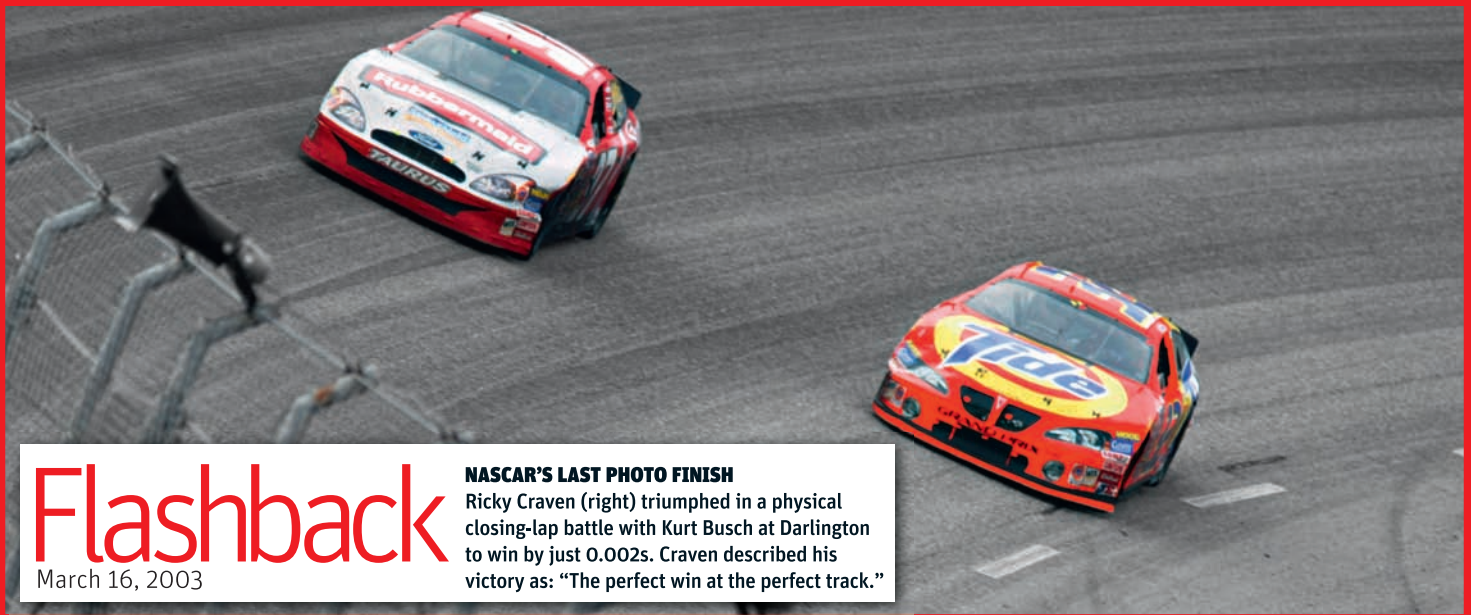

Flashback

March 16, 2003

NASCAR'S LAST PHOTO FINISH

Ricky Craven (right) triumphed in a physical closing-lap battle with Kurt Busch at Darlington to win by just 0.002s. Craven described his victory as: "The perfect win at the perfect track."

TOP FIVE

WRC closest finishes

- JORDAN 2011**
Sebastien Ogier edges Jari-Matti Latvala on the last stage to win by 0.2s.
- NZ 2007**
Marcus Gronholm beats Sebastien Loeb by 0.3s after a three-day fight.
- ARGENTINA 1999**
Subaru dominates, and Juha Kankkunen (below) tops team-mate Richard Burns by 2.1s.



- NZ 2010**
Latvala and Ogier again, but this time the Finn won by 2.4s.
- AUSTRALIA 2000**
Tommi Makkinen's exclusion hands victory to Marcus Gronholm with Burns 2.4s behind.

Weekly poll: Red Bull's KERS

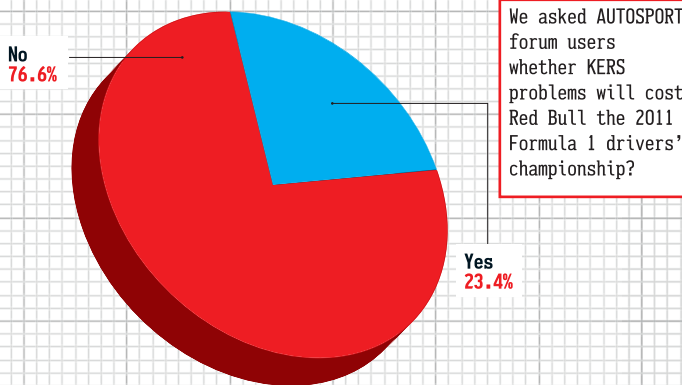

We asked AUTOSPORT forum users whether KERS problems will cost Red Bull the 2011 Formula 1 drivers' championship?

top tweets

- @mw55 (Michael Waltrip)**
Went for a Nice run. Except this hippy looking dude kept yellin 'run forrest'. Real funny man. He had on a bunch of rings.
- @MikeGascoyne**
Trying to expand taxi drivers english vocabulary to include the word idiot
- @jimmiejohnson**
Yes, I do use a coffee mug with my racecar on it...
- @MarioAndretti**
With Ferrari Club at my winery in Napa. Strangers assume the 60 Ferraris are mine. I wont confirm or deny
- @andypriaulx**
Just watched the @lancearmstrong "man behind the legend" dvd. That is a great reminder why he's my biggest hero!
- @andretti26 (Marco Andretti)**
Sorry for saying the F word on TV haha. Long day.

NEXT WEEK



JENSON BUTTON EXCLUSIVE
Why the former champ has never felt happier than he does now up against Hamilton at McLaren

DTM PREVIEW
It's Mercedes v Audi time again. Featuring Jamie Green and Mike Rockenfeller



PLUS
Sergio Perez interview; Indy 500 retro: the split years; Kris Meeke on Mini; Zolder WTCC; F3/GT at Oulton

**ON SALE
APR 28**



WRC

WRC IN THE DOCK

Delayed by three days and halted by two engine failures, the boat transporting the kit for last week's Jordan Rally finally arrives in Haifa. The delay cost Jordan the first day of its event and the teams returned to Italy via a car ferry.

WRC

Rally GB faces route crisis

Teams contact Rally GB organisers to request changes to 'nightmare' event logistics



Teams are angry over GB logistics

The manufacturers involved in the WRC have reacted angrily to the route for this year's Rally GB – and have contacted the organisers requesting changes to be made to the November event.

In emails to Rally GB chief executive Andrew Coe, leaked to AUTOSPORT, the teams have expressed their concerns with the route for Britain's WRC qualifier.

The issue surrounds basing the service park in Builth Wells, with its major lack of accommodation in the area, rather than Cardiff, where Rally HQ remains.

The email states: "This is an inappropriate centre for such a prestigious WRC event. Experience has shown the benefits of having a HQ near the service park. Given the choice, the teams would prefer to be based in and have main service in Cardiff."

FURTHER CONCERNS

While the teams aren't keen on the Builth base, they're even more unhappy with the need for crews to drive to Cardiff for each overnight halt, with a request for parc ferme to be moved to mid-Wales to avoid the long road sections each end of the day.

The teams are also keen for the organisers to move the start away from Llandudno, where a medical conference is believed to have booked up large quantities of hotels.

"To avoid the need for the teams to hotel in Llandudno, it is proposed the rally starts from Builth Wells and completes the loop of stages before returning to Builth."

Citroen team manager Sven Smeets said: "This route is a complete nightmare. We have one big hotel for the team which is not even in Wales! Going down to Cardiff is too much, this is the main thing we have asked to be changed. This has become the rally of the road section."

Petter Solberg World Rally Team manager Ken Rees said: "I've got a lot of time for [route co-ordinator] Andrew Kellitt and his team, but I don't want to be in Builth Wells all week – it's not appropriate for the final round of the world

championship. I've nothing against Builth, but it's not the right setting. Logistically, this is a nightmare. For example, when the drivers leave the hotel in Llandudno on Friday morning, we need somebody taking all their bags from the top of Wales to the bottom. It would have been nice to have been consulted on this."

NOT ALL BAD

The response to the event wasn't universally negative, however, with Ford's Malcolm Wilson saying: "Don't get me wrong, there's a lot that's going to be hard to sort, such as the accommodation, but I think for the good of the sport and the rally I think it's got potential."

Wilson's son Matthew agreed, adding: "I think it's great – it's going to be a real challenge. Yes, the drive to Cardiff's a pain in the arse, but going into those stages is something special – and they're going to get people coming visiting from the north."

Coe added: "We will look at what the teams have said, of course. But, we should remember the Royal Welsh Showground hosts the largest agricultural show in Europe with 200,000 visitors – and there are 1000 hotel rooms in a 15-mile radius of Builth."

RALLY GB ITINERARY

THURSDAY NOVEMBER 10

Start Llandudno	1430
SS1 Great Orme 1	1438
SS2 Great Orme 2	1455
SS3 Clocaenog	1610
Remote service Llandudno	1730

FRIDAY NOVEMBER 11

Parc ferme out Llandudno	0600
SS4 Dyfi West 1	0818
SS5 Dyfi East 1	0832
SS6 Gartheiniog 1	0843
SS7 Dyfnant 1	0946
Service Builth Wells	1206
SS8 Dyfi West 2	1434
SS9 Dyfi East 2	1448
SS10 Gartheiniog 2	1459
SS11 Dyfnant 2	1602
Service Builth Wells	1825
Parc ferme Cardiff	2120

SATURDAY NOVEMBER 12

Parc ferme out Cardiff	0530
SS12 Hafren 1	0908
SS13 Sweet Lamb 1	0949
SS14 Myherin 1	1007
Service Builth Wells	1140
SS15 Hafren 2	1338
SS16 Sweet Lamb 2	1419
SS17 Myherin 2	1437
Service Builth Wells	1625
SS18 Cardiff	1918
Parc ferme Cardiff	1928

SUNDAY NOVEMBER 13

Parc ferme out Cardiff	0530
Service Builth Wells	0718
SS19 Halfway 1	0813
SS20 Crychan 1	0838
SS21 Monument 1	0917
Service Builth Wells	0951
SS22 Halfway 2	1111
SS23 Crychan 2	1136
SS24 Monument 2	1243
Service Builth Wells	1320
Finish Cardiff	1540

WRC
Citroen chief: rethink running order



Latvala (l) lost to Ogier by 0.2s in Rally Jordan

THE REGULATIONS surrounding the running order on rallies must be changed in order to have a deserving world champion, according to Citroen team principal Olivier Quesnel.

The question of running order was raised

in Jordan last week, after Sebastien Loeb and Jari-Matti Latvala slowed down on Friday night to force Sebastien Ogier to go first on the road and sweep the loose gravel from the surface.

"Before this rally started," said Quesnel,

"we knew that the fight would be between Ogier and Latvala. Only two drivers could win. We knew Mikko [Hirvonen] and Seb [Loeb] would not be able to fight because they were first on the road. We want all four drivers to go flat out from the start. This needs to be changed. If we really want to find the champion this year, to find who is the fastest, we must reverse the [start] order from the start of the rally for the top 15 drivers.

"We can have the best championship fight, with four drivers all of the time included, but only if we change this regulation. It is easy to do."

Loeb added that he felt this year's title fight was shaping up to be a classic, saying: "This year it will be a tight fight with the four drivers, it's a good championship."

Quesnel went on to praise Ogier for winning the closest-ever WRC round. "When he made his mistake in Mexico, the media said he had lost his nerve – that's wrong, that was nothing. Ogier was amazing here. He is really strong now. You can bet the media who said Ogier is nothing will, tomorrow, say he is amazing. And they will say Loeb is down. No, Loeb is still up and can win the next one."

AUTOSPORT SAYS...

DAVID EVANS
RALLIES EDITOR

david.evans
@haymarket.com



The deliberation over this column took me from the Middle East to the middle of France. Normally, I'm quite clear on how to fill this space. Not this week. Hence the considered flight home from Jordan.

I wanted to write about Jordan, the debt the world championship owes it and how we'll miss it next year. Those words are on autosport.com. The here and now is the controversial route for Rally GB.

I can see the teams' point of view: Built is not the centre of the universe, Cardiff's quite a long way away and the Royal Welsh Showground does provide a pretty incongruous backdrop for Red Bull's energy station – if the principality is to be graced with its presence.

But I kept coming back to three things: the Orme, Cloc and Dyfi. Being entirely selfish, the rest of the world championship can go figure. The world's best woods are back. I'll sleep in a tent if I have to. And, yes, I am well aware that I will have to.

Yes, the WRC is all about promotion: the glitz, the glam and the high-speed, broadband-connected nanosecond results this twitter-fed world demands. But, every now and then, the heart has to rule the head.

Let's give it a go. Rally fans in the north of England, come down and support your sport. Big numbers of spectators may convince the Welsh Assembly Government of the event's worthiness.

And that may save us from the WRC wilderness.



Get out there and give Rally GB your support

IN BRIEF

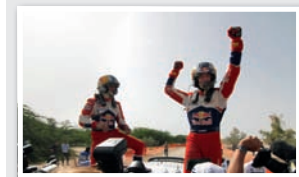

FIVE MINIS FOR ITALY

Swede Patrik Flodin will drive Grifone's Mini S2000 on next month's Rally d'Italia. There will be five Minis present on the Olbia-based event, with the factory WRCs of Dani Sordo and Kris Meeke joined by the similar cars of Armino Araujo and Daniel Oliveira.

2012 CALENDAR CLUES

The FIA has confirmed that next year's WRC calendar will include: Abu Dhabi (may include Dubai and Oman), Argentina (may include Uruguay), Finland, France, Great Britain, Germany, Greece, Mexico, New Zealand, Portugal, Spain and Sweden/Norway.

AL-ATTIYAH: ALL TO DO

Nasser Al-Attiyah's hopes of bouncing back from his Rally Mexico exclusion ended with engine failure on the final morning of the Jordan Rally last week. The Ford Fiesta driver (below) has zero points from his first two SWRC rounds, despite leading both by minutes.



CLOSE-RUN POWERSTAGE

The result of last week's Jordan Rally PowerStage was the first to go down to hundredths of a second, with Sebastien Ogier (above) beating Mikko Hirvonen through the 6.52-mile test by 0.046s.

VW SET FOR MAY 5 LAUNCH

Volkswagen has issued invites to the motorsport media to keep May 5 free in order to "experience the opening day of a new chapter in motorsport for the Volkswagen brand". The German firm will launch its WRC programme on the eve of the next WRC round in Sardinia.

MICHELIN PRAISED

Teams have praised Michelin's new gravel tyre used on last week's Jordan Rally. The French firm's tougher-construction rubber ensured there was nothing like the number of punctures seen on the first three rounds of the series. Jari-Matti Latvala said: "The tyre worked well. The grip was nearly the same as on the old tyre and we didn't get the puncture."

WRC

Jordan: we must focus



Prince Feisal, with Kimi Raikkonen, is unhappy

JORDAN'S PRINCE FEISAL has cited the lack of direction in the World Rally Championship as the reason he is unwilling to commit major investment to the Jordan Rally.

The Dead Sea event will be replaced by Abu Dhabi next season, but it could return on a rotation basis the following year. Prince Feisal has taken a personal interest and involvement in the rally and he admitted he was disappointed at what he saw as the absence of a clear vision.

He said: "When we first came to WRC we were told to keep our event compact and centralised – and that's what we built our rally around. Now they are saying different things. I cannot start spending millions in developing an infrastructure to get two or three years down the line and have them say: 'Oh, that didn't work out, let's go back to being compact.' Once there is a clear understanding, and I think the FIA is working very hard to do that, we can listen and agree on the way forward."

QUOTE OF THE WEEK



It was stupid to start with, but when I saw the bill, I thought it was really stupid!"



MM Motorsport boss Markko Martin on the cost of chartering the (delayed) boat to Israel



CHINESE GP

Shanghai, April 17

ROUND 3/19

LAPS 56

WINNER

Lewis Hamilton
1h36m58.226s

POLE POSITION

Sebastian Vettel
1m33.706s

FASTEST LAP

Mark Webber
1m38.993s

RACE RATING

★★★★★

Mixed strategies set up plenty of overtaking and a thrilling climax

DRIVERS STANDINGS

Vettel	68pts
Hamilton	47pts
Button	38pts

MILESTONE

● 23 classified finishers is the largest number ever in a grand prix.



HAMILTON TAKES CHINA IN HAND

Three-stop strategy gives Lewis Hamilton fresh tyres to make a surge to victory ahead of Sebastian Vettel. MARK HUGHES reports

QUALIFYING

Red Bull dominant, but Webber demonstrates that there's no margin for error



You would not have got many takers on Saturday morning on Red Bull not filling the front row.

The RB7's superiority was back to Melbourne levels, freed of the need to introduce understeer into its balance to save the rear tyres. Yet Red Bull didn't sweep the front row. Sebastian Vettel had to share it with Jenson Button, even though the McLaren was over 0.7s behind.

Seb can do no wrong at the moment. Everything he touches is sprinkled in gold dust. Mark Webber, on the other hand... A wiring loom problem made his KERS totally non-operative from Friday into Saturday morning. He was forced to eject from the car in a hurry as electrical smoke rose from its nether regions. This in addition to sundry brake and upshift problems. If there's such a thing as a Friday afternoon RB7, it's Mark's. With the car in a thousand pieces on Saturday morning, it was only just rebuilt in time for Q1, sans KERS.

Hard tyres, a second a lap slower than the softs, were the favoured Q1 choice of the Red Bull and McLaren guys. Everyone else, Ferrari included, felt the need to use at least one set of softs to ensure they graduated. The hards needed at least two, sometimes three laps before they worked properly, and on his first run Mark messed up his third lap. Returning to the pits, he was pulled for a weight check. The time this occupied meant that there were no longer two flying laps available – and at that point with hindsight the change should have been made onto softs. But it wasn't, Webber couldn't get under-heated new hards up to temperature for the one flying lap – and out he went, a disastrous 18th on the grid.

Vettel's first Q3 run is what eventually stood as pole; at the end, once it was clear no-one was going to beat the first run, he abandoned his second to save the tyres. In reality, no-one ever was, but after the



Webber joined evictees in Q1

McLarens had headed Q2 Jenson Button fancied giving it a go. He planned for two runs, the first of them 0.7s off Vettel, the second abandoned just like Vettel's when he was left trailing by 0.4s after two sectors. Lewis Hamilton, with the tyre lessons of Malaysia fresh in his mind, opted for just a single run in Q3 and this was marginally slower than Button, third fastest. The McLarens were using the floor and diffuser updates that had been tried but removed in Malaysia.

Mercedes were in rather better shape than a week earlier and Nico Rosberg slotted his car into fourth place, just a couple of tenths adrift of the McLarens. "The biggest difference is that the cooler temperatures here don't require us to open the bodywork," explained Ross Brawn. "We have a fairly chronic cooling issue which forces us into a very aero-inefficient area when we have to open it up. Here that wasn't the case." There were

still hints of the previous problems with airflow re-attachment of the DRS wing, but not on Nico's car. Michael Schumacher was not so lucky, suffering the problem at the crucial time in Q2, causing him to oversteer wide at turn 14 in the last-gasp flurry created by a red flag with just a couple of minutes of the session to go.

The form of Rosberg's Merc demoted Ferrari to only fourth fastest car, Fernando Alonso and Felipe Massa going fifth and sixth, very closely matched. Again Alonso used Friday morning for aero testing before reverting to the car's basic configuration. There was no particular problem with balance, but the basic downforce deficit proved to be in the order of 1.3s to the Red Bull. Massa has gone his own way on set up of late and since Malaysia has been much more confident. He was separated from his team-mate by just a couple of hundredths.

There was a big gap then to the remaining Q3 qualifiers. Vitaly Petrov, after going fourth fastest in Q2, came to a halt on the approach to turn six due to an airbox backfire starving the engine of air. The lap was enough to ensure he graduated to Q3 but the red flag he'd created meant he was not permitted to take part in it, consigning him to 10th on the grid. This happened with just a couple of minutes of Q2 left so as it restarted there was effectively a 10-car race between those who hadn't already secured a place in order to get to the start line in time to begin a flying lap.

They all made it to the start/finish and of the marginal qualifiers, those who then put a good enough lap together included the Toro Rossos of Jaime Alguersuari and Sebastien Buemi – and the Force India of

Paul di Resta. The 0.016s difference between his lap and that of team-mate Adrian Sutil's was the difference between getting through and not. Once into Q3, di Resta split the Toro Rossos for eighth on the grid. It was yet another coolly impressive performance from the rookie, having missed all of FP3 to a fuel pump failure. Alguersuari celebrated his first time in Q3 by out-pacing team-mate Buemi and lining up seventh.

Sutil headed those in the Q2 part of the grid, the Saubers of Sergio Perez and Kamui Kobayashi some way adrift in 12th and 13th respectively. They needed longer than most to get their tyres up to temperature and suffered for this as everyone's rubber cooled while they were waiting for the Q2 restart. Schumacher's difficulties left him 14th ahead of the Williams of Rubens Barrichello, running without the new Red Bull-type exhaust that had been tried in practice. His last-gasp Q2 lap compromised when Sutil passed him into turn one.

Nick Heidfeld was caught out by Renault's holding him back late in order to do one Q2 run with the track at its quickest. The red flag induced by his team-mate meant he had to take his chances in the final two minutes along with the other nine and he failed to find a space. It left him a disappointing 16th ahead of Pastor Maldonado.



Button had to give best to Vettel again



P38 RESULTS
The stats from Shanghai





Massa barged past Hamilton early on



RACE CONDITIONS

Sunny, albeit with typical Shanghai haze. Track temp ranged from 30-27C.

The Pirellis mixed it up beautifully, making it far from certain whether two or three stops was the right strategy. So the protagonists diverged and then met again near the end for a thrilling showdown, fast cars hunting down slow, six drivers in the mix.

The two-stop bought you position, but would the tyres last long enough not to make you a sitting duck towards the end? The three was racier, but if your rival was to three-stop too, it was potentially very tricky to call the correct laps to leapfrog or to defend from being leapfrogged. It also required you to make a lot of overtaking moves, especially if your rival two-stopped. Knowing which was correct was impossible to deduct in advance – even for the teams; way too many unknown variables.

But for it to have produced the electrically exciting race it did required cars that were reasonably evenly matched – and that hadn't looked the case after qualifying, with a Red Bull that was 0.7s clear. But three key things altered the picture on Sunday. One was Sebastian Vettel's slow start, leaving him third and therefore never really getting to show the pace he might have – had he been out front.

Secondly it's becoming quite clear that Red Bull is finding more drag reduction from its DRS wing than McLaren – thereby flattering the RB7 in qualifying when it can be used freely. Thirdly, the tightly packaged Red Bull continues to suffer problems with its KERS – a crucial handicap when there's a circling shark like Lewis Hamilton within striking distance.

Combine Hamilton with a three-stop strategy and you had probably two-thirds of the winning of this race. He was at his magical best, bouncing back from his over-centre race a week earlier with his heady mix of adrenaline and ambush. When the McLaren refused to start in the garage and only left the pitlane for the grid with 30s to spare, you sensed it might be the perfect scenario to bring out his good stuff. A fuel pressure valve had malfunctioned, allowing fuel to drip and collect around the air tray, meaning the cylinders were ingesting neat fuel.

Removing the engine cover and soaking up the pool of petrol allowed the engine to be brought to life. He'd be starting from the second row, not the pitlane.

Even the teams did not yet know for certain which strategy they would be pursuing; several of those choices would be reactive and even those that were not came from estimates rather than hard data. It formed a Y in the shape of the race, and a re-merging of the Y with about 20 laps to go as the two strategies weaved into and out of

each other, which is when the race truly came alive. Here are each of those three stages.

Vettel's Red Bull bogged down at the lights, Jenson Button's McLaren was immediately past and heading unchallenged into turn one, leaving Seb desperately trying to fend off Lewis – to no avail. Lewis was too brave and committed to be denied using his better start even by Vettel's intimidation.

Seb was left having to defend hard from Nico Rosberg's Mercedes up to turn six, Nico finding himself bundled out to the edge of the grass for his troubles, with a pair of Ferraris swarming all over him just behind as he re-found his composure. Felipe Massa had yet again beaten Fernando Alonso away and this was to prove pivotal to their respective race fortunes. Paul di Resta's Force India was next,

having even had a nibble at Alonso through turns 1-2-3.

Button was eager to get himself out of the one-second DRS zone in the first couple of laps before the feature could be used, but with Hamilton staying right with him and the need not to over-stress these tyres, that was an unrealistic expectation. As it was, even when use of the wing was permitted, it didn't make the crucial difference. The McLarens were geared identically and the moving of the zone's starting point by the FIA from 900 metres on Friday, when the gearing was worked out, to 750 metres made it less powerful.

With Vettel hanging on to the silver cars, the threesome gradually broke away from the Rosberg/Massa/Alonso group. For McLaren and Red Bull it now became a matter of judging when to pit: late enough ▶

Take note JB: this is the McLaren pit





Pit error cost
Button position



The McLarens chased
down Rosberg's Merc



Loose wheel put
Alguersuari out

DRIVER BY DRIVER by Edd Straw

1  **8/10**
Event rating

SEBASTIAN VETTEL

Red Bull-Renault RB7-3
Start: 1st. Finish: 2nd

There was never any doubt that Vettel would take yet another pole position, but he lost the advantage when he bogged down and dropped behind the McLarens. After passing Hamilton on track and Button in the pits, a two-stopper proved a stretch.

2  **9/10**
Event rating

MARK WEBBER

Red Bull-Renault RB7-2
Start: 18th. Finish: 3rd

A wiring loom problem led to him being without KERS in qualifying, and time lost on the weighbridge prevented him completing the second warm-up lap needed to make prime tyres work in Q1. From 18th, got rid of the hard tyre early and made great progress.

3  **10/10**
Event rating

LEWIS HAMILTON

McLaren-Mercedes MP4-26-01
Start: 3rd. Finish: 1st

This drive showcased Hamilton at his best. A great overtaker (even without the assistance of DRS), a fighter and capable of looking after his tyres when he needed to. Also showed he could stay calm after only just making it out of the pits in the time for the start.

4  **7/10**
Event rating

JENSON BUTTON

McLaren-Mercedes MP4-26-04
Start: 2nd. Finish: 4th

Led early on, but lost out to Vettel when he embarrassed himself by pulling into the Red Bull pit box at his first stop. That, and Hamilton later passing him at Turn 1, put him third. Would have finished there, but for Webber's last gasp charge on soft tyres.

5  **7/10**
Event rating

FERNANDO ALONSO

Ferrari 150° Italia-288
Start: 5th. Finish: 7th

Resigned to being off the pace in qualifying, Alonso expected more from the race. Ran sixth early on and his two-stop strategy was compromised by an intense scrap with Schumacher, costing him any chance of a top six. Ended up 15 seconds adrift of his team-mate.

6  **8/10**
Event rating

FELIPE MASSA

Ferrari 150° Italia-289
Start: 6th. Finish: 6th

Only a couple of hundredths of a second behind Alonso in qualifying, he jumped ahead of his team-mate at the start and spent much of the race in podium contention. Two-stop strategy proved a step too far and he faded to sixth behind Rosberg late on as his tyres gave out.

PICLS: FERRARO, DUNBAR, HONE, ETHERINGTON/LAT



HRT is starting to give Virgin cause for worry



◀ to be able to do a two-stop if needed, but early enough to try to use the track position benefit of getting onto fresh tyres first – the undercut. It’s a horrible dilemma because it’s not fully under your control; it depends upon what your opponent does. Nor is there a ‘correct’ answer. The degradation rates of the soft and hard Pirellis could not be accurately forecast and what might be favourable in the short term could easily leave you looking sick later on.

Mercedes was the exception to the uncertainty: Ross Brawn and

“Mercedes had been decisive with strategy, with little to lose. Red Bull and McLaren were in far more complex positions”

crew had committed fully to a three-stop with both cars and Rosberg was brought in on lap 12 and was quickly underway again.

McLaren and Red Bull respectively instructed Button and Vettel in on the next lap – but the two leaders passed the pit entry road and continued merrily on! Remarkably, neither had heard their instructions. Vettel was suffering a radio problem, mainly in the transmitting, but occasionally in the receiving too. Both drivers got the repeated messages next time.

Rosberg’s fresh tyres proved around 3s faster than the used ones and as he pounded round on them for two laps while Button and Vettel struggled – and as Hamilton was left out there until after Button’s stop – so Nico was able to leapfrog them all.

He was aided in this by a bizarre misjudgement from Button. “I was

looking down at the steering wheel to adjust a switch,” said Jenson, “when I looked up, I thought I was in my pitbox, but then I saw the Red Bull pitcrew in front of me!”

He was encouraged to get out of there at his own convenience by the Red Bull boys and duly made the shuffle up to the adjacent McLaren pits. This lost him a chunk of time, and delayed the following Vettel a little too, though Seb managed to leave before the McLaren and thereby jump ahead.

Button’s pitting a lap later than McLaren wished was bad news for Hamilton, keeping him out yet longer on tyres that were now finished, making him vulnerable not only to the early-stopping Rosberg, but also to the following Ferrari of Massa which was evidently much easier on the tyres, for Felipe was able to close down what had been a 5s gap – and pass Hamilton out of the hairpin as they each made their way pitward.

After all the frontrunners had stopped and changed their tired old softs for fresh ones, Rosberg led from Vettel, Button, Massa, Hamilton, Michael Schumacher’s Mercedes (jumping up the order courtesy of having stopped as early as lap 10) and Alonso, the latter losing out through having had to wait until the lap after Massa to pit. He would be about to be further delayed as he fought with a very defensive Schuey. Not only did this cost time, but used up much of that valuable tyre life too.

Mercedes had been decisive with strategy, with little to lose. Red Bull and McLaren were in more complex positions. “We’d originally been thinking of a three-stop,” explained Christian Horner, “but in fighting two McLarens and a Mercedes it was going to be difficult to cover everyone if they were all doing the same. We decided shortly after the

first stop that the most efficient way to the end would now be to two-stop. That way they couldn’t beat us on the undercut.” That left Red Bull rather hoping that the remaining two sets of tyres could between them cover 42 laps – and that was unknown territory. But it was encouraged to make the call by a great 20-lap run Vettel had done on Friday afternoon, when he’d been doing virtually the same times at the end of the stint as at the beginning. Nonetheless, the combination of a fairly early first stop and a two-stop strategy potentially left Seb vulnerable later.

McLaren went the opposite way. “We’d been intending to two-stop,” revealed Martin Whitmarsh, “but because we’d dropped positions at the first stop, we needed to try something more aggressive. In a way it was a pity, because in making Lewis’ second stint short it meant we lost most of the benefit of the brand new option tyres we’d put on.” These were the set he’d saved the day before by doing just one Q3 run.

Ferrari, also encouraged by its relatively light tyre usage, reckoned two-stopping was the way to go and prepared Massa and Alonso for long 17-19 lap middle stints. So Rosberg pounded round at the front, around 5s clear of the pack comprising Vettel, Button, Massa and Hamilton.

Mark Webber had made relatively little progress in his first stint from his 18th grid slot. But this much had been expected, hence his choice of starting on the hards. These left him relatively grippless – he was even passed by Sergio Perez’s Sauber at one point – but on a three-stop strategy he had the luxury of three brand new sets of softs for his remaining stints.

He lay back in 11th, half a minute off the lead on the 20th lap, but was sure to set the track alight very soon. He even had his KERS ▶

7  **7/10**
Event rating

MICHAEL SCHUMACHER
Mercedes MGP W02-01
Start: 14th. Finish: 8th
A big moment at Turn 14, caused by the DRS not closing as expected, cost him a possible Q3 place and condemned him to an afternoon scrapping in the bottom half of the top 10. Race pace was strong and in the circumstances eighth was about par.

8  **9/10**
Event rating

NICO ROSBERG
Mercedes MGP W02-03
Start: 4th. Finish: 5th
Tyre conservation work paid off in free practice and he had strong car all weekend. An early stop allowed him to take the lead, but it was always illusory and fifth place in a car that is, at best, third or fourth fastest was a superb result.

9  **6/10**
Event rating

NICK HEIDFELD
Renault R31-01
Start: 16th. Finish: 12th
Did himself no favours with a Friday crash-fest that meant he had to start Saturday without the latest front wing. Decision to make only one run late in Q2 bit him when Petrov stopped and caused a red flag. Spent the race continually in traffic.

10  **7/10**
Event rating

VITALY PETROV
Renault R31-04
Start: 10th. Finish: 9th
An airbox fire when he backed off on his warm-down lap in Q2 sidelined him for Q3. Opted for a two-stop strategy that gave him little chance to capitalise on a car with top six pace, and never escaped the battle for the final points places.

11  **6/10**
Event rating

RUBENS BARRICHELLO
Williams-Cosworth FW33-03
Start: 15th. Finish: 13th
Barrichello’s enthusiasm usually shows no bounds, but the plight of Williams has definitely got to him. Reckoned a Q3 slot might just have been possible, only for the red flag to catch him out, but was always headed for an afternoon in the midfield.

12  **5/10**
Event rating

PASTOR MALDONADO
Williams-Cosworth FW33-02
Start: 17th. Finish: 18th
Having managed only 17 laps on his first two F1 starts, the Venezuelan got the finish that he needed. Qualified half a second off Barrichello and did his best to keep the midfield in sight during the race, but didn’t have the raw pace to go further.

◀ available some of the time. Vettel also began to suffer a KERS problem from around lap 24 onwards. In fact its cutting out, and the way that messes with the brake balance, led him to flat spot a front tyre soon afterwards. This was potentially bad news in what was to be a long stint.

While McLaren strongly suspected that Rosberg, like them, was three-stopping, they had no way of knowing if Vettel was. Button was brought in early, on lap 24, in an attempt at undercutting Vettel. But as the Red Bull stayed out there so it became clear that they were going to try to get Seb through on just two.

Rosberg pitted from the lead on lap 25. But already he'd been receiving messages over the radio that he needed to eke out the fuel. Running so much more competitively than at the previous two races had led the team to underestimate its consumption. Now Nico was having to back off early in the braking zones to get things back on schedule. Hamilton pitted on the same lap and for a

16-17s clear of Vettel and Massa, with a stop taking around 23s. It was looking good for the two-stoppers, but would their tyres hold out?

Vettel could have done with pitting later in order to shorten his final stint, but his KERS-induced flat-spot had prevented that.

Meanwhile, Button was struggling with his rear tyres despite being on a three-stop. He'd pushed hard quite early in the stint and perhaps this had over-extended them. He soon had his team-mate looming big in his mirrors, but even Jenson was surprised when Lewis made a stunningly committed dive down the inside of turn one at the beginning of lap 36.

Button came in on the following lap, Hamilton the lap after that. That should have given the advantage back to Jenson, but so quickly had Lewis pulled away from him after passing that combined with a pit stop 0.9s faster, Hamilton was able to rejoin still ahead of his team-mate, his sights set now on the fuel-saving Rosberg.

This set the scene for the final slug-out between six drivers on two strategies. With everyone's stops now completed Vettel led by around 4s, with Massa, Rosberg, Hamilton and Button close behind. Some way adrift of them ran Alonso, being caught rapidly by Webber. Mark was now taking full advantage of a Red Bull on brand new softs and lapping at times a full 2s faster than everyone else now that the others were on the hard tyre. He'd had to pull off a lot of passing moves on slower traffic in order to get to this point and had sold a particularly exquisite dummy to Schumacher, sending him looking into the wrong mirror down the back straight.

Vettel and Massa were on tyres now 10 laps old or so, while Rosberg and the McLarens had only just changed. They began to lap up to 1s

“Webber sold an exquisite dummy to Schumacher, sending him looking into the wrong mirror down the back straight”

time Vettel led the two Ferraris. Seb's problems, the Ferrari's light tyre usage and Massa's rediscovered flair was keeping him within 3s or so of the leader. Alonso had lost a lot of ground and would soon be passed by the rejoining Rosberg.

When the two-stopping Vettel and Massa pitted out the way, so Rosberg re-inherited the lead ahead of the two McLarens. But with another stop to make he was only



Lewis describes Plato's BTCC shunt



DRIVER BY DRIVER by Edd Straw

14  6/10
Event rating

ADRIAN SUTIL

Force India-Merc VJM04-04
Start: 11th. Finish: 15th
Beaten to the final Q3 place by his team-mate, but only by the narrowest of margins, and seemed to struggle more with tyre degradation than the Scot. Diced on the periphery of the points, but any chance of a top 10 ended when Perez pushed him off.

15  8/10
Event rating

PAUL DI RESTA

Force India-Merc VJM04-02
Start: 8th. Finish: 11th
Outqualified and outraced team-mate Sutil for the second consecutive event. After making Q3 for the first time, he held seventh until his first stop but then struggled with tyre degradation late on as he was running on a two-stop strategy.

16  8/10
Event rating

KAMUI KOBAYASHI

Sauber-Ferrari C30-03
Start: 13th. Finish: 10th
Denied a third consecutive Q3 appearance by the Petrov-induced red flag, the Japanese battled hard on the fringes of the top 10 throughout the race. On a two-stop strategy, he passed di Resta for the final point and then nursed his shot tyres to the finish.

17  4/10
Event rating

SERGIO PEREZ

Sauber-Ferrari C30-01
Start: 12th. Finish: 17th
A very mixed weekend for Perez, who outqualified his team-mate for the first time but missed a shot at Q3 in the chaos that followed the red flag in Q2. Battled hard, but clashed with Heidfeld and then bulldozed Sutil off the track, earning a penalty.

18  6/10
Event rating

SEBASTIEN BUEMI

Toro Rosso-Ferrari STR6-02
Start: 9th. Finish: 14th
Shaded by his team-mate in qualifying, he knew that he would be fighting a rearguard action in the race and wheelspun his way down to 13th at the start. Suffered chronic understeer and opted to change the front wing, costing precious time.

19  6/10
Event rating

JAIIME ALGUERSUARI

Toro Rosso-Ferrari STR6-03
Start: 7th. Finish: DNF
Bagged a career-best seventh on the grid running used options in Q3. Slipped to 11th after getting hung out to dry on the outside of Turn 1 and was 12th when he pitted earlier than planned. Lost right-rear wheel, which had not been tightened.



Kobayashi had to fight for his point



Di Resta set Force India pace again



Webber's gritty drive deserved plaudits

faster than the Red Bull and Ferrari. In the midst of this chase Hamilton closed down Rosberg and after locking up at the hairpin and failing to pull off the move, he then got inside him on the approach to turn six on lap 42 as Nico locked up his fronts. Next in Lewis' sights: Massa. He got the Ferrari on the 45th lap, rounding the hairpin side-by-side and finally completing the move into turn one. "Hamilton is catching you and he's on newer tyres," was probably not what Vettel needed to hear with just 10 laps to go.

Meanwhile Rosberg braked later than late at the hairpin in attempting to pass Massa but slid wide, enabling both Massa and the closely following Button to pass the Mercedes, and Jenson then tried to nail the Ferrari into the first turn. The action was coming faster than

the TV directors could follow it as the race built to a stunning crescendo. On the same lap Webber effortlessly passed Alonso, lapping 1.5s faster now than the leader and catching Rosberg fast for fifth.

Button finally took third from Massa on lap 46. The Ferrari's rear tyres were now well past their best and a few laps later Felipe got the grass exiting the final turn in his efforts to keep Rosberg behind. He rescued the moment but the Mercedes was back up to fourth and a lap later Massa was demoted further by the flying Webber.

With seven laps to go Hamilton was in the leader's wheeltracks, looking for an opening, slipstreaming down the back straight but despite the advantage of DRS and KERS over the Red Bull he still couldn't quite make it past.

They exited the hairpin and made the run to the final turn side by side on the 50th lap but still Vettel was hanging on. A lap later Hamilton tried to get the advantage of momentum around the outside of the hairpin but Vettel was wise to it and simply backed off, forcing Hamilton to do likewise to avoid a collision. It was desperate stuff but such was the grip advantage Hamilton's newer tyres were giving him, it was only a matter of time – and he finally took the lead with four laps to go by simply aiming the McLaren to the inside of the Red Bull on the fast Turn 7. It was another beautiful – and highly unconventional – move that took Seb completely by surprise.

But if the lead battle was now apparently settled, virtually nothing else was. With two laps to go Webber nailed Rosberg into the hairpin and they both now began to close on Button, who was struggling once more with his rear tyres. A lap later Webber got himself inside Button into the Turn 14 hairpin, but Jenson crowded him on the exit, desperately trying to hang on. There was even light contact as they fought out their territory up to the final corner before Button accepted the inevitable and concentrated on holding Rosberg at bay, which he did to the end as Hamilton took a sublime, high-octane victory from Vettel and Webber. After such a performance Lewis could be forgiven a bit of indulgence: "I feel so proud," he said. "This race is in my top three of race wins, up there with Silverstone and Monaco in 2008. I exist and I live and I breathe to win: I love winning and I just couldn't be happier."

Button said of his own eventful fortunes: "That was unbelievable. I could have been second, I could have been seventh."

And that's how it was. ☒

20  **8/10**
Event rating

HEIKKI KOVALAINEN
Lotus-Renault T128-01
Start: 19th. Finish: 16th
The best of the Lotuses in qualifying, beating Trulli by over four tenths. He again raised the bar by beating both Perez and Maldonado. While Perez had two stop-go penalties, defeating Maldonado's Williams after making one stop less was genuine.

21  **5/10**
Event rating

JARNO TRULLI
Lotus-Renault T128-03
Start: 20th. Finish: 19th
Suffering more than Kovalainen with Lotus's power steering problems, Trulli struggled with tyre degradation in the race, which partly explains how he ended up over 20 seconds behind his team-mate. The rest of the gap was down to being slower.

22  **6/10**
Event rating

NARAIN KARTHIKEYAN
HRT-Cosworth F111-03
Start: 22nd. Finish: 23rd
Continuing to show a handy turn of pace on his return to F1, the Indian notched up his first F1 race finish since 2005. Kept out of trouble while being lapped and put vital mileage on the HRT but couldn't stay ahead of Liuzzi at the end.

23  **7/10**
Event rating

VITANTONIO LIUZZI
HRT-Cosworth F111-02
Start: 23rd. Finish: 22nd
If you'd offered him a race finish within 17 seconds of the nearest car after being hit with a drive-through penalty for a jump start a few weeks ago, he would have bitten your hand off. With updates coming, he proved that it won't take much to get near Virgin.

24  **6/10**
Event rating

TIMO GLOCK
Virgin-Cosworth MVR-02-02
Start: 22nd. Finish: 21st
Regretted the decision to soften off the suspension during qualifying, which created a tyre warm-up problem and left him over half-a-second off his team-mate. Passed d'Ambrosio early on, but had to switch from a two to a three-stop strategy and slipped behind.

25  **7/10**
Event rating

JEROME D'AMBROSIO
Virgin-Cosworth MVR-02-01
Start: 21st. Finish: 20th
An accomplished weekend for d'Ambrosio, who beat his team-mate for the first time. Fell behind Glock after a mistake at Turn 13 on the first lap but had far less tyre degradation, prevailing in the intra-team scrap and beating the HRTs, which was as much as could be asked.



**FREEZE
FRAME**

Marble madness

During GPs this year we've seen growing amounts of spent rubber off the racing line. MARK HUGHES finds out why

“THE MARBLES POSE NO DANGER”

“Where you have heavy tyre wear it can lead to strips of rubber being deposited which vary in size but are generally the shape and consistency of toffees,” says Pirelli’s Paul Hembery, “weighing between 10 and 20 grams on average. These strips are pliable when warm but become more rigid when they cool. They have always existed in F1 but the characteristics of Pirelli’s new compounds mean that the pieces are on average larger and softer than the hard and round ‘marbles’ that might have been seen before. An F1 tyre weighing 8.5kg when new will lose around 1.5kg as it wears over the course of a stint. Pirelli is looking at ways to reduce these deposits in the future but rubber on the circuit is an inevitable by-product of degradation and the marbles pose no danger.”

If each tyre is shedding 1.5kg per stint, that’s up to 576kg of rubber debris deposited on the track during a three-stop race with 24 cars. The stiffness of the Pirelli construction combined with the soft compounds introduced to vary the strategic possibilities is largely responsible for the increased production of marbles.



Drawing board



Gary Anderson, Mark Hughes and Giorgio Piola analyse the tweaks made by Ferrari, Williams and Toro Rosso for the Chinese Grand Prix

WILLIAMS EXHAUST

→ Williams had a Red Bull-like blown exhaust outlet on Rubens Barrichello's car in Shanghai. It was removed for qualifying and the race after burning parts of the car and the old version (inset) was refitted. The plan is now to re-introduce a revised version of the new system as part of a wider-ranging aero update in Spain in two races time.

GARY ANDERSON: The Williams exhaust system more or less mimics what Red Bull has done in that it exits the high energy, high velocity exhaust gases down the inside of the rear tyre. This is to help speed up the airflow on the undersurface of the diffuser and to reduce the spillage that is created as

the airflow disperses around the inside of the rear tyre. Basically with a system working like this the exhaust gases help seal the diffuser from the influence of turbulent airflow around the rear tyre, allowing the diffuser to work more efficiently. The very small component on the outer edge of the floor helps turn some airflow around the outside of the rear tyre again, helping the performance of the underfloor. It is always difficult to introduce this sort of development with no testing available, and making sure that the floor structure does not suffer with the increased heat requires miles dedicated to this area – which you don't get during a race weekend.

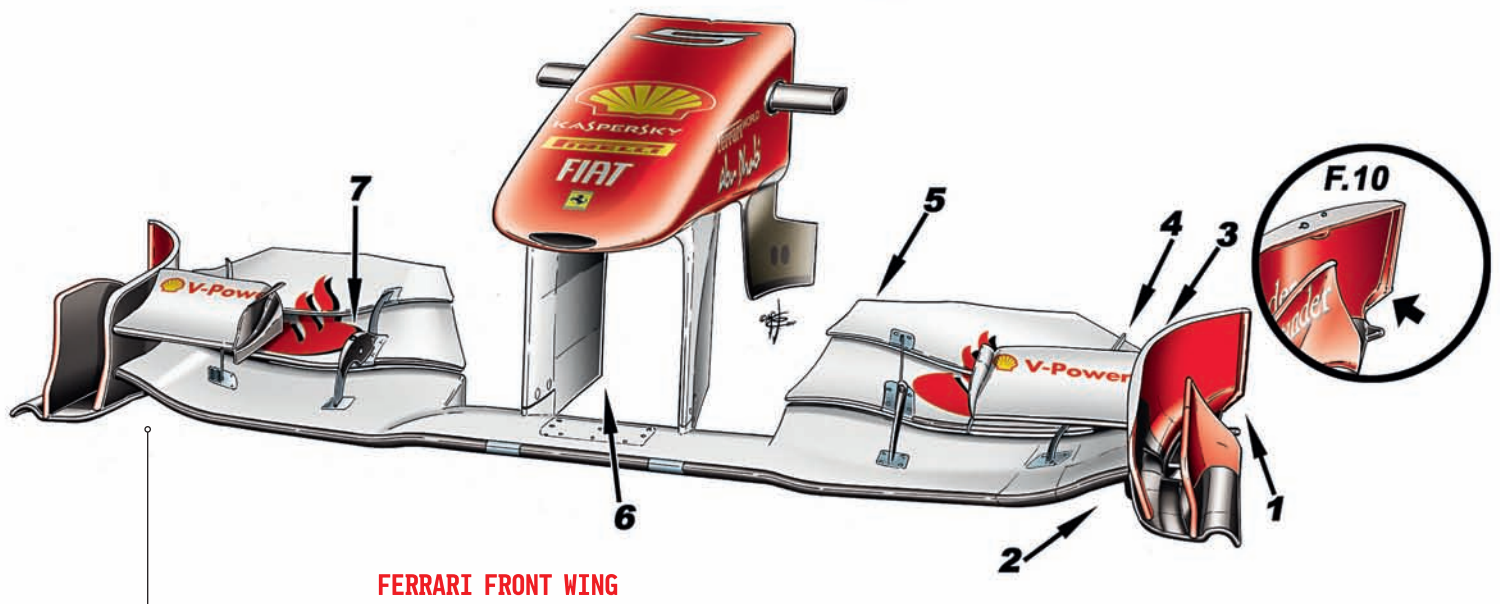
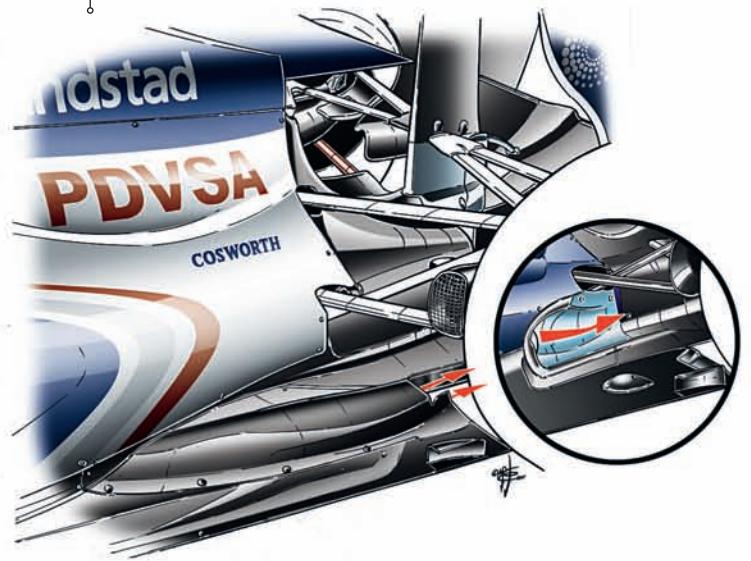

FERRARI FRONT WING

→ Ferrari again tried this experimental front wing in FP1, just as in Malaysia. The team is trying to correlate apparently anomalous data between the windtunnel and winter testing on the one hand, and the first two races on the other. The cut-out in the endplate (1) is like that of last year's wing. The ramp up from the main plane (2) is less aggressive than on the normal wing, and the endplate section (3) is thinner. There is a flap angle link (4) with adjusting

point shown (7). It has different flaps (5) to the usual wing and the nose pillars (6) are no longer straight but angled slightly outwards.

GARY ANDERSON: Like its usual wing this one has three main elements, but now with a single element upper forward wing. The endplate is also fairly similar, and in my opinion both the wing and endplate are fairly basic relative to what we see on the cars at the front of the grid. The endplate itself consists of two vertical turning

vanes to help turn the air around the front tyre, and there is also an inlet duct on the lower edge of the internal vane to reduce airflow separation on the inner surface of the endplate. During Friday's Ferrari was using a tracer liquid called fluorescein. This helps you to understand the surface flow on the wing profiles themselves, but more importantly what other parts of the car the airflow coming off the wing might influence as it travels further downstream.

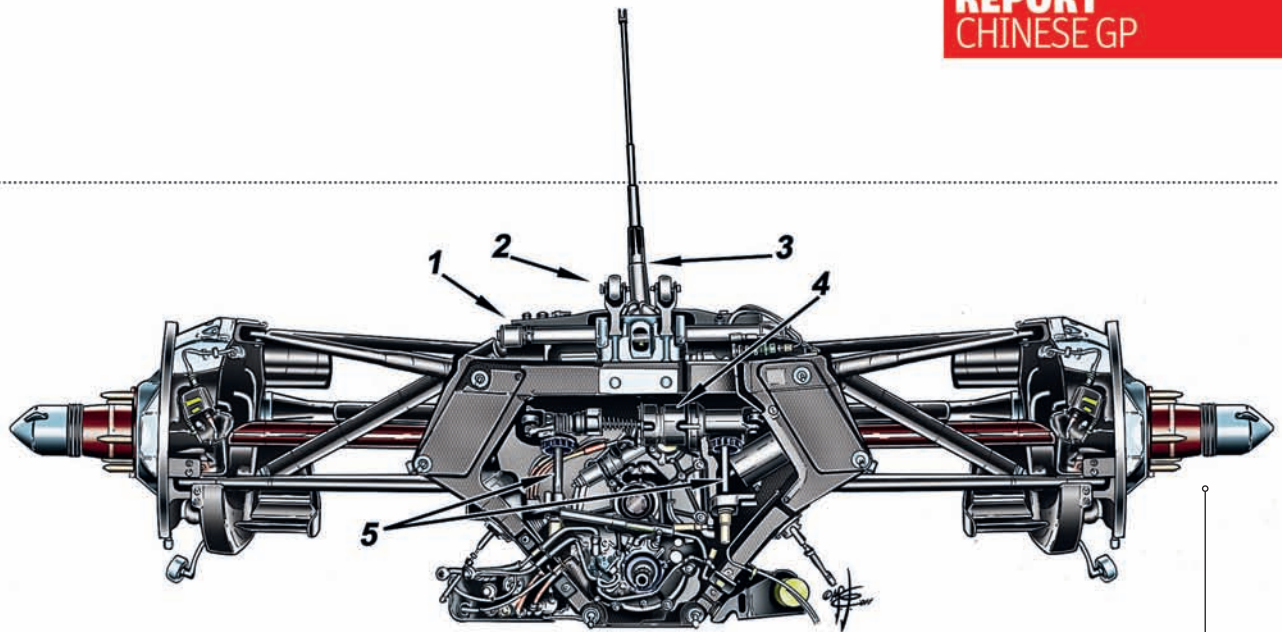

FERRARI GEARBOX

➔ This shows the very compact Ferrari gearbox and the layout of the pushrod rear suspension. Shown is the hydraulic ram for the DRS wing (1), the rocker (2) – up high on this pushrod layout, in contrast to its low sitting on the pullrod of Red Bull and most others – the anti-roll bar (3) and the inertia damper (4).

GARY ANDERSON: For 2011 quite a few teams followed the trend set by Red Bull and converted to a pullrod rear suspension system but Ferrari was not one of those converts. It repackaged the pushrod system to reduce the aerodynamic blockage created by the inertia damper being mounted over the top of the gearbox. This layout was

the norm with the conventional pushrod system. The inertia damper can be seen mounted horizontally across the car between the two rockers and the two side damper shafts can be seen mounted vertically each side of centre line (5). When you consider that the hydraulic manifold is mounted low on the left hand side of the gearbox

and everything else is as low as possible to help lower the centre of gravity, not taking the opportunity to completely commit to a pullrod rear suspension (which would reduce the aero blockage and lower the centre of gravity) seems a strange decision and just might be something Ferrari will pay the price for all through 2011.

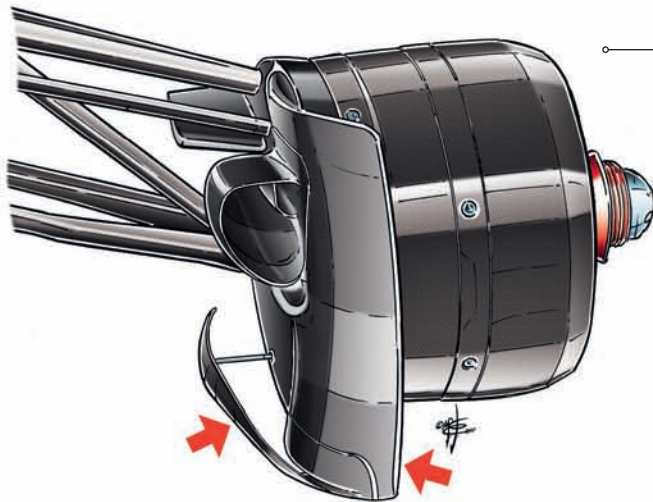

FERRARI FRONT BRAKE SHROUD

➔ As part of its aerodynamic testing in FP1, Ferrari tried this front brake disc shroud. It was only ever intended for testing and there was just one example. It was used by Alonso in conjunction with the experimental front wing (see opposite). The 2010 Force India was the first to use this sort of shroud.

GARY ANDERSON: Basically there is a box area allowed for brake cooling ducts which does not have to comply with bodywork regulations. The hole

in the front of the duct at the top is all that has anything to do with brake cooling and the rest is all for downforce creation. This shroud and the turning vanes help control the airflow displaced by the front tyres and re-align the wake coming off the trailing edge of the front wing. This improves the quality of the airflow that goes between the chassis and the inside of the front wheel. Improve this airflow and the underfloor's performance will be enhanced.

TORO ROSSO

➔ Toro Rosso had this newly placed shroud over the exit route of the exhaust but it was removed from both cars from qualifying onwards because the hot gases from the exhaust were causing it to melt.

GARY ANDERSON: The big thing for 2011 is the location of the exhaust outlets; using the high velocity, high energy flow from the exhausts to help power the diffuser is now de rigueur. To help train this air flow to the correct

parts of the diffuser, Toro Rosso has added small horizontal turning vanes just above the exhaust outlet and a small vertical turning vane on the upper surface of the floor. These will contain the exhaust flow. The vertical vanes will also reduce the negative influence the surrounding airflow being displaced by the rear tyre would normally have on this area of the floor, again helping the overall performance of the diffuser.

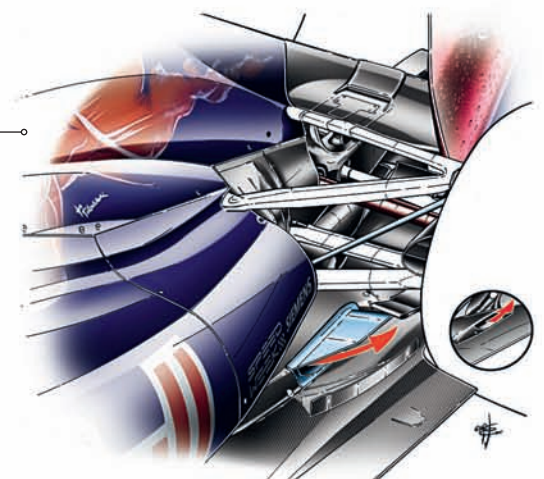

CHINESE GP RESULTS



PRACTICE 1 - Friday

POS	DRIVER	TIME
1	VETTEL	1m38.739s
2	WEBBER	1m39.354s
3	HAMILTON	1m40.845s
4	BUTTON	1m40.940s
5	HEIDFELD	1m40.987s
6	MASSA	1m41.046s
7	PEREZ	1m41.189s
8	MALDONADO	1m41.222s
9	PETROV	1m41.231s
10	BUEMI	1m41.328s
11	ROSBERG	1m41.361s
12	ALONSO	1m41.434s
13	HULKENBERG	1m41.494s
14	KOVALAINEN	1m41.579s
15	DI RESTA	1m41.610s
16	RICCIARDO	1m41.752s
17	BARRICHELLO	1m41.939s
18	SCHUMACHER	1m43.301s
19	KOBAYASHI	1m43.792s
20	D'AMBROSIO	1m44.089s
21	LIUZZI	1m44.359s
22	GLOCK	1m44.438s
23	RAZIA	1m44.542s
24	KARTHIKEYAN	1m45.019s

Weather: dry

PRACTICE 2 - Friday

POS	DRIVER	TIME
1	VETTEL	1m37.688s
2	HAMILTON	1m37.854s
3	BUTTON	1m37.935s
4	ROSBERG	1m37.943s
5	SCHUMACHER	1m38.105s
6	MASSA	1m38.507s
7	SUTIL	1m38.735s
8	HEIDFELD	1m38.805s
9	PETROV	1m38.859s
10	WEBBER	1m39.327s
11	KOBAYASHI	1m39.538s
12	MALDONADO	1m39.667s
13	BUEMI	1m39.771s
14	ALONSO	1m39.779s
15	ALGUERSUARI	1m39.828s
16	BARRICHELLO	1m39.925s
17	PEREZ	1m39.953s
18	KOVALAINEN	1m40.476s
19	TRULLI	1m41.482s
20	KARTHIKEYAN	1m42.902s
21	LIUZZI	1m43.850s
22	D'AMBROSIO	1m44.008s
23	GLOCK	1m44.747s
24	DI RESTA	no time

Weather: dry

PRACTICE 3 - Saturday

POS	DRIVER	TIME
1	VETTEL	1m34.968s
2	BUTTON	1m35.176s
3	HAMILTON	1m35.373s
4	ROSBERG	1m35.677s
5	MASSA	1m35.818s
6	ALONSO	1m35.971s
7	PETROV	1m36.098s
8	SUTIL	1m36.125s
9	SCHUMACHER	1m36.141s
10	DI RESTA	1m36.370s
11	HEIDFELD	1m36.404s
12	KOBAYASHI	1m36.582s
13	PEREZ	1m36.596s
14	BUEMI	1m36.717s
15	WEBBER	1m36.896s
16	ALGUERSUARI	1m36.953s
17	BARRICHELLO	1m37.007s
18	MALDONADO	1m37.304s
19	KOVALAINEN	1m38.176s
20	TRULLI	1m38.739s
21	GLOCK	1m39.938s
22	D'AMBROSIO	1m39.998s
23	LIUZZI	1m40.593s
24	KARTHIKEYAN	1m40.881s

Weather: dry



QUALIFYING

POS	DRIVER	QUALIFYING 1	QUALIFYING 2	QUALIFYING 3
1	VETTEL	1m35.674s	1m34.776s	1m33.706s
2	BUTTON	1m35.924s	1m34.662s	1m34.421s
3	HAMILTON	1m36.091s	1m34.486s	1m34.463s
4	ROSBERG	1m35.272s	1m35.850s	1m34.670s
5	ALONSO	1m35.389s	1m35.165s	1m35.119s
6	MASSA	1m35.478s	1m35.437s	1m35.145s
7	ALGUERSUARI	1m36.133s	1m35.563s	1m36.158s
8	DI RESTA	1m35.702s	1m35.858s	1m36.190s
9	BUEMI	1m36.110s	1m35.500s	1m36.203s
10	PETROV	1m35.370s	1m35.149s	no time
11	SUTIL	1m36.092s	1m35.874s	-
12	PEREZ	1m36.046s	1m36.053s	-
13	KOBAYASHI	1m36.147s	1m36.236s	-
14	SCHUMACHER	1m35.508s	1m36.457s	-
15	BARRICHELLO	1m35.911s	1m36.465s	-
16	HEIDFELD	1m35.910s	1m36.611s	-
17	MALDONADO	1m36.121s	1m36.956s	-
18	WEBBER	1m36.468s	-	-
19	KOVALAINEN	1m37.894s	-	-
20	TRULLI	1m38.318s	-	-
21	D'AMBROSIO	1m39.119s	-	-
22	GLOCK	1m39.708s	-	-
23	LIUZZI	1m40.212s	-	-
24	KARTHIKEYAN	1m40.445s	-	-

Weather: dry

QUALIFYING

Head to head			
VETTEL	3	0	WEBBER
HAMILTON	2	1	BUTTON
ALONSO	3	0	MASSA
SCHUMACHER	0	3	ROSBERG
HEIDFELD	1	2	PETROV
BARRICHELLO	2	1	MALDONADO
SUTIL	0	3	DI RESTA
KOBAYASHI	2	1	PEREZ
BUEMI	2	1	ALGUERSUARI
KOVALAINEN	3	0	TRULLI
KARTHIKEYAN	0	3	LIUZZI
GLOCK	2	1	D'AMBROSIO



THE GRID

1 VETTEL RED BULL 1m33.706s Soft	2 BUTTON McLAREN 1m34.421s Soft
3 HAMILTON McLAREN 1m34.463s Soft	4 ROSBERG MERCEDES 1m34.670s Soft
5 ALONSO FERRARI 1m35.119s Soft	6 MASSA FERRARI 1m35.145s Soft
7 ALGUERSUARI TORO ROSSO 1m36.158s Soft	8 DI RESTA FORCE INDIA 1m36.190s Soft
9 BUEMI TORO ROSSO 1m36.203s Soft	10 PETROV RENAULT no time Soft
11 SUTIL FORCE INDIA 1m35.874s Soft	12 PEREZ SAUBER 1m36.053s Soft
13 KOBAYASHI SAUBER 1m36.236s Soft	14 SCHUMACHER MERCEDES 1m36.457s Soft
15 BARRICHELLO WILLIAMS 1m36.465s Soft	16 HEIDFELD RENAULT 1m36.611s Soft
17 MALDONADO WILLIAMS 1m36.956s Soft	18 WEBBER RED BULL 1m36.468s Hard
19 KOVALAINEN LOTUS 1m37.894s Soft	20 TRULLI LOTUS 1m38.318s Soft
21 D'AMBROSIO VIRGIN 1m39.119s Soft	22 GLOCK VIRGIN 1m39.708s Soft
23 LIUZZI HRT 1m40.212s Soft	24 KARTHIKEYAN HRT 1m40.445s Soft

THE RACE: 56 LAPS, 189.568 MILES

POS	DRIVER	TEAM	LAPS	TOTAL TIME	FASTEST LAP	PITSTOP	FASTEST STOP	TYRE CHOICE			
								STINT 1	STINT 2	STINT 3	STINT 4
1	HAMILTON	McLAREN-MERCEDES	56	1h36m58.226s	1m40.415s	3	20.53s	Soft	Soft	Soft	Hard
2	VETTEL	RED BULL-RENAULT	56	+5.198s	1m41.321s	2	21.53s	Soft	Soft	Hard	
3	WEBBER	RED BULL-RENAULT	56	+7.555s	1m38.993s	3	21.09s	Hard	Soft	Soft	Soft
4	BUTTON	McLAREN-MERCEDES	56	+10.000s	1m40.623s	3	20.76s	Soft	Soft	Soft	Hard
5	ROSBERG	MERCEDES	56	+13.448s	1m41.166s	3	20.72s	Soft	Soft	Soft	Hard
6	MASSA	FERRARI	56	+15.840s	1m41.678s	2	21.17s	Soft	Soft	Hard	
7	ALONSO	FERRARI	56	+30.622s	1m42.070s	2	21.25s	Soft	Soft	Hard	
8	SCHUMACHER	MERCEDES	56	+31.026s	1m41.215s	3	20.52s	Soft	Soft	Soft	Hard
9	PETROV	RENAULT	56	+57.404s	1m41.261s	2	21.98s	Soft	Soft	Hard	
10	KOBAYASHI	SAUBER-FERRARI	56	+1m03.273s	1m42.577s	2	21.86s	Soft	Soft	Hard	
11	DI RESTA	FORCE INDIA-MERCEDES	56	+1m08.757s	1m42.614s	2	21.22s	Soft	Soft	Hard	
12	HEIDFELD	RENAULT	56	+1m12.739s	1m42.406s	2	21.82s	Soft	Soft	Hard	
13	BARRICHELLO	WILLIAMS-COSWORTH	56	+1m30.189s	1m42.031s	2	21.48s	Soft	Soft	Hard	
14	BUENI	TORO ROSSO-FERRARI	56	+1m30.671s	1m41.696s	3	21.93s	Soft	Hard	Hard	Hard
15	SUTIL	FORCE INDIA-MERCEDES	55	-1 lap	1m41.157s	3	20.99s	Soft	Soft	Hard	Soft
16	KOVALAINEN	LOTUS-RENAULT	55	-1 lap	1m42.672s	2	21.89s	Soft	Soft	Hard	
17	PEREZ	SAUBER-FERRARI	55	-1 lap	1m41.643s	3	21.47s	Soft	Soft	Hard	Hard
18	MALDONADO	WILLIAMS-COSWORTH	55	-1 lap	1m41.702s	3	22.06s	Soft	Soft	Hard	Hard
19	TRULLI	LOTUS-RENAULT	55	-1 lap	1m42.052s	2	22.26s	Soft	Soft	Hard	
20	D'AMBROSIO	VIRGIN-COSWORTH	54	-2 laps	1m44.806s	2	22.80s	Soft	Soft	Hard	
21	GLOCK	VIRGIN-COSWORTH	54	-2 laps	1m44.381s	3	21.91s	Soft	Soft	Soft	Hard
22	LIUZZI	HRT-COSWORTH	54	-2 laps	1m43.384s	2	23.50s	Soft	Hard	Soft	
23	KARTHIKEYAN	HRT-COSWORTH	54	-2 laps	1m46.081s	1	26.05s	Soft	Hard		
R	ALGUERSUARI	TORO ROSSO-FERRARI	9	wheel off	1m45.700s	1	22.42s	Soft	Soft	DNF	

Weather: Dry. Fastest lap: Mark WEBBER 1m38.993s (123.181mph) on lap 42. Lap leaders: 1-13 Button;

14 Hamilton; 15-16 Alonso; 17-24 Rosberg; 25-30 Vettel; 31-33 Massa; 34-39 Rosberg; 40-51 Vettel; 52-56 Hamilton

SEASON SO FAR - Points and positions

POS	DRIVER	PTS	AUS	MAL	PRC	TR	E	MC	CDN	EU	GB	D	H	B	I	SGP	J	ROK	IND	UAE	BR	
1	VETTEL	68	1 st	1 st	2 nd																	
2	HAMILTON	47	2 nd	8 th	1 st																	
3	BUTTON	38	6 th	2 nd	4 th																	
4	WEBBER	37	5 th	4 th	3 rd																	
5	ALONSO	26	4 th	6 th	7 th																	
6	MASSA	24	7 th	5 th	6 th																	
7	PETROV	17	3 rd	17 th	9 th																	
8	HEIDFELD	15	12 th	3 rd	12 th																	
9	ROSBERG	10	ret	12 th	5 th																	
10	KOBAYASHI	7	dsq	7 th	10 th																	
11	SCHUMACHER	6	ret	9 th	8 th																	
12	BUENI	4	8 th	13 th	14 th																	
13	SUTIL	2	9 th	11 th	15 th																	
14	DI RESTA	2	10 th	10 th	11 th																	
15	ALGUERSUARI	0	11 th	11 th	ret																	
16	TRULLI	0	13 th	ret	19 th																	
17	BARRICHELLO	0	ret	ret	13 th																	
18	D'AMBROSIO	0	14 th	ret	20 th																	
19	KOVALAINEN	0	ret	15 th	16 th																	
20	GLOCK	0	nc	16 th	21 st																	
21	PEREZ	0	dsq	ret	17 th																	
22	MALDONADO	0	ret	ret	18 th																	
23	LIUZZI	0	dnq	ret	22 nd																	
24	KARTHIKEYAN	0	dnq	ret	23 rd																	

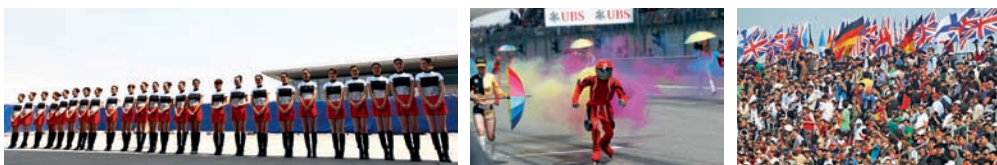

SEASON SO FAR - Points and positions

POS	TEAM	PTS	AUS	MAL	PRC	TR	E	MC	CDN	EU	GB	D	H	B	I	SGP	J	ROK	IND	UAE	BR	
1	RED BULL	105	35	37	33																	
2	McLAREN	85	26	22	37																	
3	FERRARI	50	18	18	14																	
4	LOTUS	32	15	15	2																	
5	MERCEDES	16	0	2	14																	
6	SAUBER	7	0	6	1																	
7	TORO ROSSO	4	4	0	0																	
8	FORCE INDIA	4	3	1	0																	
9	LOTUS	0	0	0	0																	
10	WILLIAMS	0	0	0	0																	
11	VIRGIN	0	0	0	0																	
12	HRT	0	-	0	0																	



TRACKSIDE VIEW



Mark Hughes
Grand Prix editor

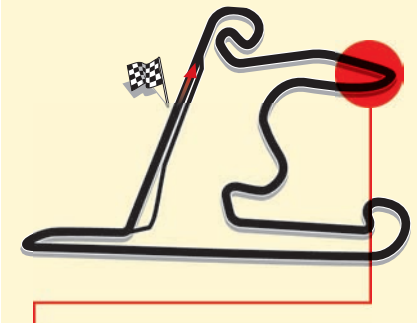

Violent beacons of fast colour through a haze of smoky pollution, Friday morning. A Lotus new boy is on an out-lap and gets mugged, almost blown off the track, by a massively faster Felipe Massa, well into an on-the-limit multi-lap run, no allowances made, get outta my way, you're playing with the big boys now. Into the hairpin of Turn 6, five downshifts, four of them rapid-fire, the last delayed. Jenson Button's discs glow orange, contrasting sharply with the thick, grey smog. Out of there, with the torque-multiplication of second gear and without much downforce pressing down, there are occasional sudden spike rises in engine revs as a left-rear tyre is briefly overwhelmed – Michael Schumacher's Merc betraying him, a short-changing surrender of catapulting tractive force for useless noise. By the short distance to the fast, slightly downhill kink that precedes Turn 7, the rear ends are totally smothered in

“At the downhill kink the rears are smothered in downforce”

a downforce that squares as a multiple of the speed, cars changing up into sixth after they've turned in, giving the motor liberty to unleash its full howling fury to the tyres, the front ends not quite as nailed, everyone going through there in a shallow high-speed understeer. Tyres ground into the Tarmac through the 3g of Turn 7, spitting the cars out uphill in an awkward part of the track to then decelerate for the right-hander of 8, loads not balanced four-square. Massa's still on it, but the front end of the Ferrari is not co-operating here, Felipe repeatedly having to get out of the gas, ease off the lock and try again as the front tyres just stall.



DONINGTON PARK

GB
April 16-17
BTCC
Round 2/10



AT A GLANCE RACE 1

- Winner **Matt Neal**
- Pole **Matt Neal**
- Fastest lap **Matt Neal**



Onslow-Cole starred again to take points in VW Golf

New men take control

Andrew Jordan starred at Donington Park as James Nash took the lead in the title race



Jordan and Nash were at the front all weekend

THE NEXT GENERATION HAS arrived. Not the NGTC regulations in the British Touring Car Championship, but the young driving talent that could be in the title fight in the years to come.

At Donington Park last

weekend, 21-year-old Andrew Jordan took his first non-reversed grid victory in the series, while 25-year-old James Nash took the lead in the standings. Both have shown flashes of pace before, but both have

stepped up a gear in 2011.

Given Jordan's pace during testing and throughout the first two meetings of the season it almost seems surprising it has taken this long. He qualified on the front row at the Brands Hatch season opener, only to be delayed by the Matt Neal/Alex MacDowall clash at Druids and then pick up a puncture. He charged through to sixth in the second race, and was shaping up to challenge Neal for the reversed-grid win before hitting a kerb and puncturing again.

It all came together at Donington. Despite suffering a damper problem that resulted in frantic work by his Eurotech Racing squad to get him out for qualifying – and having

to run a compromised set-up as a result – Jordan qualified fourth. He passed the works Honda of Gordon Shedden early on in race one and then dived past Nash into Redgate to set off after leader Neal.

Having lost out by less

chaos broke out behind him.

“We knew we were quick, but we had to get to the finish,” said Jordan. “I had a lot in reserve in race one but there was a tyre vibration.”

Getting the turbo cars to make their tyres last has been one of the challenges

“Swindon has done a great job - the engine is 100 per cent better than last year. The potential was always there”

Jordan is happy with TOCA turbo improvements for 2011

than 0.4 seconds to the double champion, Jordan took the lead from the outset of race two. Nash followed him through, but Jordan held firm to take victory. He finished the day with second from row five in the reversed-grid event, avoiding trouble while

facing many of the teams this year. Eurotech, having run the Swindon-built TOCA unit last year, has more experience with an NGTC turbo than anyone else and seems on top of the tyre issue. “At Brands the first puncture was due to debris and the second was



Remarkably, RML fixed this to get Plato out for race three

RACE RATING

★★★★☆

Some good drives and plenty of action, but driving standards were woeful at times

MILESTONES

First BTCC points for AmD Milltek VW Golf, Liam Griffin and Nick Foster. Series debut for Rob Austin and the Next Generation Touring Car Audi A4

REPORT BTCC DONINGTON PARK

KEVIN TURNER
reports



Jordan celebrates his race-two victory



Neal dives by Nash on way to second 2011 win

me hitting a kerb, so we knew it wasn't tyre wear," said Jordan.

On top of that, the engine itself has been improved. Jordan believes that has provided the biggest step: "Swindon has done a great job – the engine is 100 per cent better than last year. The potential was always there, it was reliability that was the problem.

"We were able to do a lot of testing and make it count."

Andrew's father and team boss Mike Jordan agrees the TOCA engine has been improved, but also points to a step forward made by Jordan Jr since he graduated from rallycross, via Renault Clios and Ginettas. "When Andrew was with me in '08 [as his team-mate] he was very inexperienced," he said.

"In rallycross everything had to happen in the first couple of corners and getting him to be patient was difficult. He was used to a race that lasted four and a half minutes instead of 30 and he was working his tyres too hard.

"In 2009 [in the works Vauxhall team], he had a few issues and it got to him. In hindsight, he was very young to be in a works environment and he dropped off the radar a little bit there.

"Last year it was critical I got his head right. I just needed him to go out and enjoy himself. That worked and he matured massively. He knows in the right car on the right day he can win."

Just as importantly, Jordan Sr is confident

Eurotech has the engineering expertise to compete at the front. After nearly giving up on the BTCC at the end of 2008, Jordan restructured his team, moving into cheaper premises on his friend Nigel Ainge's farm, and started focusing on people. It means he now has a number of ex-Triple 8 and RML personnel, including Carl Faux, who oversees Andrew's Vectra.

Nevertheless, Andrew is trying not to get too carried away. "Our aim is to win the Independents," he said. "If you do a good job with that you'll be in the hunt for the overall title. I'm enjoying myself and this is a nice place to be."

Jordan's Donington results have moved him to ▶



Jackson took his first win of the year in race three

NEAL, JORDAN AND JACKSON GET A BOOST

After Jason Plato's success at the twists of Brands Hatch, the turbo runners dominated at Donington. Plato was the quickest normally aspirated runner in qualifying, over one second from Matt Neal's pole time in the turbo Honda, and Neal, Andrew Jordan and Mat Jackson all came away with forced-induction victories.

The Hondas struggled with their starts and Triple 8's James Nash took advantage to grab the lead in race one. But trouble getting heat into his tyres – and accidentally knocking his brake bias forwards – made Nash easy prey and Neal dived by into Redgate at the start of lap two.

Gordon Shedden was then delayed by the Vectra at the Old Hairpin, allowing Eurotech's Jackson to snatch third. He then duplicated Neal's move on Nash and set off after the leader.

Jordan applied pressure, but could not get close enough to make a move and had to settle for second, while Nash's brake problems allowed Shedden to take third. The Civic would later be excluded for running with too much turbo boost.

Jordan and Nash both beat the now 45kg-laden Neal off the line in race two and had their own personal duel. Nash couldn't find a way past, despite two safety-car

periods, but held off Neal for second. Tom Chilton (Arena Ford Focus) couldn't quite match the leaders as he took fourth.

The reversed-grid race three had far too much drama. Alex MacDowall led from pole, but Tony Gilham's Triple 8 Vectra caused trouble behind, clipping two of the best performers of the weekend, Tom Onslow-Cole's AmD Milltek VW Golf and Rob Collard's WSR BMW. More contact at the Old Hairpin between Jackson and Nash led to Onslow-Cole and Chilton retiring.

Jackson emerged second and overcame MacDowall out of Coppice a few laps later before driving away.

Neal initially ran third, but a delaminated front splitter slowed him, allowing the impressive Jordan to take second from row five, while Nash recovered to third.

Plato, title leader coming into Donington, suffered a torrid weekend in his RML Chevrolet Cruze. He looked set for sixth in race one before getting a puncture, and was then tipped into a roll at the Craner Curves at the start of race two.

Remarkably, the team got the car out for race three and Plato took a fine sixth, avoiding the destruction-derby driving that hindered or halted much of the field.



Boardman was quick and unlucky. Again

AT A GLANCE RACE 2

- Winner **Andrew Jordan**
- Pole **Matt Neal**
- FL **Tom Boardman**

AT A GLANCE RACE 3

- Winner **Mat Jackson**
- Pole **Alex MacDowall**
- FL **Mat Jackson**

◀ fourth in the overall table, two ahead of reigning champion Jason Plato, but 14 behind Nash. Four podiums so far demonstrate a level of consistency Nash and his Triple 8 Engineering Vectra (now with TOCA power) were lacking in 2010. He was beaten by less than a second in his two P2s, one to Plato and one to Jordan, and that elusive first win seems to be moving closer.

“The Vectra has always been a good car, we were just a bit down on power last year,” said Nash, who did cross the line first at Snetterton in 2009, only to be penalised for removing Rob Collard. “I was really pleased when I heard we were going with the turbo.”

Like Jordan, Nash points to the winter as an important aspect to his good start. Many other teams are still developing new cars. “We prepared a lot better this year,” said the former British Formula Ford frontrunner. “But we didn’t expect to lead the championship given how

the Hondas are going.”

The pace of the Civics of Neal and Gordon Shedden provided another talking point at Donington, and could prove just as much of an obstacle to the young chargers as Plato and the RML Chevrolet squad.

Neal and Shedden dominated qualifying, being 0.3 seconds clear of third man Nash, and Neal took his second win of the season in race one. It’s not all been plain sailing – Neal was punted off at Brands, Shedden was excluded from third in race two at Donington, and both hit trouble in race three – but even BTCC boss Alan Gow believes the Team Dynamics squad has the best package.

Nevertheless, weaknesses remain. Neal was visibly having to take care of his tyres while leading at both Brands and Donington, and seemed to suffer with 45kg of success ballast in race two. “It was making all the noises in race one – rumbling of the tyres and

Collard was on fine form in ageing BMW



“We put weight on it in the second race and we really struggled, it was tougher than I expected”

Neal found 45kg of ballast difficult in his Honda Civic



Nash left Donington with the series lead

brakes – as though things were going off,” he said.

“We put weight on it in the second race and we really struggled, it was tougher than I expected.”

Given that the next round is Thruxton, which is a notorious tyre shredder, Neal is not confident, despite the fact the powerful Neil Brown-prepared turbo engines should give him a raw-pace advantage. “We blew tyres on the normally aspirated car, so it’s going to be a race where we’ve got to try and get to the end,” he said.

“Every circuit we go to is a brand new adventure – trying to make the car not eat its tyres. Get it wrong and we’ll get a load of non-finishes.”

Add this to Plato’s puncture and a frightening crash at Donington, as well as a lack of pace in his normally aspirated Chevy Cruze, and it doesn’t seem unreasonable to expect to see the likes of Jordan and Nash towards the top of the table at the end of the year. ☒

Onslow-Cole (99) and Chilton were just two victims of race-three mayhem





Austin had trying debut in new Audi

NEXT ROUND THRUXTON April 30-May 1



DRIVER BY DRIVER

Jason Plato (18/R/6)



Lacked straightline speed, got a puncture, then had a big crash. Great sixth in R3.

Alex MacDowall (9/9/4)



Quiet weekend after the drama of Brands Hatch, but picked up some good points against the turbos.

Matt Neal (1/3/7)



Used Honda's pace well to take pole and two podiums. Delaminating splitter hindered R3.

Gordon Shedden (EX/6/R)



As at Brands, involved in lots of drama. Excluded from R1, then had scrapes in other encounters.

Tom Chilton (4/4/R)



Happy with progress on under-developed Focus. Contact not of his making prevented points in R3.

Andy Neate (14/11/R)



Still struggling to get on the pace, but would have been in R3 points but for Gilham clash.

Mat Jackson (5/10/1)



Unusually involved in contact in all three races, but controlled performance to win R3.

Liam Griffin (13/R/9)



Still learning how to get the best out of the Focus and avoid contact, but picked up first points.

Rob Collard (6/5/R)



Great job and fine starts all weekend. Lots of contact in R3 prevented three good points hauls.

Nick Foster (12/R/10)



Forced off Craners by Smith in R2. Otherwise, it was another mature effort as he learns the BMW and the BTCC.

Tony Gilham (15/8/R)



Blotted his copybook with a tad too much enthusiasm in R3, but once again showed some good speed.

James Nash (3/2/3)



R3 clash with Chilton apart, kept his nose clean to take three podiums and points lead.

Paul O'Neill (8/R/8)



Team was happy with its efforts, less so with the pace of the turbos and the Collard clashes.

John George (R/12/11)



Feeling increasingly comfortable in the Cruze. Involved in R1 startline melee with Griffin/Newsham.

Andrew Jordan (2/1/2)



Breakthrough weekend. Bounced back from damper issue in practice to take third BTCC win.

Jeff Smith (10/13/5)



Good speed, if prone to over-driving at times. Tough R3 battle with Neal led to first top five.

Tom Boardman (7/R/R)



Same as ever. Had great speed, which went unrewarded thanks to various engine issues.

Tom Onslow-Cole (11/7/R)



Took first points for team in R2 and might have done even more in R3 if he'd not been taken off.

Dave Newsham (R/15/R)



Disappointing weekend. Not a great qualifying and involved in two startline shunts.

Frank Wrathall (16/R/R)



Much improved run. Top NGTC car and qualified within 2.3s of pole. Shouldn't have hampered leaders in R3.

Tony Hughes (19/16/R)



Team and driver are still struggling with new-car issues. Unlucky to be hit spinning Newsham in R3.

Rob Austin (DNS/R/13)



Austin pushed hard in great sounding but underdeveloped Audi on BTCC debut. Fell off in R2, but finished R3.

Chris James (17/14/12)



Clashed with Boardman in qualifying, but kept it all together on Sunday to take another three finishes.

RESULTS

British Touring Car Championship, Donington Park (GB), April 16-17, round 2 of 10

GRID		RACE 1 - 16 LAPS, 31.36 MILES					RACE 2 - 19 LAPS, 37.24 MILES					RACE 3 - 19 LAPS, 37.24 MILES				
POS	DRIVER (NATIONALITY)	TEAM	CAR	TIME/REASON	GRID	POS	DRIVER	TIME/REASON	GRID	POS	DRIVER	TIME/REASON	GRID			
1	NEAL			1:10.129		1	Jordan	26m54.737s	2	1	Jackson	24m32.921s	10			
2	SHEDDEN			1:10.172	4	2	Nash	+0.776s	3	2	Jordan	+2.640s	9			
3	NASH			1:10.477	3	3	Neal	+1.359s	1	3	Nash	+3.498s	8			
4	JORDAN			1:10.556	5	4	Chilton	+2.009s	4	4	MacDowall	+5.761s	1			
5	CHILTON			1:10.737	7	5	Collard	+2.472s	6	5	Smith	+18.639s	13			
6	SMITH			1:11.074	10	6	Shedden	+3.155s	23	6	Plato	+20.614s	21			
7	JACKSON			1:11.309	12	7	Onslow-Cole	+8.091s	11	7	Neal	+23.902s	7			
8	PLATO			1:11.362	11	8	Gilham	+8.800s	15	8	O'Neill	+23.922s	19			
9	MACDOWALL			1:11.425	9	9	MacDowall	+8.909s	9	9	Griffin	+28.815s	22			
10	COLLARD			1:11.440	6	10	Jackson	+9.179s	5	10	Foster	+29.117s	17			
11	O'NEILL			1:11.540	16	11	Neate	+10.657s	14	11	George	+42.375s	12			
12	BOARDMAN			1:11.572	17	12	George	+12.011s	20	12	James	+52.158s	14			
13	GILHAM			1:11.656	15	13	Smith	+16.829s	10	13	Austin	+58.304s	23			
14	NEATE			1:11.766	14	14	James	+18.235s	17	R	Neate	18 laps-accident	11			
15	GRIFFIN			1:11.799	20	15	Newsham	+21.041s	21	R	Gilham	18 laps-acc damage	2			
16	O-COLE			1:12.052	20	16	Hughes	+22.233s	19	R	Collard	17 laps-accident	5			
17	FOSTER			1:12.167	22	R	Foster	12 laps-accident	12	R	Boardman	17 laps-wastegate	18			
18	GEORGE			1:12.289	8	R	Boardman	10 laps-engine	7	R	Newsham	14 laps-acc damage	15			
19	NEWSHAM			1:12.352	23	R	O'Neill	9 laps-accident	8	R	Wrathall	9 laps-gear linkage	20			
20	WRATHALL			1:12.429	2	R	Wrathall	7 laps-manifold	16	R	Shedden	8 laps-acc damage	4			
21	AUSTIN			1:13.283	18	R	Griffin	0 laps-accident	13	R	Onslow-Cole	1 lap-acc damage	3			
22	JAMES			1:14.787	19	R	Plato	0 laps-accident	18	R	Hughes	1 lap-accident	16			
23	HUGHES			1:15.126	21	R	Austin	0 laps-spin	22	R	Chilton	0 laps-accident	6			

DRIVERS' CHAMPIONSHIP					
POS	DRIVER	PTS	5	43	
1	Nash	59	6	Chilton	32
2	Neal	55	7	Shedden	30
3	Jackson	54	8	O'Neill	26
4	Jordan	45	9	MacDowall	19
			10	Collard	17

Race 1 Winner's average: 98.81mph. Fastest lap: Neal, 1m10.902s, 100.491mph.
Race 2 Winner's average: 83.83mph. Fastest lap: Boardman, 1m11.096s, 100.217mph.
Race 3 Winner's average: 91.90mph. Fastest lap: Jackson, 1m11.491s, 100.096mph.

DONINGTON PARK

Great Britain

April 16-17
TOCA supports
Round 2/10



FORMULA RENAULT AT A GLANCE

- Race 1 Alex Lynn
- Race 2 Tio Ellinas
- Poles Lynn/Ellinas
- FLs Hawksworth/Ellinas



Morris won again in Ginetta Junior



Ellinas celebrates his first Renault victory

FORMULA RENAULT & CLIO CUP DONINGTON, APRIL 16-17

Tio takes it to the top by defeating rival Lynn

CYPRIOUS SENSATION

Eftihios 'Tio' Ellinas finally broke Alex Lynn's stranglehold on Formula Renault UK with a win in the second of two races at Donington Park last Sunday.

Lynn had made it a hat-trick for 2011, following up his Brands Hatch double with a win in the morning race, before Ellinas turned the tables in the afternoon – but in effect the work had been done during Saturday's qualifying. With neither man prone to making mistakes, overtaking was never going to be on the cards at the front.

Lynn and the Fortec Motorsport team battled back from problems in the pre-weekend test on Thursday to take pole for race one. Ellinas tried to respond, but a wild spin at the Old Hairpin meant flat-spotted tyres, and the Atech Reid team would need to scrutineer two moreMichelins. Try as he might Lynn could not vanquish Ellinas in the afternoon.

If anything, Ellinas seemed to have the edge in the early part of each race, while Lynn would come on strong later. As a result, Essex boy Lynn stretched

his long legs late in race one, while in race two he slashed into the early gap built up by lanky Larnaca lad Ellinas, who felt understeer set in. Then came a shock, as Lynn and Fortec team-mate Oliver Rowland were excluded from race two (see Sports Extra News).

Rowland and Jack Hawksworth had been best of the rest. After setting a new lap record, Hawksworth damn nearly pipped Rowland to the line in race one as the Racing Steps rookie backed off on the final lap – then screwed up the chicane. After much chiding from his team, he missed past Hawksworth's Mark Burdett Motorsport car into Redgate with six laps remaining in race two. Hawksworth was angry with the 'win-or-crash' move, but there's no other way to pass at Donington, unless you do it in post-race scrutineering...

Ollie Millroy pressured Hawksworth in race one before a couple of slips forced him to settle for fifth. Later on he got trapped behind Manor Competition team-mate Alice Powell, who had qualified fourth, as Josh Hill closed in.

Just as they did at Brands, Paul Rivett and James Dixon shared the wins in the Clio Cup, but this time Rivett was fuming after contact with Dixon forced him to play catch-up in race two.

Rivett drove away from double poleman Dixon – who was caught out by the new (to him) experience of having to keep the brakes on as he sat on his downhill grid spot – and Jake Packun in the Saturday race. On Sunday the two men went side by side into Redgate before, said Rivett: "James ruined my race completely when he pushed me wide." A sheepish Dixon said: "I got on the power and unfortunately pushed wide into him. I admit my mistake but it was a racing incident."

While Dixon's Total Control Racing car defended from Lee Pattison (JHR), the Stancombe Vehicle Engineering-run Rivett, who got dirt on his tyres and lost a mirror, was forced to recover. He finally got onto the podium when he forced Packun into an error exiting the Old Hairpin.

New boy Adam Bonham emerged from chaos around him to take fourth in race one, while his shadow Tom

Grice was held responsible for some of this degeneracy and was penalised down the order. In the second encounter, Matt Allison and James Colburn moved up to tail the leading quartet, the top six covered by just 2.581s at the flag.

● Marcus Simmons

RESULTS

Formula Renault UK (16 laps)

1 Alex Lynn; 2 Tio Ellinas +0.788s; 3 Oliver Rowland; 4 Jack Hawksworth; 5 Ollie Millroy; 6 Josh Hill; 7 Jordan King; 8 Mitchell Gilbert; 9 Alice Powell; 10 Dan Wells. **Fastest lap** Hawksworth 1m04.204s (110.96mph) **record.**

Race 2 (16 laps) 1 Ellinas;

2 Hawksworth +7.357s; 3 Powell; 4 Millroy; 5 Hill; 6 J King; 7 Oscar King; 8 Pedro Calbimonte; no other finishers. **FL** Ellinas 1m04.561s (110.35mph).

Points 1 Ellinas, 115;

2 Lynn, 98; 3 Hawksworth, 95; 4 Millroy, 88; 5 Hill, 66; 6 Powell, 63.

Clio Cup (14 laps) 1 Paul Rivett;

2 James Dixon +1.662s; 3 Jake Packun; 4 Adam Bonham; 5 Matt Allison; 6 James Colburn. **FL** Rivett 1m18.233s (91.06mph).

Race 2 (14 laps) 1 Dixon;

2 Lee Pattison +0.390s; 3 Rivett; 4 Packun; 5 Allison; 6 Colburn. **FL** Rivett 1m17.933s (91.42mph) **record.** **Points 1 Rivett, 122;** 2 Dixon, 100; 3 Packun, 75; 4 Colburn, 72; 5 Aron Smith, 70; 6 Pattison, 68.



Rivett leads the Clio Cup standings

CARRERA CUP AT A GLANCE

- Race 1 Euan Hankey
- Race 2 Michael Meadows
- Poles Gelzinis/Meadows
- FLs Tordoff/Meadows

“I got a lightning start. That put me clear, and it was the easiest race of my life”

Meadows found winning simple at Donington, aided by willing RedLine Racing team-mate James Sutton

REPORT TOCA DONINGTON PARK

OTHER BTCC SUPPORTS DONINGTON, APRIL 16-17

Meadows blooms in the spring sun

THE FASCINATING CARRERA

Cup season took more twists and turns over a balmy Donington weekend, culminating in a second victory for Euan Hankey and a duck-breaker for fellow ex-Porsche scholar Michael Meadows.

But it's Meadows's RedLine Racing team-mate James Sutton who has ominously moved to the top of the points. The 2007 champion hasn't won yet this year, but is proving ultra-consistent, and everyone knows the speed will come.

Meadows led Sutton around all day on Sunday. The son of Mercedes GP team manager Ron Meadows, he knew he would face no challenge for second in race one after Sutton signalled that all was tickety-boo and he wouldn't try anything. It was a similar story in race two, except this time it was for the lead. “It was just a case of making sure the team bagged the points,” said Sutton. “We're coming to terms with the new car and I think we've now probably got the best out there.”

Hankey chased fellow Team Parker Racing man Sam Tordoff in race one,

but Tordoff was denied a sensational win on only his second Carrera Cup outing when he got onto the marbles while lapping a backmarker and slid off the road. Now into the lead, Hankey backed off big-time to conserve his tyres for race two (after flat-spotting his other set in qualifying). He was shocked they lasted for him to take third in race two, as Tordoff went out when he buzzed his engine.

Lithuanian Jonas Gelzinis (Juta Racing) shocked by being fastest in qualifying, but dropped to third at the start and slid off on the dirt at the Old Hairpin. Stephen Jelley, the man to beat at Brands, had a nightmare weekend, which included elimination from race one after a collision with double champion Tim Harvey.

In the world of Ginettas, two drivers currently stand head and shoulders above their rivals with 100 per cent strike rates after the first two weekends of 2011.

Tom Sharp has amassed an incredible streak of six race victories in the GT Supercup, while in the Ginetta Juniors, Seb Morris is undefeated from the first four rounds.

The action from both



Sutton twice followed Meadows's car home

categories was as fierce and entertaining as ever but in the GT Supercup in particular, nobody seems to have an answer for Sharp's early-season dominance.

Nathan Freke took pole for the first of Donington's three races but he and three others had times disallowed due to yellow-flag infringements. This left Sharp at the front with Carl Breeze alongside but the TCR man wasn't able to usurp the IDL driver.

In races two and three, Sharp was peerless again – another lights-to-flag success followed by a strong

drive through from fifth in the reversed-grid race to build a series lead of almost 80 points.

“We've made really good progress with the car”, said Sharp, “It's not doing anything out of the ordinary but it is doing everything I want it to. It hangs on in there and I'm able to keep delivering good lap times at the end of a race as well as early on.”

In the G50 Cup class, 2010 Junior champion Tom Ingram and fellow graduates Jody Fannin and Jake Hill shared a win apiece after some thoroughly outstanding racing.

Reigning winter champion Seb Morris kept up his fantastic early momentum in the third and fourth rounds of the Ginetta Junior series with a brace of pole positions and race victories. He, like Sharp, can't seem to put a wheel wrong at the moment, unlike several of his rivals.

● M Simmons & Marc Orme

RESULTS

Porsche Carrera Cup (23 laps)

1 Euan Hankey; 2 Michael Meadows +7.130s; 3 James Sutton; 4 Richard Plant; 5 Ben Hetherington; 6 Ahmad Al Harthy. **Class winners** Al Harthy;

Andrew Shelley. **FL** Sam Tordoff 1m07.581s (105.42mph) **record**.

Race 2 (23 laps) 1 Meadows; 2 Sutton +0.575s; 3 Hankey; 4 Jonas Gelzinis; 5 Stephen Jelley; 6 Tim Harvey. **CW** Gelzinis; George Brewster. **FL** Meadows 1m07.895s (104.93mph). **Points 1 Sutton, 70**; 2 Meadows, 66; 3 Hankey, 61; 4 Jelley, 52; 5 Plant, 42; 6 Gelzinis, 38.

Ginetta GT Supercup (12 LAPS)

1 Tom Sharp; 2 Carl Breeze +1.191s; 3 Adam Morgan; 4 George Murrells; 5 Freddie Hetherington; 6 Tom Ingram. **CW** Ingram. **FL** Breeze 1m10.844s (100.56mph).

Race 2 (16 LAPS) 1 Sharp; Morgan +5.307s; 3 Murrells; 4 Hetherington; 5 Colin White; 6 Joachim Ritter. **CW** Jody Fannin. **FL** Sharp 1m10.713s (100.75mph) **establishes record**.

Race 3 (18 LAPS) 1 Sharp; 2 Hetherington +2.814s; 3 Breeze; 4 Nathan Freke; 5 Jake Hill; 6 Murrells. **CW** Hill. **FL** 1m11.361s (99.83mph).

Points 1 Sharp, 215; 2 Murrells, 138; 3 Breeze, 130; 4 Morgan, 116; 5 White, 98; 6 Freke, 75.

Ginetta Juniors (11 LAPS)

1 Seb Morris; 2 Charlie Robertson +2.236s; 3 Niall Murray; 4 William Foster; 5 George Gamble; 6 Max Coates. **FL** Morris 1m23.875s (84.94mph) **record**. **Race 2 (10 LAPS) 1 Morris**; 2 Foster +0.285s;

3 Tom Howard; 4 Coates; 5 Gamble; 6 Myles Collins. **FL** Gamble 1m24.492s (84.32mph). **Points 1 Morris, 144**; 2 Robertson, 93; 3 Foster, 92; 4 Howard, 82; 5 Coates, 74; 6 Gamble, 70.

No-one could stop Sharp in GT Supercup





JORDAN RALLY

Dead Sea

ROUND 4/13

WINNER

Sebastien Ogier
2h48m28.2s

RACE RATING

★★★★★

Might have been shorter than expected, but it turned into a record-breaking thriller

DRIVERS' STANDINGS

Loeb 74pts
Hirvonen 72pts
Ogier 69pts

POWERSTAGE WINNER

Ogier

MILESTONES

Closest ever finish to a WRC round. Sebastien Ogier's first back-to-back wins in the WRC



DAVID EVANS
reports

Dead-heat denial in Dead Sea drama

Sebastien Ogier pipped Jari-Matti Latvala by just 0.2s to win in Jordan and claim the WRC's closest ever finish record



WITH THE BOAT NICKNAMED 'the Black Pig' bobbing around at the far eastern side of the Mediterranean, the Jordan Rally was beginning to look doubtful. Just as well, the engine-less sailboat with no sails made it to dock in the nick of time for one of the most entertaining WRC rounds in history. The Jordan Rally was an absolute epic, almost worthy of the biblical backdrop it was played out in front of. And, for the second round on the trot, it was Sebastien Ogier who came out on top. The Powerstage was introduced to spice up the final stage of WRC rounds, but when two drivers go into that last test with just half a second between them, the extra points were no more than icing on a very tasty cake. It

was winner takes all this time around. And Ogier was that winner, by the smallest margin ever. But for real entertainment, check out the Latvala in-car from, well, just about anywhere last weekend. He made roads where there were none and chopped corners in half to take lines that will live long in the memory of those fortunate enough to witness them. Thank goodness the 'Black Pig' made it.

LEG ONE (89.66 miles) SUNNY
- AMBIENT TEMP RANGE ON STAGES 15-32C

With the paint on the service park still drying, metaphorically speaking, the cars left the shores of the Dead Sea on Friday morning. The teams had battled incredible odds and worked through the night to get the infrastructure in

place for the story of Jordan Rally 2011 to begin.

Through the madness of the week that had passed, one obstacle remained: the loose gravel on the roads just north of the Dead Sea and along the Israeli border. And now, Mikko Hirvonen had to take his Ford Fiesta RS WRC and sweep the stones aside in search of a solid surface. Encouraged by the way he had kept his car in touch with the leaders last time out in Portugal, Hirvonen was looking forward to it. Briefly.

Just over seven minutes later, he wasn't so sure.

"That was a terrible start," he said. "A couple of times I couldn't find the right braking point on the gravel, then my confidence had gone and I was running wide. It wasn't working at

all. It's a real shame."

The hugely downbeat Hirvonen had dropped 10 seconds to fastest man Sebastien Loeb. Starting the event as joint championship leader, Loeb was running directly behind Hirvonen – the Frenchman turned the screw on his rival.

"The road didn't clean much at all," he said,

adding to Hirvonen's agony, "so we had to push as hard as possible to see what was possible."

It was more of the same for Hirvonen in the second test, when he dropped a further 17.6s. He would alter the ride height and tweak the dampers on his Ford in the hope that he would find something in the longest

Third for Sebastien Loeb gave him the points lead



PICS: WWW.MCKLEIN.DE



Latvala used all the road and more for P2



Ogier was on a knife-edge all the way to another win

stage of the rally, the ensuing 25 miles of Jordan River. He didn't. He dropped a second per mile and his miserable morning was complete.

A power-steering failure on the repeat run through the afternoon left the Finn struggling to see the positives from the delayed opening day. "It was fucked, but now it's *really* fucked" was his appraisal of Friday.

Up ahead of Hirvonen, another fascinating fight was building as a four-way scrap emerged from the morning. After two stages, there was nothing to split Loeb and Ogier – they had completed the first 19 competitive miles to the same tenth of a second, with Ford's Jari-Matti Latvala just 4.3s behind them and Petter Solberg a

further half a second down.

Running fourth on the road, Ogier found some lines through the gravel in Jordan River and he made the most of them. He blitzed the stage the drivers enjoyed the most on this rally to carve himself a 7.2s lead in time for lunch.

"I'm leading the rally, so the morning has not been so bad," said Ogier. "But this lead is not enough for tomorrow," he warned.

Clearly, the Frenchman was planning his attack for the second and final day of this rally. Asked what would be enough, he slid into the Citroen and replied with a smile: "About 10 minutes!"

Third on the morning's three stages, Latvala went fastest on the afternoon's first two, moving himself into second place in time

for the tactical battle ground of Jordan River 2.

Loeb was the first to make his move, stopping mid-way through the stage. He hoped to catch his rivals off guard and force them to make their own tactical decisions.

"What could I do?" said Loeb. "There was nothing else, so I thought this was a different idea. I had seen the split times and for sure I would have been first on the road with Jari-Matti and Ogier close behind. So, I stopped. But after that, I made some small mistakes and ended up losing more time than I wanted to."

Seeing his team-mate and rival's split time, Ogier made the split-second decision. He could have slowed and slotted in just behind Loeb, but when a seven-time world champion

hands you 10 seconds, you don't ask questions. You take them and try to build on it. Ogier pressed on.

"We pushed as hard as we could," he said. The end result was a 31.6s lead at the end of the day. Would that be enough?

"We'll see," was his reply. "We have led from the front and won rallies in the past, so we'll see what we can do tomorrow. It'll have to be enough..."

Loeb was pretty sure the buffer to Ogier was too big.

"Don't forget," said Loeb, "some sections of some of the stages tomorrow have already been used today. The cleaning shouldn't be so bad tomorrow. We're going for the podium."

Latvala and Solberg slotted in just behind Loeb, with both of them hoping to prove Loeb wrong and win from further down the field.

"I had a good feeling with the car this afternoon," said Latvala. "If I can find that feeling and keep the consistency tomorrow, then I believe I have a good chance."

Solberg's afternoon hadn't got off to the best of starts when he stalled on the line in SS10. He'd been trying to get rid of the oversteer (that almost helped land him in a ditch on the morning's second stage), but Solberg's frustrations spilled over at the end of the day.

"It's so frustrating," he said. "What are we doing slowing down? We just want to race and to drive flat out, that's what this sport is about."

At least he remained in touch and with a shot at

the win, which was more than could be said for Hirvonen behind him. Kimi Raikkonen enjoyed a positive day in his Citroen DS3 WRC. The Iceman admitted Michelin's new tyres were taking a bit of getting used to, but he was happy enough with his sixth place at the end of the day. The Finn was firmly in the sights of Matthew Wilson, whose Stobart Ford ended the day just 12 seconds behind the Citroen.

POSITIONS AFTER DAY ONE

1 OGIER/INGRASSIA	1h32m53.4s
2 LOEB/ELENA	+31.6s
3 LATVALA/ANTTILA	+33.1s
4 SOLBERG/PATTERSON	+35.3s
5 HIRVONEN/LEHTINEN	+2m30.9s
6 RAIKKONEN/LINDSTROM	+2m45.8s

LEG TWO (71.62 miles) SUNNY -AMBIENT TEMP RANGE ON STAGES 14-29C

Loeb was immediately in the groove and intent on proving wrong his own prediction of the previous evening. He went fastest. He wanted to win. As the times for Saturday morning's opening dash through Yakrut came in, there were knowing glances among the cognoscenti crowded around the timing screens.

But then Loeb's plan fell apart a little bit. He struggled in the middle two stages, making small mistakes, running wide and unable to match the pace he'd shown straight after breakfast.

It was Hirvonen who set that pace in Bahath and Mahes, the Ford man determined to put in times that would help rebuild his confidence after a tough first day. Hirvonen ▶

iZONE

DRIVER PERFORMANCE

WITH ANDY PRIAULX

iZone is a unique driver development centre based at Silverstone Circuit



Peak Performance

At iZone you will:

- Learn how to operate in 'your' Peak Performance Zone
- Learn the science that underpins natural sub-conscious driving
- Learn how your mind influences performance and results

Coming Soon:

iZone Gym - iZone Academy - iZone Junior Academy

Our state of the art facilities include:

- Advanced technology motion simulator
- Eye tracking, EEG and human performance monitoring
- Specialised training rooms with full AV equipment
- A Zone room optimised for mind conditioning and visualisation training.

Find us on [facebook](#) [twitter](#)

01327 856 872 www.izoneperformance.com

Unit 2255, Silverstone Technology Park, Silverstone Circuit, Silverstone, UK, NN12 8GX

A SUPERB BUSINESS OPPORTUNITY TO

JOIN A WINNING TEAM

"Its great to be part of such a forward-thinking, friendly and supportive company that has an excellent reputation."

Phillip Edwards - Newbury, Berks

Existing Mac Tools franchisees are typically earning gross profits ranging from £50,000 to £75,000 from one territory. Mac Tools provides a full support team and a comprehensive training & support programme.

Available from
£15k
OTE £50k - £75k
CALL TODAY!...
AND START DRIVING
YOUR FUTURE
FORWARDS



www.mactools.co.uk

Call: 08450 6000 60 email: franchise@mactools.co.uk





First-on-the-road
Hirvonen took P4



Petter Solberg launched
his DS3 off into oblivion

STAGE TIMES

SS7 SUWAYMA 1 (8.38 MILES)

Fastest: Loeb 7m01.0s
Leader: Loeb

SS8 KAFRAIN 1 (10.68 MILES)

Fastest: P Solberg 12m11.6s
Leader: Loeb

SS9 JORDAN RIVER 1 (25.75 MILES)

Fastest: Ogier 27m32.6s
Leader: Ogier

SS10 SUWAYMA 2 (8.38 MILES)

Fastest: Latvala 6m59.0s
Leader: Ogier

SS11 KAFRAIN 2 (10.68 MILES)

Fastest: Latvala 11m48.2s
Leader: Ogier

SS12 JORDAN RIVER 2 (25.75 MILES)

Fastest: Ogier 27m13.5s
Leader: Ogier

SS13 YAKRUT 1 (8.79 MILES)

Fastest: Loeb 8m30.6s
Leader: Ogier

SS14 BAHATH 1 (7.78 MILES)

Fastest: Hirvonen 9m30.0s
Leader: Ogier

SS15 MAHES 1 (12.70 MILES)

Fastest: Hirvonen 14m33.0s
Leader: Ogier

SS16 BAPTISM SITE 1 (6.52 MILES)

Fastest: Loeb 5m21.7s
Leader: Ogier

SS17 YAKRUT 2 (8.79 MILES)

Fastest: Latvala 8m15.8s
Leader: Ogier

SS18 BAHATH 2 (7.78 MILES)

Fastest: Latvala 9m10.5s
Leader: Ogier

SS19 MAHAES 2 (12.70 MILES)

Fastest: Latvala 14m09.1s
Leader: Latvala

SS20 BAPTISM SITE 2 (6.52 MILES)

Fastest: Ogier 5m21.7s
Leader: Ogier



Fifth for Matt Wilson
after a solid drive

◀ throttled back a little in the morning's final test, the first run through Baptism Site. This stage would be rerun as the Powerstage in the afternoon with three points on offer for fastest time. With nothing to lose by taking his time, Hirvonen used that first run as a high-speed recce, checking and changing the notes he'd made from the comfort of a bungalow-sized 4x4 in the absence of his regular recce car (that was stuck on the boat) a couple of days earlier.

Latvala had trailed his team-mate through both stages 14 and 15, but while he'd been unable to match Hirvonen for speed, his efforts were enough to wrestle second from Loeb.

A second scratch time of the morning for Loeb in SS16 ensured the defending champion would remain in touch for the final loop of stages, just 1.8s behind Latvala and 20.7s away from the DS3 WRC out front. Typically, Loeb played down his chances of a win.

Latvala, on the other hand, couldn't stop talking about his desperation to take the fight to the rally leader. He was bubbling at lunchtime service.

"I want to win this rally, really I want to win," he said. "I wanted the difference to be less than 15 seconds, so this is a little bit more than I wanted, but I believe it is still possible. I have to be consistent, fast and make no mistakes at all.

But I believe I can win."

Latvala's only problem through the morning had been what he saw as an overly cautious approach to the asphalt section at the end of Yakrut.

He was ready. And Ogier was under no illusions that the fight was going to be a big one.

"Right now we are still leading, so that's a good sign," he said. "I had a moment in the last stage when I saw the tape at the edge of the corner. I couldn't see clearly and I thought this was the inside of the corner, but it was the outside. We ran wide and dropped some time. I am happy with what we have done this morning, I think it's normal when you are first on the road. It's not going to be easy."

But could he win from the front?

"Why not? I did it before."

And, with a nonchalant shrug he slipped his sunnies back on, took a long slug of water and turned his attention elsewhere.

The one driver who wouldn't be taking part beyond the first stage of the final loop was Solberg. He had dropped back through the morning, ending it 28s off the lead in fourth.

Typically, the Norwegian was resolute that everything remained possible. Possible that was, until the first stage of the afternoon, when he dropped his Citroen off the road. 'Dropped' is probably not the best

adjective to use here: the DS3 landed awkwardly after an infamous jump in Yakrut, twisted, tank-slapped and launched itself off the road. Fortunate not to roll over any of the rocks, which the Citroen shifted in its unplanned manoeuvre, the car came to rest in a ditch at the side of the road. He was going no further. The 2003 champion's miserable year continues.

If you were looking for a driver to deliver on their promise in Jordan last week, look no further than Latvala on Saturday afternoon. He won the first stage and chopped Ogier's advantage to 10.2s; he won the second stage and halved that again; he won the third stage and moved into the lead.

Latvala was sensational on Saturday and Ogier appeared powerless to halt the charge of the Fiesta.

"The cleaning is worse this afternoon," he said. "I cannot do anything.

Latvala was bouncing. "I have been on a charge," he said. "And now we have to see what is possible."

As had been the case through the morning, Loeb was quick in the first stage and struggling in the rest. "The car has too much oversteer," he complained. "I'm almost having to stop the car in the twisty sections."

Loeb was third and gearing himself up for a big Powerstage push.

The biggest push would be coming from Latvala ▶



Kimi Raikkonen kept out of trouble for sixth

◀ and Ogier, however.

Hirvonen set the benchmark, his high-speed recce through the morning working a treat as he looked well-set for three points. Loeb was three tenths down on Hirvonen and Latvala six tenths down on his Ford team-mate.

And now the wait. The two-minute wait before the Citroen burst into view, slashing its way through the final corner with no hint of a lift. Ogier was on a mission.

Latvala looked on anxiously. Would his half second be enough? No.

Ogier's face was a picture. He'd done it. By two tenths. The closest WRC result ever, eclipsing Marcus Gronholm v Loeb in New Zealand 2007 (0.3s).

Joy and despair were yards apart at the end of the last stage. Latvala and Ogier shook hands, this towering fight could only have one winner. And that winner wasted no time in paying tribute to Latvala.

"He was incredible this afternoon, I could do nothing about his times," said Ogier. "He did this to me in New Zealand last year, so I know what he is feeling, it's not nice, but this is a special win for me."

Latvala could barely disguise his post-event disappointment, saying: "I made two or three mistakes in there. And, to be honest, I knew it was going to be tough. Before the start, my front-left [tyre] had nothing left. My times in the stages before were costing me in

this one. Unfortunately, for the man who wins the rally by the closest ever margin, there is also the man who loses the rally by the closest ever margin, that's me and it's not a nice feeling."

Loeb took the final step of the podium, with Hirvonen fourth. Wilson moved up to fifth despite a grip-less Fiesta on the final afternoon, with Raikkonen dropping to sixth after a penultimate-stage puncture.

Loeb was undoubtedly disappointed with third – doubly so when he realised his status as championship leader means he has to run first on the road in Sardinia. "It's always a pleasure..." he said dryly.

But, for the second time in three weeks, the real pleasure was all Ogier's. ☒

SWRC

Sousa's surprise success after Al-Attayah's agony

↗ Nasser Al-Attayah shook the proffered hand and wished Bernardo Sousa good luck. The charming Qatari driver was distraught, but he didn't let it show to the man who would be taking over from him at the front of the field.

The record books will reflect Sousa's maiden SWRC win on this event, but what it won't show is the exceptional dominance demonstrated by Al-Attayah through the first day down his native Middle Eastern roads. But for all his monster lead at the end of day one, Al-Attayah went home empty-handed for the second SWRC round in succession.

The Ford Fiesta driver started in determined fashion, resolute in his opportunity to make up for the disappointment of his post-event exclusion from the winners' circle in Mexico (for a fuel-cell ventilation issue). Despite a misfire through the afternoon, Al-Attayah still made it to the end of the day with two minutes on Sousa.

His Portuguese rival raised his eyebrows when he saw the times, before adding sagely: "There is Nasser's rally here and there is the rally for the rest of us. I am leading the rally for the rest of us."

With such a big advantage, Al-Attayah was ready to take his time through the second

and final day. And then his Fiesta lost power at the start of the first Saturday stage.

"We got about five kilometres in and it stopped," he said. "It was finished. There is a broken valve in the engine. At least my speed was good... again."

Passing the silenced Ford, Sousa couldn't believe his eyes. "My head was all over the place," he said. He dropped half a minute to his rival as he struggled to find the focus, spinning at the end of the stage.

"This is shit," Sousa added. "You don't want to take the lead like this. I feel sorry for Nasser, really sorry."

That pity was kept in check when he smacked a football-sized rock on the final stage of the morning. That was enough to convince Sousa of the merits of an even more careful approach. And, in the end, it paid off with victory.

"It's incredible, a great feeling to win," he said. "This has been one tough rally."

Estonian 18-year-old Karl Kruuda narrowed the gap to the winner to 21.7s. Kruuda's had struggled to get his Skoda started after the second run through Jordan River on Friday. Fortunately, he did and his second place allied to the fourth he bagged in Mexico was enough for him to move into the championship lead.

RESULTS

Jordan Rally, April 14-16, round 4 of 13

14 SPECIAL STAGES, 161.29 MILES

POS	NO	DRIVER/NAVIGATOR	CAR	TIME
1	2	Sebastien Ogier/Julien Ingrassia	Citroen DS3 WRC	2h48m28.2s
2	4	Jari-Matti Latvala/Miikka Anttila	Ford Fiesta RS WRC	+0.2s
3	1	Sebastien Loeb/Daniel Elena	Citroen DS3 WRC	+27.7s
4	3	Mikko Hirvonen/Jarmo Lehtinen	Ford Fiesta RS WRC	+2m44.7s
5	15	Matthew Wilson/Scott Martin	Ford Fiesta RS WRC	+5m44.9s
6	8	Kimi Raikkonen/Kaj Lindstrom	Citroen DS3 WRC	+6m14.9s
7	7	Federico Villagra/Jorge Perez Compagnon	Ford Fiesta RS WRC	+9m18.7s
8	10	Khalid Al Qassimi/Michael Orr	Ford Fiesta RS WRC	+9m43.7s
9	9	Dennis Kuipers/Bjorn Degandt	Ford Fiesta RS WRC	+14m27.5s
10	24	Bernardo Sousa/Antonio Costa	Ford Fiesta S2000	+15m05.5s
OTHERS				
14	5	Henning Solberg/Ilka Minor	Ford Fiesta RS WRC	3h10m29.9s
R	11	Petter Solberg/Chris Patterson	Citroen DS3 WRC	SS17-crash

CLASS WINNERS WRC: Ogier/Ingrassia; SWRC: Sousa/Costa. Starters/finishers: 29/23; Leaders: SS1-6 CANCELLED; SS7-18 Ogier; SS19 Latvala; SS20 Ogier

CHAMPIONSHIP TABLE

POS	DRIVER	PTS
1	Sebastien Loeb	74
2	Mikko Hirvonen	72
3	Sebastien Ogier	69
4	Jari-Matti Latvala	66
5	Petter Solberg	31
6	Mads Ostberg	28
7	Matthew Wilson	22
8	Kimi Raikkonen	18
9	Federico Villagra	12
10	Henning Solberg	10
MANUFACTURERS' POINTS		
1	Ford Abu Dhabi WRT	130
2	Citroen Total WRT	130
3	Stobart Ford	43



Sousa lucked in after Al-Attayah retired

PWRC - Round 2 of 8

POS	DRIVER/NAVIGATOR	CAR	TIME
1	Bernardo Sousa/Antonio Costa	Ford Fiesta S2000	3h03m33.7s
2	Karl Kruuda/Martin Jarveoja	Skoda Fabia S2000	+21.7s
3	Hermann Gassner/Kathi Wustenhagen	Skoda Fabia S2000	+2h22m.1s



GINETTA JUNIOR CHAMPIONSHIP

GINETTA Challenge

GINETTA GT SUPERCUP

Hillspeed's Seb Morris secured win number four of the 2011 Ginetta Junior Championship season at Donington Park this Sunday, 17th April, to keep his 100 per cent win record intact and move further clear of his young rivals in the chase for the coveted title.

Tollbar Racing duo William Foster and Tom Howard provided the main opposition with the team-mates finishing the race in that order, with Foster securing a career best finish in second and taking the chequered flag only 0.285 seconds behind Morris. Howard, meanwhile, made it three visits to the rostrum from four races as he crossed the line a further 0.3 seconds shy.

Next Ginetta Junior Championship is a visit to Thruxton Circuit in Hampshire Saturday, 30th April, and Sunday, 1st May.

The Fuchs Ginetta Challenge has been synonymous with full grids and close racing for many years now, but for 2011 it is set to be even better starting at Oulton Park with 34 cars on the grid. A broader spread of the new G40 models to take on the older, yet lighter, G20 will add to the spectacle while the entry boasts newcomers, a former champion and a host of competitive drivers. The first round of the Fuchs Ginetta Challenge series takes place as this magazine goes to print so watch closely.

"A huge amount of drivers in British Motorsport today have come up through our Ginetta career ladder.

We will continue to offer value and affordable access to racing through our competitive cars and high profile championships"

Lawrence Tomlinson - Ginetta Boss.

IDL driver Tom Sharp added the fifth and sixth wins of the year to his remarkable tally at Donington Park this Sunday, 17th April. Sharp fought through from fifth on the Michelin Ginetta GT Supercup 'reverse grid' to prove he can win from the front or from in the middle of the pack.

Even so, he had to fend off Adam Morgan, George Murrells and Freddie Hetherington. Scorching away at the front, at the end of lap 16 Sharp's winning margin was over five seconds.

In G50s, Aaron Williamson took an excellent early lead rising from fourth. The lead changed hands lap after lap with fantastic door handle-to-door handle action between Tom Ingram and Andrew Richardson down the Craner Curves. Jody Fannin came through in the end to take the win with Louise Richardson second and Jake Hill taking third place.

RESULTS SO FAR...

GINETTA JUNIOR CHAMPIONSHIP

POS	DRIVER	PTS
1	Seb Morris	144
2	Charlie Robertson	93
3	William Foster	92
4	Tom Howard	82
5	Max Cotes	74
6	George Gamble	70

2010 Review...



Frank Wrathall began in a Ginetta G20 moving up to the Ginetta **G50** Cup where he was a title contender for 3 years winning in 2010. Frank now races in the prestigious British **Touring Cars** Championship.

2010 Ginetta Challenge winner George Murrells started in the Challenge series racing a **G40**. He now races a new-for-2011 **G55** in the Michelin Ginetta GT Supercup.



Tom Ingram began as a Ginetta Junior where he spent two years finishing 2010 with an impressive win in the first ever **G40J** car. Tom made his 2011 season debut in a **G50**.

GINETTA.COM

RESULTS SO FAR...

MICHELIN GINETTA GT SUPERCUP

POS	G55	PTS
1	Tom Sharp	216
2	George Murrells	138
3	Carl Breeze	126
4	Adam Morgan	116
5	Colin White	98
6	Nathan Freke	78

POS	G50	PTS
1	Jody Fannin	158
2	Tom Ingram	156
3	Robert Gaffney	124
4	Jake Hill	111
5	Louise Richardson	92
6	Aaron Williamson	88

BORN TO RACE. BRED TO WIN. JUST LIKE YOU.

Behind the famous scorpion badge on every Abarth motor car lies over sixty years of Italian racing heritage. The pedigree is built on motorsport legend Carlo Abarth, a man born to compete and win, and whose passion for design quality and engineering excellence earned great glory. Better still, the constant desire for ever-better efficiency sees today's Abarth range provide exhilarating performance, low emissions, low road tax and optimum running costs. Abarth never accepted second best – neither should you.

DRIVE THE LEGEND, ENJOY THE EMPOWERMENT.



**FOR MORE INFORMATION OR
TO BOOK YOUR TEST DRIVE VISIT
WWW.ABARTH-TESTDRIVE.CO.UK**

Abarth Punto Evo Fuel Cons mpg (l/100km): urban 35.3 (8.0) / extra-urban 56.5 (5.0) / combined 46.3 (6.1) / CO₂ emissions: 142g/km. Abarth 500 1.4 16v Turbo fuel cons mpg (l/100km): urban 33.2 (8.5) / extra-urban 52.3 (5.4) / combined 43.5 (6.5), CO₂ emissions: 155g/km.



**A WORLD OF
EMPOWERMENT**



**ABARTH 500
1.4 16V TURBO T – JET**

**POWER OUTPUT 135HP (99KW) AT 5,500RPM
PEAK TORQUE 206NM AT 3,000RPM
ACCELERATION 0 – 62 MPH 7.9 SEC
TOP SPEED 127MPH**



**ABARTH PUNTO EVO
1.4 TURBO MULTI AIR**

**POWER OUTPUT 165BHP (121KW) AT 5,500RPM
PEAK TORQUE 250NM AT 2,250RPM
ACCELERATION 0 – 62 MPH 7.9 SEC
TOP SPEED 133MPH**



CHINA WIN SENDS HAMILTON SOARING

British driver moves into top three after win in Shanghai

Lewis Hamilton's victory at the Chinese Grand Prix launched him into the top three of the Castrol EDGE Rankings for the first time this year. A sensational win moved the British driver up two places, past Ferrari's Fernando Alonso and WRC's Sebastien Loeb, and into his highest position since July 2010.

Alonso maintained his fourth place in the Rankings, after Loeb failed to win Rally Jordan and slipped two places as a result.

Ahead of them, podium positions for Sebastian Vettel and Mark Webber kept the Red Bull duo first and second in the Rankings, with Vettel maintaining his top spot for a 56th consecutive week. His score of 25,805 is also the highest ever recorded in the Castrol EDGE Rankings.

Vettel now also leads the Castrol EDGE Race for 2011, the German having taken over the lead from Carl Edwards.

JOHNSON LOSES NASCAR No.1 SPOT

An eighth-place finish at Texas meant that Jimmie Johnson (right) lost his status as the top NASCAR driver in the Castrol EDGE Rankings for the first time.



The Hendrick Motorsports driver was overtaken by Carl Edwards, whose third-place finish at Texas also moved him into an all-time high ninth place in the Castrol EDGE Rankings.

Johnson meanwhile, is at an all-time low 10th place in the Rankings – seven lower than his position of a year ago.

CURRENT STANDINGS

1	◀▶	Sebastian Vettel	F1	25,805
2	◀▶	Mark Webber	F1	21,803
3	▲	Lewis Hamilton	F1	20,258
4	◀▶	Fernando Alonso	F1	19,981
5	▼	Sébastien Loeb	WRC	19,492
6	◀▶	Will Power	IndyCar	17,966
7	◀▶	Jenson Button	F1	17,239
8	◀▶	Dario Franchitti	IndyCar	16,701
9	◀▶	Carl Edwards	Sprint Cup	15,907
10	◀▶	Jimmie Johnson	Sprint Cup	15,788

DATA CORRECT AS OF 18 APRIL 2011

TEAM BOW WINS PRIZE TRIP TO CANADIAN GP



The Chinese Grand Prix not only produced the most exciting F1 race in a while, it also gave the Castrol EDGE Grand Prix Predictor its best weekend of the 2011 season.

The Predictor scored a total of 35 points in China, correctly predicting a sixth place finish for Felipe Massa's Ferrari and being only one place out on the finishing positions of Sebastian Vettel, Mark Webber, Vitaly Petrov and Kamui Kobayashi.

Over 100 players correctly guessed the podium finishers in order, but top scorer was 'delboy', whose 114 points out of 130 was the highest score of the season so far.

Despite this score, 'delboy' didn't quite make the head of the leaderboard. That honour instead went to 'Team Bow', whose score of 174 won him a trip to the Canadian Grand Prix in June. Congratulations!

<http://predictor.castroledgerankings.com/>

FREE! PLAY NOW

BEAT THE GRAND PRIX PREDICTOR

Win Ultimate Motorsport Experiences worth up to £20,000

Follow us
twitter.com

Join our group
facebook.com

QUICK RESULTS

- Rally winner **Juho Hanninen**
- Most stage wins **Jan Kopecky (5)**
- Points leader **Hanninen**

RACE RATING



Hanninen edges Kopecky in thriller, as Neuville stars



Hanninen got one over Kopecky on asphalt

INTERCONTINENTAL RALLY CHALLENGE RALLY ISLAS CANARIAS (E), APRIL 14-16, RD 2/12

Hanninen trumps Kopecky in island thriller

JAN KOPECKY THOUGHT he had seen the back of Juho Hanninen, his Skoda team-mate and nemesis since 2009.

Hanninen, who beat Kopecky to the Intercontinental Rally Challenge drivers' crown in 2010, is supposed to be concentrating on the Super 2000 world championship with Skoda this year, leaving the Czech to chase the IRC crown that has eluded him for the past two campaigns.

While Hanninen's unsuccessful appearance on the Monte Carlo IRC season-opener was supposed to be a one-off, he returned for round two on Gran Canaria and promptly stole Kopecky's thunder.

It was on Gran Canaria in 2010 that Hanninen first emerged as a true asphalt contender, shadowing Kopecky – the recognised

sealed-surface specialist – throughout and finishing 10.5s adrift. However, with four stages left to run of this year's rally, and with a margin of more than eight seconds over Hanninen, Kopecky could have been forgiven for thinking that win number two was a distinct possibility.

While Kopecky realised Hanninen's menace remained very real, he hadn't banked on an inspired effort by Thierry Neuville. The 22-year-old Belgian has shown occasional glimpses of promise in his Kronos Peugeot 207. On Gran Canaria he was a revelation, completing Friday's leg just 5.7s behind Kopecky.

Neuville then went faster than Kopecky to snatch the lead, the Skoda man rueing a lack of precision with his pacenotes for his tardy time,

while Neuville admitted to going flat out in his pursuit of an unlikely win.

It transpired that Neuville's attack was just a bit too rapid in the rising temperatures, for his Michelin tyres were pretty much spent by the time he started the next stage. The lack of grip caused his car to understeer on the downhill sections. He also suffered a brief spin.

There were no such problems for Hanninen who won the stage to move ahead of Kopecky into the lead by dint of one-tenth of a second with two stages left, including the repeat of the San Matteo stage where Kopecky had come unstuck on the first run through.

He struggled again, and with Hanninen going quickest, the defending IRC champion was now 3.9s clear. Although Kopecky

won the final stage to trim Hanninen's margin to 1.5s it wasn't enough and he duly settled for second with Neuville a very creditable third.

Freddy Loix started the final day nine seconds off the lead having lost precious seconds when his side windows misted on Saturday's night stage. While his challenge unravelled on day two,

fourth place on his first visit to the island kept the Belgian veteran firmly in the title race.

Guy Wilks, in his Peugeot UK 207, won two of the three opening stages on Friday but struggled through the middle stage of the loop after reporting a lack of confidence with the handling of his car.

A new driving seat was also causing the Briton considerable discomfort and he fell to seventh overnight following a spin on the night stage.

By running wider-track suspension on Saturday, Wilks found the 207 more to his liking and fought back to fifth ahead of Monte Carlo winner Bryan Bouffier, who was out of sorts throughout the event in his Peugeot France entry.

● Graham Lister

RESULTS

1 Juho Hanninen/Mikko Markkula (Skoda Fabia S2000)

- 1h40m38.1s; 2 Jan Kopecky/Petr Stary (Skoda Fabia S2000) +1.5s;
- 3 Thierry Neuville/Nicolas Gilsoul (Peugeot 207 S2000); 4 Freddy Loix/Frederic Miclotte (Skoda Fabia S2000); 5 Guy Wilks/Phil Pugh (Peugeot 207 S2000); 6 Andreas Mikkelsen/Ola Floene (Skoda Fabia S2000).

Points 1 Hanninen 33; 2 Bryan Bouffier 31; 3 Loix 30; 4 Wilks 25; 5 Kopecky 22; 6 Neuville 18.



Neuville was a revelation in Peugeot



CURRENT STANDINGS

- 1 **Sebastian Vettel** ◇ 25,805
- 2 **Mark Webber** ◇ 21,803
- 3 **Lewis Hamilton** ▲ 20,258
- 4 **Fernando Alonso** ◇ 19,981
- 5 **Sebastien Loeb** ▼ 19,492

Ranking the world's best drivers

WHAT HAPPENED THIS WEEK

Juho Hanninen's victory moved him up five places to 39th in the Rankings, while Jan Kopecky (101) made up 13 places on a great weekend for Skoda. Kris Meeke (259), who won the corresponding event last year, did not take part and dropped 101 places.

To see the full list, visit castroldriverrankings.com

- Race 1 winner **Rick Kelly**
- Race 2 winner **Van Gisbergen**
- Poles **Whincup/Rick Kelly**



Kelly wins Saturday's opener

V8 SUPERCARS HAMILTON (NZ), APRIL 16-17, RD 3/14

Van Gisbergen scores home win at Hamilton

WEATHER PLAYED A huge role in determining the winners of the V8 Supercars races at Hamilton in New Zealand.

On Saturday Rick Kelly emerged from a recent dark period with a win, while on Sunday Shane van Gisbergen triumphed in front of his home fans. Kelly showed that his win was no fluke, in spite of coming in an older, backup car after a wreck in Melbourne three weeks ago, by taking pole on Sunday and finishing sixth.

To make the weekend even better, his brother and team-mate Todd finished third on Saturday, and the siblings locked out the front row for Sunday's race.

But after half a dozen podium finishes without a first place, it was van Gisbergen that the crowd wanted to see win. He had looked to be in contention for the Saturday victory

until crashing in the pitlane. In Sunday conditions that everyone knows suit him, the weight of a nation was on his shoulders.

The fact that he had never won a V8 Supercar race, and that the NZ-owned Stone Brothers team had never won at 'home', in spite of taking three series titles, just added to the drama.

So it finally happened. Van Gisbergen ran with the leaders for the race, made sure that he had plenty of fuel and held off a battle between Lee Holdsworth and Garth Tander, who had flown through the pack after starting 19th.

"When you have a whole nation behind you, it's hard not to get excited," the 21-year old grinned after the race. "I owe the boys some beers tonight!"

The weekend was a tough one for Jamie Whincup. On



Van Gisbergen gave home fans something to cheer

Saturday he hit the wall while exiting the pits on cold slicks, while any hopes of a salvage mission on Sunday ended in an incident with a spinning Michael Caruso. Mark Winterbottom also got tangled up in the kerfuffle, and as a result of Whincup's 23rd and 18th finishes, his points lead has been cut to 81.

The slippery conditions meant that there were plenty of incidents, and one of those struck James

Courtney on Sunday. The defending champion had to settle for Saturday's fifth place after bending a steering arm on a tyre stack on Sunday, and is now back in 13th on the points table.

The teams now face a rush to return to Australia, repair their cars and make it to the westernmost round, in Perth, in two weeks time.

● Phil Branagan

RESULTS

Race 1 1 Rick Kelly (Holden

Commodore VEII), 59 laps in 1h38m27.066s; 2 Craig Lowndes (Holden) +1.313s; 3 Todd Kelly (Holden); 4 Mark Winterbottom (Ford Falcon FG); 5 Steven Johnson (Ford); 6 Will Davison (Ford).

Race 2 1 **Shane van Gisbergen (Ford)**, 59 laps in 1h34m19.875s; 2 Lee Holdsworth (Holden) +0.782s; 3 Garth Tander (Holden); 4 W Davison; 5 Steve Owen (Holden); 6 R Kelly.

Points 1 Whincup, 654; 2 R Kelly, 573; 3 Lowndes, 552; 4 Tander, 543; 5 Winterbottom, 543; 6 van Gisbergen, 534.

AMERICAN LE MANS SERIES LONG BEACH (USA), APRIL 16, RD 2/9

Lola-Aston and BMW scoop the spoils at Long Beach

ASTON MARTIN SCORED its first overall victory in the ALMS when the Muscle Milk team's Lola-built car beat the field's only other LMP1. But it was the street fight in the GT class that provided the real action in the two-hour race.

A safety car period with eight minutes remaining ensured a second straight

victory for the BMW M3 GT of Joey Hand and Dirk Muller in front of the Corvette C6.R of Jan Magnussen and Oliver Gavin. "Luckily, I saved my tyres because Jan pushed really hard at the end," said Muller. "I was happy to see the yellow!"

The winners bounced back from a bizarre incident

with their fellow Team RLL entry. Bill Auberlen spun his BMW in the opening minutes at Turn 2 after getting passed by the Porsche of Patrick Long and hit by the Corvette of Tommy Milner. As he tried to resume nearly a minute later, Auberlen blocked class leader Hand in the tight confines around the

fountain, enabling Gavin and Long to get past.

But pole winner Hand soon overtook both Long and Gavin at Turn 5 when they were baulked by a GTC Porsche. After moving past Hand several minutes later, Long crashed at Turn 8. The irate Porsche driver laid blame on Ferrari pilot Scott Sharp, who blocked the leader off the line while coming out of the pits on cold tyres.

Sharp was busy "doing his hair," sniped Long after the debris he picked up on his tyres caused him to slide into the wall and out of the race. Hand pitted early for the exchange to Muller, enabling Wolf Henzler's Porsche to lead briefly.

Following the pitstops, Magnussen began his charge, but ran out of time.

"After the race I walked around the car and looked at

all the places where I'd tapped the walls," he said.

Guy Smith won the pole in the Lola-Mazda B09/86, but Lucas Luhr passed starter Chris Dyson at Turn 5 on the first lap. Klaus Graf was leading Smith by 60s when the safety car came out. "We thought we had an opportunity to win, but it turned out we did not have the pace in the race that we had in qualifying," said a disappointed Smith.

● Jonathan Ingram

RESULTS

1 Lucas Luhr/Klaus Graf (Lola-Aston Martin B08/62), 83 laps in 2h01m23.764s; 2 Chris Dyson/Guy Smith (Lola-Mazda B09/86); +24.624s; 3 Ricardo Gonzalez/Gunnar Jeannette (Oreca FLM09); 4 Tomy Drissi/Kyle Marcelli (Oreca FLM09); 5 Joey Hand/Dirk Muller (BMW M3); 6 Oliver Gavin/Jan Magnussen (Chevrolet Corvette C6 ZR1).

Lola-Aston beat Lola-Mazda in LMP1



BLANCPAIN ENDURANCE SERIES MONZA (I), APRIL 17, RD 1/5

Porsche squad uses guile to outwit its Audi and Ford rivals

THE NEW BLANCPAIN Endurance Series for GT3 and GT4 cars kicked off with a host of top teams and a smattering of factory drivers, but it was crack Italian Porsche squad AutOrlando Sport that showed the rest how to win.

Its all-Italian line-up of Gianluca Roda, Raffaele Gianmaria and Paolo Ruberti (Porsche 997 GT3 R) wasn't the fastest package

around Monza, but it was more reliable than the new Ferrari 458 and the Aston Martin DBRS9.

The Porsche had the best fuel consumption, which meant it could avoid the late splash and dash required by the runner-up WRT Audi R8 LMS – driven by factory driver Filipe Albuquerque, Stephane Ortelli and Bert Longin.
 ● Ben Anderson

RESULTS
1 Paolo Ruberti/Gianluca Roda/Raffaele Gianmaria (Porsche 997 GT3 R), 94 laps in 3h00m36.529s; 2 Bert Longin/Filipe Albuquerque/Stephane Ortelli (Audi R8 LMS), +58.504s; 3 Markus Palmtala/Maxime Martin/Bas Leinders (Ford GT); 4 Marc Hayek/Peter Kox (Lamborghini Gallardo LP560); 5 Gianluca de Lorenzi/Alessandro Bonetti/Stefano Borghi (Porsche 997 GT3 R); 6 Tommaso Maino/Andrea Invernizzi/Mirko Venturi (Ferrari 430 Scuderia).



Winning Porsche overcame big field

NEW ZEALAND V8s HAMILTON (NZ), APRIL 16-17, RD 7/7

Fogg clears for McIntyre to triumph

JOHN MCINTYRE GAINED his third New Zealand V8 championship as former points leader Angus Fogg suffered a double setback in the final round at the Hamilton street circuit. Fogg extended his points

lead with a fine victory in the damp race one but in the next heat a gearbox failure forced him to crawl round to finish at the tail of the field. He was third in the final – but then officials found a minor

discrepancy in his engine and removed all his points for the meeting.

That left fellow Ford Falcon driver McIntyre with an official clean sweep of the three races and his third title in the team he runs himself.

Andy Booth was second for the meeting with a second and two thirds in his Holden Commodore, showing that the Holdens were now able to challenge the dominant Fords after

rule changes brought in this season.
 ● Bernard Carpinter

RESULTS
Race 1 1 John McIntyre (Ford Falcon BA), 12 laps in 23m42.2520s; 2 Craig Baird (Ford) +0.3844s; 3 Andy Booth (Holden Commodore VY); 4 Andy Knight (Ford); 5 Wade Henshaw (Ford); 6 Eddie Bell (Ford). **Race 2 1 McIntyre**, 12 laps in 19m55.1455s; 2 Bell +0.8346; 3 Booth; 4 Henshaw; 5 Anderson; 6 Matt Lockwood (Holden). **Race 3**

1 McIntyre, 12 laps in 20m11.9796s; 2 Booth +10.6444s; 3 Henshaw; 4 Scott McLaughlin (Holden); 5 Baird; 6 Nick Ross (Holden). **Points** 1 McIntyre, 1156; 2 Baird, 1075; 3 Booth, 1002; 4 Angus Fogg, 975; 5 Knight 898.



McIntyre: champion again



Daly grabbed unexpected win

INDY LIGHTS LONG BEACH (USA), APRIL 17, RD 3/12

Daly inherits a late gift

JOSEF NEWGARDEN thought he had victory in hand, driving away from his competitors out front at Long Beach. But then he made a vital mistake just two laps from the chequered flag, which allowed Conor Daly to win his first career Indy Lights race.

By lap 40 Newgarden had a healthy 1.5s lead over Daly, but one lap later the leader stuffed it into the tyre barrier at Turn 9. That put Daly in the lead in a race

that ended under caution two laps later. Daly, the son of former F1, CART and Indycar driver Derek, drove to victory in just his third Indy Lights start.

"I was right up behind him a couple times," Daly said of Newgarden. "Actually in the hairpin I hit his rear tyre with my nose. But then my car jumped gears from second to fourth, so I dropped back a lot."

Newgarden's mistake cost him a trip to Victory Lane.

"This is probably the toughest moment I have had in my career," said Newgarden. "It is certainly the first time this has happened to me and it isn't a fun feeling to have. I think I just caught the drain ditch and it popped me up on the ground. I hadn't hit it all weekend, so it caught me off guard when it happened."

Esteban Guerrieri finished second to give Sam Schmidt Motorsports a sweep of the top two positions. Stefan Wilson was third for Andretti Autosport with Gustavo Yacaman and another Brit, James Winslow, rounding out the top five.
 ● Bruce Martin

RESULTS
1 Conor Daly, 43 laps in 1h00m35.2947s; 2 Esteban Guerrieri, +0.9302s; 3 Stefan Wilson; 4 Gustavo Yacaman; 5 James Winslow; 6 Victor Carbone. **Points** 1 Daly, 109; 2 Josef Newgarden, 99; 3 Wilson, 89; 4 Victor Garcia, 86; 5 Guerrieri, 85; 6 Peter Dempsey, 83.

FRENAULT EURO CUP ARAGON (E), APRIL 16-17, RD 1/7

Sainz and Stevens on top

FRESH FROM A DOUBLE Formula Renault 2.0 NEC victory at Hockenheim, Carlos Sainz Jr delighted a packed Spanish crowd with victory in the opening Eurocup round at Motorland Aragon.

The 16-year old inherited the lead in race one after polesitter Will Stevens retired with fuel pump failure, but the Briton, on pole for both races, enjoyed a troublefree race two win.

Stevens, Robert Frijns and Sainz circulated tightly in the opener, which had to be restarted after a seven-car crash on the run to Turn 1.



Race one needed a restart

Sainz passed Frijns on the back straight for second on lap five, before picking up the lead as Stevens ground to a halt on the next turn. The Red Bull Junior pulled away, setting the race's fastest lap to win by 2.4s.

Race two was a quieter affair. Stevens led Sainz and Frijns into Turn 1 at the start. The Fortec driver assuredly extended his lead as the trio held station to the chequered flag.
 ● Peter Mills

RESULTS
Race 1 1 Carlos Sainz Jr, 11 laps in 25m36.422s; 2 Robin Frijns, +2.426s; 3 Alex Riberas; 4 Mathieu Jaminet; 5 Oscar Andres Tunjo; 6 Come Ledogar.
Race 2 1 Will Stevens, 14 laps in 27m25.269s; 2 Sainz, +3.013s; 3 Frijns; 4 Timmy Hansen; 5 Daniil Kyvat; 6 Javier Tarancon.
Points 1 Sainz, 43; 2 Frijns, 33; 3 Stevens, 25; 4 Riberas, 15; 5 Jaminet 12; 6 Hansen 12.

Precision Hub Plate Scale Systems

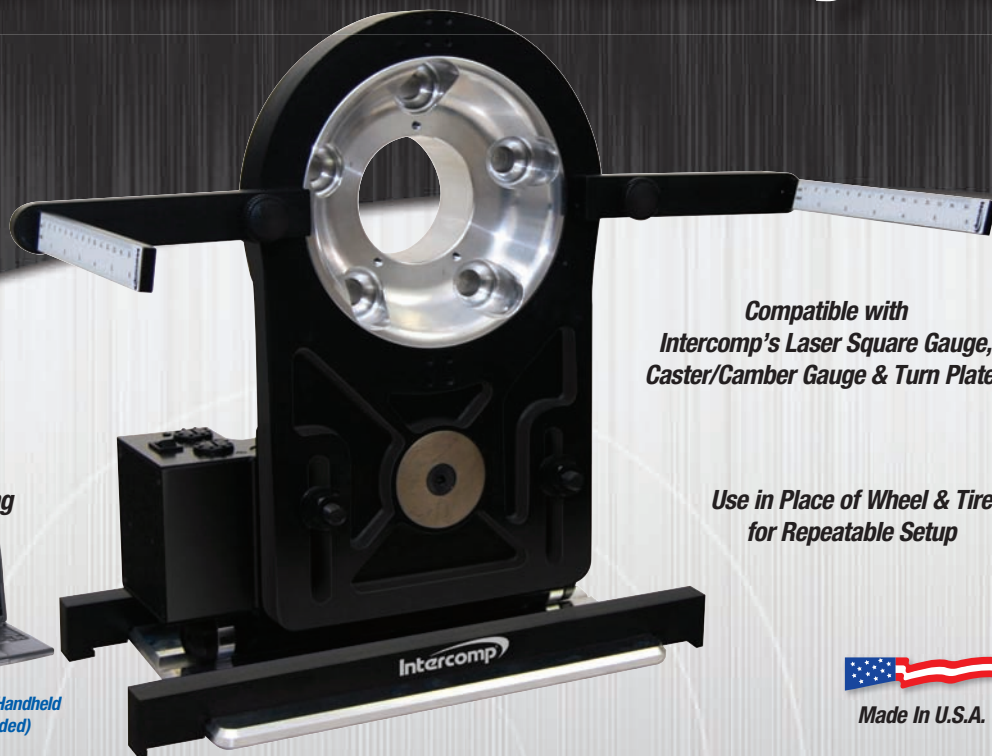

WIRELESS WEIGHING

Fully Integrated
RFX™ Wireless Weighing



Includes RaceWeigh™ Software for PC & Handheld
Wireless Professional (PC not included)

Compatible with
Intercomp's Laser Square Gauge,
Caster/Camber Gauge & Turn Plates

Use in Place of Wheel & Tire
for Repeatable Setup



Made In U.S.A.

Precision Hub Plate Wireless Scale System (Set of Four)

- Part # 170210 - RFX - Low Profile Precision Hub Plate Scale System
Tire Diameter 19.63" (499mm) to 25.63" (644mm)
- Part # 170211 - RFX - Precision Hub Plate Scale System
Tire Diameter 23.25" (591mm) to 29" (736mm)

Precision Hub Plate System (Set of Four)

- Part # 170212 - Precision Low Profile Hub Plate System
Tire diameter 19.63" (499mm) to 25.63" (644mm)
- Part # 170213 - Precision Hub Plate System
Tire diameter 23.25" (591mm) to 29" (736mm)

Intercomp's industry leading, RFX™ Wireless Weighing Technology is the most widely used advanced weighing technology of its kind and is used by champions in all forms of motorsports.

Intercomp offers you the most comprehensive line of indicator options
Euro Cross Weights Shown!

Now Includes:
RaceWeigh™ Software & Wireless Node!



SW787RFX™
PC Wireless Scale System
Part # 170154-PC
(PC not included)



SW650RFX™
Wireless Scale System
Part # 170126-W



SW777RFX™
Wireless Scale System
Part # 170127-WPC



SW500™
Cabled Scale System
Part # 170125

Intercomp®
advanced weighing technology... by any measure



Available in 2011
Racing Season!

Intercomp Scale
Systems App for iPhone™
Compatible with All Intercomp
Scale Systems with RS232 Output

Call to request our 2011 Racing Products Catalog or log on to:

44 0118 932 0578 EUROPE

intercompracing.com

763-476-2531 USA

European Sales & Service

DEMON TWEAKS
Wrexham, Clwyd
Tel: 44(0) 1978 664466
Fax: 44(0) 1978 664467

ROLLCENTRE
St. Ives, Cambs
Tel: 44(0) 1480 464052
Fax: 44(0) 1480 461454

RACE HARDWARE
The Netherlands
Tel: 31(0)36-5370689
Fax: 31(0)36-5371794

DANIELSON
Magny-Cours, France
Tel: 33(0) 3 86 21 22 55
Fax: 33(0) 3 86 21 22 65

GIEFFE SRL
Castelceriolo, (AL), Italia
Tel: 39(0) 131 216505
Fax: 39(0) 131 216506

ISA RACING
Kottenheim, Germany
Tel: 49(0) 2651 96250
Fax: 49(0) 2651 962510

NIMEX
Monheim, Germany
Tel: 49(0) 2173 54253
Fax: 49(0) 2173 51089

- Winner **Jimmie Johnson**
- Pole **Jeff Gordon**
- Most laps led **Clint Bowyer**



Constant action with the result in doubt until final moment



Johnson (48) was pushed to victory by Earnhardt Jr (88)

NASCAR SPRINT CUP TALLADEGA SPEEDWAY (USA), APRIL 17, RD 8/36

Johnson times his run to the front to perfection

NOAH WOULD HAVE LOVED last weekend's NASCAR Sprint Cup race at Talladega: the cars running round in perfect two-by-two order for 499 miles.

With two cars significantly quicker than one – or three – there were lead changes on average every other lap, but in the end there was only one move that counted, and that took place literally inches before the finish line...

With three laps to go, the Roush Ford pairing of Carl Edwards and Greg Biffle barged their way to the front. They led onto the

final lap but as they crossed the line, Jeff Gordon and Mark Martin swept by in their Hendrick Chevro.

They were also joined by the Childress Chevys of Clint Bowyer and Kevin Harvick, while on the bottom of the track the other Hendrick pair of Jimmie Johnson and Dale Earnhardt Junior timed their run to perfection.

Going into the final corner the pairs were three-wide, the top six covered by a fraction of a second. First Gordon led – seeking a record-extending 13th restrictor-plate win

– then Bowyer edged ahead, and finally, just before the line, Johnson inched in front to grab a sensational win by 0.002s! The top eight were covered by 0.145s.

"It's never very good to know you made NASCAR history by losing," said Bowyer following the closest-ever finish. "Sooner or later I need to start making history by winning. That guy's won enough. The only thing that bums me out about that is those guys lagged back all day long. That's what makes it tough, losing to somebody that did that. We were up front, digging all day long. When you get it taken from you at the end by somebody who lagged back, it's hard."

Even though Earnhardt Jr extended his winless streak to 100 races, he was

delighted to have played a key part in Johnson's 54th career win. "If I couldn't win the race, I wanted Jimmie to win the race, because I had worked with him all day," he said.

Despite the closeness of the action, the 'big one' never happened. There were a couple of small multi-car accidents, two of them triggered by the Penske Dodge of Kurt Busch.

The Red Bull Toyota of Brian Vickers bore the brunt of the damage after Busch sent Landon Cassill spinning, while later on it was Busch's team-mate Brad Keselowski who was fired into the wall, taking out Marcos Ambrose, Trevor Bayne, David Ragan (who was blowing up anyway) and Kasey Kahne in his wake.

Later on Kurt's brother Kyle was tipped into a spin by his Joe Gibbs Racing team-mate Joey Logano, wiping out Roush's Matt Kenseth in the process.

RESULTS

- 1 Jimmie Johnson (Chevrolet Impala), 188 laps in 3h12m01s;
- 2 Clint Bowyer (Chevy), +0.002s;
- 3 Jeff Gordon (Chevy); 4 Dale Earnhardt Jr (Chevy); 5 Kevin Harvick (Chevy); 6 Carl Edwards (Ford Fusion); 7 Greg Biffle (Ford); 8 Mark Martin (Chevy); 9 David Gilliland (Ford); 10 Joey Logano (Toyota Camry). **Points** 1 Edwards, 295; 2 Johnson, 290; 3 Earnhardt Jr, 276; 4 Harvick, 268; 5 Kurt Busch, 267; 6 Kyle Busch, 257.

IN BRIEF



EUROPEAN F3 OPEN

Denmark's Johan Jokinen (red car, above) and Spain's Tono Fernandez shared the wins at Valencia. Fernandez's victory owed much to a drive-through penalty in the opening race, which demoted him to sixth which meant pole for race two. Jokinen was forced out on the opening lap of the second event.

ARCA

Ty Dillon passed veteran Frank Kimmel late on the final lap at Talladega Superspeedway to win Friday's '3 Amigos 250'. It was poleman Dillon's third win in five career ARCA starts.

RENAULT MEGANE TROPHY

The Italian Oregon Team made a strong start to the season, completing a double one-two at Motorland Aragon. Stefano Comini won both races ahead of Niccolò Nalio.

LAMBORGHINI TROFEO

Soloist Eugenio Amos scored a double win at Monza. He led from lights-to-flag in race one, before inheriting victory in race two when rivals Fabio Babini/Matteo Zucchi punctured. Amos was denied a hat-trick by a poor start in the finale, so Cedric Leimer grabbed a maiden win.

BRAZILIAN STOCK CARS RIBEIRAO PRETO (BR), APRIL 17, RD 3/12

Abreu rules the streets again

THERE'S NO SECRET FOR Atila Abreu at the Ribeirao Preto street circuit. Winner of the first edition of this race held last season, he did it again last weekend.

He missed out on pole position, though, and had to start the race from third place after being 0.064s slower than pole-sitter Luciano Burti, who had beaten Caca Bueno by a mere 0.001s. But a faster refuelling pitstop put the AMG Motorsport driver back in the lead, and after

that all he had to do was stay away from the walls and ahead of some mid-race attempts from second-place man Allam Khodair.

Abreu had used his 70bhp push-to-pass button to jump to second soon after the start, and three laps later he became the leader by getting out of the pits ahead of Burti – who was later punished with a drive-through for taking a shortcut into the pits.

Fighting against a hydraulic steering fault,

Bueno was not able to keep Khodair and Max Wilson behind. Then Wilson and Khodair battled hard, using their push-to-pass systems to good effect, but excessive oversteer meant Khodair slipped back to fourth, behind Wilson and Bueno.

RESULTS

- 1 Atila Abreu (Chevrolet Vectra), 38 laps in 49m25.193s; 2 Max Wilson (Chevy), +0.959s; 3 Caca Bueno (Peugeot 408); 4 Allam Khodair (Chevy); 5 Ricardo Mauricio (Chevy); 6 Marcos Gomes (Chevy). **Points** 1 Wilson, 52; 2 Camilo, 47; 3 Bueno, 46; 4 Abreu, 46; 5 Mauricio, 28; 6 Zonta, 24.

BUSCH SCORES MAIDEN 'DEGA NATIONWIDE SERIES WIN
 Kyle Busch (18) won Saturday's Nationwide race at Talladega. He was leading when a green-white-chequered attempt was curtailed when Mike Wallace (01) flipped, freezing the order



LONG BEACH

USA

April 17
IndyCar Series
Round 3/17

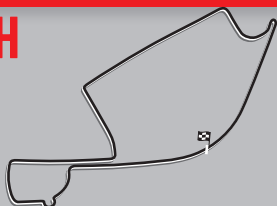

AT A GLANCE

- Winner Mike Conway
- Pole Will Power
- Most laps led Ryan Briscoe
- Fastest lap Dario Franchitti



Franchitti congratulates Conway

Conway bounces like a rubber ball

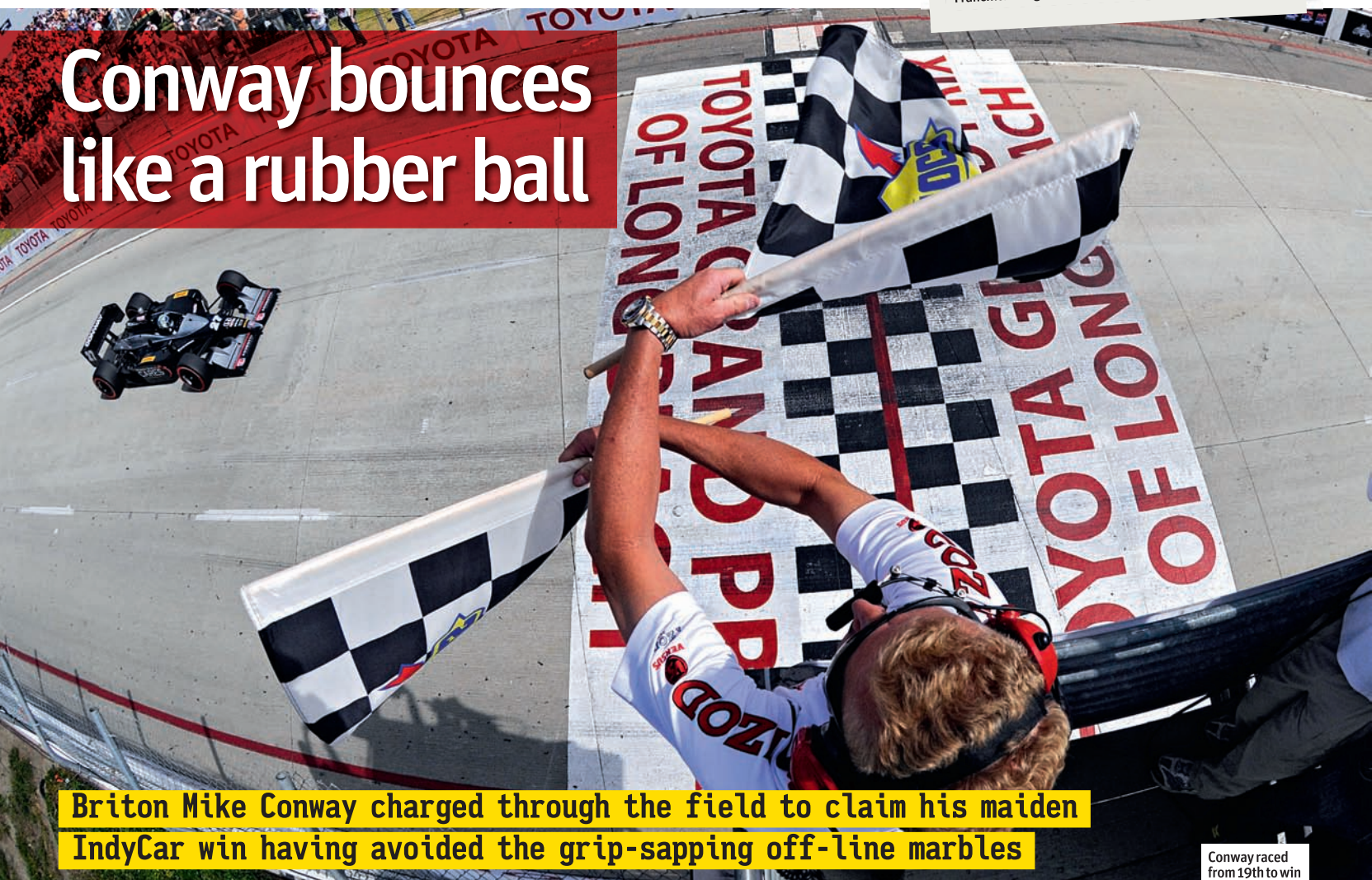

Briton Mike Conway charged through the field to claim his maiden IndyCar win having avoided the grip-sapping off-line marbles

Conway raced from 19th to win

MIKE CONWAY'S MAIDEN

victory in the IndyCar Series around the streets of Long Beach on Sunday afternoon owed much to rubber balls. Metaphorically, his win completed his bounce-back from multiple broken bones sustained in that crazy airborne crash at Indianapolis last year. But it was literally rubber balls – the so-called ‘marbles’ –

that were the final element to his amazing comeback charge from 19th position to record a sensational victory at America's most-famous street circuit.

Early doors, Conway had run a competitive third in a stupefyingly dull first 20 laps of fuel-saving, following one of the most scruffy, stretched-out starts Long Beach has ever seen.

He kept poleman Will Power (Team Penske) and his Andretti Autosport team-mate Ryan Hunter-Reay in sight until the first round of pitstops.

Then it all went badly wrong. Conway admitted to locking-up as he entered his box on the incredibly narrow pitlane, and a problem changing his left-front wheel dropped him so far down the order that his strategist opted for a second stop to top-off his fuel tank, dropping him to 19th. “My fault – I thought our day might be done,” Conway admitted. Not by a long chalk. Andretti's chief ops man Tom Anderson warned him not to get too aggressive over the radio – not yet, anyway...

In the next 15 laps, he passed four cars, and after the final pitstops unfolded

during green-flag conditions, he was up to 11th for the final 30 tours. A restart following yet another crash for EJ Viso, this time after contact with Danica Patrick, set-up Conway's big moment. The double-file rules were always going to be challenging here, with Long Beach's tight first left-hander, and just as he'd predicted from Victory Lane in Barber last weekend, frontrunner Power was on the receiving end (see right).

The multi-car Turn 1 smash removed four cars ahead of Conway, and a clash between Takuma Sato and Graham Rahal didn't harm his chances either. At the final restart, with 15 to go, Conway was sixth. And here's where the rubber balls came in...

This restart was as tightly-bunched as they

had been all day, with leader Ryan Briscoe (Penske) defending hard from a feisty Hunter-Reay, Ganassi's Dario Franchitti, fast-starting Schmidt driver Alex Tagliani, James Hinchcliffe (Newman-Haas) and Conway. Mike made a great restart, and quickly dispatched Hinchcliffe and Tagliani, but crucially his path had been swept clear by Briscoe, Hunter-Reay and Franchitti.

“We drove through about 600-feet of marbles,” said Dario. “I'm guessing he stayed off them. They were supposed to sweep them under caution, we talked about them doing that so we could run side-by-side down there on the restarts. I guess they forgot to do it. After that, the Conway express blew by.”

In a rub-your-eyes



Conway lines up Briscoe to take the lead

RACE RATING

★★★★☆

One of the most amazing comeback drives, and plenty of drama to keep it entertaining

MILESTONE

Mike Conway is the first man in history to win on the classic street tracks of Monaco, Macau and Long Beach

REPORT INDYCAR LONG BEACH

CHUCK BRADBURY JR
reports

moment, Conway nailed Franchitti with ease under braking for Turn 7, just as Hunter-Reay hit gear-selection trouble and was forced out. Now only Briscoe stood between Conway and his maiden win, and Mike zapped past him at Turn 7 a lap later, after gaining incredible traction from the previous corner. If your jaw wasn't already on the floor, he went on to lap over a second faster than his pursuers on Long Beach's sub-two-mile layout.

"He was in a class of his own, he was so much faster," said Briscoe. "He came out of nowhere. He had massive traction out of corners and drove off into the distance. I don't think he had any pick-up on his tyres, which made him like a bullet."

Conway said his car was quick after restarts all day,

which he'd used to regain so many of the places he'd lost.

"The car came to life on the reds [the 'alternate' softer tyre]," he said. "It was awesome on the restarts, and came up to temperature very quickly. It wasn't easy running back there in the pack, so it was nice to come back and be fighting for the lead. I made two good passes [on Franchitti and Briscoe] and pushed the car to the limit, and they disappeared from my mirrors. It was like they were struggling to get temperature in the tyres. My car was good to go.

"It's awesome to win race three of the season. There were tears of joy at the end; it sunk in straight away. I'm so happy. These are exciting times, I'm so full of energy and feel ready for this. I was determined last year's crash wouldn't halt my career."



Conway's first pitstop didn't quite go to plan



Castroneves (3) takes out team-mate Power

CASTRONEVES PUTS HIS FOOT IN IT

FOR SOMEONE RENOWNED for having twinkle-toes, Helio Castroneves appears to have forgotten which foot is on the brake pedal. For the second time in three races he took not only himself but one of his team-mates out of the running, when he harpooned Will Power out of a potentially race-winning position on a lap 65 restart.

When shown a replay of the incident, Power's reaction was: "Oh nice... ooh, gee, that was pretty blatant." He recovered to finish 10th, Castroneves trailed in 12th.

Castroneves was a picture of contrition: "My behaviour is unacceptable. I feel terrible. If I could turn back time, I would. I apologise."

Ryan Briscoe was left to save the day for Penske with a second-place finish, thanks to what he called "another master call" from 'The Captain' on the pitwall. He instructed Briscoe to pit on lap 24, just after Helio claimed his first victim of the day when he spun out Justin Wilson at the hairpin.

The yellow he'd been hoping for didn't come then, but did a couple of laps later when Paul Tracy, driving for

Penske's son Jay (insert conspiracy theory here), did the same thing to Simona de Silvestro a lap later.

From 12th, and having started on the slower hard tyres, he was propelled to the front of the pack.

It was during that yellow that Marco Andretti and Sebastien Bourdais collided in pitlane, reminiscent of his grandfather's clash with Emerson Fittipaldi 20 years ago. "I had no idea he was there!" said Marco, before getting out to apologise and then being told to get back into his car by his team. He retired a few laps later.

RESULTS

IndyCar Series, Long Beach (USA), April 15-17, round 3 of 17

GRID	
1 POWER 1:09.0649	7 HUNTER-REAY 1:09.1409
3 CONWAY 1:09.6414	4 SERVIA 1:09.6828
5 WILSON 1:09.8097	6 CASTRONEVES 1:09.8423
7 FRANCHITTI 1:09.6037	8 DIXON 1:09.6385
9 TAGLIANI 1:09.6497	10 KANAAN 1:09.7352
11 HINCHCLIFFE 1:09.8122	12 BRISCOE 1:09.8243
13 MEIRA 1:10.1010	14 ANDRETTI 1:09.9400
15 SAAVEDRA 1:10.1146	16 RAHAL 1:10.5883
17 VISO 1:10.1465	18 SILVESTRO 1:10.6407
19 MATOS 1:10.3477	20 PATRICK 1:10.7836
21 BOURDAIS 1:10.8050	22 SATO 1:10.8197
23 JAKES 1:10.8197	24 KIMBALL 1:10.8672
25 TRACY 1:11.0249	26 BEATRIZ 1:11.0341
27 HILDEBRAND 1:11.4916	

85 LAPS, 167.28 MILES

POS	DRIVER (NATIONALITY)	TEAM	CAR	TIME	GRID
1	Mike Conway (GB)	Andretti Autosport	Dallara-Honda	1h53m11.1000s	3
2	Ryan Briscoe (AUS)	Team Penske	Dallara-Honda	+6.3203s	12
3	Dario Franchitti (GB)	Chip Ganassi Racing	Dallara-Honda	+6.7163s	7
4	James Hinchcliffe (CDN)	Newman/Haas Racing	Dallara-Honda	+9.1705s	11
5	Alex Tagliani (CDN)	Sam Schmidt Motorsports	Dallara-Honda	+16.0177s	9
6	Oriol Servia (E)	Newman/Haas Racing	Dallara-Honda	+16.8966s	4
7	Danica Patrick (USA)	Andretti Autosport	Dallara-Honda	+17.5016s	20
8	Tony Kanaan (BR)	KV Racing Technology-Lotus	Dallara-Honda	+18.9655s	10
9	Vitor Meira (BR)	AJ Foyt Racing	Dallara-Honda	+19.4723s	13
10	Will Power (AUS)	Team Penske	Dallara-Honda	+19.8909s	1
11	Raphael Matos (BR)	AFS Racing	Dallara-Honda	+20.4660s	19
12	Helio Castroneves (BR)	Team Penske	Dallara-Honda	+20.7784s	6
13	Graham Rahal (USA)	Chip Ganassi Racing	Dallara-Honda	+21.3464s	16
14	Sebastian Saavedra (CO)	Conquest Racing	Dallara-Honda	+23.1137s	15
15	James Jakes (GB)	Dale Coyne Racing	Dallara-Honda	+24.5926s	23
16	Paul Tracy (CDN)	Dragon Racing	Dallara-Honda	+1m03.7578s	25
17	JR Hildebrand (USA)	Panther Racing	Dallara-Honda	+1m10.9001s	27
18	Scott Dixon (NZ)	Chip Ganassi Racing	Dallara-Honda	-1 lap	8
19	Ana Beatriz (BR)	Dreyer & Reinbold Racing	Dallara-Honda	-2 laps	26
20	Simona de Silvestro (CH)	HVM Racing	Dallara-Honda	-3 laps	18
21	Takuma Sato (J)	KV Racing Technology-Lotus	Dallara-Honda	-4 laps	22
22	Justin Wilson (GB)	Dreyer & Reinbold Racing	Dallara-Honda	-7 laps	5
23	Ryan Hunter-Reay (USA)	Andretti Autosport	Dallara-Honda	72 laps-gearbox selector	2
24	Charlie Kimball (USA)	Chip Ganassi Racing	Dallara-Honda	66 laps-accident damage	24
25	EJ Viso (YV)	KV Racing Technology-Lotus	Dallara-Honda	59 laps-accident	17
26	Marco Andretti (USA)	Andretti Autosport	Dallara-Honda	37 laps-steering	14
27	Sebastien Bourdais (F)	Dale Coyne Racing	Dallara-Honda	27 laps-accident	21

CHAMPIONSHIP TABLE

POS	DRIVER	PTS
1	Franchitti	122
2	Power	115
3	Kanaan	87
4	Servia	80
5	Conway	74
6	Tagliani	73
7	Dixon	66
8	Briscoe	66
9	De Silvestro	66
10	Meira	64

Winner's average: 88.676mph. Fastest lap: Franchitti, 1m10.6597s, 100.269mph. Qualifying: field divided into two groups for qualifying. The fastest six from each move into a 12-car second round. The fastest six from this move into the pole shootout.

SILVERSTONE

Great Britain

April 16-17

Formula 2

Round 1/8

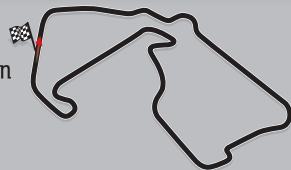

AT A GLANCE

- Race 1 **Mirko Bortolotti**
- Race 2 **Miki Monras**
- Poles **Bortolotti/Monras**
- Fastest laps **Bortolotti/Monras**



Monras led race two from lights to flag

Bortolotti back on track

A smoothly assured victory and a second place at Silverstone restores faith in Italian's ability



Bortolotti showed pace and maturity

MOTORSPORT HAS THE

ability to relaunch careers as much as it has to stall them. Ask Mirko Bortolotti.

A dominant win, followed by a comfortable second place during the opening round of the Formula 2 Championship at Silverstone, has done much to put back on track a single-seater career that a disappointing GP3 campaign in 2010 threatened to derail.

That he leads the series by a slender three-point margin from race two winner Miki Monras is already, he believes, a vindication of his decision to return to the championship in which he was a race-winner in 2009.

"I came here to win the championship. There is no other aim," Bortolotti said.

"I have the same attitude when I start any season."

The ease with which Bortolotti, 21, cruised to a six-second victory during the season opener was a testament to his maturity, which has been crafted in the two years since he won the Italian F3 crown and broke the Fiorano lap record during his maiden F1 test. In the interim he has been part of both the Ferrari and Red Bull junior programmes.

That maturity was proved by his pace at Silverstone, which did not come by a stroke of luck, but instead by careful preparation during pre-season testing.

"We had two days of running at Silverstone in March," he said. "Lots of drivers went for quick lap

times and used lots of tyres, but we just focused on getting comfortable in the car and on finding a good race set-up. We had to find the right way to treat the tyres over a race distance.

"I don't think I'd have done that two years ago. Sure, I'm not with Ferrari or Red Bull any more, but I've learned so much from being on those programmes. It's made me a stronger driver."

There were still mistakes; going out too early on fresh rubber during qualifying for race two meant that he had posted his banker time with 20 minutes still to go. It was only the searing pace he'd initially shown that ensured only Monras – with a sensational late effort – demoted him from pole.

"Perhaps I should have realised that in a morning session, there would be more

improvement in the track between the start and the end. I won't make that mistake again."

Had it not been for that 'mistake', then perhaps he wouldn't have started on the less grippy right hand side of the track, and perhaps he wouldn't have been beaten into Copse on the opening lap by Monras. But he was, and was no match for the Spaniard – who finished a spot above him in last year's GP3 standings – as Monras swept to victory by 10s. He'd made his point, though.

Just as Bortolotti's weekend performance will reawaken interest in his career, so Alex Brundle also showed more strongly than at any other point since he started racing cars.



Will Bratt (17) led Monras in race one

RACE RATING

★★★★☆

Dull at the front, but at least some midfield ineptitude created some excitement

MILESTONE

An F2 season last began with an Italian victor in 1983 with Beppe Gabbiani (right)



REPORT F2 SILVERSTONE

JAMIE O'LEARY
reports



This was not the same Brundle who struggled so badly in British F3 last year with T-Sport, and who finished in the points only twice during his previous F2 campaign in 2009. No, this was a man who put his car on the second row for race one, and who might have had pole for race two had he not come across backmarker Parthiva Sureshwaren in the final sector of his hot lap and dropped to third (still a career best). So how has Brundle changed?

"I've grown up," he said. "Both in driving racing cars and in terms of learning about life. I look at it now and realise I was a kid when I first did F2."

"Doing F3 last year without a team-mate [in a championship class car] was an eye-opener, and I'm trying to put everything I've learned into this year."

Unfortunately for Brundle, he was not to get the opportunity to show his pace in the races. A slow puncture slowly dropped him backwards from fourth in race one before the left-rear blew altogether coming through Club.

Worse was to follow as a clutch failure caused him to stall at the start of race two. Any hopes of a recovery drive were then dashed when an unsighted Sureshwaren – again – clipped Brundle's car while swerving to avoid it and damaged its left-rear suspension. Brundle was left to reflect on what might have been.

Whether Brundle is able to challenge the likes of Bortolotti for the title is unknown for now. One thing is for certain, though: both drivers' careers are firmly back on track. ☘



Improved Brundle unlucky in the races

MAKING QUALIFYING COUNT PROVES ESSENTIAL



Clean start helped Monras in race two

MAKING YOUR QUALIFYING ADVANTAGE

count was of massive importance at Silverstone last weekend. Both Mirko Bortolotti and Miki Monras made great starts from their respective pole positions to record dominant victories. Bortolotti then set the fastest lap on his penultimate tour in race one, as if to underline his command of the race, and Monras did the same the next day.

The most consistent challenger to the pair during the weekend was Will Bratt, who was remaining in F2 for a second straight year. In race one the former Euroseries 3000 champion took advantage of a slow getaway from front-row starter Monras to jump into a second place he would keep (under sustained pressure) to the chequered flag.

The same looked like happening in race two, but there was a sting in the tail for Bratt, who was slapped with a drive-through just before half-distance for exceeding the track limits at the exit of Stowe.

Bratt failed to notice the signals being given to him from the pitwall and did not take his penalty within the required three laps, resulting in a black flag, which he also didn't realise was being shown. It only became clear to him that he had been disqualified from his second place on the road when he was turned away from parc ferme at the end of the race.

That handed the final podium spot in race two to series debutant Christopher Zanella, who had brilliantly made it up from 10th to fourth by the end of the opening lap and had taken seventh place in race one.

Formula Palmer Audi graduate Ramon Pineiro was an impressive fifth in race one, but ruined his chances of a race two podium when he clipped Bortolotti on the opening lap and spun to the rear of the field.

Tobias Hegewald and Mihai Marinescu finished both races in the top six while practice pace-setter Jack Clarke came home eighth and sixth.

RESULTS

FIA Formula 2, Silverstone (GB), April 16-17, round 1 of 8

GRID
1 BORTOLOTTI
2 MONRAS
3 BRATT
4 BRUNDLE
5 MARINESCU
6 HEGEWALD
7 PINEIRO
8 CLARKE
9 JO THEO'D
10 ZANELLA
11 STORZ
12 GLADDIS
13 SNEGIREV
14 LARICHE
15 MAC
16 EBRAHIM
17 SNOEKS
18 COLE
19 ABADIN
20 SURESHWARIN
21 KOWALSKA
22 JU THEO'D
23 KRALJEV
24 MUN

RACE 1 - 21 LAPS, 76.988 MILES			
POS	NAME	TIME	GRID
1	Mirko Bortolotti (I)	39m36.405s	1
2	Will Bratt (GB)	+5.337s	3
3	Miki Monras (E)	+6.929s	2
4	Mihai Marinescu (RO)	+19.381s	5
5	Ramon Pineiro (E)	+26.243s	7
6	Tobias Hegewald (D)	+27.072s	6
7	Christopher Zanella (CH)	+28.901s	10
8	Jack Clarke (GB)	+40.496s	8
9	Max Snegirev (RUS)	+45.852s	13
10	Tom Gladdis (GB)	+53.612s	12
11	Armaan Ebrahim (IND)	+54.607s	16
12	Mikkel Mac (DK)	+58.323s	15
13	Benjamin Lariche (F)	+59.945s	14
14	Thiemo Storz (D)	+1m03.601s	11
15	James Cole (GB)	+1m04.747s	18
16	Jose Luis Abadin (E)	+1m24.152s	19
17	Julian Theobald (D)	+1m29.379s	22
18	Parthiva Sureshwaren (IND)	-1 lap	20
19	Alex Brundle (GB)	-1 lap	4
20	Sung-Hak Mun (PRK)	-2 laps	24
R	Plamen Kralev (BG)	14 laps-accident	23
R	Kelvin Snoeks (NL)	12 laps-acc damage	17
R	Johannes Theobald (D)	11 laps-accident	9
R	Natalia Kowalska (PL)	11 laps-electrical	21

GRID
1 MONRAS
2 BORTOLOTTI
3 BRUNDLE
4 BRATT
5 PINEIRO
6 HEGEWALD
7 CLARKE
8 EBRAHIM
9 MARINESCU
10 ZANELLA
11 STORZ
12 MAC
13 SNOEKS
14 KRALJEV
15 JO THEO'D
16 SNEGIREV
17 LARICHE
18 KOWALSKA
19 GLADDIS
20 JU THEO'D
21 COLE
22 SURESHWARIN
23 ABADIN
24 MUN

RACE 2 - 21 LAPS, 76.988 MILES			
POS	DRIVER	TIME/REASON	GRID
1	Monras	39m45.402s	1
2	Bortolotti	+10.668s	2
3	Zanella	+14.907s	10
4	Hegewald	+16.873s	6
5	Marinescu	+21.753s	9
6	Clarke	+26.801s	7
7	Ebrahim	+33.573s	8
8	Snoeks	+37.573s	13
9	Mac	+39.127s	12
10	Lariche	+49.281s	17
11	Pineiro	+52.251s	5
12	Kowalska	+1m03.243s	18
13	Cole	+1m04.764s	21
14	Storz	+1m07.885s	11
15	Gladdis	+1m09.754s*	19
16	Jo Theobald	+1m13.975s	15
17	Kralev	+1m19.821s	14
18	Abadin	+1m20.280s	23
19	Mun	-1 lap	24
R	Snegirev	13 laps-withdrew	16
R	Ju Theobald	6 laps-accident	20
R	Brundle	0 laps-accident	3
R	Sureshwaren	0 laps-accident	22
EX	Bratt	Ignored black flag	4

CHAMPIONSHIP TABLE		
POS	DRIVER	PTS
1	Bortolotti	43
2	Monras	40
3	Marinescu	22
4	Zanella	21
5	Hegewald	20
6	Bratt	18
7	Clarke	12
8	Pineiro	10
9	Ebrahim	6
10	Snoeks	4

KEY R=Retired, EX=Excluded.
Race 1 Winner's average speed 116.62mph. Fastest lap: Bortolotti, 1m52.281s, 117.54mph.
Race 2 Winner's average speed 116.18mph. Fastest lap: Monras, 1m52.640s, 117.16mph.
 *20s added to race time for exceeding track limits

MONZA

ITALY
April 16-17
BRITISH F3
Round 1/10

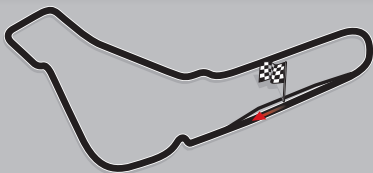

AT A GLANCE

- R1 winner Felipe Nasr
- R2 Rupert Svendsen-Cook
- R3 Nasr



Rupert Svendsen-Cook won reverse-grid race

Nasr doubles up at Monza

The Carlin team brought its stunning pre-season form to the first race at Monza, and in Felipe Nasr it has a star in the making



Clinical Nasr took two victories

CARLIN HAS RUN THE LAST three British Formula 3 champions and has looked almost peerless in pre-season testing. Five of its six-car 2011 line-up has spent a year or more in the category and they are all pushing each other hard, because this is the season they must deliver results.

Felipe Nasr, Carlos Huertas, Kevin Magnussen, Rupert Svendsen-Cook and Jazeman Jaafar are all under pressure to go for the title. Team boss Trevor Carlin is understandably concerned this means his drivers will inevitably crash into each other at some stage.

The fear elsewhere is that Carlin's fierce intra-team rivalry (with rookie Jack Harvey snapping at his team-mates' heels) will simply drive the team further into the distance.

When Carlin drivers filled the first four places in free

practice, those predictions looked prophetic. But that didn't count on a remarkable resurgence from Fortec, which had endured a dismal pre-season, but came out fighting in the first round.

Fortec established itself as the nearest threat to Carlin last season, but lost its way over the winter. Problems getting the best from the tyres left the team off the pace and dented new signing Will Buller's confidence.

But the team has worked hard to close the gap. Richard Dutton's boys put in "82 hours in five days" in the lead up to Monza and it almost paid off. Buller made best use of an aerodynamic tow around the 3.6-mile Grand Prix circuit to nail a pair of poles, but trouble not all of his own making contrived to ruin his chances of victory.

He couldn't take up the first pole, owing to a timing

mistake that meant he and five others had to start from the pitlane after reaching the exit too late to join the grid. The teams were convinced the organisers were running five minutes ahead, but SRO insisted otherwise...

With the help of three safety cars and numerous crashes, Buller charged through to fourth in race one. He repeated the result in the 40-minute feature race, after Jaafar had forced him through the gravel trap at the Curva Di Biassono as they disputed the lead, but was later penalised for corner-cutting – dropping him to seventh – and handed a 10-place grid penalty for banging wheels with the Malaysian.

Nevertheless these salvage jobs, coupled with a podium and fastest lap (worth an extra two points) in the reversed grid race, were enough for Buller to

leave Monza lying fourth in the title race.

"Will's a different driver to last year," reckoned race engineer Andi Scott. "He's a different driver to last week even! A lot of it has just been about getting him to believe in what we're doing."

With Lucas Foresti almost denying Carlin's Felipe Nasr a double win in the final race, Carlin chief engineer Mark Owen acknowledged Fortec's resurgence.

"We've got a lot to work on to improve in our weaker areas," he said. "They took the fight to us and they've done a really good job."

For all that Fortec achieved at Monza, it could not quite get on terms with Carlin's ace in the hole – Nasr. The Brazilian raced superbly to win the main points paying races, and his maximum score from these two hotly contested encounters – coupled with



Foresti (4) showed well in final race

RACE RATING

★★★★★

Great slipstreaming action in all three races and two supreme drives by Felipe Nasr

MILESTONE

Felipe Nasr's race one triumph means Carlin has now won the first race of the year for the fifth straight season



REPORT BRIT F3 MONZA

BEN ANDERSON
reports



Will Buller showed improved form



a strong second behind practice pacesetter Svendsen-Cook in the reversed grid event – means he's already 18 points clear in the championship table.

"New drivers do a lot of mistakes in the first race," said Nasr. "I knew I had a good car, so it was just a question of having the moments to overtake and keeping it calm."

His run to victory in race three, where he started eighth, fell to 12th, then battled back through to win, was particularly stunning.

"His race pace has been fantastic," enthused Owen. "We made it hard for ourselves by being quick in practice and not quick enough in qualifying, but we knew it was a long race and set the car up to last."

"He's very calm and certainly during the races I'm sure he's a lot calmer than the others. Felipe is a very mature driver – he's in control and prepared to wait. He had to deal with some fairly hard opposition, so you've got to say it was a very impressive drive."

FULL CONTACT RACING AT MONZA

Monza produced F3 racing at its most frantic and chaotic.

There were no fewer than four contact incidents in Saturday's first race, which forced six drivers out and caused three safety cars.

These interruptions probably cost Carlin's Kevin Magnussen victory on his British F3 debut. The Dane fought past team-mate Jazeman Jaafar in the early stages to lead, but repeated safety cars bunched the field and meant a slightly unwell Magnussen struggled to find his rhythm. He lost out to Fortec's Lucas Foresti in the closing stages and the pair came together at the second chicane as Foresti defended following the final restart.

Thus Felipe Nasr (Carlin),



Run to first chicane was typically tight

who climbed coolly from fifth on the grid to lie third at the crucial moment, stole through to claim the spoils.

Team-mate Rupert Svendsen-Cook was quickest in practice, but "lost his way" in qualifying. He fought up to fifth in race one and then won the reversed grid race from the front with a smooth and mature drive, after passing poleman Riki Christodoulou (Hitech).

Nasr and Buller worked

their way through to fill the podium in that one and had to do it all again in the feature race, after which five drivers were penalised for corner-cutting.

Nasr started eighth, made a poor start, and fell out of the top 10 on the first lap. Undeterred, he climbed brilliantly through the order and fought his way through the determined defences of long-time leader Foresti to take a valiant victory.

RESULTS

British F3, Monza (I), April 16-17, round 1 of 10

RACE 1 - 14 LAPS, 50.4 MILES						RACE 2 - 12 LAPS, 43.2 MILES						RACE 3 - 21 LAPS, 75.6 MILES						
GRID	POS	DRIVER	TEAM	CAR	TIME	GRID	POS	DRIVER	TEAM	CAR	TIME	GRID	POS	DRIVER	TEAM	CAR	TIME	GRID
1	1	Felipe Nasr (BR)	Carlin	DVM F308	30m56.691s	6	1	Svendsen-Cook	Carlin	DVM F308	21m30.188s	2	1	Nasr	Carlin	DVM F308	40m37.942s	8
2	2	Jazeman Jaafar (MAL)	Carlin	DVM F308	+3.116s	5	2	Nasr	Carlin	DVM F308	+1.045s	6	2	Foresti	Carlin	DVM F308	+2.114s	3
3	3	Carlos Huertas (COL)	Carlin	DVM F308	+3.166s	4	3	Buller	Fortec Motorsport	DMB F311	+1.568s	3	3	Jaafar	Carlin	DVM F308	+5.542s	4
4	4	Will Buller (GB)	Fortec Motorsport	DMB F311	+4.103s	1*	4	Christodoulou	Fortec Motorsport	DMB F311	+6.636s	1	4	Huertas	Carlin	DVM F308	+6.437s	5
5	5	Rupert Svendsen-Cook (GB)	Carlin	DVM F308	+5.140s	10	5	Jaafar	Carlin	DVM F308	+7.713s	5	5	Fantin	Fortec Motorsport	DMB F311	+8.707s	9
6	6	Riki Christodoulou (GB)	Hitech Racing	DVM F310	+6.674s	7	6	Huertas	Fortec Motorsport	DMB F311	+15.692s	4	6	Magnussen	Carlin	DVM F308	+9.437s	2
7	7	Hywel Lloyd (GB)	Sino Vision Racing	DMB F308	+9.995s	17*	7	Lloyd	Sino Vision Racing	DMB F308	+20.050s	7	7	Buller	Fortec Motorsport	DMB F311	+11.125s***	1
8	8	Menasheh Idafar (BRN)	T-Sport	DVM F311	+10.018s	13	8	Magnussen	Carlin	DVM F308	+20.506s	15	8	Svendsen-Cook	Carlin	DVM F308	+12.879s***	10
9	9	Lucas Foresti (BR)	Fortec Motorsport	DMB F311	+10.137s	3	9	Fantin	Fortec Motorsport	DMB F311	+22.013s	17	9	Derani	Double R Racing	DMB F308	+13.602s	11
10	10	Bruno Mendez (E)	Hitech Racing	DVM F308	+11.324s	18	10	Harvey	Fortec Motorsport	DMB F311	+22.205s	20	10	Idafar	Fortec Motorsport	DMB F311	+21.375s	13
11	11	Harry Tinknell (GB)	Fortec Motorsport	DMB F311	+11.447s	8*	11	Tinknell	Fortec Motorsport	DMB F311	+22.397s	11	11	Christodoulou	Fortec Motorsport	DMB F311	+21.884s***	6
12	12	Fahmi Ilyas (MAL)	Fortec Motorsport	DMB F311	+13.553s	15*	12	Pye	Fortec Motorsport	DMB F311	+28.940s	18	12	Ilyas	Fortec Motorsport	DMB F311	+24.152s***	15
13	13	Adderly Fong (PRC)	Sino Vision	DMB F308	+13.857s	16*	13	Cunha	Sino Vision	DMB F308	+31.305s	14	13	Cunha	Sino Vision	DMB F308	+25.481s	20
14	14	Yann Cunha (BR)	T-Sport	DVM F311	+14.121s	19*	14	Mendez	T-Sport	DVM F311	+31.651s	10	14	Pye	Fortec Motorsport	DMB F311	+25.589s***	12
15	15	Kevin Magnussen (DK)	Carlin	DVM F308	+1m21.068s	2	15	(R) Hylkema	Carlin	DVM F308	+32.581s	16	15	Lloyd	Fortec Motorsport	DMB F311	+26.166s	16
16	R	(R) Bart Hylkema (NL)	T-Sport	DMH F307	10 Laps-damage	20	16	Fong	Sino Vision	DMB F308	+43.369s	13	16	Tinknell	Fortec Motorsport	DMB F311	+26.481s	7
17	R	Pietro Fantin (BR)	Hitech Racing	DVM F308	9 Laps-crash	9	17	Foresti	Fortec Motorsport	DMB F311	+47.030s**	9	17	Harvey	Fortec Motorsport	DMB F311	+28.014s	14
18	R	Scott Pye (AUS)	Double R Racing	DMB F308	9 Laps-crash	12	18	Idafar	Fortec Motorsport	DMB F311	+53.212s	8	18	Mendez	Double R Racing	DMB F308	+40.745s	18
19	R	(R) Kotaro Sakurai (J)	Hitech Racing	DMH F307	2 Laps-crash	21	R	Derani	Double R Racing	DMB F308	9 Laps-off	21	19	Hylkema	Carlin	DVM F308	+41.861s	19
20	R	Jack Harvey (GB)	Carlin	DVM F308	1 Lap-damage	21	R	Ilyas	Fortec Motorsport	DMB F311	2 Laps-off	12	20	Fong	Sino Vision	DMB F308	+47.557s	17
21	R	Pipo Derani (BR)	Double R Racing	DMB F308	0 Laps-crash	14	NS	(R) Sakurai	Fortec Motorsport	DMB F311	0 Laps-damage	19	NS	(R) Sakurai	Fortec Motorsport	DMB F311	0 Laps-damage	21

CHAMPIONSHIP

POS	DRIVER	PTS
1	Nasr	51
2	Jaafar	33
3	Huertas	27
4	Buller	24

CHAMPIONSHIP (ROOKIE CUP)

POS	DRIVER	PTS
1	Hylkema	33
5	Svendsen-Cook	21
6	Foresti	17
7	Christodoulou	13
8	Fantin	10
9	Magnussen	9
10	Lloyd	8

Key: D=Ballara; VW=Volkswagen; MB=Mercedes Benz/HWA; MH=Mugen Honda/Brown; (R)=Rookie Cup
*Started from pitlane; **25-second penalty; ***5-second penalty

KEY R=Retired; NS=Non Starter

Race 1 Winner's average: 97.75mph. Fastest lap: Nasr, 1m46.532s, 121.67mph.

Race 2 Winner's average: 120.55mph. Fastest lap: Buller, 1m46.377s, 121.79mph.

Race 3 Winner's average: 111.60mph. Fastest lap: Nasr, 1m46.298s, 121.92mph.



2012 Sunoco Rolex 24 At Daytona Challenge

Felipe Nasr stormed ahead in the challenge after a brilliant opening first round of the British F3 at Monza, claiming 2 x fastest lap and 2 x race wins. Buller showed great pace and gained points for both pole positions, however he lost out in the first race due to starting from the pits.

1	Felipe Nasr	Carlin F3	120.00
2	Javier Morcilo	Azteca/Britcar	105.00
3	Keith Robinson	MJC/Britcar	87.50
4	Jay Shepherd	Hawthorns/Britcar	82.75
5	Manuel Cintrano	Azteca/Britcar	65.00

6	Jan Persson	Hawthorns/Britcar	63.75
7	Rod Barrett	Hawthorns/Britcar	63.75
8	William Buller	Fortec Motorsport F3	50.00
9	Sean McInerney	Edipse/Britcar	50.00
10	Michael McInerney	Edipse/Britcar	50.00



AUTOSPORT

FREE VODAFONE McLAREN MERCEDES CAP WHEN YOU SUBSCRIBE TO AUTOSPORT

SAVE
21%



OR



RRP
£25

JUST
~~£3.30~~
£2.61
PER
ISSUE



5 GREAT REASONS TO SUBSCRIBE:

- FREE Vodafone McLaren Mercedes cap worth £25
- Save 21% on the cover price
- Spread the cost with easy direct debit instalments
- FREE P&P - every issue direct to your door
- PLUS - all AUTOSPORT subscribers get a FREE AUTOSPORT Digital Edition subscription AND unlimited access to AUTOSPORT.com (worth £158)

Subscribe online at:

themagazineshop.com

www.themagazineshop.com/ASPO/M0411P

Or call our hotline and quote offer code M0411P:



+



+

FREE
DELIVERY

08456 777 817

Offer closes May 5, 2011. Please have your bank details ready

Terms and conditions: This is a direct debit offer open to readers in the UK only. Overseas rates are available by calling +44 (0)1795 592 974 or for US rates call +1 866 978 1446. Offer closes on May 5, 2011. Direct debit prices are valid for one year, after which they are subject to change. Should prices change you will be informed in writing. Please allow 35 days for delivery of your first issue and gift. Gift will be sent under separate cover. Should we run out of gifts you will be offered an alternative - there is no cash alternative.

ARAGON

Spain
April 16-17
Renault 3.5
Round 1/9

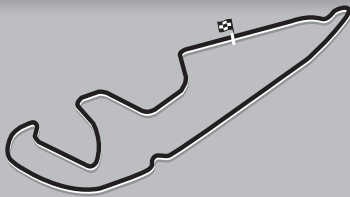

AT A GLANCE

- Race 1 **Alexander Rossi**
- Race 2 **Kevin Korjus**
- Pole position **R Wickens/C Ramos**
- Fastest laps **Rossi/Korjus**

REPORTS FR 3.5 ARAGON

PETER MILLS
reports



Rossi: just what the doctor ordered

American Alex Rossi took a win and a second to build up a crucial points buffer while Daniel Ricciardo was absent



Korjus gets his nose in front at race-two start

ALEXANDER ROSSI came close to fulfilling absent Red Bull F1 reserve driver Daniel Ricciardo's worst fears at the opening Formula Renault 3.5 round at Motorland Aragon. GP3 graduate Rossi backed up a decisive victory in race one with a worthy second to sensational Formula Renault 2.0 Eurocup champion Kevin Korjus in race two. ISR's Ricciardo is now faced with a challenging points' deficit to the American when he returns to the series at Spa later this month.

Race one was enlivened in the early laps by polesitter Robert Wickens locking his left-front wheel and running wide at Turn 1. Third-fastest qualifier Daniil Move seized the opportunity to take the lead, the Russian running out in front for the first time since the Nurburgring in 2009. Rossi also sneaked past Wickens, and was soon hounding a struggling Move.

Move was given a reprieve by the early appearance of the safety car. Anton Nebylitskiy's KMP Racing

car had collided with and somersaulted over Arthur Pic's Tech 1 machine as the Frenchman rejoined after an off-track moment.

On lap five, Rossi tried the outside of Move at Turn 1 and showed how hard he was pushing by gaining some serious oversteer on the exit. Move, well versed in defensive tactics, covered the Fortec driver off, as six cars formed line astern behind him. Entering his fifth season in the category, Move was determined to hang onto his position and claim a debut victory.

Despite Move's spirited resistance, Rossi would demote him in dramatic fashion on lap 12, squeezing between the P1 car and the pitwall. The Fortec machine caused a line of black pitboards to be withdrawn like a row of tumbling dominoes.

"I think the force of the cars going past caused the numbers of the pitboards to fly off," quipped the chasing

Wickens, who would find his own way past Move at the hairpin a lap later.

Nelson Panciatici and Albert Costa took advantage of Wickens forcefully cutting off Move's fightback on the exit of Turn 17 to steal third and fourth spots.

Rossi's fastest lap was 0.5s faster than the opposition, and Wickens conceded an 8.5s margin of victory.

Despite self-doubt of his potential to stand on the top step of the podium this year, understated Estonian Korjus became the series' youngest-ever FR3.5 winner thanks to a faultless drive for Tech 1 Racing in the second race.

Korjus led into Turn 1 after poleman Cesar Ramos made a tardy getaway and dropped two places. Costa then mounted a fleeting challenge for the lead, only to be slowed by a long brake pedal on his EPIC machine.

Down in sixth, Rossi had opted to pit relatively early.

Emerging in clean air on lap seven, some searing tours propelled the Fortec man into contention for victory after the mandatory pitstop phase.

The charge closed the gap to Korjus to just 0.7s, but the effort cooked Rossi's rear tyres and confirmed the Estonian's record-breaking triumph.

RESULTS

Race 1 1 Alexander Rossi, 25 laps in 46m29.465s; 2 Robert Wickens, +8.521s; 3 Nelson Panciatici; 4 Albert Costa; 5 Daniil Move; 6 Jean-Eric Vergne; 7 Walter Grubmuller; 8 Chris van der Drift; 9 Daniel Zampieri; 10 Sten Pentus.

Race 2 1 Kevin Korjus, 26 laps in 46m11.799s; 2 Rossi, +1.735s; 3 Costa; 4 Cesar Ramos; 5 Wickens; 6 Anton Nebylitskiy; 7 Vergne; 8 Nathanael Berthon; 9 Andre "Deco" Negro; 10 Sergio Canamasas.

Points

1 Rossi, 43; 2 Wickens, 28; 3 Costa, 27; 4 Panciatici, 15; 5 Vergne, 14; 6 Ramos, 12; 7 Move, 10; 8 Nebylitskiy, 8; 9 Grubmuller, 6; 10= Van der Drift/Berthon, 4.



Rossi came close to the perfect double in Spain



NORTHERN

Ex-BTCC champions James Thompson and Colin Turkington have headed to Scandinavia to earn their crust for this season. *JAMIE O'LEARY* finds out why

There's absolutely nothing new about touring car fans waiting with bated breath to see James Thompson and Colin Turkington take each other on. After all, they've been doing it in one way or another on circuits all over Britain since 2002.

This year, a new arena has been set for the battle between the former British Touring Car champions: both have moved north and will compete instead in the Scandinavian Touring Car Championship.

The creation of the STCC, by merging the Swedish and Danish tin-top series, has occurred largely due to the huge success of a four-round mini series, dubbed the Scandinavian Touring Car Cup, that ran alongside both national championships in 2010. Falling grid numbers meant that the Danish series, which sometimes failed to muster more than eight cars for a round last year, was dying a death anyway. Even so, the presence of just two cars from the old Danish

championship is disappointing.

Such a detail is not likely to bother Thompson, who has raced for Danish squad Hartmann Racing since 2008 (and secured back-to-back European Touring Car Cups with the team), but who has secured a plum drive with Volvo's in-house tin-top outfit Polestar Racing for the coming season.

The two-time BTCC champion has repeatedly had his quest to become the best on a world stage dashed by promising programmes (with Lada and N.Technology) collapsing around him. But he believes that what he now has with Volvo is a secure foundation on which to build.

"For years I've been looking for a manufacturer with a clear plan to go forward and win things and the resources to do it too. Volvo gives me that," says the 36-year-old.

"They want me to play a key role in not only racing the C30 in the STCC, but also in developing the WTCC car for next year. Plus, me and Robert [Dahlgren, last year's Scandinavian Cup

winner] will be testing road cars for Volvo as well, so they're really trying to involve me with everything."

Feeling comfortable within a team is one thing, but driving a touring car quickly is quite another. Fortunately for Polestar, Thompson's achievements speak for themselves, and he has raced in Scandinavia for long enough to know what goes on. However, he is not without his worries.

"Yes, I've raced in the Danish series, but I still don't have experience of the Swedish tracks," he points out. "Plus, in terms of testing, we did a couple of days at Barcelona in February and one day at Knutstorp last week, and that's it. The C30 looks like a very strong car, but then so do the BMWs, the VW Scirocco and the works Chevrolet. And my biggest rival is my team-mate Tommy Rustad, who won the Swedish title twice. I'm confident I can compete for wins, but I'm under no illusions that it's going to be a walkover."

Like Thompson, Turkington is keeping a lid on expectations. After



Head to head: Volvo, BMW, VW and Chevy

EXPOSURE

ending an eight-year stint in the BTCC by winning the 2009 title in a WSR BMW, and capping off a partial world championship campaign with a victory for the same team at Okayama, his switch to the STCC with Jan Nilsson's crack BMW squad, Flash Engineering, came as something of a surprise.

"I was looking at every option available, here and in the BTCC and WTCC," says the Northern Irishman. "Jan first got in touch a year ago about coming here, but I was so set on going to the WTCC with WSR that I didn't think about it too seriously.

"Jan got back in touch during the winter and I was very keen, especially as it was becoming really difficult to piece something together with WSR. It's a shame I couldn't stay with WSR, because I've spent eight of the last nine years racing for them, but I'm really excited about the new challenge."

Challenge is the appropriate word, for lying in wait for the British pair is a high-quality field of drivers in a variety of different Super 2000-spec cars.

"The BMW tends to be better on the twisty circuits, and there are a lot of them in this series"

Colin Turkington



Former BTCC champion and multiple WTCC race winner Rickard Rydell has an ex-RML Cruze fielded by Nika Racing-run Chevrolet Team Sweden at his disposal, while 2006 Formula Renault 3.5 champion Alx Danielsson will drive a SEAT Leon run by his own squad. Jan Magnussen is expected to squeeze in selected races

around his American Le Mans Series commitments in a Chevy Lacetti.

Not only that, but four-time Swedish champion Richard Goransson again heads the West Coast Racing BMW team, and fellow former title winners Fredrik Ekblom (VW) and Rustad (Volvo) are in the mix too.

It is the BMWs that have looked ▶



Airstream Skydeck



Europe's leader in American motorhome rental & sales



Fleetwood Revolution

We are currently taking bookings for all British and European Motorsport events for 2011

FOR SALE FINANCE AVAILABLE

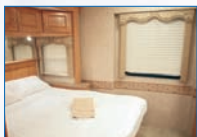

2008 36' Four Winds Magellan
Sleeps 4 in 2 double beds, electric roll out awnings, onboard generator. **£85,000**

FOR SALE FINANCE AVAILABLE



2007 29' Chateau Citation
Triple slide, Sky TV, DVD, air con. Sleeps 5 in 3 beds. 3,900 miles **£49,995**

FOR SALE FINANCE AVAILABLE

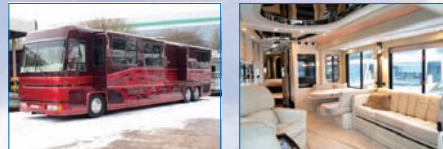

Jenson Button's 45' Newell - 2000
Double slides, cream leather, Satellite TVs, sleeps 6 in 3 beds. 64,000 miles. **£149,000**

For more information email simon@stingrayRV.com or call **0870 241 5614**

www.stingrayRV.com



The **vodafone** DMAX Championship 2011

The UK's fastest Arrive & Drive Two Stroke Race Series
Electric Start - Centrifugal Clutch - 22 BHP



Sunday February 20th	Milton Keynes
Sunday March 20th	Lydd
Sunday April 17th	Sandown Park
Sunday May 15th	PF International
Sunday June 12th	Milton Keynes
Sunday July 24th	Lydd
Sunday Aug 21st	Wilton Mill
Sunday Sept 11th	Milton Keynes
Sunday Oct 9th	Sandown Park
Sunday Nov 13th	Milton Keynes



AUTOSPORT

ROTAX
NEW AGE KARTING



Tel: 0845 644 5504
www.daytonamax.co.uk



Turkington's Flash BMW

◀ strongest so far, with Carrera Cup graduate Martin Ohlin (West Coast) and tin-top regular Johan Stureson (IPS Motorsport) emerging on top of last week's official pre-season test at Knutstorp, just ahead of Turkington.

"It's encouraging," says Turkington. "The BMWs tend to be better on the twisty circuits, and there are a lot of them in this championship, so that's probably why they're more competitive here than in the BTCC or WTCC. We need that, because we don't have standing starts in the STCC, so the big advantage of rear-wheel drive is done away with."

One of Turkington's major trump cards has been convincing John Morton, who engineered him to his BTCC title and WTCC victory, to follow him to Flash. Thompson is in no doubt that this will be a major boost to his rival's title hopes.

"John's one of the best around," says the bearded Yorkshireman. "He was my

engineer in Marco Calovolo, and between us we've got a great thing going and have won lots of races.

"He's off managing N.Technology's Ferrari Nurburgring 24 Hours project this year though, and the guy Polestar have given me doesn't have that much experience. It's another challenge, and I hope my experience of racing these cars can bring him up to speed quickly. There are so many good drivers here that it's going to be critical for us."

But just how has a new championship managed to muster such a high-quality field of drivers when its main rivals – the BTCC and WTCC – have lost so many of theirs?

"Money," says Turkington. "I heard that 10 drivers earned a wage in Sweden last year, which is a lot more than in the BTCC. The difference seems to be that the teams sort out the sponsors, not the drivers, and there are more businesses in Scandinavia who are willing to put in enough money to make sure the teams can afford good drivers, not just rich guys. Other championships could learn a lot from the STCC."

Thompson agrees: "Cash is not my prime motivator, but I'm a professional driver and I think I'm pretty good at what I do. I wouldn't ask an engineer or a mechanic to work for free, so why should a driver? That's what's stopped me going back to the BTCC and what's stopped a lot of these Swedish guys from going international. They don't need to. Why give up a good wage to scrimp together a budget to do a couple of WTCC races in a midfield car? It doesn't make sense."

Whatever happens at Jyllands-Ringen's opening round this weekend, both Thompson and Turkington have programmes that out-of-work drivers can only dream of, and numerous chances to add yet more tin-top victories to their CVs. Britain's loss is most definitely Scandinavia's gain. ❧

CALENDAR

- April 22
Jyllands-Ringen
(Denmark)
- May 7
Knutstorp
(Sweden)
- May 21
Mantorp Park
(Sweden)
- June 18
Gothenburg
(Sweden)
- July 2
Falkenberg
(Sweden)
- August 13
Karlskoga
(Sweden)
- August 28
Jyllands-Ringen
(Denmark)
- September 10
Knutstorp
(Sweden)
- September 24
Mantorp Park
(Sweden)

VIKING RACERS

Sweden has a long history of touring car racing dating back to the 1960s, but it was not until the success of Rickard Rydell in the BTCC in the '90s that the popularity of this form of racing exploded – helped enormously by TV coverage of Rydell's UK exploits and the domestic championship.

Peggen Andersson, whose son Per-Gunnar is now a WRC regular, was top dog before the Super Touring era, taking four crowns between 1987 and '93. This figure was equalled last year by Richard Goransson, while future DTM ace Mattias Ekstrom also came to prominence by taking the '99 crown.

Between 1991 and '95 there was a Nordic series that combined the best drivers from (predominantly) Sweden and Denmark in much the same way that the new Scandinavian championship is doing now. But it was Finn Mika Hakkinen who took the inaugural title in a BMW M3 – this was a one-off event at Alastaro.

With Super Production cars from 1999, Denmark's series began to attract bigger grids and then more prestigious names – such as Jan Magnussen and later James Thompson – when it aligned itself to the S2000 rules package that the rest of Europe was using midway through the last decade. Finland wasn't to be left out either, with a tin-top championship for Super Production cars run from 1996-2009.



Rydell's BTCC success boosted Swedish tin-tops



Turkington with John Morton

engineer when I won my 2004 BTCC title, and what he and Colin don't know about setting up that Beemer probably isn't worth knowing.

"Having that relationship with your engineer is crucial, which is why this year is a bit of an unknown for me. For the last few years I've had a brilliant

AUTOSPORT

CLASSIFIED

ROAD CARS FOR SALE **p 72**

WEB DIRECTORY **p 73**

TRAILERS & TRANSPORTERS **p 74**

RACE & RALLY CARS **p 76**

MARKETPLACE **p 77**

APPOINTMENTS **p 82**

PHONE 020 8267 5858 autosport.ads@haymarket.com

AC

AC HERITAGE Ac factory craftsmen - Restoration - Conservation - Fabrication - Jigwork - Aluminium Welding - lowbake paint system - Expert colour matching - Insurance Appointed - Full or Part restorations - Service - Parts - Transportation - (Official AC repair agent and distributor) www.acheritage.co.uk Tel Steve Gray - 01932 828545 - 07860 912217 - Brooklands - Surrey - England - KT15 3JE - Wanted Dead or Alive All Acs - Projects - Parts - Memorabilia

A Hawk Kirkham 289 Replica / The 289 and 427 SC are both available exact as original with the original spec. chassis and hand formed aluminium bodies. Body/chassis units fully wrapped with all internal panelling, foot boxes, doors, boot and bonnet, all fitted £23,500 + VAT. Agents for the UK and Europe. Hawk Cars Ltd, Oakdene, Riverhall Hill, Frant, E. Sussex TN3 9EP. Tel: (01892) 750341 gerry@hawkcars.co.uk

ASTON MARTIN

Aston Martin Factory quality Bodyshop For all Aston Martin cars, restoration, fabrication, jigwork, aluminium welding, low bake paint system, expert colour matching. Competitive rates, trade welcome. www.brooklandsmotorcompany.co.uk Brabham Buildings, Weybridge, Surrey. Tel: 01932 828545 or 07860 912217. Wanted dead or alive all Aston Martin, projects etc etc.

AUSTIN

Austin Healey 3000 MK3 BJ8 Phase 2 LHD Ex Californian car. Very original, structurally superb example finished in B.R.G. w/wheels & overdrive. £39,950 .9 other Big Healeys available. Largest selection in UK, we also offer the complete Austin Healey service. We will collect and deliver Nationwide. If you are selling, please ring 01723 361227 or 07831 830270 seven days a week or visit our website at www.murrayscott-nelson.com

BENTLEY

Bentley Azure 1996 One Titled owner, only 7,000 miles with 14 main dealer service stamps. £69,950 www.peter-byrne.com or Tel 0208 467 6916

CATERHAM

1600 Beaulieu NO 22 51 reg BRG Yellow Nose Band & Alloy, 5 Speed, 6,395 Miles, 13" Minilite wheels, Caterham Black Cloth Seats, 4 into 1 Exhaust, Motallita Steering Wheel, Heater, Full Weather Equipment, MOT In Excellent Condition Not To Be Missed. £12,995. Tel: 07831 240733 (T)

2000 R500 GWP Caterham R 500 101 Engine No 1 of 13, 6 Speed, 13" Split Rim Barbie Wheels with Avon CR500, Carbon Tillet Seats, Dry Sump With Oil Cooler and Apollo Tank, Large Bag Petrol Tank, Brake Bias Valve, Plumed in Fire Extinguisher, Pessent Engine Over haul, Gear Box and Diff Refurb, New Paddle Clutch, The car was Repaired early this Year, Colour Coded Full Cage, High Density Fog Light, 8,783 Miles, MOT, The car is in Stunning Condition. £25,000. Tel: 07831 240733 (T)

2001 1800 Roadsport 120 BHP 5 Speed, Silver black stripe, black leather Seats, 13" Minilite Wheels, Caterham 4 Point belts, Q Momo Wheel, Full weather equipment, heater, 26,000 Miles £13,500. Tel: 07831 240733 (T)

2001 1800 Roadsport 120 BHP 5 Speed, One Owner 6,700 Miles, Caterham Red With Black Cloth Seats, 14" Minilite Wheels, Heater, Full Weather Equipment, Excellent Condition £13,995. Tel: 07831 240733 (T)

2004 R300 SV DAV Upgrade 245 BHP 6 Speed Viper Blue With White Stripe Carbon Front & Rear Wings DAV Upgrade to 245 BHP Emerald ECU With Dyno New VHPD Head in 2007 when upgrade was done Omega Forged Pistons 15" R300 Wheels 6" Front 8" Rear Black Leather Seats Big Brake Kit Black Pack Apollo Tank Change Up Light Carbon Lights F & R White lenses Wide Track Nose Wings Q Momo Full Weather Equipment Plus Tonneau Cover 16,000 Miles Tons of Bills R 500 Power for a lot less money £23,500.00. Tel: 07831 240733 (T)

CATERHAM

2001 1800 Roadsport SV 185 BHP DVA 5 Speed DAV Upgrade With Throttle Bodies. Jaguar BRG White Nose Band. One Owner Factory Built. 8,000 Miles. DAV ported head. Paul Ivy valves 29.5mm inlet 16mm exhaust. Shimmed solid followers. Jemvey DHT throttle bodies. Piper cams verniers. Bernard Scouse airbox. Emerald ECU. Black Leather Seats. 16" HPC Wheels. Think Automotive Laminova heat exchanger. Pace Dry Sump. Brise Dry Sump Tank. Brise Competition Starter. Powerspeed 4-2-1 custom exhaust re-packable silencer. Freestyle Adjustable widetrack front suspension, DiDeion rear with watts linkage. Momo Steering Wheel. Starter button. Battery cut off switch. Black Pack. Carbon Stone Guards. Full Weather Equipment. Tonneau Cover. Heater. ONE OWNER 8,000 MILES ONLY in Lovely Condition £17,500. Tel: 07831 240733 (T)

2001 Y reg 1600 Roadsport SV 185 BHP 5 Speed DAV Upgrade With Throttle Bodies. Jaguar BRG White Nose Band. One Owner Factory Built. 8,000 Miles. DAV ported head. Paul Ivy valves 29.5mm inlet 16mm exhaust. Shimmed solid followers. Jemvey DHT throttle bodies. Piper cams verniers. Bernard Scouse airbox. Emerald ECU. Black Leather Seats. 16" HPC Wheels. Think Automotive Laminova heat exchanger. Pace Dry Sump. Brise Dry Sump Tank. Brise Competition Starter. Powerspeed 4-2-1 custom exhaust re-packable silencer. Freestyle Adjustable widetrack front suspension, DiDeion rear with watts linkage. Momo Steering Wheel. Starter button. Battery cut off switch. Black Pack. Carbon Stone Guards. Full Weather Equipment. Tonneau Cover. Heater. ONE OWNER 8,000 MILES ONLY in Lovely Condition £17,500. Tel: 07831 240733 (T)

CITROEN

Citroen DS Super LHD. Manual, one of the last produced. Tints, radio, stainless handles, interesting history. Rust-proofed from new. Genuine 66,000 miles. Virtually one owner. Chassis/ panel never welded. All original with history inc. build sheets etc. very rare in this original condition. £15,950. Tel: 01425 672260

LANCIA

LET US BUILD YOU a beautifully crafted re-creation of one of the worlds most successful rally cars of all time, the Stratos. The HF 3000 by Hawk Cars is available as a starter kit or as a fully finished ready to go car. For more details contact Hawk Cars Ltd, Tel (01892) 750341 gerry@hawkcars.co.uk or Talon Sports Cars Ltd who are now our official build agents for the HF 3000. Talon Sports Cars, Unit 23, Hatherware Industrial Estate, Station Works, Rempstone Road, Leicestershire LE12 5EW. Tel (01509) 842740.

LOTUS

Lotus 340R Lots of proper upgrades. £29,500. For more information please call Rod, Cambs 01480 431323 (W) or mobile 07710 012366 (before 10pm), email: rod@semcosigns.com

PORSCHE

PORSCHE 911 3.2 CARRERA TARGA (RHD) Very low mileage (49,000), three owner car with fully documented history from new. Supplied by AFN and finished in quartz metallic grey with 16" Fuchs wheels, no spoilers & sport suspension. Immaculate example. £15,000 Tel. 01260 223440 (CGOC)

RELIANT

Reliant Scimitar SE6 1976 Three owners, extensive history file. Up-rated engine, suspension, brakes. Mechanically excellent with many new parts. A very well sorted car. £3,500. Tel: 01905 830316

TVR

TVR T350C 2004/04 Pearl Blue with full cream/blue hide and air con. Only 5000mls from new with full service history. Possibly the lowest mileage T350 currently for sale. £24950. Adrian Blyth. Please see our website for full details. www.adrianblyth.com 01428 608255

UP AND COMING AUTOSPORT FEATURES INCLUDE:

DRIVES AVAILABLE

Got seats still available? Fill them in our feature.

DRIVING DEVELOPMENT

Get the next generation of drivers up to speed.

RACEWEAR FEATURE

Get the teams kitted out in your gear.

PRODUCT SHOWCASE

Let your latest products stand out in our showcase.

WORKSHOP FEATURE

Get your workshop equipment flying off the shelves.

COMING SOON

TRACK DAYS

Are you looking to promote track days in the UK or abroad? We have fanatical readers who fancy themselves as the next Lewis Hamilton and are looking for the perfect gift.

WEB DIRECTORY

ROAD CARS FOR SALE

WEB DIRECTORY

TRAILERS & TRANSPORTERS

RACE & RALLY CARS

MARKETPLACE

APPOINTMENTS

ACCOUNTANT

Get in pole position - 99% of our clients pay less than £200 in tax
 - 86% of our clients pay less than £300 for book keeping and accountancy fees.
 - 93% save more than £1000 by outsourcing their payroll to us.

0845 676 8890
www.intelligentbookkeeping.co.uk
motorsportaccountants@googlemail.com

AWNINGS

HAMILTON Motorsport LTD
 Suppliers of: Race & Rally Shelters,
 Minilite, Piloti, Moto-lita, Car Covers etc
www.hamiltongrouponline.com

EXHAUSTS

Inconel & Stainless Steel Specialists
SIMPSON
 Race Exhausts
 Tel: 01753 532222
www.simpsonraceexhausts.com

GEARBOXES

Gearboxman.com
 COMPETITION TRANSMISSION SERVICES
 Gearboxes and Axles for Road, Race, Rally, and more
 Telephone: 01582 840008, Fax: 01582 840007

GEARBOXES

ELITE
 Rally & Race Gearboxes,
 GearKits, LSD's and Driveshafts
 Tel: 01782 280136 Fax: 01782 269913
 Email: sales@eliteracingtransmissions.com
www.eliteracingtransmissions.com

HELMET GRAPHICS

Mike Fairholme Designs
 Sole approved painter of Arai helmets.
 Silver Birches, Corby Birkholme, Nr Grantham, Lincs NG33 4LE.
 Tel: 01476 550630. Fax: 01476 550029.
 email: fairholmedesigns@btconnect.com
www.fairholmedesigns.co.uk

MACHINERY

METAL WORKING MACHINERY
BAILEIGH
 INDUSTRIALS
www.bifabuk.co.uk

MEMORABILIA

FINAL LAP
 For Everything Formula One
www.finallap.net WE BUY AND SELL
 +44 (0)1245 287588 / 07771 920345

MEMORABILIA

JMJ AUTOMOBILIA America's #1 supplier
 of CART and Formula
 One Racing memorabilia. Large selection of signed
 original collectables. See our ad under marketplace
 Memorabilia. Call or fax or a mail listing at (609) 575 1143
 or visit our website @ www.JMJAuto.com

MERCHANDISE

LA PASSIONE
www.lapassione.co.uk
 Tel. 0113 285 7884 **NEW SITE**

MOTORHOMES

BRIAN JAMES TRAILERS
CLUBMAN
 Tel. 01327 308833
 Web. www.brianjames.co.uk

RACE PARTS

ARE DRY SUMP SYSTEMS
 ARMSTRONG RACE ENGINEERING INC.
WWW.DRYSUMP.COM (916) 652-5282

RACE PARTS

CARTEK
 Electronic Battery Isolators
 Don't compromise
 on Safety or Reliability
www.CarteKMotorsport.com

PIPER
www.pipercams.co.uk

RACE PRODUCTS

Pit to Car Radio
 0044(0)1508
 528837
www.raceradio.co.uk

demon tweeks
 MOTORSPORT
www.demon-tweeks.co.uk

RACE PRODUCTS

SCHROTH
 RACING
www.schroth.com

www.porscheshop.co.uk
PORSCHESHOP
 +44 (0) 121 585 6088

CHAMPIONS OF SAFETY
lifeline Motorsport Fire
 & Safety Systems
www.lifeline-fire.co.uk

Sabelt
www.moderacewear.co.uk

RACEWEAR

RACEWEAR

RACEWEAR MANUFACTURER
AWS
awsracewear.com

JJC race and rally
 PASSIONATE ABOUT MOTORSPORT
www.jjcraceandrally.com

CROYDON RACE & RALLY CENTRE
www.croydonraceandrally.co.uk
 220-222 Portland Road
 South Norwood
 London SE25 4QB
For Racewear & Motorsport equipment
 FORECOURT PARKING Tel: 020 8656 7031

GPR Grand Prix Racewear
THE RACEWEAR EMPORIUM
www.gprdirect.com

RACEWEAR

MPH PERSONALISED CLOTHING
www.MPHClothing.co.uk
 Motorsport Teamwear & Workwear / Embroidered & Printed
 0808 2255 674 / 07595 120063

msar LONDON
 MOTORSPORT
 SHOWROOM
www.msar.co.uk

piloti
 driving shoes
www.piloti-europe.com

ALL OMP RACEWEAR
 AVAILABLE NOW
www.ybracing.co.uk **OMP**

RACING OILS

WWW.ROYALPURPLE.CO.UK
ROYAL PURPLE
 SYNTHETIC RACE OILS
 01209 216 666

OLD HALL PERFORMANCE LTD
RED LINE tel: +44 24
 SYNTHETIC OIL 7671 7100
 fax: +44 24
 7671 7400
sales@redlineoil-europe.com www.redlineoil-europe.com

RACING

RACING CARS FOR SALE
 ALAN CORNOCK FCS
 BUYING - SELLING - BROKERAGE
www.racingcarsforsale.co.uk
 TEL: 01480 891212

STORAGE

LISTA
www.listacabinets.co.uk
 Tel: 01228560911 / 07733137911

AUTOSPORT.COM

TO ADVERTISE IN THE WEB DIRECTORY PLEASE CALL
 020 8267 5858 OR E-MAIL autosport.ads@haymarket.com

TRAILERS & TRANSPORTERS



Call Us Now! tel. 01327 263 384

www.woodfordtrailers.com sales@woodfordtrailers.com



RL 2000
£4,900 + vat



RL 3000
£5,950 + vat

Look Beyond

optional colour finishes shown

PRG Trailers | Cheshire | UK | Tel: +44 (0) 1270 812402
Web: www.prgtrailers.co.uk | Email: info@prgtrailers.co.uk

Evolution Raceboxes
We've Got it covered

GRP construction, purpose built body, all leading makes of trailers. Day living area available on larger trailers.

From **£4000**

07773069994 01253894268

ENTER NOW
BEAT THE GRAND PRIX PREDICTOR EXPERTS

Visit castroledgerankings.com/predictor

Engineered by
Castrol EDGE
Rankings



MONACO – Windsor RV 38 ft Quad Slide Out 6 Berth, only 7500 miles, yr Nov 2004, POA, Reg by Neg, A/C, Hyd Jacks, TV Sat System, Leather Chairs/ Sofa, Reversing Monitor, Invertor/Charger, 12V Awning, Alarm, NavTrak, Washer/Dryer, Microwave, 4 Door Fridge/Freezer, 2 x Sofas, Dsl Generator & Many More Features.

Contact **Arthur** Tel: **01621 776391** or arthur@bradwellmarina.com



Renault £15,000.00

Scania £25,000.00

SCANIA & RENAULT ARTIC RACE CAR TRANSPORTERS for sale

Each carries 4 racing cars, both are plated/tested and in perfect mechanical order, are very reliable, have good generators, sleeper cabs, full awnings (which do require repairs) although each truck would benefit from some cosmetic t.l.c.

The Scania has air suspension, fitted machine shop and extensive cabinets - the Renault has a good size drivers' lounge with fitted seating, wardrobe, cupboards etc. and extensive cabinets throughout the trailer.

Telephone: +44 (0) 1480 861233 | Fax: +44 (0) 1480 861313 | Mobiles: 07970 206661 or 206662
Email: hooleracing@btconnect.com | sid@hooleracing.co.uk | suze@hooleracing.co.uk

Advatec
International Transport Specialist

Classic & Vintage
Car Transport Services

Any Vehicle Any European Destination

0808 100 3550
www.advatec.co.uk

Advatec Transport - Part of the Belle Group
Visit our website for more information

Call today or go Online for a Free Quotation!

Uniquely, Brian James.

Our trailers constantly evolve and improve. Innovating to enhance user experience over successive generations is our way. Perhaps its in the DNA. As a result thousands of Brian James owners enjoy best available quality, reliability and functionality. Just ask one.

Motor Shuttle

A firm favourite for valuable race or classic car transportation. Whether as a part of a commercial operation or private individuals transporting their own race cars Motor Shuttle has an enduring quality and a timeless appeal, offering much more than any other transporter.

Motor Shuttle's capability extends to accommodating the widest, longest and heaviest vehicles.



Motor Shuttle
now with optional Alloy wheels
on Tri-Axle models

A-max range



Clubman range



TT Tilt-bed range



Race Shuttle RS5

Visit the brand new Brian James Trailers web site at www.brianjames.co.uk for full pricing details of the product range and our extensive national dealer network.

BRIAN JAMES TRAILERS

www.brianjames.co.uk

Tel. 01327 308833

ref. 11/04

RACE & RALLY CARS

DRIVING DEVELOPMENT

DRIVER & CAR DEVELOPMENT

FASTER, SAFER DRIVER COACHING FOR RACE & TRACK DAYS

Yorkshire-based (ARDS) race instructor Tim Harmer caters for all driving abilities and race circuits



"I approach each driver as an individual, therefore providing bespoke training to improve your skills"

DRIVER
ONE-TO-ONE INSTRUCTION
COST EFFECTIVE SHARED INSTRUCTION
BRITISH AND EUROPEAN CIRCUITS

CAR
FULL WORKSHOP SUPPORT
RACE PREPARATION
DESIGN AND ENGINEERING

Call Tim on 07779 250 882 www.revelationmotorsport.com

RALLY CARS



WRC S9 X TOMMI MAKINEN FULL PRODRIVE CAR
 New engine 0 miles
 Turbo rebuilt 0 miles
 Gearbox and diff only done 180k
 180k
 Gravel speck car
 8 Gravel wheels
 Clutch 180k - still on 0 shim
 Maintained by GJM regardless of cost
 Bargain at £95 k ono



MOB: 07831 535668
 E-MAIL: GEOFF@GJMS.BIZ
 CONTACT: GEOFF



C2 Max coming soon
Gp4 and Pinto hire car Coming soon (stage and Road rally)
GJM offers an on event Service:
 Car preparation
 Car setup
 Rally driving instruction

N11
 2 Rallies old + test
 Built with Prodrive bits
 EXTC suspension
 Prodrive Dog Box (can be bought with std 6speed 21k)
 R+D step 3 Cage
 Prodrive under floor Bag Tank Coralba
 4 Gravel and 8 tar wheels
 £26,500.00 ono

DRIVES AVAILABLE



DRIVE AVAILABLE FOR THE 2011 BARC FORMULA RENAULT CHAMPIONSHIP



As part of their multicar team MTECH Lite seek suitably funded drivers for the highly competitive BARC Formula Renault Championship.

For more information please contact **Dave Moore** at MtechLite on **07584 015 077** or david@mtechlite.co.uk

FORD

AJL Racing Ford GT 40 with FIA Papers ready to race



£250,000

Contact 01827 713335, E-mail peter.shead@arragonproperties.com

RACING CARS



INFORMATION & HISTORY ARE SOUGHT FOR THIS 1950s COMPETITION CAR
 QUALITY ENGINEERED FORD 1172 "COMPETITION SPECIAL" SUPERBLY MADE ALLOY BODY WITH TUBULAR SPACE FRAME & INDEPENDENT COIL SPRING SUSPENSION. FUEL TANK HAS BEEN REDUCED IN SIZE TO ONE GALLON AT SOME POINT IN ITS LIFE PROBABLY FOR CHANGE OF USE FROM RACE TRACK TO HILL CLIMB COMPETITION. THIS CAR HAS BEEN STORED AS IT IS FOR THE LAST FORTY YEARS & COMES WITH A COUPLE OF FORD ENGINES BUT PROBABLY NOT THE ORIGINAL. IF ANYONE KNOWS ANY HISTORY OR CAN POINT ME IN THE RIGHT DIRECTION TO OBTAIN IT I WOULD BE GRATEFUL. MORE PICTURES CAN BE SUPPLIED ON REQUEST. If you can help please make contact. Tel: 07831 715400 or 02476 349879 or: chapelendcars@yahoo.com or see: www.rjohnson.co.uk

2ND DRIVER WANTED

Running costs only, brand new Mosler GT, transporter supplied

POTENTIAL CHAMPIONSHIP WINNER, BRITCAR, DUTCH SUPERCAR, ETC. CHAMPAGNE HOSPITALITY & TV COVERAGE. BUDGET NEGOTIABLE.



Tel 07973 675 734

email fred-davies@live.co.uk

TO ADVERTISE IN THIS SECTION OF

AUTOSPORT

PLEASE CALL 0208 267 5858

MARKETPLACE

AWNINGS

Grumpygrip Ltd
Official UK main dealers for all shelters, spares, accessories and custom graphics.

E-Z UP® Instant Shelters
Tel: 01462 894479

Sizes 5'x5' up to 20'x20'.
Custom Graphics and Accessories

✓ Order by debit/credit card.
✓ Competitive prices.
✓ Next Day UK Delivery.
✓ Full Product Spares.

www.grumpygrip.co.uk
Sections 8/9 Unit 4
London Road Ind Estate
Baldock
Hertfordshire
SG7 6NG

FLOORING

Kiwi Tiles
Interlocking Plastic Floor Tiles, as used by leading race teams throughout Europe.

- ◆ Easy installation & removal
- ◆ Many colours
- ◆ Lightweight
- ◆ Strong & durable
- ◆ Self draining
- ◆ Compact & easy to store
- ◆ Top quality
- ◆ Value for money

Stock Colours:
Red, Blue, Green, Yellow,
Silver, Orange, Grey,
Black, White, Dayglo Red

Ralt Engineering
Tel: 01865 883354 Fax: 01865 883789
E-mail: enquiries@kiwitiles.com
Web: www.kiwitiles.com

HOSPITALITY

5* HOSPITALITY @ OULTON PARK

OUR **LUXURY OLD HALL SUITE** CAN COMFORTABLY ACCOMMODATE UP TO **25 GUESTS**. WITH PANORAMIC VIEWS OF THE START LINE, PITS AND THE FIRST CORNER.

WHAT YOU GET...

- Experienced host
- Privileged parking
- Entrance tickets into circuit & suite
- Flat Screen plasma TV's with race & timing feeds
- Air conditioning
- Privileged view of start line, pits & Old Hall corner
- Coffee & breakfast
- Luxury 3 course buffet lunch
- Afternoon tea & cakes
- Complimentary bar serving beer, wines & soft drinks all day long (main events only)

PRICES FROM
£75
PER PERSON + VAT

UPCOMING EVENTS

MODIFIED LIVE APRIL 16TH **BRITISH F3/GT** APRIL 23RD - 25TH **BRITISH TOURING CARS** JUNE 4TH - 5TH

BOOK YOUR PLACE NOW 01204 669566
OR EMAIL CHRIS@ABSOLUTERACING.CO.UK
FOR MORE INFO VISIT US AT WWW.ABSOLUTERACING.CO.UK

absolute racing

COMPETITION DIFFERENTIALS

GRIPPER DIFFERENTIALS LIMITED

Multi plate LSD's

Peugeot 205-£625.00. Peugeot 106 inc c/wheel £700.00. F/drive pinion £245.00.
Renault Clio £750.00. Clio CWP 14/60, 13/59 & 12/63 £450.00.
VW Polo £625.00. VW 02A/J £625.00. VW 02Q/M £785.00. VW 020 £625.00.
Astra F20 £625.00. BMW 188 £850.00. BMW 210 £850.00.
Ford Atlas £745.00. English Ford £625.00. Cosworth 7.5" £750.00. Cosworth 7.0" £625.00.
Honda Y21 £625.00. Honda R type £625.00.
Jaguar 4HA&HU £850.00 Alloy body £950.00.

We have a full range of Historic Race and Rally car Lsd units. We specialise in the manufacture of one off units from £900.00. If we cannot make it, no one else can.

These prices do not include VAT. Fitting and installation service available.

LIFETIME GUARANTEE

Phone: 024 7663 8564

Fax: 024 7658 1852

sales@gripperlsd.com

For more information please visit www.gripperlsd.com

ENGINES

Xtec ENGINEERING
Championship winning engine rebuilding and preparation
Modern and Historic
Contact Paul Knapton
01922 454 858
paul@xtceengineering.com

ENTER NOW

BEAT THE GRAND PRIX PREDICTOR EXPERTS

Visit castroledgerankings.com/predictor

Engineered by
Castrol EDGE
Rankings

MEMORABILIA

F1 COLLECTORS .COM

#1 FOR F1 MEMORABILIA
We buy and sell F1 items
AYRTON SENNA specialists
Call CHRIS GRINT 01763 274448
email: sales@f1collectors.com

WHEELS & TYRES

FOR ALL YOUR
AVON TYRES MOTORSPORT
RACING TYRES
Inc. ACB 10 Formula Ford
Contact

BMTR LTD

Tel: 0121 331 1122
Fax: 0121 331 1144
email: sales@bmtr.co.uk
see our new web site at www.bmtr.co.uk

JMJ Automobilia

SUPPLIERS OF RACE MEMORIBILIA SINCE 1992

Florida, USA (609) 575-1143

email: JMJAUTO.COM
WWW.JMJAUTO.COM

INSURANCE



Lloyd, Trainer & Sales Clerk.

The winning team for motor insurance.

Adrian Flux Insurance Services will provide you with a tailor-made quote based on your own personal requirements and driving history. Call us today for a free quote.

FREEPHONE
0800 081 8989

Quoteline hours: Mon to Fri 9am-7pm | Sat 9am-4pm

adrianflux.co.uk

Authorised and regulated by the Financial Services Authority.

ADRIAN FLUX



ROAD CARS FOR SALE

WEB DIRECTORY

TRAILERS & TRANSPORTERS

RACE & RALLY CARS

MARKETPLACE

APPOINTMENTS

THE NATIONAL KIT CAR MOTOR SHOW 2011

STONELEIGH

» **BANK HOLIDAY WEEKEND** Sunday 1st & Monday 2nd May 2011 «



The **BIGGEST** kit car show in the WORLD!

THE ANNUAL MECCA FOR ALL KIT CAR ENTHUSIASTS

4000 KIT CARS ON DISPLAY



complete **KITCAR** show sponsor

at **STONELEIGH PARK**
ROYAL SHOWGROUND,
STONELEIGH,
Nr. KENILWORTH,
WARWICKSHIRE
CV8 2LZ

GATES OPEN EACH DAY

9.30am – 5.00pm

BE THERE!

DIRECTIONS

From London M40:

Exit J15. A46 to A452. B4113

From M6 or M69: Exit M6 J2 to join A46.

M69 to A46. Exit A46 to join B4113.

From M1 Northbound: Exit J21, M69,

A46, Exit A46 to join B4113.

TICKETS

Advance Tickets: £12*

Available until 21st April

Accompanied children (under 16) FREE

Tickets on the Door £15

Accompanied children (under 16) FREE

FREE Show Guide

FREE Parking

ALL ENQUIRIES
TELEPHONE

01406 372600

01406 372601

*Credit and Debit Card bookings are subject to a 50p booking fee per transaction.

JOIN THE STARS!

Perry McCarthy (Original Stig) & Mark Blundell



Sunday



Monday

MANUFACTURERS' NEW LAUNCHES
400 Trade Stands in 5 Exhibition Halls plus 300
Outside Trade & Club Stands in over 5 Acres!

PLUS: LIVE ACTION

HAVE A GO!



THE DAKAR 4X4 EXPERIENCE



750 MOTOR CLUB DISPLAY



WESTFIELD TEST CIRCUIT



MONDAY JENNIFER METCALFE
HOLLYOAKS' MERCEDES MCQUEEN

complete **KITCAR** night out

MUSIC NIGHT SUNDAY
LIVE BAND

CAMP ON SITE

Camping & caravanning available from midday Saturday 30th April.

Book now: www.nationalkitcarshow.co.uk

FREE

» **SHOW GUIDE**
» **ENTRY FOR KIT CAR DRIVERS***

*(For drivers arriving in their kit cars on the day!)

MARKETPLACE

INSURANCE

Product & Public Liability



Cover includes:

- * Product Liability for Manufacturers
- * Public Liability for any Motorsport Risk
- * Liability for Circuit Owners & Event Organisers

We offer tailor-made packages to suit your individual needs
To find out more call 0207 929 6880 or email
motorsport@oamps-sr.com

www.oampslondon.com/motorsport

Oamps Special Risks is authorised and regulated by the FSA Reg. No. 307958 | La016 Feb 2011

RACE PRODUCTS

• EXPERT ADVICE • MASSIVE STOCKS • RAPID DELIVERY

www.demon-tweaks.co.uk



DON'T DELAY, CALL TODAY
0844 375 2196

demon tweaks
MOTORSPORT *Direct*

LOW CALL RATE CALLS MAY BE RECORDED FOR TRAINING PURPOSES

London Motorsport Showroom

www.msar.co.uk



ORDER HOTLINE: 020 8655 7877



"Fuel Pumps for the Professionals"

- ALFA
- BMW
- CITROEN
- FIAT
- FORD
- HONDA
- LANCIA
- MAZDA
- MITSUBISHI
- NISSAN
- PEUGEOT
- SUBARU
- TOYOTA
- VAUXHALL



Genuine Pumps
UK Distributor

Original Equipment
Formula One
Race Teams
Rally Teams
Military

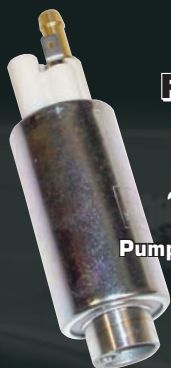

FAST ROAD
'IN TANK PUMP'
UPGRADES

From **£56.20**
Pump kits..... **£60.40**

NEW
EVO 10

Motorsport
Pump Kit

TOP SPEC - 255 LTR/HR
'HIGH FLOW' +
'HIGH PRESSURE'
£139.00

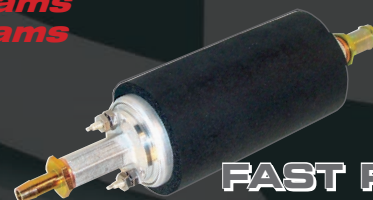

From **£97.52**
FAST ROAD

'OUT OF TANK'
REPLACEMENT PUMPS
For (BOSCH)
(PIERBURG)
(LUCAS)

JIC - 8

MOTORSPORT

350 BHP From **£77.60**
190 LTR / HR

500 BHP From **£79.90**

TOP SPEC - 255 LTR/HR
'HIGH FLOW' + 'HIGH PRESSURE'

Motorsport pump kit prices....**£86.55**



JIC - 6

MPB001B
MOTORSPORT
MOUNTING BRACKET

From **£116.45**
MOTORSPORT

280 LTR / HR
(180 LTR / HR @ 3 BAR)
5 BAR FUEL PUMP

Tel: +44 (0) 1784 493 555
Fax: +44 (0) 1784 493 222
Email: sales@glencoeltd.co.uk
Web: www.fuelsystem.co.uk



Prices exclude VAT @ 20%

TO ADVERTISE IN THIS SECTION
PLEASE CALL 0208 267 5858



ROAD CARS FOR SALE

WEB DIRECTORY

TRAILERS & TRANSPORTERS

RACE & RALLY CARS

MARKETPLACE

APPOINTMENTS

MARKETPLACE

Grand Prix Racewear

DRIVEN BY PASSION

RACEWEAR EMPORIUM



gprdirect.com



SPARCO OMP ALPINESTARS ARAI BELL PUMA SCHROTH CARBON X LITE MOLECULE HANS TW STEEL

BELL MAG 1 £169.00	RZ 860 £165.00	ARAI CK-6 £364.99	BELL RS3 PRO £395.00	ARIA GP 65 £624.99	BELL HP3 £2129.00	ARAI GP-6 RC £2749.17

DYNAMO £443.38	SPRINT £225.00	GP PRO LM From £708.29	TRIONFO £890.00	PUMA £63.63	DAYTONA £146.96	OMP TRS £119.60
FREE SAMPLE						
				LAND £42.60	SLALOM £99.95	SPRINT £129.00
FREE SAMPLE						
				TECH 1 £58.29	FUTURE CAT £123.63	RACETECH From £365.00
FREE SAMPLE						
				WINS EVO £73.91	TECH 1-T £145.79	CLUBMAN £122.17

HUGE STOCK IN STORE & ONLINE GPRDIRECT.COM

BALACLAVA From £17.50	SPORT £358.00	PYROMETER, PRESSURE, MEMORY £349.00	MULTI CAR WATCH £73.00	HD HERO CAM £254.46	TYRE GAUGE From £18.50
VEST From £42.00	PRO From £704.00	WIRELESS SCALES £1602.03	MIRRORS From £22.50	EXTINGUISHERS From £41.25	UK GUIDE From £39.99
PANTS From £35.50	SOCKS From £13.10	GLOVES £10.95	GLOVES £10.95	EXTINGUISHERS From £41.25	UK GUIDE From £39.99

ORDER ONLINE GPRDIRECT.COM 01327 855 585



CALL FOR YOUR
FREE
CATALOGUE



No 1, Silverstone Circuit, Silverstone, NN12 8TN 01327 855 585 **OPENING HOURS** Mon - Fri 9 - 6 Sat 9 - 4

PRICES + VAT

RACE PRODUCTS

WWW.REIGERSUSPENSION.COM

REIGER Racing Suspension

info@reigersuspension.com

The best suspension for:

- Rally
- Rallycross
- Autocross
- MotoCross
- Quads
- Sidecar Cross
- Rallye Raid

Reiger Suspension BV
Molenenk 5a
NL-7255 AX Hengelo Gld.
Tel: +31 (0)575-462077
Fax: +31 (0)575-463316

TRACK DAYS

ULTIMATE SUPERCAR

DRIVING EXPERIENCE

FOUR AMAZING DRIVES!
Ascari GT3 Race Car, TVR Sagaris Super Sport, Porsche GT3 Oakley Race Car, and Murcielago LP640!
A track day experience like no other ever offered before!

Normally retails at **£625** book now **ONLY £99.00** limited availability

This offer can be booked today and may be used anytime within the next 6 months. FOUR mind blowing drives on our purpose built 1.8 mile F1 style test track including an unbelievable hot lap in our Ascari KZ1-R GT3 Group B championship winning race car with ex F1 racing driver!

PLUS!
Professional safety briefing and track familiarisation laps with a professional race instructor. A mind blowing adrenaline pumping experience - only known by the likes of Hamilton and Button!

SUPERCAR Lifestyle

Call 01782 822 655 | www.supercarlifestyle.co.uk

AUTOSPORT

MISSED AN ISSUE?
THEN CALL OUR BACK ISSUE HOTLINE
08456 777 817

RACE PRODUCTS

UK manufacturer of performance transmission & driveline components

- Bespoke design and manufacture
- Digital design & development
- Gear cutting & super finishing
- Gearbox overhauls
- Servicing & spares
- Manufactured in UK

NEW 2011 Catalogue
Order yours TODAY

TRAN-X

It's all in the detail.
www.tran-x.com
T: +44 (0) 24 7665 9061

LSDs from £535.80
Half Shafts from £386.40
Gear Kits from £714.00
Gear Boxes from £1104.00

VALETING PRODUCTS

- reduces brake dust by up to 75%
- ultimate protection & shine
- no harmful abrasives
- easy on / off

Trade enquiries, T: 01920 420868, info@smartwax.net
Smartwax UK Limited
Tel. +44 (0) 1920 420868
Available at good car accessory shops
www.smartwax.eu

RimWax is amino functional heat resistant wax for all wheels & metal surfaces. Cleans, polishes, shines & protects. Bonds to wheel surfaces, delivering a slippery non-stick surface shield that deflects damaging brake dust and dirt.

the ultimate wax for rims
the ultimate add-on item



smartwax
solution in car care born in california U.S.A.

APPOINTMENTS



Truckie required, must have relevant International experience at GP2 series or similar level. iSport are offering a competitive remuneration package, with excellent working conditions.

Applications including a current CV and references should be sent to **Pat Precious, iSport Racing Limited, Unit 6 Oaks Farm, Besthorpe Road, Carleton Rode, Norwich, NR16 1NF** or emailed to pat@isportinternational.com

iSport International Limited
Unit 6 Oaks Farm, Besthorpe Road
Carleton Rode, Norwich
Norfolk NR16 1NF, UK



Our Oxfordshire based engine shop has been rebuilding and uprating 911 air cooled engines for over 35 years, while our extensive 'Silsleeve' programme caters for 996, 997 and Boxster engines.

EXPERIENCED ENGINE BUILDER

We are looking for a highly competent fully qualified Engine Builder with the potential to assist in further developing and expanding our well established Engine Shop.

The successful candidate will have extensive experience of high performance engine building as well as the versatility to assist in the workshop when required. Knowledge of modern automotive technology, computer literacy, attention to detail and excellent time-management skills are highly desirable. Porsche experience preferable but not essential.

Salary dependent on experience, circa £30,000 p.a. plus O/T.

Please apply with a covering letter and C.V. by email to porsche@autofarm.co.uk



At McLaren we believe that anything is possible. We know what it takes to win & we achieve this by working together & encouraging innovation in an extraordinary high performance environment.

MULTI BODY SYSTEM ENGINEER

We have an opportunity for a Multi Body System Engineer to join our Structural Design and Materials team based in Woking, Surrey.

Applicants must possess a working knowledge of multi body system codes (ADAMS or Simpack) including flex bodies and ideally have a basic knowledge of finite element analysis. The calculation of internal dynamics and the development of durability tools, particularly on powertrain applications, will be an essential part of this role and candidates should possess basic CAD skills.

As with all professional motorsport roles the candidate must demonstrate the ability to work in a well organised manner, effectively, precisely and neatly in a high pressure environment, delivering results to tight deadlines with excellent communication skills.

For this role we offer a competitive package including private healthcare, access to an executive car scheme and company pension scheme. If you think that you have what it takes then please send your C.V. to mclarenhr@mclaren.com. Please detail your salary expectations and the job title you are applying for. Applicants must have the right to work in the UK on applying for this position.

Closing date for this role is 4th May 2011.



French racing car constructor offers three challenging opportunities to work for immediate start in its factory, located at the Magny-Cours circuit:

SENIOR CHASSIS DESIGN ENGINEER (permanent)

In charge of the technical follow up and development of a single seater project, working on various chassis components and assemblies. Some track support will also be required. Good understanding of car performance and strong mechanical design skills (Catia V5). Knowledge of FEA and/or surface design appreciated. Previous experience within a motorsport design office environment is required.

SURFACING DESIGNER (4 months contract)

Design of bodywork parts and associated tooling (moulds and patterns) as well as detailed drawings for production. Solid knowledge of Catia V5 surfacing required.

SPARE PARTS STOREMAN (permanent)

Delivery and dispatch, inventory management, customers relationships, travel to Intl tracks.

French/English required for the 3 positions.

To apply please Email CV and covering letter to: jobs@mygale.fr Details on mygale.fr



LOOKING TO RECRUIT FOR 2011? THE LATEST SELECTION OF MOTORSPORT JOB VACANCIES UPDATED EVERY WEEK.

- The appointment page of the website receives on average 200,000 page impressions per month
- The magazine you are looking at has a readership of 139,000 (Source: NRS Survey Q3)
- All appointment adverts placed in Autosport magazine are listed on the website.

Company	Job Title	Publication Deadline
A leading UK motorsport organisation	Data/Systems Engineer (Fixed Term Contract)	10 February 2011
Castrol	Various Vacancies	10 February 2011
Grand Prix Racecar	Retail Sales and Business Development Account Management Vacancies	10 February 2011
BMW Group, Home Power GT	Various Vacancies	10 February 2011
Lotus Renault GP	Various Vacancies	10 February 2011
Honda GP Refractory Formula One Team	Various Vacancies	10 February 2011
Hofor Racing Ltd	Race Team Truckie (Class 1)	10 February 2011
Rockingham	Event Coordinator - Carby, Northamptonshire	10 February 2011

WHERE ARE YOU ADVERTISING YOUR MOTORSPORT JOB VACANCIES?

We know you're into cars but do you have a passion for motorcycles?

4th Dimension, a FastTrack 100 Company, provide innovative solutions for Motorcycle manufacturers, insurers and brokers in Motorcycle insurance claims management, network management and engineering services, as well as having franchise dealership retail operations.

The company is passionate about its people, innovation, quality-output and delivering exceptional customer service. At our specialist engineering and repair facility in Egham, Surrey we have the following opportunities.

Motorcycle Damage Estimator/Assessor Up to £35,000 dependant on experience

An ideal candidate will be a fully qualified experienced technician or highly experienced Motorcycle parts executive who is looking to move into a customer liaison role whilst maintaining hands on experience. A candidate with experience within a technical department of a manufacturer would also suit this position.

This is a varied customer-facing role where methodical attention to detail, quality of service delivery and exceptional telephone and face-to-face communication skills are essential.

Working with all motorcycle makes/models, you will undertake detailed damage and condition assessments on motorcycles and deal with a variety of customers, clients, their agents and suppliers in servicing the customer. You may also work with customers on specialist bespoke design and customisation of their motorcycle.

You must have a full motorcycle licence and be computer literate. Experience in utilising manufacturer parts catalogues is an advantage.

Based at Egham, Surrey; Monday to Friday.

Motorcycle Technicians Up to £27,000 dependant on experience

Candidates can either be semi or fully qualified but must have extensive technician experience.

Working with all makes and models you will be working with a professional highly motivated team in a modern workshop environment where quality and attention to detail is the prime focus.

You must have a full and preferably clean motorcycle licence and have a 'can do' attitude to integrate well within the team.

Based at Egham, Surrey; Monday to Friday.



Please apply in confidence with your full CV, advising current salary details. Submit your application by email to nicky.edge@4th-d.co.uk or call 08430 500567

autosport.ads@haymarket.com

To advertise call 020 8267 5027

Build Your Dream!

05717 1:24 Vodafone McLaren Mercedes MP4-25 (L. Hamilton & J. Button)



British Steel



1:24 Vodafone McLaren Mercedes MP4-25

05717

The Vodafone McLaren Mercedes team's 2010 chassis, the MP4-25, was an aggressive evolution of its race-winning '09 car. Unlike its predecessor, however, the MP4-25 was designed to fully exploit regulations which permitted double-diffuser under-body aerodynamics. In addition, further development to the floor was carried out during the season to harness the aerodynamic benefits of the engine's exhaust gases over the rear diffuser.

In Lewis Hamilton's hands, the car took notable victories in Istanbul, Montreal and Spa-Francorchamps. While reigning world champion Jenson Button took a memorable wet-weather victory at the Australian Grand Prix, following it up two races later with another victory in the wet in China.

Model-details:

- Highly detailed front and rear wings
- Multi-part eight-cylinder engine
- Detailed front and rear suspension
- True-to-original underfloor including diffuser
- Authentic tyres and rotating wheels
- Detailed cockpit
- Authentic decals for the MP4-25 in the GP versions for Bahrain, Canada and Great Britain

For more details on these brand new 1:24 scale model kits as well as the complete range of Revell products check out our International website at www.revell.eu

Available from branches of



and all good Toy & Hobby Stores.

Revell GmbH & Co. KG,

Orchard Mews, 18c High Street, Tring, Herts HP23 5AH. Tel: 01442 890285. Fax: 01442 827919.

Email: ukbranch@revell.de Trade enquiries welcome.

©Revell is the registered trademark of Revell GmbH & Co. KG, Germany. All rights reserved.



Build Your Dream!

Mini mania!



Sunoco is the official fuel of



Season premier for Mini Challenge and GT Cup at Silverstone, both part of the new and exciting Sunoco GRAND-AM 200 Challenge, and what a start for Jason Richardson in the Mini Challenge: Jason was near to perfect with a pole, two race wins and two fastest laps. In GT Cup Sunoco powered Andy Ruhen also had a strong start. However, be assured that the rest of the 90 registered racers in the Sunoco GRAND-AM Challenge will be in hot pursuit!

Design by Paradisi • Photos by Oliver Read



Sunoco GRAND-AM 200 Challenge – latest results*



Driver standings – average per race		www.grand-am.com	*correct at time of print				
1	J Richardson	Dart Motorsport/MINI	130.00	6	S Treherne	Handy Motorsport/Legends	64.17
2	A Ruhan	JMH/GT Cup class 1	99.00	7	J Cook	Cooksport/PTC	63.00
3	A Churchill	Courtenay Sport/PTC	90.00	8	C Broster	ABG/GT Cup class 2	63.00
4	A Steele	MSV F3	80.25	9	S Belcher	Handy Motorsport/Legends	59.17
5	C Needham	MSV F3	80.25	10	L Caudle	EXCELR8/MINI	57.50

Eligible championships:
 Mini Challenge, MSV F3
 Cup, Legends, Production
 Tourcar Trophy, Britcar
 Production and GT Cup

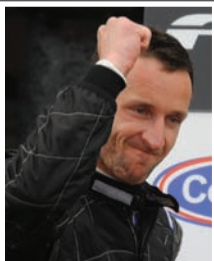

Anglo American Oil Company

+44 (0)1929 551557 (tel) +44 (0)1929 551567 (fax) info@aaoil.co.uk www.aaoil.co.uk

Sports Extra

NATIONAL RACING • HISTORICS • CLUB • RALLY • RALLYCROSS • HILLCLIMB



After contact, Bgatov (55) and Chapman both hit barrier



Bgatov gets launched towards gap in debris fence



Bgatov flies through gap as Chapman is caught by the fence



Marshals take cover as the cars roll either side of the fencing



Bgatov's car smashed outer fence before coming to rest

AUTOSPORT SAYS...

KEVIN TURNER
NATIONAL EDITOR

kevin.turner@haymarket.com



EVERY NOW AND AGAIN WE

seem to go through a spell of accidents. The Brands Hatch crash was particularly bad, but there were plenty of incidents at Donington Park last weekend too.

Of course, with so much competitive and close racing, accidents will happen. No blame has been apportioned in the Brands crash, but generally too many drivers get away with too many dubious, or plain outrageous moves.

Getting drivers to behave correctly as early as possible is clearly a good idea, which perhaps explains why even Ginetta's Lawrence Tomlinson has expressed some sympathy with Hillspeed boss Richard Ollerenshaw's view that contact incidents in Ginetta Juniors need to be reduced (see page 86).

Such youngsters are influenced by the actions of drivers in higher categories and the BTCC field did not set the best example at Donington.

All the more reason for stewards and clerks of the course to get tough. We all like a good race, but having cars flying off the track is dangerous and expensive. And it shouldn't decrease overtaking because it is often in defence that drivers make their worst moves.

As for the circuits, there is no need for knee-jerk reactions. Like all modern tracks, Brands is safer now than it has ever been. That doesn't mean developments should stop, but it is worth remembering that there is always the chance of a crash that nobody can prepare for.

Extra contact details

Ben Anderson, editorial assistant
ben.anderson@haymarket.com

Brands to investigate after crash breaches its defences

Toyota MR2 racer lands in public area after clash on start-finish straight

BRANDS HATCH BOSS Jonathan Palmer is to launch an investigation after Toyota MR2 racer Andrei Bgatov crashed into an area open to the public at the 750 Motor Club meeting last weekend.

Bgatov and rival Zac Chapman collided at an estimated 90-100mph approaching Paddock Hill Bend on Sunday. The Russian's machine flew through a gap for ambulance access and came to rest upside down in the external access road, having been flipped by an outer fence it tore down as it descended.

AUTOSPORT understands the accident was caused when the duo inched past leader Roland Wilkinson as they passed the pits.

Wilkinson was pincered from both sides as the trio went up the rise on lap 10. Chapman's red car turned sharp

left into Bgatov's black version and they charged the guardrail. The flattened barrier launched both cars above the 1.9-metre gabion [fenced stone] wall, whereupon Chapman's rode around the debris fencing before cartwheeling back into the gravel. It landed on its wheels and he emerged with bruises.

Bgatov was taken to Darenth Valley Hospital by road (the Kent Air Ambulance was on standby) with concussion and suspected bruising to the brain, but was expected to be released this week. Nobody else was injured.

Despite the ends of Bgatov's MR2 being crushed, its custom-designed roll cage maintained the cockpit's integrity.

MSA circuit inspector John Symes was summoned from home nearby following the accident. "During all my years working at Brands I've not seen a

similar accident," he said.

Palmer told AUTOSPORT he would be looking into the crash. "It was a very dramatic and unusual accident and the most significant thing is one of the cars ended up in what could have been a crowd access area," he said.

"We're pleased no one was injured, but it needs urgent investigation."

Palmer does not anticipate the area being closed off to spectators, but expects some modifications to the debris fence.

"We'll be looking at it in detail and I have little doubt we'll re-align the fence to eliminate the gap," he said.

The MR2 incident comes less than 12 months after a SEAT Supercopa car vaulted barriers on the run to Stirling's on the GP loop. Since then, the fence has been moved back and there is no public access to the area where the SEAT landed.

PICCS: BRYANT/SHAPPI/RACERS, STEVE JONES

CONTENTS

p90 REPORTS
BRSCC/750MC

p92 REPORTS
MSVR/BARC

p94 SEASON PREVIEW
BRITISH GT



Mallock won with KTM X-Bow in 2010

British GT

More aces to British GT

Carrera Cup champ, ex-Clio Cup ace and European GT racer all sign-up

Bridgman tested GT3 R at Snetterton

FORMER PORSCHE Carrera Cup champion Tim Bridgman, tin-top ace Stefan Hodgetts and GT racer Michael Mallock will all join the British GT season opener at Oulton Park this weekend. Bridgman will share a Trackspeed Porsche 997 GT3 R with Gregor Fiskens. "I'm pleased to be joining Trackspeed alongside Gregor for what looks set to be one of the most competitive seasons of British GT for many years," said

Bridgman. "With a strong car, a strong team and a strong co-driver I think we have every chance of success." Hodgetts will also appear in the main GT3 class at Oulton, sharing a JHR-run Ginetta G55 with former GT Supercup runner Adam Morgan. "It's a one-off at the moment to see how it goes," said Hodgetts, who believes JHR's experience in the Renault Clio Cup will help its expansion into GTs. "As long as you can run competitively

in a high-class championship you can get on top of a car – they're a very professional outfit." Mallock will again team up with Greek Athanasios Ladas in an ABG Motorsport GT4 KTM X-Bow, a pairing that won at Rockingham last season. "It's great to have a full-time programme in the UK after several seasons based in Europe," said the 28-year-old. "The KTM is a great little car and the target is the GT4 title."

Also in the GT4 entry is Formula Renault convert David McDonald, who will share Scuderia Vittoria's G50 with ex-Caterham Superlight champion Dan Dennis, and the similar machine of Century Motorsport, which will be driven by former Trofeo Abarth 500 GB racer Josh Wakefield and single-seater graduate Jake Rattenbury.

[P94 BRIT GT PREVIEW](#)

British GT

G55 gains GT3 homologation

GINETTA'S NEW G55 HAS GAINED its GT3 homologation, just ahead of its scheduled British GT debut at Oulton Park this weekend.

Four G55s are entered for Oulton and the model passed the national homologation tests it requires to run in GT3 last week.

Ginetta boss Lawrence Tomlinson said: "We've been working quite hard on that and we've been fully supported by [British GT promoter] SRO and the [governing body] MSA."

Tomlinson conceded that the car will be off the pace in its initial 370bhp spec, but confirmed upgrades were planned.

"The teams know we'll start with a lack of power and hopefully over the course of the year we'll develop it," he said.

Tomlinson believes the experience gained with the G50Z, which ran in British GT's Invitation class at GT3 pace in 2009, will help.

"We balanced that car and it helped us to decide where to pitch the G55 – we reckon 420bhp will get the G55 to where the G50Z was," he added.



G55 has gained clearance to race in British GT3

Ginetta Junior

Hillspeed slams junior driving

LEADING GINETTA JUNIOR TEAM boss Richard Ollerenshaw has called for a clamp down on "completely unacceptable" driving standards in the age-capped series.

Hillspeed's Struan Moore was among several drivers caught up in incidents at Donington Park last weekend and Ollerenshaw feels contact driving is too frequent.

Ollerenshaw said: "Some drivers are completely out of control. Ginetta Junior is a fantastic series but the standards so far have been appalling."

"Drivers are leaning on others like they see in touring cars and blatantly running people off the road, which is



Robertson incurred the wrath of officialdom

bad sport and extremely dangerous." Charlie Robertson was excluded from race two and penalised four points on his licence and Ginetta boss Lawrence Tomlinson has vowed to stamp out any more bad driving.

Tomlinson said: "Ginetta are interested in quality not quantity and will have no problems excluding drivers, teams, or dads/managers should standards not improve."

EVERY type of insurance that ANY person involved in Motorsport may require

MIS MOTORSPORT
INSURANCE
SERVICES

ON EVENT - PERSONAL ACCIDENT -
MOTORTRADE - COMMERCIAL - LIABILITY

www.rallyinsurance.co.uk or call 01943 884555

Motorsport Insurance Services Limited is Authorised and Regulated by the Financial Services Authority

Formula Renault UK

Fortec drivers excluded after technical checks at Donington

FORMULA RENAULT UK TITLE

favourite Alex Lynn and Fortec team-mate Oliver Rowland were both excluded from last weekend's second race at Donington Park for a technical infringement.

Lynn, who led the championship table coming into Donington, won the first race of the weekend with Rowland third. They finished second and third on the road in race two, behind Atech's Tio Ellinas, but were later thrown out for their rear-suspension geometry

being outside the prescribed limits.

AUTOSPORT understands Fortec's interpretation of the rules regarding rear suspension rose-joints allows the team to run more rear camber.

A rival Formula Renault engineer told AUTOSPORT that the latest Barazi-Epsilon cars require more rear camber than can be achieved with the standard arrangement, particularly through high-speed corners. Several teams tried the modification last year, which is believed to provide a significant advantage, prior to a rules clarification.

AUTOSPORT understands Fortec is appealing the decision.

Team boss Richard Dutton said: "There's a grey area [in the regulations] and it depends on how you interpret that."



Exclusion cost Rowland a podium

Porsche Carrera Cup GB

Caine and Harvey still struggling

PORSCHE CARRERA

Cup veterans Tim Harvey and Michael Caine now believe the series' new minimum-weight regs are not the only reason they are off the pace.

The Motorbase drivers achieved a best finish of sixth (for Harvey) at Donington Park last weekend, while Harvey and 2010 runner-up Caine both qualified outside the top six.

Harvey, who has criticised the new regs, which mean he runs around 35kg heavier than some rivals, said: "Some

of it is the weight, and some of it is not optimising our set-up. Our pace is good."

Caine added: "Ninth at Brands Hatch was my worst-ever Carrera Cup qualifying position, and I've matched it here. The weight is a contributing

factor, but we can't put it all down to that."

Caine damaged his car in testing and forfeited his grid spot for race one, after flat-spotting tyres in qualifying and requiring new ones. He was up to seventh when he ran out of fuel.



Caine damaged car in testing

MARCUS PYE

HUMBLE PYE

The voice of club motor racing



Price's Chevron will take on the Marches at Cadwell

Cadwell Park may not have featured in the British Formula 3 championship since Ayrton Senna binned two Ralt RT3 'wing cars' in as many days in 1983, but the gloriously scenic Lincolnshire circuit had cemented its role in the class's heritage since the 500cc days of the '50s; certainly sufficient to warrant celebration in F3's 60th year.

That jamboree takes place this weekend, courtesy of an expanded two-day HSCC fixture, promoted on the strength of 1000cc (1964-'70) and 1600/2000cc (1971-'80) double-headers on Sunday and Monday, and a charismatic half-litre (1951-'58) race on day two.

The HSCC's proven recipe of linking races with competitors and personalities of its era continues. Philip Robinson, who cut his teeth in 500s (and went on to race in F1's fringes) will present the trophies for the motorcycle-engined machines; the family of the late Justin Halperin (one-litre F3 guru and period AUTOSPORT scribe) sees his favourite cars as a fitting tribute, while three-time F1 champ Nelson Piquet's 1978 Cadwell-winning Ralt RT1 colours the late pack.

That won't be the only winning chassis designed by Ron Tauranac present either, because Leif Bosson will be racing the beautifully sleek Brabham BT28 in which fellow Swede Ulf Svensson scored a

popular win in the Wolds in 1970.

Period stars set to watch the 'screamers' include Tyrrell Cooper teamster Warwick Banks, Louth Trophy winner Mike Walker, and '66 and '67 BF3 champ Harry Stiller.

They should be impressed, for the pack includes the super fast David Methley (Merlyn), Nigel Bancroft (Chevron), Chris Holland (Brabham), Paul McMorrان (Crossle) and Ian Bankhurst (Alexis), who take on European stars Francois Derossi (Chevron) and Mauro Popenocini (Cooper).

Classic F3, for the youngest cars, pitches March chargers Benn Simms, Simon Hadfield and Jamie Brashaw against Paul Smith (Martini) and Hugh Price (Chevron), with the possibility that former Porsche Carrera Cup racer Tom Bradshaw may bring father John's Argo JM6. Derek Buckton (Royale RP11) and Andy Jones (Brabham BT38) bolster the 1600cc division.

Nigel Ashman and Neil Hodges (Coopers) square up to Richard Ellingworth (Kieft Parker) in Monday's 500cc event, which features chassis from 10 marques! And for those who love the Formula Junior interlude, which bridged F3's 'gap years' of 1958-'63, two full grids (front and rear engined) contest Monday's Barry Westmoreland Trophy events. Pure magic!

Cadwell has cemented its role in Formula 3's heritage since the 500cc days of the 1950s"

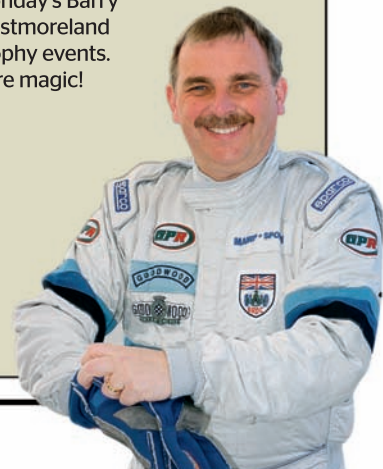

VW Racing Cup

Howard to return to racing in VW

FORMER RENAULT 5 TURBO

champion Mark Howard will come out of retirement to race in the first round of the 2011 VW Racing Cup at Oulton Park this weekend.

The 46-year-old, who hung up his helmet after winning his title in 1993, will give the MKVI Golf GTI its British racing debut.

The new Golf has been created by Volkswagen Racing UK and will feature a special '35 years of the GTI'

livery. The 24-car entry for the first two of 14 races this season will also include reigning champion Steve Chaplin and former double title winner Joe Fulbrook.

Howard said: "I've always wanted to come back to racing, but knew that I was addicted, so I stayed away while I built my business and started a family.

"I looked around at what I could do and within three weeks of seeing the plans for the new Golf, here I am."

Stand out from the crowd and keep your sponsors happy!



Personalised Race Suit Service

- Suits made to measure
- Non standard colour options
- Logo embroidery
- Name & bloodgroup embroidery
- Fast turnaround times

Contact us

NOW with your
suit requirements on

01978 663003

customsuits@demon-tweaks.co.uk

MEDIA CODE
TZ244A

demon tweaks
MOTORSPORT *Direct*



CLUB100

SIMPLY, 2-STROKE KARTING AT IT'S BEST...

With over 15 years of growth, development and race management experience, **CLUB100** boasts an unrivalled status.

"The highest level of 2-stroke 'arrive & drive' championship kart racing in the UK and Europe."

CLUB100 has brought powerful arrive-and-drive karting within reach of everyone. Whichever of our 2-stroke events you choose – Test Days, Sprint or Endurance, all the karts are prepared to an identical standard.

For more information on our various formats, circuits we visit and all of our upcoming events visit our website.

CLUB100 Racing Limited

Bon Accord House, Castle Road, Eurolink Commercial Park, Sittingbourne, Kent ME10 3SJ

Tel: +44 (0)1795 422455 Fax: +44 (0)1795 427606 Email: racing@club100.co.uk

www.CLUB100.co.uk

JOIN AUTOSPORT AT THE BRITISH GRAND PRIX

WHITTLEBURY PARK IS OFFERING ALL AUTOSPORT SUBSCRIBERS CAMPING FOR THE BRITISH GRAND PRIX AT SILVERSTONE IN THE RESERVED AUTOSPORT AREA, FOR JUST £145 PER PLOT

● **IN ADDITION** campers are invited to join us for an exclusive motorsport party night at 7.30pm on Saturday, July 9th. Tickets are £17.50 per head, and include a goodie bag plus the chance to win prizes in our motorsport quiz, while enjoying complimentary food and drink*

● **TO BOOK** your plot and party night place visit

www.whittlebury.com

quoting your *Autosport* subscriber number.

● **ALREADY BOOKED** a camping plot and subscribe to *Autosport*? Then call 01327 850071 to update your existing booking and join in the fun! Places are limited, so book early to avoid disappointment. Tickets for the party night must be collected on arrival at the campsite.

*A food and drink voucher will be allocated to each participant



For general enquiries or more information
call 01327 850071



IN BRIEF

DUNCAN GRAHAM won the Time Attack season opener at Oulton Park last weekend. His Subaru Impreza (left) headed the final times by nearly two seconds from Michael Mahoney's Mitsubishi Evo 8. Class wins went to Andrew



Barbour, Charlie Butler-Henderson, Jimmy White and David Thorpe.

EX-BTCC race winner and British F3 champion Kelvin Burt has taken a team-principal role with MGR Motorsport in Formula Renault BARC. Burt, who is driver coach for FR UK squad Atech this year, will help Mark Godwin run four cars in FR BARC this season.

FORMULA RENAULT UK racer Dan Wells escaped a 135mph testing crash at Donington Park last Thursday when his rear suspension failed. Wells was forced off on the Craner Curves and rolled three times. The Antel Motorsport team repaired his car for the weekend's race meeting. "It was like being in a washing machine," said Wells.

THE LANCIA LC2 Group C car that claimed pole for the 1984 Le Mans 24 Hours ran for the first time in more than 25 years last week.



New owner Rupert Clevely drove the car on the Silverstone Stowe circuit (above) following a ground-up rebuild by the Chamberlain-Synergy team.

BRITISH ENDURANCE Championship leaders Aaron Scott and Craig Wilkins have won their appeal against exclusion from the opening round at Silverstone. The duo were thrown out due to data logging issues, but have now been reinstated to third.



SPORTS 2000 veteran John 'Pancho' Webb (1172cc Rawson-Ford) scored his first win for 32 years (left) in last Saturday's 750 Trophy event at Brands Hatch.

JORDAN ANNELLS scored his maiden Saxmax victory at Brands Hatch last Saturday. Will Davison, third on day one, pummeled the lap record as he dropped his nine rivals on Sunday.

FORMER DOUBLE Porsche Carrera Cup GB class champion Nigel Rice will return to racing after a two-year hiatus in this year's Porsche GT3 Cup Challenge. Rice will make his series debut in a RedLine Racing-run car at Croft this weekend.



Watts chases F2 rival Stretton



BV-R leads F1 pack into the Nordkurve

Historic Formula 1

Verdon-Roe wins HF1 opener

McLaren MP4 driver repeats his Hockenheim triumph of 12 months ago

BOBBY VERDON-ROE WON ROUND one of the FIA Historic Formula 1 Championship at Hockenheim last Sunday, in a repeat of last year's performance in his McLaren MP4/1B.

On pole by 1.7s, he beat Steve Hartley (Arrows A4) by half a minute. German Peter Wuensch (Wolf WR1-2) pipped Richard Eyre (Williams FW08) and Luxembourg's Nico Bindels (Lotus 87) for third in the 12-car field.

March-BMW returnees Martin Stretton (742) and Matthew Watts (772) were the class of the HSCC-run F2 series opener and scored a win apiece. Northern Irishman Darwin Smith (March-BDG 722) and Swiss Hans Peter (Ralt-BMW RT1) led the chase.

Italy's Pierenrico Tonetti (Brabham BT6) dominated round two of the FIA Lurani Trophy Formula Junior contest, with Scot John Fyda (Lotus 22) his most

consistent rival over the two legs.

The most remarkable comeback was that of Jan Biekens who rolled his Stanguellini at Monza's series opener a fortnight previously. Following much chassis and body work, and physio for the pilot, Biekens won the Italian-engined class both times.

Arnold Wagner (Arrows A22) and Marijn van Kalmthout (Benetton B197) won the BOSS GP races.

European Rallycross

Hansen and Jernberg give way to youngsters

THE OPENING ROUND OF the European Rallycross Championship at Lydden this weekend will not include multiple champion Kenneth Hansen and frontrunner Michael Jernberg.

Hansen, 50, has moved into a team management role in his eponymous Citroen squad, while

48-year-old Jernberg has taken his Skoda to America for a year of Global/US championship events.

Nevertheless, there are several young drivers stepping into the ERC this season: reigning Super Timerzyanov will drive a Hansen Citroen, alongside

British star Liam Doran, who will compete at Lydden despite a major crash at the BRC opener last month (see AUTOSPORT, March 31).

Finnish champion

Toomas Heikkinen, 19, returns under the tutelage of rally legend Per Eklund, while French champion Davy Jeanney, 24, steps up in a new Citroen C4.



Lydden will host ERC first round

Trofeo Abarth 500 GB

Trofeo Abarth discontinued after single season



UK Abarth series struggled to grow in 2010

THE TROFEO ABARTH 500 GB WILL not continue into a second season in 2011, after cancelling its opening round at Oulton Park this weekend.

The single-make tin-top category attracted 13 cars to its first round at Oulton last year, but struggled to maintain grids of more than 10.

Nevertheless, the MSVR-run Trofeo Abarth looked set to continue for a

second year after announcing a six-race calendar - including FIA Formula 2 and DTM support slots - at AUTOSPORT International, but has now been discontinued for unspecified reasons.

David Scott, race operations manager of MSVR, said: "After all our efforts it's a great shame that Abarth could not make this work. It has great potential to be successful in the UK."

NATIONAL RACES & RESULTS
BRSCC
ROCKINGHAM & OULTON

QUICK RESULTS
→ GT winner **Sean McInerney/ Michael McInerney**
→ Prod winner **Clarke/Gibson**

“One of the most exciting races we’ve ever had”

Michael McInerney’s take on a BEC thriller



Boston took Mk3 MX5 Cup double

IN BRIEF



MA5DA MX5

Alan Henderson, Adam Gore and Wayne le Montais (above) all took hard-fought victories in the Ma5da MX5s at Rockingham, while Tom Roche won twice.

MA5DA MX5 CUP

Robert Boston took a double victory at Rockingham. In race one he dropped to fourth, but managed to claw his way back and past Jim Edwards Jr. Tom Roche pressured Boston in race two, but to no avail.

FORMULA VEE

Defending Formula Vee champion Martin Farmer (GAC) drew steadily away from John Hughes (Scarab) and the feisty Steve Ough (AHS Dominator) at Brands Hatch, to annex the points lead in Mallory winner Ben Anderson’s absence.

STOCK HATCH

Carl Swan inched clear at Brands in a race restarted after Mallory victor Andy Tibbs was flicked into the Cooper Straight guardrail. Matt Digby and Martin Ward led the chase, but couldn’t deny Swan a maiden win.

MORGAN CHALLENGE

Clutch failure rendered poleman Keith Ahlers a spectator, so Russell Paterson staved off Matthew Wurr to win in a sensational race by 0.08s. Tony Rivers (Roadster) and Steve Ayres (+8) won class battles that were almost as close-fought.

FORMULA 4

Robbie Watts (below middle) survived a brush with early leader Oliver Sirrell (who retired with buckled suspension) to win the F4 opener. Lee Cunningham and Jennifer Scott joined the all-Van Diemen podium.



BRITISH ENDURANCE CHAMPIONSHIP ROCKINGHAM, APRIL 16

McInerneys inflict rare defeat on MJC Ferrari

AFTER TWO AND A half hours, five cars finished on the lead lap in round two of the British Endurance Championship, but some familiar faces still topped the podium at Rockingham.

The Ferrari 430 of Sean and Michael McInerney and the similar car of category dominators Witt Gamski and Keith Robinson weren’t a feature at the front early on but came to the fore when it mattered.

Calum Lockie took an early lead in the Mosler he shared with Paul White, while Aaron Scott started aggressively in his Viper and moved into second.

Lockie’s lead was to be shortlived though: Michael Millard, in the rapid Rapier 6 SR2, dived up the inside at Deene on lap seven.

Scott was handed a drive-through penalty on

lap eight for being out of position at the start, but got the bit between his teeth and caught and passed Lockie for third just 10 laps after taking the punishment.

However, Scott lost a lap when he pitted under a safety car on lap 20 of 100 and the Viper he shared with Craig Wilkins could only recover to fifth.

A second safety car at half distance was to prove crucial to the outcome. The MJC team pulled off a tactical masterstroke, pitting the Gamski/Robinson Ferrari F430 GTC on two successive laps in order to avoid a late splash-and-dash stop.

Ian Heward retired the Rapier with 40 minutes left and, after Javier Morcillo’s Mosler pitted, this left the two Ferraris out front.



Ferrari 430s duked it out at the end

Robinson then harried McInerney, but was unable to pass and with just seven minutes left, he went off at Gracelands. This secured victory for the McInerneys, but Robinson hunted them down and still finished less than two seconds behind.

The Lotus Elise S2 of Simon Phillips and Peter Storey looked good for Production honours early on, but the BMW M3 E46 of Kevin Clarke and Wayne Gibson came on strong later to take victory by two laps.

● Matt Upton

RESULTS (100 LAPS)

- 1 Sean McInerney/Michael McInerney (Ferrari F430 GT3);
 - 2 Witt Gamski/Keith Robinson +1.648s (Ferrari F430 GTC);
 - 3 Javier Morcillo/Manuel Cintrano (Mosler MT900 GT3);
 - 4 Paul White/Calum Lockie (Mosler MT900 GT3);
 - 5 Aaron Scott/Craig Wilkins (Dodge Viper);
 - 6 Glenn McMeniman/Simon Atkinson (Lamborghini Gallardo GT4).
- Class winners** Scott/Wilkins; Morgan Jones/Phillip Jones/Gareth Jones (Porsche 997); Kevin Clarke/Wayne Gibson (BMW M3 E46); Ian Lawson/Anthony Wilds (BMW 320i).
- Fastest lap** Morcillo 1m20.924s (86.30mph).

MIGHTY MINI/SUPER MIGHTY MINI OULTON PARK, APRIL 16

Tuckley’s tactics make him mighty

MIGHTY MINIS ALWAYS produce excitement and close racing, and so it was again as they supported the Modified Live event at Oulton Park last weekend.

Adrian Tuckley scored a narrow Mighty Mini victory, despite immense pressure from a persistent Chris Slade.

Slade pinched the advantage from polesitter Louise Inch and controlled

the pace for much of the opening lap. In true Mighty Mini style the lead position was not secure for long, and Ben van den Bos dived passed Slade for the lead at the end of the second tour.

Detecting that reigning champion Inch was struggling early on, Mark Burnett fought past and chased the lead duo – dragging Inch with him.

Before long, Tuckley had fought his way back from a cautious getaway to be within touching distance of the leaders. Tasting victory, he weaved through this battling quartet to take control on the penultimate tour. Slade held onto second, while Inch took third.

Van den Bos, Peter Tervet and Michael Dryden completed a tightly

contested top six.

Elliot Stafford eventually converted pole position to victory in the Super Mighty Mini encounter.

Fellow fron-row starter David Kirkpatrick grabbed an early lead, but soon dropped down the order.

Scott Kendall temporarily looked after top spot in Kirkpatrick’s absence, before Stafford fought his way through.

The lead pair controlled the pace from here on out and Stafford resisted a challenge from Kendall on the penultimate lap.

Patrick Ford was third, despite a race-long fight with battery issues.

● Leanne Fahy



Tuckley leads Mini pack through Hislops

RESULTS

- Mighty Mini (10 LAPS)** 1 Adrian Tuckley; 2 Chris Slade +0.141s; 3 Louise Inch; 4 Ben van den Bos; 5 Peter Tervet; 6 Michael Dryden.
- FL** Slade 1m57.846s (68.00mph).
- Super Mighty Mini (11 LAPS)** 1 Elliot Stafford; 2 Scott Kendall +0.144s; 3 Patrick Ford; 4 Jonathan Lewis; 5 David Young; 6 Alex Comis.
- FL** Stafford 1m50.030s (72.83mph).

PICS: DEREK BINSTED; BOURNE PHOTOGRAPHIC; GARY HAWKINS

RGB BRANDS HATCH, APRIL 16-17

Rogers doubles up as RGB record falls

EAST ANGLIAN RIVALS John Cutmore and Derek Rogers fought for honours as the quality and pace of RGB hit a new high, while Tim Gray's stunning race two charge to third indicated that competition will only get tougher.

Cutmore put Paul Nightingale's Honda-powered Spire GT3 on pole by 0.11s from Rogers' Contour-Suzuki. John's landmark 49.99s charge was half a second inside Rogers' lap record, set with a 1200cc Kawasaki engine last April.

Derek Jones (Fisher Fury-Honda) and reigning champ Al Boulton (now wingletted STM Phoenix-Honda) proved that front-engined cars can still mix it, starting third and fifth in the 25-car field, alongside Gary Goodyear

(Contour-Suzuki) and Tim Pell (Genesis Evo-Kawasaki) respectively.

David Wale (BDN S2-Kawasaki) and Richard Wise (ABP Sabre-Honda) headed the rest.

Cutmore made the best getaway, but Rogers was soon on his tail and shot past as his rival juggled new cockpit-adjustable anti-roll bars to balance the Spire's handling.

Locked together for most of the race, Rogers held sway to win but Cutmore aced him by 0.02s for the lap record.

Jones finished a class-winning third, ahead of fast-starter Pell, who repelled the resurgent Goodyear. Hobbled by clutch dramas at Mallory, sixth-placed Boulton was grateful to beat Wise and bag his first points.



Rogers chases as Cutmore slides

Race two was longer, but conducted at the same furious pace by Cutmore and Rogers. John's day ended in a cloud of tyre smoke when a rear suspension pushrod collapsed, pitching him into a wild spin at Surtees.

Rogers was untroubled thereafter, but all eyes were on Gray, permitted to start the unique Sabre from the

back as Wise had aggravated a neck injury.

His tigerish rise to third, closing fast on the breathless Jones, showed the car's winning potential.

After Goodyear retired with a cockpit full of fire extinguishant, Boulton, Mathew Green (Spire GTR) and Wale completed the top six.

● Marcus Pye

RESULTS – RACE 1 (17 LAPS)

1 Paul Rogers (Contour); 2 John Cutmore (Spire GT3) +1.03s; 3 Derek Jones (Fisher Fury); 4 Tim Pell (Genesis Evo); 5 Gary Goodyear (Contour); 6 Alastair Boulton (STM Phoenix). **CW** Rogers; Pell. **FL** Cutmore 49.74s (86.78mph) **record.** **RACE 2 (22 LAPS)** **1 Rogers;** 2 Jones +6.94s; 3 Tim Gray (ABP Sabre); 4 Boulton; 5 Mathew Green (Spire GTR); 6 David Wale (BDN S2). **CW** Jones; Wale. **FL** Gray 50.05s (86.24mph).



Cross leads MR2 pack at Surtees

TOYOTA MR2 BRANDS HATCH, APRIL 16-17

Cross nabs MR2 gold as the Geordie boys star

EIGHTH IN LAST YEAR'S MR2 title race, with a best finish of third at Anglesey, James Cross started the championship's Toyota-backed era with a superbly judged maiden victory at the end of a long and trying double-header weekend.

For much of the only points-payer to be finished, Cross chased gifted newcomer Roland Wilkinson – his buddy

and fellow Newcastle-upon-Tyne resident – round the Indy circuit, probing for the chink in his armour.

Wilkinson, who debuted in the 2010 winter race at Donington, was leading the finale when a multi-car incident between Druids and Graham Hill Bend eliminated several competitors. When his car started to wag its tail luridly after the restart, Cross and

Paul Hinson pounced in quick succession.

“James got me into this, and I jumped in with him on the seven-hour trip down here, so I'm delighted to have seen him score his first win,” offered Rogue Motorsport racer Wilkinson magnanimously. His day will come.

Confidence boosted by two Super GT outings on Saturday, 21-year-old Wilkinson's pace and maturity in the sequel astonished onlookers.

He led Andrei Bgatov and defending champ Zac Chapman, but was pincerred between them at the root of a monumental shunt at Paddock, from which the Russian miraculously escaped (see news).

● Marcus Pye

RESULTS

TOYOTA MR2 (10 LAPS) **1 James Cross;** 2 Paul Hinson +0.86s; 3 Roland Wilkinson; 4 Alexander Lennon; 5 George Robinson; 6 Steve Lumley. **CW** Simon Phillips; Dave Hemingway. **FL** Hinson 57.64s (74.89mph) **record.**

750 FORMULA BRANDS HATCH, APRIL 16-17

Harris Darvi-ctorious!

THE 750 FORMULA continues to go from strength to strength.

Ten-time champion Mick Harris holds the trump cards and he kept the unique Darvi 877 at the head of a scintillating five-way lead battle at Brands Hatch.

Poleman Harris did not have to play the usual catch-up game. His best start in years fired the yellow car ahead into Paddock and there it stayed, despite everything fellow champions Bob Simpson (SS/F) and Dave Robson (SDAR/83), plus Bill Rutter (Darvi Mk5) and Nathaniel Cooper (Davis T7), threw at him.

Rutter forged his front-engined Darvi alongside a couple of times, but the extraordinary speed

Harris carried through the apex of Paddock decided matters.

Robson got to third and was flying, before a moment at Graham Hill Bend let Simpson and Cooper back past.

Cooper had displaced Simpson for third when his Davis faltered at Surtees on the final lap.

He coasted in fifth, albeit with a mighty lap record (0.44s inside spectator Peter Bove's target) to his credit.

● Marcus Pye

RESULTS

750 FORMULA (16 LAPS) **1 Mick Harris (Darvi 877);** 2 Bill Rutter (Darvi Mk5) +1.37s; 3 Dave Robson (SDAR/83); 4 Bob Simpson (SS/F); 5 Nathaniel Cooper (Davis T7); 6 Roger (Centaur Mk14). **CW** Alan Bunter (Bunterbuilt Shark 8). **FL** Cooper 52.26s (82.59mph) **record.**

QUICK RESULTS

→ Mini winner R1 **Richardson**
→ Mini winner R2 **Richardson**

"I didn't make any mistakes, but wasn't quick enough"

An honest Luke Caudle after race-one defeat



Soloist Staff took a Radical win

MINI CHALLENGE SILVERSTONE GP, APRIL 16-17

Richardson takes last-gasp double in Mini opener

JASON RICHARDSON started his Mini Challenge campaign with a double victory at Silverstone despite the best efforts of 2009 champ Luke Caudle.

Initially it was Caudle who had the edge, as Richardson disputed second with the fast-starting Chris Knox in race one. Once clear of Knox, however, Richardson closed in.

He made his move for the lead on the second lap, but was on two wheels riding the kerb. "I might have rolled if Luke hadn't been there," he explained after nosing ahead. A battle for third allowed the lead pair to escape, but on this occasion Caudle had no answer to the Kent driver. "I didn't make any mistakes, but just wasn't quick enough," said Caudle.

Knox retained third, but for a while was at the head

of a five-car train. Lee Allen and Sam Osborne shared a number of exchanges, which allowed Martin Depper and Chris Smith to catch them. Osborne had the legs of Allen, just, and then managed to get alongside Knox just after half-distance. But Depper called on all his experience to oust the teenager for fourth on the last lap.

Allen was on pole for the second race and made sure he maximised his opportunity by taking the early lead. While Osborne and Caudle duelled for second, Knox took them both, before Caudle reclaimed the place into Copse on the second lap.

Richardson had lost out at the start, but began to work his way back, as both he and Osborne ousted Knox into Aintree on lap four. After taking third at



Caudle leads, but rival Richardson (left) would win

Copse a lap later, Richardson's quest was assisted when Caudle suddenly slowed. "I changed into second gear too early and it went into limp mode," he explained.

It was now a clear track to Allen and the lead, but time was running out. They arrived at Brooklands for the final time nose to tail, but exiting Luffield

Richardson had the inside line and snatched victory in the drag to the flag.

Osborne and Depper had a terrific scrap for third, with the youngster coming out on top this time.

Arthur Forster secured fifth in a car closer to road specification and returnee Stewart Lines completed the top six.

● Peter Scherer

RESULTS (BOTH 8 LAPS)

RACE 1 Jason Richardson; 2 Luke Caudle +7.667s; 3 Chris Knox; 4 Martin Depper; 5 Sam Osborne; 6 Lee Allen. **Class winners** Antony Whorton-Eales; Len Coed. **Fastest lap** Richardson 2m28.821s (88.68mph).
RACE 2 Richardson; 2 Allen +0.102s; 3 Osborne; 4 Depper; 5 Forster; 6 Stewart Lines. **CW** Whorton-Eales; Coed. **FL** Richardson 2m29.432s (88.32mph).



Ruhan took a GT Cup double

GT CUP SILVERSTONE GP, APRIL 16-17

Ruhan out-runs Ferraris as TVRs hit post-race trouble

ANDY RUHAN'S Porsche 997 GT3 was a double winner on paper, but his first victory was inherited when Michael Saunders' TVR Cerbera was excluded post-race.

With over 20 cars in a sprint format, some close action was anticipated from the GT Cup. But once poleman Saunders had established himself at the head, from Ruhan and the Ferraris of Gary Eastwood

and Leon Price, very little happened.

The top three held station for the entire race and Price was gradually reeled in by Don Grice's BMW M3 GTR. Into Brooklands on lap nine Grice sealed fourth, while Price fell back with a late spin and promoted David Tomlin's Ferrari and Danny Winstanley's TVR Sagaris. Winstanley also suffered a post-race exclusion, like

Saunders, for unspecified 'technical reasons'.

It was all very easy for Ruhan in race two, and Eastwood had to pit from second after almost stopping at Luffield. Toby Tarrant-Willis's Ferrari moved up but was unable to fend off the challenge from David Tomlin's similar car. Tarrant-Willis joined the retirements with three laps to go, leaving Tomlin well clear of Price and Grice.

Eastwood rejoined but could only reach ninth. Tom Andrew's Morgan Aero 8GT and Colin Broster's Porsche 996 GT3 shared the Class 2 wins, with Barclay Dougal's BMW twice topping Class 3. ● Peter Scherer

RESULTS (BOTH 12 LAPS)

RACE 1 Andy Ruhan (Porsche 997 GT3); 2 Gary Eastwood (Ferrari 430 GTC) +0.520s; 3 Don Grice (BMW M3 GTR V8); 4 David Tomlin (Ferrari 430). **FL** Eastwood 2m13.216s (99.07mph). **RACE 2** 1 Ruhan; 2 Tomlin +20.455s; 3 Leon Price (Ferrari 430 GTC); 4 Grice. **FL** Ruhan 2m13.499s (98.86mph).

RADICAL UK CUP/MASTERS SILVERSTONE GP, APRIL 16-17

Staff spins then wins

ROGER BROMILEY and Shaun Balfe were on hand to take the first Radical win of the weekend, after Per Staaf Jr spun. But Staaf made amends with no mistakes on his way a race-two win.

Manhal Allos led the first half of race one, with Bromiley pressing hard. The pressure finally paid dividends as Bromiley squeezed ahead into Brooklands just before half-distance, as Staaf closed in too. Bromiley pitted with the lead intact, but after a couple of laps Balfe let Staaf go and sat patiently in second. That paid off when Staaf's tyres went off and he spun at Copse.

Alexander Sims was on pole for race two and disappeared into the distance. James Swift just

held off Alex Mortimer, with Staaf in fourth before the stops. John Stanley took over from Swift, but pitstop issues hurt them, while Hyman fell foul of a backmarker.

Rachel Davies took over from Sims, but had Staaf and Christian Kronegard (in for William Vermont) hunting her. She ran wide with three to go and both shot by.

● Peter Scherer

RESULTS - RACE 1 (18 LAPS)

1 Roger Bromiley/Shawn Balfe; 2 Per Staaf Jr +5.427s; 3 Chris Hyman/Alex Mortimer; 4 Christian Kronegard/William Vermont. **FL** Sims 1m58.889s (111.01mph).

RACE 2 (19 LAPS) 1 Staaf Jr;

2 Vermont/Kronegard +2.102s; 3 Alex Sims/Rachel Davies; 4 Manhal Allos. **FL** Sims 1m58.811s (111.08mph).

CATERHAM SUPER GRADUATES SNETTERTON, APRIL 16-17

Stanley edges it in Super Graduates thriller

THE CATERHAM SUPER Graduates served up one of the races of the weekend in their first outing, with the flat-out slipstreaming action we’ve come to expect from the series. Twenty frantic minutes finally culminated in the top three being separated by less than a tenth of a second across the line.

Having taken a win apiece in the season opener at Silverstone, Neil Shinner and Reece Somerfield were the in-form men going into the weekend. But it was Dylan Stanley and Toby Briant who filled the front row, with Stanley leading into Riches only to run wide through the in-field section and allow



Stanley won frantic opening scrap

Somerfield to steal past. Somerfield, the 2010 Sigma Graduate champ, held a fragile lead for the next four laps, with Stanley filling his mirrors. Briant, Luke Tzourou, Shinner and Kenny Young followed in short order.

While Stanley stalked the leader, the rapid Shinner made his move from fifth to third and closed in on the top two. As they headed into Riches just after half distance, Stanley and Shinner both leapfrogged Somerfield, only for the former leader to retake the place before the end of the lap.

Less than a second covered the top five as they blasted into the seventh tour of the 10-lapper, and the order shuffled once more after Somerfield was hung out to dry on the outside of Riches, allowing Stanley, Shinner, Briant and Tzourou to flash past. Shinner and Stanley exchanged the lead twice more, until Stanley asserted himself going into the final lap. With his

rivals scrapping behind him, Stanley eked out enough of a gap down Bentley Straight to hold off the inevitable charge from Shinner and Somerfield. The trio swept across the line almost as one, with Stanley grabbing the glory.

The top three broke away in a less eventful second race, as Somerfield put in a faultless performance to lead every lap. Stanley and Tzourou’s race-long squabble for second proved just enough to keep them from mounting a serious challenge. Meanwhile, Shinner recovered from seventh in the opening corners to win a three-way fight for fourth.

● Oliver Timson

RESULTS (BOTH 10 LAPS)

RACE 1 1 Dylan Stanley; 2 Neil Shinner +0.014s; 3 Reece Somerfield; 4 Toby Briant; 5 Luke Tzourou; 6 Charles Elliott. **FL** Elliott 2m14.666s (79.36mph).

RACE 2 1 Somerfield; 2 Tzourou +0.397s; 3 Stanley; 4 Shinner; 5 Elliott; 6 Kenny Young. **FL** Stanley 2m14.189s (79.64mph) **establishes record.**

KUMHO BMW SNETTERTON, APRIL 16-17

Whittaker wins, while Bacon and Bellamy battle

ALTHOUGH GARRIE Whittaker shrugged off Ian Crisp’s attentions to claim a comfortable victory in the first Kumho BMW race, there was plenty of action behind. Not least in the battle for Class D, where Richard Bacon and Paul Bellamy were glued together for most of the contest.

Bellamy had the edge early on, before being tapped into a spin at Agostini. Undeterred,

he made light work of recovering lost time, quickly latching back onto his rival’s bumper before retaking the class lead within three laps. Bacon stayed resolutely in his mirrors, but couldn’t find a way through.

The race’s other highlight came courtesy of Colin Wells’ all-out charge from the back of the grid. Having missed qualifying because he was still travelling back from holiday, Wells arrived

at the track at midnight on Saturday, and was clearly in the mood to race. By the end of lap one he was already up to fourth, with his commitment obvious as he swept through the in-field section, taking chunks of time out of those ahead. He was third by lap five, but although he pushed hard, Wells couldn’t quite dislodge Crisp from second by the time they swept line-astern past the flag.

With Wells lining up third for the sequel, the big question was whether he could threaten Whittaker’s unbeaten run. Sadly the answer came emphatically and quickly, as Wells’ M3 succumbed to fuel-pump problems. Unopposed, Whittaker dominated for his fourth 2011 win ahead of Crisp and Stephen Pearson, while Rodger Card fought off Mark Smith for fourth.

● Oliver Timson

RESULTS - RACE 1 (10 LAPS)

1 Garrie Whittaker (E36 M3); 2 Ian Crisp (E36 M3) +26.918s; 3 Colin Wells (M3); 4 Stephen Pearson (M3). **Class winners** Mark Smith (E90 M3); Paul Bellamy (318i); Peter Miller (E36 328i).

FL Whittaker 2m06.381s (84.57mph) **establishes record.**

RACE 2 (7 LAPS) 1

Whittaker; 2 Crisp +13.807s; 3 Pearson; 4 Rodger Card (E30 M3). **CW** Card; Bellamy; Miller. **FL** Whittaker 2m07.259s 83.98mph).

Whittaker won again in his E36 M3



PICS: OLIVER READ, RICHARD STYLES

IN BRIEF



LOTUS ELISE/UK CUP

Steve Quick grabbed a last-lap victory over Stuart Rowland in the Lotus Elise Trophy at Silverstone and won the red-flag shortened second outing. Mark Fullalove’s 2-Eleven (above) dominated the Lotus Cup UK race.

HERITAGE GT

Tiff Needell took over John Dickson’s RAM Cobra at the head of the Heritage GT Series at Silverstone, only to shed a rear wheel. Oliver Bryant’s Morgan Plus 8 closed in on John Wilson’s MGB GT V8 and surged ahead on the final lap.

SIGMA/CLASSIC GRADS

Ian Henderson’s Sigma-powered Caterham dominated both Graduate races at Snetterton. Paul Hawker and Rowan Williams duelled for Classic honours in race one, before Hawker retired. Williams also won race two.

MEGA GRADS

Myles Packman won both Mega Graduate events. He was pressed all the way in race one by Daniel Malkin, while Trevor Carvey edged a 10-car train for third. Malkin spun in race two, allowing Carvey to claim second.

CLASSIC THUNDER

There was no stopping Andy Robinson breaking his victory duck as he took a dominant pair of Classic Thunder wins in his Ford Falcon V8.

BLUE OVAL

Despite launching his Ford Escort MK2 into a clear lead in the Blue Oval opener, Craig Rainer was reeled in and passed by Craig Jamieson’s pole-winning Sierra (below). They duelled flat-out in race two, with Jamieson making the decisive move round Riches on lap five.



New Merc SLS will try to topple champion Porsche



British GT is back

After recent struggles, British GT is in rude health for 2011. **KEVIN TURNER** takes a look as new cars prepare for battle

British GT stalwart Matt Griffin reckons 2011 is going to be a classic: "This'll be the best year in the championship – the competition is a lot stronger than 2010."

Looking at the entry list it's hard to disagree. After the highs of 2008, British GT was one of the first categories to be hit by the economic slump. Things improved last year and this season we have new cars, fresh drivers, and a 26-car grid for the Oulton Park opener this weekend.

There are top teams and star drivers in the line-up too. United Autosports, the team of Zak Brown and Richard Dean that made its race debut at the Oulton round last year, is back for a full two-car challenge, and has former BTCC racer John Bintcliffe on board.

Then there is CRS Racing, which returns to the series for the first time since its successful 2008 campaign, and elsewhere on the grid we have

international GT aces Richard Westbrook and Allan Simonsen, former British Touring Car racers Steven Kane, Jonathan Adam and Anthony Reid, and former champions Alex Mortimer, Godfrey and David Jones, and 2010 winner David Ashburn.

NEW CARS

One of the appeals of GT racing has always been the cars and there are no fewer than five machines new to British GT this season.

The 458 is the latest GT3 offering from Ferrari and it certainly looks fast. MTECH duo Griffin and Duncan Cameron, whose title challenge was stymied last year by reliability problems with their 430 Scuderia, drive one, while single-seater convert Michael Lyons and ex-Porsche Carrera Cup racer Charles Bateman will share another for new squad Scuderia Vittoria.

CRS will begin the season with 430

United Autosports brings two Audi R8s



Lotus returns for GT4 assault with Evora





Speedworks will run Chevrolet Corvette

“I’m happy to be moving on to the 458. The Scuderia broke my heart last year”

Griffin likes new Ferrari

Scuderias for Glynn Geddie/Jim Geddie and Alex Mortimer/Andrew Tate, but should have its 458s ready in time for the second round at Snetterton in May.

Griffin, who has done much of the development work on the car, believes the 458 is a step forward. “The 458 is right at the beginning of its development, the 430 Scuderia is right at the end, which is why I think it was a little unreliable – we were pushing the envelope so much,” says Griffin, who also points out the 458’s wider rear tyres should last better over a race distance than the 430’s.

“Overall, it’s a better racecar – the gearbox and driveshafts are stronger. I don’t expect it to be any quicker at the start of the season – though it will definitely end up quicker – because it’s quite late.

“But I’m happy to be moving on from the Scud – it broke my heart last year. The 458 is a much stronger car.”

Ranged against the Ferraris will be the Mercedes AMG SLS GT3 of the Jones twins and a Chevrolet Corvette Z06R. After an unreliable final season with their Ascari, the Joneses bring the striking Merc, which made its debut in Europe at the end of last season and immediately proved competitive. A lot will depend on how the heavy front-engined machine uses its Avon tyres, and how much the veterans can get out of the new car, but it’d be a surprise not to see it near the front.

The Corvette is not a new car – versions have been winning FIA GT3 races since 2007 – but it is new to British GT. Speedworks Motorsport, which took the G4 title last year with Christian Dick and Jamie Stanley, will run the American V8 for the unrelated Piers and Ron Johnson. Piers should be quick, though club racer Ron’s inexperience at this

level may prevent a title challenge.

The other new cars are the Ginetta G55 and the Lotus Evora GT4. The G55 is Ginetta’s GT3 machine and got its national homologation as recently as last week. The under-powered, under-aeroed GT Supercup-based car is not going to challenge the GT3 big guns at the start of the year, but developments should move it towards the front in preparation for a more aggressive 2012 assault.

The factory-supported Evoras have a strong line-up of promising youngsters. Tin-top racers Leyton Clarke and Freddy Nordstrom team up in one car, single-seater convert Jack Drinkall and former Carrera Cup racer Ollie Jackson drive the other.

The cars are likely to be competitive in GT4, along with the ever-present GT4 benchmark Ginetta G50s and the unusual KTM X-Bows.

OLDER BUT QUICK

It won’t just be new cars at the front. A combination of equalisation measures and top teams and drivers should mean older machines will run at the sharp end, too.

UA is a serious outfit and is well prepared. Jay Palmer lacks experience, but Richard Dean is confident the team, which will also run John Bintcliffe and Matt Bell/Michael Guasch, can compete.

“Testing’s been going well and we’ve done something like 16 days,” he says.

“John has been very quick and got straight on the pace. We have high hopes of what he can achieve, but I think Matt and Mike should challenge because they’re ready straight away.”

Allan Simonsen, Adam Wilcox and Steven Kane are bound to be quick in their 430 Scuderias, though – as ever – their ultimate success will be dictated by how their respective co-drivers Hector Lester, Phil Burton and Iain Dockerill perform against the increased competition.

The Trackspeed Porsche line-ups will probably change depending on the availability of David Ashburn’s pool of

CALENDAR

April 23 & 25
Oulton Park
(two 60min races)

May 14-15
Snetterton
(one 2-hour race)

June 18-19
Brands Hatch
(one 2-hour race)

July 8-9
Spa
(two 60min races)

September 3-4
Rockingham
(two 60min races)

September 24-25
Donington Park
(one 3-hour race)

October 7-9
Silverstone GP
(one 2-hour race)

GT aces, but Richard Westbrook and former Carrera Cup champion Tim Bridgman provide a pretty good starting point! The car is a proven winner and the team seems even stronger than last year, when Glynn Geddie helped Ashburn to the crown.

The Aston Martin DBRS9 has been in British GT since the start of the GT3 class in 2006 and the sole Beechdean Motorsport entry of team boss and good amateur Andrew Howard and Jonathan Adam will run to the latest specification. The duo could spring a few surprises – expect the V12 to star at fast tracks like Spa and Silverstone.

The final entries populate one-car classes. MTECH will run a Ferrari 430 GT3 for Aaron Scott/John Dhillon in the new GT3B category, designed to attract older (and cheaper) GT3 cars back to the series, while Anthony Reid and ex-Sport Maxx racer Jordan Witt team up in a works Chevron in GTC.

The hope is that more cars will join them as the year goes on, but even if they don’t there looks like enough quality at the front to make this a great British GT season. ☼

New 458 has already raced and heads to Brit GT



BRITISH GT ENTRY LIST

DRIVERS	CAR	TEAM	CLASS
David Ashburn/Richard Westbrook	Porsche 997 GT3 R	Trackspeed	GT3
Gregor Fiske/Tim Bridgman	Porsche 997 GT3 R	Trackspeed	GT3
Hector Lester/Allan Simonsen	Ferrari 430 Scud	Rosso Verde	GT3
Iain Dockerill/Steven Kane	Ferrari 430 Scud	Chad Racing	GT3
Michael Lyons/Charles Bateman	Ferrari 458 GT3	Scuderia Vittoria	GT3
Ron Johnson/Piers Johnson	Chevrolet Corvette	Speedworks M'Sport	GT3
Andrew Howard/Jonathan Adam	Aston Martin DBRS9	Beechdean M'Sport	GT3
Glynn Geddie/Jim Geddie	Ferrari 430 & 458	CRS Racing	GT3
Andrew Tate/Alex Mortimer	Ferrari 430 & 458	CRS Racing	GT3
Phil Burton/Adam Wilcox	Ferrari 430 Scud	Predator Racing	GT3
Duncan Cameron/Matt Griffin	Ferrari 458 GT3	MTECH	GT3
David Jones/Godfrey Jones	Mercedes AMG SLS	Team Pyro	GT3
Matt Bell/Michael Guasch	Audi R8 GT3	United Autosports	GT3
John Bintcliffe/Jay Palmer	Audi R8 GT3	United Autosports	GT3
Ian Stinton/Michael Simpson	Ginetta G55	Stark Racing	GT3
Adam Morgan/Stefan Hodgetts	Ginetta G55	JHR	GT3
Colin White/Tom Sharp	Ginetta G55	Team LNT	GT3
Freddie Hetherington/Julian Draper	Ginetta G55	Century Motorsport	GT3
Aaron Scott/John Dhillon	Ferrari 430 GT3	MTECH	GT3B
Josh Wakefield/Jake Rattenbury	Ginetta G50	Century Motorsport	GT4
Peter Belshaw/Marcus Clutton	KTM X-Bow	ABG Motorsport	GT4
Athanasios Ladas/Michael Mallock	KTM X-Bow	ABG Motorsport	GT4
Leyton Clarke/Freddy Nordstrom	Lotus Evora GT4	Lotus Sport UK	GT4
Ollie Jackson/Jack Drinkall	Lotus Evora GT4	Lotus Sport UK	GT4
Dan Denis/David McDonald	Ginetta G50	Scuderia Vittoria	GT4
Jordan Witt/Anthony Reid	Chevron GR8	Chevron Racing	GTC

YOUR SAY

What you think of the motorsport news of the past week



Three reasons to be cheerful

What an amazing weekend of drama in WRC, IRC and F1. To see Jari-Matti Latvala waiting nervously at the end of the final stage; Juho Hanninen winning on asphalt; and a spellbinding Chinese GP where no one knew who would win until the final five laps.

Hopefully many people can now place their rose-tinted glasses back in the drawer and come and enjoy this great racing with the rest of us. The F1 rulemakers have found a winning formula, and in no way does it feel fabricated or false. Strategy, speed and overtaking ability are more important than ever, in fact.

Nick Alterskye by email

EDITORIAL CONTACT mail@autosport.com

It's a shame that F1, the pinnacle of our sport, is constantly trying to find ways to make the races more exciting.

If you look at the lower levels of motorsport – club racing especially – the on-track action is far better.

It seems anything above Formula Ford in terms of racing's ladder has turned dull. F1 and club single-seater or saloon action offers much greater entertainment for all, whether a driver, marshal or spectator.
Mark Noble
Warrington

I know there is a lot of smog in Shanghai, but Jenson Button's pitstop in the wrong (the Red Bull) garage is not something you can blame on poor visibility.

Of course, he didn't even try to shift the blame for his error and admitted that he had been 'looking down' when he drove into the pitlane.

What exactly, Jenson, were you looking at? Whatever it was, I hope it was worth it; it cost you a place on the podium.
Sharon Wolstenholme
Cambridge

For the first time this season, at the Chinese GP, it was all about the tyres. Had Vettel and Button had fresher tyres, it's probable they both would have defended their positions.

So, despite the much talked about KERS and DRS, the teams must once again consider the bigger picture: race strategy.

Simply, Red Bull's two-stop strategy for Vettel was wrong. Thank goodness then (for them) that they got it so right for Mark Webber – 18th to third is *some* drive!
Steve Griffin
Suffolk

Write off Mark Webber at your peril! To drive from 18th on the grid to third in China must be all the evidence Red Bull needs to realise it can stop looking for another driver to partner Sebastian Vettel.

By showing such grit and tenacity, he has surely proved he belongs to the elite class of F1 drivers. Moreover, it was clear from his comments in the post race press conference that he believes he can catch his team-mate in the championship.

I hope he does.
Keith Spicer
Hertfordshire

AUTOSPORT.COM

TOP FIVE ON OUR WEBSITE

1. HAMILTON WINS THRILLING CHINESE GRAND PRIX
2. WEBBER RELIEVED VETTEL'S RUN ENDED
3. MERCEDES 'OPTIMISTIC AGAIN' ABOUT PACE
4. FIA ASKED TO LOOK AT COCKPIT SAFETY
5. HAMILTON SAYS LOYALTY HAS ITS LIMITS

AUTOSPORT.COM PLUS

TOP STORY ONLINE

F1'S TOP 10 MOST WIN-EFFICIENT TEAMS

To read this exclusive feature and many others like it, log on to autosport.com/plus and choose which package you'd like. A month will cost £5.50, a year £46. Includes access to Forix – the ultimate stats website.

WIN!



ROAD ANGEL VANTAGE

This week's star letter will receive a Road Angel Vantage – a dedicated safety camera and blackspot locator that displays the legal speed limit of every road you drive, automatically and wirelessly updating its database every few minutes as you drive. For more details on Road Angel visit www.roadangelgroup.com Please ensure that your full address is included on all correspondence.

CORRECTIONS AND CLARIFICATIONS

● We wrote last week (p24) that Matt Halliday's best result at Bathurst was 15th in '08 – it was actually fourth last year.
● Last week's Golden Helmet table (for race winners in UK and Ireland) on p83 should have included Russell Paterson (Morgan Plus 8) in 10th place, for two overall wins and one class success, with those below him demoted one place.
It is the policy of AUTOSPORT to correct significant errors as soon as possible. Please note the issue date and page number when contacting us on autosport.editorial@haynet.com

THE LATEST GEAR

The most desirable new releases for motor racing fans: books, DVDs, models, art and gifts



HAKKINEN McLAREN 1:43 MODEL

£42.99
autosport.com/shop

Minichamps' latest addition to its 1:43-scale World Champions Collection is the 1998 McLaren-Mercedes MP4/13 used by Mika Hakkinen to take the first of his two consecutive world titles. The Flying Finn took eight victories that season, clinching the title in the final round at Suzuka, after a puncture forced Ferrari nemesis Michael Schumacher to retire.

The model is superbly detailed, but comes without West tobacco branding. But don't let that deter you – this is a highly collectable model of a famous car.

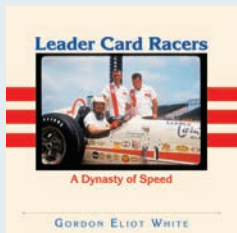

LEADER CARD BOOK
\$55 (0 9766683 8 6)
[GE White \(racemaker.com\)](http://GEWhite(racemaker.com))

Paper magnate Bob Wilke led the family Leader Card team to huge success in midget racing before WW2, before branching out into Indycar racing.

This lovingly chronicled story recalls Leader Card's three Indy 500 and title wins as well as this four-generation team's glorious return to midget racing.



FORMULA 2 1982 DVD
£19.99 (55 mins)
dukevideo.com

The 1982 European F2 championship was all about Stefan Belloc's Maurer, the works March 822s of Johnny Cecotto and Corrado Fabi, and the Spirit of Thierry Boutsen. But it was Italian Fabi who took the title with five wins.

Relive all 13 rounds of a classic F1-feeder formula with Duke Archive's DVD.



MARTINI RACING SHOES
£99.99
gearboxgifts.com

Officially licensed by Le Mans organiser the ACO, these leather driving shoes feature the iconic colours of a Nicolas Hunziker-inspired Martini Porsche 917. They feature tyre-tread soles, full-leather lining with removable insoles, a rolled heel for easy 'pedalling' and an abrasion panel for 'heel and toe' gear changes.

HOT ON THE WEB THIS WEEK

YOUTUBE: BRABHAM-HONDAS DOMINATE F2 IN 1966



SEARCH FOR: 1966 Formula 2 season (9:20)

The FIA Formula 2 season got underway at Silverstone last weekend, but those old enough to remember the 1966 domination by the Brabham-Honda 1000cc screamers will enjoy this classic review footage.

WHAT'S ON...

Your guide to the best events taking place in the UK and around the world this week – plus TV and online

OULTON PARK

F3/GT

April 23-25

Admission £12 Sat on the gate, £21 Mon on the gate, £21 weekend ticket (online purchase)

Tel: 01829 760301

The traditional season-opener for British Formula 3 is round two this season, as the teams and drivers hotfoot it to Cheshire (below) from Monza. It's the first action of the season for a bumper British GT grid, though, so here's a chance to see Audi, Ferrari, Porsche and Mercedes go at it on the picturesque parkland circuit. Remember, there's no on-track action on Sunday – it's Saturday and Monday only. Support races include British Formula Ford, Ginetta Challenge and VW Racing Cup.



LYDDEN

ERC

April 24-25

Admission £15 Sat, £20 Sun

Tel: 01304 830557

SILVERSTONE

VSCC

April 23

Admission £10 on the gate

Tel: 0844 3728 200

CROFT

DDMC

April 23-24

Admission £12

Tel: 01325 721815

SNETTERTON

MASTERS

April 23

Admission £13 on the gate

Tel: 01953 887303

ANGLESEY

BRSCC

April 22-23

Admission £12 on the gate each day, or £15 weekend

Tel: 01407 811400

DONINGTON PARK

BARC

April 23-24

Admission £12 Sat, £16 Sun, £20 weekend

Tel: 01332 810048

CADWELL PARK

HSCC

April 24-25

Admission £13 Sun on the gate, £13 Mon on the gate, £16 weekend ticket (online purchase)

Tel: 01507 343248

SNETTERTON

BRSCC

April 24-25

Admission £13 on the gate each day, or £16 weekend ticket (online only)

Tel: 01953 887303

MONDELLO PARK

IMRC

April 24

Admission €15

Tel: +353 (0)45 860200

CASTLE COMBE

CCRC

April 25

Admission €15

Tel: 01249 782417

Combe all ye faithful to the Castle of racing fever

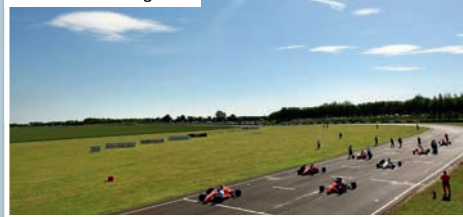

WORLD TOURING CARS

Rd 2/12

Zolder, Belgium

April 24

fiawtcc.com

The RML Chevrolet Cruze squad dominated the season-opener in Brazil (below), but how will they stack up against the privately-run SEATs and BMWs in Belgium? And don't forget Robert Dahlgren in the Polestar Volvo.



SCANDINAVIAN TOURING CARS

Rd 1/9

Jyllands-Ringen, Denmark

April 23

stcc.se

GERMAN F3 CUP

Rd 1/9

Oschersleben, Germany

April 24-25

formel3.de

GT4 EUROPEAN CUP

Rd 1/6

Zandvoort, Holland

April 24-25

gt4cup.com

NASCAR NATIONWIDE

Rd 8/34

Nashville, Tennessee, USA

April 23

nationwide.nascar.com

NASCAR TRUCK SERIES

Rd 5/25

Nashville, Tennessee, USA

April 22

nascar.com



There's no Cup action, so Nationwide takes centre stage

Television

THURSDAY APRIL 21

1200-1300 [Sky Sports 4](#)
F3 Euro Series: Paul Ricard
1310-1340 [Motors TV](#)
British Formula Ford: Silverstone
1700-1800 [Sky Sports 4](#)
Racemax
2000-2205 [Motors TV](#)
Blancpain Endurance Series: Monza

FRIDAY APRIL 22

0235-0350 [ITV1](#)
BTCC: Donington Park highlights
0530-0600 [ESPN](#)
Planet Speed
0600-0700 [Sky Sports 4](#)
Racemax
1300-1330 [Eurosport 2](#)
WTCC: Inside WTCC
1330-1500 [ITV4](#)
BTCC: Donington Park highlights
1545-1750 [Motors TV](#)
Formula 2: Silverstone
2200-2300 [ESPN](#)
WRC: Access All Areas

SATURDAY APRIL 23

0145-0340 [Motors TV](#)
Formula 2: Silverstone
0405-0430 [Five](#)
Motorsport Mundial
0730-0800 [Channel 4](#)
British F3: Monza
0730-0800 [Eurosport](#)
WTCC: Inside WTCC
1300-1345 [Eurosport 2 LIVE](#)
WTCC: Zolder qualifying
1415-1445, 2100-2130 [Motors TV](#)

Belcar: Zolder
1445-1515, 2130-2205 [Motors TV](#)
Belgian Touring Cars: Zolder
1545-1755 [Motors TV](#)
Blancpain Endurance Series: Monza
1755-2000 [Motors TV](#)
V8 Supercars: Hamilton
1930-2100 [ITV4](#)
BTCC: Donington Park highlights
2000-2100 [Motors TV](#)
British F3: Monza

SUNDAY APRIL 24

0130-0230 [ESPN](#)
ALMS: Long Beach
0600-0700, 1000-1100,
1700-1800 [Sky Sports 3](#)
Racemax
0700-0730 [Channel 4](#)
The Grid
0900-1005, 2340-0040 [Motors TV](#)
British F3: Monza
1005-1035 [Motors TV](#)
Belcar: Zolder
1000-1315 [Eurosport](#)
WTCC: Zolder
Replay of qualifying, followed by the warm-up and two races back-to-back.
1035-1240 [Motors TV](#)
V8 Supercars: Hamilton
1445-1650 [Motors TV](#)
Formula 2: Silverstone
2000-2100 [Motors TV](#)
WRC: Rally Jordan highlights
2100-2130 [Motors TV](#)
The Grid
2300-0000 [Eurosport 2](#)
WTCC: Zolder

Online

AUTOSPORT.COM

Coming up on the web this week

MIKA HAKKINEN INTERVIEW

It's a weekend off for much of the world of international motorsport, but we'll be keeping you up to date with the World Touring Car Championship at Zolder and British Formula 3 at Oulton Park. But that doesn't mean the website won't be packed full of stuff to read this week, including an exclusive interview with double world champion Mika Hakkinen and an insight into Kimi Raikkonen's introduction to NASCAR.



Read AUTOSPORT.com on your phone to keep up to date

AUTOSPORT.COM ANDROID APP OUT NOW

The AUTOSPORT app is now available for Android. Dial up AUTOSPORT.com on your smart phone for instant access to news, feature articles, image galleries and live text race commentary for a one-off fee of only £2.99 (there is no renewal cost). For more info, visit www.autosport.com/app

REVVED UP OVER WHAT'S ON THE BOX

We cast a critical eye over the best and worst of this week's TV coverage



Jenson stops to ask 'Crunch' for his latest race insights

IN SHAKESPEARE'S play *As You Like It* the heroine asks: "Can one desire too much of a good thing?" When Shakey wrote this classic line, he was clearly thinking that, a few hundred years later, a lovely sunny April Sunday was going to be ruined by there being far too much motorsport on the telly.

Park picnic? Lido? Beer garden? No, it's staying in and a Samsung 42in for me. If I go out I might miss something. Besides, Vitamin D is for sissies.

Yet another early morning call, yet more Formula 1 from a far-off land, this time with even more overtaking. The only thing lacking was Eddie

Jordan's unique blend of fashion atrocity and unfathomably bonkers statements – see, we miss him when he's not there.

Instead, our comic turn came from Mark Webber's number-one mechanic 'Crunch' – who boldly declared on the red button F1 Forum that McLaren "were cheating from the beginning" when Jenson Button joined them in the pits. Give that man a salary hike. I'd love to hear his opinion of Ferrari's DRS wing: he'd probably call it a "cheat-flap". He could have his own slot called 'Crunch-time' where he slags off everyone else in the pitlane. I'd tune in.

High jinks continued as Martin Brundle finally set DC straight on his pispronunciation (as Ronnie Barker used to say) of Nick Heidfeld. It's "Heid-FIELD" – come on DC, everyone knows that! One day he might even say "Vit-tell" properly (I'm joking of course).

And on and on it went, from F1 to banger racing at Donington Park to Formula Renault 3.5 at Aragon to NASCAR at Talladega to IndyCar at Long Beach.

The best prediction came at the very last, as the intensely coiffured James Rossiter picked Mike Conway to do the biz at Long Beach. His sidekick Johnny Mowlem (who appears to have lost an argument with a hedge strimmer) had run the London marathon earlier that day. Johnny, if you want to lose the power of your legs, and get a numb backside, you don't even have leave your sofa.

But it did take 15 hours.
Revved Up

"Brundle finally put DC straight on his pronunciation of Nick Heidfeld. It's 'Heid-FIELD' – everyone knows that"

THE WEEK IN PICTURES

The lensmen pounding the beat from Aragon to Long Beach



THAT'S RICH, PUNCHING THE AIR IN MID-FLIGHT

Draco's Stephane Richelmi gets airbourne in race two at Motorland Aragon's FRenault 3.5 opener. Lewis Williamson (3) steers clear

RAMSAY PASSES UP THE CHANCE TO USE THE F-WORD SHOCK!

Potty-mouthed TV chef Gordon Ramsay was the grand marshal for IndyCar's Long Beach event. He resisted the temptation to shout "Start your f*cking engines!"



BANKING ON THE FUTURE IN BRITISH FORMULA 3'S RANKS

A trip to Monza just isn't the same without a visit to its famous old banked corners. We think they're trying to make a '3-shape' here...



A SOUVENIR FOR THE WALL OF PLATO TOWERS

AUTOSPORT's Kevin Turner (left) and Motorsport News's Matt James presented JP with a set of covers after his BTCC record-breaking feat



FROM THE ARCHIVE

British Formula 3 Championship's Monza debut, 1975

"With hordes of Italian series regulars joining the 'Brits' and 'Europeans', the entry swelled to 75 cars"

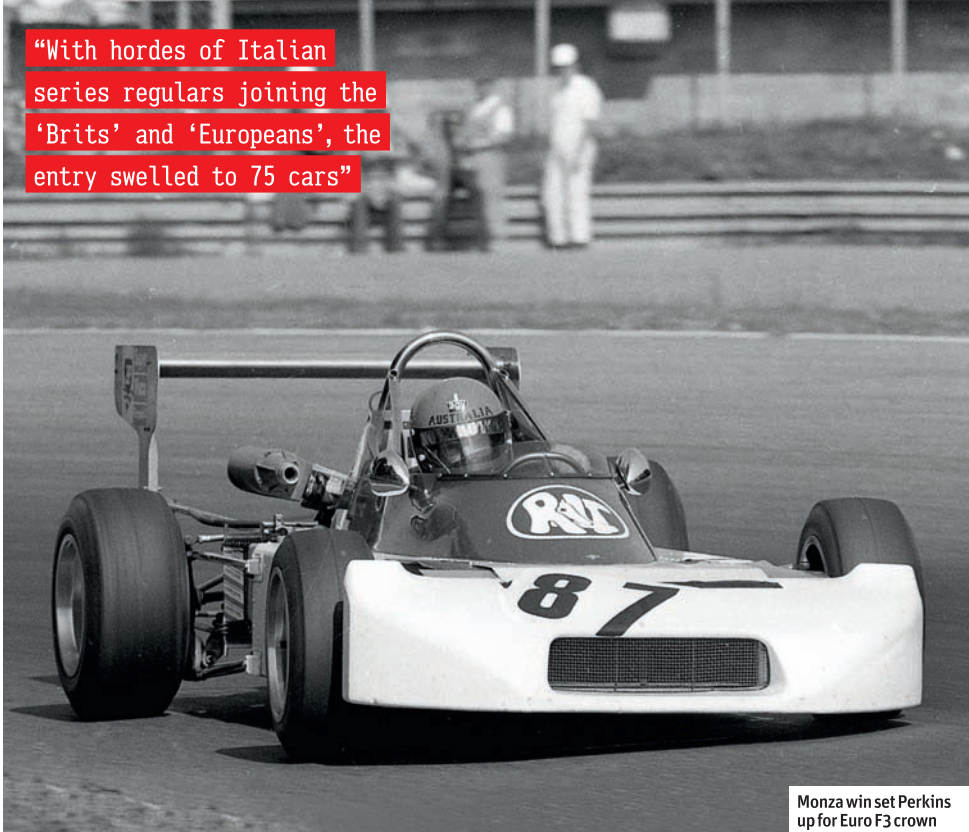

Monza win set Perkins up for Euro F3 crown

BRITISH FORMULA 3 began its season at the iconic Italian speedbowl of Monza last weekend – the first time the series has visited the venue since 2008, when Sauber's new Mexican Formula 1 star Sergio Perez won twice from 14th on the grid after a pair of typically frantic slipstreamers.

Long straights, punctuated by slow chicanes, are a great way to partially overcome the downforce dependency of modern F3 cars and produce the kind of close racing the category usually lacks.

British F3 has only been to the Milanese Autodrome five times in its 60-year history. The first of those visits was 36 years ago, when the eighth round of the 1975 BP F3 Championship doubled up as the fourth rubber in the inaugural European F3 series.

Australian Larry Perkins had endured an indifferent start to his season with a puncture at Silverstone and a crash at Monaco. His best result heading to Italy had come in the opening round of the British season, when he finished fifth in Ron Tauranac's Ralt RT1 at Thruxton.

With hordes of Italian series regulars joining the 'Brits' and 'Europeans', the entry swelled to a staggering 75 cars, so organisers had to split the race into four practice

sessions and two 10-lap qualifying heats, with the top 25 drivers going through to the final.

Perkins set the fastest time overall in practice, ahead of works March driver Alex Ribeiro and BP championship leader Gunnar Nilsson, who flipped his March after clipping one of the high chicane kerbs. The accident wrote the car off and eliminated Nilsson from the running.

Brazilian Ribeiro comfortably claimed honours in the first heat, while Perkins took a similarly straightforward win in the second qualifying race. In the final, however, Perkins and Ribeiro were joined at the front by Italian racer Ricardo Spreafico and his GRD 374.

A fraught battle between Ribeiro and Spreafico allowed Perkins to break clear, and an irate Ribeiro chopped Spreafico's GRD as the Italian tried to pull out of the March's slipstream on the run to the flag. Spreafico crossed the line sideways, but claimed runner-up spot when Ribeiro was disqualified for dangerous driving.

All this drama was of little concern to Perkins. His first triumph of the season marked an upswing in form for the ex-Australian F2 champion, who went on to win the next two European rounds at Croix and Djurslandring and claim the inaugural Euro F3 crown. 🏆

THIS WEEK IN...



APRIL 26, 1984

RALT-HONDAS AGAIN set the pace in Formula 2, but Roberto Moreno (above) was forced out of a potential fourth-place finish by a wheel bearing failure at Thruxton, as team-mate Mike Thackwell took the spoils.

"I was really expecting a hard race today because we never really got the car right here," said Thackwell. "But I didn't even break sweat." Poleman Thackwell romped home to a 22s win after passing Philippe Streiff's AGS on lap 11 of 55. Christian Danner (March) also overhauled Streiff to finish second.

The 1984 World Endurance Championship began with a familiar duel between the two works Porsche 956s (below). Stefan Bellof/Derek Bell held off the sister car of Jacky Ickx/Jochen Mass for the entire 173-lap distance at Monza, and ran out winners by 24s.

However, post-race scrutineering revealed that the winning car had been running underweight, handing victory to the Ickx/Mass combination.



PICS: LACTUALFOTO

FREE! PLAY NOW
BEAT THE GRAND PRIX PREDICTOR
And win the Ultimate Motorsport Experience worth £20,000

Castrol EDGE
Rankings
Visit castroledgerankings.com/predictor

TONY ADAMOWICZ

■ Daytona 24 Hours ■ Jan 31-Feb 1 1970 ■ Ferrari 312P ■ Fifth with David Piper in 'dry' 312P on Ferrari debut

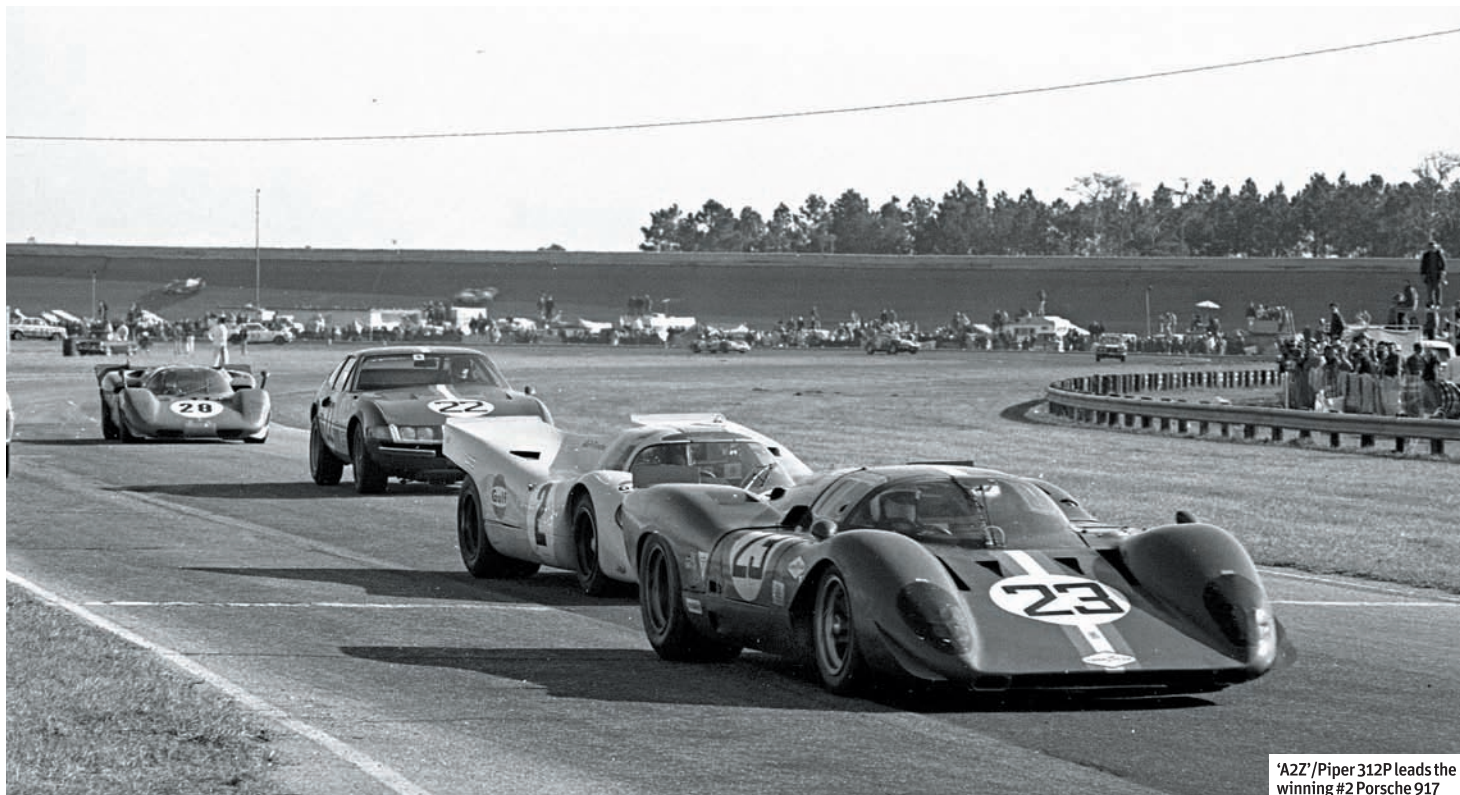

'A2Z'/Piper 312P leads the winning #2 Porsche 917

I'D BEEN A Ferrari fan all my life and here I was in a world endurance 312P that was capable of winning one of the world's biggest races!

Racing in the Daytona 24 Hours was a massive privilege for me. It all came about because the guy who had backed me in Trans-Am with a Porsche, Marvin Davidson, bought a couple of Ferraris — he was a Wall Street investment banker! He was no longer going to fund any racing but he talked to Luigi Chinetti of the great North American Racing Team about having a [Trans-Am] champion in his team. Chinetti thought it was a good idea so I was in — this was my introduction to world endurance racing.

I was part of a two-car effort with the glorious 312P in coupe configuration. It was a Formula 1 car with a body on it. You could run it to 10,500–11,000rpm and it would just sing. The handling and braking and everything else were unbelievable.

I was paired with veteran sportscar racer David Piper. I was thrilled to be with him because I thought he was a great guy and he was a big racer for Ferrari and Porsche over the years. NART's other car was shared by Sam Posey

"I was told the team's other car had the only spare radiator in it and to carry on with no water in the car. It lasted five-and-a-half hours until the finish!"

and Mike Parkes — it needed a cockpit bubble because they were so tall! My car was looked after by Carroll Smith, an old ally from my US F5000 title year in '69.

In the race, things were going really well. After Parkes had hit the wall and pitted to have the damaged radiator fixed, our car took the lead and built up a good

margin. It all felt too easy, which is when the race became an unbelievable chain of events.

The track surface began to break up and bits of the coral surface under the asphalt were flying up. Eventually, some of the debris damaged our radiator. I came into the pits shouting, 'Aqua, aqua!' to be told the other car had the only

spare radiator in it and I should carry on with no water. Well, that wasn't going to work, was it?!

I was told to run no more than 9500rpm and get on with it. And, amazingly, it kept going.

Later on, the car went up in smoke and I thought, 'Well, that's that, the engine has finally expired.' I pitted again and was surrounded by Ferrari mechanics. Turned out it was just an oil seal that had gone, so the guys replaced it and sent me on my way again.

That car ran for more than five-and-a-half hours with no water in it and we finished second in the prototype class — to Sam and Mike — and fifth overall.

I'd always been a Ferrari fan, but after that I thought it was the greatest car in the world! **✎ Tony Adamowicz was talking to Henry Hope-Frost**

IN PROFILE



EX-US GOVERNMENT communication liaison expert Tony Adamowicz, who served under presidents Eisenhower, Kennedy and Johnson, started racing aged 25 in a humble Volvo. 'A2Z' soon attracted the attention of Bob Tullius's Group 44 stable and shared a Dodge with the boss in Trans-Am. He won the class title in '68 in a Porsche and moved to single-seaters for '69, winning the US F5000 title first time out. Sportscars then beckoned, with Ferrari and Porsche drives on offer in the big internationals in Europe and the States. He retired in the early '80s but still races in historic.

NEXT WEEK
Malcolm WILSON





Seamless Nomex
Double Faced
Balaclava

£27.30
+ VAT

SEAMLESS
NOMEX UNDERWEAR

- all of our garments are **totally seamless** so won't cause irritation or wear out
- all of our garments are **made in the UK**
- all of our garments are the **most comfortable money can buy**



019 Racewear would like to congratulate Dan de Zille on his two podiums at the Silverstone rounds of the Dunlop MSA Formula Ford Championship and thank all the team at JTR for their support. Good luck to Dan & JTR for the next rounds at Oulton Park this weekend.



To order now, visit:

www.019racewear.com



Porsche Carrera Cup GB

Rounds 3 and 4, Donington Park, April 16-17

Race wins for Euan Hankey and Michael Meadows
 Pro-Am1 wins for Ahmad Al Harthy and Jonas Gelzinis
 Pro-Am2 wins for Andrew Shelley and George Brewster
 Overall podiums for James Sutton
 'Driver of the weekend' award for Michael Meadows
 'Team of the weekend' award for SAS/Redline

Round 3 results

- 1 Euan Hankey (Parker with Juta)
- 2 Michael Meadows (SAS/Redline)
- 3 James Sutton (SAS/Redline)
- 4 Richard Plant (Team Parker Racing)
- 5 Ben Hetherington (Redline/Oman Air)
- 6 Ahmad Al Harthy (Redline/Oman Air)

Round 4 results

- 1 Michael Meadows (SAS/Redline)
- 2 James Sutton (SAS/Redline)
- 3 Euan Hankey (Parker with Juta)
- 4 Jonas Gelzinis (Juta Racing)
- 5 Stephen Jelley (Parker with Juta)
- 6 Tim Harvey (Nationwide/Motorbase)

For more information on the Porsche Carrera Cup GB visit
www.porsche.com

Overall points' position after round 4

1	James Sutton	70
2	Michael Meadows	66
3	Euan Hankey	61
4	Stephen Jelley	52
5	Richard Plant	42
6	Jonas Gelzinis	38
7	Sam Tordoff	35
8	Michael Caine	33
9	Ben Hetherington	28
10	Tim Harvey	26
11	Ahmad Al Harthy	24
12	Rory Butcher	17
13	Derek Pierce	13
14	Daniele Perfetti	9
15	Alex Martin	7
16	Michael Leonard	6
=	George Richardson	6
18	Andrew Shelley	5
=	George Brewster	5

Pro-am1 category

1	Jonas Gelzinis	43
2	Ahmad Al Harthy	24
3	Rory Butcher	18
4	Derek Pierce	14
5	Daniele Perfetti	9
6	Alex Martin	7

Pro-am2 category

1	George Brewster	41
2	Andrew Shelley	39
3	Keith Webster	28
4	Tautvydas Barstys	26
5	Richard Denny	19
=	John Taylor	19
=	Tommy Dreelan	19

Team championship

1	SAS/Redline	136
2	Parker with Juta	113
3	Team Parker Racing	77
4	Nationwide/Motorbase	59
5	Redline/Oman Air	52
6	Juta Racing	38
7	Celtic Speed	22
8	Dextra/J&D Pierce by Parker	20

PORSCHE

**CARRERA
 CUP**
 GREAT BRITAIN